

ND133 NEUTRON ACER TENDL-2021 LIBRARY; T=293.6K

Principal cross sections

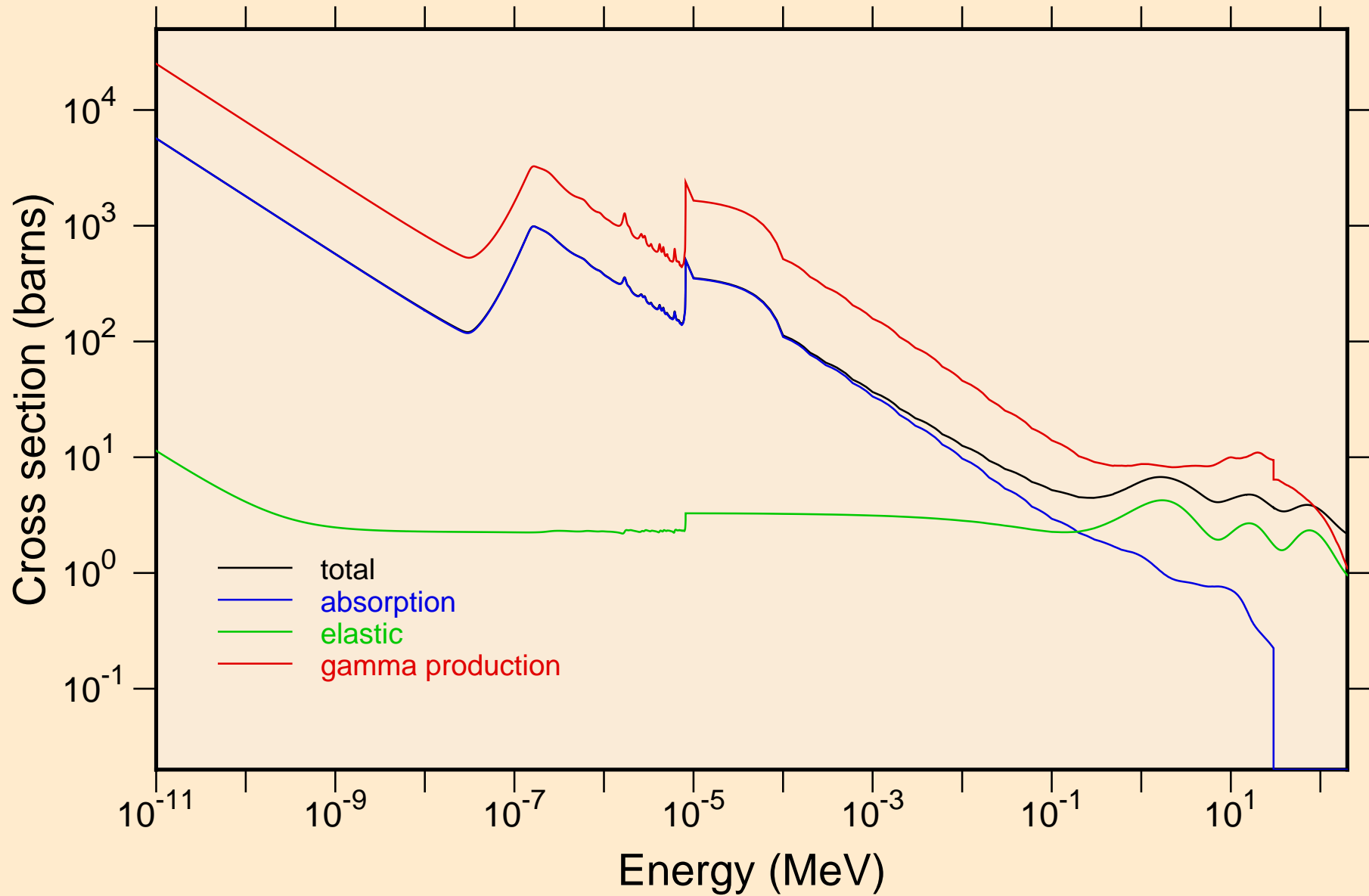

ND133 NEUTRON ACER TENDL-2021 LIBRARY; T=293.6K
resonance total cross section

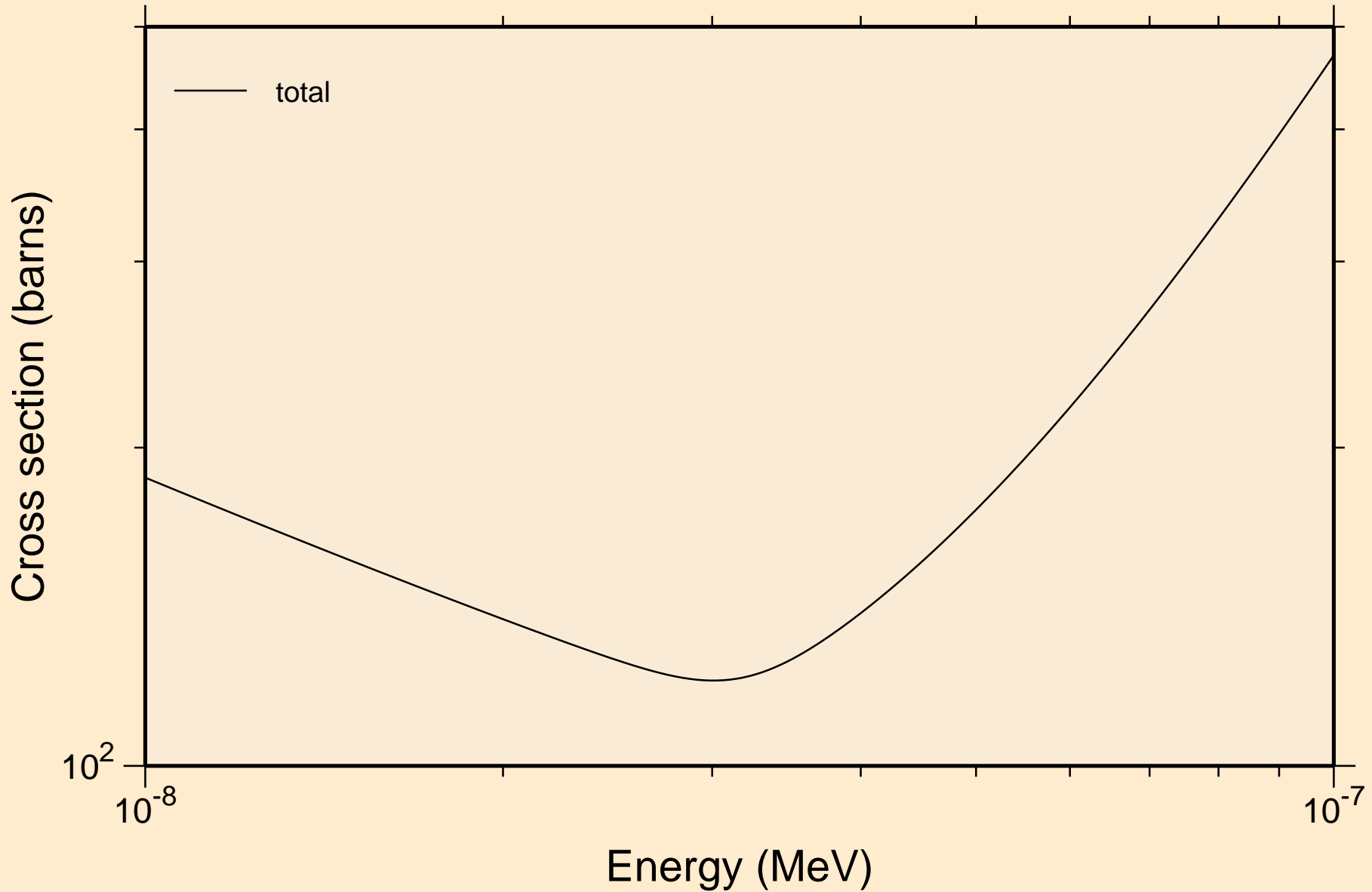

ND133 NEUTRON ACER TENDL-2021 LIBRARY; T=293.6K
resonance total cross section

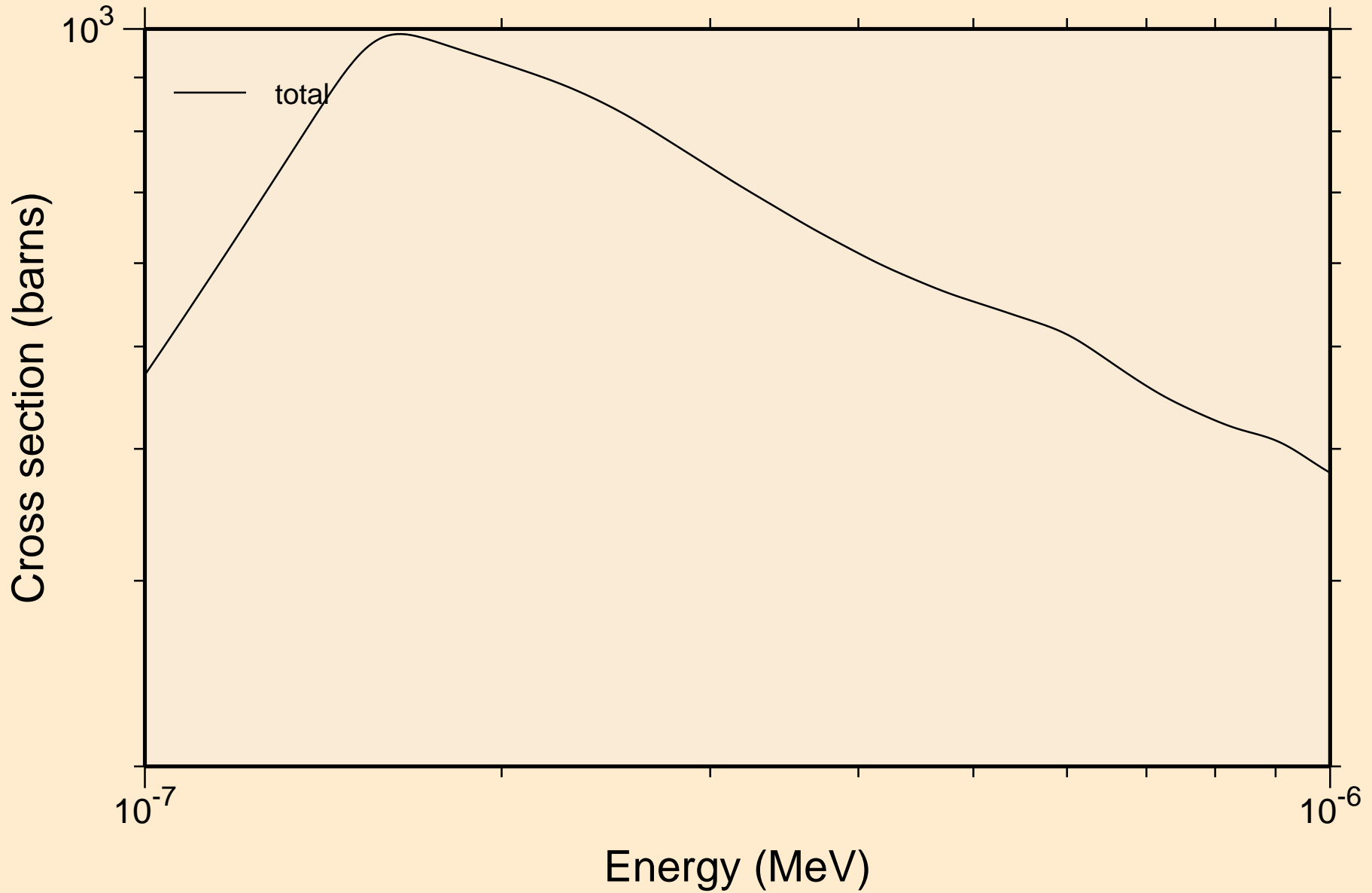

ND133 NEUTRON ACER TENDL-2021 LIBRARY; T=293.6K
resonance total cross section

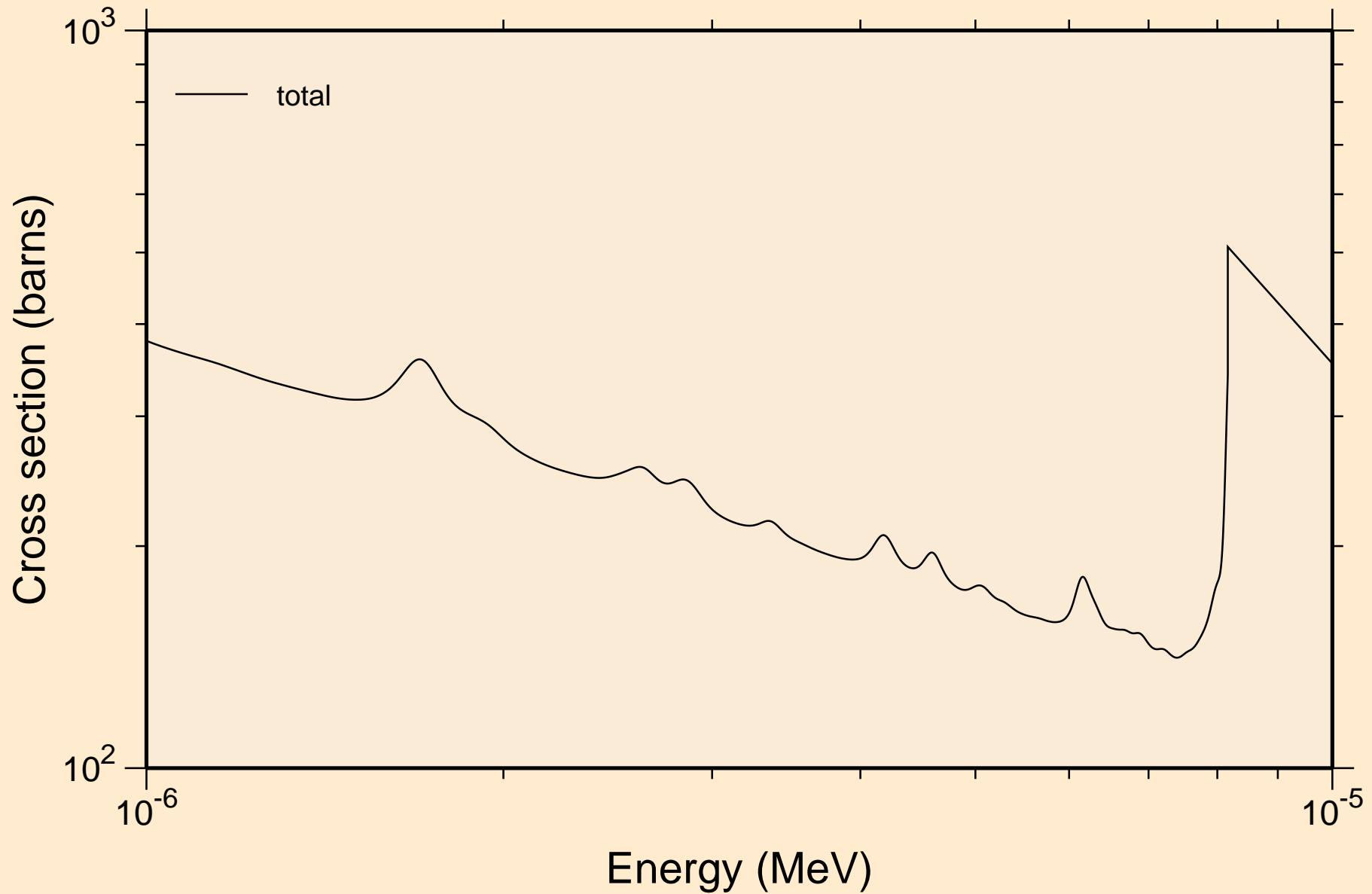

ND133 NEUTRON ACER TENDL-2021 LIBRARY; T=293.6K
resonance total cross section

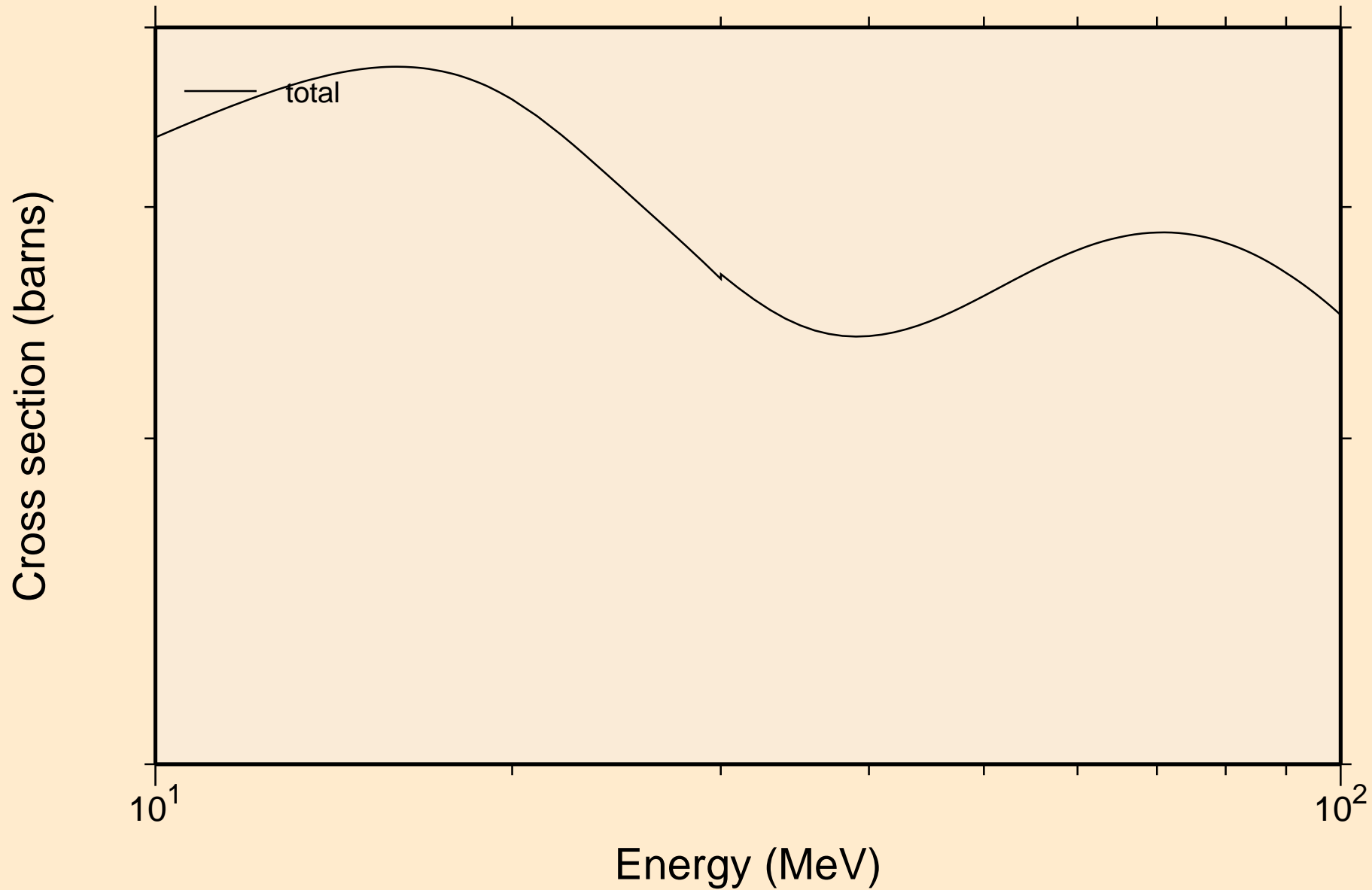

ND133 NEUTRON ACER TENDL-2021 LIBRARY; T=293.6K
resonance absorption cross sections

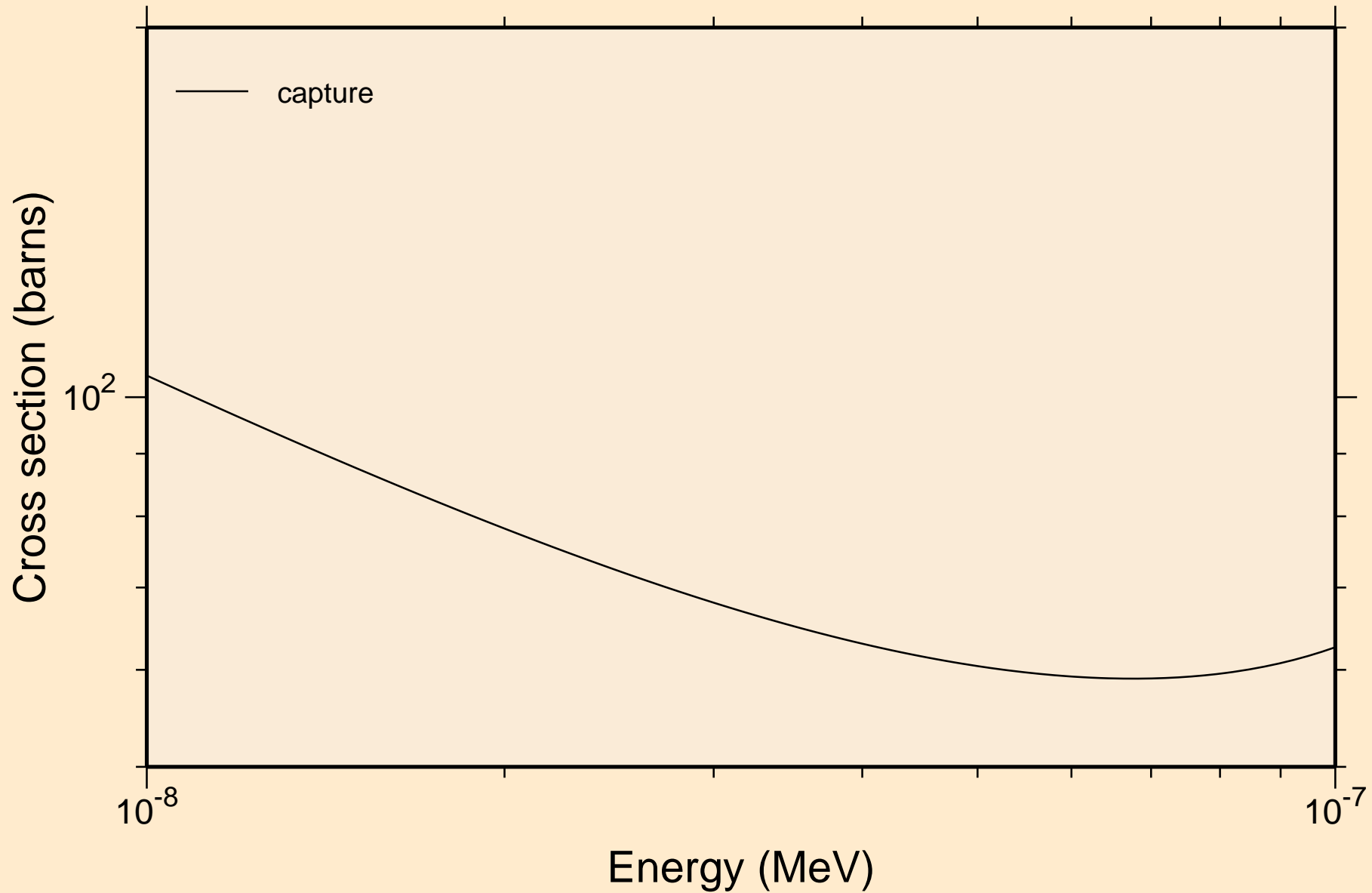

ND133 NEUTRON ACER TENDL-2021 LIBRARY; T=293.6K
resonance absorption cross sections

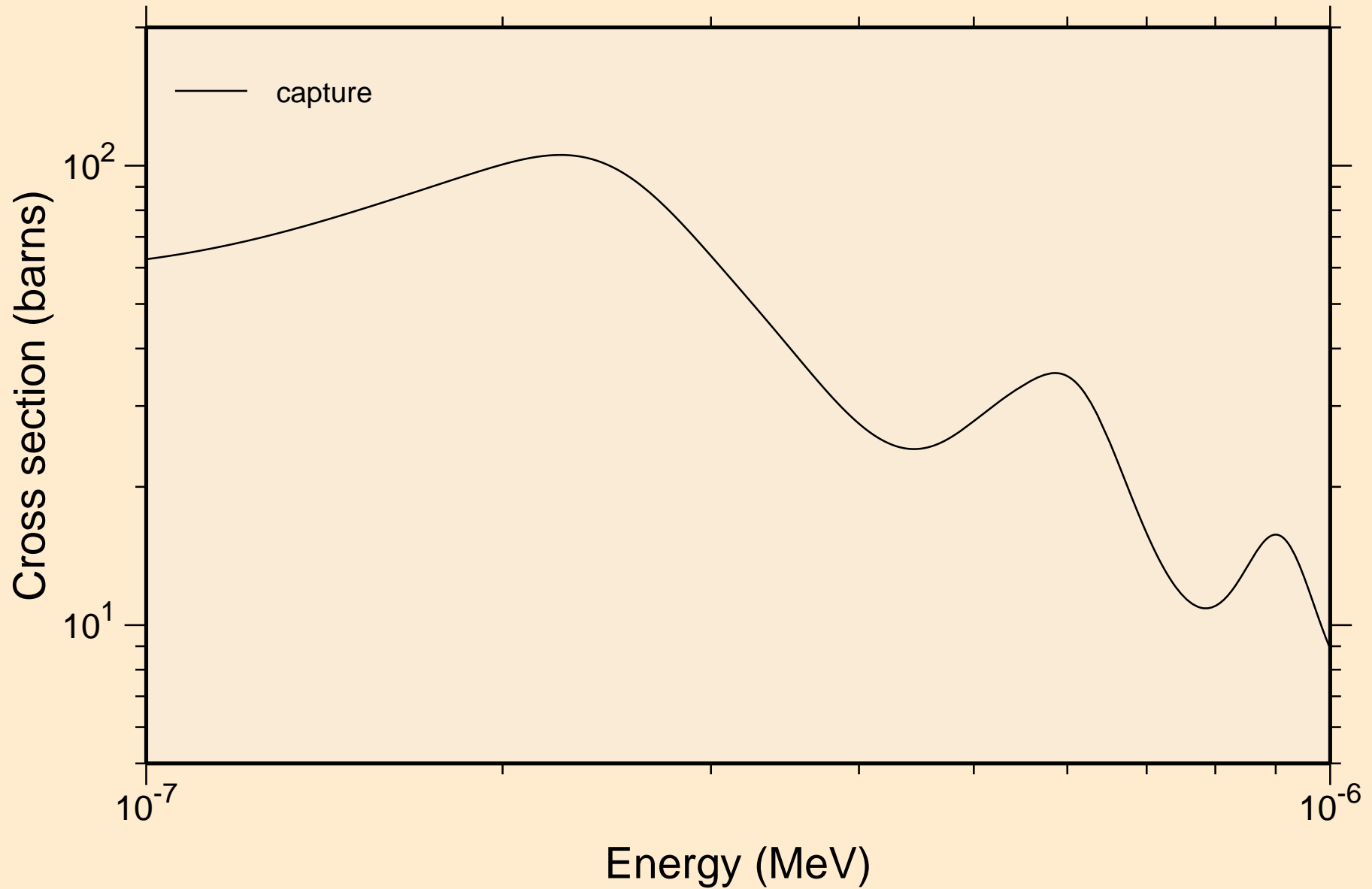

ND133 NEUTRON ACER TENDL-2021 LIBRARY; T=293.6K
resonance absorption cross sections

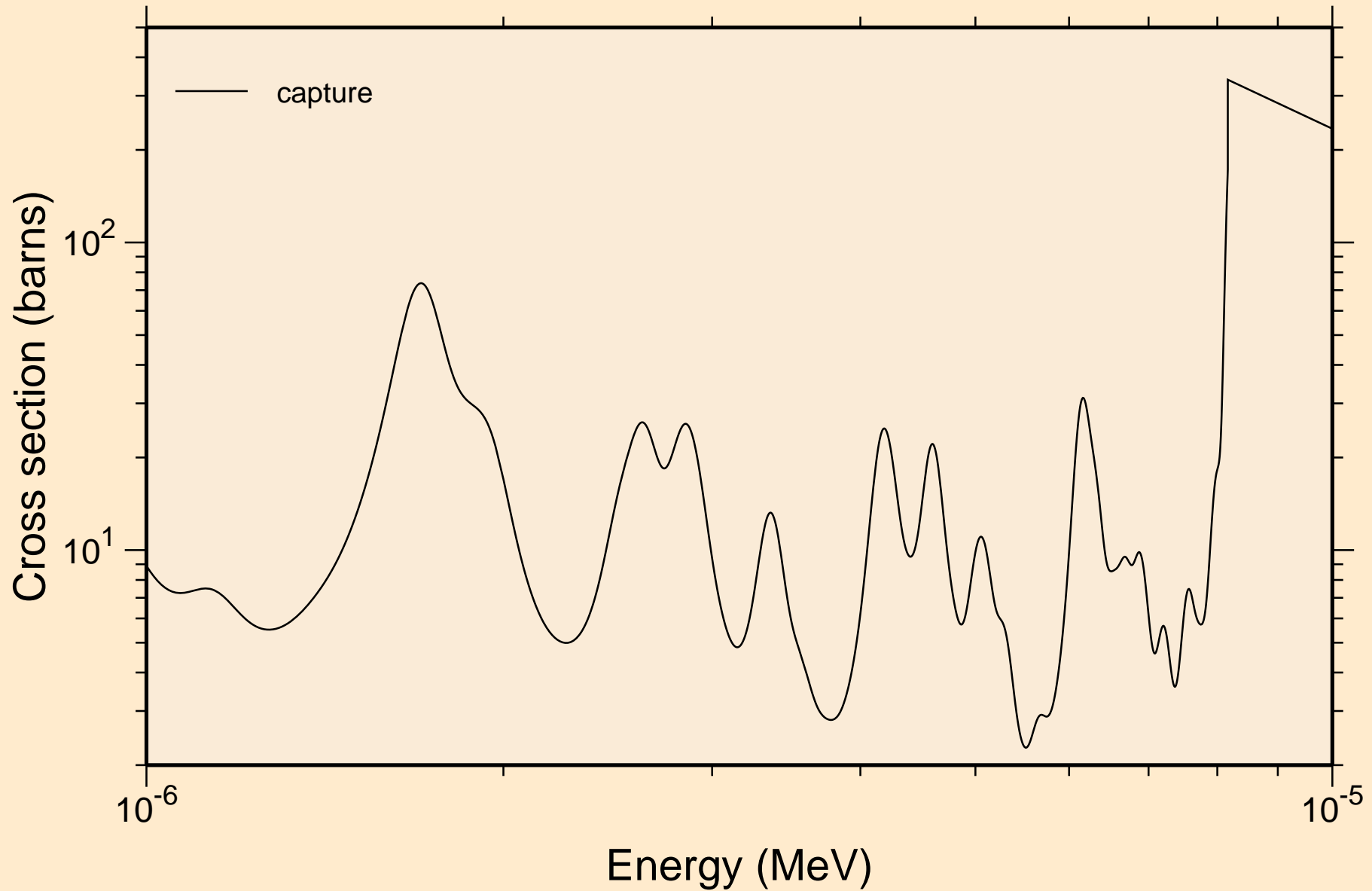

ND133 NEUTRON ACER TENDL-2021 LIBRARY; T=293.6K
resonance absorption cross sections

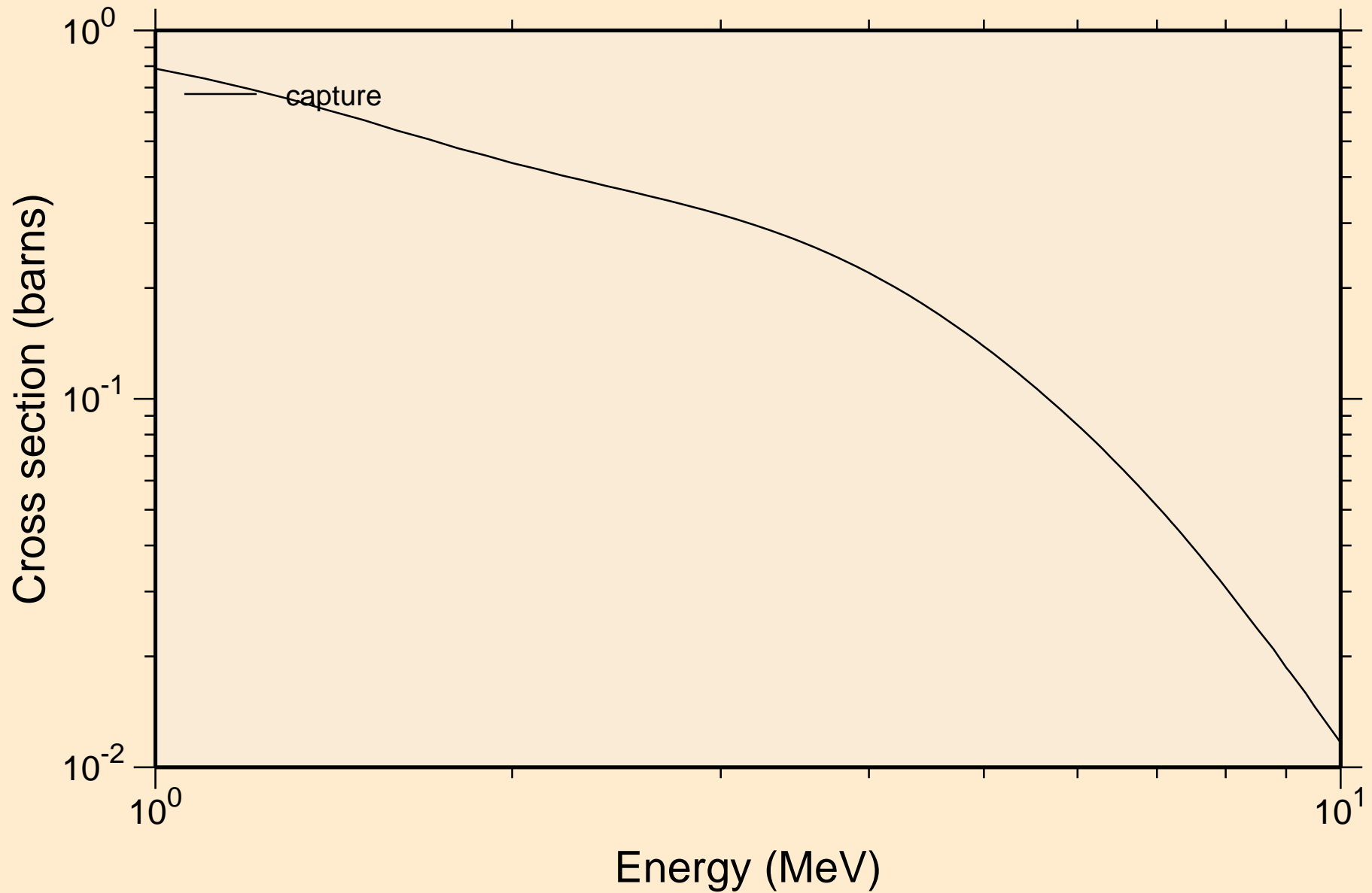

ND133 NEUTRON ACER TENDL-2021 LIBRARY; T=293.6K
Heating

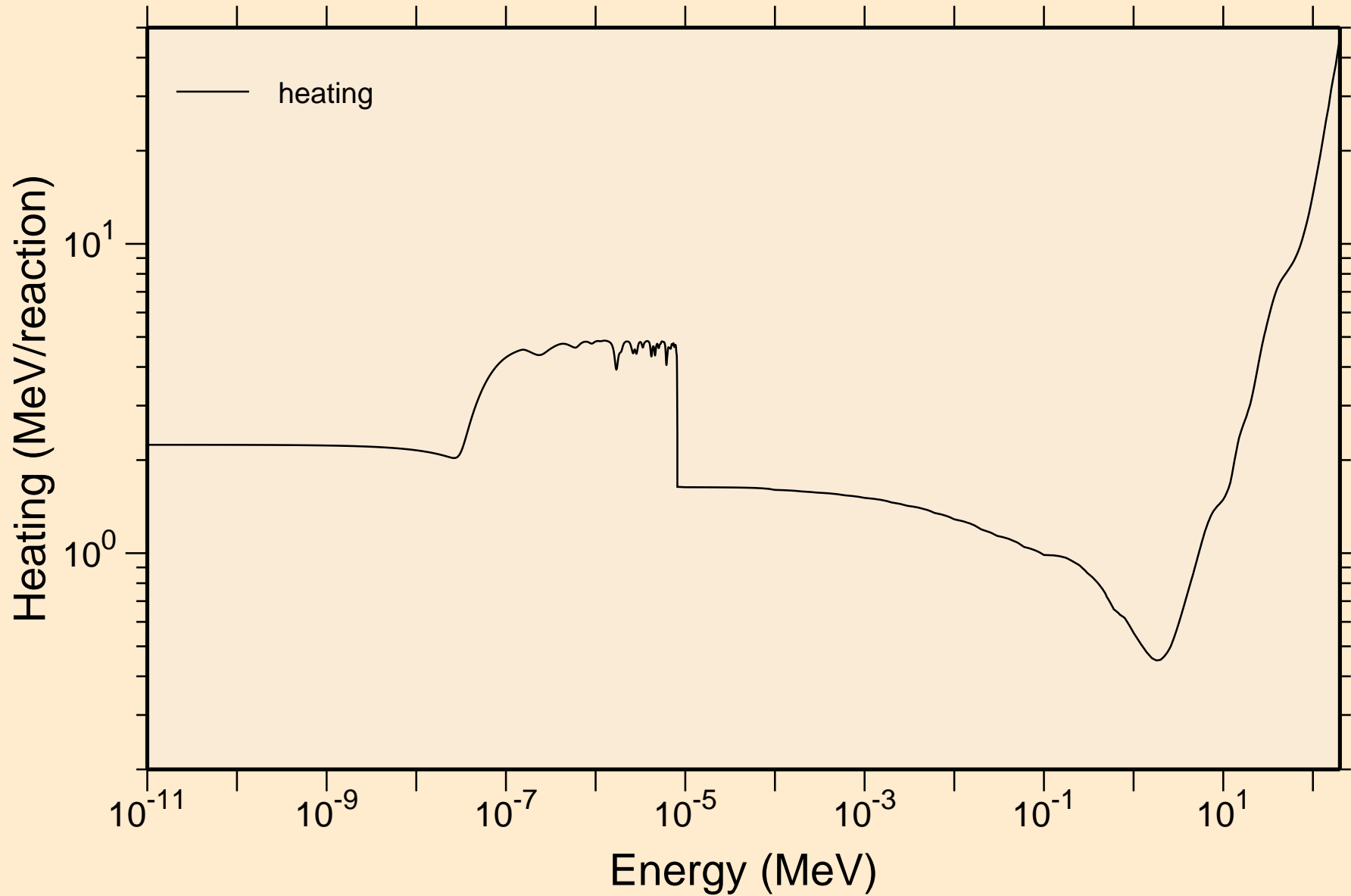

ND133 NEUTRON ACER TENDL-2021 LIBRARY; T=293.6K
Damage

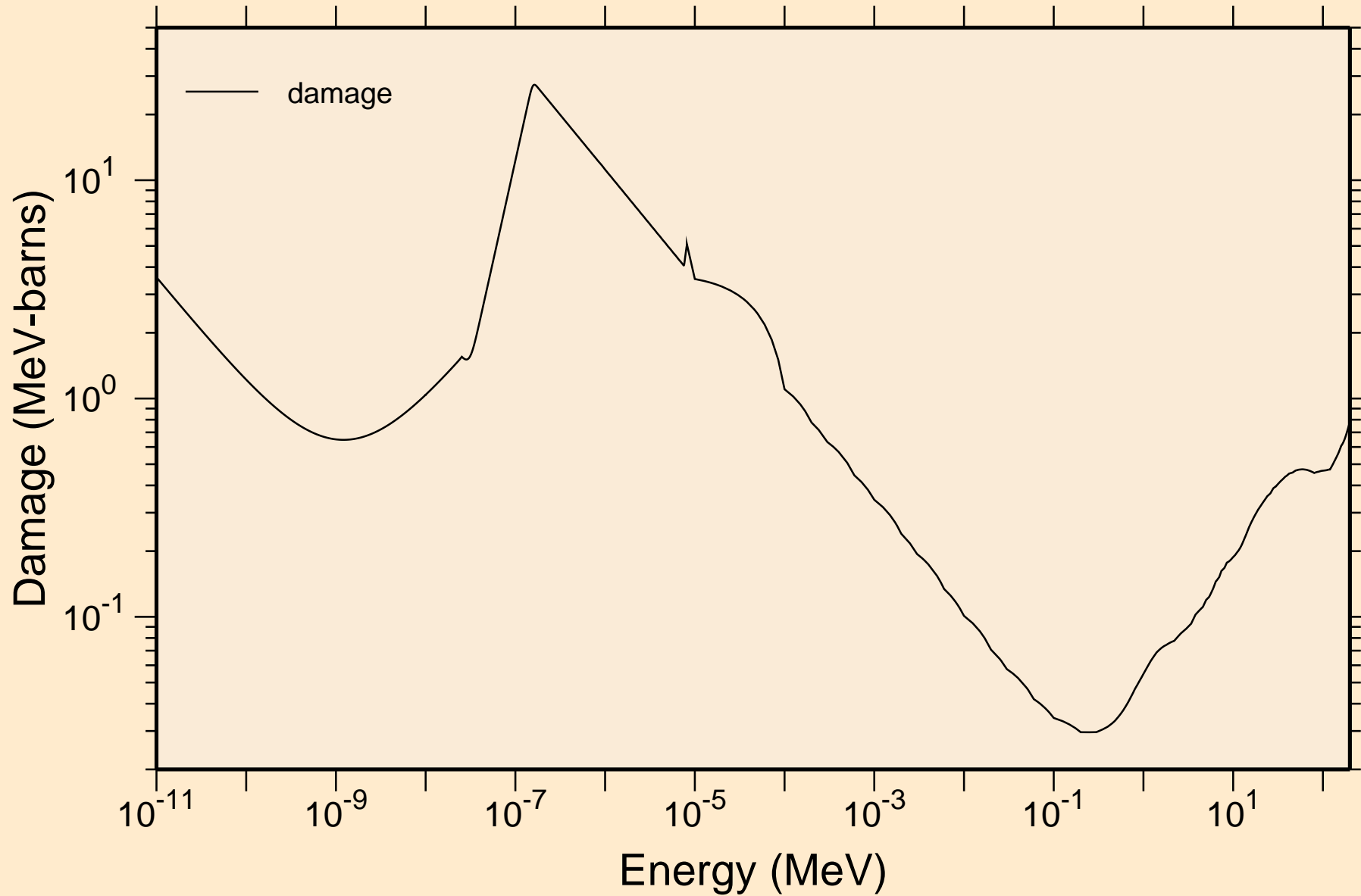

ND133 NEUTRON ACER TENDL-2021 LIBRARY; T=293.6K

Non-threshold reactions

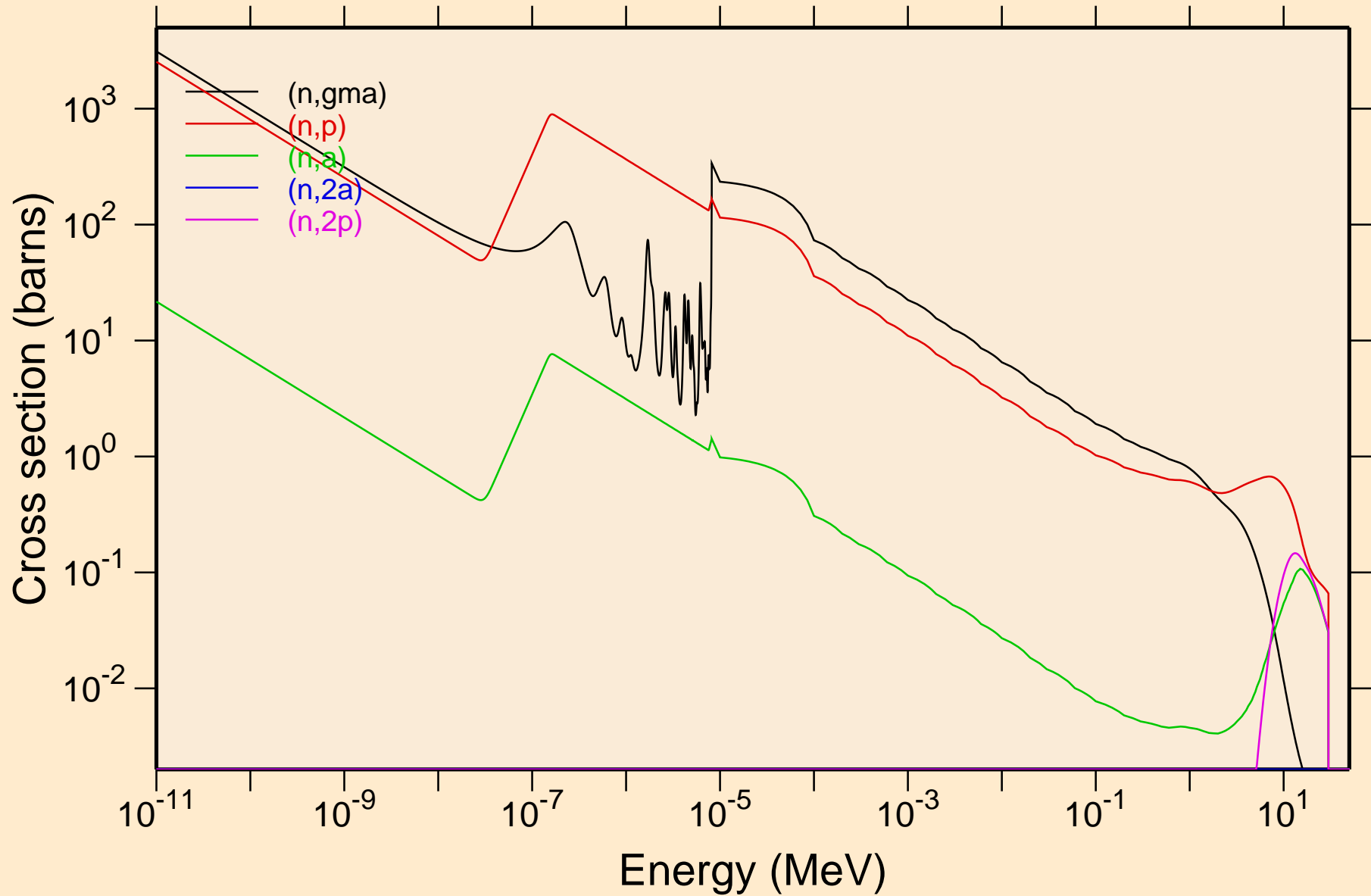

ND133 NEUTRON ACER TENDL-2021 LIBRARY; T=293.6K
Non-threshold reactions

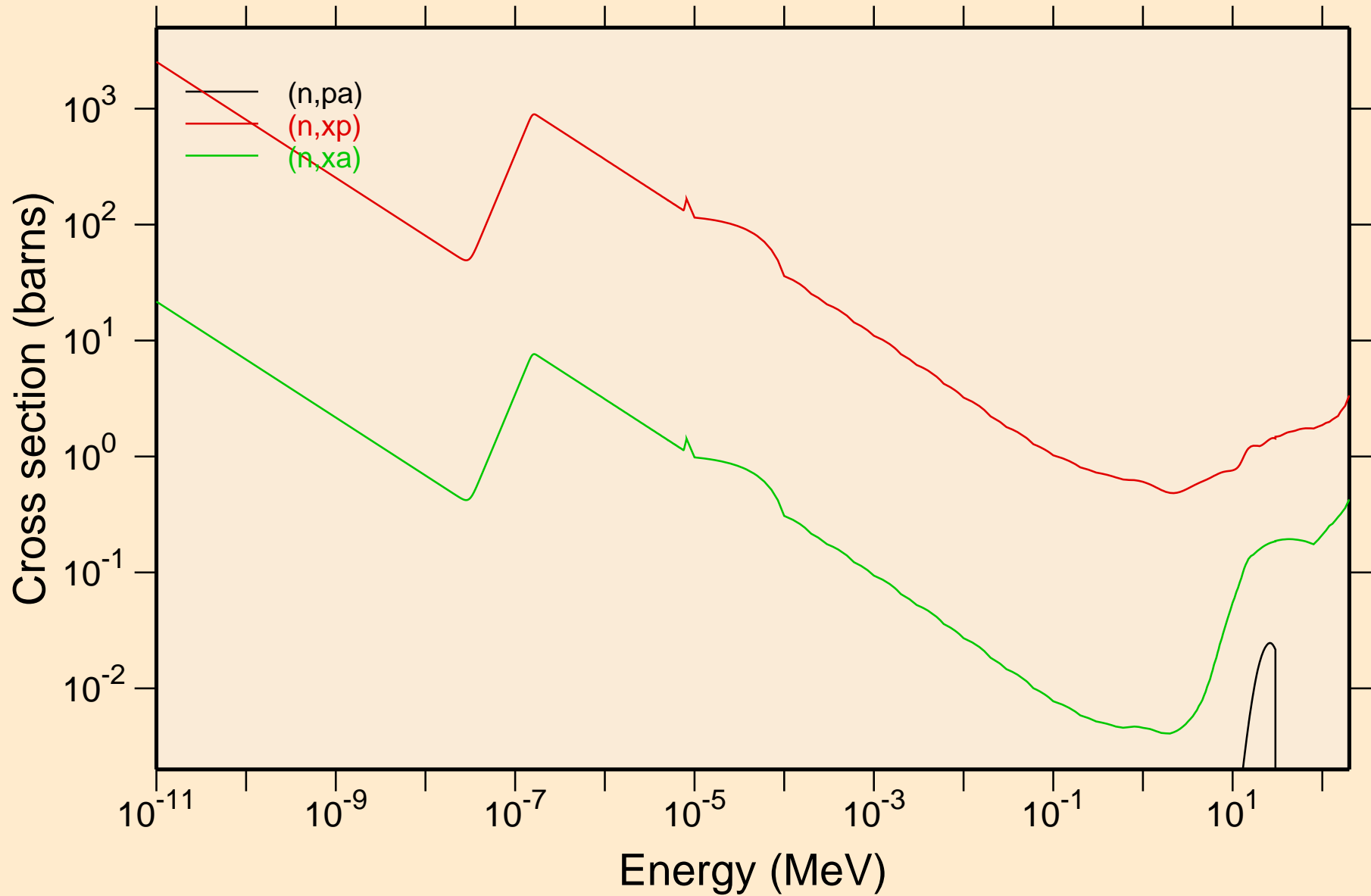

ND133 NEUTRON ACER TENDL-2021 LIBRARY; T=293.6K

Principal cross sections

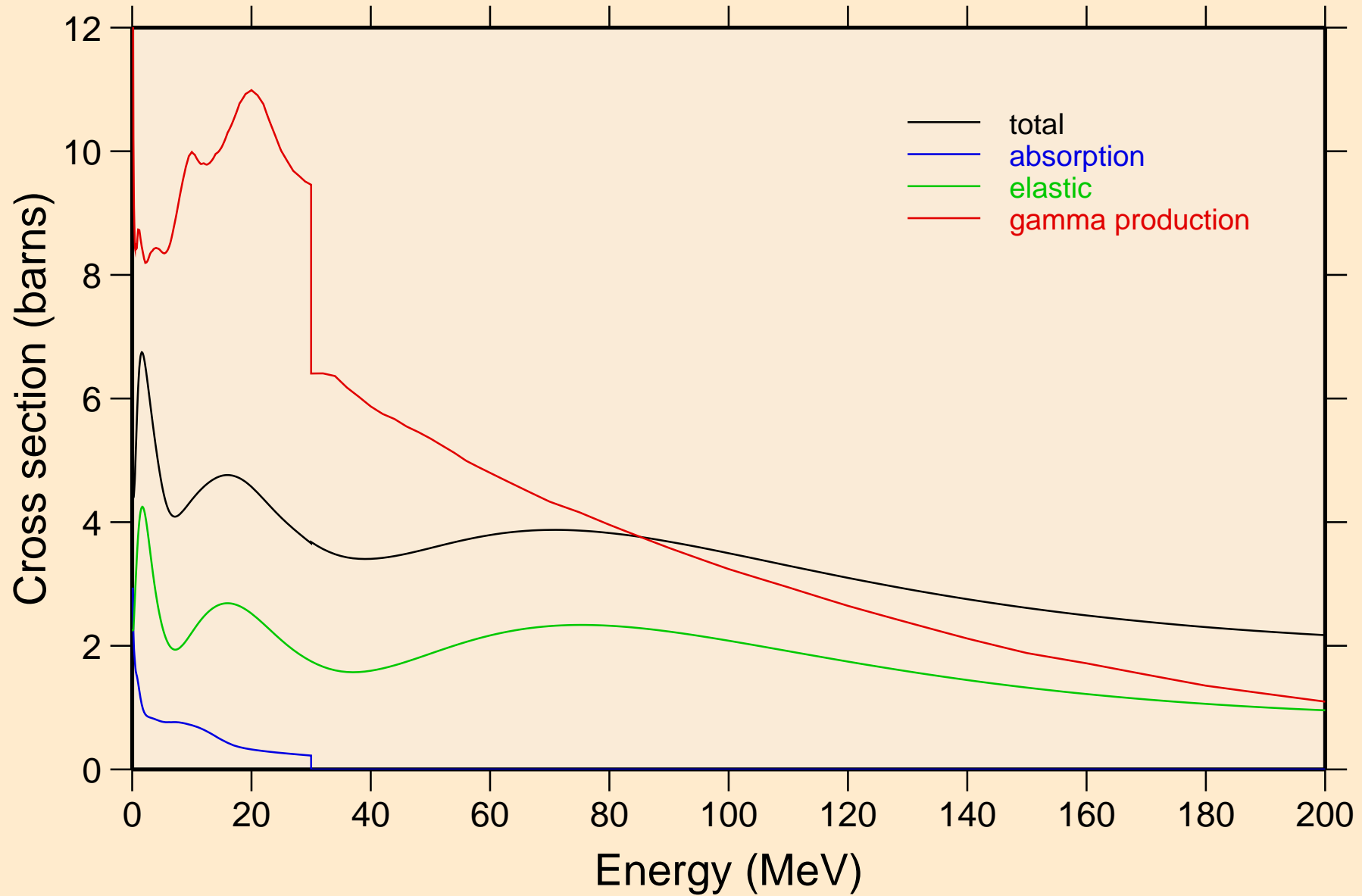

ND133 NEUTRON ACER TENDL-2021 LIBRARY; T=293.6K
Heating

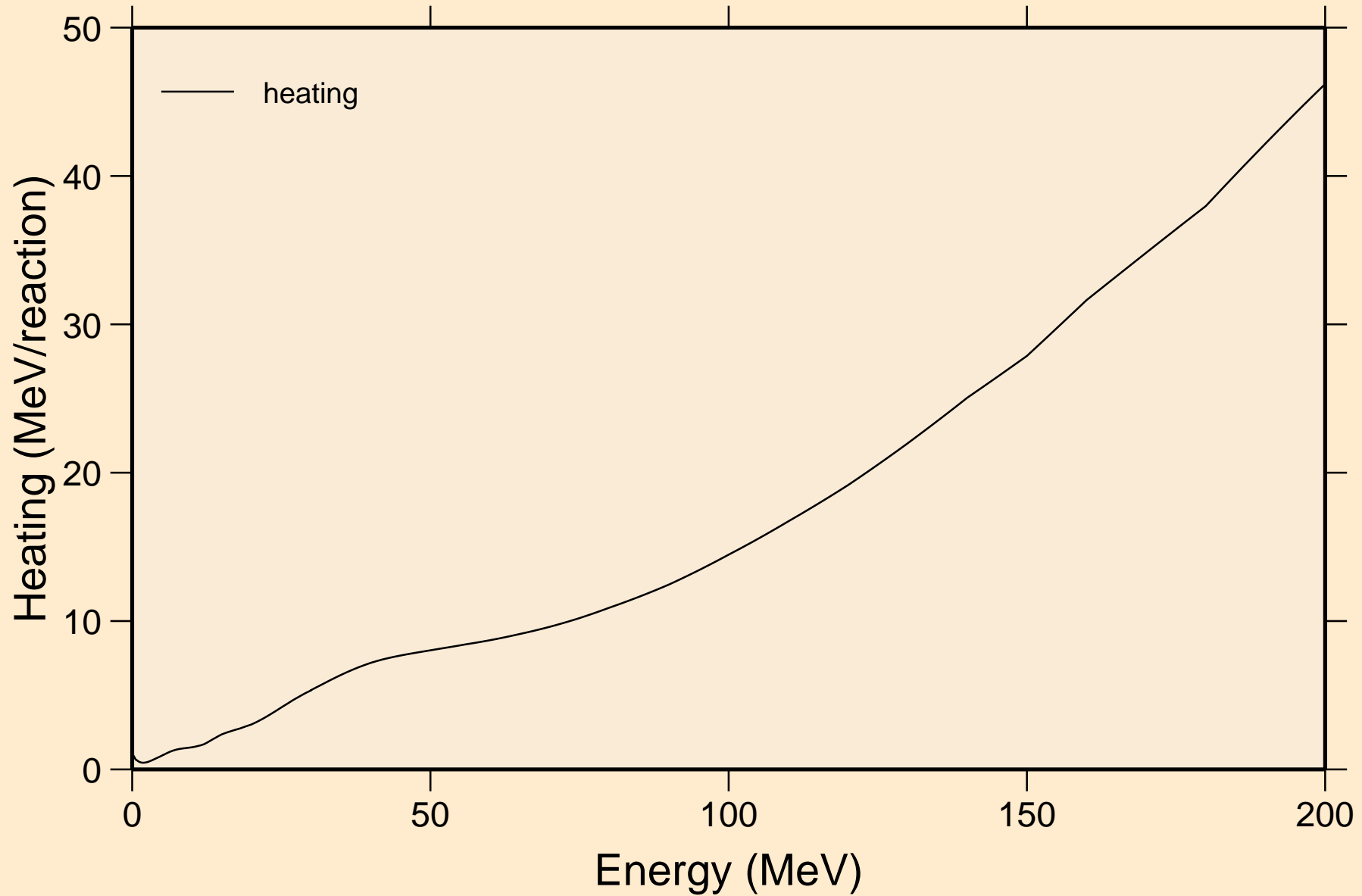

ND133 NEUTRON ACER TENDL-2021 LIBRARY; T=293.6K

Damage

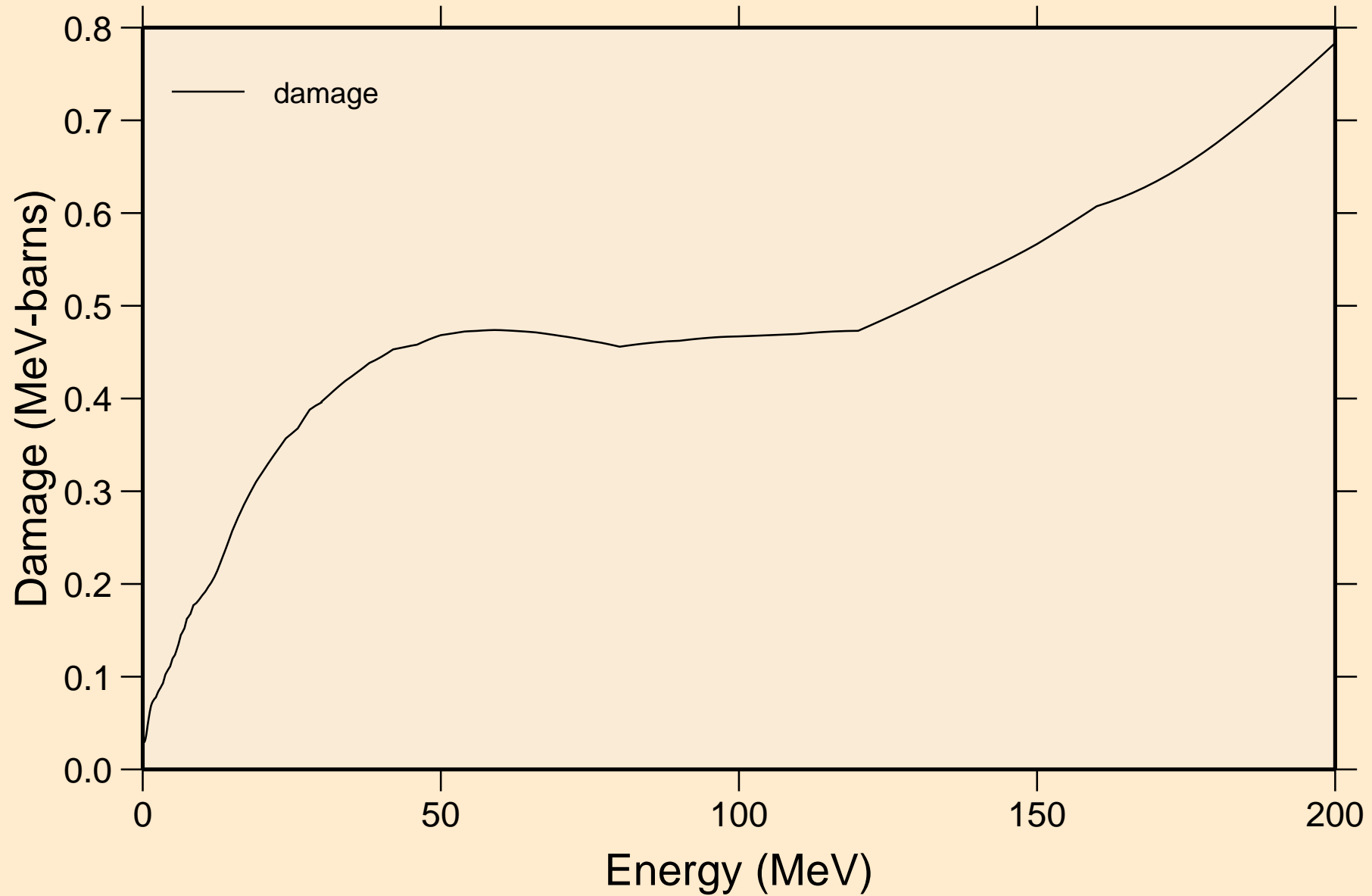

ND133 NEUTRON ACER TENDL-2021 LIBRARY; T=293.6K

Non-threshold reactions

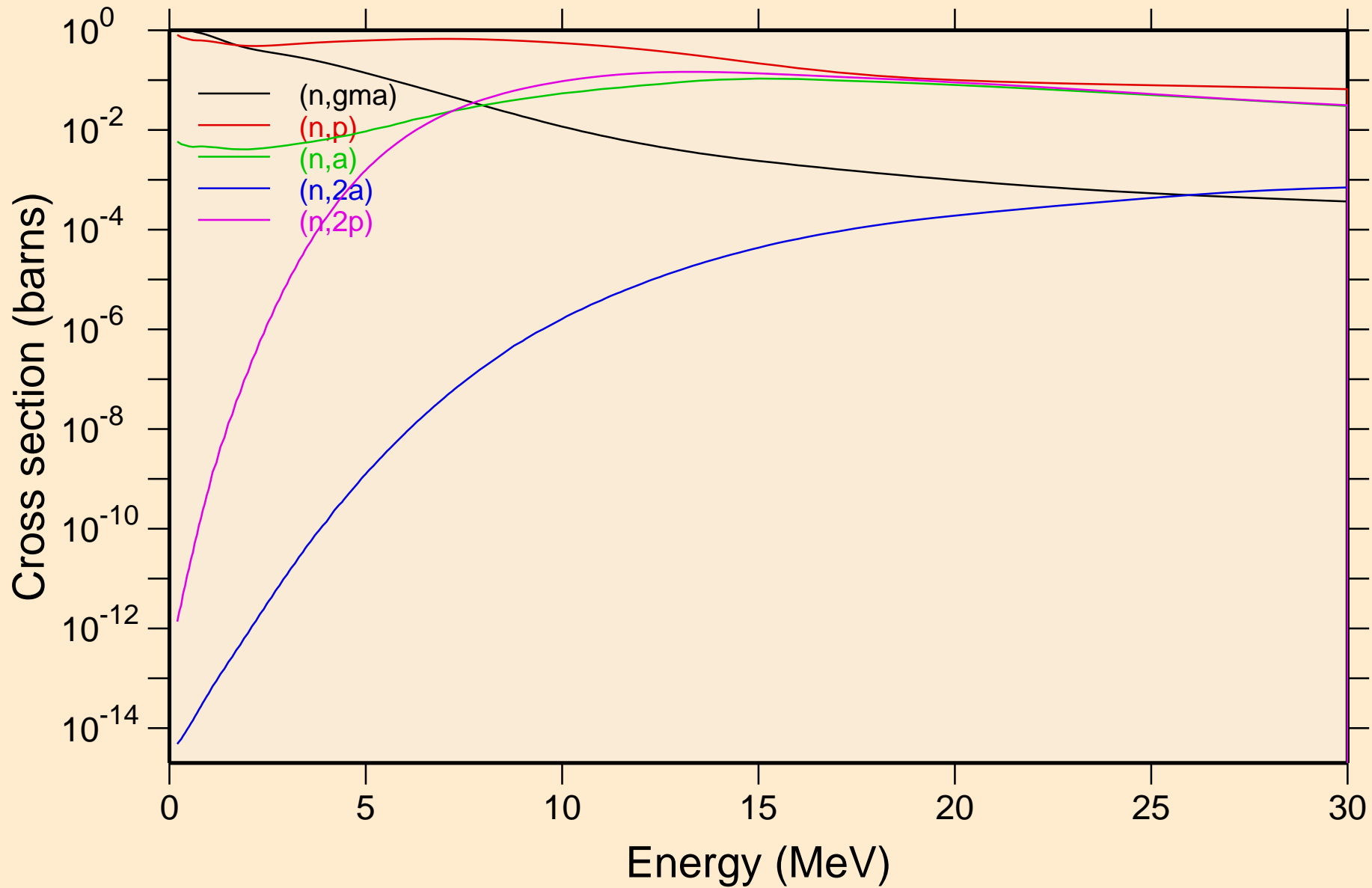

ND133 NEUTRON ACER TENDL-2021 LIBRARY; T=293.6K
Non-threshold reactions

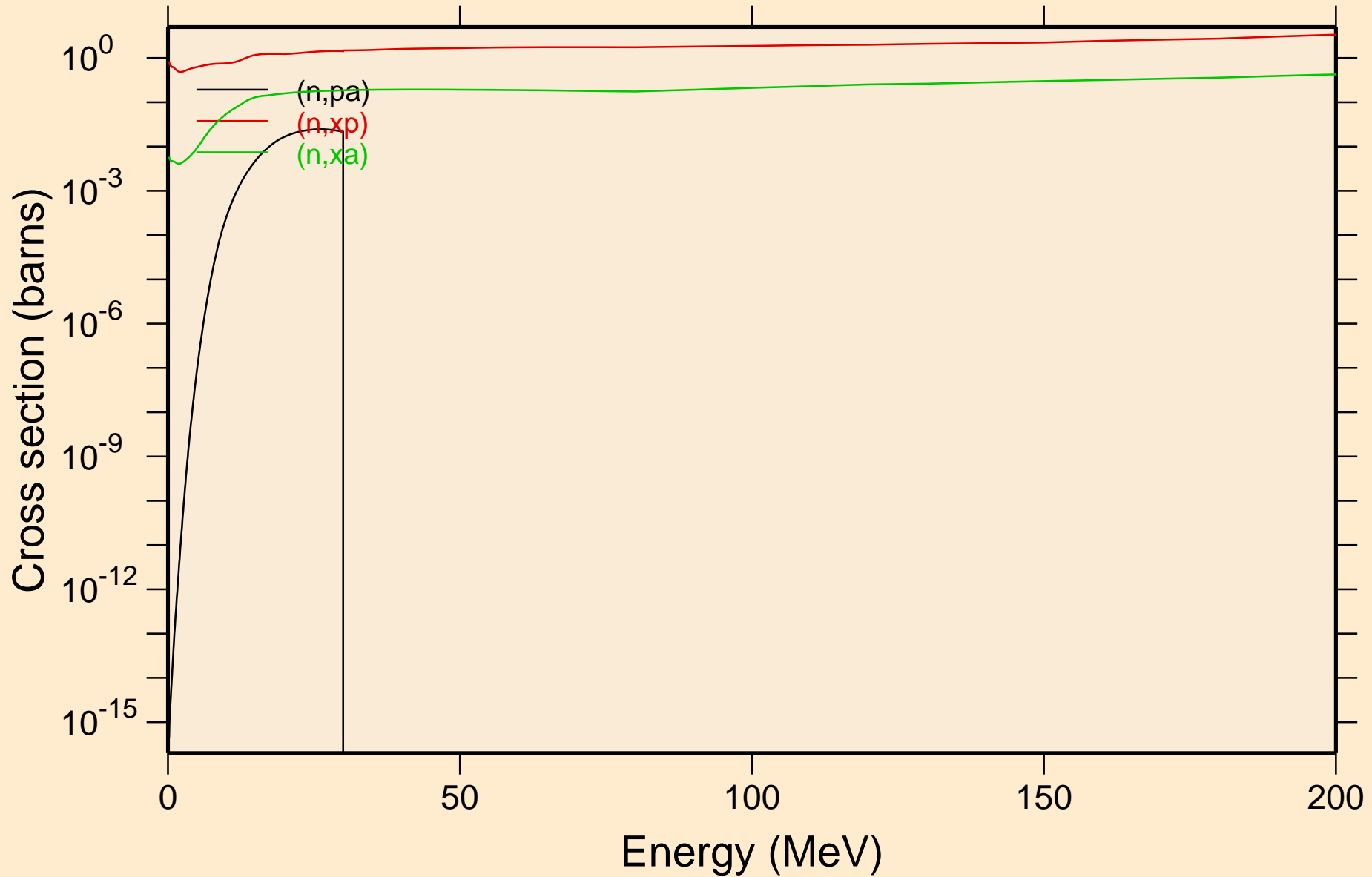

ND133 NEUTRON ACER TENDL-2021 LIBRARY; T=293.6K
Inelastic levels

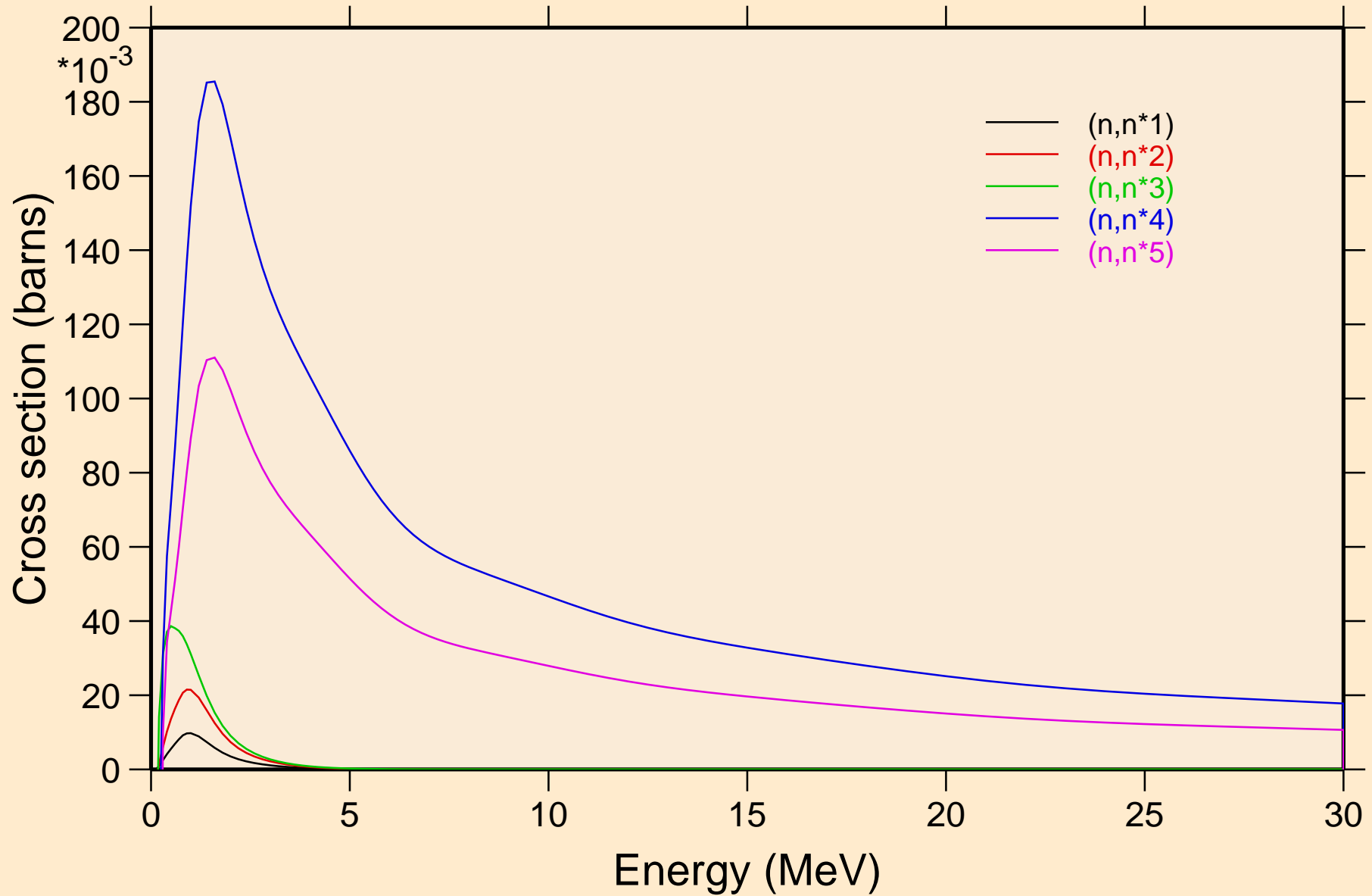

ND133 NEUTRON ACER TENDL-2021 LIBRARY; T=293.6K
Inelastic levels

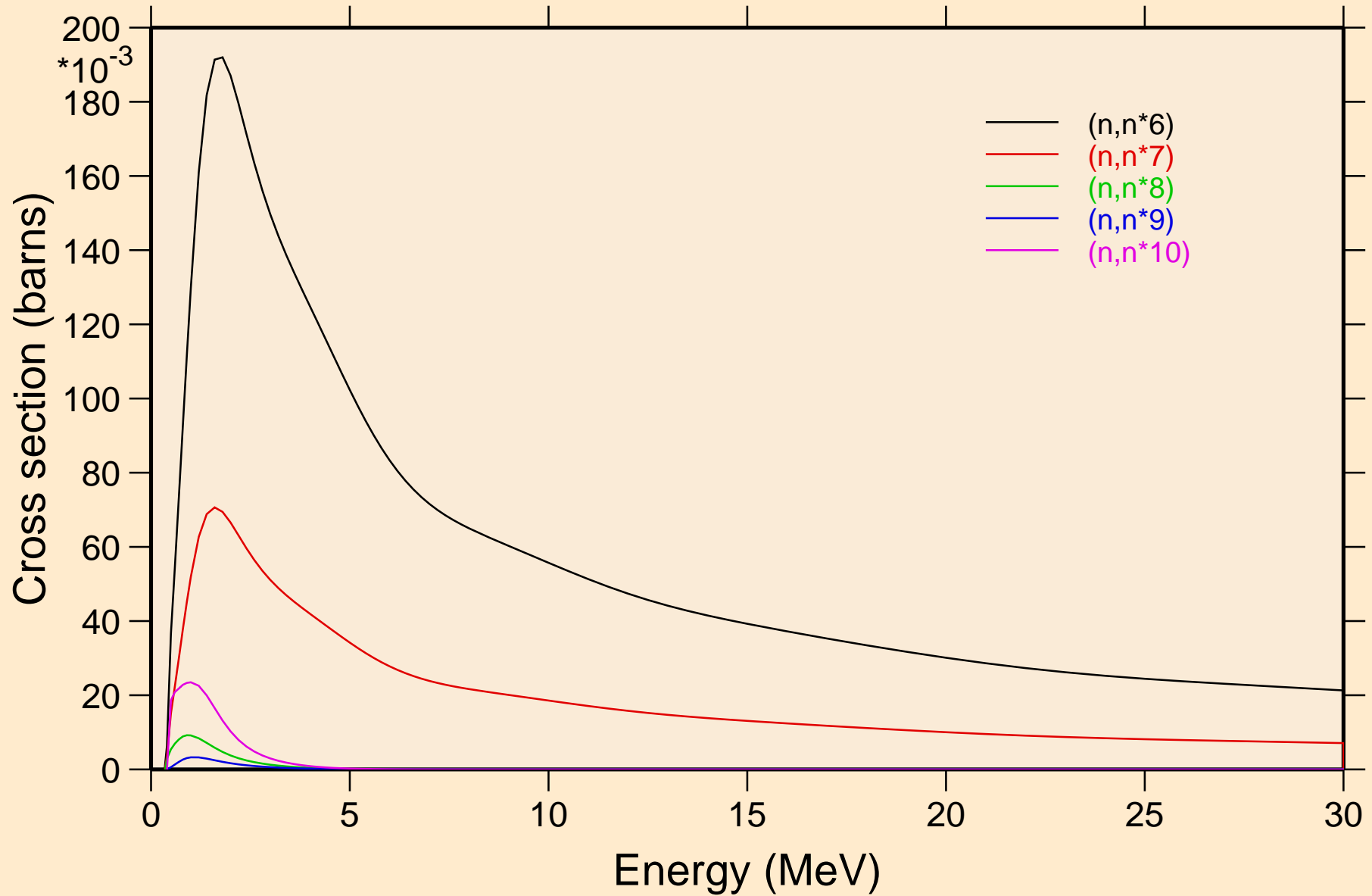

ND133 NEUTRON ACER TENDL-2021 LIBRARY; T=293.6K
Inelastic levels

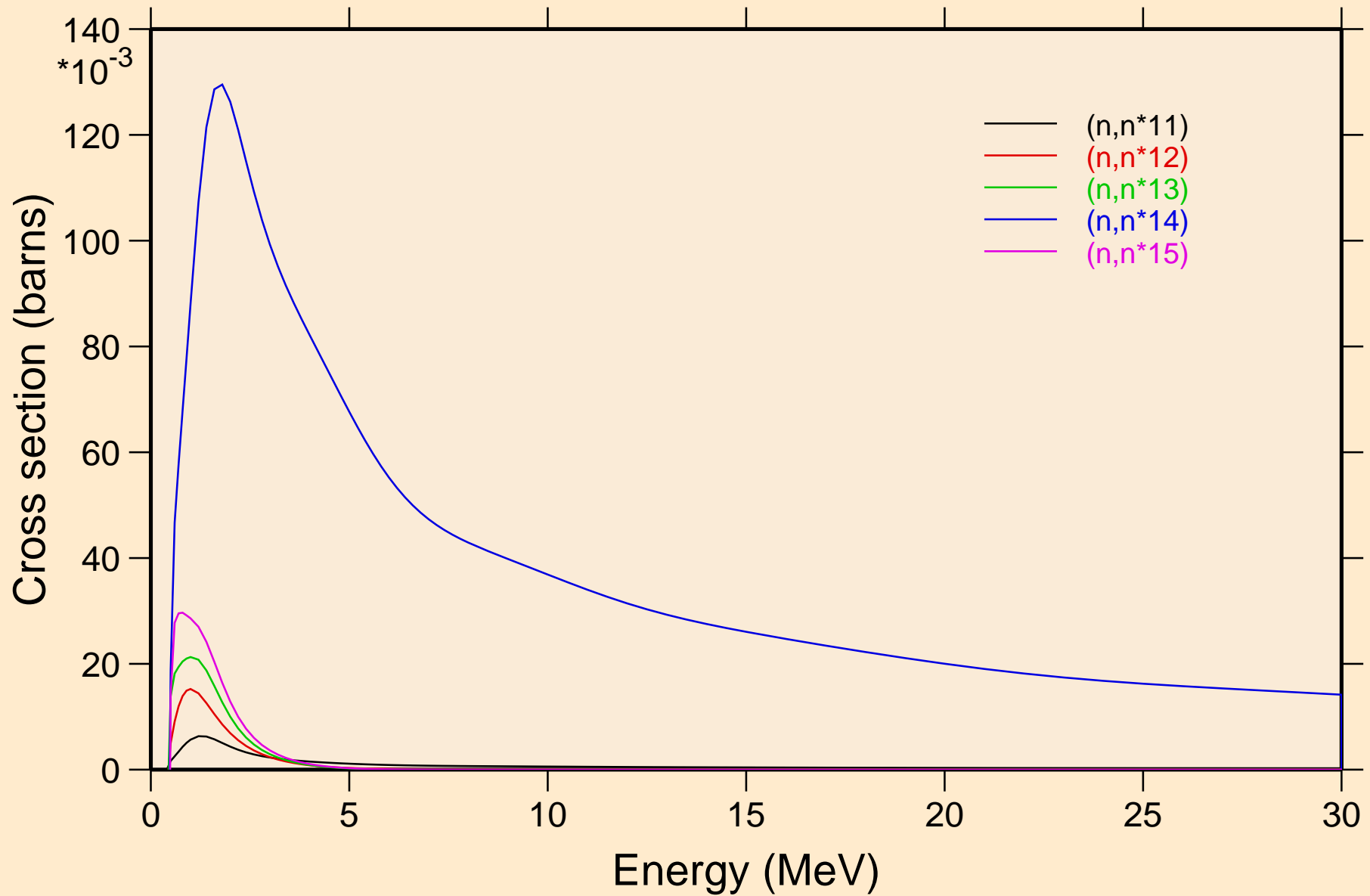

ND133 NEUTRON ACER TENDL-2021 LIBRARY; T=293.6K
Inelastic levels

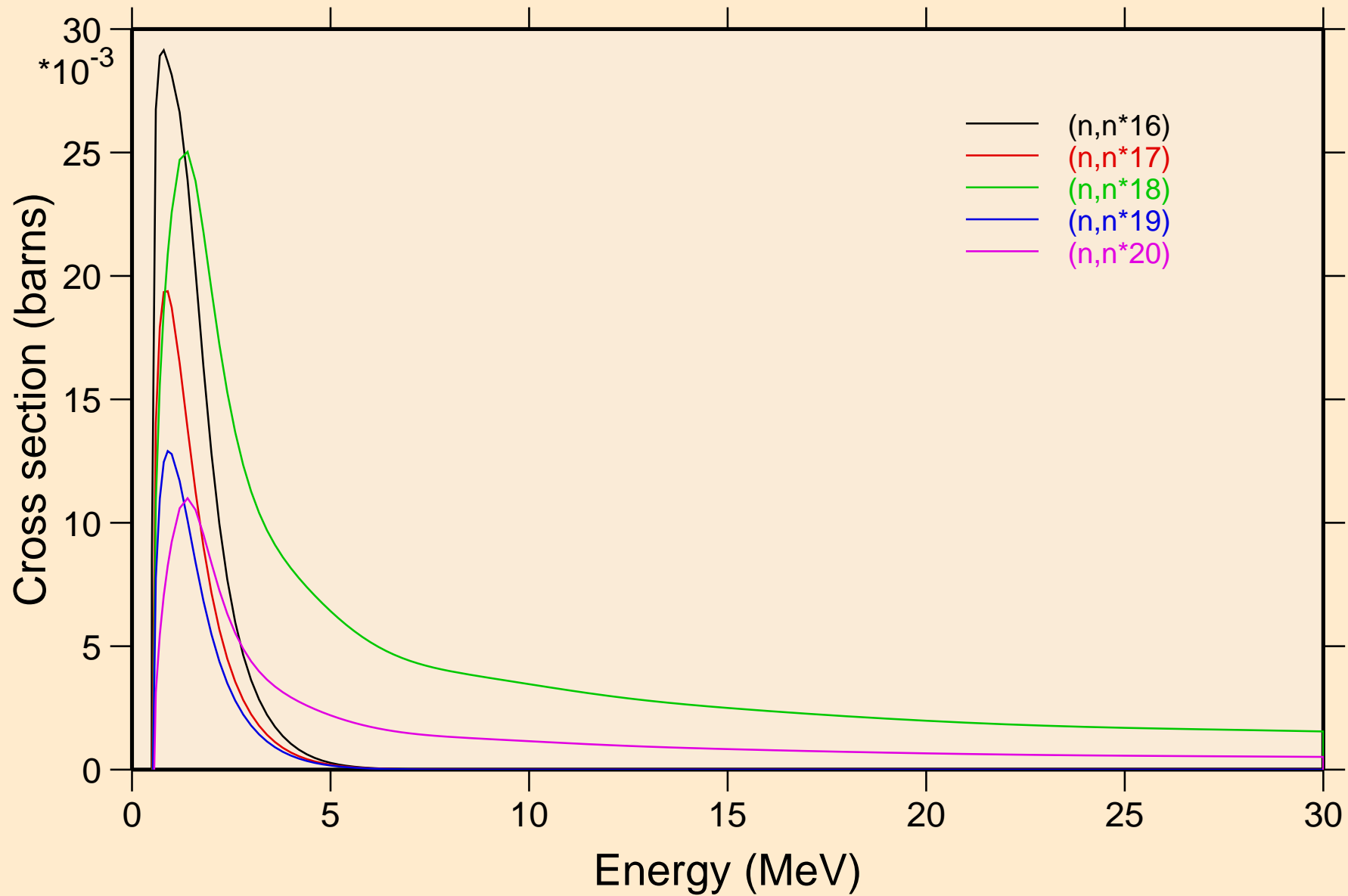

ND133 NEUTRON ACER TENDL-2021 LIBRARY; T=293.6K
Inelastic levels

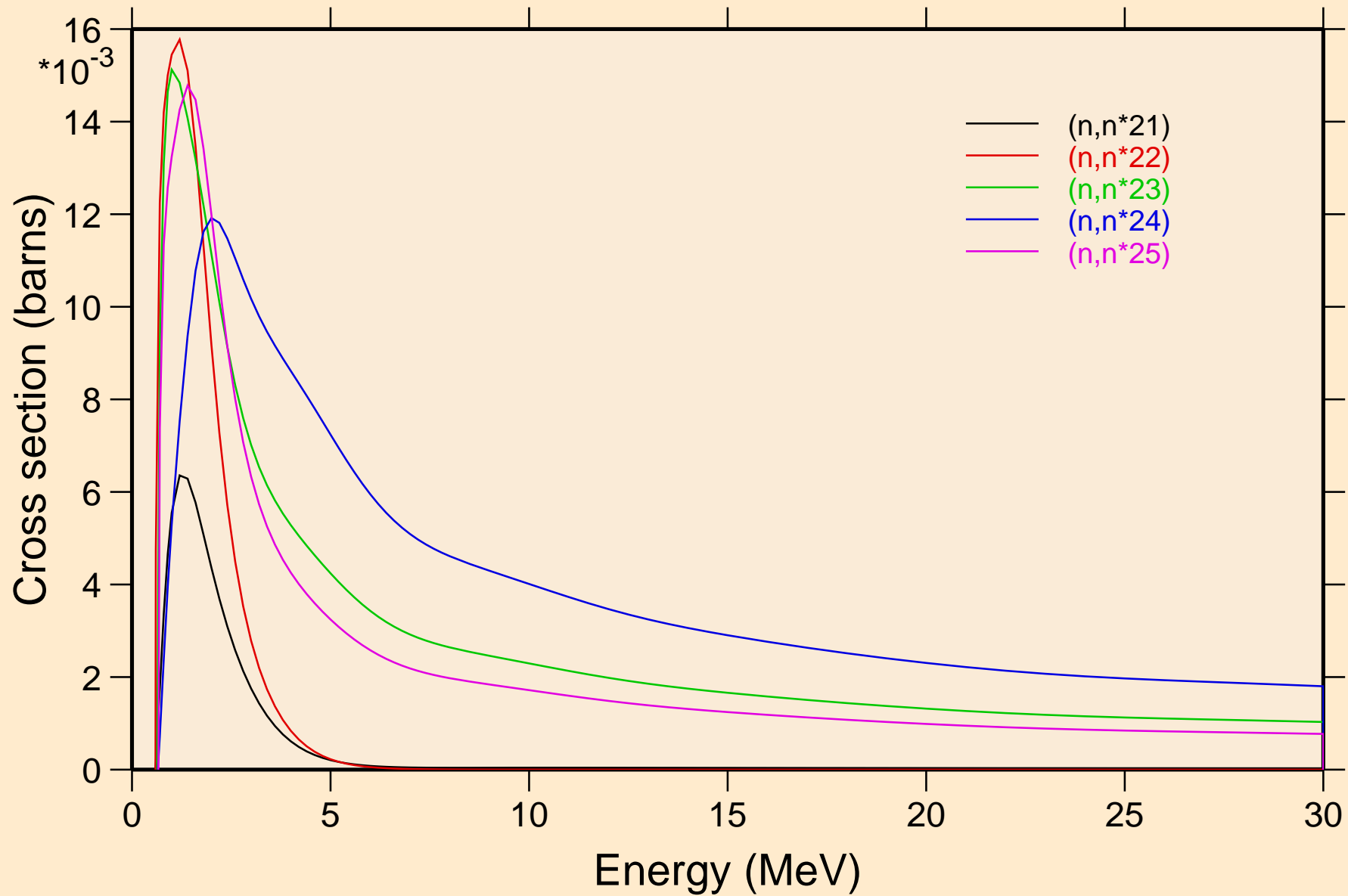

ND133 NEUTRON ACER TENDL-2021 LIBRARY; T=293.6K
Inelastic levels

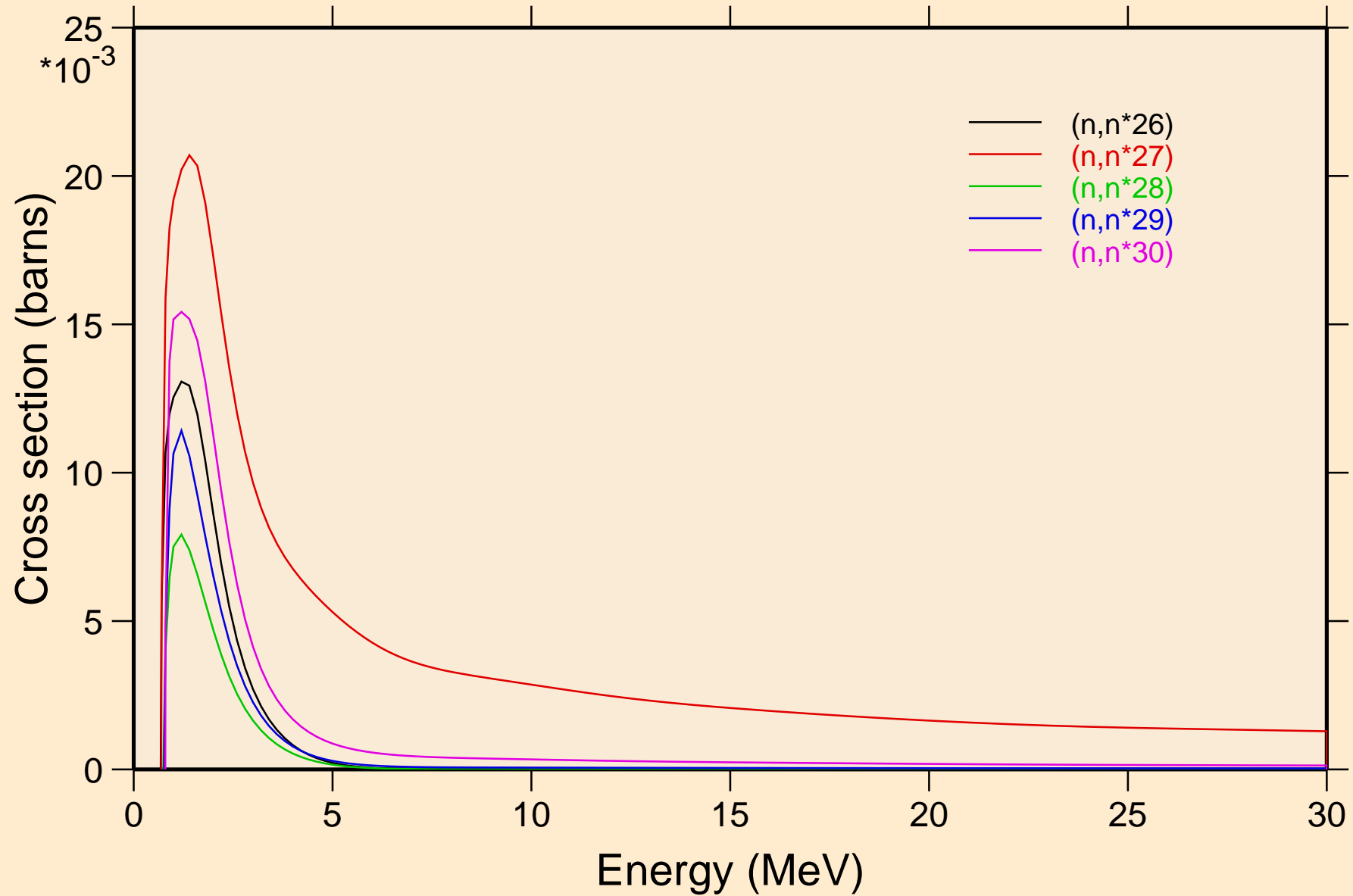

ND133 NEUTRON ACER TENDL-2021 LIBRARY; T=293.6K

Threshold reactions

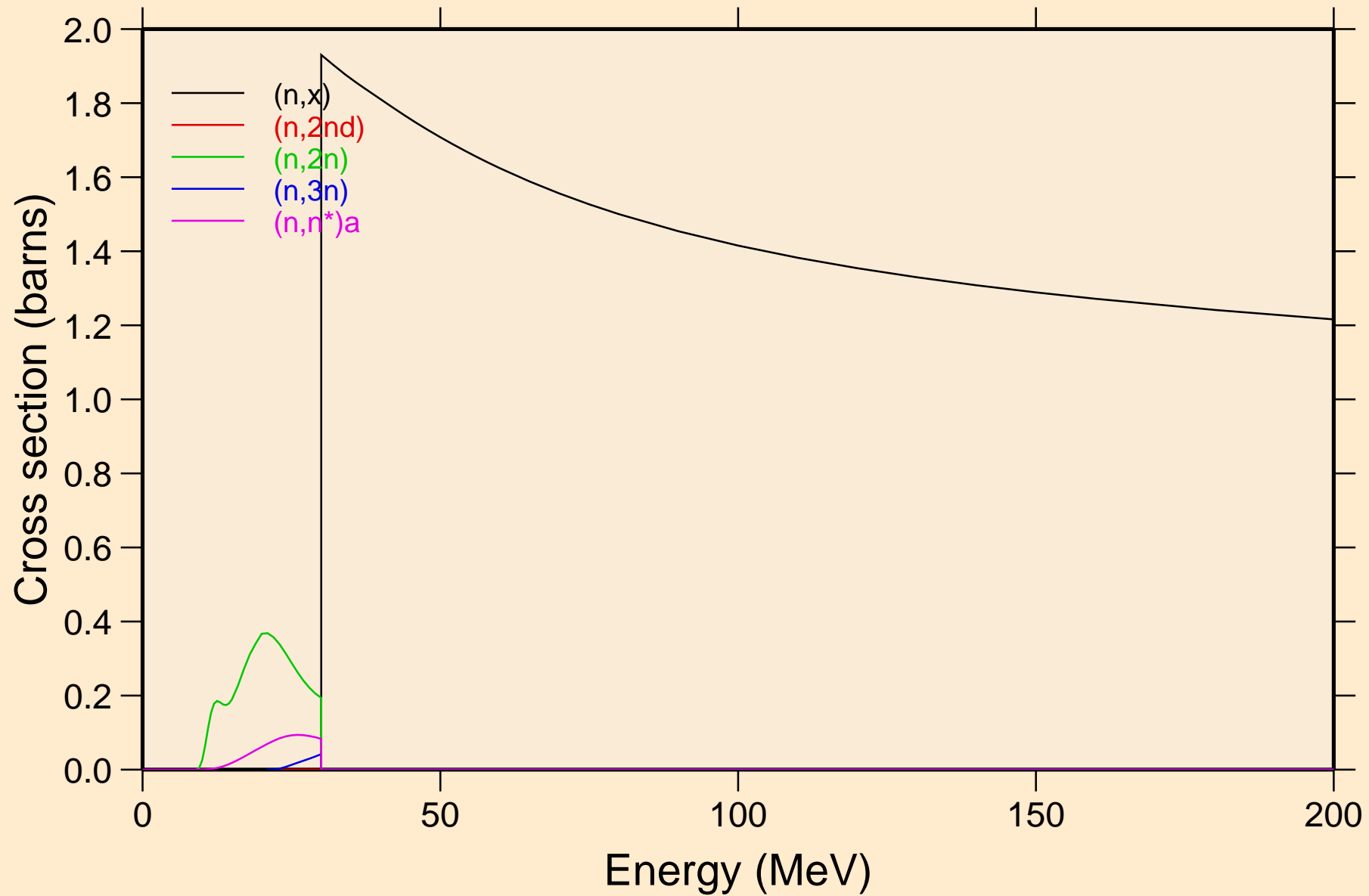

ND133 NEUTRON ACER TENDL-2021 LIBRARY; T=293.6K

Threshold reactions

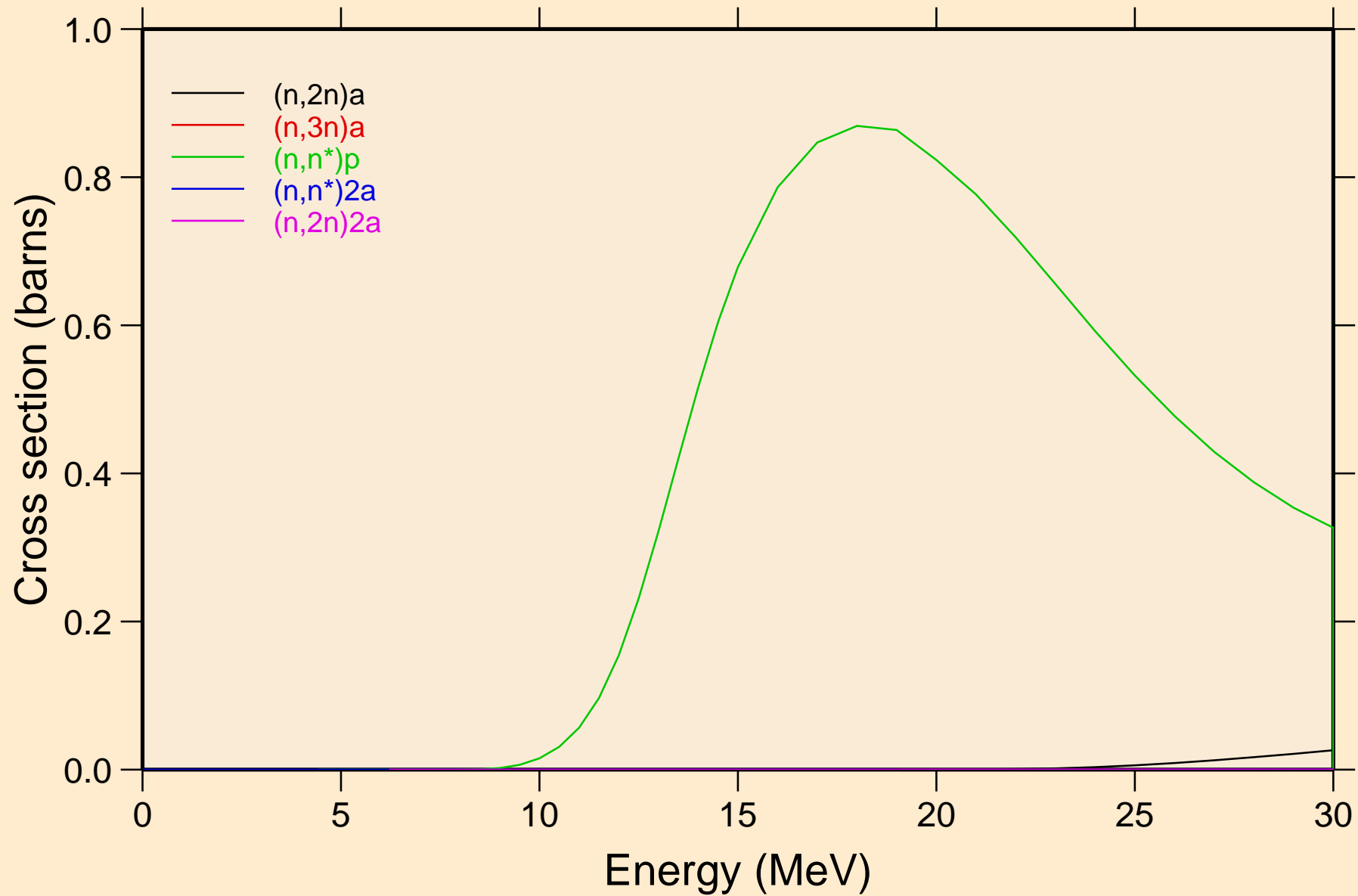

ND133 NEUTRON ACER TENDL-2021 LIBRARY; T=293.6K
Threshold reactions

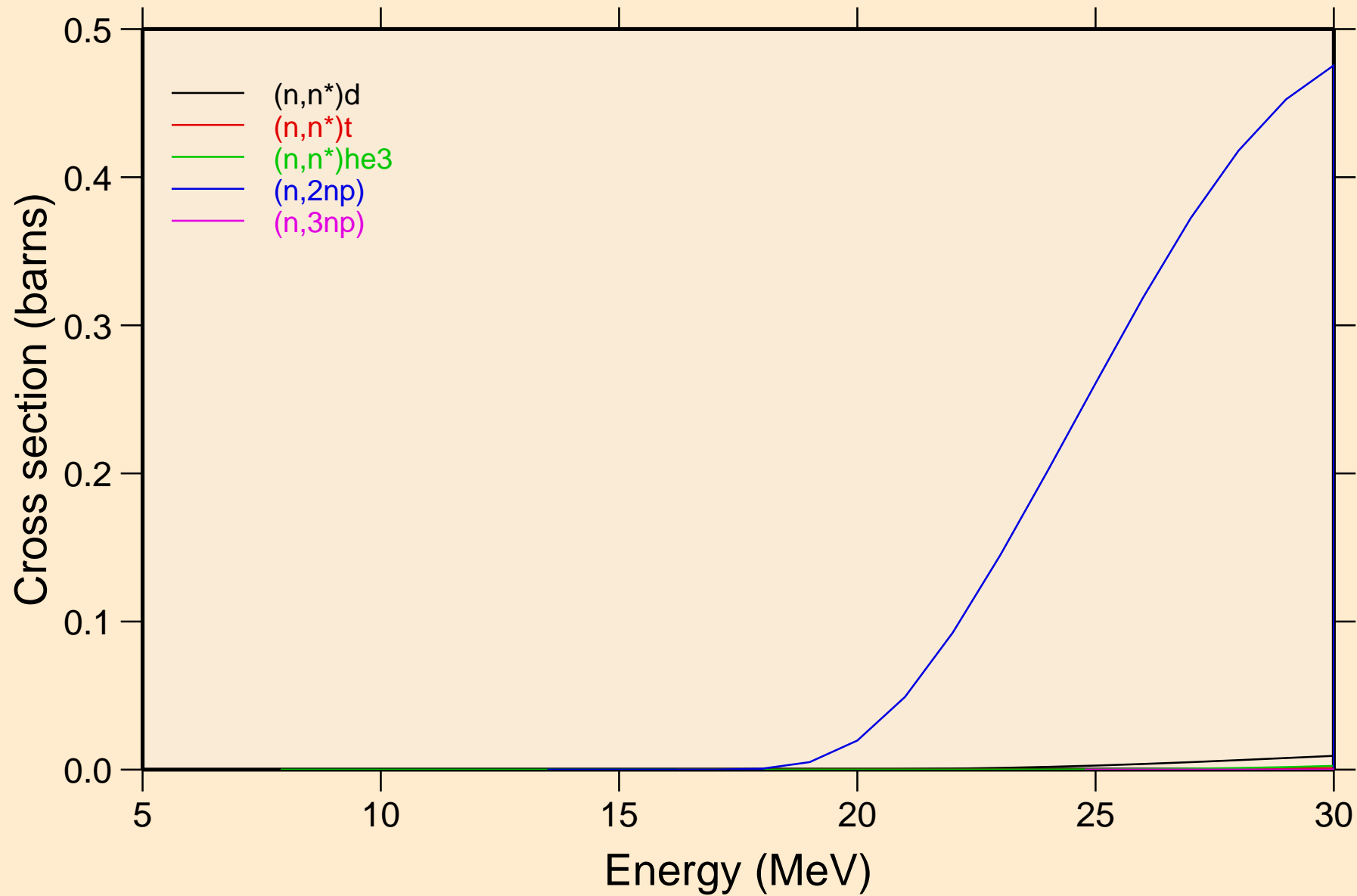

ND133 NEUTRON ACER TENDL-2021 LIBRARY; T=293.6K

Threshold reactions

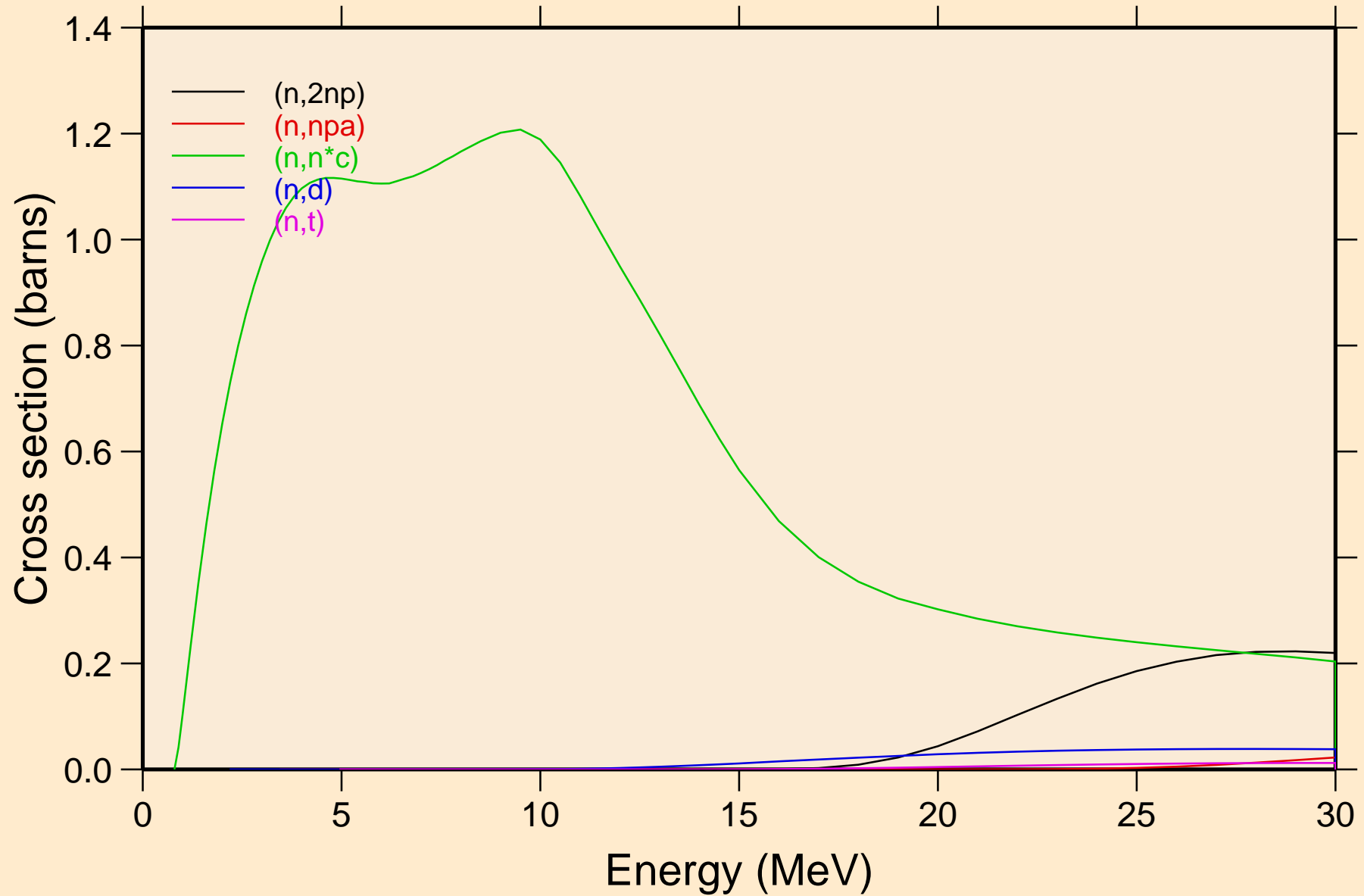

ND133 NEUTRON ACER TENDL-2021 LIBRARY; T=293.6K
Threshold reactions

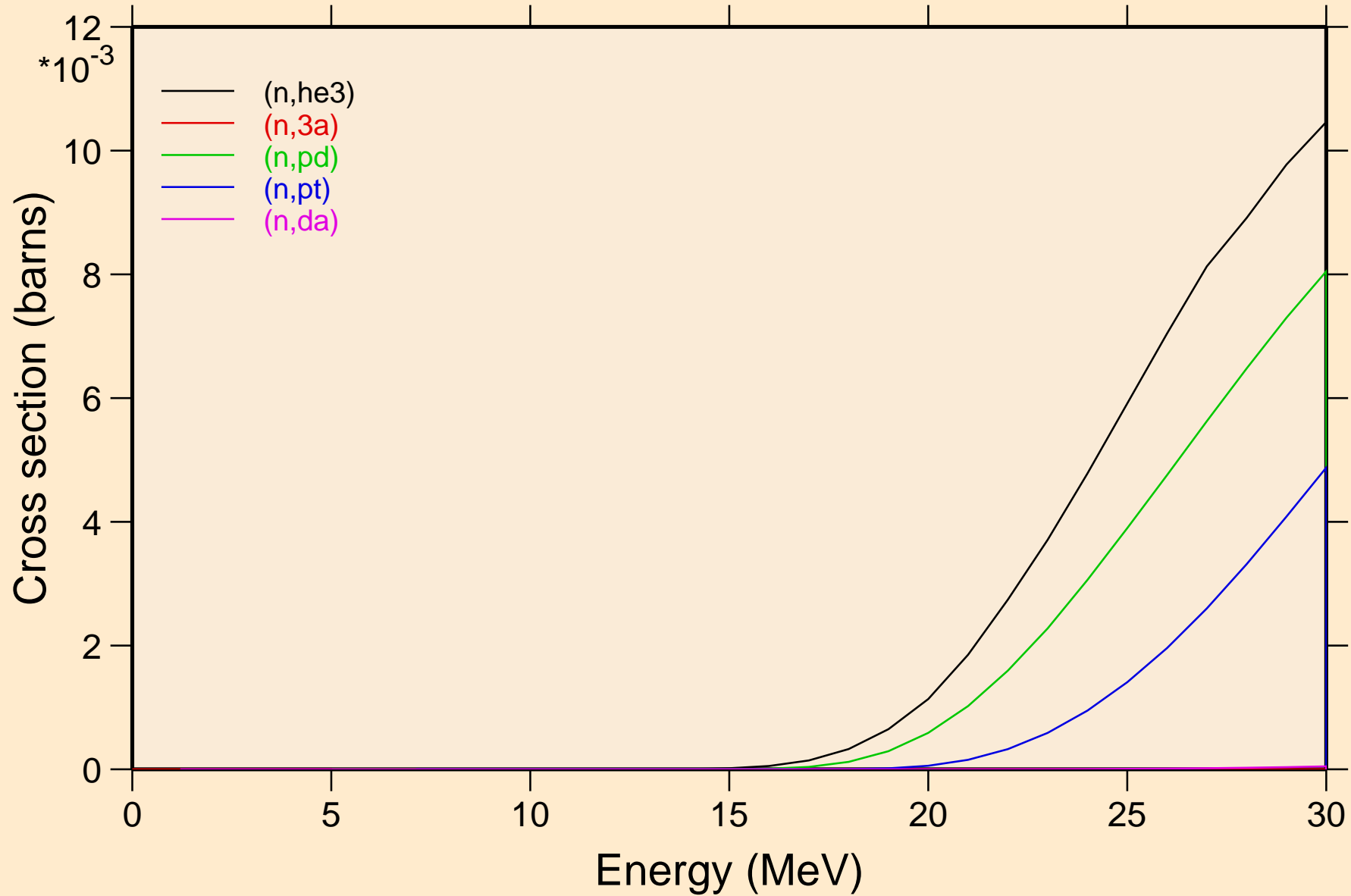

ND133 NEUTRON ACER TENDL-2021 LIBRARY; T=293.6K

Threshold reactions

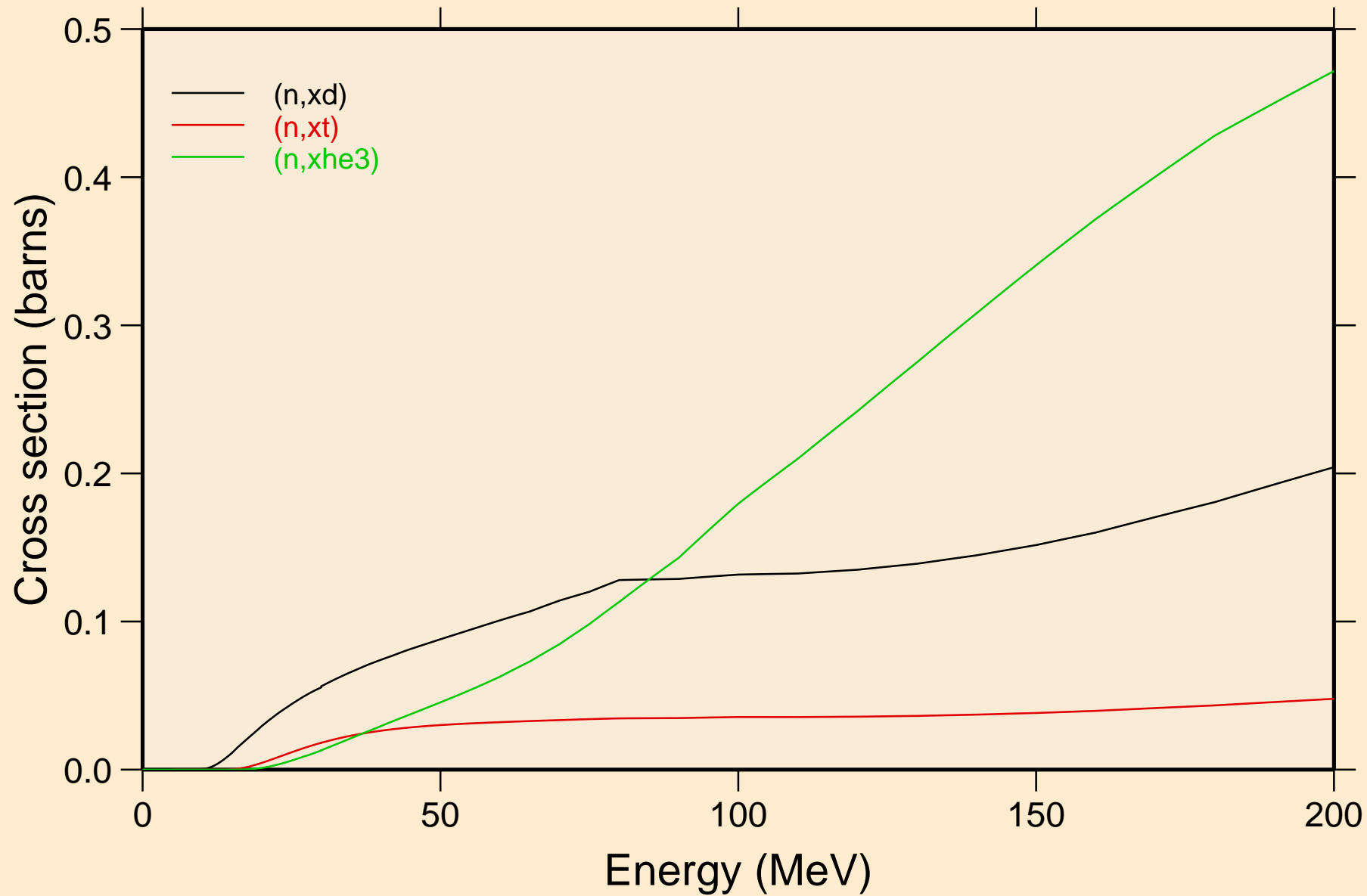

ND133 NEUTRON ACER TENDL-2021 LIBRARY; T=293.6K
angular distribution for elastic

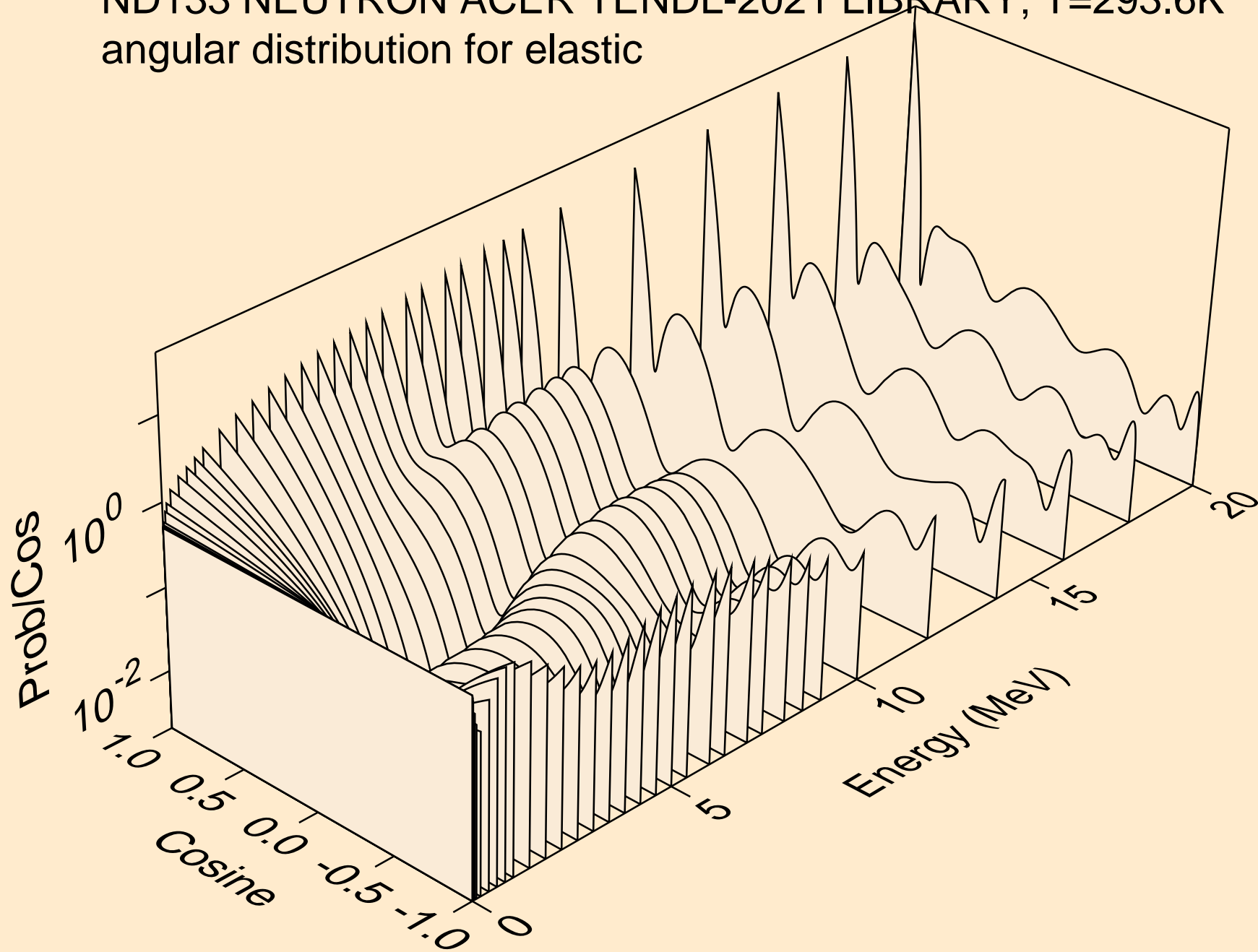

ND133 NEUTRON ACER TENDL-2021 LIBRARY; T=293.6K
angular distribution for elastic

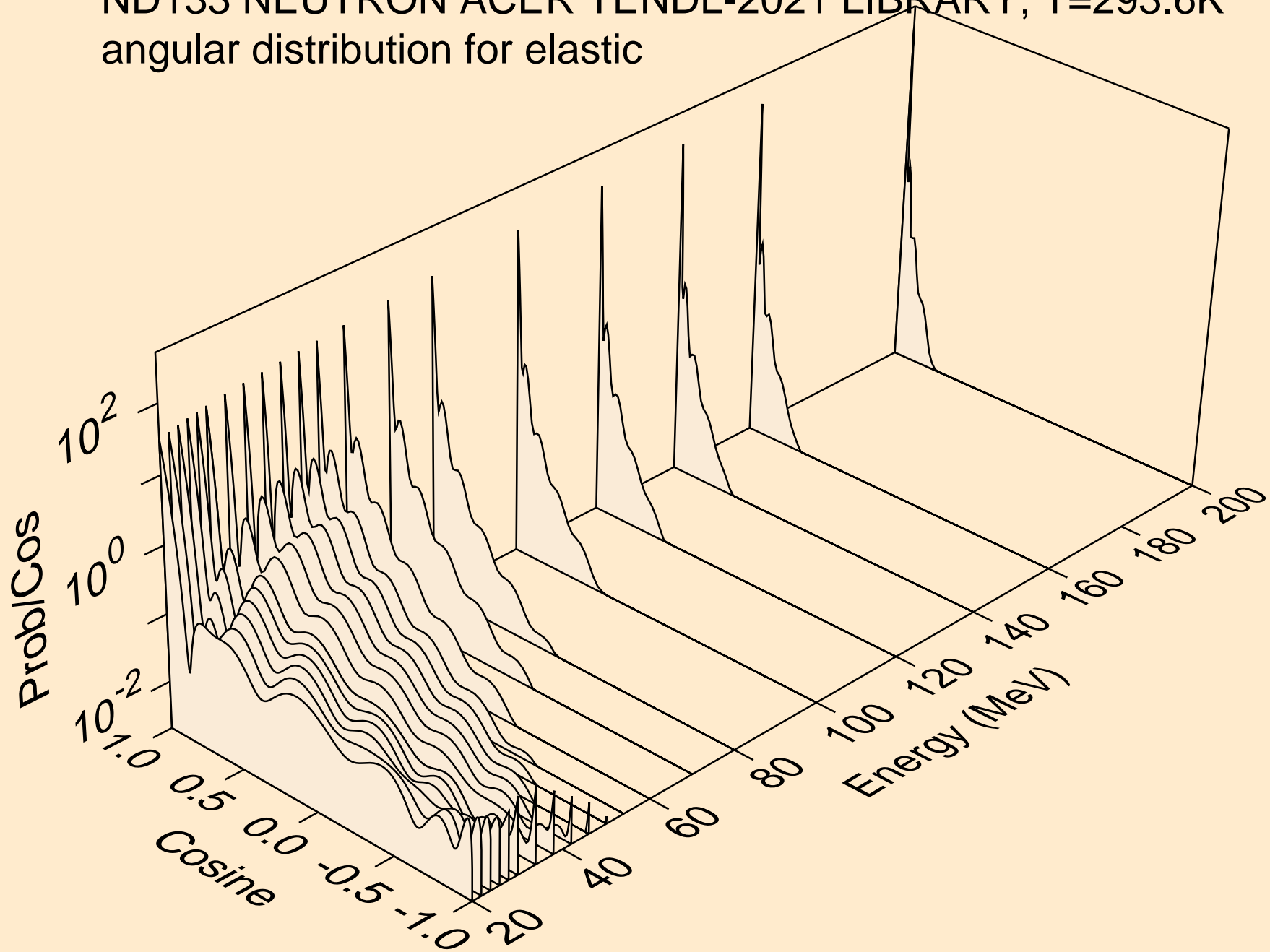

ND133 NEUTRON ACER TENDL-2021 LIBRARY; T=293.6K
angular distribution for (n,n*1)

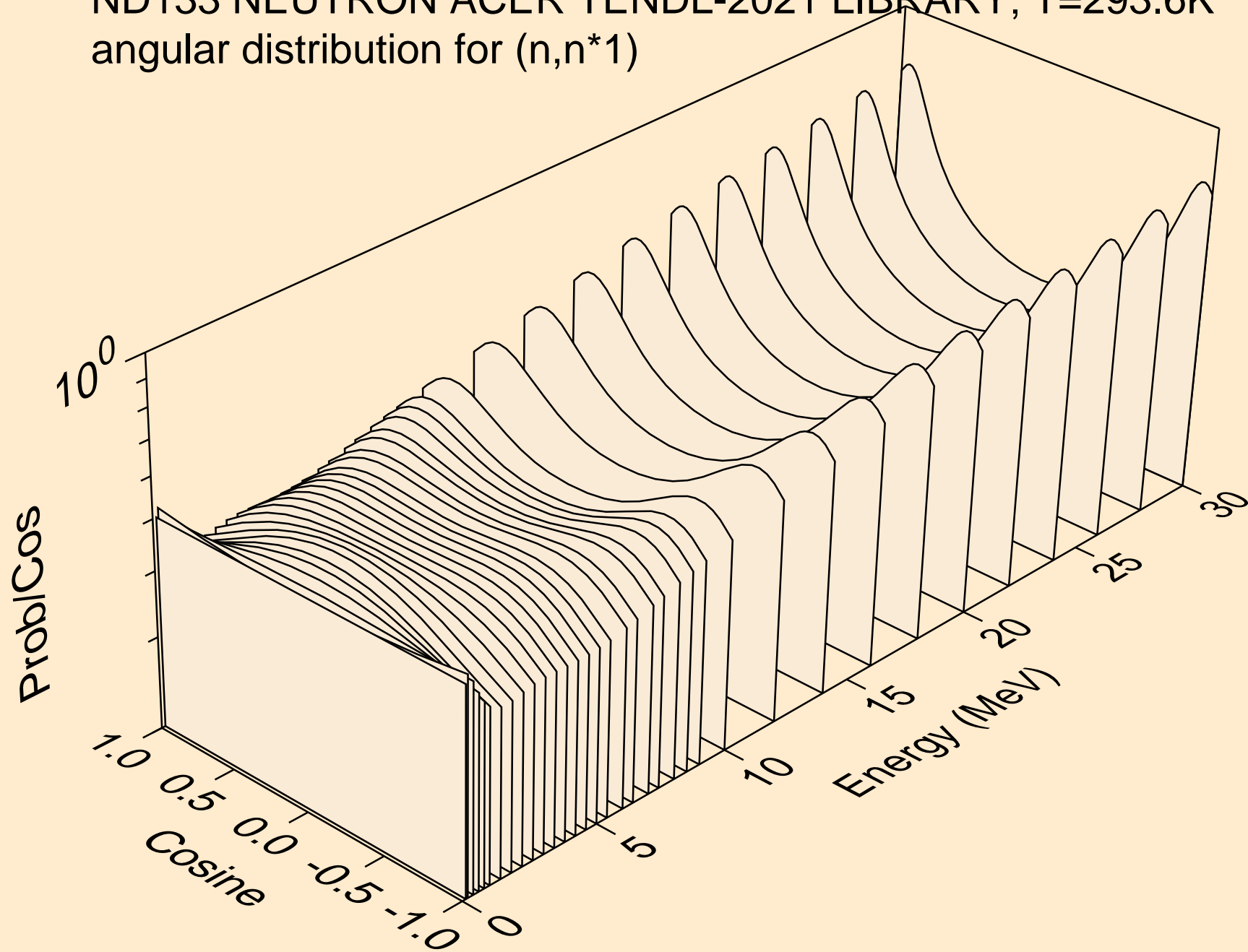

ND133 NEUTRON ACER TENDL-2021 LIBRARY; T=293.6K
angular distribution for (n,n*2)

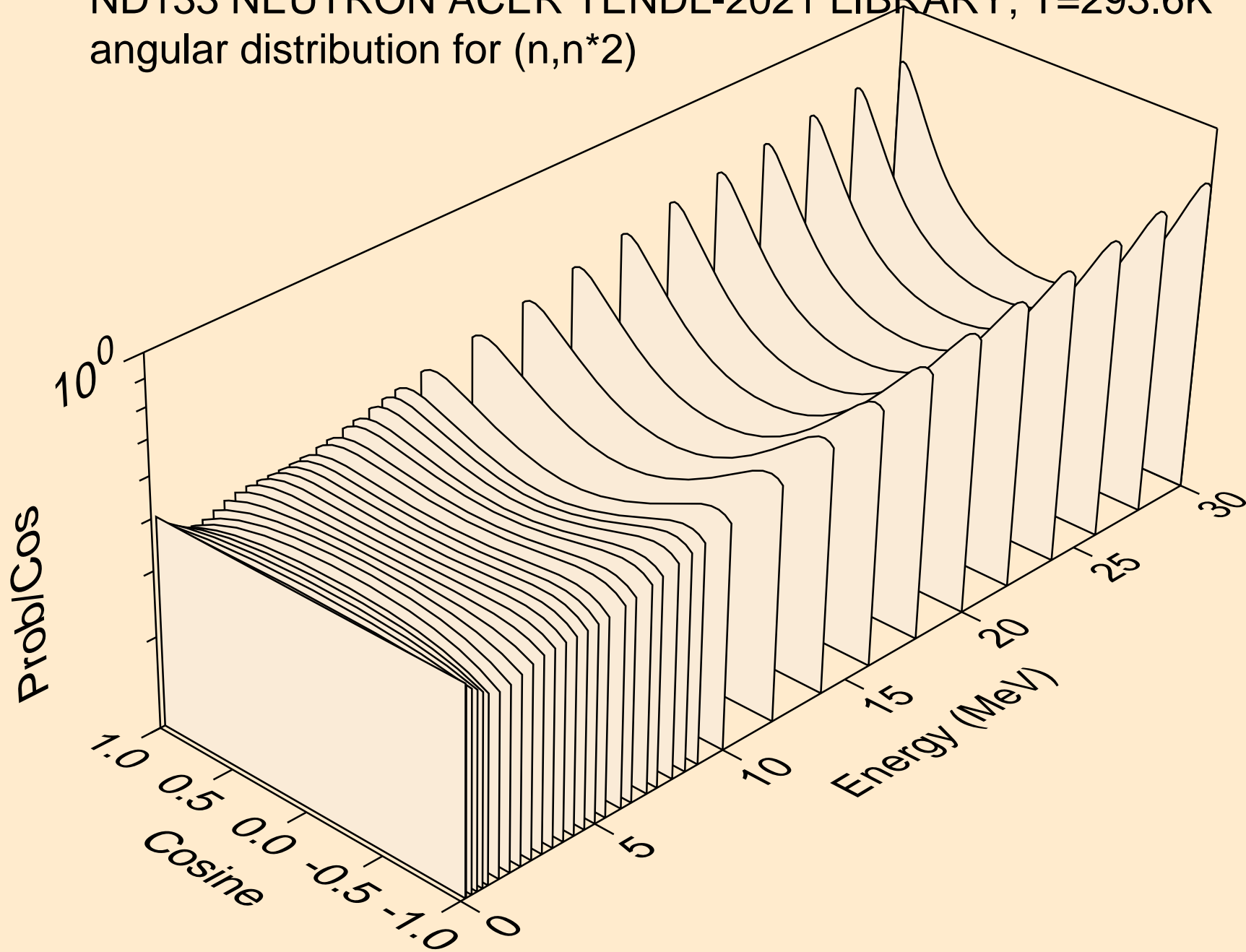

ND133 NEUTRON ACER TENDL-2021 LIBRARY; T=293.6K
angular distribution for (n,n*3)

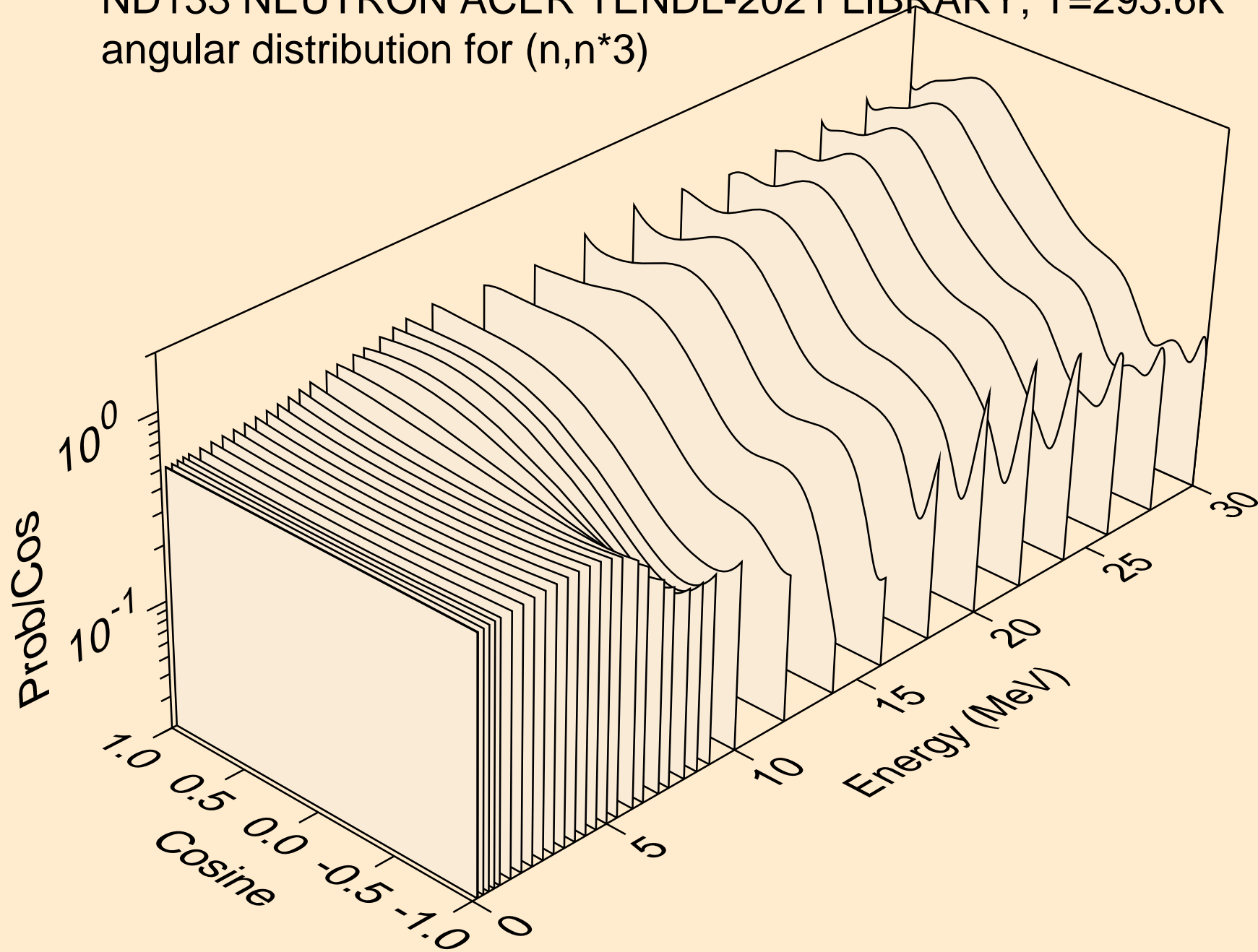

ND133 NEUTRON ACER TENDL-2021 LIBRARY; T=293.6K
angular distribution for (n,n*4)

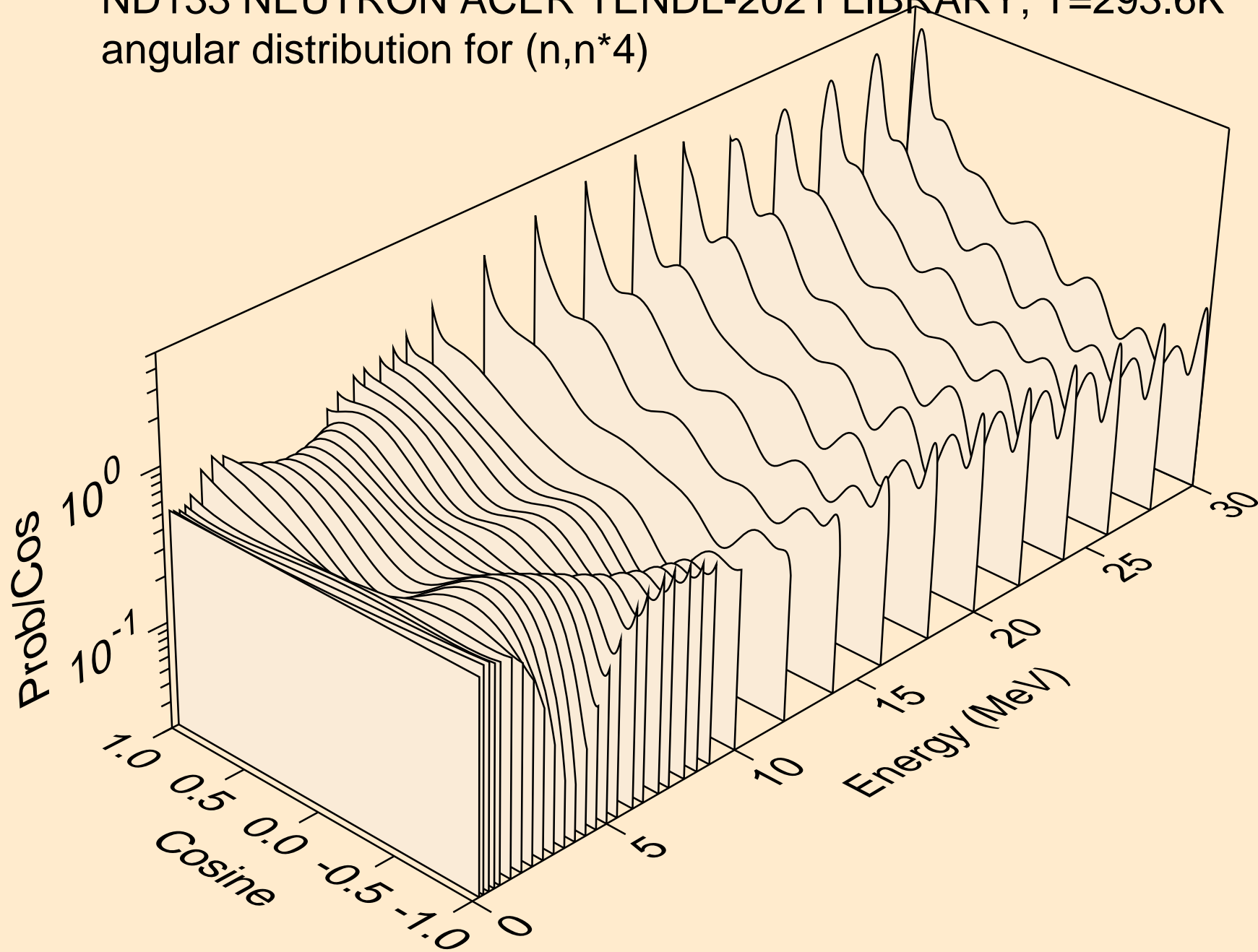

ND133 NEUTRON ACER TENDL-2021 LIBRARY; T=293.6K
angular distribution for (n,n*5)

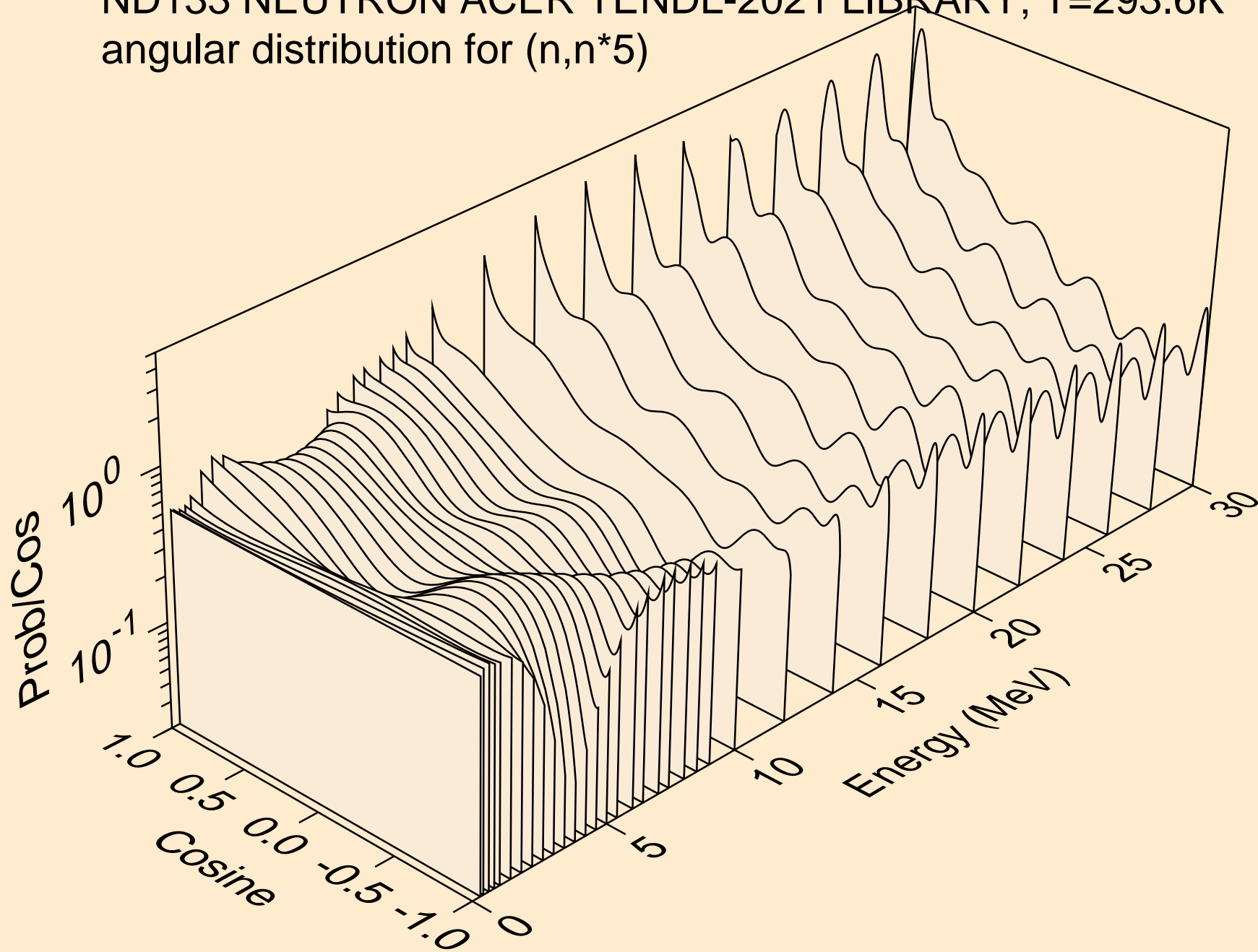

ND133 NEUTRON ACER TENDL-2021 LIBRARY; T=293.6K
angular distribution for (n,n*6)

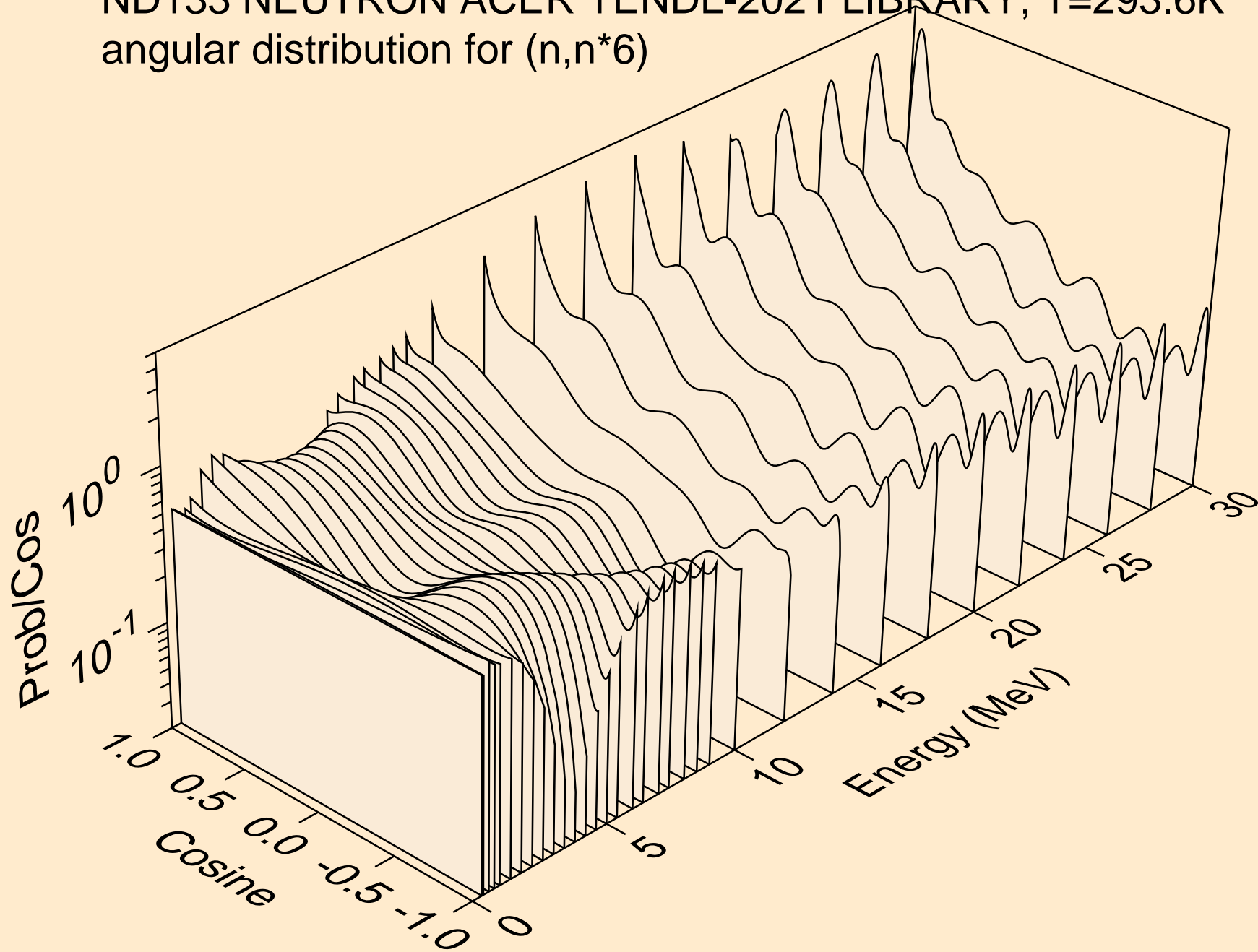

ND133 NEUTRON ACER TENDL-2021 LIBRARY; T=293.6K
angular distribution for (n,n*7)

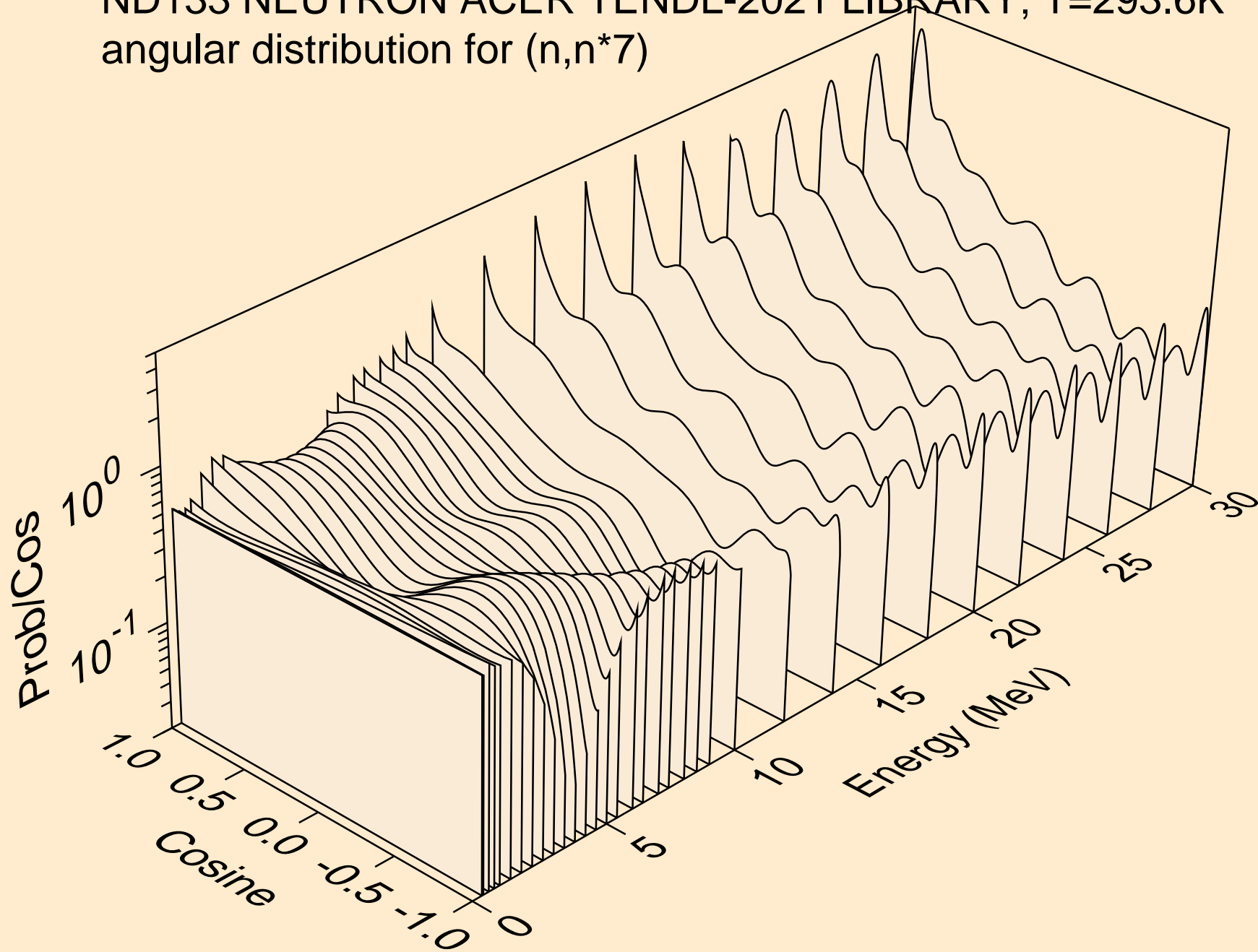

ND133 NEUTRON ACER TENDL-2021 LIBRARY; T=293.6K
angular distribution for (n,n*8)

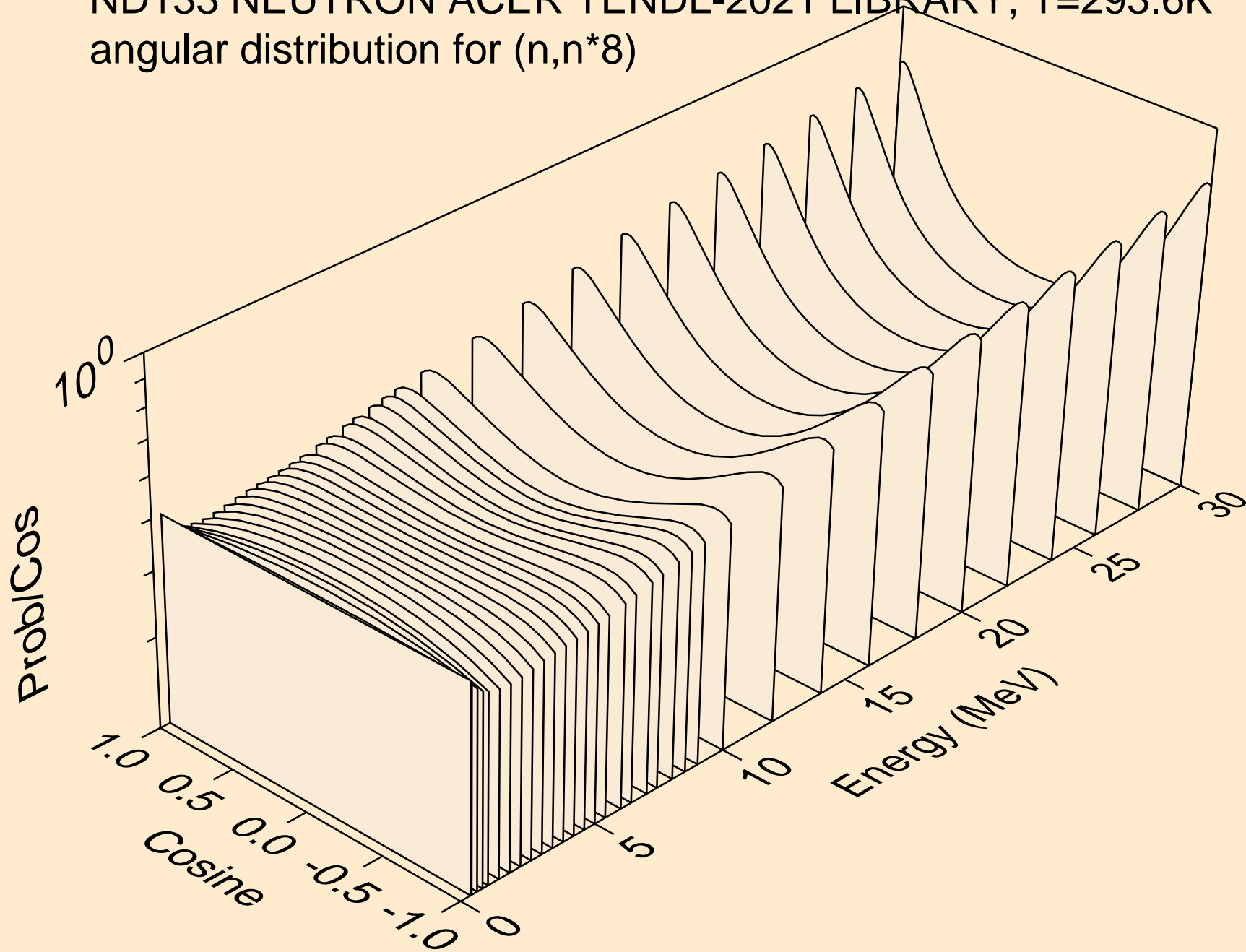

ND133 NEUTRON ACER TENDL-2021 LIBRARY; T=293.6K
angular distribution for (n,n*9)

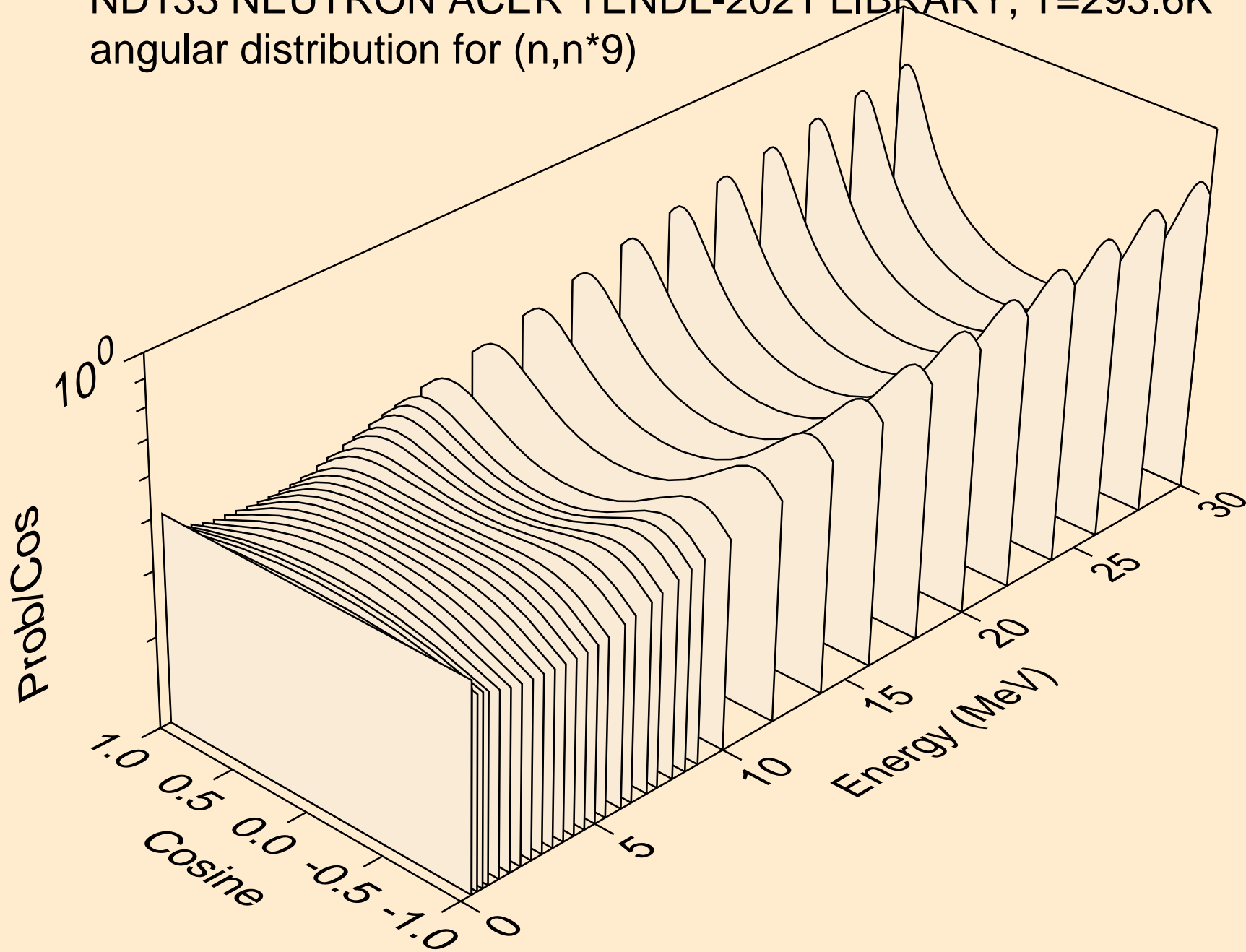

ND133 NEUTRON ACER TENDL-2021 LIBRARY; T=293.6K
angular distribution for (n,n*10)

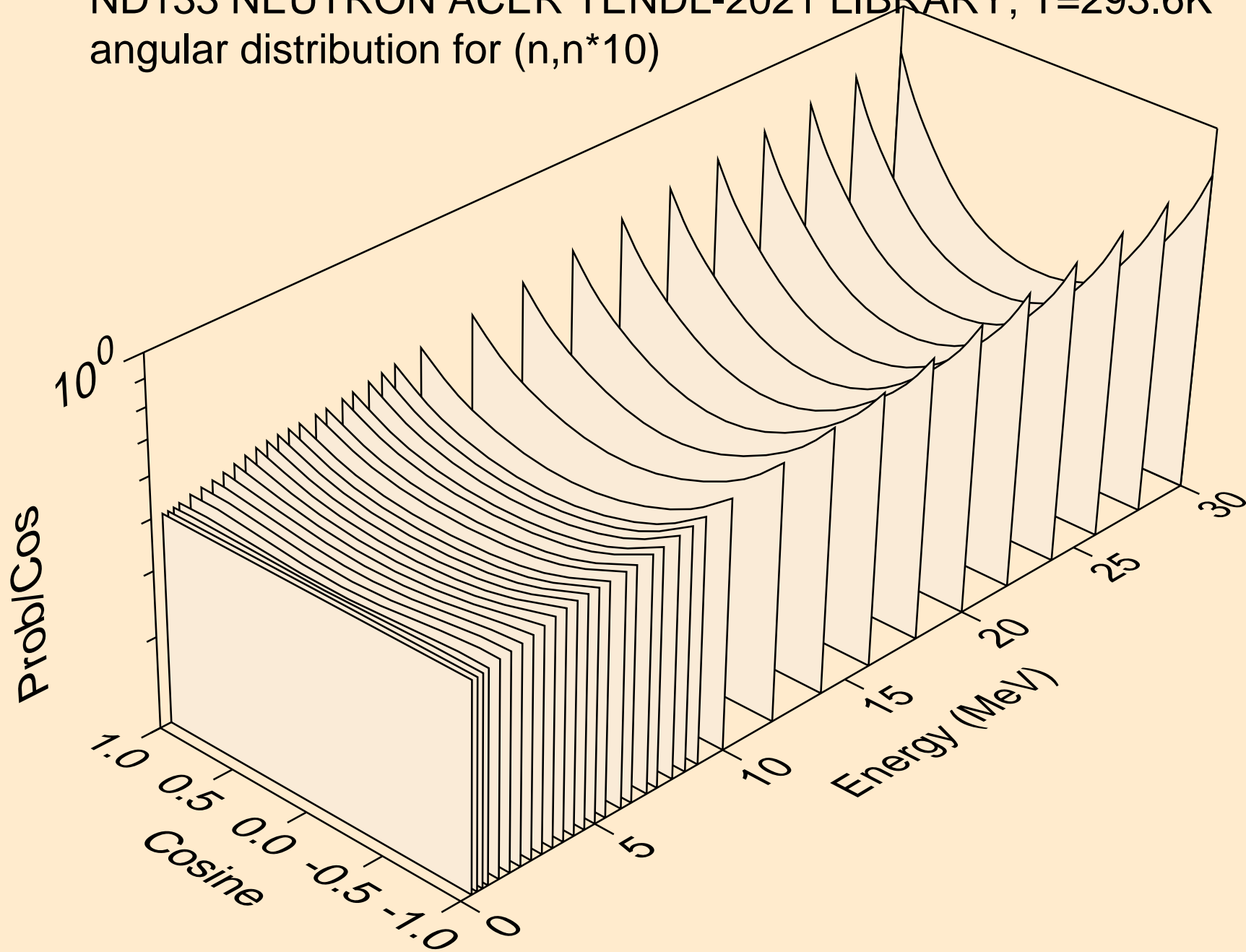

ND133 NEUTRON ACER TENDL-2021 LIBRARY; T=293.6K
angular distribution for (n,n*11)

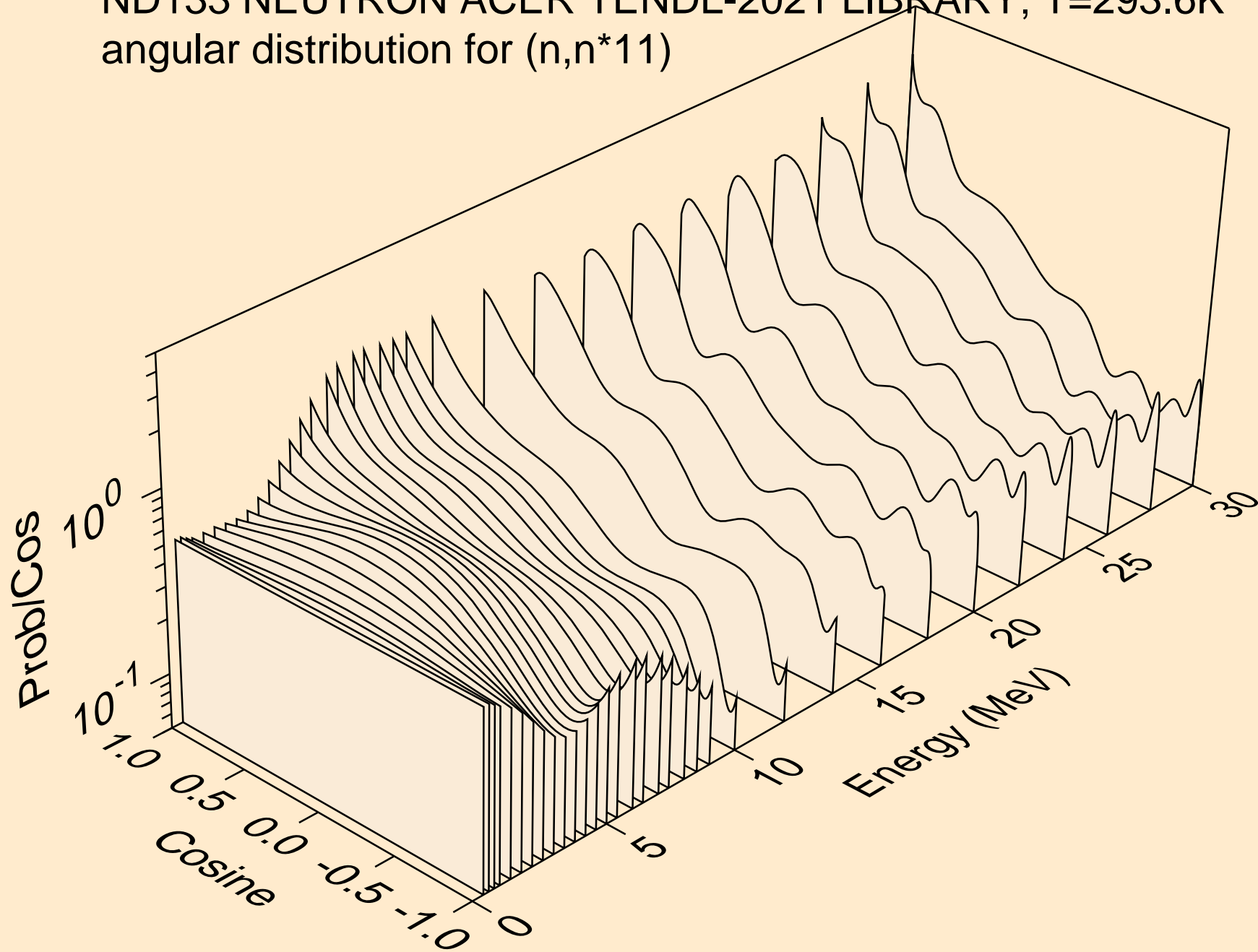

ND133 NEUTRON ACER TENDL-2021 LIBRARY; T=293.6K
angular distribution for (n,n*12)

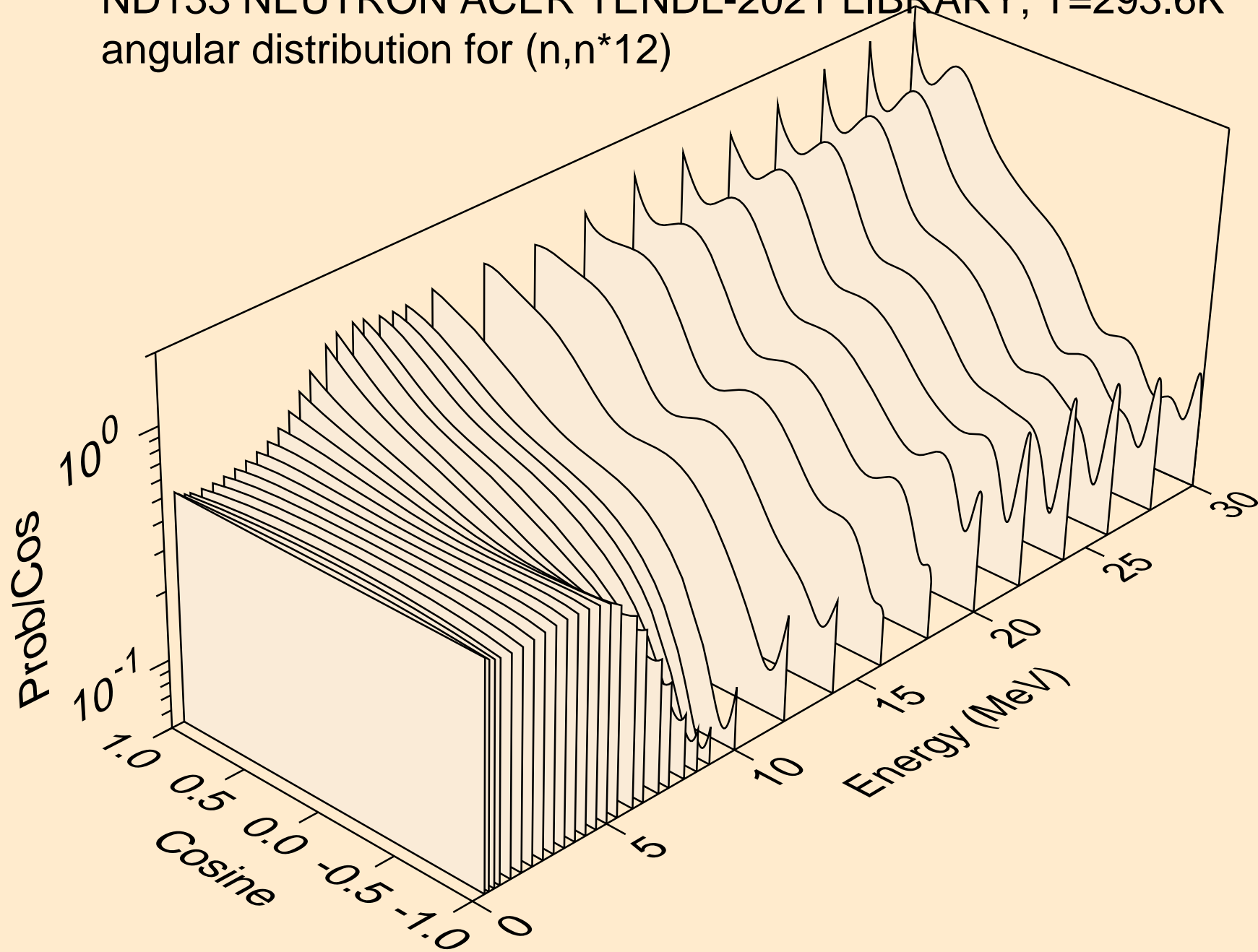

ND133 NEUTRON ACER TENDL-2021 LIBRARY; T=293.6K
angular distribution for (n,n*13)

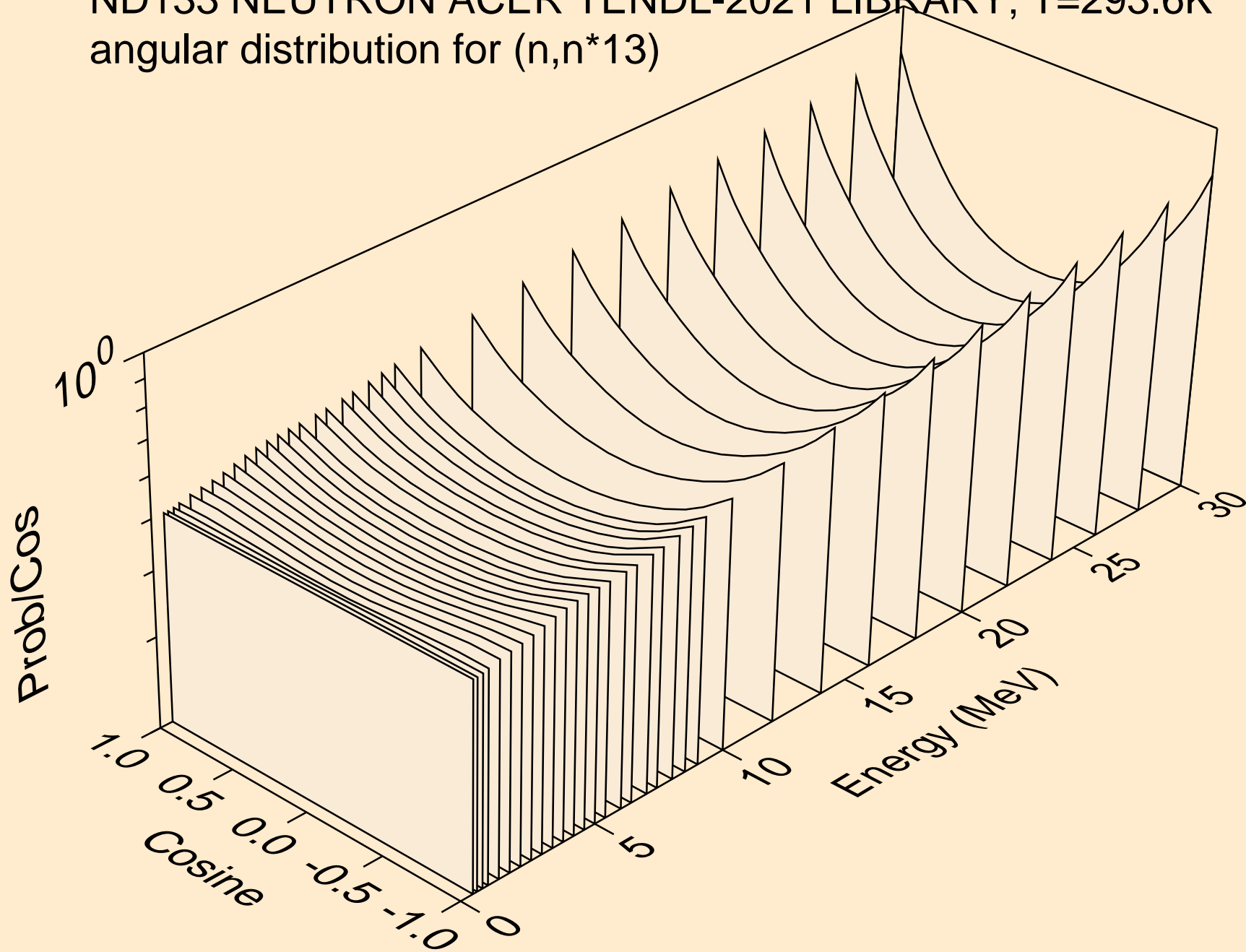

ND133 NEUTRON ACER TENDL-2021 LIBRARY; T=293.6K
angular distribution for (n,n*14)

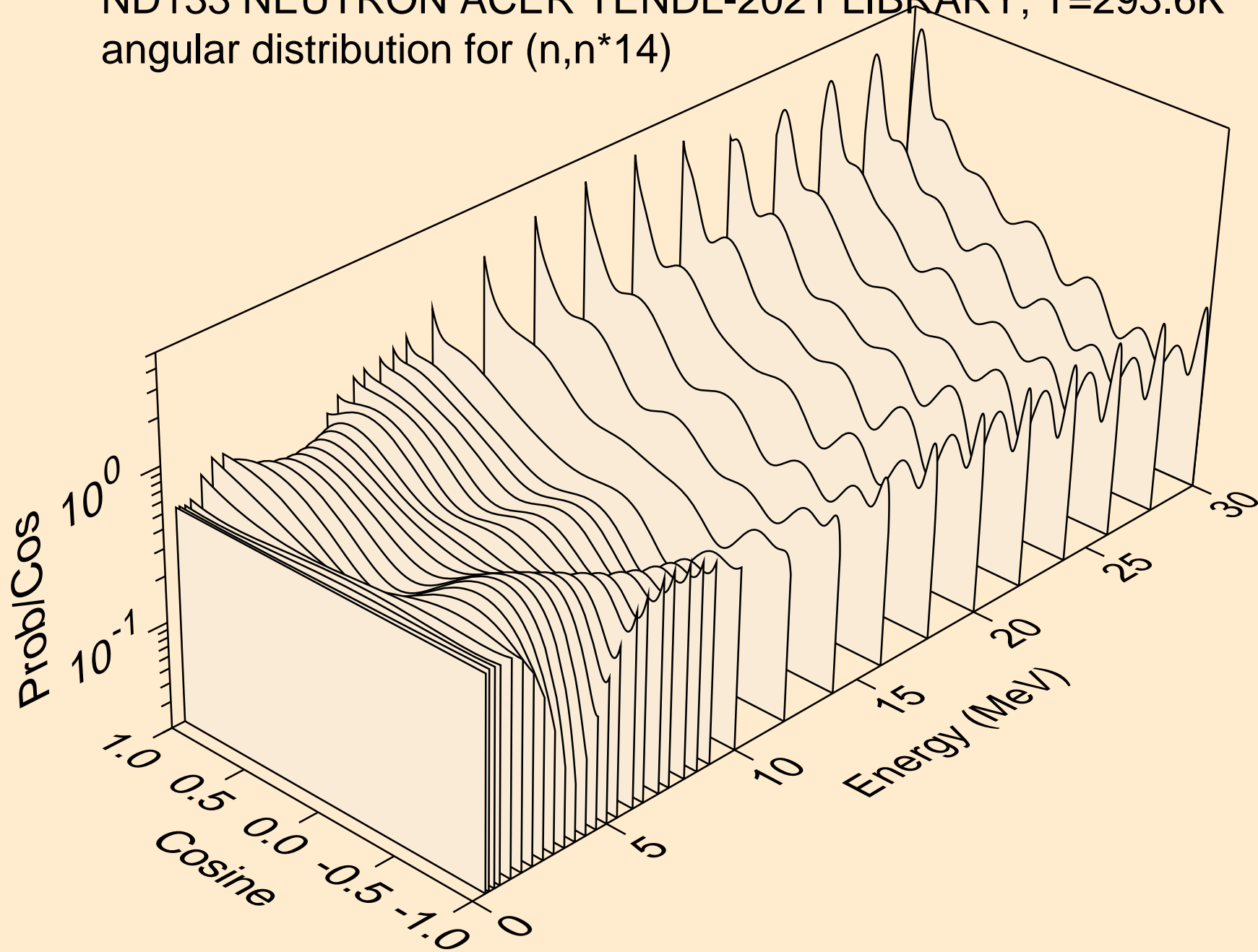

ND133 NEUTRON ACER TENDL-2021 LIBRARY; T=293.6K
angular distribution for (n,n*15)

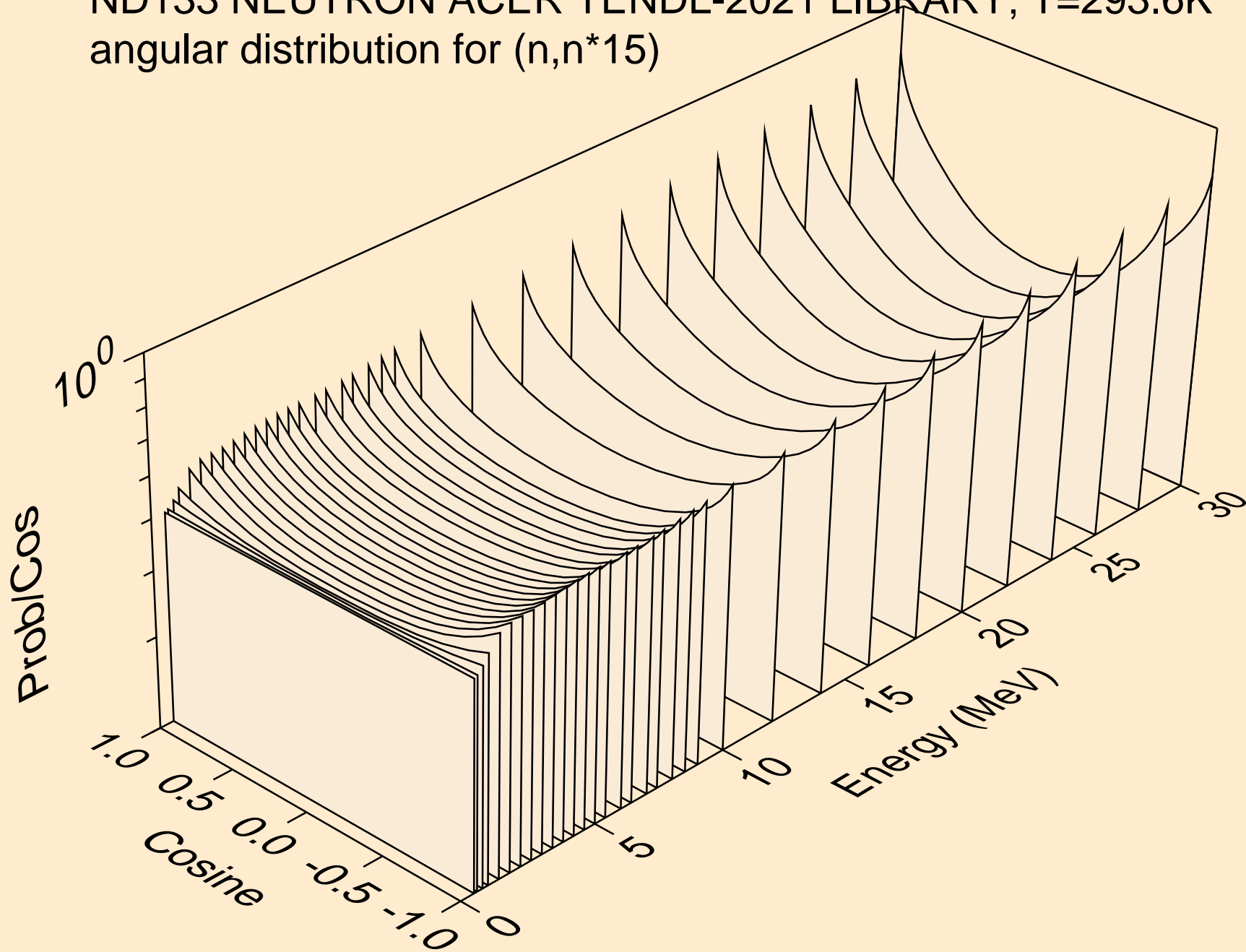

ND133 NEUTRON ACER TENDL-2021 LIBRARY; T=293.6K
angular distribution for (n,n*16)

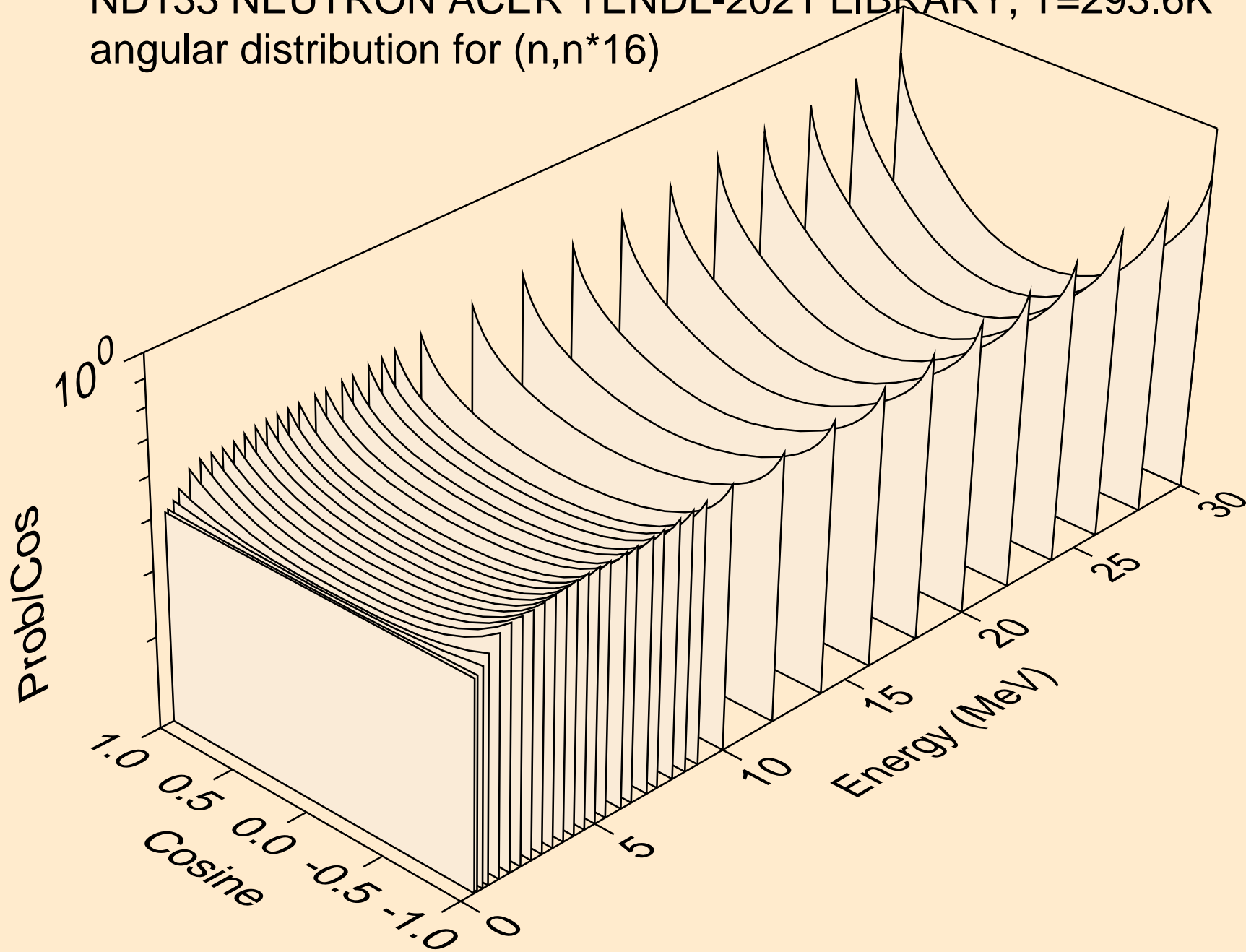

ND133 NEUTRON ACER TENDL-2021 LIBRARY; T=293.6K
angular distribution for (n,n*17)

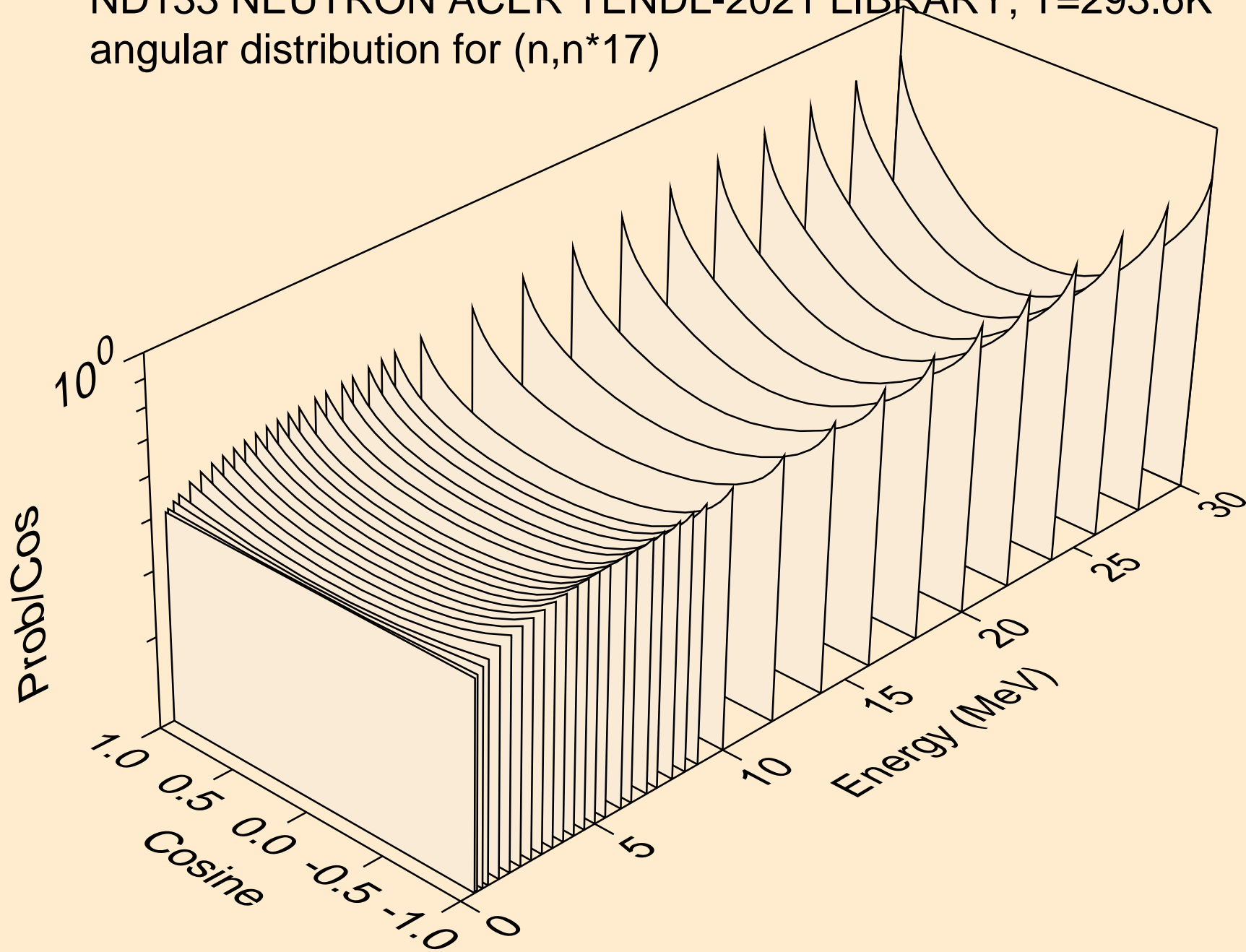

ND133 NEUTRON ACER TENDL-2021 LIBRARY; T=293.6K
angular distribution for (n,n*18)

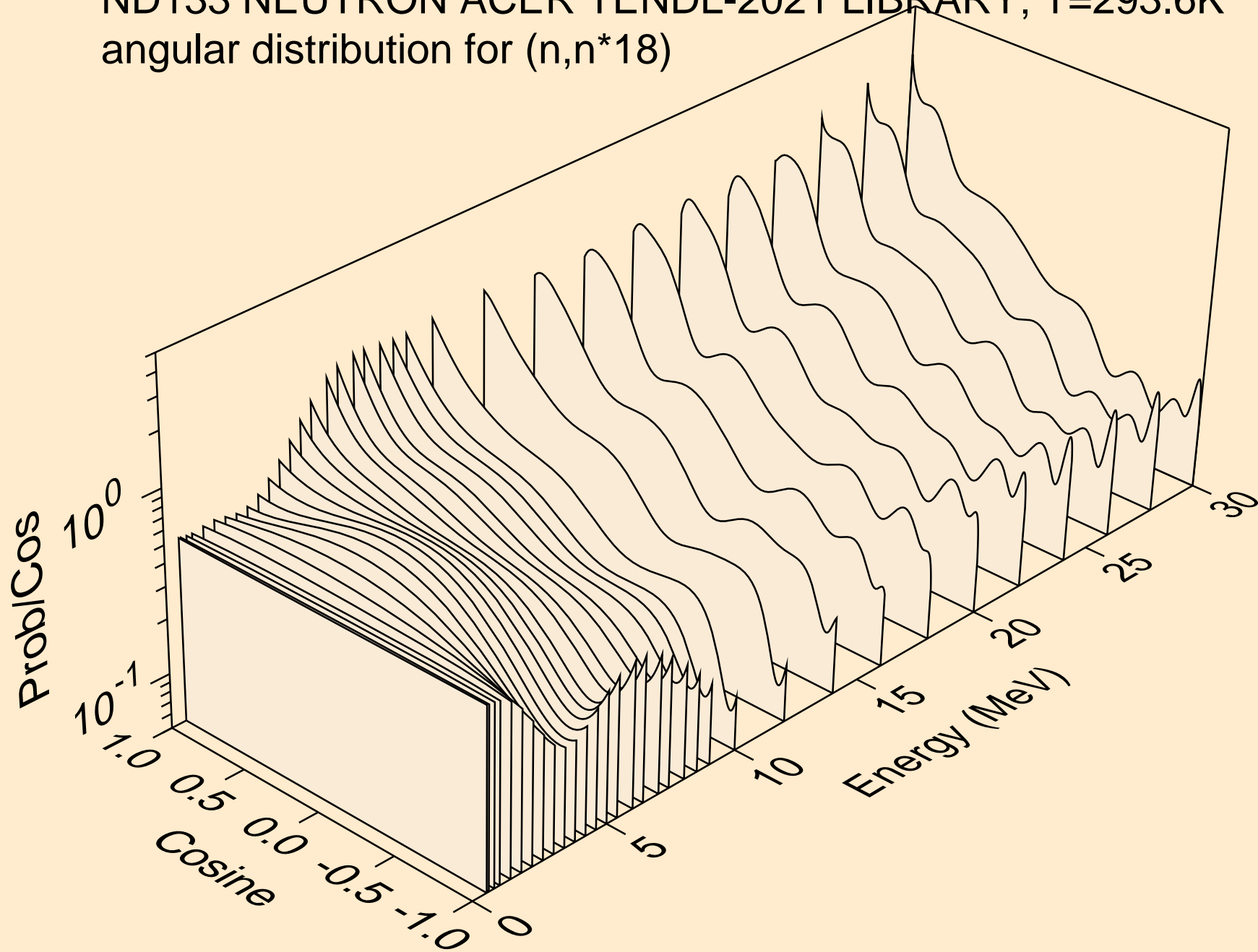

ND133 NEUTRON ACER TENDL-2021 LIBRARY; T=293.6K
angular distribution for (n,n*19)

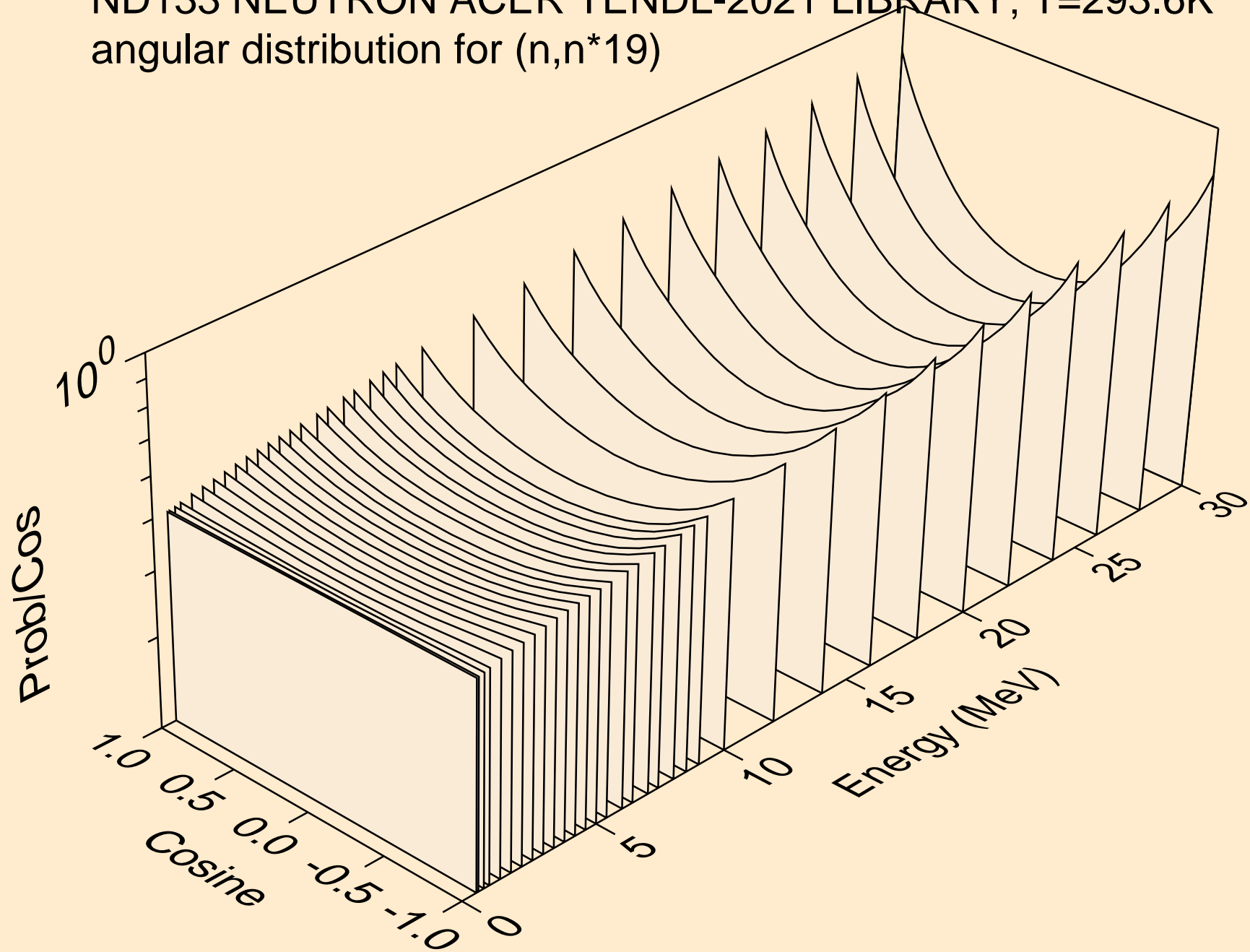

ND133 NEUTRON ACER TENDL-2021 LIBRARY; T=293.6K
angular distribution for (n,n*20)

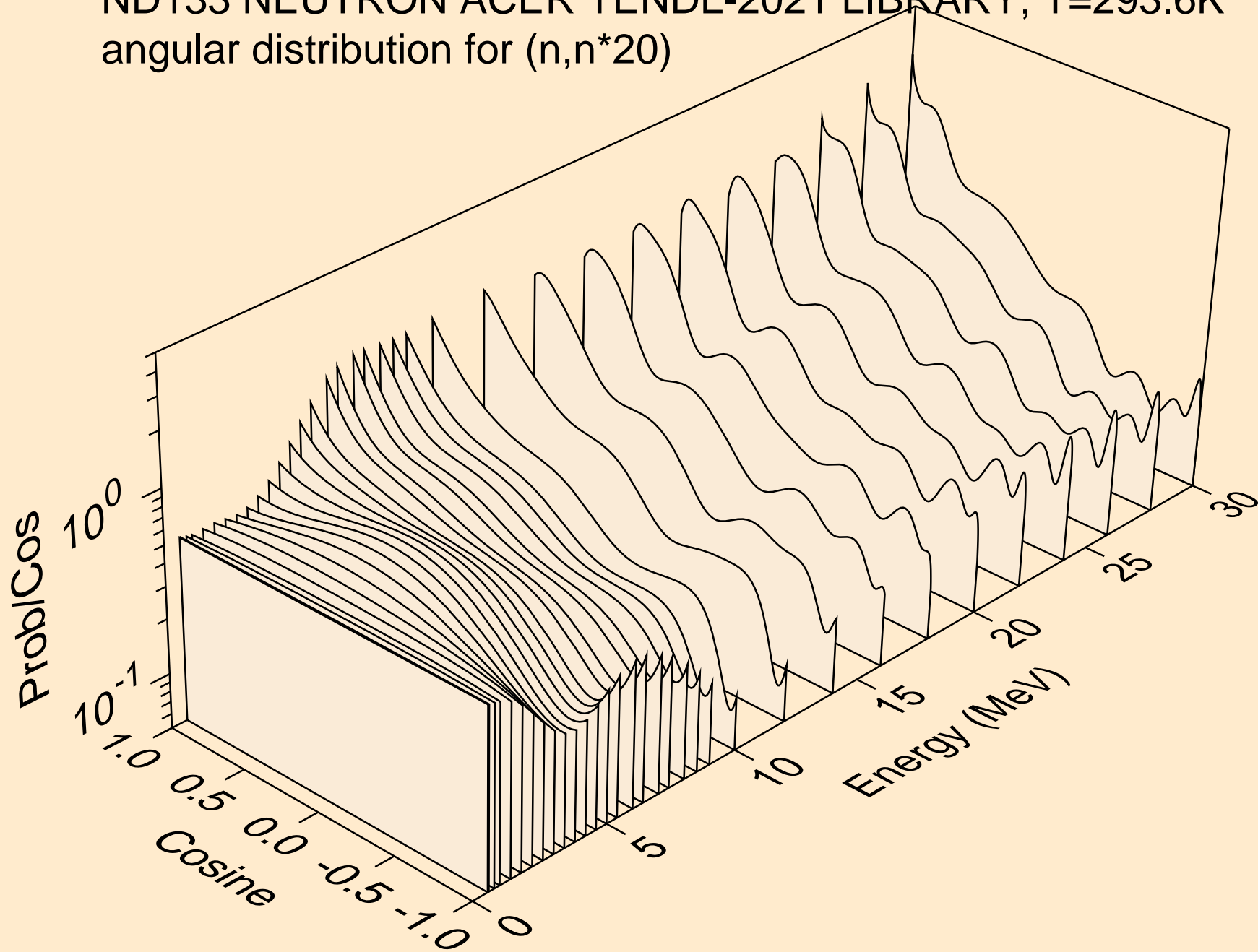

ND133 NEUTRON ACER TENDL-2021 LIBRARY; T=293.6K
angular distribution for (n,n*21)

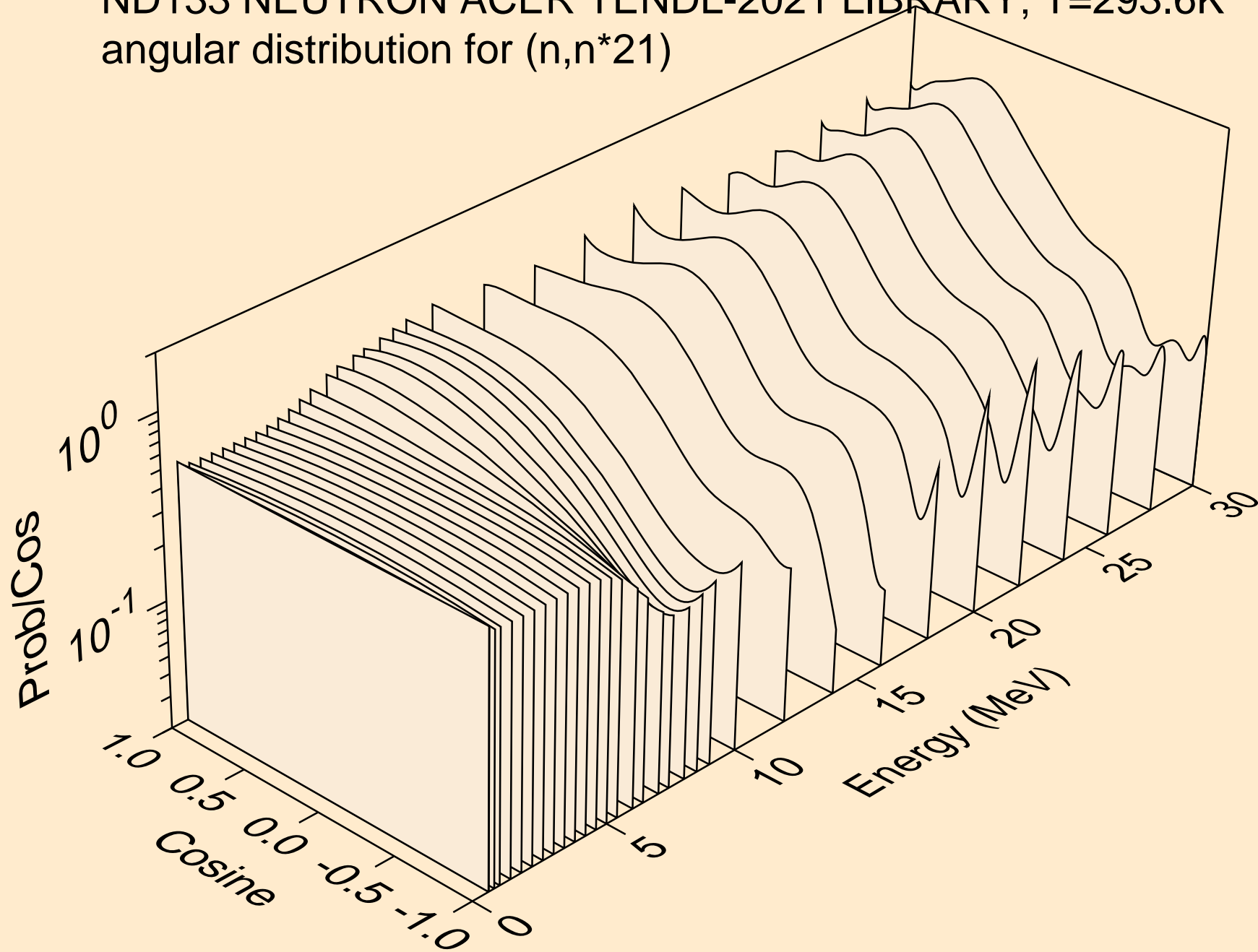

ND133 NEUTRON ACER TENDL-2021 LIBRARY; T=293.6K
angular distribution for (n,n*22)

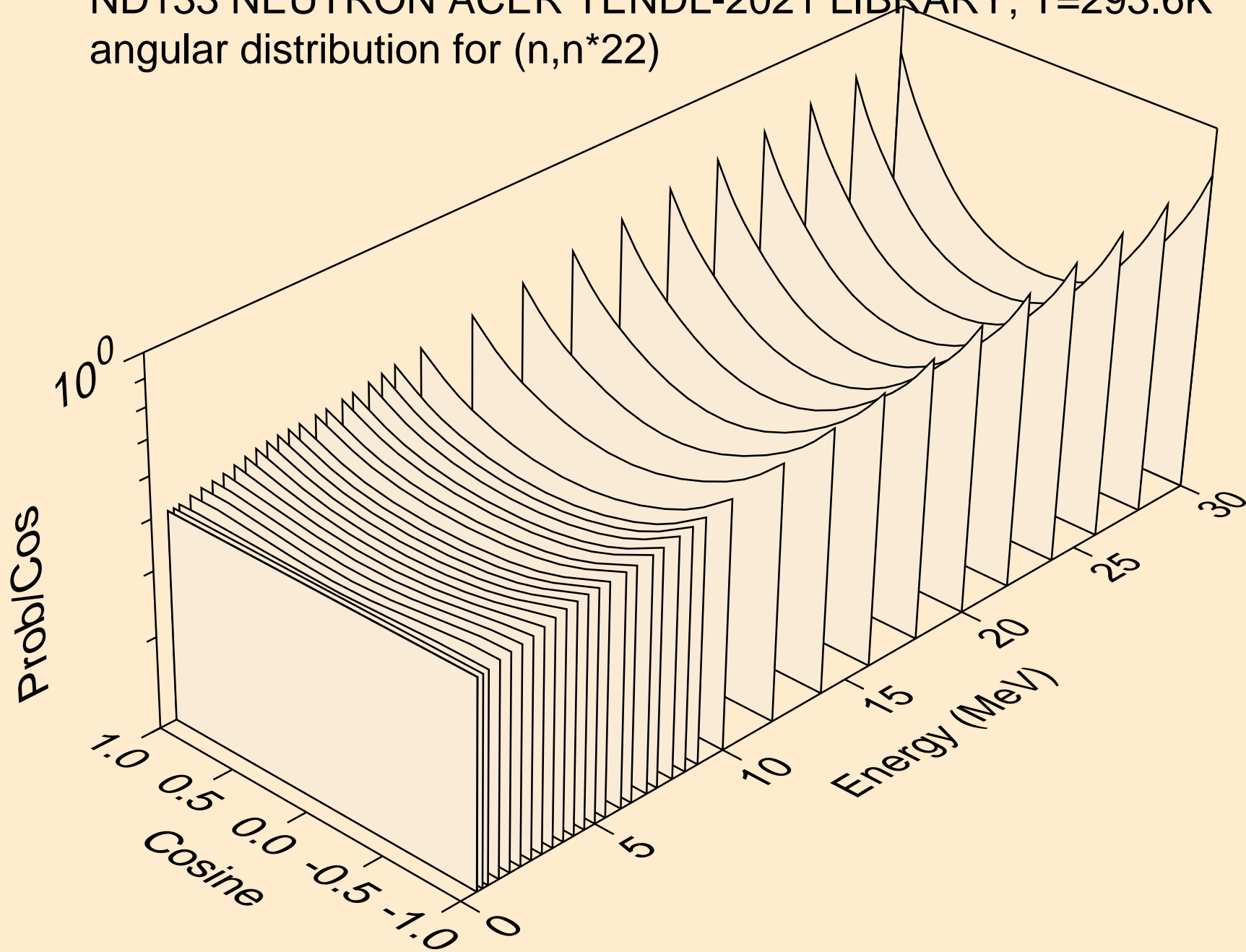

ND133 NEUTRON ACER TENDL-2021 LIBRARY; T=293.6K
angular distribution for (n,n*23)

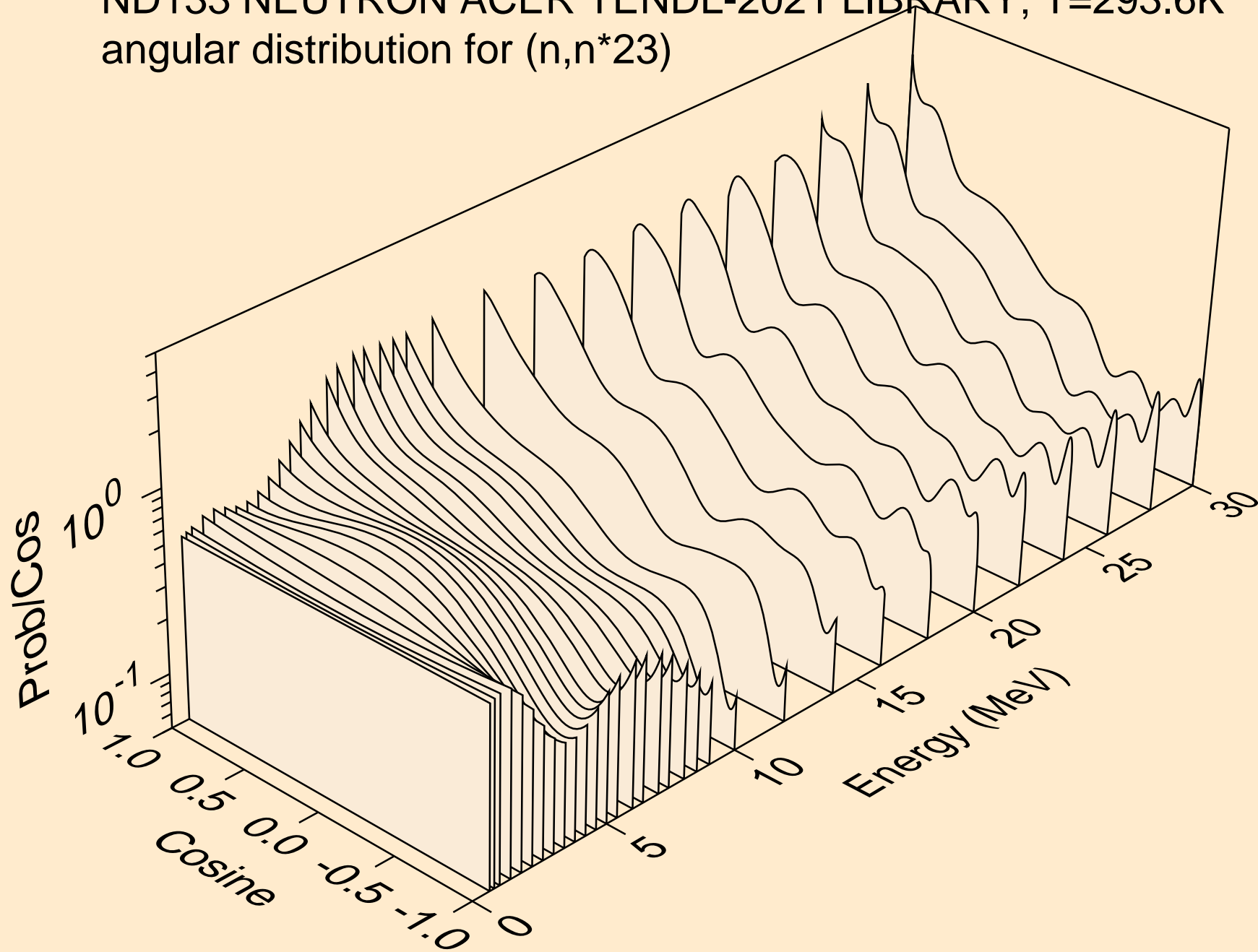

ND133 NEUTRON ACER TENDL-2021 LIBRARY; T=293.6K
angular distribution for (n,n*24)

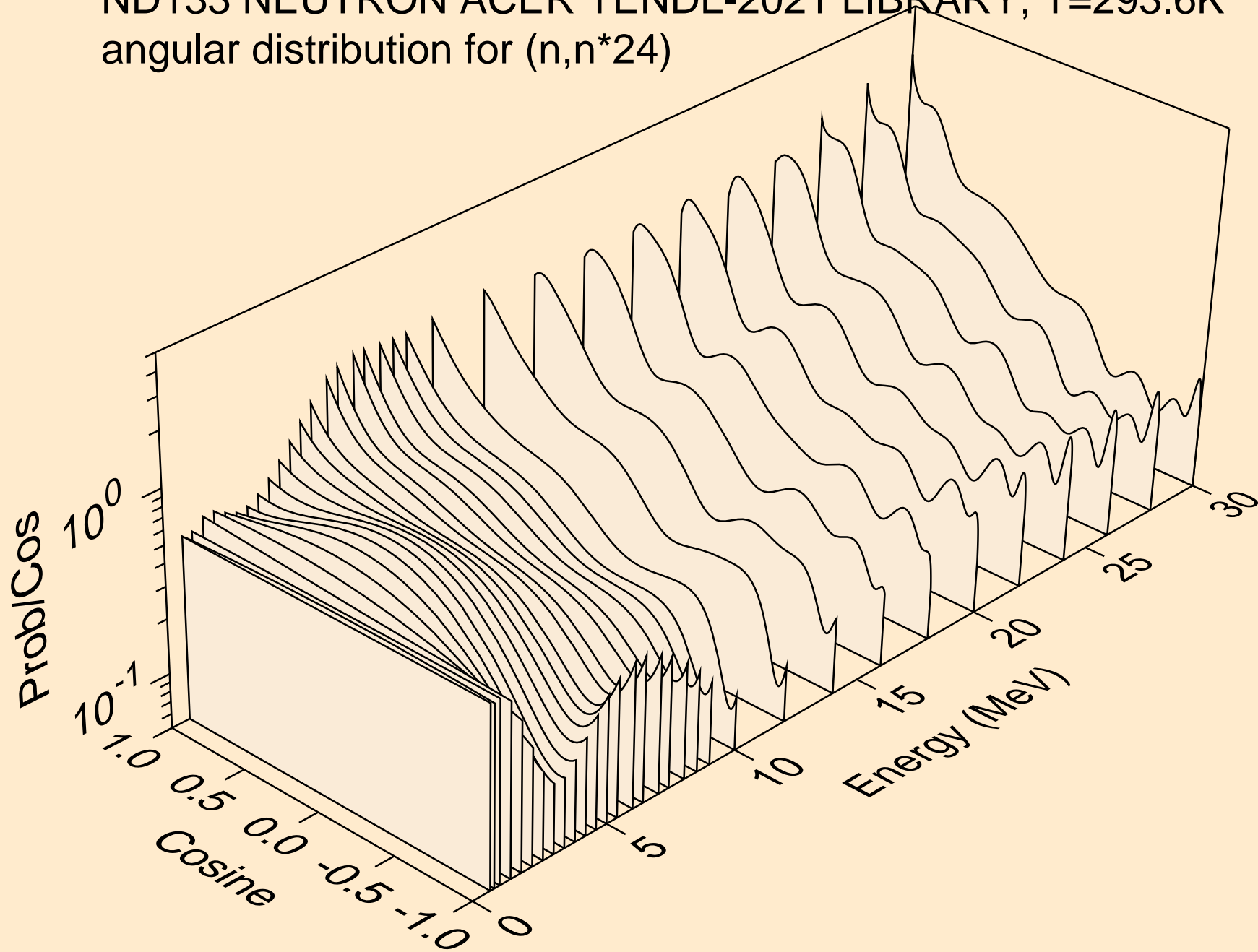

ND133 NEUTRON ACER TENDL-2021 LIBRARY; T=293.6K
angular distribution for (n,n*25)

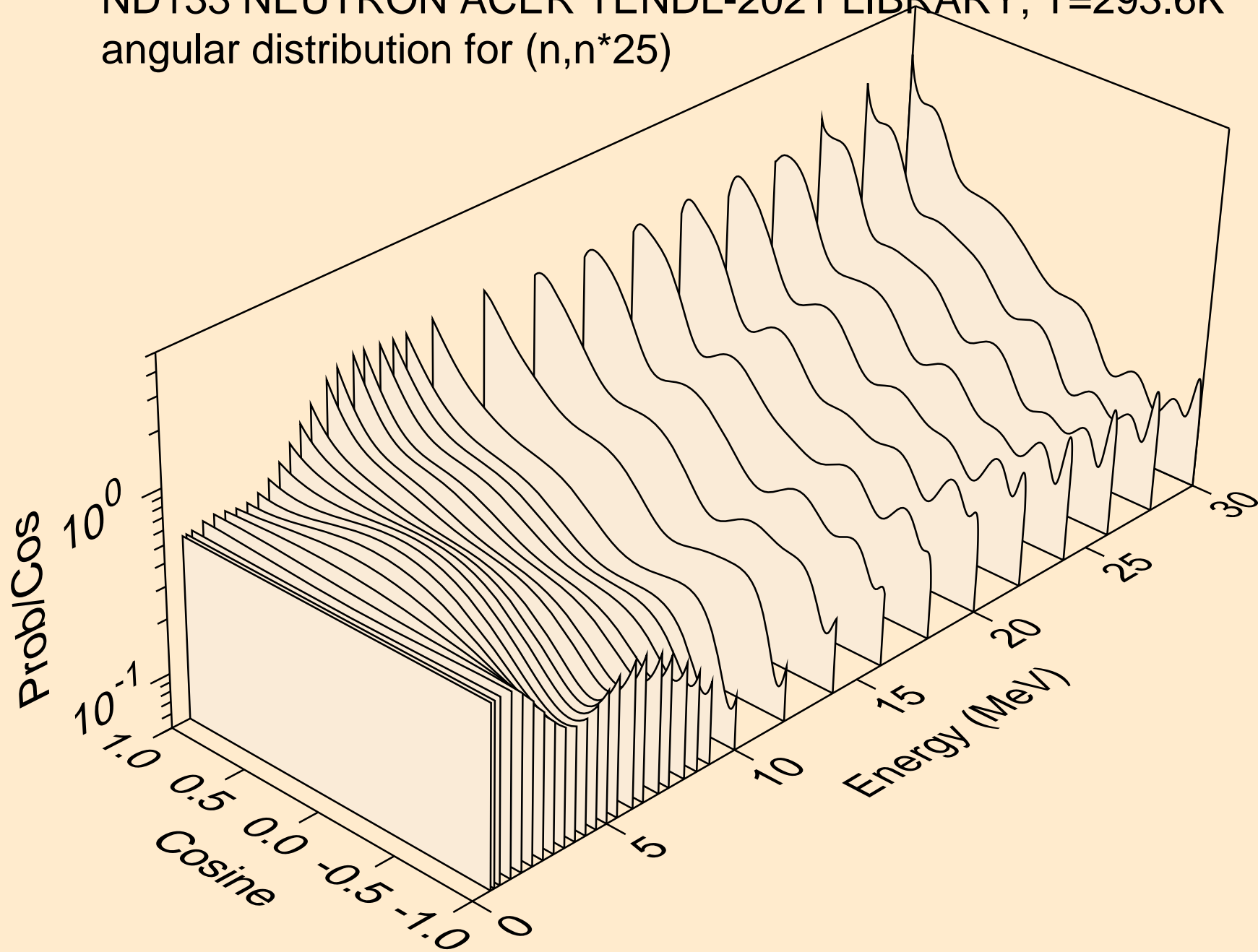

ND133 NEUTRON ACER TENDL-2021 LIBRARY; T=293.6K
angular distribution for (n,n*26)

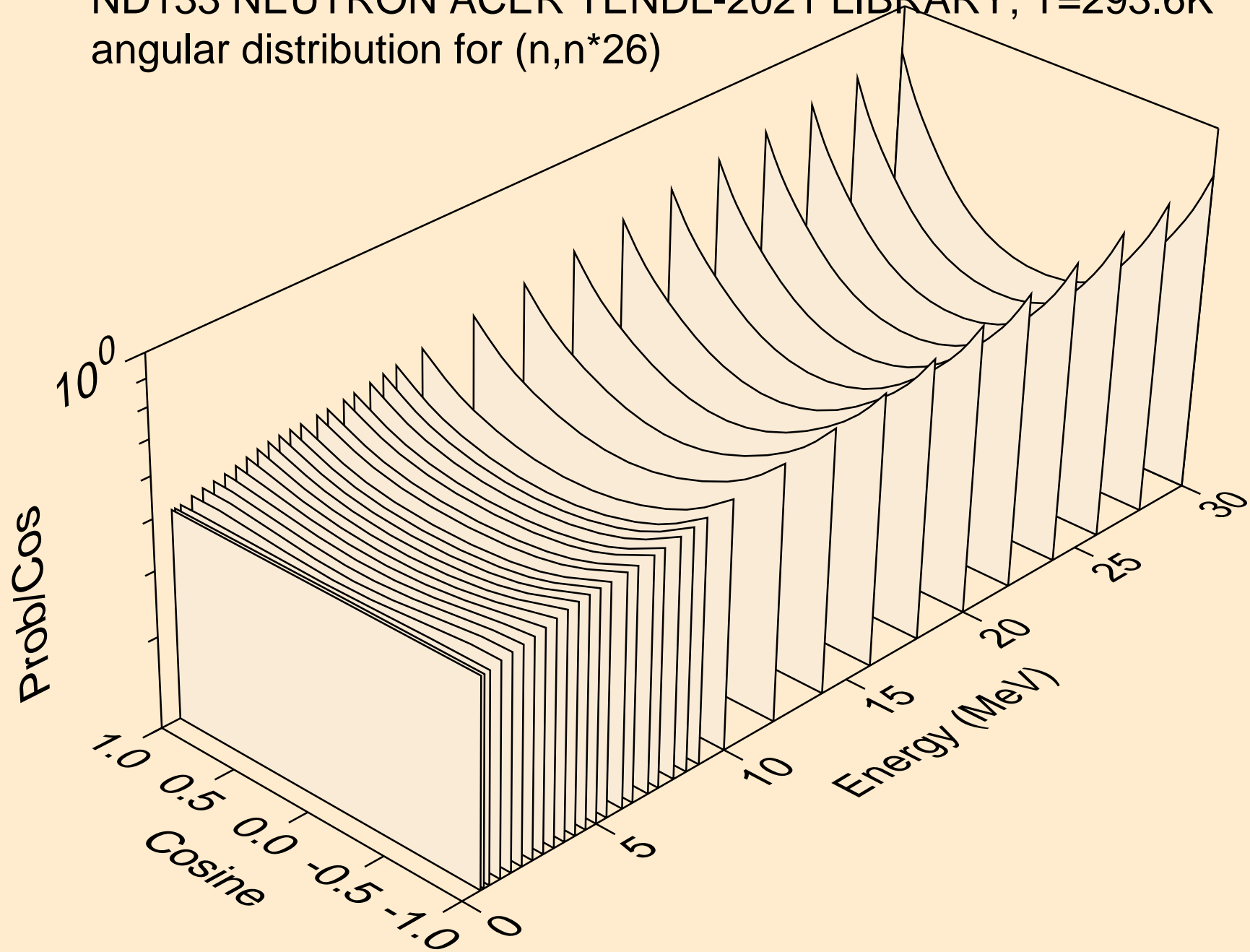

ND133 NEUTRON ACER TENDL-2021 LIBRARY; T=293.6K
angular distribution for (n,n*27)

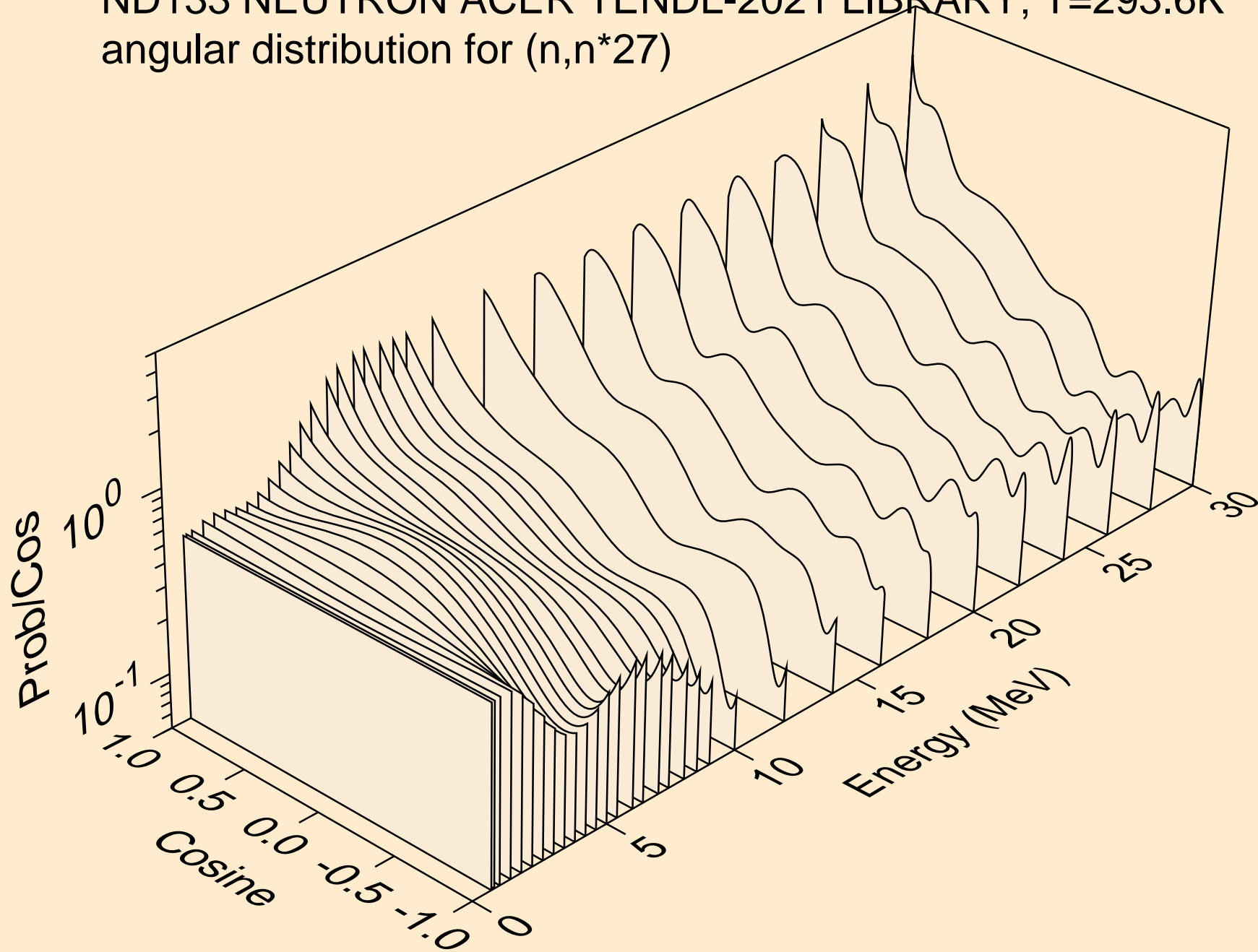

ND133 NEUTRON ACER TENDL-2021 LIBRARY; T=293.6K
angular distribution for (n,n*28)

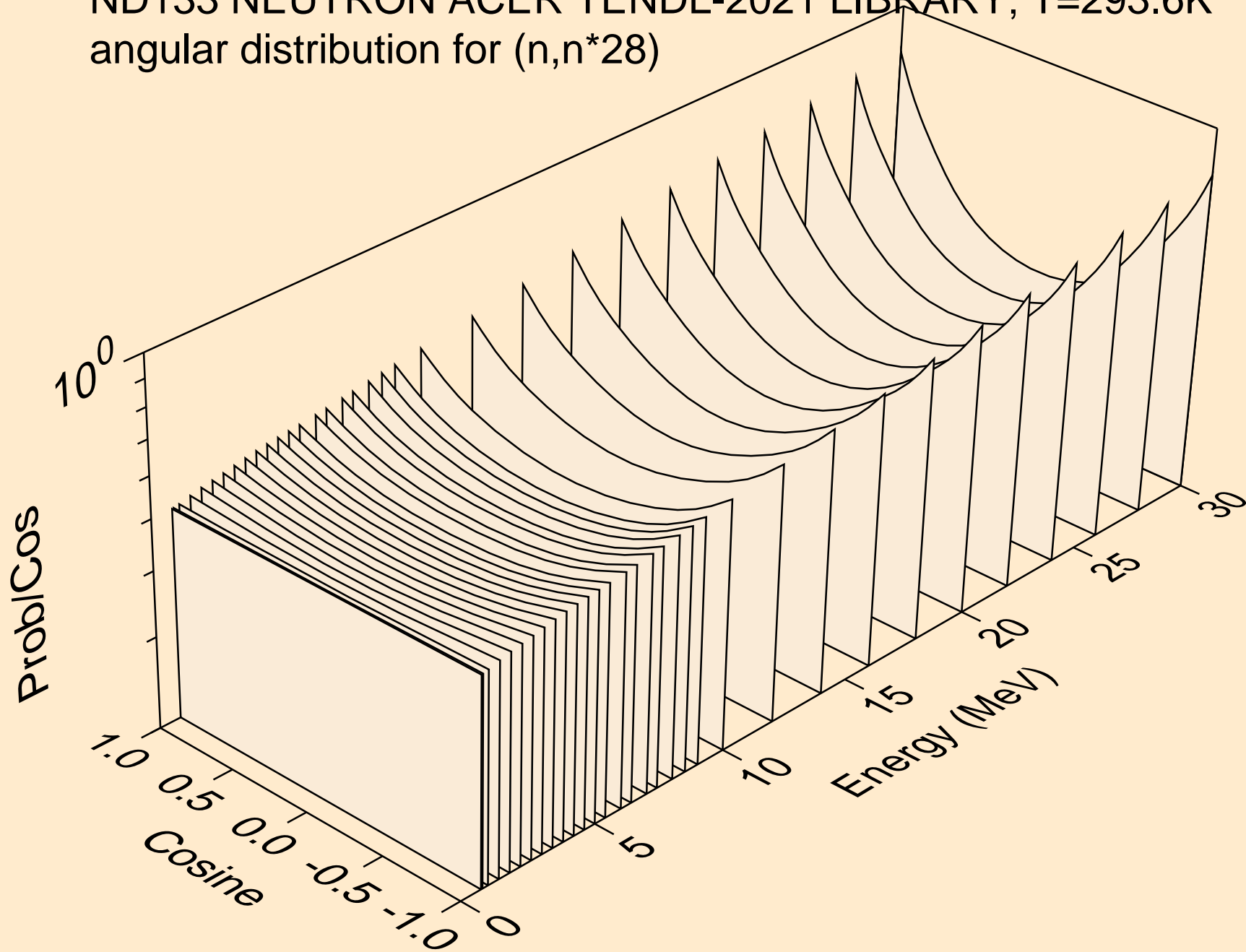

ND133 NEUTRON ACER TENDL-2021 LIBRARY; T=293.6K
angular distribution for (n,n*29)

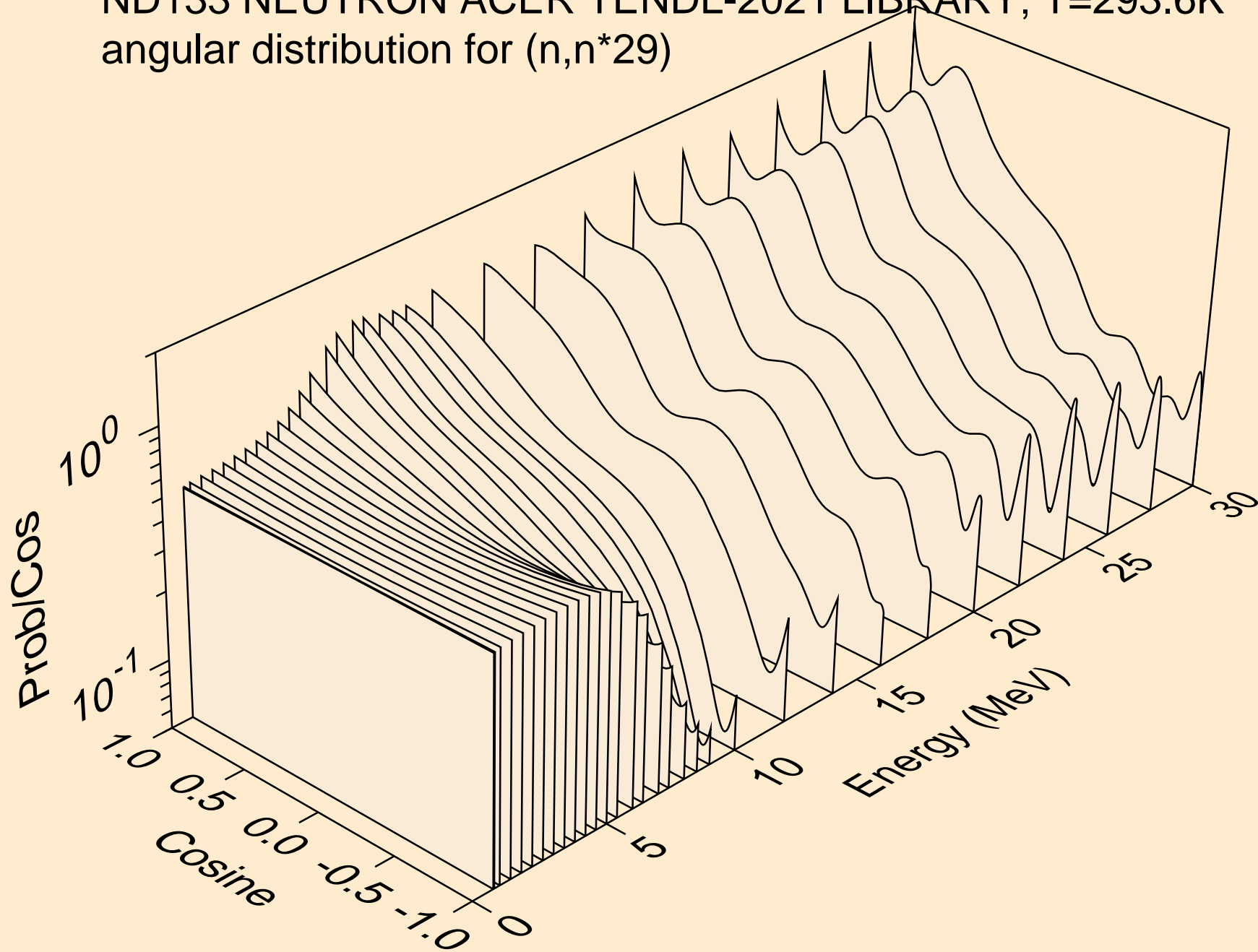

ND133 NEUTRON ACER TENDL-2021 LIBRARY; T=293.6K
angular distribution for (n,n*30)

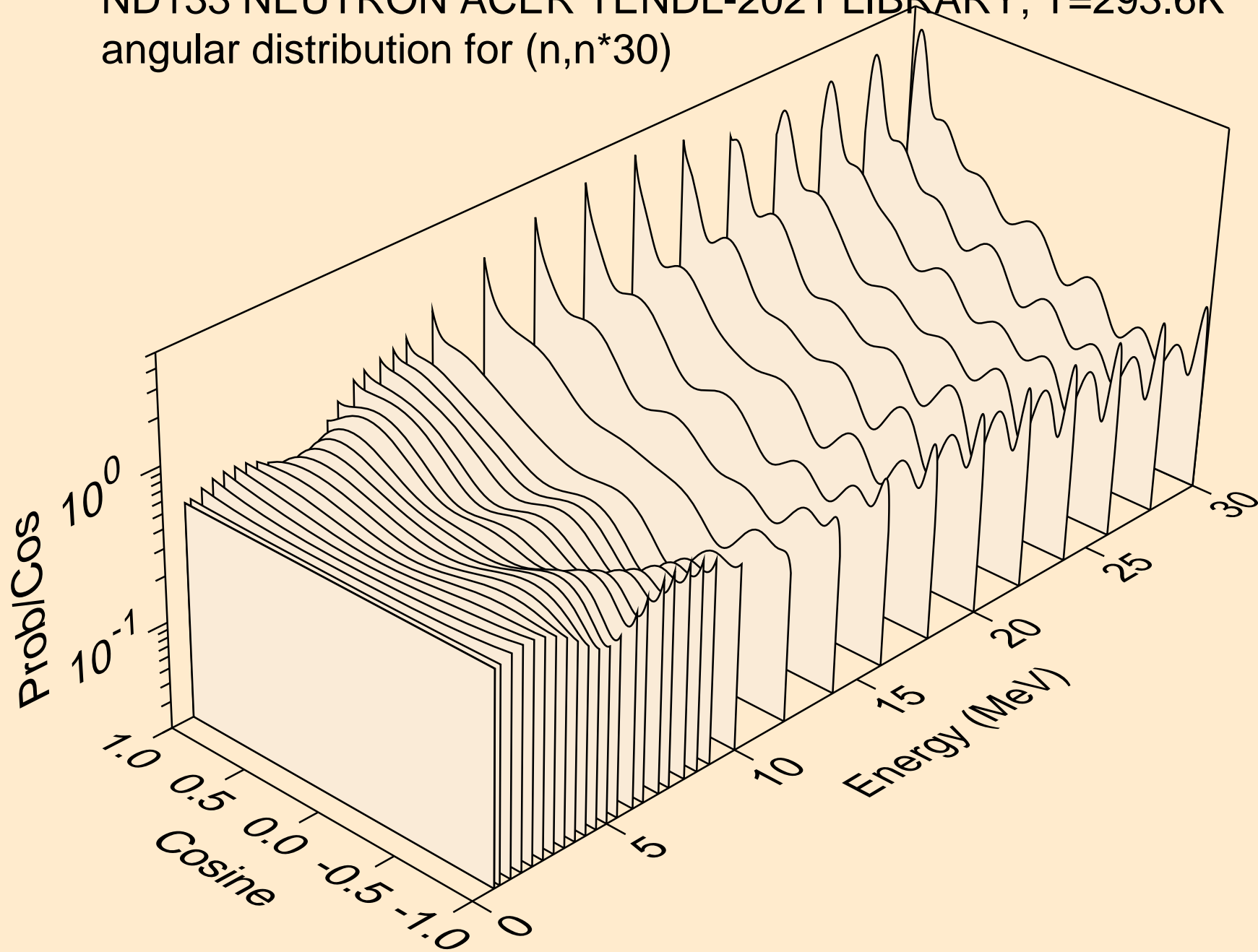

ND133 NEUTRON ACER TENDL-2021 LIBRARY; T=293.6K
Neutron emission for (n,x)

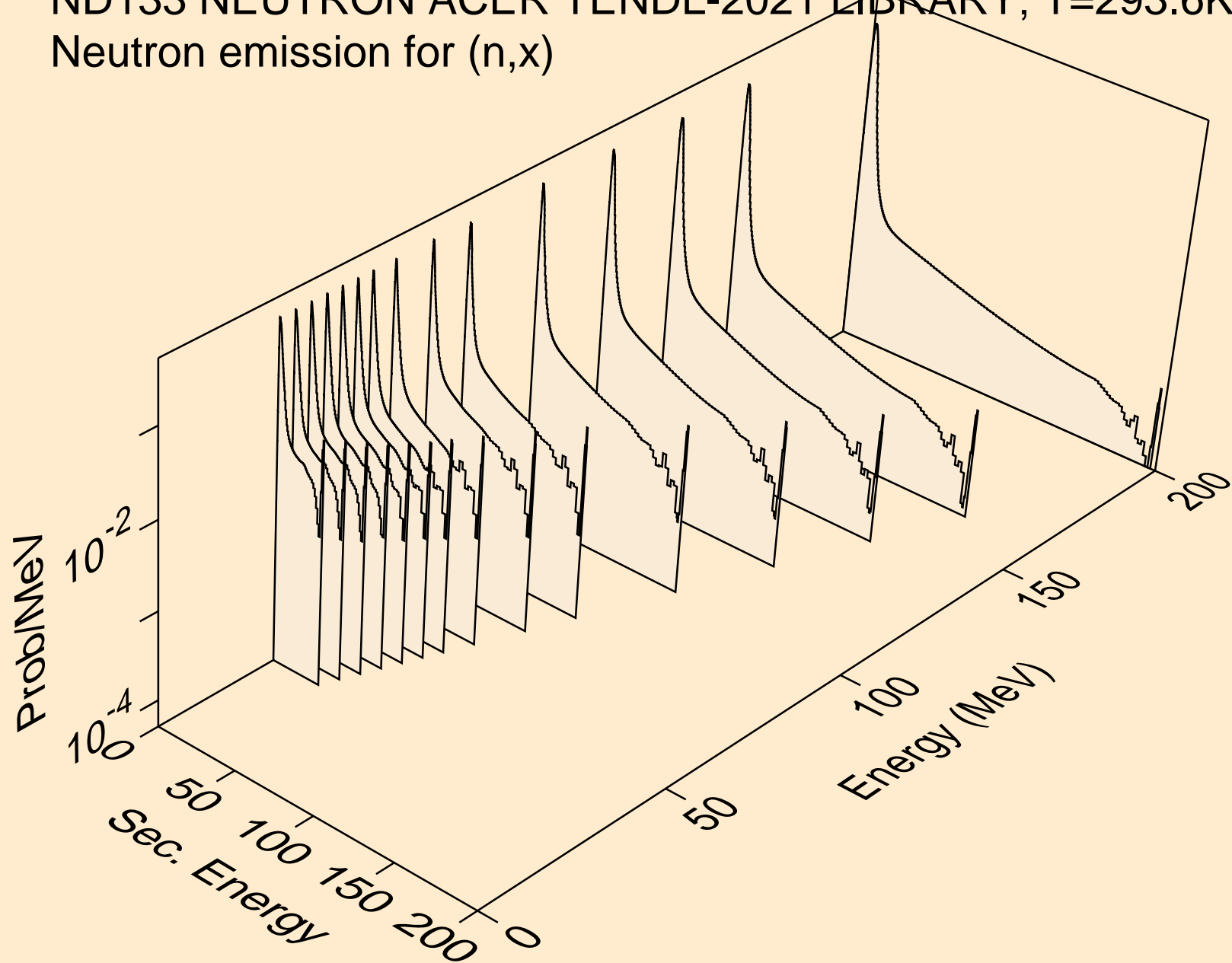

ND133 NEUTRON ACER TENDL-2021 LIBRARY; T=293.6K
Neutron emission for (n,2nd)

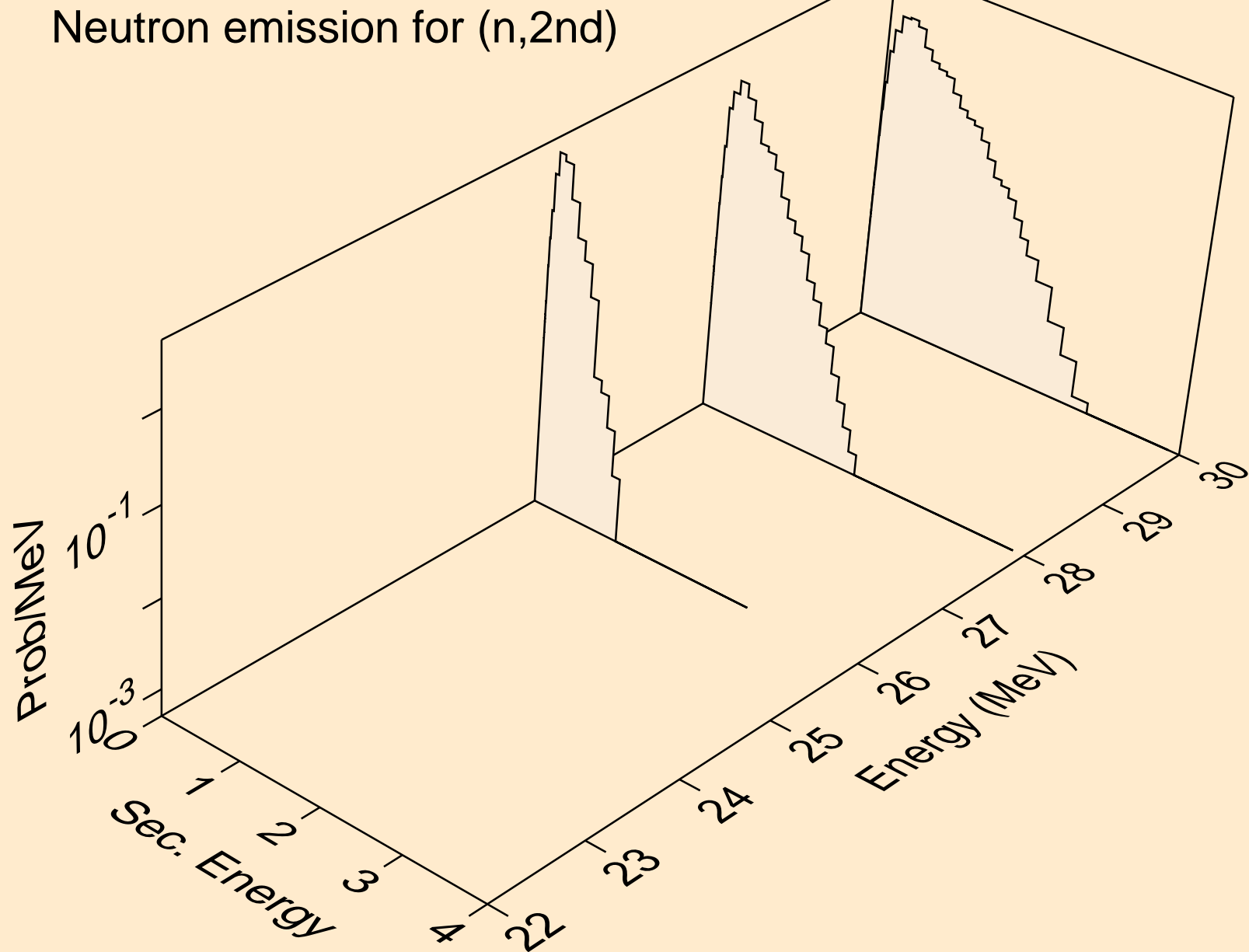

ND133 NEUTRON ACER TENDL-2021 LIBRARY; T=293.6K
Neutron emission for (n,2n)

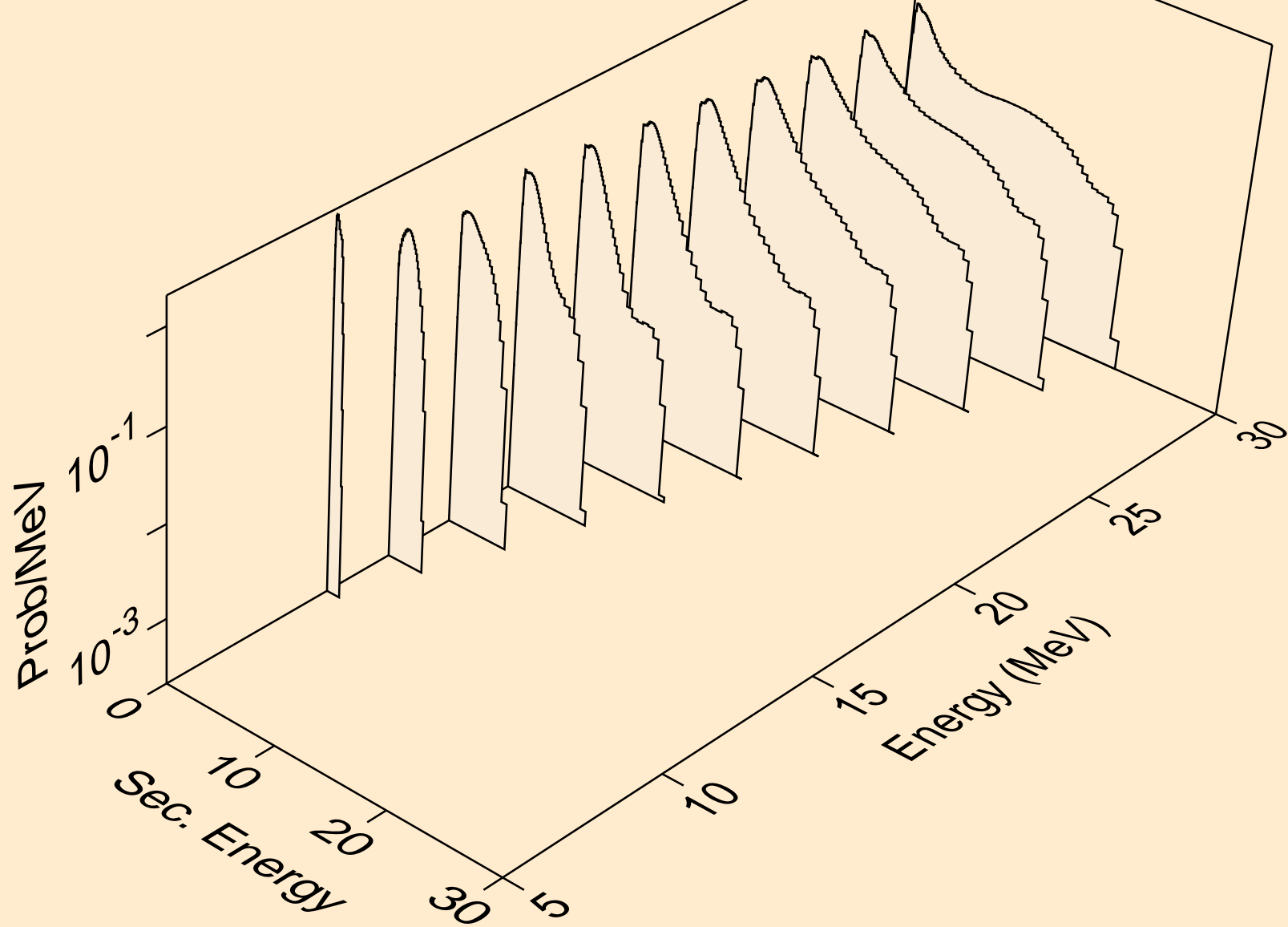

ND133 NEUTRON ACER TENDL-2021 LIBRARY; T=293.6K
Neutron emission for (n,3n)

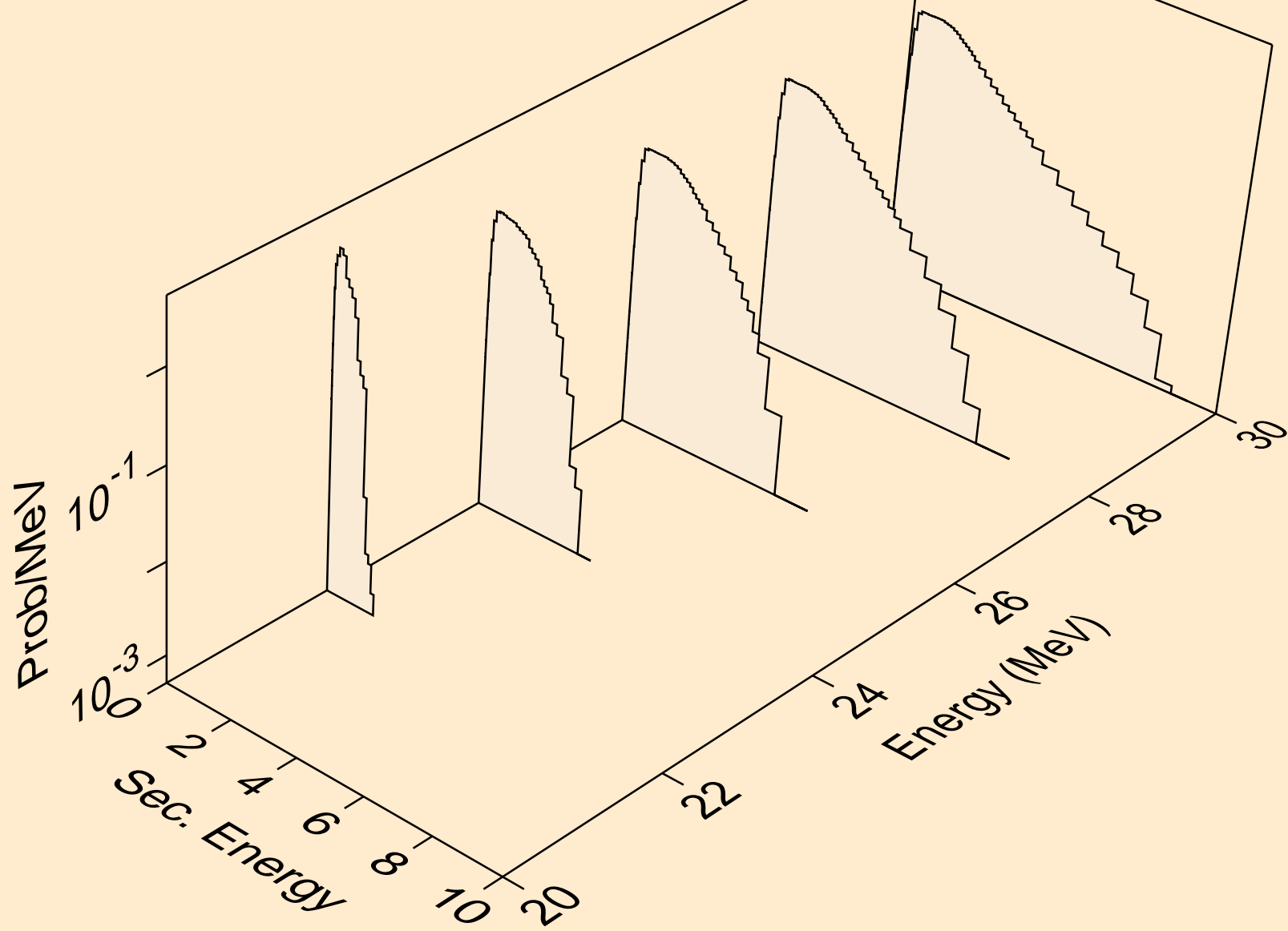

ND133 NEUTRON ACER TENDL-2021 LIBRARY; T=293.6K
Neutron emission for (n,n*)a

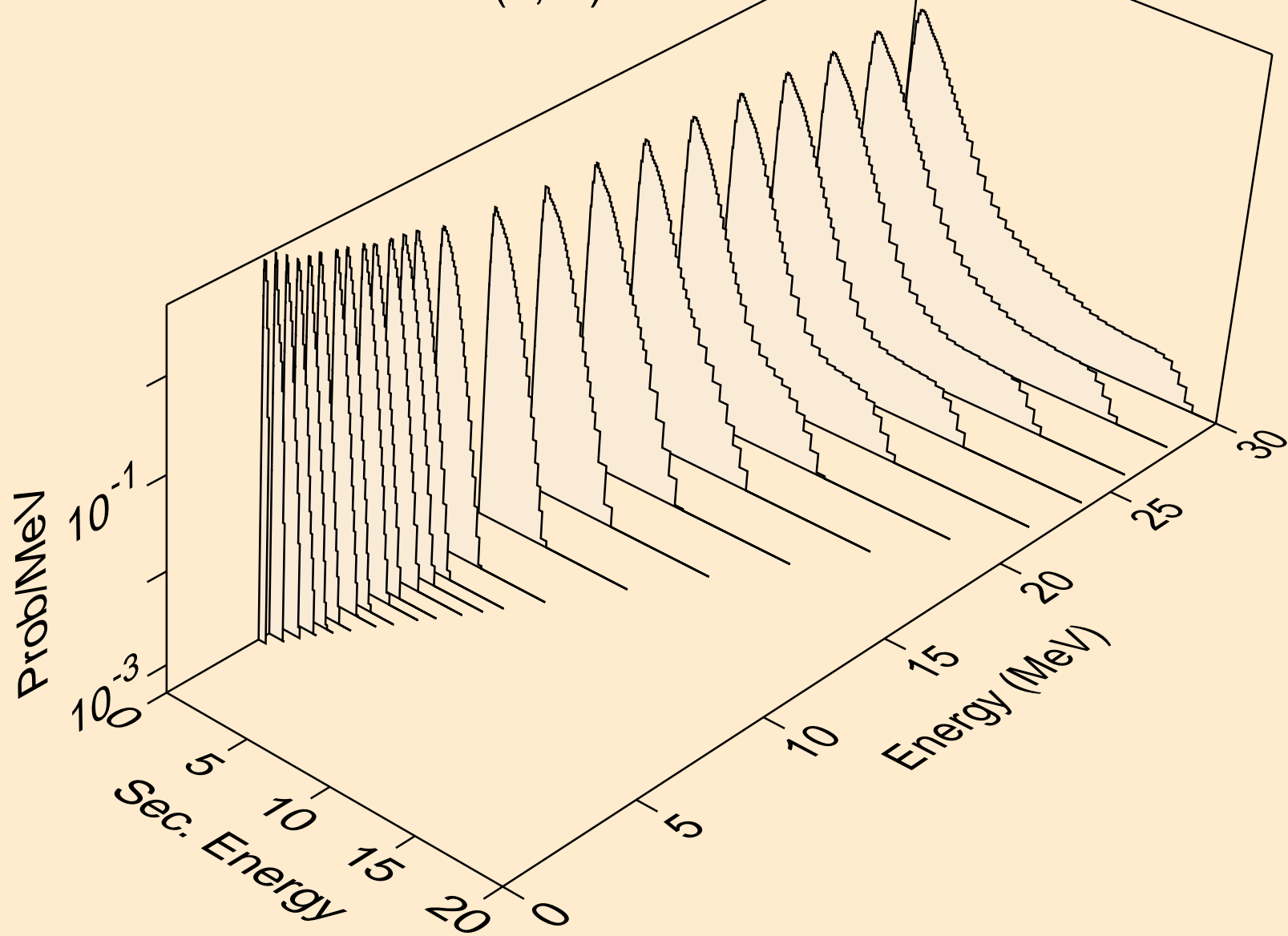

ND133 NEUTRON ACER TENDL-2021 LIBRARY; T=293.6K
Neutron emission for (n,2n)a

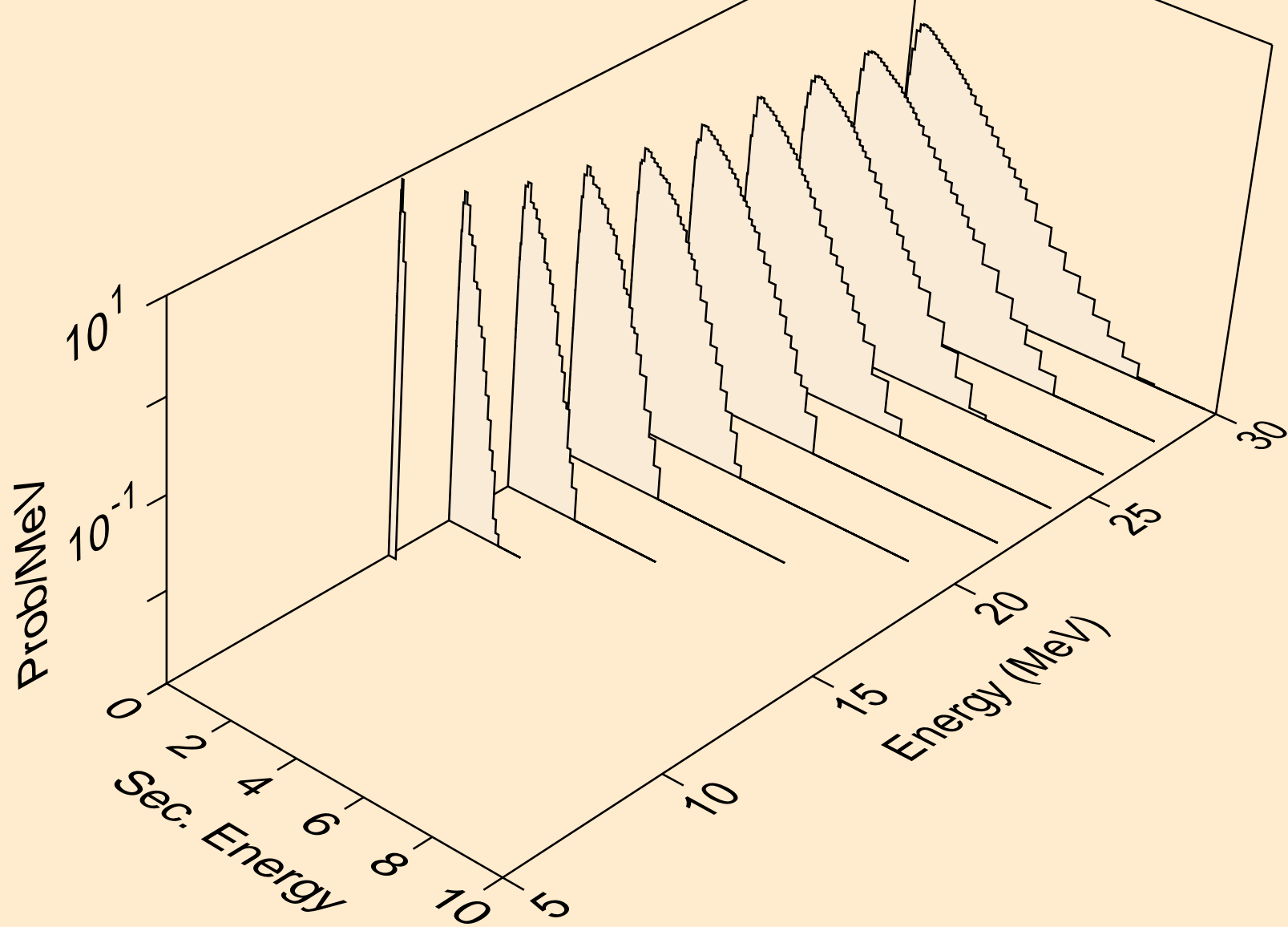

ND133 NEUTRON ACER TENDL-2021 LIBRARY; T=293.6K
Neutron emission for (n,3n)a

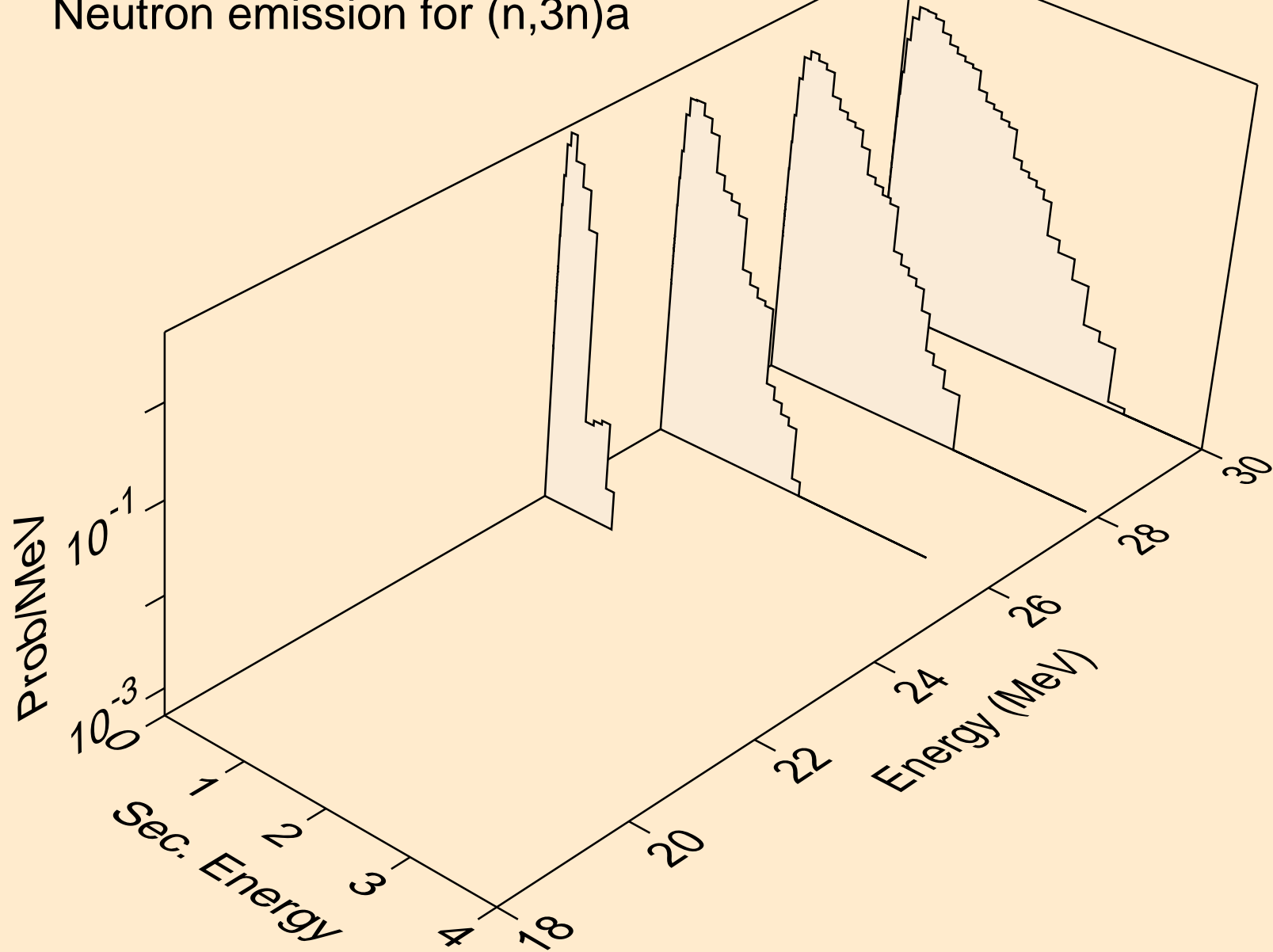

ND133 NEUTRON ACER TENDL-2021 LIBRARY; T=293.6K
Neutron emission for (n,n*)p

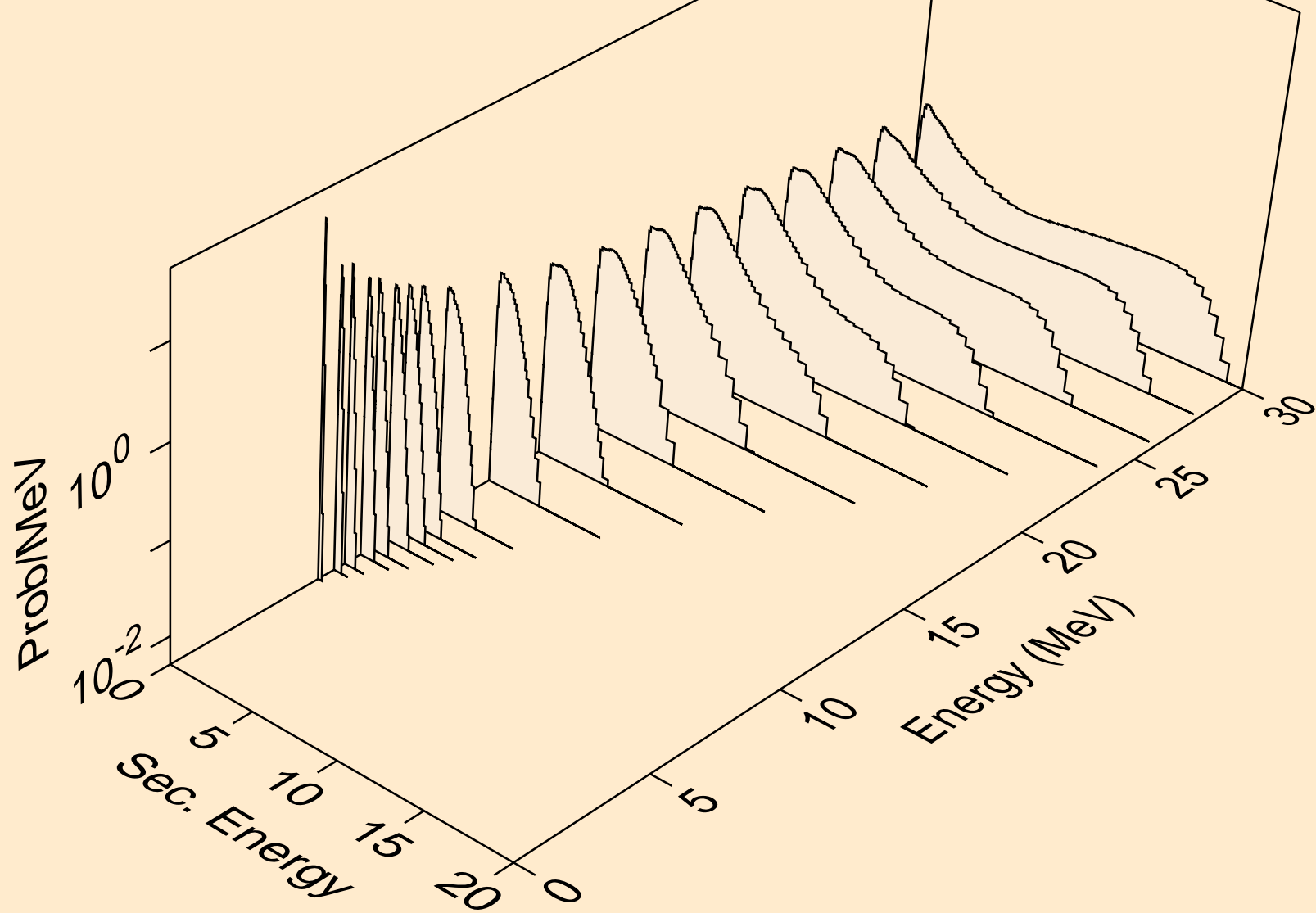

ND133 NEUTRON ACER TENDL-2021 LIBRARY; T=293.6K
Neutron emission for (n,n*)2a

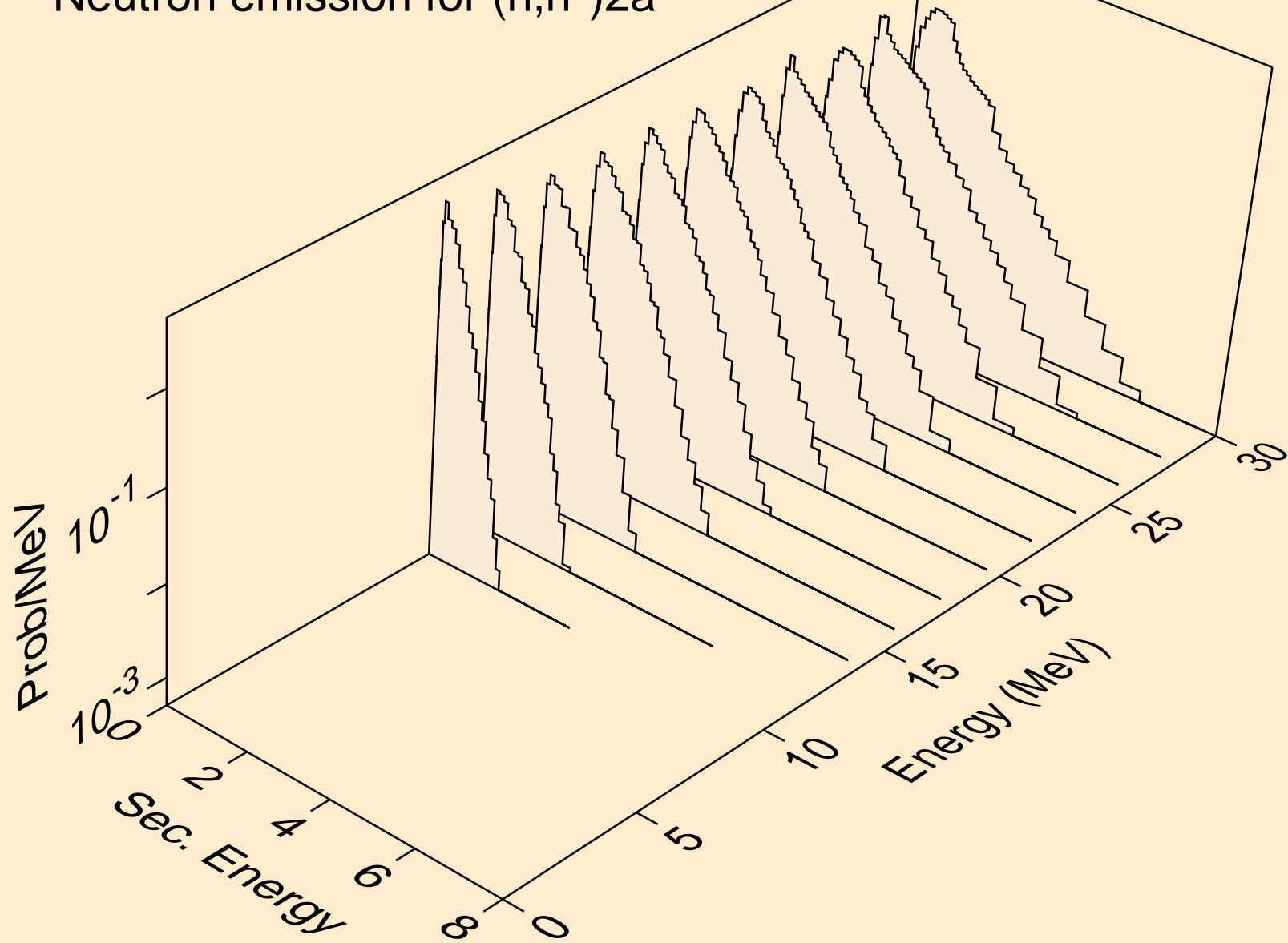

ND133 NEUTRON ACER TENDL-2021 LIBRARY; T=293.6K
Neutron emission for (n,2n)2a

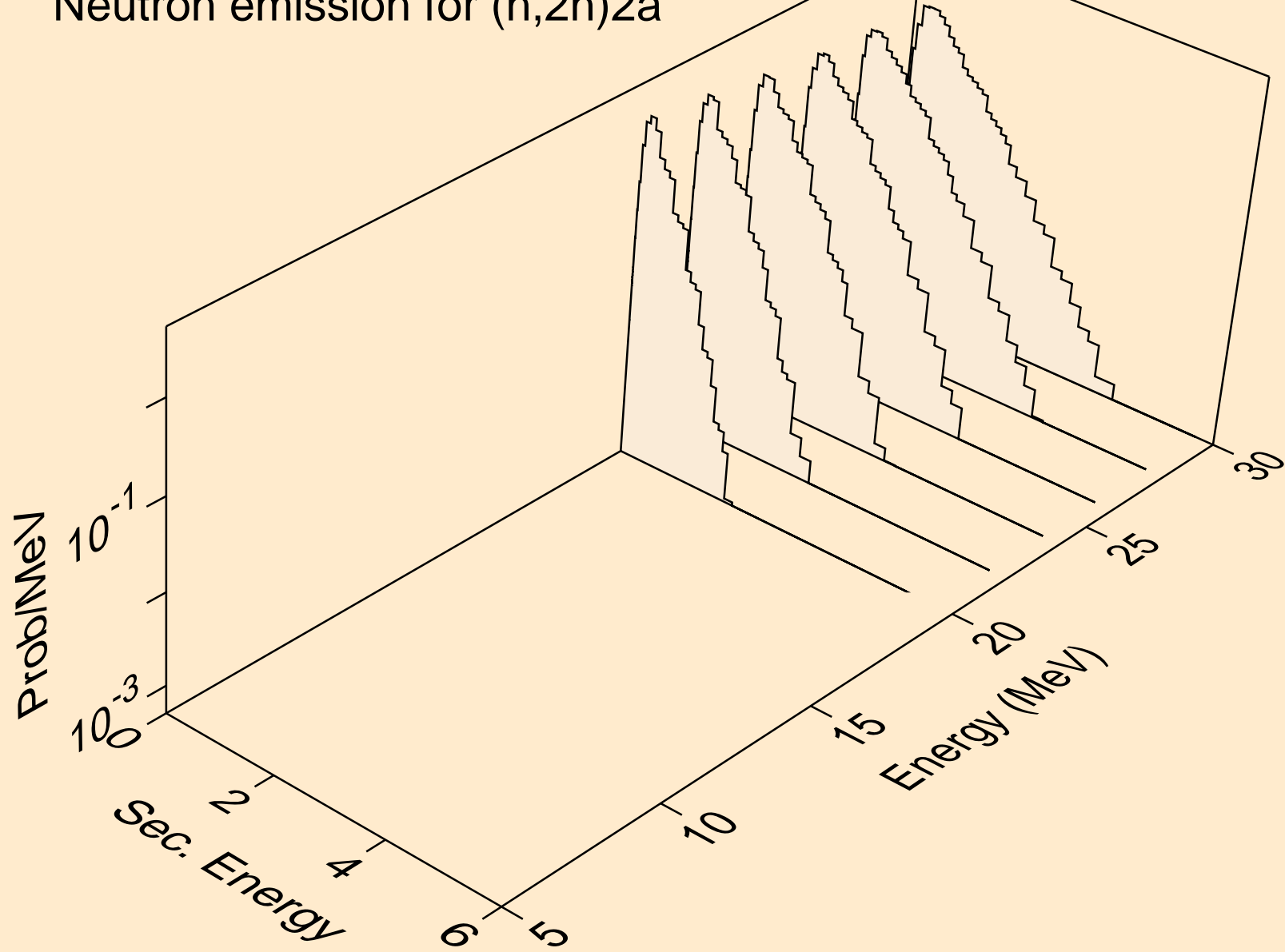

ND133 NEUTRON ACER TENDL-2021 LIBRARY; T=293.6K
Neutron emission for (n,n*)d

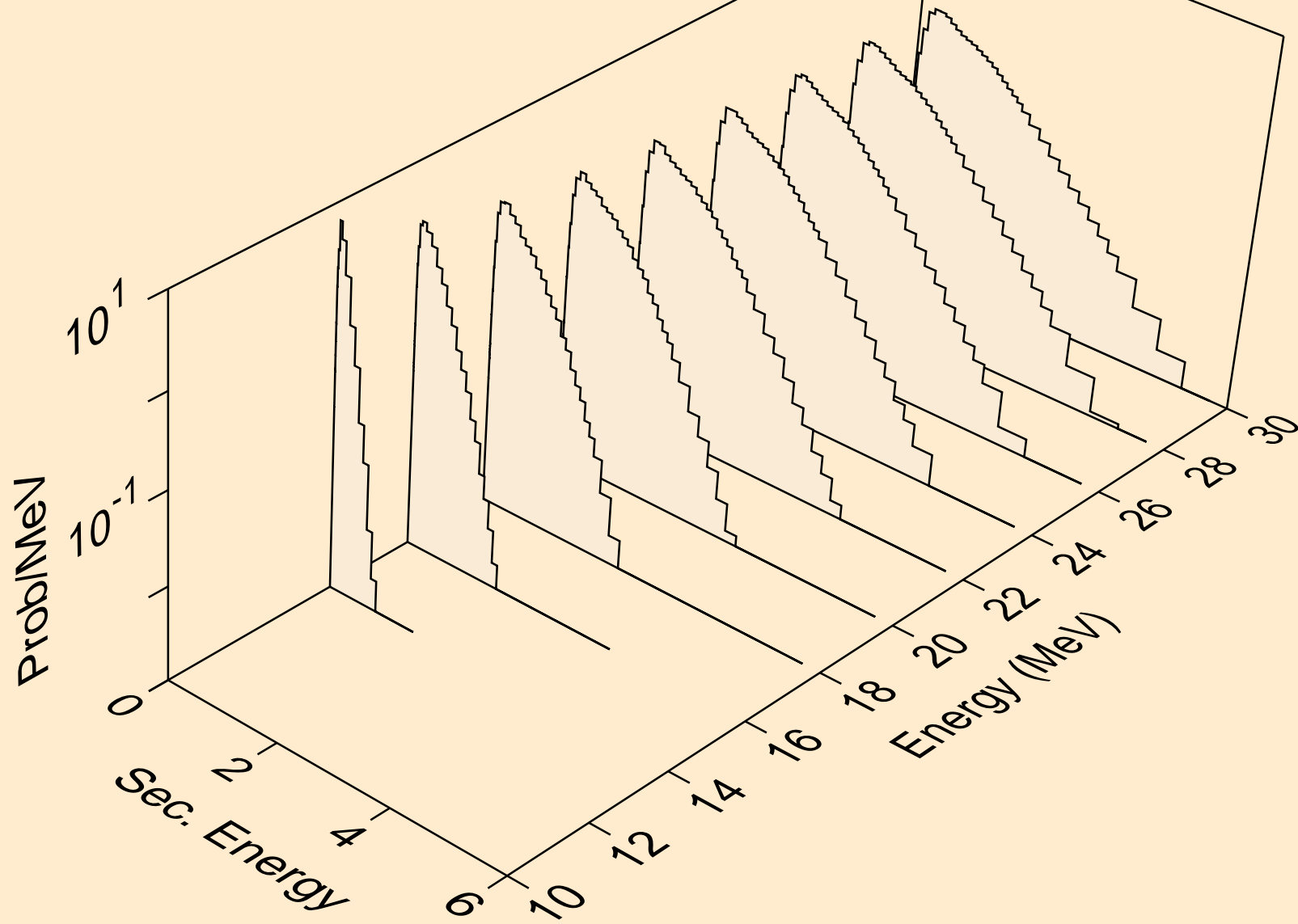

ND133 NEUTRON ACER TENDL-2021 LIBRARY; T=293.6K
Neutron emission for (n,n*)t

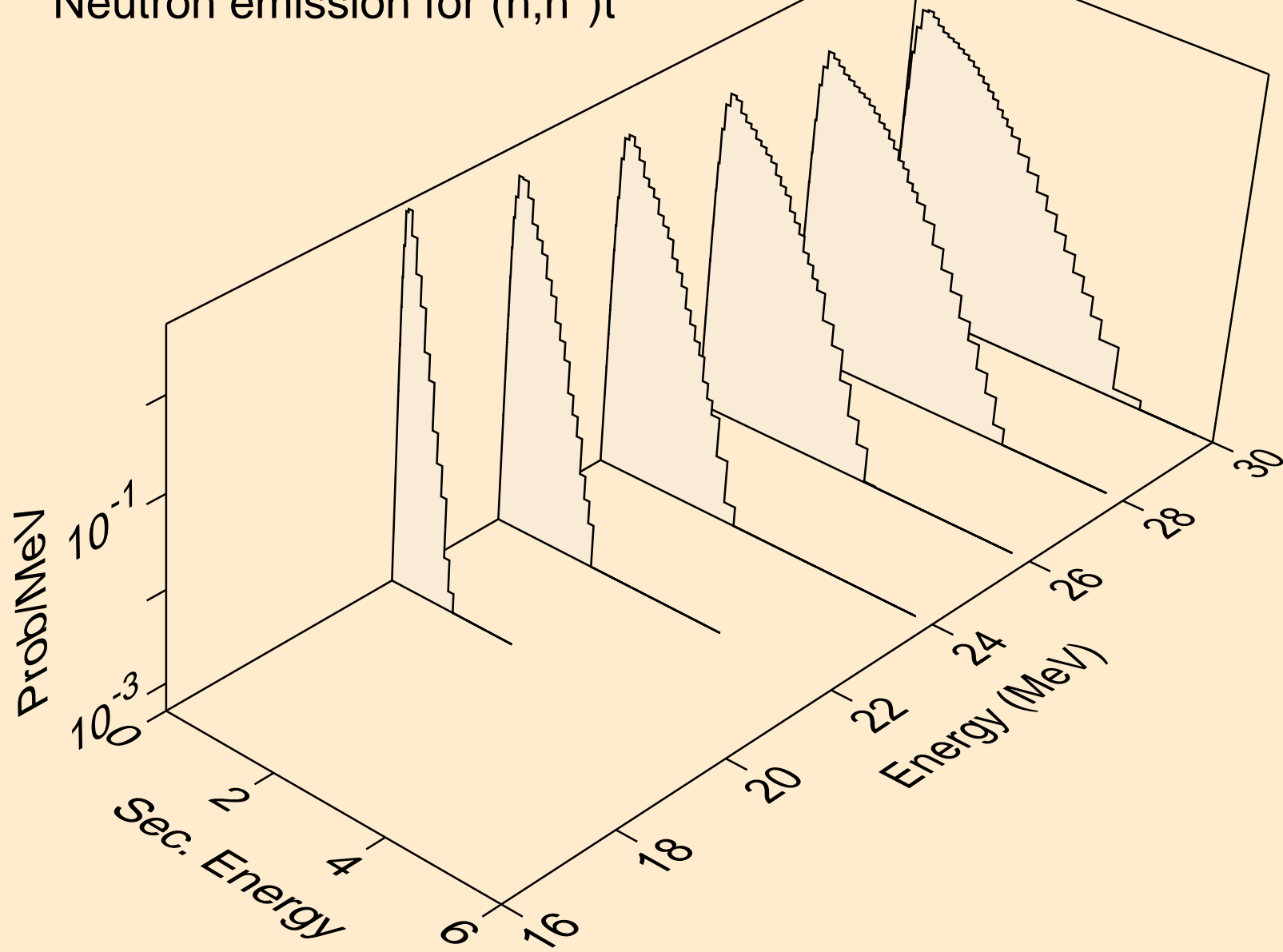

ND133 NEUTRON ACER TENDL-2021 LIBRARY; T=293.6K
Neutron emission for (n,n*)he3

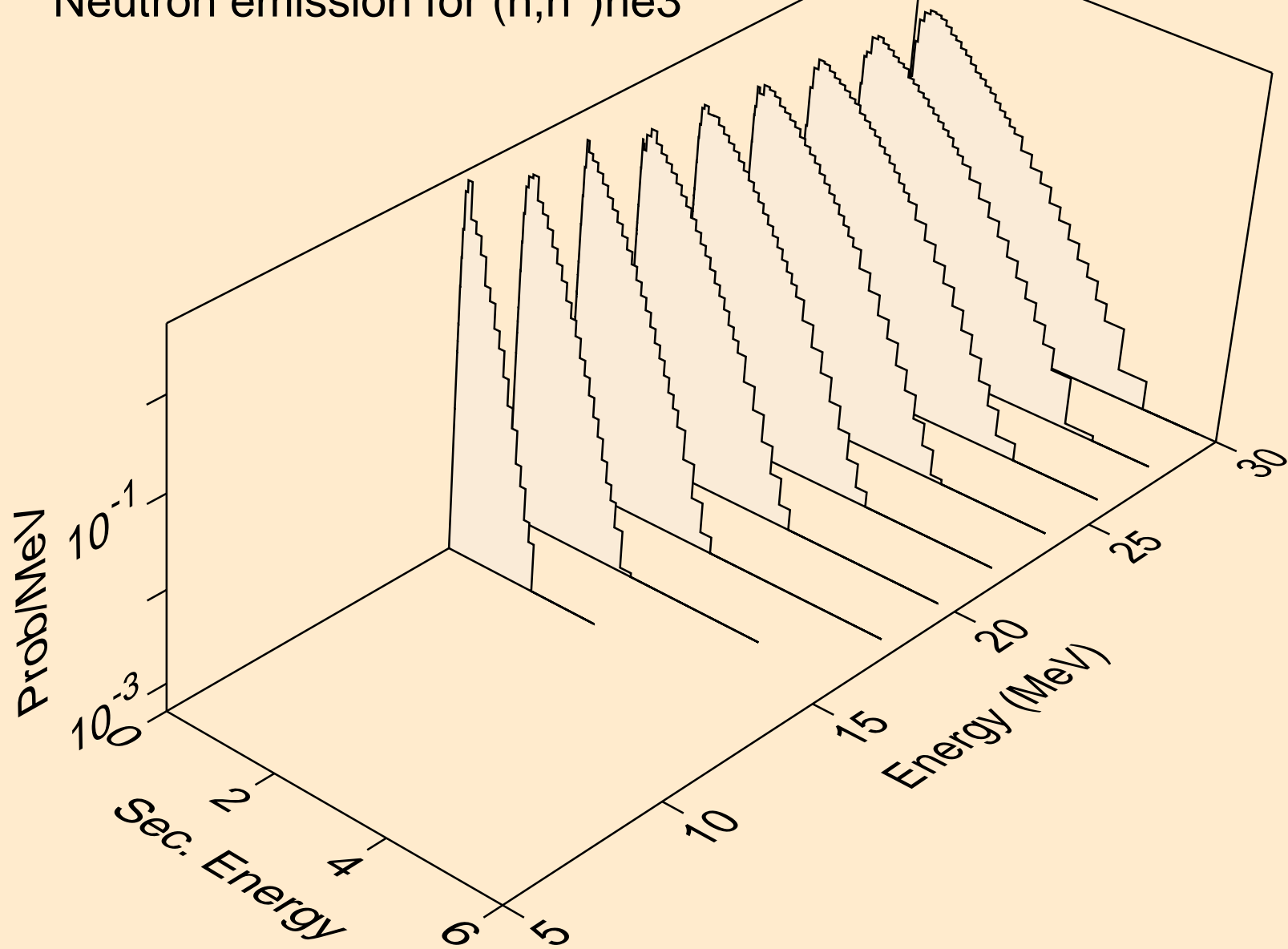

ND133 NEUTRON ACER TENDL-2021 LIBRARY; T=293.6K
Neutron emission for (n,2np)

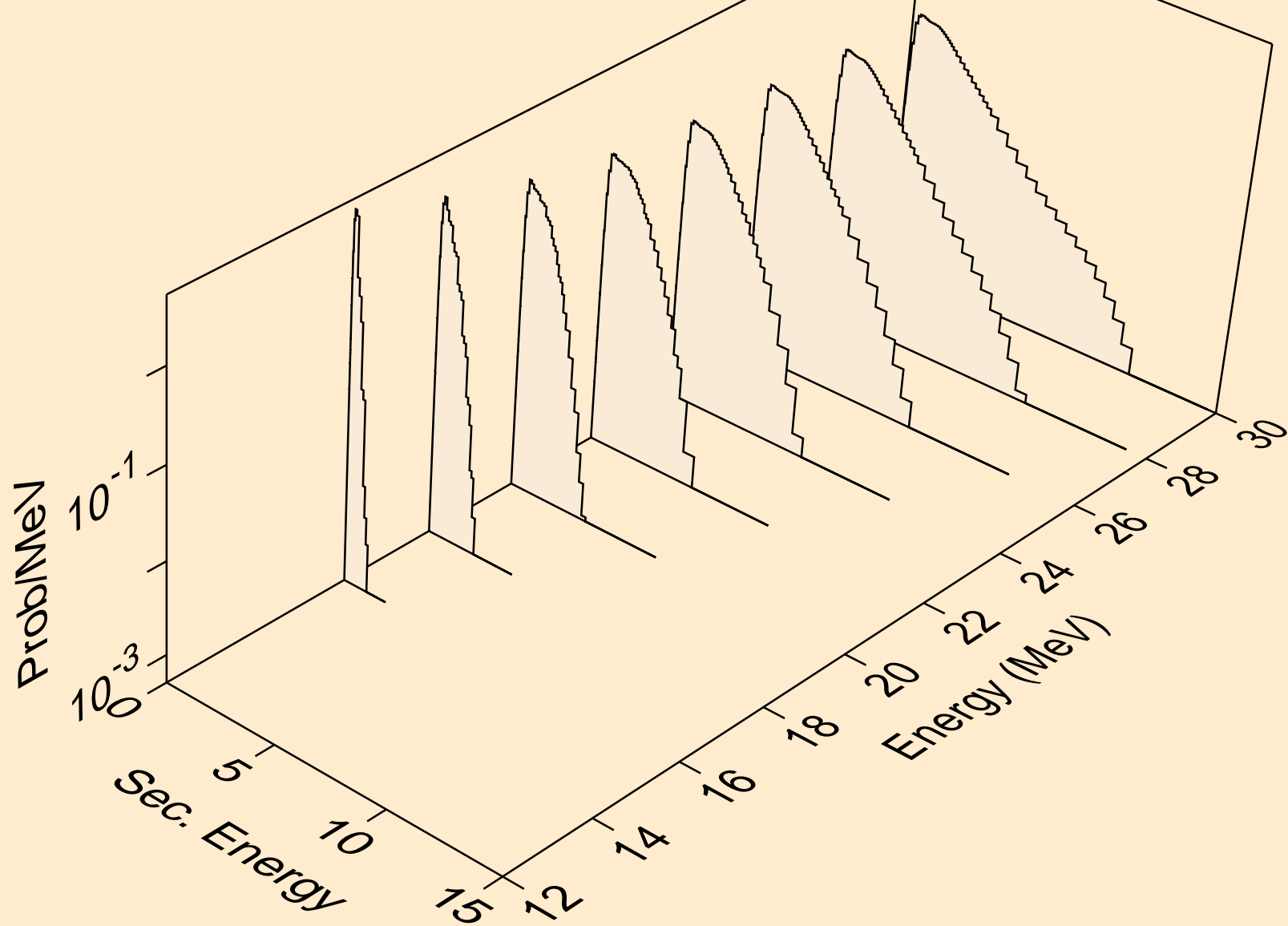

ND133 NEUTRON ACER TENDL-2021 LIBRARY; T=293.6K
Neutron emission for (n,3np)

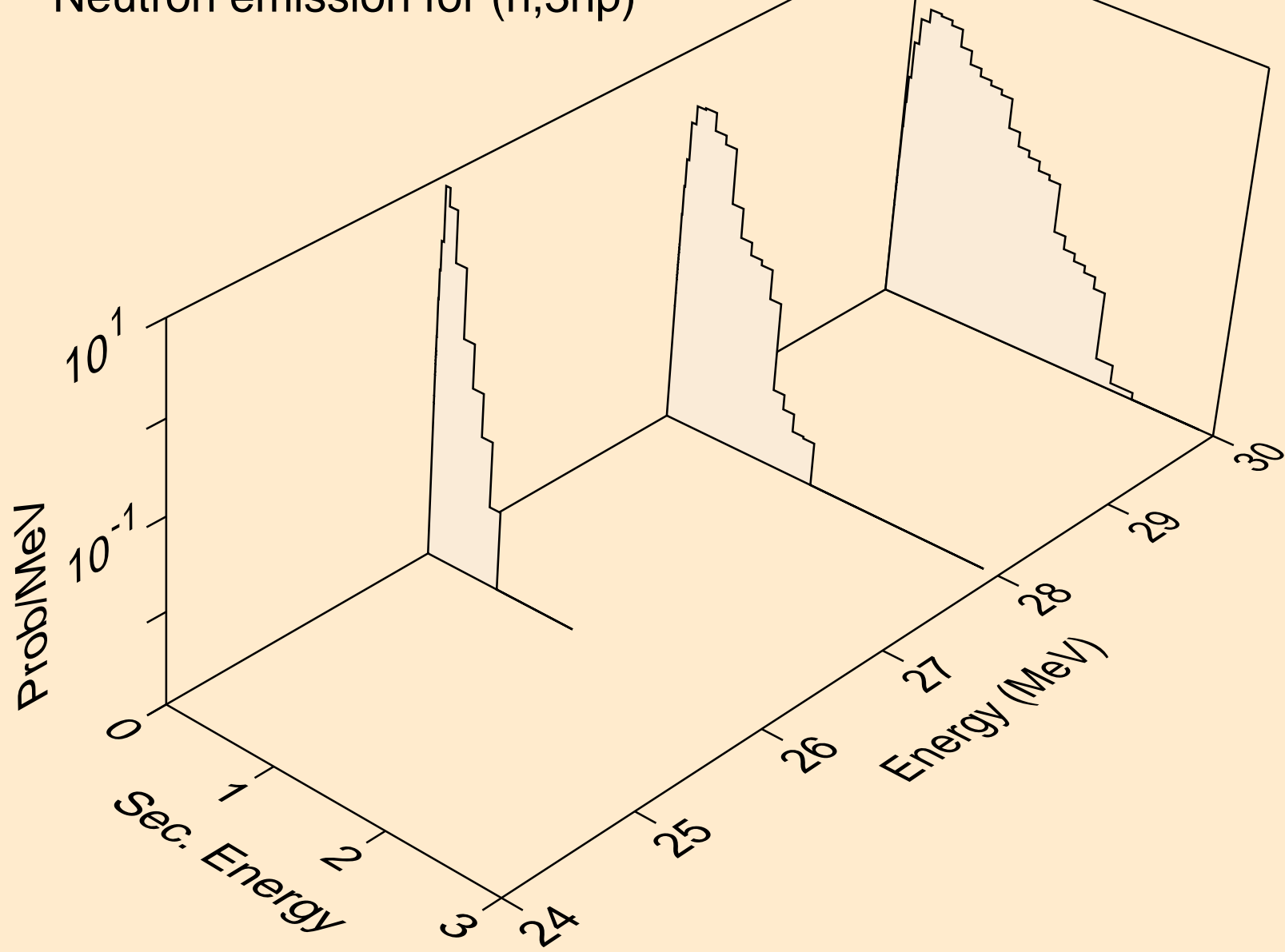

ND133 NEUTRON ACER TENDL-2021 LIBRARY; T=293.6K
Neutron emission for (n,2np)

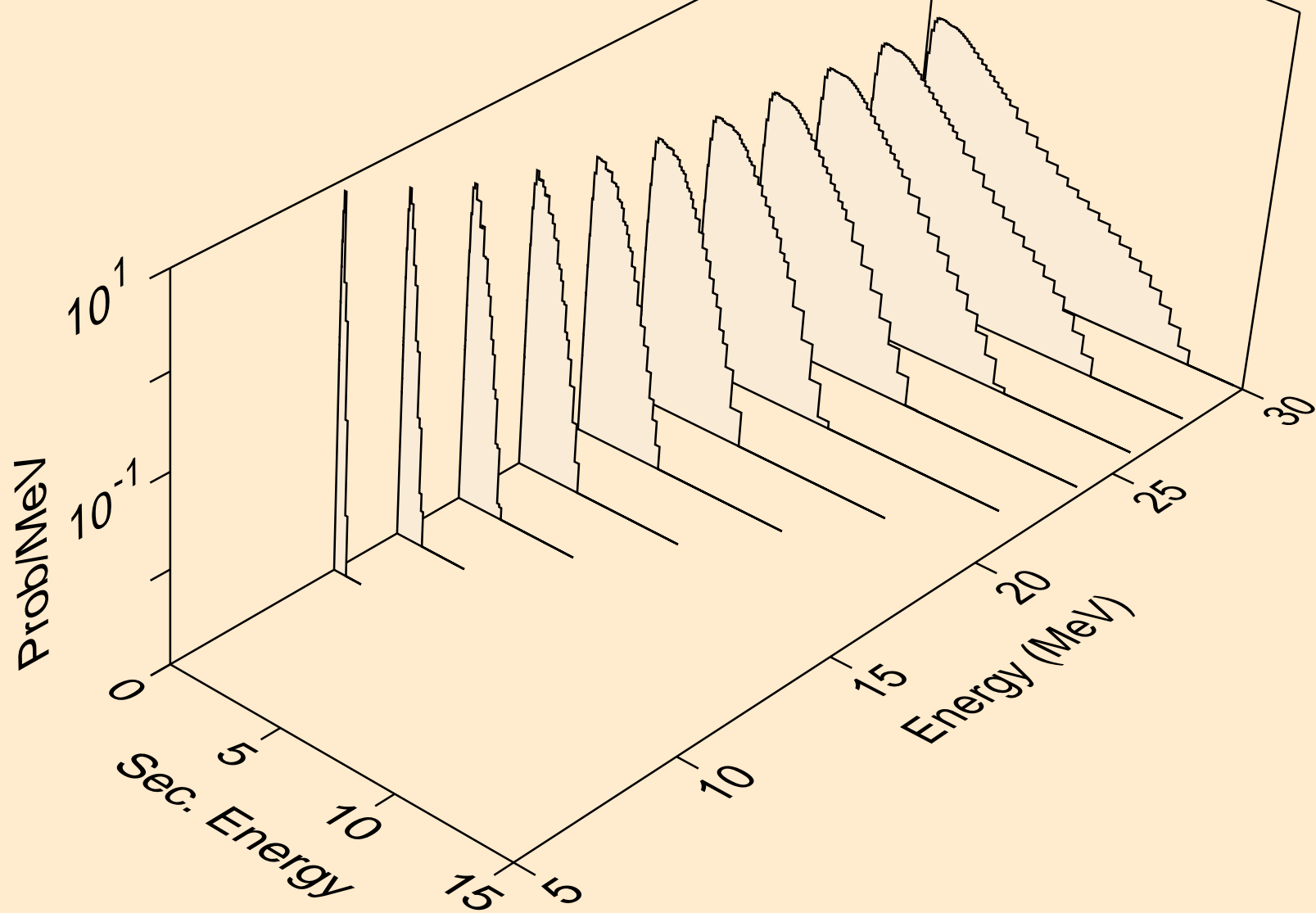

ND133 NEUTRON ACER TENDL-2021 LIBRARY; T=293.6K
Neutron emission for (n,npa)

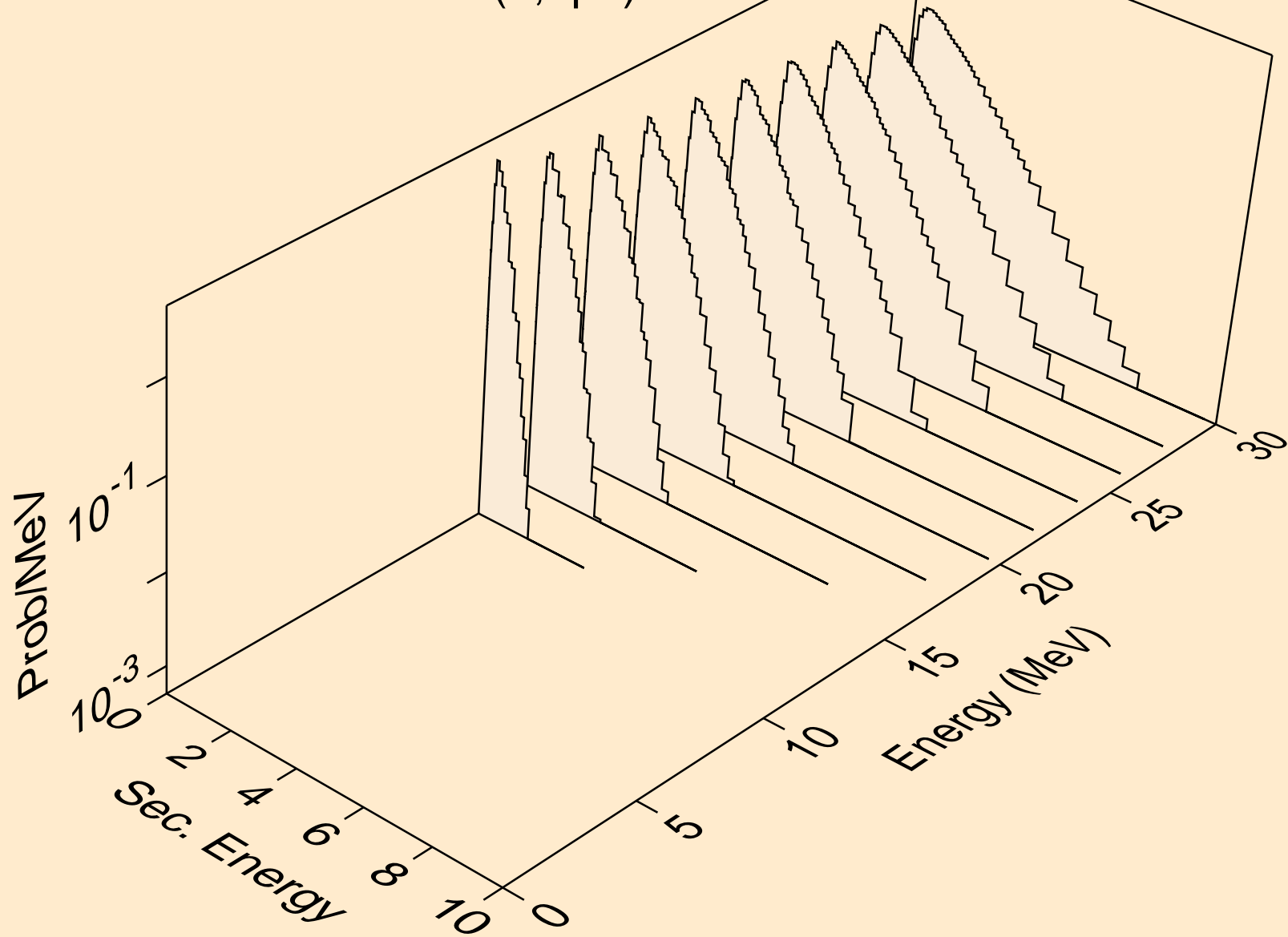

ND133 NEUTRON ACER TENDL-2021 LIBRARY; T=293.6K
Neutron emission for (n,n*c)

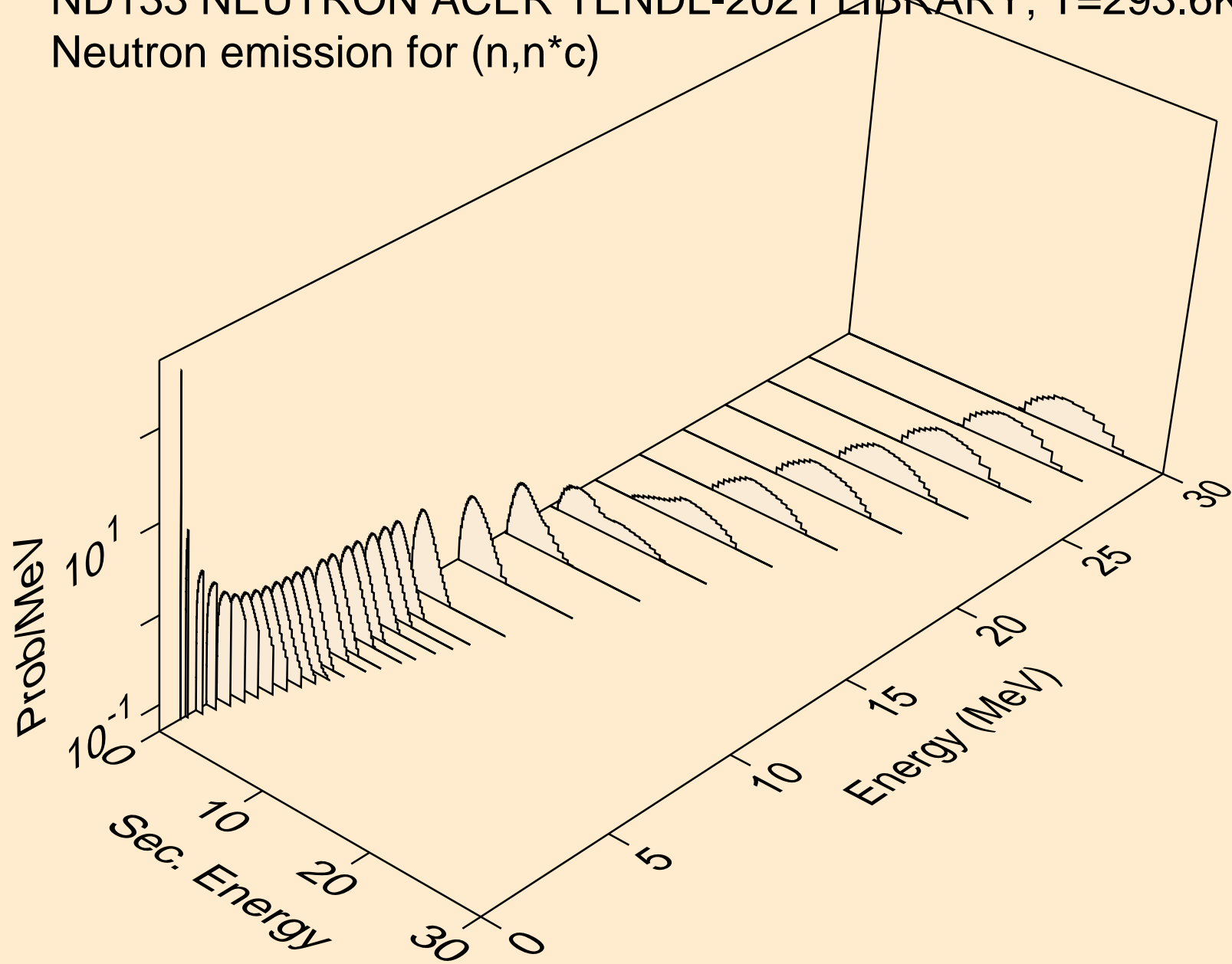

ND133 NEUTRON ACER TENDL-2021 LIBRARY; T=293.6K
Photon emission for (n,x)

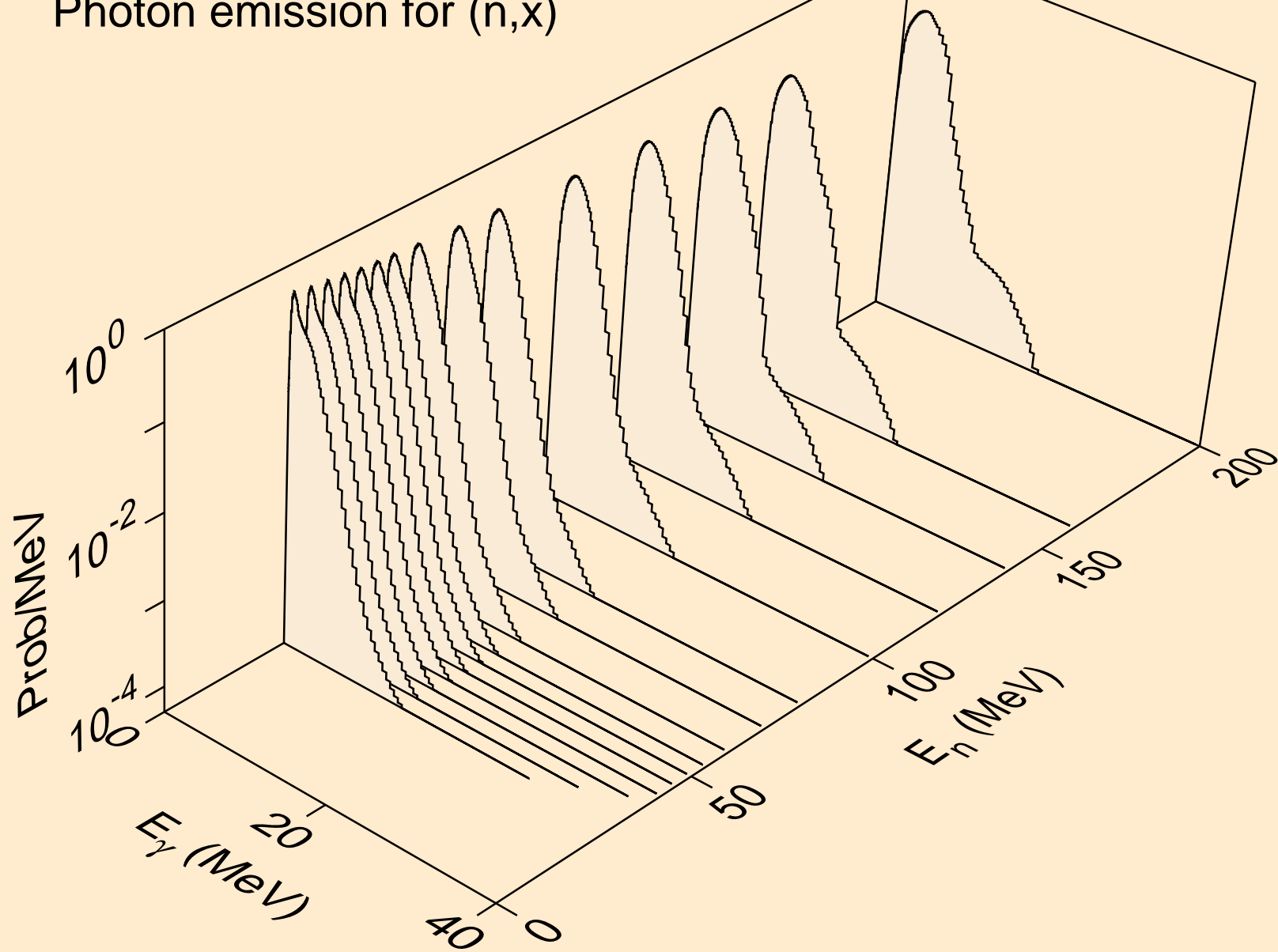

ND133 NEUTRON ACER TENDL-2021 LIBRARY; T=293.6K
Photon emission for (n,2nd)

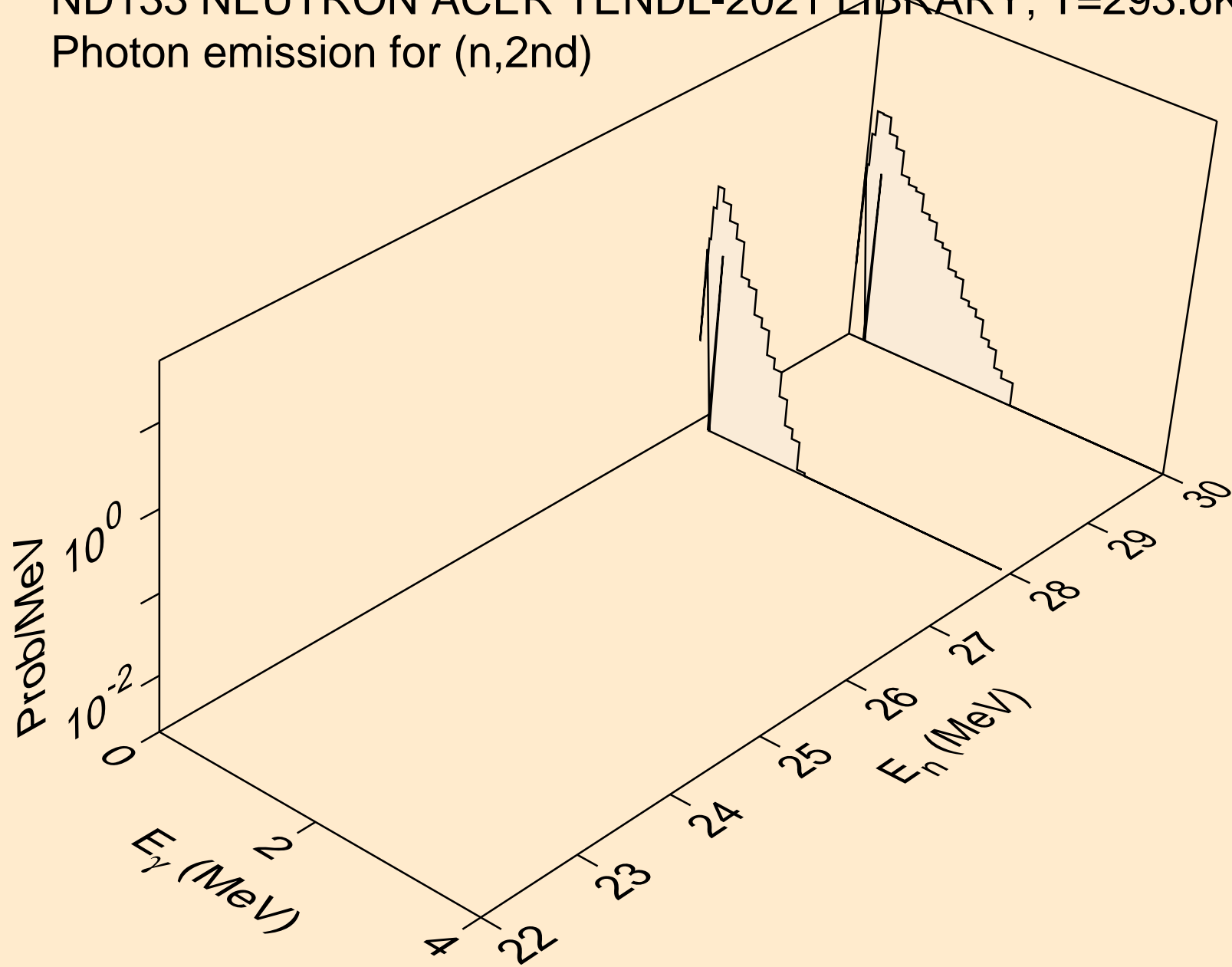

ND133 NEUTRON ACER TENDL-2021 LIBRARY; T=293.6K
Photon emission for (n,2n)

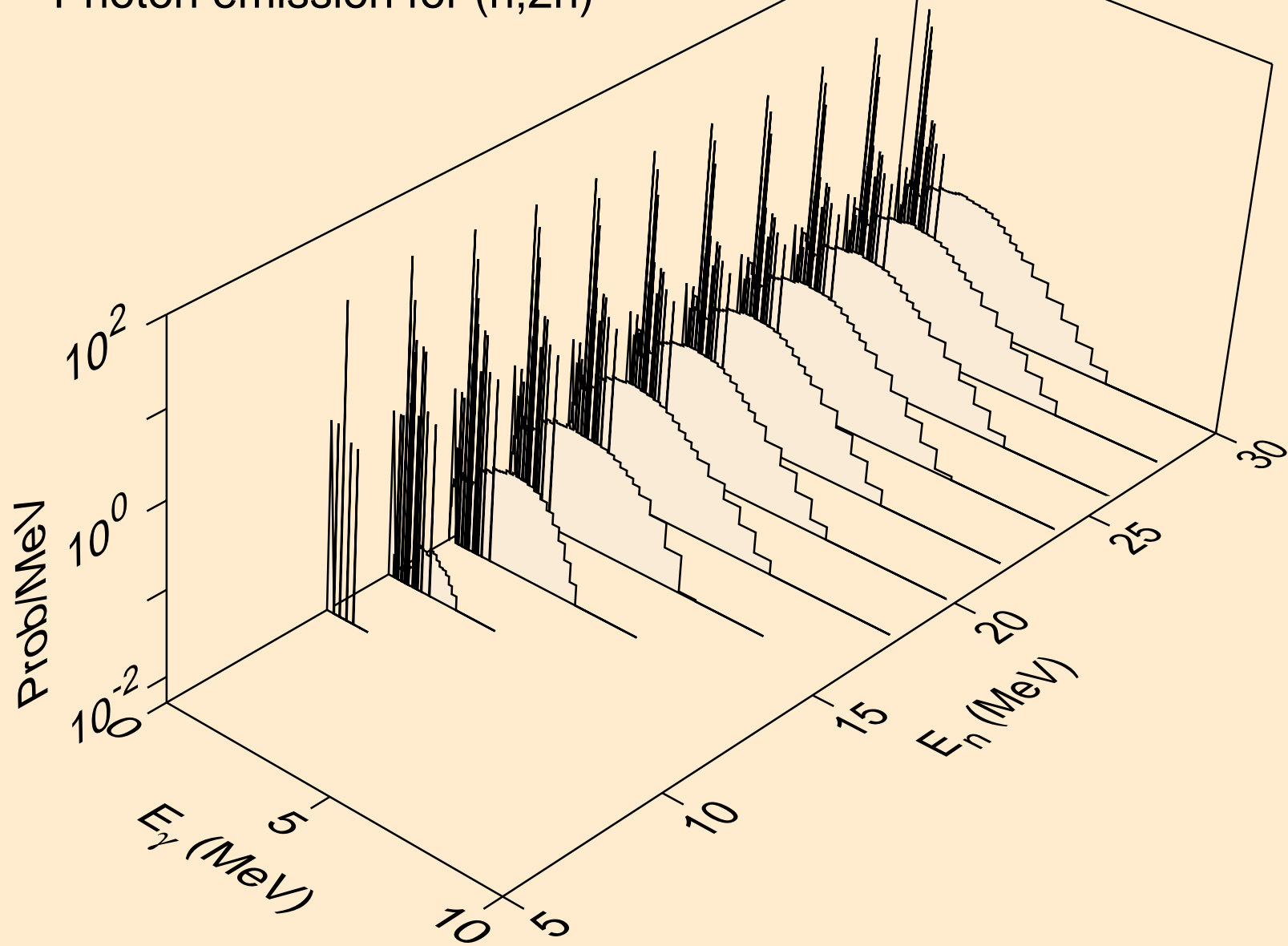

ND133 NEUTRON ACER TENDL-2021 LIBRARY; T=293.6K
Photon emission for (n,3n)

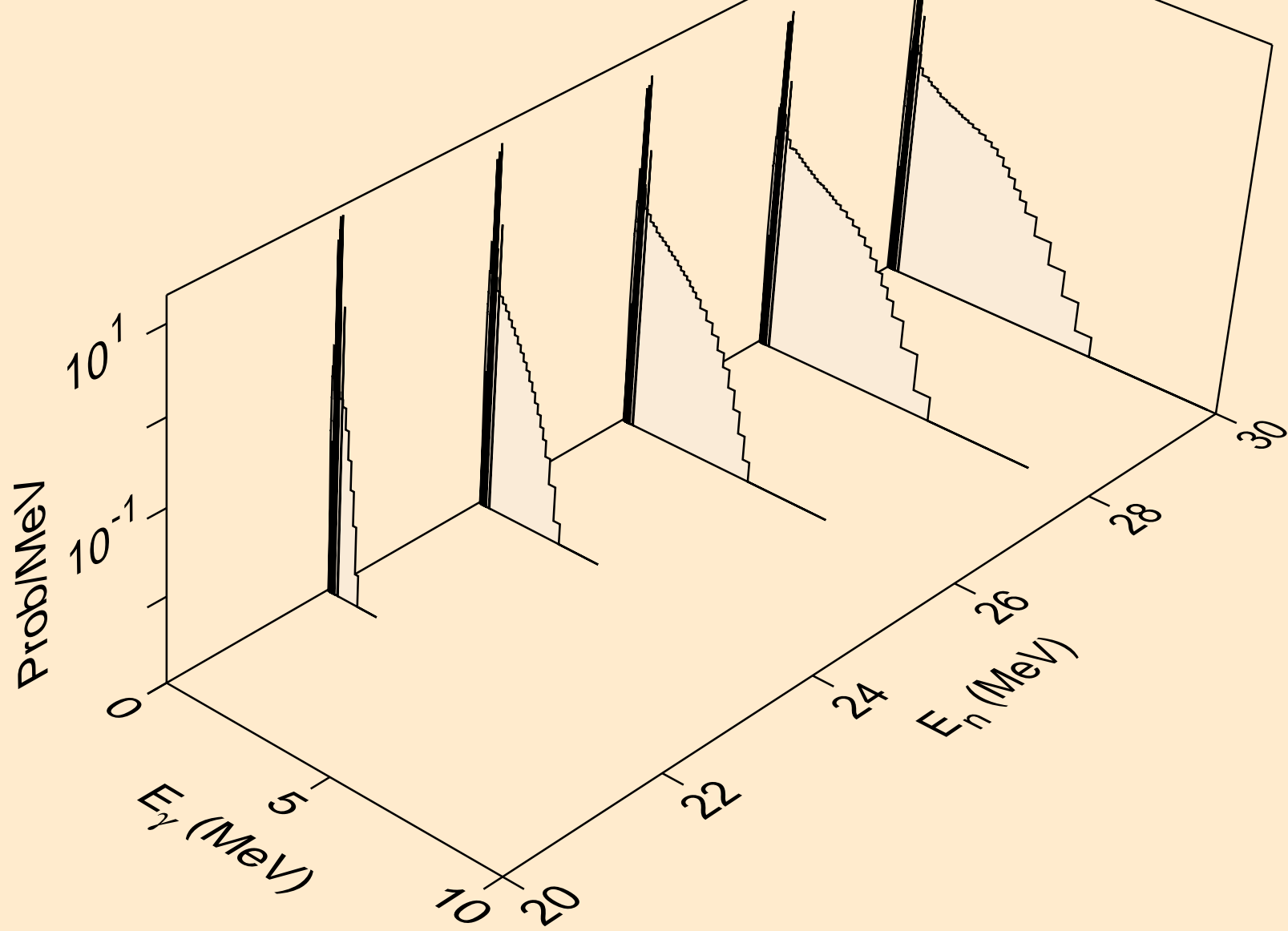

ND133 NEUTRON ACER TENDL-2021 LIBRARY; T=293.6K
Photon emission for (n,n*)a

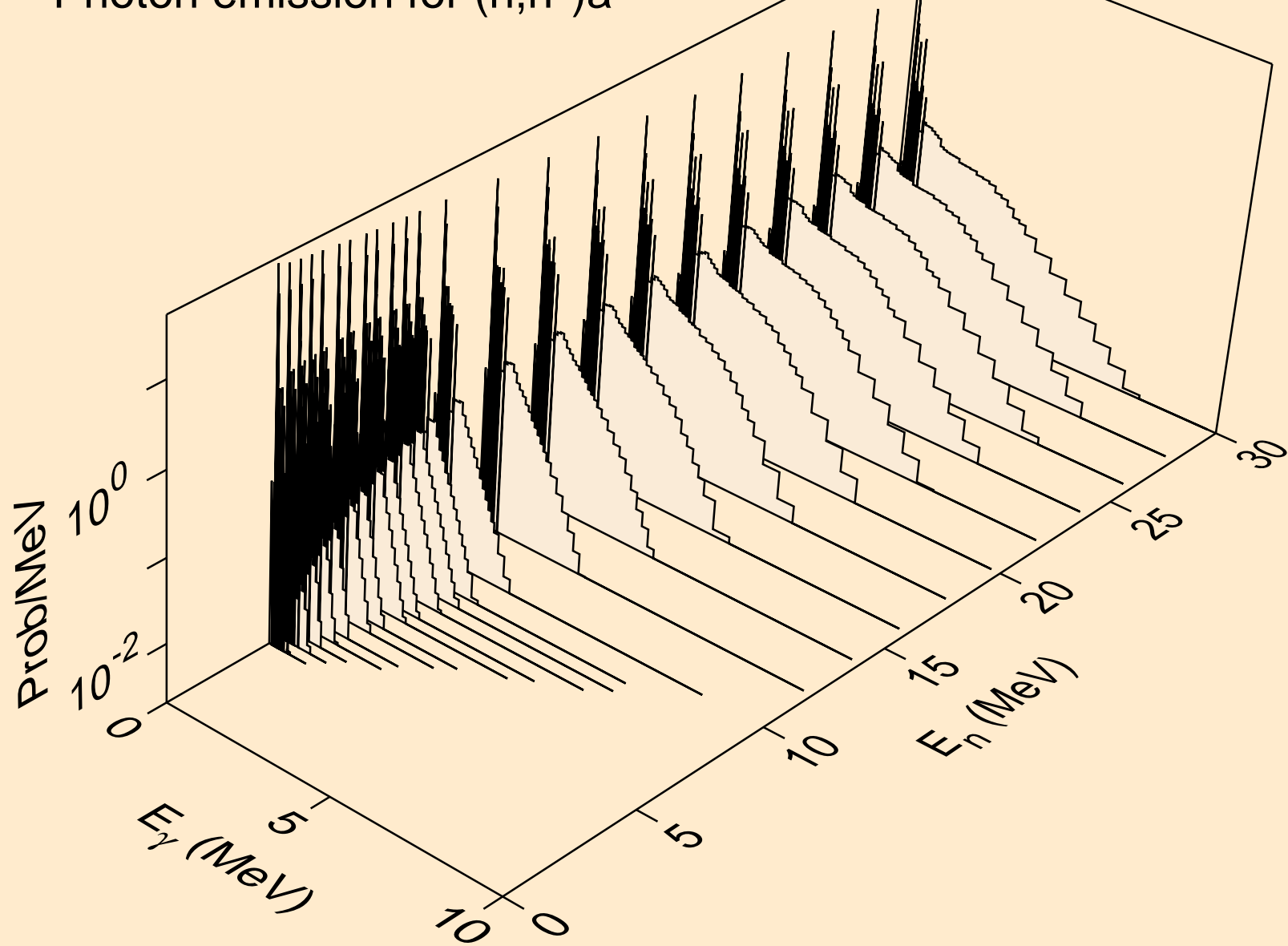

ND133 NEUTRON ACER TENDL-2021 LIBRARY; T=293.6K
Photon emission for (n,2n)a

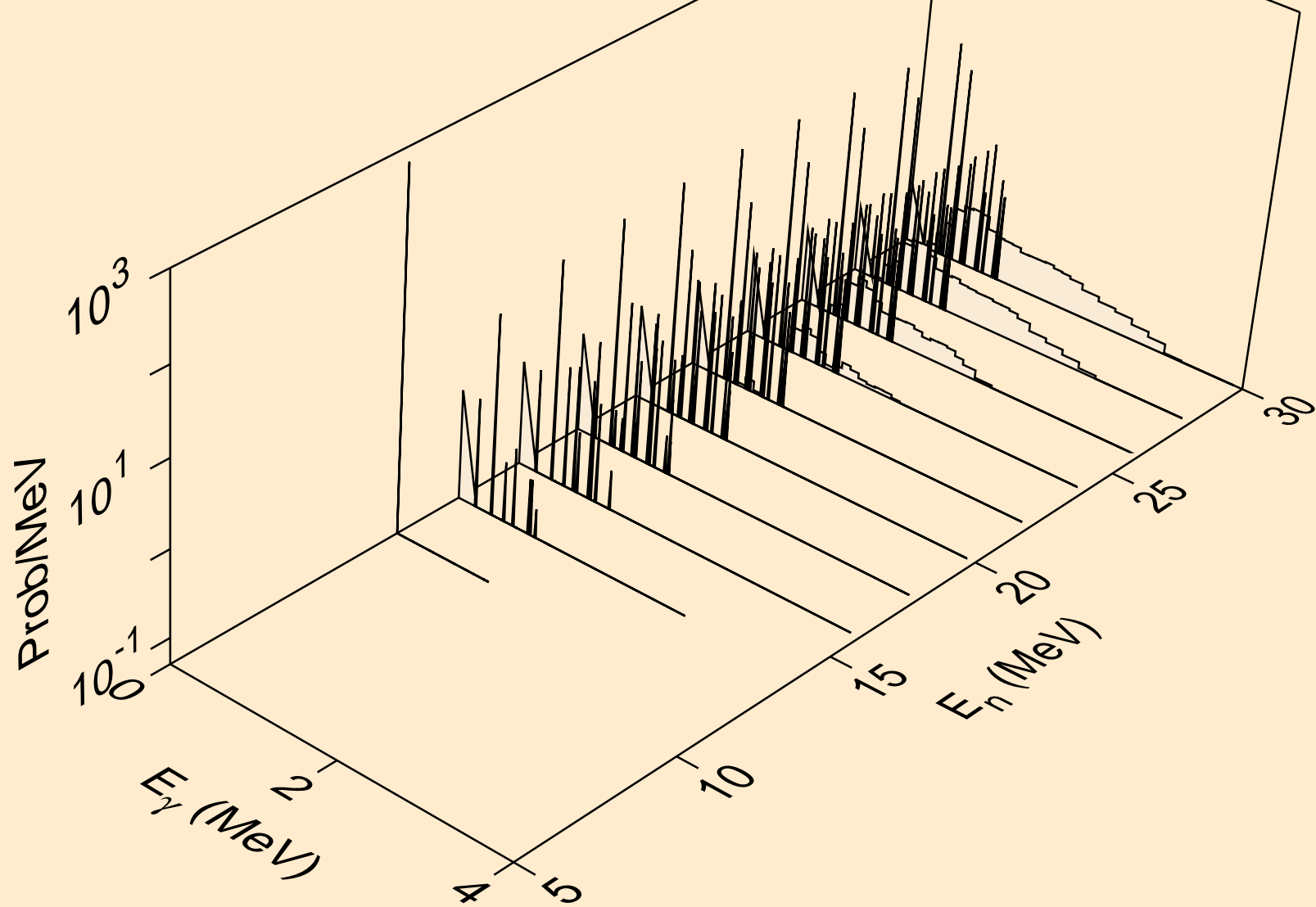

ND133 NEUTRON ACER TENDL-2021 LIBRARY; T=293.6K
Photon emission for (n,3n)a

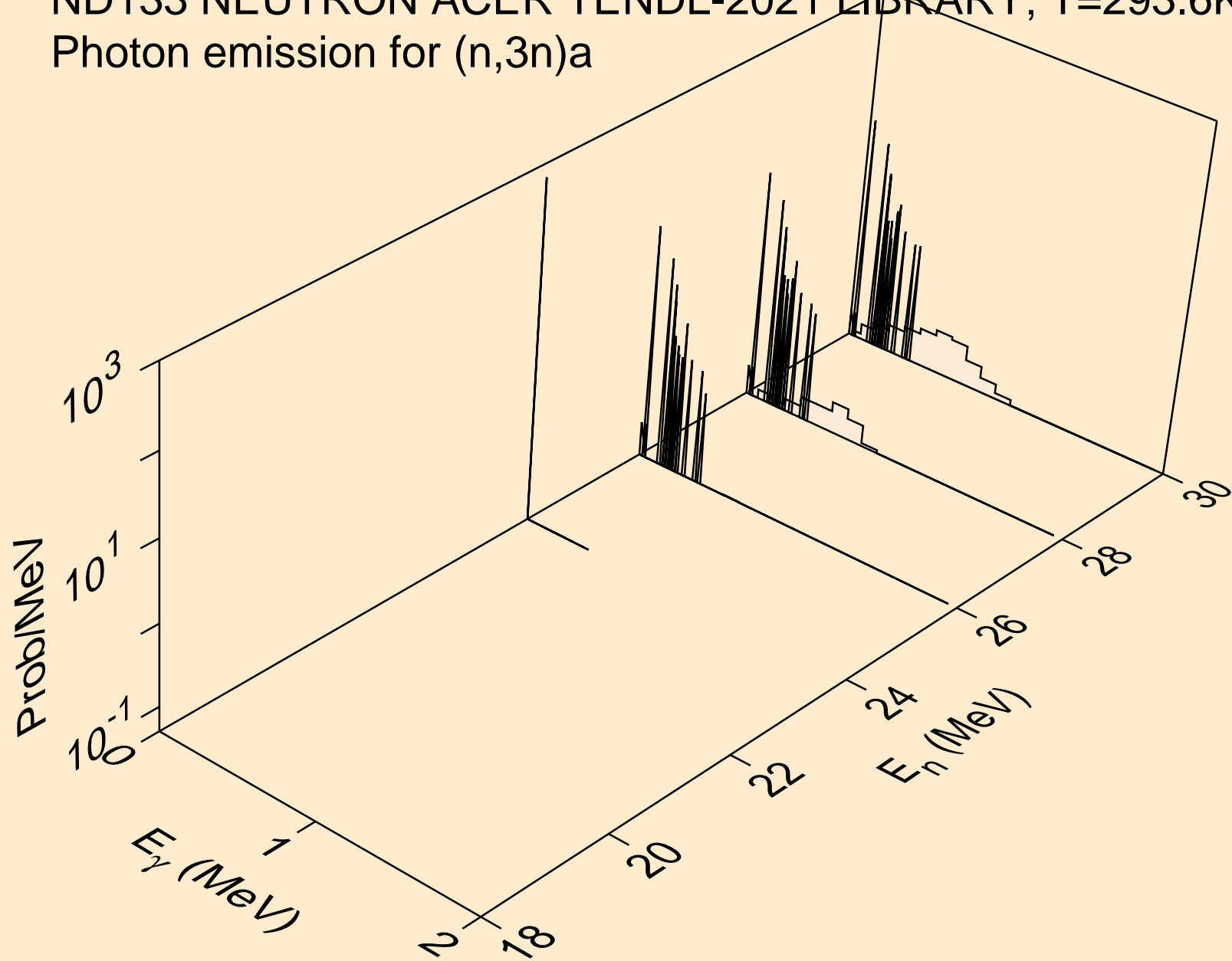

ND133 NEUTRON ACER TENDL-2021 LIBRARY; T=293.6K
Photon emission for (n,n*)p

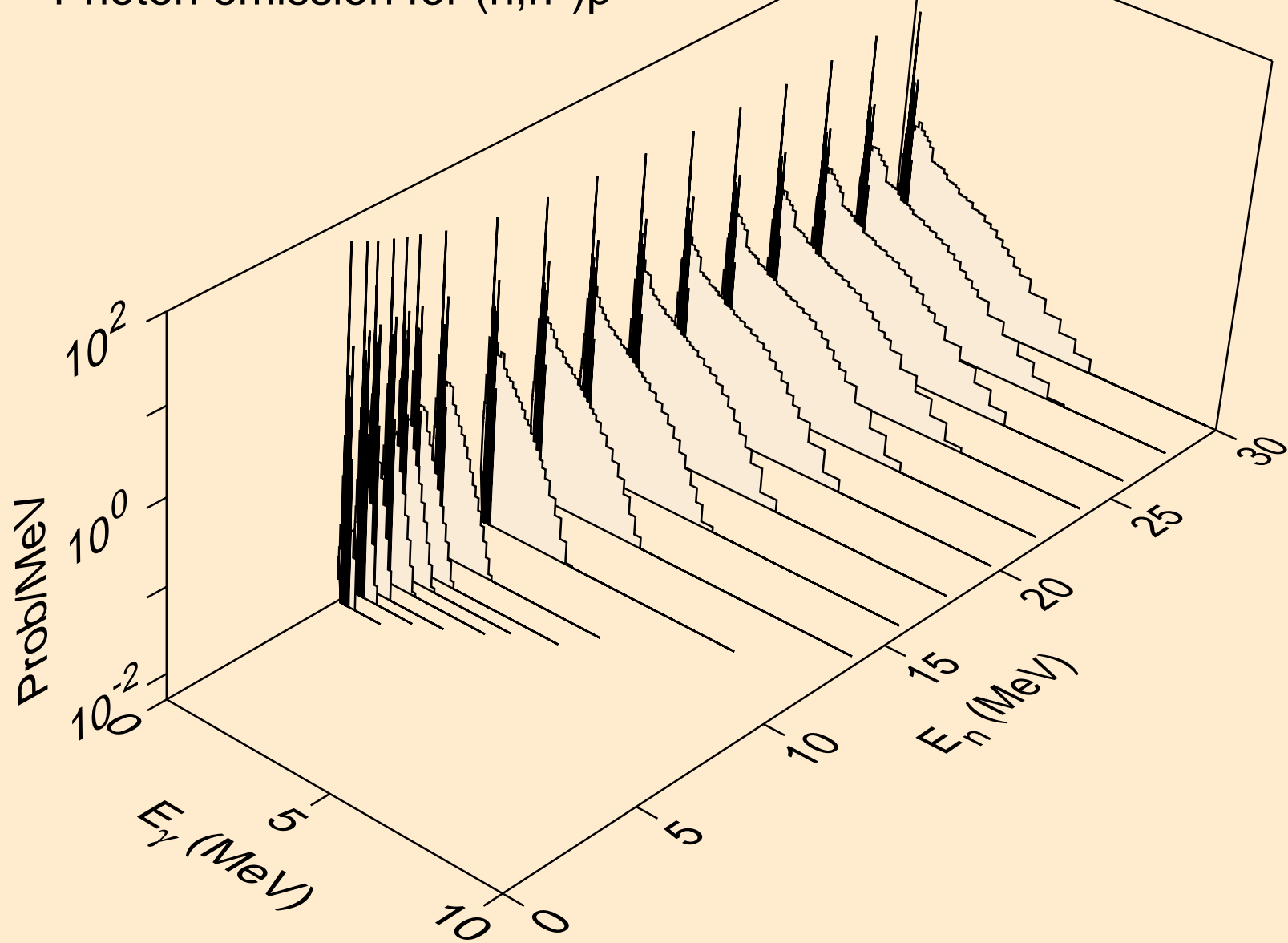

ND133 NEUTRON ACER TENDL-2021 LIBRARY; T=293.6K
Photon emission for (n,n*)2a

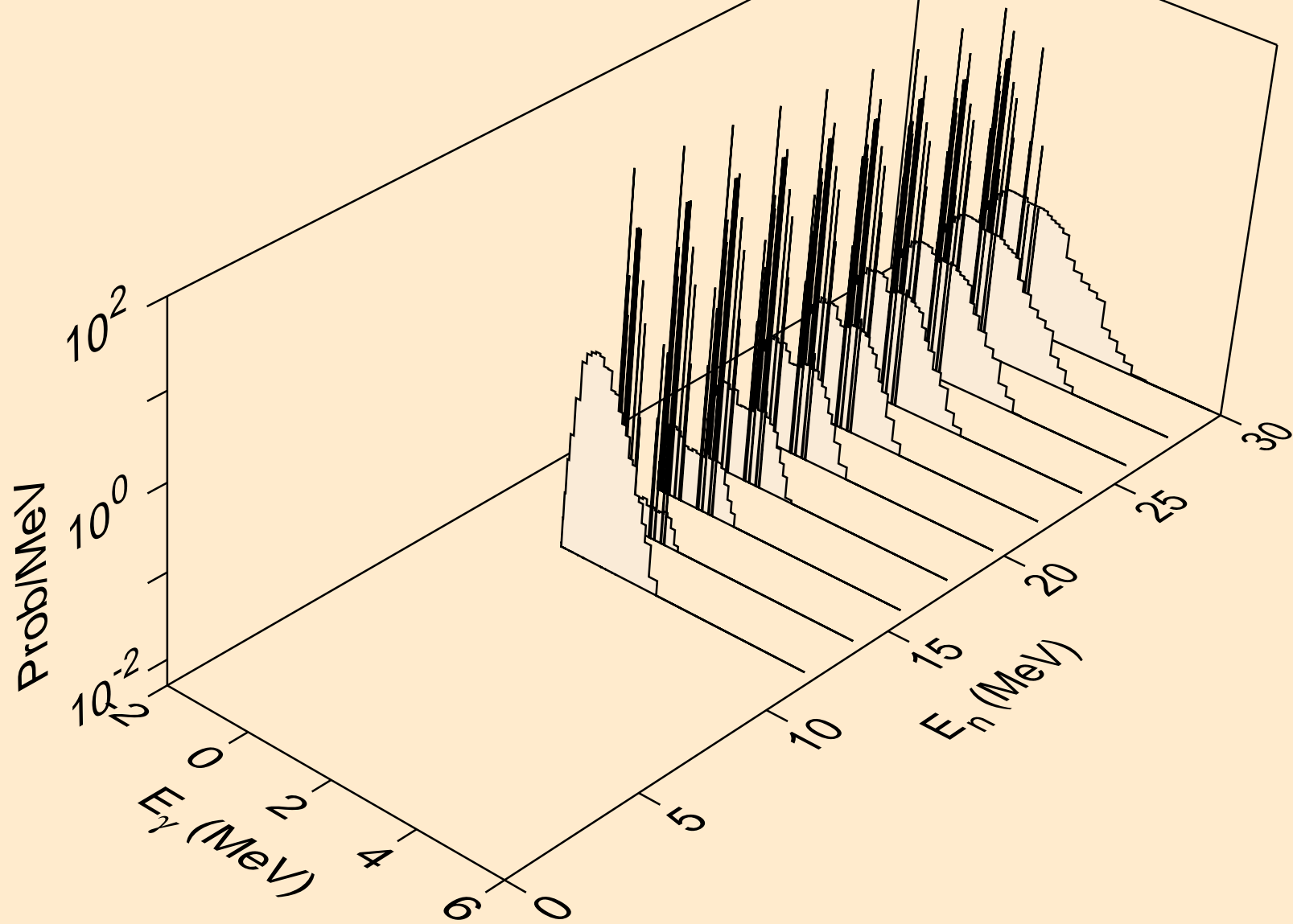

ND133 NEUTRON ACER TENDL-2021 LIBRARY; T=293.6K
Photon emission for (n,2n)2a

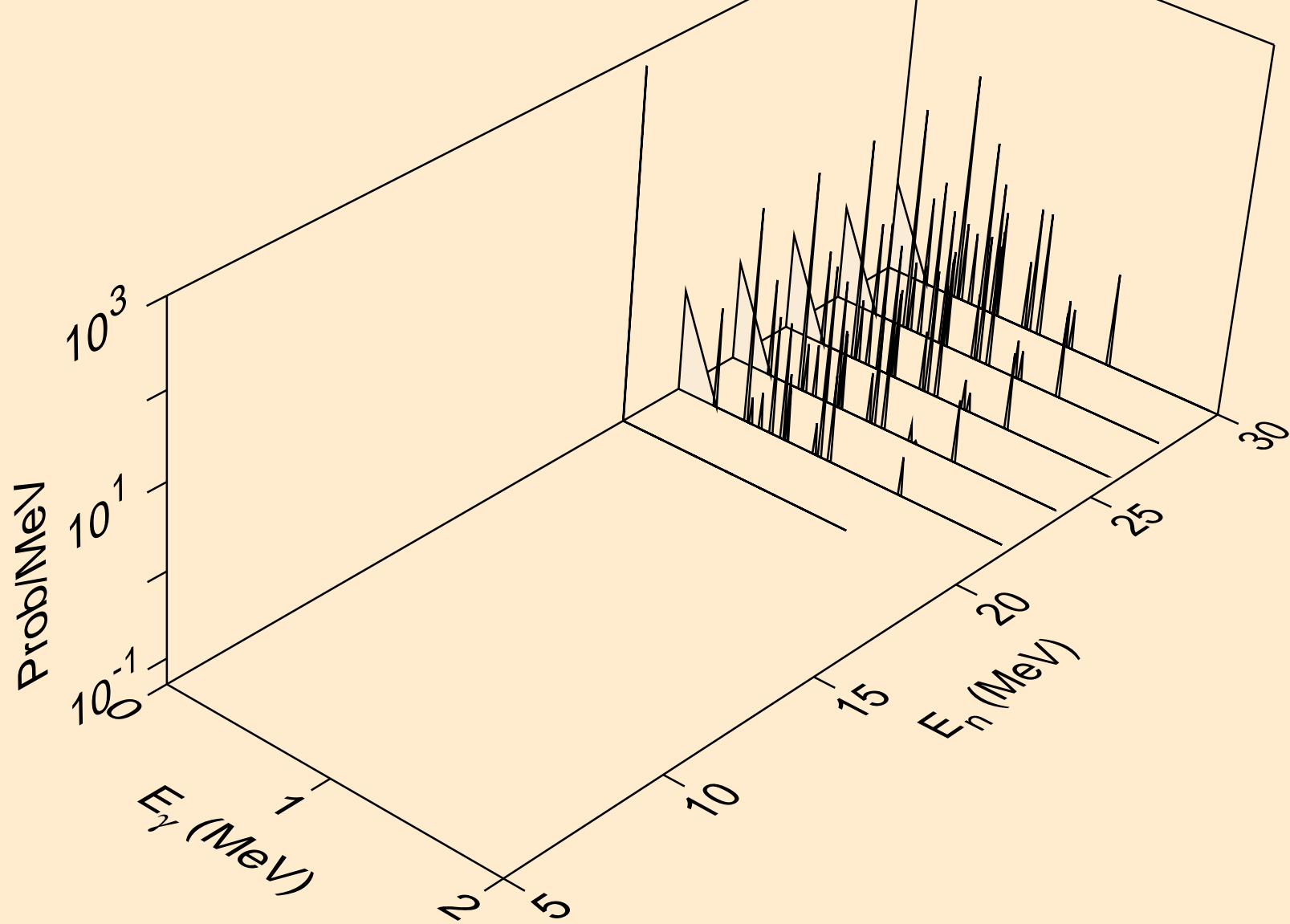

ND133 NEUTRON ACER TENDL-2021 LIBRARY; T=293.6K
Photon emission for (n,n*)d

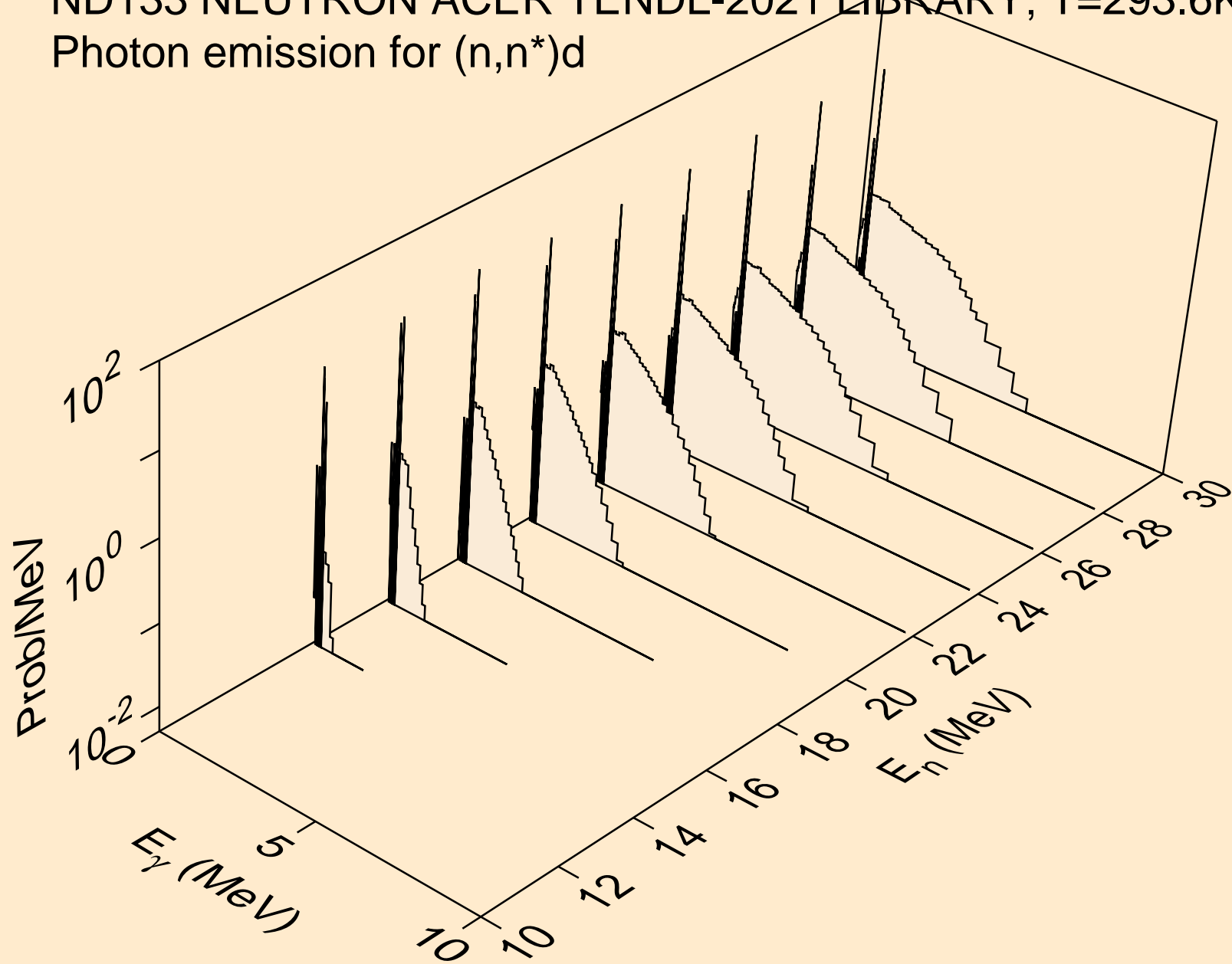

ND133 NEUTRON ACER TENDL-2021 LIBRARY; T=293.6K
Photon emission for (n,n*)t

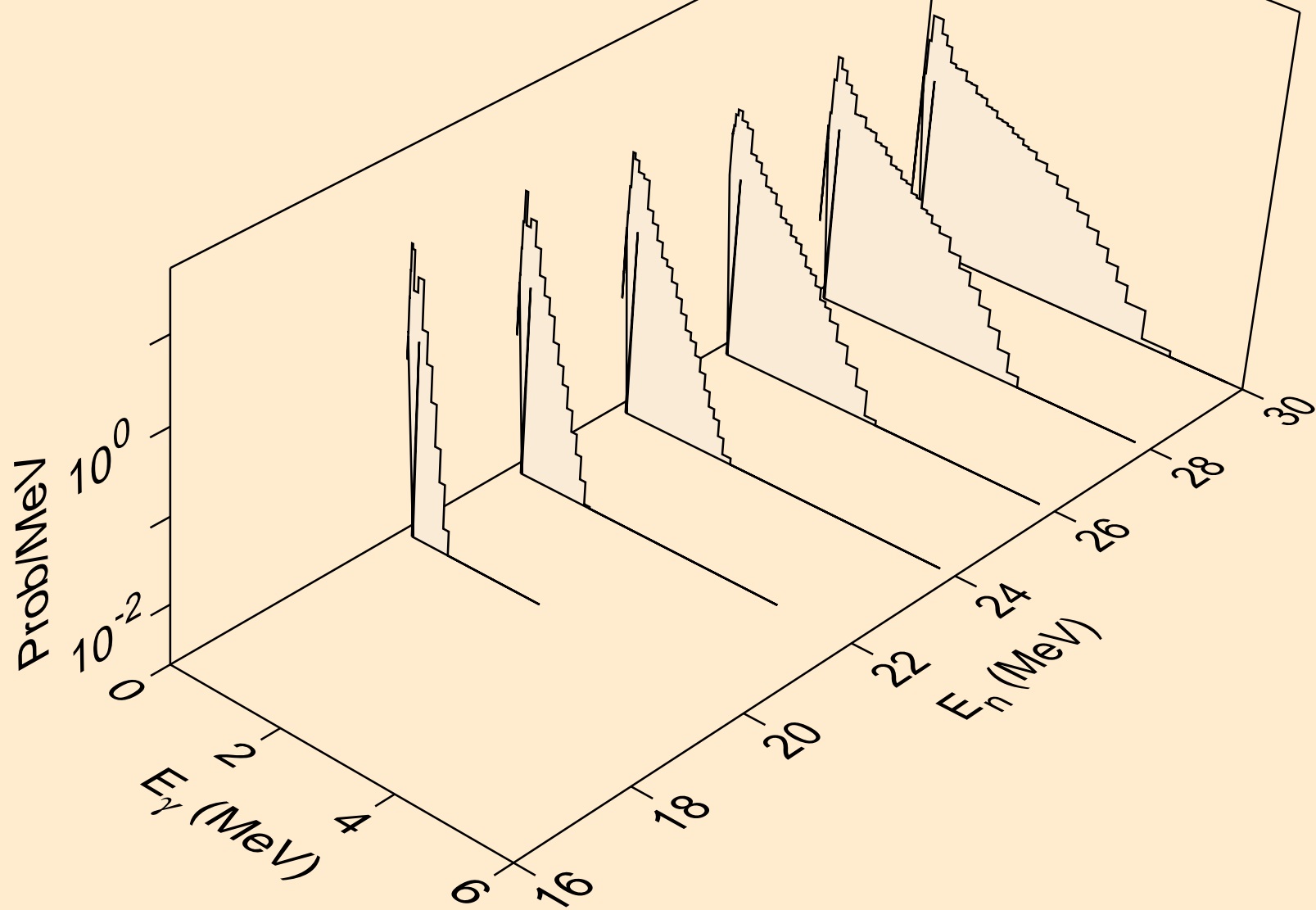

ND133 NEUTRON ACER TENDL-2021 LIBRARY; T=293.6K
Photon emission for (n,n*)he3

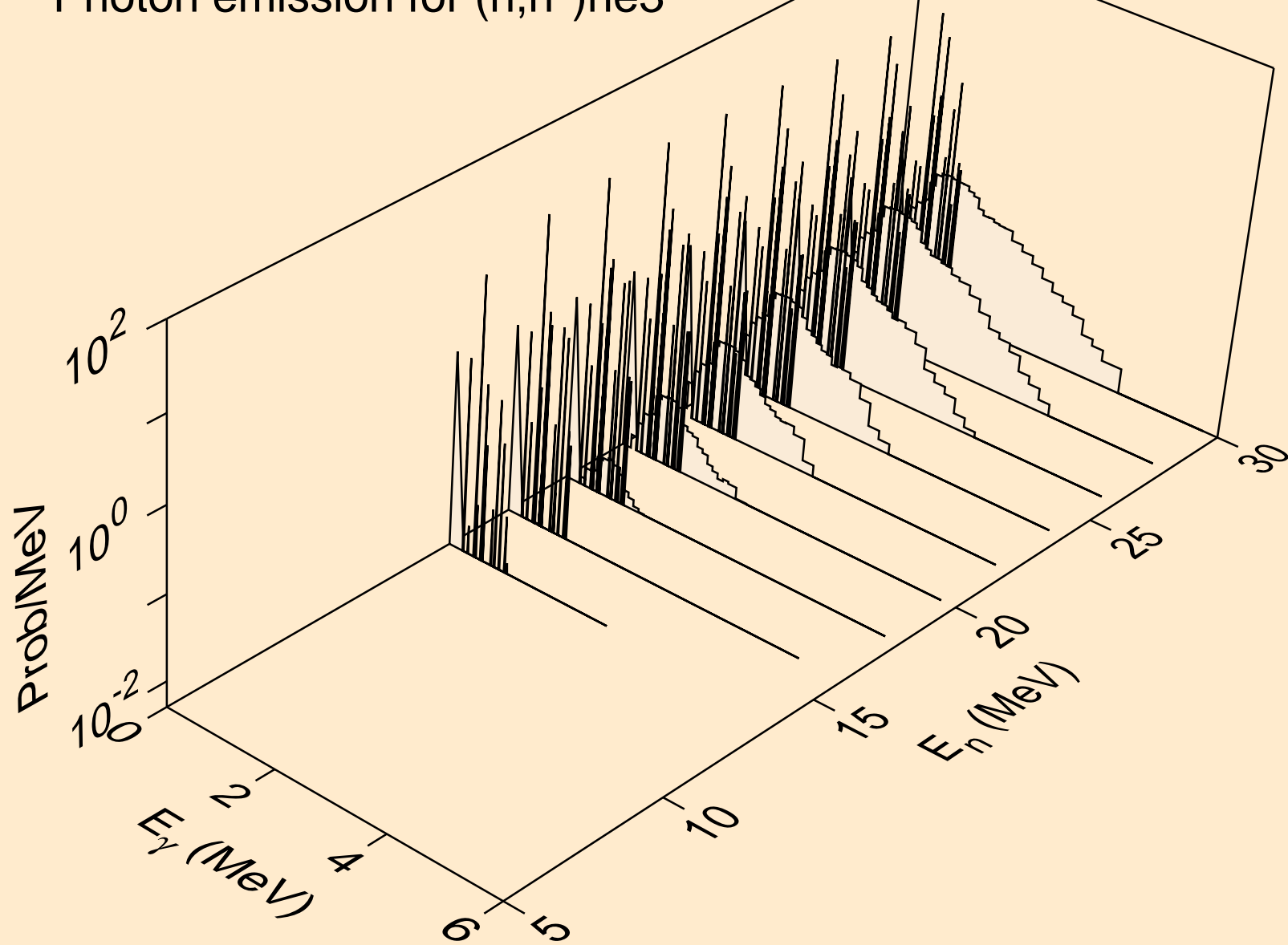

ND133 NEUTRON ACER TENDL-2021 LIBRARY; T=293.6K
Photon emission for (n,2np)

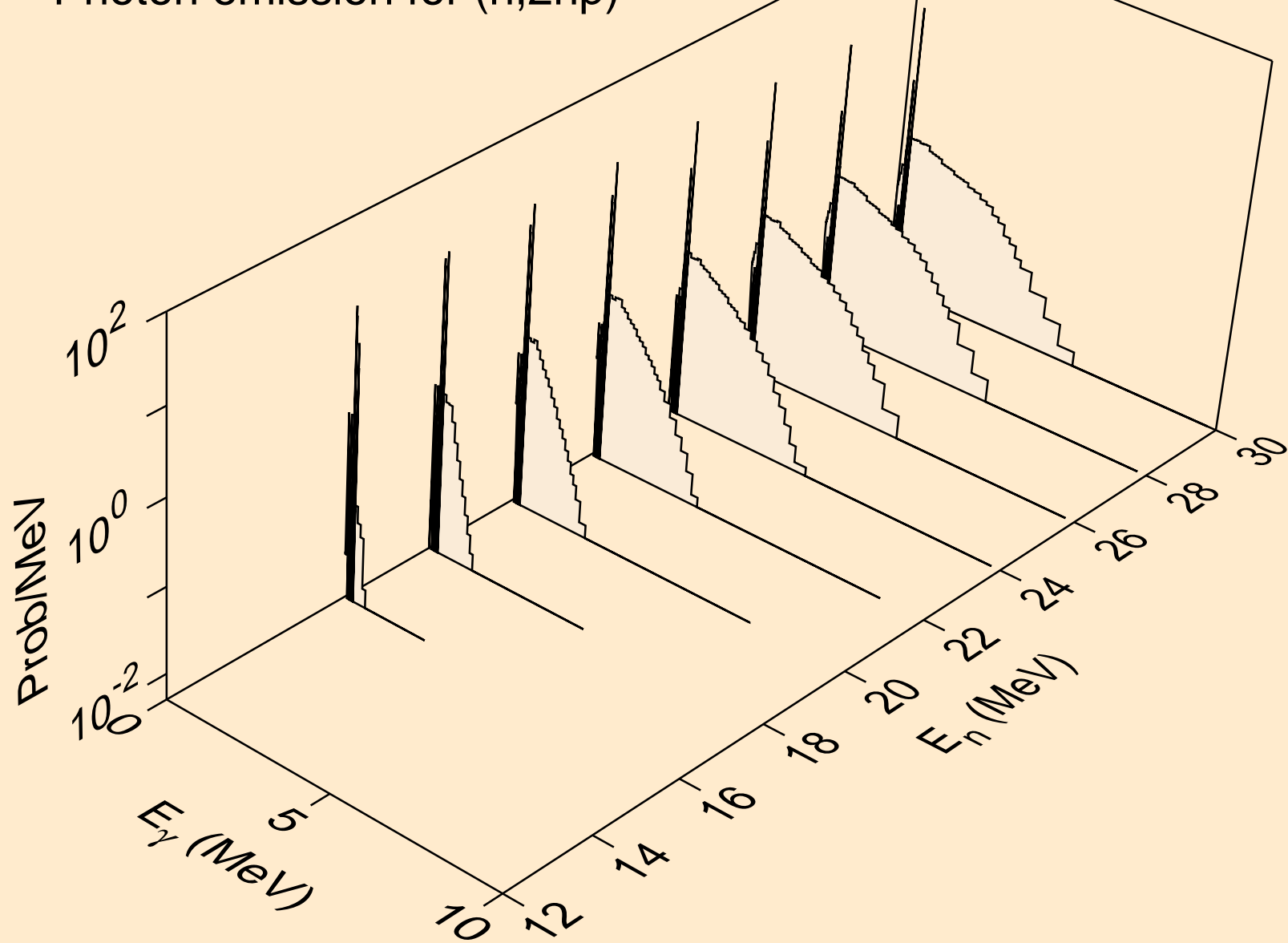

ND133 NEUTRON ACER TENDL-2021 LIBRARY; T=293.6K
Photon emission for (n,3np)

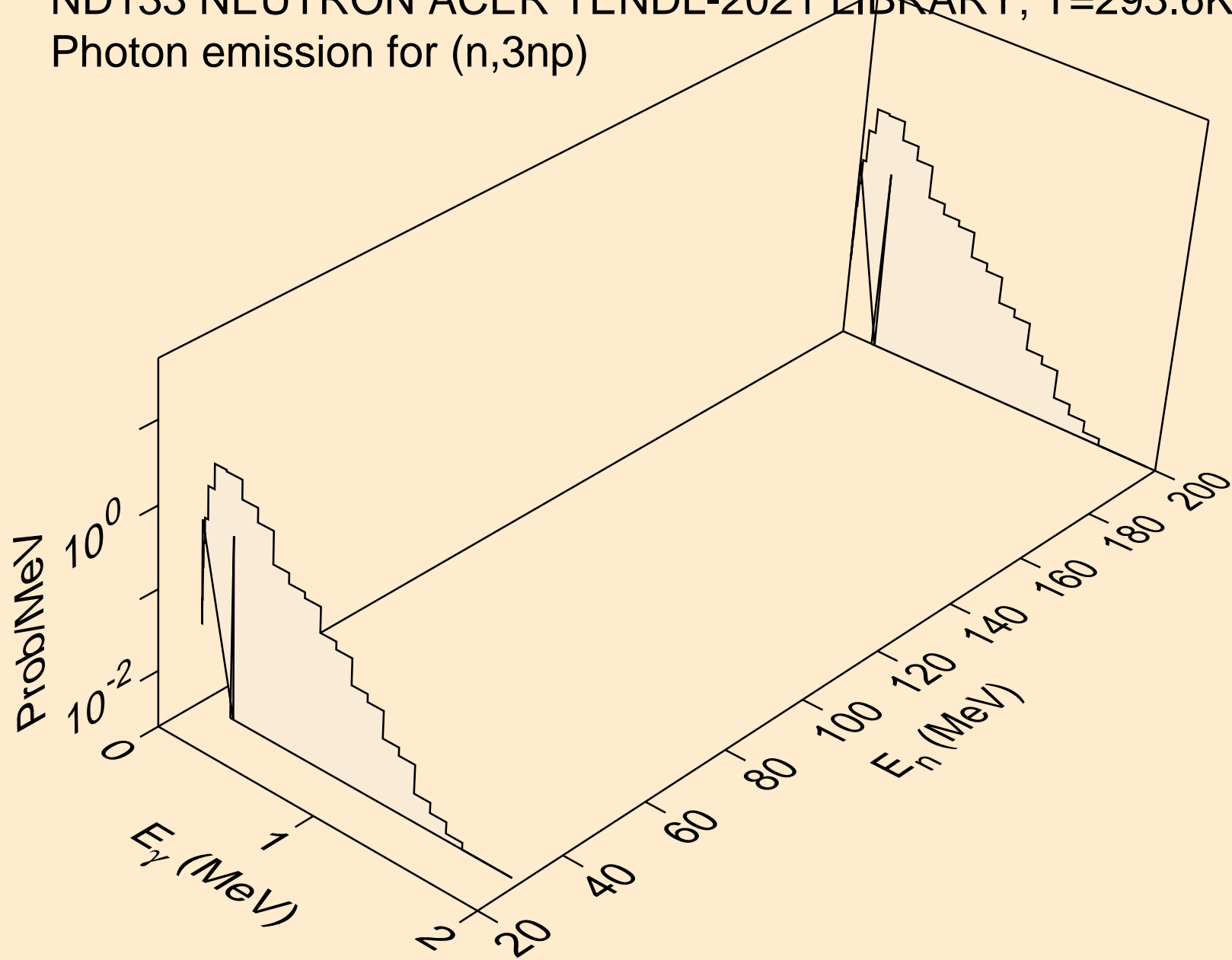

ND133 NEUTRON ACER TENDL-2021 LIBRARY; T=293.6K
Photon emission for (n,2np)

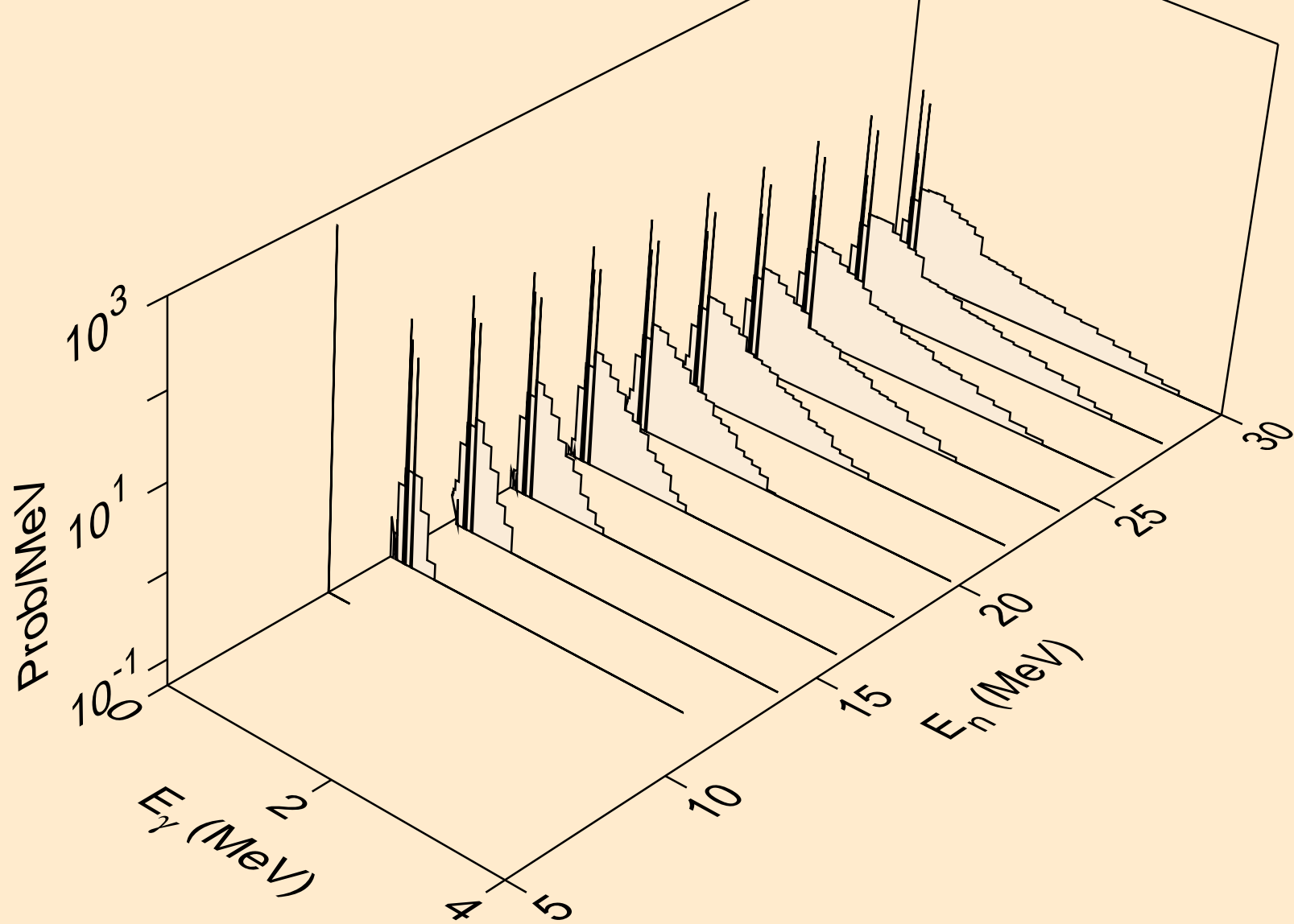

ND133 NEUTRON ACER TENDL-2021 LIBRARY; T=293.6K
Photon emission for (n,npa)

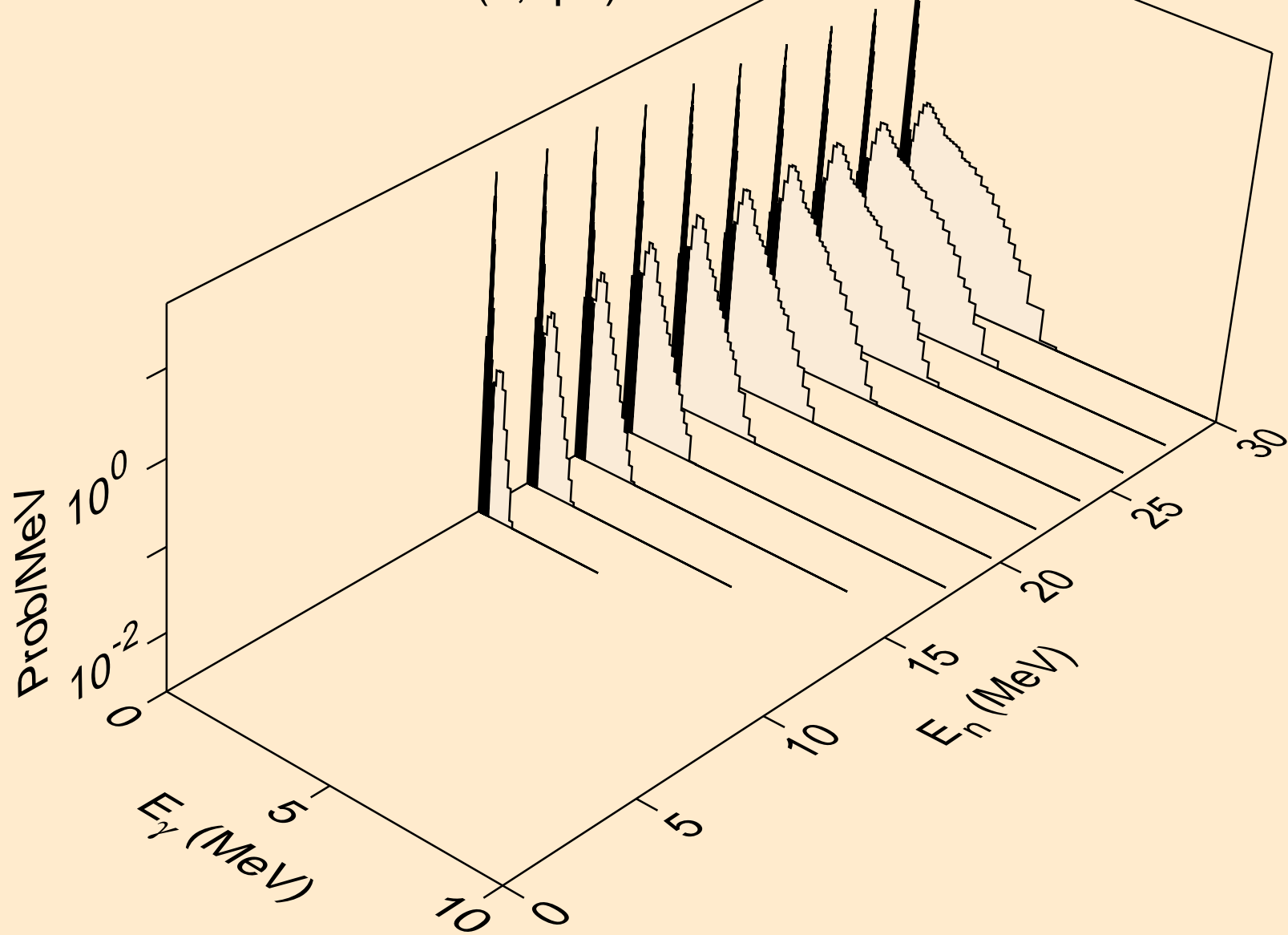

ND133 NEUTRON ACER TENDL-2021 LIBRARY; T=293.6K
Photon emission for (n,n*c)

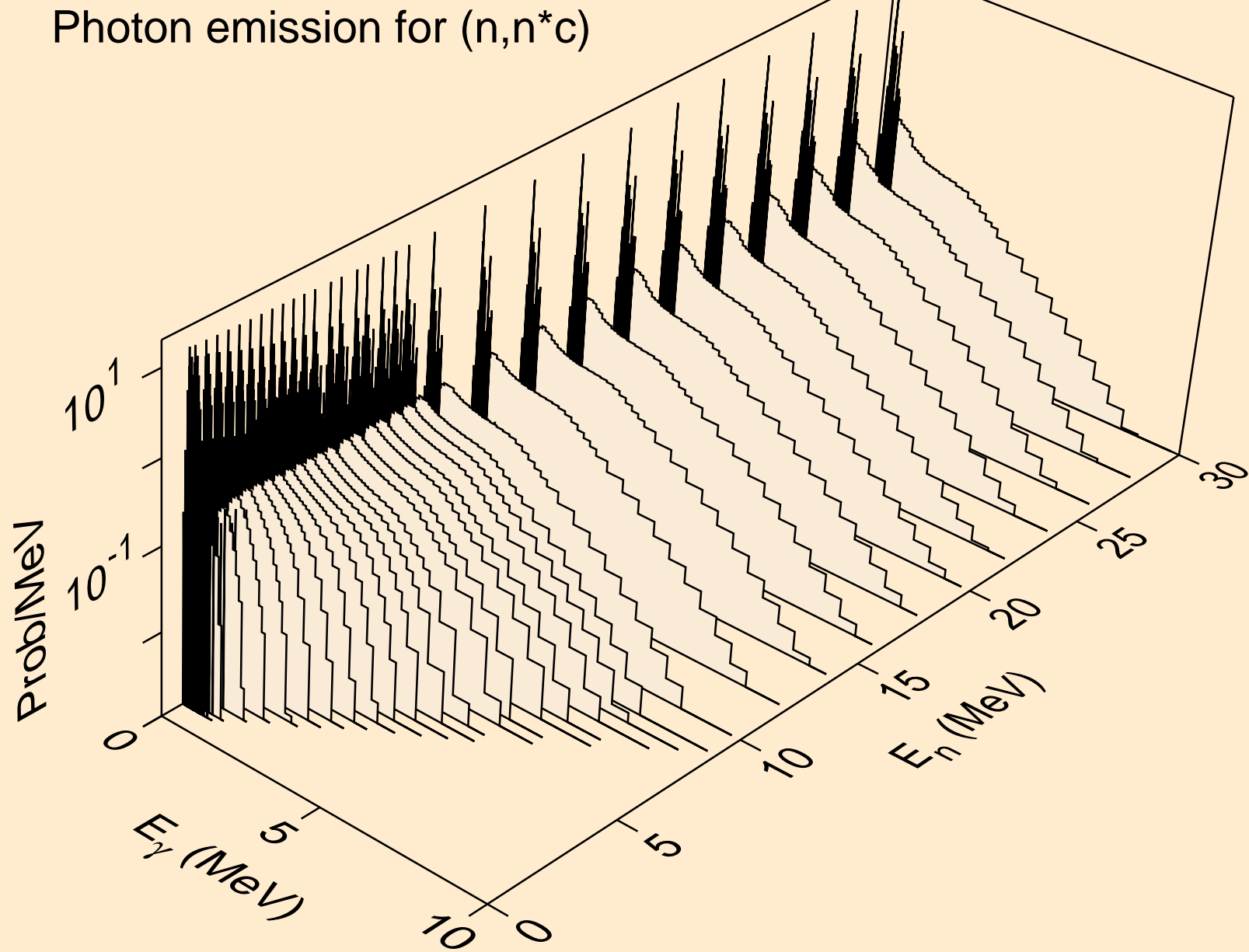

ND133 NEUTRON ACER TENDL-2021 LIBRARY; T=293.6K
Photon emission for (n,gma)

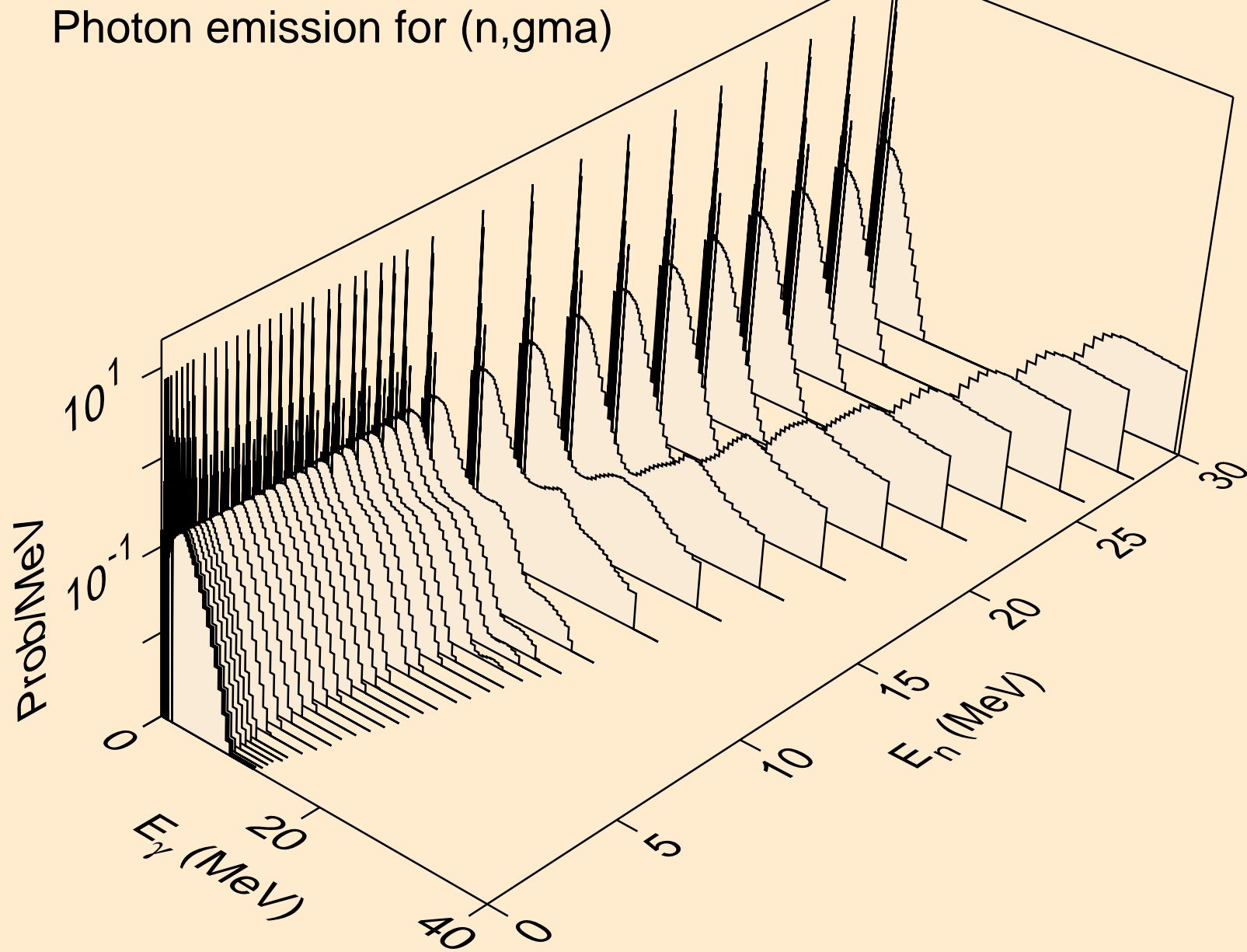

ND133 NEUTRON ACER TENDL-2021 LIBRARY; T=293.6K
Photon emission for (n,p)

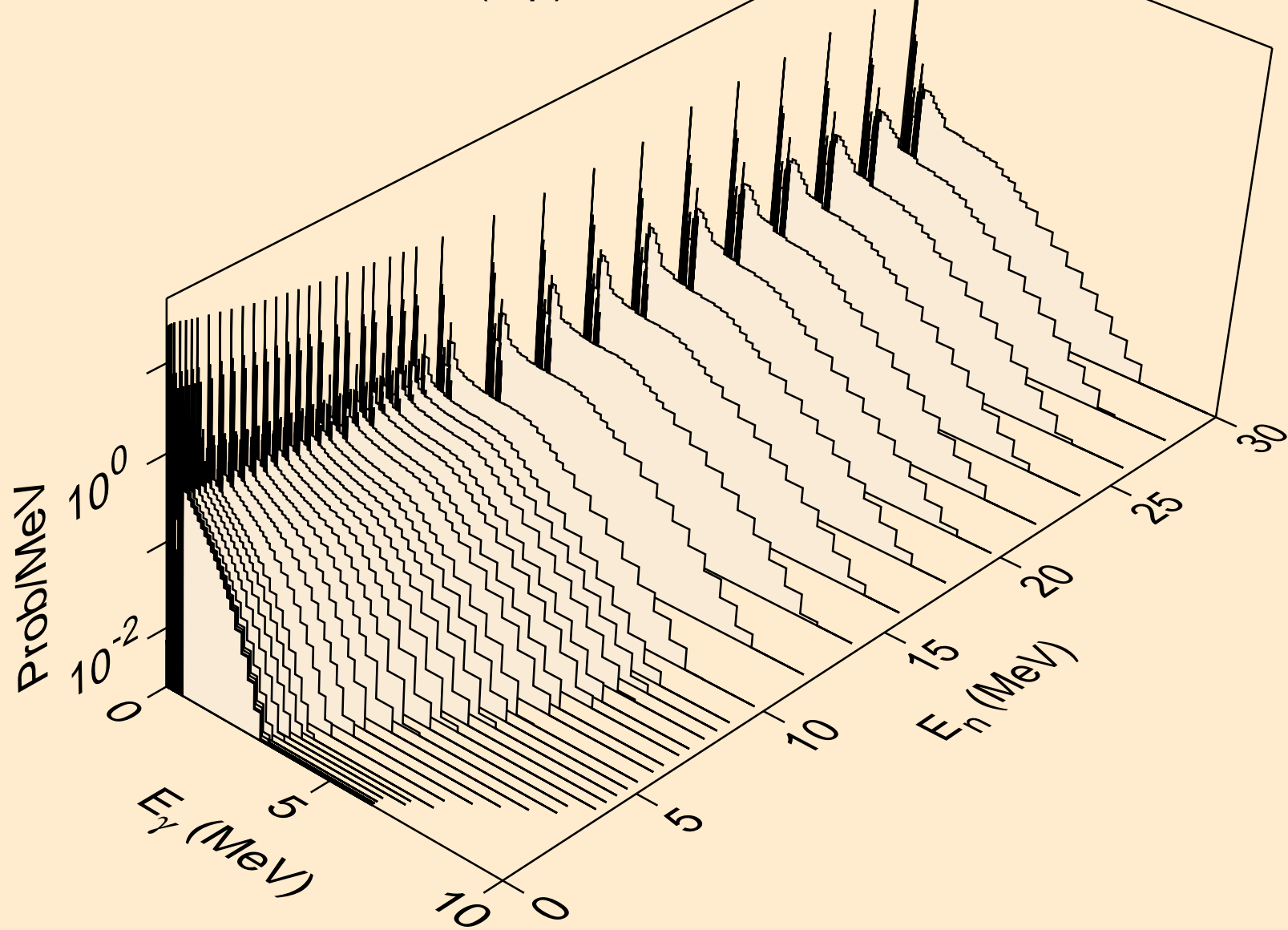

ND133 NEUTRON ACER TENDL-2021 LIBRARY; T=293.6K
Photon emission for (n,d)

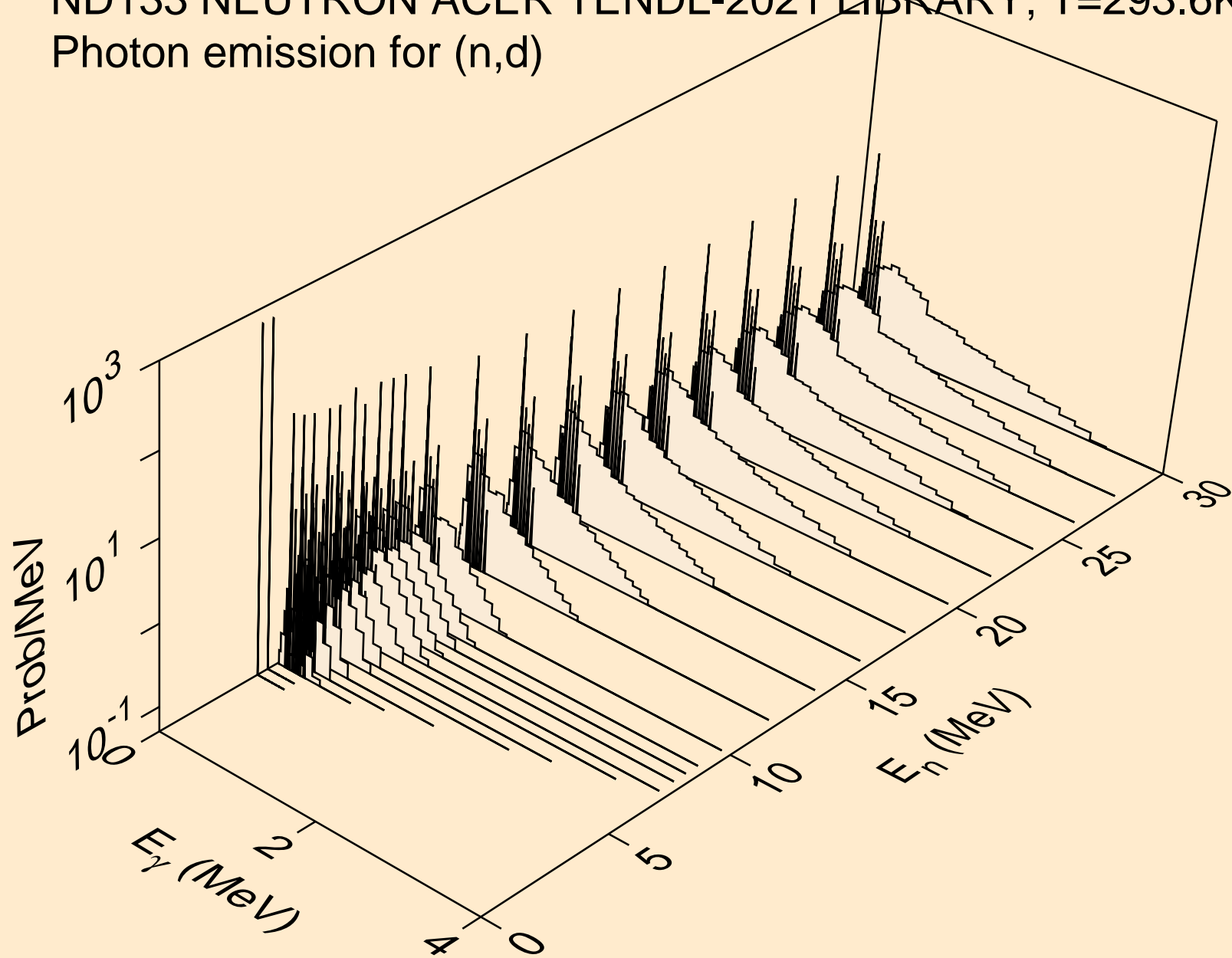

ND133 NEUTRON ACER TENDL-2021 LIBRARY; T=293.6K
Photon emission for (n,t)

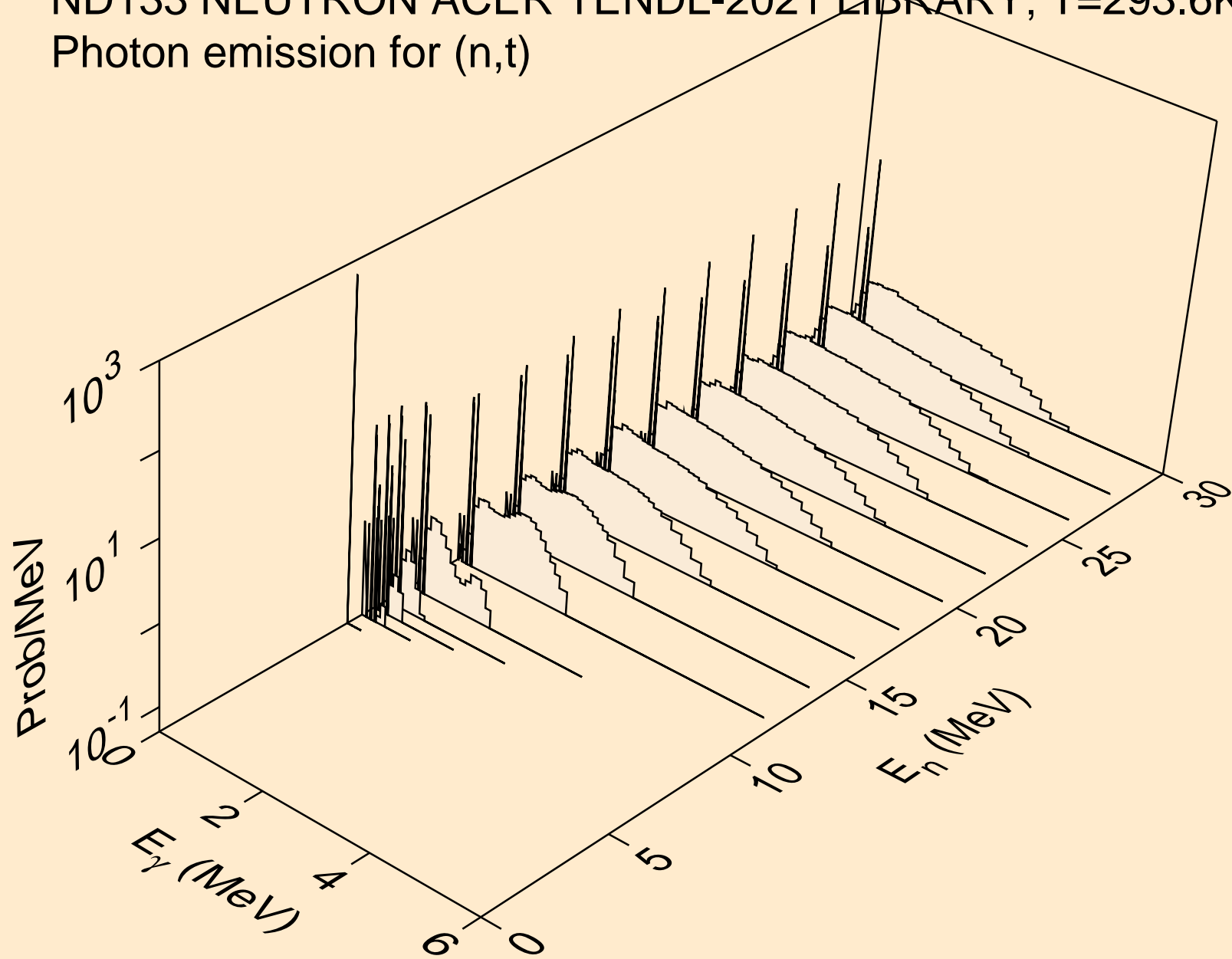

ND133 NEUTRON ACER TENDL-2021 LIBRARY; T=293.6K
Photon emission for (n,he3)

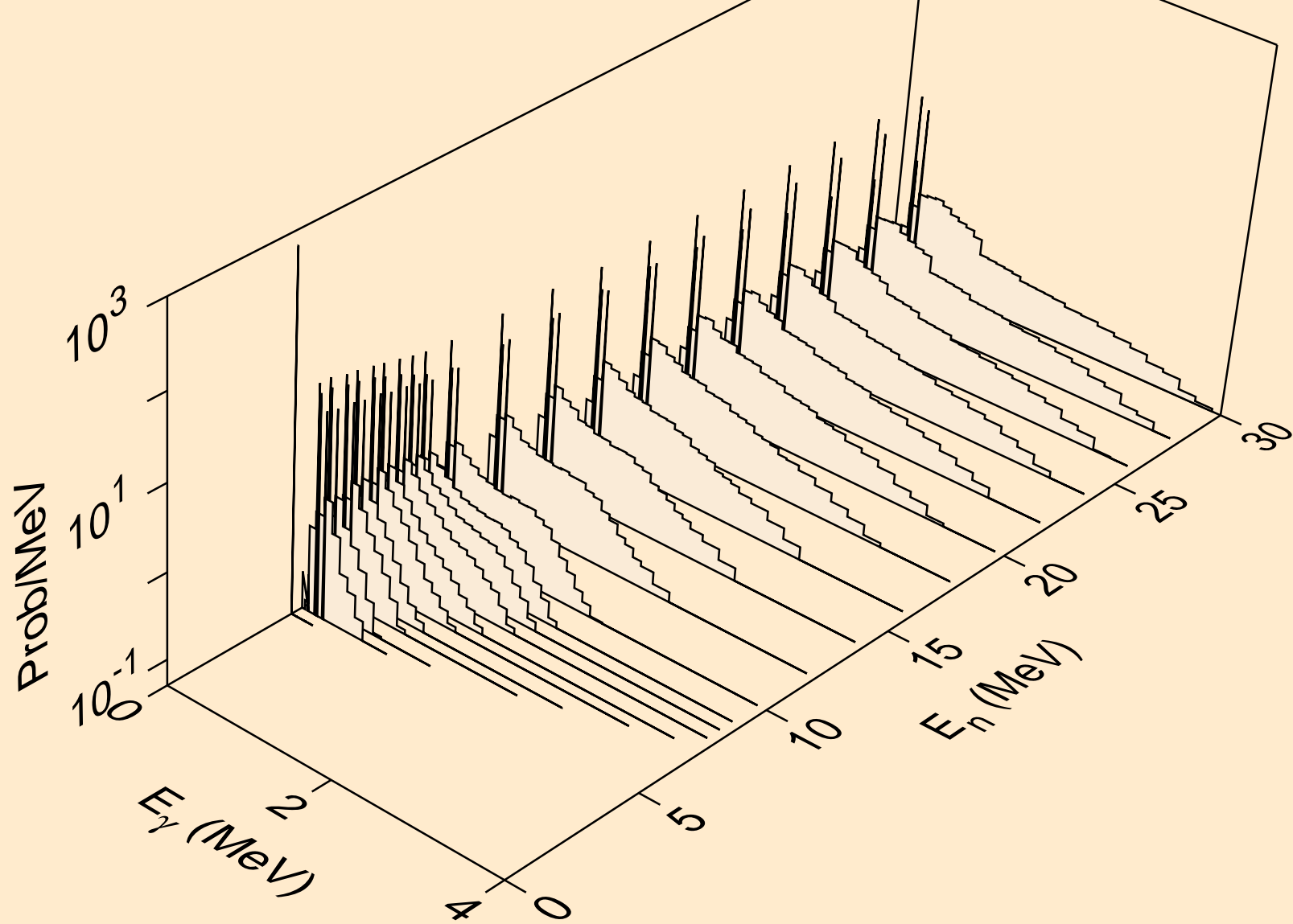

ND133 NEUTRON ACER TENDL-2021 LIBRARY; T=293.6K
Photon emission for (n,a)

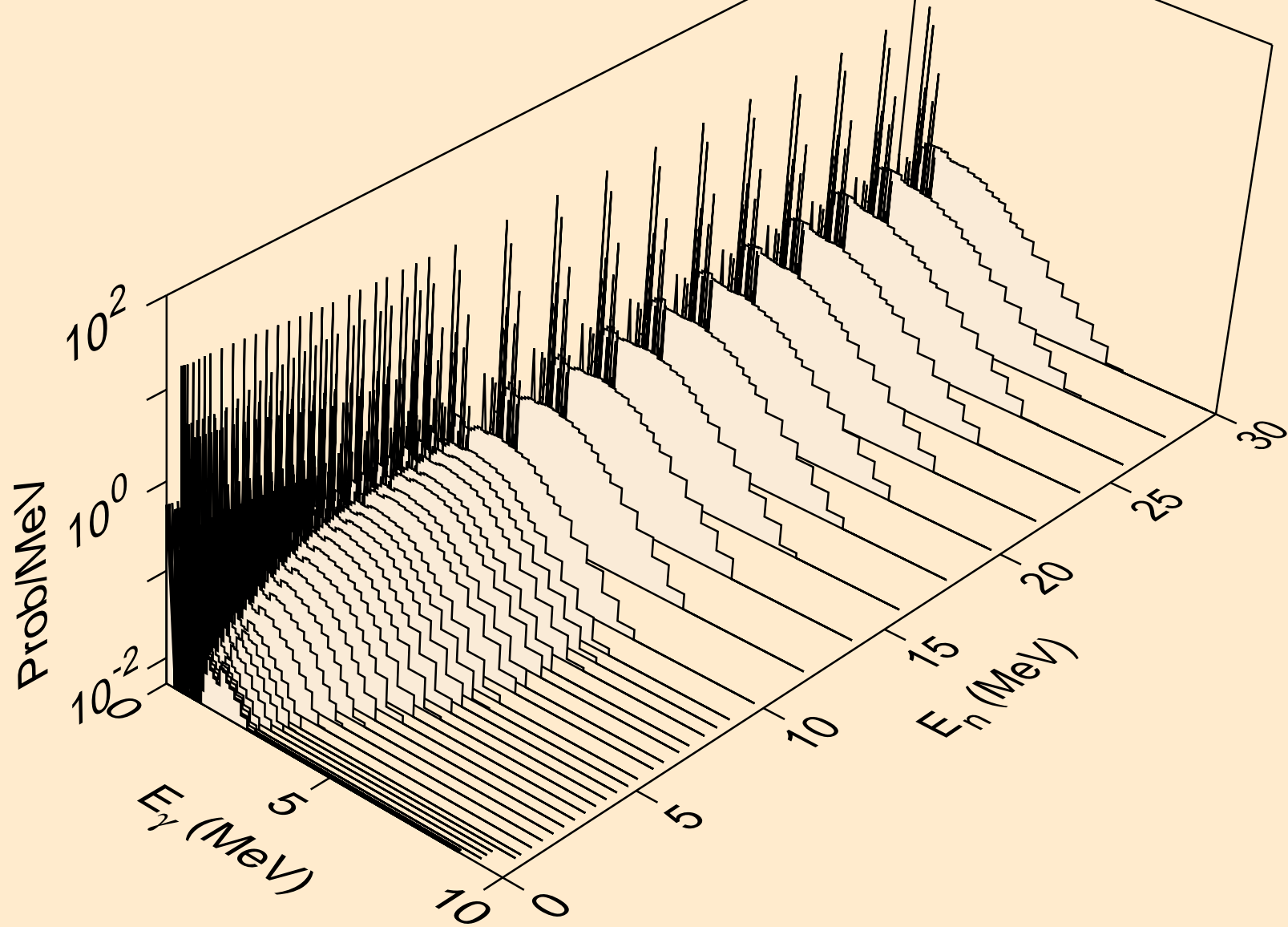

ND133 NEUTRON ACER TENDL-2021 LIBRARY; T=293.6K
Photon emission for (n,2a)

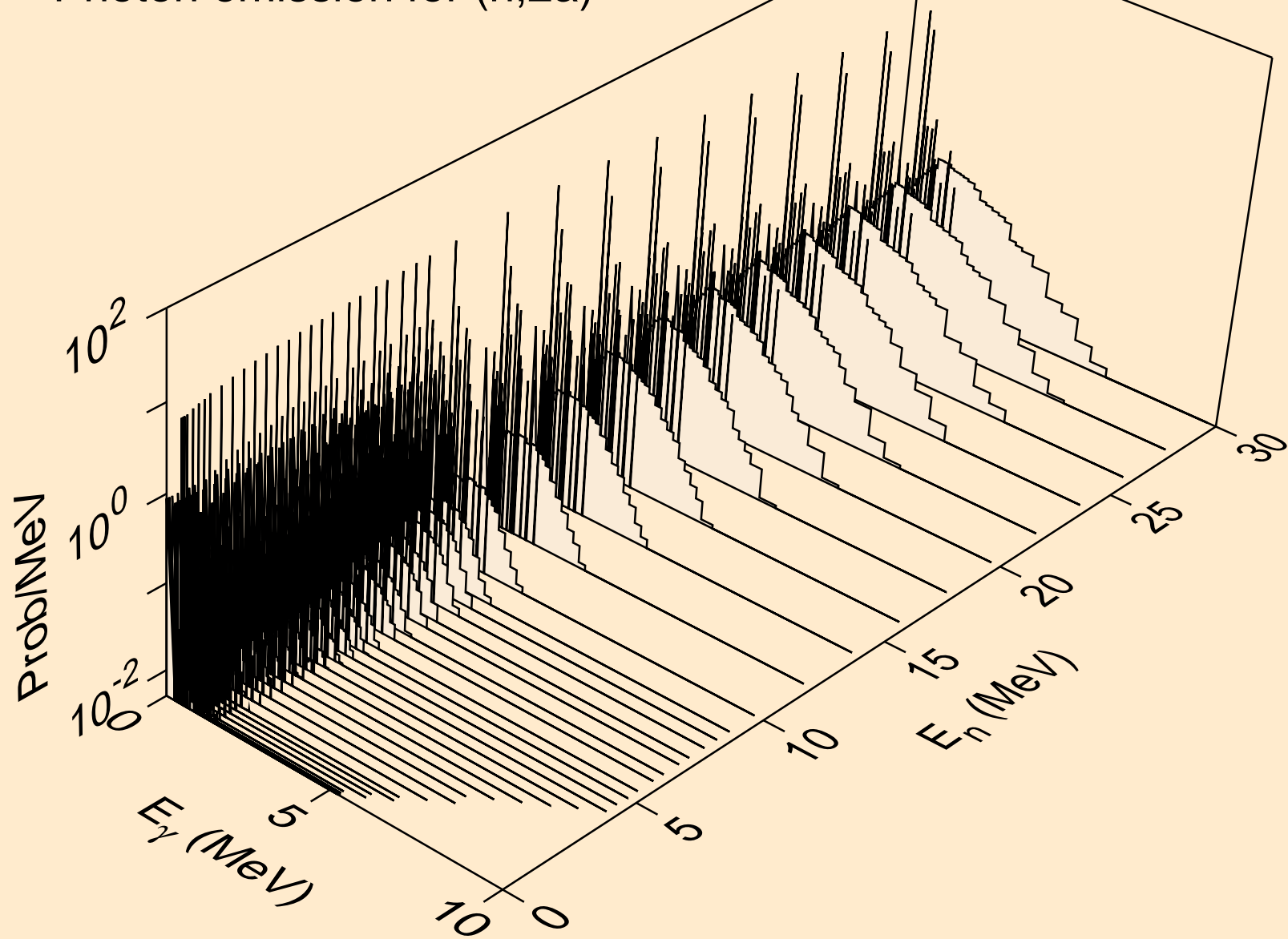

ND133 NEUTRON ACER TENDL-2021 LIBRARY; T=293.6K
Photon emission for (n,3a)

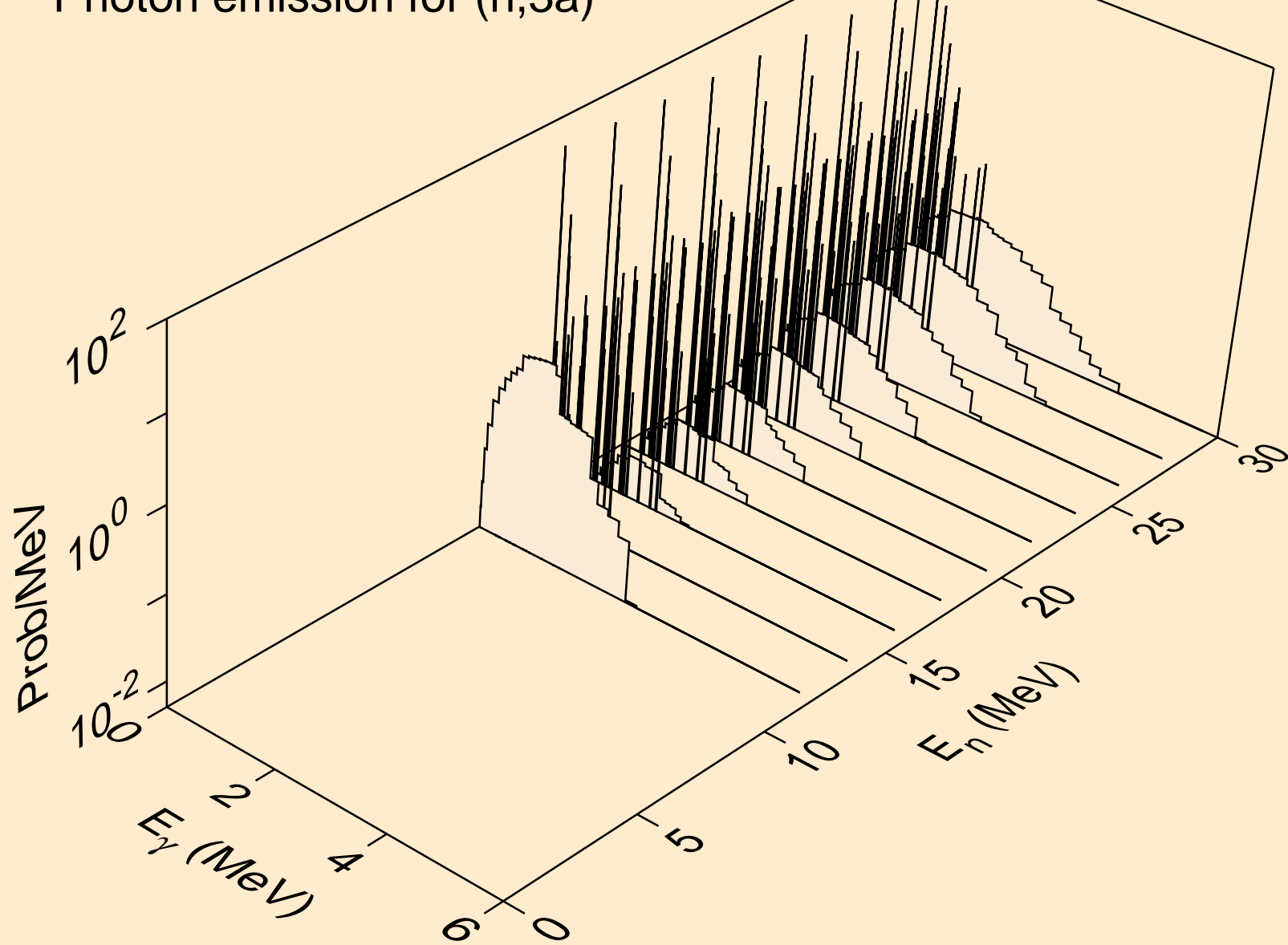

ND133 NEUTRON ACER TENDL-2021 LIBRARY; T=293.6K
Photon emission for (n,2p)

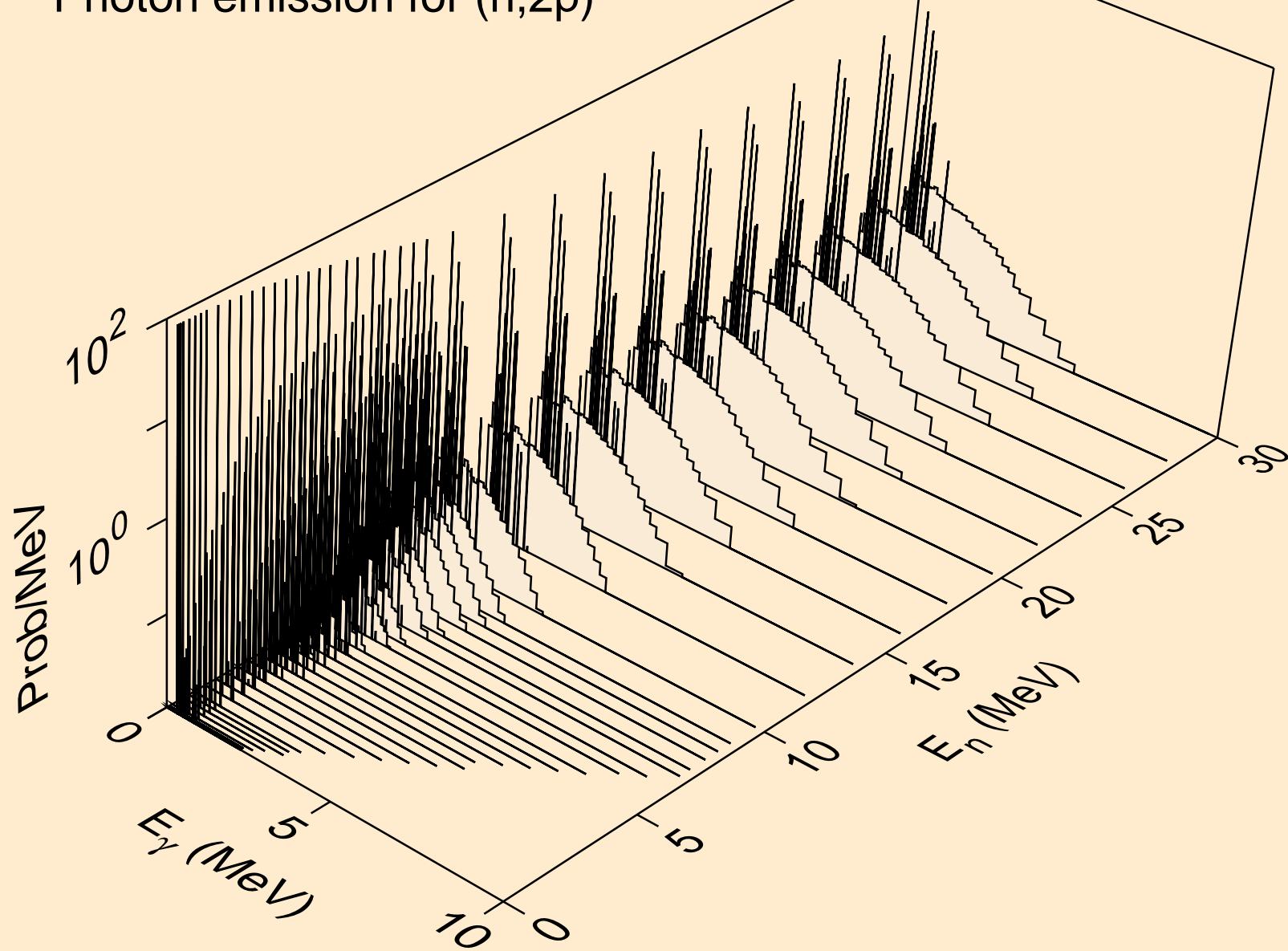

ND133 NEUTRON ACER TENDL-2021 LIBRARY; T=293.6K
Photon emission for (n,p)

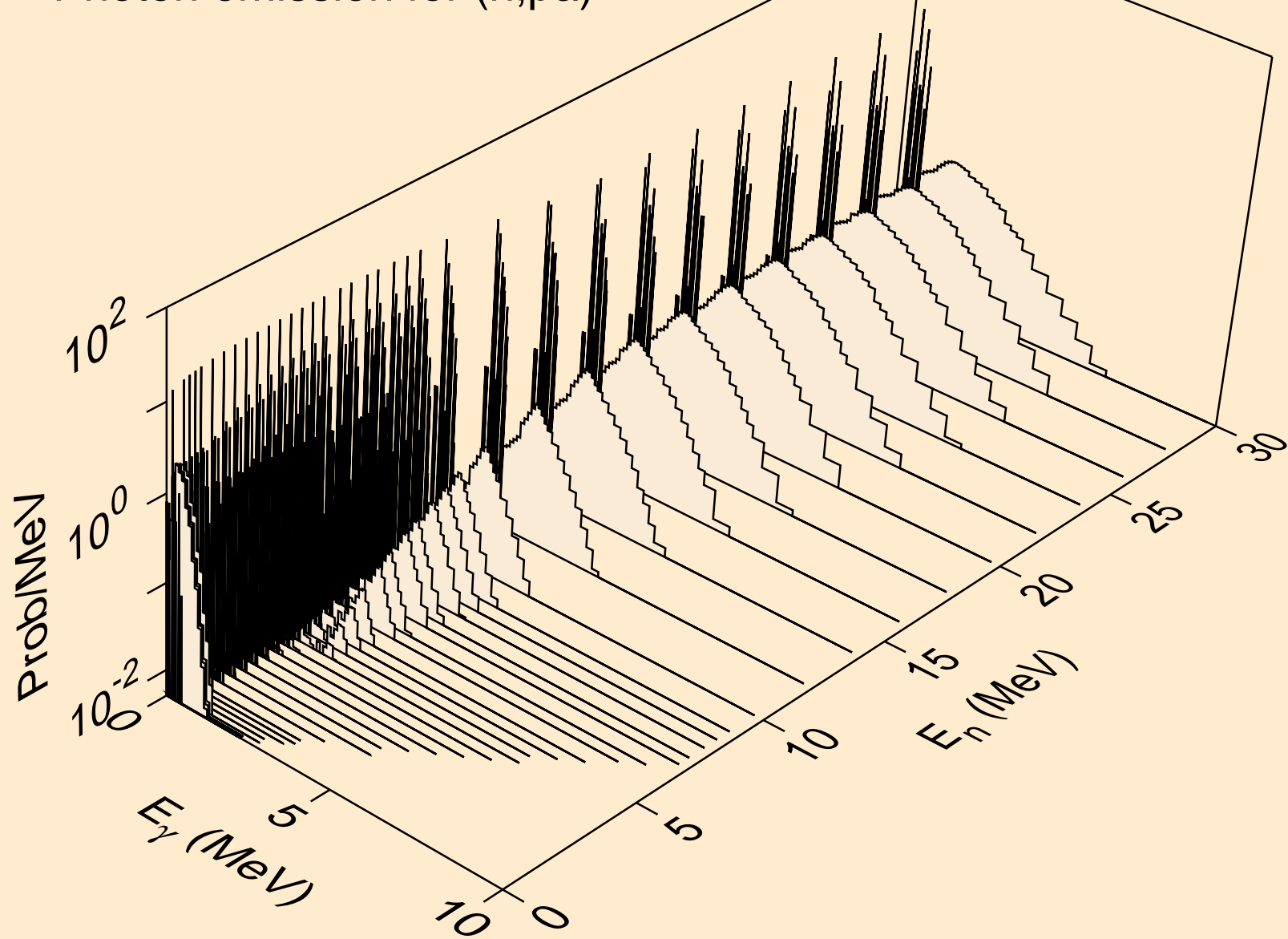

ND133 NEUTRON ACER TENDL-2021 LIBRARY; T=293.6K
Photon emission for (n,pd)

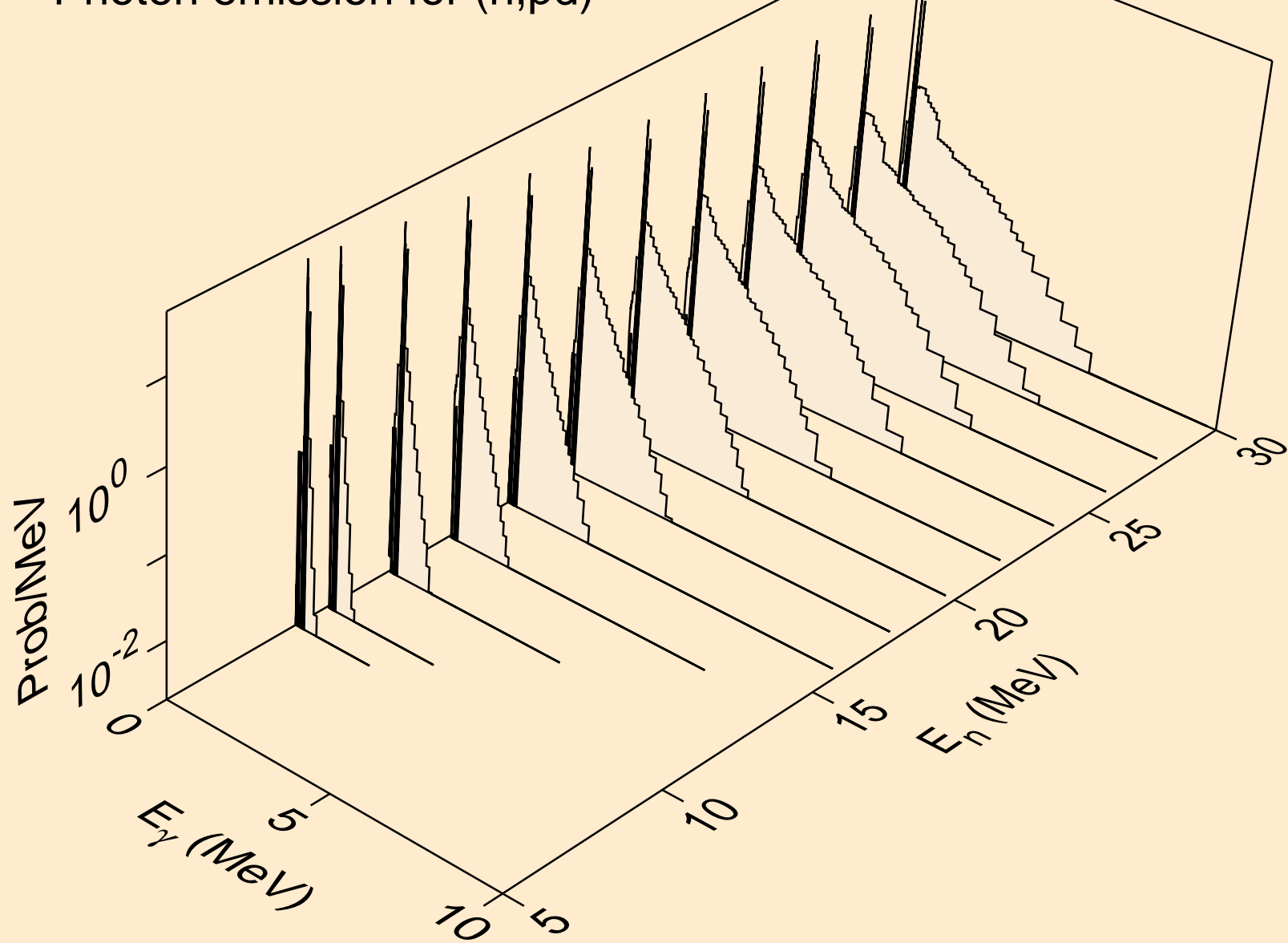

ND133 NEUTRON ACER TENDL-2021 LIBRARY; T=293.6K
Photon emission for (n,pt)

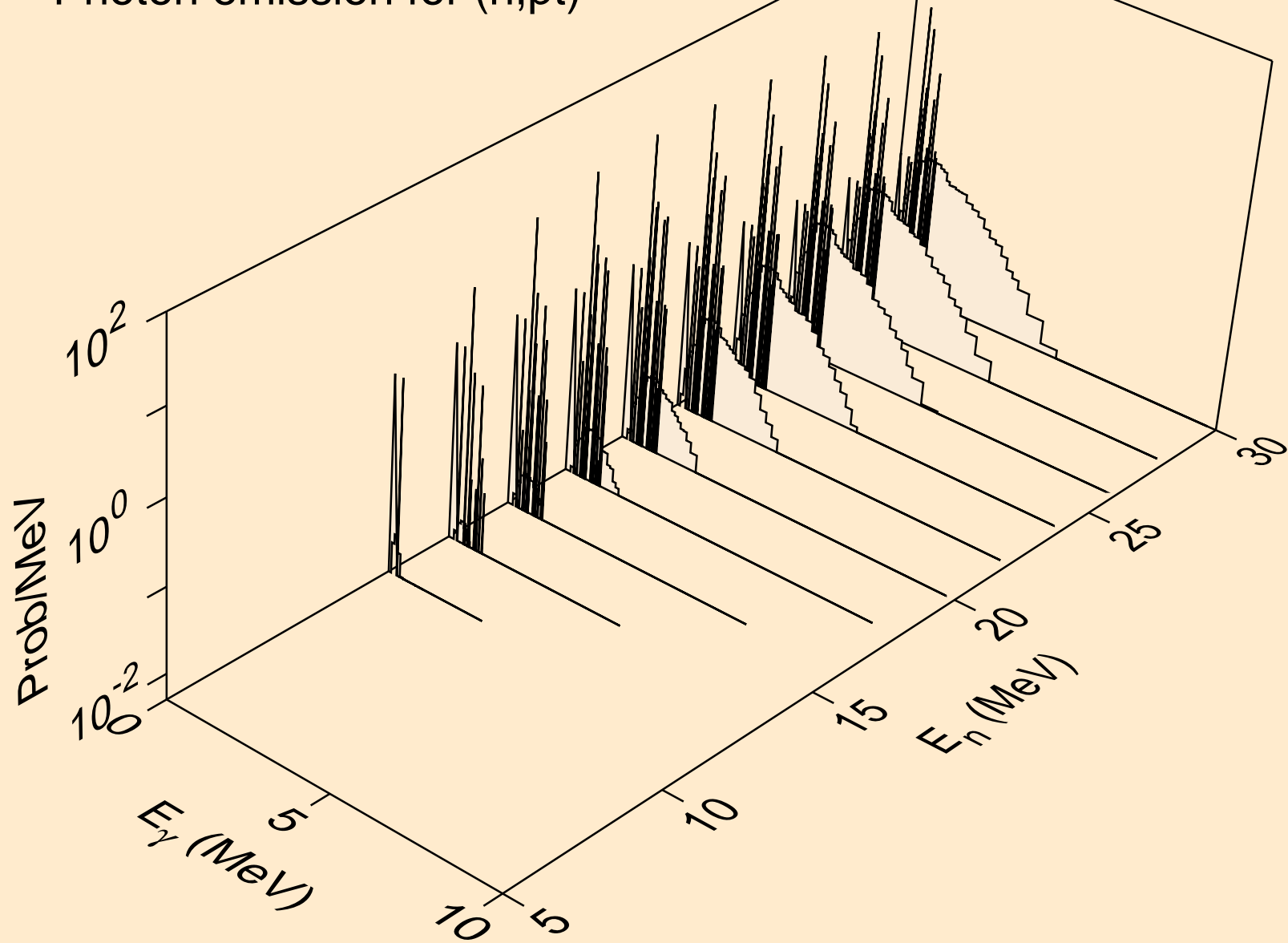

ND133 NEUTRON ACER TENDL-2021 LIBRARY; T=293.6K
Photon emission for (n,da)

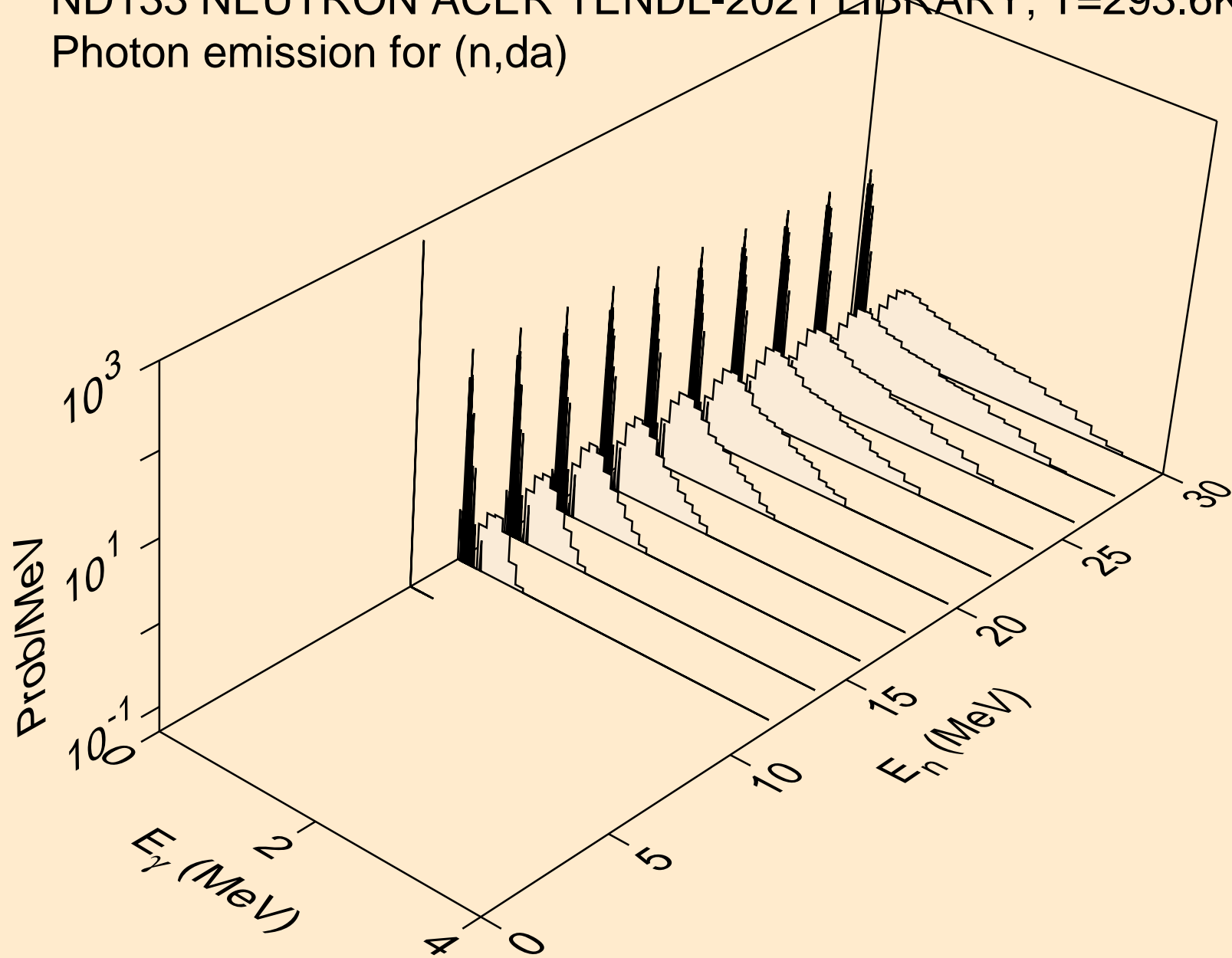

ND133 NEUTRON ACER TENDL-2021 LIBRARY; T=293.6K
thermal capture photon spectrum

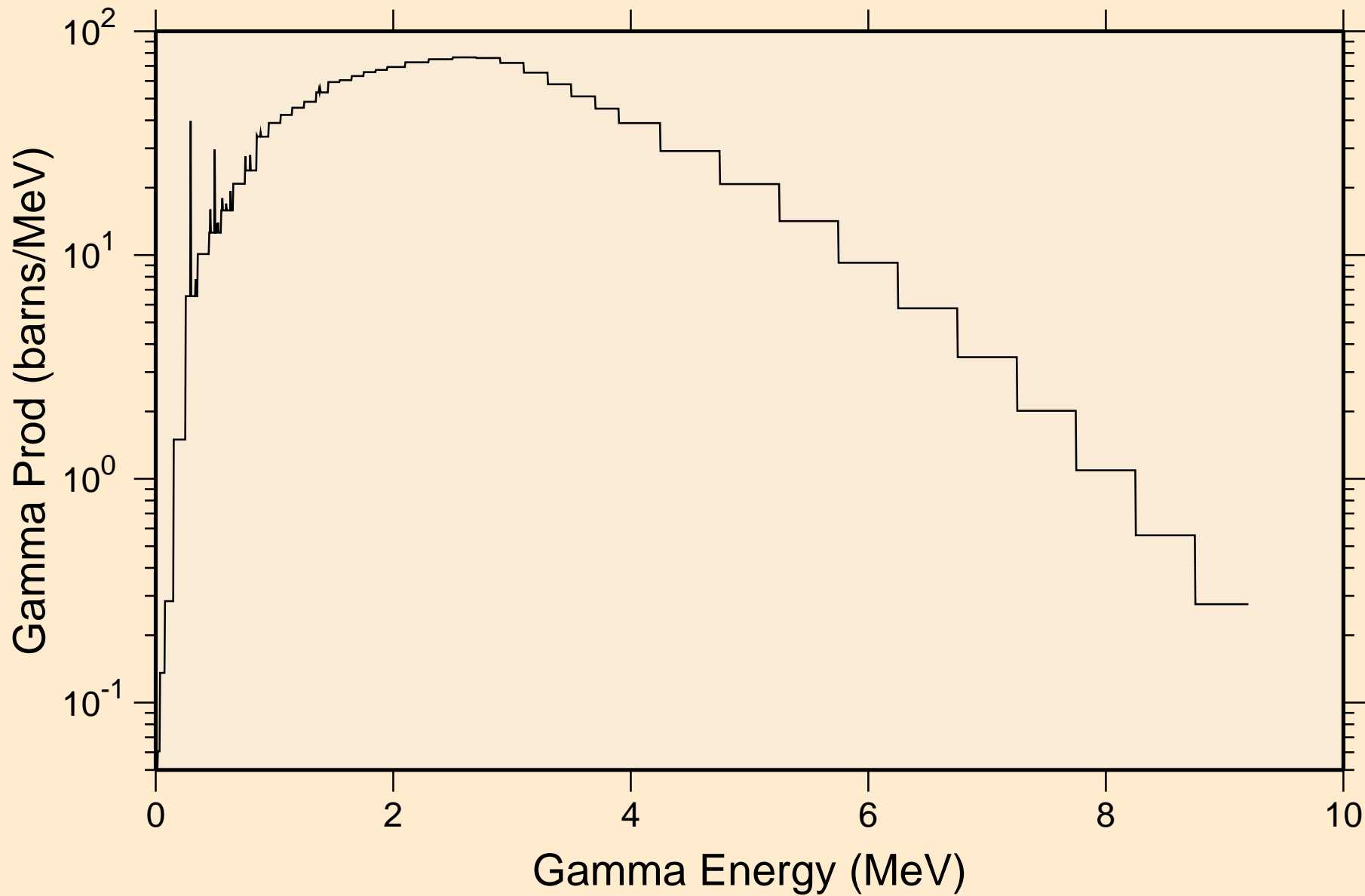

ND133 NEUTRON ACER TENDL-2021 LIBRARY; T=293.6K
14 MeV photon spectrum

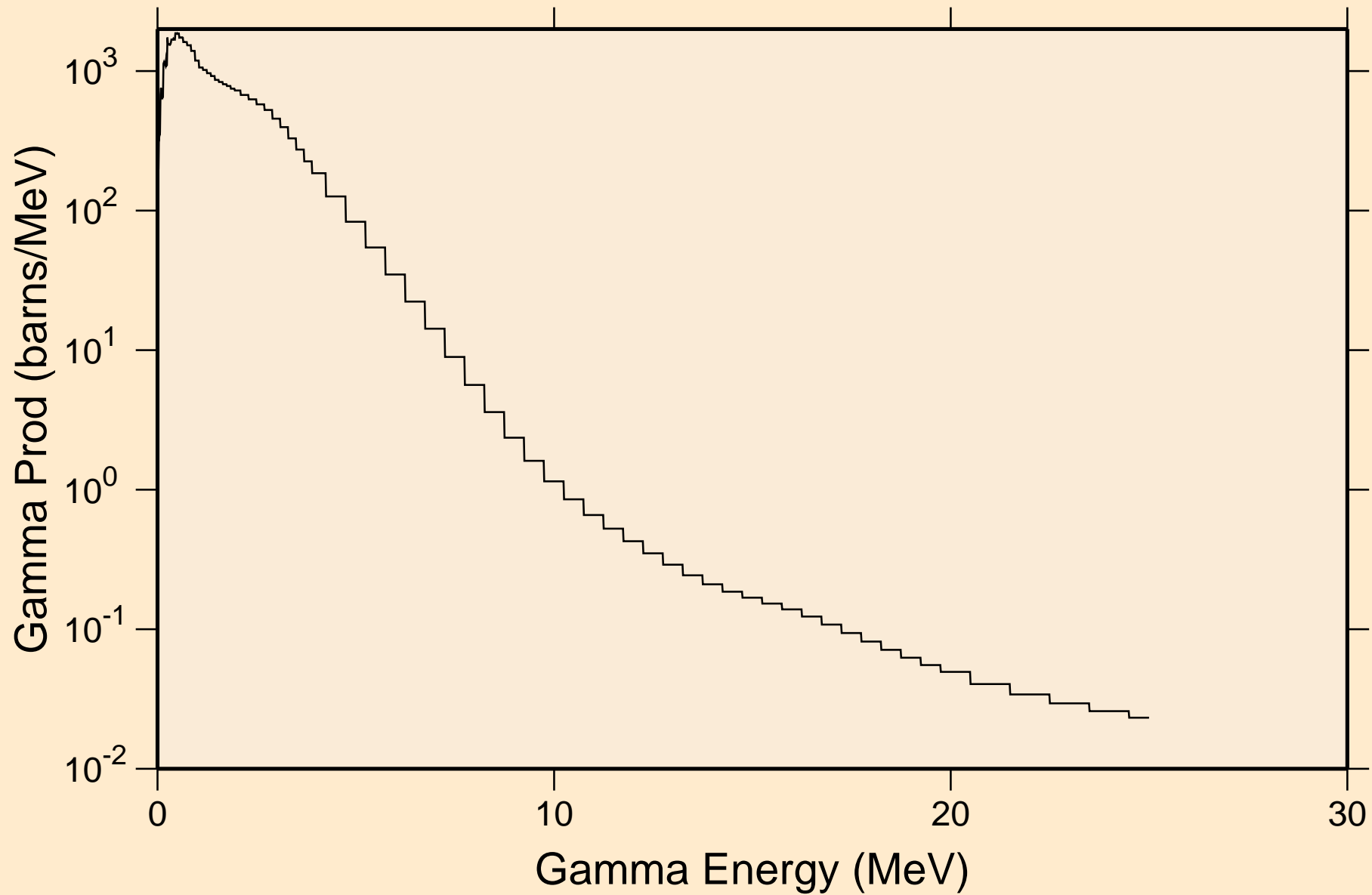

ND133 NEUTRON ACER TENDL-2021 LIBRARY; T=293.6K

Particle heating contributions

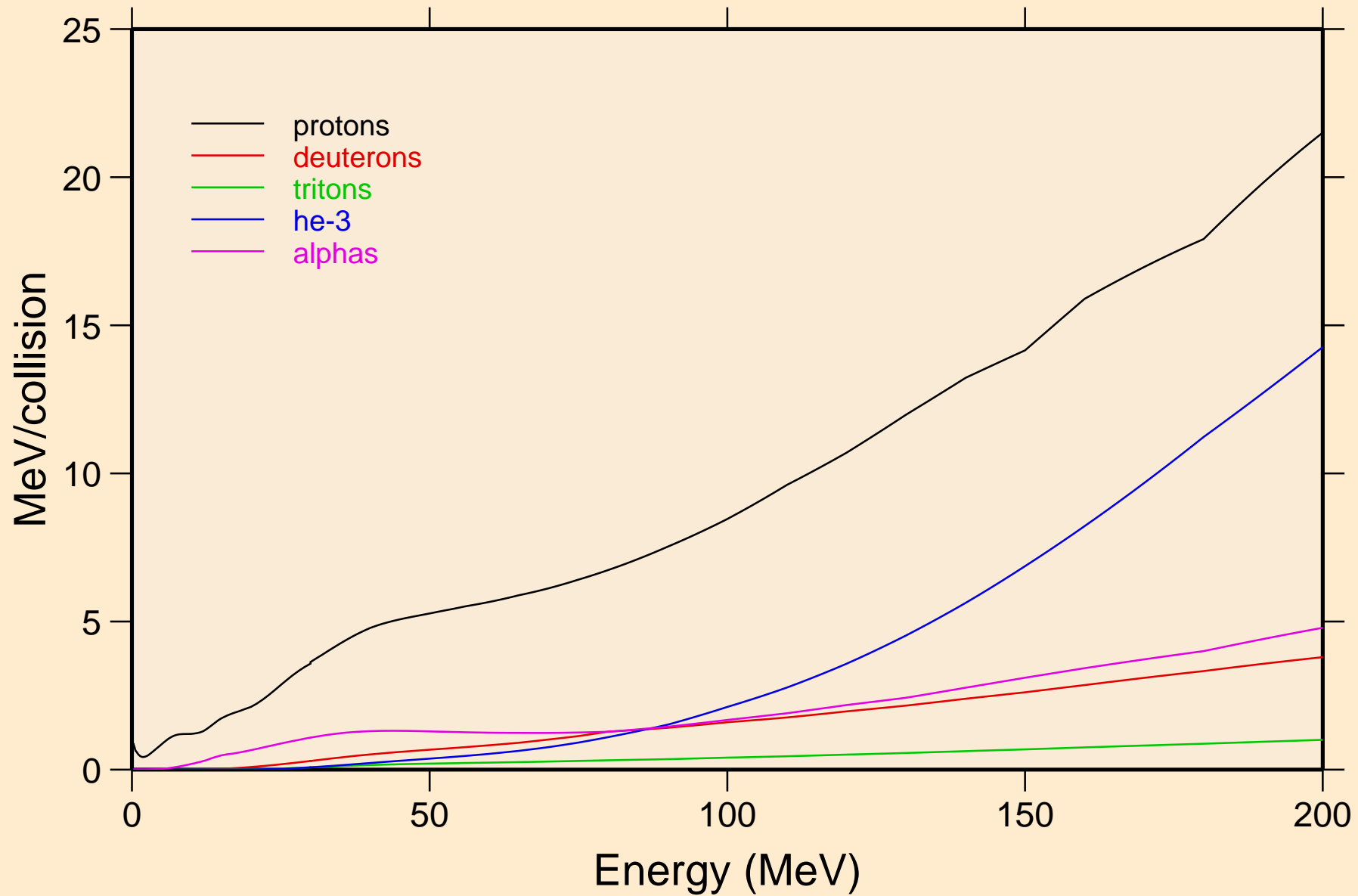

ND133 NEUTRON ACER TENDL-2021 LIBRARY; T=293.6K
Recoil Heating

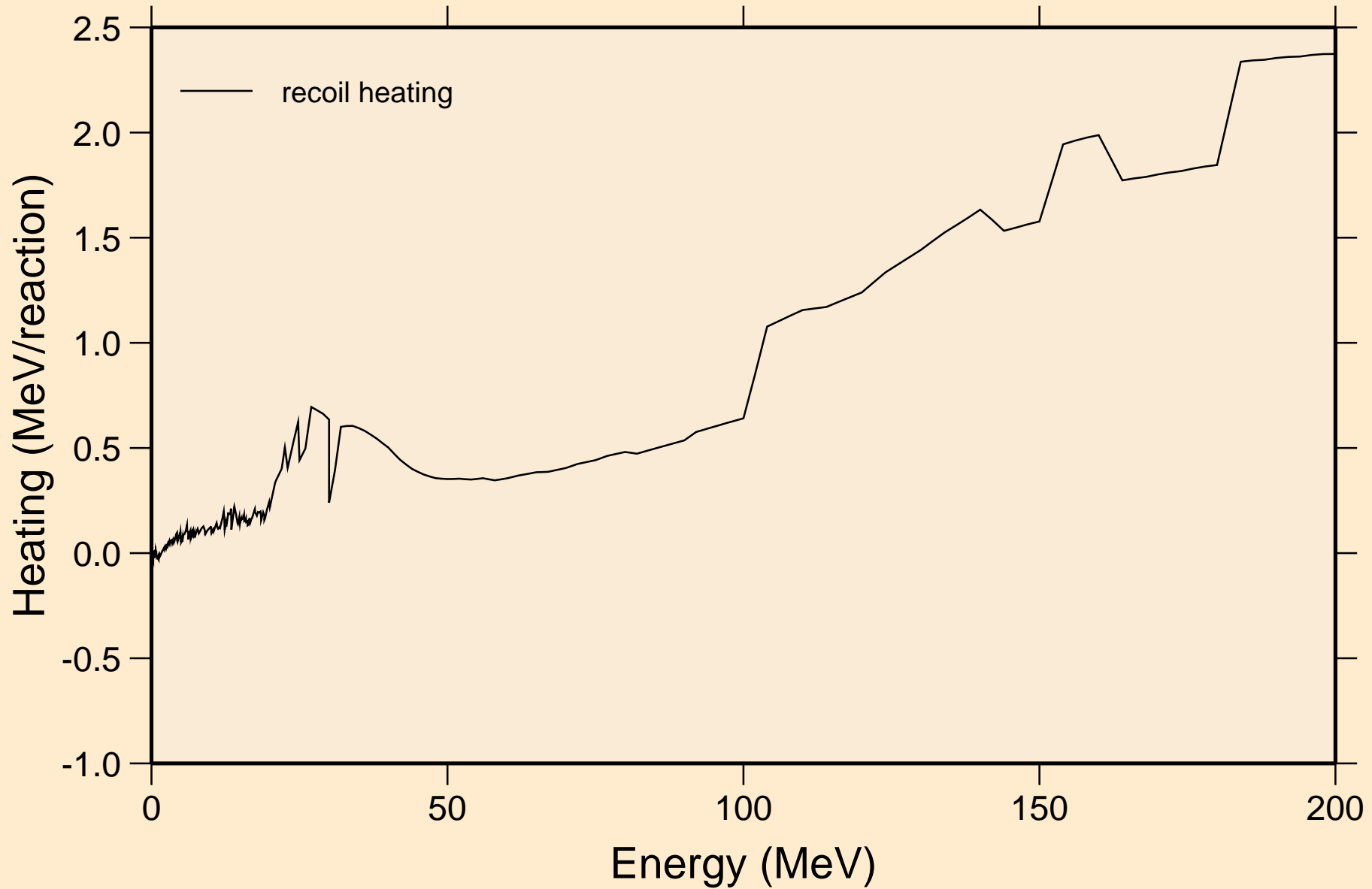

ND133 NEUTRON ACER TENDL-2021 LIBRARY; T=293.6K

Particle production cross sections

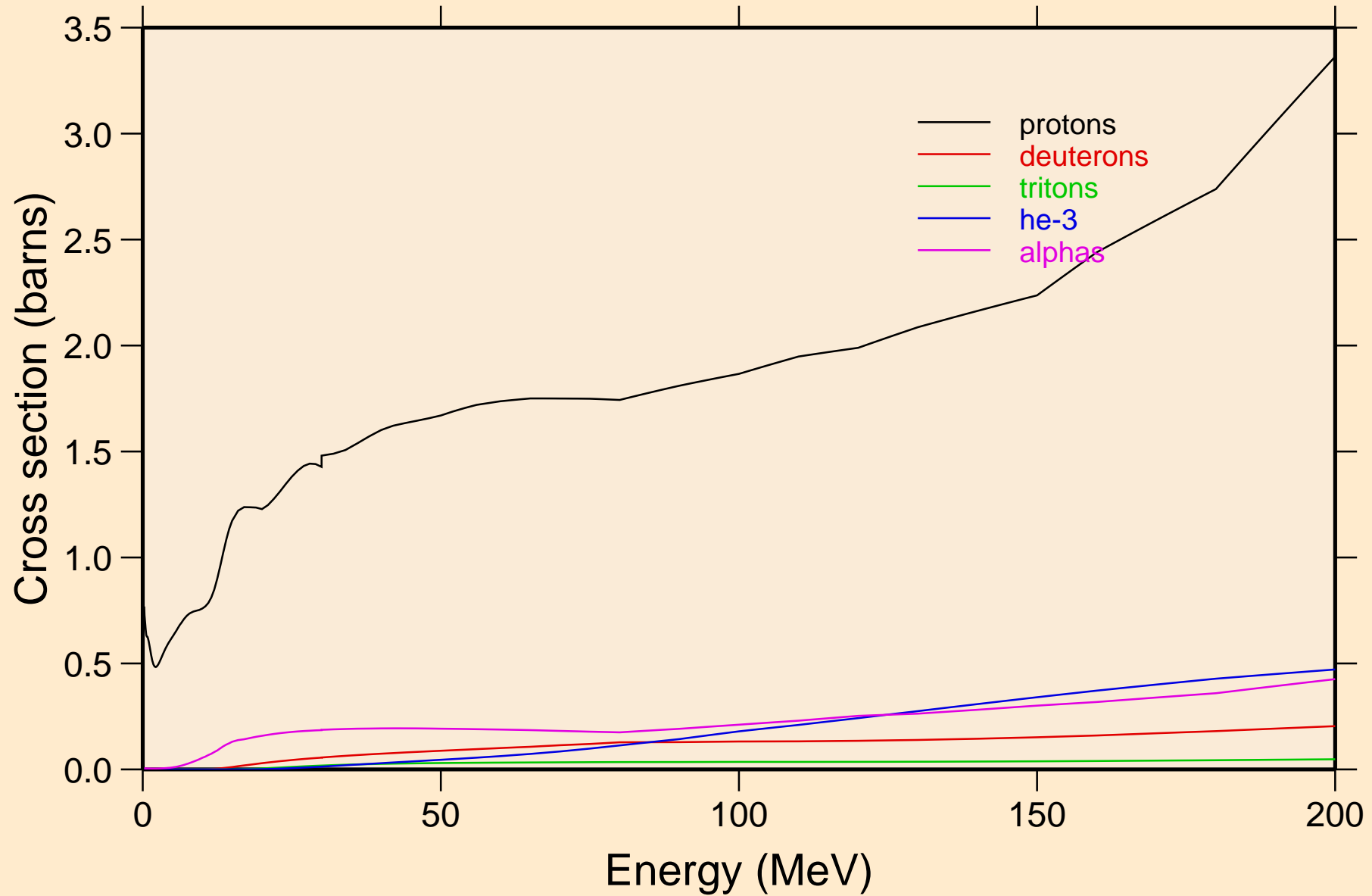

ND133 NEUTRON ACER TENDL-2021 LIBRARY; T=293.6K
protons from (n,x)

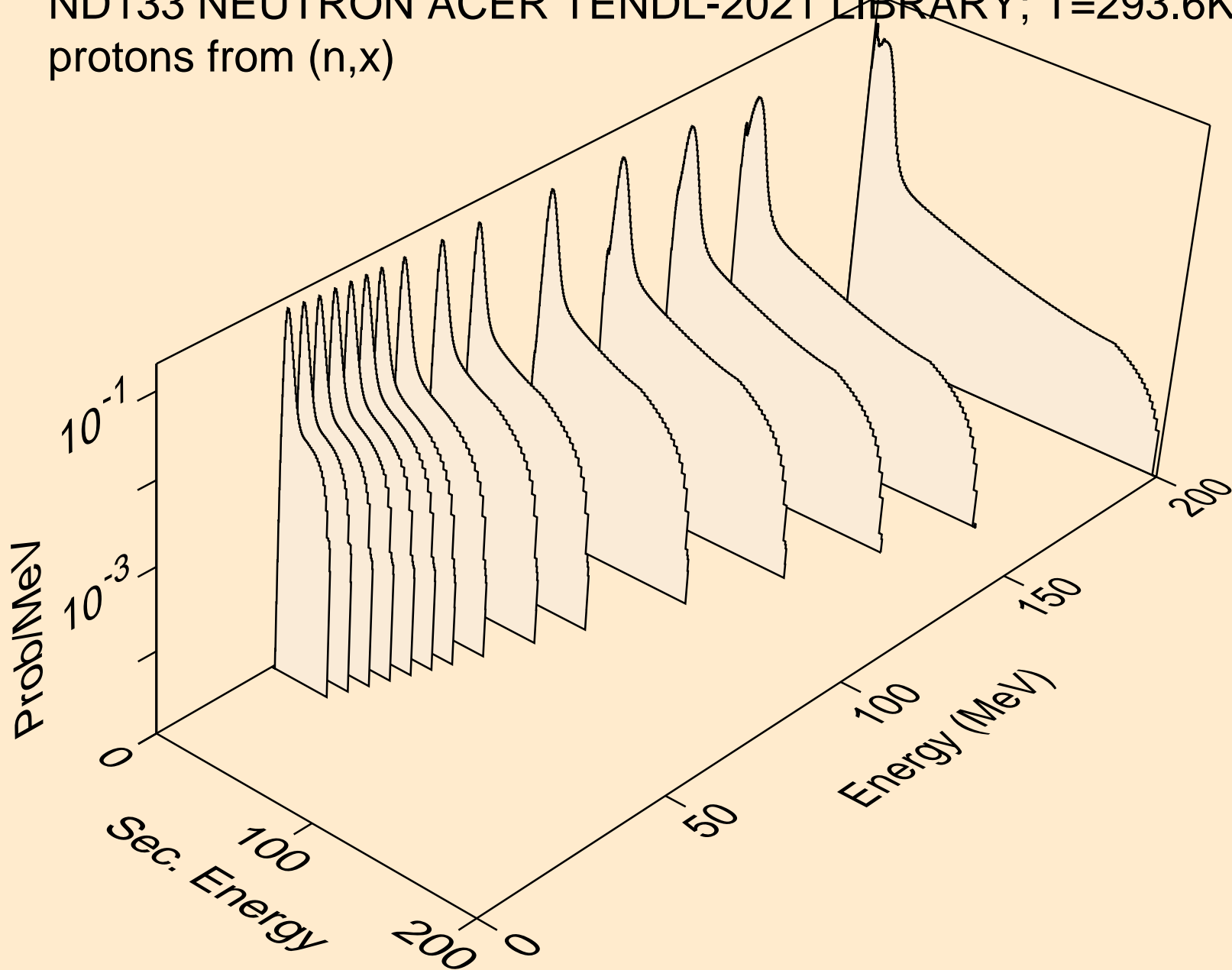

ND133 NEUTRON ACER TENDL-2021 LIBRARY; T=293.6K
protons from (n,n*)p

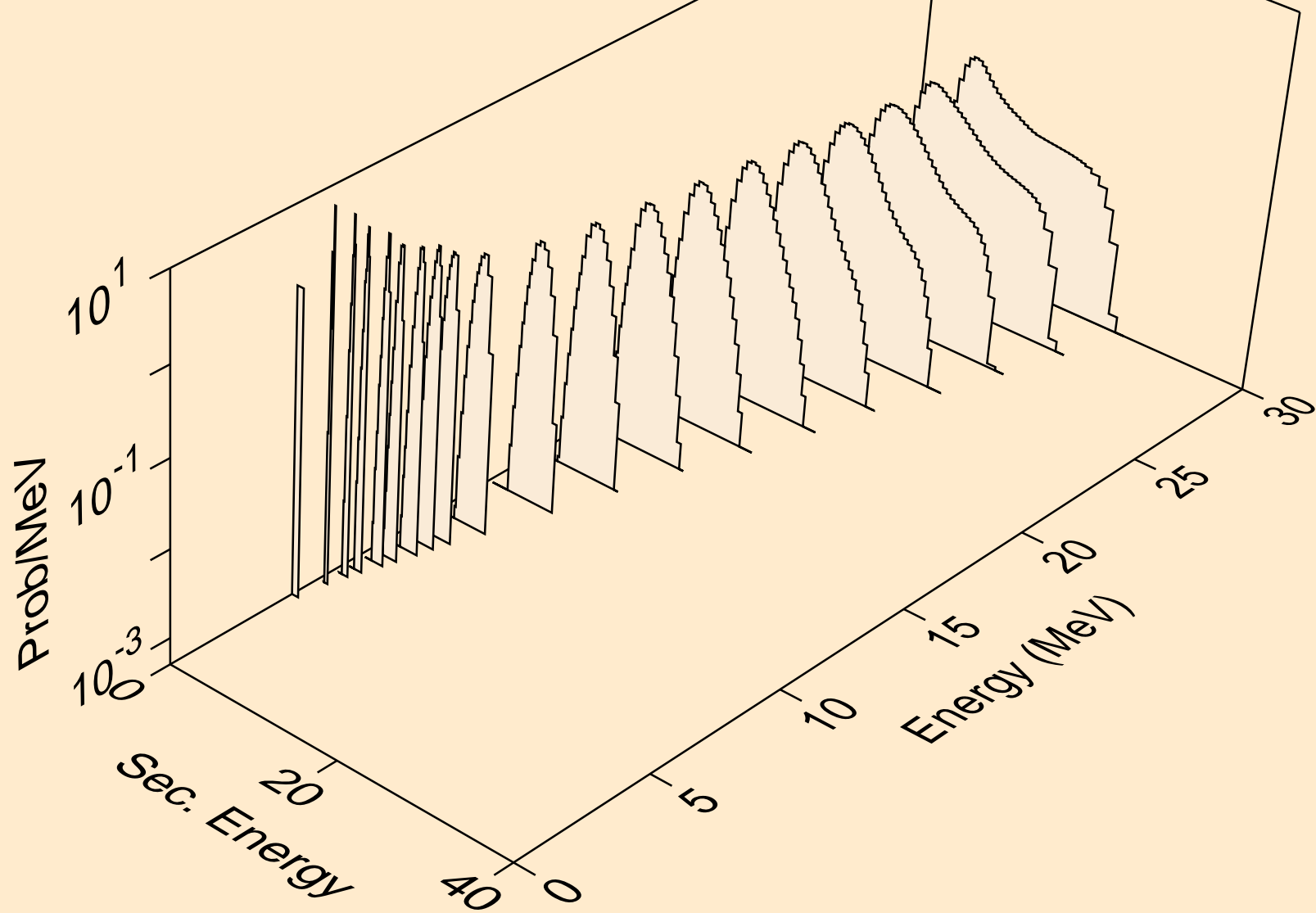

ND133 NEUTRON ACER TENDL-2021 LIBRARY; T=293.6K
protons from (n,2np)

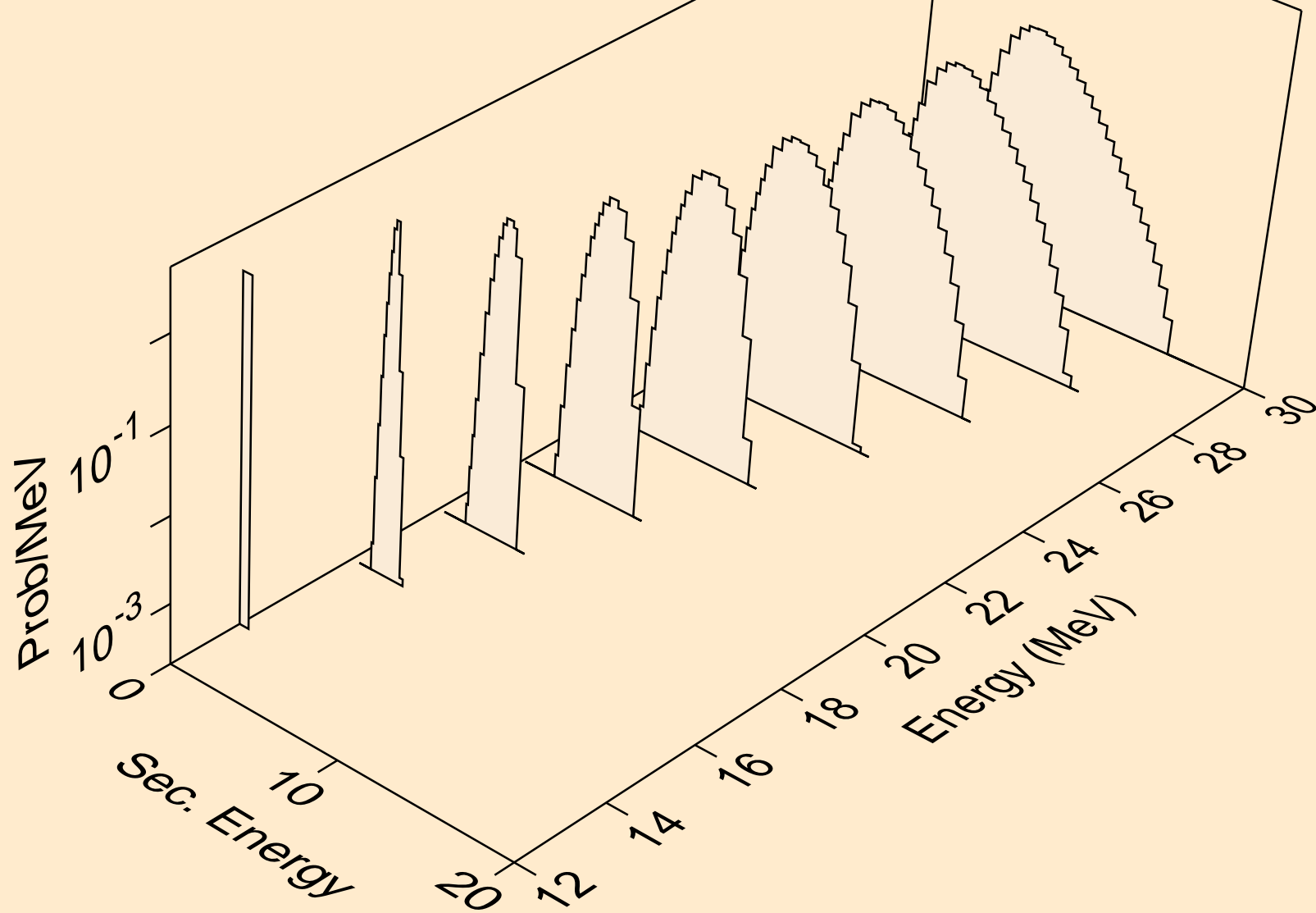

ND133 NEUTRON ACER TENDL-2021 LIBRARY; T=293.6K
protons from (n,3np)

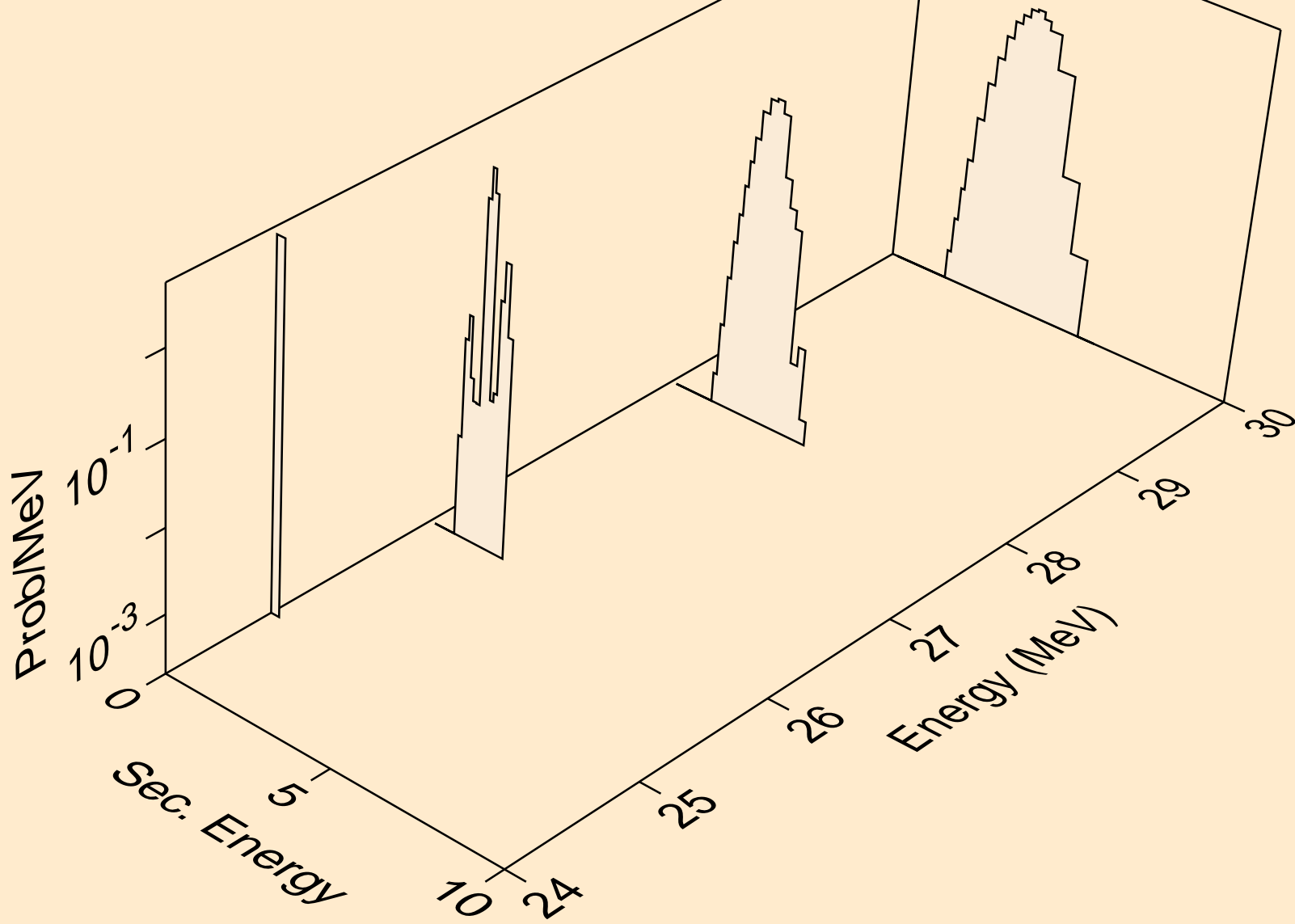

ND133 NEUTRON ACER TENDL-2021 LIBRARY; T=293.6K
protons from (n,2np)

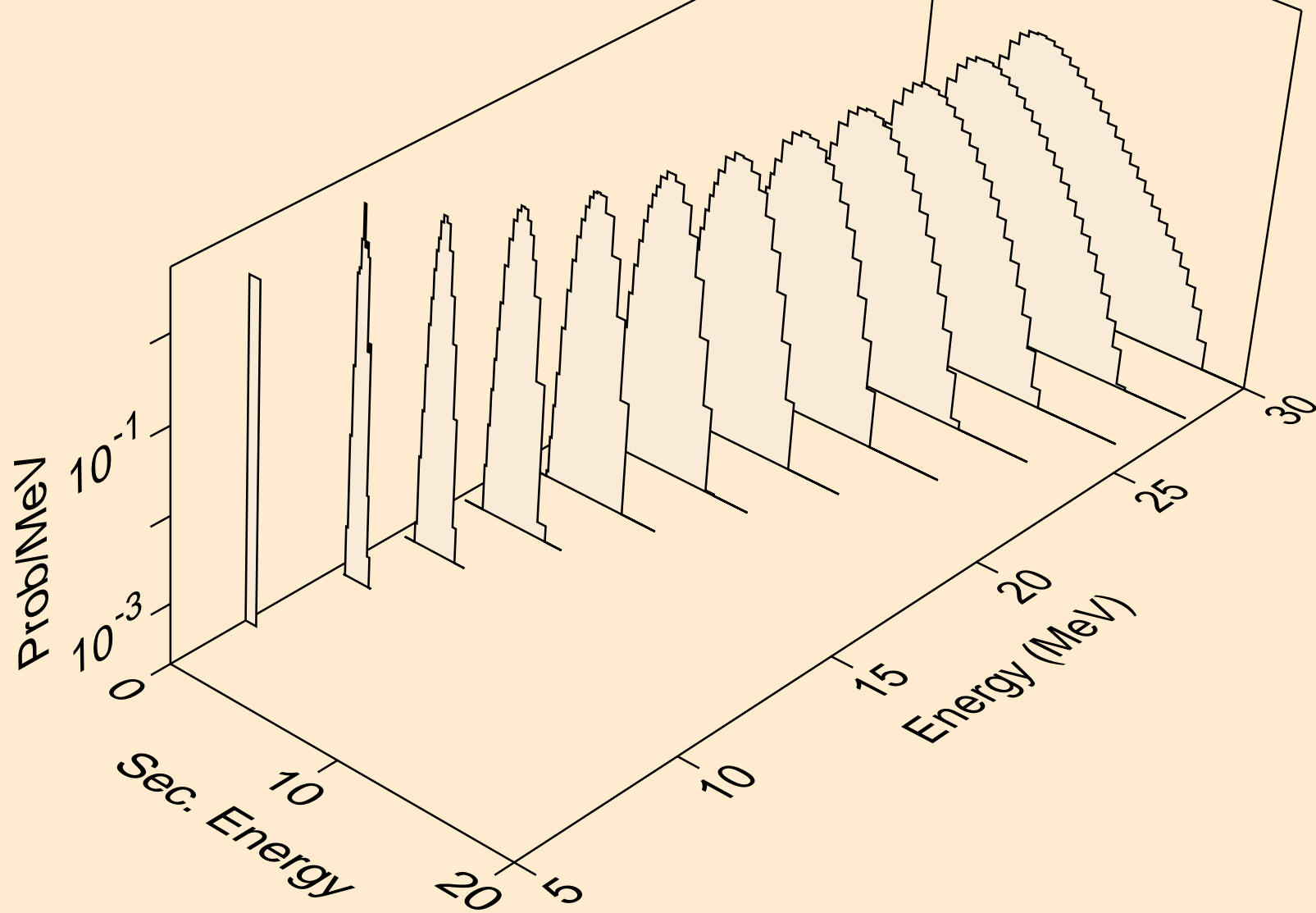

ND133 NEUTRON ACER TENDL-2021 LIBRARY; T=293.6K
protons from (n,npa)

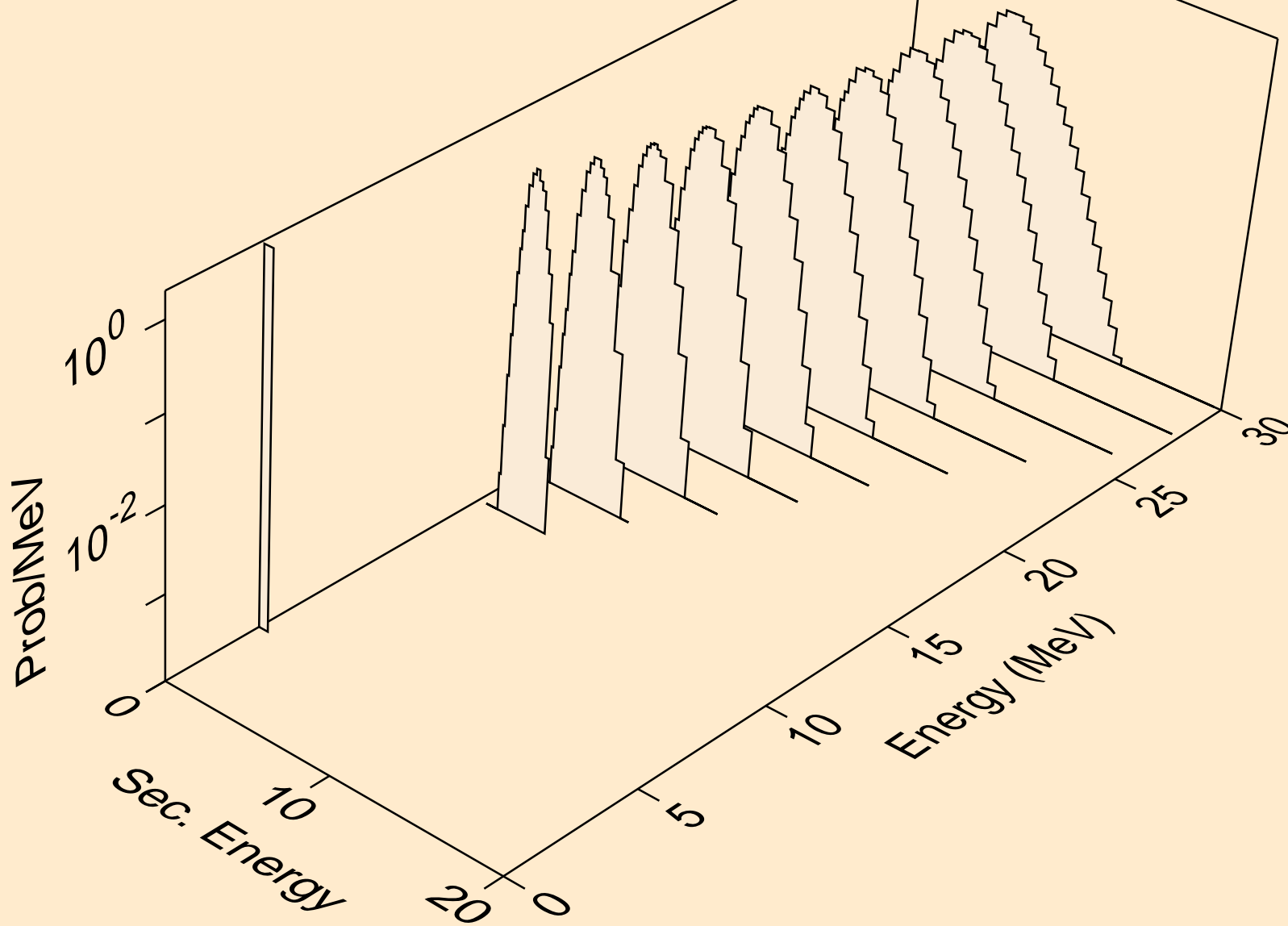

ND133 NEUTRON ACER TENDL-2021 LIBRARY; T=293.6K
protons from (n,p)

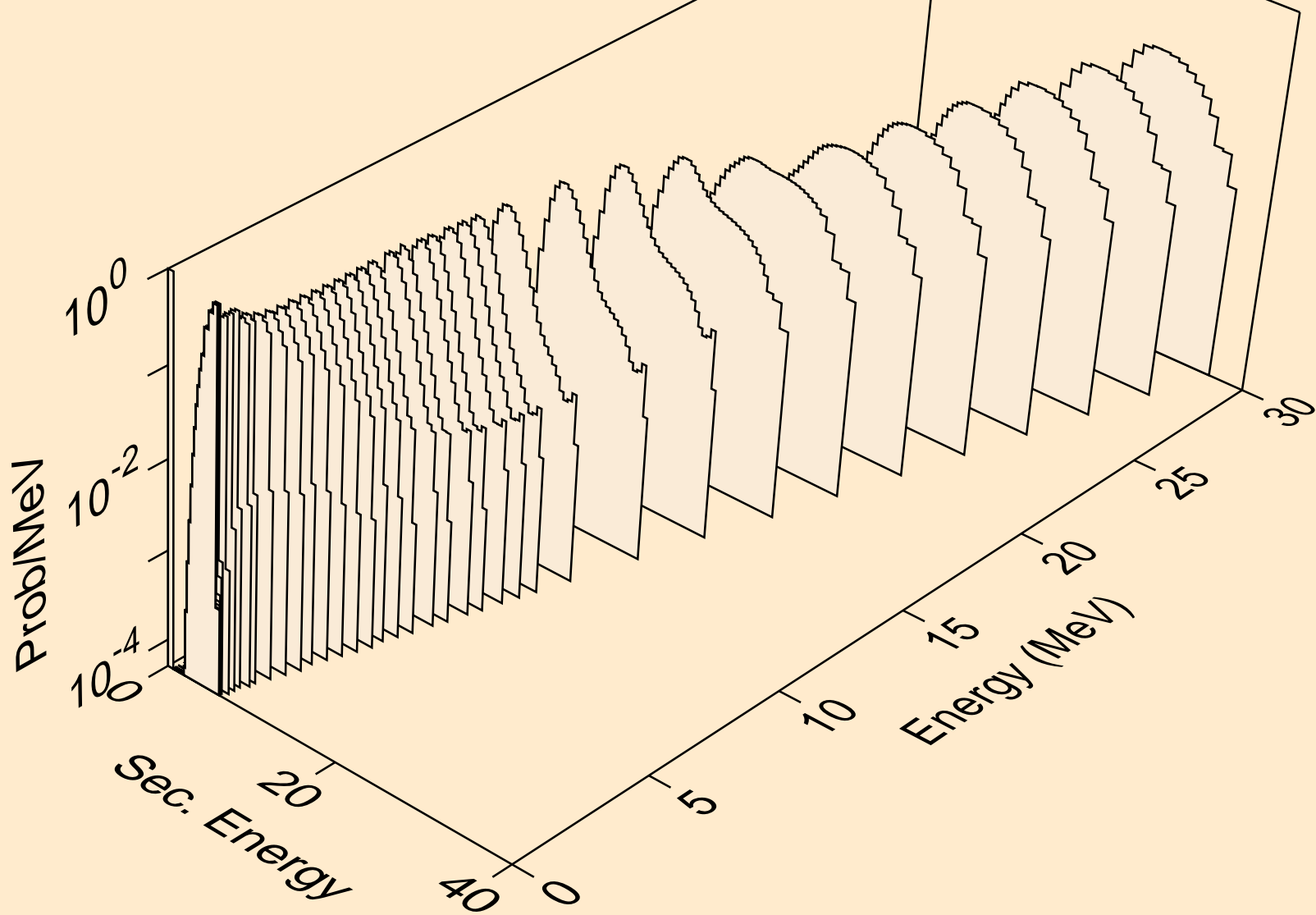

ND133 NEUTRON ACER TENDL-2021 LIBRARY; T=293.6K
protons from (n,2p)

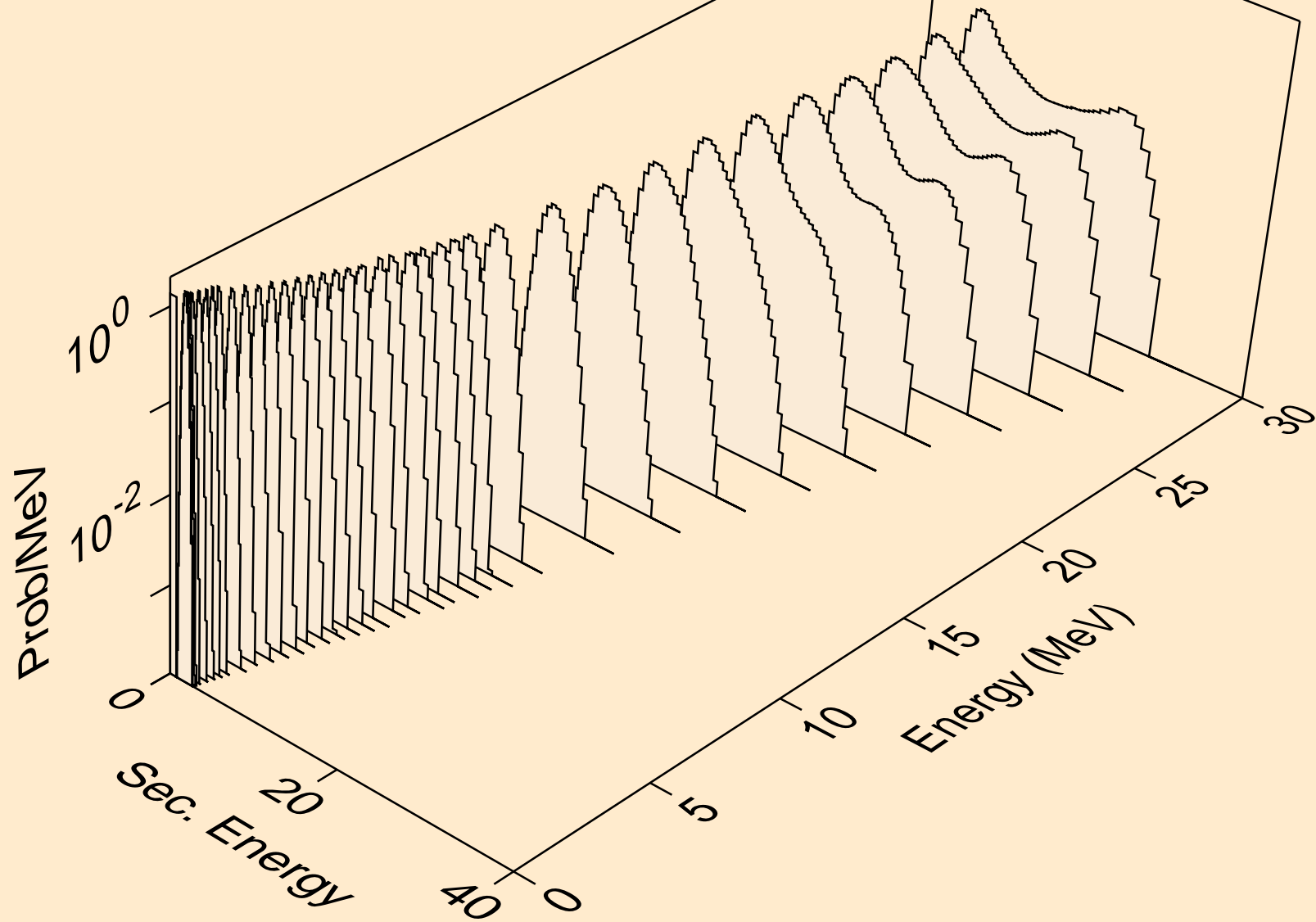

ND133 NEUTRON ACER TENDL-2021 LIBRARY; T=293.6K
protons from (n,p)

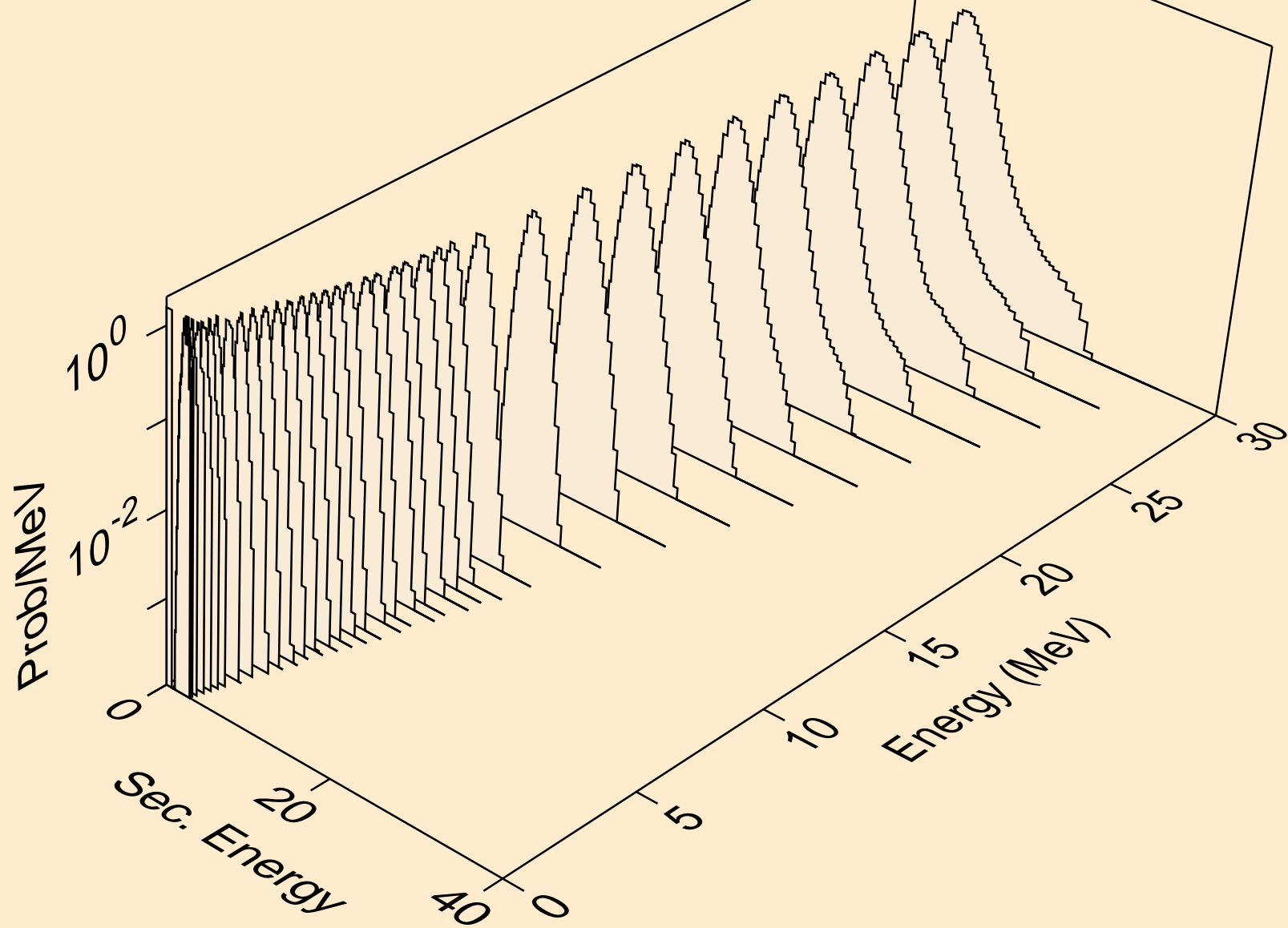

ND133 NEUTRON ACER TENDL-2021 LIBRARY; T=293.6K
protons from (n,pd)

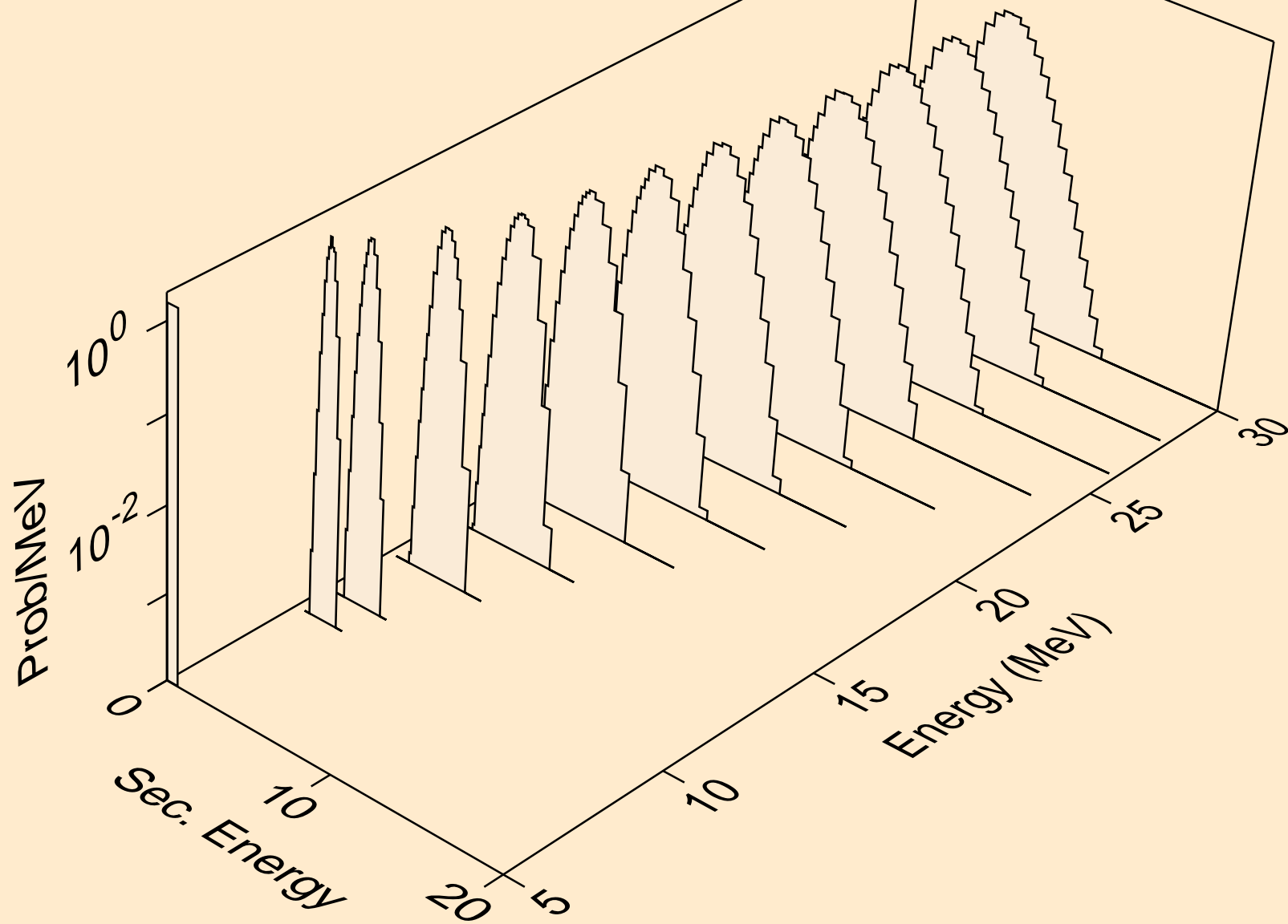

ND133 NEUTRON ACER TENDL-2021 LIBRARY; T=293.6K
protons from (n,pt)

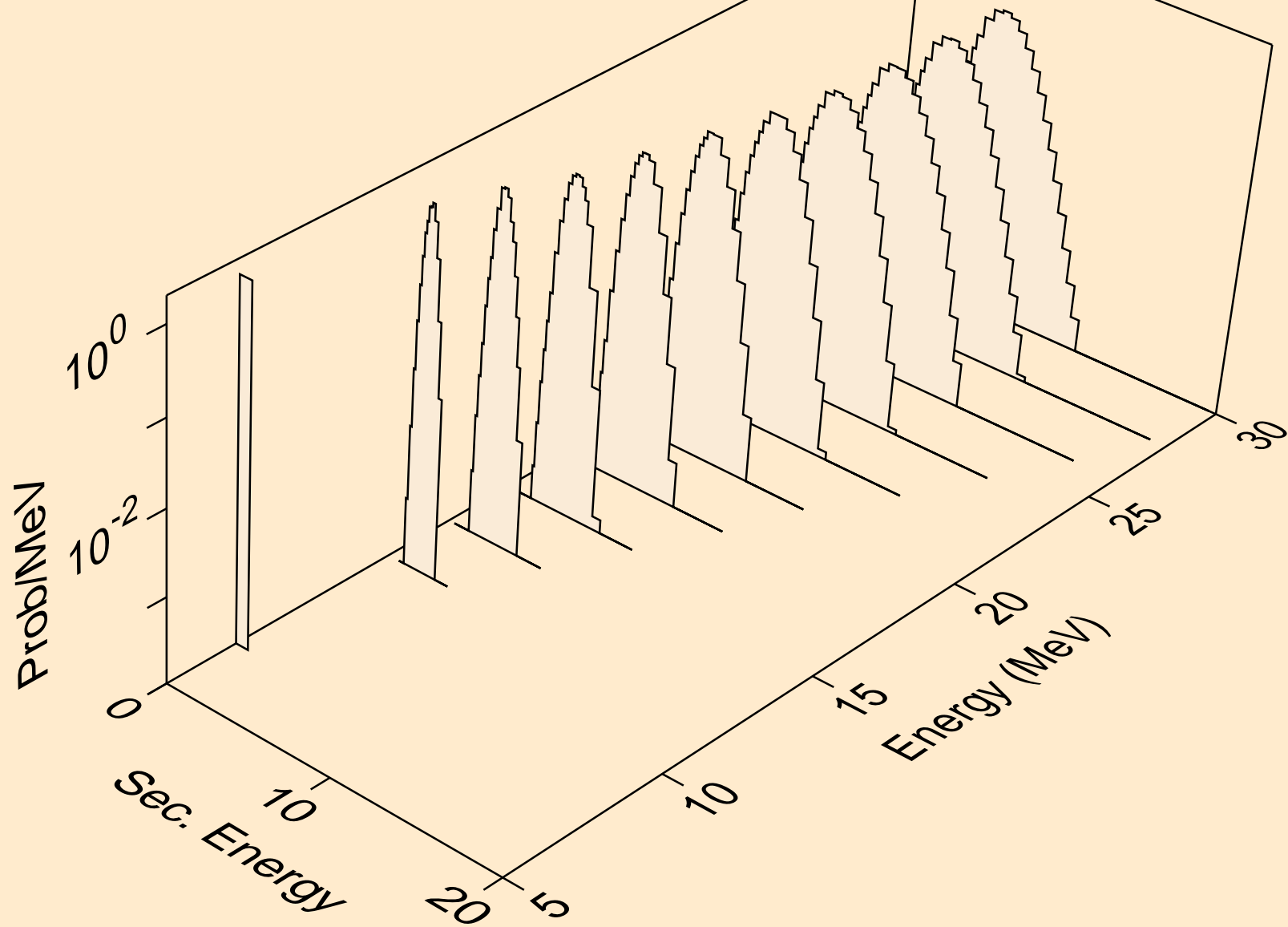

ND133 NEUTRON ACER TENDL-2021 LIBRARY; T=293.6K
deuterons from (n,x)

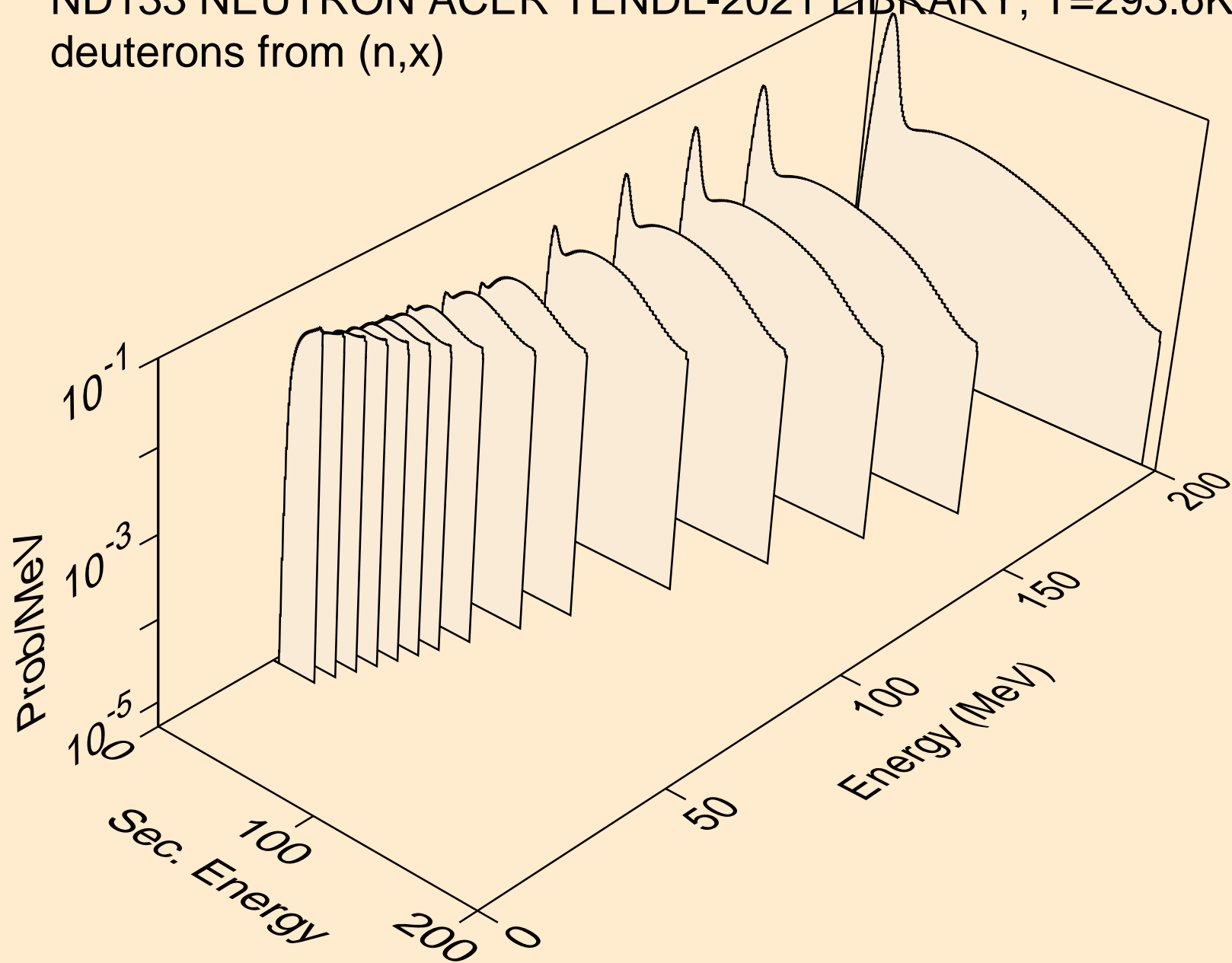

ND133 NEUTRON ACER TENDL-2021 LIBRARY; T=293.6K
deuterons from (n,2nd)

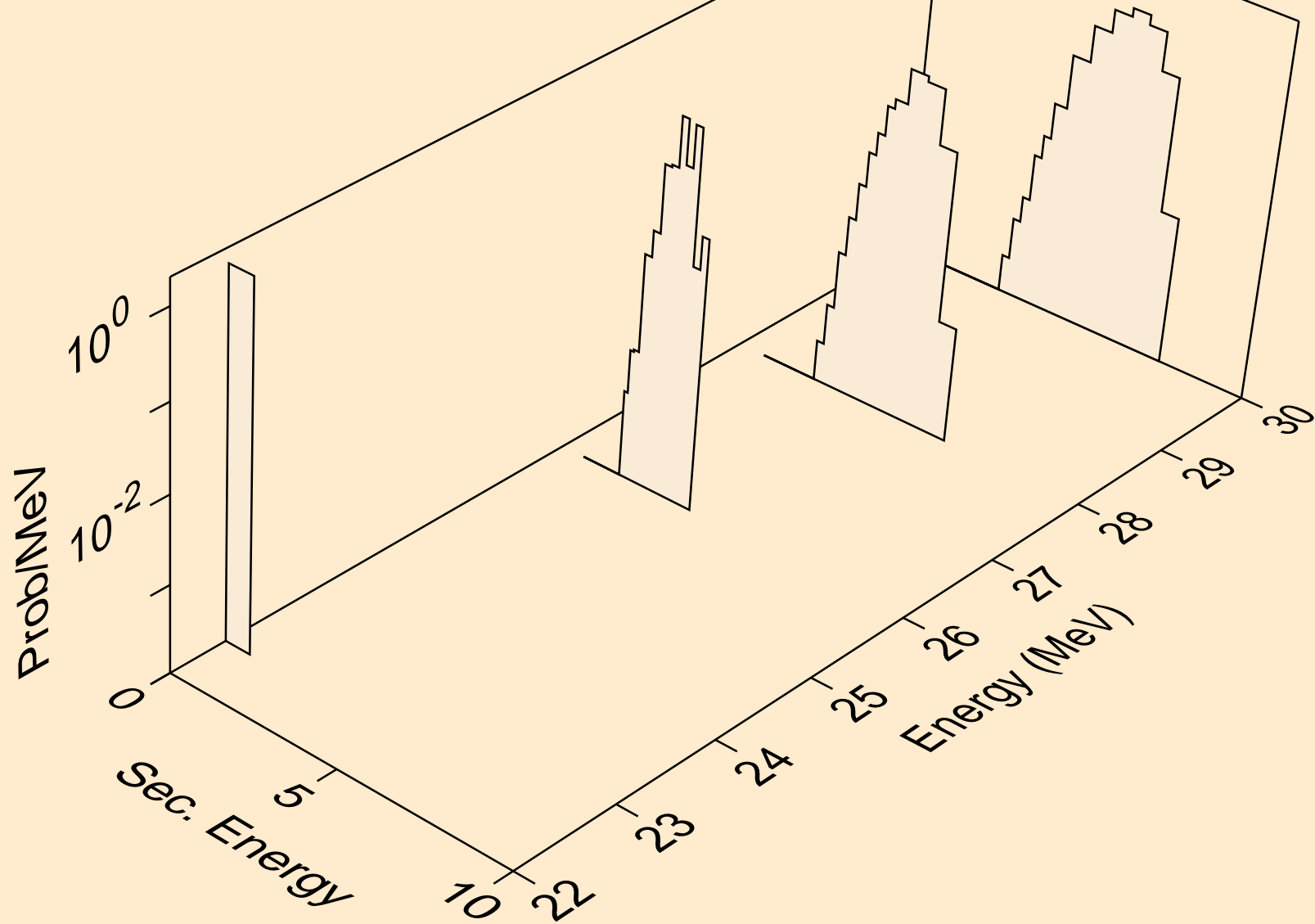

ND133 NEUTRON ACER TENDL-2021 LIBRARY; T=293.6K
deuterons from (n,n*)d

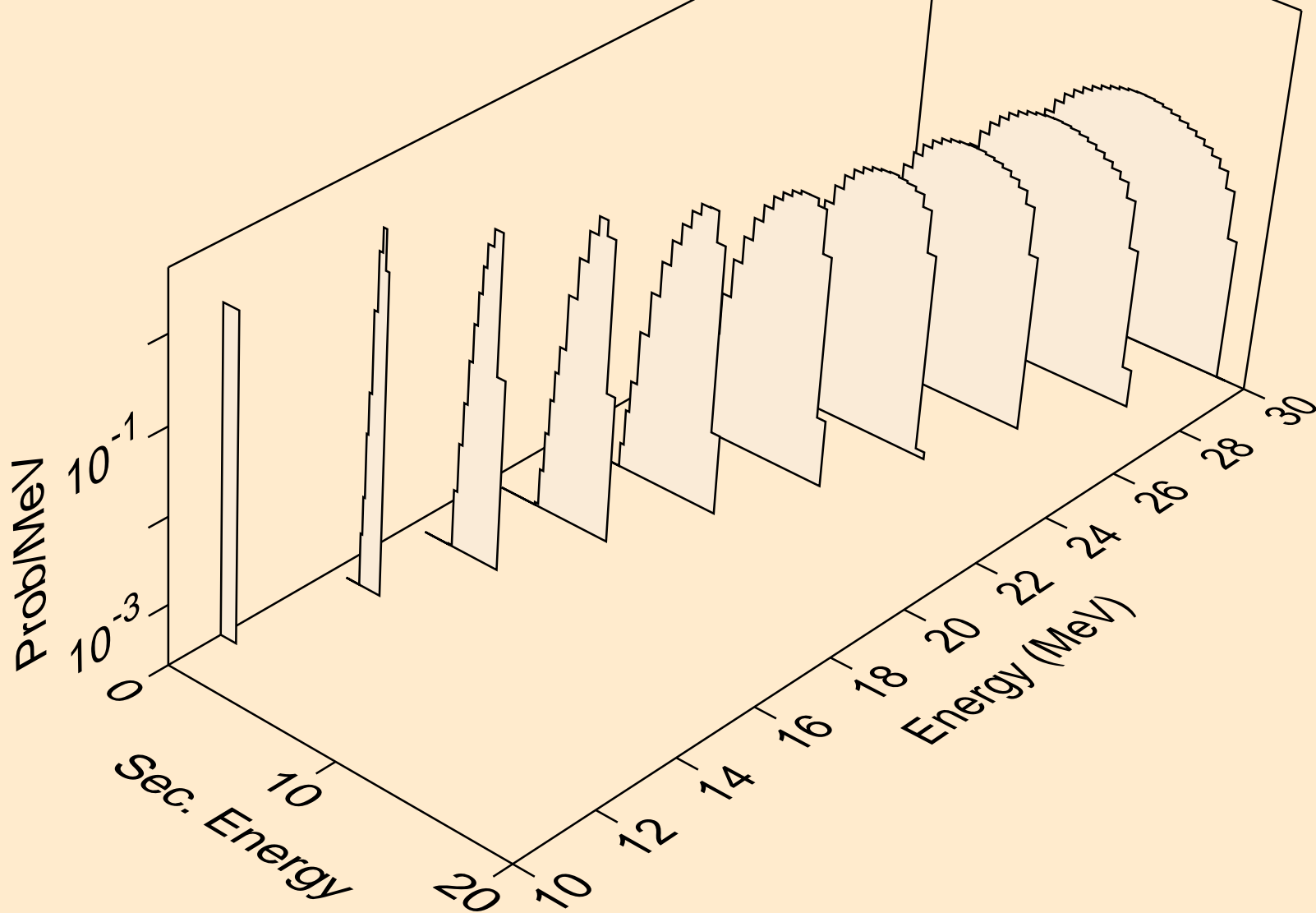

ND133 NEUTRON ACER TENDL-2021 LIBRARY; T=293.6K
deuterons from (n,d)

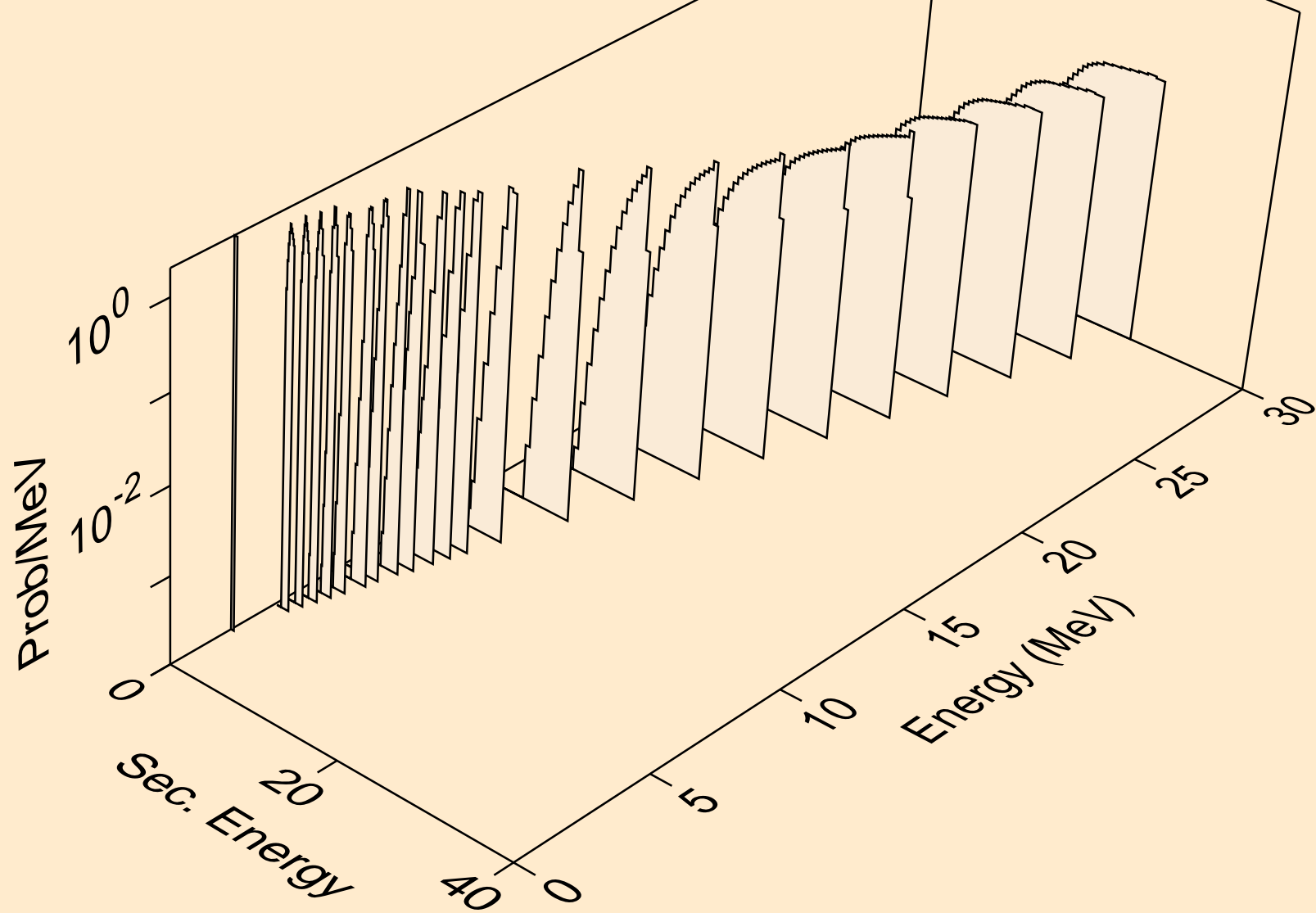

ND133 NEUTRON ACER TENDL-2021 LIBRARY; T=293.6K
deuterons from (n,pd)

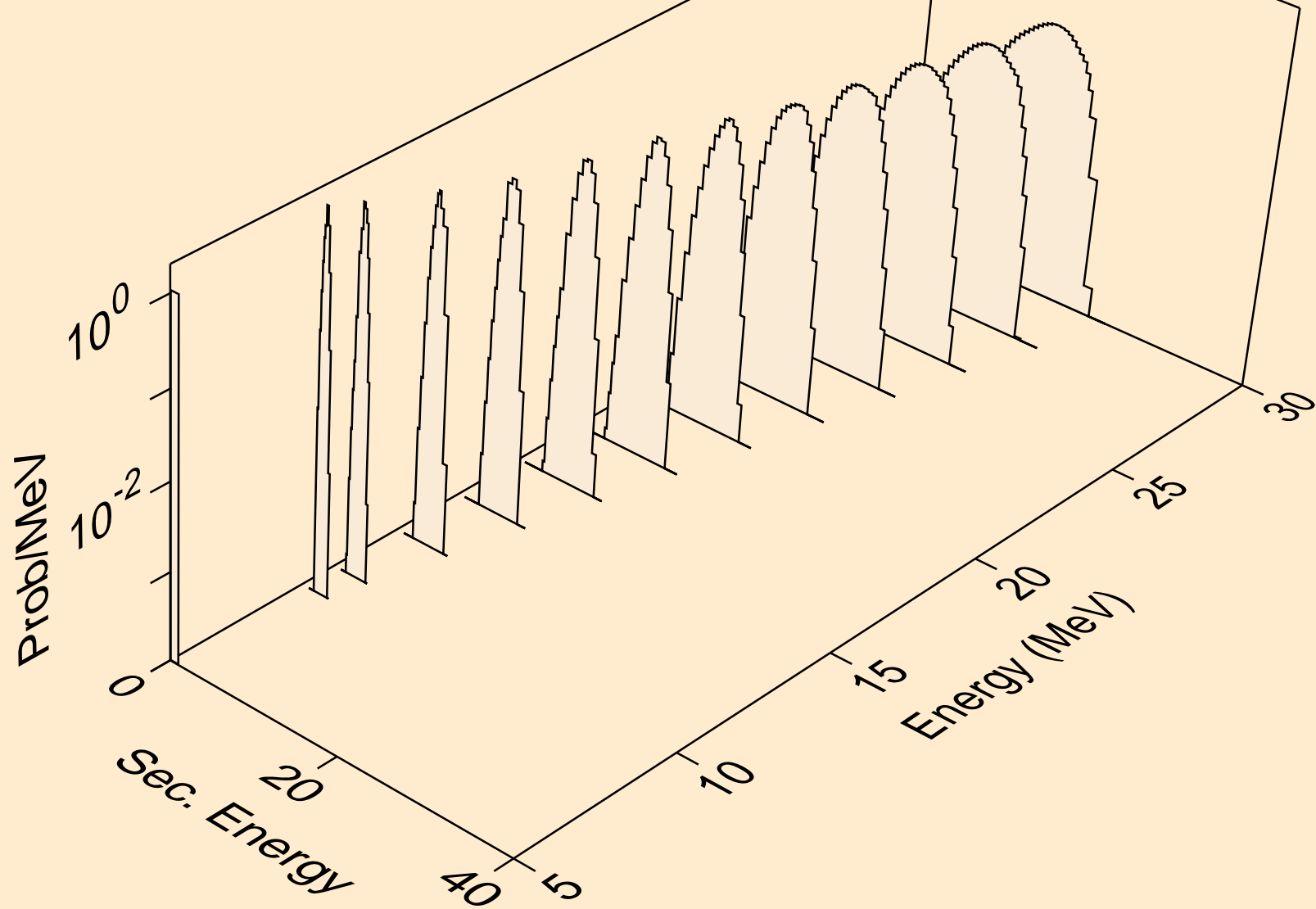

ND133 NEUTRON ACER TENDL-2021 LIBRARY; T=293.6K
deuterons from (n,da)

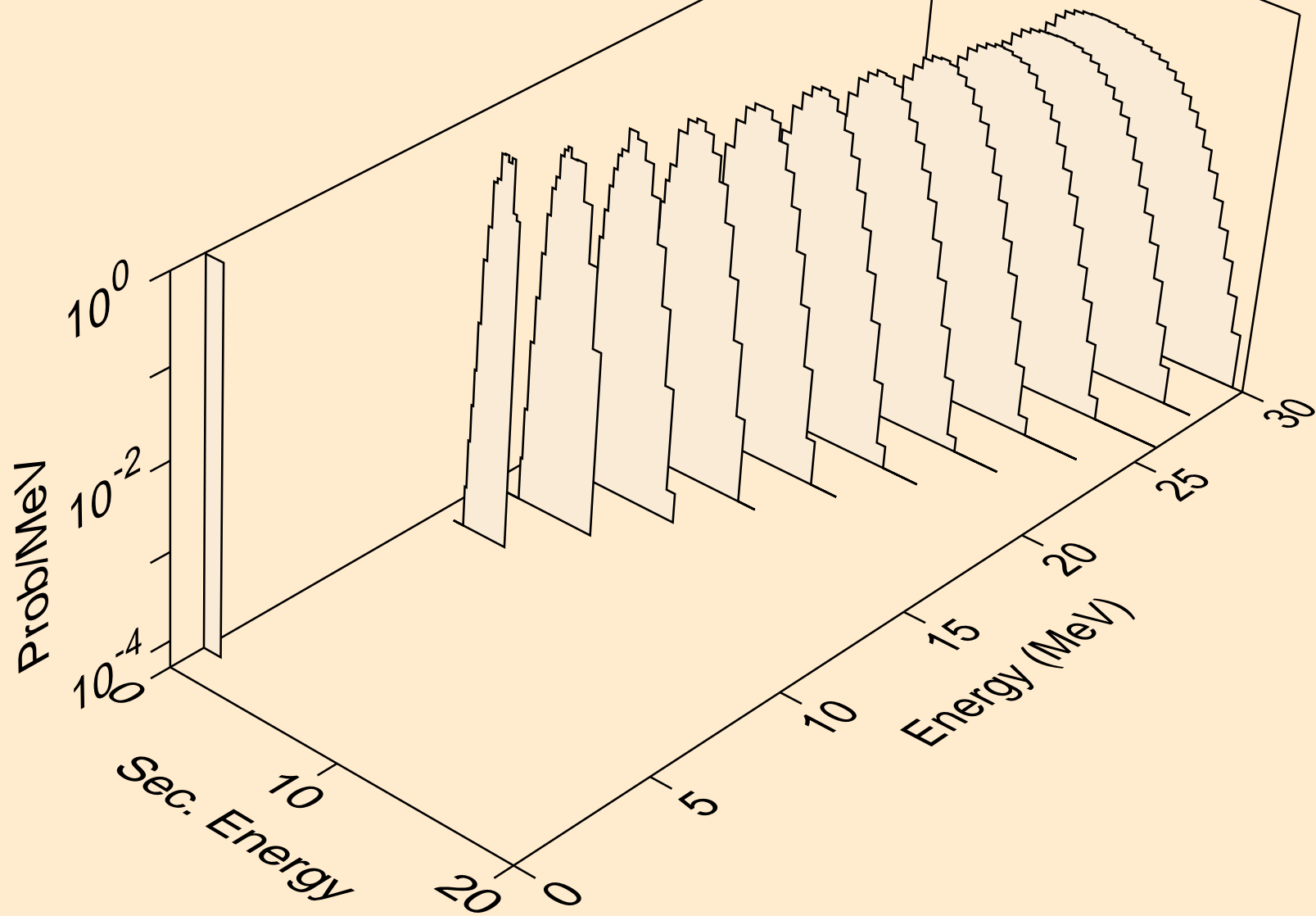

ND133 NEUTRON ACER TENDL-2021 LIBRARY; T=293.6K
tritons from (n,x)

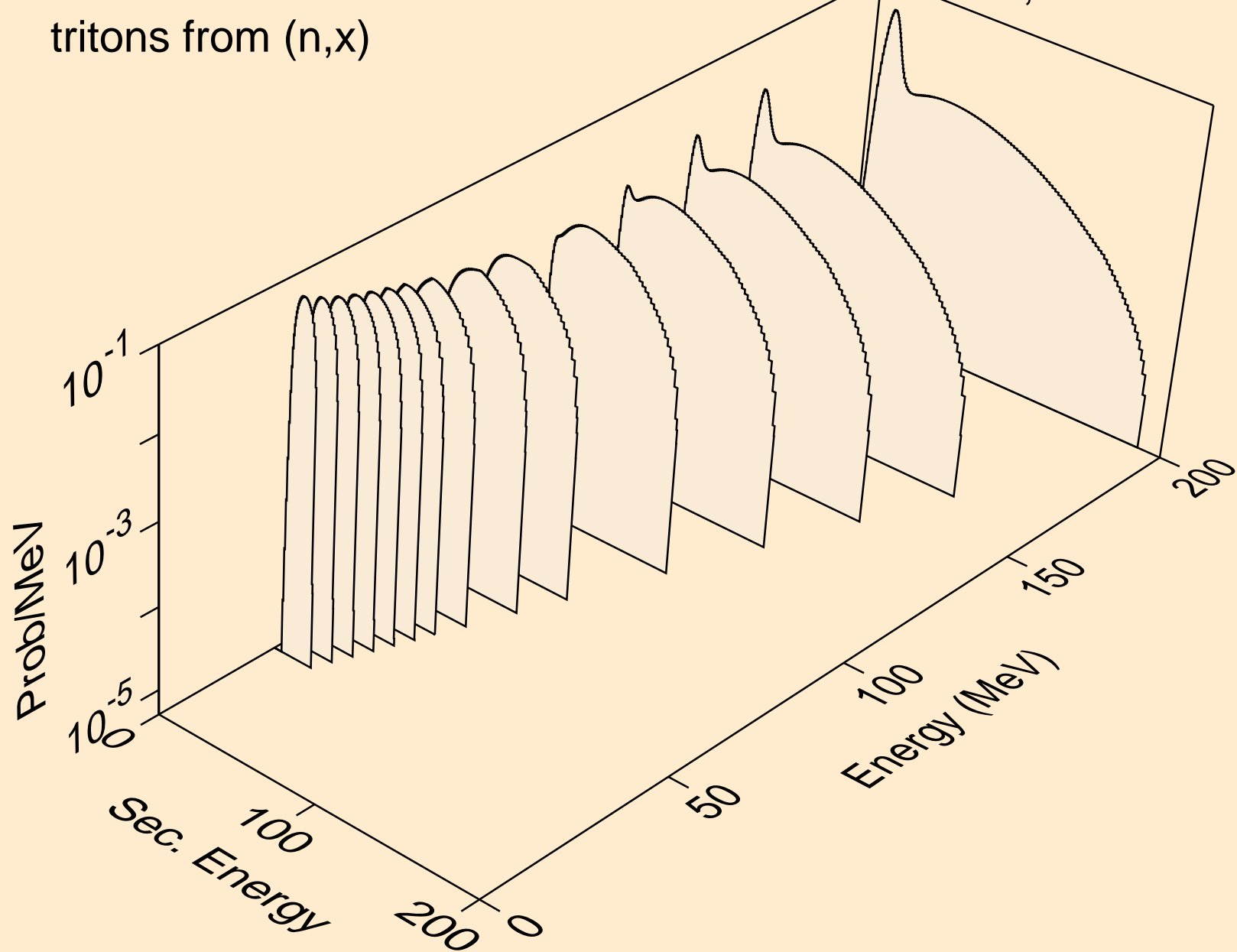

ND133 NEUTRON ACER TENDL-2021 LIBRARY; T=293.6K
tritons from (n,n*)t

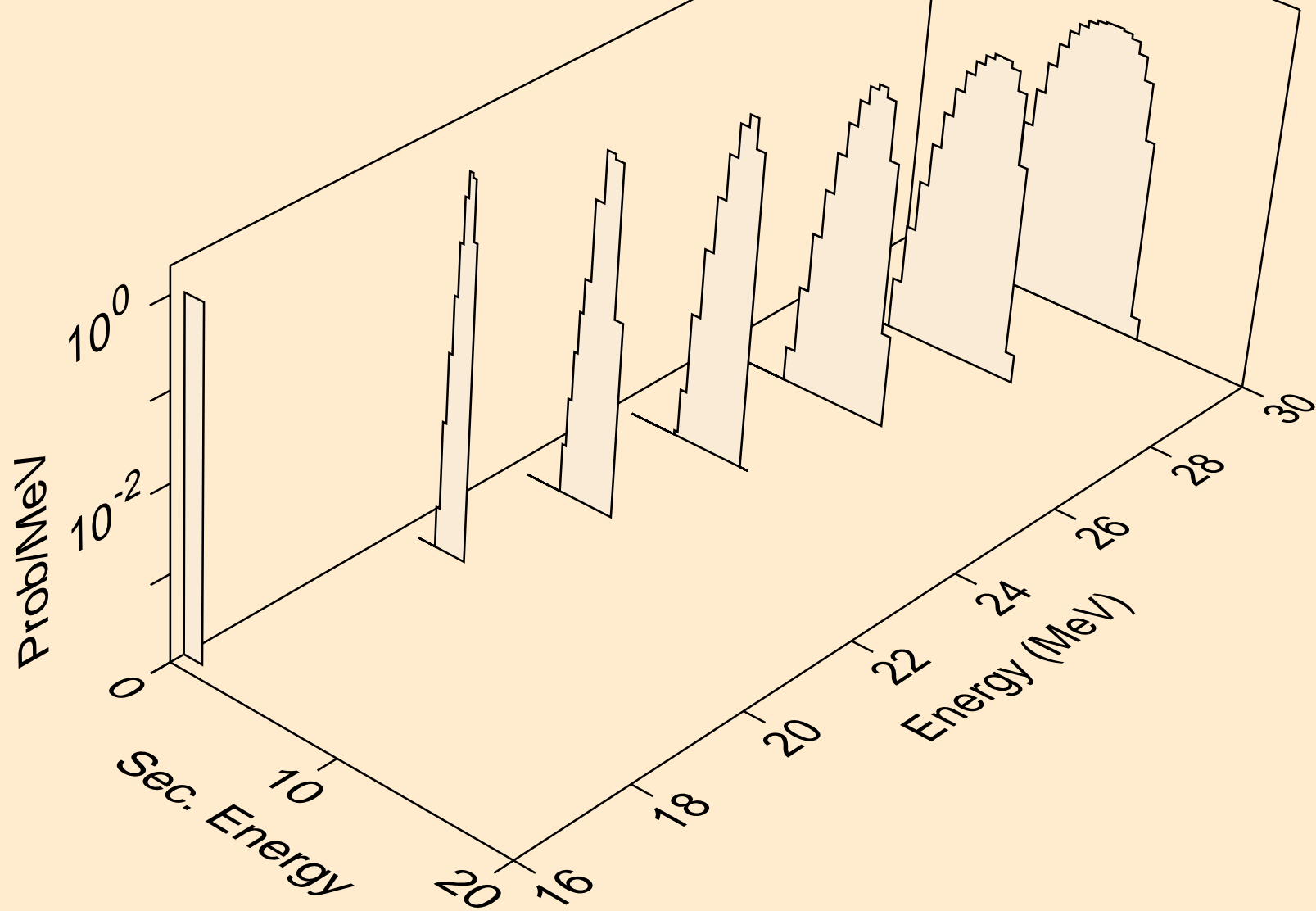

ND133 NEUTRON ACER TENDL-2021 LIBRARY; T=293.6K
tritons from (n,t)

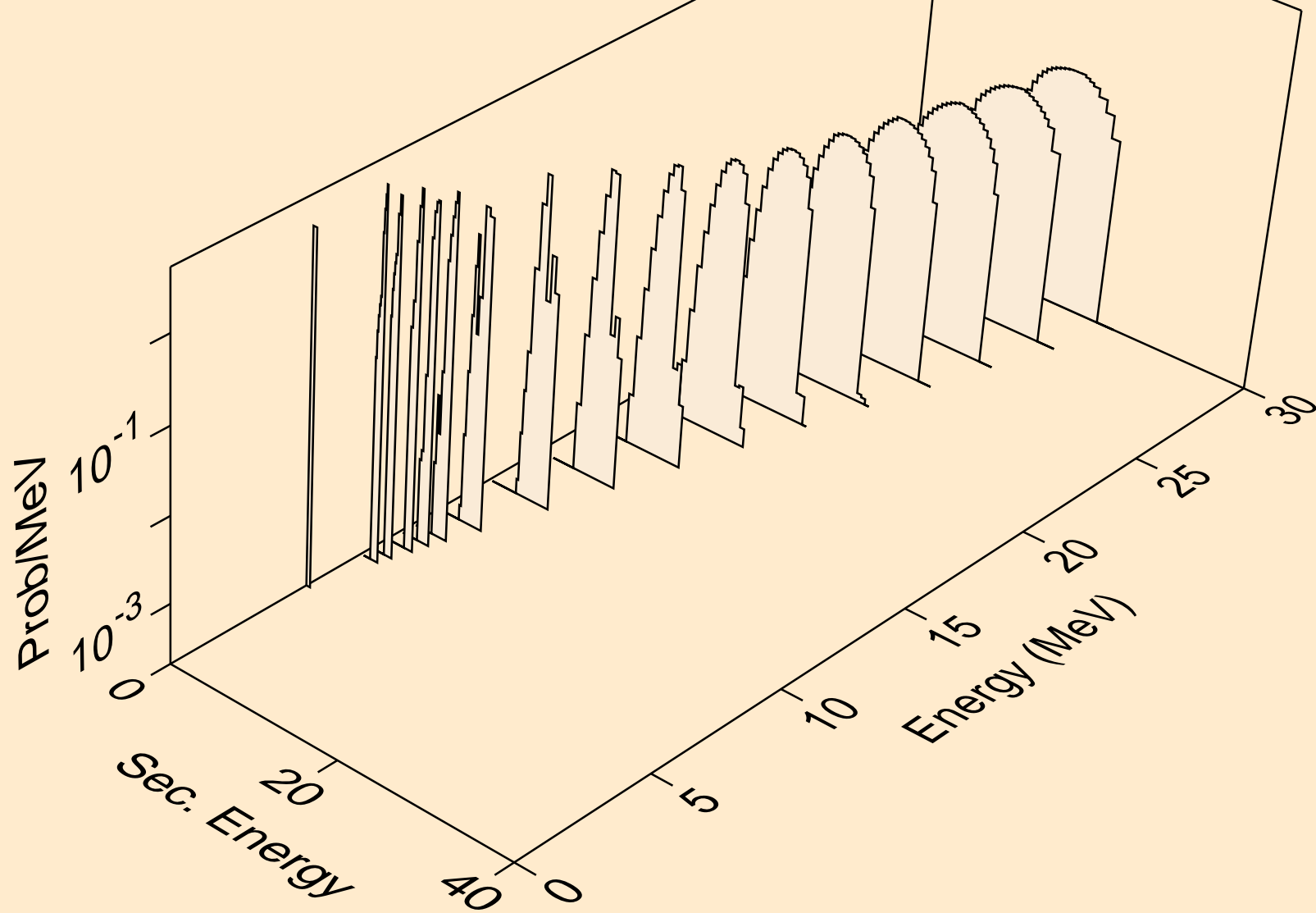

ND133 NEUTRON ACER TENDL-2021 LIBRARY; T=293.6K
tritons from (n,pt)

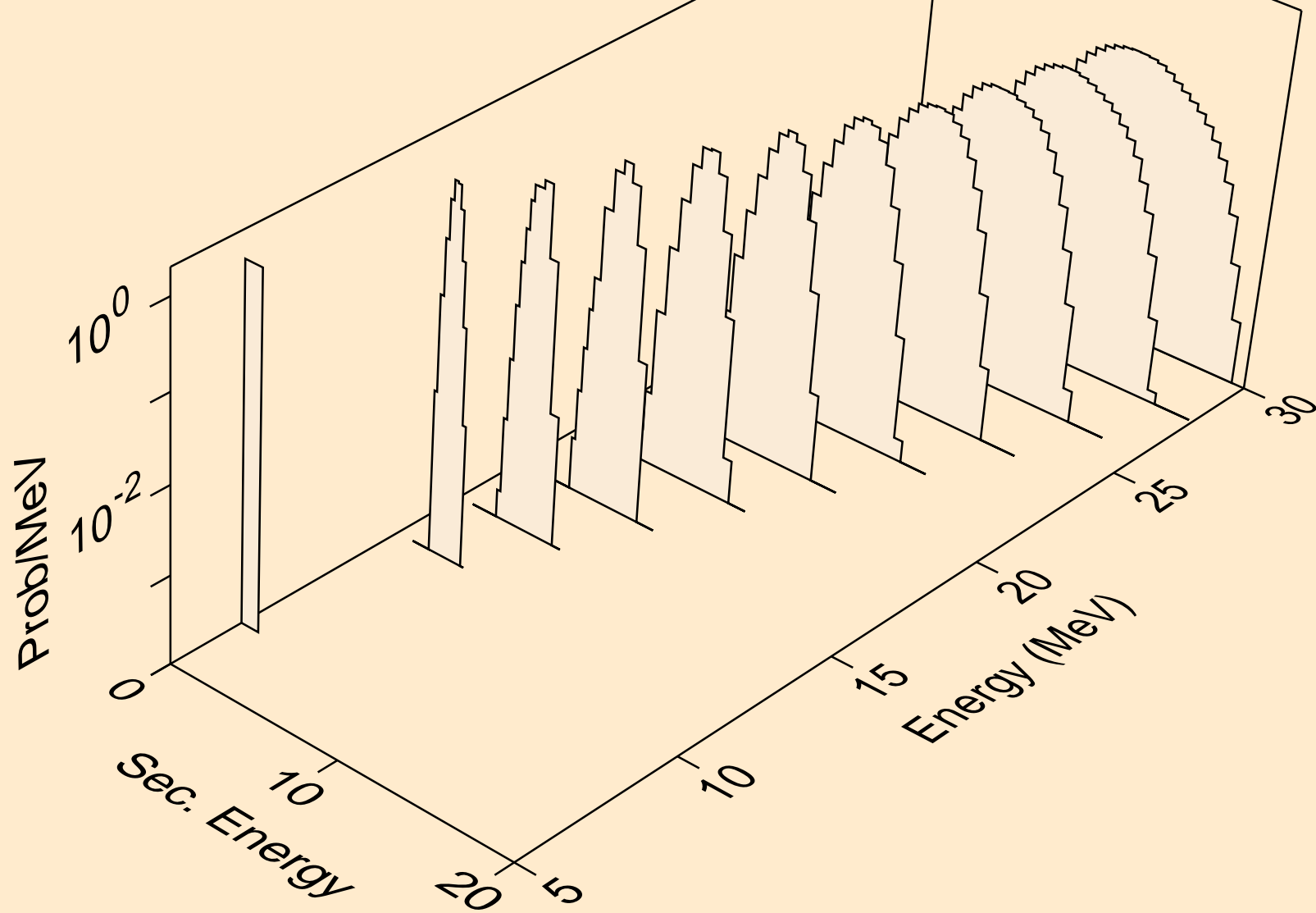

ND133 NEUTRON ACER TENDL-2021 LIBRARY; T=293.6K
he3s from (n,x)

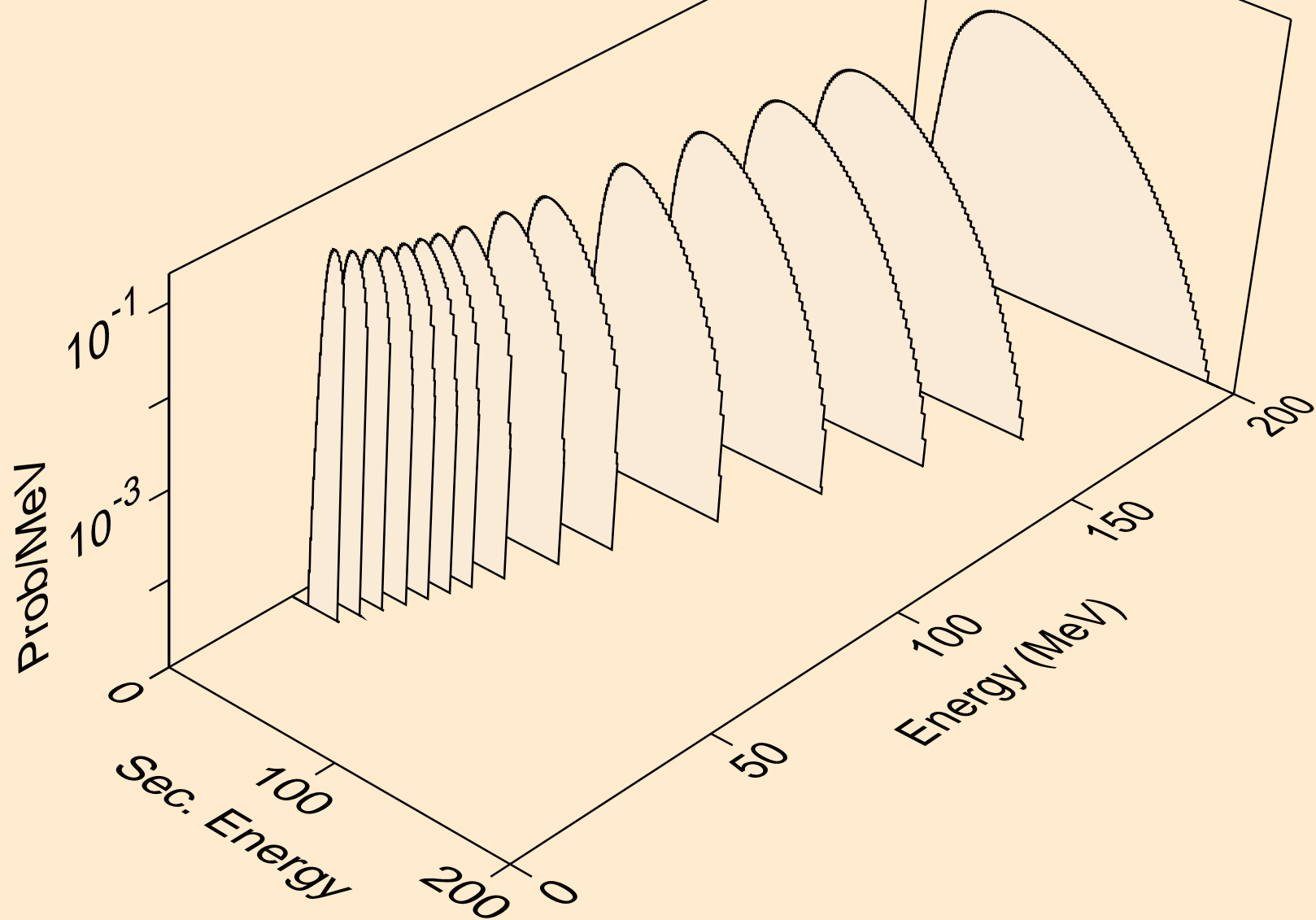

ND133 NEUTRON ACER TENDL-2021 LIBRARY; T=293.6K
he3s from (n,n*)he3

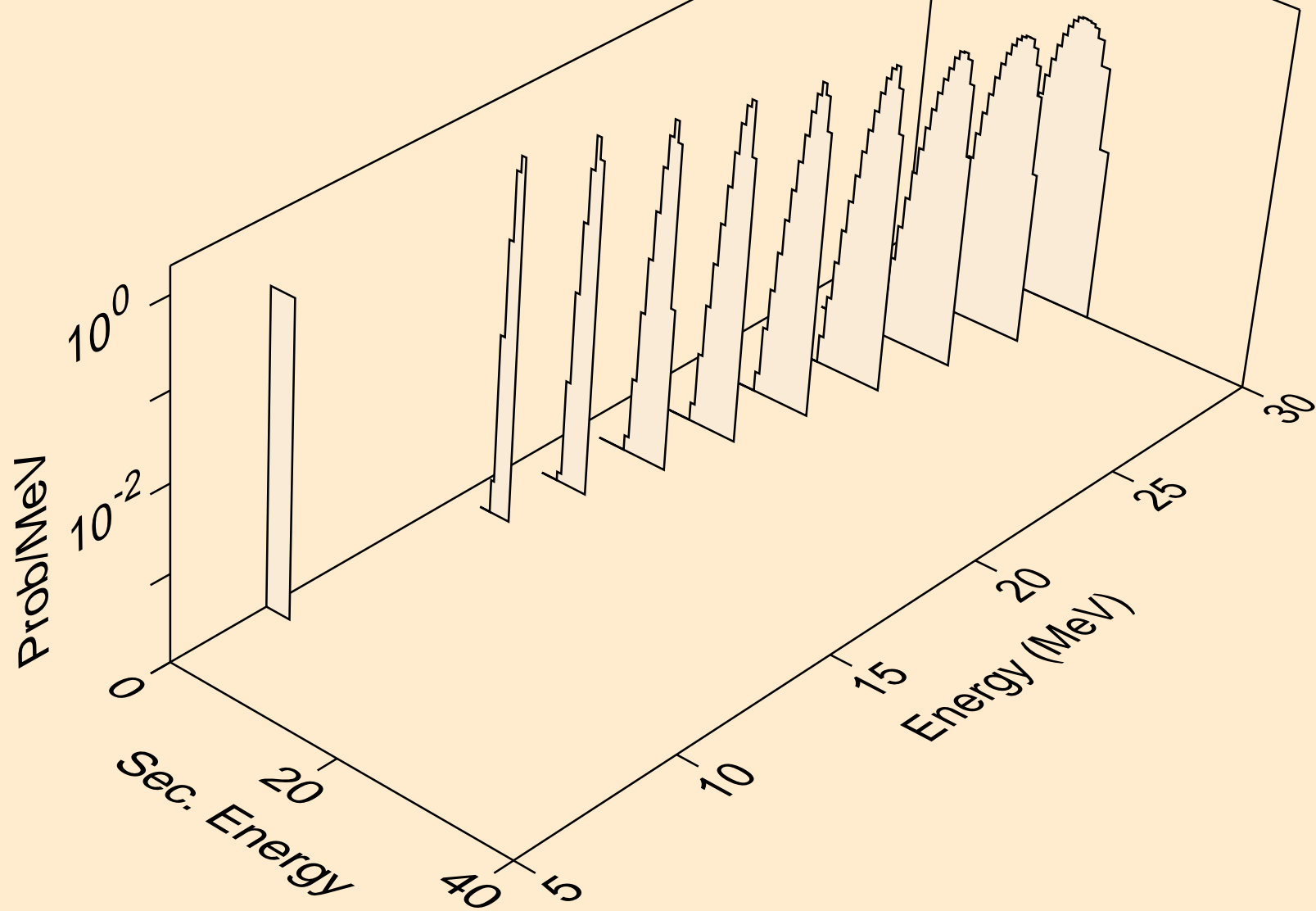

ND133 NEUTRON ACER TENDL-2021 LIBRARY; T=293.6K
he3s from (n,he3)

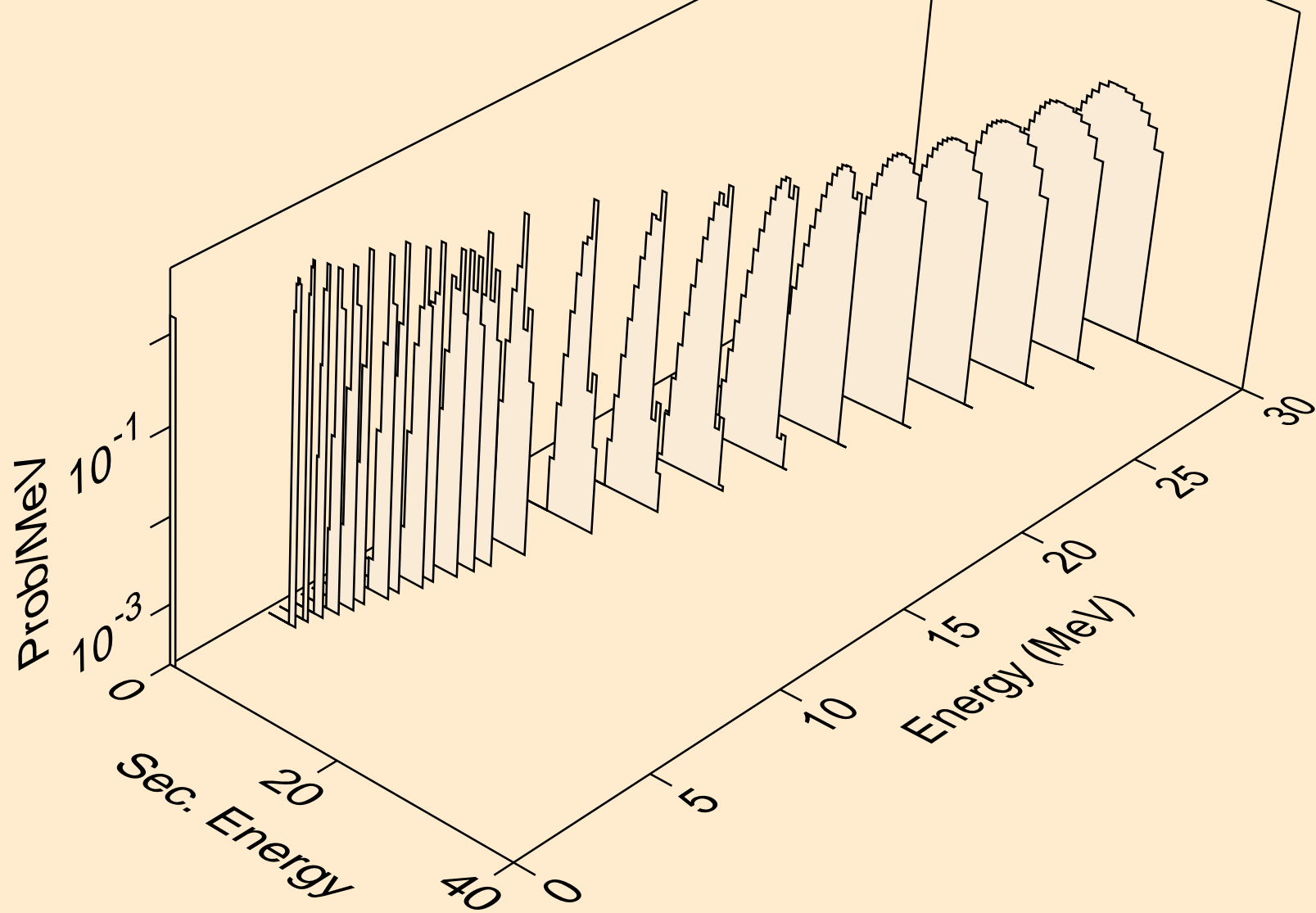

ND133 NEUTRON ACER TENDL-2021 LIBRARY; T=293.6K
alphas from (n,x)

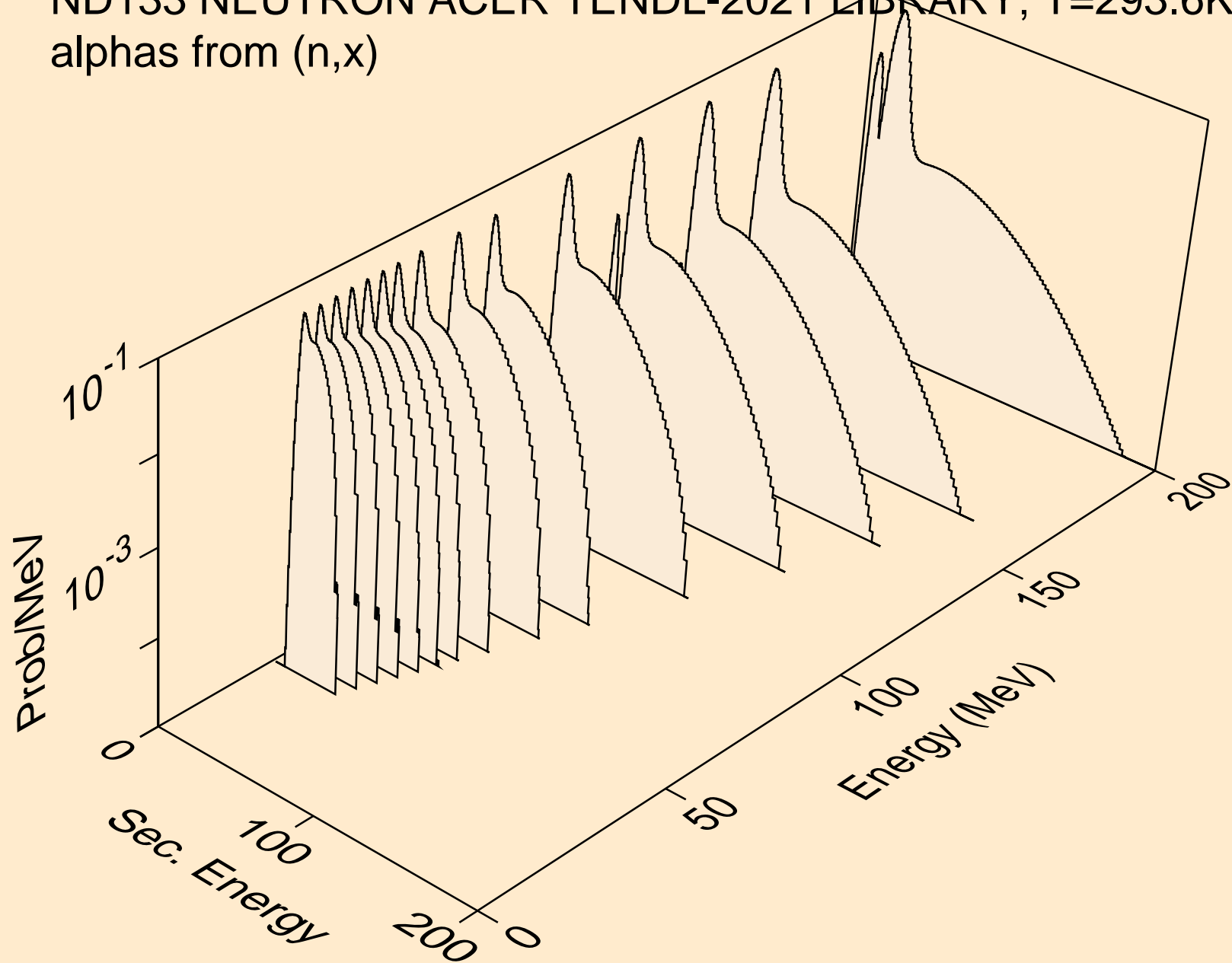

ND133 NEUTRON ACER TENDL-2021 LIBRARY; T=293.6K
alphas from (n,n*)a

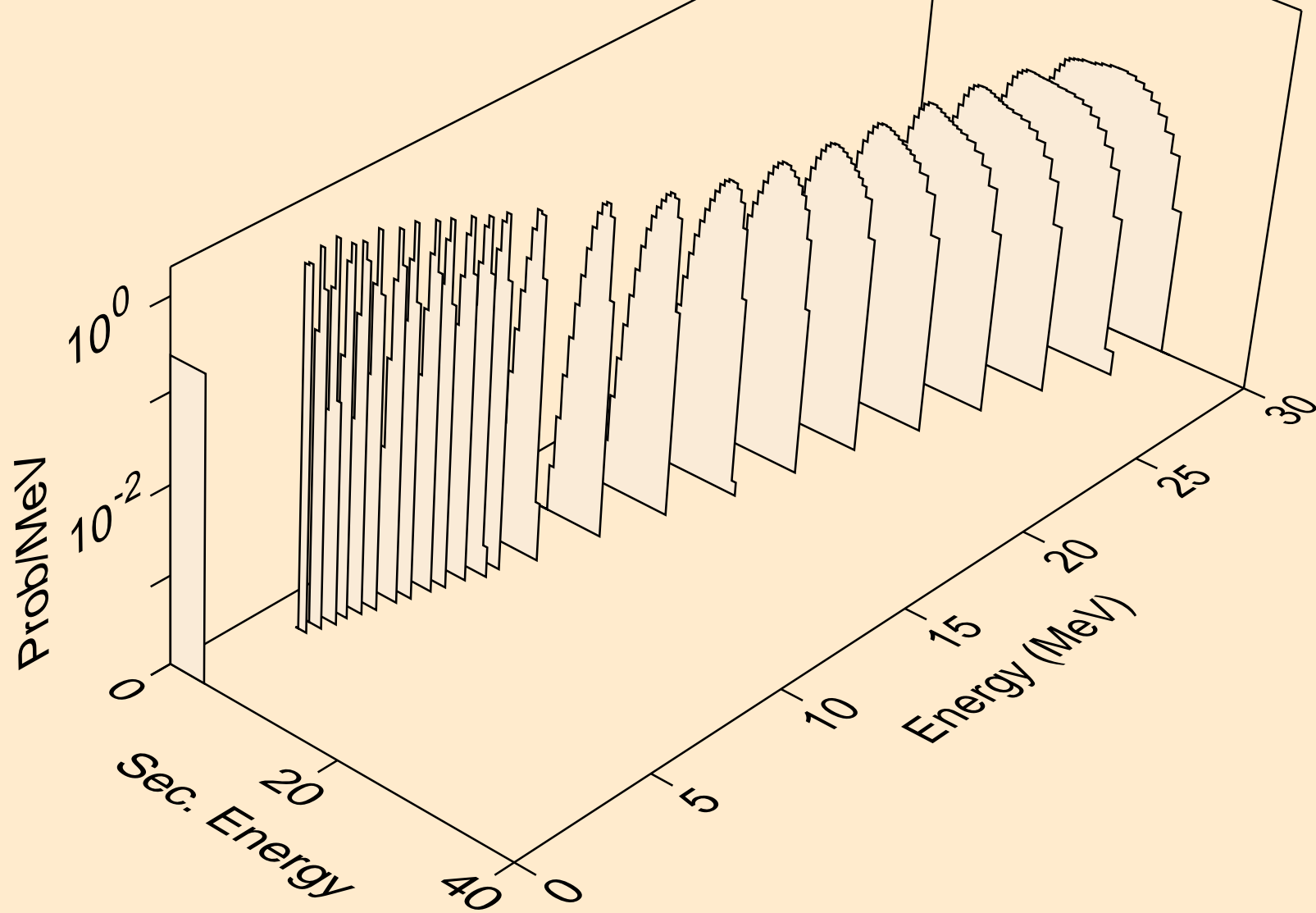

ND133 NEUTRON ACER TENDL-2021 LIBRARY; T=293.6K
alphas from (n,2n)a

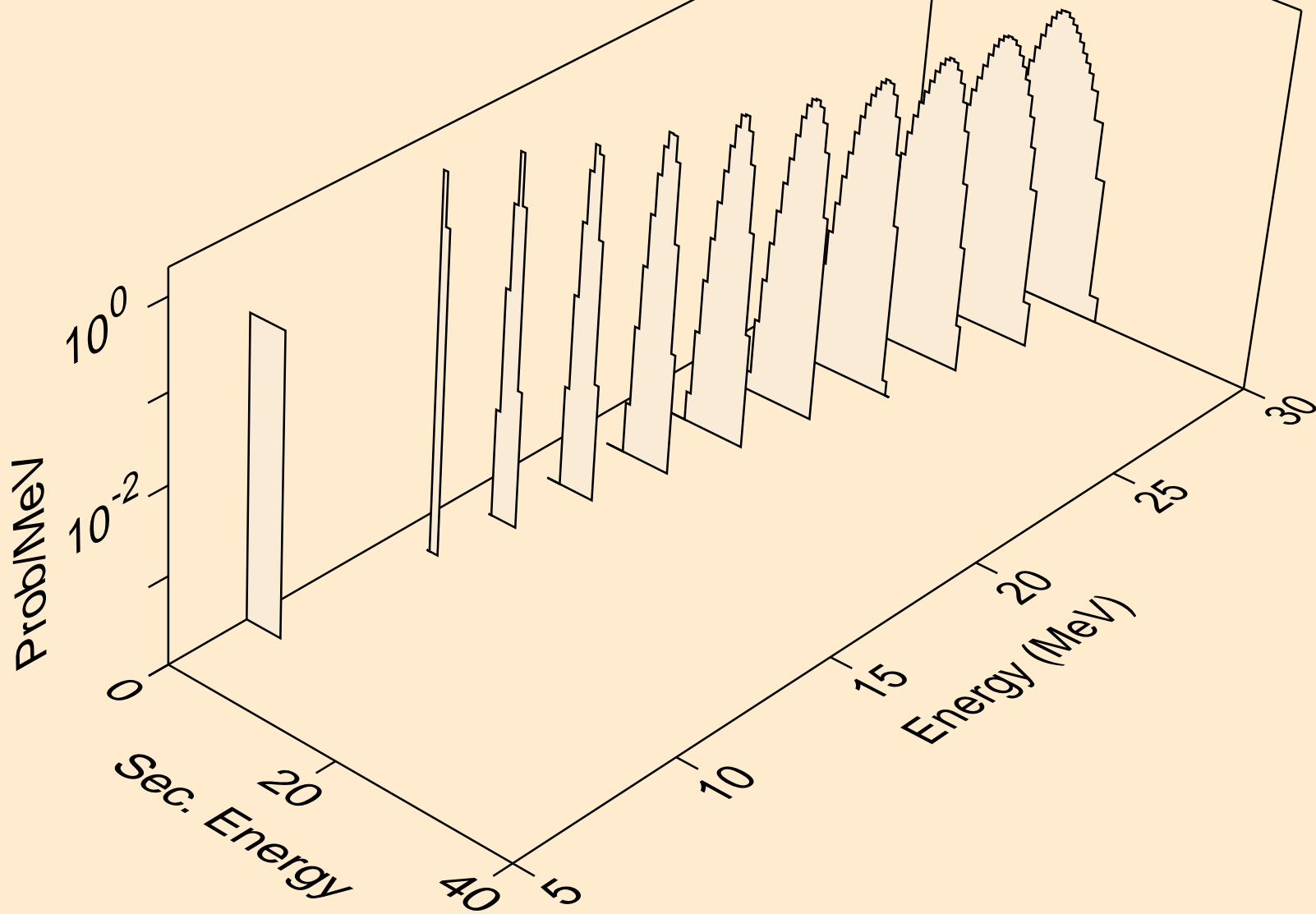

ND133 NEUTRON ACER TENDL-2021 LIBRARY; T=293.6K
alphas from (n,3n)a

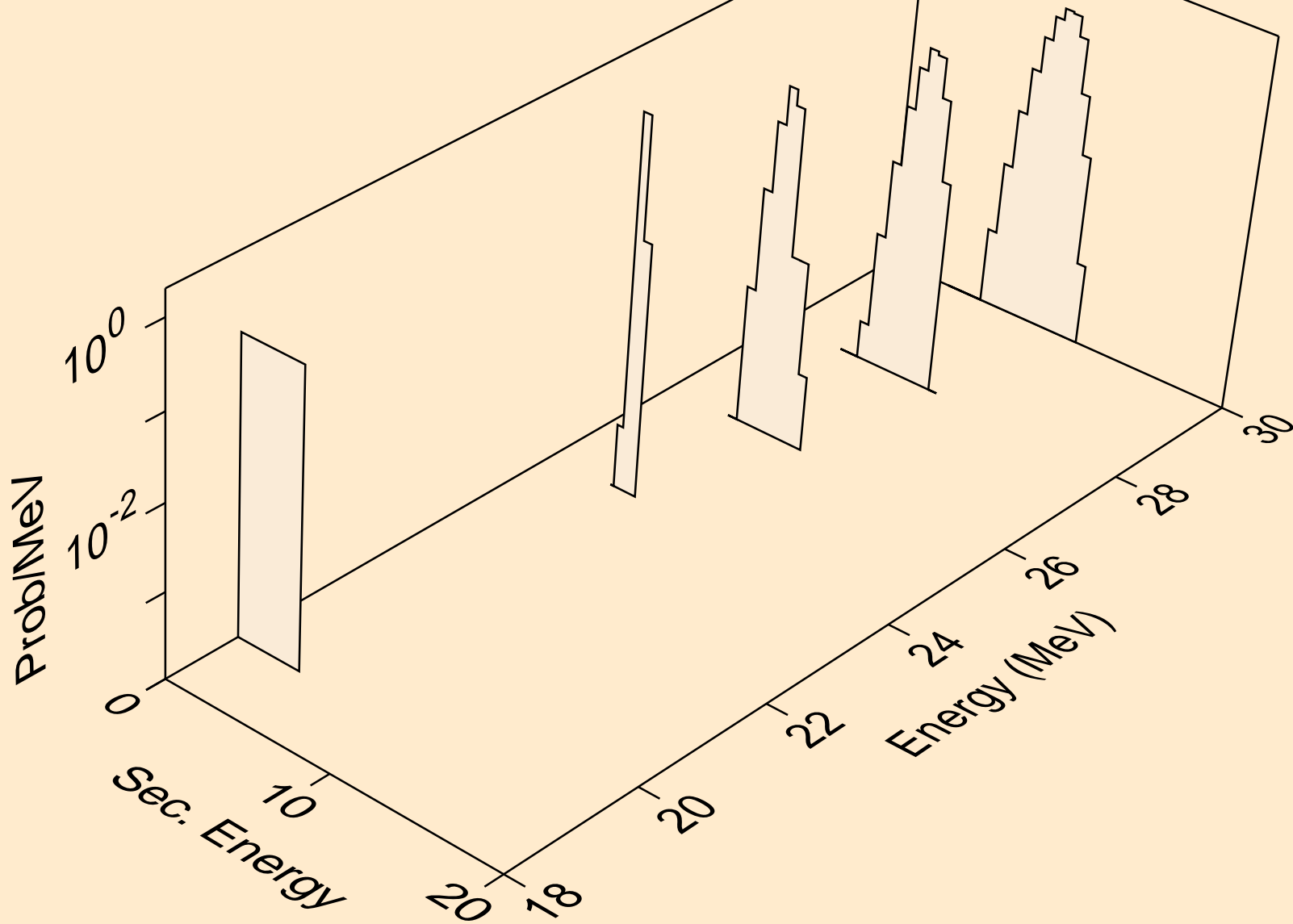

ND133 NEUTRON ACER TENDL-2021 LIBRARY; T=293.6K
alphas from (n,n*)2a

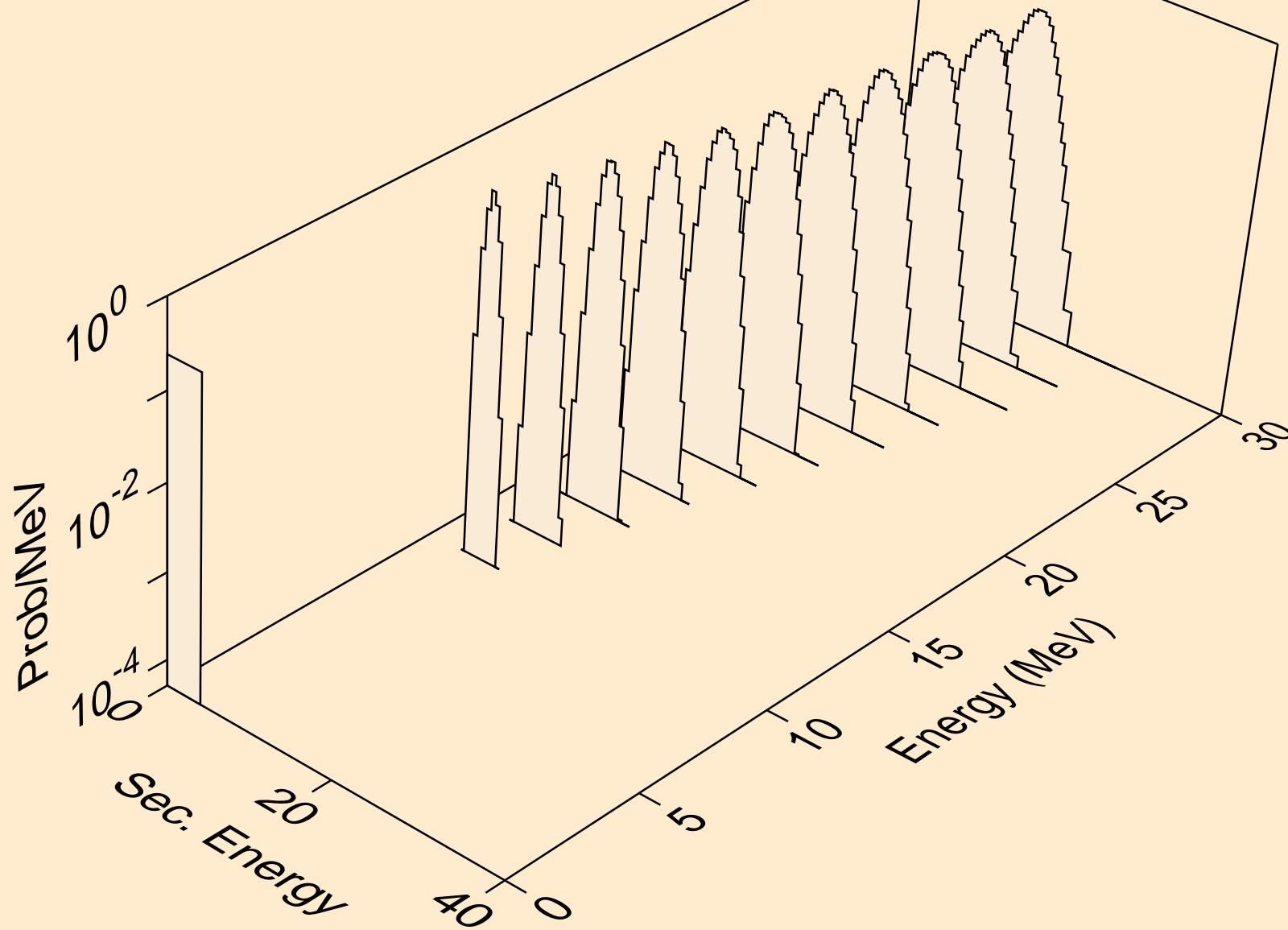

ND133 NEUTRON ACER TENDL-2021 LIBRARY; T=293.6K
alphas from (n,2n)2a

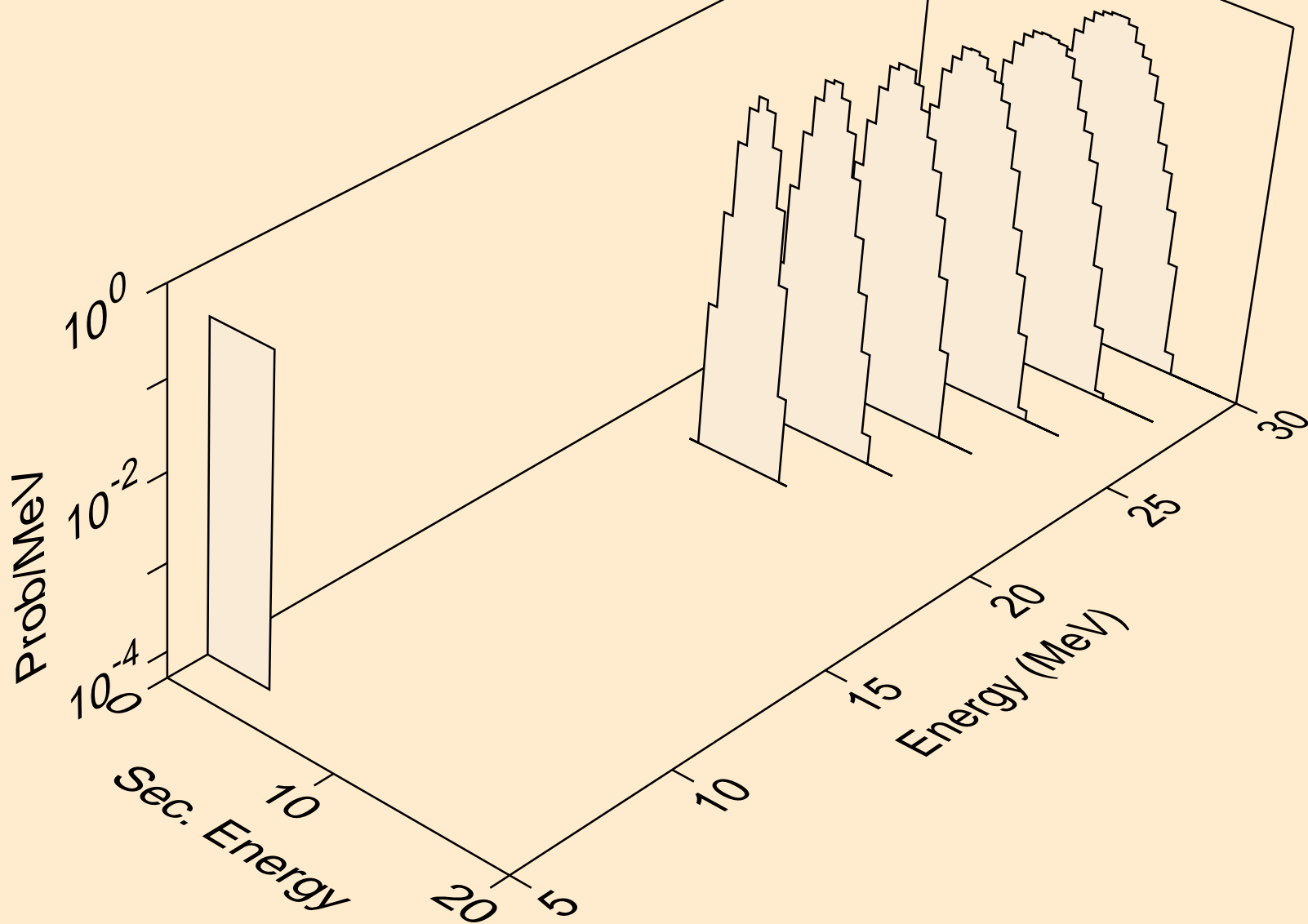

ND133 NEUTRON ACER TENDL-2021 LIBRARY; T=293.6K
alphas from (n,npa)

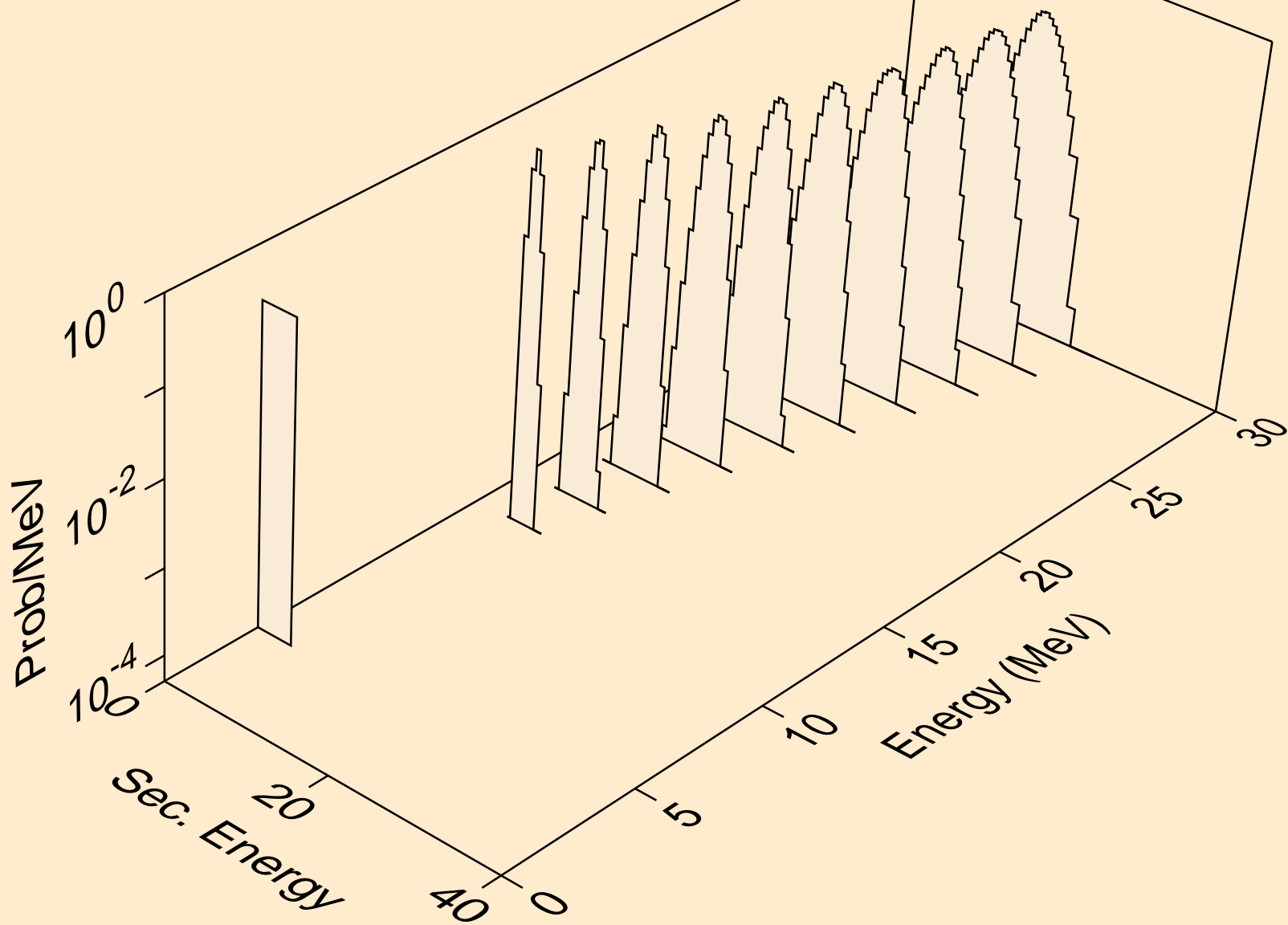

ND133 NEUTRON ACER TENDL-2021 LIBRARY; T=293.6K
alphas from (n,a)

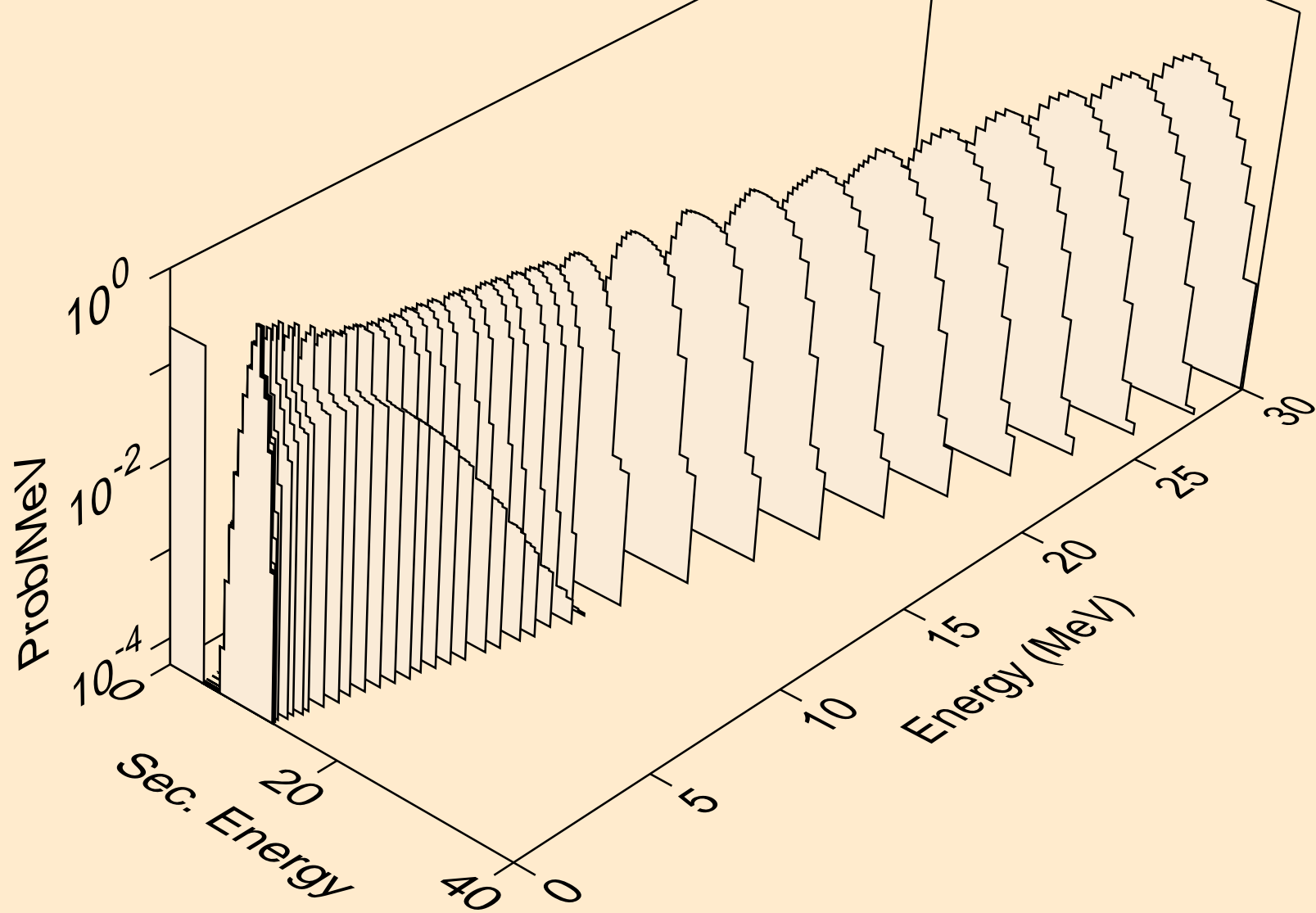

ND133 NEUTRON ACER TENDL-2021 LIBRARY; T=293.6K
alphas from (n,2a)

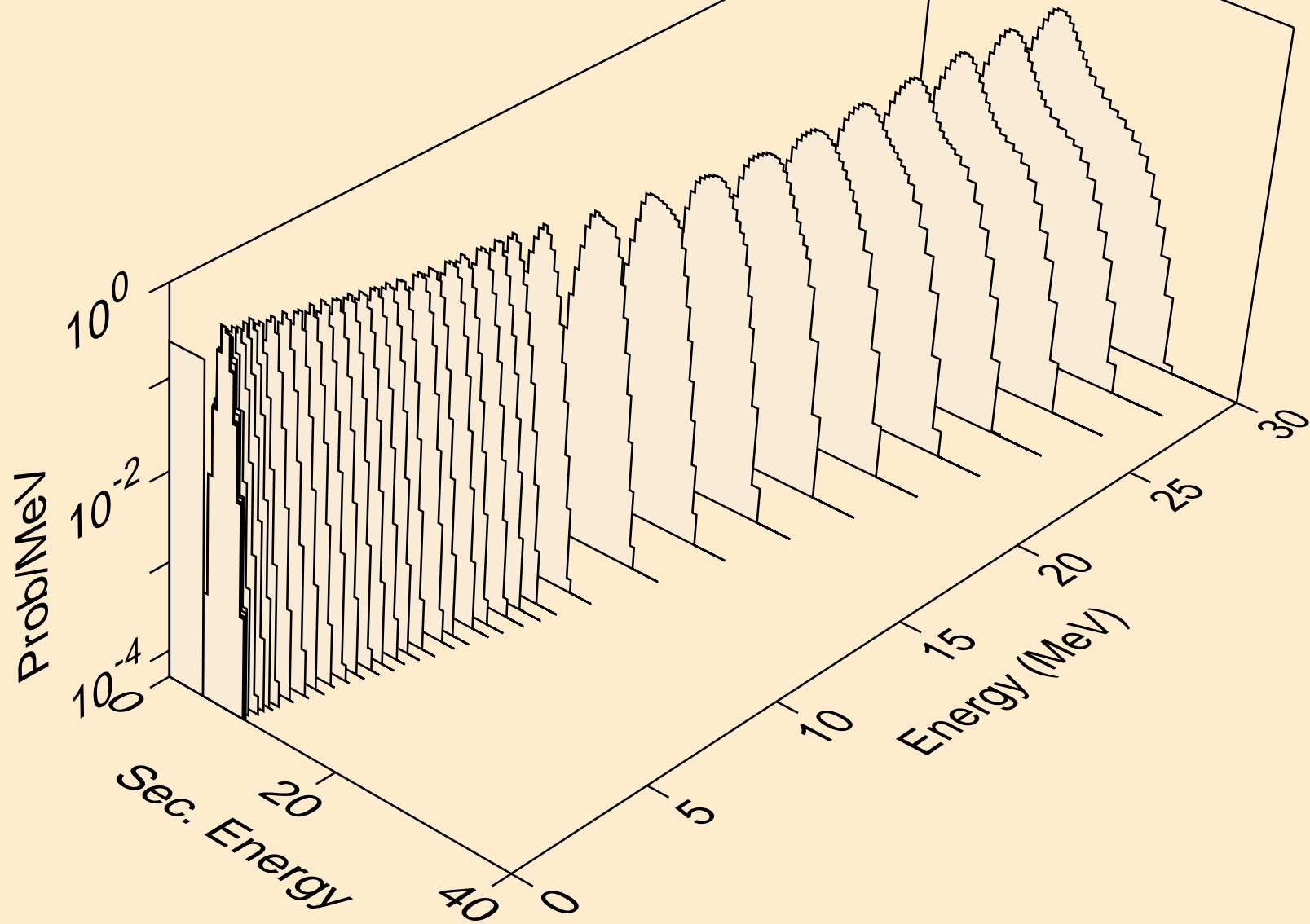

ND133 NEUTRON ACER TENDL-2021 LIBRARY; T=293.6K
alphas from (n,3a)

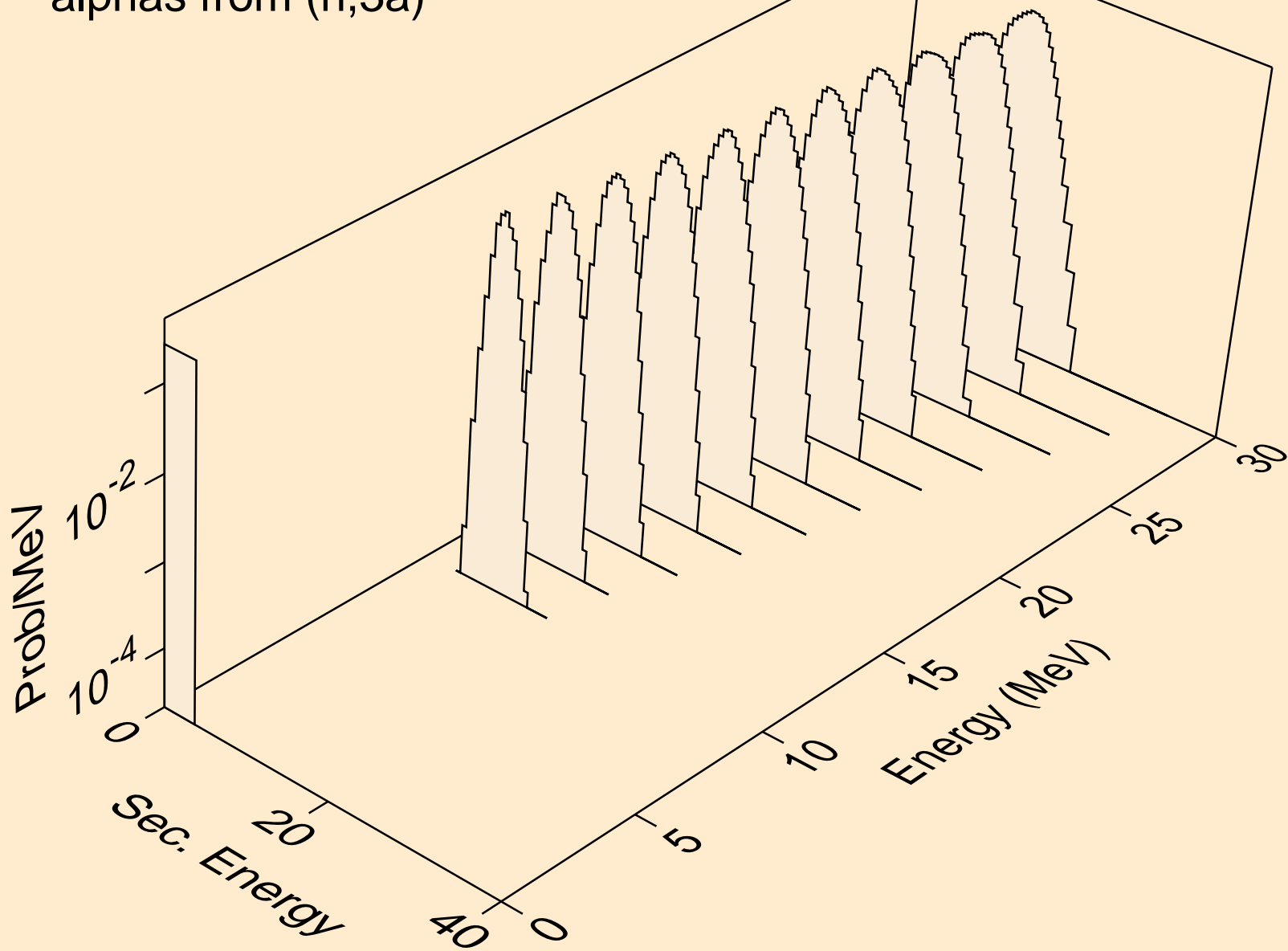

ND133 NEUTRON ACER TENDL-2021 LIBRARY; T=293.6K
alphas from (n,pa)

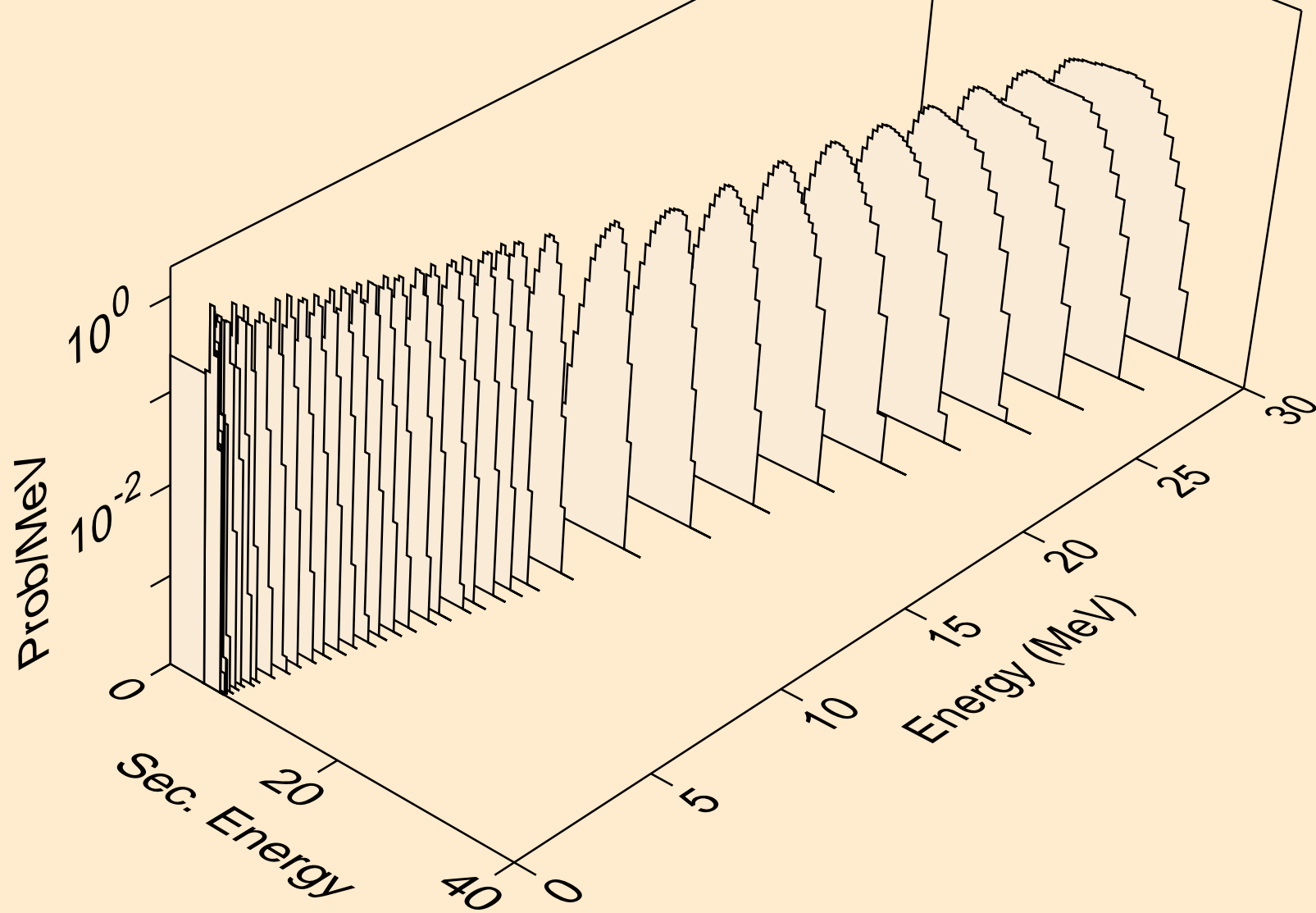

ND133 NEUTRON ACER TENDL-2021 LIBRARY; T=293.6K
alphas from (n,da)

