

ND142 NEUTRON ACER TENDL-2021 LIBRARY; T=293.6K

Principal cross sections

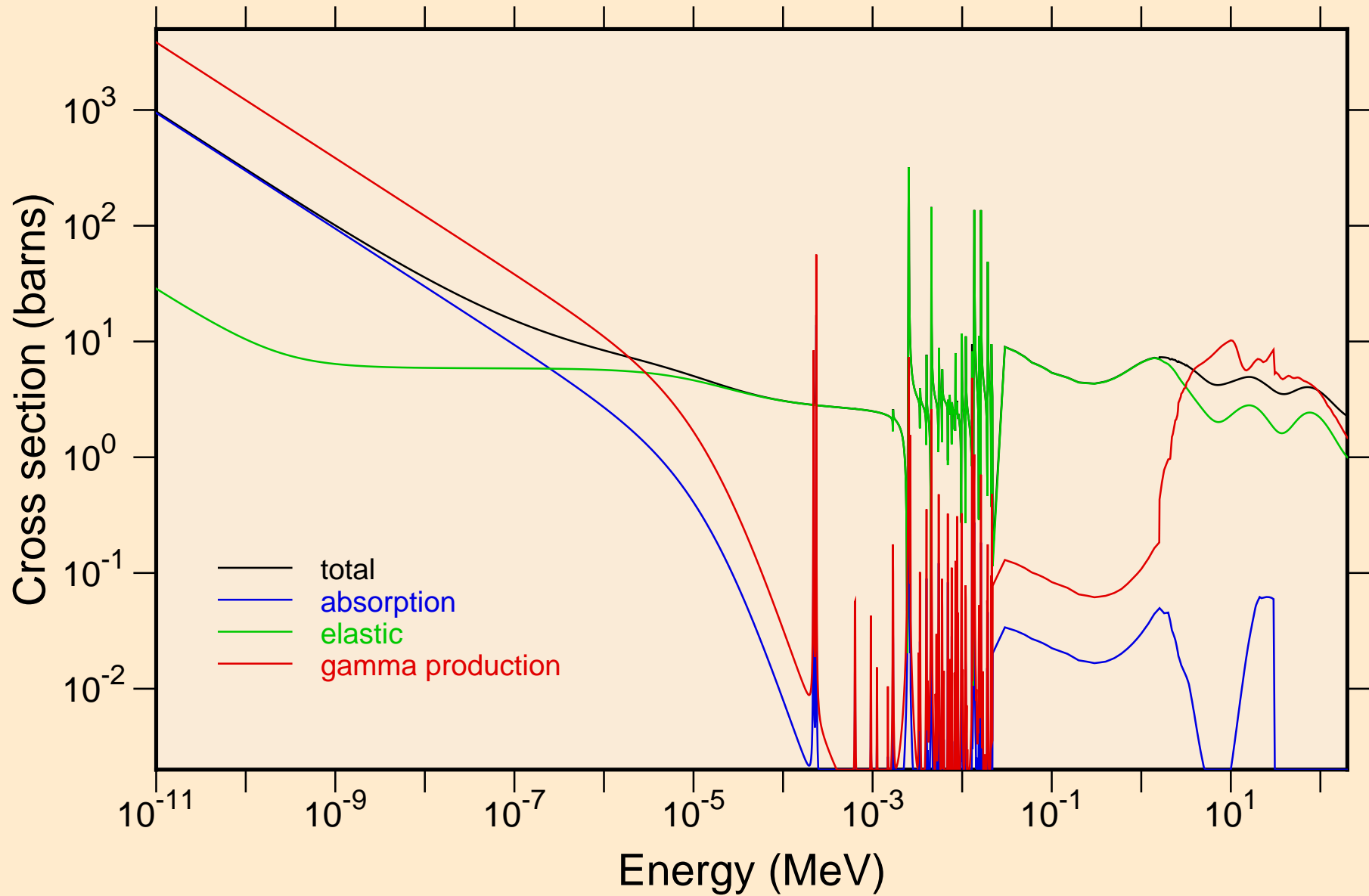

ND142 NEUTRON ACER TENDL-2021 LIBRARY; T=293.6K
resonance total cross section

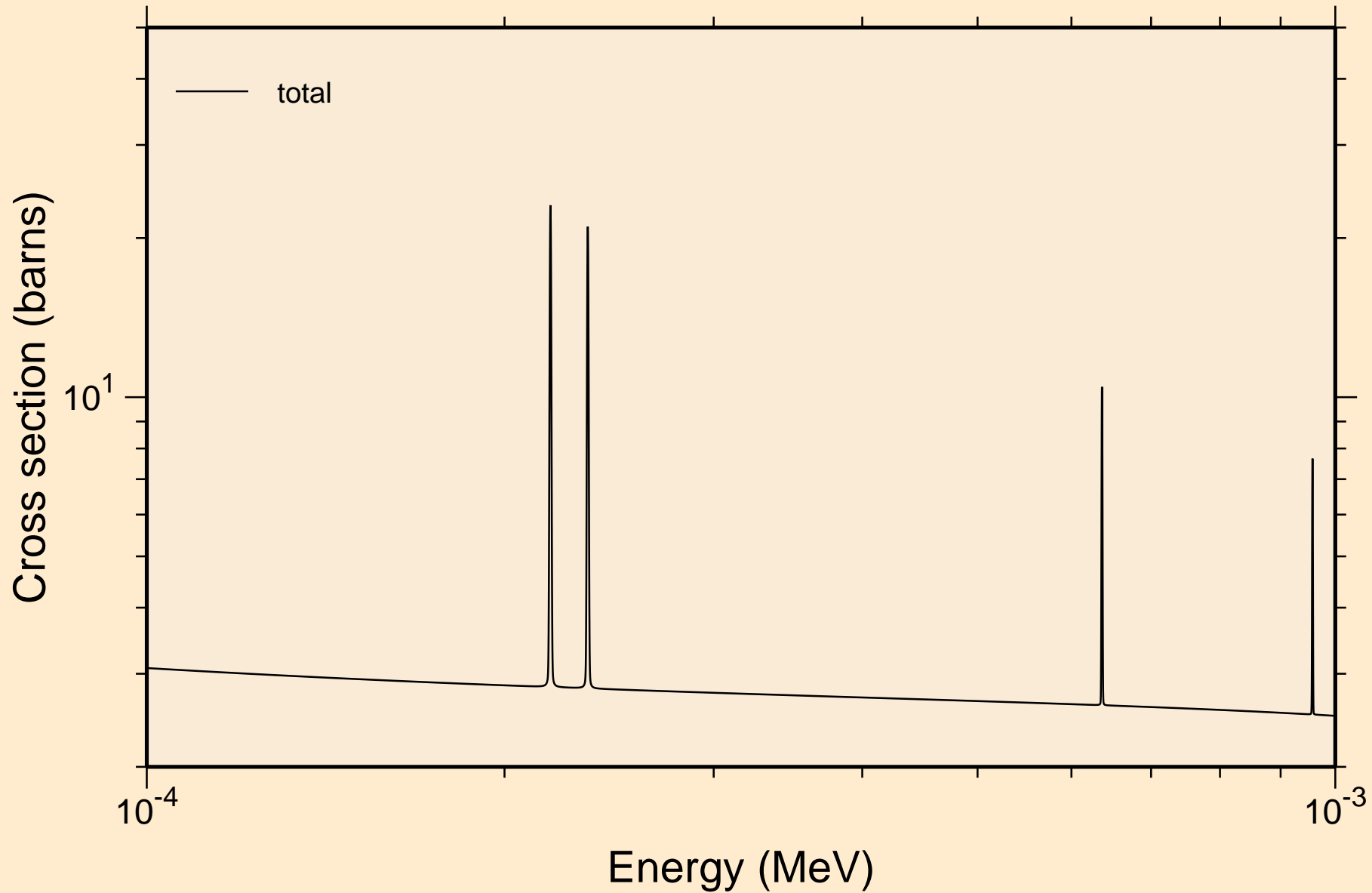

ND142 NEUTRON ACER TENDL-2021 LIBRARY; T=293.6K
resonance total cross section

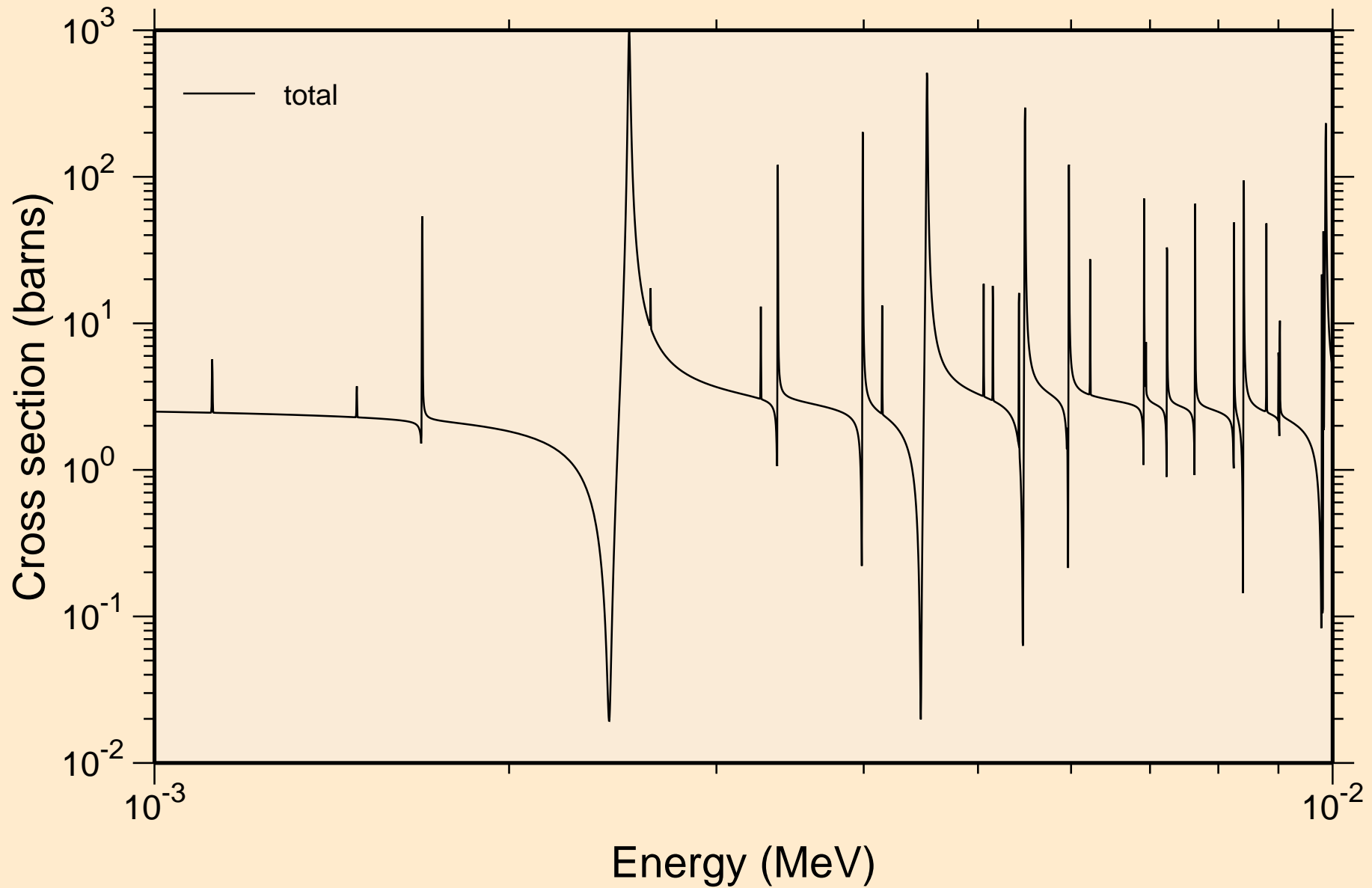

ND142 NEUTRON ACER TENDL-2021 LIBRARY; T=293.6K
resonance total cross section

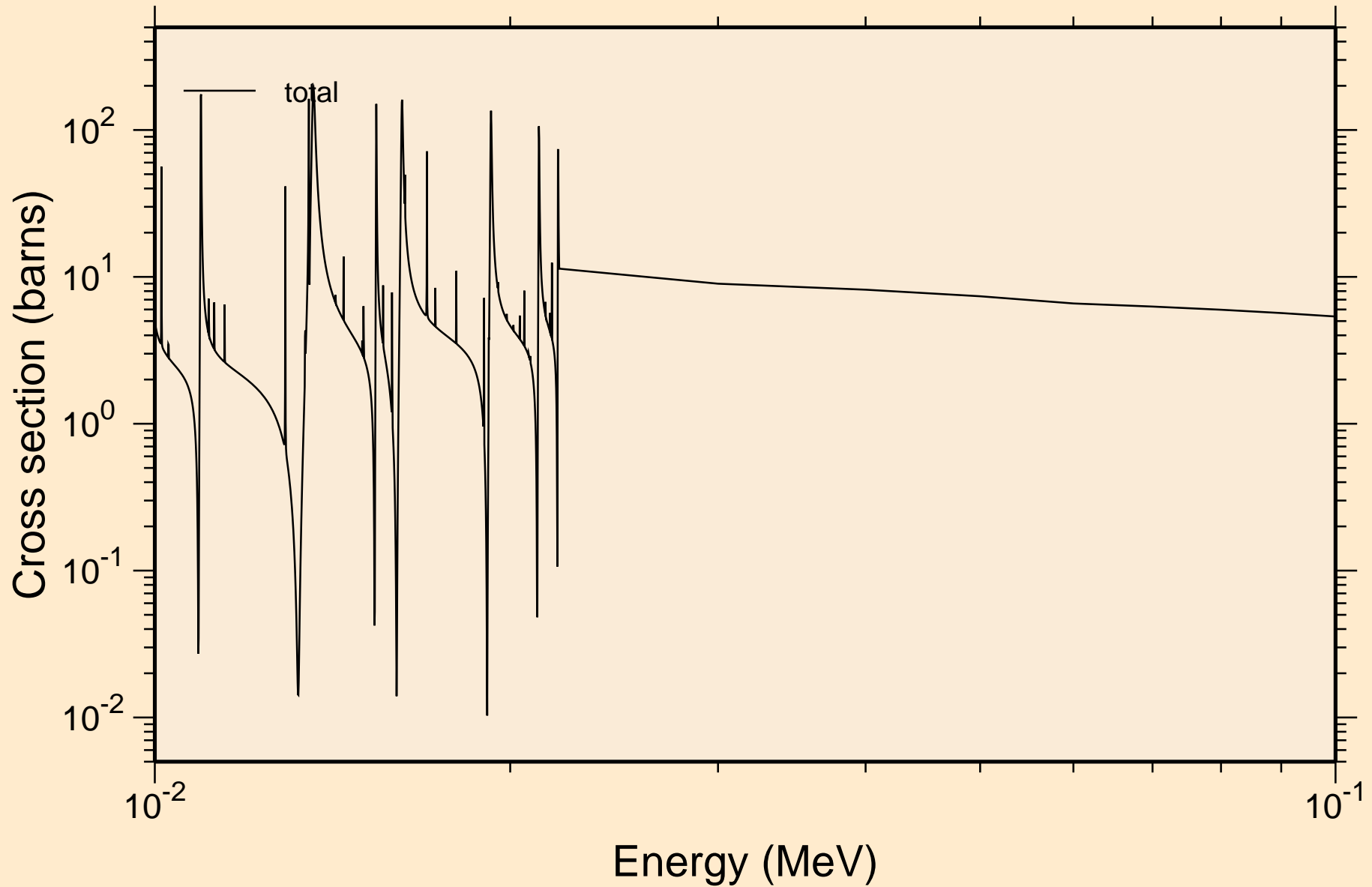

ND142 NEUTRON ACER TENDL-2021 LIBRARY; T=293.6K
resonance total cross section

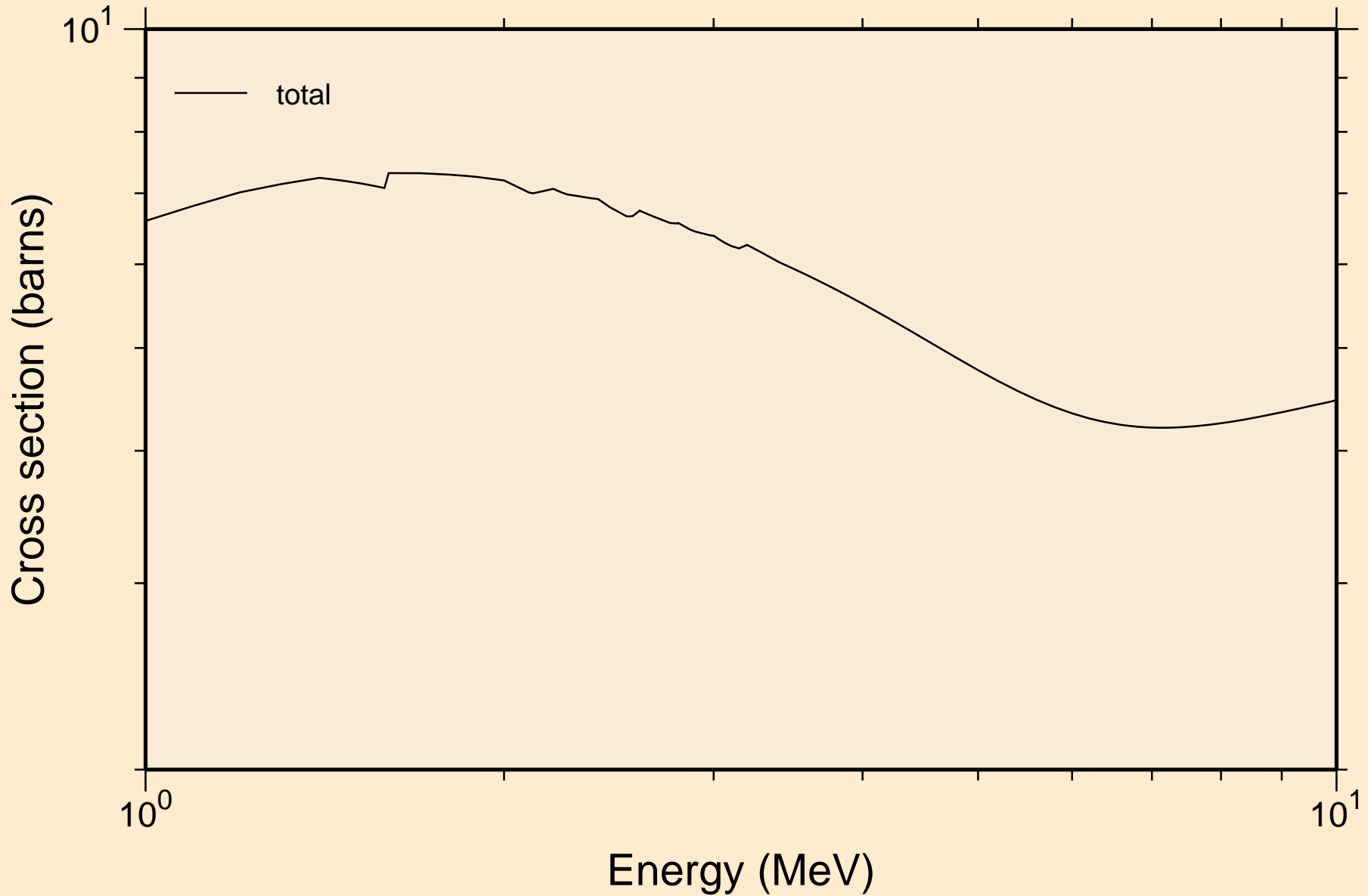

ND142 NEUTRON ACER TENDL-2021 LIBRARY; T=293.6K
resonance absorption cross sections

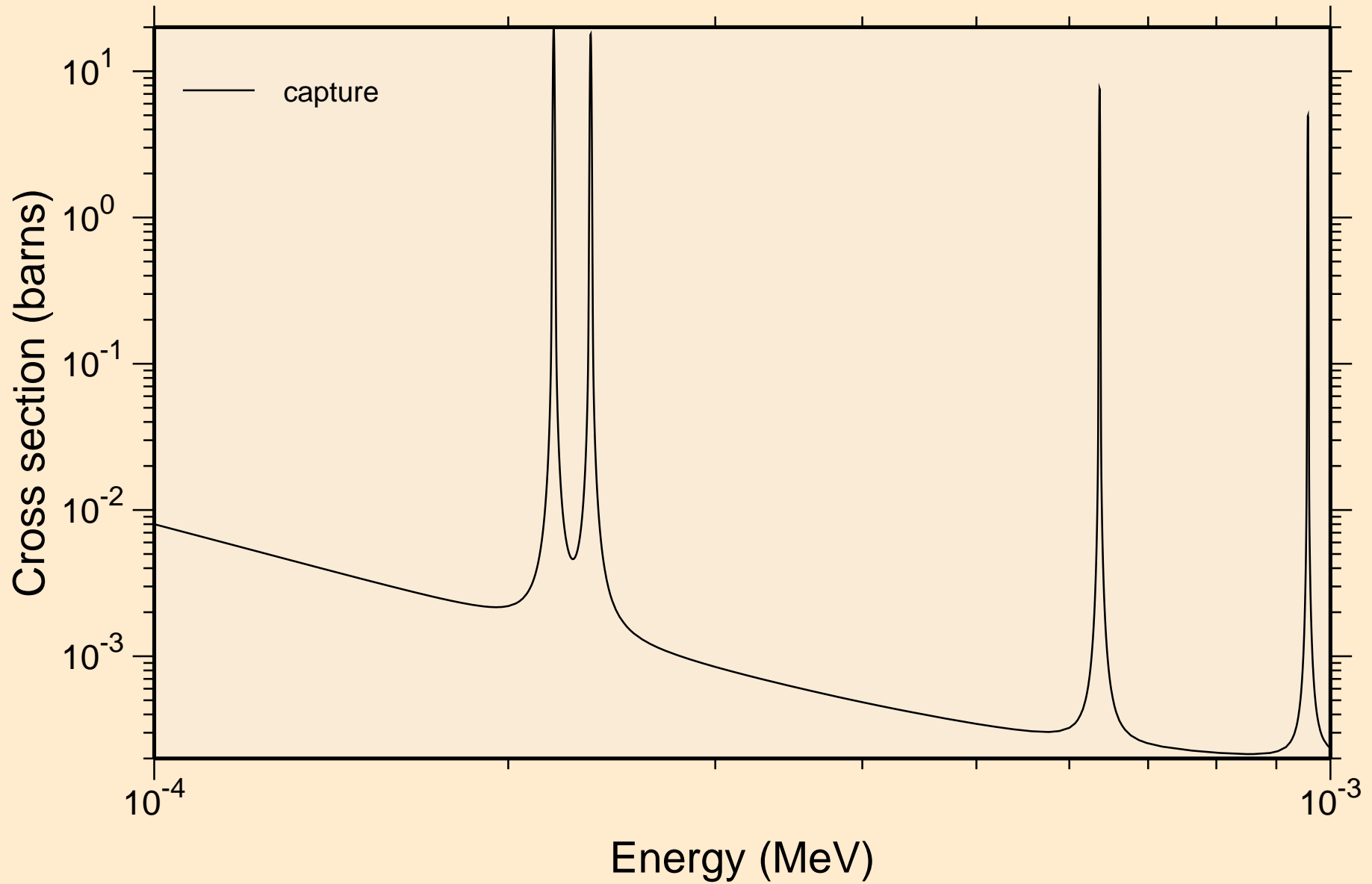

ND142 NEUTRON ACER TENDL-2021 LIBRARY; T=293.6K
resonance absorption cross sections

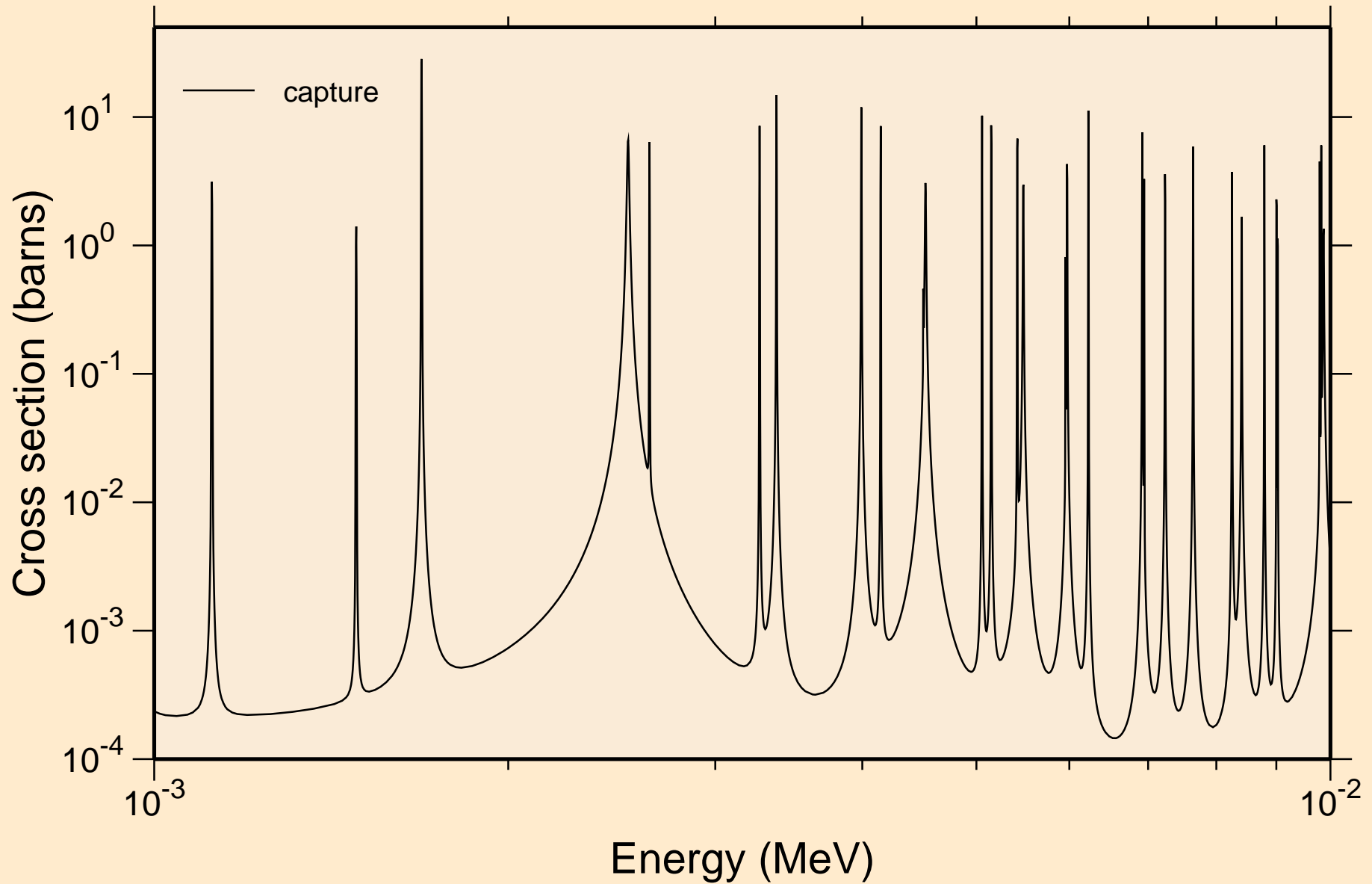

ND142 NEUTRON ACER TENDL-2021 LIBRARY; T=293.6K
resonance absorption cross sections

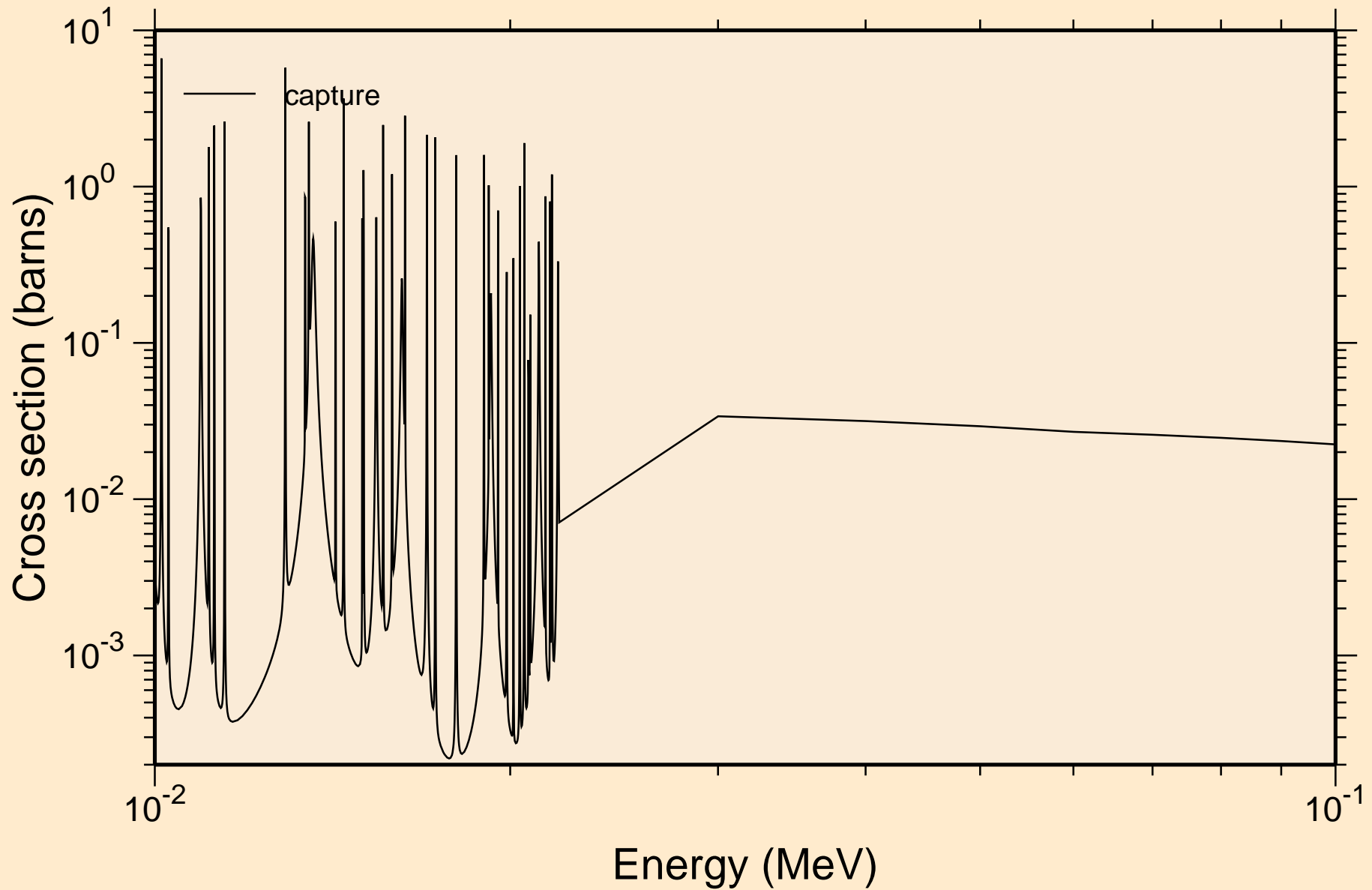

ND142 NEUTRON ACER TENDL-2021 LIBRARY; T=293.6K
resonance absorption cross sections

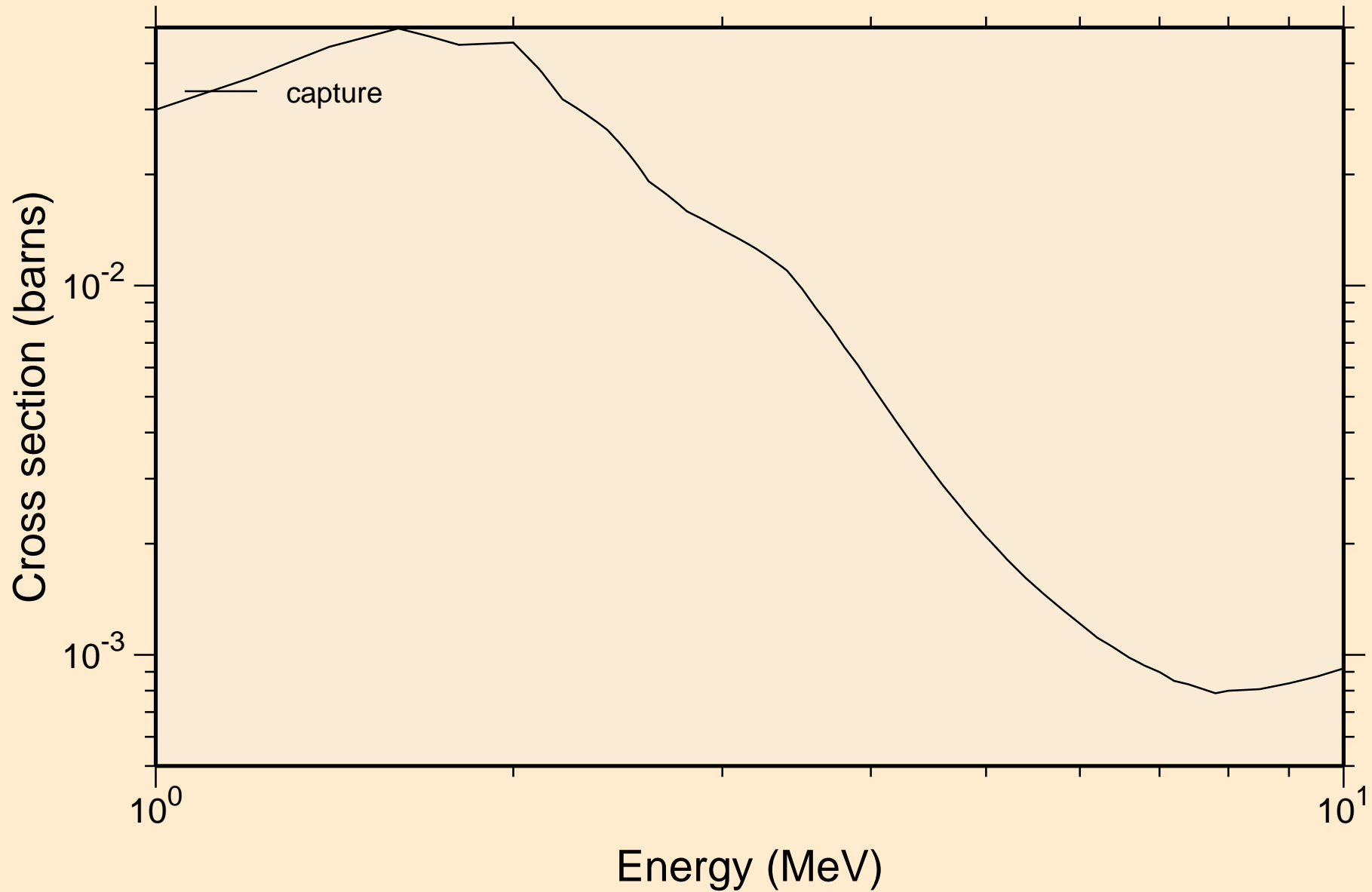

ND142 NEUTRON ACER TENDL-2021 LIBRARY; T=293.6K
Heating

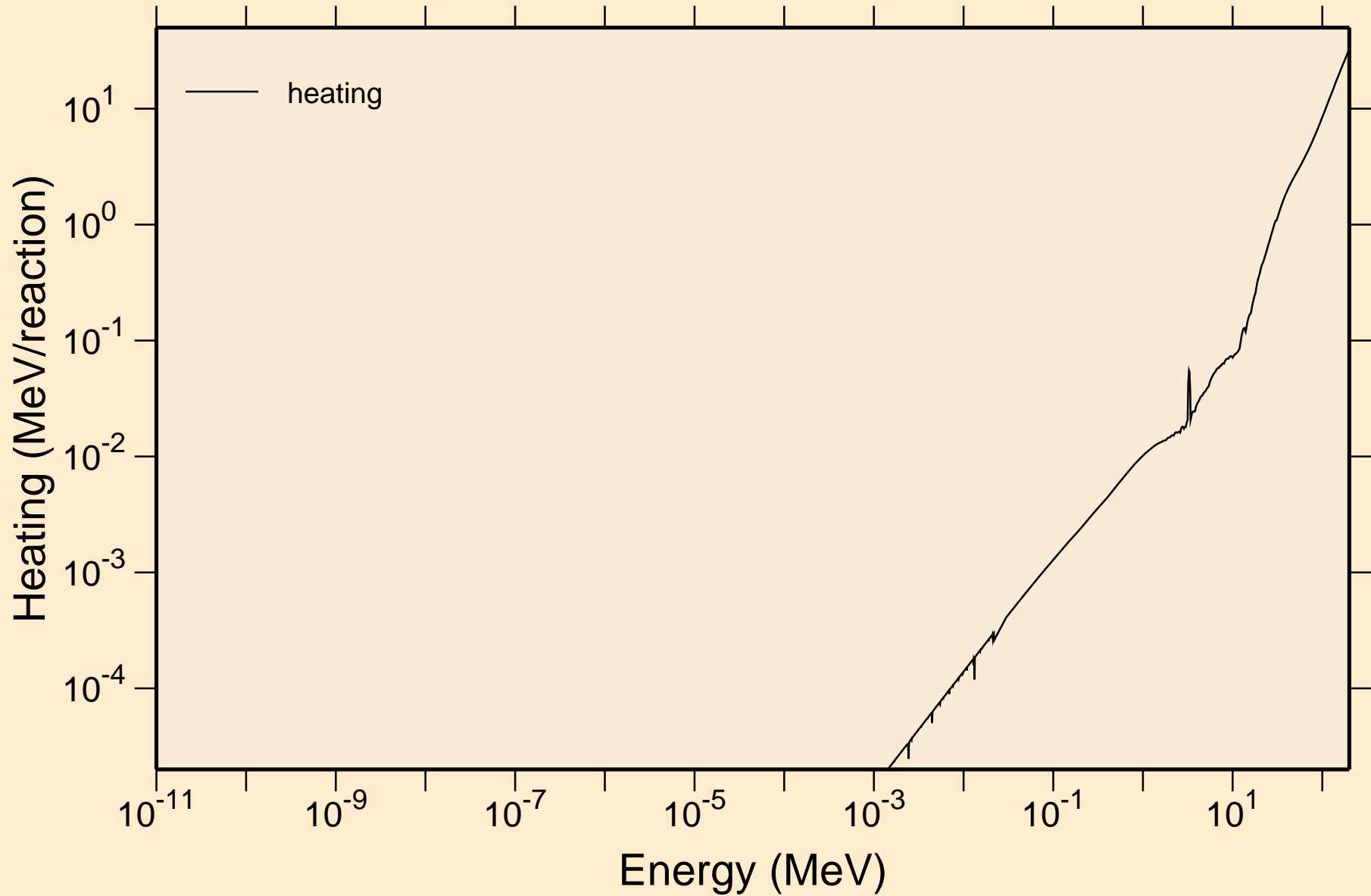

ND142 NEUTRON ACER TENDL-2021 LIBRARY; T=293.6K

Damage

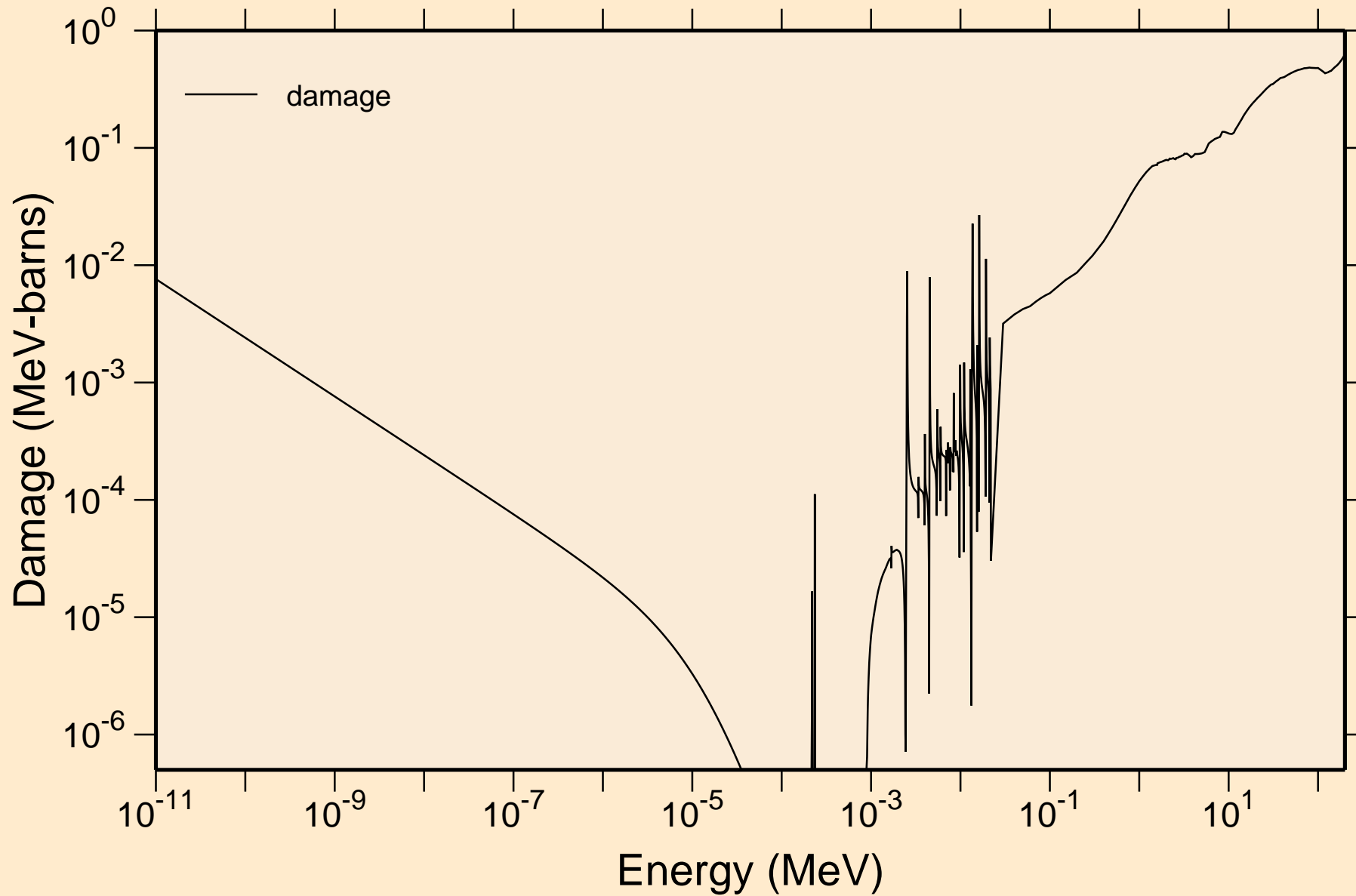

ND142 NEUTRON ACER TENDL-2021 LIBRARY; T=293.6K
Non-threshold reactions

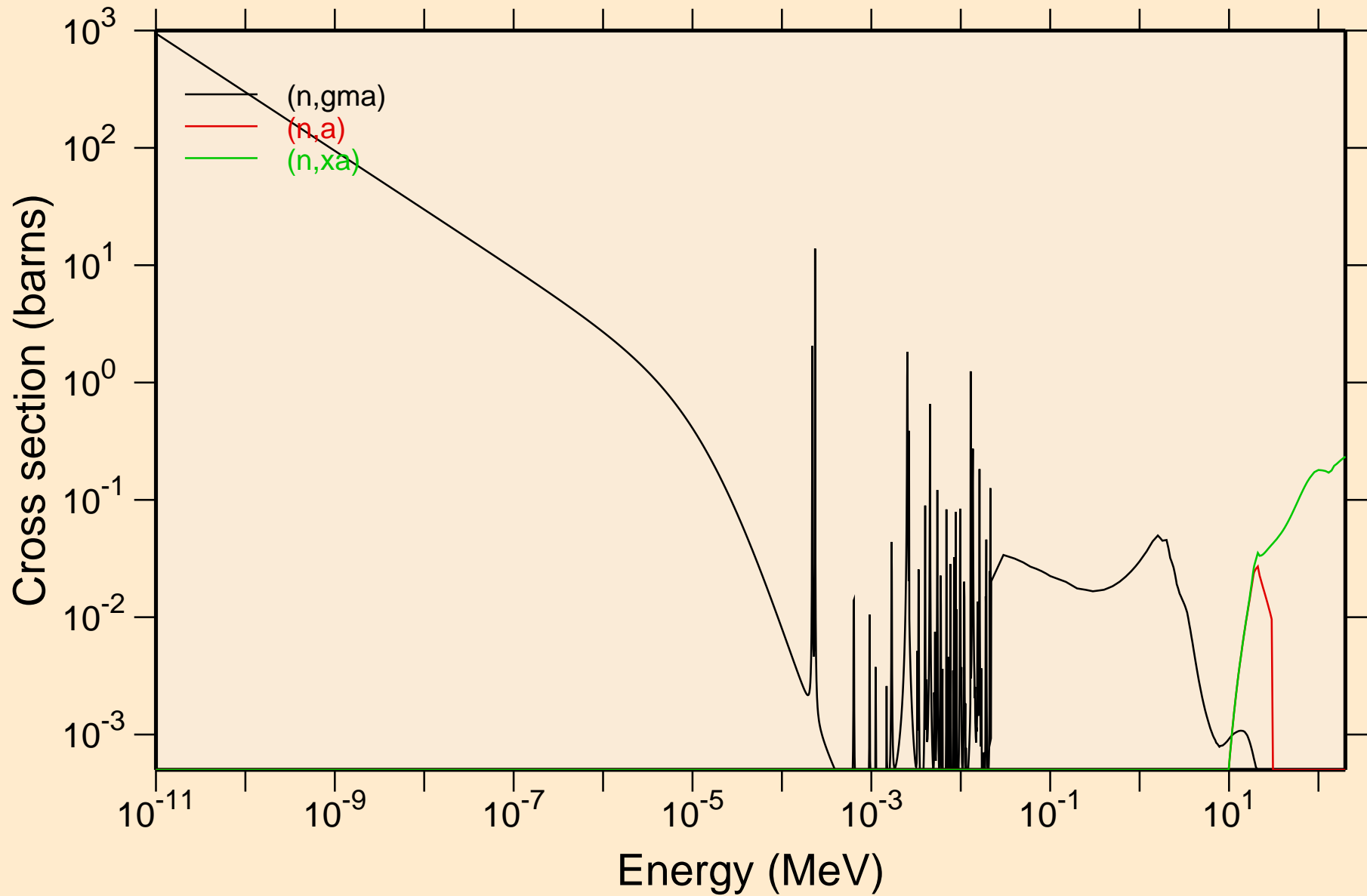

ND142 NEUTRON ACER TENDL-2021 LIBRARY; T=293.6K

Principal cross sections

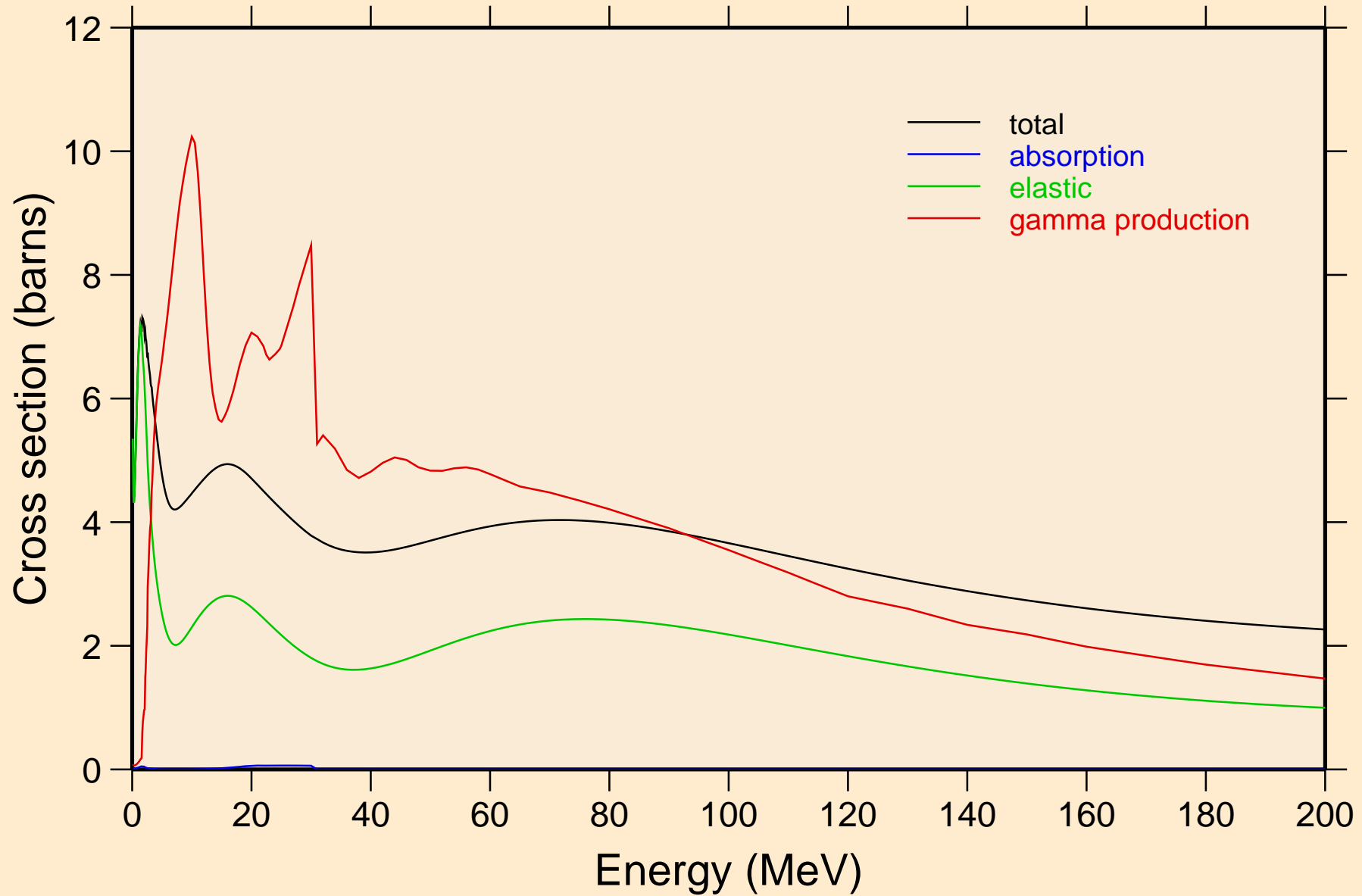

ND142 NEUTRON ACER TENDL-2021 LIBRARY; T=293.6K
Heating

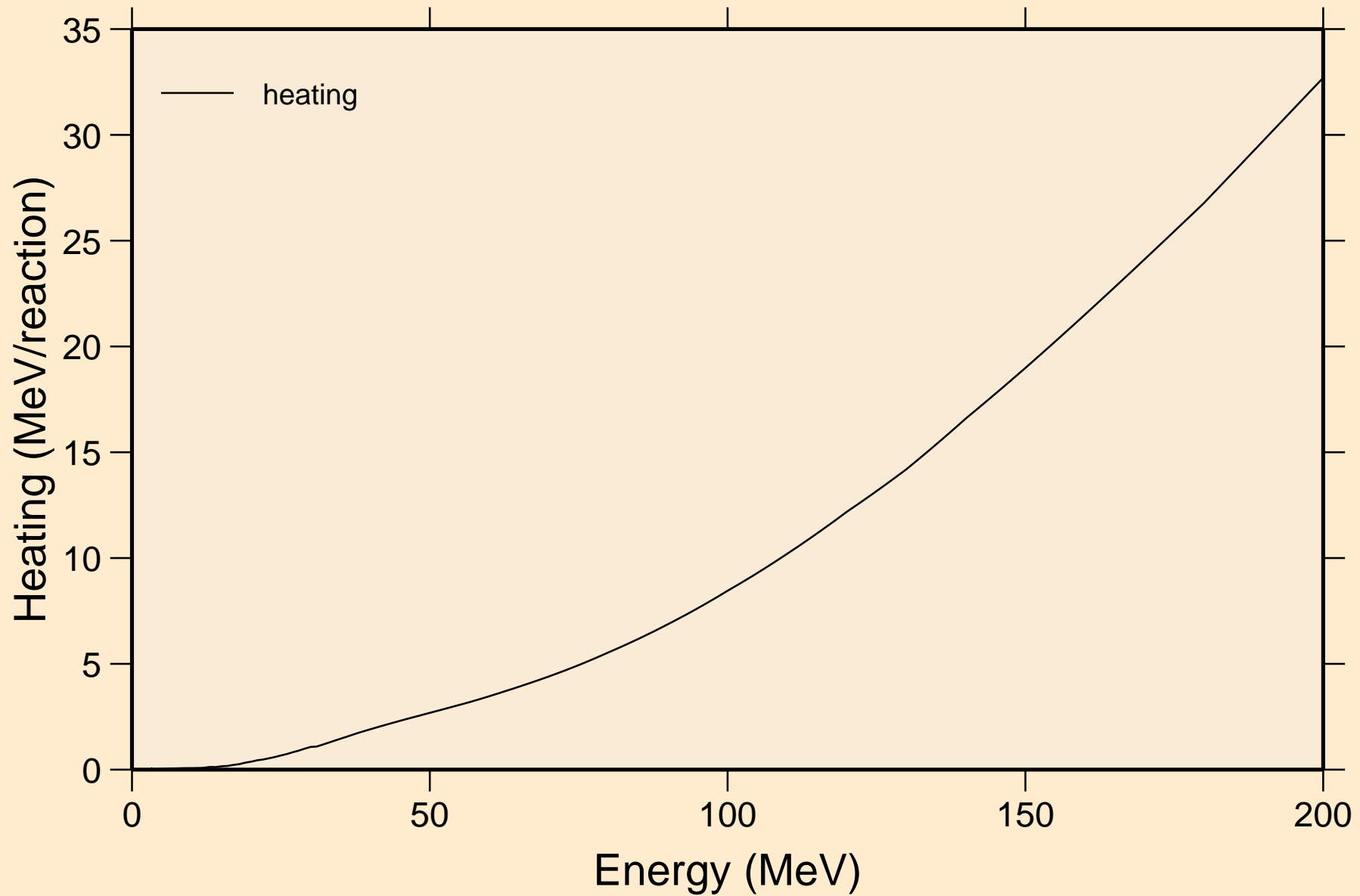

ND142 NEUTRON ACER TENDL-2021 LIBRARY; T=293.6K

Damage

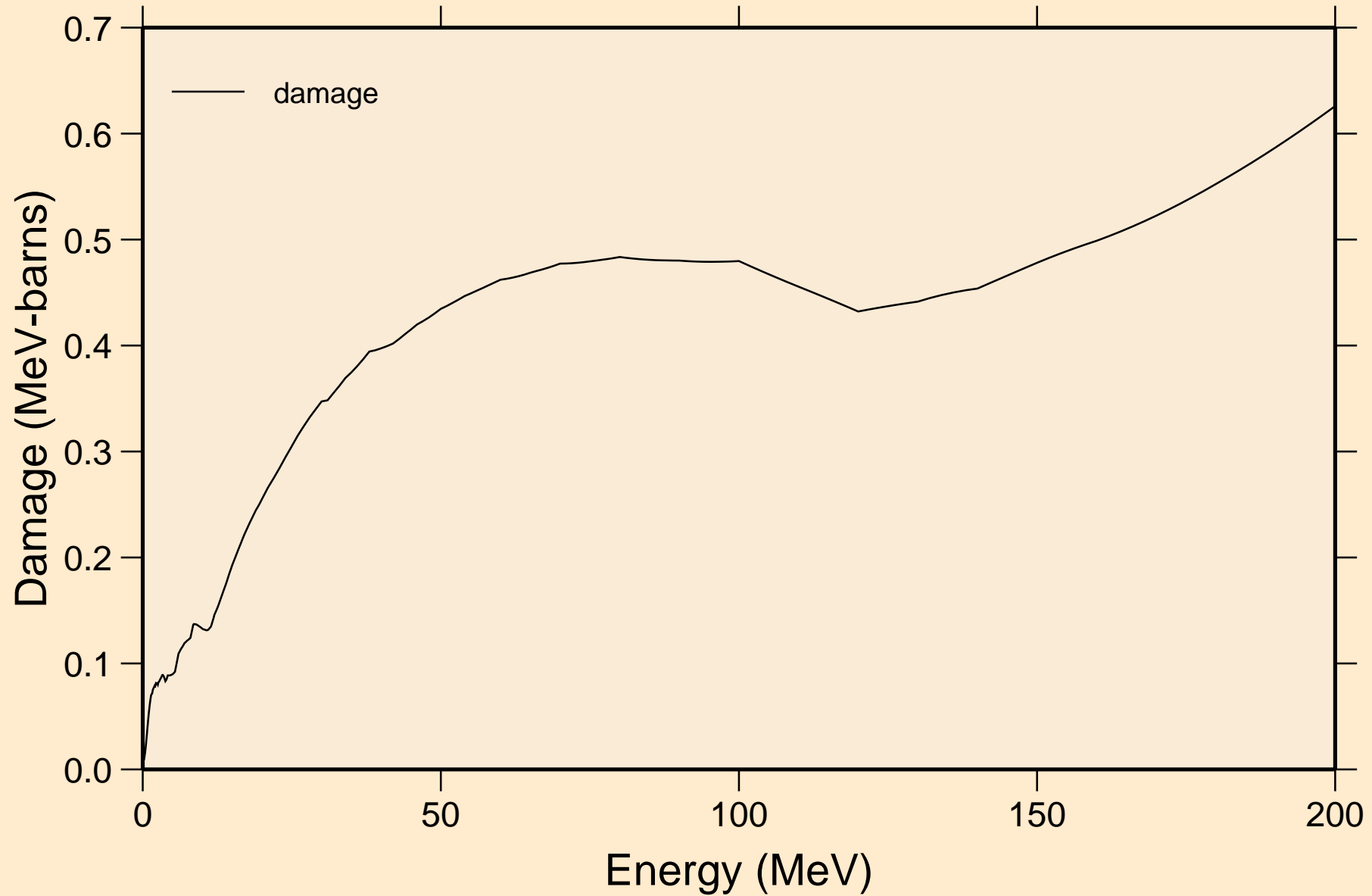

ND142 NEUTRON ACER TENDL-2021 LIBRARY; T=293.6K
Non-threshold reactions

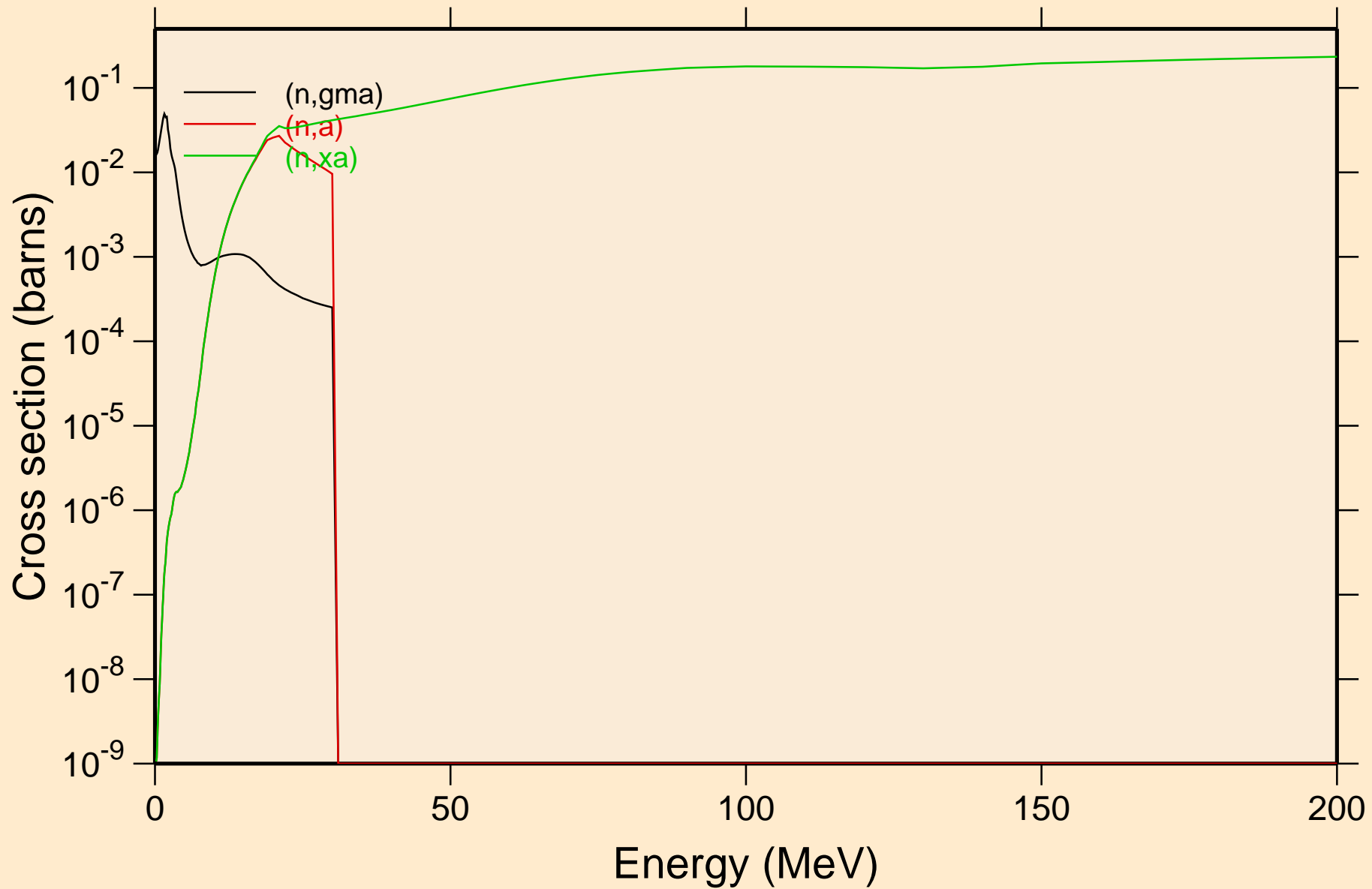

ND142 NEUTRON ACER TENDL-2021 LIBRARY; T=293.6K
Inelastic levels

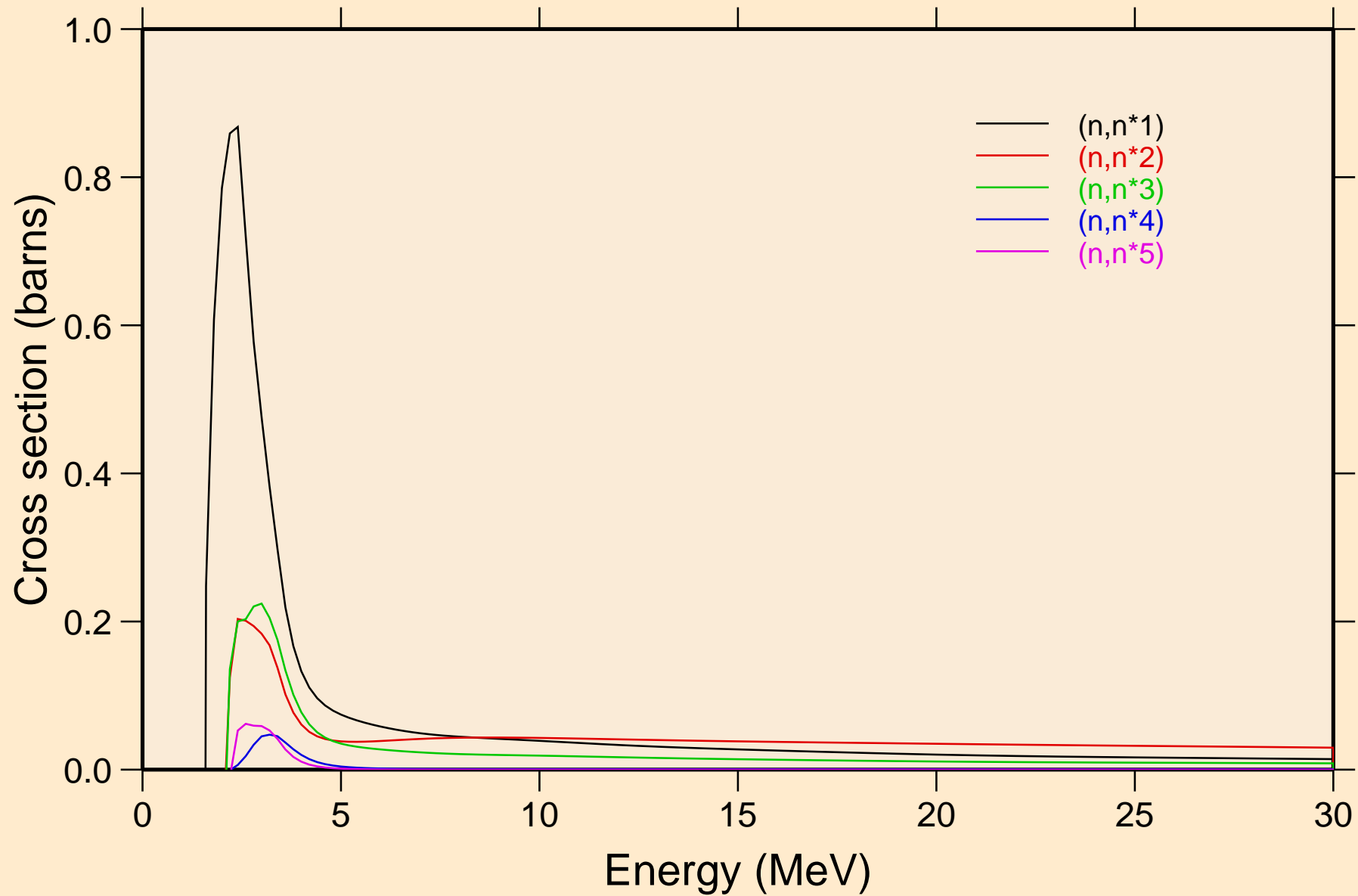

ND142 NEUTRON ACER TENDL-2021 LIBRARY; T=293.6K
Inelastic levels

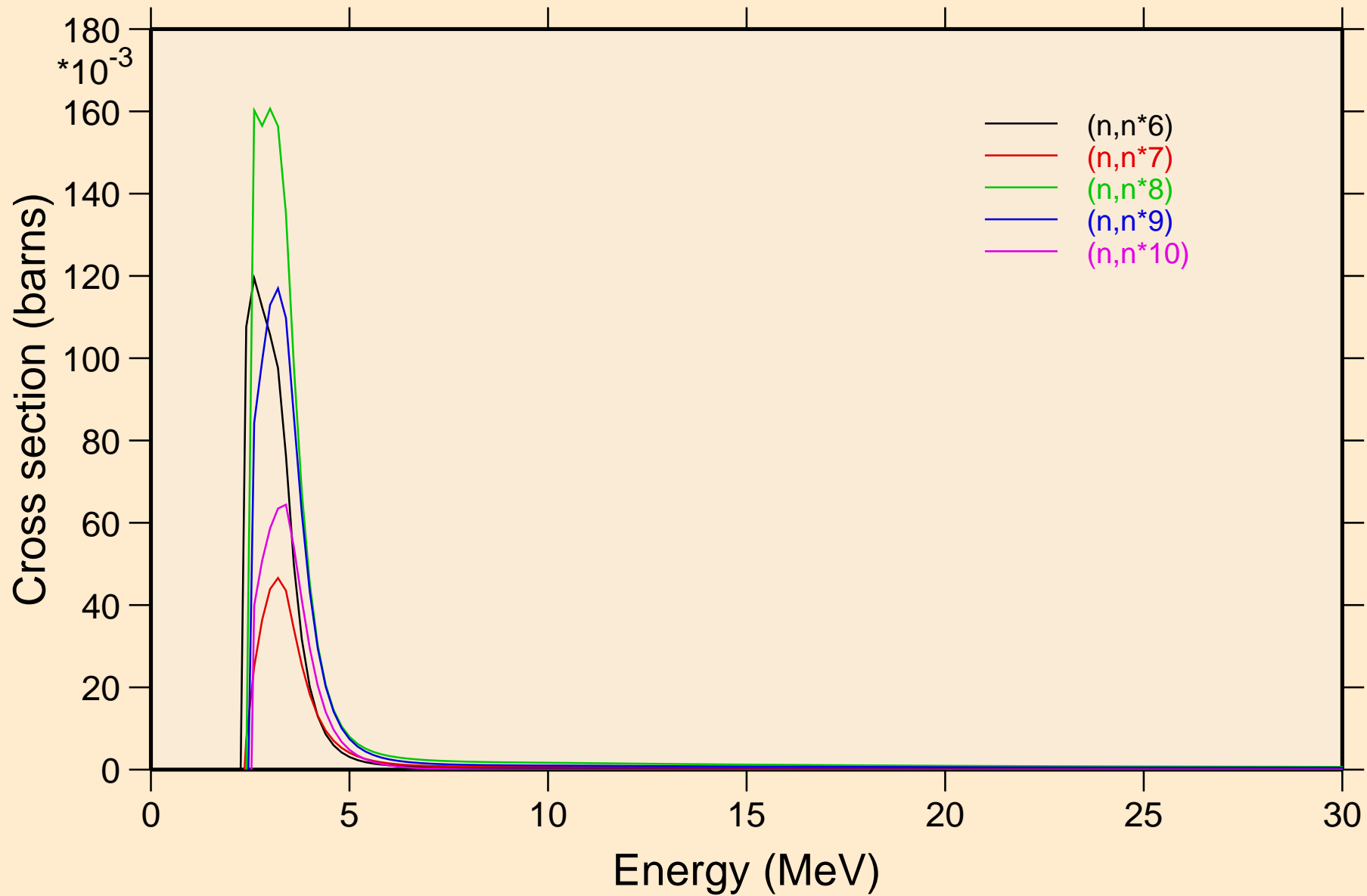

ND142 NEUTRON ACER TENDL-2021 LIBRARY; T=293.6K
Inelastic levels

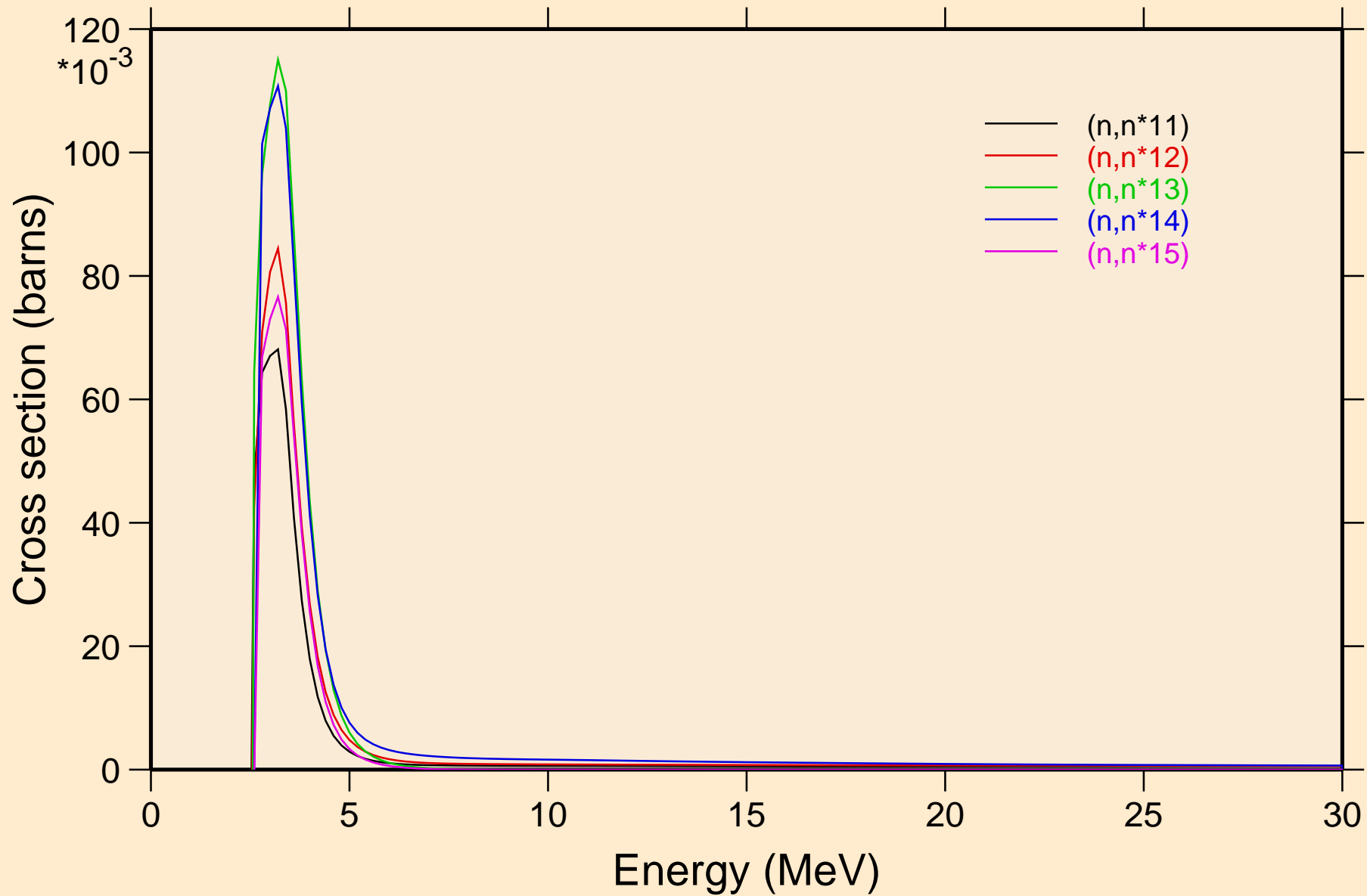

ND142 NEUTRON ACER TENDL-2021 LIBRARY; T=293.6K
Inelastic levels

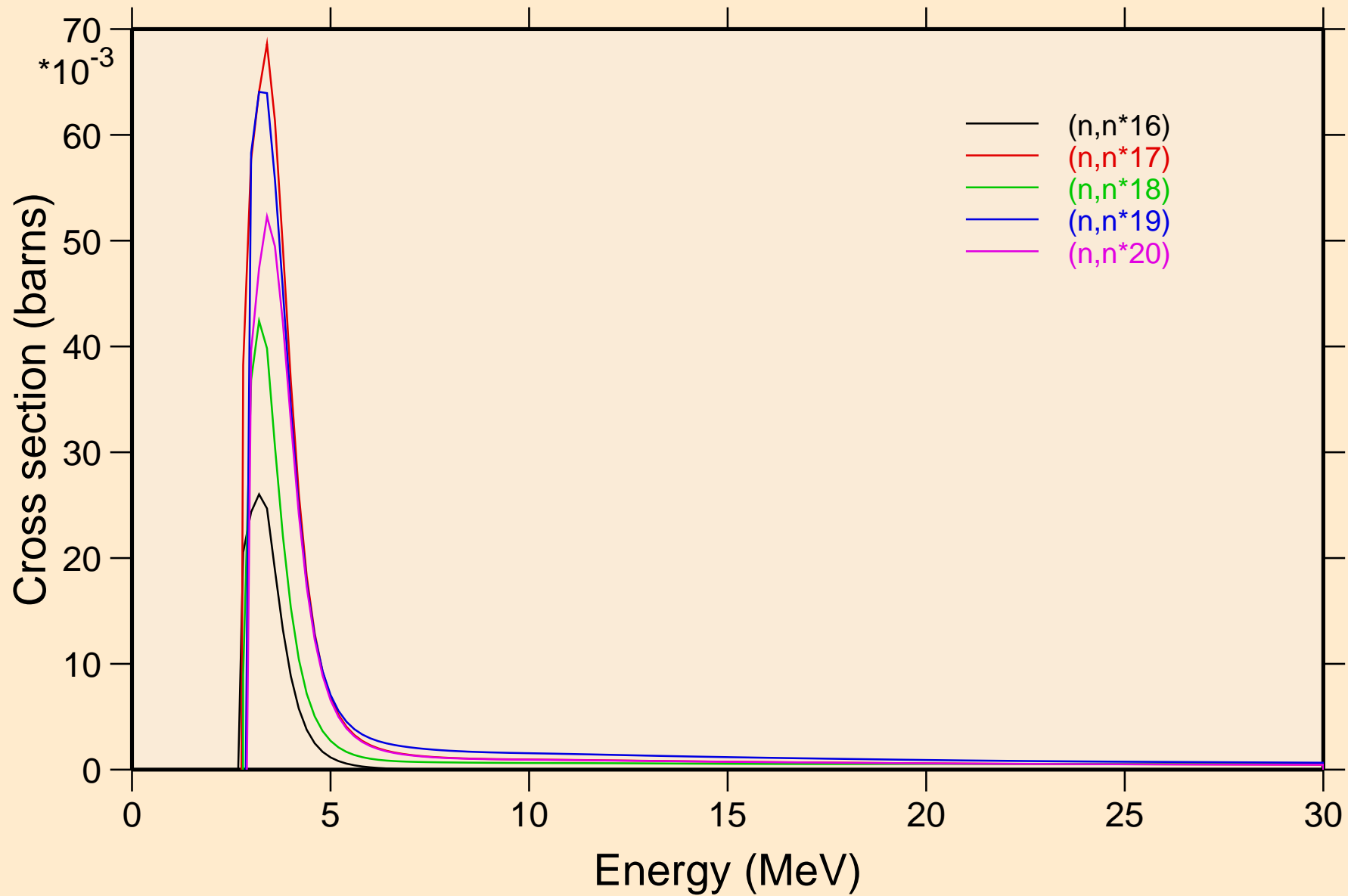

ND142 NEUTRON ACER TENDL-2021 LIBRARY; T=293.6K
Inelastic levels

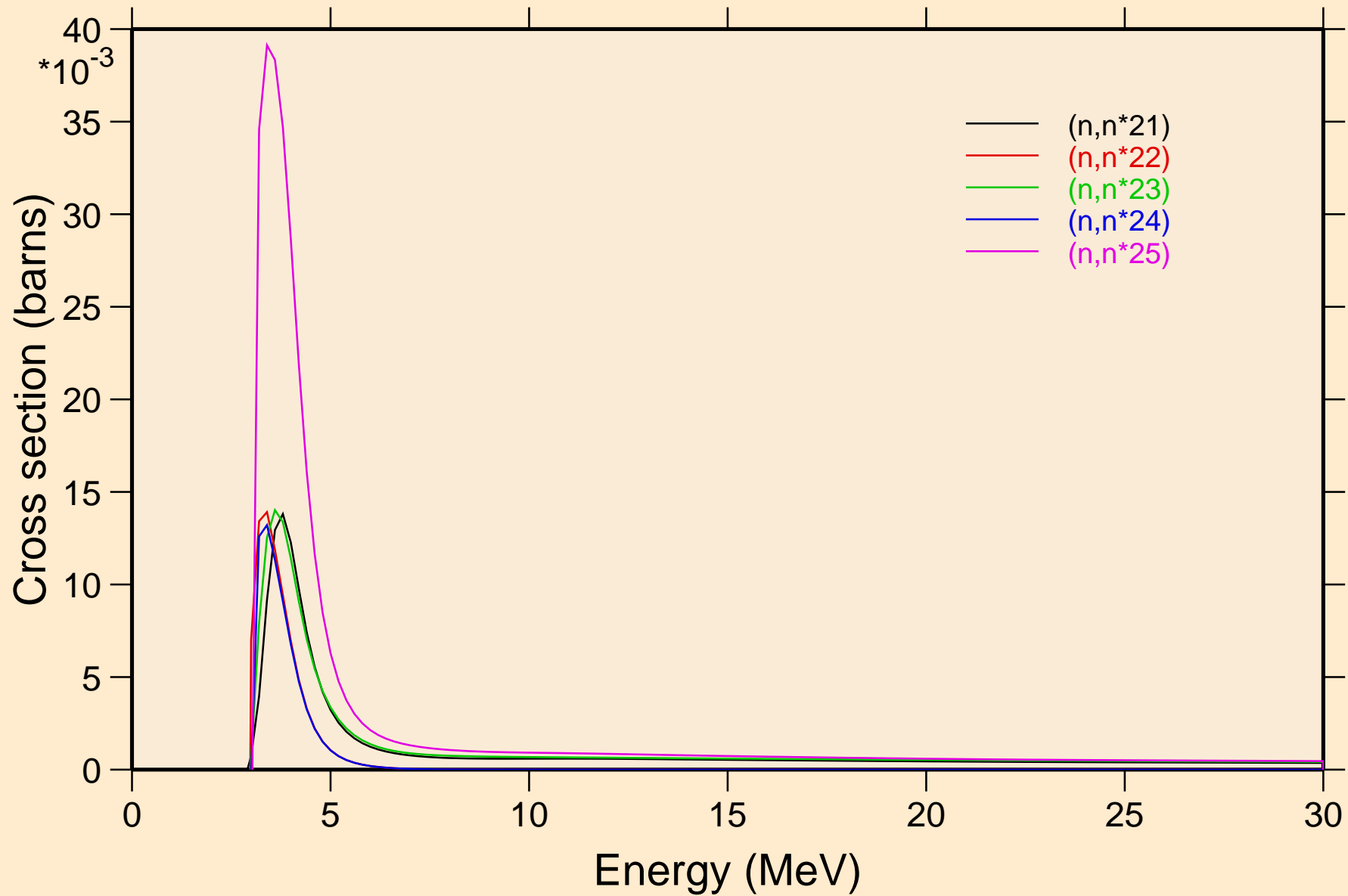

ND142 NEUTRON ACER TENDL-2021 LIBRARY; T=293.6K
Inelastic levels

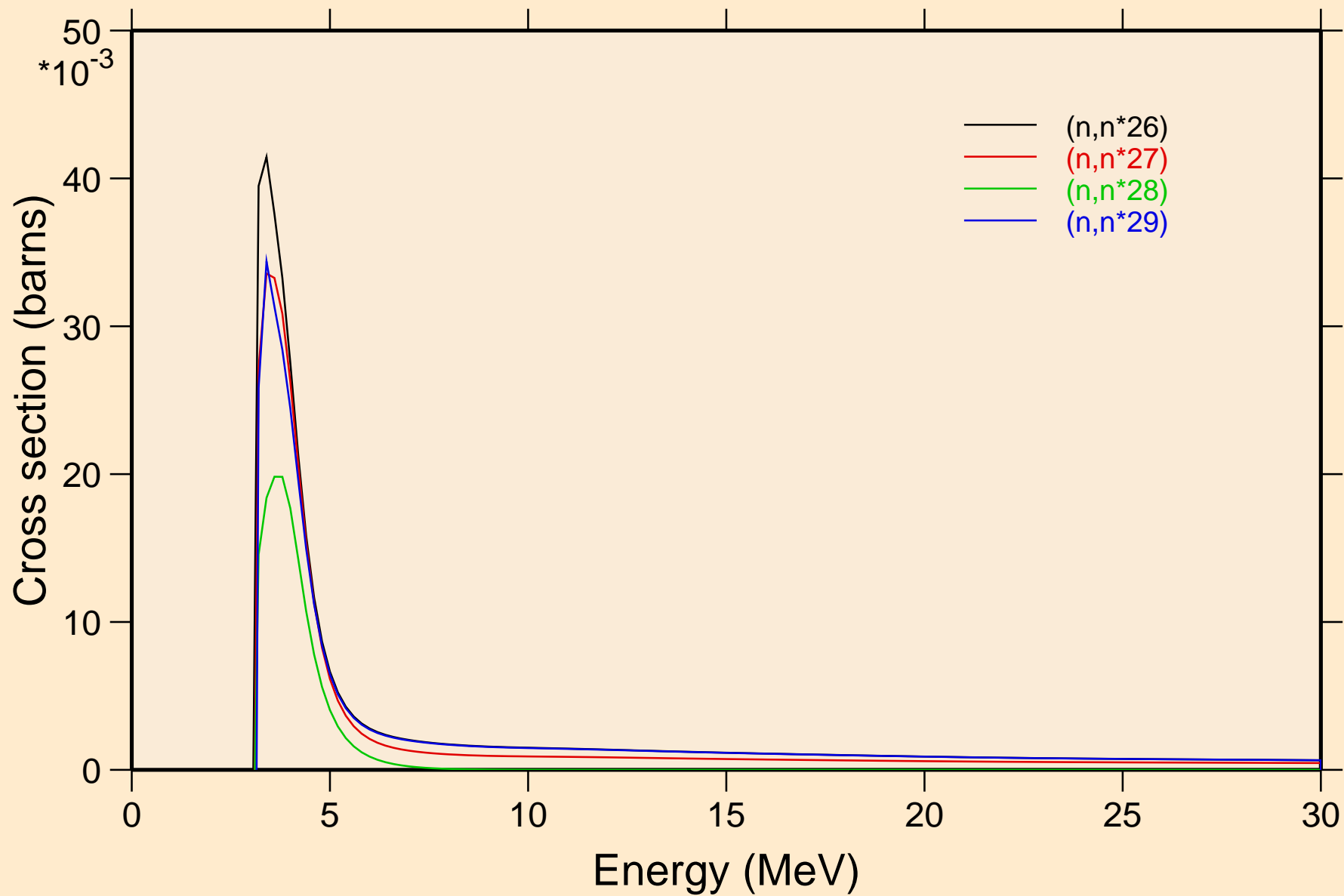

ND142 NEUTRON ACER TENDL-2021 LIBRARY; T=293.6K
Threshold reactions

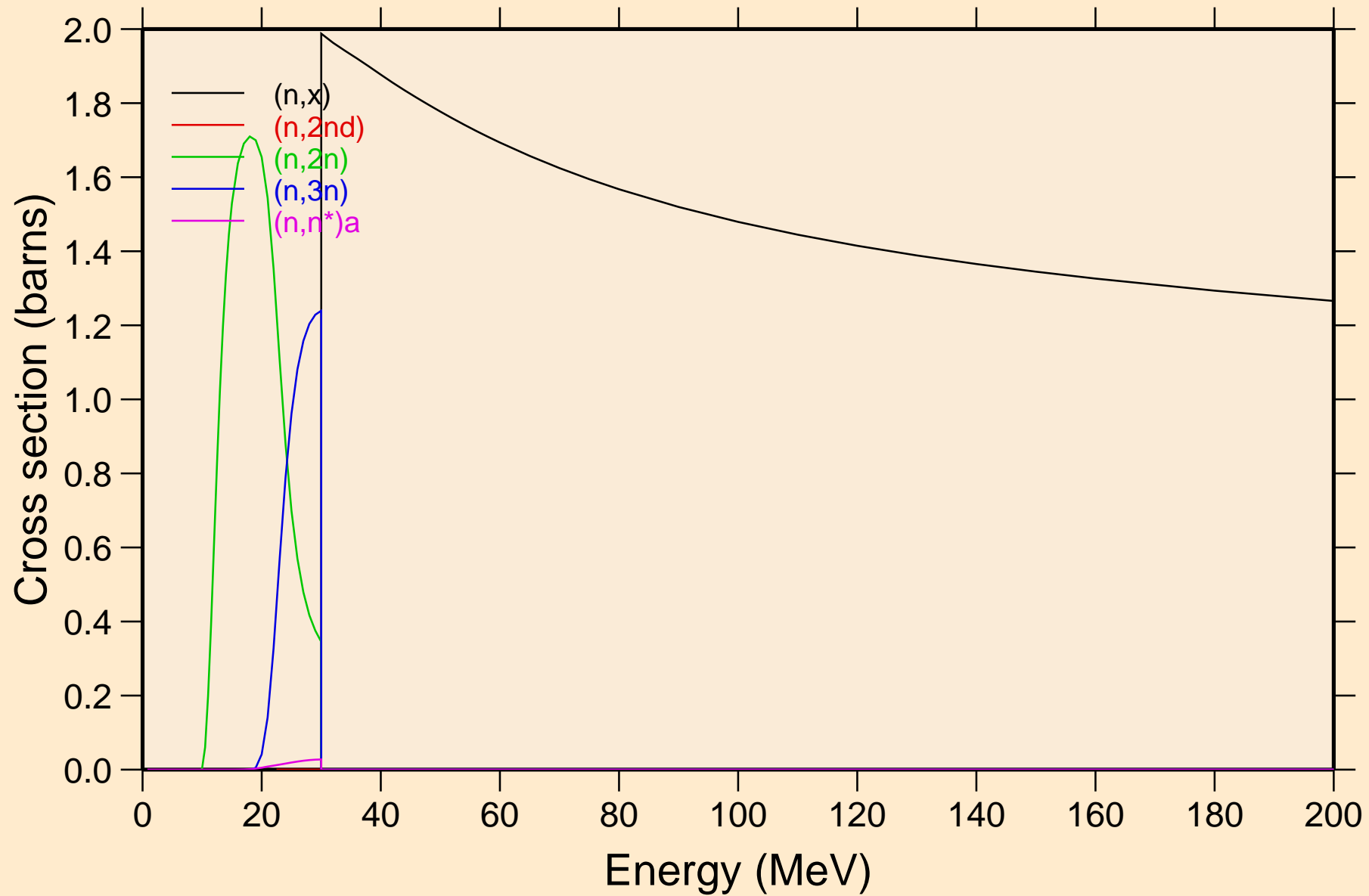

ND142 NEUTRON ACER TENDL-2021 LIBRARY; T=293.6K
Threshold reactions

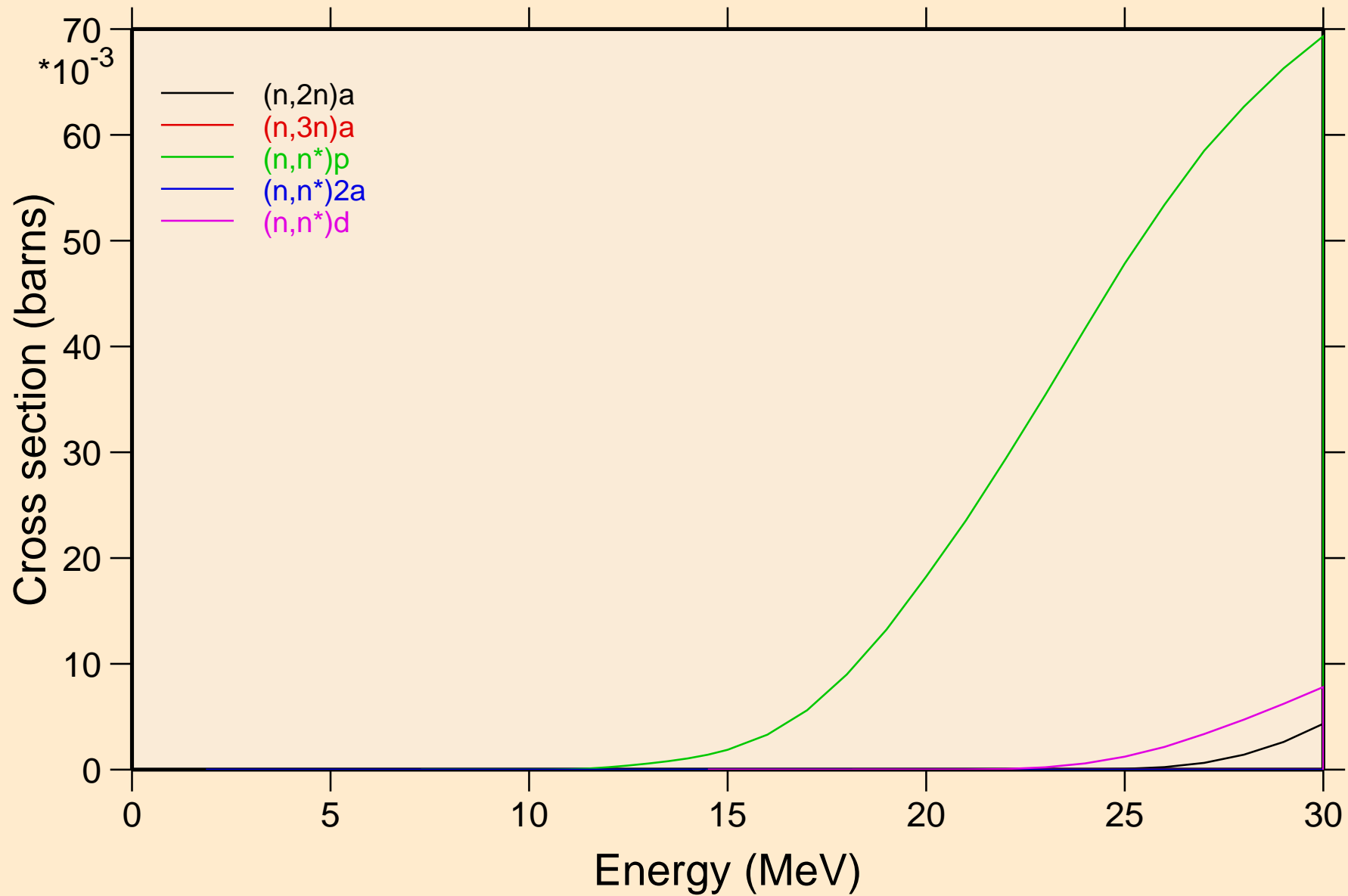

ND142 NEUTRON ACER TENDL-2021 LIBRARY; T=293.6K

Threshold reactions

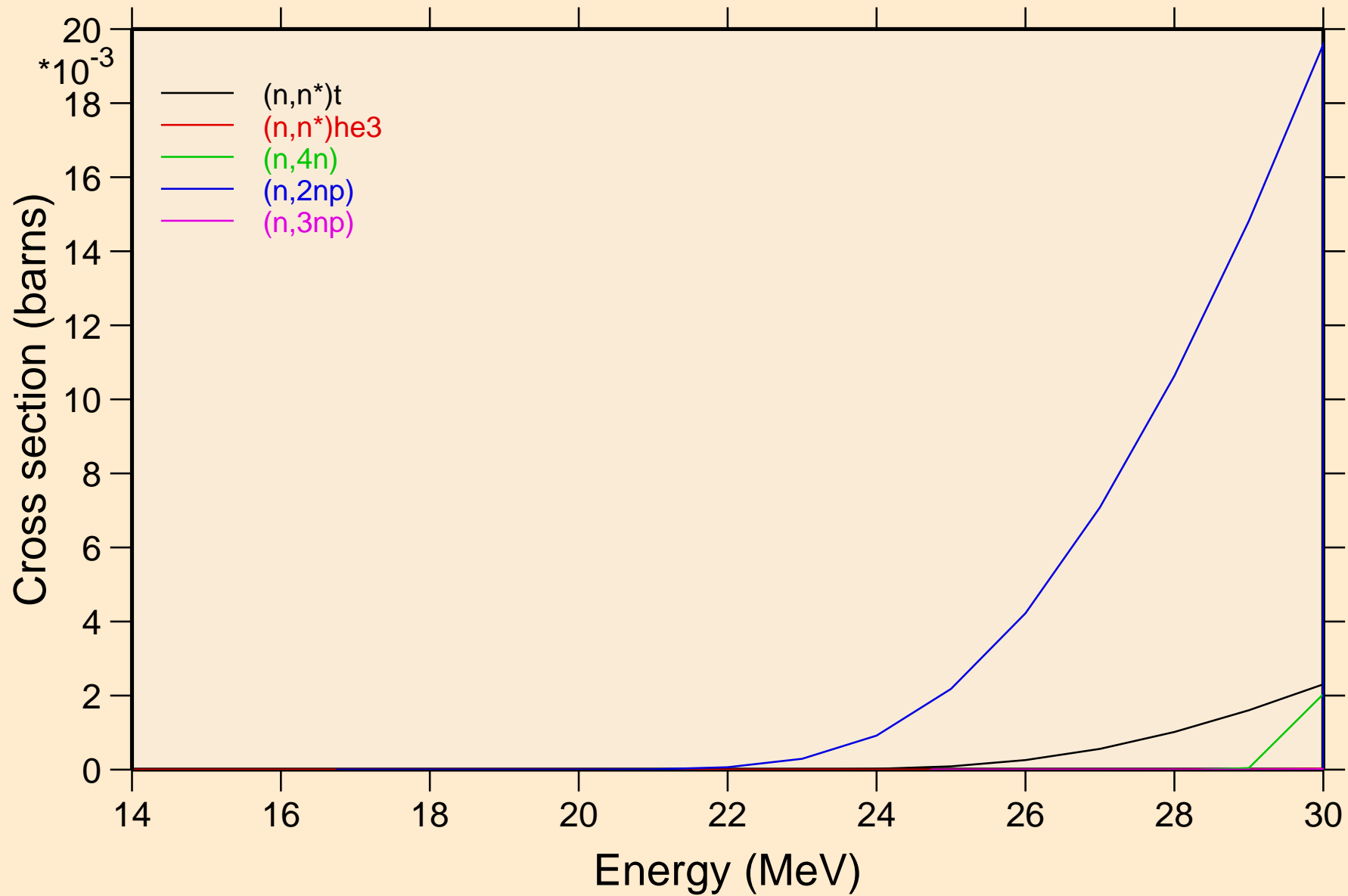

ND142 NEUTRON ACER TENDL-2021 LIBRARY; T=293.6K
Threshold reactions

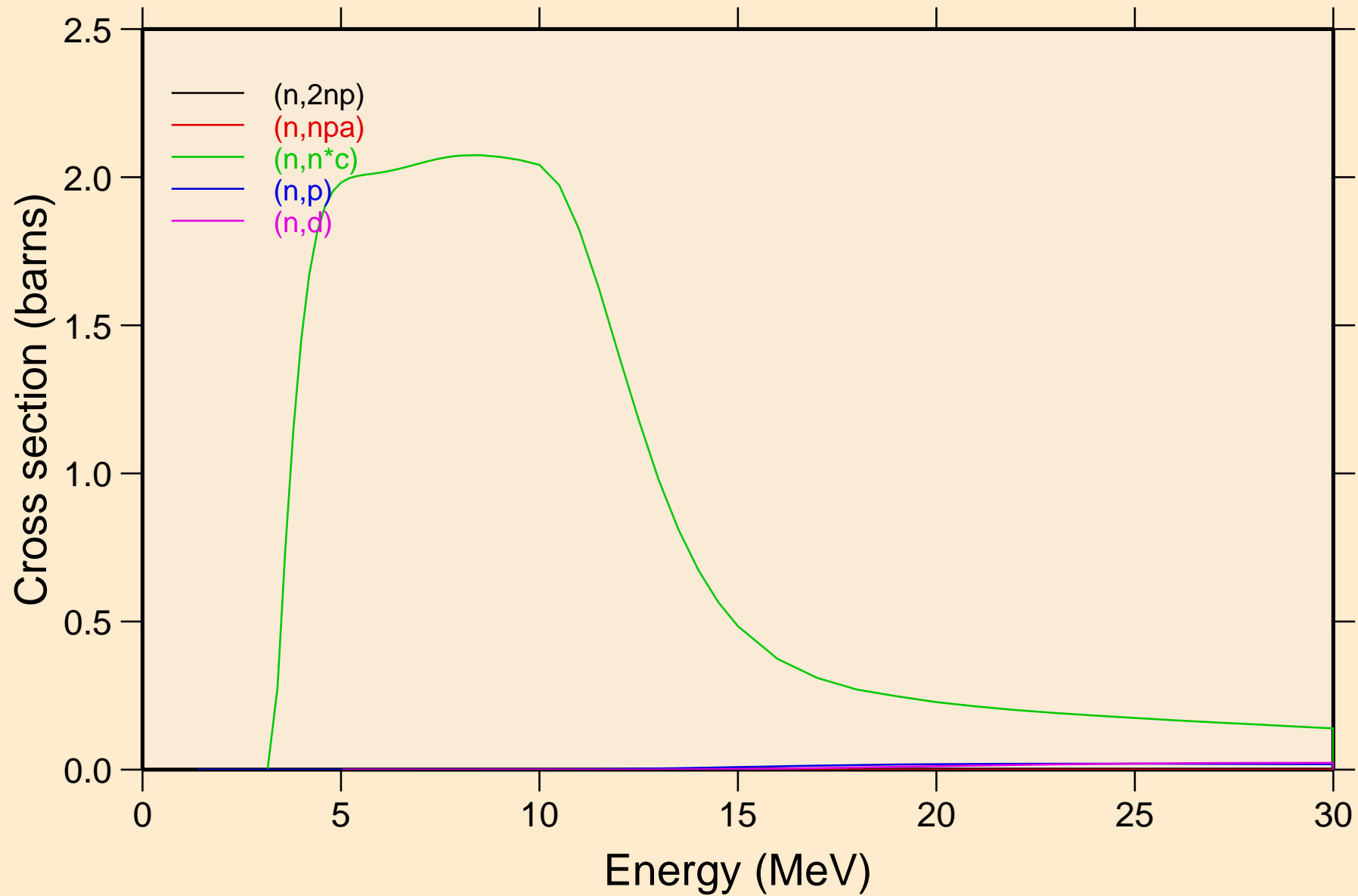

ND142 NEUTRON ACER TENDL-2021 LIBRARY; T=293.6K

Threshold reactions

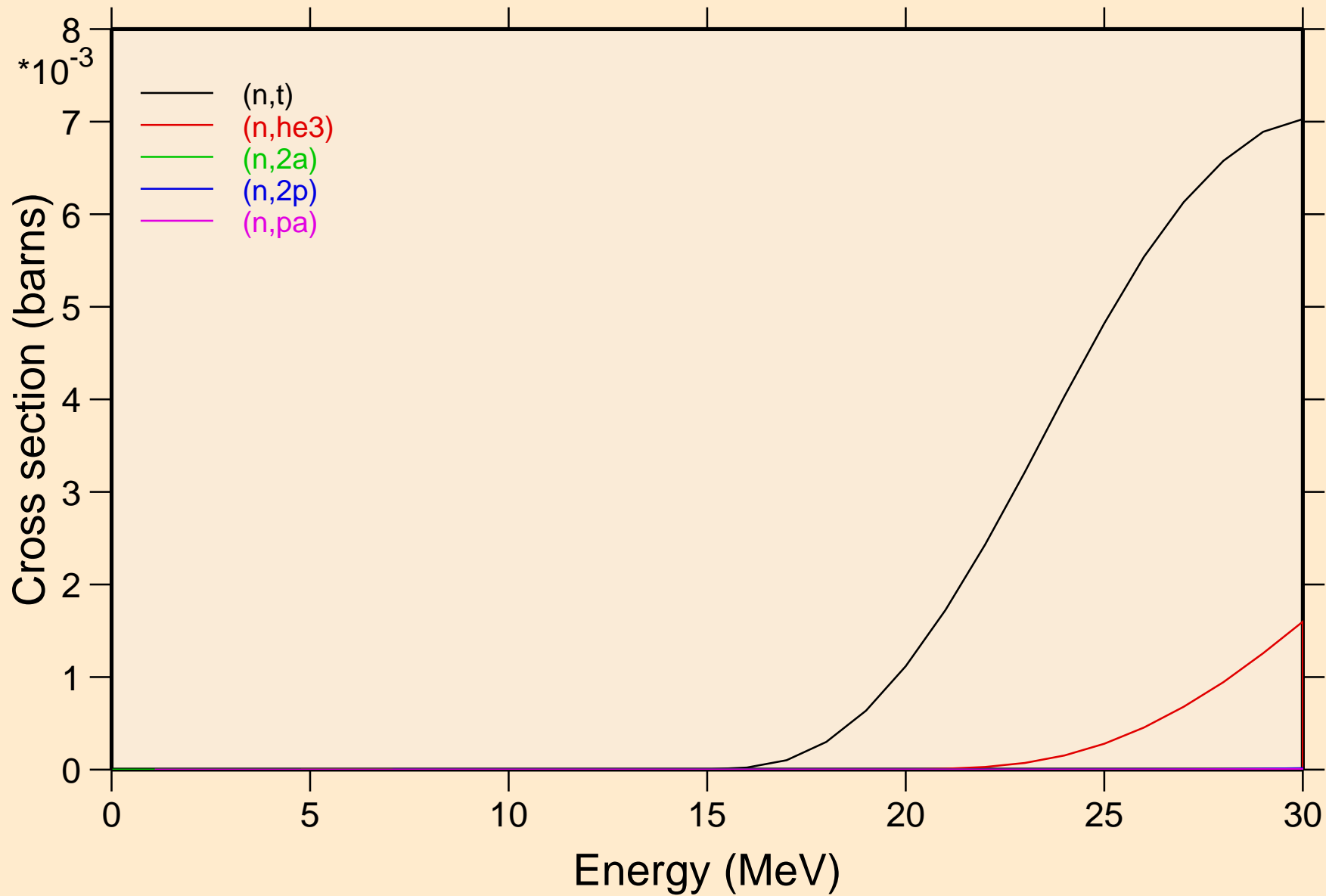

ND142 NEUTRON ACER TENDL-2021 LIBRARY; T=293.6K

Threshold reactions

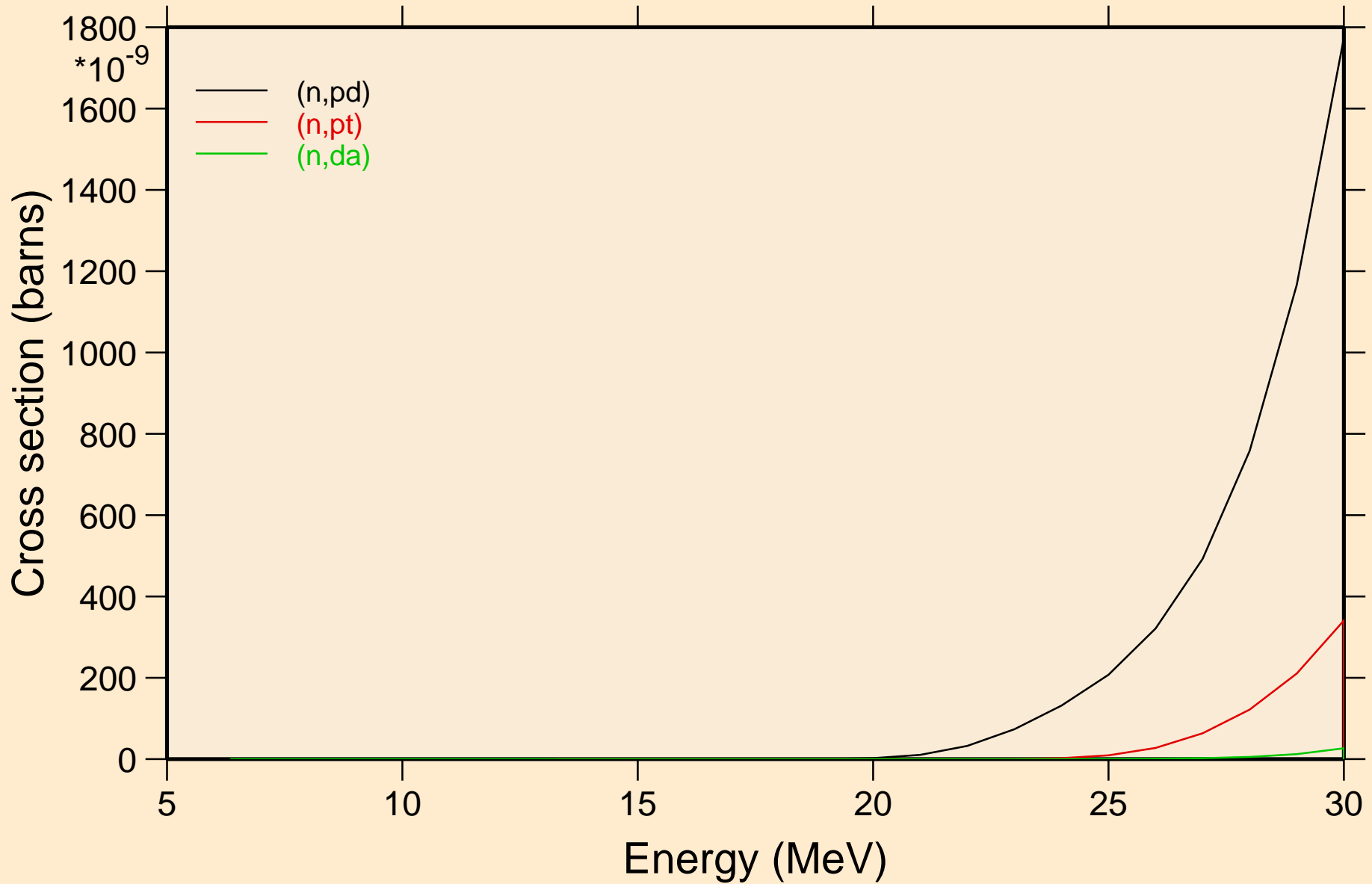

ND142 NEUTRON ACER TENDL-2021 LIBRARY; T=293.6K
Threshold reactions

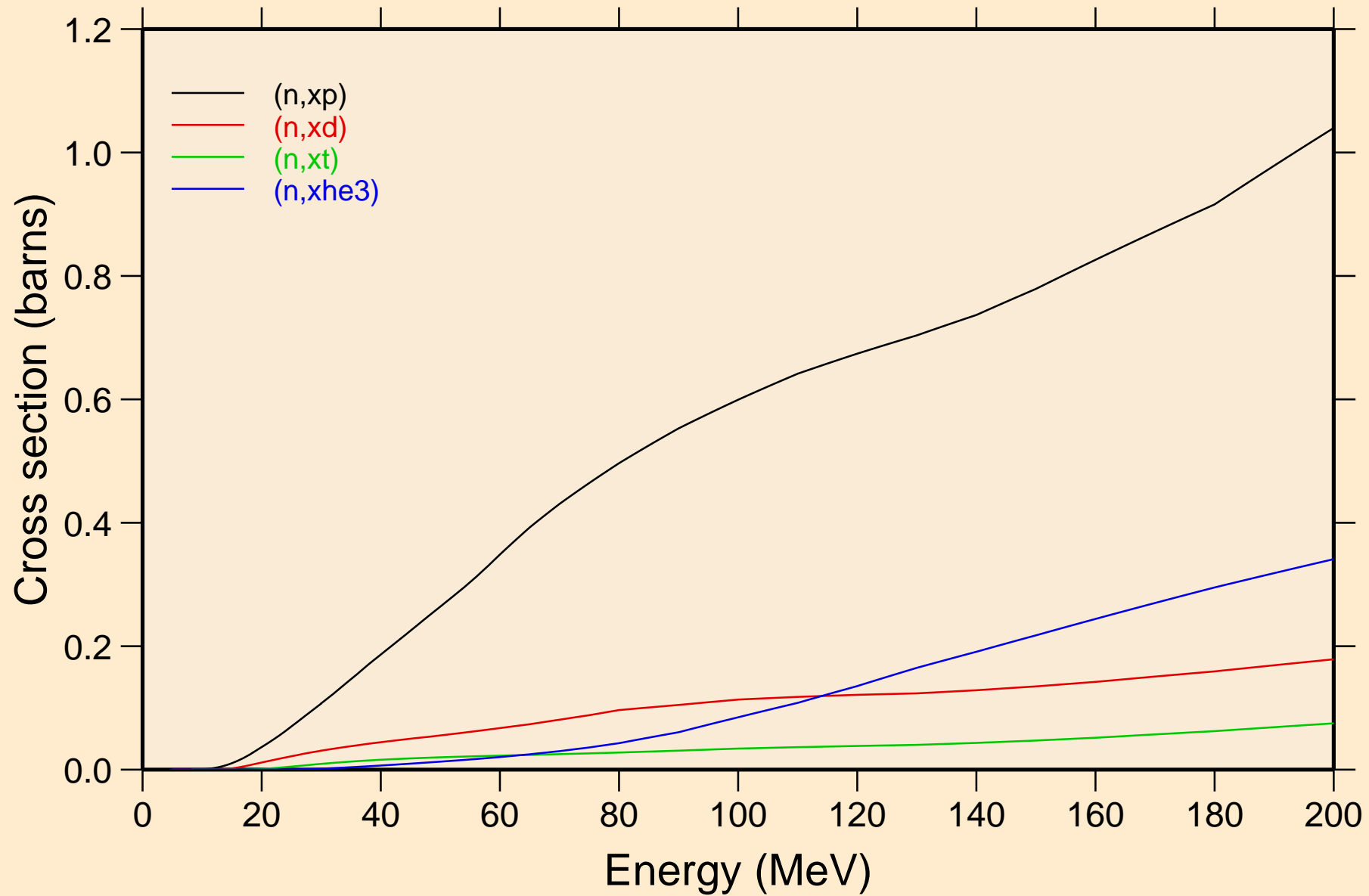

ND142 NEUTRON ACER TENDL-2021 LIBRARY; T=293.6K
angular distribution for elastic

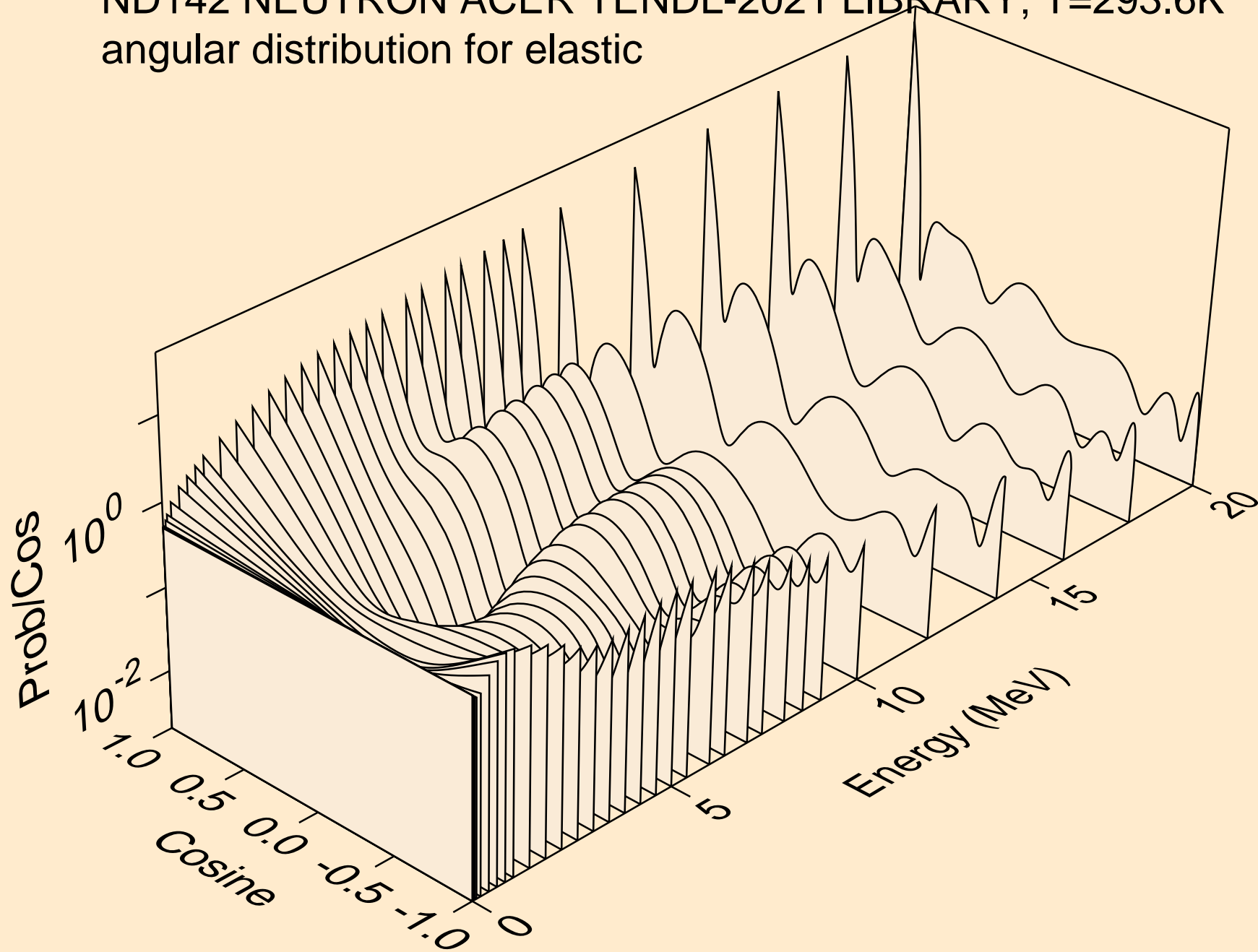

ND142 NEUTRON ACER TENDL-2021 LIBRARY; T=293.6K
angular distribution for elastic

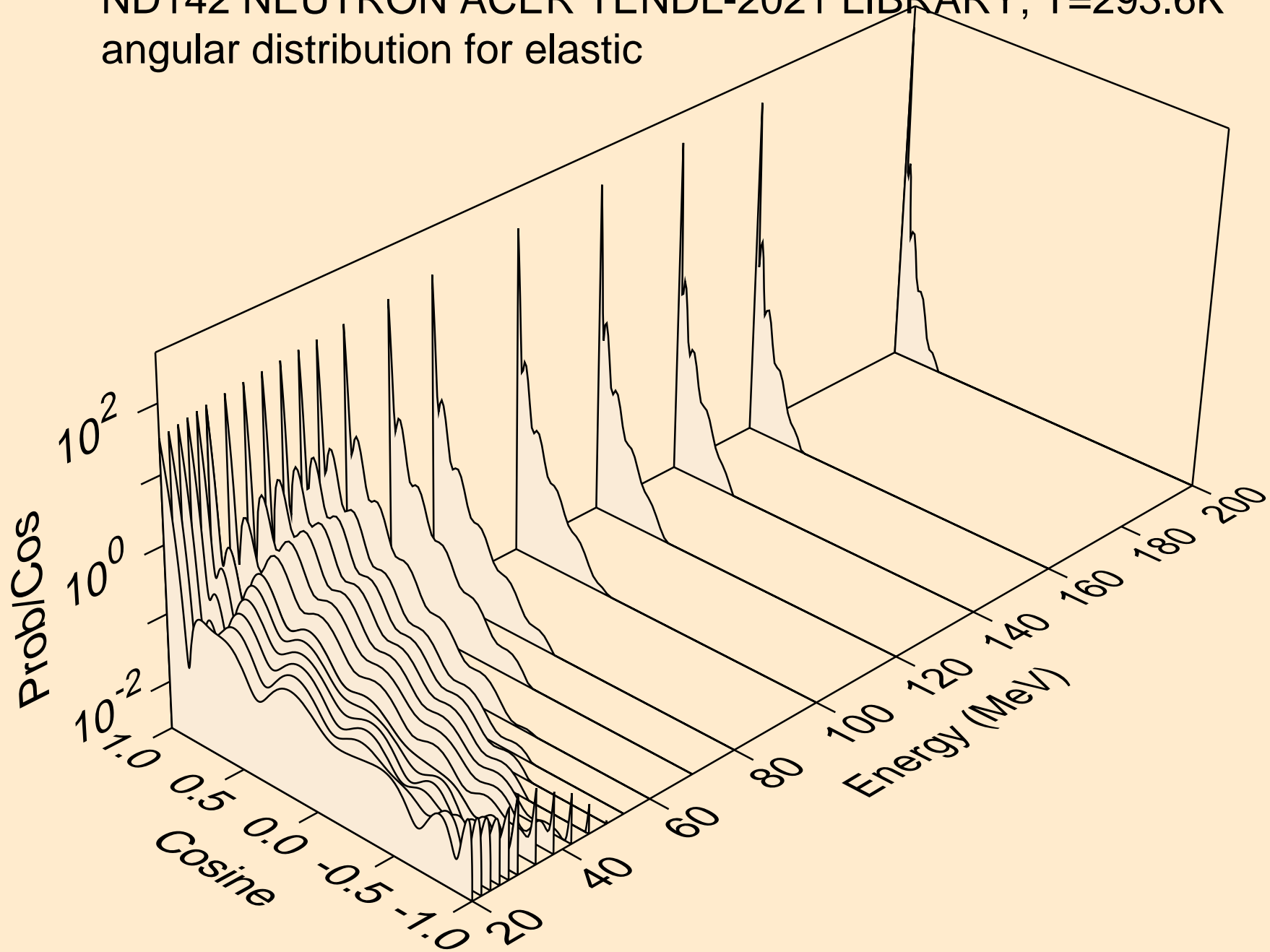

ND142 NEUTRON ACER TENDL-2021 LIBRARY; T=293.6K
angular distribution for (n,n*1)

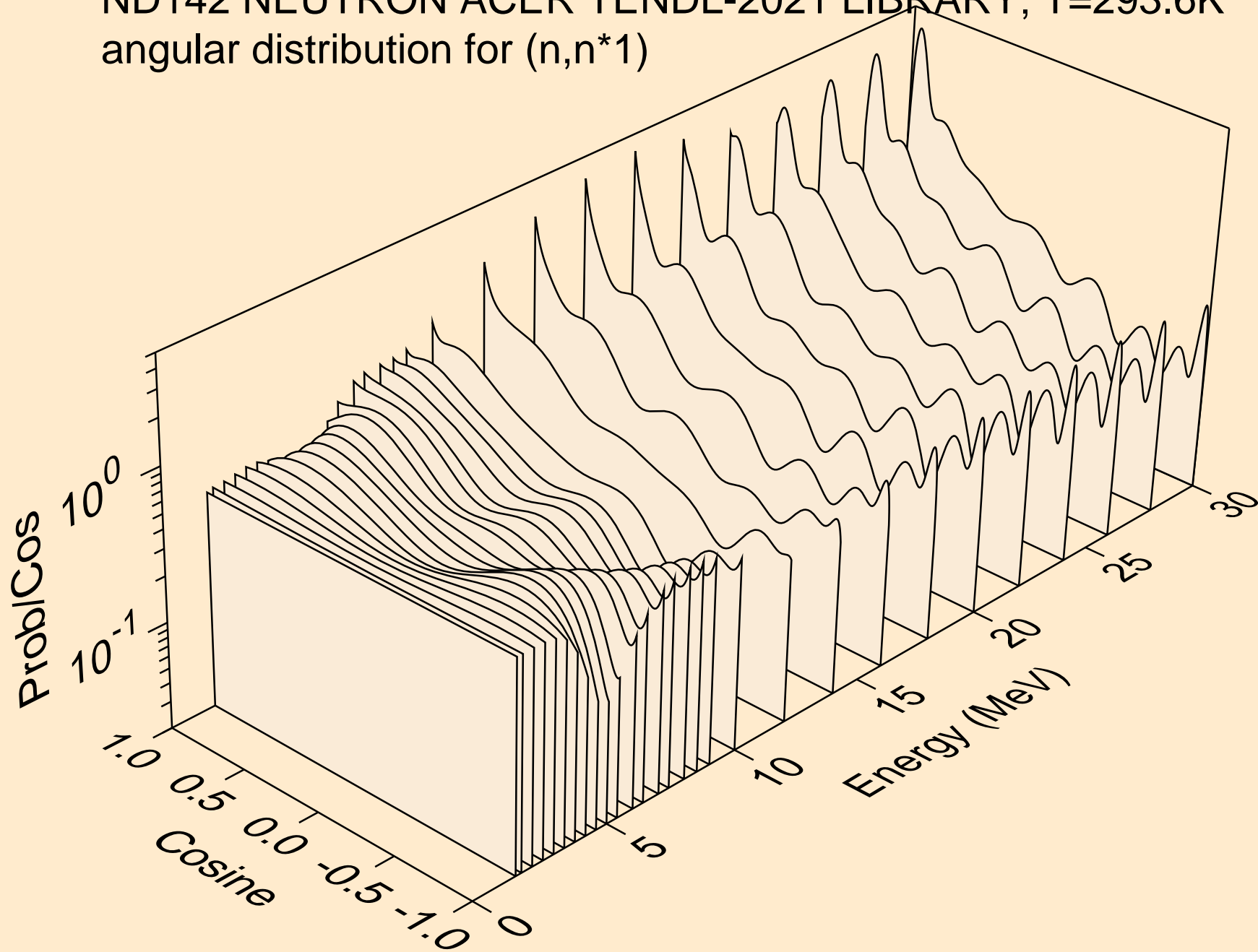

ND142 NEUTRON ACER TENDL-2021 LIBRARY; T=293.6K
angular distribution for (n,n*2)

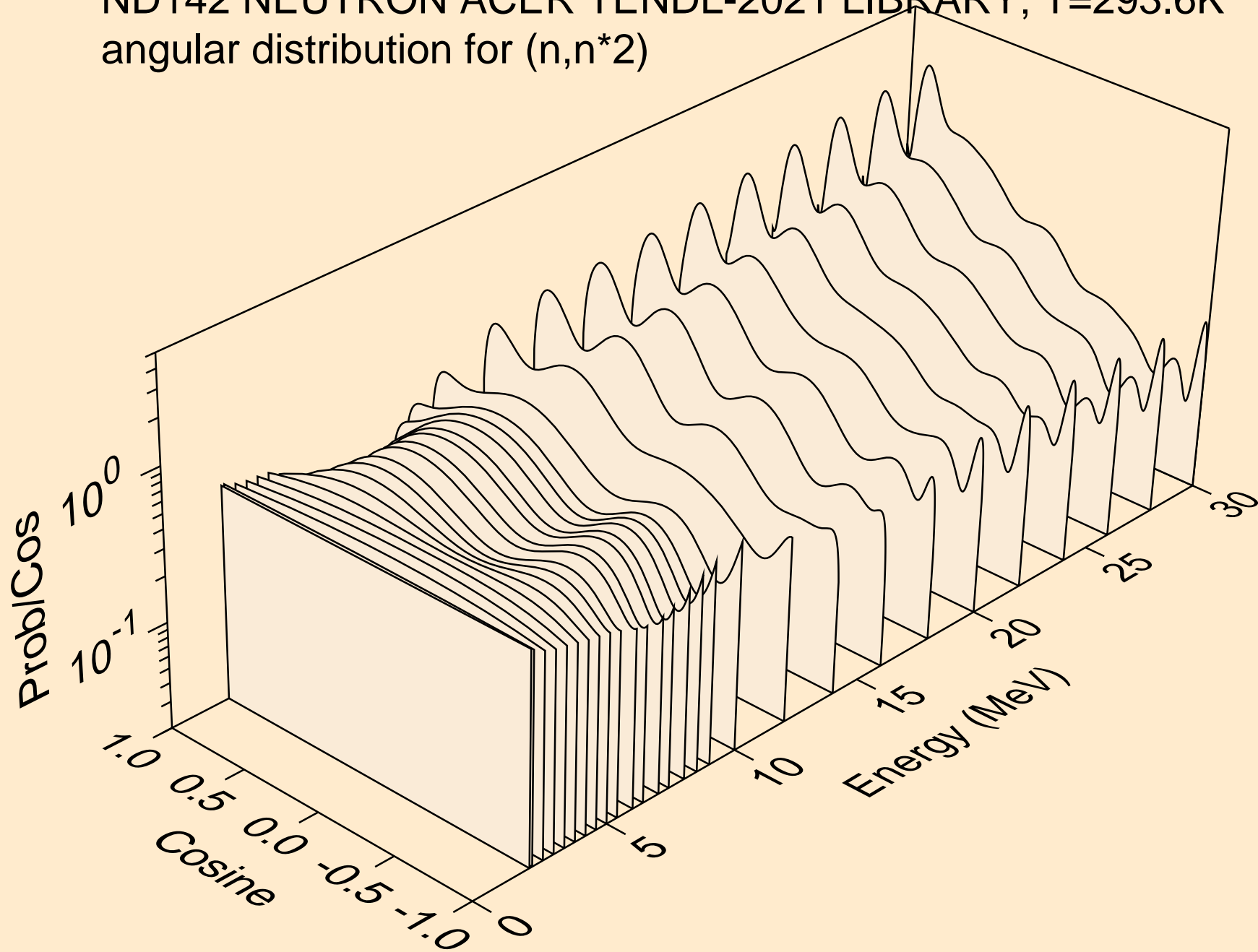

ND142 NEUTRON ACER TENDL-2021 LIBRARY; T=293.6K
angular distribution for (n,n*3)

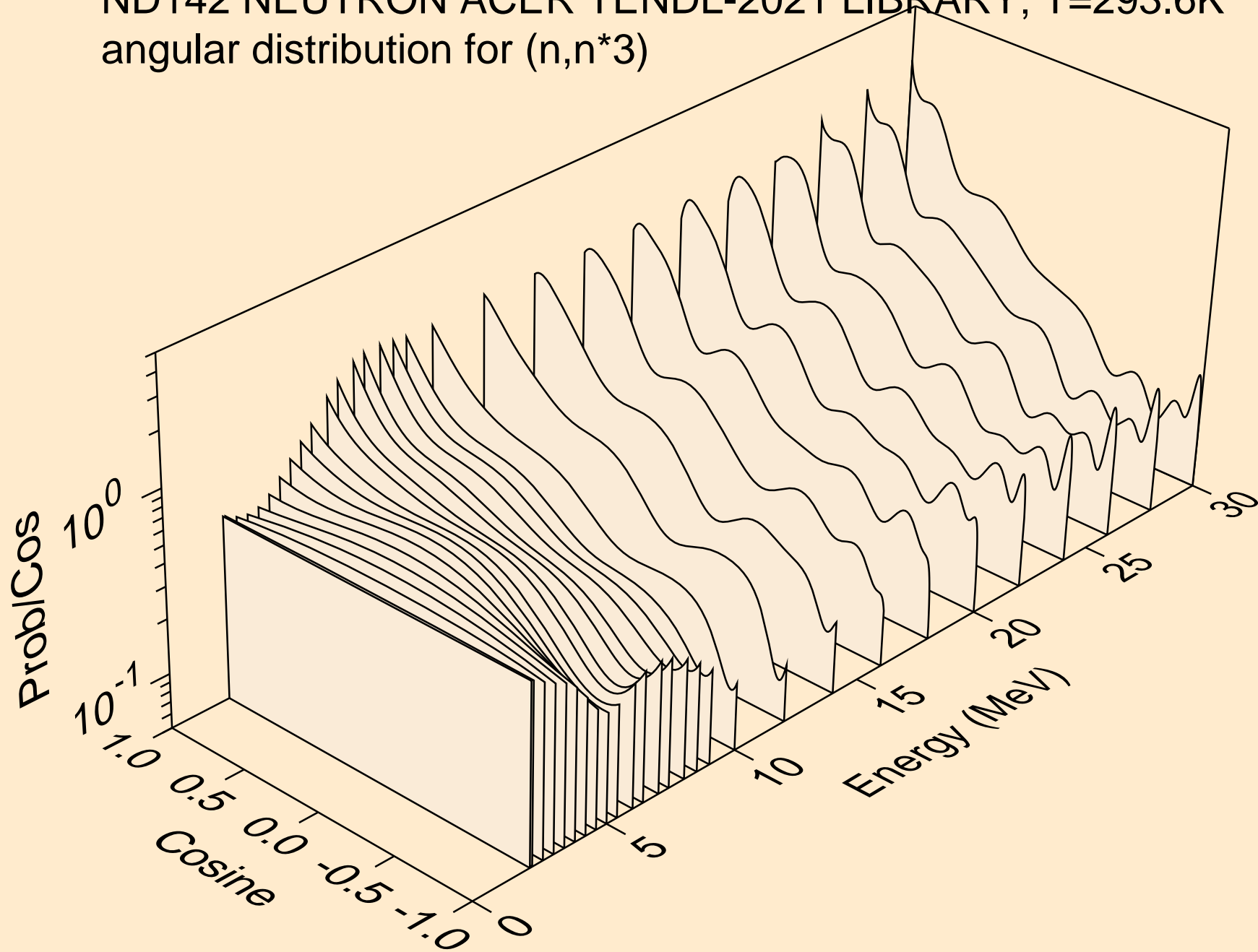

ND142 NEUTRON ACER TENDL-2021 LIBRARY; T=293.6K
angular distribution for (n,n*4)

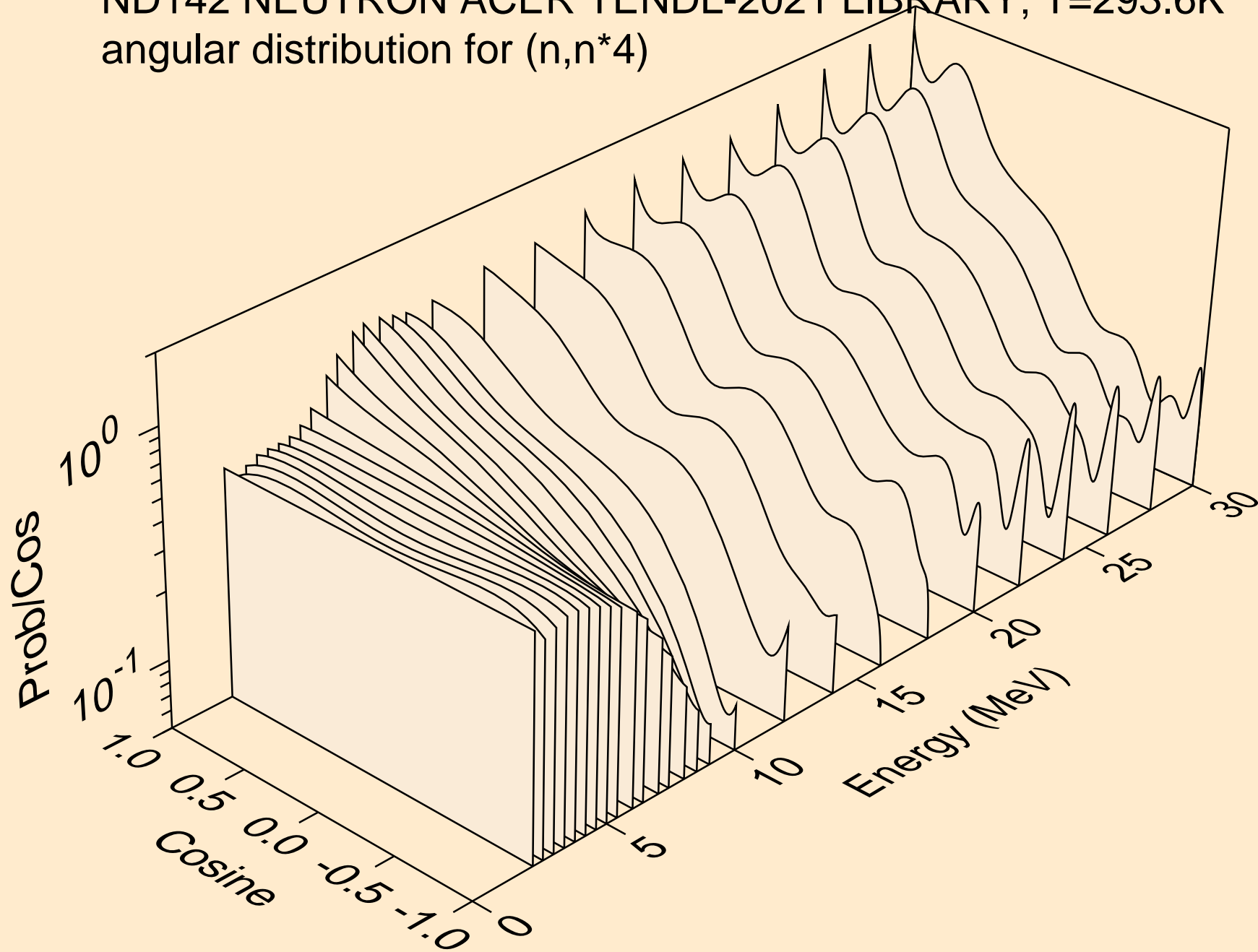

ND142 NEUTRON ACER TENDL-2021 LIBRARY; T=293.6K
angular distribution for (n,n*5)

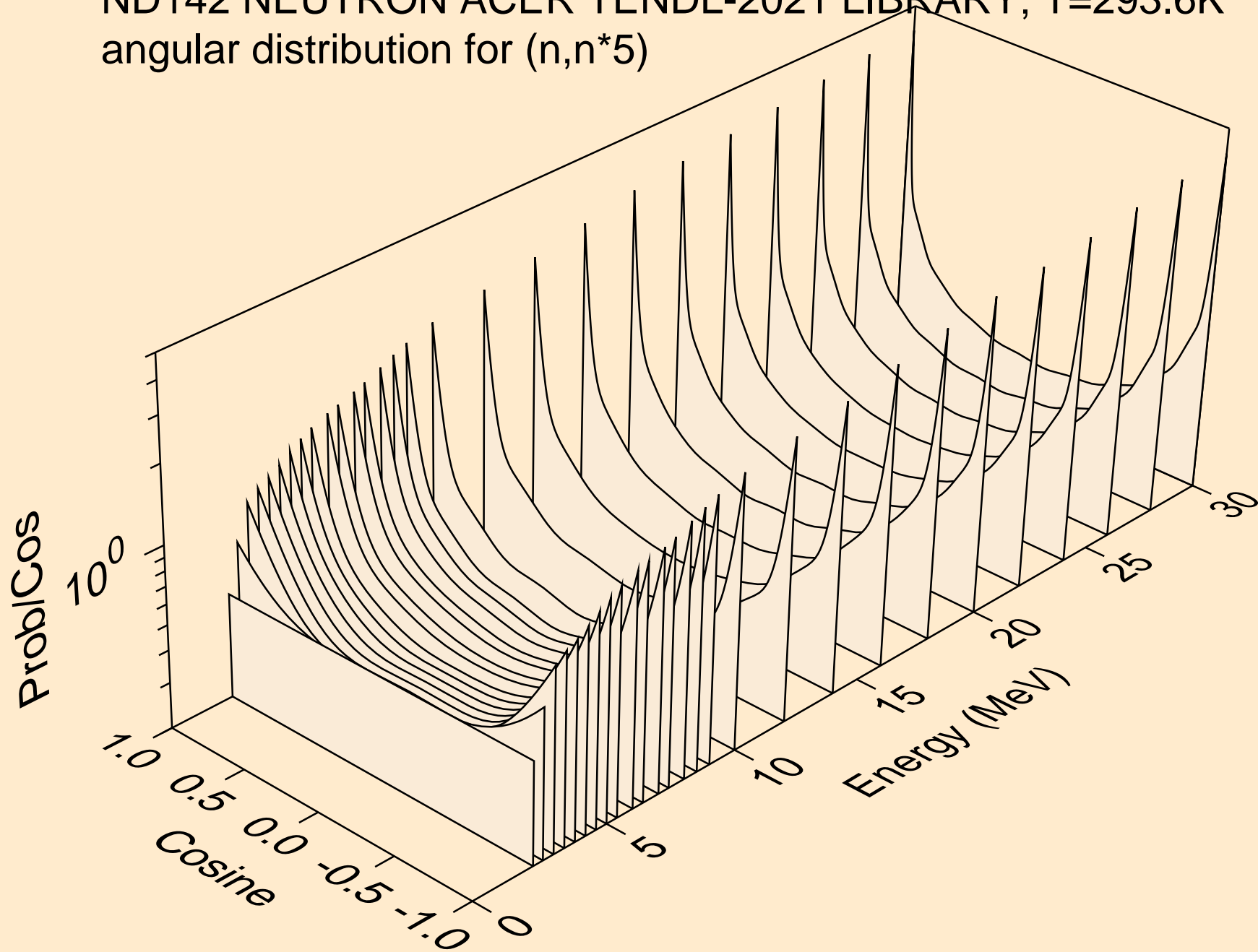

ND142 NEUTRON ACER TENDL-2021 LIBRARY; T=293.6K
angular distribution for (n,n*6)

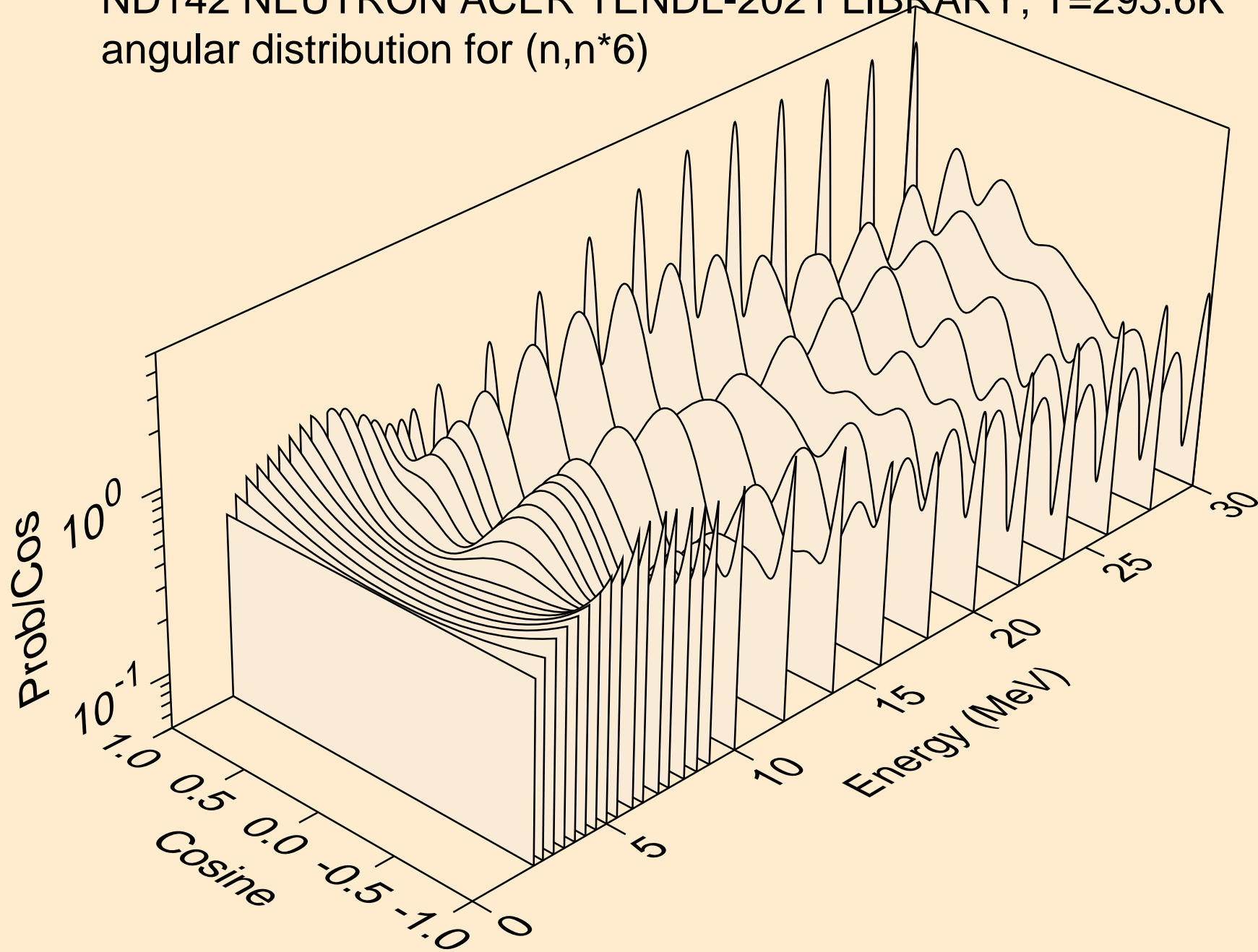

ND142 NEUTRON ACER TENDL-2021 LIBRARY; T=293.6K
angular distribution for (n,n*7)

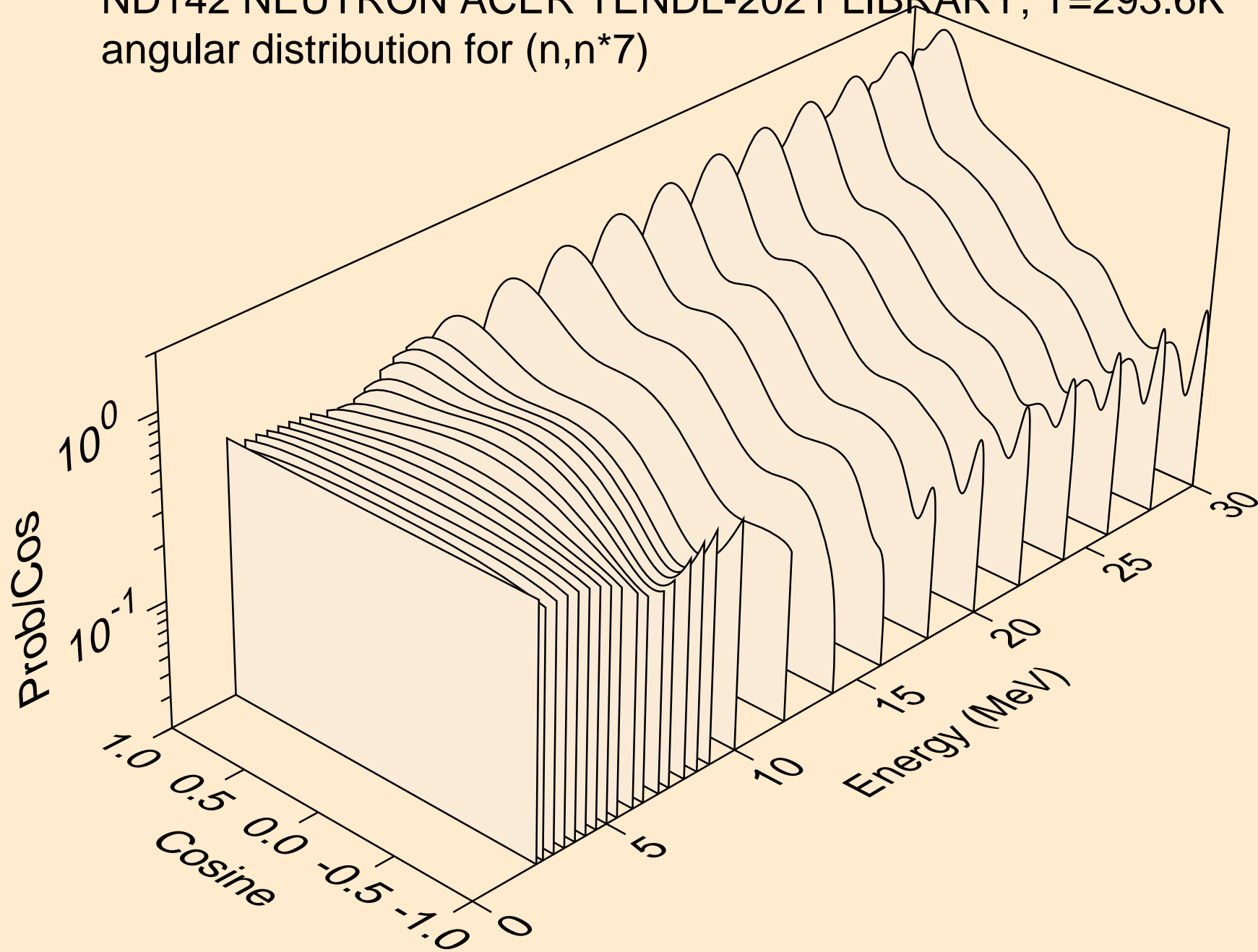

ND142 NEUTRON ACER TENDL-2021 LIBRARY; T=293.6K
angular distribution for (n,n*8)

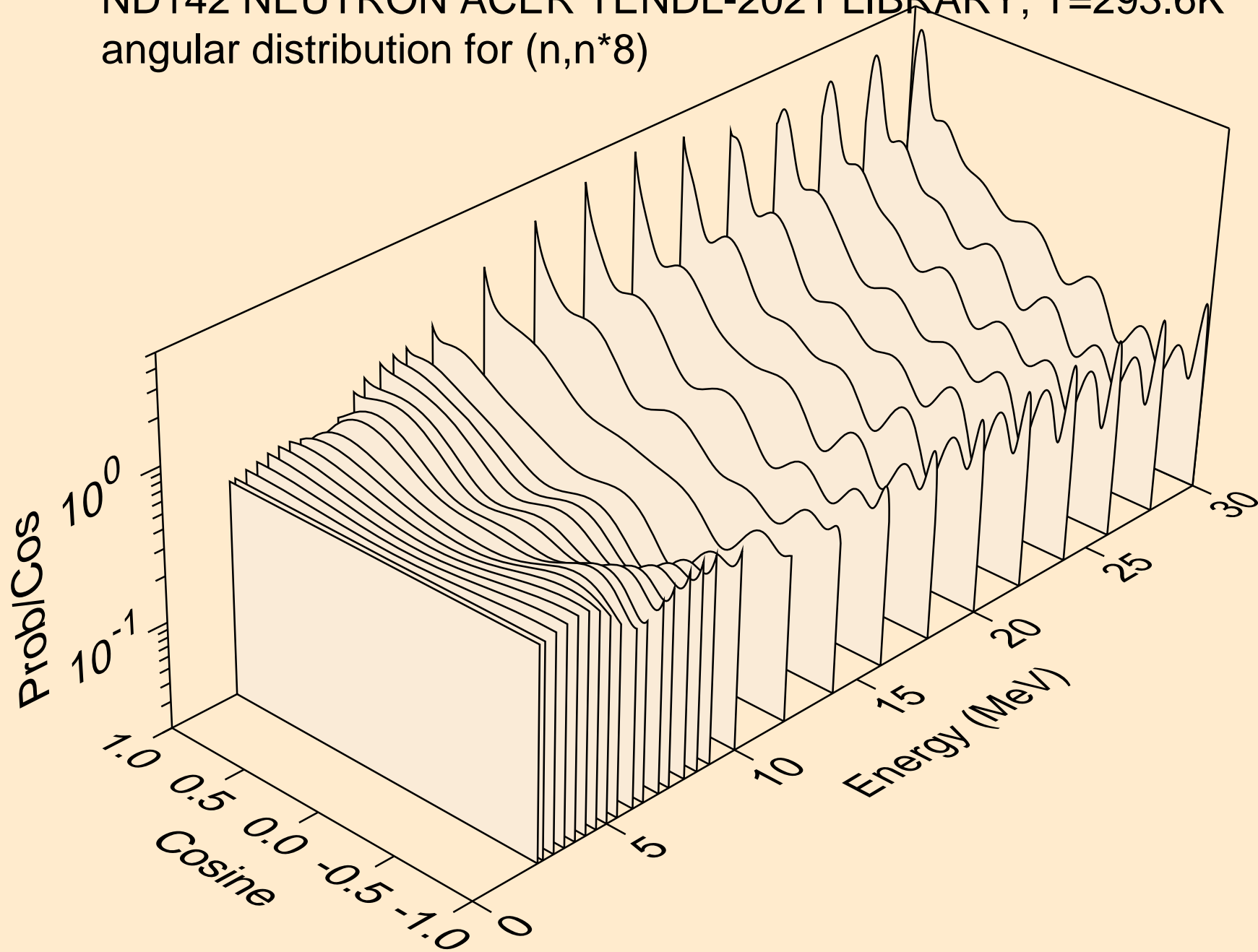

ND142 NEUTRON ACER TENDL-2021 LIBRARY; T=293.6K
angular distribution for (n,n*9)

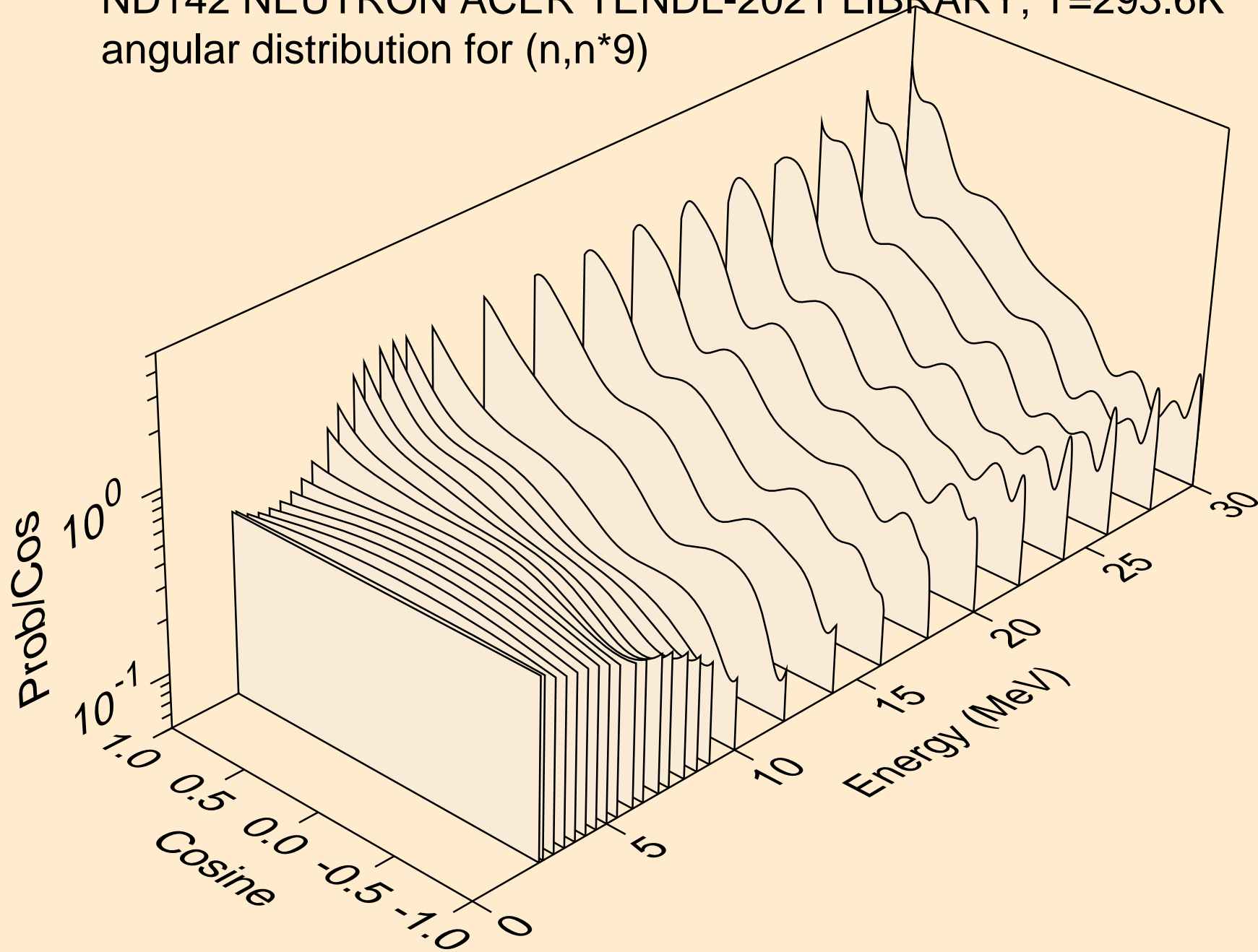

ND142 NEUTRON ACER TENDL-2021 LIBRARY; T=293.6K
angular distribution for (n,n*10)

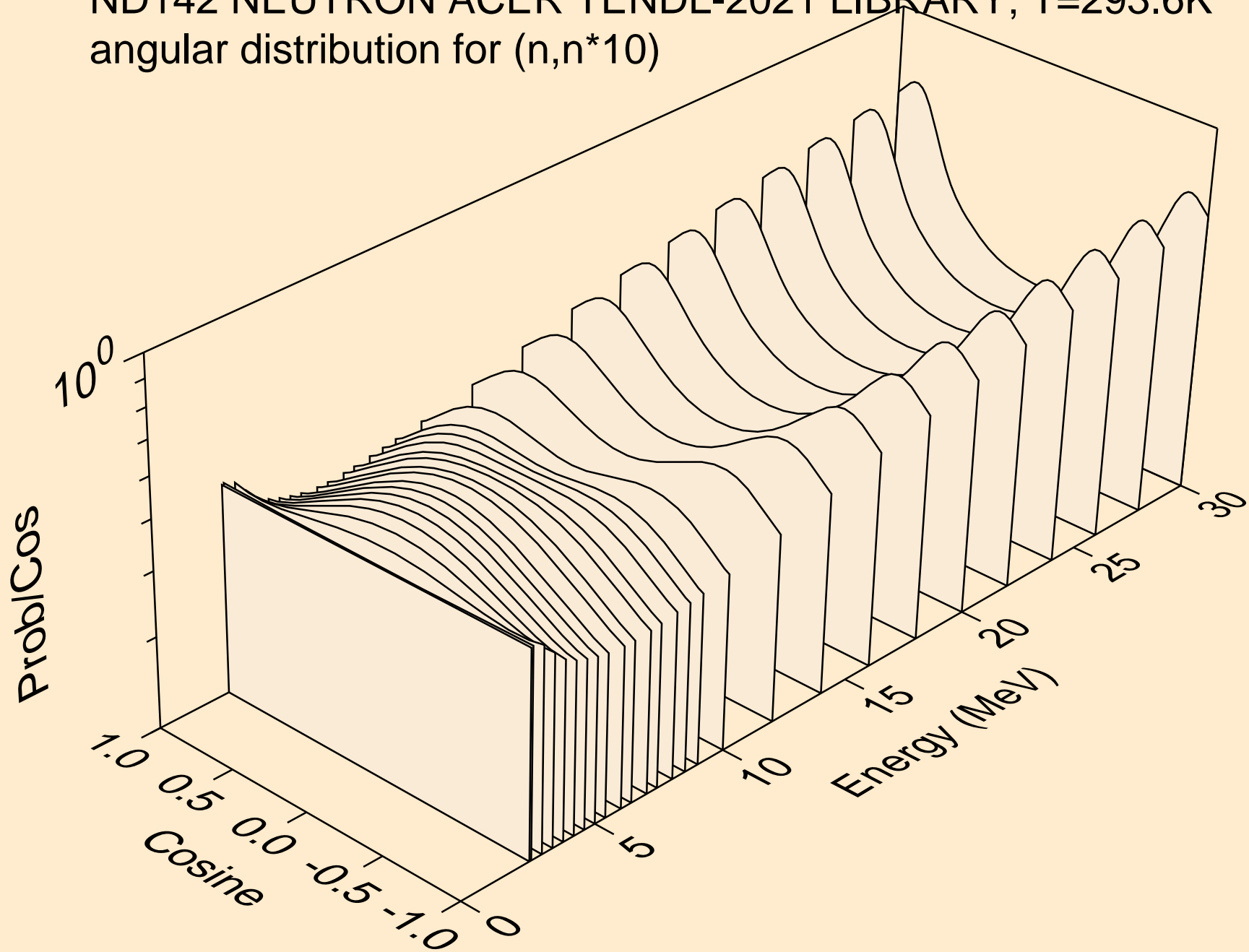

ND142 NEUTRON ACER TENDL-2021 LIBRARY; T=293.6K
angular distribution for (n,n*11)

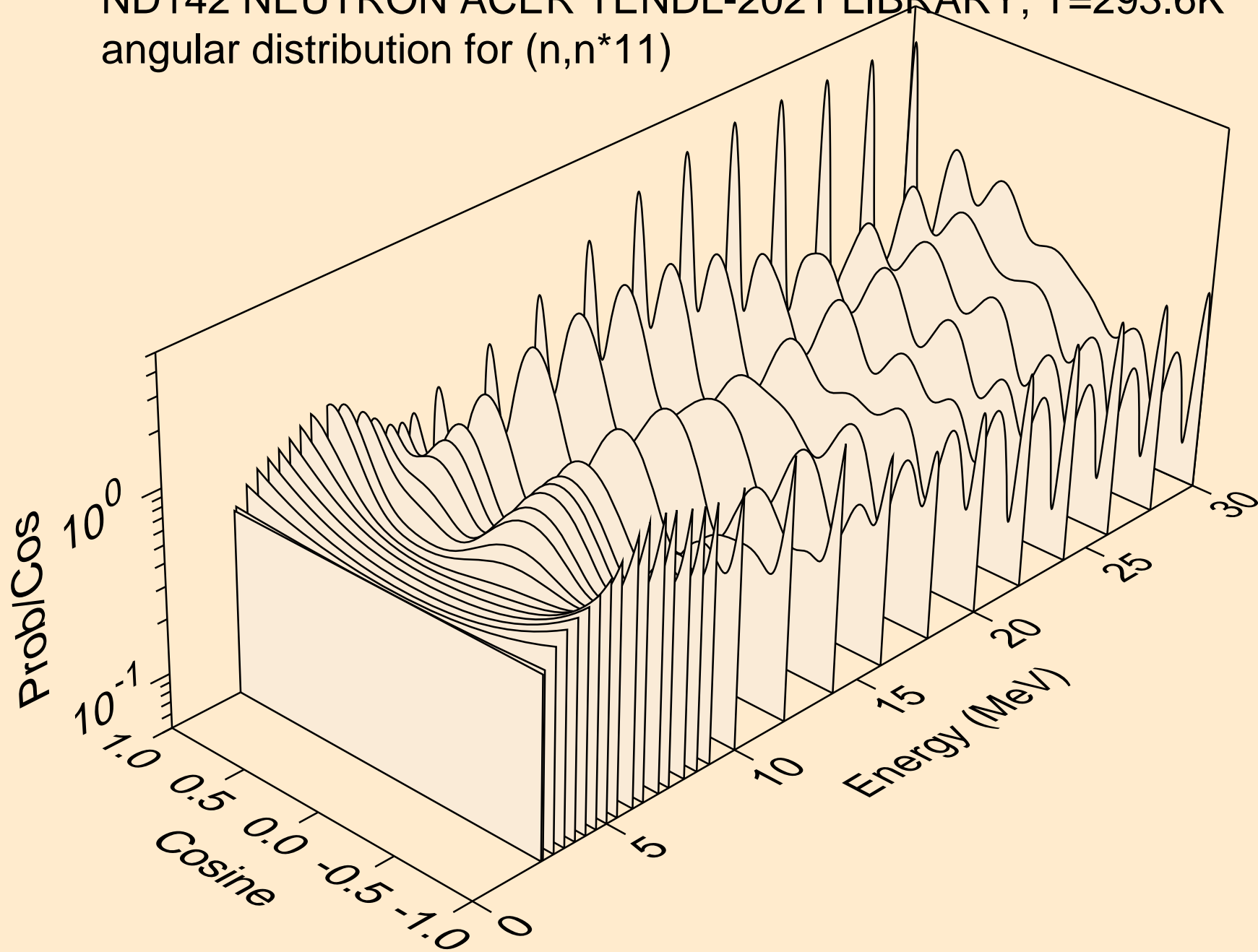

ND142 NEUTRON ACER TENDL-2021 LIBRARY; T=293.6K
angular distribution for (n,n*12)

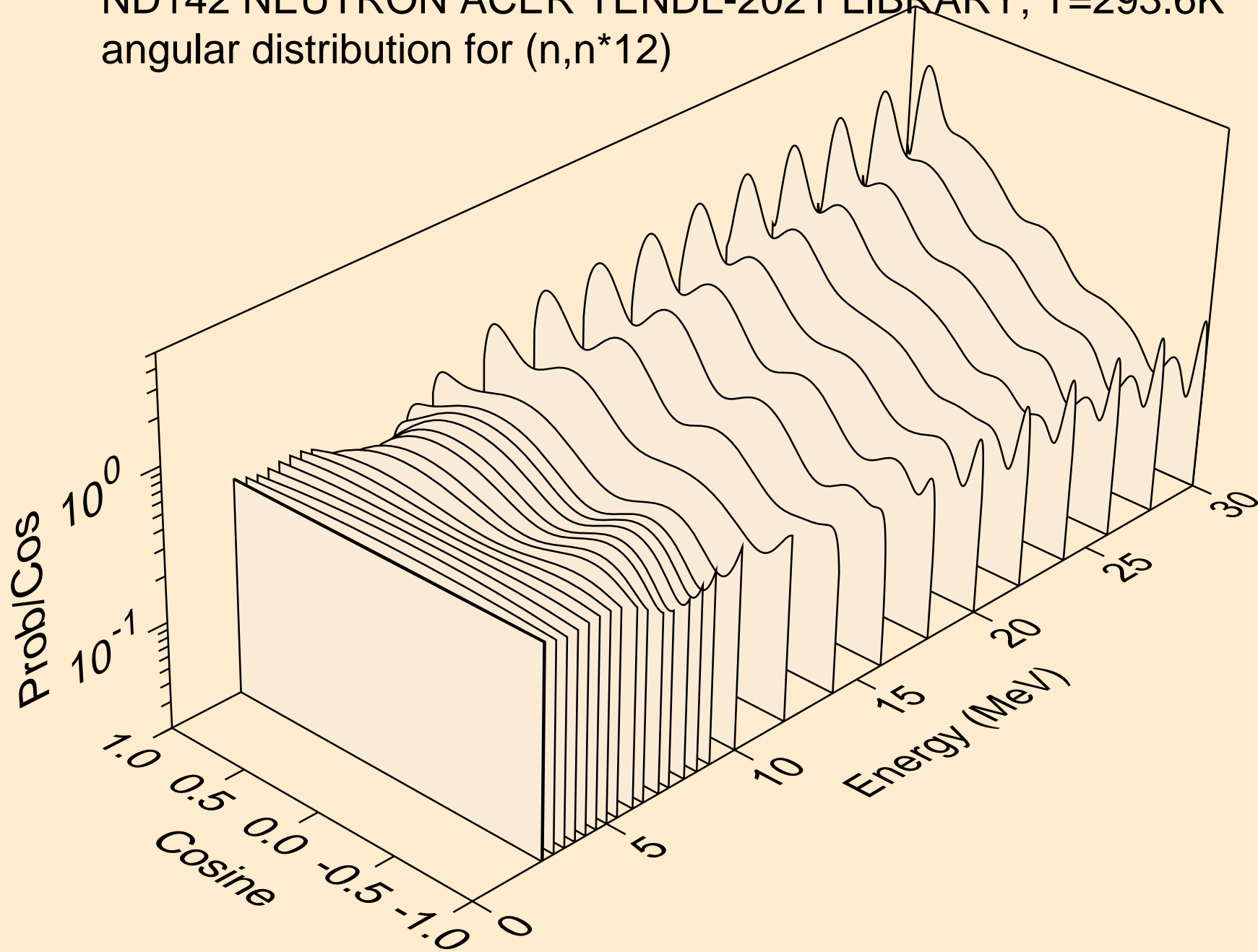

ND142 NEUTRON ACER TENDL-2021 LIBRARY; T=293.6K
angular distribution for (n,n*13)

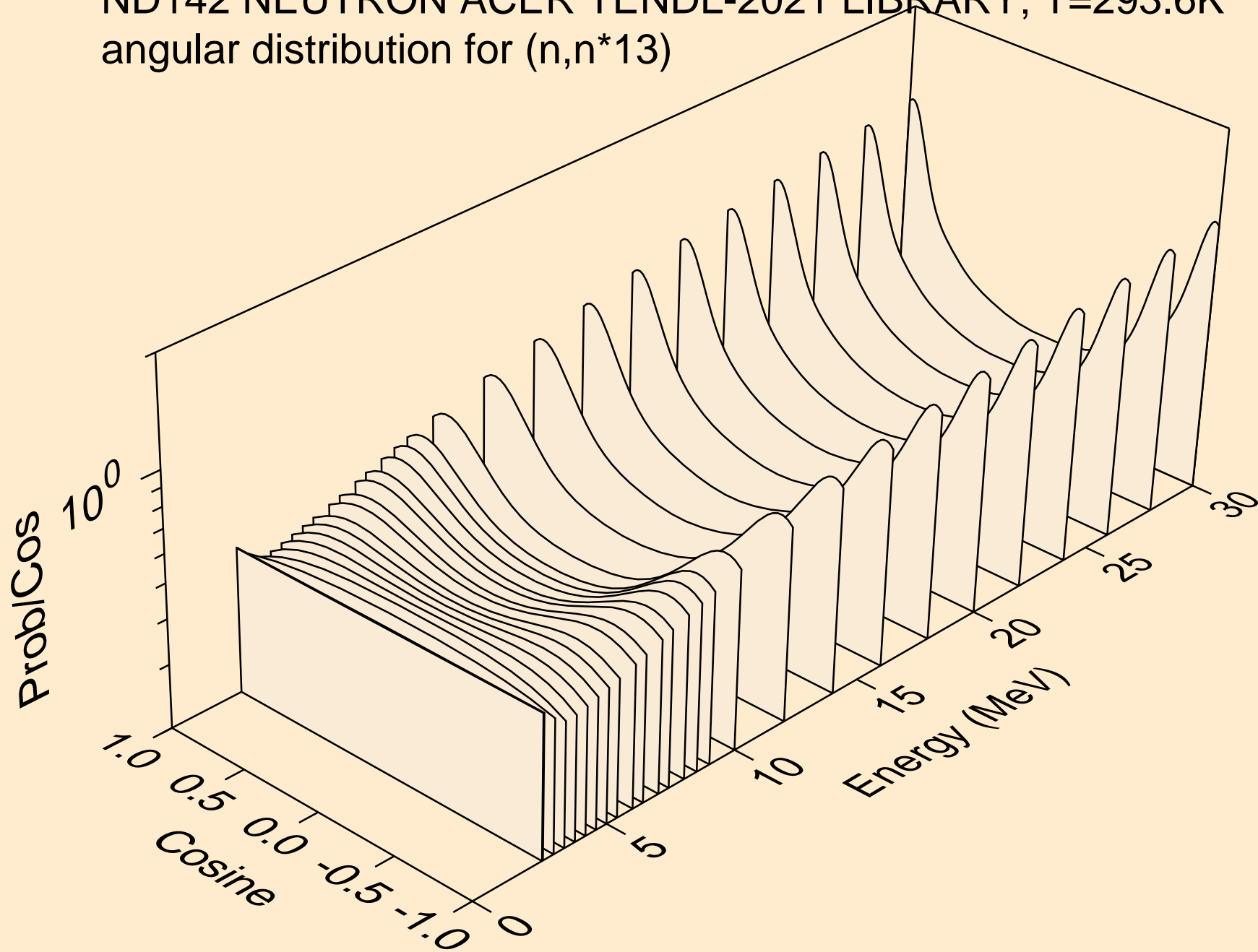

ND142 NEUTRON ACER TENDL-2021 LIBRARY; T=293.6K
angular distribution for (n,n*14)

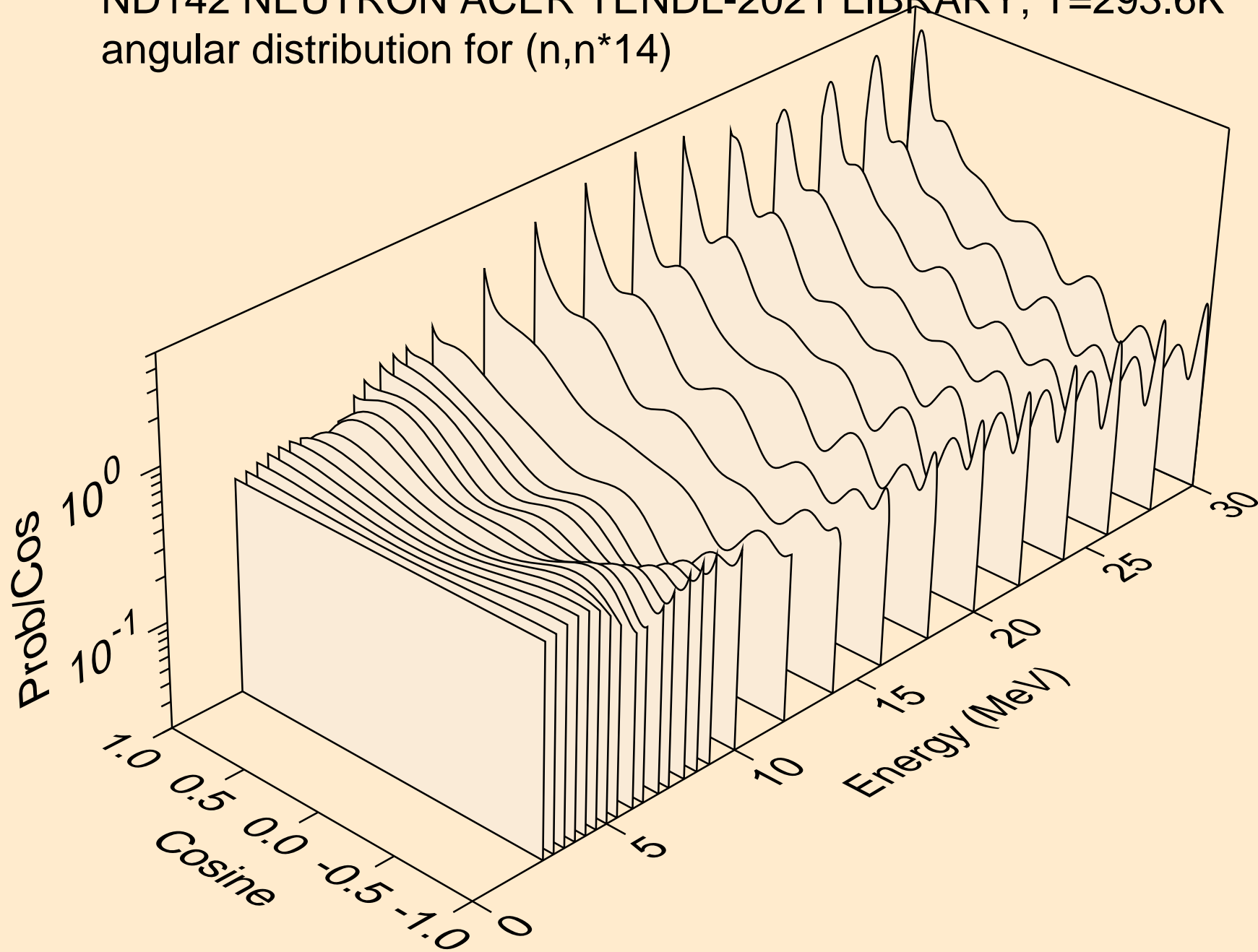

ND142 NEUTRON ACER TENDL-2021 LIBRARY; T=293.6K
angular distribution for (n,n*15)

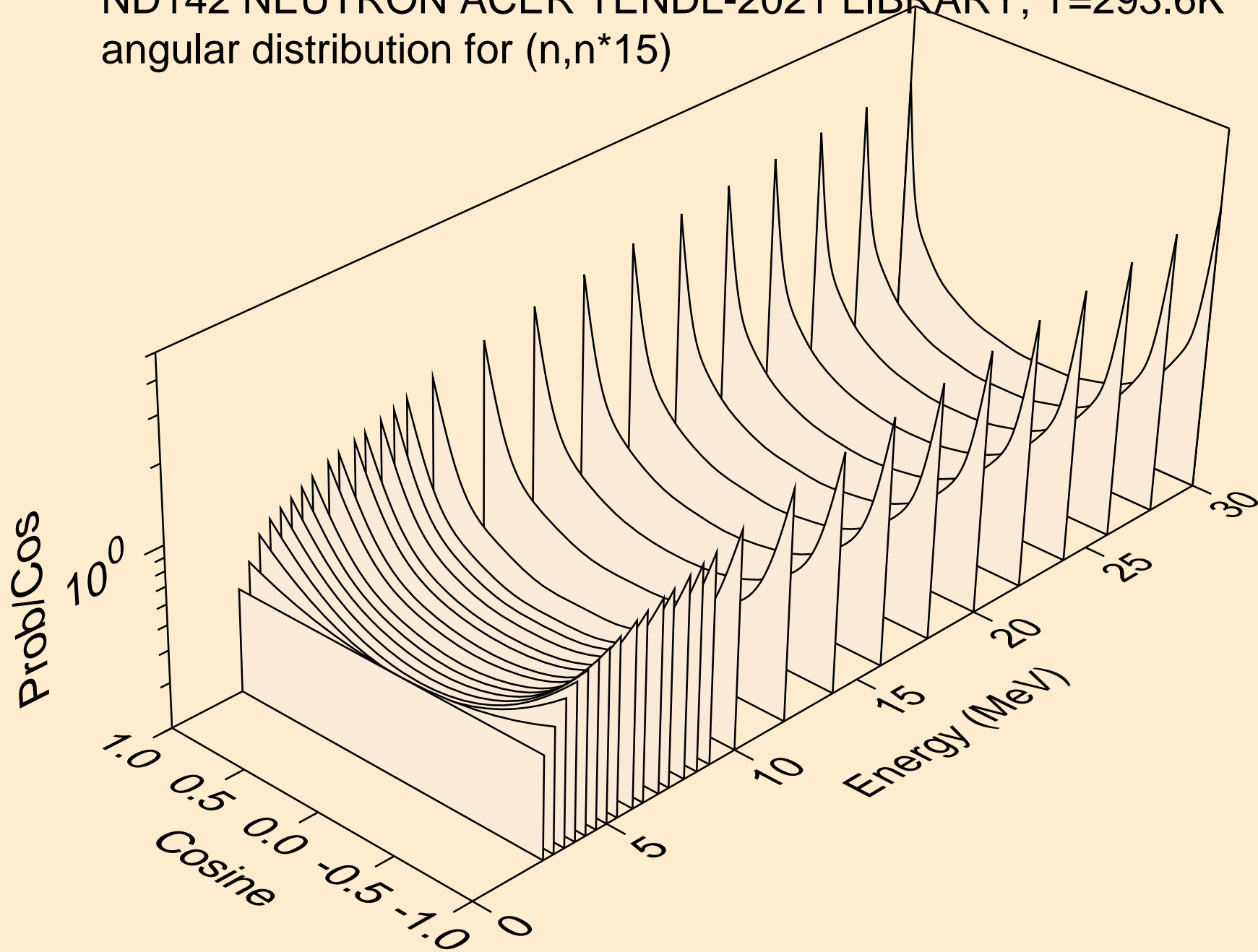

ND142 NEUTRON ACER TENDL-2021 LIBRARY; T=293.6K
angular distribution for (n,n*16)

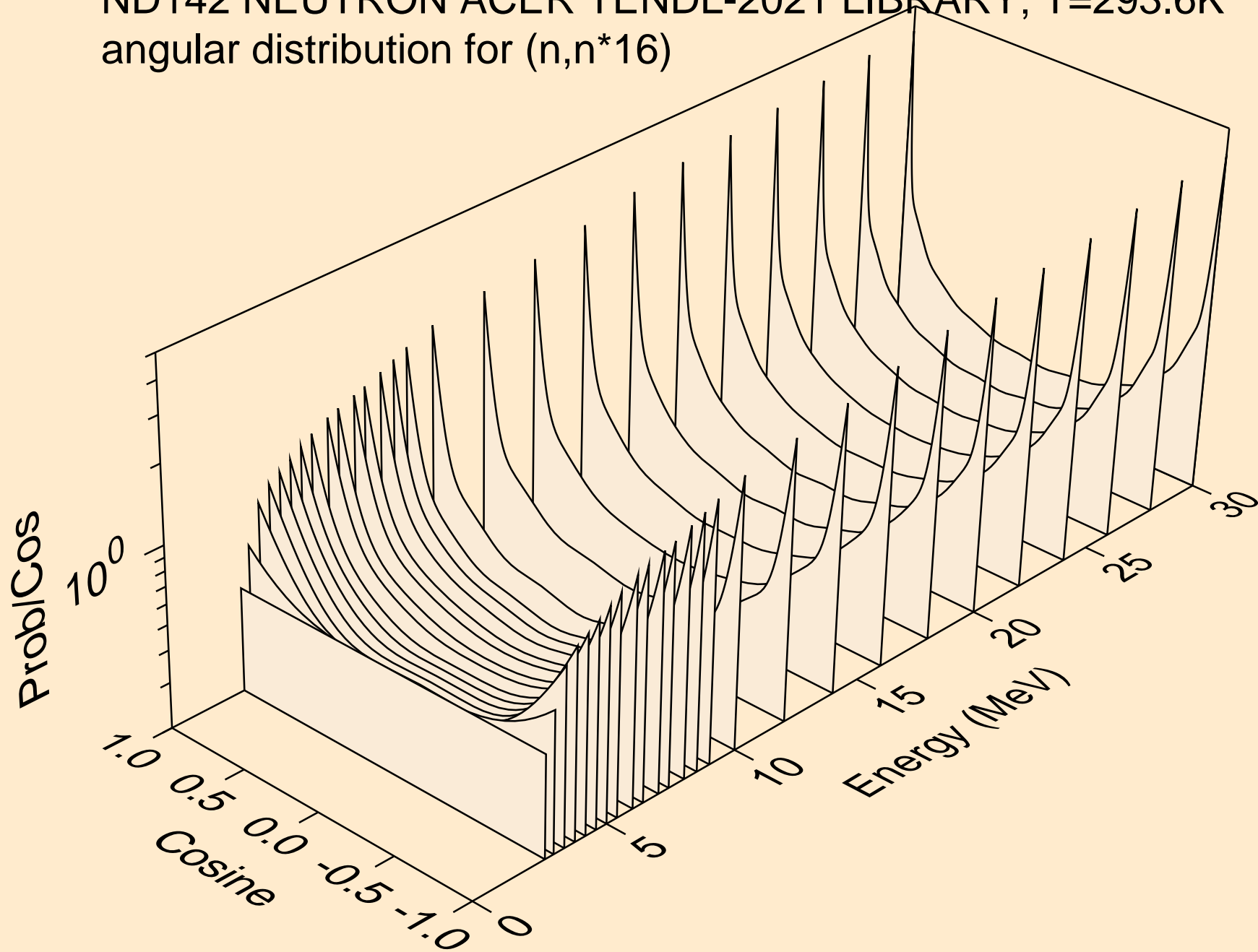

ND142 NEUTRON ACER TENDL-2021 LIBRARY; T=293.6K
angular distribution for (n,n*17)

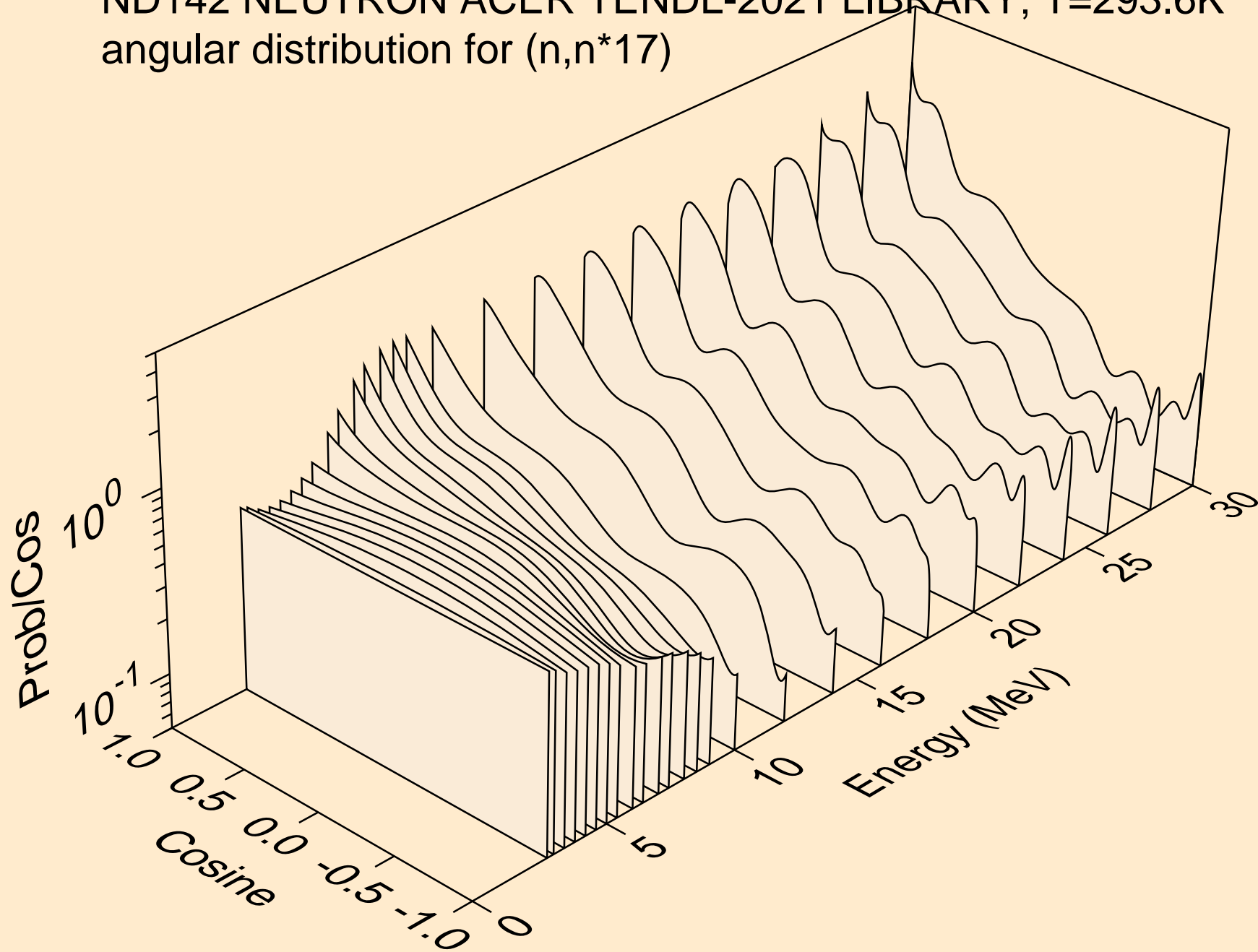

ND142 NEUTRON ACER TENDL-2021 LIBRARY; T=293.6K
angular distribution for (n,n*18)

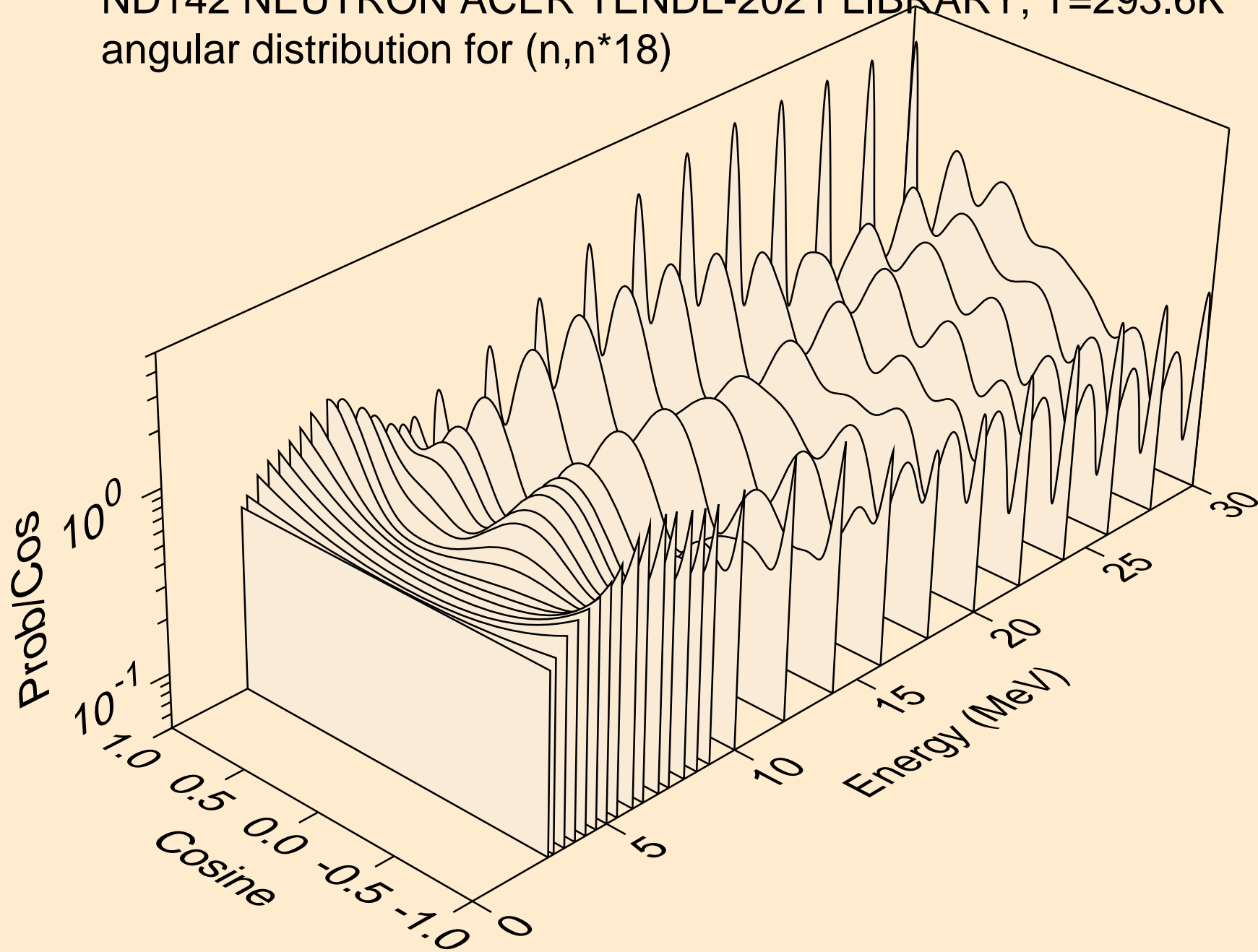

ND142 NEUTRON ACER TENDL-2021 LIBRARY; T=293.6K
angular distribution for (n,n*19)

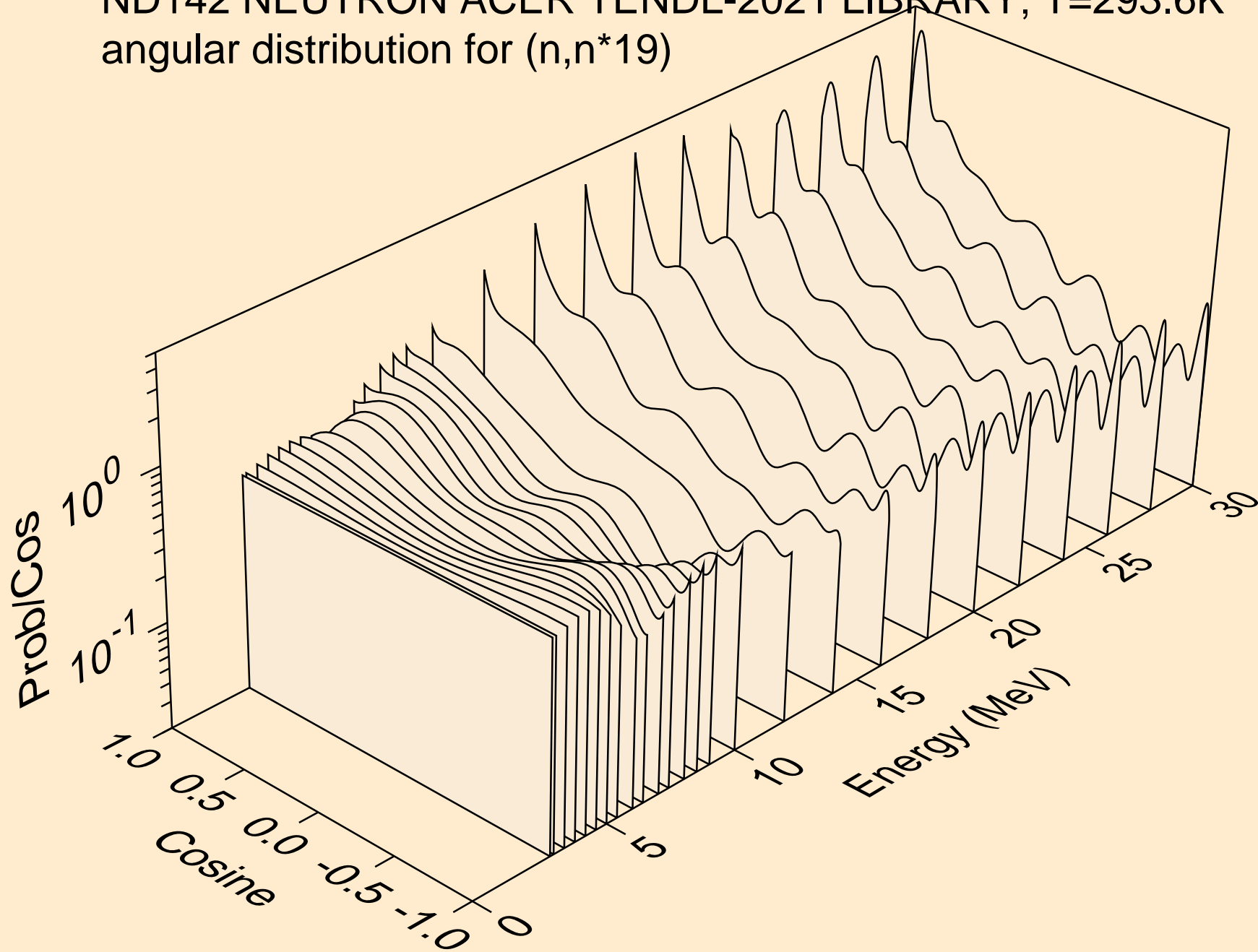

ND142 NEUTRON ACER TENDL-2021 LIBRARY; T=293.6K
angular distribution for (n,n*20)

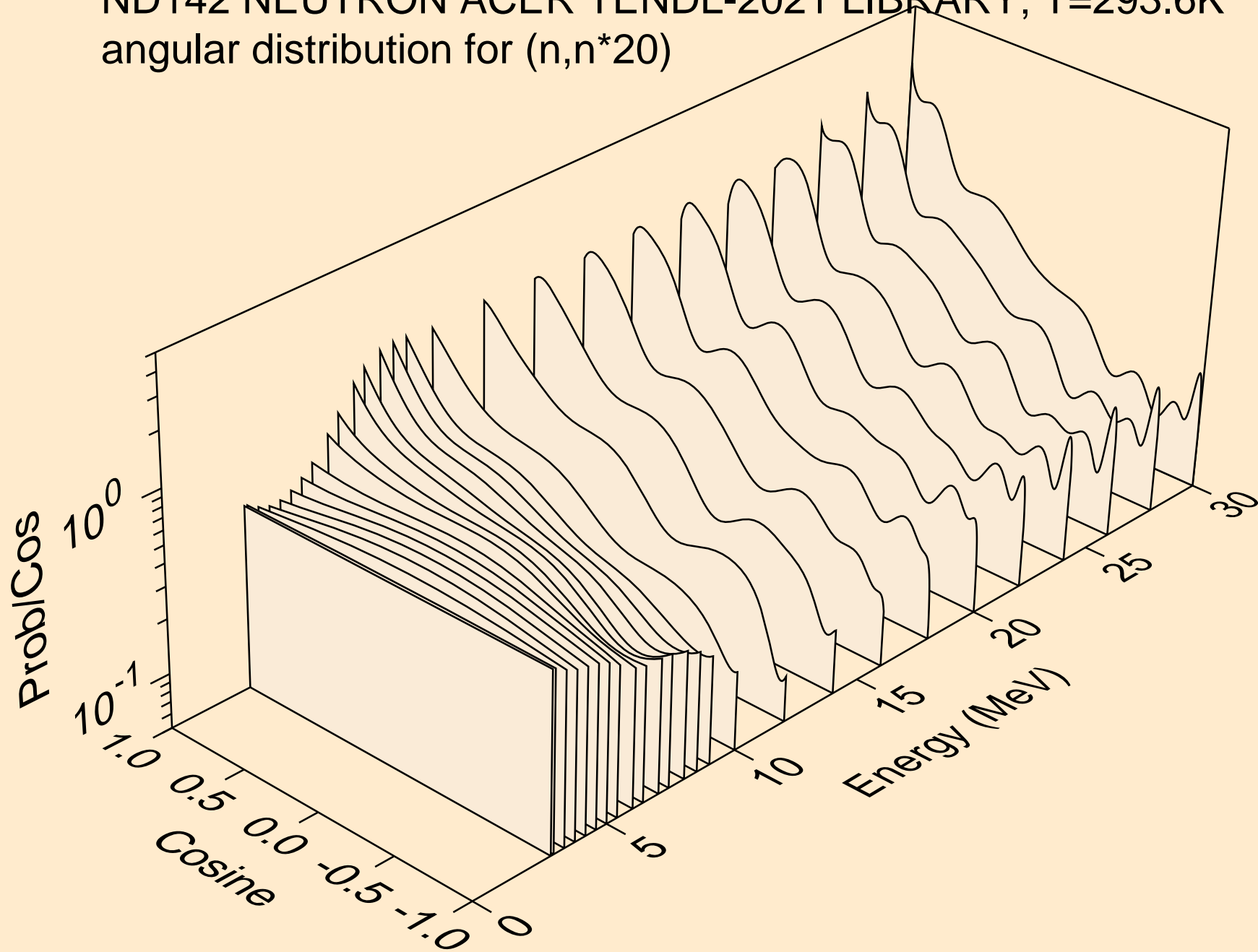

ND142 NEUTRON ACER TENDL-2021 LIBRARY; T=293.6K
angular distribution for (n,n*21)

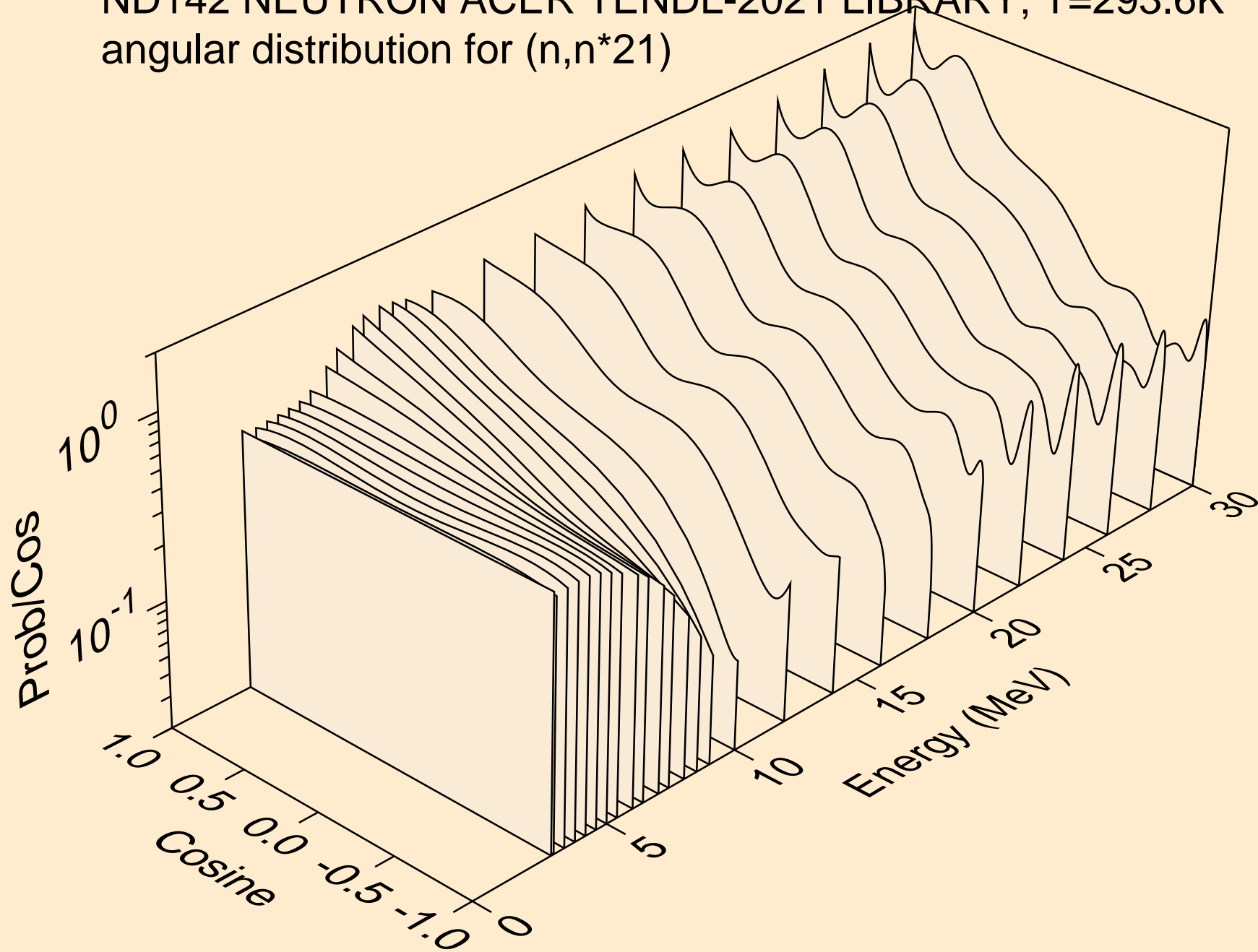

ND142 NEUTRON ACER TENDL-2021 LIBRARY; T=293.6K
angular distribution for (n,n*22)

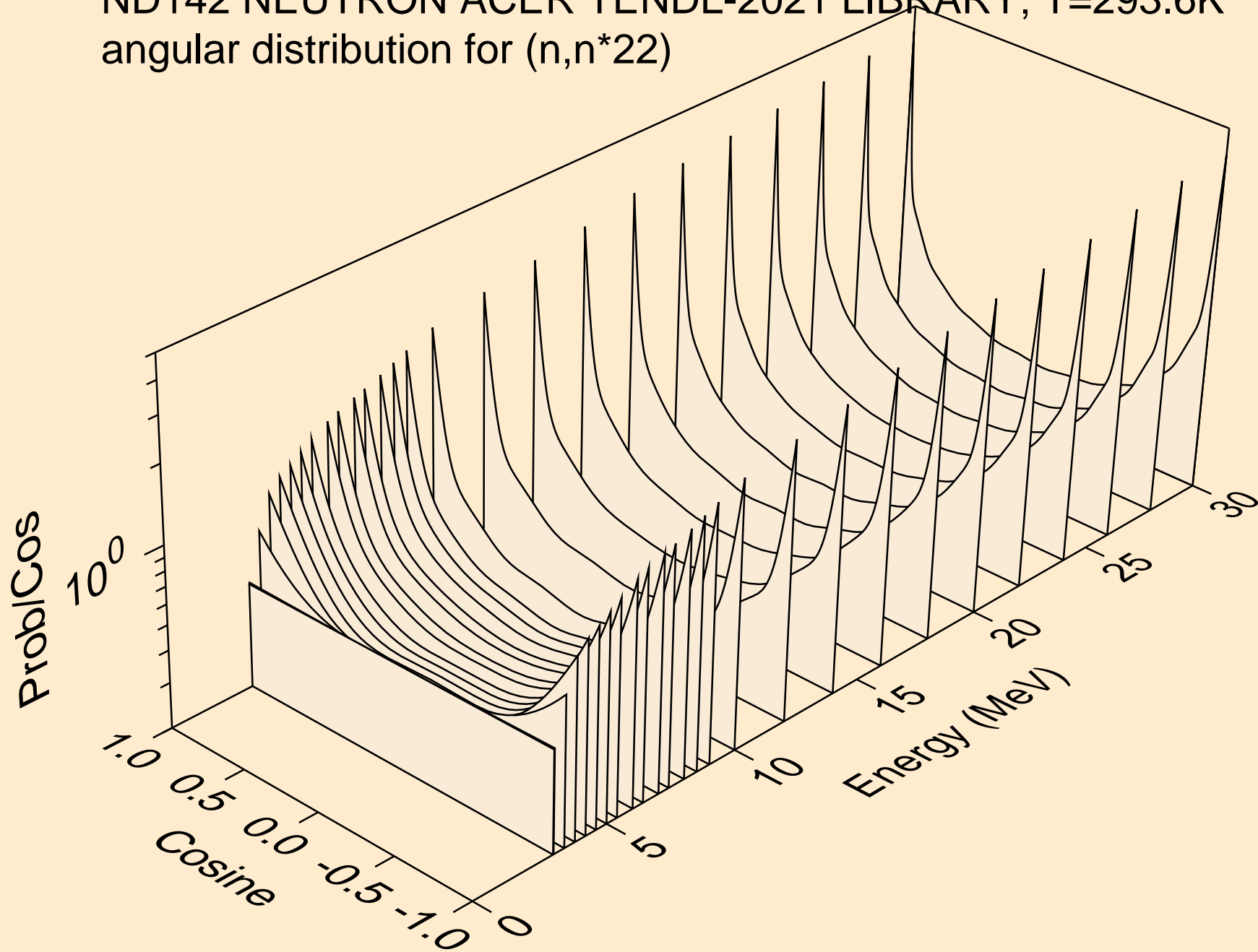

ND142 NEUTRON ACER TENDL-2021 LIBRARY; T=293.6K
angular distribution for (n,n*23)

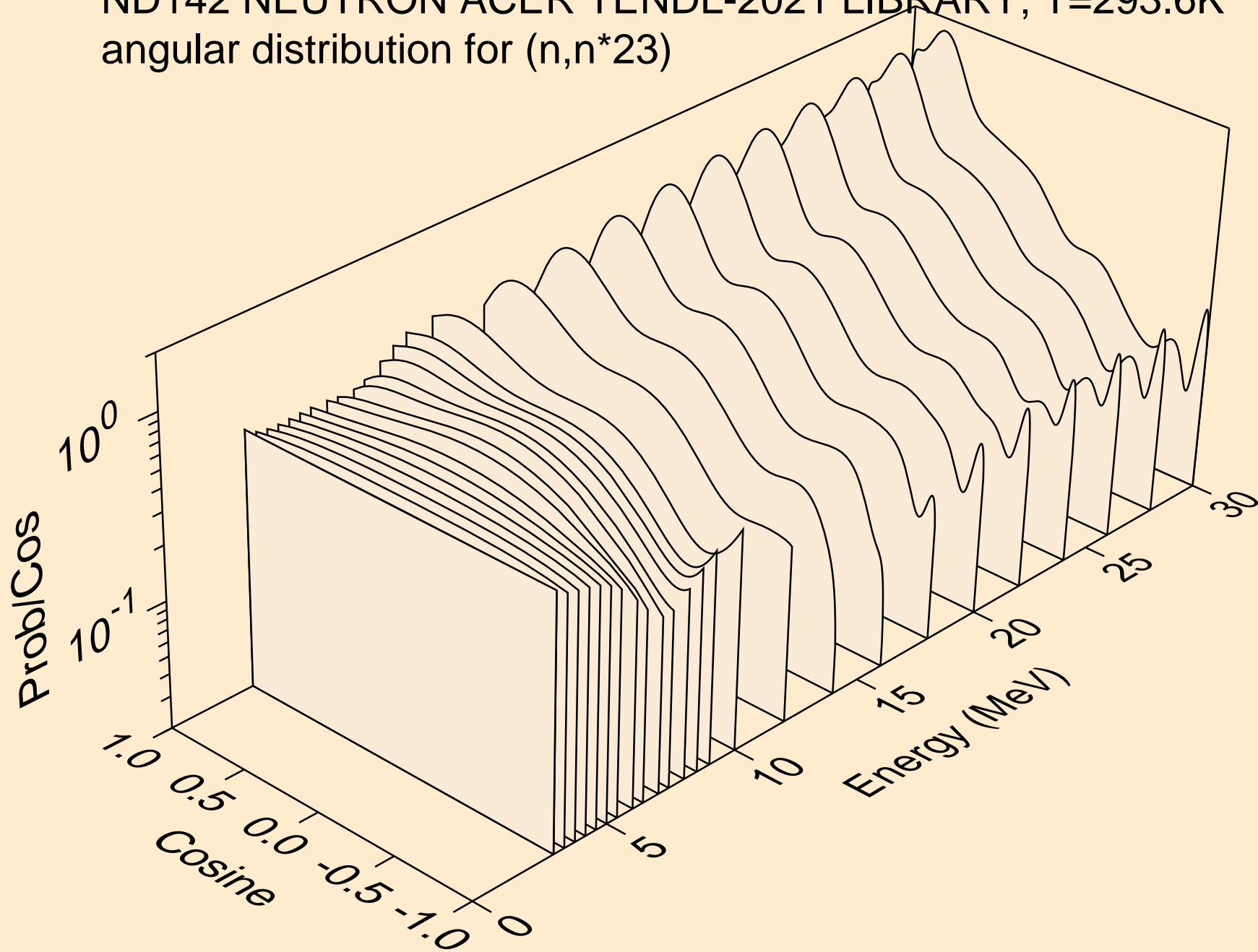

ND142 NEUTRON ACER TENDL-2021 LIBRARY; T=293.6K
angular distribution for (n,n*24)

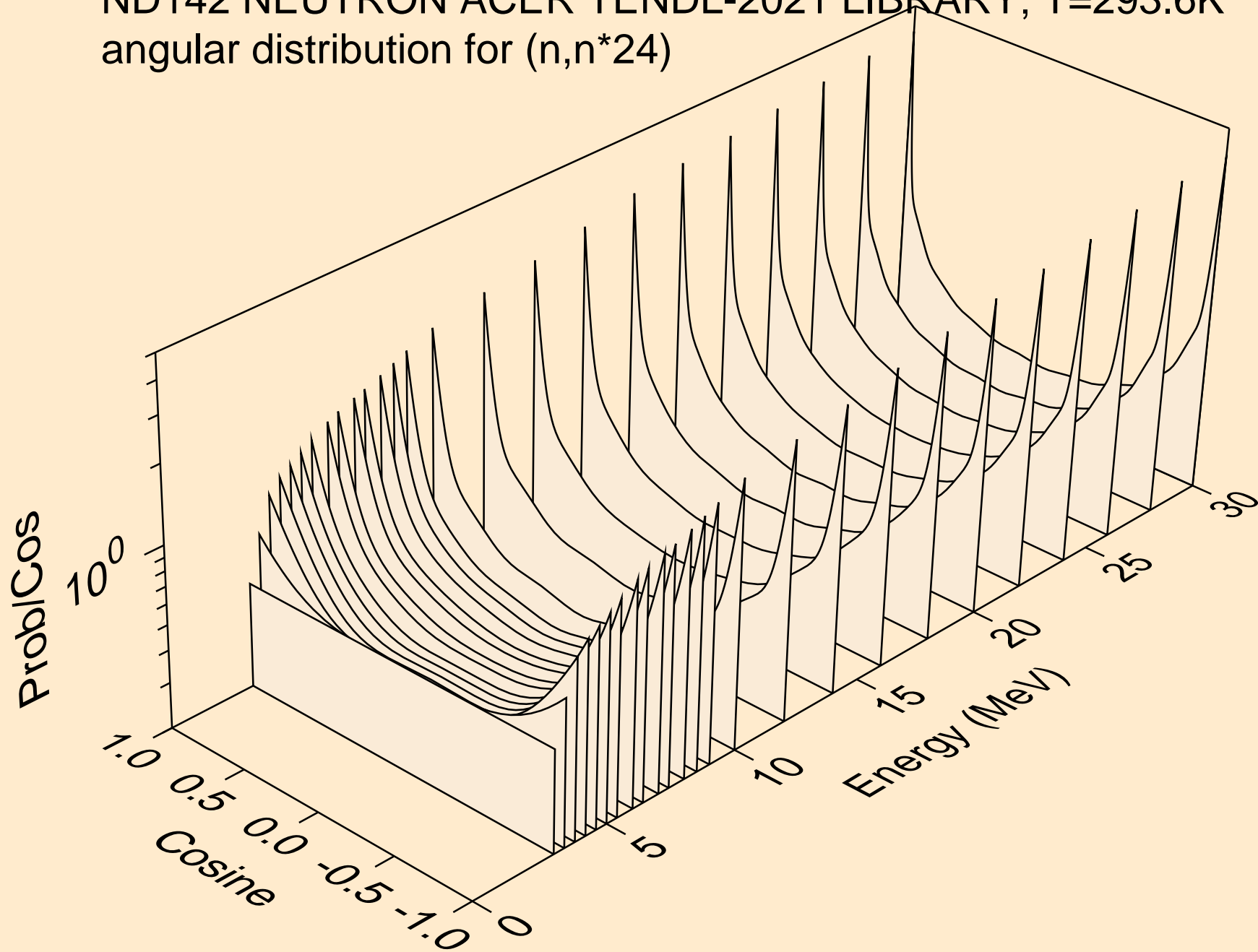

ND142 NEUTRON ACER TENDL-2021 LIBRARY; T=293.6K
angular distribution for (n,n*25)

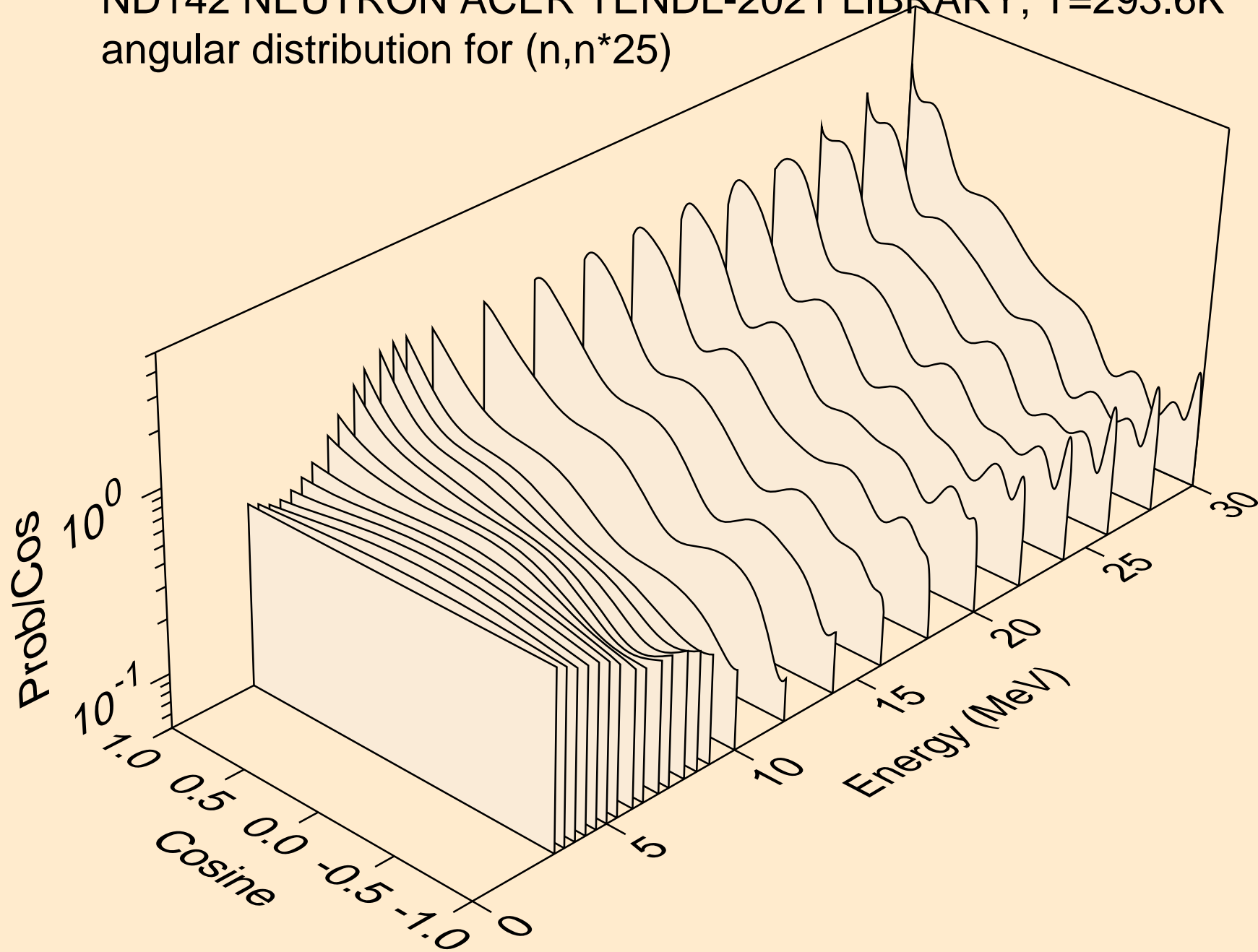

ND142 NEUTRON ACER TENDL-2021 LIBRARY; T=293.6K
angular distribution for (n,n*26)

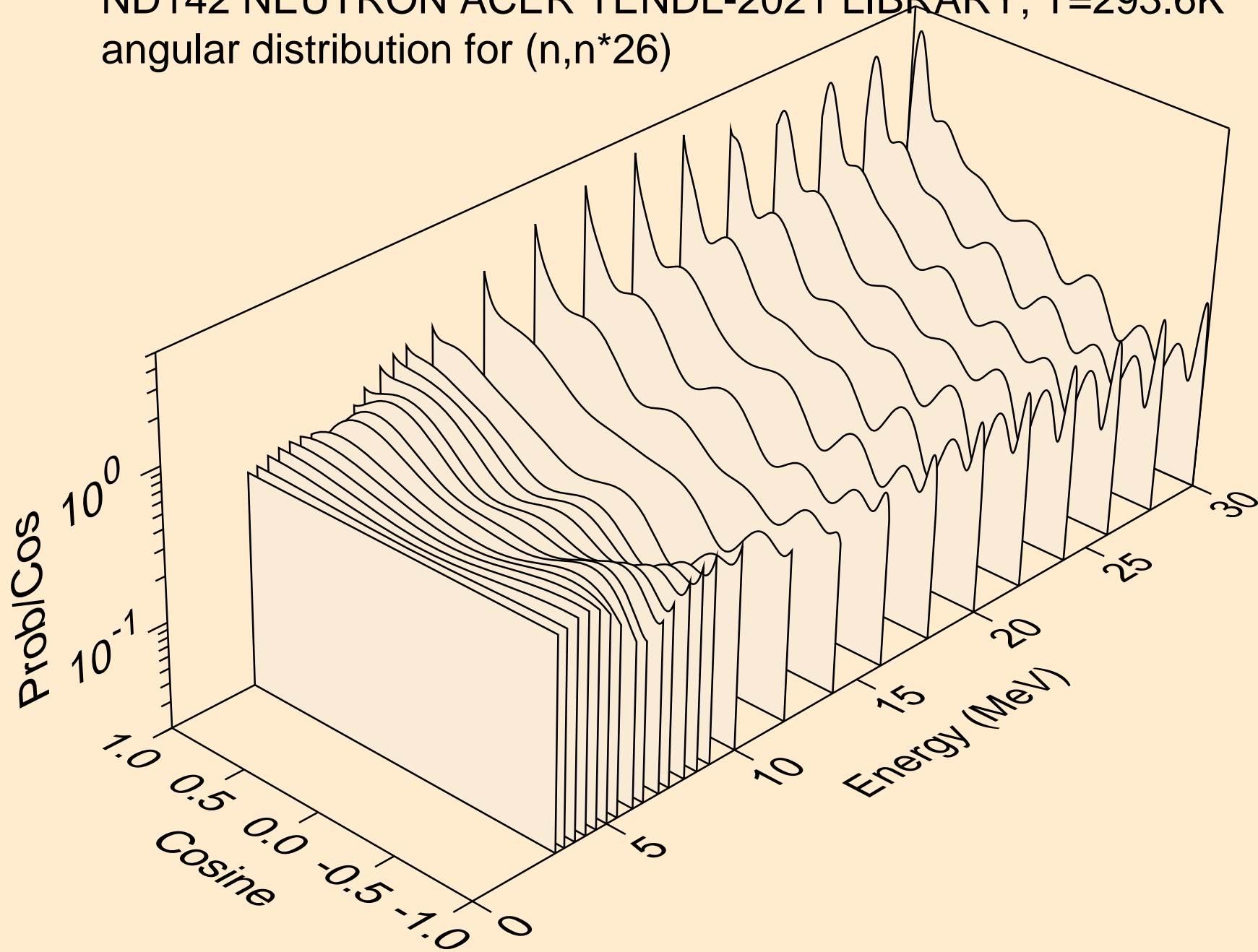

ND142 NEUTRON ACER TENDL-2021 LIBRARY; T=293.6K
angular distribution for (n,n*27)

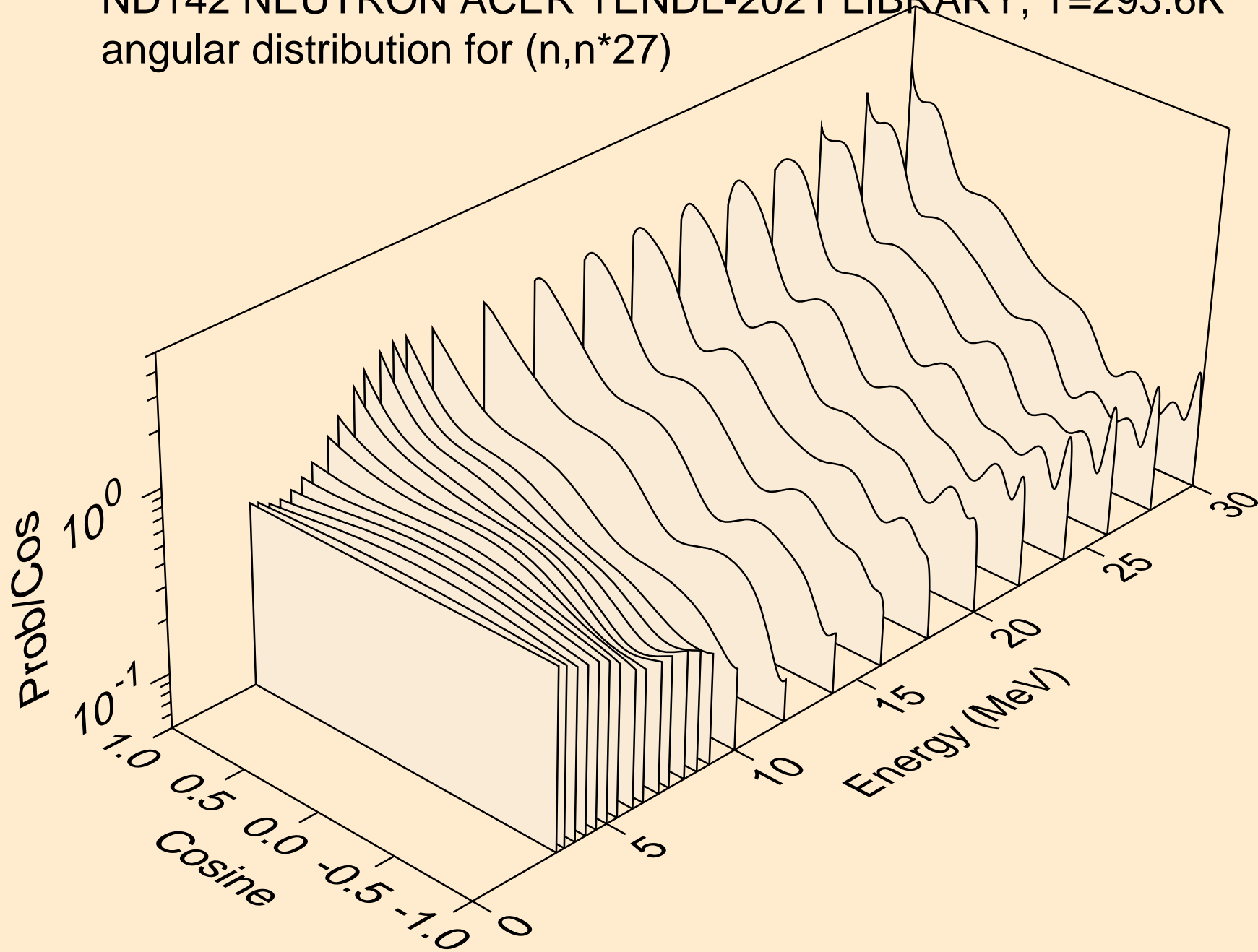

ND142 NEUTRON ACER TENDL-2021 LIBRARY; T=293.6K
angular distribution for (n,n*28)

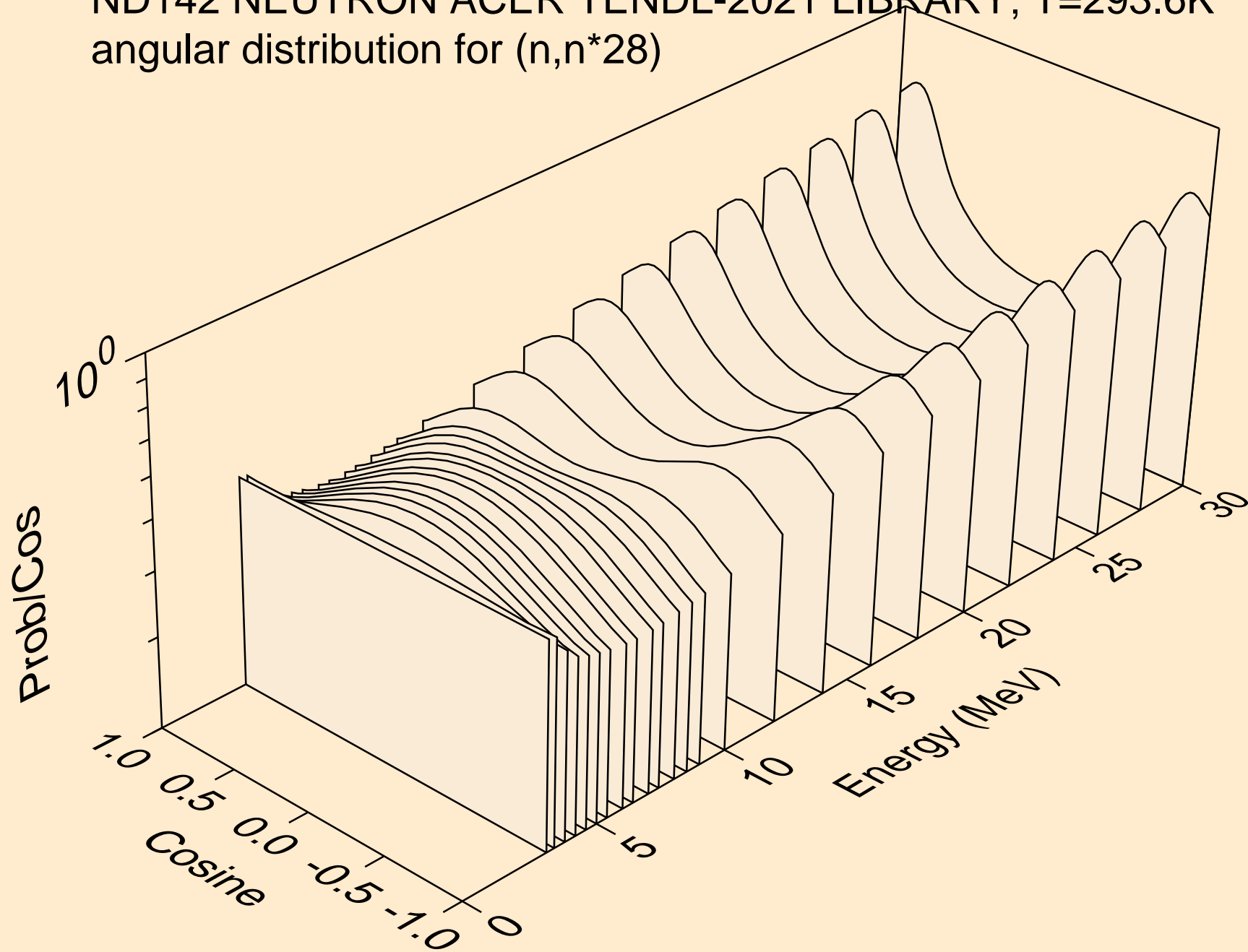

ND142 NEUTRON ACER TENDL-2021 LIBRARY; T=293.6K
angular distribution for (n,n*29)

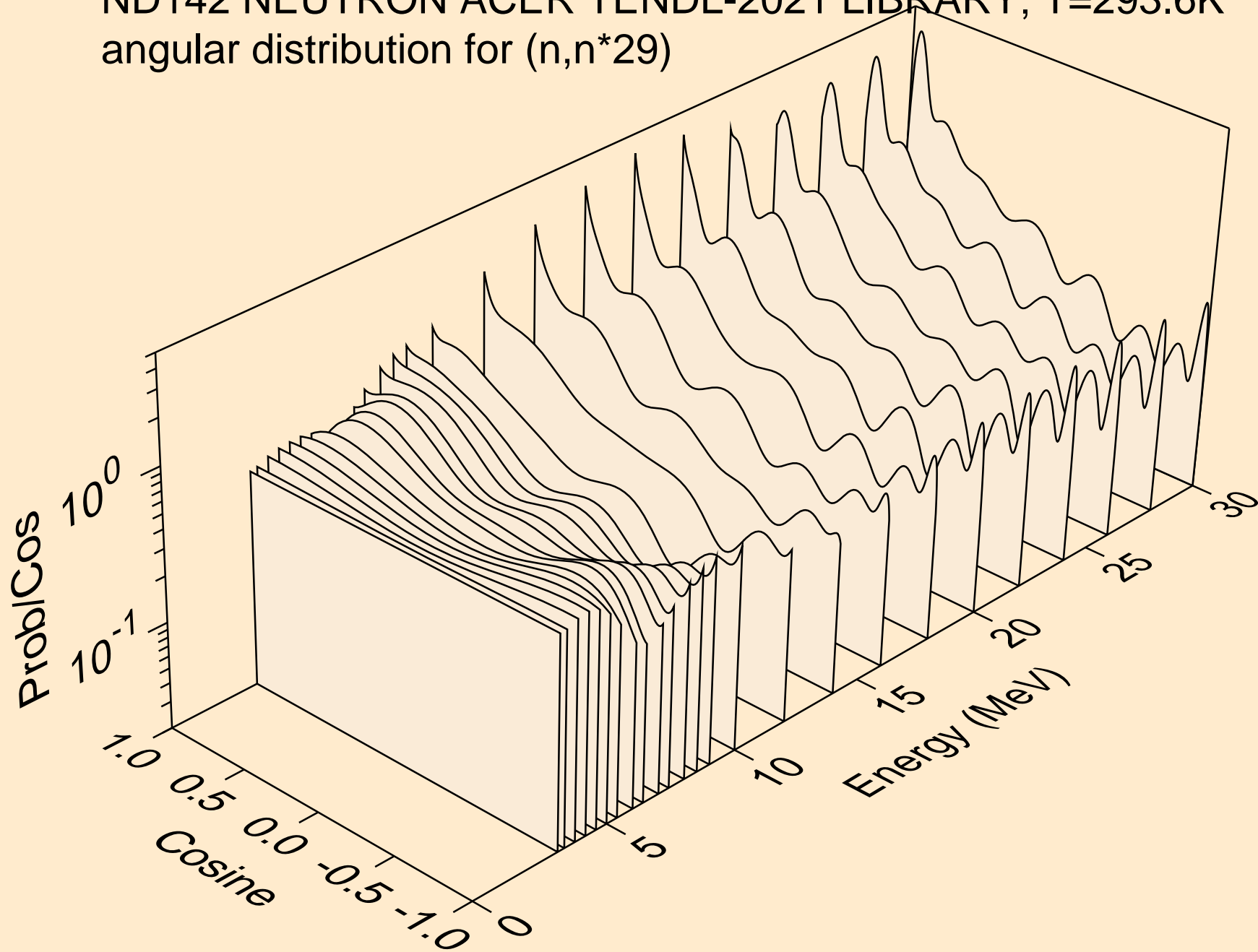

ND142 NEUTRON ACER TENDL-2021 LIBRARY; T=293.6K
Neutron emission for (n,x)

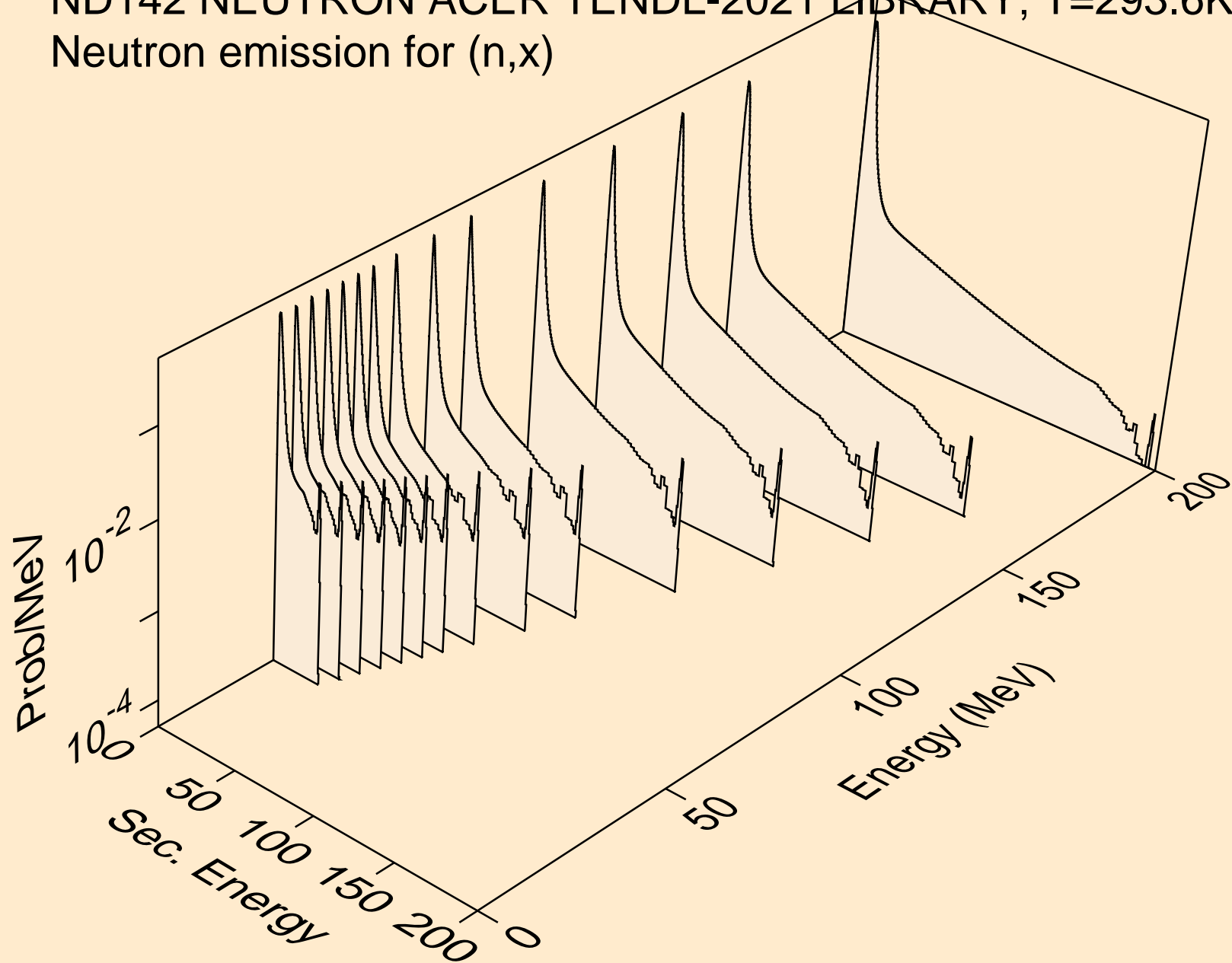

ND142 NEUTRON ACER TENDL-2021 LIBRARY; T=293.6K
Neutron emission for (n,2nd)

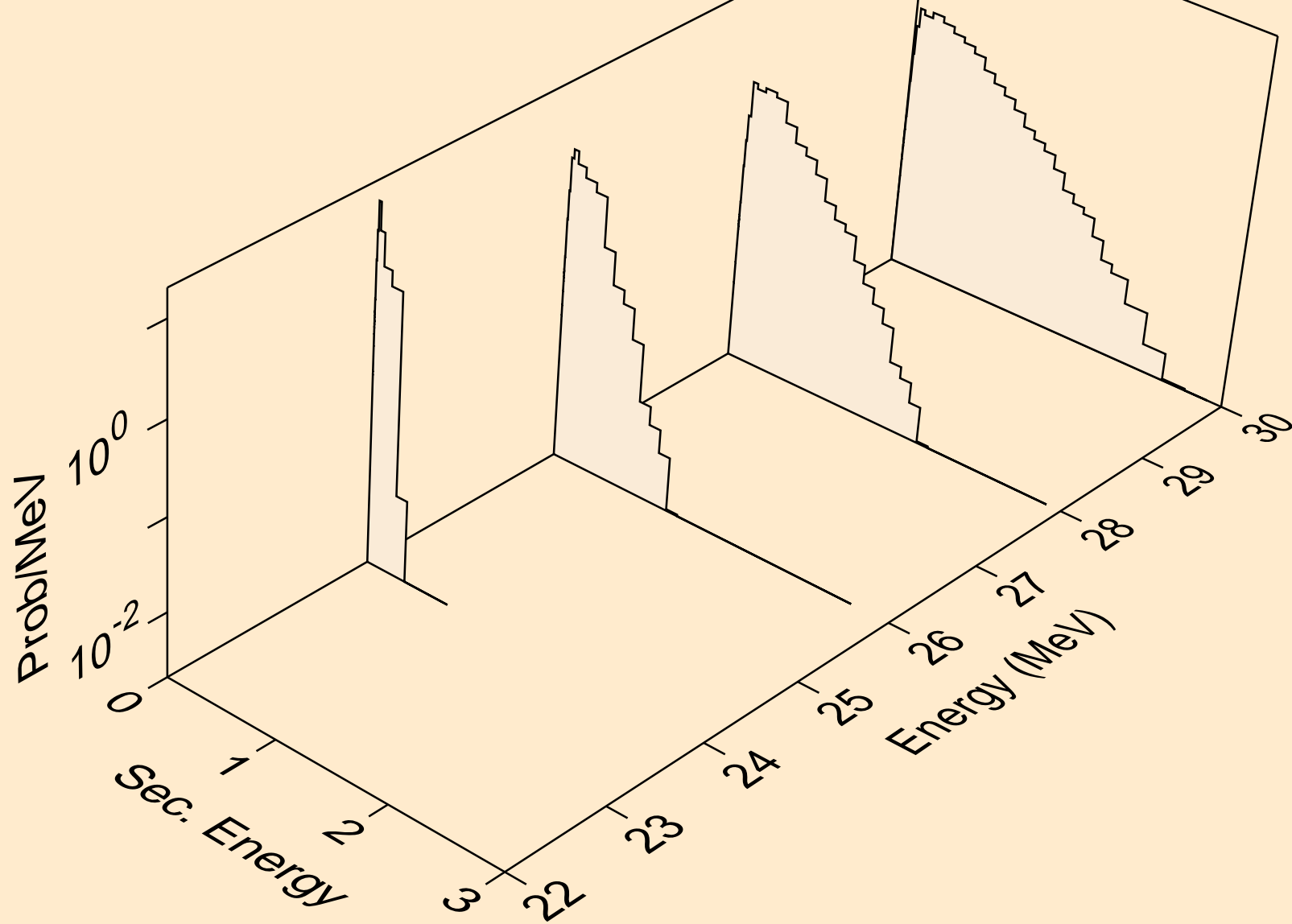

ND142 NEUTRON ACER TENDL-2021 LIBRARY; T=293.6K
Neutron emission for (n,2n)

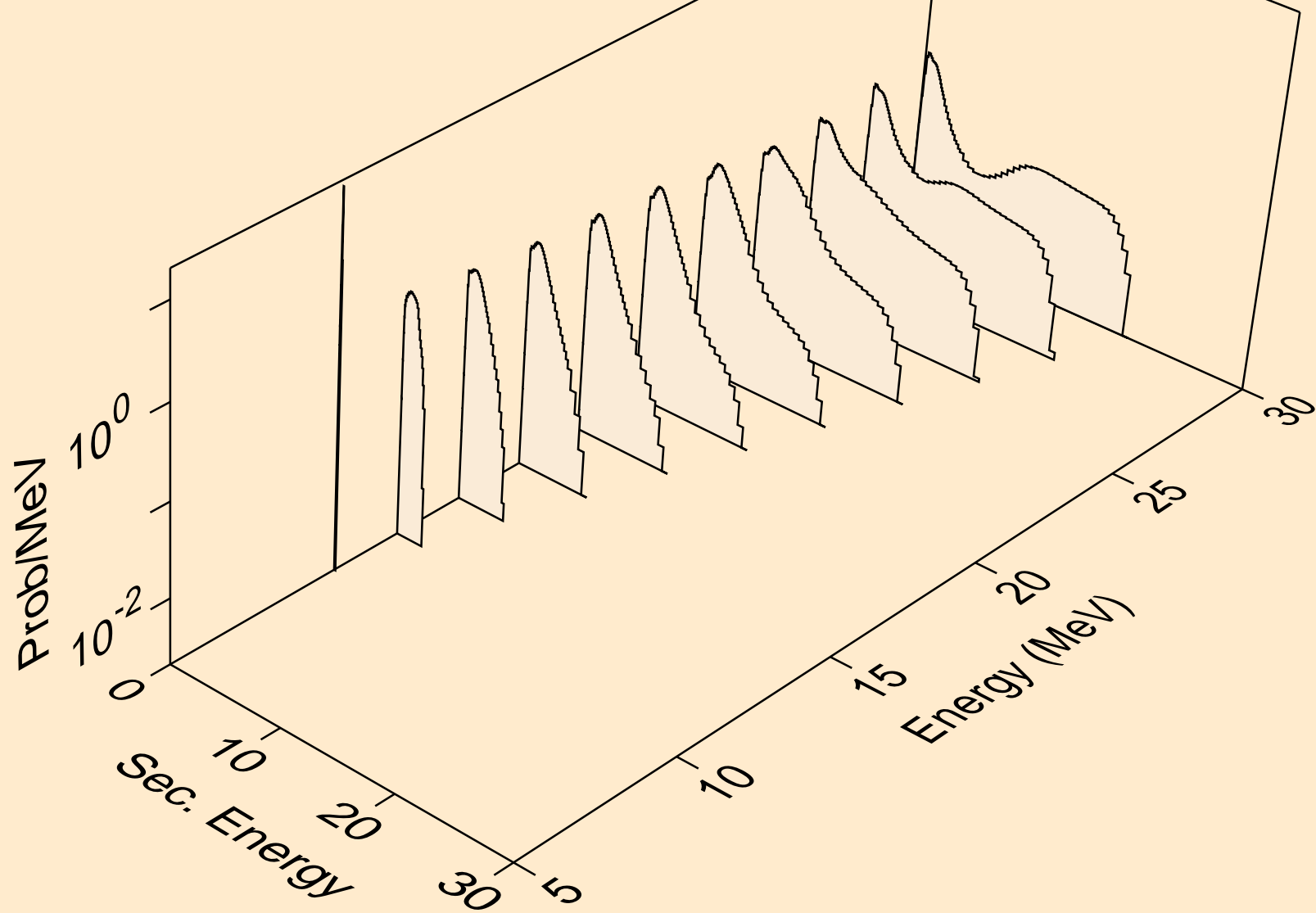

ND142 NEUTRON ACER TENDL-2021 LIBRARY; T=293.6K
Neutron emission for (n,3n)

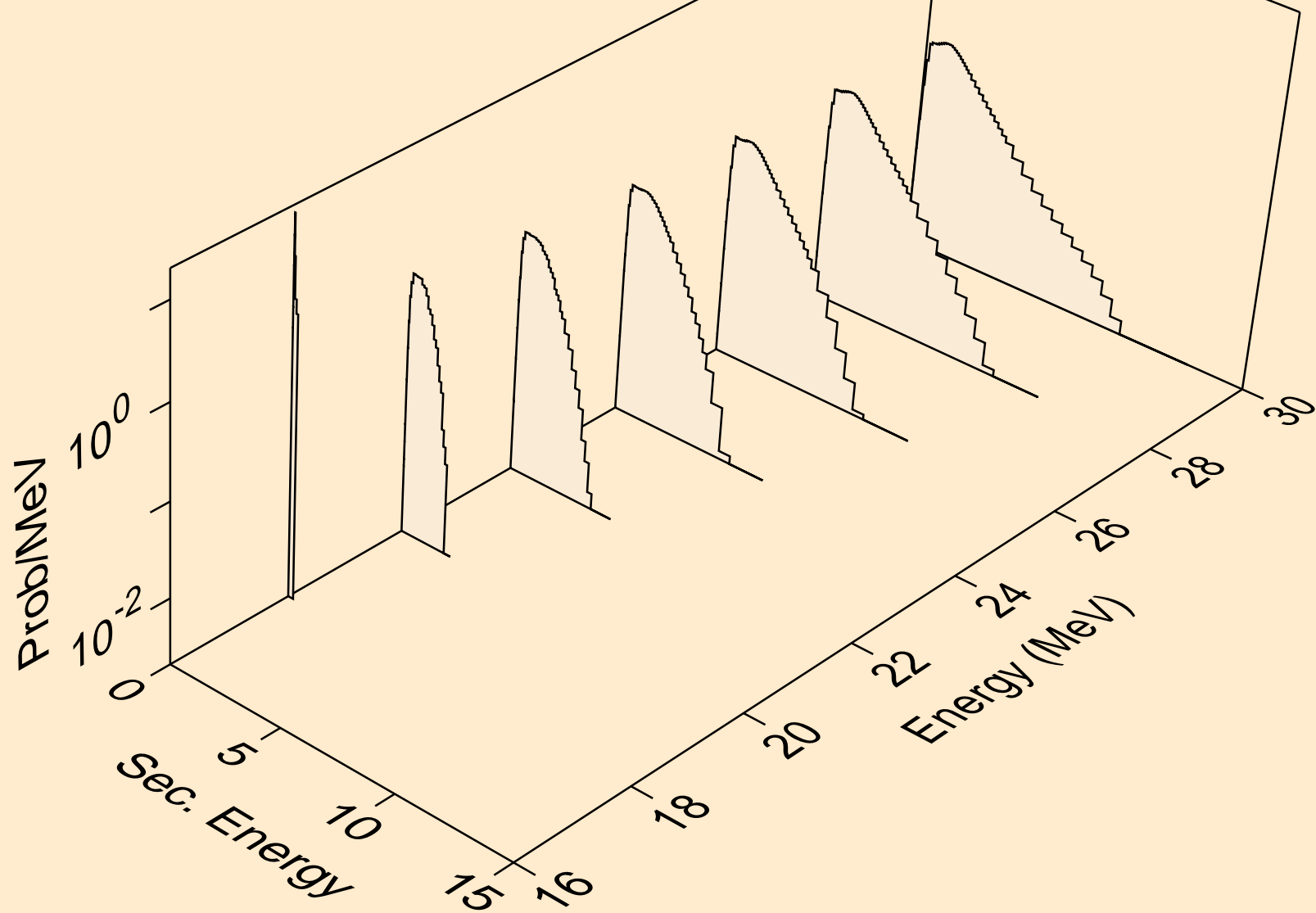

ND142 NEUTRON ACER TENDL-2021 LIBRARY; T=293.6K
Neutron emission for (n,n*)a

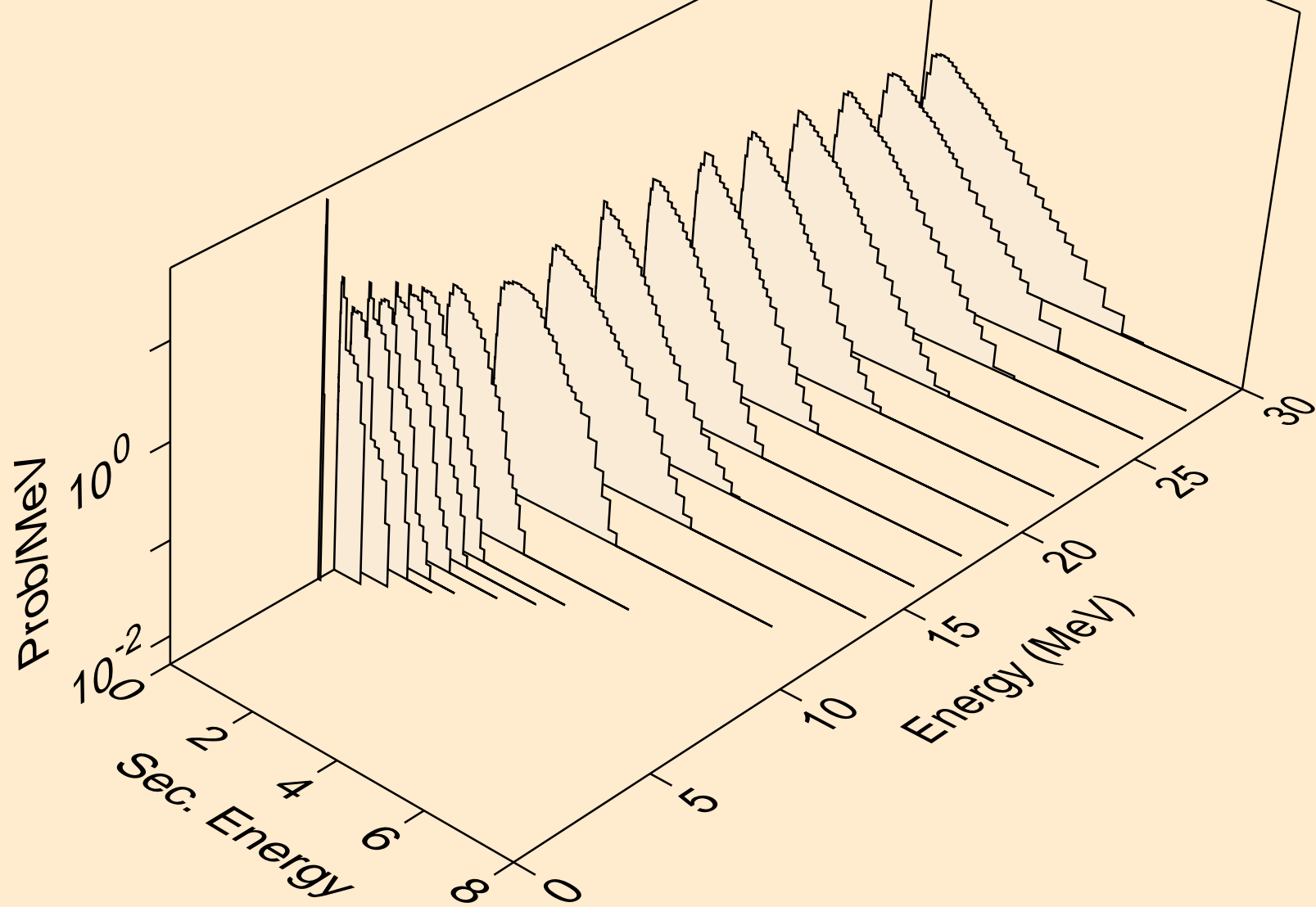

ND142 NEUTRON ACER TENDL-2021 LIBRARY; T=293.6K
Neutron emission for (n,2n)_a

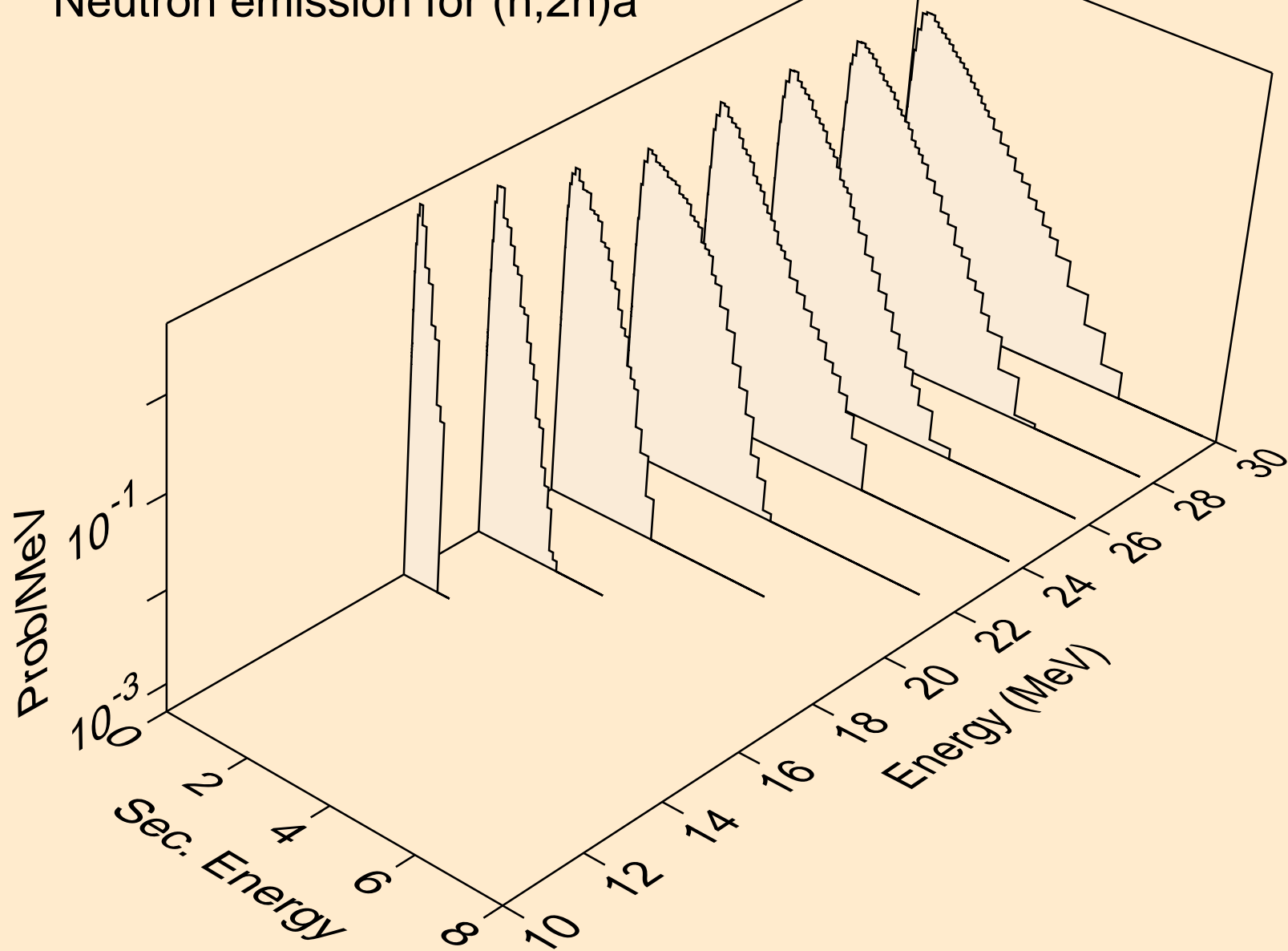

ND142 NEUTRON ACER TENDL-2021 LIBRARY; T=293.6K
Neutron emission for (n,3n)a

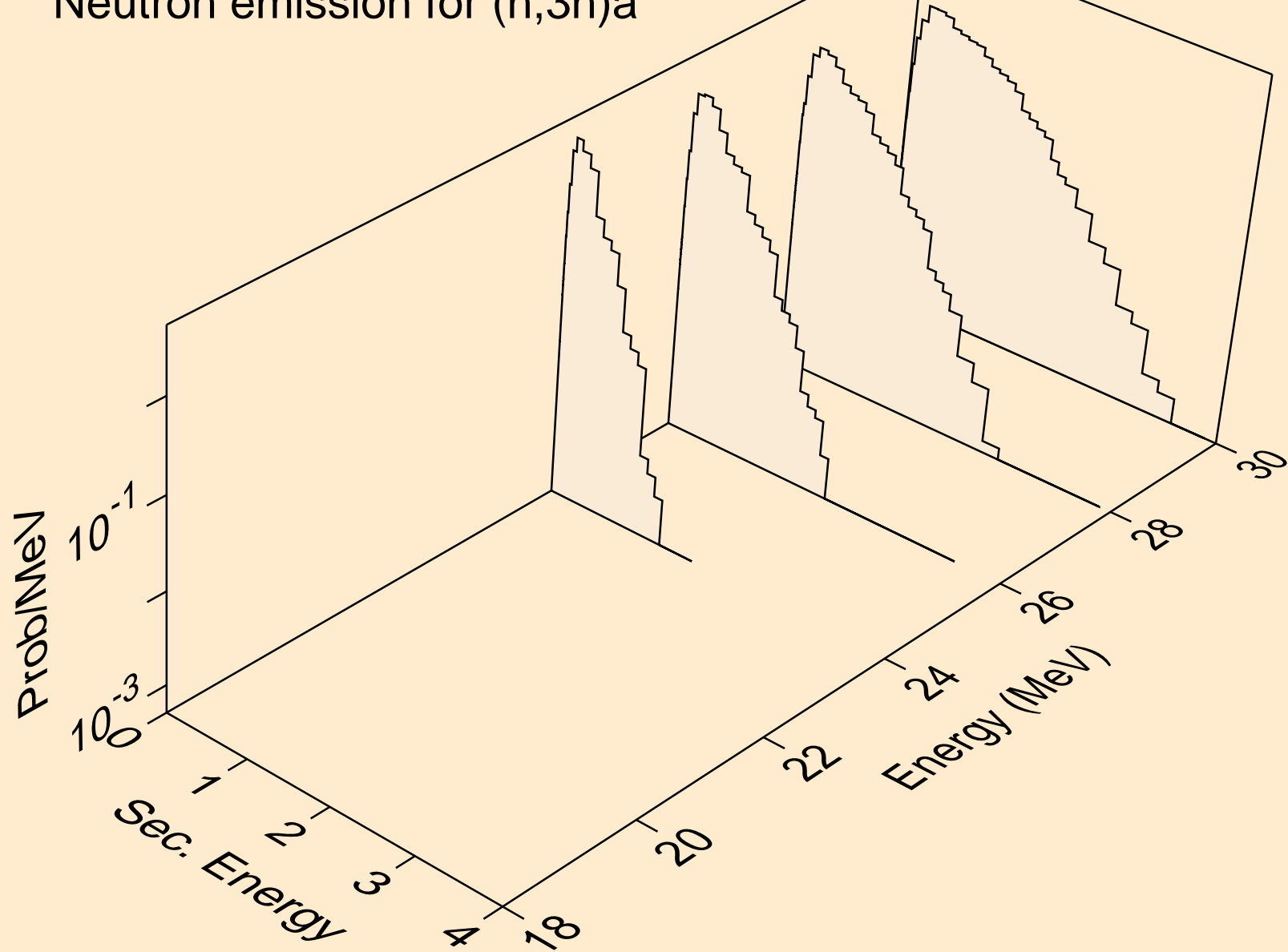

ND142 NEUTRON ACER TENDL-2021 LIBRARY; T=293.6K
Neutron emission for (n,n*)p

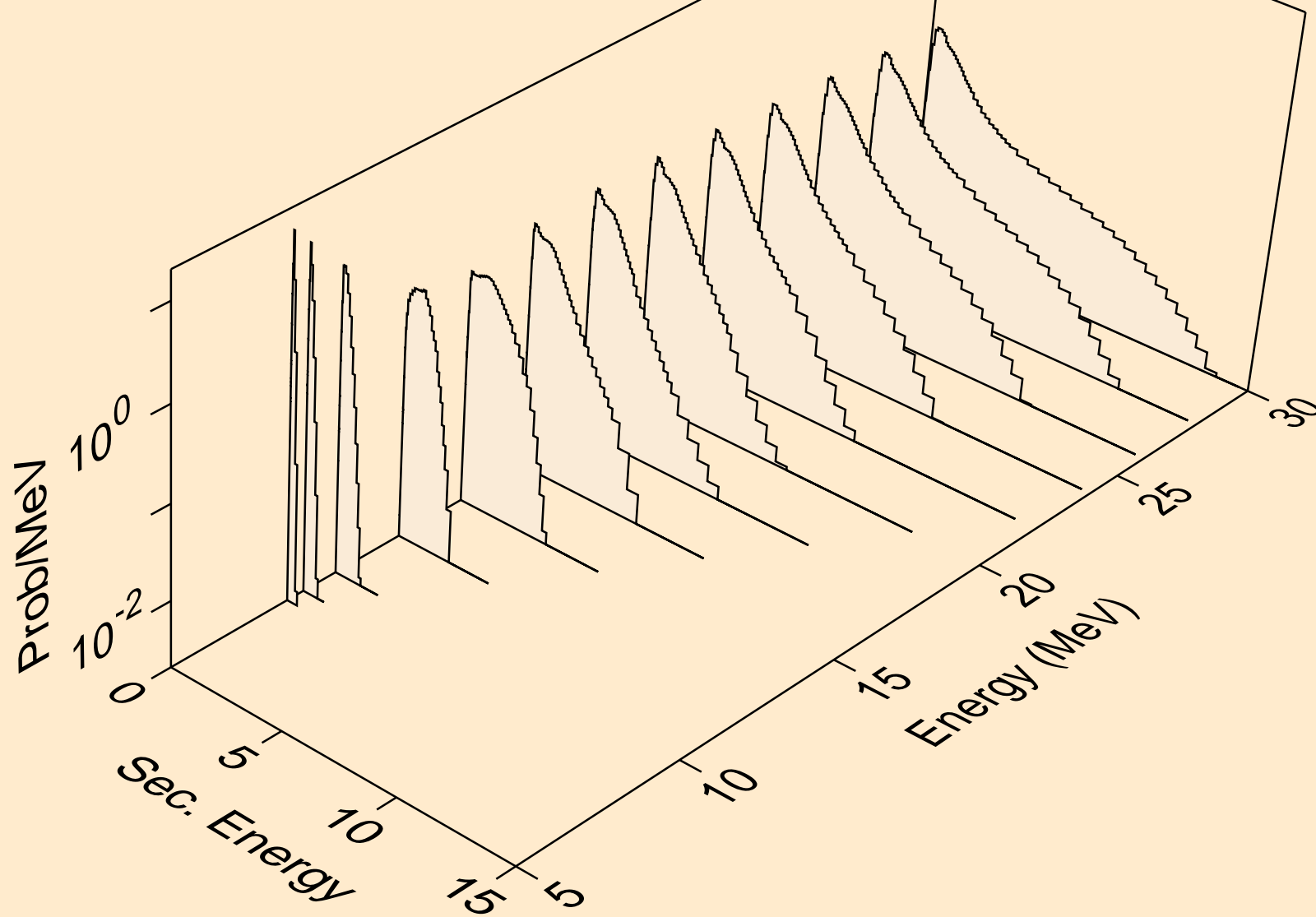

ND142 NEUTRON ACER TENDL-2021 LIBRARY; T=293.6K
Neutron emission for (n,n*)2a

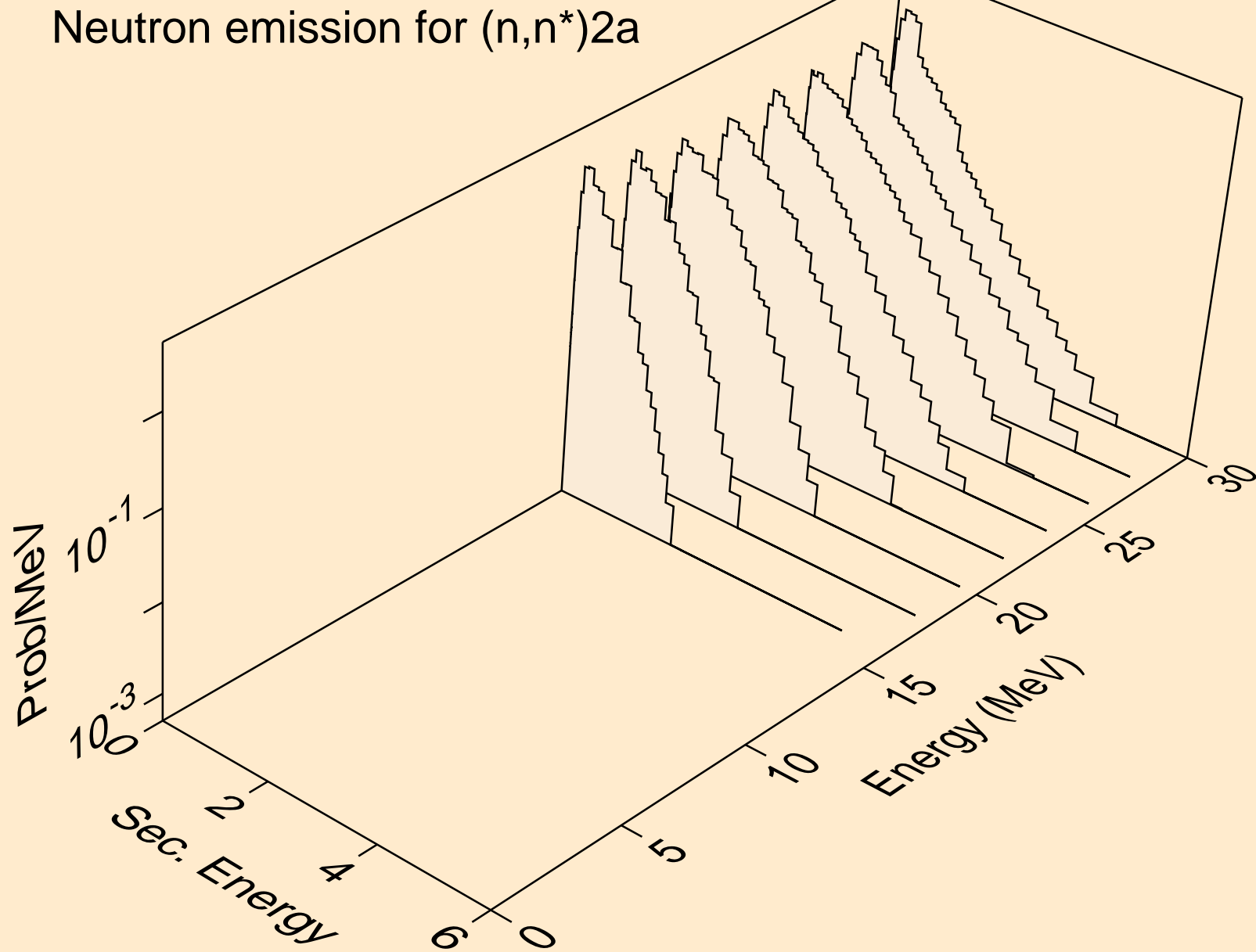

ND142 NEUTRON ACER TENDL-2021 LIBRARY; T=293.6K
Neutron emission for (n,n*)d

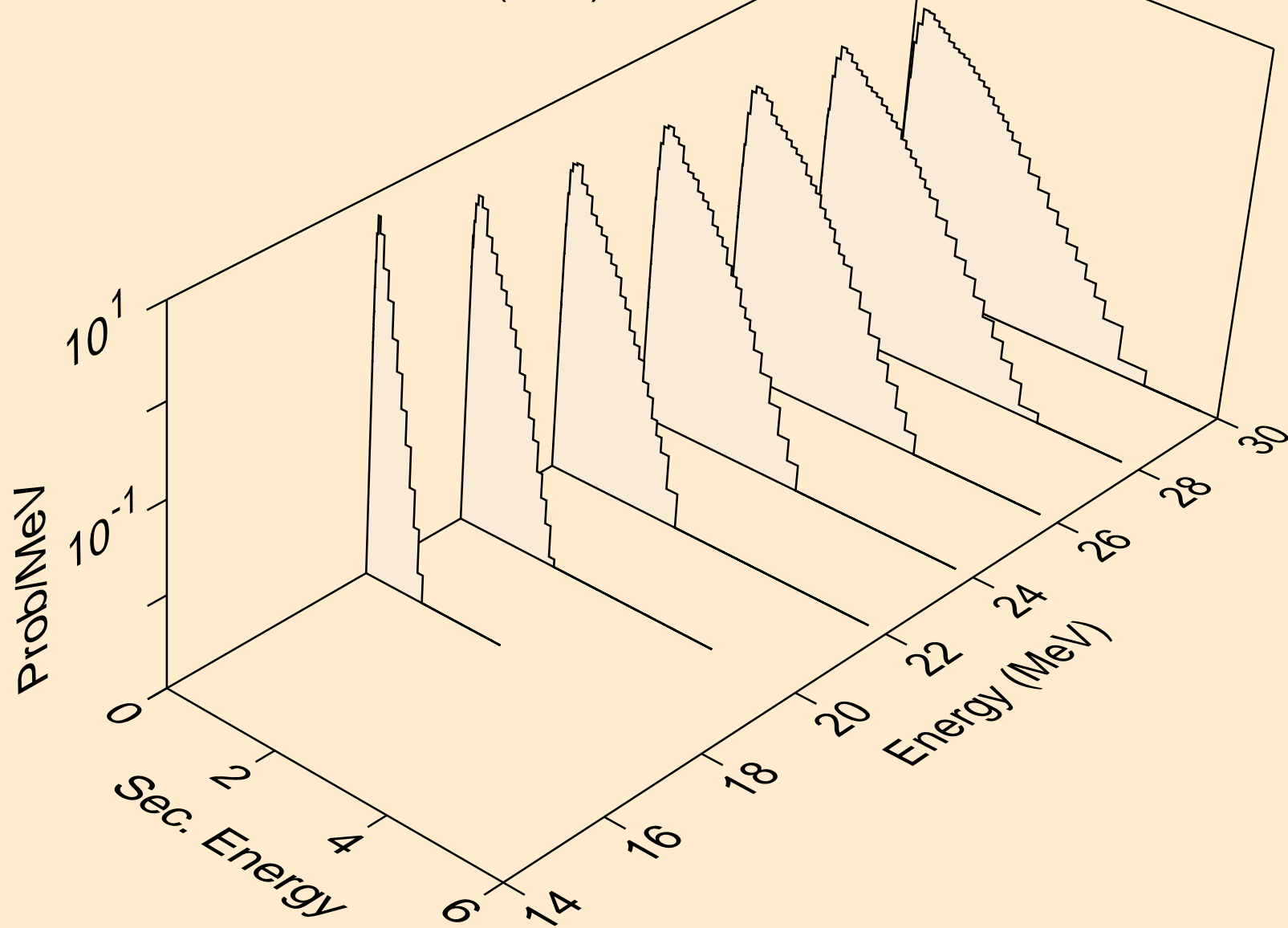

ND142 NEUTRON ACER TENDL-2021 LIBRARY; T=293.6K
Neutron emission for (n,n*)t

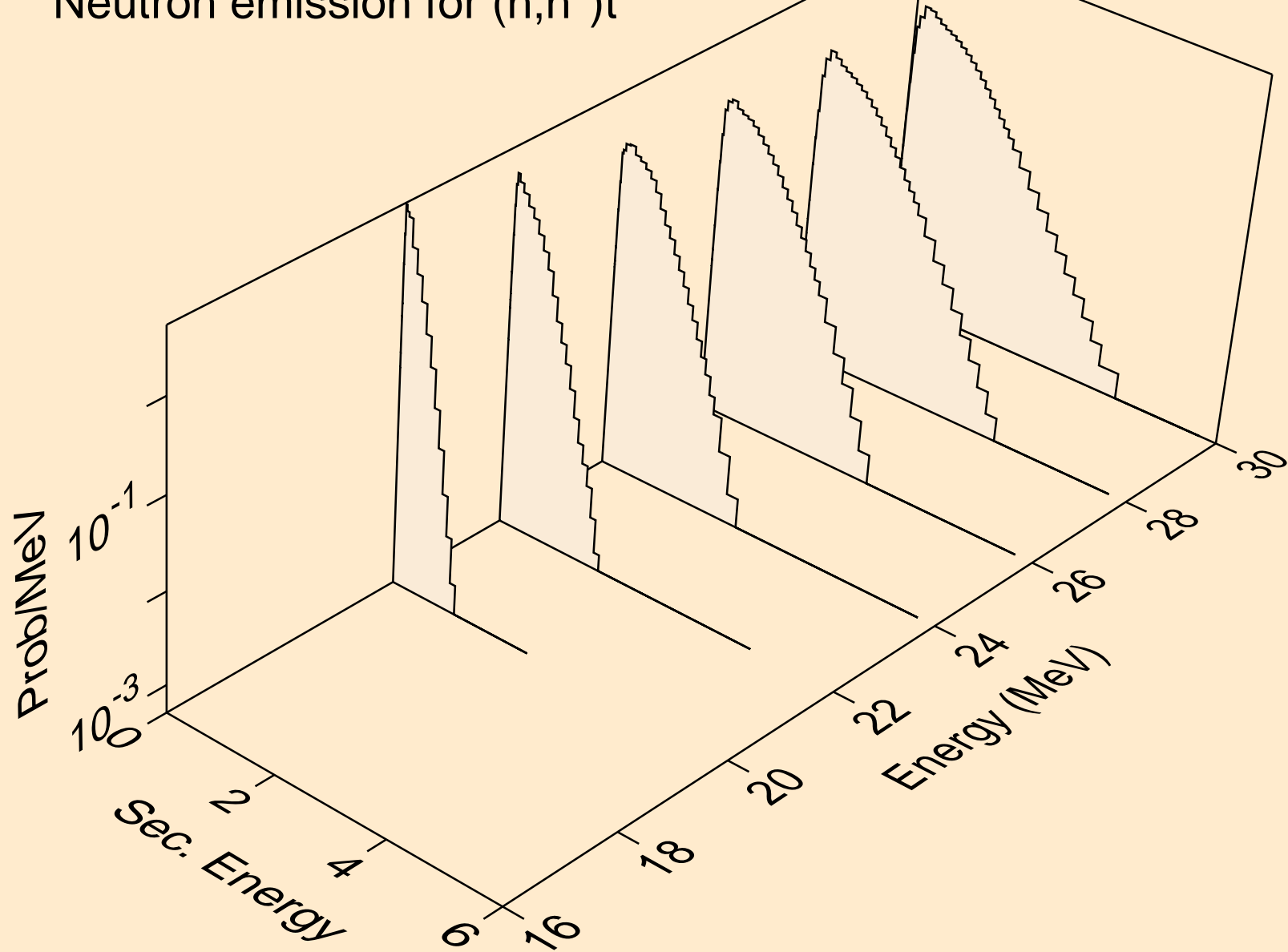

ND142 NEUTRON ACER TENDL-2021 LIBRARY; T=293.6K
Neutron emission for (n,n*)he3

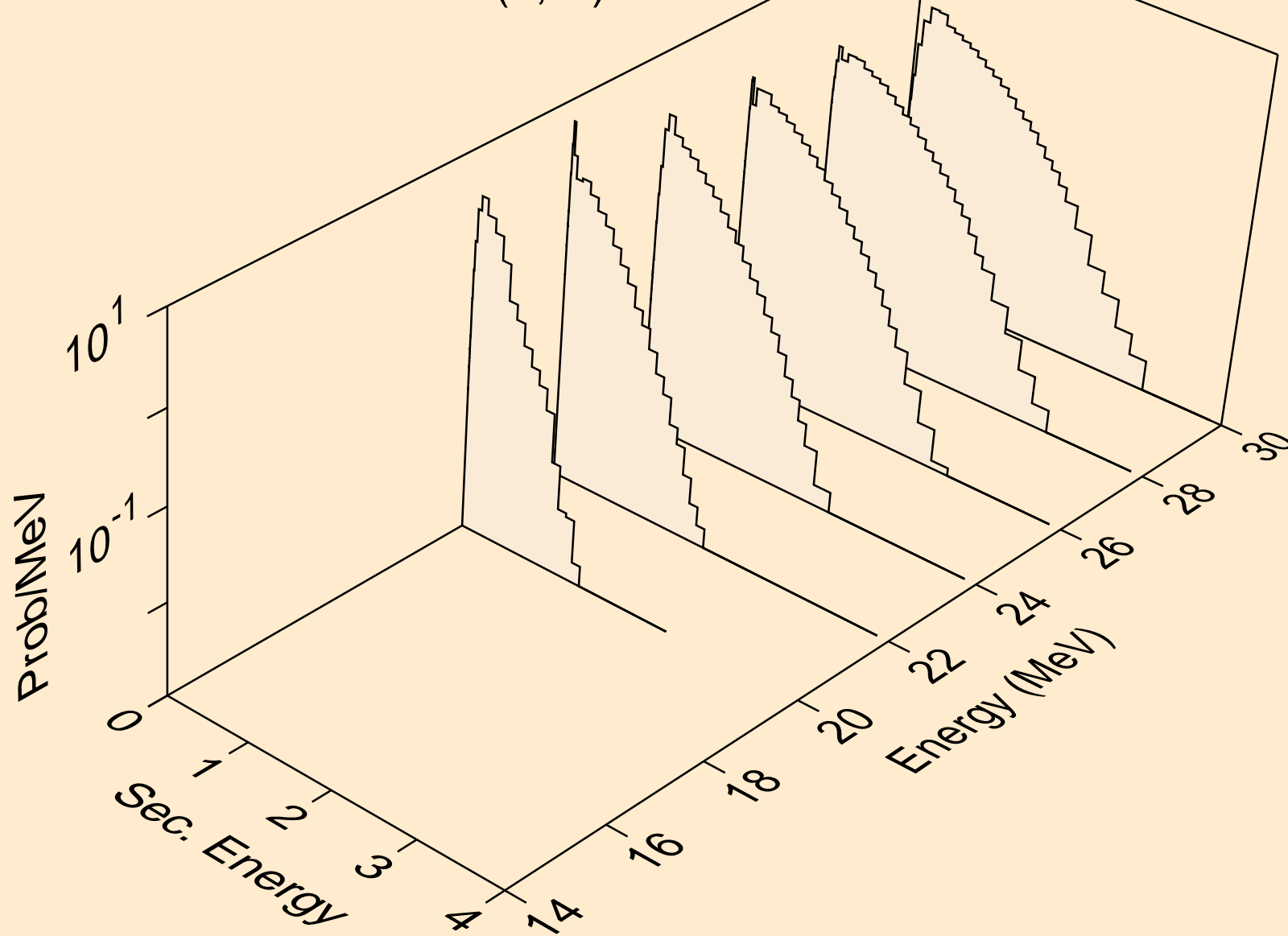

ND142 NEUTRON ACER TENDL-2021 LIBRARY; T=293.6K
Neutron emission for (n,4n)

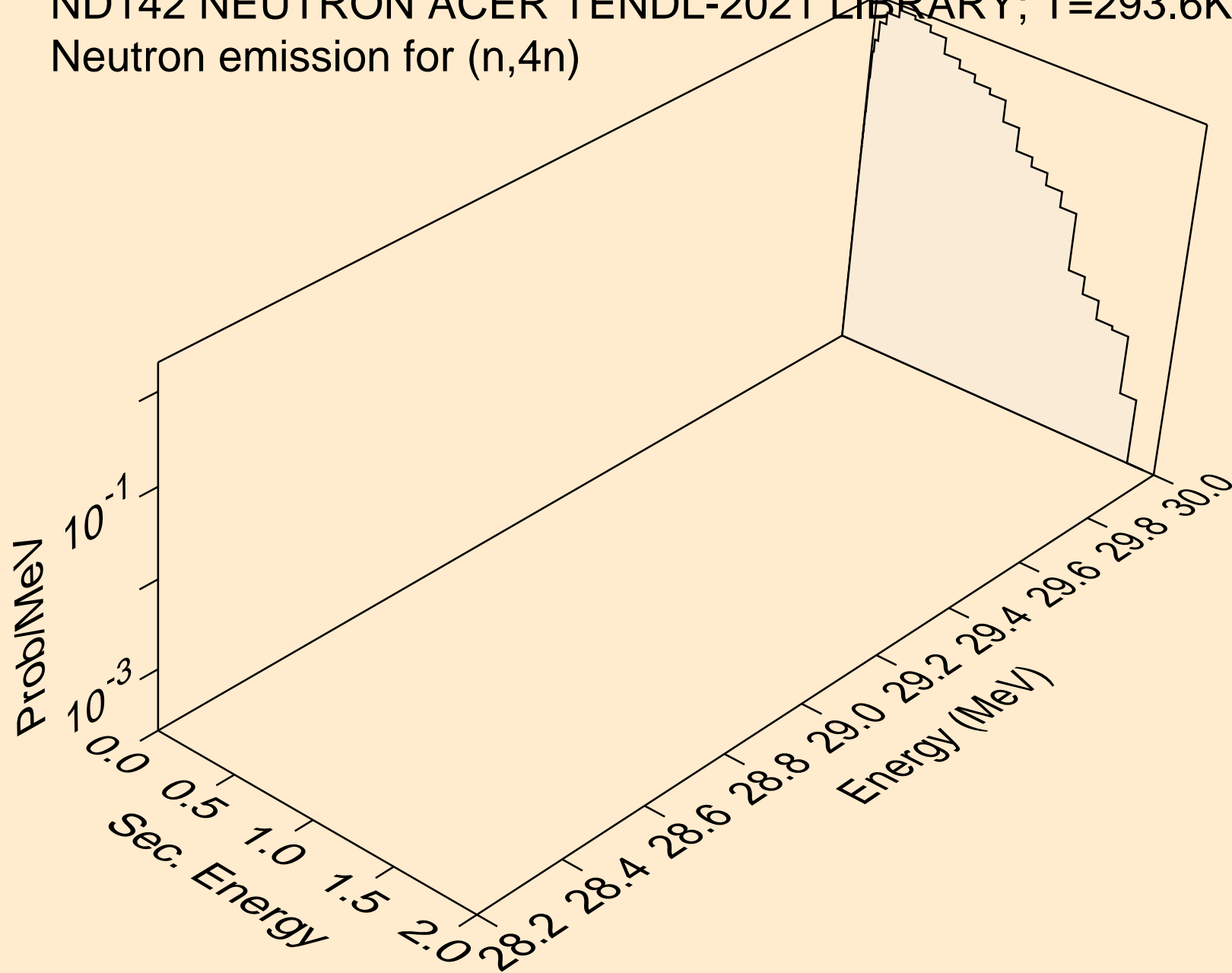

ND142 NEUTRON ACER TENDL-2021 LIBRARY; T=293.6K
Neutron emission for (n,2np)

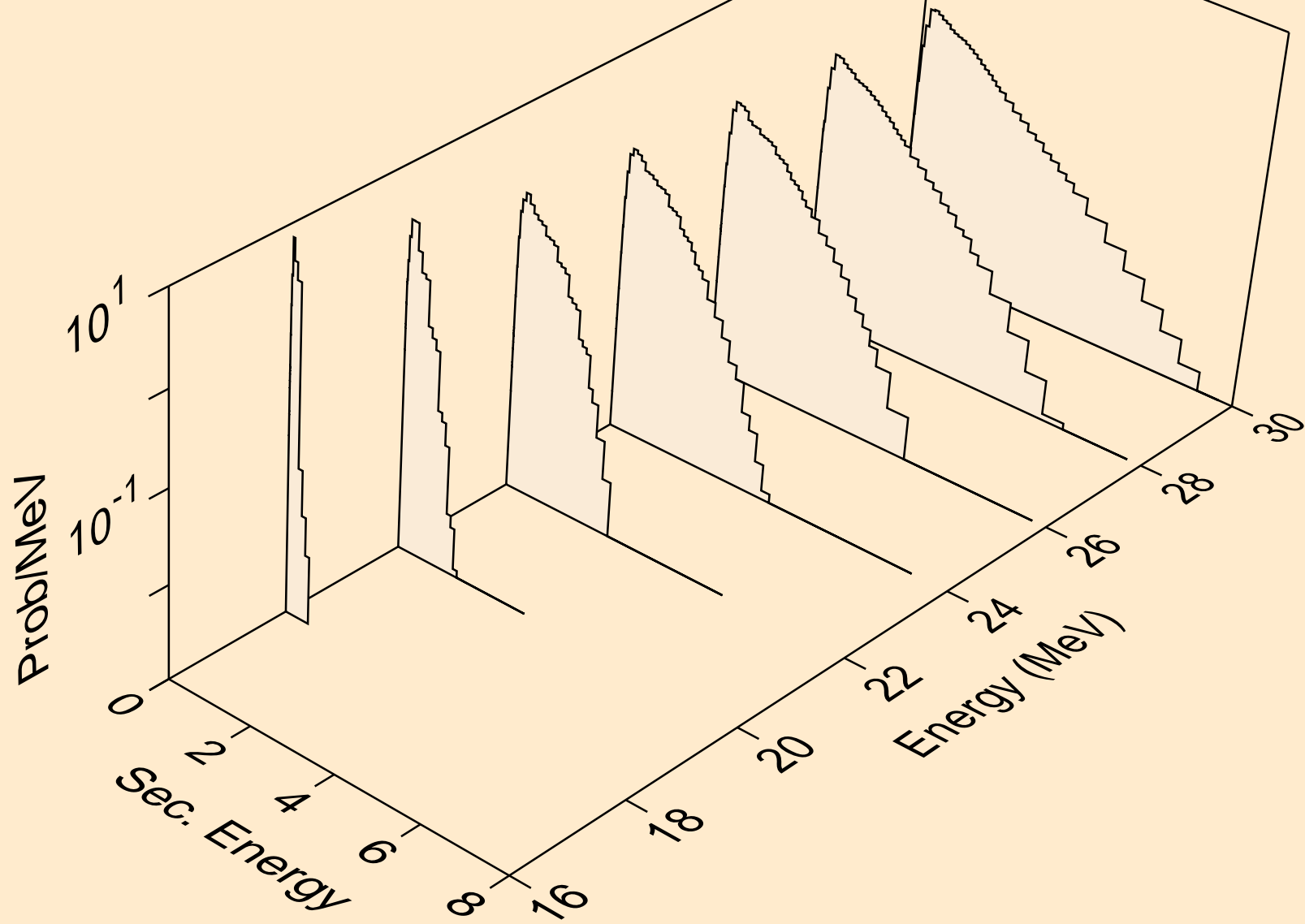

ND142 NEUTRON ACER TENDL-2021 LIBRARY; T=293.6K
Neutron emission for (n,3np)

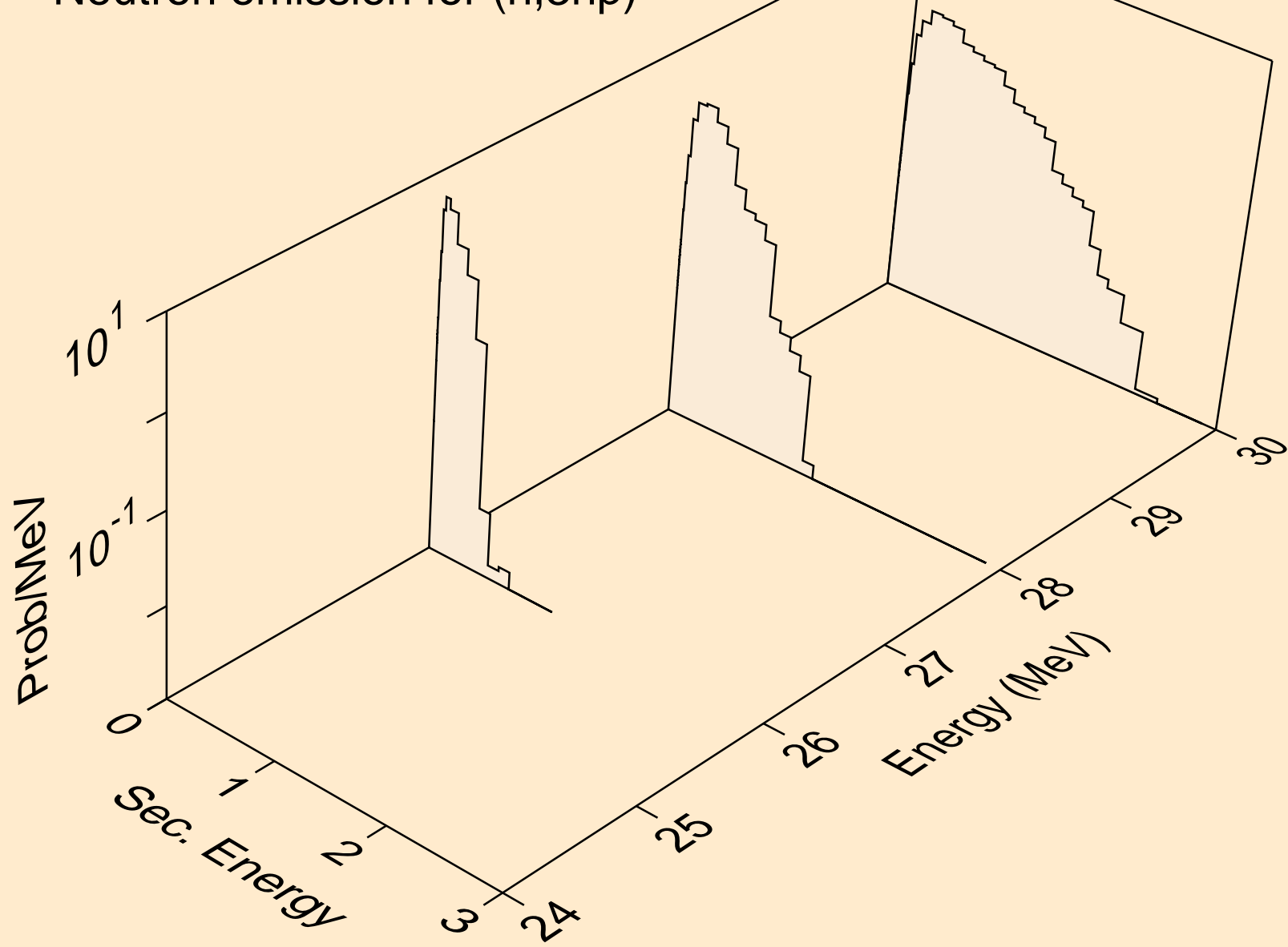

ND142 NEUTRON ACER TENDL-2021 LIBRARY; T=293.6K
Neutron emission for (n,2np)

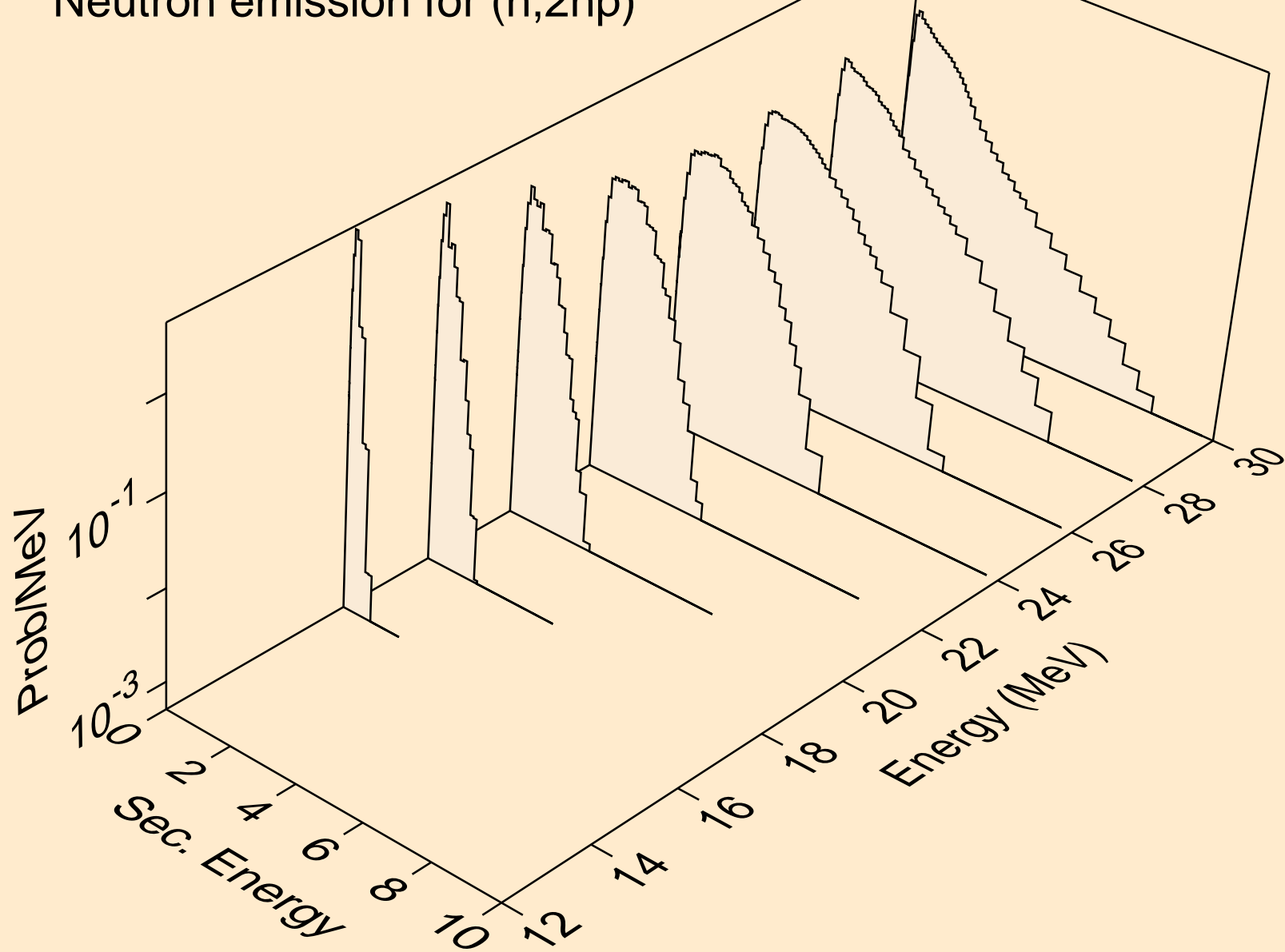

ND142 NEUTRON ACER TENDL-2021 LIBRARY; T=293.6K
Neutron emission for (n,npa)

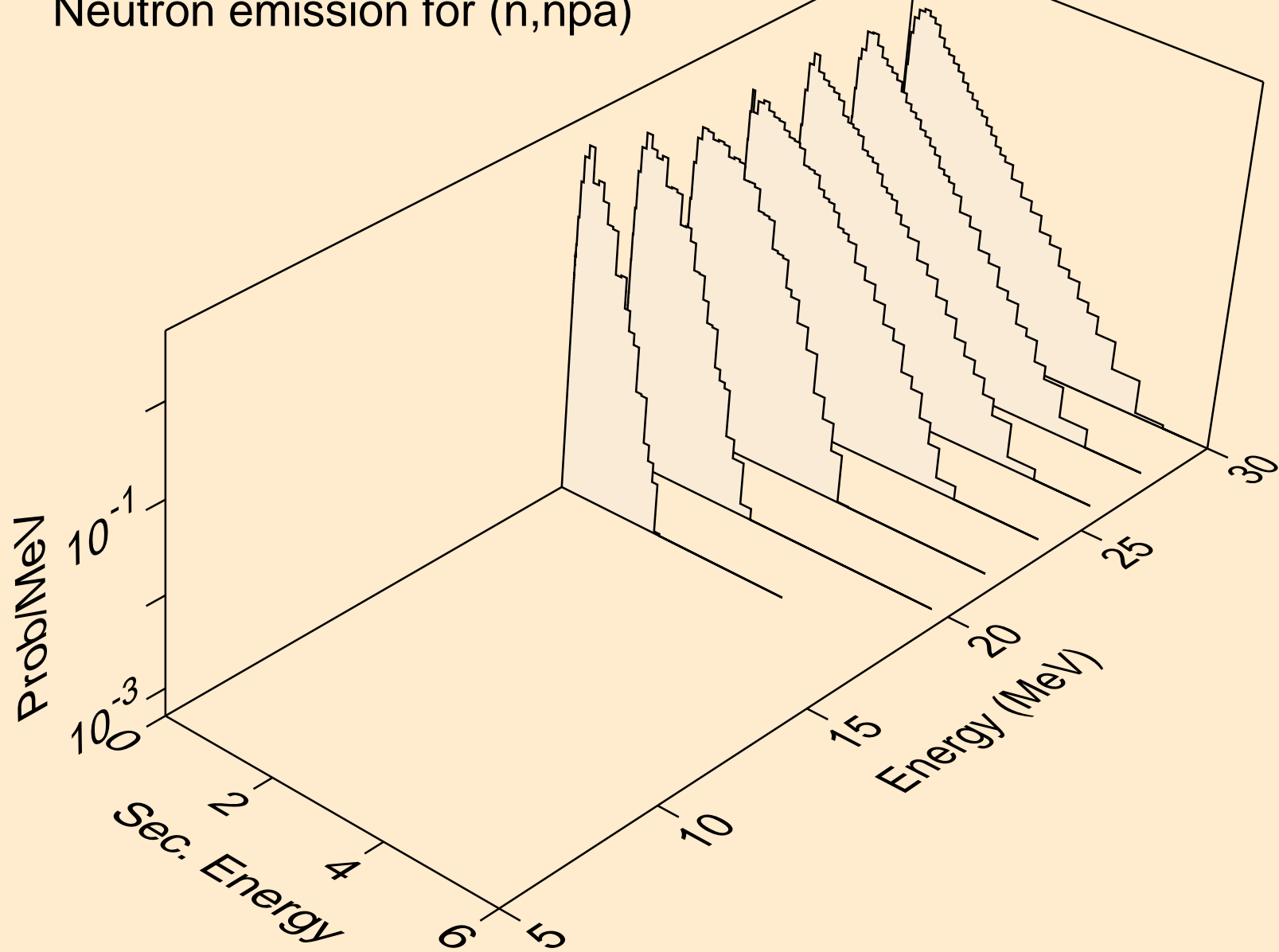

ND142 NEUTRON ACER TENDL-2021 LIBRARY; T=293.6K
Neutron emission for (n,n*c)

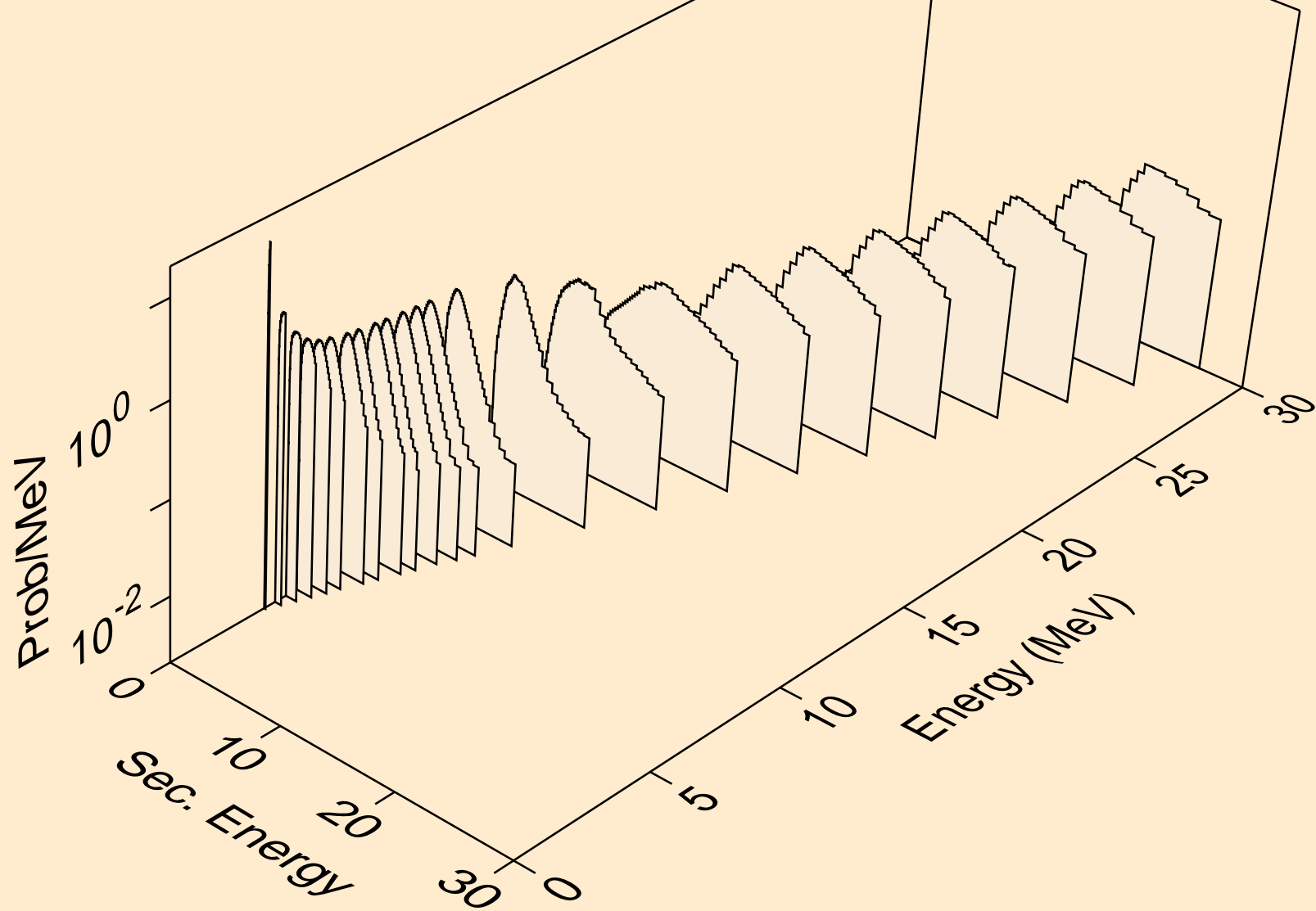

ND142 NEUTRON ACER TENDL-2021 LIBRARY; T=293.6K
Photon emission for (n,x)

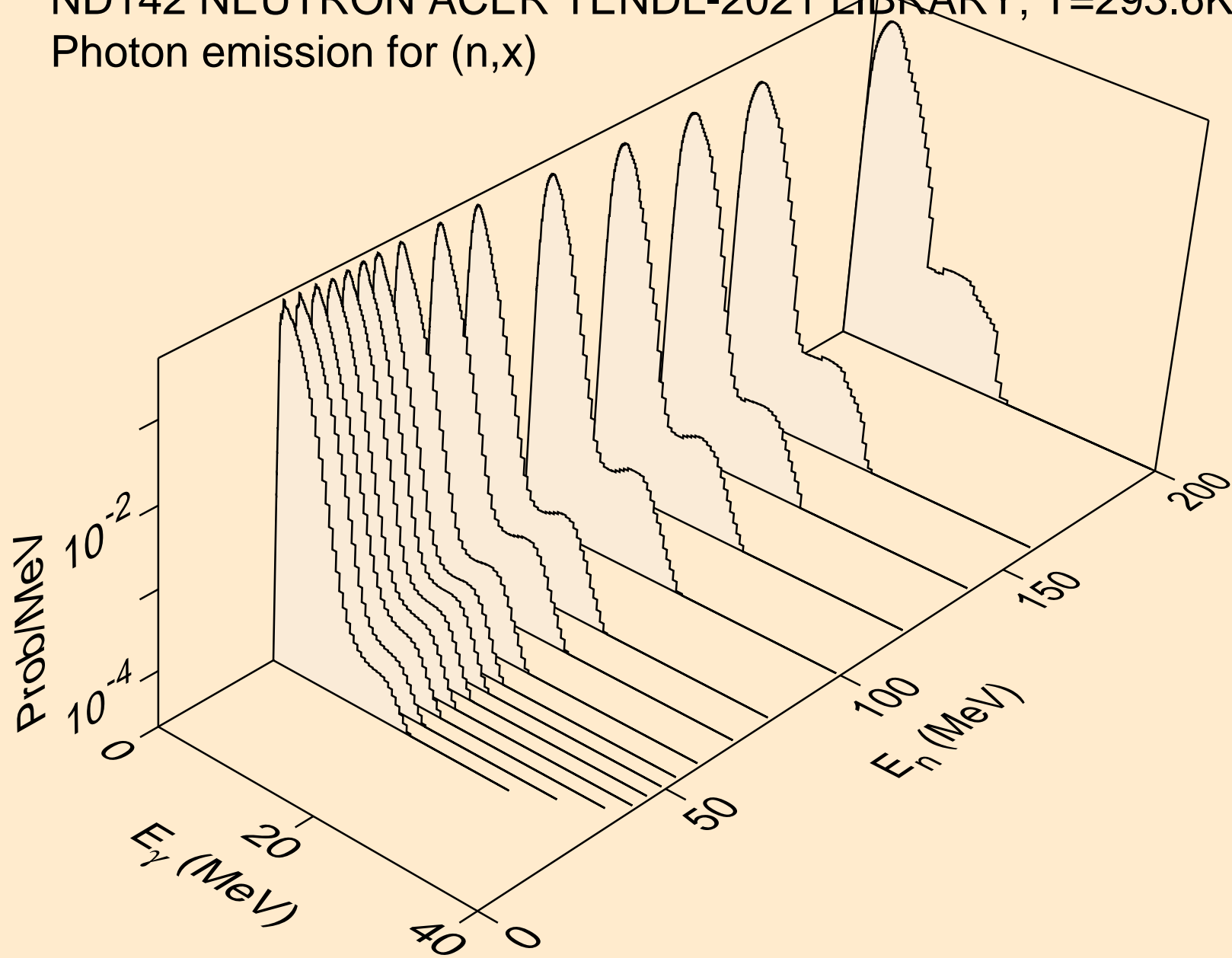

ND142 NEUTRON ACER TENDL-2021 LIBRARY; T=293.6K
Photon emission for (n,2nd)

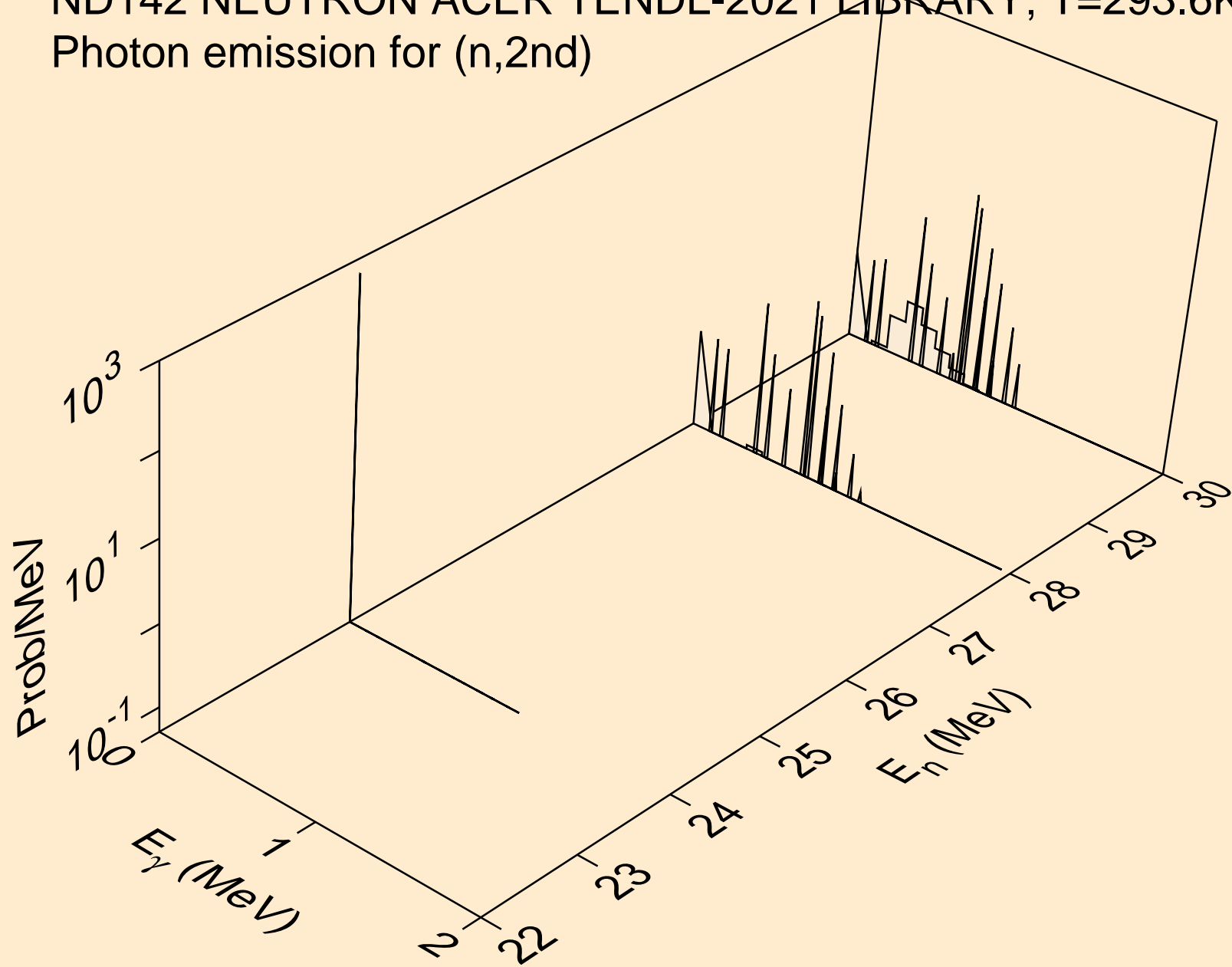

ND142 NEUTRON ACER TENDL-2021 LIBRARY; T=293.6K
Photon emission for (n,2n)

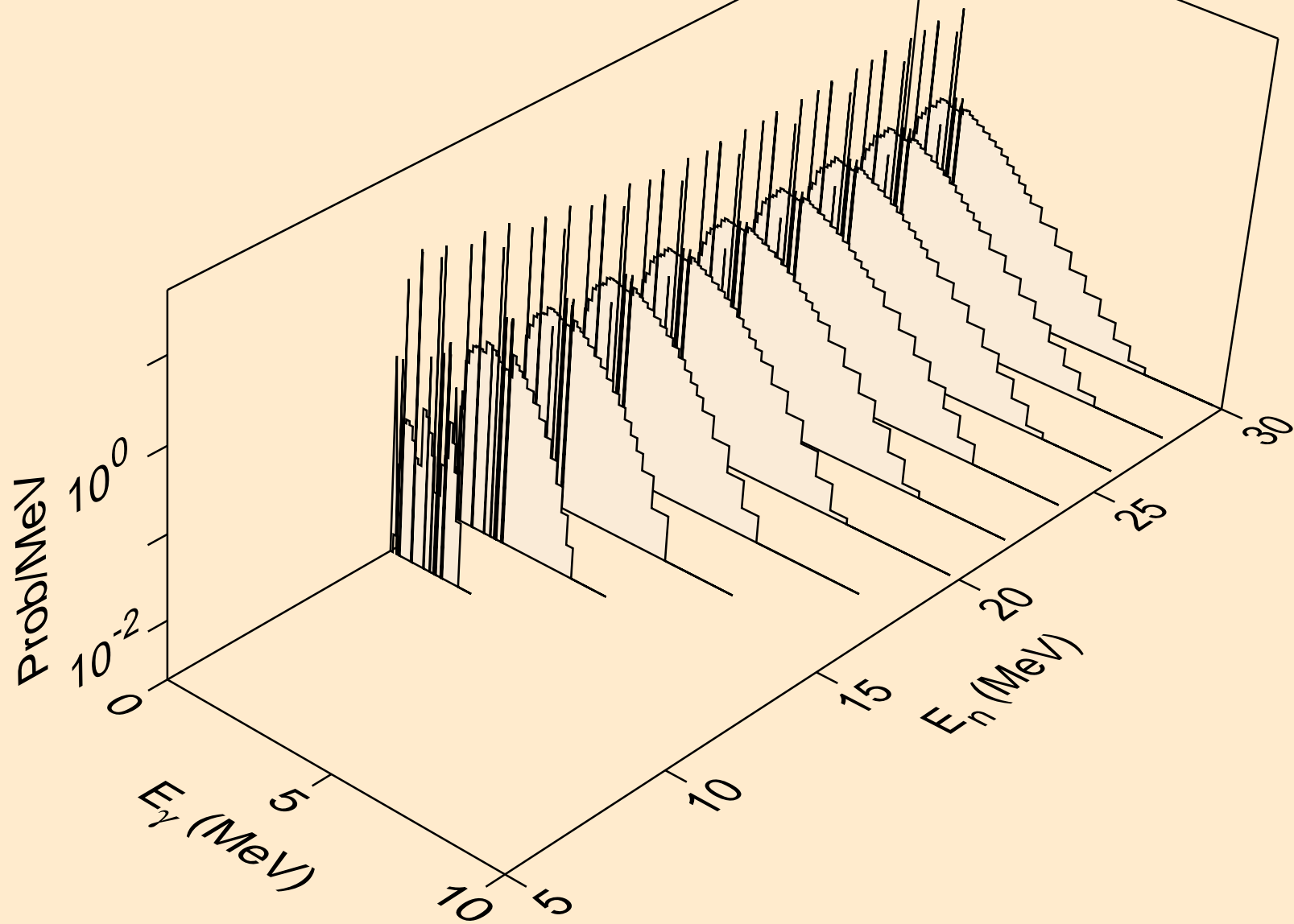

ND142 NEUTRON ACER TENDL-2021 LIBRARY; T=293.6K
Photon emission for (n,3n)

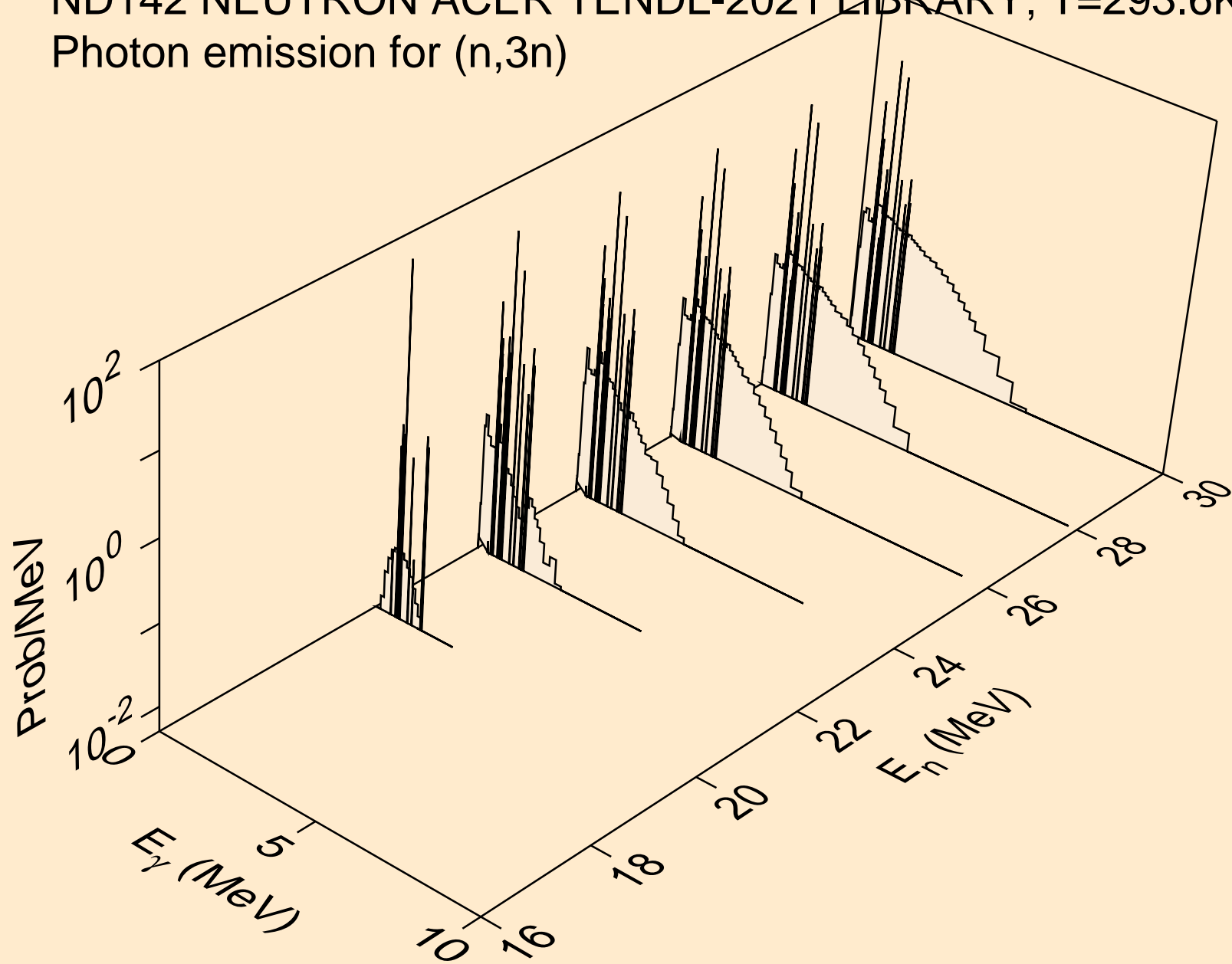

ND142 NEUTRON ACER TENDL-2021 LIBRARY; T=293.6K
Photon emission for (n,n*)a

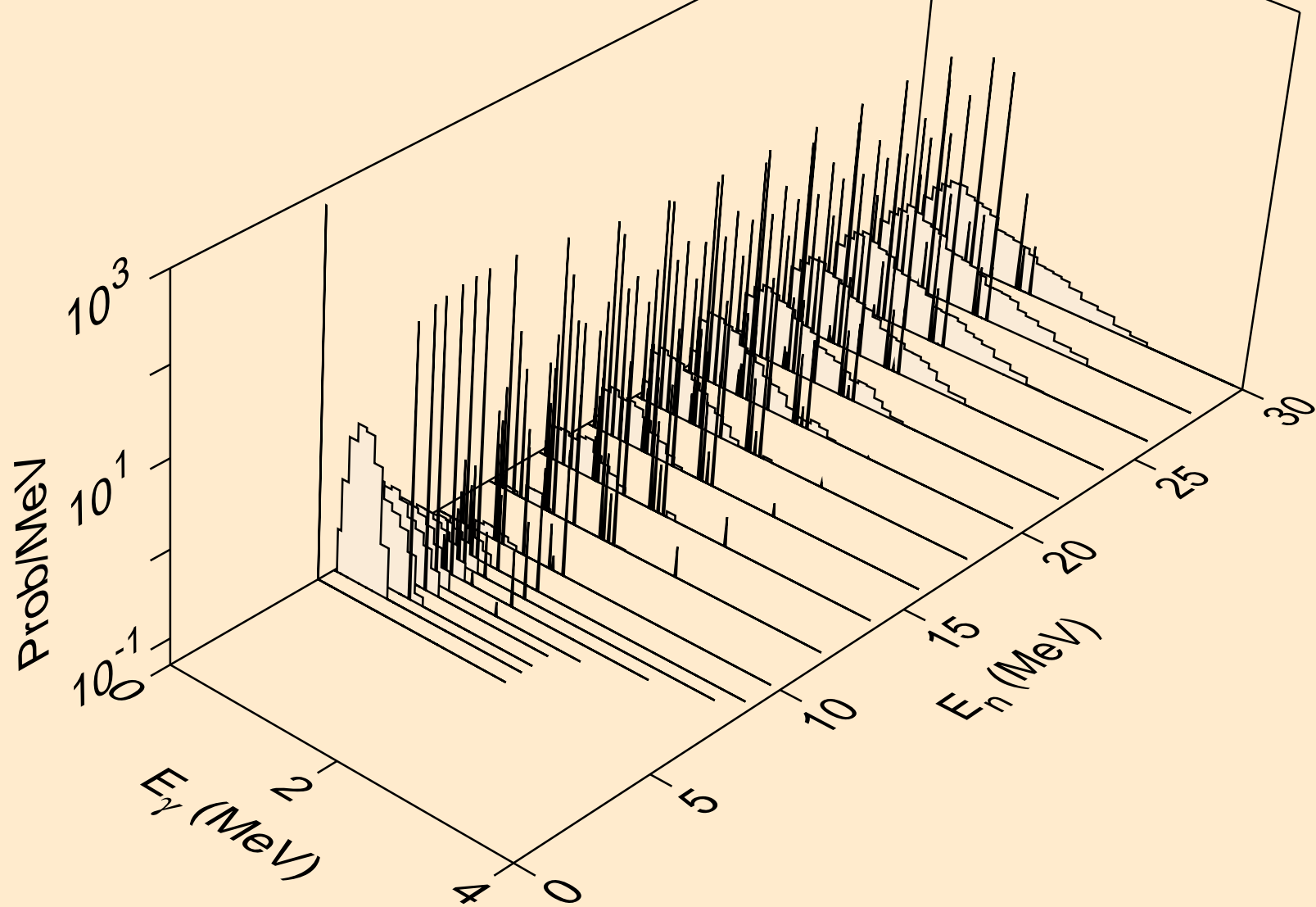

ND142 NEUTRON ACER TENDL-2021 LIBRARY; T=293.6K
Photon emission for (n,2n)a

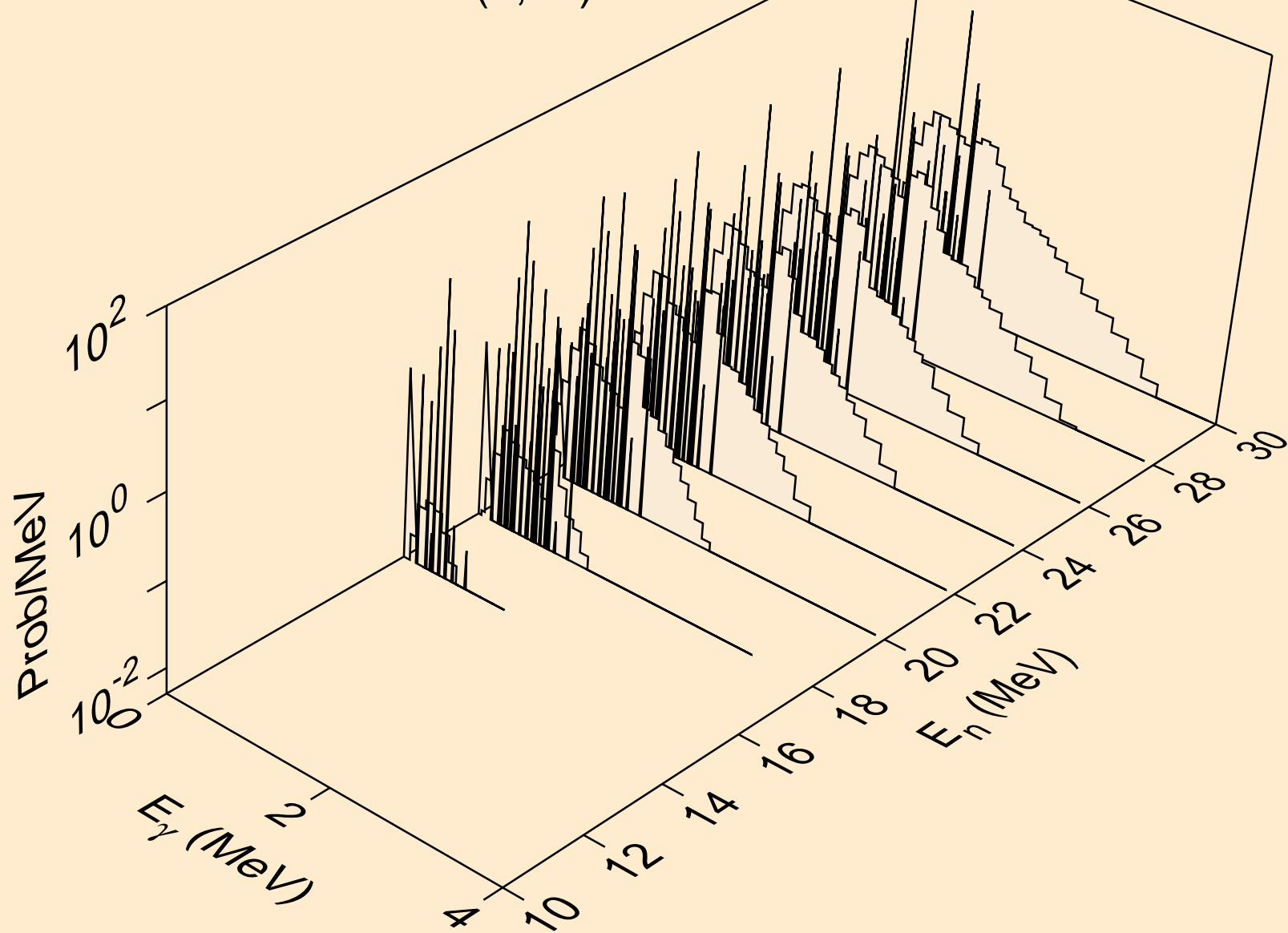

ND142 NEUTRON ACER TENDL-2021 LIBRARY; T=293.6K
Photon emission for (n,3n)a

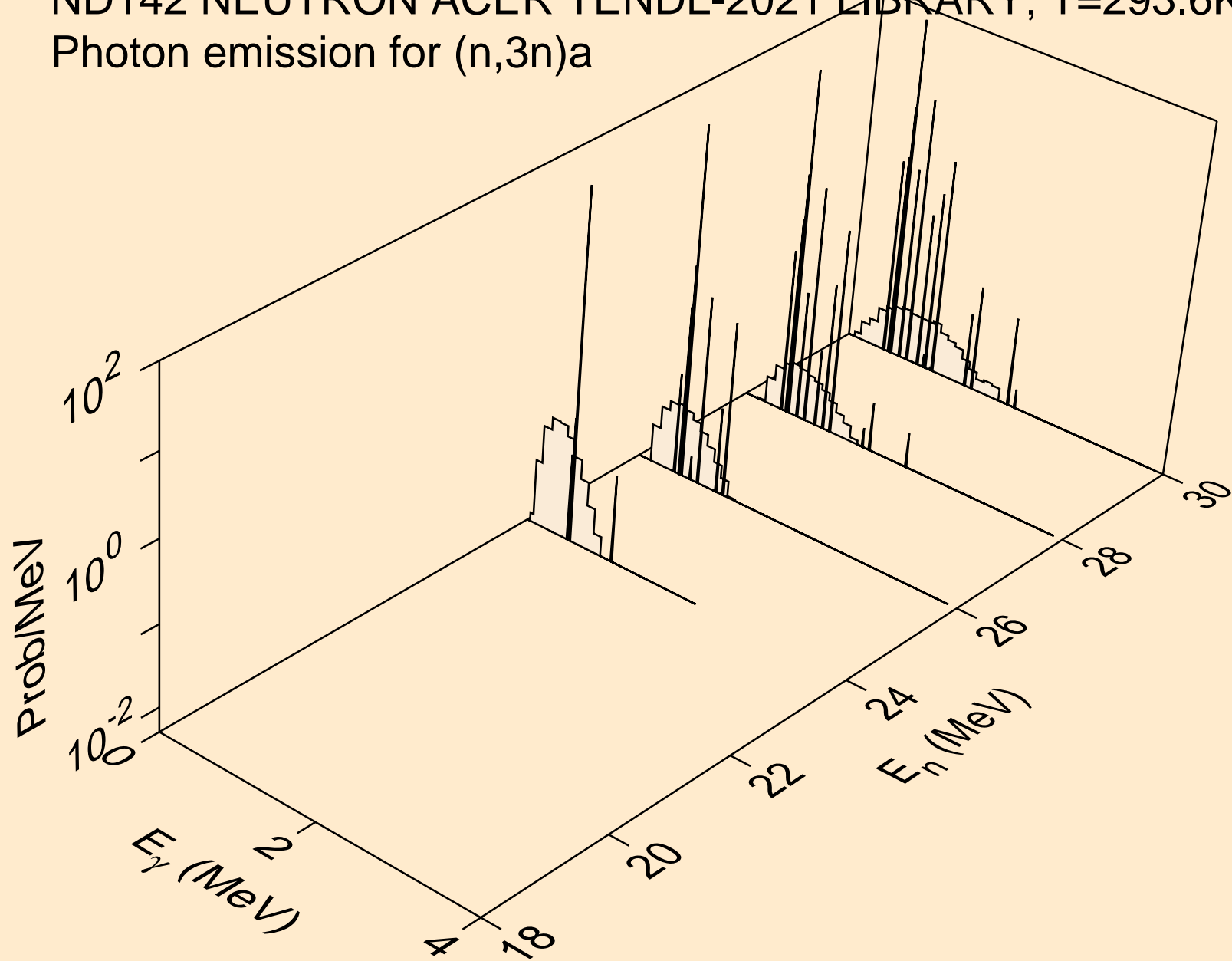

ND142 NEUTRON ACER TENDL-2021 LIBRARY; T=293.6K
Photon emission for (n,n*)p

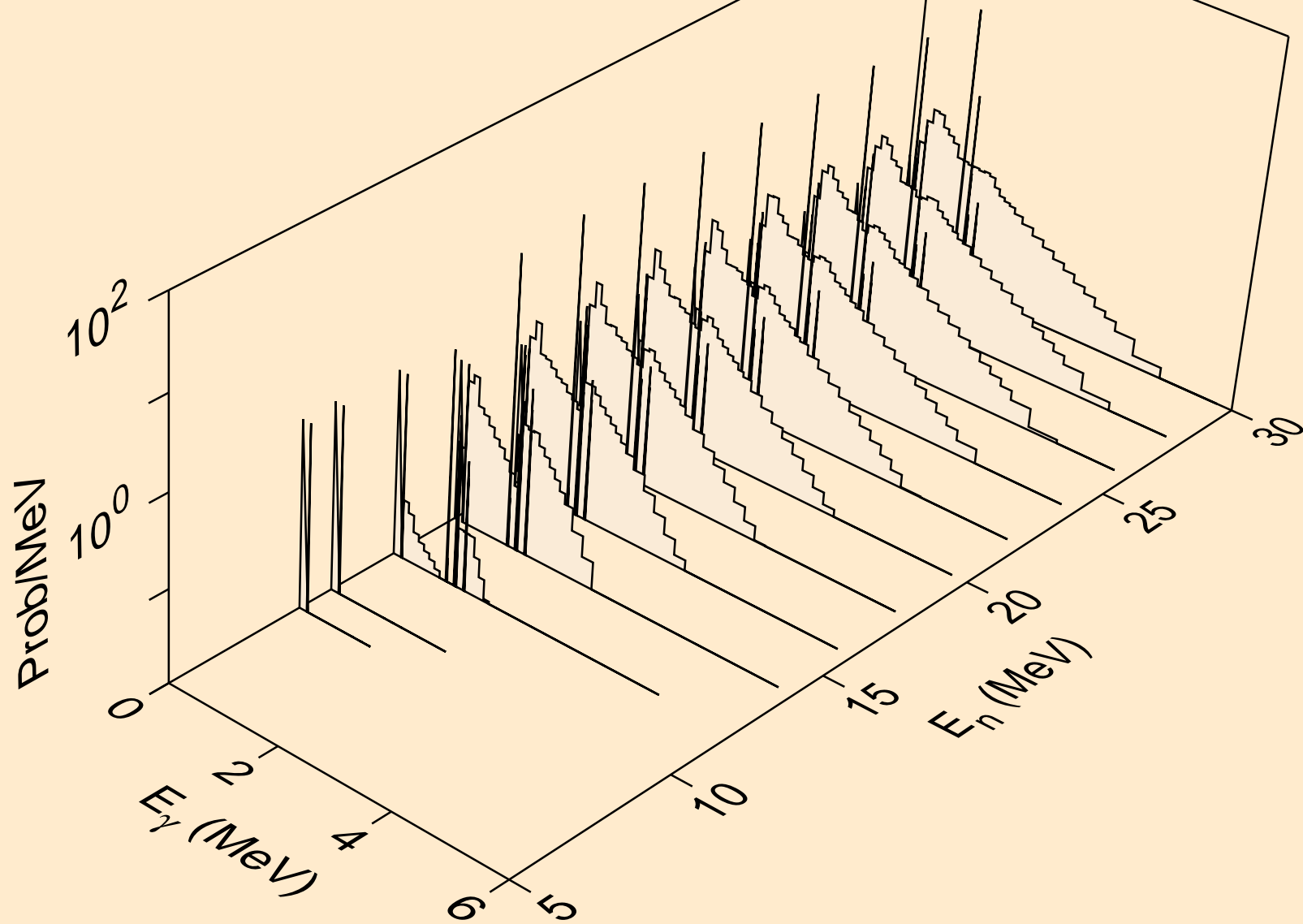

ND142 NEUTRON ACER TENDL-2021 LIBRARY; T=293.6K
Photon emission for (n,n*)2a

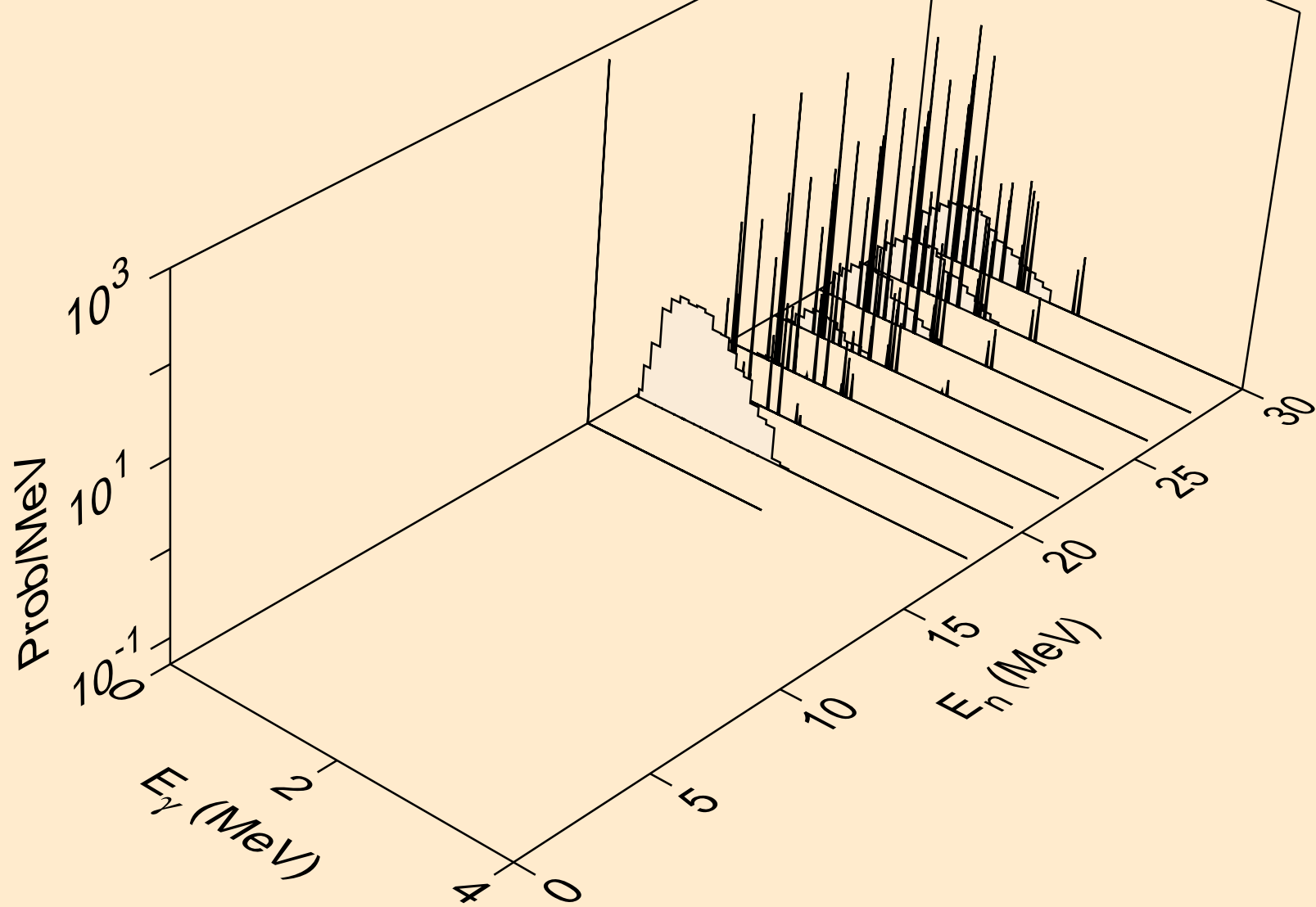

ND142 NEUTRON ACER TENDL-2021 LIBRARY; T=293.6K
Photon emission for (n,n*)d

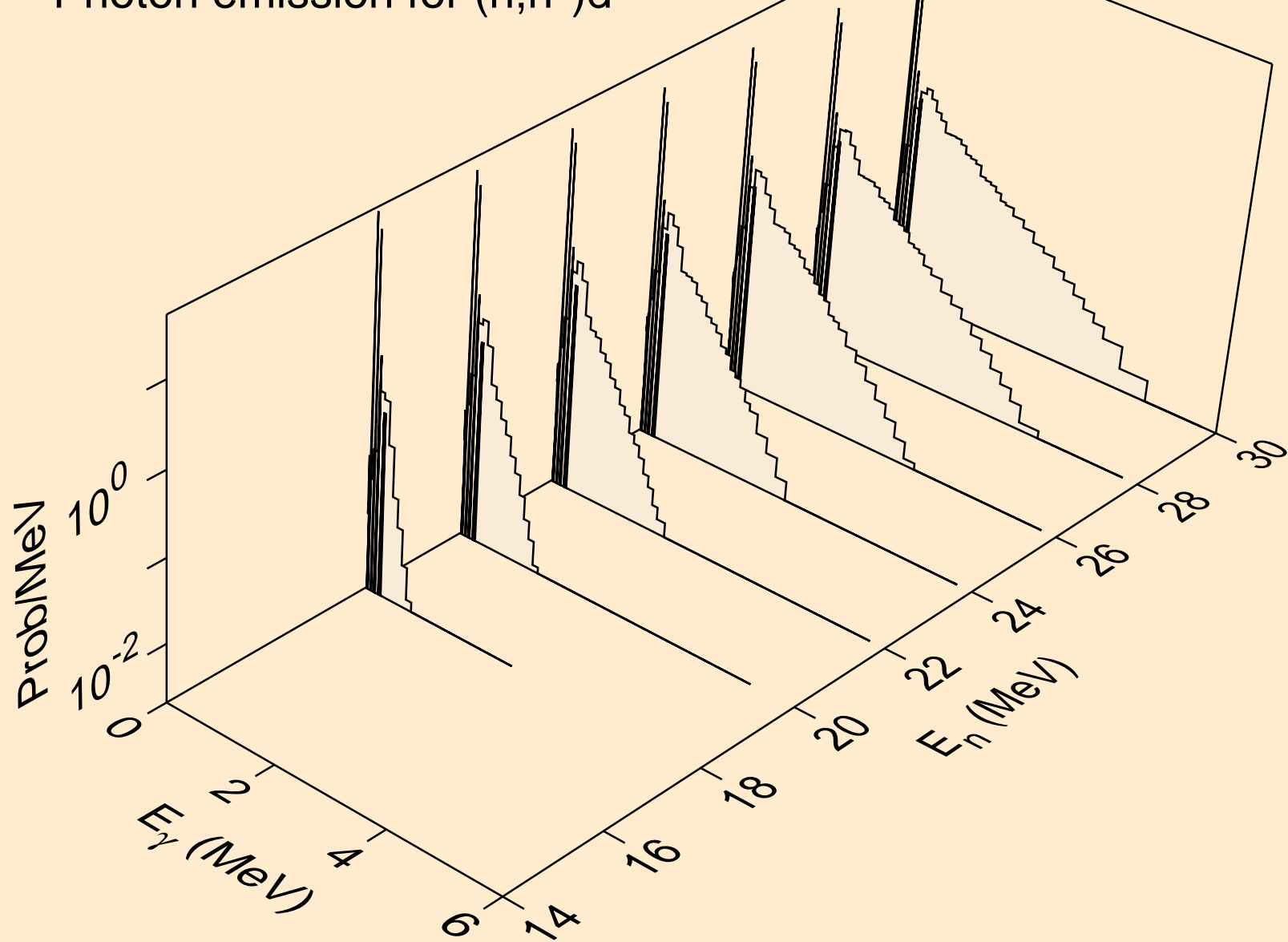

ND142 NEUTRON ACER TENDL-2021 LIBRARY; T=293.6K
Photon emission for (n,n*)t

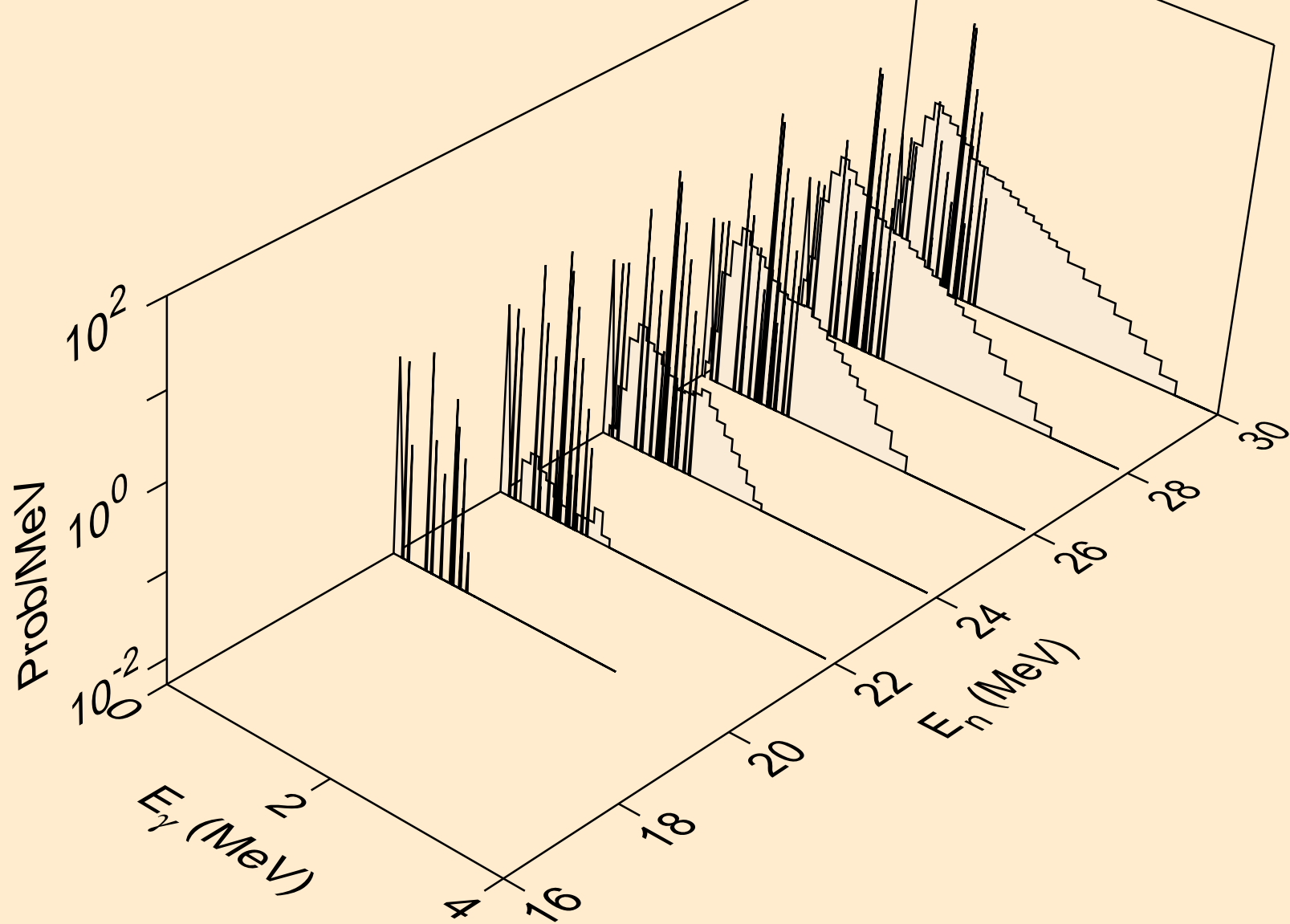

ND142 NEUTRON ACER TENDL-2021 LIBRARY; T=293.6K
Photon emission for (n,n*)he3

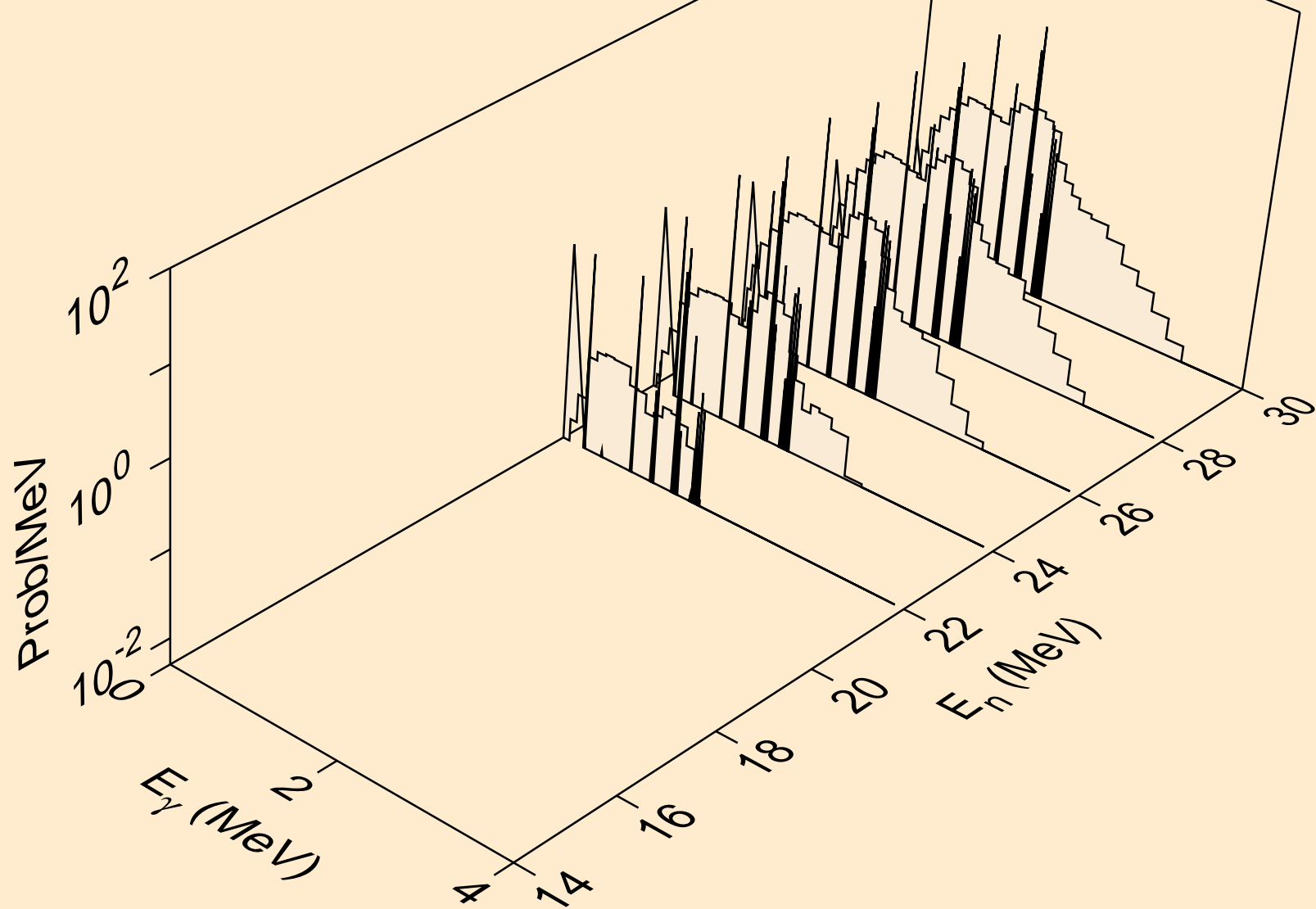

ND142 NEUTRON ACER TENDL-2021 LIBRARY; T=293.6K
Photon emission for (n,4n)

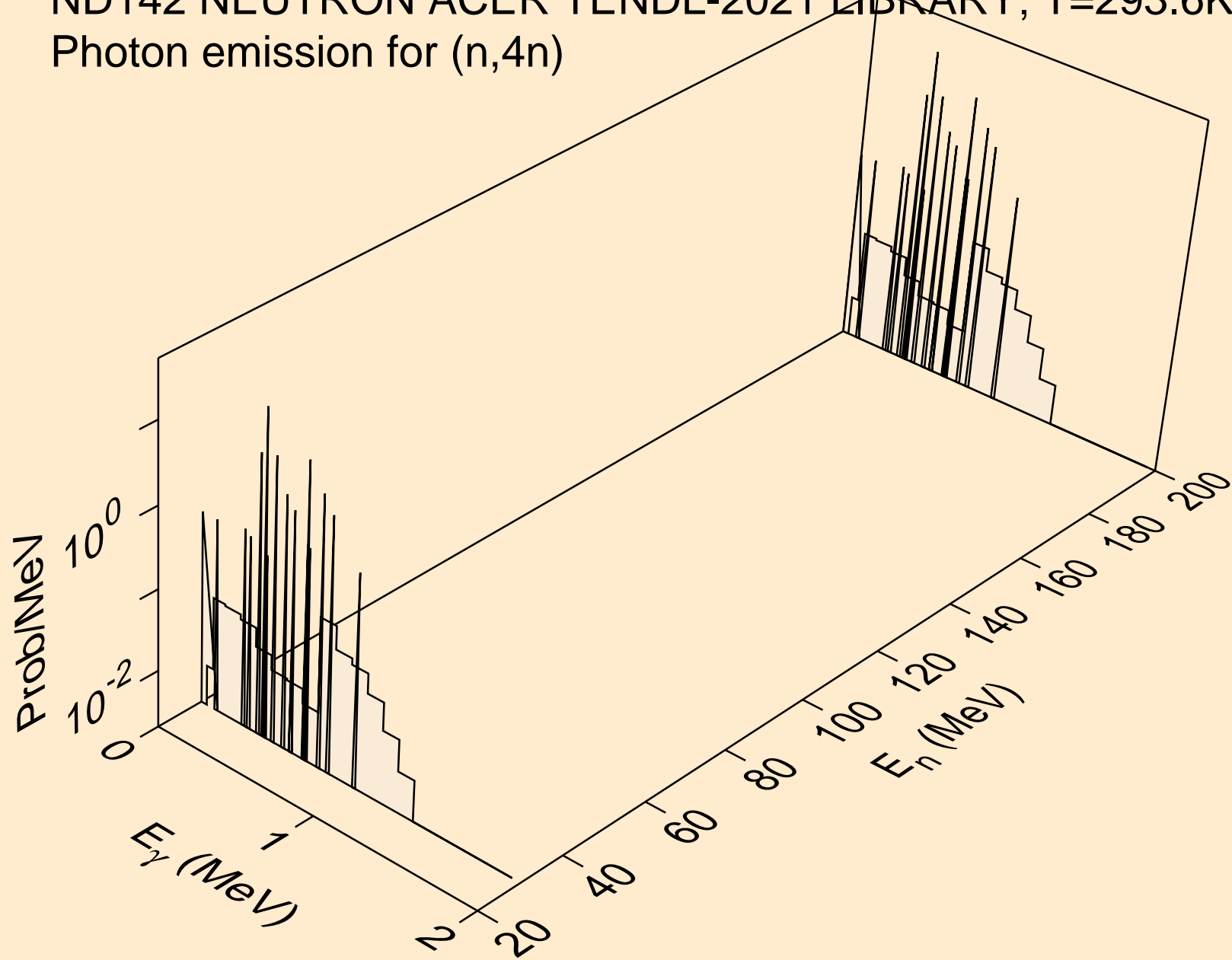

ND142 NEUTRON ACER TENDL-2021 LIBRARY; T=293.6K
Photon emission for (n,2np)

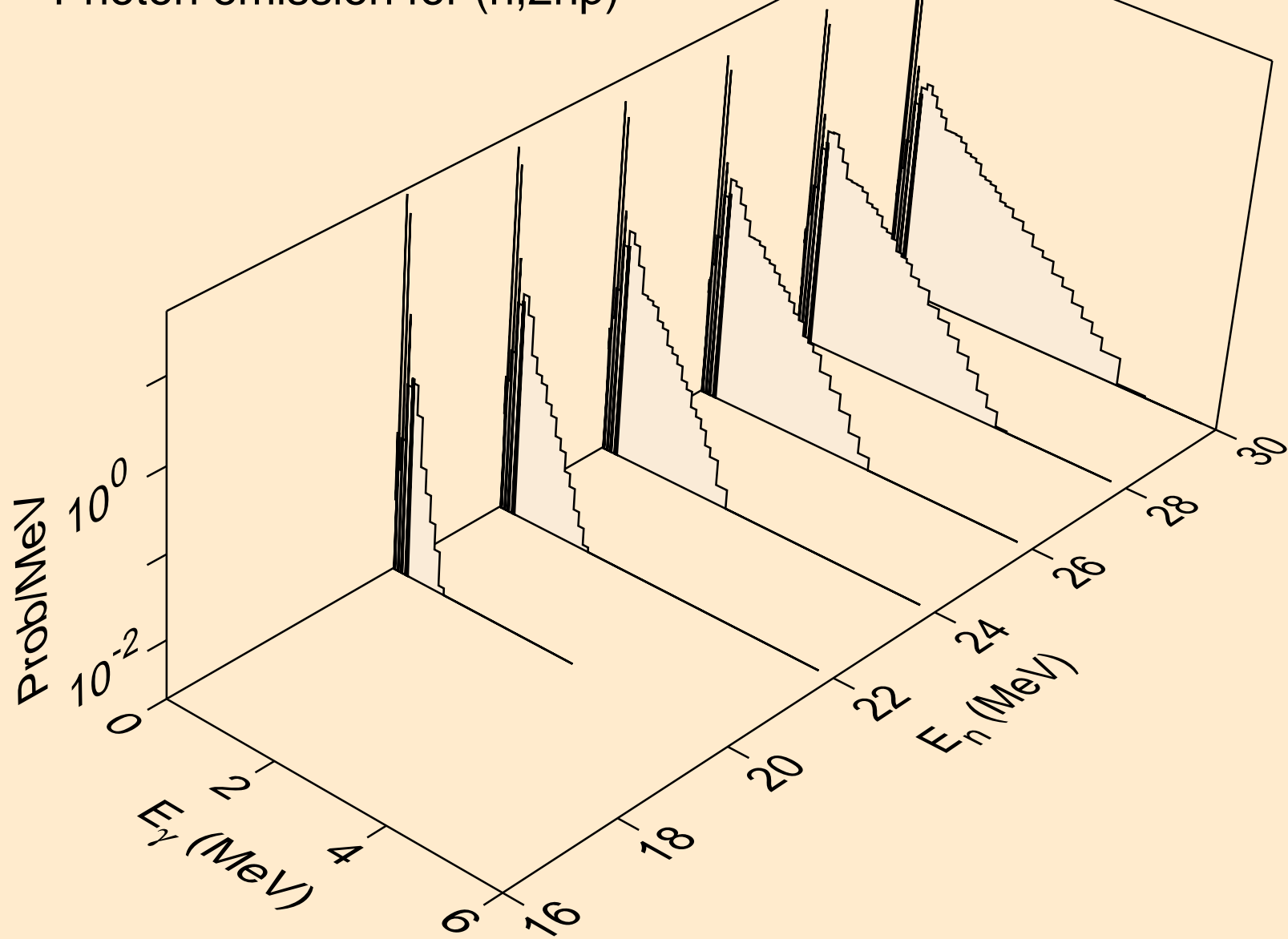

ND142 NEUTRON ACER TENDL-2021 LIBRARY; T=293.6K
Photon emission for (n,3np)

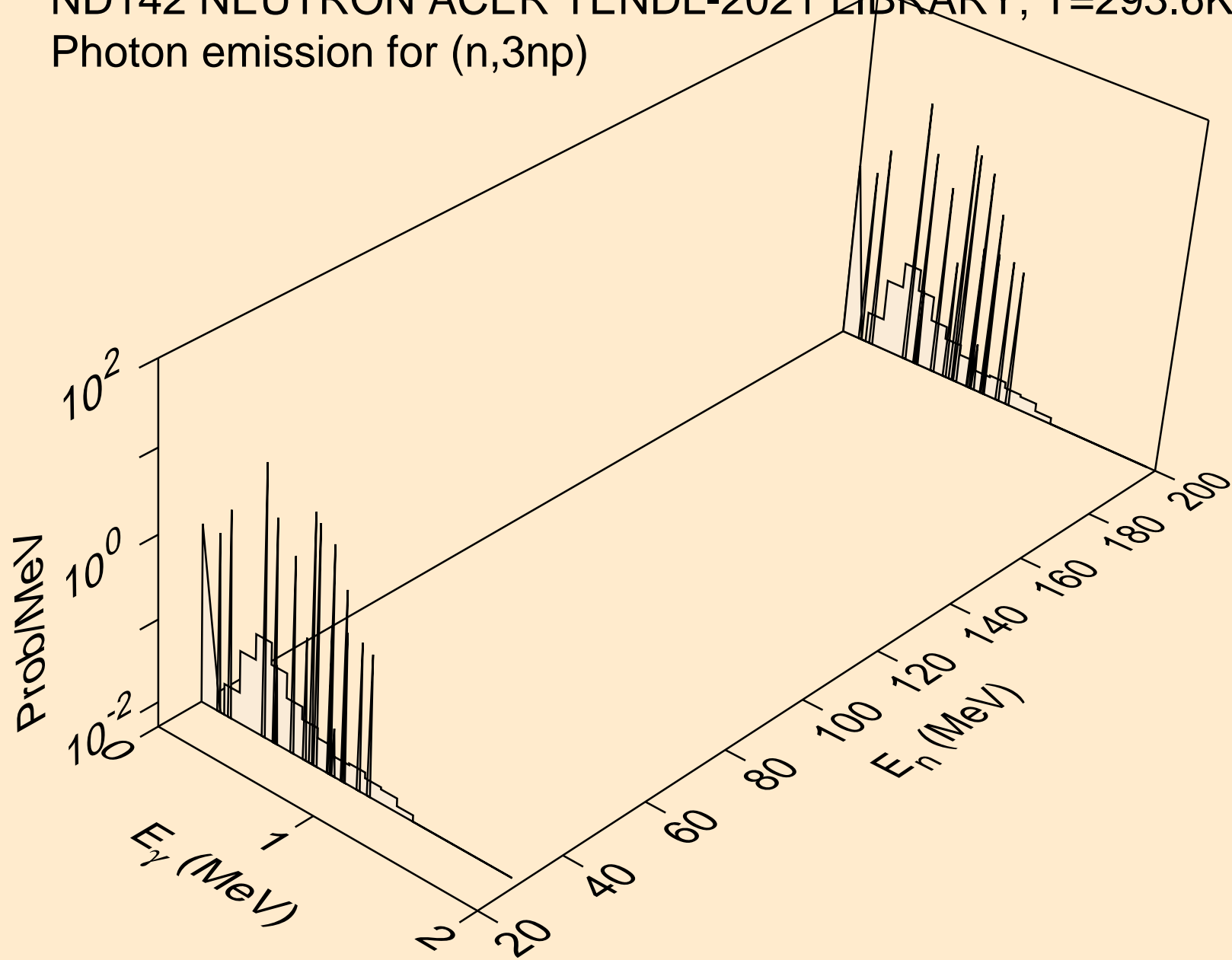

ND142 NEUTRON ACER TENDL-2021 LIBRARY; T=293.6K
Photon emission for (n,2np)

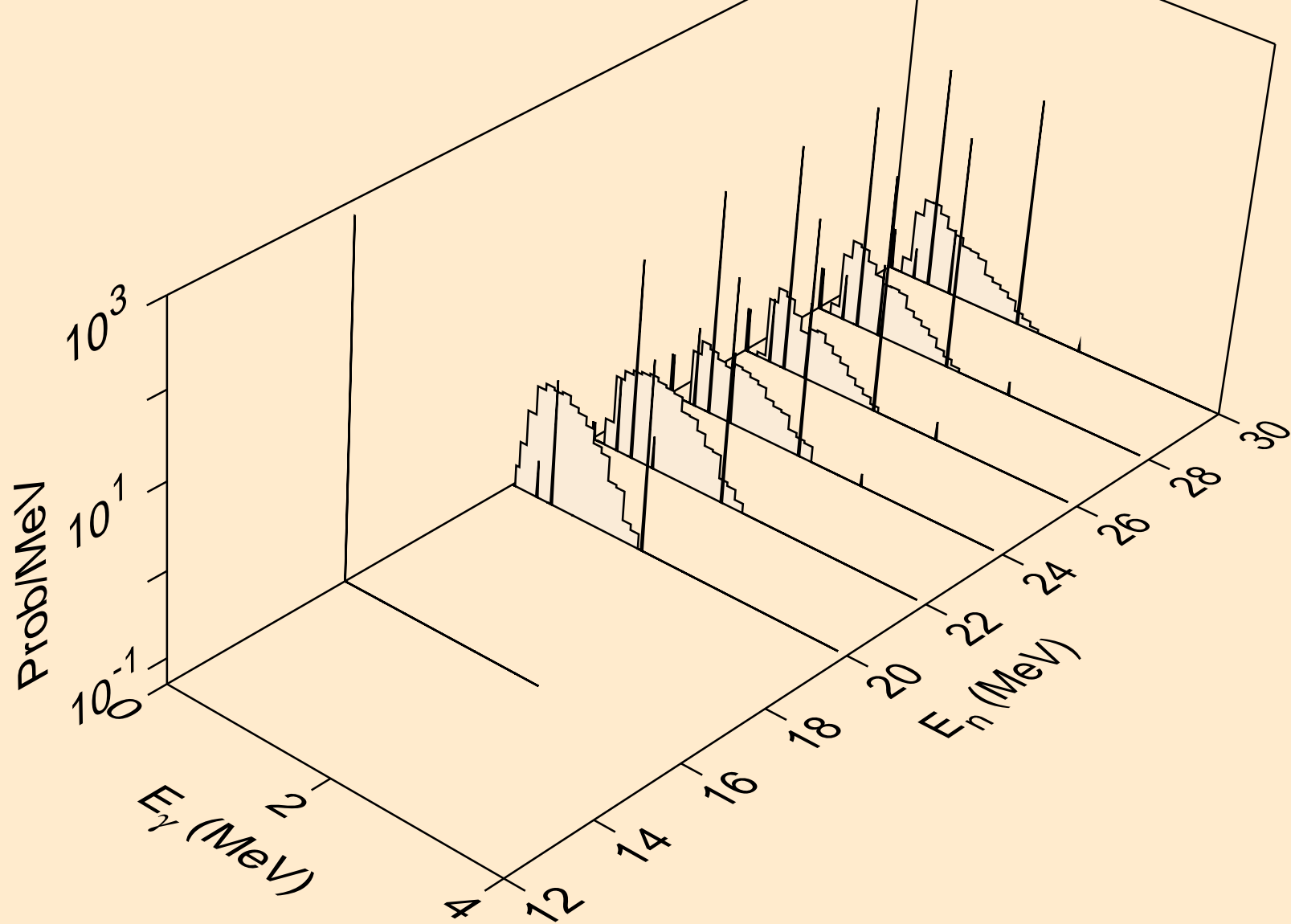

ND142 NEUTRON ACER TENDL-2021 LIBRARY; T=293.6K
Photon emission for (n,npa)

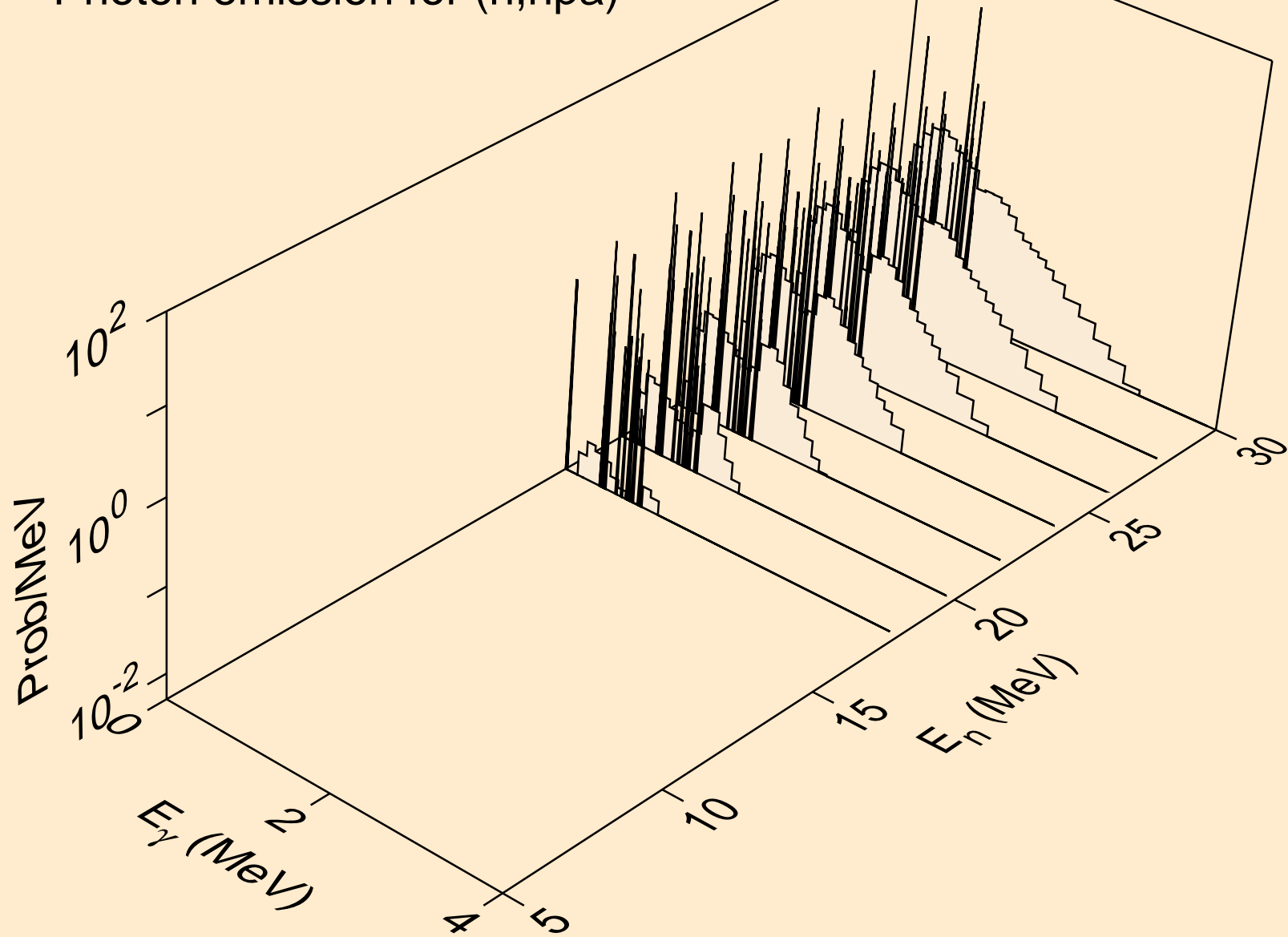

ND142 NEUTRON ACER TENDL-2021 LIBRARY; T=293.6K
Photon emission for (n,n*c)

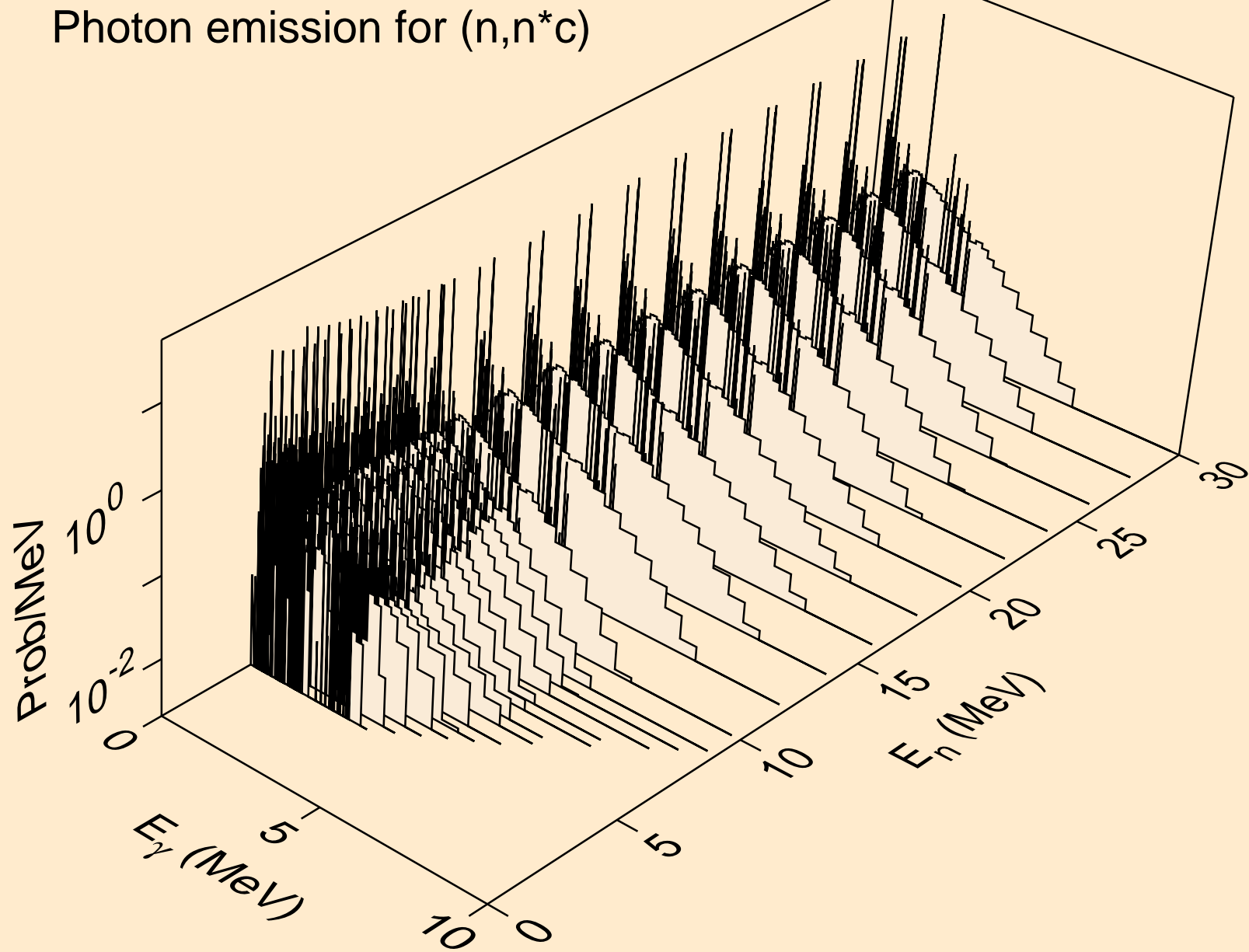

ND142 NEUTRON ACER TENDL-2021 LIBRARY; T=293.6K
Photon emission for (n,gma)

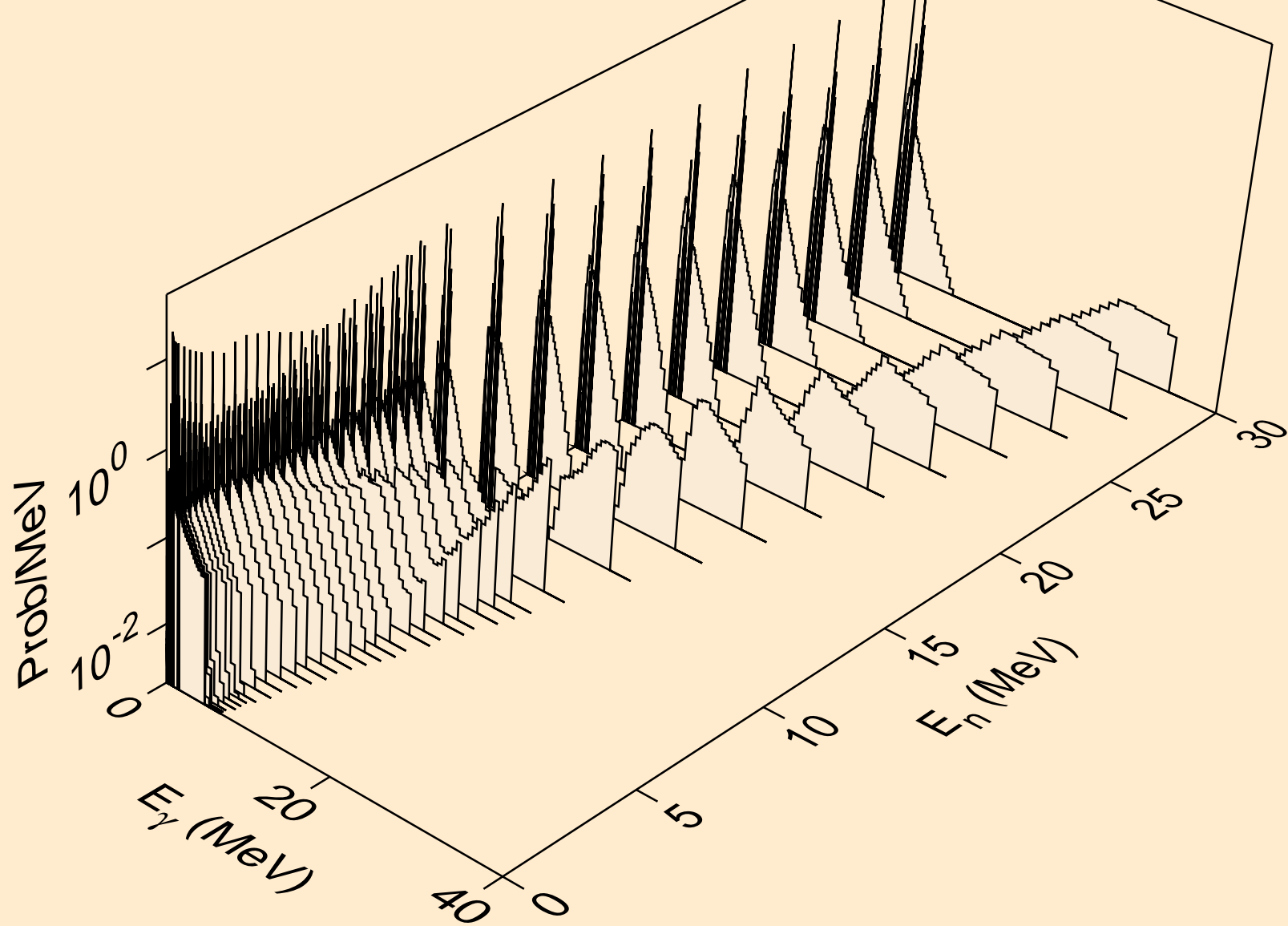

ND142 NEUTRON ACER TENDL-2021 LIBRARY; T=293.6K
Photon emission for (n,p)

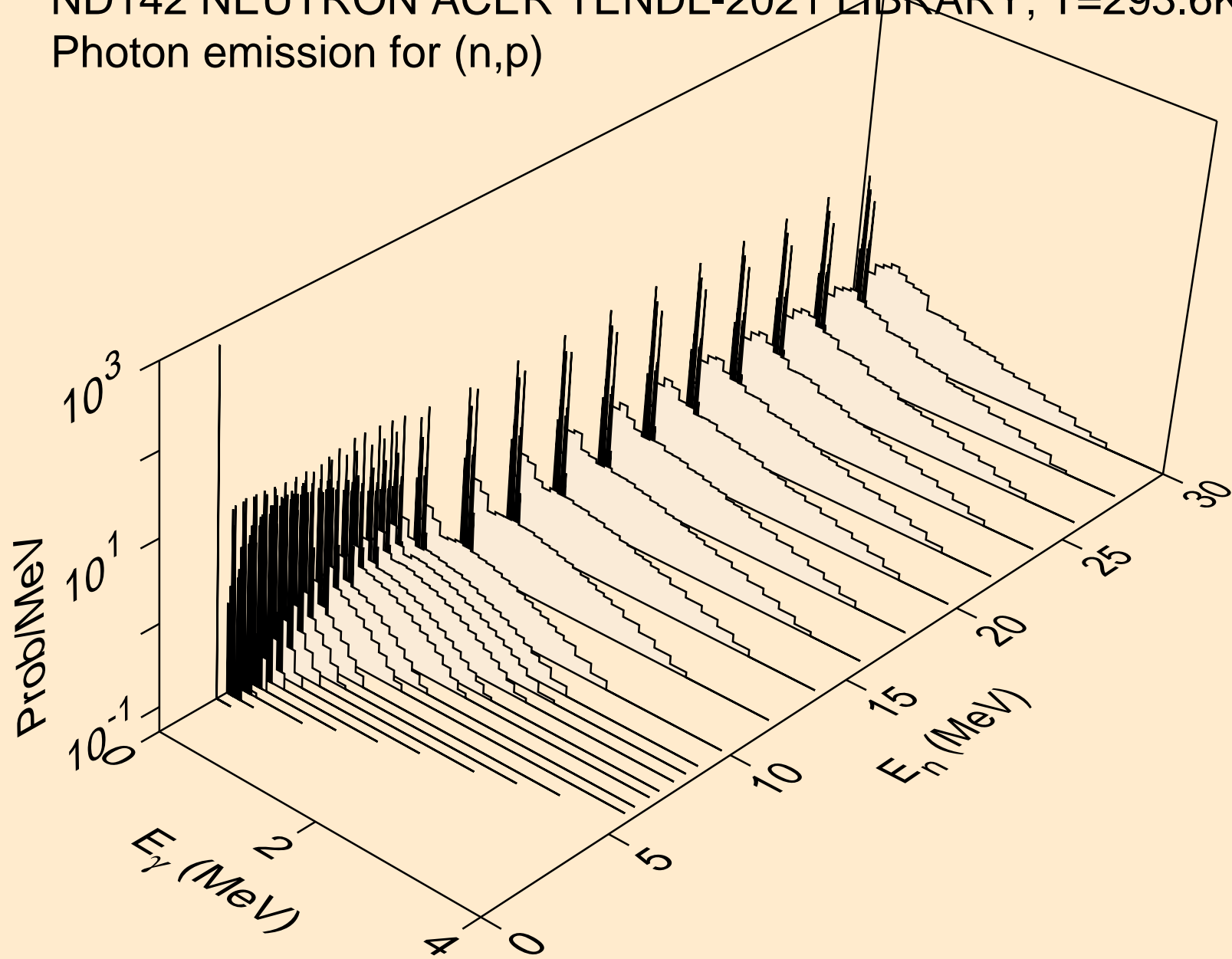

ND142 NEUTRON ACER TENDL-2021 LIBRARY; T=293.6K
Photon emission for (n,d)

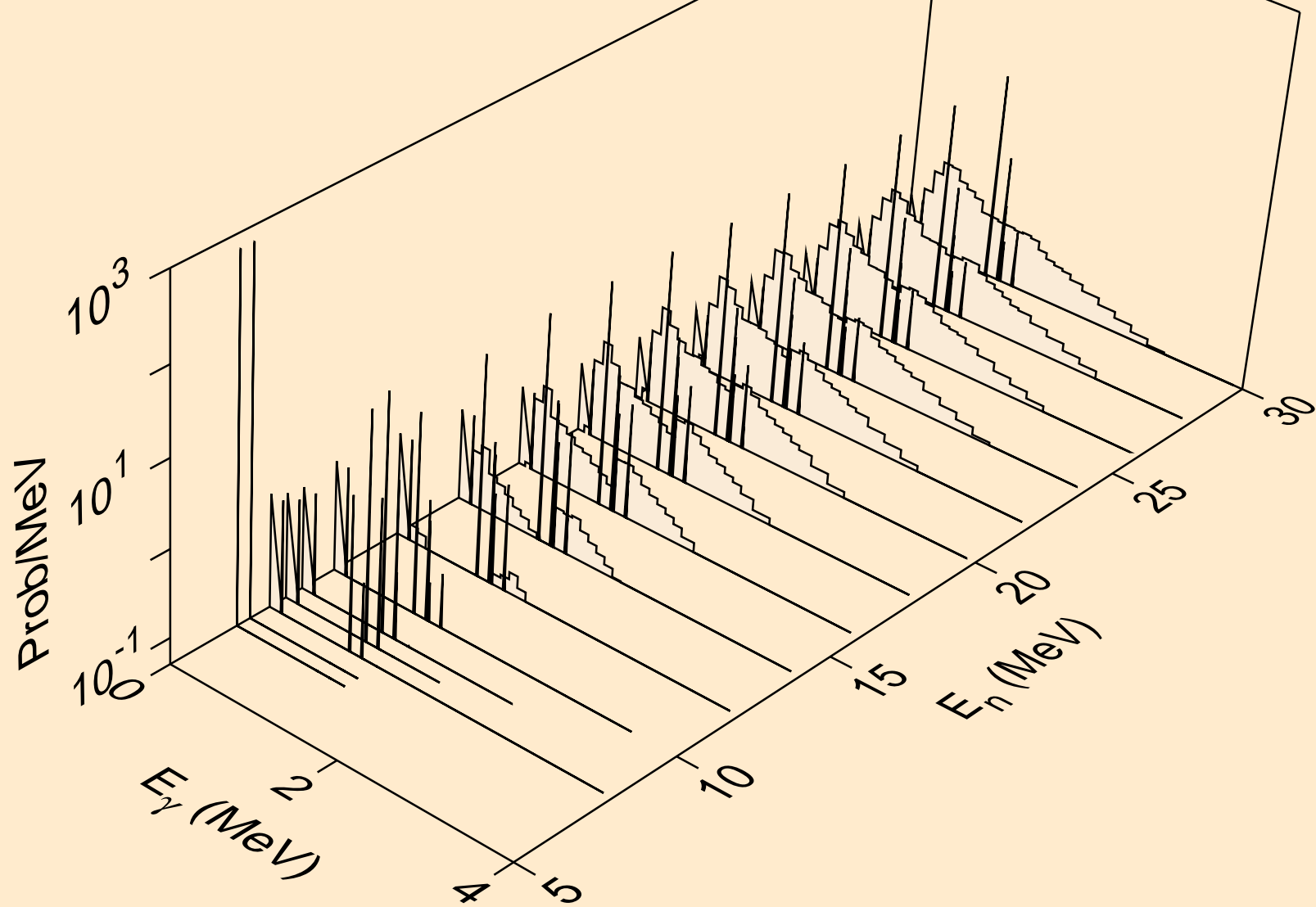

ND142 NEUTRON ACER TENDL-2021 LIBRARY; T=293.6K
Photon emission for (n,t)

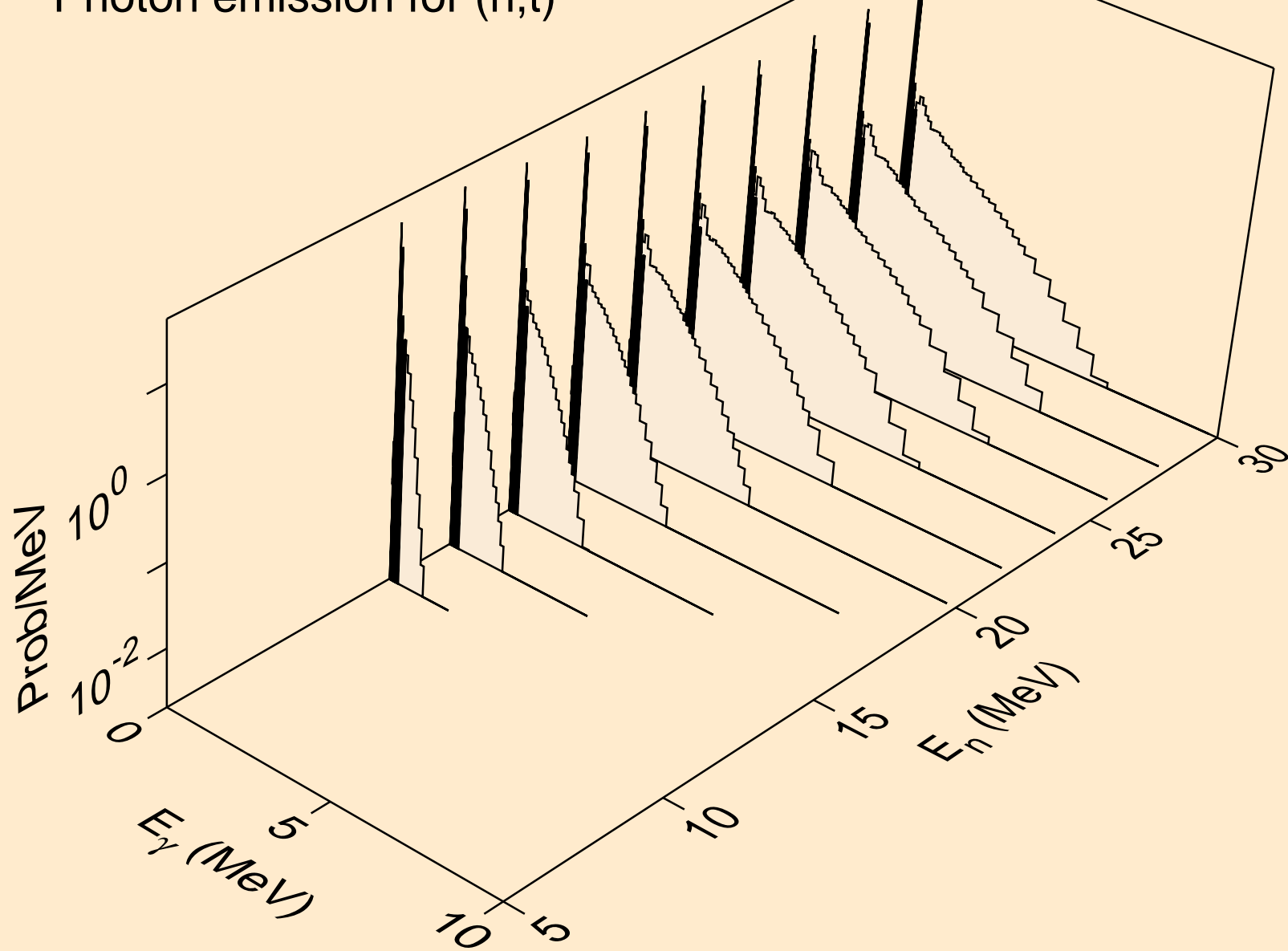

ND142 NEUTRON ACER TENDL-2021 LIBRARY; T=293.6K
Photon emission for (n,he3)

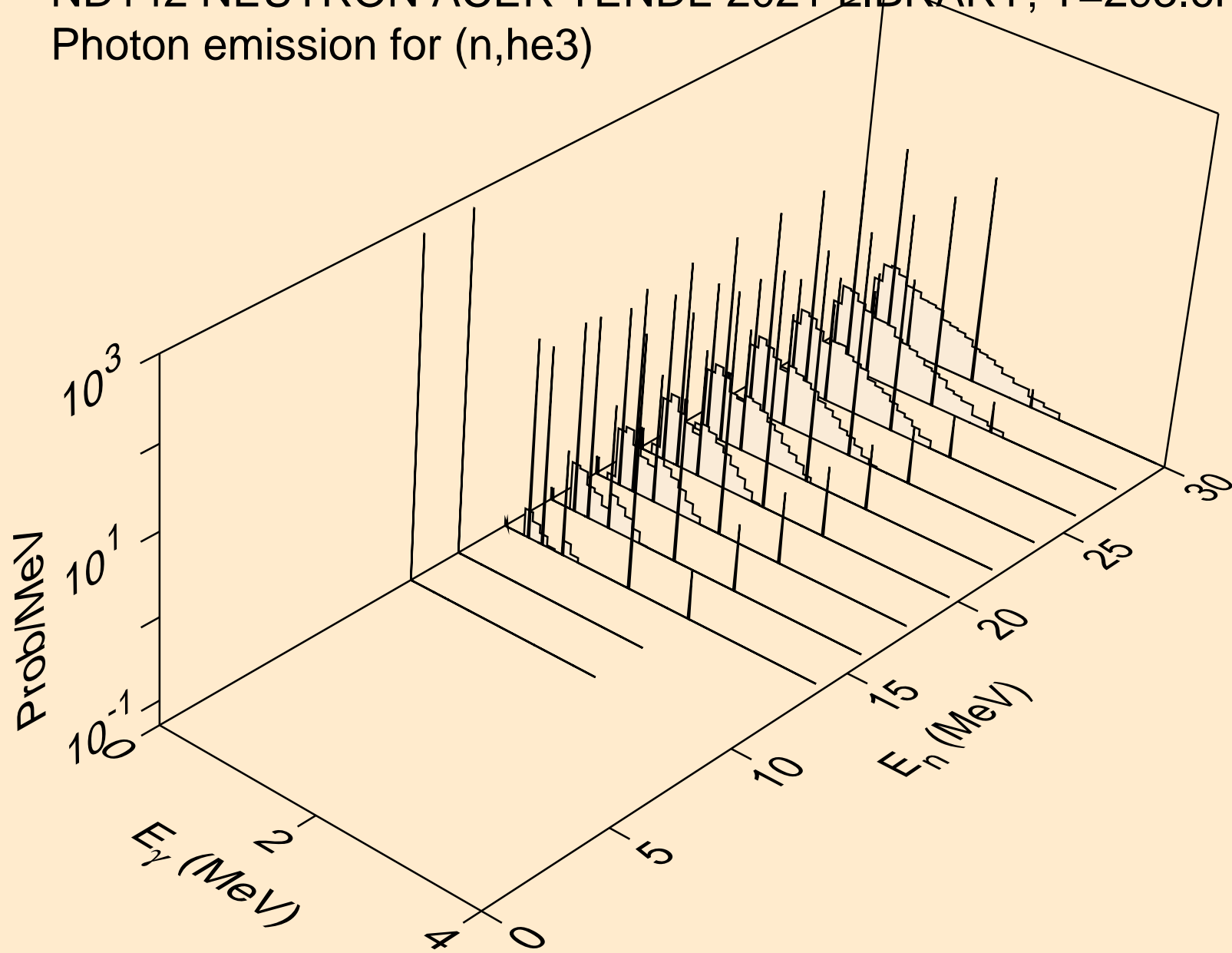

ND142 NEUTRON ACER TENDL-2021 LIBRARY; T=293.6K
Photon emission for (n,a)

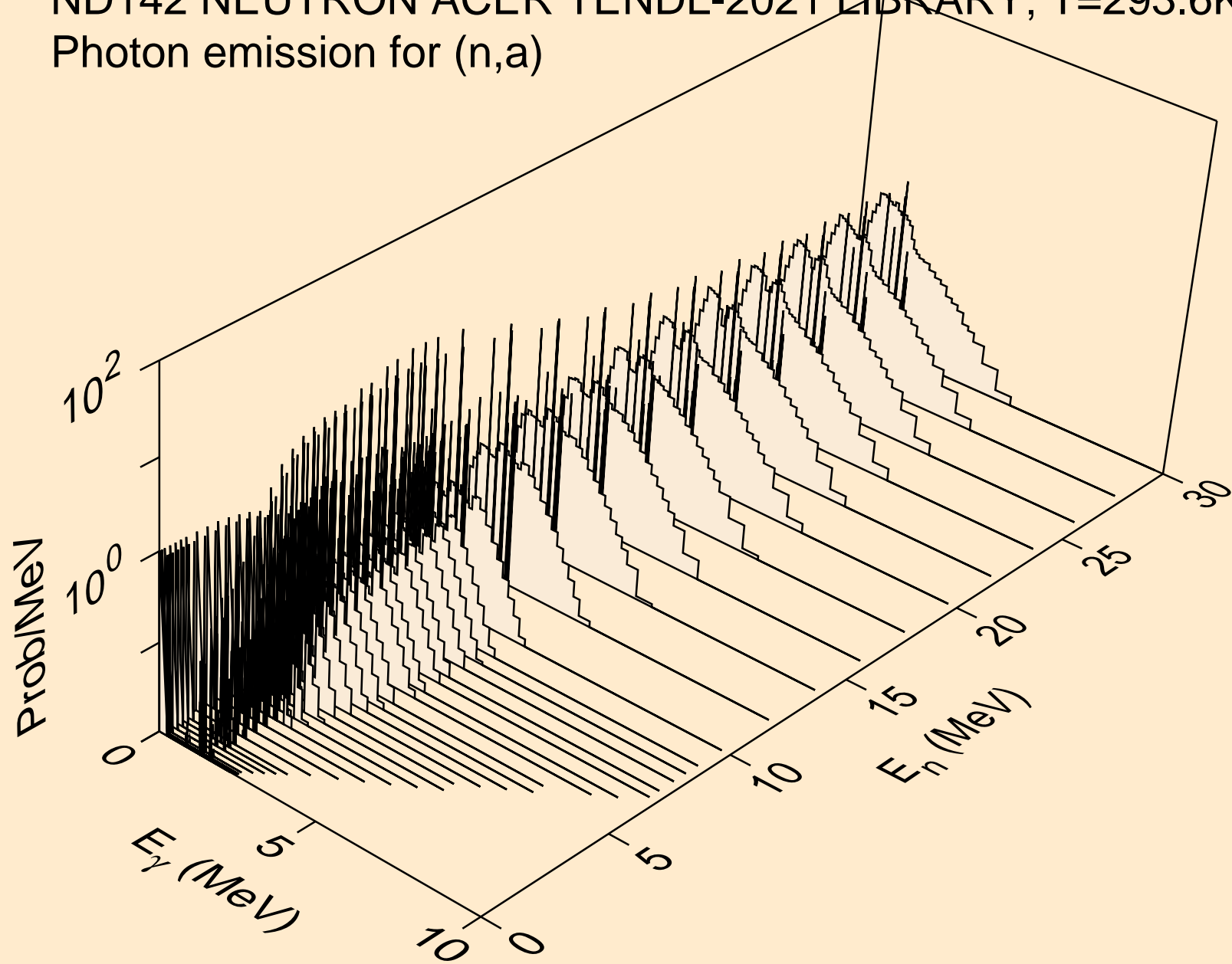

ND142 NEUTRON ACER TENDL-2021 LIBRARY; T=293.6K
Photon emission for (n,2a)

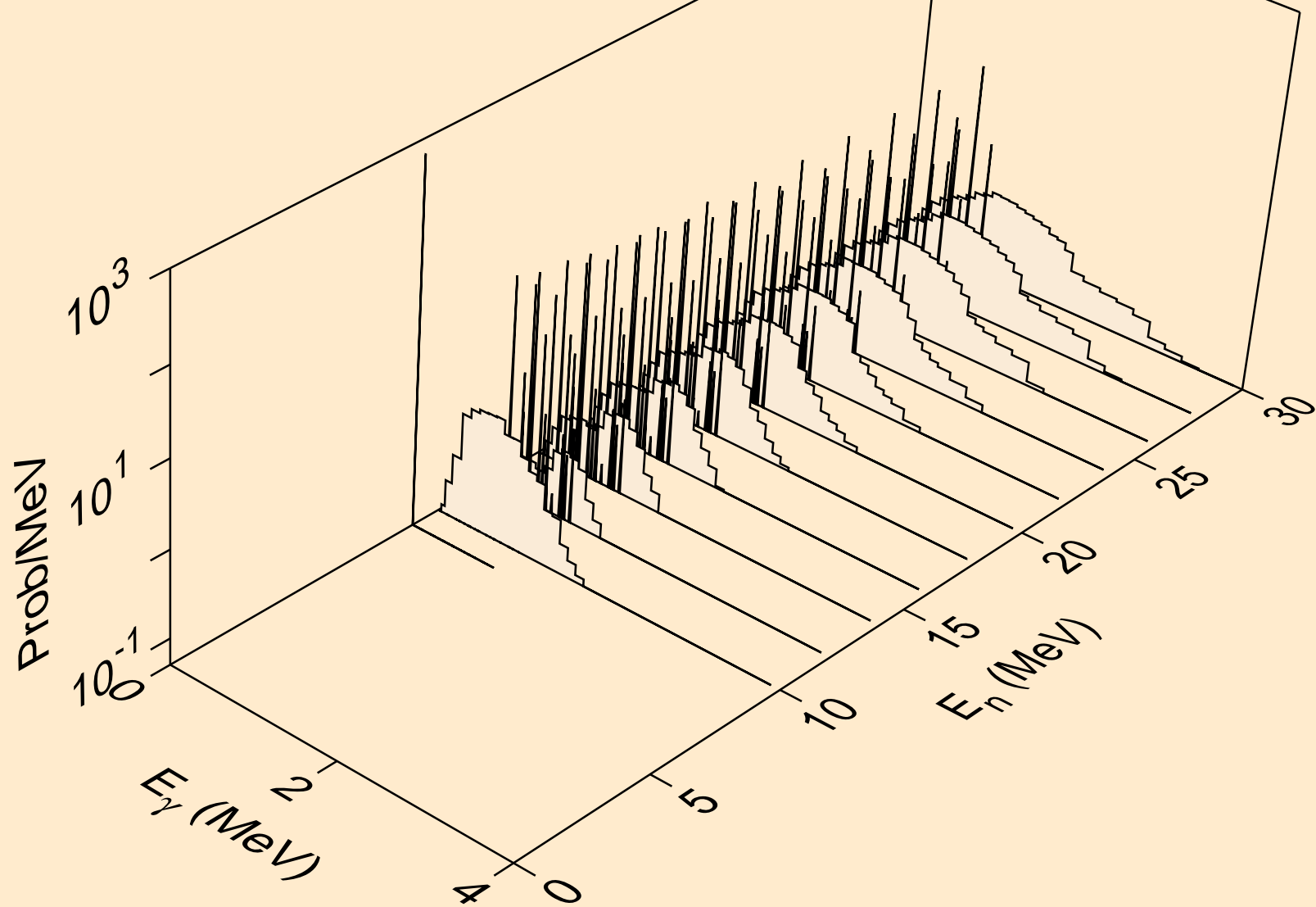

ND142 NEUTRON ACER TENDL-2021 LIBRARY; T=293.6K
Photon emission for (n,2p)

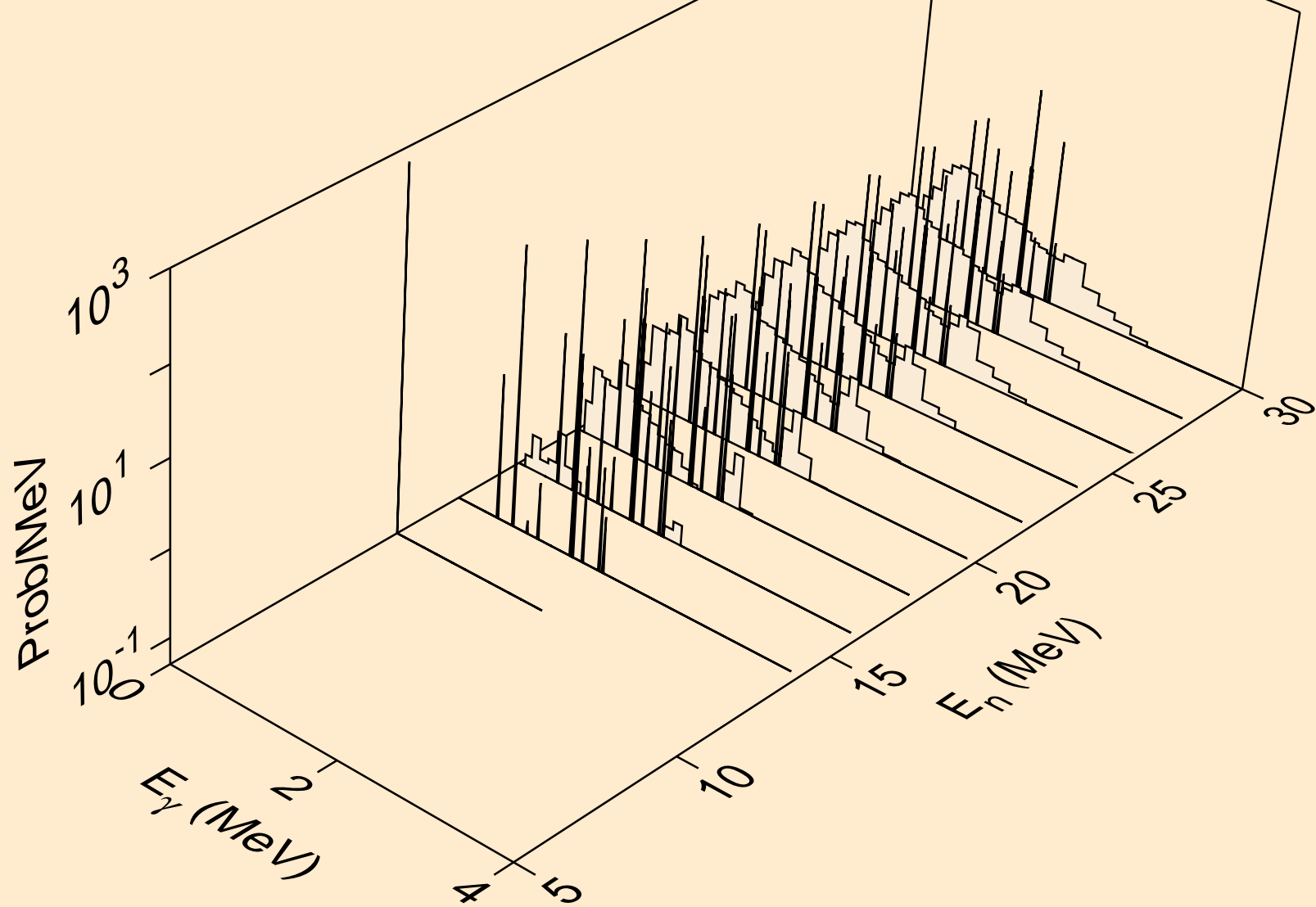

ND142 NEUTRON ACER TENDL-2021 LIBRARY; T=293.6K
Photon emission for (n,p)

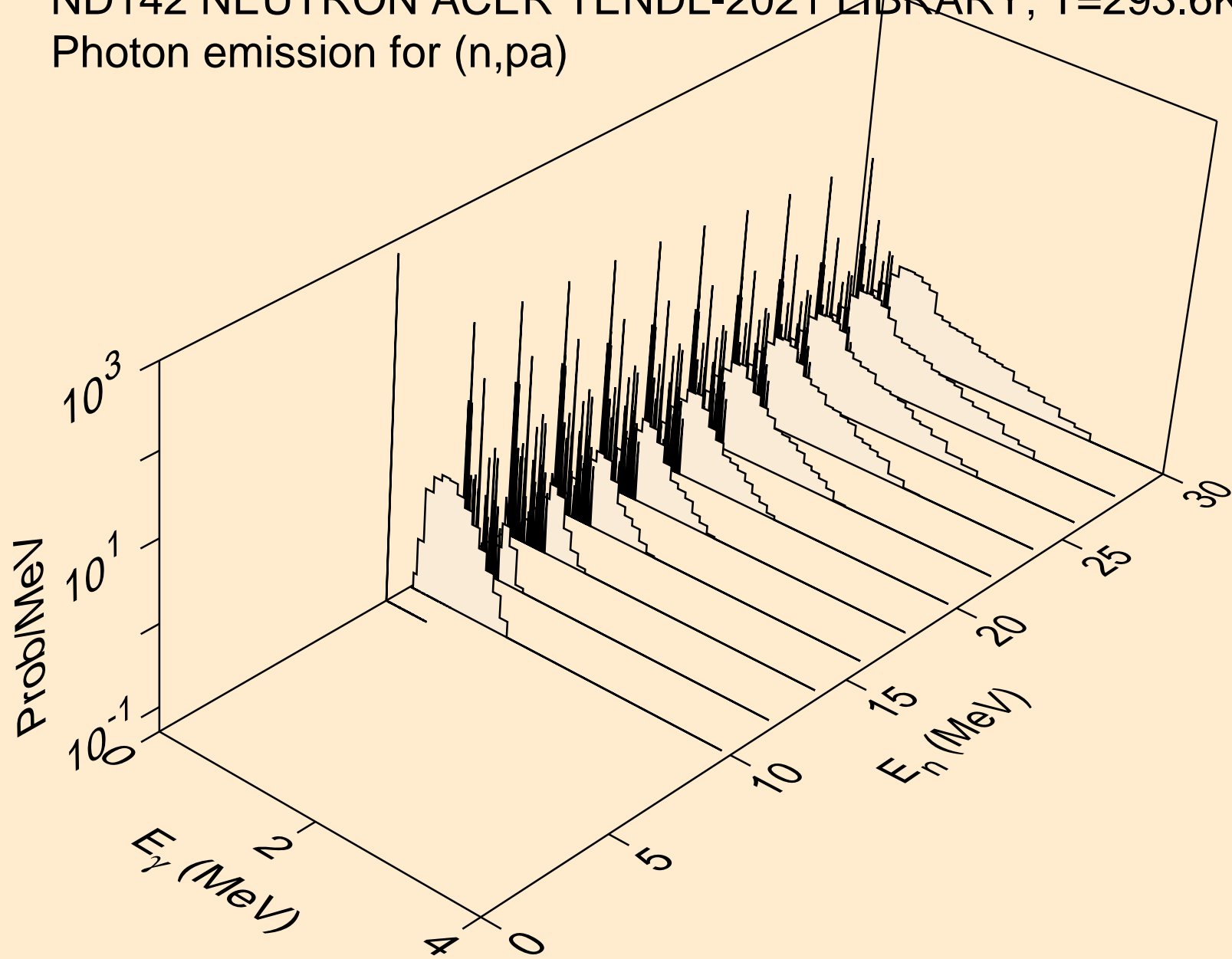

ND142 NEUTRON ACER TENDL-2021 LIBRARY; T=293.6K
Photon emission for (n,pd)

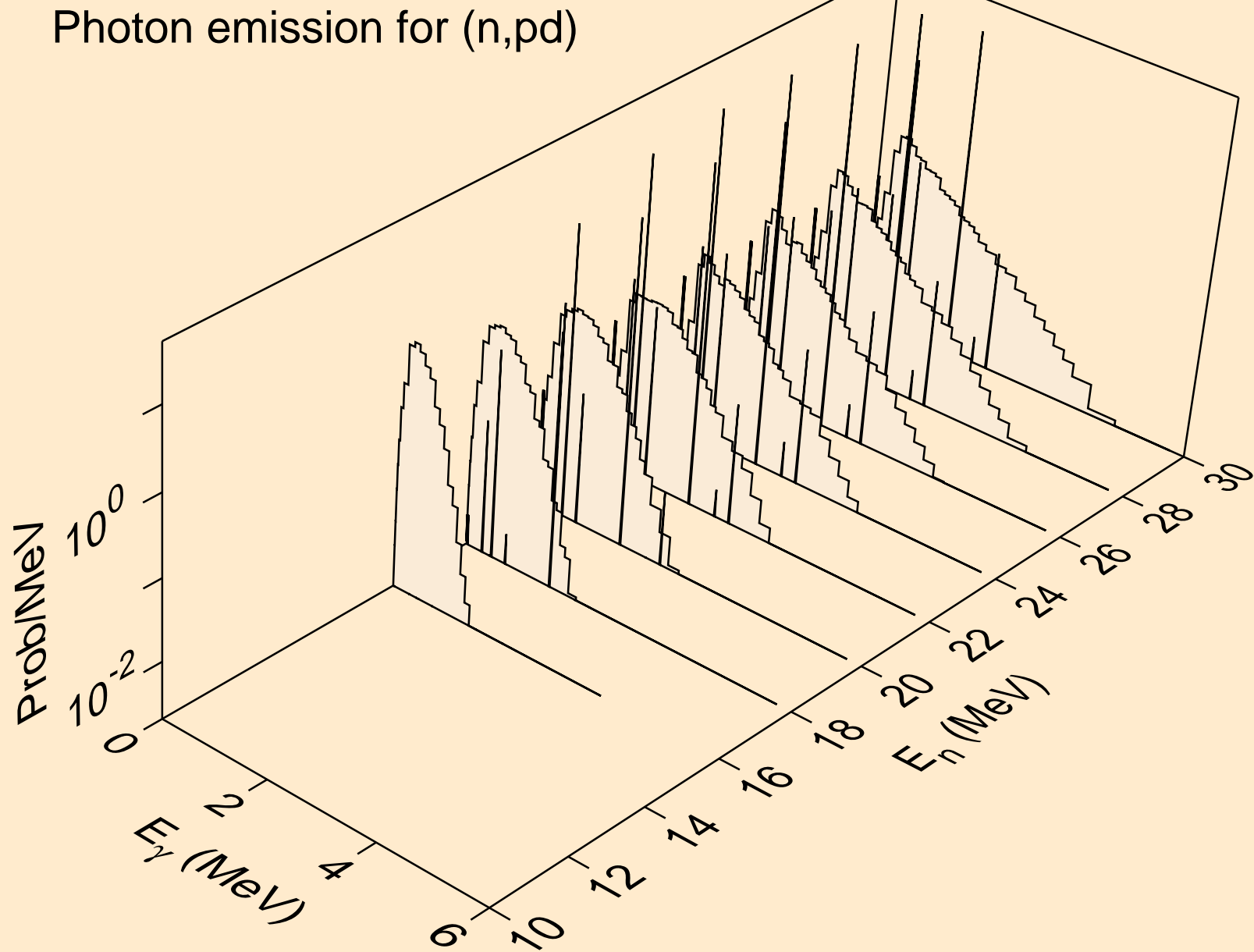

ND142 NEUTRON ACER TENDL-2021 LIBRARY; T=293.6K
Photon emission for (n,pt)

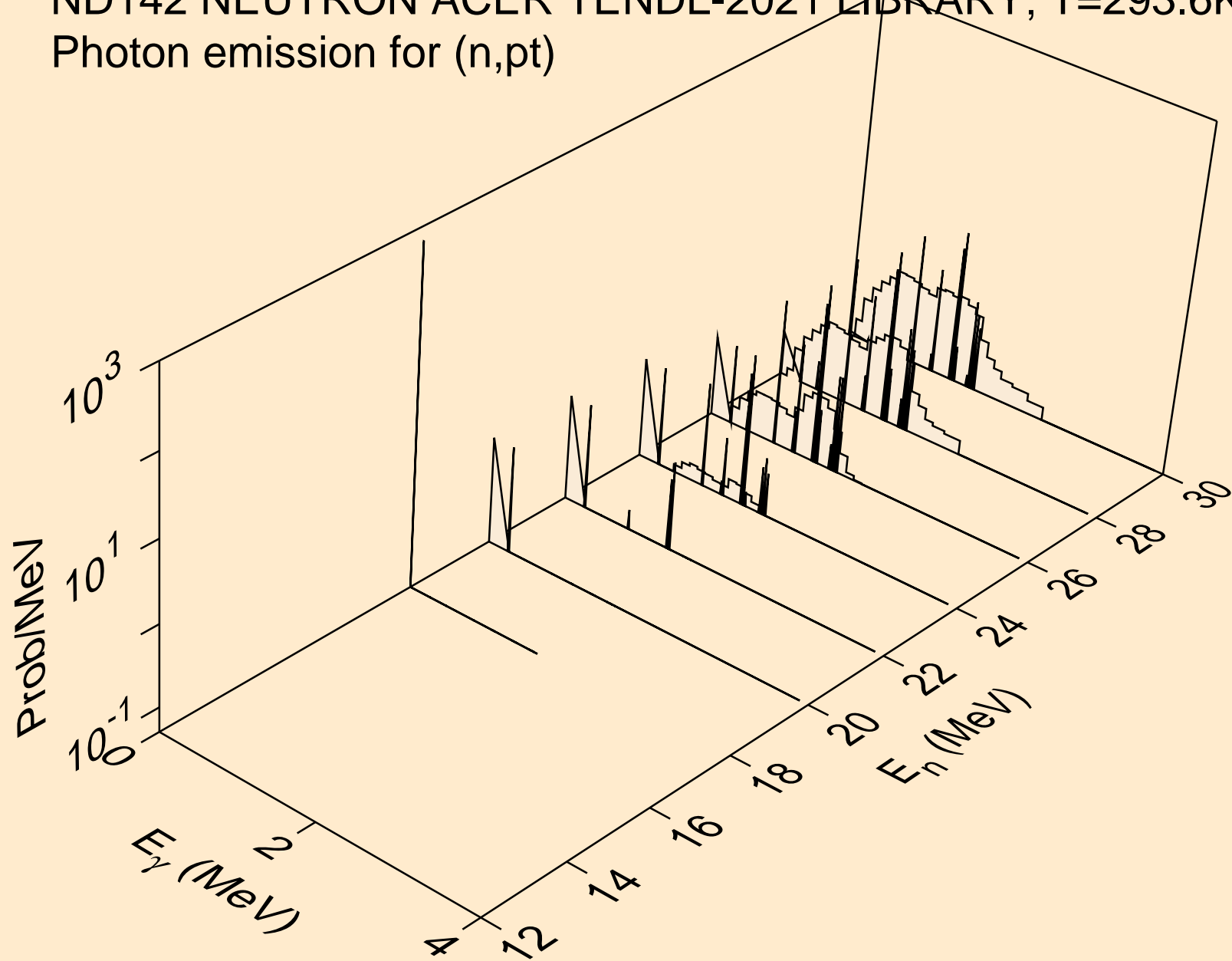

ND142 NEUTRON ACER TENDL-2021 LIBRARY; T=293.6K
Photon emission for (n,da)

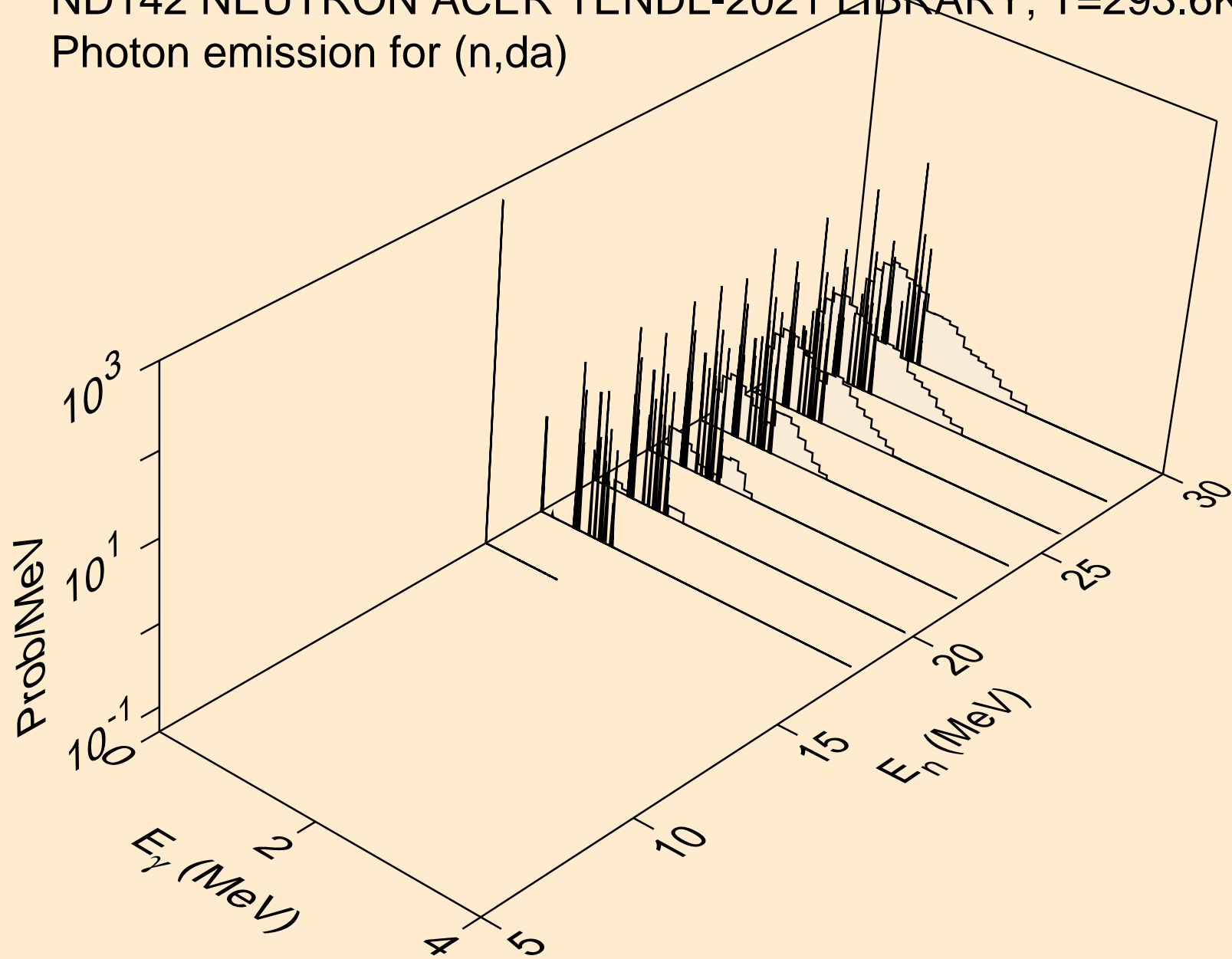

ND142 NEUTRON ACER TENDL-2021 LIBRARY; T=293.6K
thermal capture photon spectrum

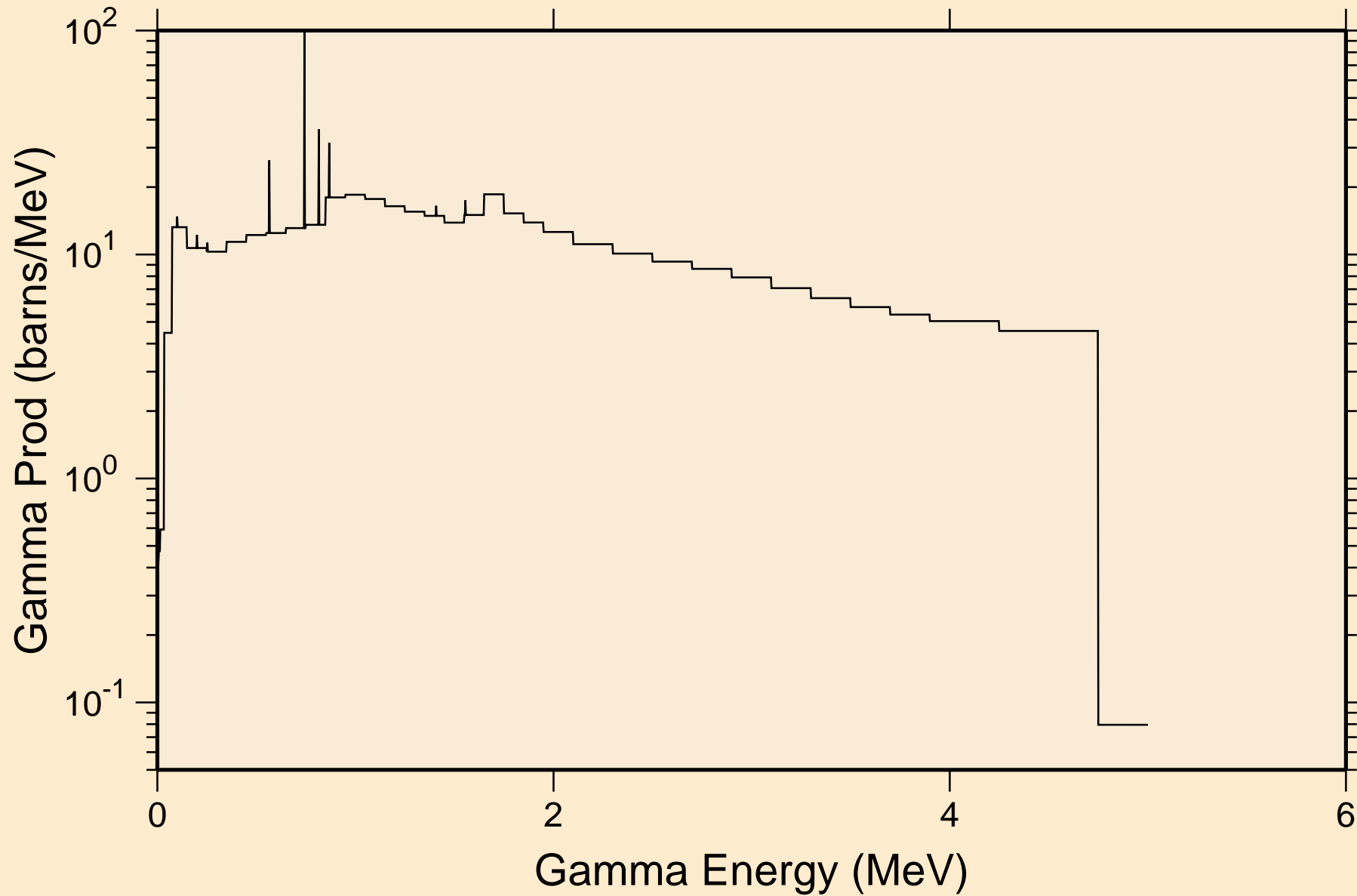

ND142 NEUTRON ACER TENDL-2021 LIBRARY; T=293.6K
14 MeV photon spectrum

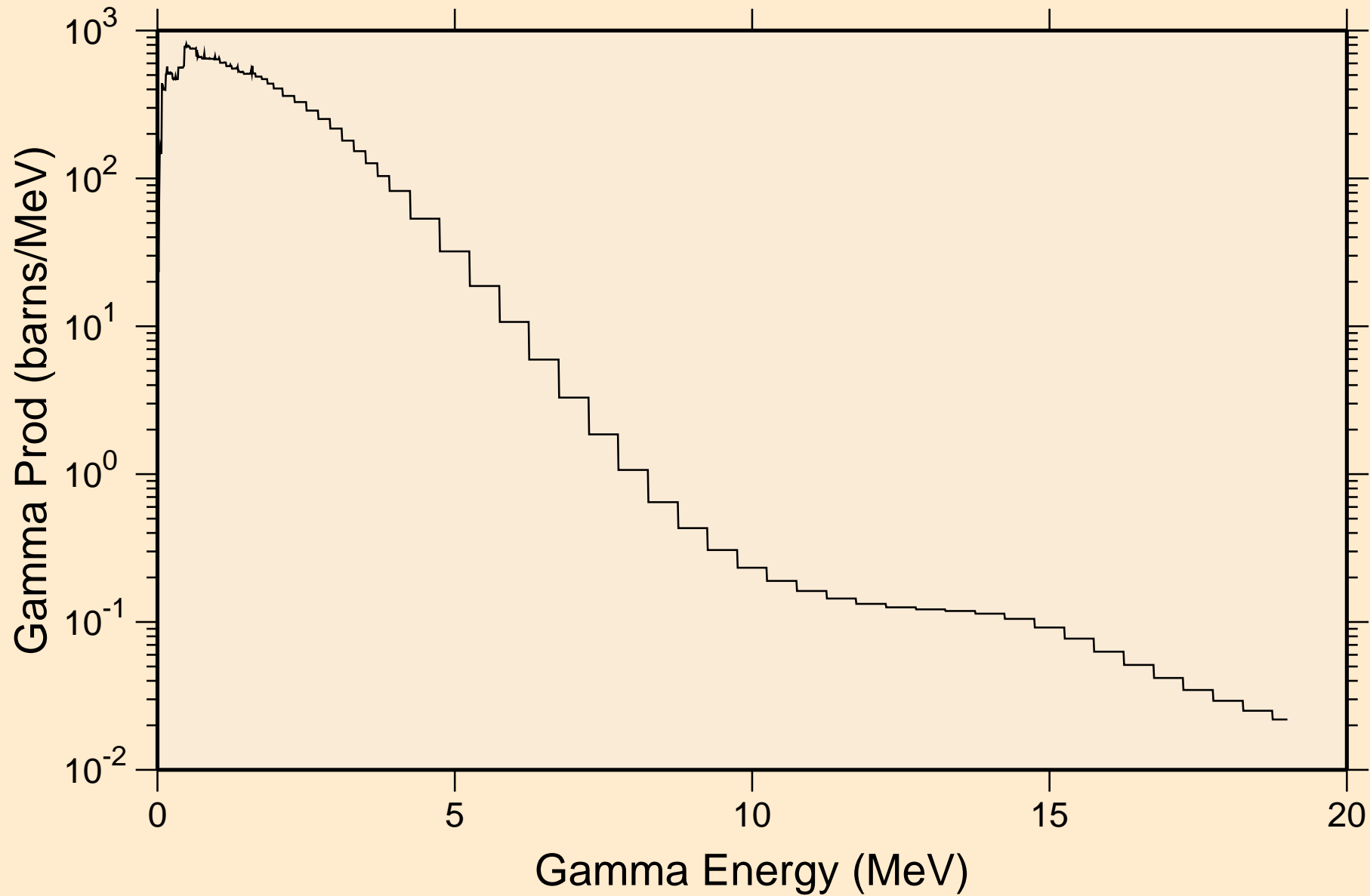

ND142 NEUTRON ACER TENDL-2021 LIBRARY; T=293.6K

Particle heating contributions

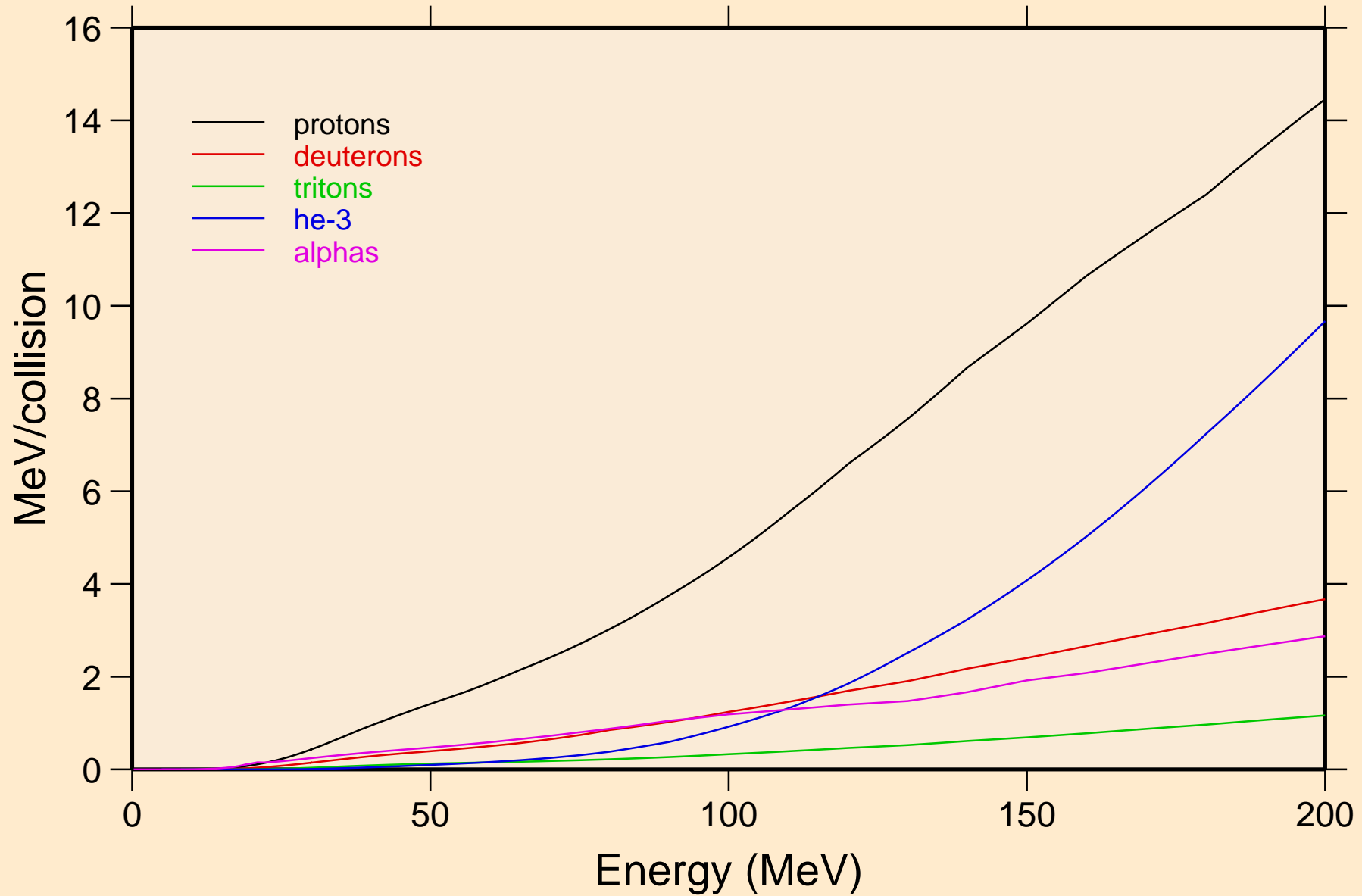

ND142 NEUTRON ACER TENDL-2021 LIBRARY; T=293.6K
Recoil Heating

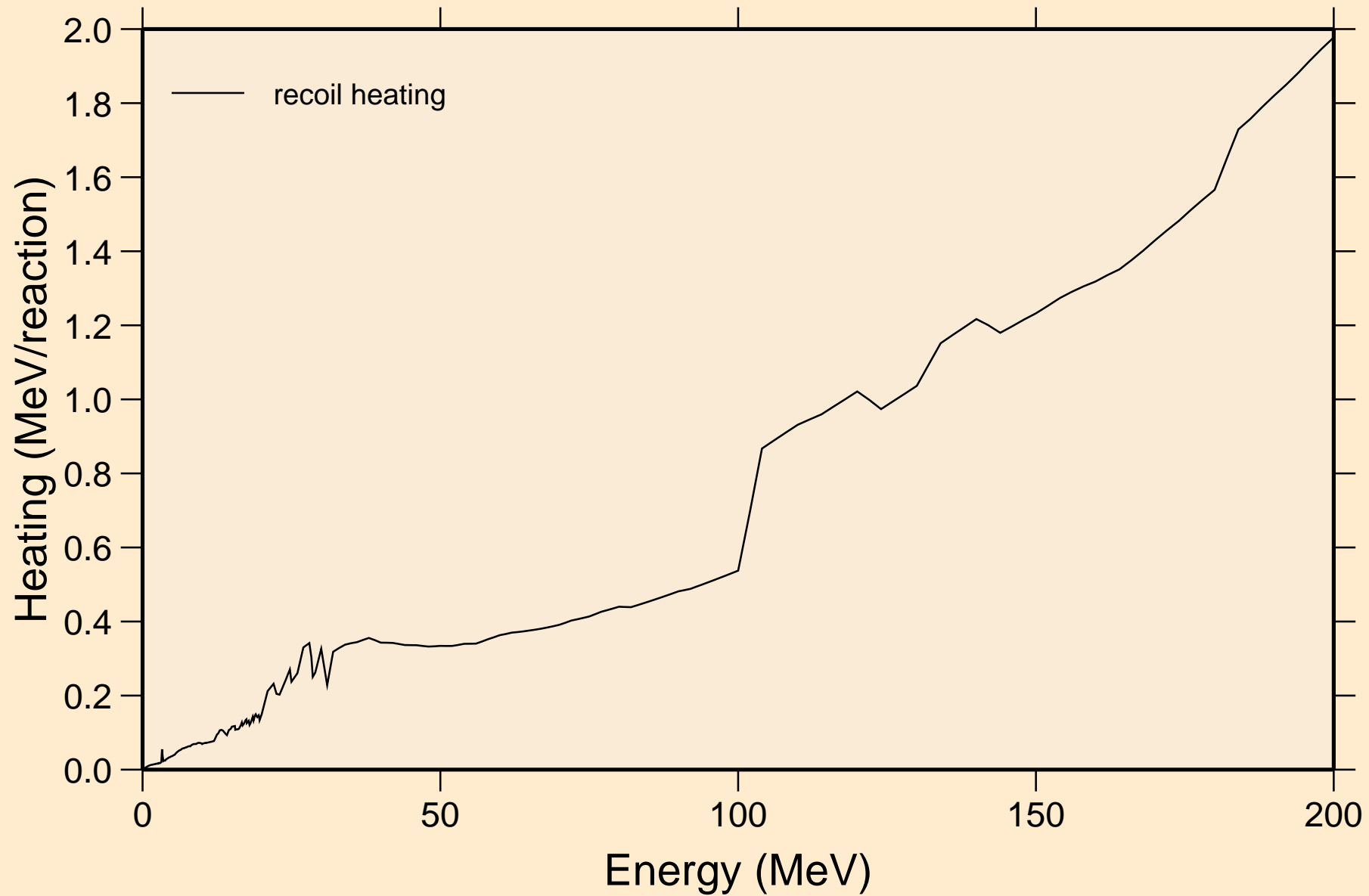

ND142 NEUTRON ACER TENDL-2021 LIBRARY; T=293.6K

Particle production cross sections

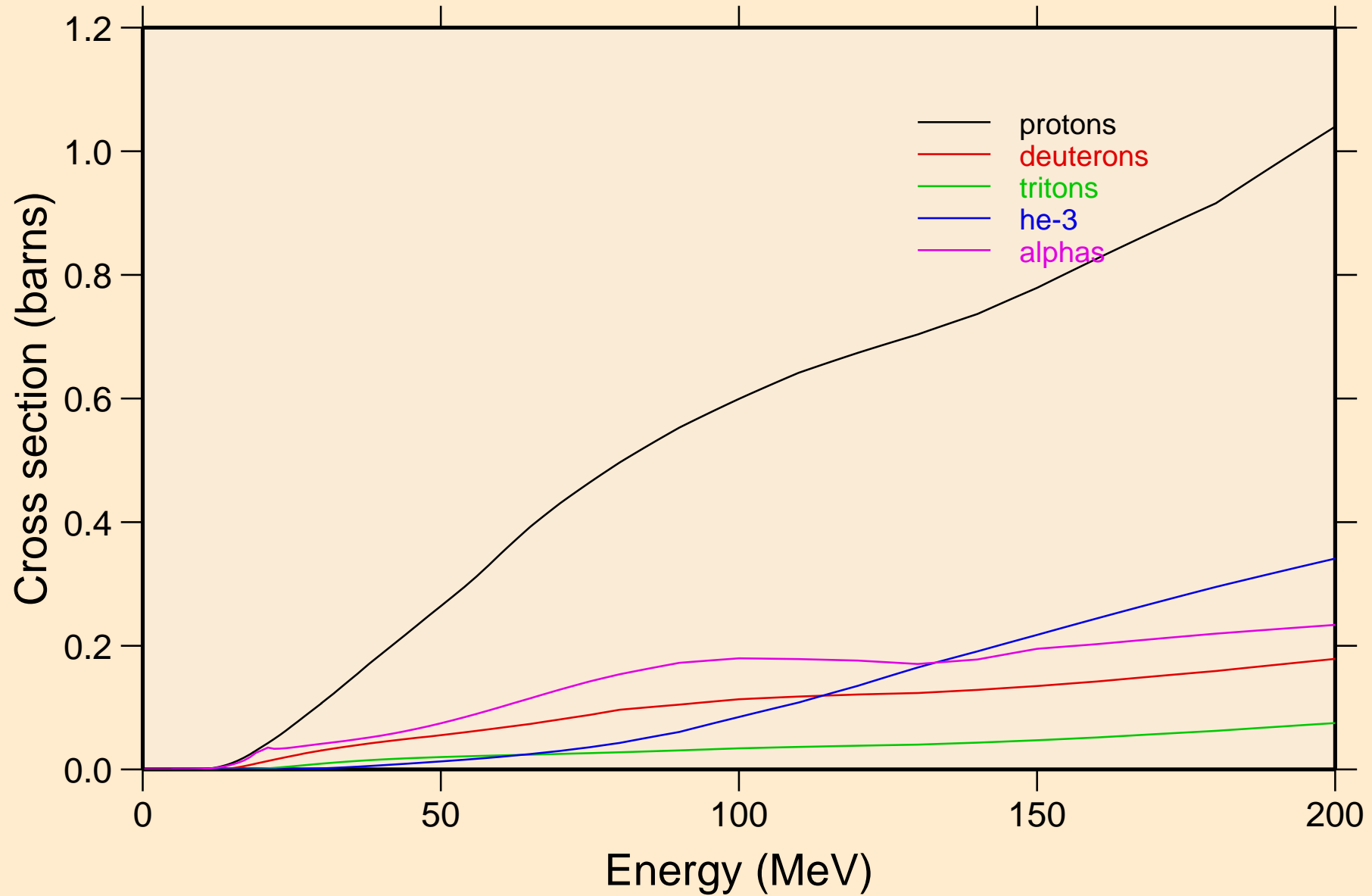

ND142 NEUTRON ACER TENDL-2021 LIBRARY; T=293.6K
protons from (n,x)

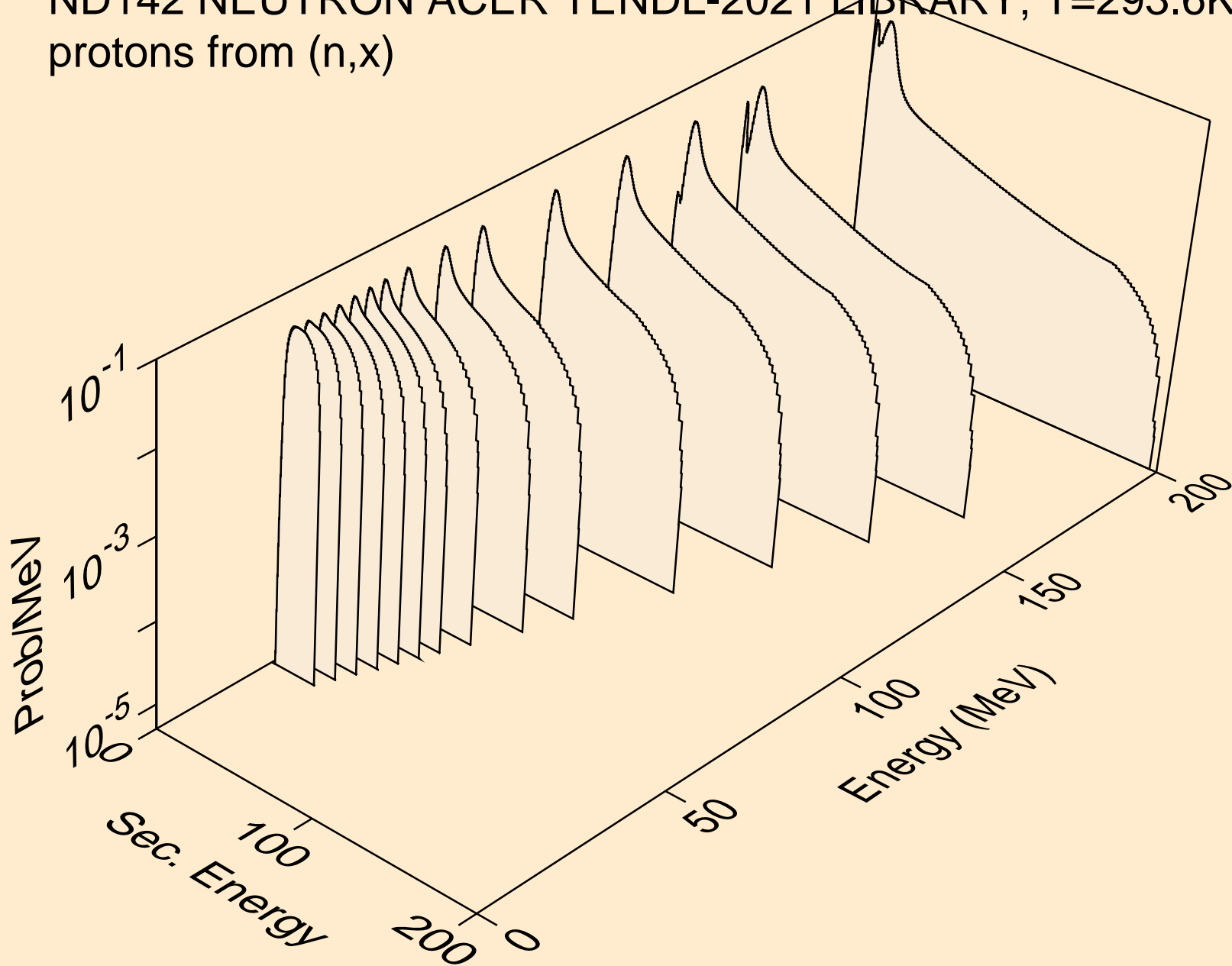

ND142 NEUTRON ACER TENDL-2021 LIBRARY; T=293.6K
protons from (n,n*)p

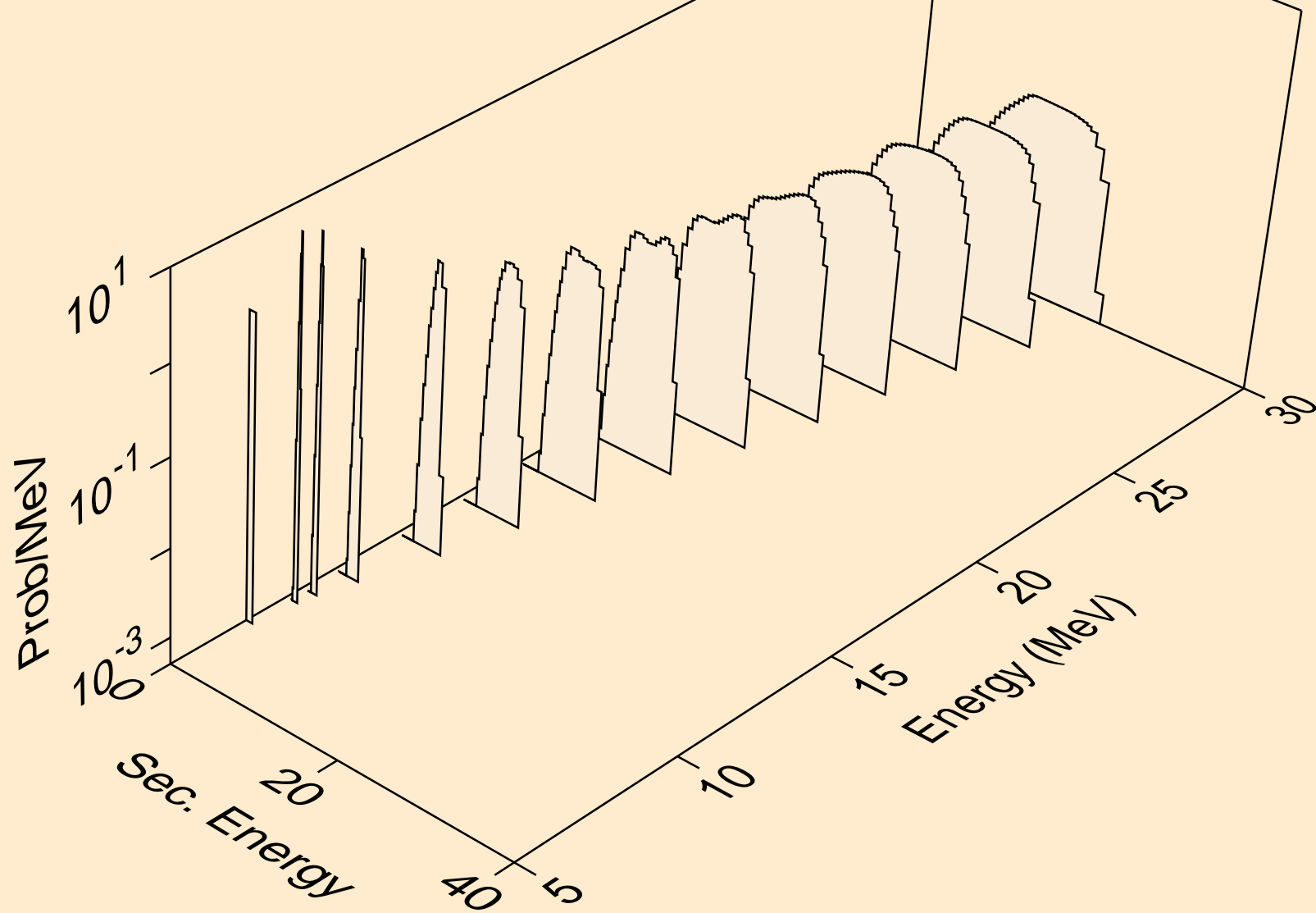

ND142 NEUTRON ACER TENDL-2021 LIBRARY; T=293.6K
protons from (n,2np)

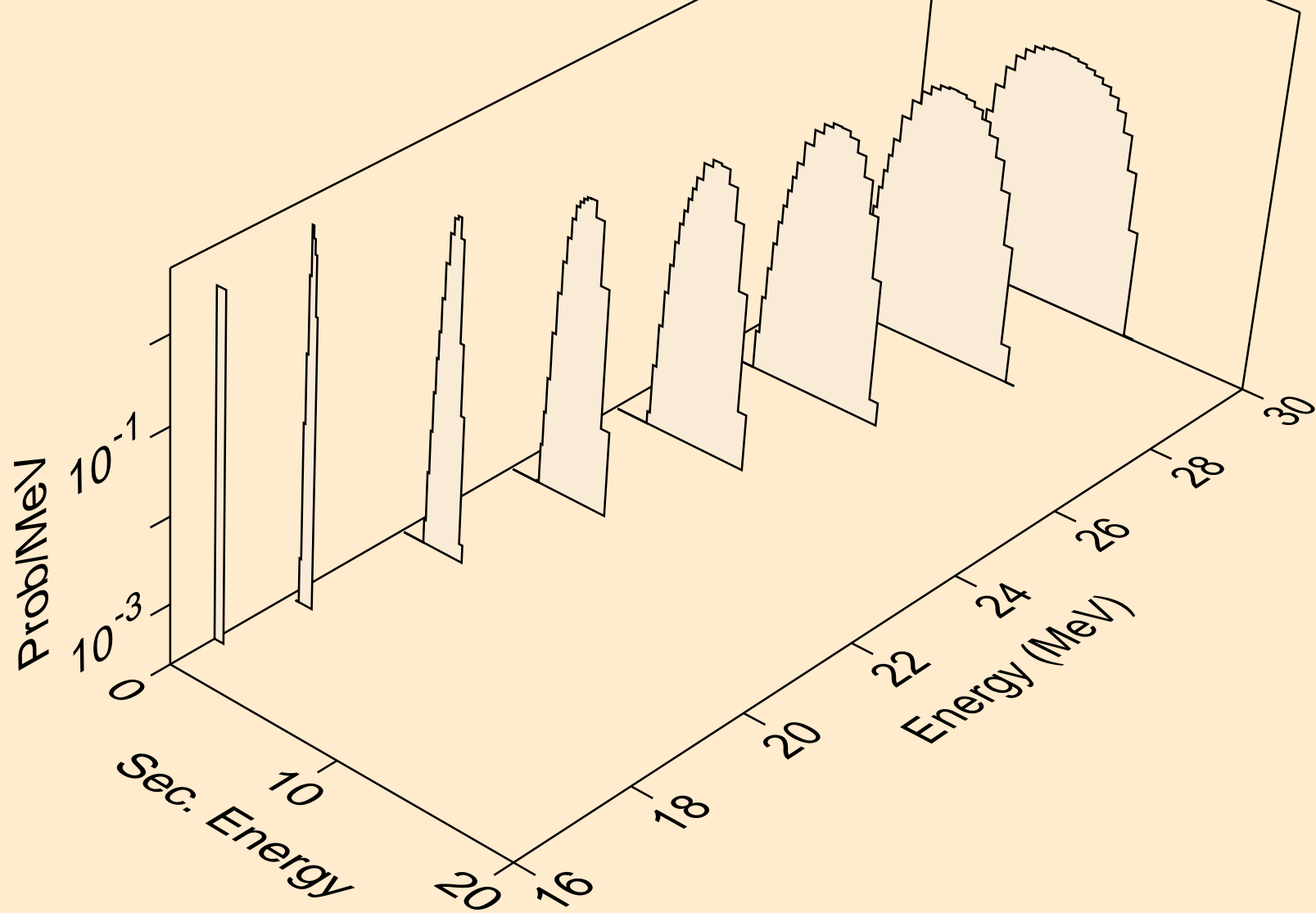

ND142 NEUTRON ACER TENDL-2021 LIBRARY; T=293.6K
protons from (n,3np)

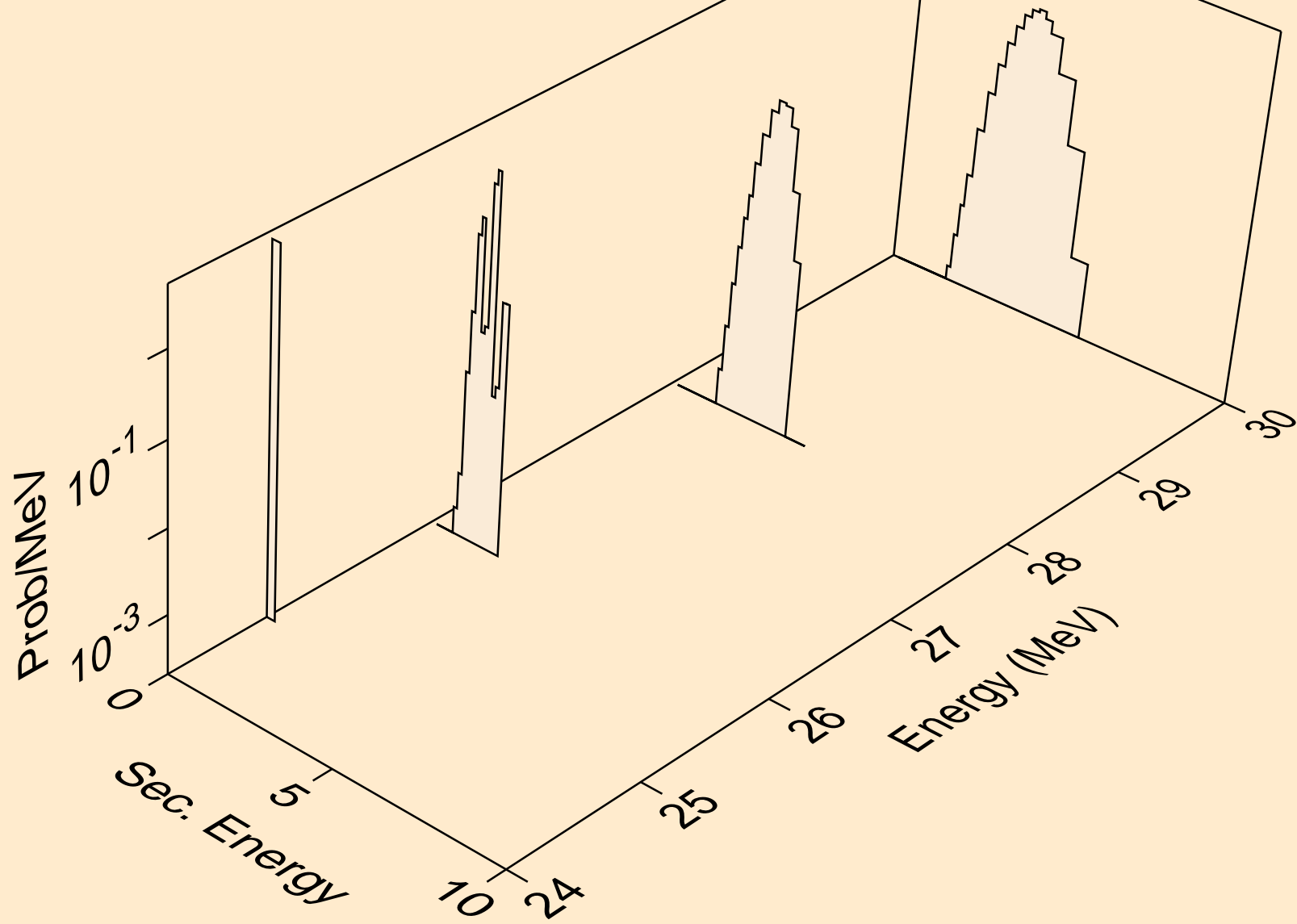

ND142 NEUTRON ACER TENDL-2021 LIBRARY; T=293.6K
protons from (n,2np)

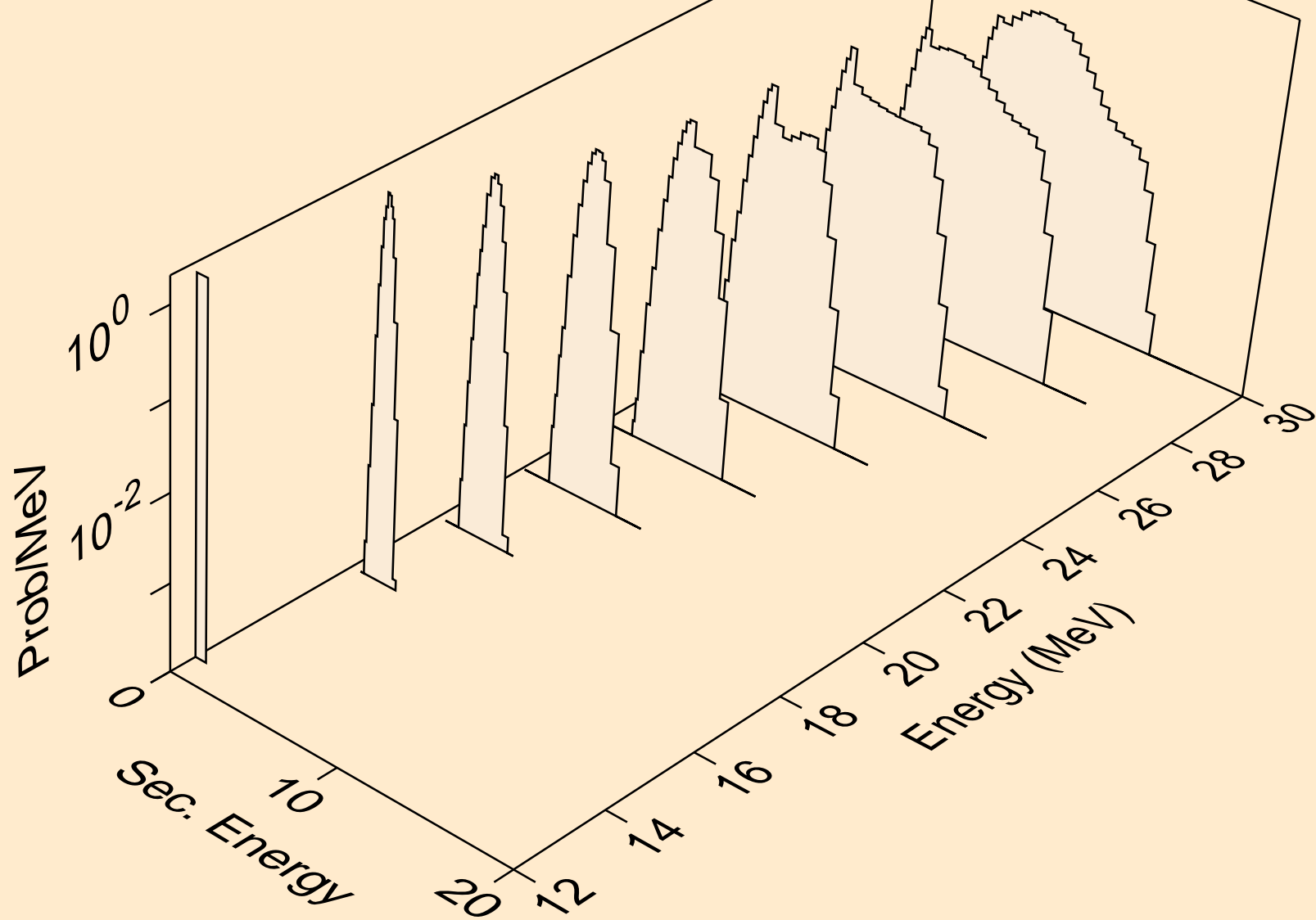

ND142 NEUTRON ACER TENDL-2021 LIBRARY; T=293.6K
protons from (n,npa)

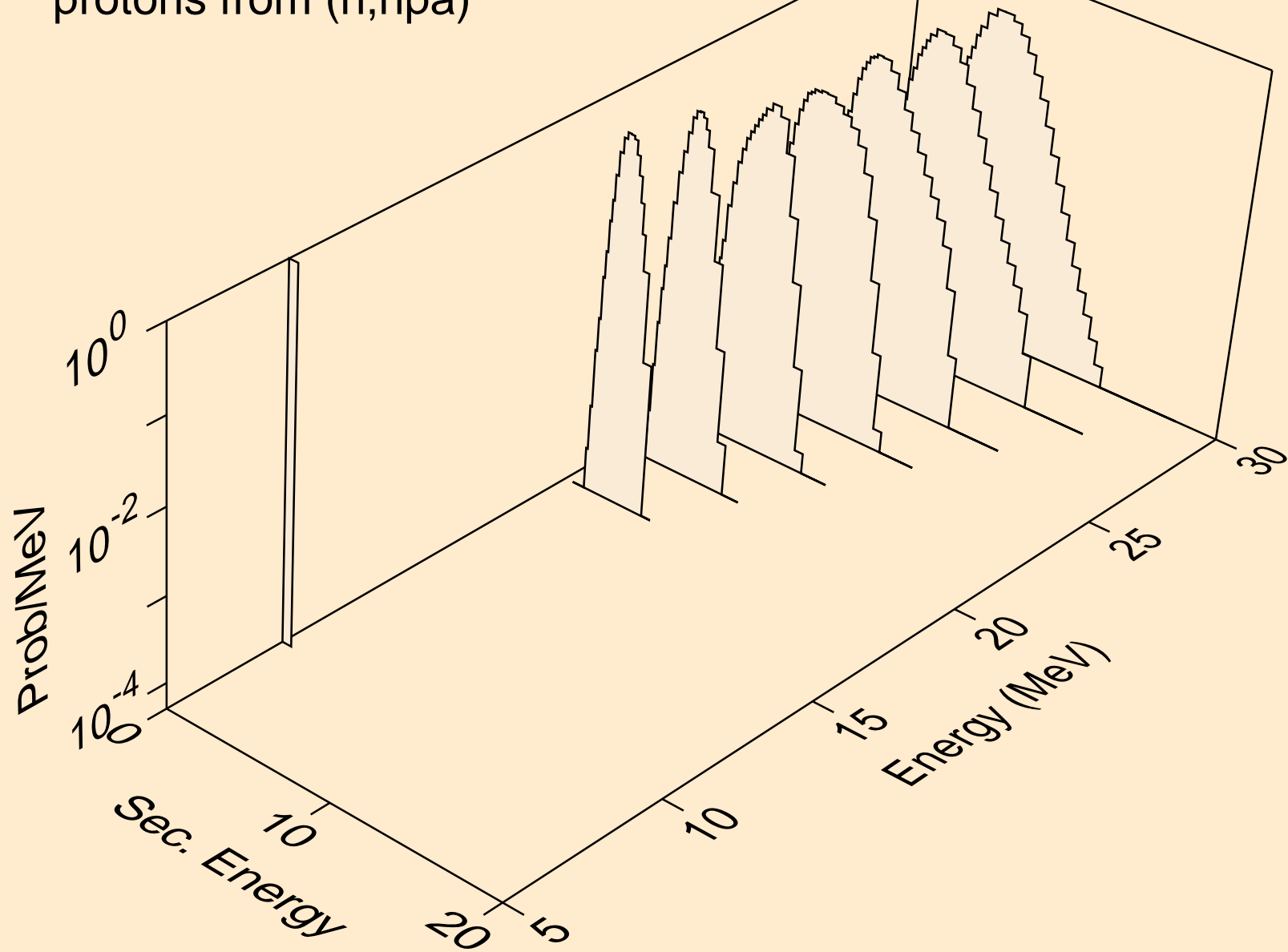

ND142 NEUTRON ACER TENDL-2021 LIBRARY; T=293.6K
protons from (n,p)

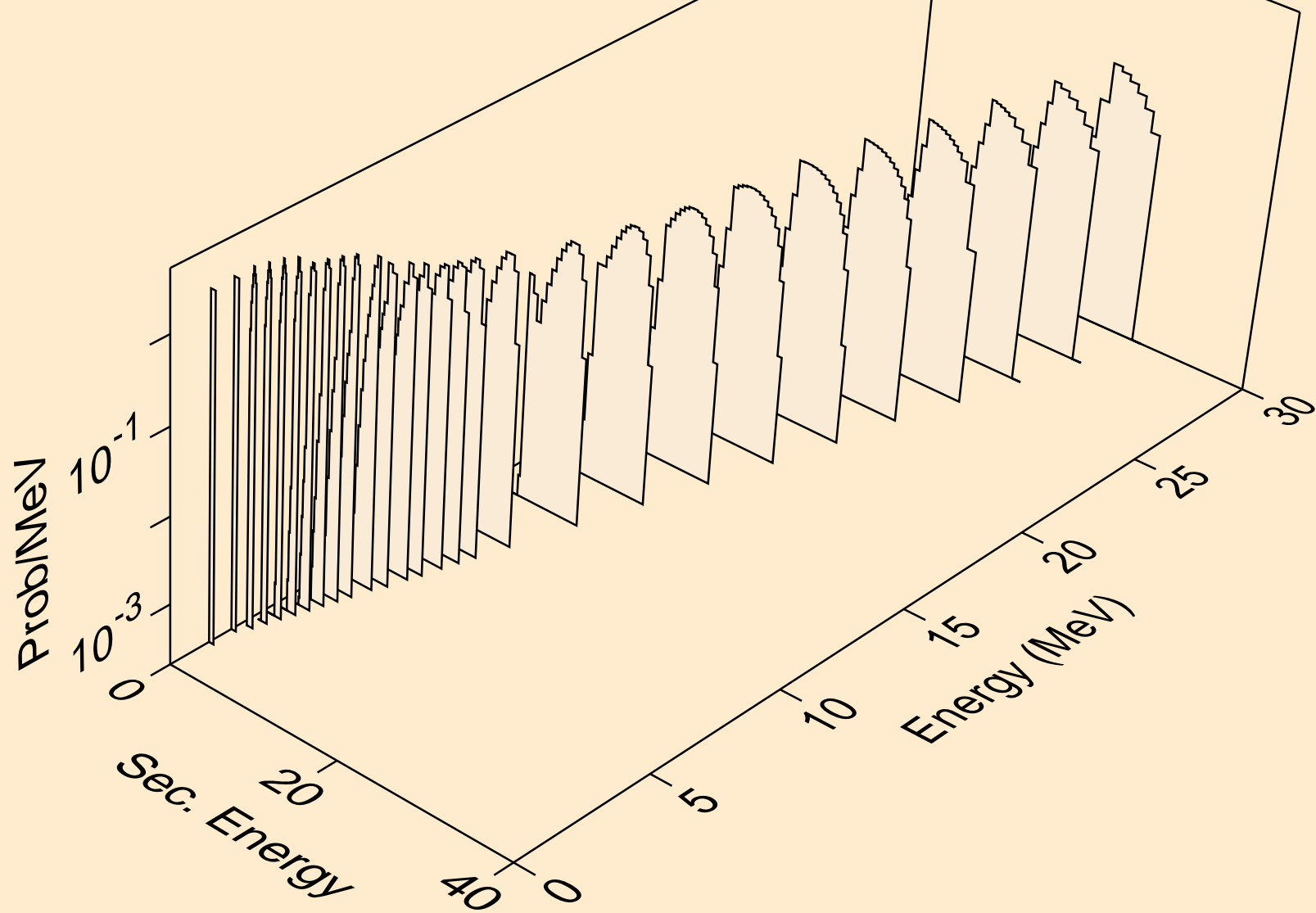

ND142 NEUTRON ACER TENDL-2021 LIBRARY; T=293.6K
protons from (n,2p)

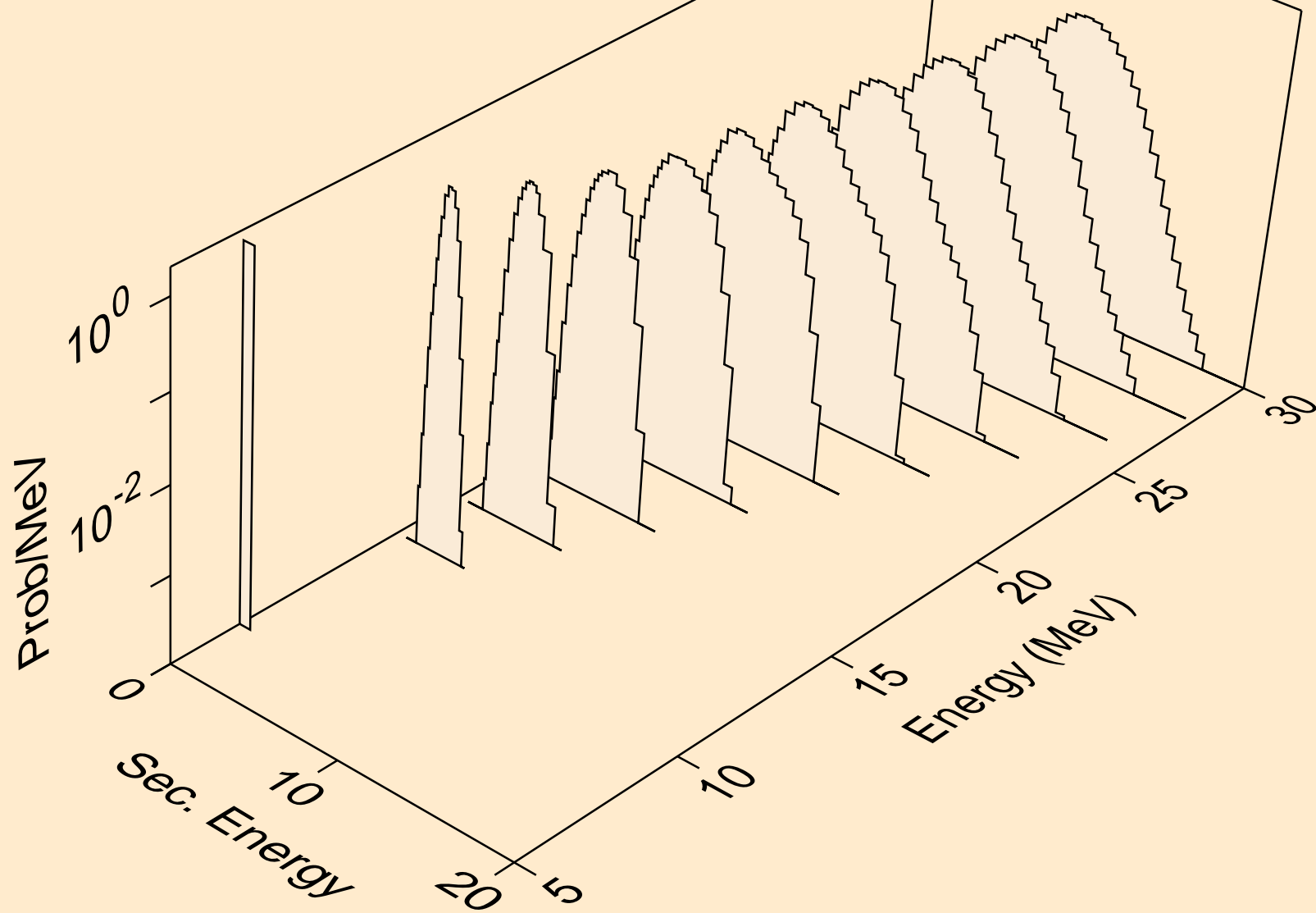

ND142 NEUTRON ACER TENDL-2021 LIBRARY; T=293.6K
protons from (n,p)

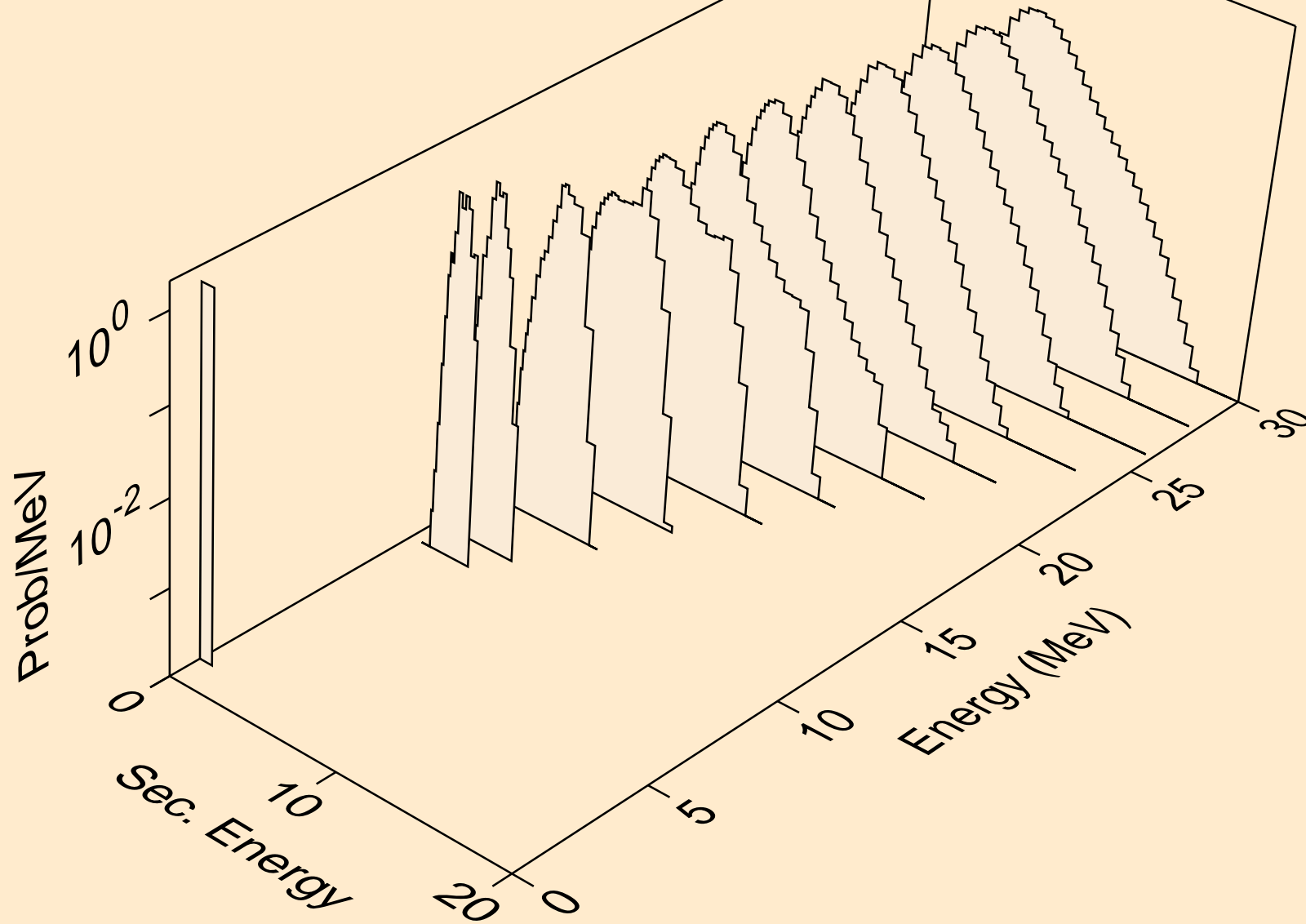

ND142 NEUTRON ACER TENDL-2021 LIBRARY; T=293.6K
protons from (n,pd)

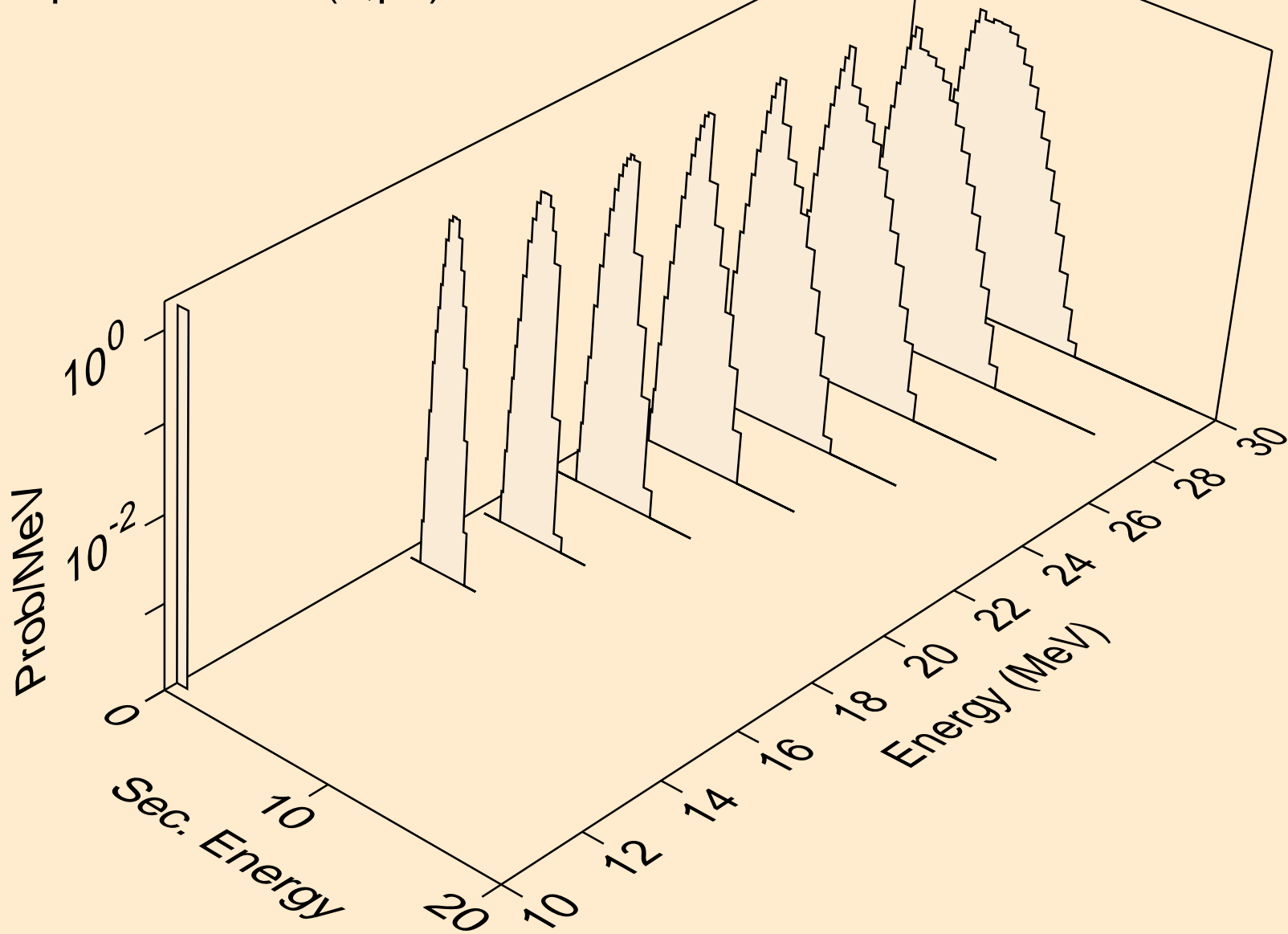

ND142 NEUTRON ACER TENDL-2021 LIBRARY; T=293.6K
protons from (n,pt)

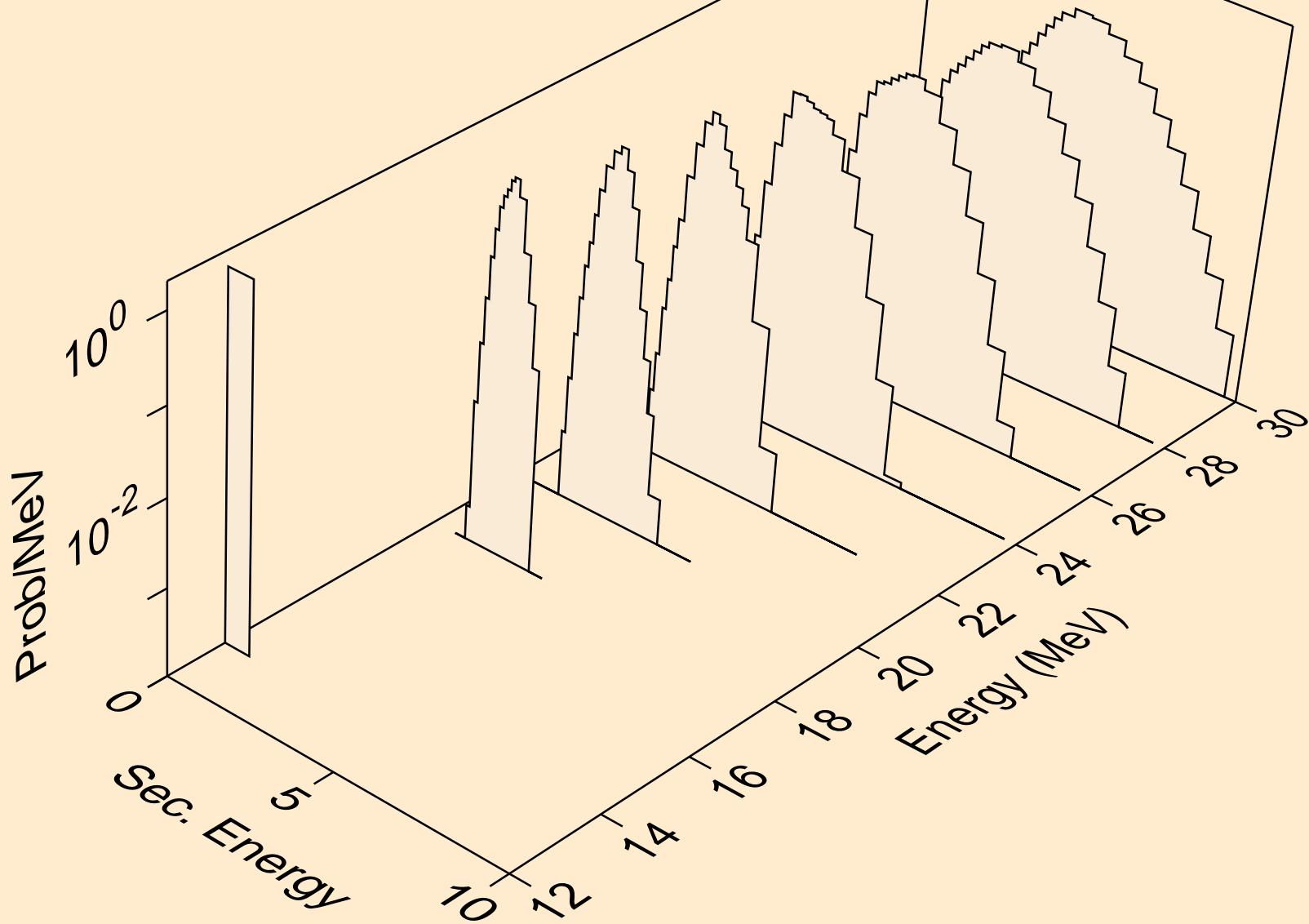

ND142 NEUTRON ACER TENDL-2021 LIBRARY; T=293.6K
deuterons from (n,x)

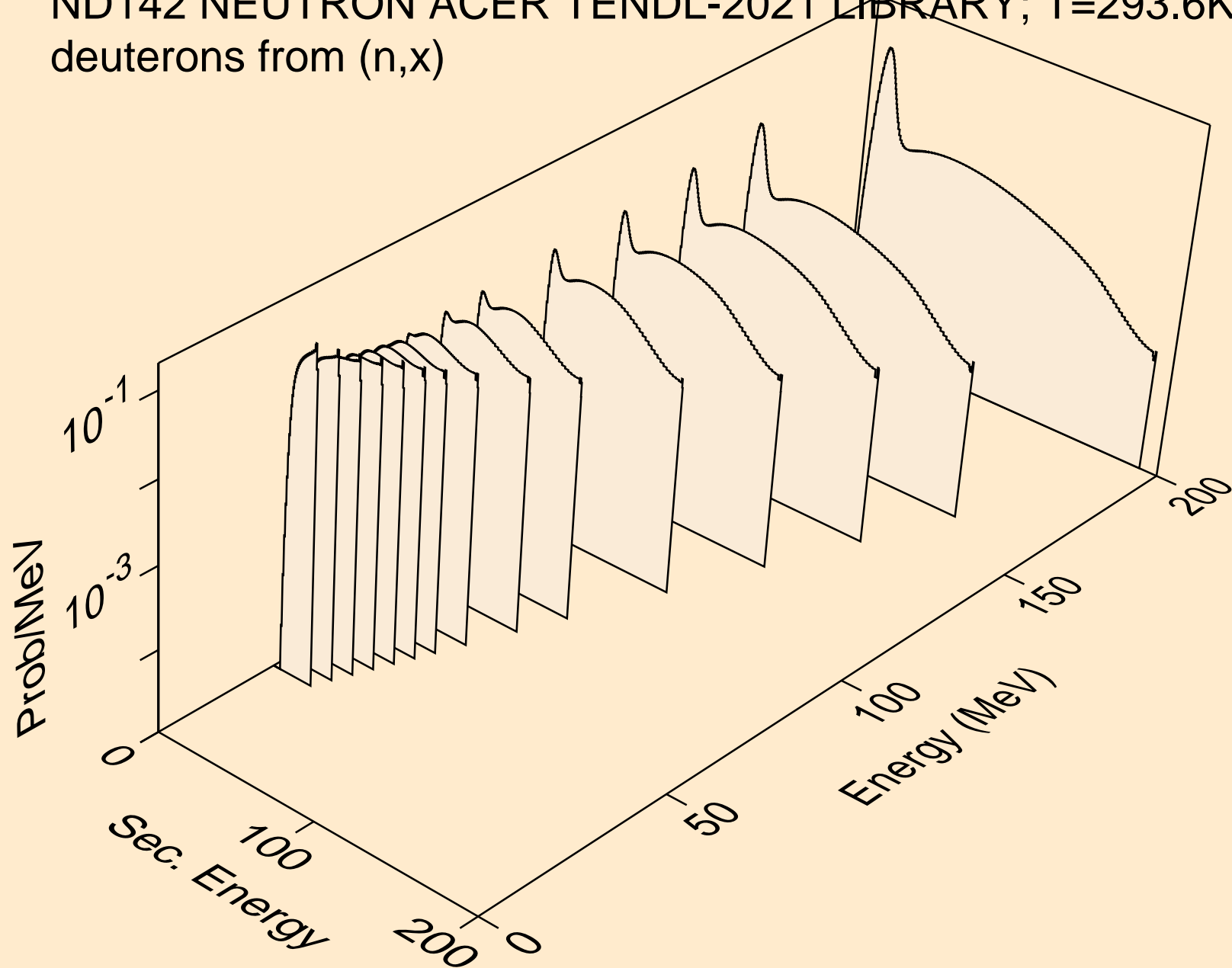

ND142 NEUTRON ACER TENDL-2021 LIBRARY; T=293.6K
deuterons from (n,2nd)

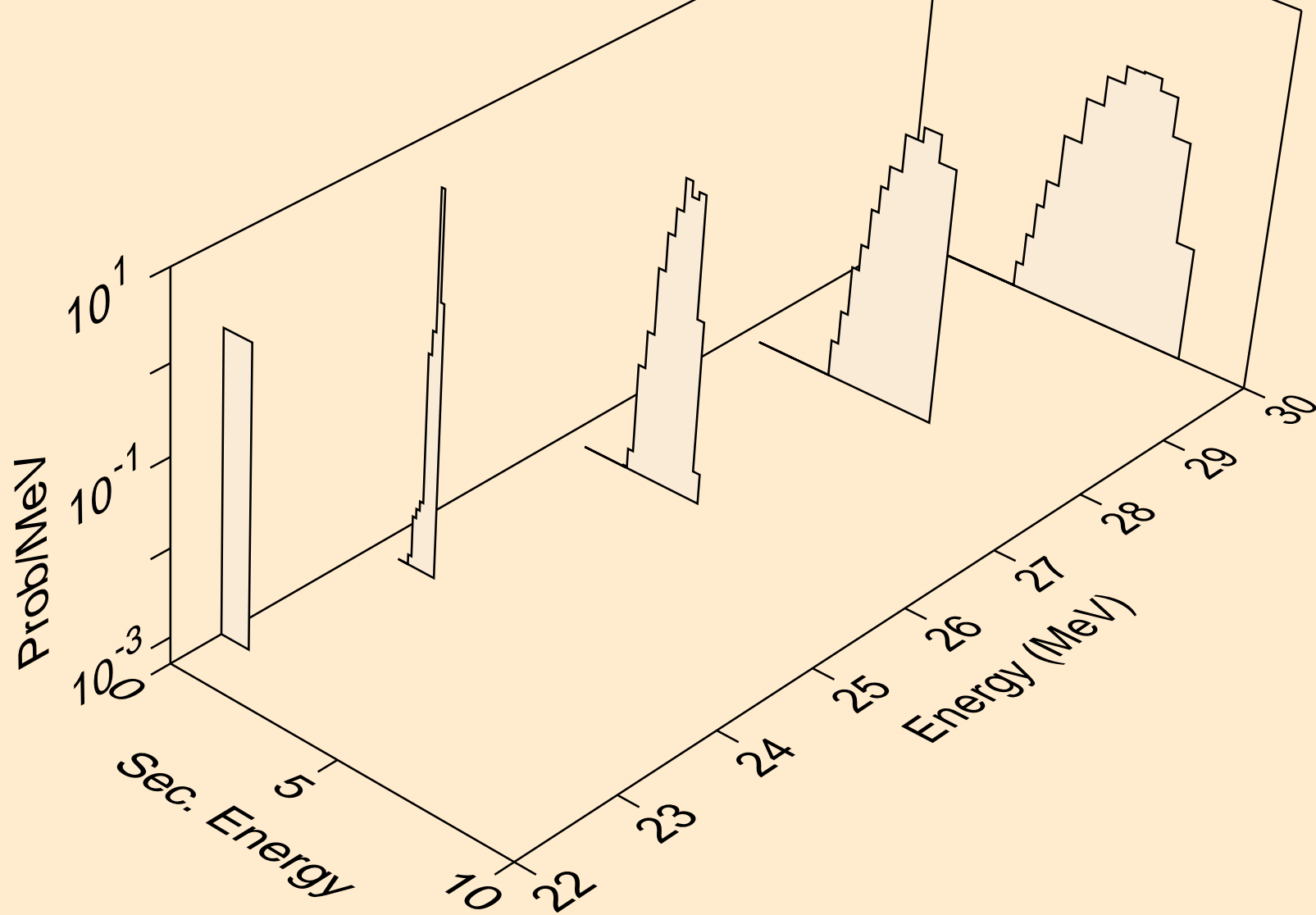

ND142 NEUTRON ACER TENDL-2021 LIBRARY; T=293.6K
deuterons from (n,n*)d

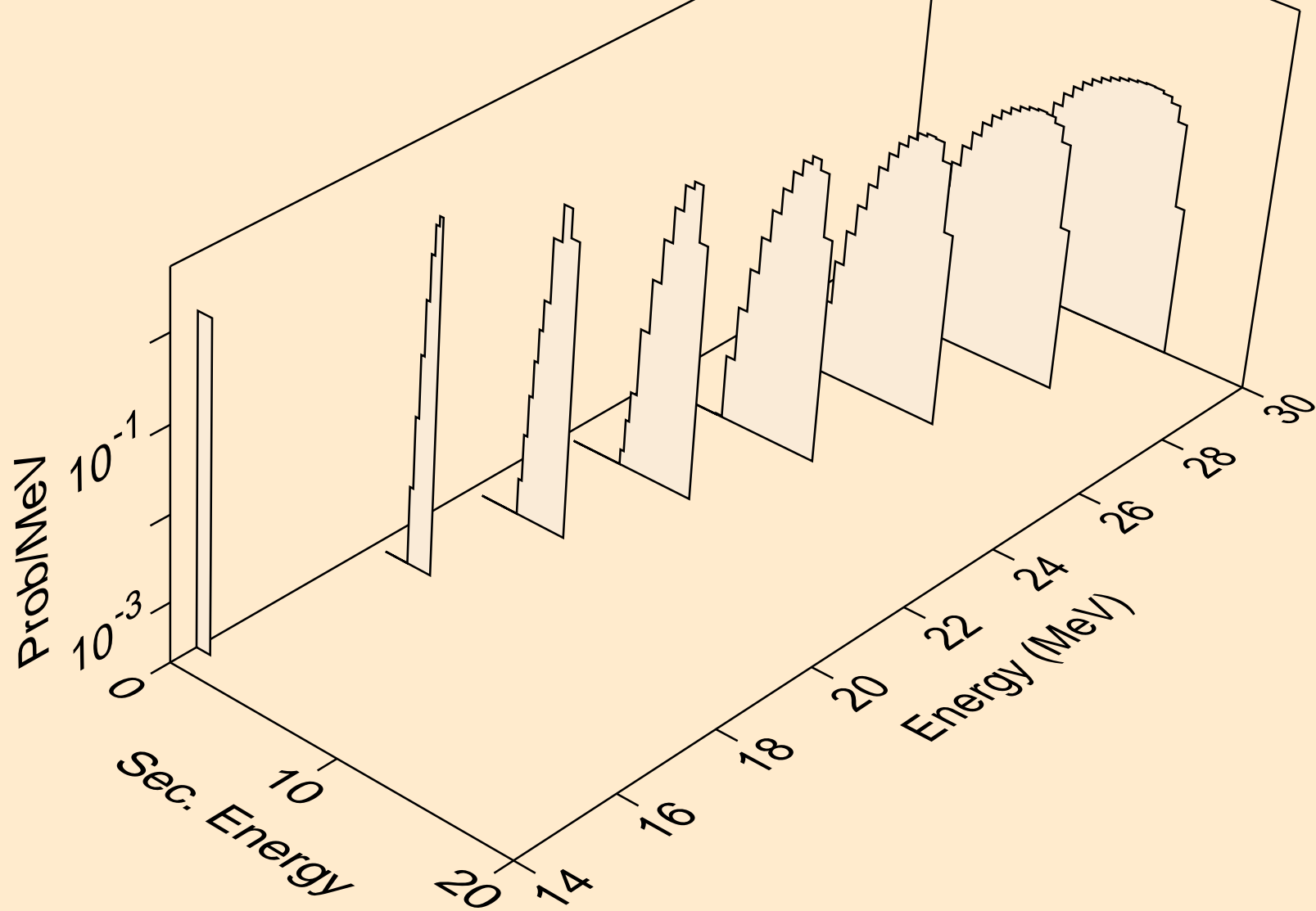

ND142 NEUTRON ACER TENDL-2021 LIBRARY; T=293.6K
deuterons from (n,d)

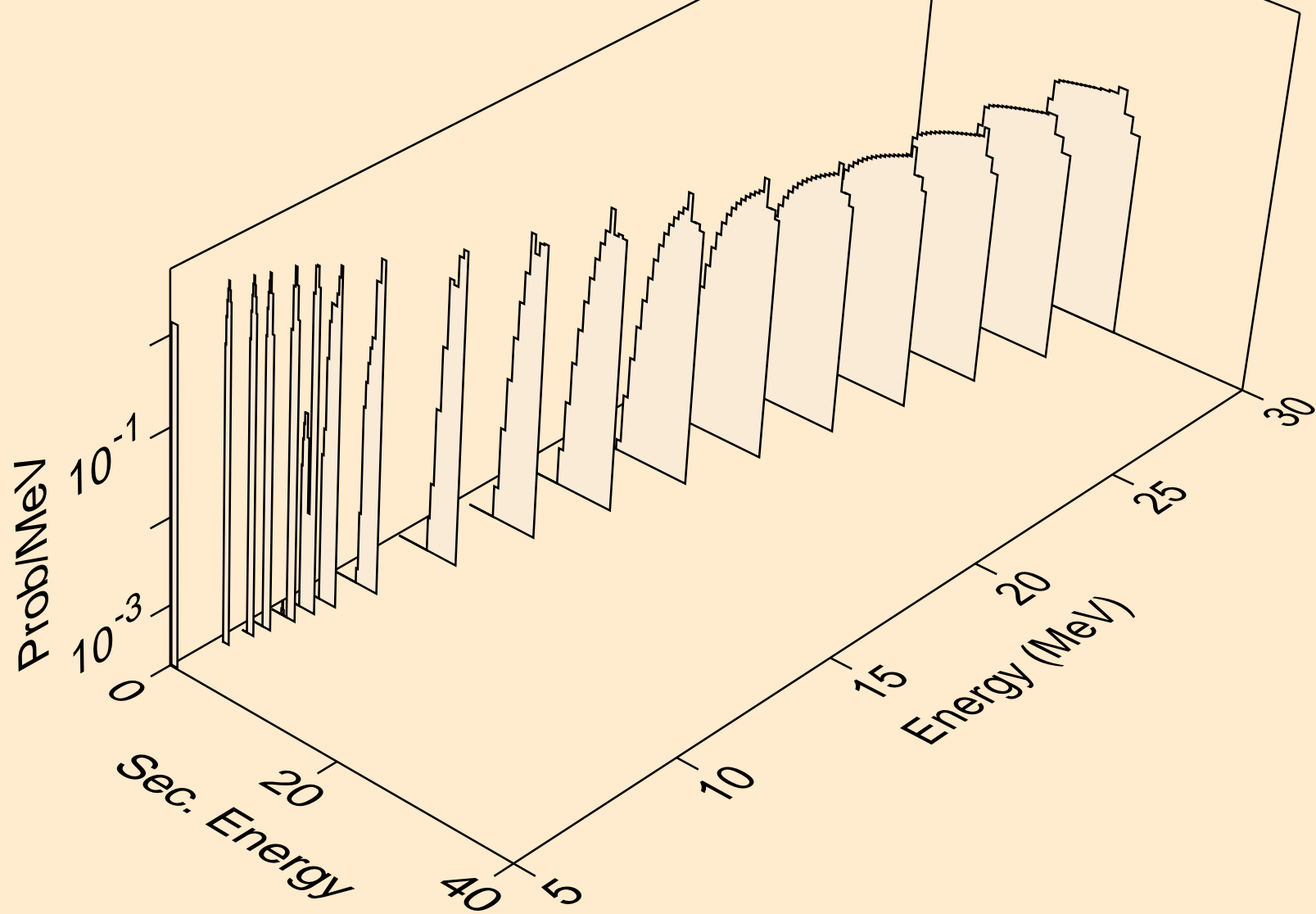

ND142 NEUTRON ACER TENDL-2021 LIBRARY; T=293.6K
deuterons from (n,pd)

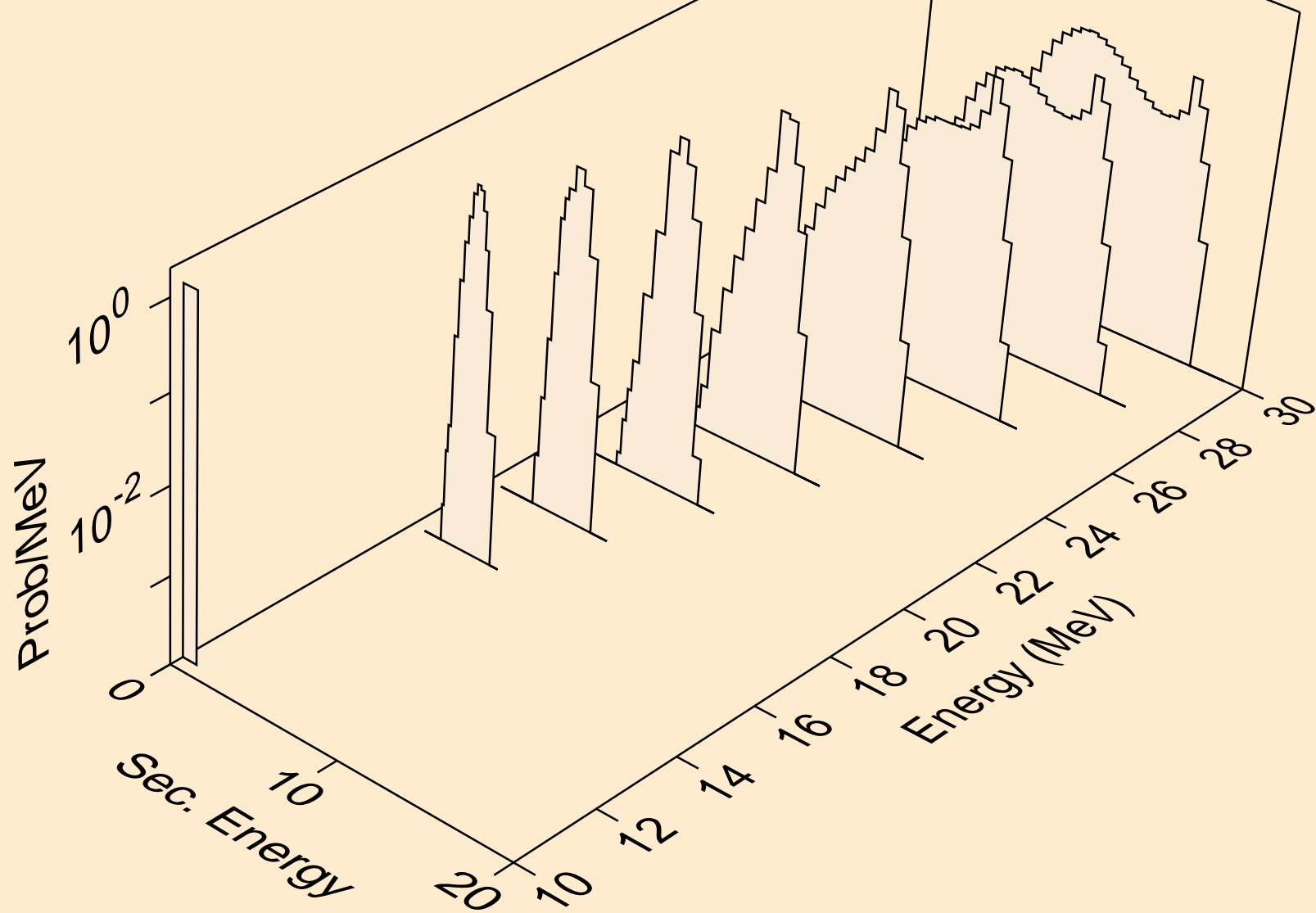

ND142 NEUTRON ACER TENDL-2021 LIBRARY; T=293.6K
deuterons from (n,da)

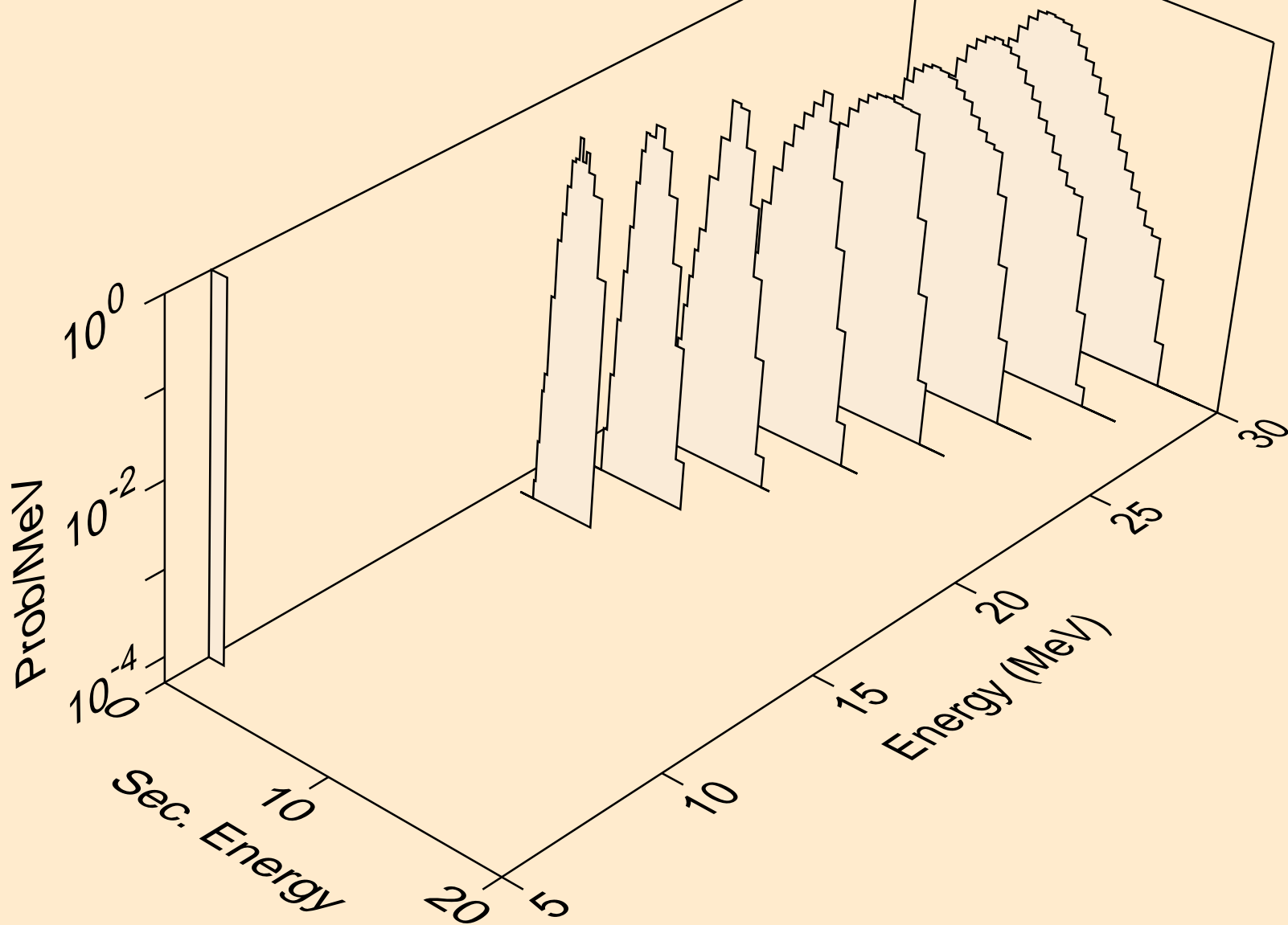

ND142 NEUTRON ACER TENDL-2021 LIBRARY; T=293.6K
tritons from (n,x)

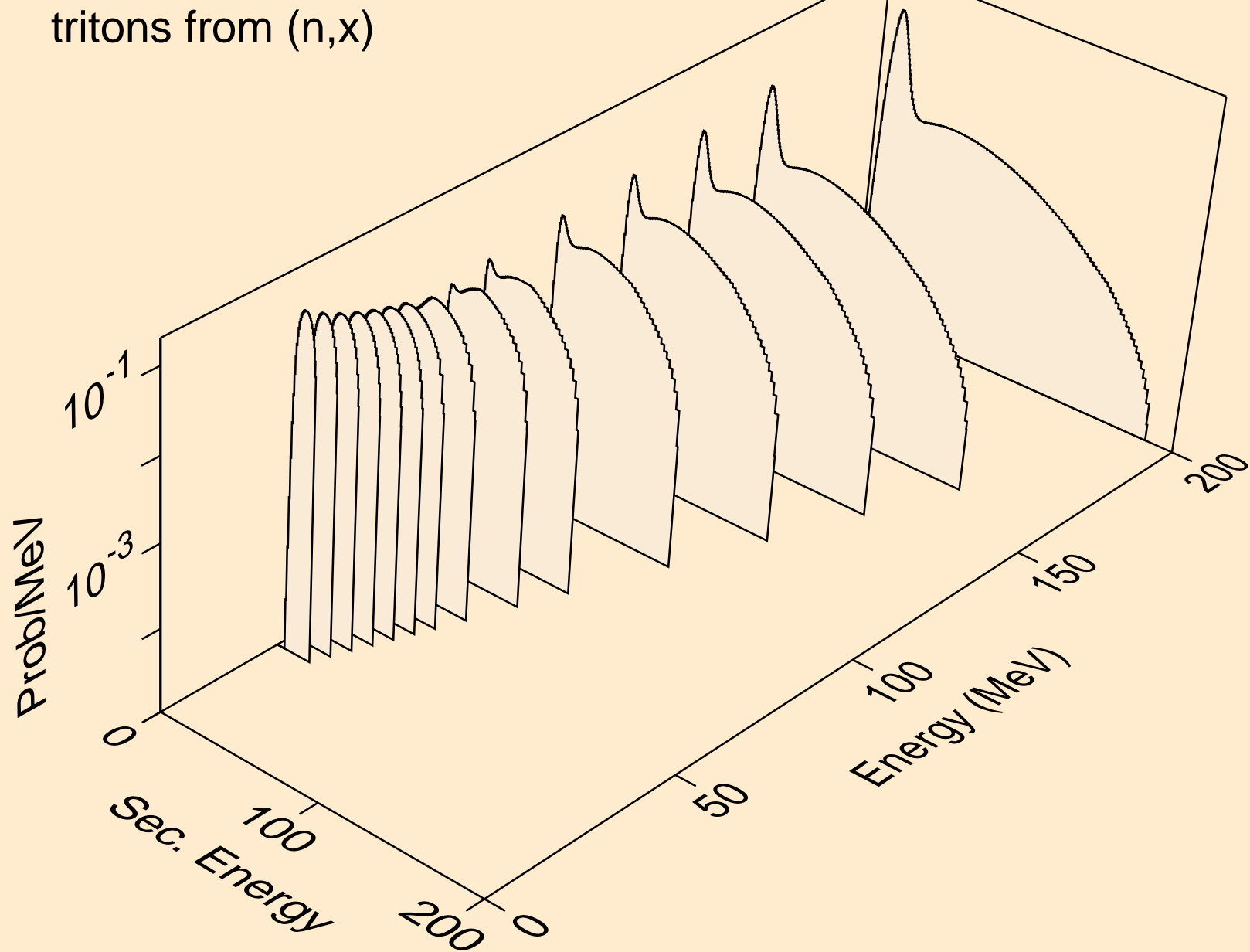

ND142 NEUTRON ACER TENDL-2021 LIBRARY; T=293.6K
tritons from (n,n*)t

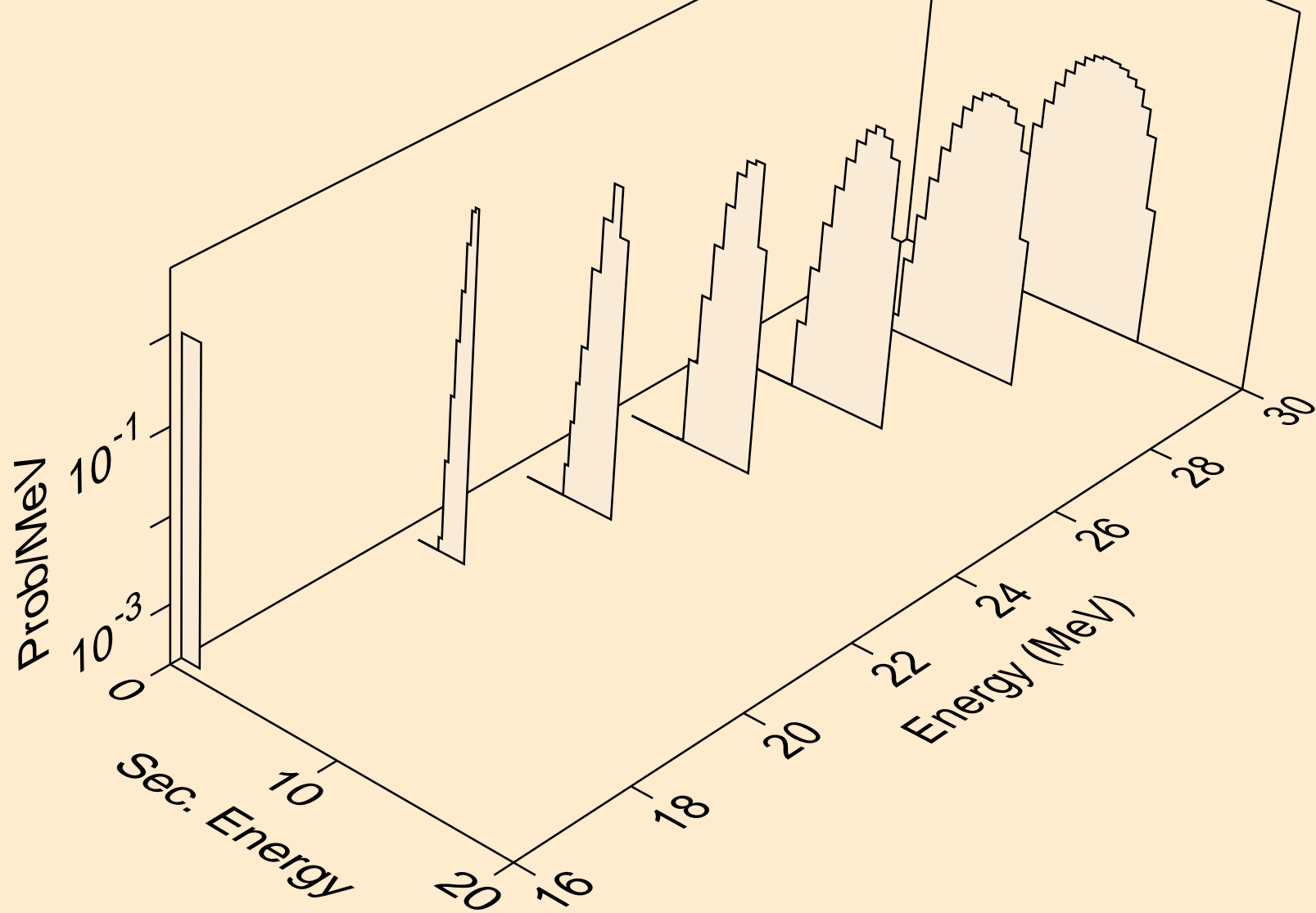

ND142 NEUTRON ACER TENDL-2021 LIBRARY; T=293.6K
tritons from (n,t)

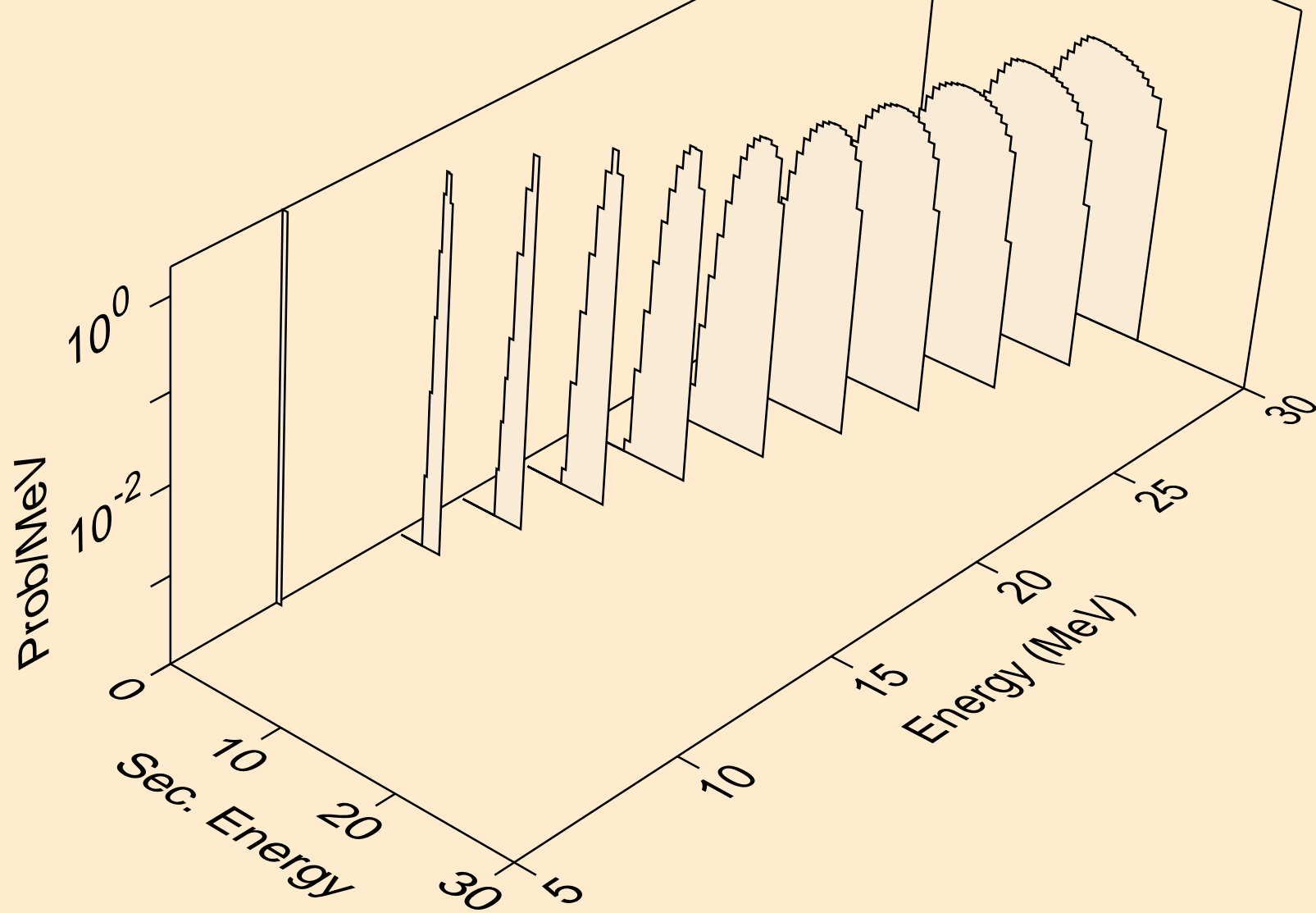

ND142 NEUTRON ACER TENDL-2021 LIBRARY; T=293.6K
tritons from (n,pt)

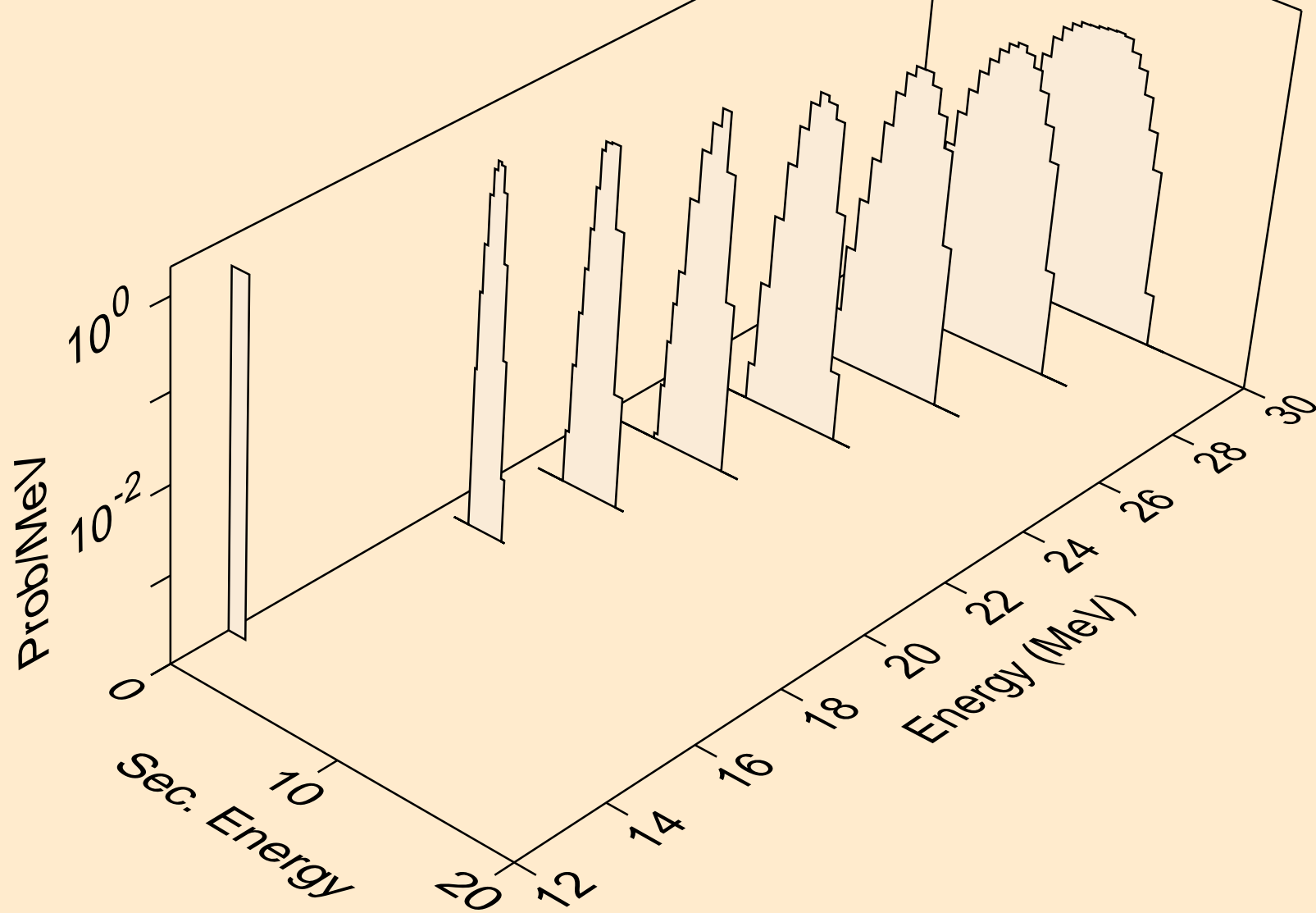

ND142 NEUTRON ACER TENDL-2021 LIBRARY; T=293.6K
he3s from (n,x)

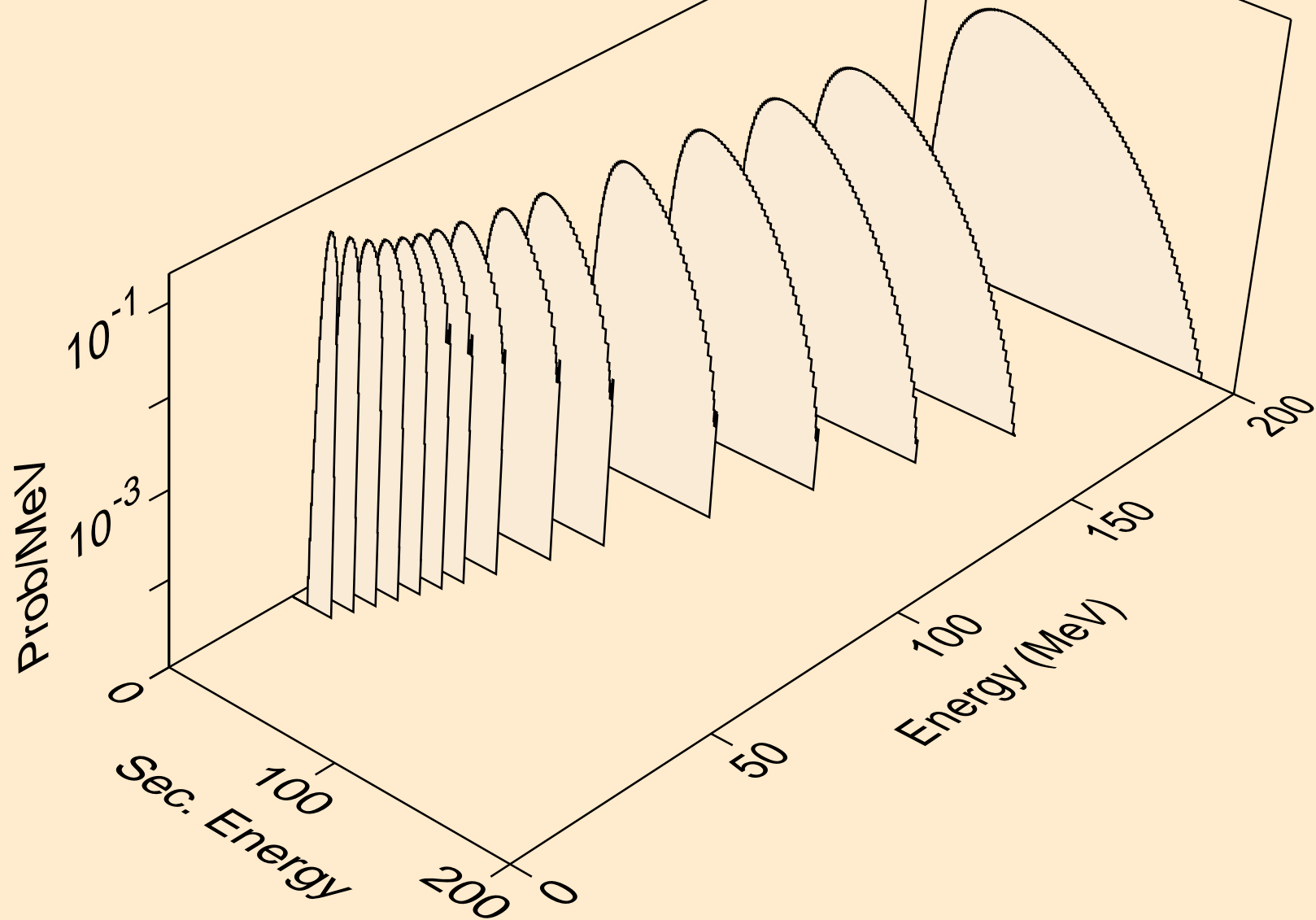

ND142 NEUTRON ACER TENDL-2021 LIBRARY; T=293.6K
he3s from (n,n*)he3

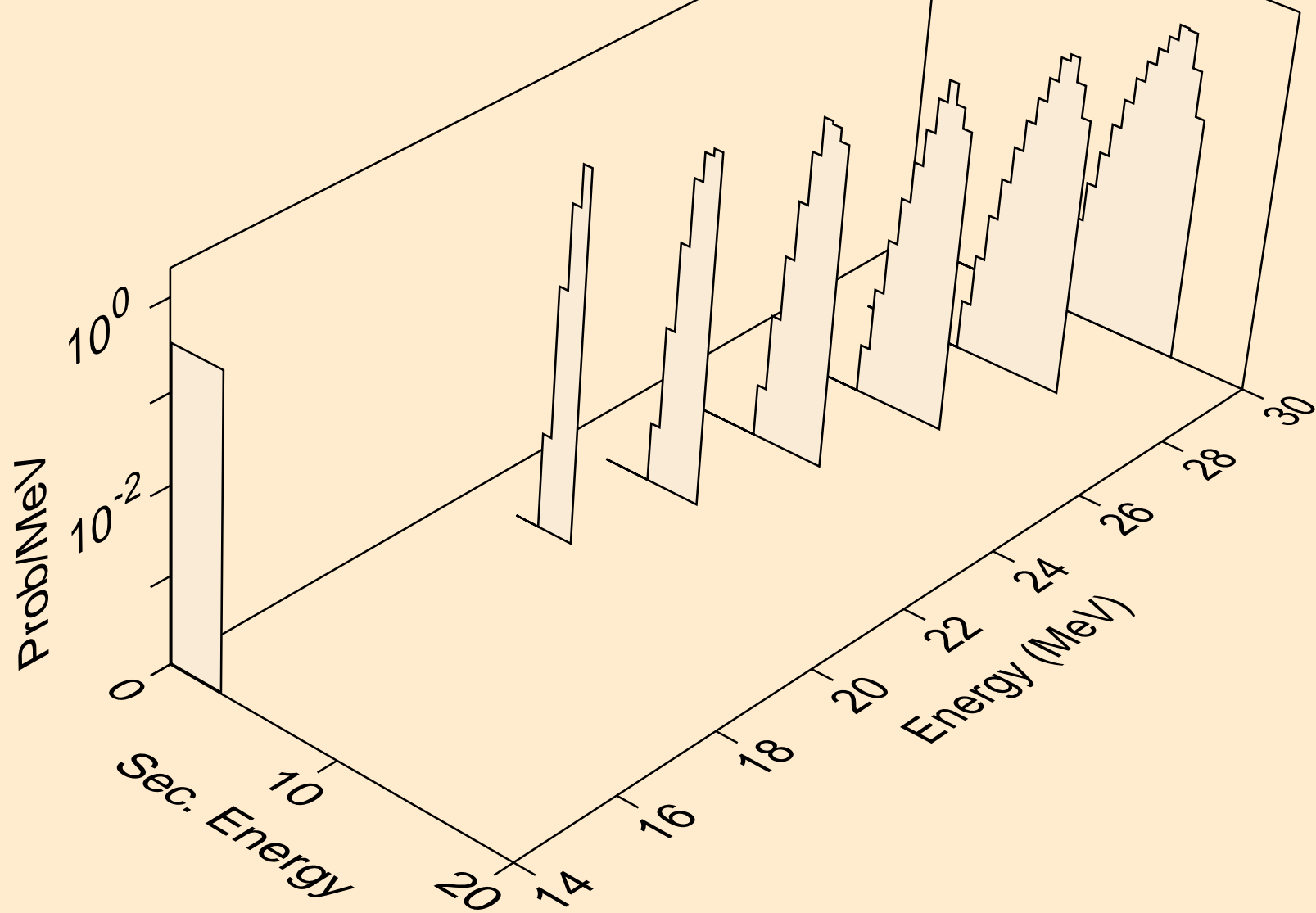

ND142 NEUTRON ACER TENDL-2021 LIBRARY; T=293.6K
he3s from (n,he3)

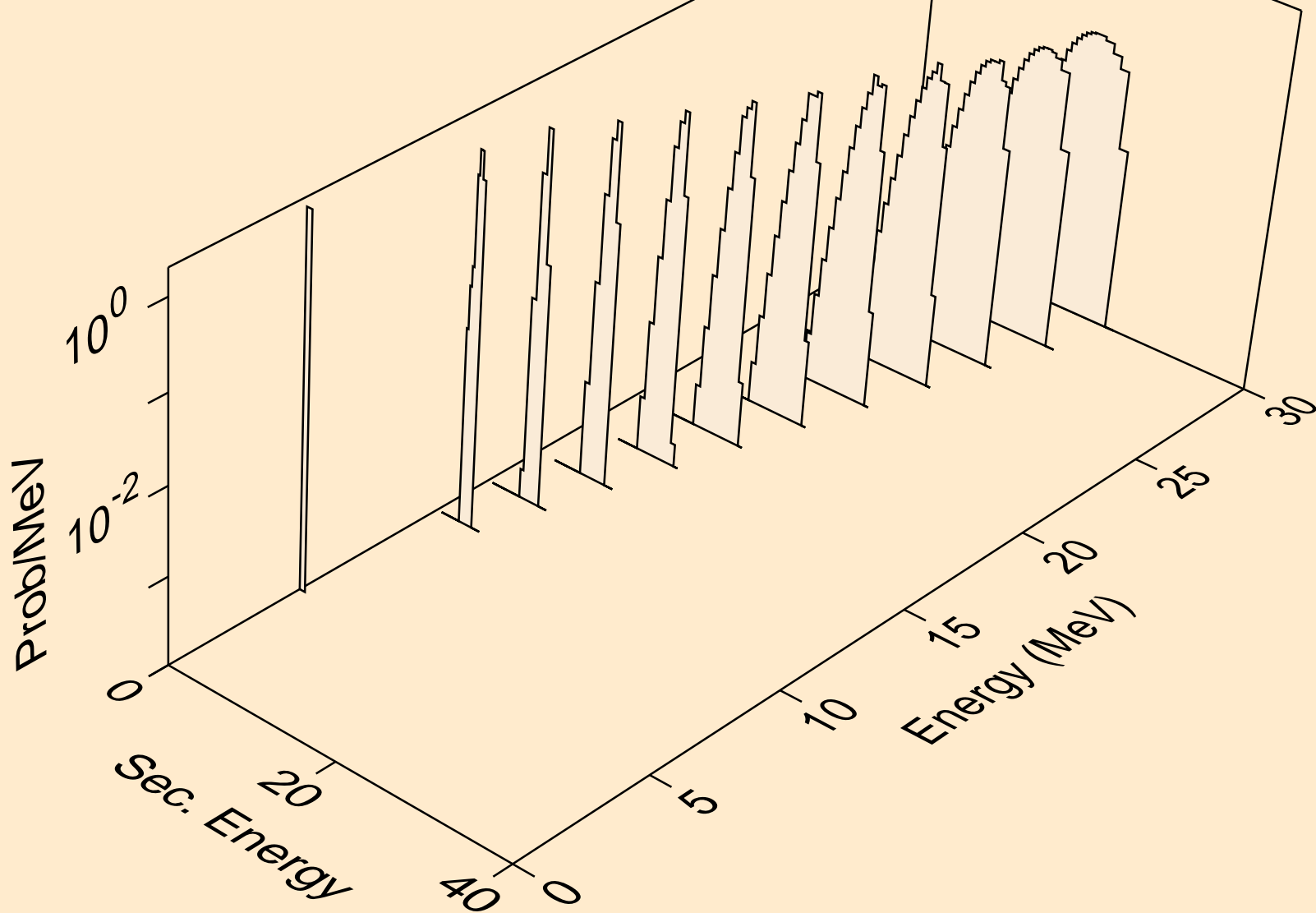

ND142 NEUTRON ACER TENDL-2021 LIBRARY; T=293.6K
alphas from (n,x)

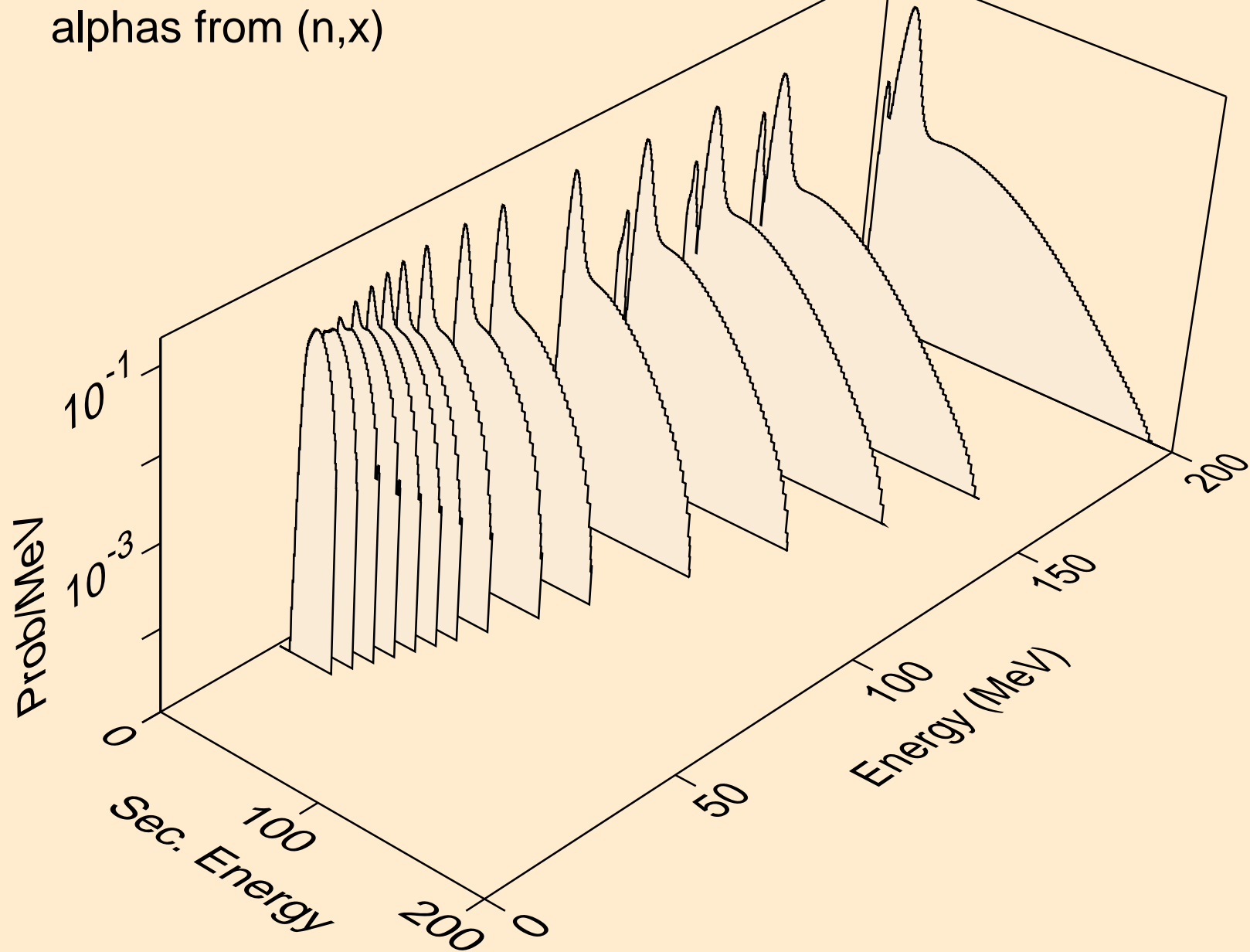

ND142 NEUTRON ACER TENDL-2021 LIBRARY; T=293.6K
alphas from (n,n*)a

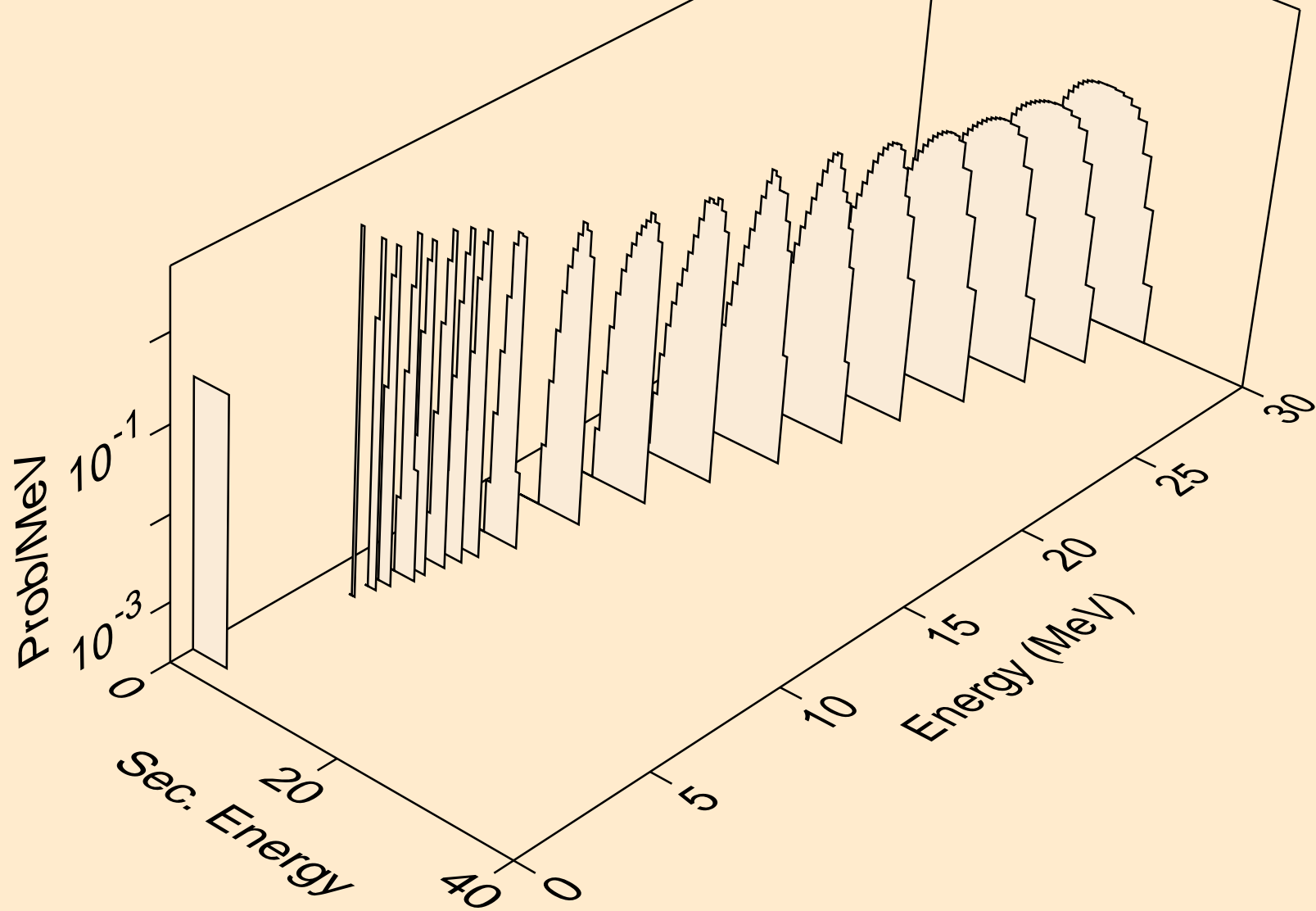

ND142 NEUTRON ACER TENDL-2021 LIBRARY; T=293.6K
alphas from (n,2n)a

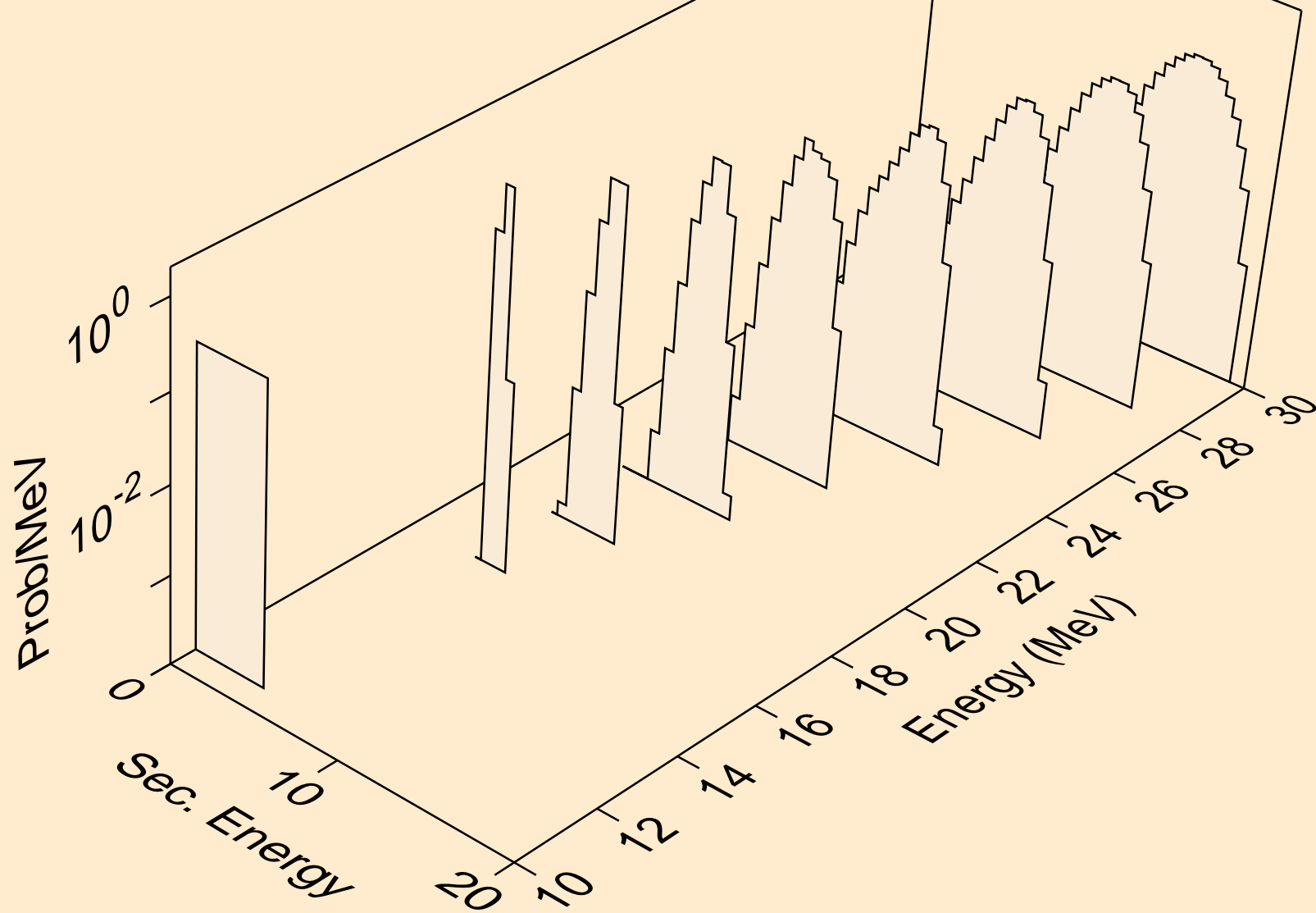

ND142 NEUTRON ACER TENDL-2021 LIBRARY; T=293.6K
alphas from (n,3n)a

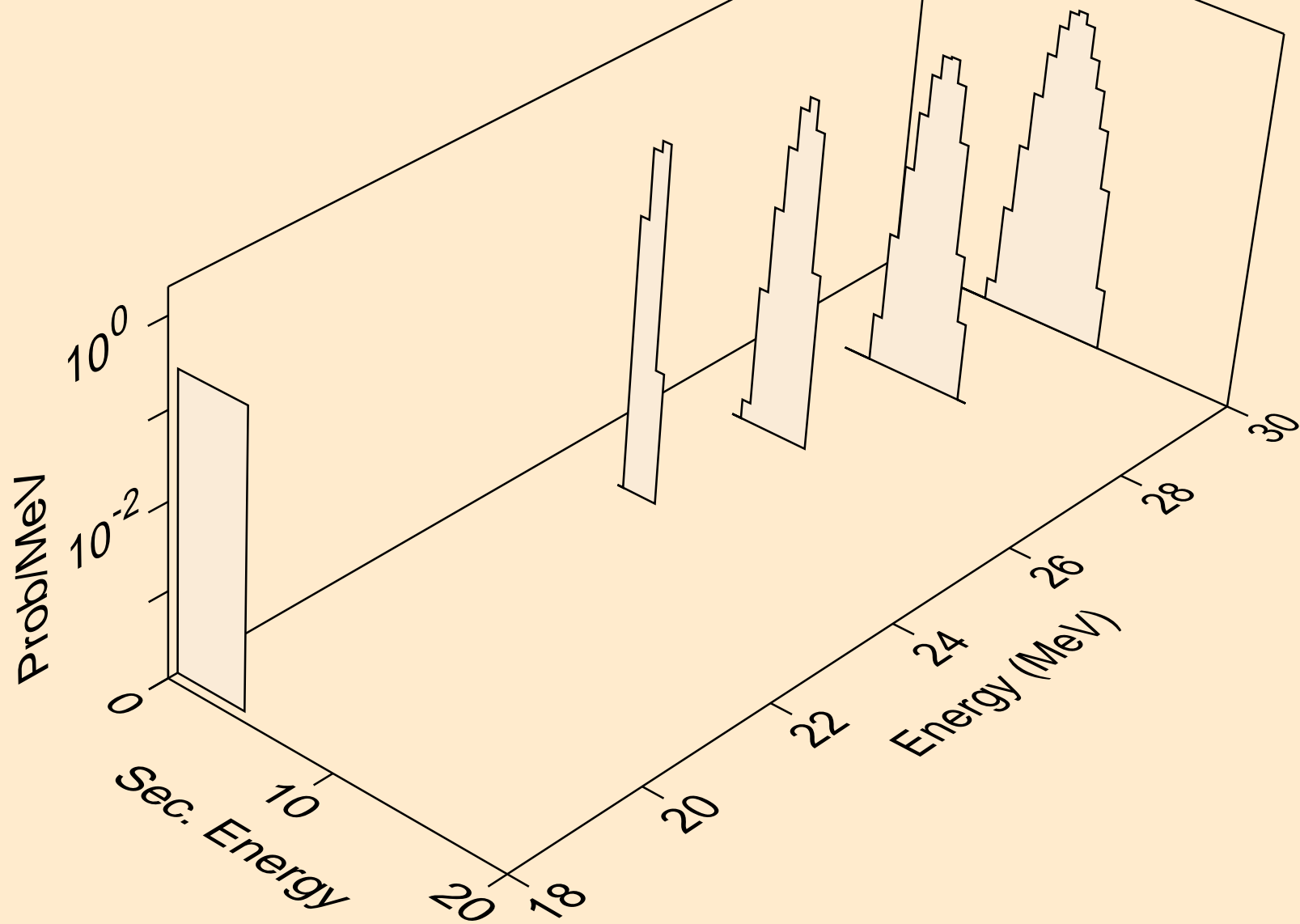

ND142 NEUTRON ACER TENDL-2021 LIBRARY; T=293.6K
alphas from (n,n*)2a

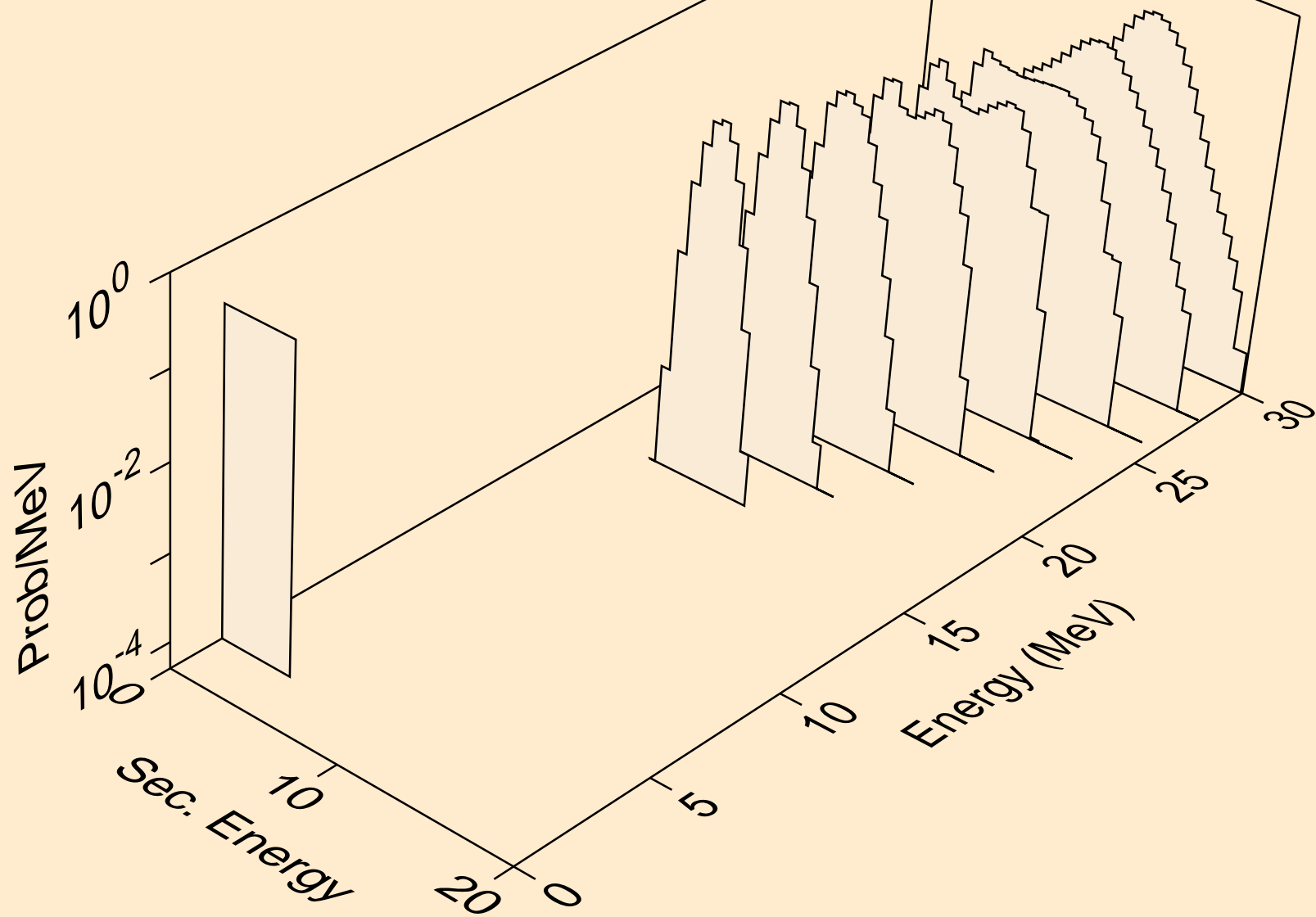

ND142 NEUTRON ACER TENDL-2021 LIBRARY; T=293.6K
alphas from (n,npa)

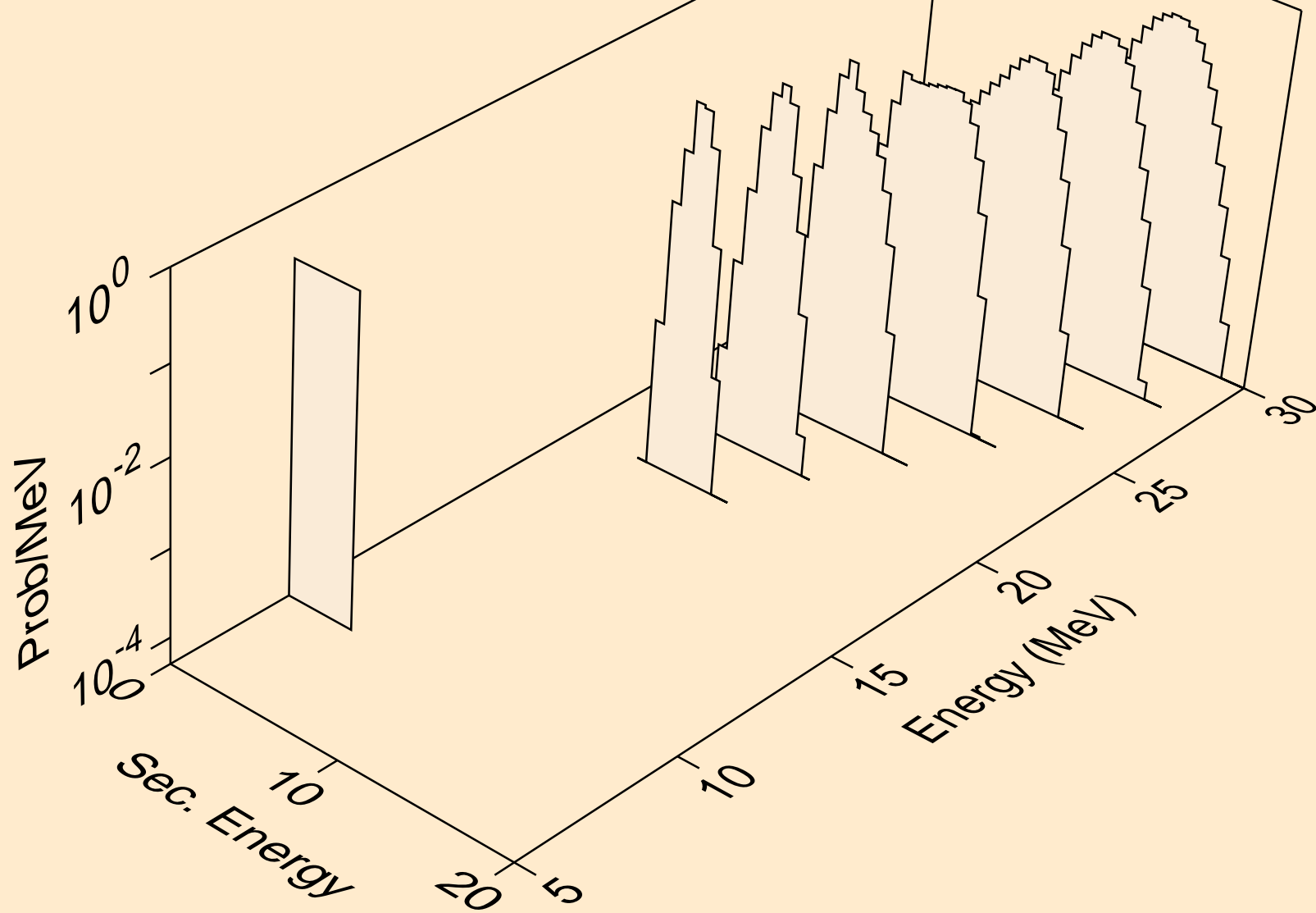

ND142 NEUTRON ACER TENDL-2021 LIBRARY; T=293.6K
alphas from (n,a)

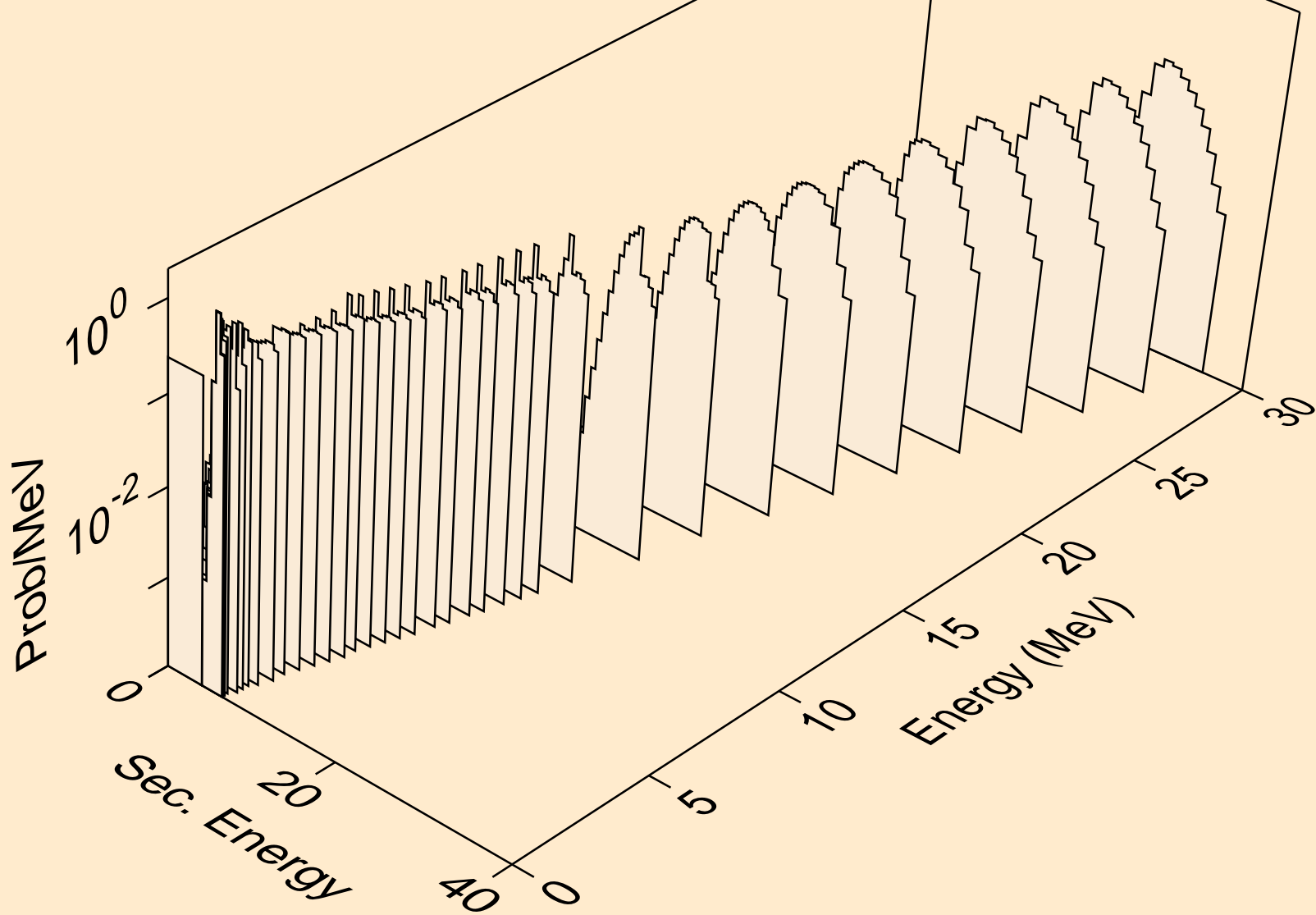

ND142 NEUTRON ACER TENDL-2021 LIBRARY; T=293.6K
alphas from (n,2a)

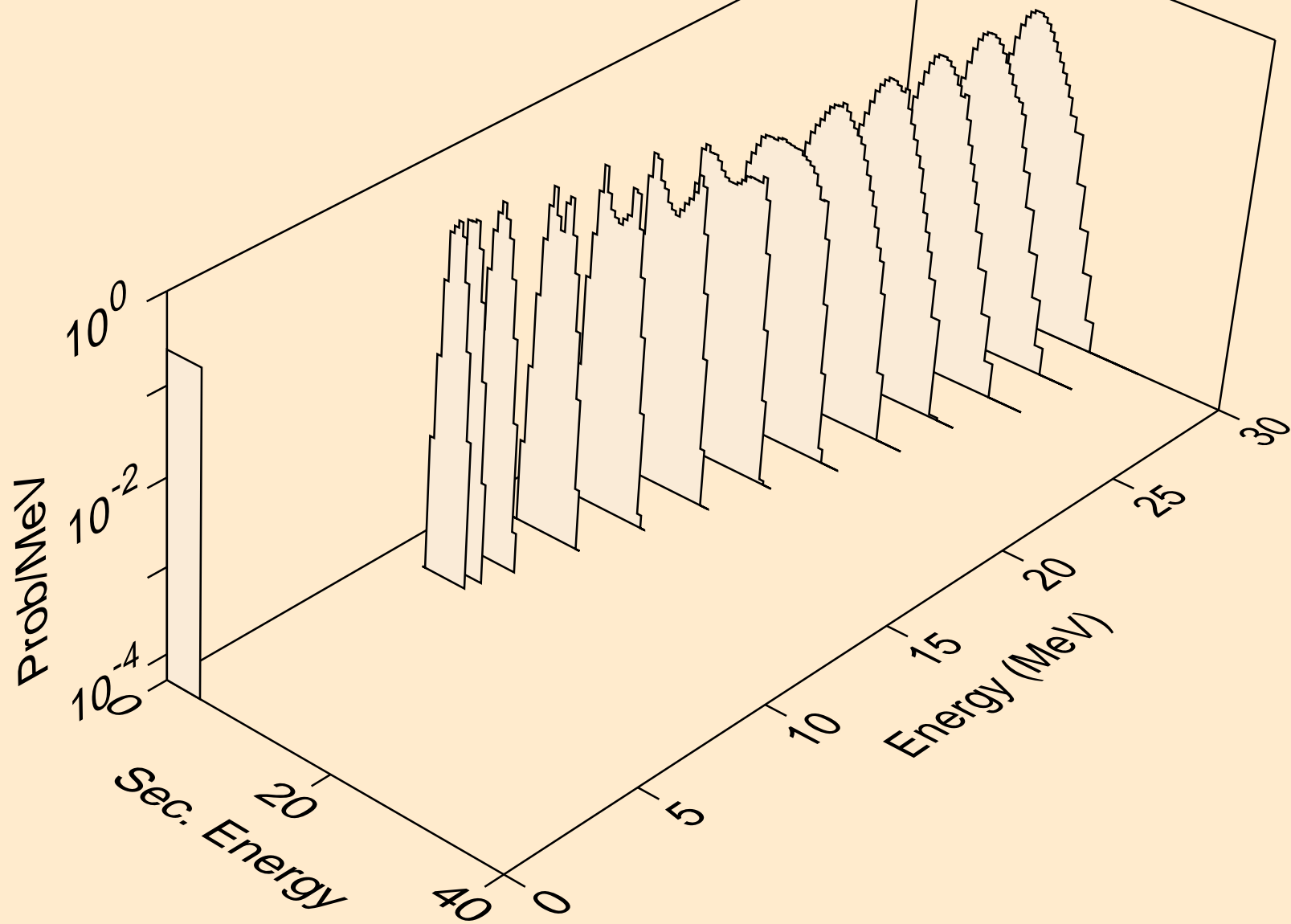

ND142 NEUTRON ACER TENDL-2021 LIBRARY; T=293.6K
alphas from (n,pa)

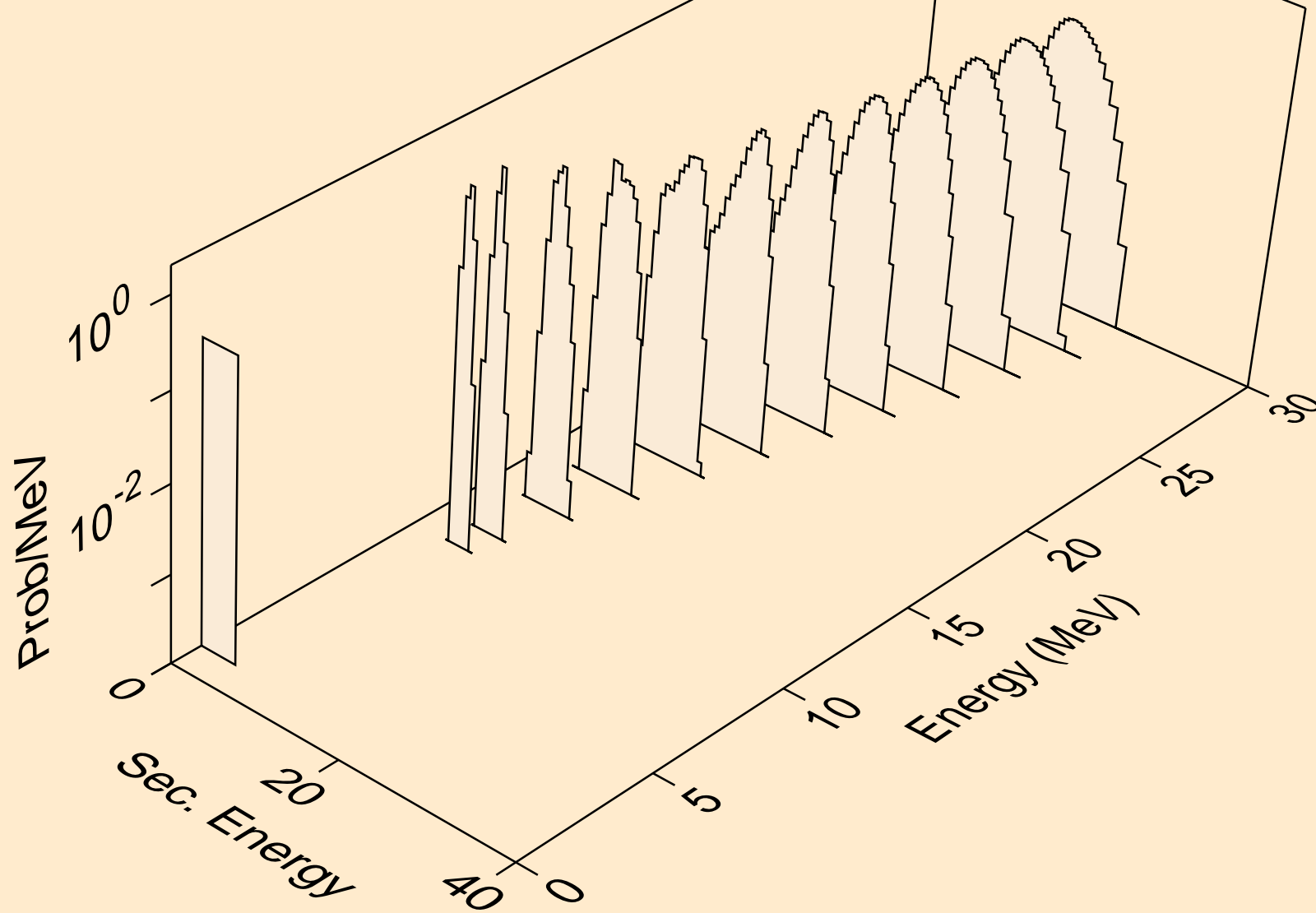

ND142 NEUTRON ACER TENDL-2021 LIBRARY; T=293.6K
alphas from (n,da)

