

NE024 NEUTRON ACER TENDL-2021 LIBRARY; T=293.6K
Principal cross sections

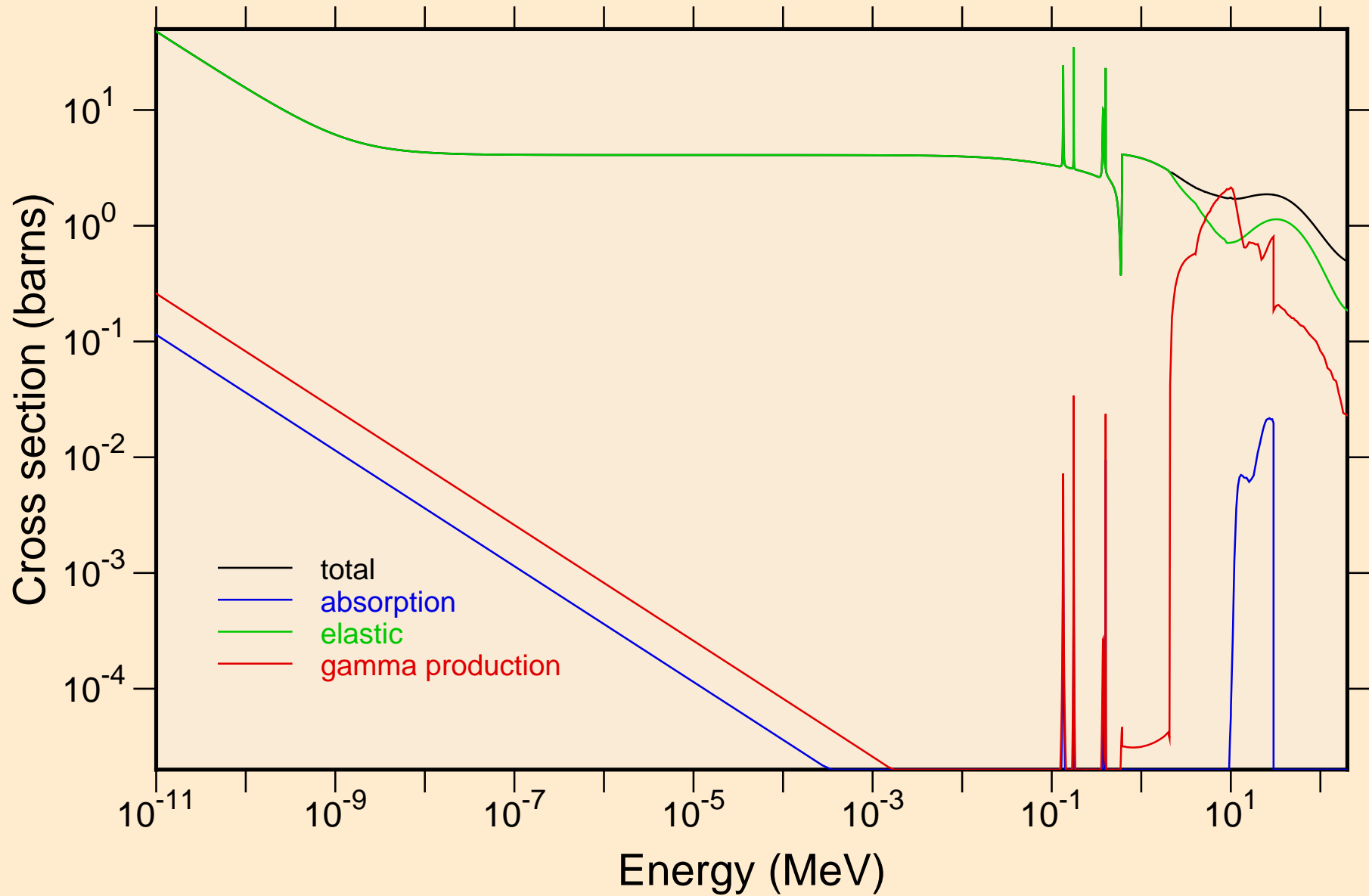

NE024 NEUTRON ACER TENDL-2021 LIBRARY; T=293.6K
Heating

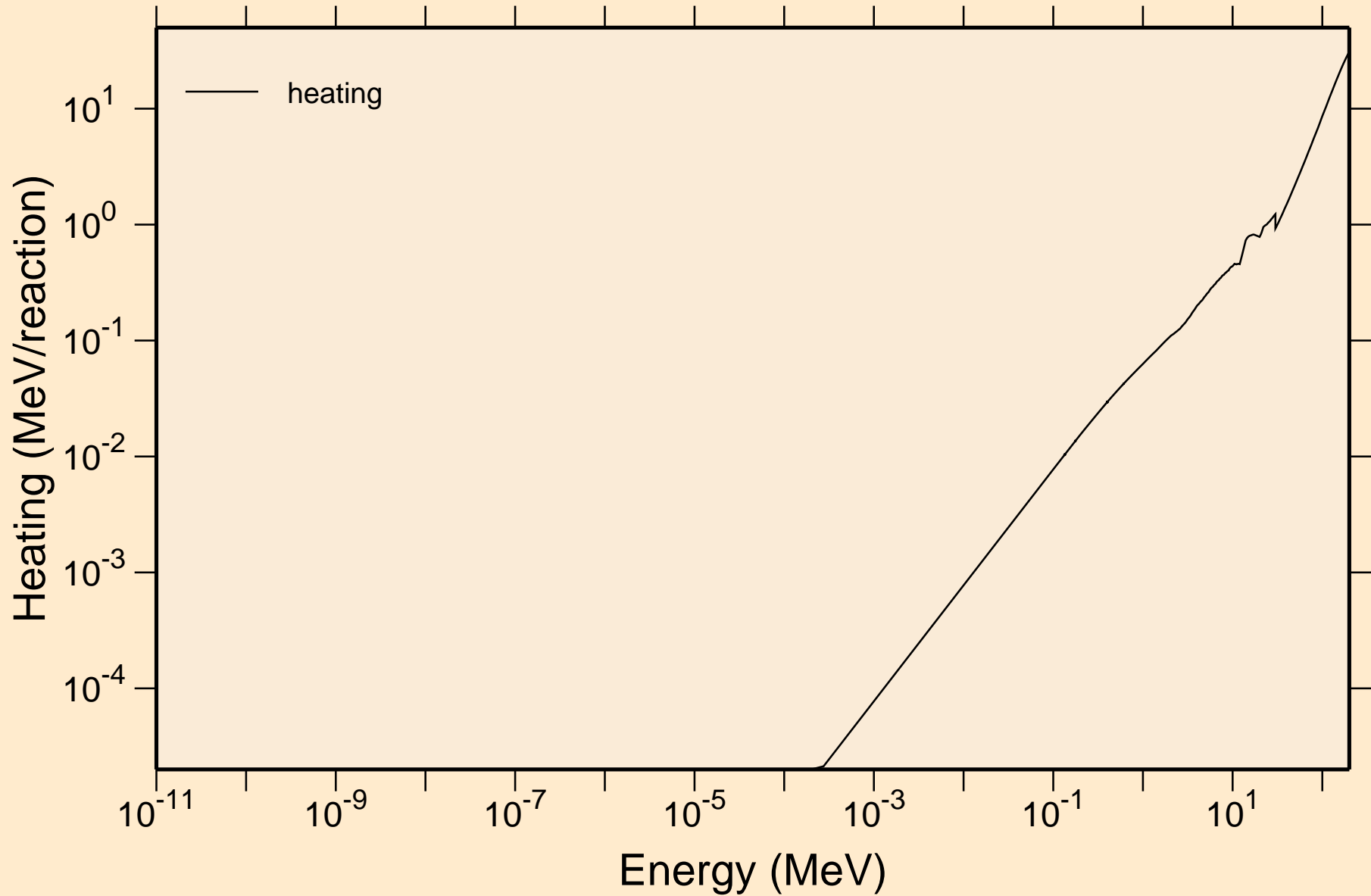

NE024 NEUTRON ACER TENDL-2021 LIBRARY; T=293.6K
Damage

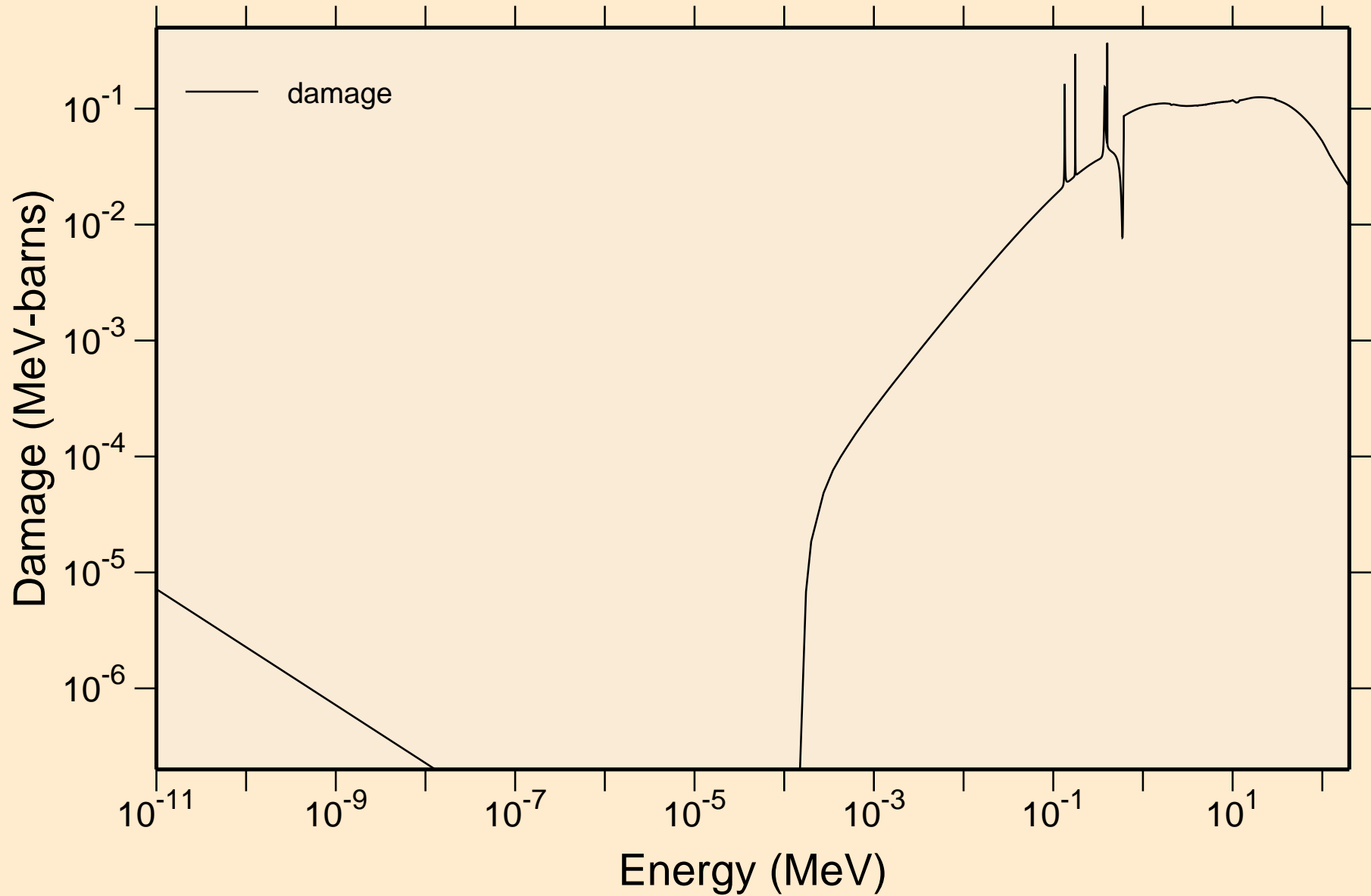

NE024 NEUTRON ACER TENDL-2021 LIBRARY; T=293.6K
Non-threshold reactions

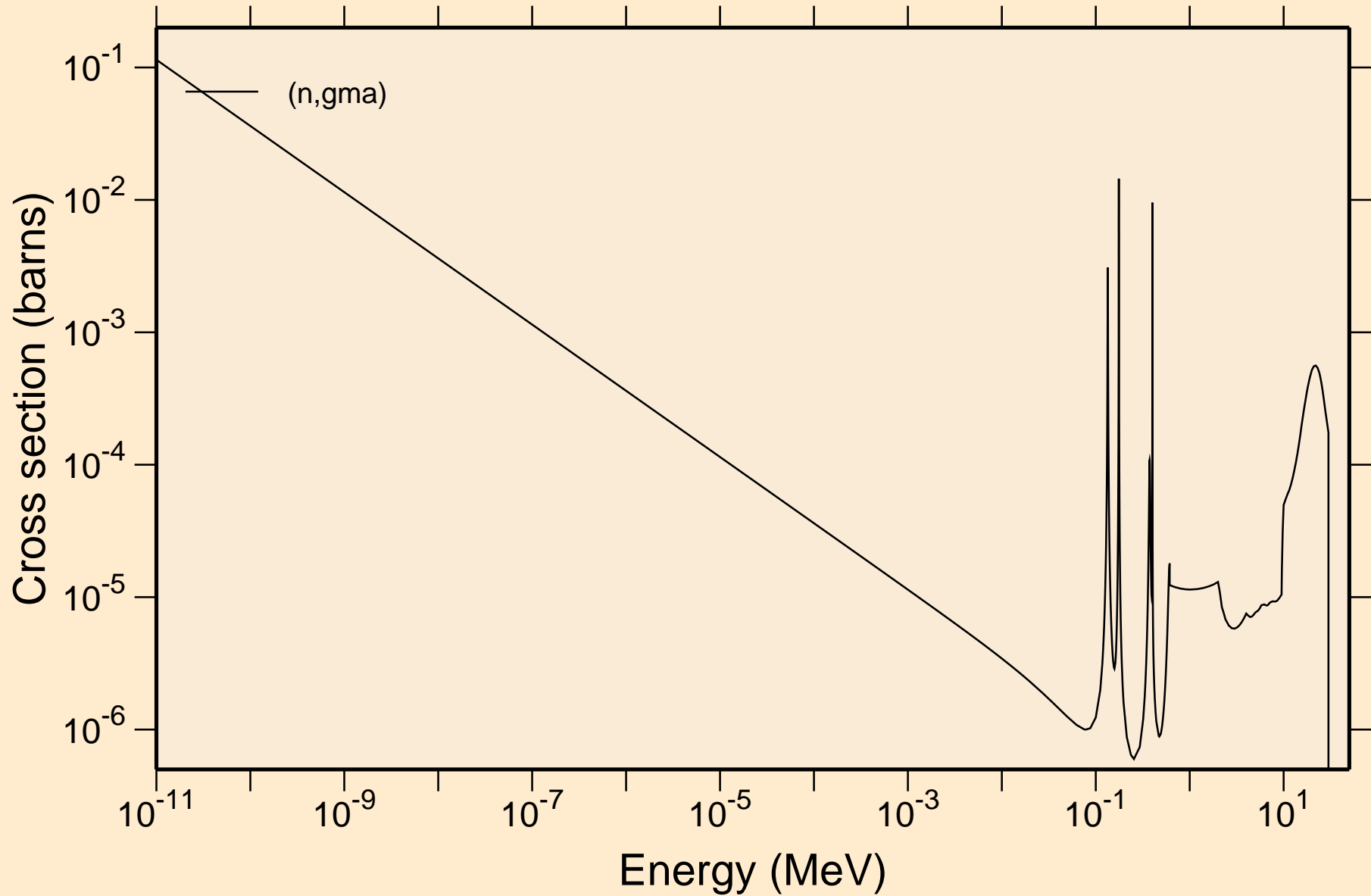

NE024 NEUTRON ACER TENDL-2021 LIBRARY; T=293.6K
Principal cross sections

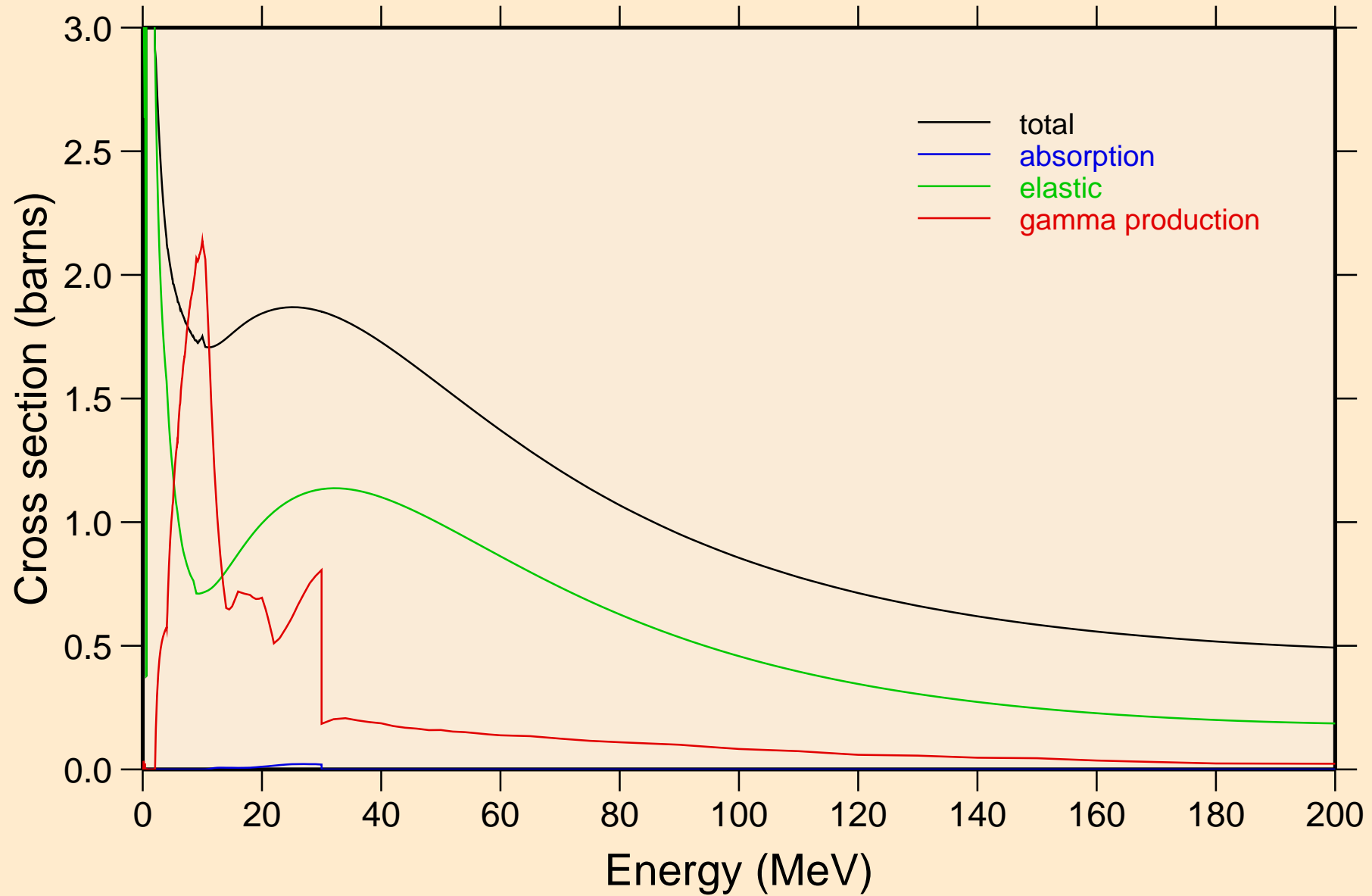

NE024 NEUTRON ACER TENDL-2021 LIBRARY; T=293.6K
Heating

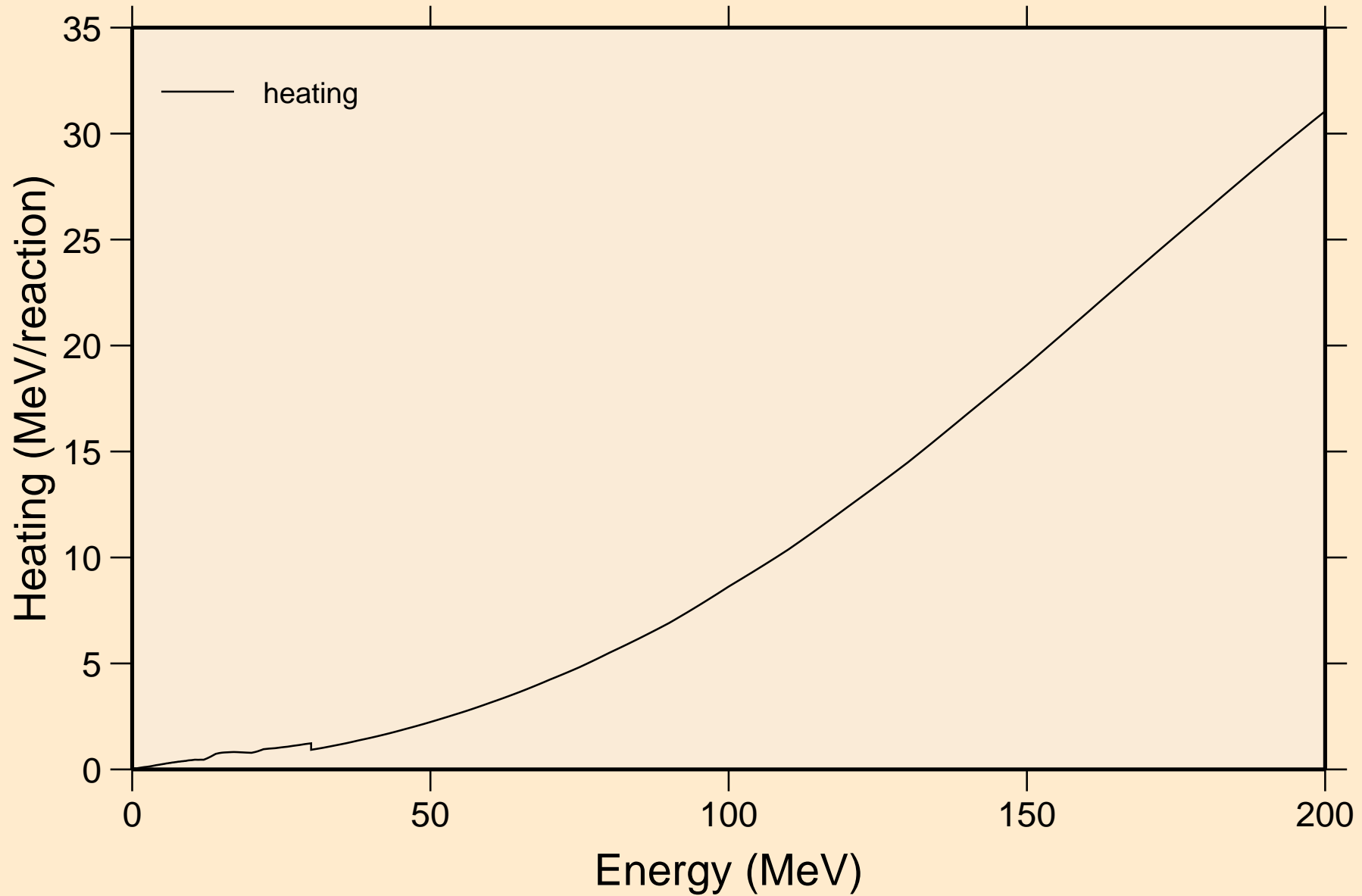

NE024 NEUTRON ACER TENDL-2021 LIBRARY; T=293.6K
Damage

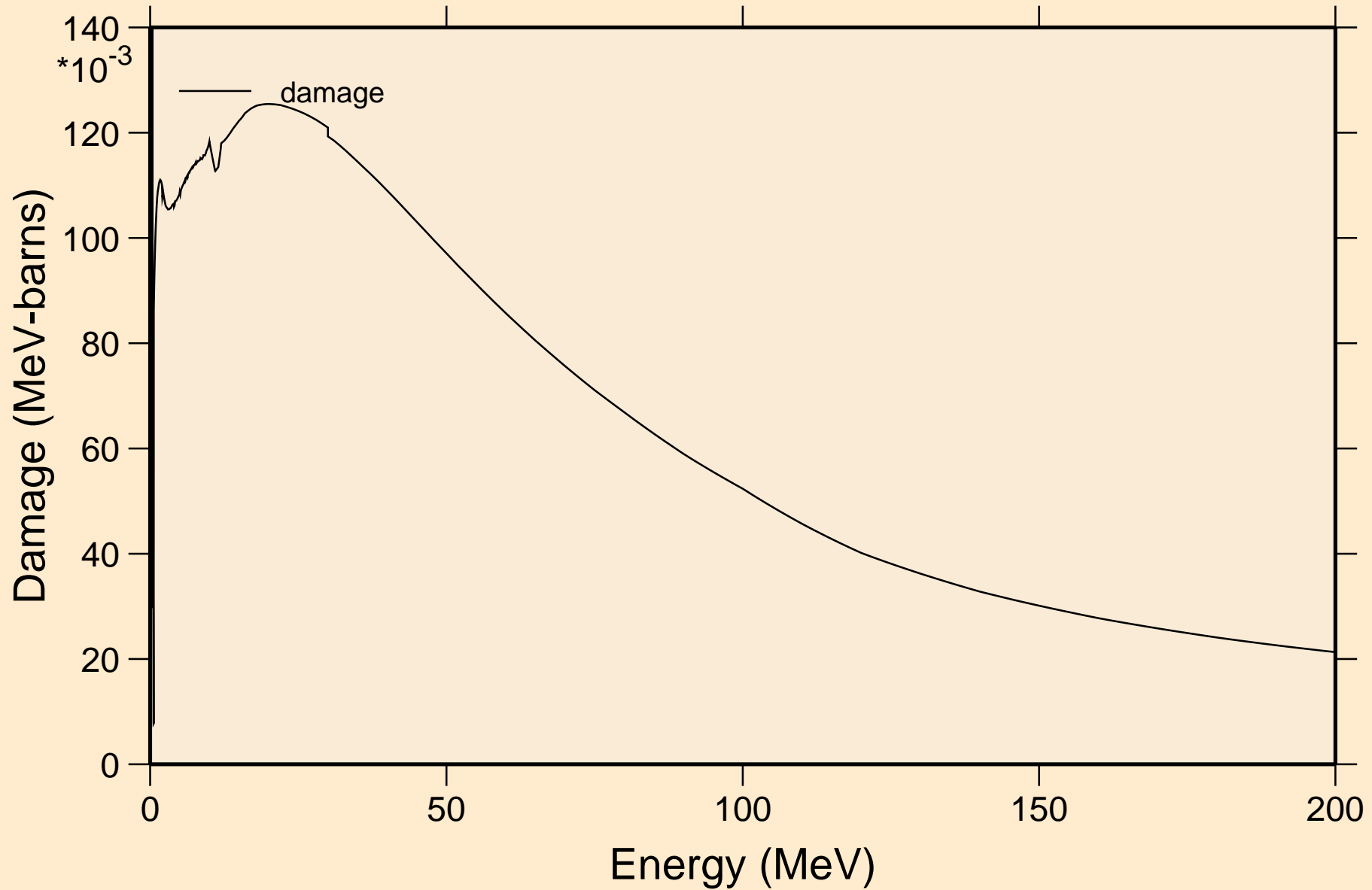

NE024 NEUTRON ACER TENDL-2021 LIBRARY; T=293.6K
Non-threshold reactions

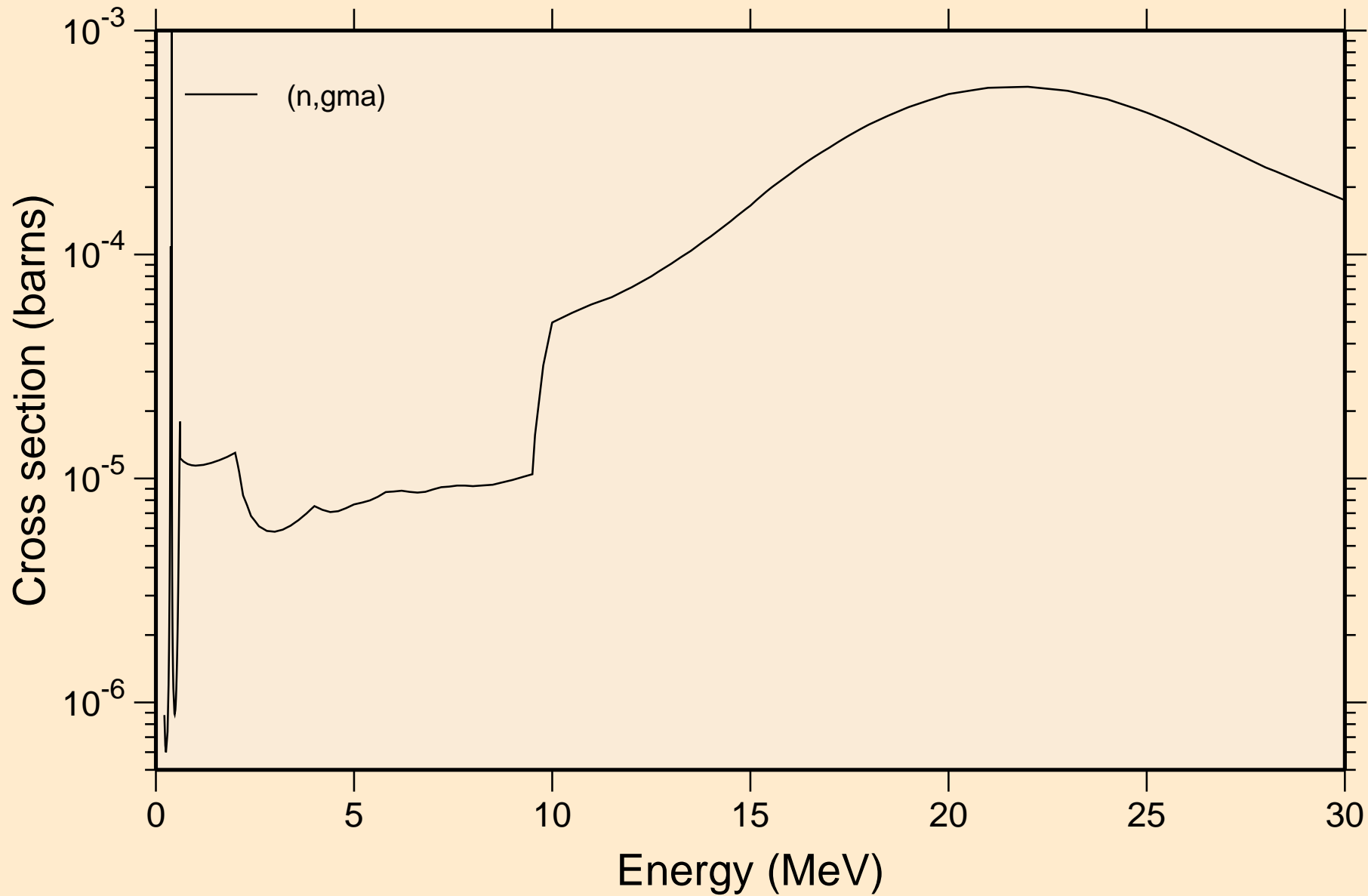

NE024 NEUTRON ACER TENDL-2021 LIBRARY; T=293.6K
Inelastic levels

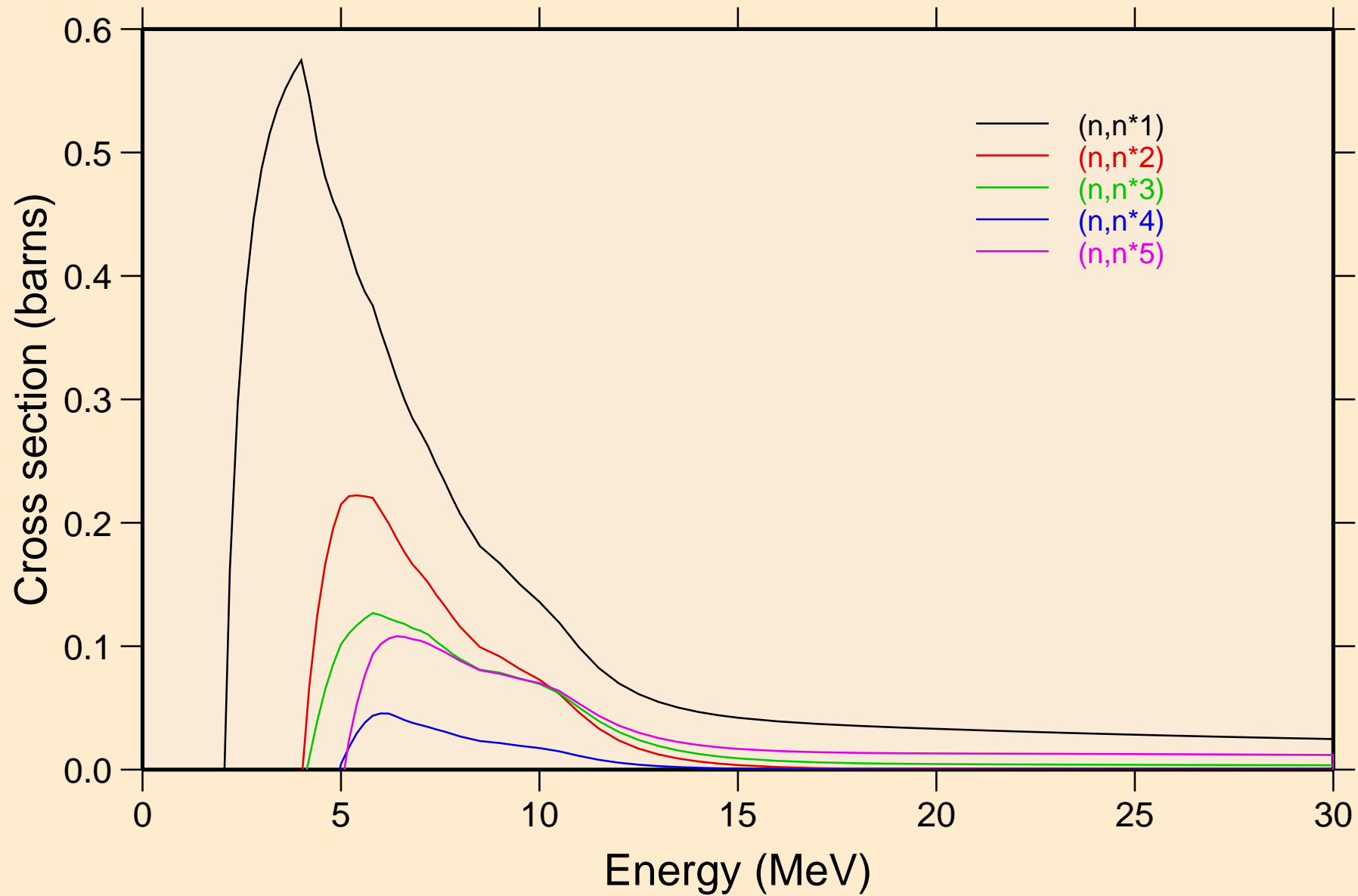

NE024 NEUTRON ACER TENDL-2021 LIBRARY; T=293.6K
Inelastic levels

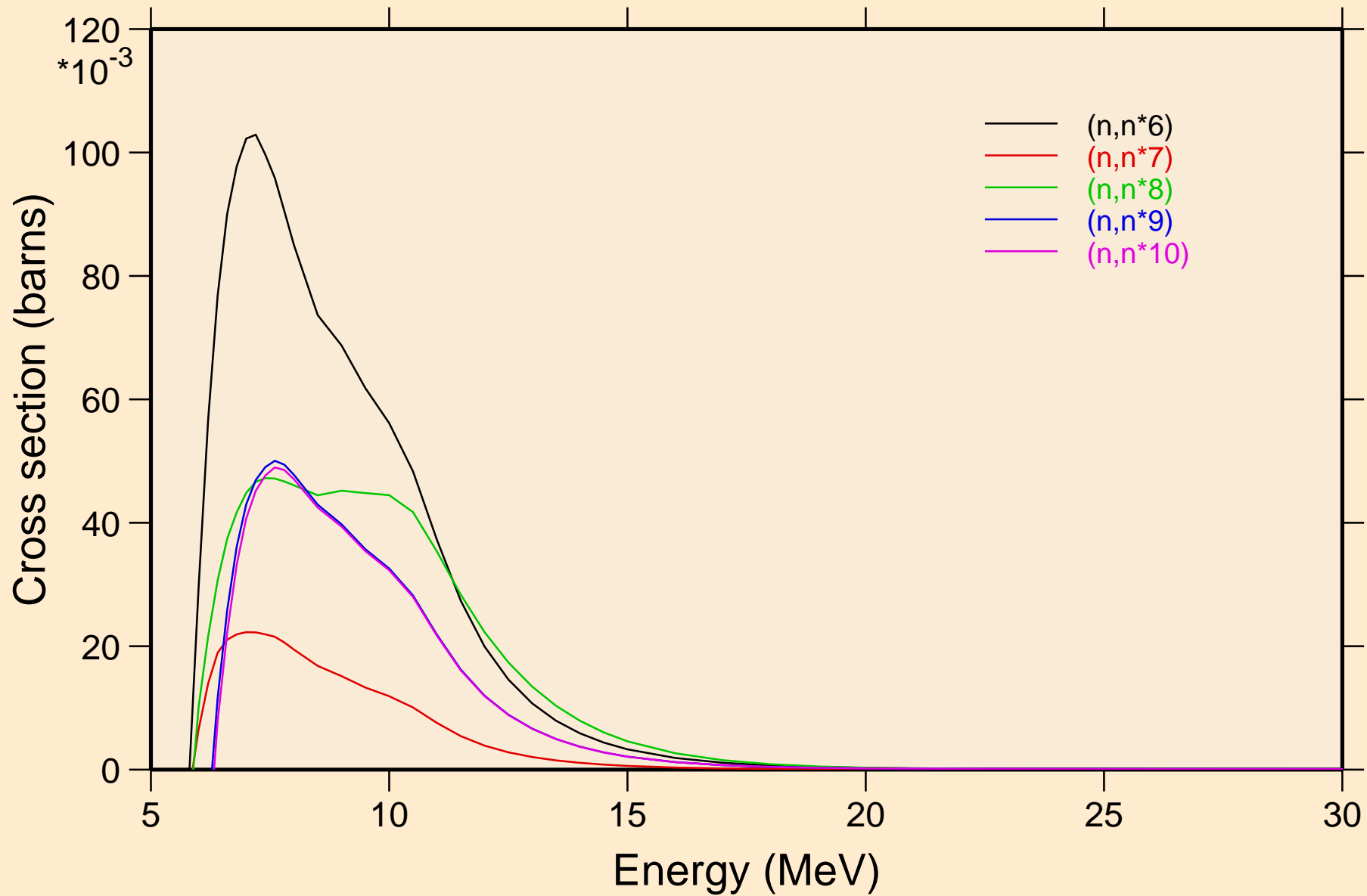

NE024 NEUTRON ACER TENDL-2021 LIBRARY; T=293.6K
Inelastic levels

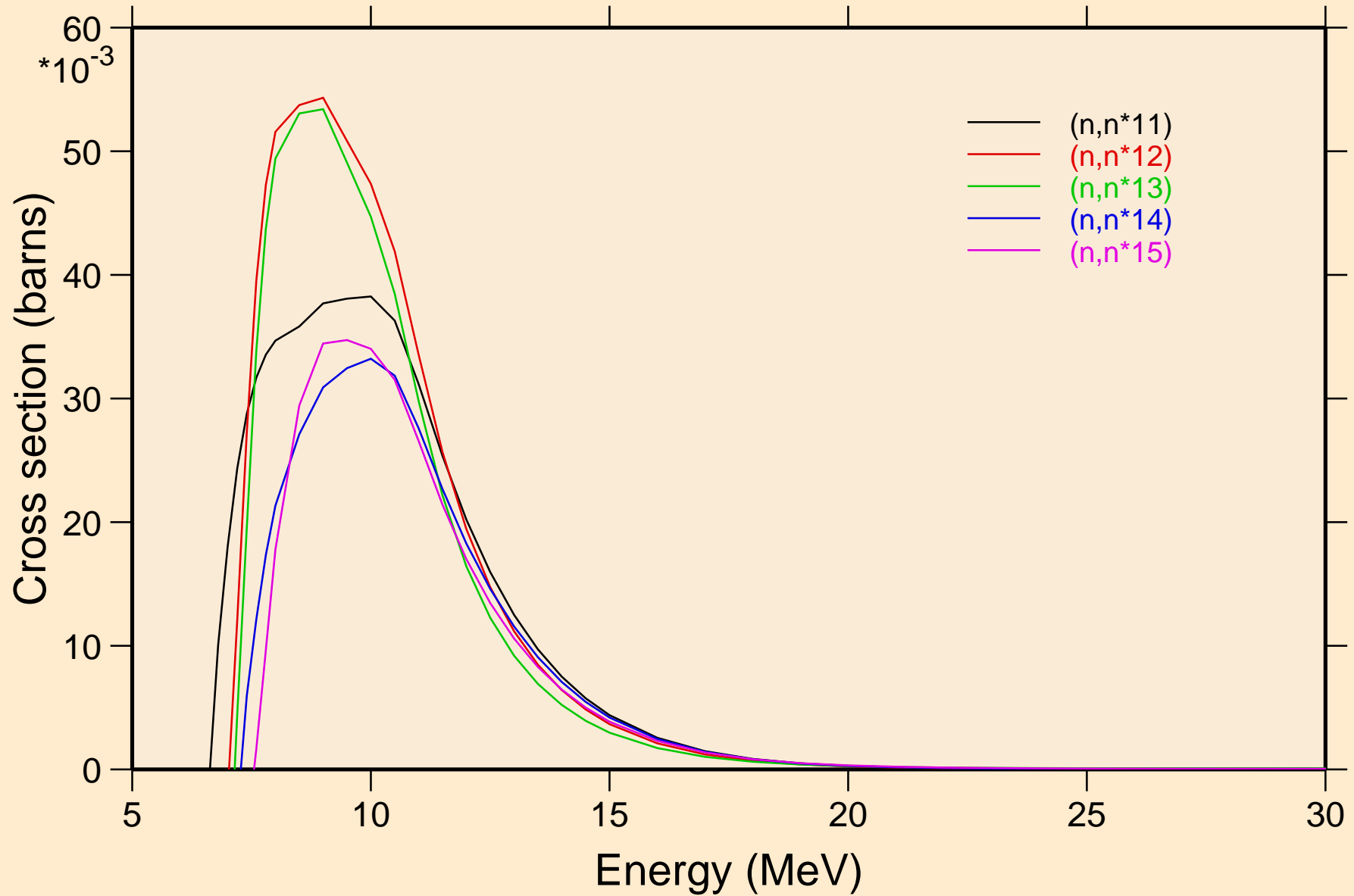

NE024 NEUTRON ACER TENDL-2021 LIBRARY; T=293.6K
Inelastic levels

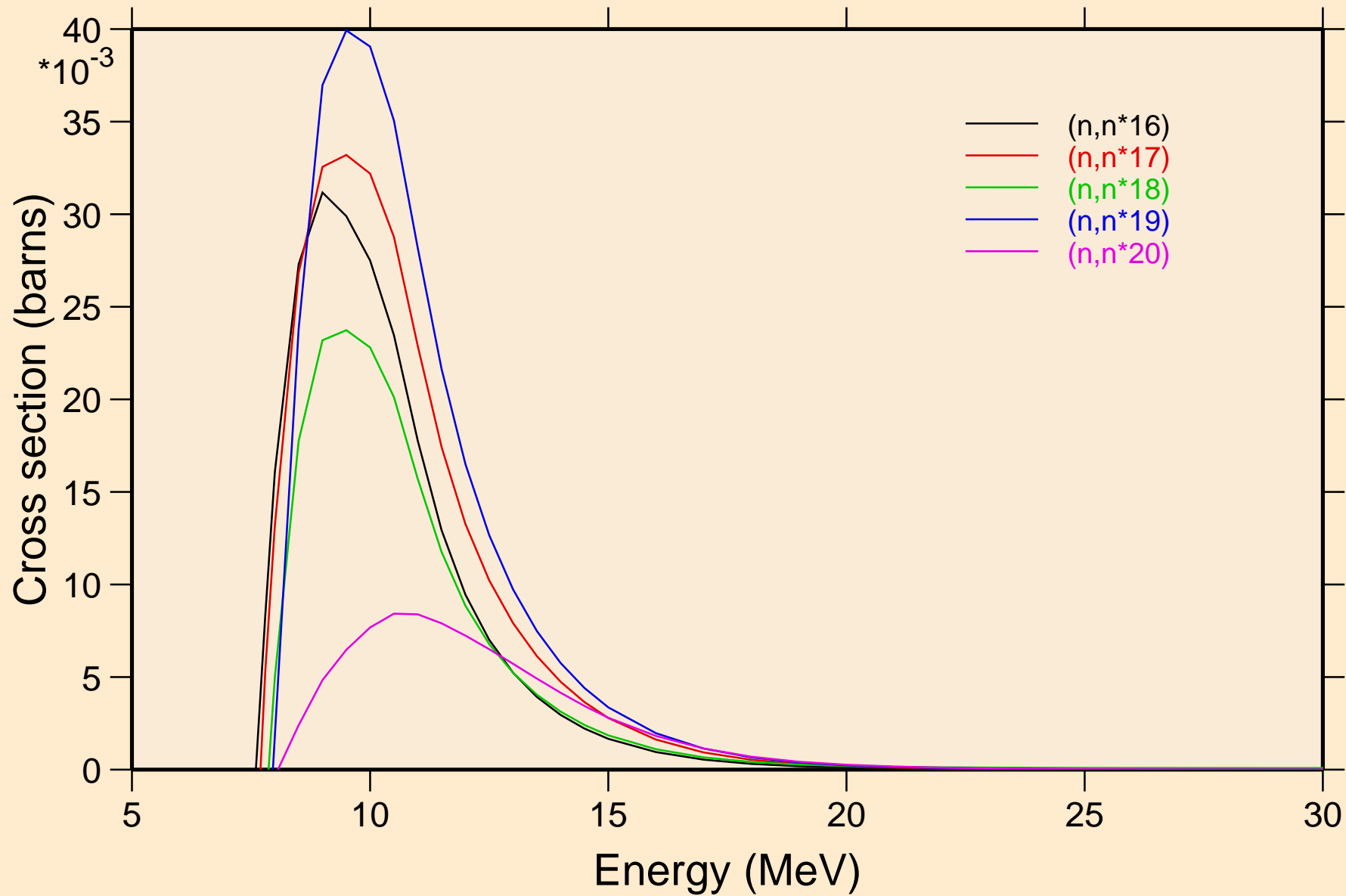

NE024 NEUTRON ACER TENDL-2021 LIBRARY; T=293.6K
Inelastic levels

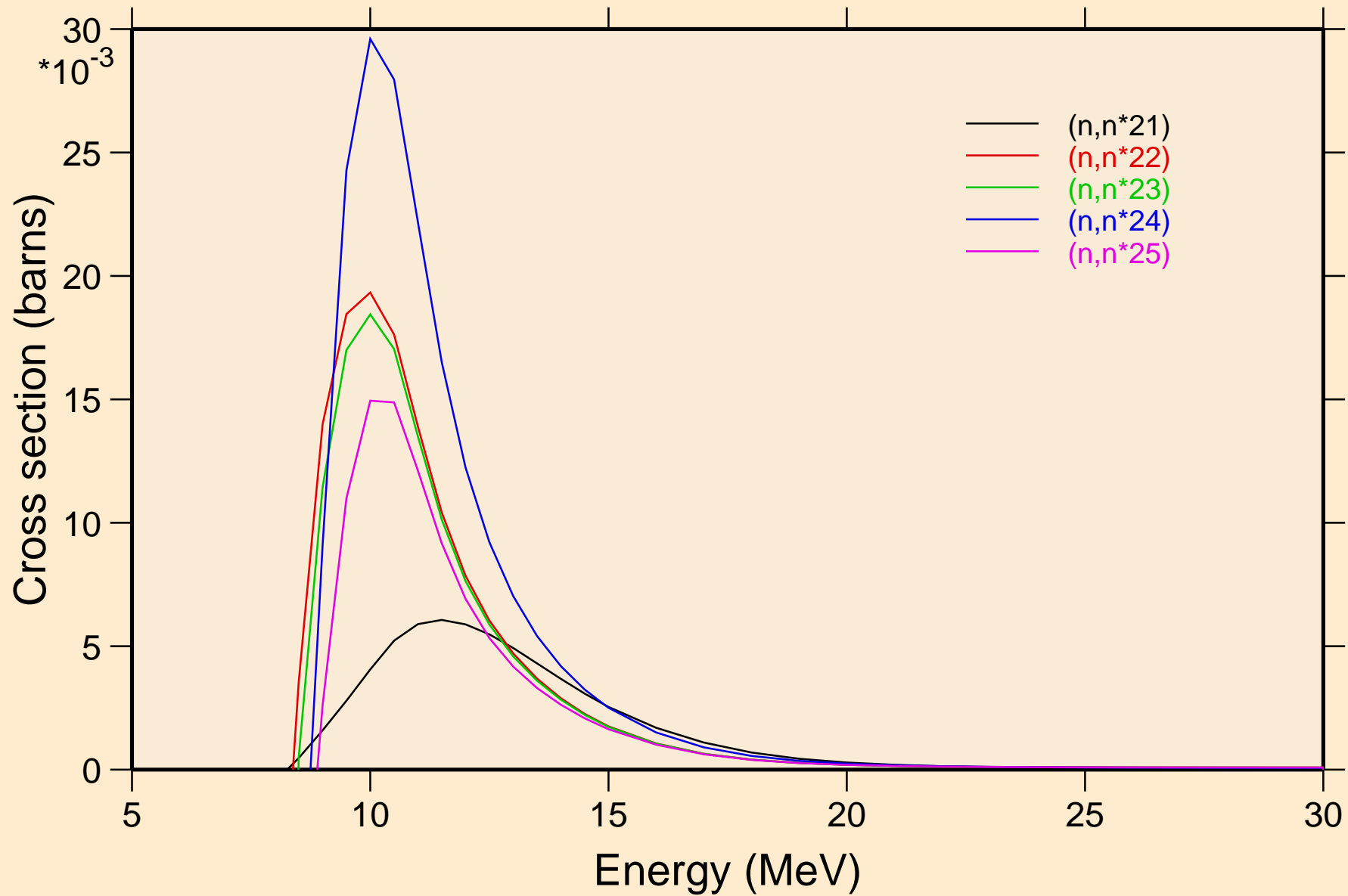

NE024 NEUTRON ACER TENDL-2021 LIBRARY; T=293.6K
Inelastic levels

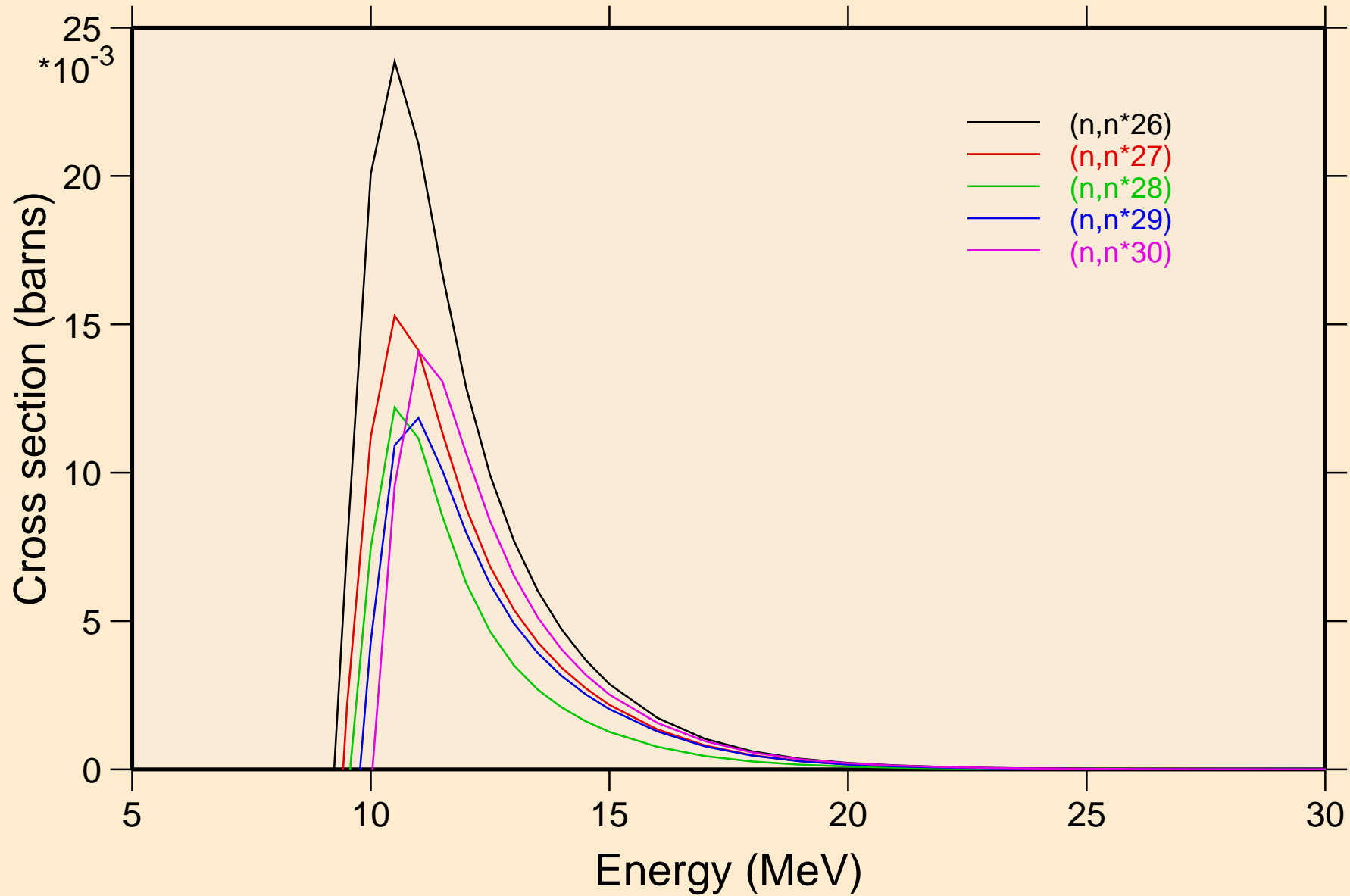

NE024 NEUTRON ACER TENDL-2021 LIBRARY; T=293.6K
Threshold reactions

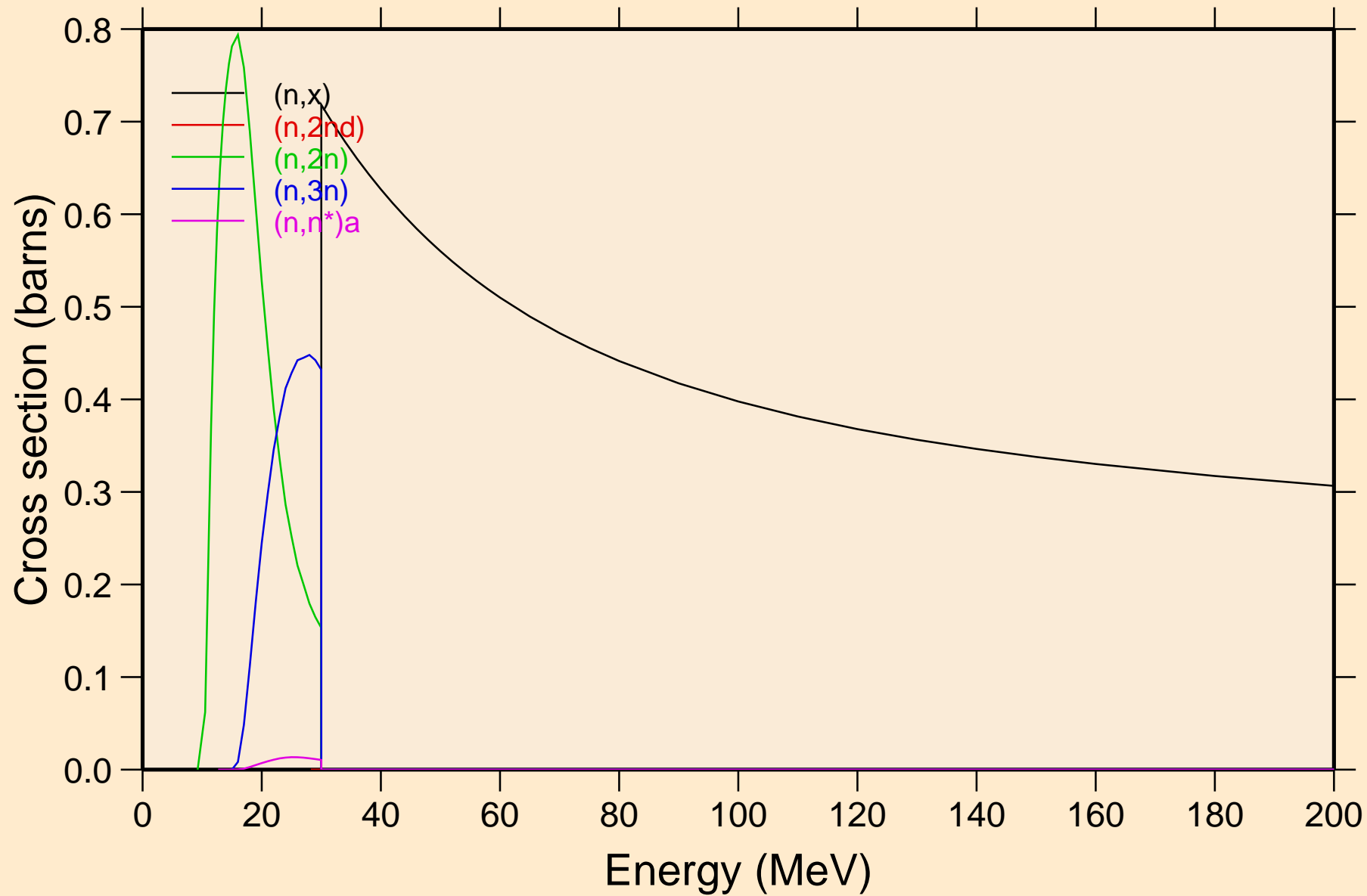

NE024 NEUTRON ACER TENDL-2021 LIBRARY; T=293.6K
Threshold reactions

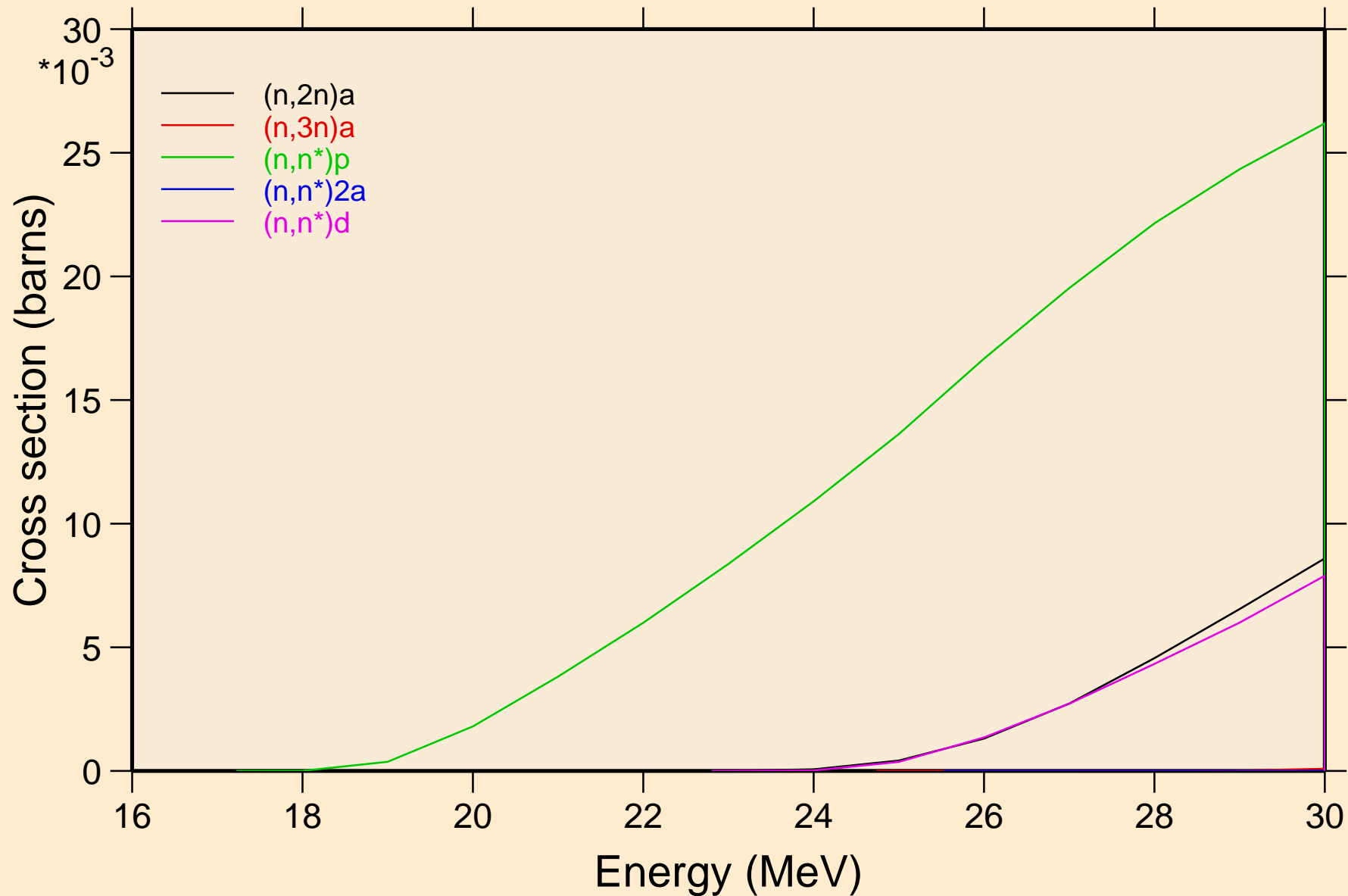

NE024 NEUTRON ACER TENDL-2021 LIBRARY; T=293.6K
Threshold reactions

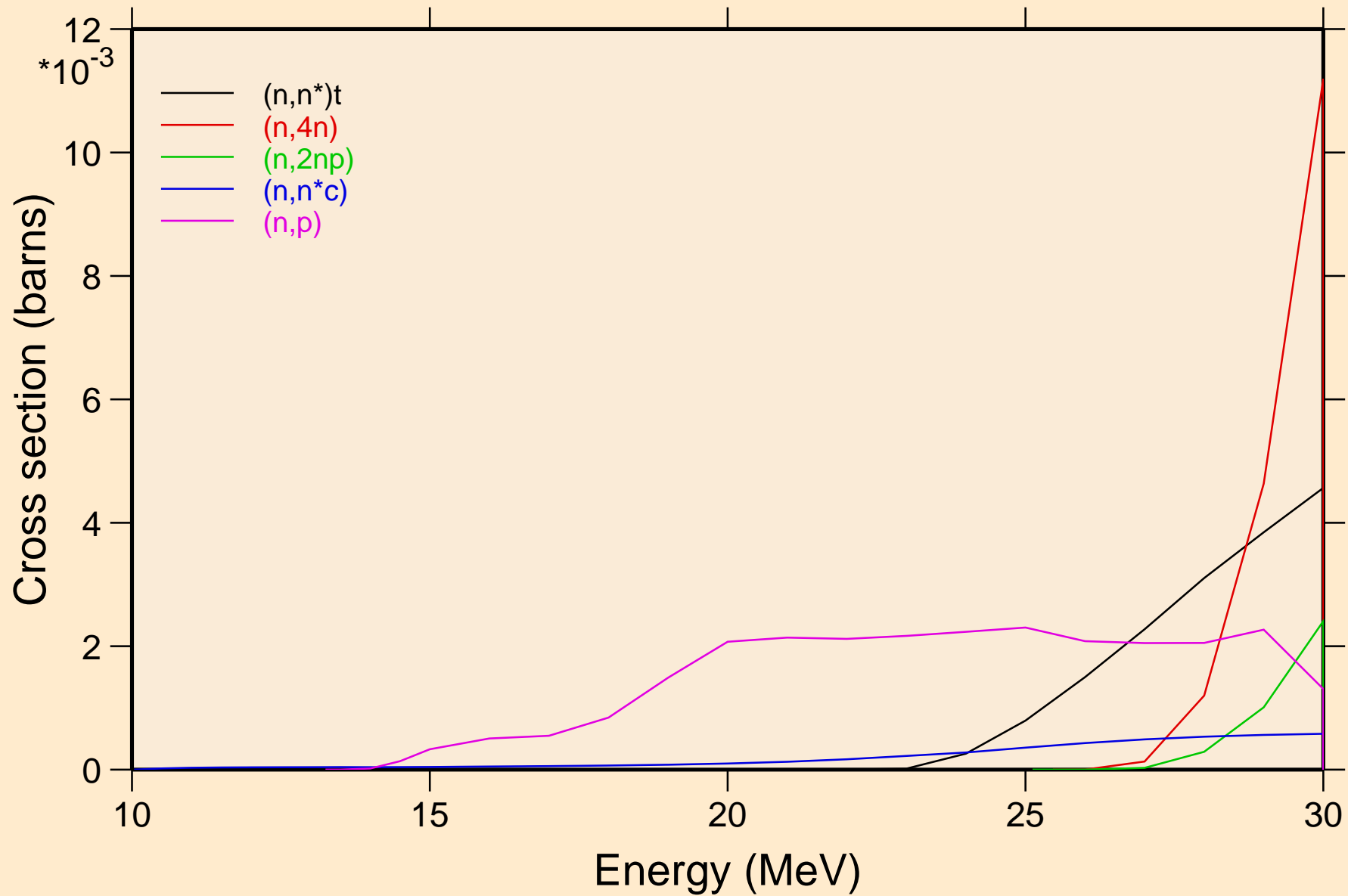

NE024 NEUTRON ACER TENDL-2021 LIBRARY; T=293.6K
Threshold reactions

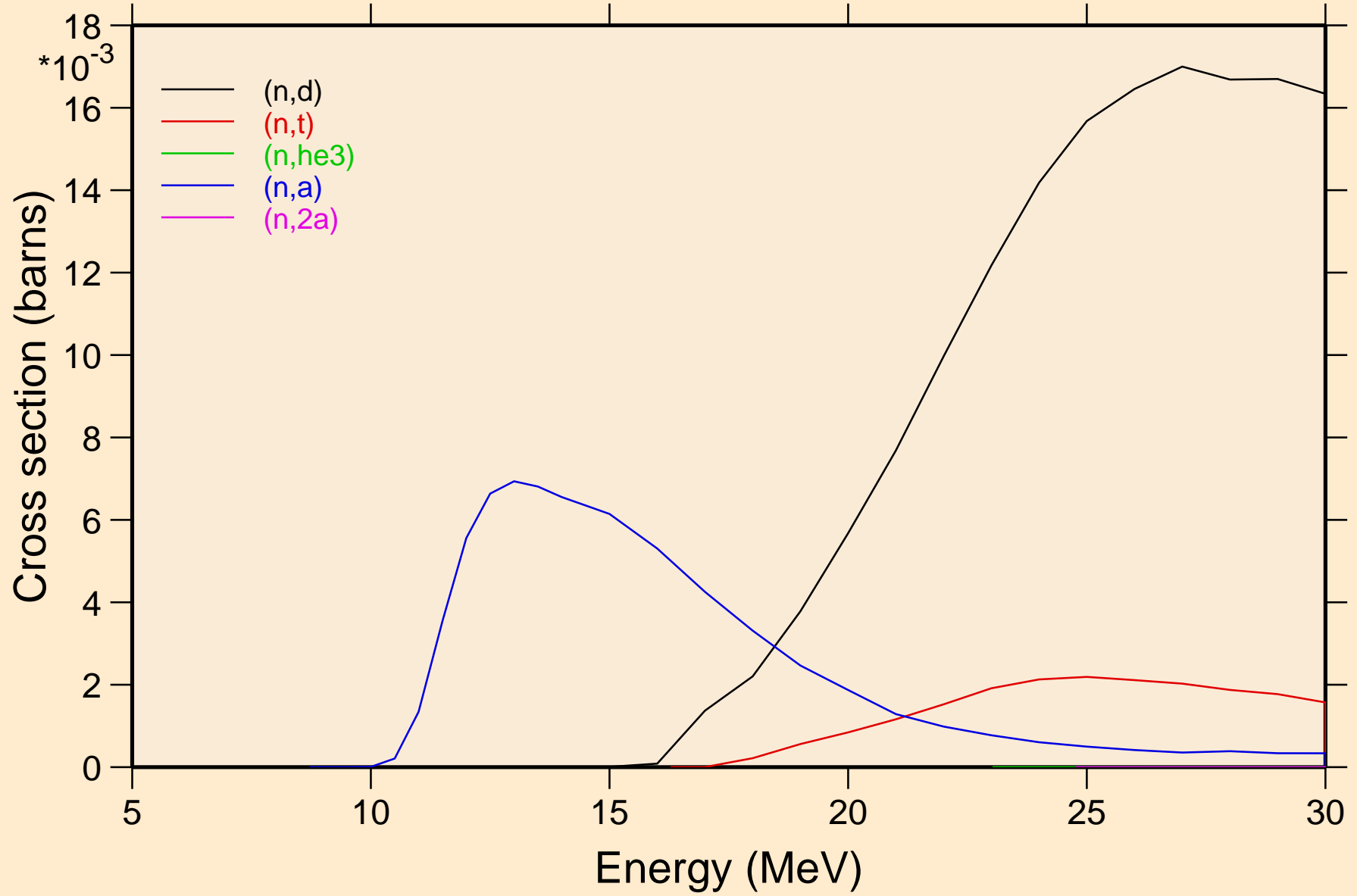

NE024 NEUTRON ACER TENDL-2021 LIBRARY; T=293.6K
Threshold reactions

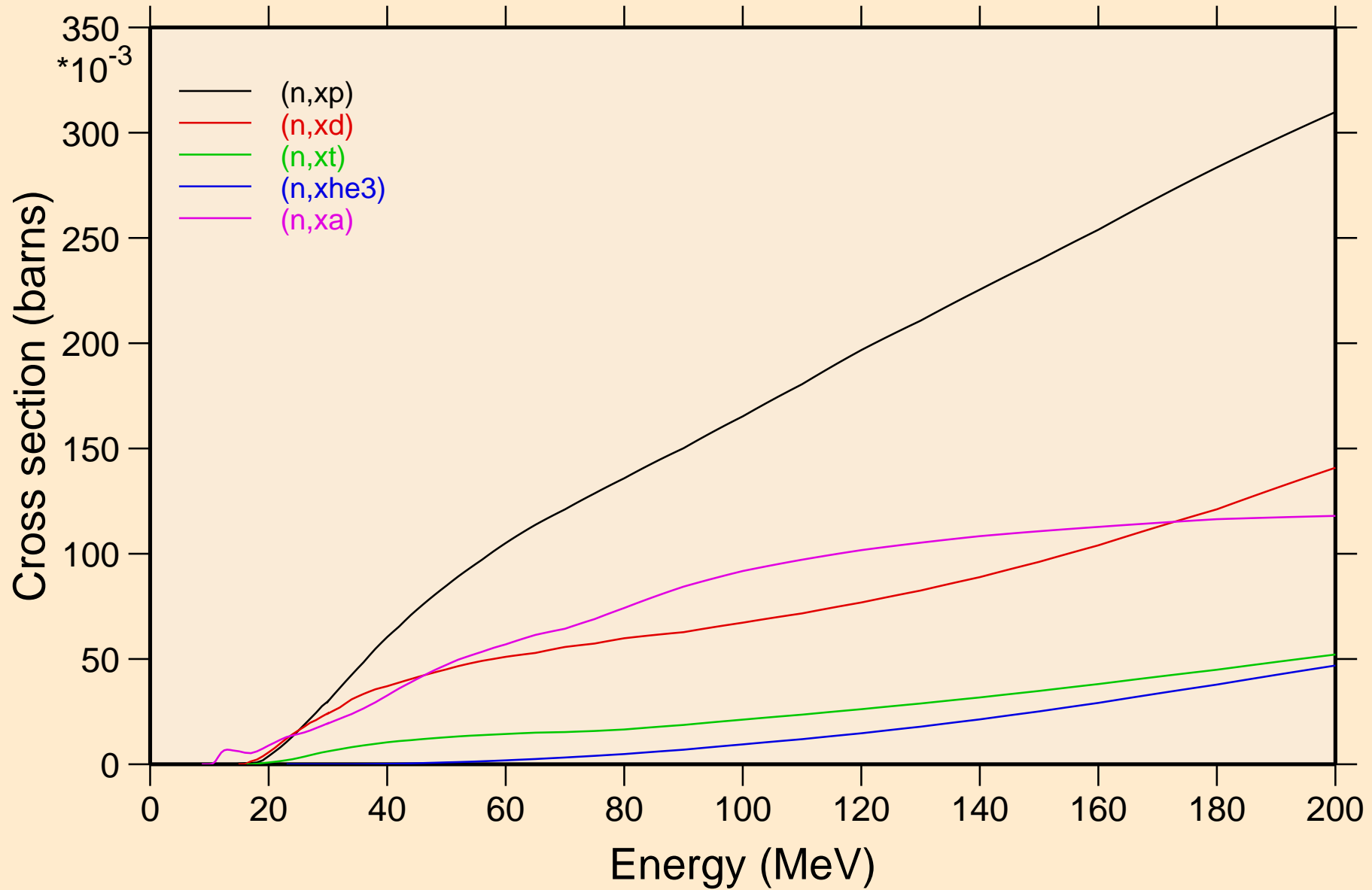

NE024 NEUTRON ACER TENDL-2021 LIBRARY; T=293.6K
angular distribution for elastic

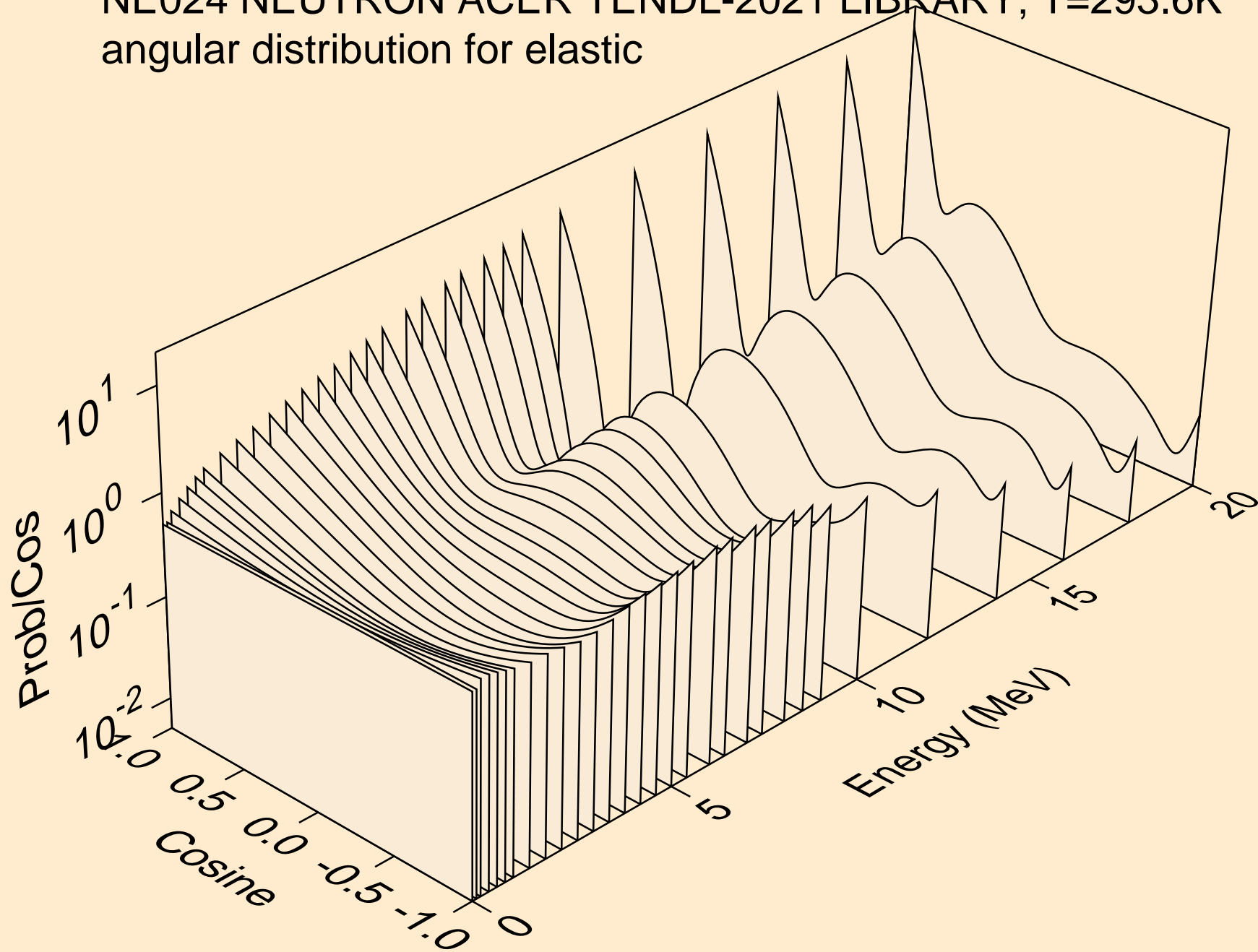

NE024 NEUTRON ACER TENDL-2021 LIBRARY; T=293.6K
angular distribution for elastic

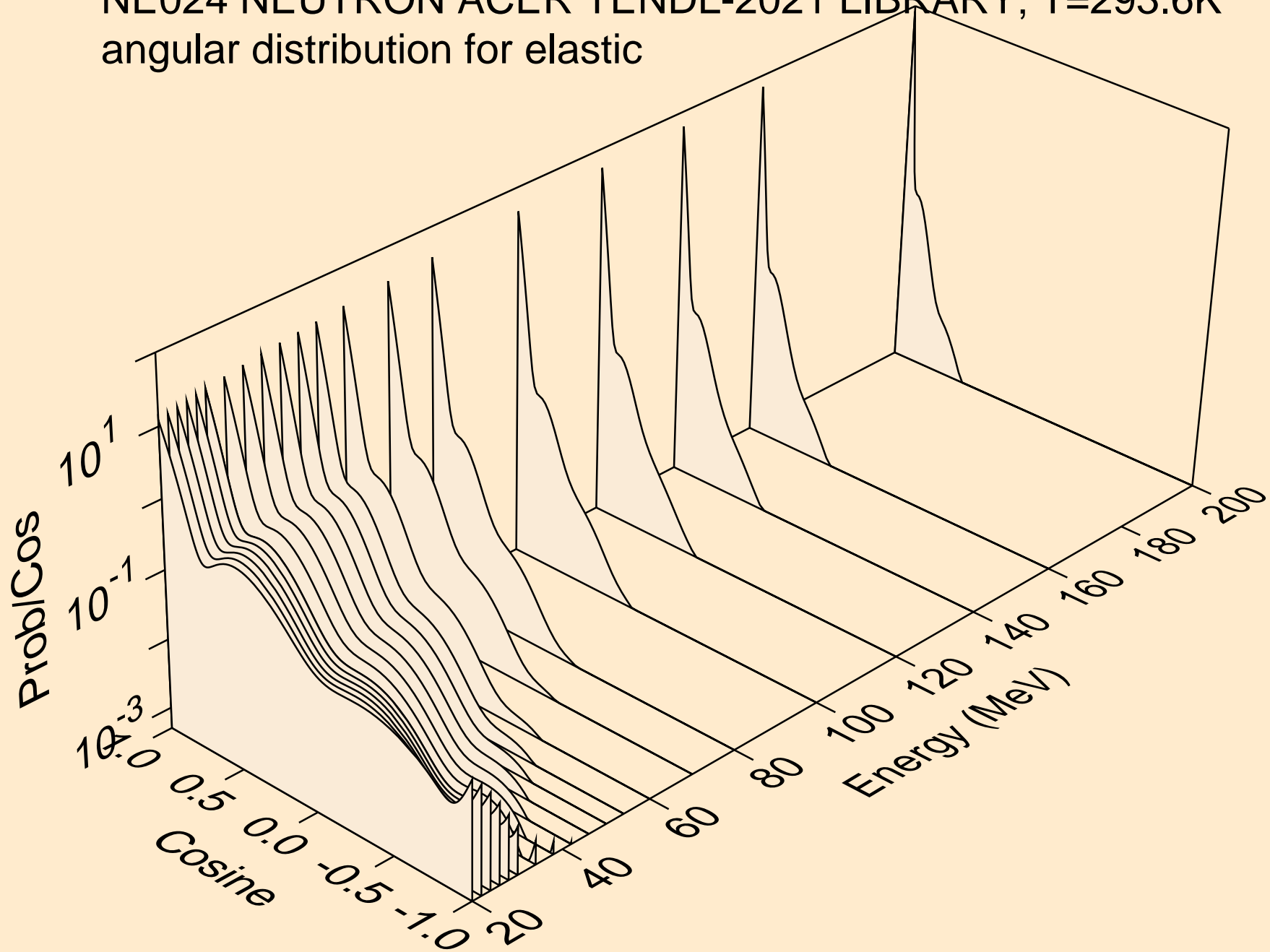

NE024 NEUTRON ACER TENDL-2021 LIBRARY; T=293.6K
angular distribution for (n,n*1)

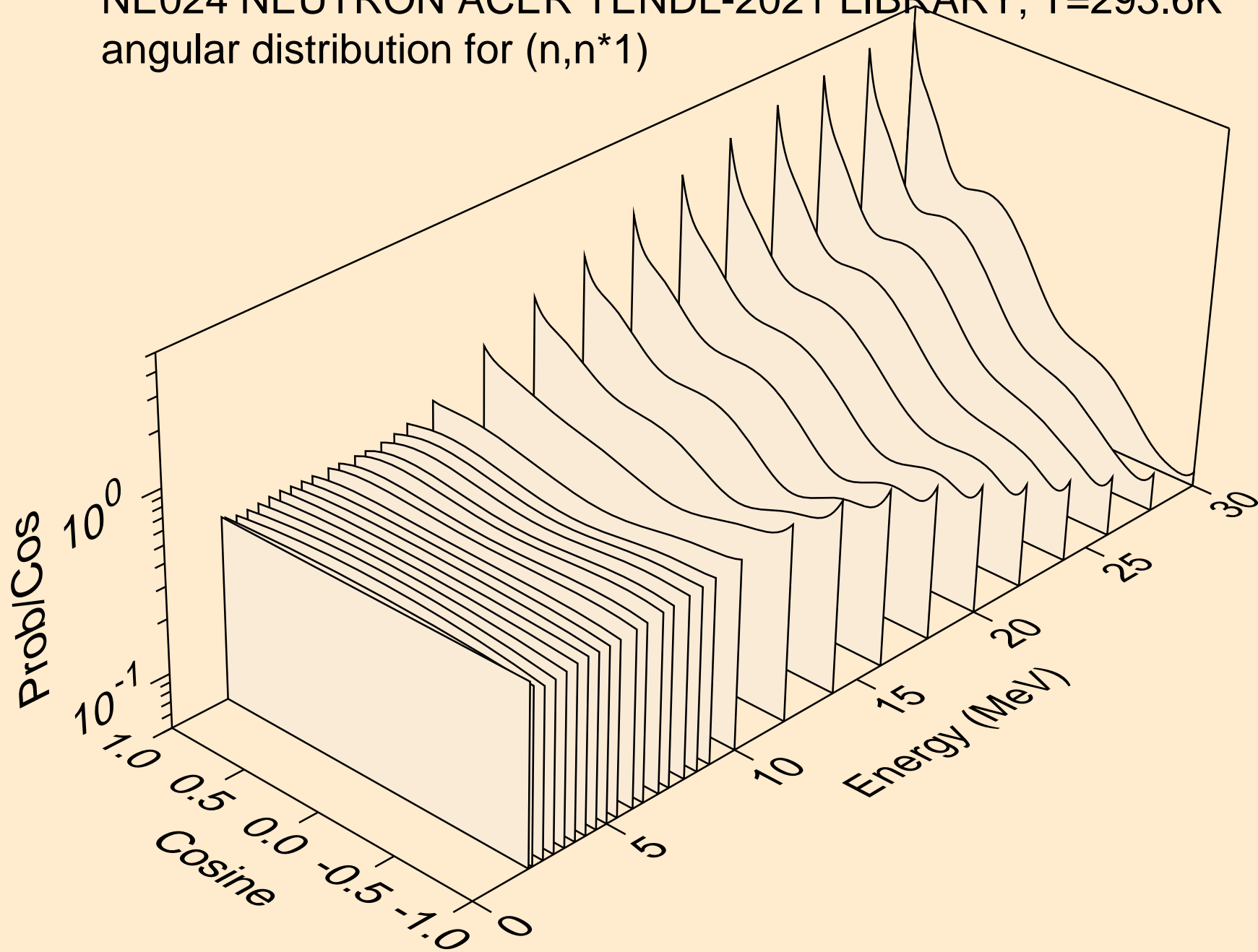

NE024 NEUTRON ACER TENDL-2021 LIBRARY; T=293.6K
angular distribution for (n,n*2)

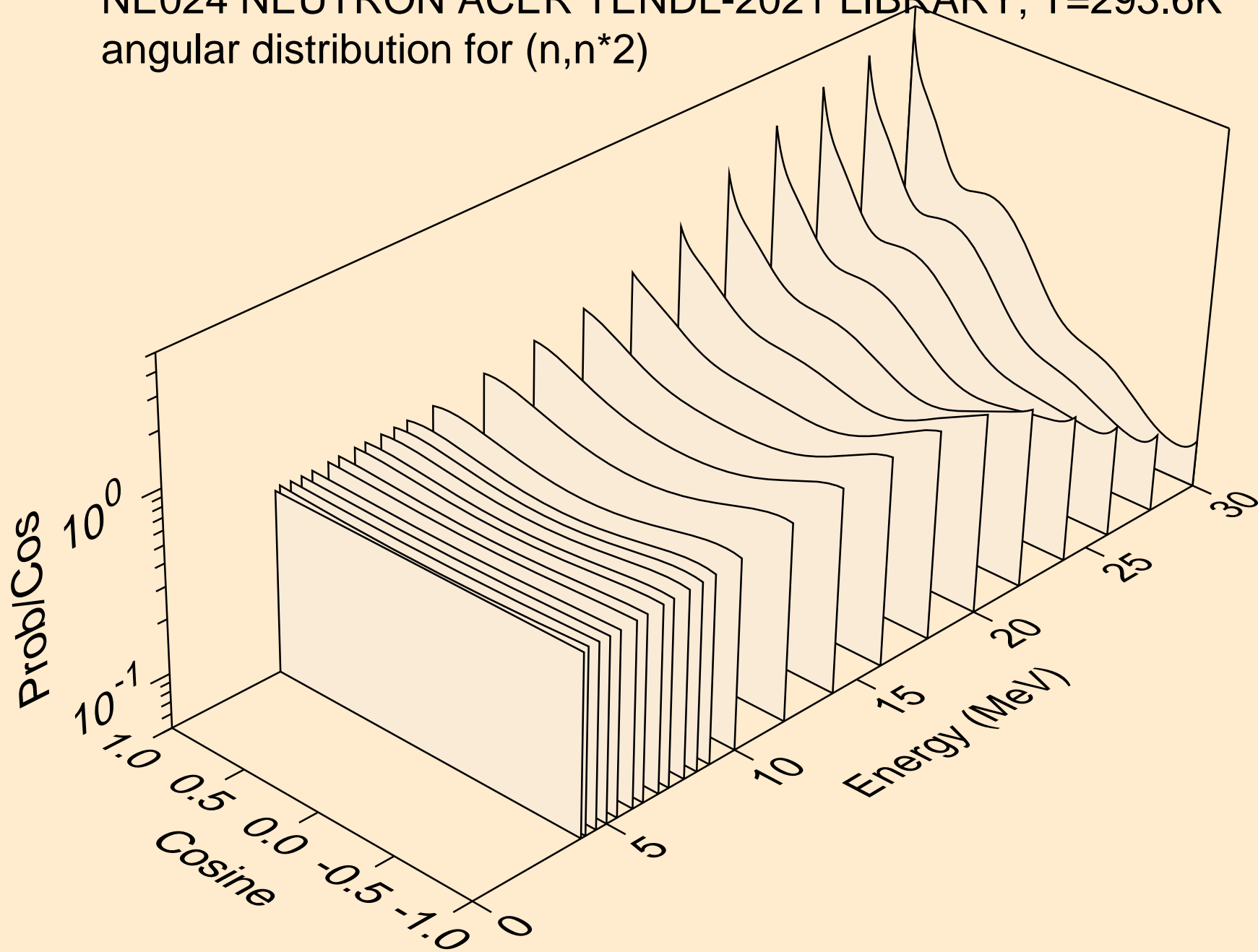

NE024 NEUTRON ACER TENDL-2021 LIBRARY; T=293.6K
angular distribution for (n,n*3)

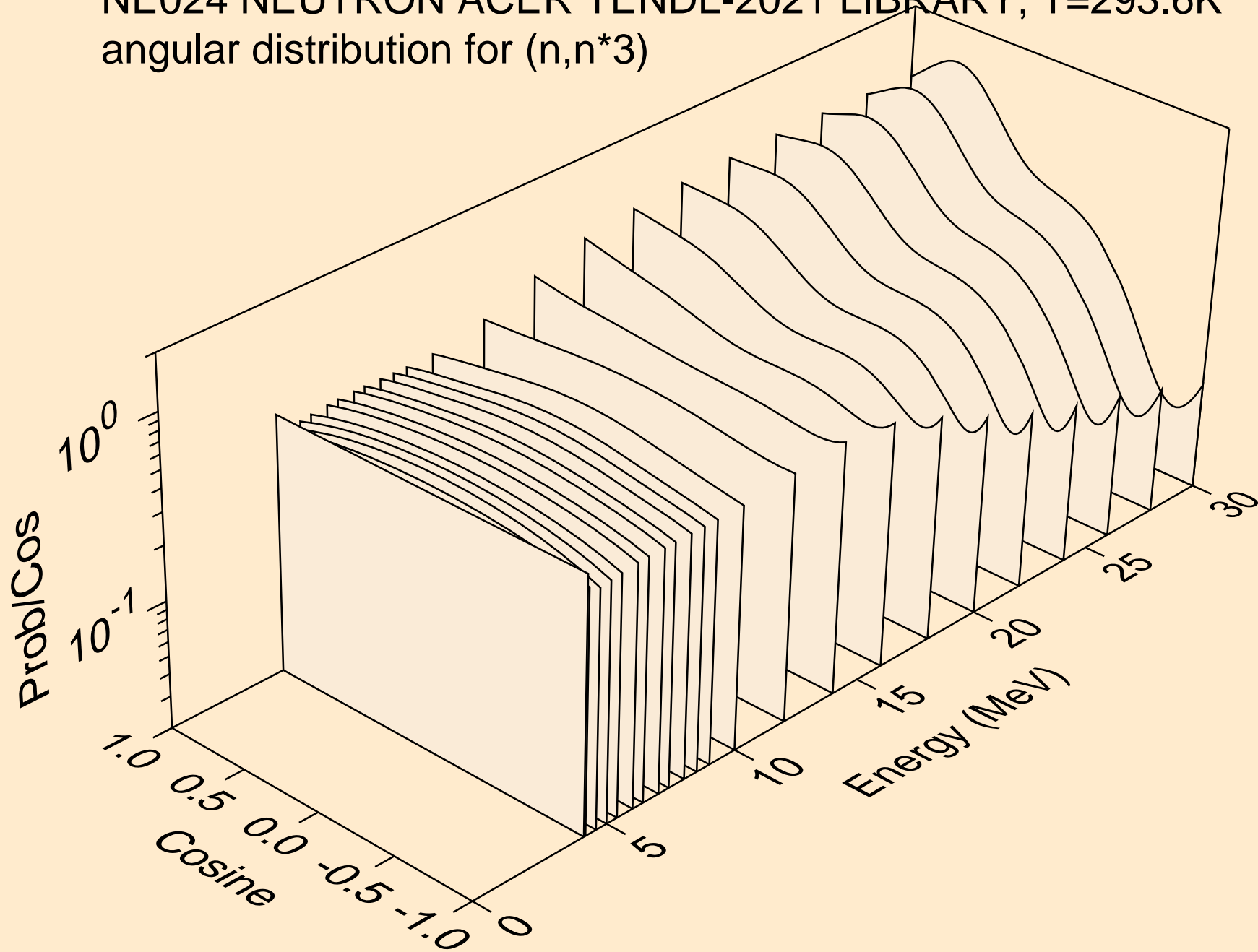

NE024 NEUTRON ACER TENDL-2021 LIBRARY; T=293.6K
angular distribution for (n,n*4)

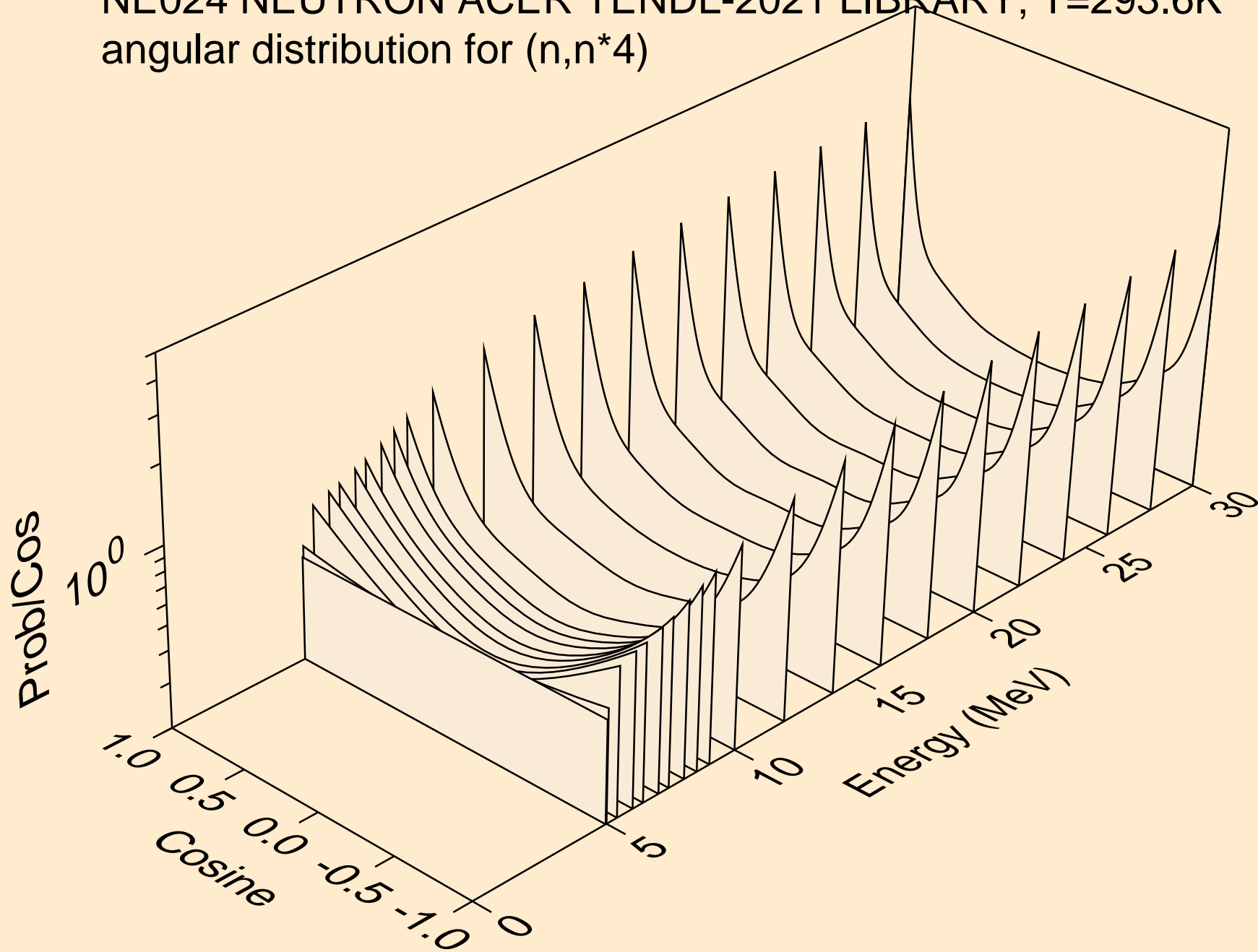

NE024 NEUTRON ACER TENDL-2021 LIBRARY; T=293.6K
angular distribution for (n,n*5)

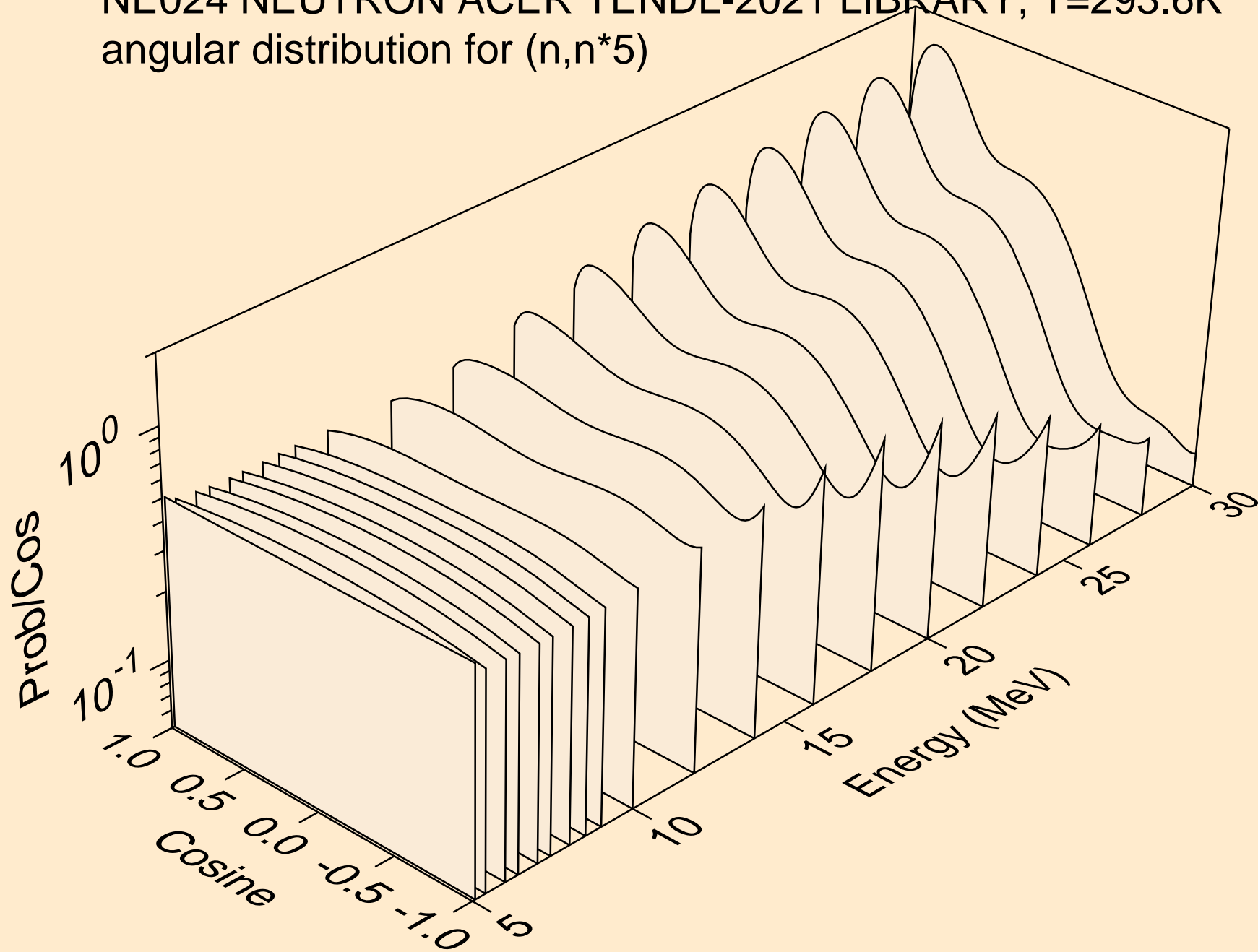

NE024 NEUTRON ACER TENDL-2021 LIBRARY; T=293.6K
angular distribution for (n,n*6)

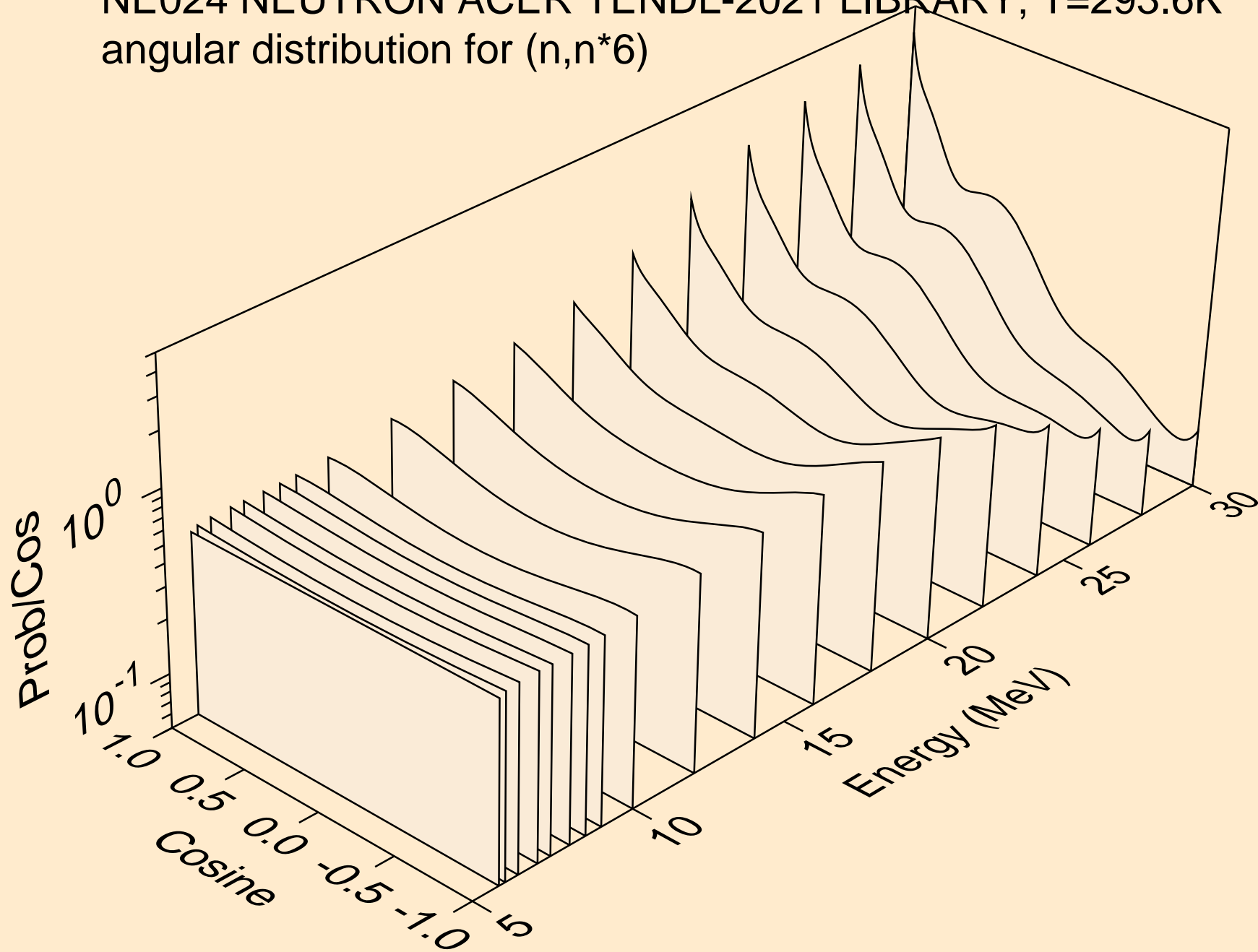

NE024 NEUTRON ACER TENDL-2021 LIBRARY; T=293.6K
angular distribution for (n,n*7)

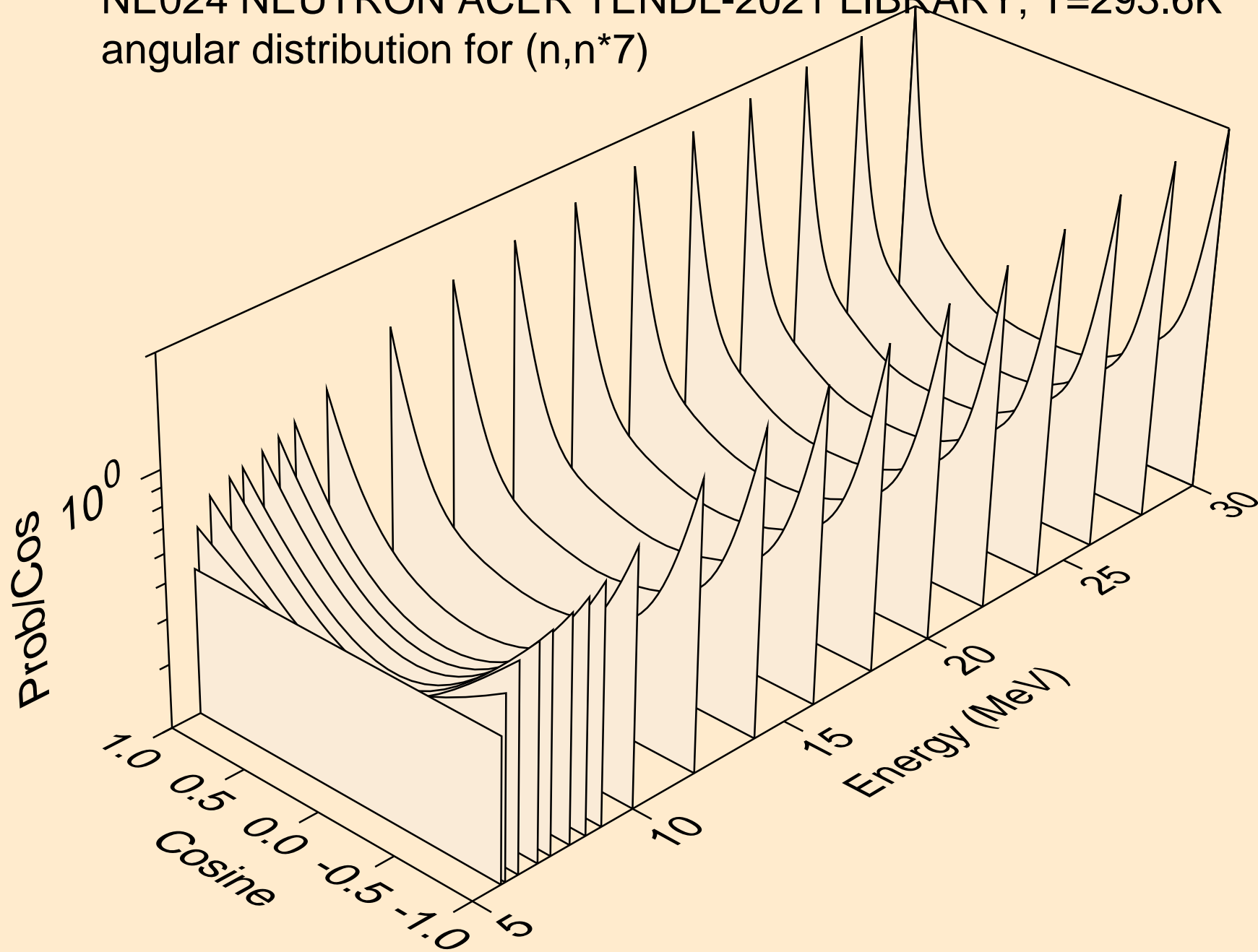

NE024 NEUTRON ACER TENDL-2021 LIBRARY; T=293.6K
angular distribution for (n,n*8)

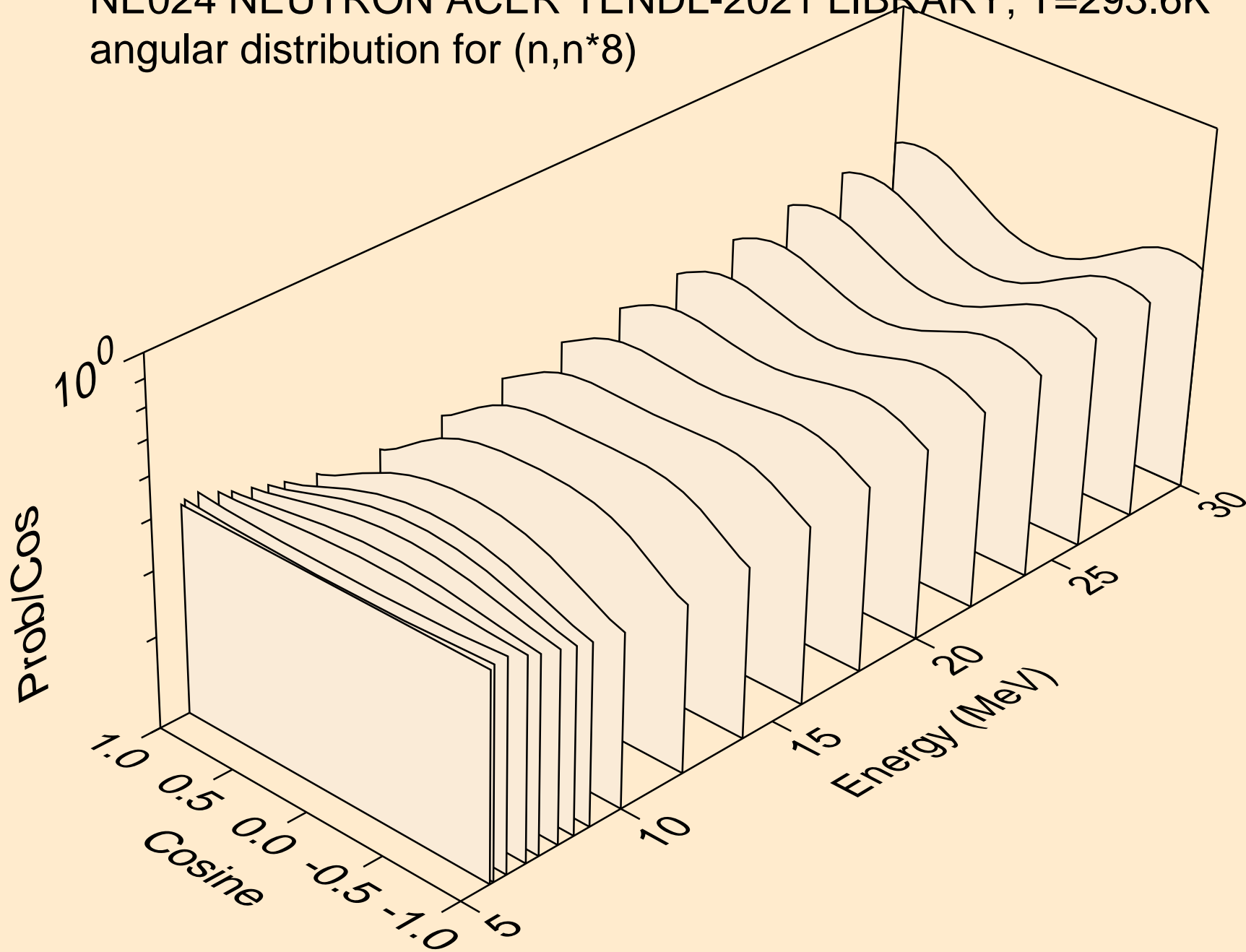

NE024 NEUTRON ACER TENDL-2021 LIBRARY; T=293.6K
angular distribution for (n,n*9)

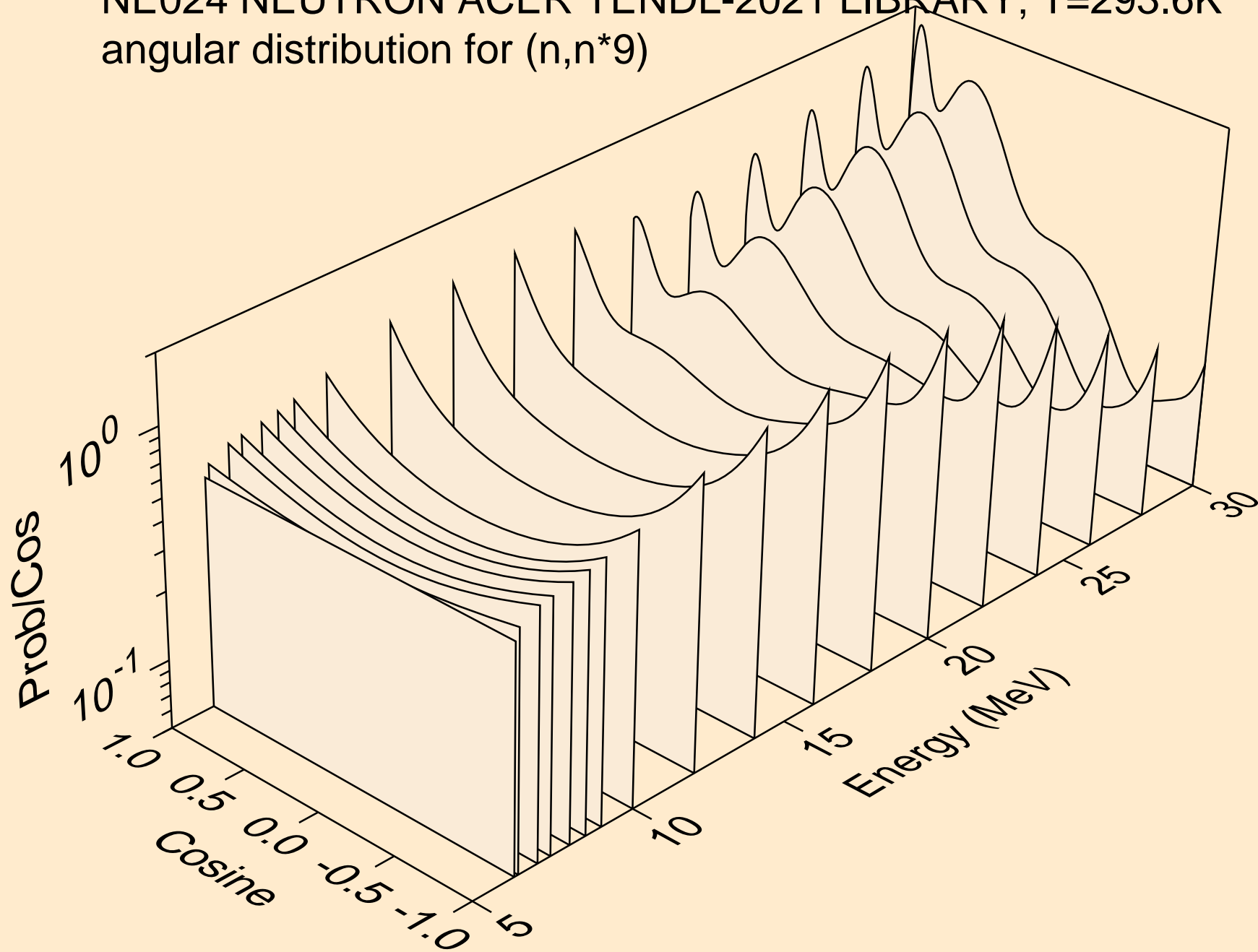

NE024 NEUTRON ACER TENDL-2021 LIBRARY; T=293.6K
angular distribution for (n,n*10)

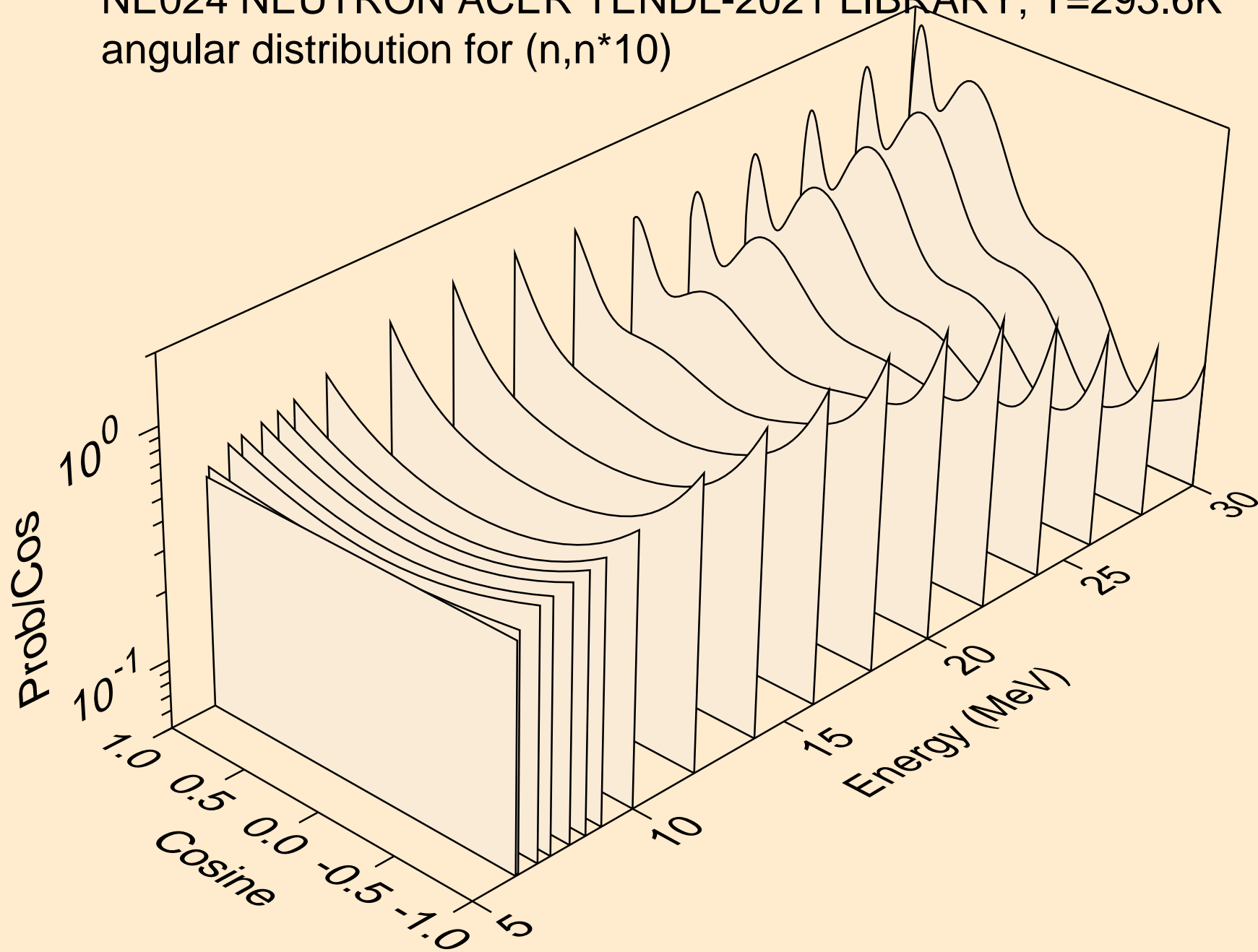

NE024 NEUTRON ACER TENDL-2021 LIBRARY; T=293.6K
angular distribution for (n,n*11)

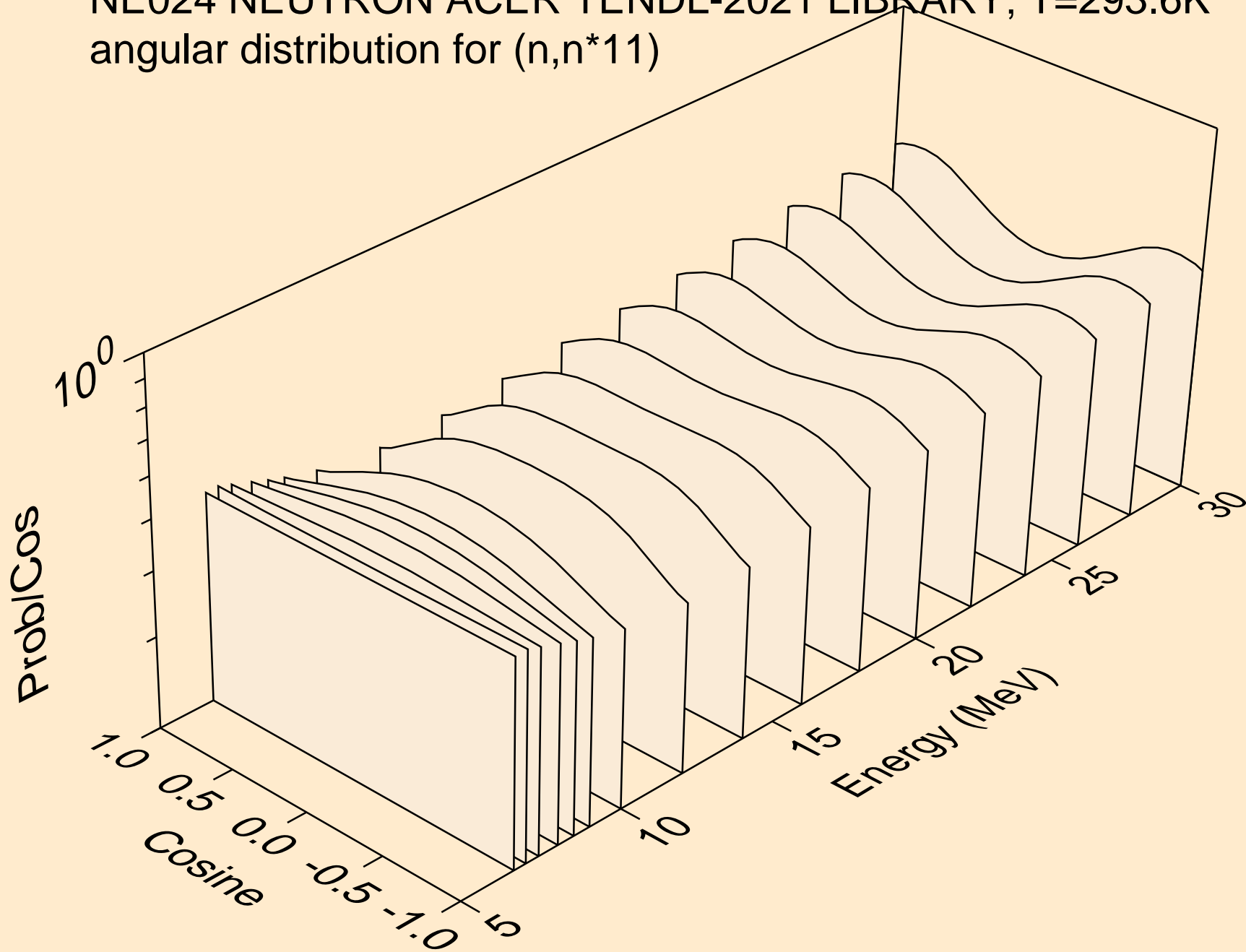

NE024 NEUTRON ACER TENDL-2021 LIBRARY; T=293.6K
angular distribution for (n,n*12)

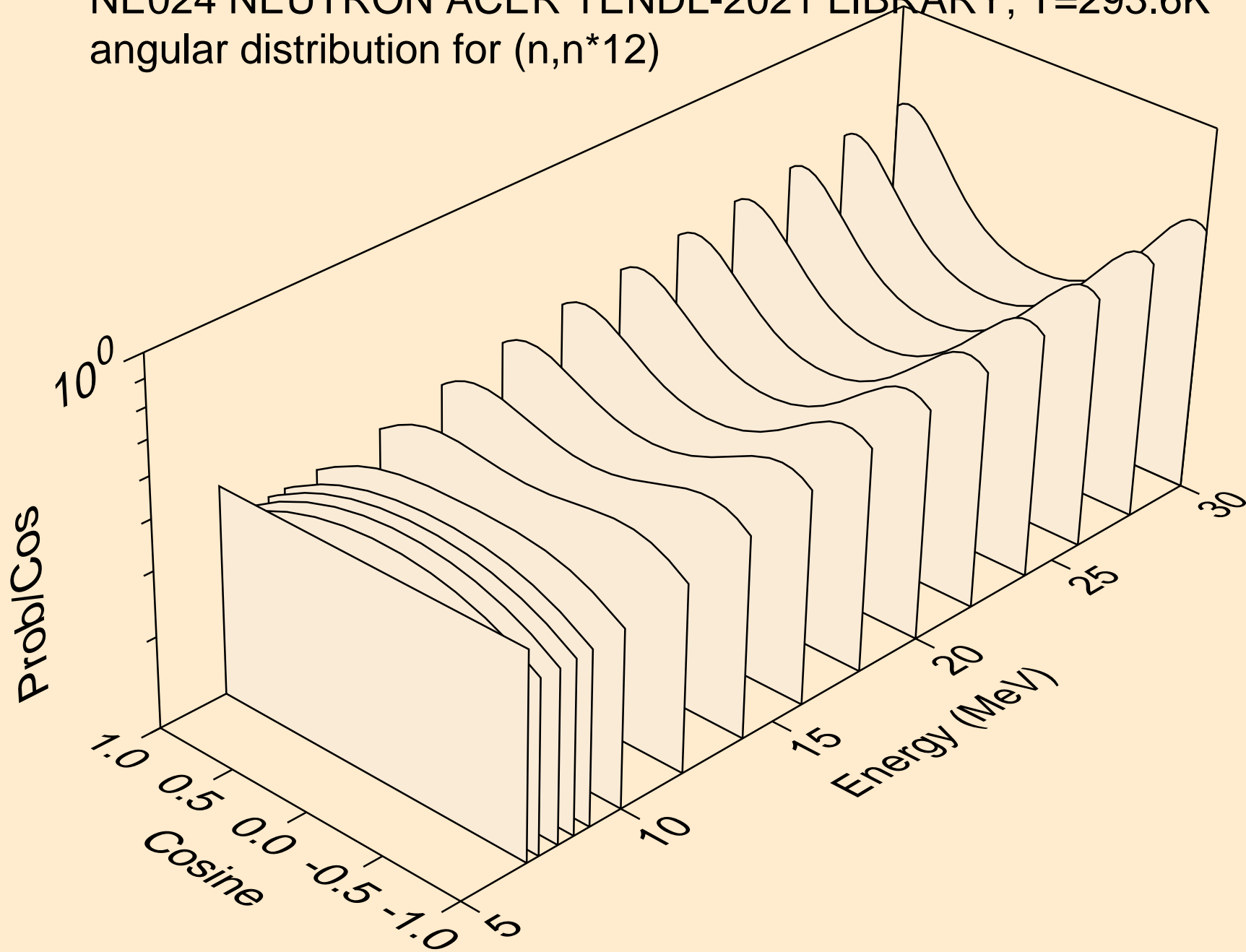

NE024 NEUTRON ACER TENDL-2021 LIBRARY; T=293.6K
angular distribution for (n,n*13)

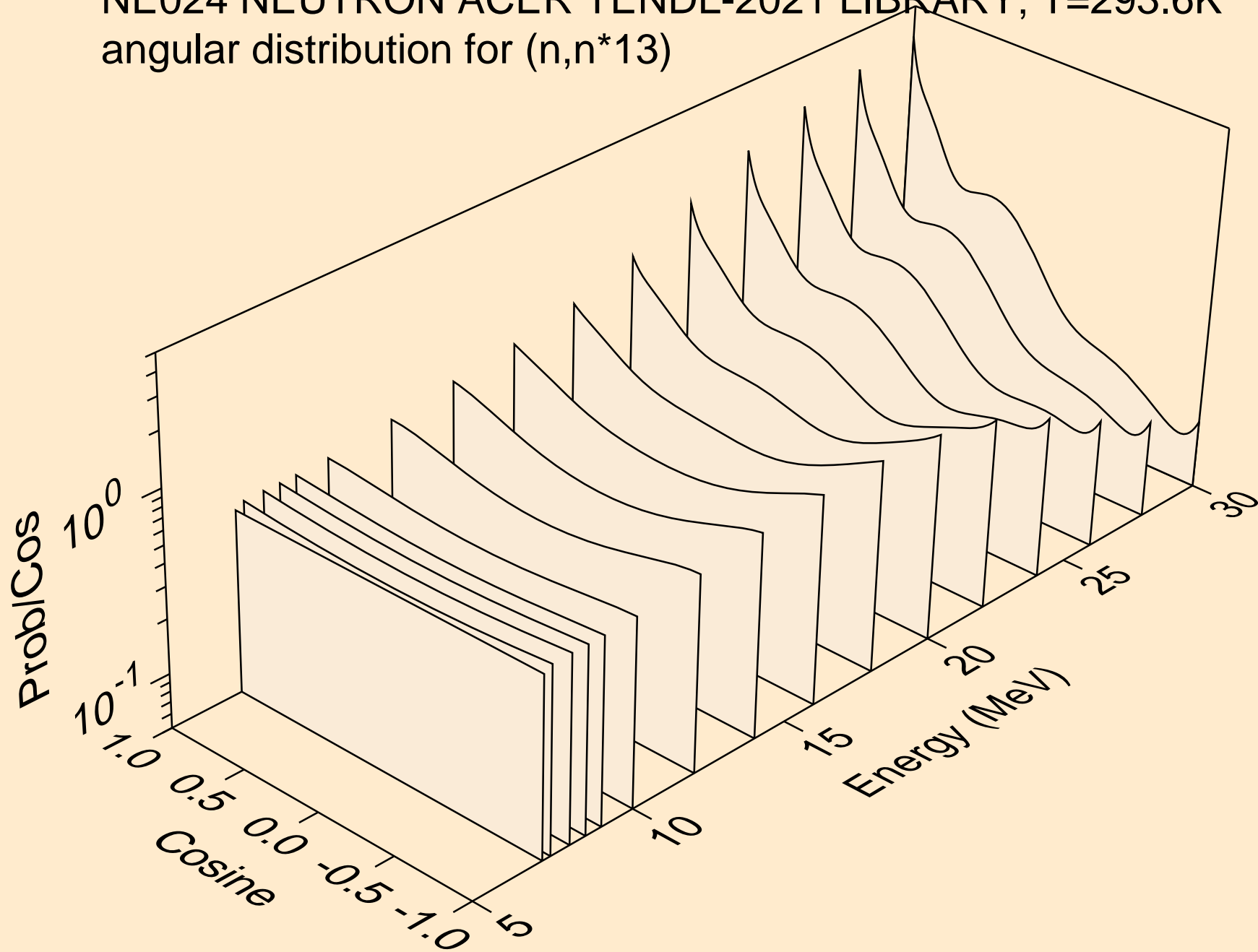

NE024 NEUTRON ACER TENDL-2021 LIBRARY; T=293.6K
angular distribution for (n,n*14)

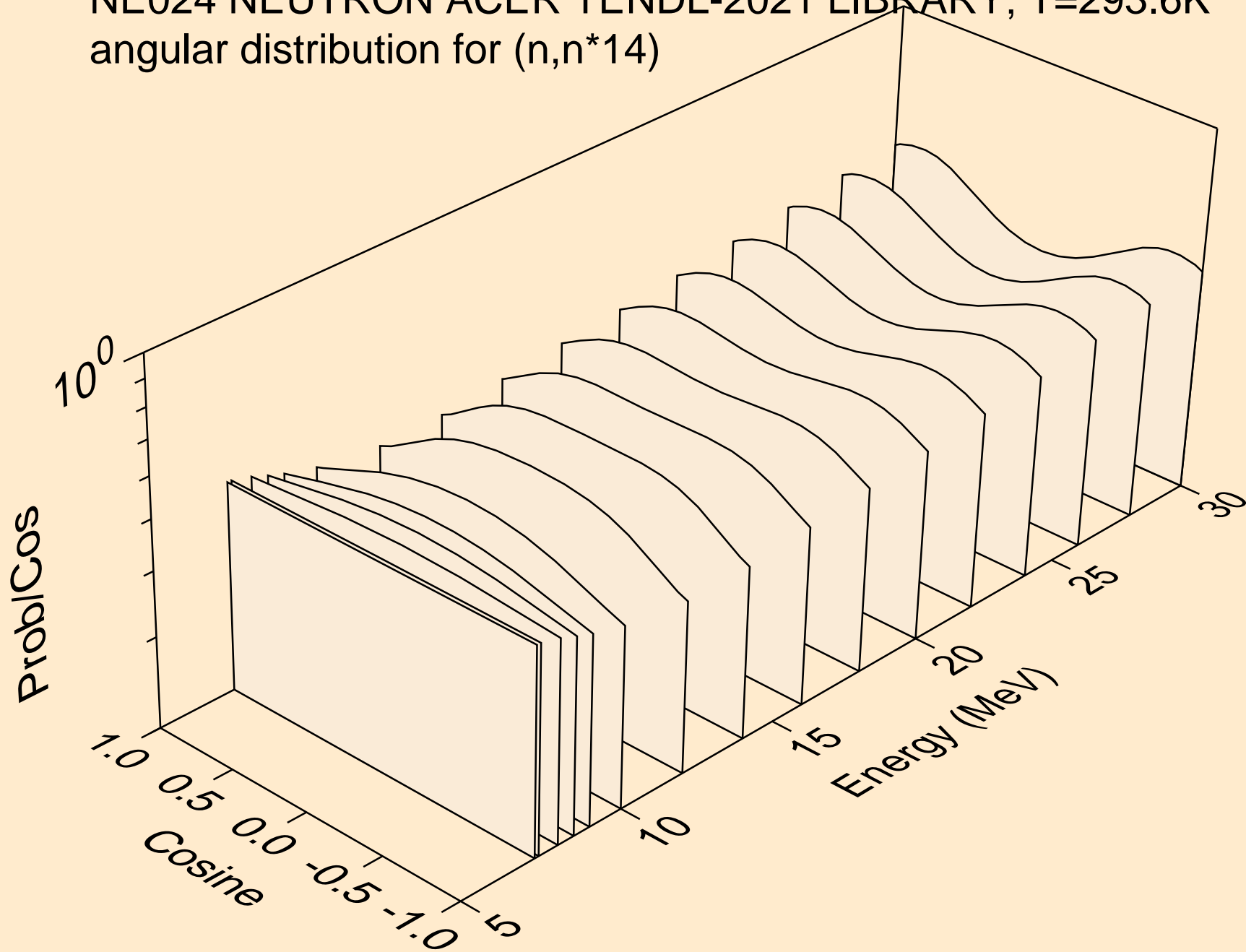

NE024 NEUTRON ACER TENDL-2021 LIBRARY; T=293.6K
angular distribution for (n,n*15)

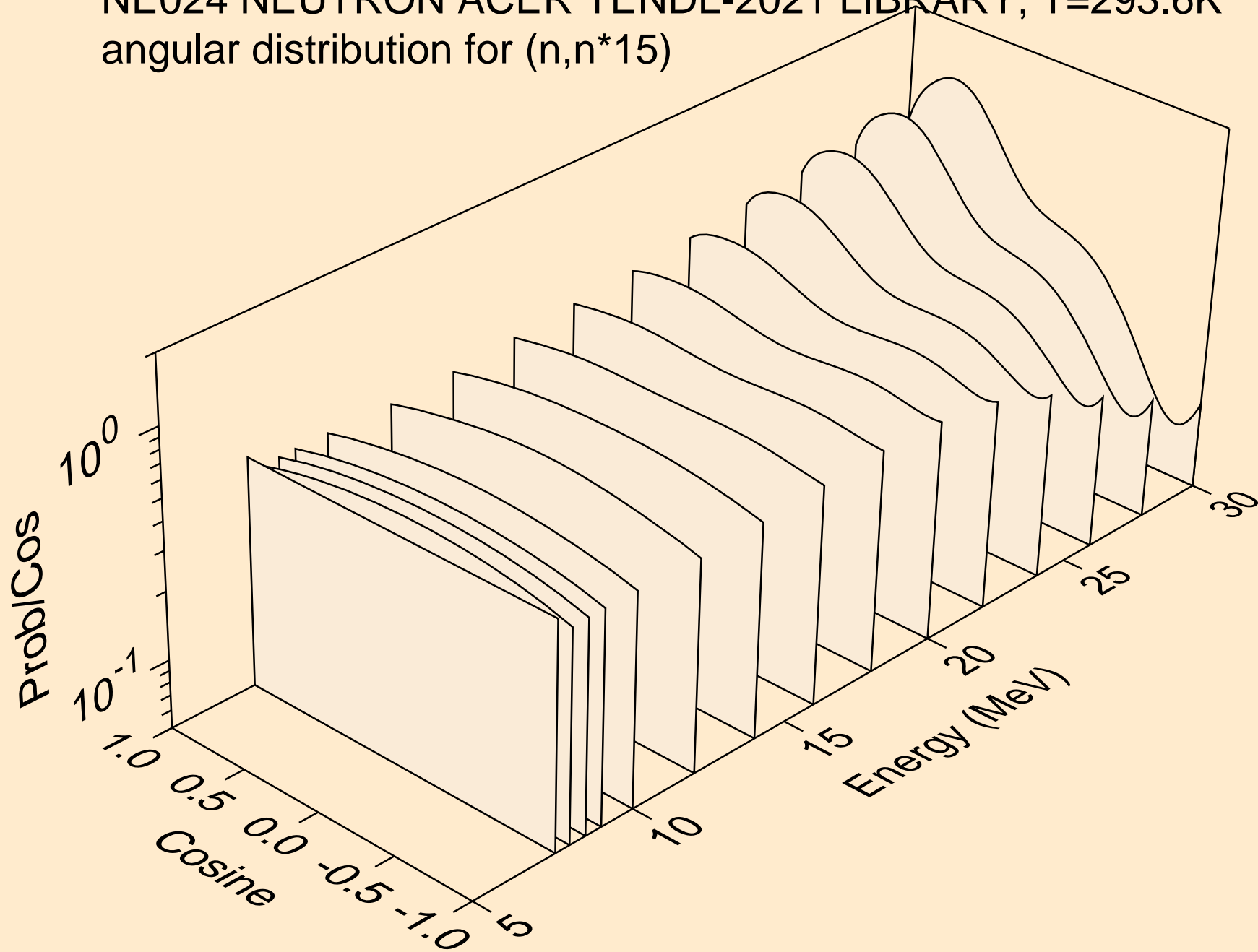

NE024 NEUTRON ACER TENDL-2021 LIBRARY; T=293.6K
angular distribution for (n,n*16)

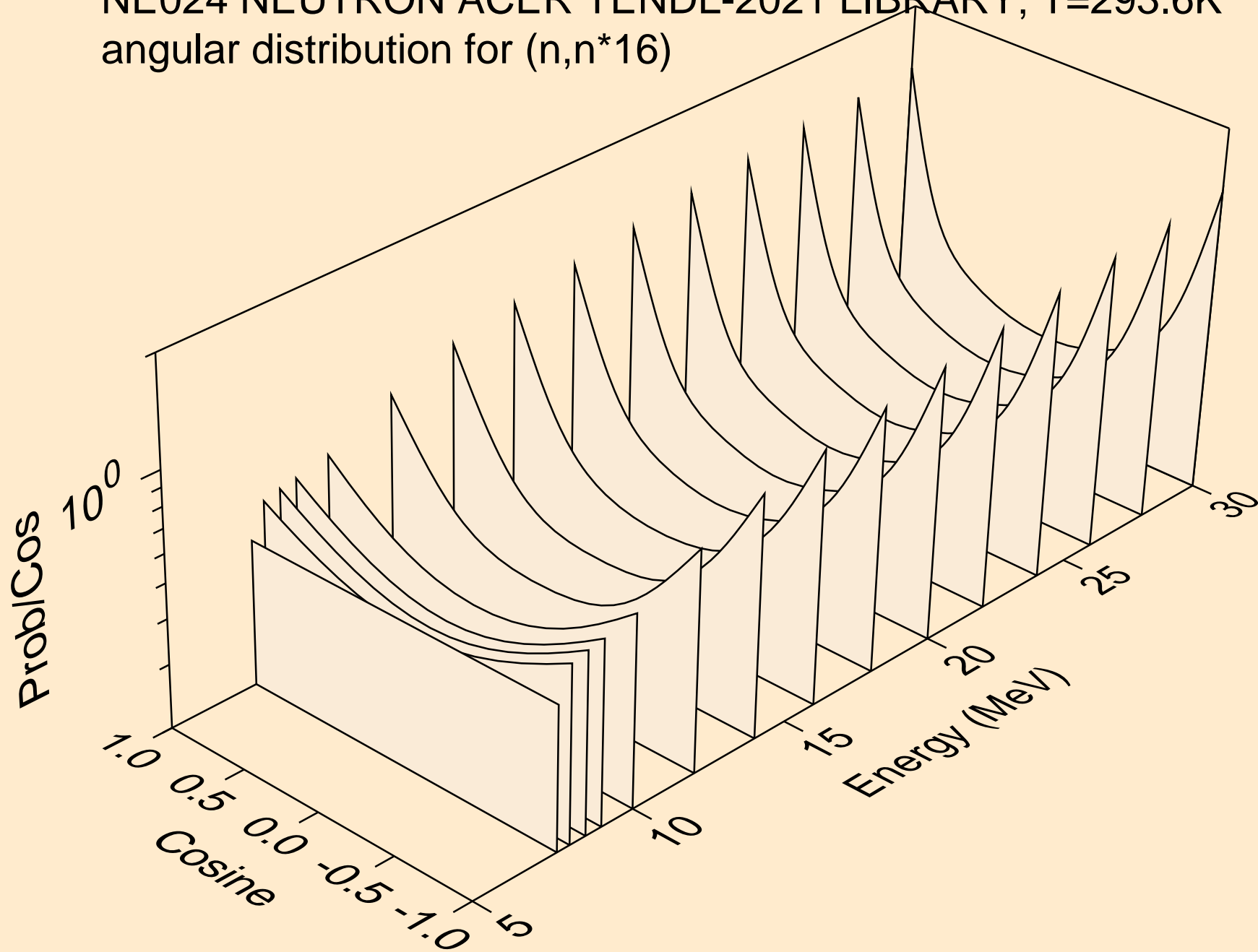

NE024 NEUTRON ACER TENDL-2021 LIBRARY; T=293.6K
angular distribution for (n,n*17)

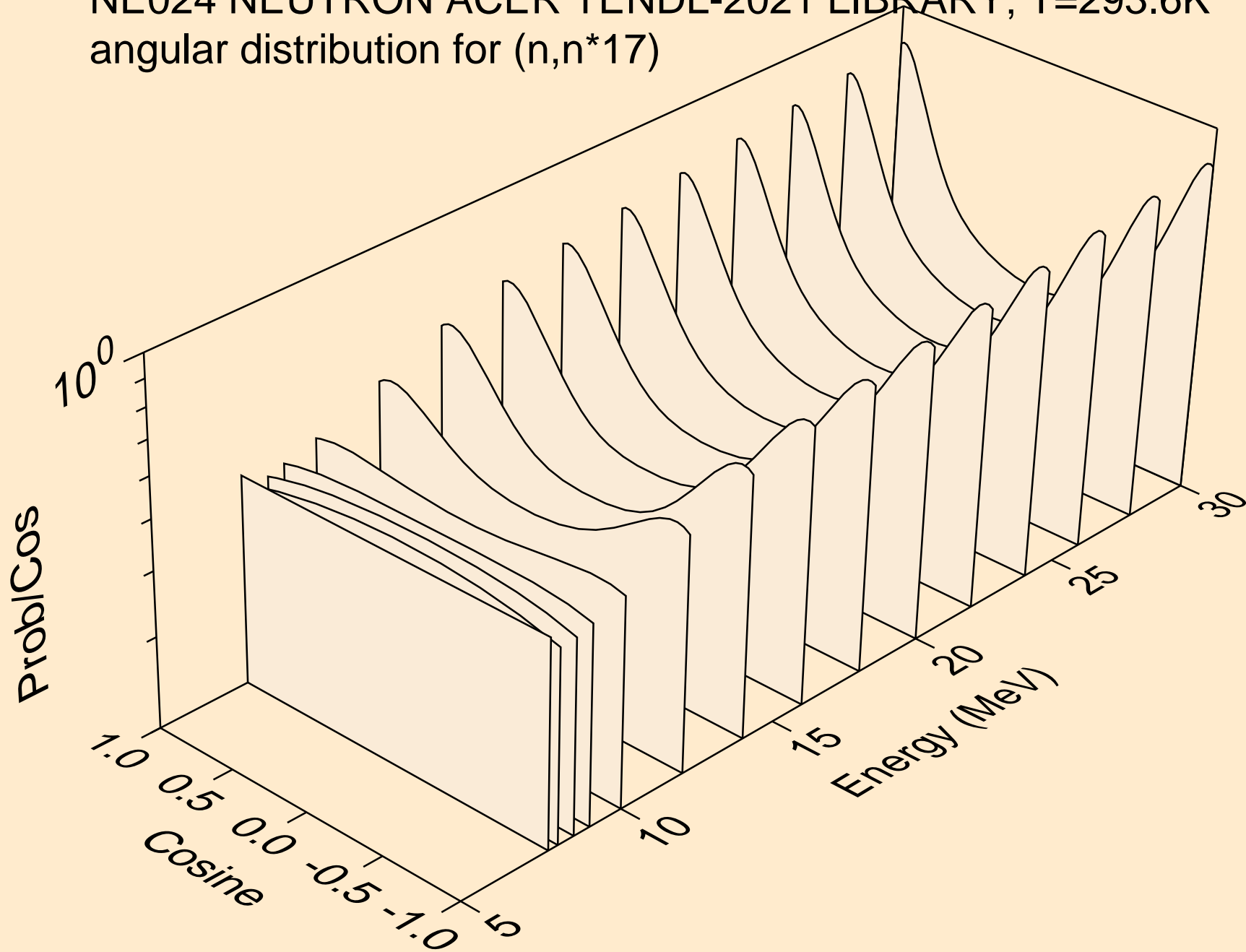

NE024 NEUTRON ACER TENDL-2021 LIBRARY; T=293.6K
angular distribution for (n,n*18)

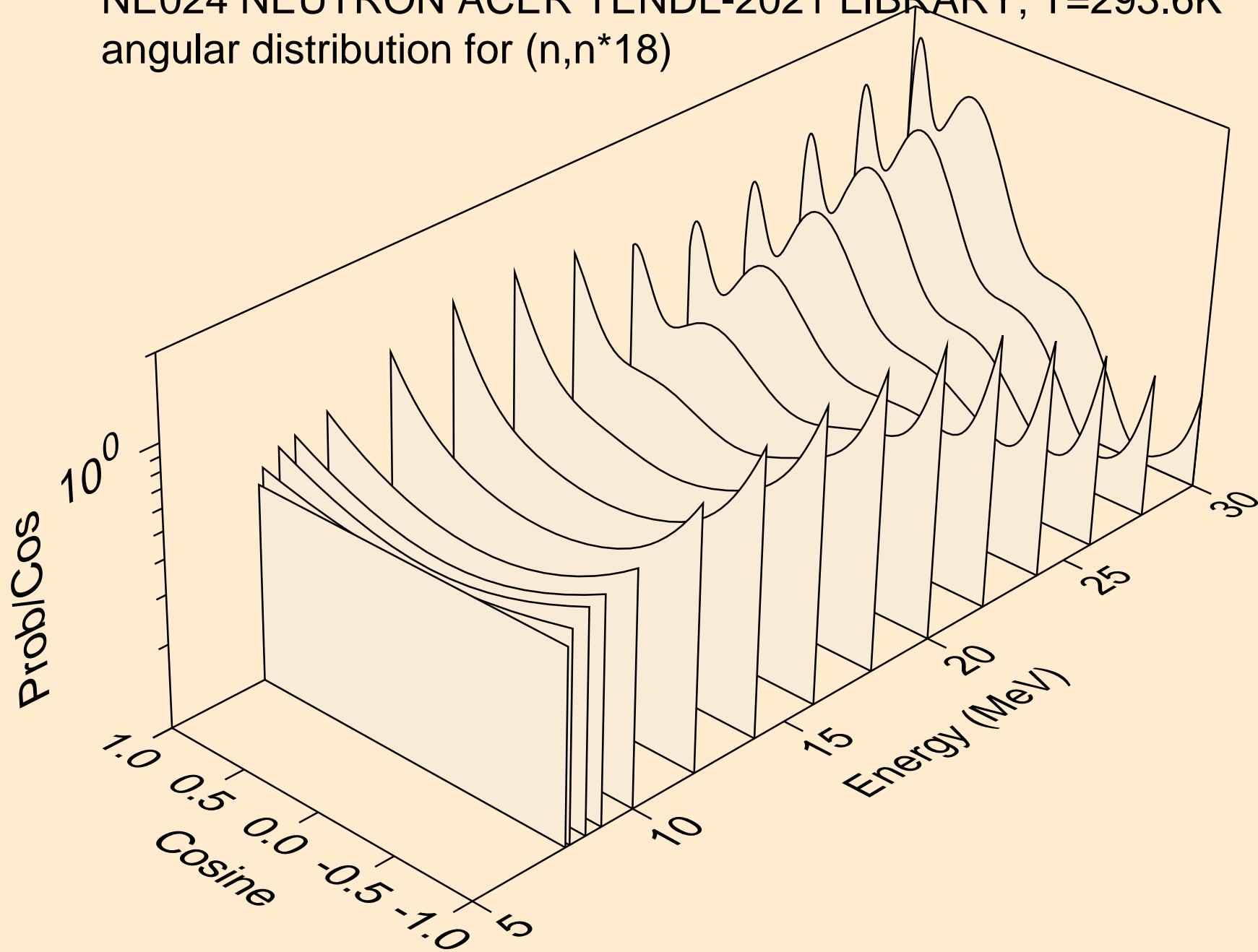

NE024 NEUTRON ACER TENDL-2021 LIBRARY; T=293.6K
angular distribution for (n,n*19)

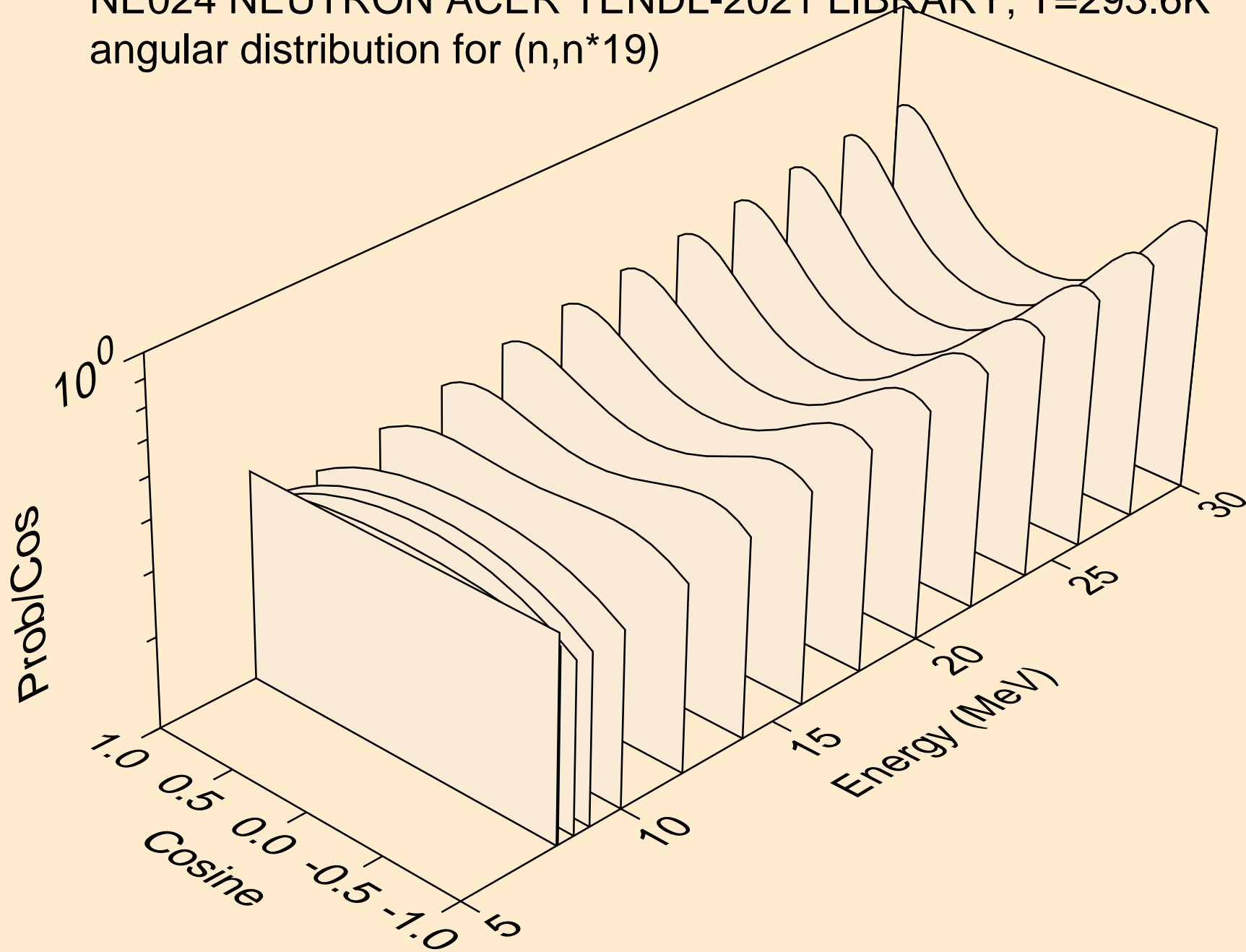

NE024 NEUTRON ACER TENDL-2021 LIBRARY; T=293.6K
angular distribution for (n,n*20)

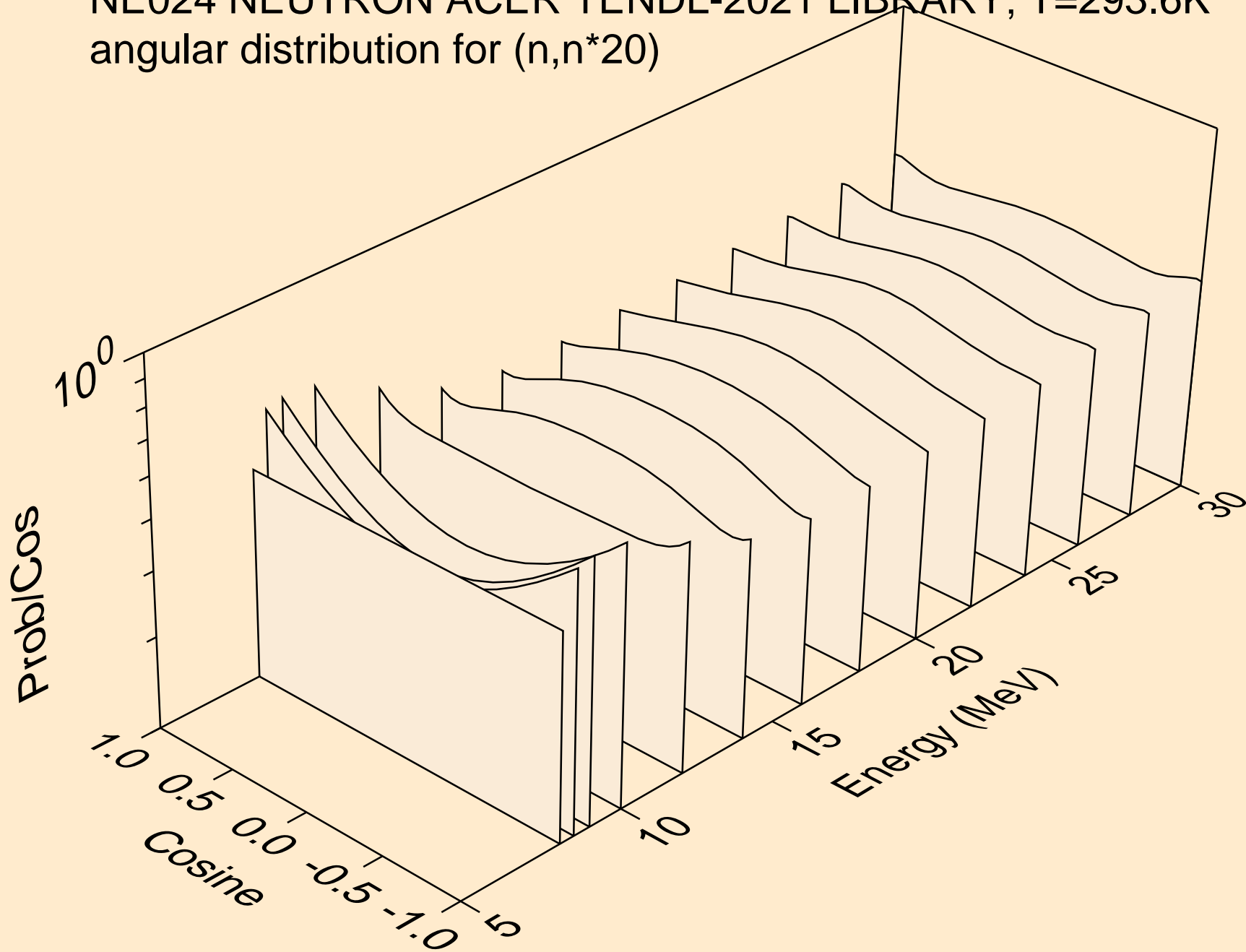

NE024 NEUTRON ACER TENDL-2021 LIBRARY; T=293.6K
angular distribution for (n,n*21)

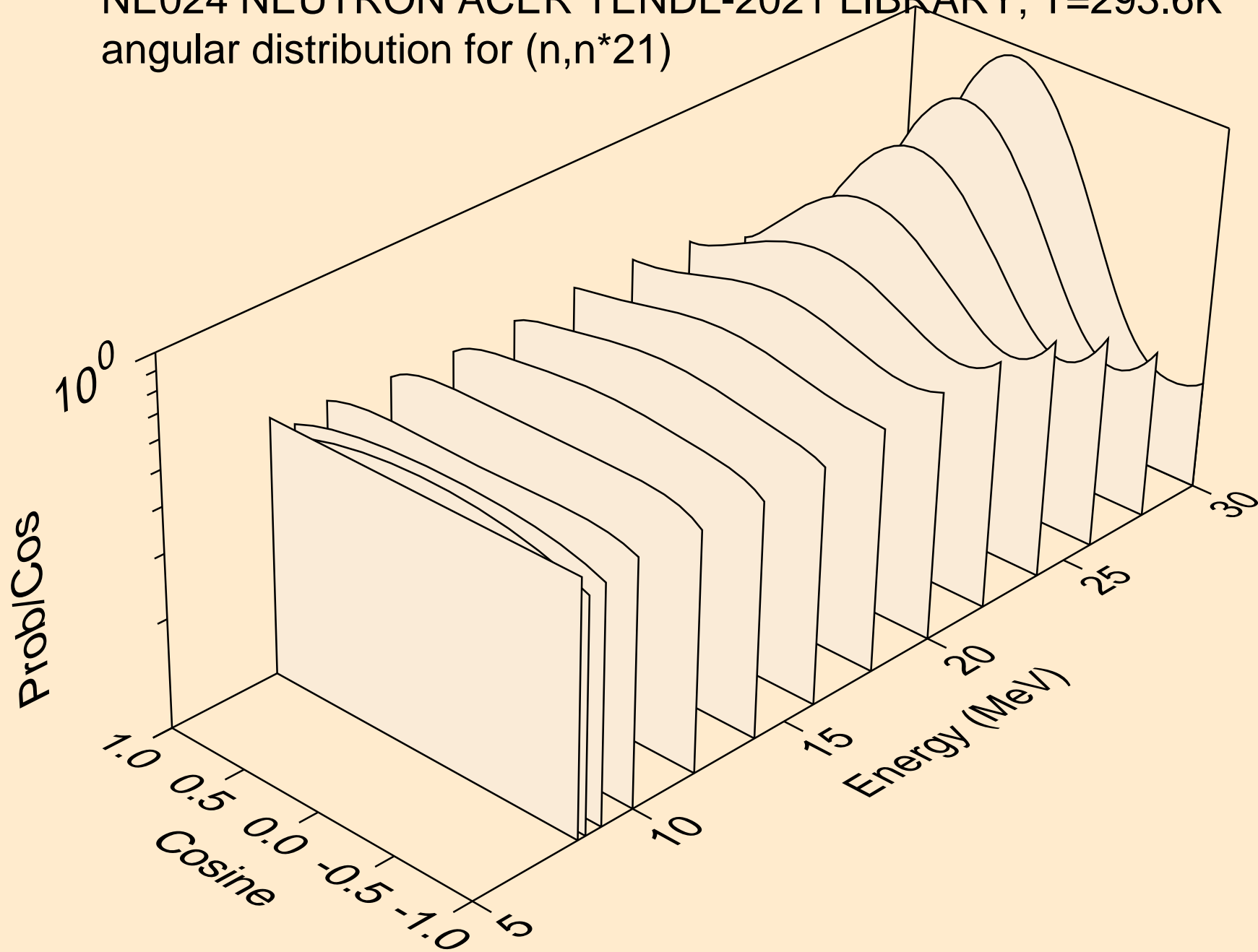

NE024 NEUTRON ACER TENDL-2021 LIBRARY; T=293.6K
angular distribution for (n,n*22)

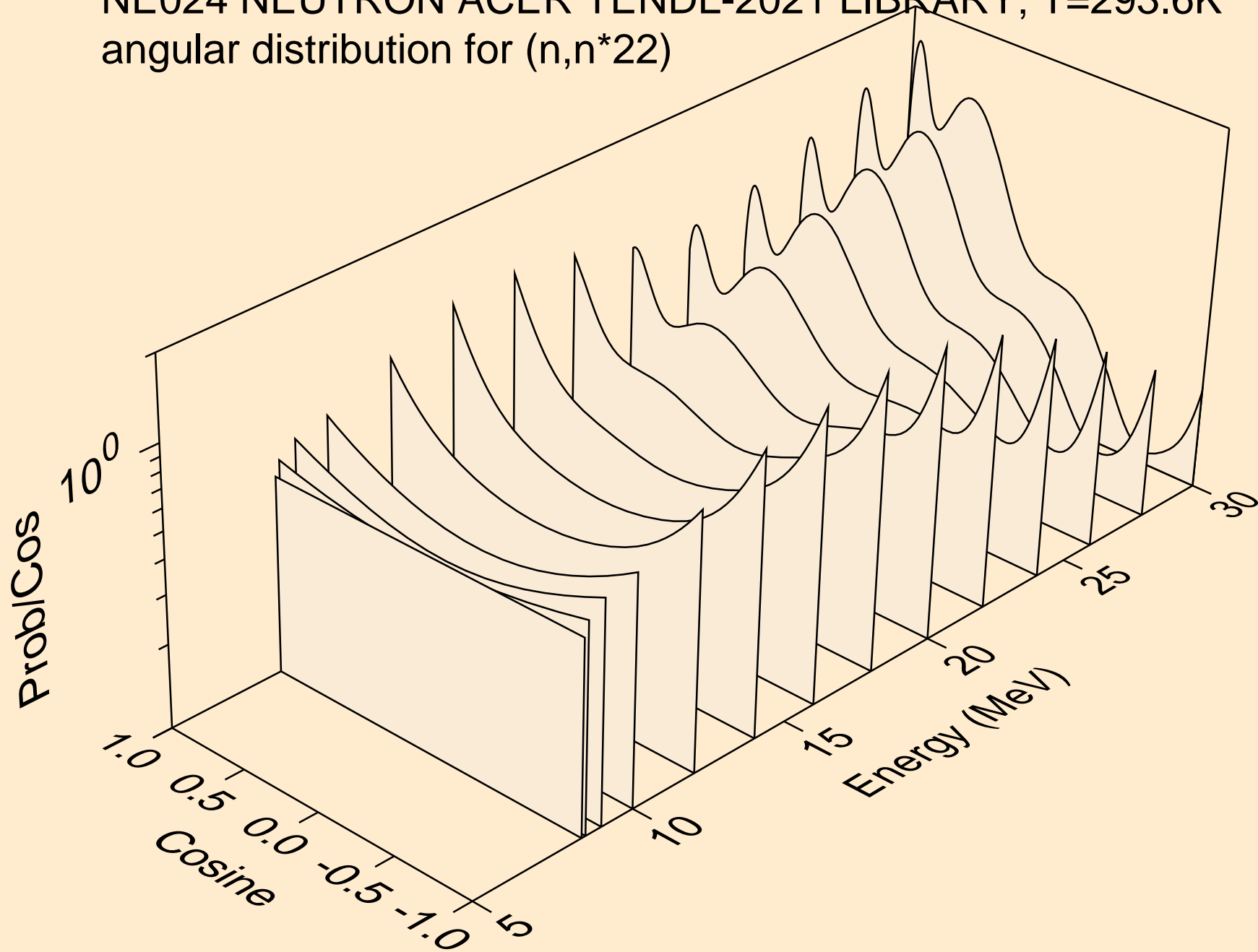

NE024 NEUTRON ACER TENDL-2021 LIBRARY; T=293.6K
angular distribution for (n,n*23)

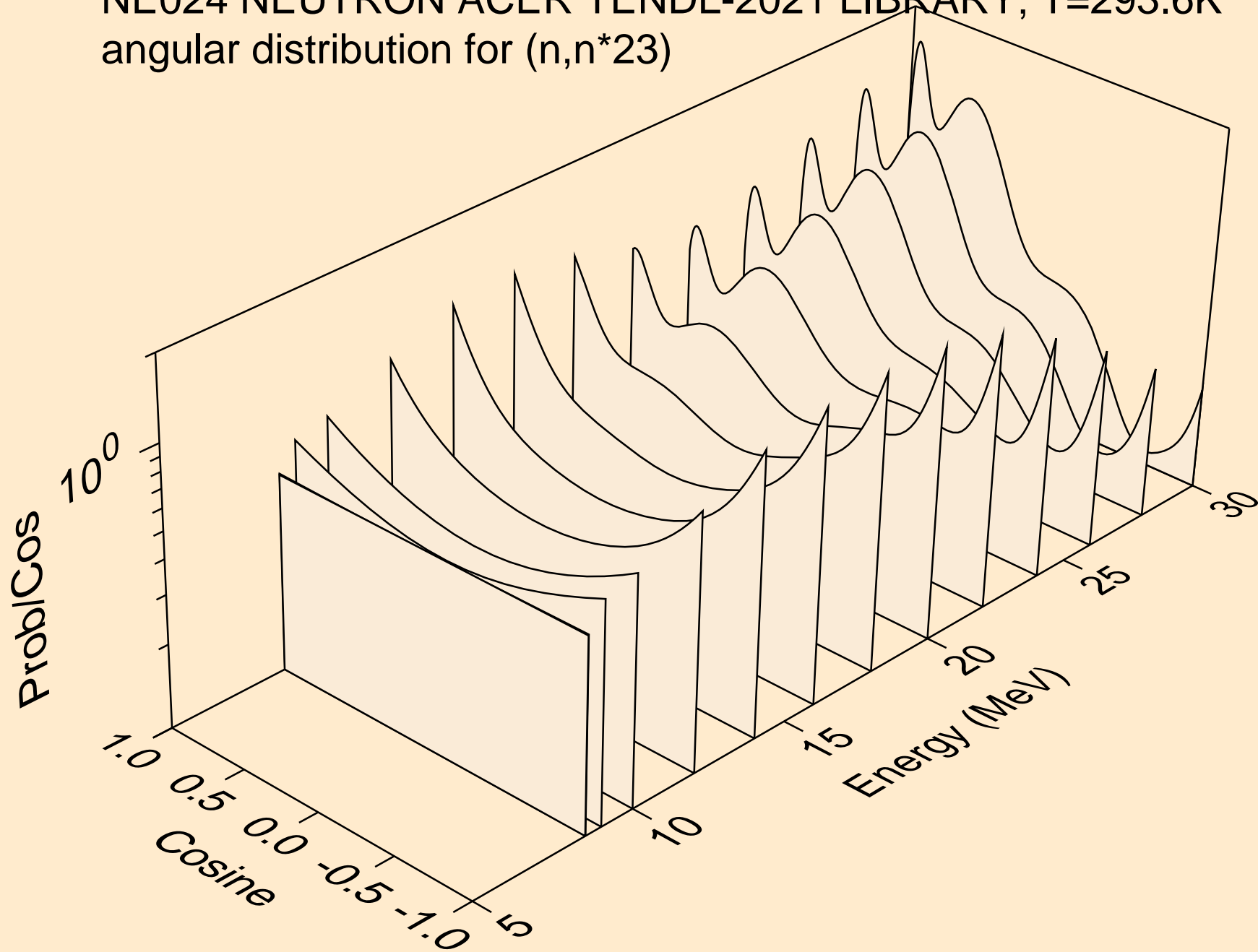

NE024 NEUTRON ACER TENDL-2021 LIBRARY; T=293.6K
angular distribution for (n,n*24)

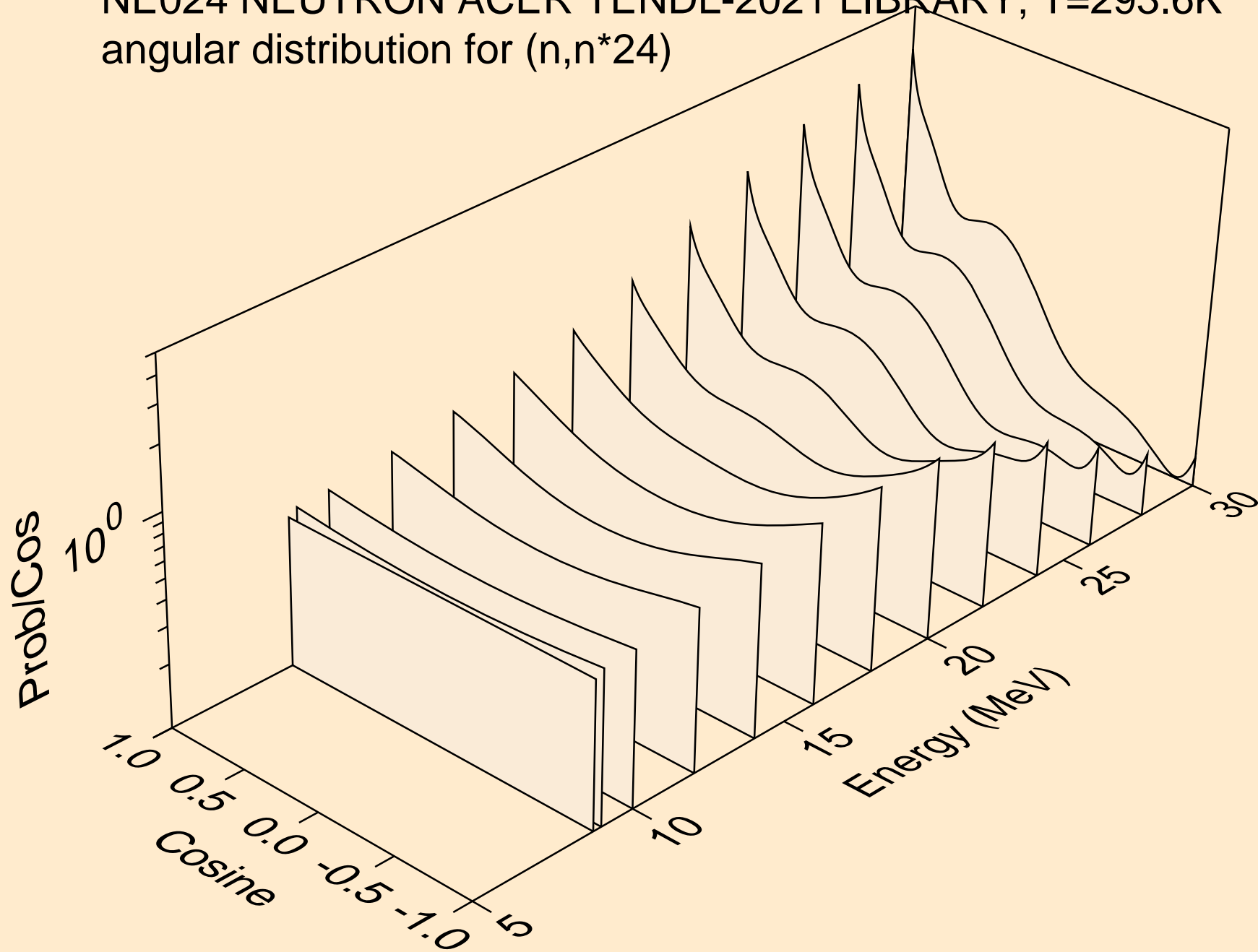

NE024 NEUTRON ACER TENDL-2021 LIBRARY; T=293.6K
angular distribution for (n,n*25)

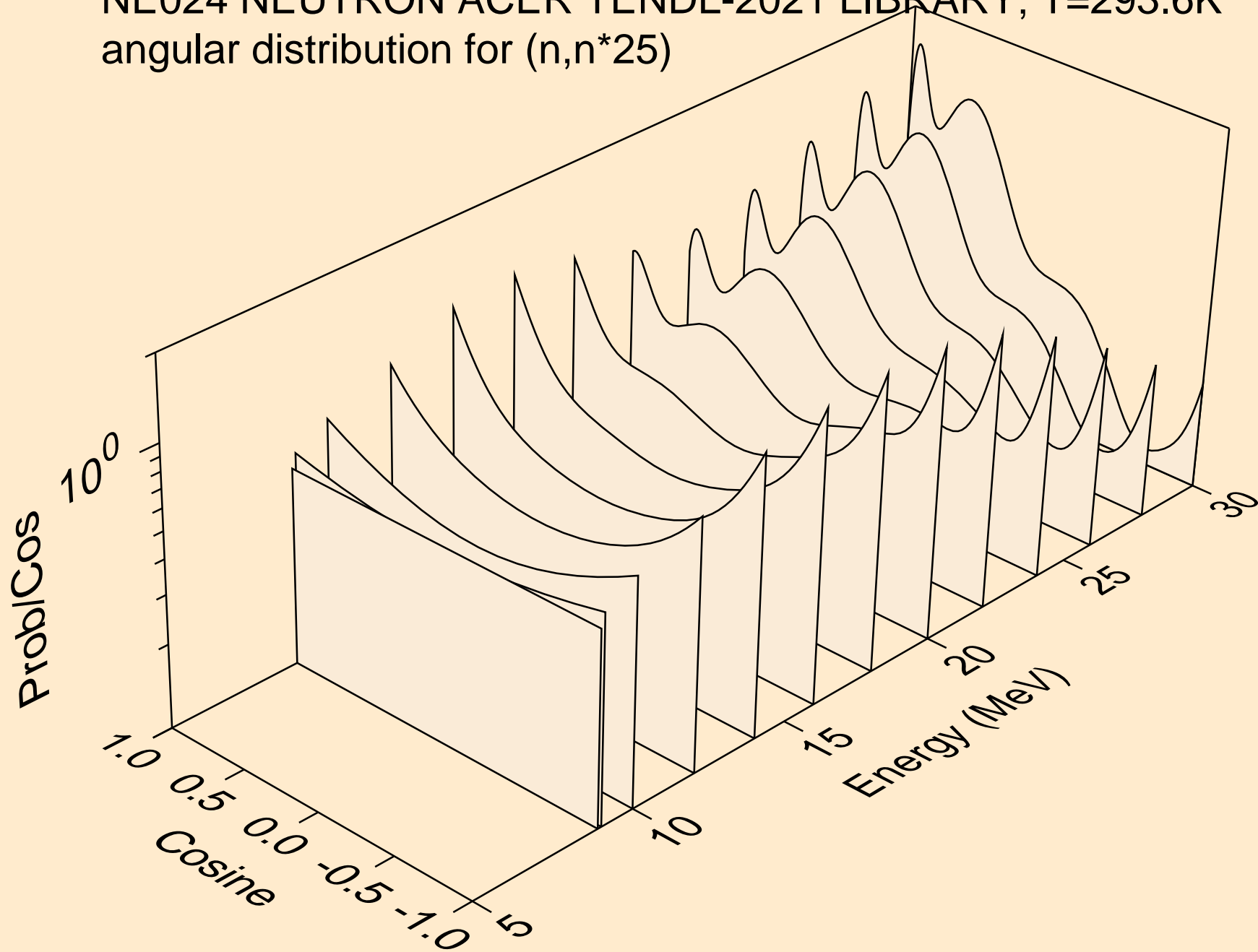

NE024 NEUTRON ACER TENDL-2021 LIBRARY; T=293.6K
angular distribution for (n,n*26)

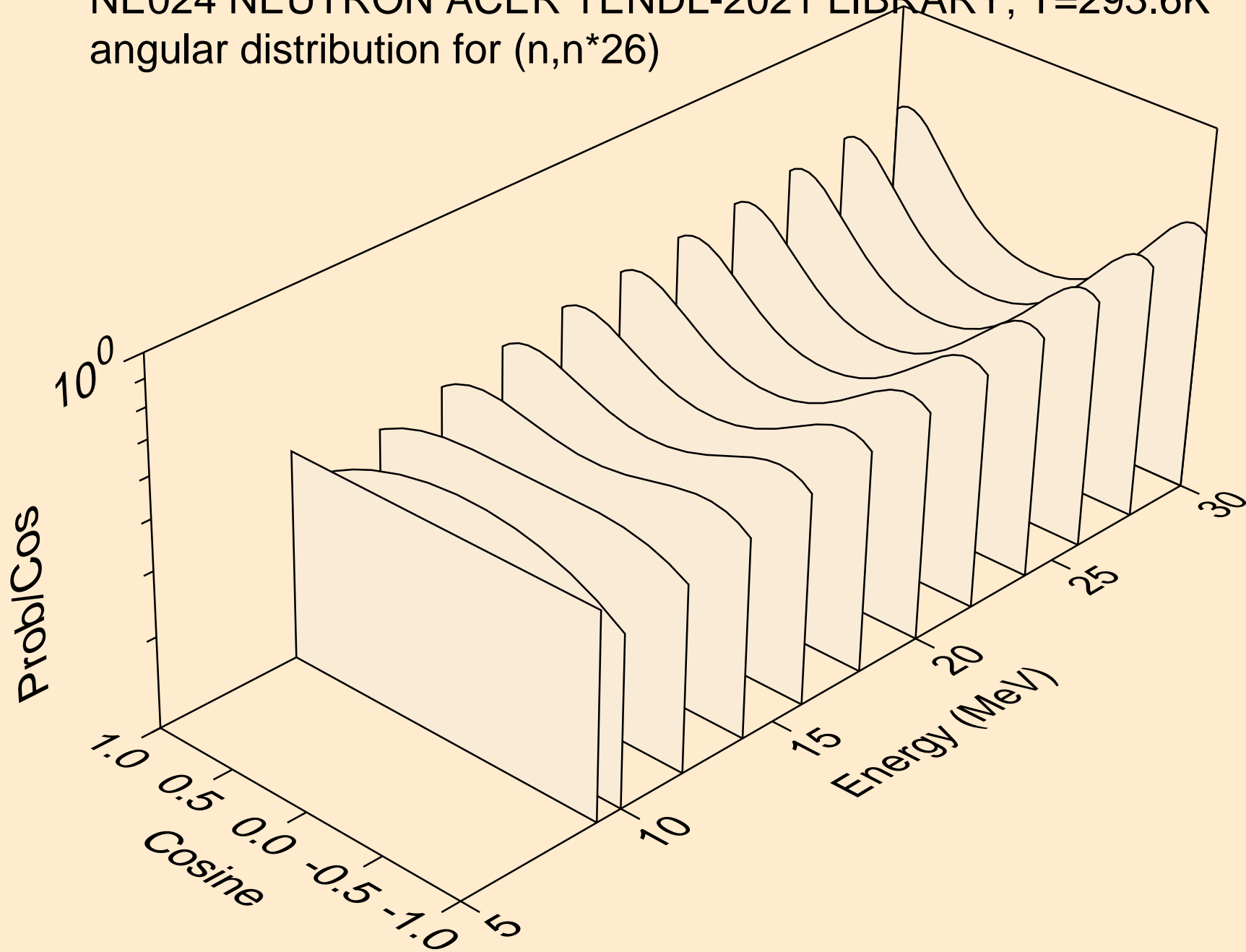

NE024 NEUTRON ACER TENDL-2021 LIBRARY; T=293.6K
angular distribution for (n,n*27)

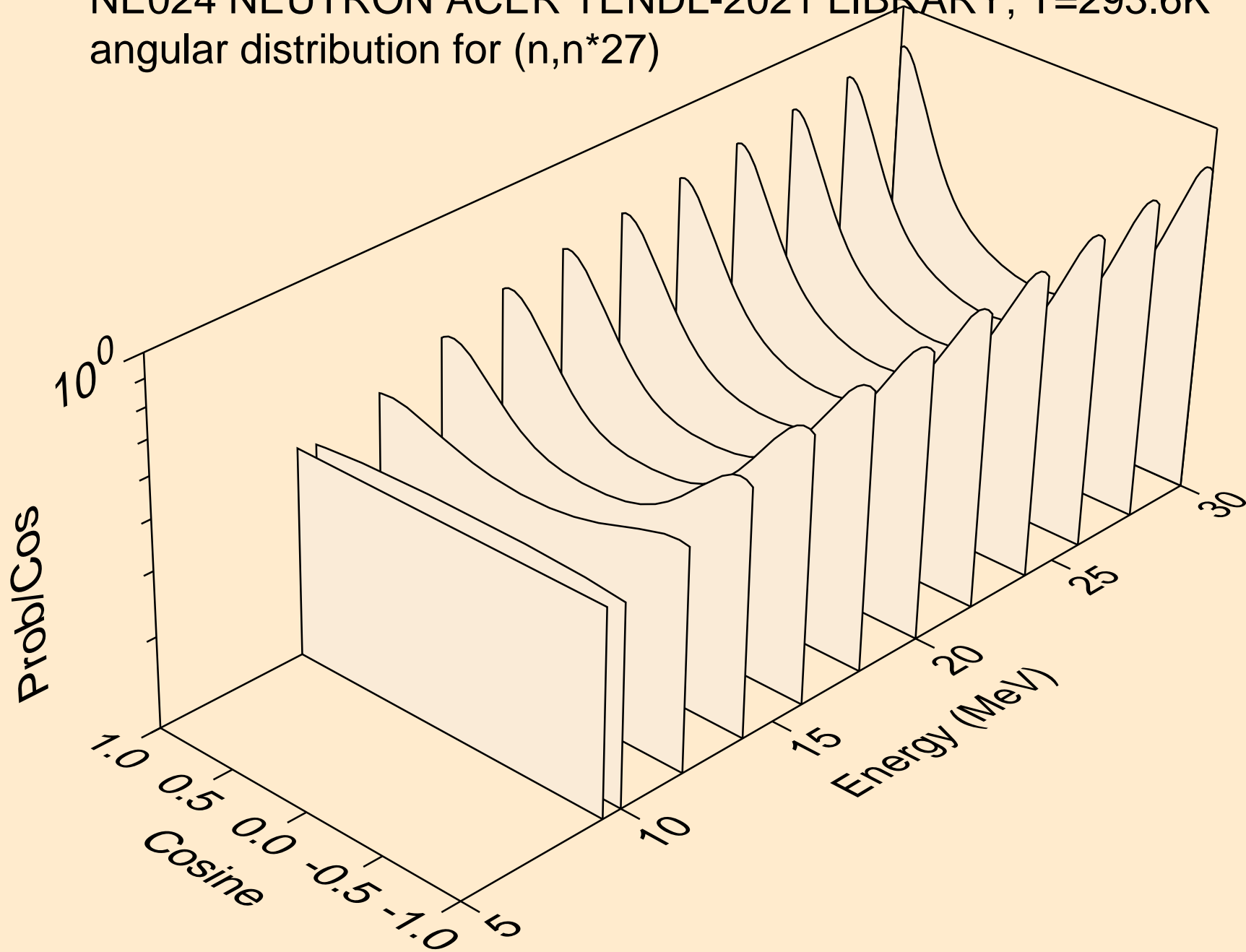

NE024 NEUTRON ACER TENDL-2021 LIBRARY; T=293.6K
angular distribution for (n,n*28)

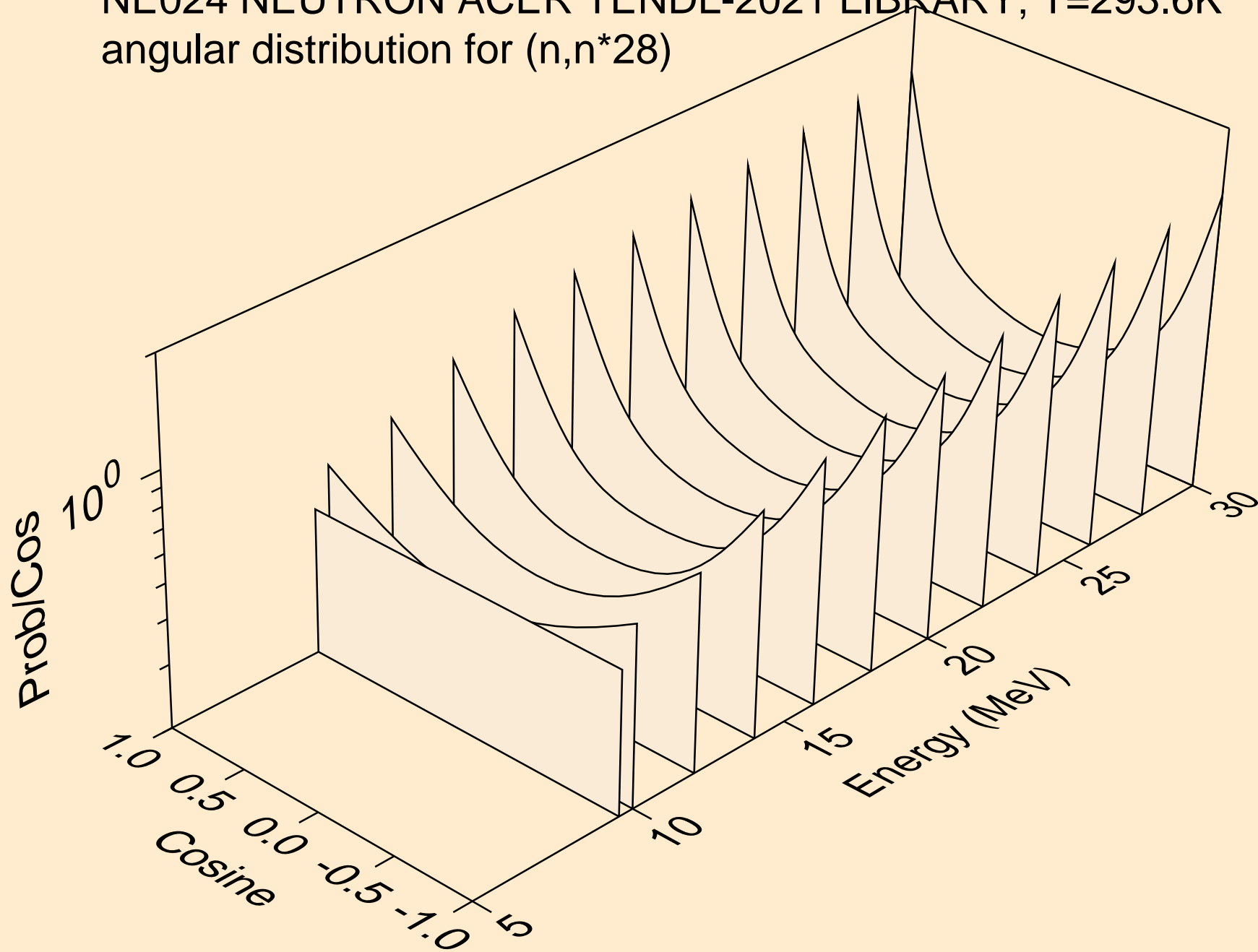

NE024 NEUTRON ACER TENDL-2021 LIBRARY; T=293.6K
angular distribution for (n,n*29)

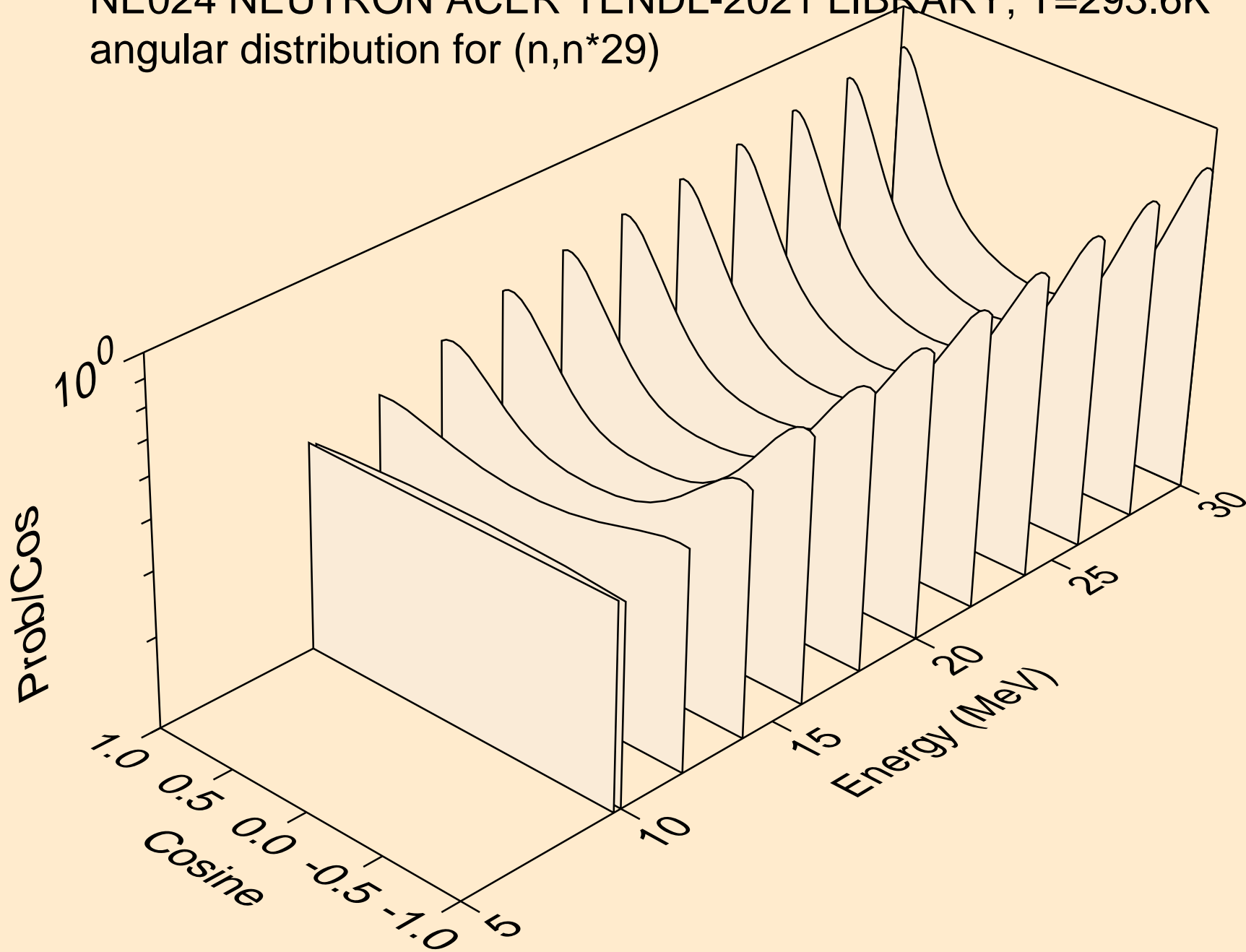

NE024 NEUTRON ACER TENDL-2021 LIBRARY; T=293.6K
angular distribution for (n,n*30)

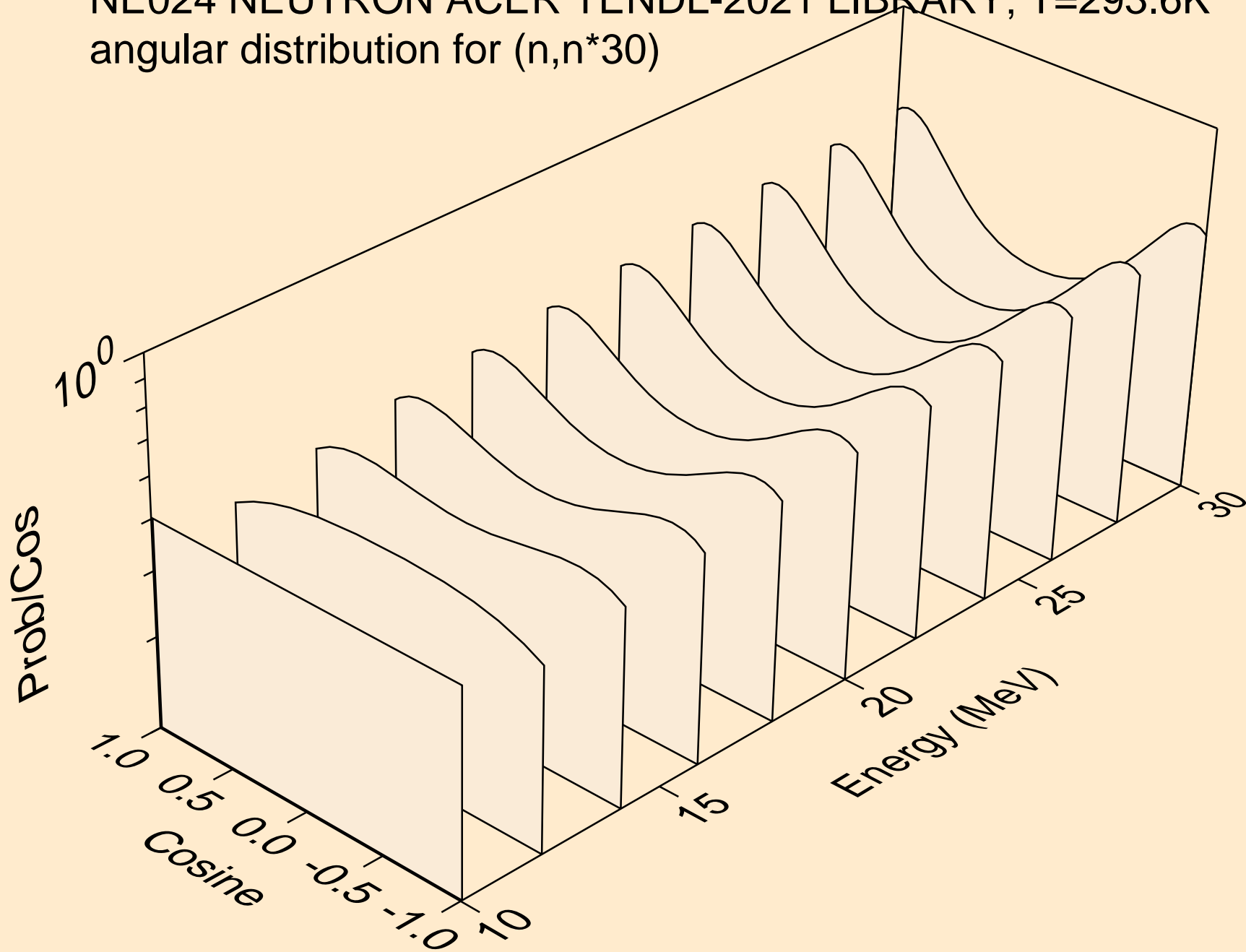

NE024 NEUTRON ACER TENDL-2021 LIBRARY; T=293.6K
Neutron emission for (n,x)

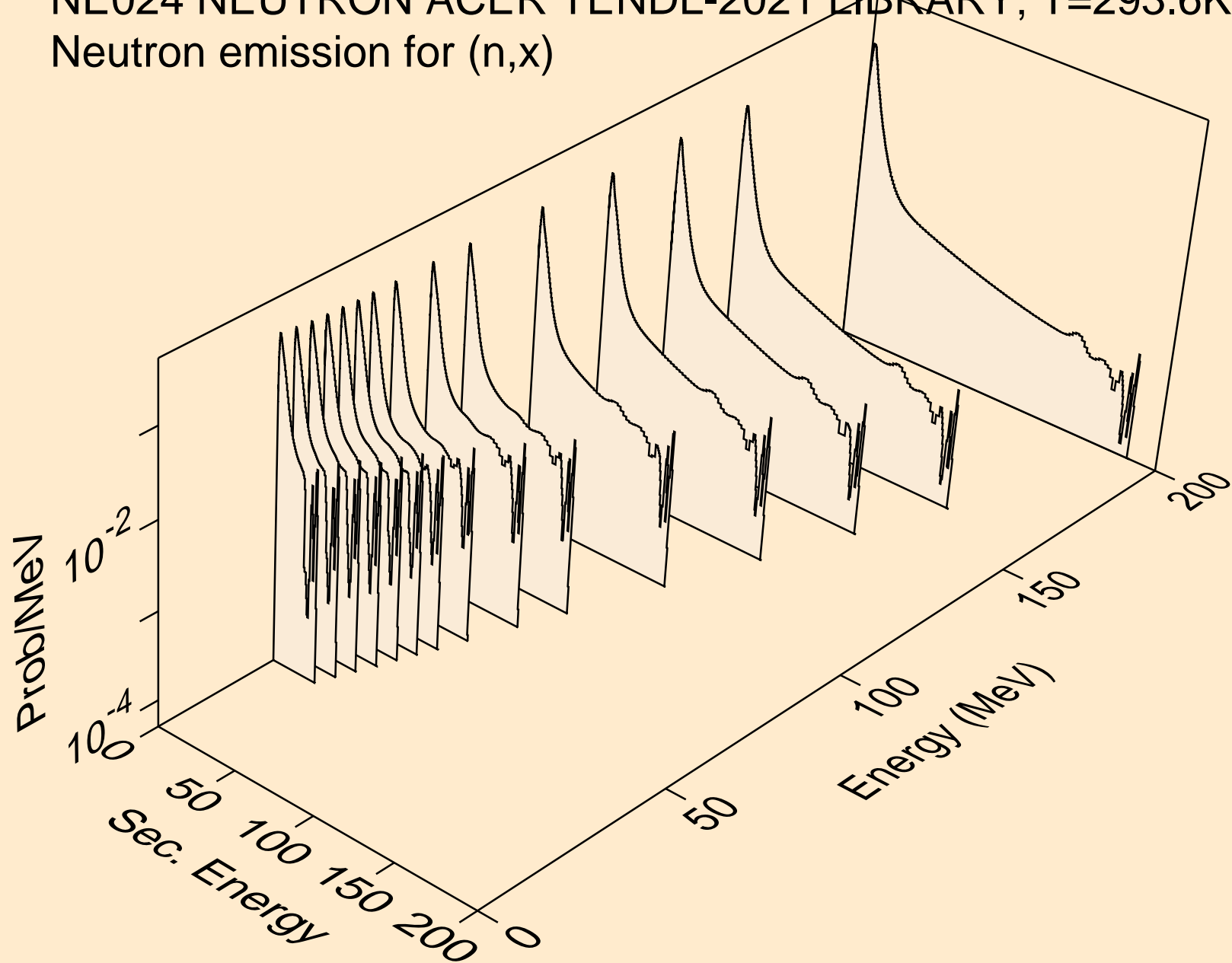

NE024 NEUTRON ACER TENDL-2021 LIBRARY; T=293.6K
Neutron emission for (n,2nd)

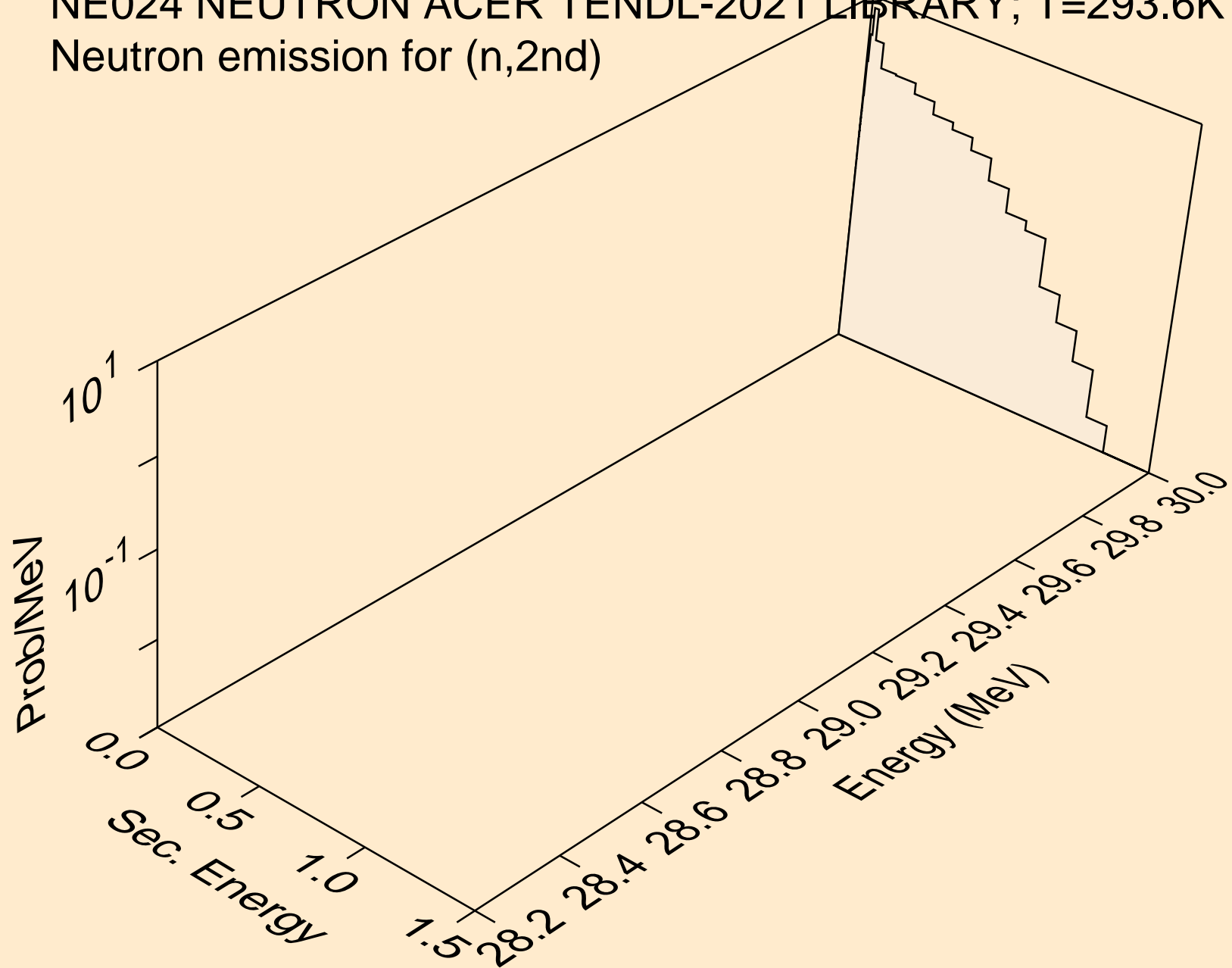

NE024 NEUTRON ACER TENDL-2021 LIBRARY; T=293.6K
Neutron emission for (n,2n)

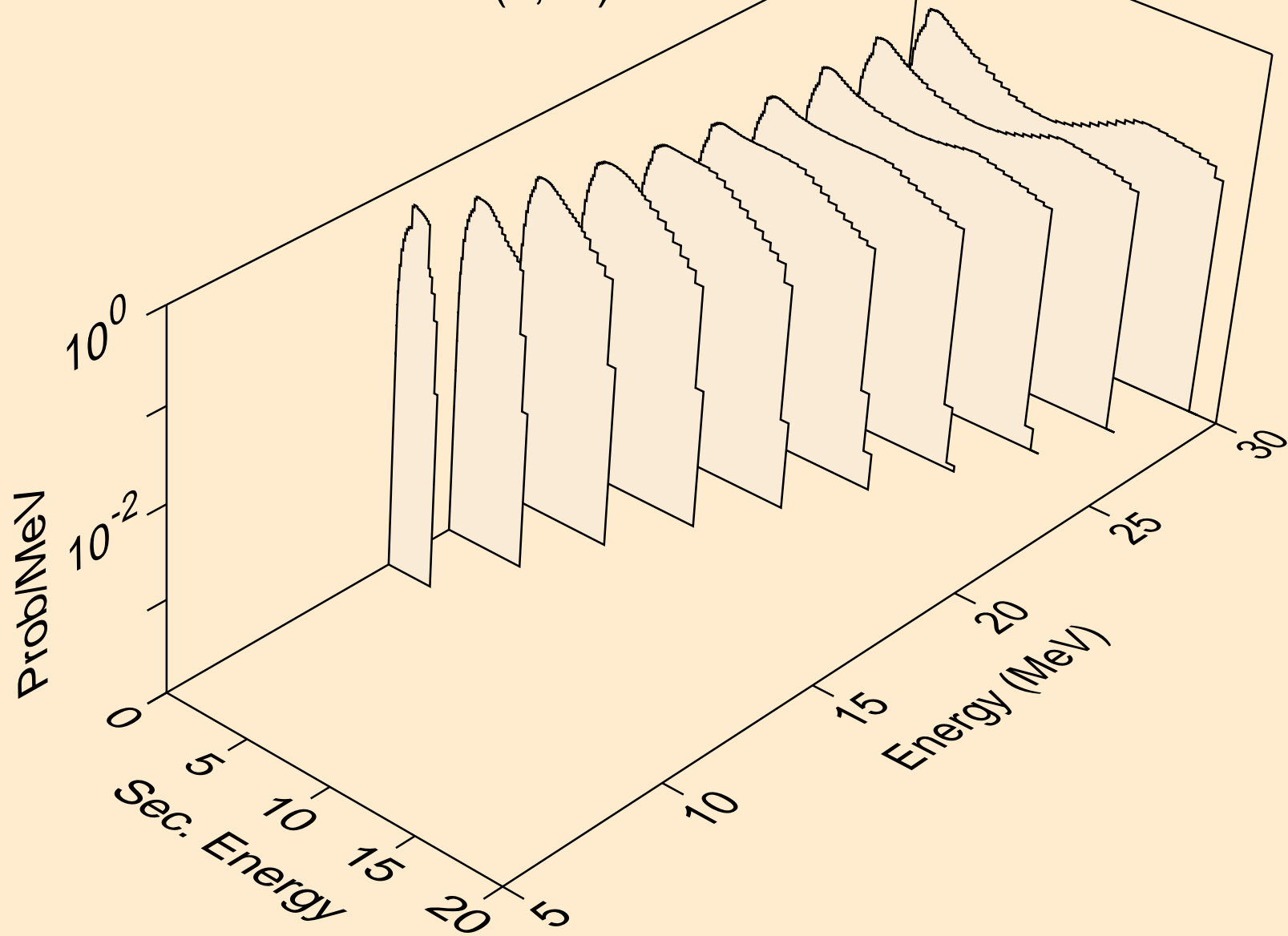

NE024 NEUTRON ACER TENDL-2021 LIBRARY; T=293.6K
Neutron emission for (n,3n)

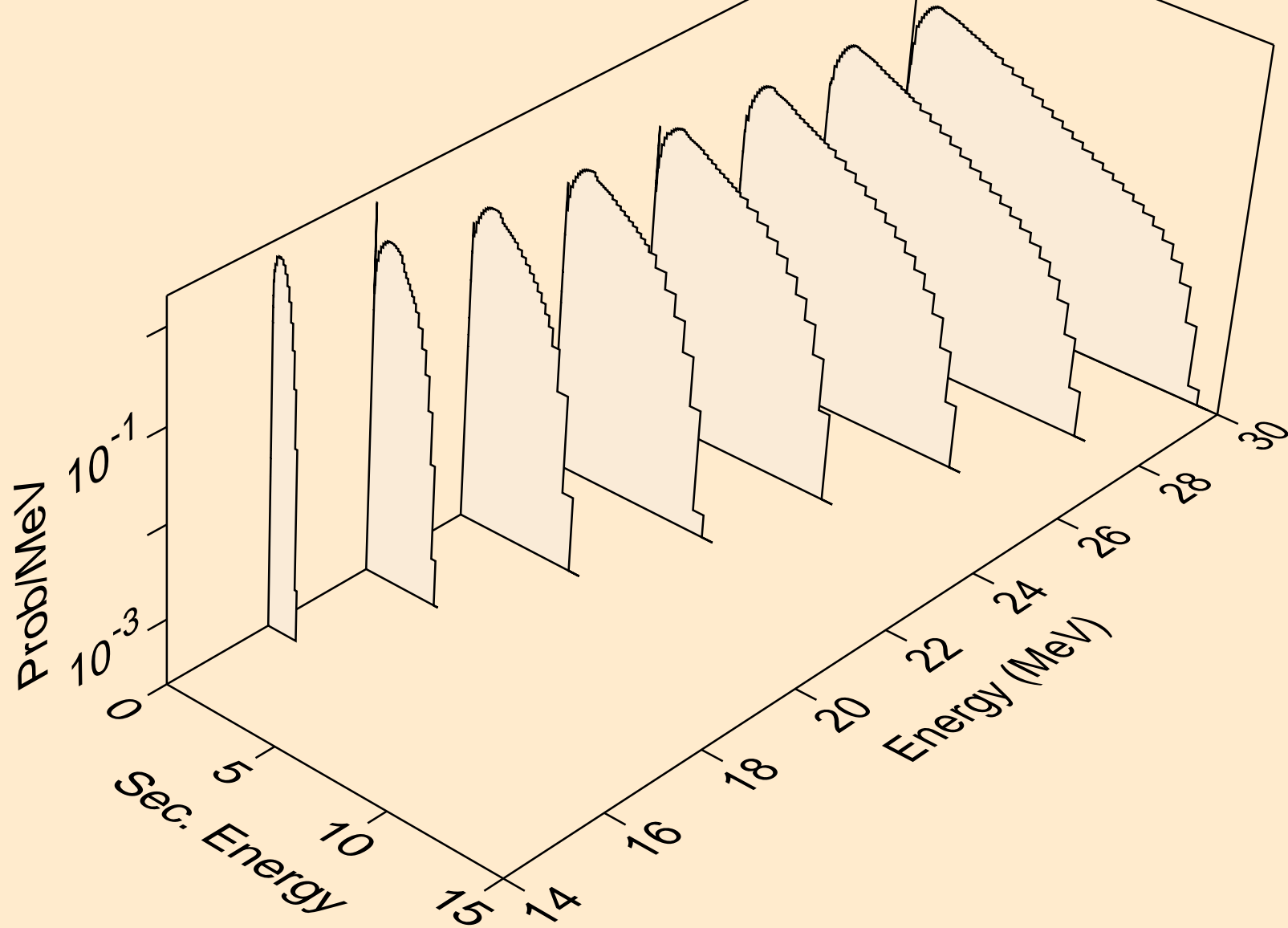

NE024 NEUTRON ACER TENDL-2021 LIBRARY; T=293.6K
Neutron emission for (n,n*)a

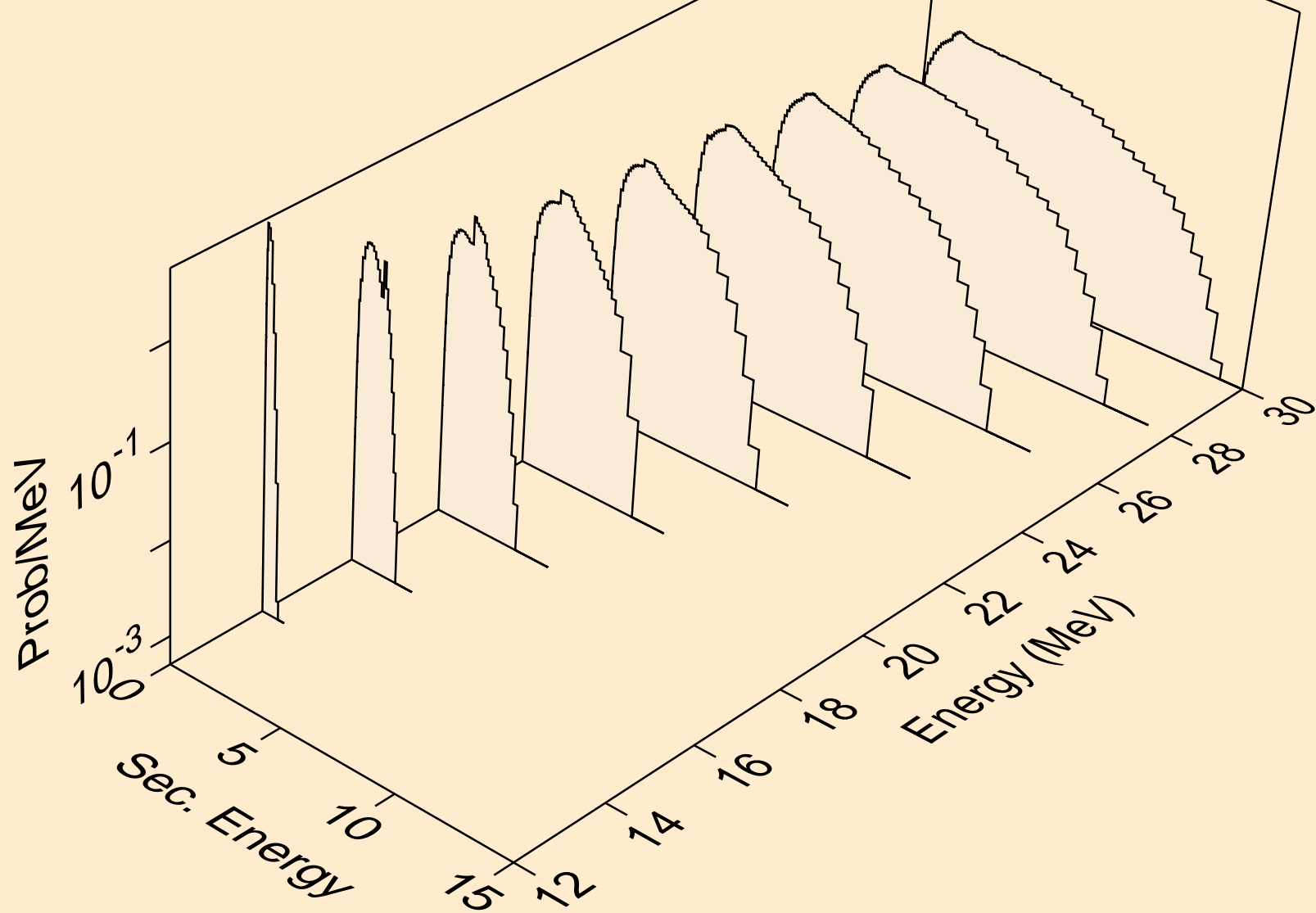

NE024 NEUTRON ACER TENDL-2021 LIBRARY; T=293.6K
Neutron emission for (n,2n)a

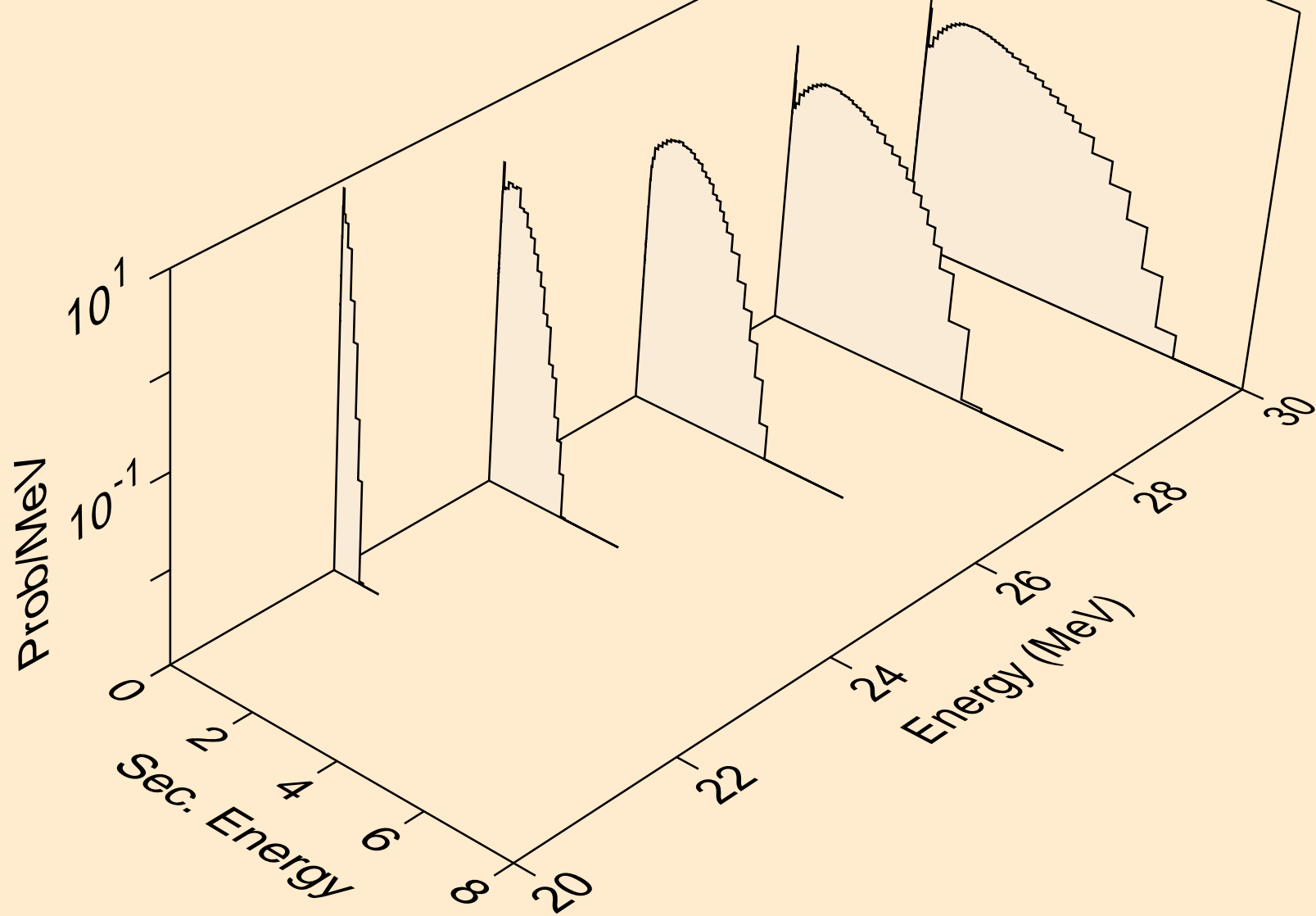

NE024 NEUTRON ACER TENDL-2021 LIBRARY; T=293.6K
Neutron emission for (n,3n)a

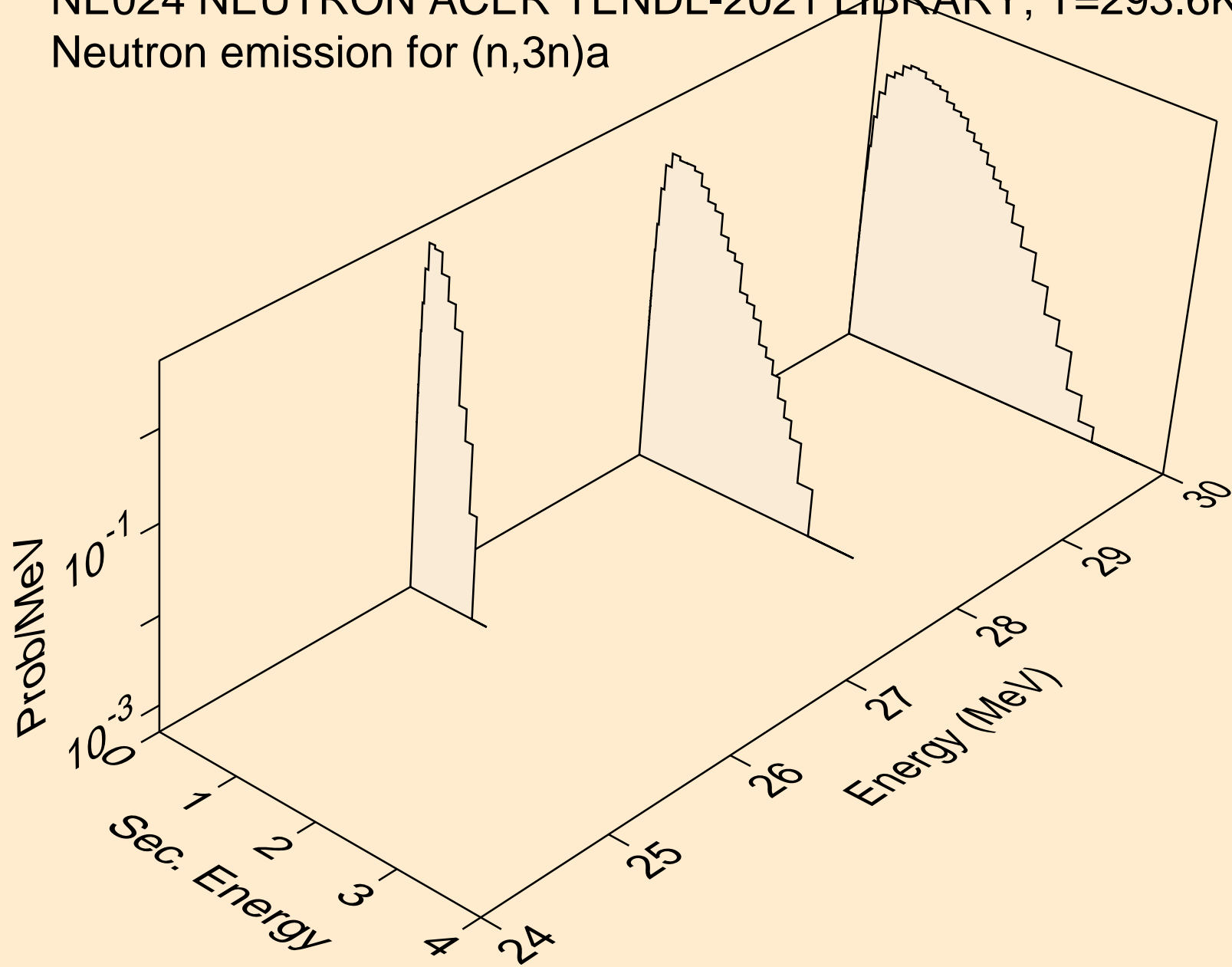

NE024 NEUTRON ACER TENDL-2021 LIBRARY; T=293.6K
Neutron emission for (n,n*)p

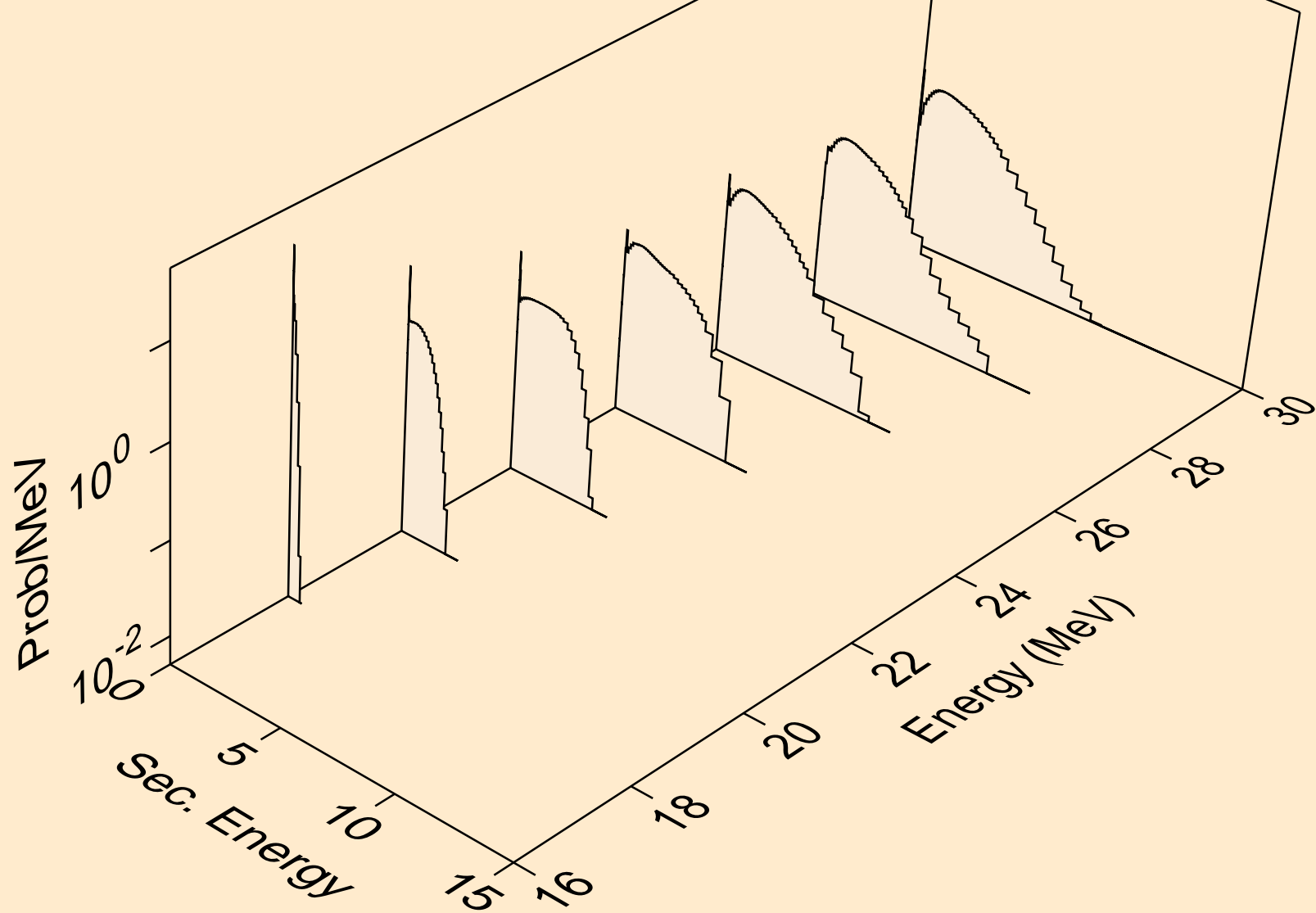

NE024 NEUTRON ACER TENDL-2021 LIBRARY; T=293.6K
Neutron emission for (n,n*)2a

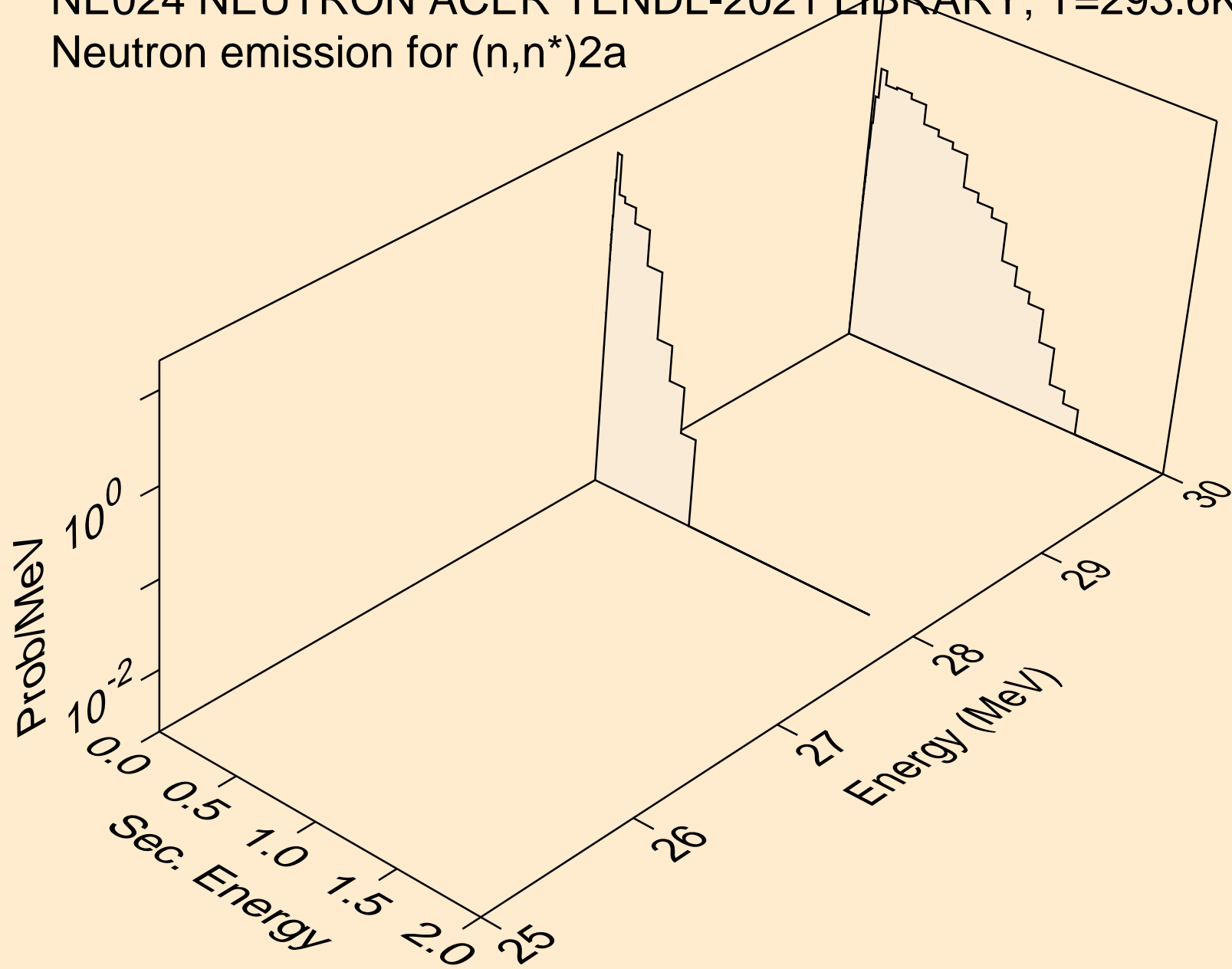

NE024 NEUTRON ACER TENDL-2021 LIBRARY; T=293.6K
Neutron emission for (n,n*)d

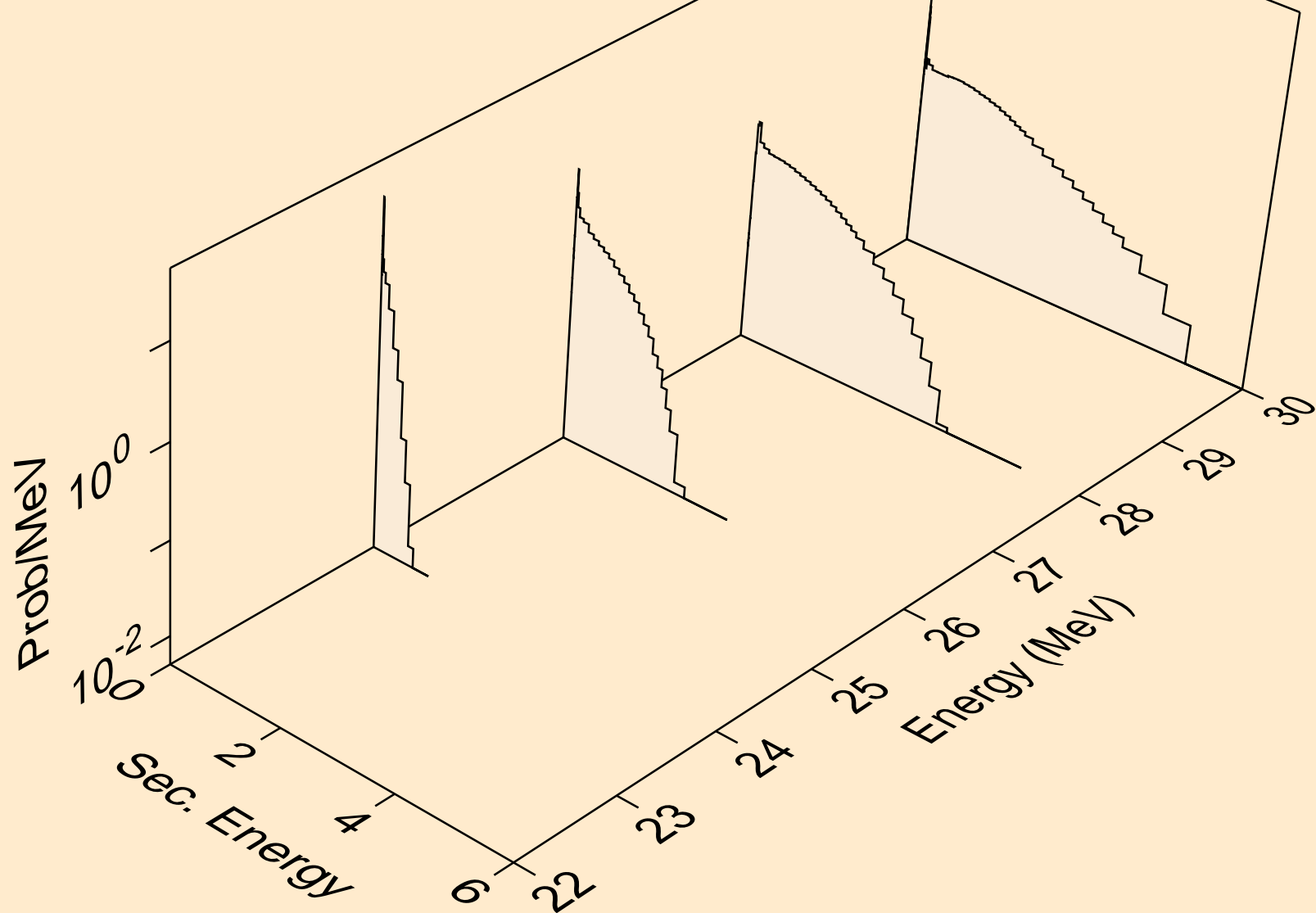

NE024 NEUTRON ACER TENDL-2021 LIBRARY; T=293.6K
Neutron emission for (n,n*)t

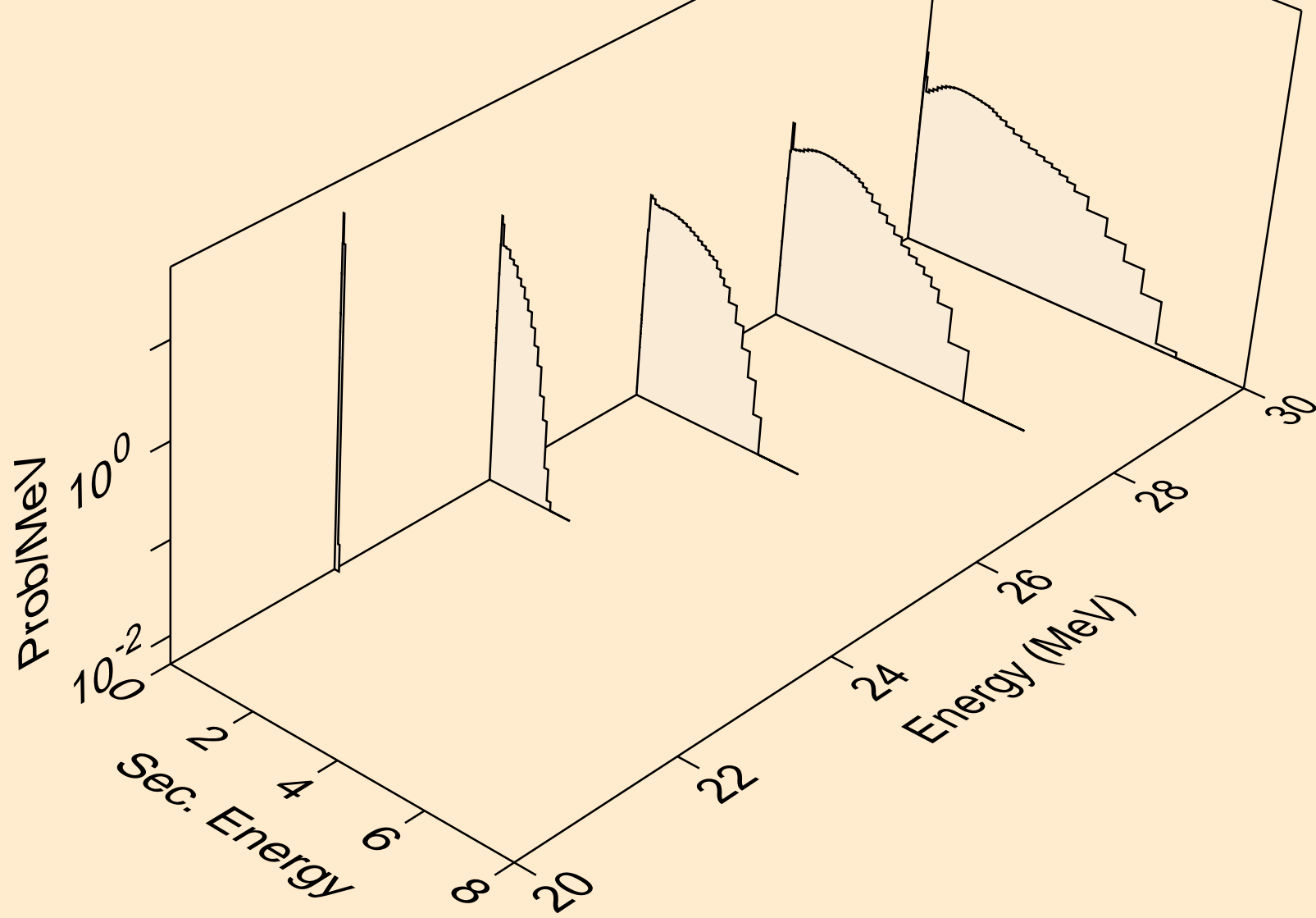

NE024 NEUTRON ACER TENDL-2021 LIBRARY; T=293.6K
Neutron emission for (n,4n)

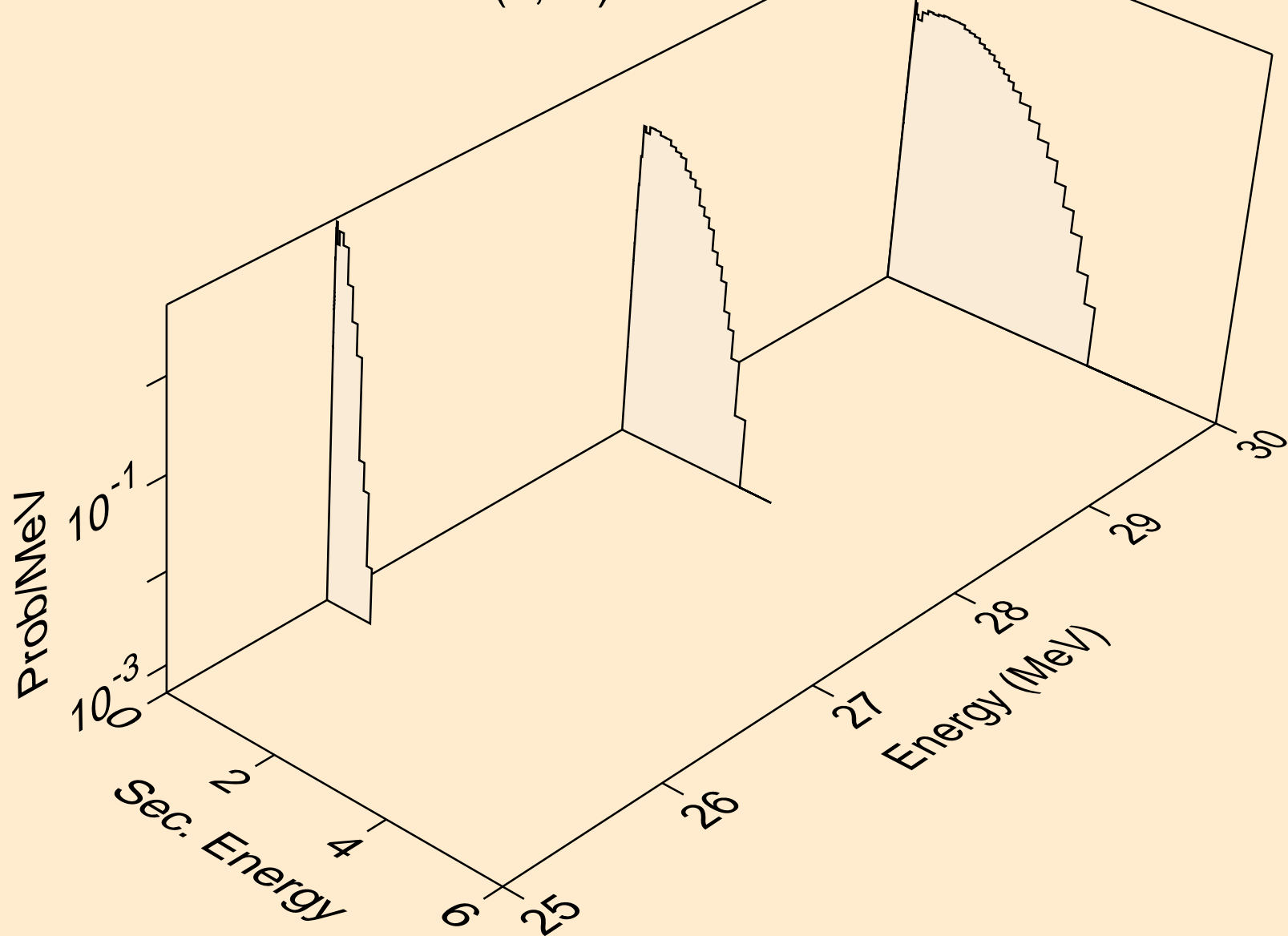

NE024 NEUTRON ACER TENDL-2021 LIBRARY; T=293.6K
Neutron emission for (n,2np)

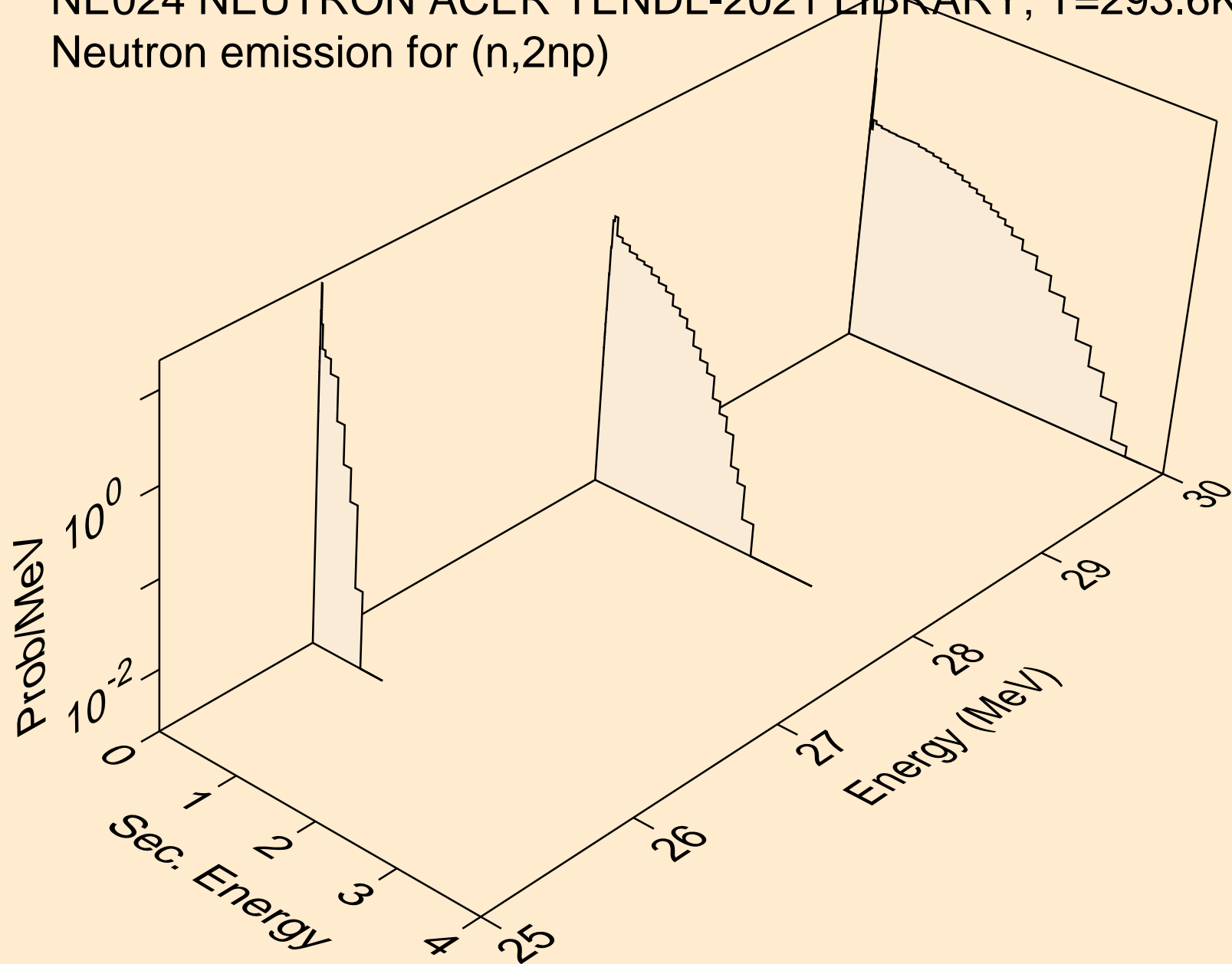

NE024 NEUTRON ACER TENDL-2021 LIBRARY; T=293.6K
Neutron emission for (n,n*c)

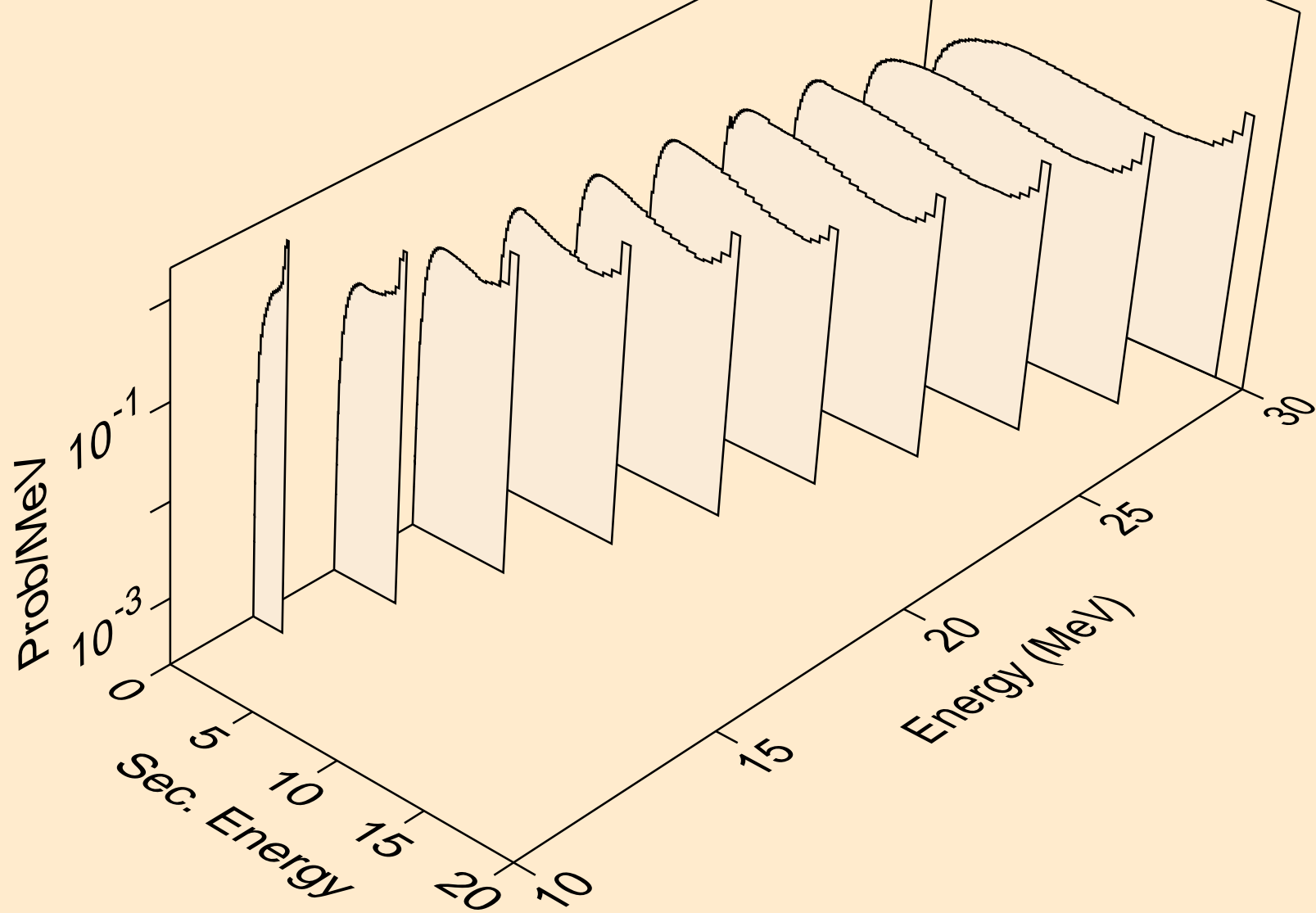

NE024 NEUTRON ACER TENDL-2021 LIBRARY; T=293.6K
Photon emission for (n,x)

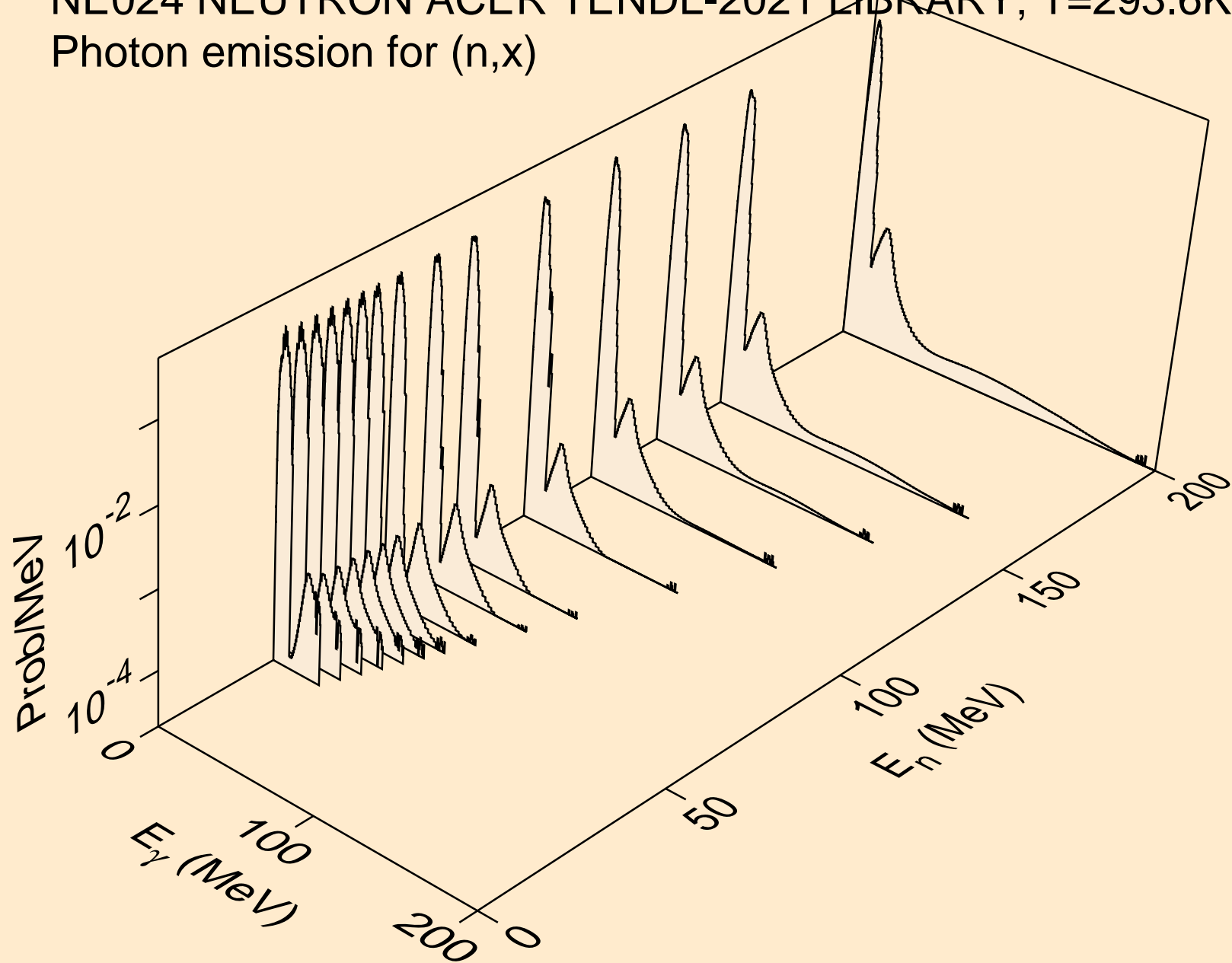

NE024 NEUTRON ACER TENDL-2021 LIBRARY; T=293.6K
Photon emission for (n,2nd)

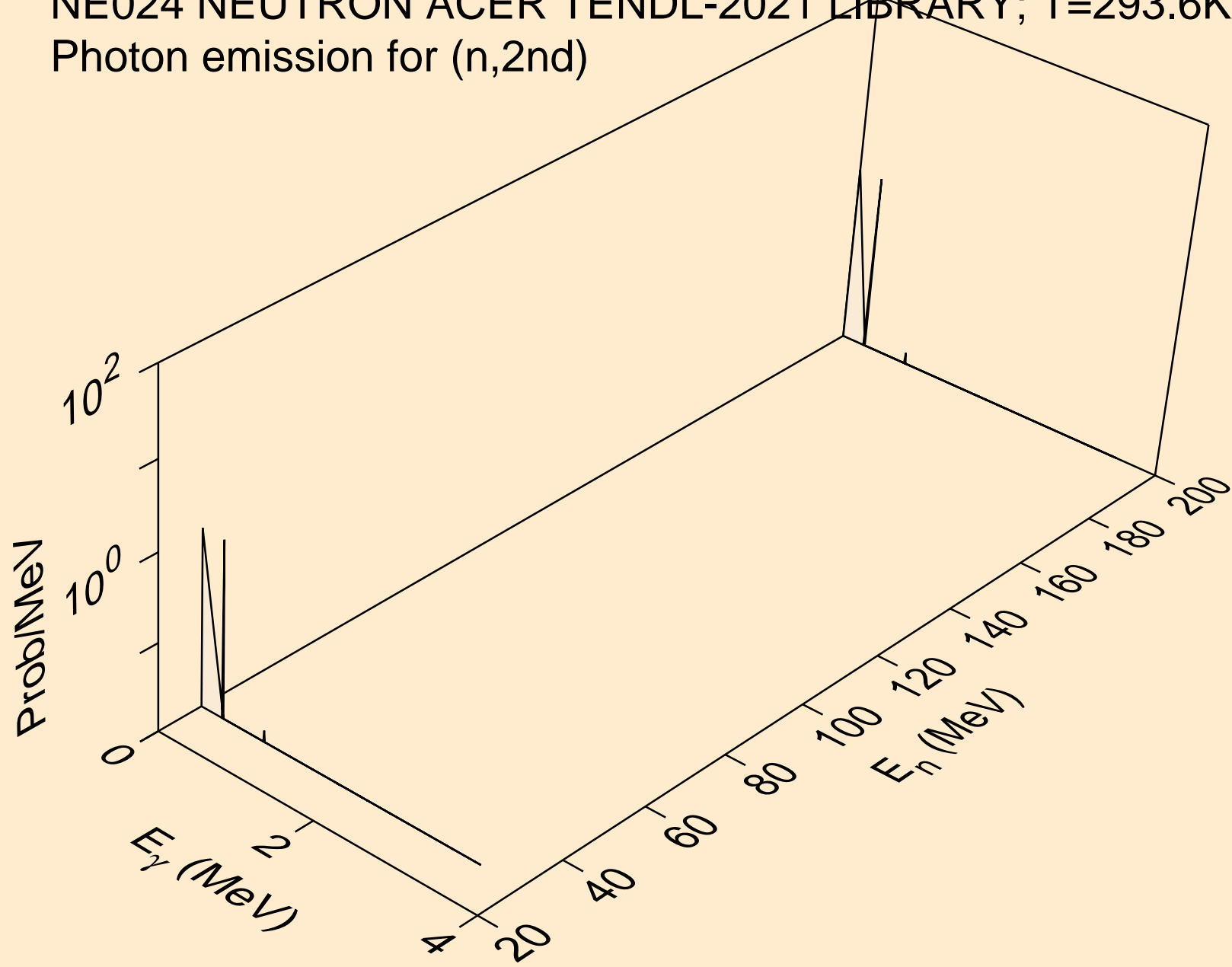

NE024 NEUTRON ACER TENDL-2021 LIBRARY; T=293.6K
Photon emission for (n,2n)

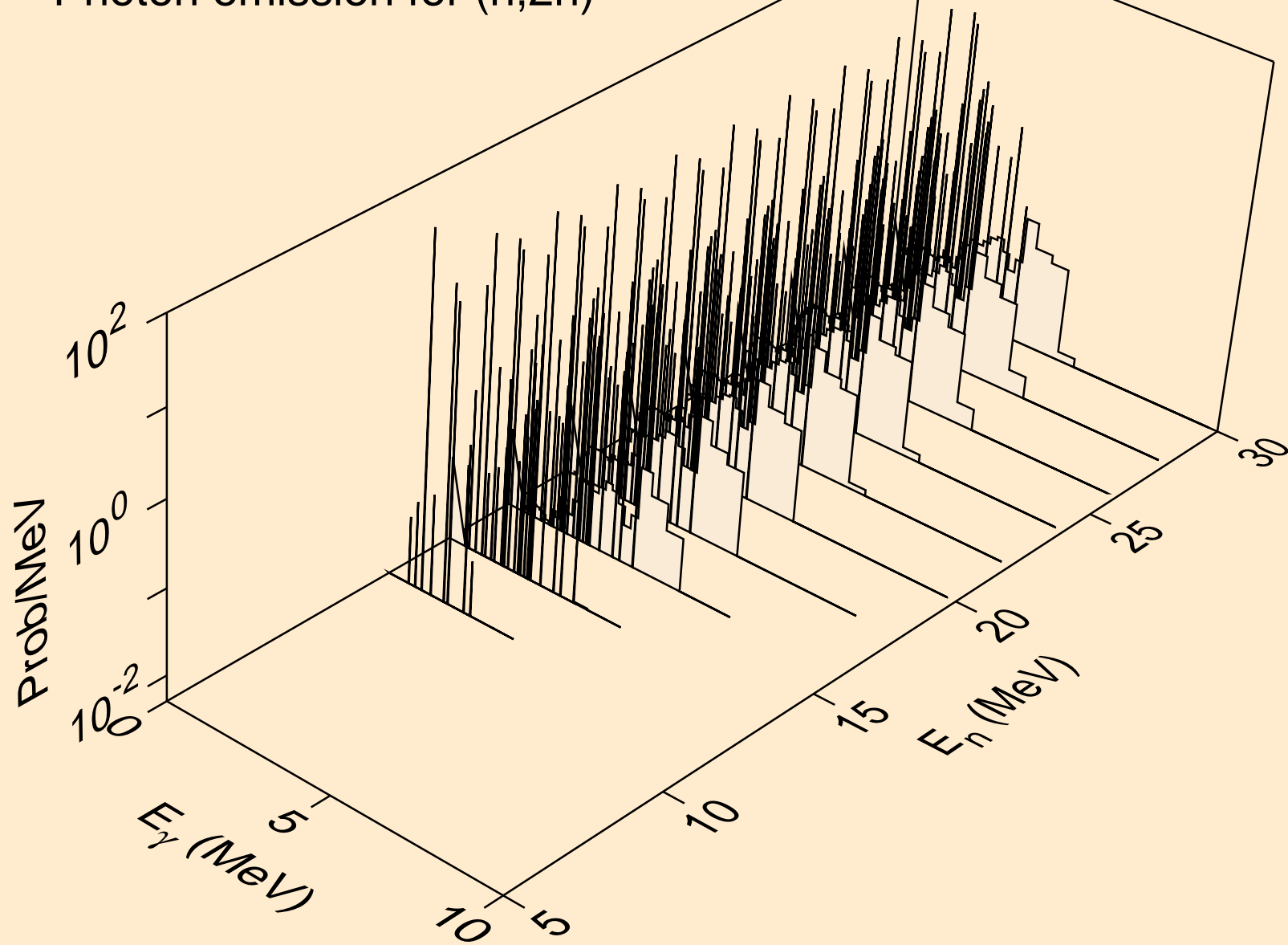

NE024 NEUTRON ACER TENDL-2021 LIBRARY; T=293.6K
Photon emission for (n,3n)

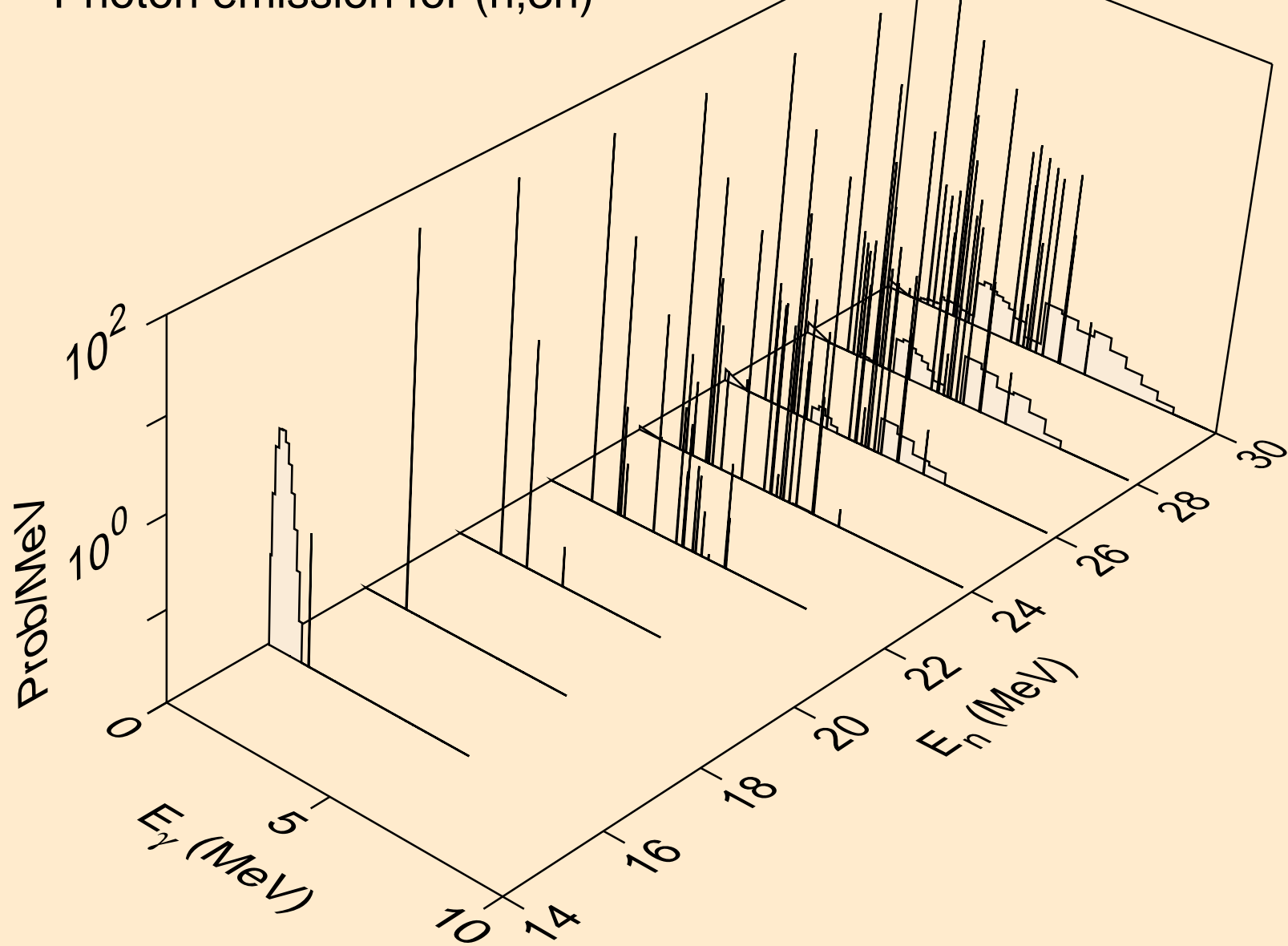

NE024 NEUTRON ACER TENDL-2021 LIBRARY; T=293.6K
Photon emission for (n,n*)a

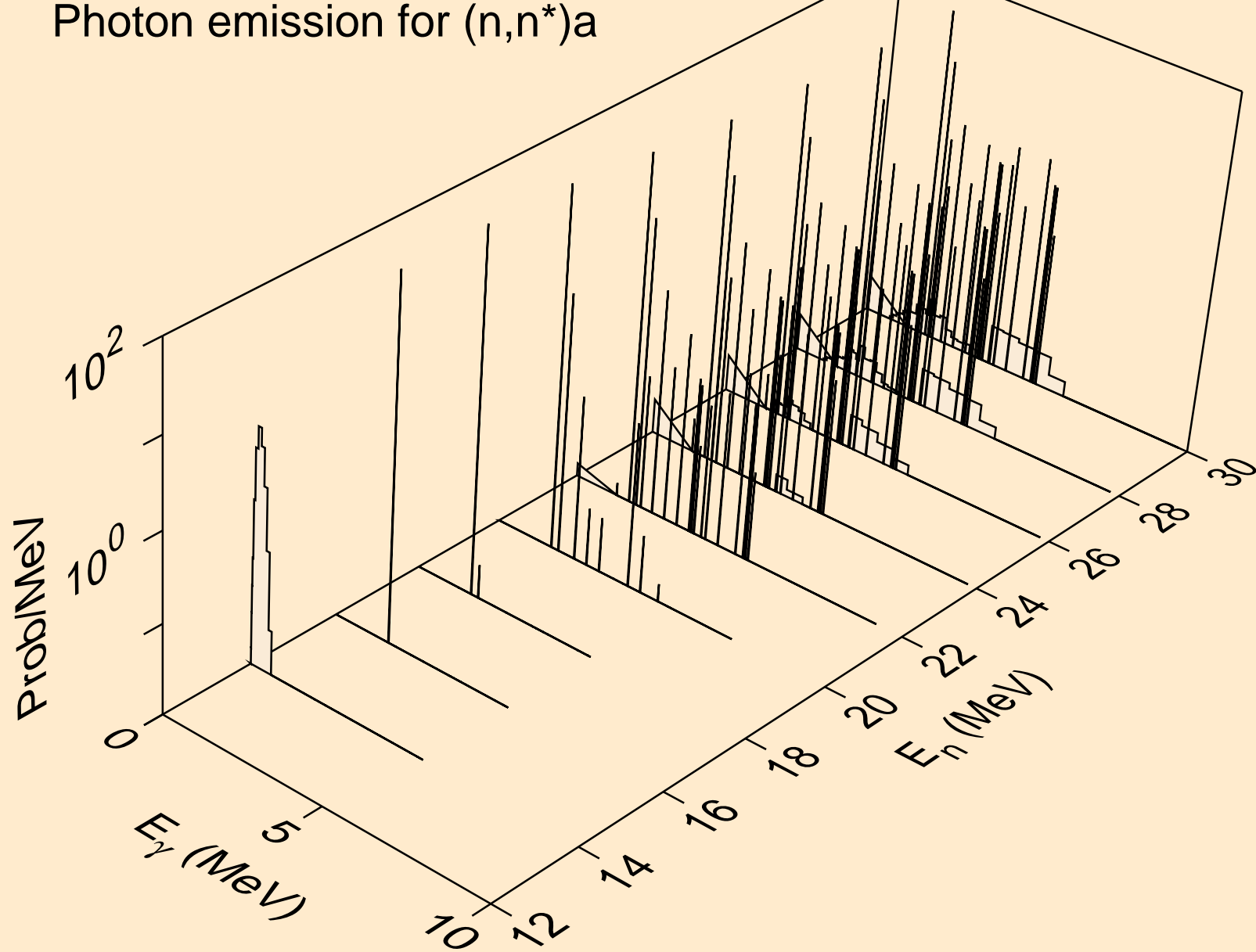

NE024 NEUTRON ACER TENDL-2021 LIBRARY; T=293.6K
Photon emission for (n,2n)a

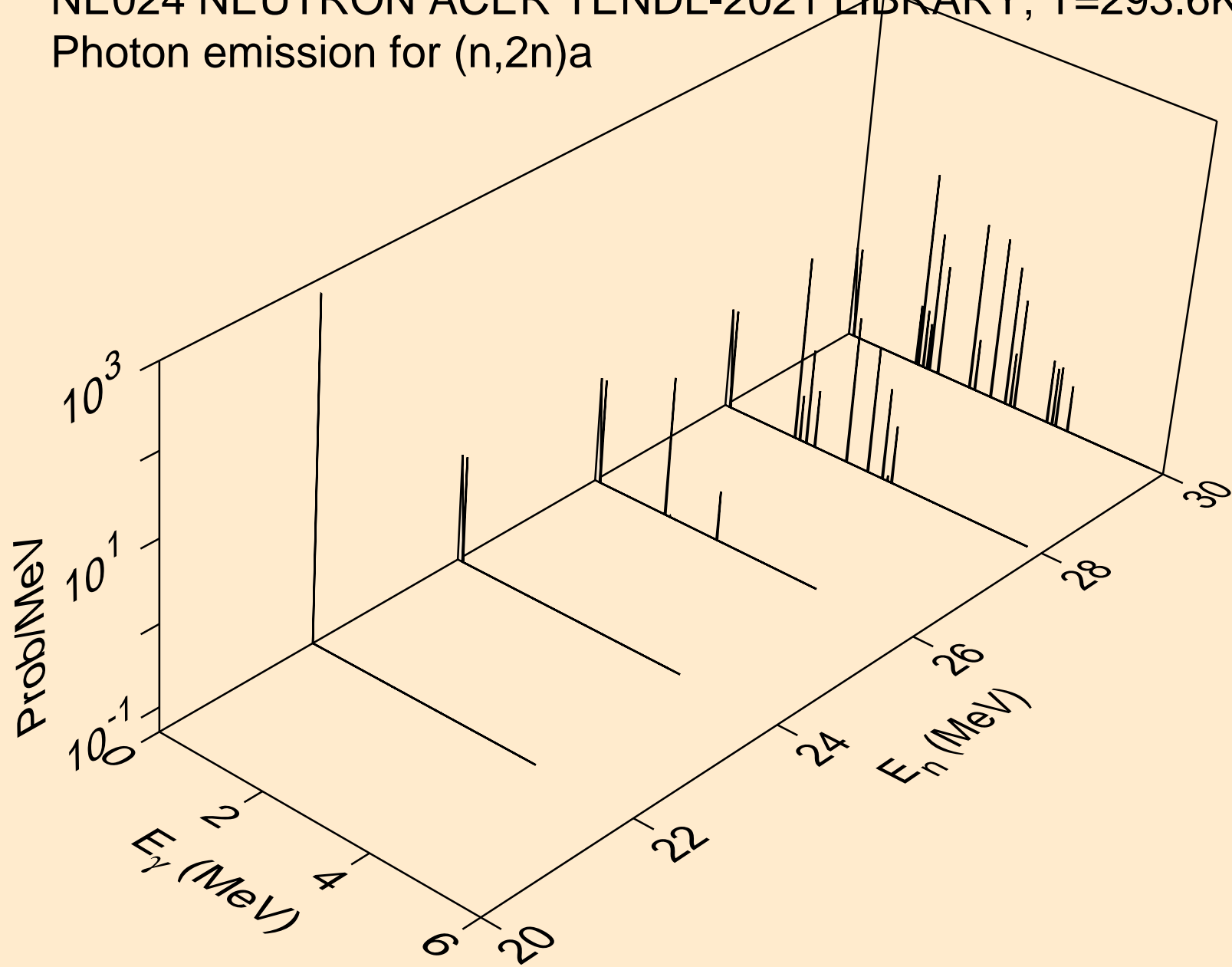

NE024 NEUTRON ACER TENDL-2021 LIBRARY; T=293.6K
Photon emission for (n,3n)a

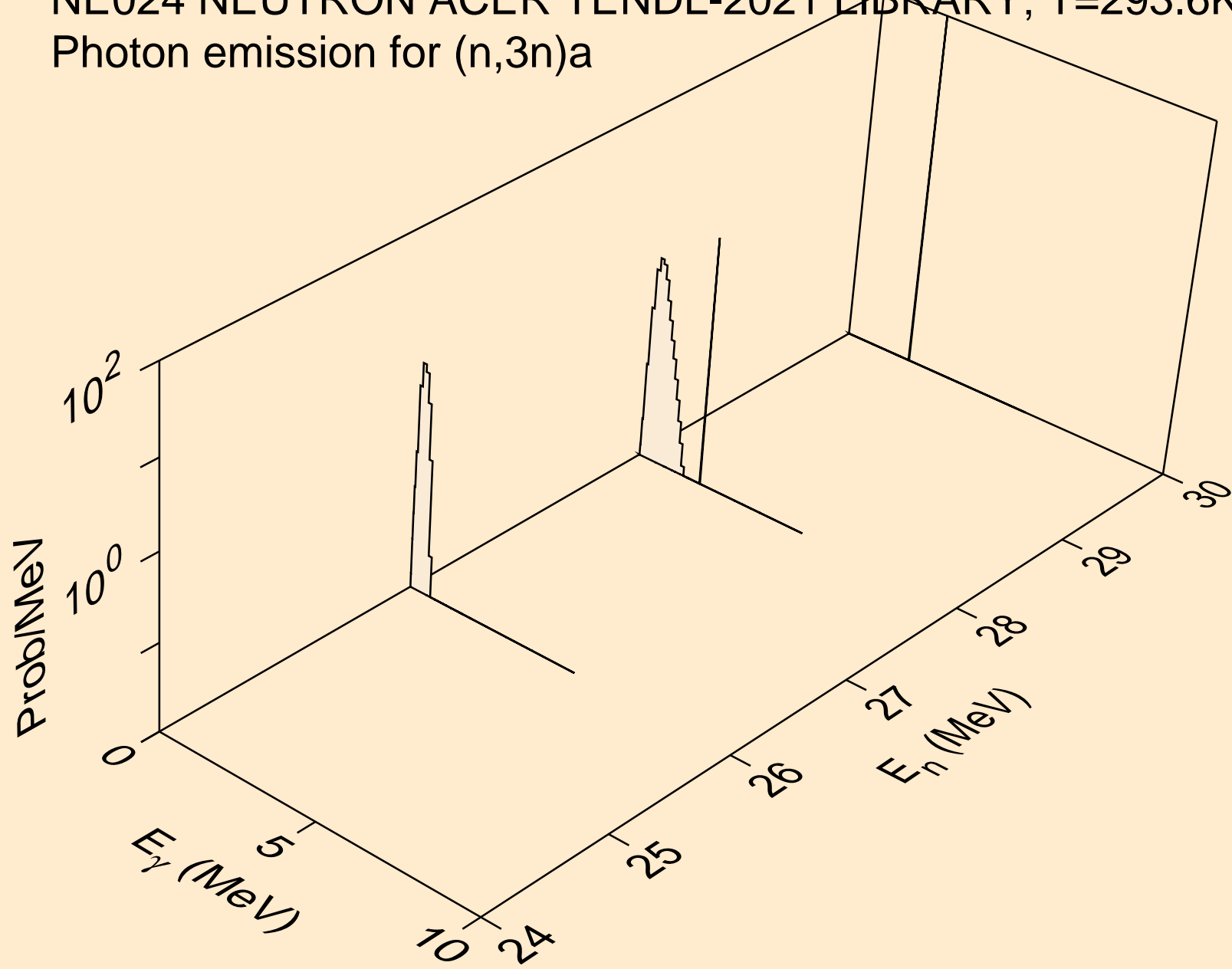

NE024 NEUTRON ACER TENDL-2021 LIBRARY; T=293.6K
Photon emission for (n,n*)p

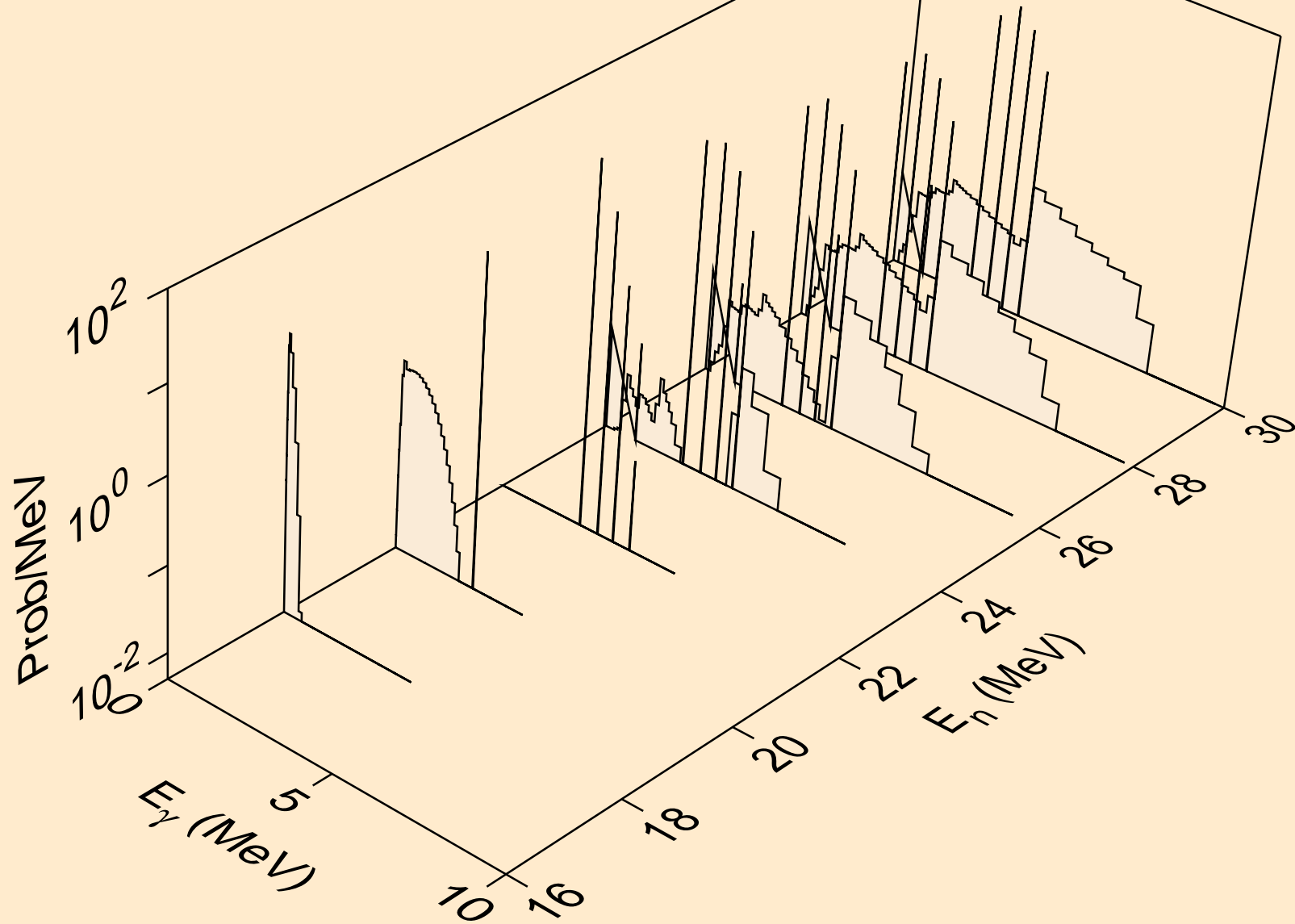

NE024 NEUTRON ACER TENDL-2021 LIBRARY; T=293.6K
Photon emission for (n,n*)2a

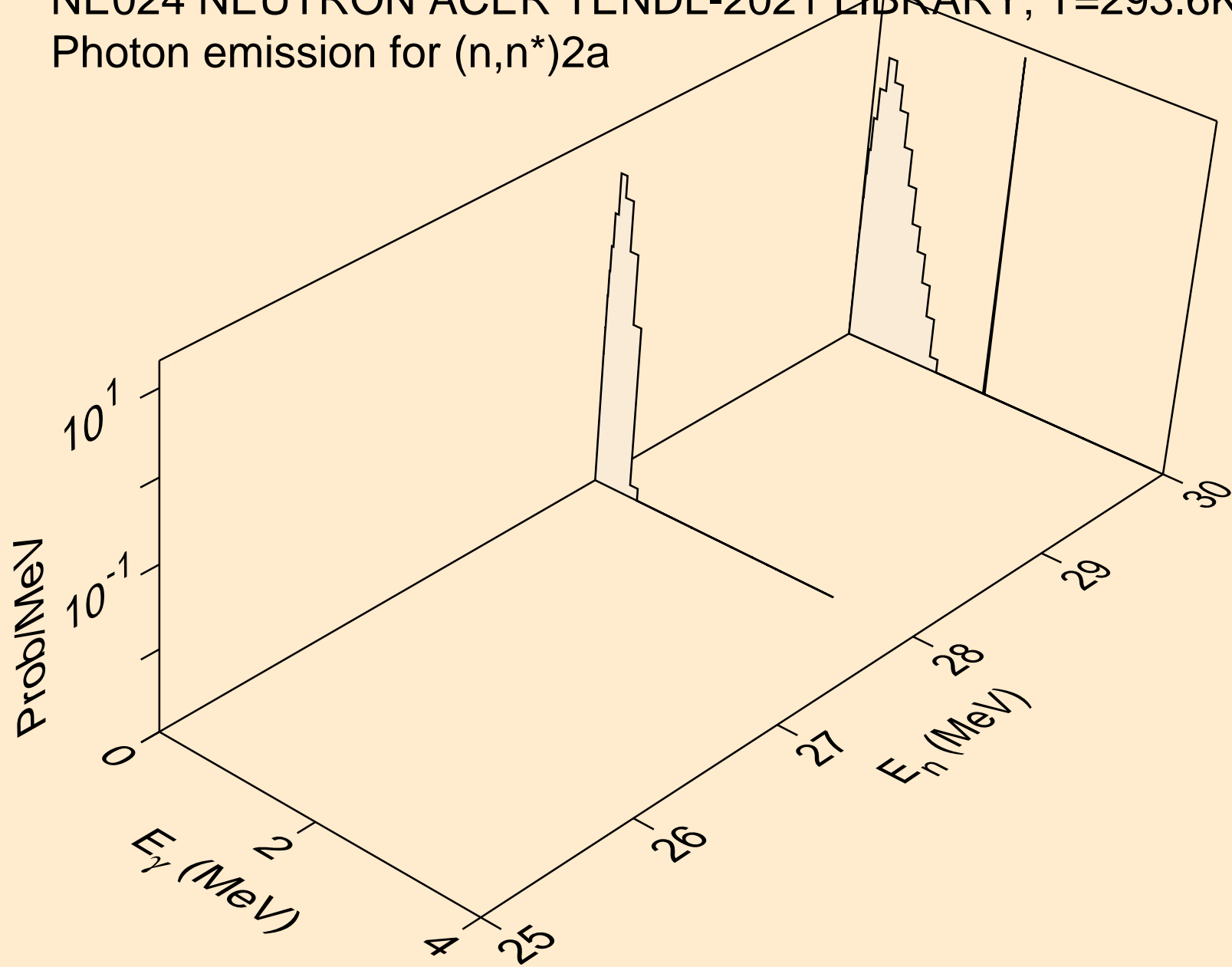

NE024 NEUTRON ACER TENDL-2021 LIBRARY; T=293.6K
Photon emission for (n,n*)d

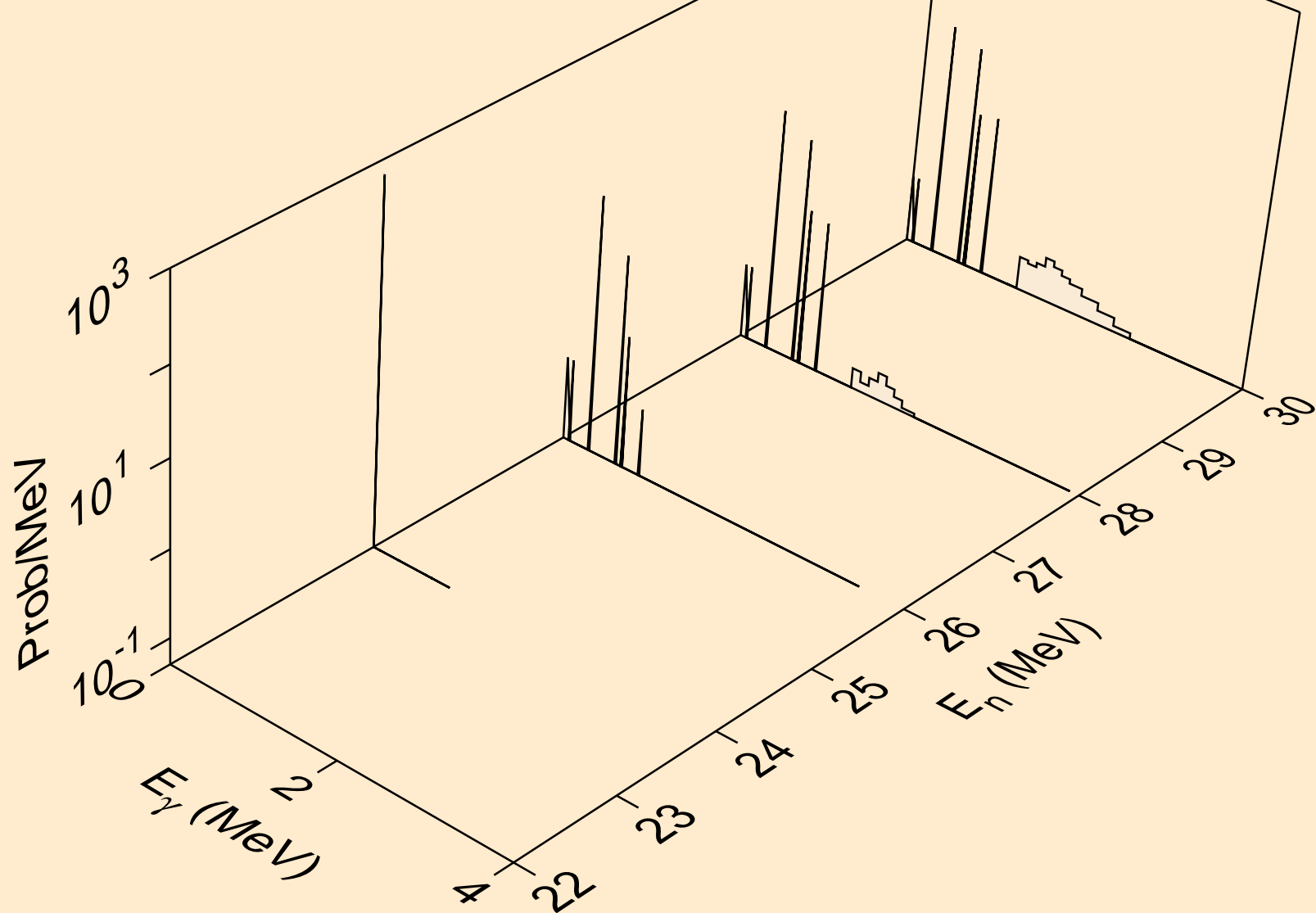

NE024 NEUTRON ACER TENDL-2021 LIBRARY; T=293.6K
Photon emission for (n,n*)t

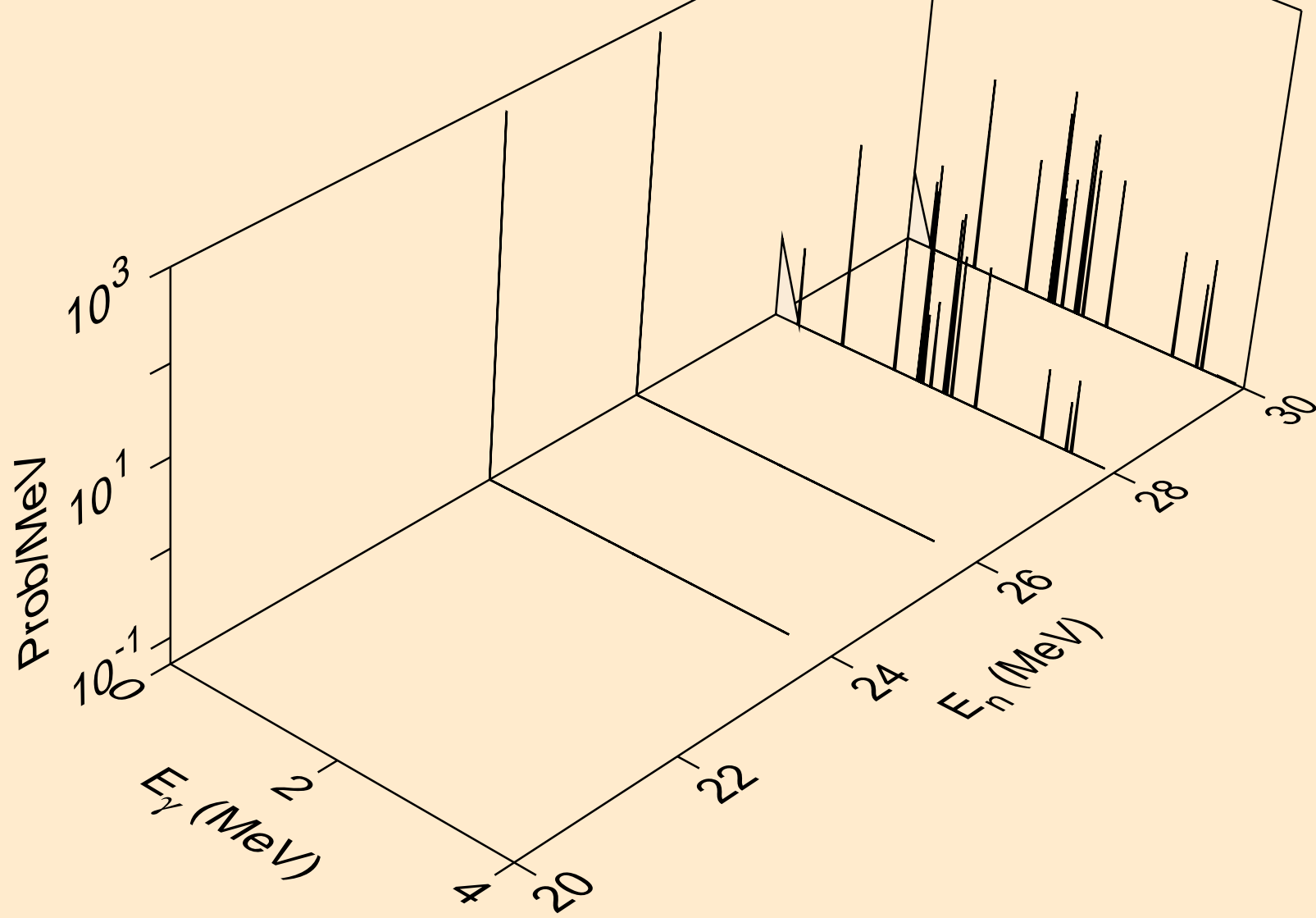

NE024 NEUTRON ACER TENDL-2021 LIBRARY; T=293.6K
Photon emission for (n,4n)

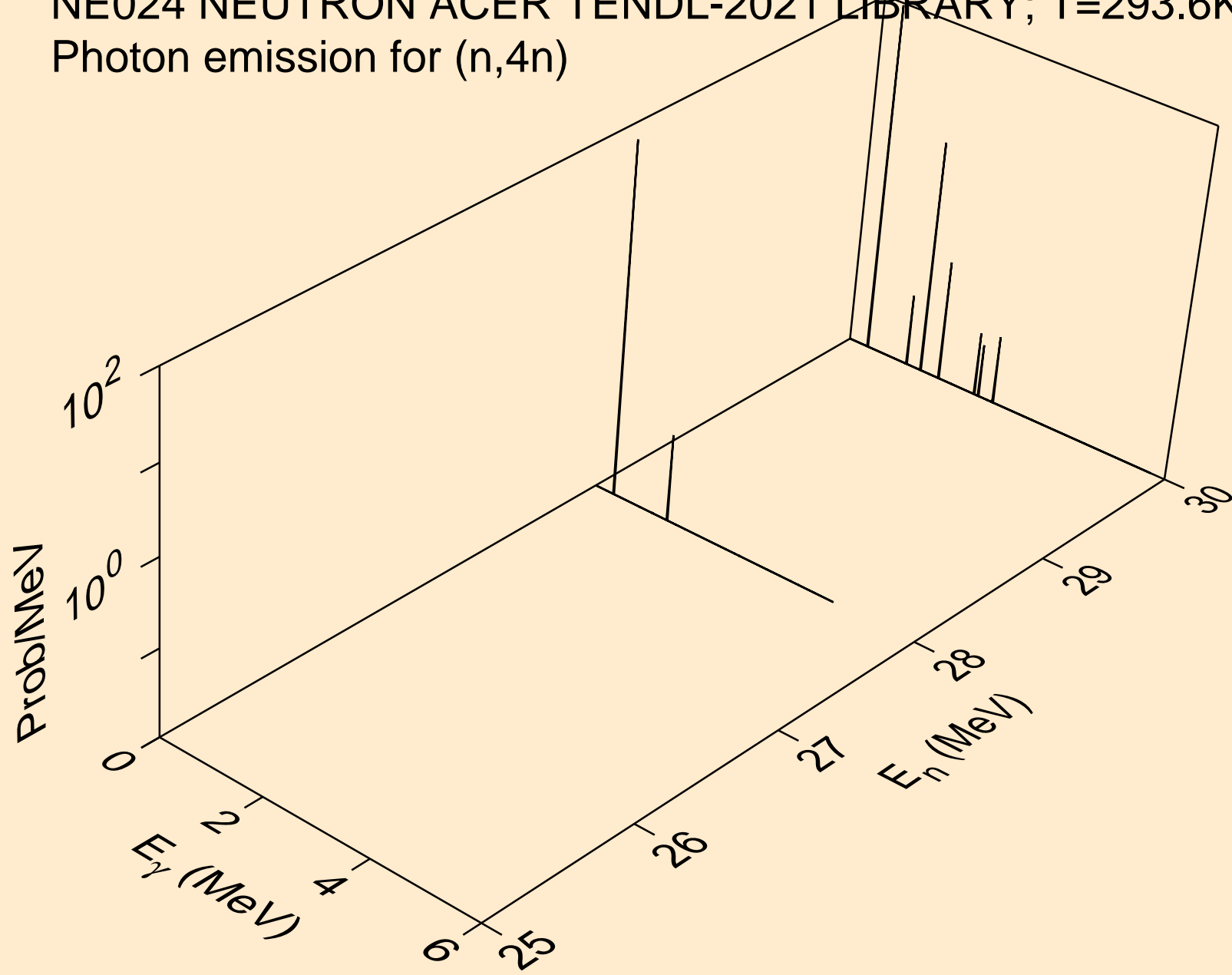

NE024 NEUTRON ACER TENDL-2021 LIBRARY; T=293.6K
Photon emission for (n,2np)

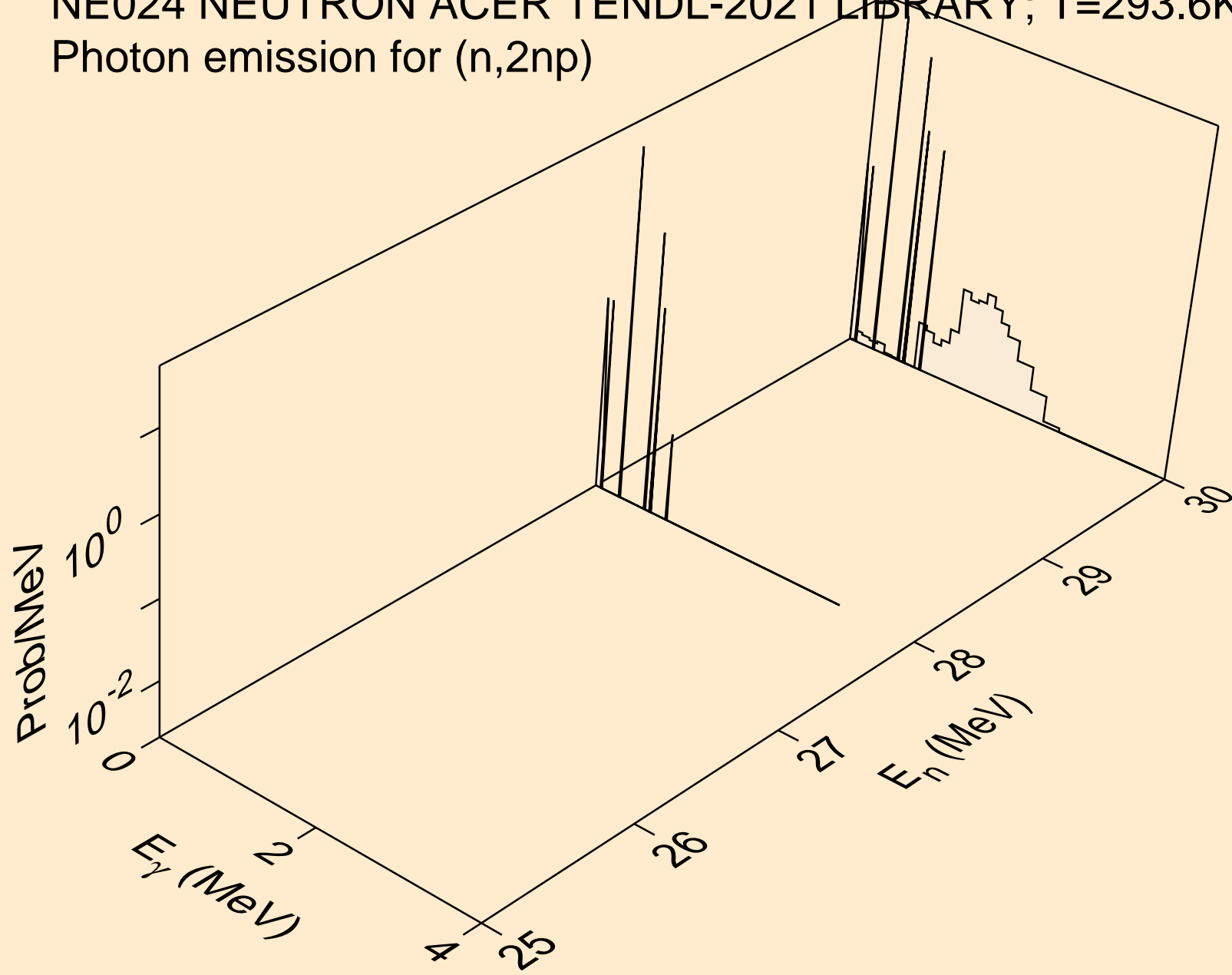

NE024 NEUTRON ACER TENDL-2021 LIBRARY; T=293.6K
Photon emission for (n,n*c)

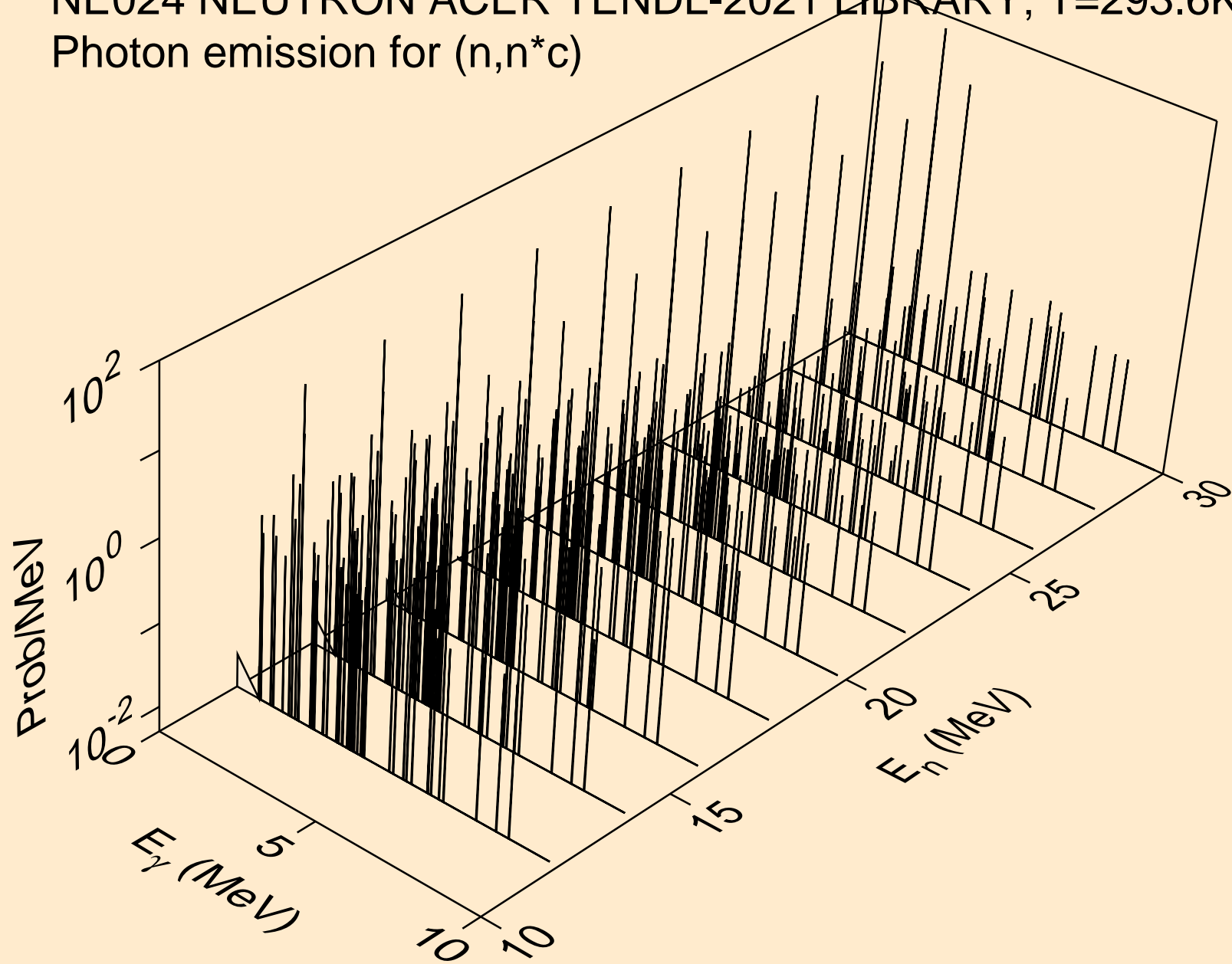

NE024 NEUTRON ACER TENDL-2021 LIBRARY; T=293.6K
Photon emission for (n,gma)

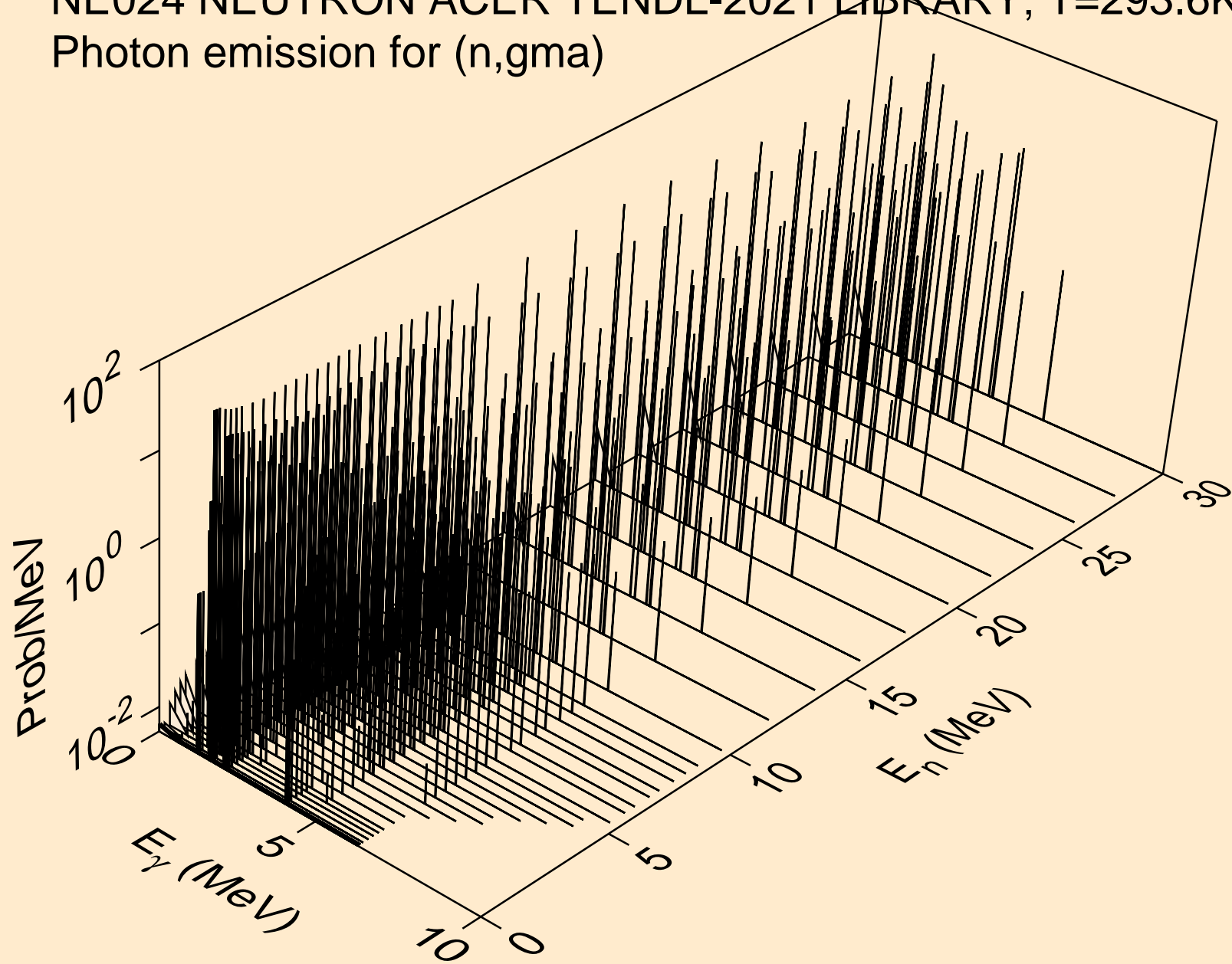

NE024 NEUTRON ACER TENDL-2021 LIBRARY; T=293.6K
Photon emission for (n,p)

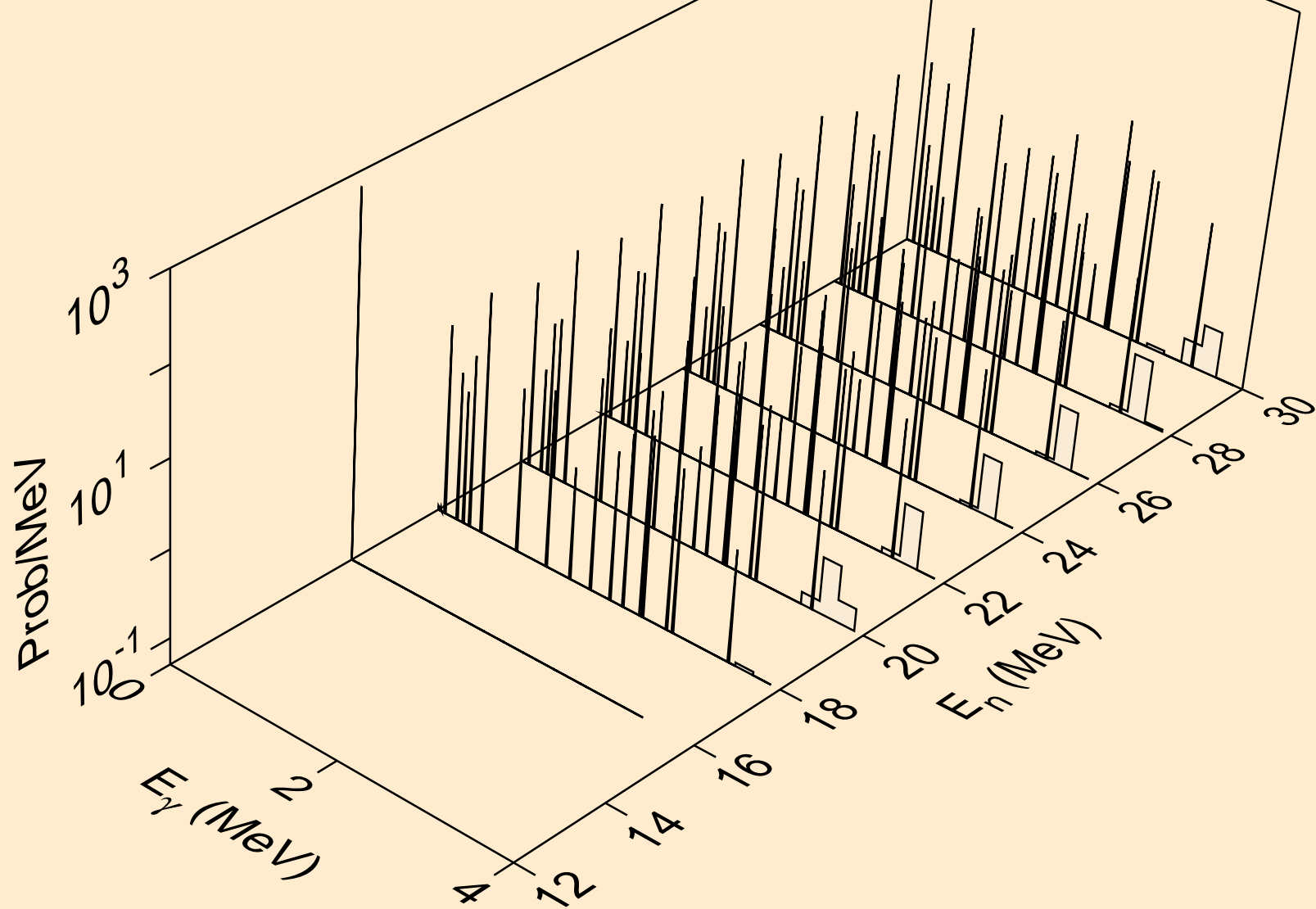

NE024 NEUTRON ACER TENDL-2021 LIBRARY; T=293.6K
Photon emission for (n,d)

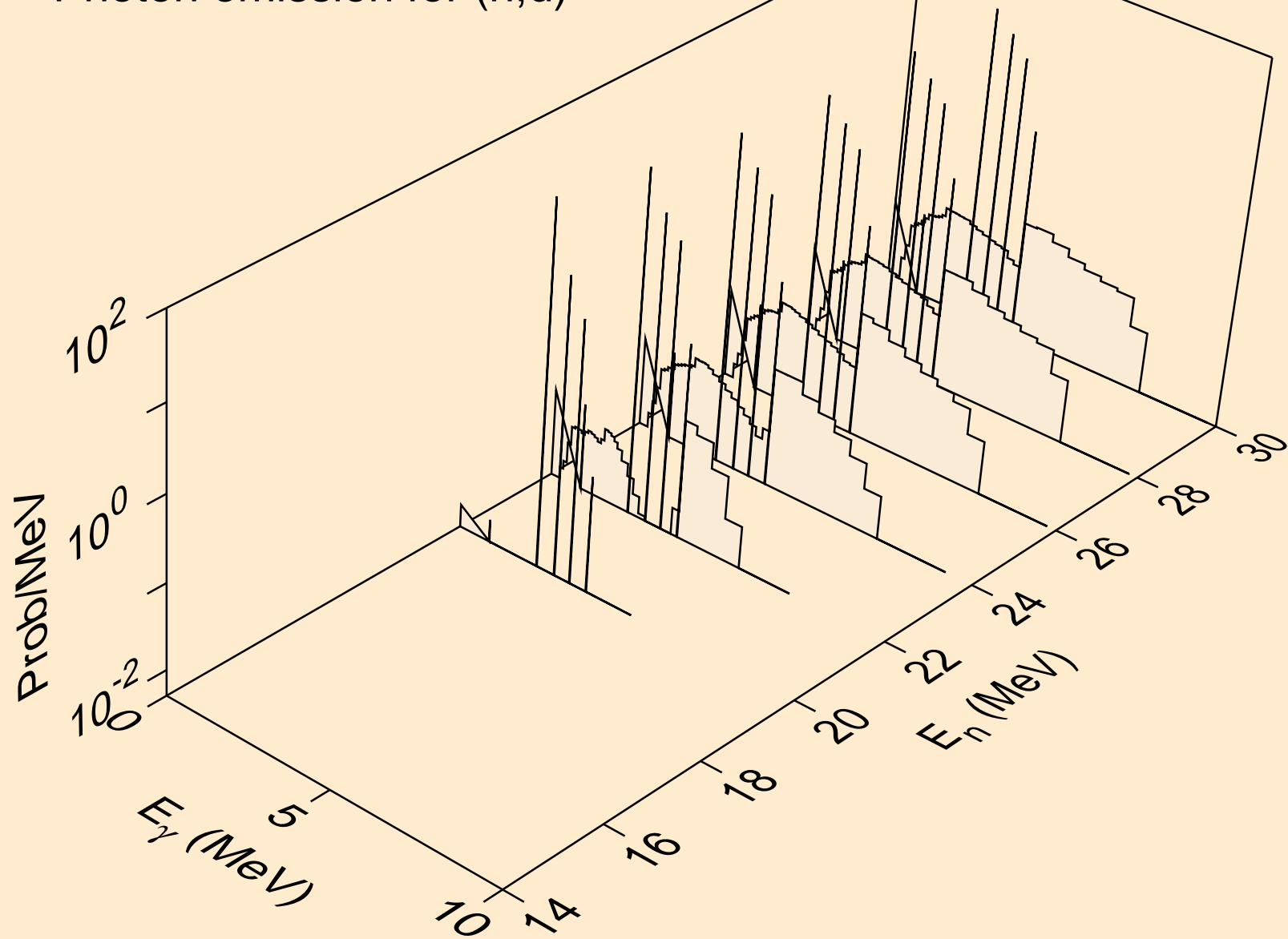

NE024 NEUTRON ACER TENDL-2021 LIBRARY; T=293.6K
Photon emission for (n,t)

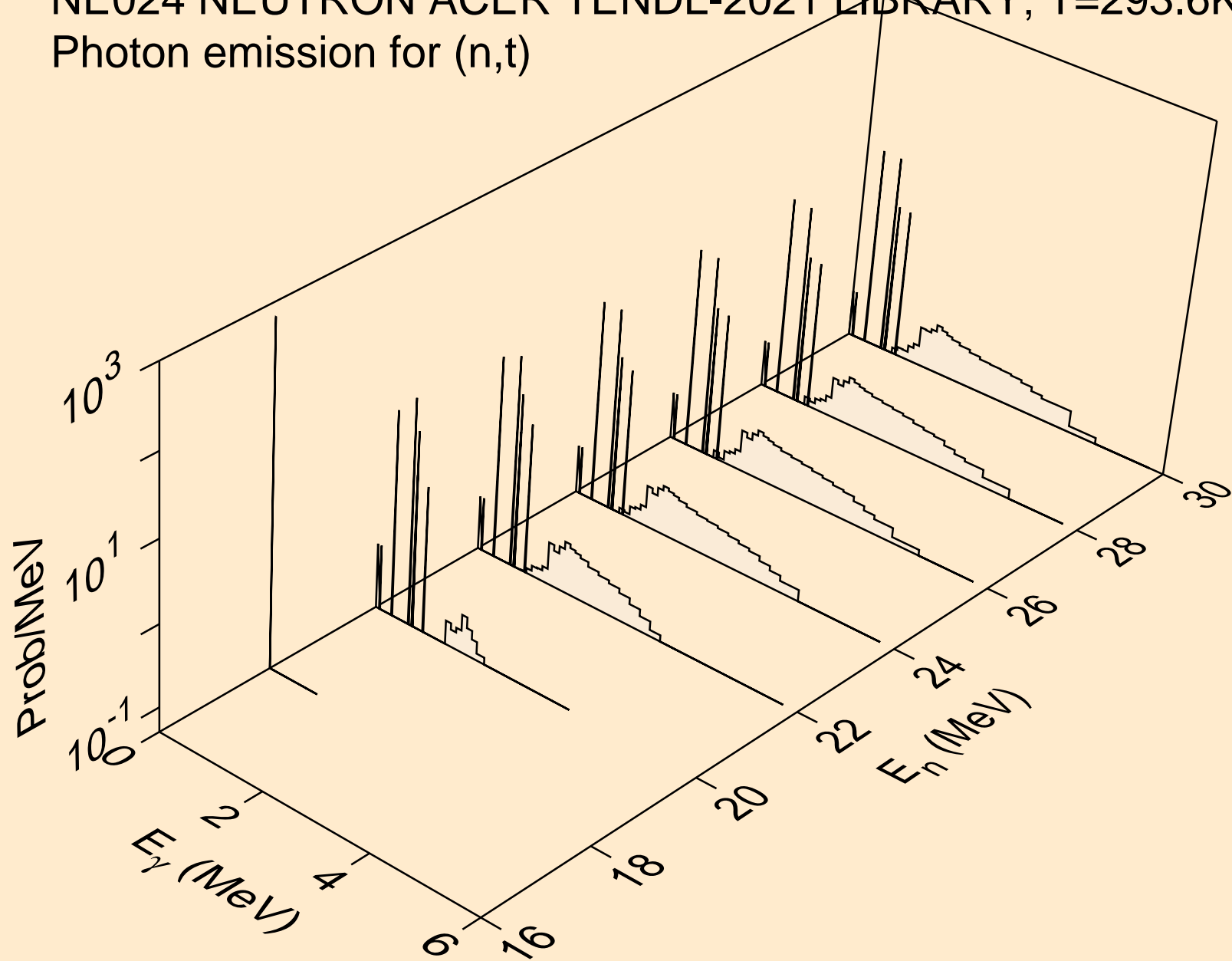

NE024 NEUTRON ACER TENDL-2021 LIBRARY; T=293.6K
Photon emission for (n,he3)

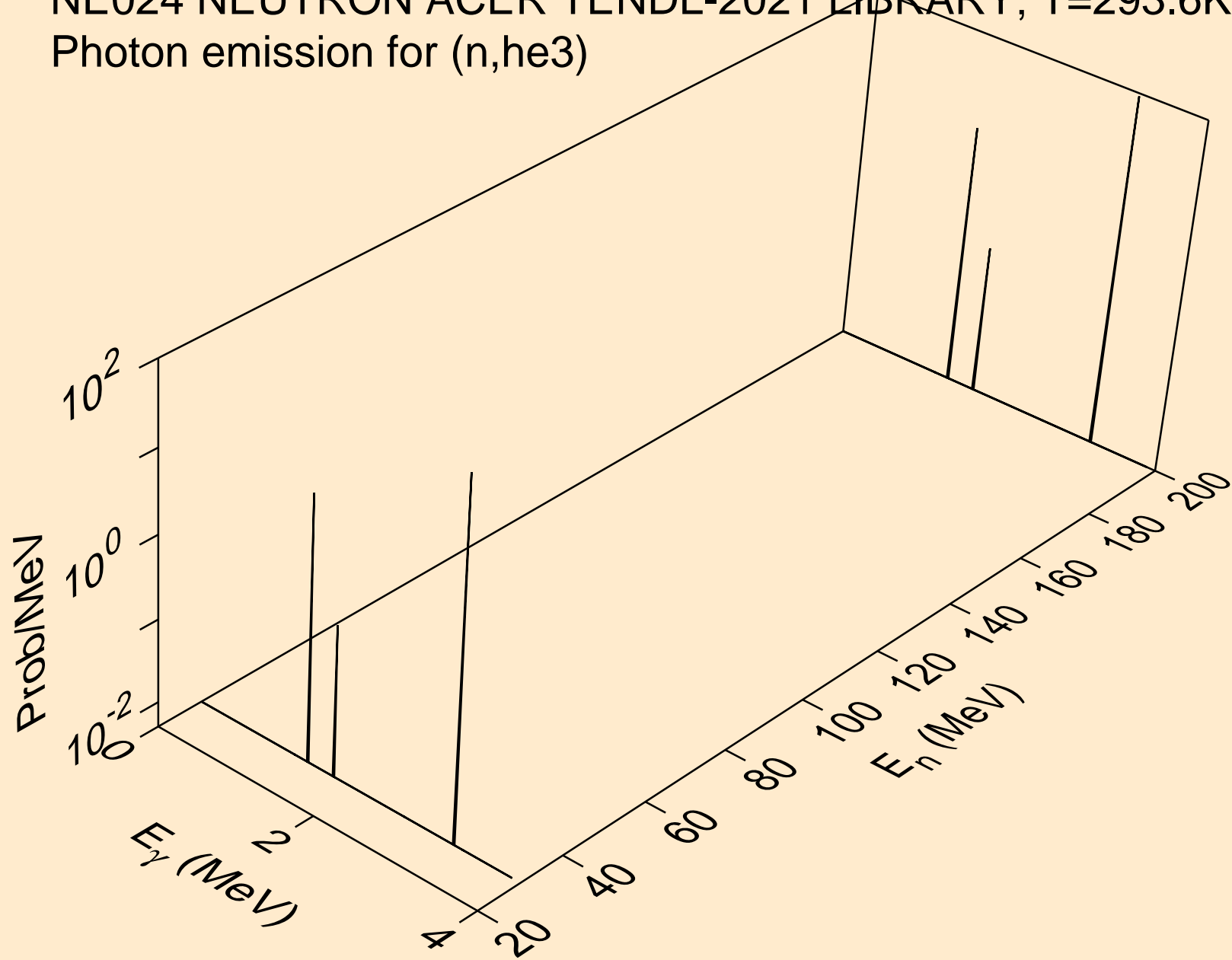

NE024 NEUTRON ACER TENDL-2021 LIBRARY; T=293.6K
Photon emission for (n,a)

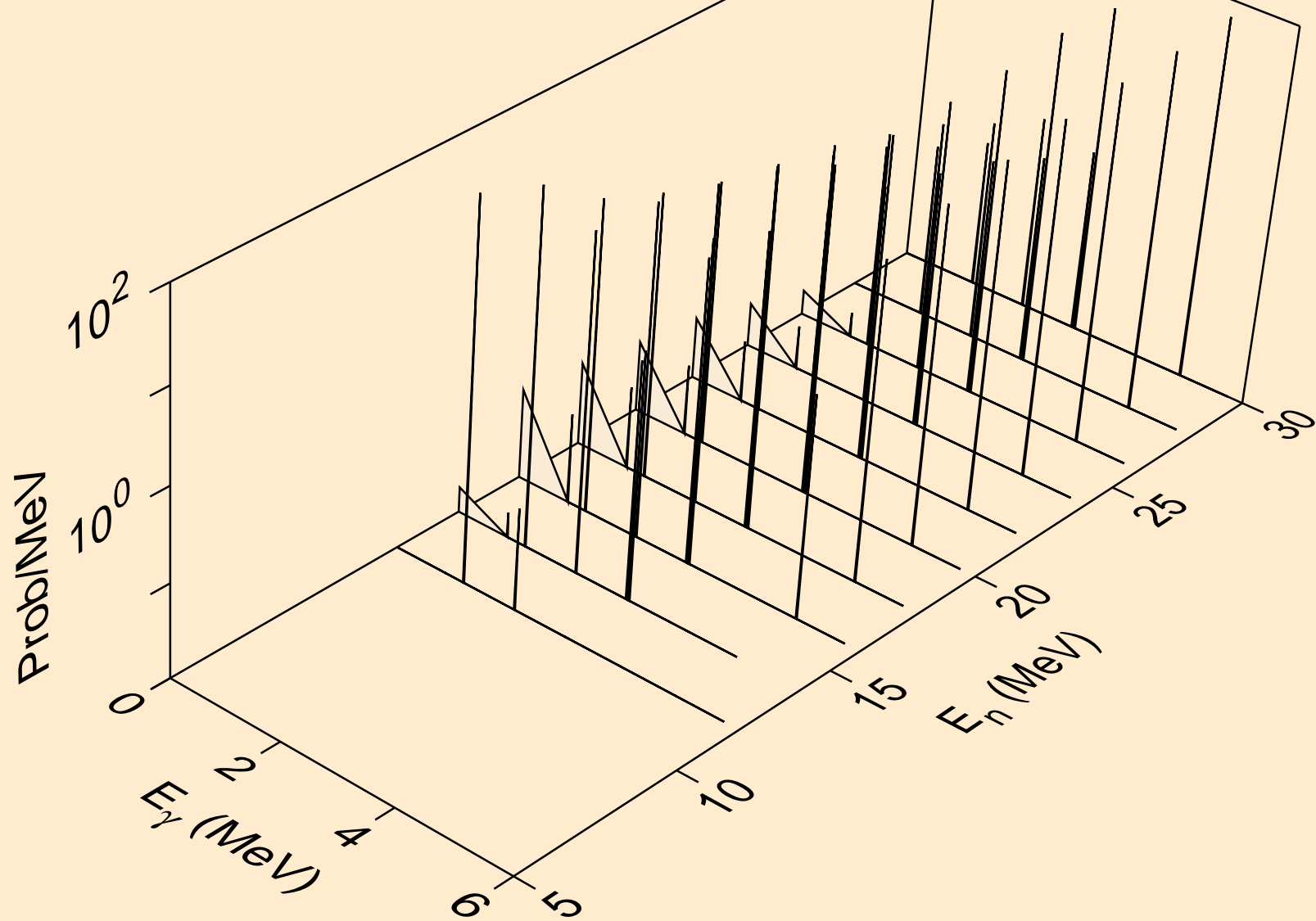

NE024 NEUTRON ACER TENDL-2021 LIBRARY; T=293.6K
Photon emission for (n,2a)

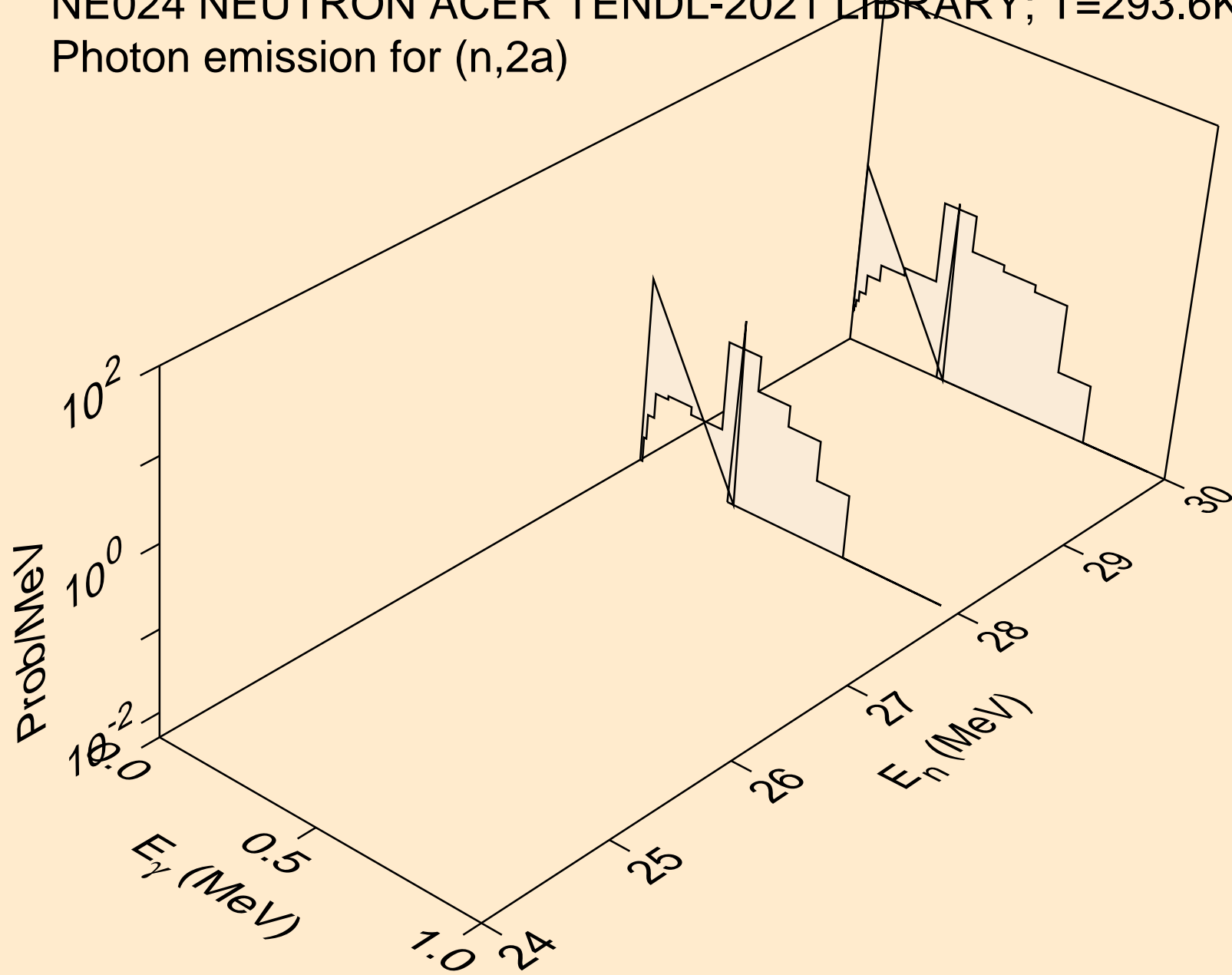

NE024 NEUTRON ACER TENDL-2021 LIBRARY; T=293.6K
thermal capture photon spectrum

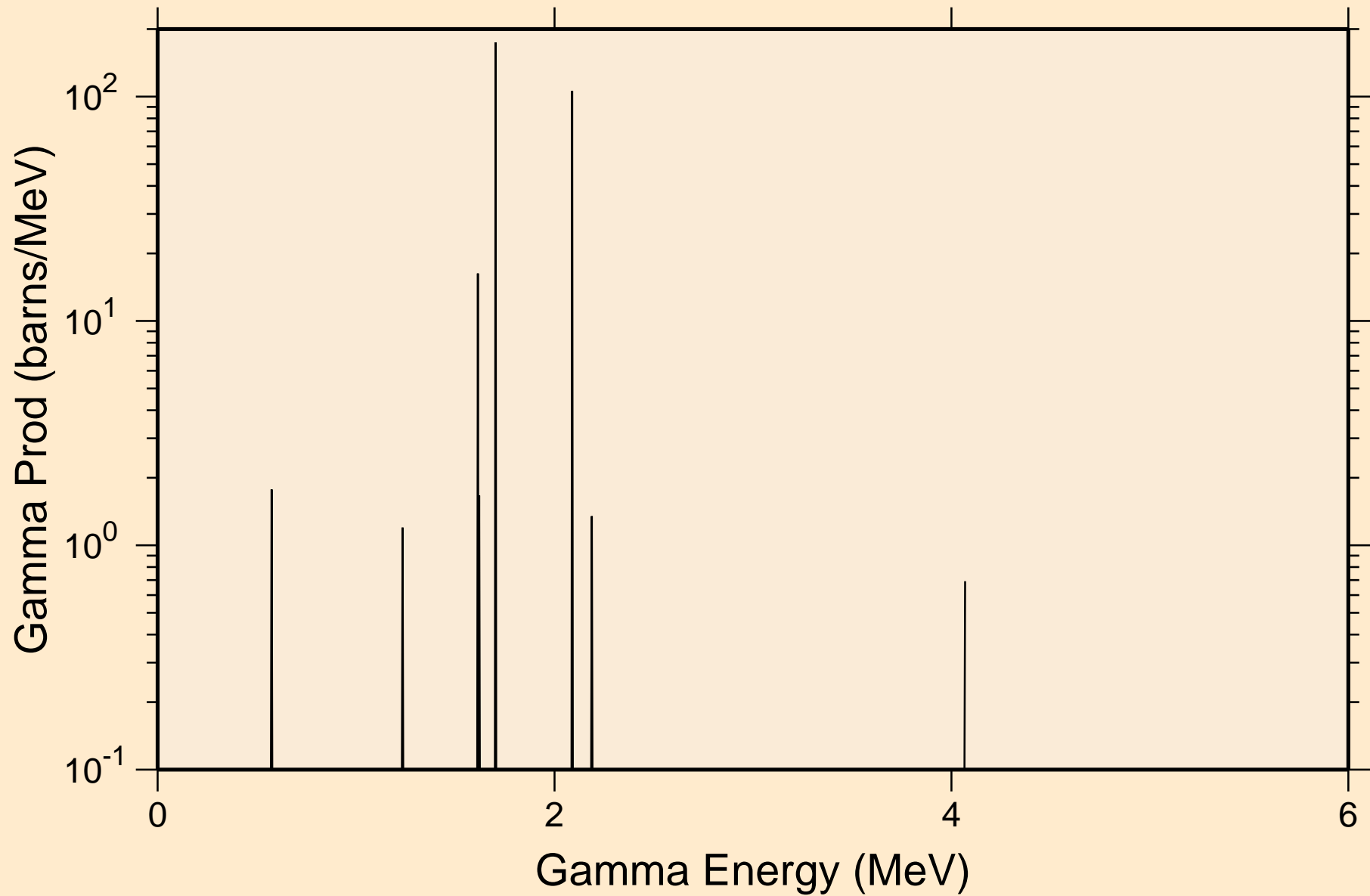

NE024 NEUTRON ACER TENDL-2021 LIBRARY; T=293.6K
14 MeV photon spectrum

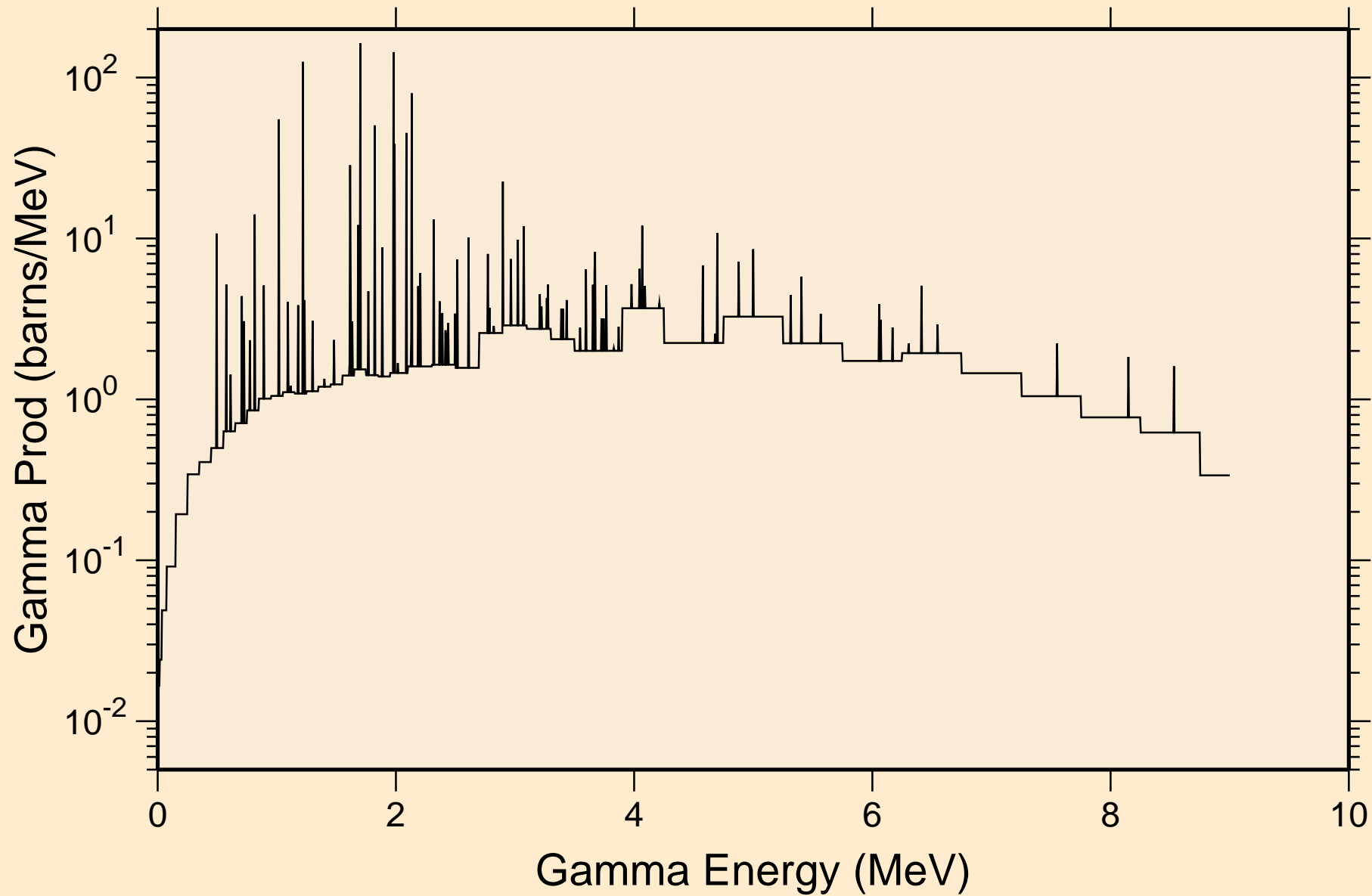

NE024 NEUTRON ACER TENDL-2021 LIBRARY; T=293.6K
Particle heating contributions

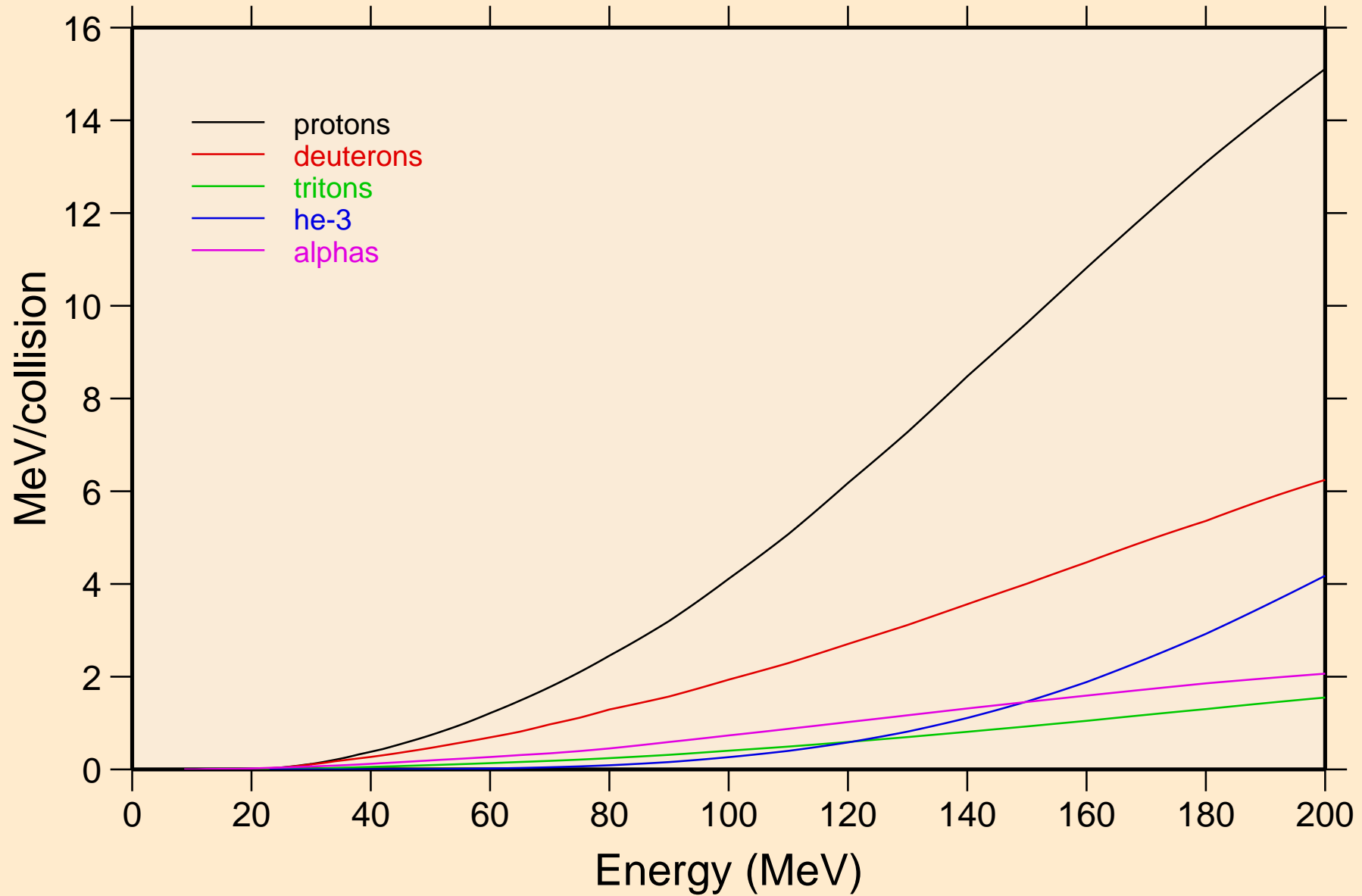

NE024 NEUTRON ACER TENDL-2021 LIBRARY; T=293.6K
Recoil Heating

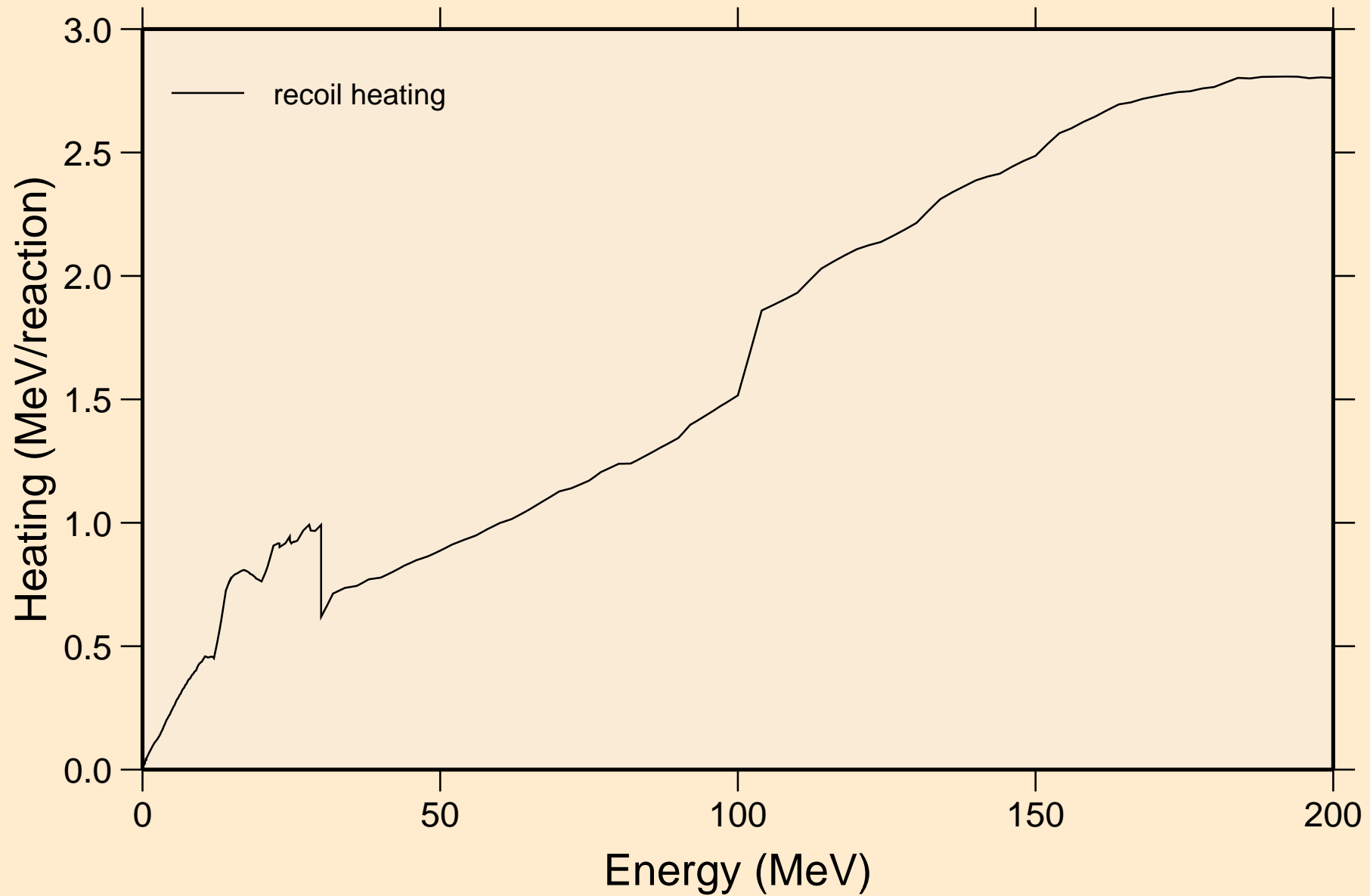

NE024 NEUTRON ACER TENDL-2021 LIBRARY; T=293.6K
Particle production cross sections

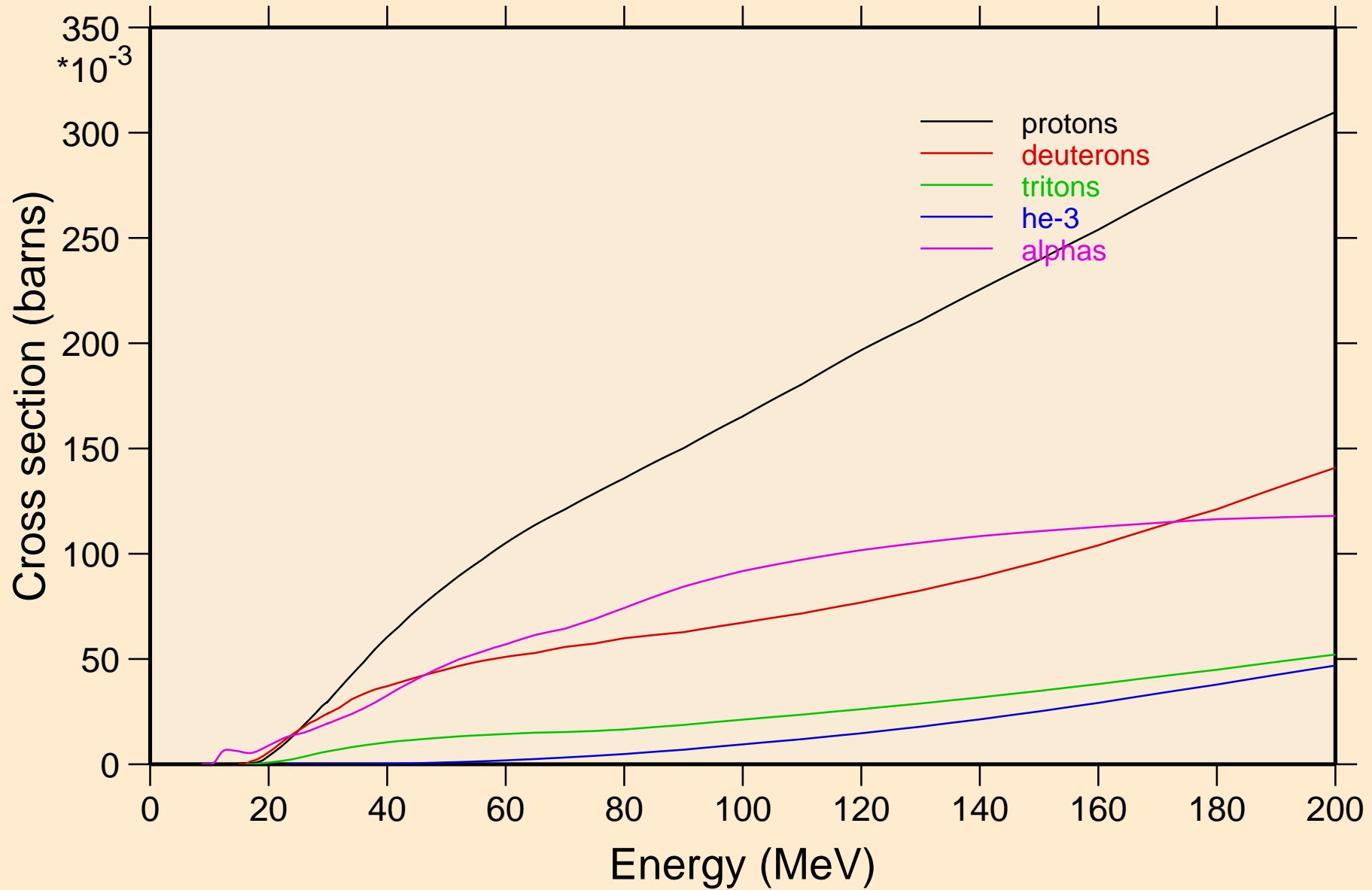

NE024 NEUTRON ACER TENDL-2021 LIBRARY; T=293.6K
protons from (n,x)

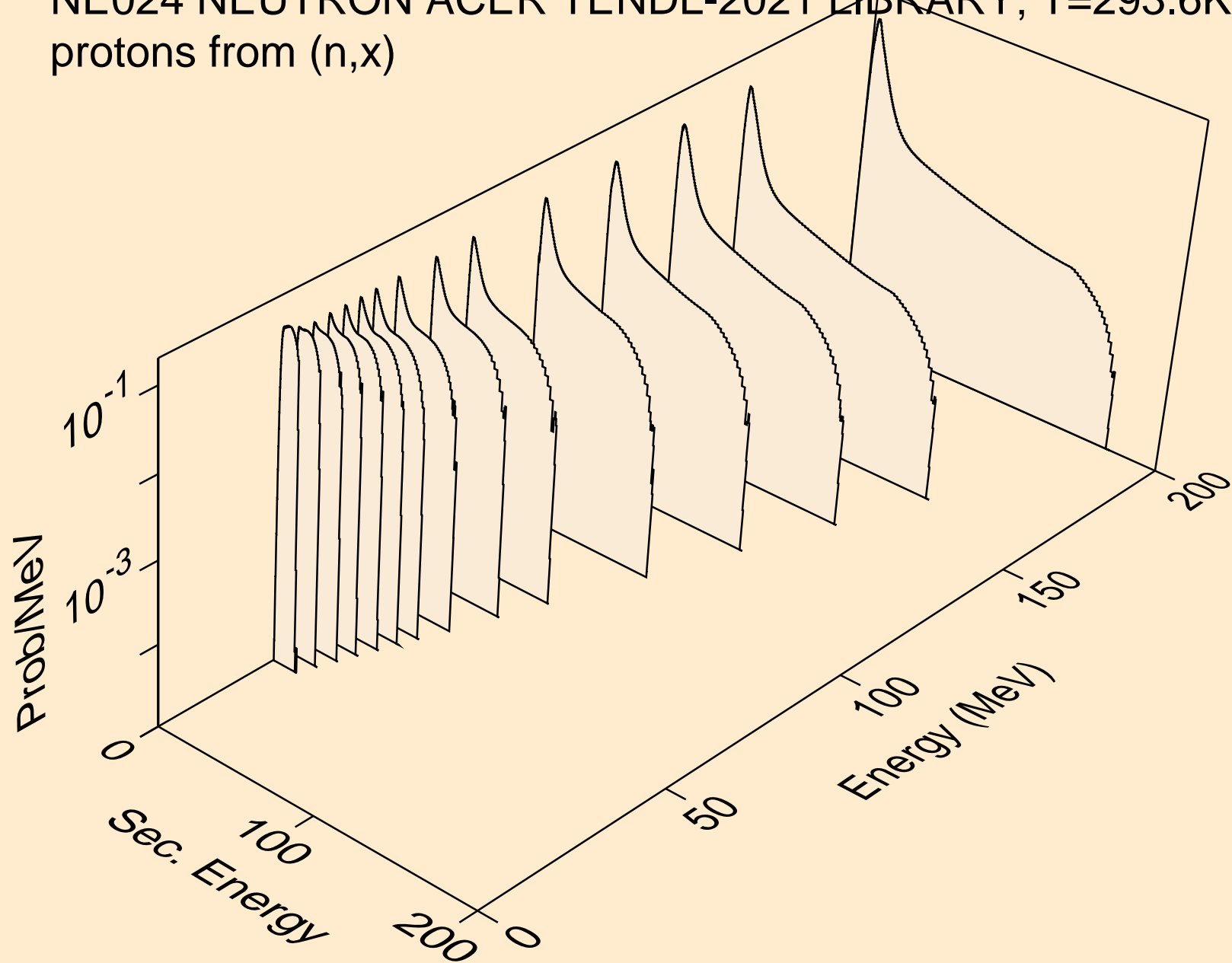

NE024 NEUTRON ACER TENDL-2021 LIBRARY; T=293.6K
protons from (n,n*)p

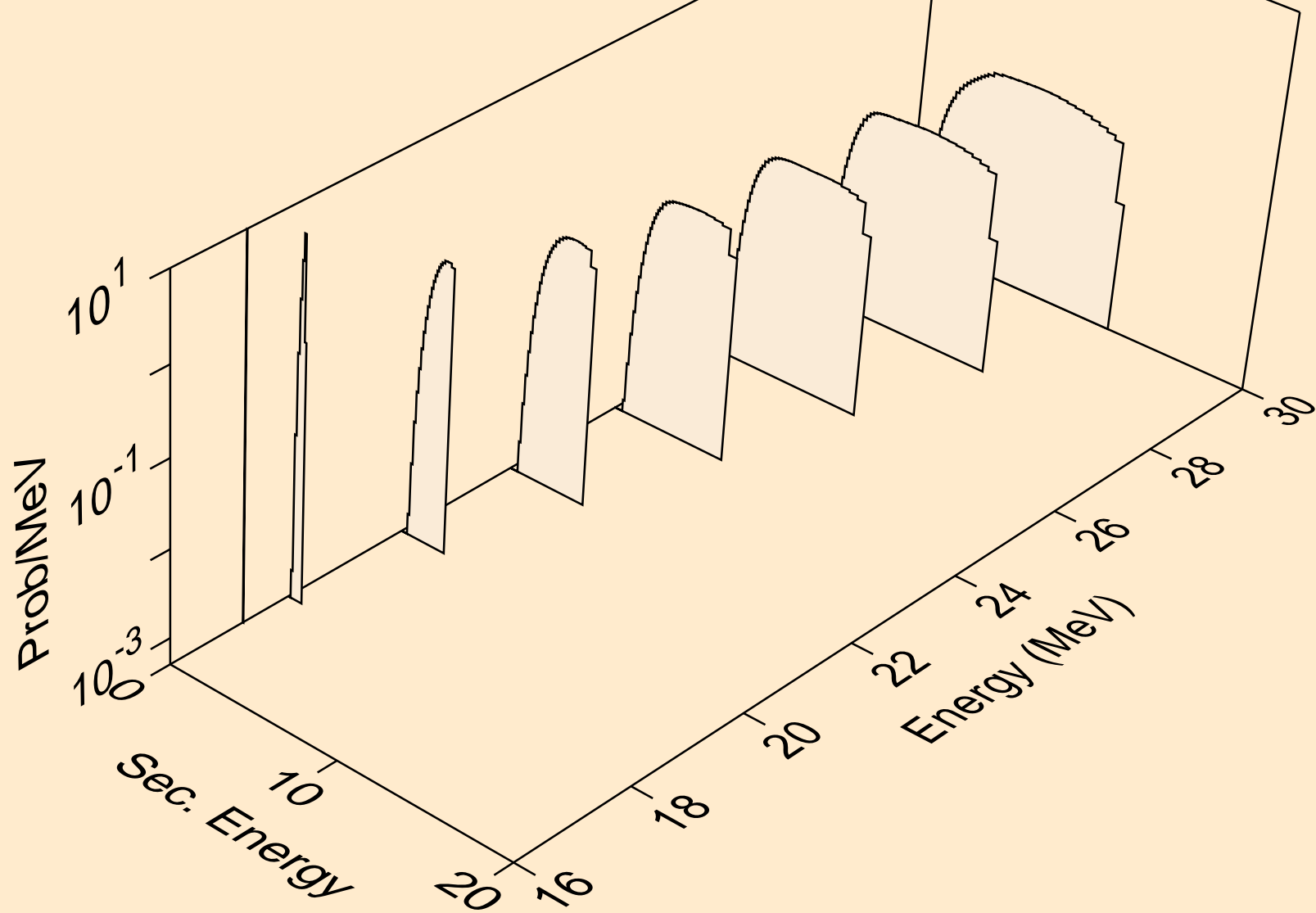

NE024 NEUTRON ACER TENDL-2021 LIBRARY; T=293.6K
protons from (n,2np)

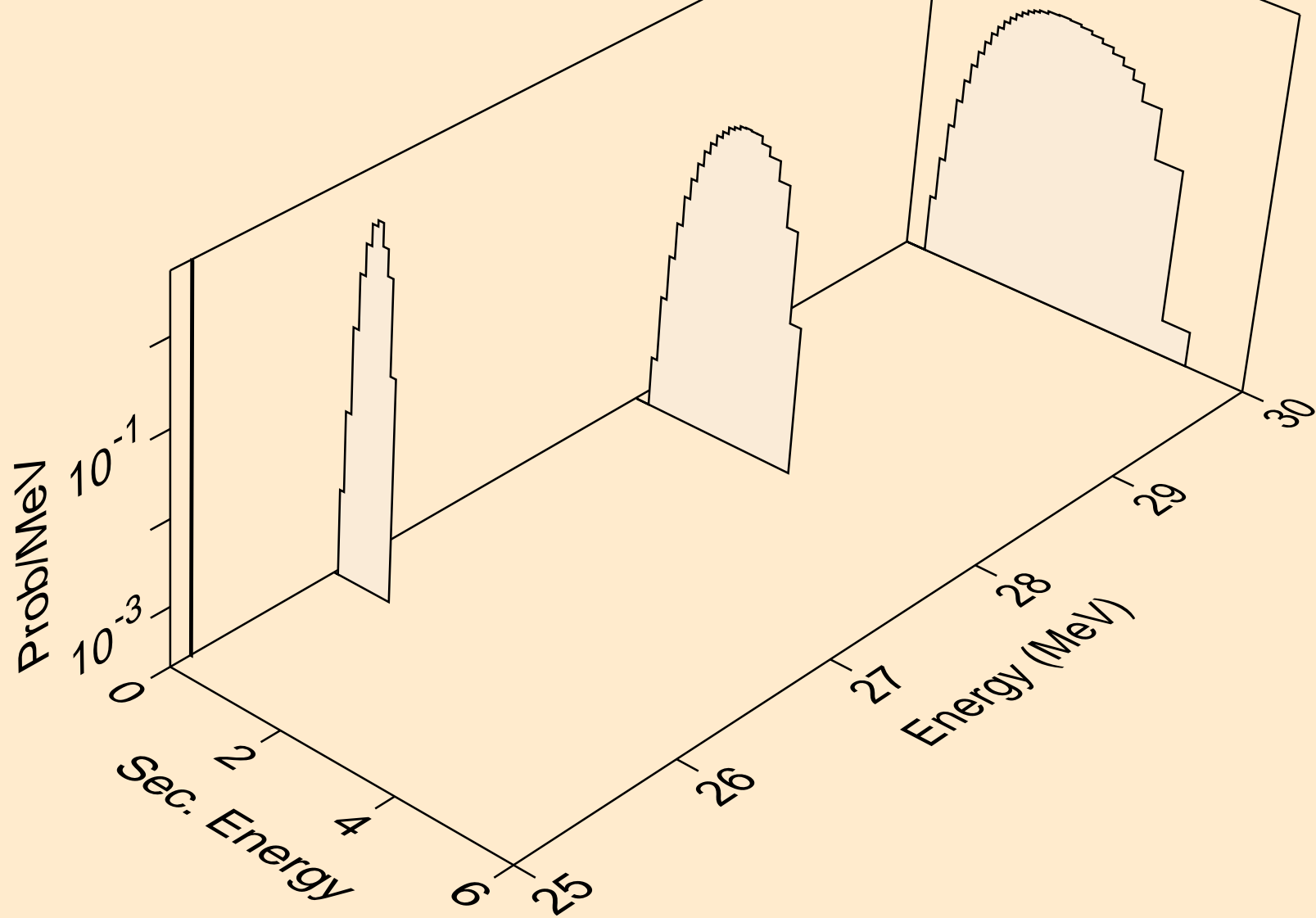

NE024 NEUTRON ACER TENDL-2021 LIBRARY; T=293.6K
protons from (n,p)

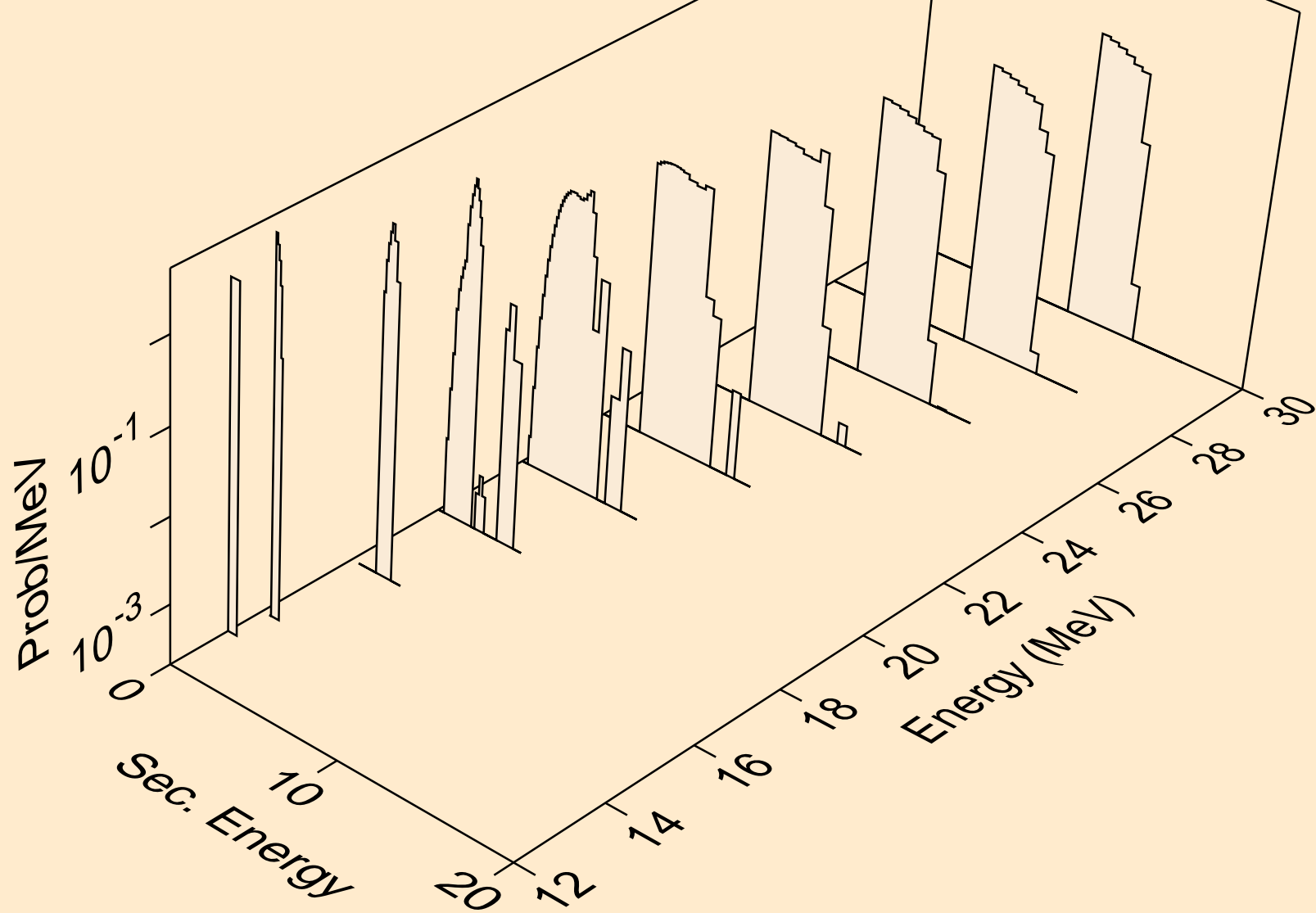

NE024 NEUTRON ACER TENDL-2021 LIBRARY; T=293.6K
deuterons from (n,x)

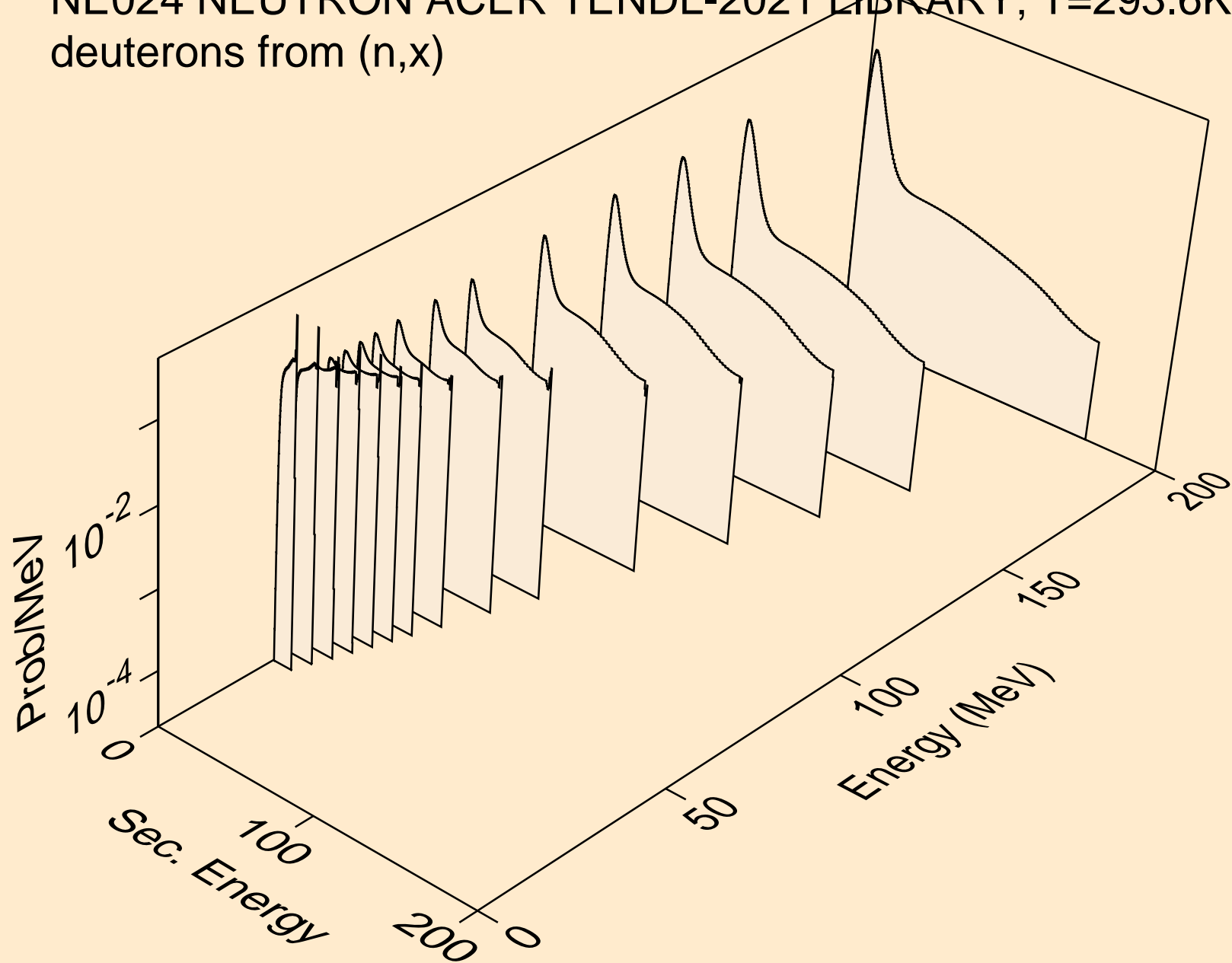

NE024 NEUTRON ACER TENDL-2021 LIBRARY; T=293.6K
deuterons from (n,2nd)

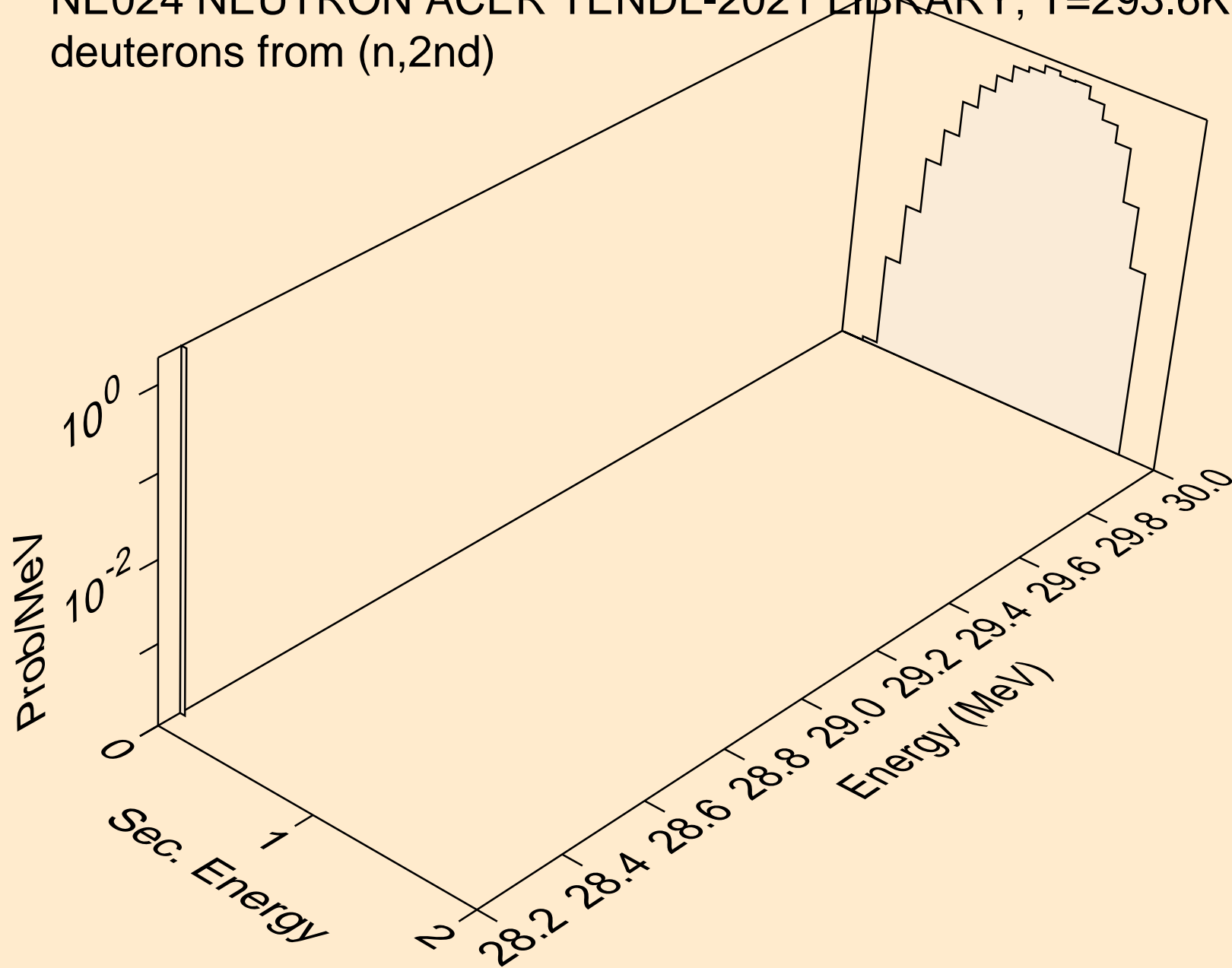

NE024 NEUTRON ACER TENDL-2021 LIBRARY; T=293.6K
deuterons from (n,n*)d

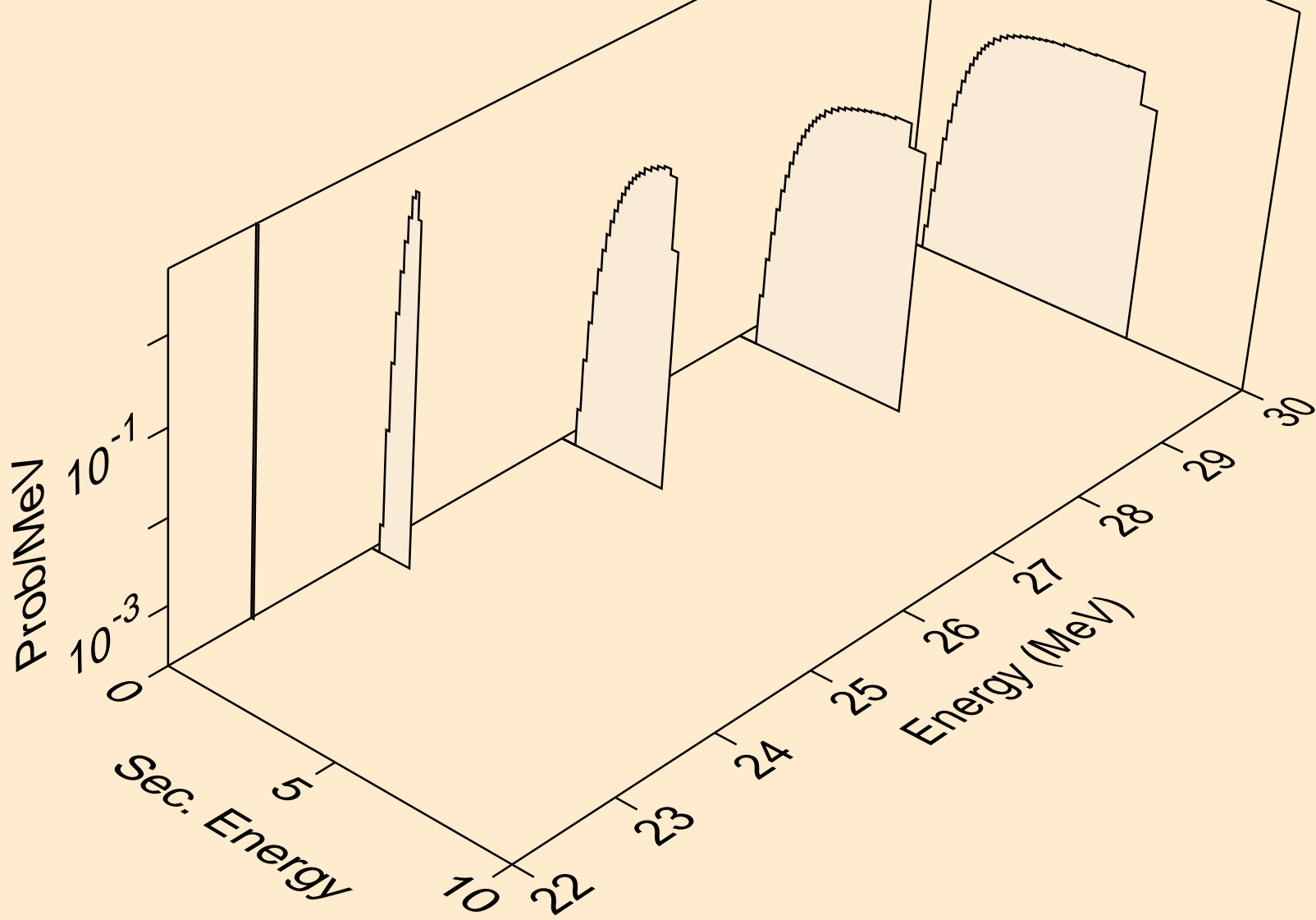

NE024 NEUTRON ACER TENDL-2021 LIBRARY; T=293.6K
deuterons from (n,d)

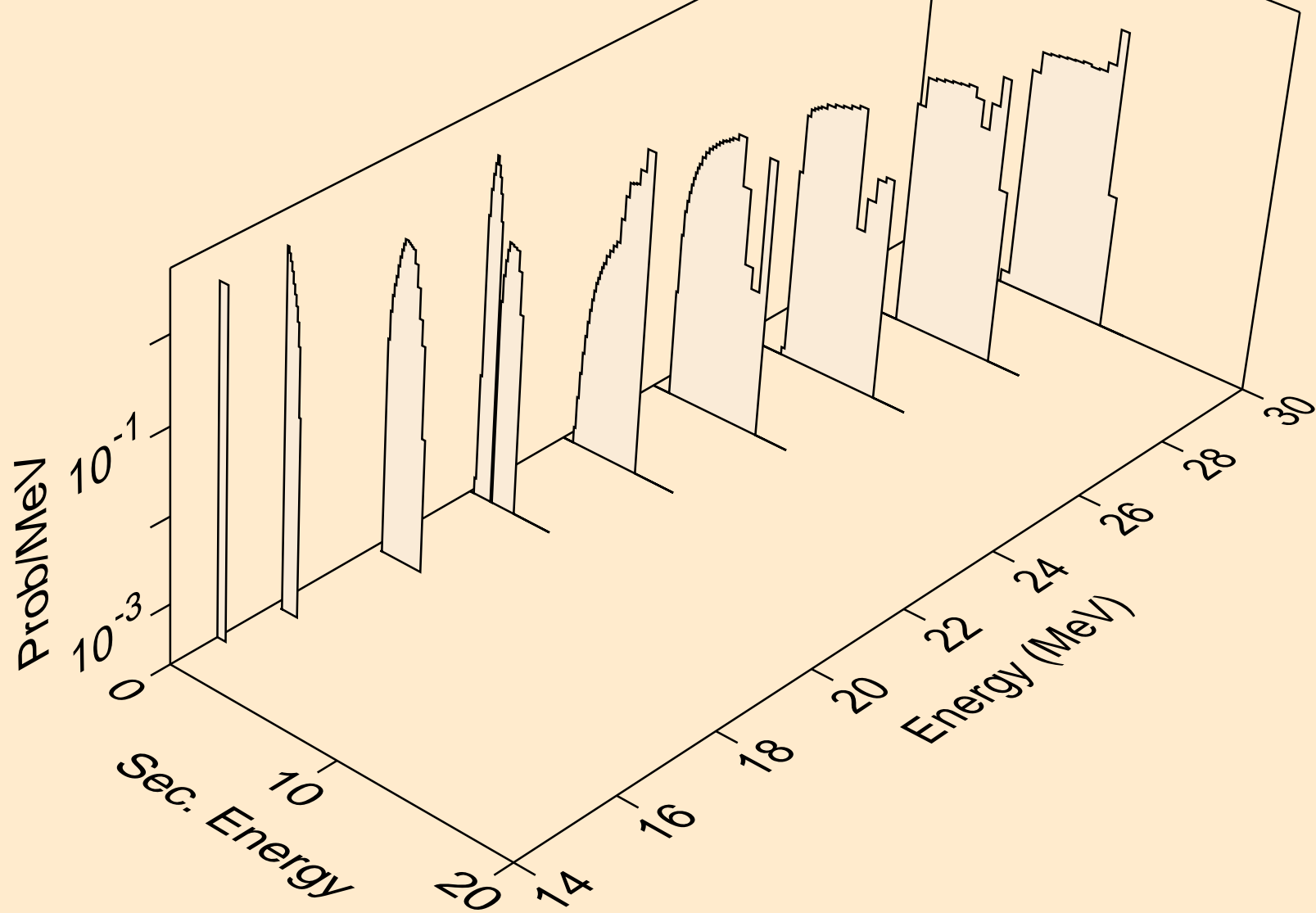

NE024 NEUTRON ACER TENDL-2021 LIBRARY; T=293.6K
tritons from (n,x)

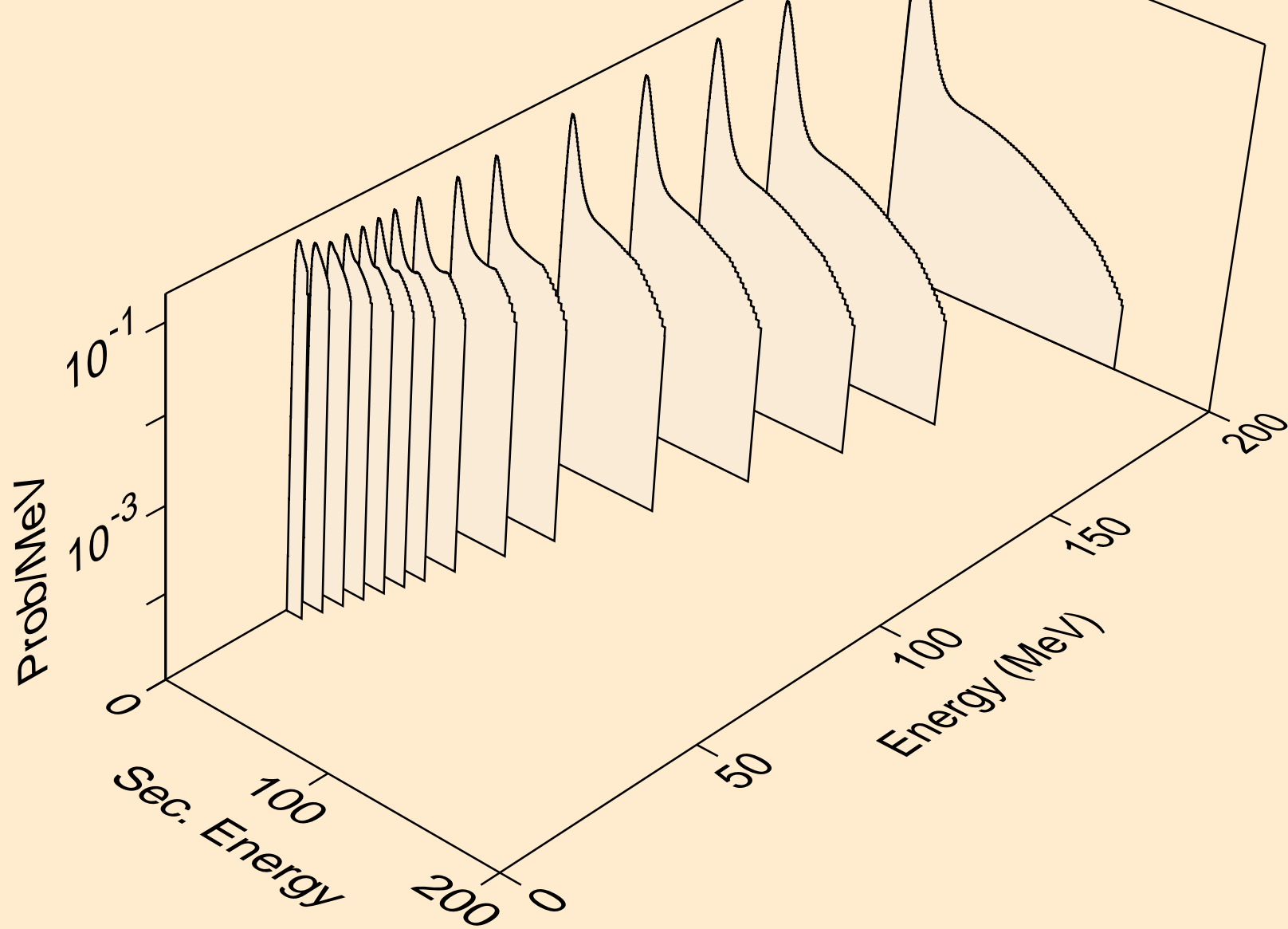

NE024 NEUTRON ACER TENDL-2021 LIBRARY; T=293.6K
tritons from (n,n*)t

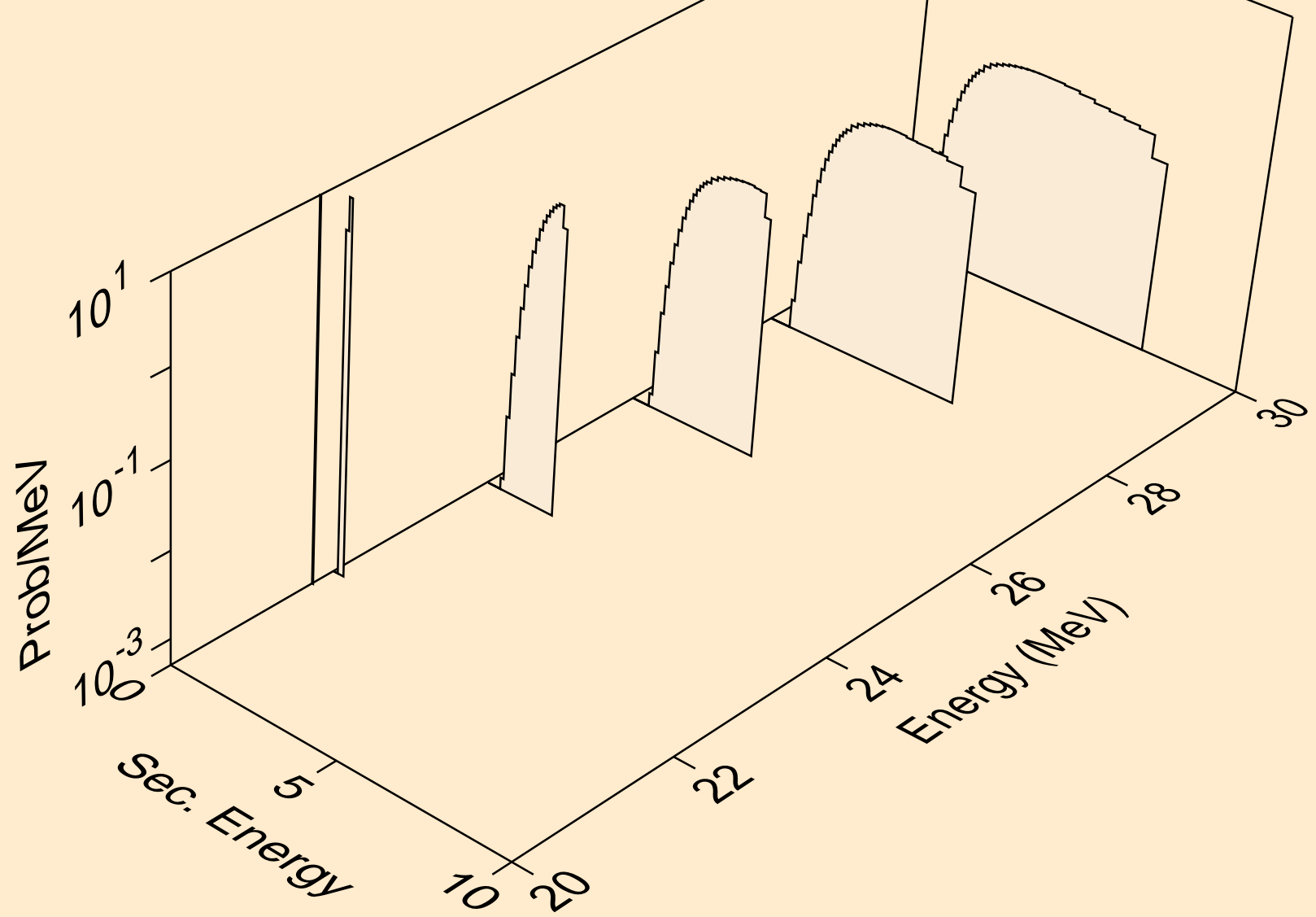

NE024 NEUTRON ACER TENDL-2021 LIBRARY; T=293.6K
tritons from (n,t)

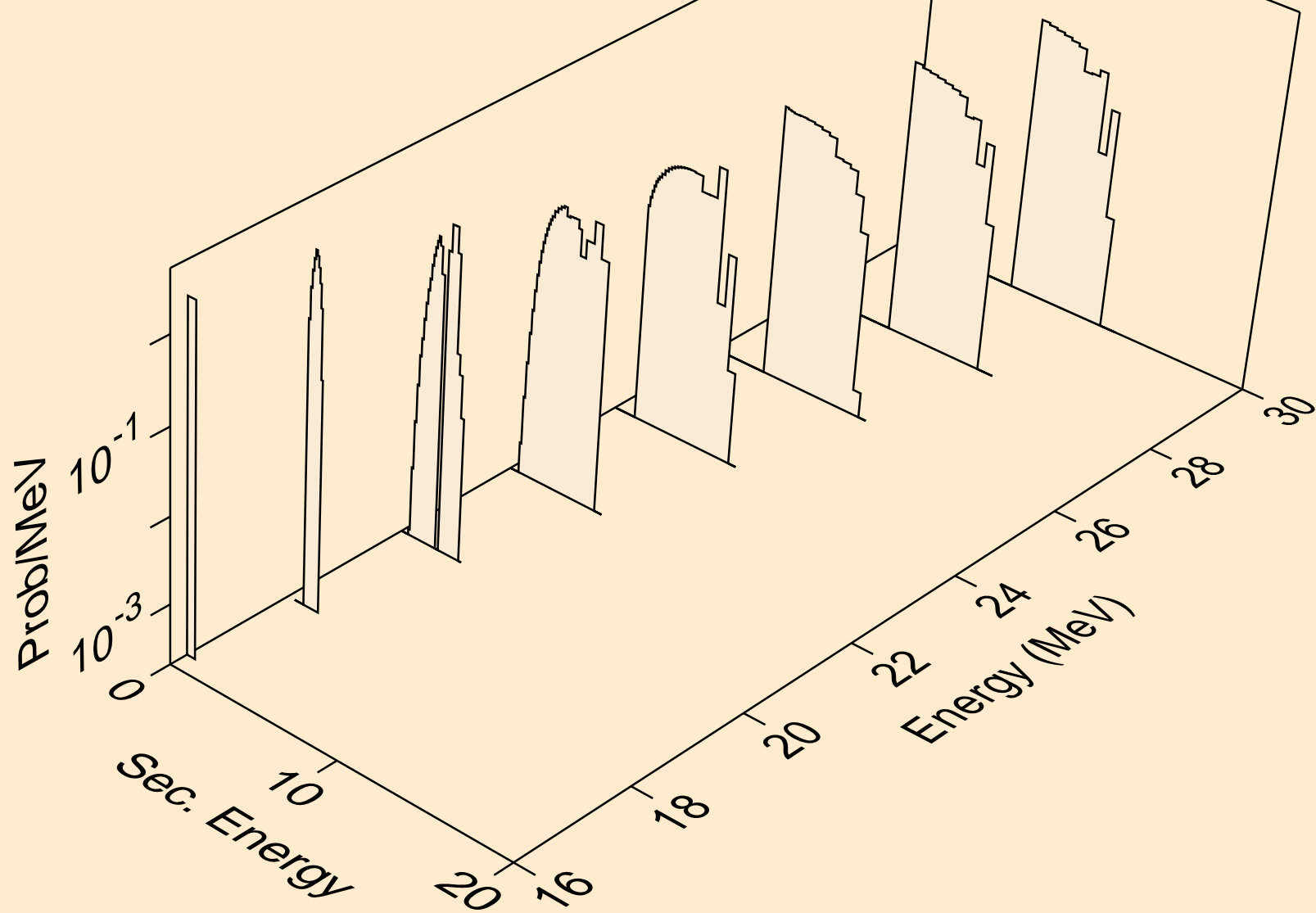

NE024 NEUTRON ACER TENDL-2021 LIBRARY; T=293.6K
he3s from (n,x)

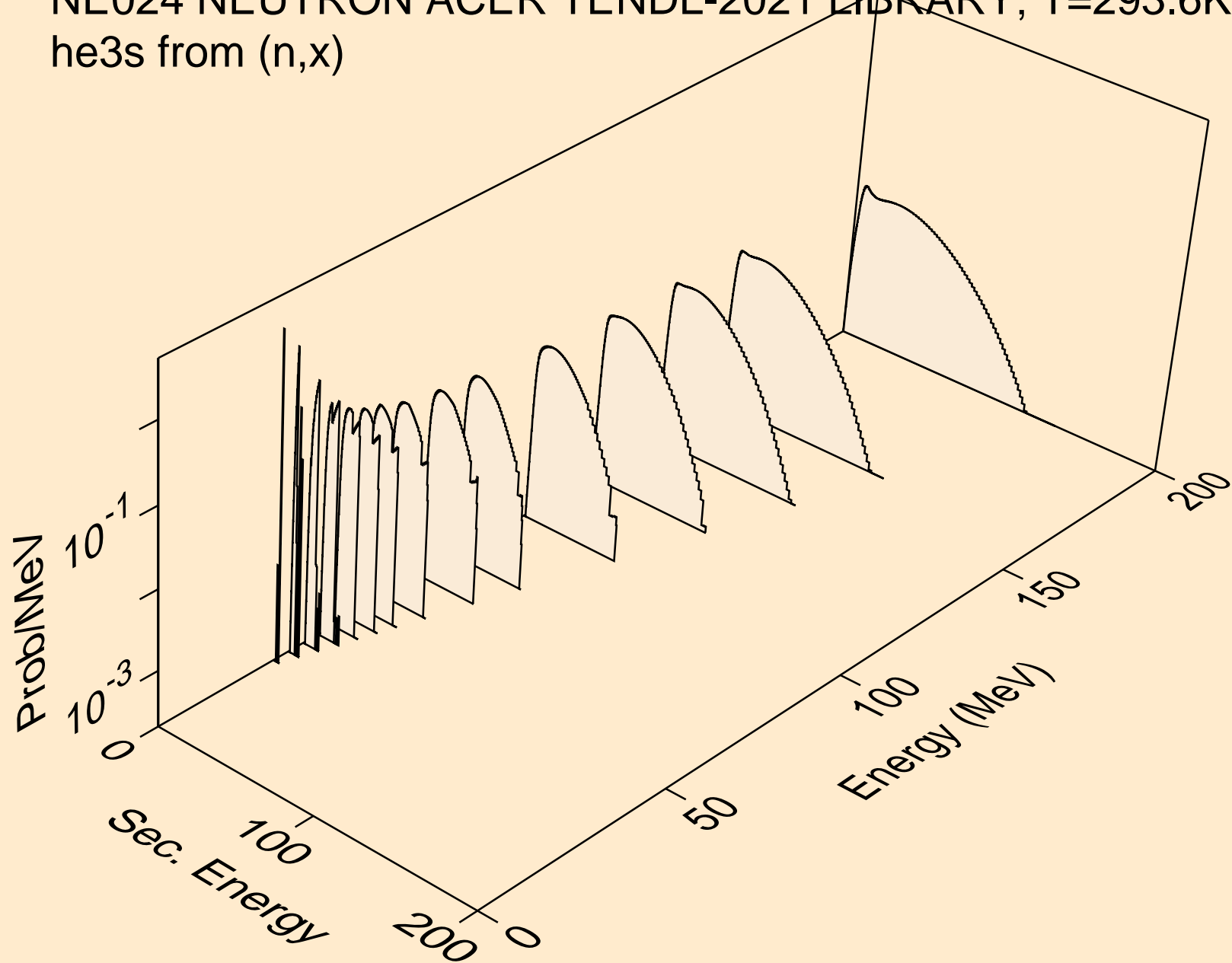

NE024 NEUTRON ACER TENDL-2021 LIBRARY; T=293.6K
he3s from (n,he3)

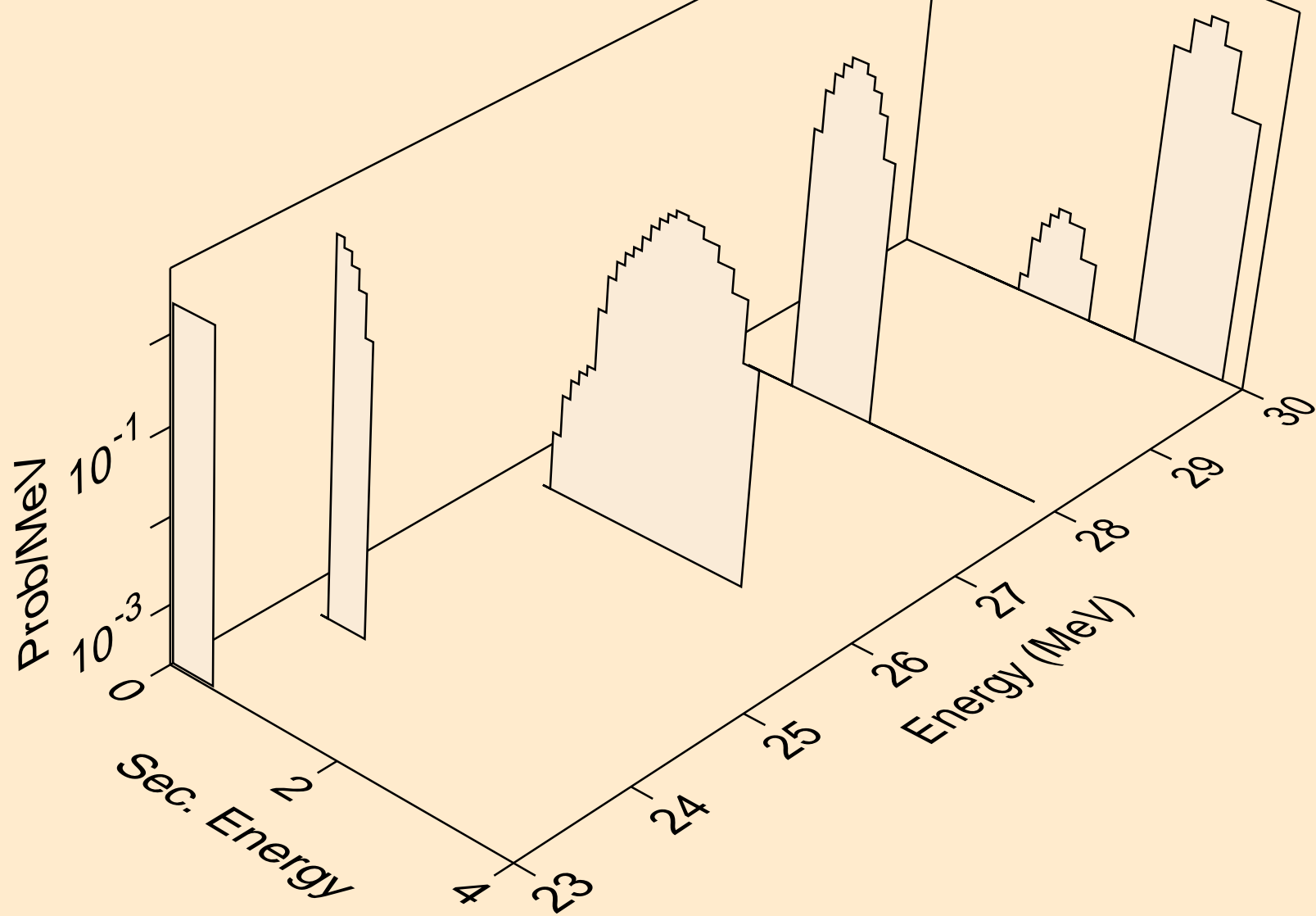

NE024 NEUTRON ACER TENDL-2021 LIBRARY; T=293.6K
alphas from (n,x)

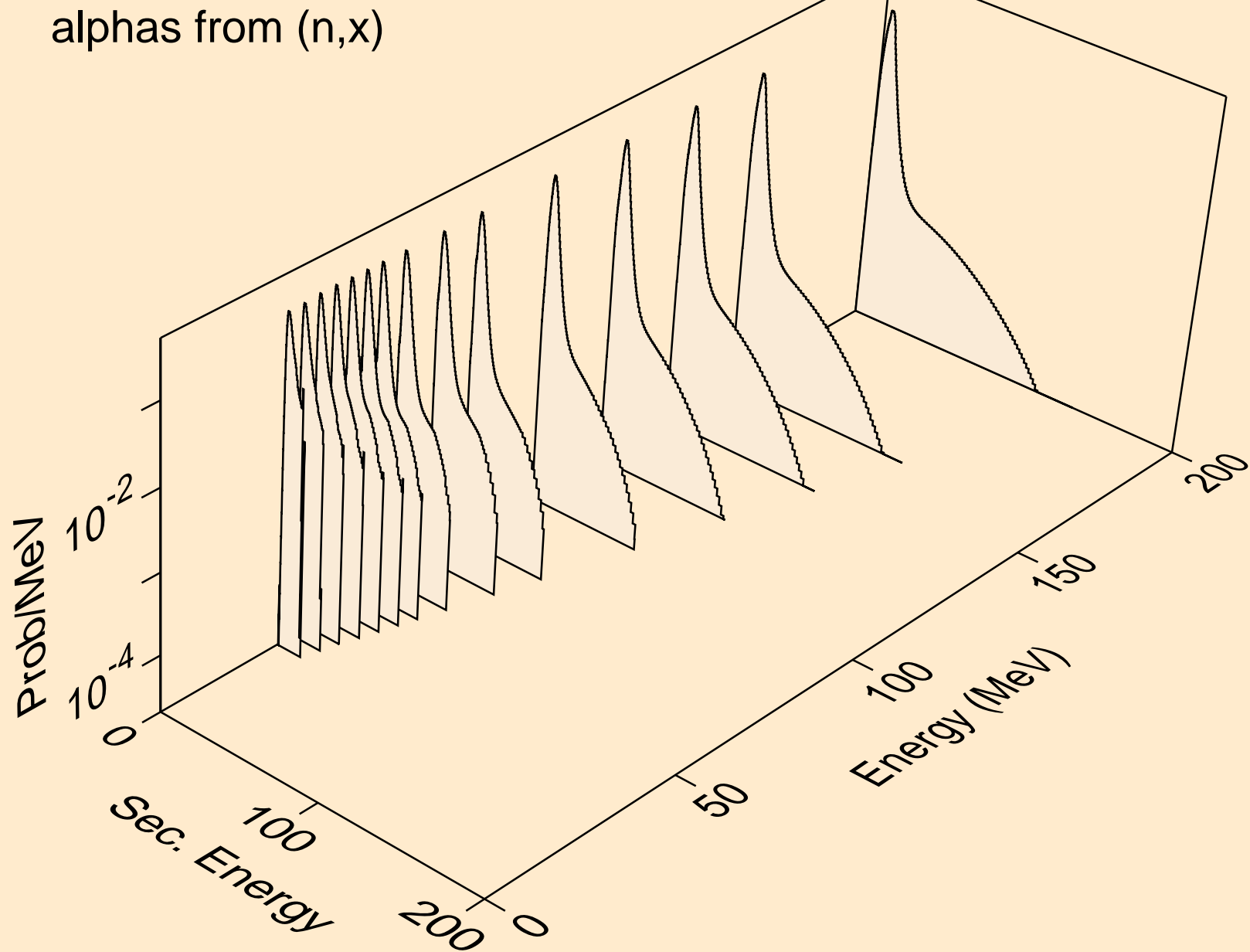

NE024 NEUTRON ACER TENDL-2021 LIBRARY; T=293.6K
alphas from (n,n*)a

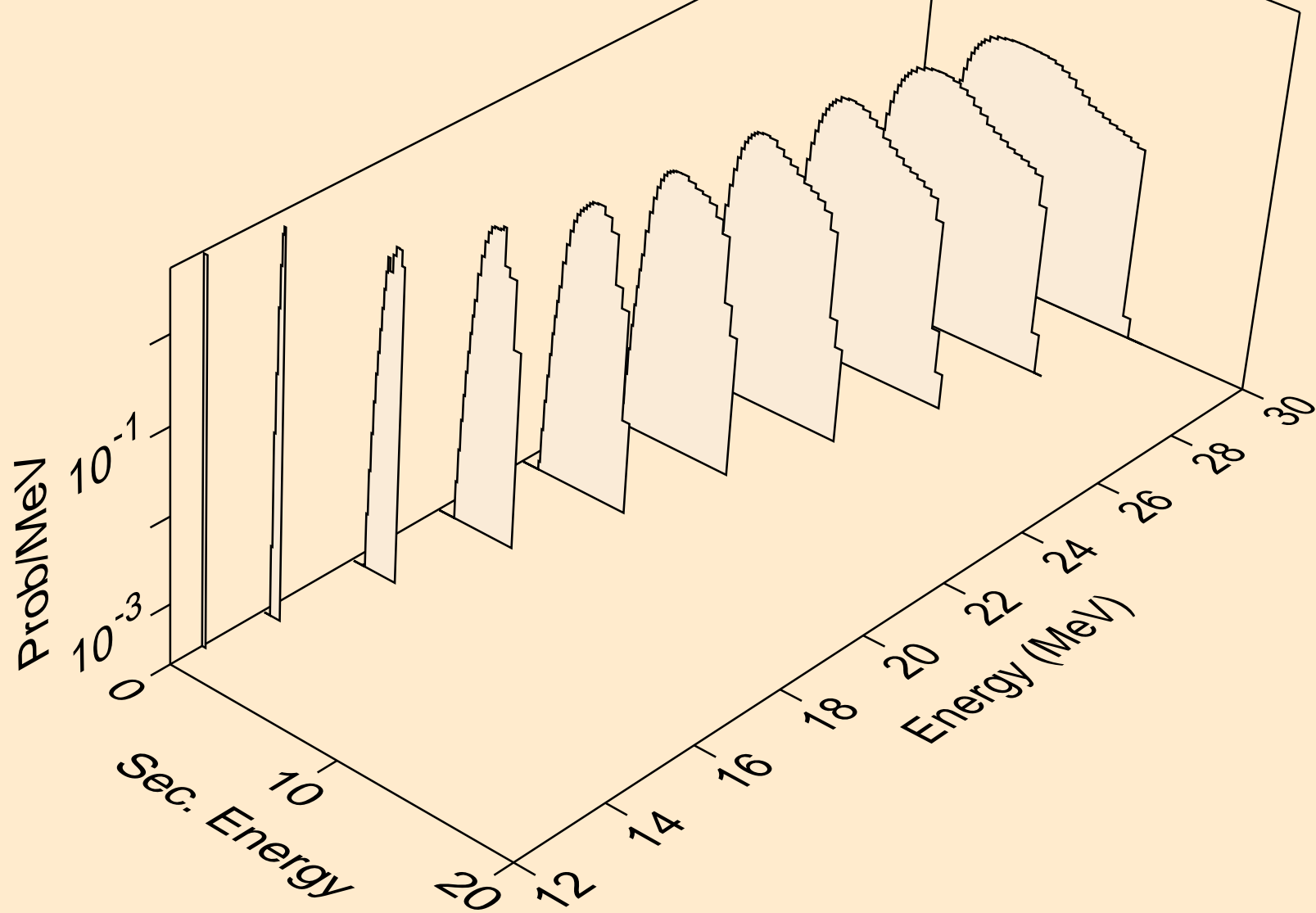

NE024 NEUTRON ACER TENDL-2021 LIBRARY; T=293.6K
alphas from (n,2n)a

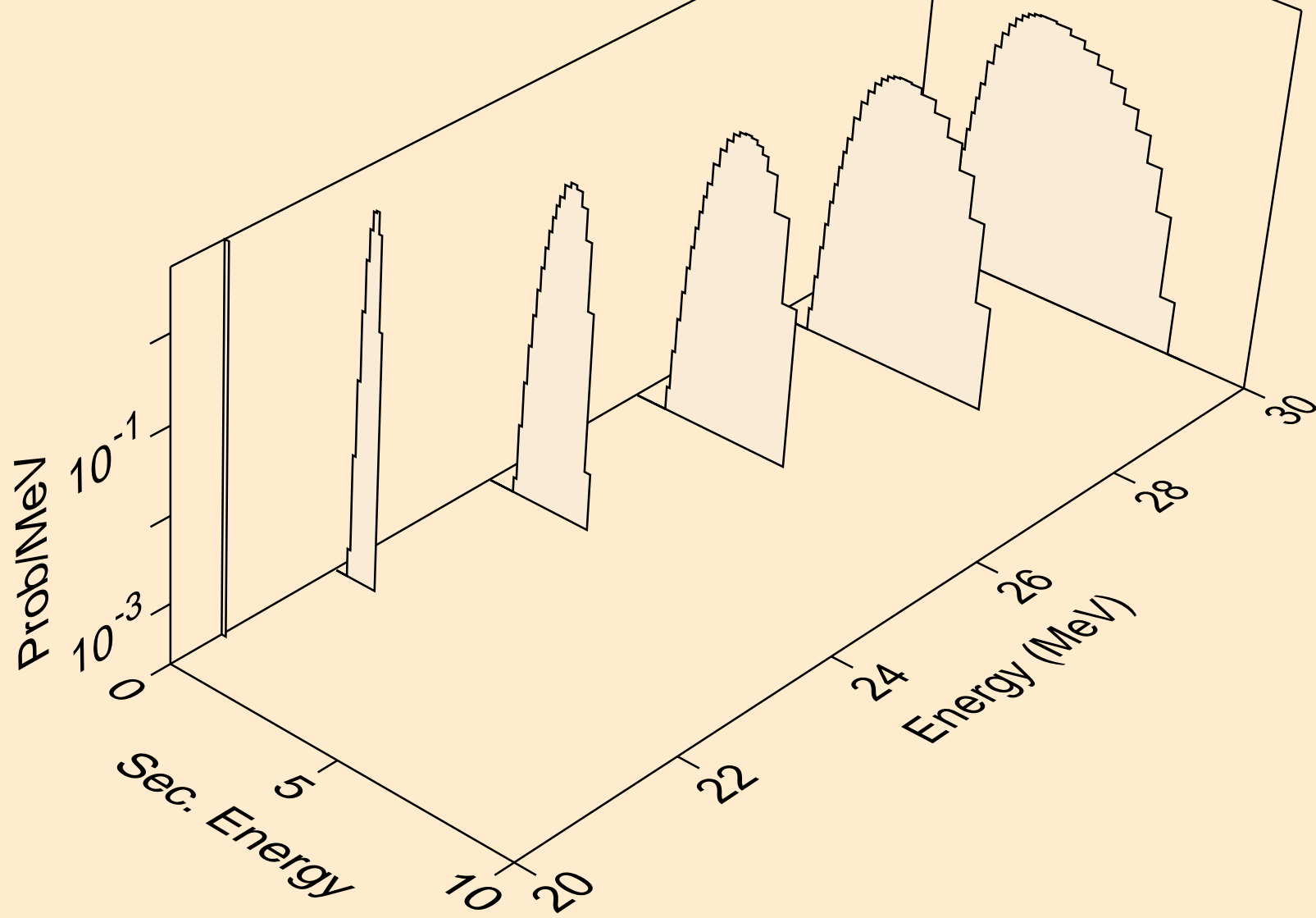

NE024 NEUTRON ACER TENDL-2021 LIBRARY; T=293.6K
alphas from (n,3n)a

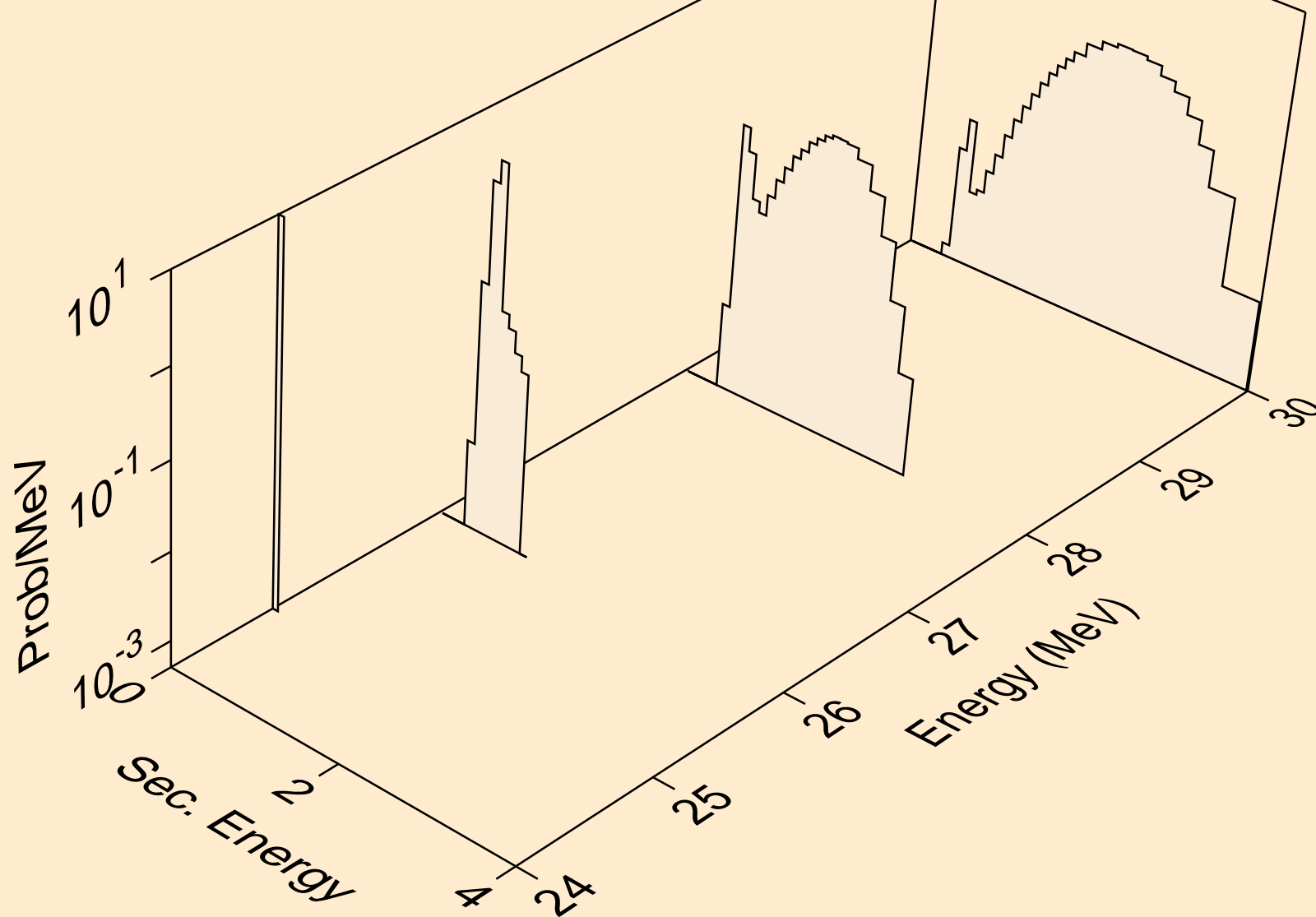

NE024 NEUTRON ACER TENDL-2021 LIBRARY; T=293.6K
alphas from (n,n*)2a

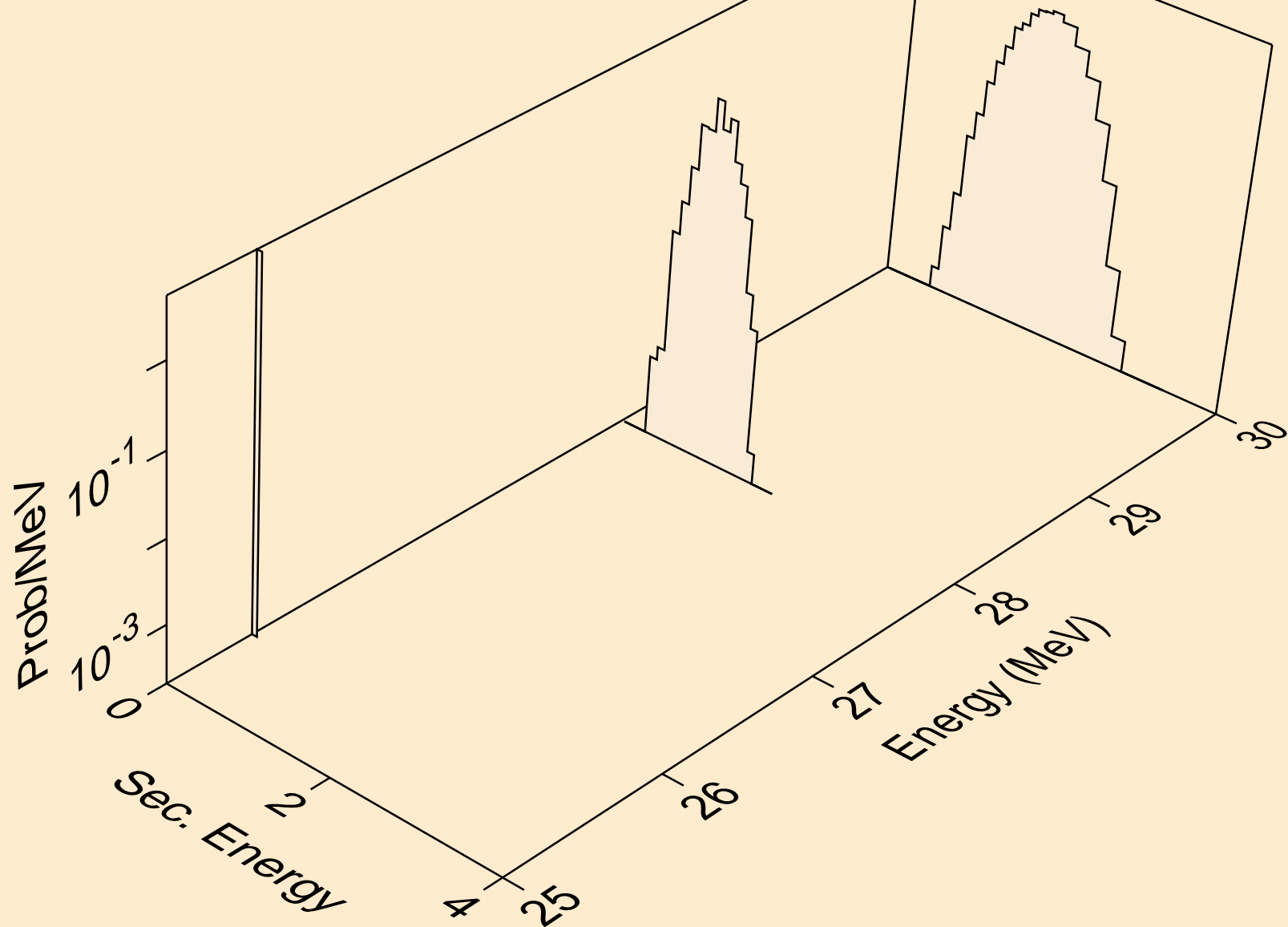

NE024 NEUTRON ACER TENDL-2021 LIBRARY; T=293.6K
alphas from (n,a)

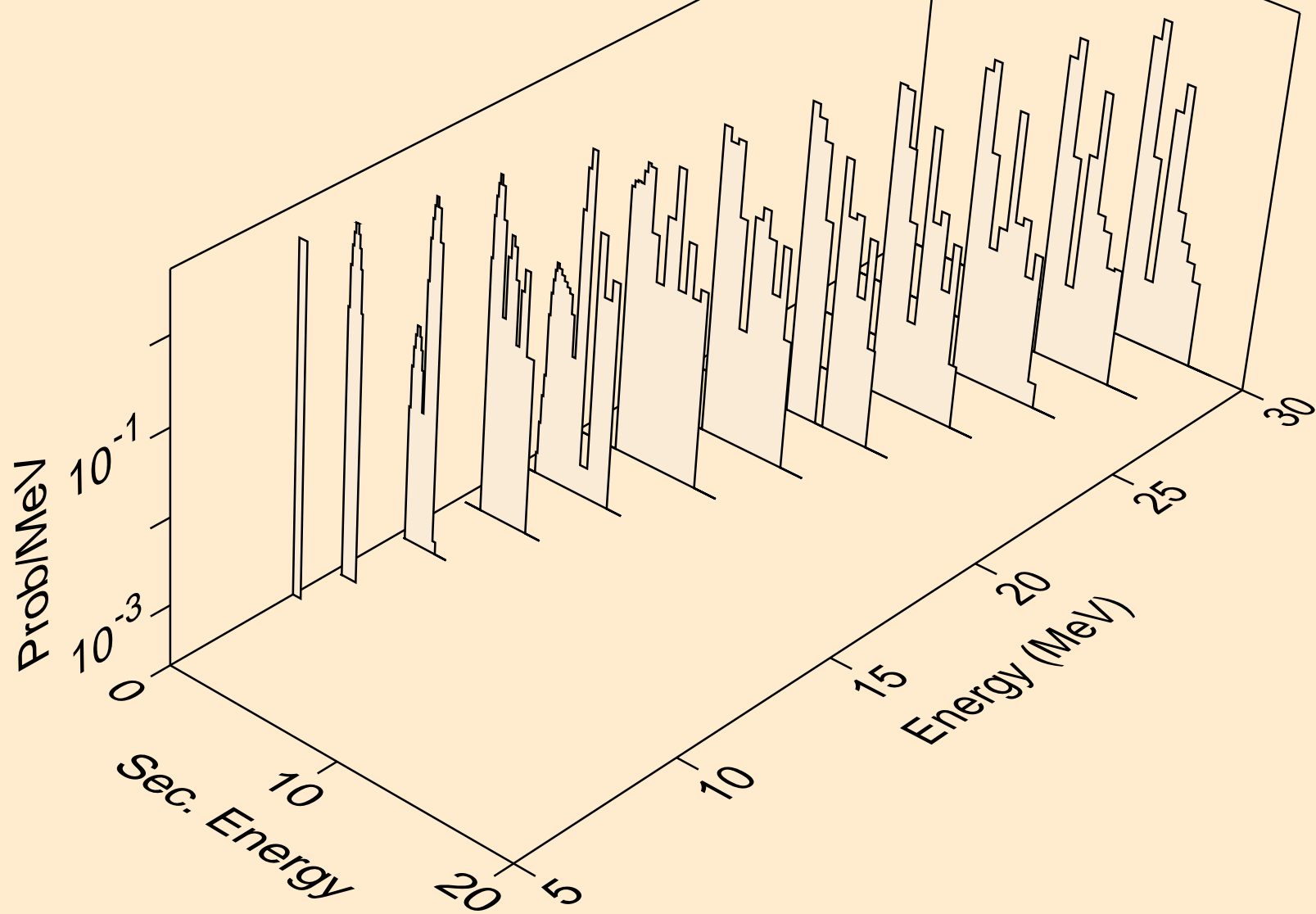

NE024 NEUTRON ACER TENDL-2021 LIBRARY; T=293.6K
alphas from (n,2a)

