

NI062 NEUTRON ACER TENDL-2021 LIBRARY; T=293.6K

Principal cross sections

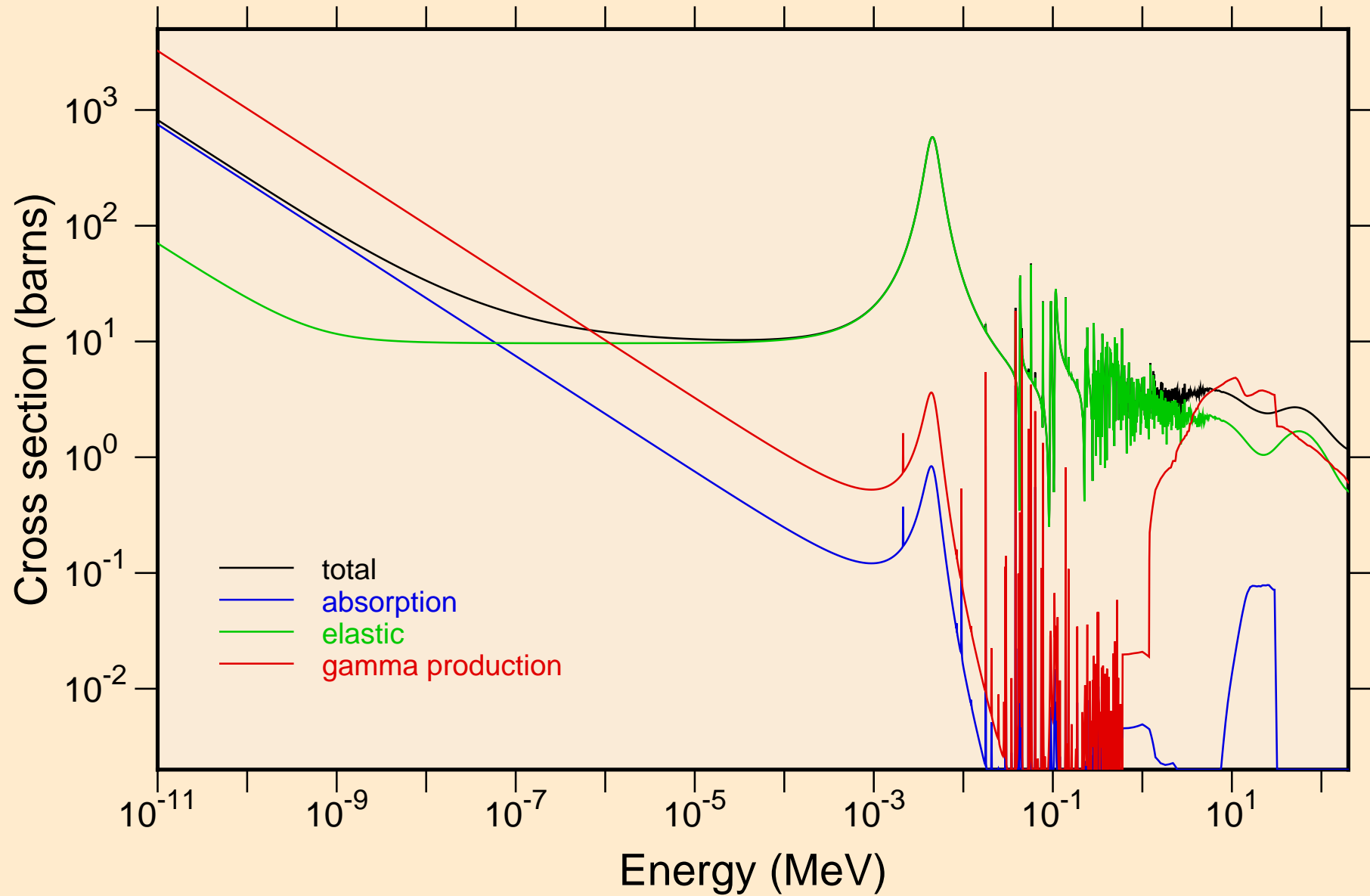

NI062 NEUTRON ACER TENDL-2021 LIBRARY; T=293.6K
resonance total cross section

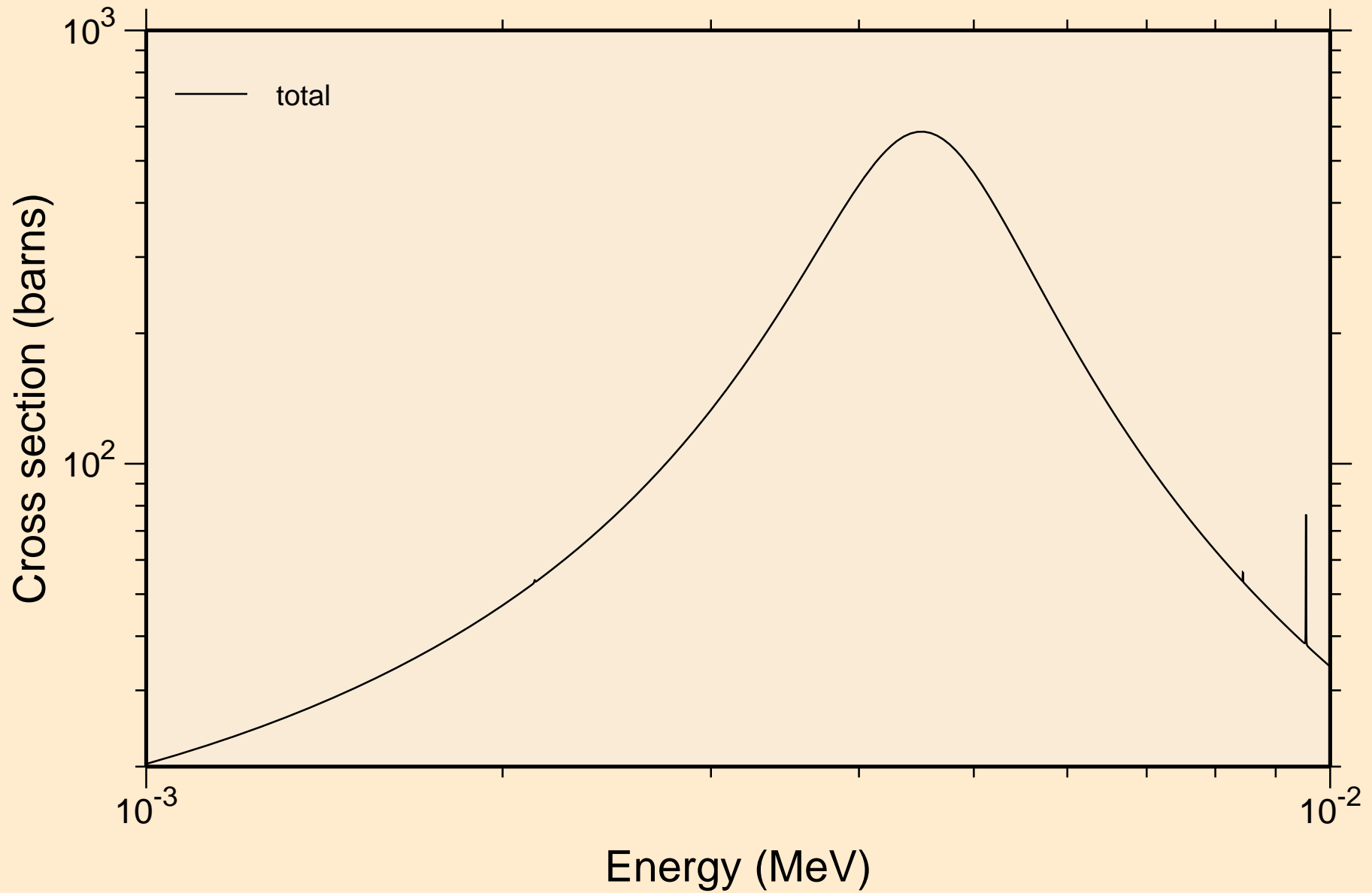

NI062 NEUTRON ACER TENDL-2021 LIBRARY; T=293.6K
resonance total cross section

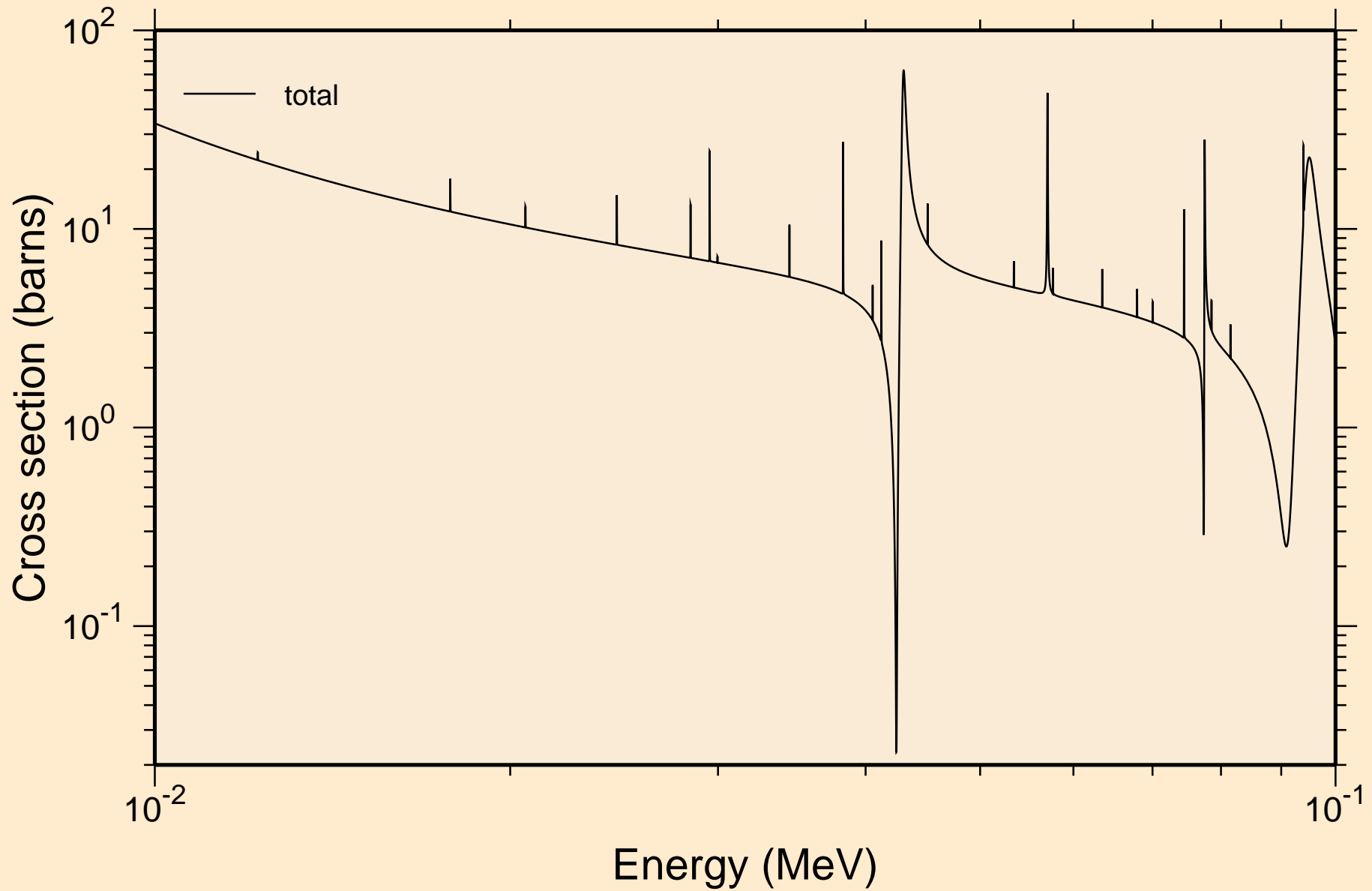

NI062 NEUTRON ACER TENDL-2021 LIBRARY; T=293.6K
resonance total cross section

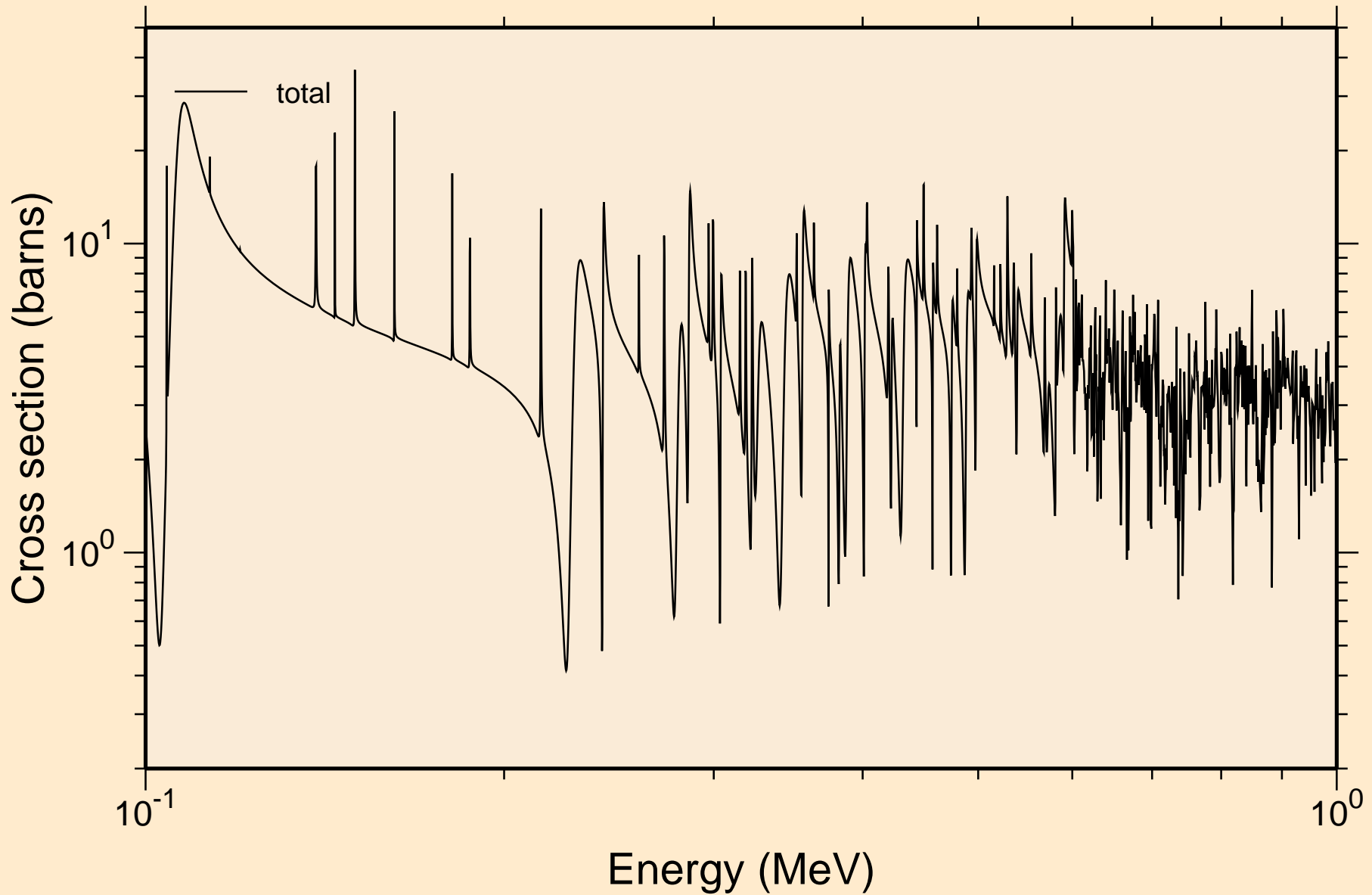

NI062 NEUTRON ACER TENDL-2021 LIBRARY; T=293.6K
resonance total cross section

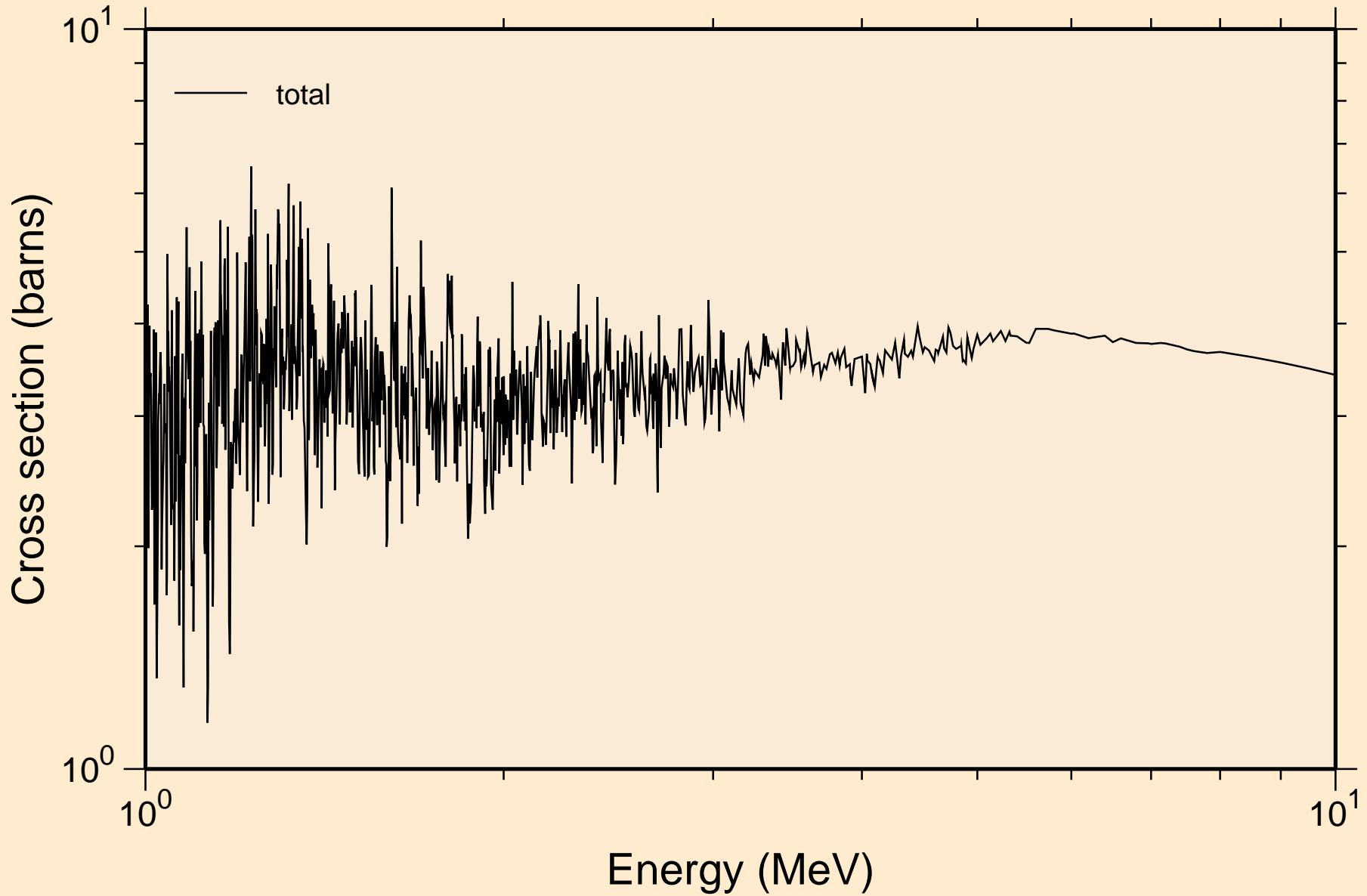

NI062 NEUTRON ACER TENDL-2021 LIBRARY; T=293.6K
resonance absorption cross sections

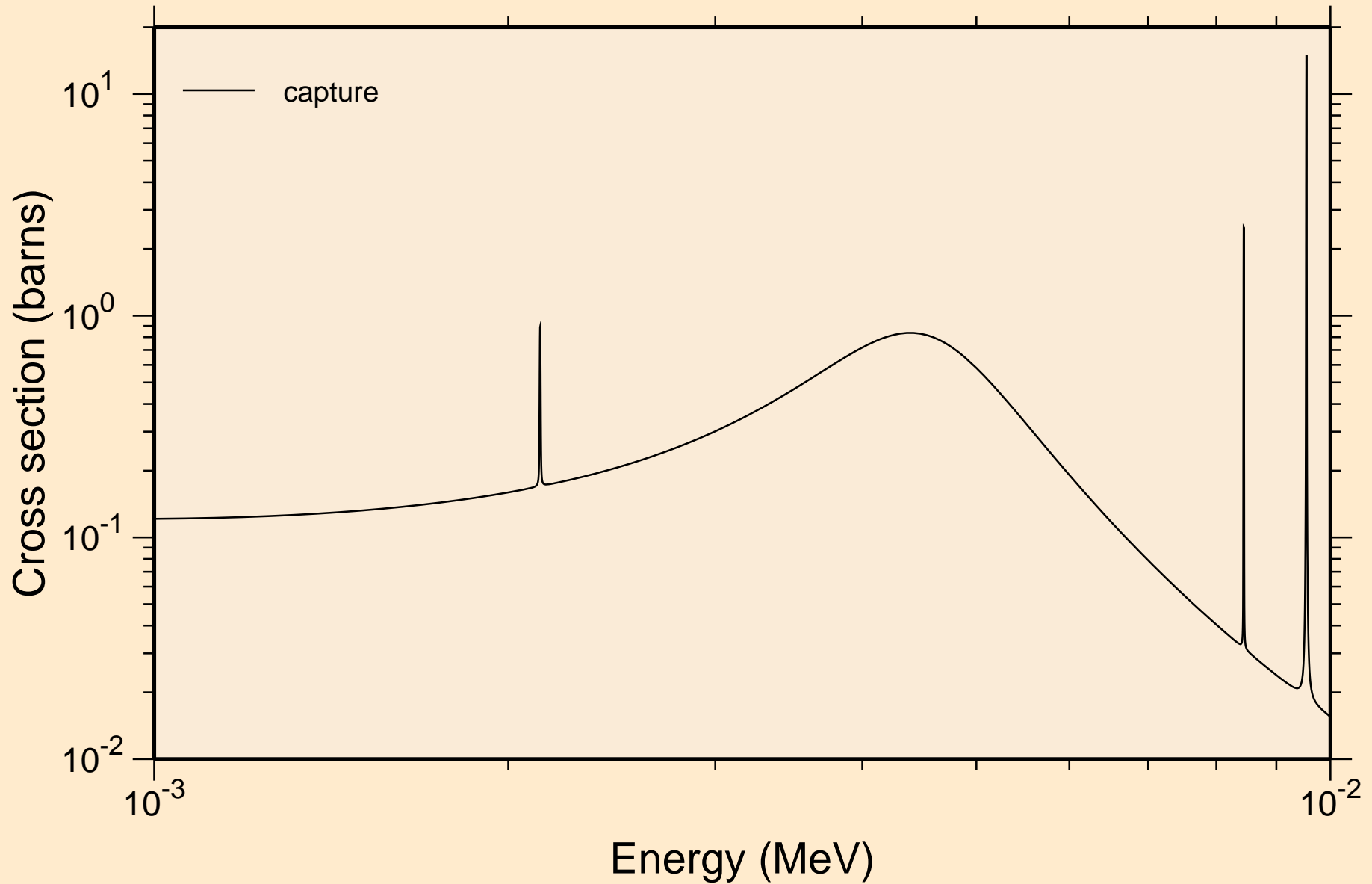

NI062 NEUTRON ACER TENDL-2021 LIBRARY; T=293.6K
resonance absorption cross sections

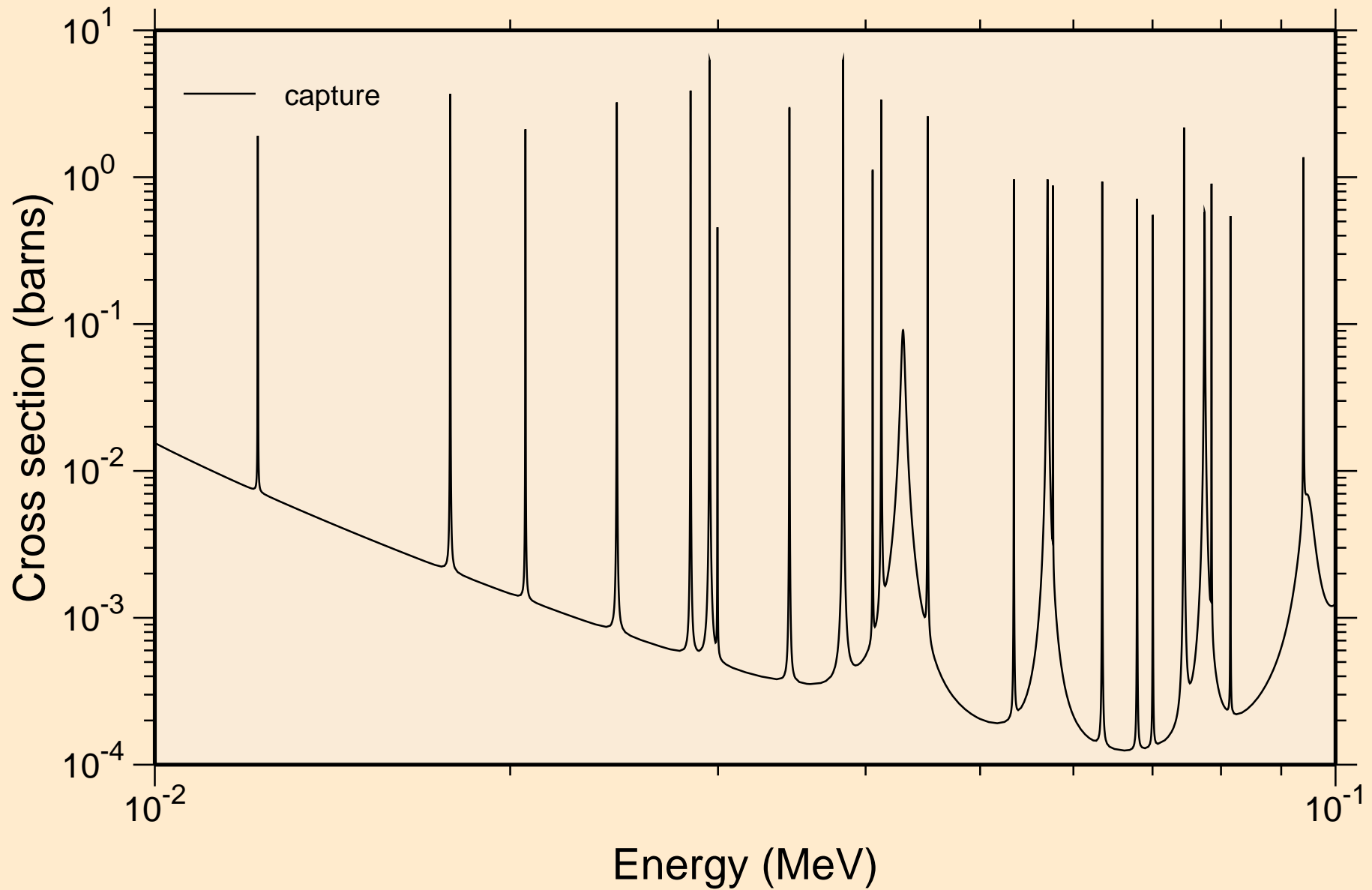

NI062 NEUTRON ACER TENDL-2021 LIBRARY; T=293.6K
resonance absorption cross sections

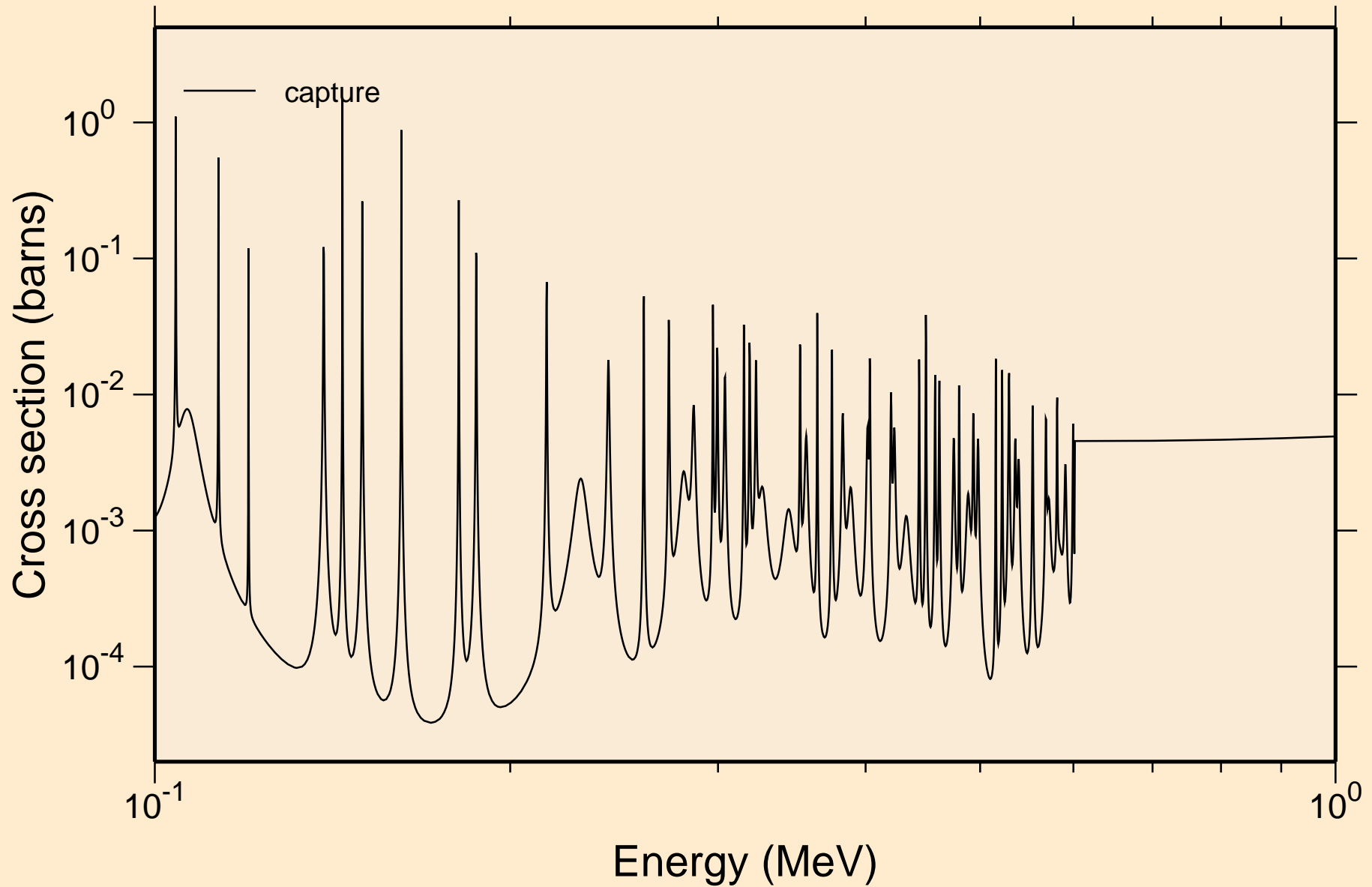

NI062 NEUTRON ACER TENDL-2021 LIBRARY; T=293.6K
resonance absorption cross sections

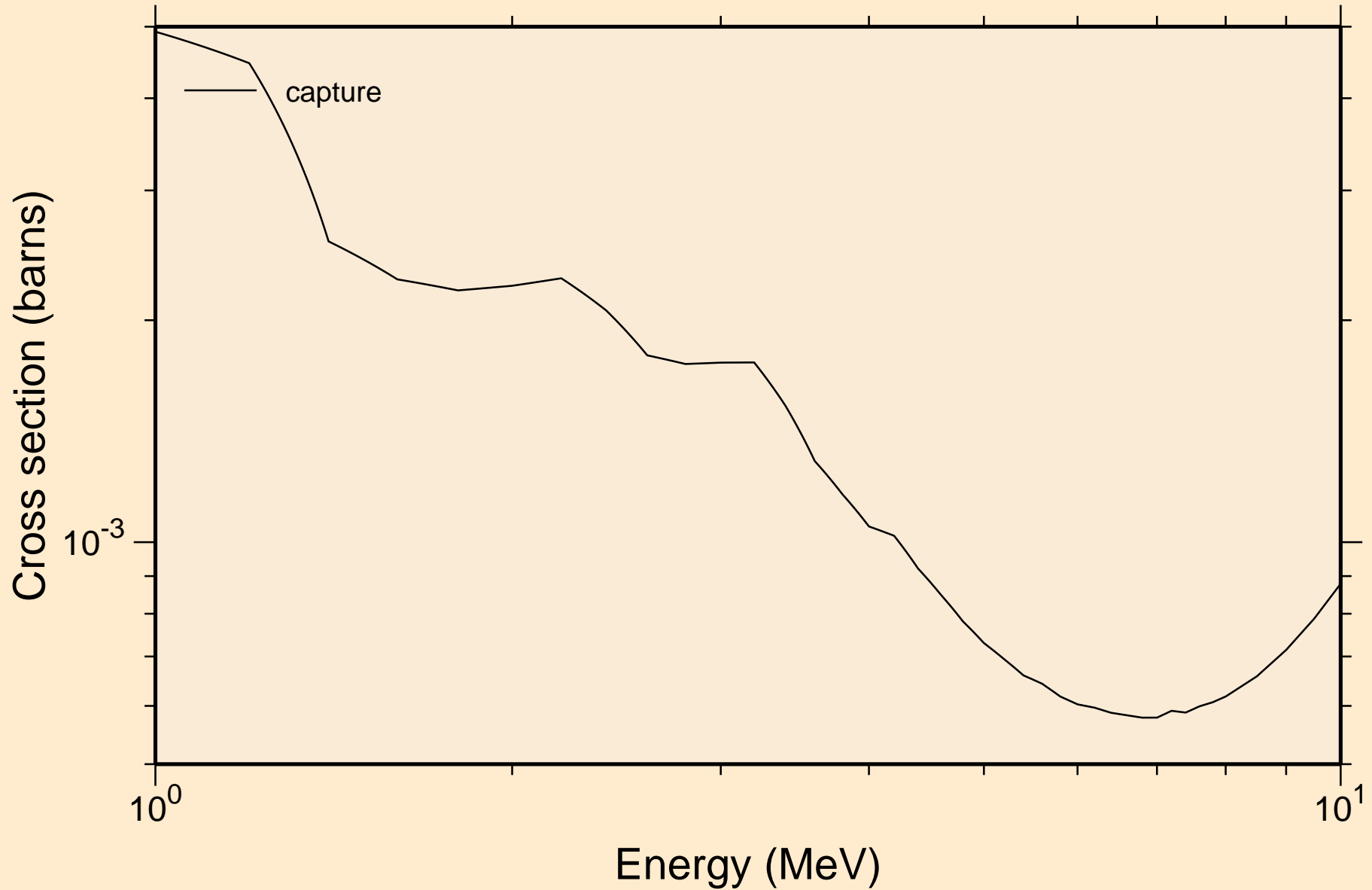

NI062 NEUTRON ACER TENDL-2021 LIBRARY; T=293.6K
Heating

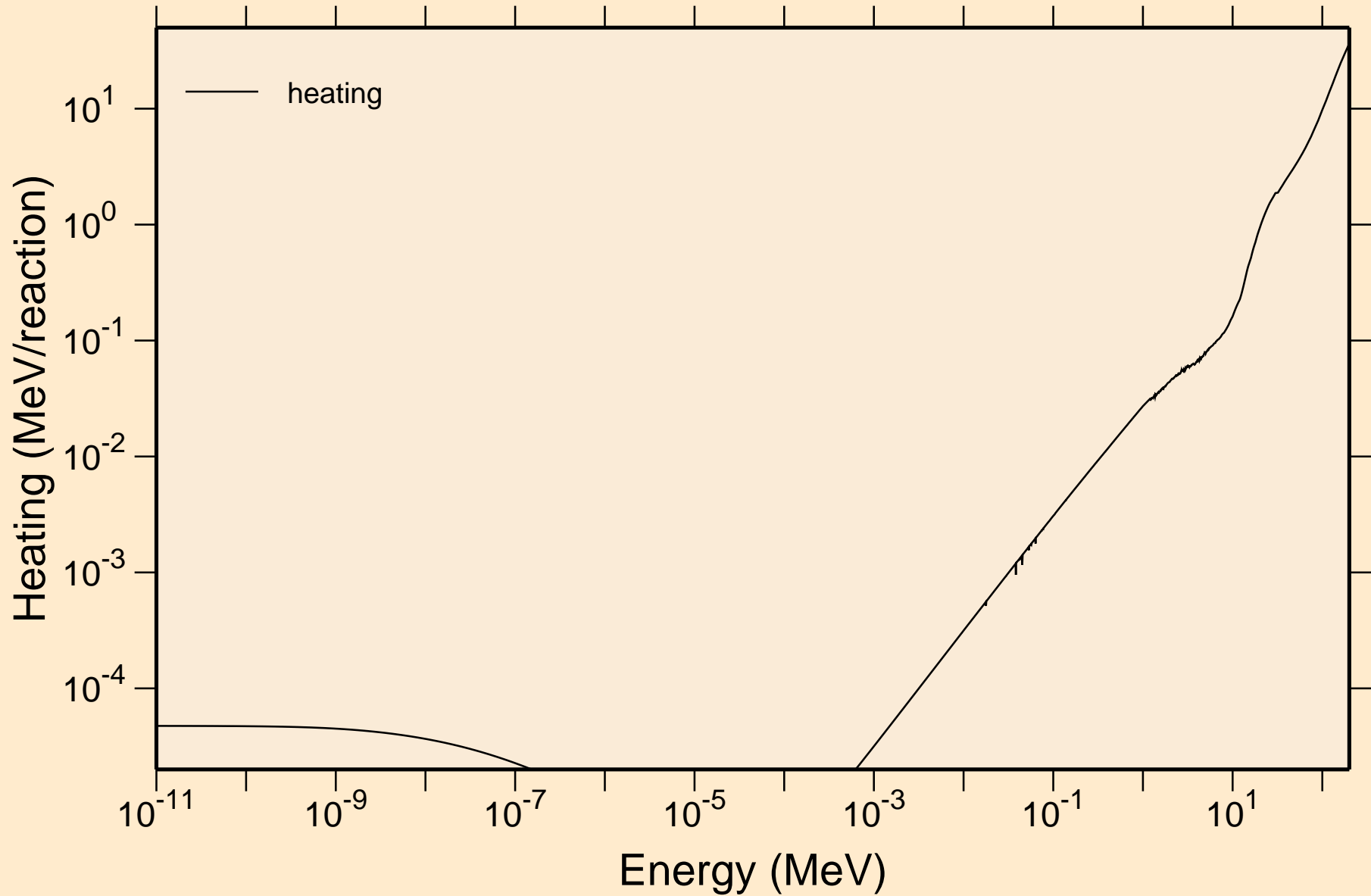

NI062 NEUTRON ACER TENDL-2021 LIBRARY; T=293.6K
Damage

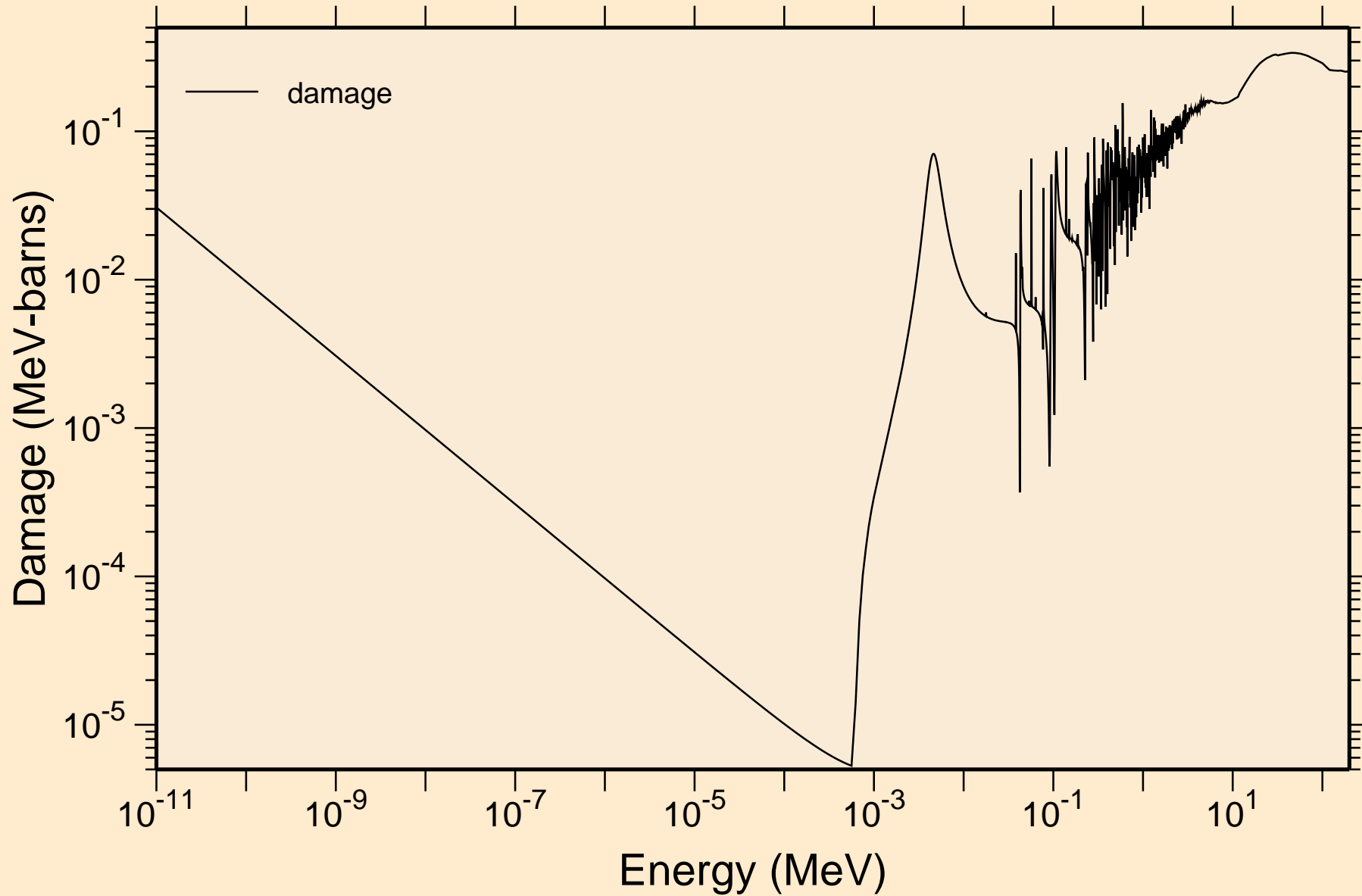

NI062 NEUTRON ACER TENDL-2021 LIBRARY; T=293.6K
Non-threshold reactions

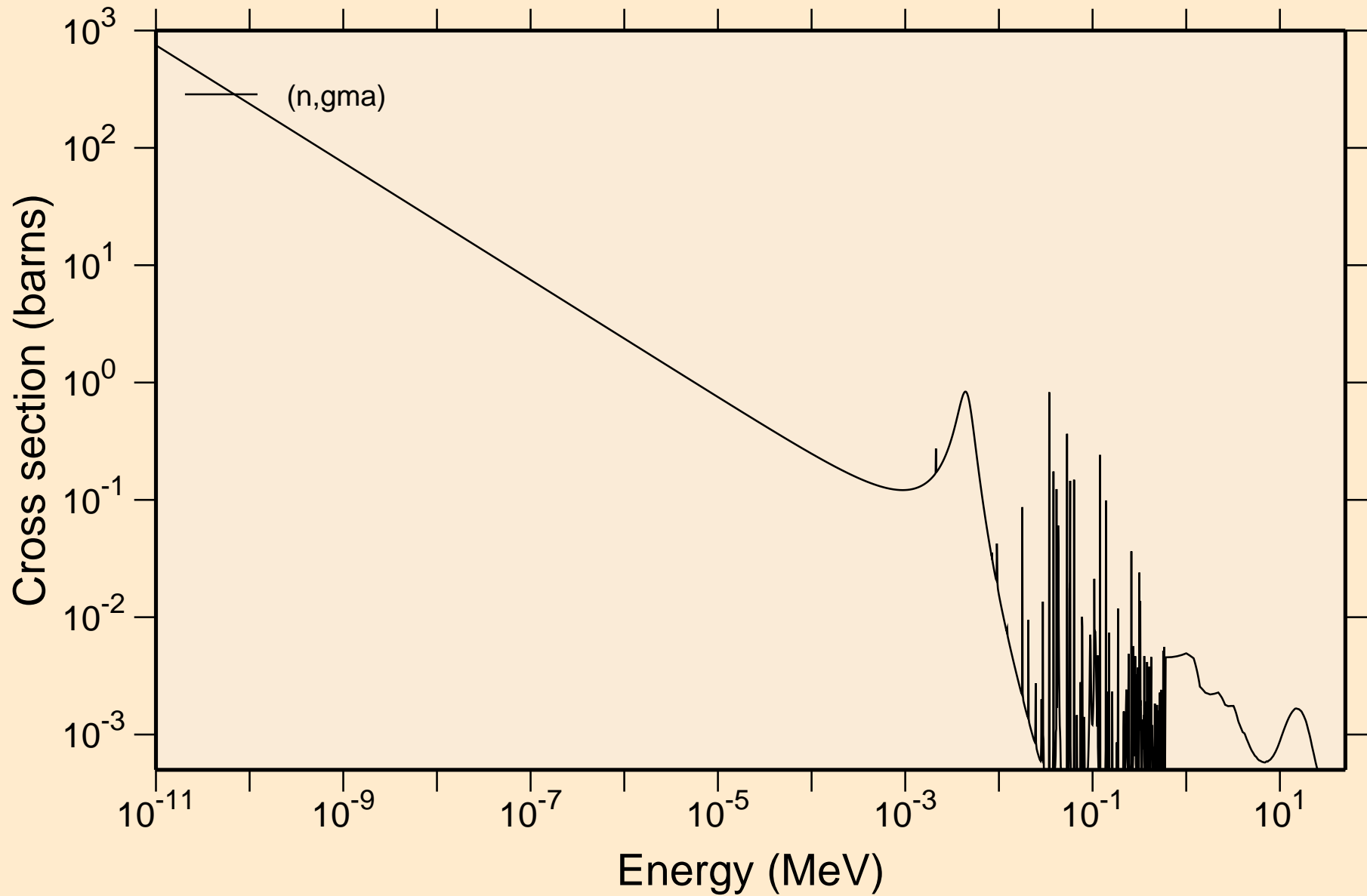

NI062 NEUTRON ACER TENDL-2021 LIBRARY; T=293.6K
Principal cross sections

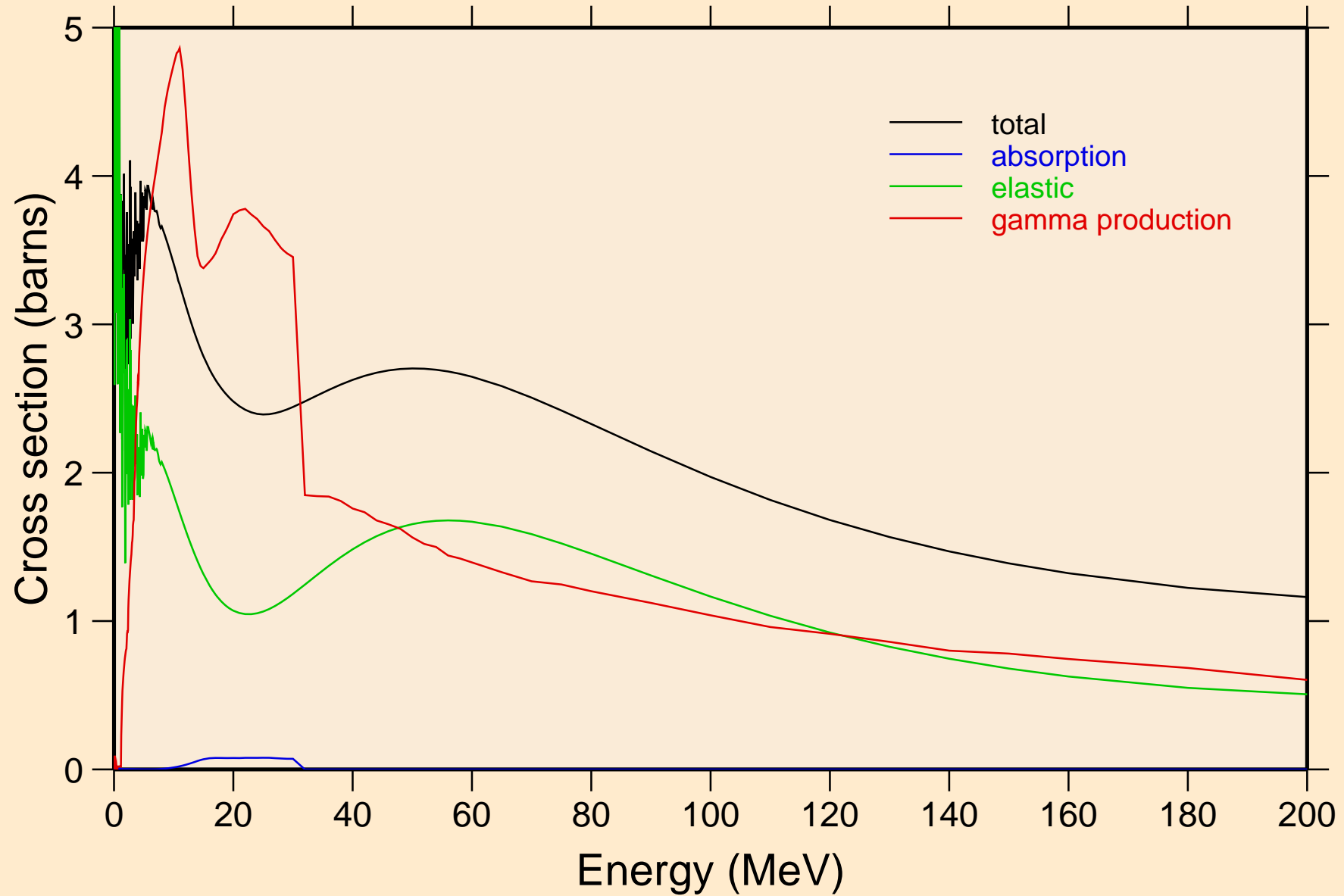

NI062 NEUTRON ACER TENDL-2021 LIBRARY; T=293.6K

Heating

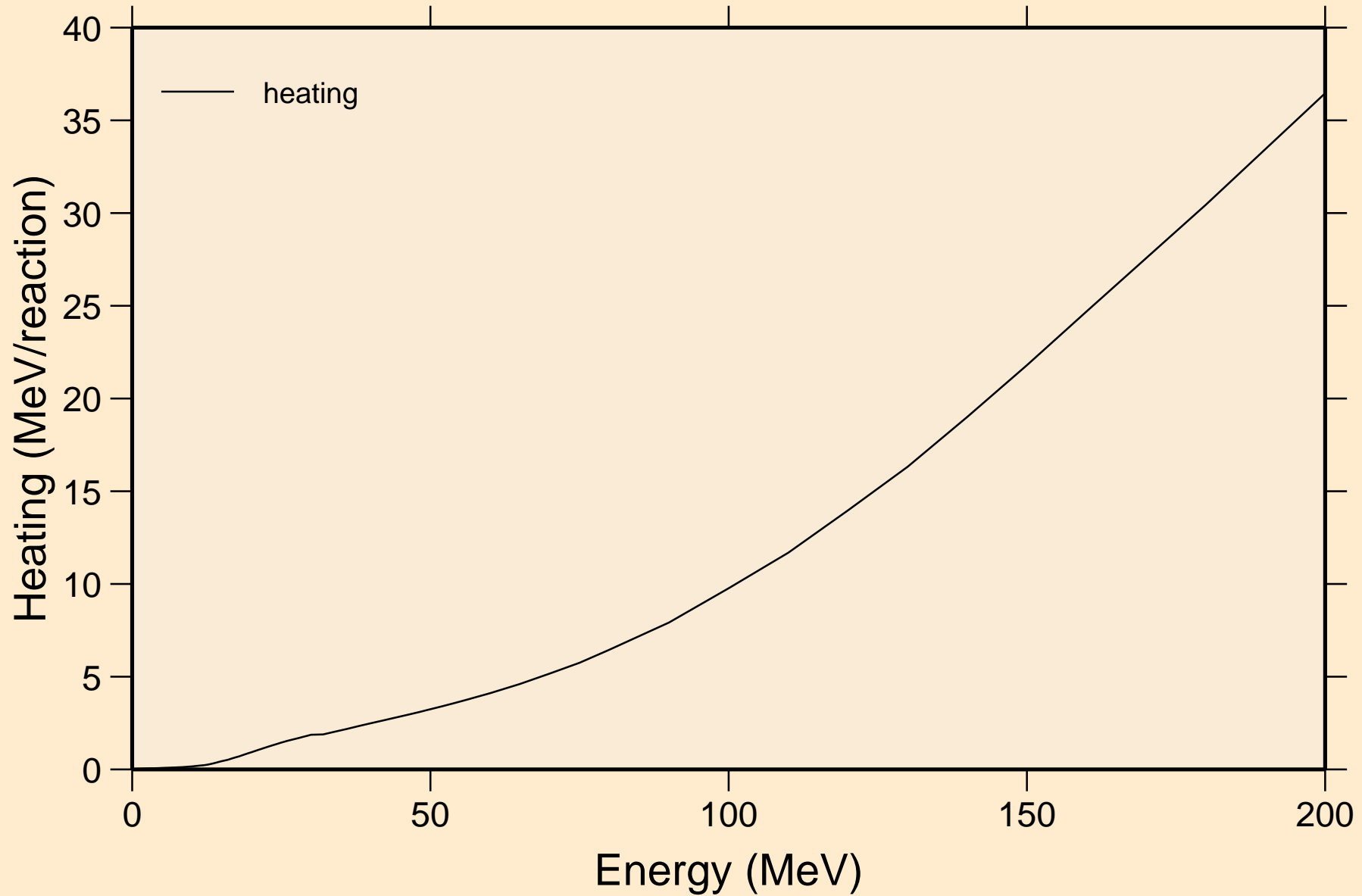

NI062 NEUTRON ACER TENDL-2021 LIBRARY; T=293.6K
Damage

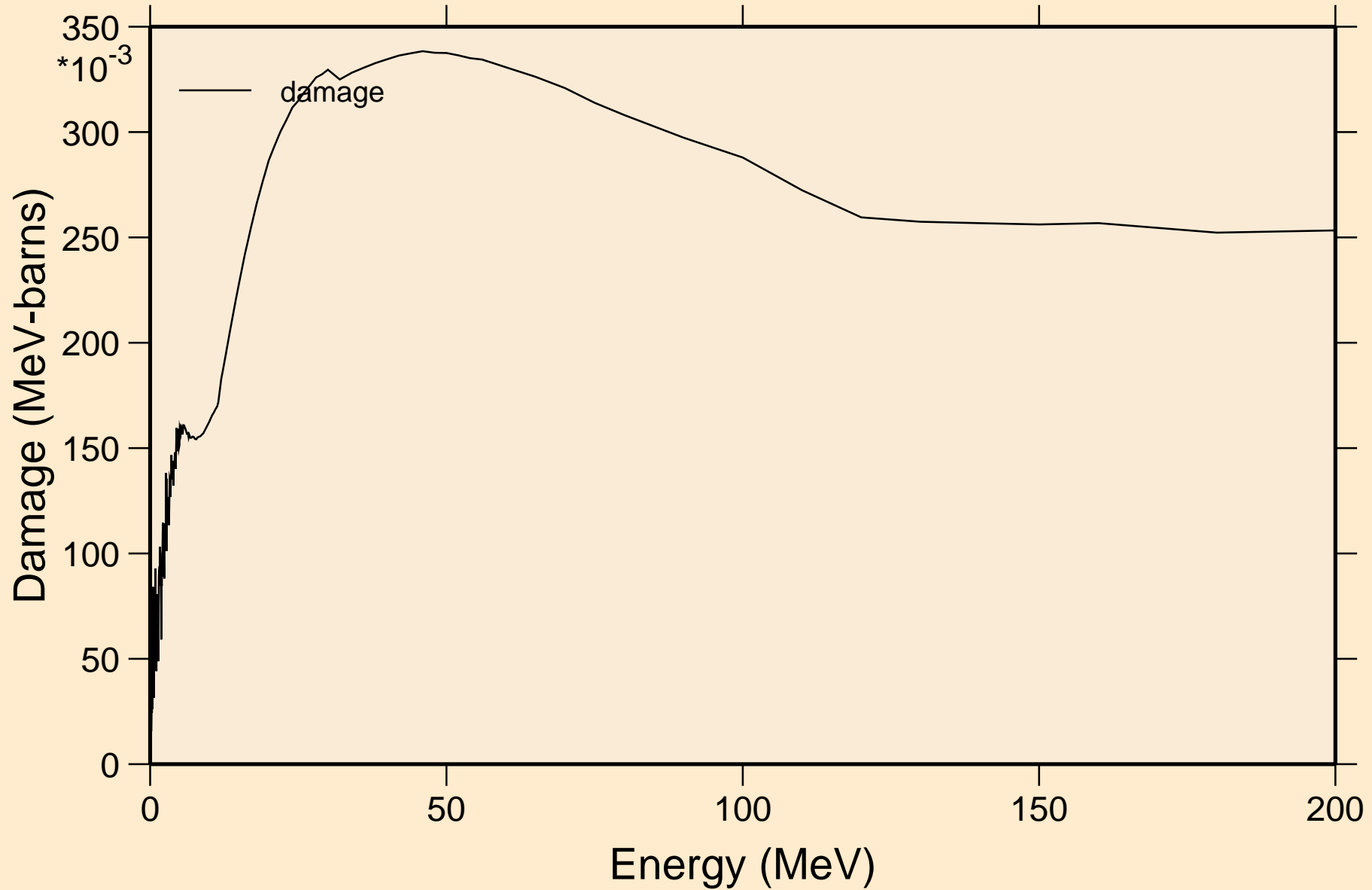

NI062 NEUTRON ACER TENDL-2021 LIBRARY; T=293.6K
Non-threshold reactions

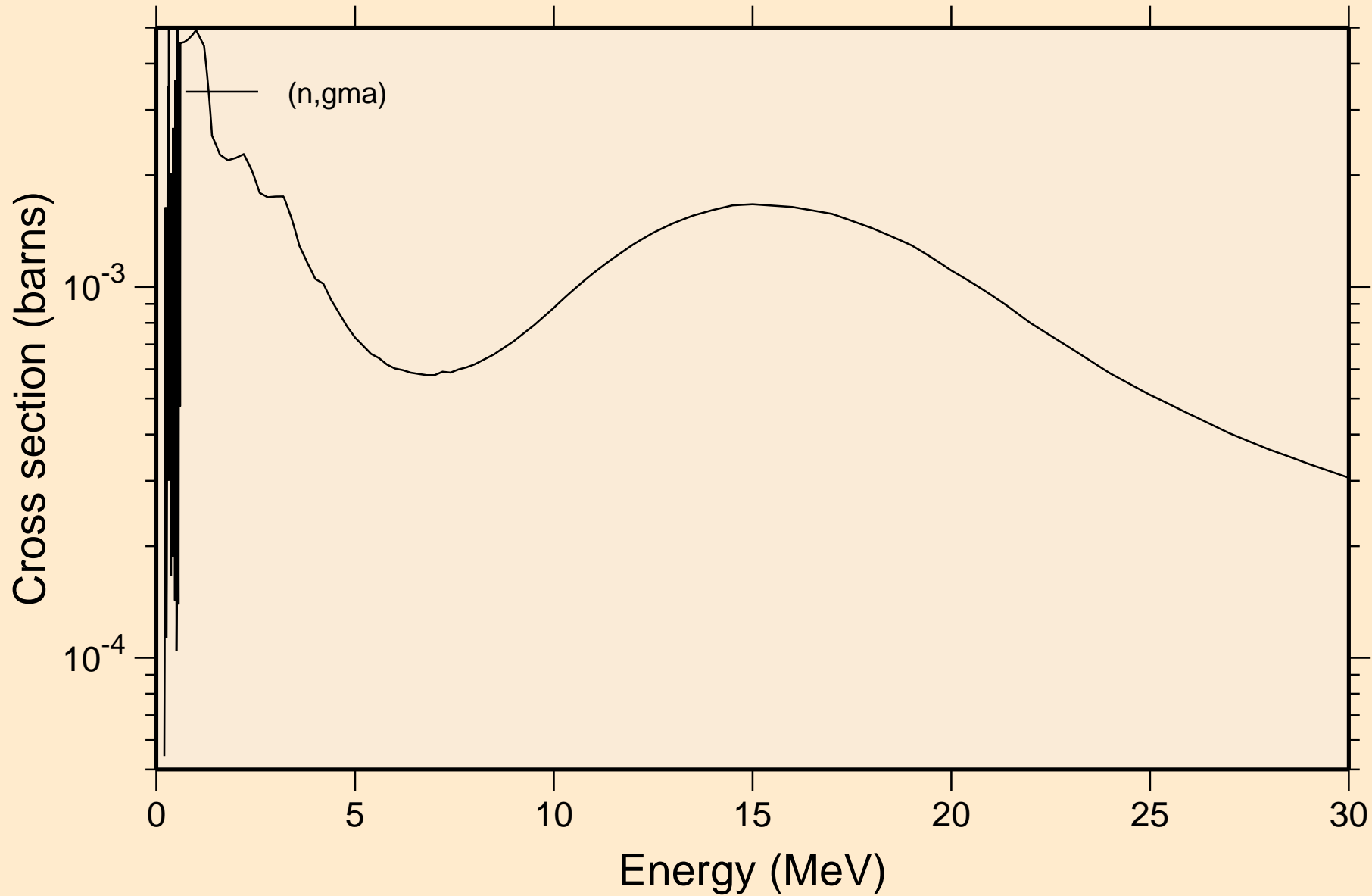

NI062 NEUTRON ACER TENDL-2021 LIBRARY; T=293.6K
Inelastic levels

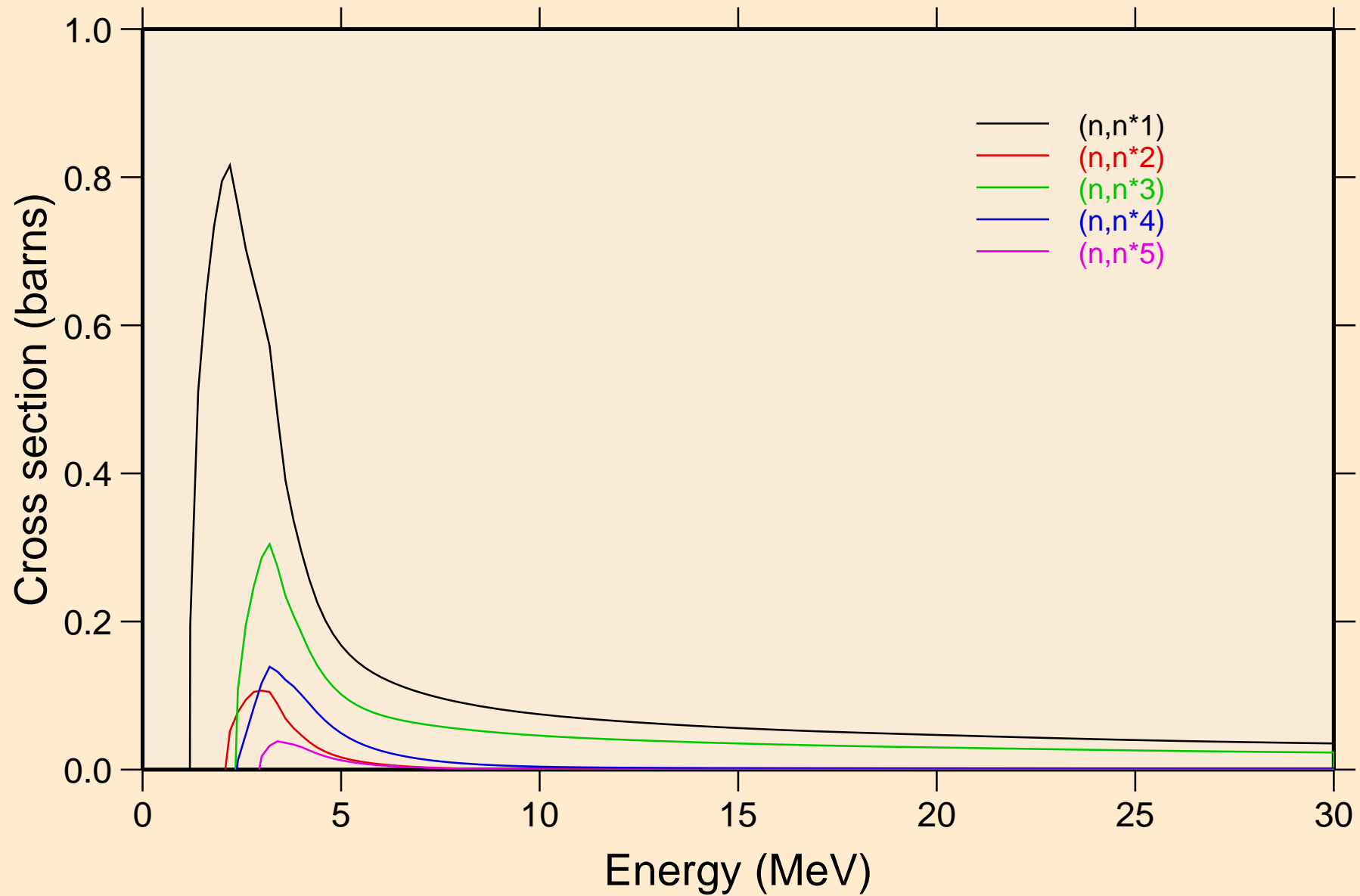

NI062 NEUTRON ACER TENDL-2021 LIBRARY; T=293.6K
Inelastic levels

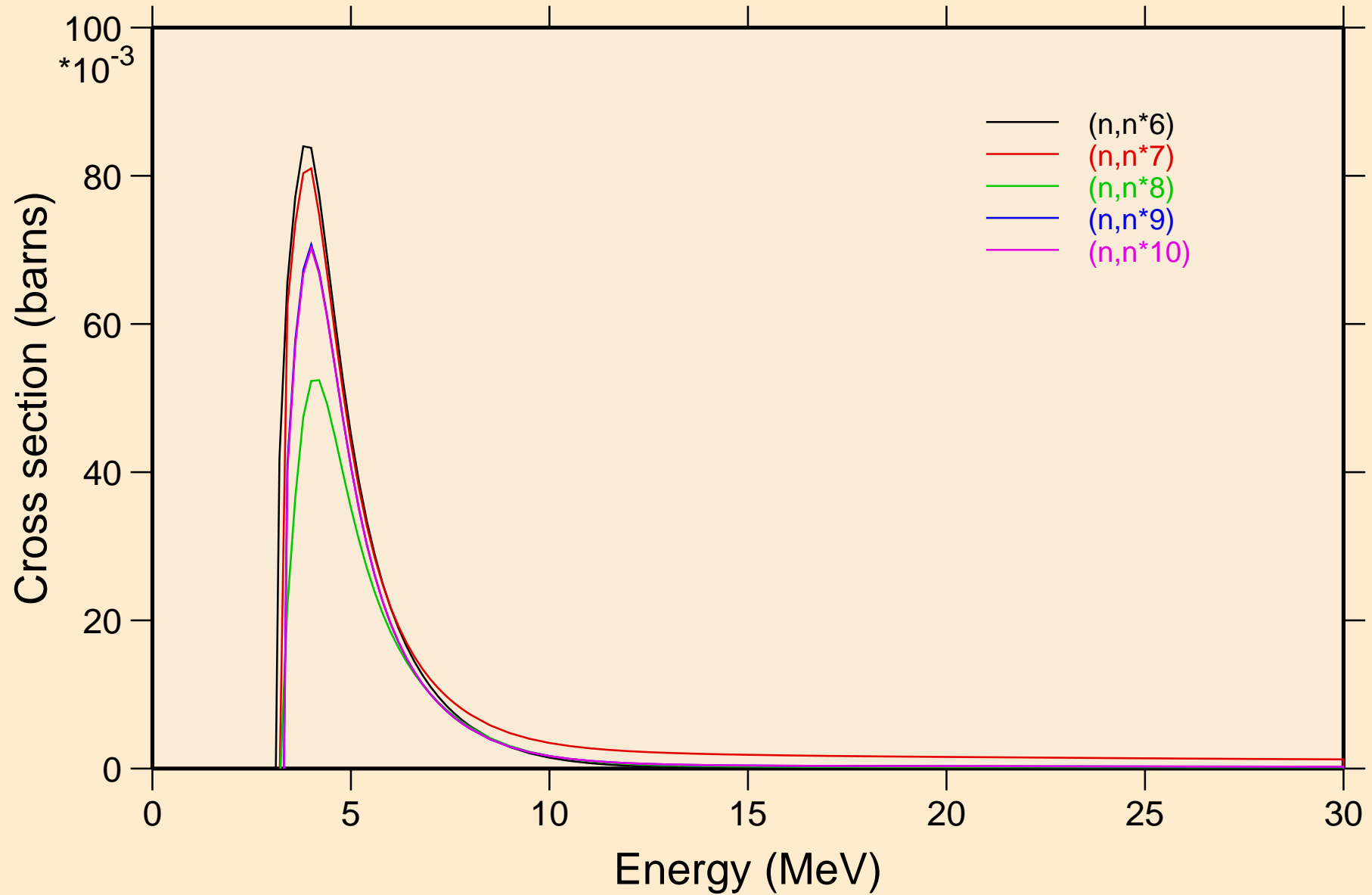

NI062 NEUTRON ACER TENDL-2021 LIBRARY; T=293.6K
Inelastic levels

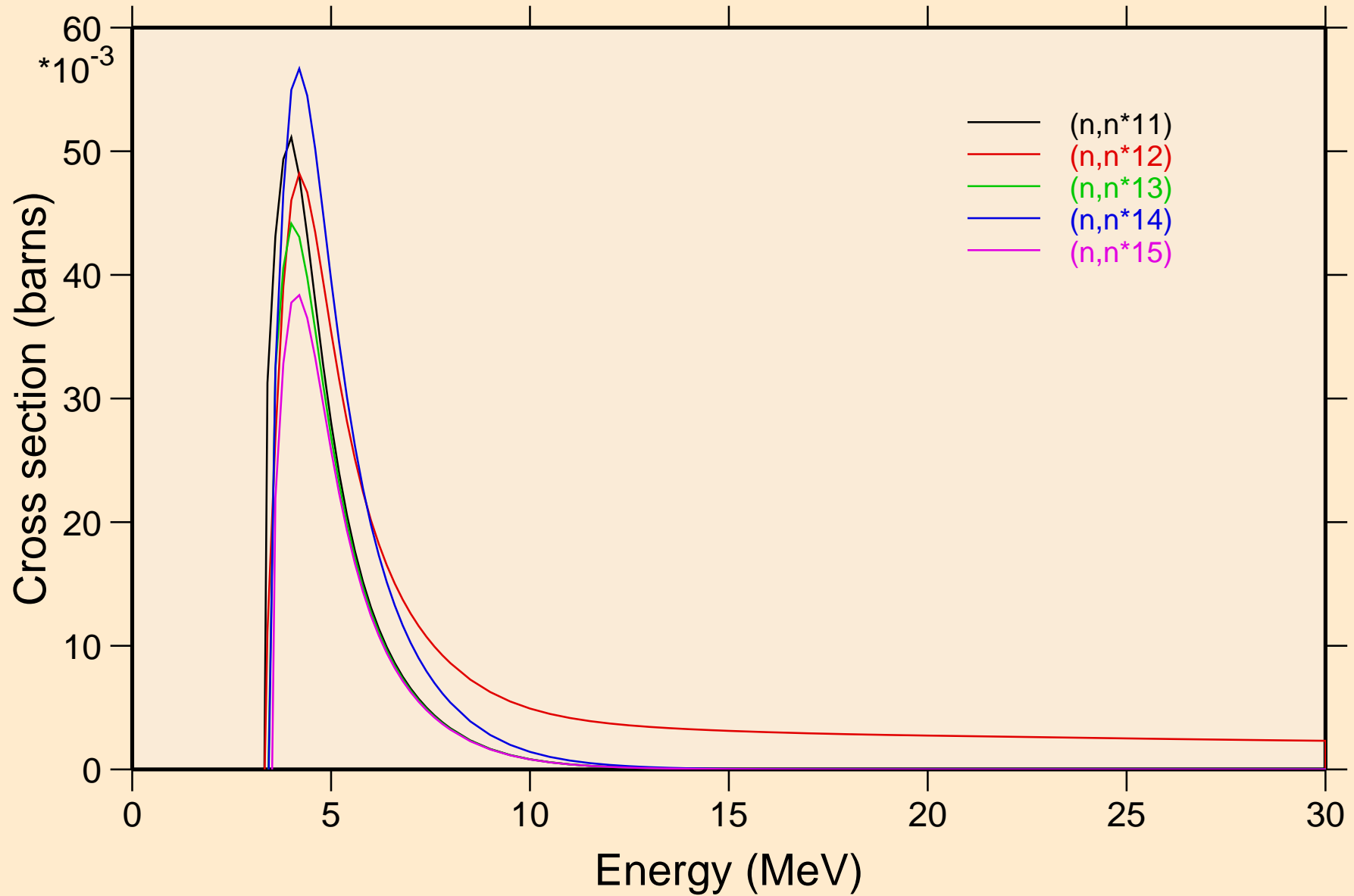

NI062 NEUTRON ACER TENDL-2021 LIBRARY; T=293.6K
Inelastic levels

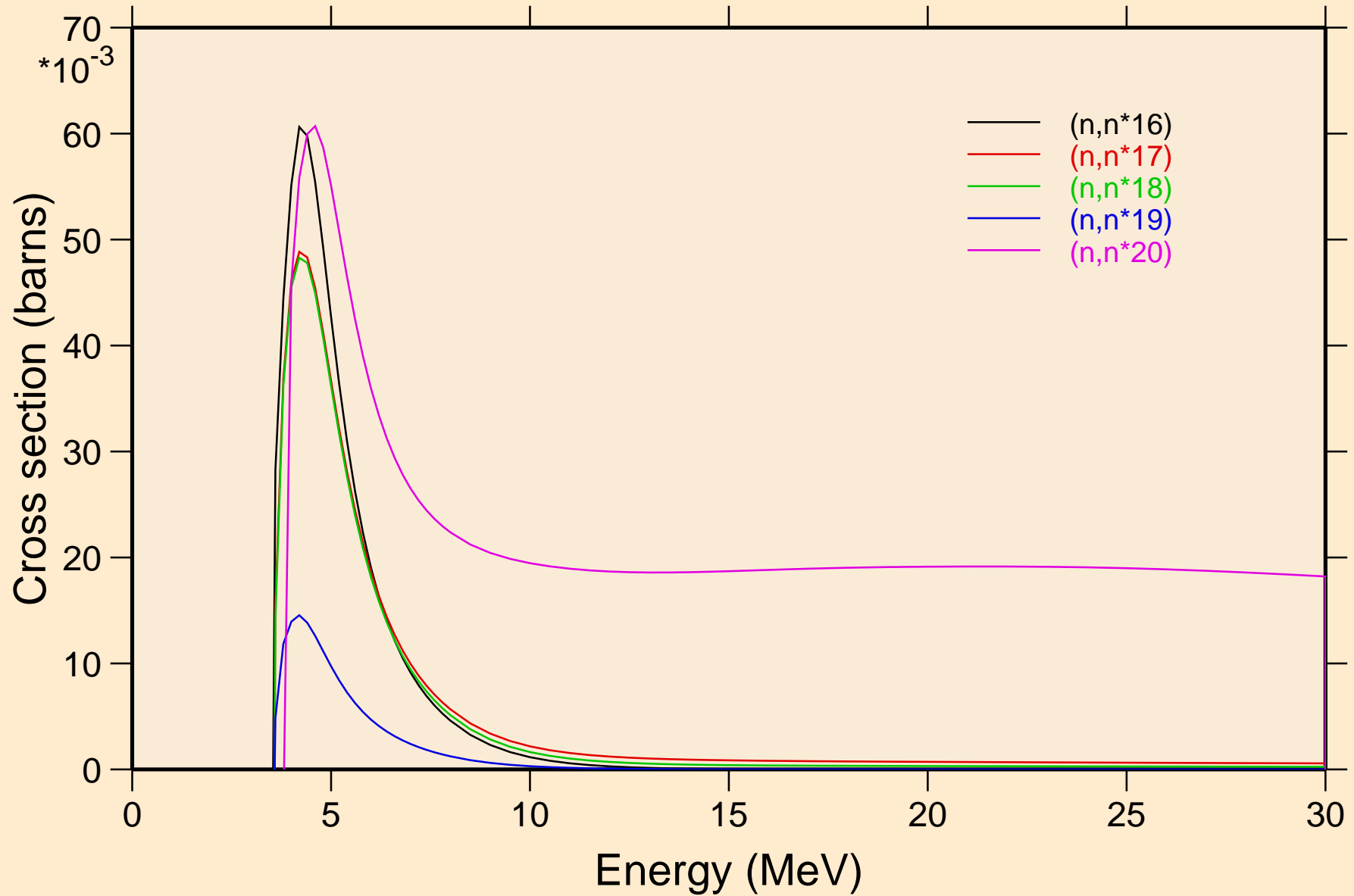

NI062 NEUTRON ACER TENDL-2021 LIBRARY; T=293.6K
Inelastic levels

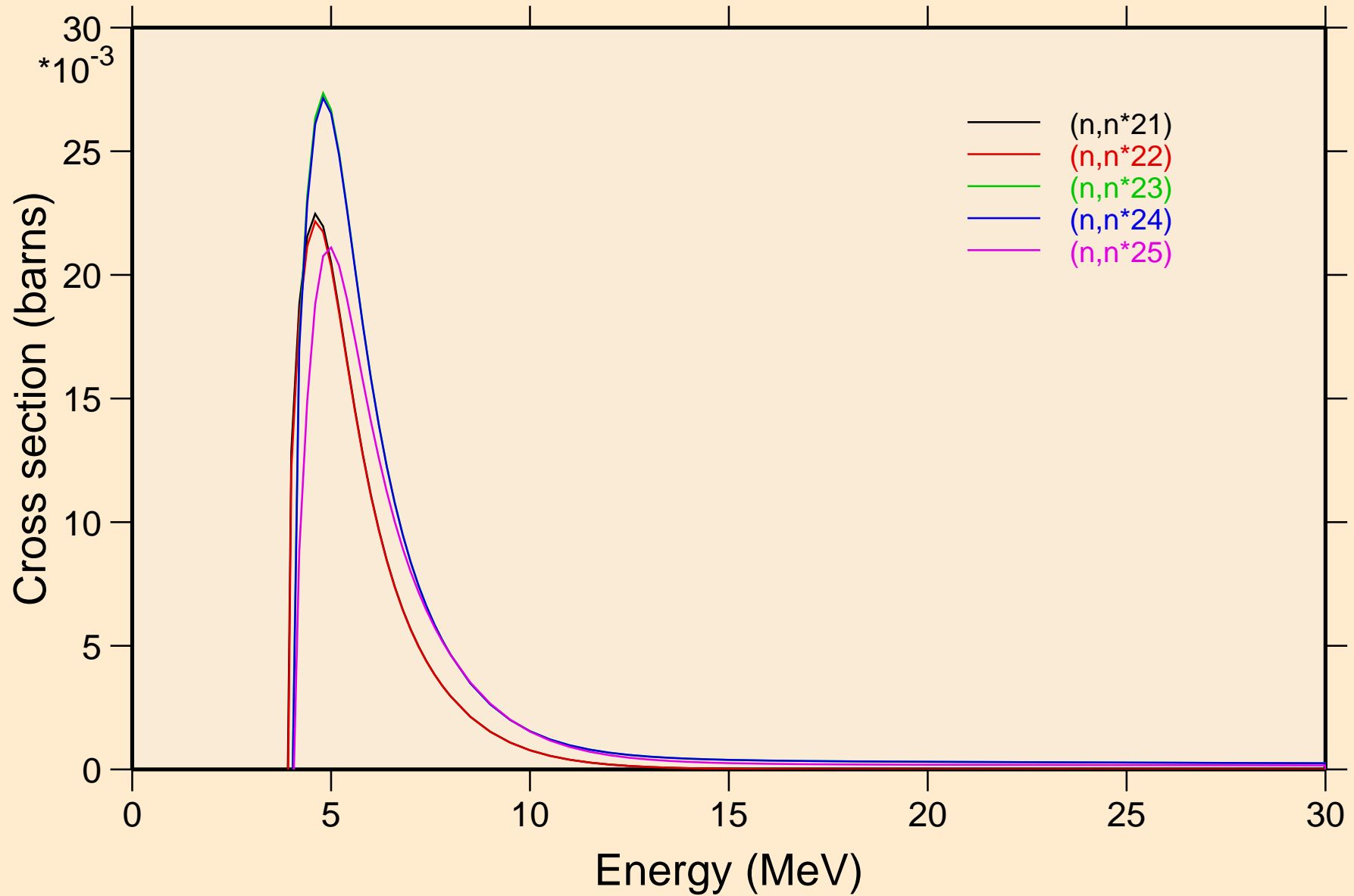

NI062 NEUTRON ACER TENDL-2021 LIBRARY; T=293.6K
Inelastic levels

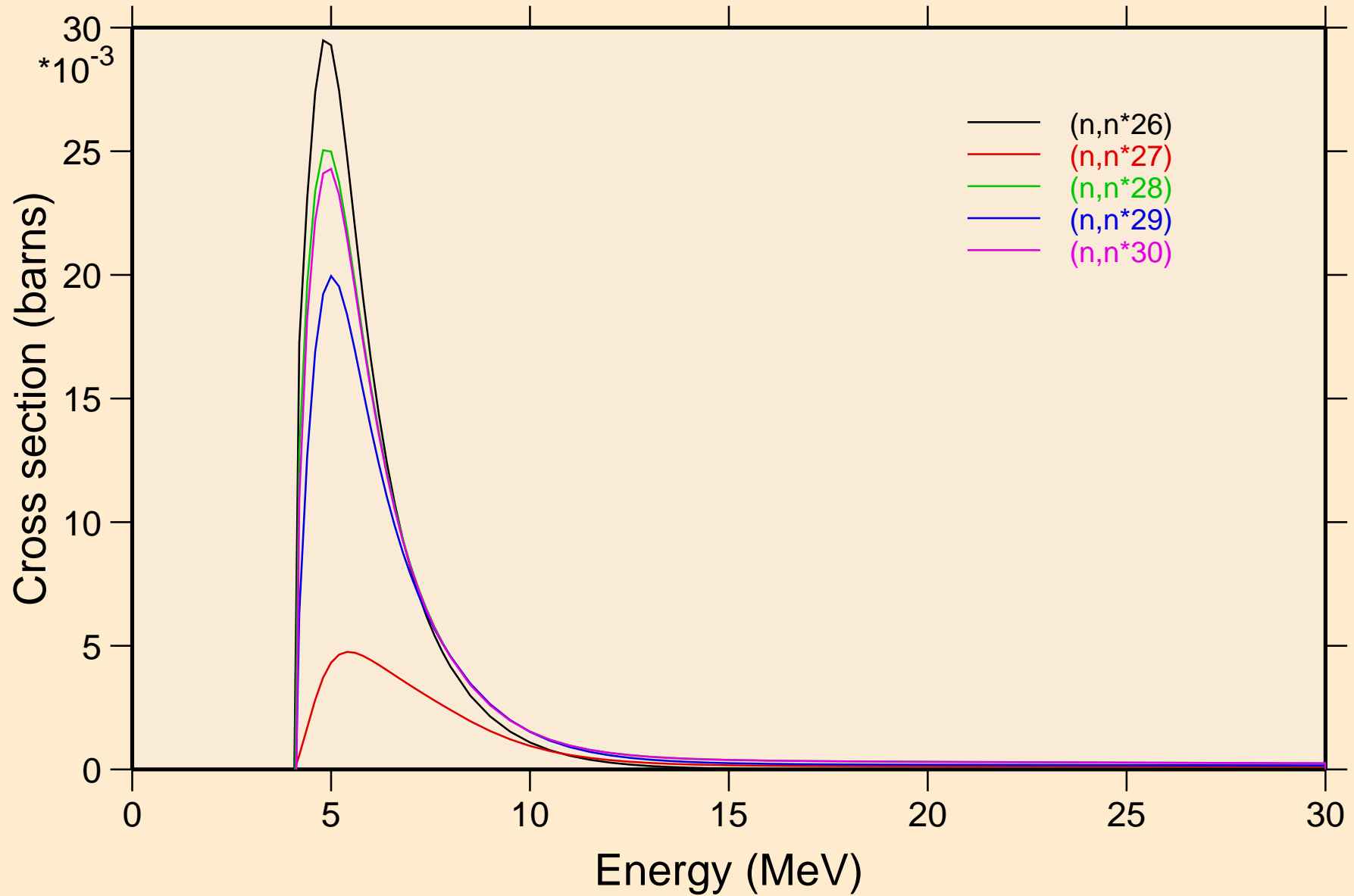

NI062 NEUTRON ACER TENDL-2021 LIBRARY; T=293.6K
Threshold reactions

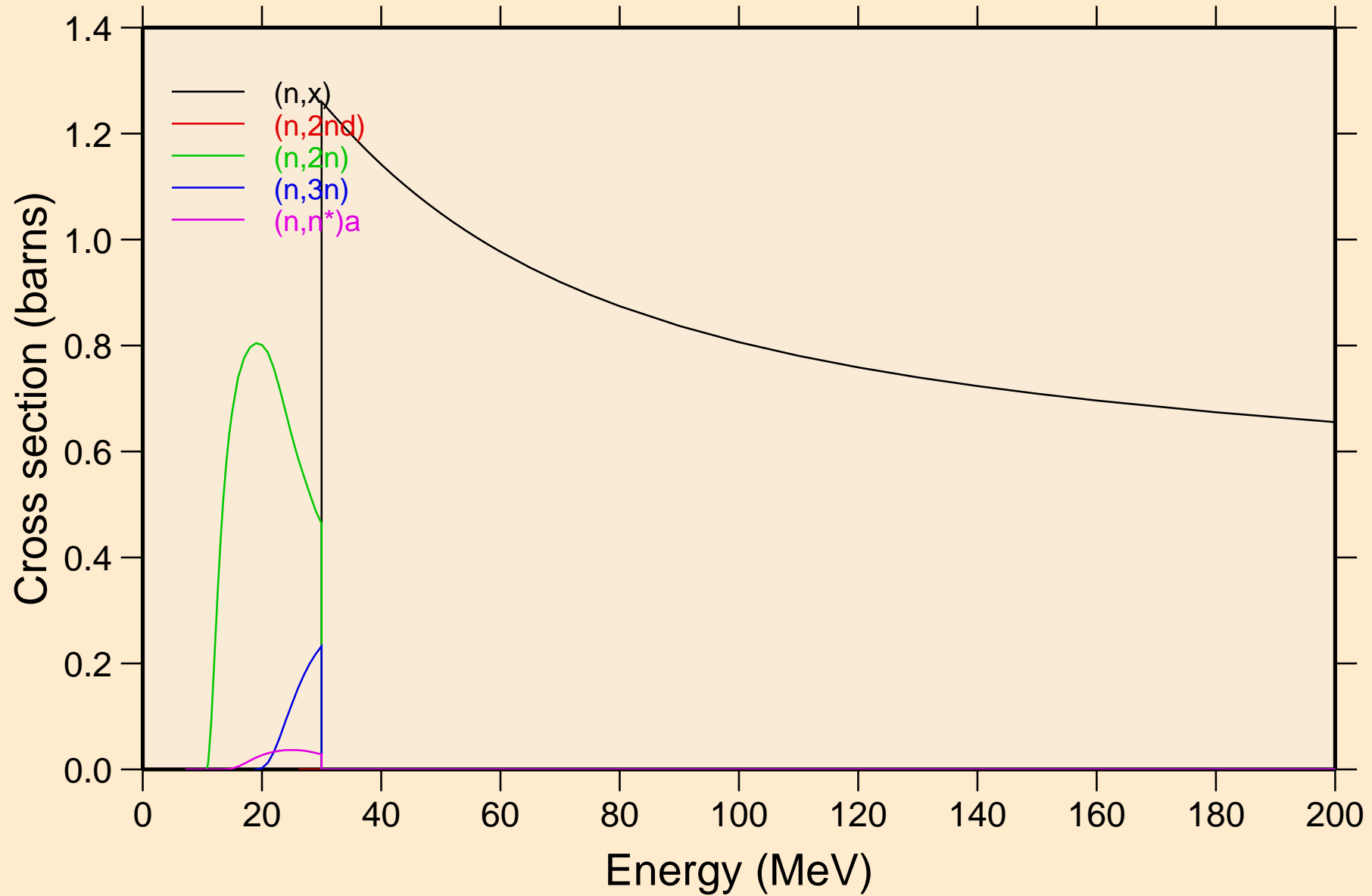

NI062 NEUTRON ACER TENDL-2021 LIBRARY; T=293.6K
Threshold reactions

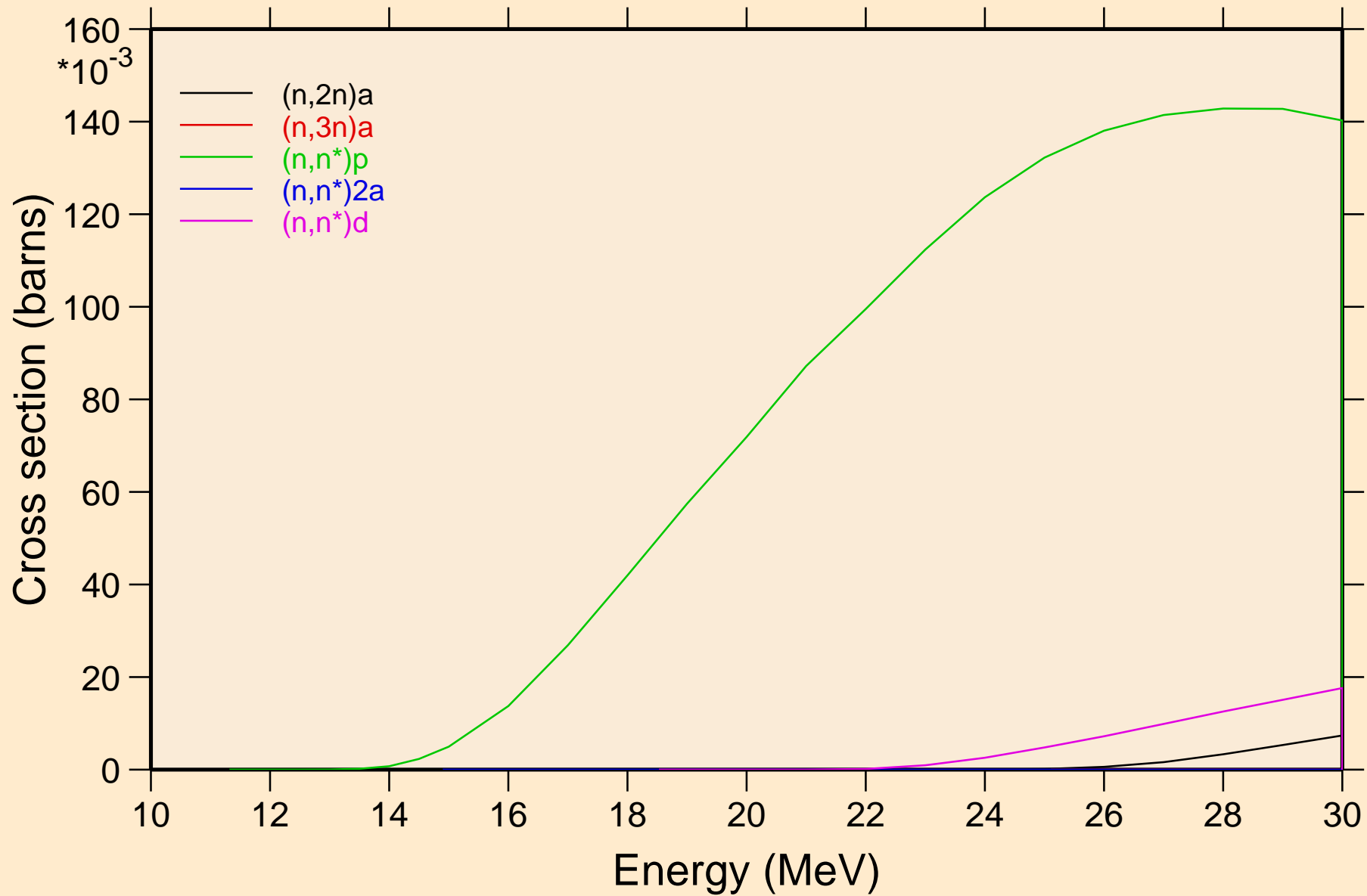

NI062 NEUTRON ACER TENDL-2021 LIBRARY; T=293.6K
Threshold reactions

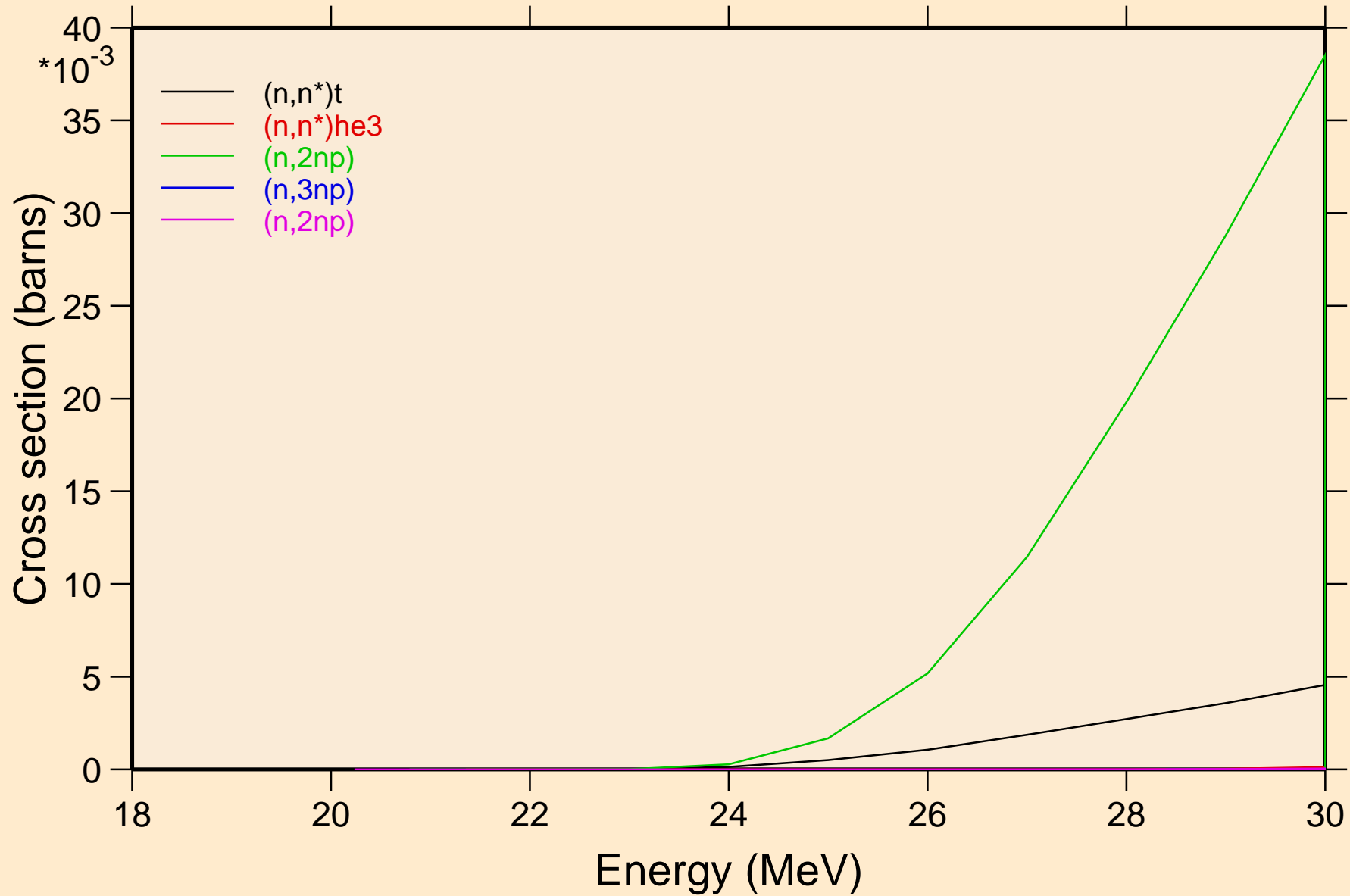

NI062 NEUTRON ACER TENDL-2021 LIBRARY; T=293.6K
Threshold reactions

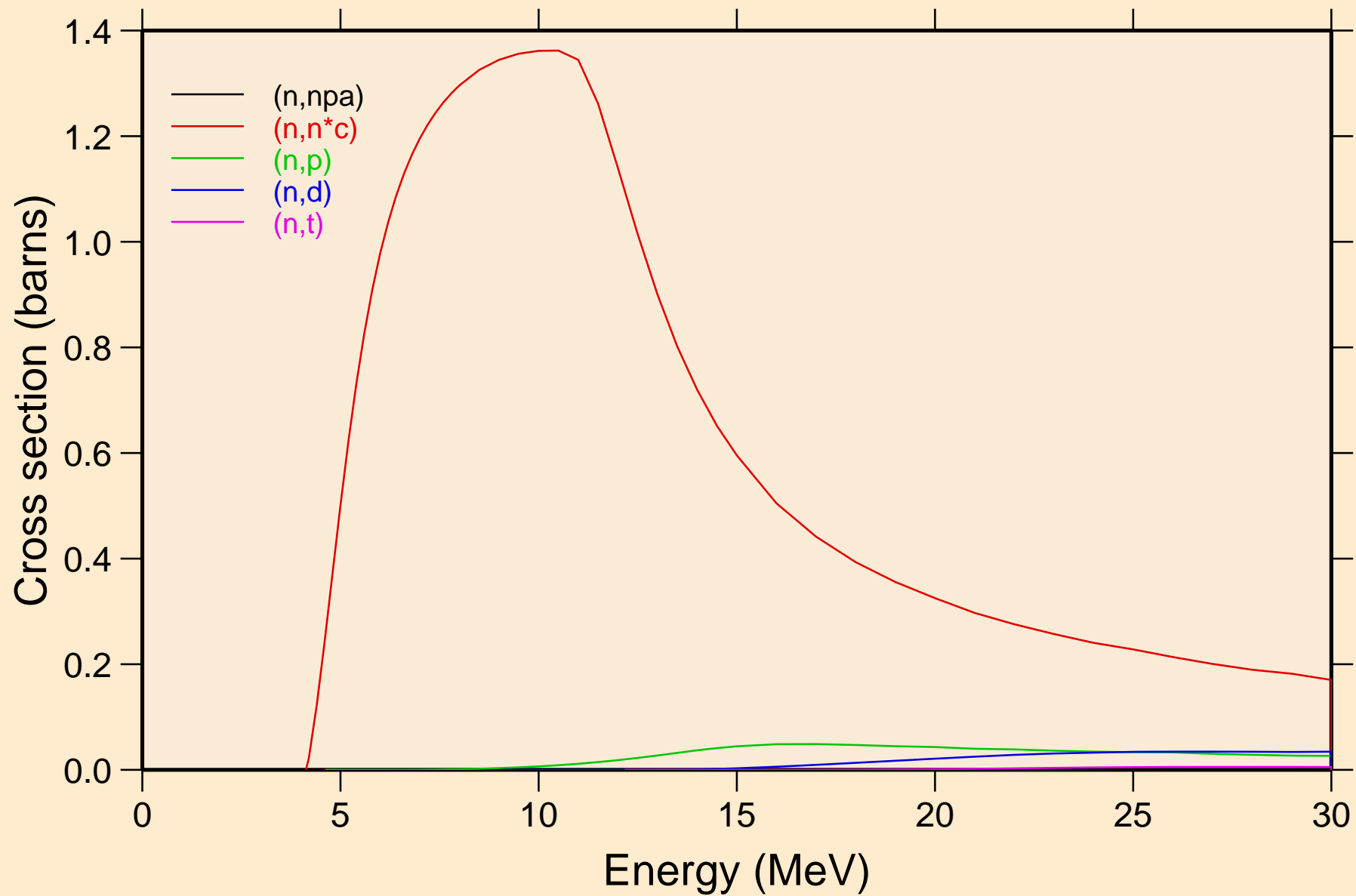

NI062 NEUTRON ACER TENDL-2021 LIBRARY; T=293.6K

Threshold reactions

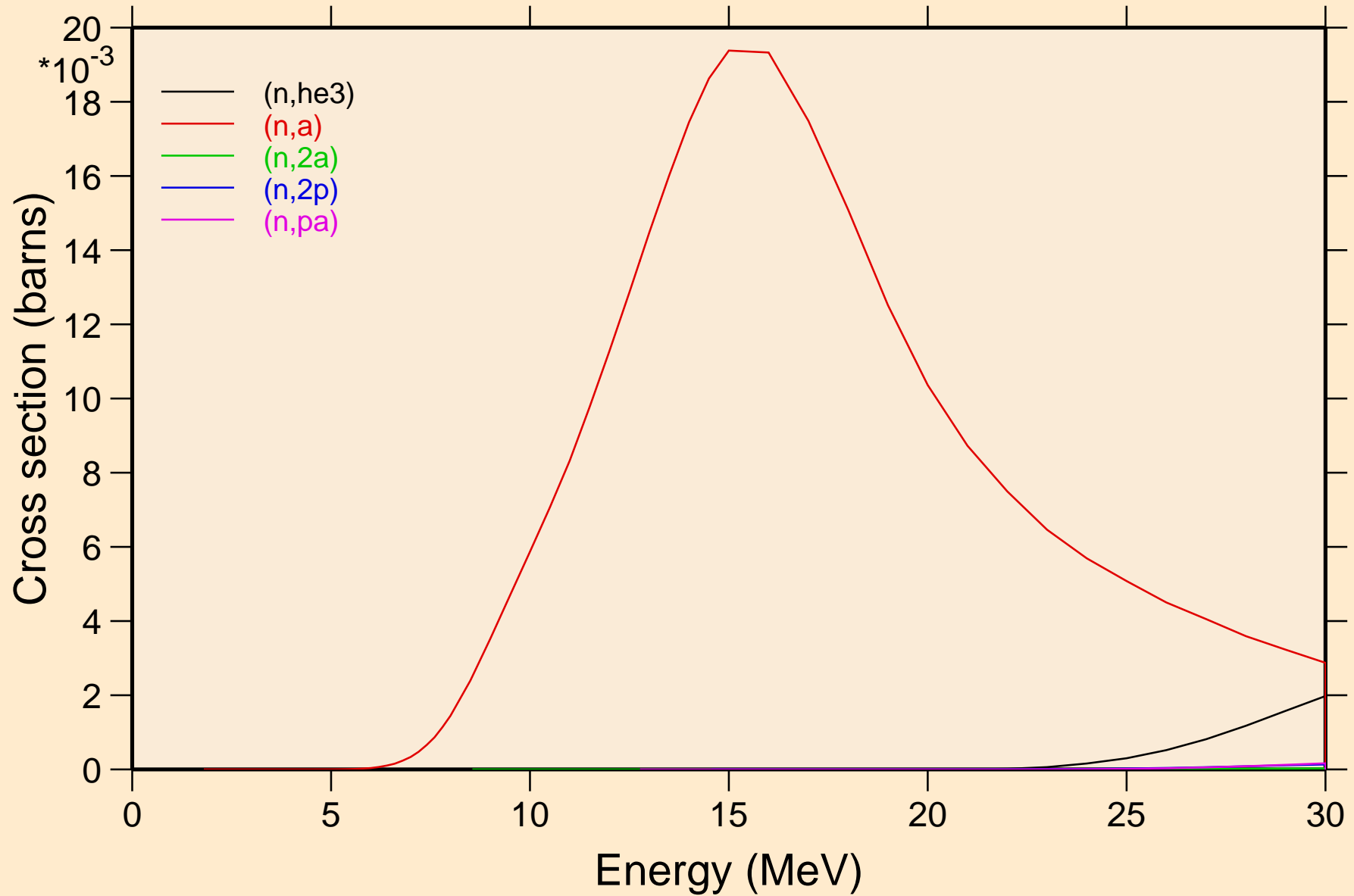

NI062 NEUTRON ACER TENDL-2021 LIBRARY; T=293.6K
Threshold reactions

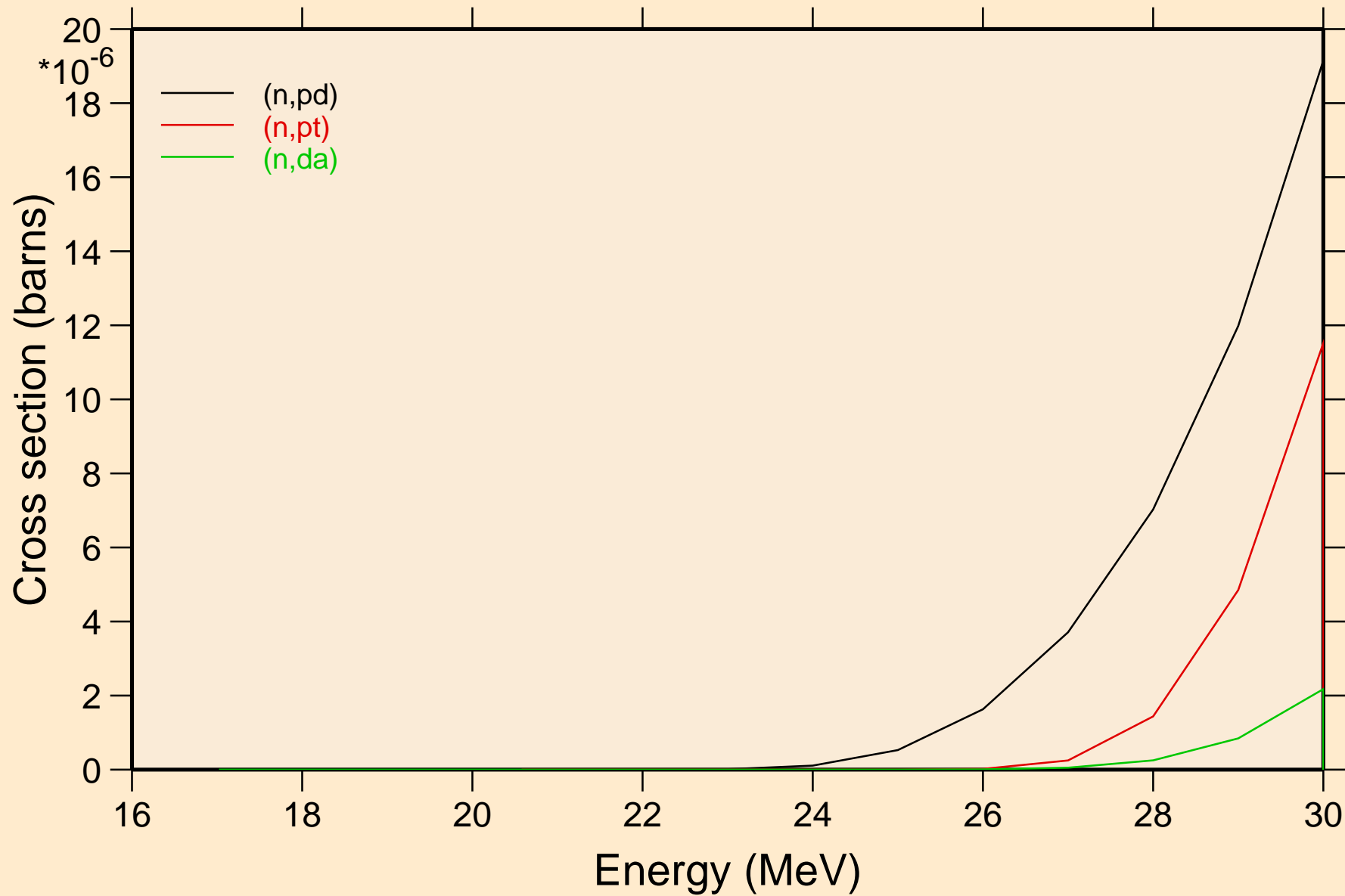

NI062 NEUTRON ACER TENDL-2021 LIBRARY; T=293.6K
Threshold reactions

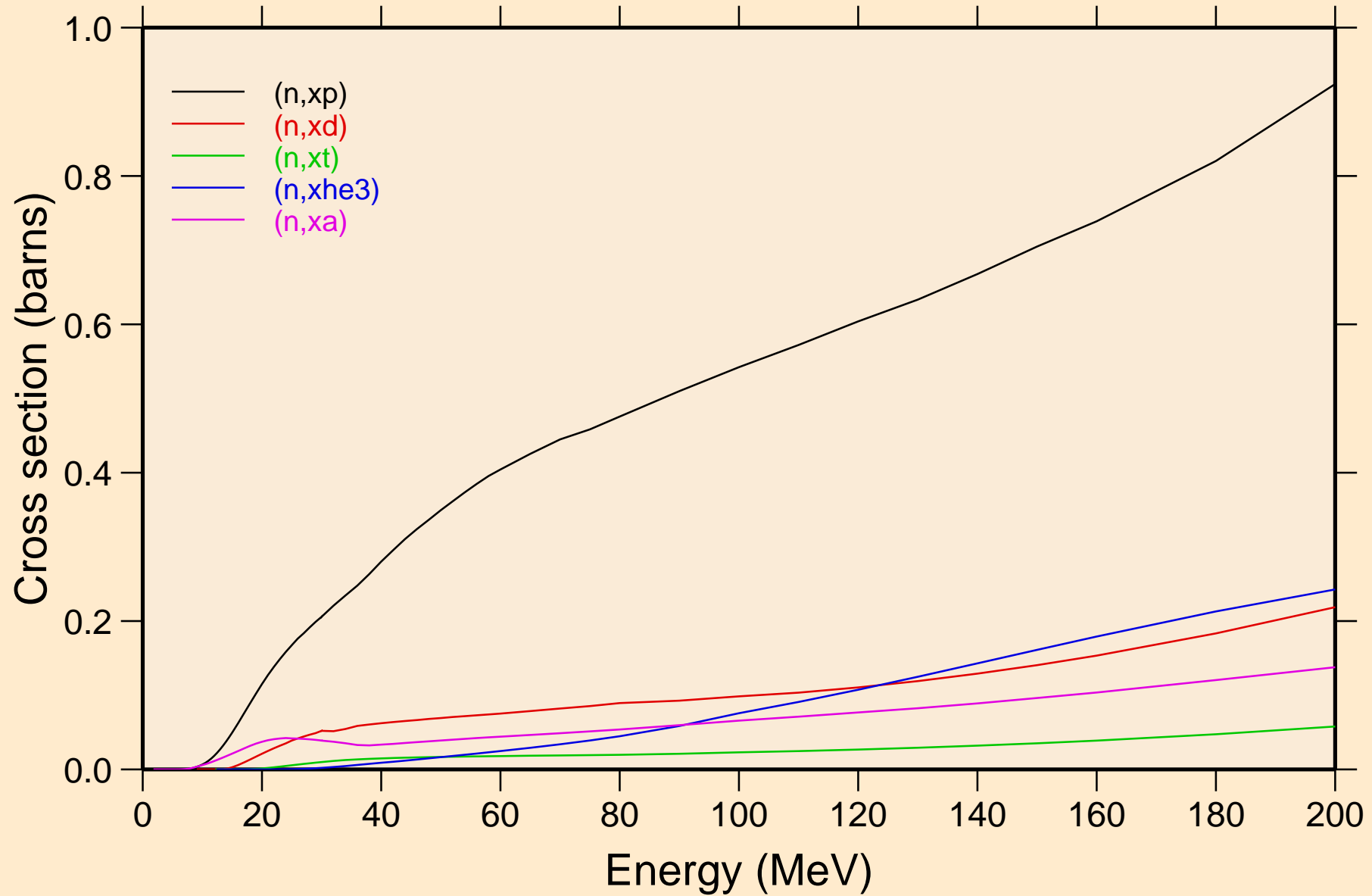

NI062 NEUTRON ACER TENDL-2021 LIBRARY; T=293.6K
angular distribution for elastic

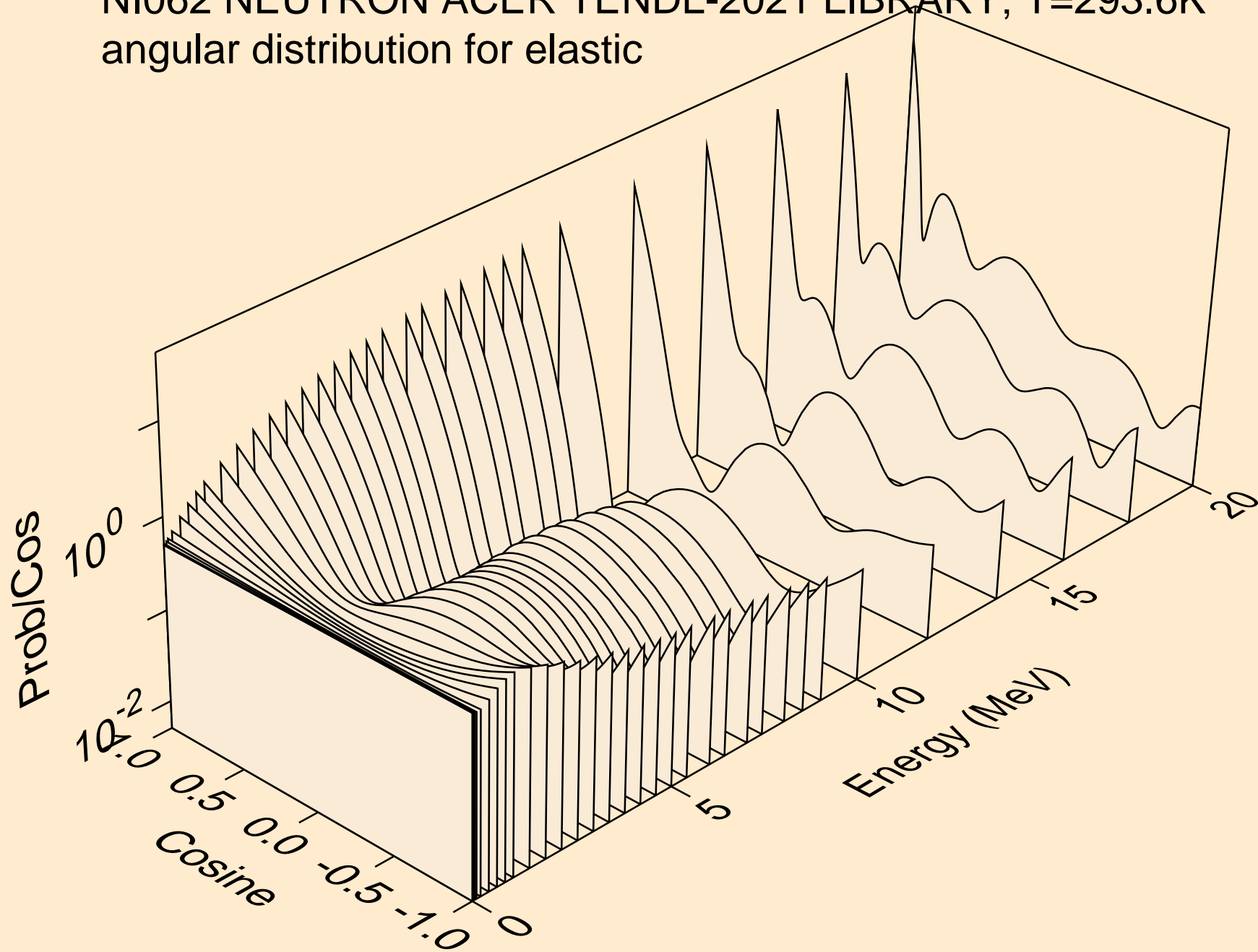

NI062 NEUTRON ACER TENDL-2021 LIBRARY; T=293.6K
angular distribution for elastic

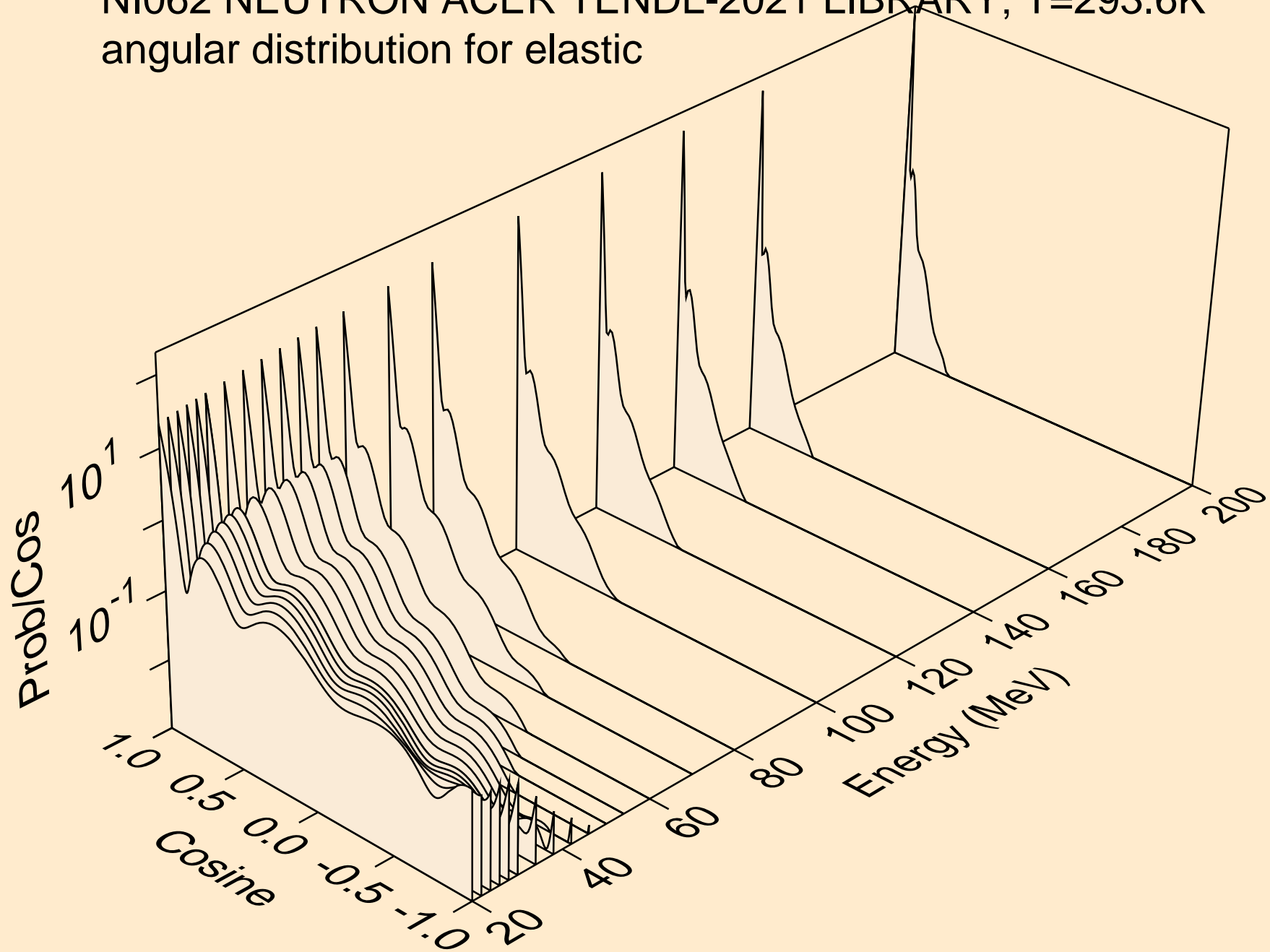

NI062 NEUTRON ACER TENDL-2021 LIBRARY; T=293.6K
angular distribution for (n,n*1)

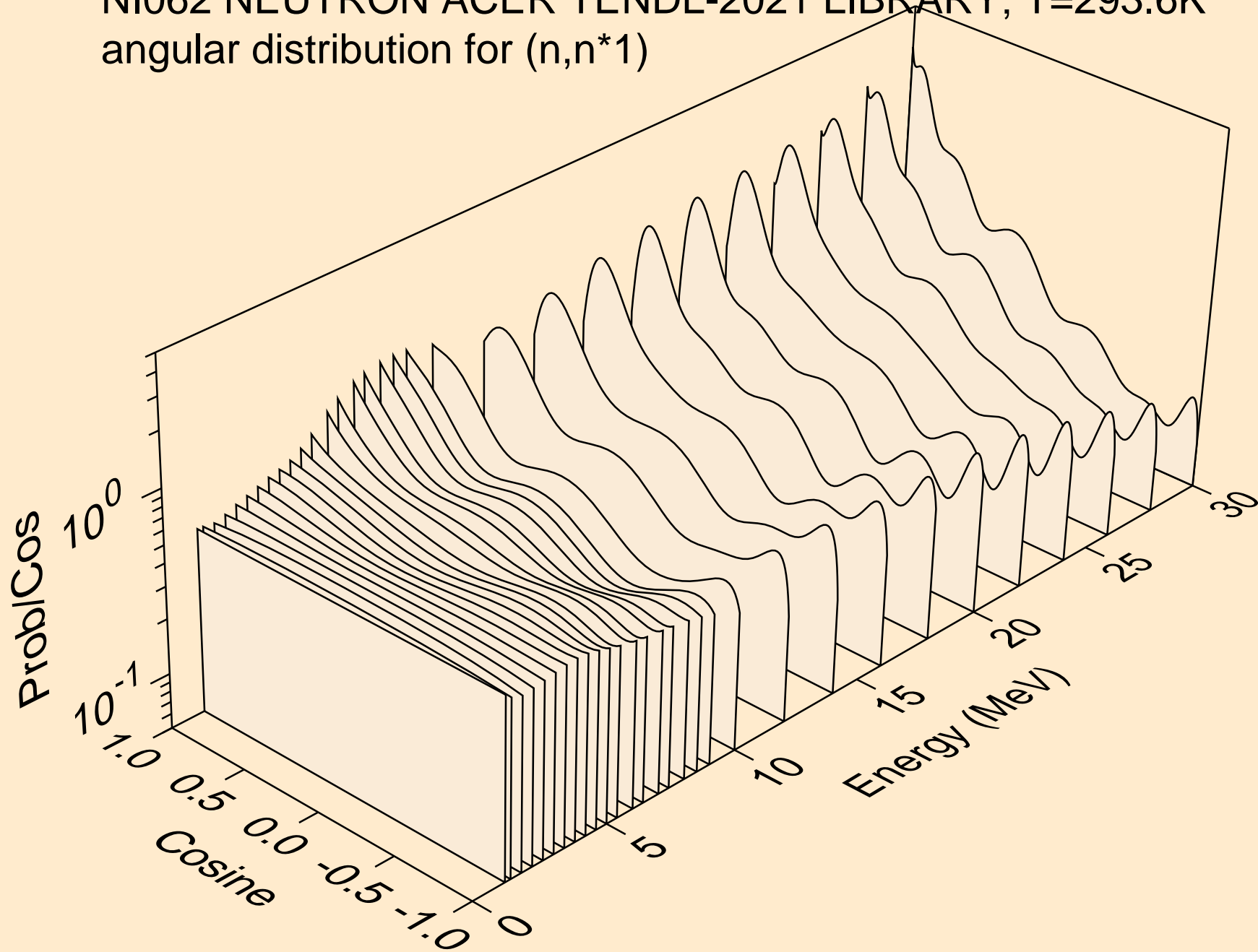

NI062 NEUTRON ACER TENDL-2021 LIBRARY; T=293.6K
angular distribution for (n,n*2)

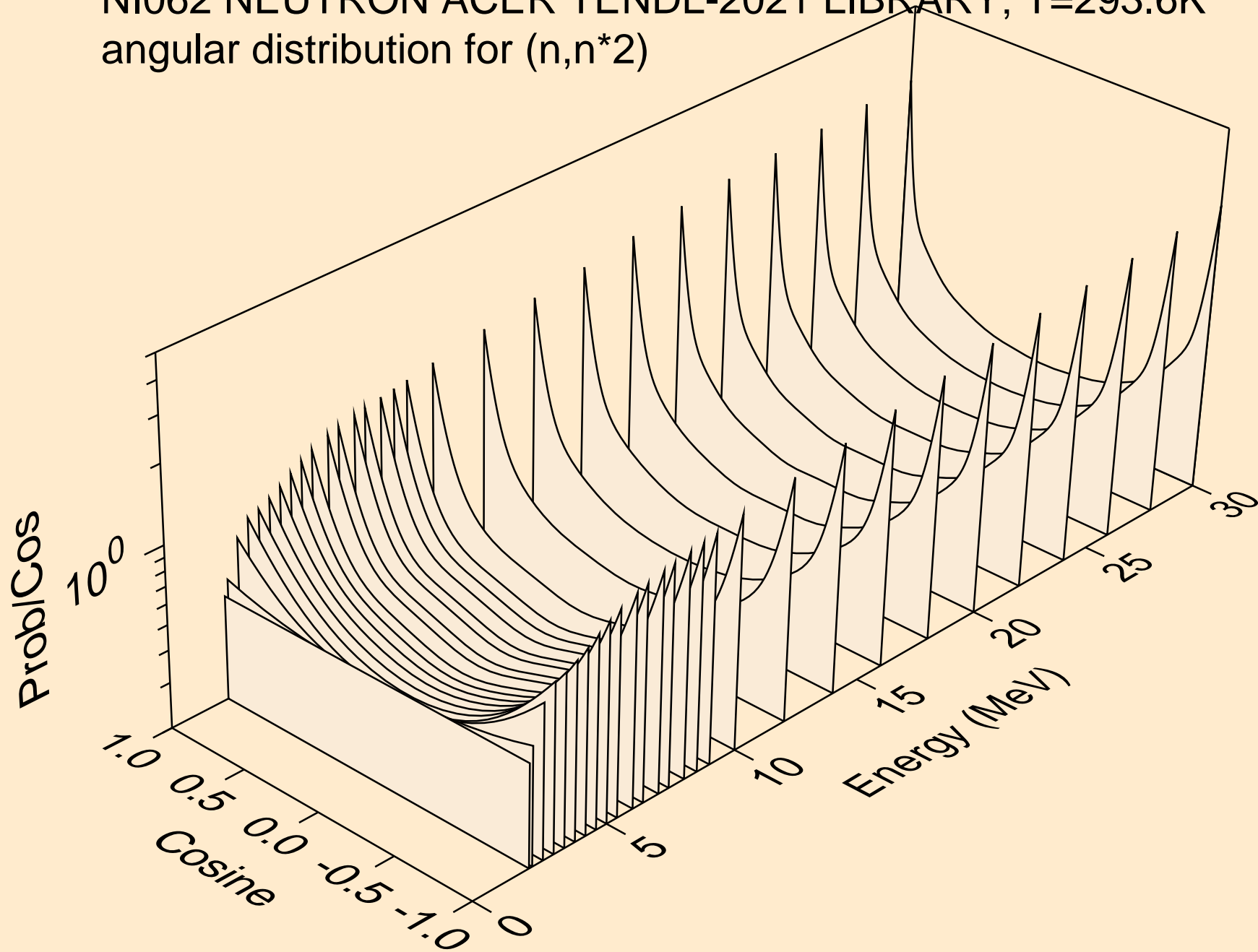

NI062 NEUTRON ACER TENDL-2021 LIBRARY; T=293.6K
angular distribution for (n,n*3)

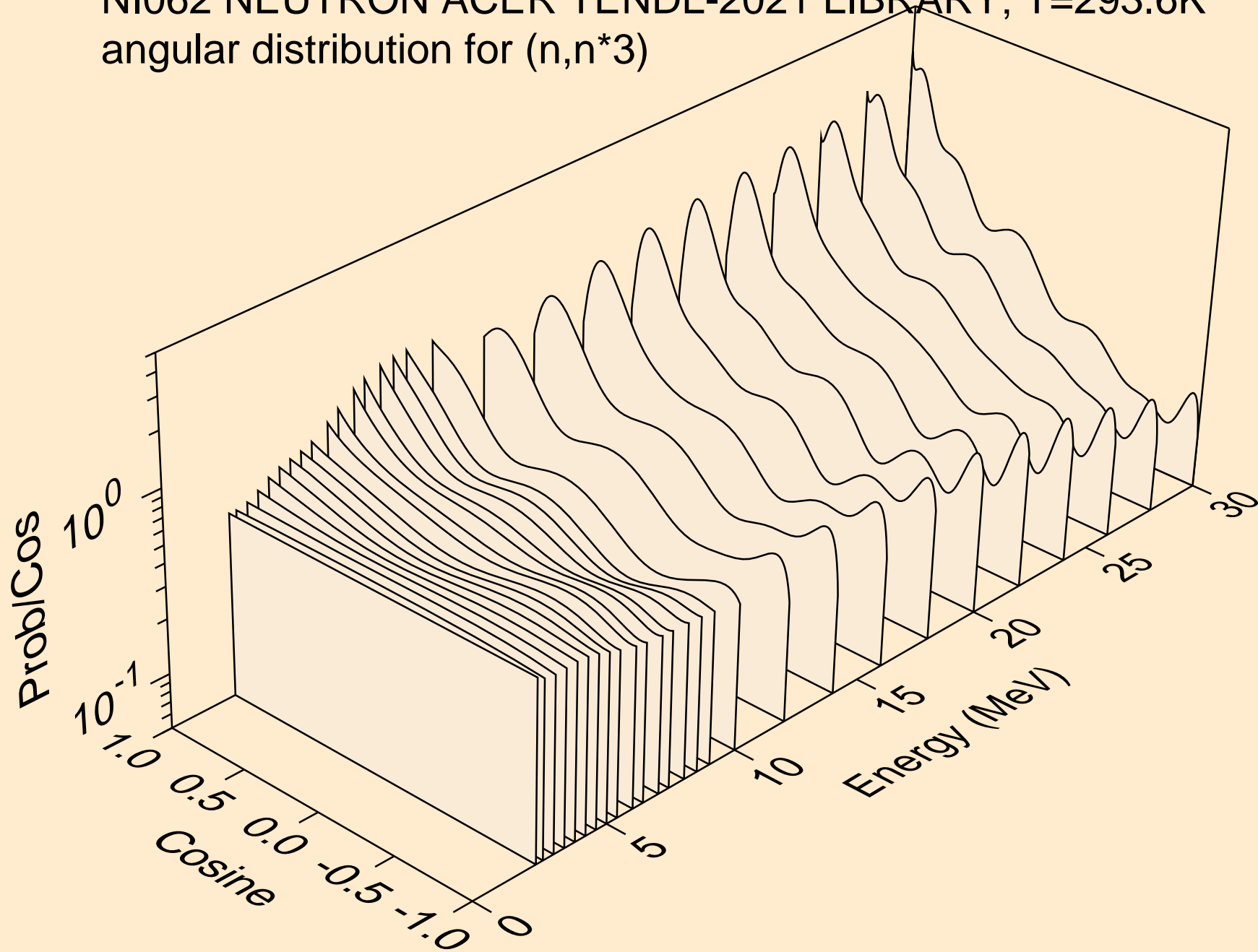

NI062 NEUTRON ACER TENDL-2021 LIBRARY; T=293.6K
angular distribution for (n,n*4)

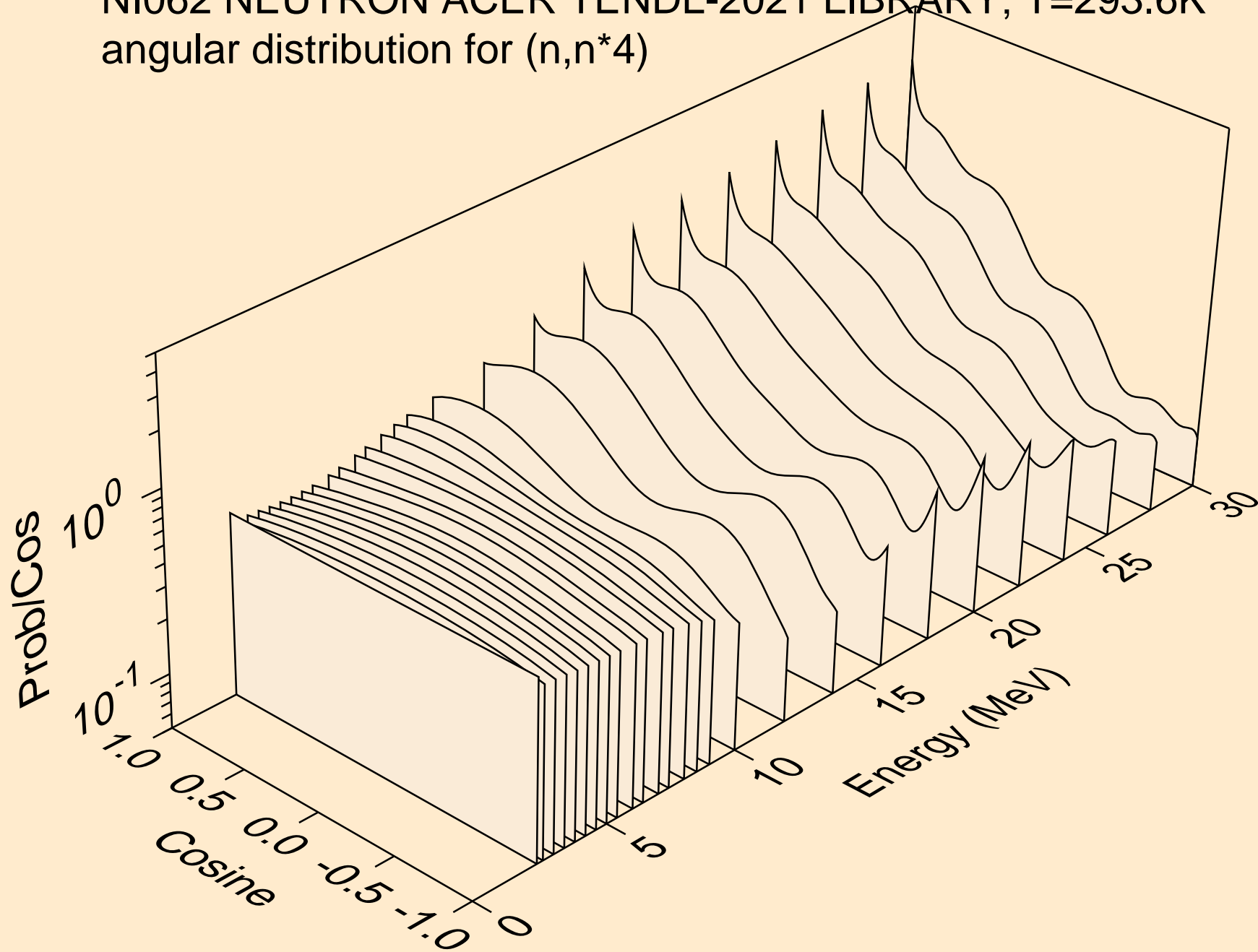

NI062 NEUTRON ACER TENDL-2021 LIBRARY; T=293.6K
angular distribution for (n,n*5)

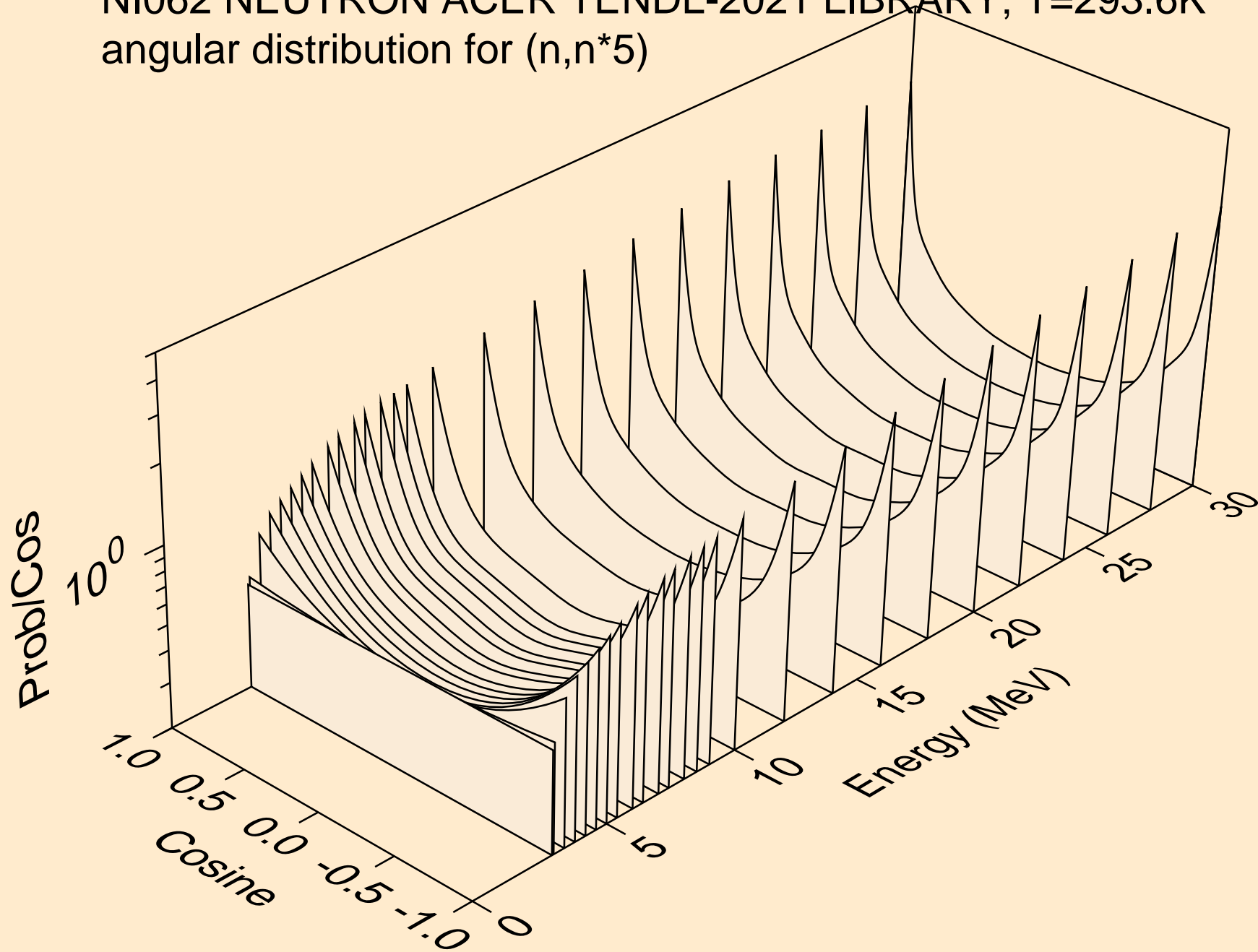

NI062 NEUTRON ACER TENDL-2021 LIBRARY; T=293.6K
angular distribution for (n,n*6)

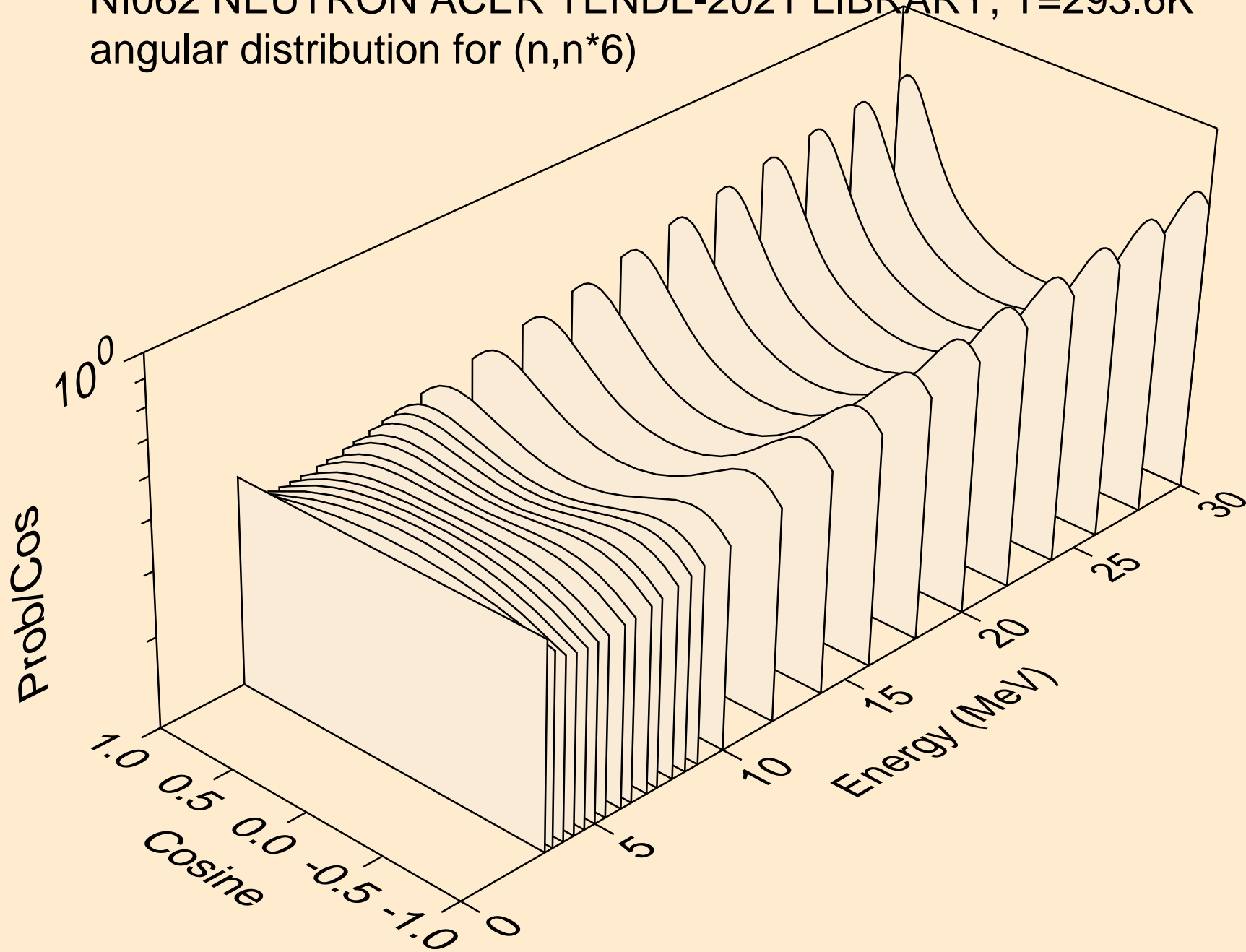

NI062 NEUTRON ACER TENDL-2021 LIBRARY; T=293.6K
angular distribution for (n,n*7)

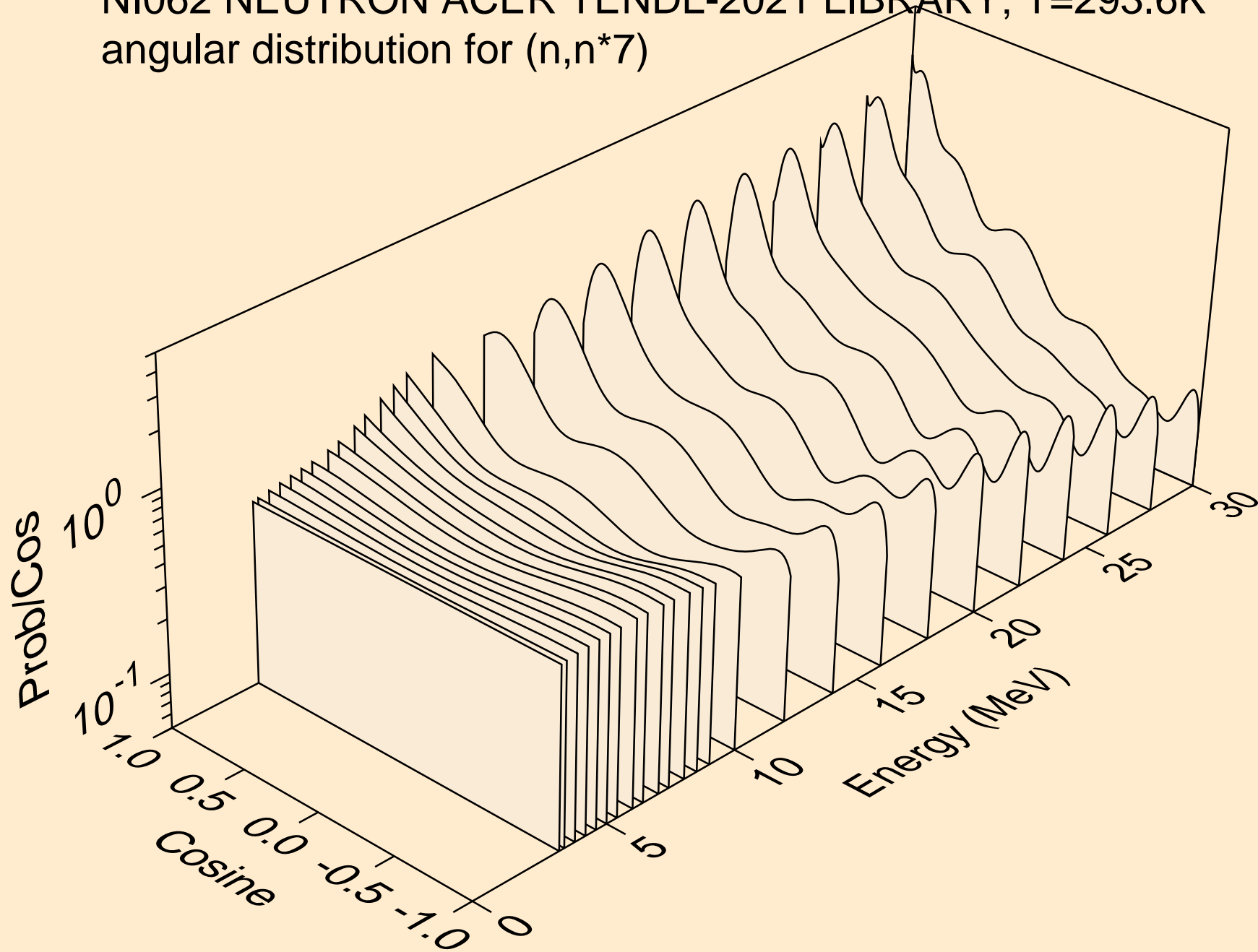

NI062 NEUTRON ACER TENDL-2021 LIBRARY; T=293.6K
angular distribution for (n,n*8)

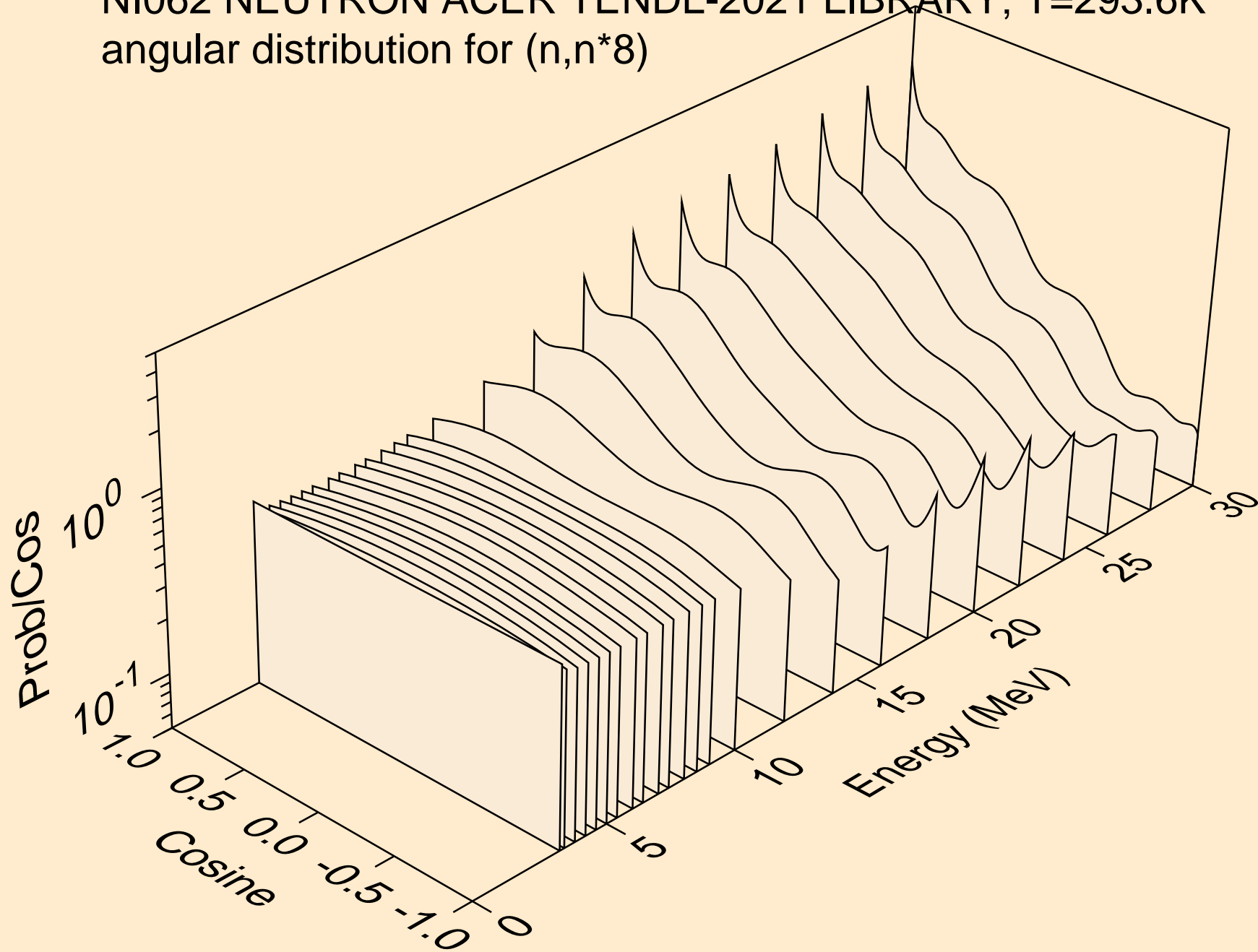

NI062 NEUTRON ACER TENDL-2021 LIBRARY; T=293.6K
angular distribution for (n,n*9)

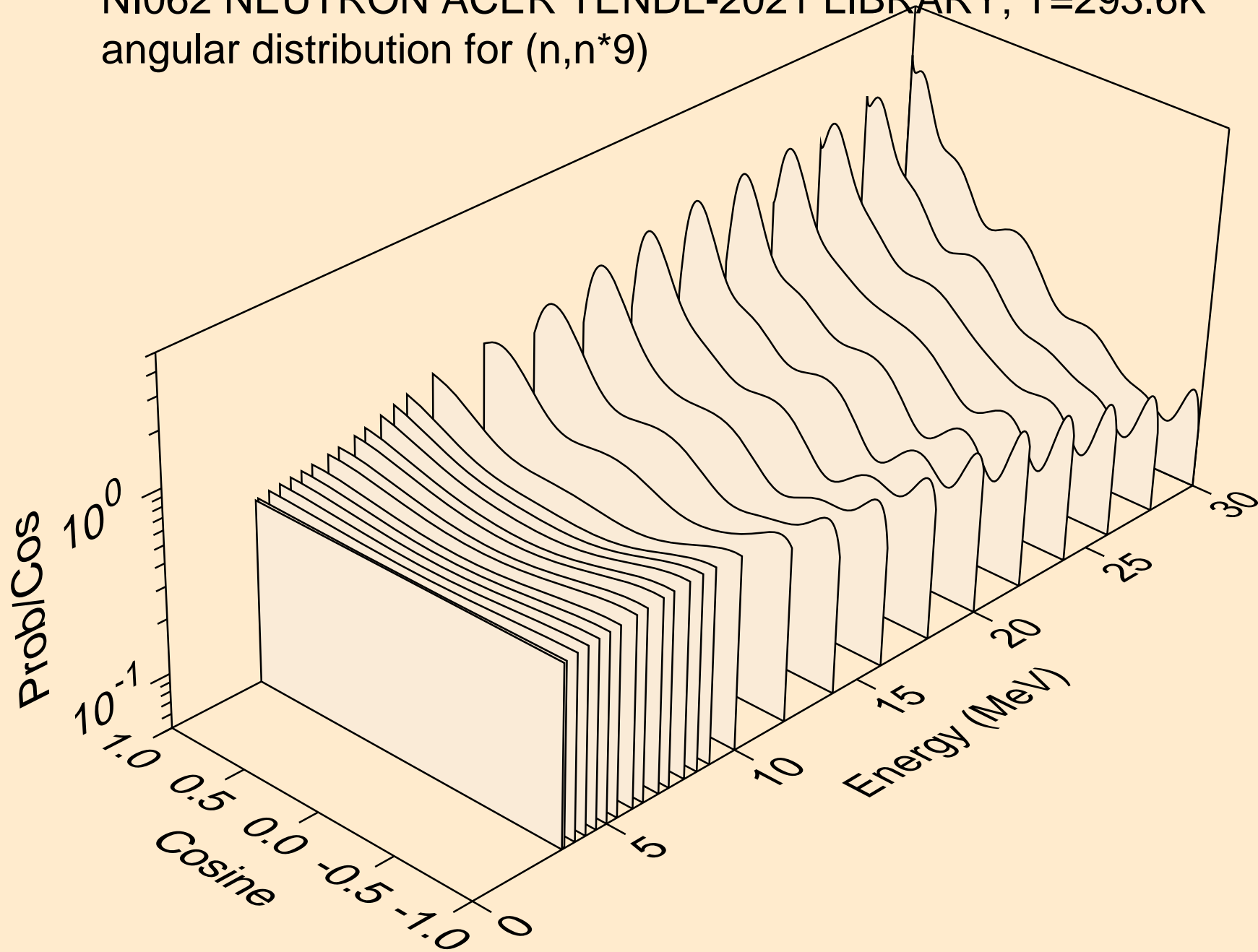

NI062 NEUTRON ACER TENDL-2021 LIBRARY; T=293.6K
angular distribution for (n,n*10)

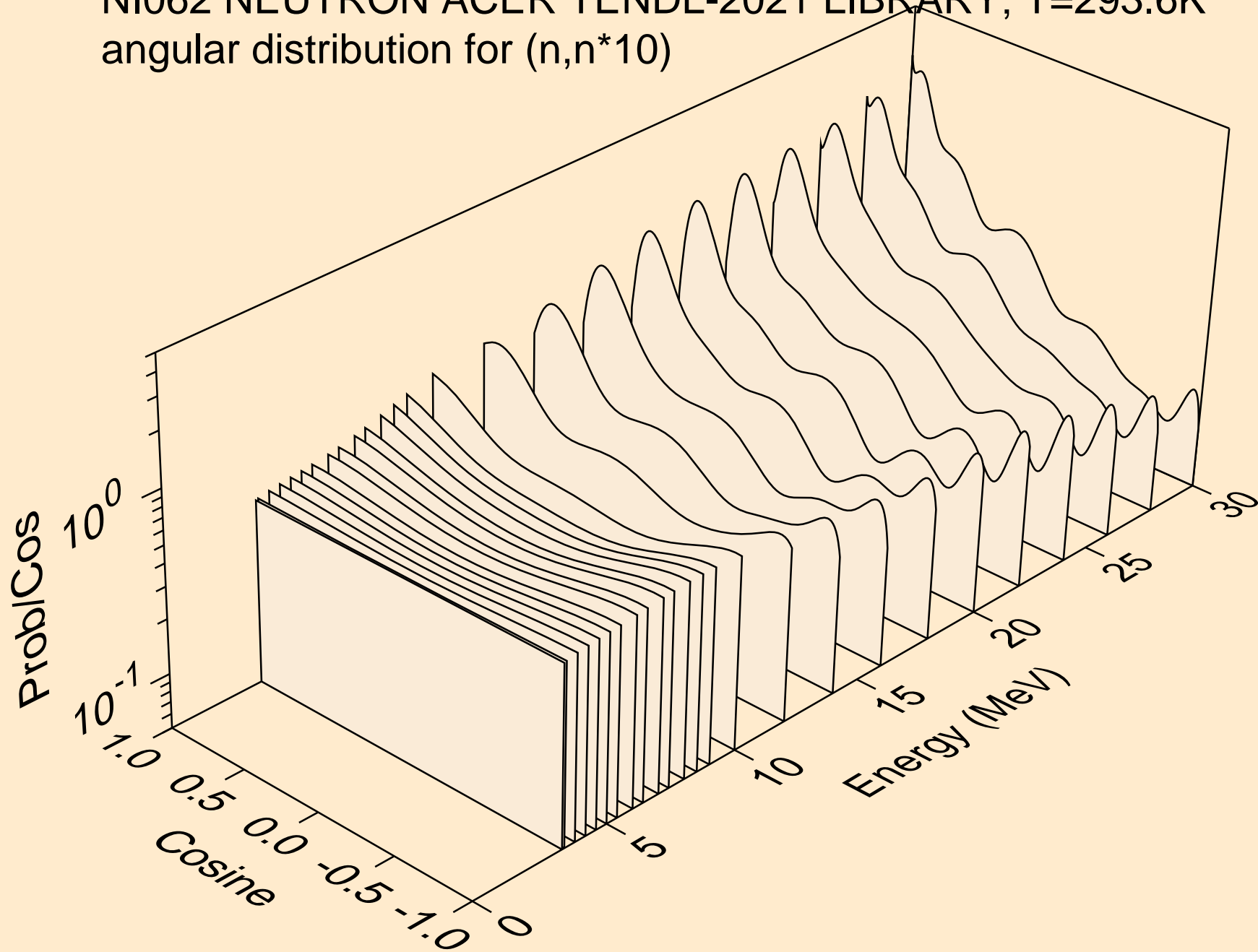

NI062 NEUTRON ACER TENDL-2021 LIBRARY; T=293.6K
angular distribution for (n,n*11)

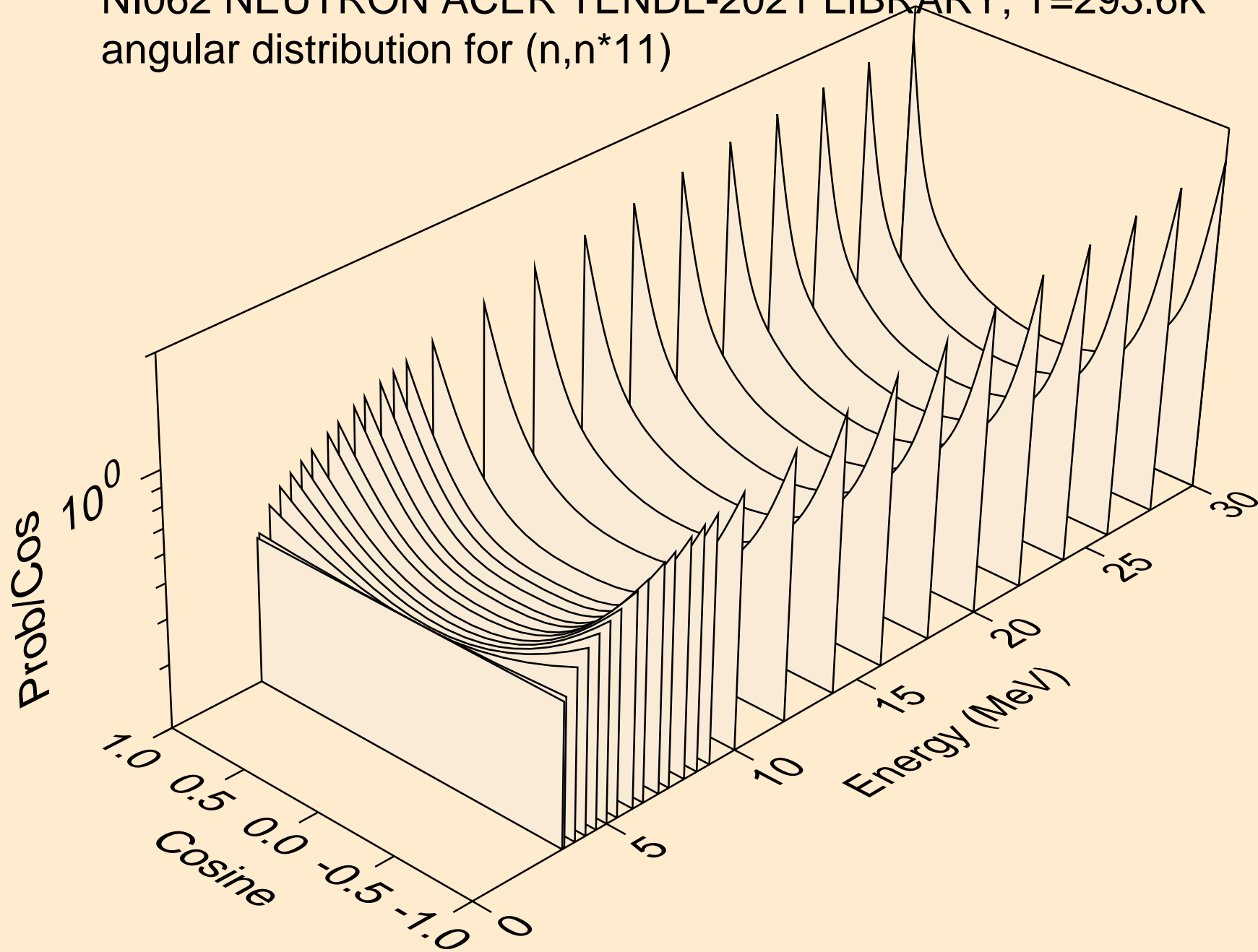

NI062 NEUTRON ACER TENDL-2021 LIBRARY; T=293.6K
angular distribution for (n,n*12)

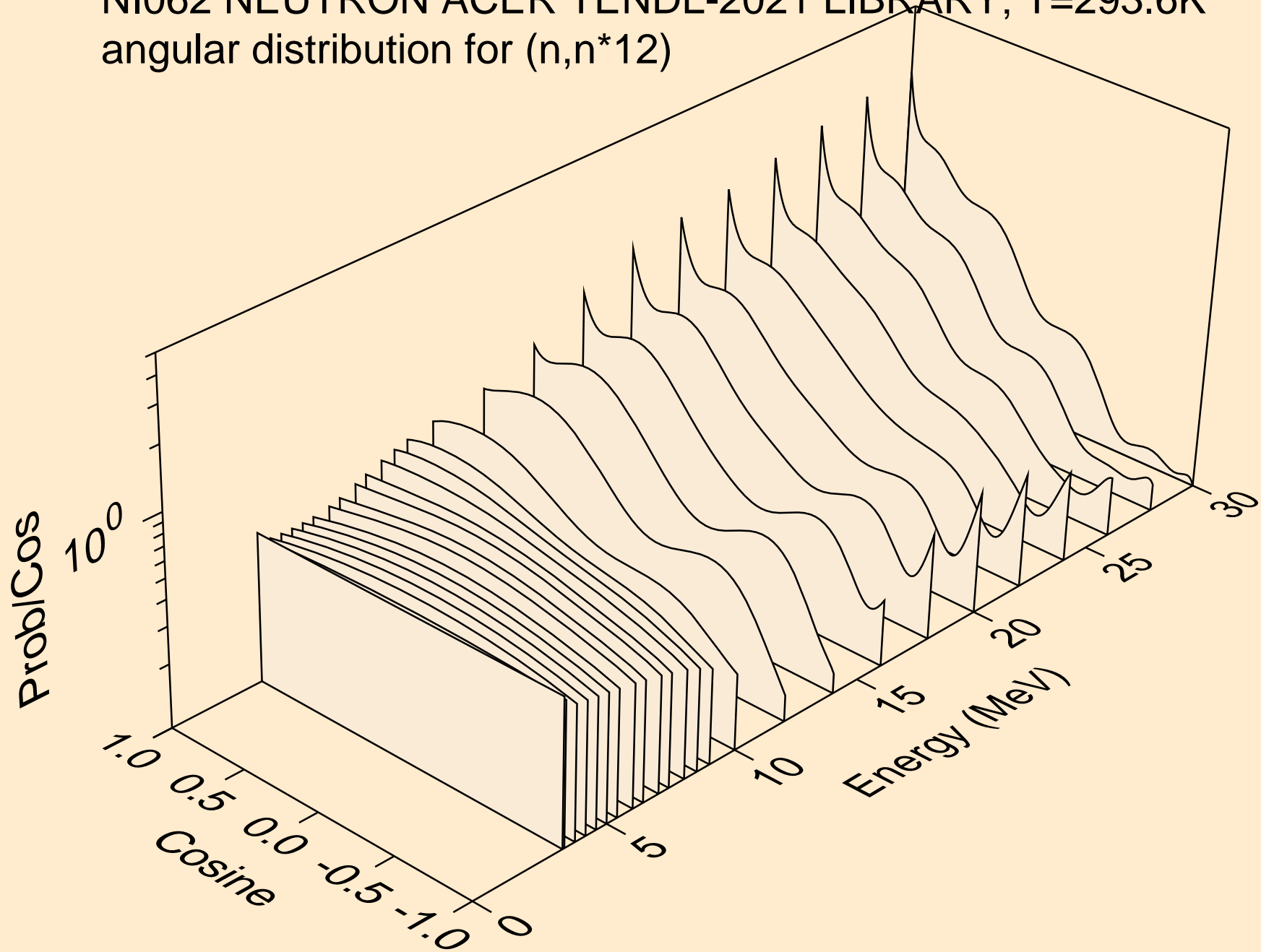

NI062 NEUTRON ACER TENDL-2021 LIBRARY; T=293.6K
angular distribution for (n,n*13)

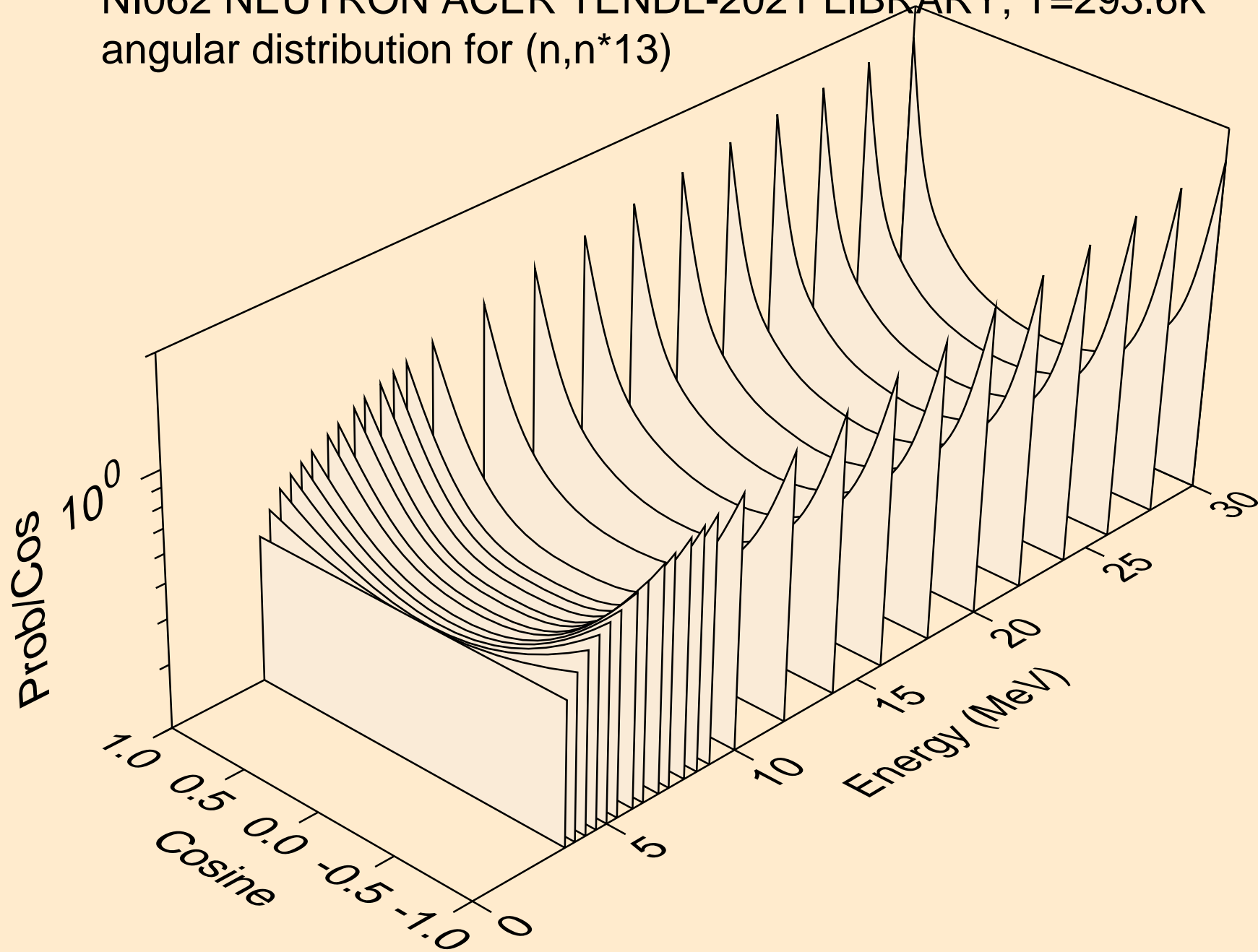

NI062 NEUTRON ACER TENDL-2021 LIBRARY; T=293.6K
angular distribution for (n,n*14)

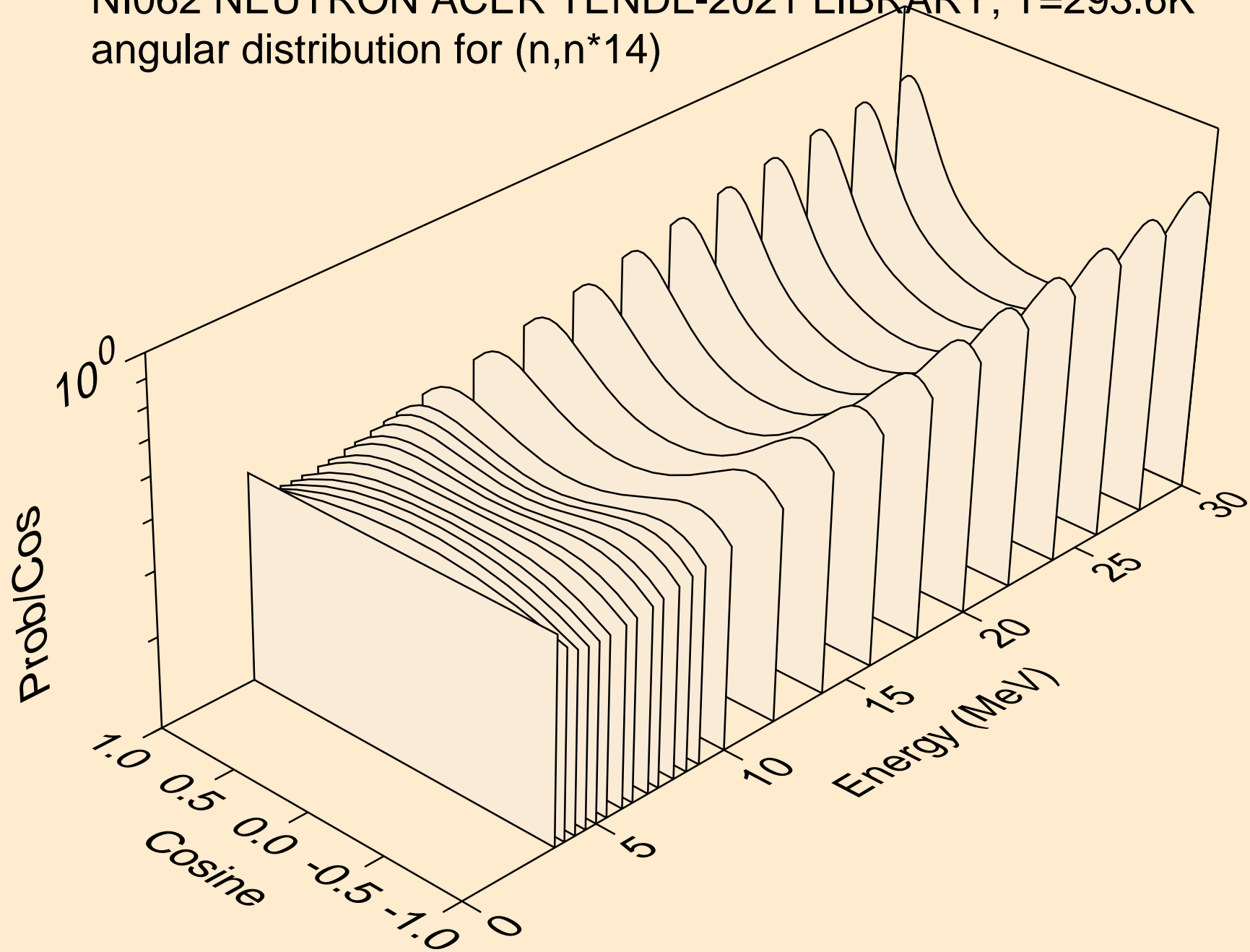

NI062 NEUTRON ACER TENDL-2021 LIBRARY; T=293.6K
angular distribution for (n,n*15)

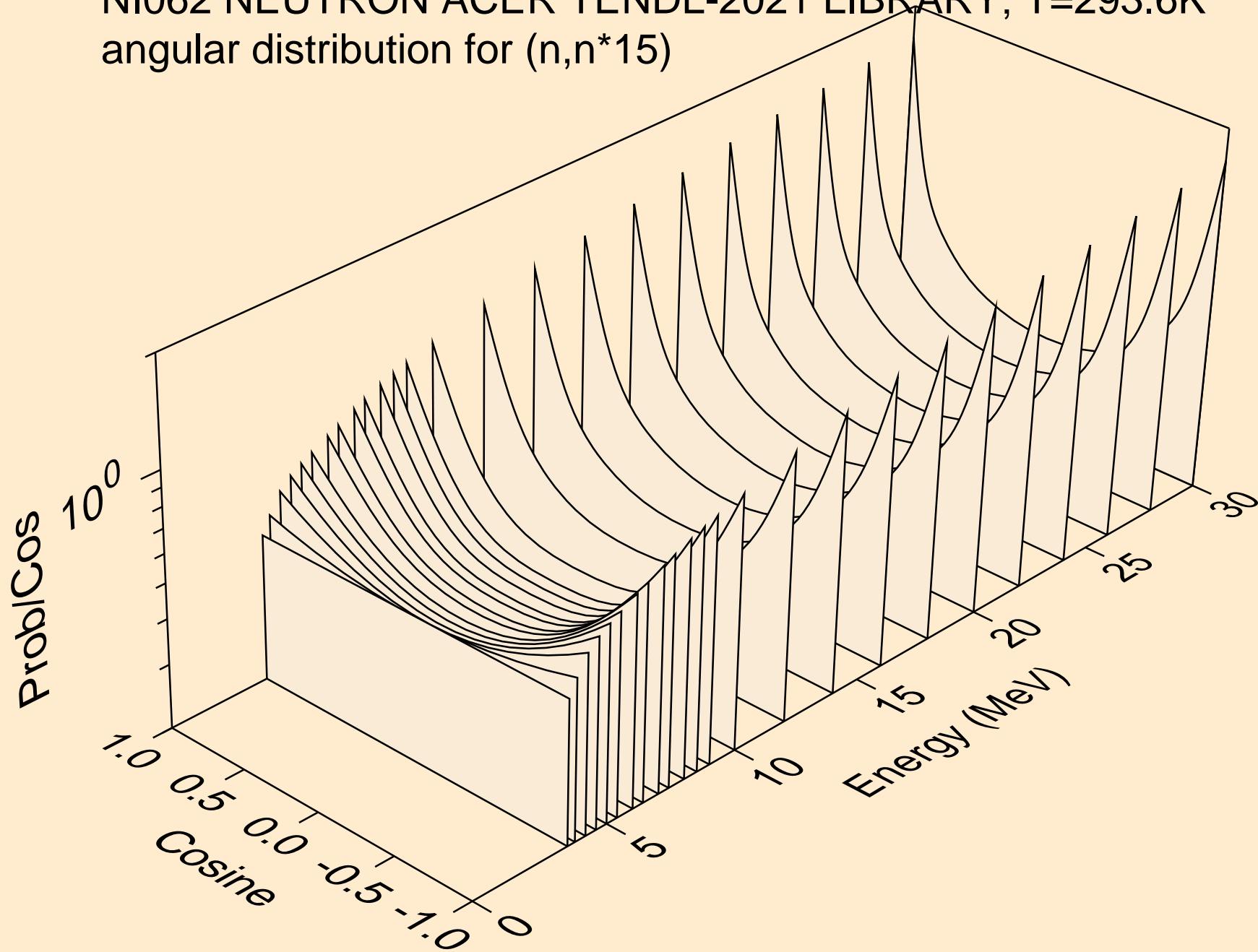

NI062 NEUTRON ACER TENDL-2021 LIBRARY; T=293.6K
angular distribution for (n,n*16)

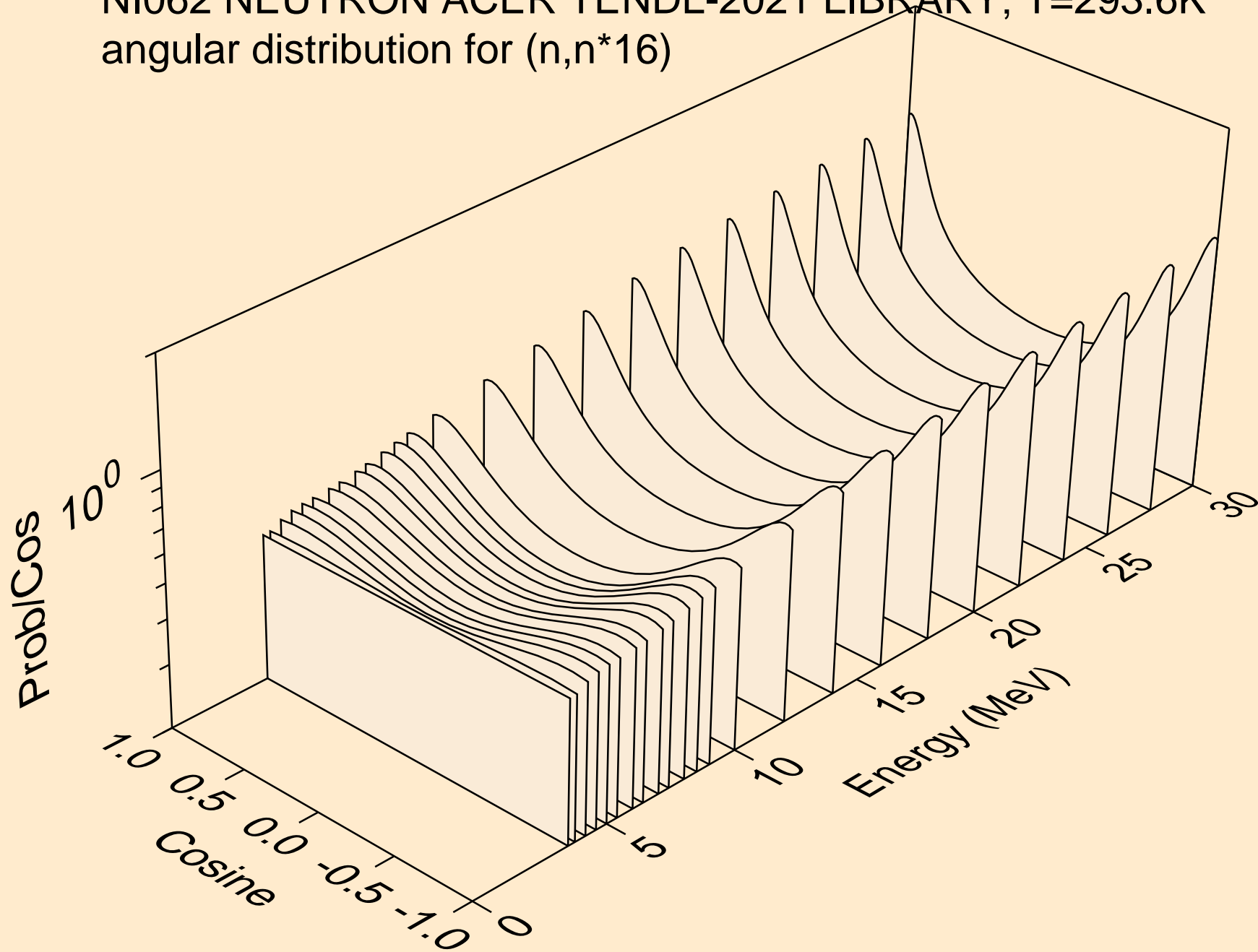

NI062 NEUTRON ACER TENDL-2021 LIBRARY; T=293.6K
angular distribution for (n,n*17)

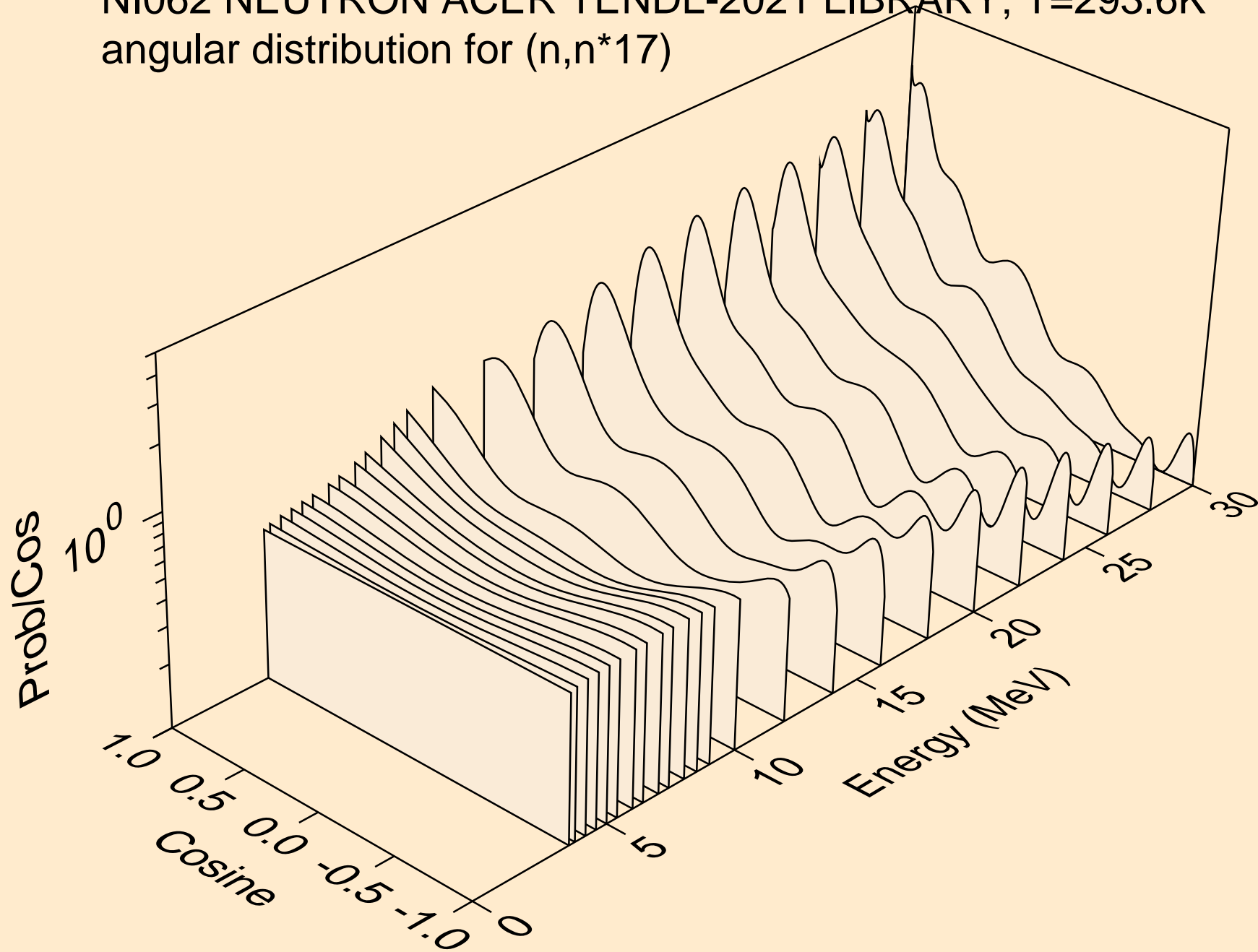

NI062 NEUTRON ACER TENDL-2021 LIBRARY; T=293.6K
angular distribution for (n,n*18)

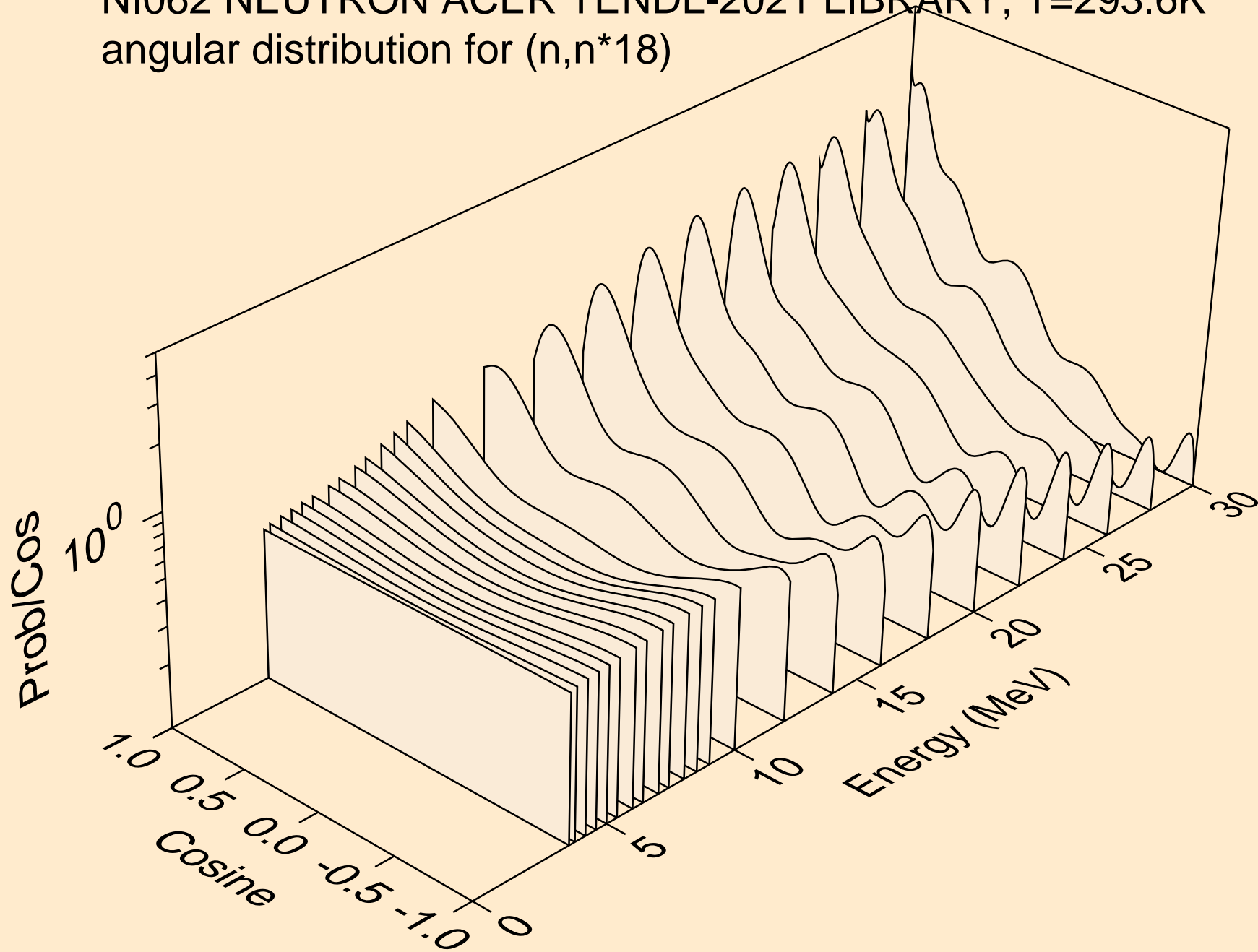

NI062 NEUTRON ACER TENDL-2021 LIBRARY; T=293.6K
angular distribution for (n,n*19)

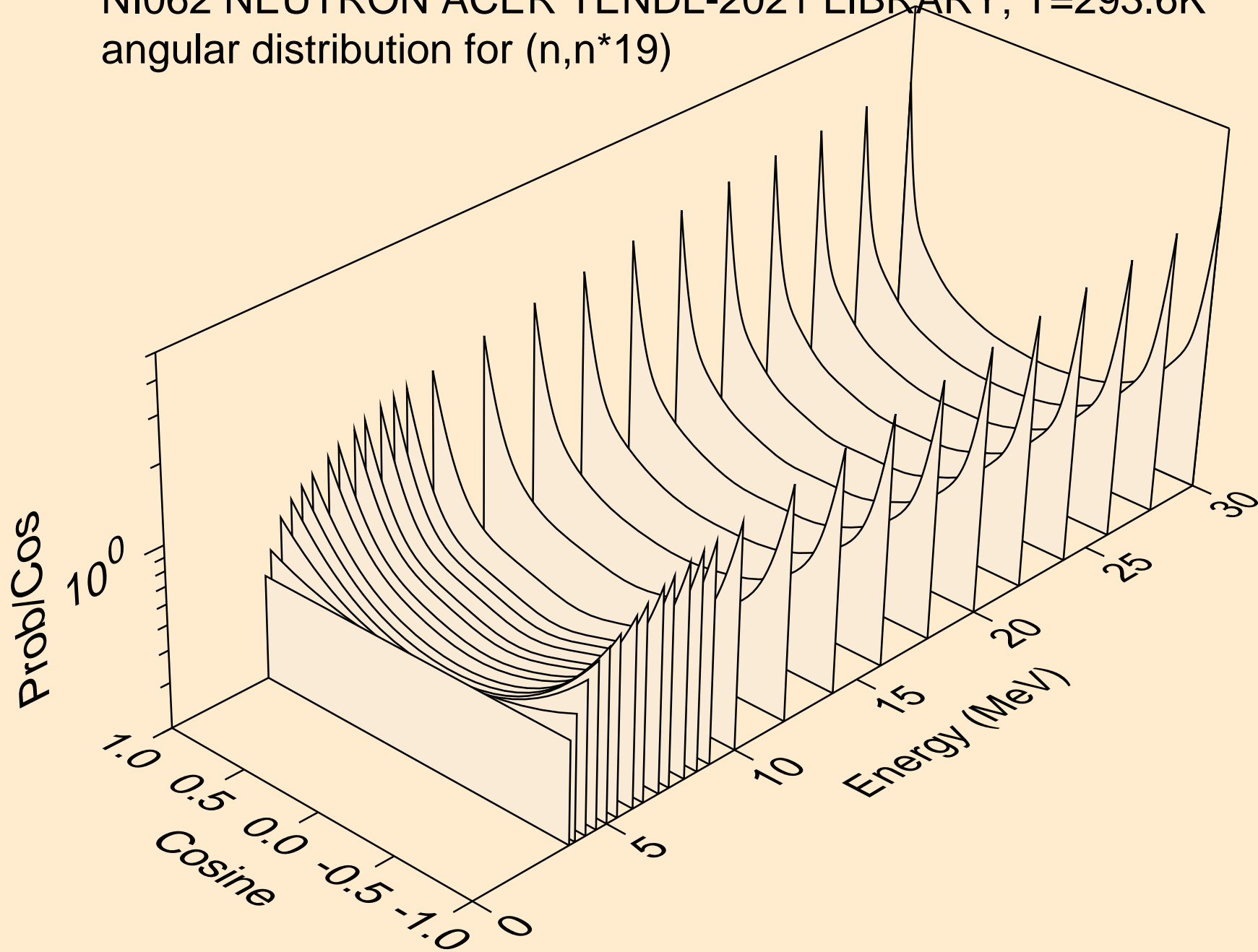

NI062 NEUTRON ACER TENDL-2021 LIBRARY; T=293.6K
angular distribution for (n,n*20)

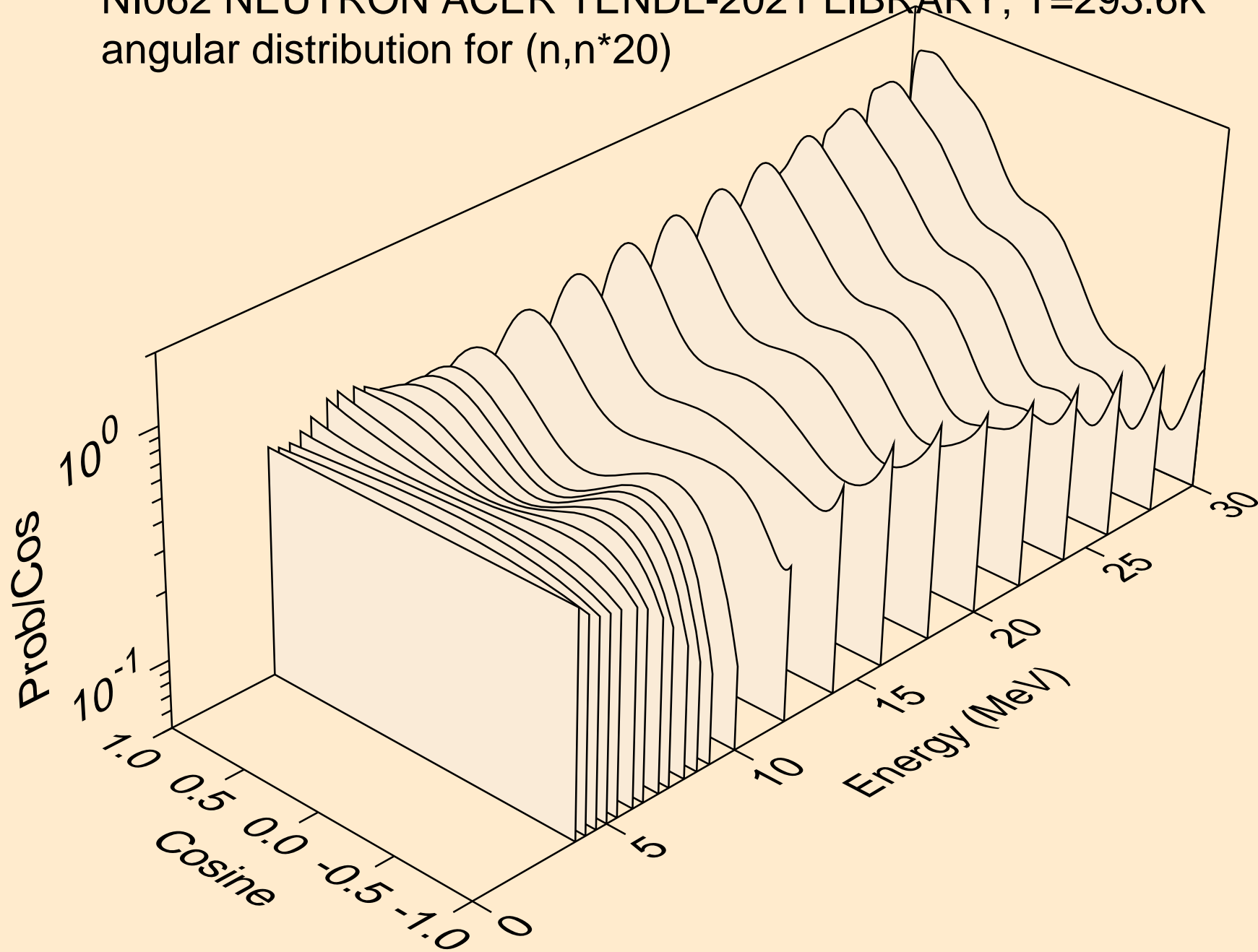

NI062 NEUTRON ACER TENDL-2021 LIBRARY; T=293.6K
angular distribution for (n,n*21)

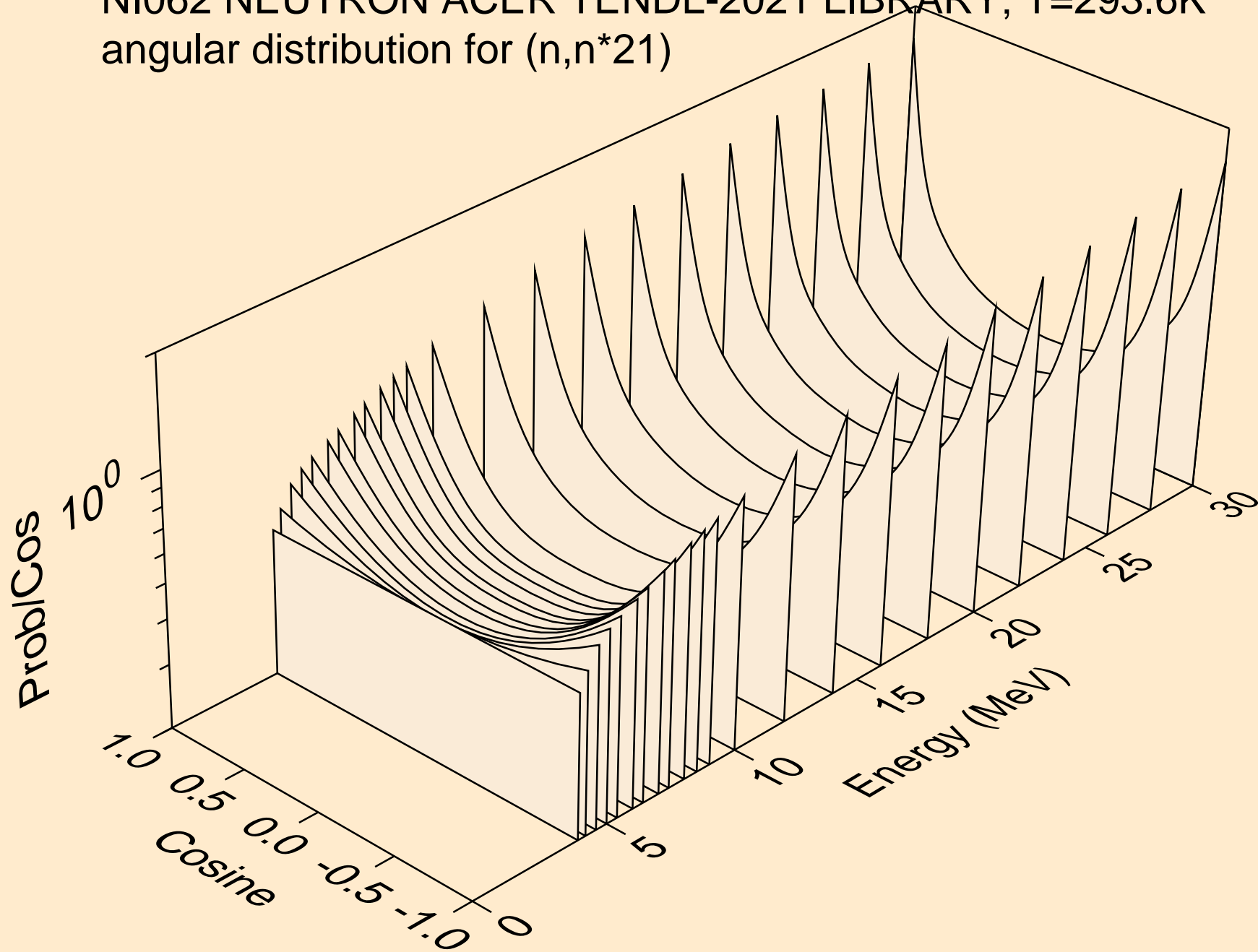

NI062 NEUTRON ACER TENDL-2021 LIBRARY; T=293.6K
angular distribution for (n,n*22)

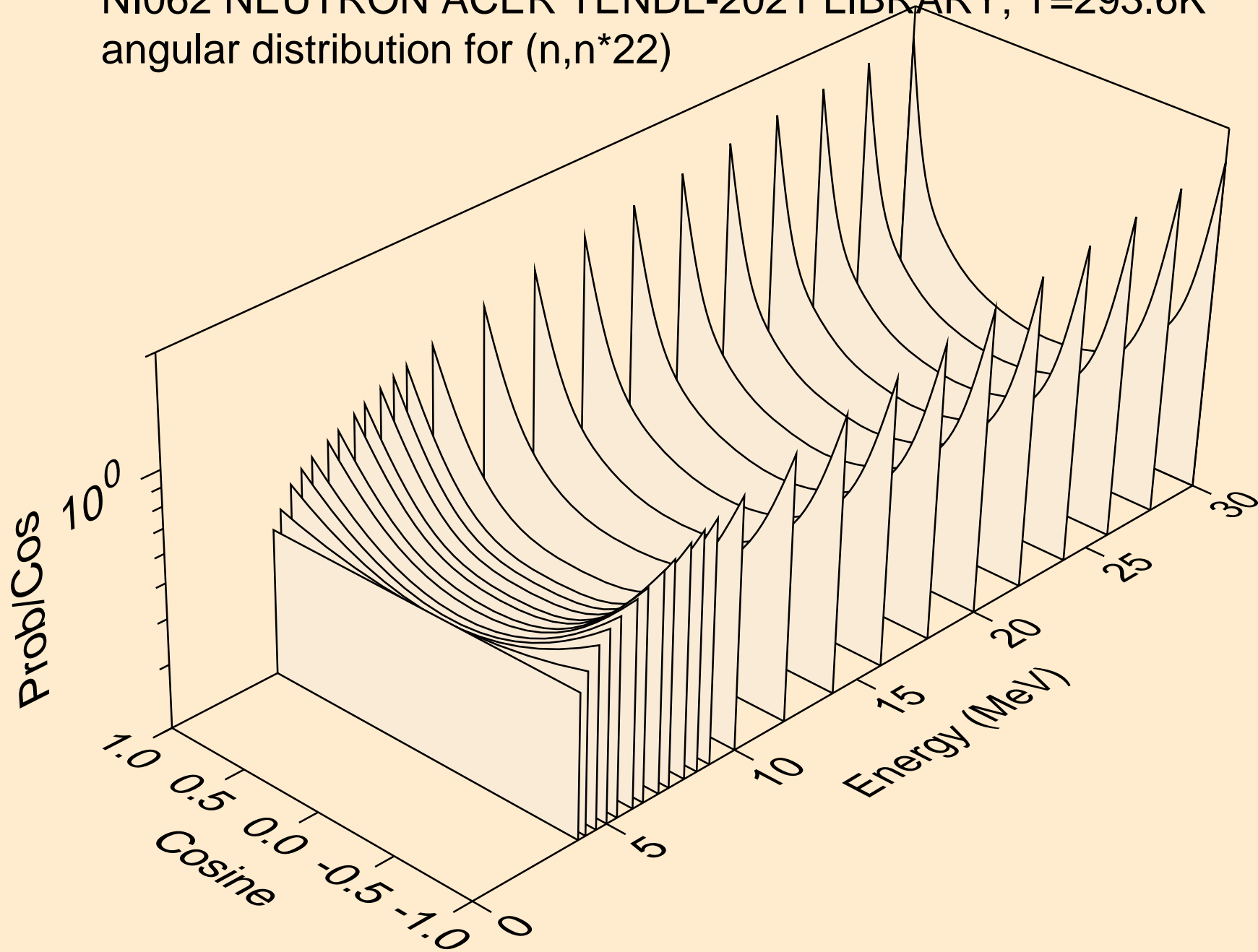

NI062 NEUTRON ACER TENDL-2021 LIBRARY; T=293.6K
angular distribution for (n,n*23)

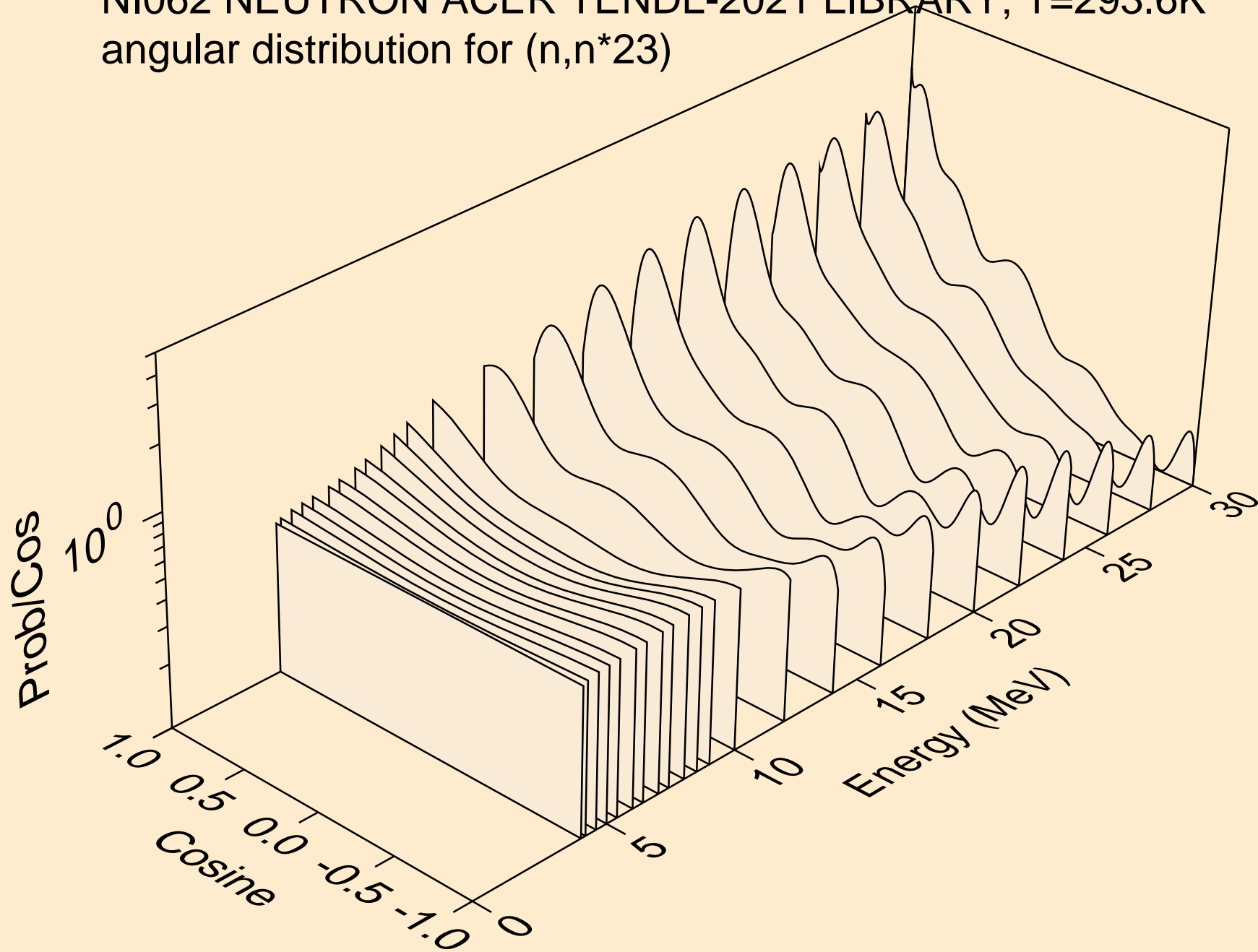

NI062 NEUTRON ACER TENDL-2021 LIBRARY; T=293.6K
angular distribution for (n,n*24)

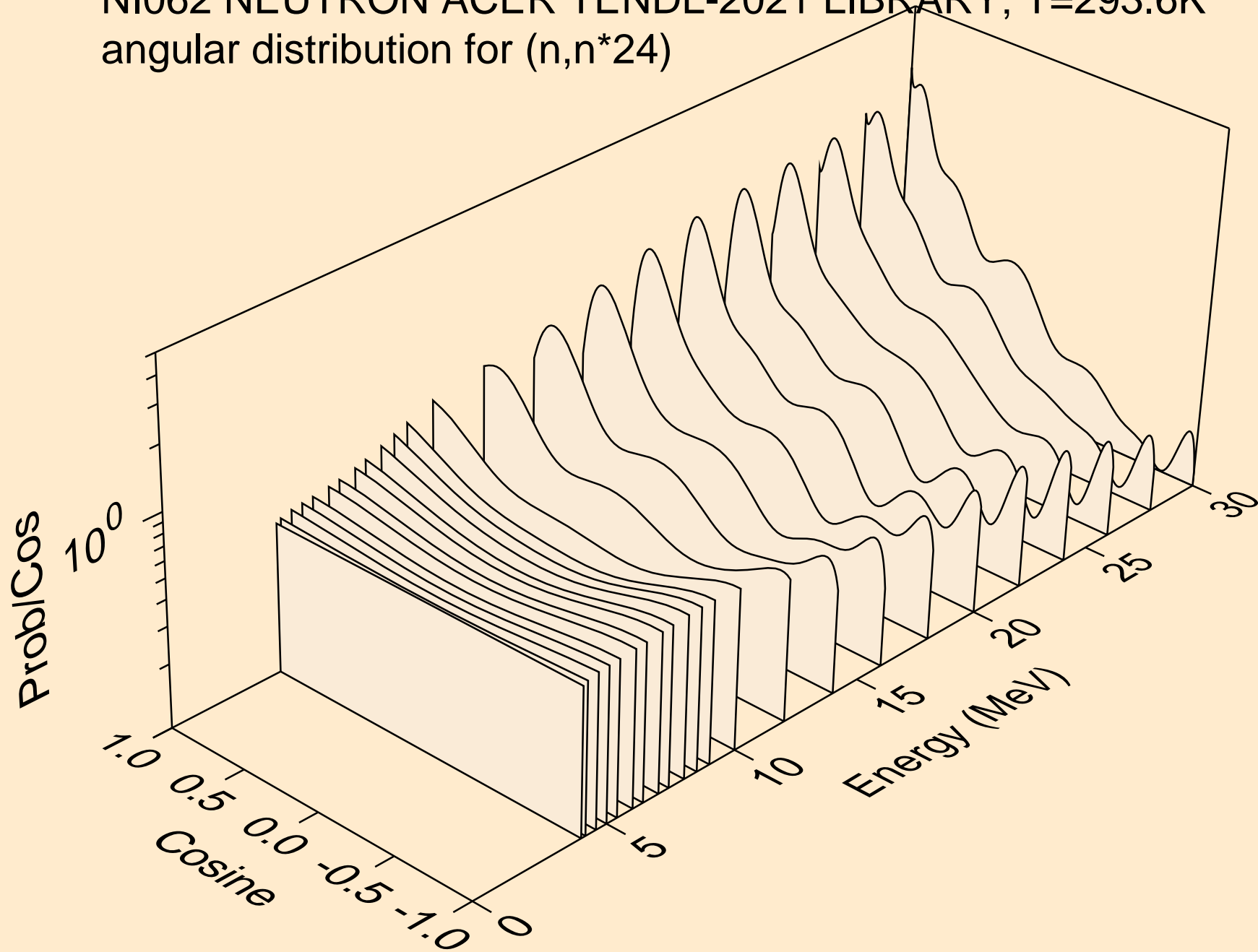

NI062 NEUTRON ACER TENDL-2021 LIBRARY; T=293.6K
angular distribution for (n,n*25)

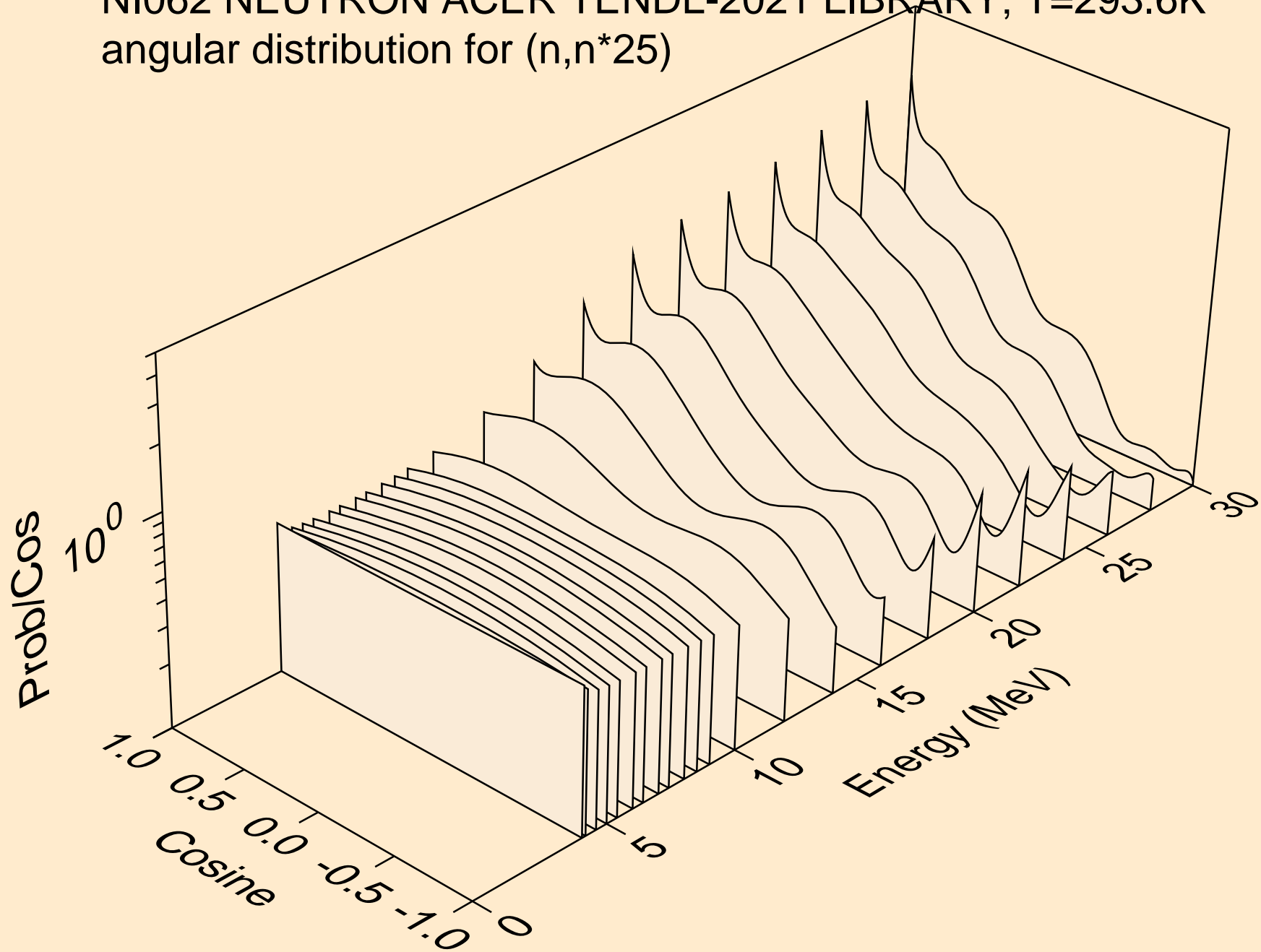

NI062 NEUTRON ACER TENDL-2021 LIBRARY; T=293.6K
angular distribution for (n,n*26)

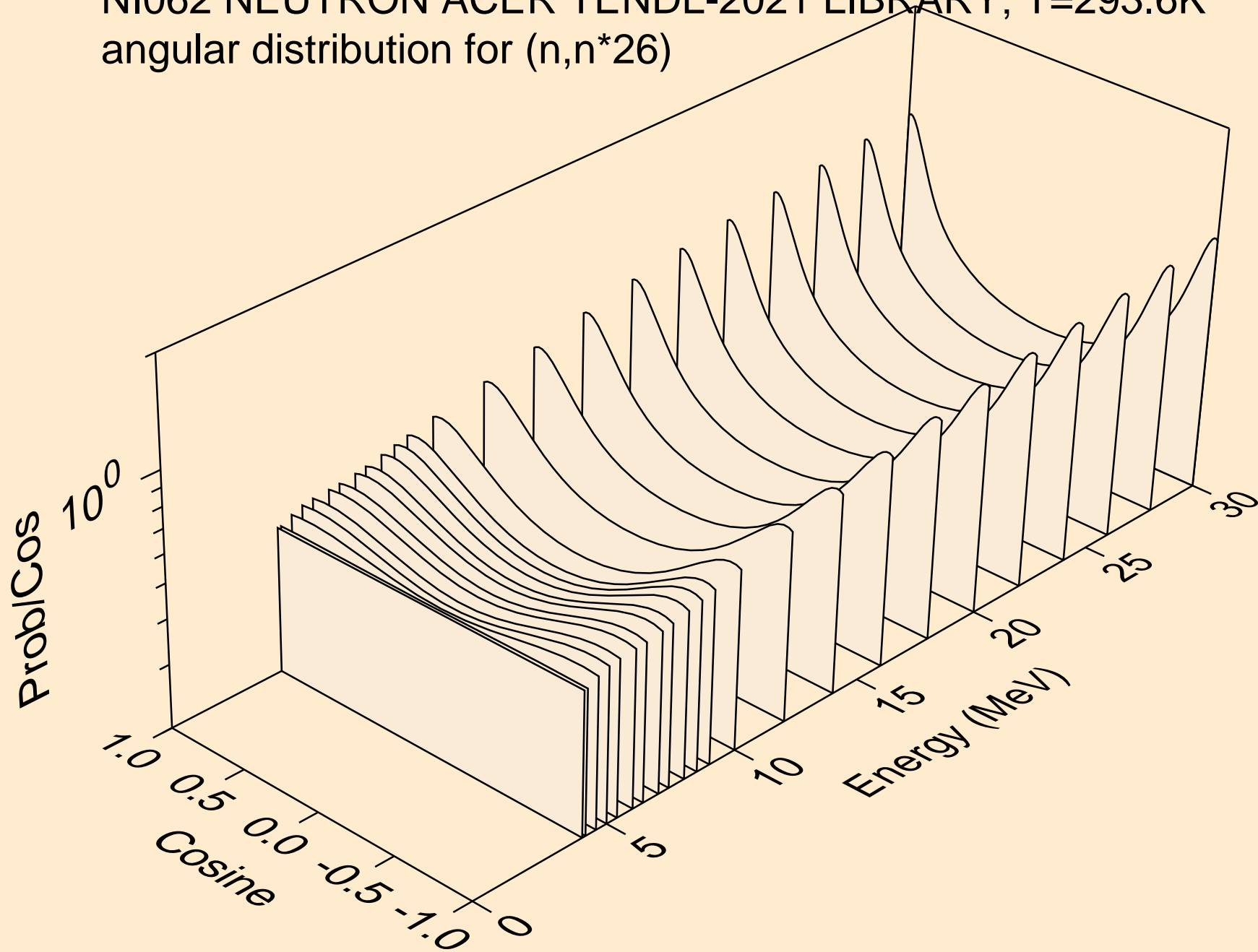

NI062 NEUTRON ACER TENDL-2021 LIBRARY; T=293.6K
angular distribution for (n,n*27)

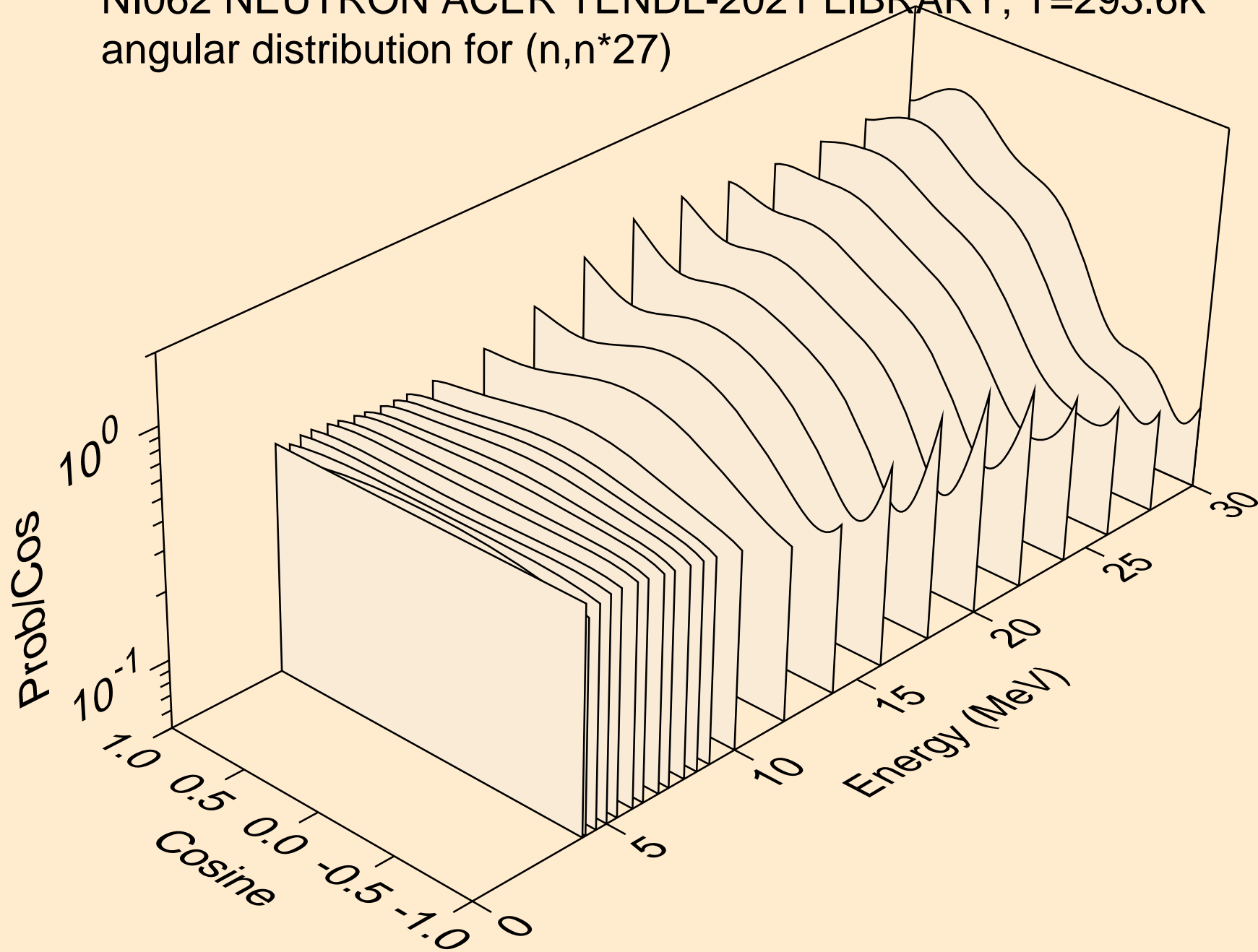

NI062 NEUTRON ACER TENDL-2021 LIBRARY; T=293.6K
angular distribution for (n,n*28)

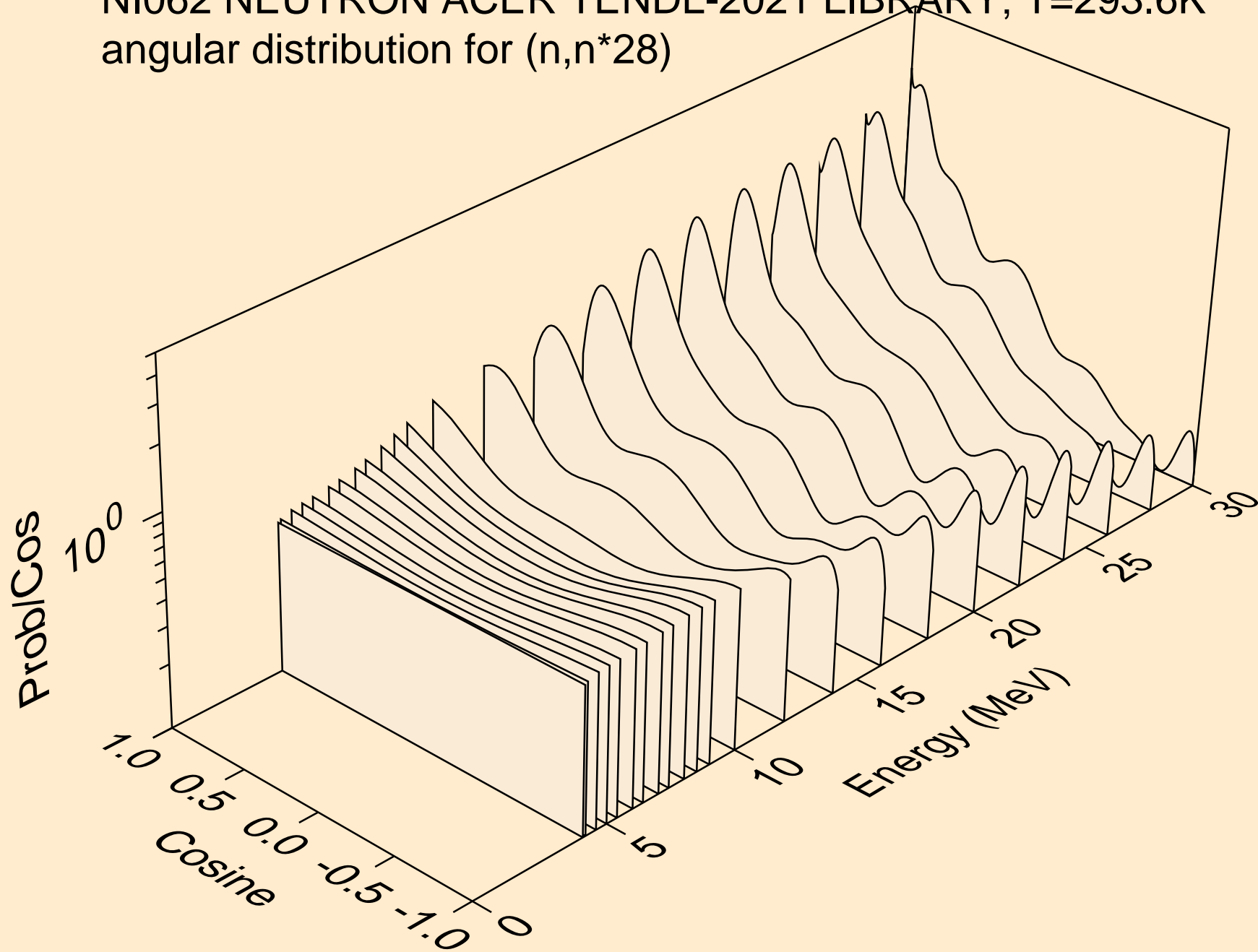

NI062 NEUTRON ACER TENDL-2021 LIBRARY; T=293.6K
angular distribution for (n,n*29)

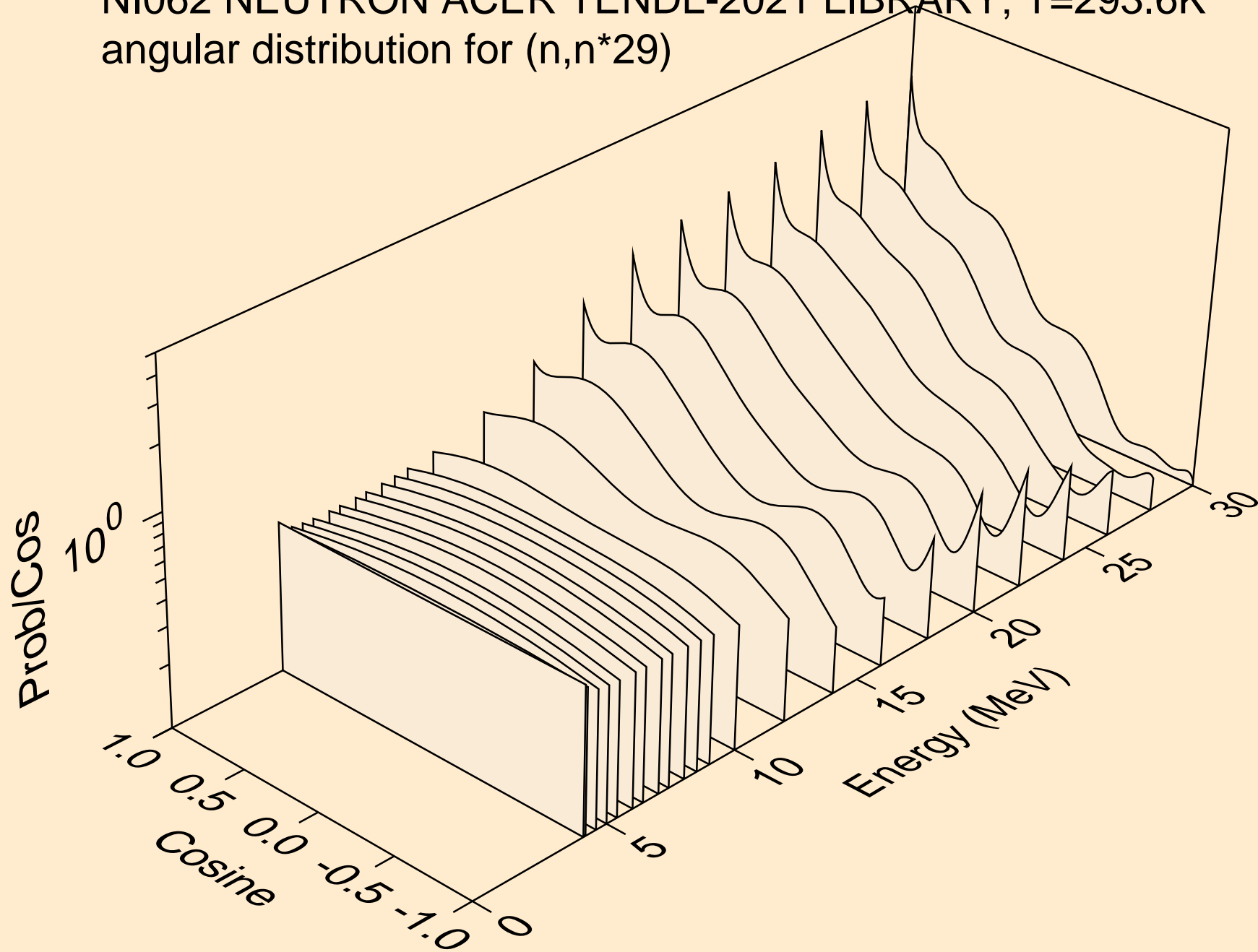

NI062 NEUTRON ACER TENDL-2021 LIBRARY; T=293.6K
angular distribution for (n,n*30)

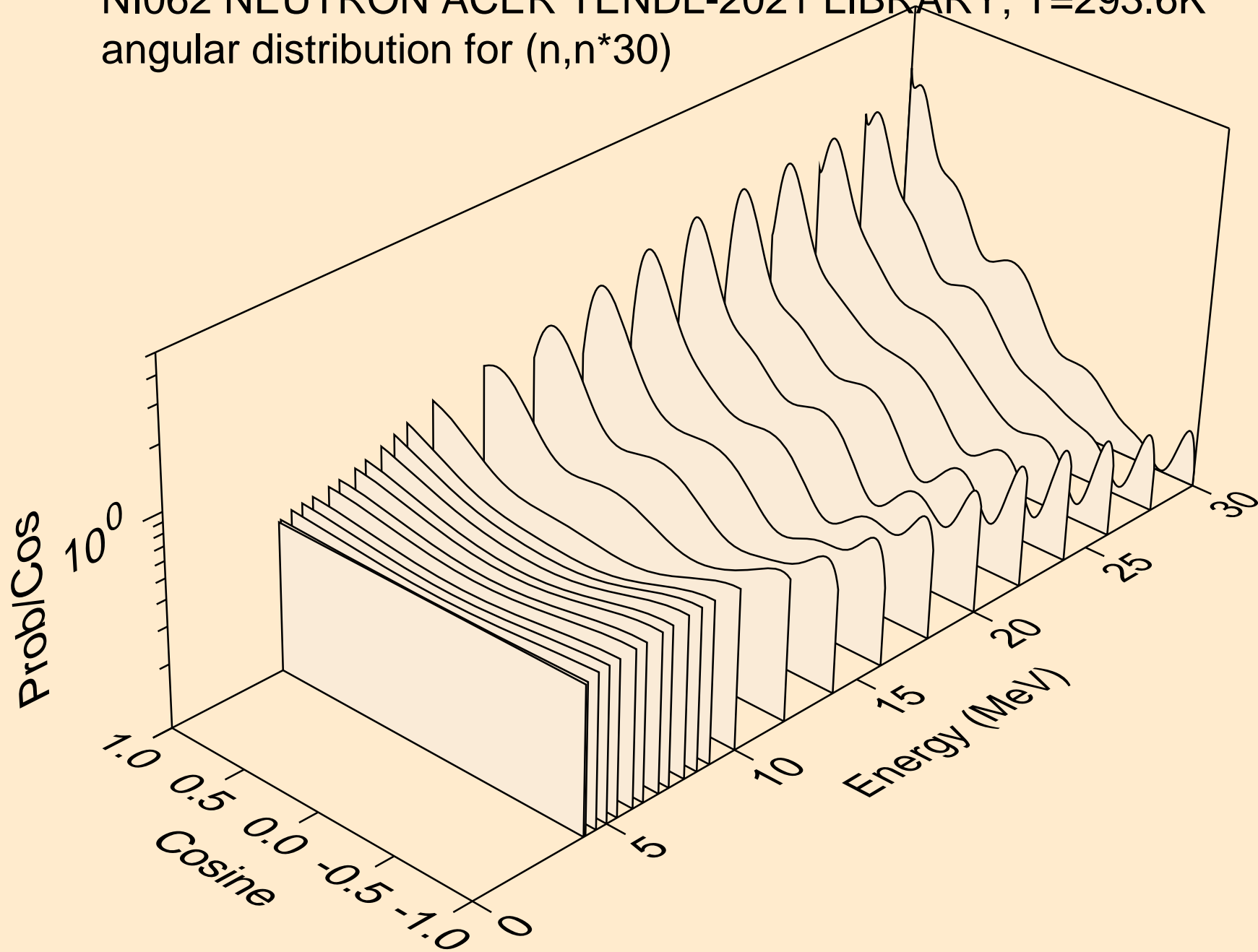

NI062 NEUTRON ACER TENDL-2021 LIBRARY; T=293.6K
Neutron emission for (n,x)

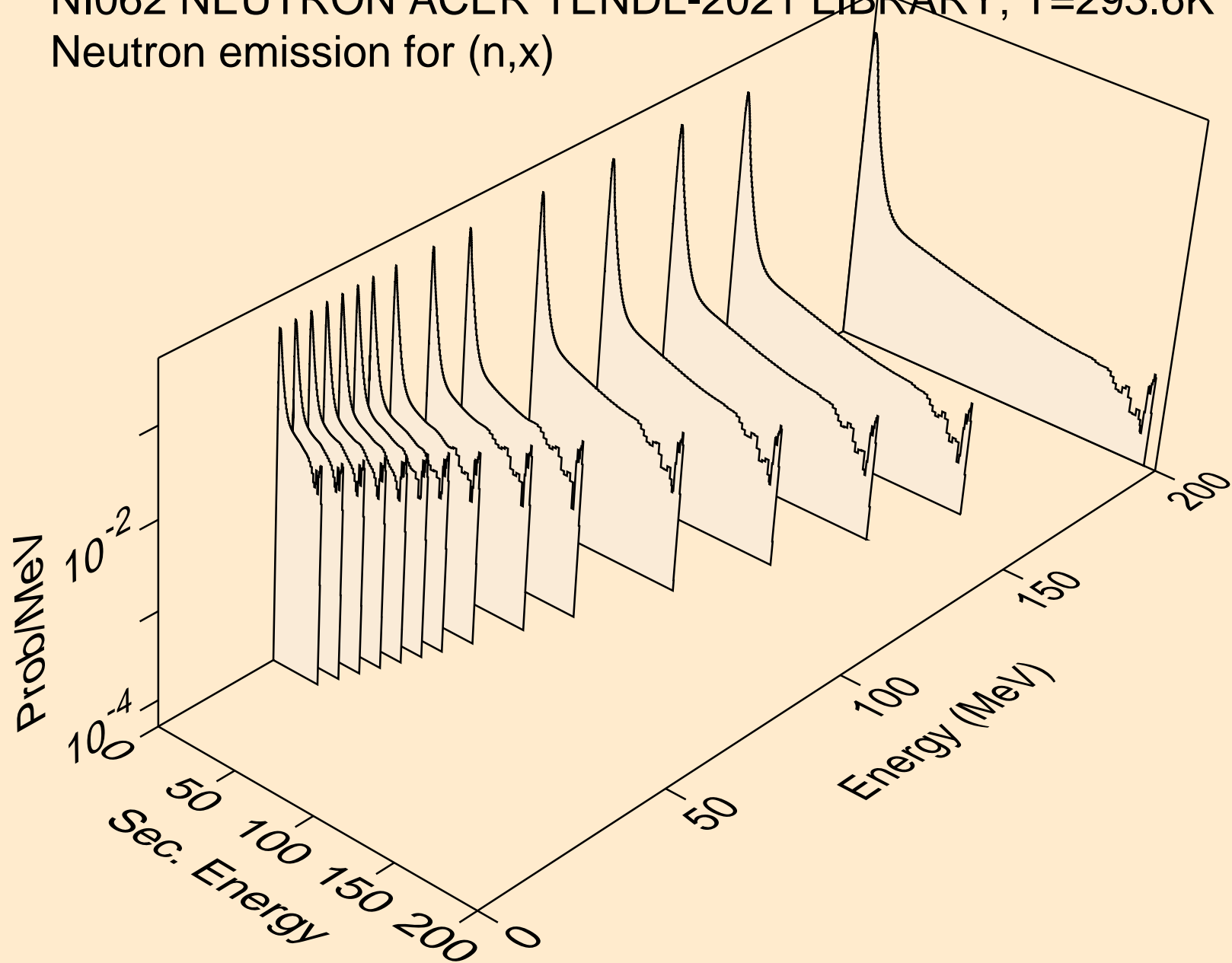

NI062 NEUTRON ACER TENDL-2021 LIBRARY; T=293.6K
Neutron emission for (n,2nd)

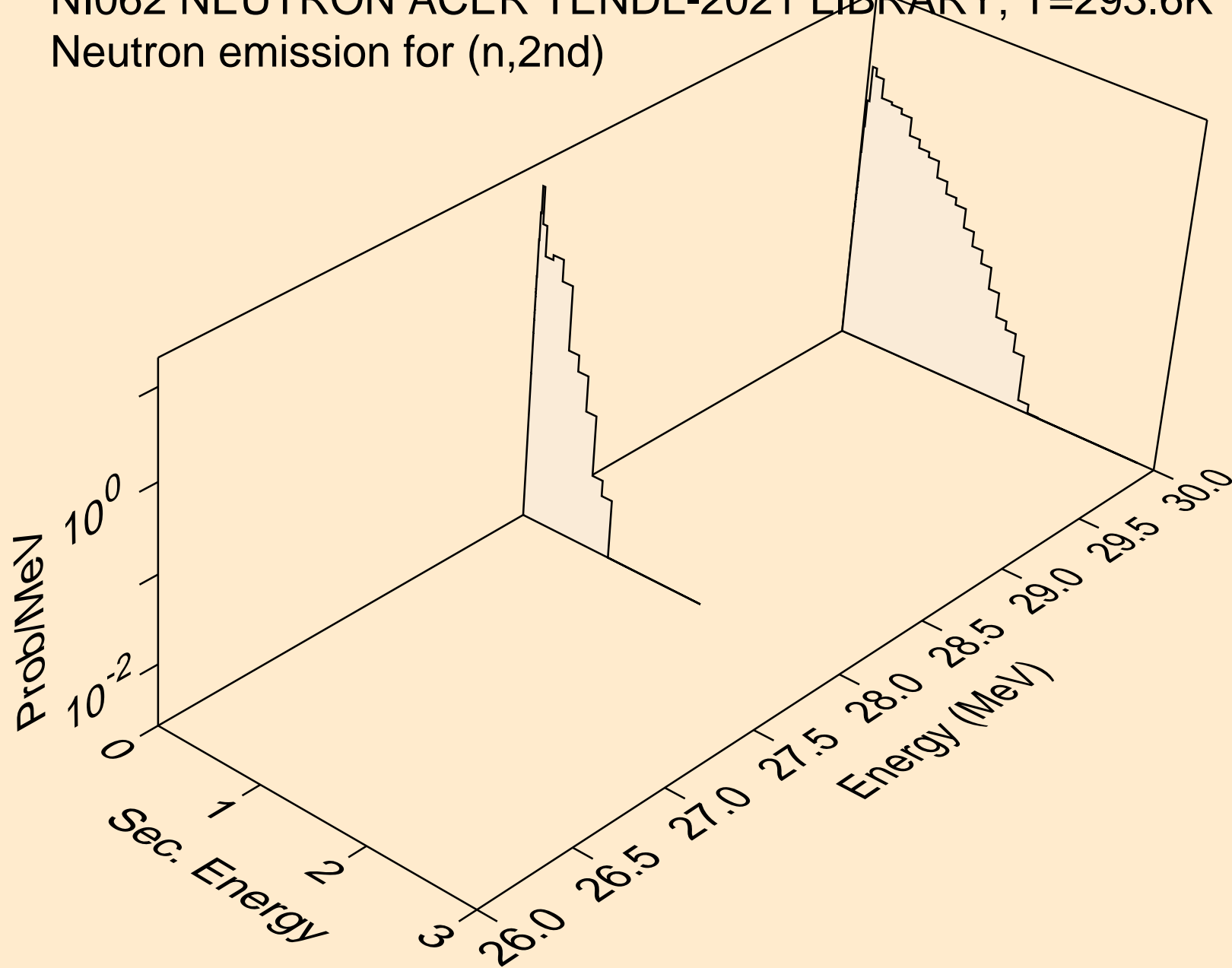

NI062 NEUTRON ACER TENDL-2021 LIBRARY; T=293.6K
Neutron emission for (n,2n)

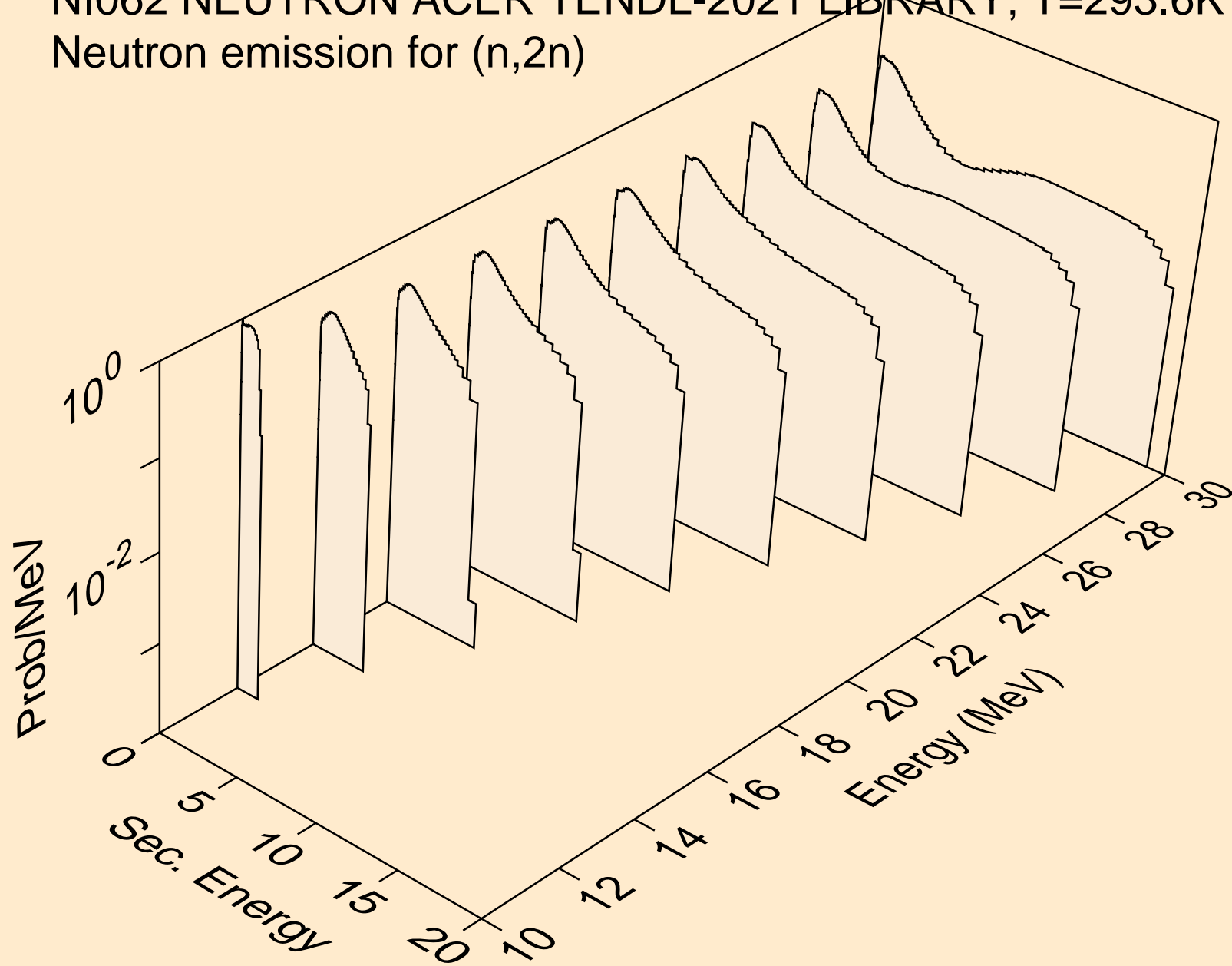

NI062 NEUTRON ACER TENDL-2021 LIBRARY; T=293.6K
Neutron emission for (n,3n)

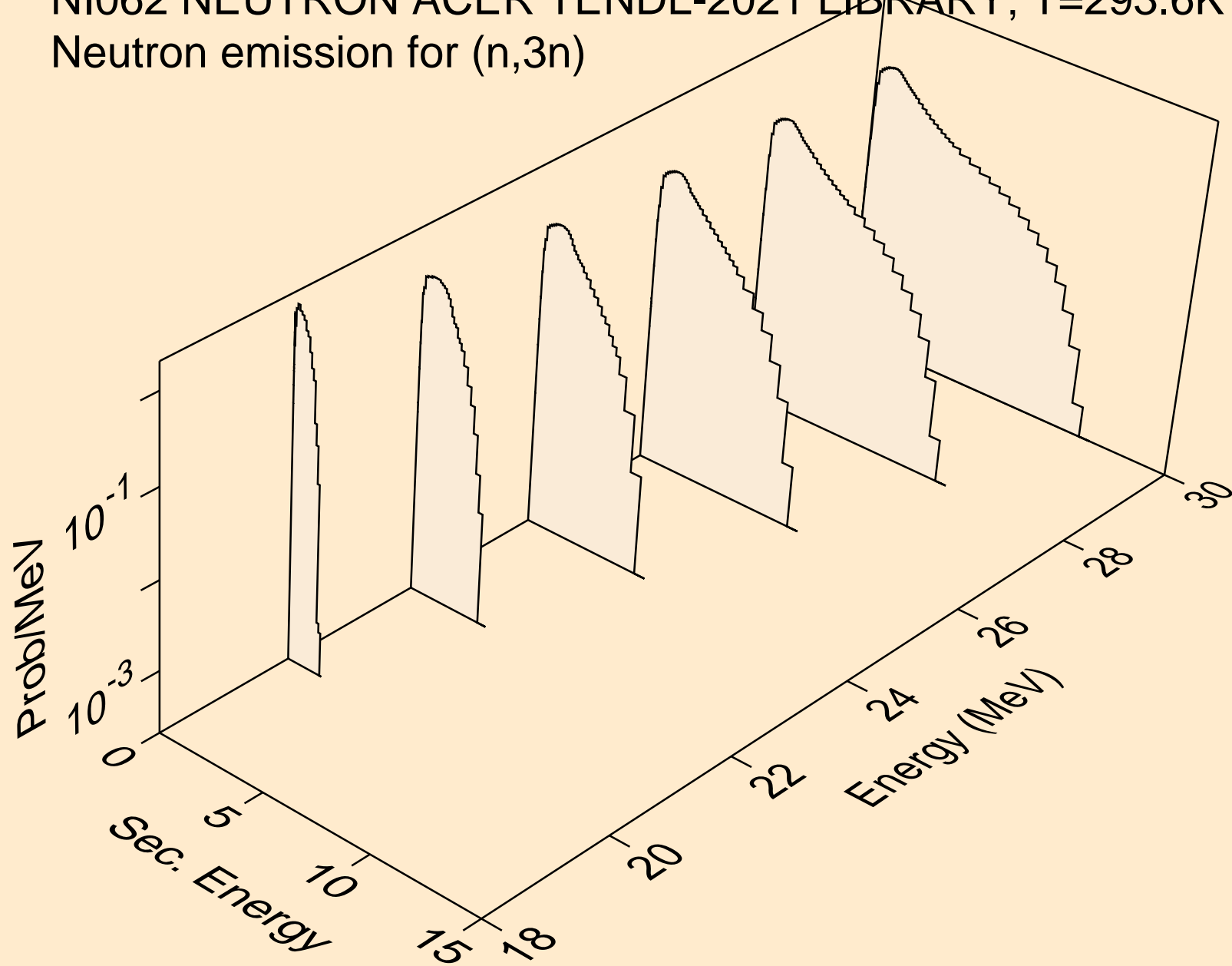

NI062 NEUTRON ACER TENDL-2021 LIBRARY; T=293.6K
Neutron emission for (n,n*)a

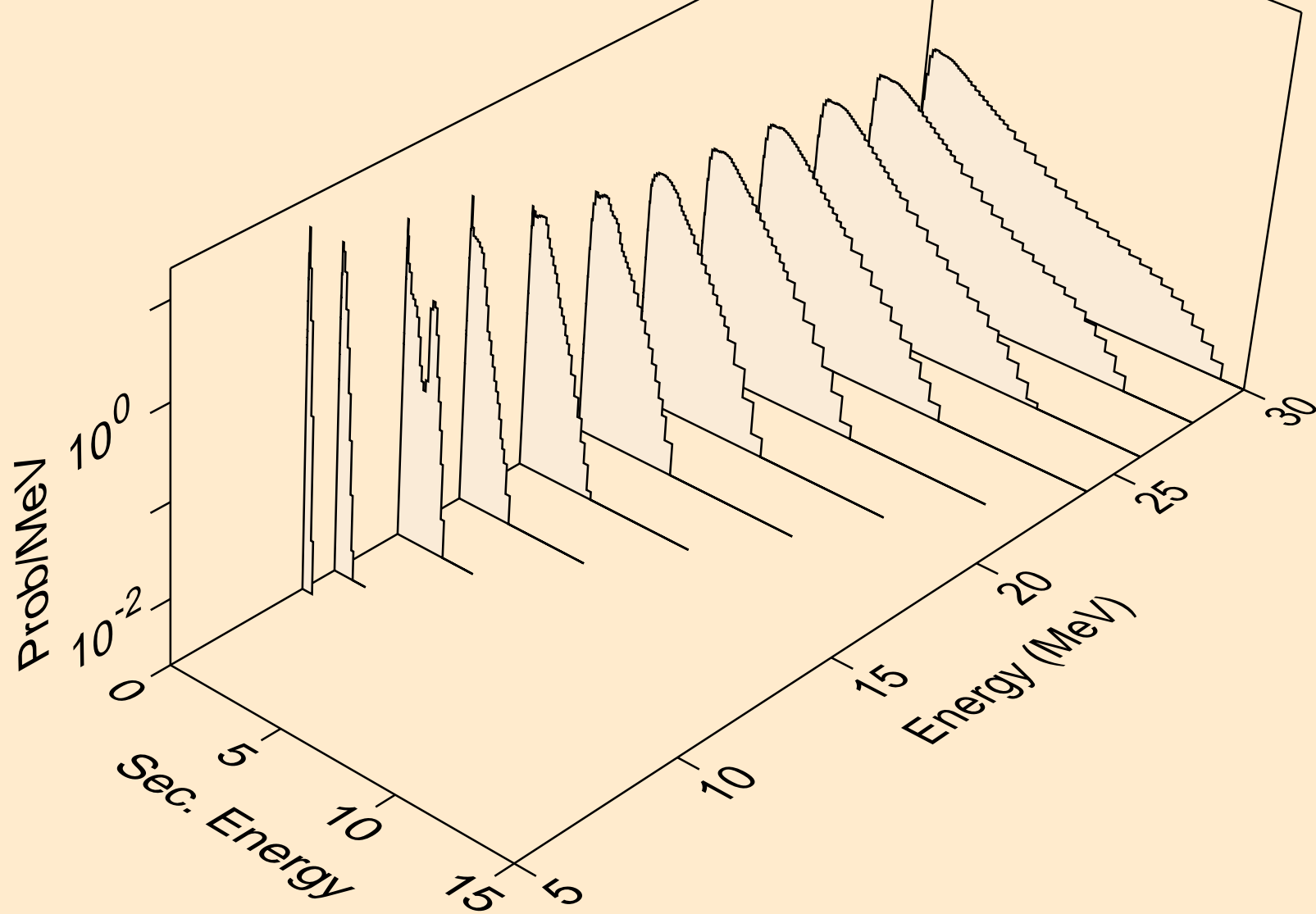

NI062 NEUTRON ACER TENDL-2021 LIBRARY; T=293.6K
Neutron emission for (n,2n)a

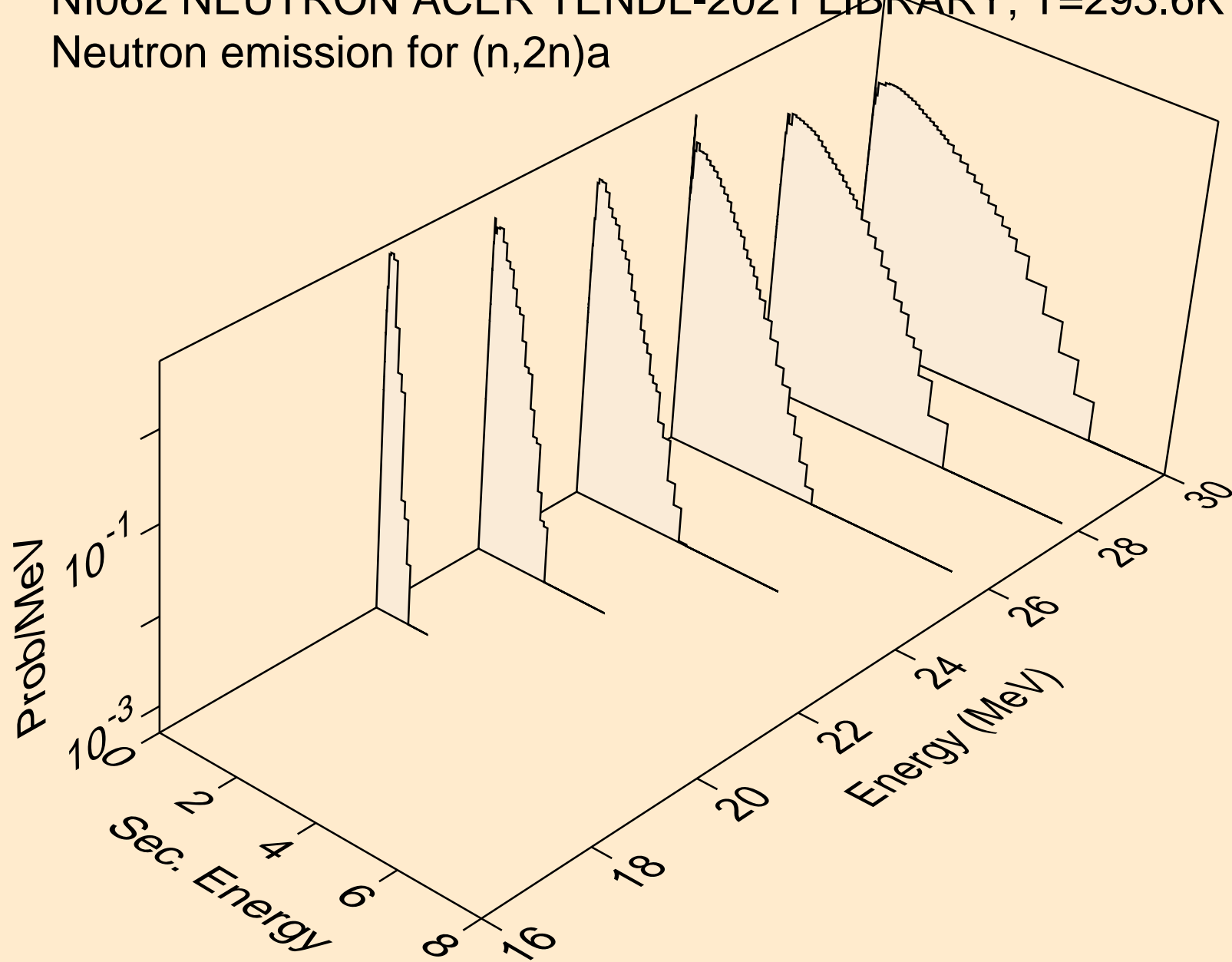

NI062 NEUTRON ACER TENDL-2021 LIBRARY; T=293.6K
Neutron emission for (n,3n)a

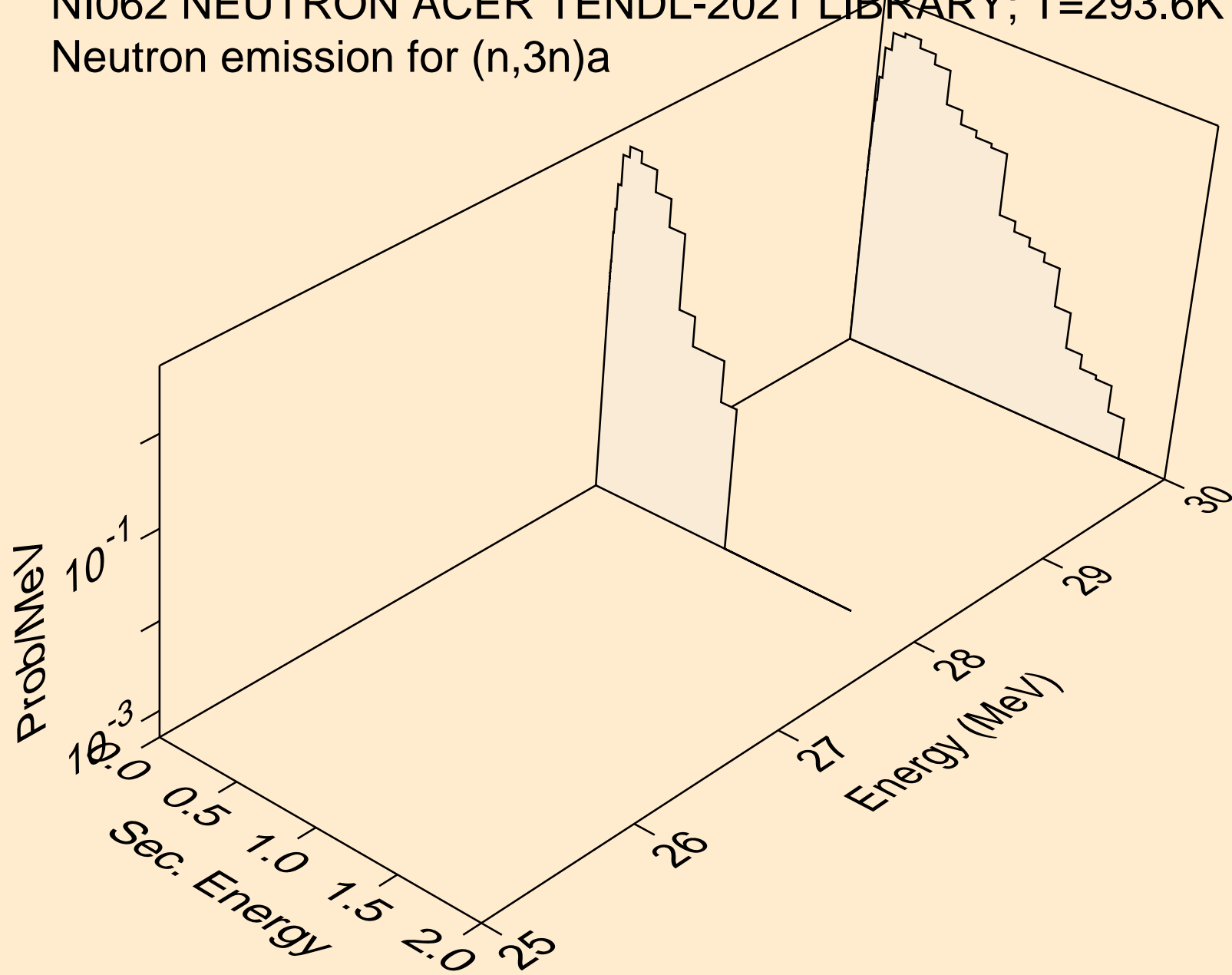

NI062 NEUTRON ACER TENDL-2021 LIBRARY; T=293.6K
Neutron emission for (n,n*)p

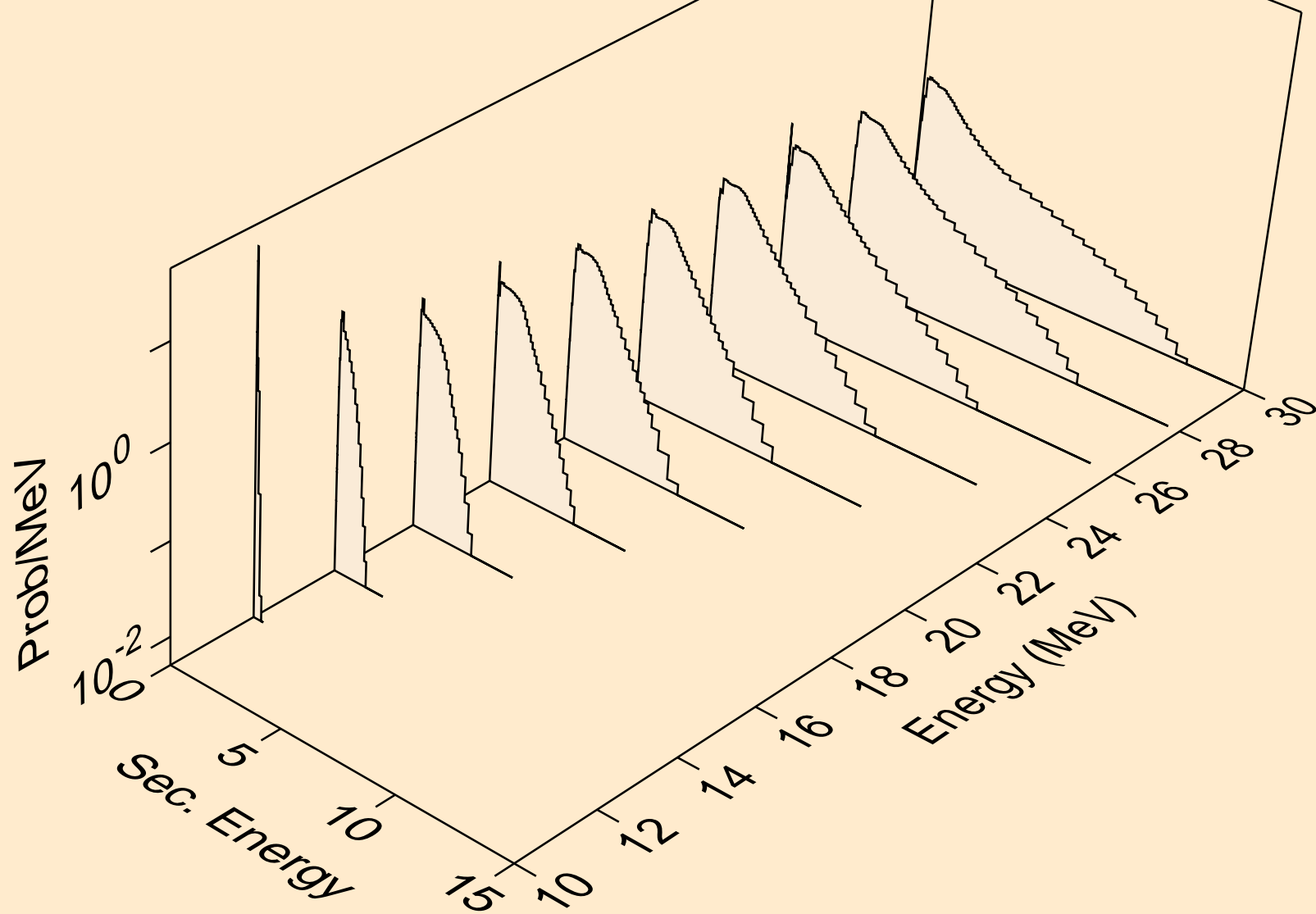

NI062 NEUTRON ACER TENDL-2021 LIBRARY; T=293.6K
Neutron emission for (n,n*)2a

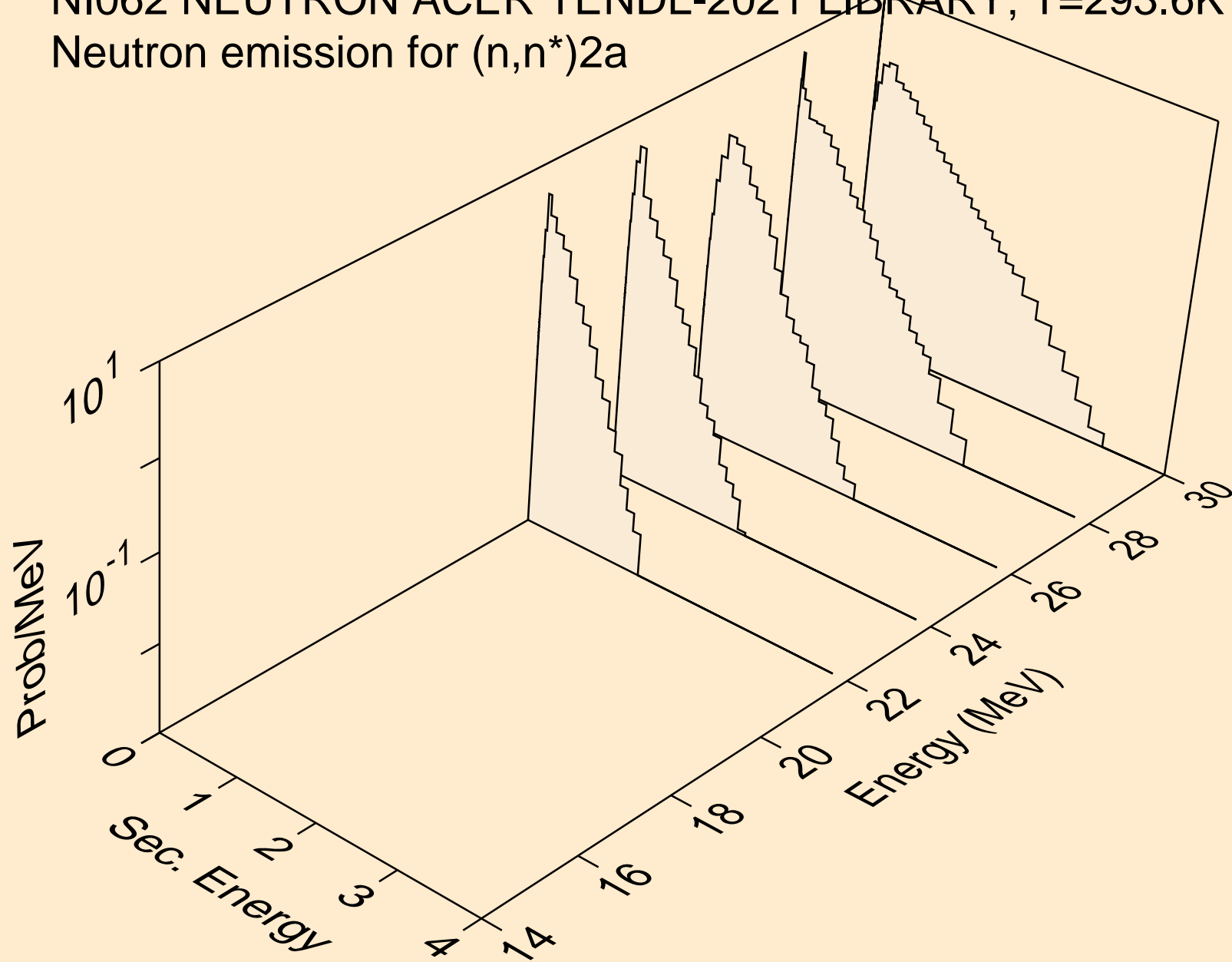

NI062 NEUTRON ACER TENDL-2021 LIBRARY; T=293.6K
Neutron emission for (n,n*)d

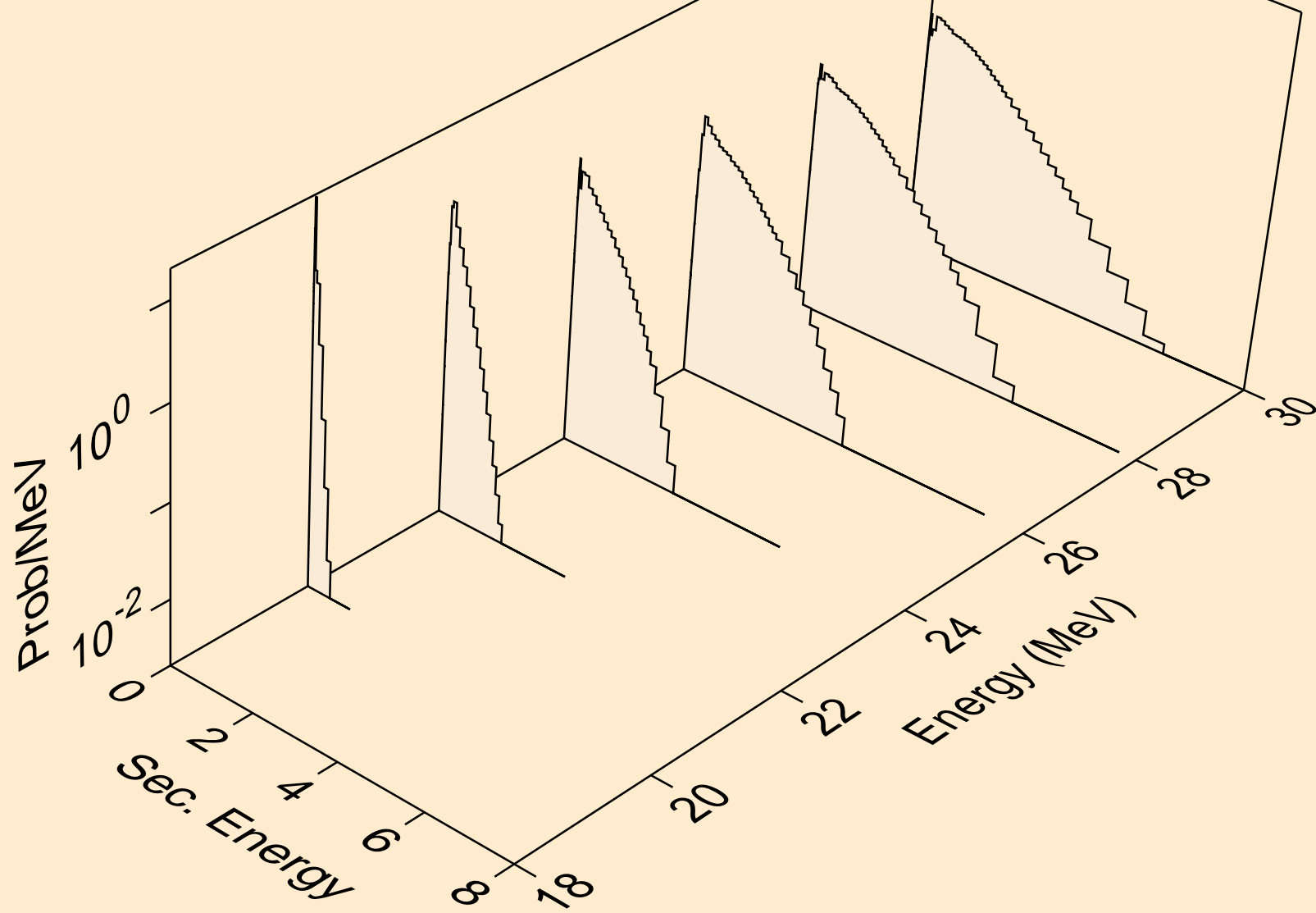

NI062 NEUTRON ACER TENDL-2021 LIBRARY; T=293.6K
Neutron emission for (n,n*)t

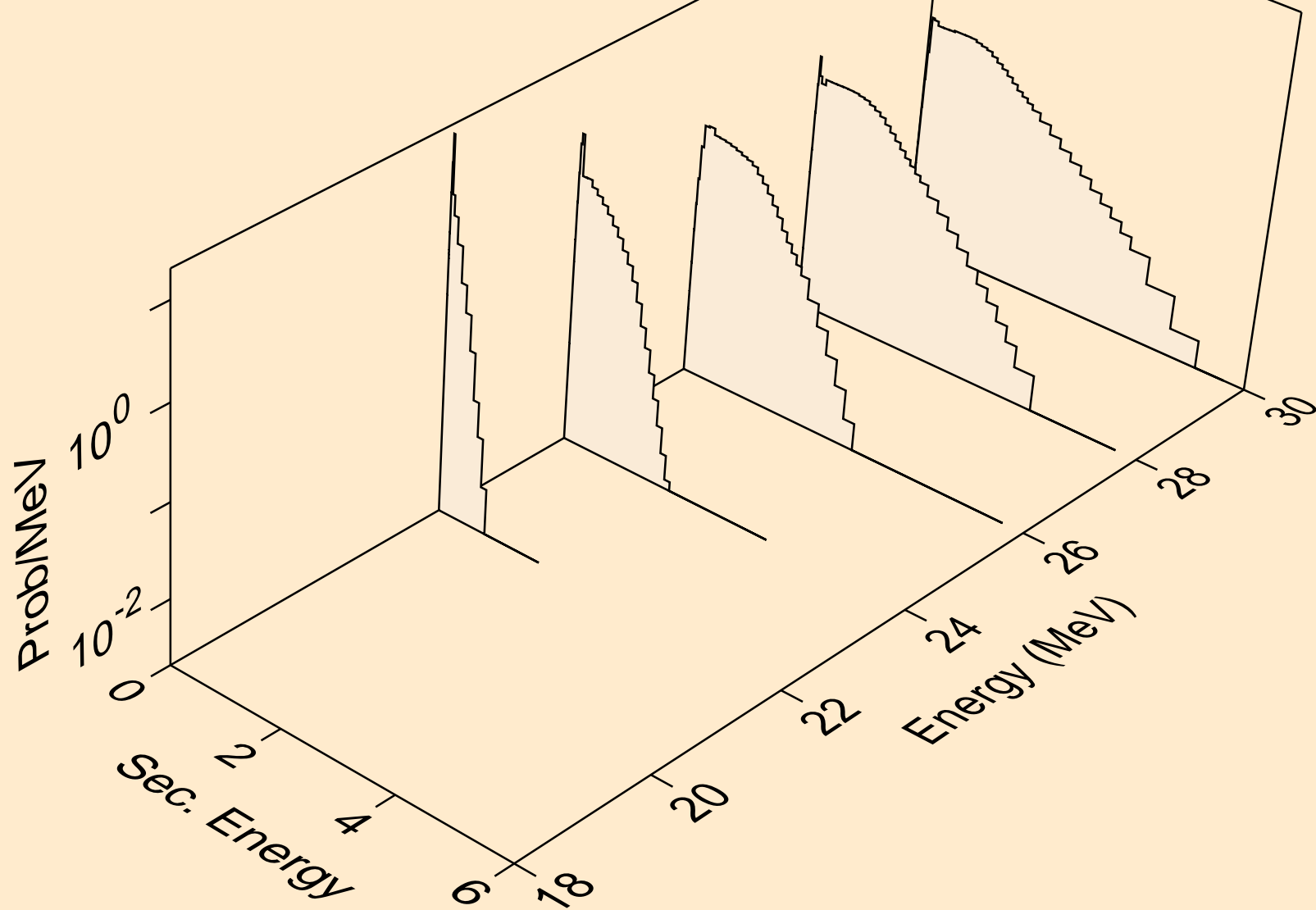

NI062 NEUTRON ACER TENDL-2021 LIBRARY; T=293.6K
Neutron emission for (n,n*)he3

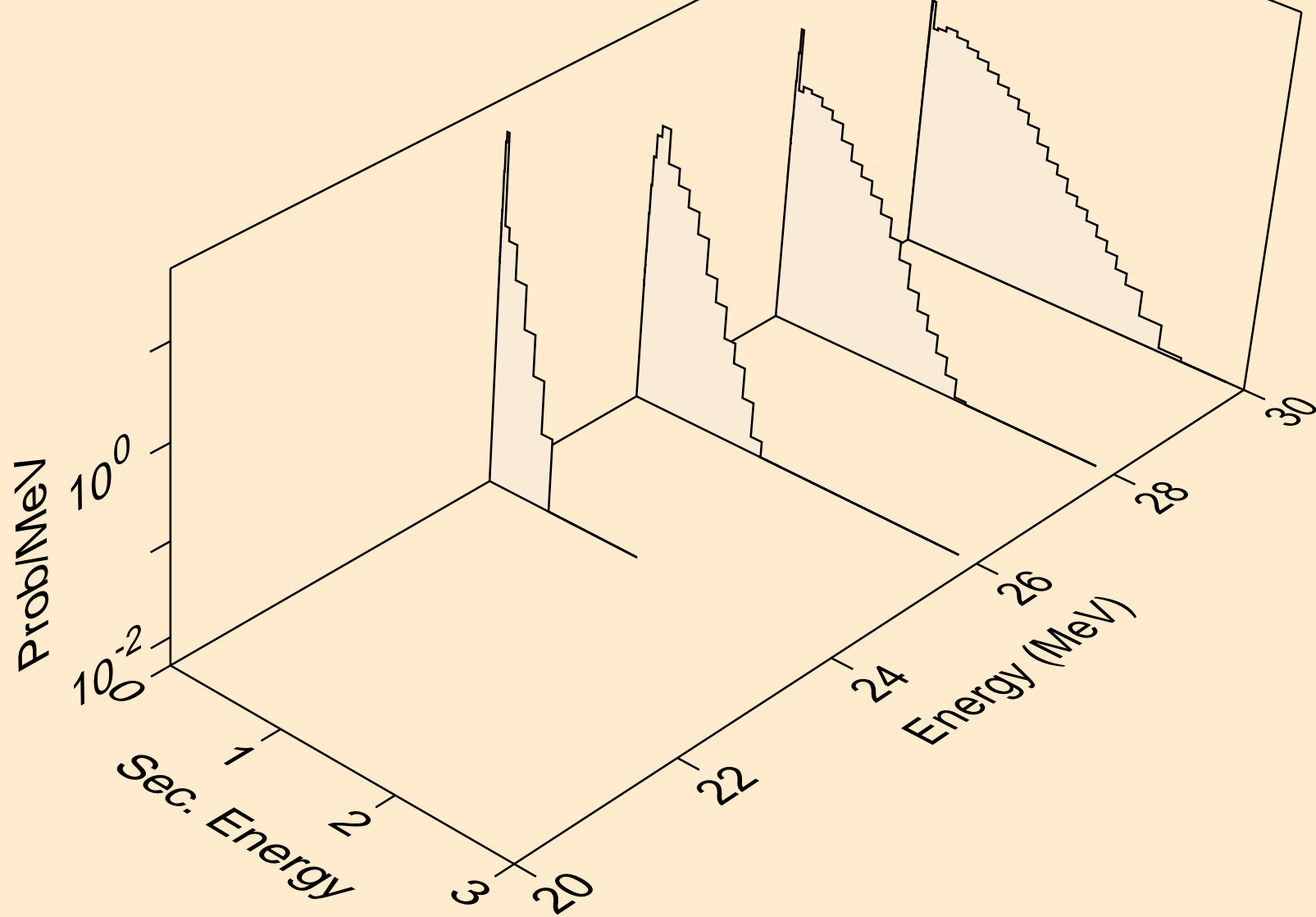

NI062 NEUTRON ACER TENDL-2021 LIBRARY; T=293.6K
Neutron emission for (n,2np)

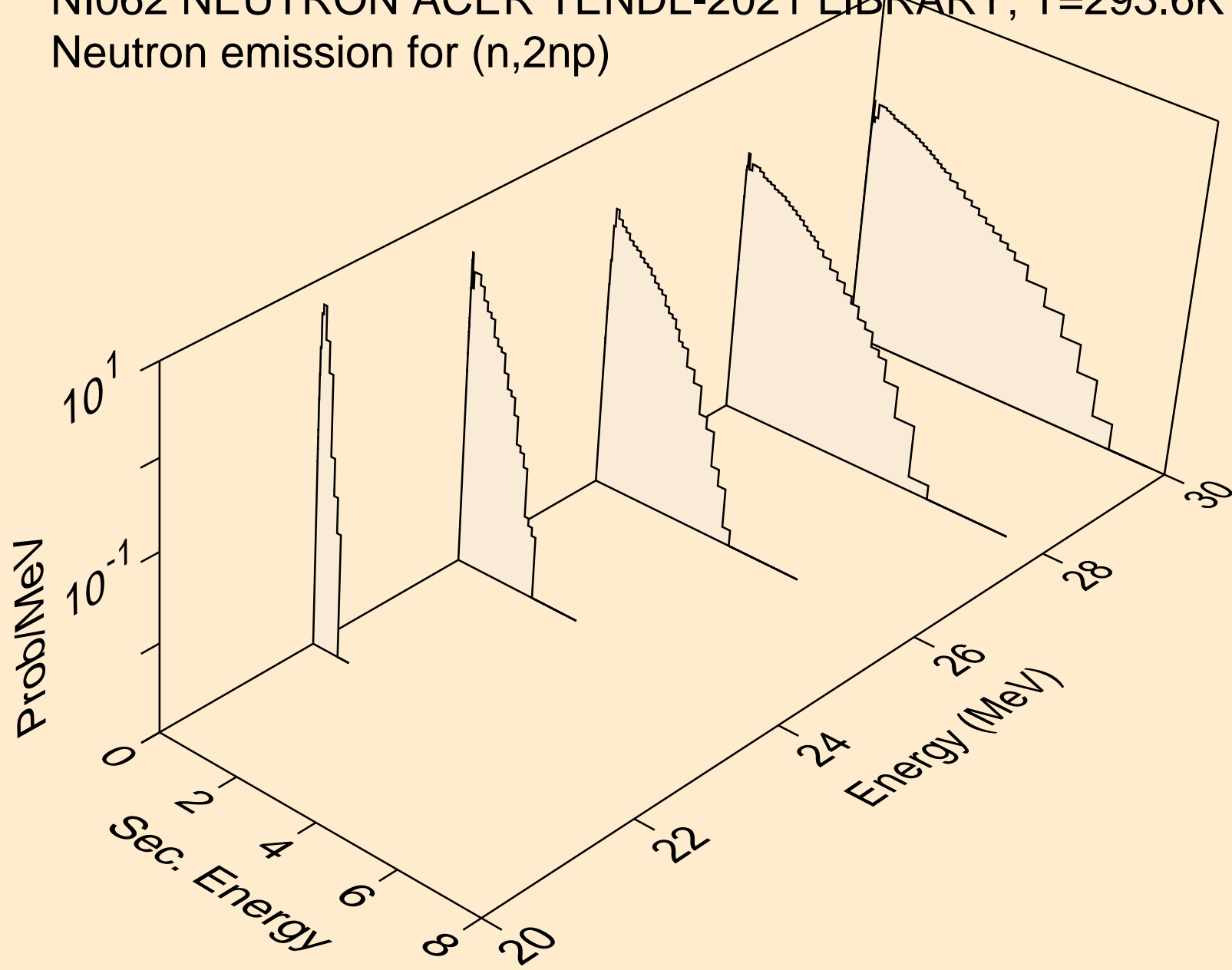

NI062 NEUTRON ACER TENDL-2021 LIBRARY; T=293.6K
Neutron emission for (n,3np)

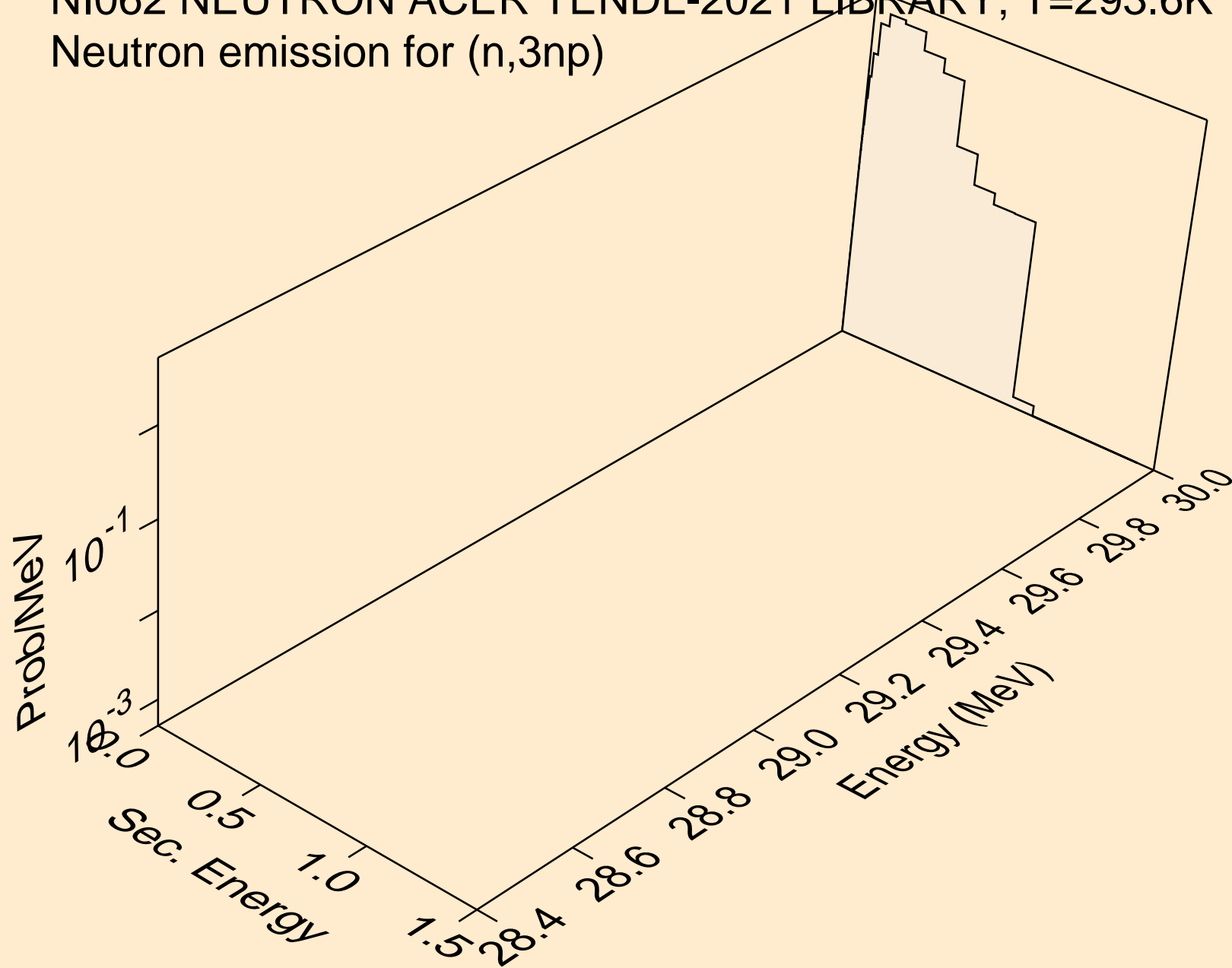

NI062 NEUTRON ACER TENDL-2021 LIBRARY; T=293.6K
Neutron emission for (n,2np)

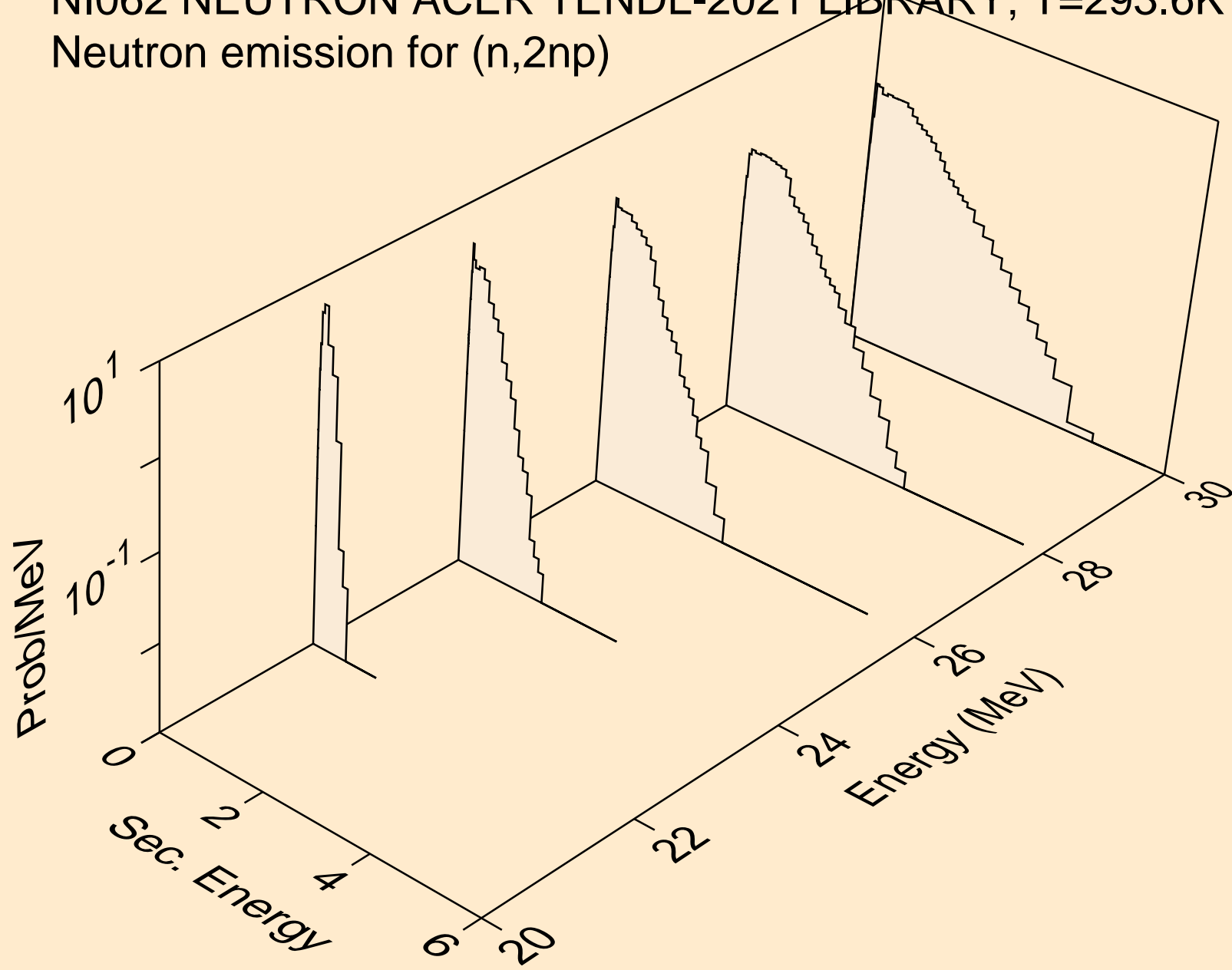

NI062 NEUTRON ACER TENDL-2021 LIBRARY; T=293.6K
Neutron emission for (n,npa)

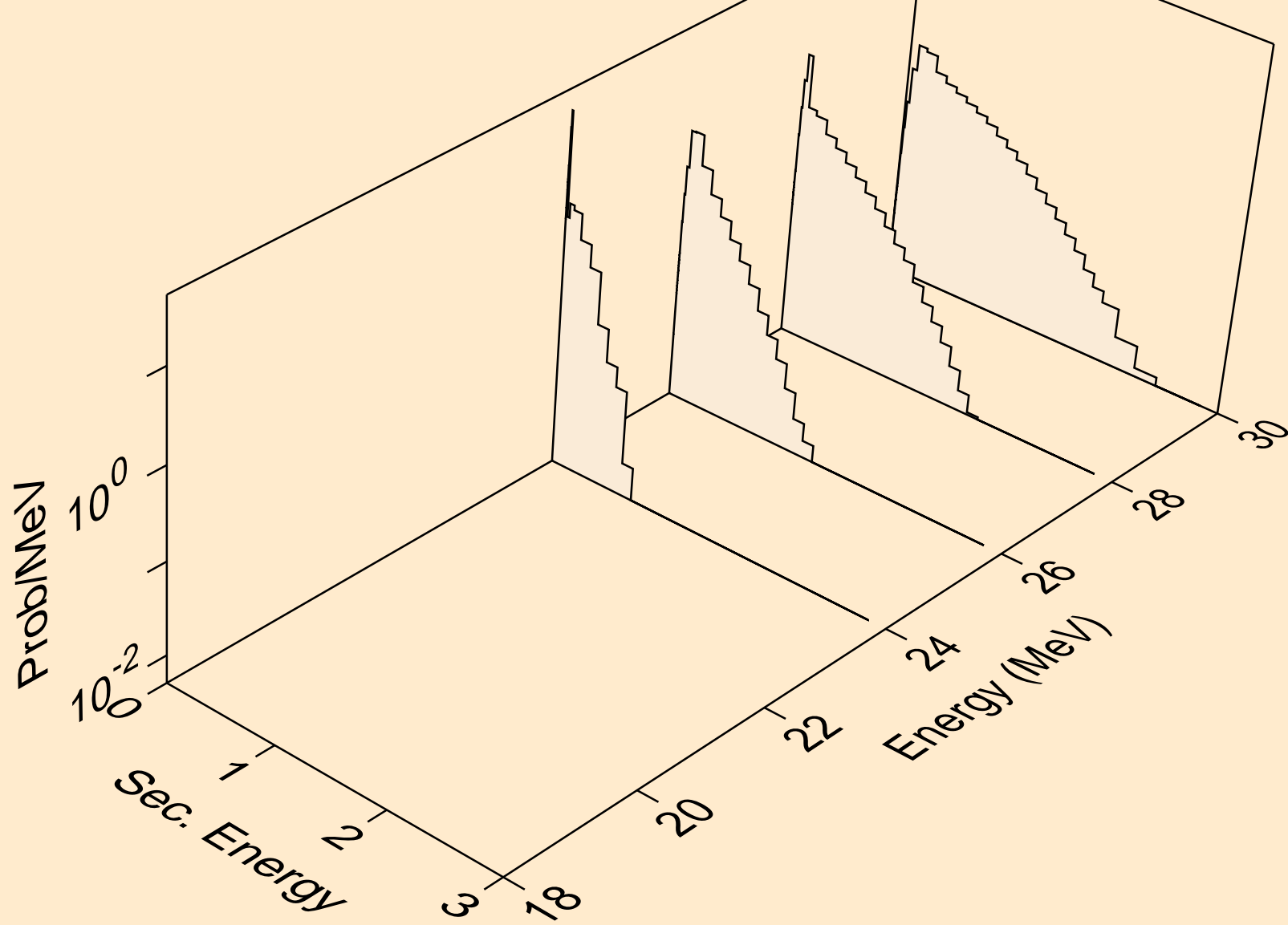

NI062 NEUTRON ACER TENDL-2021 LIBRARY; T=293.6K
Neutron emission for (n,n*c)

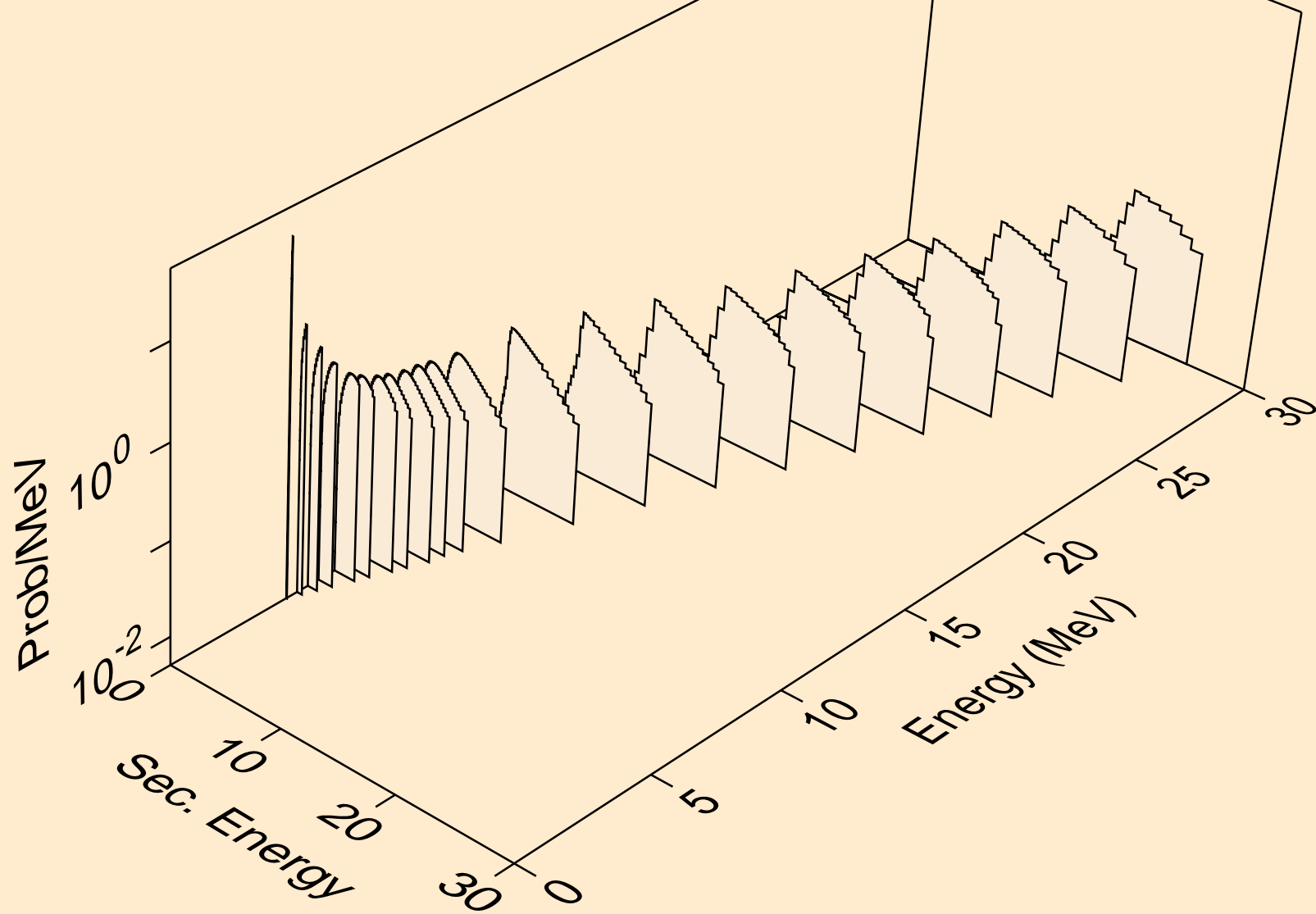

NI062 NEUTRON ACER TENDL-2021 LIBRARY; T=293.6K
Photon emission for (n,x)

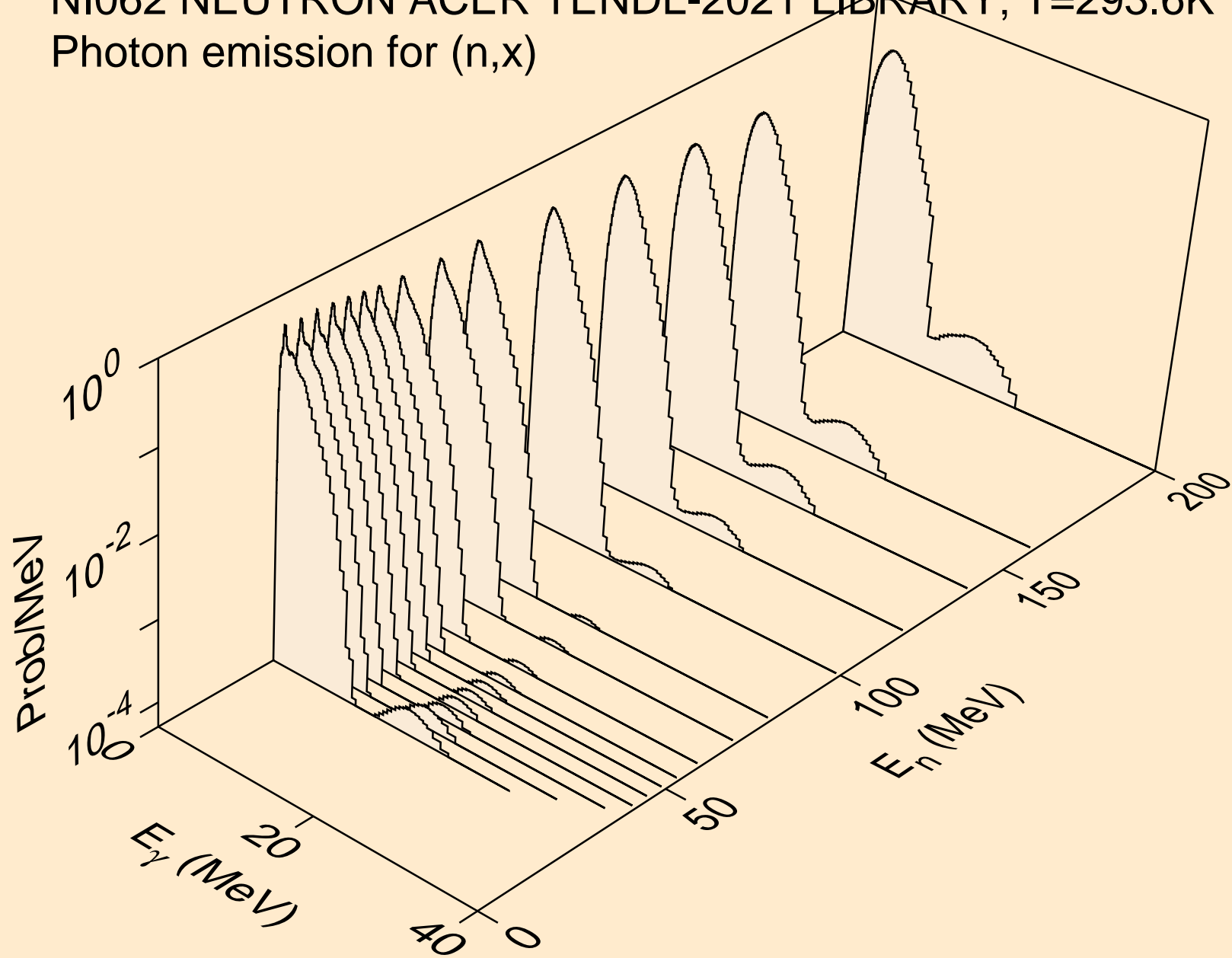

NI062 NEUTRON ACER TENDL-2021 LIBRARY; T=293.6K
Photon emission for (n,2nd)

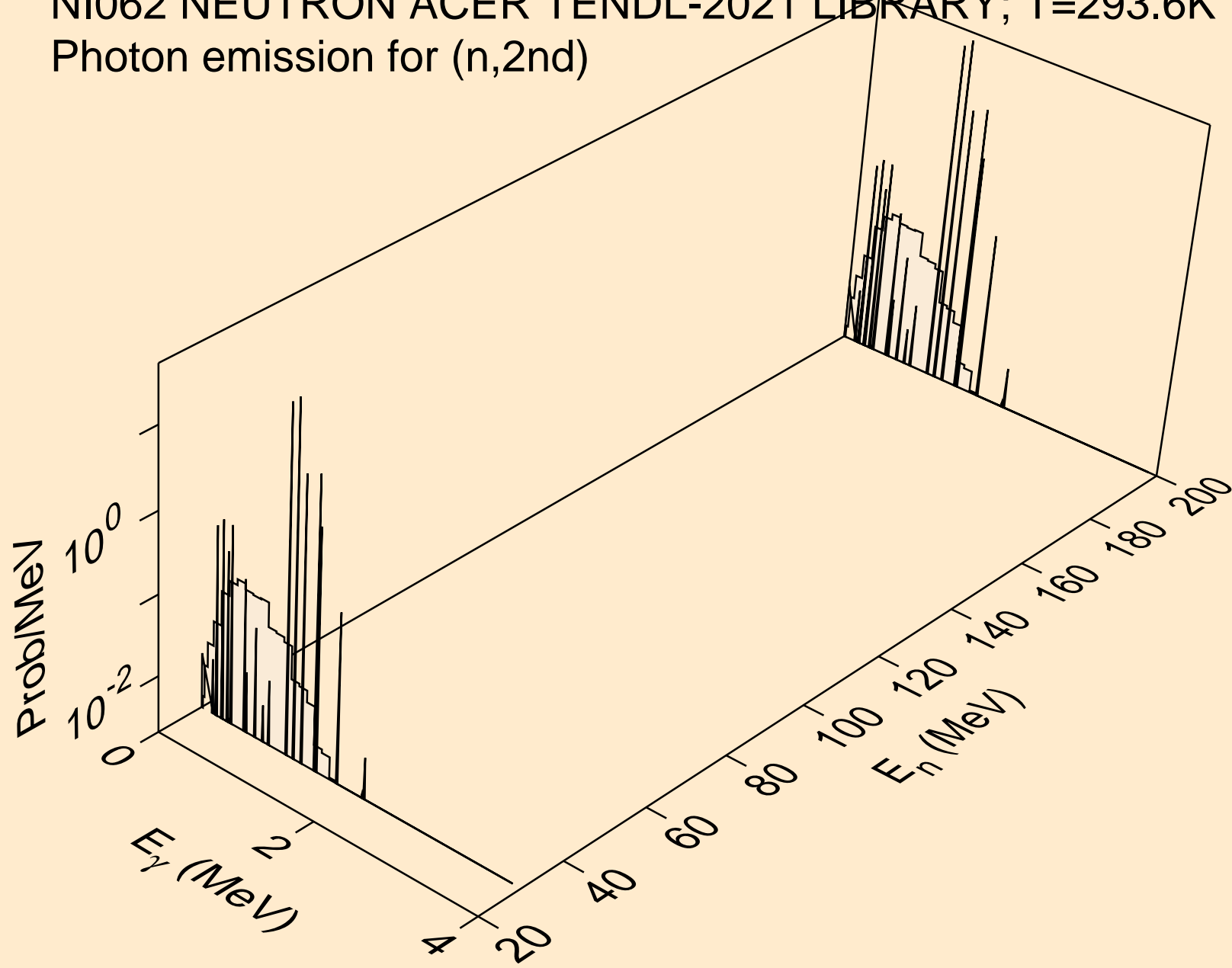

NI062 NEUTRON ACER TENDL-2021 LIBRARY; T=293.6K
Photon emission for (n,2n)

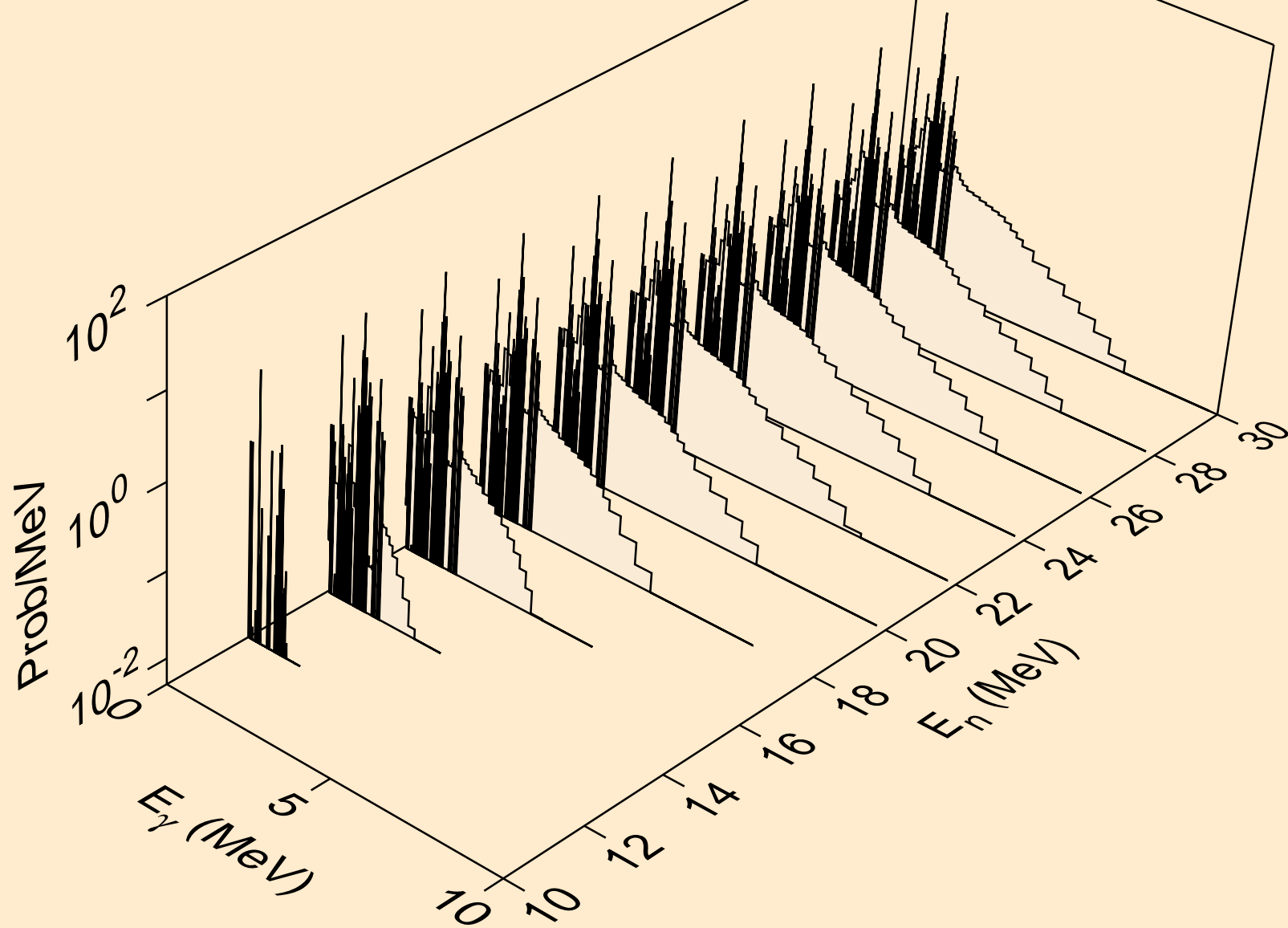

NI062 NEUTRON ACER TENDL-2021 LIBRARY; T=293.6K
Photon emission for (n,3n)

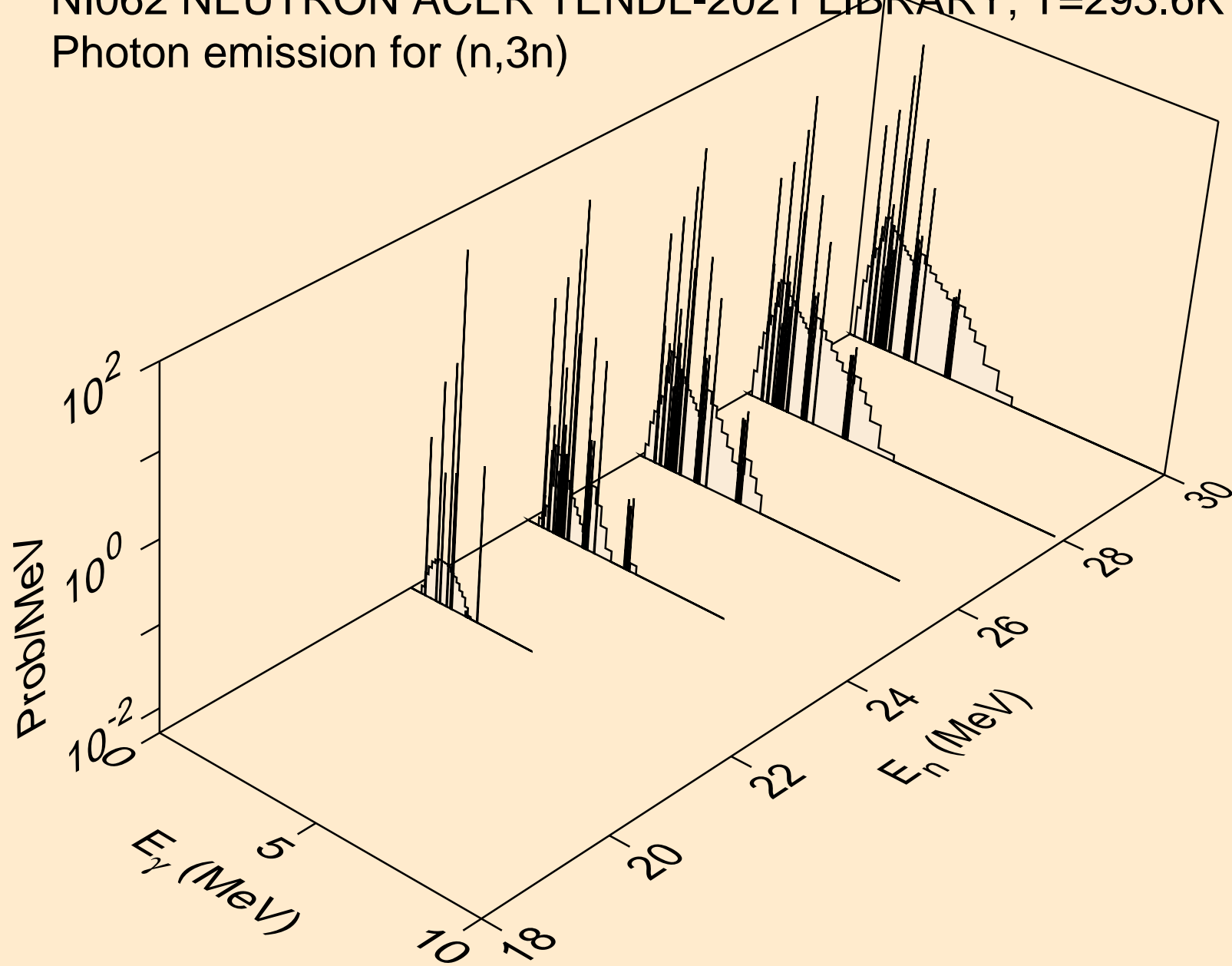

NI062 NEUTRON ACER TENDL-2021 LIBRARY; T=293.6K
Photon emission for (n,n*)a

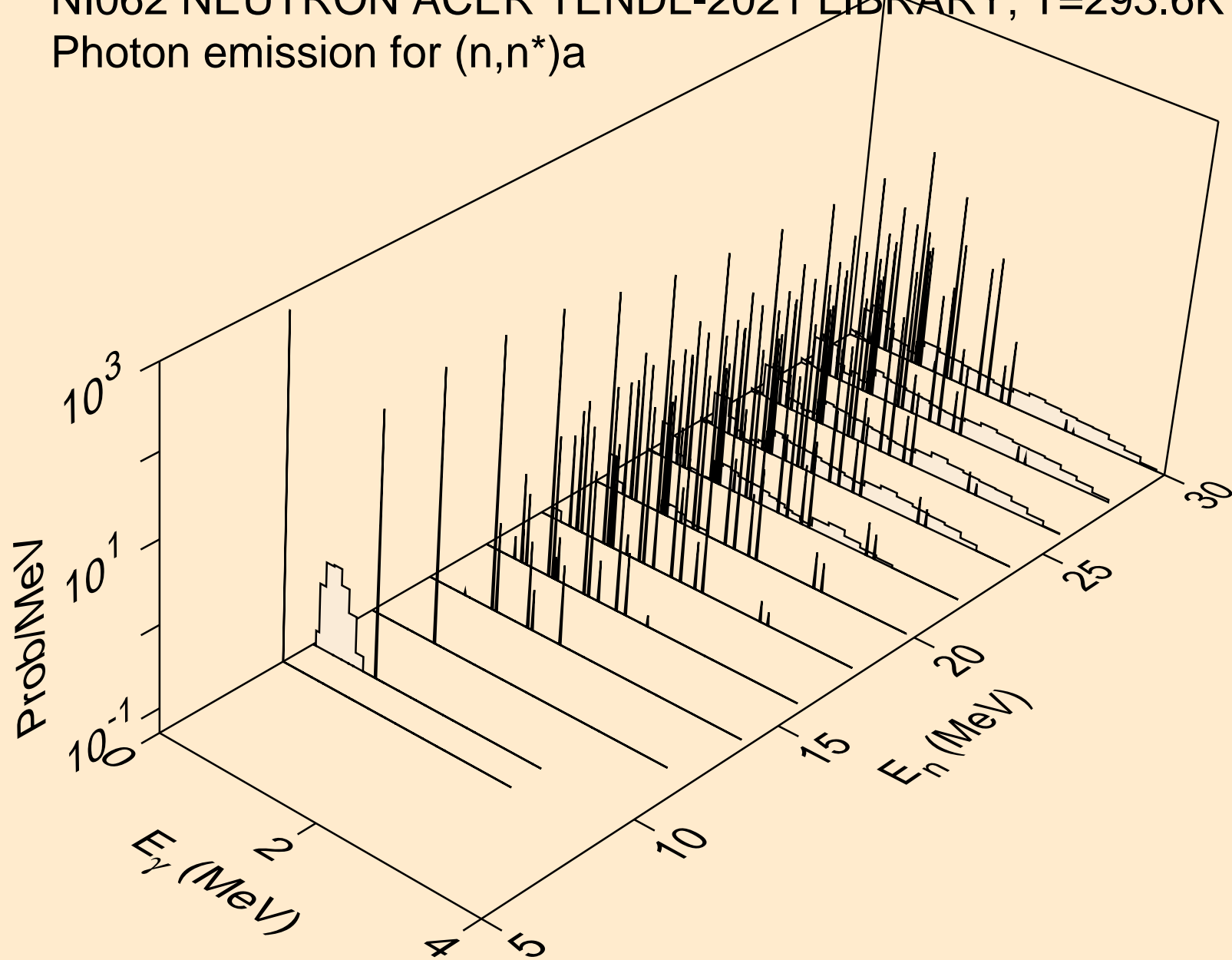

NI062 NEUTRON ACER TENDL-2021 LIBRARY; T=293.6K
Photon emission for (n,2n)a

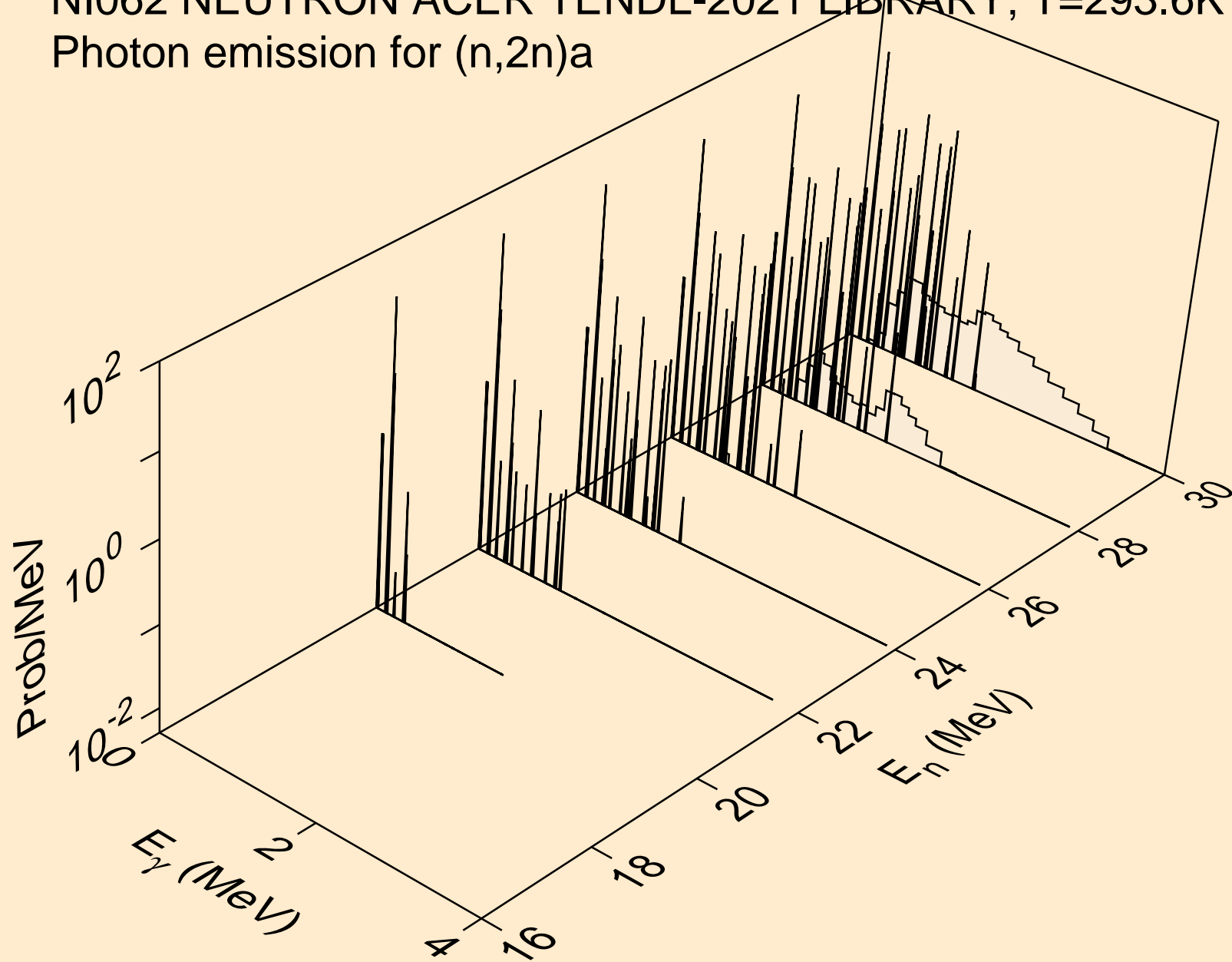

NI062 NEUTRON ACER TENDL-2021 LIBRARY; T=293.6K
Photon emission for (n,3n)a

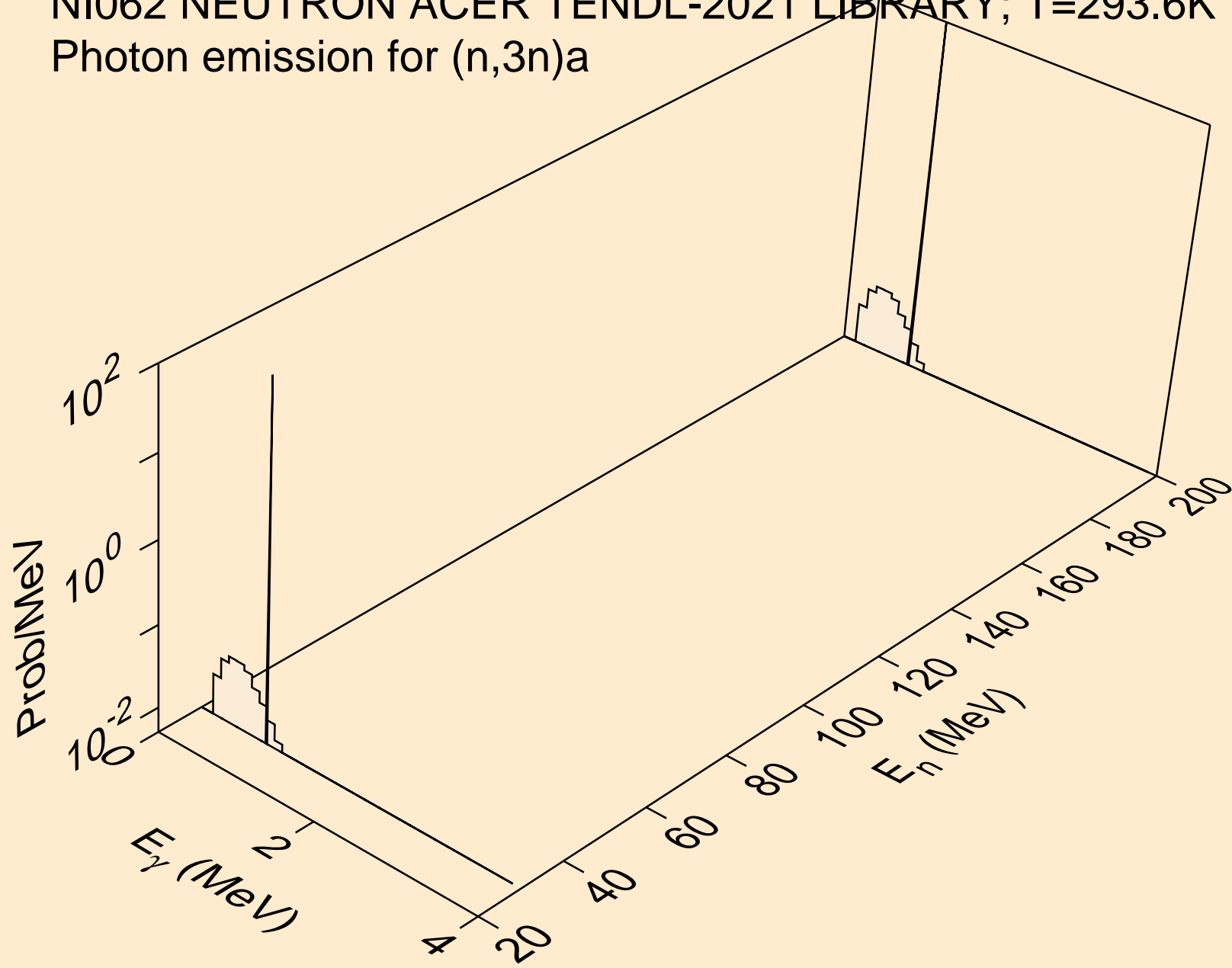

NI062 NEUTRON ACER TENDL-2021 LIBRARY; T=293.6K
Photon emission for (n,n*)p

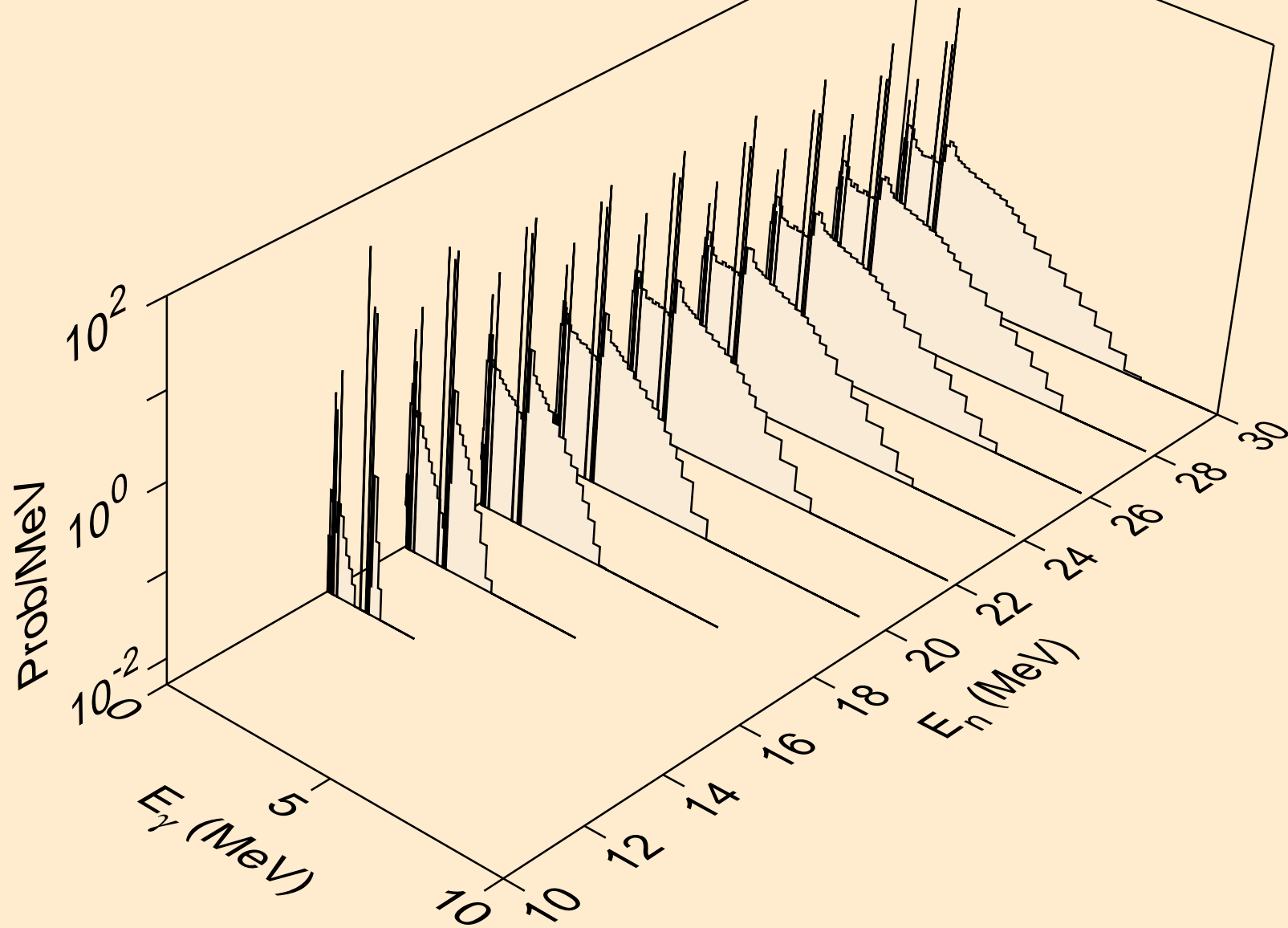

NI062 NEUTRON ACER TENDL-2021 LIBRARY; T=293.6K
Photon emission for (n,n*)2a

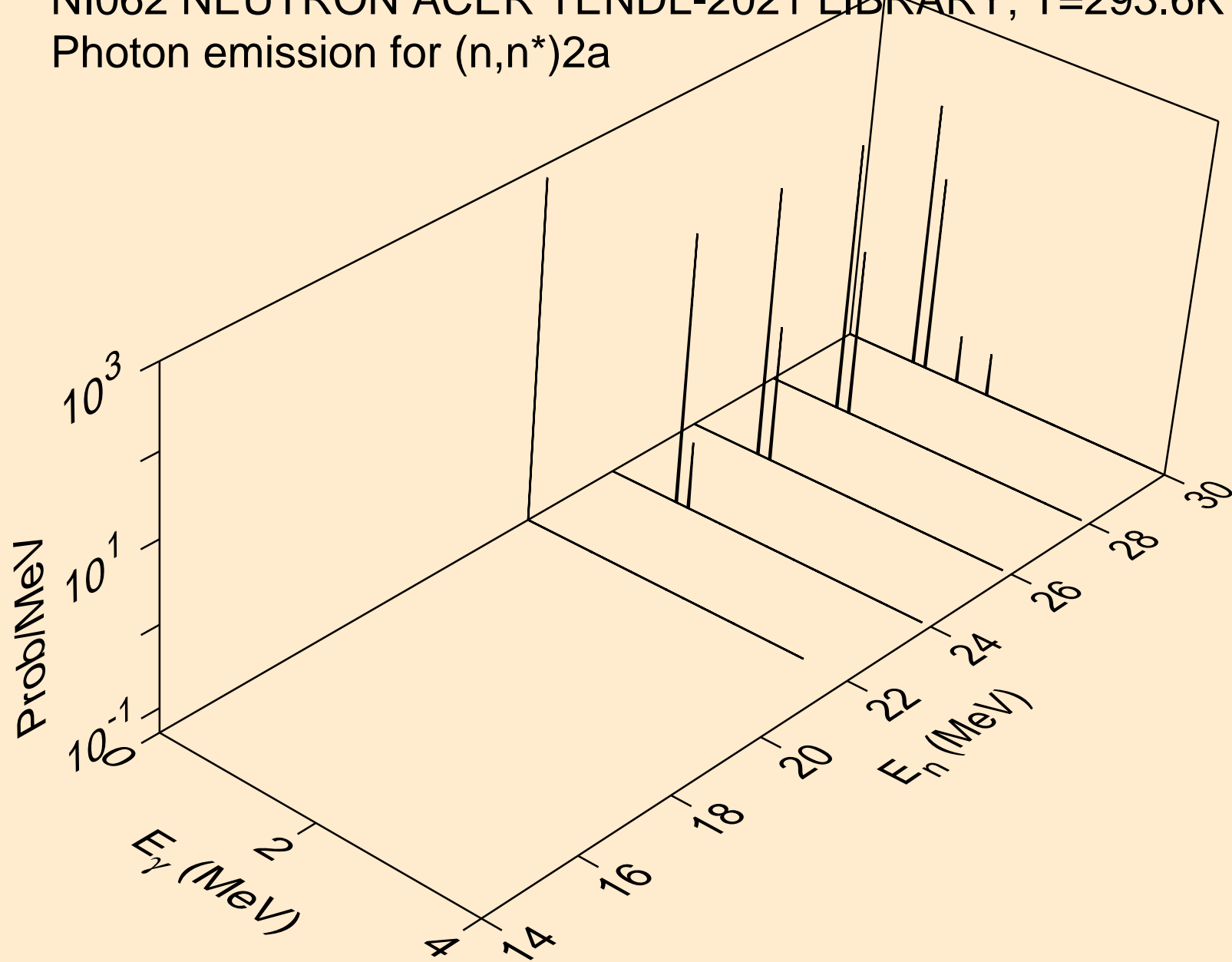

NI062 NEUTRON ACER TENDL-2021 LIBRARY; T=293.6K
Photon emission for (n,n*)d

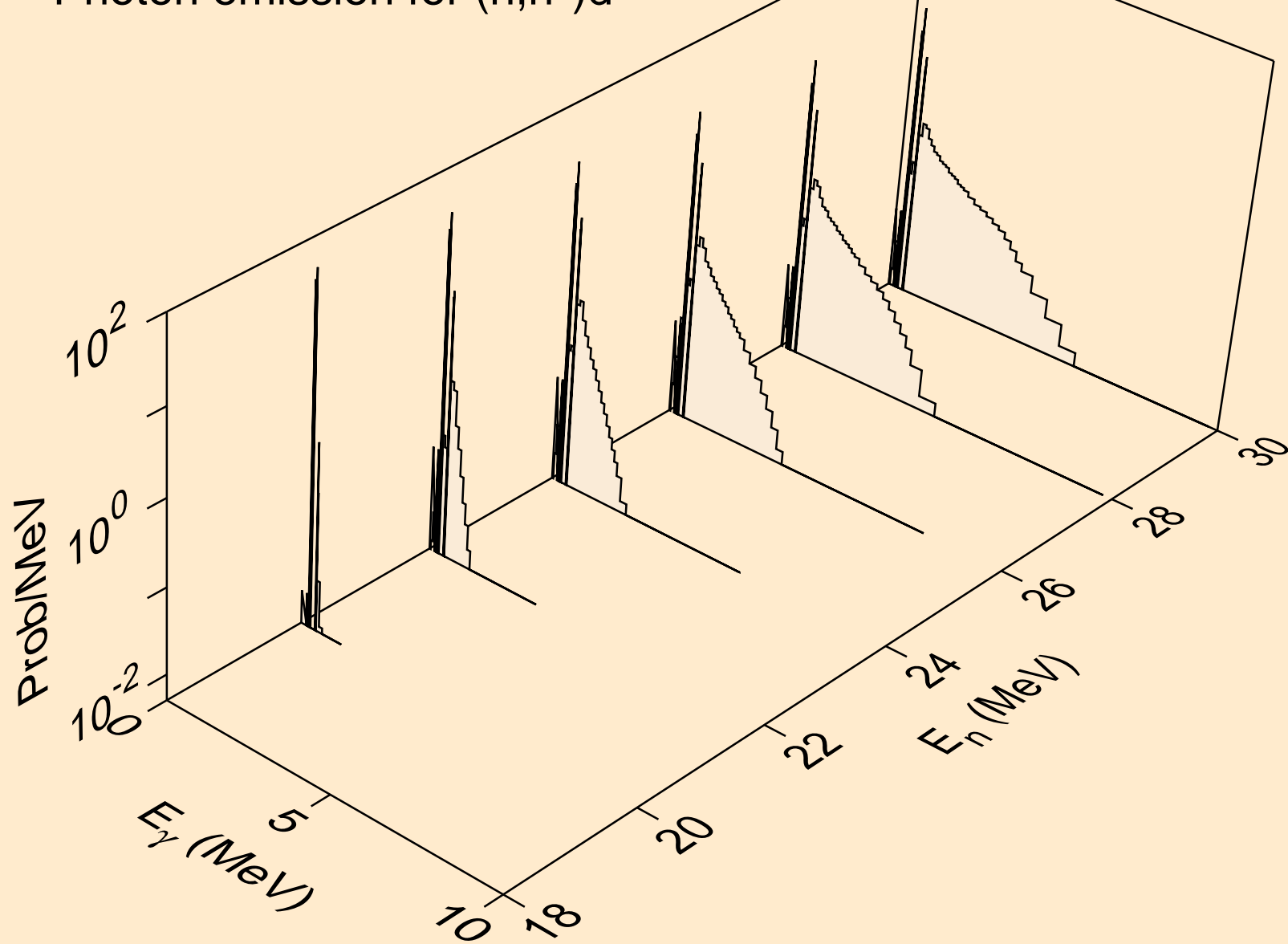

NI062 NEUTRON ACER TENDL-2021 LIBRARY; T=293.6K
Photon emission for (n,n*)t

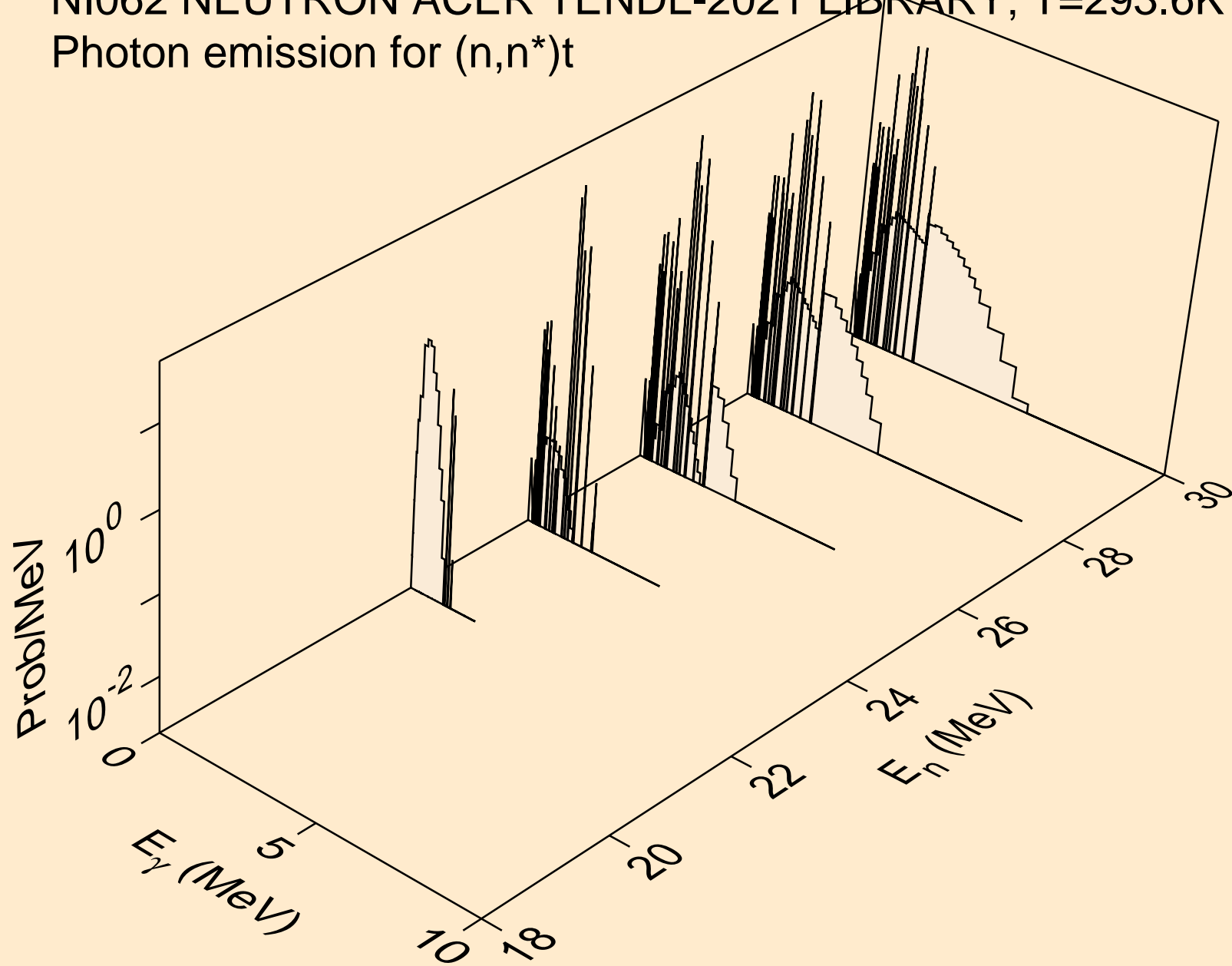

NI062 NEUTRON ACER TENDL-2021 LIBRARY; T=293.6K
Photon emission for (n,n*)he3

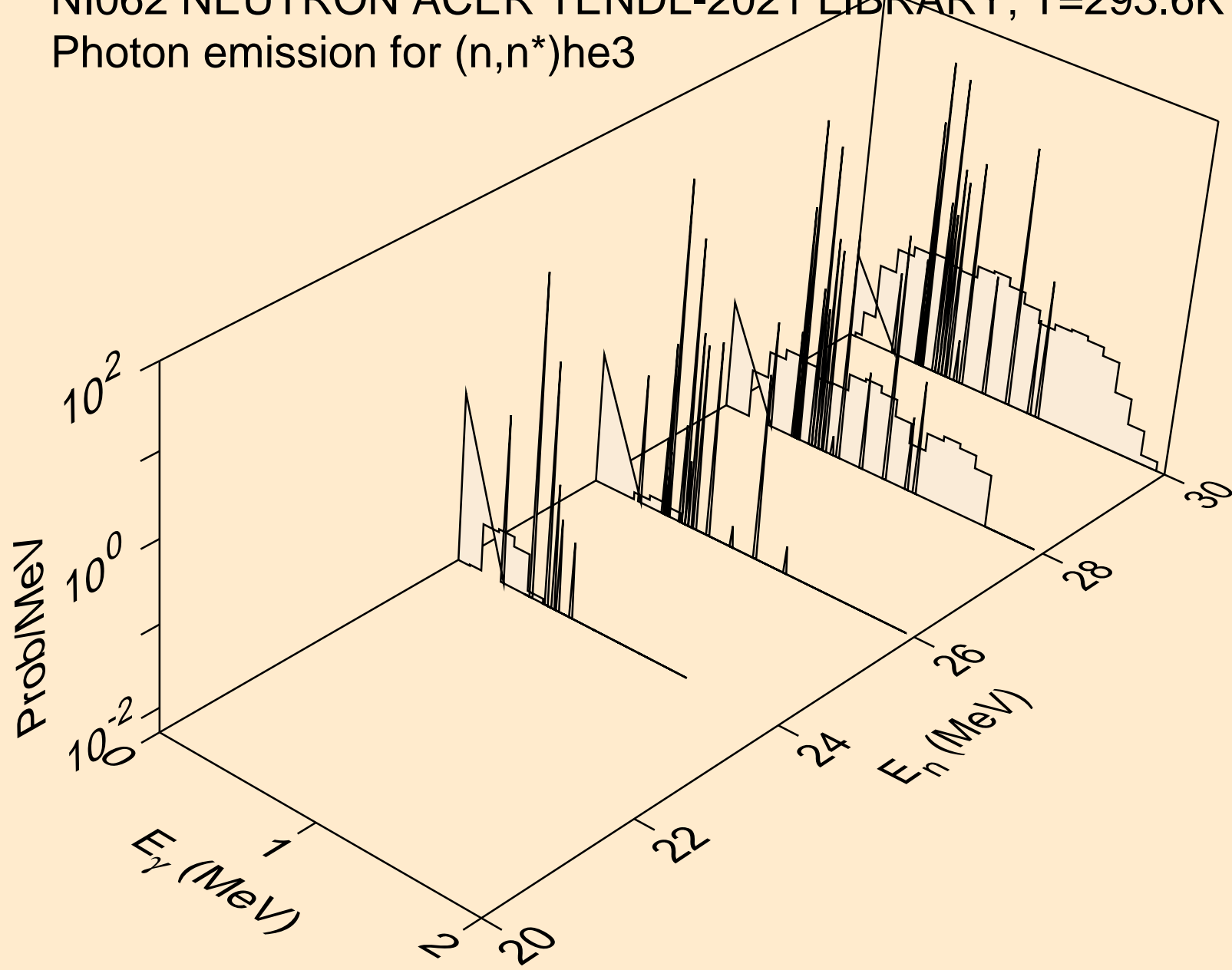

NI062 NEUTRON ACER TENDL-2021 LIBRARY; T=293.6K
Photon emission for (n,2np)

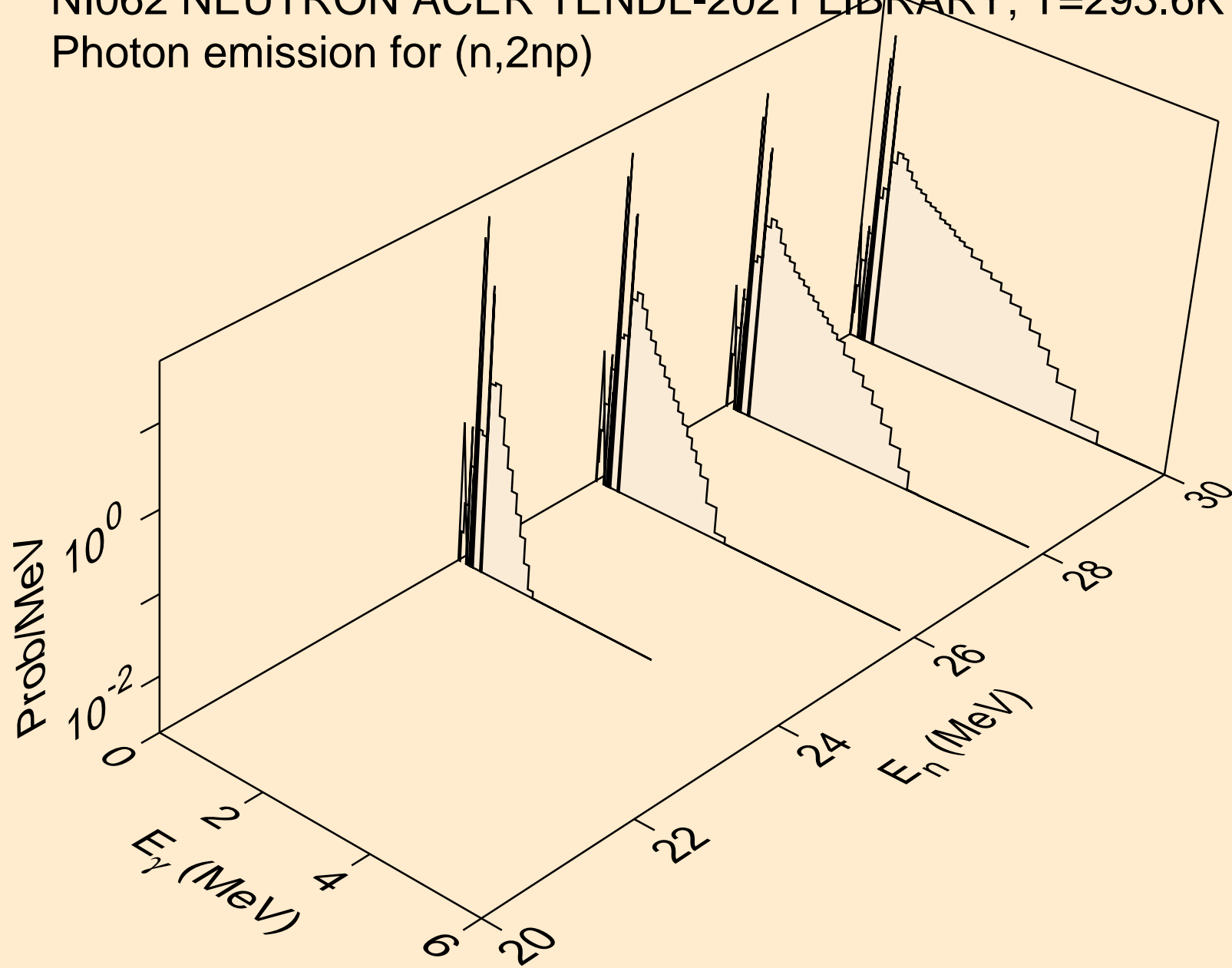

NI062 NEUTRON ACER TENDL-2021 LIBRARY; T=293.6K
Photon emission for (n,3np)

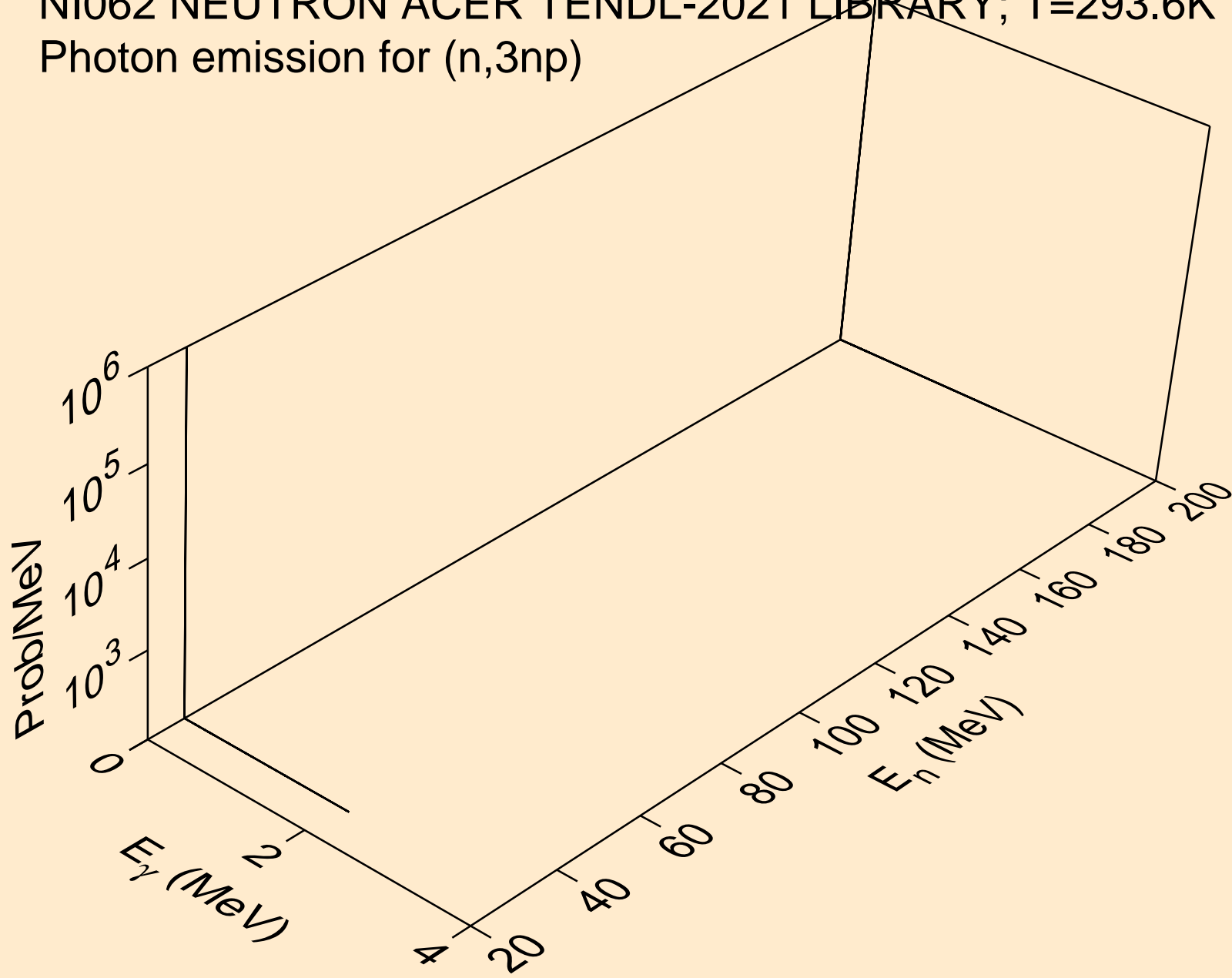

NI062 NEUTRON ACER TENDL-2021 LIBRARY; T=293.6K
Photon emission for (n,2np)

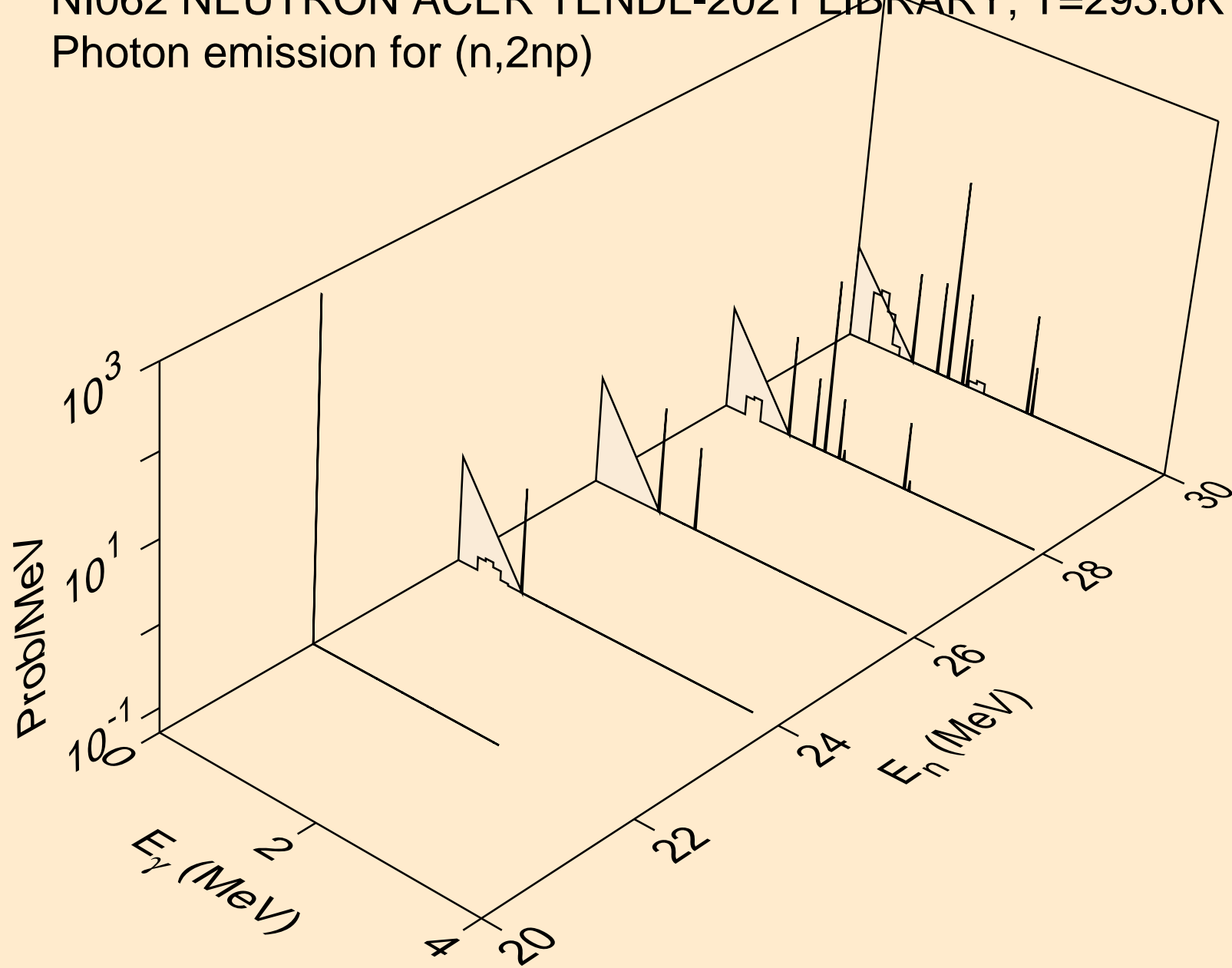

NI062 NEUTRON ACER TENDL-2021 LIBRARY; T=293.6K
Photon emission for (n,npa)

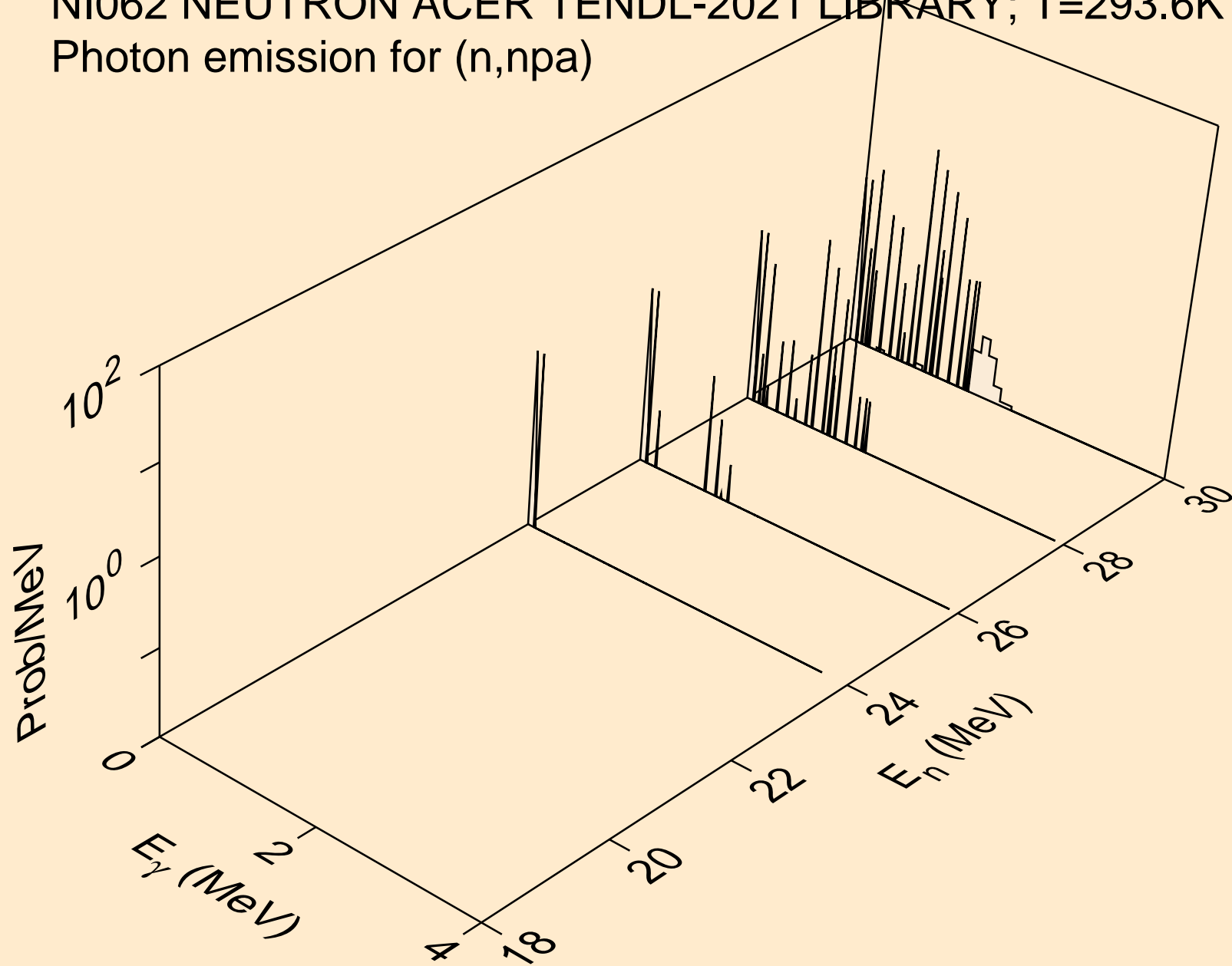

NI062 NEUTRON ACER TENDL-2021 LIBRARY; T=293.6K
Photon emission for (n,n*c)

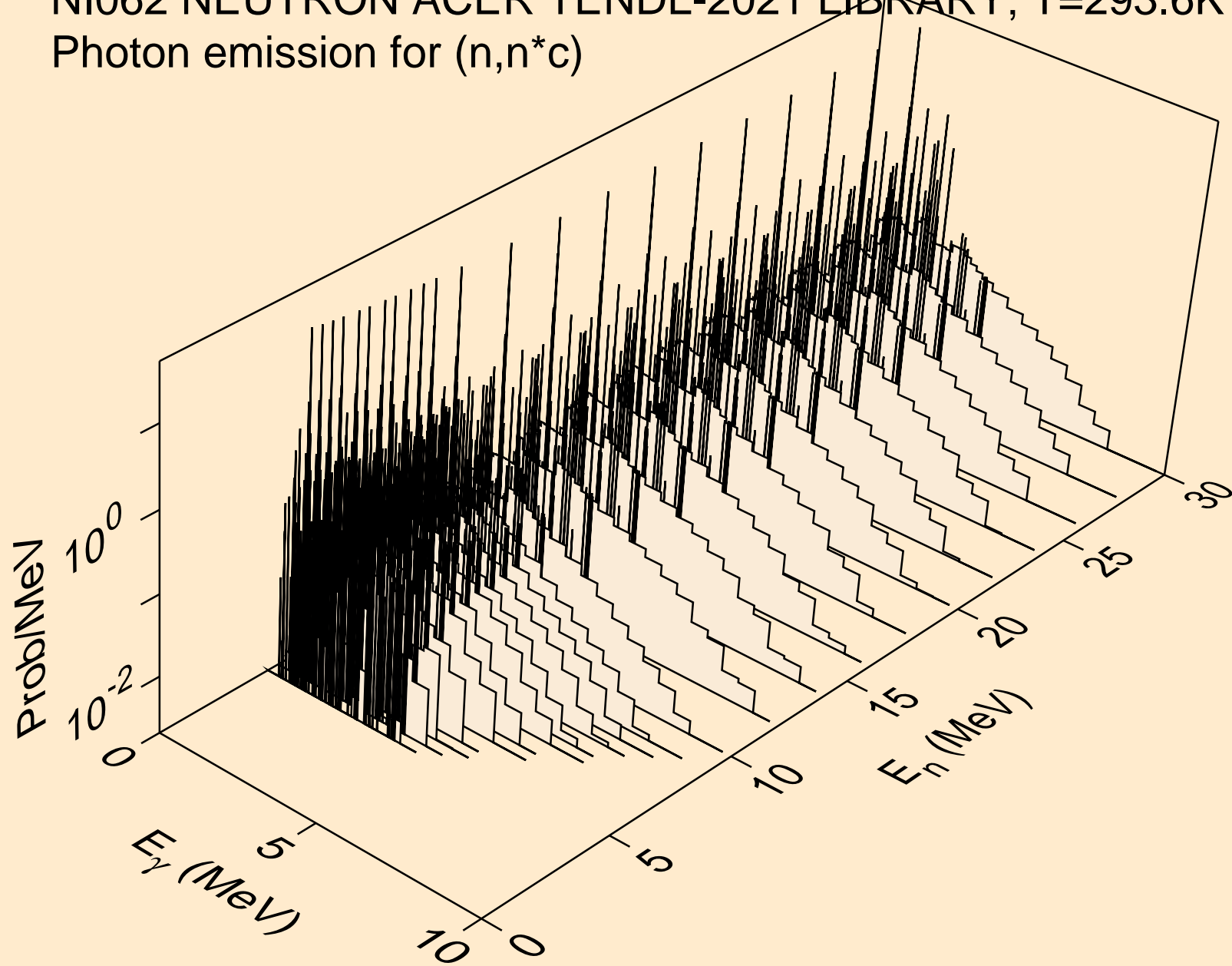

NI062 NEUTRON ACER TENDL-2021 LIBRARY; T=293.6K
Photon emission for (n,gma)

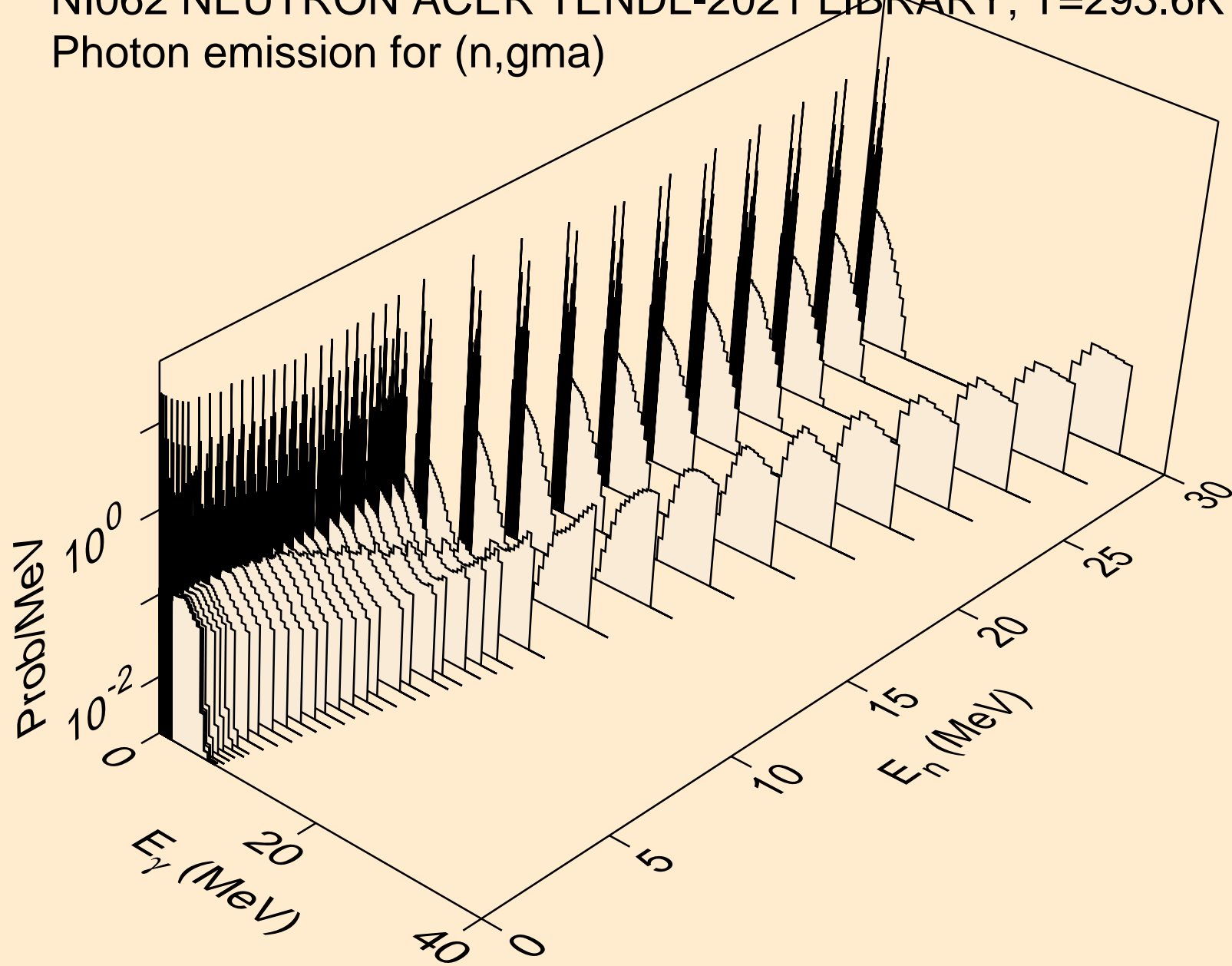

NI062 NEUTRON ACER TENDL-2021 LIBRARY; T=293.6K
Photon emission for (n,p)

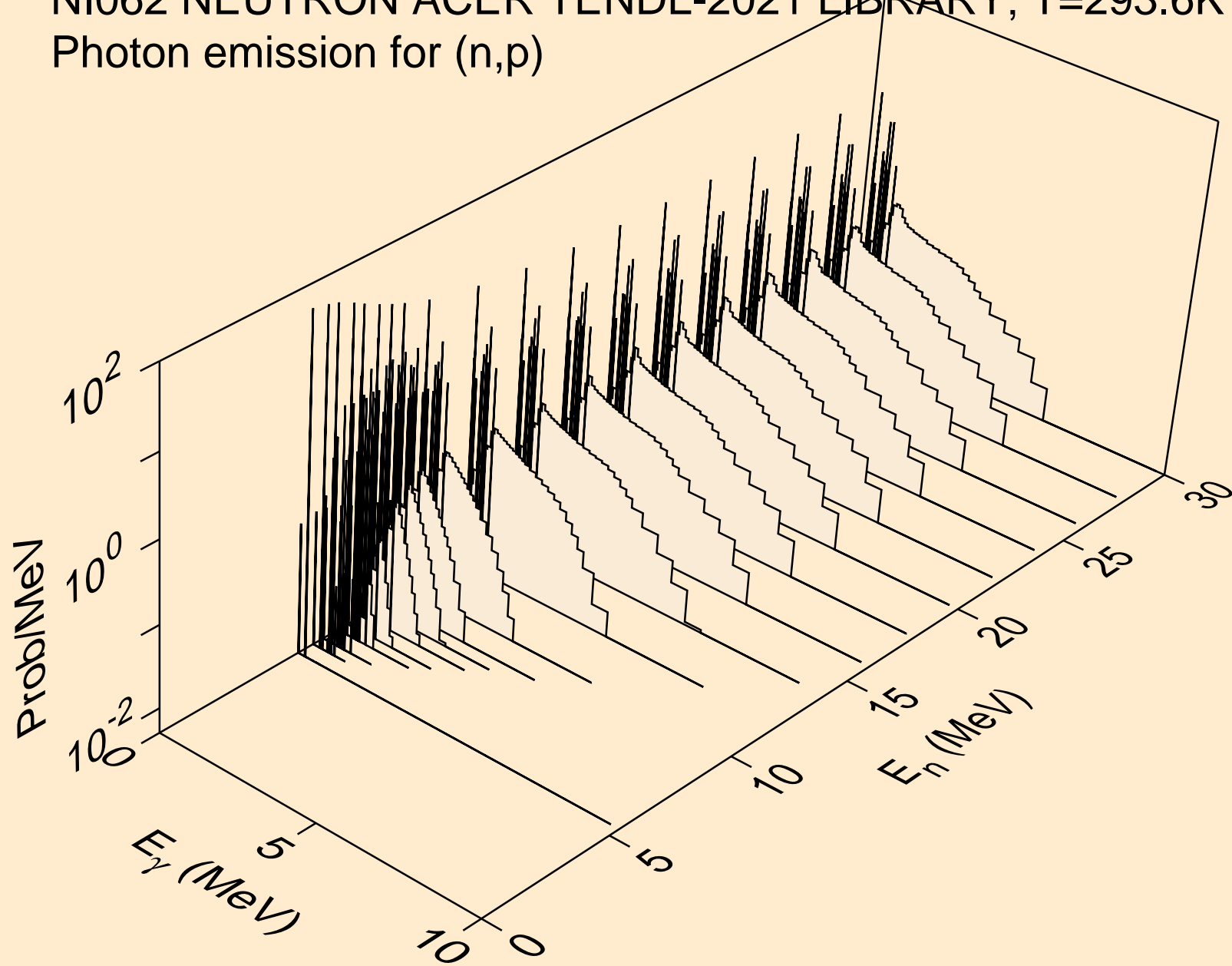

NI062 NEUTRON ACER TENDL-2021 LIBRARY; T=293.6K
Photon emission for (n,d)

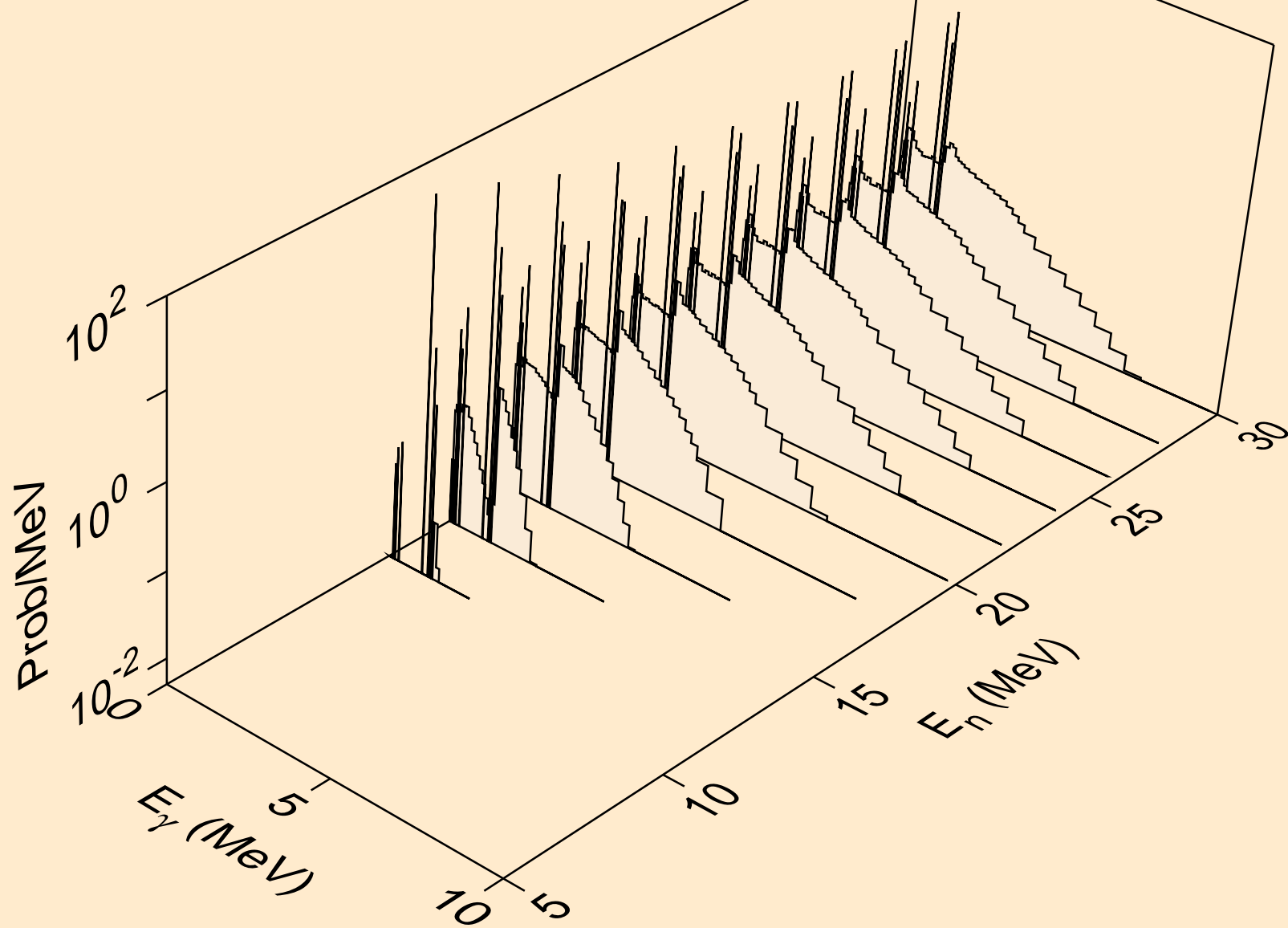

NI062 NEUTRON ACER TENDL-2021 LIBRARY; T=293.6K
Photon emission for (n,t)

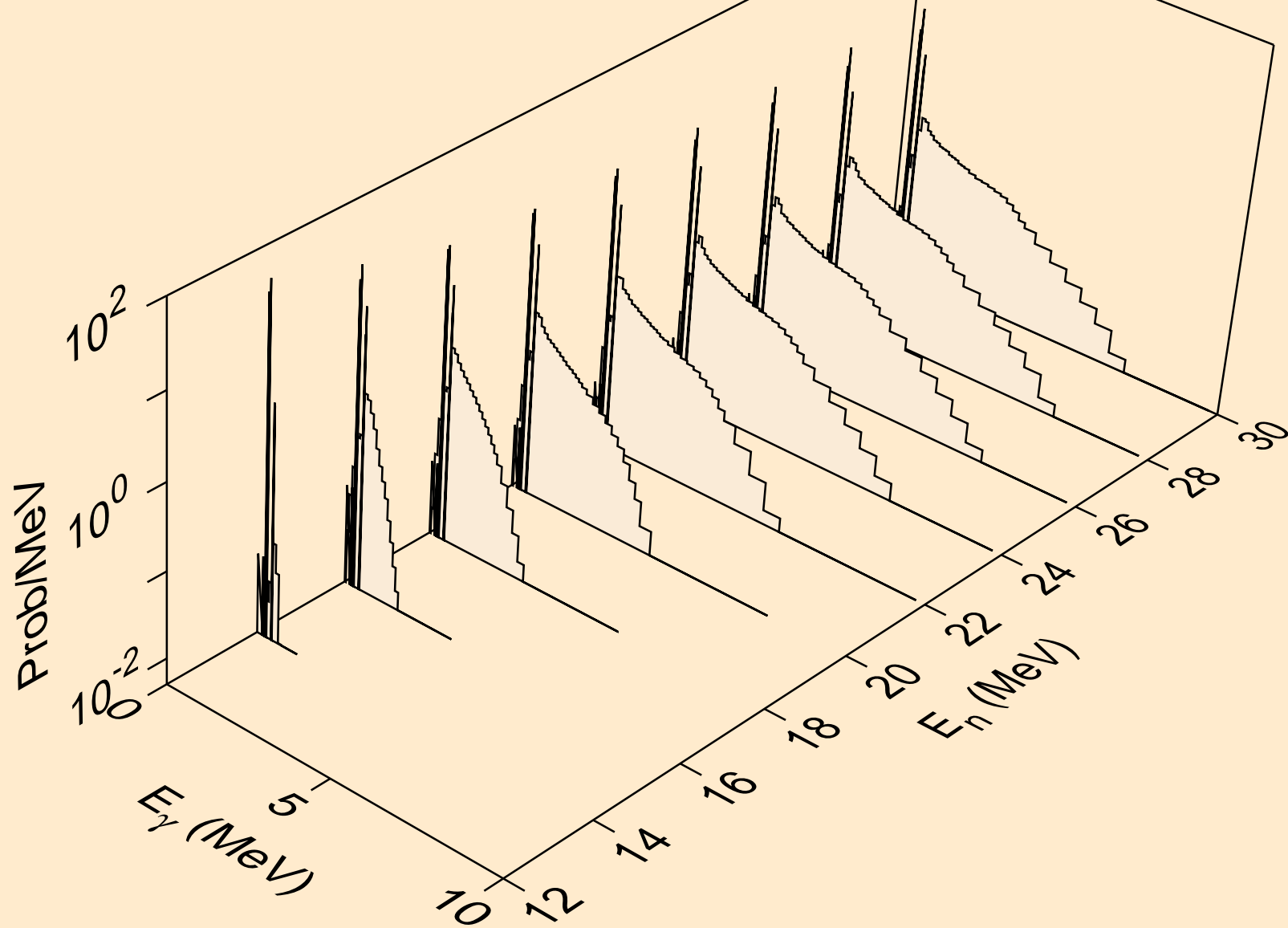

NI062 NEUTRON ACER TENDL-2021 LIBRARY; T=293.6K
Photon emission for (n,he3)

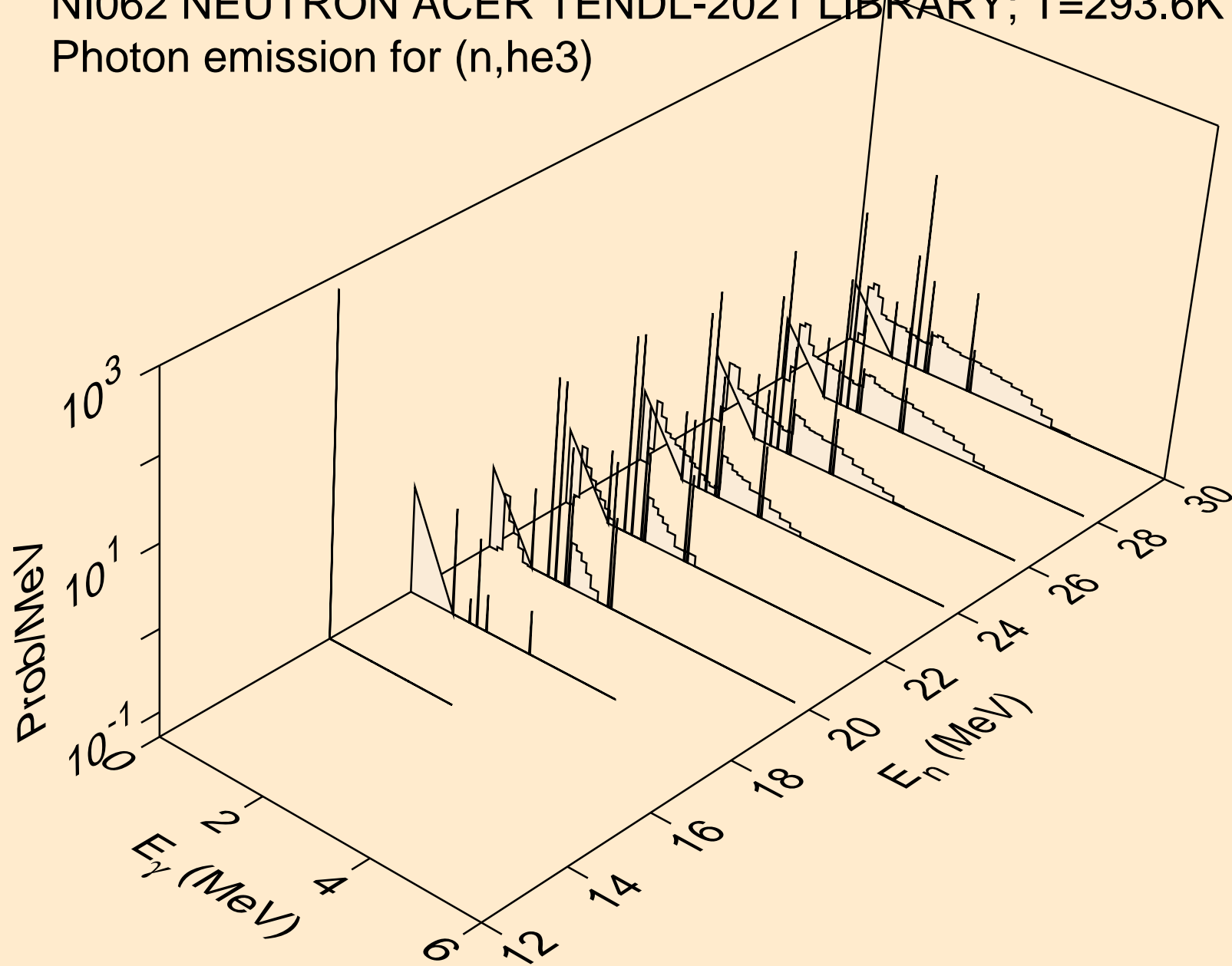

NI062 NEUTRON ACER TENDL-2021 LIBRARY; T=293.6K
Photon emission for (n,a)

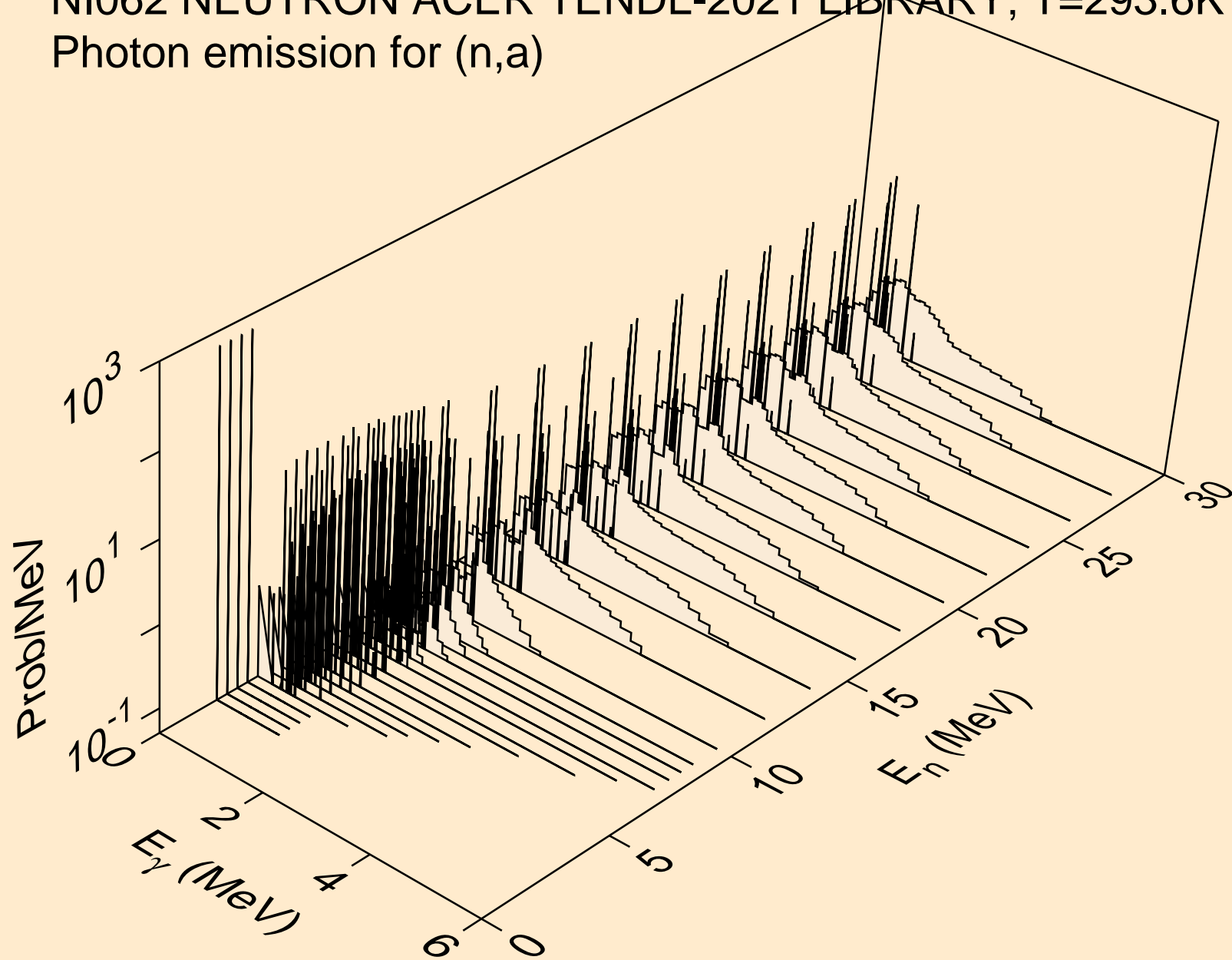

NI062 NEUTRON ACER TENDL-2021 LIBRARY; T=293.6K
Photon emission for (n,2a)

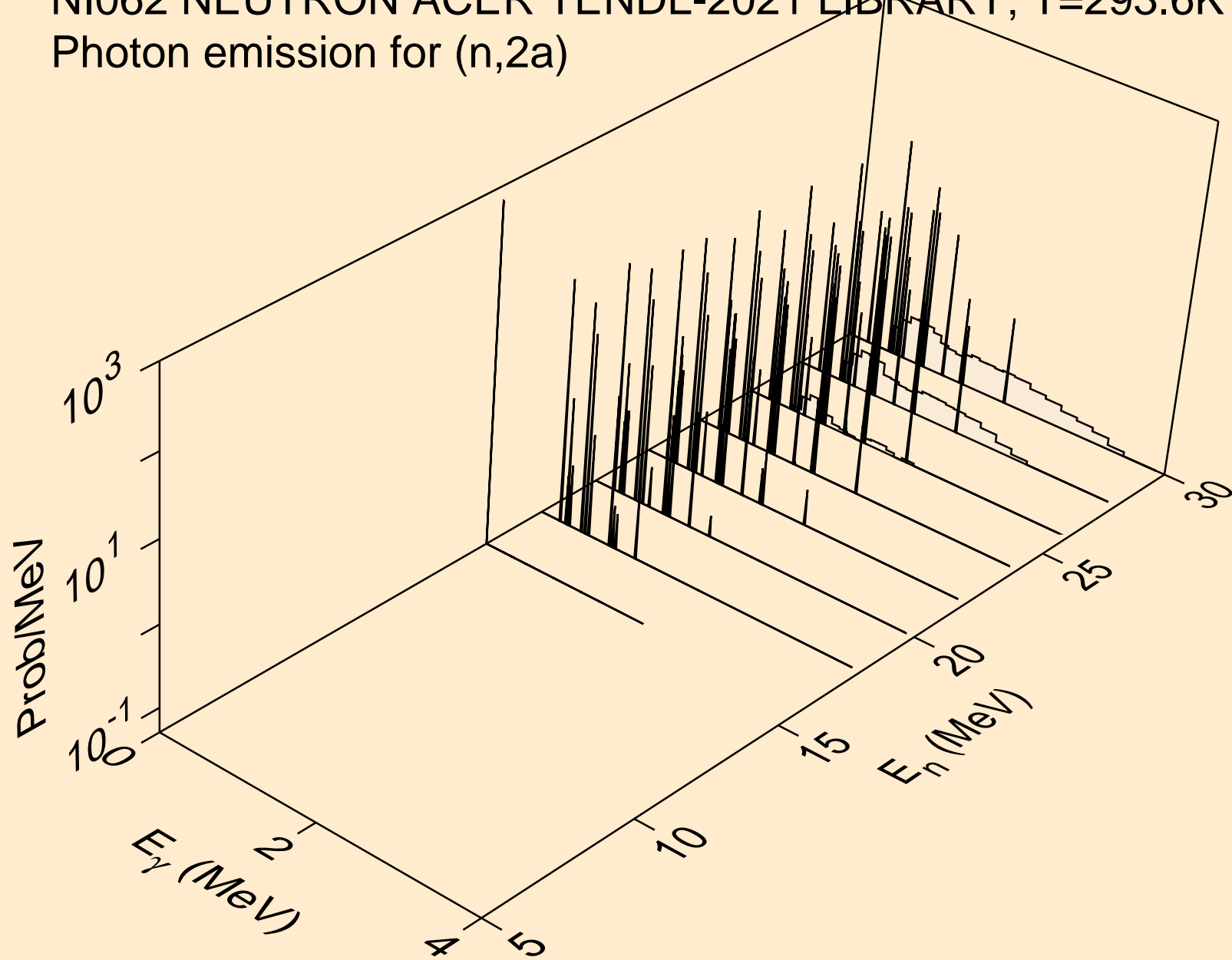

NI062 NEUTRON ACER TENDL-2021 LIBRARY; T=293.6K
Photon emission for (n,2p)

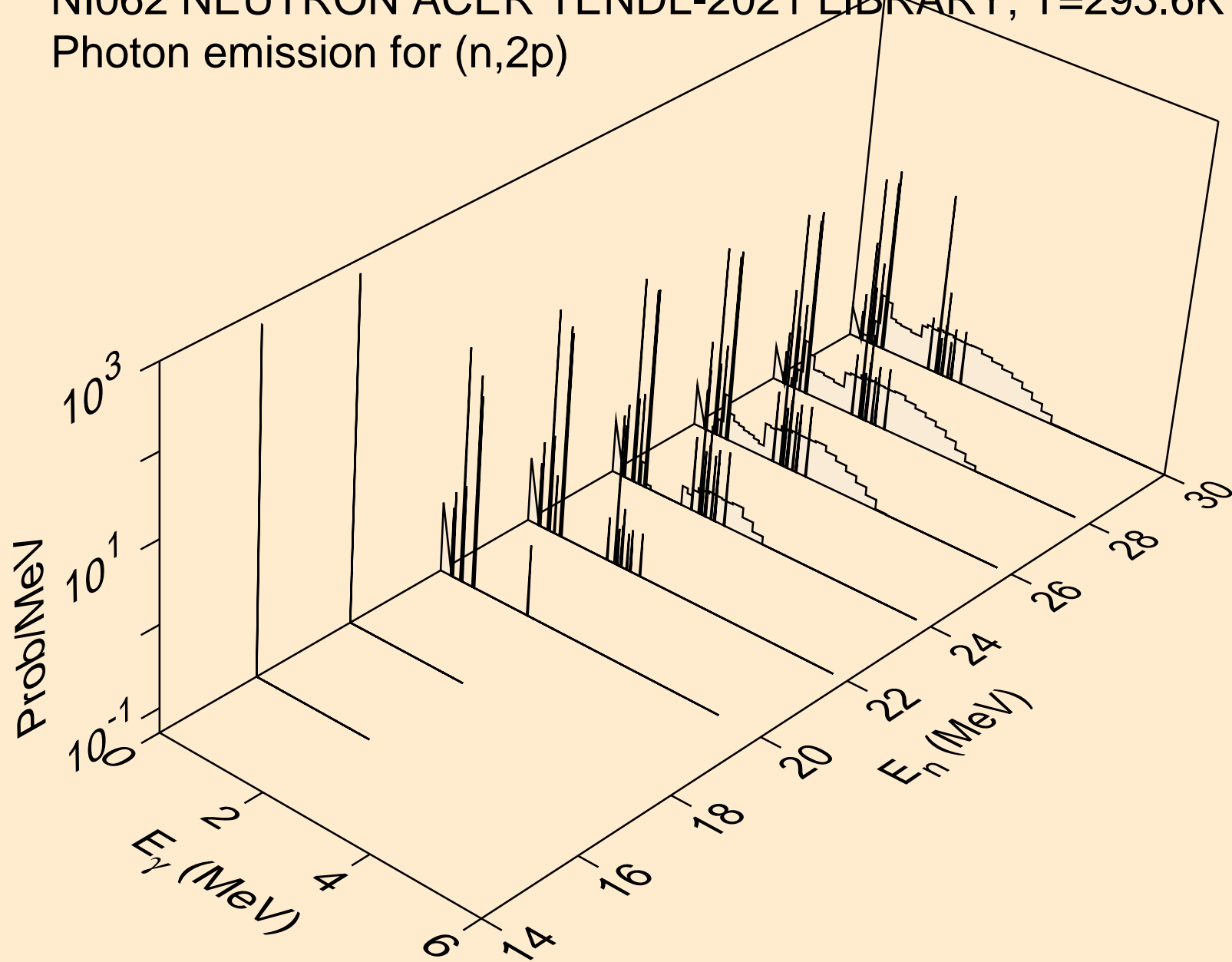

NI062 NEUTRON ACER TENDL-2021 LIBRARY; T=293.6K
Photon emission for (n,p α)

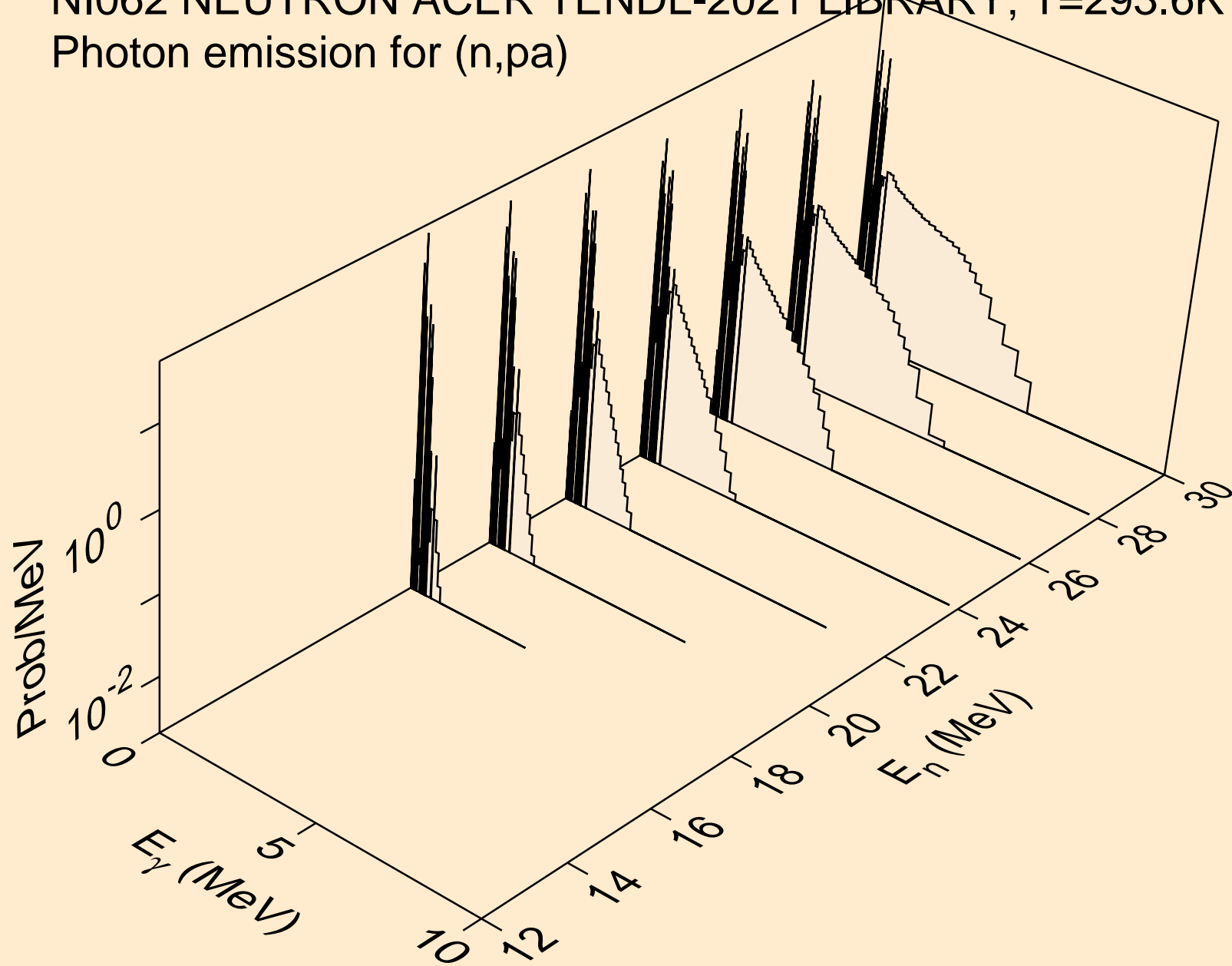

NI062 NEUTRON ACER TENDL-2021 LIBRARY; T=293.6K
Photon emission for (n,pd)

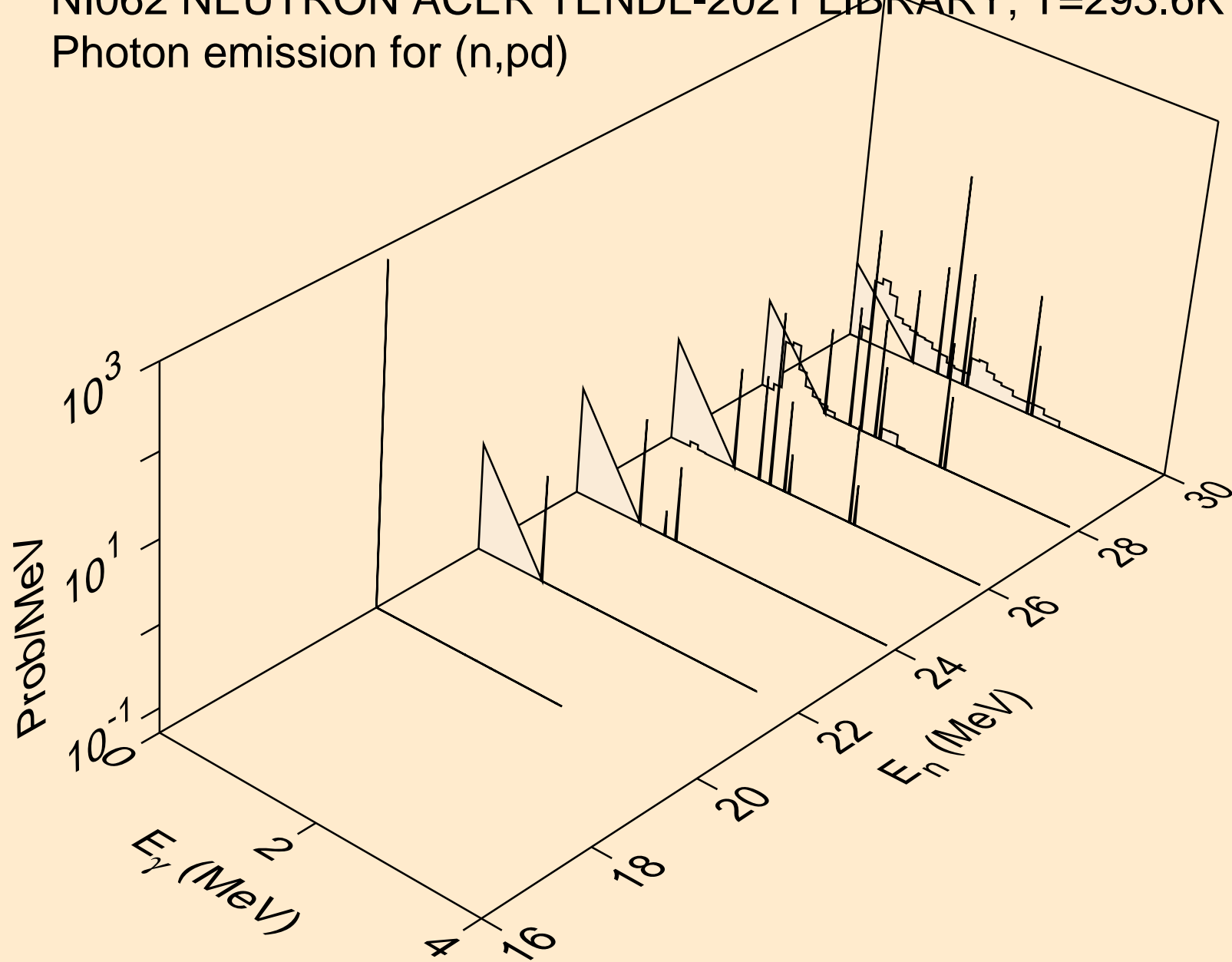

NI062 NEUTRON ACER TENDL-2021 LIBRARY; T=293.6K
Photon emission for (n,pt)

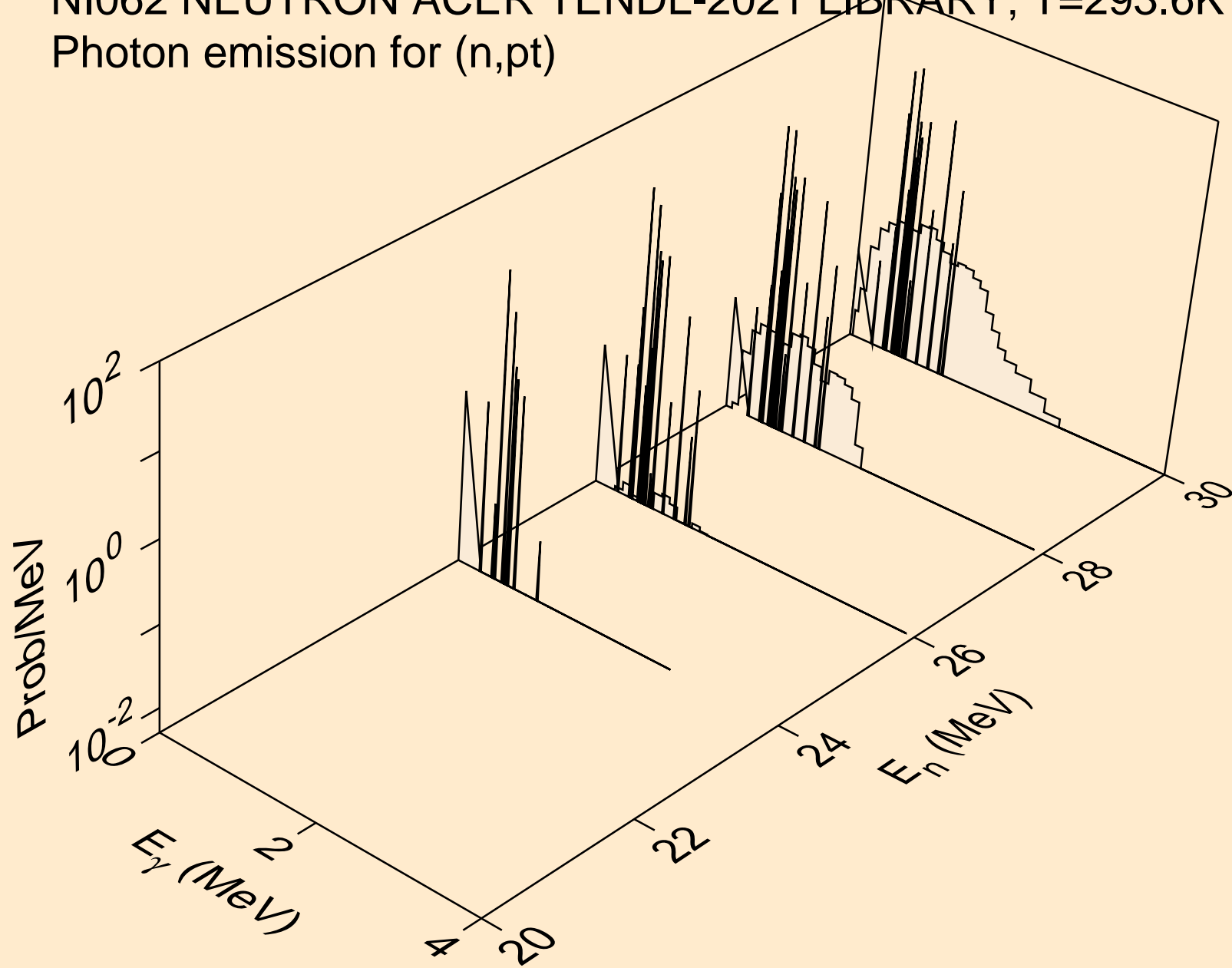

NI062 NEUTRON ACER TENDL-2021 LIBRARY; T=293.6K
Photon emission for (n,da)

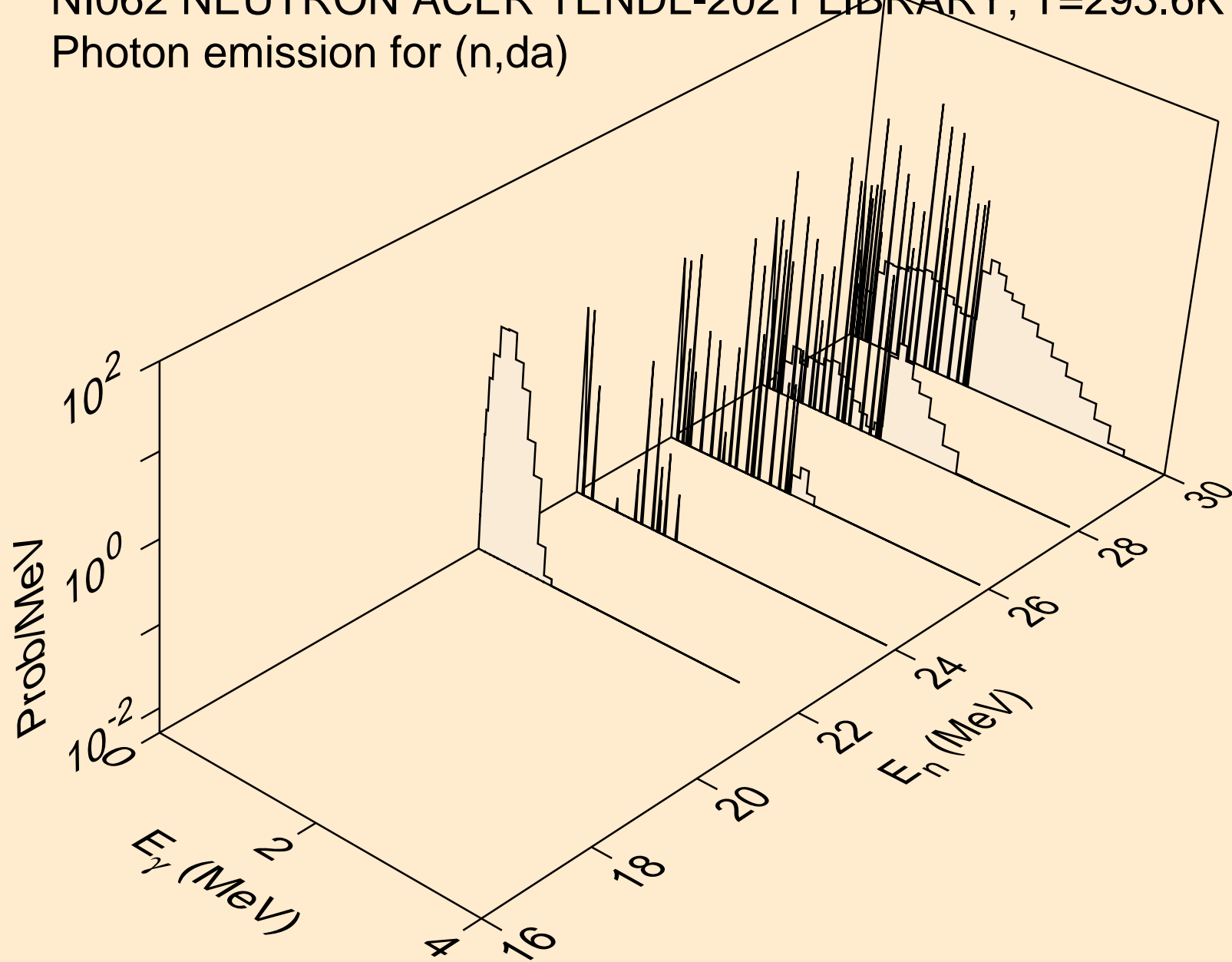

NI062 NEUTRON ACER TENDL-2021 LIBRARY; T=293.6K
thermal capture photon spectrum

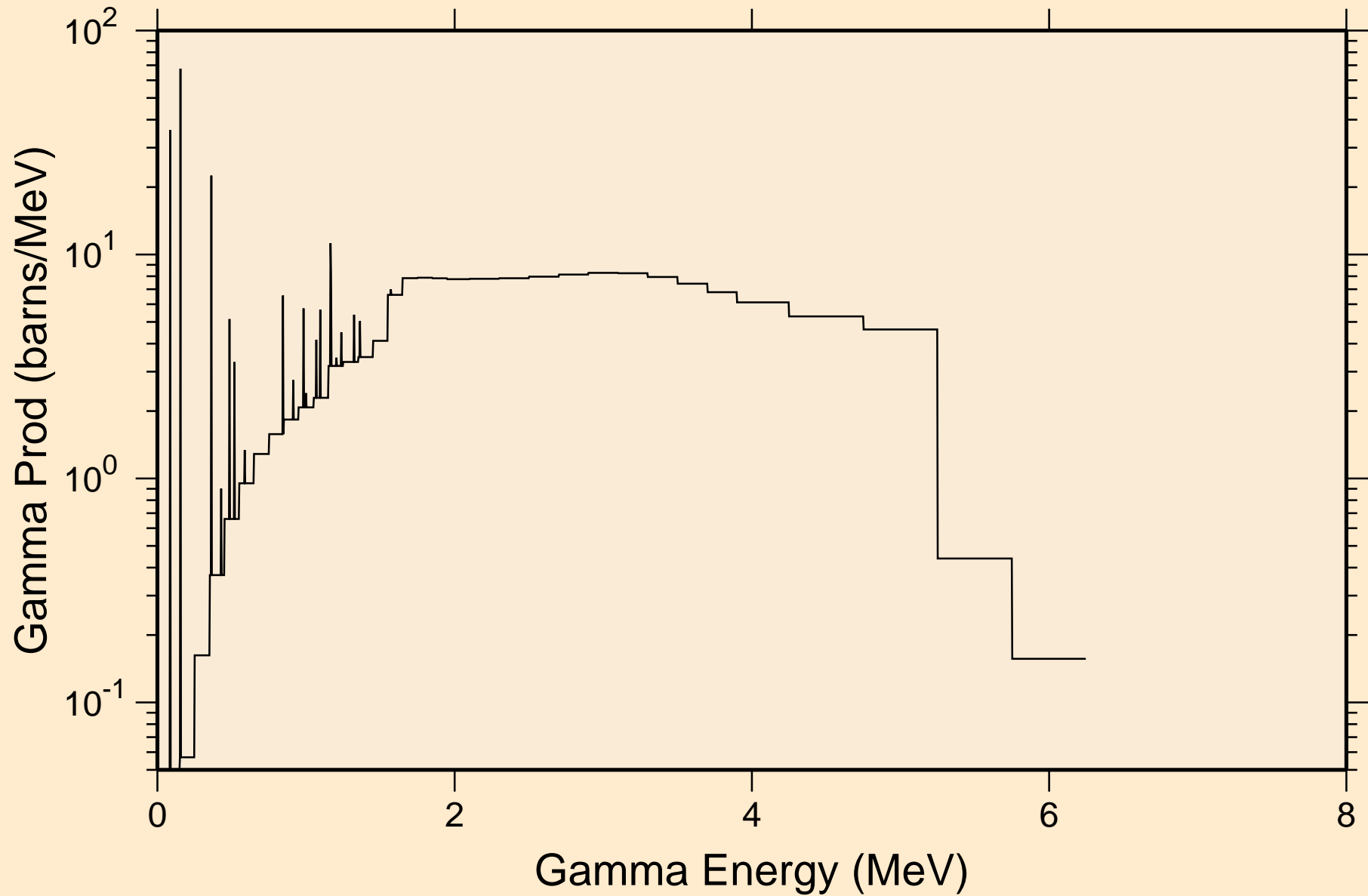

NI062 NEUTRON ACER TENDL-2021 LIBRARY; T=293.6K
14 MeV photon spectrum

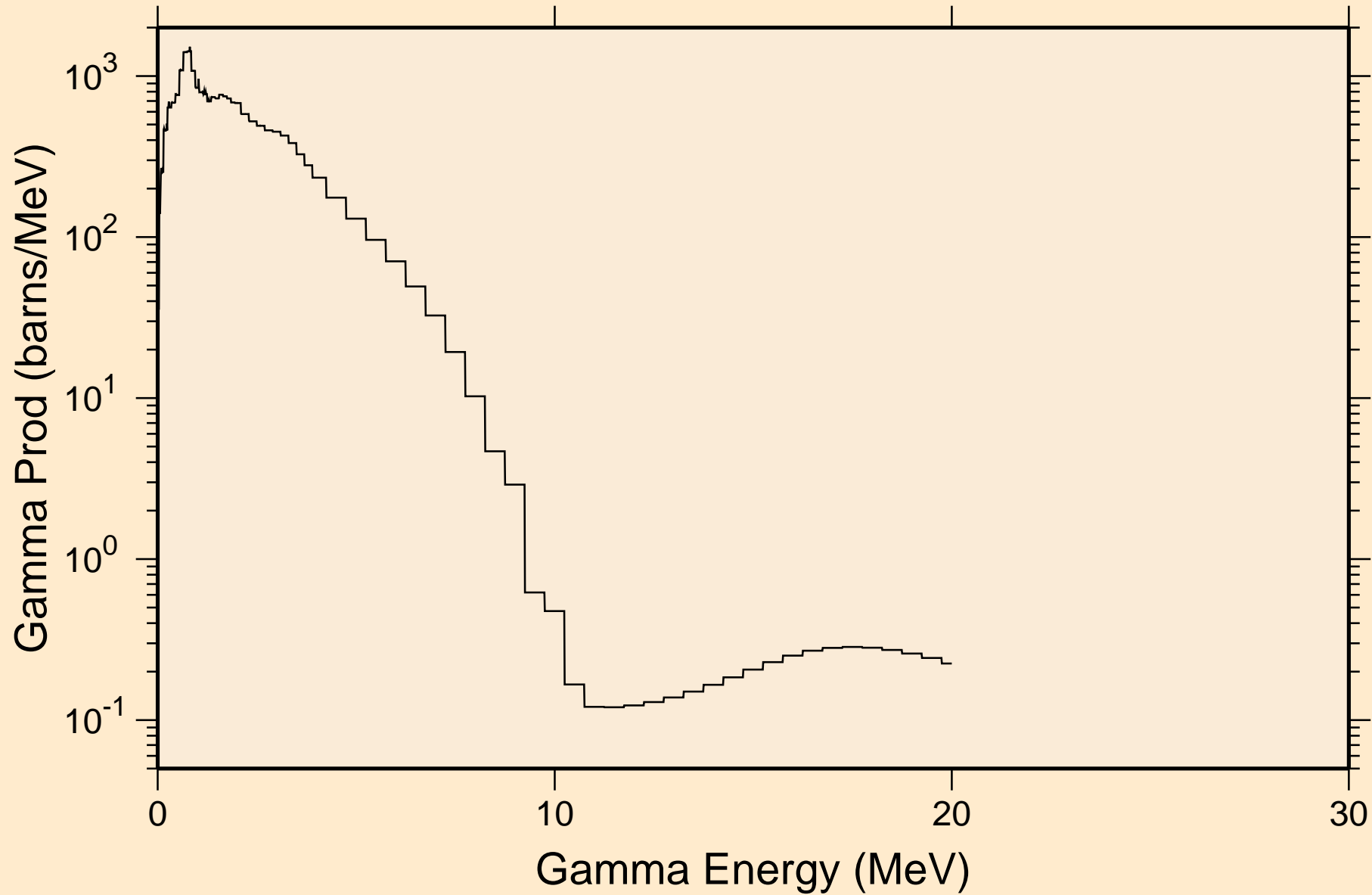

NI062 NEUTRON ACER TENDL-2021 LIBRARY; T=293.6K

Particle heating contributions

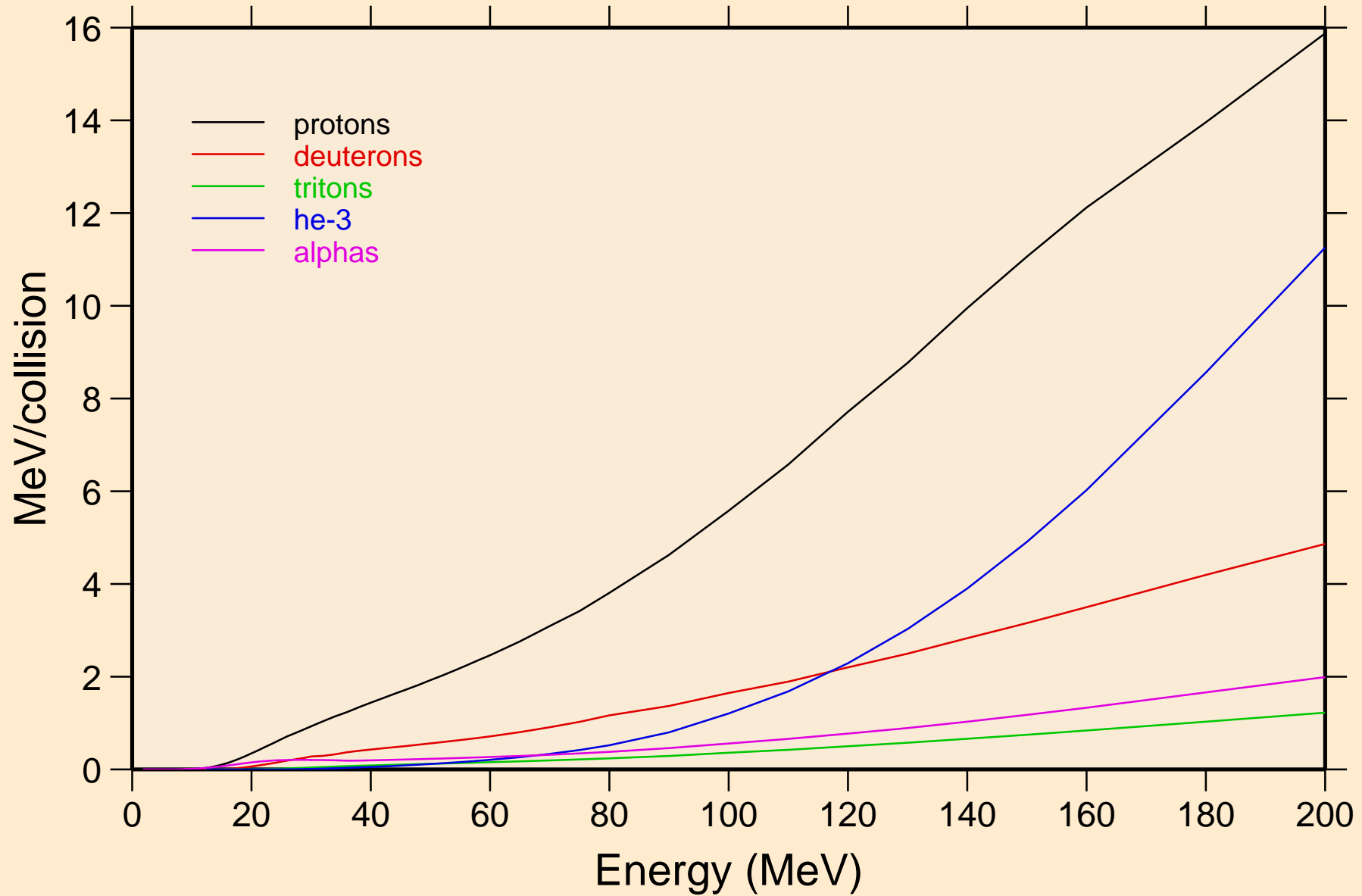

NI062 NEUTRON ACER TENDL-2021 LIBRARY; T=293.6K
Recoil Heating

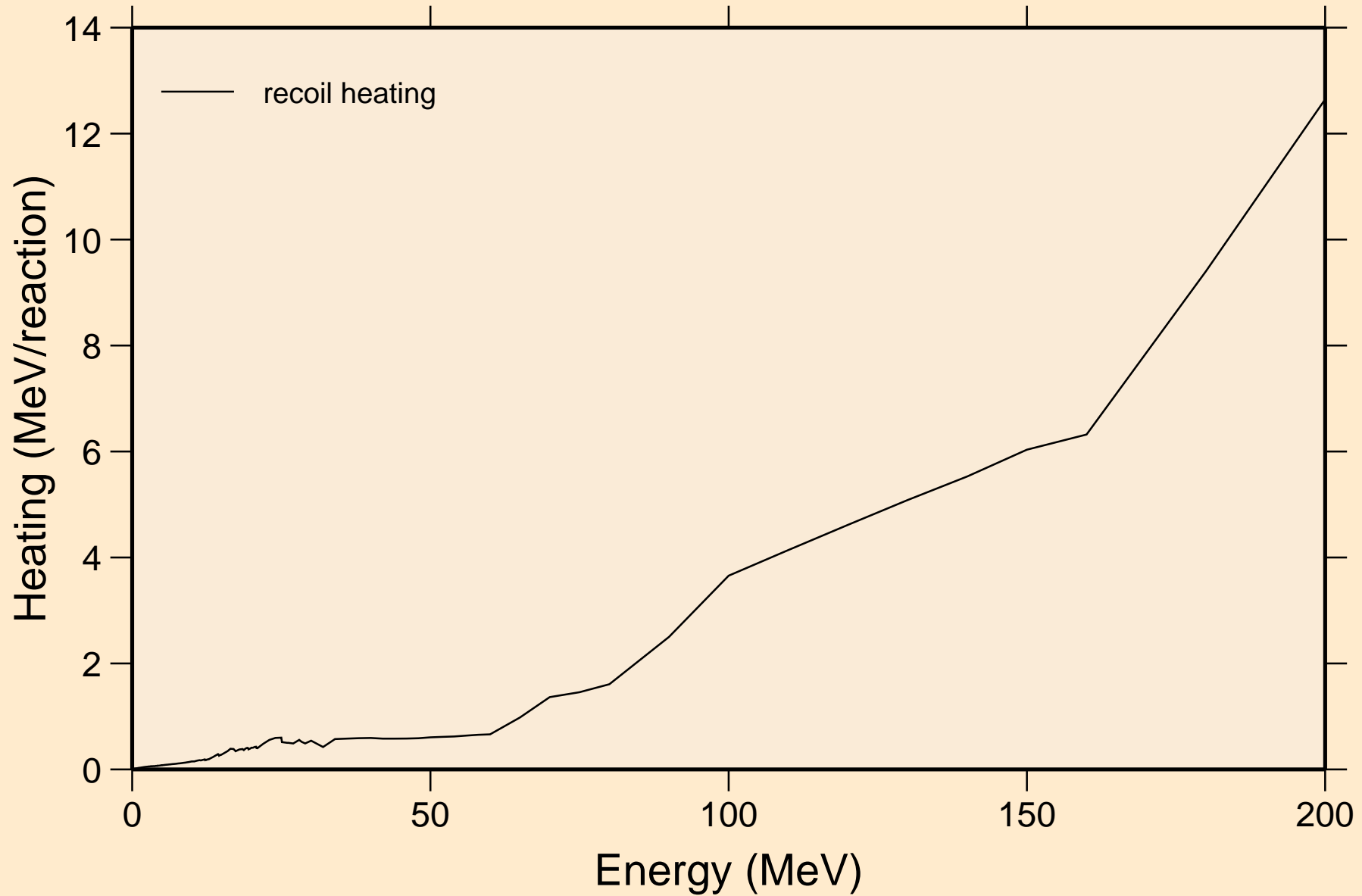

NI062 NEUTRON ACER TENDL-2021 LIBRARY; T=293.6K
Particle production cross sections

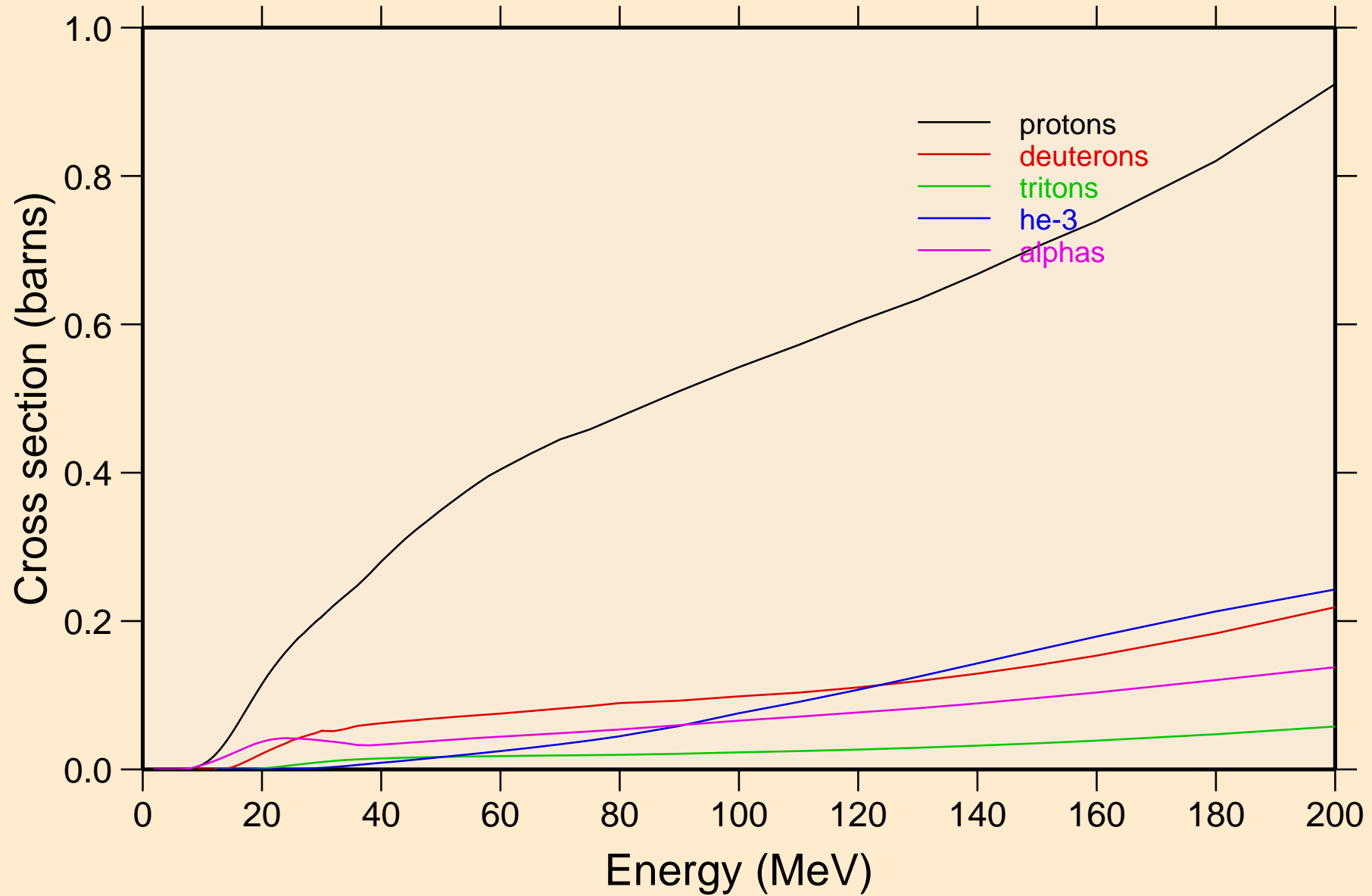

NI062 NEUTRON ACER TENDL-2021 LIBRARY; T=293.6K
protons from (n,x)

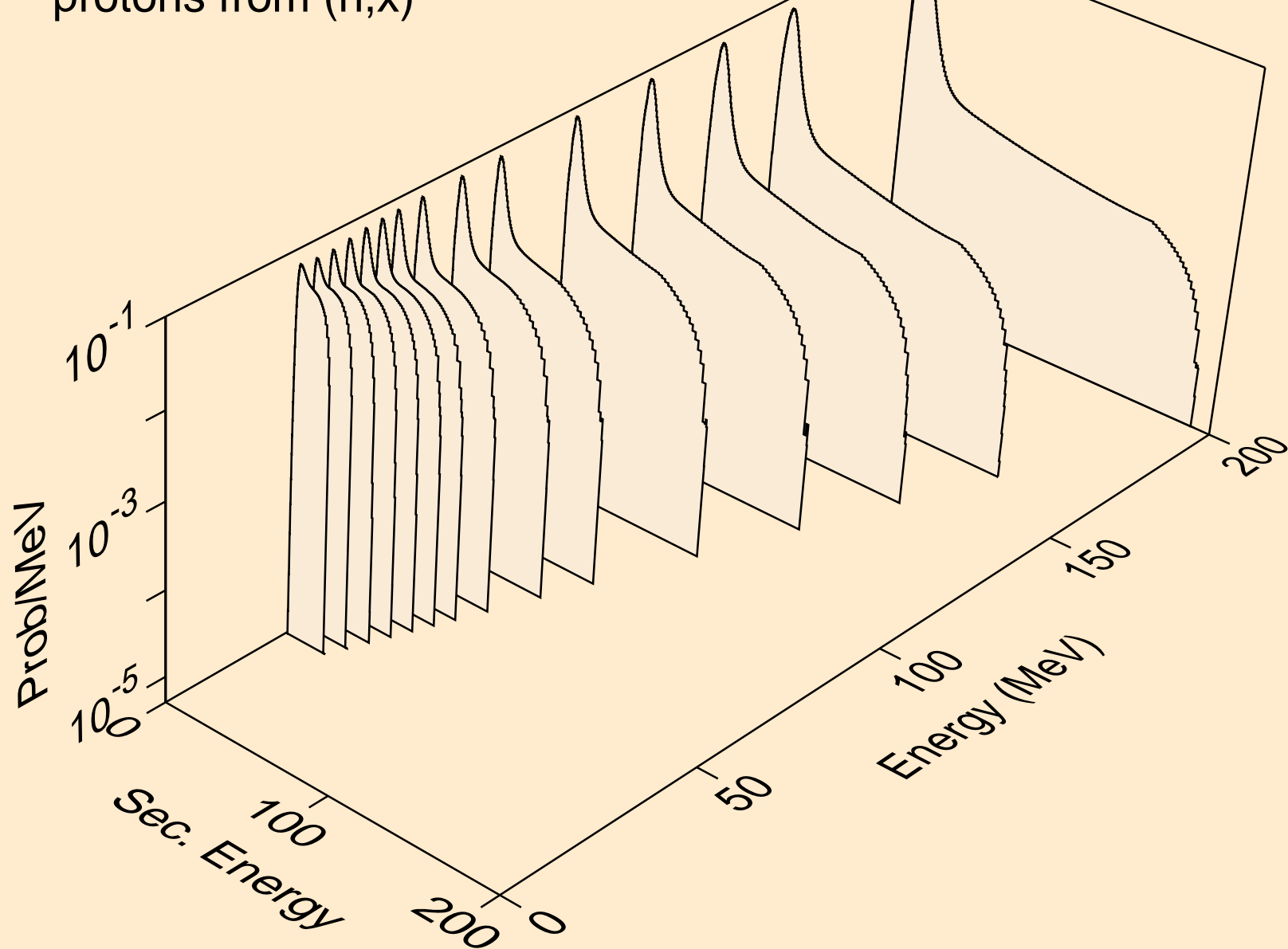

NI062 NEUTRON ACER TENDL-2021 LIBRARY; T=293.6K
protons from (n,n*)p

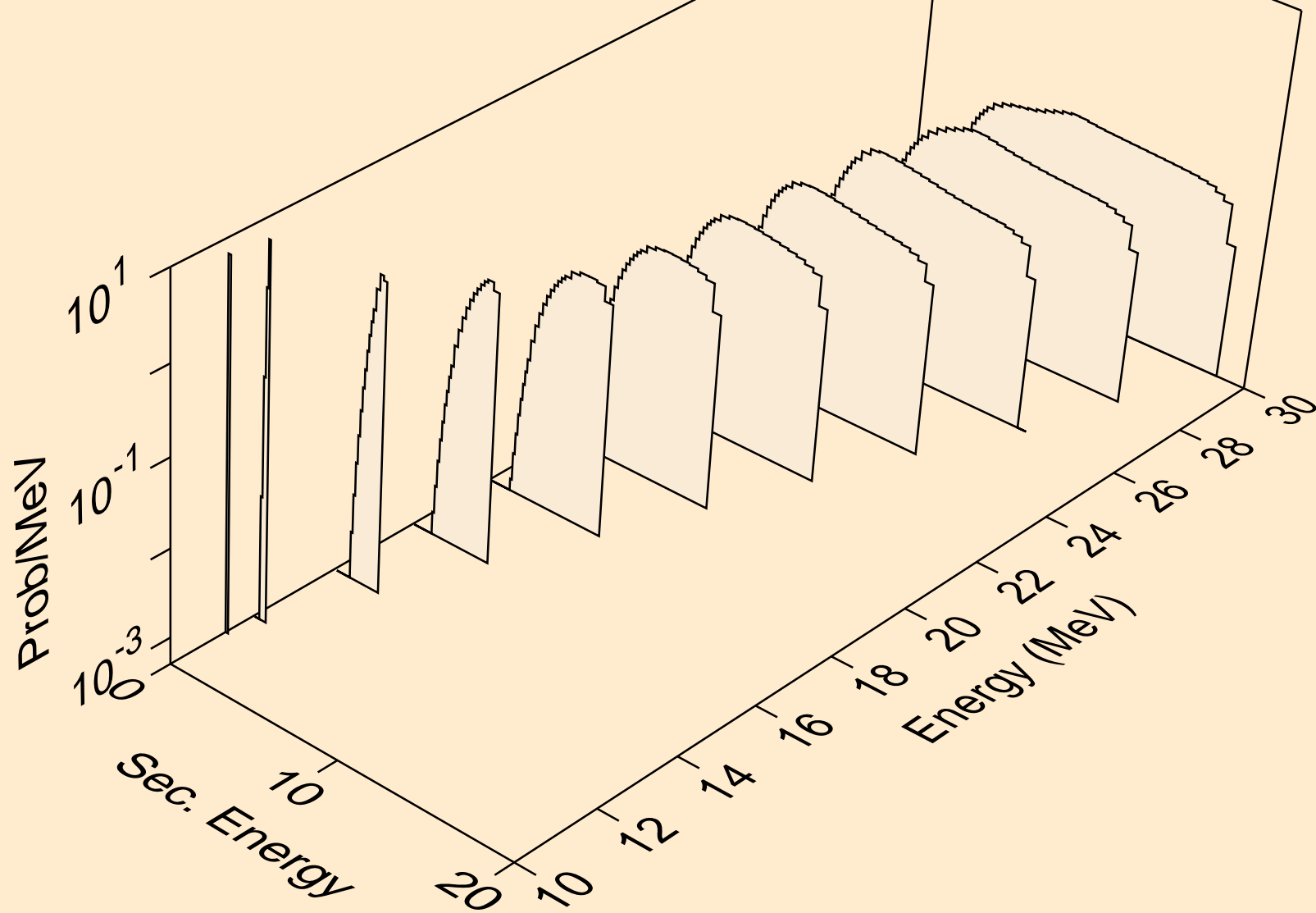

NI062 NEUTRON ACER TENDL-2021 LIBRARY; T=293.6K
protons from (n,2np)

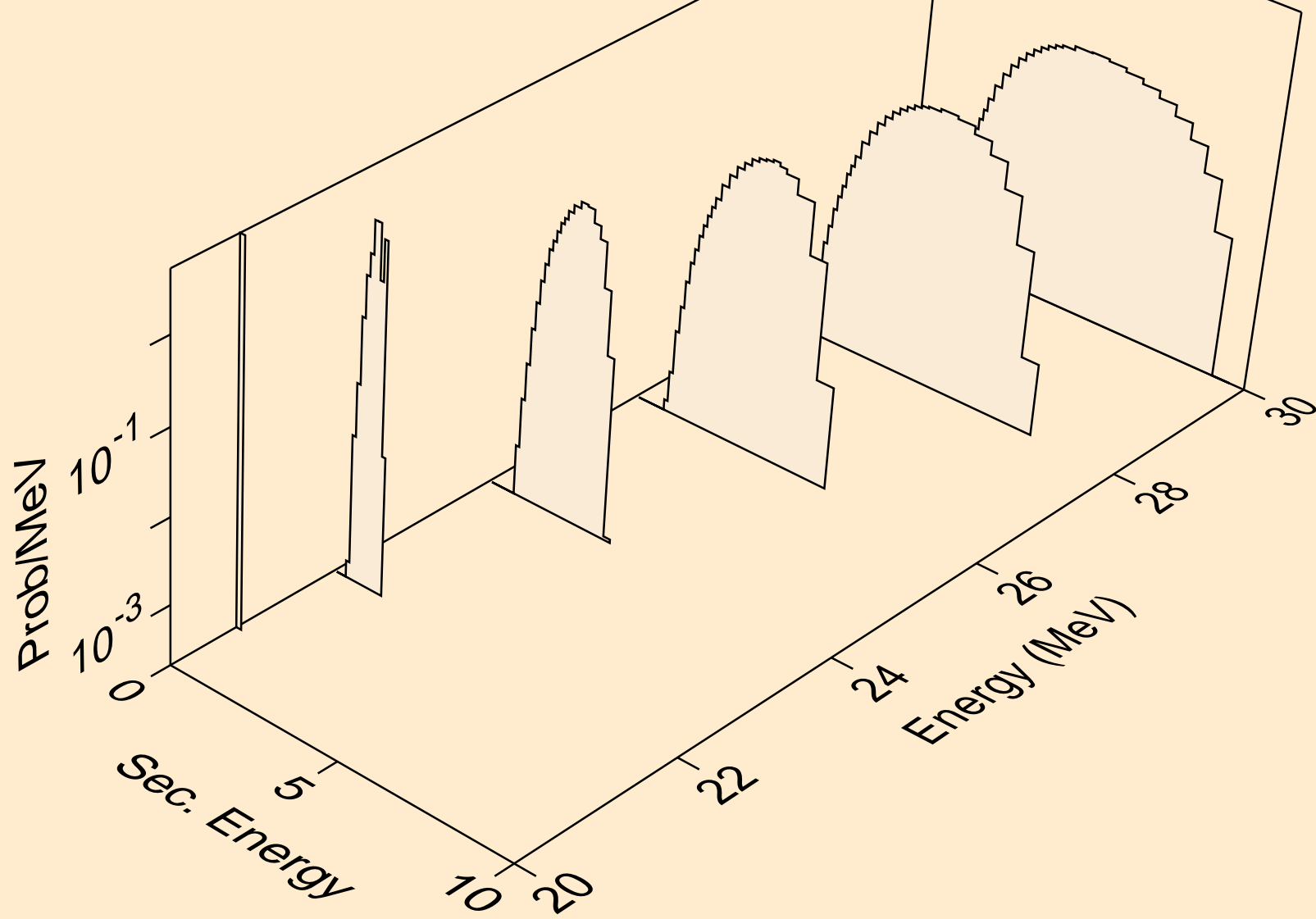

NI062 NEUTRON ACER TENDL-2021 LIBRARY; T=293.6K
protons from (n,3np)

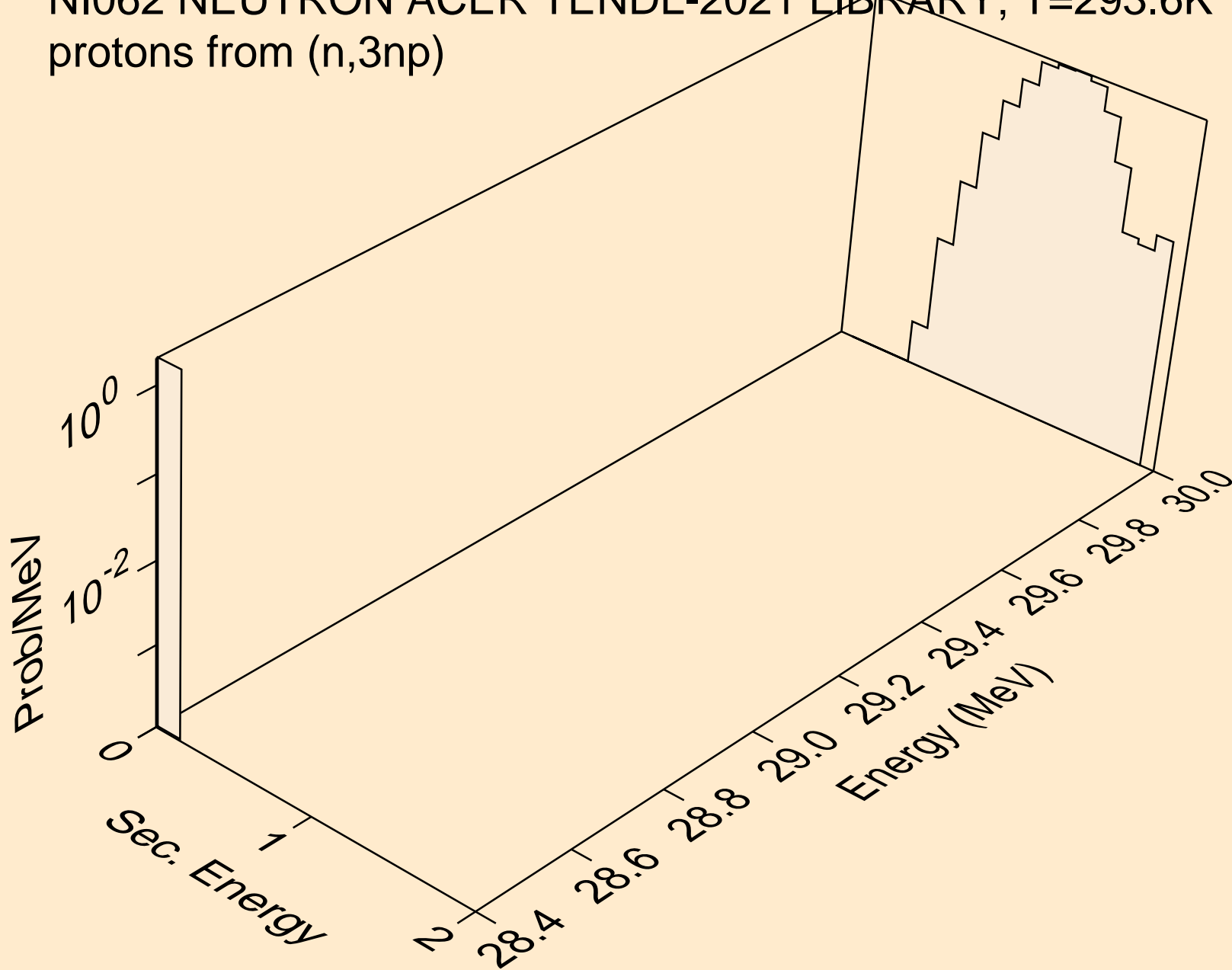

NI062 NEUTRON ACER TENDL-2021 LIBRARY; T=293.6K
protons from (n,2np)

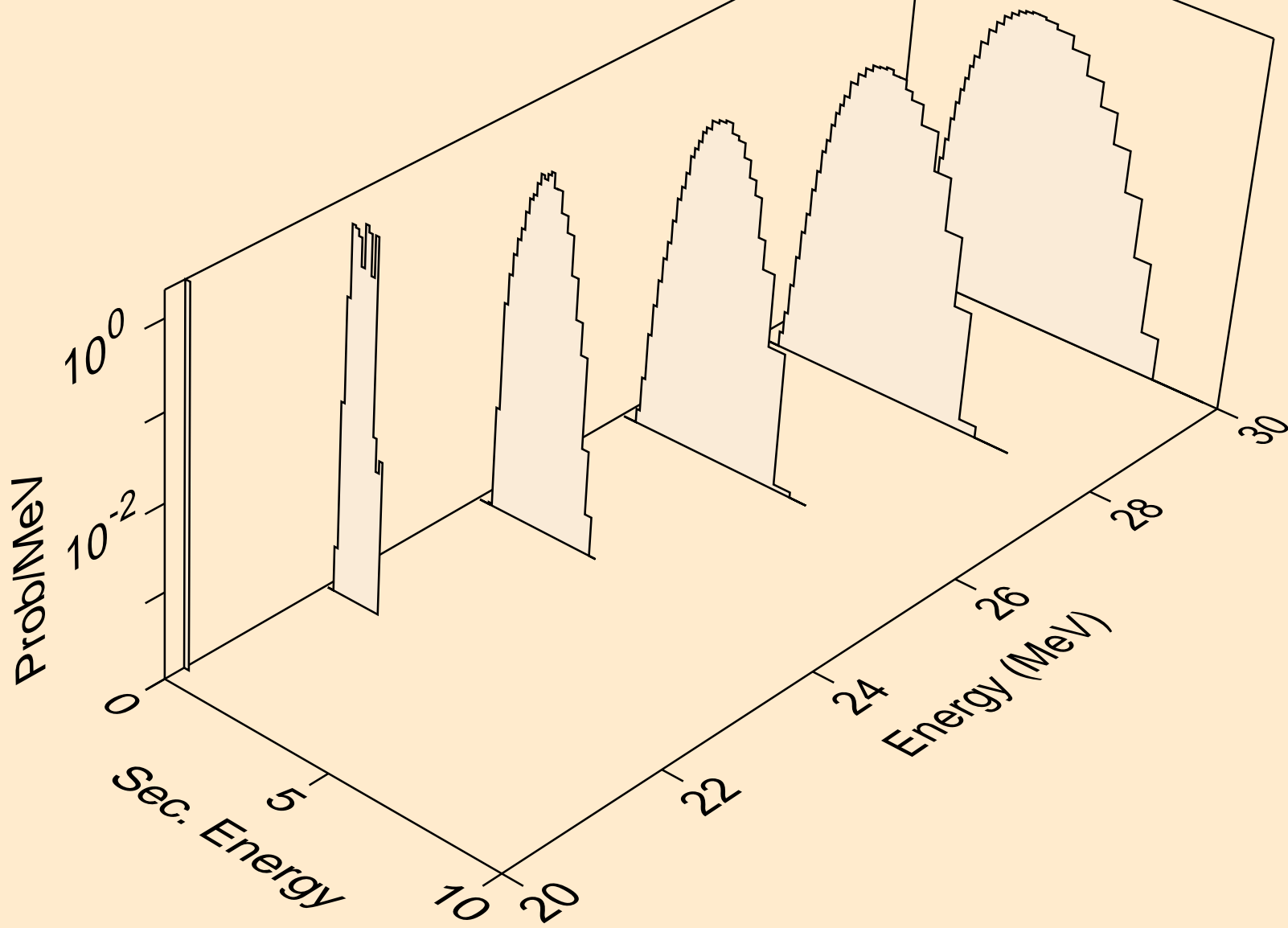

NI062 NEUTRON ACER TENDL-2021 LIBRARY; T=293.6K
protons from (n,npa)

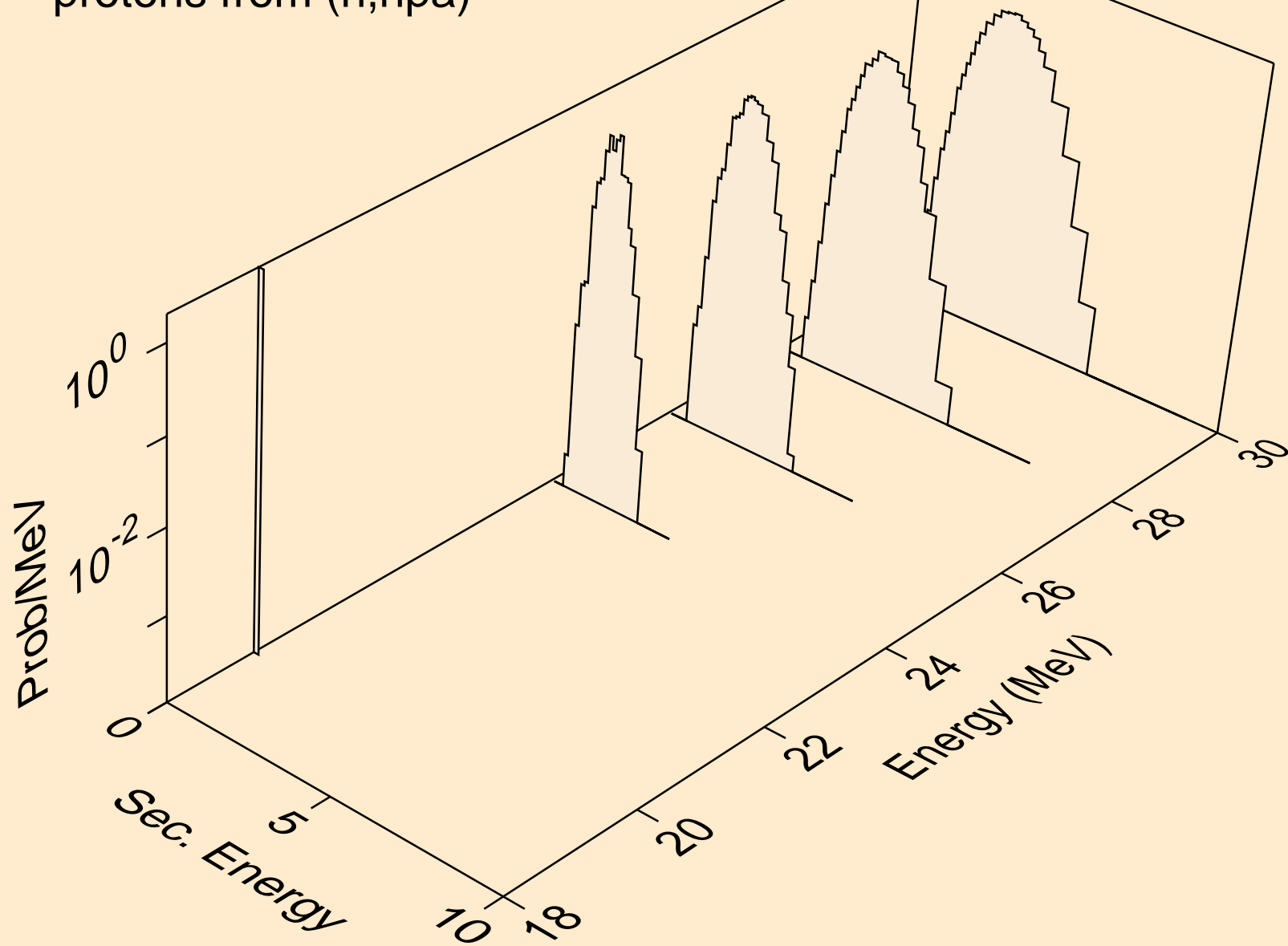

NI062 NEUTRON ACER TENDL-2021 LIBRARY; T=293.6K
protons from (n,p)

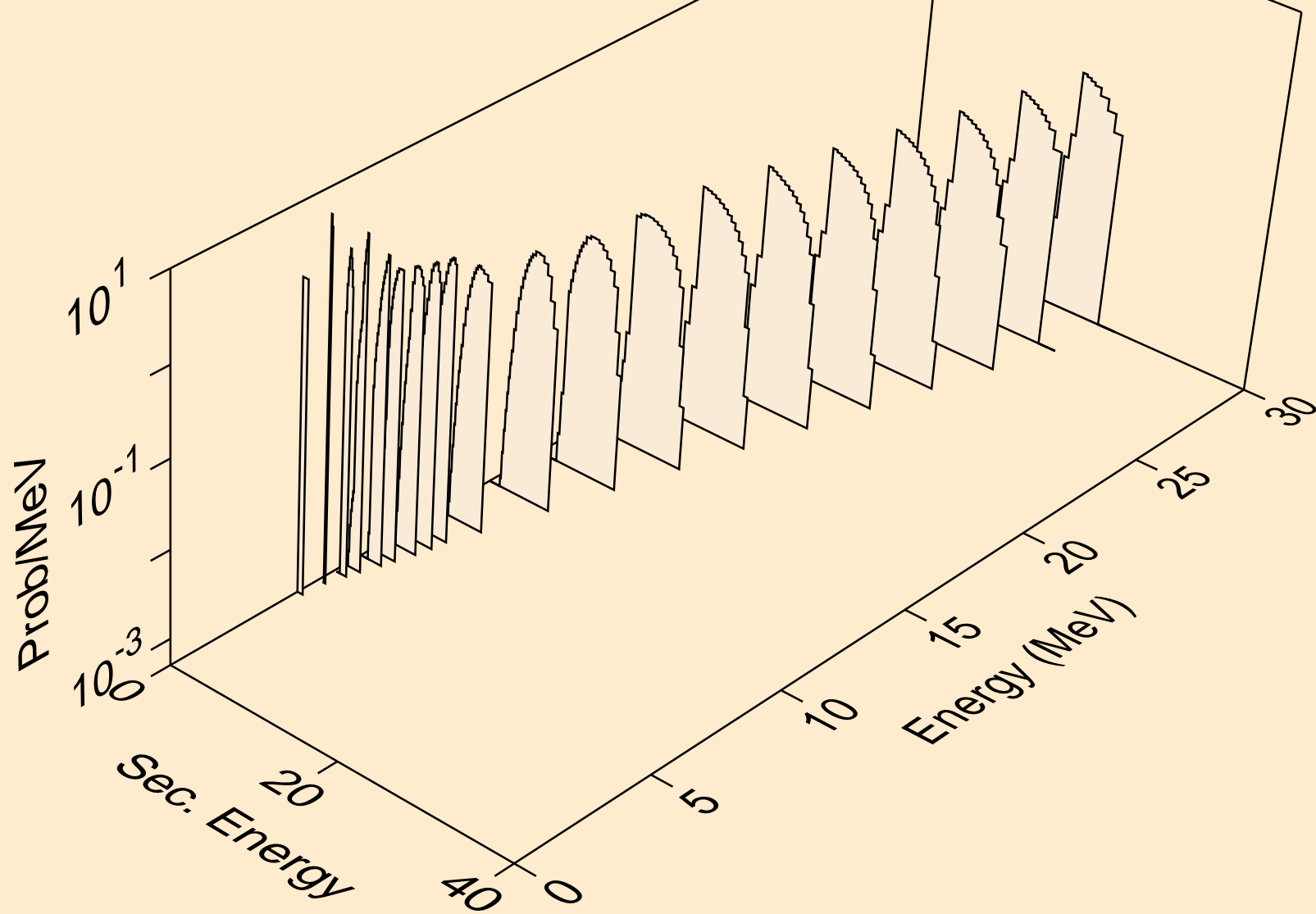

NI062 NEUTRON ACER TENDL-2021 LIBRARY; T=293.6K
protons from (n,2p)

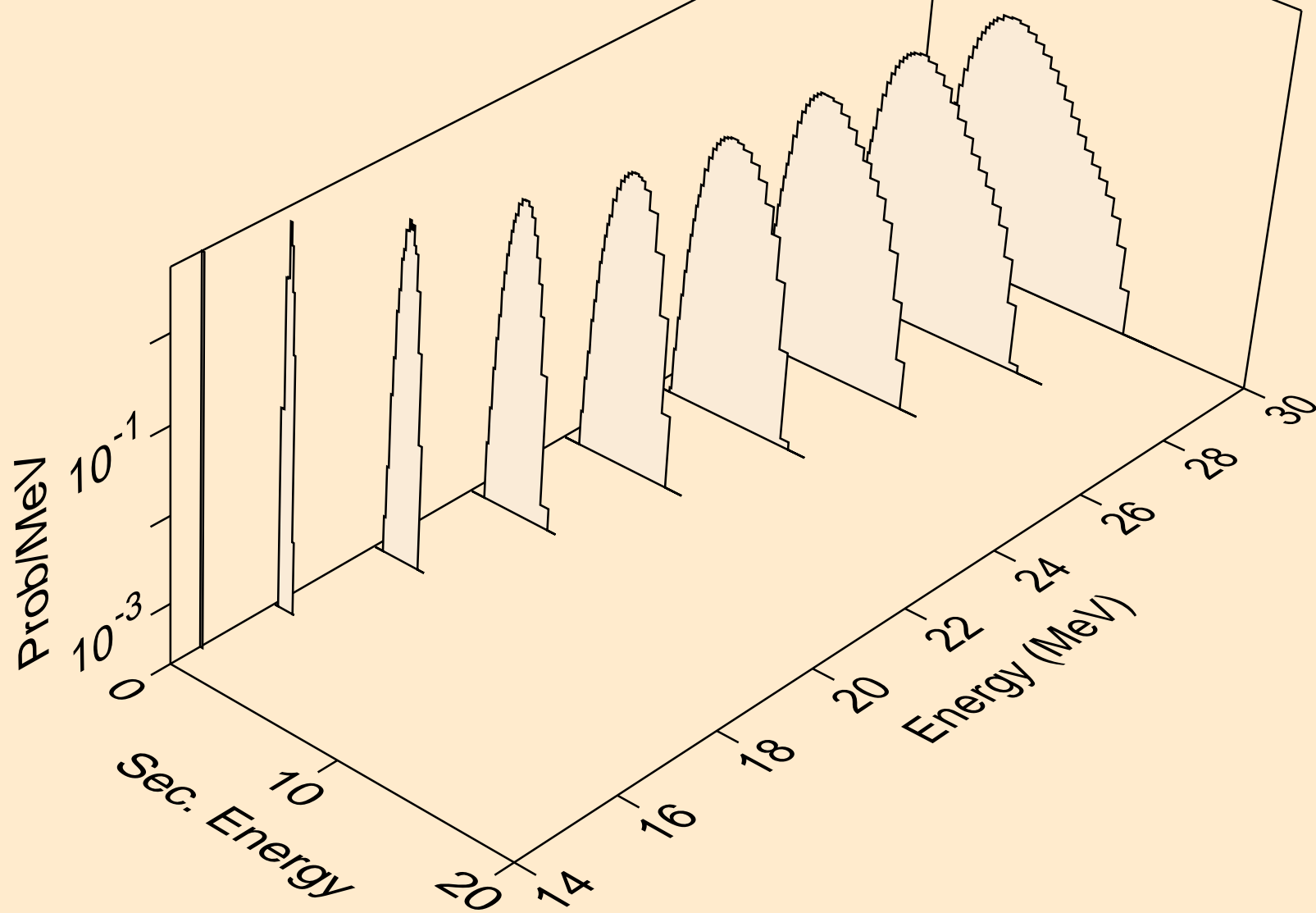

NI062 NEUTRON ACER TENDL-2021 LIBRARY; T=293.6K
protons from (n,p)

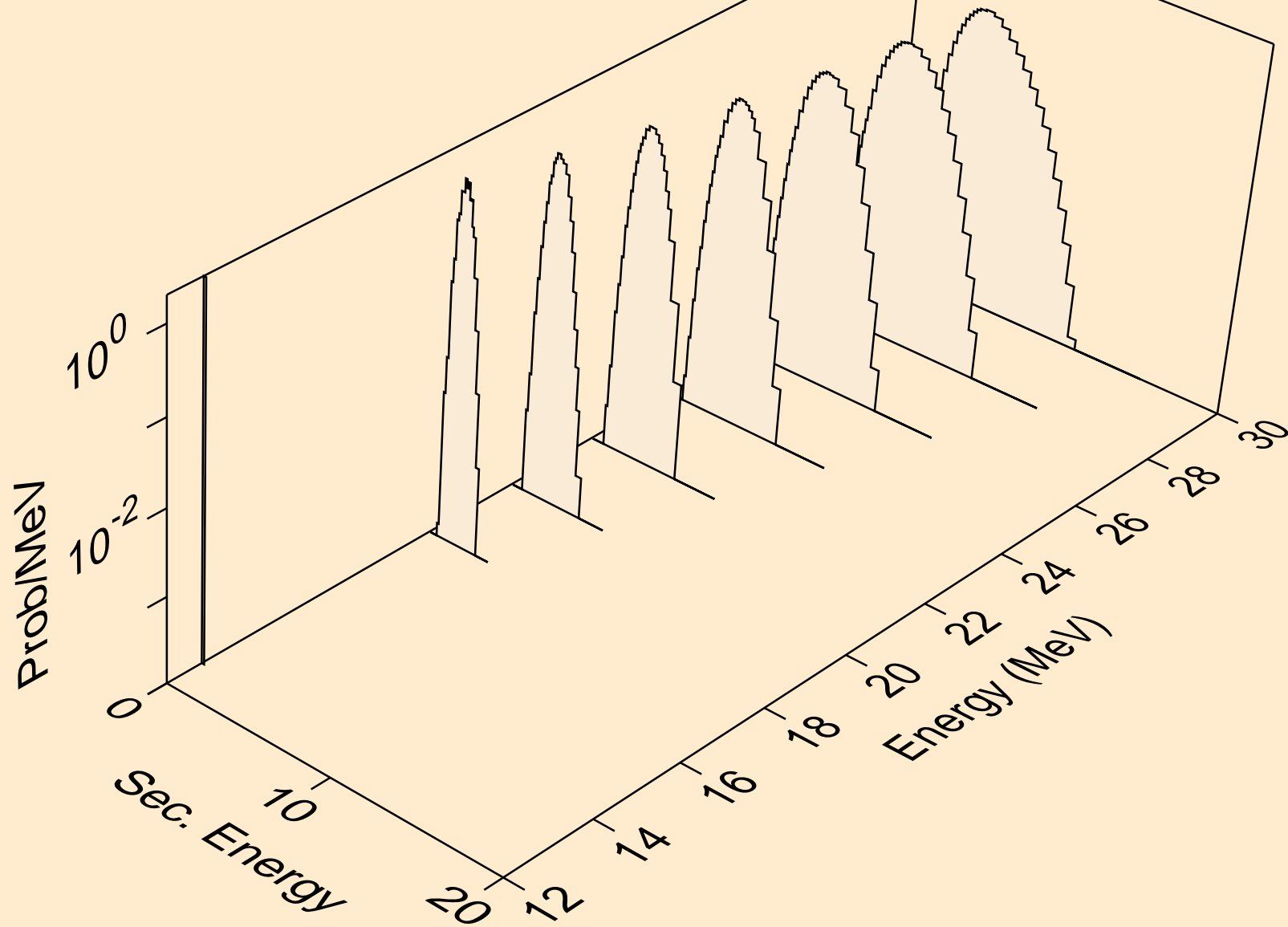

NI062 NEUTRON ACER TENDL-2021 LIBRARY; T=293.6K
protons from (n,pd)

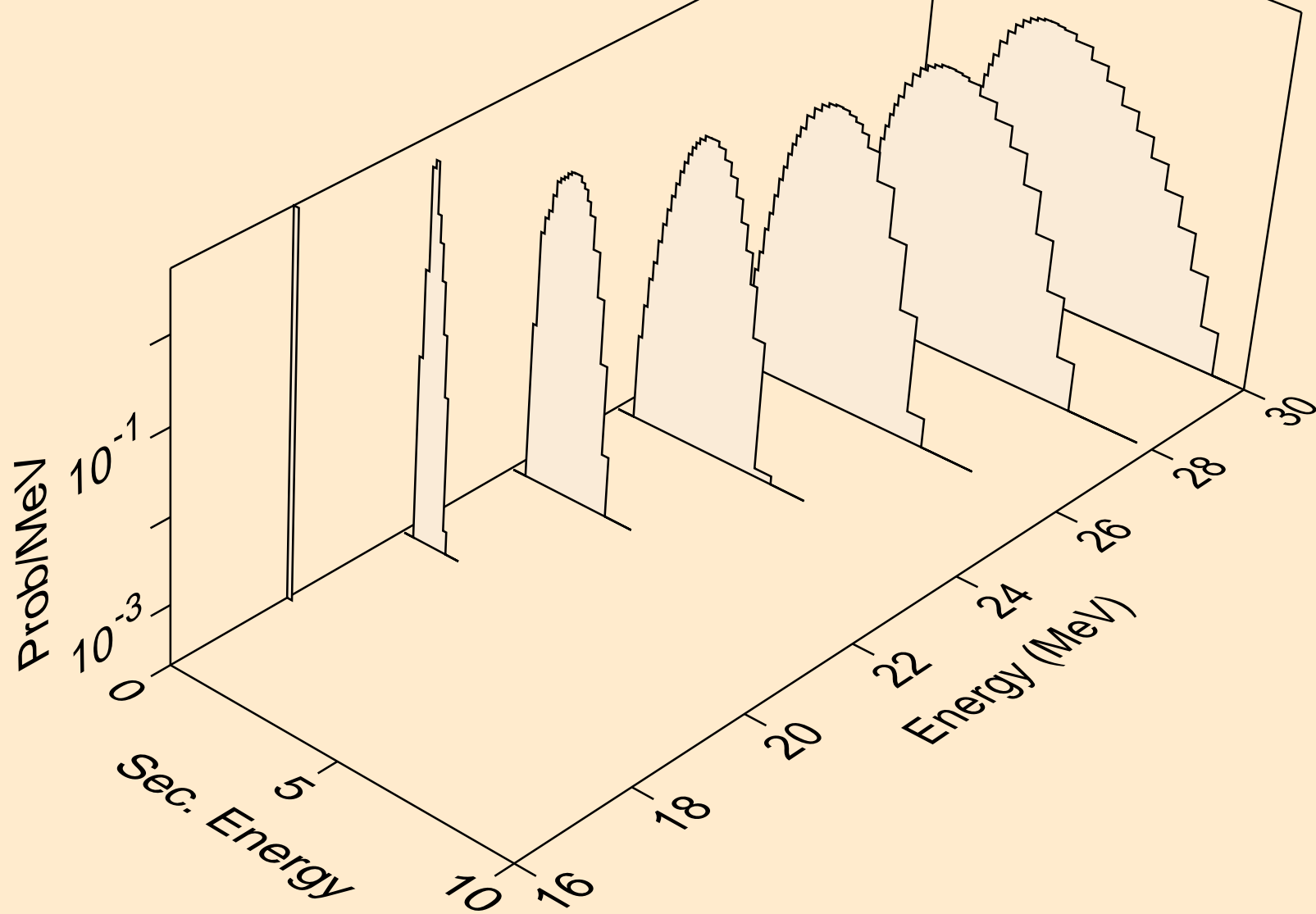

NI062 NEUTRON ACER TENDL-2021 LIBRARY; T=293.6K
protons from (n,pt)

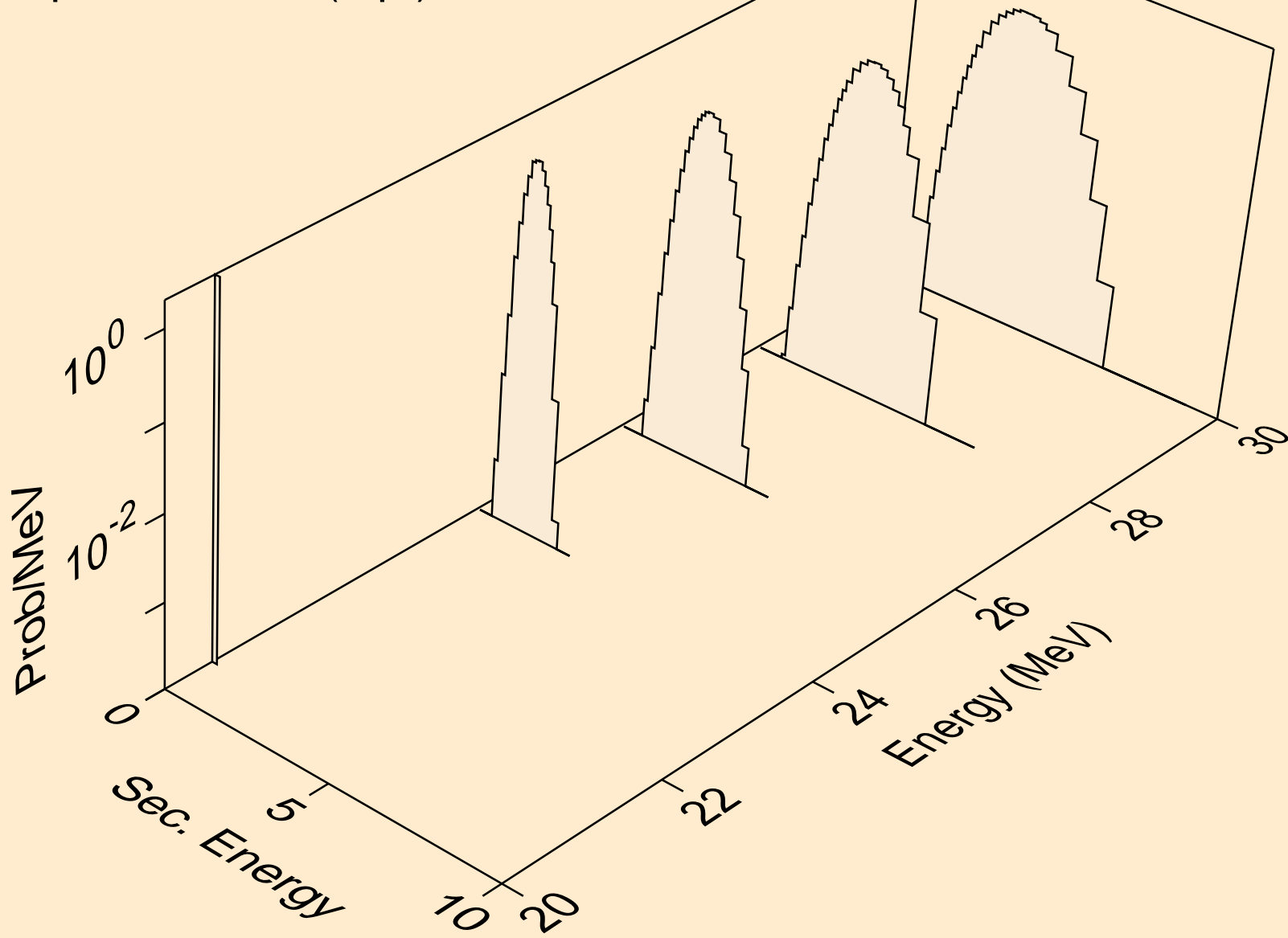

NI062 NEUTRON ACER TENDL-2021 LIBRARY; T=293.6K
deuterons from (n,x)

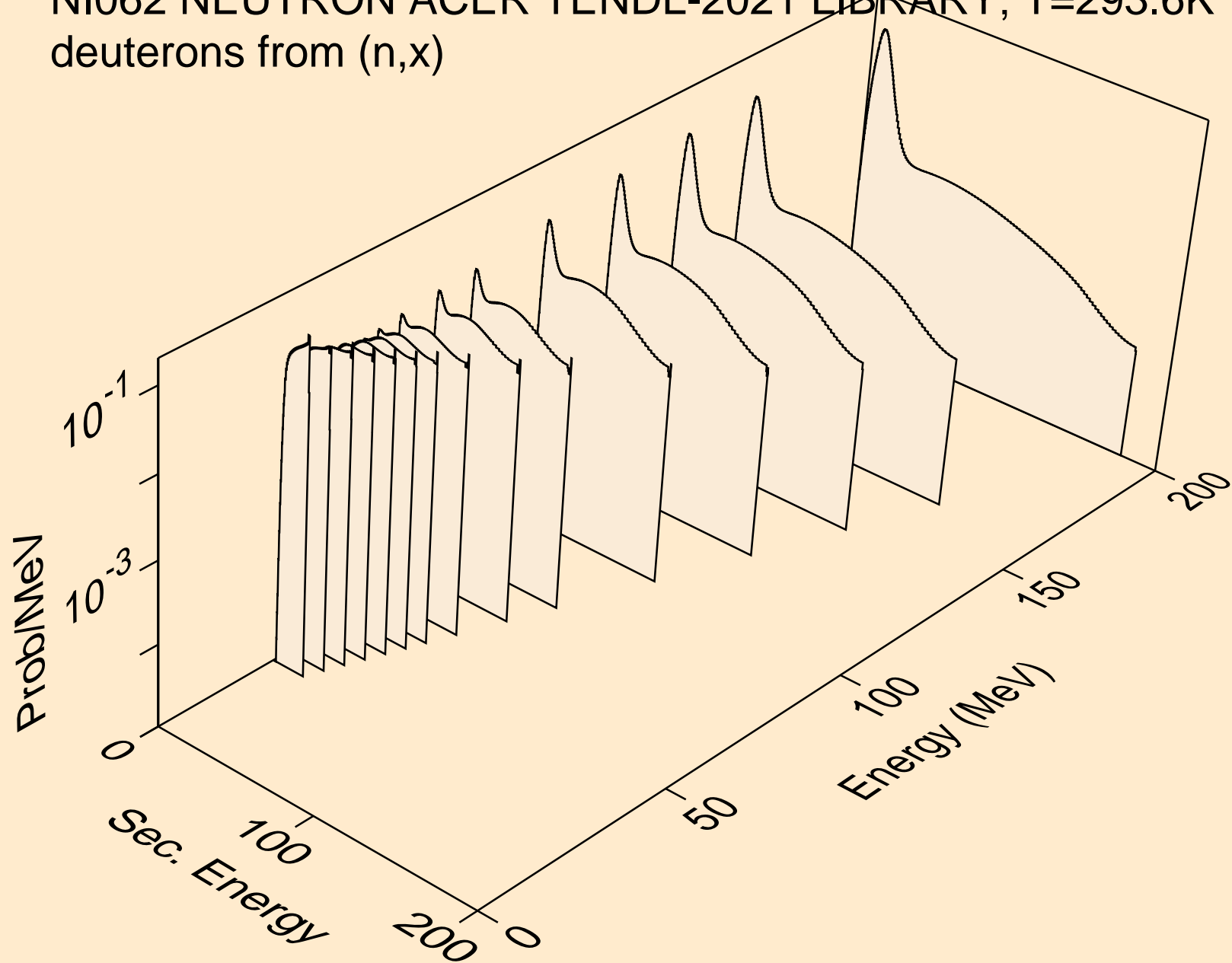

NI062 NEUTRON ACER TENDL-2021 LIBRARY; T=293.6K
deuterons from (n,2nd)

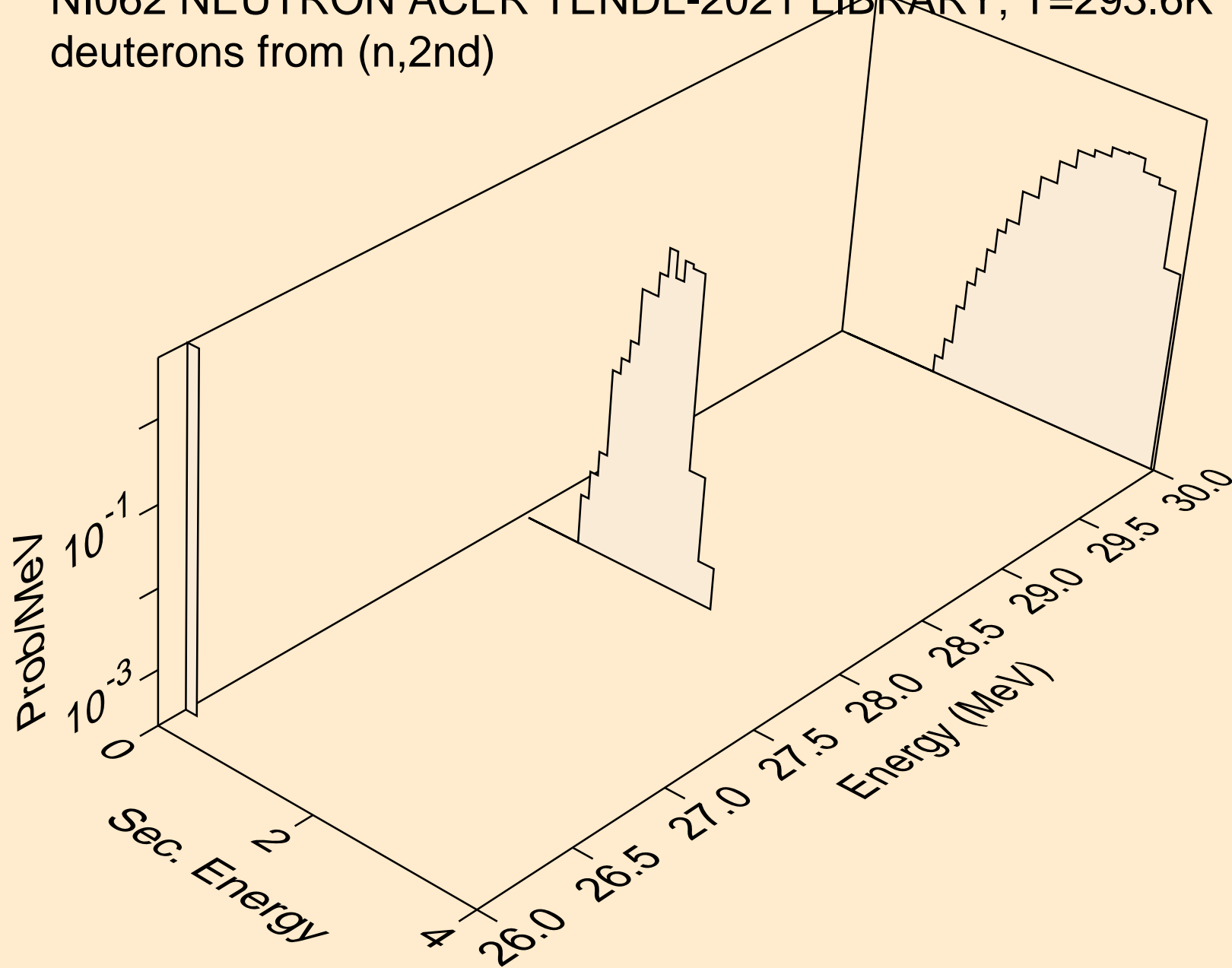

NI062 NEUTRON ACER TENDL-2021 LIBRARY; T=293.6K
deuterons from (n,n*)d

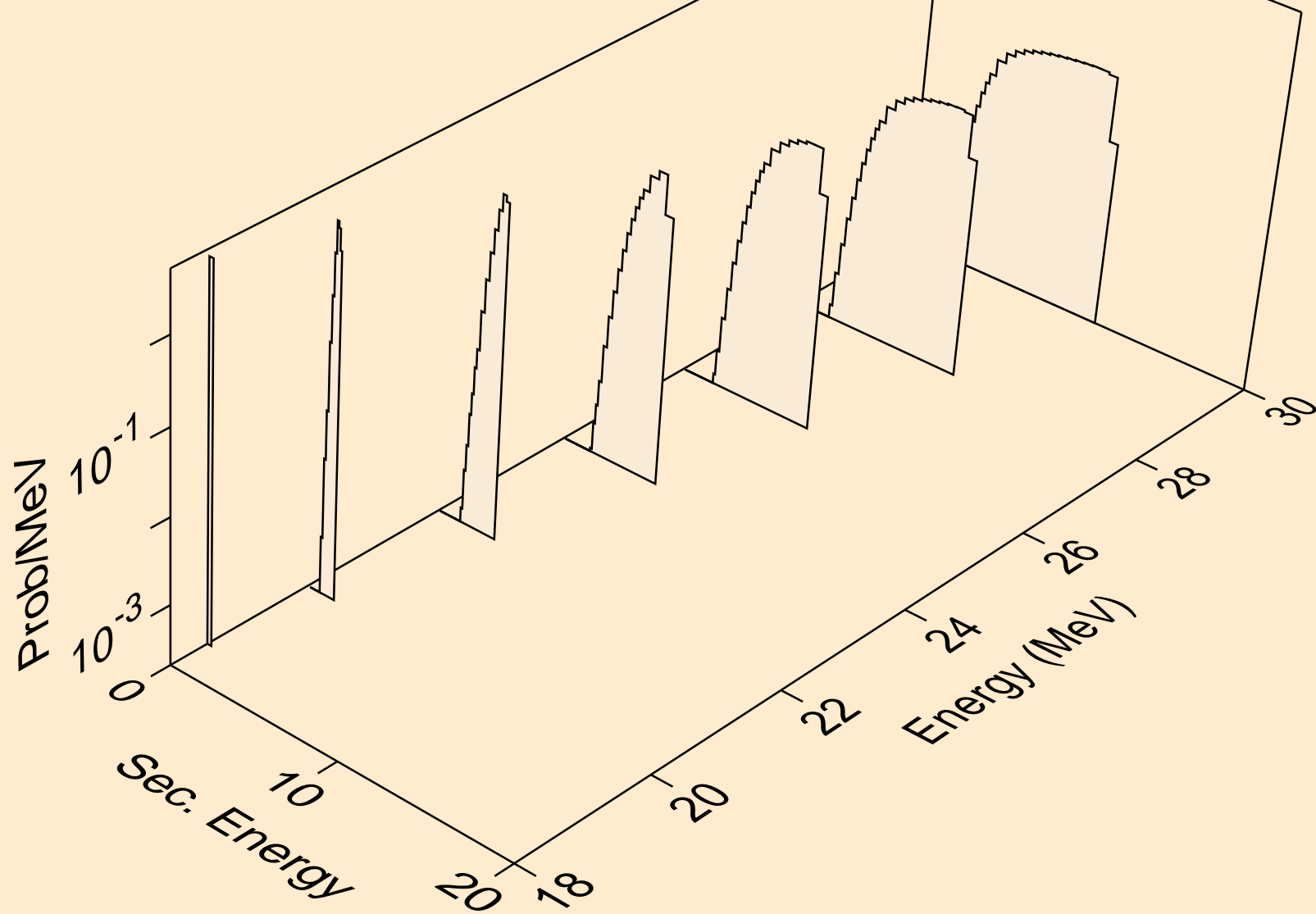

NI062 NEUTRON ACER TENDL-2021 LIBRARY; T=293.6K
deuterons from (n,d)

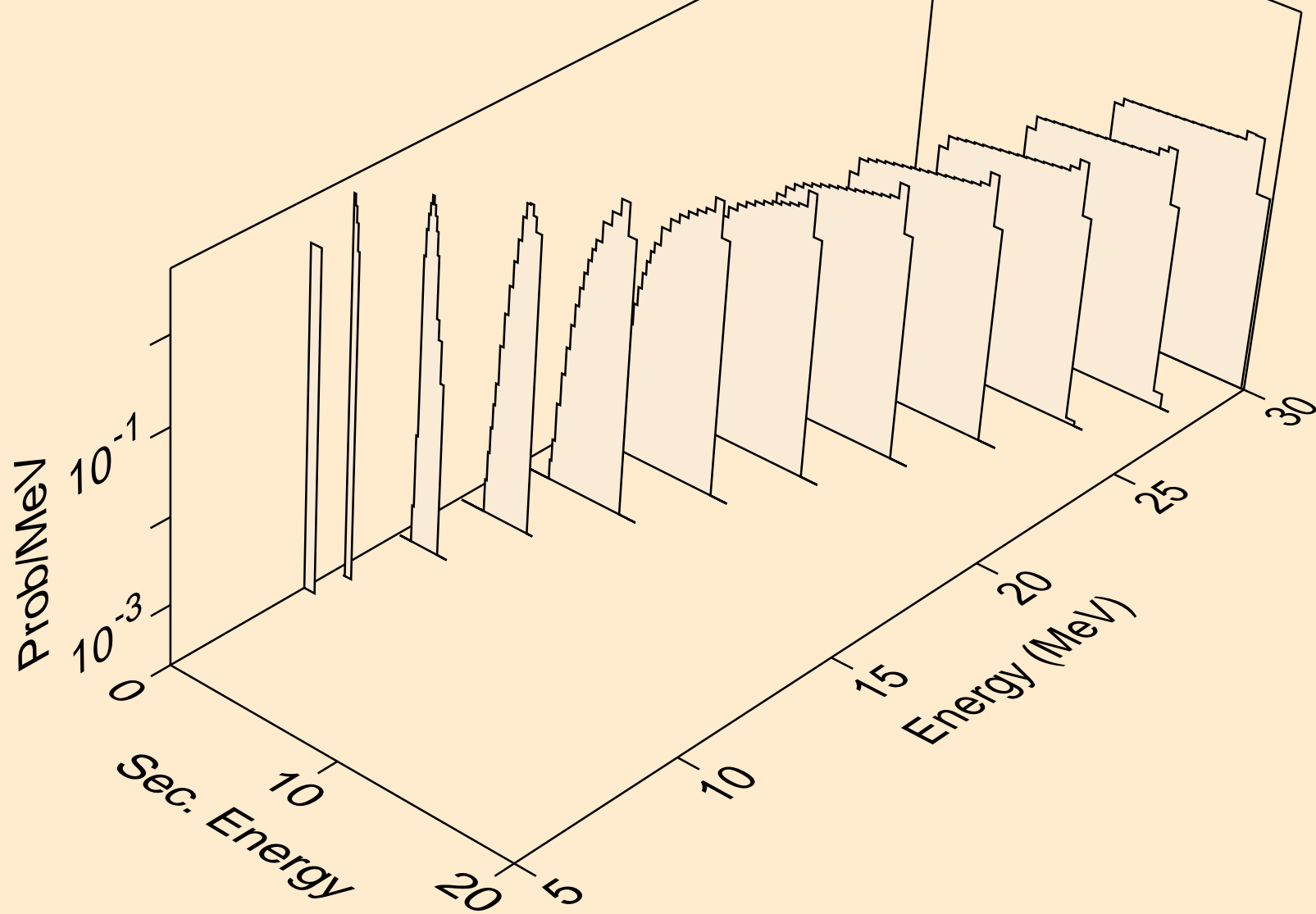

NI062 NEUTRON ACER TENDL-2021 LIBRARY; T=293.6K
deuterons from (n,pd)

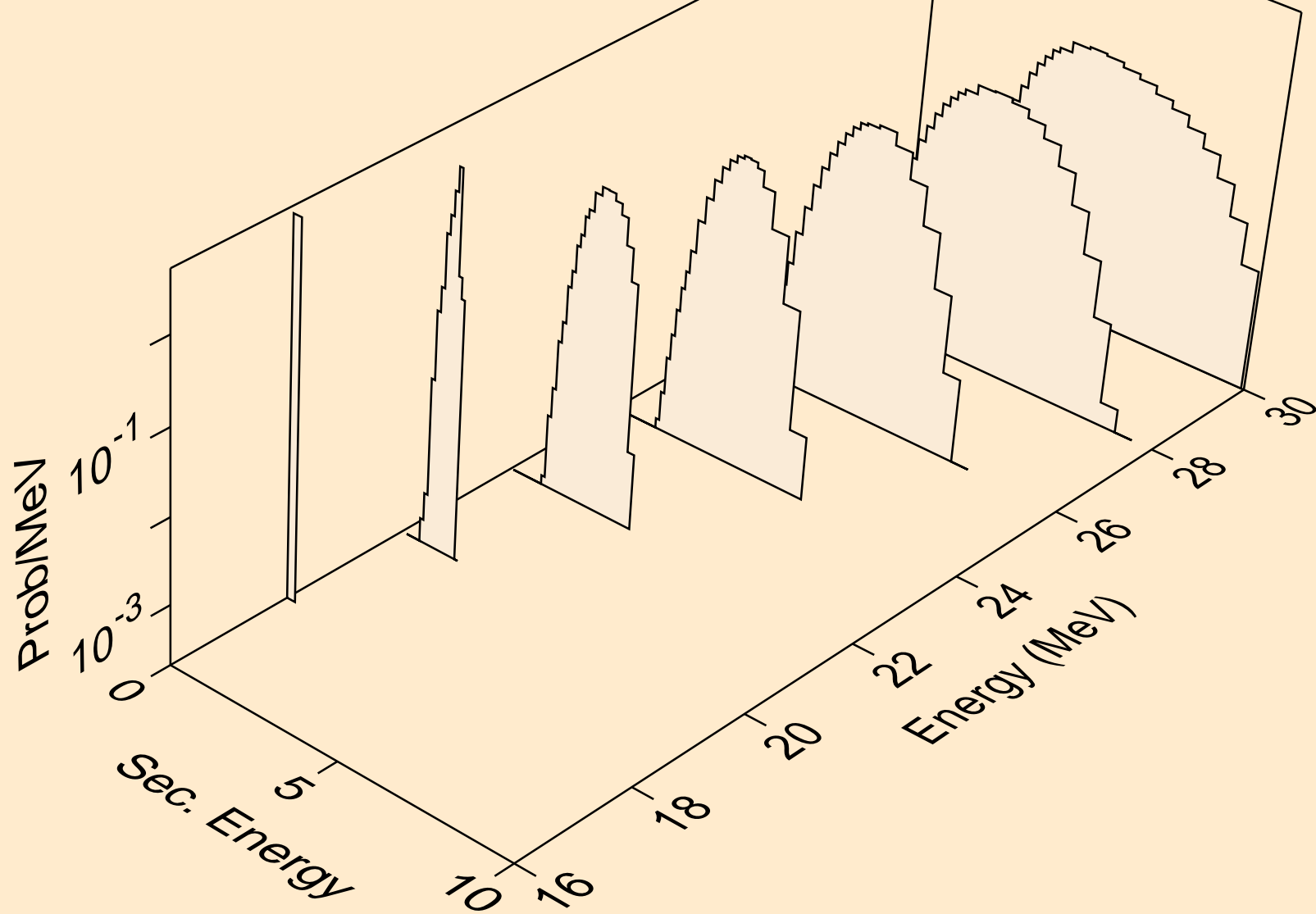

NI062 NEUTRON ACER TENDL-2021 LIBRARY; T=293.6K
deuterons from (n,da)

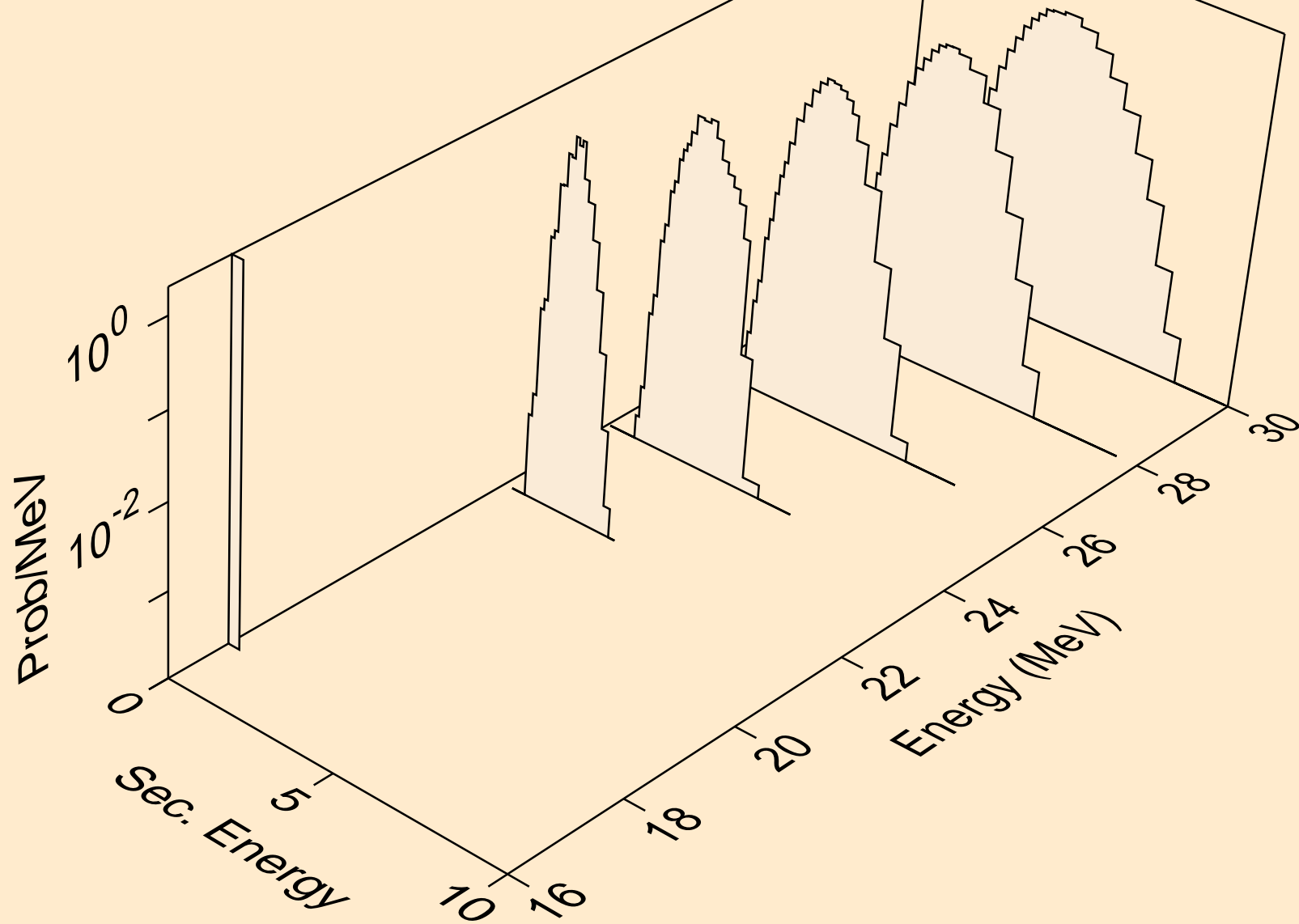

NI062 NEUTRON ACER TENDL-2021 LIBRARY; T=293.6K
tritons from (n,x)

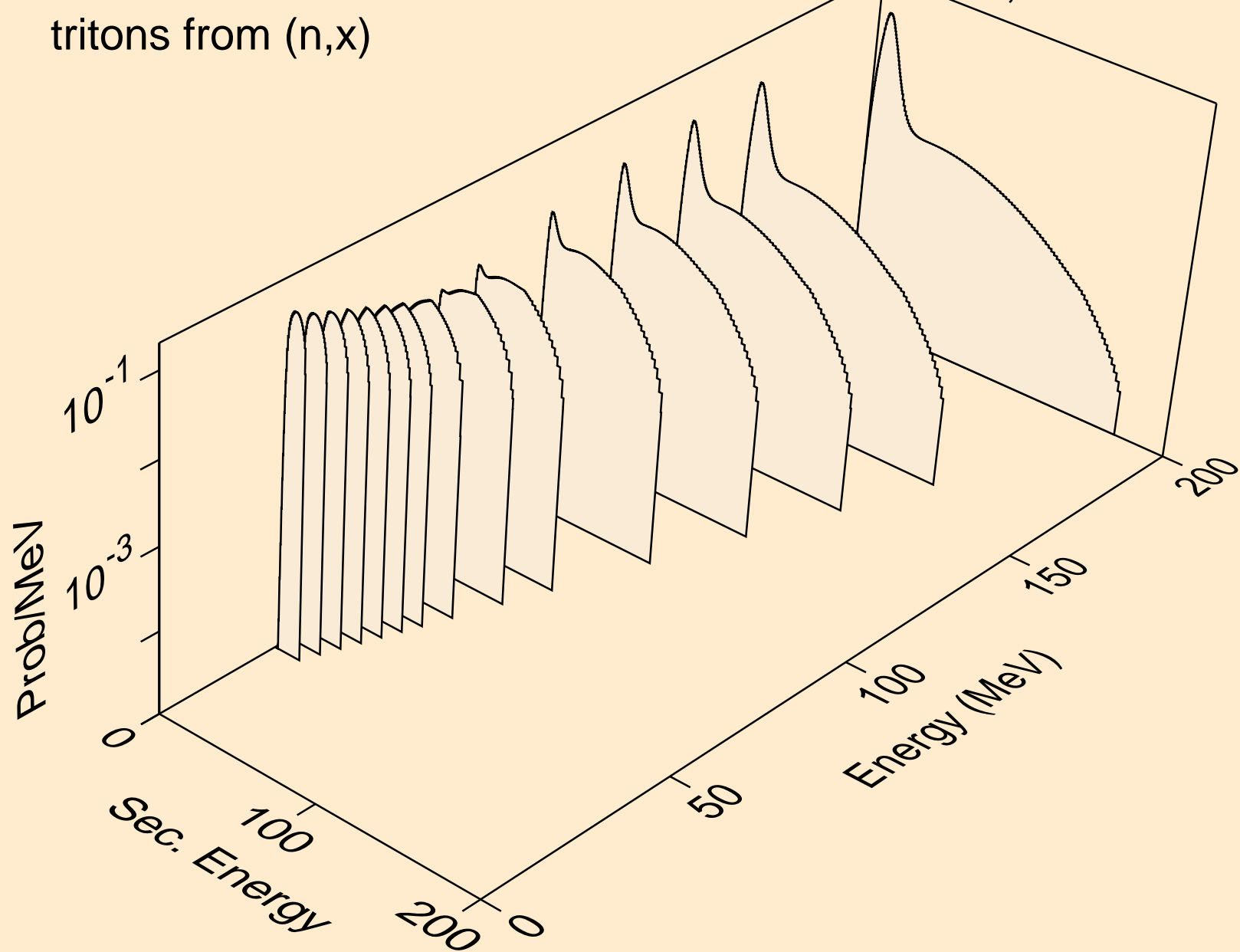

NI062 NEUTRON ACER TENDL-2021 LIBRARY; T=293.6K
tritons from (n,n*)t

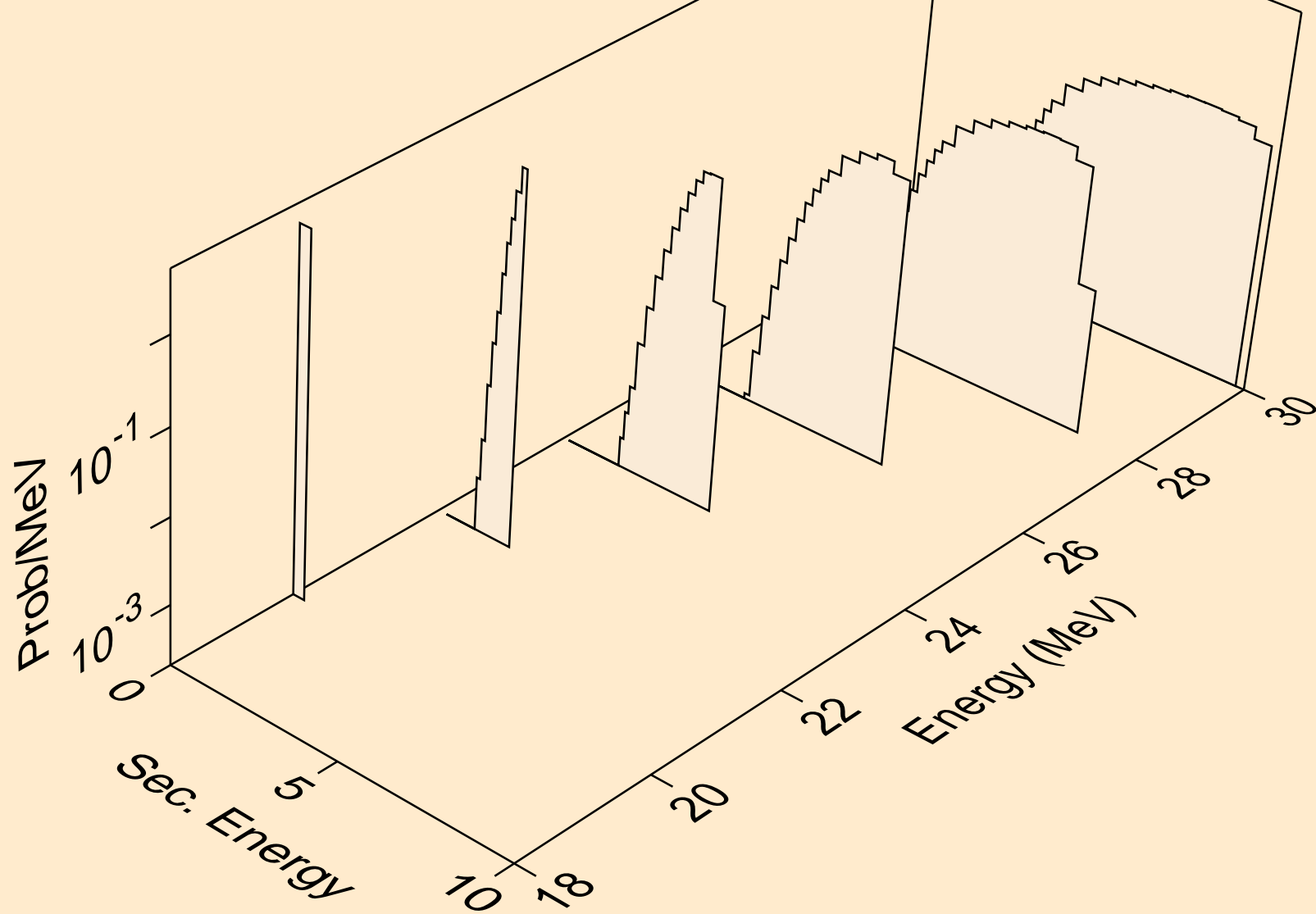

NI062 NEUTRON ACER TENDL-2021 LIBRARY; T=293.6K
tritons from (n,t)

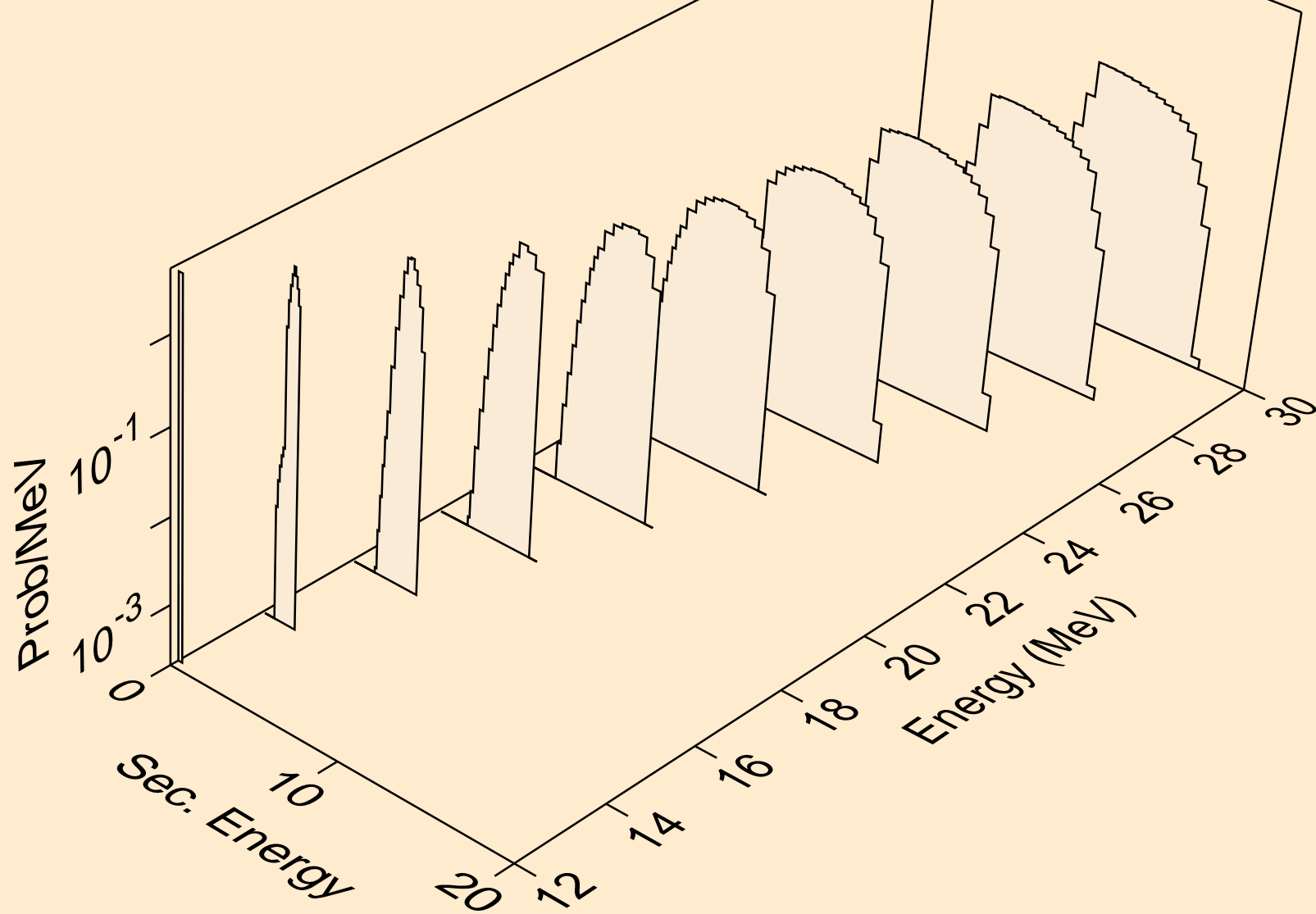

NI062 NEUTRON ACER TENDL-2021 LIBRARY; T=293.6K
tritons from (n,pt)

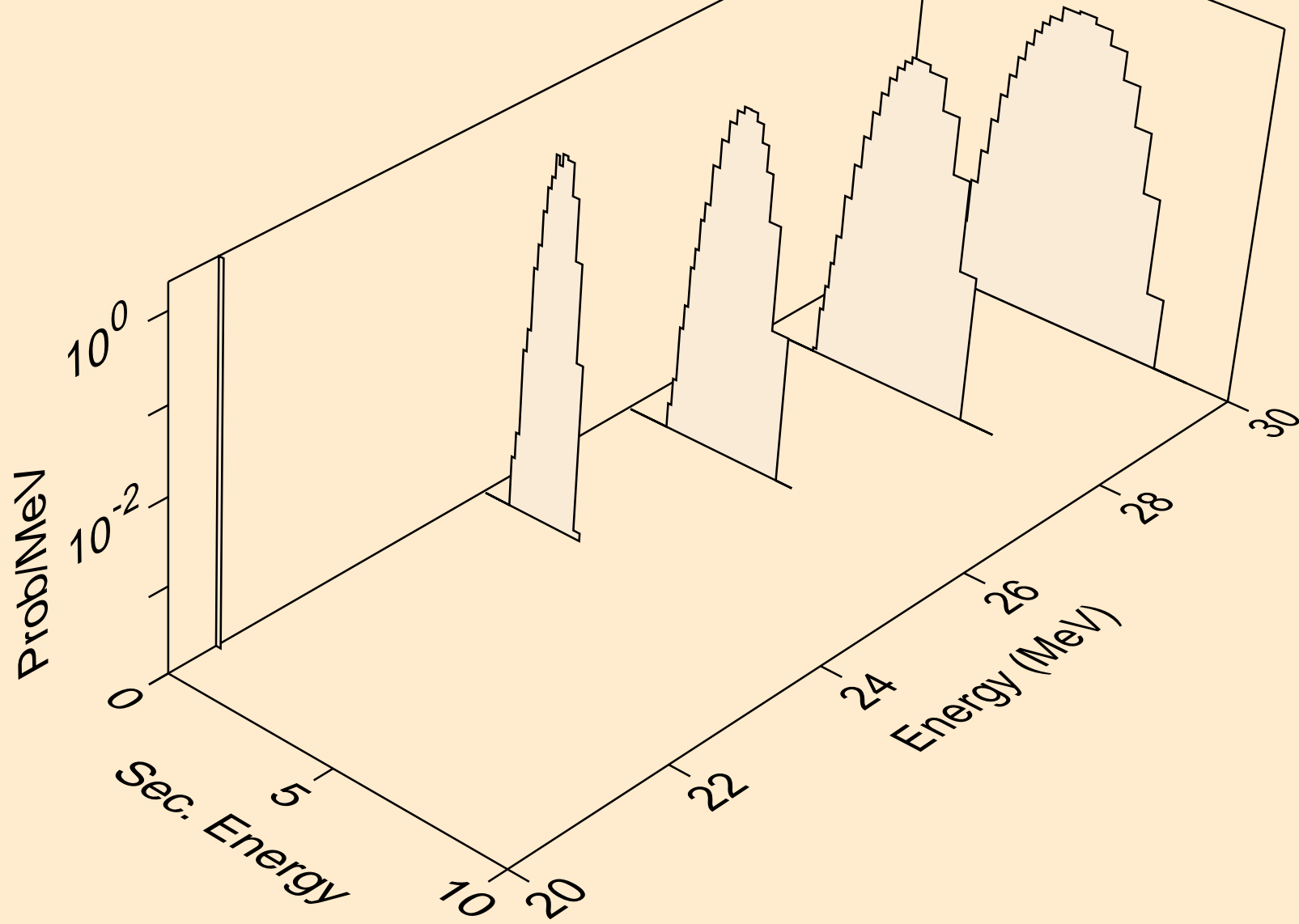

NI062 NEUTRON ACER TENDL-2021 LIBRARY; T=293.6K
he3s from (n,x)

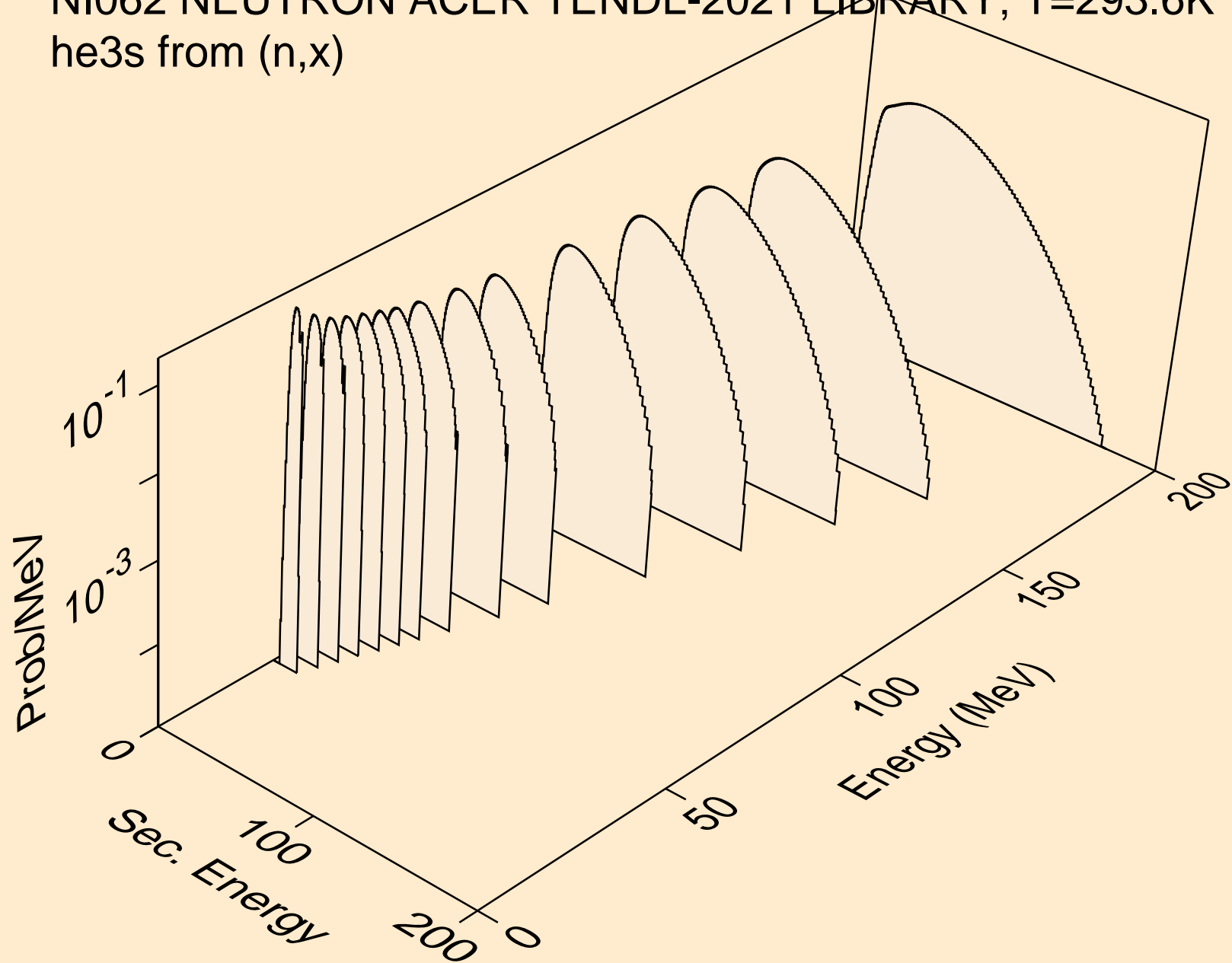

NI062 NEUTRON ACER TENDL-2021 LIBRARY; T=293.6K
he3s from (n,n*)he3

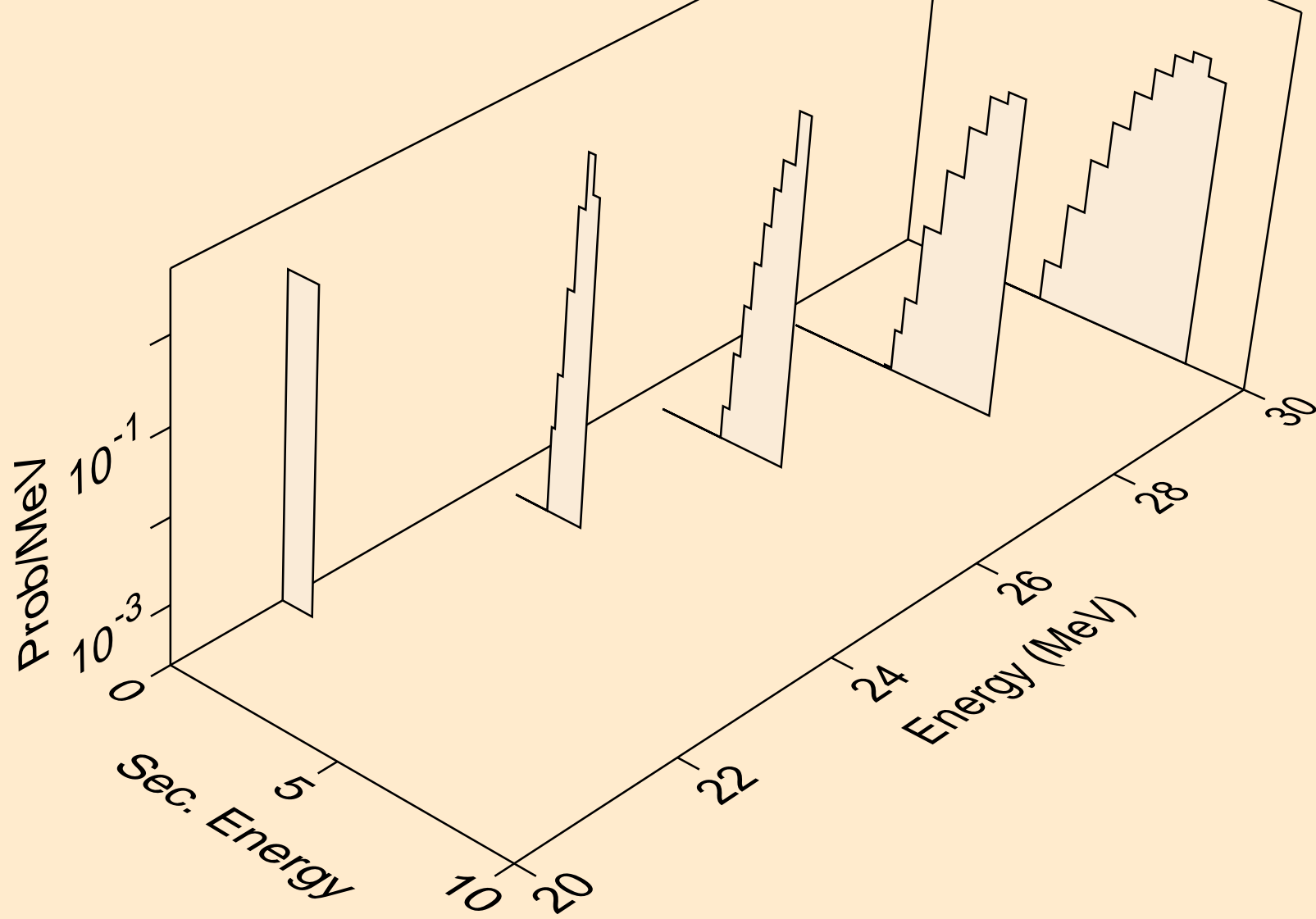

NI062 NEUTRON ACER TENDL-2021 LIBRARY; T=293.6K
he3s from (n,he3)

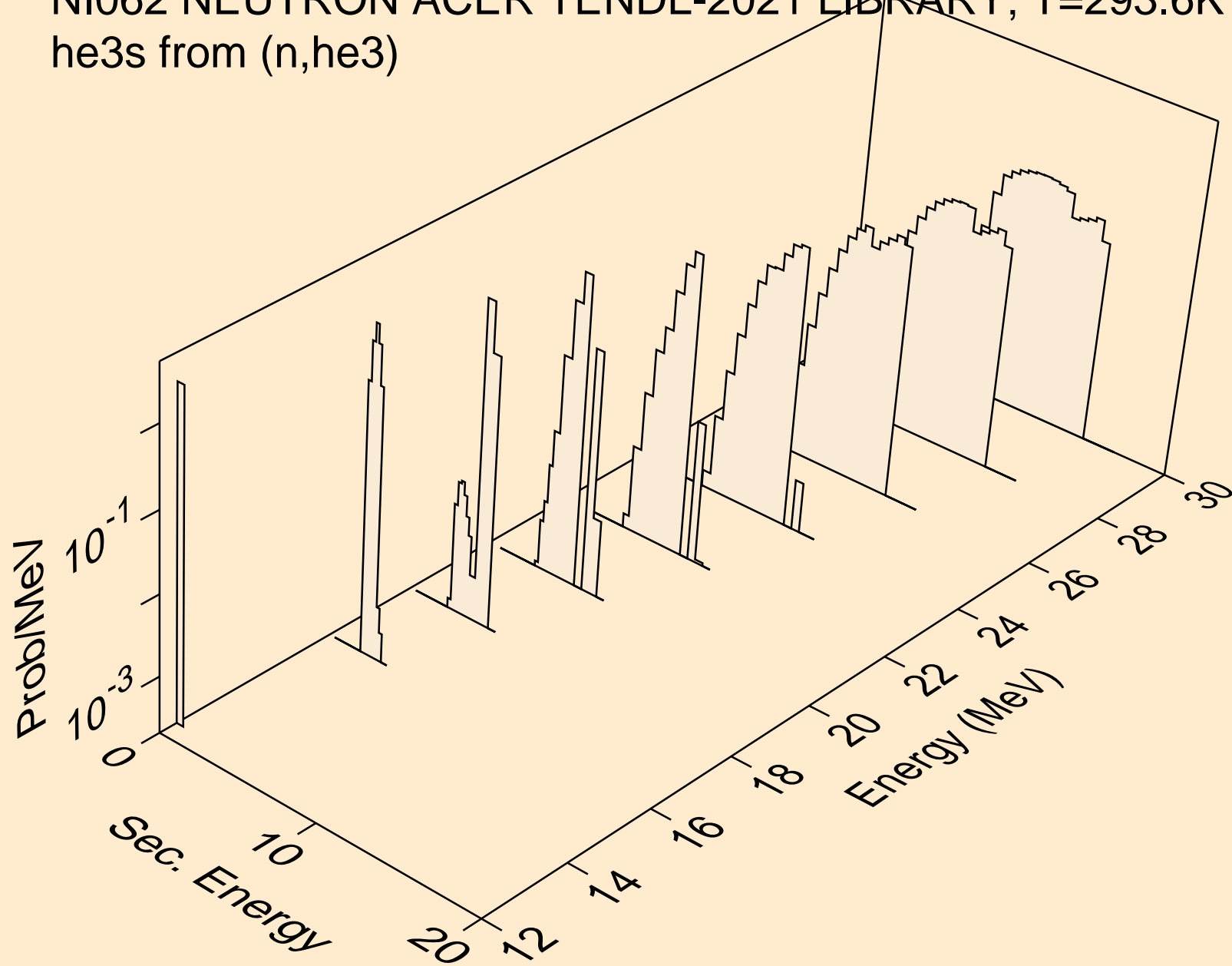

NI062 NEUTRON ACER TENDL-2021 LIBRARY; T=293.6K
alphas from (n,x)

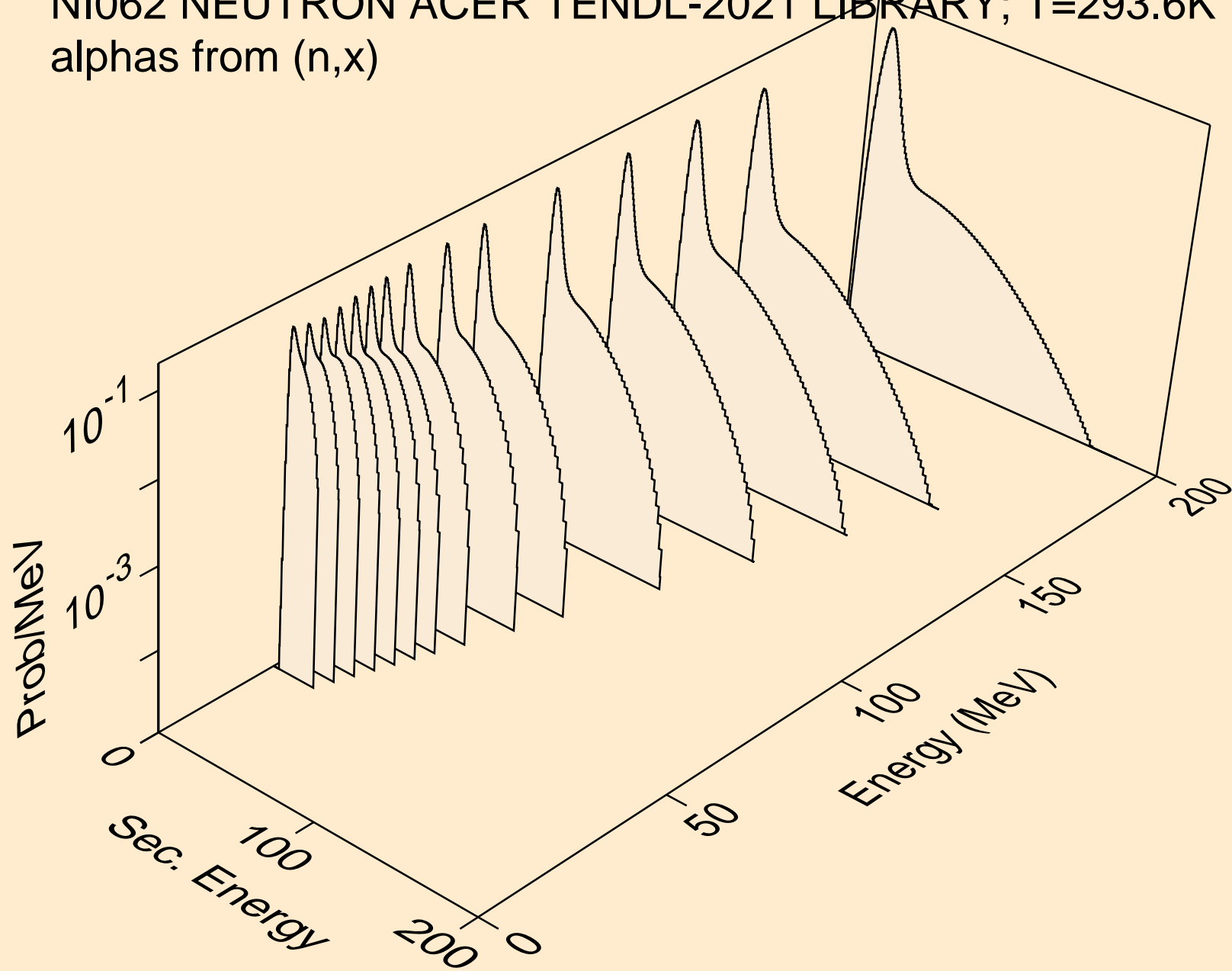

NI062 NEUTRON ACER TENDL-2021 LIBRARY; T=293.6K
alphas from (n,n*)a

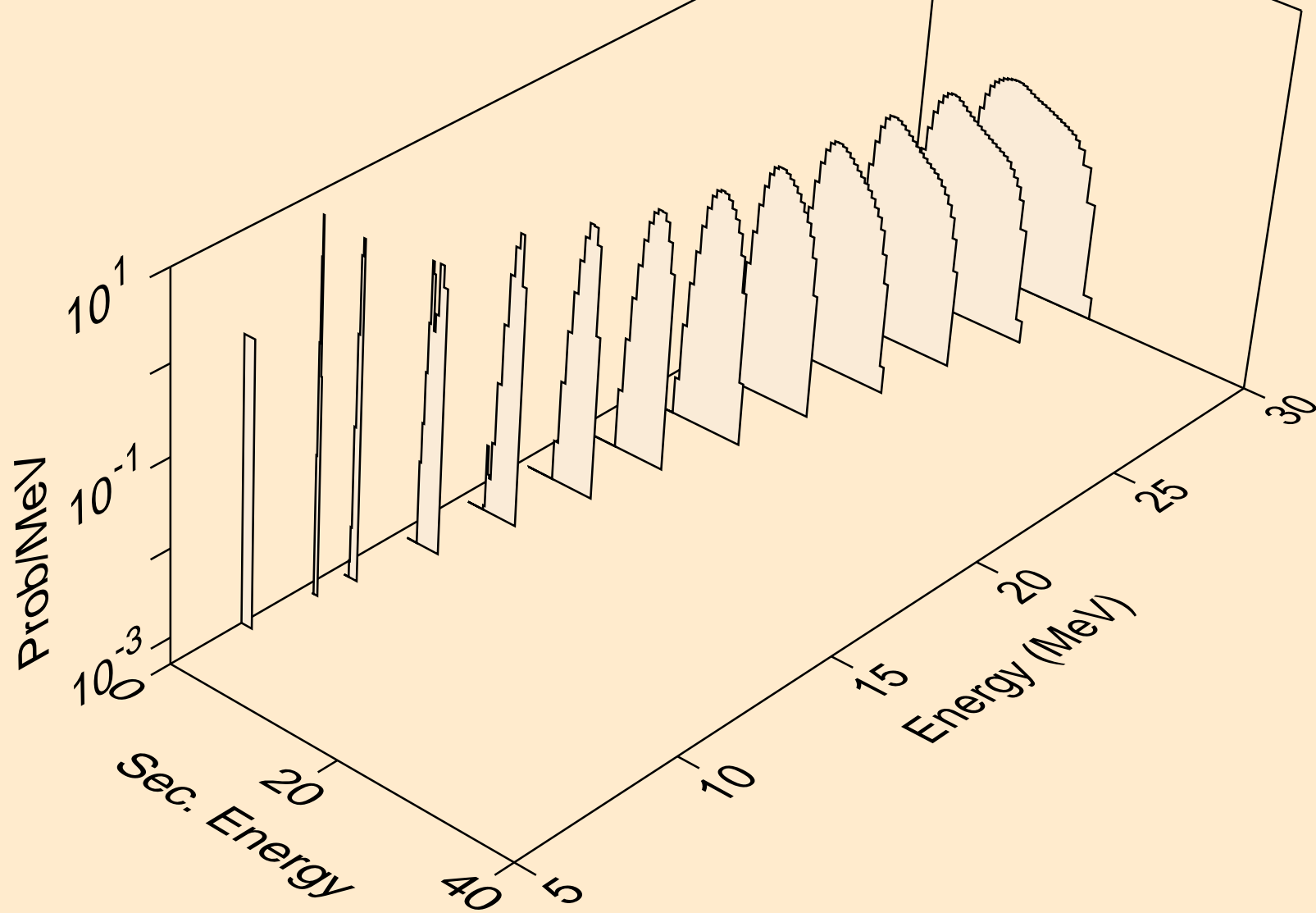

NI062 NEUTRON ACER TENDL-2021 LIBRARY; T=293.6K
alphas from (n,2n)a

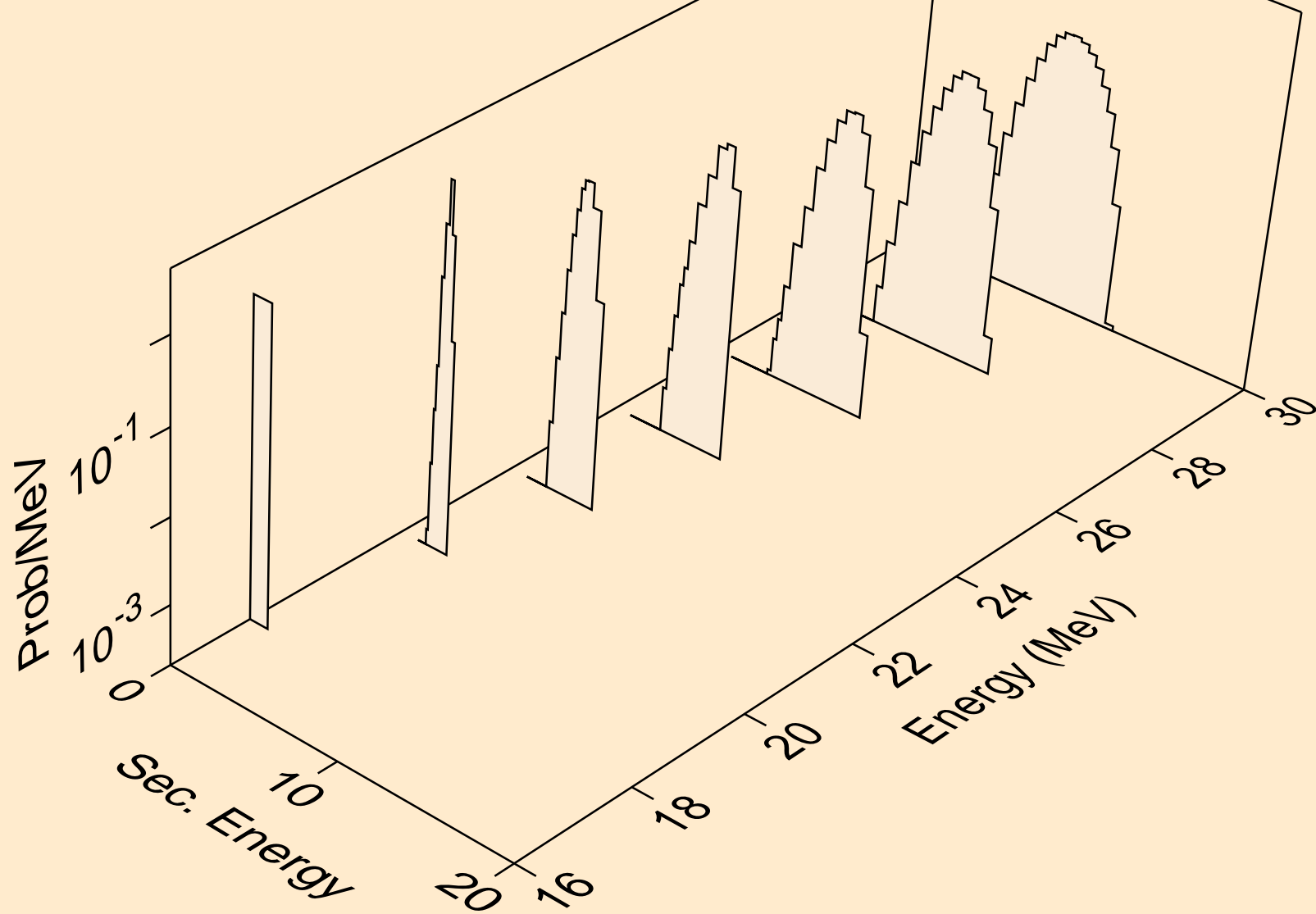

NI062 NEUTRON ACER TENDL-2021 LIBRARY; T=293.6K
alphas from (n,3n)a

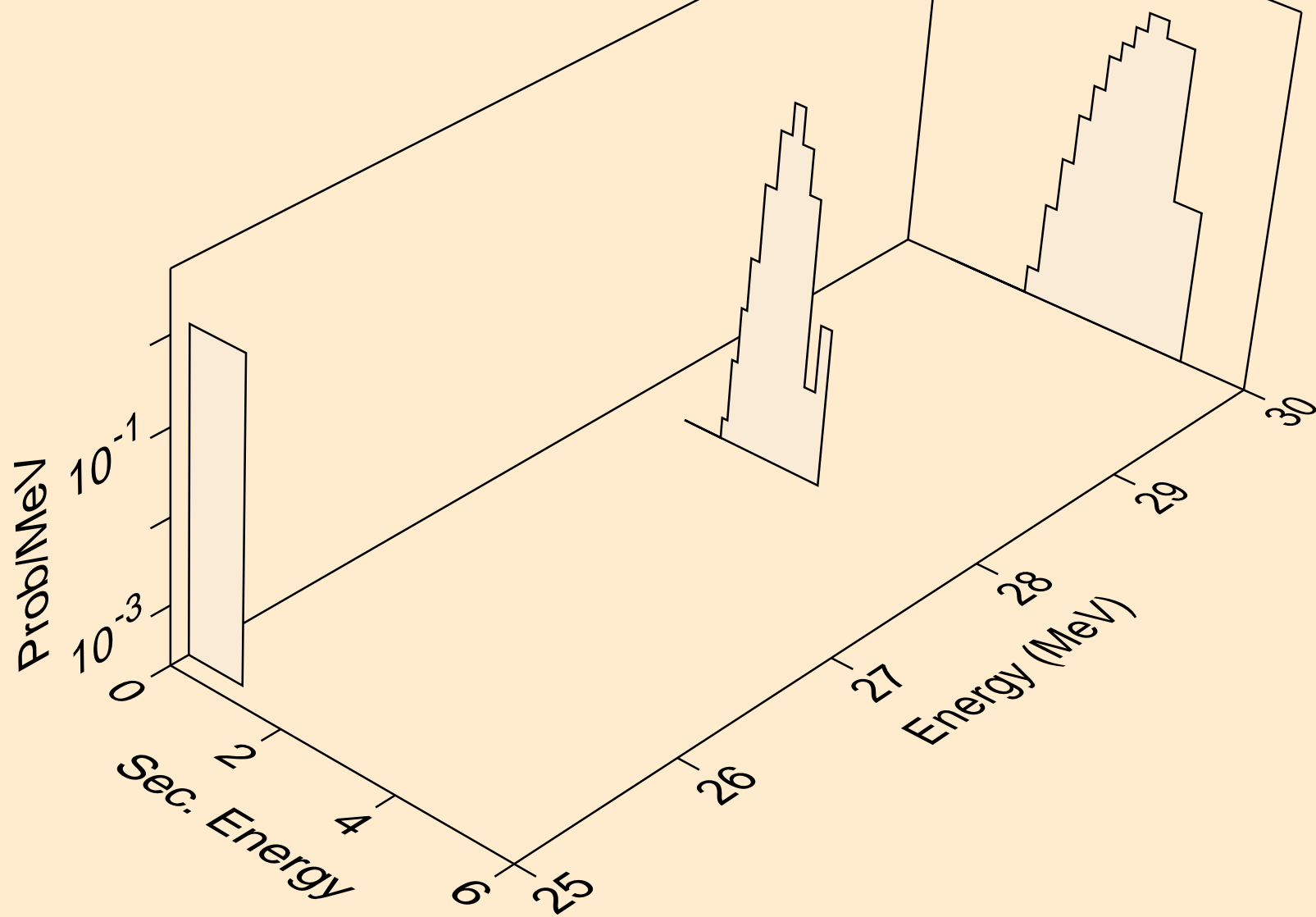

NI062 NEUTRON ACER TENDL-2021 LIBRARY; T=293.6K
alphas from (n,n*)2a

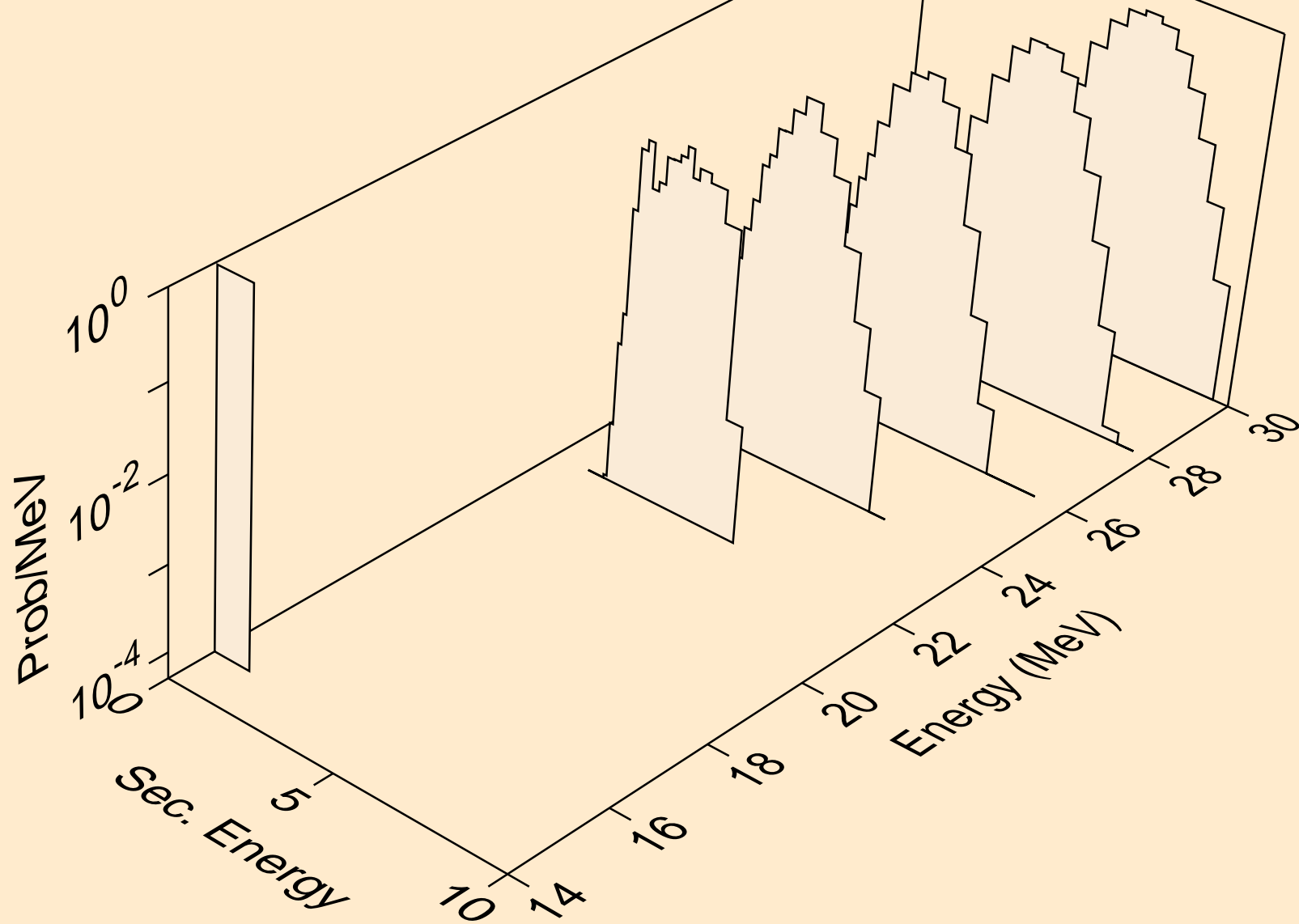

NI062 NEUTRON ACER TENDL-2021 LIBRARY; T=293.6K
alphas from (n,npa)

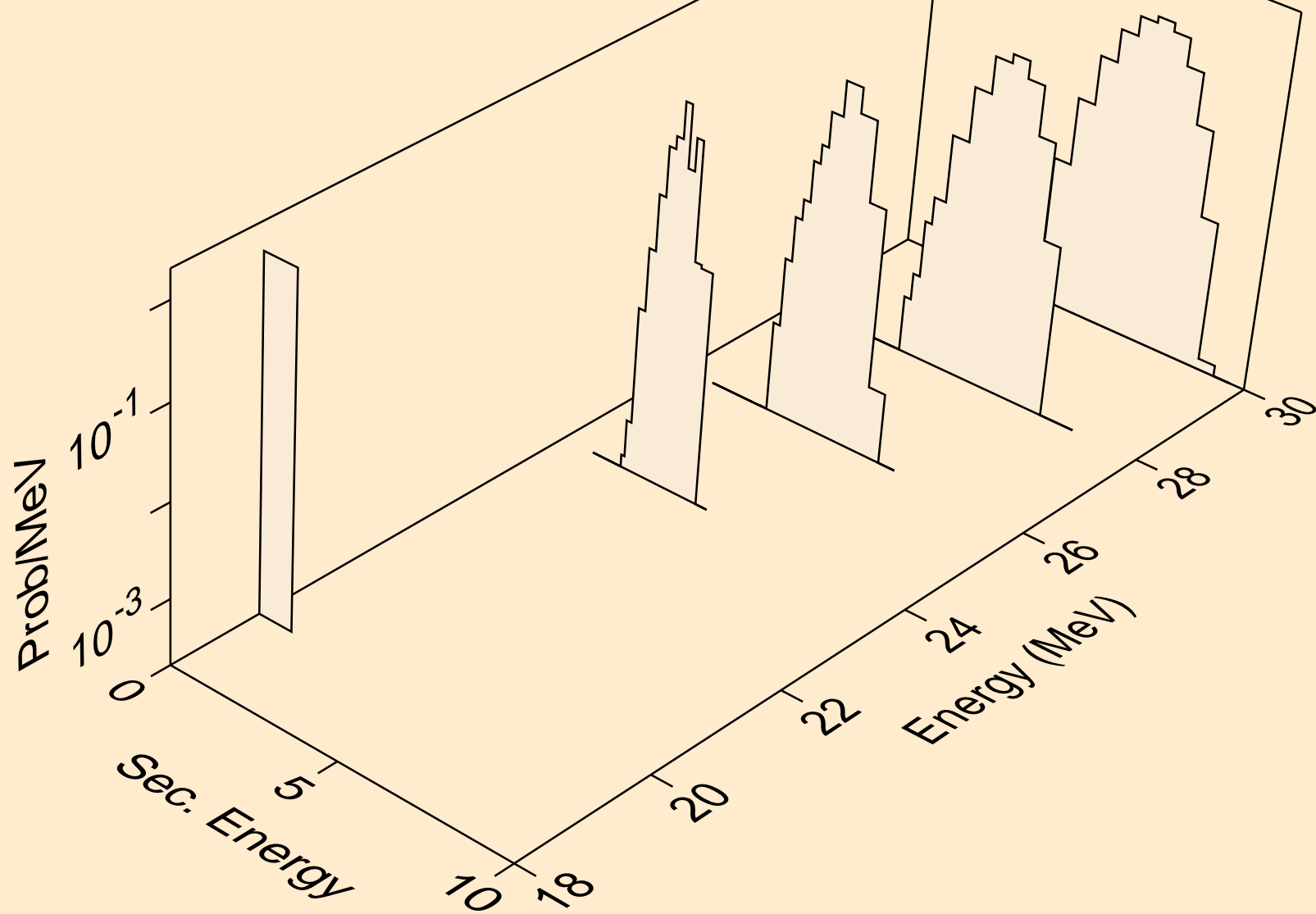

NI062 NEUTRON ACER TENDL-2021 LIBRARY; T=293.6K
alphas from (n,a)

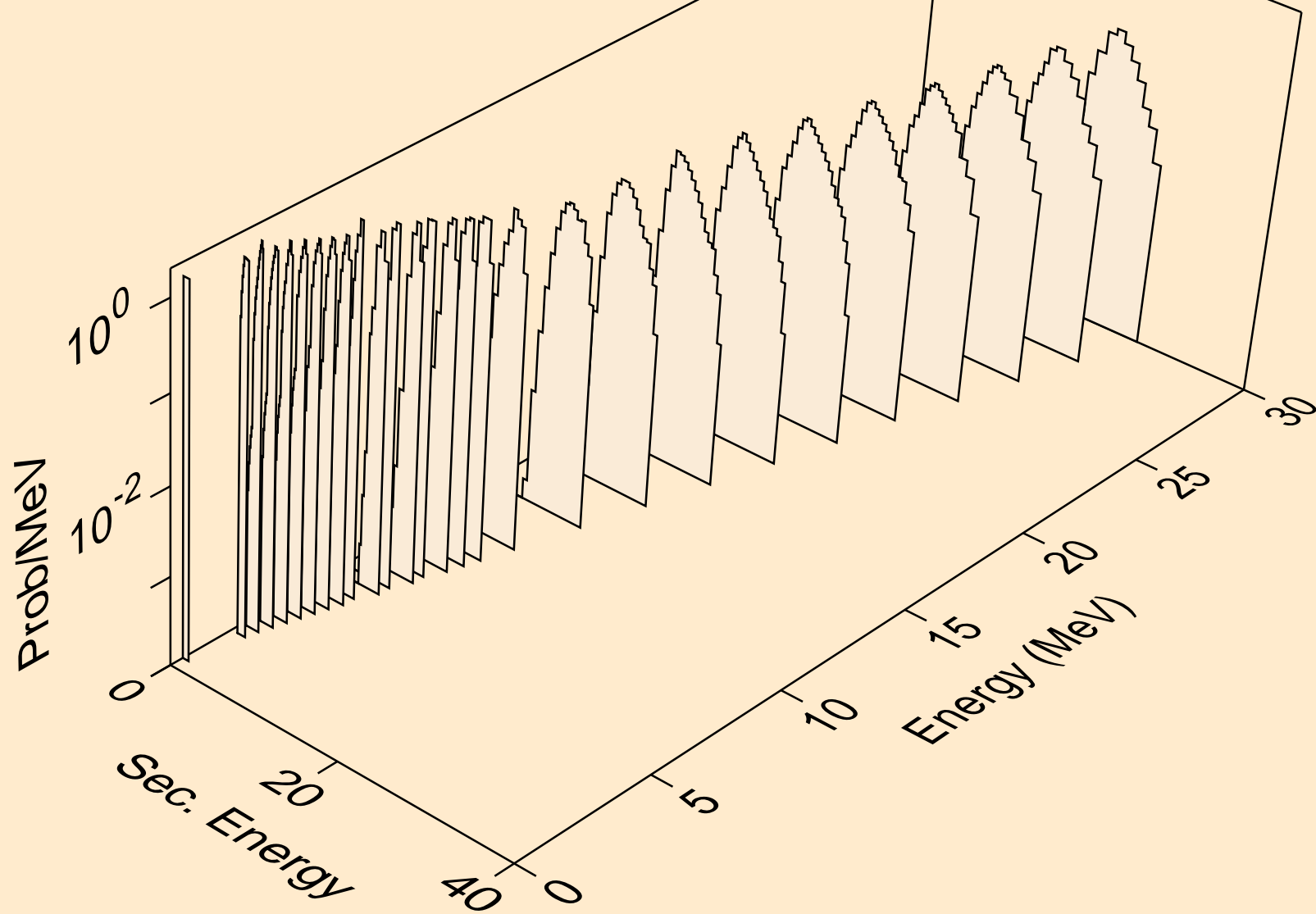

NI062 NEUTRON ACER TENDL-2021 LIBRARY; T=293.6K
alphas from (n,2a)

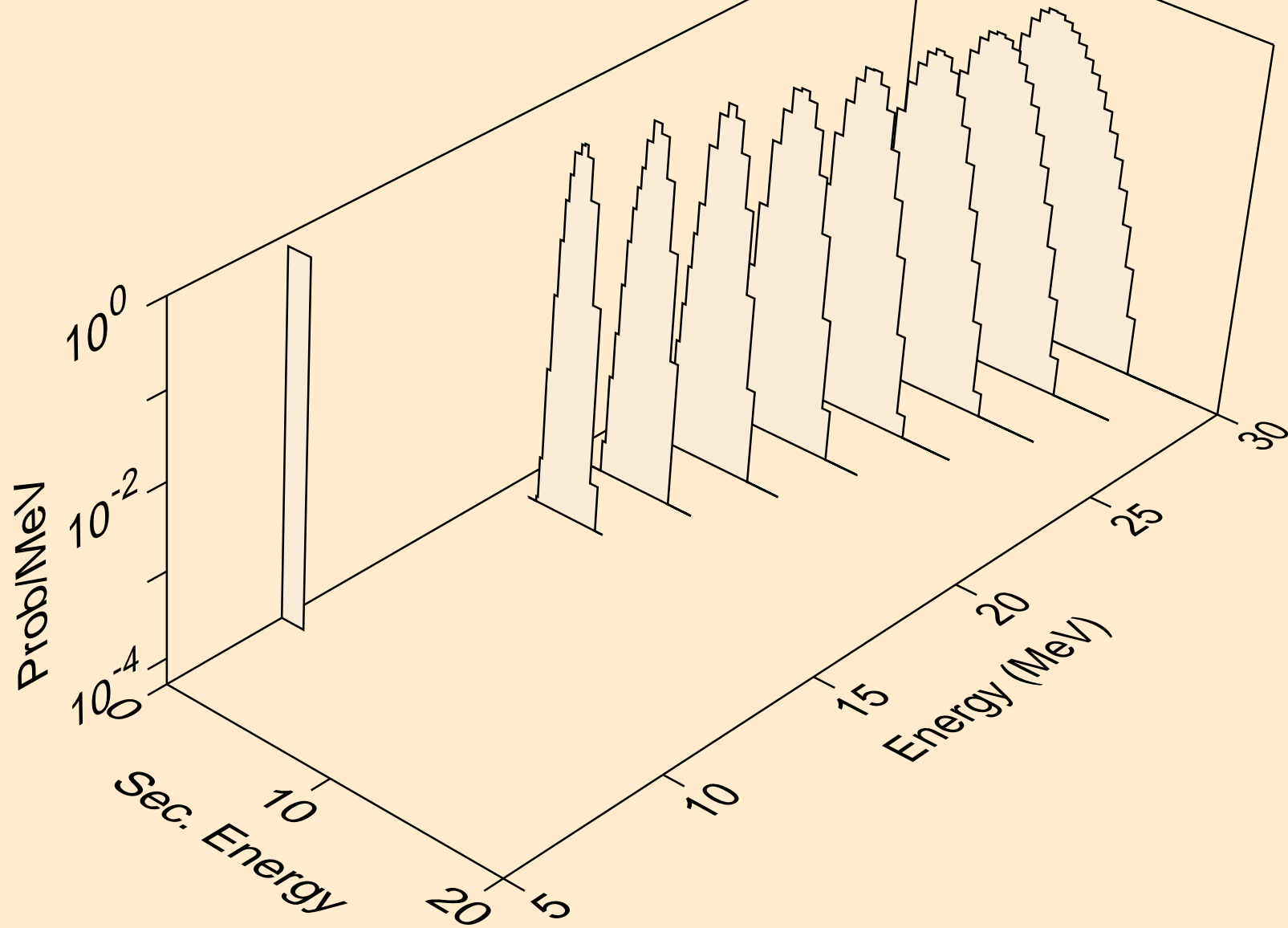

NI062 NEUTRON ACER TENDL-2021 LIBRARY; T=293.6K
alphas from (n,pa)

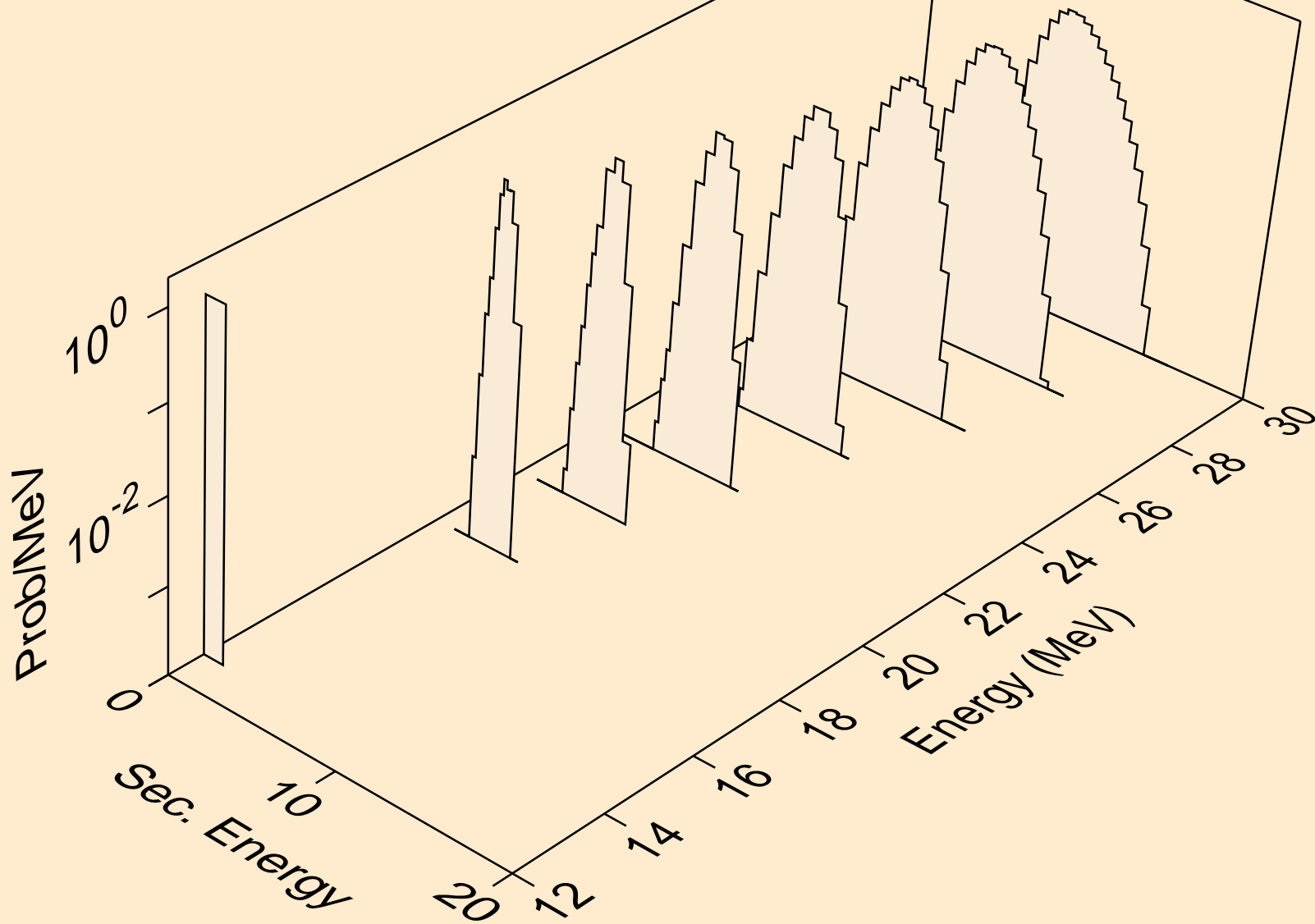

NI062 NEUTRON ACER TENDL-2021 LIBRARY; T=293.6K
alphas from (n,da)

