

NO253 NEUTRON ACER TENDL-2021 LIBRARY; T=293.6K
Principal cross sections

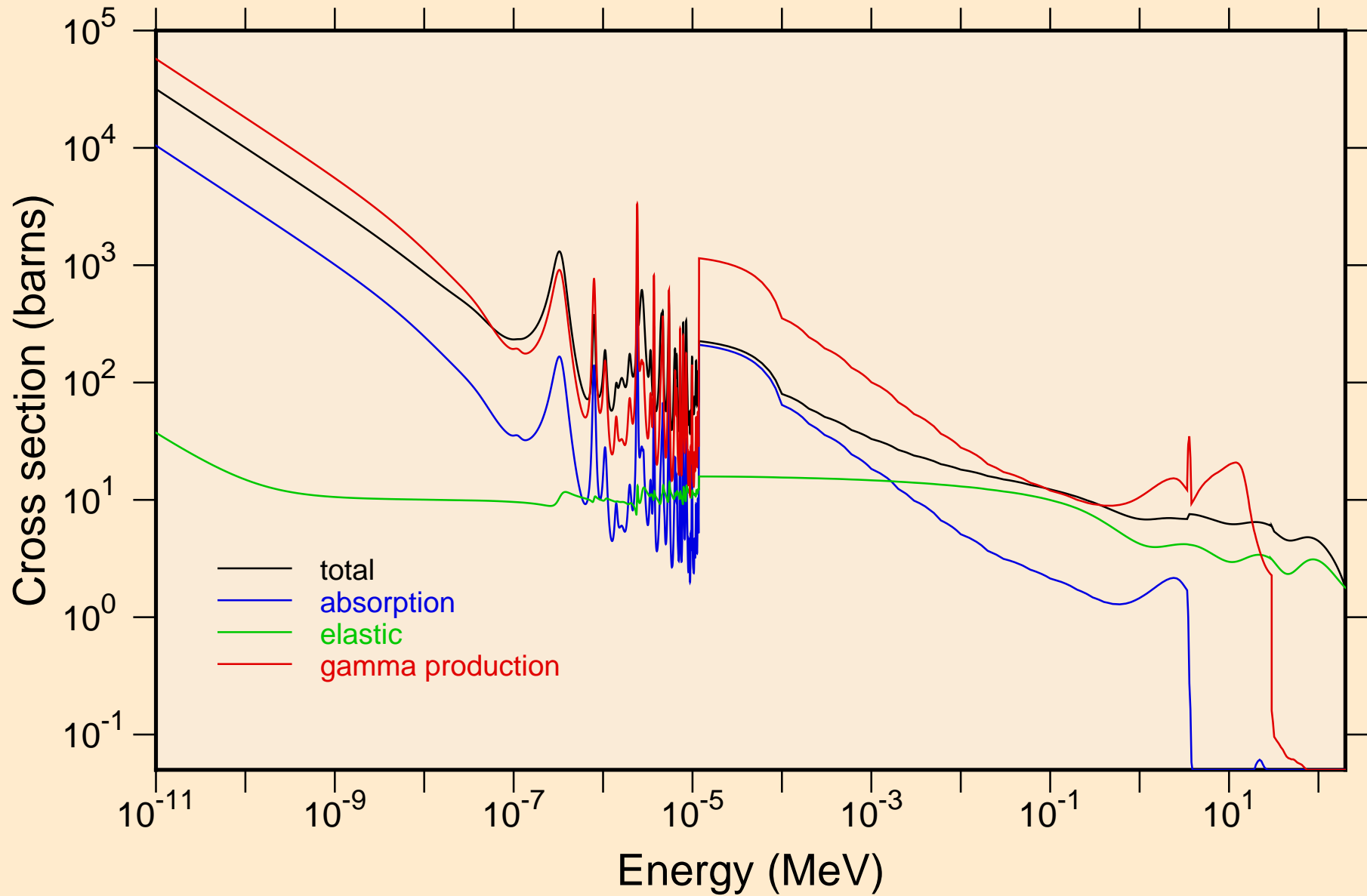

NO253 NEUTRON ACER TENDL-2021 LIBRARY; T=293.6K
resonance total cross section

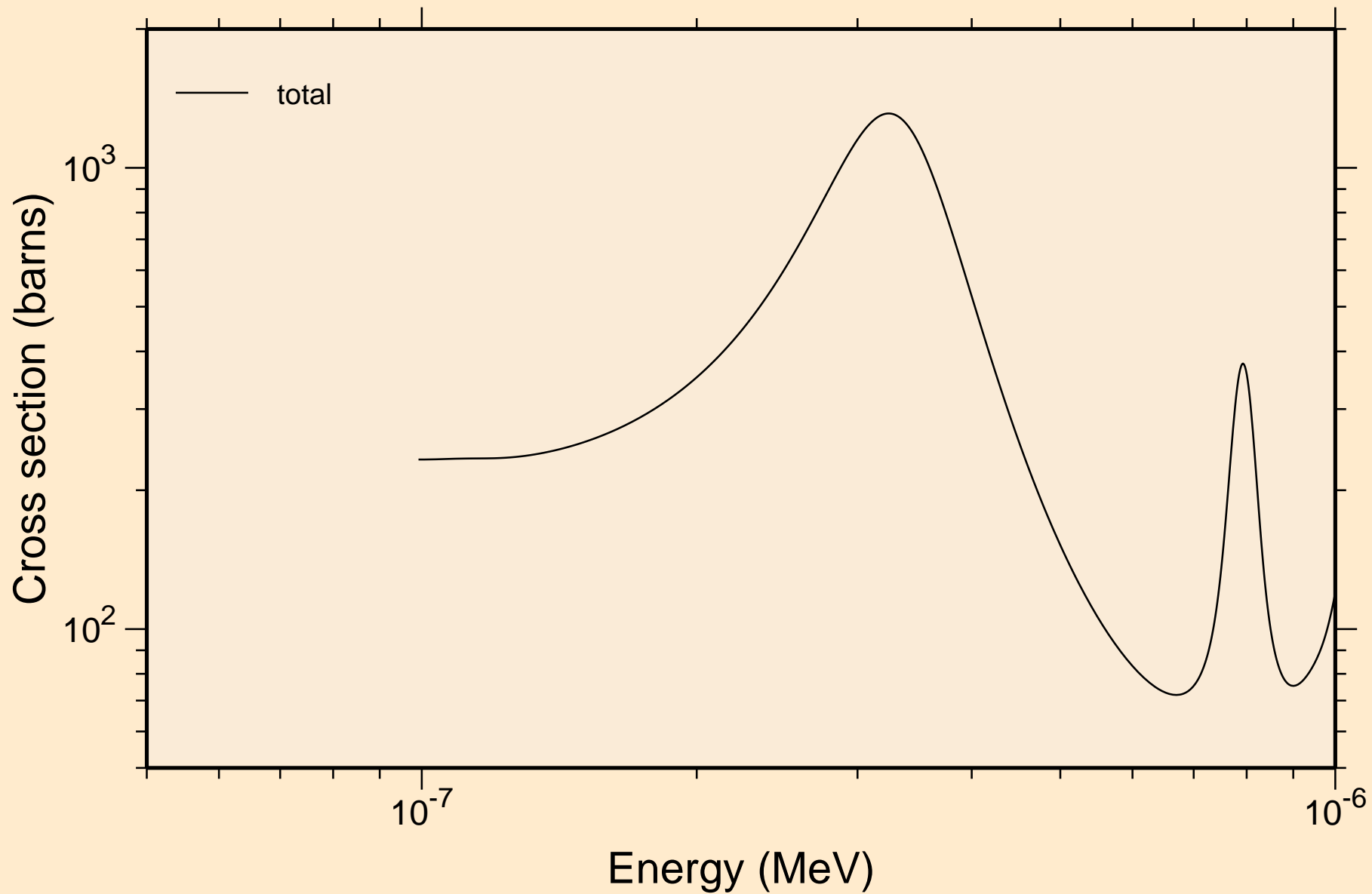

NO253 NEUTRON ACER TENDL-2021 LIBRARY; T=293.6K
resonance total cross section

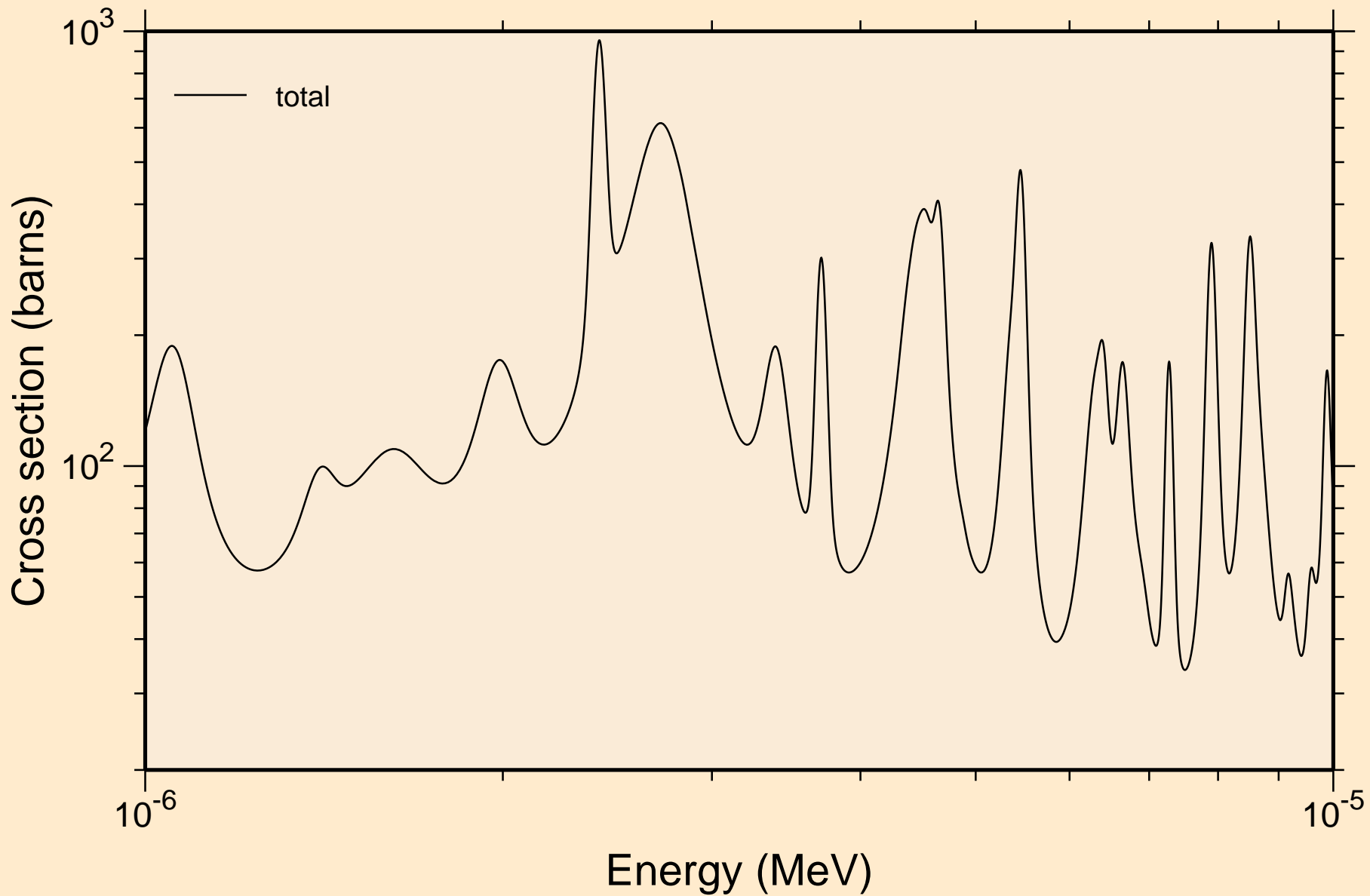

NO253 NEUTRON ACER TENDL-2021 LIBRARY; T=293.6K
resonance total cross section

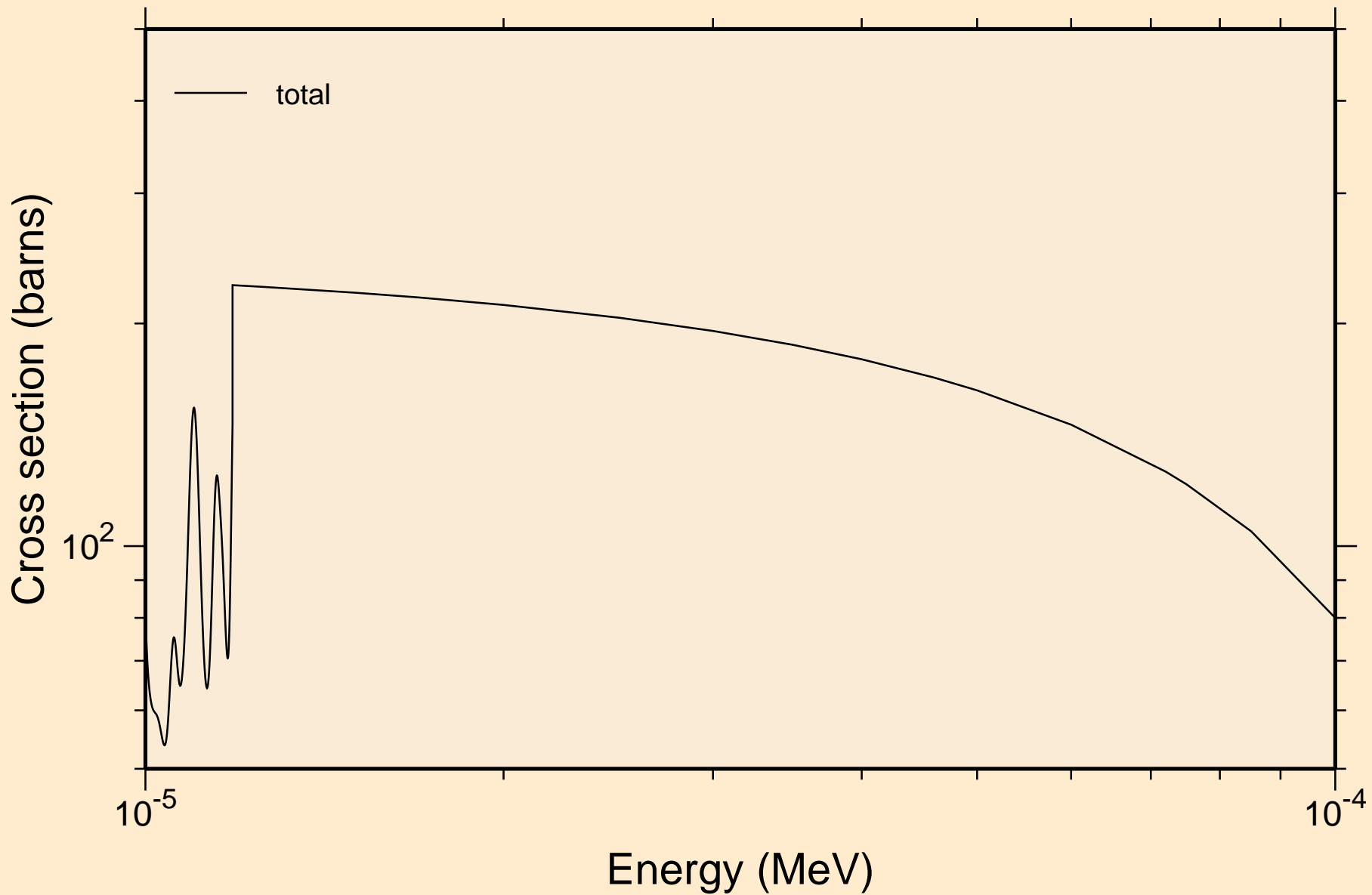

NO253 NEUTRON ACER TENDL-2021 LIBRARY; T=293.6K
resonance total cross section

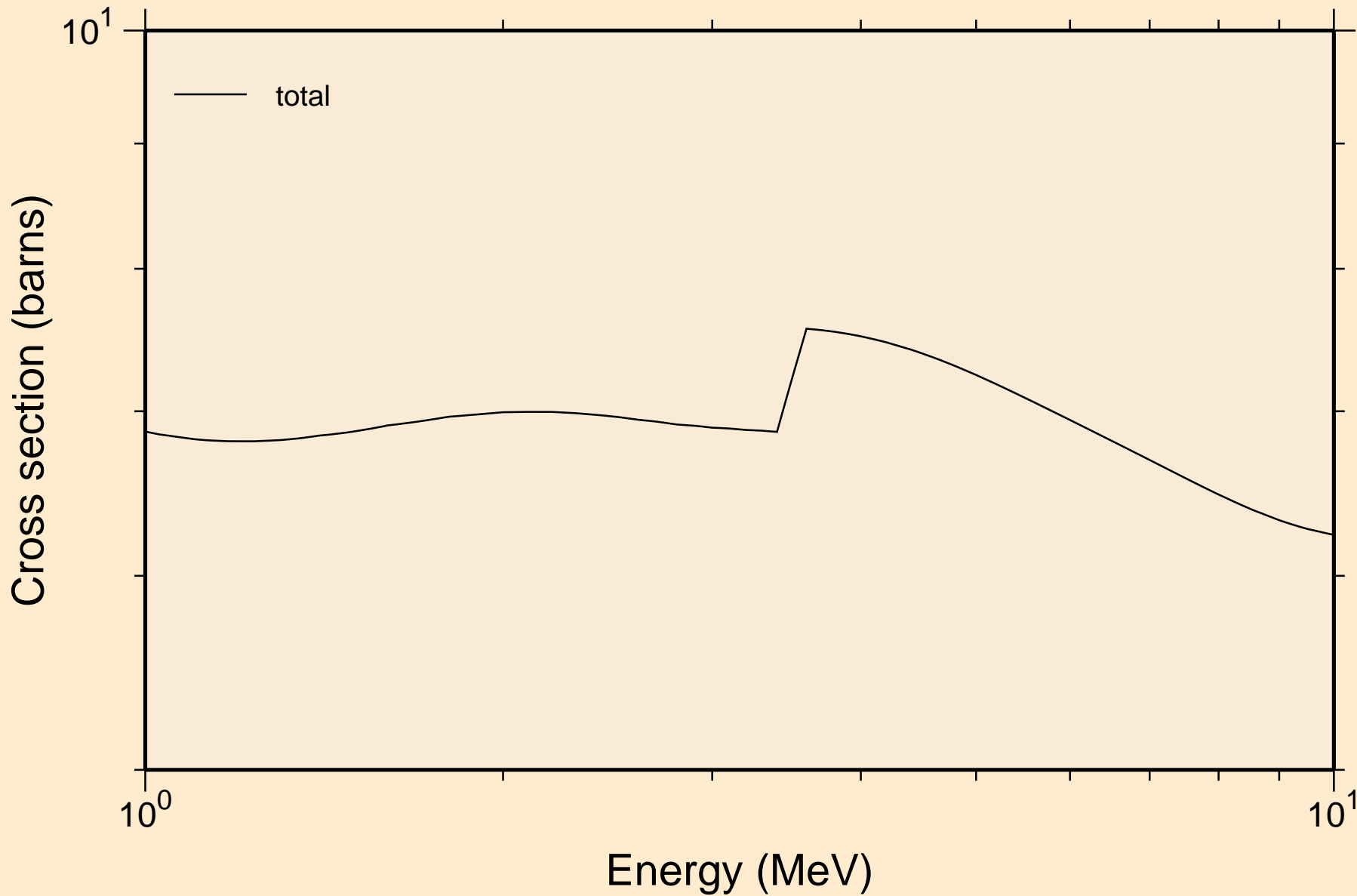

NO253 NEUTRON ACER TENDL-2021 LIBRARY; T=293.6K
resonance absorption cross sections

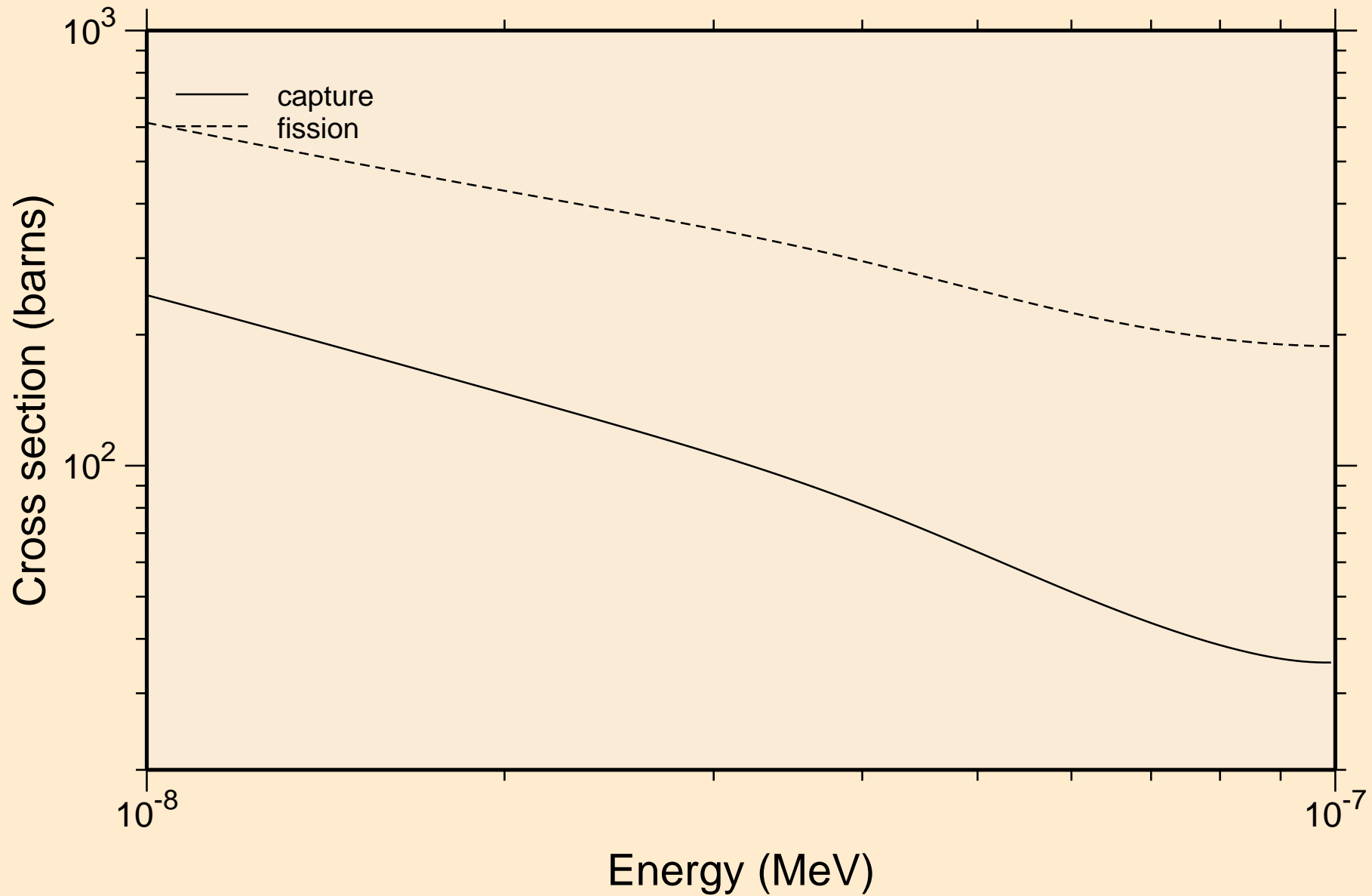

NO253 NEUTRON ACER TENDL-2021 LIBRARY; T=293.6K
resonance absorption cross sections

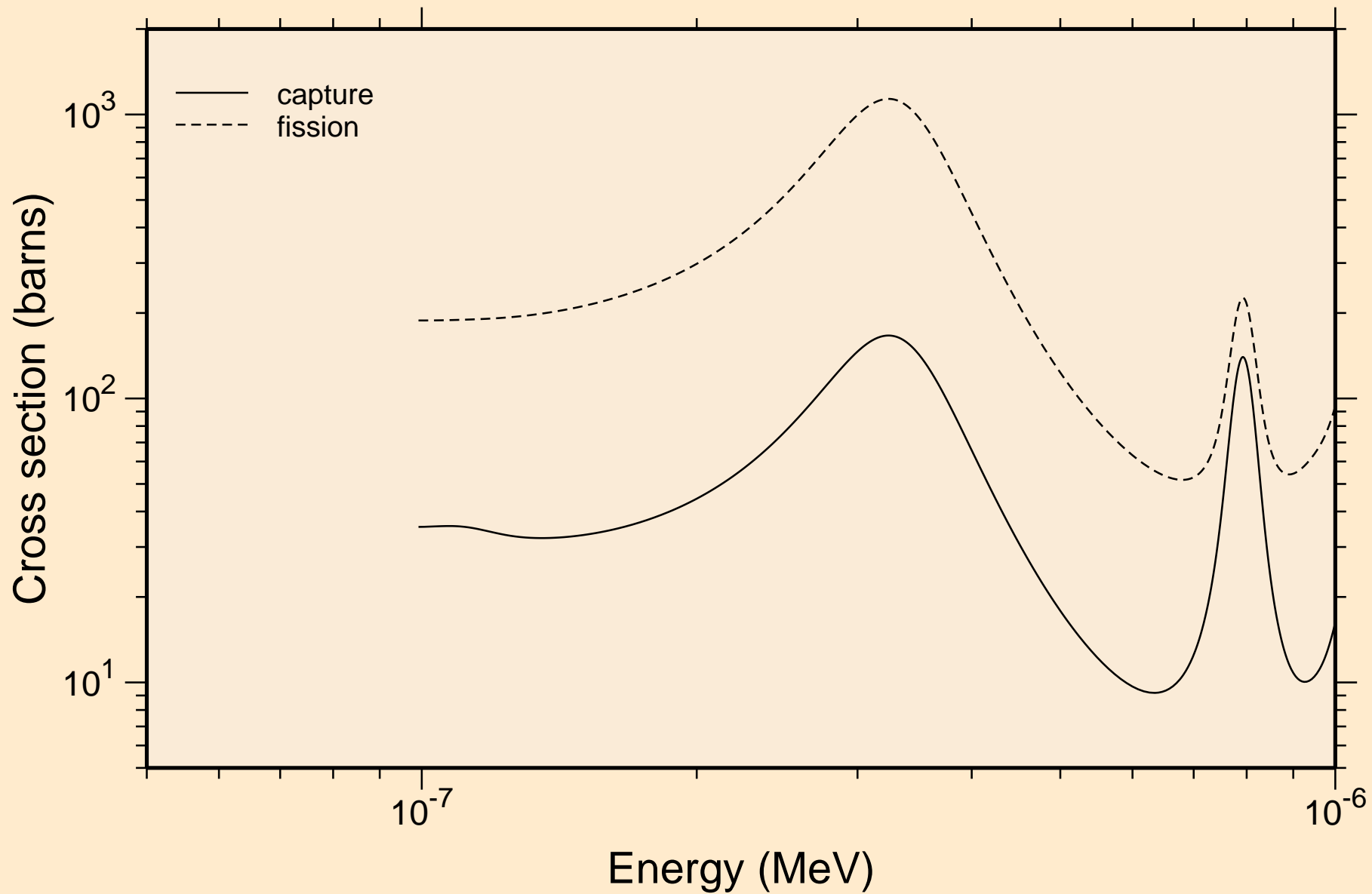

NO253 NEUTRON ACER TENDL-2021 LIBRARY; T=293.6K
resonance absorption cross sections

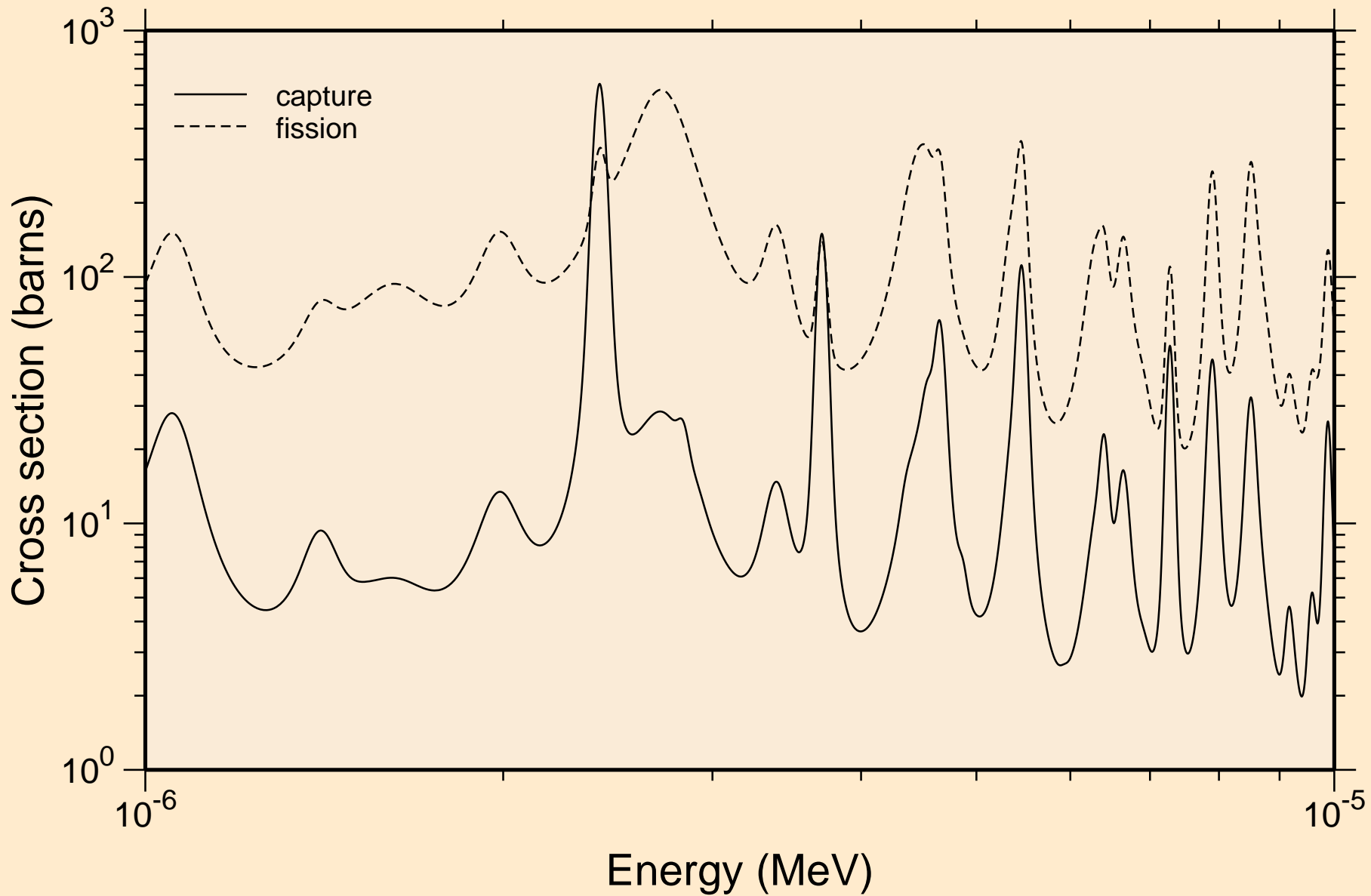

NO253 NEUTRON ACER TENDL-2021 LIBRARY; T=293.6K
resonance absorption cross sections

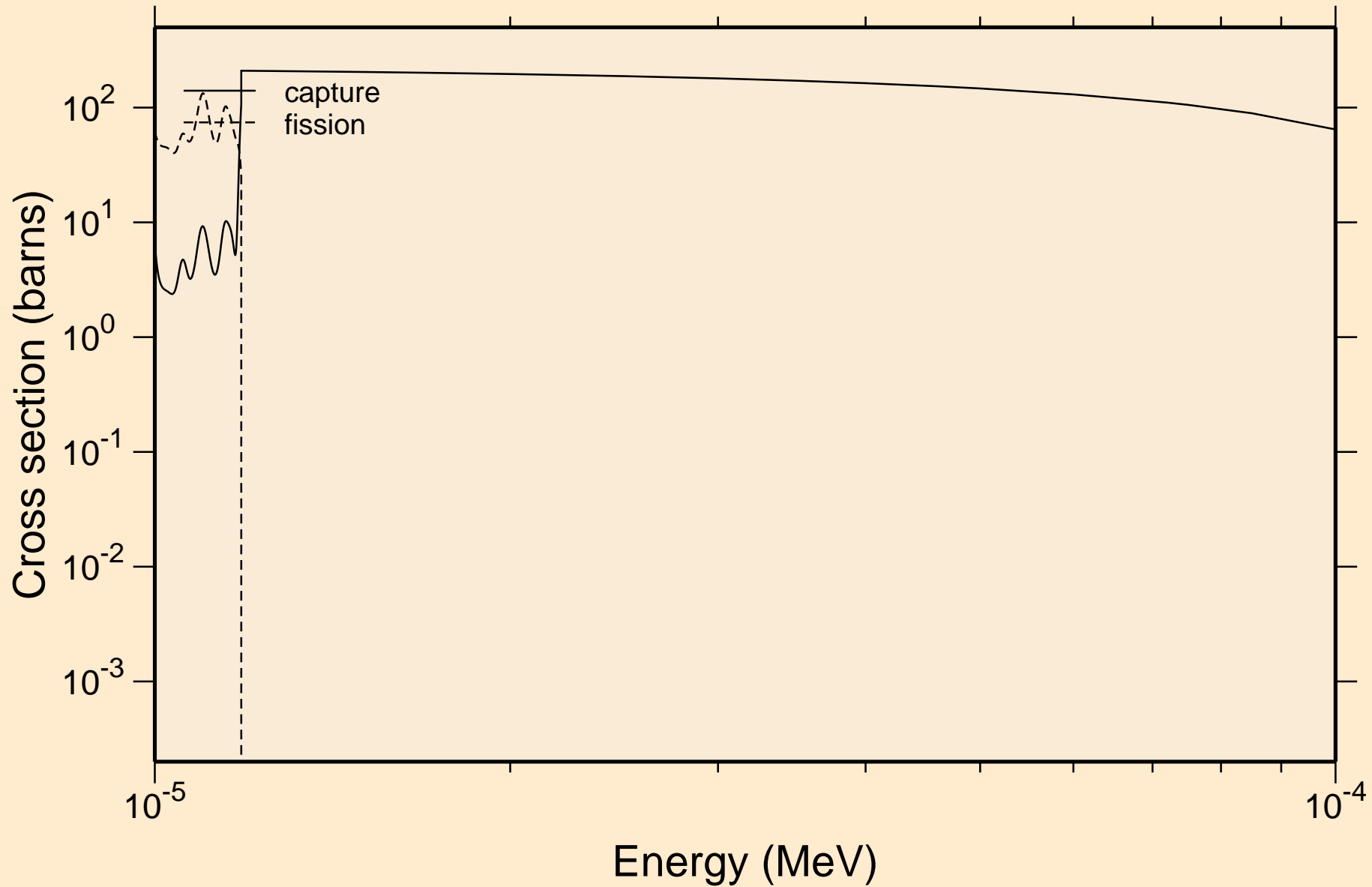

NO253 NEUTRON ACER TENDL-2021 LIBRARY; T=293.6K
resonance absorption cross sections

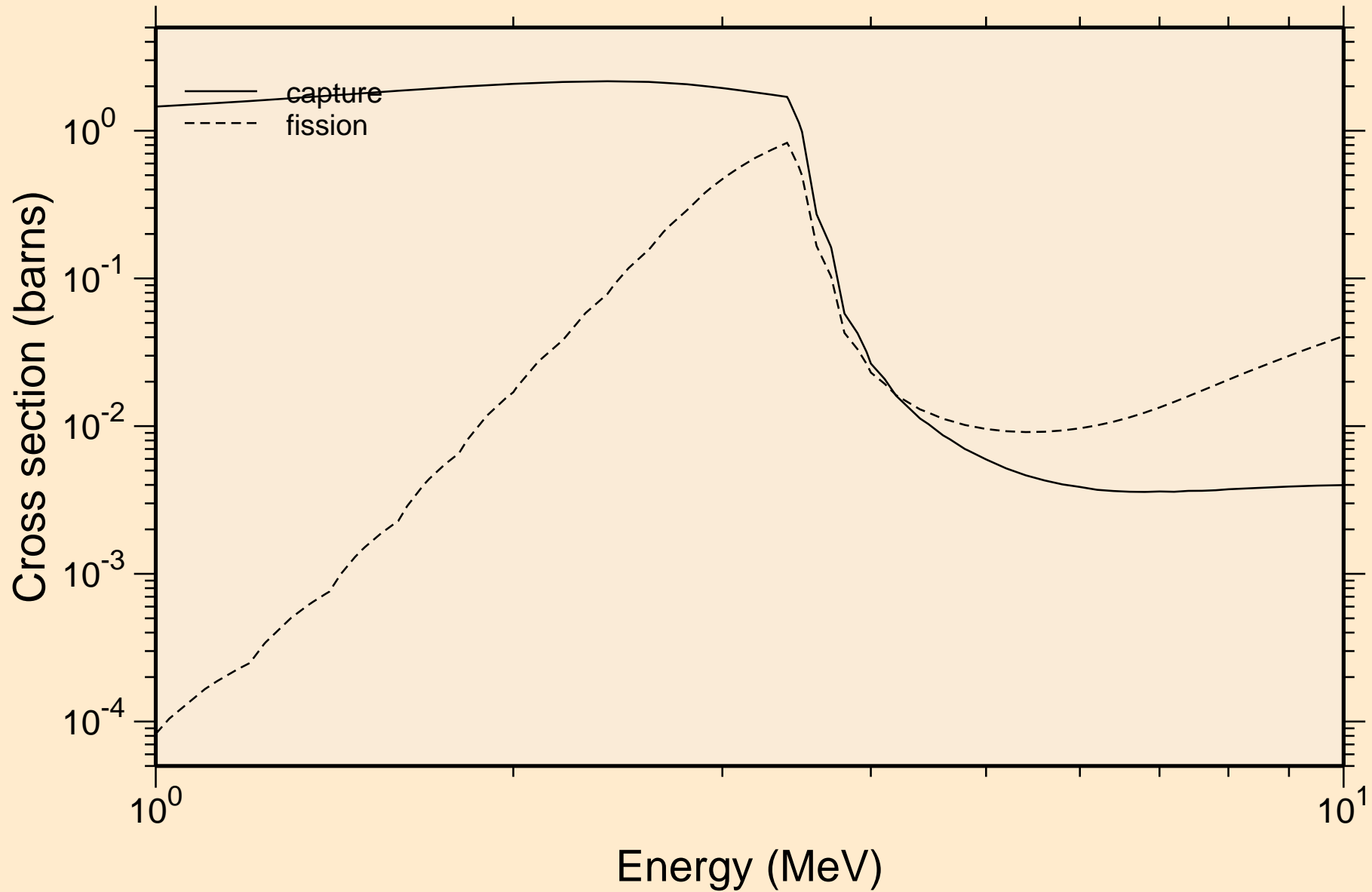

NO253 NEUTRON ACER TENDL-2021 LIBRARY; T=293.6K
Heating

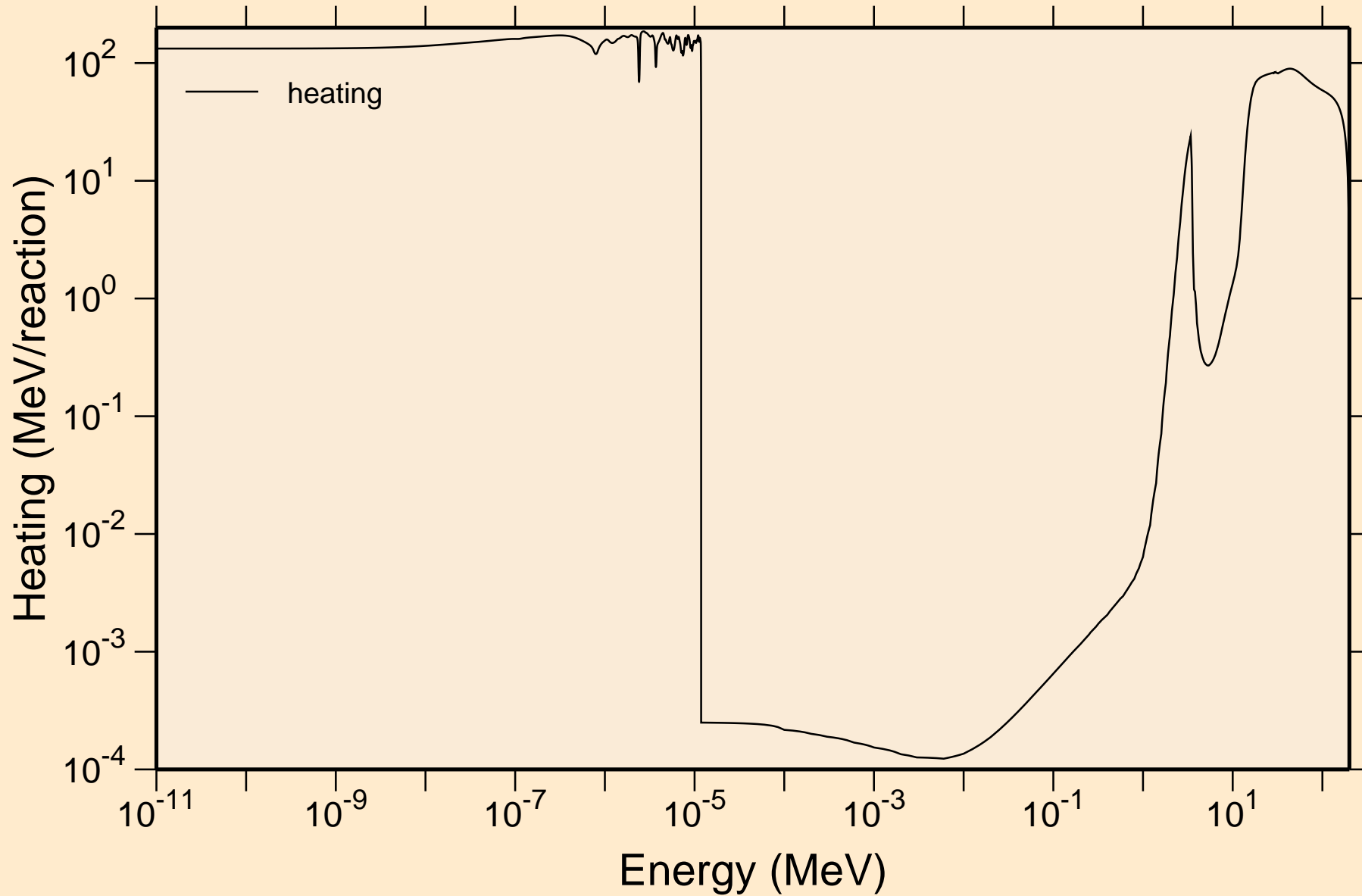

NO253 NEUTRON ACER TENDL-2021 LIBRARY; T=293.6K
Damage

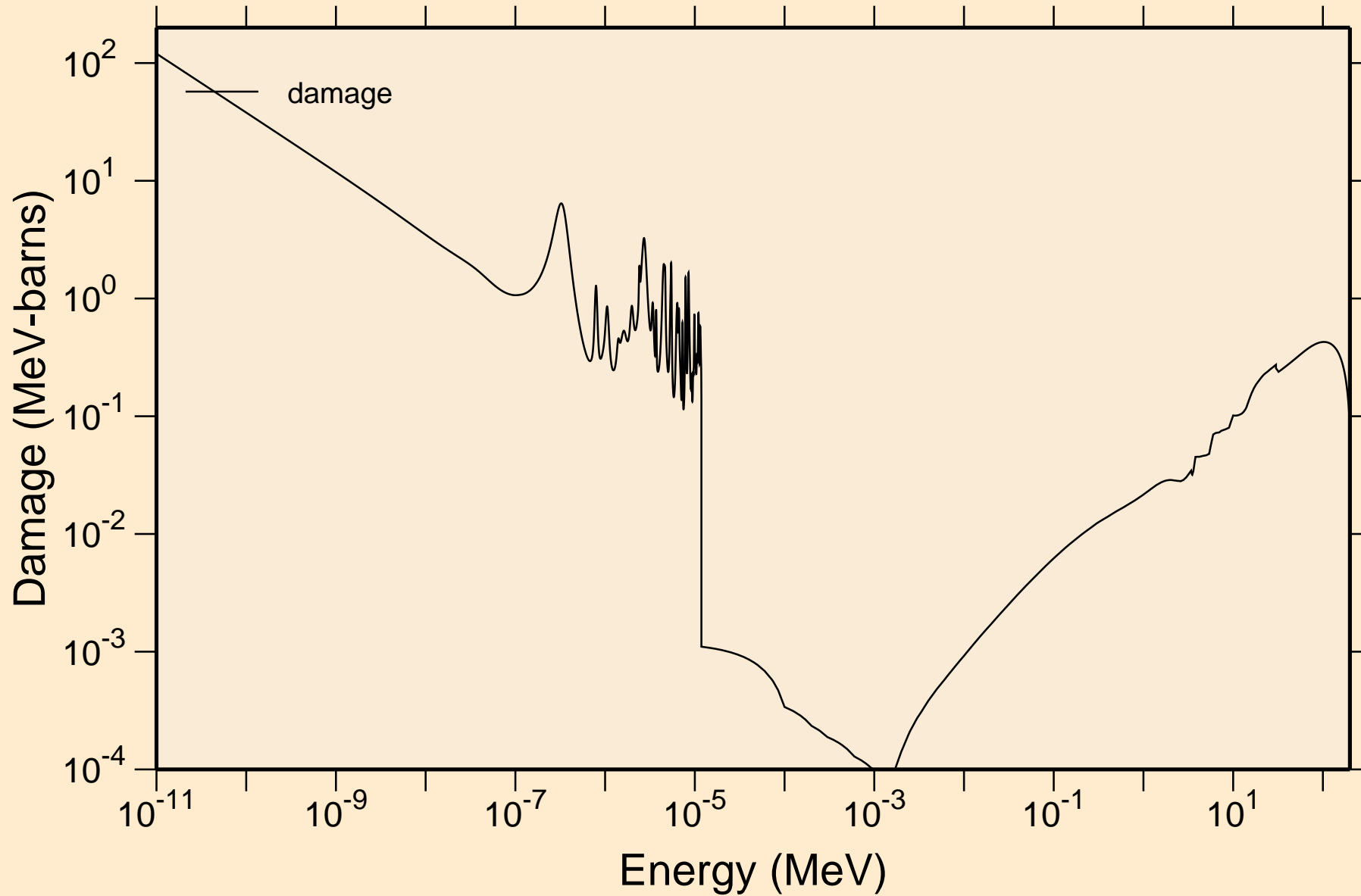

NO253 NEUTRON ACER TENDL-2021 LIBRARY; T=293.6K
Non-threshold reactions

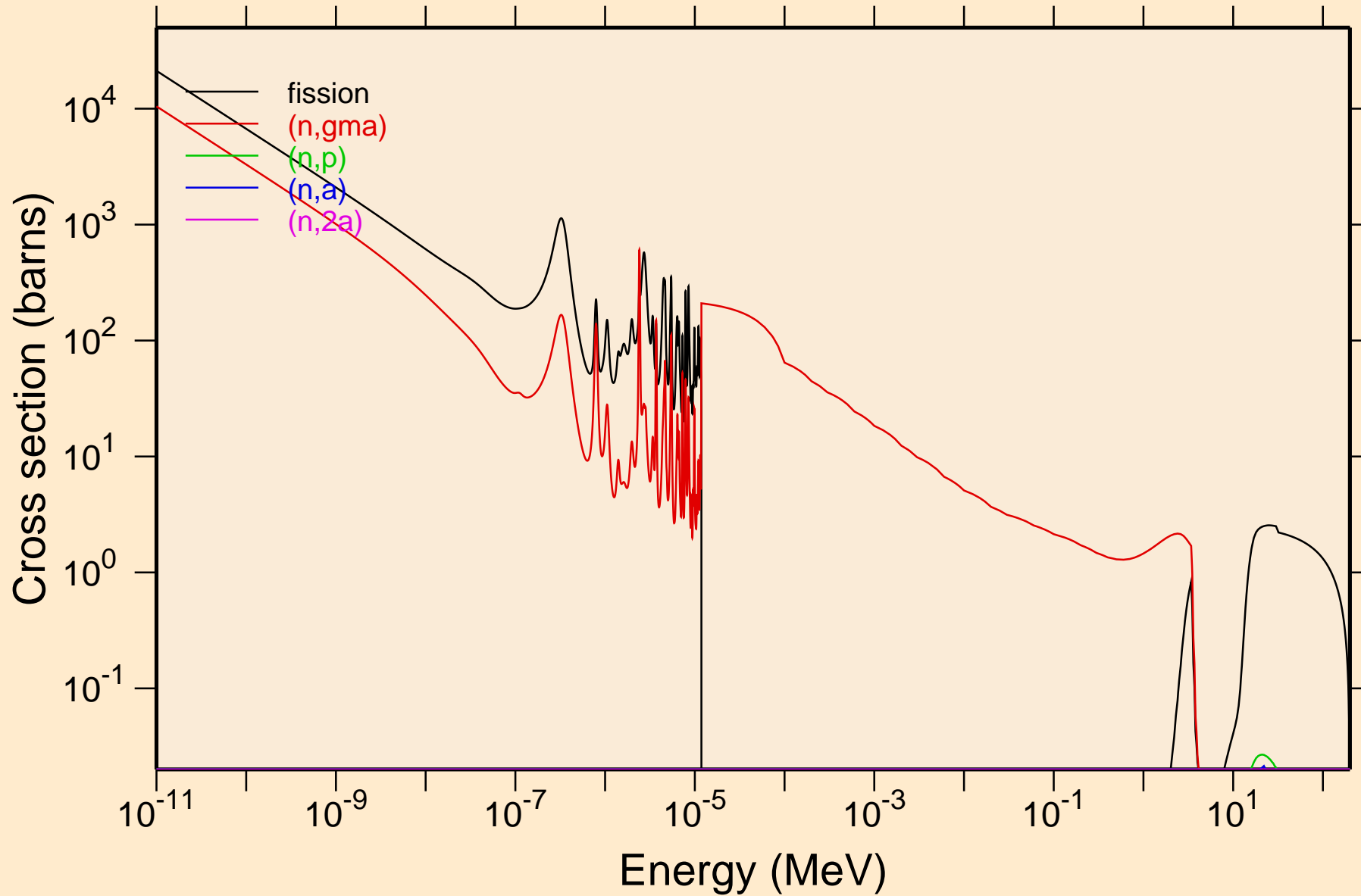

NO253 NEUTRON ACER TENDL-2021 LIBRARY; T=293.6K
Non-threshold reactions

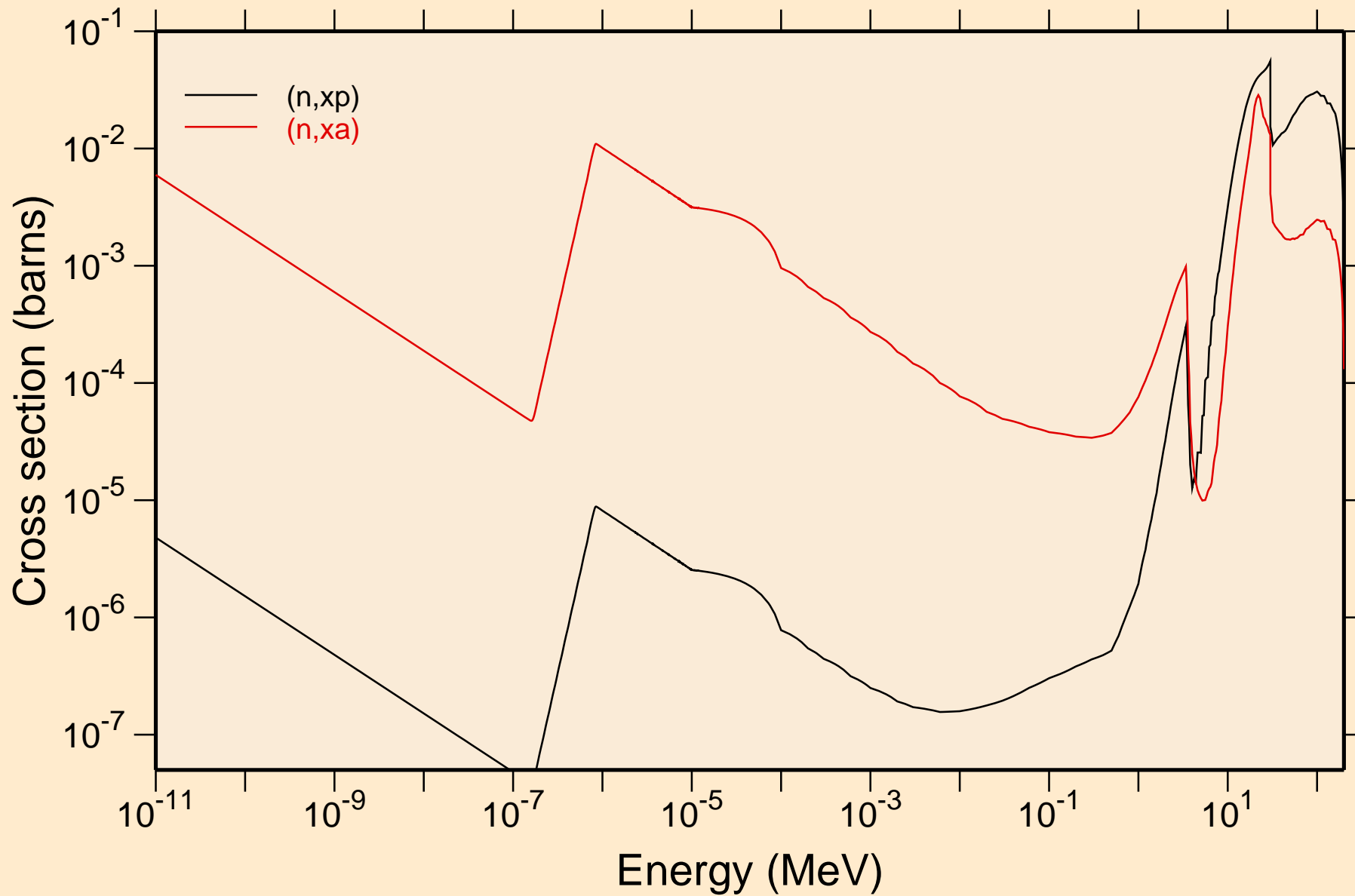

NO253 NEUTRON ACER TENDL-2021 LIBRARY; T=293.6K
Principal cross sections

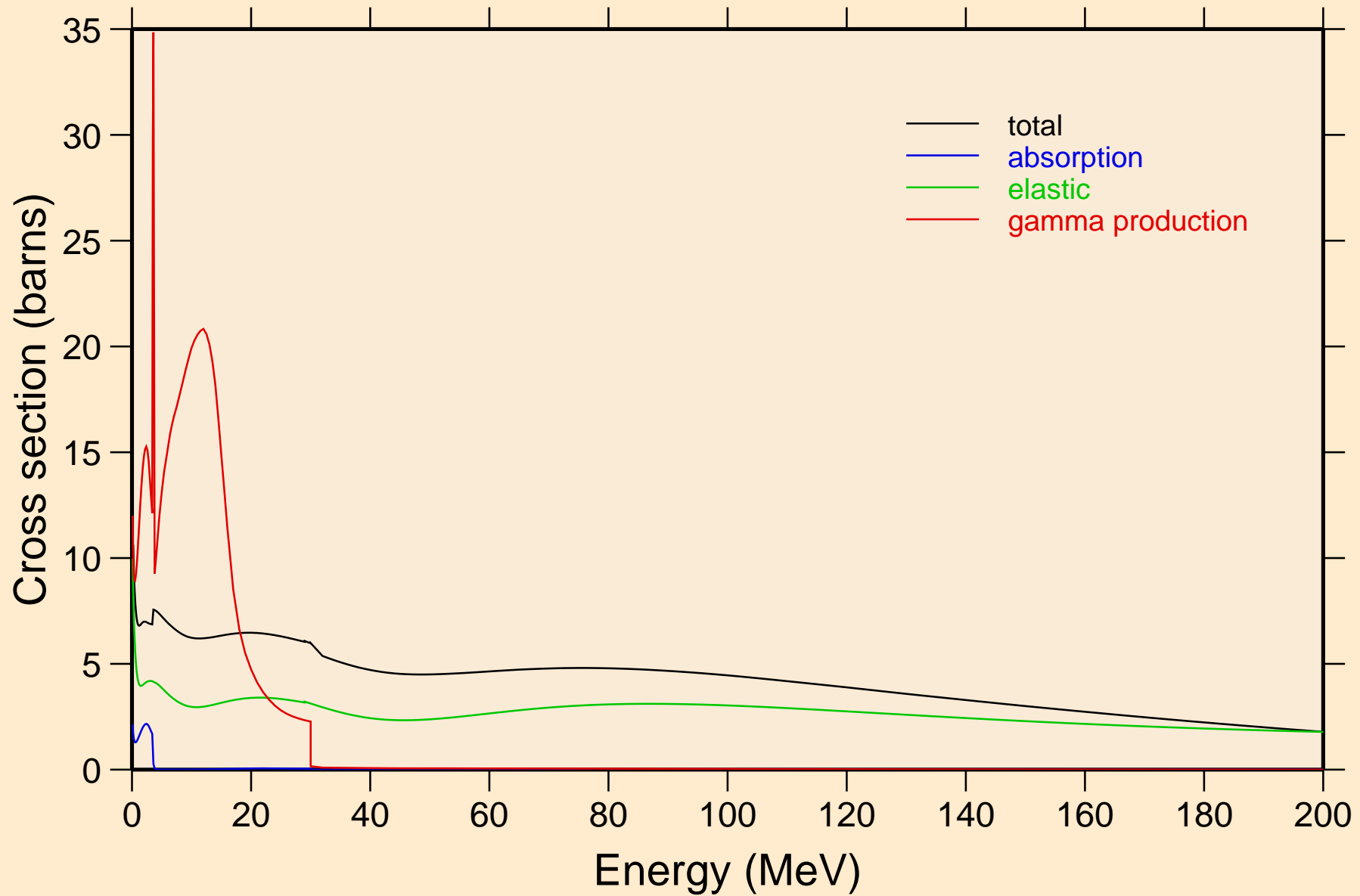

NO253 NEUTRON ACER TENDL-2021 LIBRARY; T=293.6K
Heating

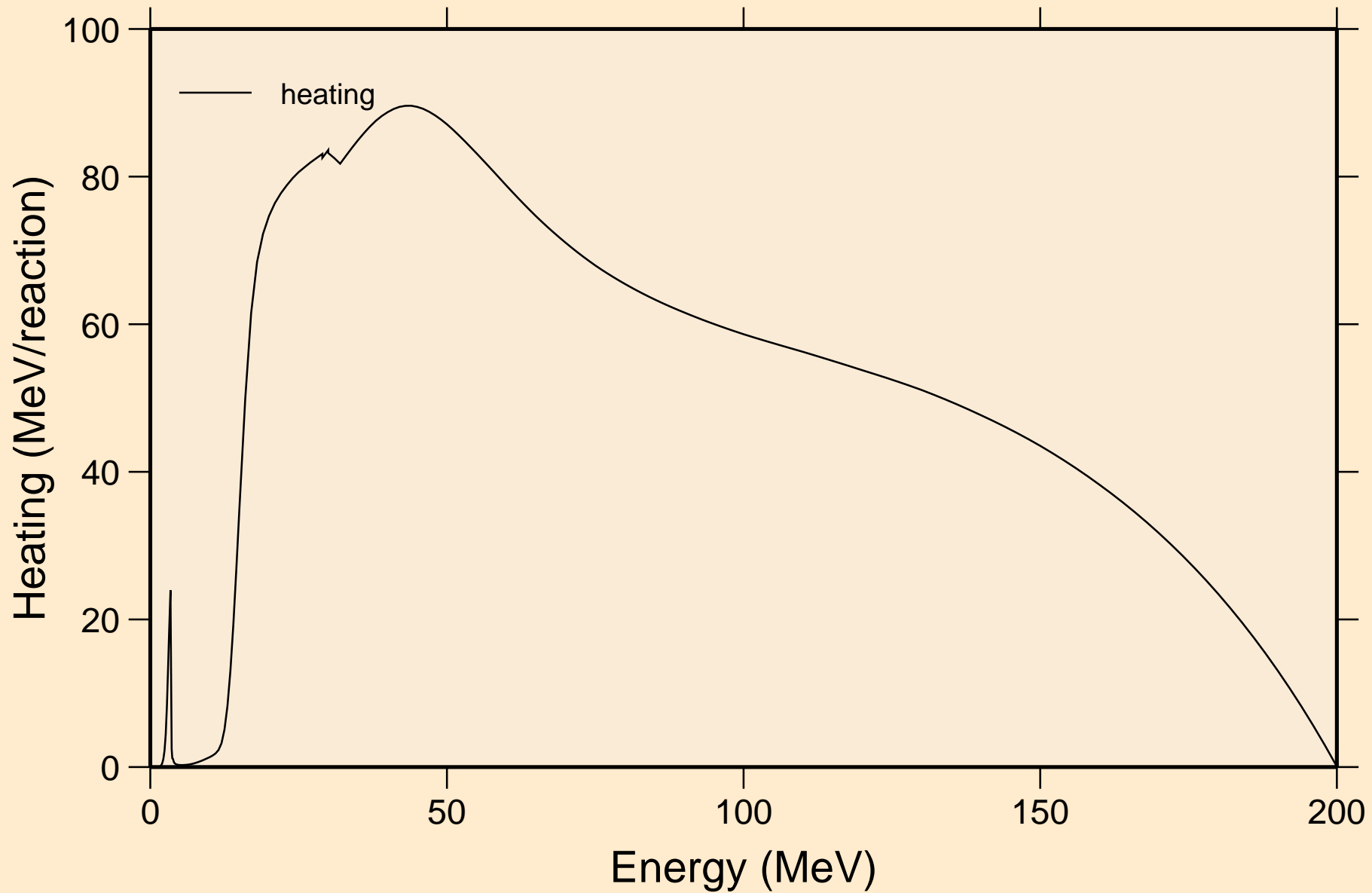

NO253 NEUTRON ACER TENDL-2021 LIBRARY; T=293.6K
Damage

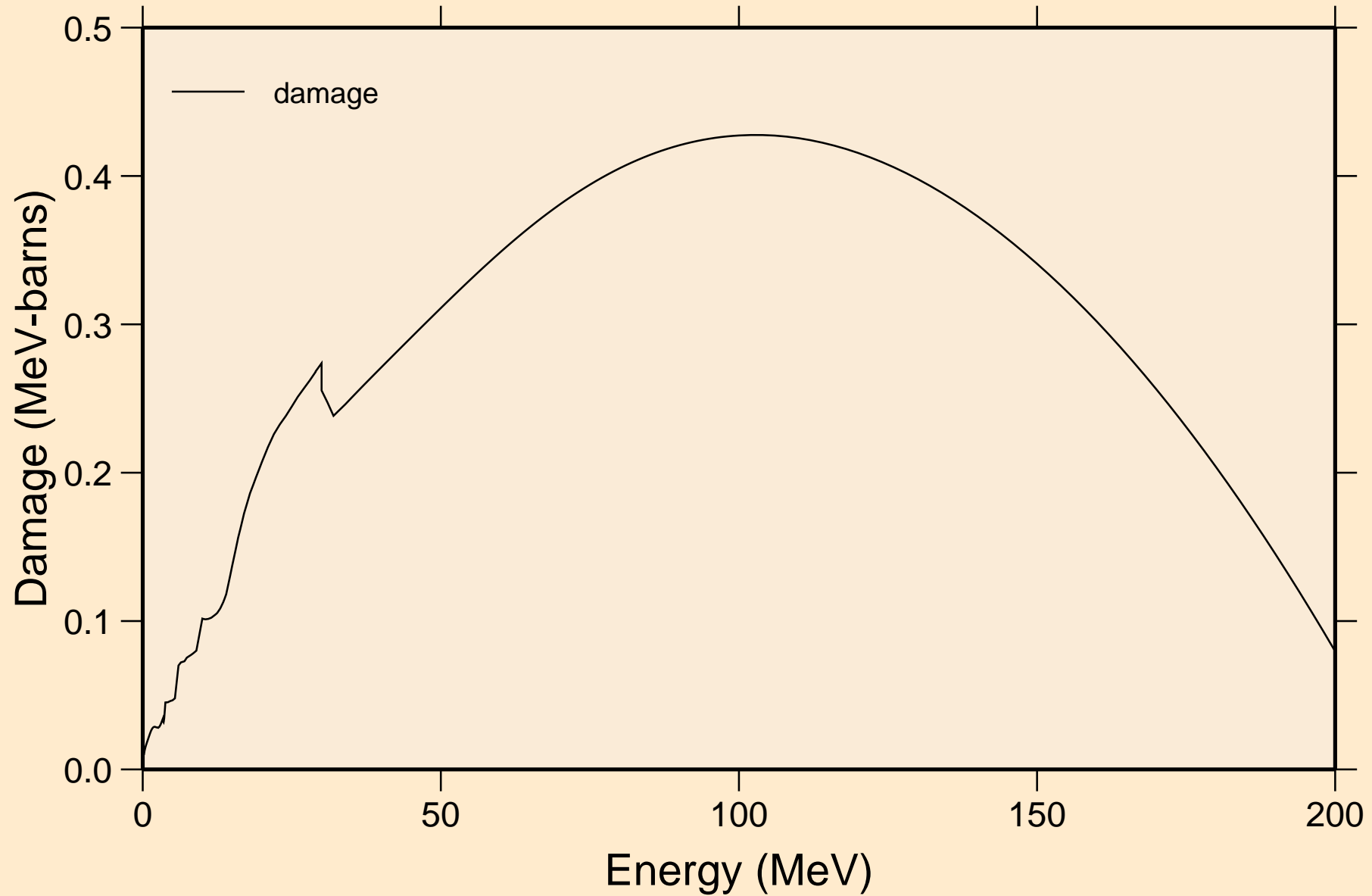

NO253 NEUTRON ACER TENDL-2021 LIBRARY; T=293.6K
Non-threshold reactions

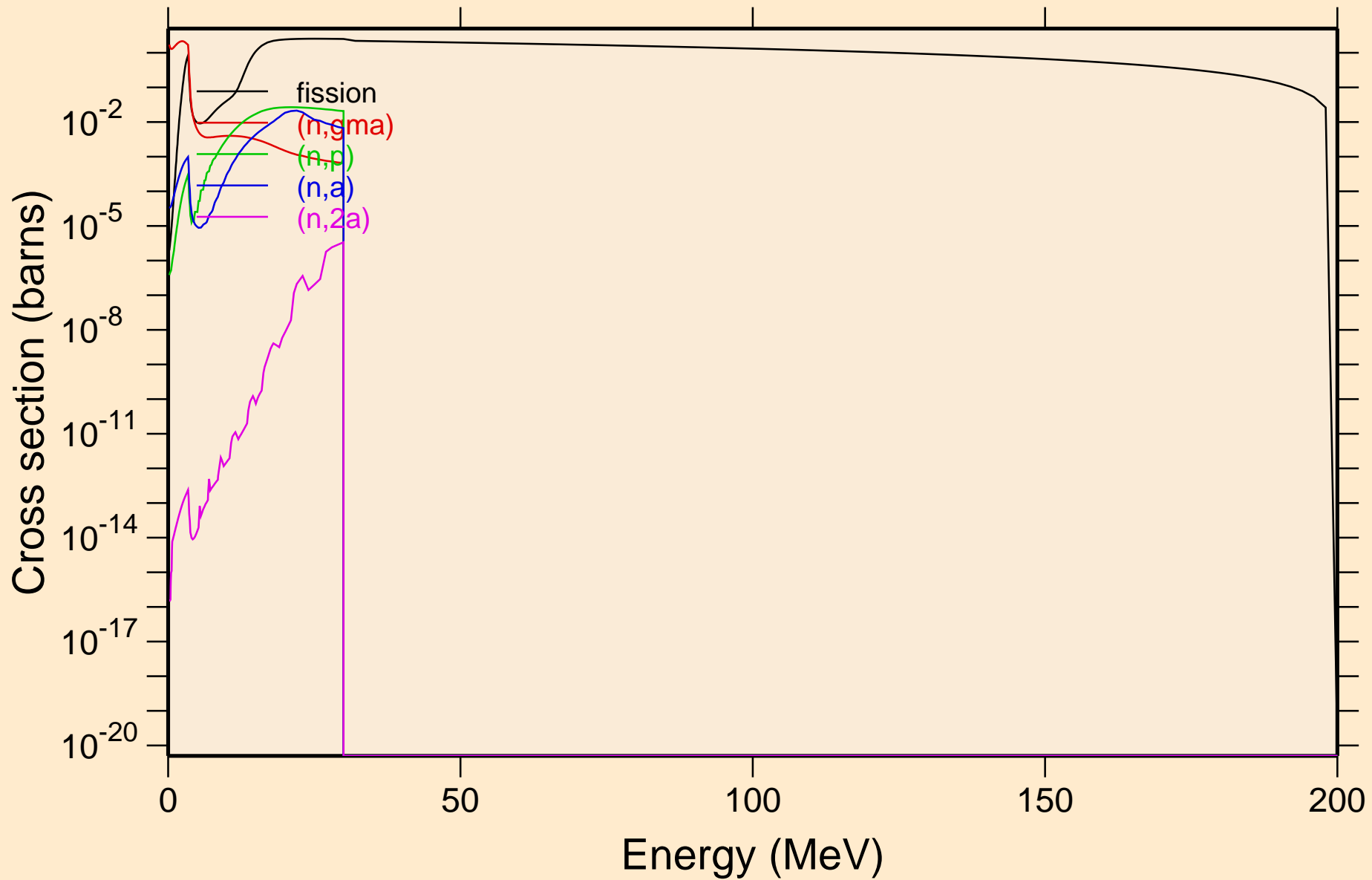

NO253 NEUTRON ACER TENDL-2021 LIBRARY; T=293.6K
Non-threshold reactions

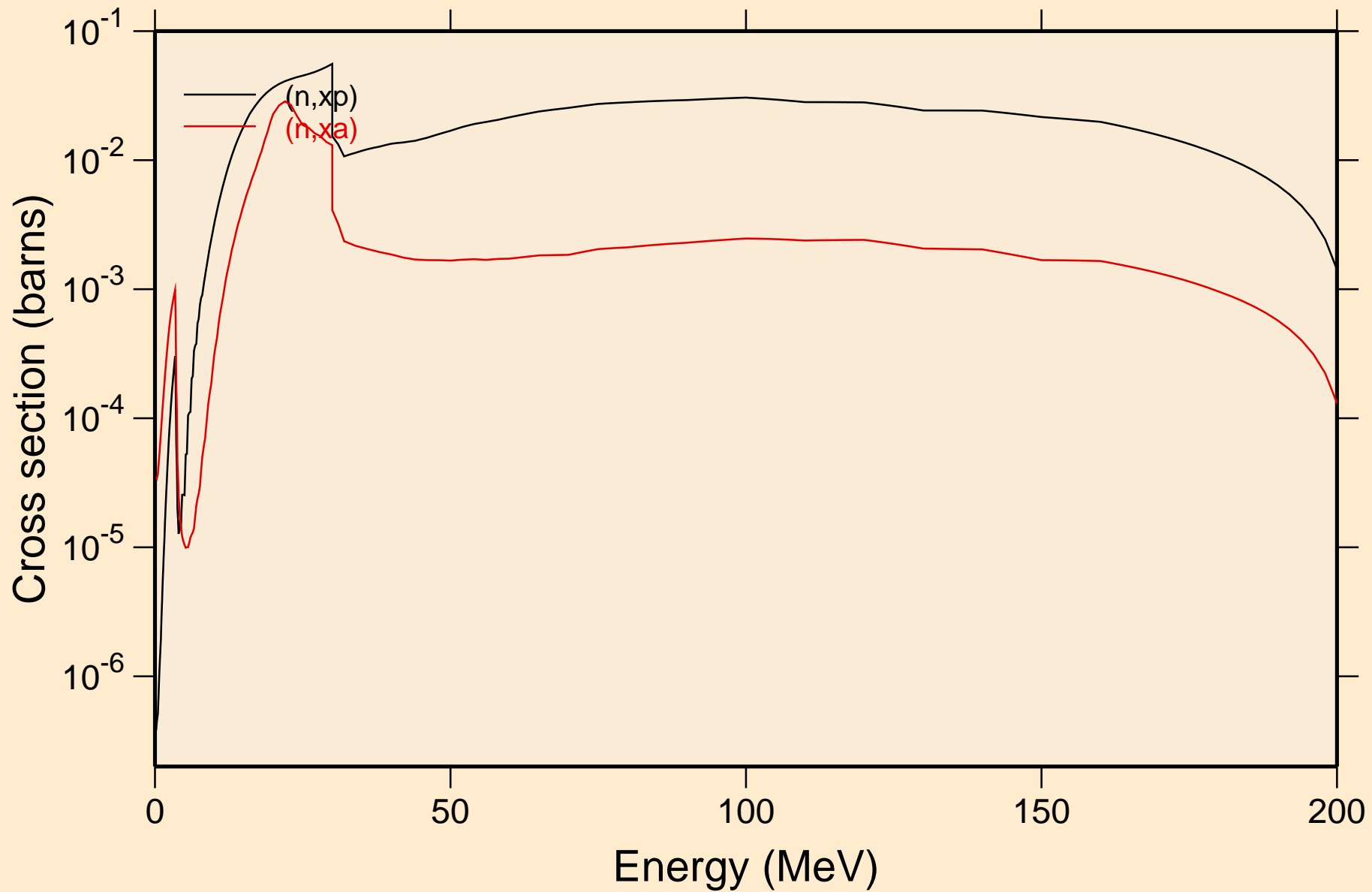

NO253 NEUTRON ACER TENDL-2021 LIBRARY; T=293.6K
Inelastic levels

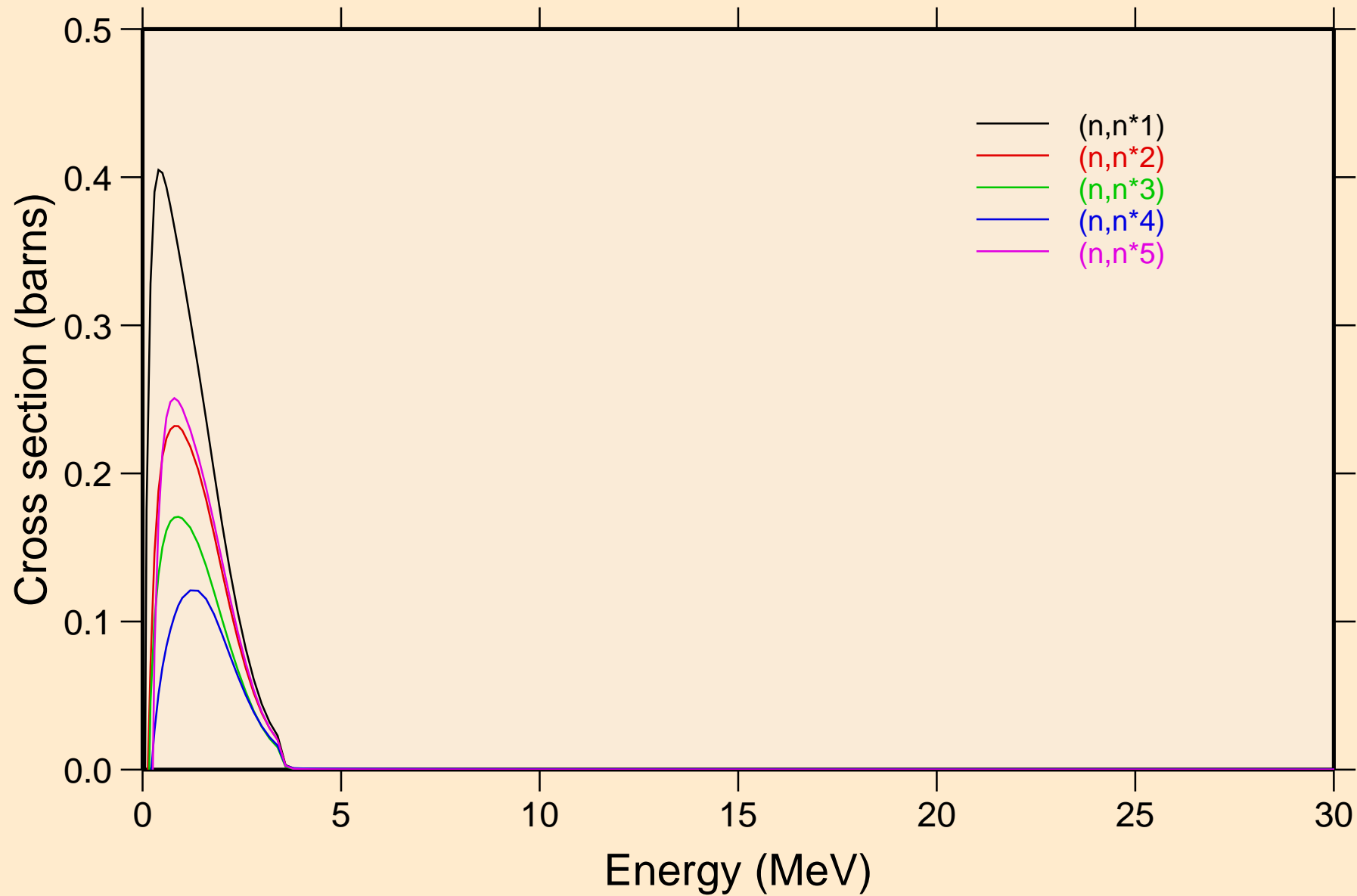

NO253 NEUTRON ACER TENDL-2021 LIBRARY; T=293.6K
Inelastic levels

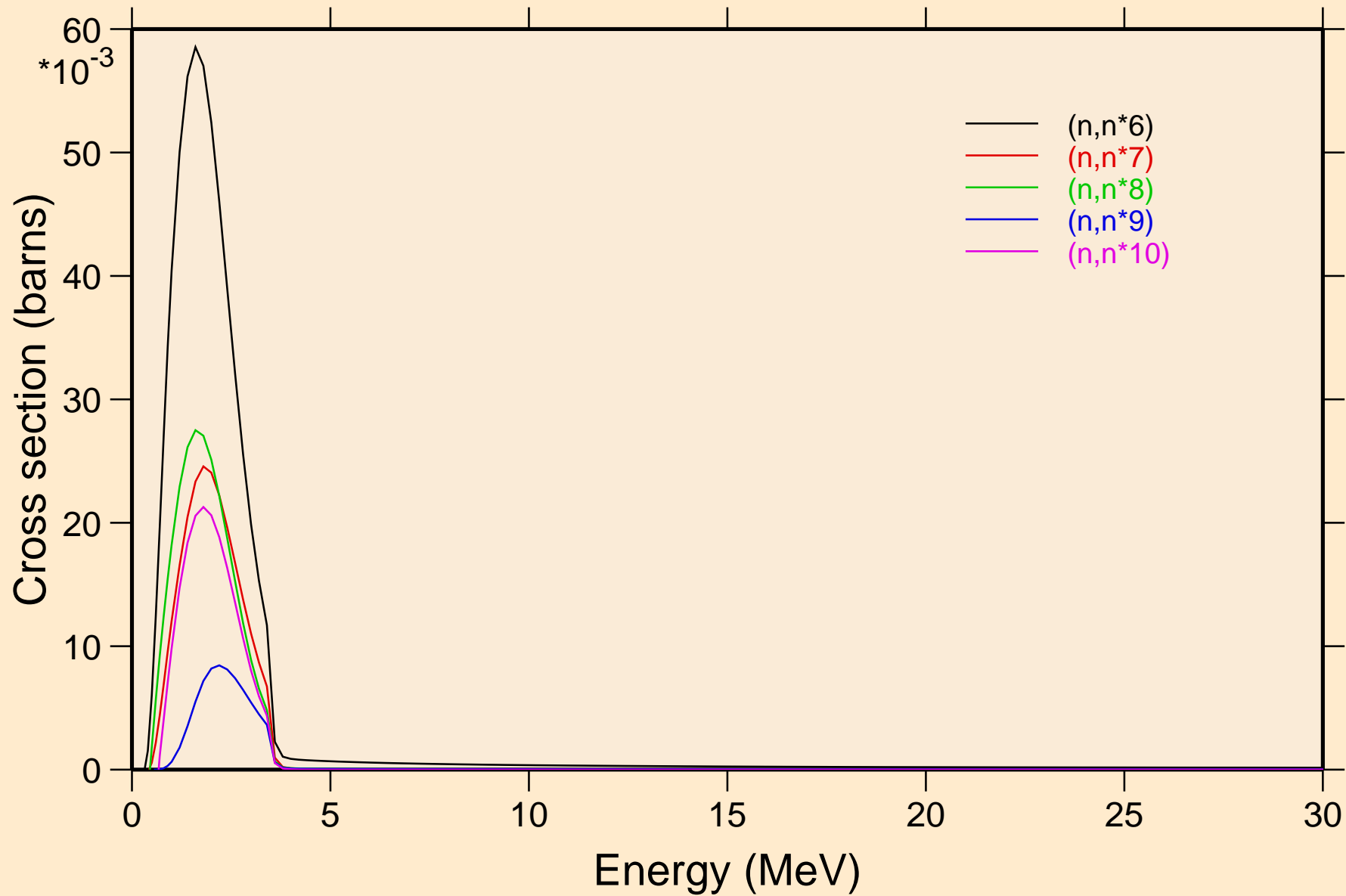

NO253 NEUTRON ACER TENDL-2021 LIBRARY; T=293.6K
Inelastic levels

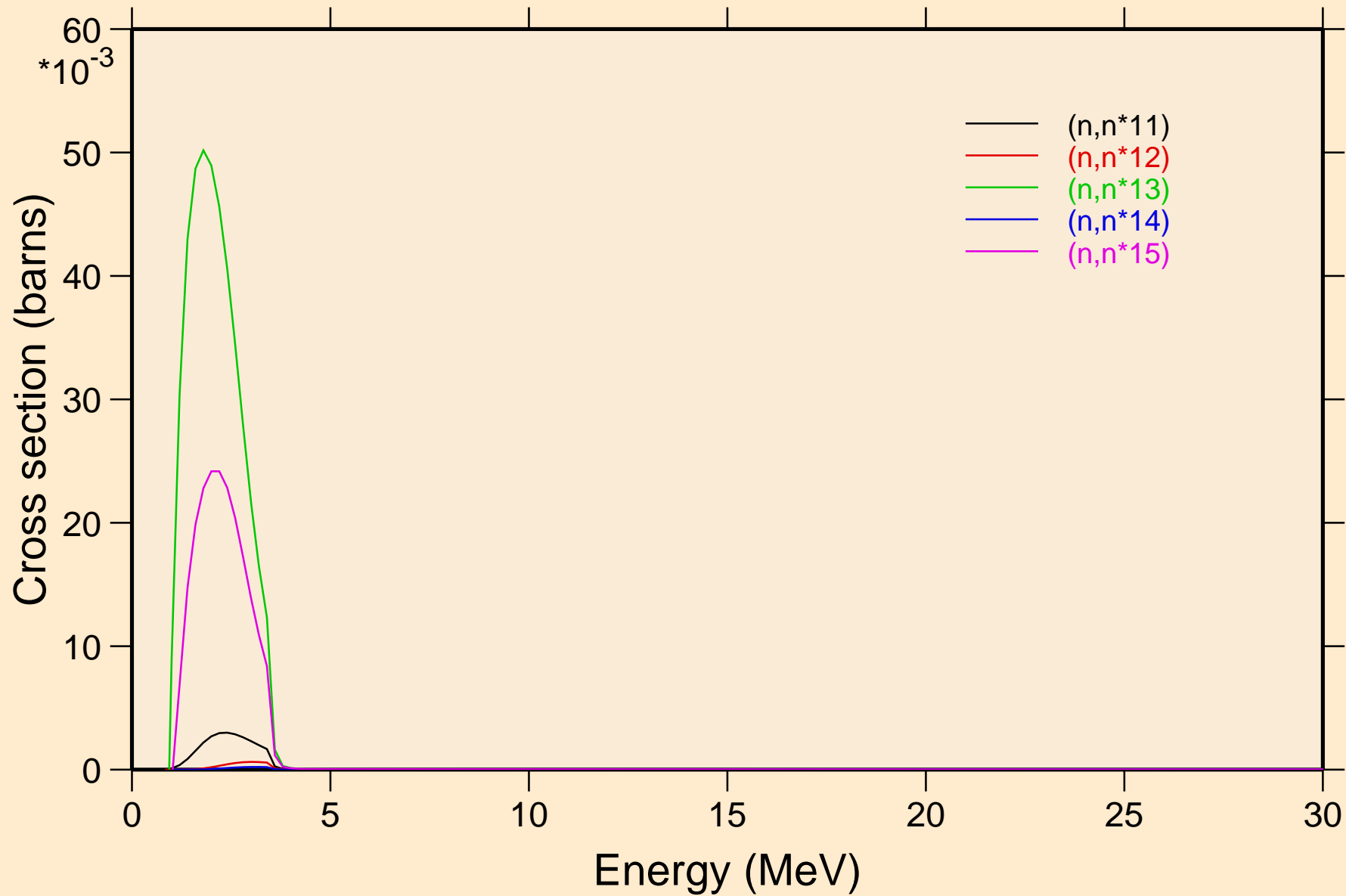

NO253 NEUTRON ACER TENDL-2021 LIBRARY; T=293.6K
Inelastic levels

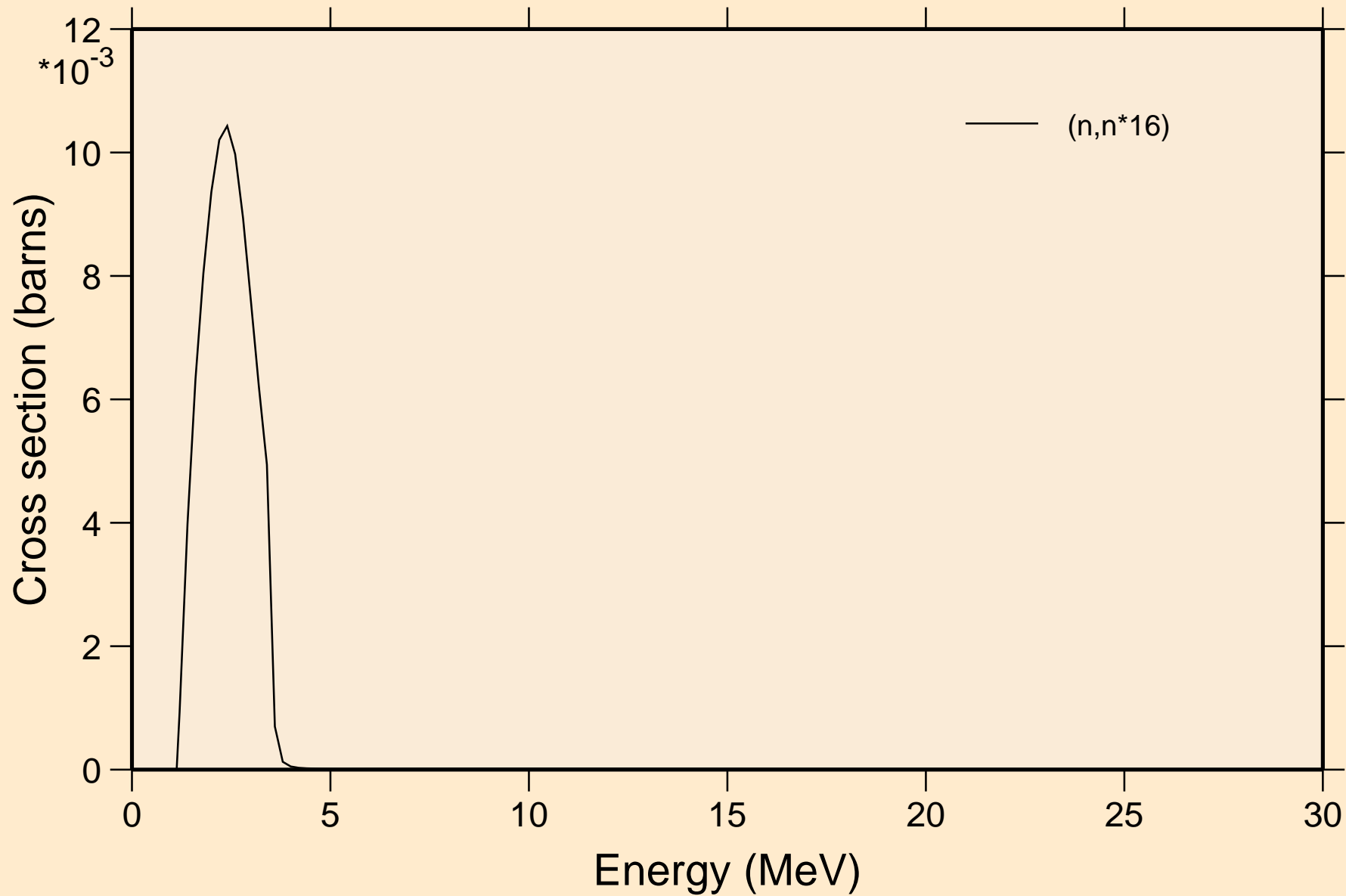

NO253 NEUTRON ACER TENDL-2021 LIBRARY; T=293.6K
Threshold reactions

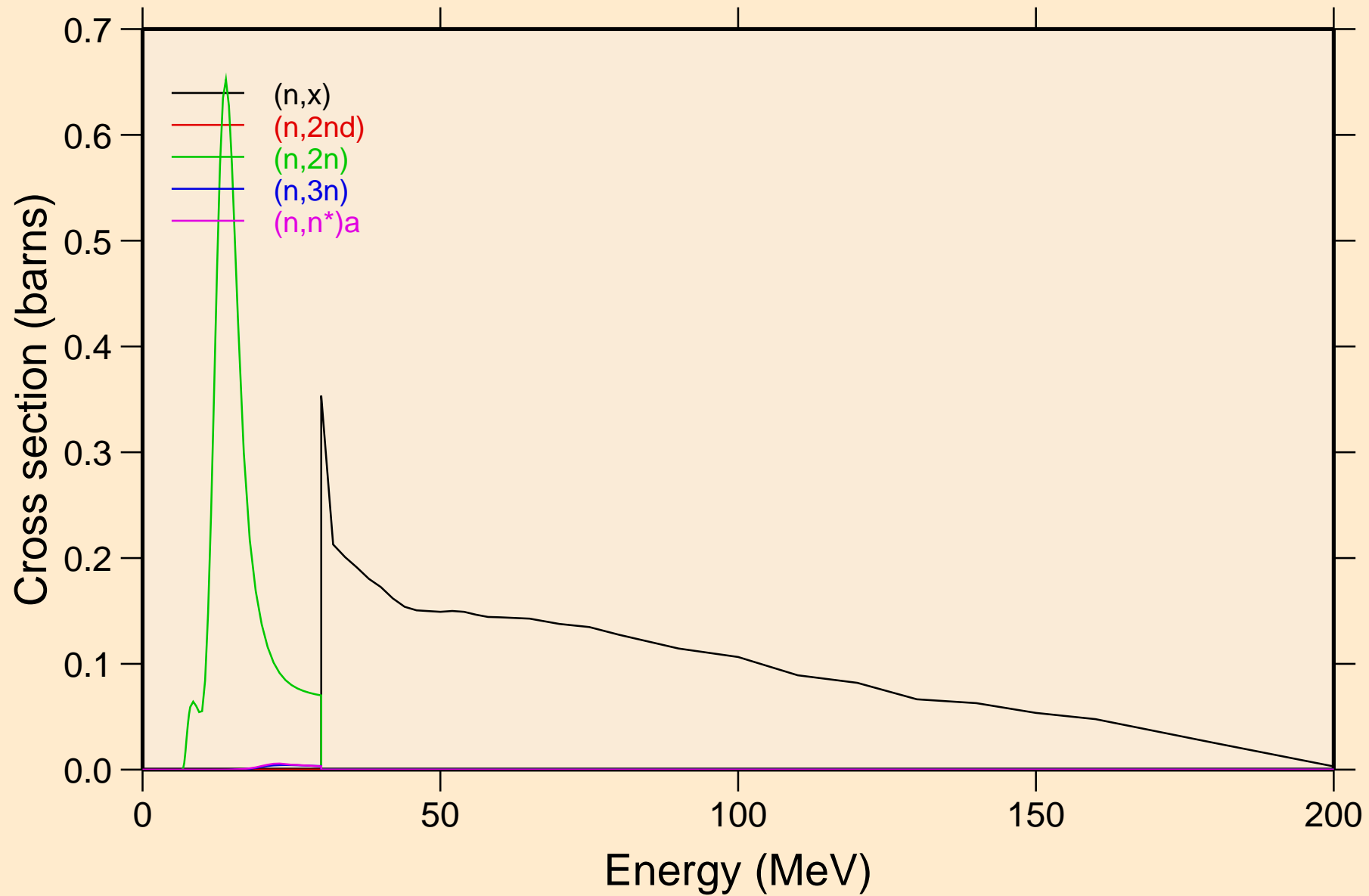

NO253 NEUTRON ACER TENDL-2021 LIBRARY; T=293.6K
Threshold reactions

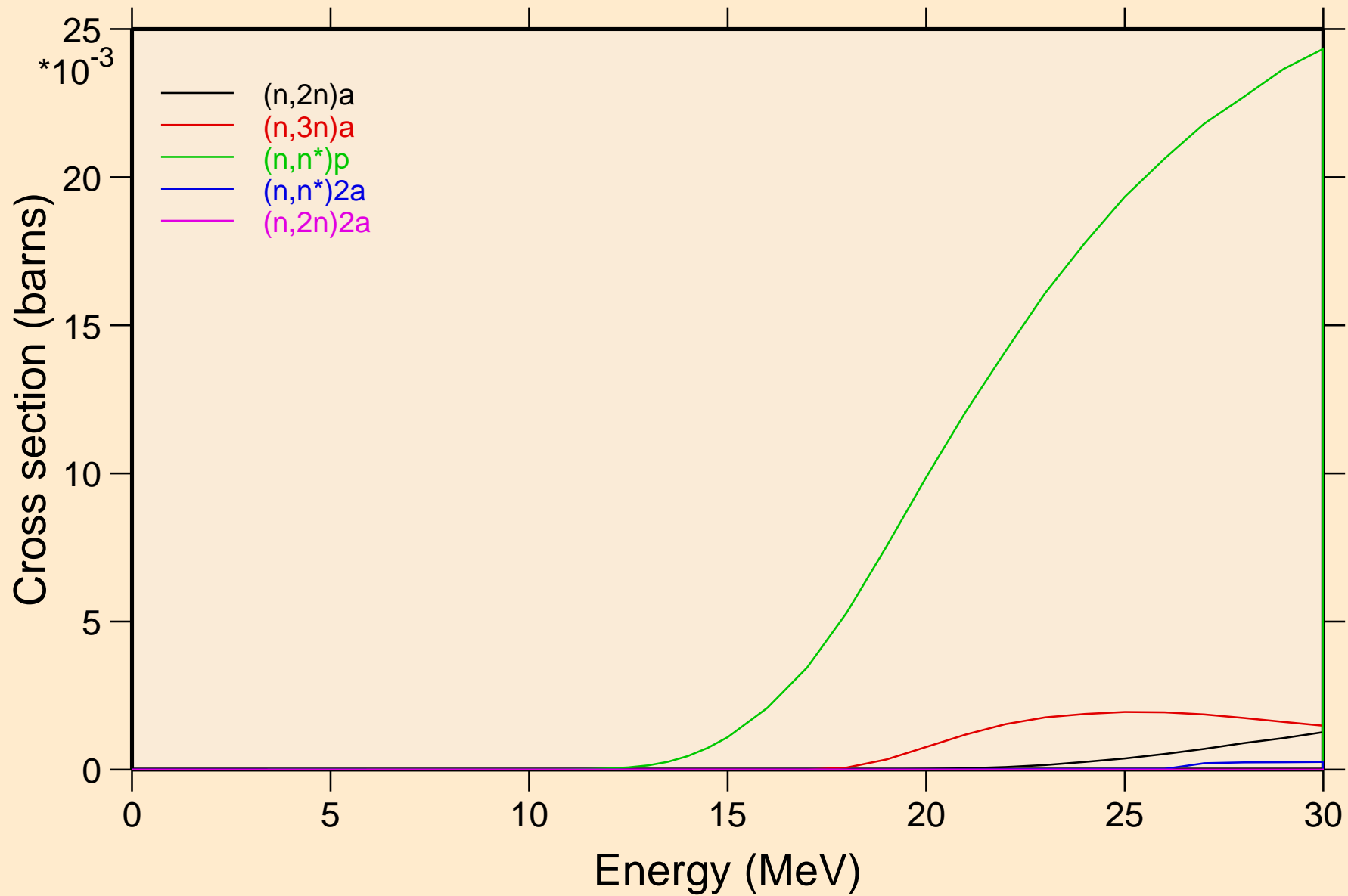

NO253 NEUTRON ACER TENDL-2021 LIBRARY; T=293.6K
Threshold reactions

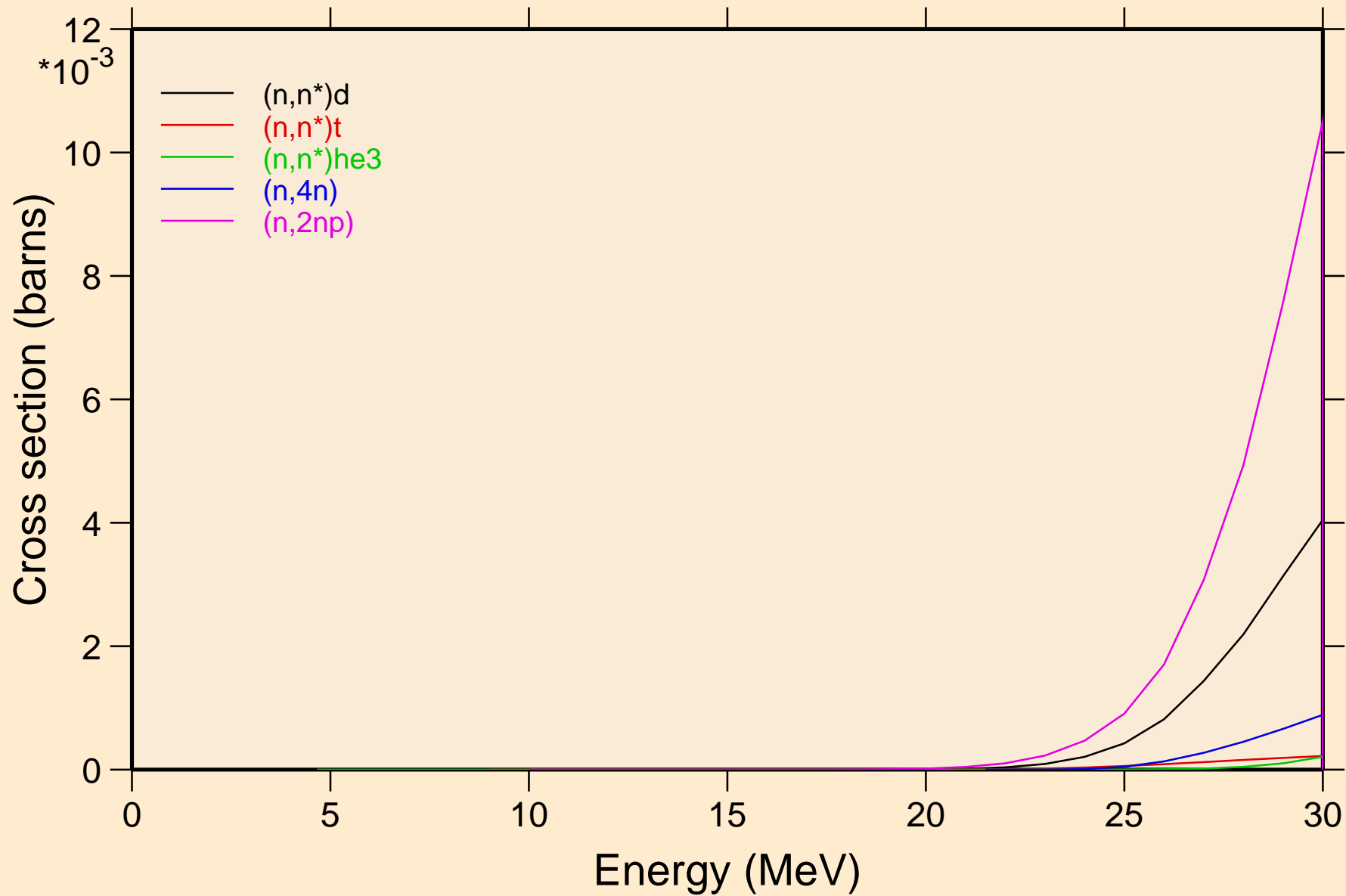

NO253 NEUTRON ACER TENDL-2021 LIBRARY; T=293.6K
Threshold reactions

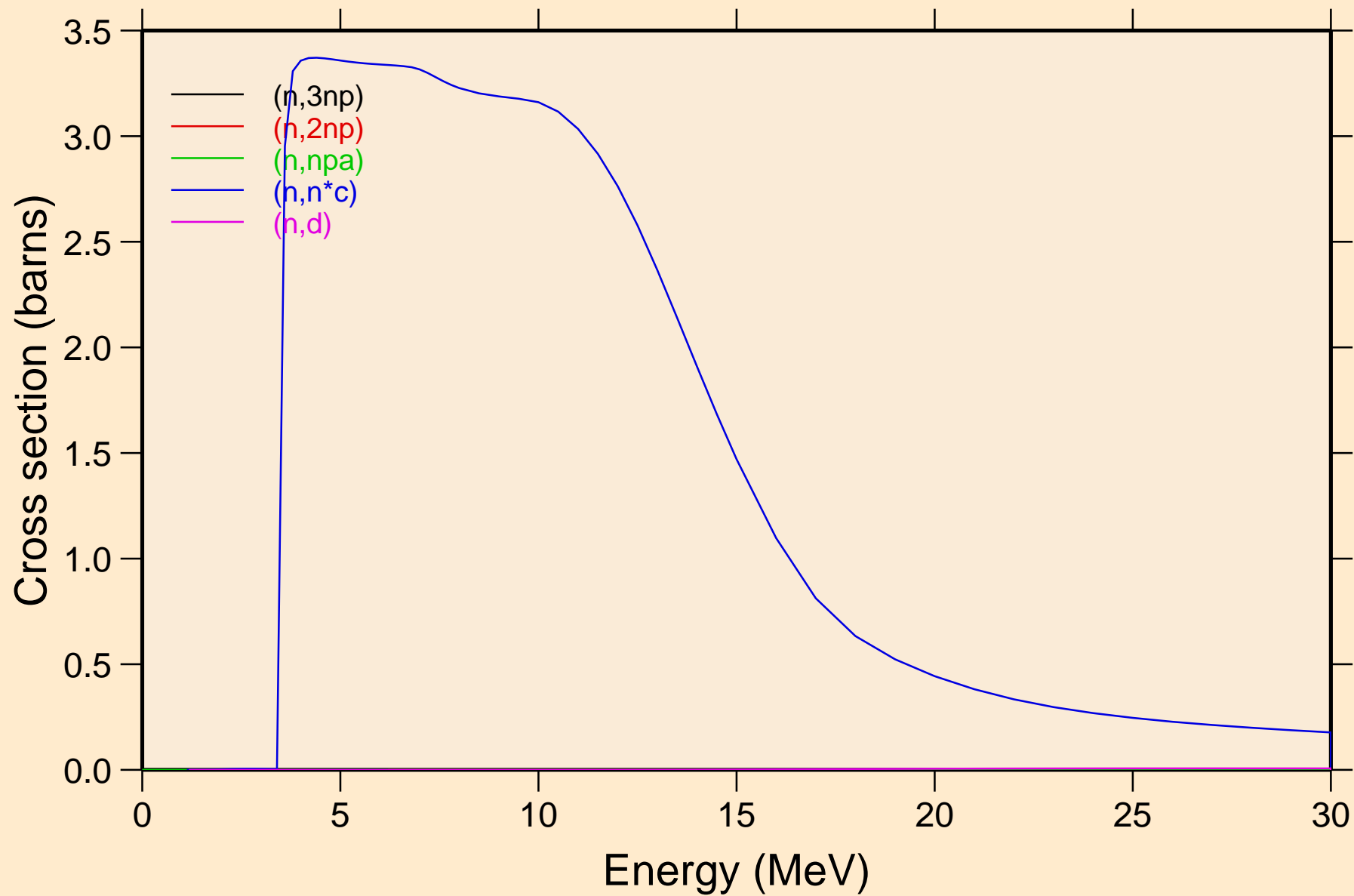

NO253 NEUTRON ACER TENDL-2021 LIBRARY; T=293.6K
Threshold reactions

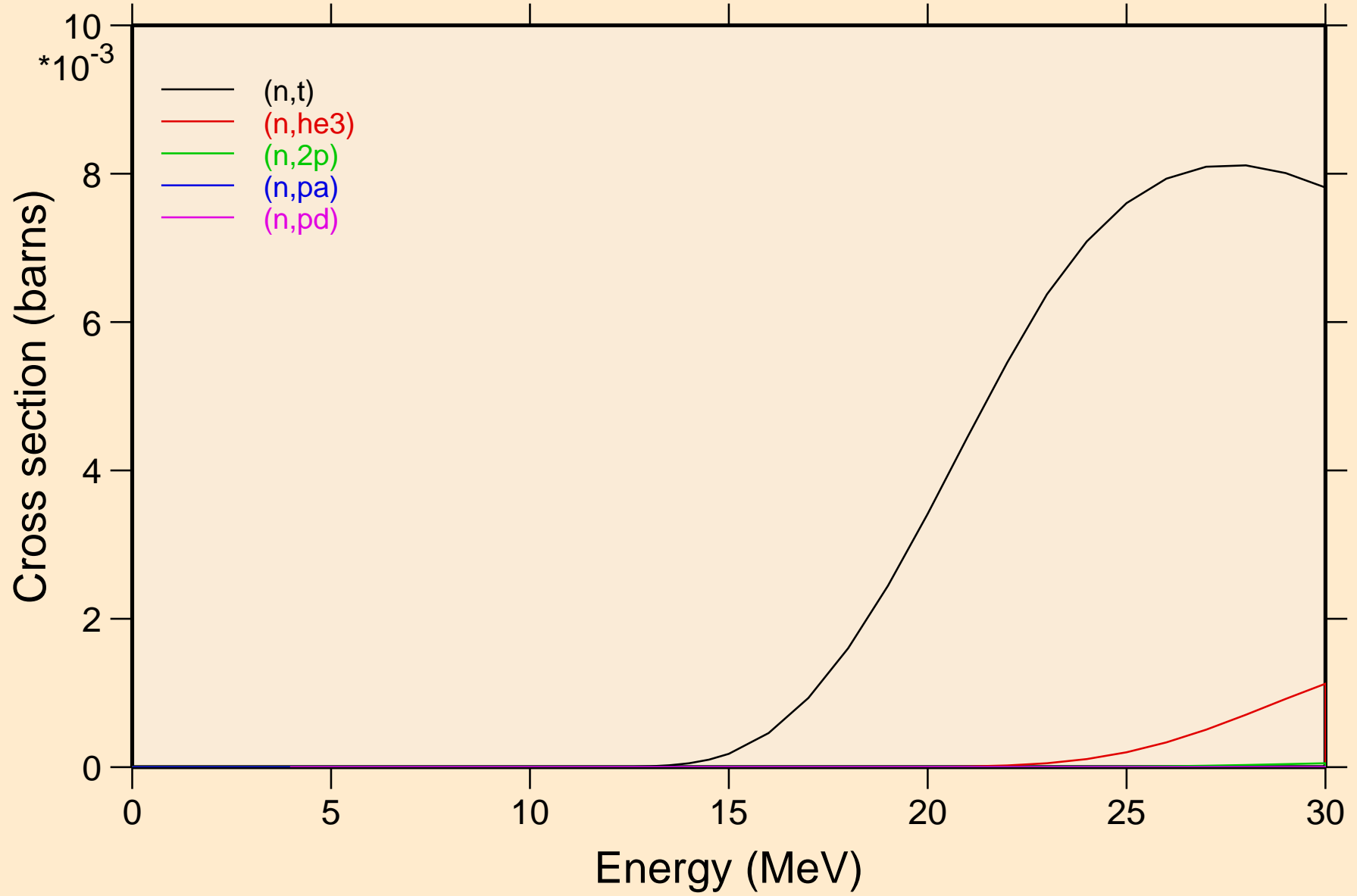

NO253 NEUTRON ACER TENDL-2021 LIBRARY; T=293.6K
Threshold reactions

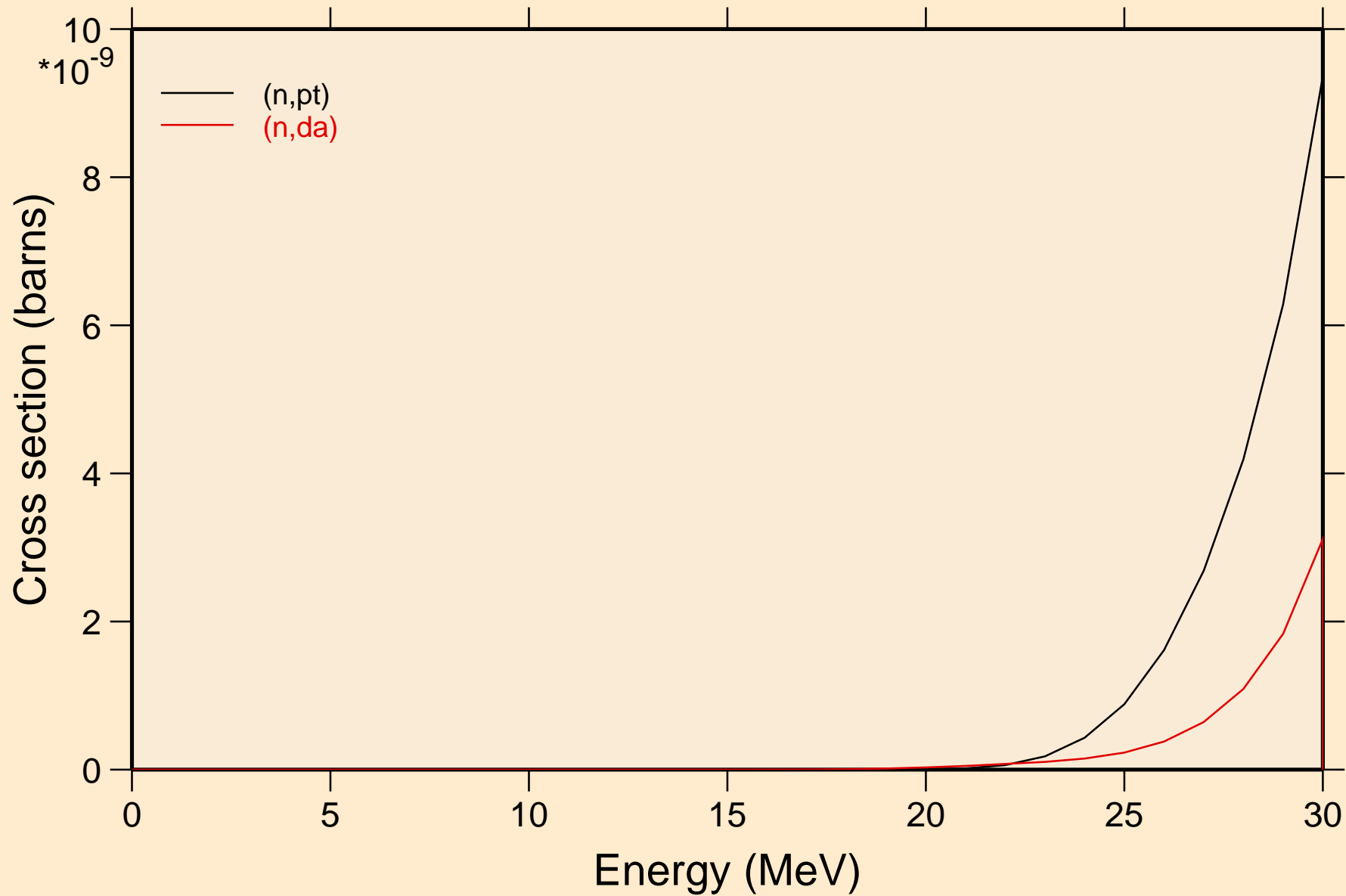

NO253 NEUTRON ACER TENDL-2021 LIBRARY; T=293.6K
Threshold reactions

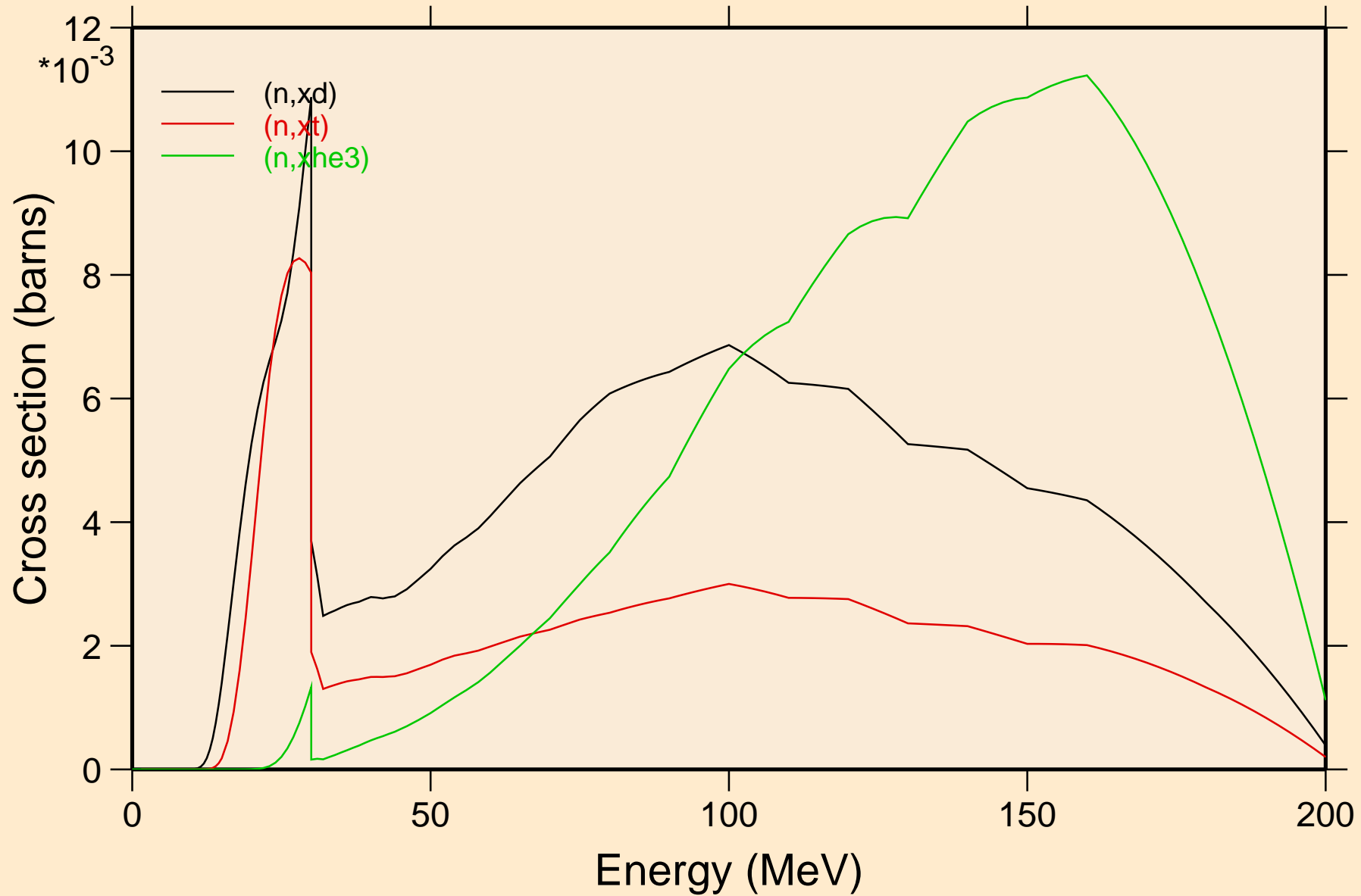

NO253 NEUTRON ACER TENDL-2021 LIBRARY; T=293.6K
angular distribution for elastic

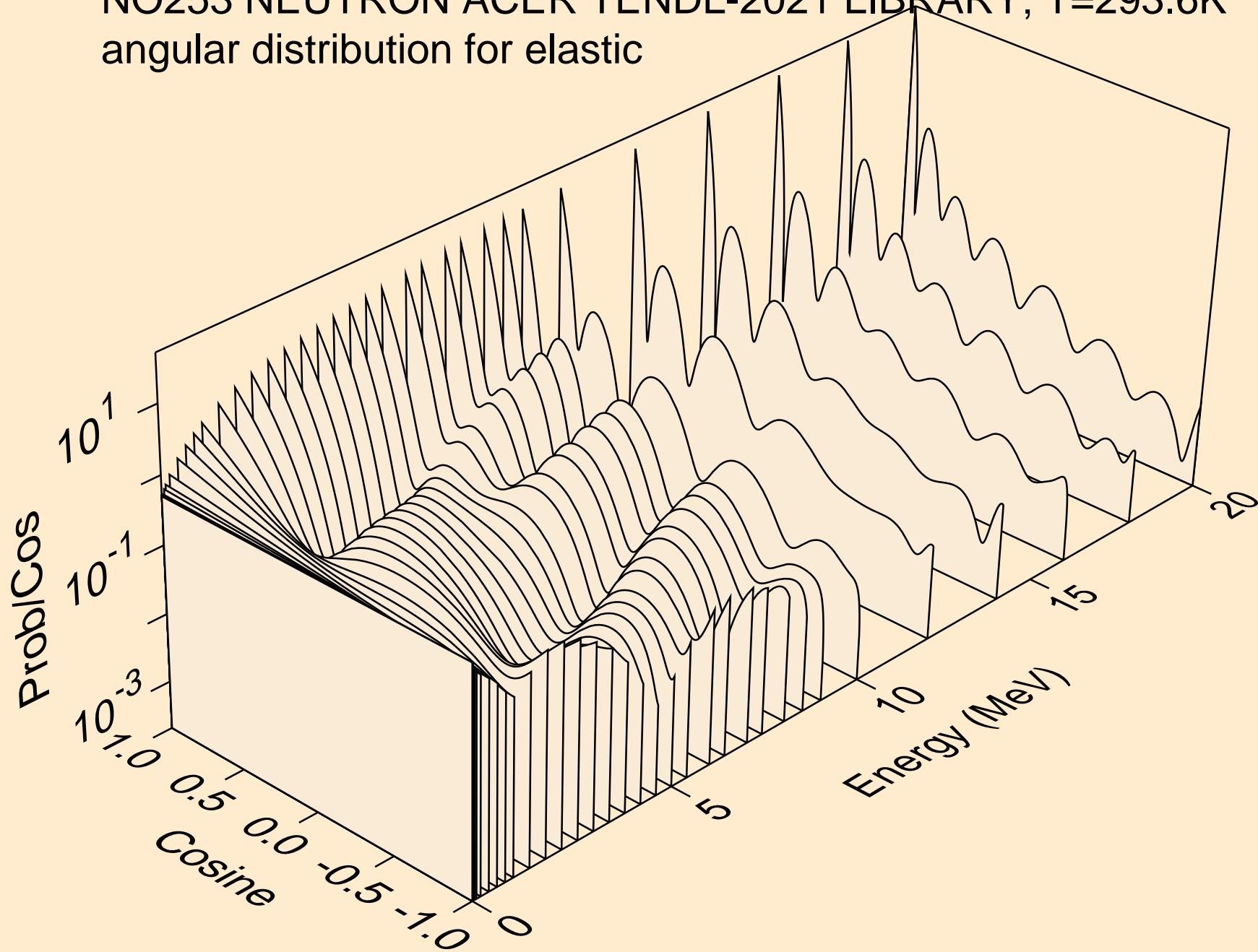

NO253 NEUTRON ACER TENDL-2021 LIBRARY; T=293.6K
angular distribution for elastic

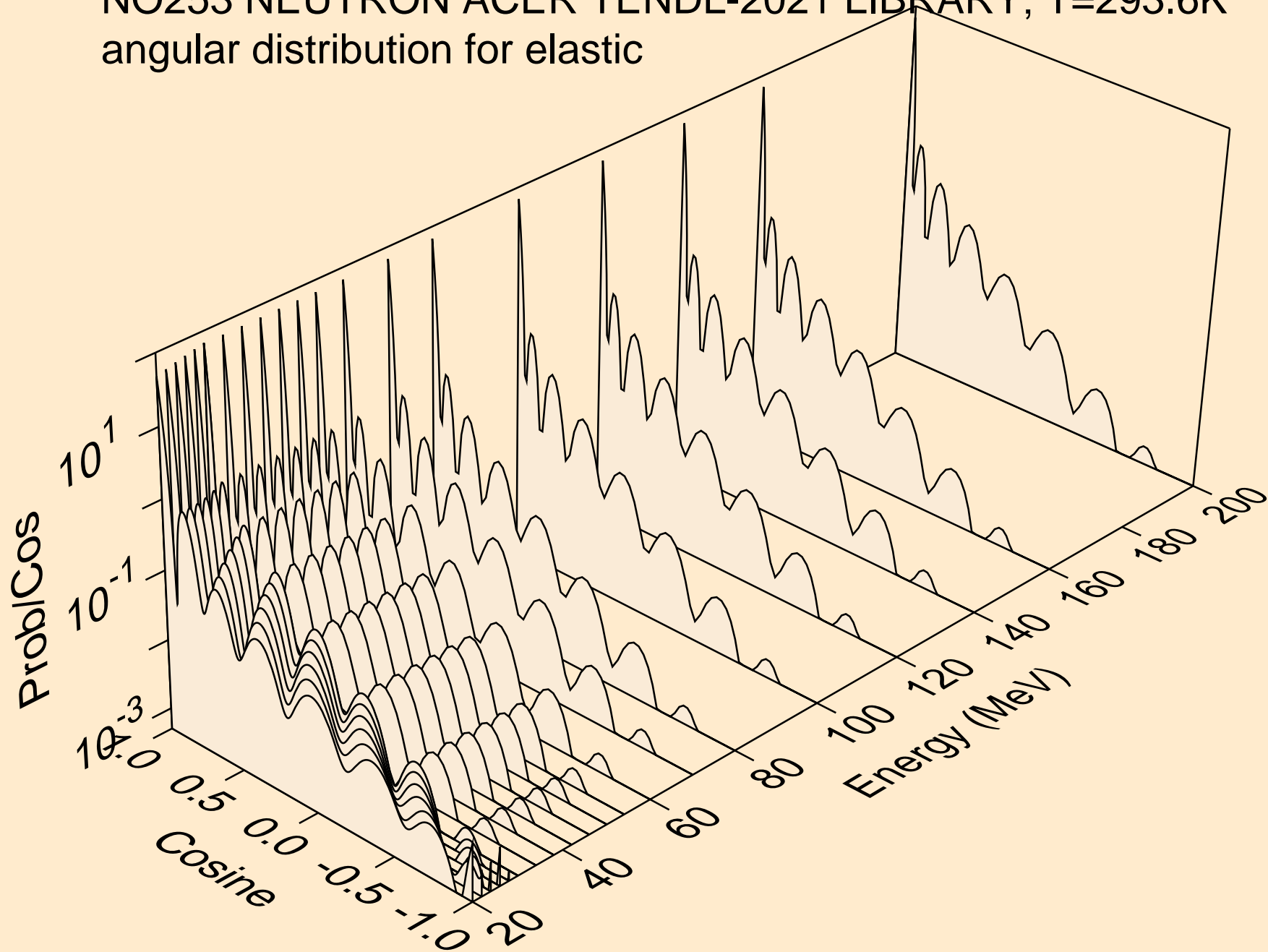

NO253 NEUTRON ACER TENDL-2021 LIBRARY; T=293.6K
angular distribution for (n,n*1)

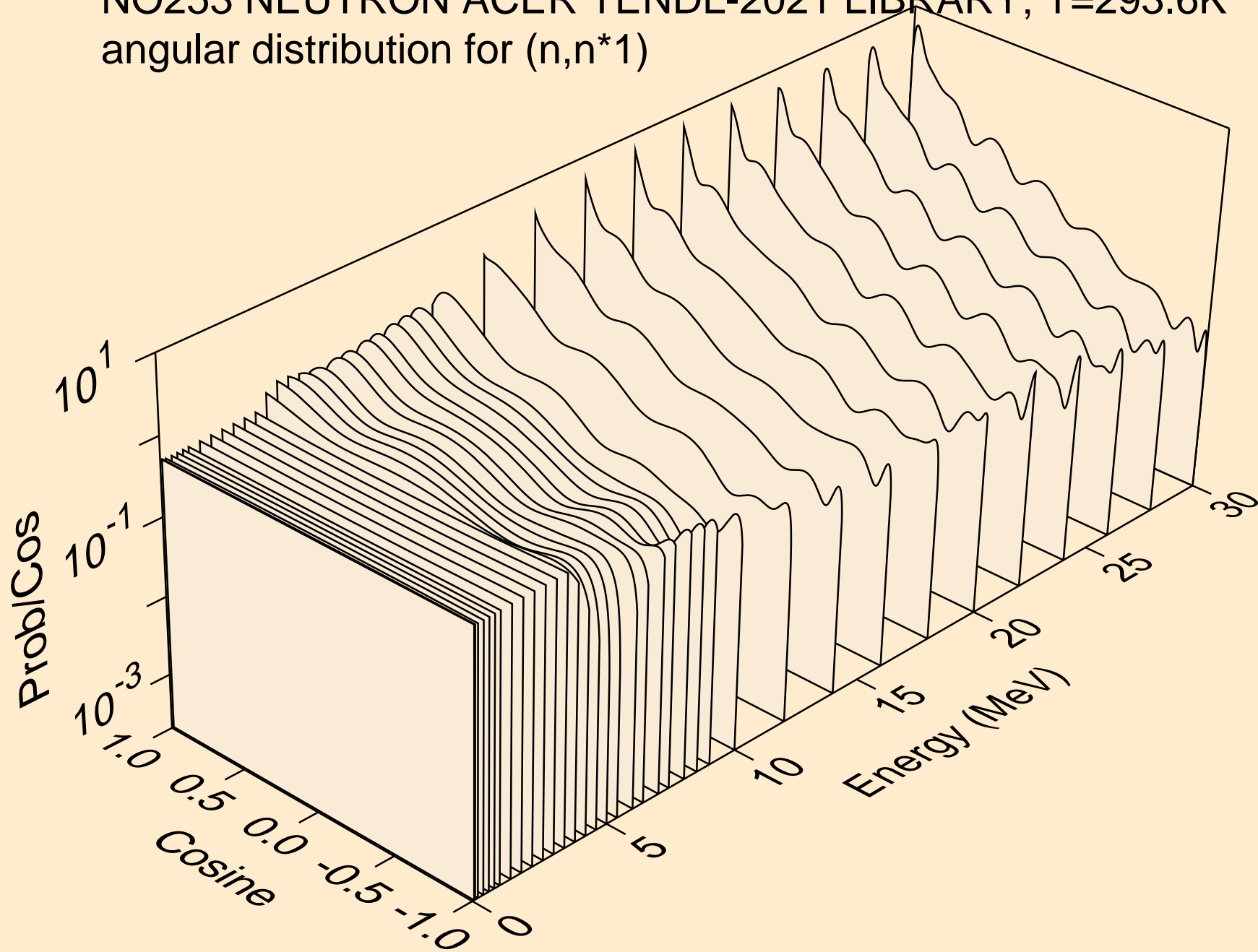

NO253 NEUTRON ACER TENDL-2021 LIBRARY; T=293.6K
angular distribution for (n,n*2)

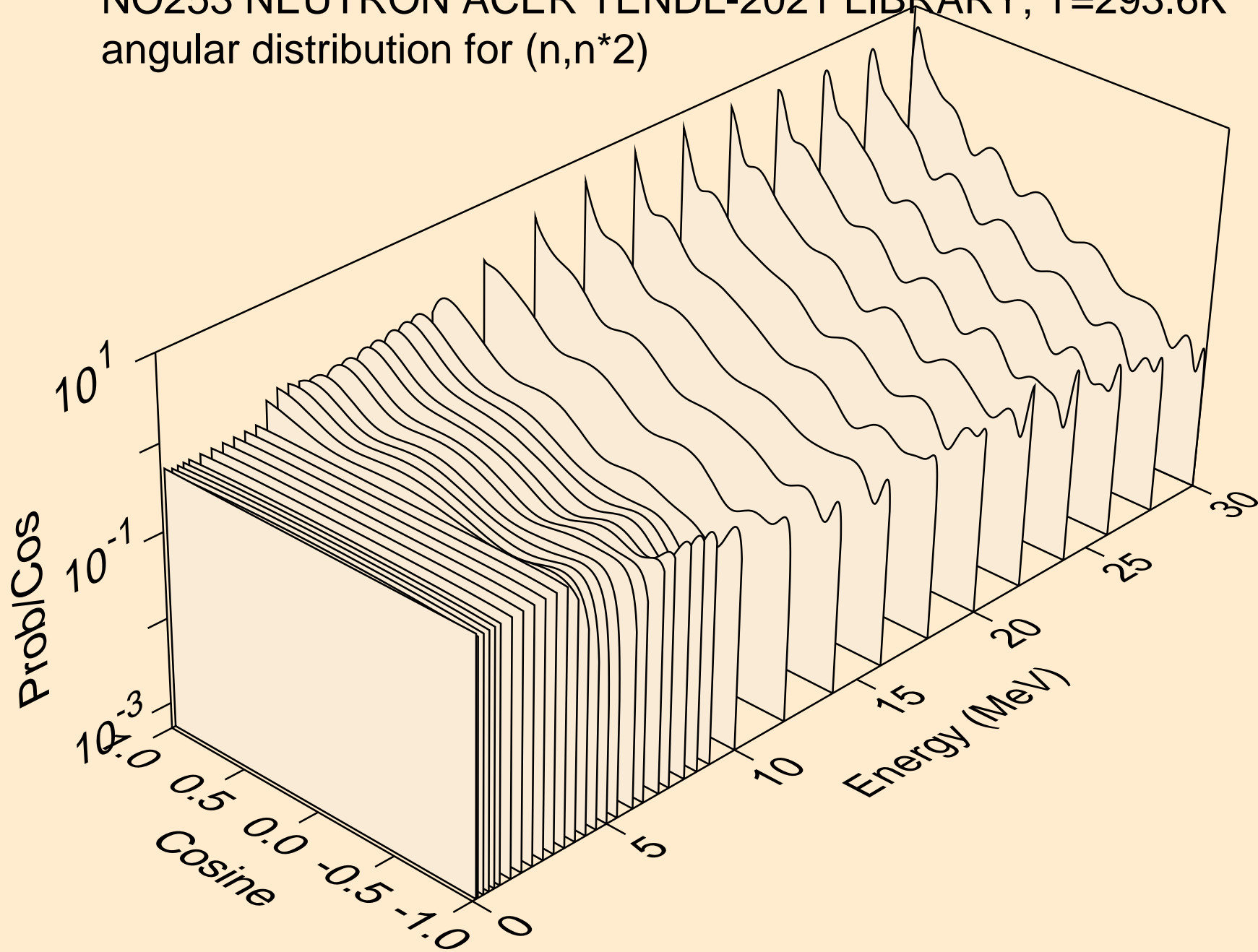

NO253 NEUTRON ACER TENDL-2021 LIBRARY; T=293.6K
angular distribution for (n,n*3)

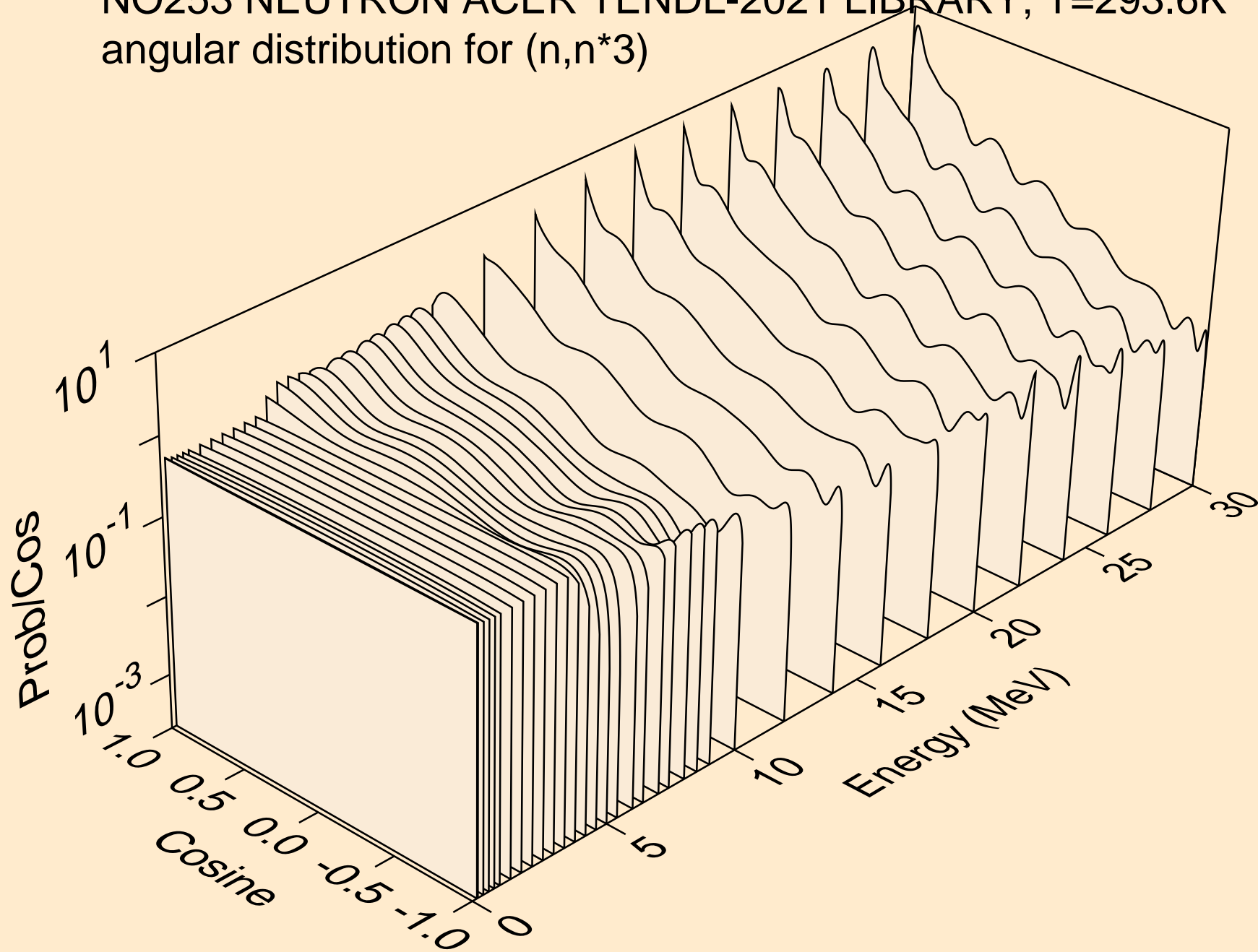

NO253 NEUTRON ACER TENDL-2021 LIBRARY; T=293.6K
angular distribution for (n,n*4)

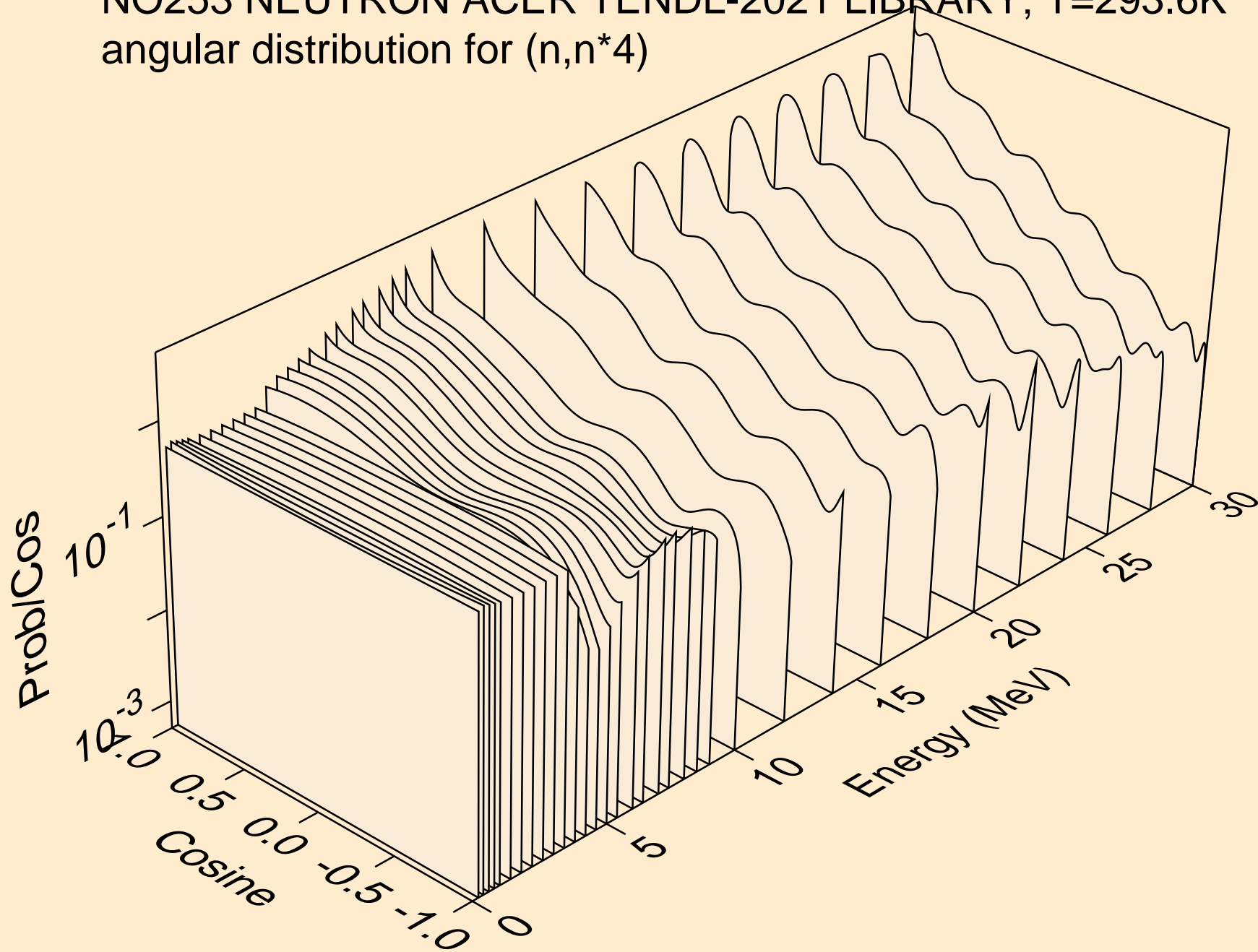

NO253 NEUTRON ACER TENDL-2021 LIBRARY; T=293.6K
angular distribution for (n,n*5)

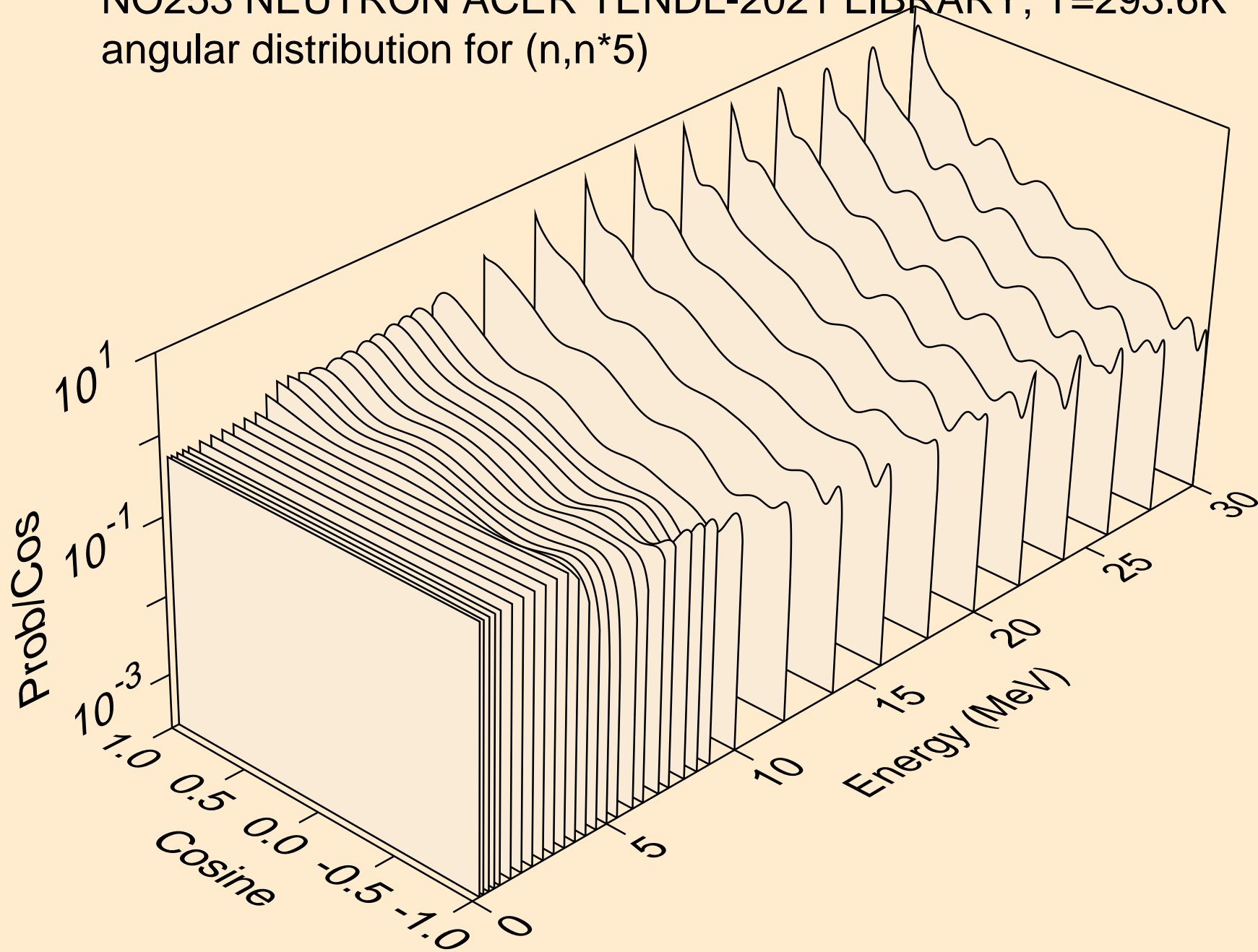

NO253 NEUTRON ACER TENDL-2021 LIBRARY; T=293.6K
angular distribution for (n,n*6)

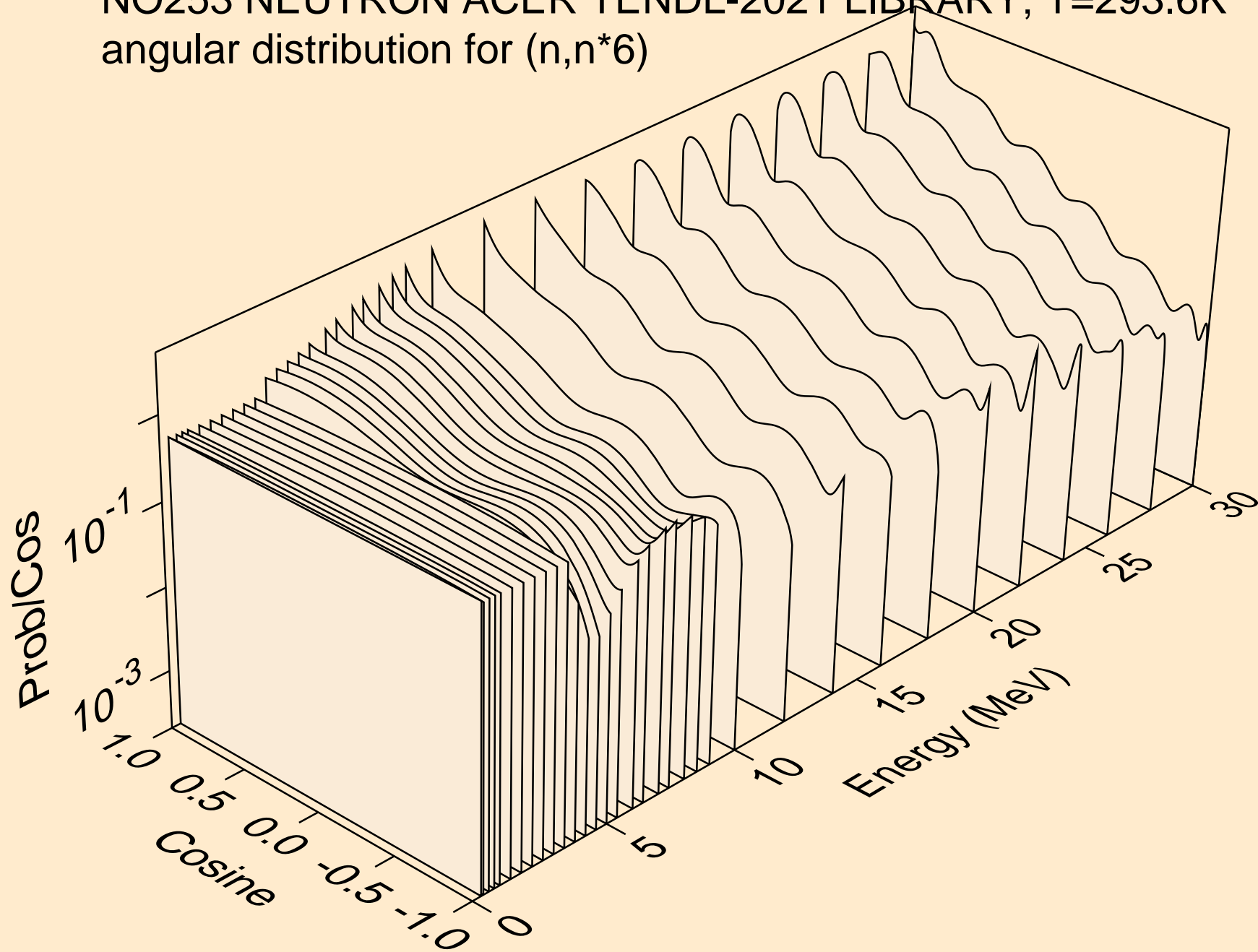

NO253 NEUTRON ACER TENDL-2021 LIBRARY; T=293.6K
angular distribution for (n,n*7)

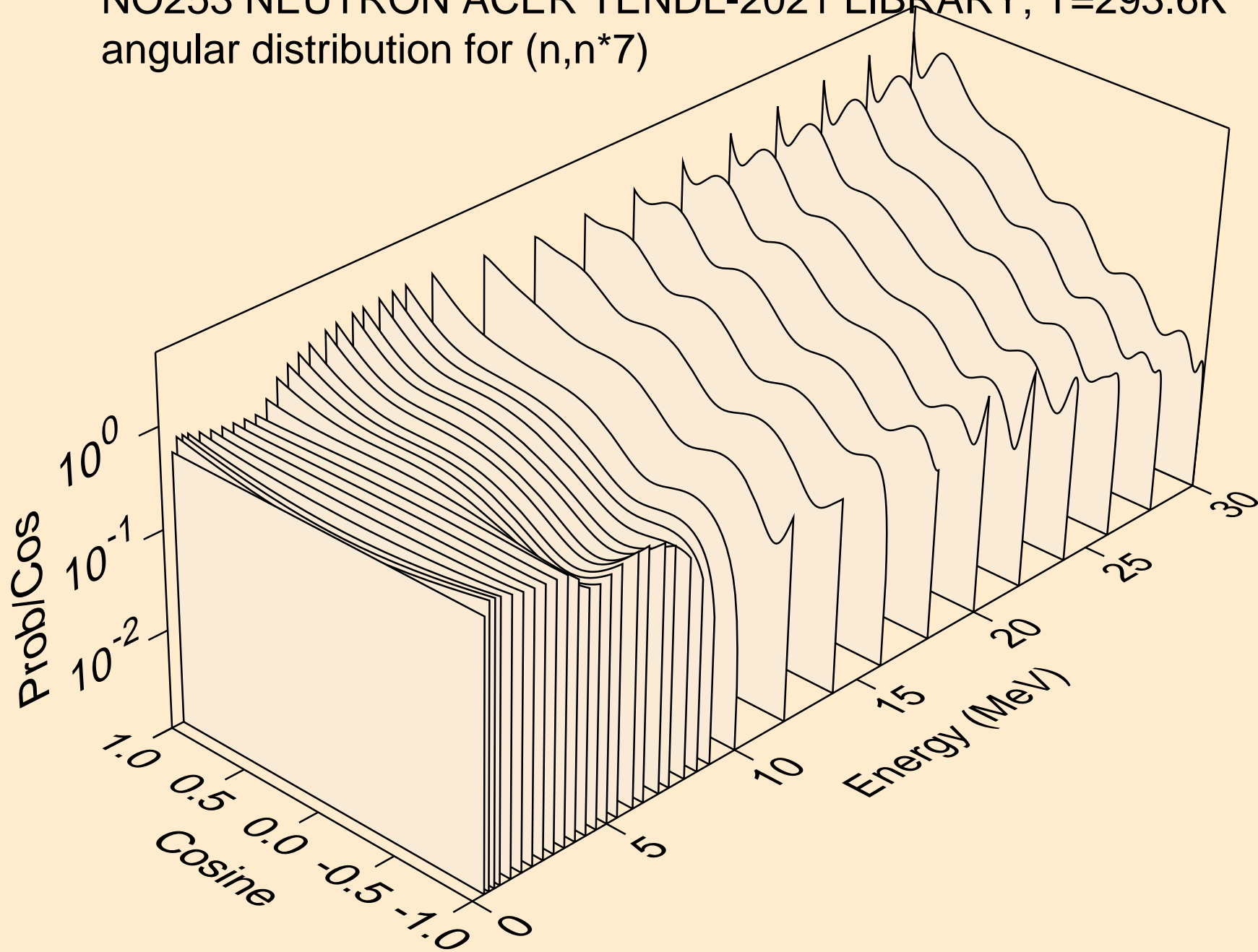

NO253 NEUTRON ACER TENDL-2021 LIBRARY; T=293.6K
angular distribution for (n,n*8)

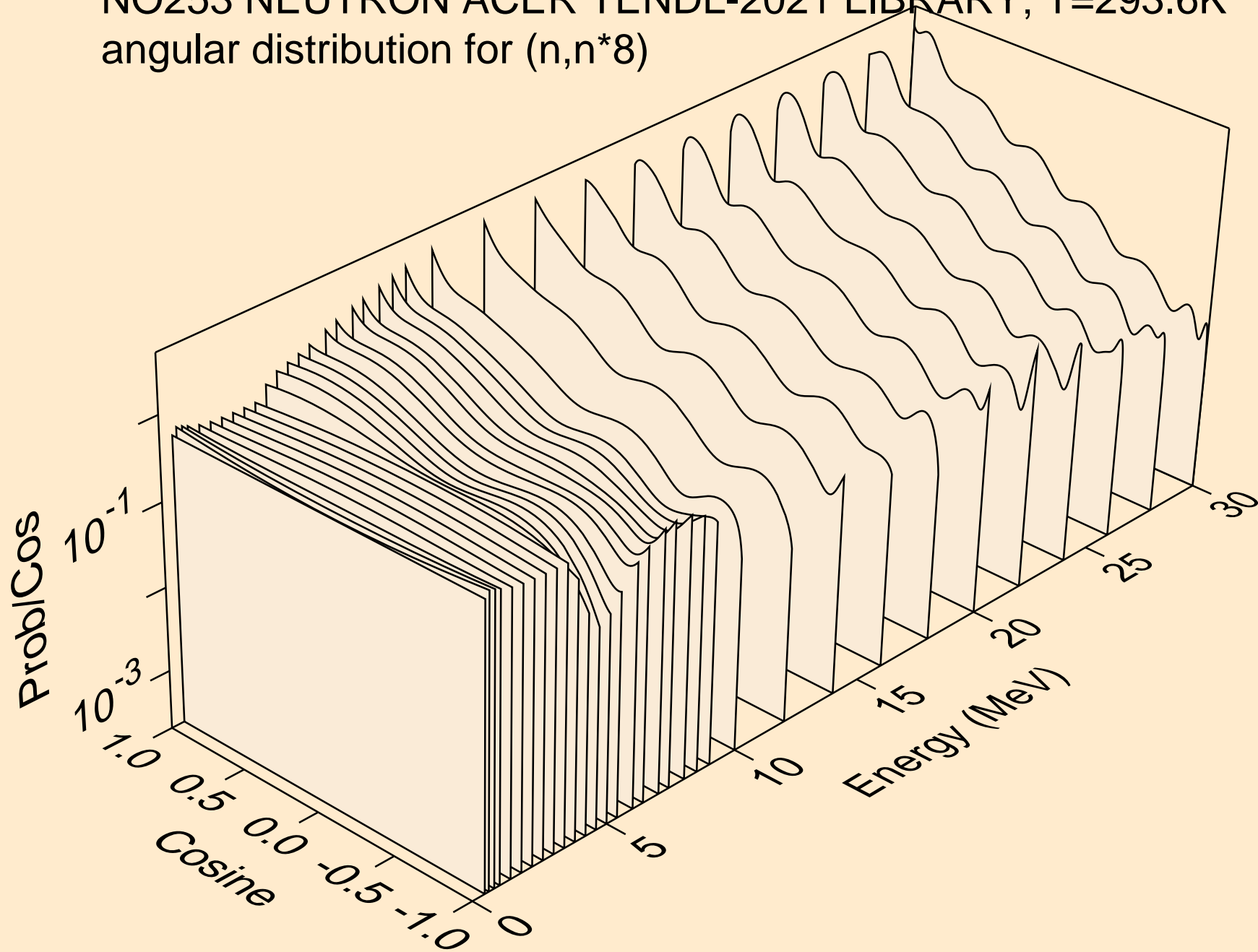

NO253 NEUTRON ACER TENDL-2021 LIBRARY; T=293.6K
angular distribution for (n,n*9)

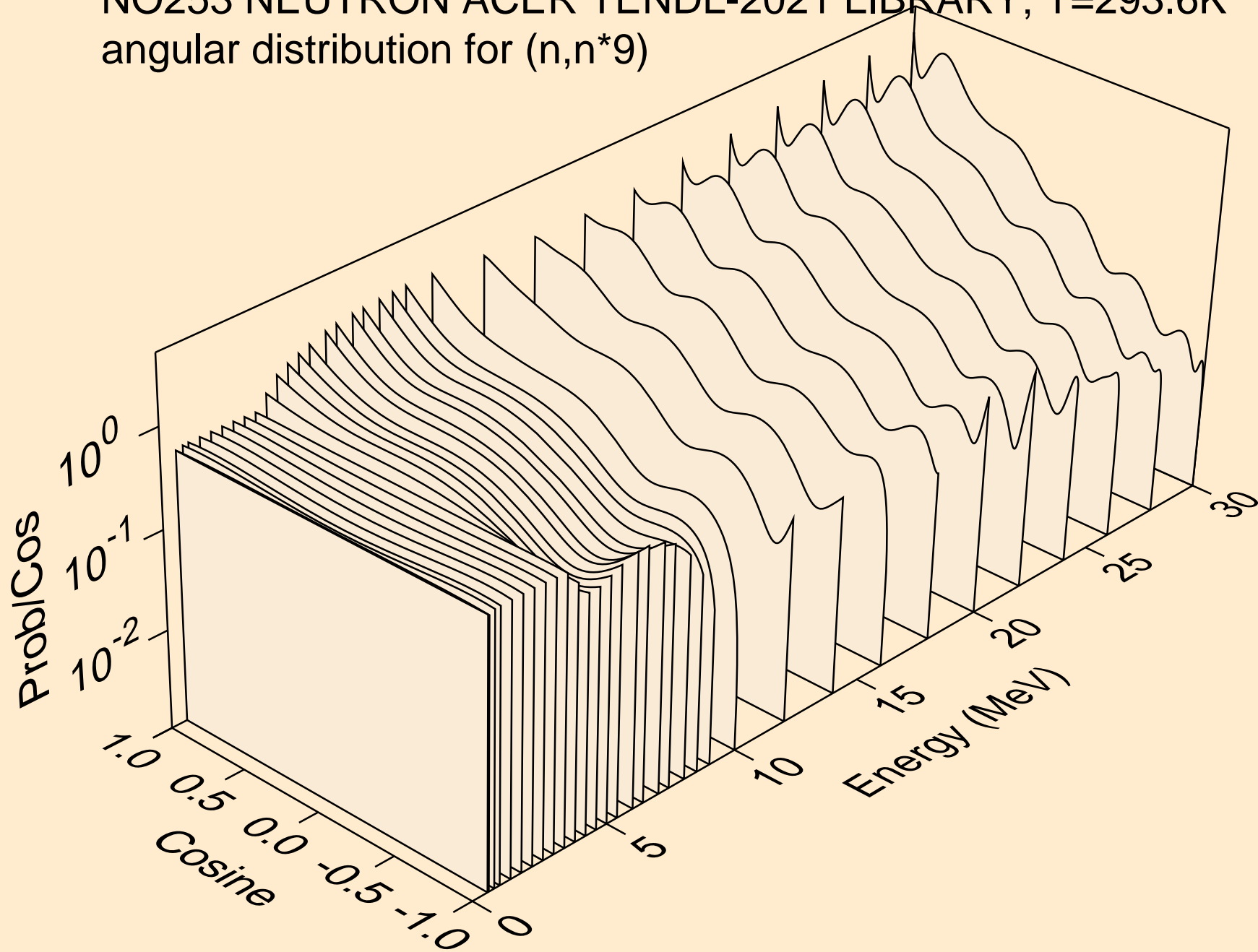

NO253 NEUTRON ACER TENDL-2021 LIBRARY; T=293.6K
angular distribution for (n,n*10)

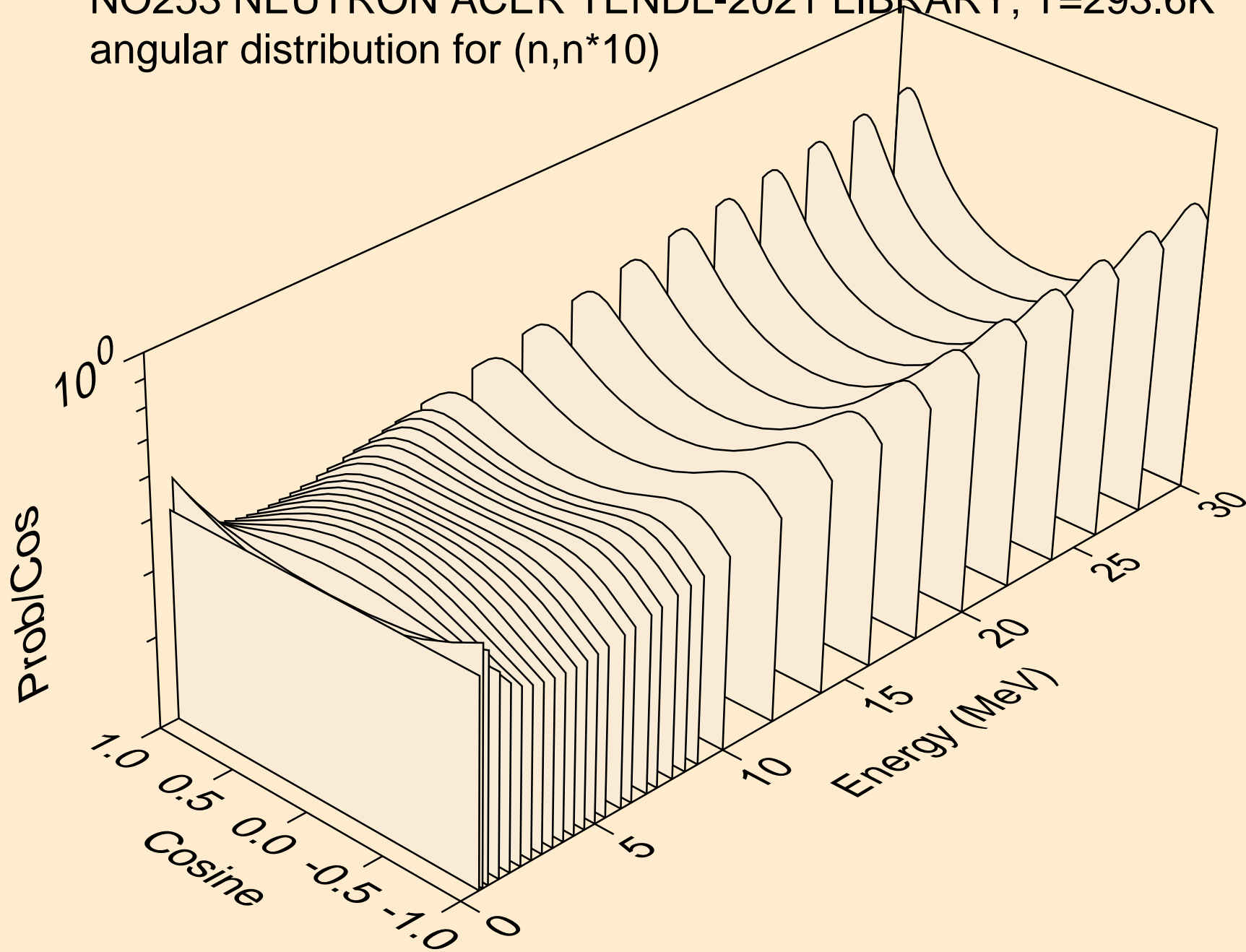

NO253 NEUTRON ACER TENDL-2021 LIBRARY; T=293.6K
angular distribution for (n,n*11)

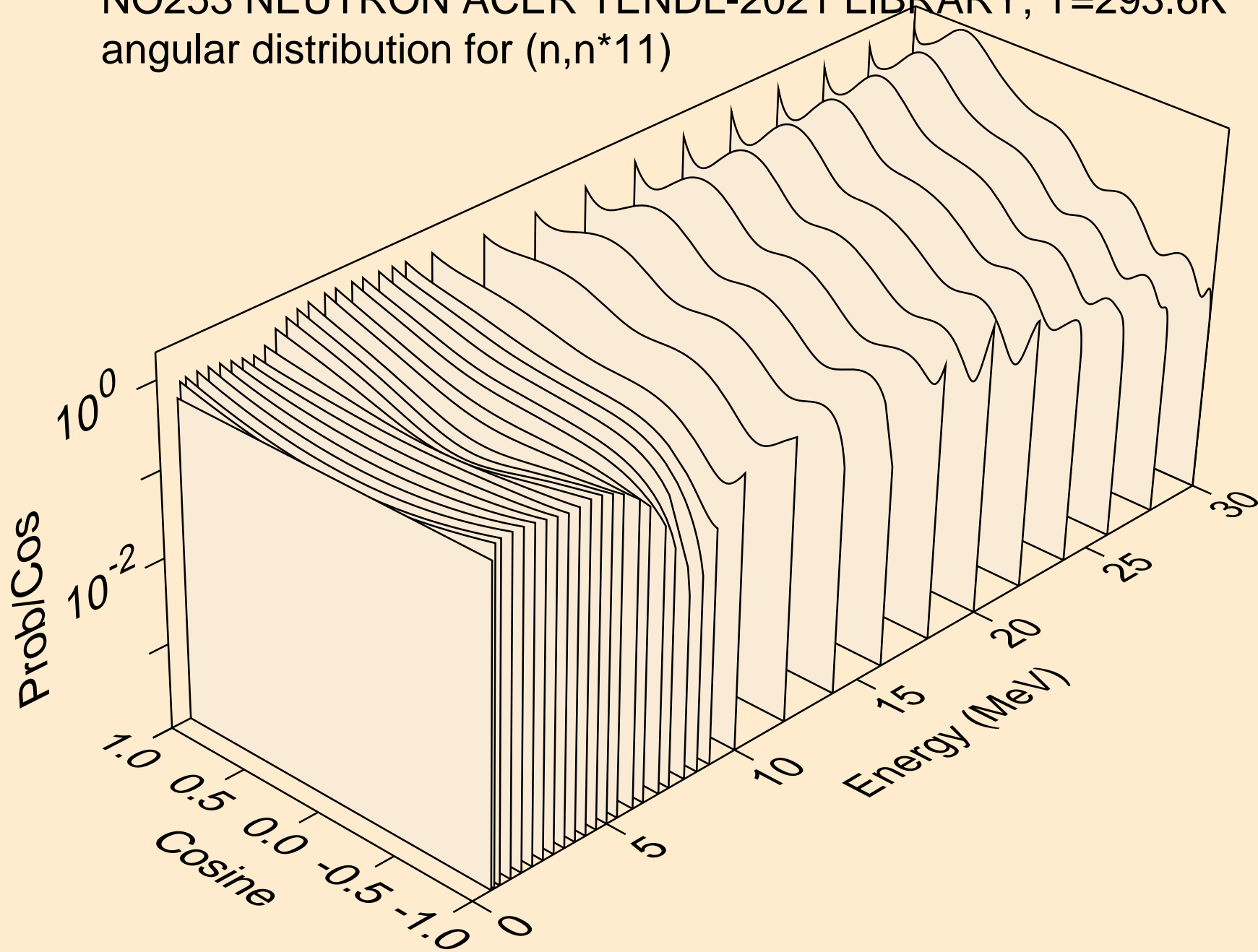

NO253 NEUTRON ACER TENDL-2021 LIBRARY; T=293.6K
angular distribution for (n,n*12)

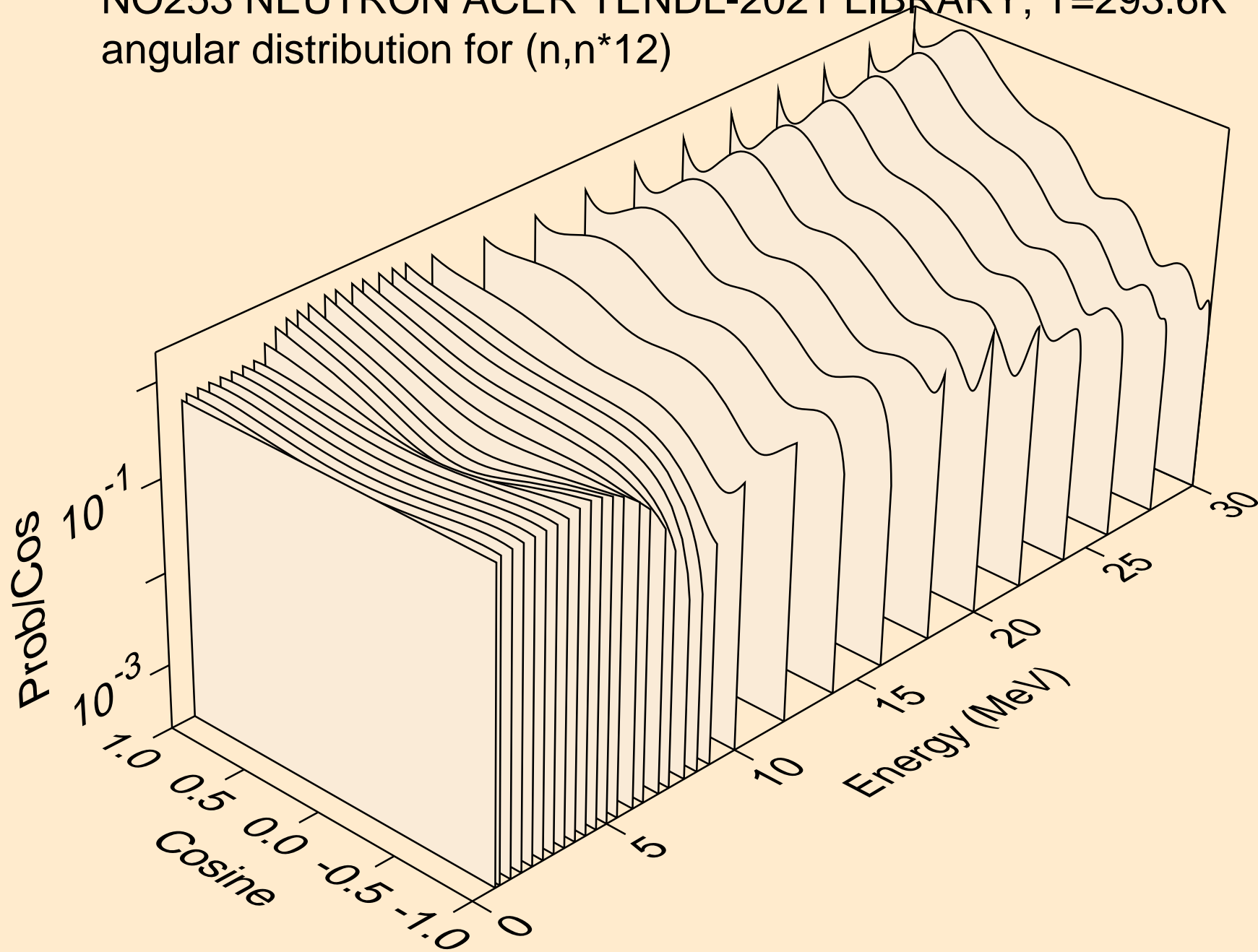

NO253 NEUTRON ACER TENDL-2021 LIBRARY; T=293.6K
angular distribution for (n,n*13)

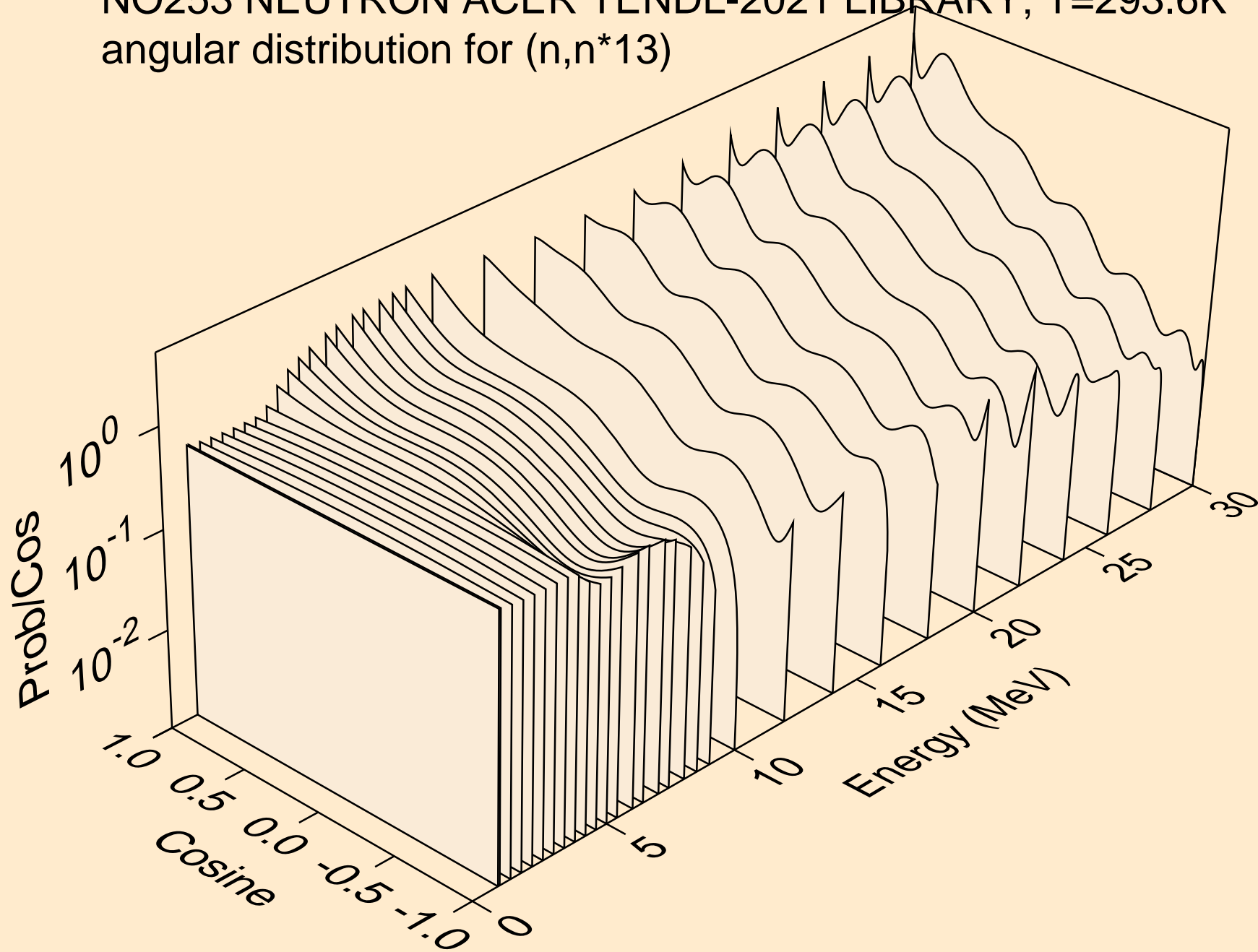

NO253 NEUTRON ACER TENDL-2021 LIBRARY; T=293.6K
angular distribution for (n,n*14)

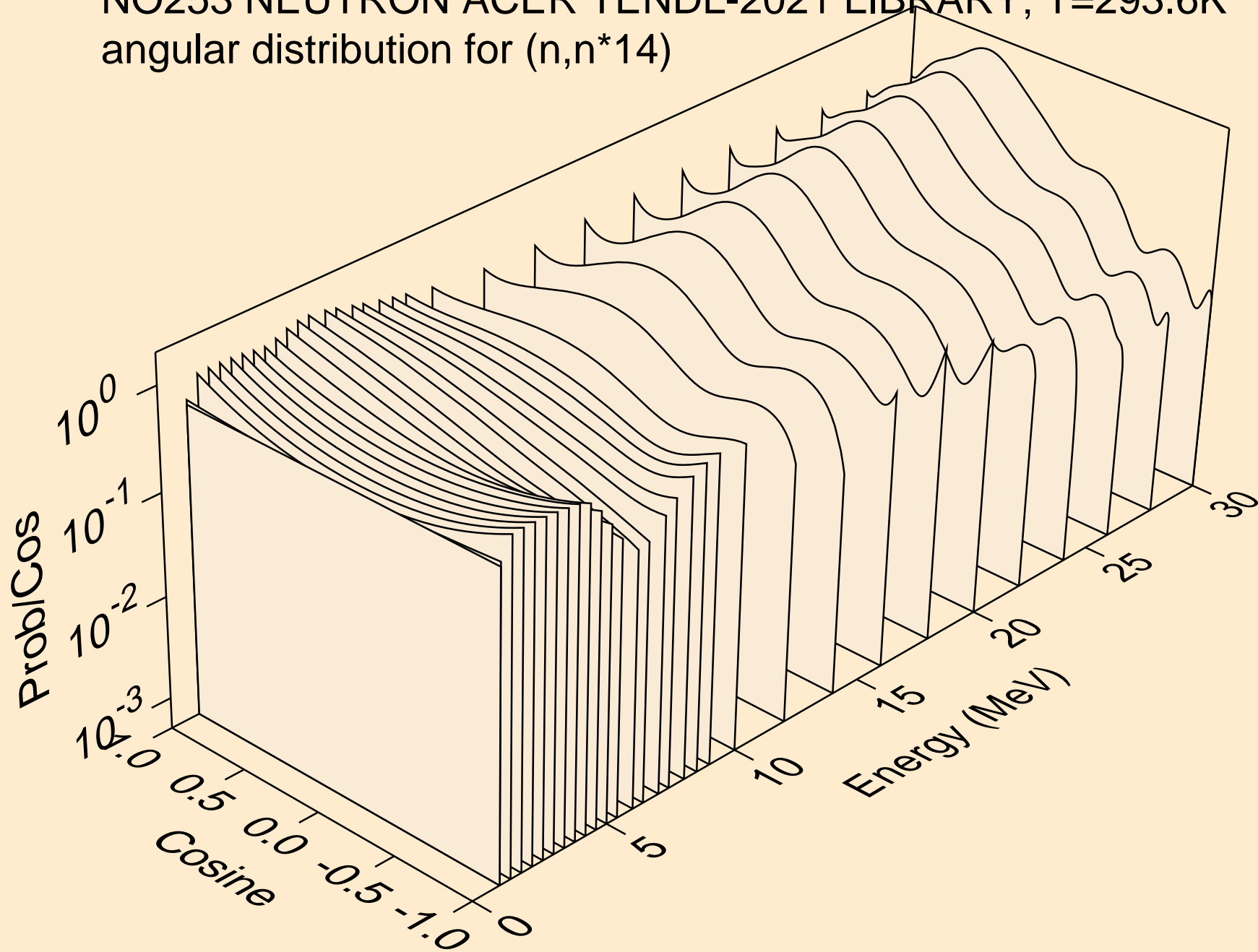

NO253 NEUTRON ACER TENDL-2021 LIBRARY; T=293.6K
angular distribution for (n,n*15)

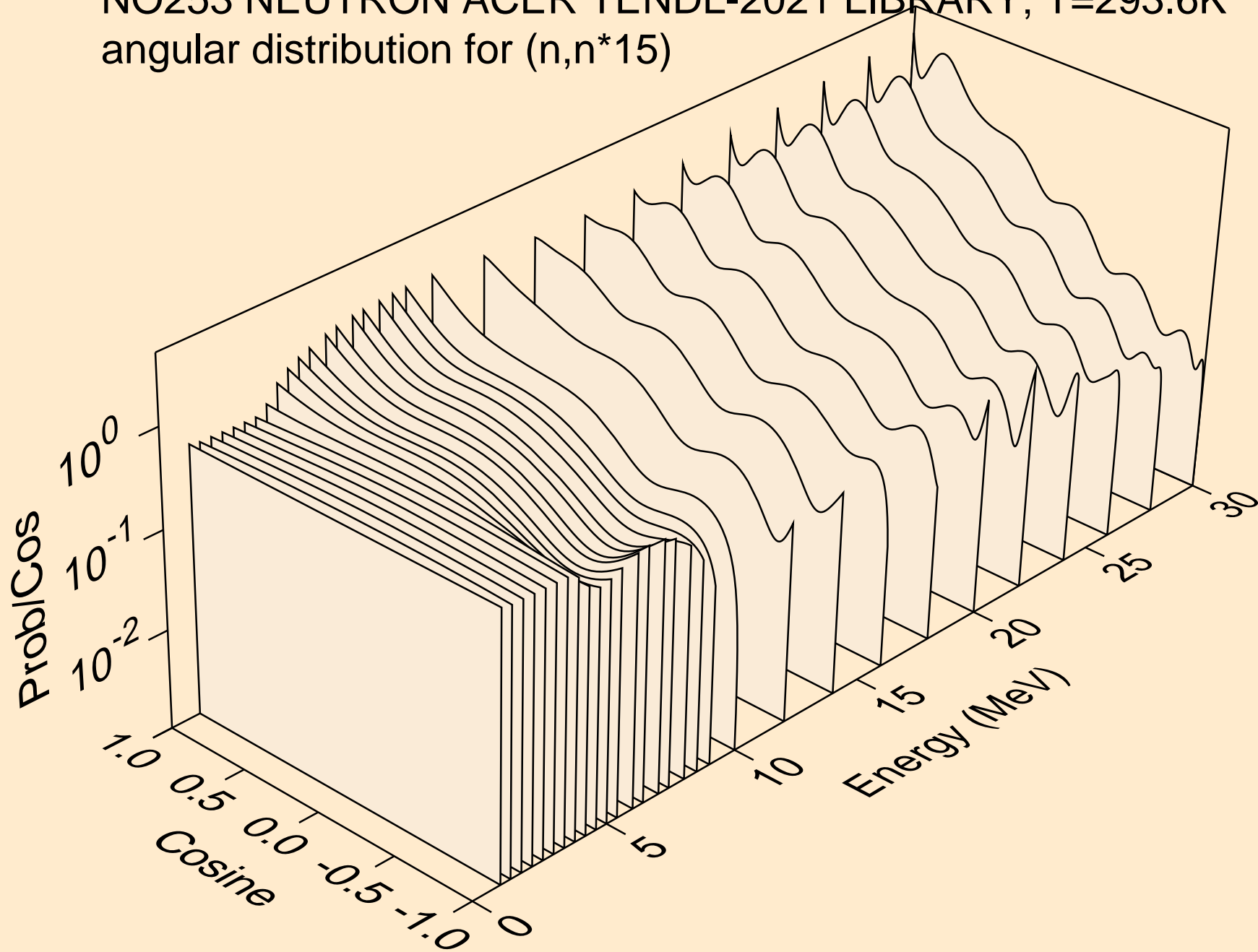

NO253 NEUTRON ACER TENDL-2021 LIBRARY; T=293.6K
angular distribution for (n,n*16)

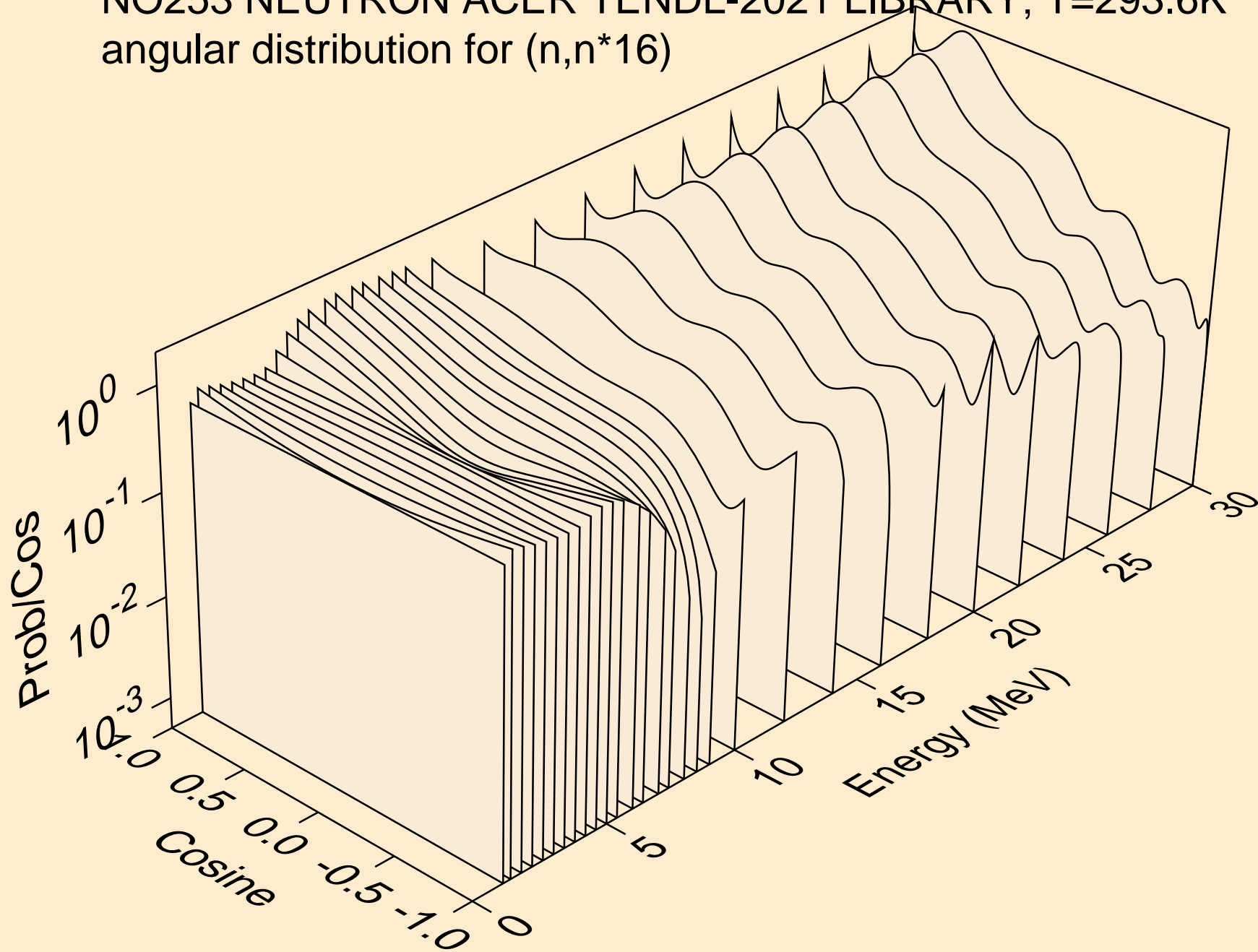

NO253 NEUTRON ACER TENDL-2021 LIBRARY; T=293.6K
Total fission nubar

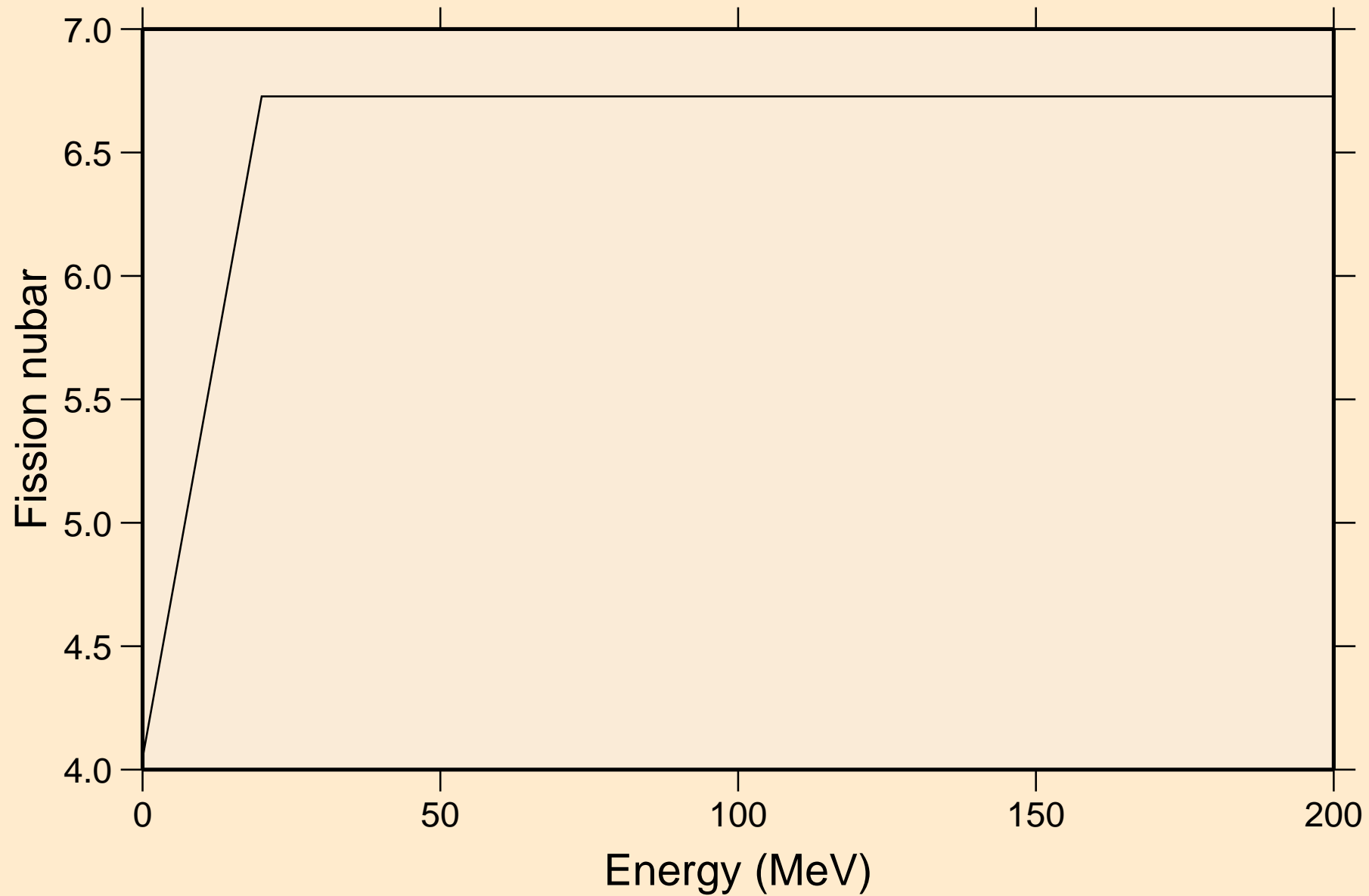

NO253 NEUTRON ACER TENDL-2021 LIBRARY; T=293.6K
Neutron emission for (n,x)

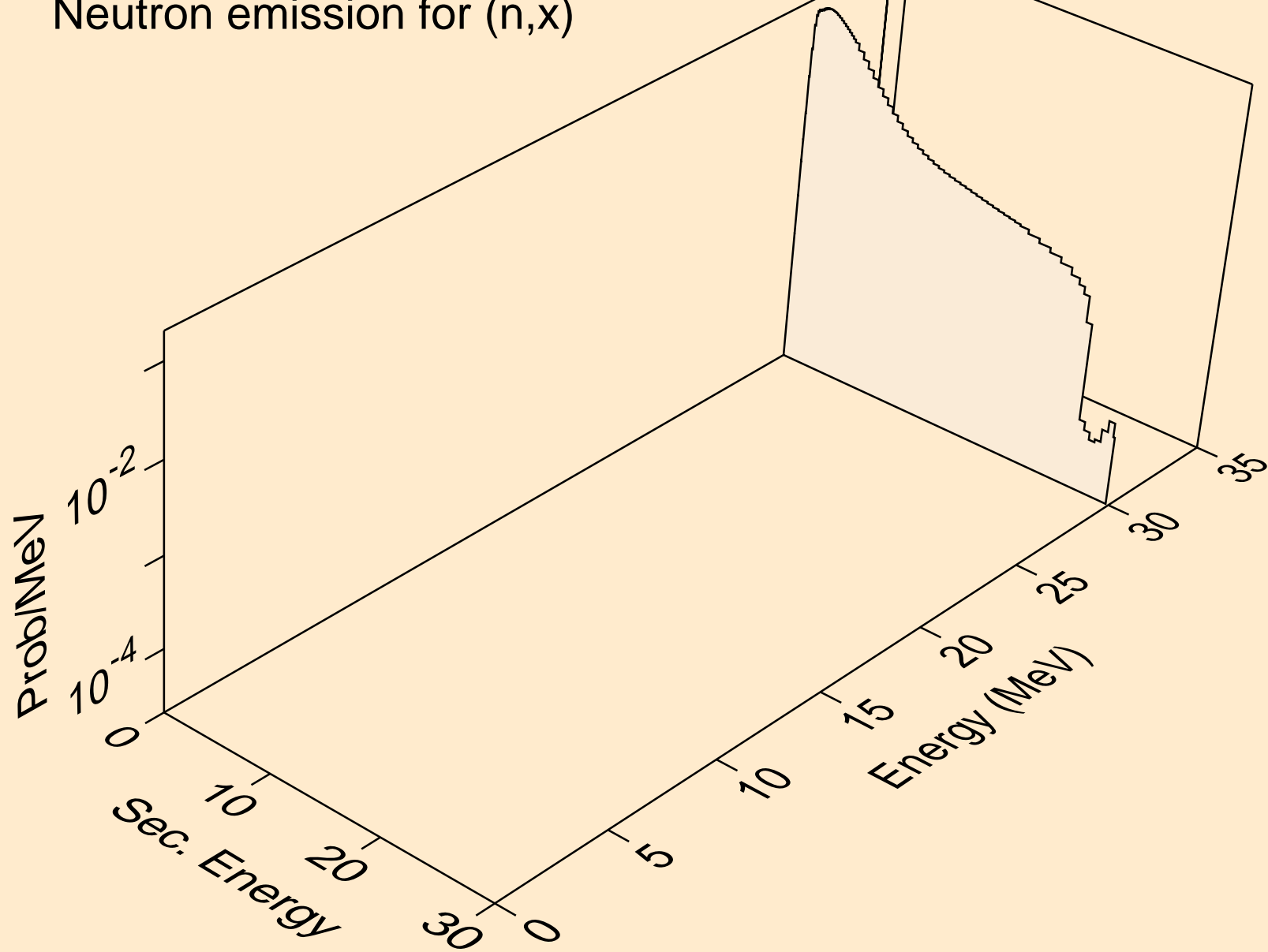

NO253 NEUTRON ACER TENDL-2021 LIBRARY; T=293.6K
Neutron emission for (n,2nd)

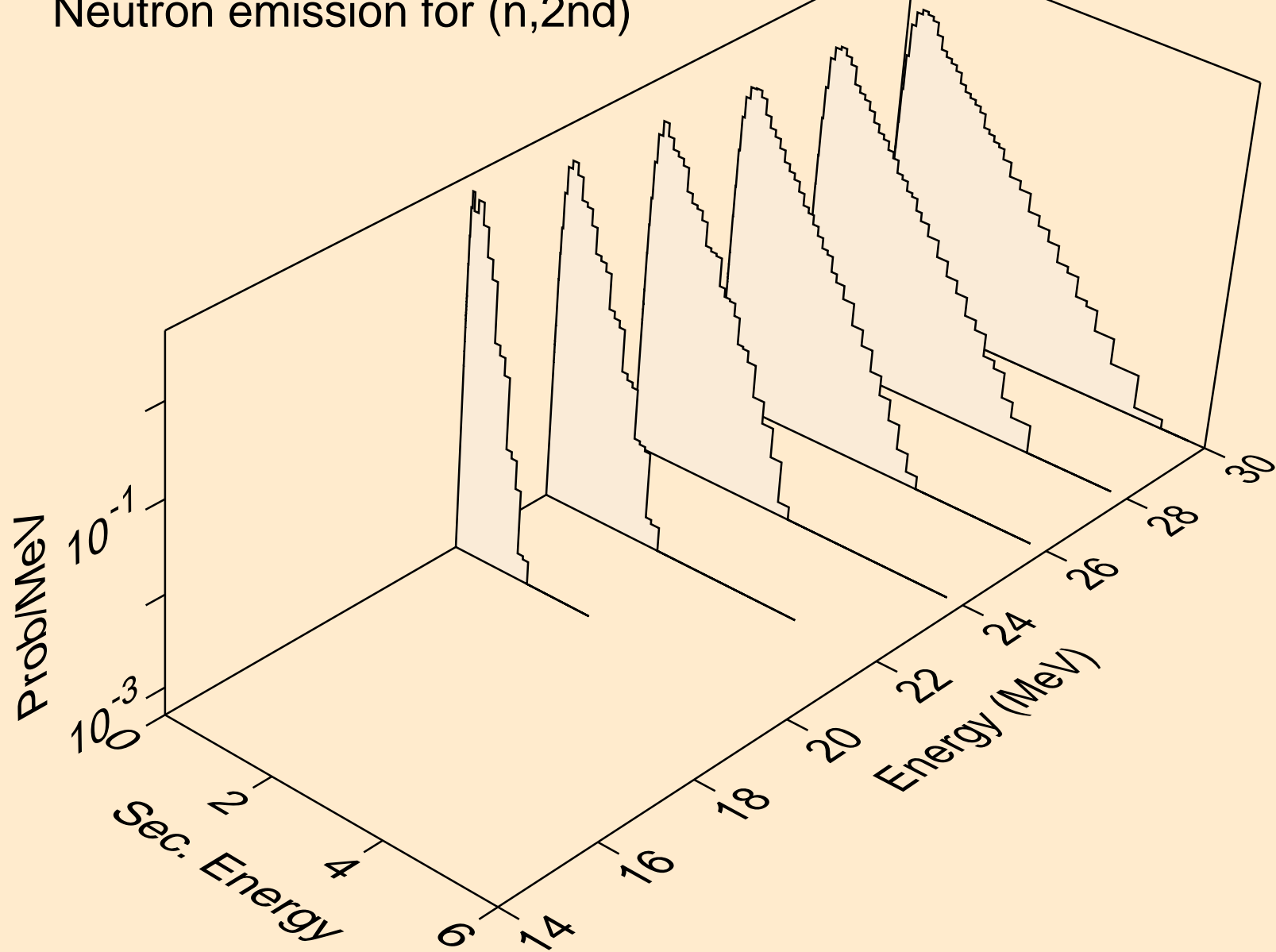

NO253 NEUTRON ACER TENDL-2021 LIBRARY; T=293.6K
Neutron emission for (n,2n)

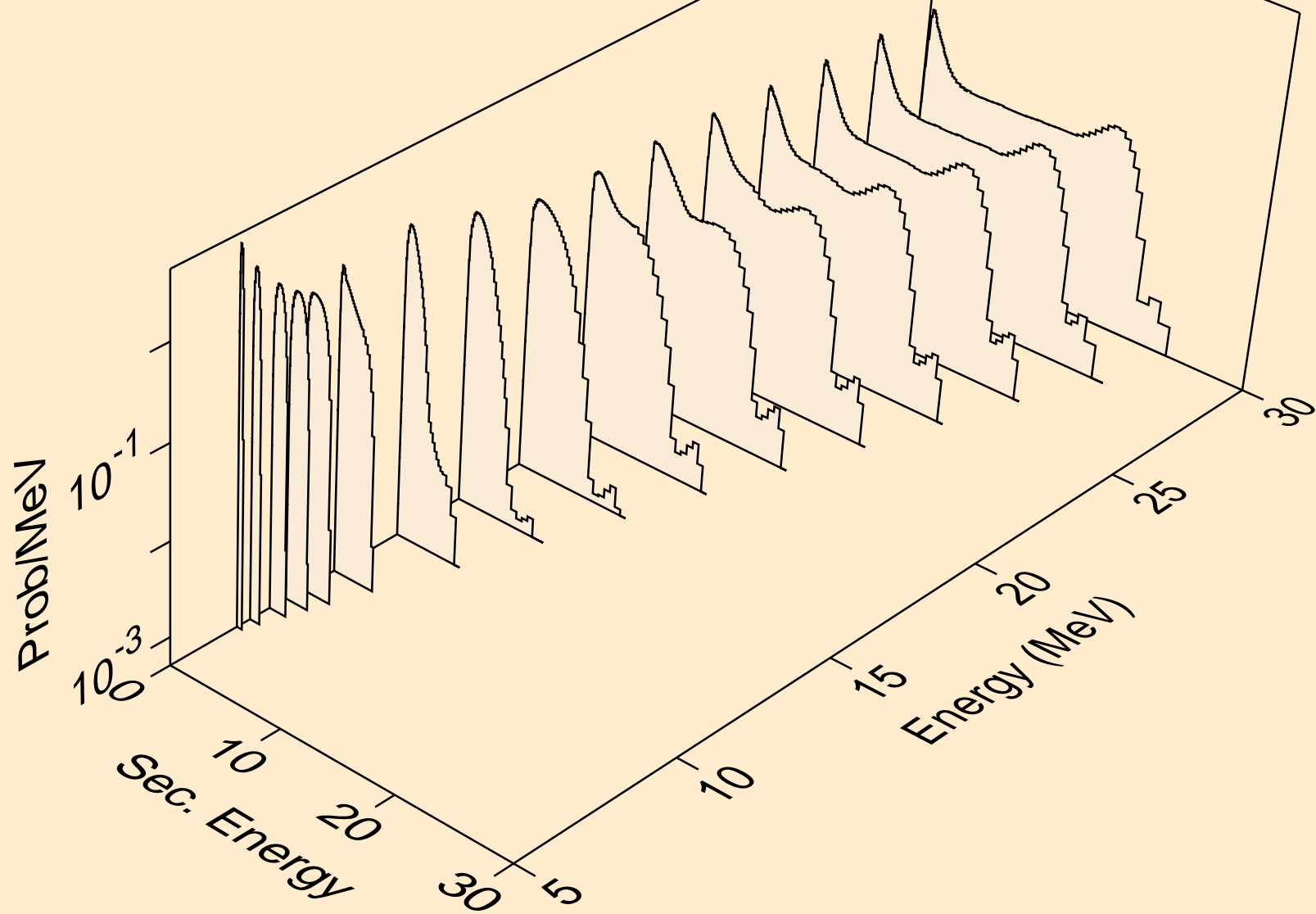

NO253 NEUTRON ACER TENDL-2021 LIBRARY; T=293.6K
Neutron emission for (n,3n)

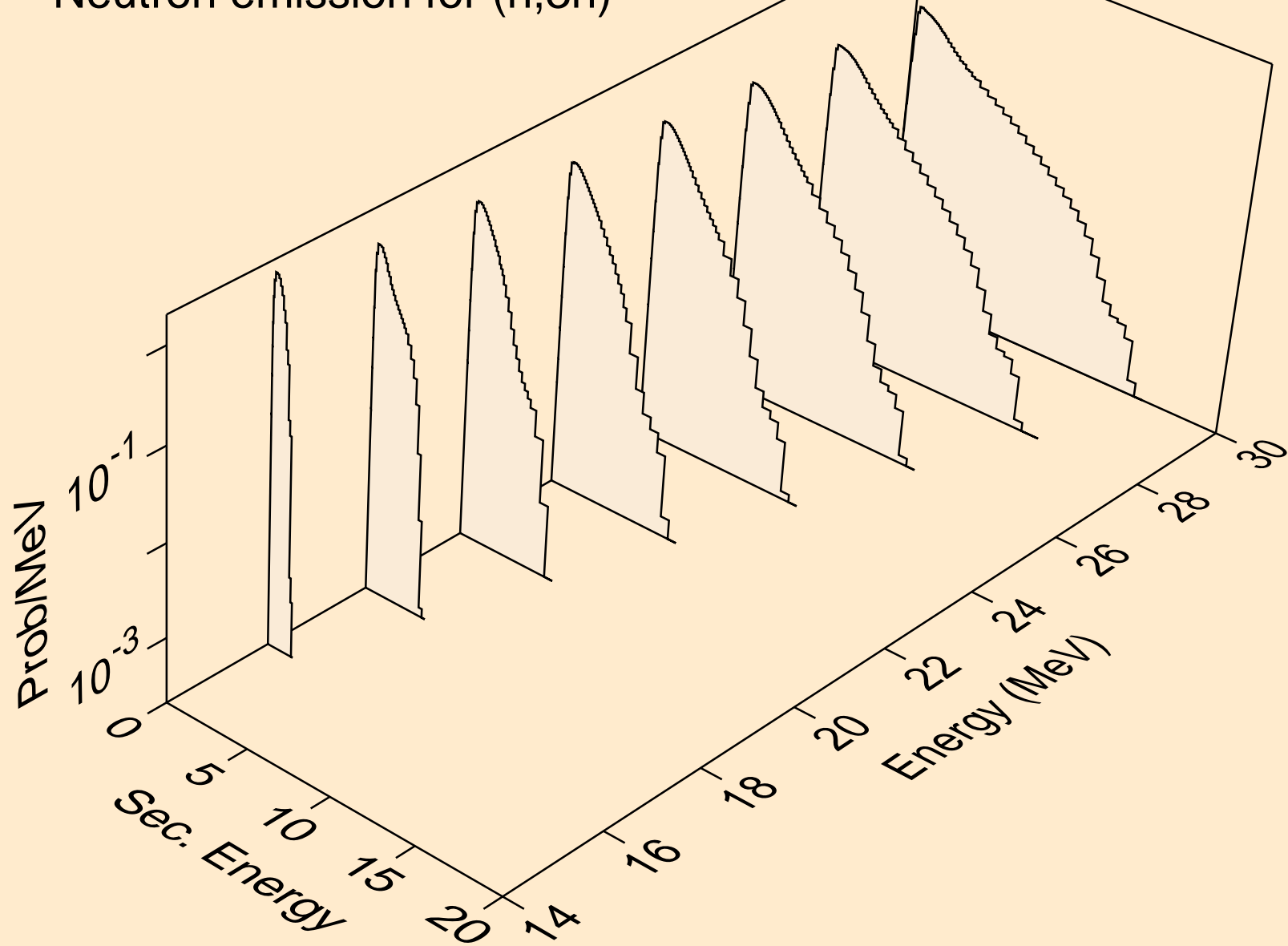

NO253 NEUTRON ACER TENDL-2021 LIBRARY; T=293.6K
Neutron emission for fission

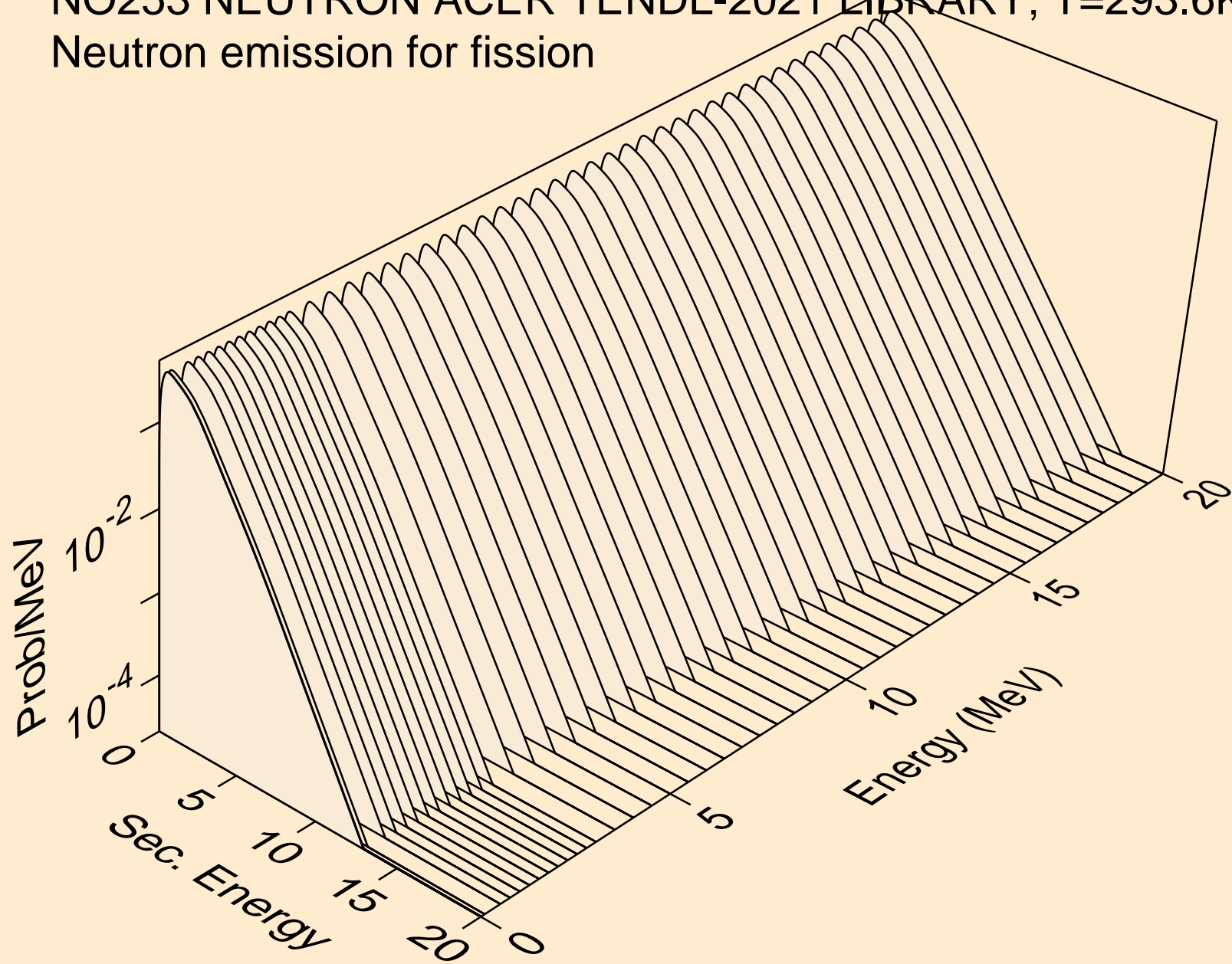

NO253 NEUTRON ACER TENDL-2021 LIBRARY; T=293.6K
Neutron emission for (n,n*)a

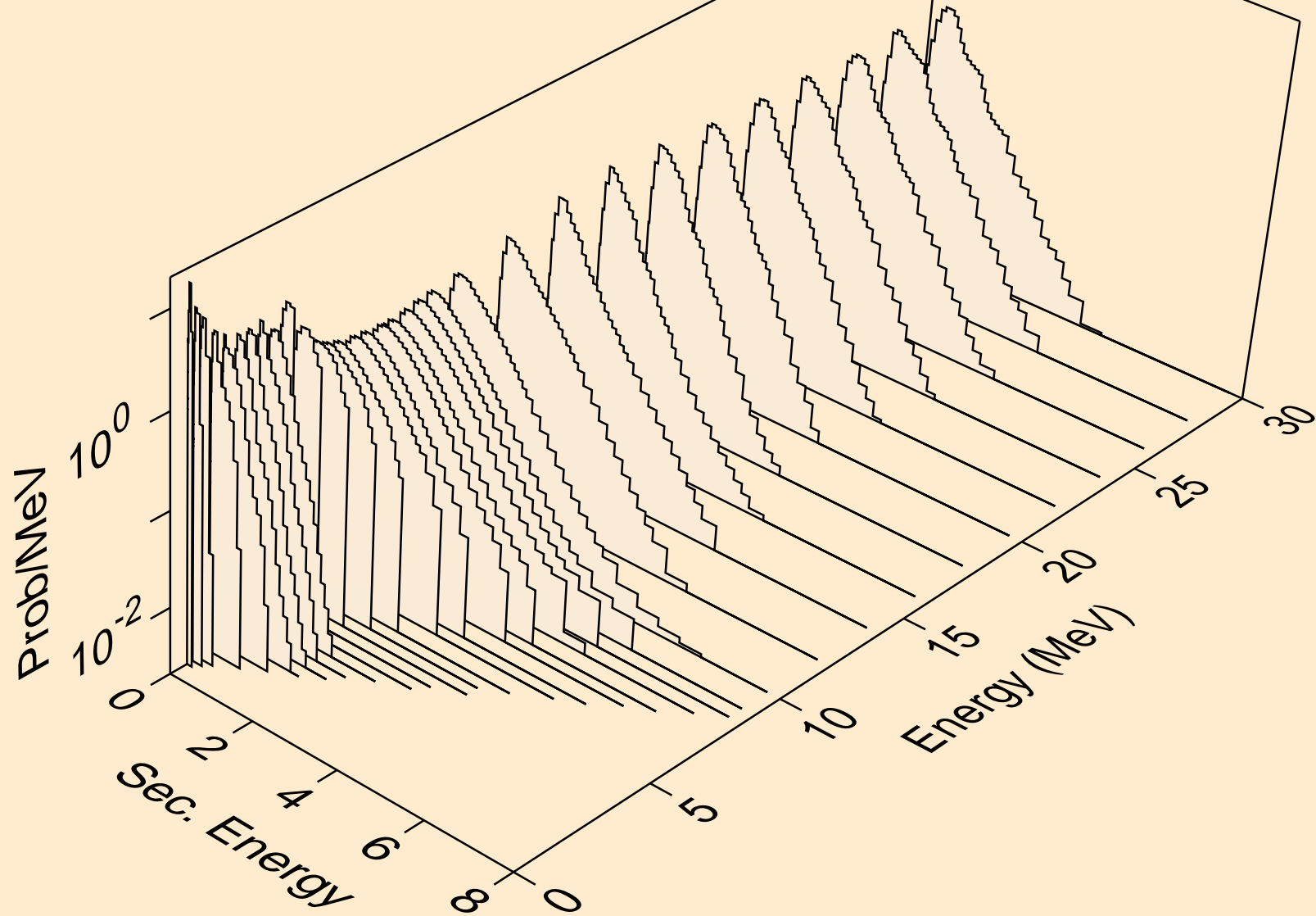

NO253 NEUTRON ACER TENDL-2021 LIBRARY; T=293.6K
Neutron emission for (n,2n)a

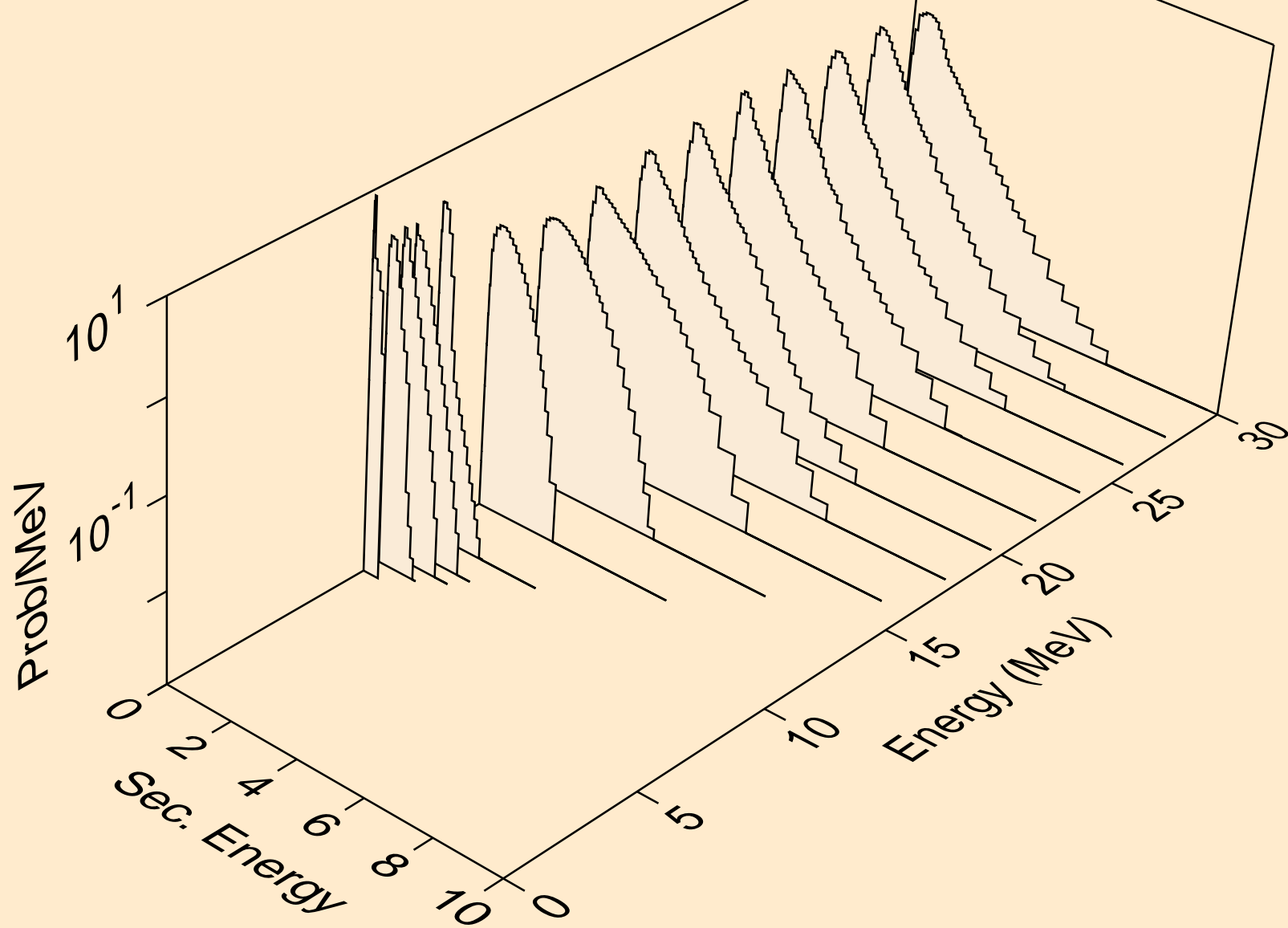

NO253 NEUTRON ACER TENDL-2021 LIBRARY; T=293.6K
Neutron emission for (n,3n)a

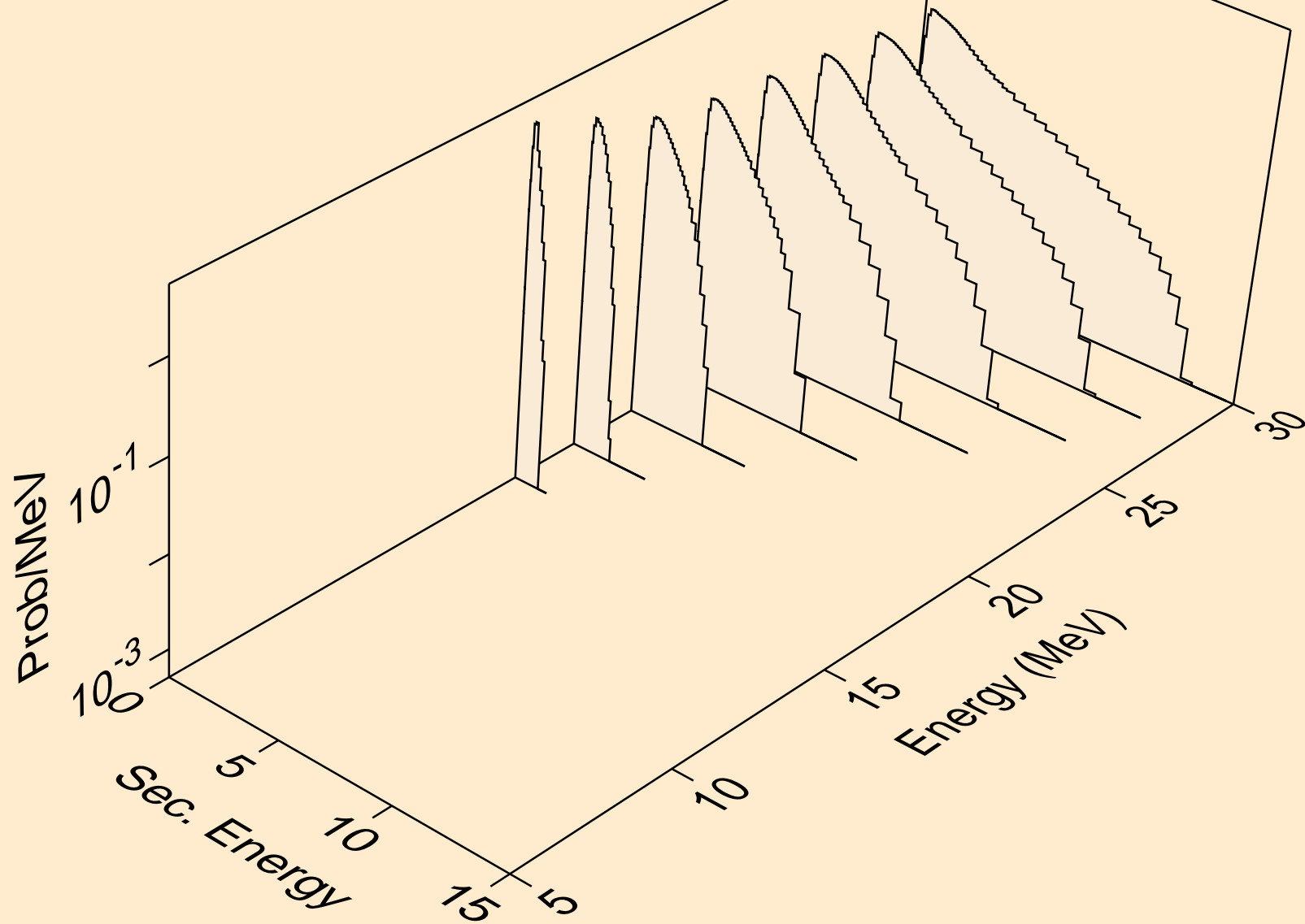

NO253 NEUTRON ACER TENDL-2021 LIBRARY; T=293.6K
Neutron emission for (n,n*)p

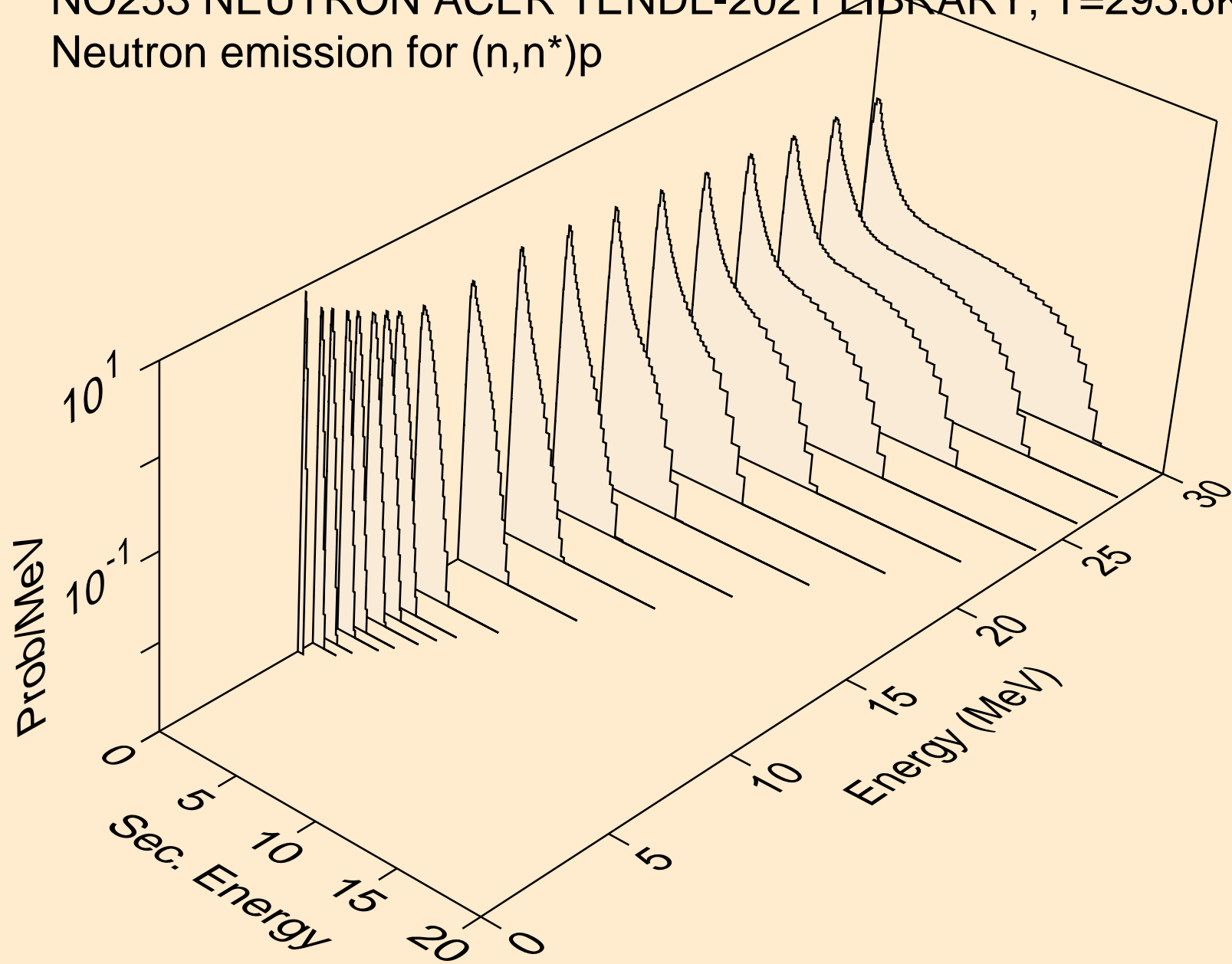

NO253 NEUTRON ACER TENDL-2021 LIBRARY; T=293.6K
Neutron emission for (n,n*)2a

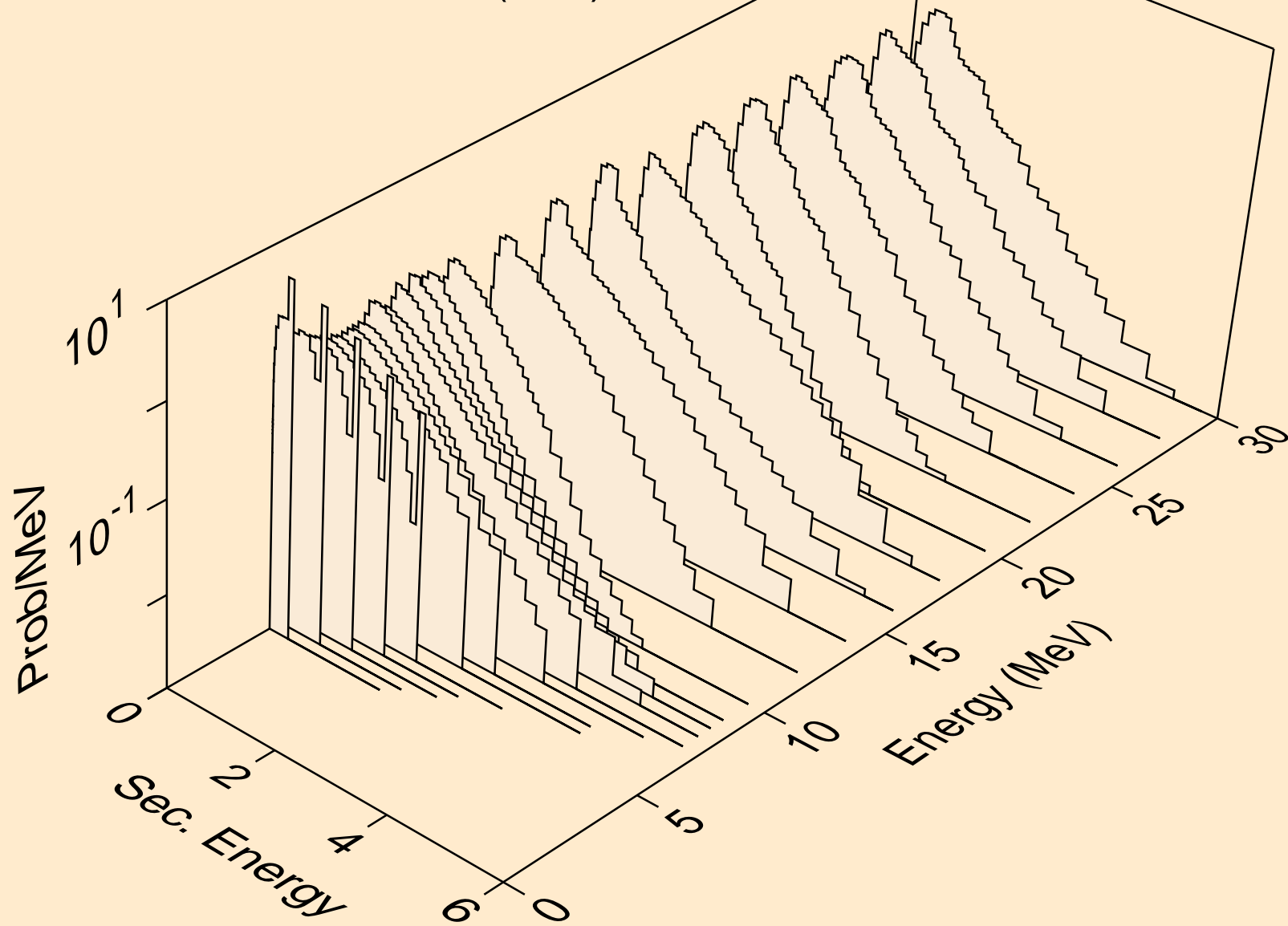

NO253 NEUTRON ACER TENDL-2021 LIBRARY; T=293.6K
Neutron emission for (n,2n)2a

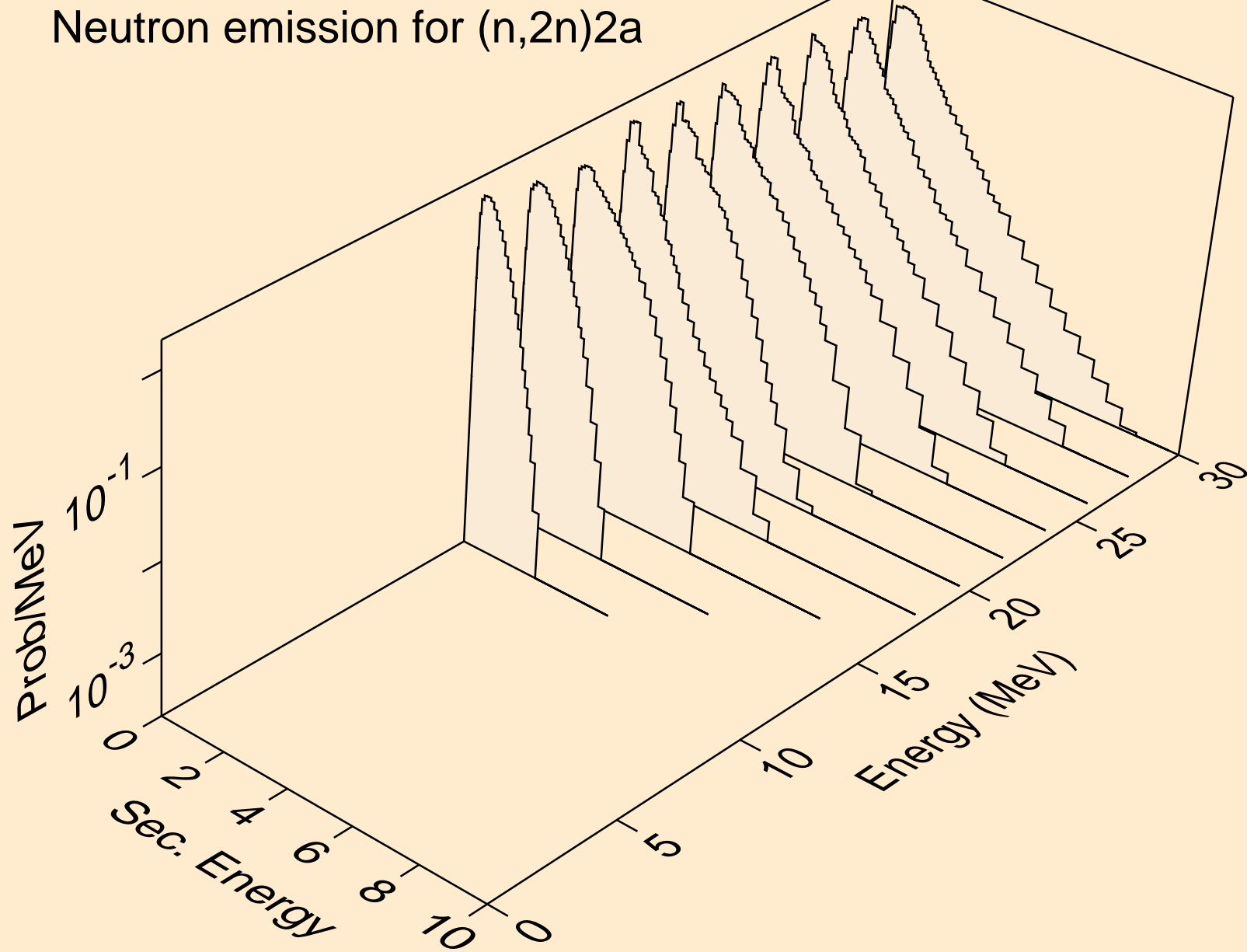

NO253 NEUTRON ACER TENDL-2021 LIBRARY; T=293.6K
Neutron emission for (n,n*)d

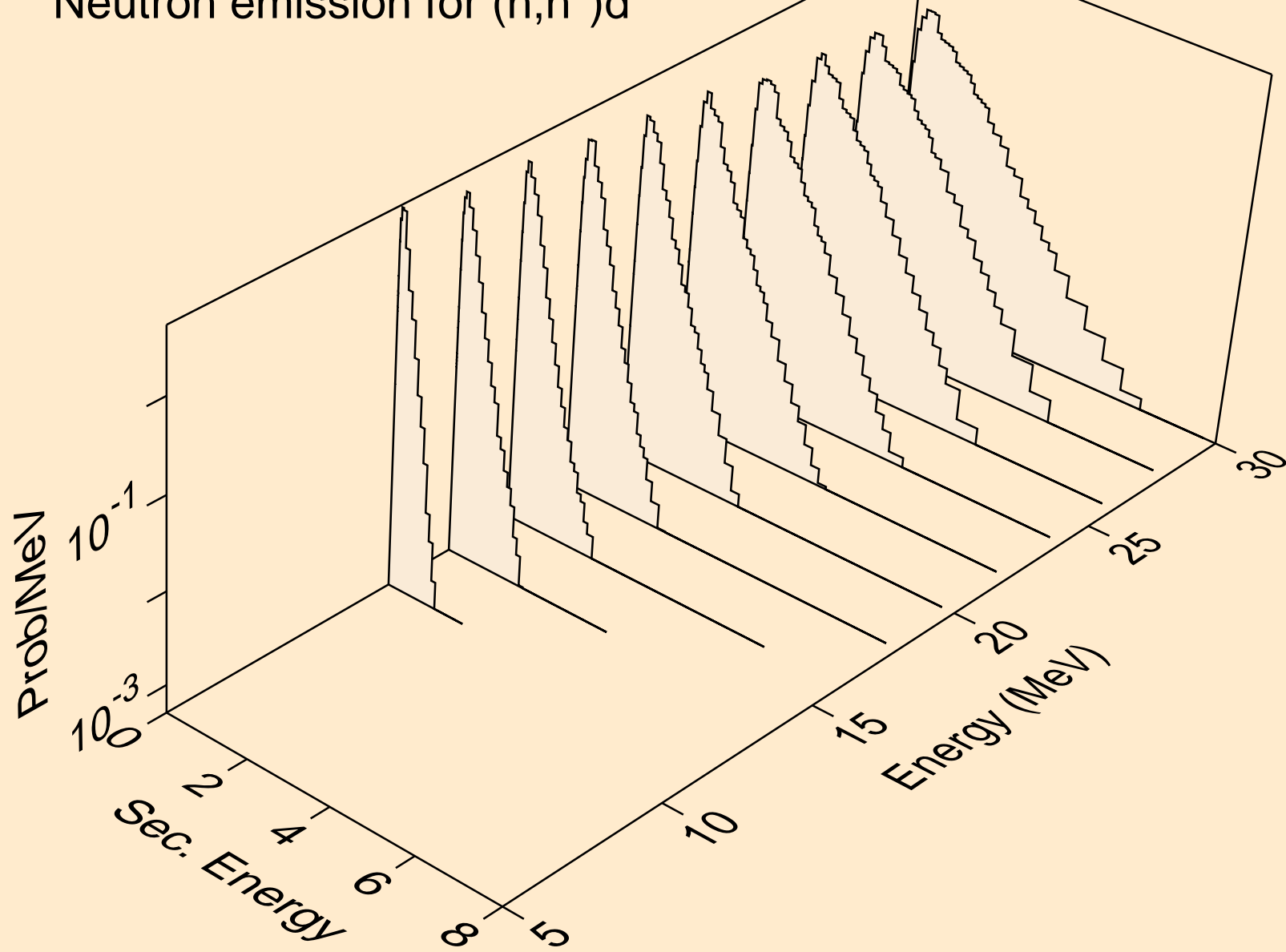

NO253 NEUTRON ACER TENDL-2021 LIBRARY; T=293.6K
Neutron emission for (n,n*)t

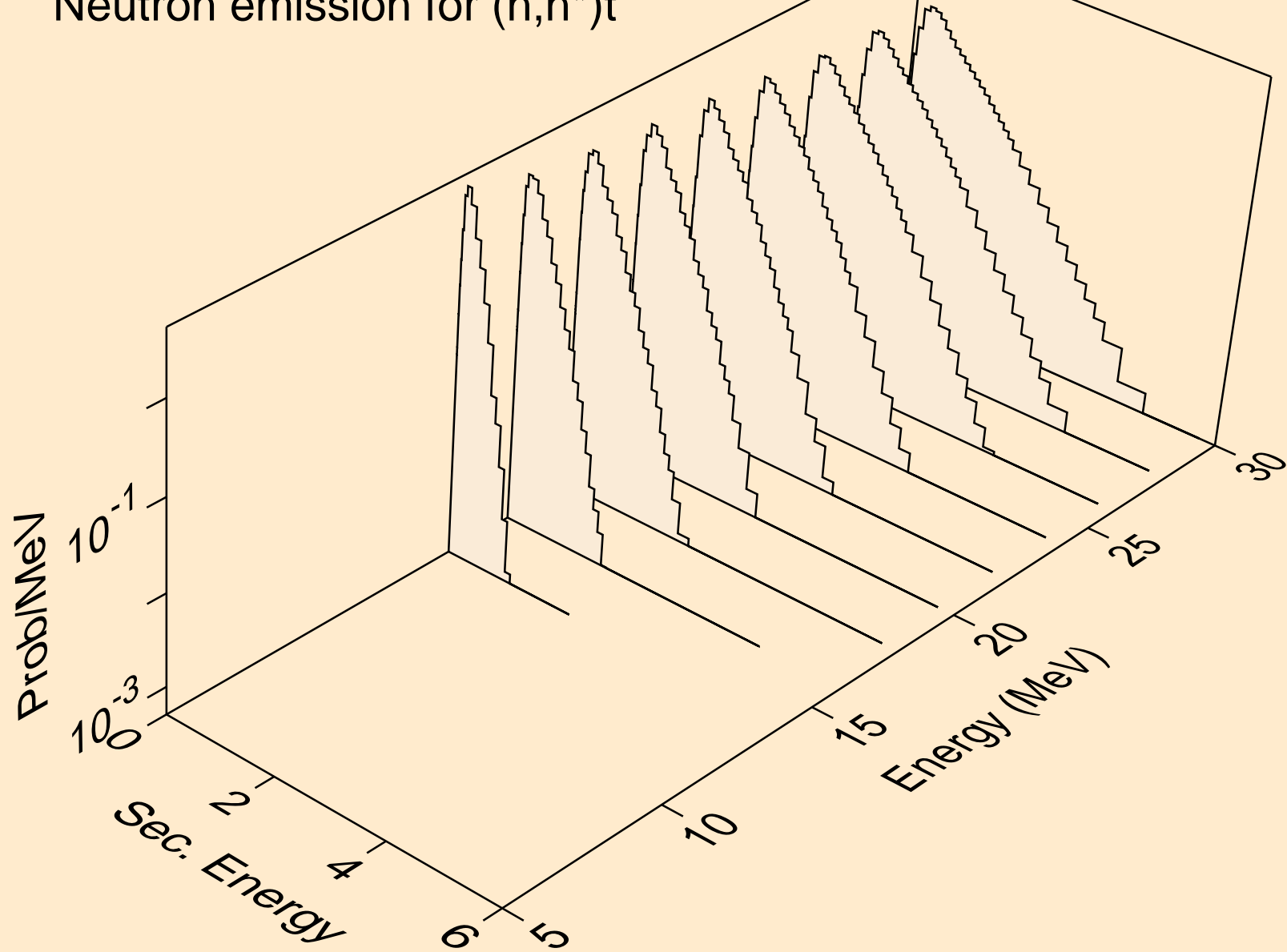

NO253 NEUTRON ACER TENDL-2021 LIBRARY; T=293.6K
Neutron emission for (n,n*)he3

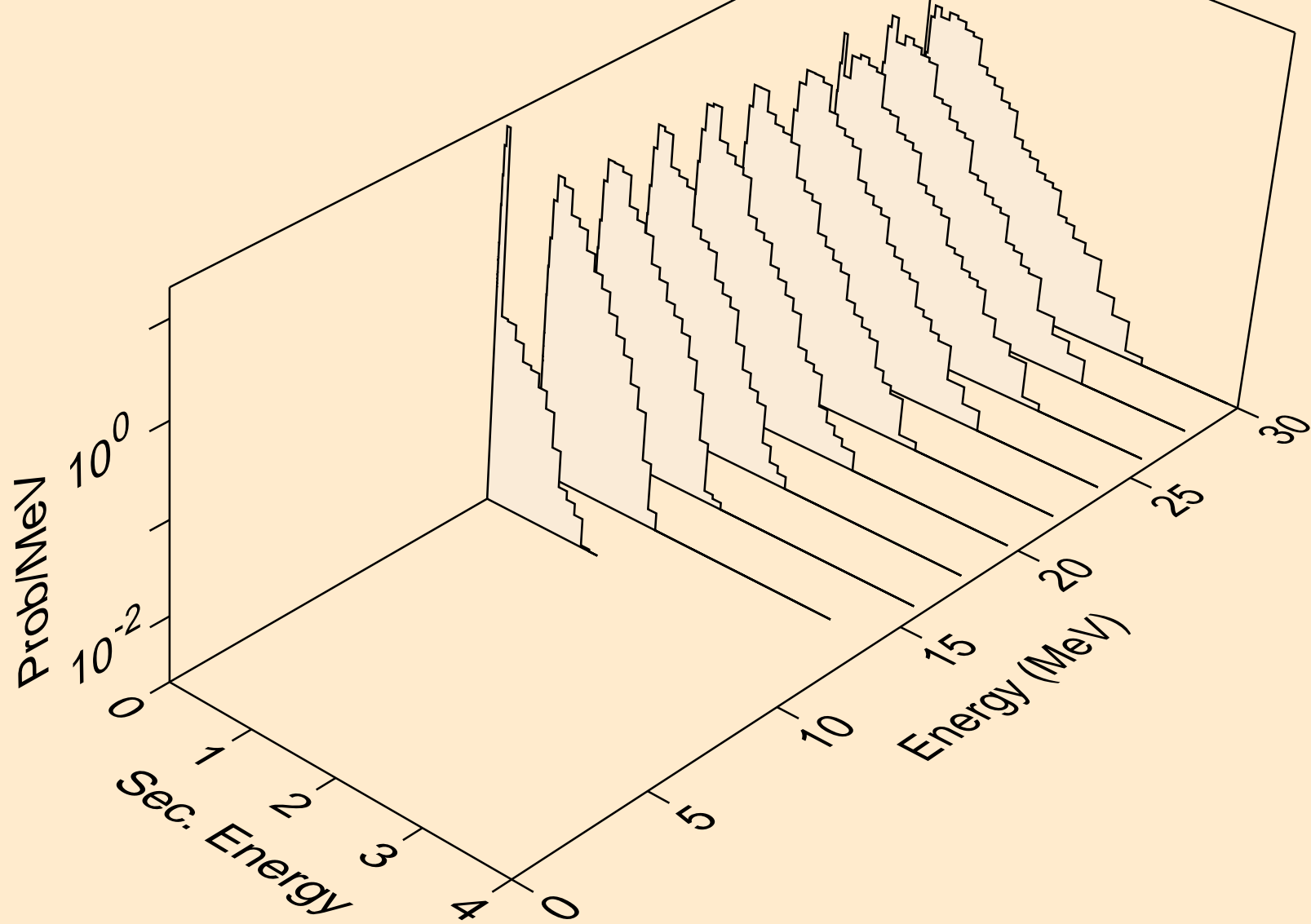

NO253 NEUTRON ACER TENDL-2021 LIBRARY; T=293.6K
Neutron emission for (n,4n)

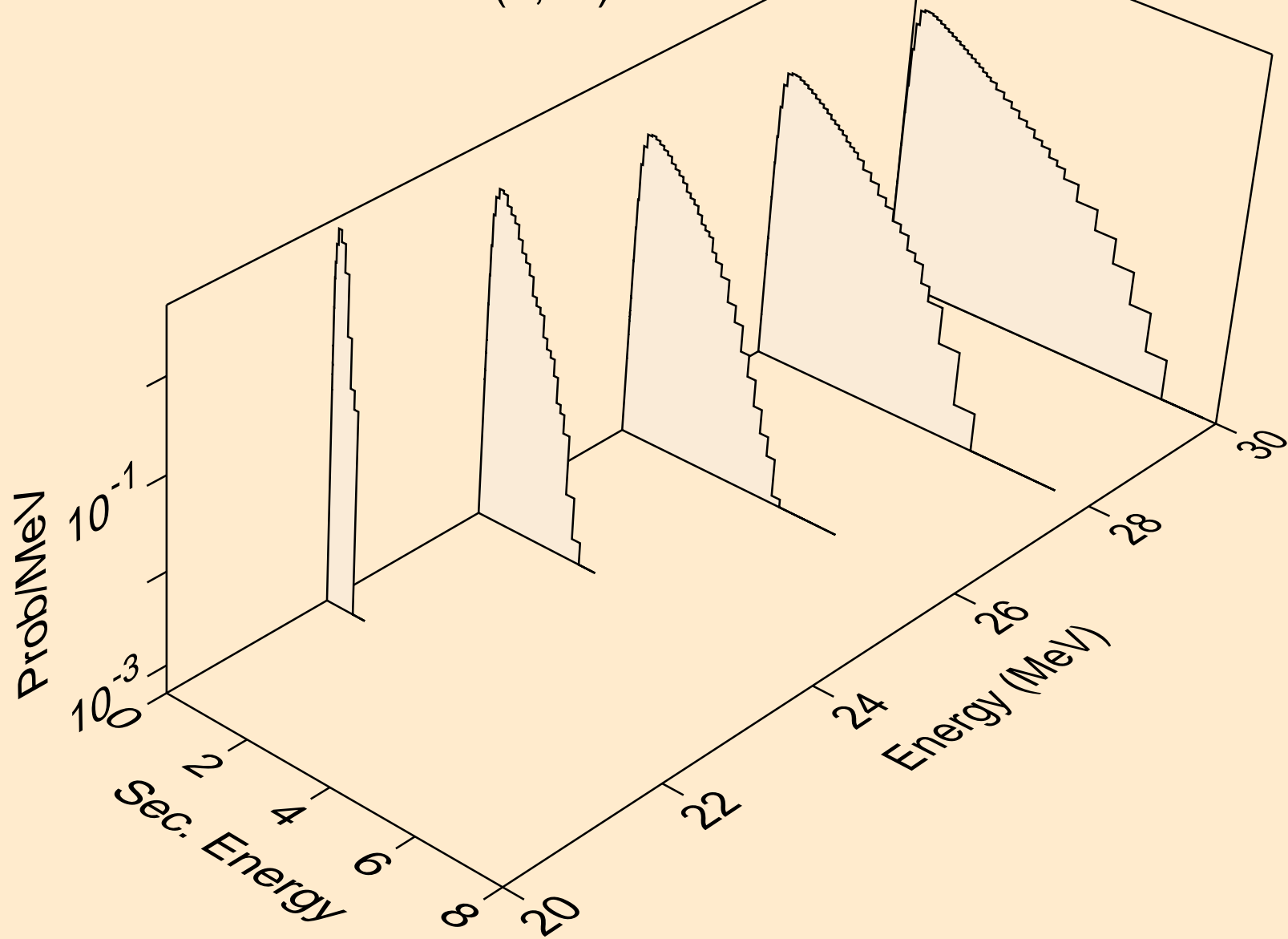

NO253 NEUTRON ACER TENDL-2021 LIBRARY; T=293.6K
Neutron emission for (n,2np)

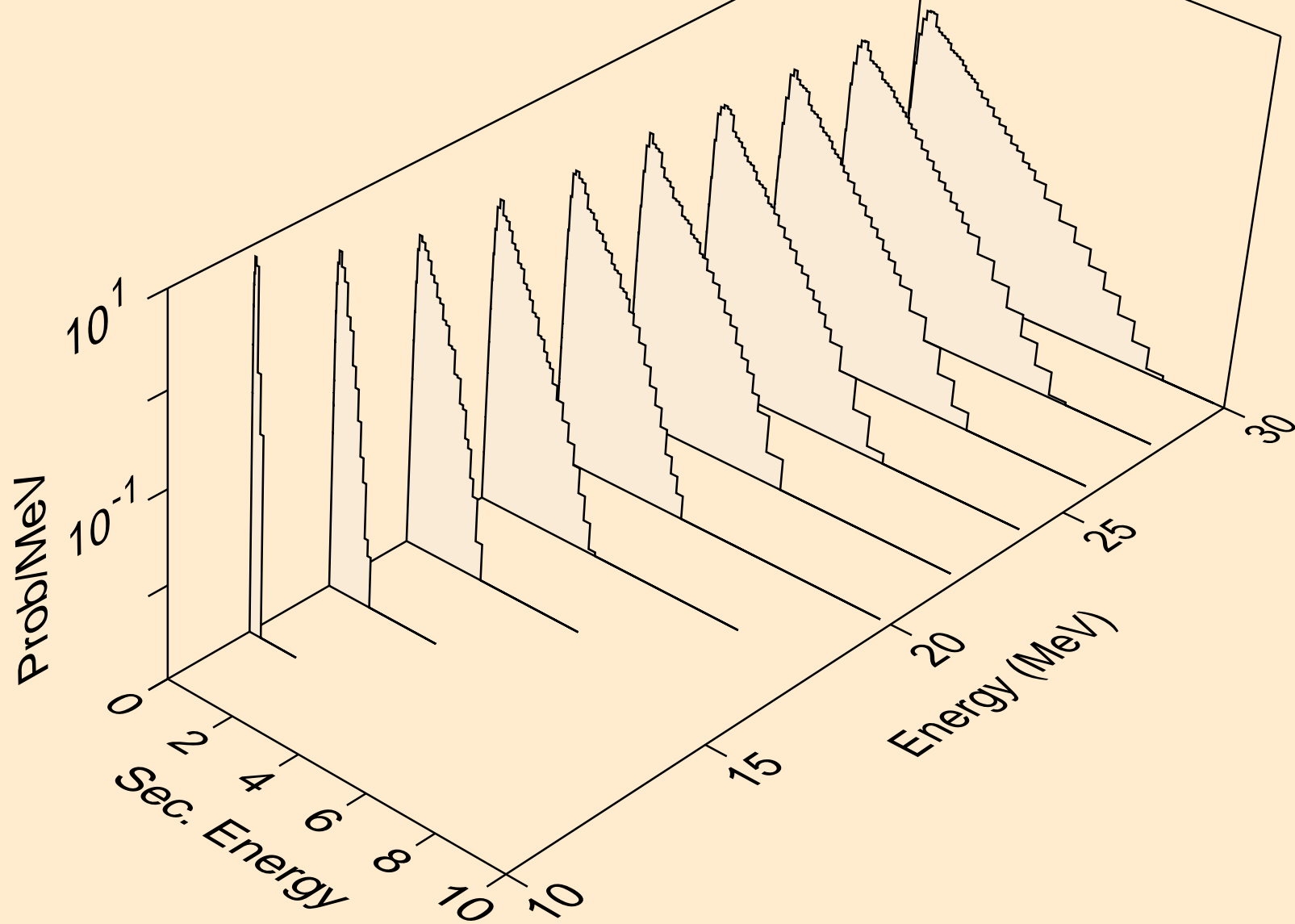

NO253 NEUTRON ACER TENDL-2021 LIBRARY; T=293.6K
Neutron emission for (n,3np)

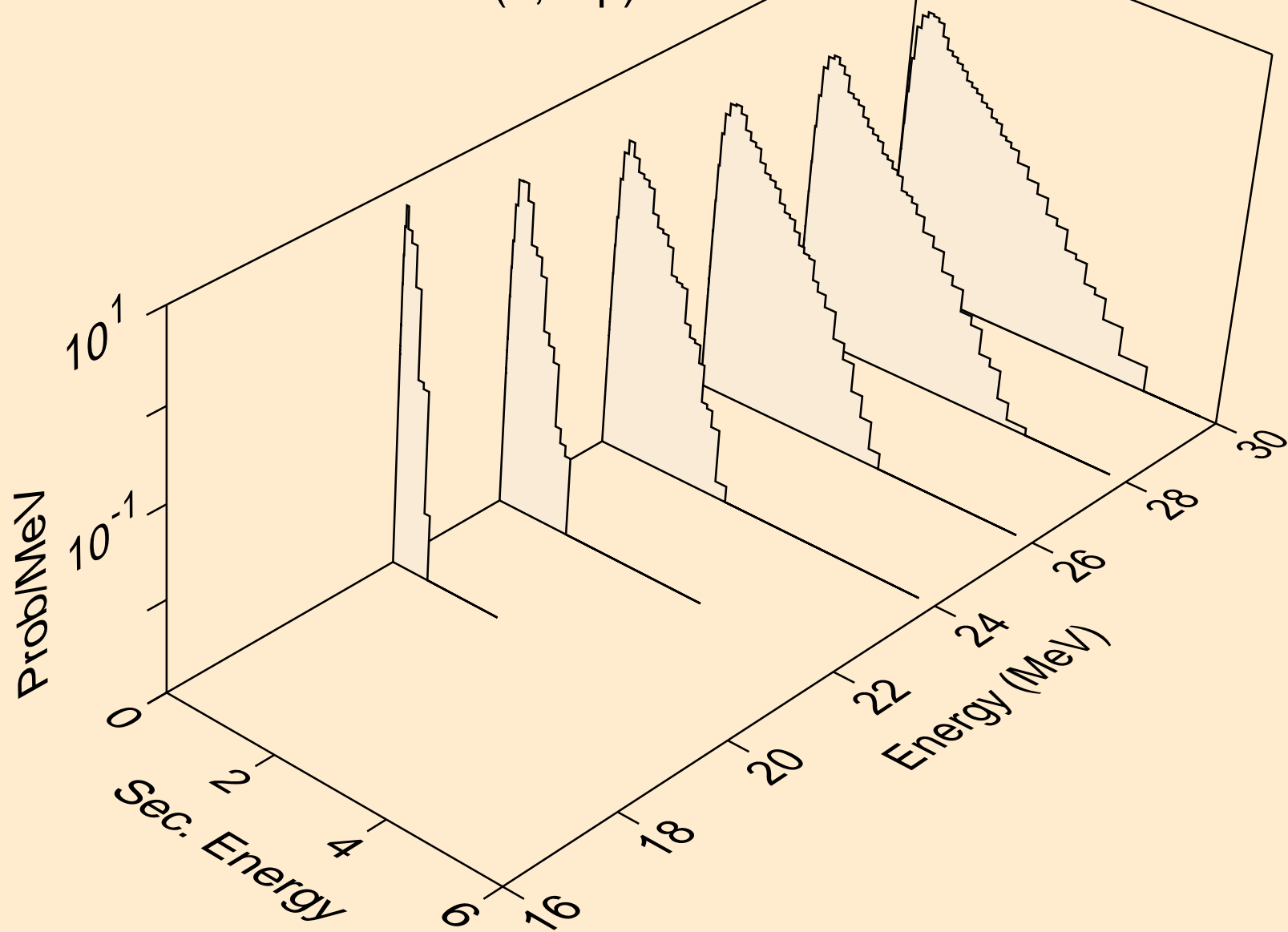

NO253 NEUTRON ACER TENDL-2021 LIBRARY; T=293.6K
Neutron emission for (n,2np)

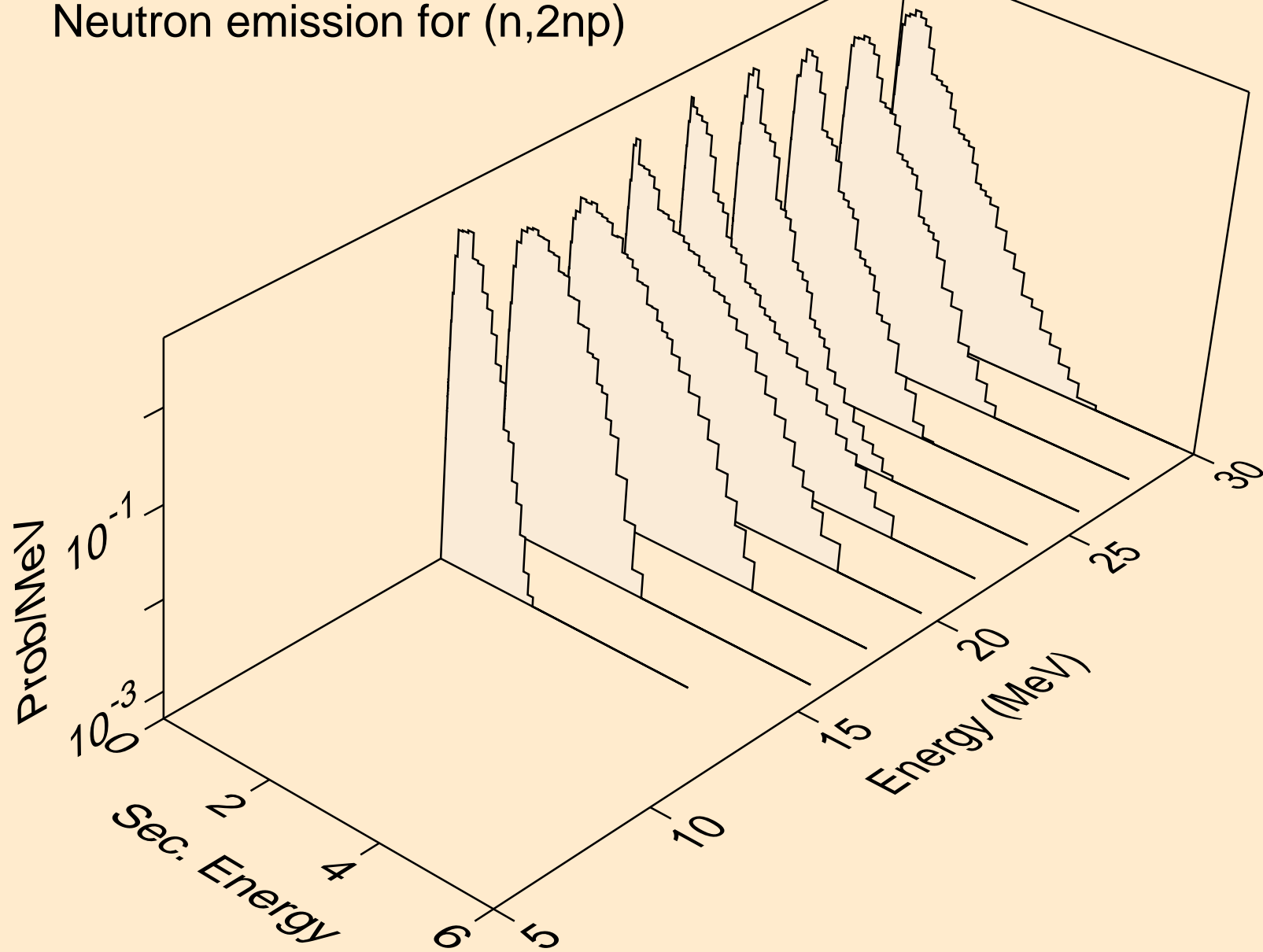

NO253 NEUTRON ACER TENDL-2021 LIBRARY; T=293.6K
Neutron emission for (n,npa)

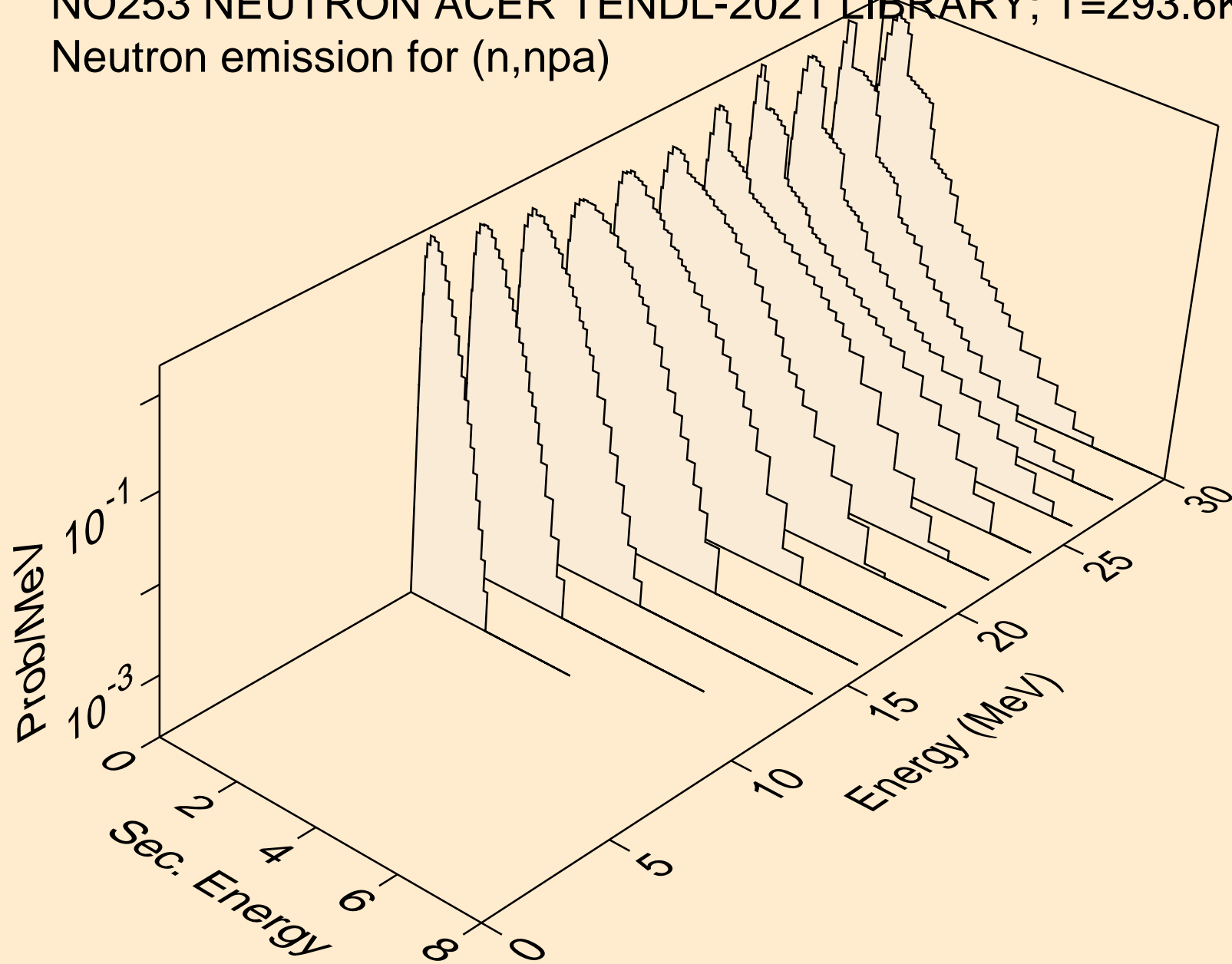

NO253 NEUTRON ACER TENDL-2021 LIBRARY; T=293.6K
Neutron emission for (n,n*c)

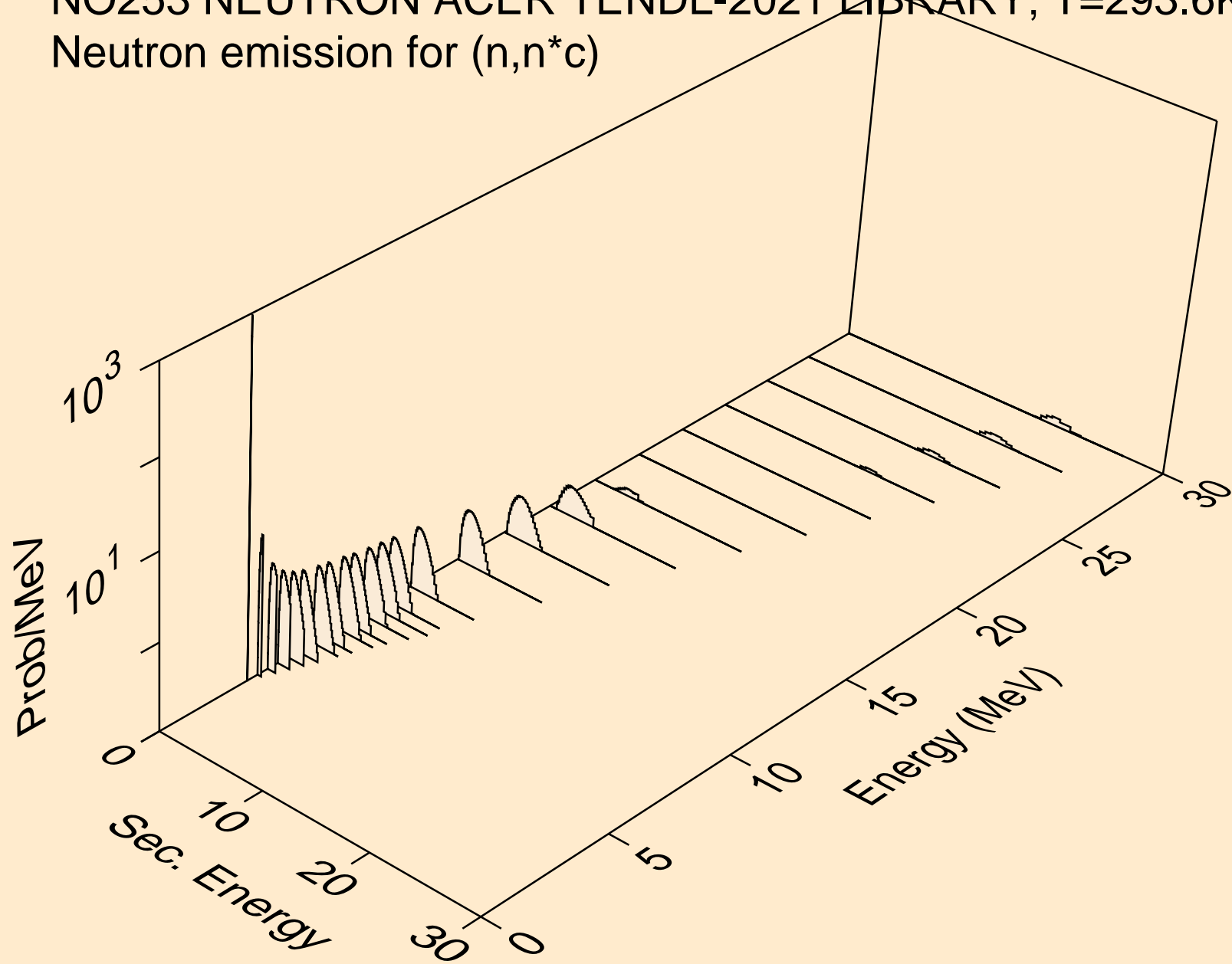

NO253 NEUTRON ACER TENDL-2021 LIBRARY; T=293.6K

Delayed nubar

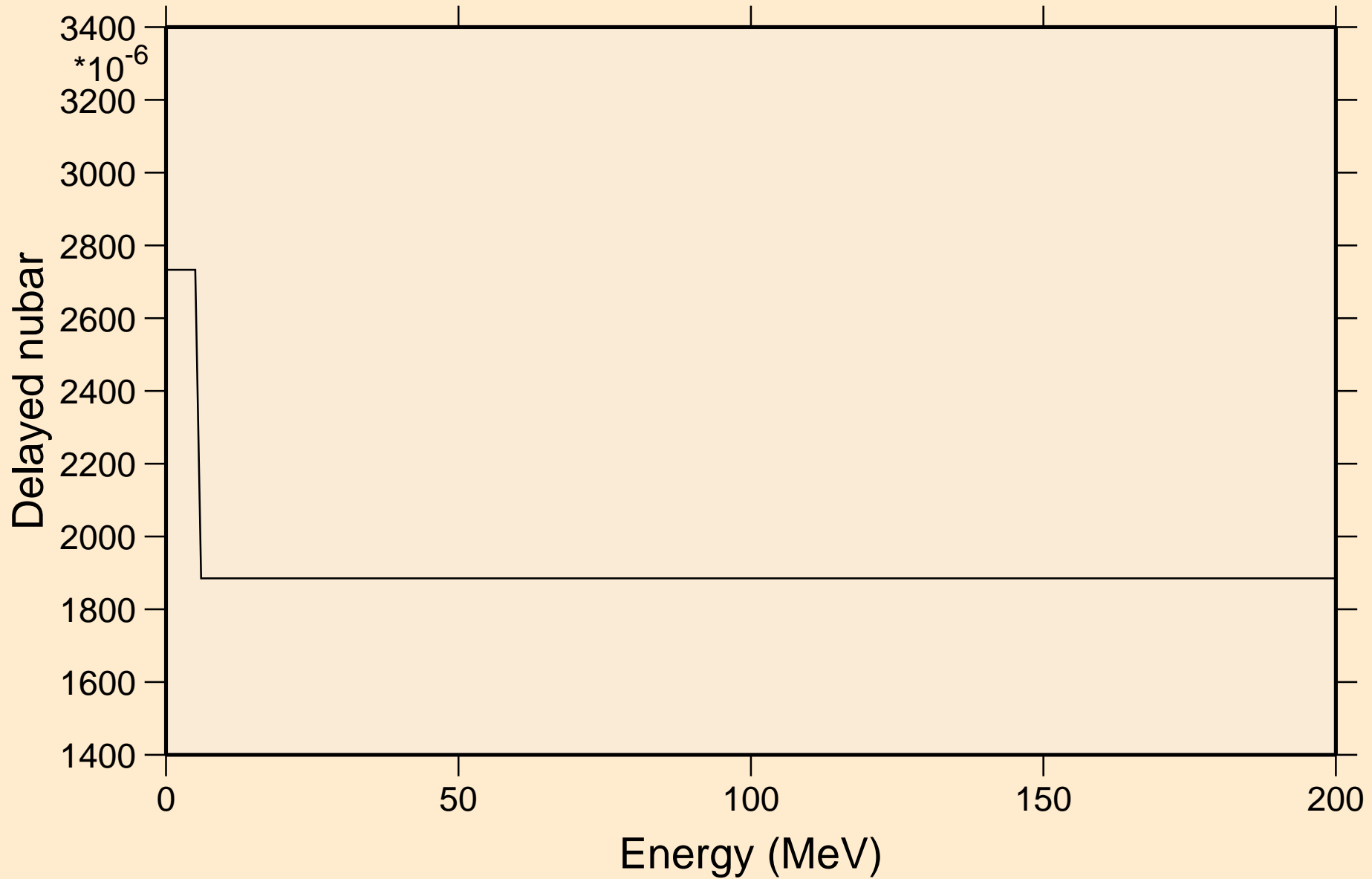

NO253 NEUTRON ACER TENDL-2021 LIBRARY; T=293.6K

Delayed neutron spectra

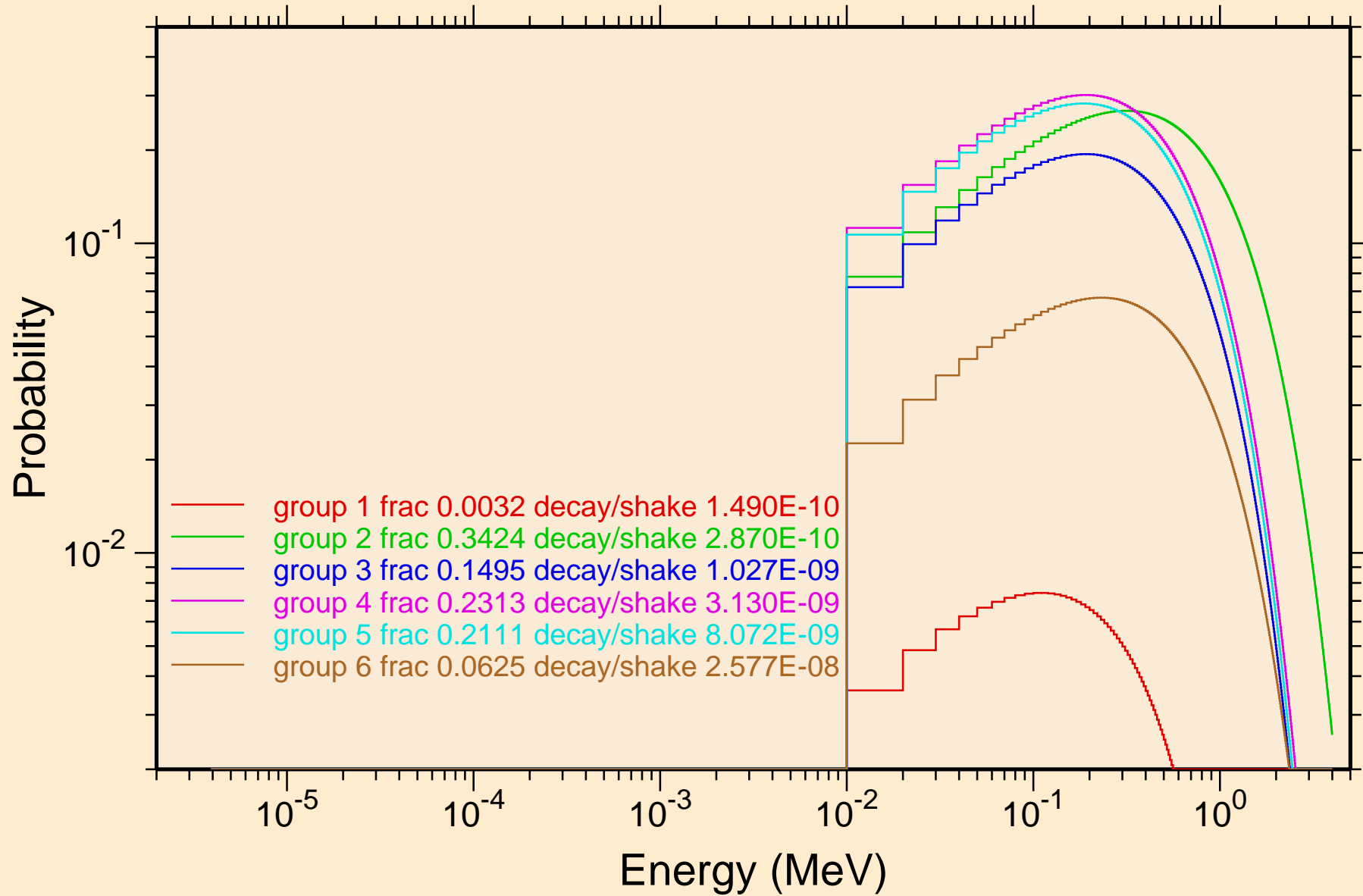

NO253 NEUTRON ACER TENDL-2021 LIBRARY; T=293.6K
Photon emission for (n,x)

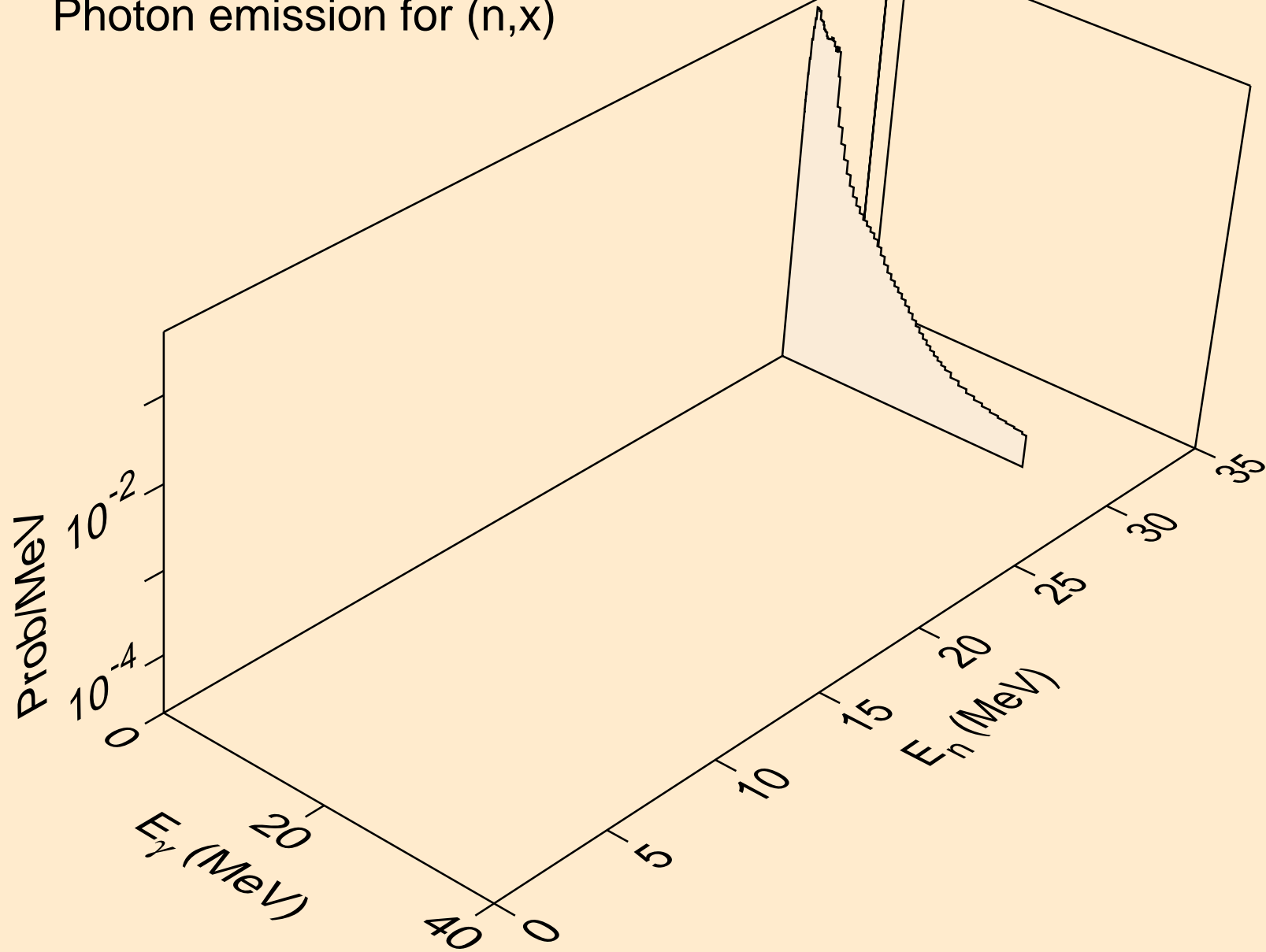

NO253 NEUTRON ACER TENDL-2021 LIBRARY; T=293.6K
Photon emission for (n,2nd)

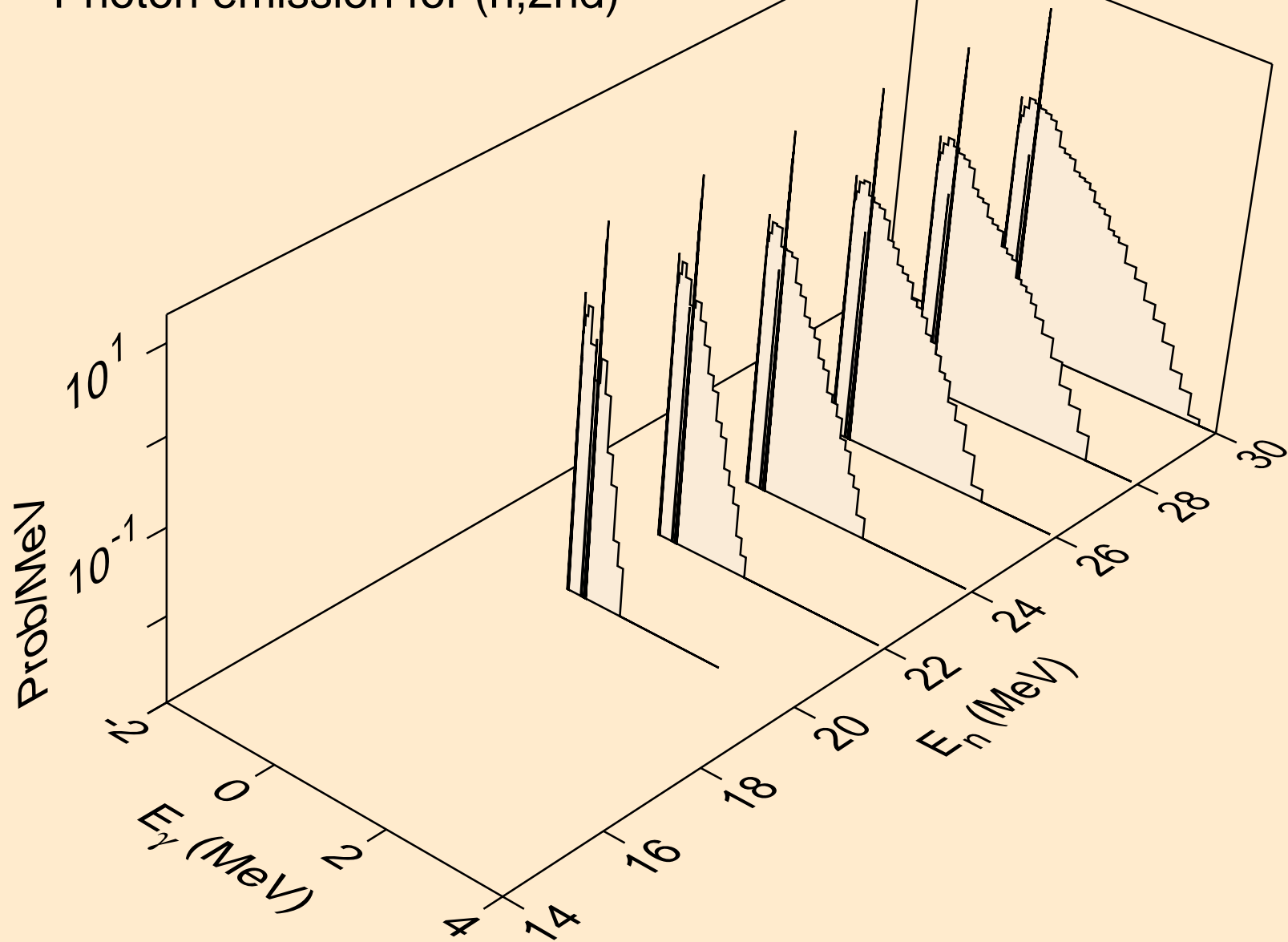

NO253 NEUTRON ACER TENDL-2021 LIBRARY; T=293.6K
Photon emission for (n,2n)

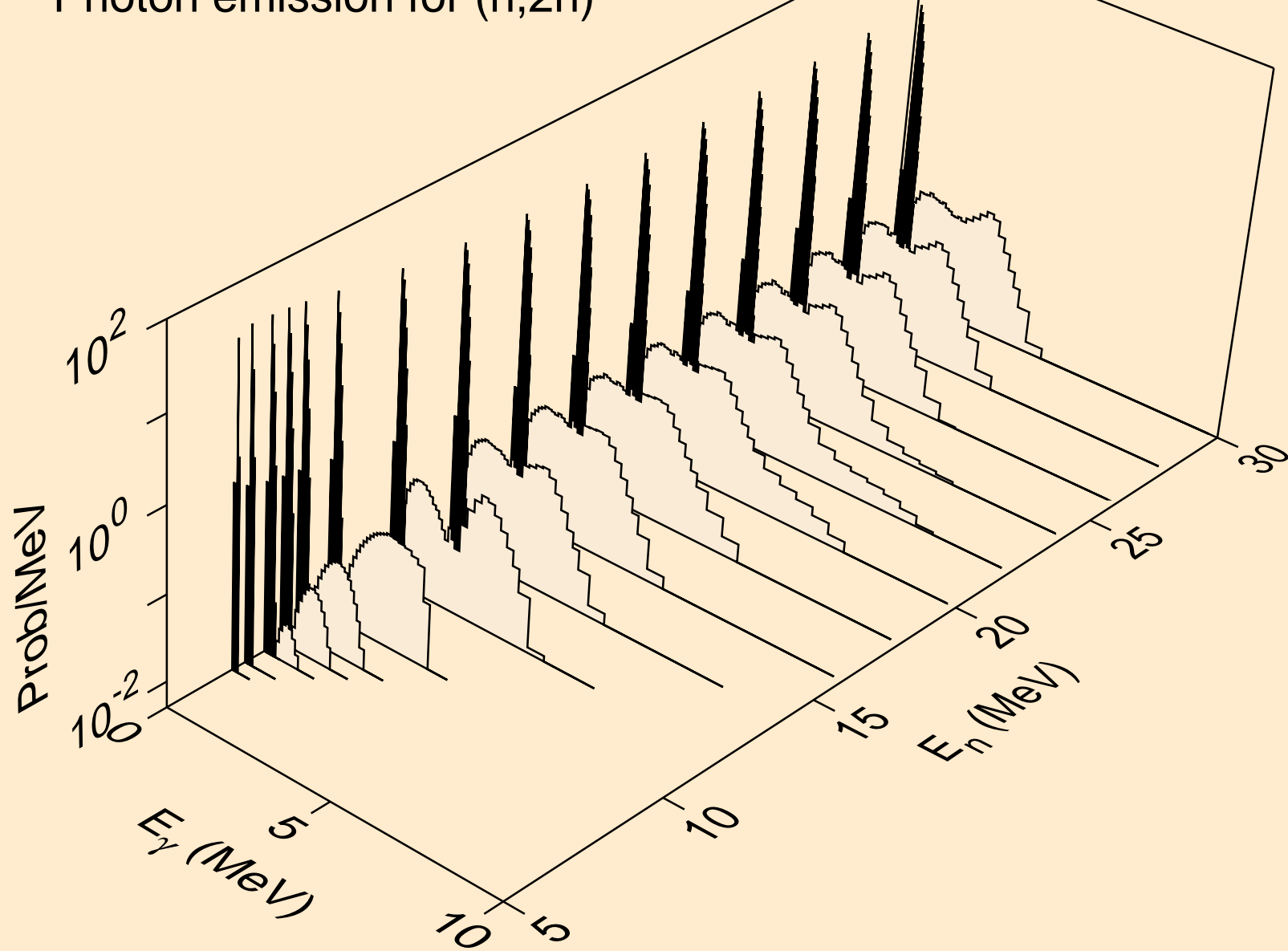

NO253 NEUTRON ACER TENDL-2021 LIBRARY; T=293.6K
Photon emission for (n,3n)

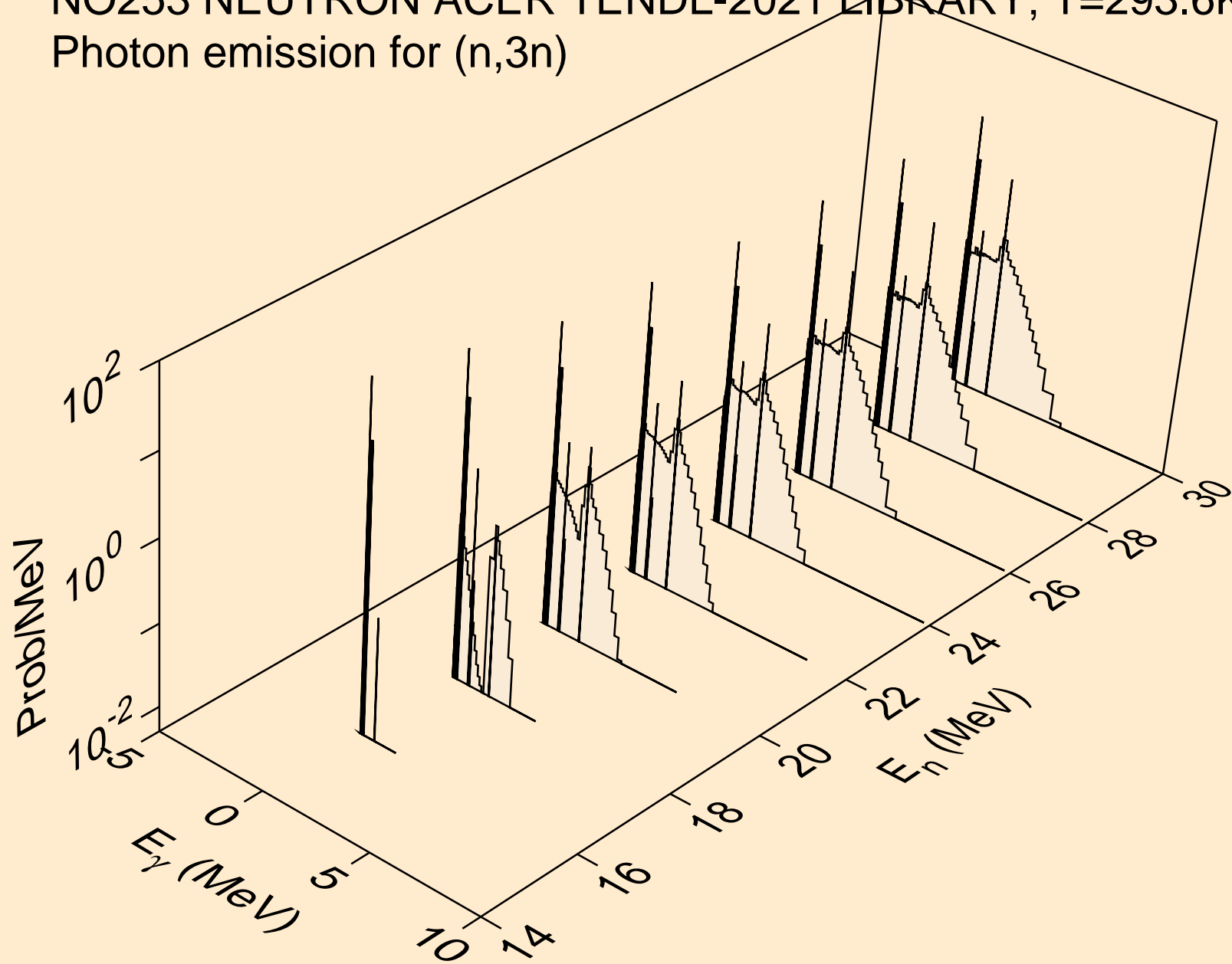

NO253 NEUTRON ACER TENDL-2021 LIBRARY; T=293.6K
Photon emission for (n,n*)a

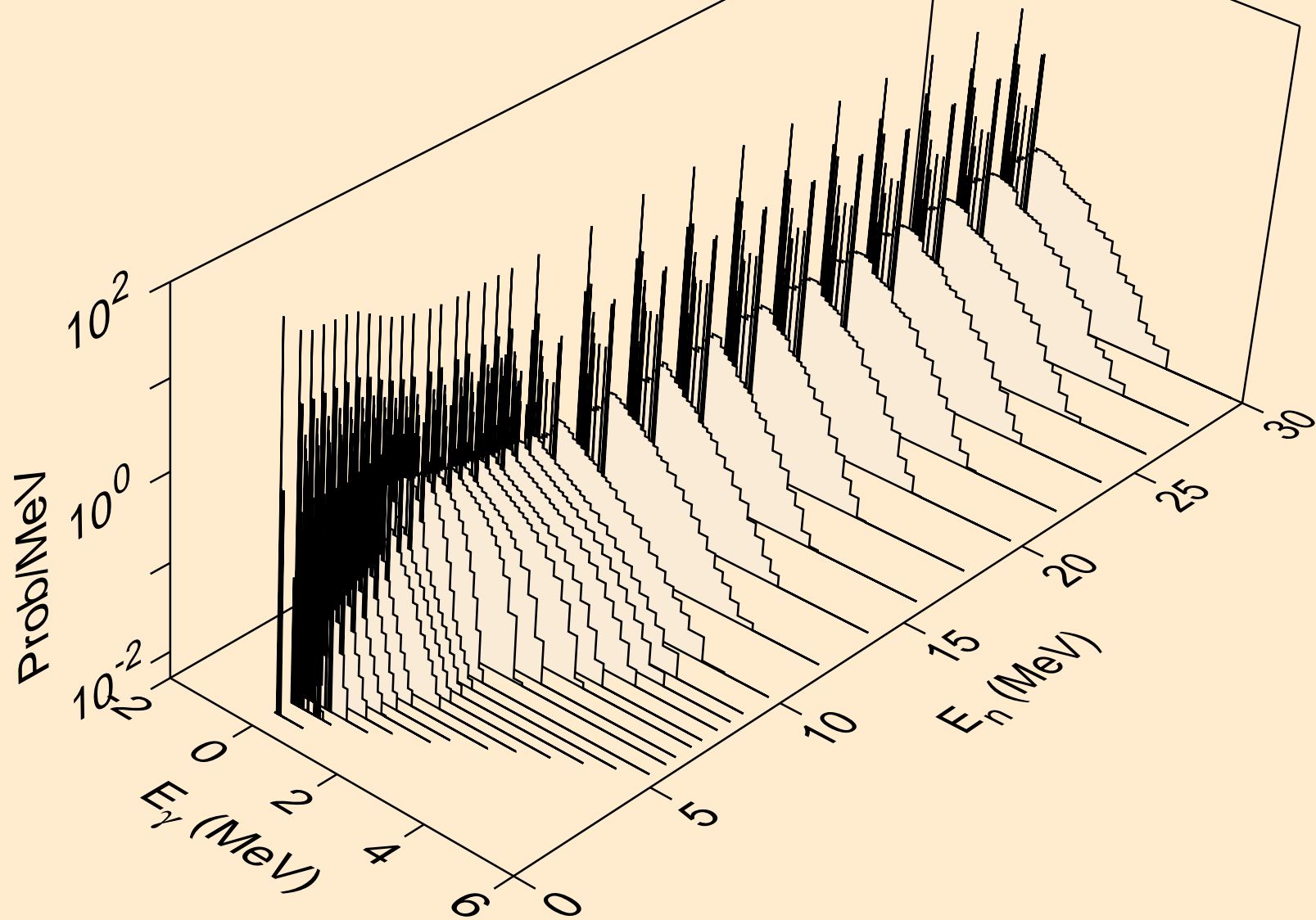

NO253 NEUTRON ACER TENDL-2021 LIBRARY; T=293.6K
Photon emission for (n,2n)a

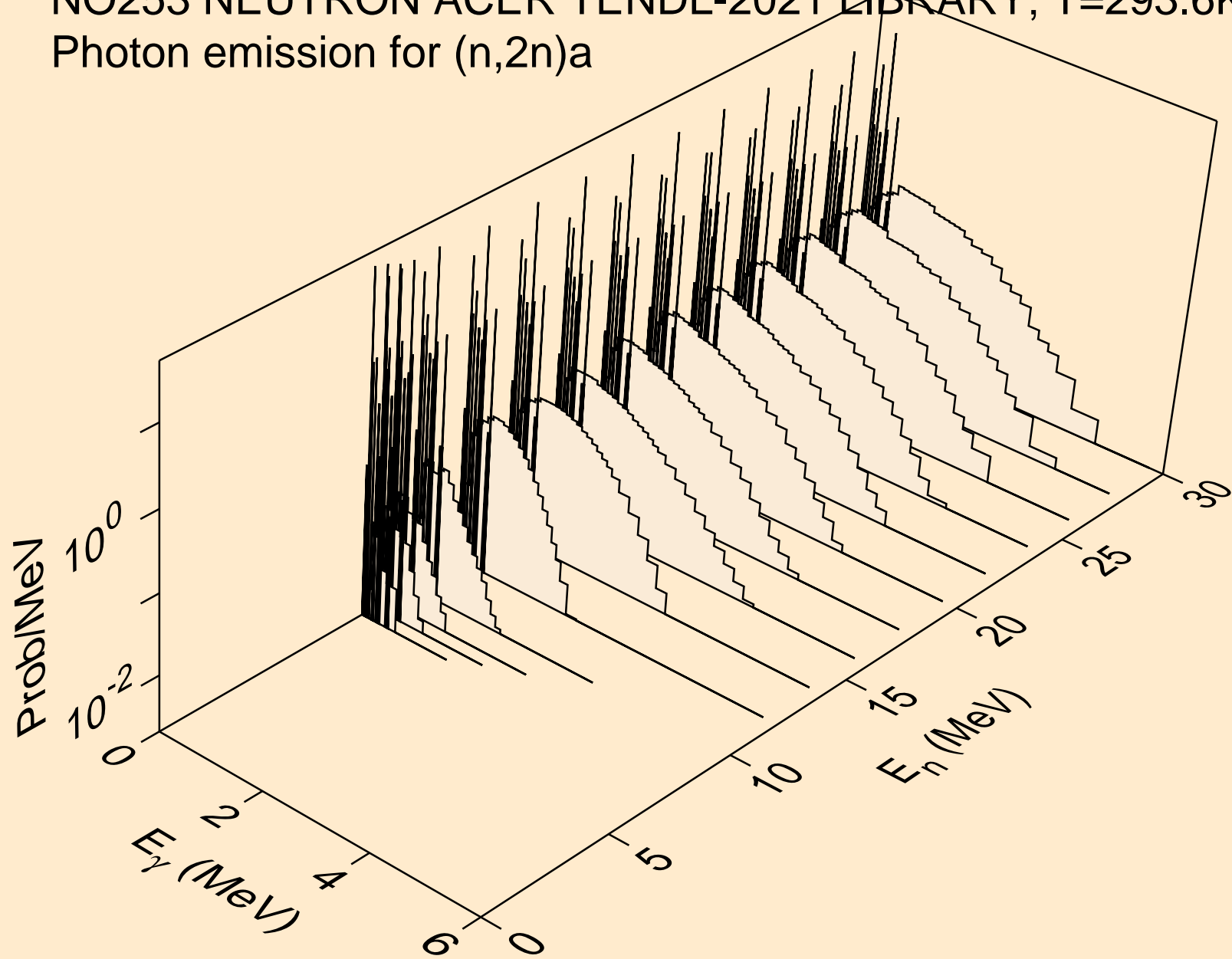

NO253 NEUTRON ACER TENDL-2021 LIBRARY; T=293.6K
Photon emission for (n,3n)a

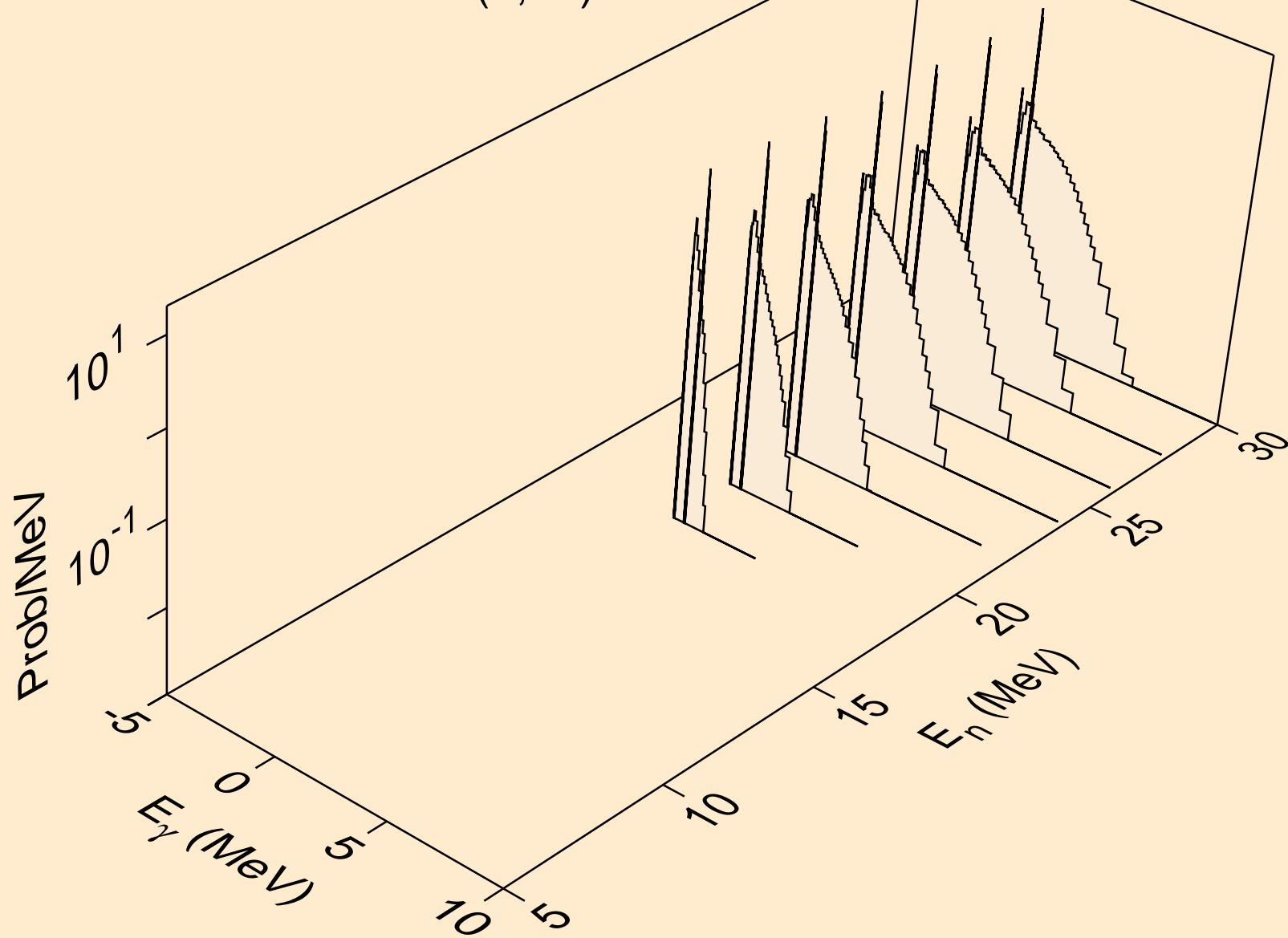

NO253 NEUTRON ACER TENDL-2021 LIBRARY; T=293.6K
Photon emission for (n,n*)p

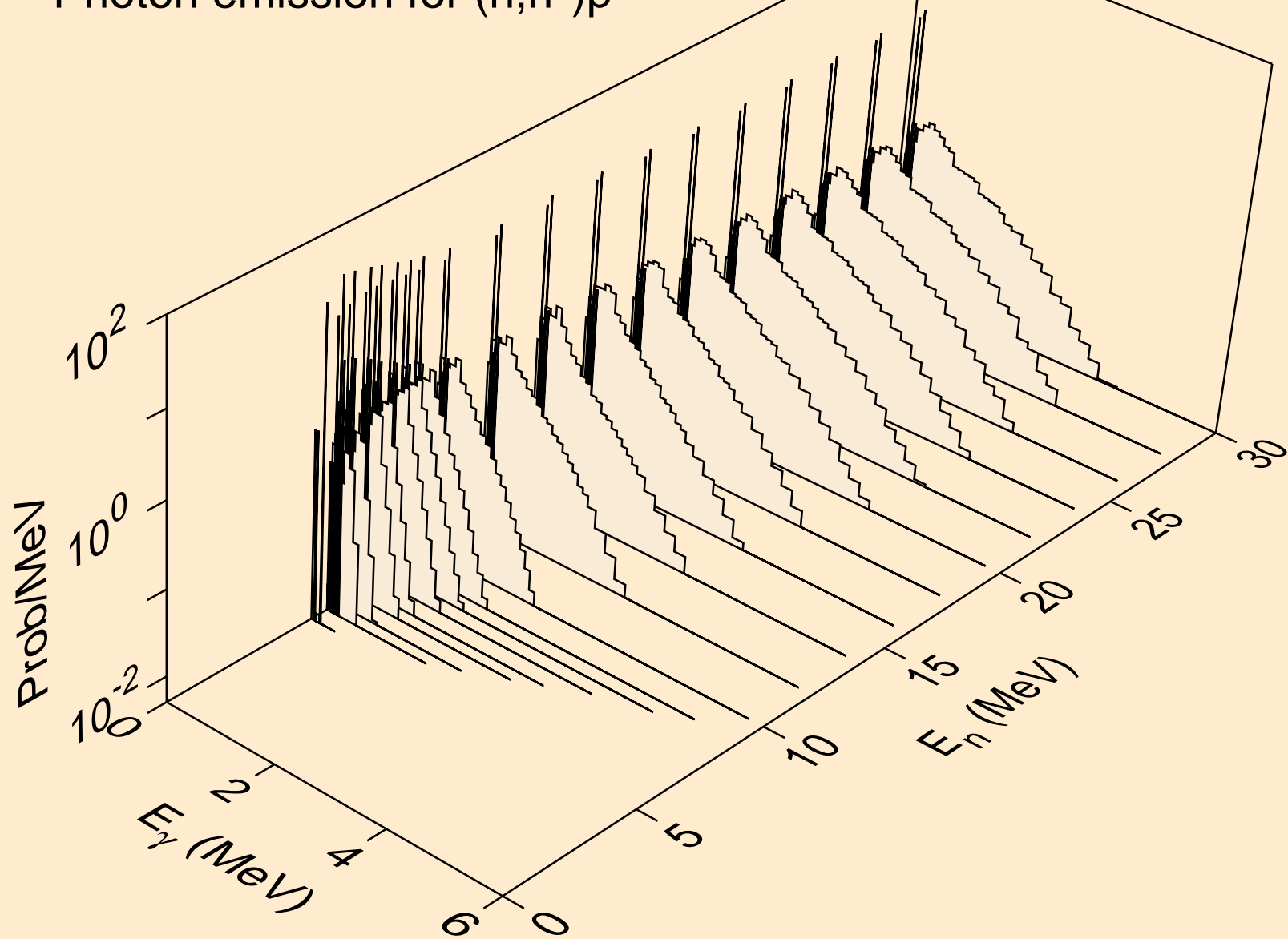

NO253 NEUTRON ACER TENDL-2021 LIBRARY; T=293.6K
Photon emission for (n,n*)2a

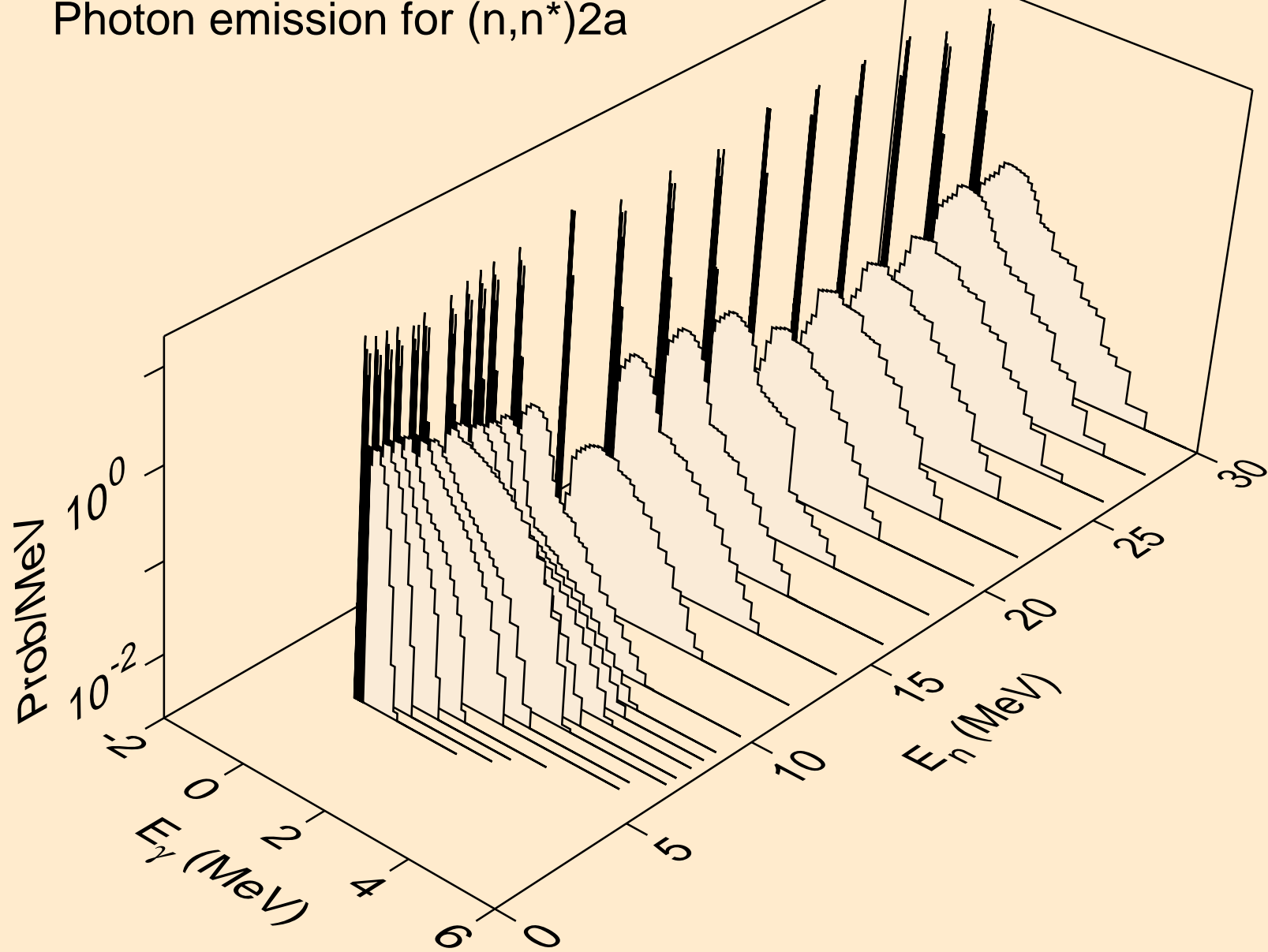

NO253 NEUTRON ACER TENDL-2021 LIBRARY; T=293.6K
Photon emission for (n,2n)2a

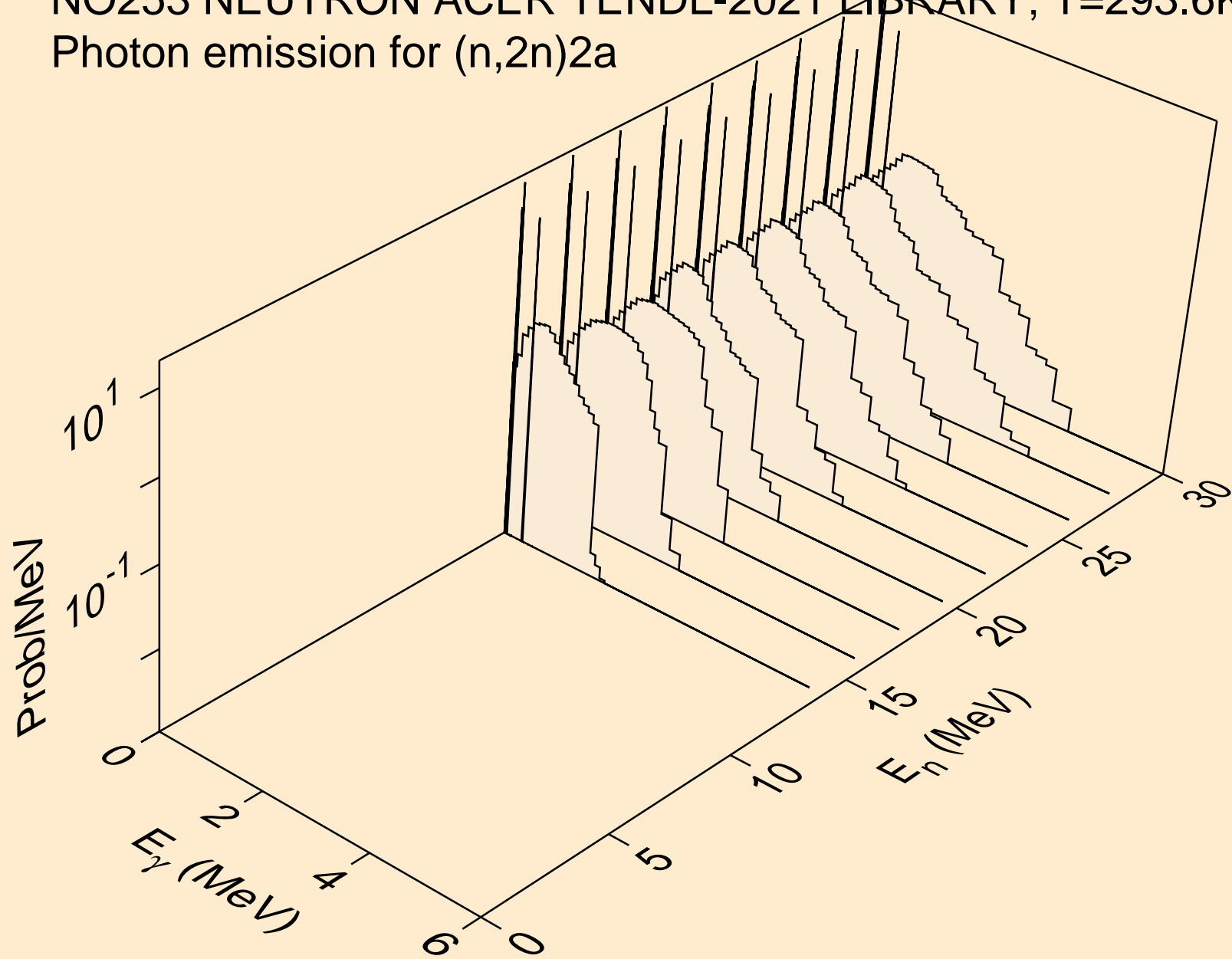

NO253 NEUTRON ACER TENDL-2021 LIBRARY; T=293.6K
Photon emission for (n,n*)d

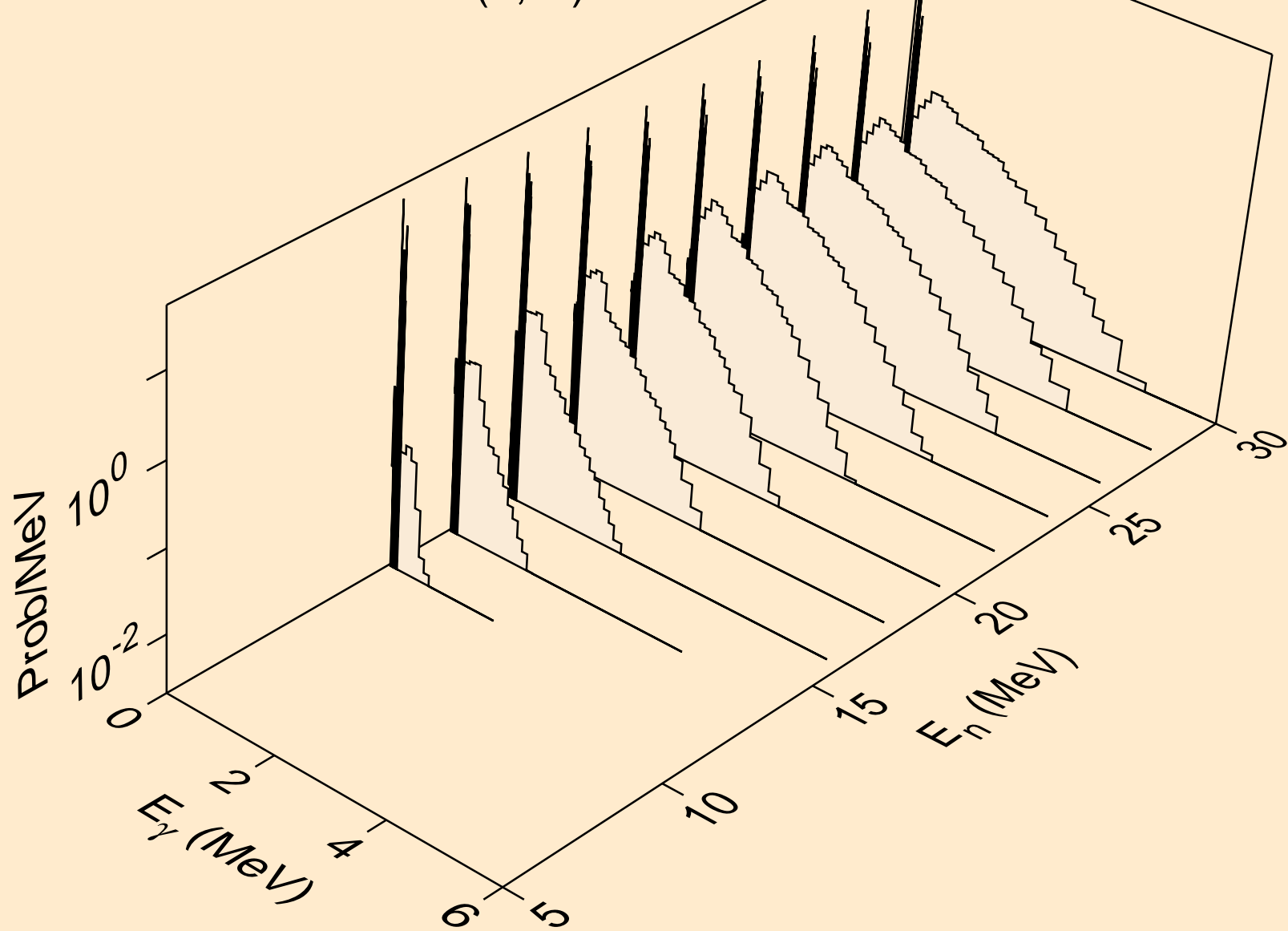

NO253 NEUTRON ACER TENDL-2021 LIBRARY; T=293.6K
Photon emission for (n,n*)t

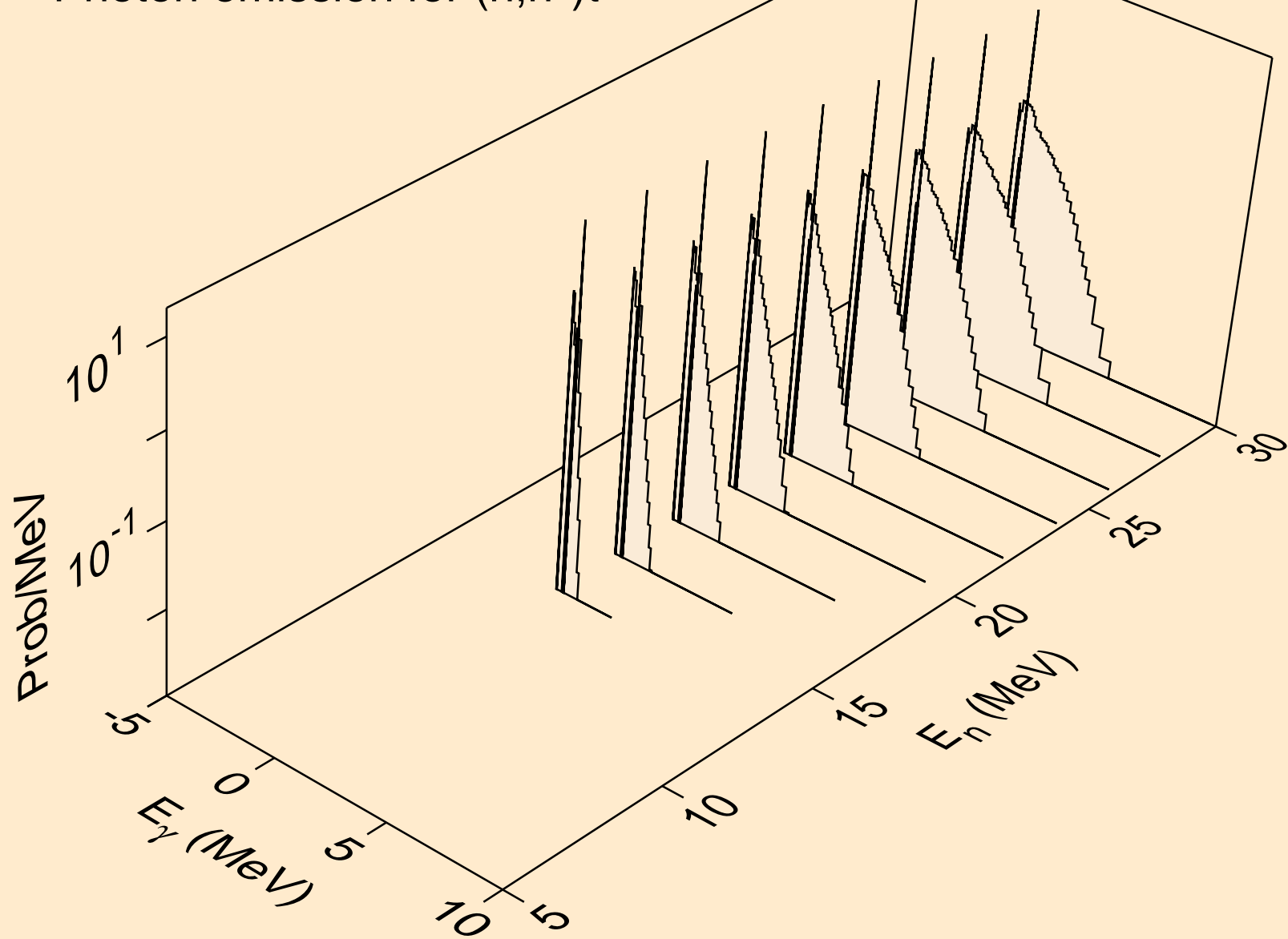

NO253 NEUTRON ACER TENDL-2021 LIBRARY; T=293.6K
Photon emission for (n,n*)he3

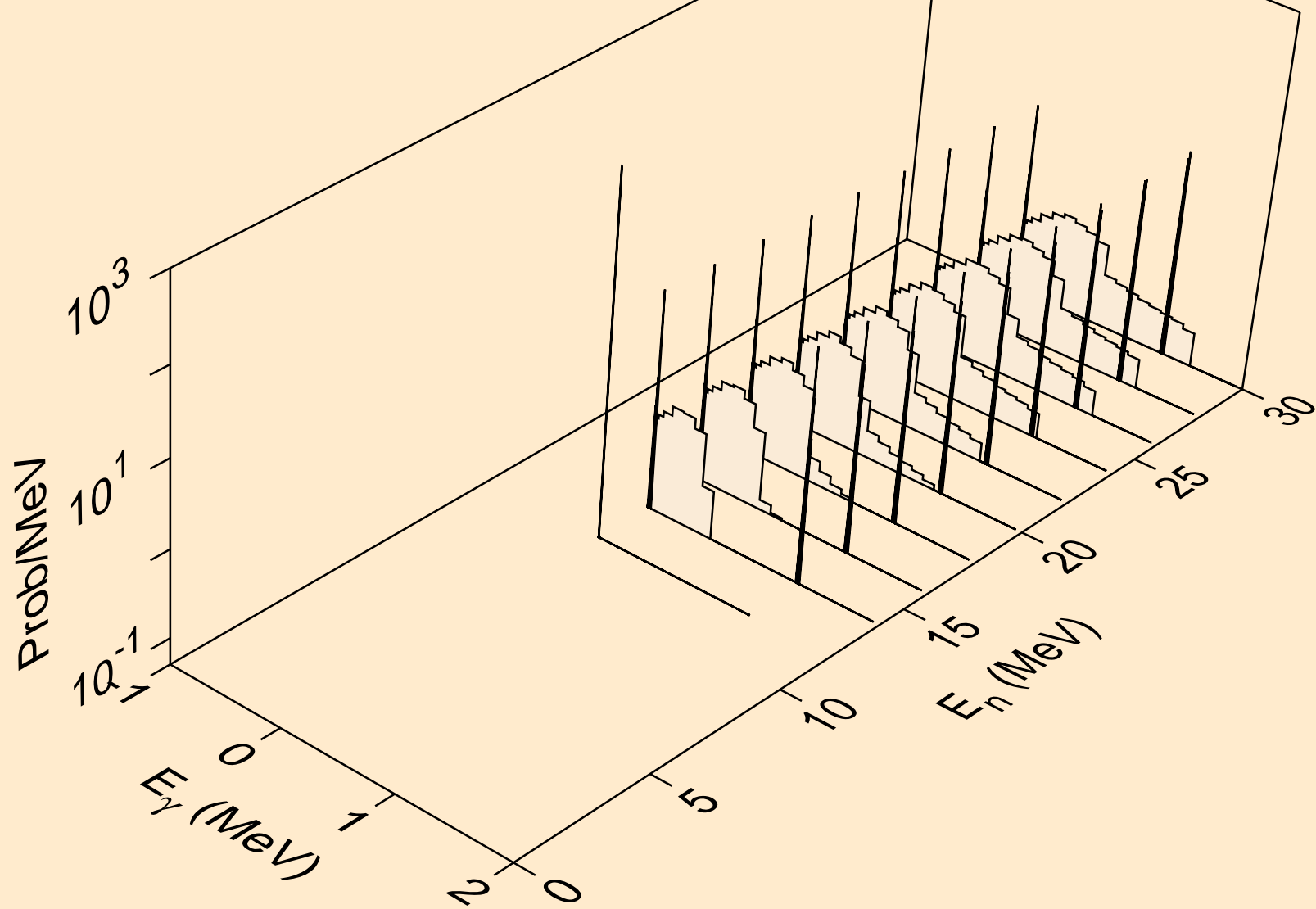

NO253 NEUTRON ACER TENDL-2021 LIBRARY; T=293.6K
Photon emission for (n,4n)

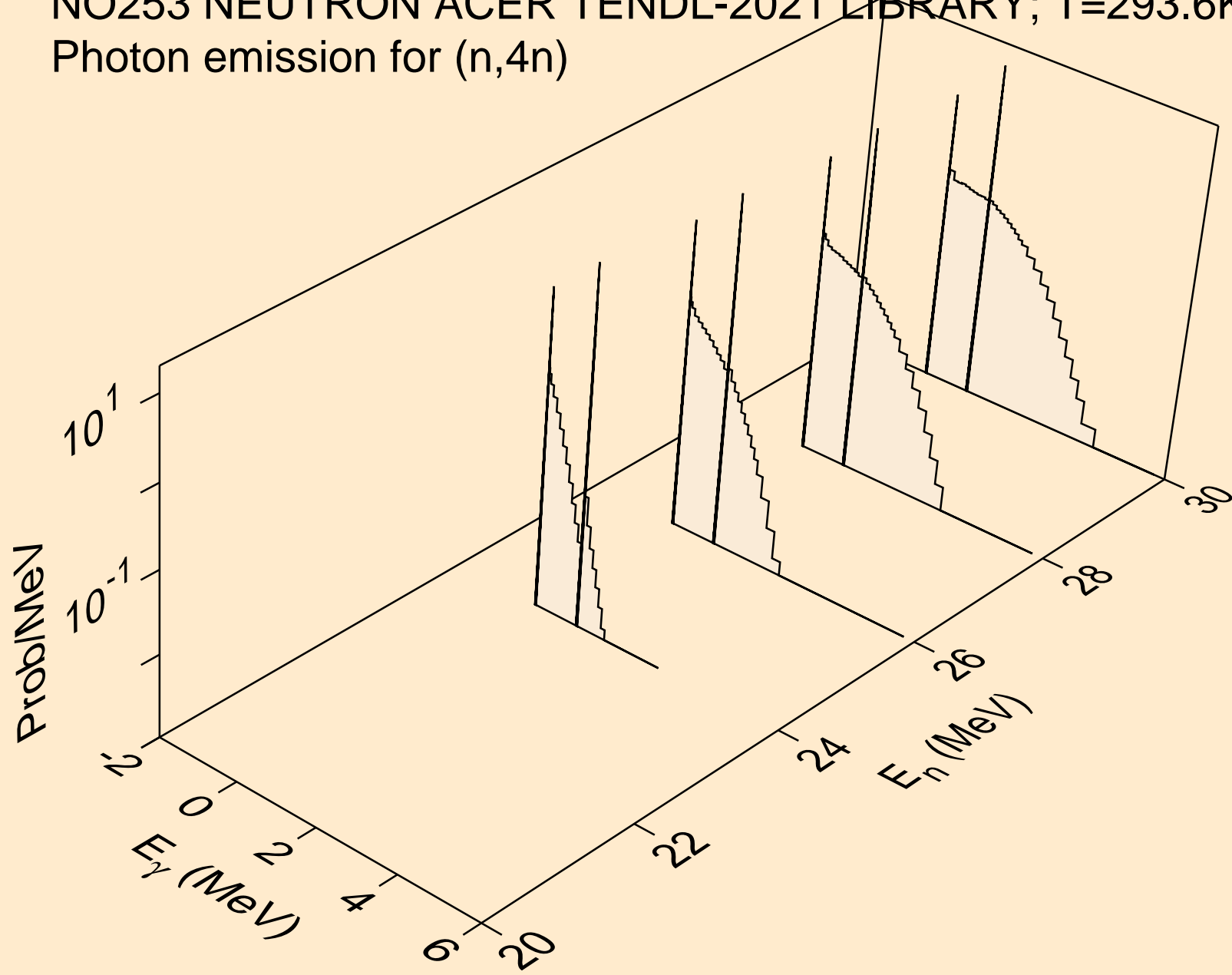

NO253 NEUTRON ACER TENDL-2021 LIBRARY; T=293.6K
Photon emission for (n,2np)

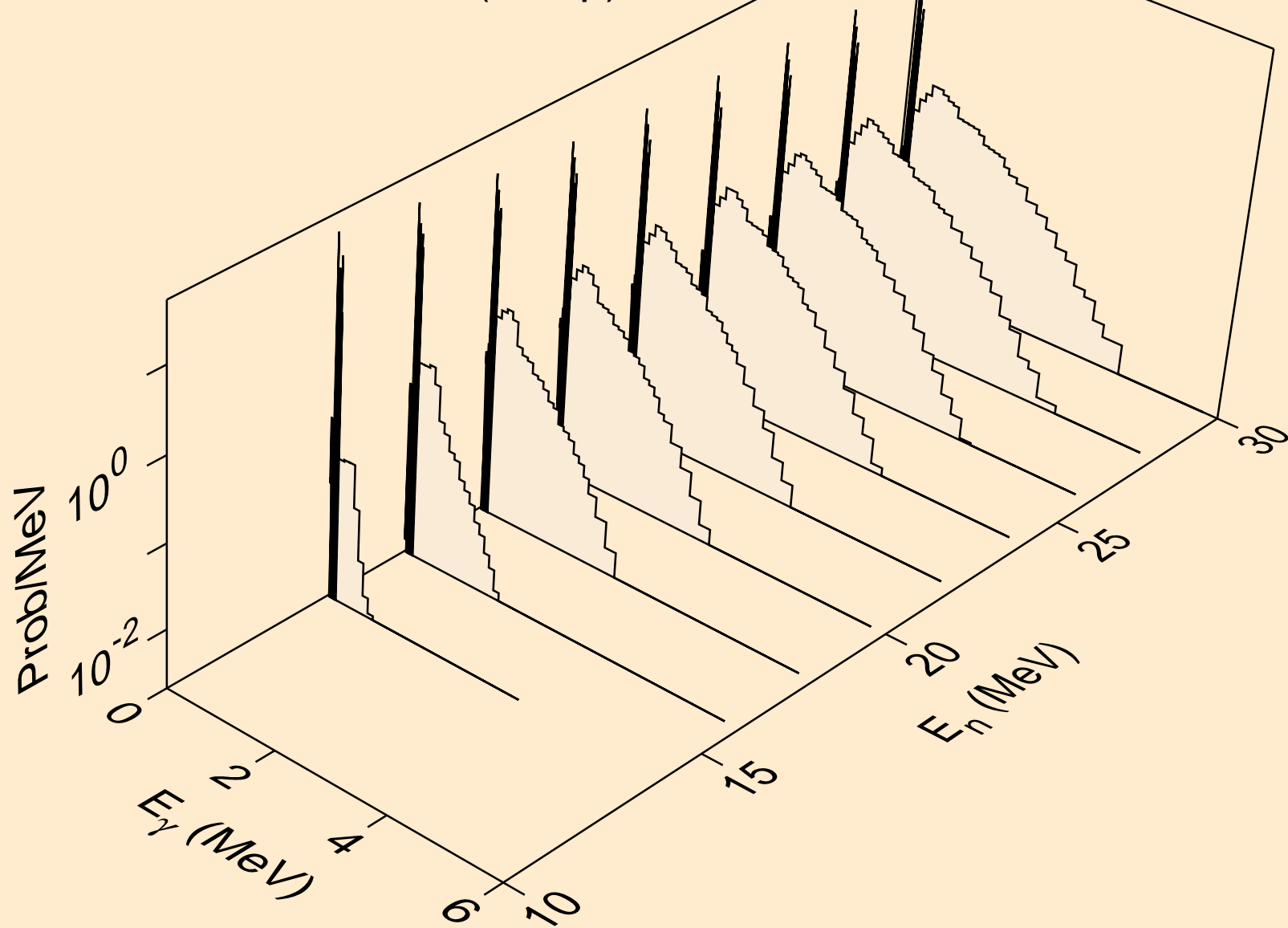

NO253 NEUTRON ACER TENDL-2021 LIBRARY; T=293.6K
Photon emission for (n,3np)

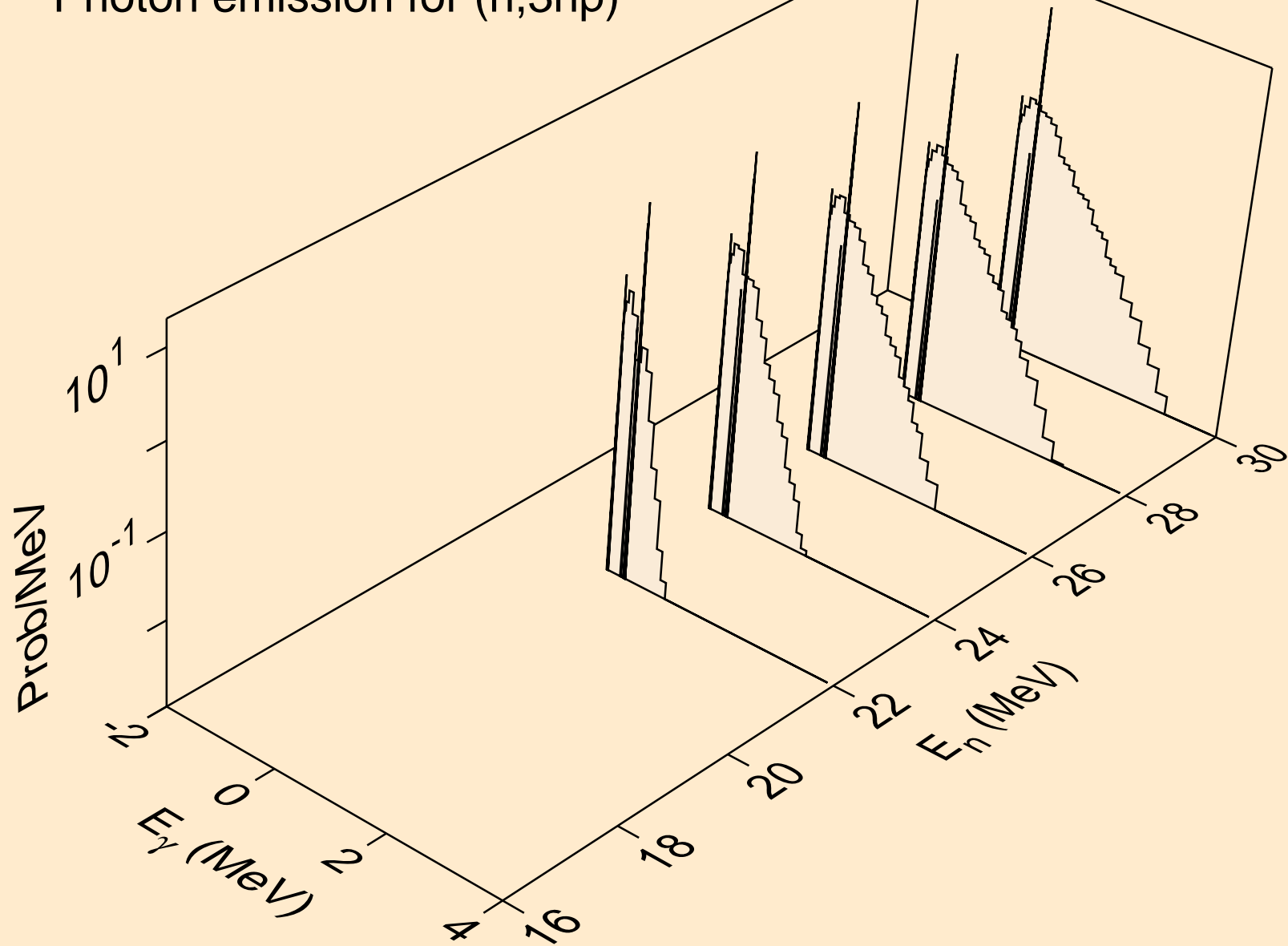

NO253 NEUTRON ACER TENDL-2021 LIBRARY; T=293.6K
Photon emission for (n,2np)

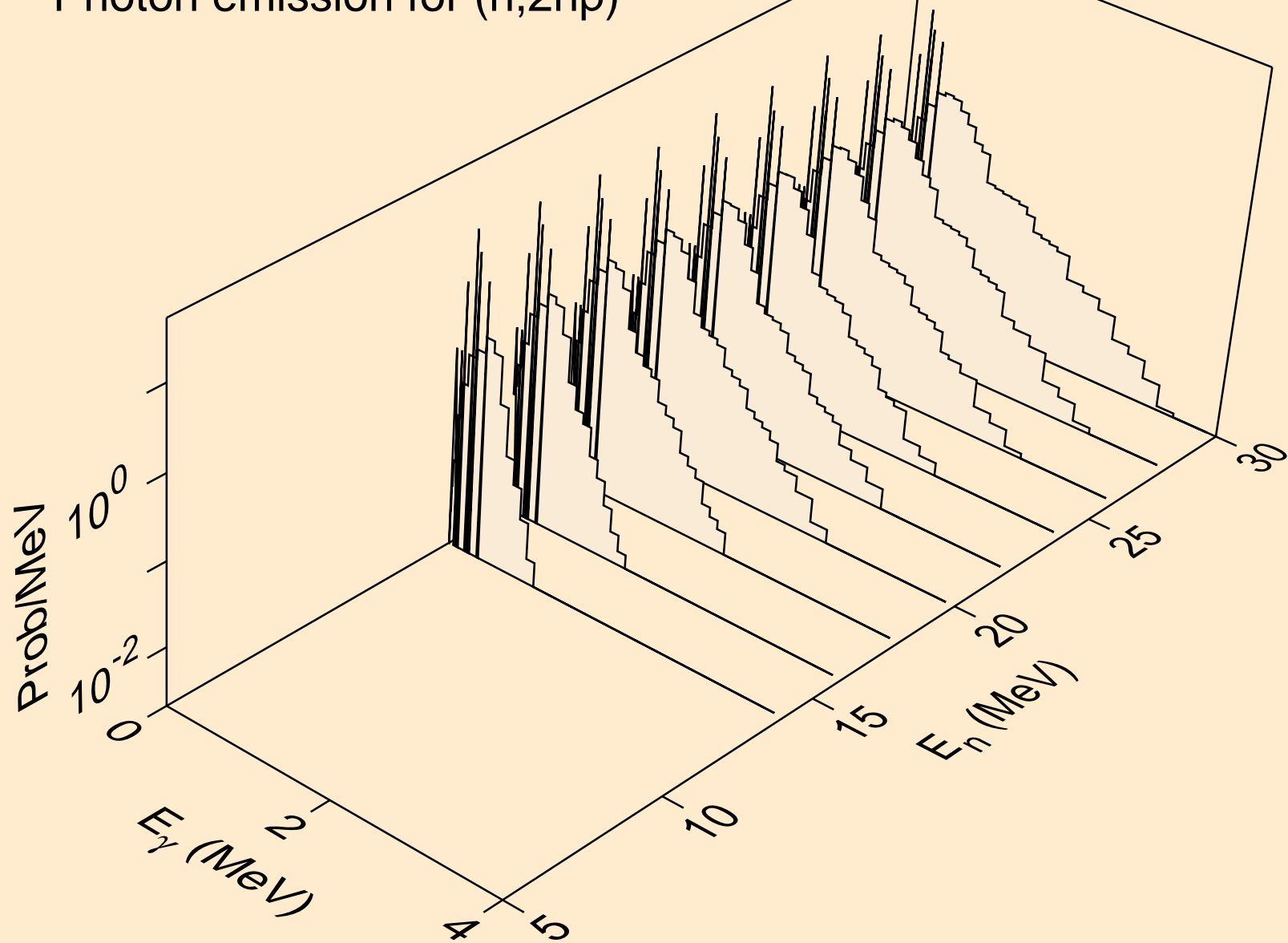

NO253 NEUTRON ACER TENDL-2021 LIBRARY; T=293.6K
Photon emission for (n,npa)

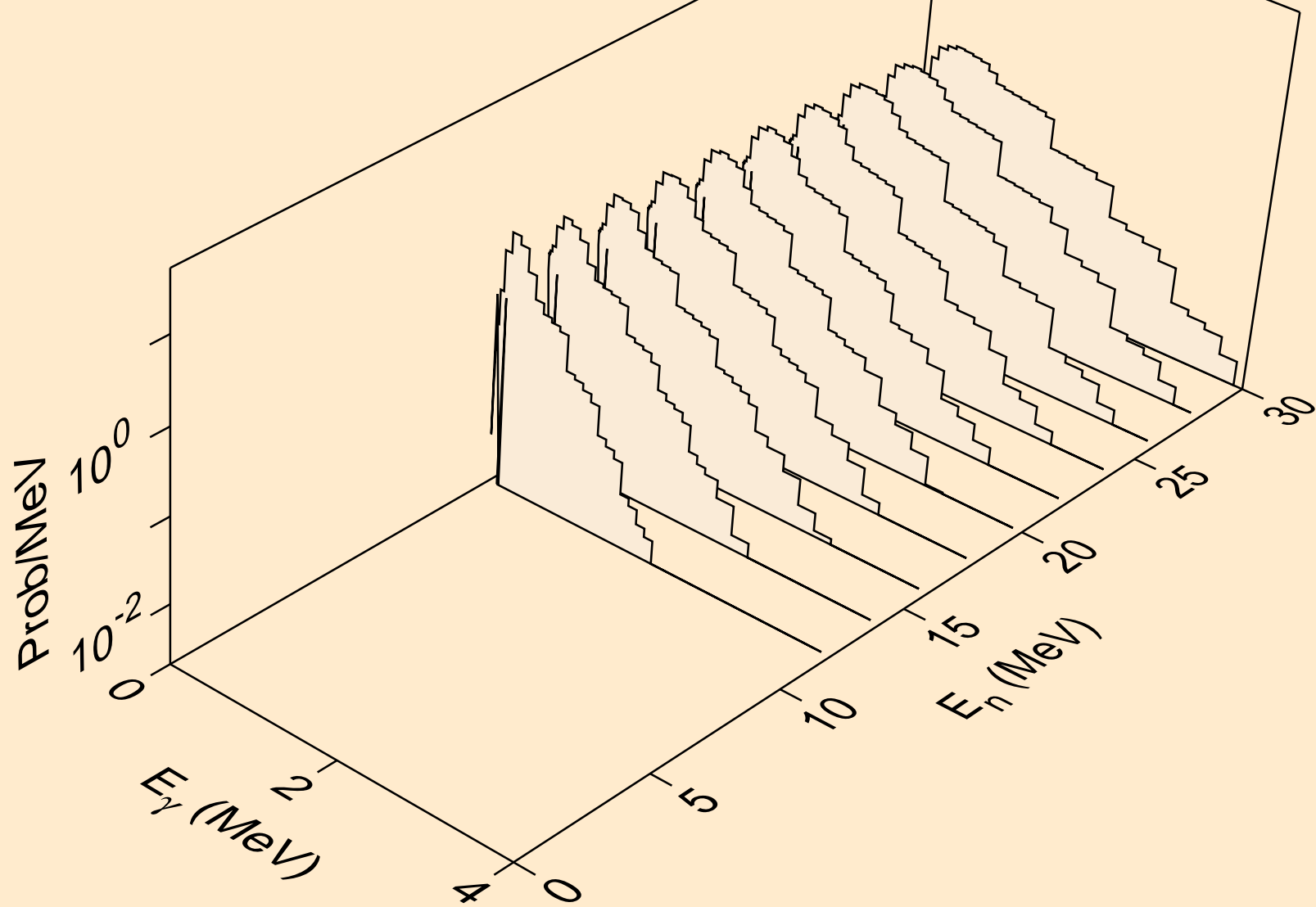

NO253 NEUTRON ACER TENDL-2021 LIBRARY; T=293.6K
Photon emission for (n,n*c)

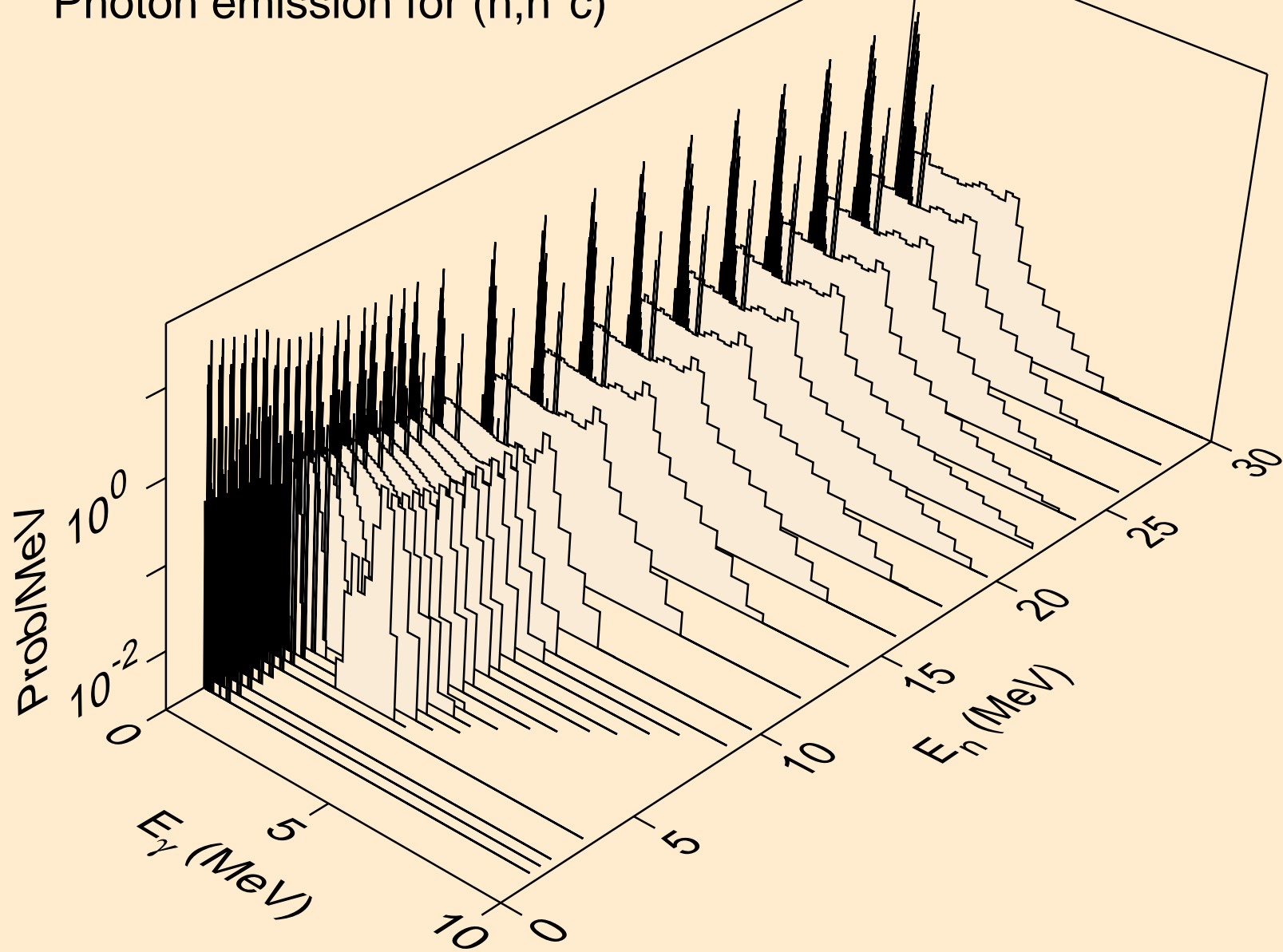

NO253 NEUTRON ACER TENDL-2021 LIBRARY; T=293.6K
Photon emission for (n,gma)

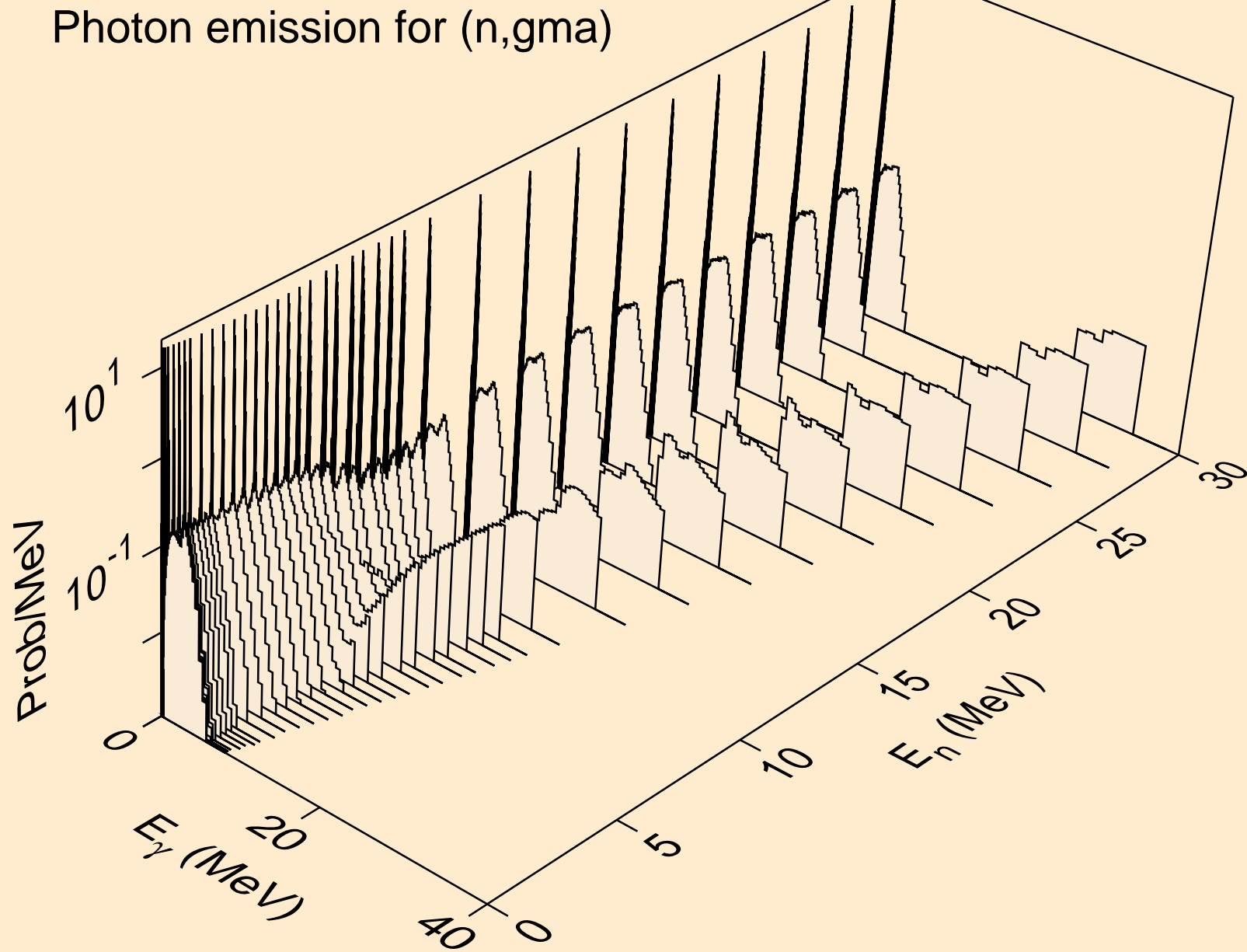

NO253 NEUTRON ACER TENDL-2021 LIBRARY; T=293.6K
Photon emission for (n,p)

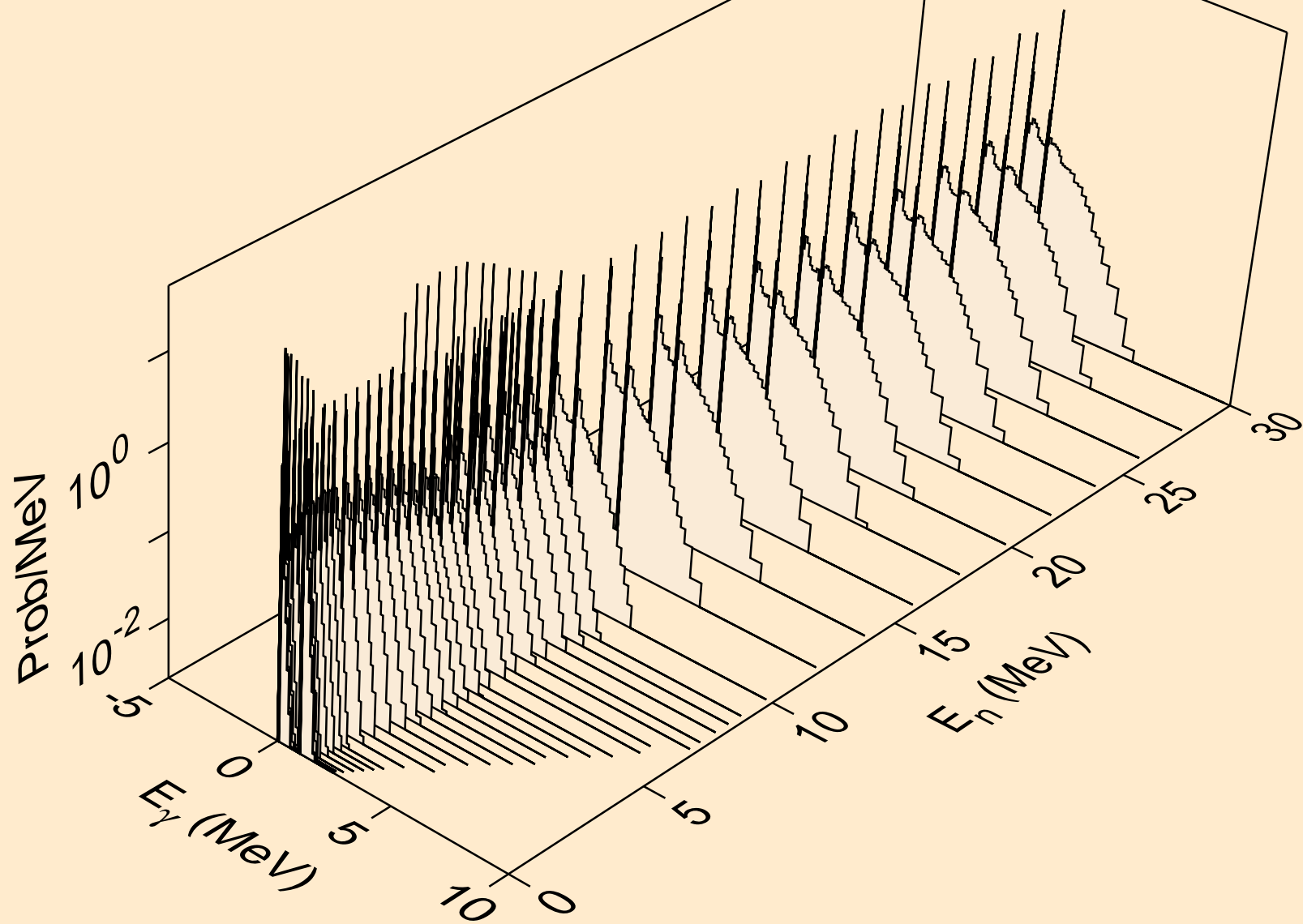

NO253 NEUTRON ACER TENDL-2021 LIBRARY; T=293.6K
Photon emission for (n,d)

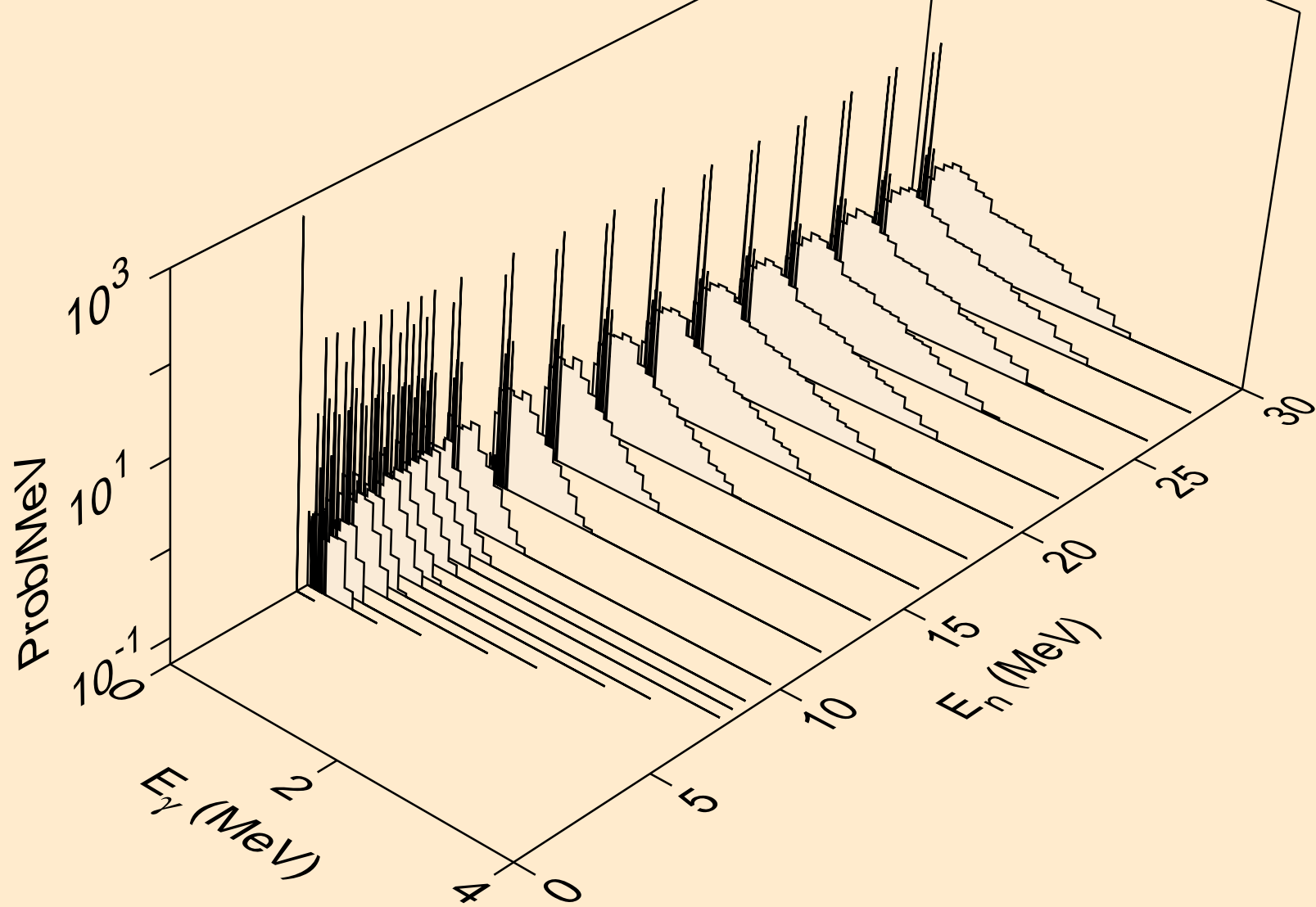

NO253 NEUTRON ACER TENDL-2021 LIBRARY; T=293.6K
Photon emission for (n,t)

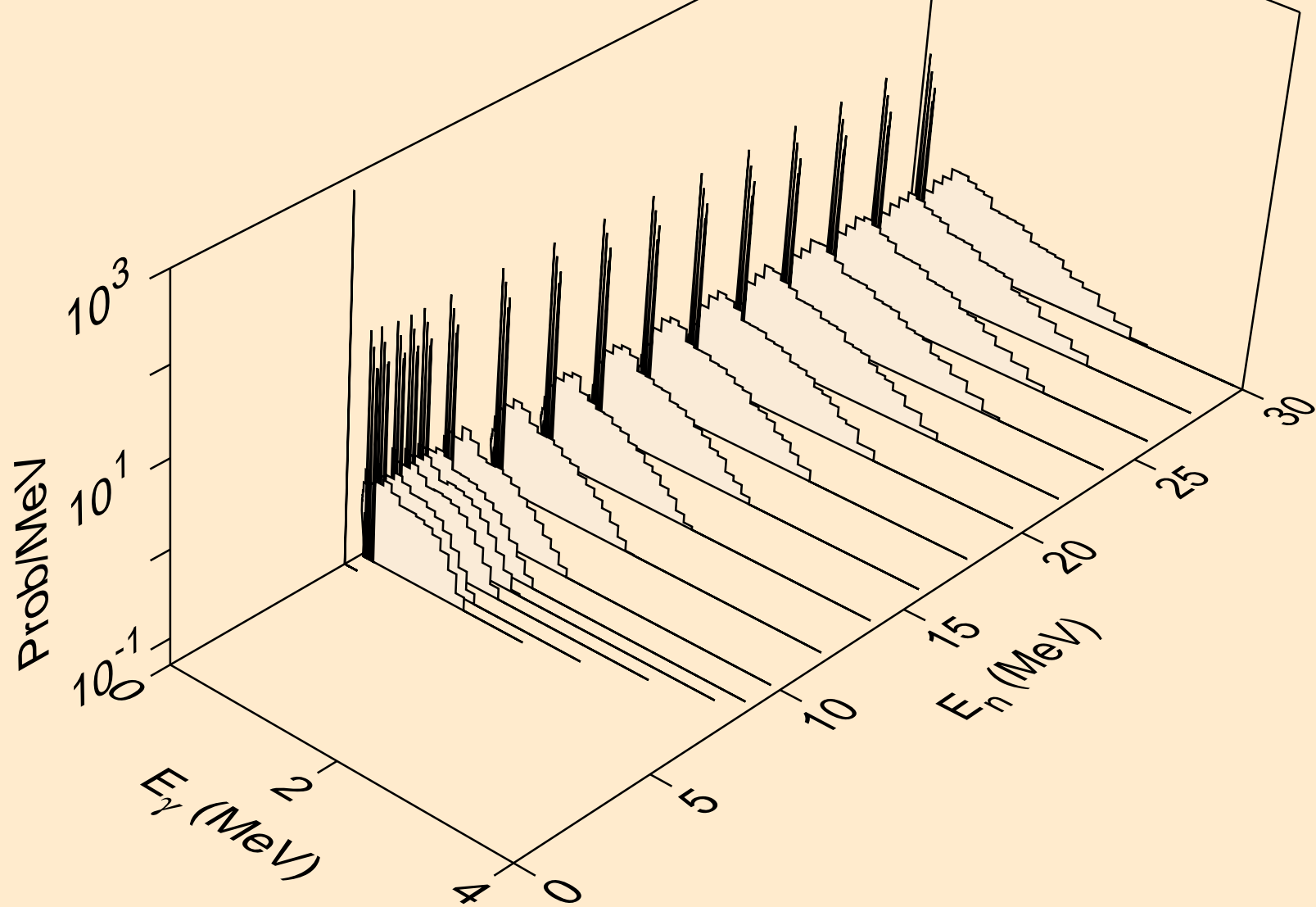

NO253 NEUTRON ACER TENDL-2021 LIBRARY; T=293.6K
Photon emission for (n,he3)

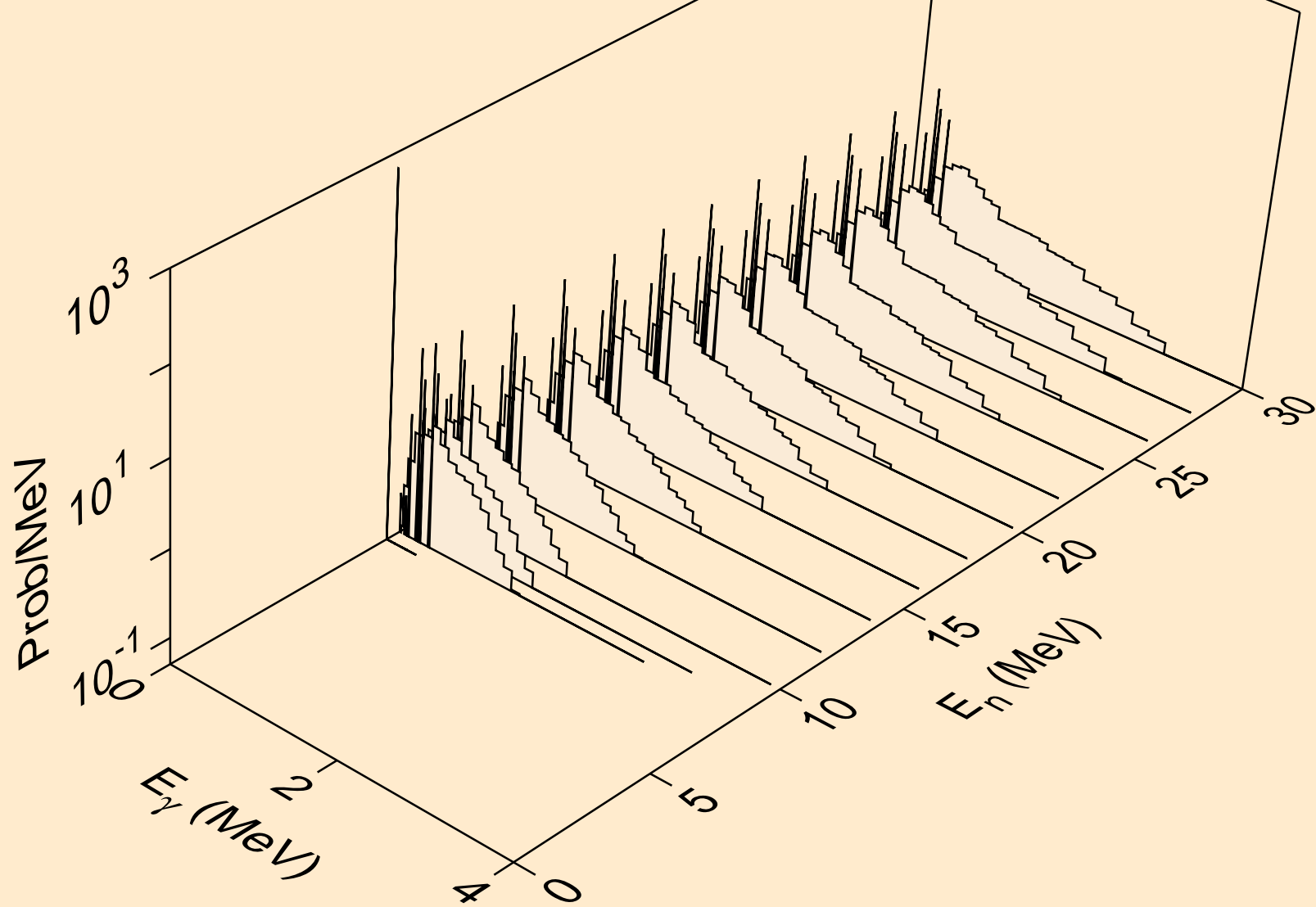

NO253 NEUTRON ACER TENDL-2021 LIBRARY; T=293.6K
Photon emission for (n,a)

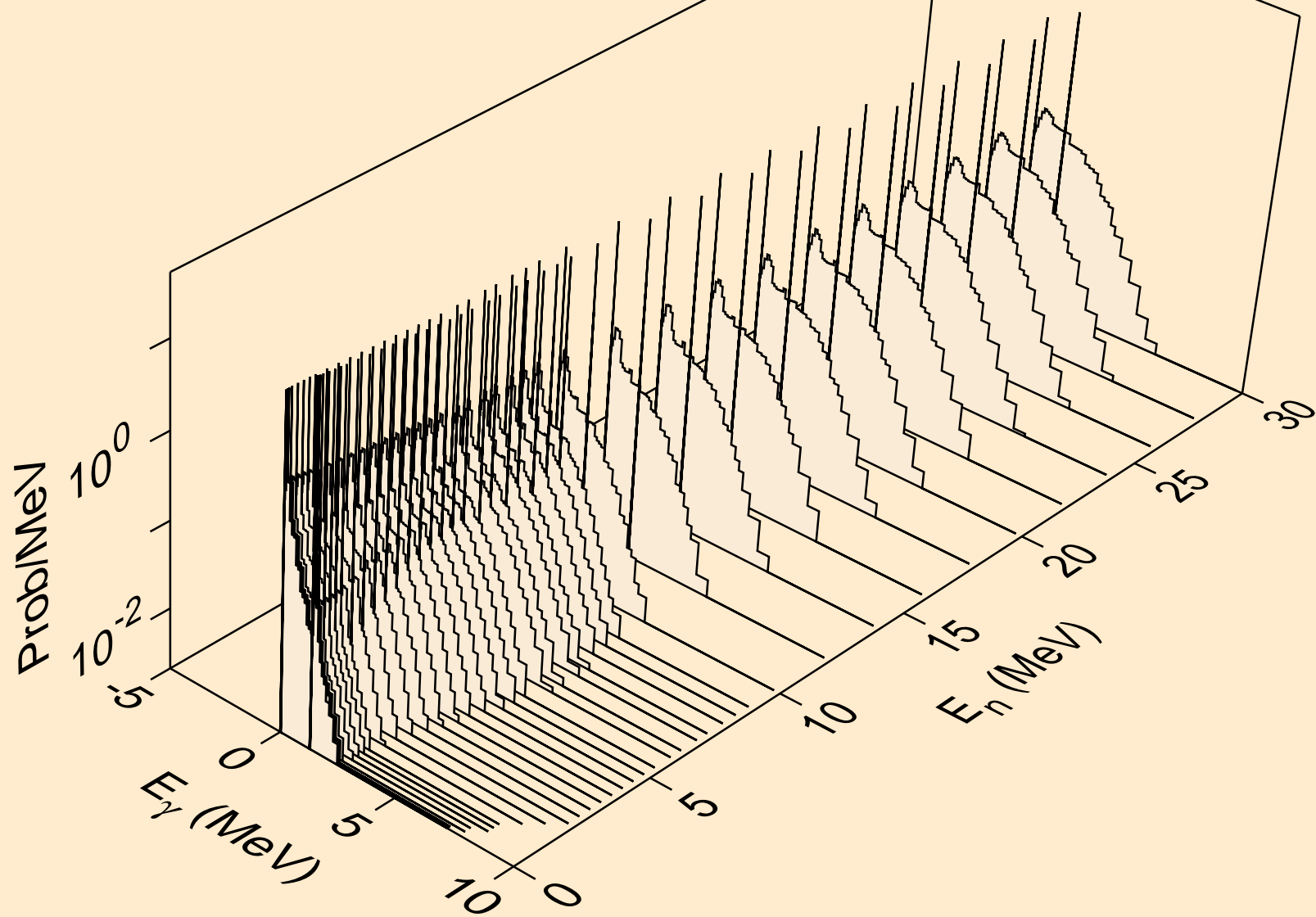

NO253 NEUTRON ACER TENDL-2021 LIBRARY; T=293.6K
Photon emission for (n,2a)

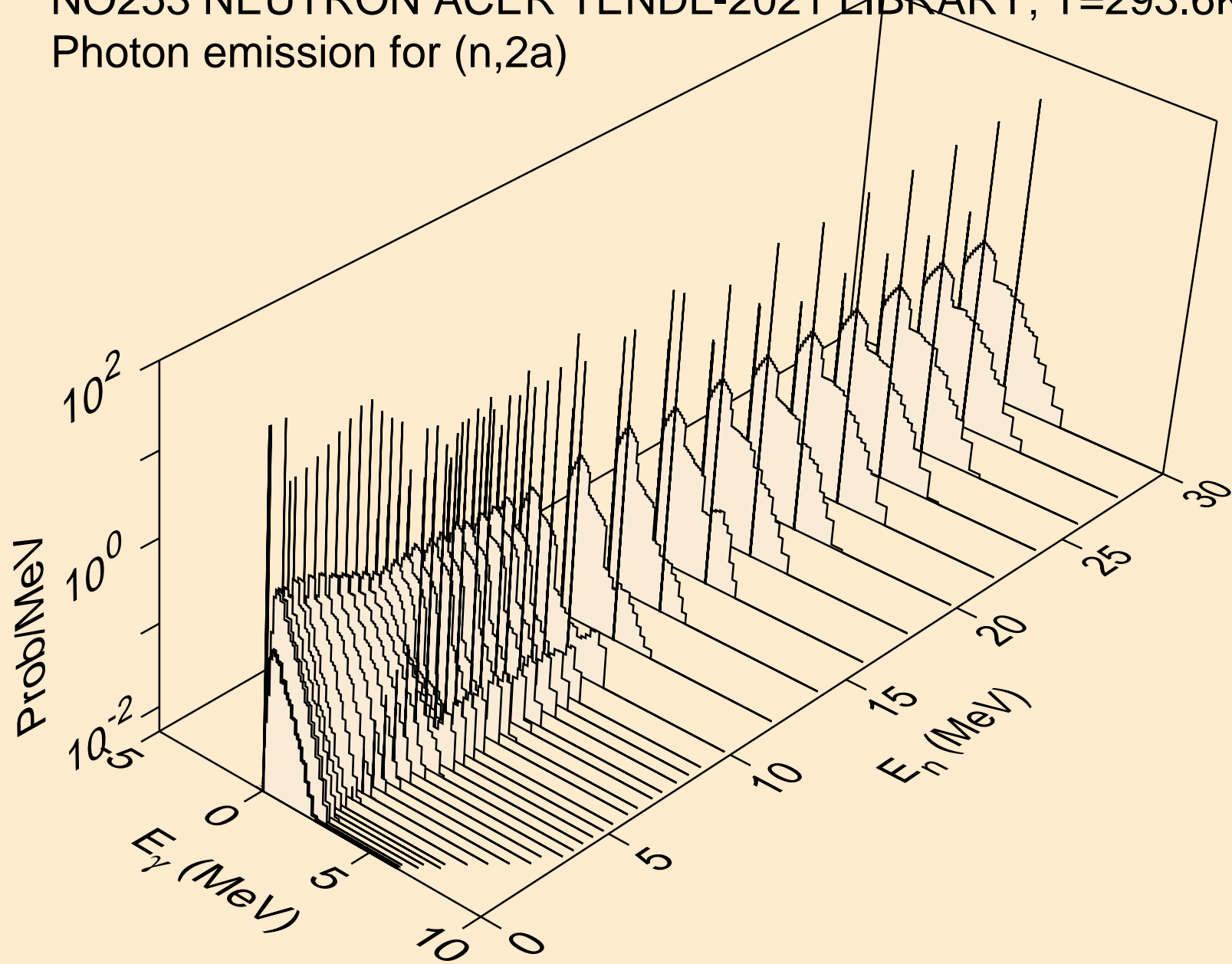

NO253 NEUTRON ACER TENDL-2021 LIBRARY; T=293.6K
Photon emission for (n,2p)

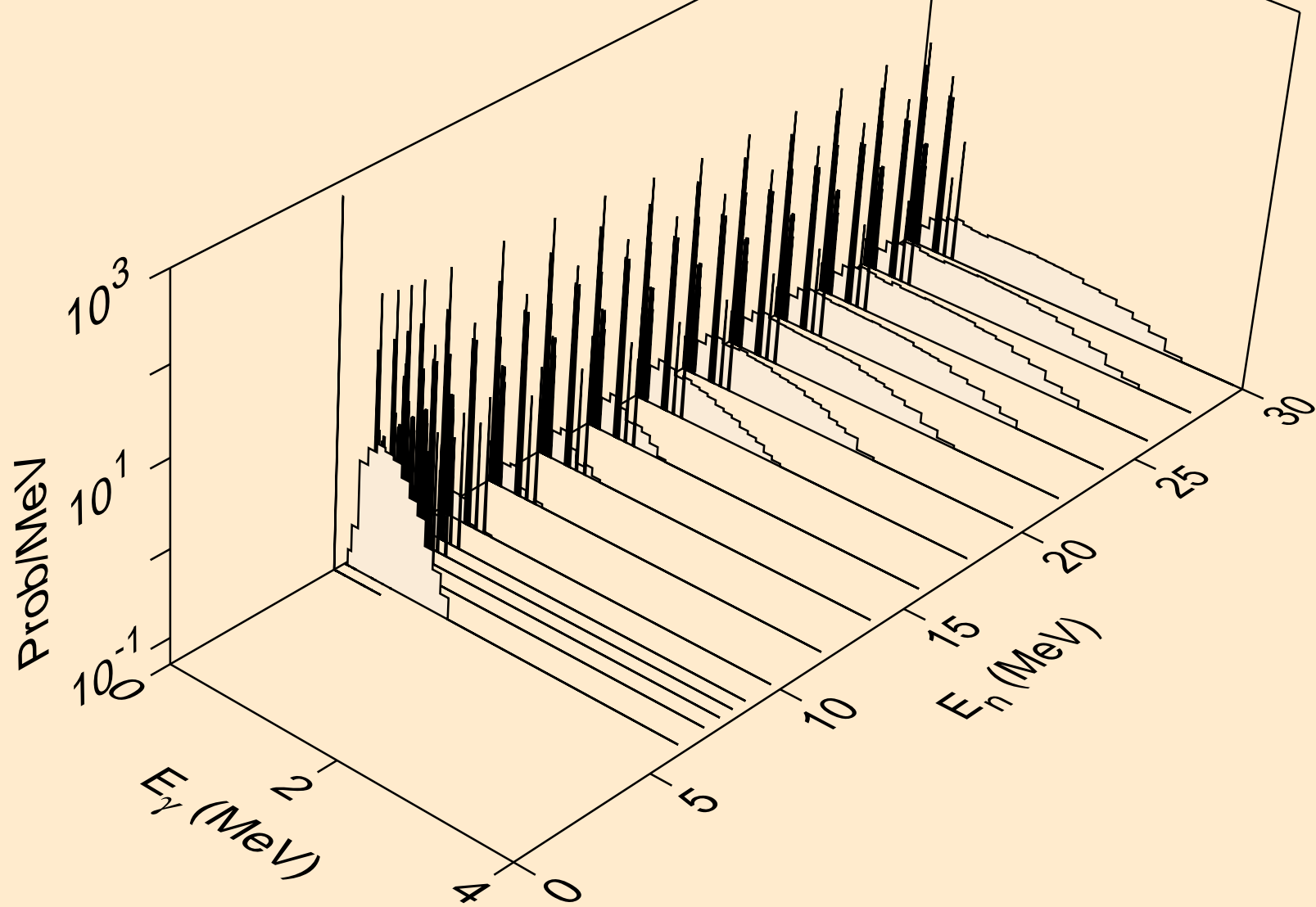

NO253 NEUTRON ACER TENDL-2021 LIBRARY; T=293.6K
Photon emission for (n,p)

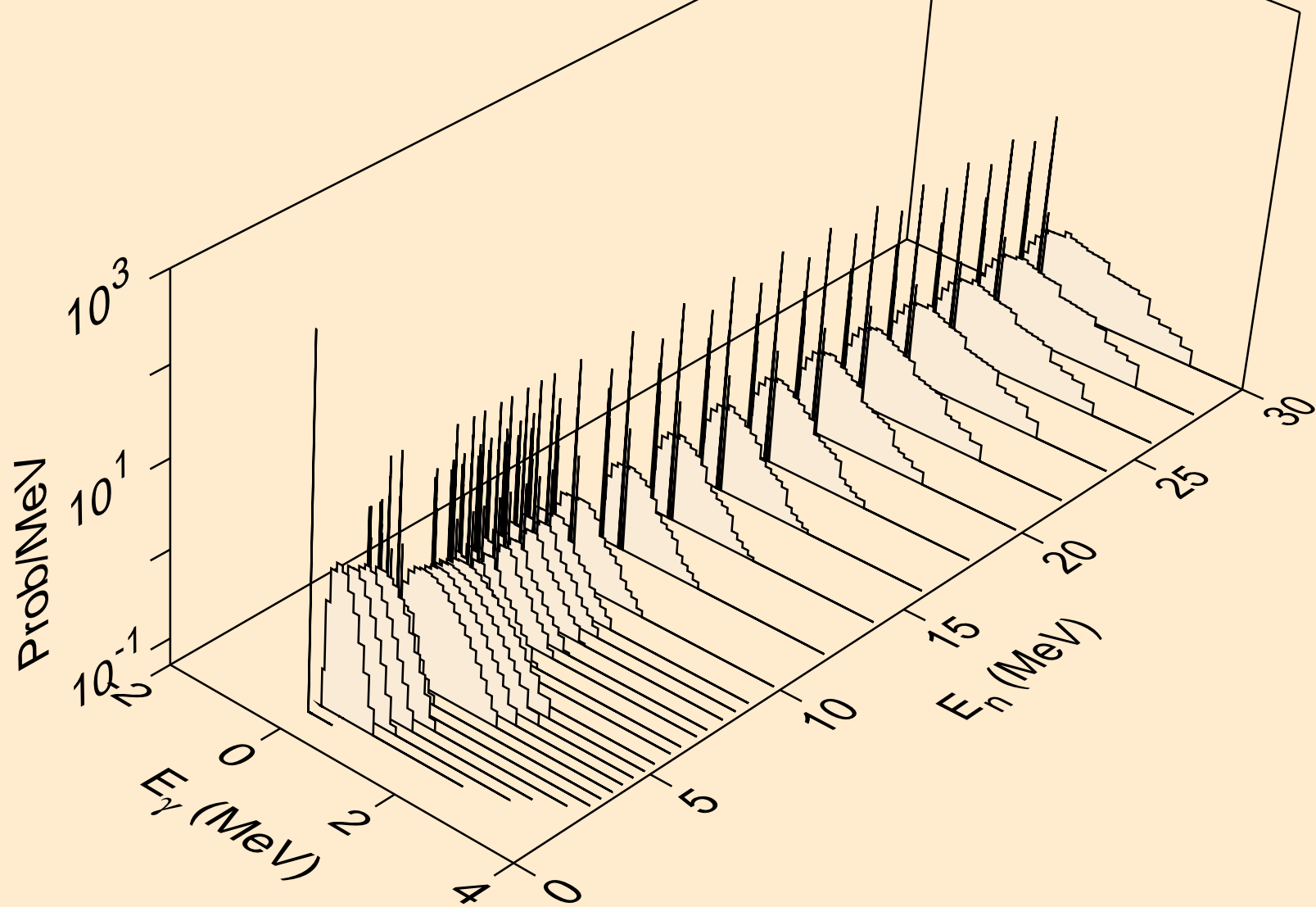

NO253 NEUTRON ACER TENDL-2021 LIBRARY; T=293.6K
Photon emission for (n,pd)

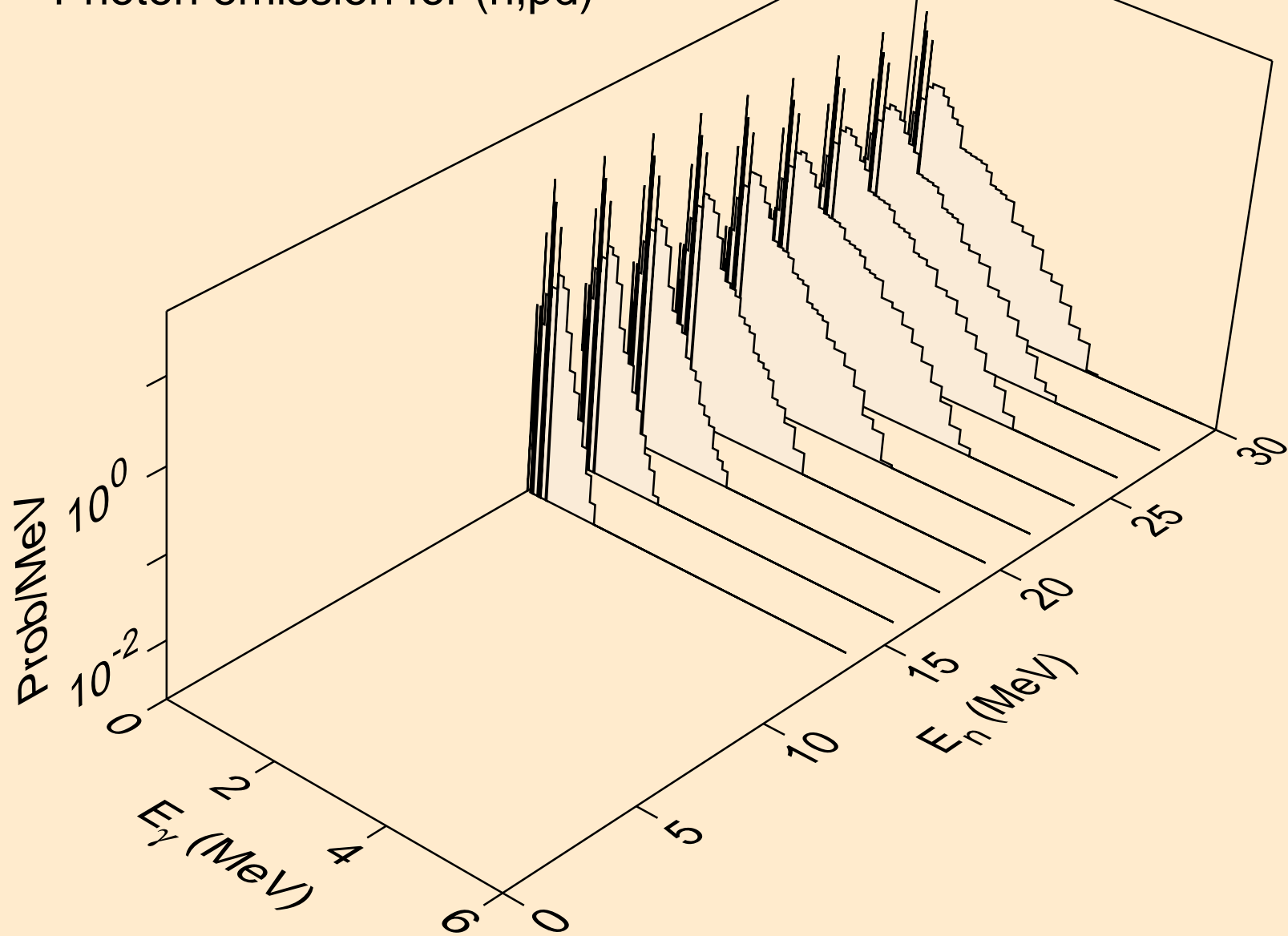

NO253 NEUTRON ACER TENDL-2021 LIBRARY; T=293.6K
Photon emission for (n,pt)

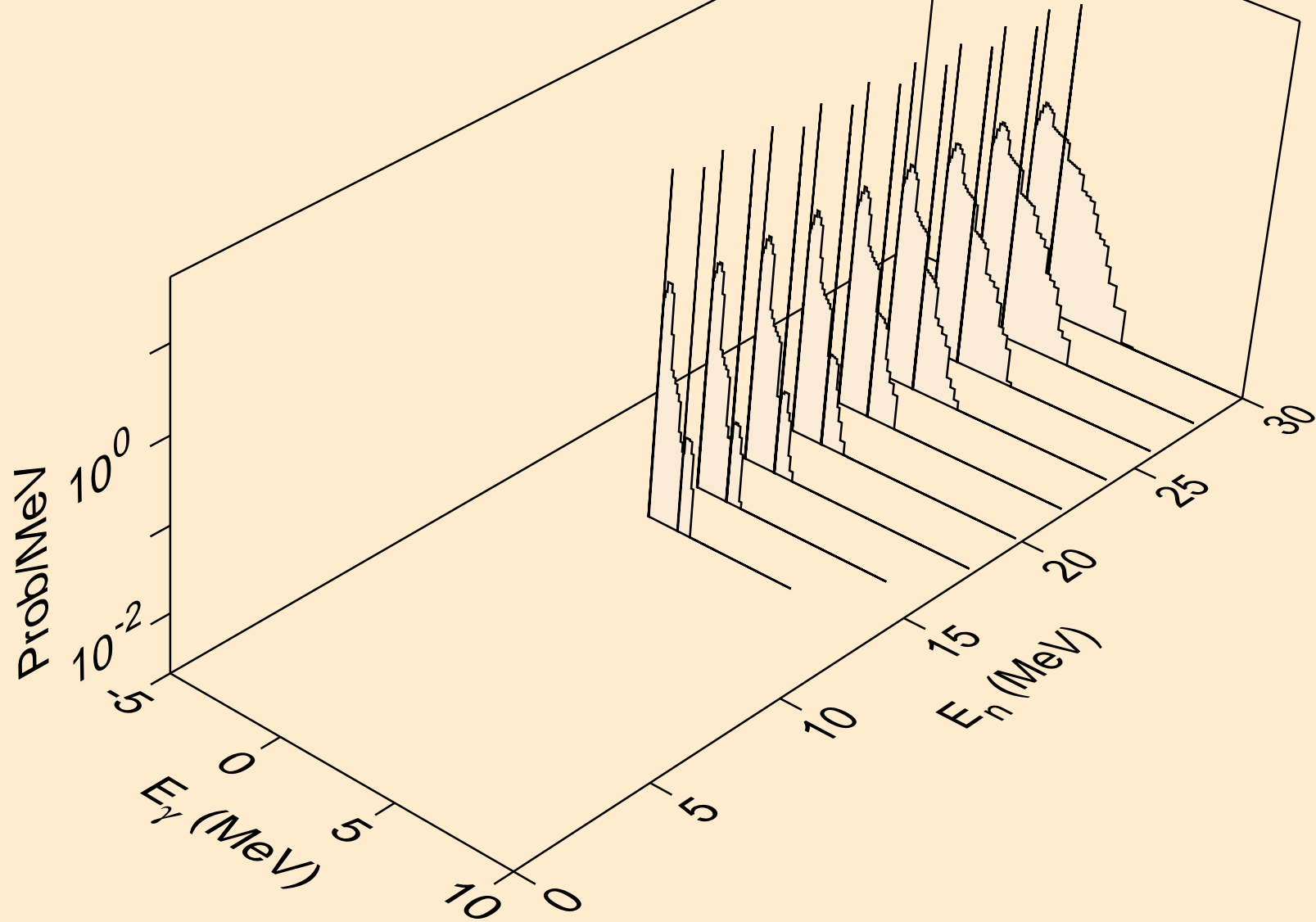

NO253 NEUTRON ACER TENDL-2021 LIBRARY; T=293.6K
Photon emission for (n,da)

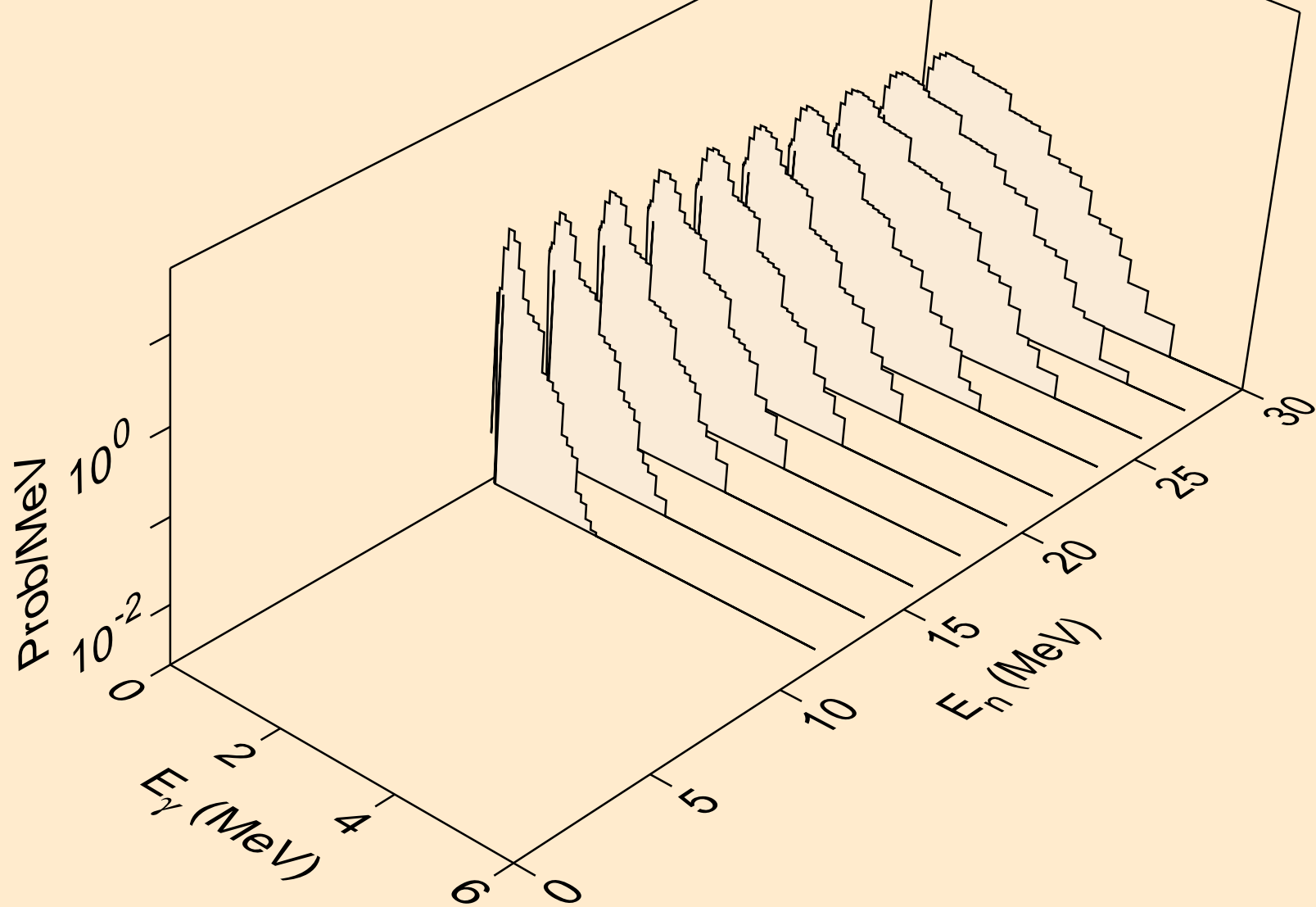

NO253 NEUTRON ACER TENDL-2021 LIBRARY; T=293.6K
thermal capture photon spectrum

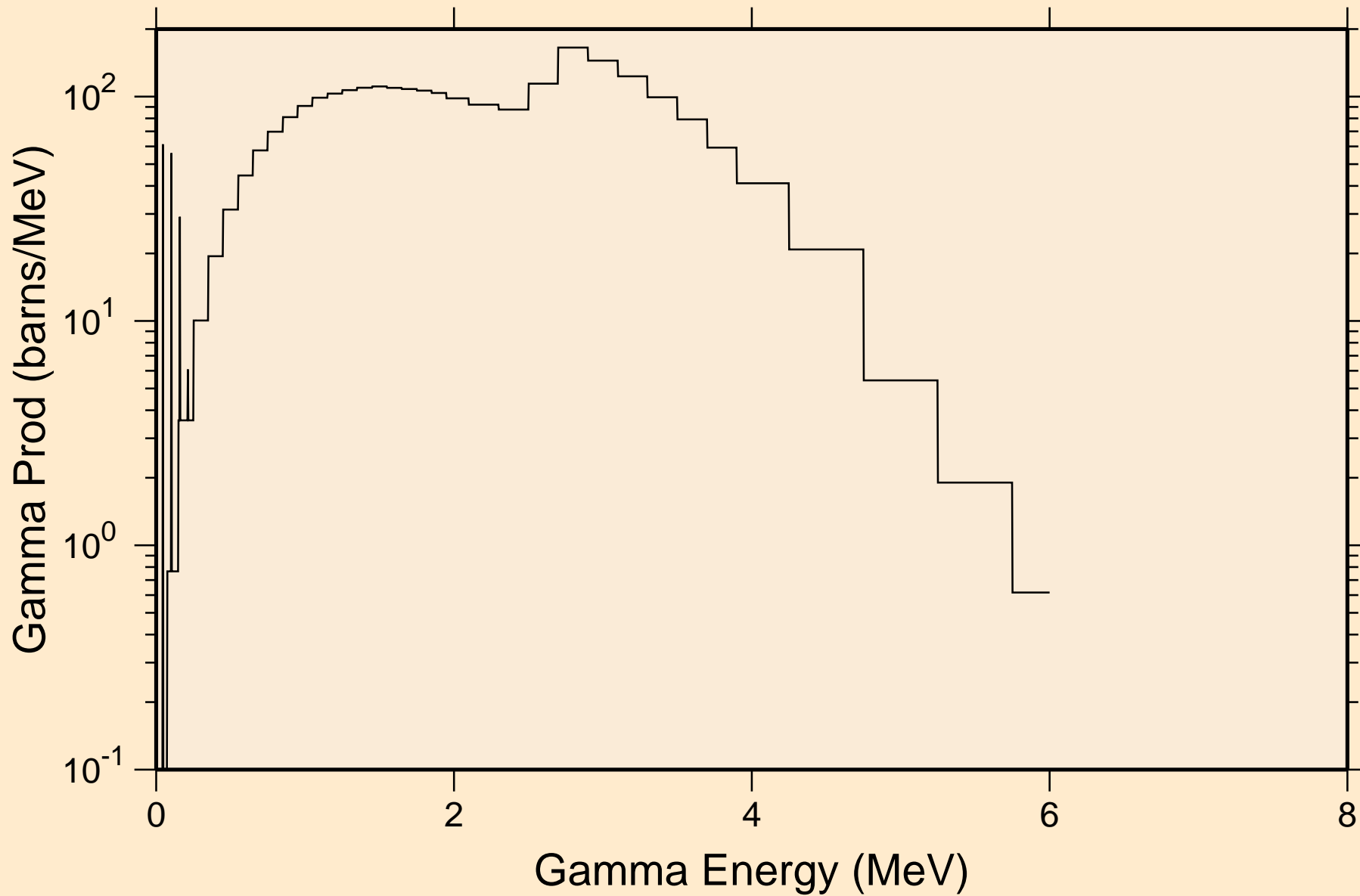

NO253 NEUTRON ACER TENDL-2021 LIBRARY; T=293.6K
14 MeV photon spectrum

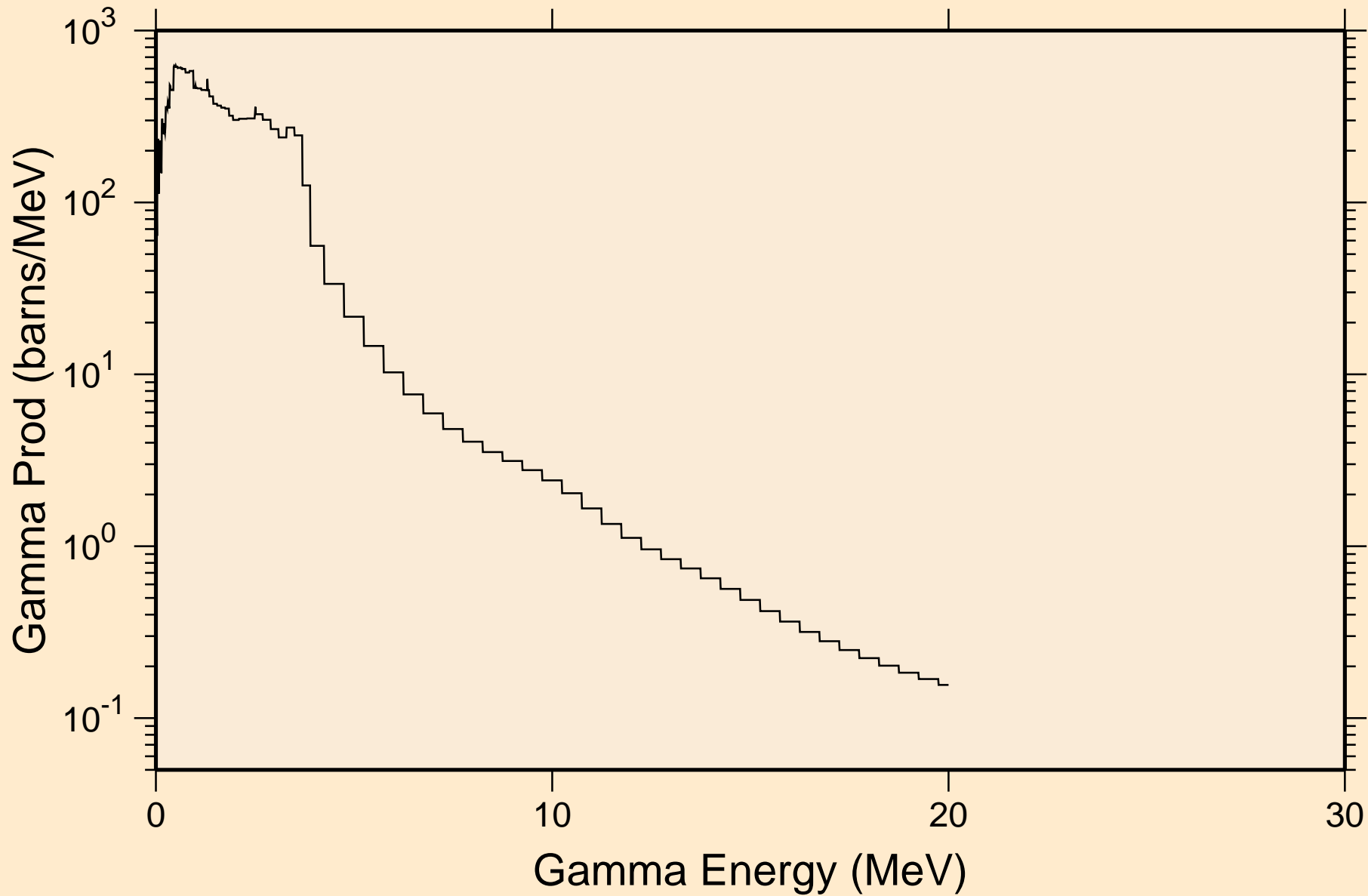

NO253 NEUTRON ACER TENDL-2021 LIBRARY; T=293.6K
Particle heating contributions

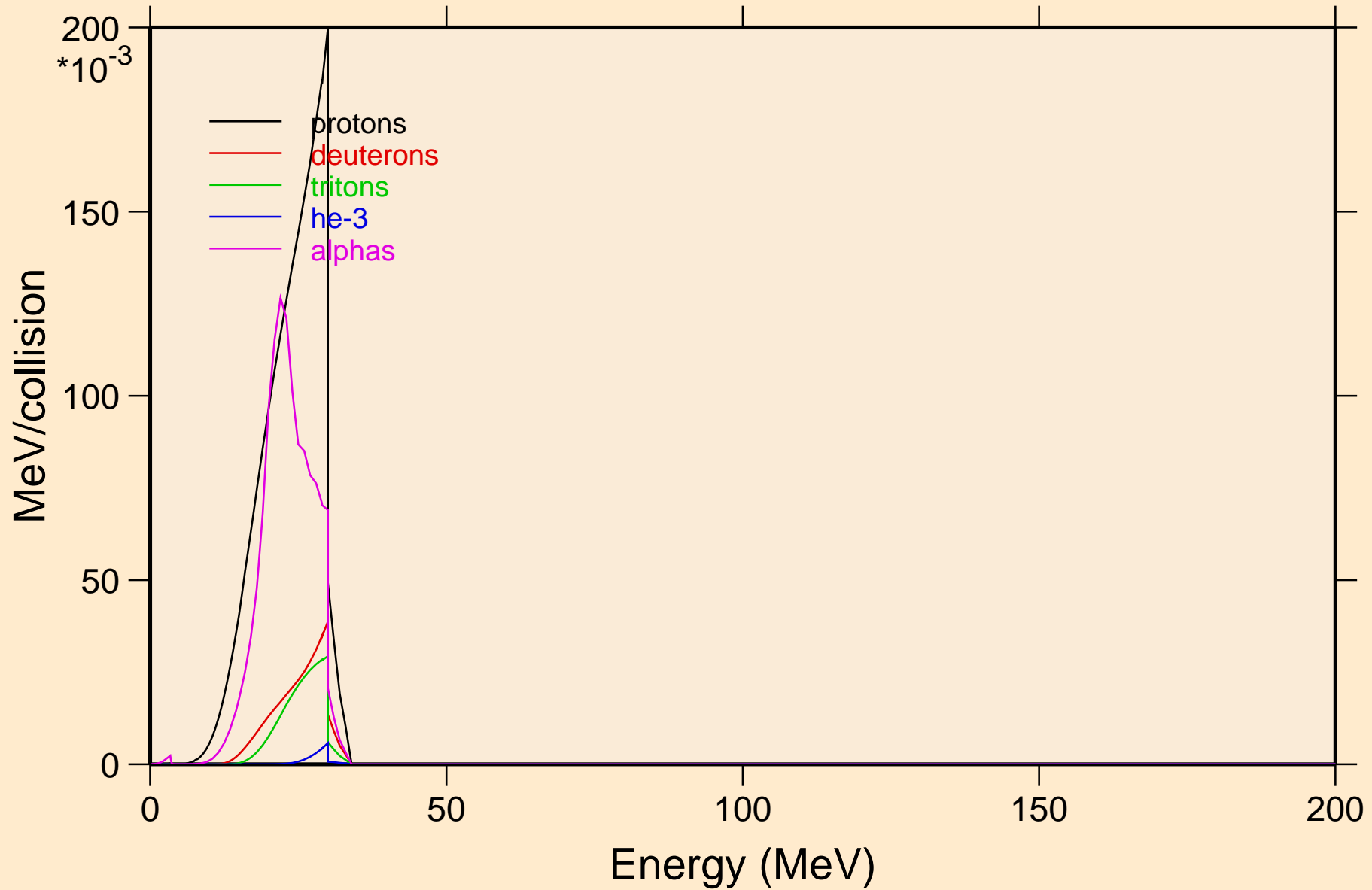

NO253 NEUTRON ACER TENDL-2021 LIBRARY; T=293.6K
Recoil Heating

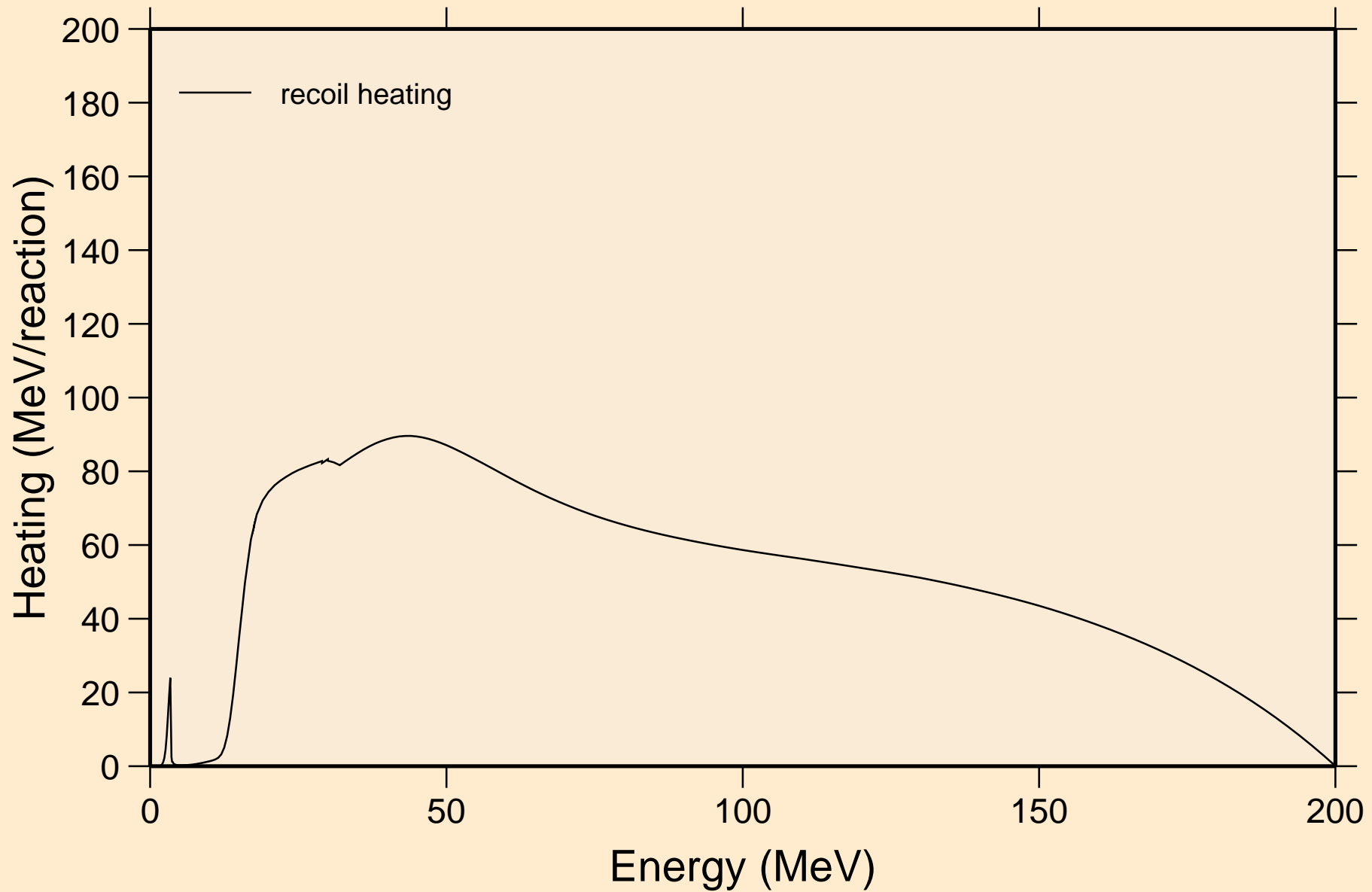

NO253 NEUTRON ACER TENDL-2021 LIBRARY; T=293.6K
Particle production cross sections

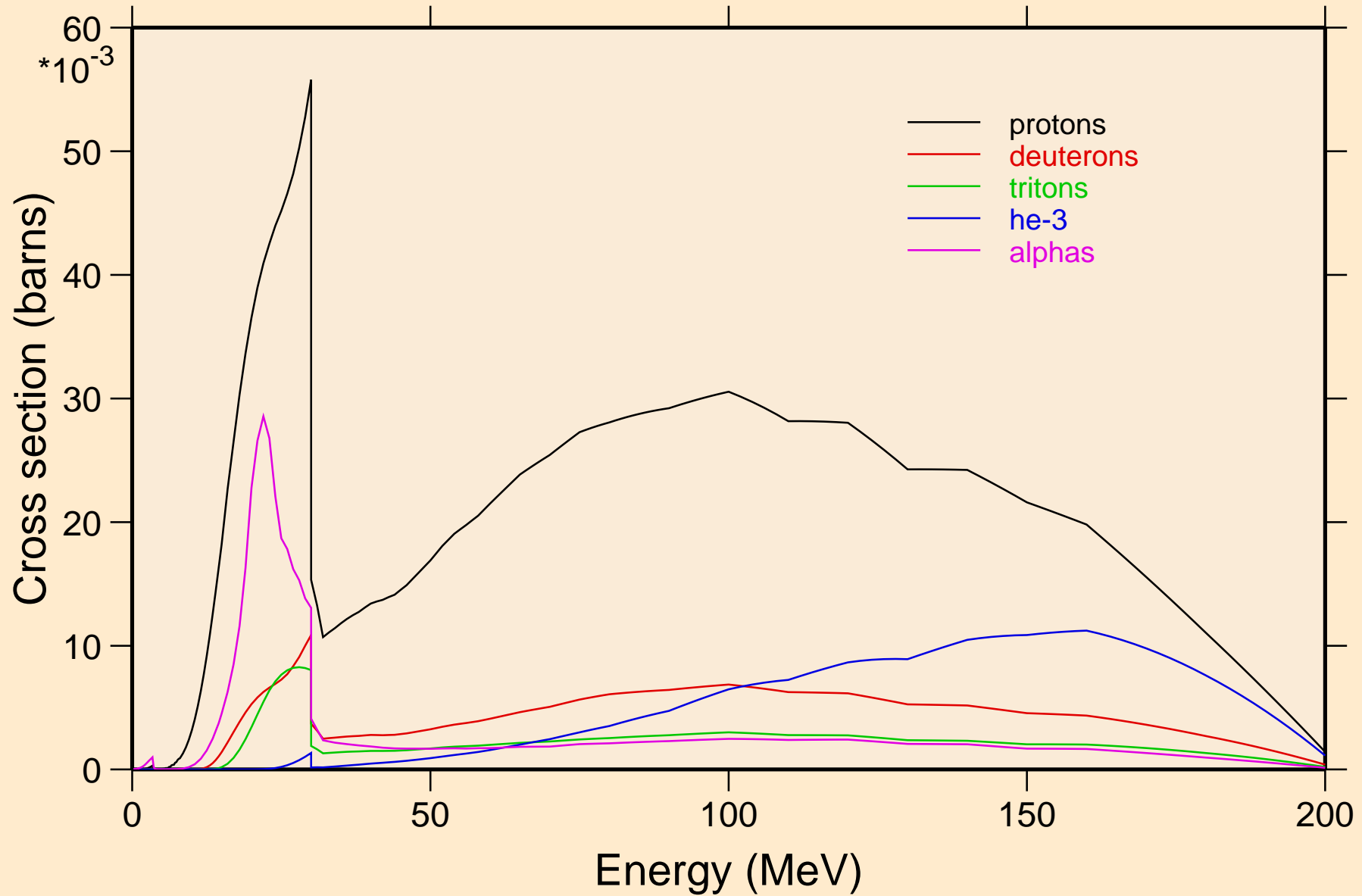

NO253 NEUTRON ACER TENDL-2021 LIBRARY; T=293.6K
protons from (n,x)

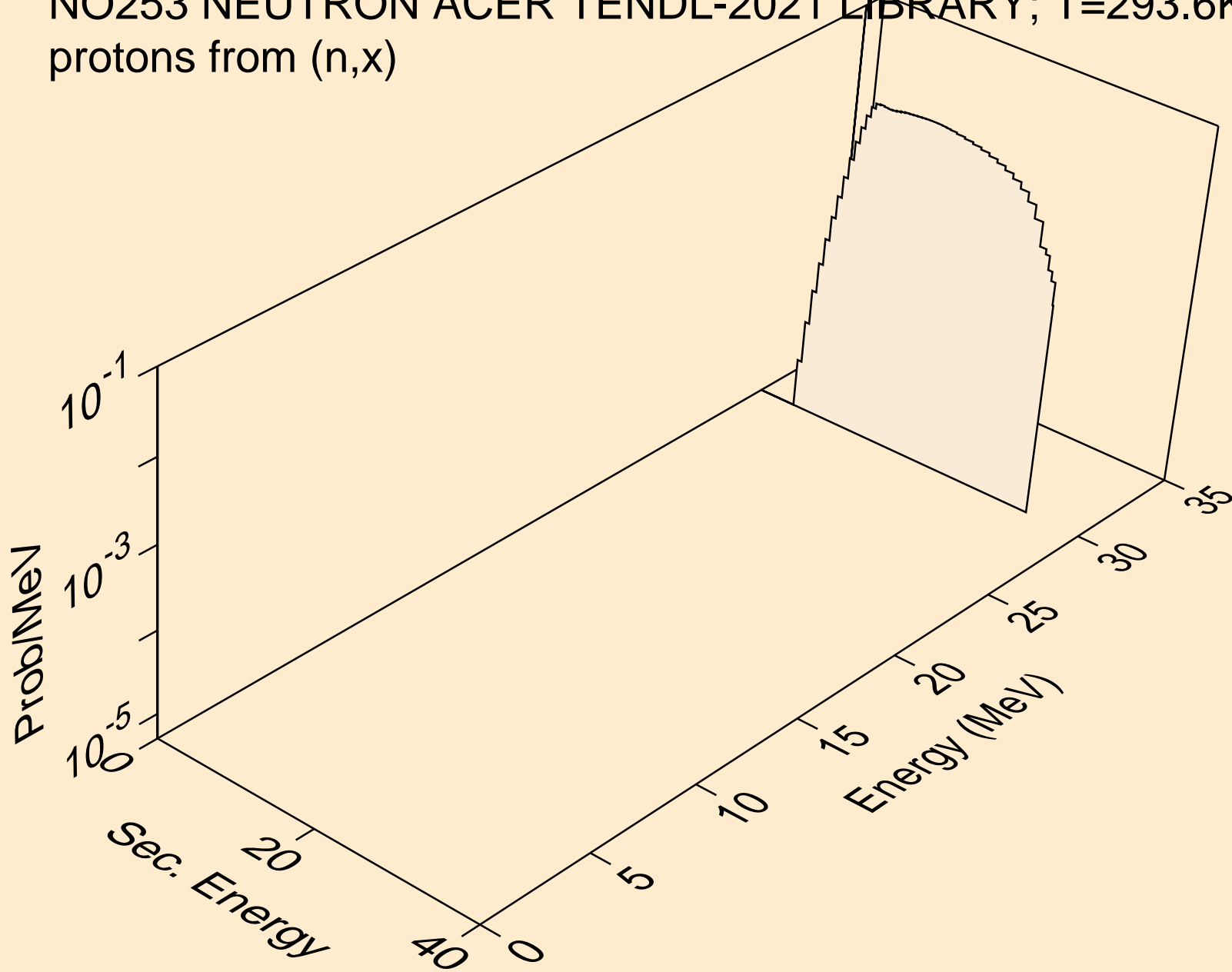

NO253 NEUTRON ACER TENDL-2021 LIBRARY; T=293.6K
protons from (n,n*)p

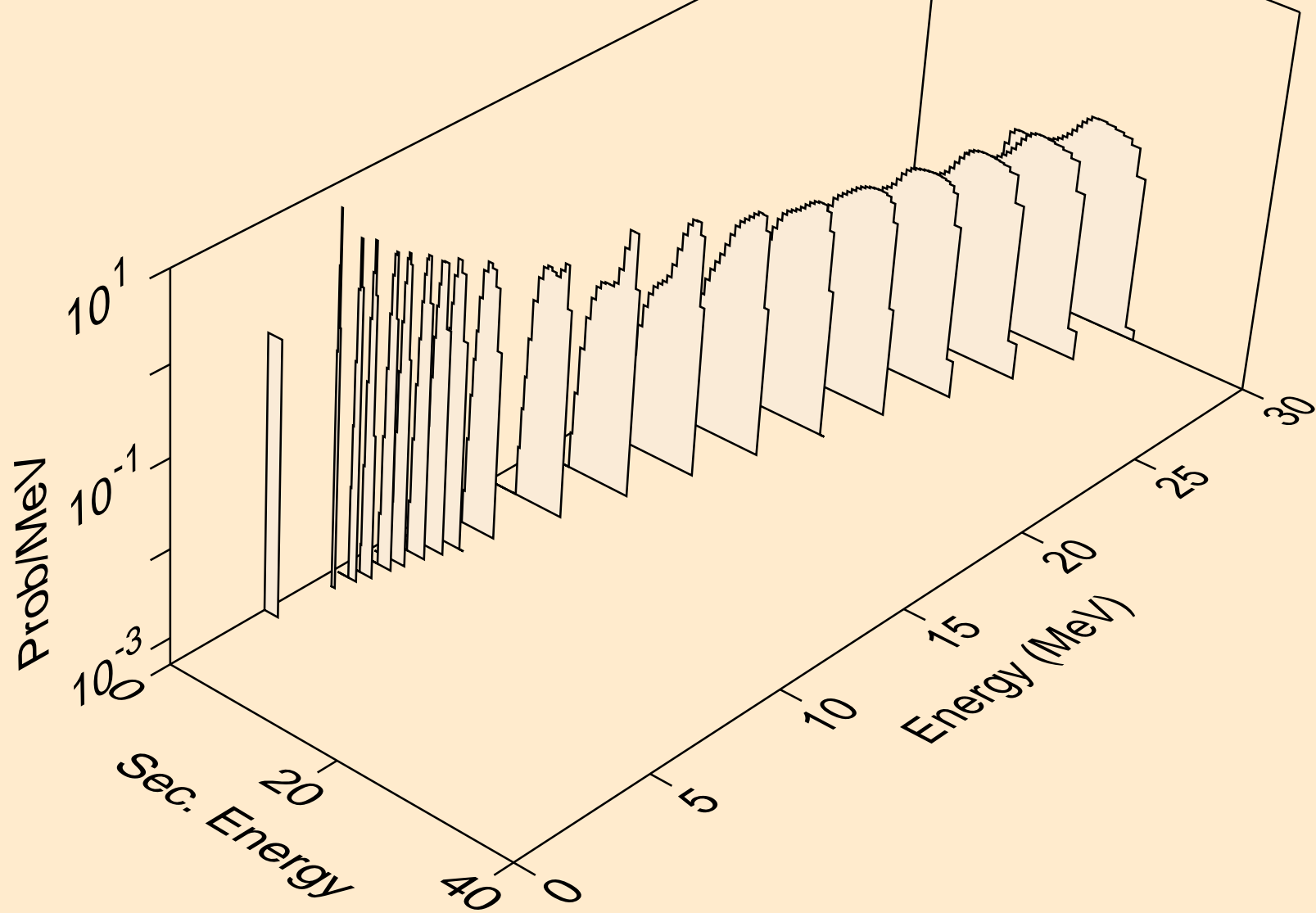

NO253 NEUTRON ACER TENDL-2021 LIBRARY; T=293.6K
protons from (n,2np)

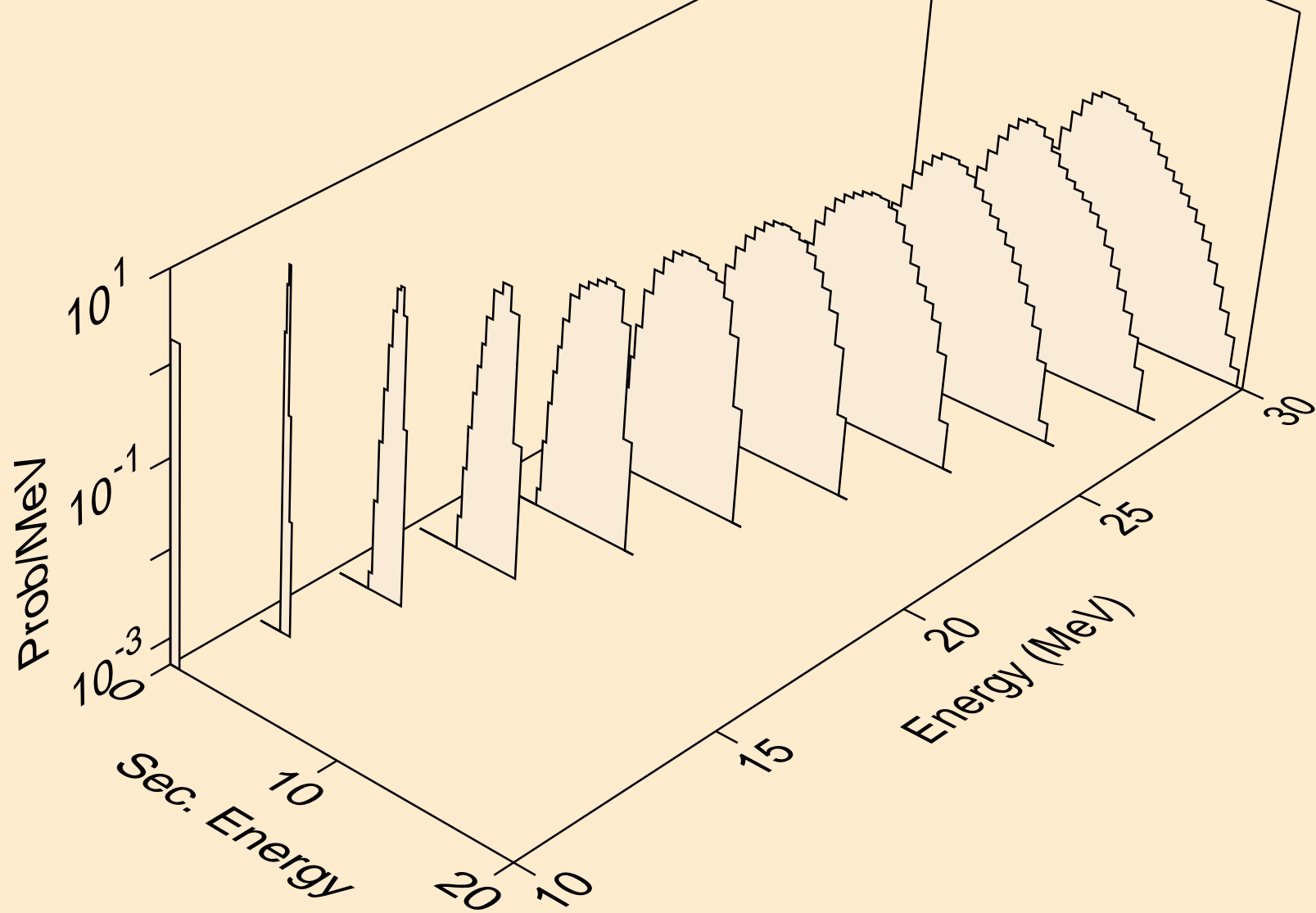

NO253 NEUTRON ACER TENDL-2021 LIBRARY; T=293.6K
protons from (n,3np)

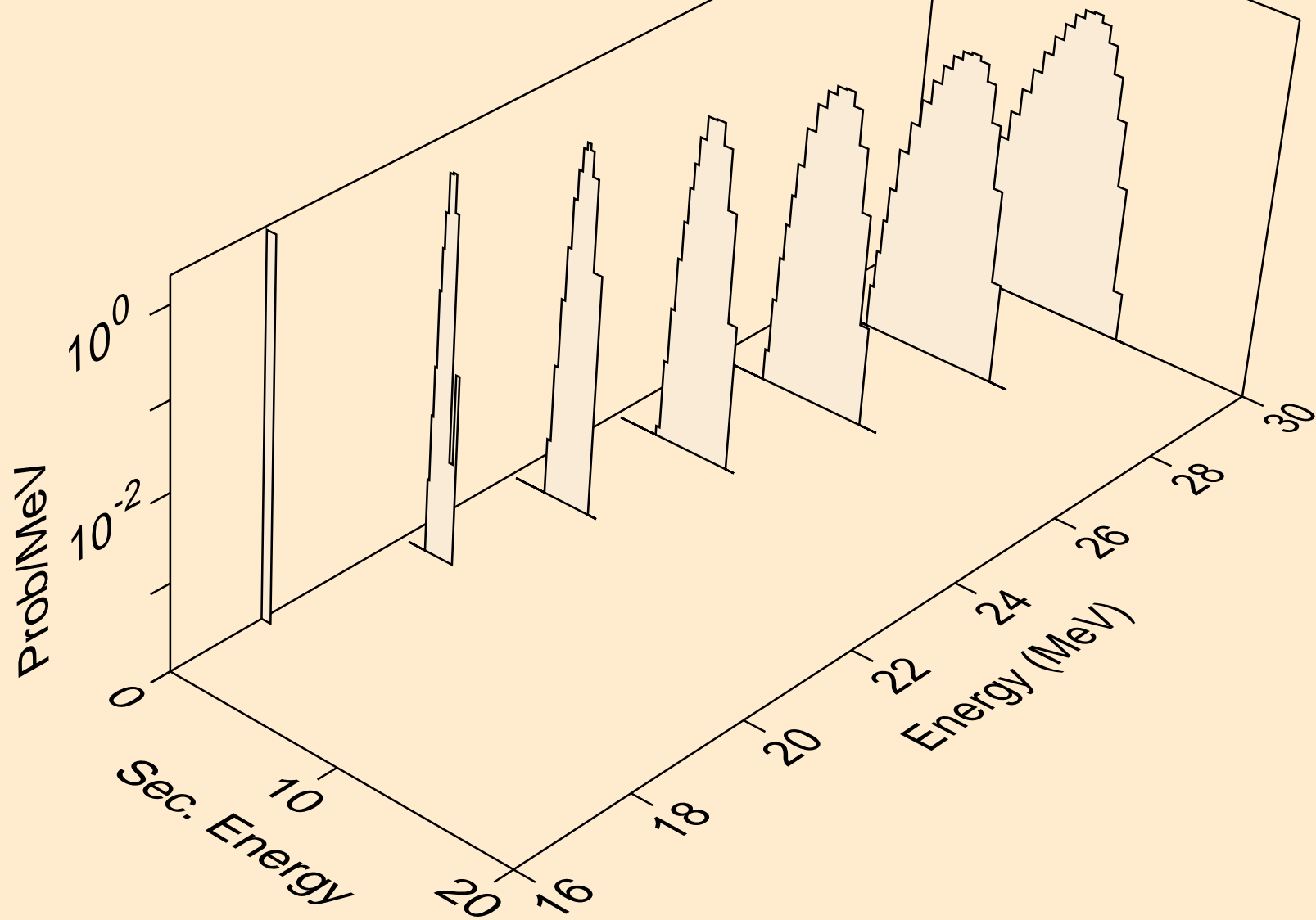

NO253 NEUTRON ACER TENDL-2021 LIBRARY; T=293.6K
protons from (n,2np)

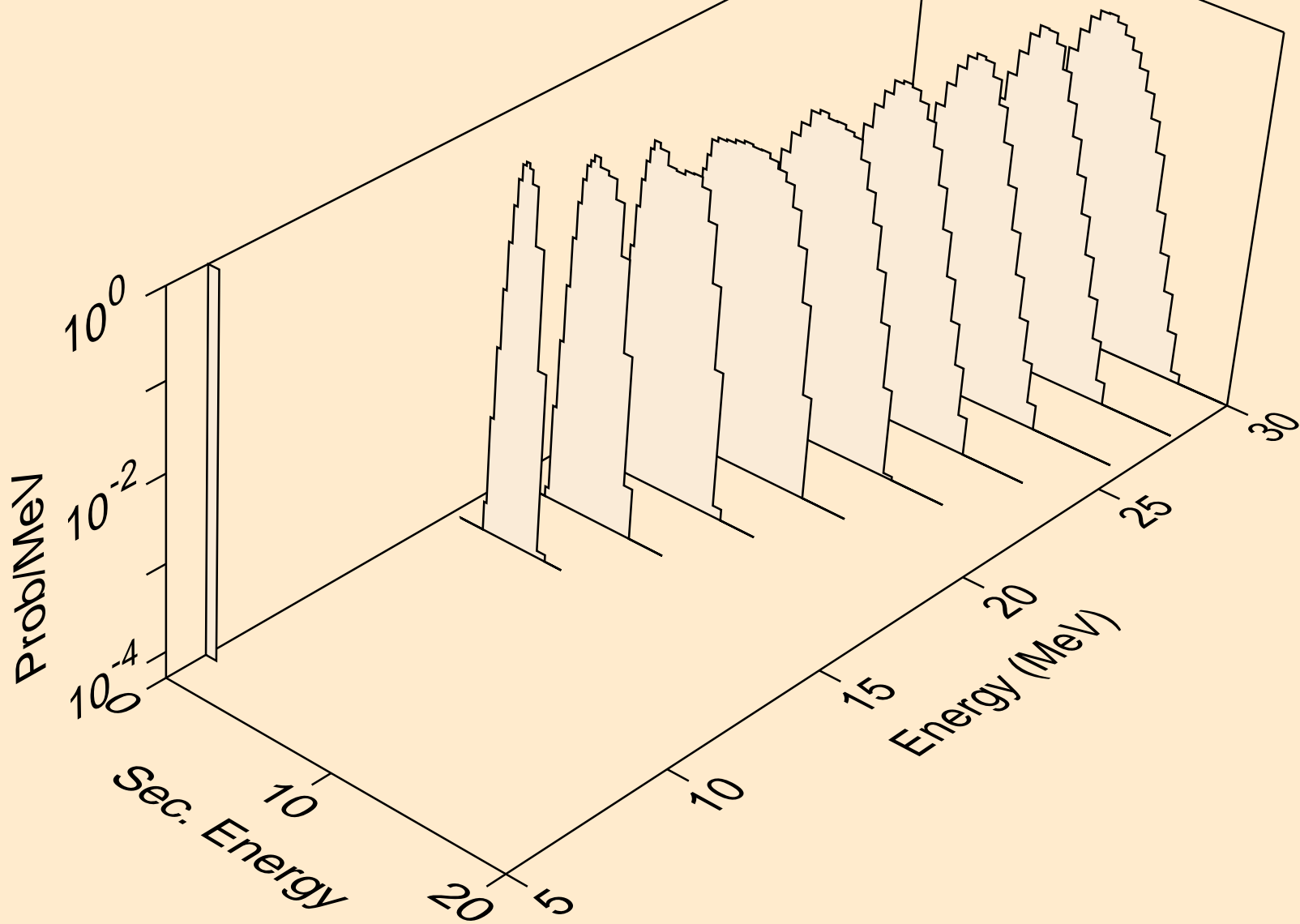

NO253 NEUTRON ACER TENDL-2021 LIBRARY; T=293.6K
protons from (n,npa)

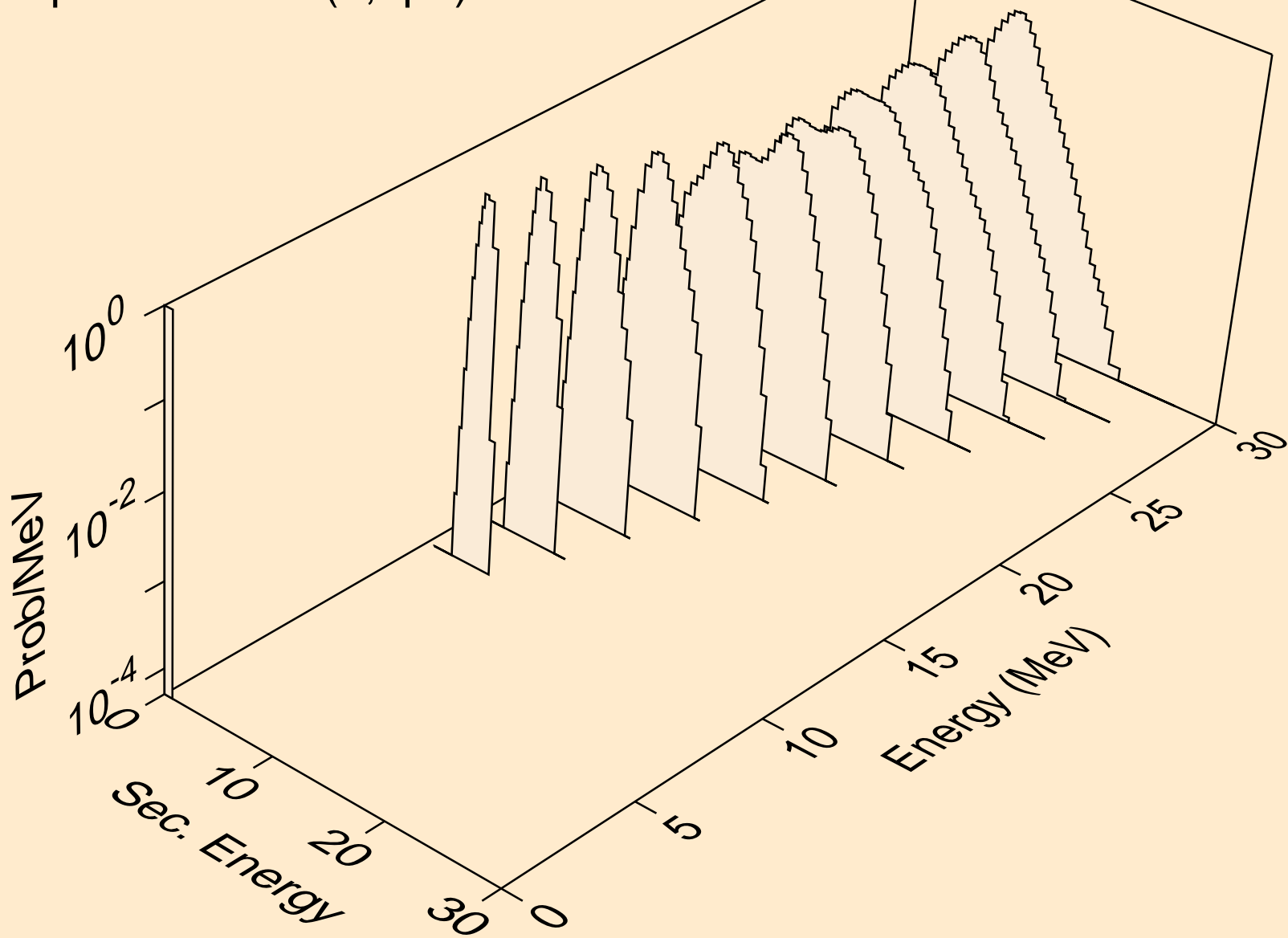

NO253 NEUTRON ACER TENDL-2021 LIBRARY; T=293.6K
protons from (n,p)

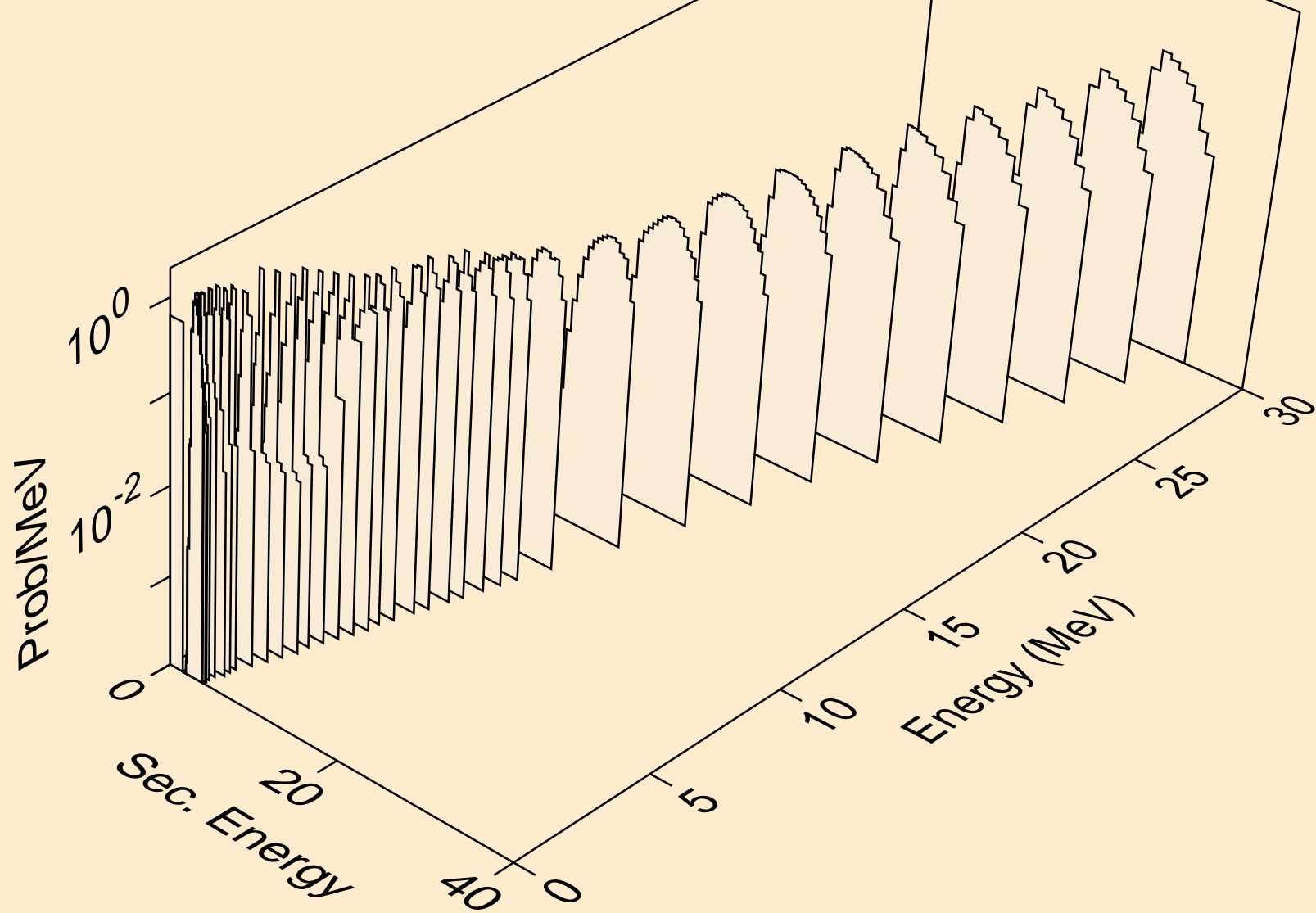

NO253 NEUTRON ACER TENDL-2021 LIBRARY; T=293.6K
protons from (n,2p)

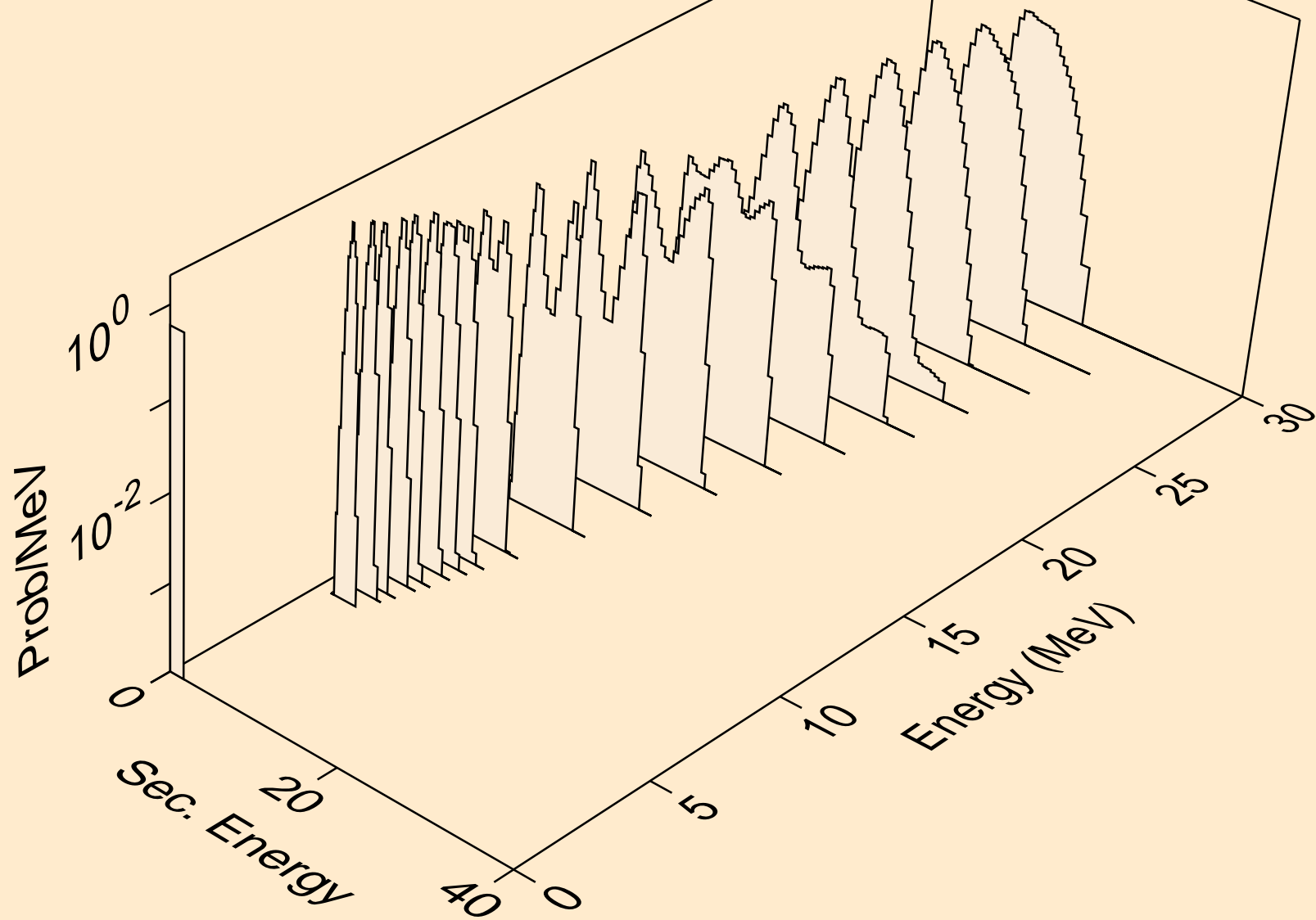

NO253 NEUTRON ACER TENDL-2021 LIBRARY; T=293.6K
protons from (n,p)

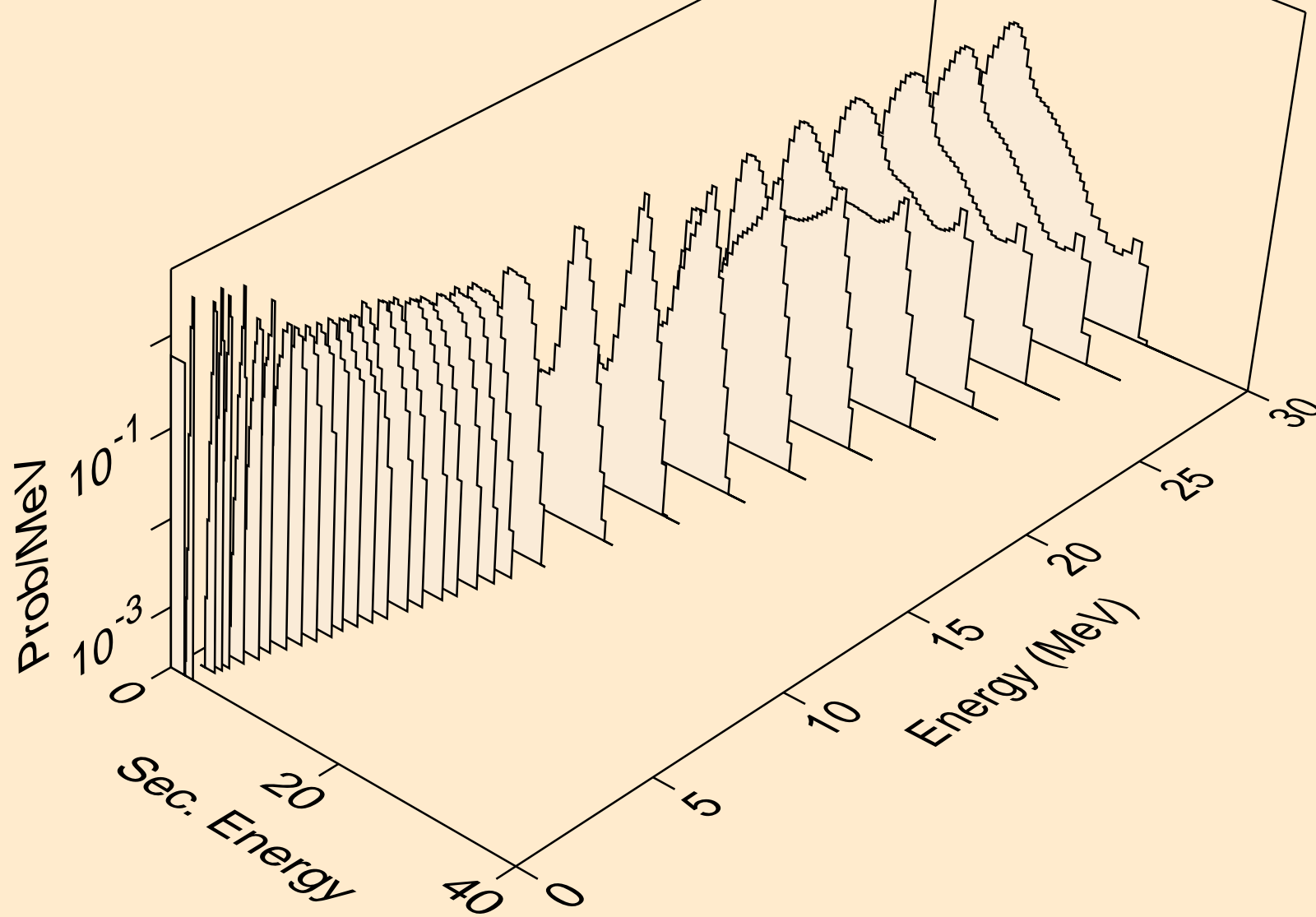

NO253 NEUTRON ACER TENDL-2021 LIBRARY; T=293.6K
protons from (n,pd)

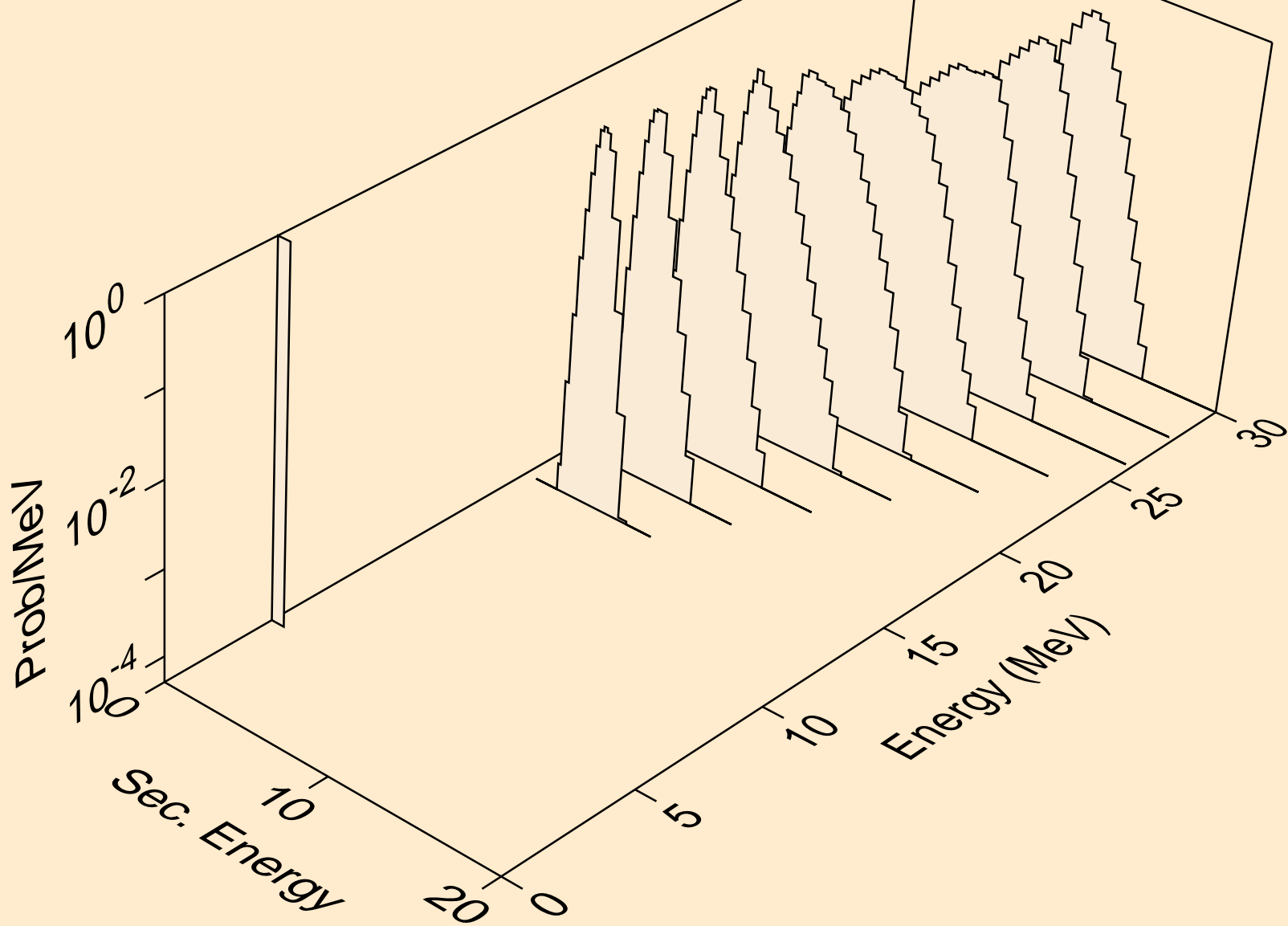

NO253 NEUTRON ACER TENDL-2021 LIBRARY; T=293.6K
protons from (n,pt)

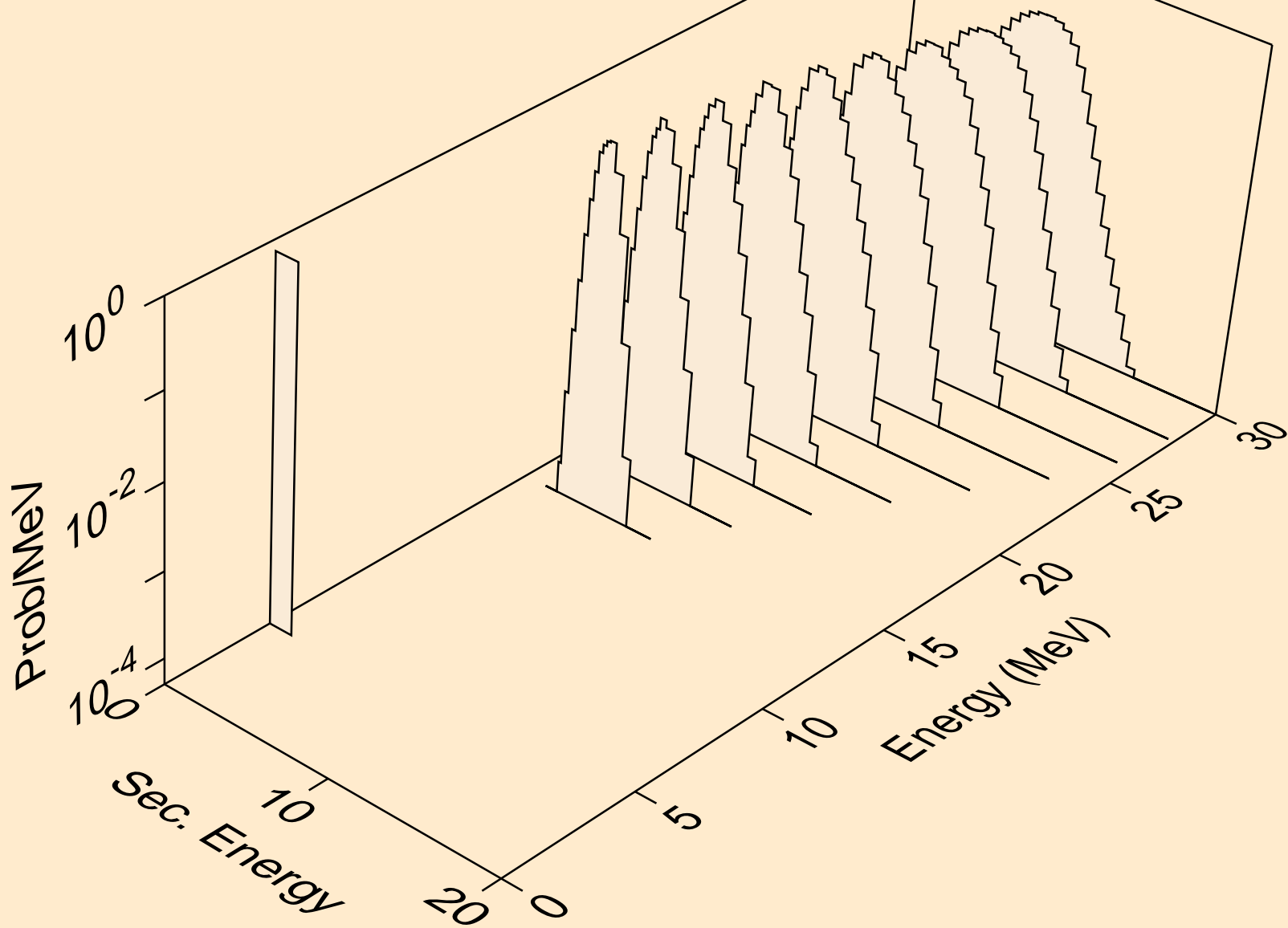

NO253 NEUTRON ACER TENDL-2021 LIBRARY; T=293.6K
deuterons from (n,x)

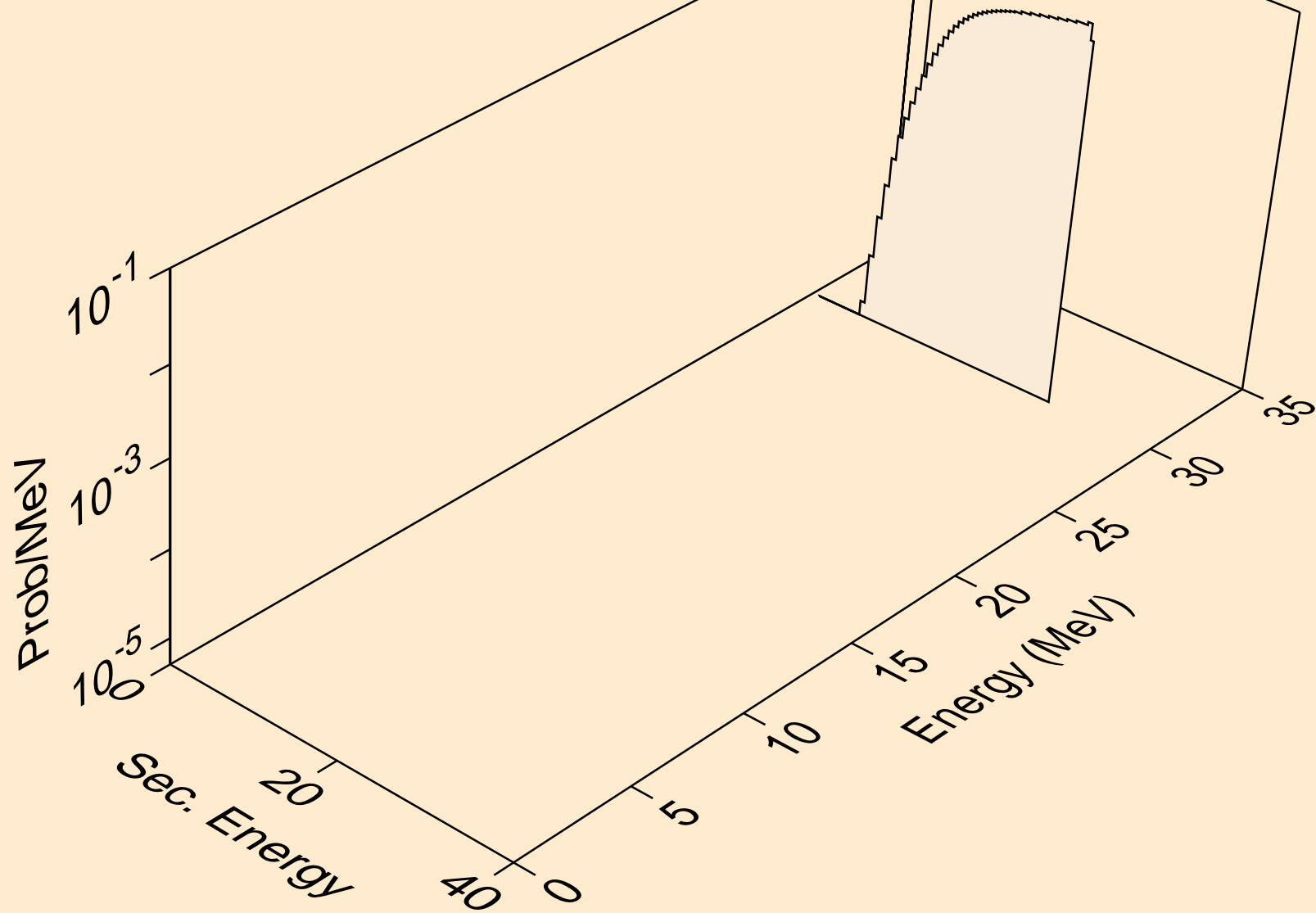

NO253 NEUTRON ACER TENDL-2021 LIBRARY; T=293.6K
deuterons from (n,2nd)

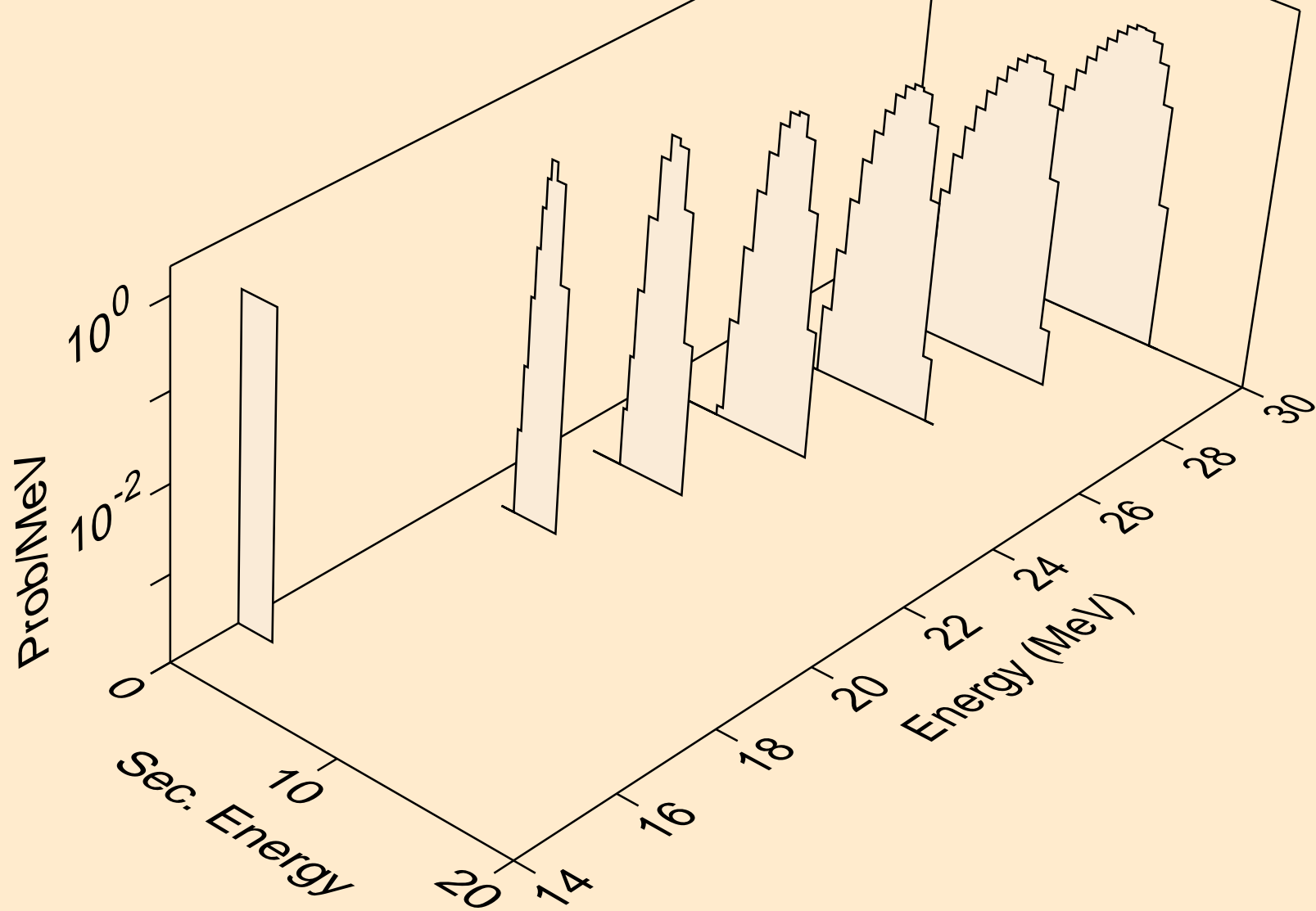

NO253 NEUTRON ACER TENDL-2021 LIBRARY; T=293.6K
deuterons from (n,n*)d

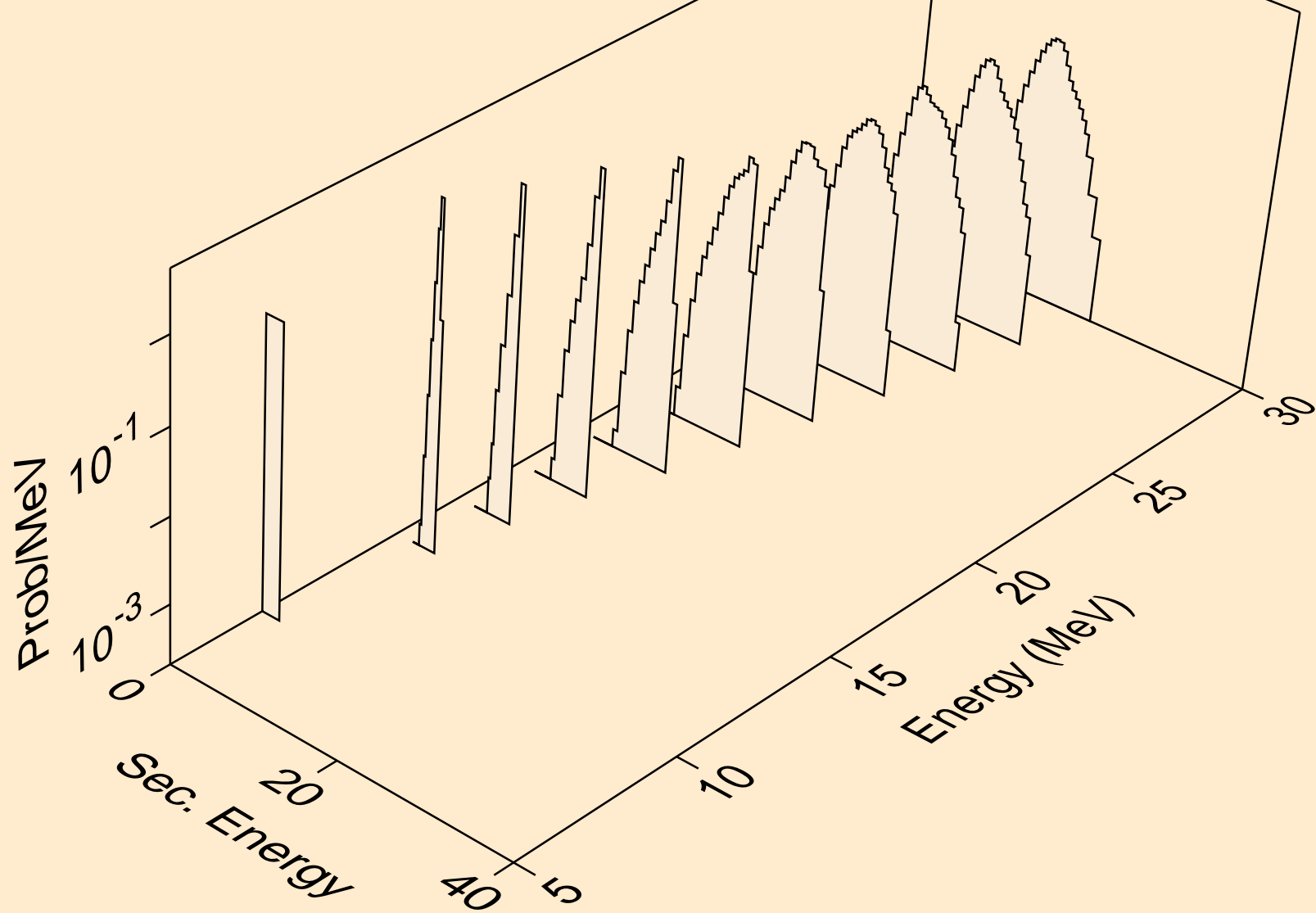

NO253 NEUTRON ACER TENDL-2021 LIBRARY; T=293.6K
deuterons from (n,d)

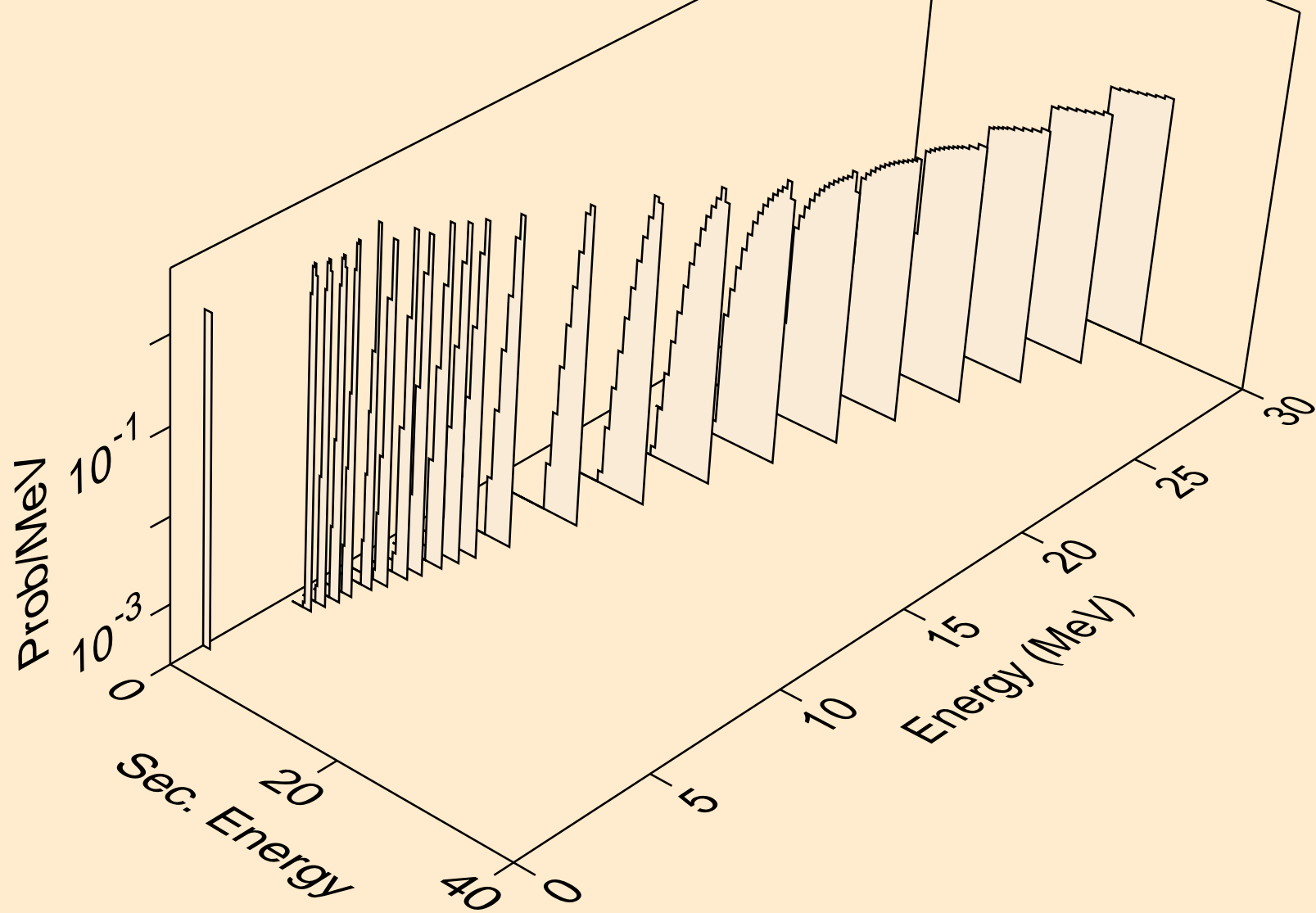

NO253 NEUTRON ACER TENDL-2021 LIBRARY; T=293.6K
deuterons from (n,pd)

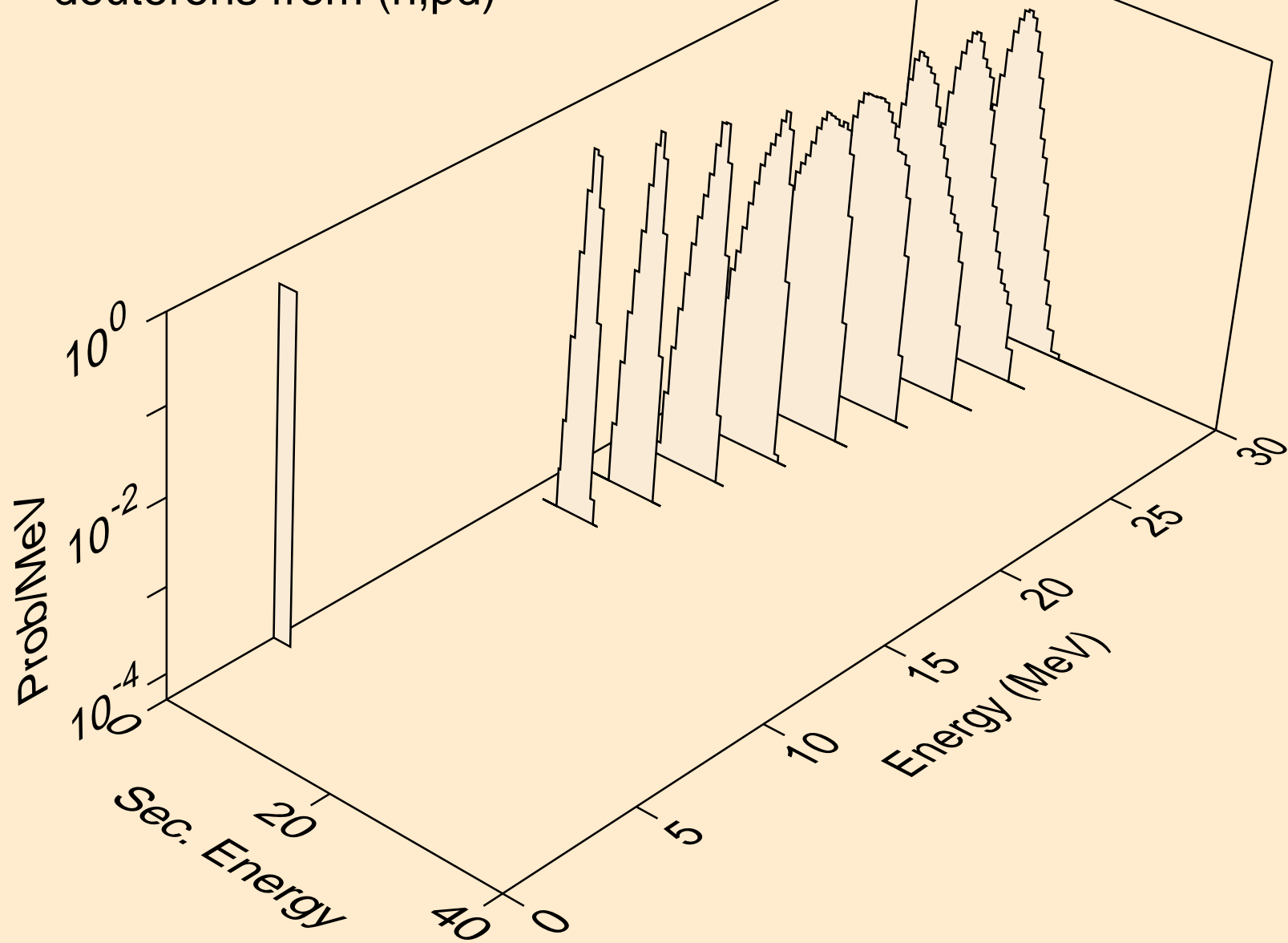

NO253 NEUTRON ACER TENDL-2021 LIBRARY; T=293.6K
deuterons from (n,da)

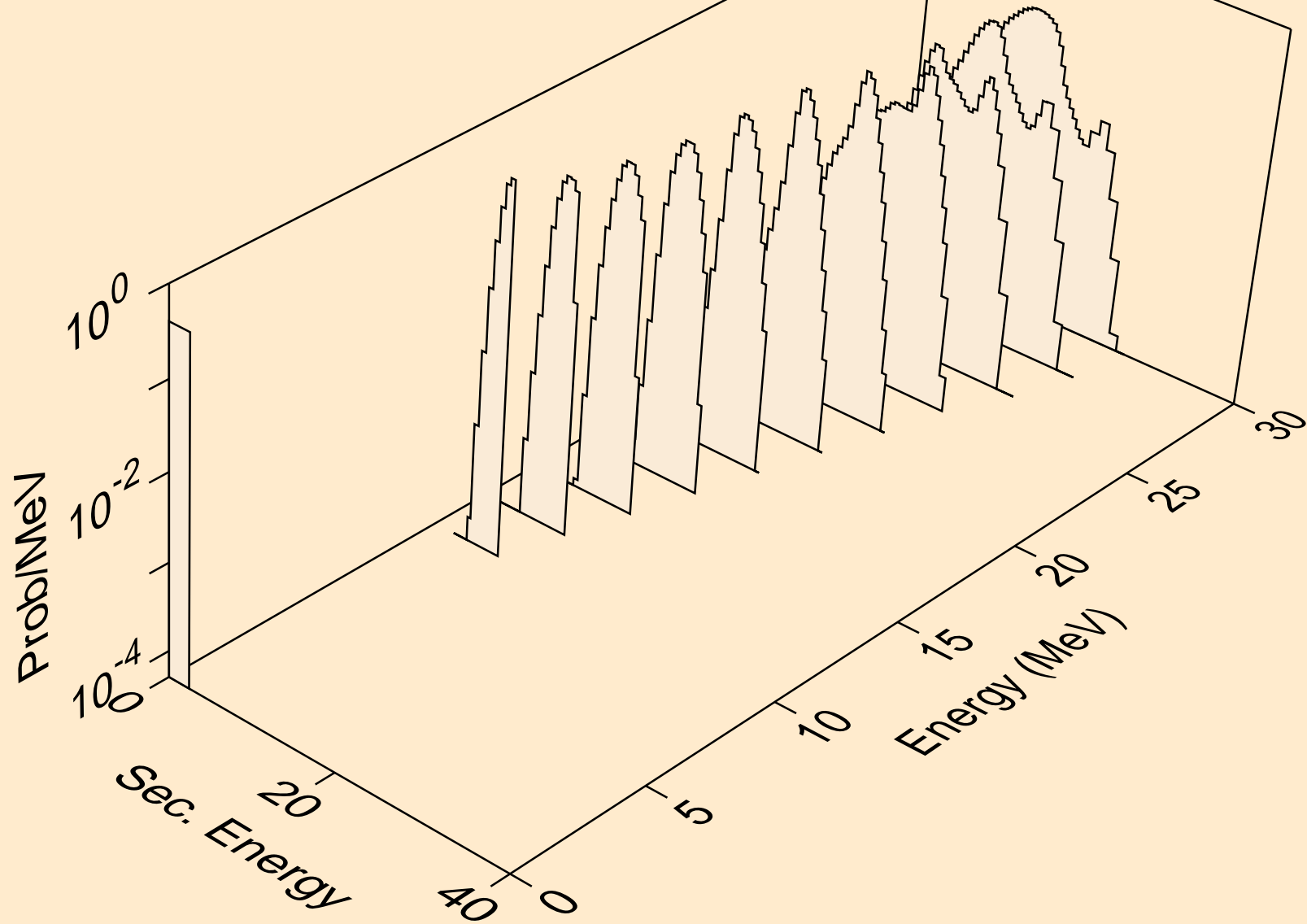

NO253 NEUTRON ACER TENDL-2021 LIBRARY; T=293.6K
tritons from (n,x)

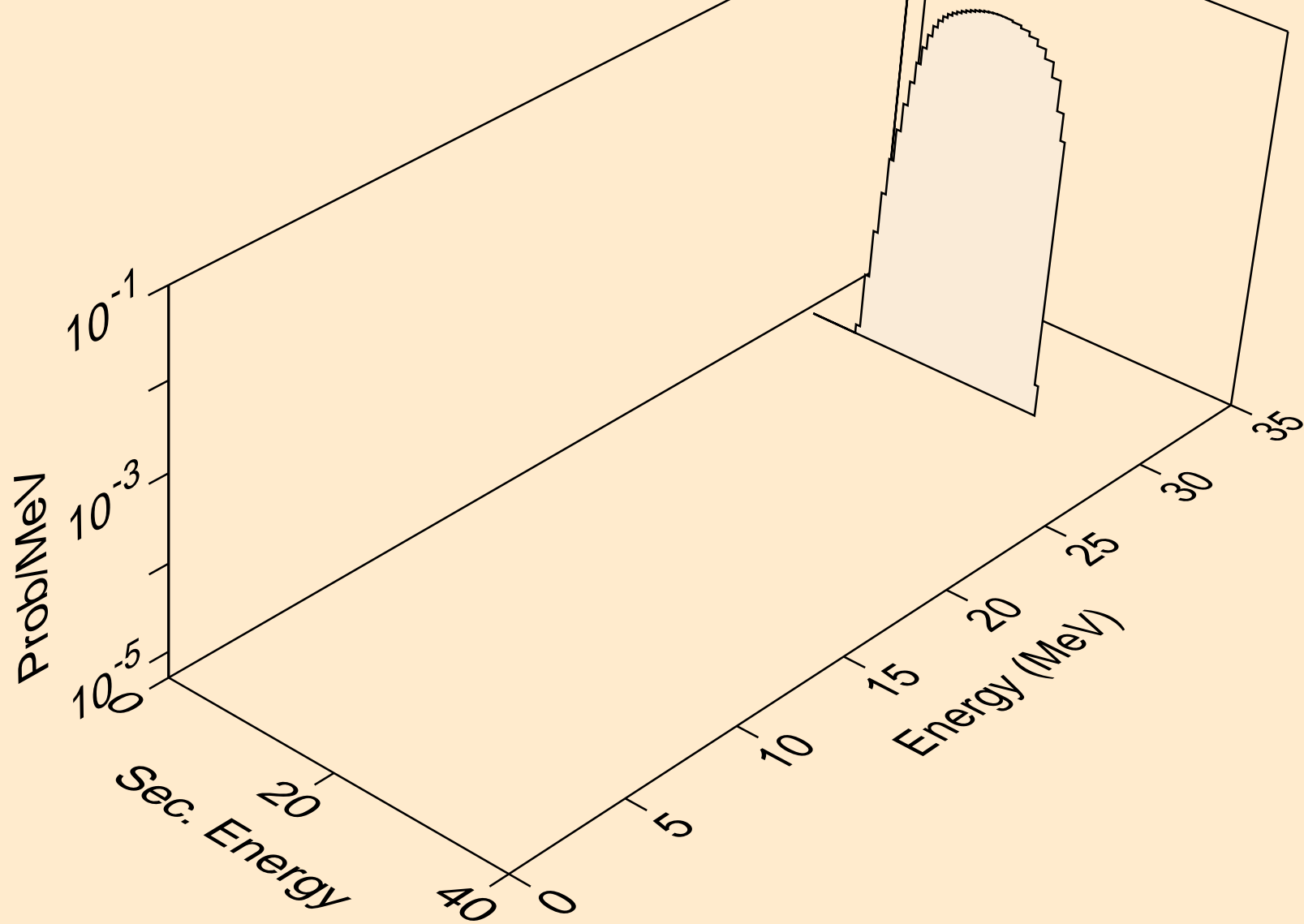

NO253 NEUTRON ACER TENDL-2021 LIBRARY; T=293.6K
tritons from (n,n*)t

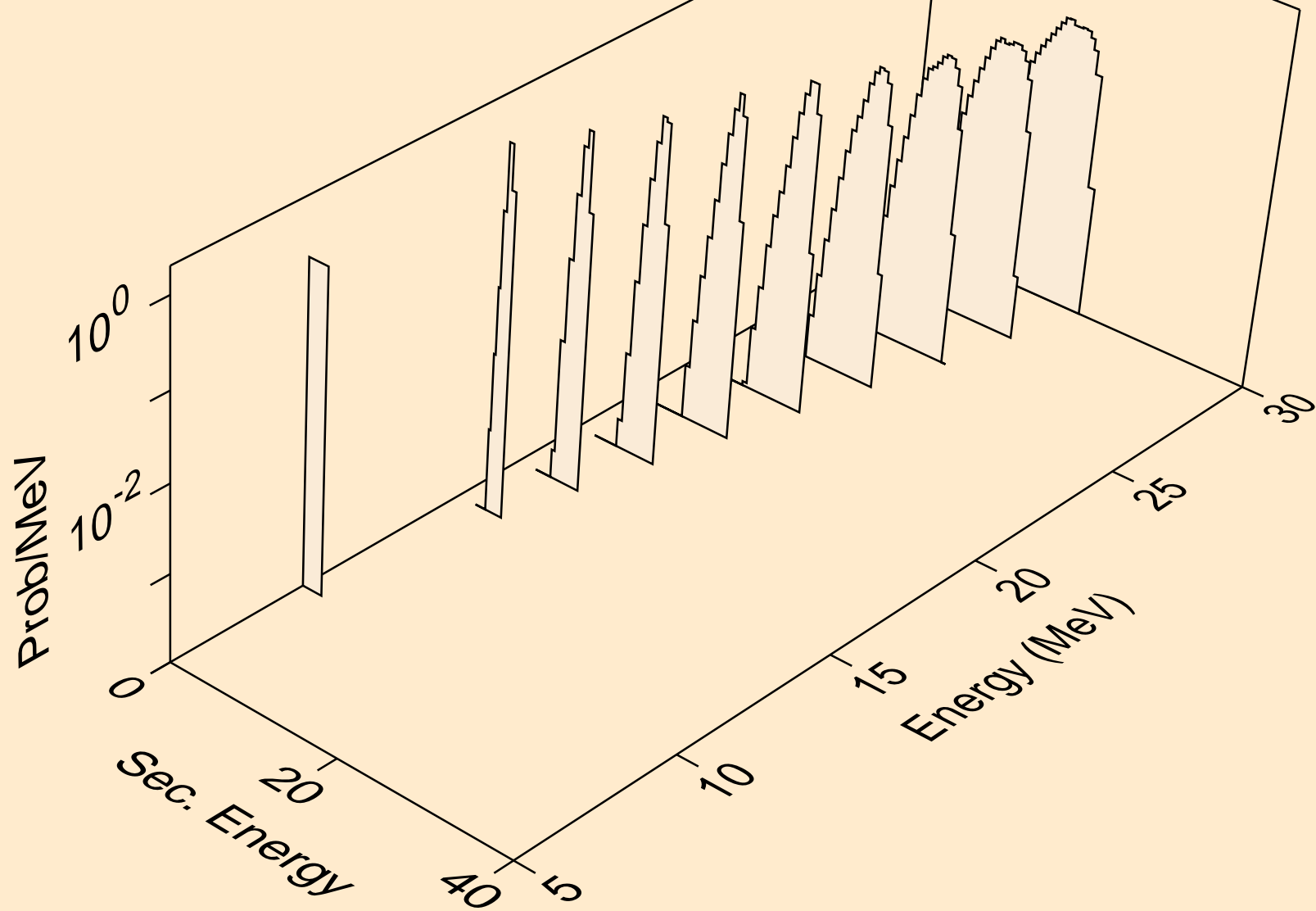

NO253 NEUTRON ACER TENDL-2021 LIBRARY; T=293.6K
tritons from (n,t)

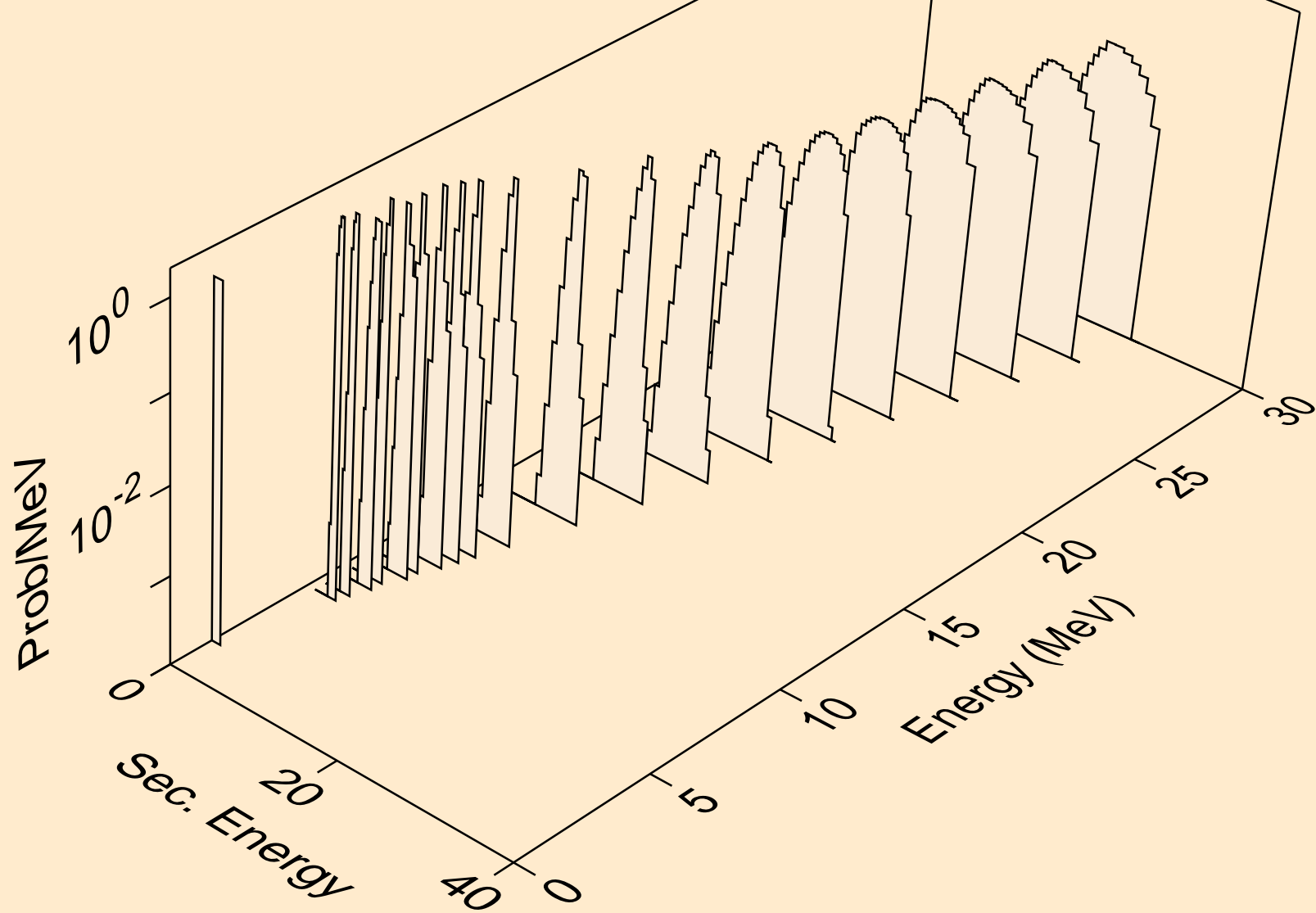

NO253 NEUTRON ACER TENDL-2021 LIBRARY; T=293.6K
tritons from (n,pt)

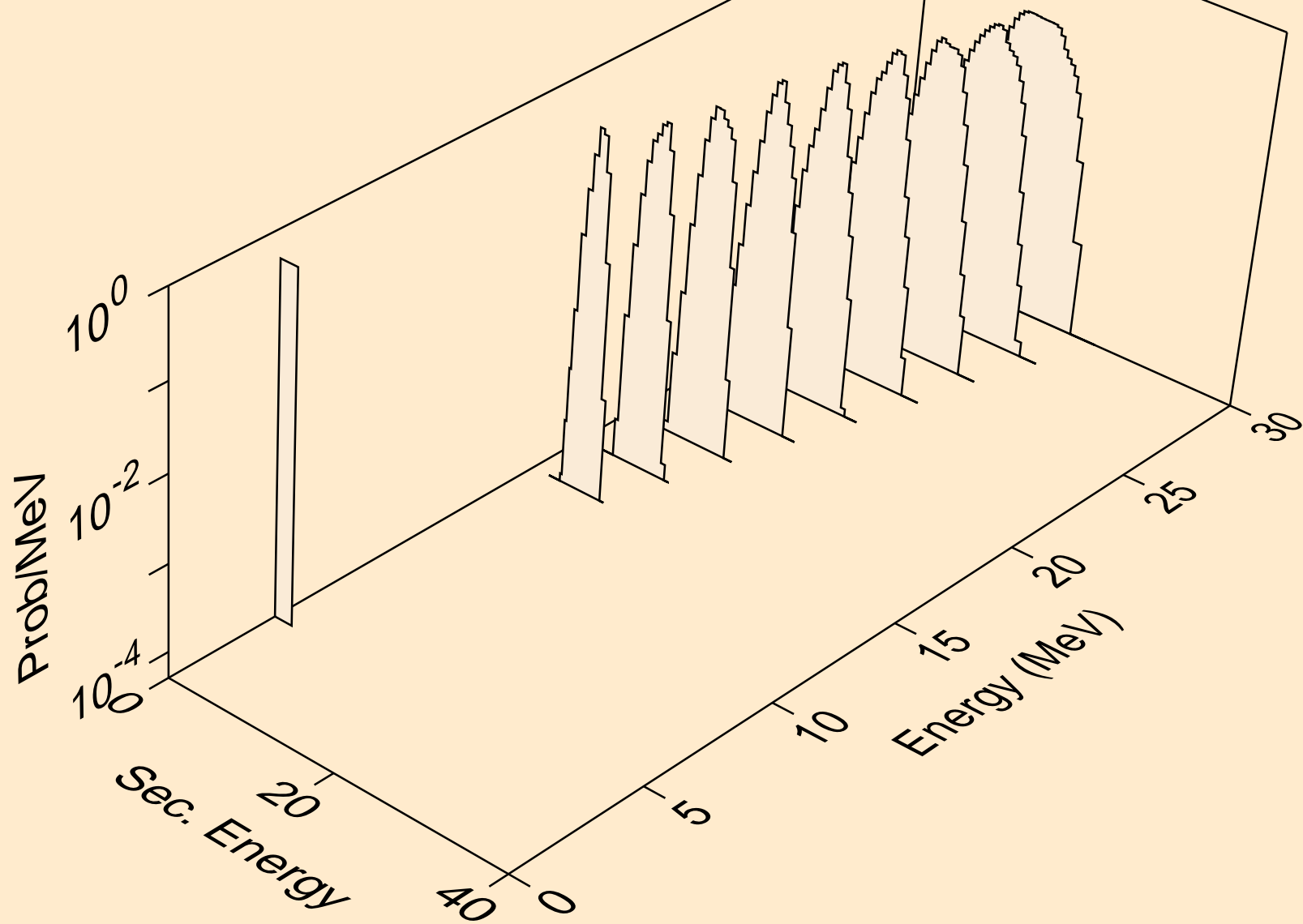

NO253 NEUTRON ACER TENDL-2021 LIBRARY; T=293.6K
he3s from (n,x)

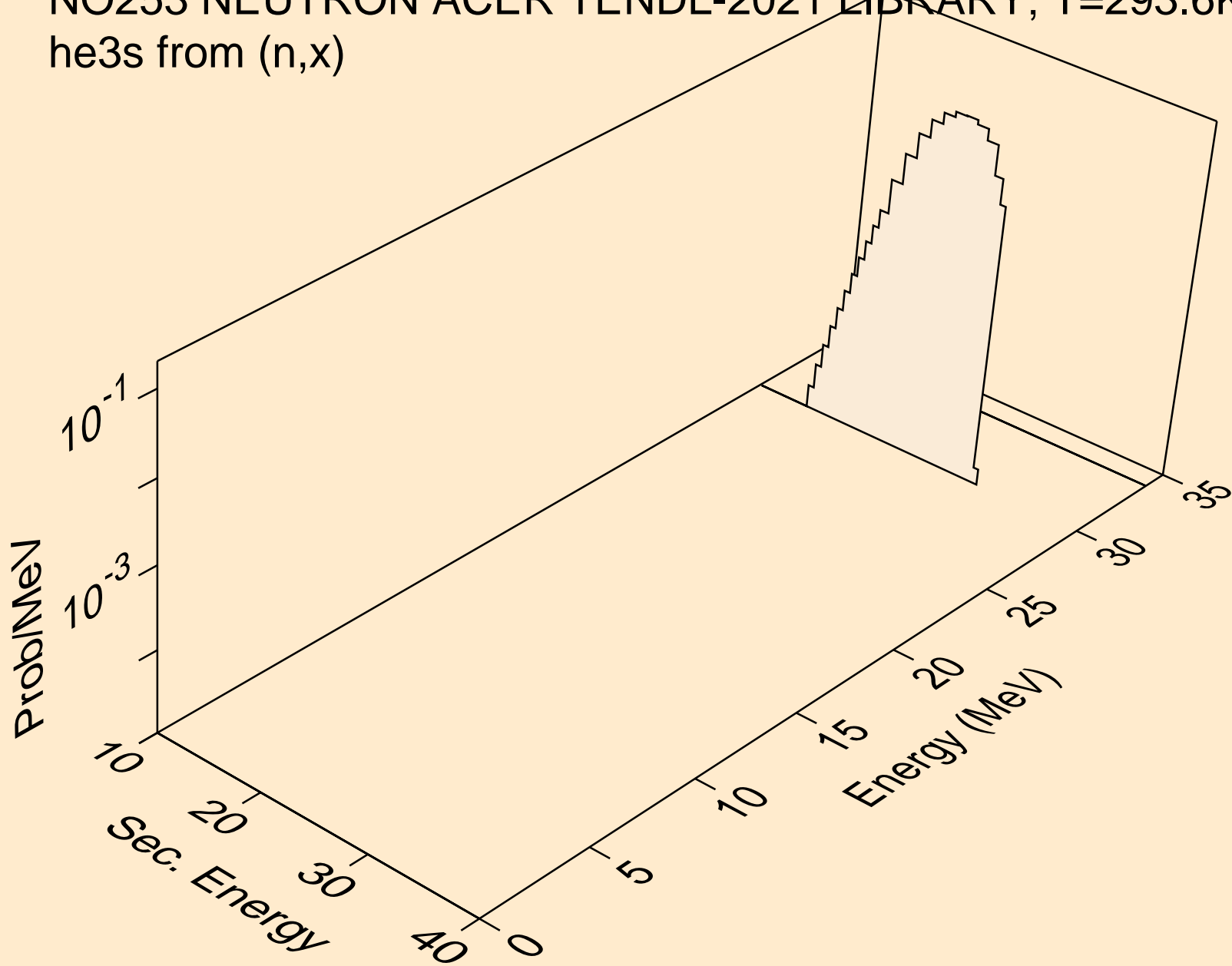

NO253 NEUTRON ACER TENDL-2021 LIBRARY; T=293.6K
he3s from (n,n*)he3

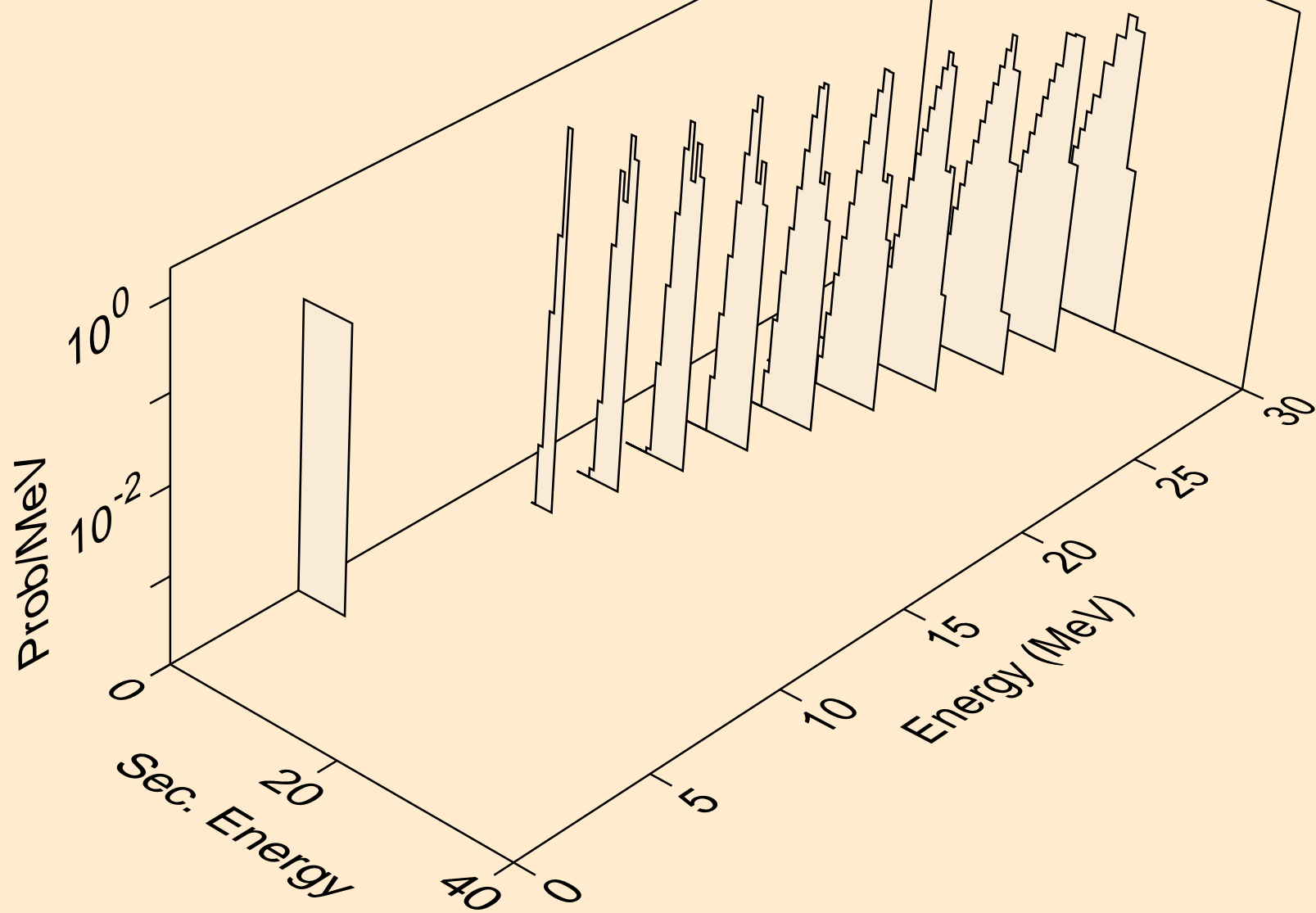

NO253 NEUTRON ACER TENDL-2021 LIBRARY; T=293.6K
he3s from (n,he3)

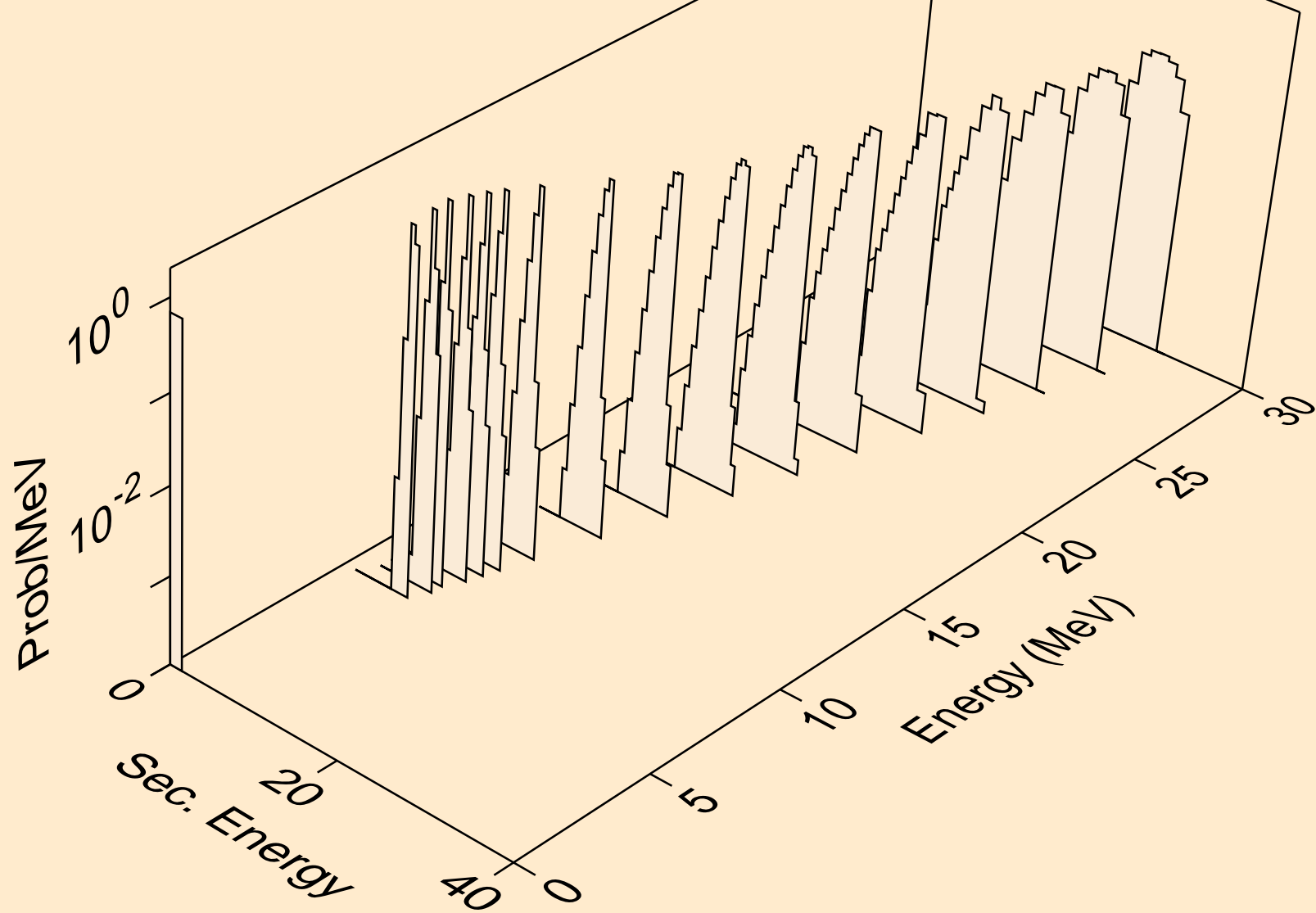

NO253 NEUTRON ACER TENDL-2021 LIBRARY; T=293.6K
alphas from (n,x)

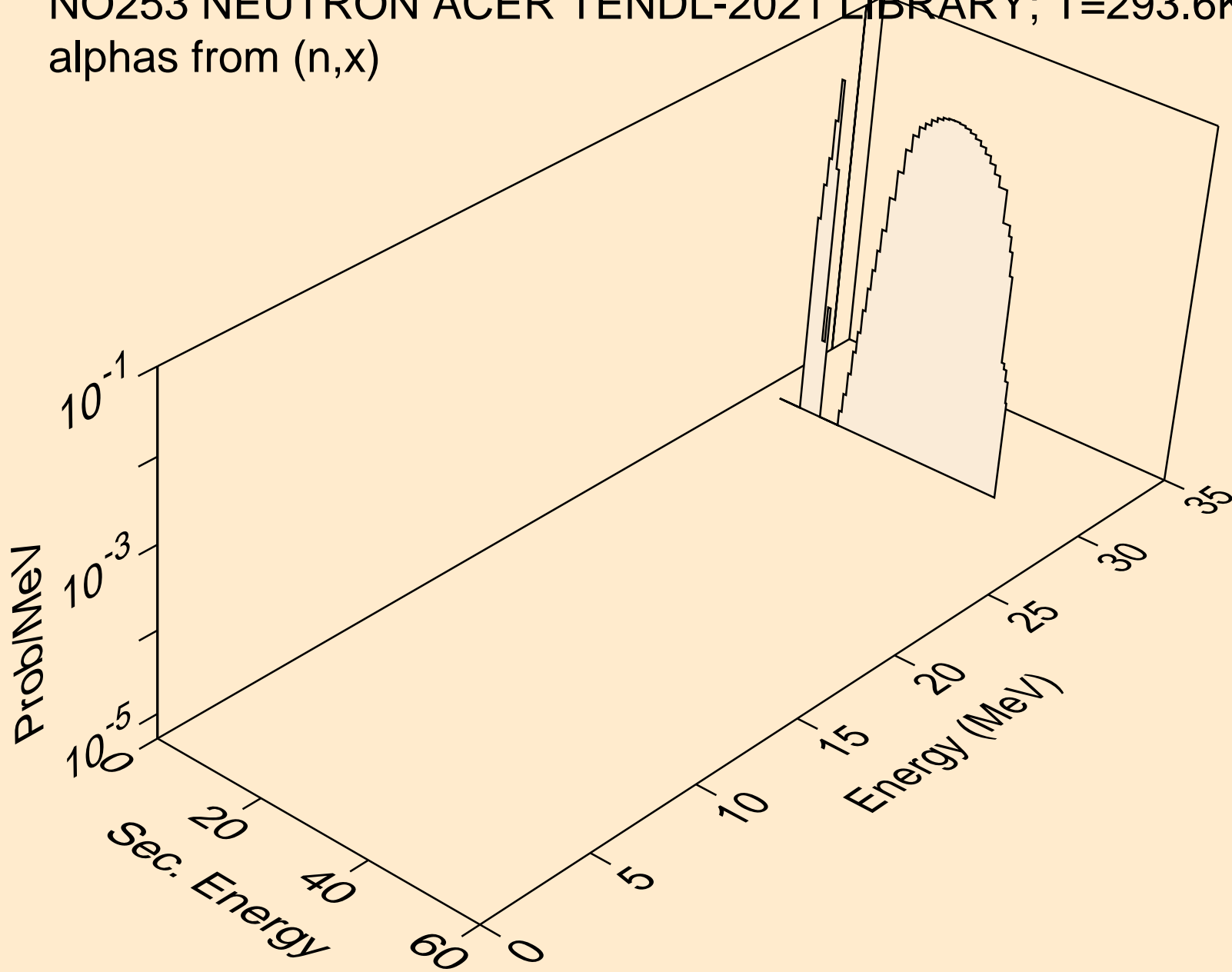

NO253 NEUTRON ACER TENDL-2021 LIBRARY; T=293.6K
alphas from (n,n*)a

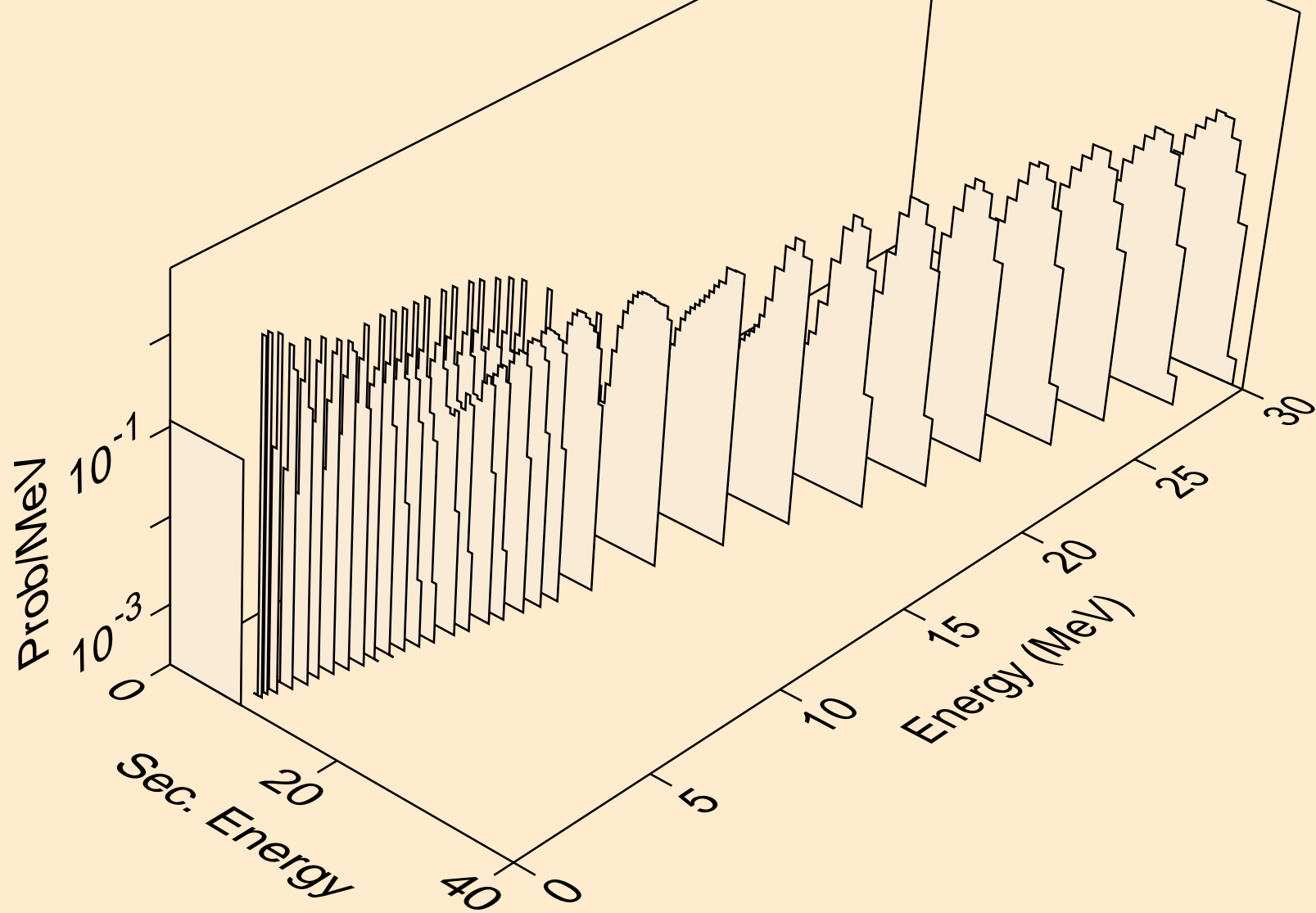

NO253 NEUTRON ACER TENDL-2021 LIBRARY; T=293.6K
alphas from (n,2n)a

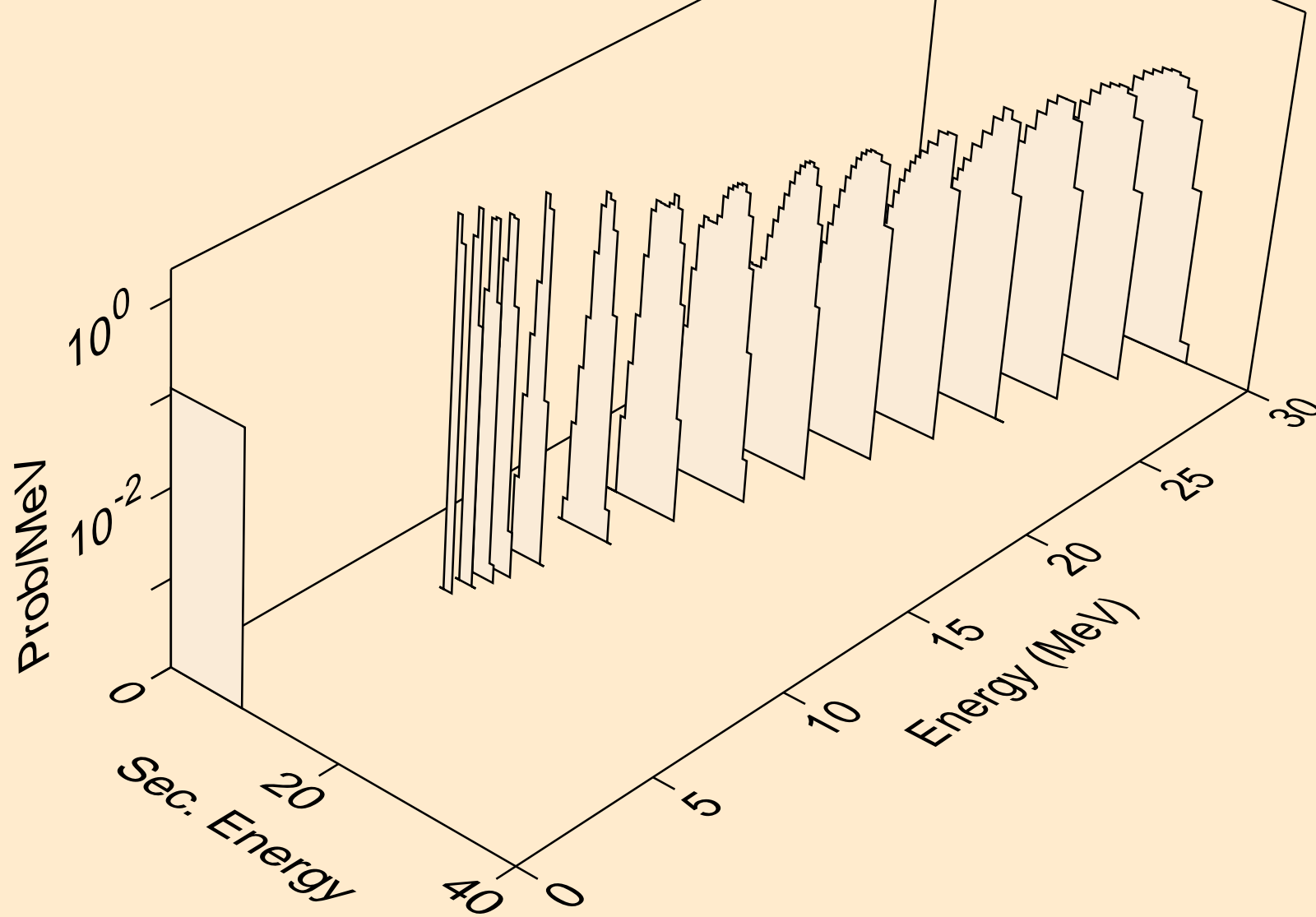

NO253 NEUTRON ACER TENDL-2021 LIBRARY; T=293.6K
alphas from (n,3n)a

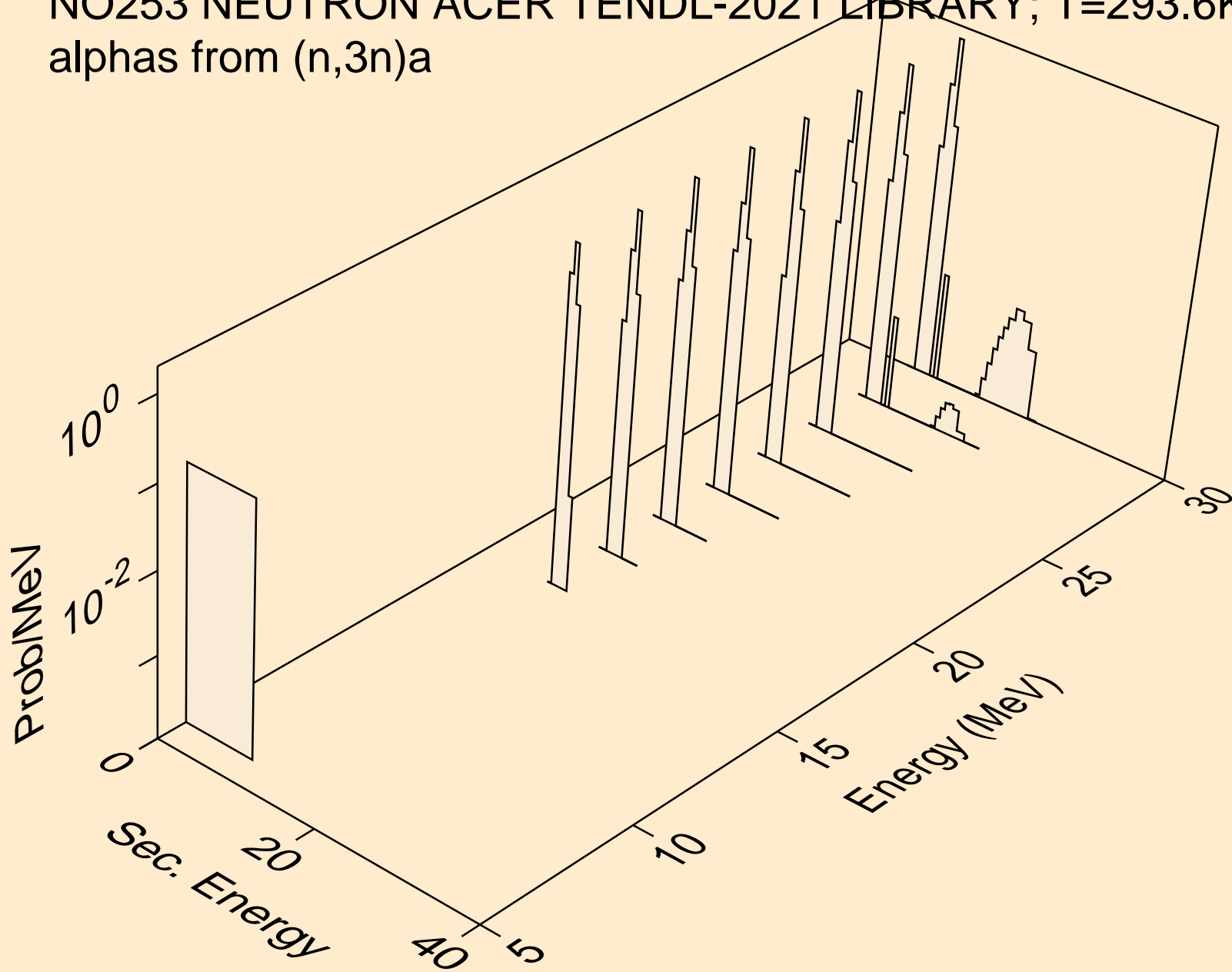

NO253 NEUTRON ACER TENDL-2021 LIBRARY; T=293.6K
alphas from (n,n*)2a

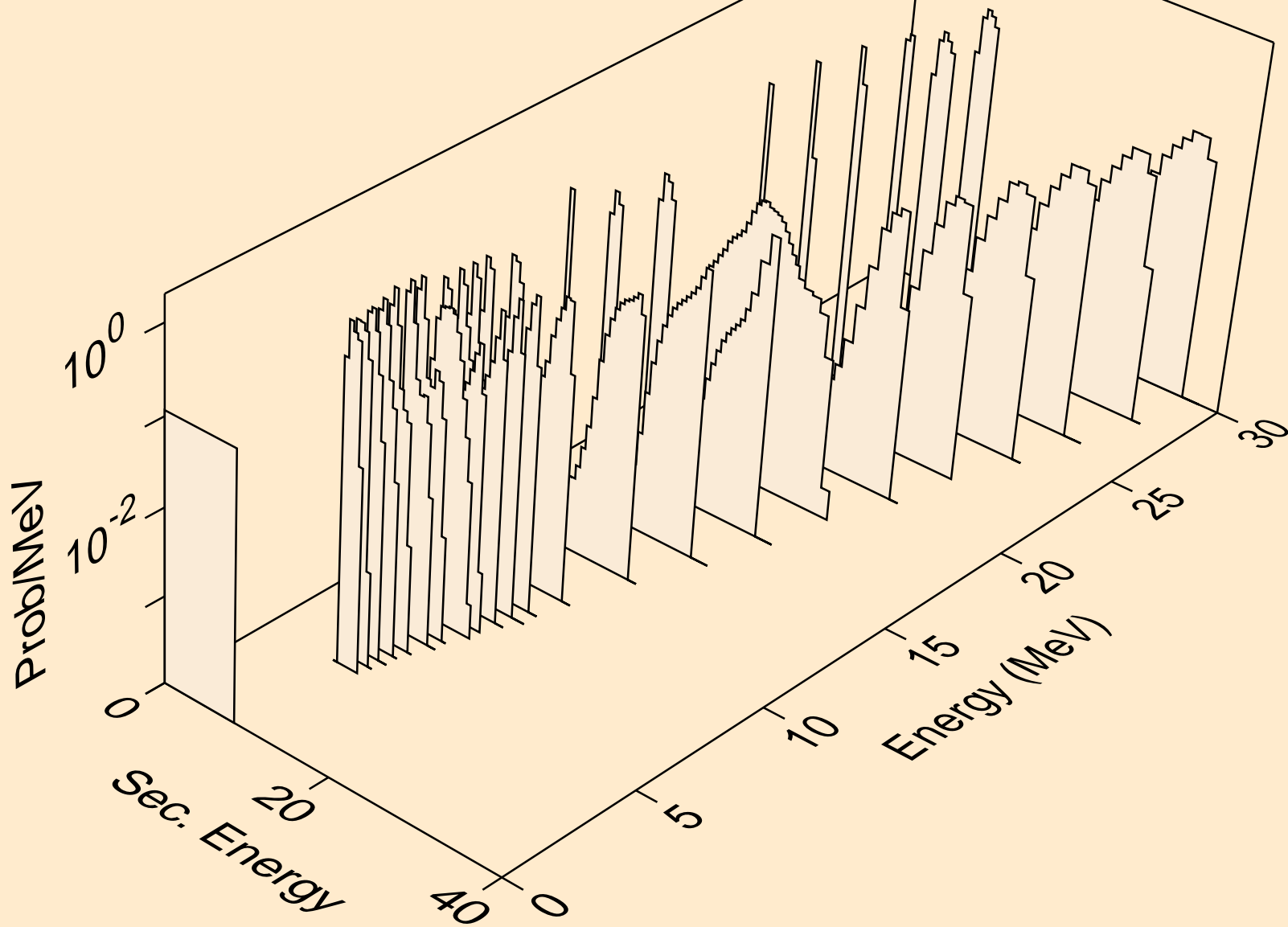

NO253 NEUTRON ACER TENDL-2021 LIBRARY; T=293.6K
alphas from (n,2n)2a

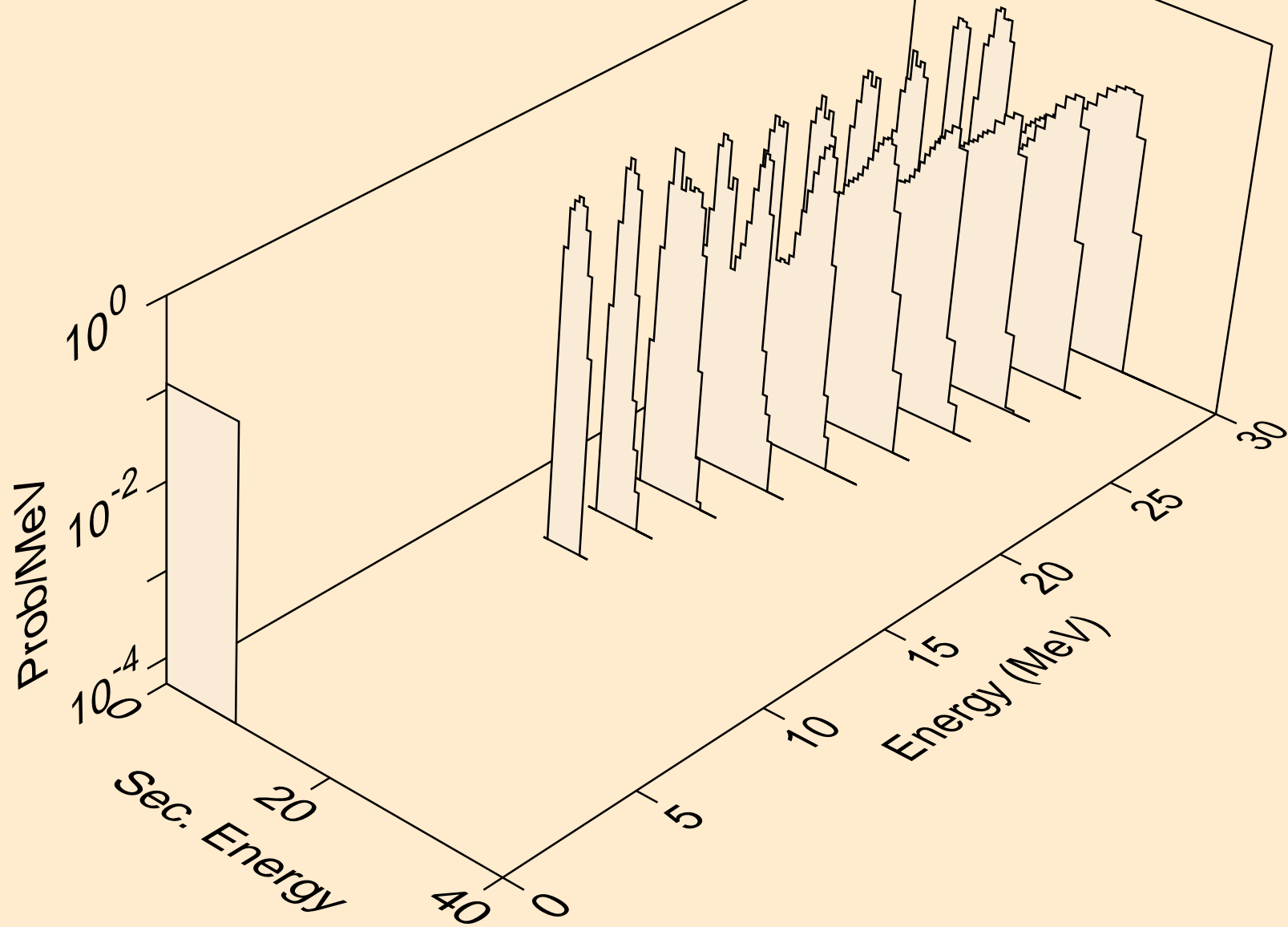

NO253 NEUTRON ACER TENDL-2021 LIBRARY; T=293.6K
alphas from (n,npa)

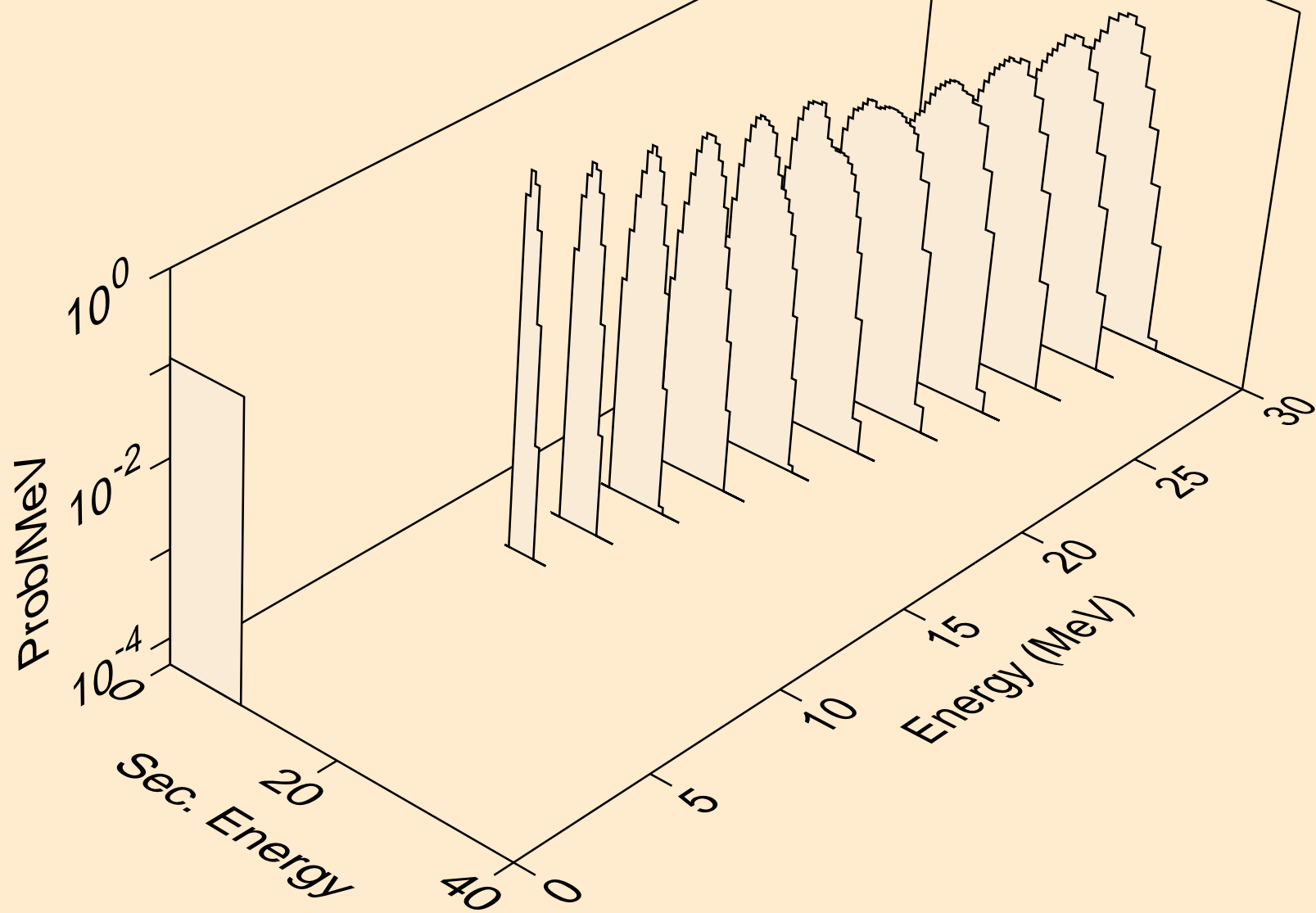

NO253 NEUTRON ACER TENDL-2021 LIBRARY; T=293.6K
alphas from (n,a)

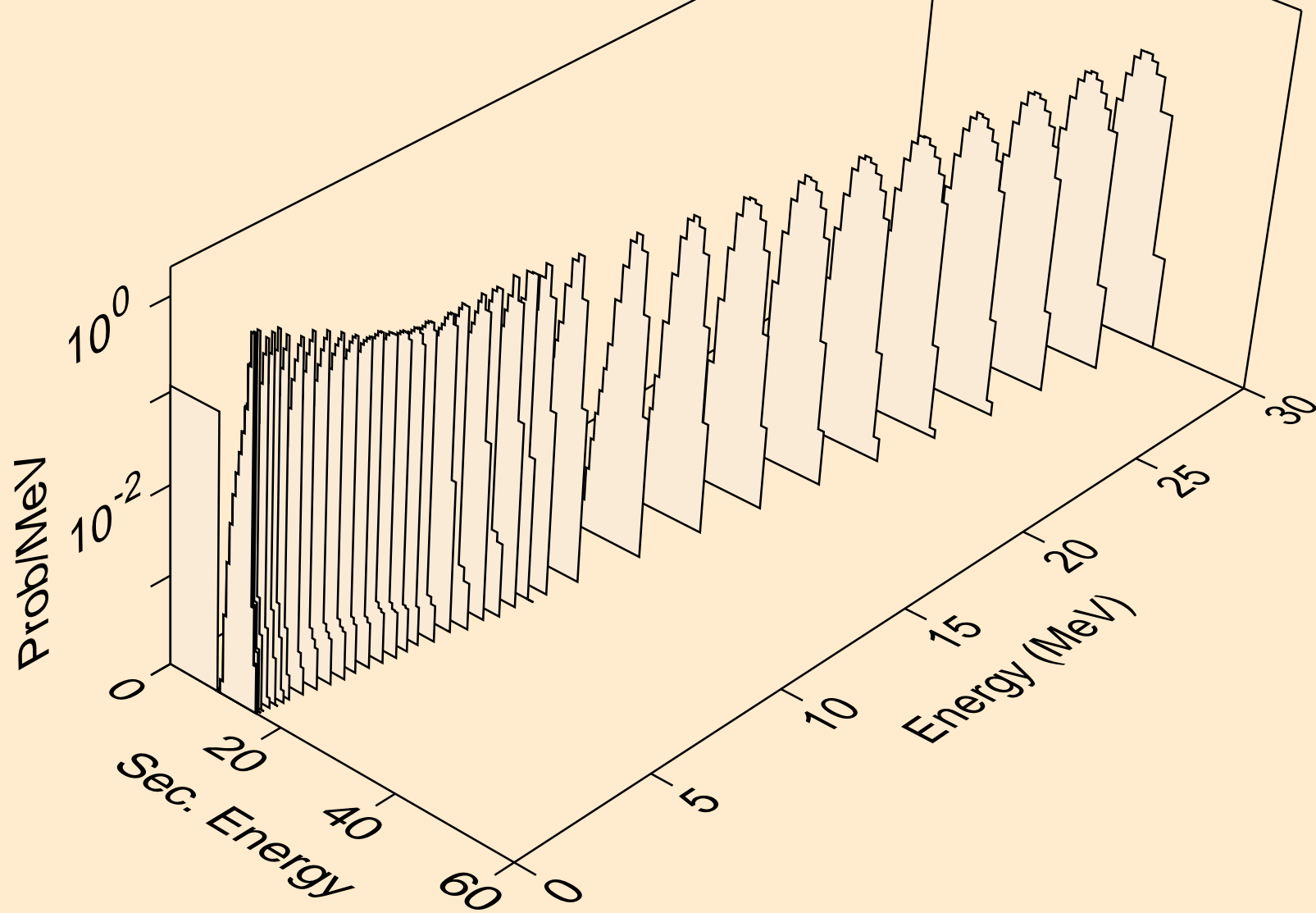

NO253 NEUTRON ACER TENDL-2021 LIBRARY; T=293.6K
alphas from (n,2a)

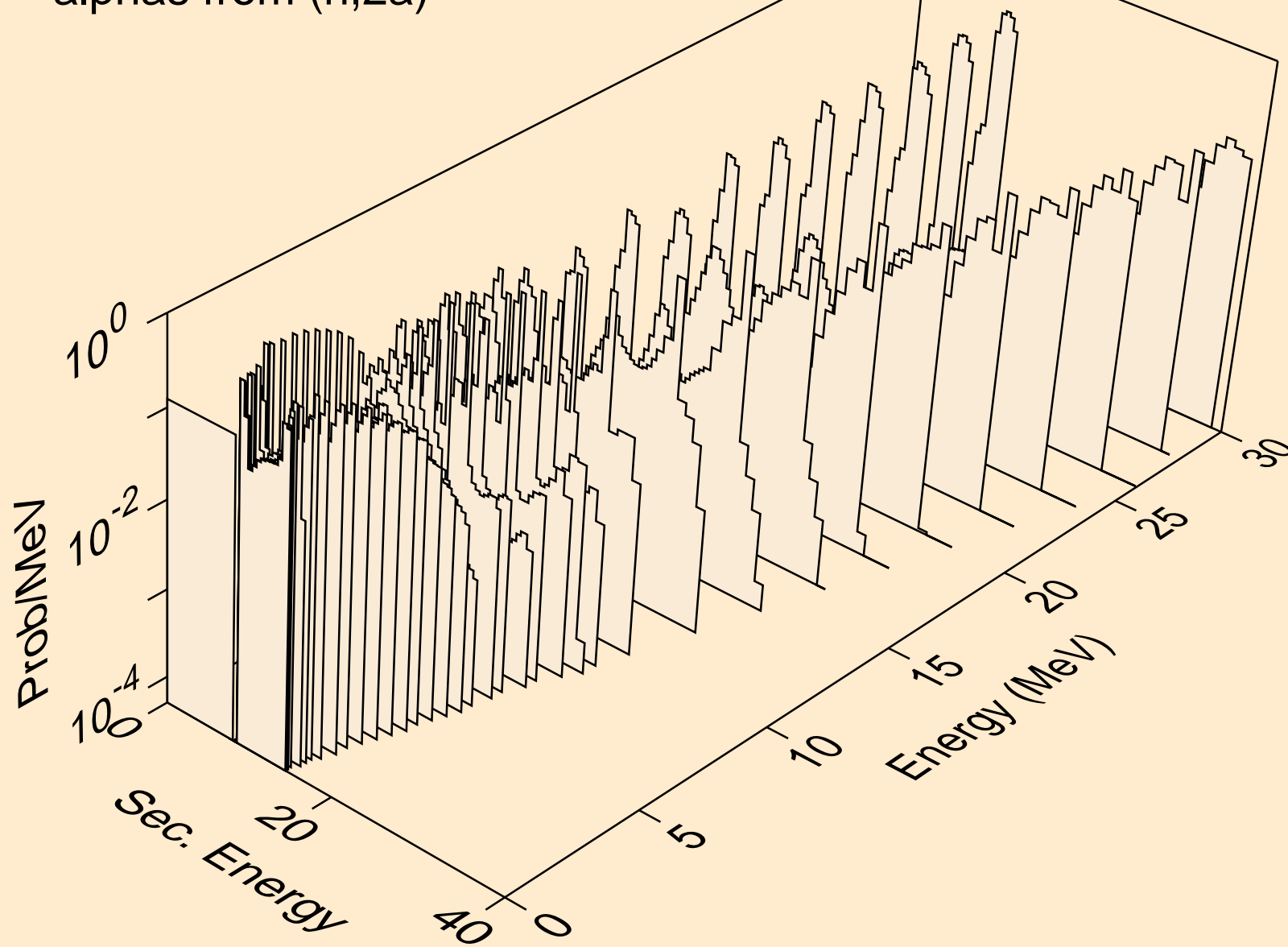

NO253 NEUTRON ACER TENDL-2021 LIBRARY; T=293.6K
alphas from (n,pa)

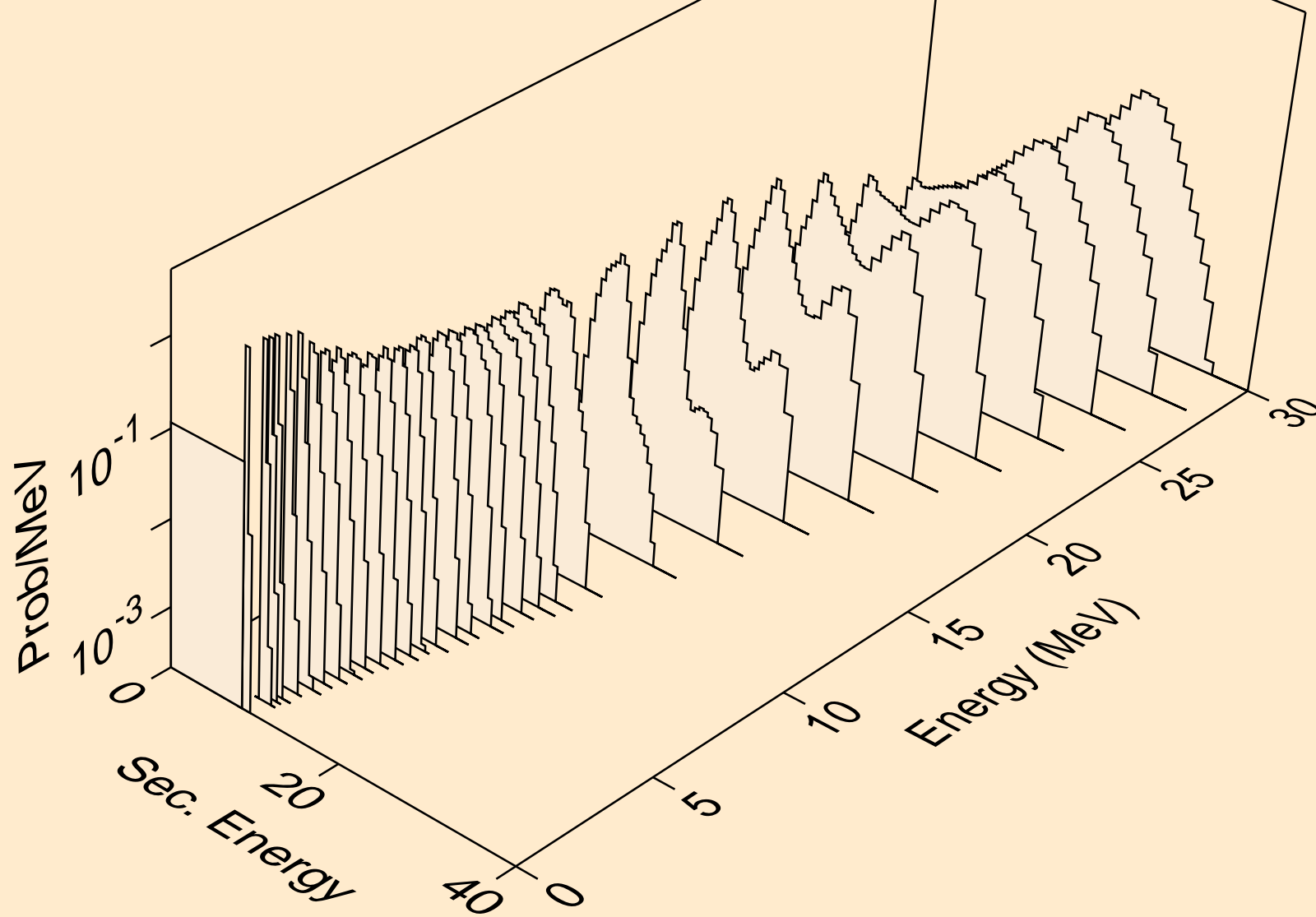

NO253 NEUTRON ACER TENDL-2021 LIBRARY; T=293.6K
alphas from (n,da)

