

NP236M NEUTRON ACER TENDL-2021 LIBRARY; T=293.6K
Principal cross sections

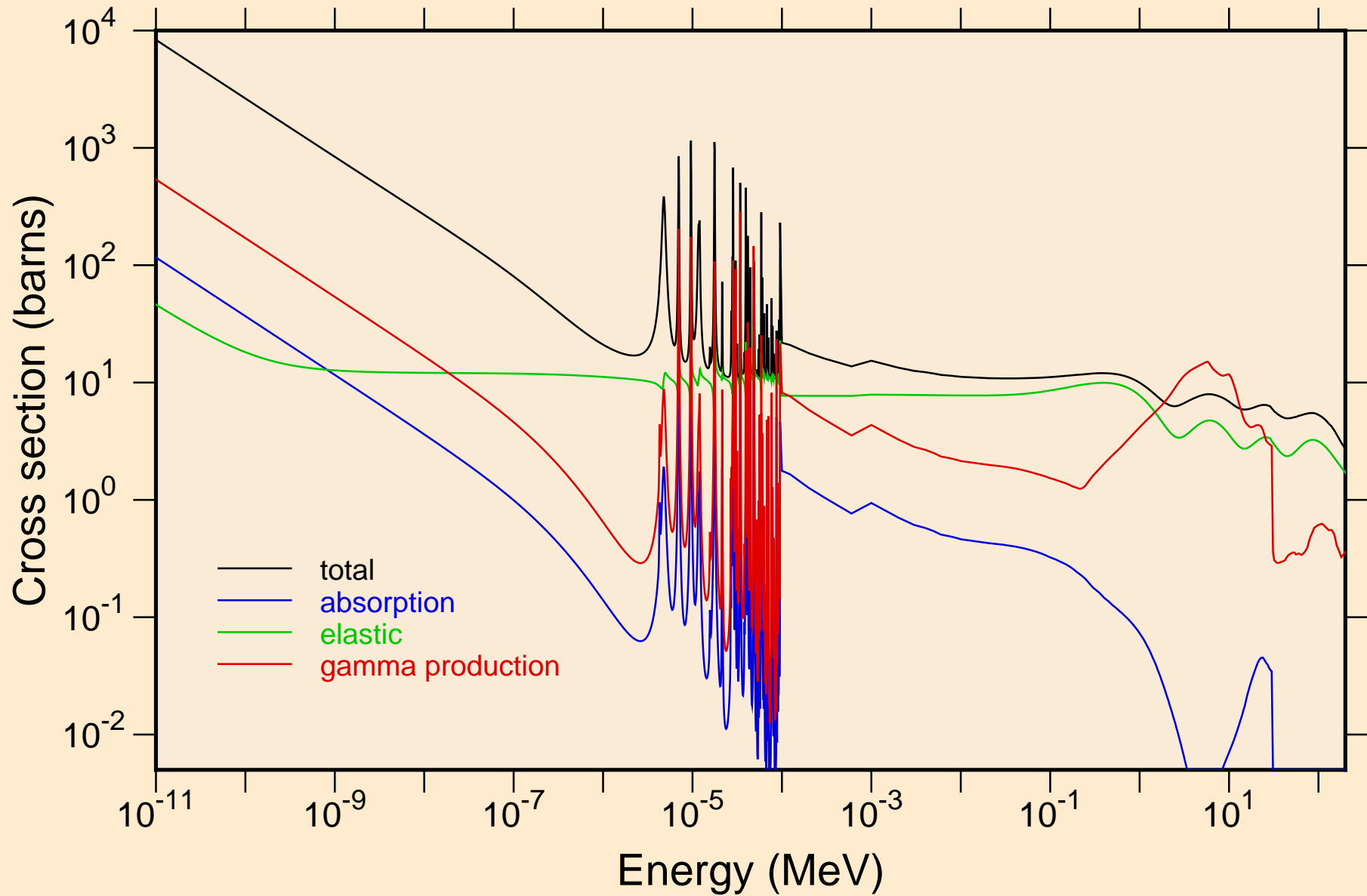

NP236M NEUTRON ACER TENDL-2021 LIBRARY; T=293.6K
resonance total cross section

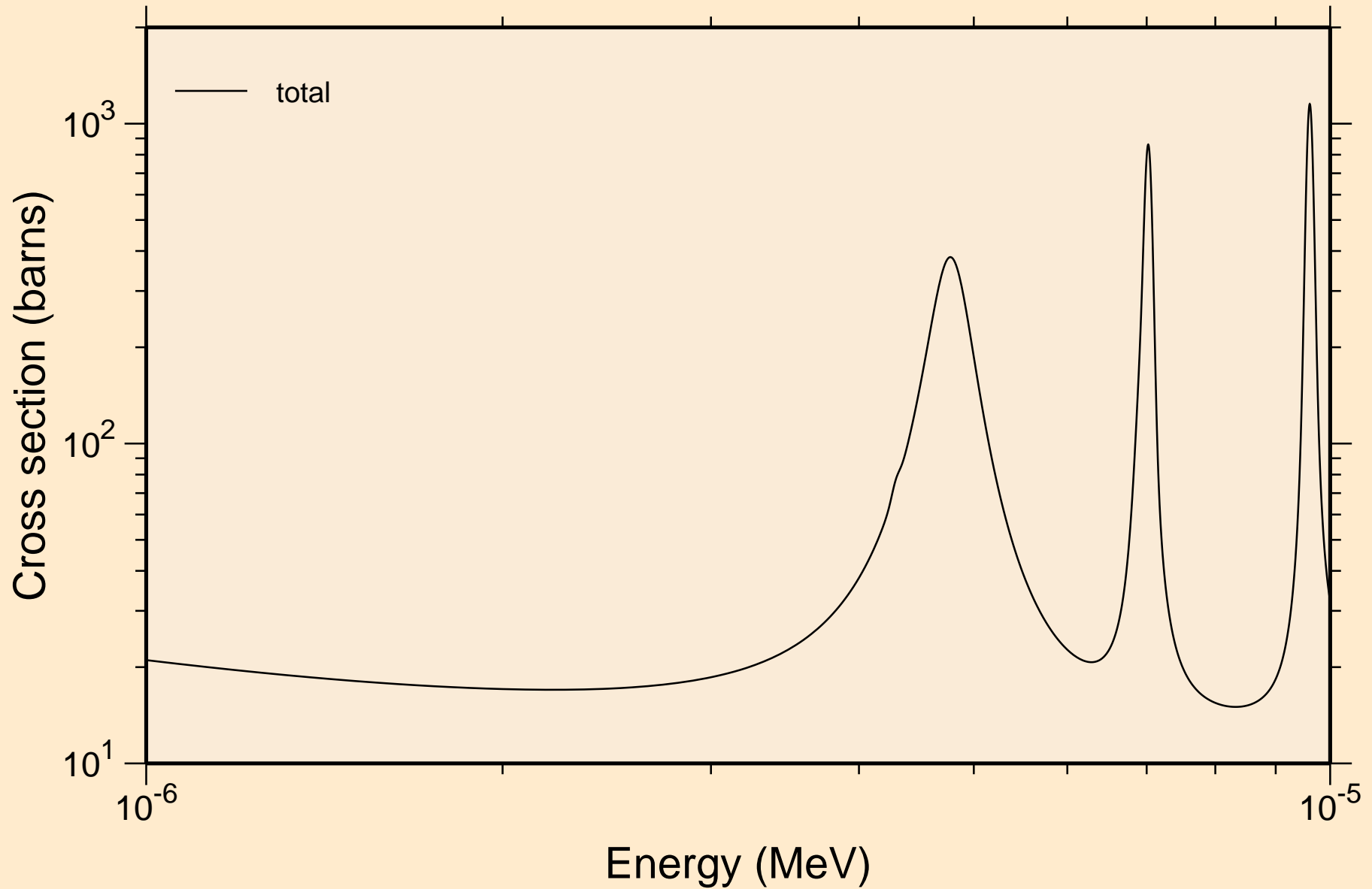

NP236M NEUTRON ACER TENDL-2021 LIBRARY; T=293.6K
resonance total cross section

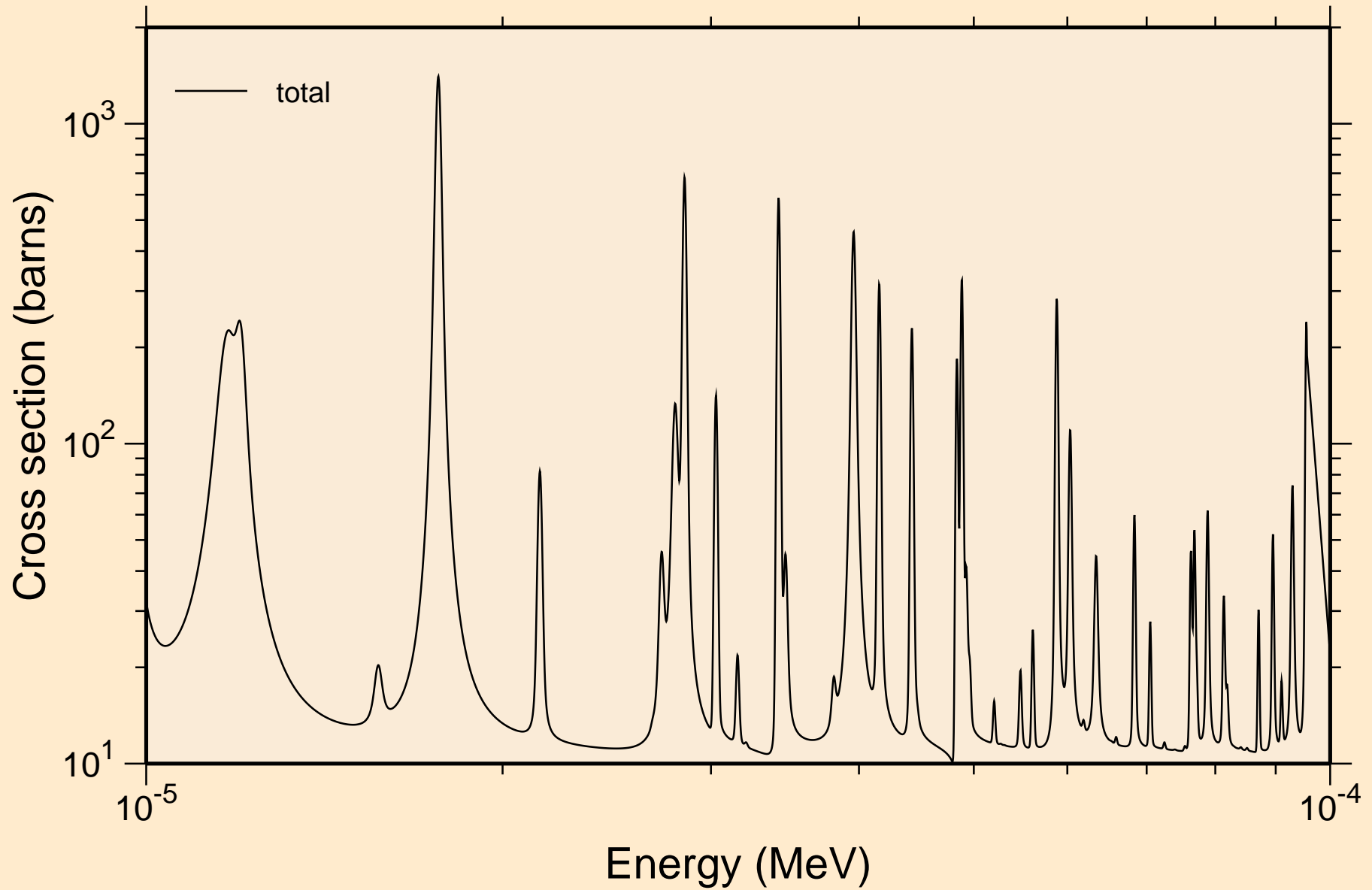

NP236M NEUTRON ACER TENDL-2021 LIBRARY; T=293.6K
resonance total cross section

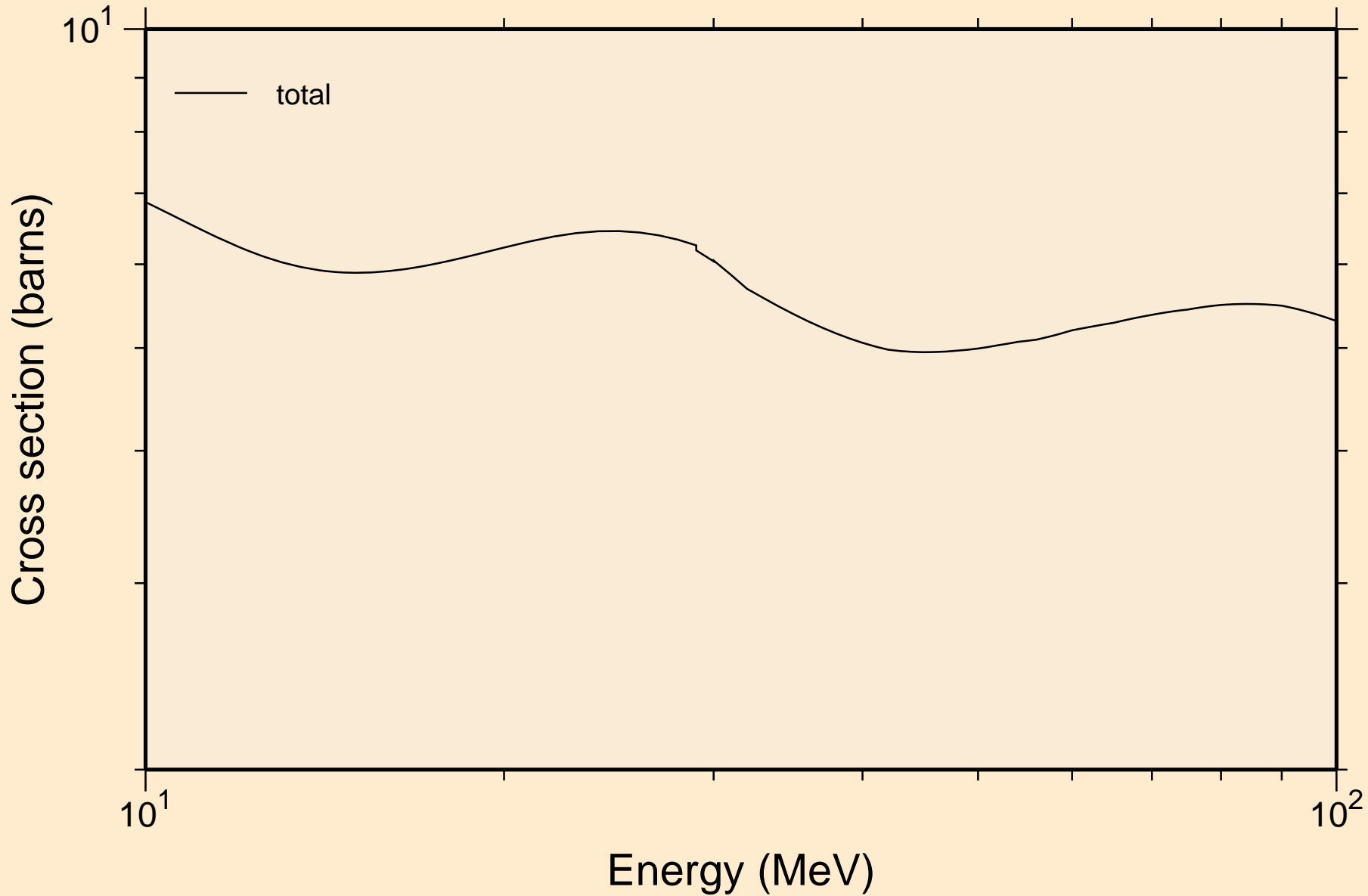

NP236M NEUTRON ACER TENDL-2021 LIBRARY; T=293.6K
resonance absorption cross sections

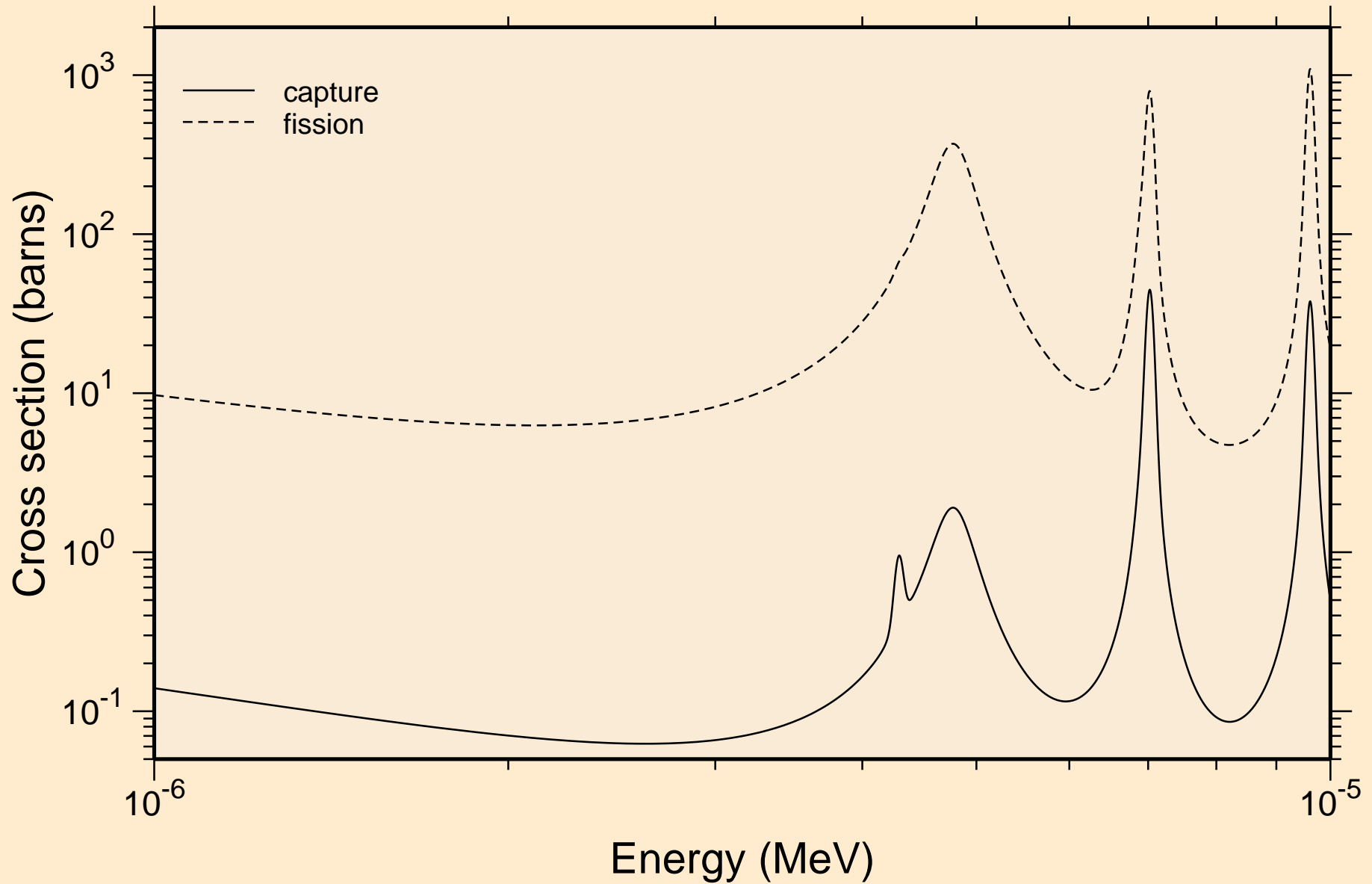

NP236M NEUTRON ACER TENDL-2021 LIBRARY; T=293.6K
resonance absorption cross sections

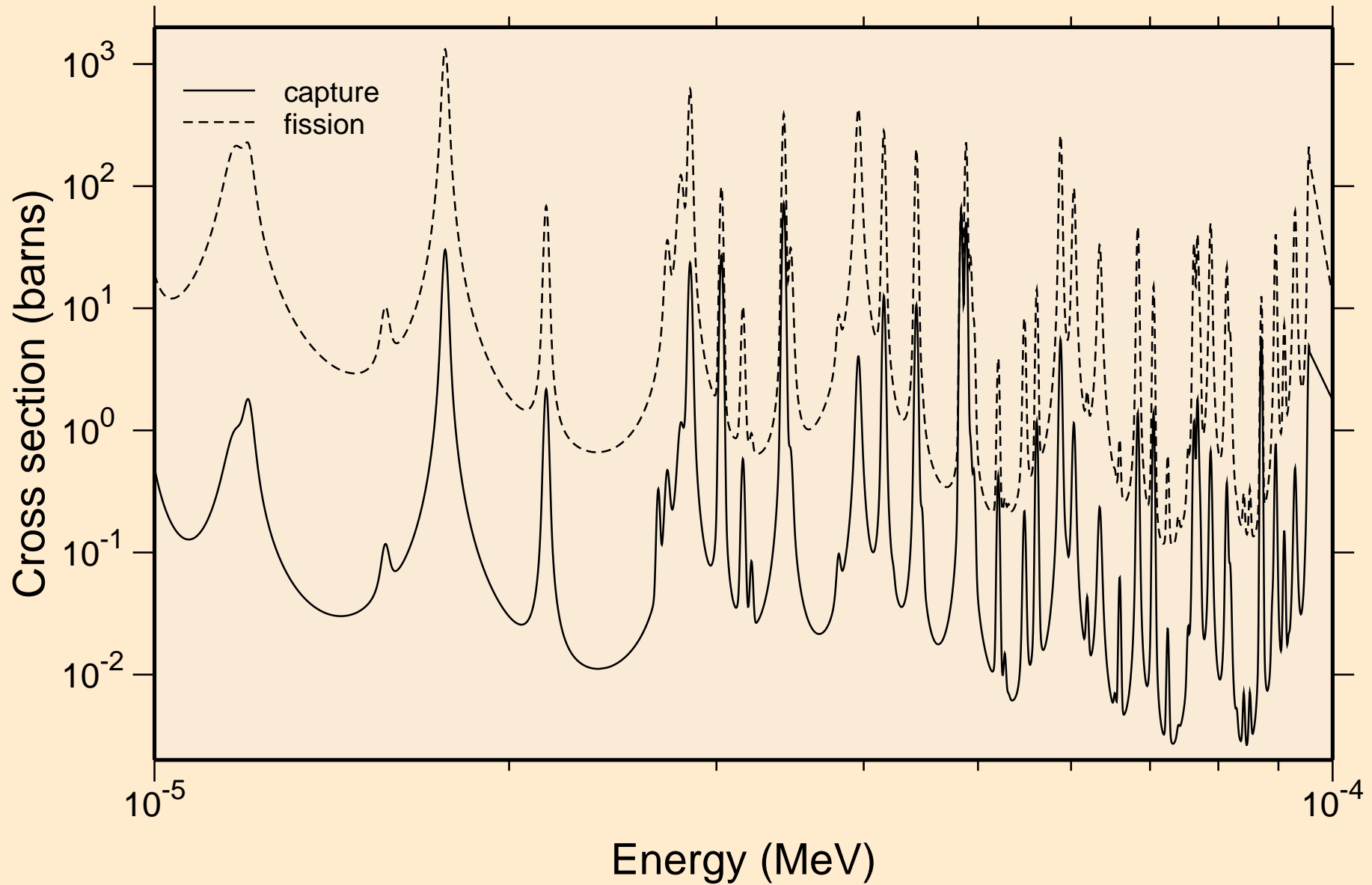

NP236M NEUTRON ACER TENDL-2021 LIBRARY; T=293.6K
resonance absorption cross sections

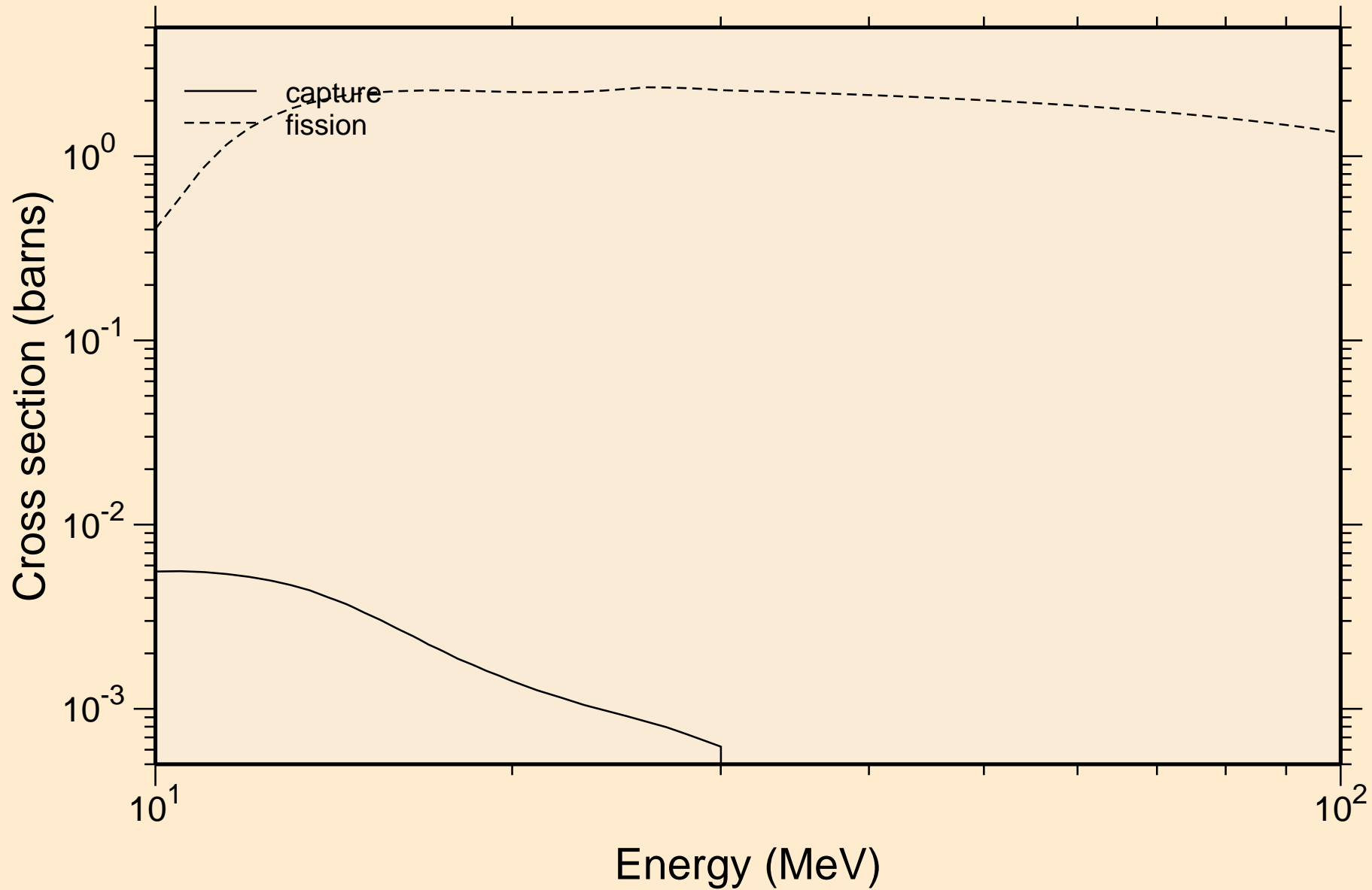

NP236M NEUTRON ACER TENDL-2021 LIBRARY; T=293.6K
Heating

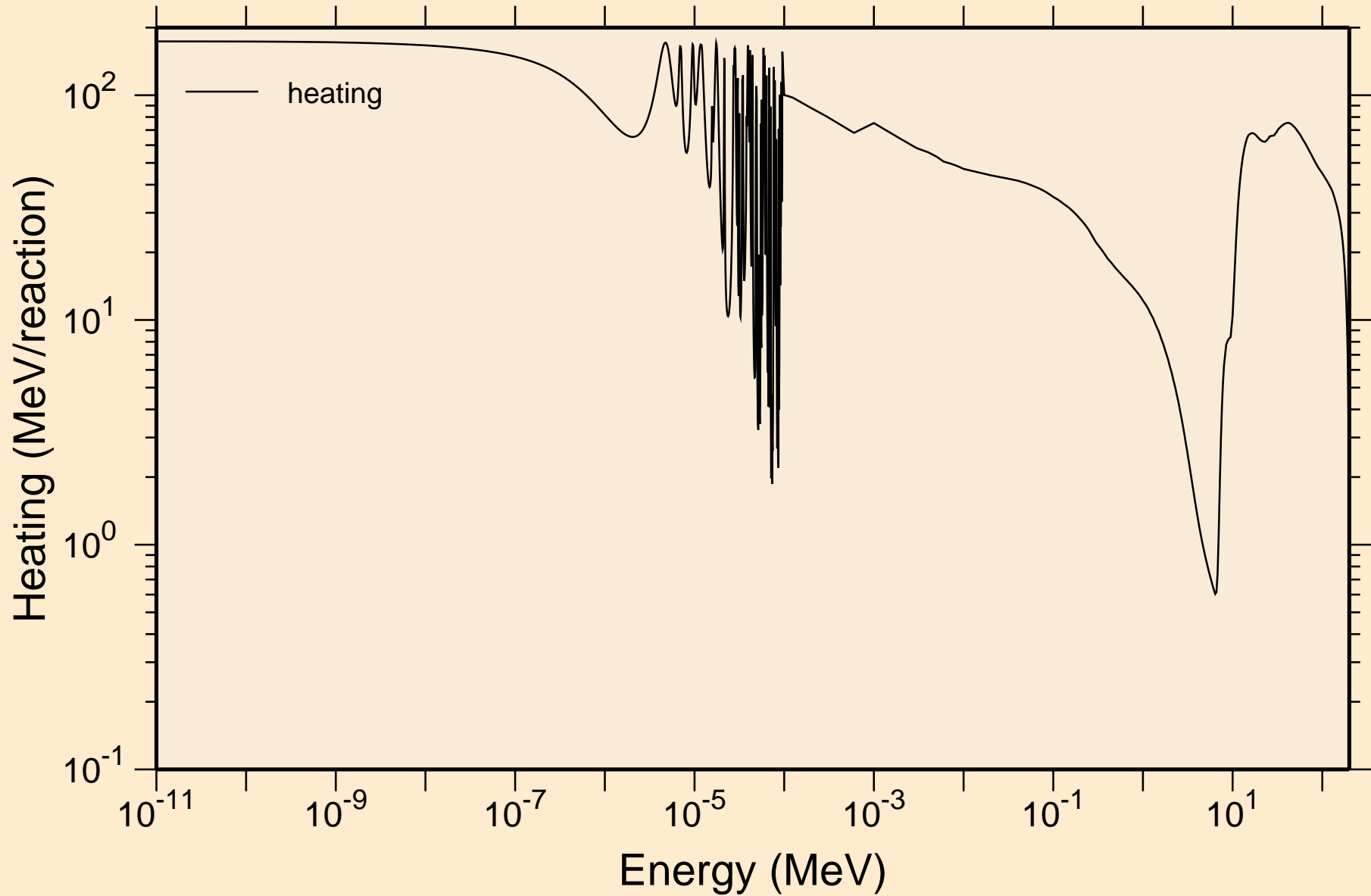

NP236M NEUTRON ACER TENDL-2021 LIBRARY; T=293.6K
Damage

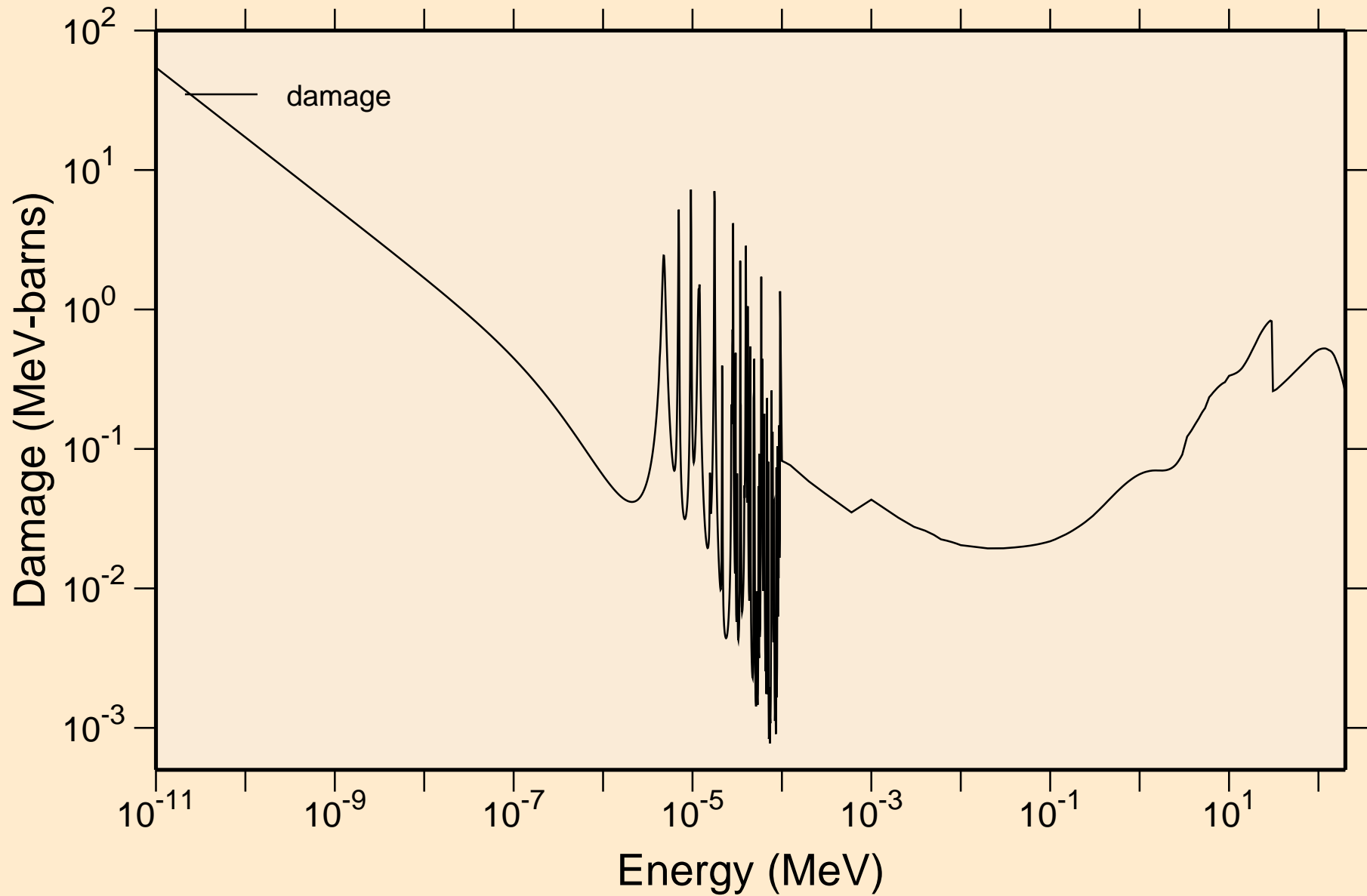

NP236M NEUTRON ACER TENDL-2021 LIBRARY; T=293.6K
Non-threshold reactions

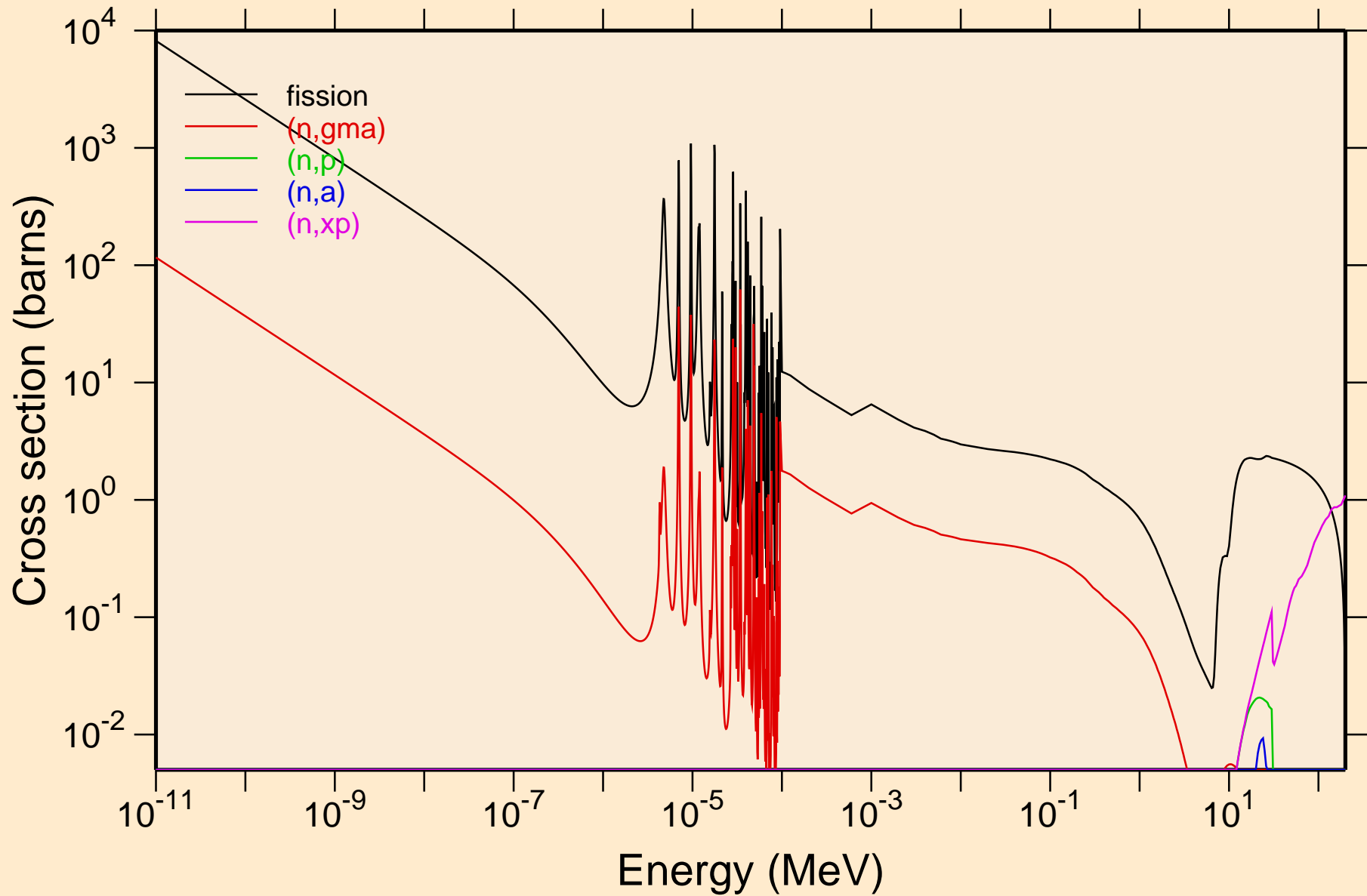

NP236M NEUTRON ACER TENDL-2021 LIBRARY; T=293.6K
Non-threshold reactions

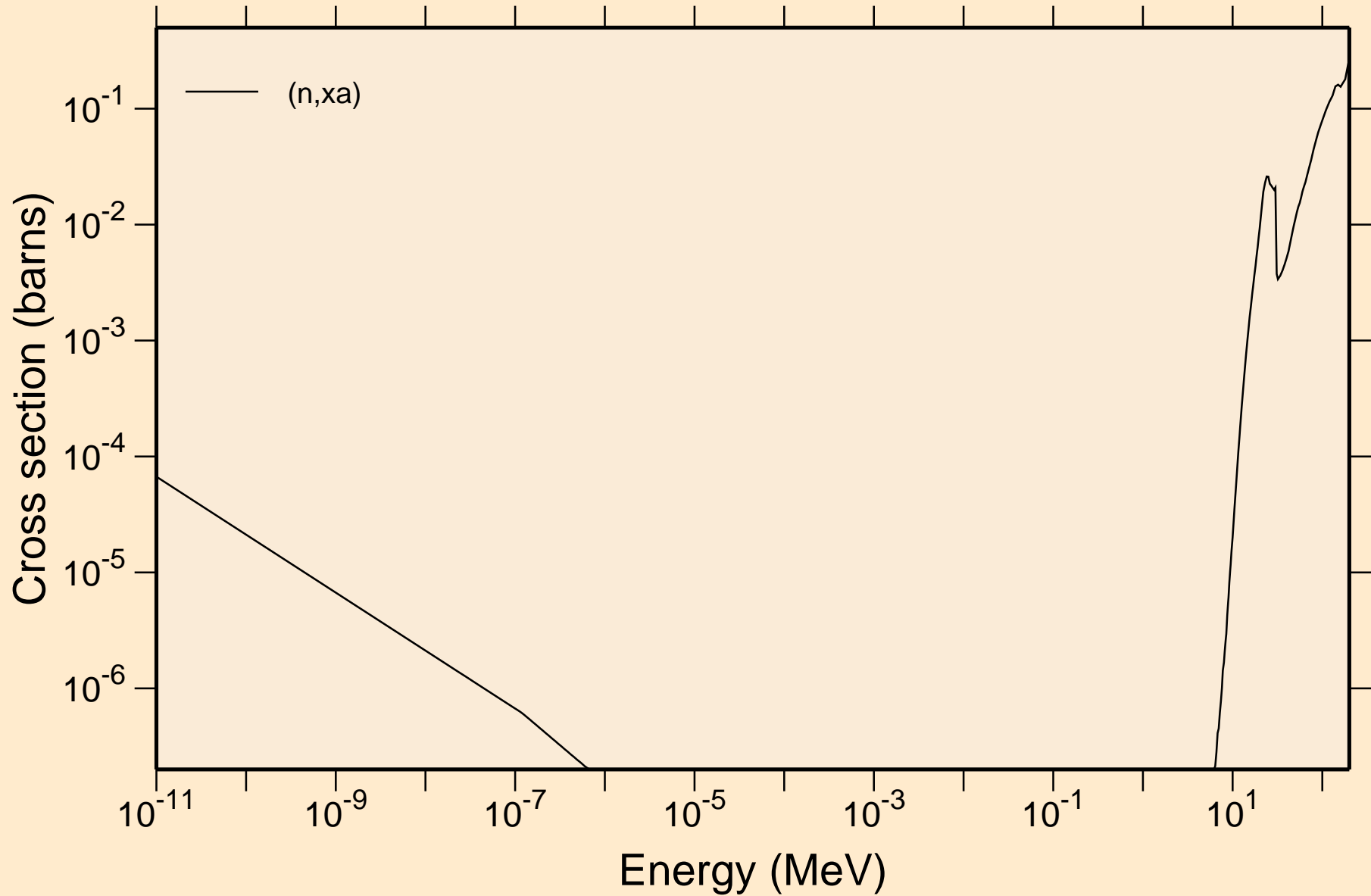

NP236M NEUTRON ACER TENDL-2021 LIBRARY; T=293.6K
Principal cross sections

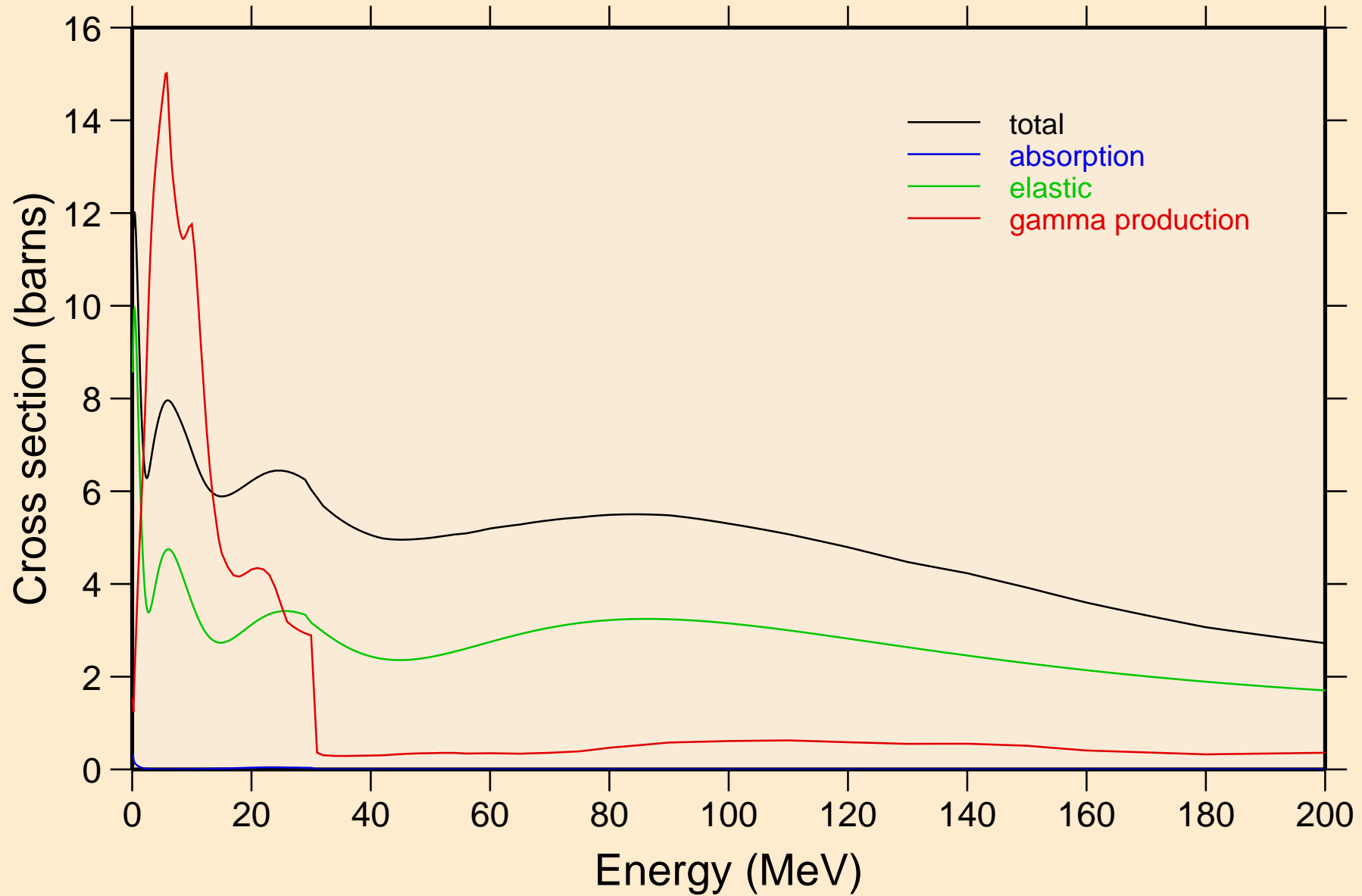

NP236M NEUTRON ACER TENDL-2021 LIBRARY; T=293.6K
Heating

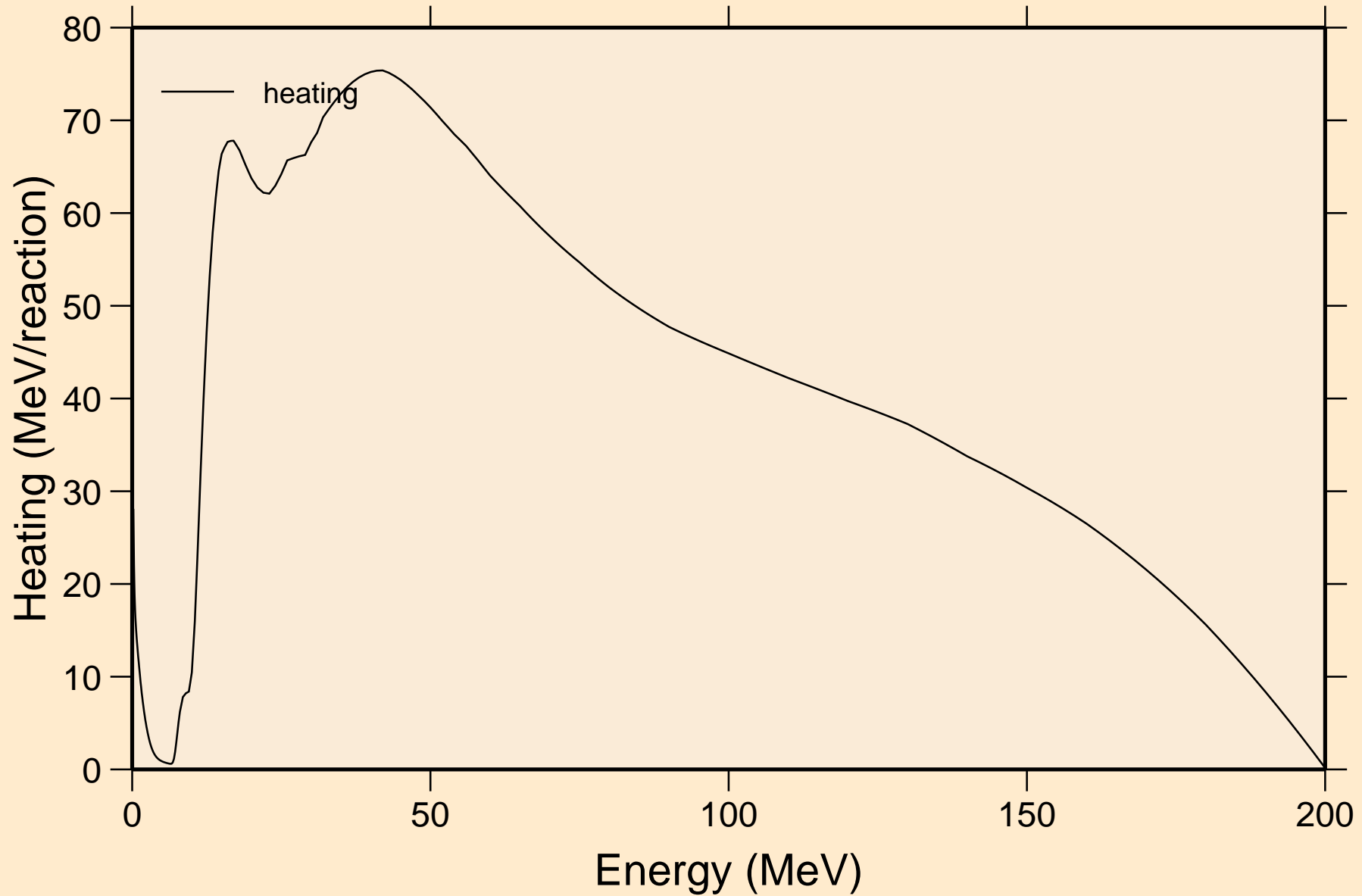

NP236M NEUTRON ACER TENDL-2021 LIBRARY; T=293.6K
Damage

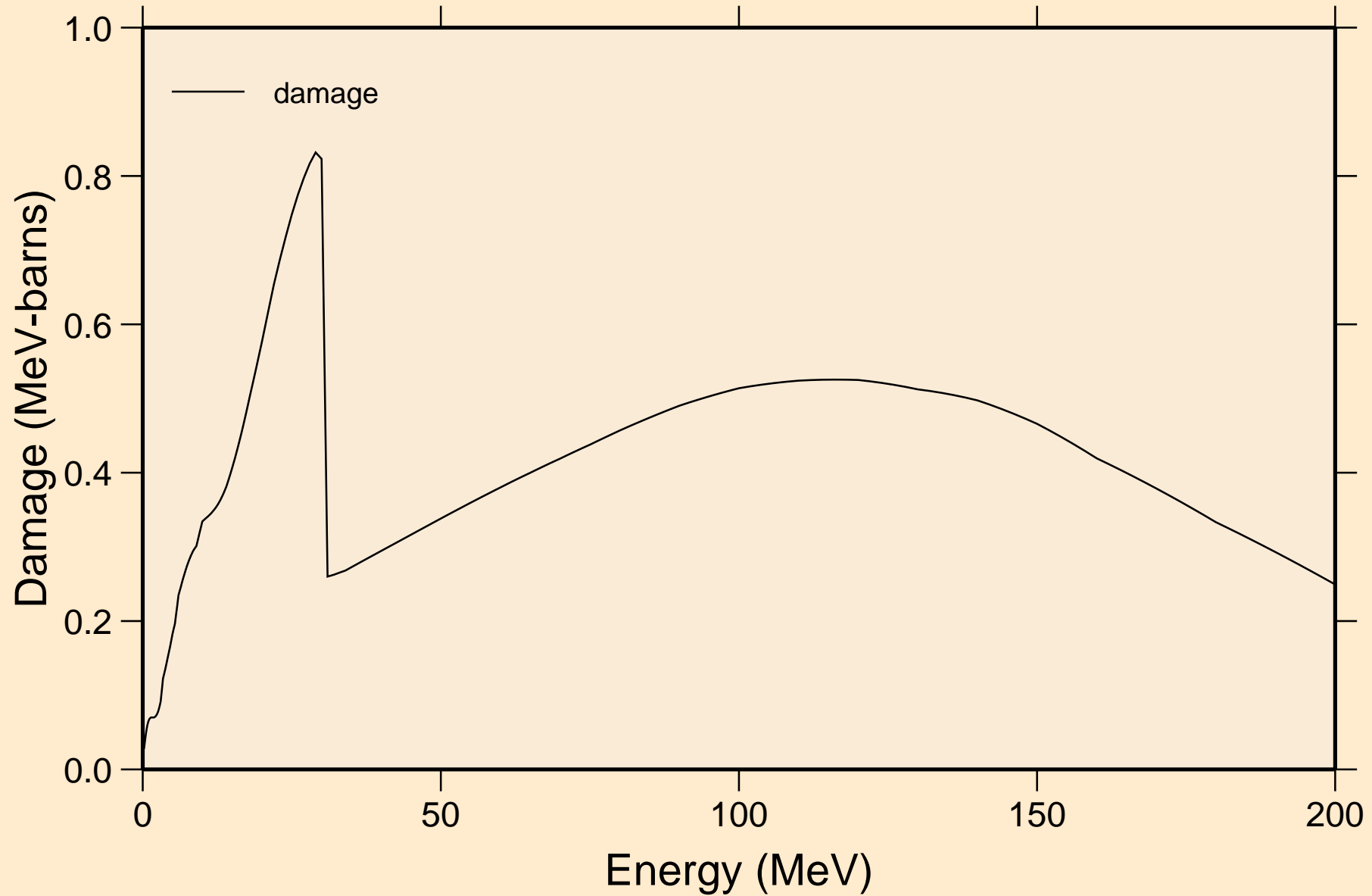

NP236M NEUTRON ACER TENDL-2021 LIBRARY; T=293.6K
Non-threshold reactions

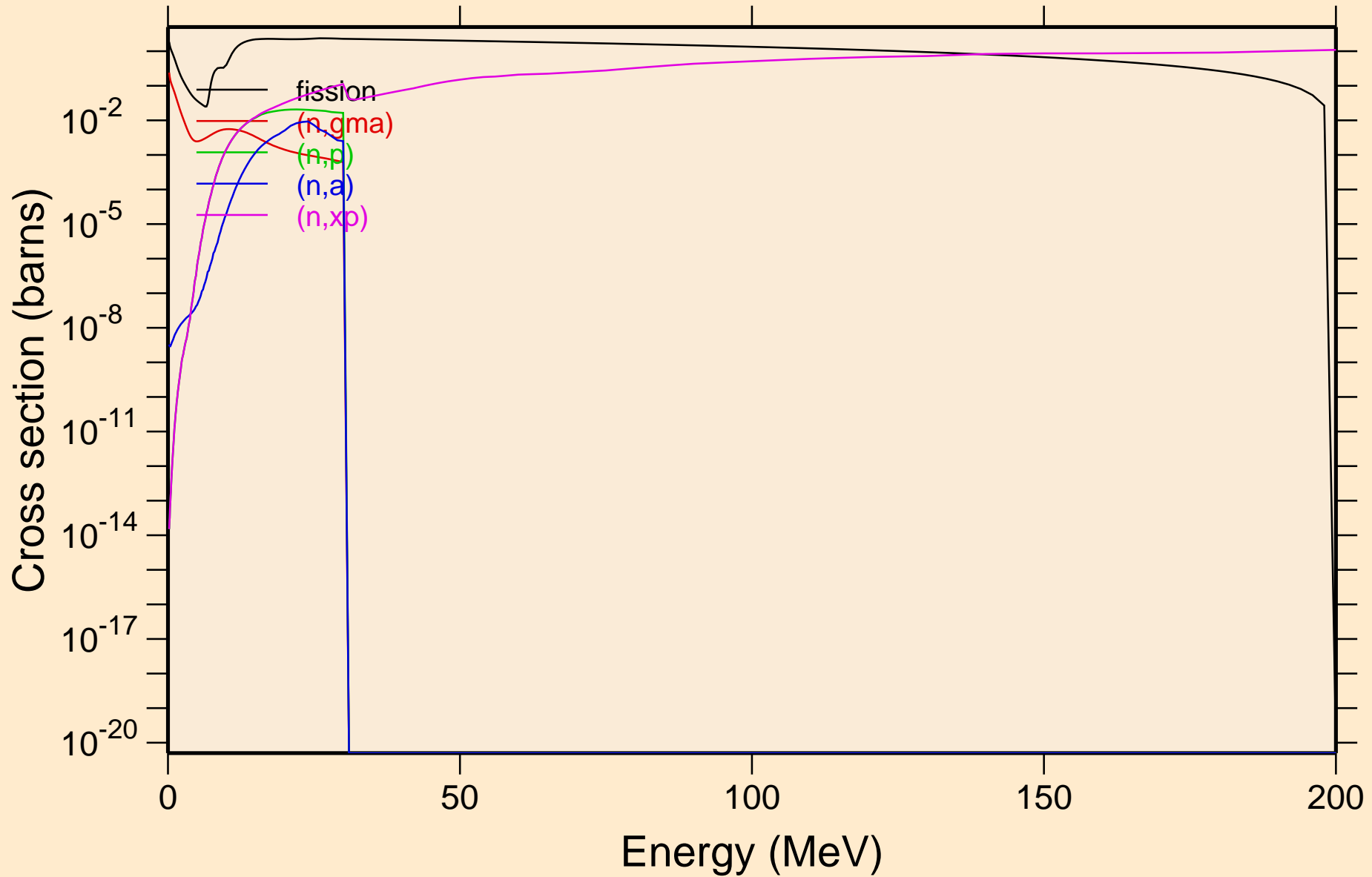

NP236M NEUTRON ACER TENDL-2021 LIBRARY; T=293.6K
Non-threshold reactions

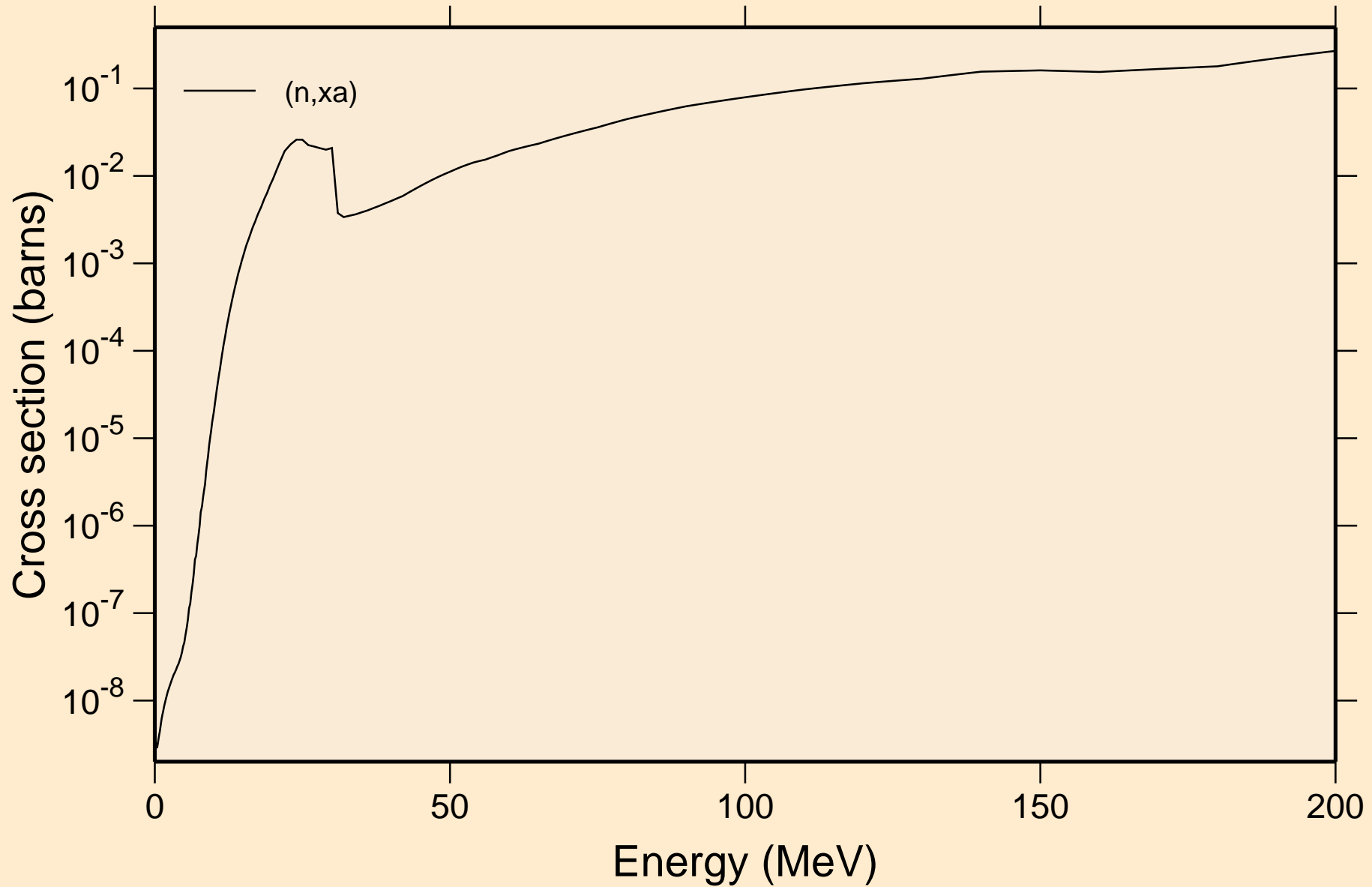

NP236M NEUTRON ACER TENDL-2021 LIBRARY; T=293.6K
Inelastic levels

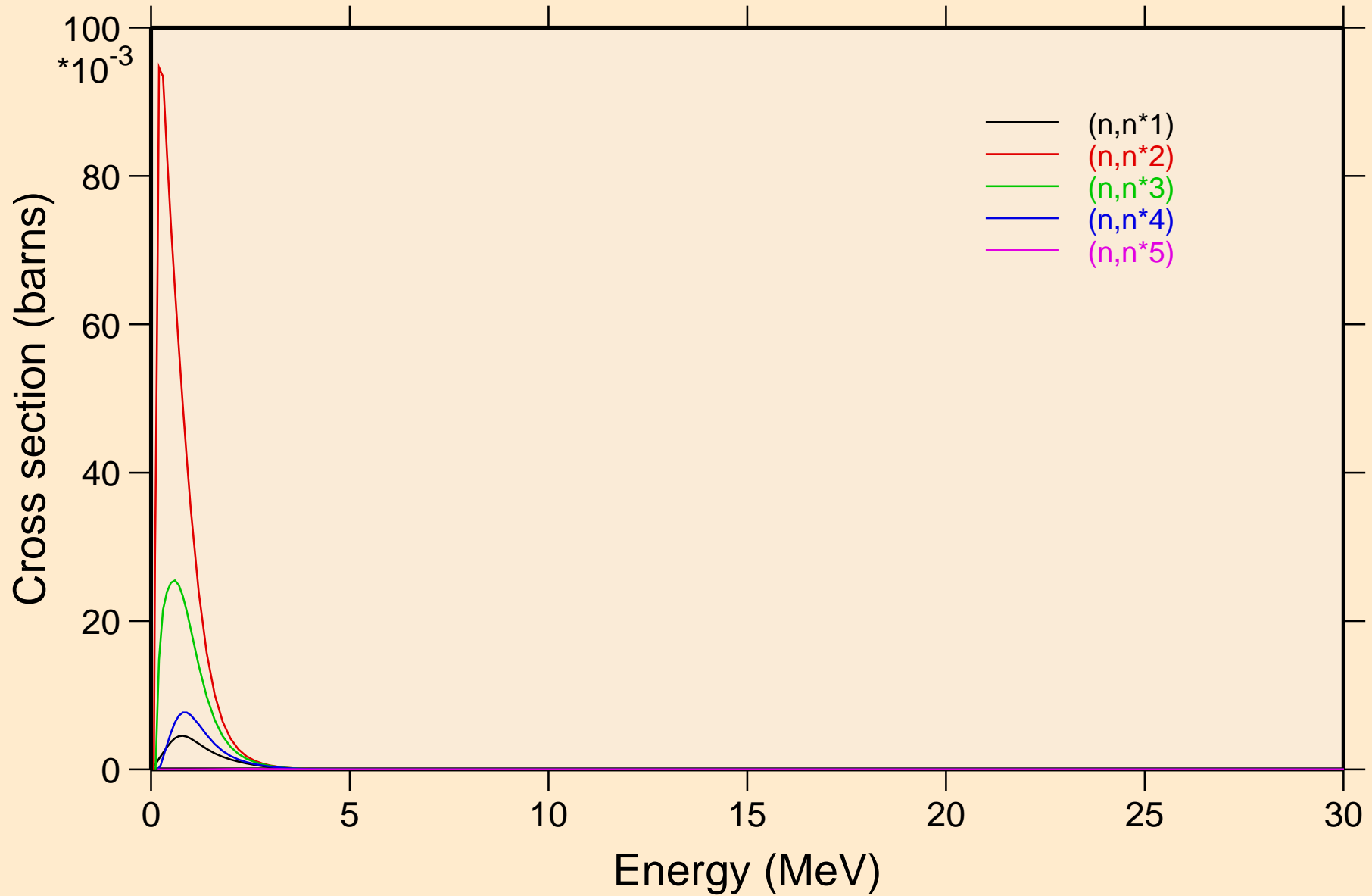

NP236M NEUTRON ACER TENDL-2021 LIBRARY; T=293.6K
Inelastic levels

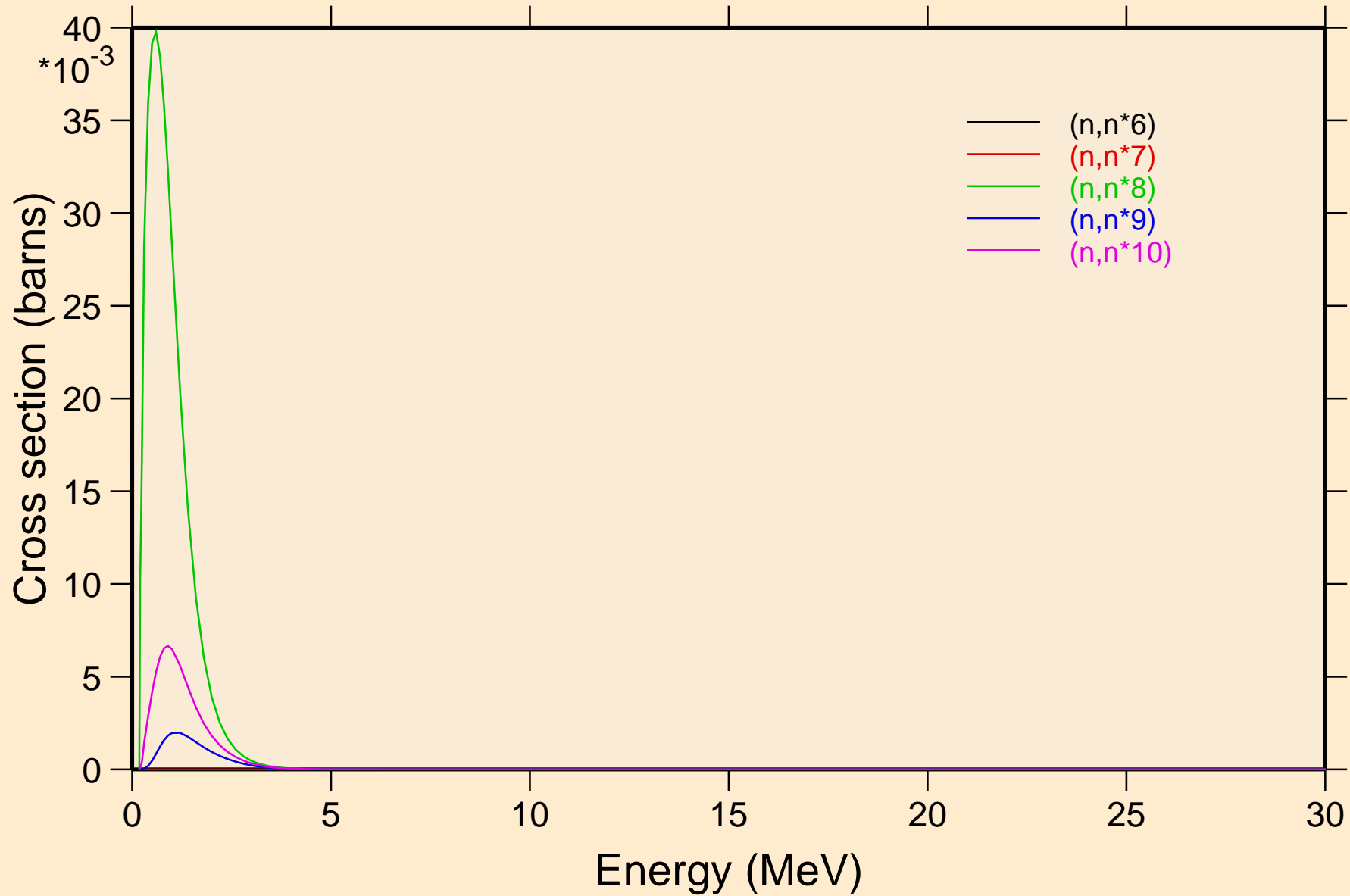

NP236M NEUTRON ACER TENDL-2021 LIBRARY; T=293.6K
Inelastic levels

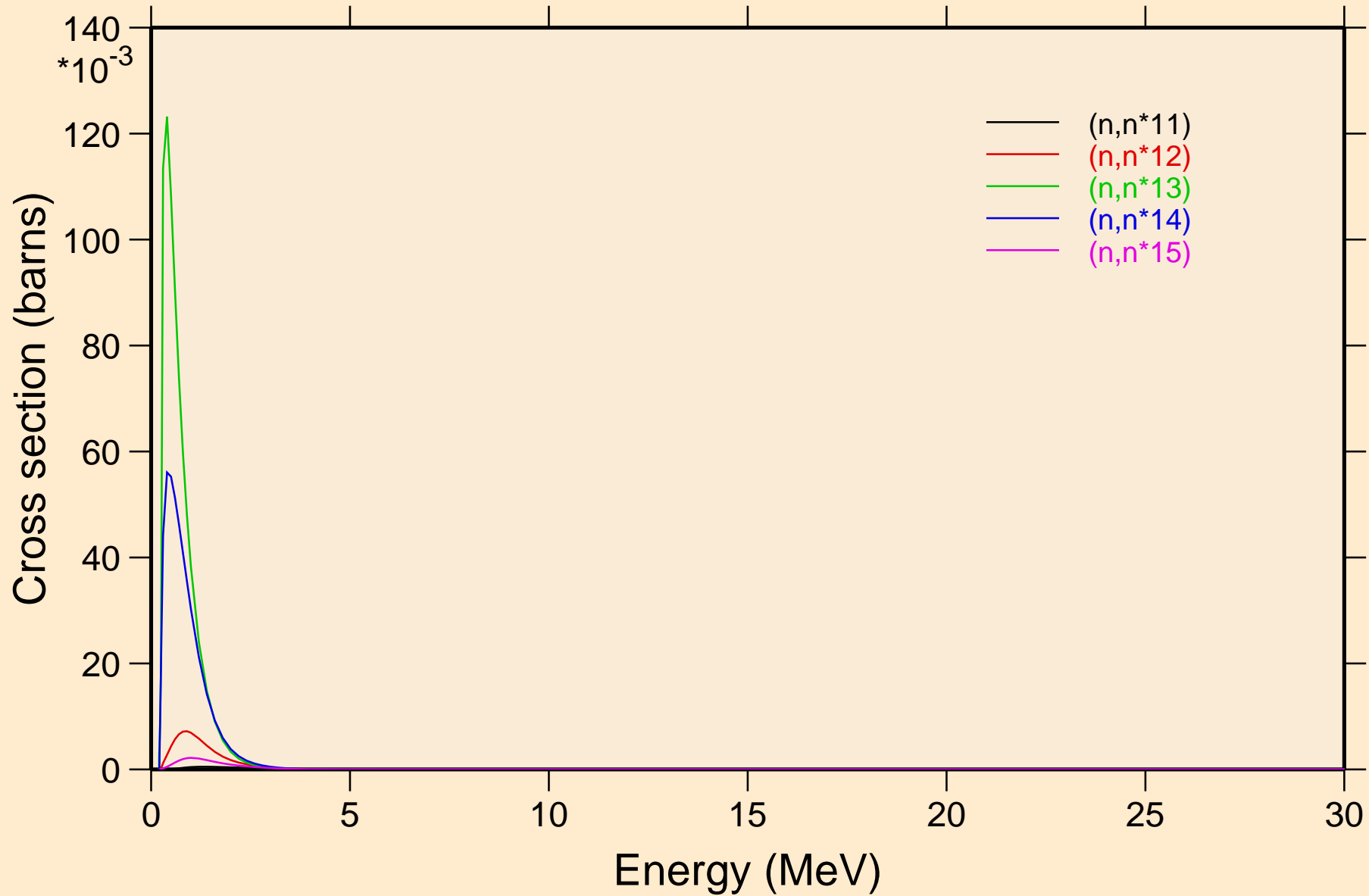

NP236M NEUTRON ACER TENDL-2021 LIBRARY; T=293.6K
Inelastic levels

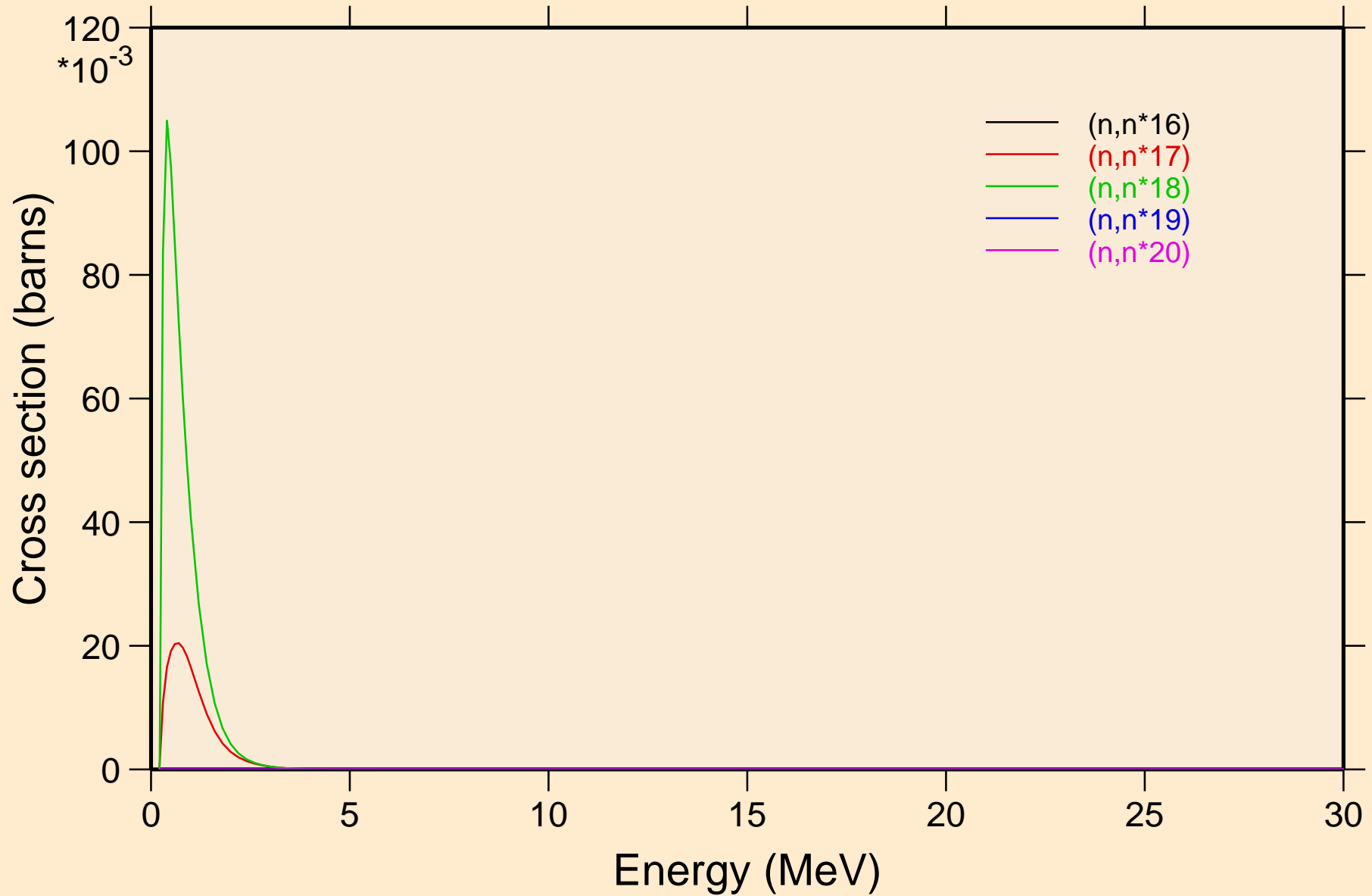

NP236M NEUTRON ACER TENDL-2021 LIBRARY; T=293.6K
Inelastic levels

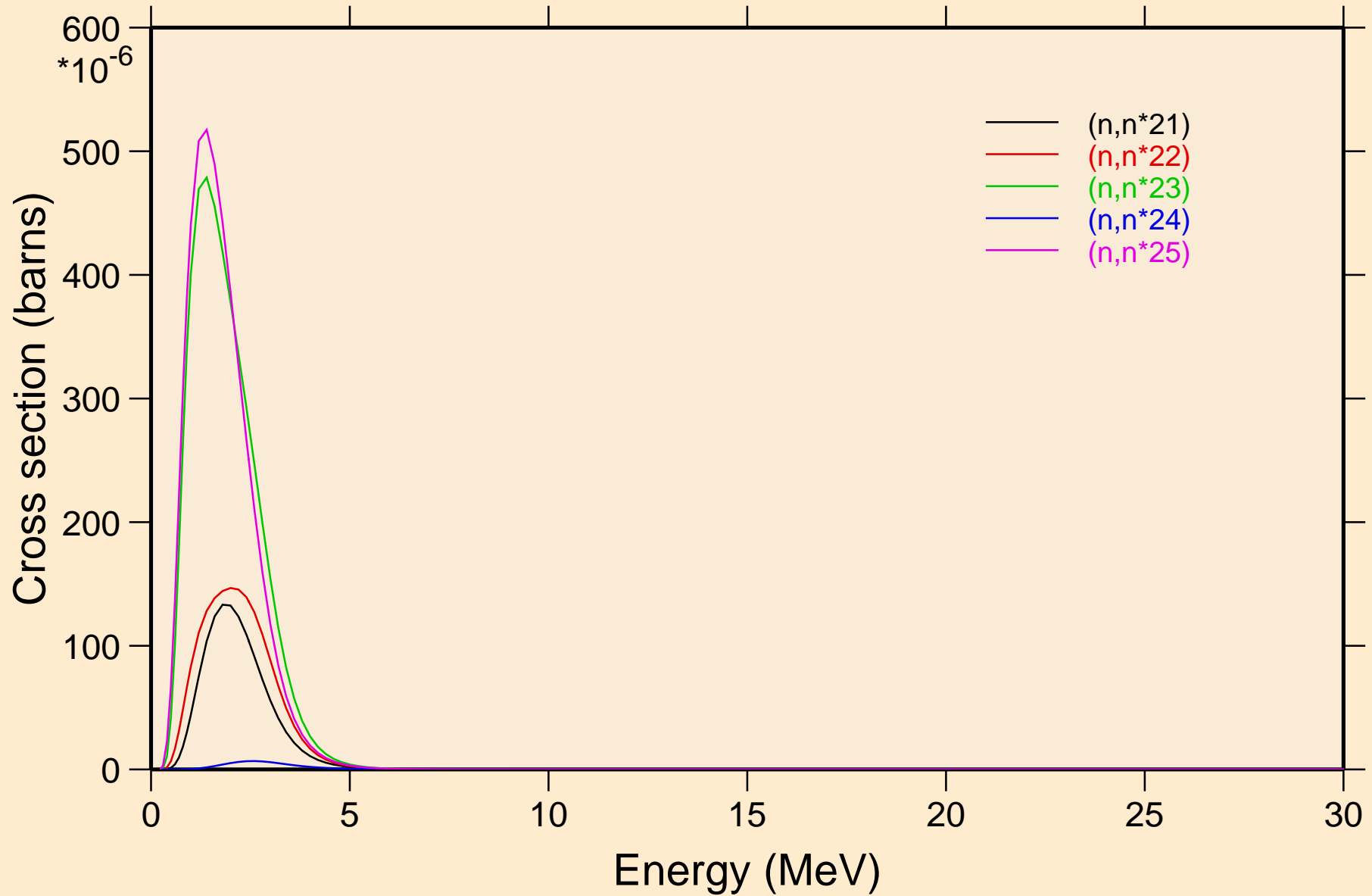

NP236M NEUTRON ACER TENDL-2021 LIBRARY; T=293.6K
Inelastic levels

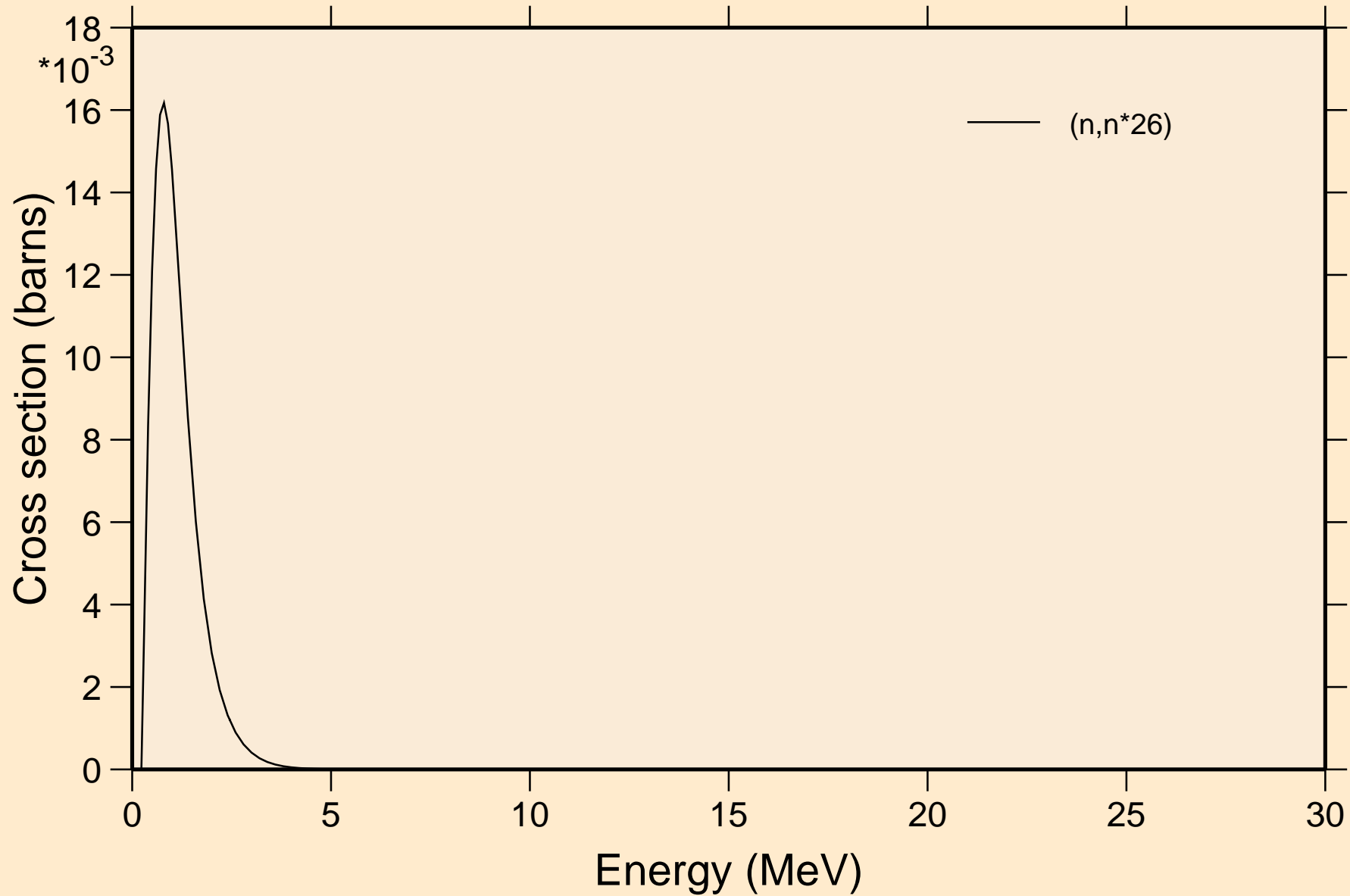

NP236M NEUTRON ACER TENDL-2021 LIBRARY; T=293.6K
Threshold reactions

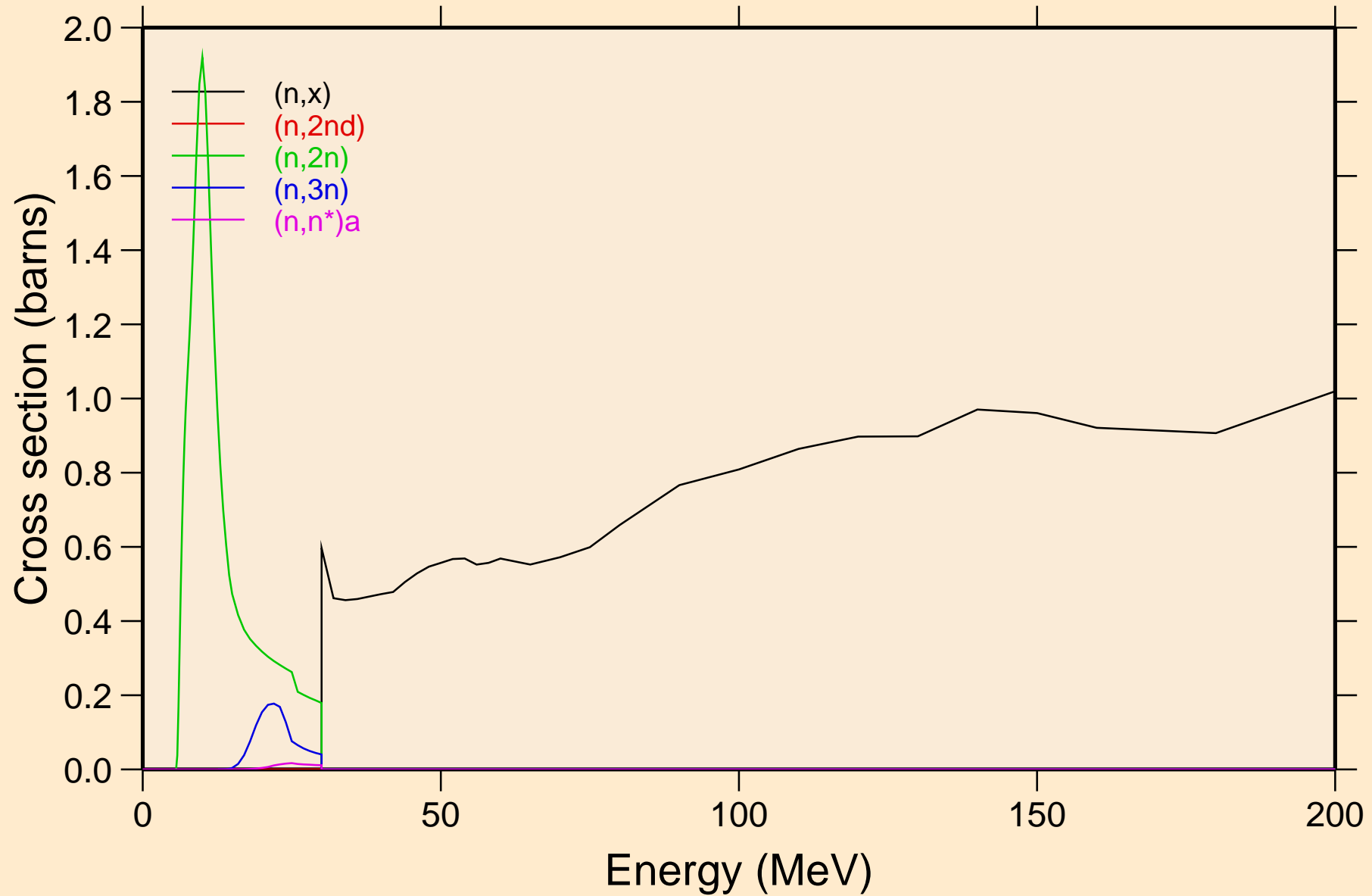

NP236M NEUTRON ACER TENDL-2021 LIBRARY; T=293.6K
Threshold reactions

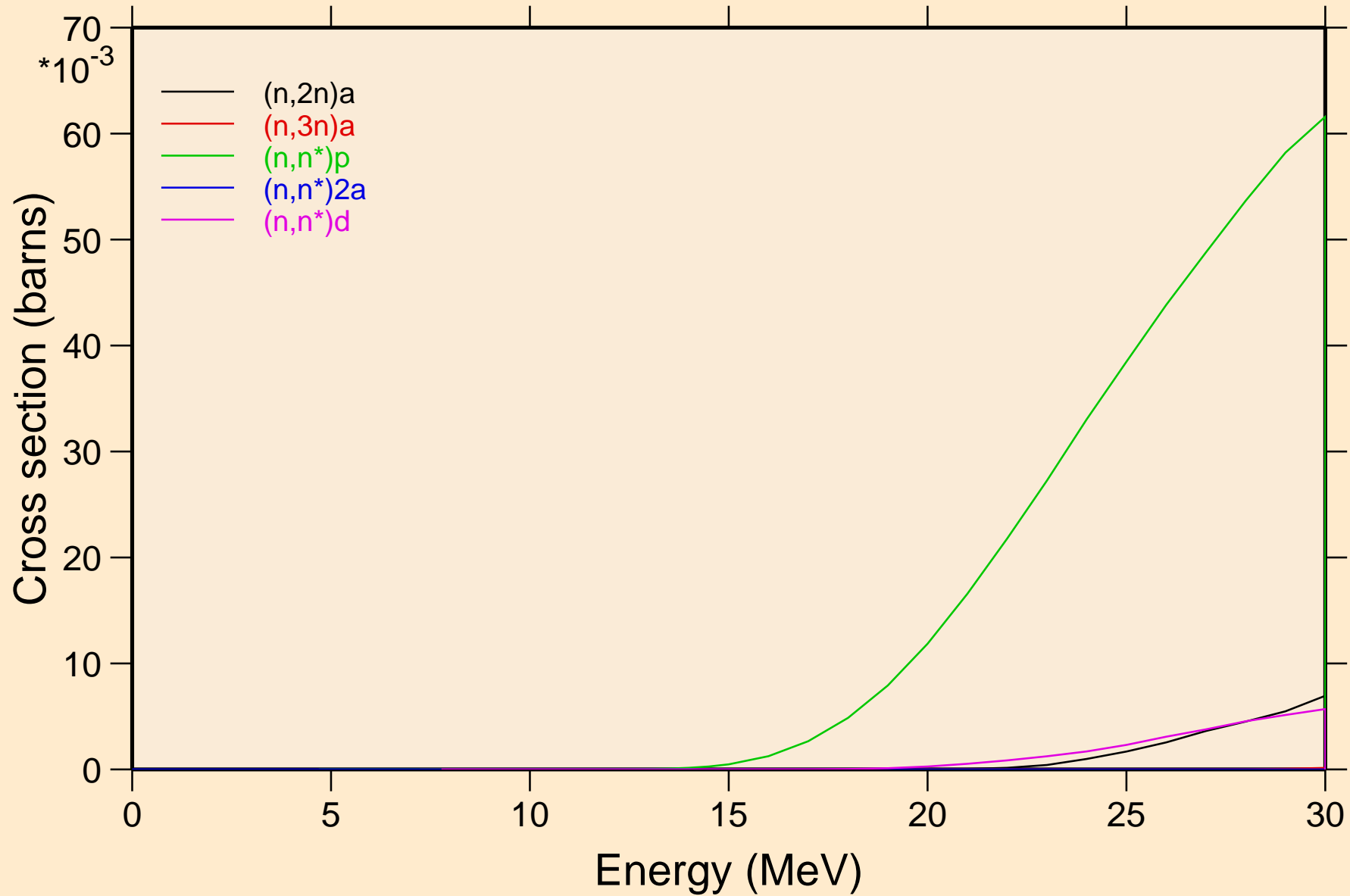

NP236M NEUTRON ACER TENDL-2021 LIBRARY; T=293.6K
Threshold reactions

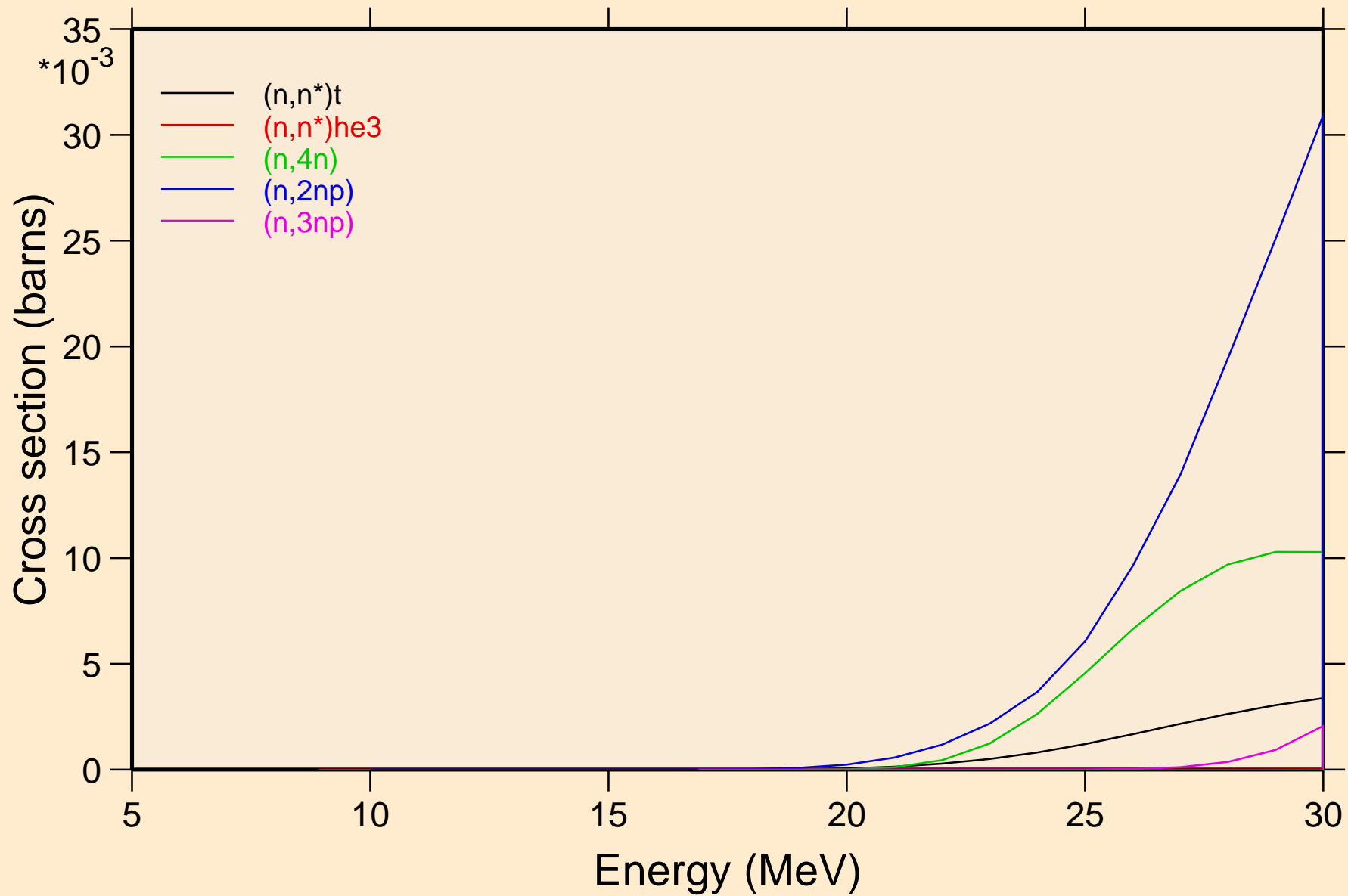

NP236M NEUTRON ACER TENDL-2021 LIBRARY; T=293.6K
Threshold reactions

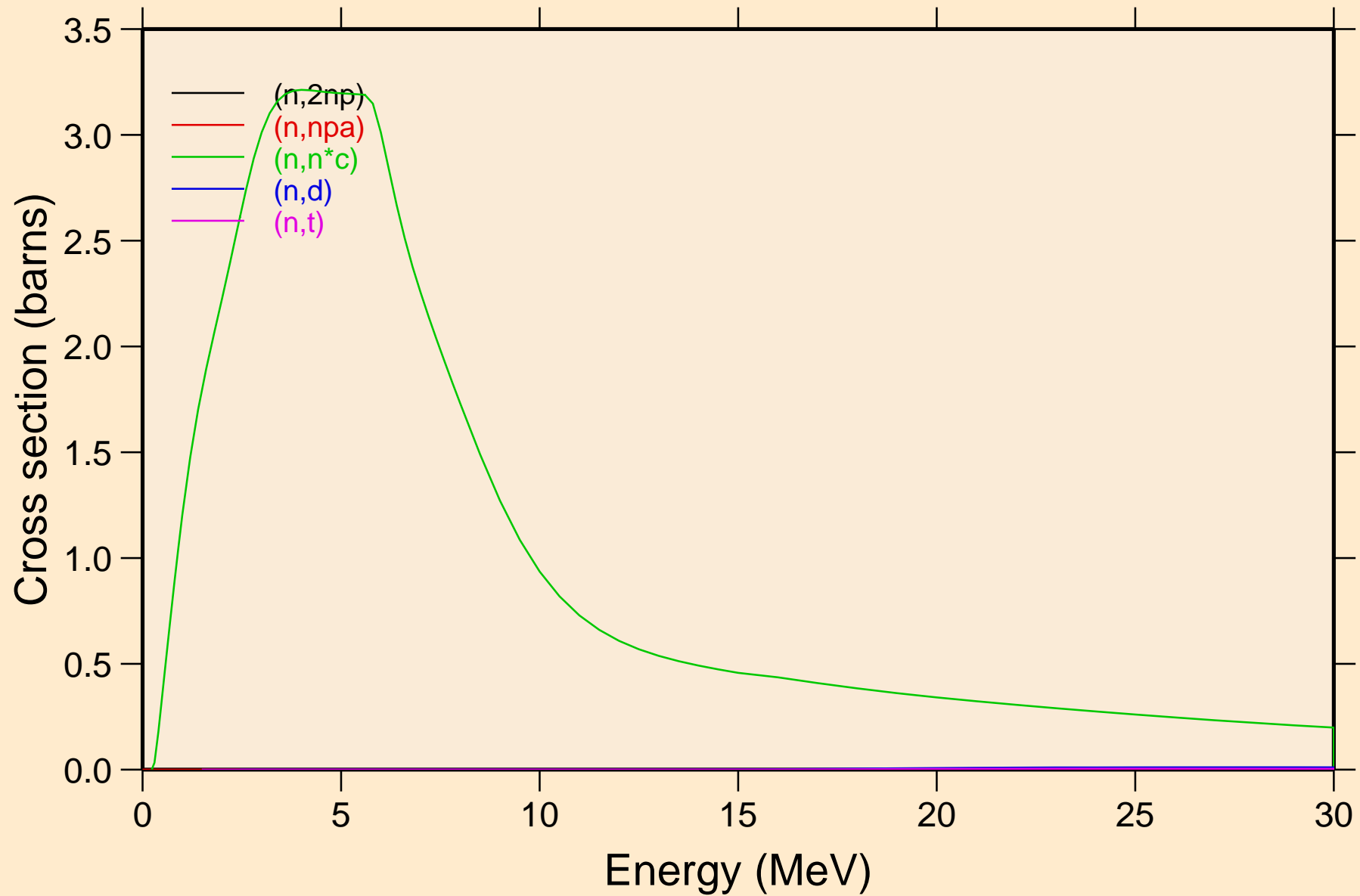

NP236M NEUTRON ACER TENDL-2021 LIBRARY; T=293.6K
Threshold reactions

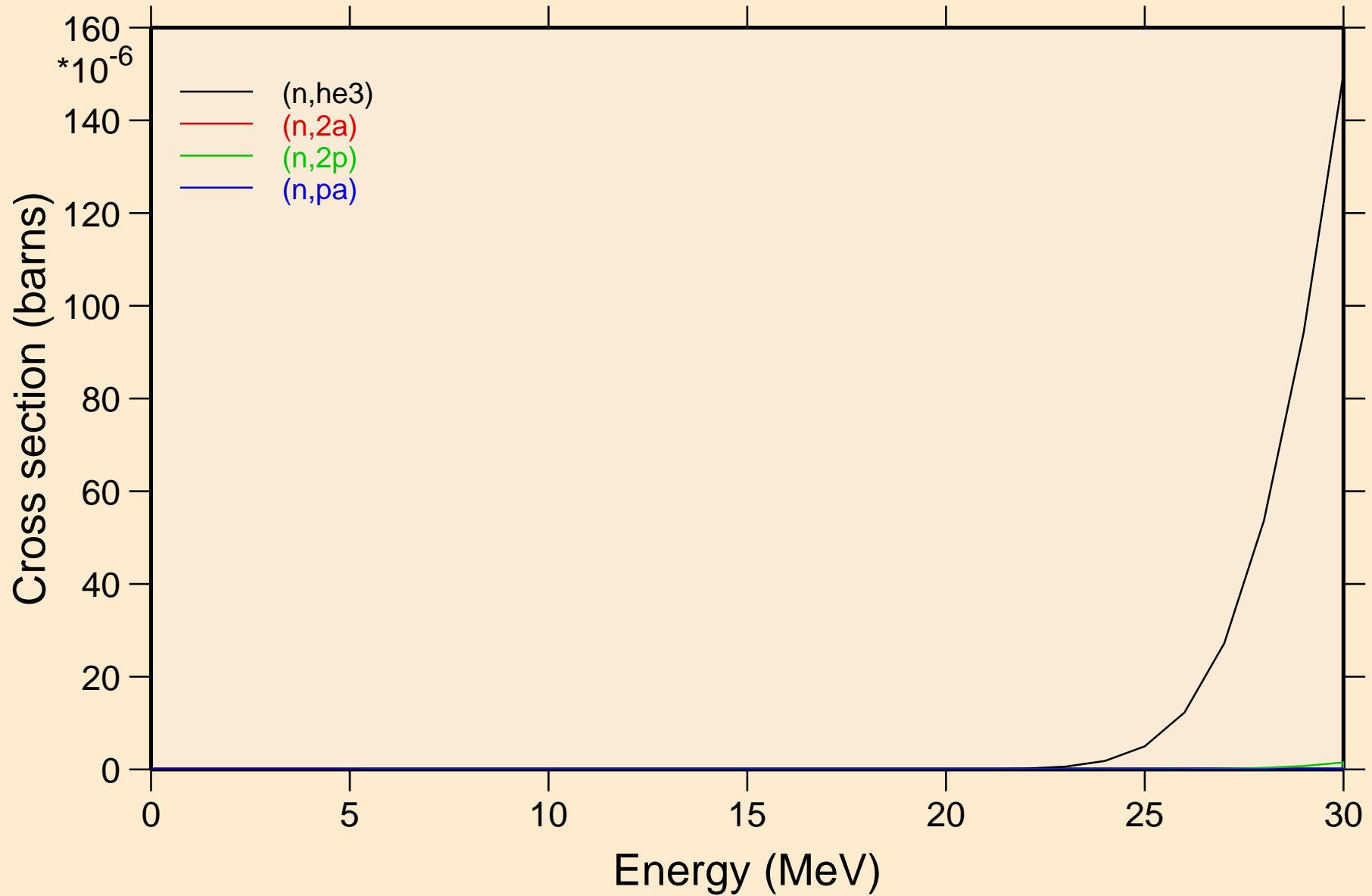

NP236M NEUTRON ACER TENDL-2021 LIBRARY; T=293.6K

Threshold reactions

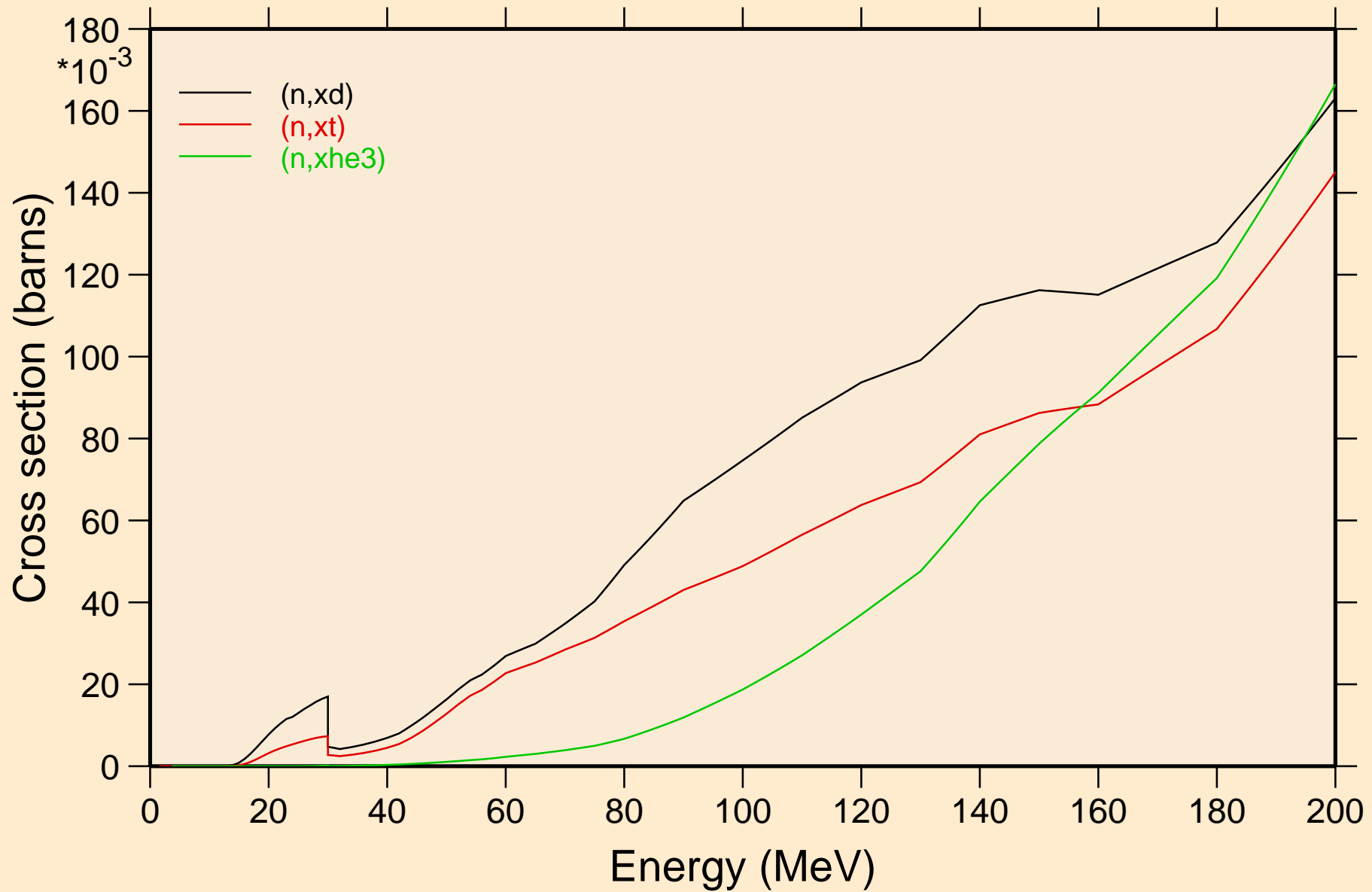

NP236M NEUTRON ACER TENDL-2021 LIBRARY; T=293.6K
angular distribution for elastic

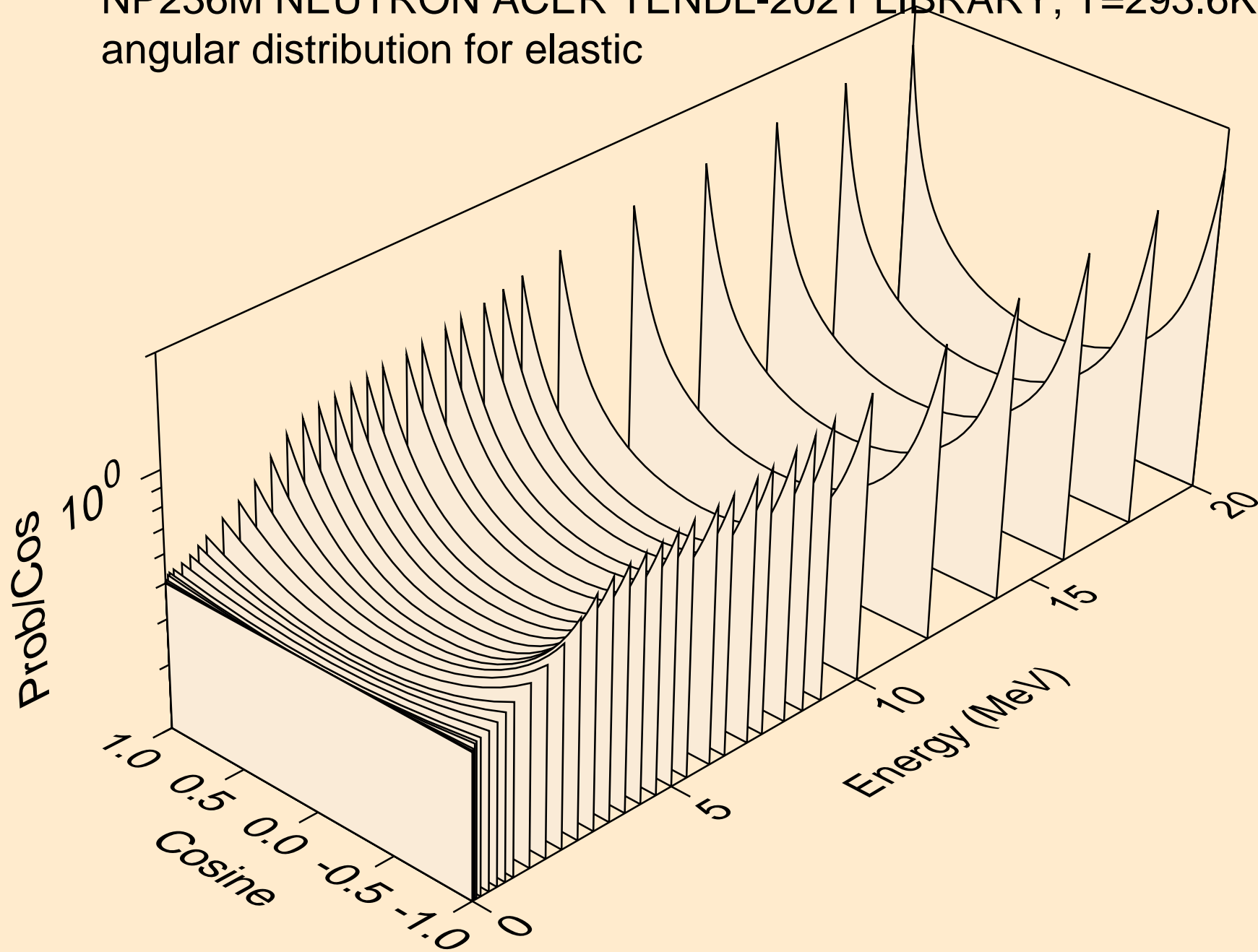

NP236M NEUTRON ACER TENDL-2021 LIBRARY; T=293.6K
angular distribution for elastic

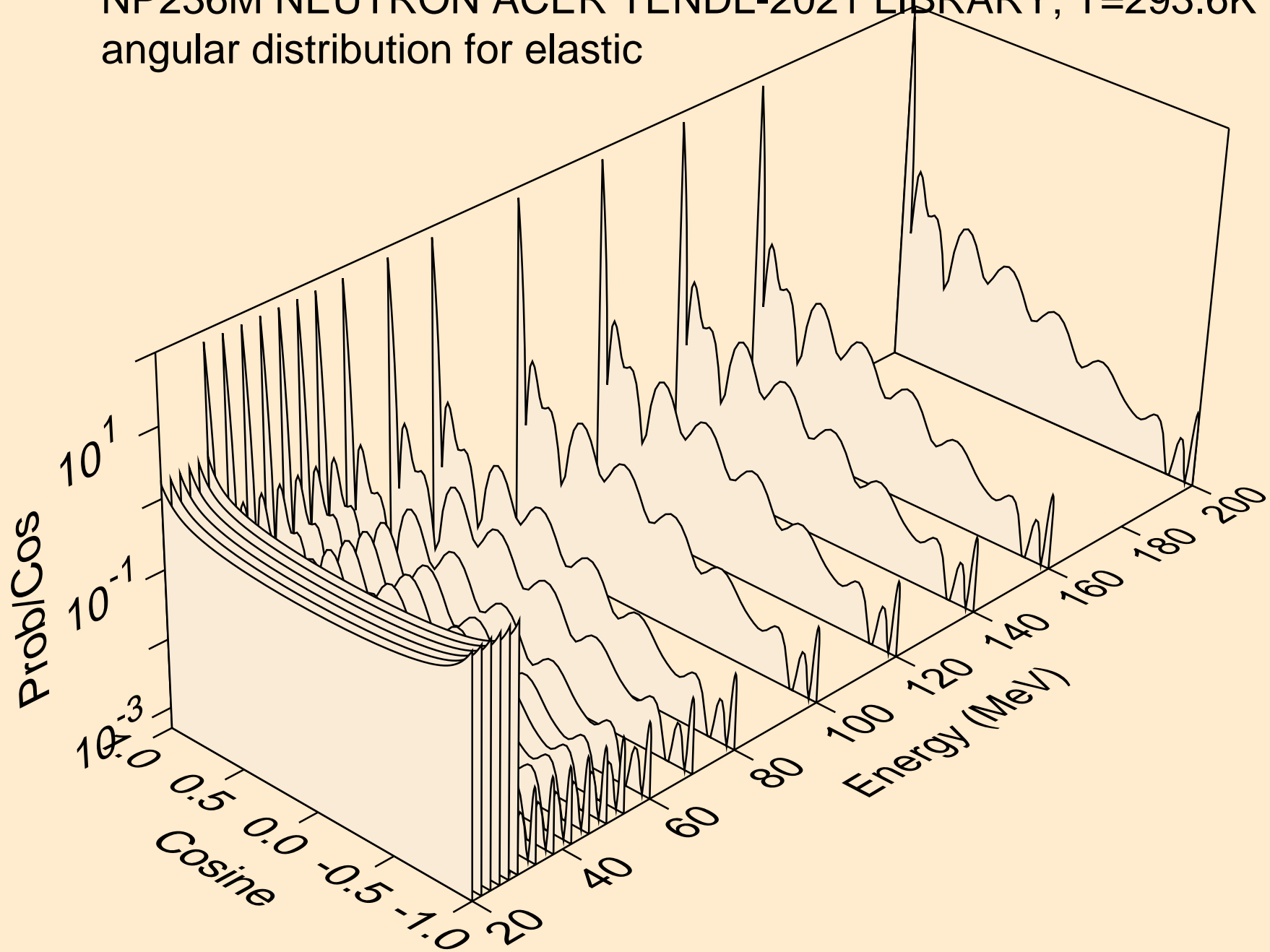

NP236M NEUTRON ACER TENDL-2021 LIBRARY; T=293.6K
angular distribution for (n,n*1)

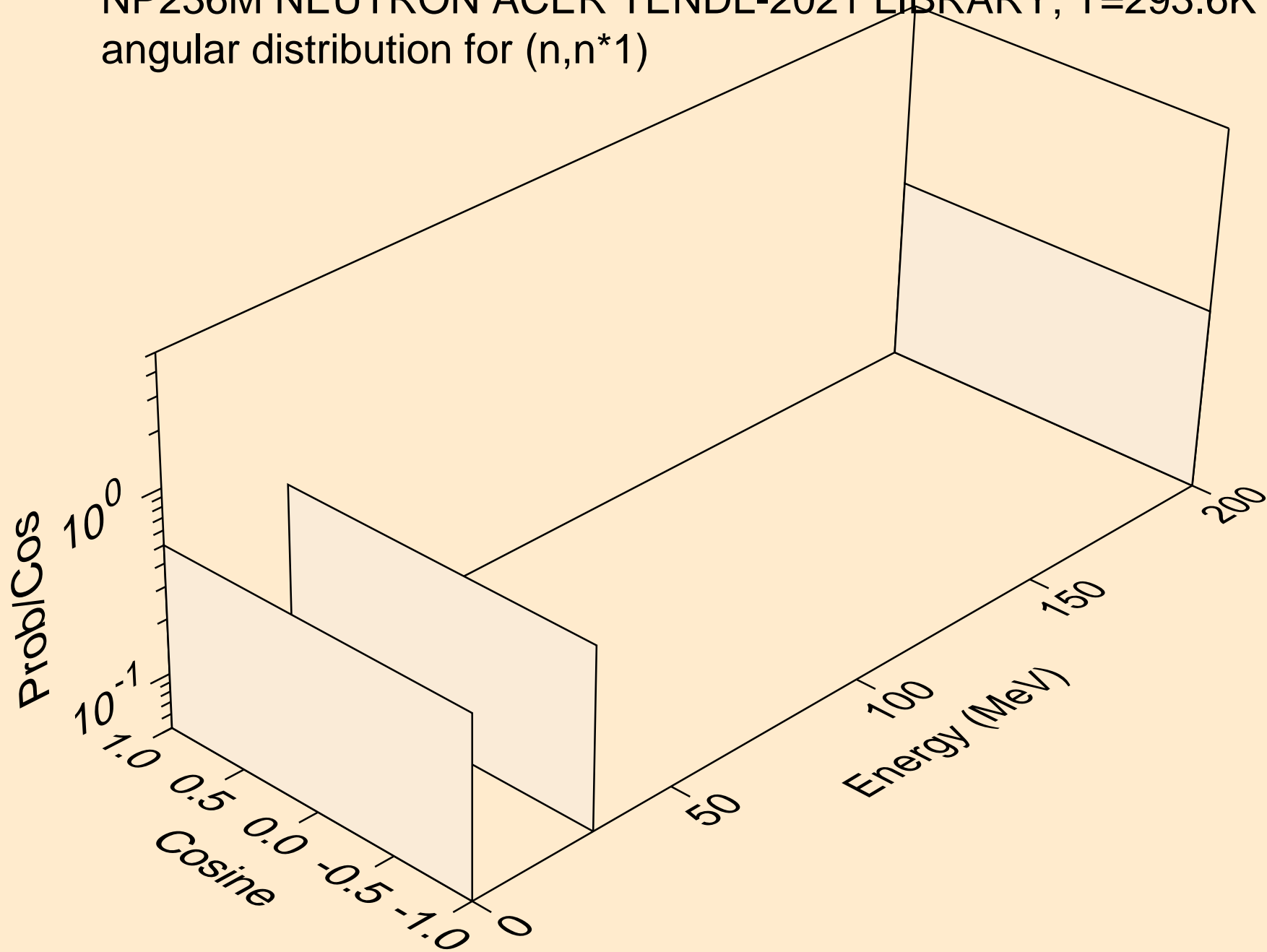

NP236M NEUTRON ACER TENDL-2021 LIBRARY; T=293.6K
angular distribution for (n,n*2)

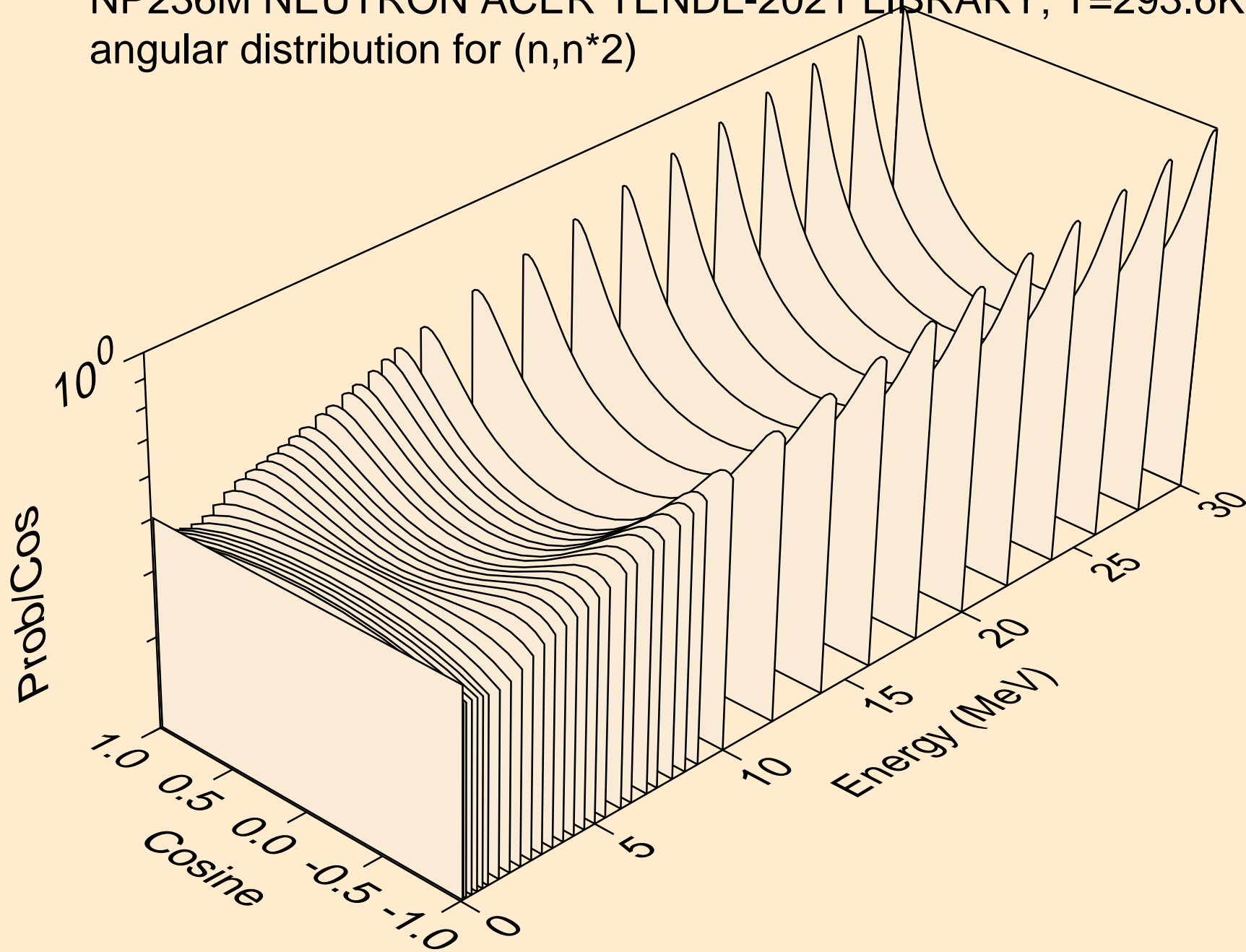

NP236M NEUTRON ACER TENDL-2021 LIBRARY; T=293.6K
angular distribution for (n,n*3)

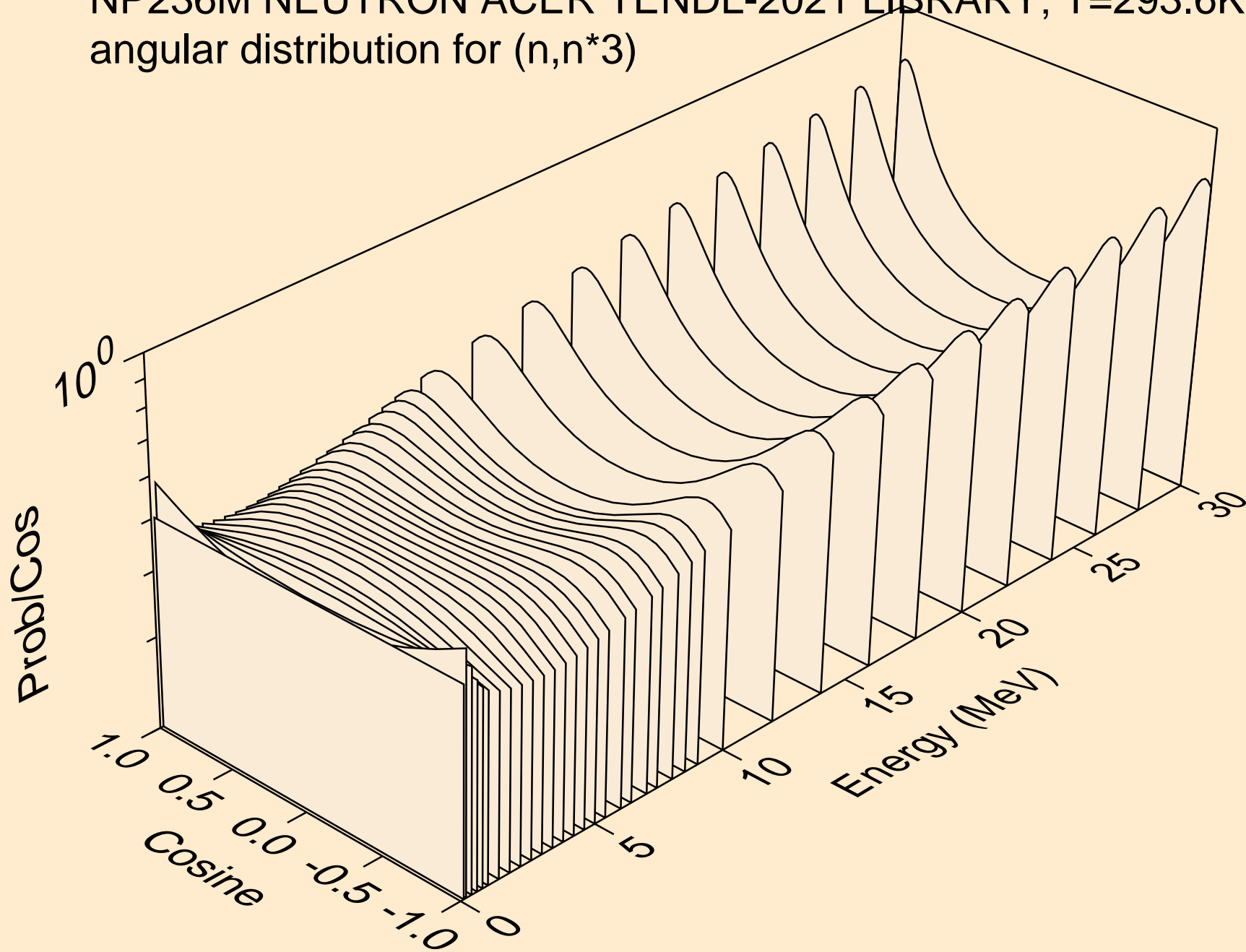

NP236M NEUTRON ACER TENDL-2021 LIBRARY; T=293.6K
angular distribution for (n,n*4)

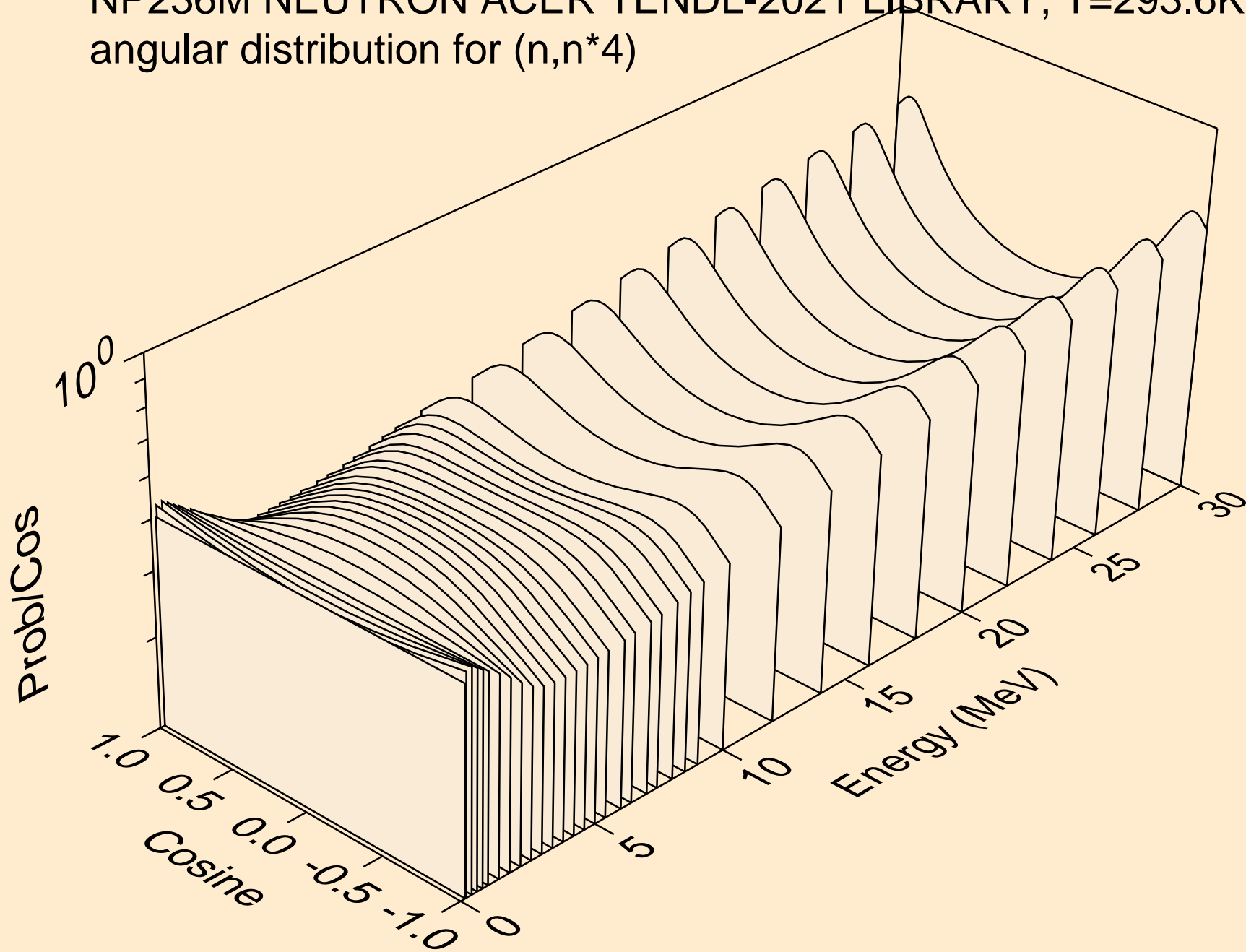

NP236M NEUTRON ACER TENDL-2021 LIBRARY; T=293.6K
angular distribution for (n,n*5)

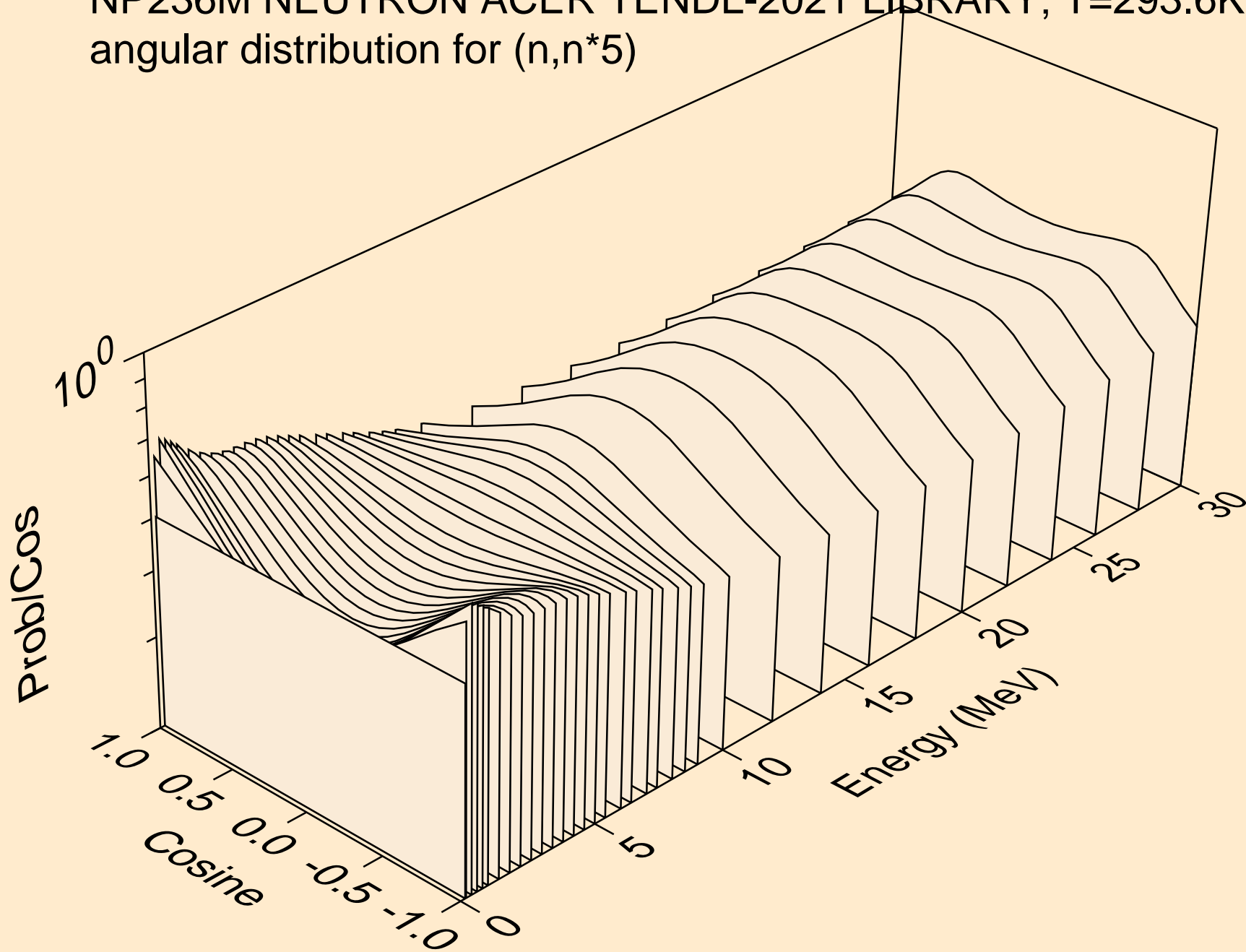

NP236M NEUTRON ACER TENDL-2021 LIBRARY; T=293.6K
angular distribution for (n,n*6)

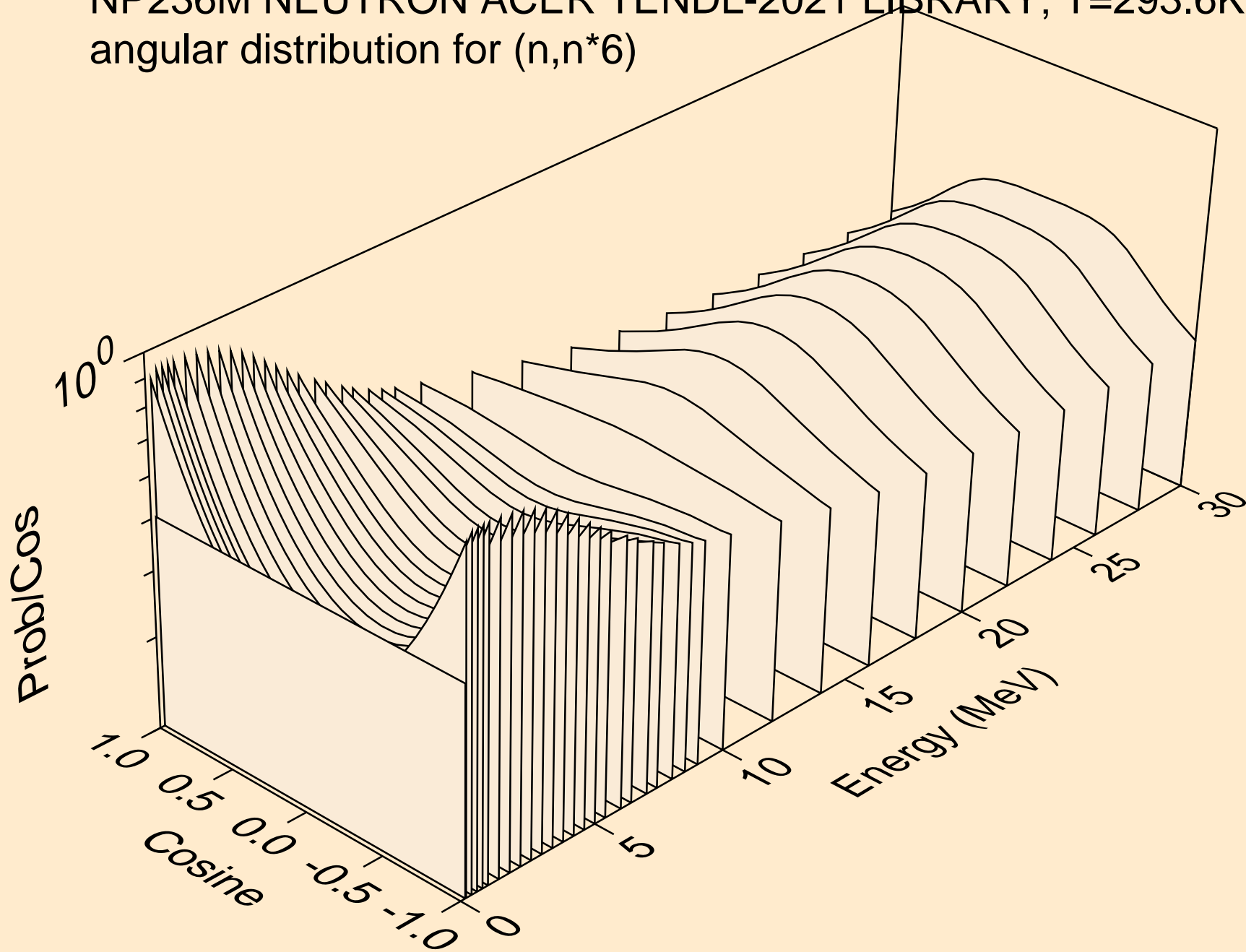

NP236M NEUTRON ACER TENDL-2021 LIBRARY; T=293.6K
angular distribution for (n,n*7)

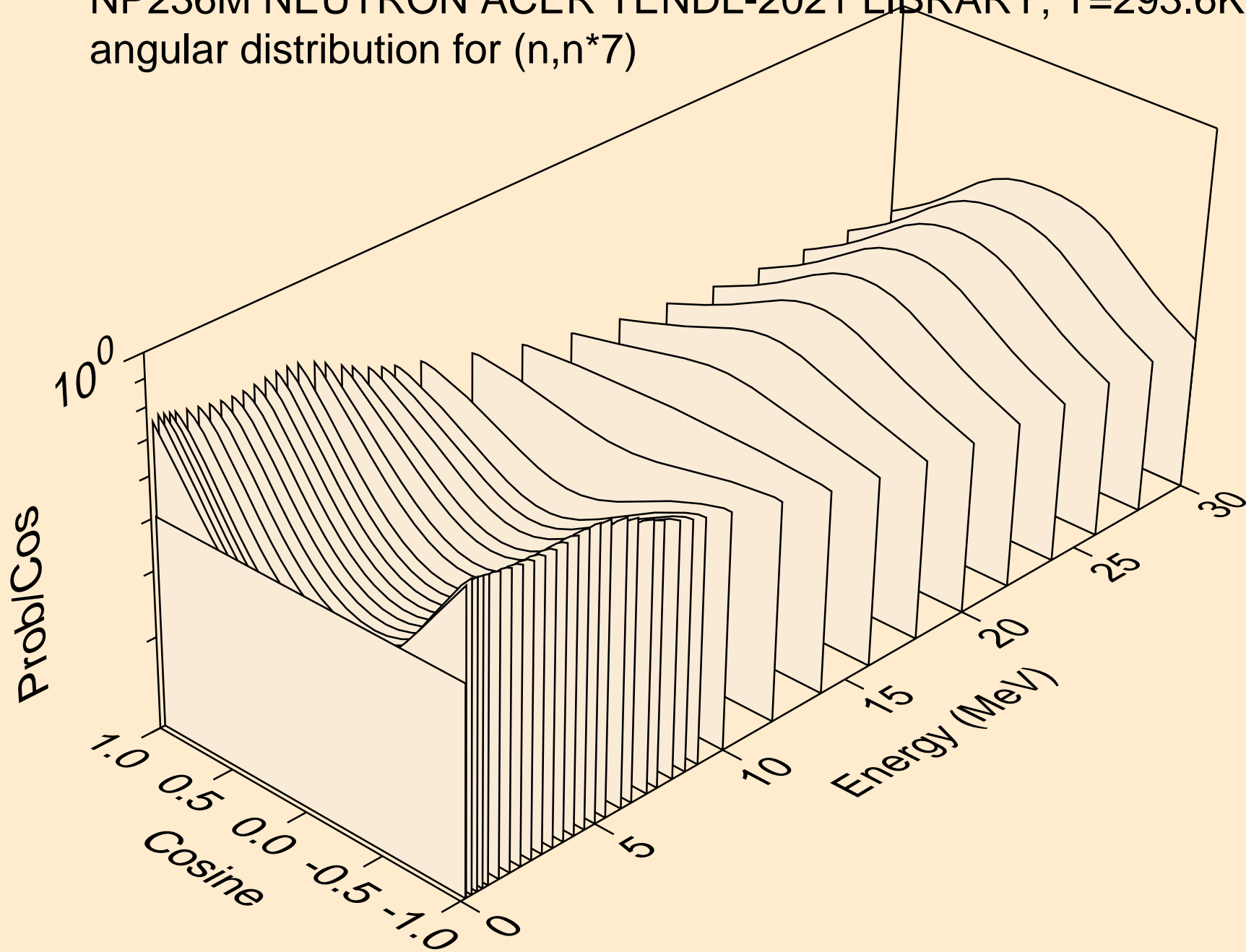

NP236M NEUTRON ACER TENDL-2021 LIBRARY; T=293.6K
angular distribution for (n,n*8)

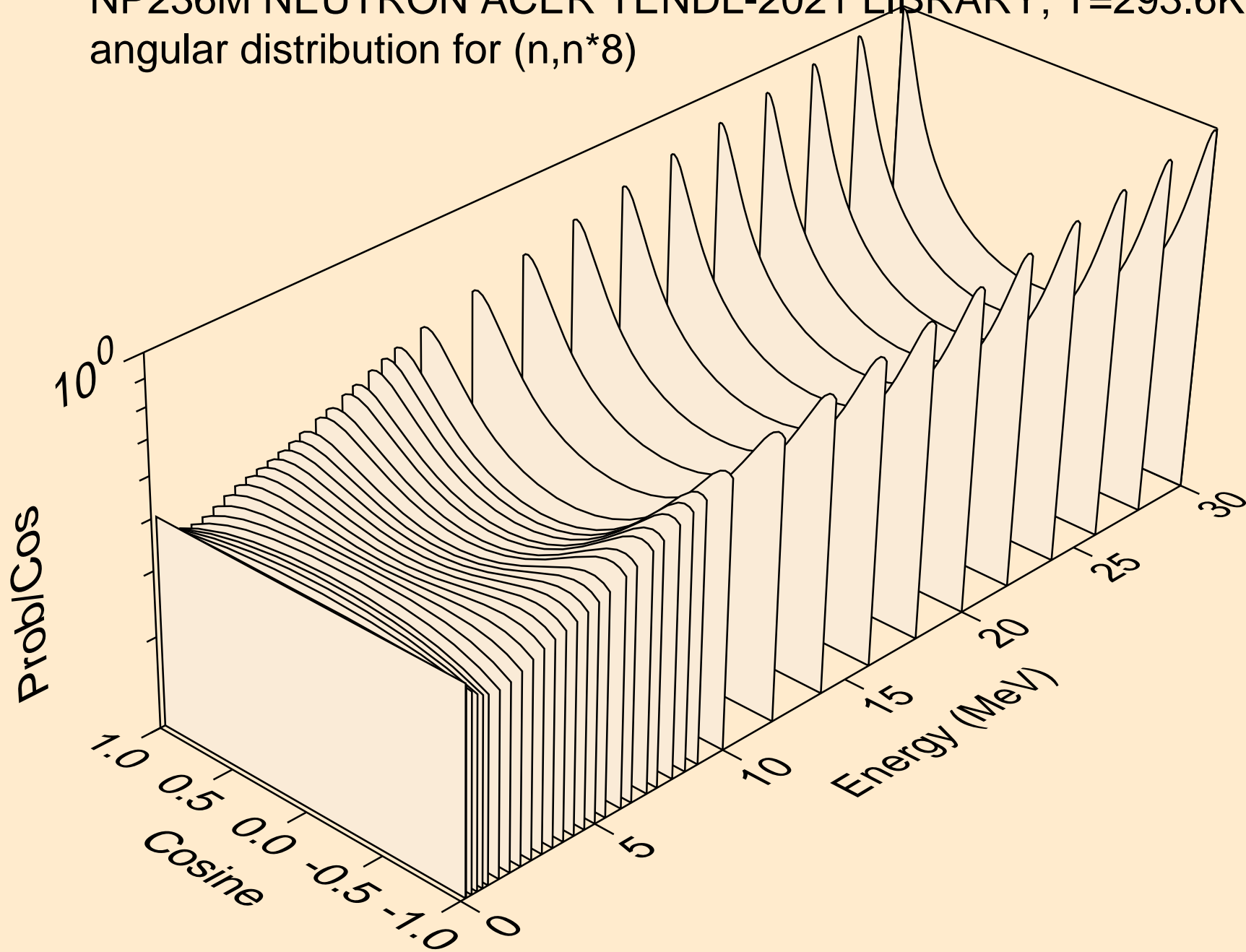

NP236M NEUTRON ACER TENDL-2021 LIBRARY; T=293.6K
angular distribution for (n,n*9)

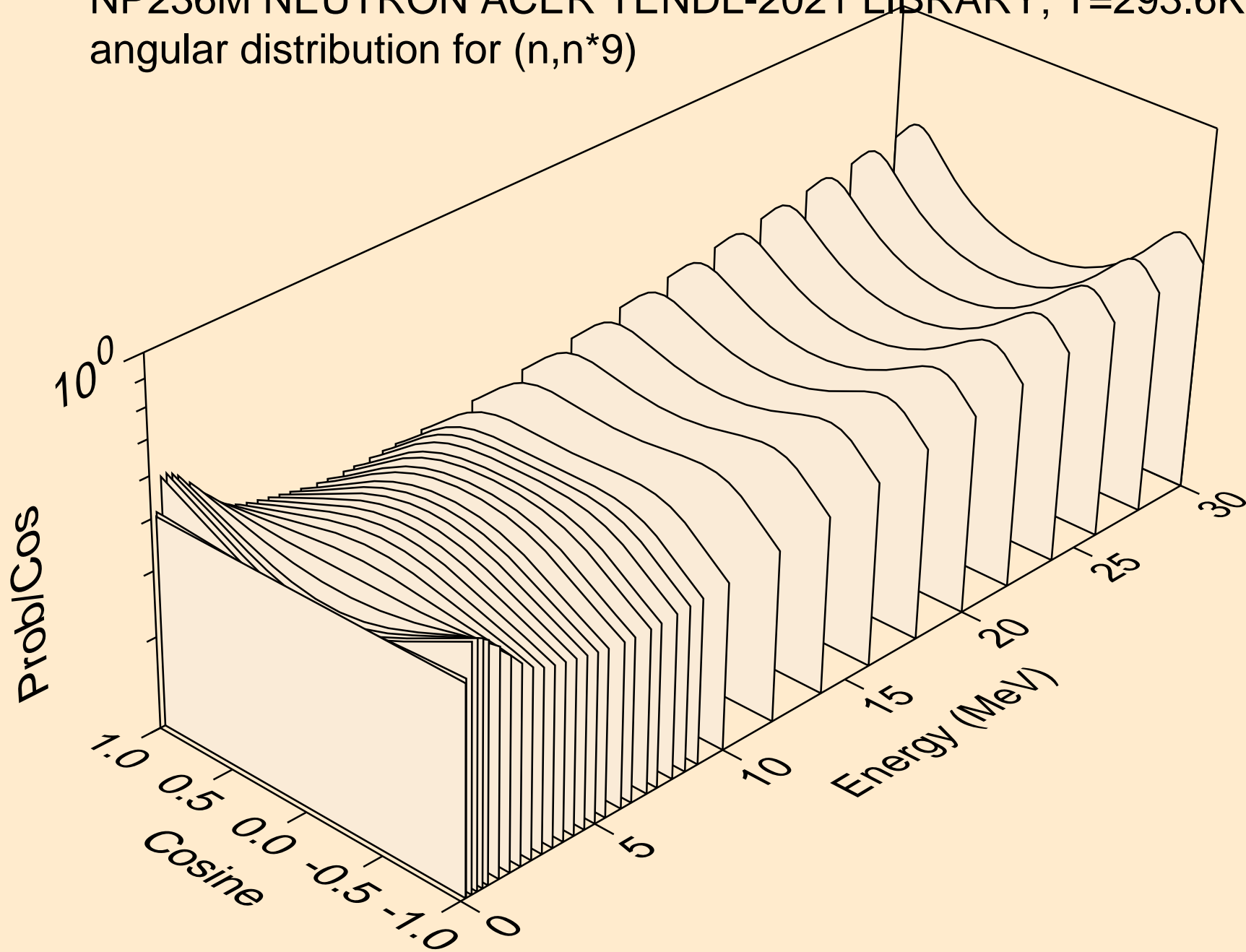

NP236M NEUTRON ACER TENDL-2021 LIBRARY; T=293.6K
angular distribution for (n,n*10)

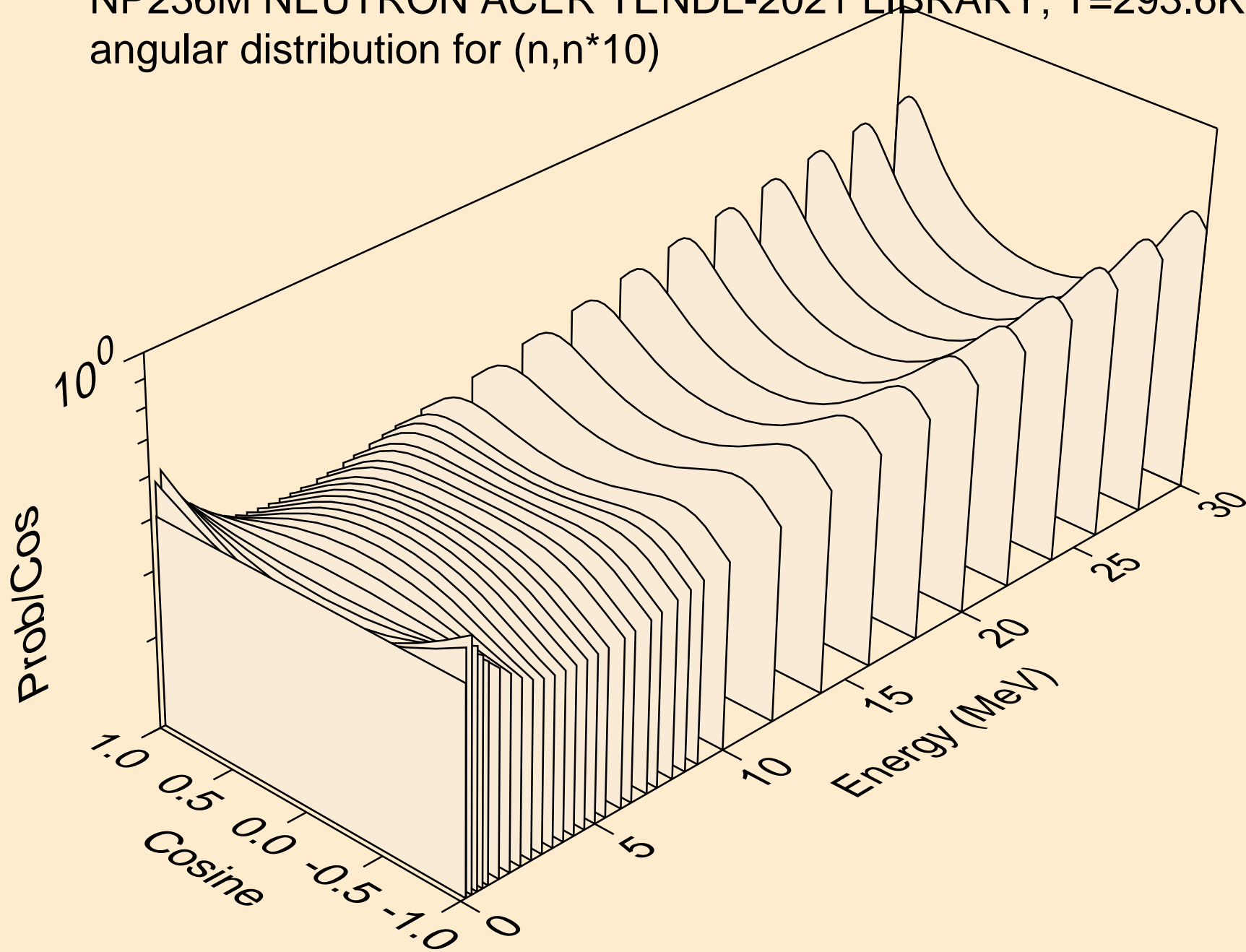

NP236M NEUTRON ACER TENDL-2021 LIBRARY; T=293.6K
angular distribution for (n,n*11)

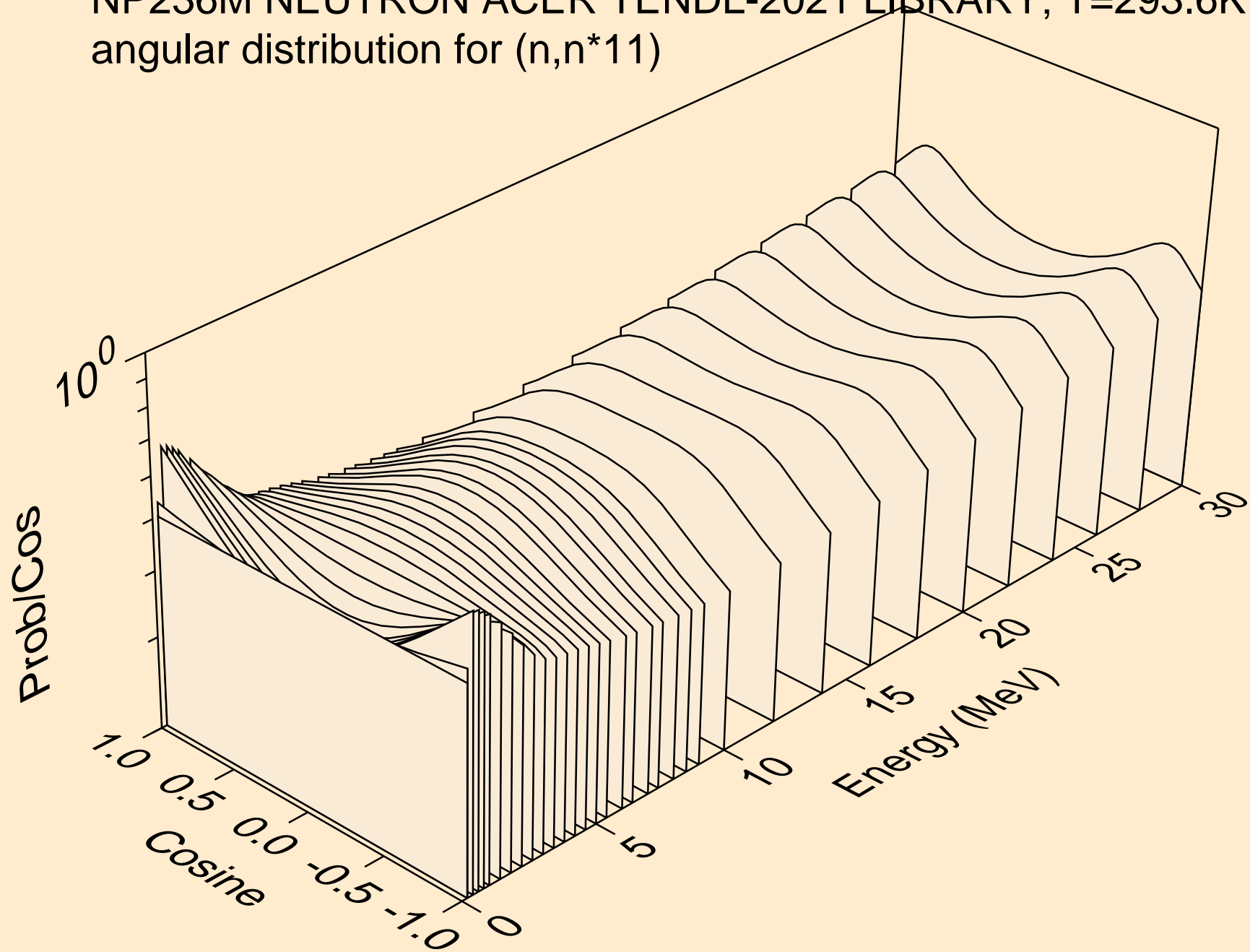

NP236M NEUTRON ACER TENDL-2021 LIBRARY; T=293.6K
angular distribution for (n,n*12)

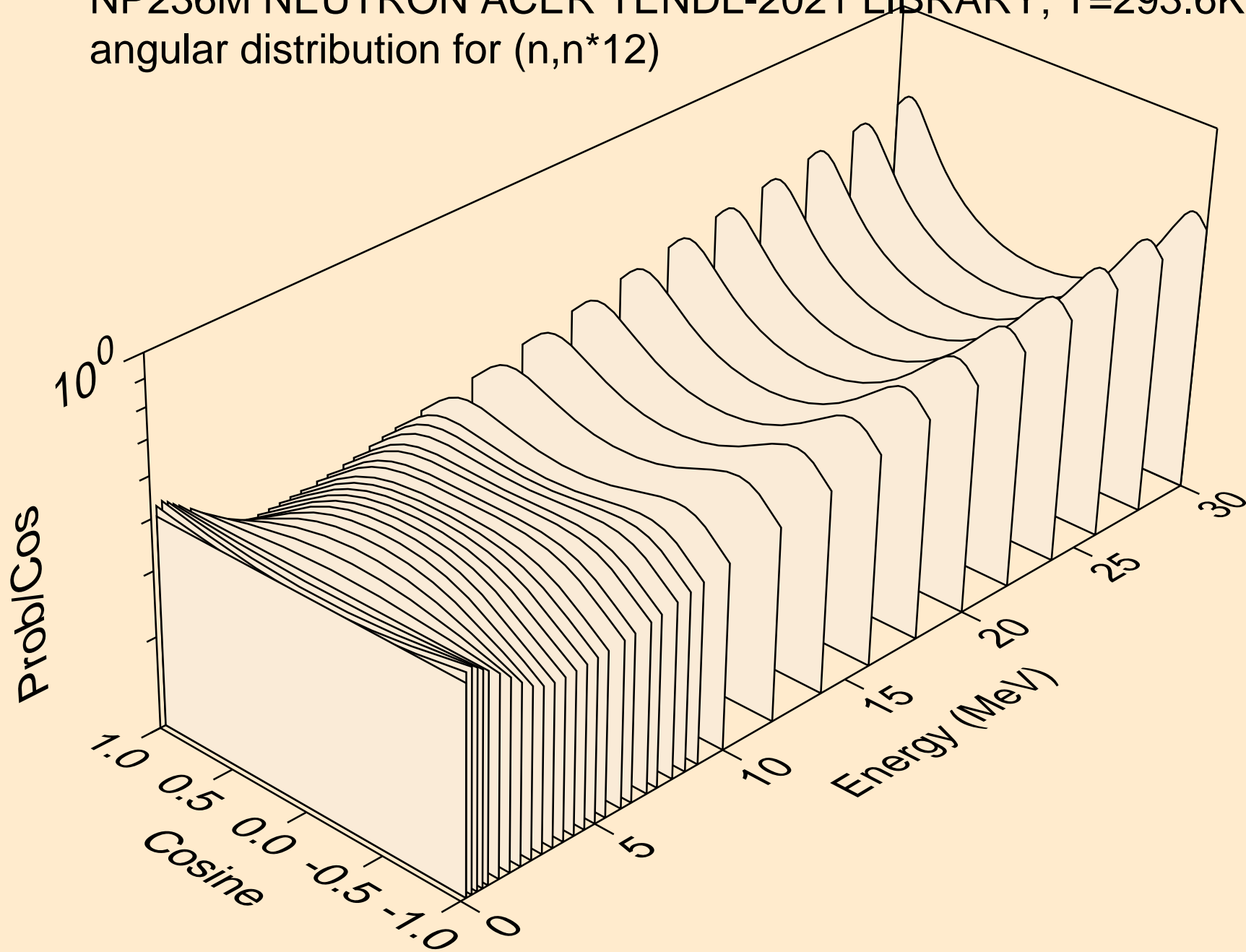

NP236M NEUTRON ACER TENDL-2021 LIBRARY; T=293.6K
angular distribution for (n,n*13)

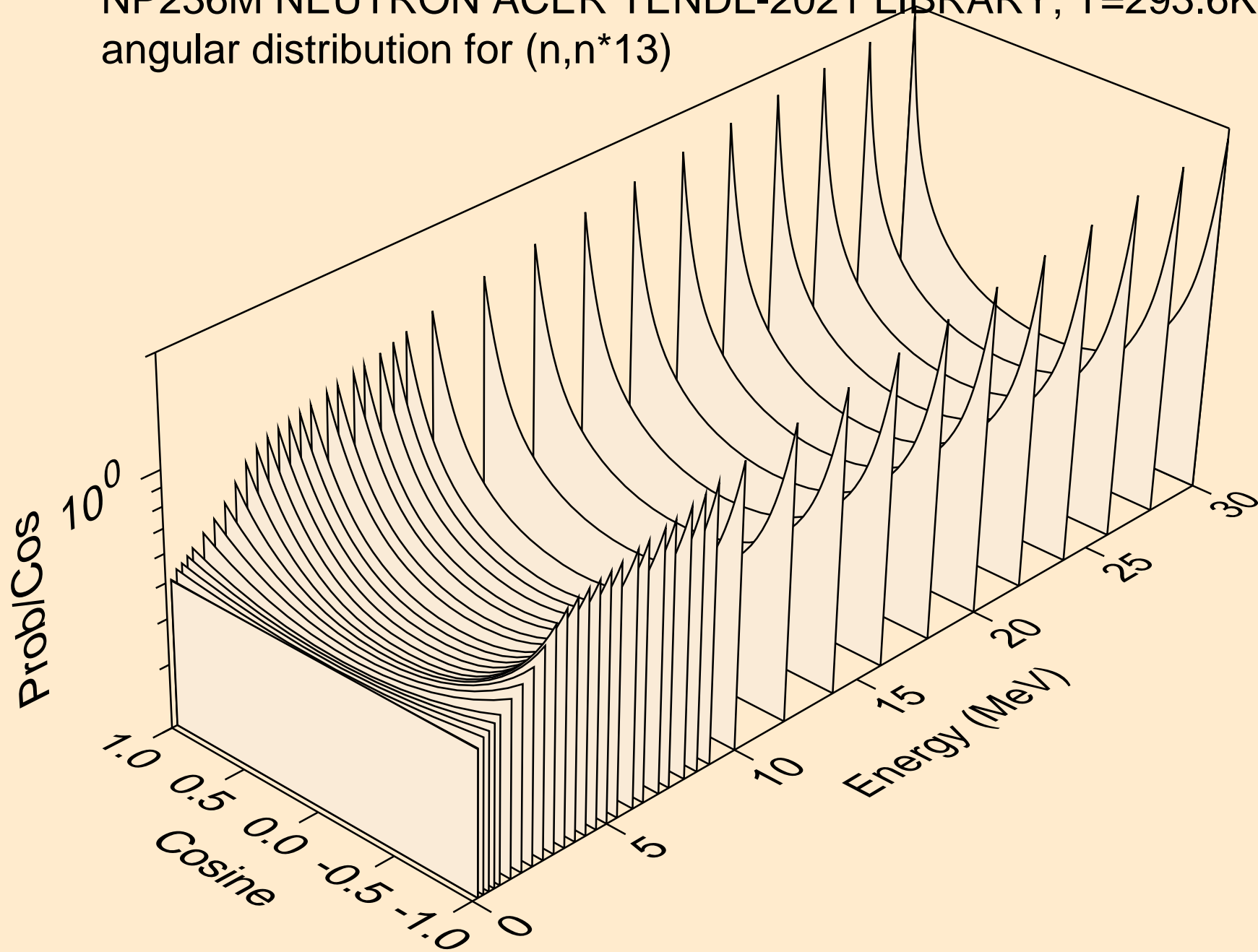

NP236M NEUTRON ACER TENDL-2021 LIBRARY; T=293.6K
angular distribution for (n,n*14)

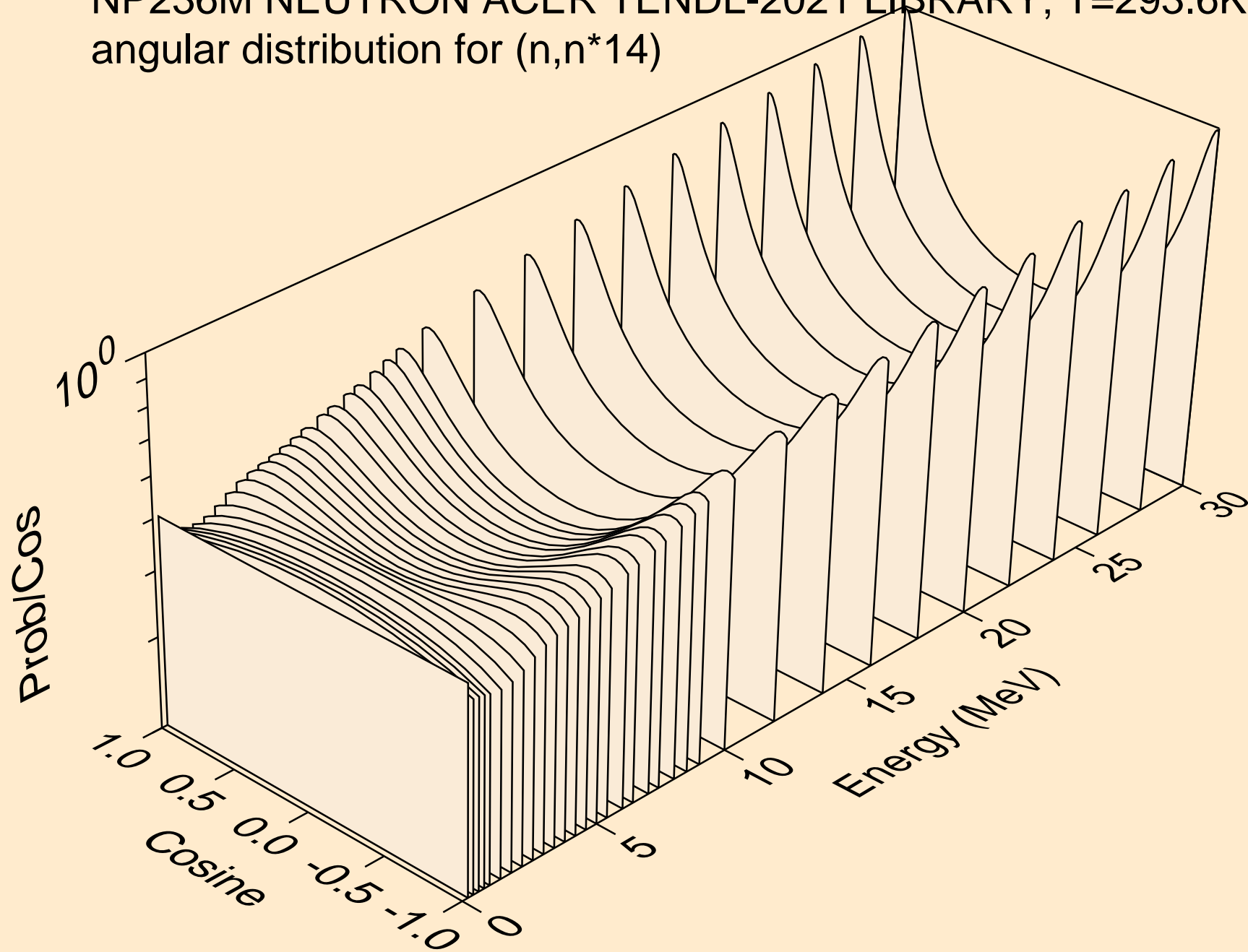

NP236M NEUTRON ACER TENDL-2021 LIBRARY; T=293.6K
angular distribution for (n,n*15)

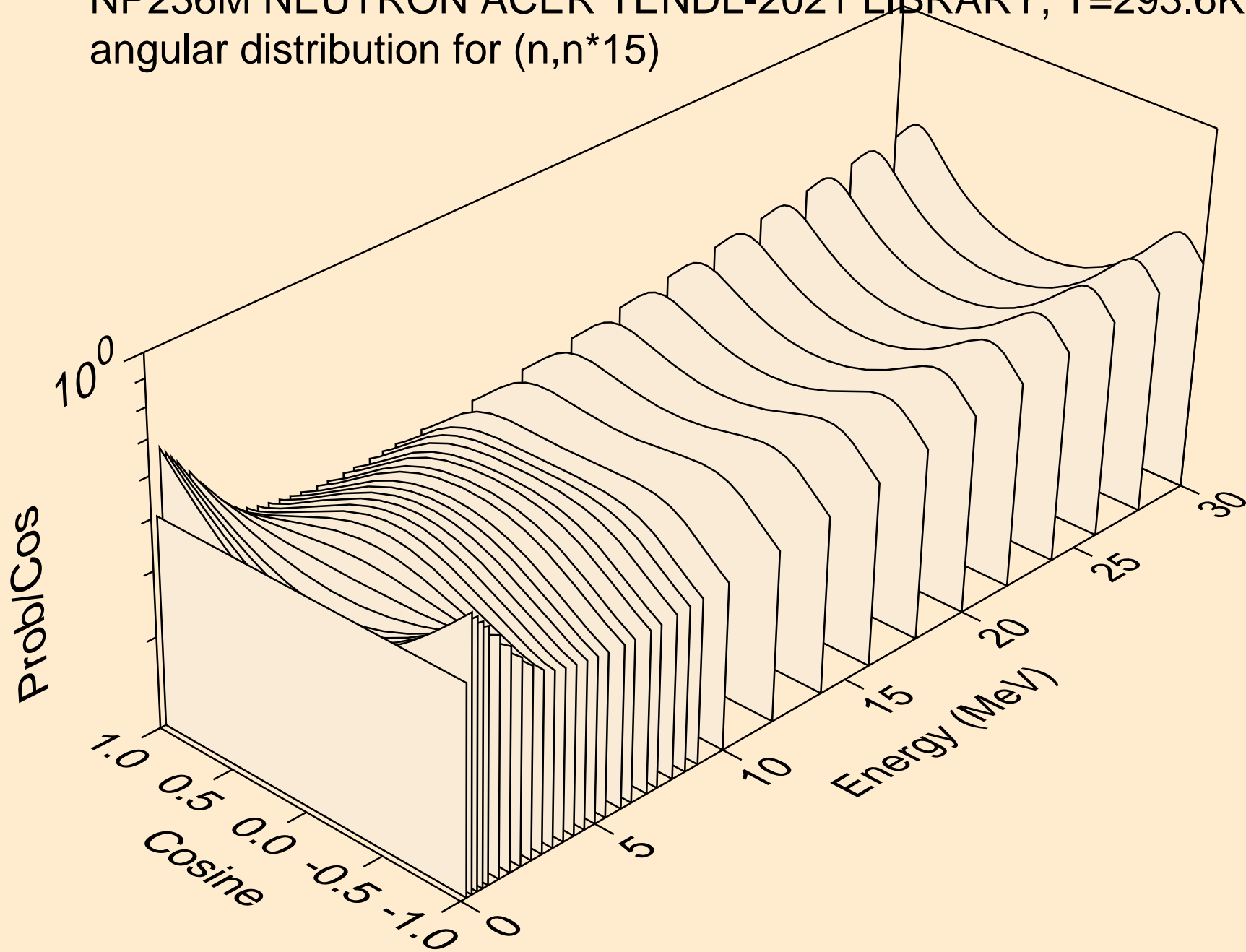

NP236M NEUTRON ACER TENDL-2021 LIBRARY; T=293.6K
angular distribution for (n,n*16)

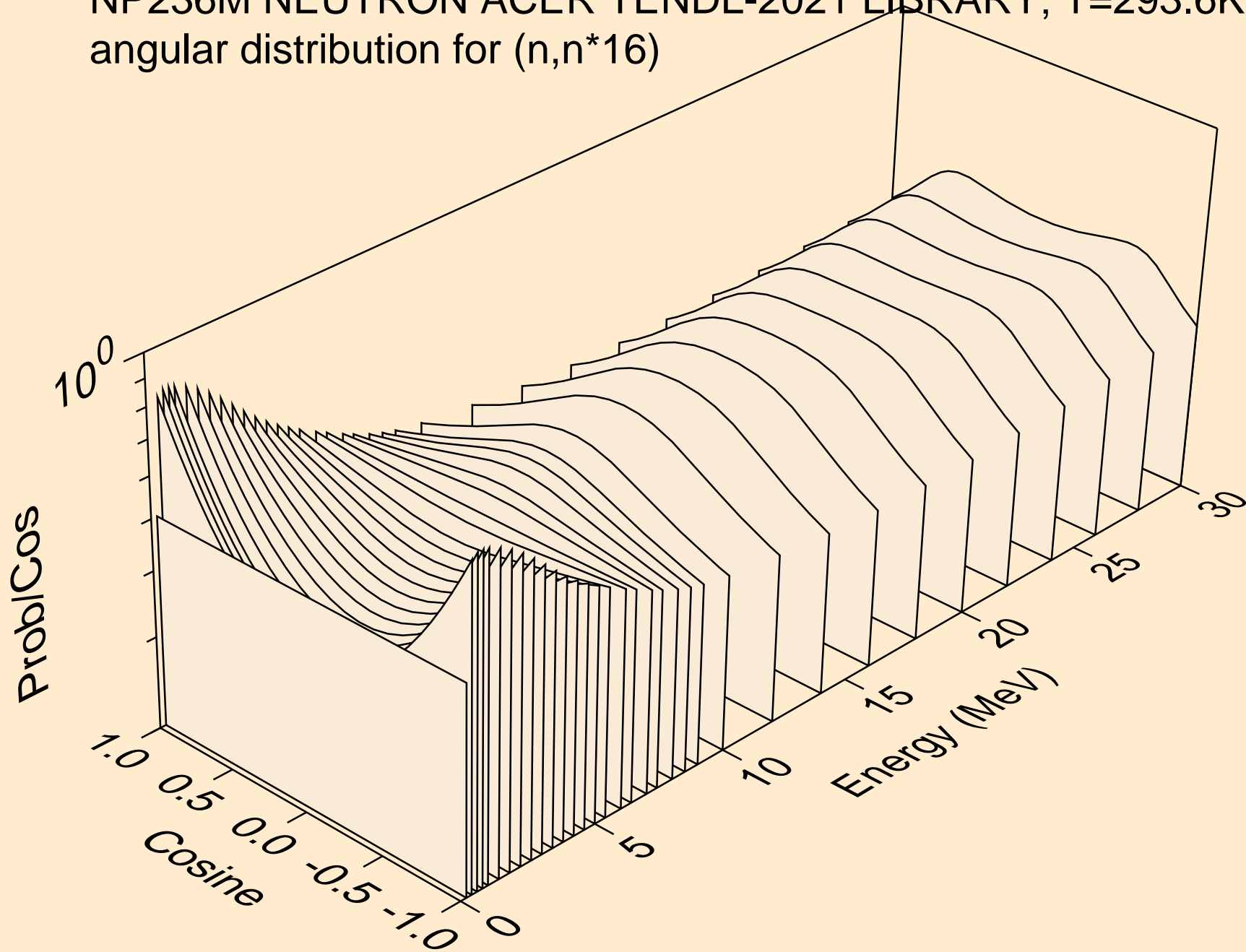

NP236M NEUTRON ACER TENDL-2021 LIBRARY; T=293.6K
angular distribution for (n,n*17)

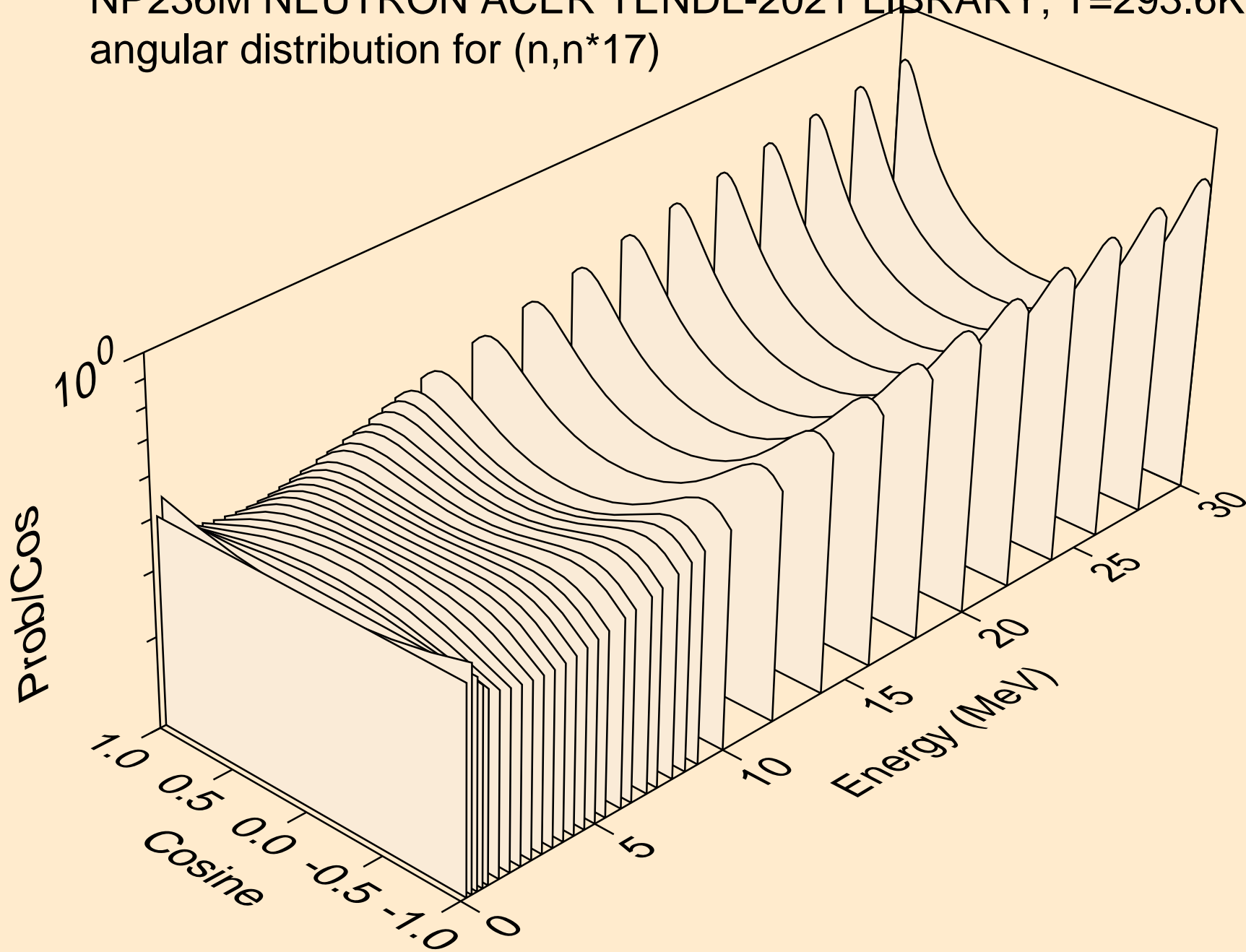

NP236M NEUTRON ACER TENDL-2021 LIBRARY; T=293.6K
angular distribution for (n,n*18)

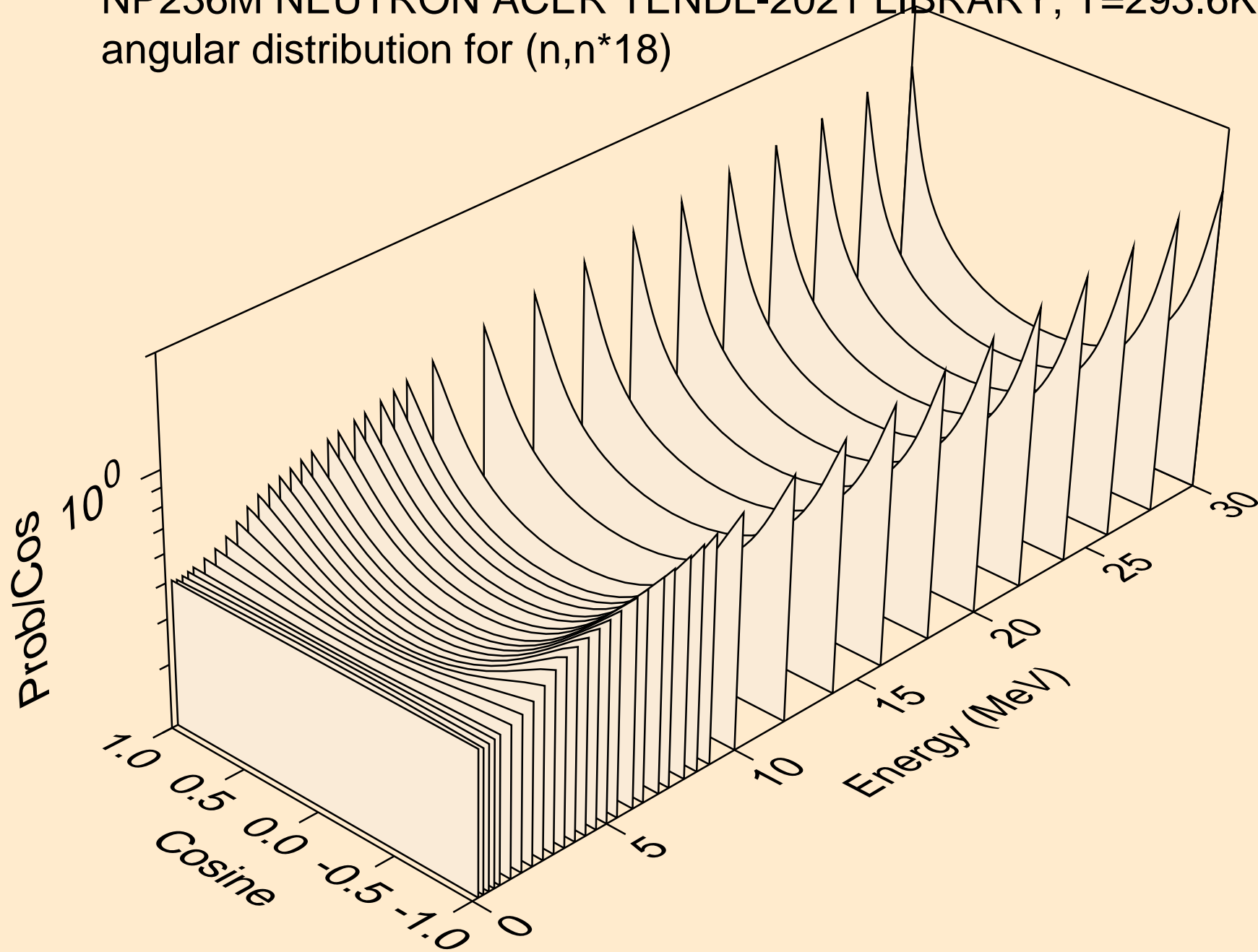

NP236M NEUTRON ACER TENDL-2021 LIBRARY; T=293.6K
angular distribution for (n,n*19)

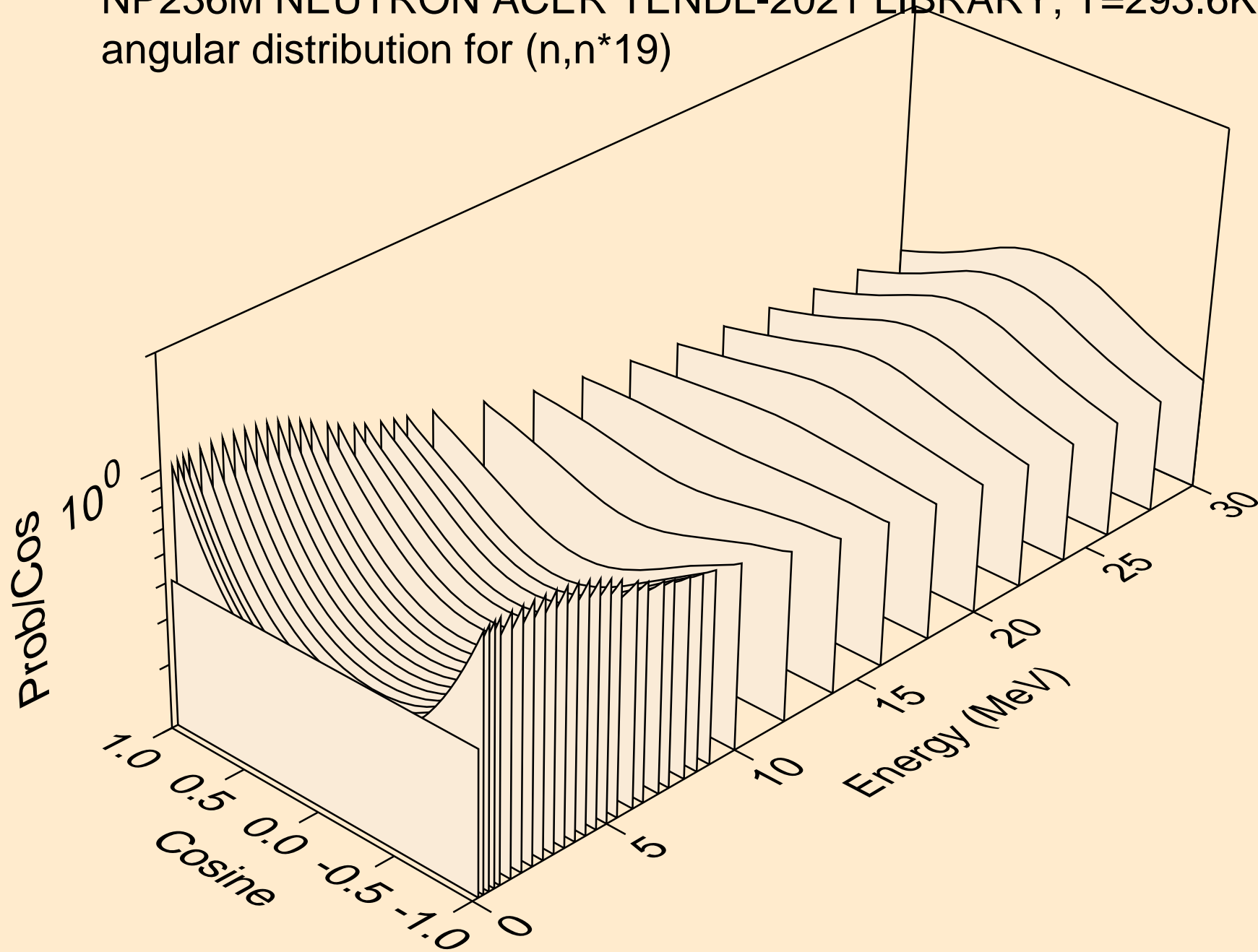

NP236M NEUTRON ACER TENDL-2021 LIBRARY; T=293.6K
angular distribution for (n,n*20)

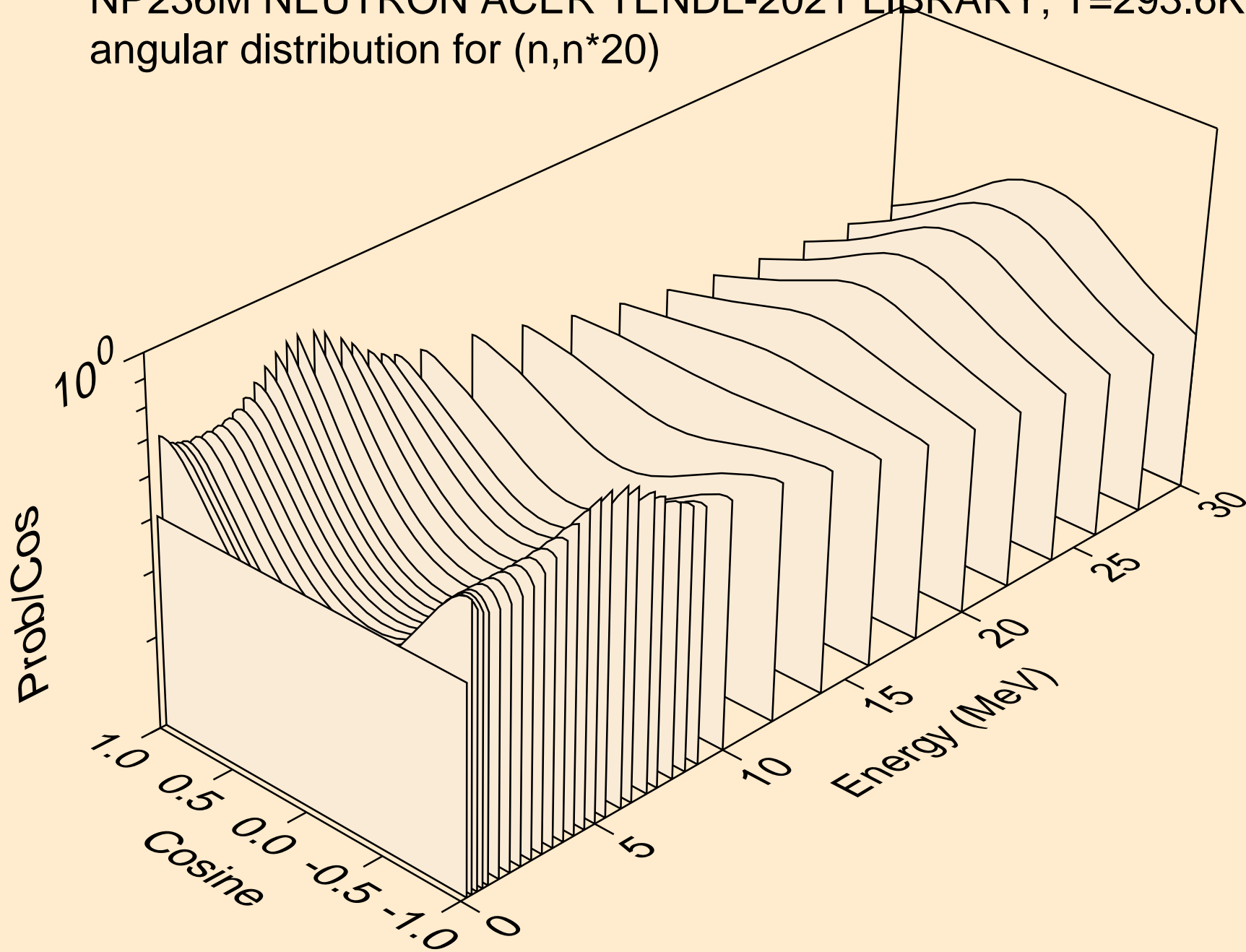

NP236M NEUTRON ACER TENDL-2021 LIBRARY; T=293.6K
angular distribution for (n,n*21)

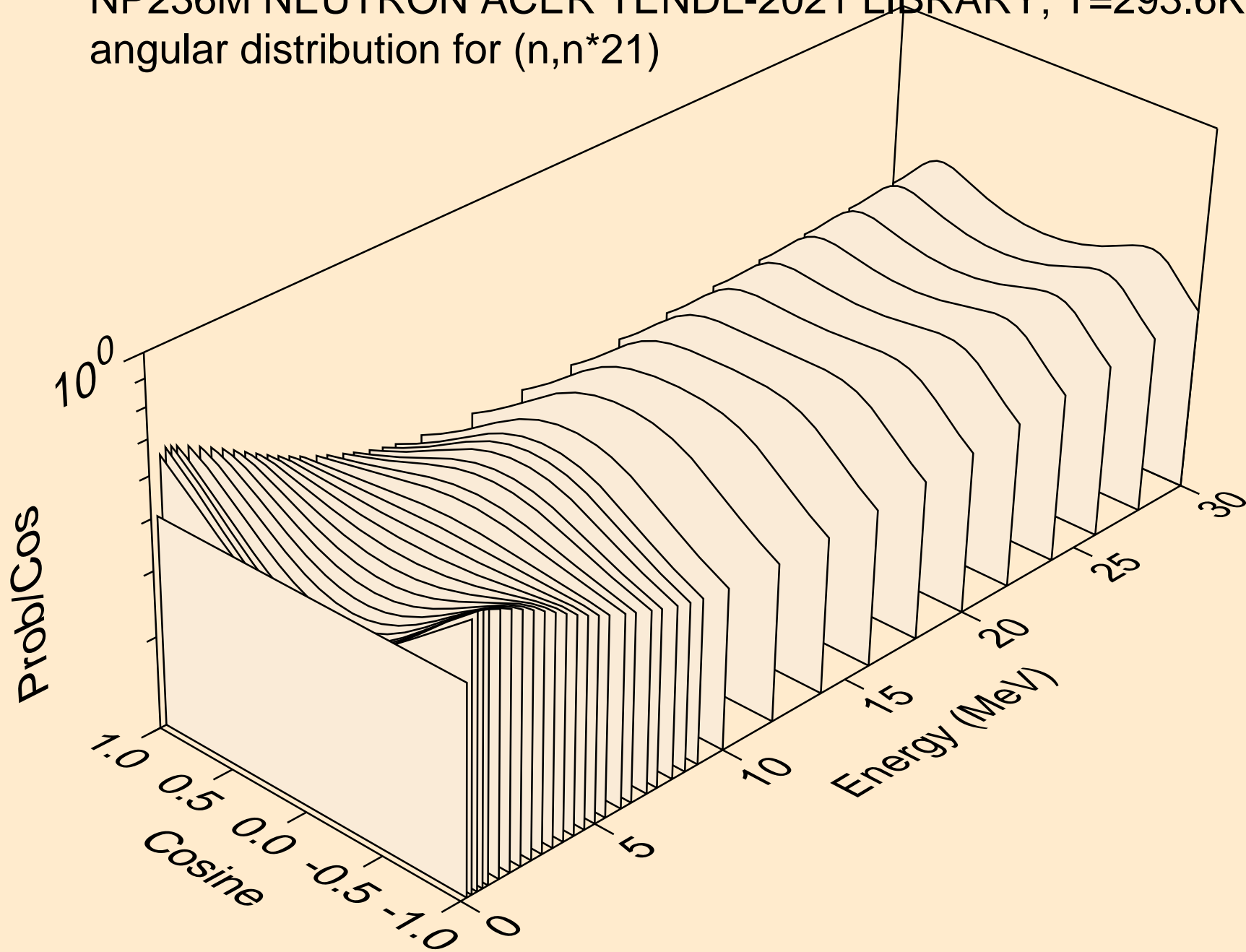

NP236M NEUTRON ACER TENDL-2021 LIBRARY; T=293.6K
angular distribution for (n,n*22)

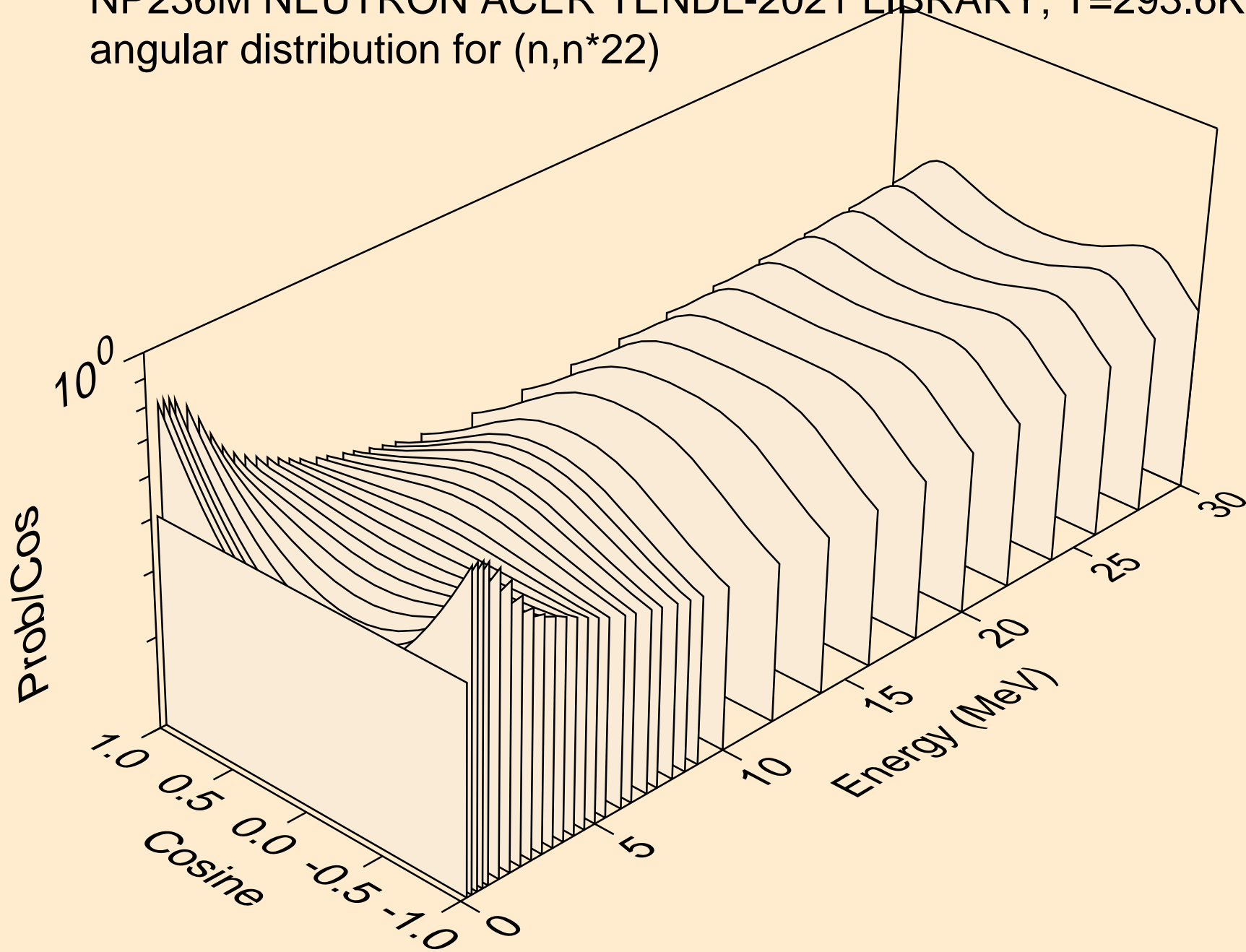

NP236M NEUTRON ACER TENDL-2021 LIBRARY; T=293.6K
angular distribution for (n,n*23)

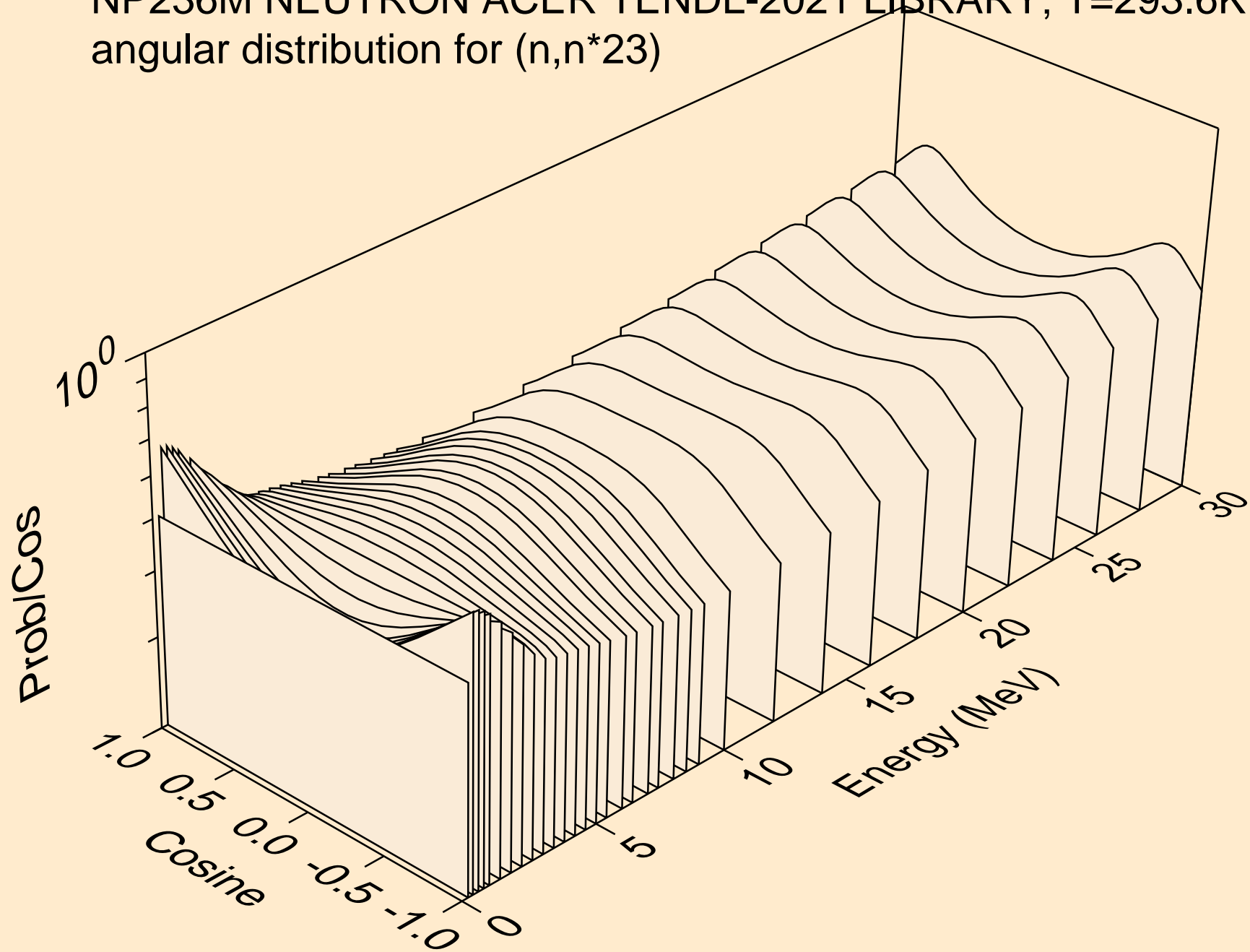

NP236M NEUTRON ACER TENDL-2021 LIBRARY; T=293.6K
angular distribution for (n,n*24)

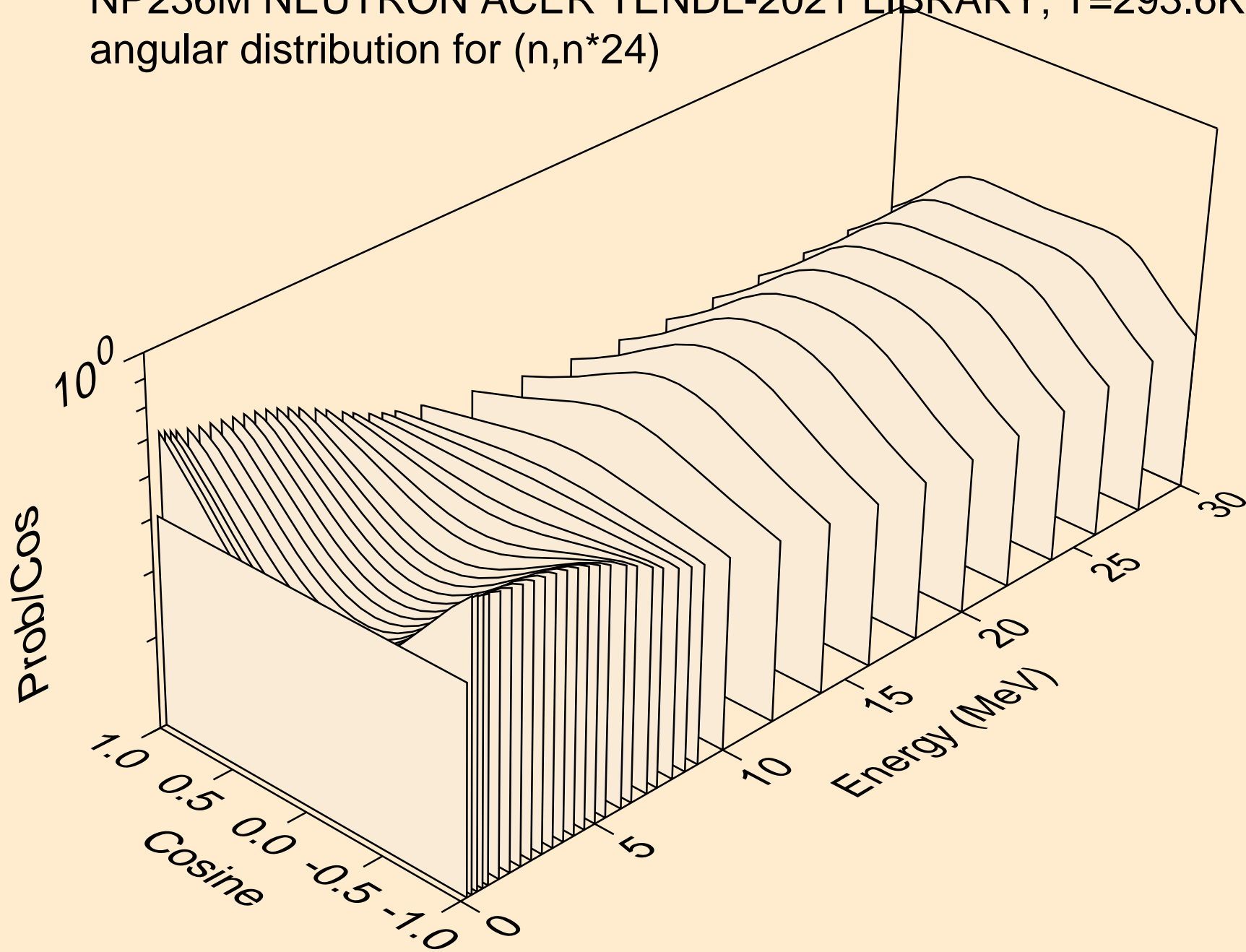

NP236M NEUTRON ACER TENDL-2021 LIBRARY; T=293.6K
angular distribution for (n,n*25)

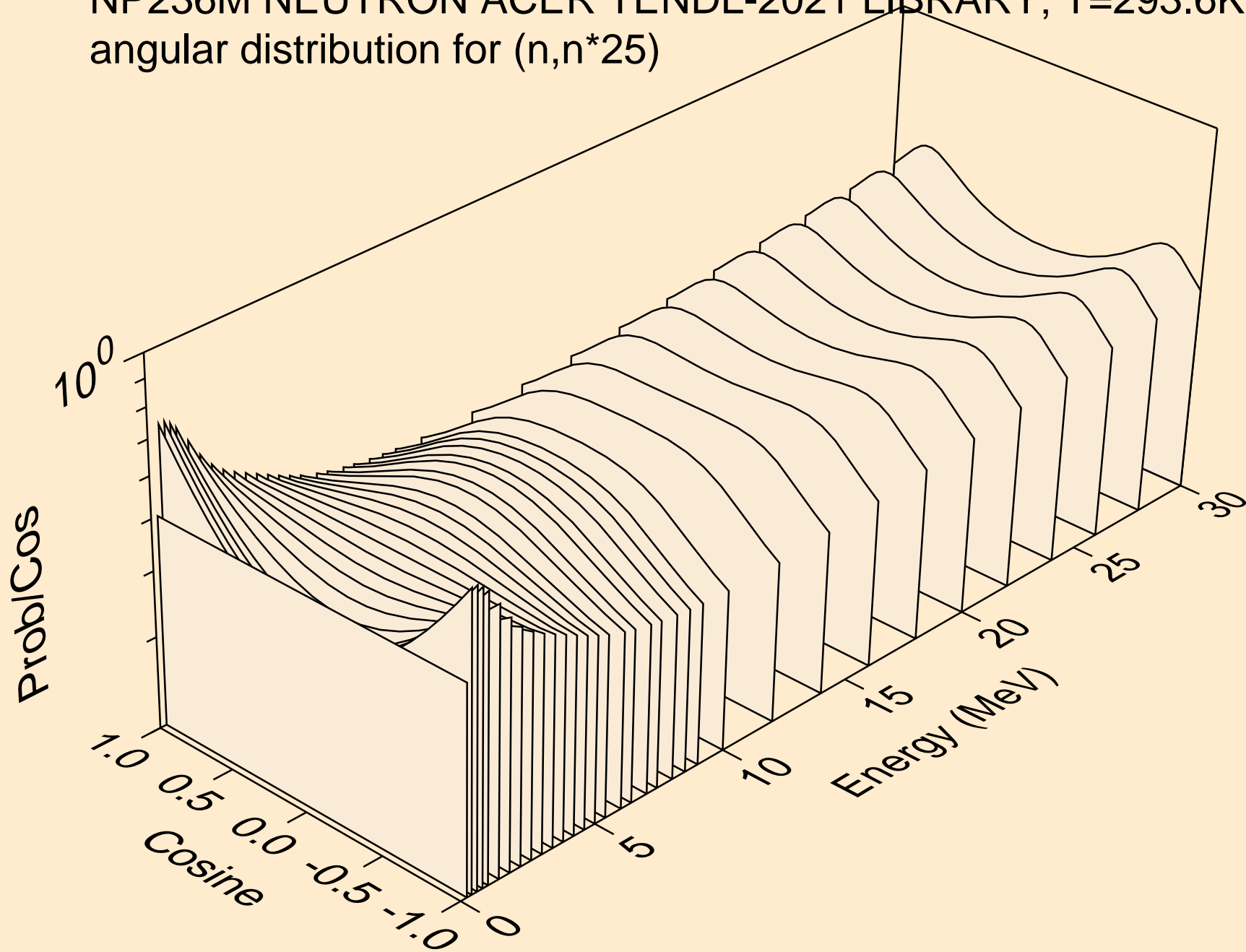

NP236M NEUTRON ACER TENDL-2021 LIBRARY; T=293.6K
angular distribution for (n,n*26)

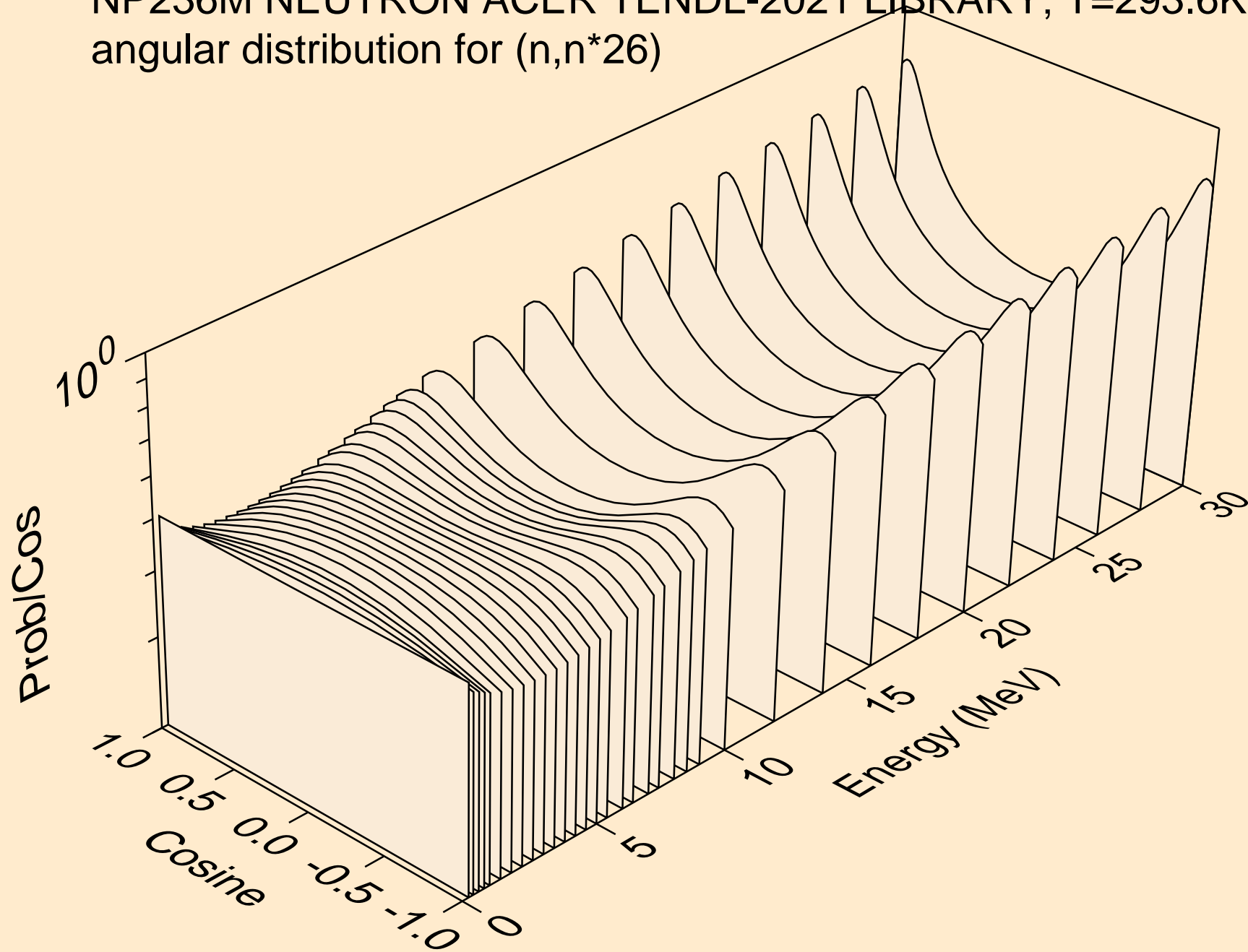

NP236M NEUTRON ACER TENDL-2021 LIBRARY; T=293.6K
Total fission nubar

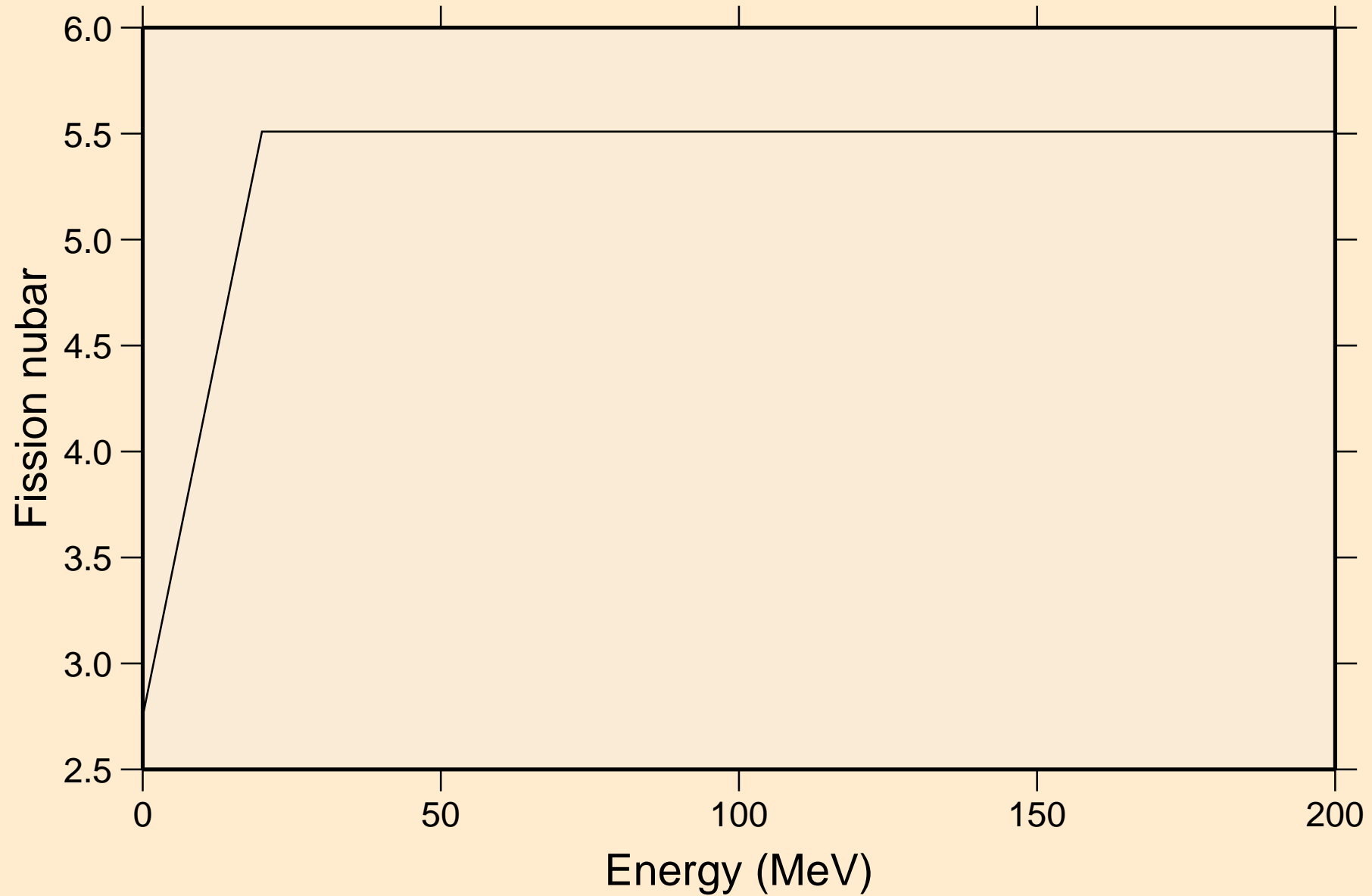

NP236M NEUTRON ACER TENDL-2021 LIBRARY; T=293.6K
Neutron emission for (n,x)

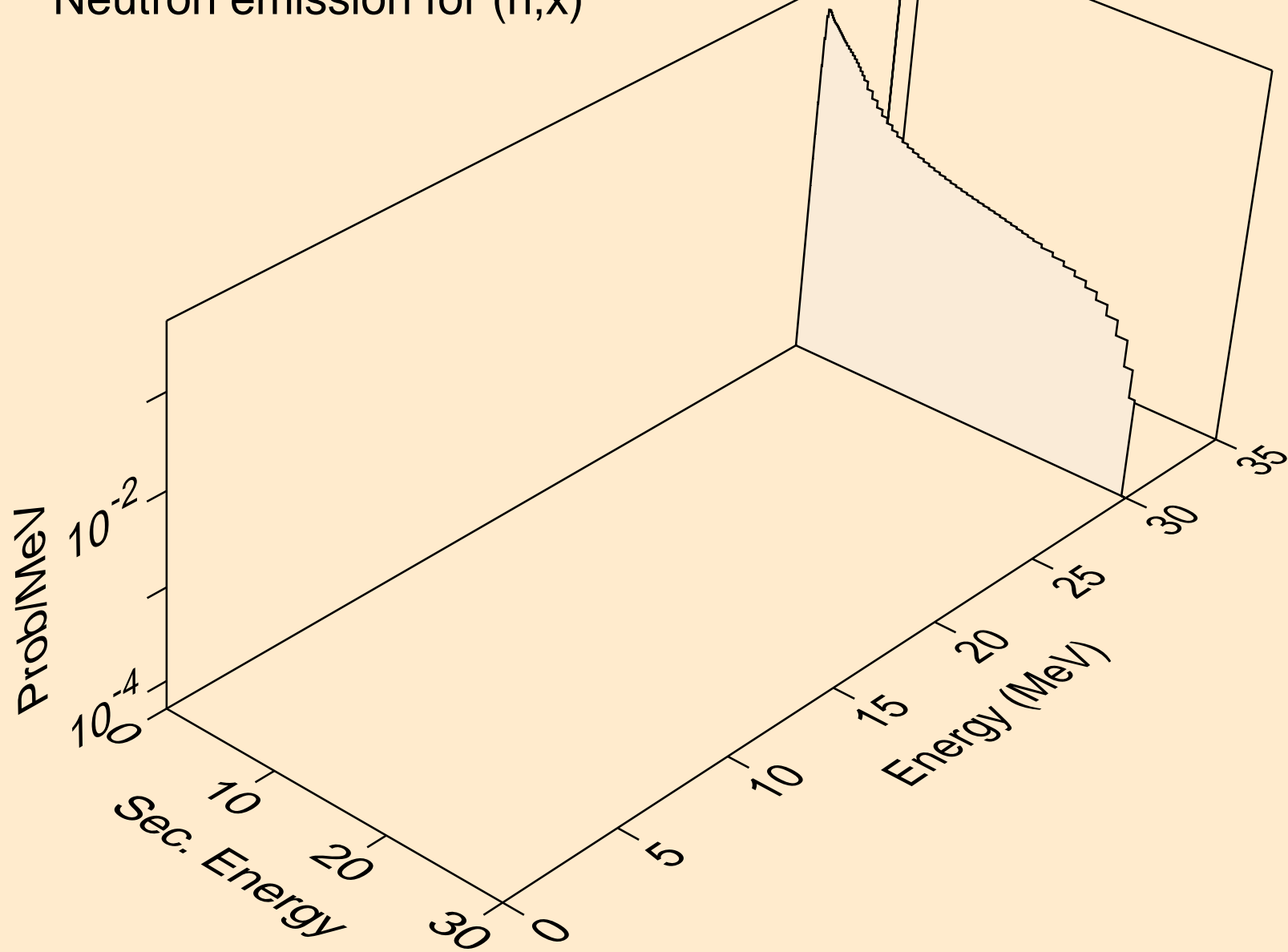

NP236M NEUTRON ACER TENDL-2021 LIBRARY; T=293.6K
Neutron emission for (n,2nd)

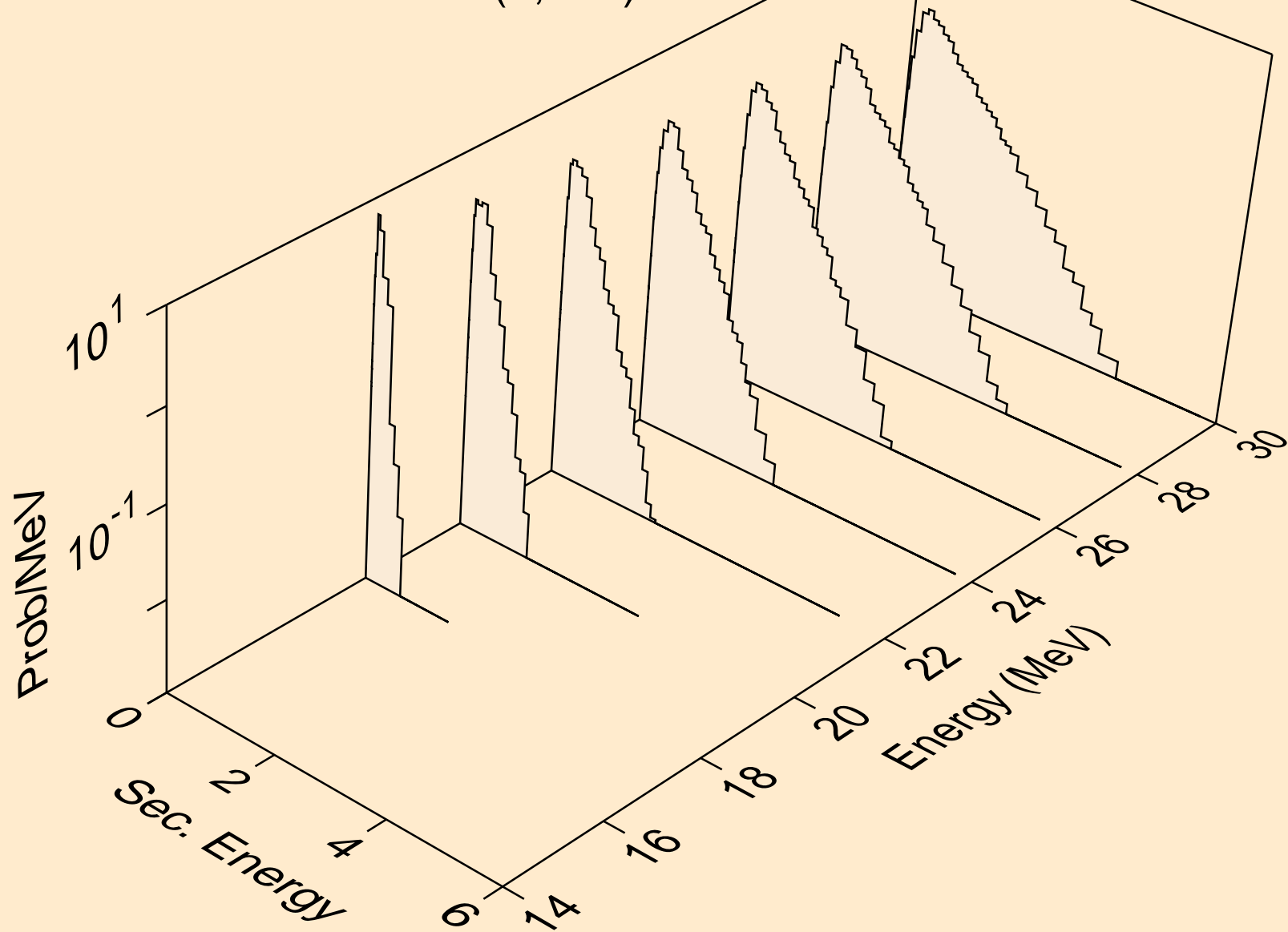

NP236M NEUTRON ACER TENDL-2021 LIBRARY; T=293.6K
Neutron emission for (n,2n)

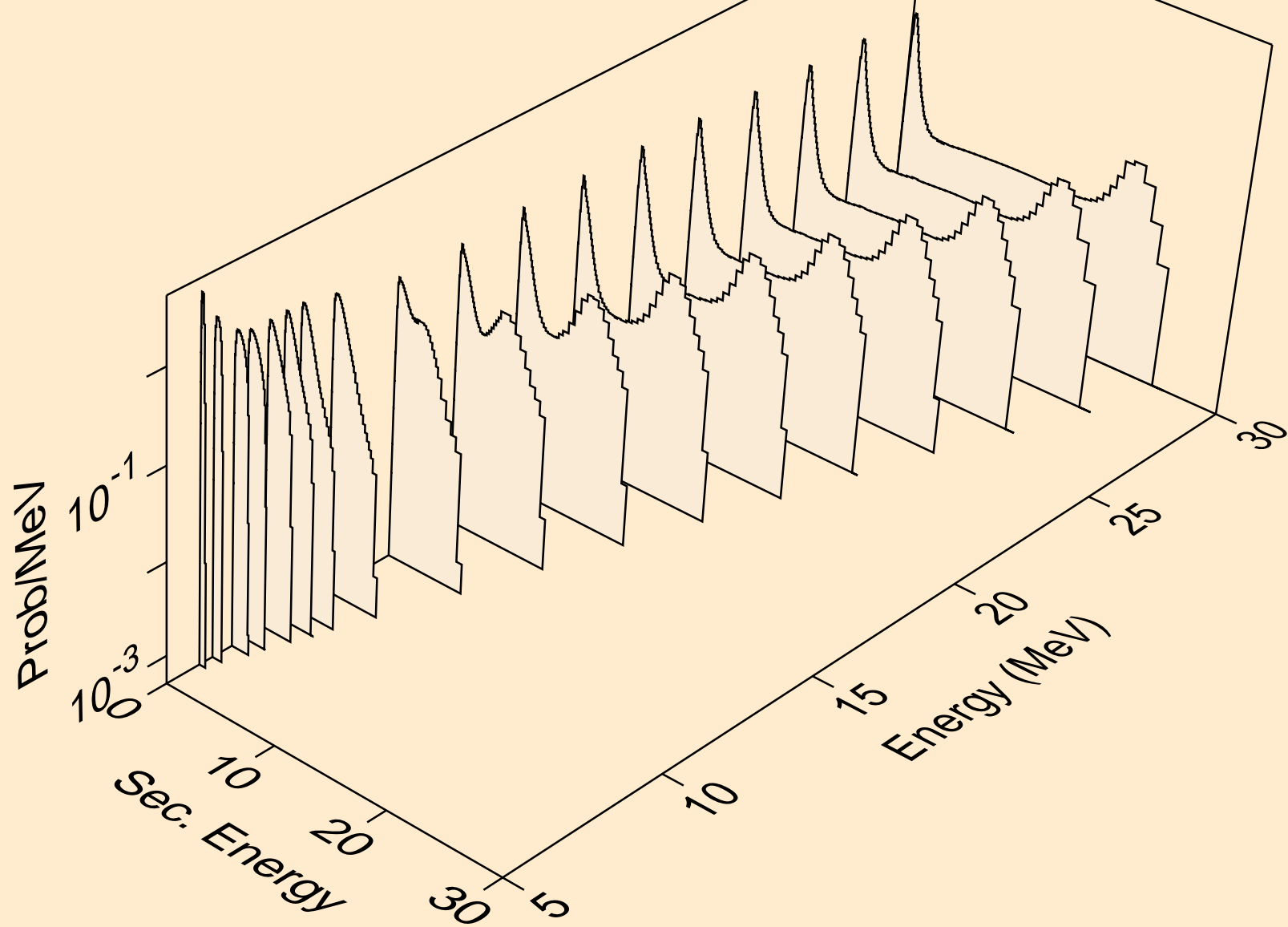

NP236M NEUTRON ACER TENDL-2021 LIBRARY; T=293.6K
Neutron emission for (n,3n)

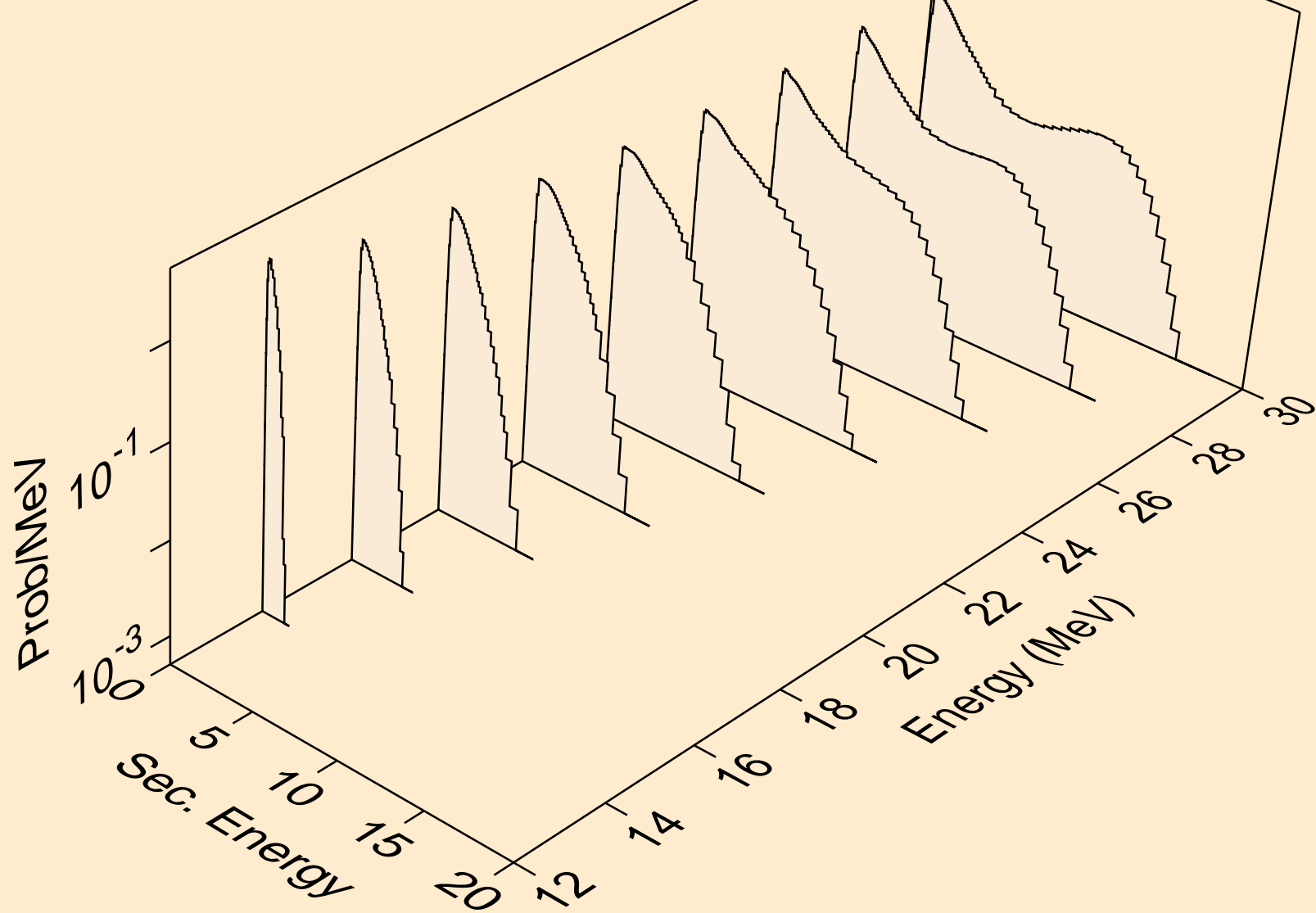

NP236M NEUTRON ACER TENDL-2021 LIBRARY; T=293.6K
Neutron emission for fission

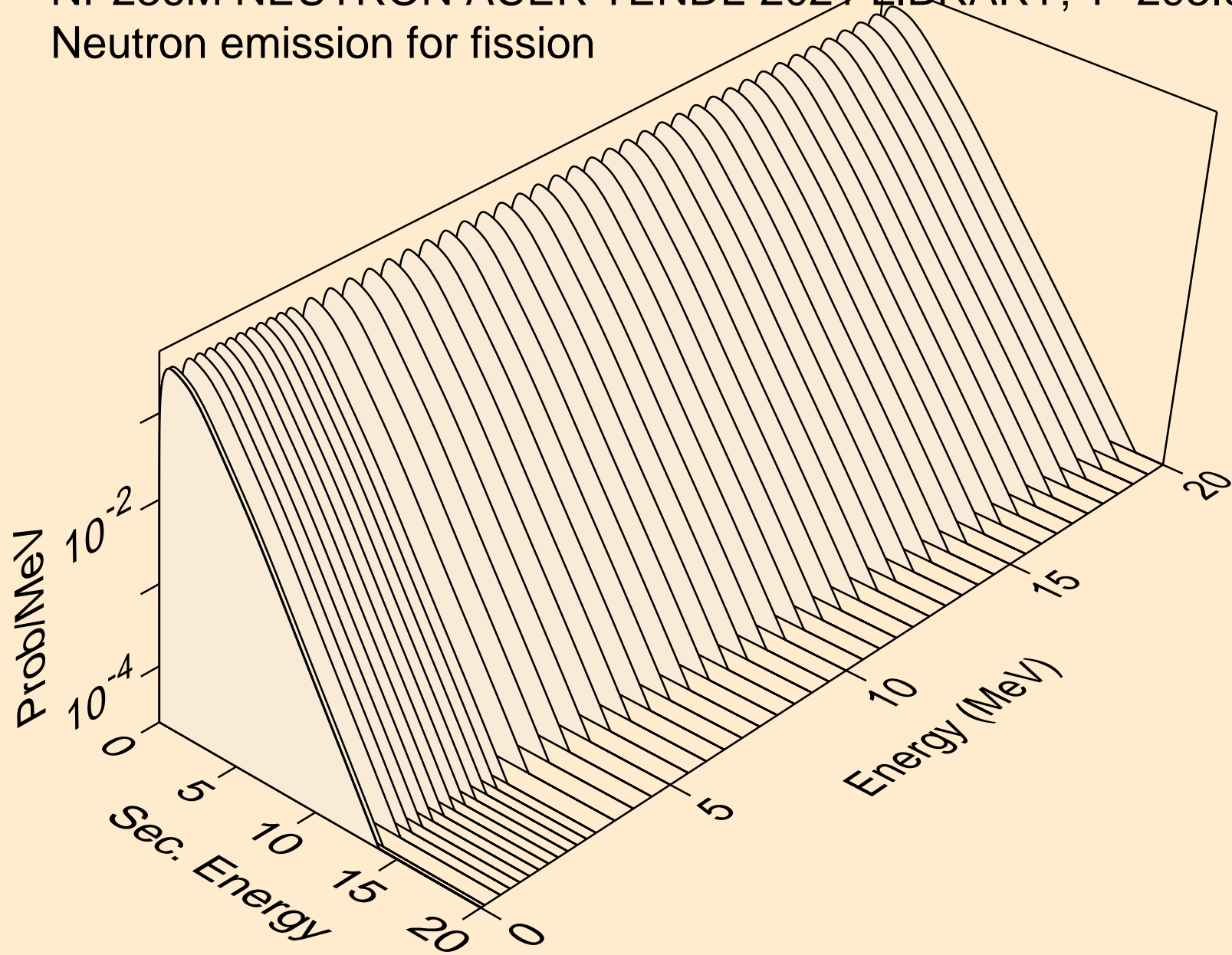

NP236M NEUTRON ACER TENDL-2021 LIBRARY; T=293.6K
Neutron emission for (n,n*)a

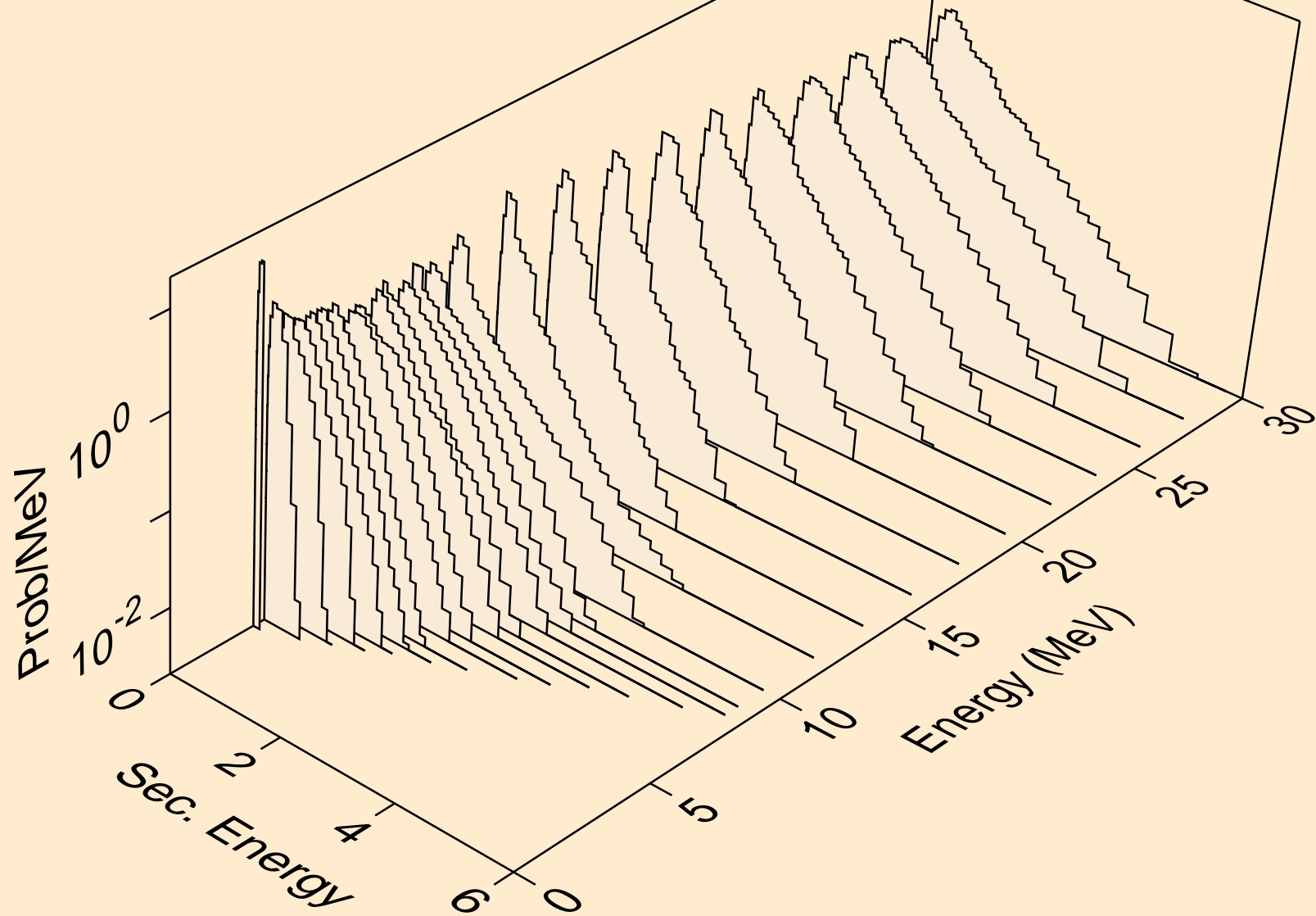

NP236M NEUTRON ACER TENDL-2021 LIBRARY; T=293.6K
Neutron emission for (n,2n)a

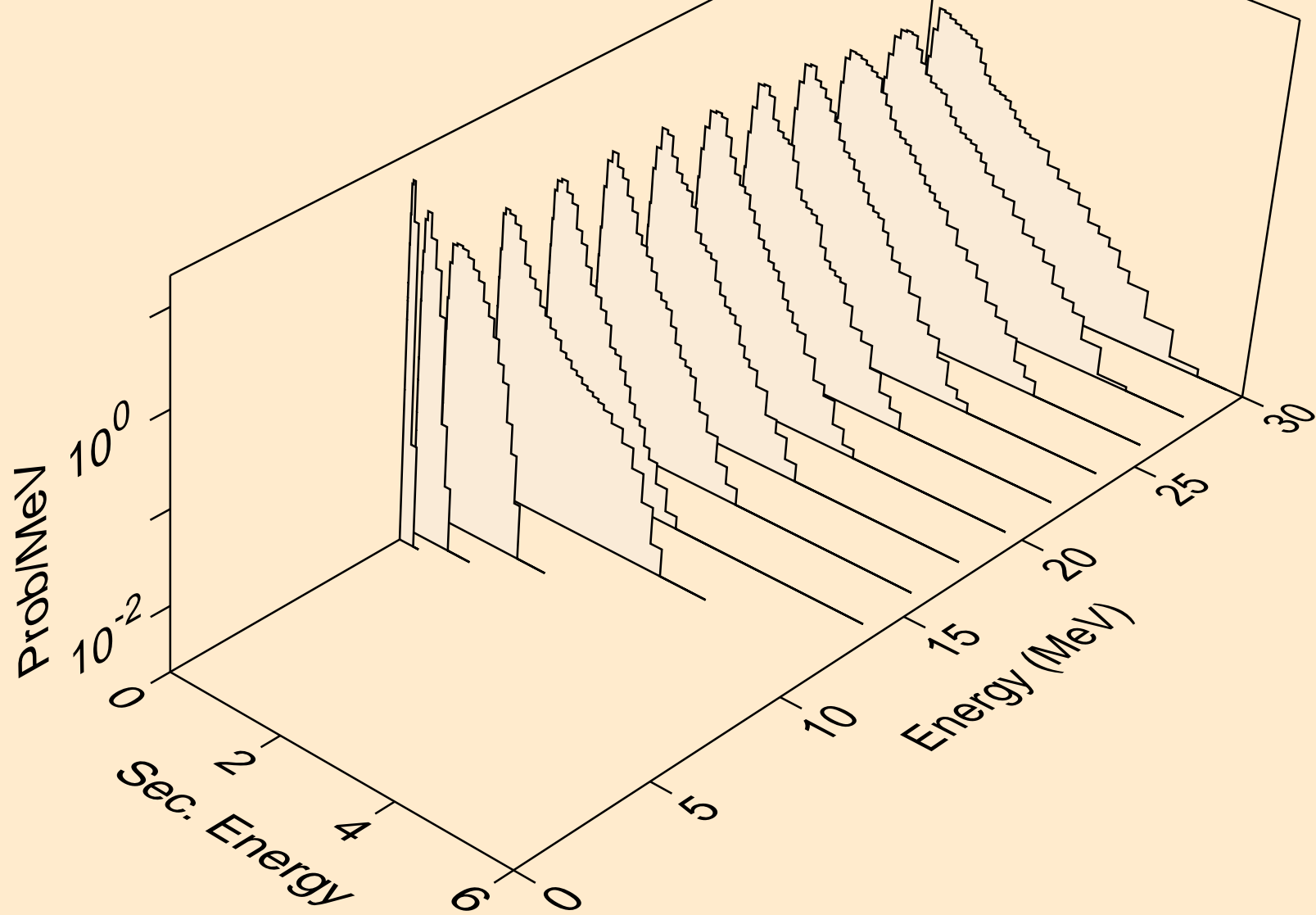

NP236M NEUTRON ACER TENDL-2021 LIBRARY; T=293.6K
Neutron emission for (n,3n)a

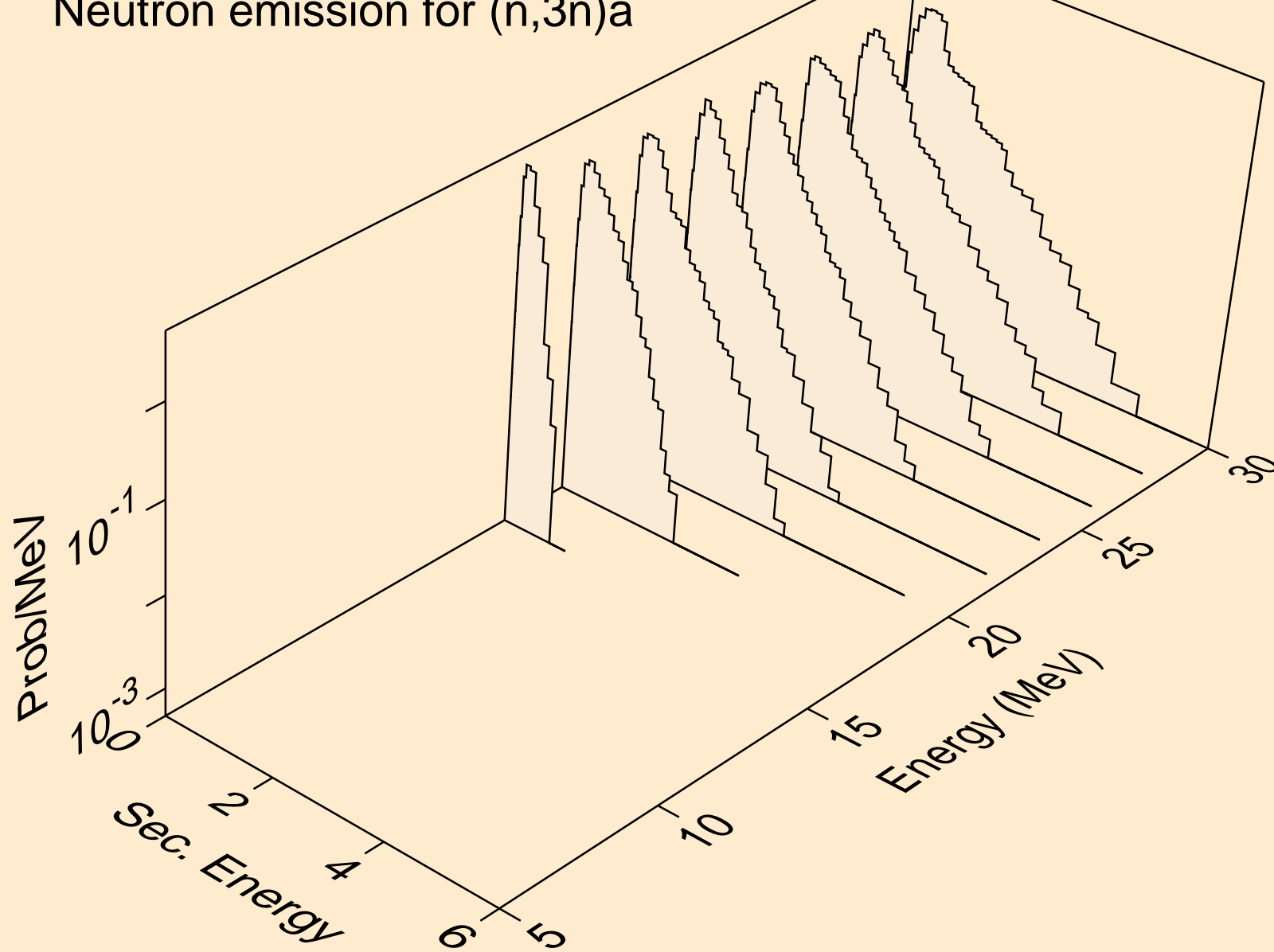

NP236M NEUTRON ACER TENDL-2021 LIBRARY; T=293.6K
Neutron emission for (n,n*)p

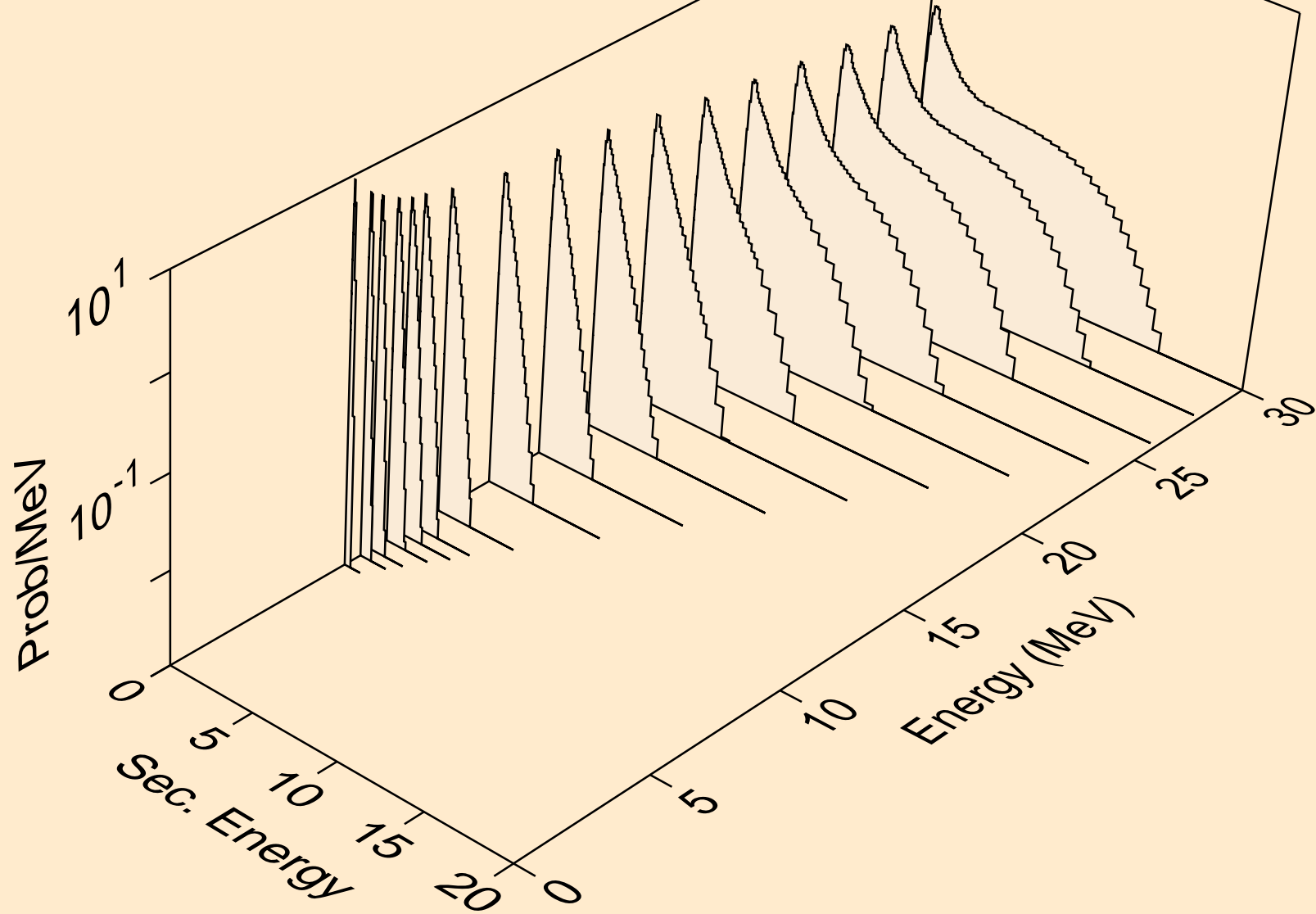

NP236M NEUTRON ACER TENDL-2021 LIBRARY; T=293.6K
Neutron emission for (n,n*)2a

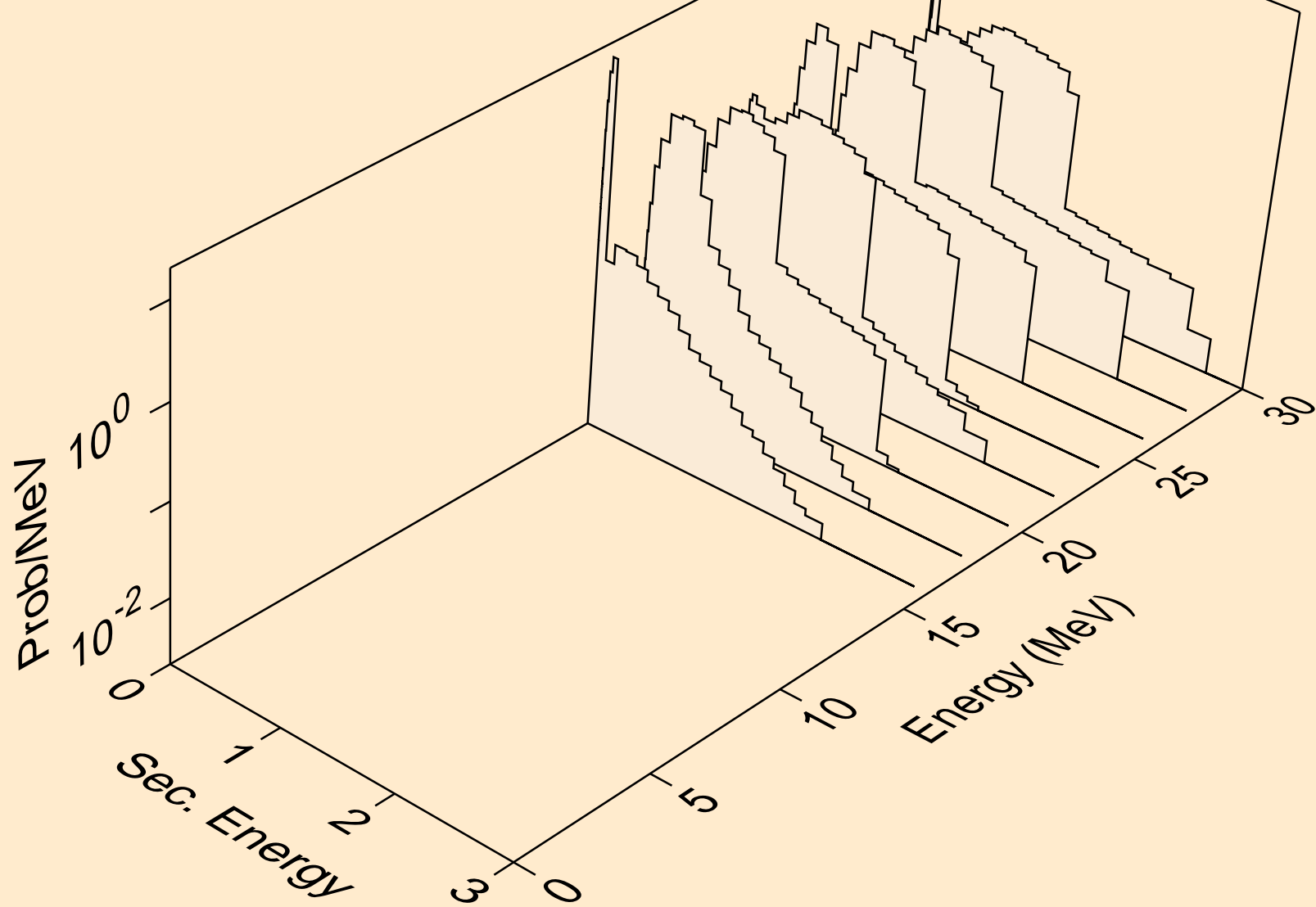

NP236M NEUTRON ACER TENDL-2021 LIBRARY; T=293.6K
Neutron emission for (n,n*)d

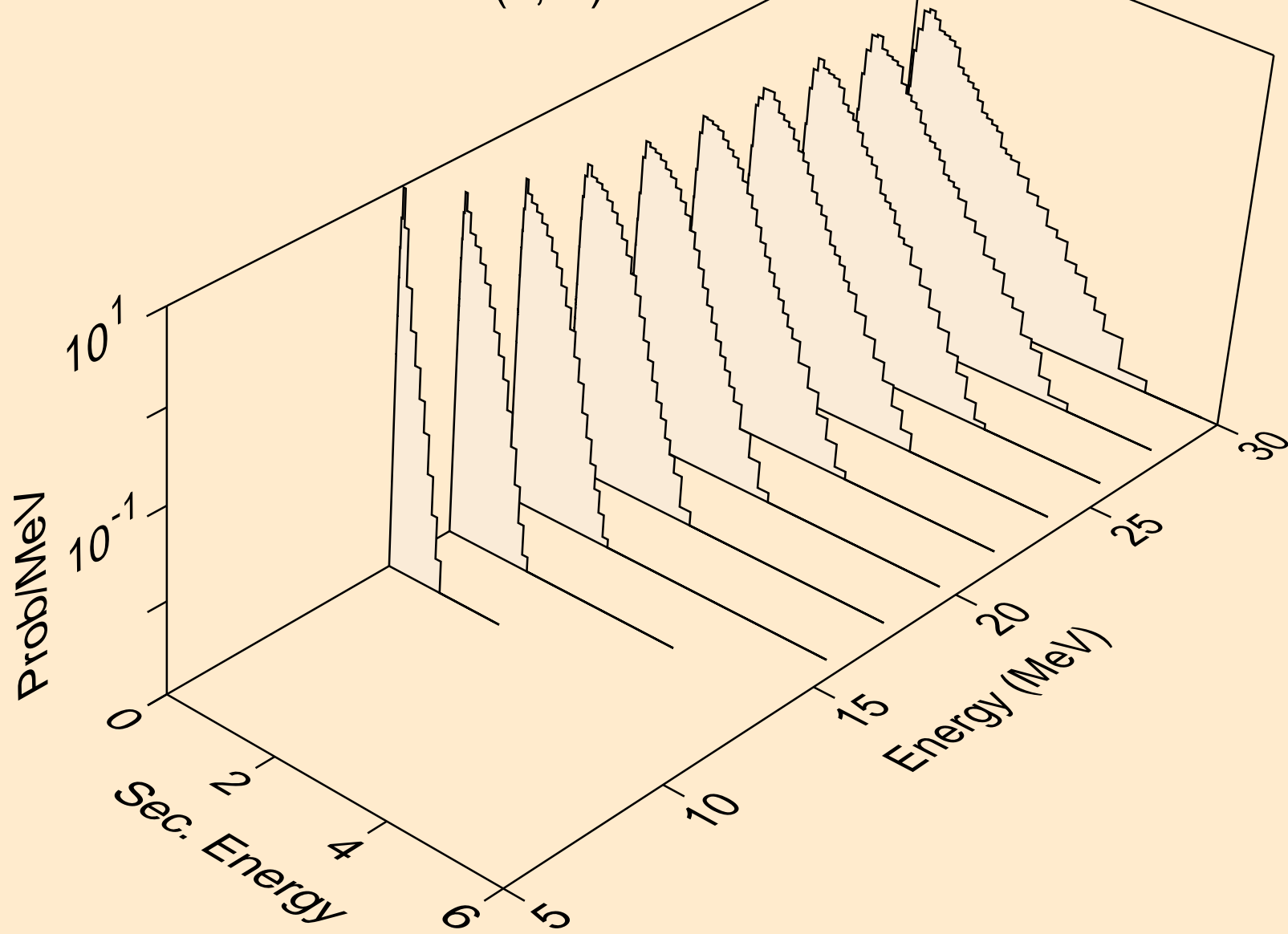

NP236M NEUTRON ACER TENDL-2021 LIBRARY; T=293.6K
Neutron emission for (n,n*)t

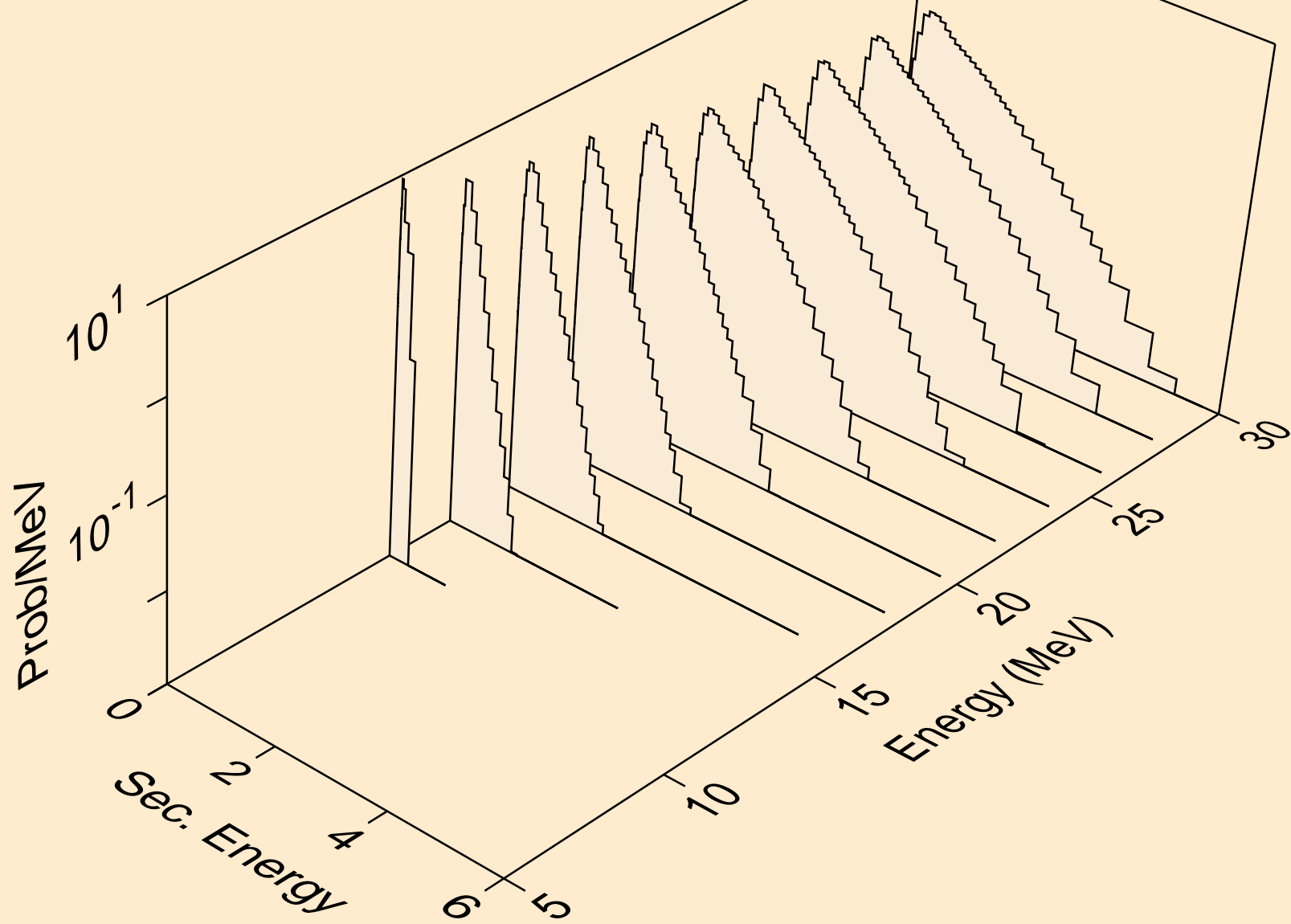

NP236M NEUTRON ACER TENDL-2021 LIBRARY; T=293.6K
Neutron emission for (n,n*)he3

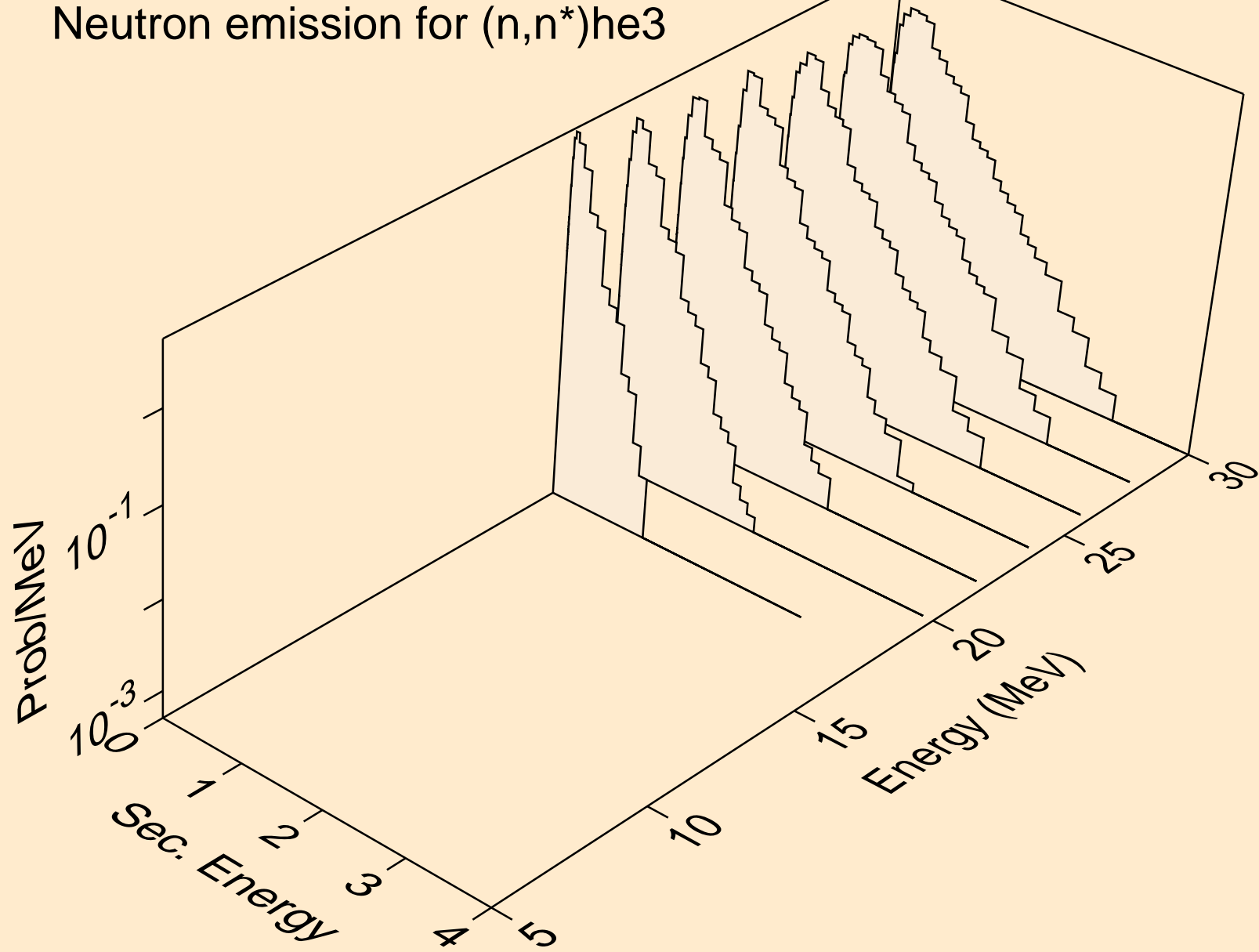

NP236M NEUTRON ACER TENDL-2021 LIBRARY; T=293.6K
Neutron emission for (n,4n)

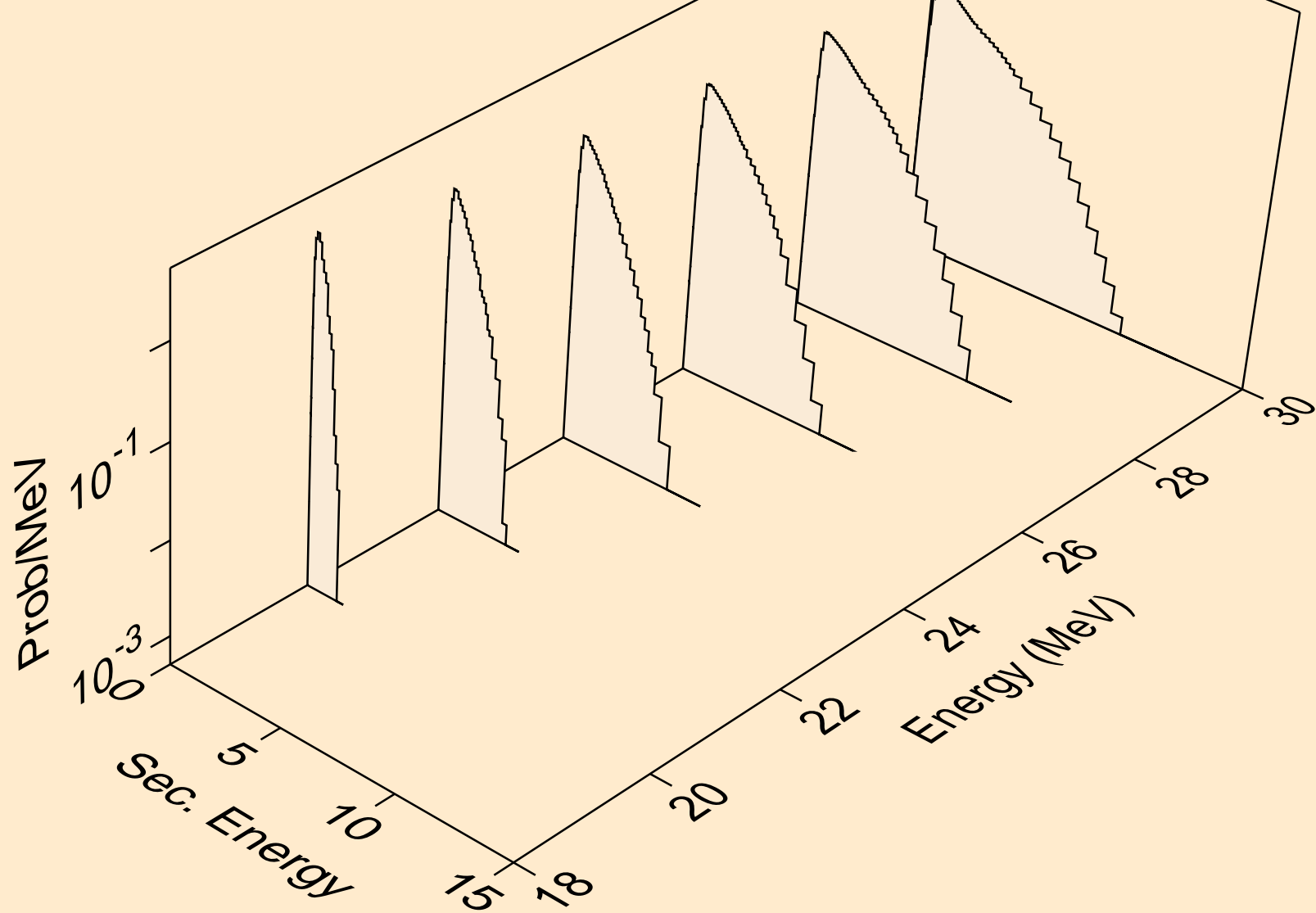

NP236M NEUTRON ACER TENDL-2021 LIBRARY; T=293.6K
Neutron emission for (n,2np)

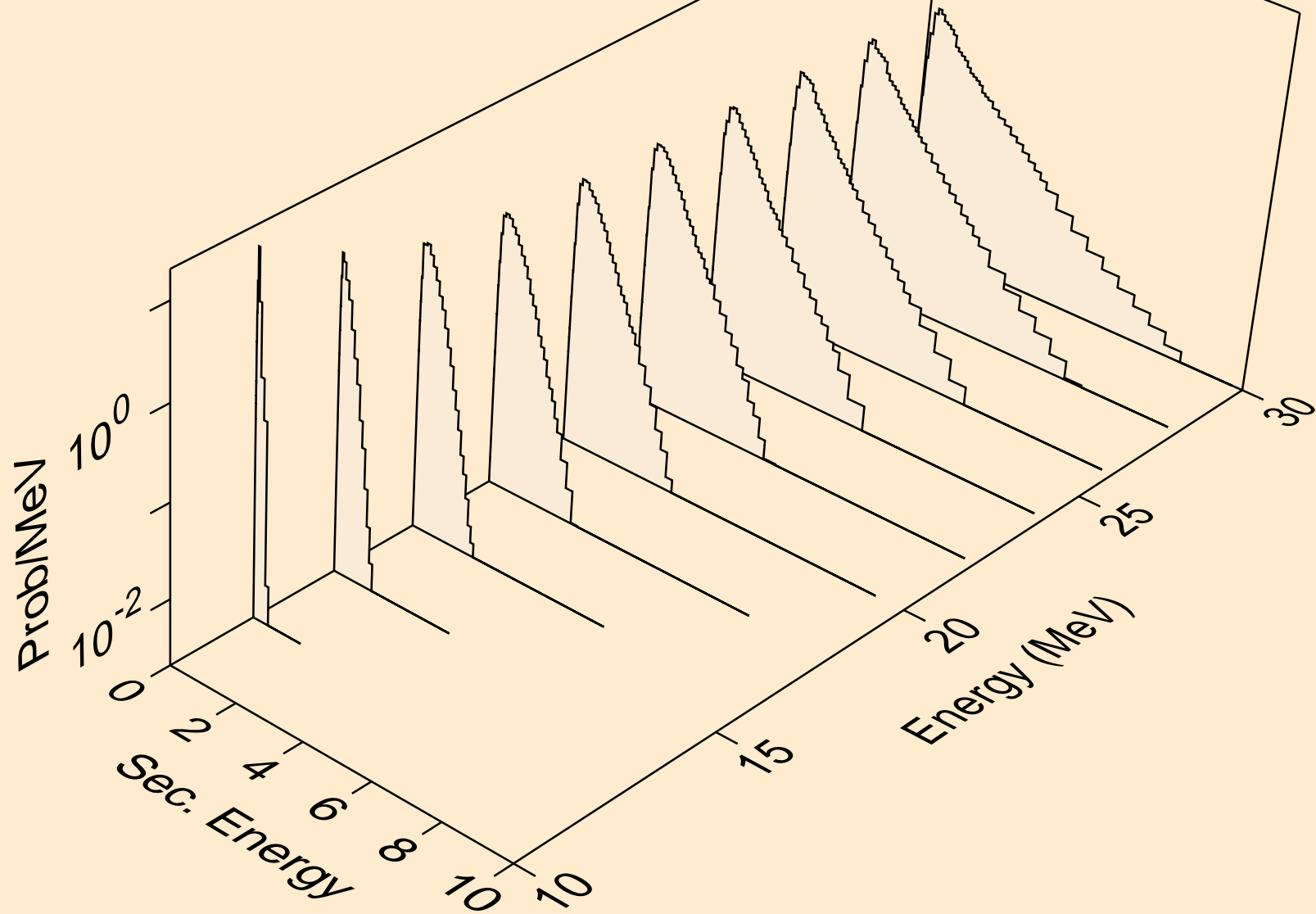

NP236M NEUTRON ACER TENDL-2021 LIBRARY; T=293.6K
Neutron emission for (n,3np)

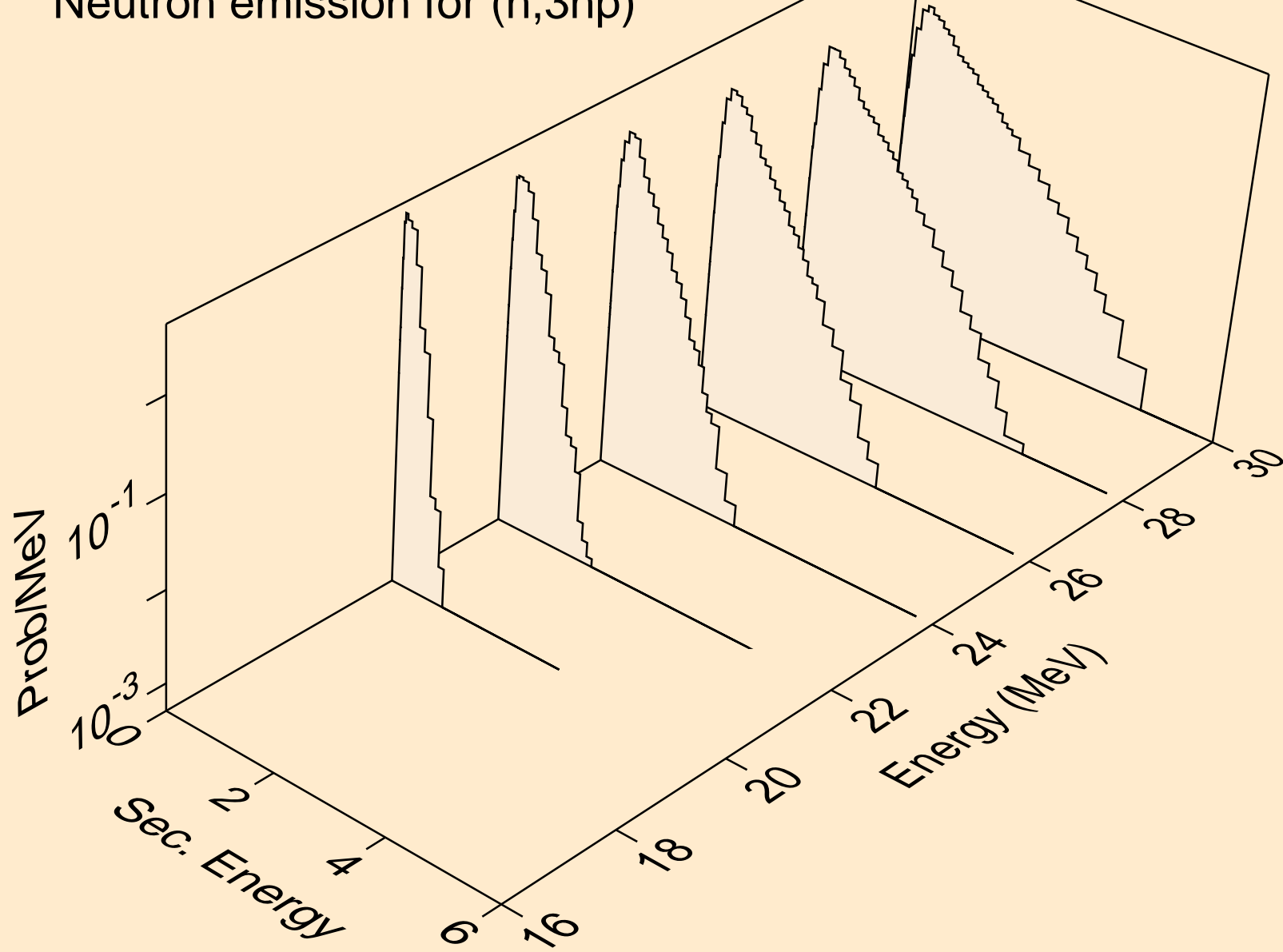

NP236M NEUTRON ACER TENDL-2021 LIBRARY; T=293.6K
Neutron emission for (n,2np)

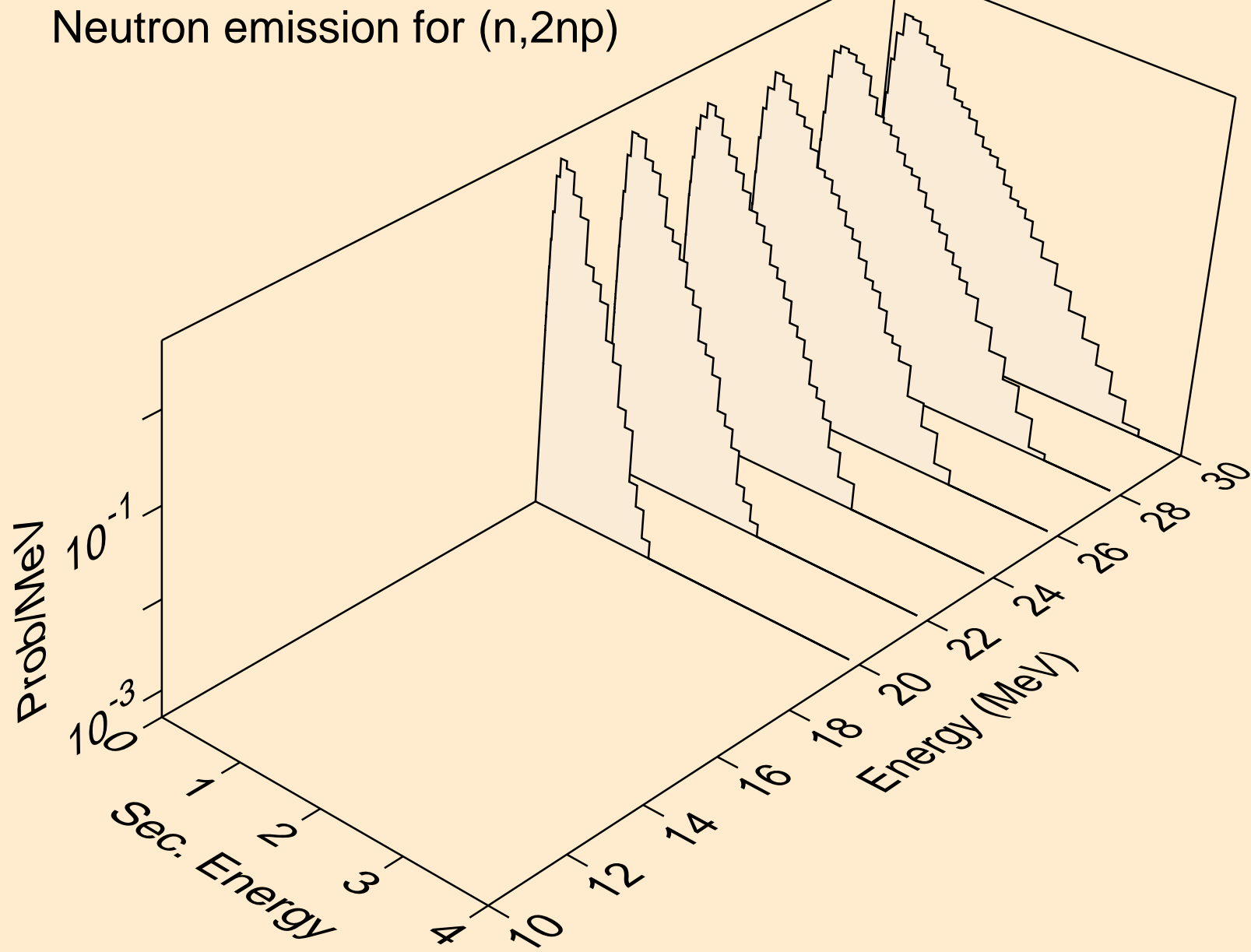

NP236M NEUTRON ACER TENDL-2021 LIBRARY; T=293.6K
Neutron emission for (n,npa)

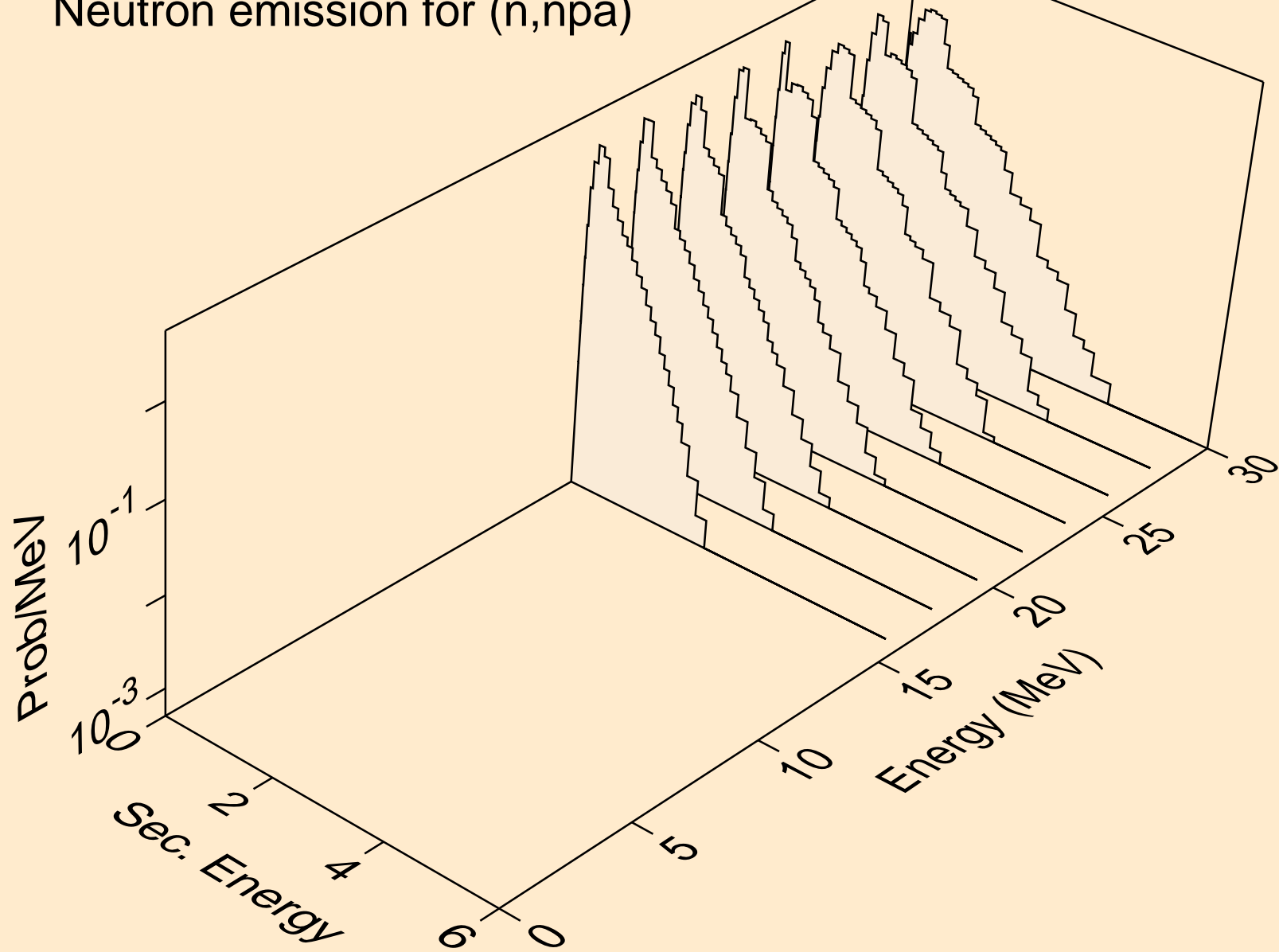

NP236M NEUTRON ACER TENDL-2021 LIBRARY; T=293.6K
Neutron emission for (n,n*c)

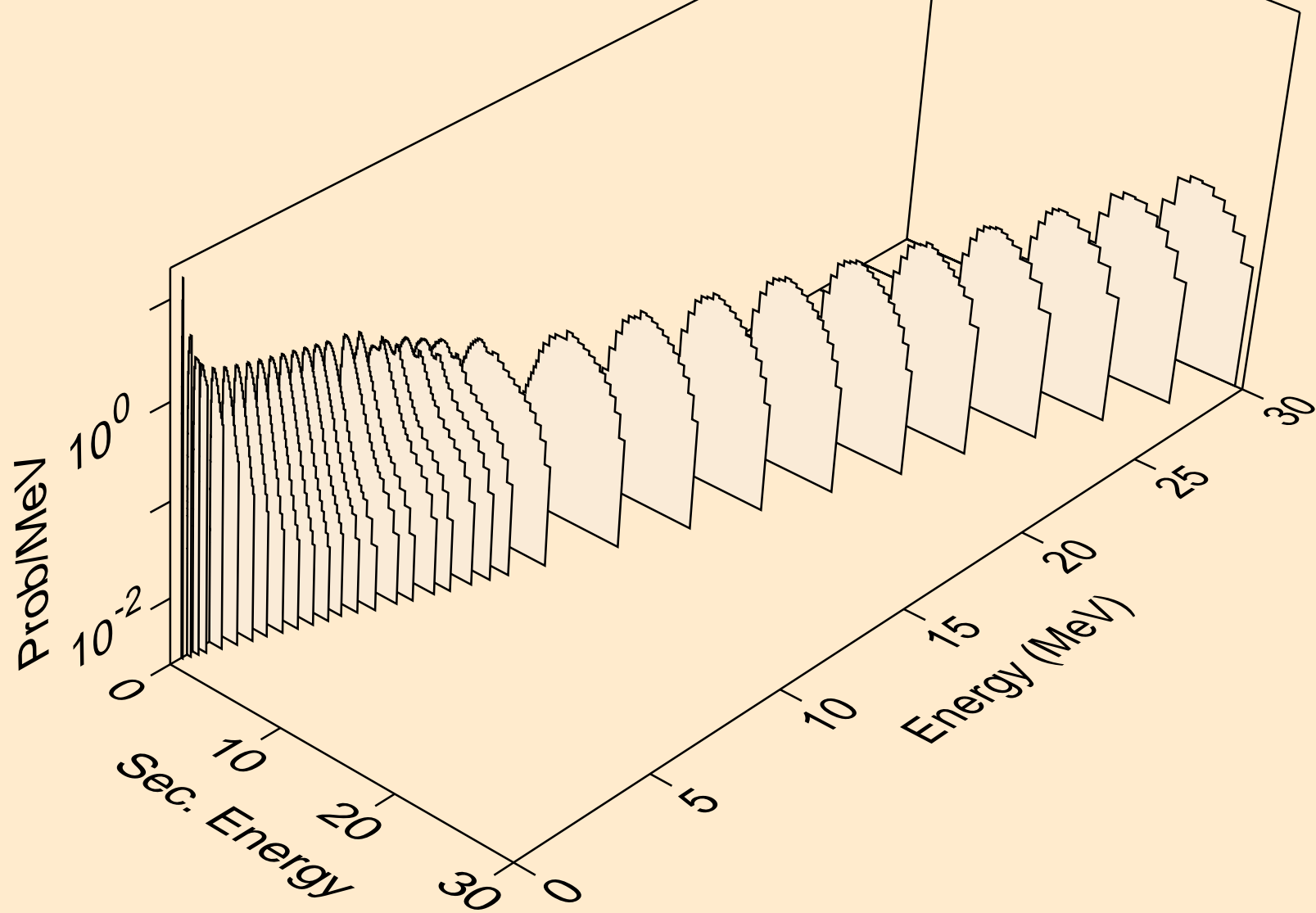

NP236M NEUTRON ACER TENDL-2021 LIBRARY; T=293.6K
Delayed nubar

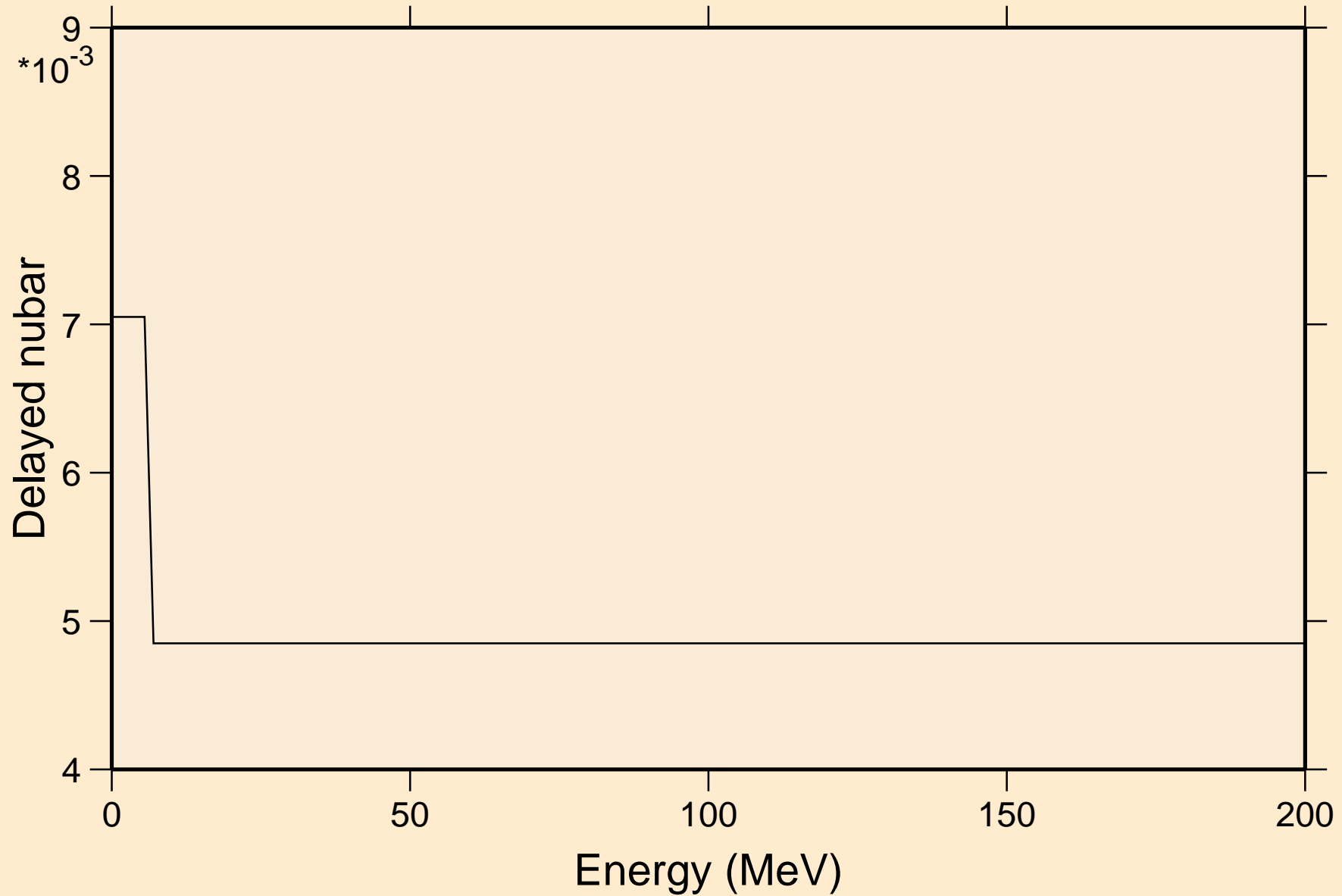

NP236M NEUTRON ACER TENDL-2021 LIBRARY; T=293.6K

Delayed neutron spectra

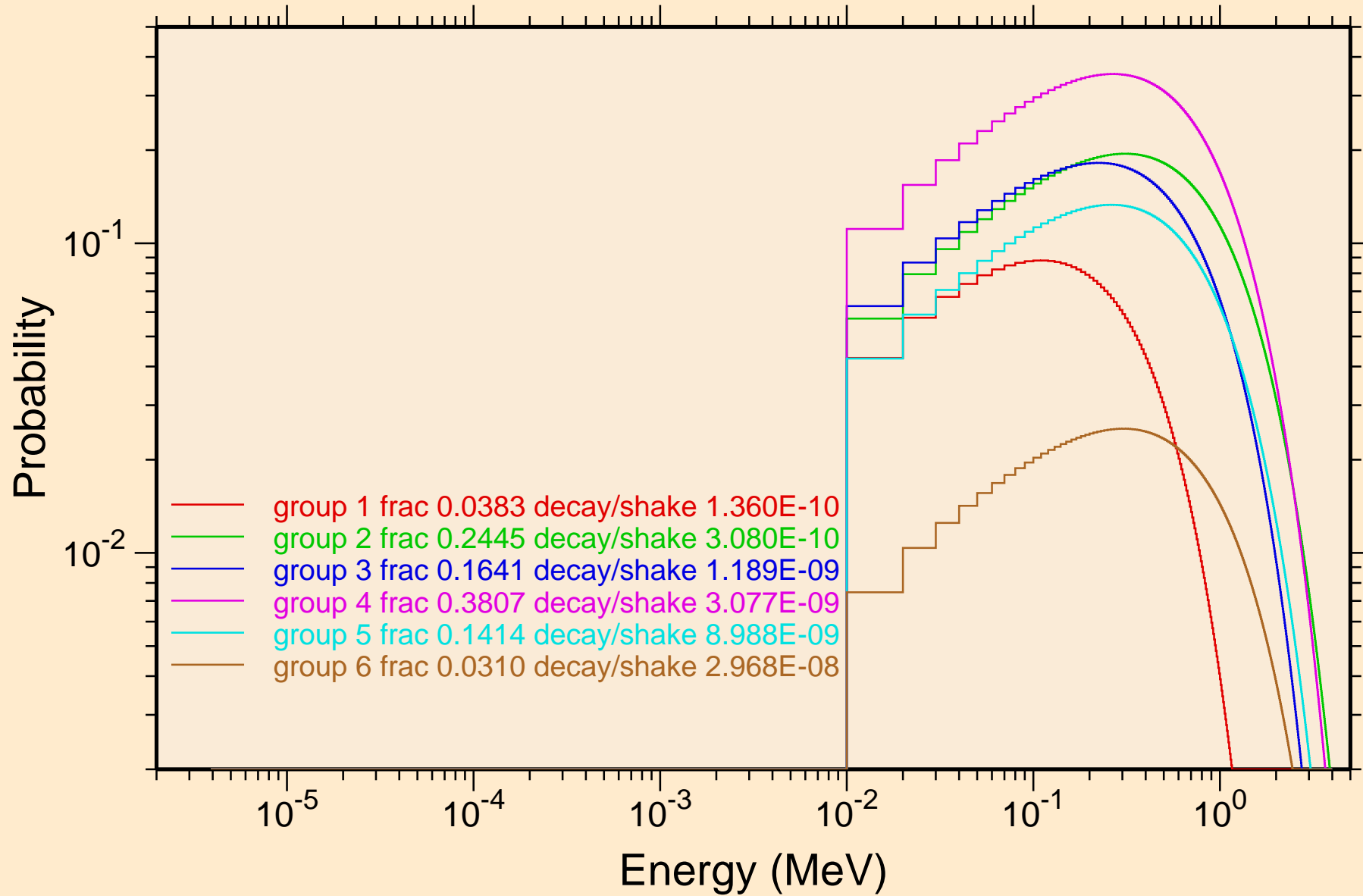

NP236M NEUTRON ACER TENDL-2021 LIBRARY; T=293.6K
Photon emission for (n,x)

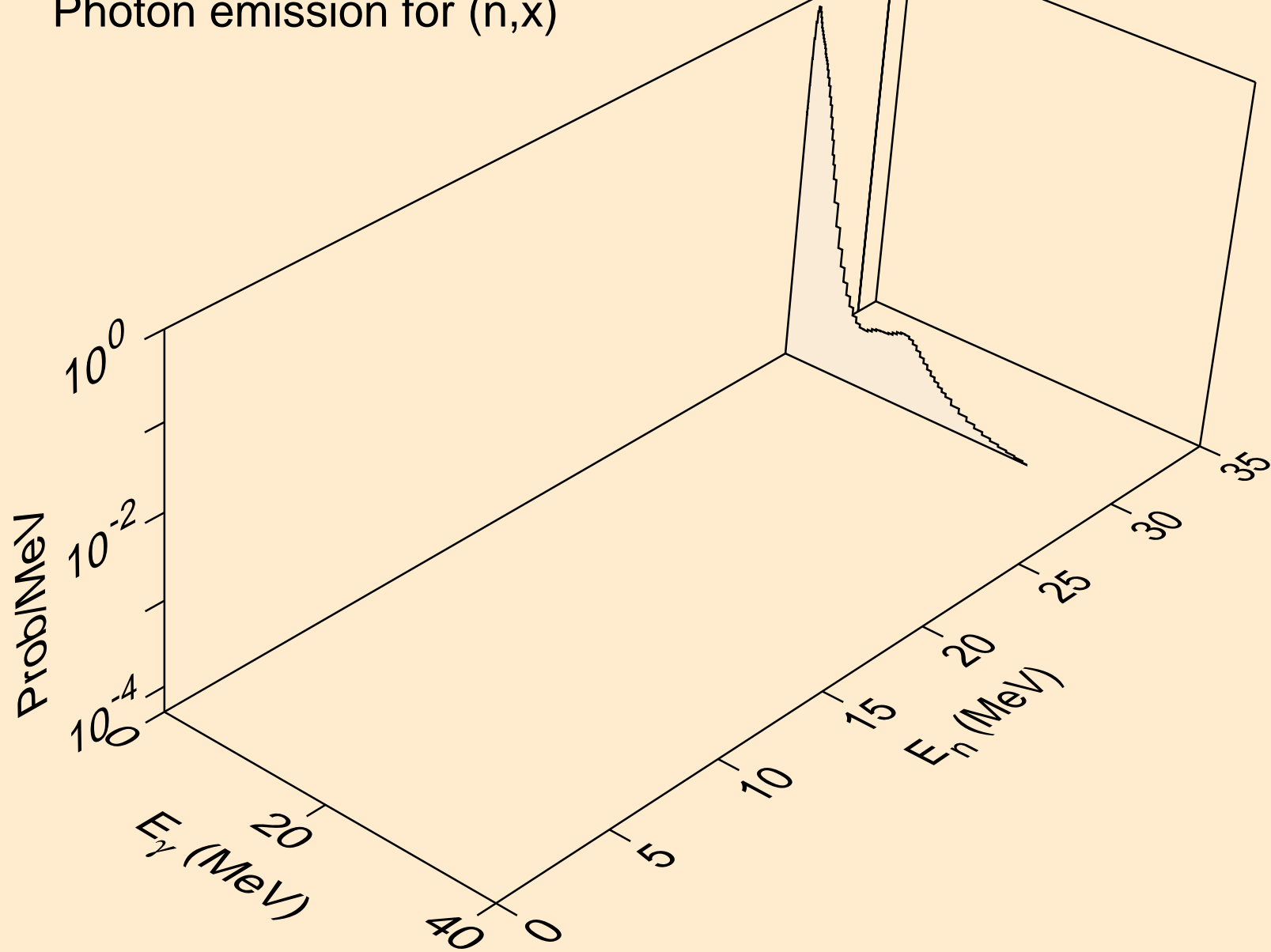

NP236M NEUTRON ACER TENDL-2021 LIBRARY; T=293.6K
Photon emission for (n,2nd)

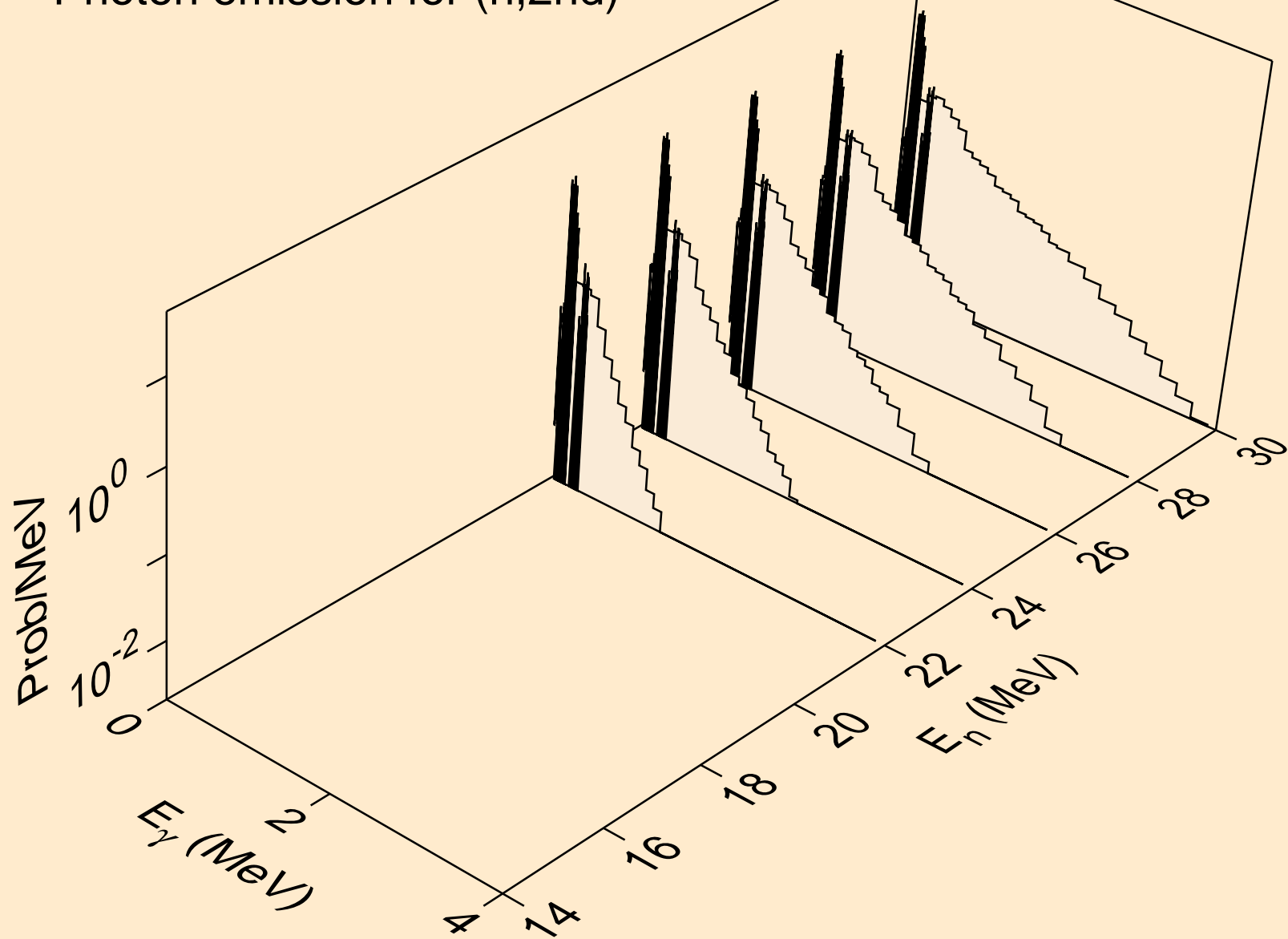

NP236M NEUTRON ACER TENDL-2021 LIBRARY; T=293.6K
Photon emission for (n,2n)

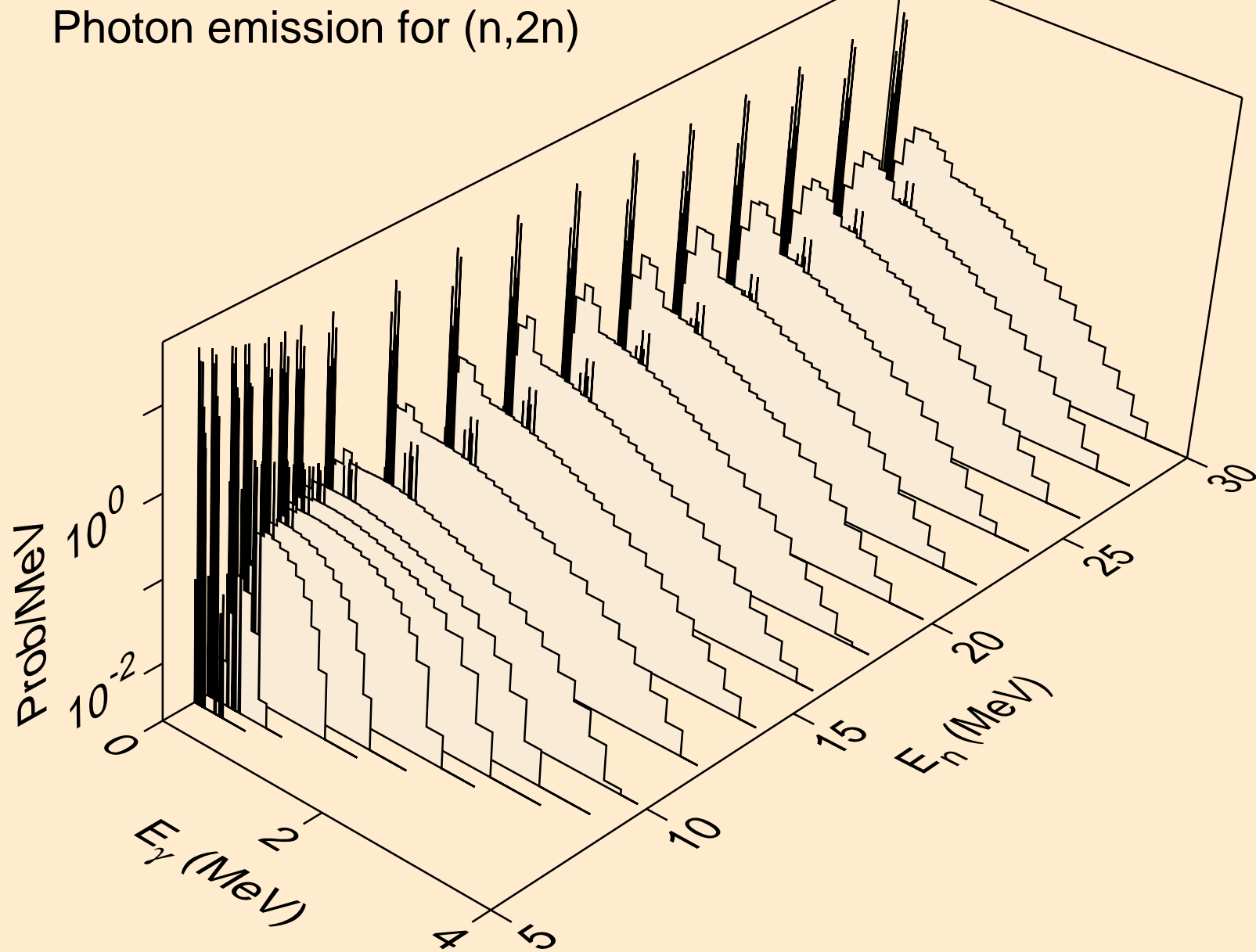

NP236M NEUTRON ACER TENDL-2021 LIBRARY; T=293.6K
Photon emission for (n,3n)

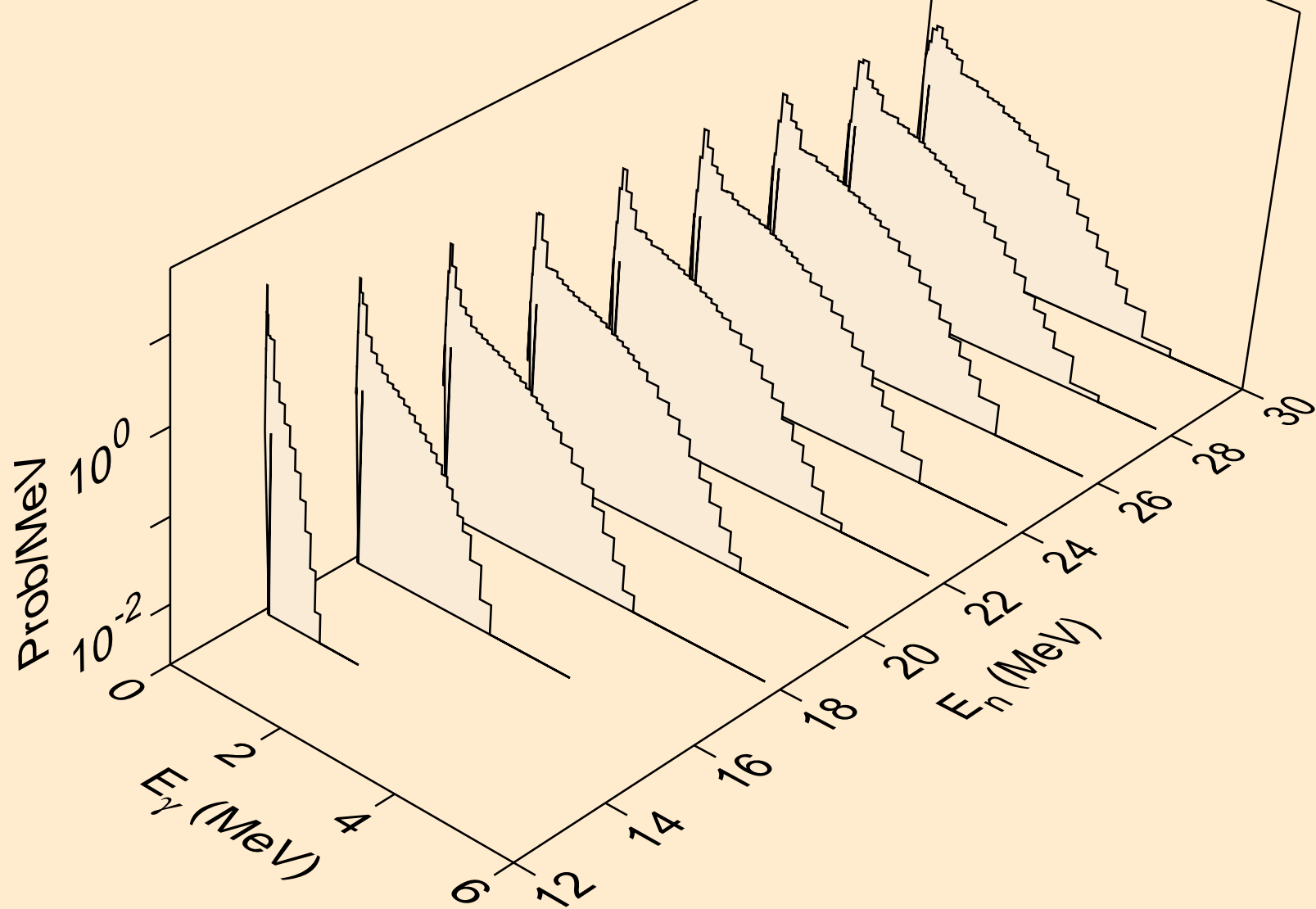

NP236M NEUTRON ACER TENDL-2021 LIBRARY; T=293.6K
Photon emission for (n,n*)a

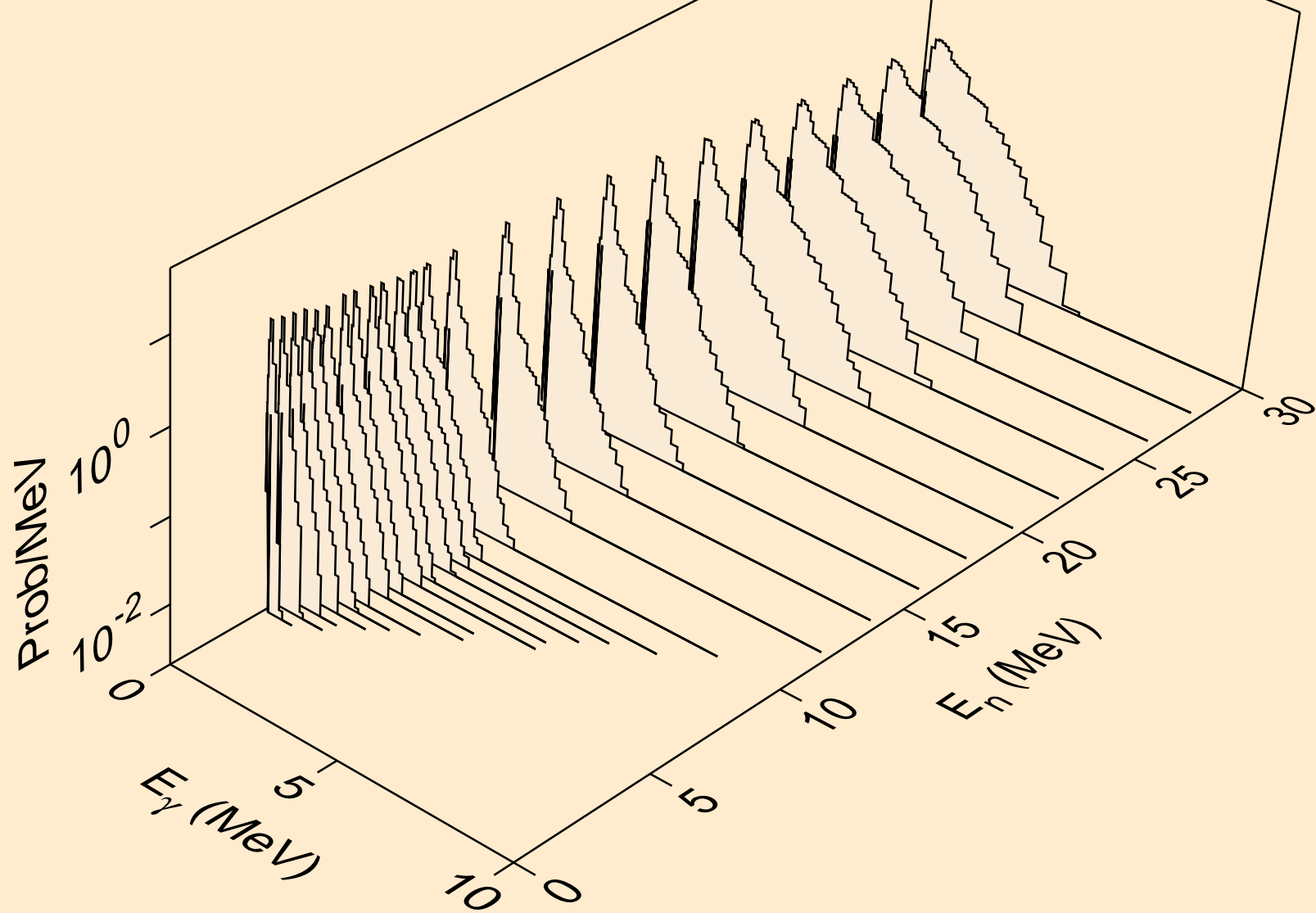

NP236M NEUTRON ACER TENDL-2021 LIBRARY; T=293.6K
Photon emission for (n,2n)a

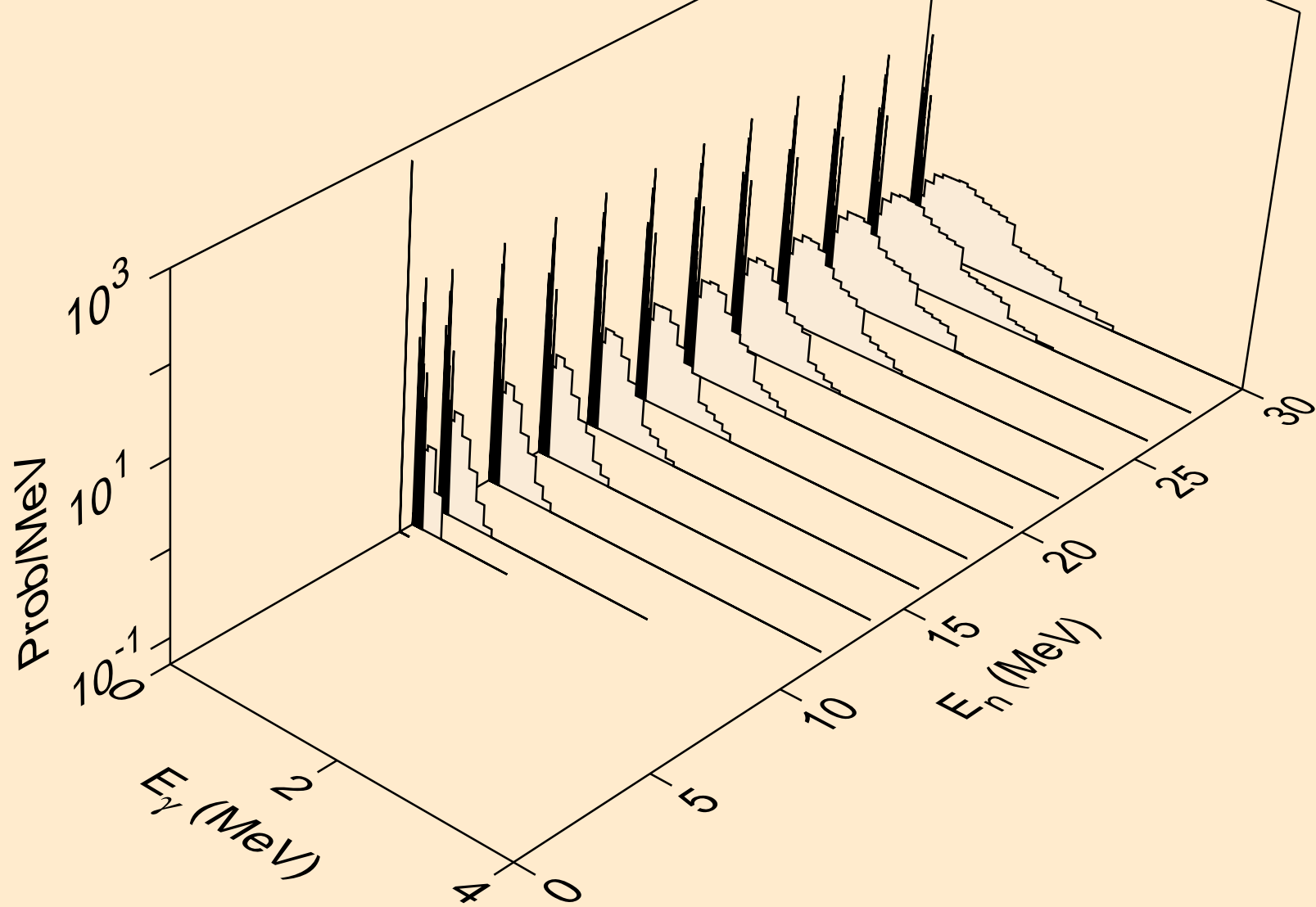

NP236M NEUTRON ACER TENDL-2021 LIBRARY; T=293.6K
Photon emission for (n,3n)a

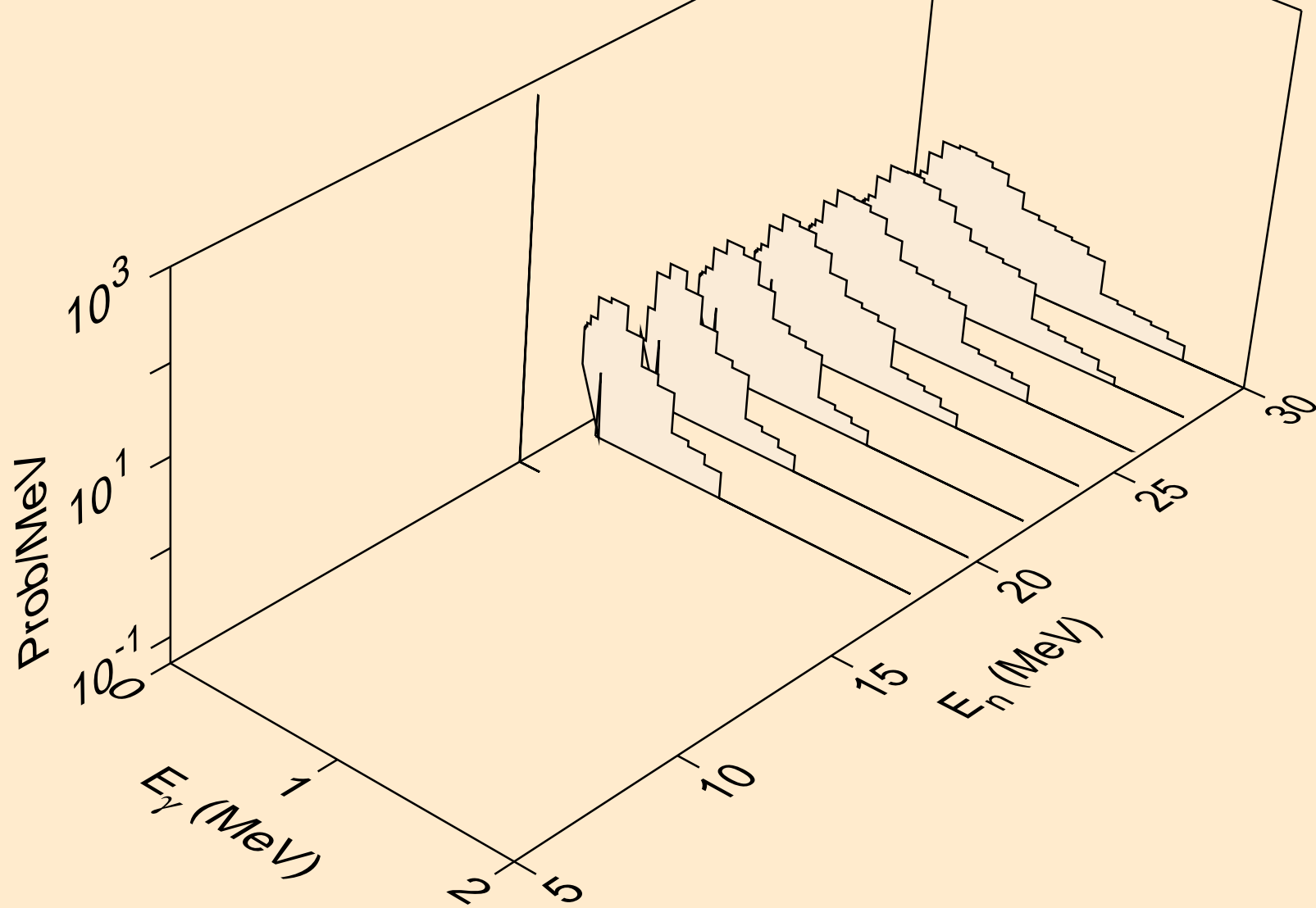

NP236M NEUTRON ACER TENDL-2021 LIBRARY; T=293.6K
Photon emission for (n,n*)p

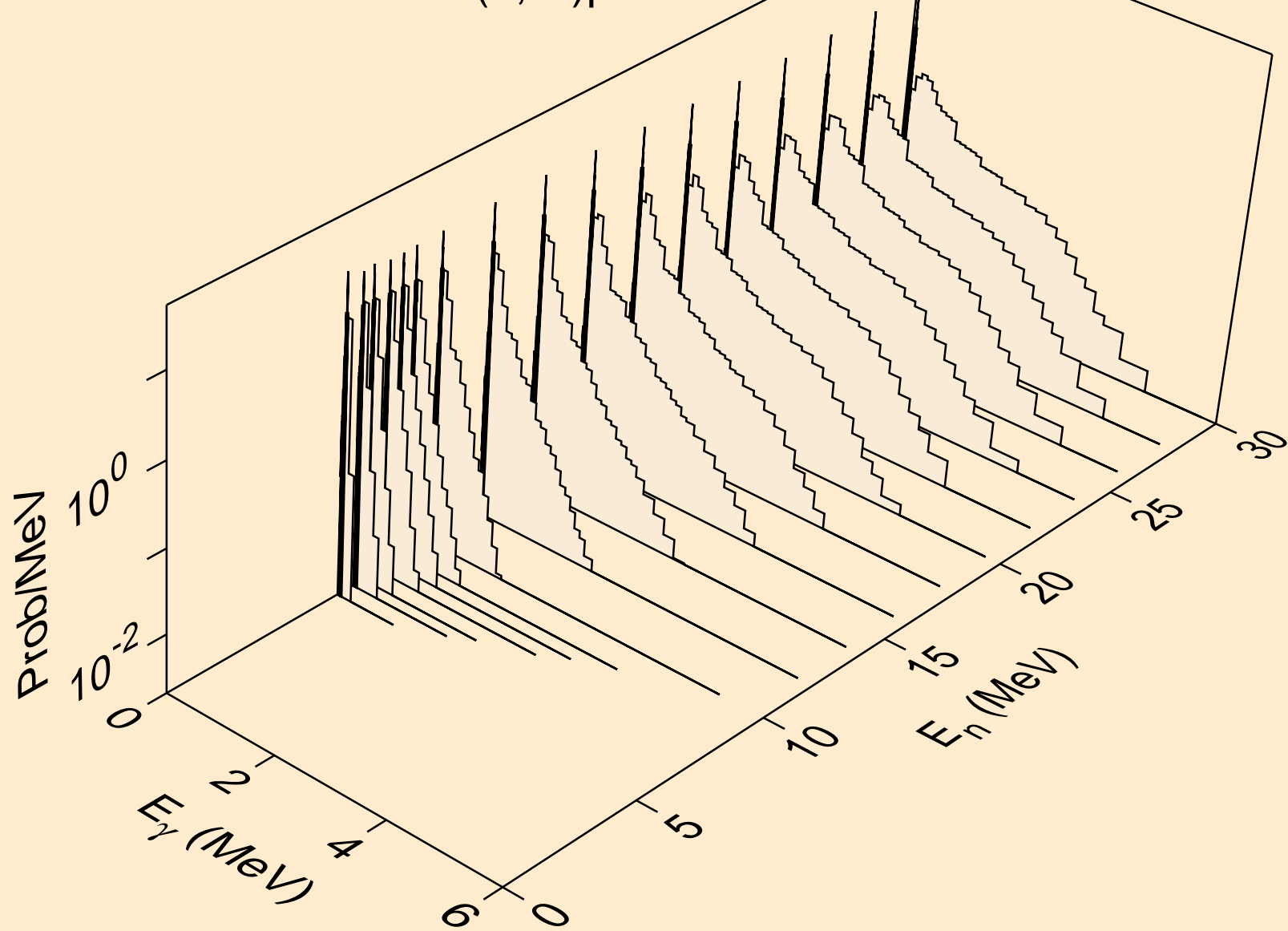

NP236M NEUTRON ACER TENDL-2021 LIBRARY; T=293.6K
Photon emission for (n,n*)2a

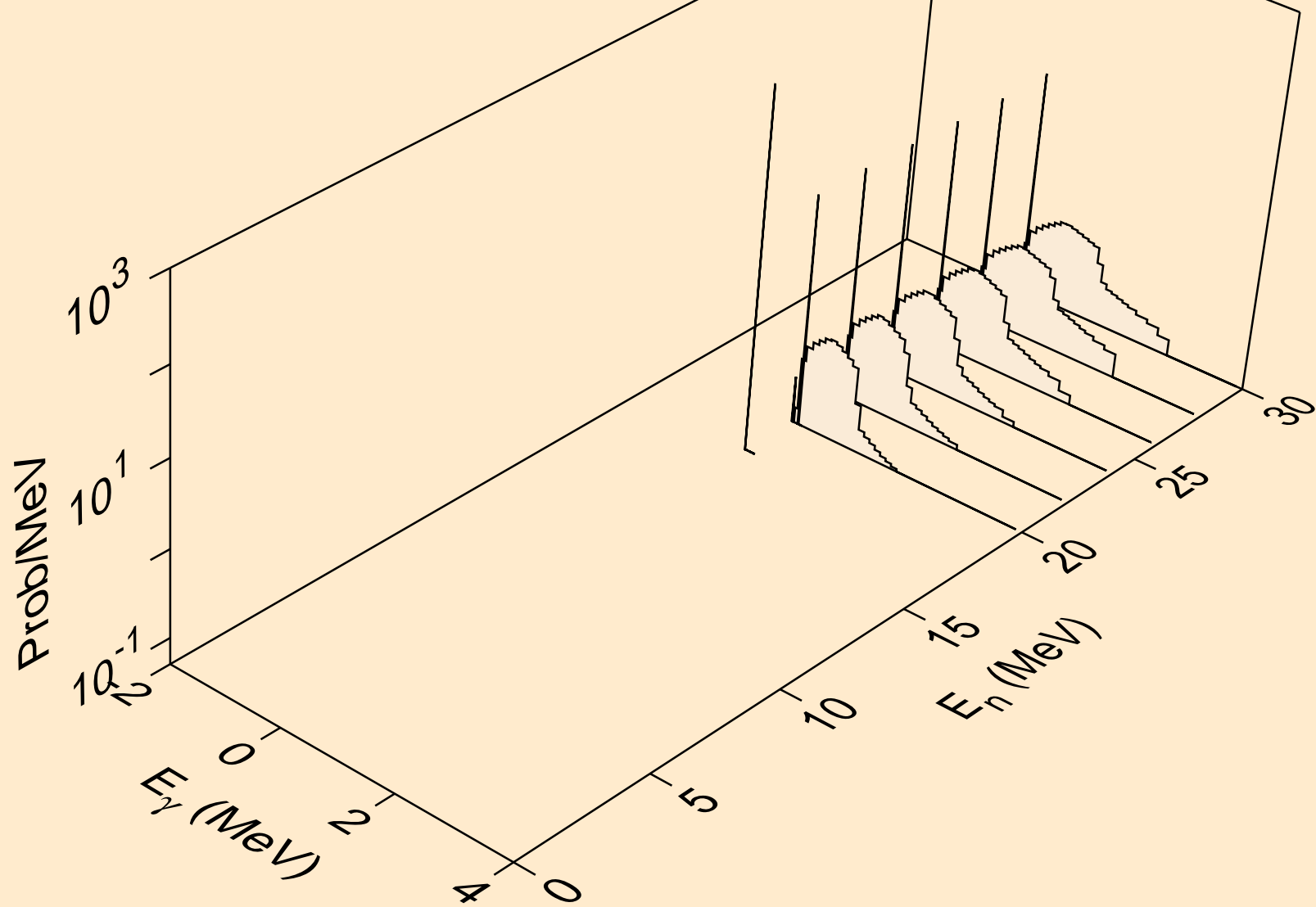

NP236M NEUTRON ACER TENDL-2021 LIBRARY; T=293.6K
Photon emission for (n,n*)d

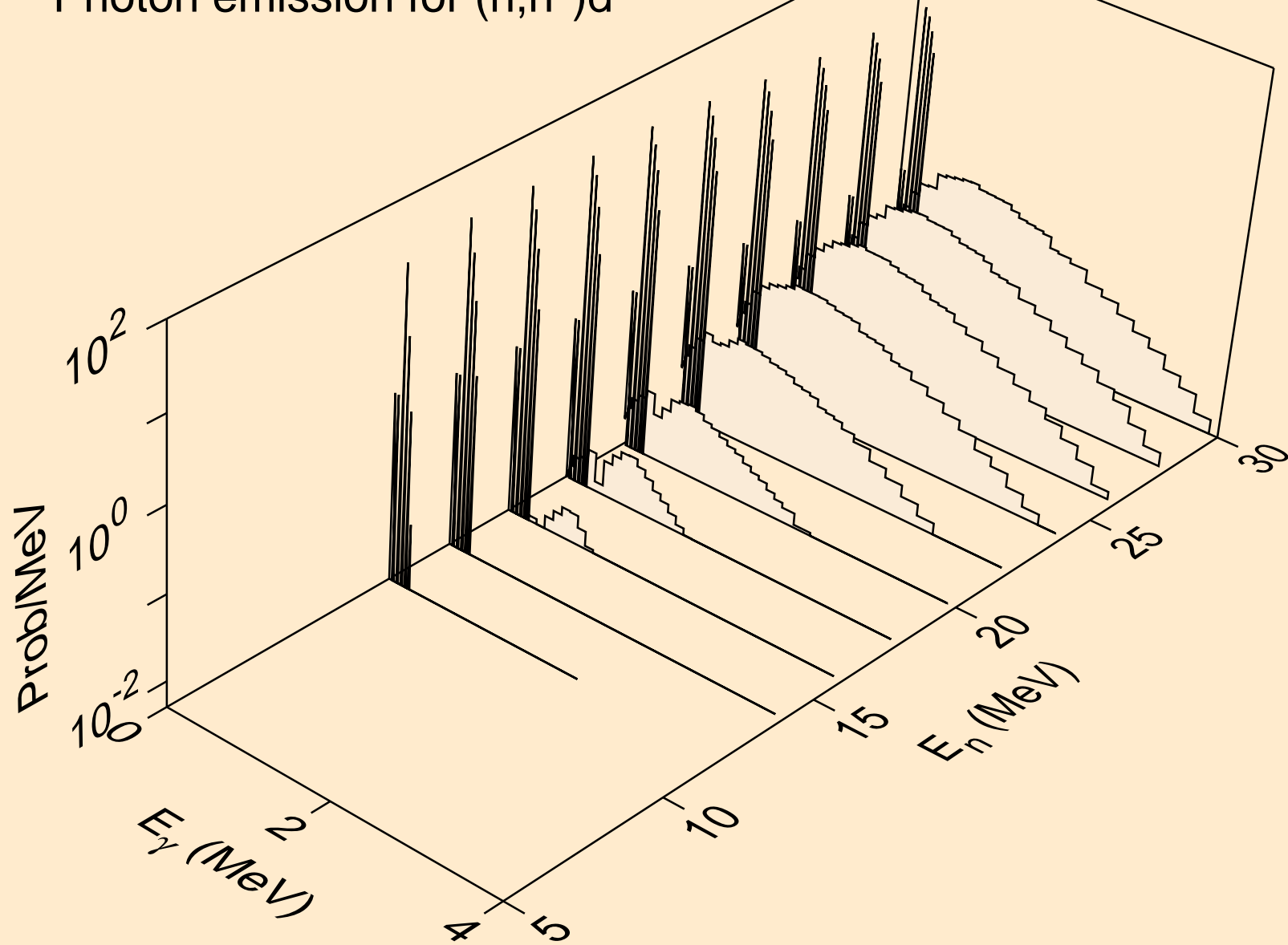

NP236M NEUTRON ACER TENDL-2021 LIBRARY; T=293.6K
Photon emission for (n,n*)t

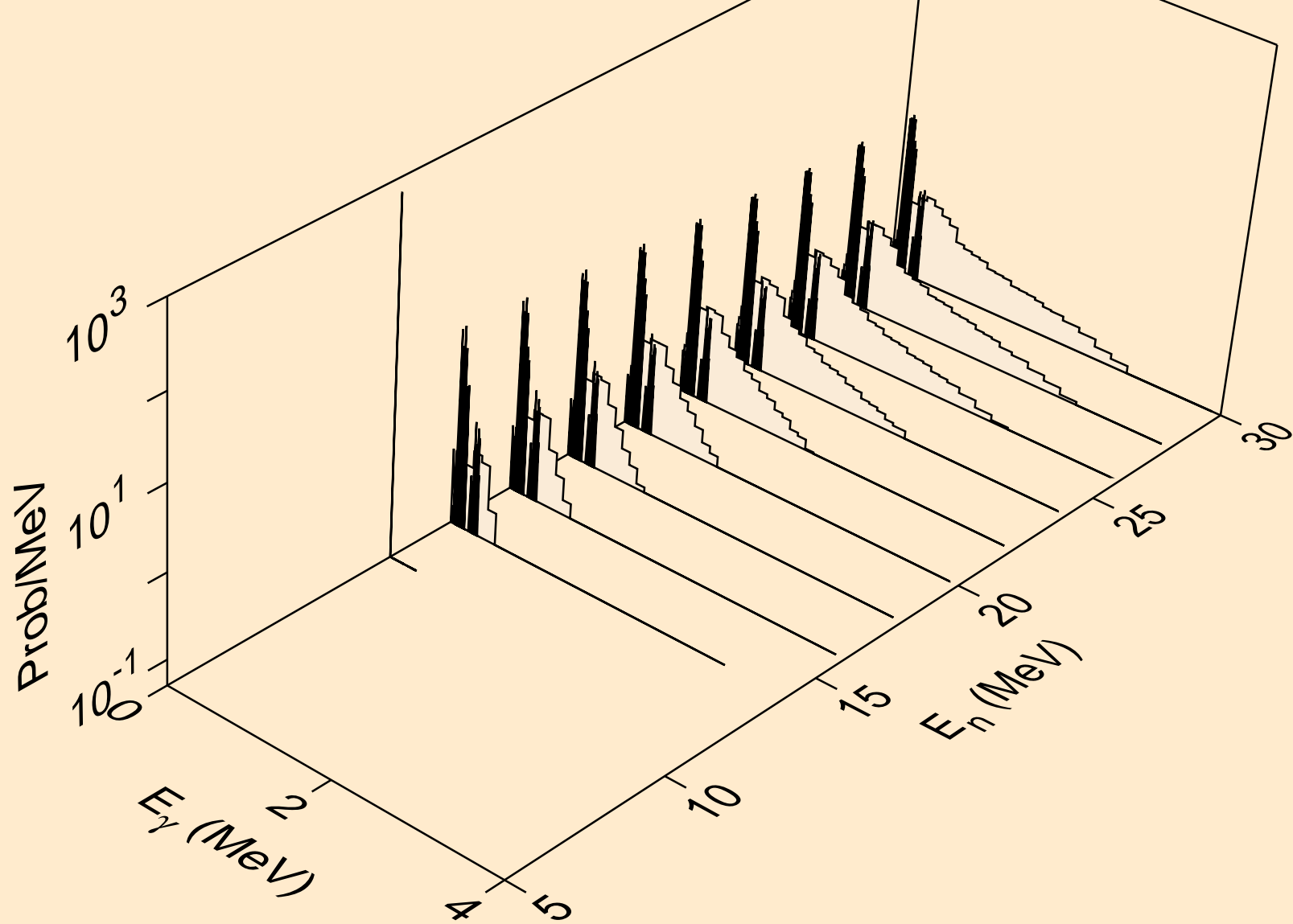

NP236M NEUTRON ACER TENDL-2021 LIBRARY; T=293.6K
Photon emission for (n,n*)he3

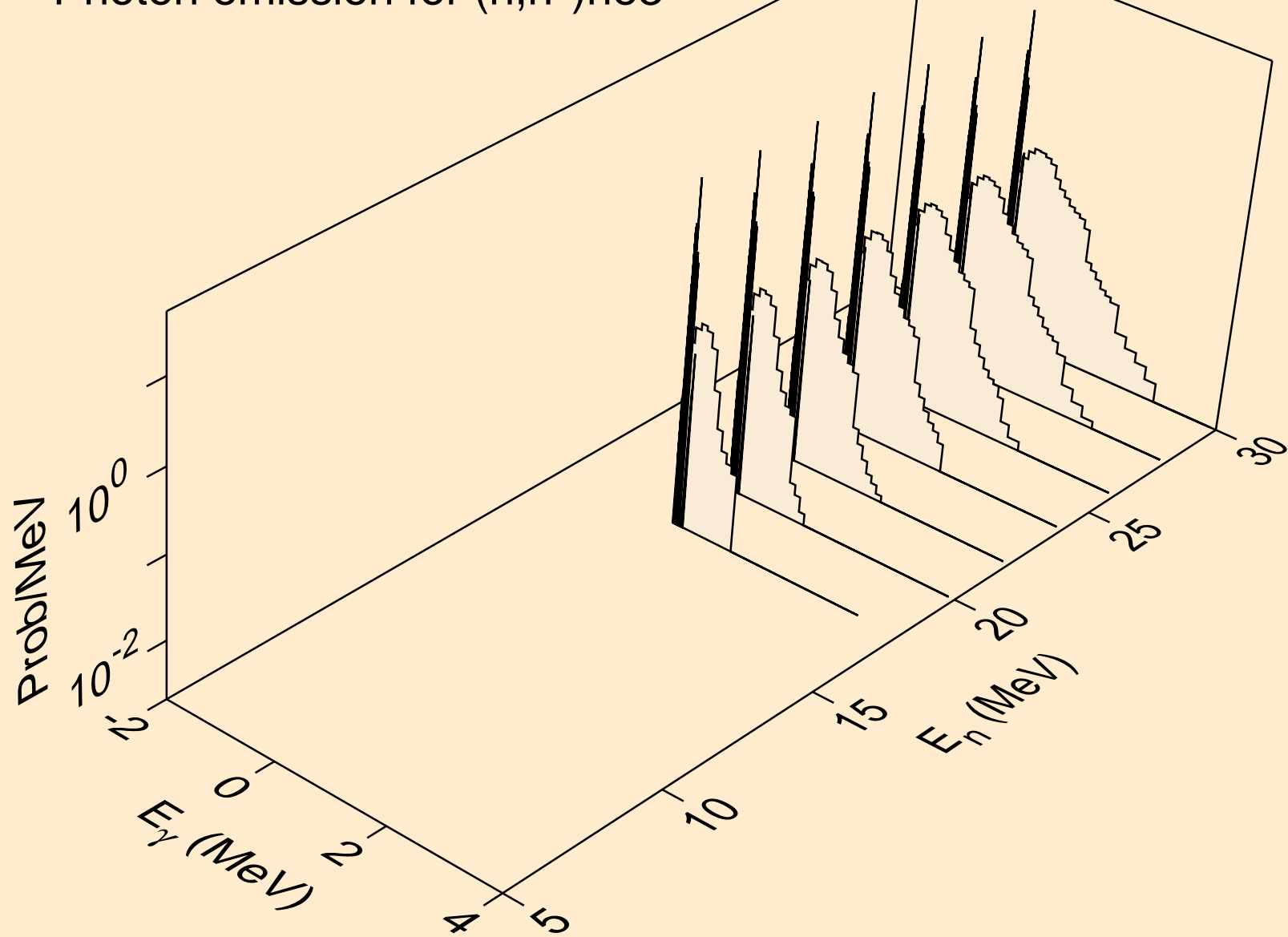

NP236M NEUTRON ACER TENDL-2021 LIBRARY; T=293.6K
Photon emission for (n,4n)

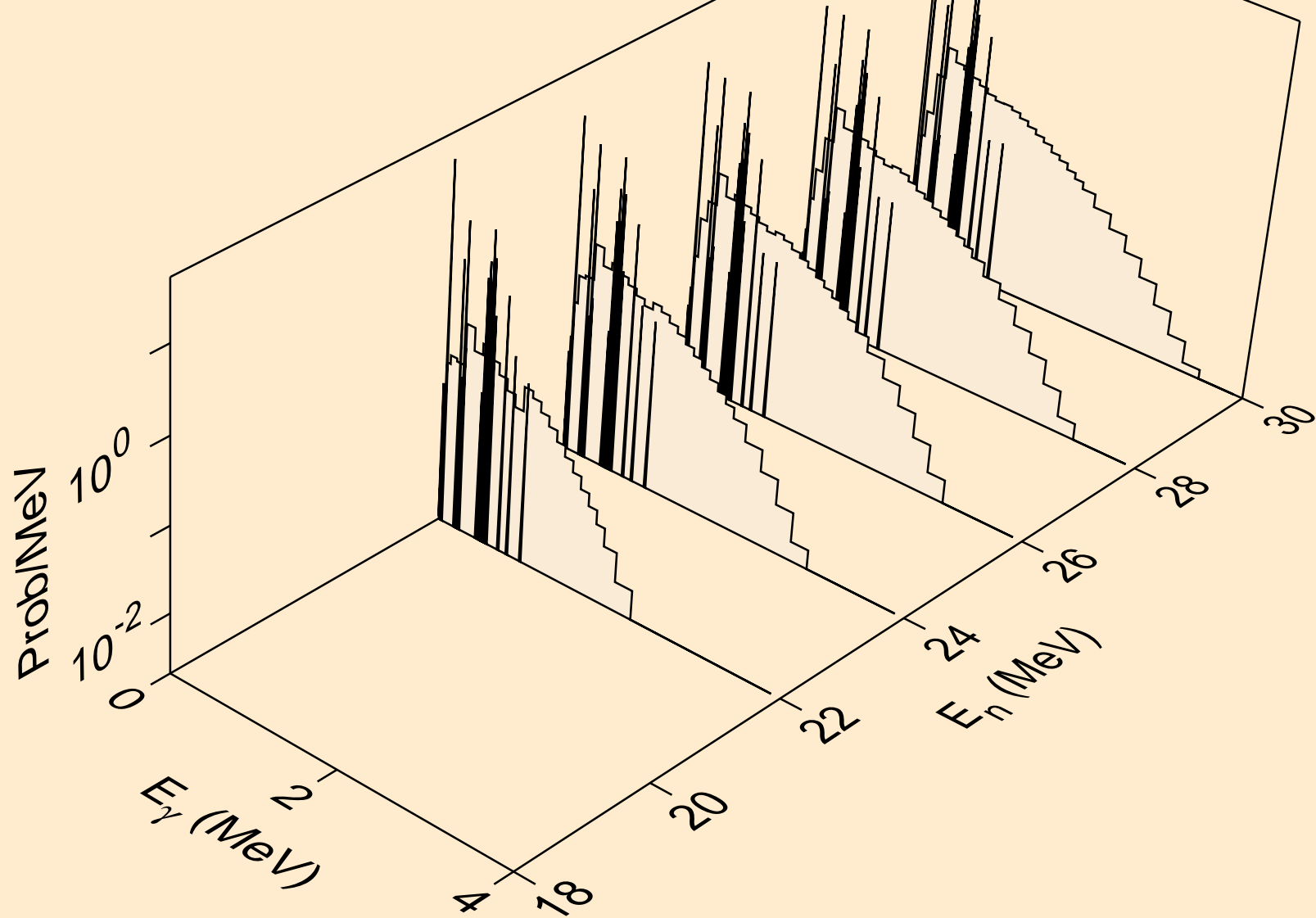

NP236M NEUTRON ACER TENDL-2021 LIBRARY; T=293.6K
Photon emission for (n,2np)

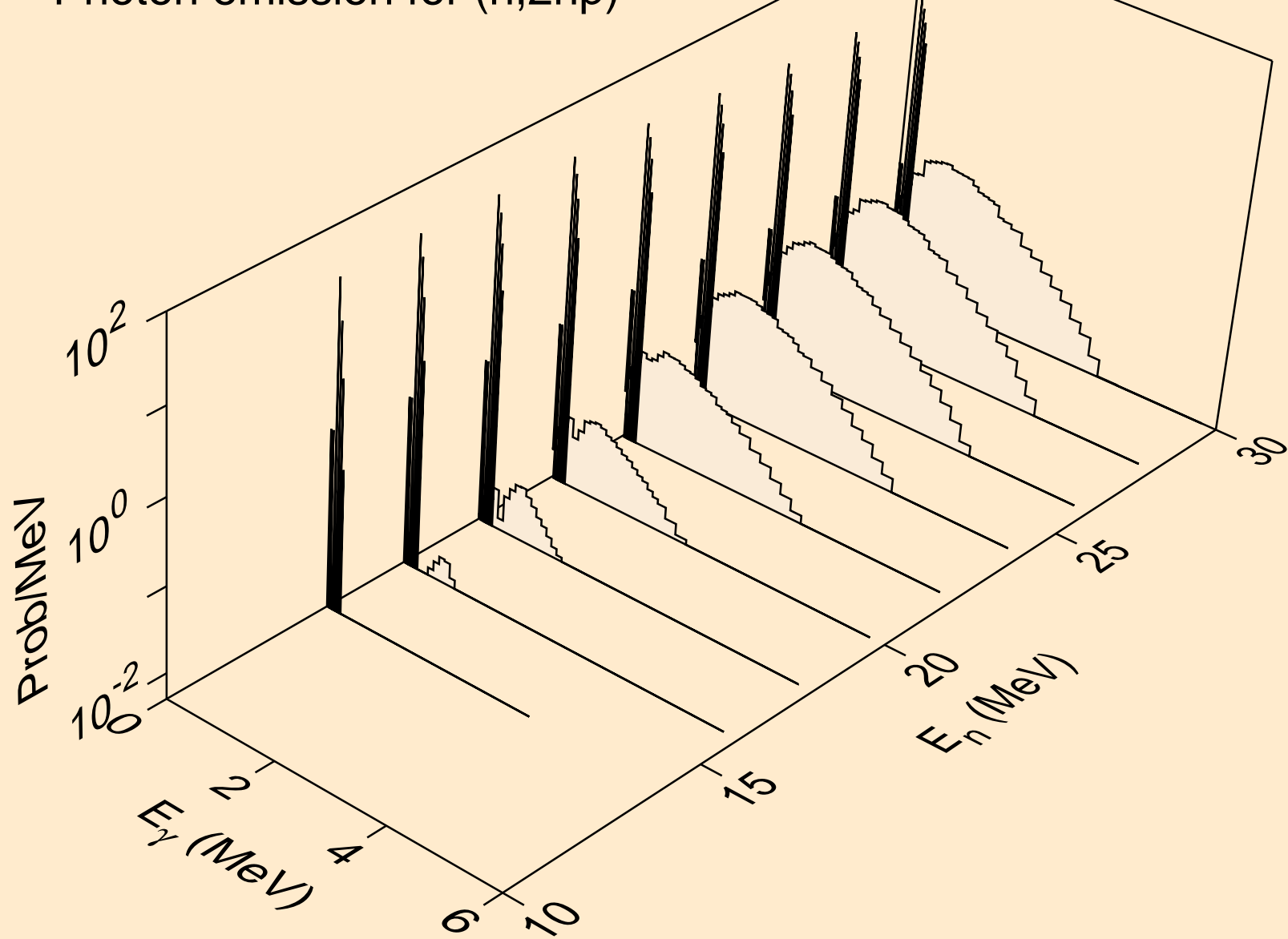

NP236M NEUTRON ACER TENDL-2021 LIBRARY; T=293.6K
Photon emission for (n,3np)

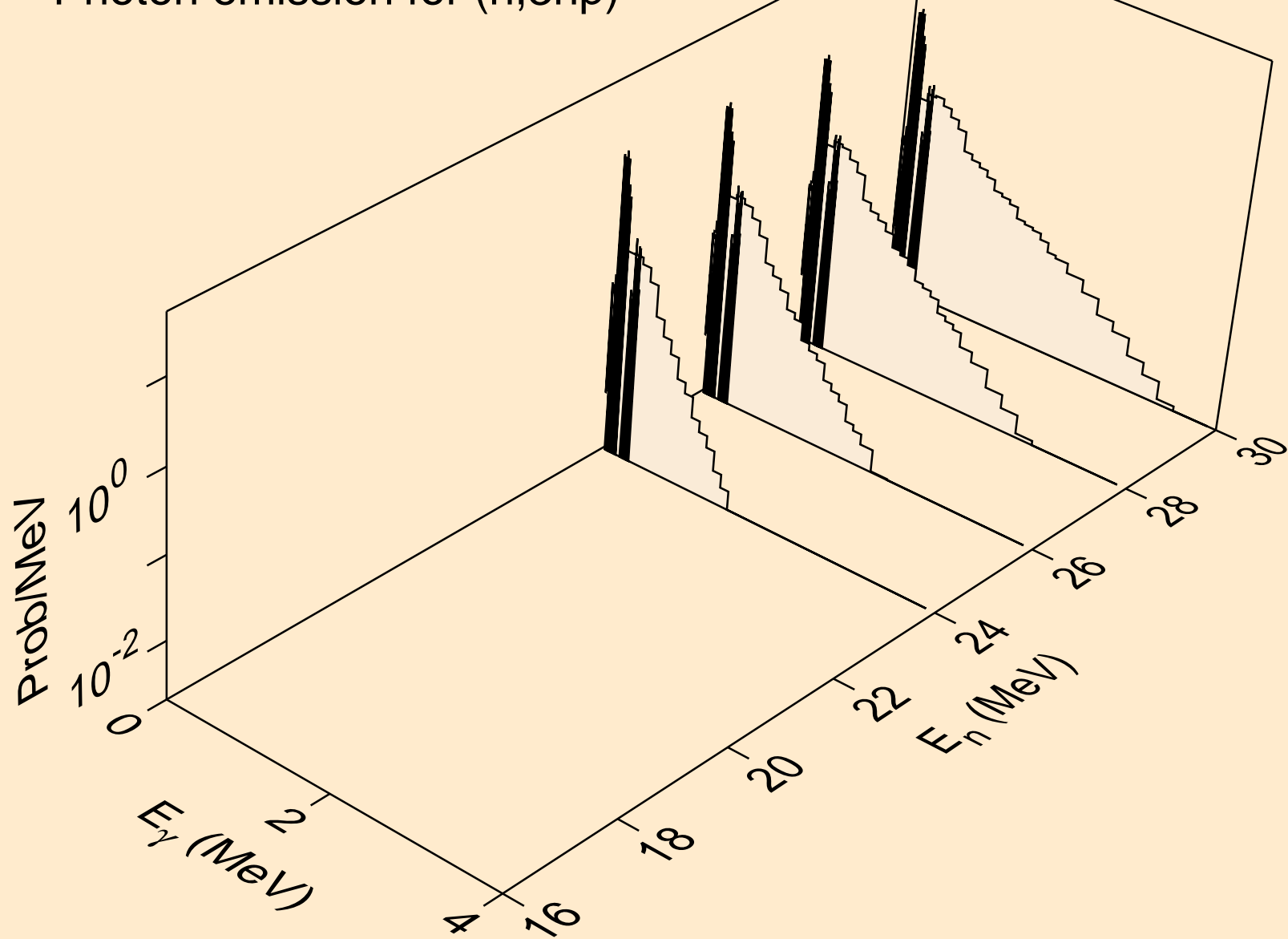

NP236M NEUTRON ACER TENDL-2021 LIBRARY; T=293.6K
Photon emission for (n,2np)

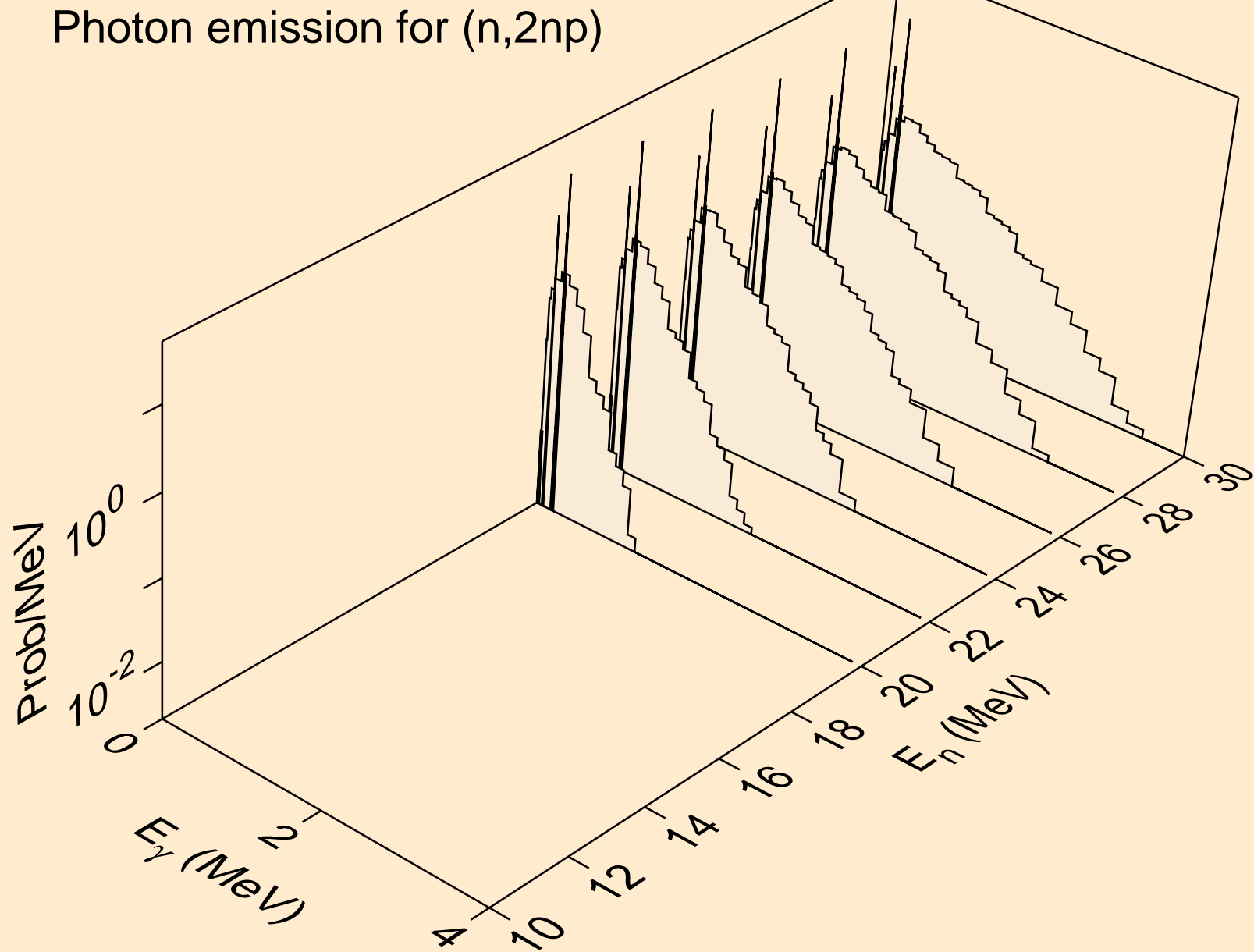

NP236M NEUTRON ACER TENDL-2021 LIBRARY; T=293.6K
Photon emission for (n,npa)

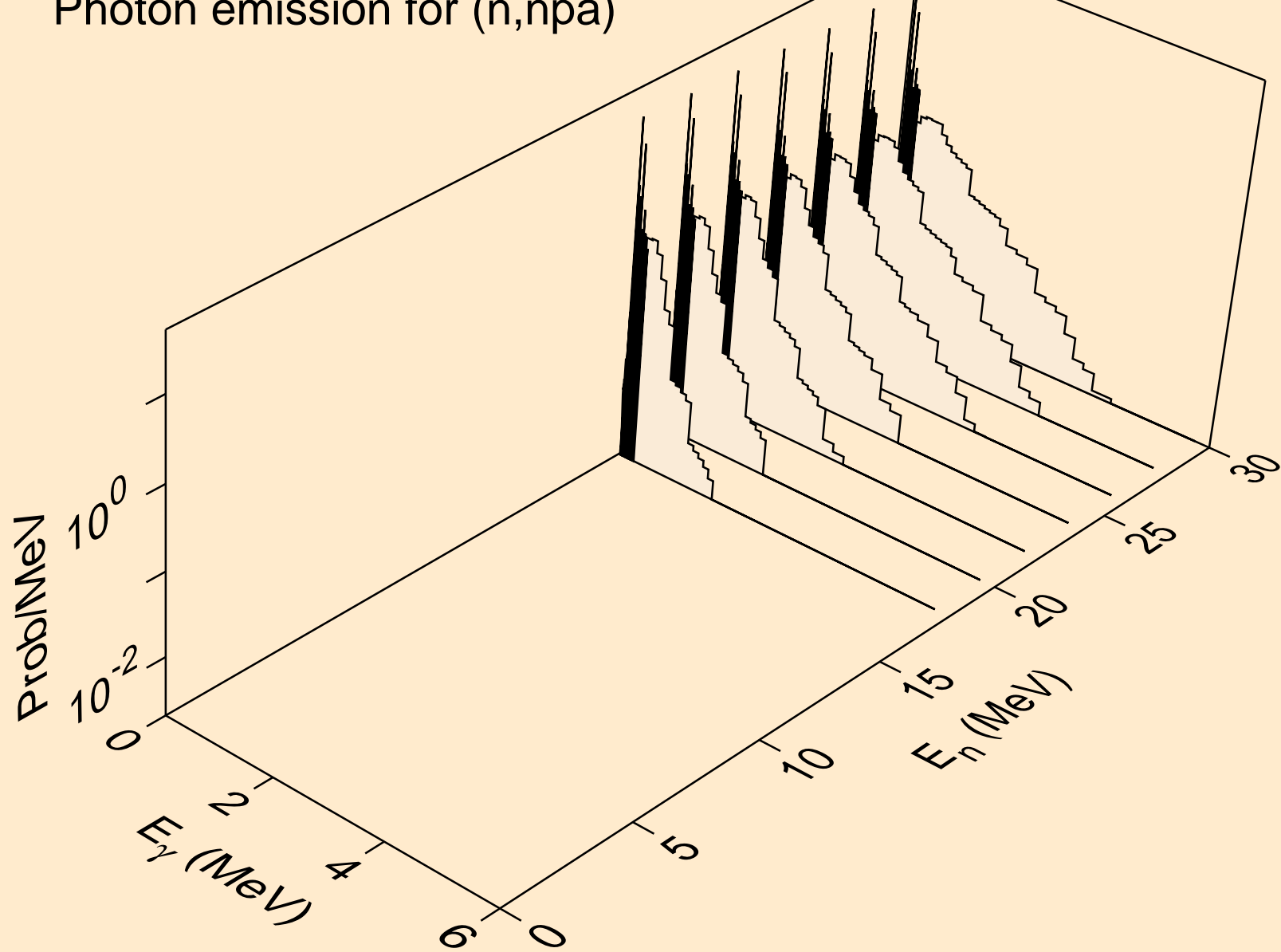

NP236M NEUTRON ACER TENDL-2021 LIBRARY; T=293.6K
Photon emission for (n,n*2)

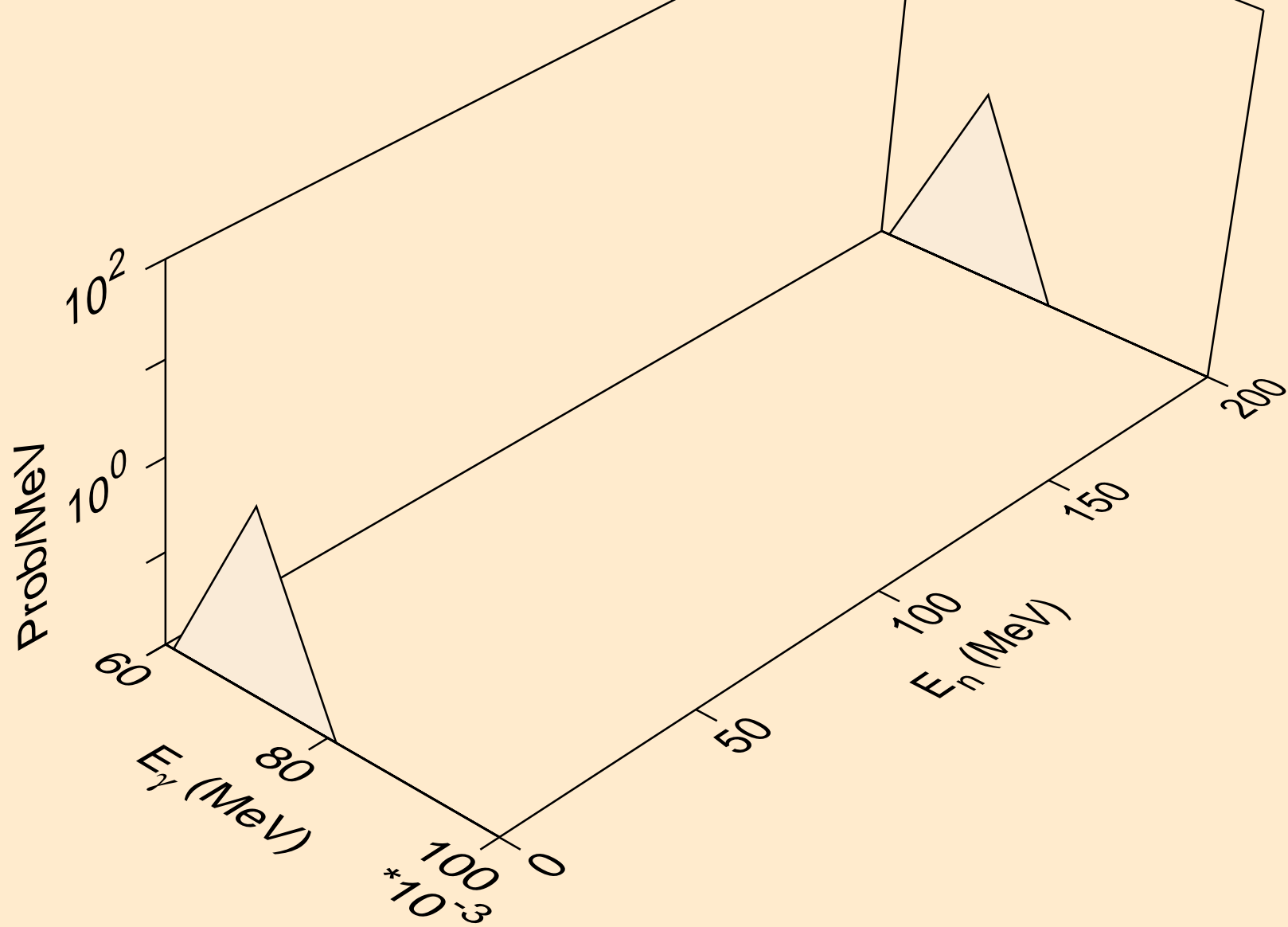

NP236M NEUTRON ACER TENDL-2021 LIBRARY; T=293.6K
Photon emission for (n,n*3)

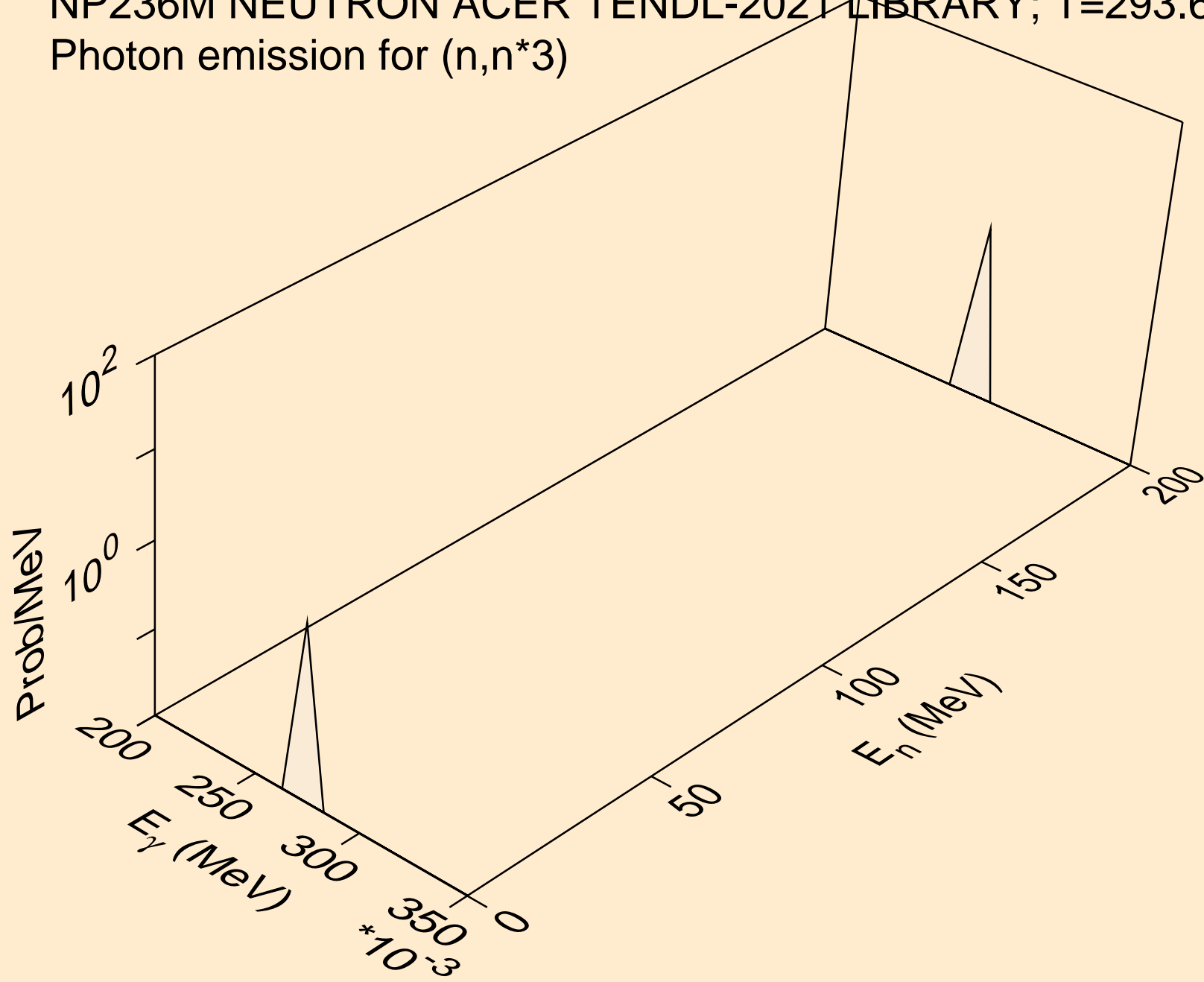

NP236M NEUTRON ACER TENDL-2021 LIBRARY; T=293.6K
Photon emission for (n,n*4)

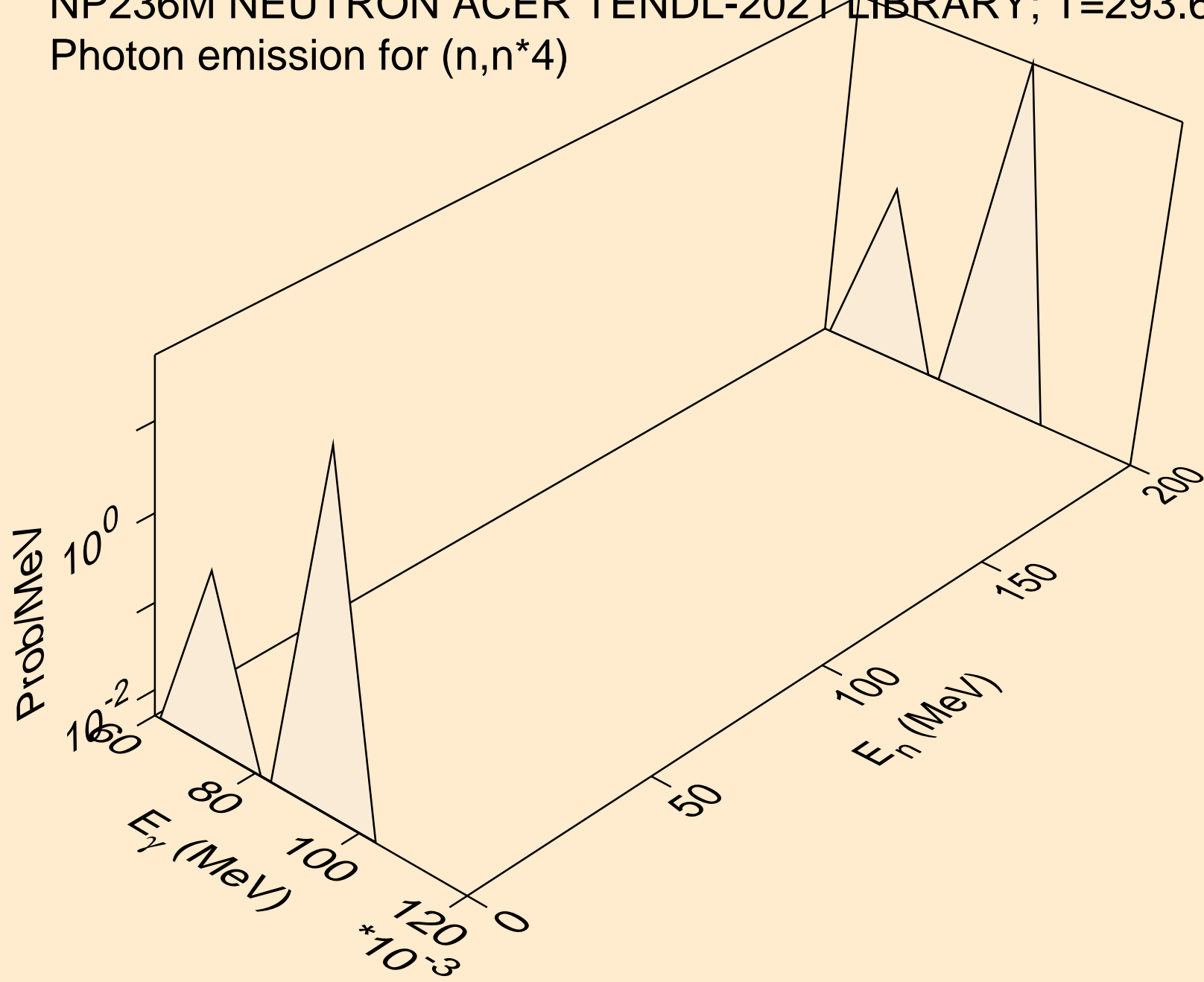

NP236M NEUTRON ACER TENDL-2021 LIBRARY; T=293.6K
Photon emission for (n,n*5)

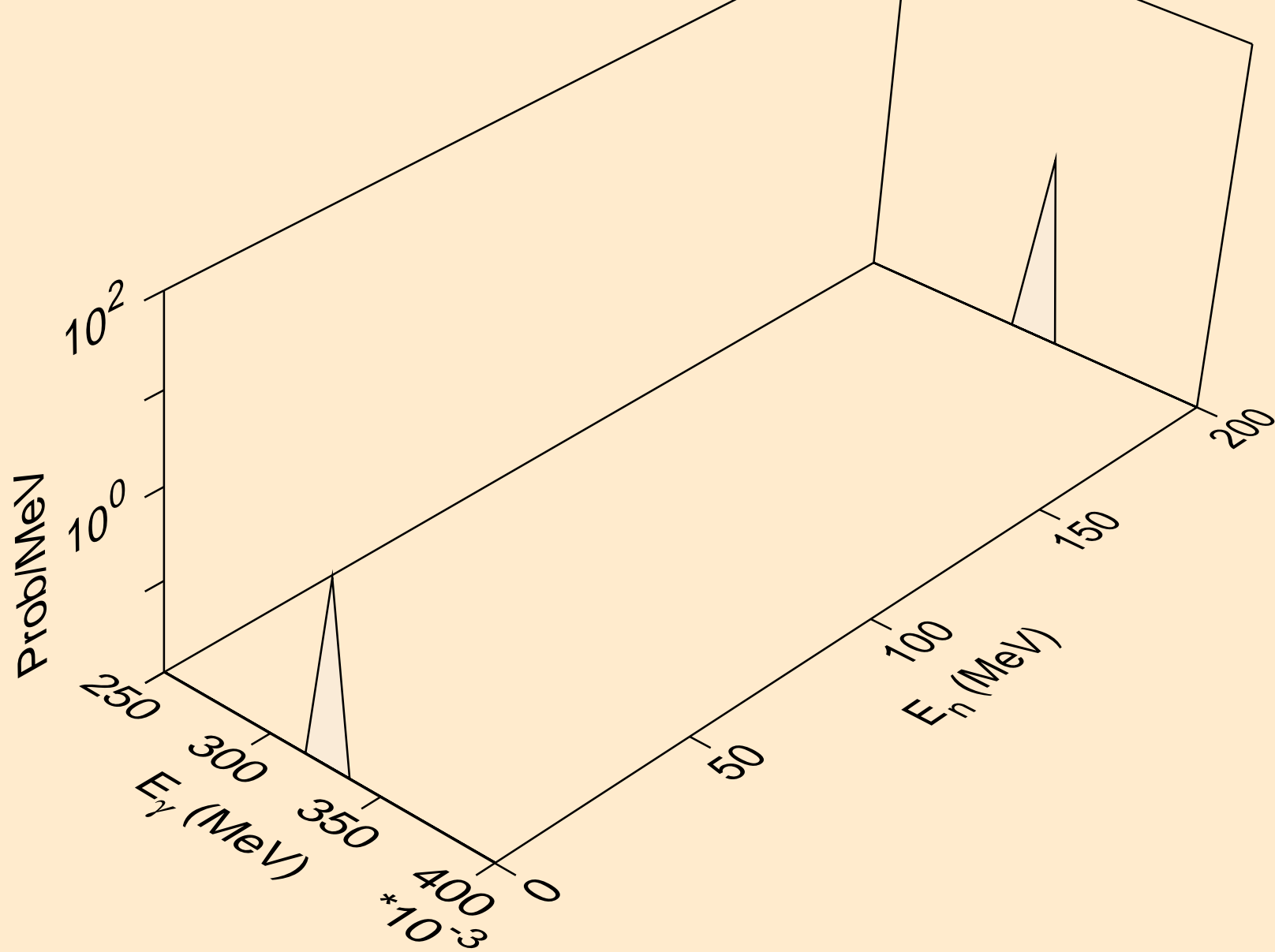

NP236M NEUTRON ACER TENDL-2021 LIBRARY; T=293.6K
Photon emission for (n,n*6)

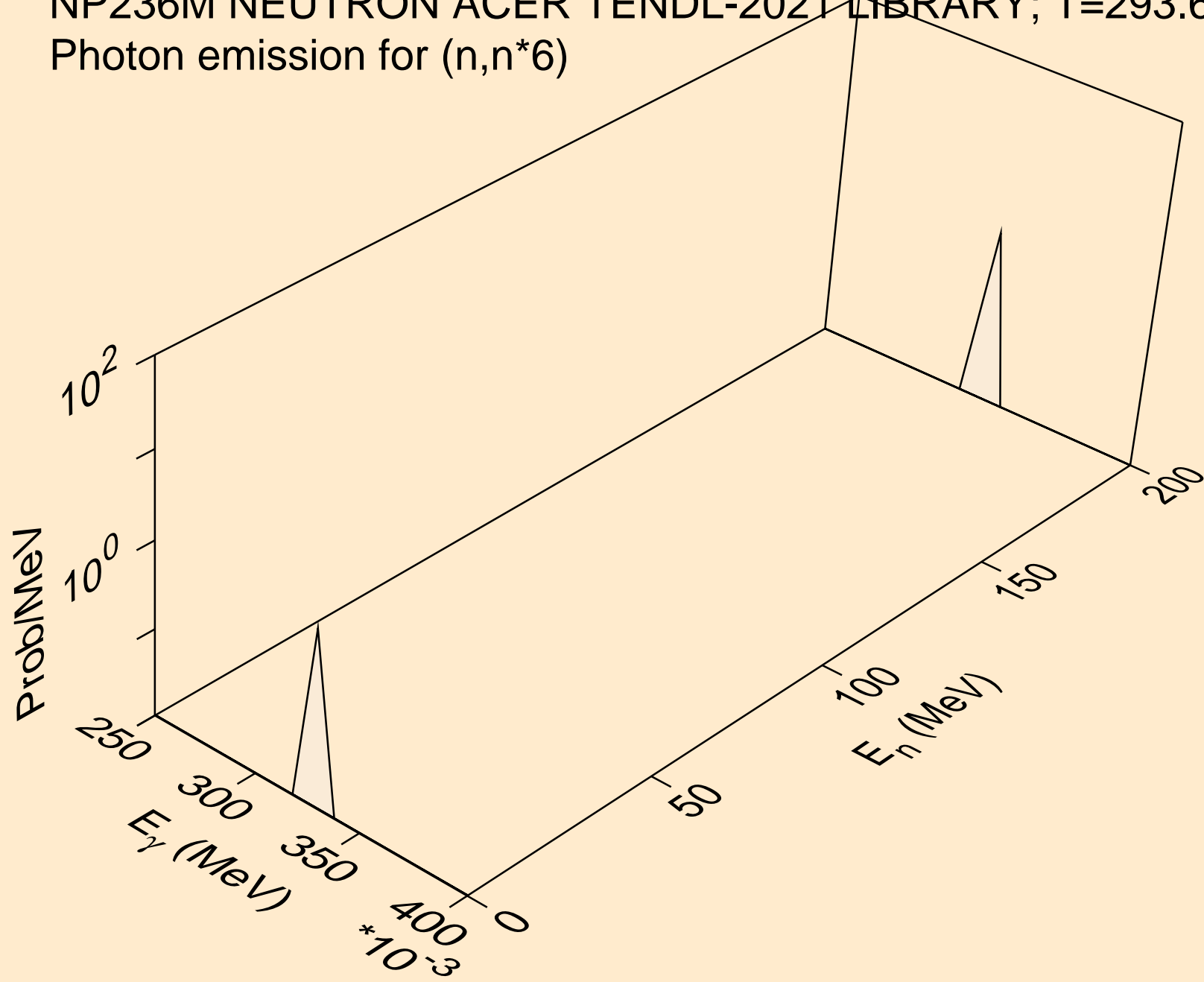

NP236M NEUTRON ACER TENDL-2021 LIBRARY; T=293.6K
Photon emission for (n,n*7)

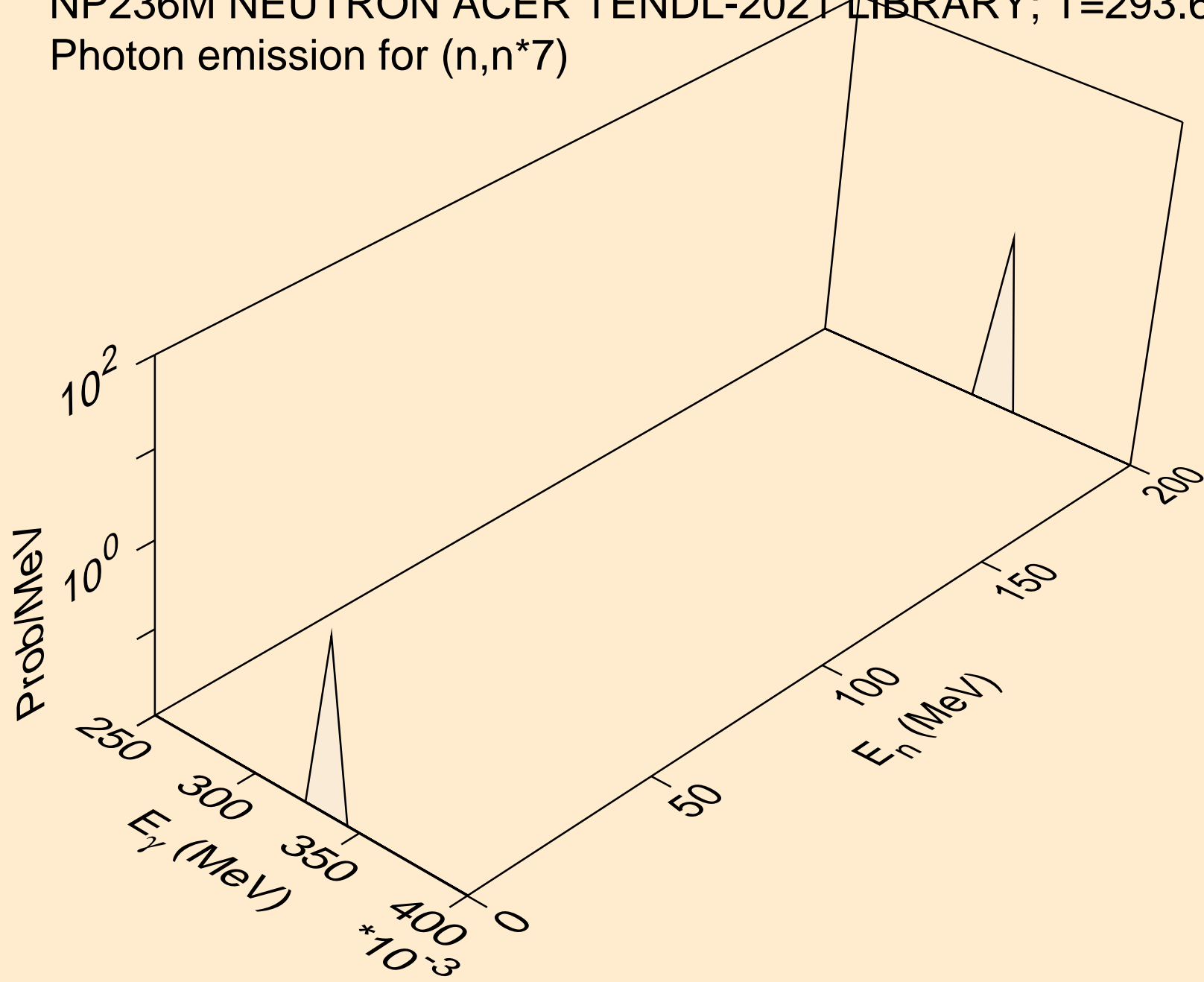

NP236M NEUTRON ACER TENDL-2021 LIBRARY; T=293.6K
Photon emission for (n,n*8)

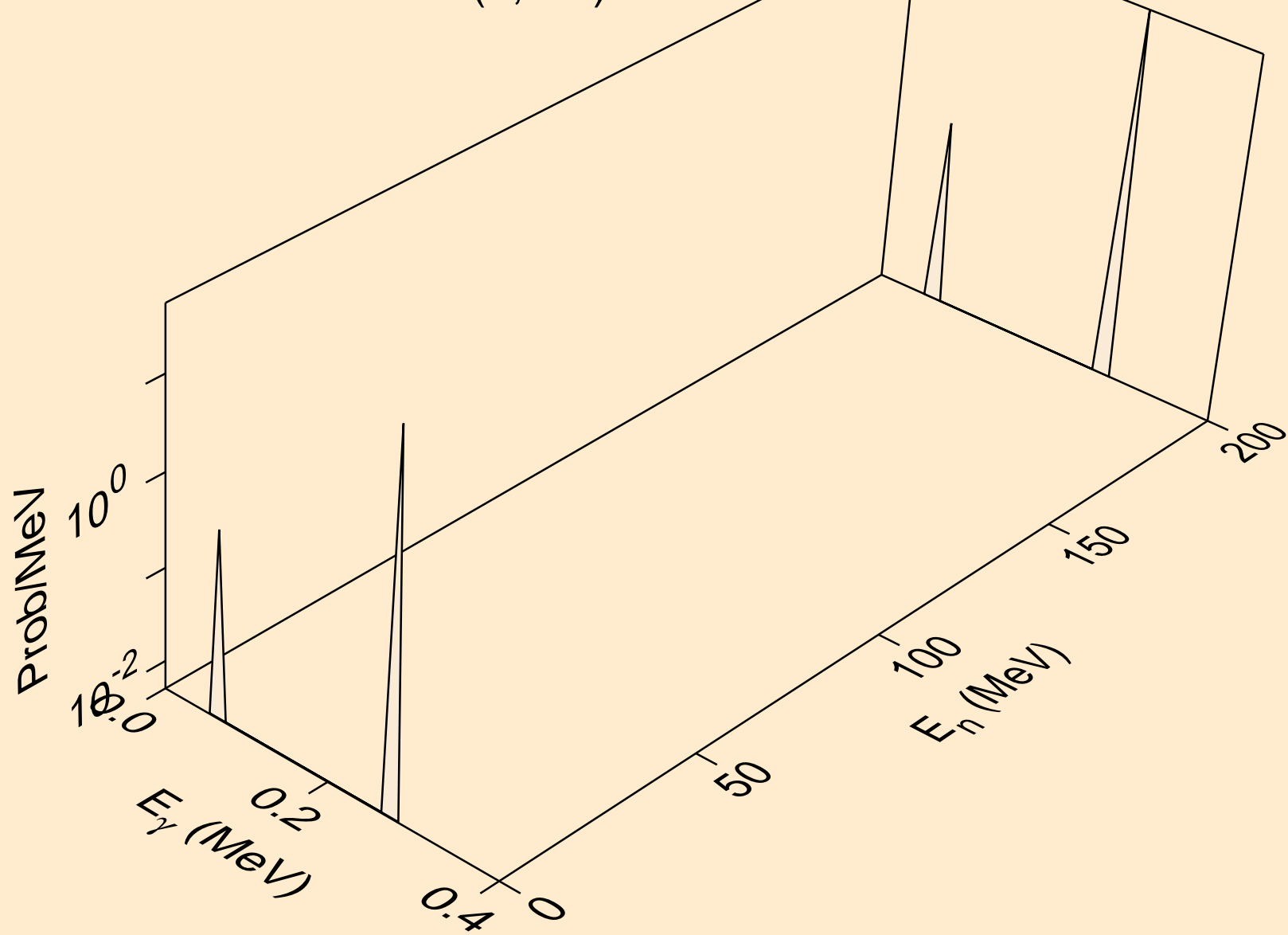

NP236M NEUTRON ACER TENDL-2021 LIBRARY; T=293.6K
Photon emission for (n,n*9)

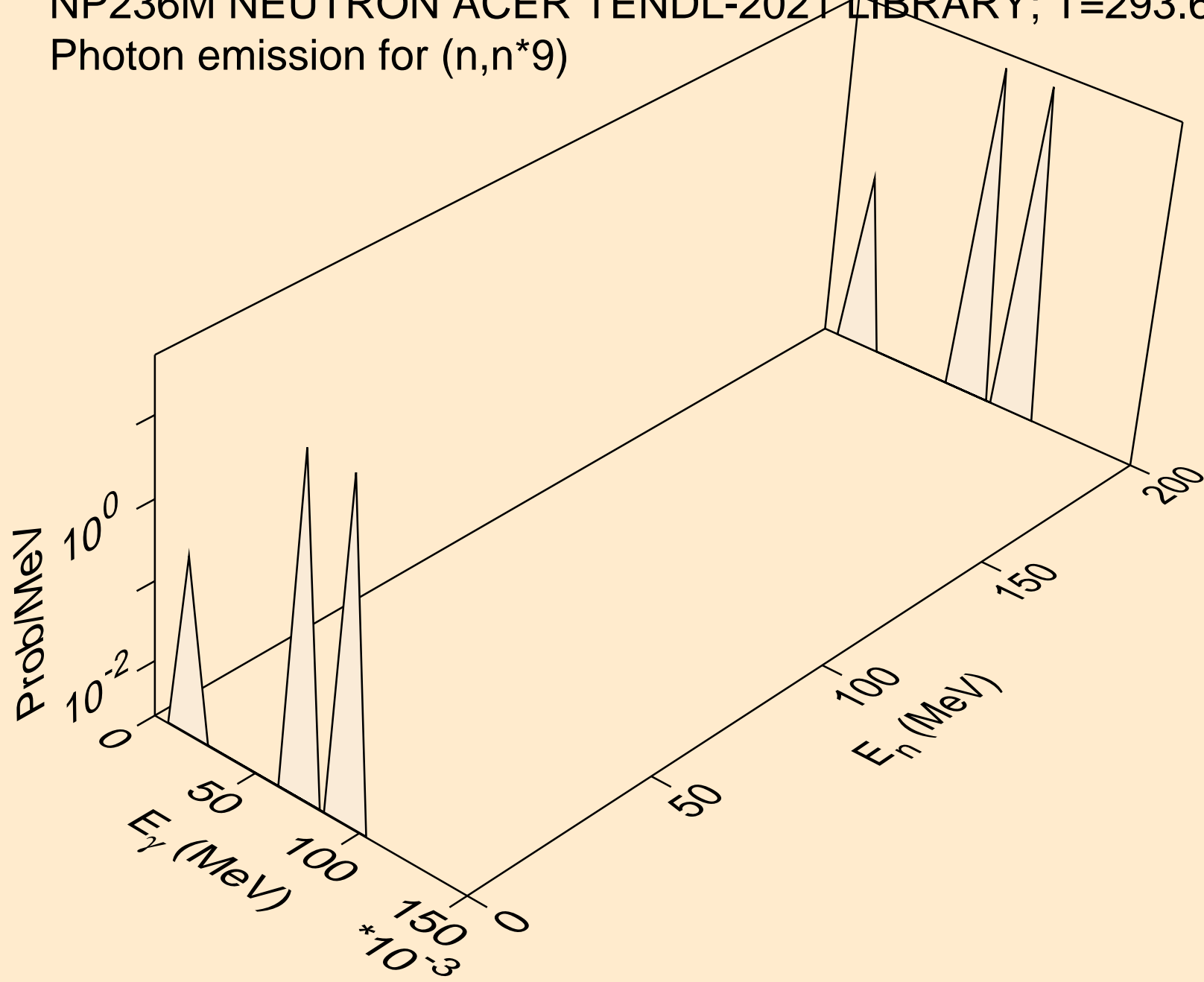

NP236M NEUTRON ACER TENDL-2021 LIBRARY; T=293.6K
Photon emission for (n,n*10)

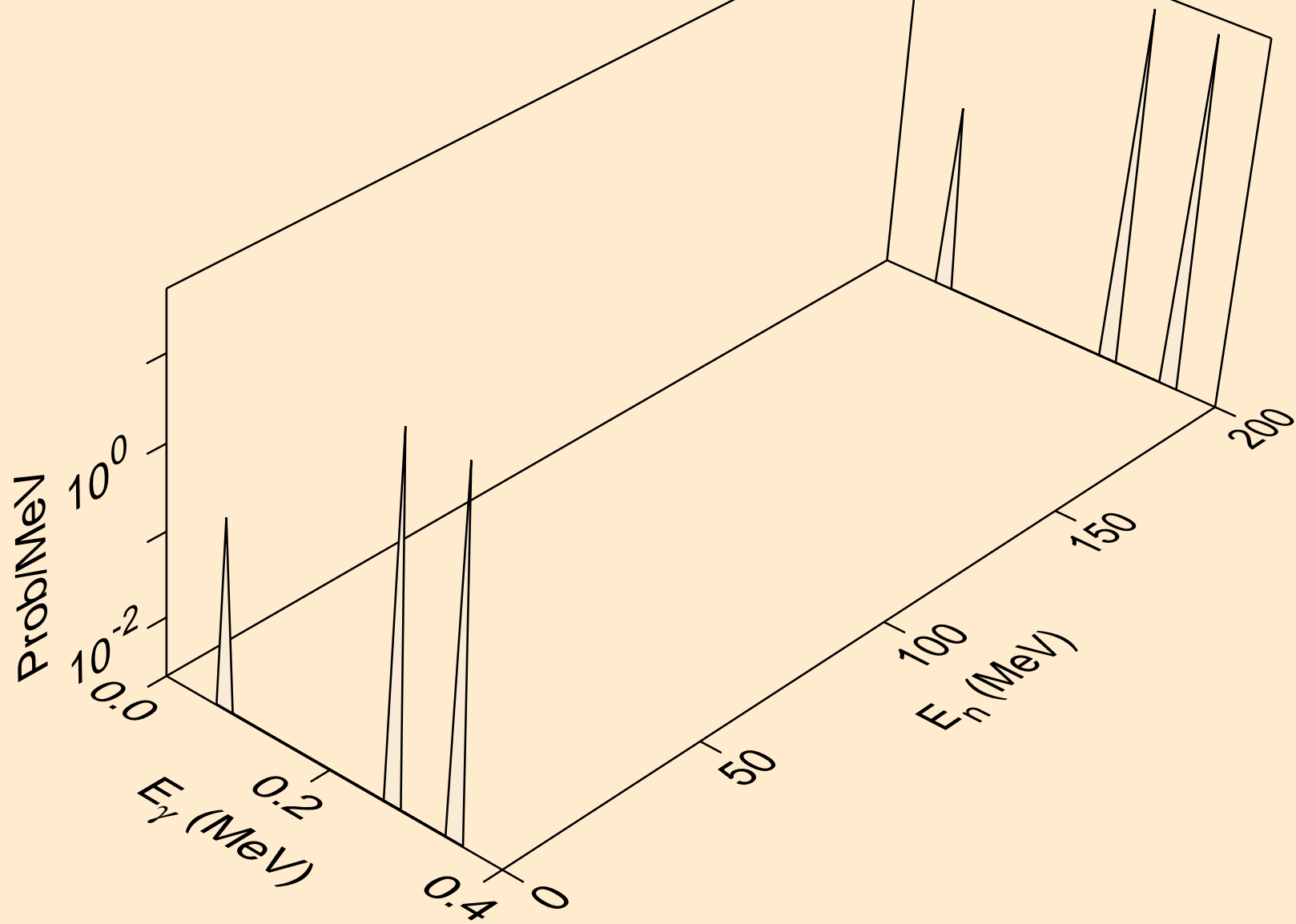

NP236M NEUTRON ACER TENDL-2021 LIBRARY; T=293.6K
Photon emission for (n,n*11)

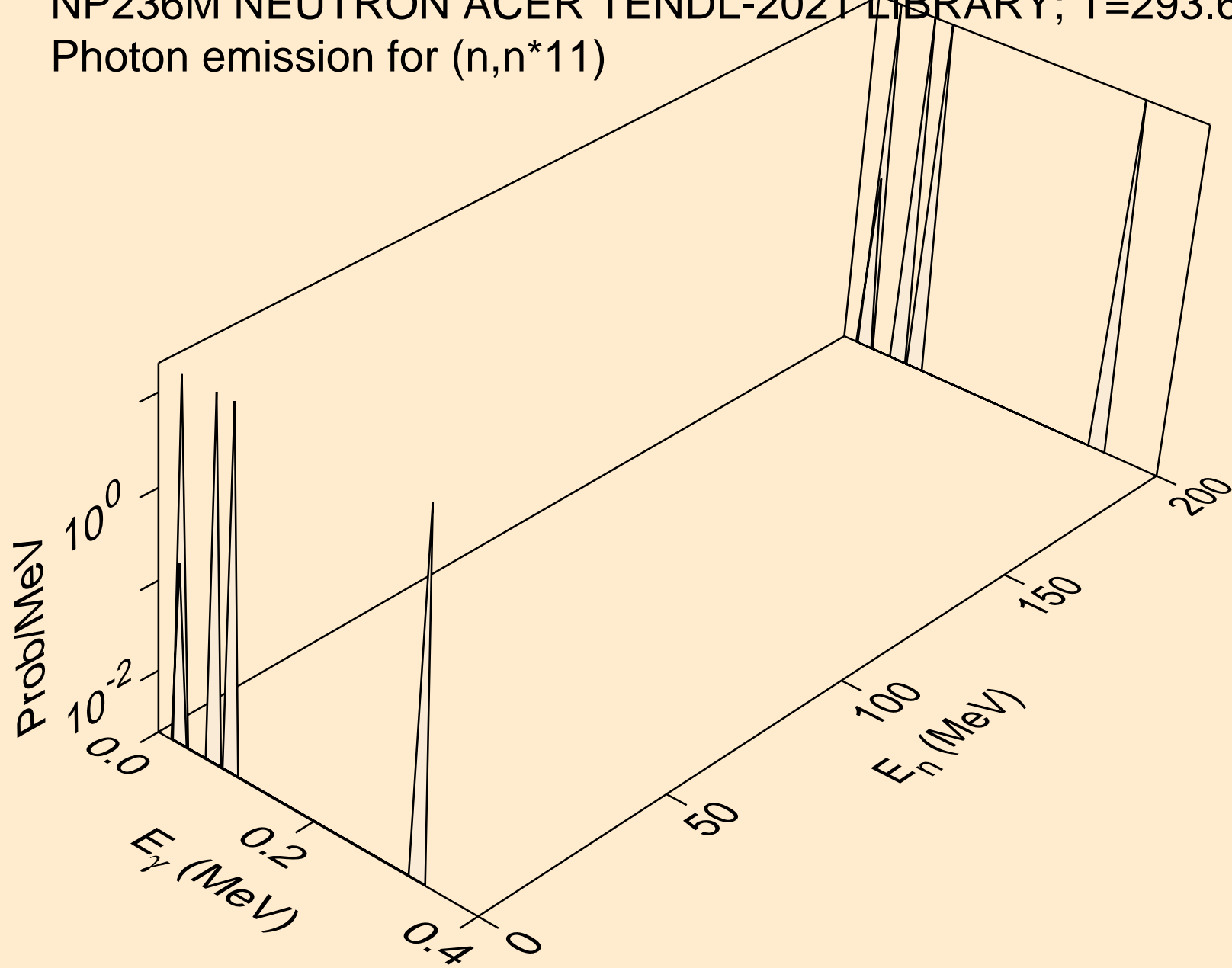

NP236M NEUTRON ACER TENDL-2021 LIBRARY; T=293.6K
Photon emission for (n,n*12)

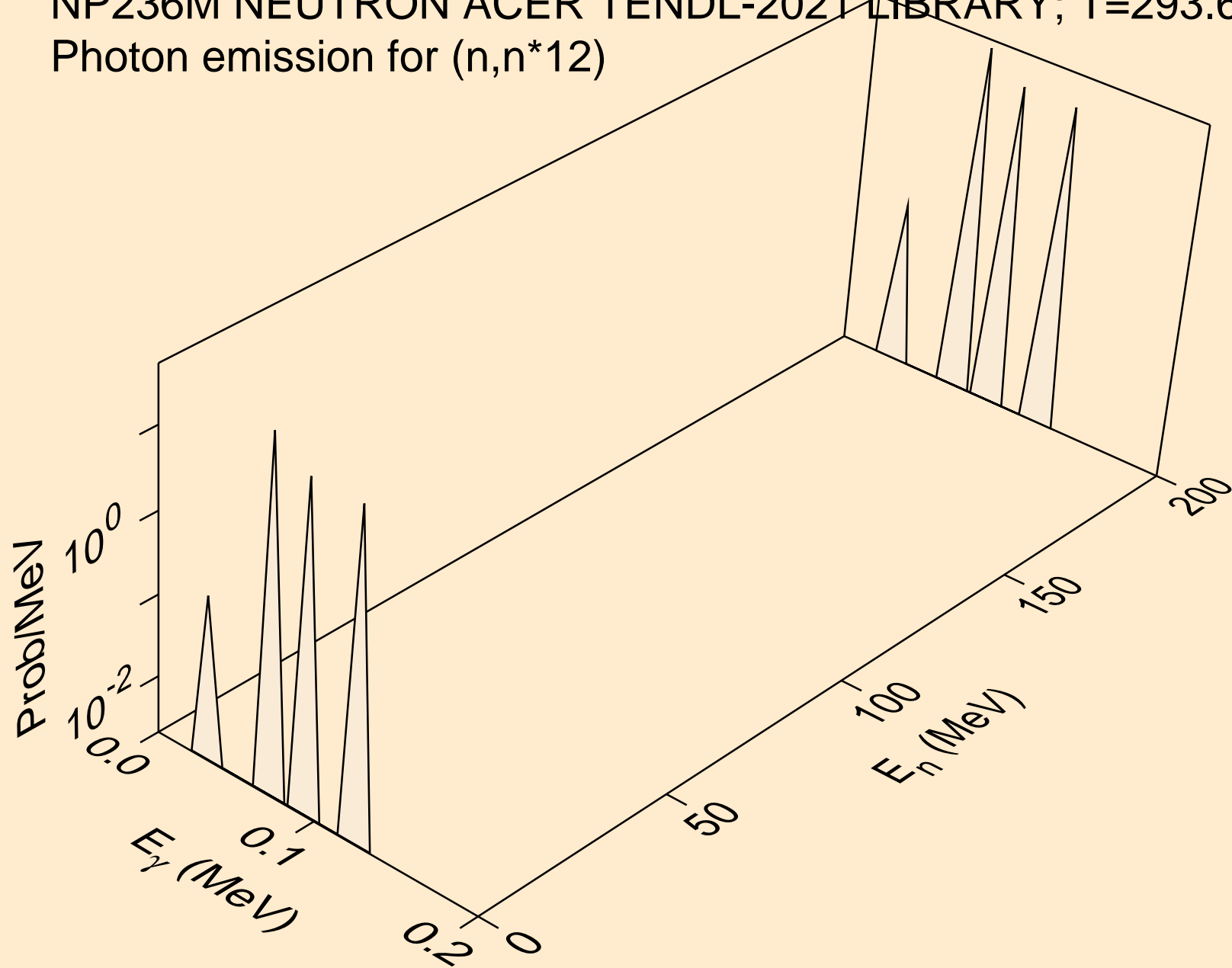

NP236M NEUTRON ACER TENDL-2021 LIBRARY; T=293.6K
Photon emission for (n,n*13)

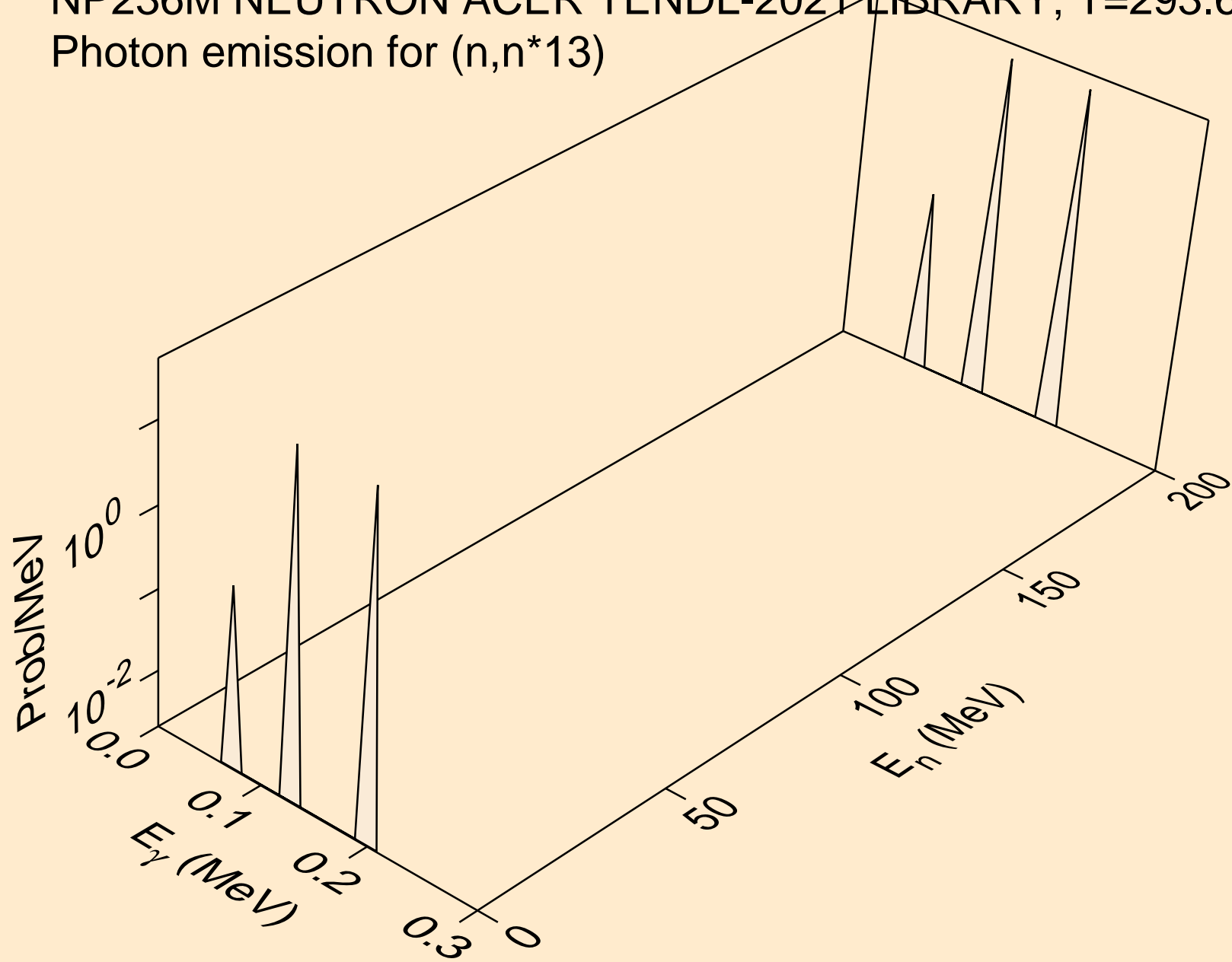

NP236M NEUTRON ACER TENDL-2021 LIBRARY; T=293.6K
Photon emission for (n,n*14)

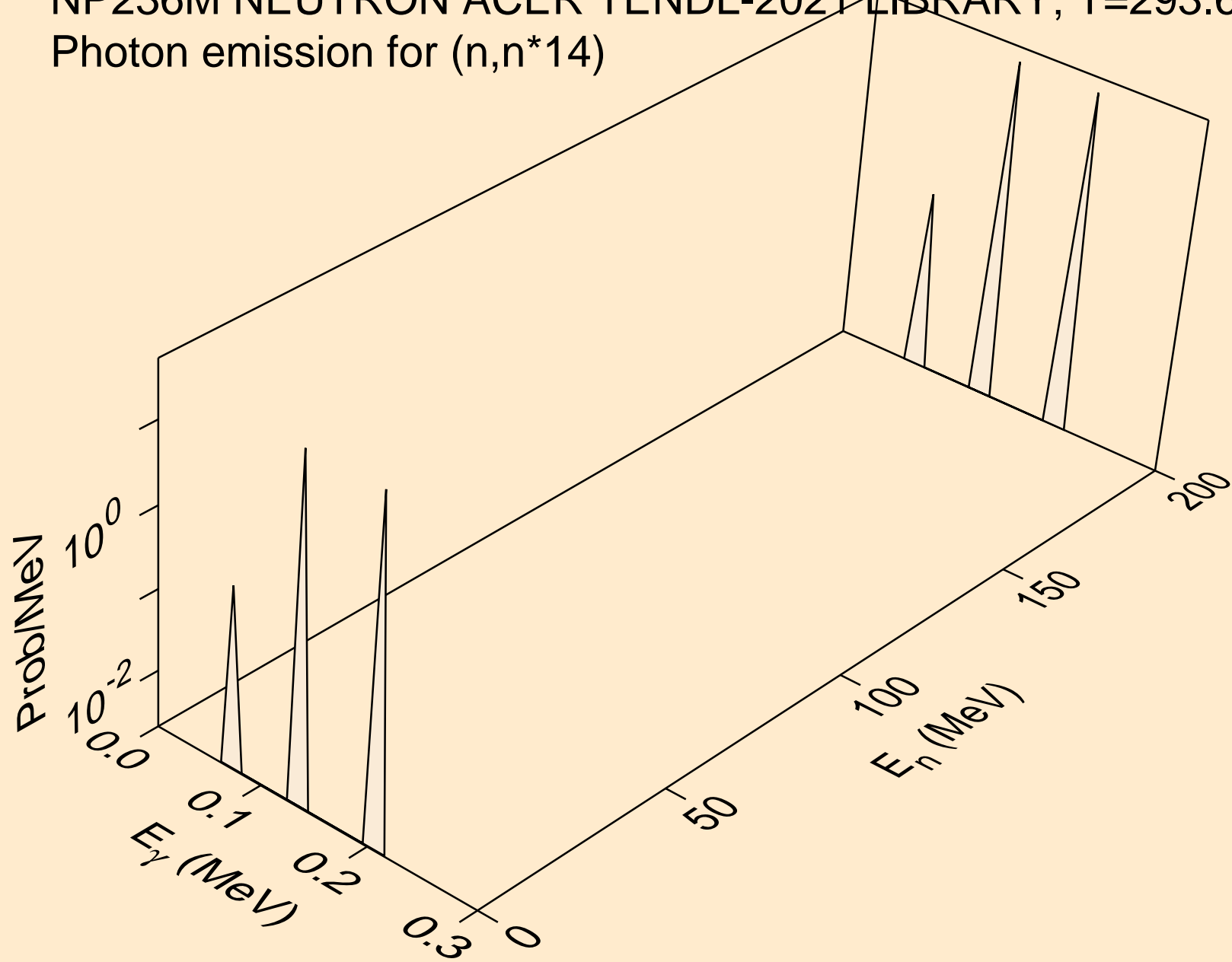

NP236M NEUTRON ACER TENDL-2021 LIBRARY; T=293.6K
Photon emission for (n,n*15)

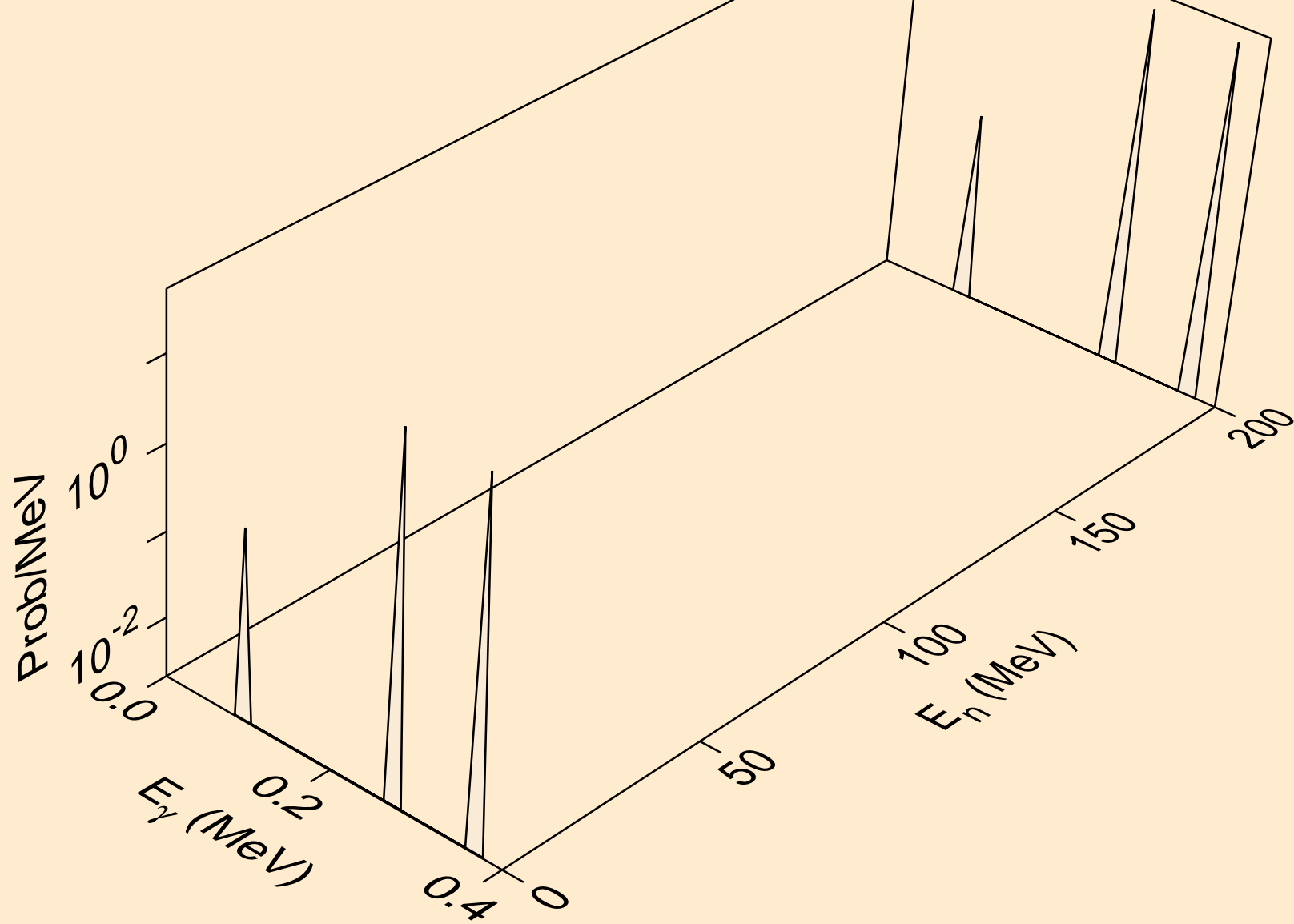

NP236M NEUTRON ACER TENDL-2021 LIBRARY; T=293.6K
Photon emission for (n,n*16)

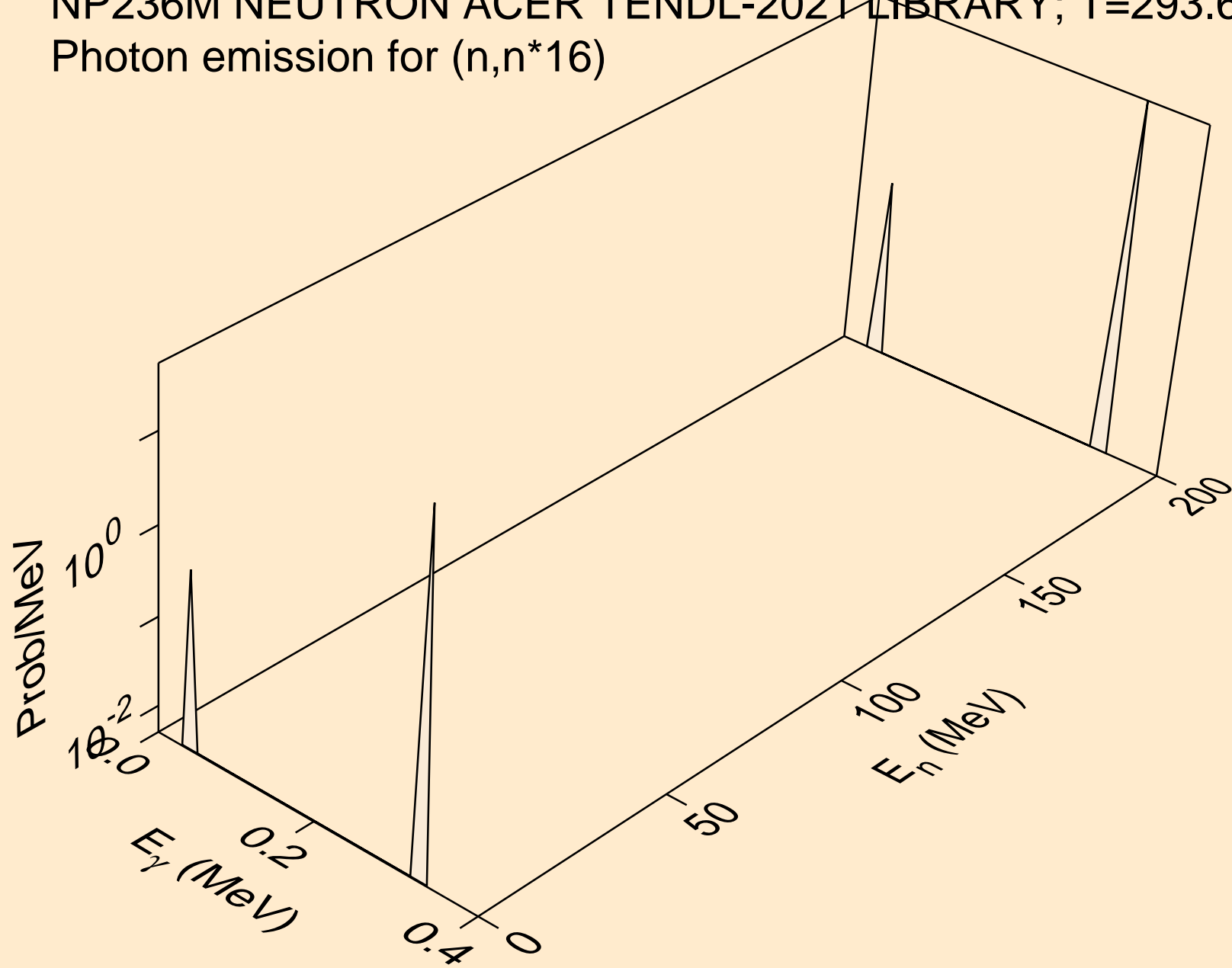

NP236M NEUTRON ACER TENDL-2021 LIBRARY; T=293.6K
Photon emission for (n,n*17)

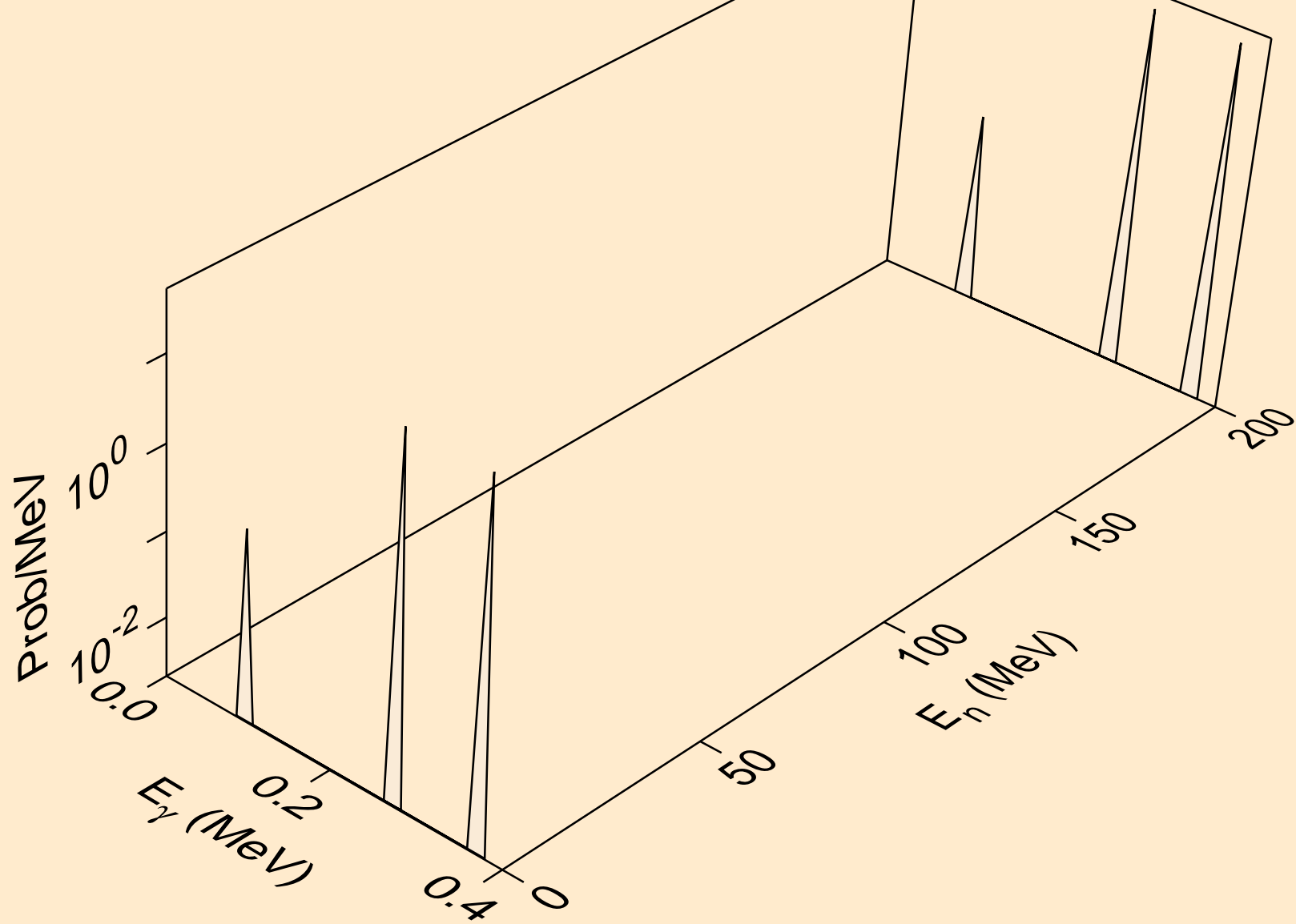

NP236M NEUTRON ACER TENDL-2021 LIBRARY; T=293.6K
Photon emission for (n,n*18)

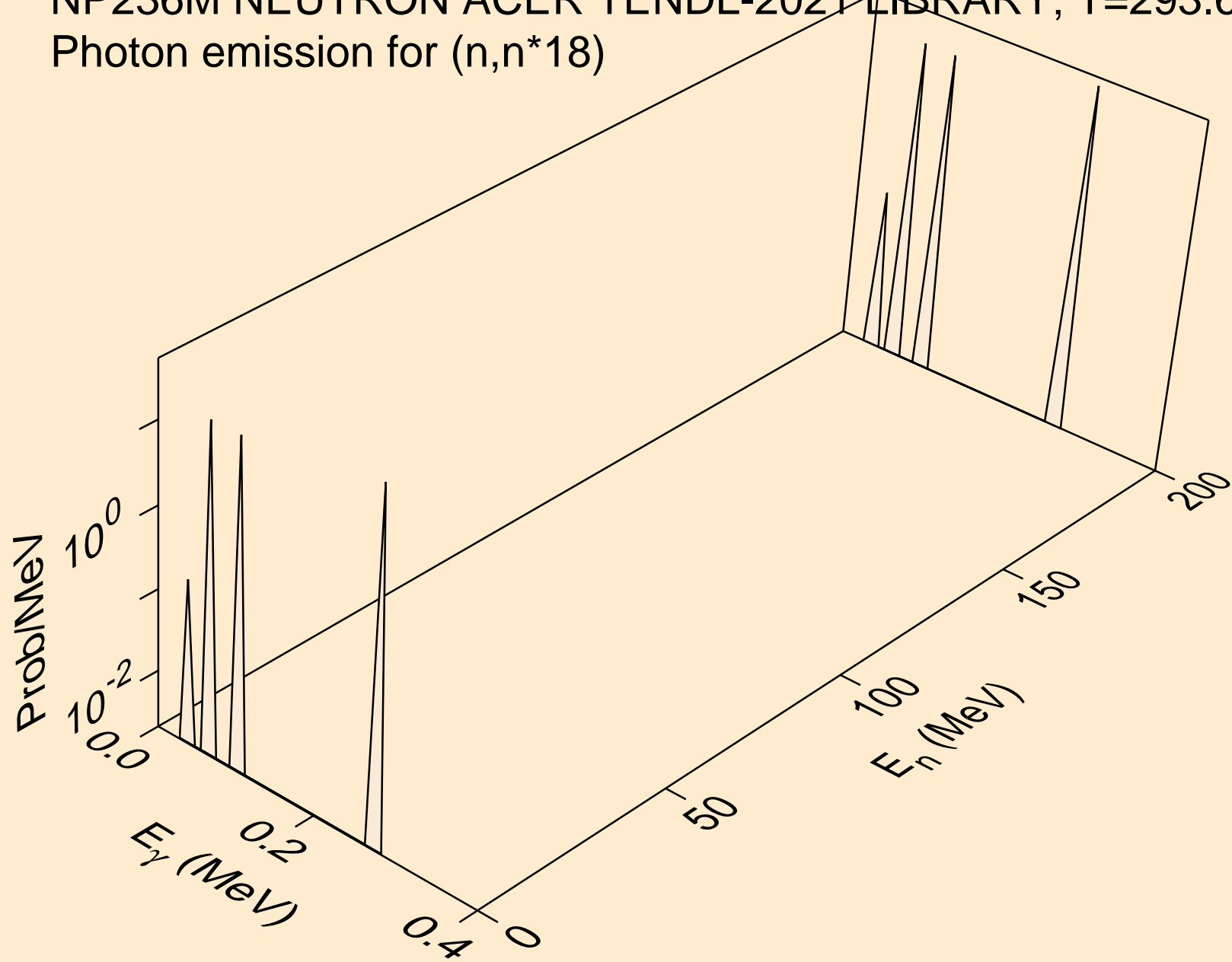

NP236M NEUTRON ACER TENDL-2021 LIBRARY; T=293.6K
Photon emission for (n,n*19)

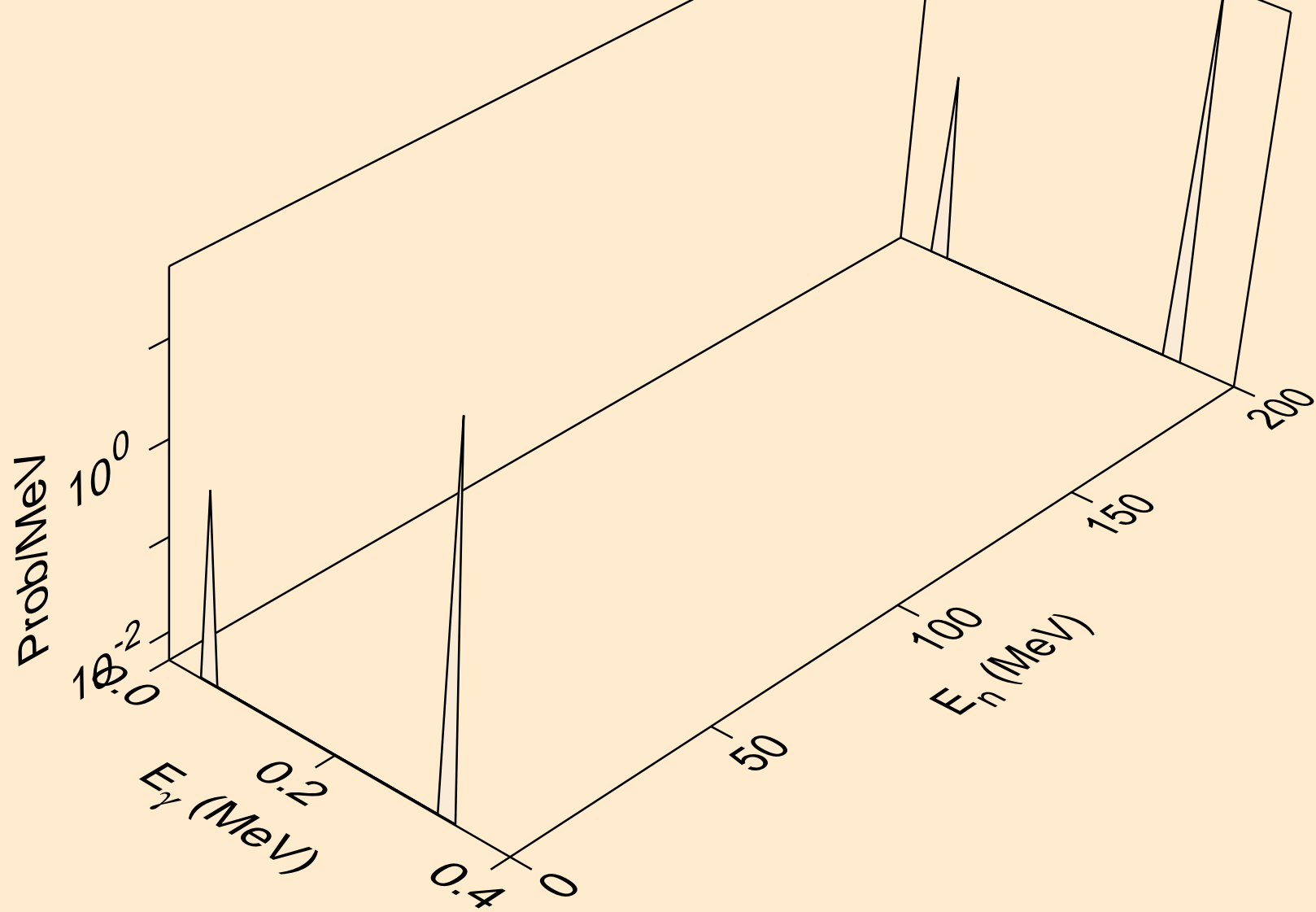

NP236M NEUTRON ACER TENDL-2021 LIBRARY; T=293.6K
Photon emission for (n,n*20)

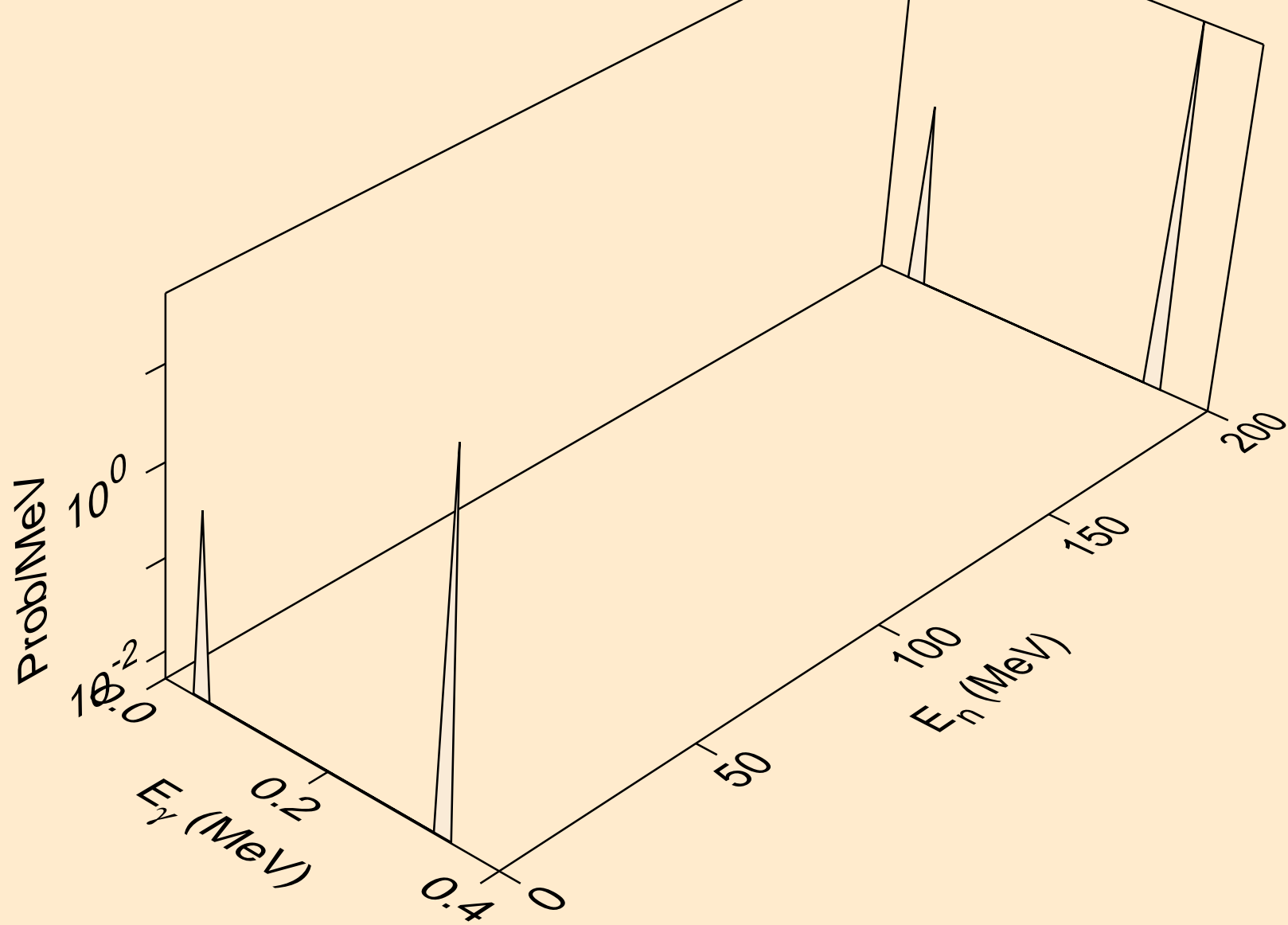

NP236M NEUTRON ACER TENDL-2021 LIBRARY; T=293.6K
Photon emission for (n,n*21)

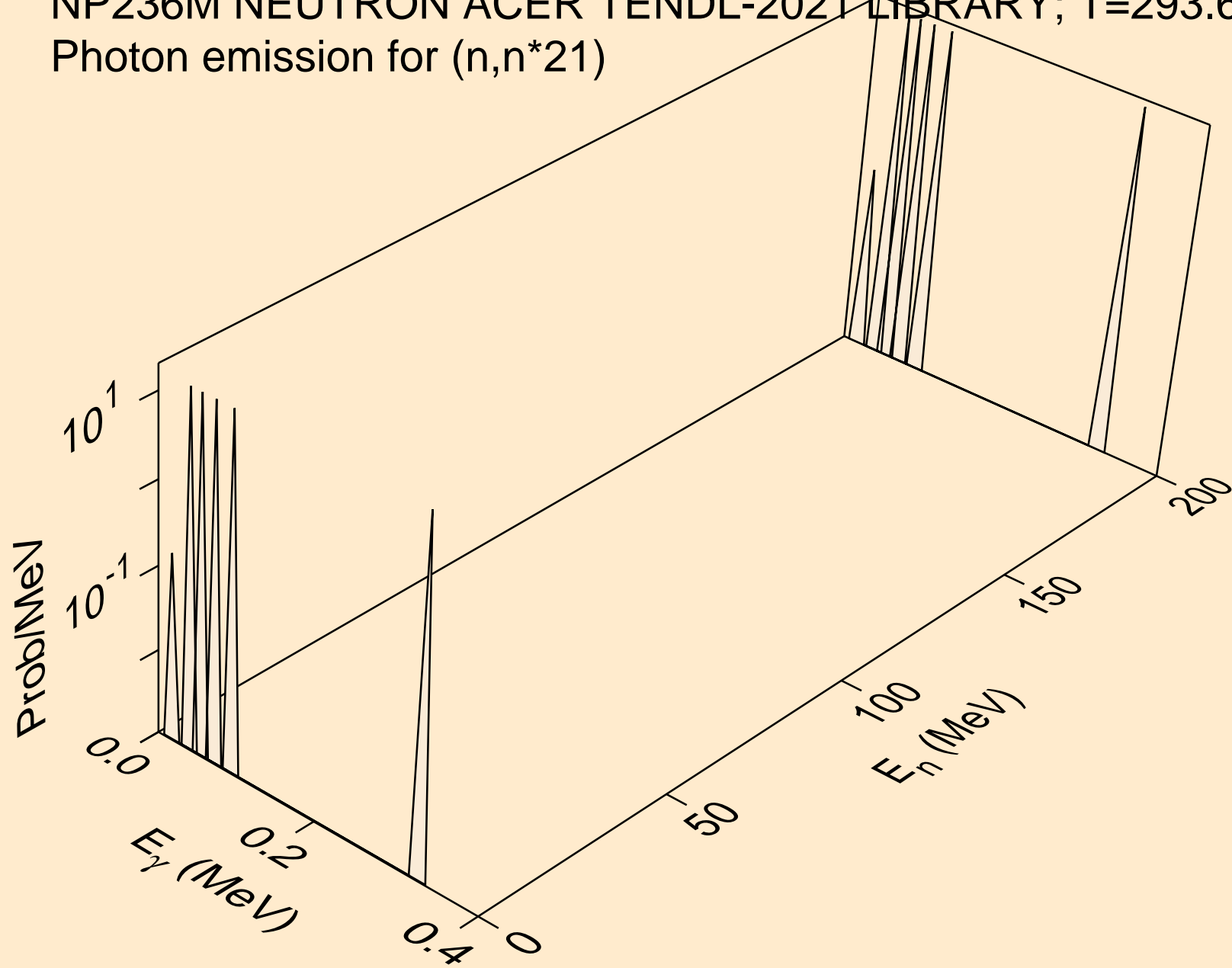

NP236M NEUTRON ACER TENDL-2021 LIBRARY; T=293.6K
Photon emission for (n,n*22)

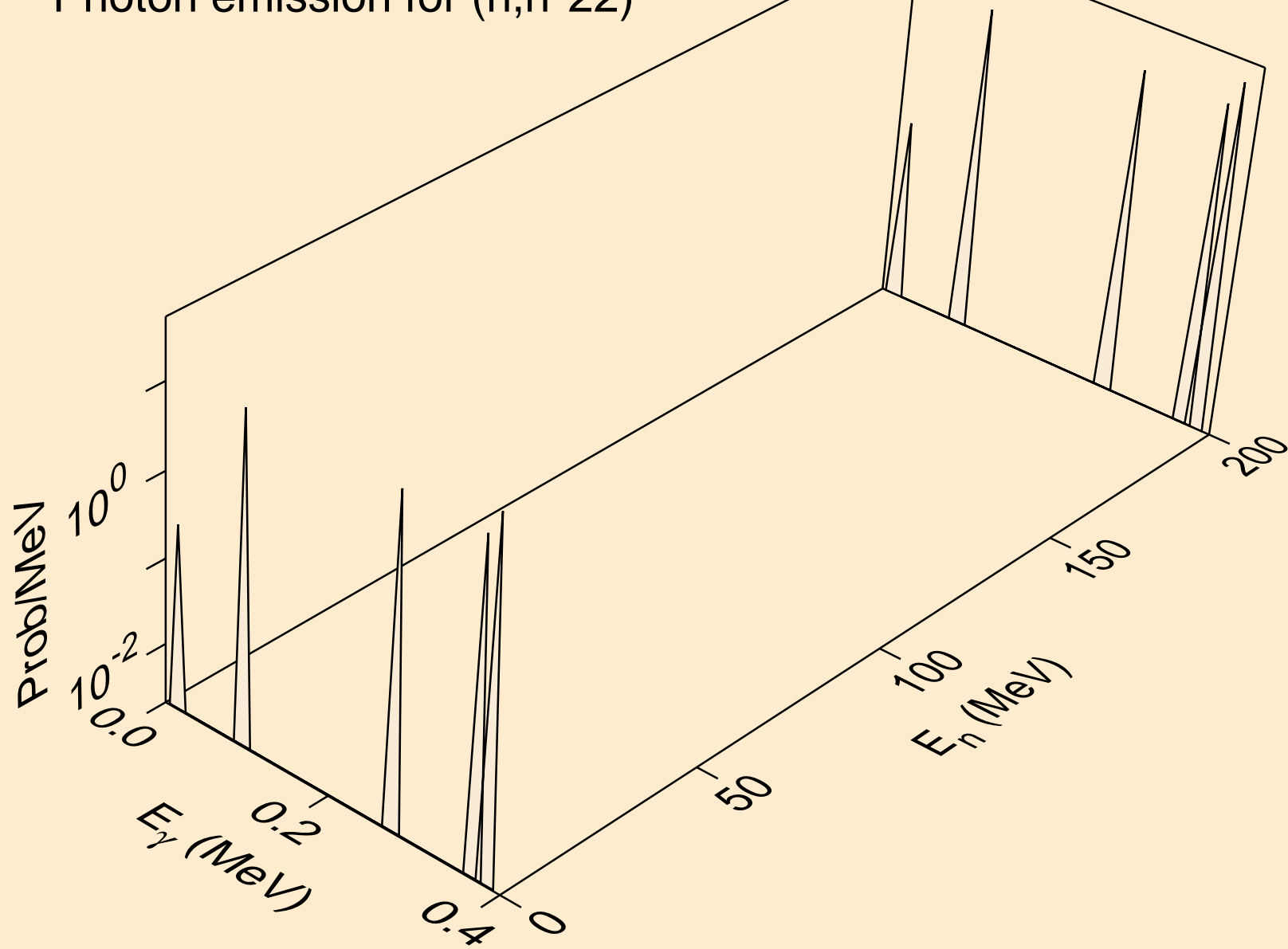

NP236M NEUTRON ACER TENDL-2021 LIBRARY; T=293.6K
Photon emission for (n,n*23)

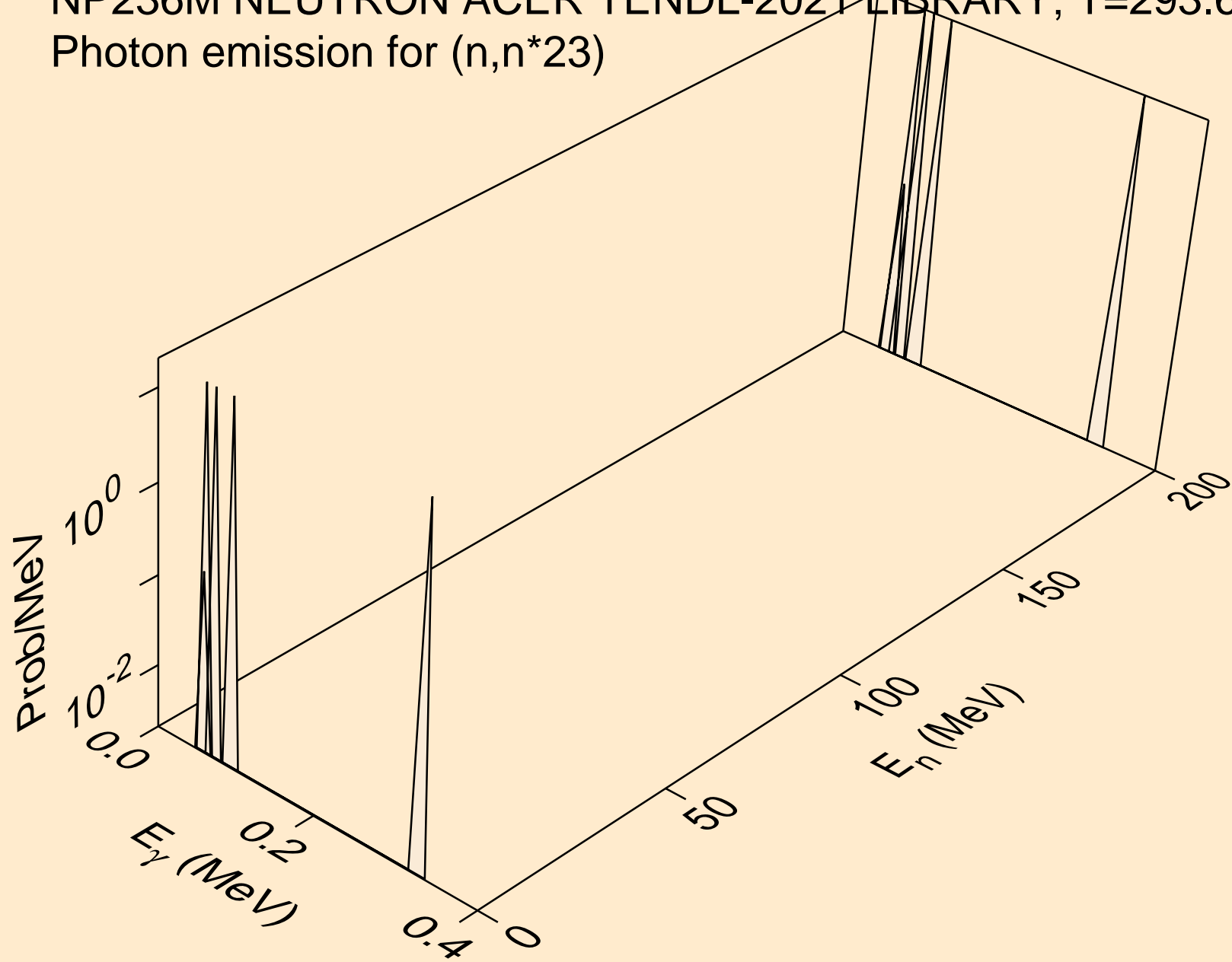

NP236M NEUTRON ACER TENDL-2021 LIBRARY; T=293.6K
Photon emission for (n,n*24)

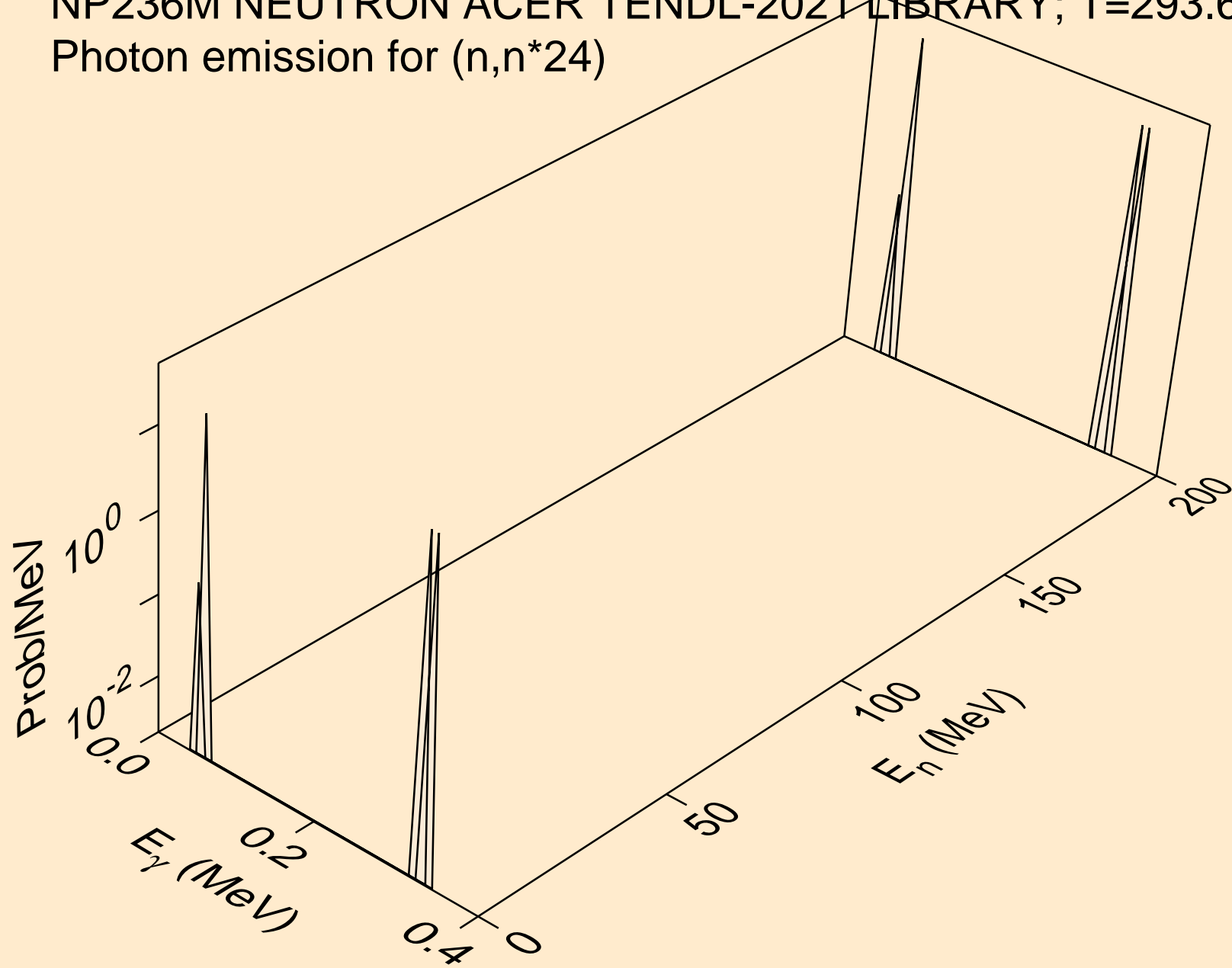

NP236M NEUTRON ACER TENDL-2021 LIBRARY; T=293.6K
Photon emission for (n,n*25)

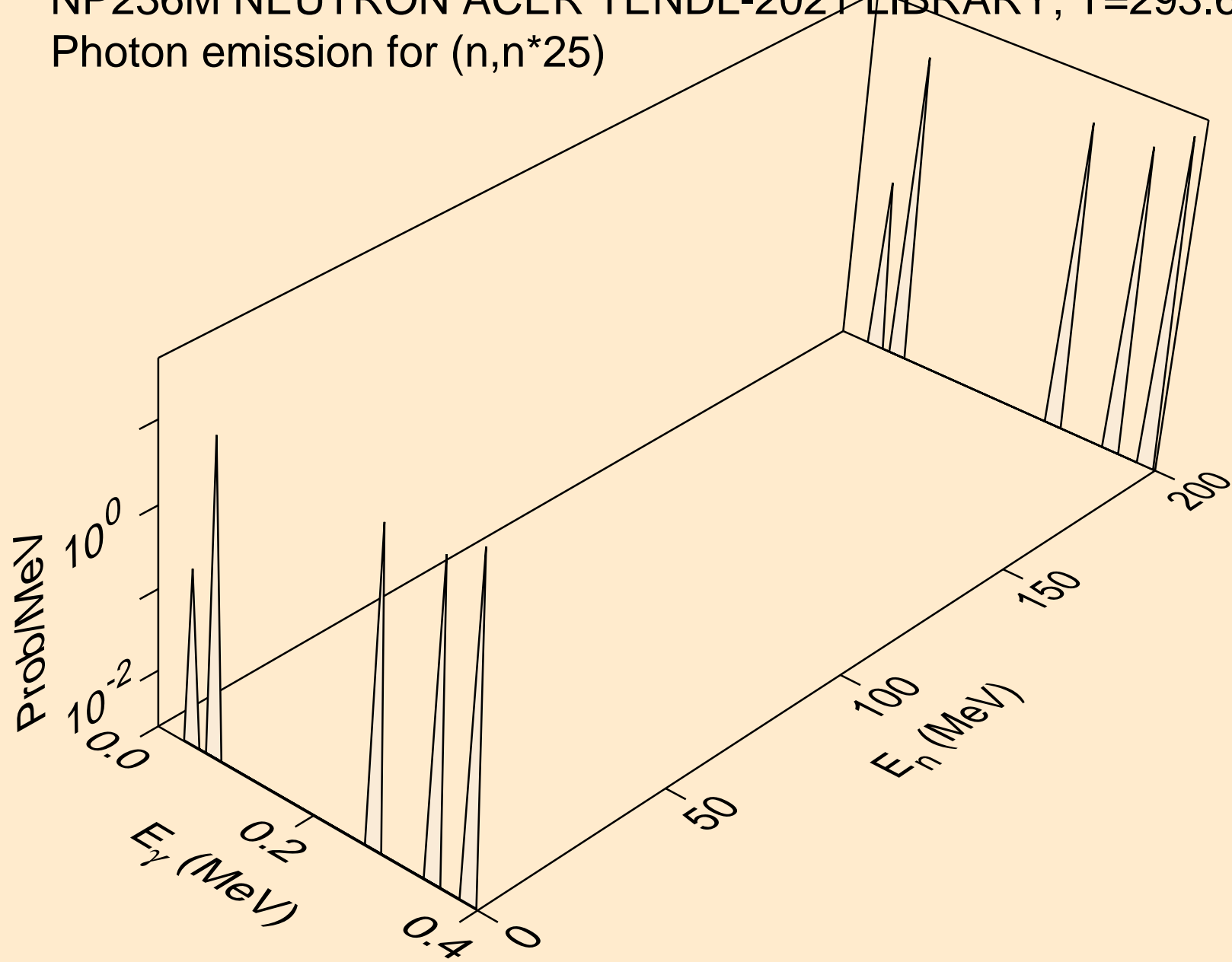

NP236M NEUTRON ACER TENDL-2021 LIBRARY; T=293.6K
Photon emission for (n,n*26)

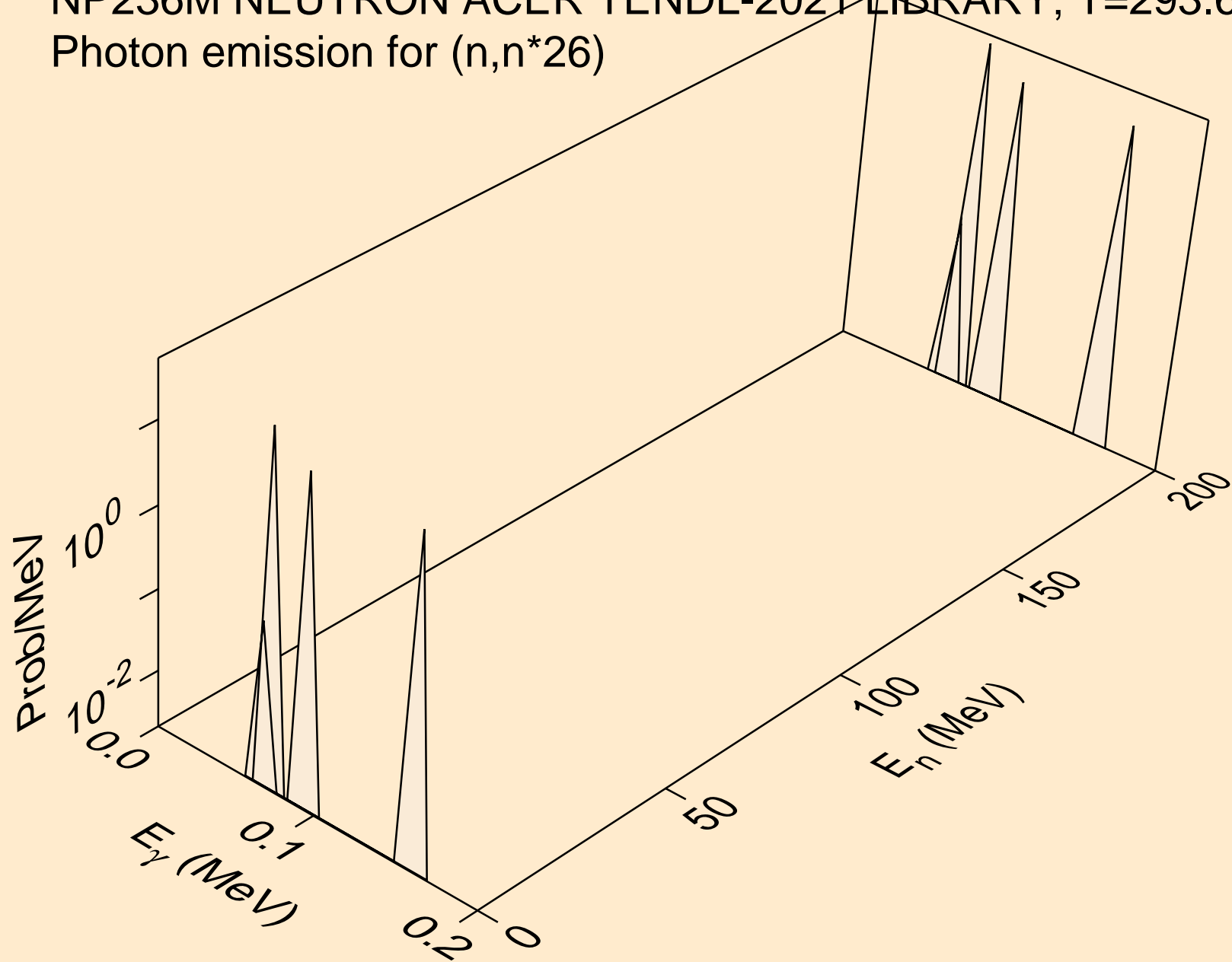

NP236M NEUTRON ACER TENDL-2021 LIBRARY; T=293.6K
Photon emission for (n,n*c)

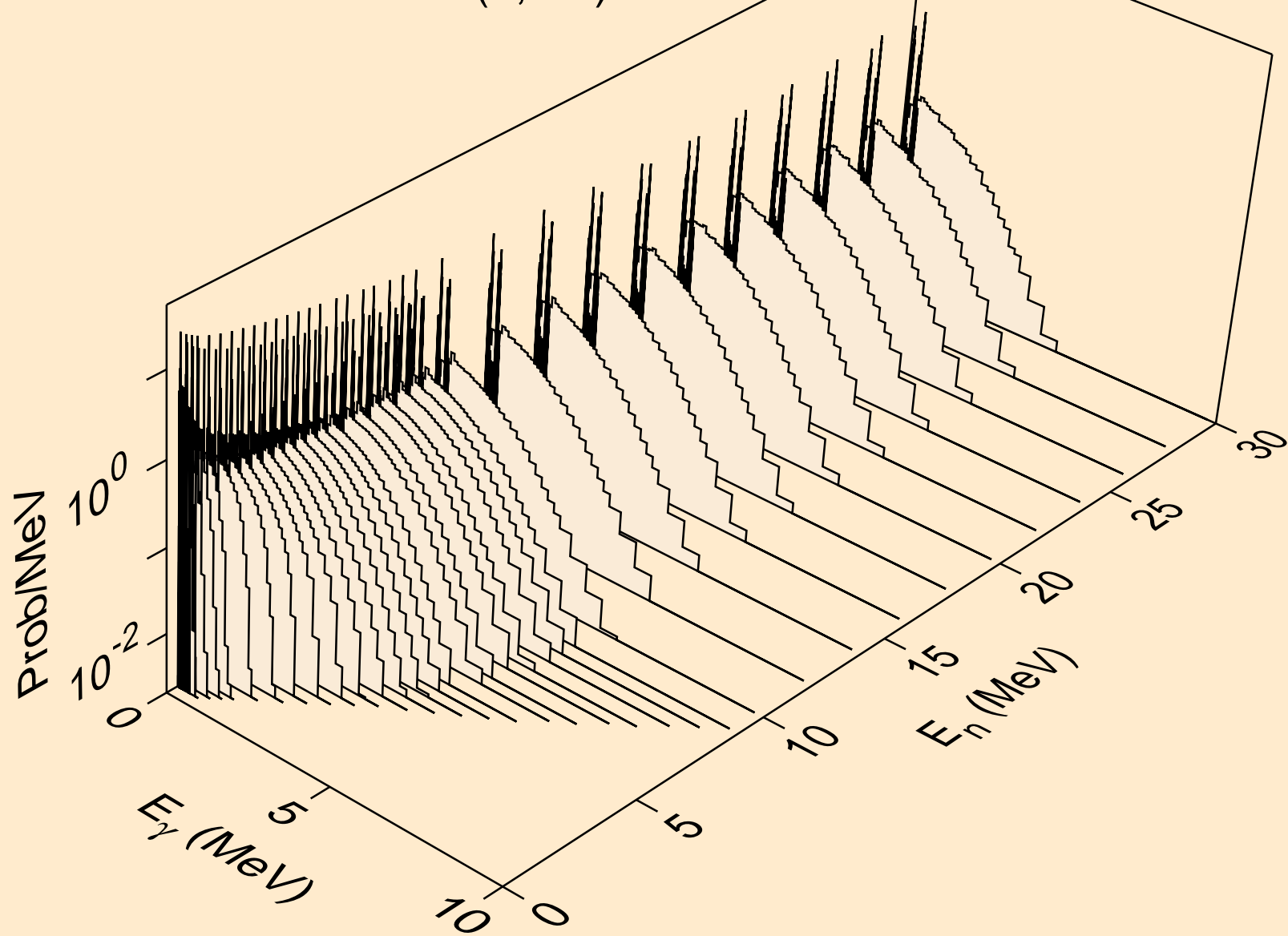

NP236M NEUTRON ACER TENDL-2021 LIBRARY; T=293.6K
Photon emission for (n,gma)

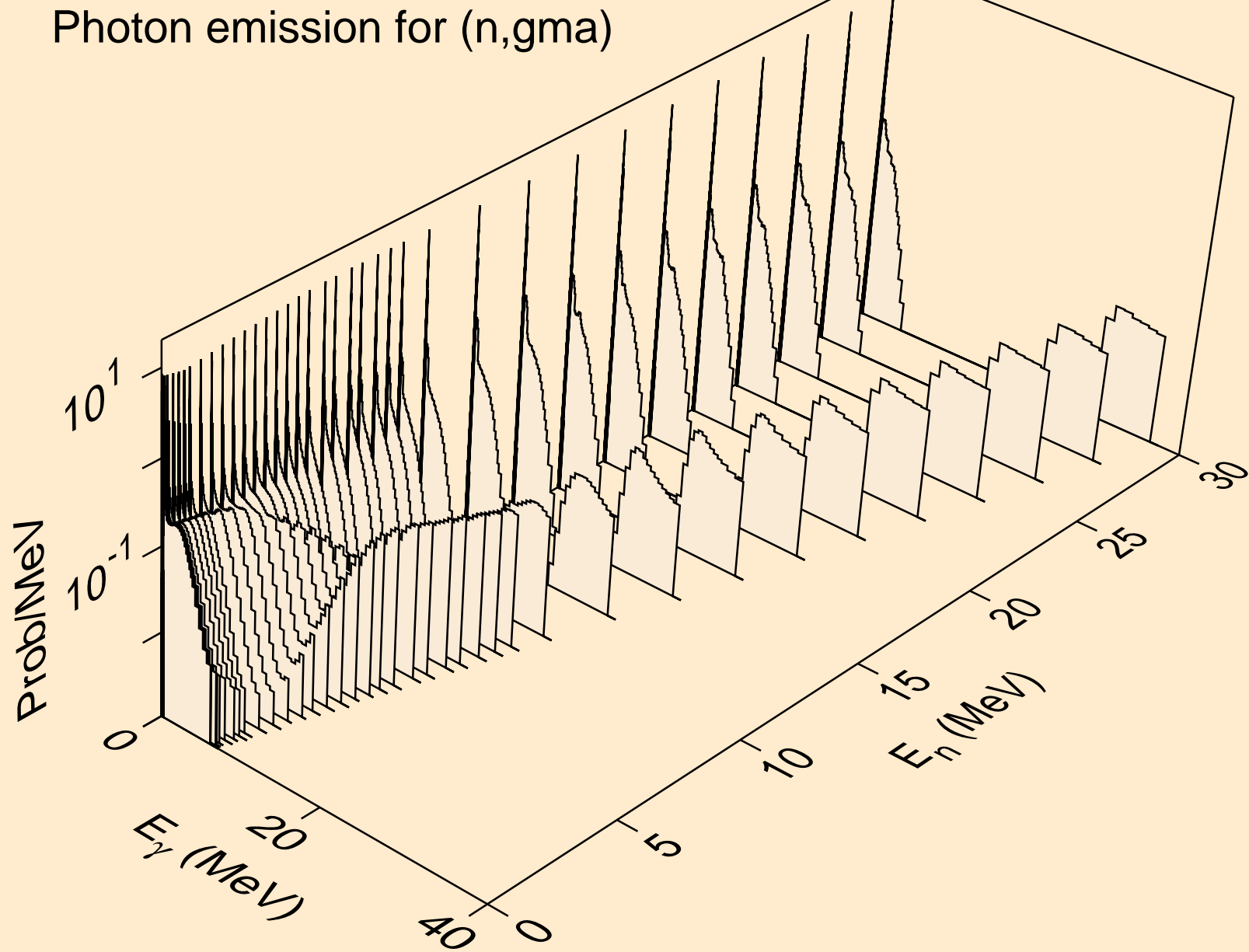

NP236M NEUTRON ACER TENDL-2021 LIBRARY; T=293.6K
Photon emission for (n,p)

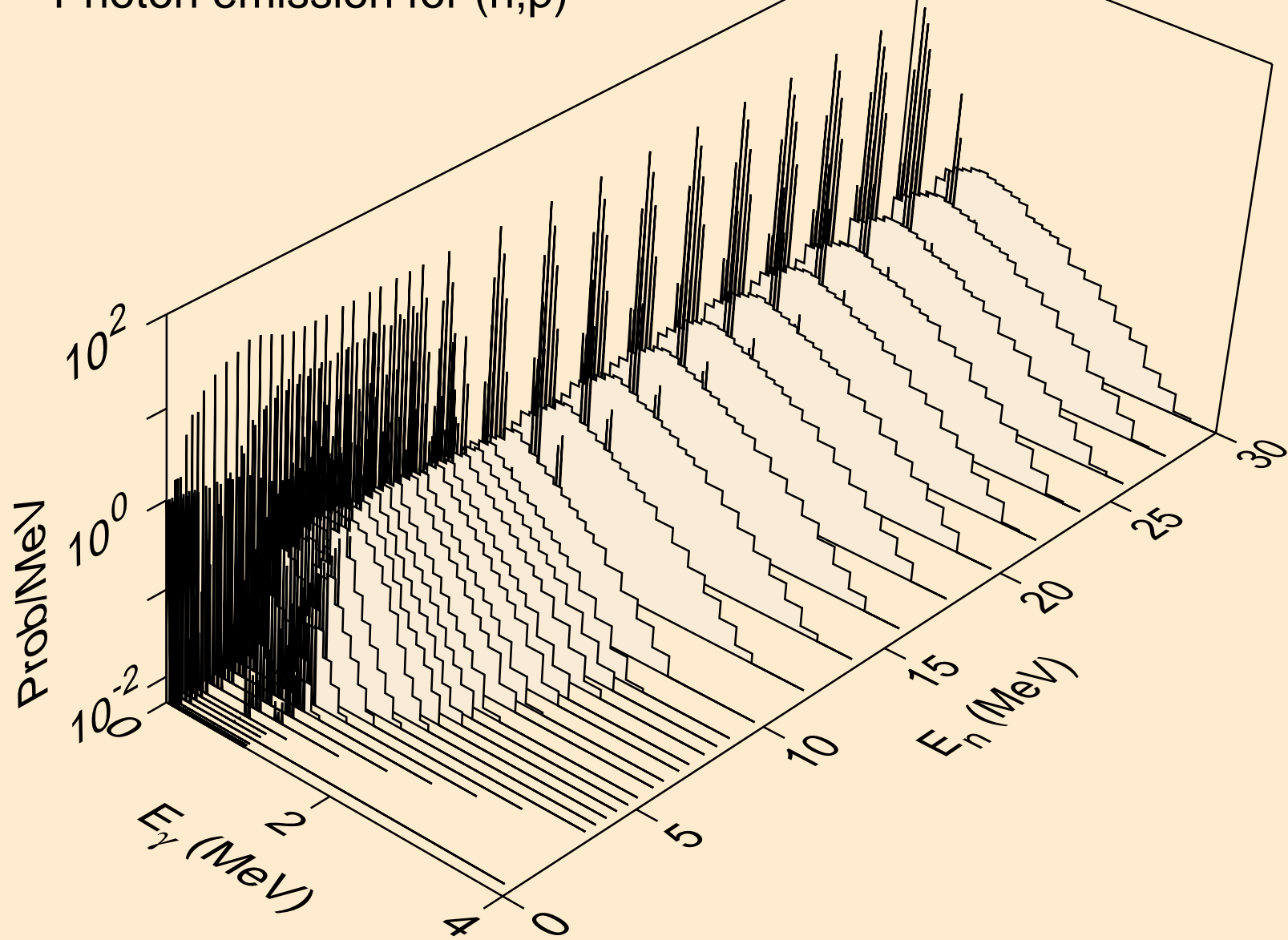

NP236M NEUTRON ACER TENDL-2021 LIBRARY; T=293.6K
Photon emission for (n,d)

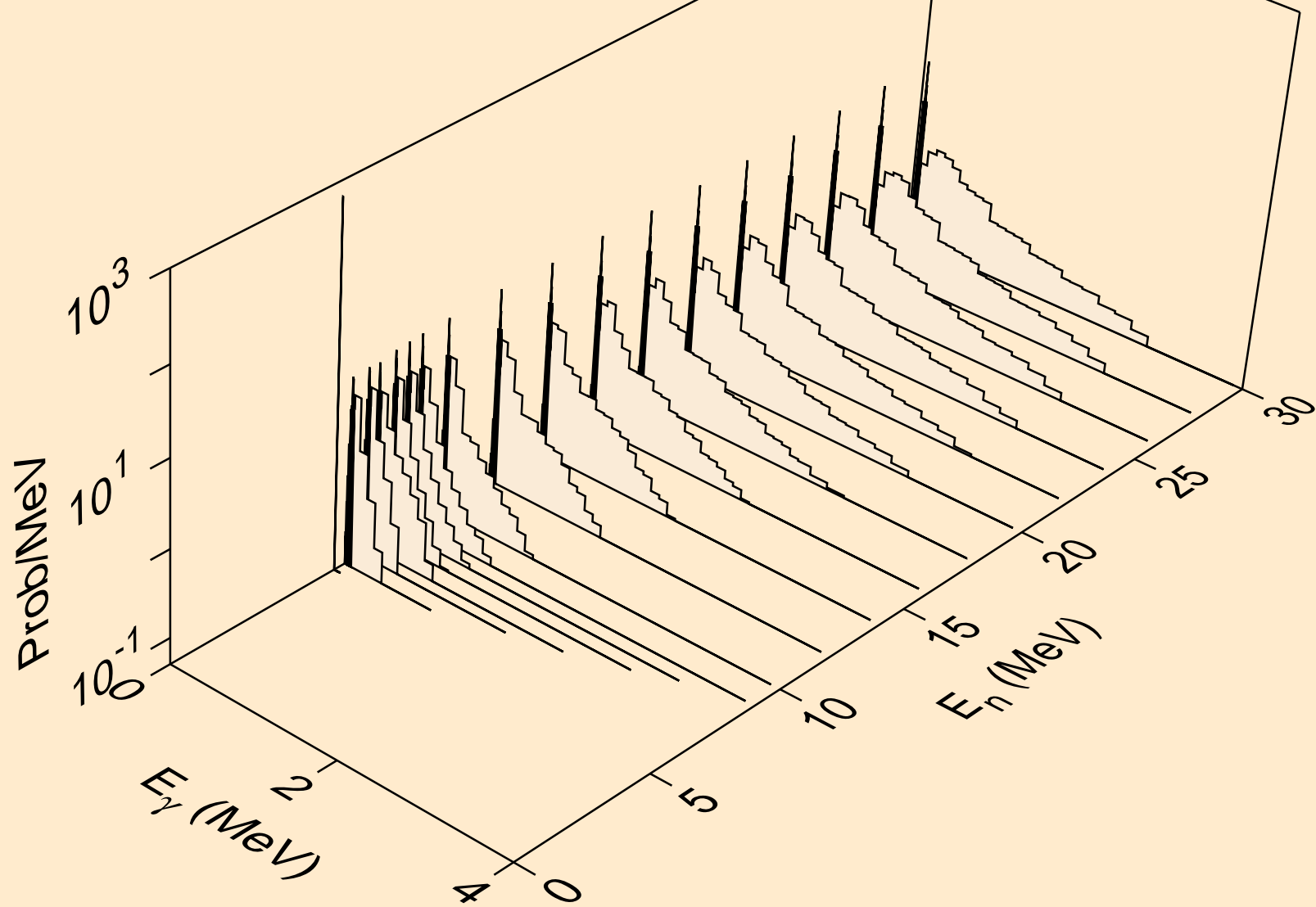

NP236M NEUTRON ACER TENDL-2021 LIBRARY; T=293.6K
Photon emission for (n,t)

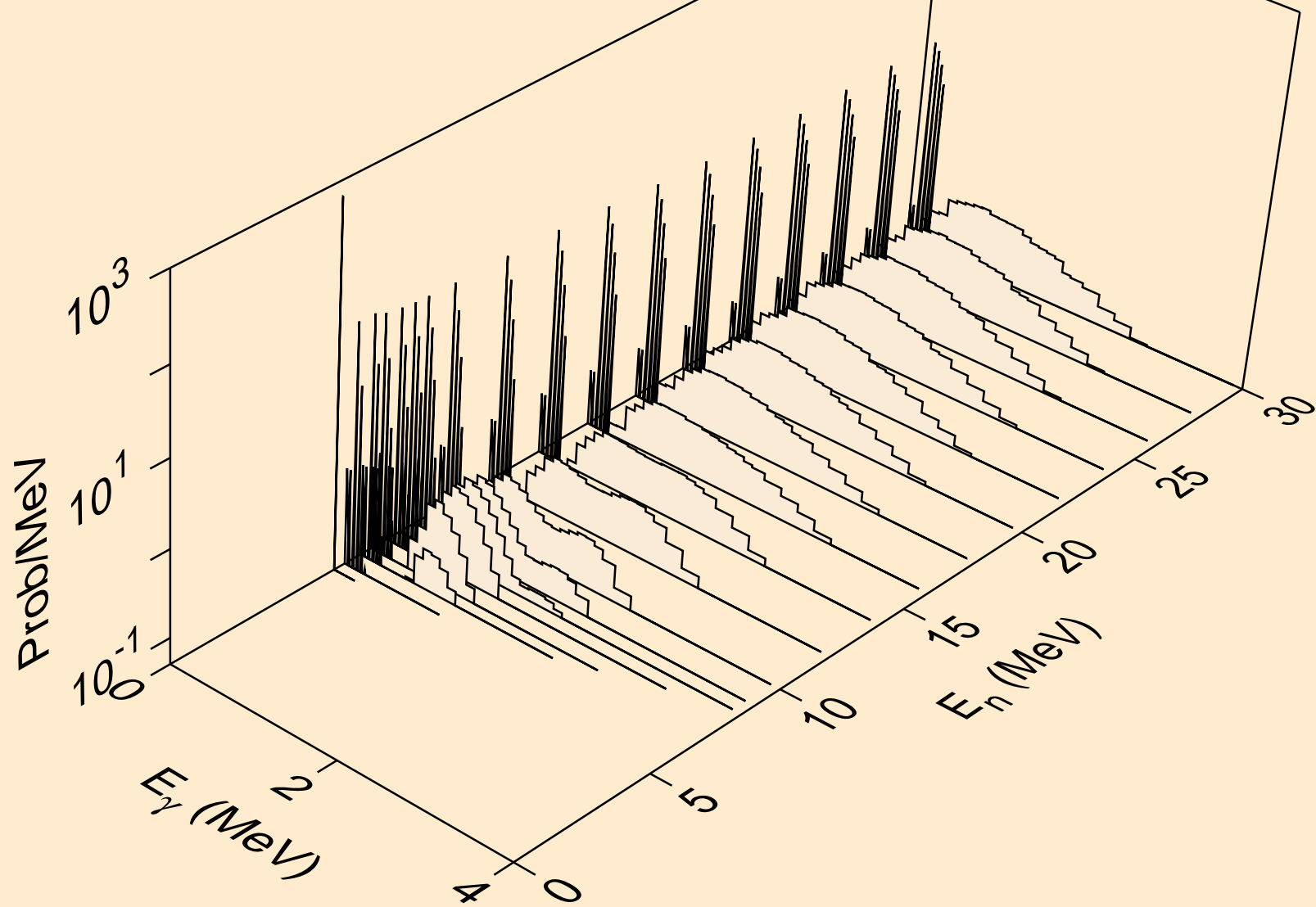

NP236M NEUTRON ACER TENDL-2021 LIBRARY; T=293.6K
Photon emission for (n,he3)

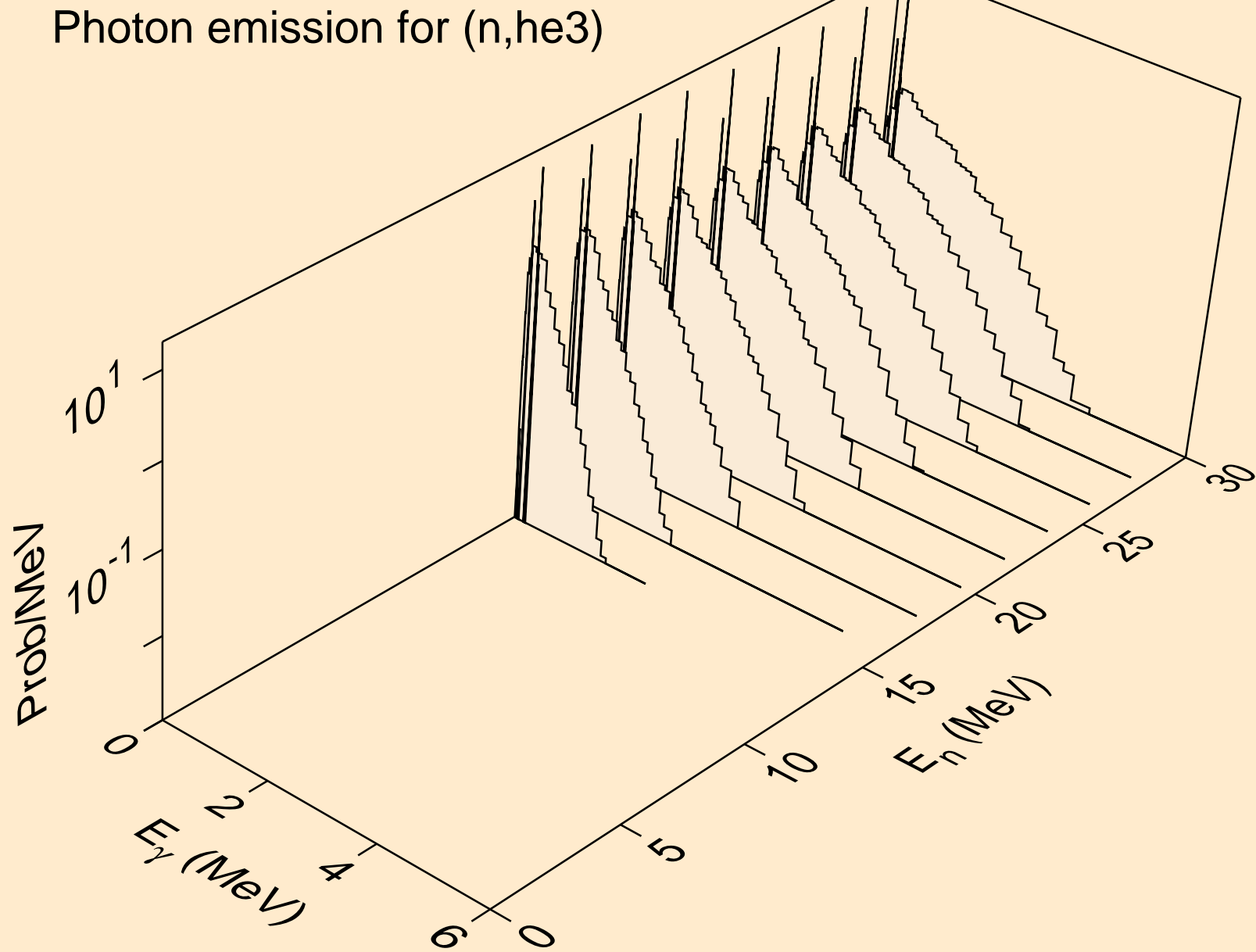

NP236M NEUTRON ACER TENDL-2021 LIBRARY; T=293.6K
Photon emission for (n,a)

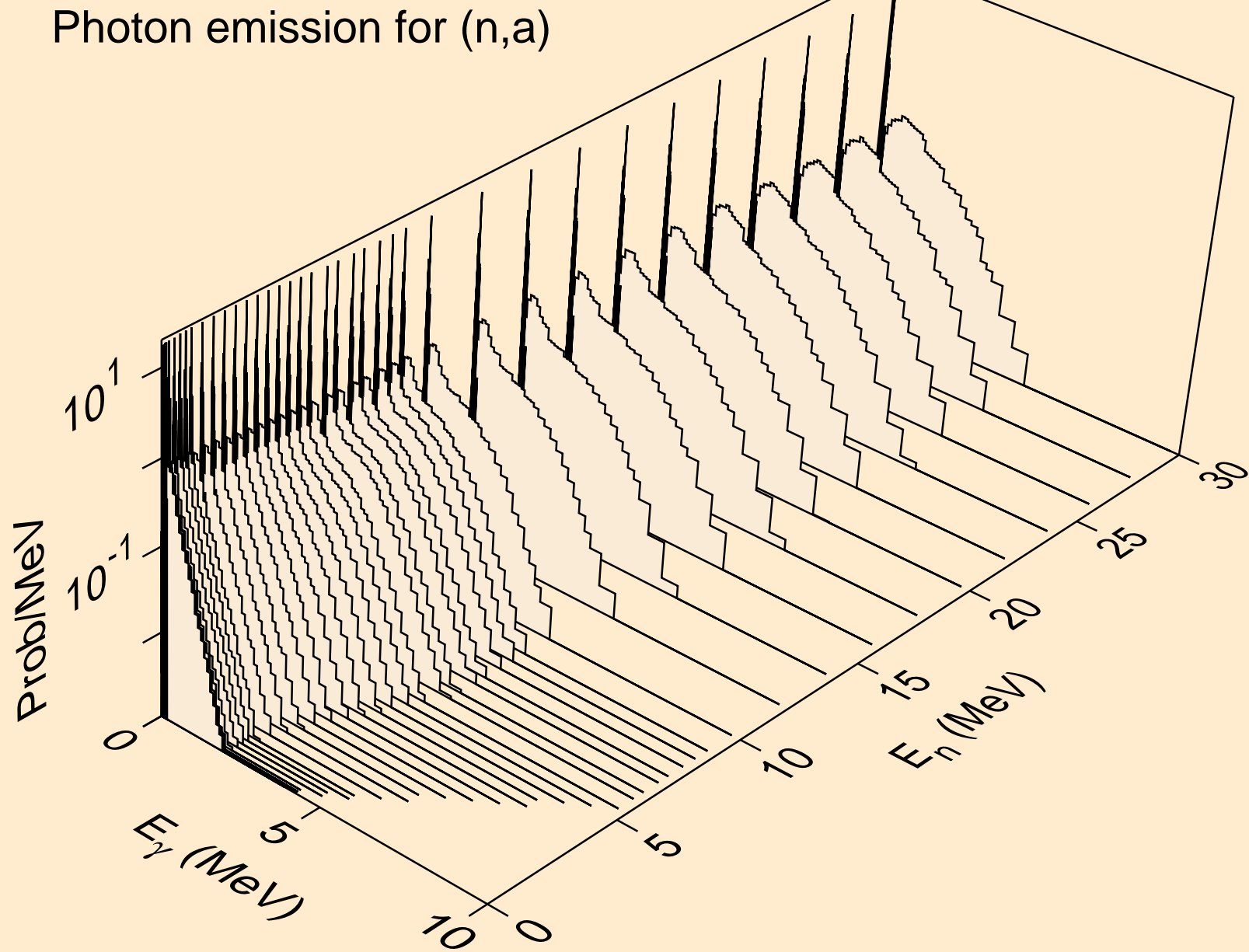

NP236M NEUTRON ACER TENDL-2021 LIBRARY; T=293.6K
Photon emission for (n,2a)

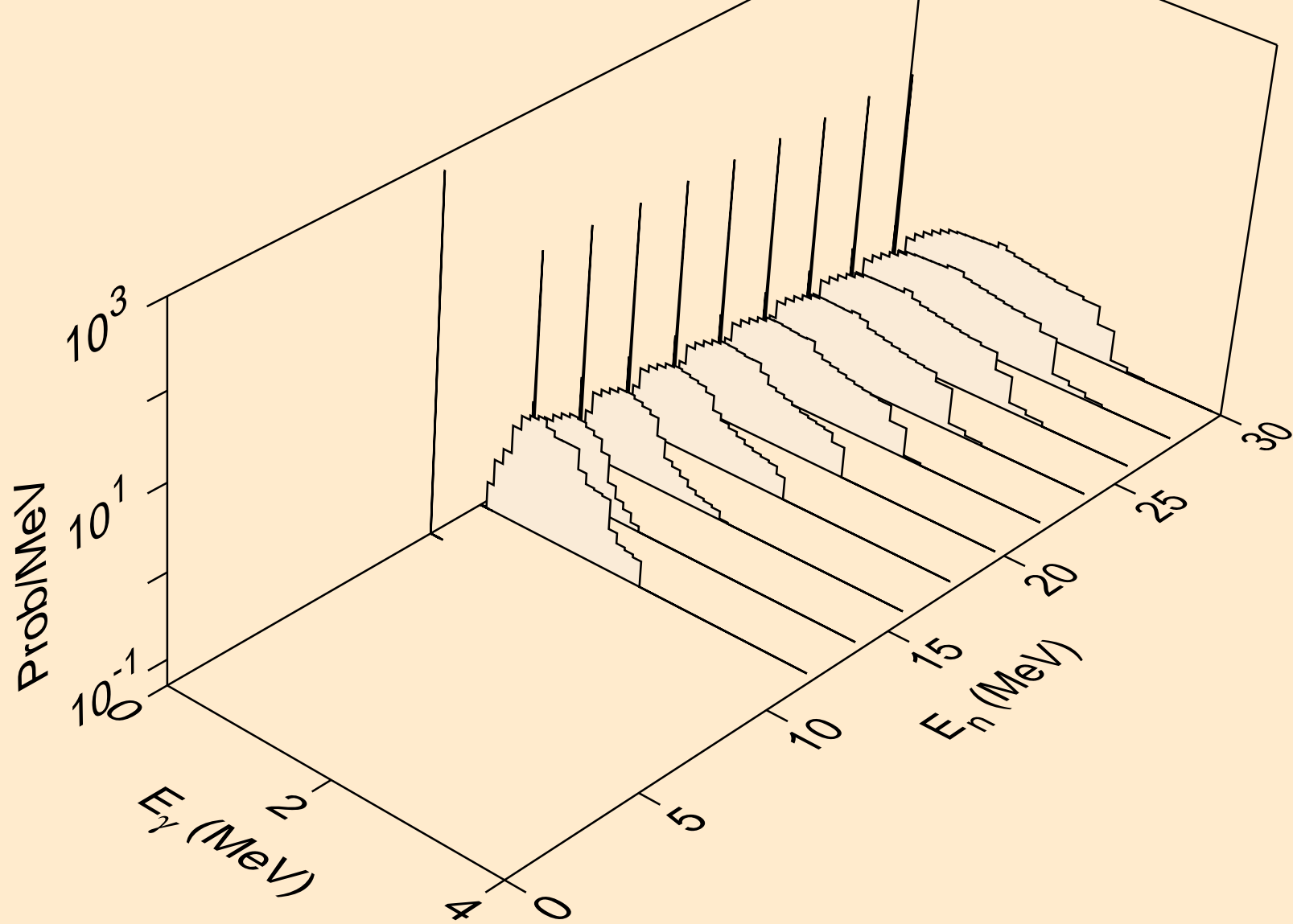

NP236M NEUTRON ACER TENDL-2021 LIBRARY; T=293.6K
Photon emission for (n,2p)

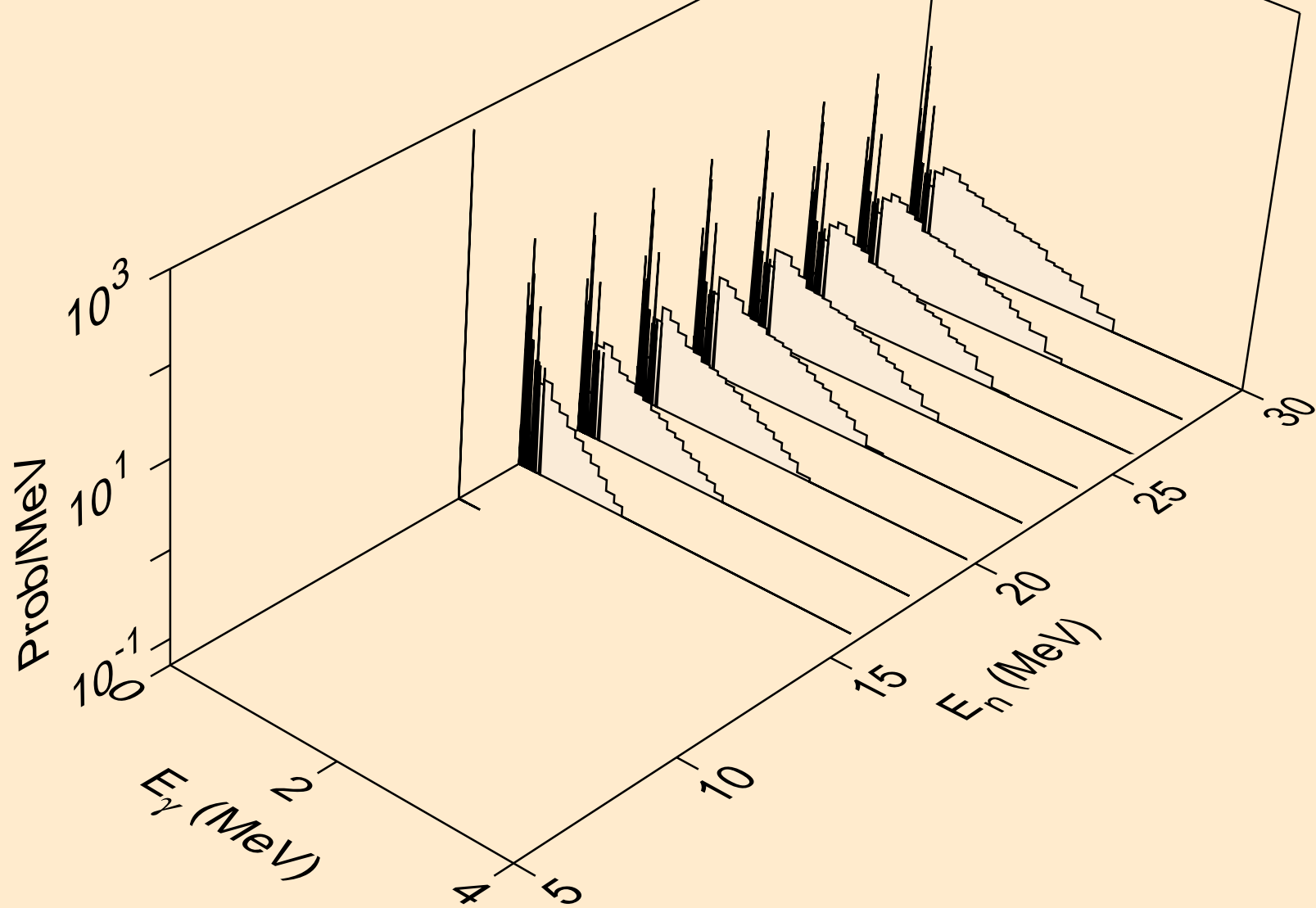

NP236M NEUTRON ACER TENDL-2021 LIBRARY; T=293.6K
Photon emission for (n,p α)

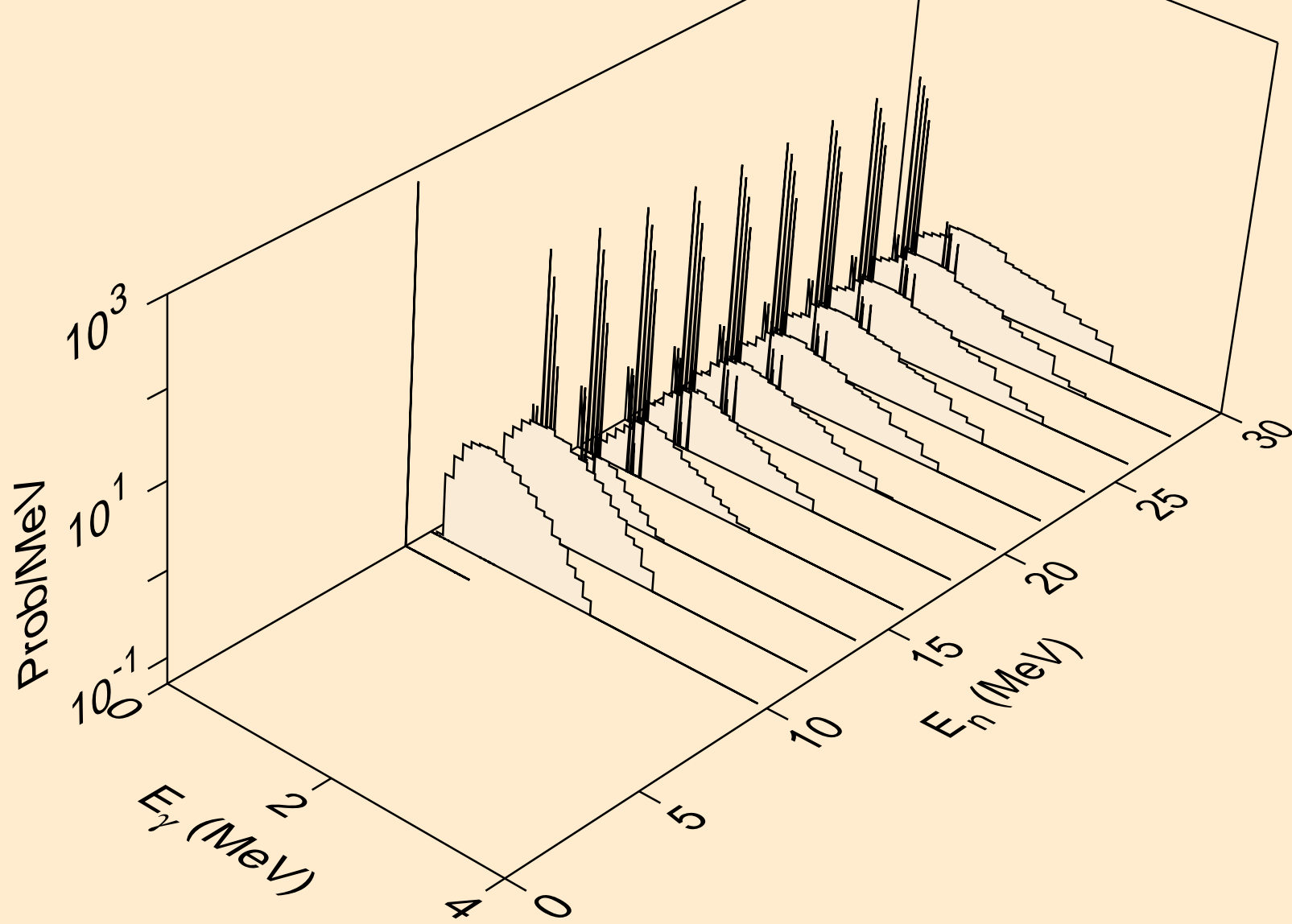

NP236M NEUTRON ACER TENDL-2021 LIBRARY; T=293.6K
thermal capture photon spectrum

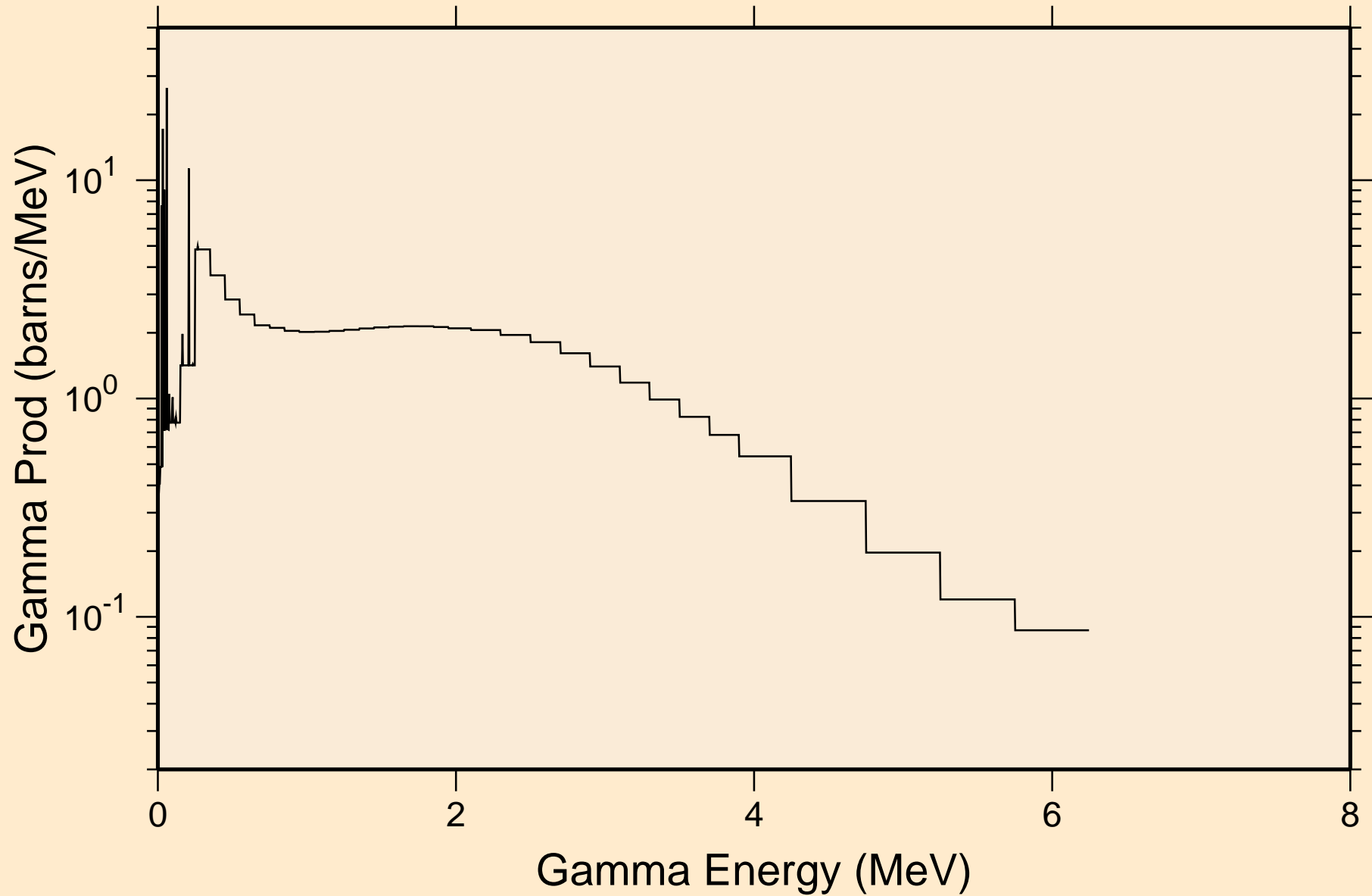

NP236M NEUTRON ACER TENDL-2021 LIBRARY; T=293.6K
14 MeV photon spectrum

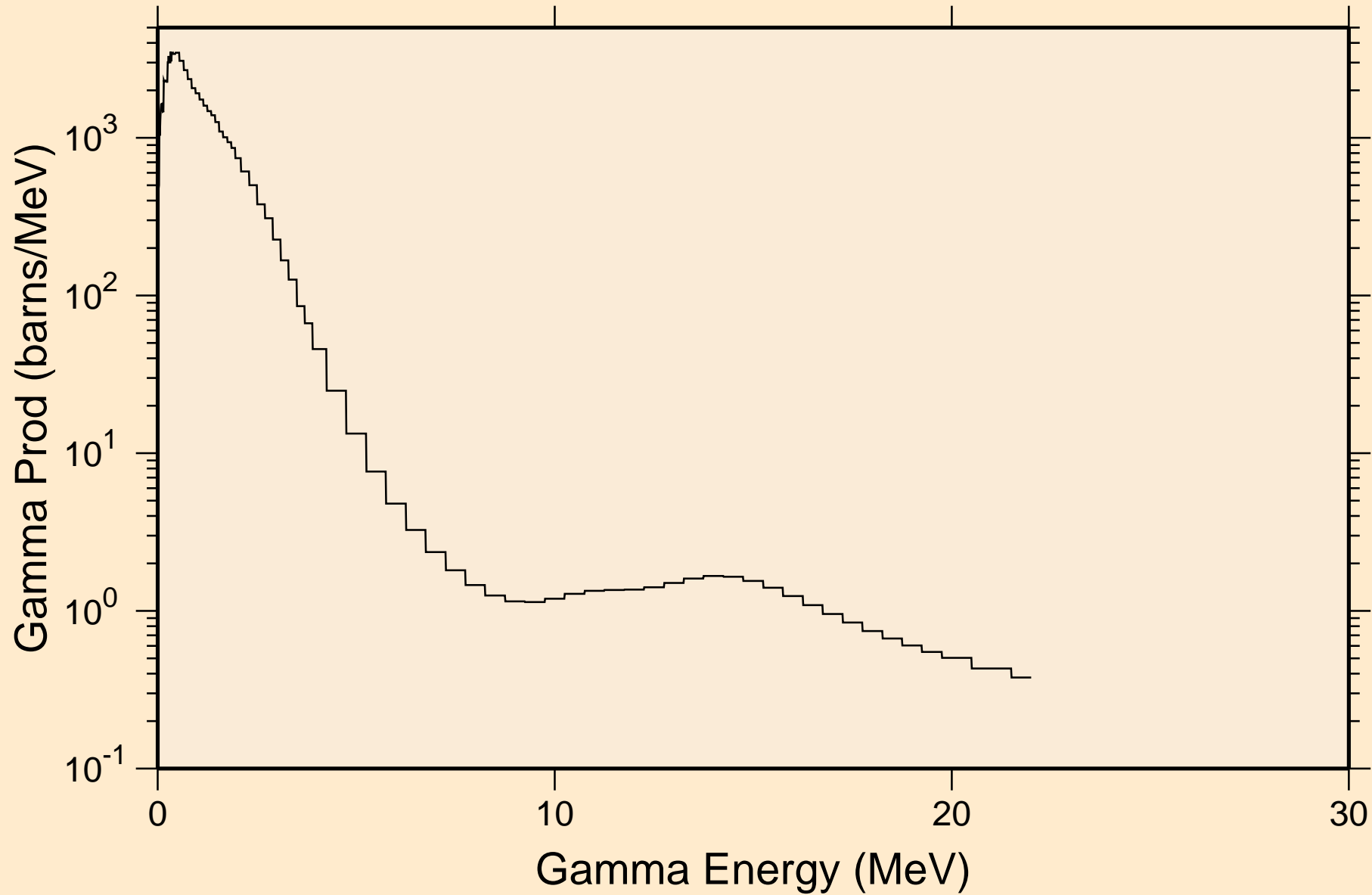

NP236M NEUTRON ACER TENDL-2021 LIBRARY; T=293.6K

Particle heating contributions

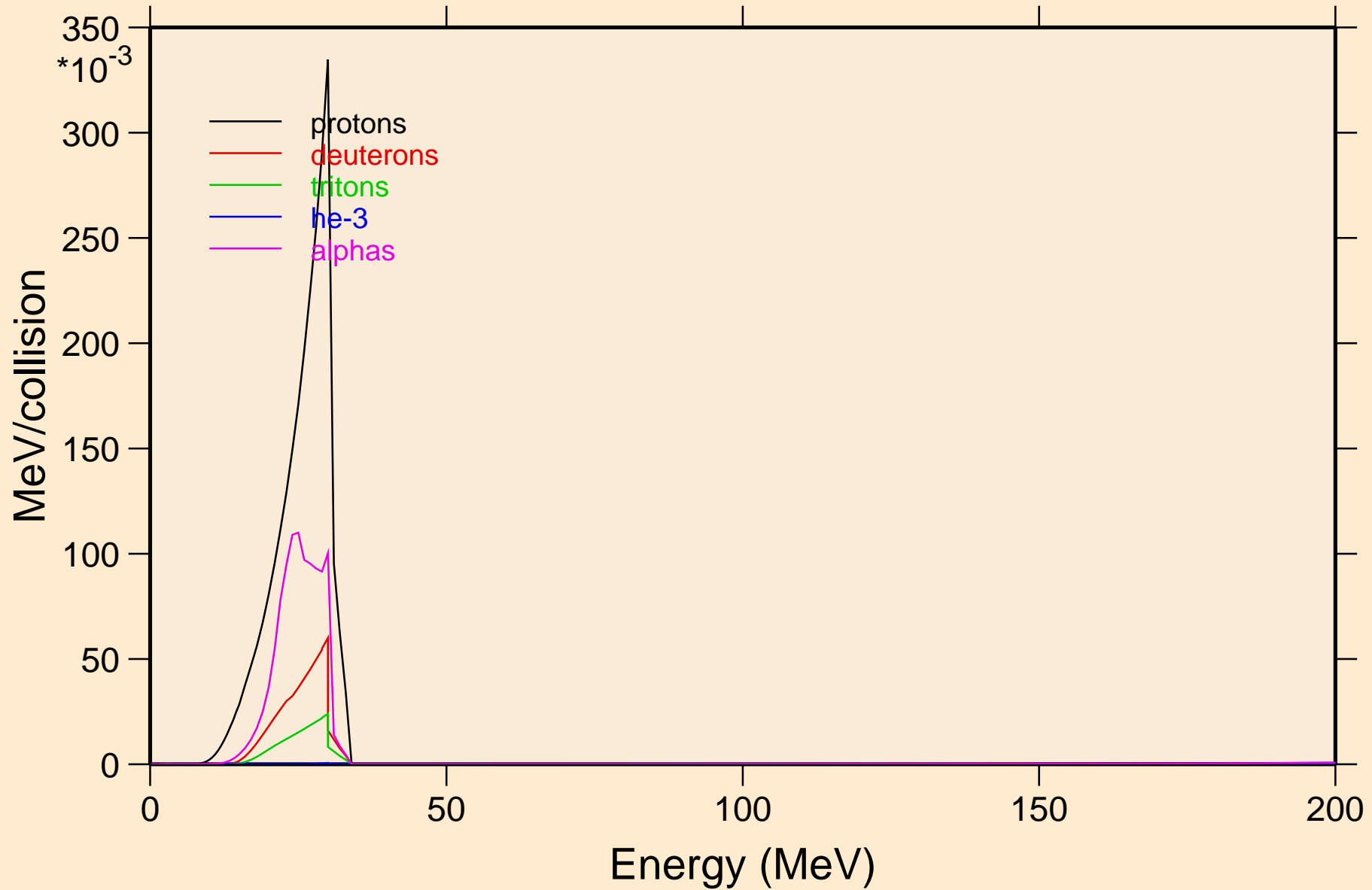

NP236M NEUTRON ACER TENDL-2021 LIBRARY; T=293.6K
Recoil Heating

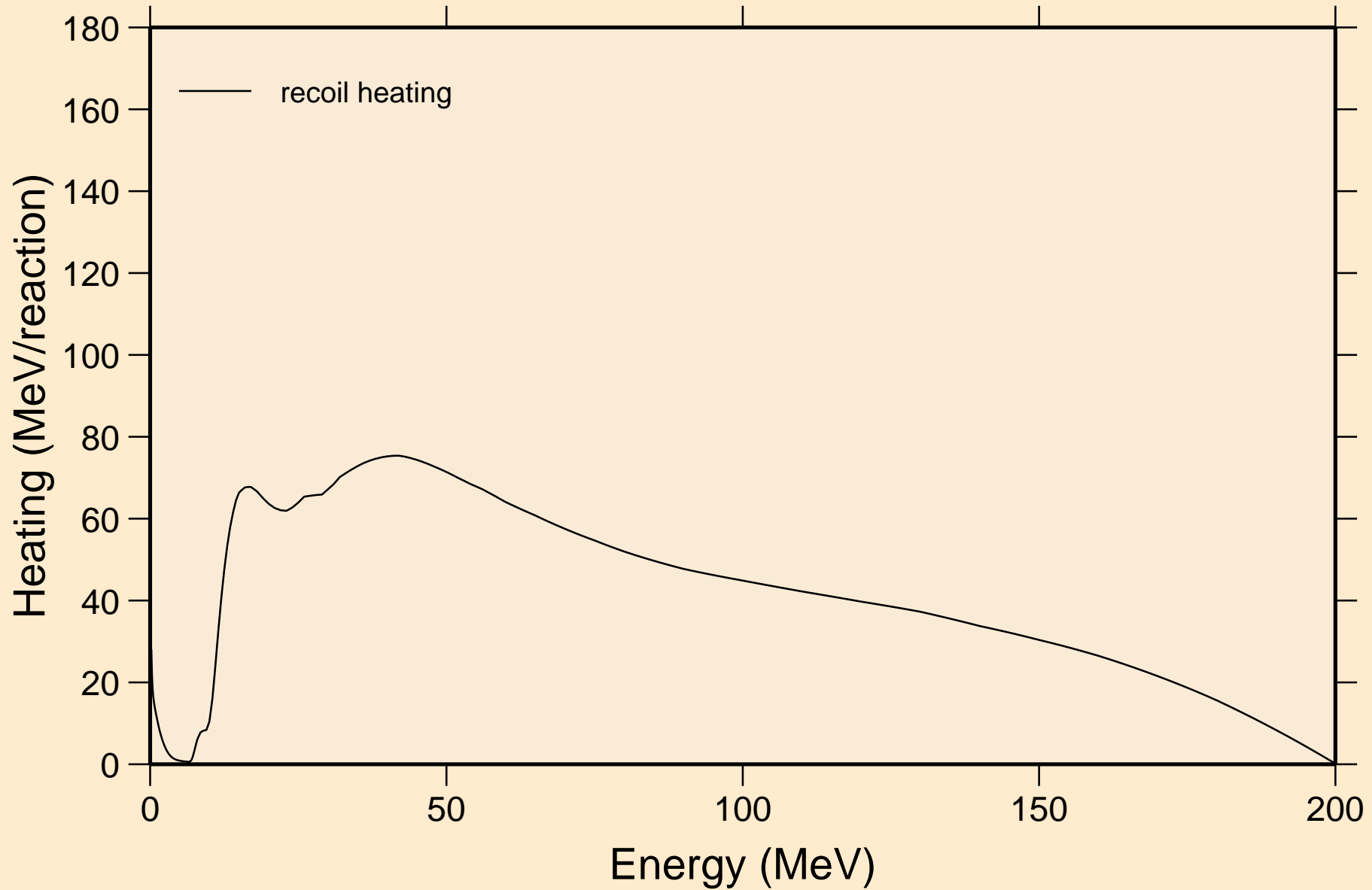

NP236M NEUTRON ACER TENDL-2021 LIBRARY; T=293.6K
Particle production cross sections

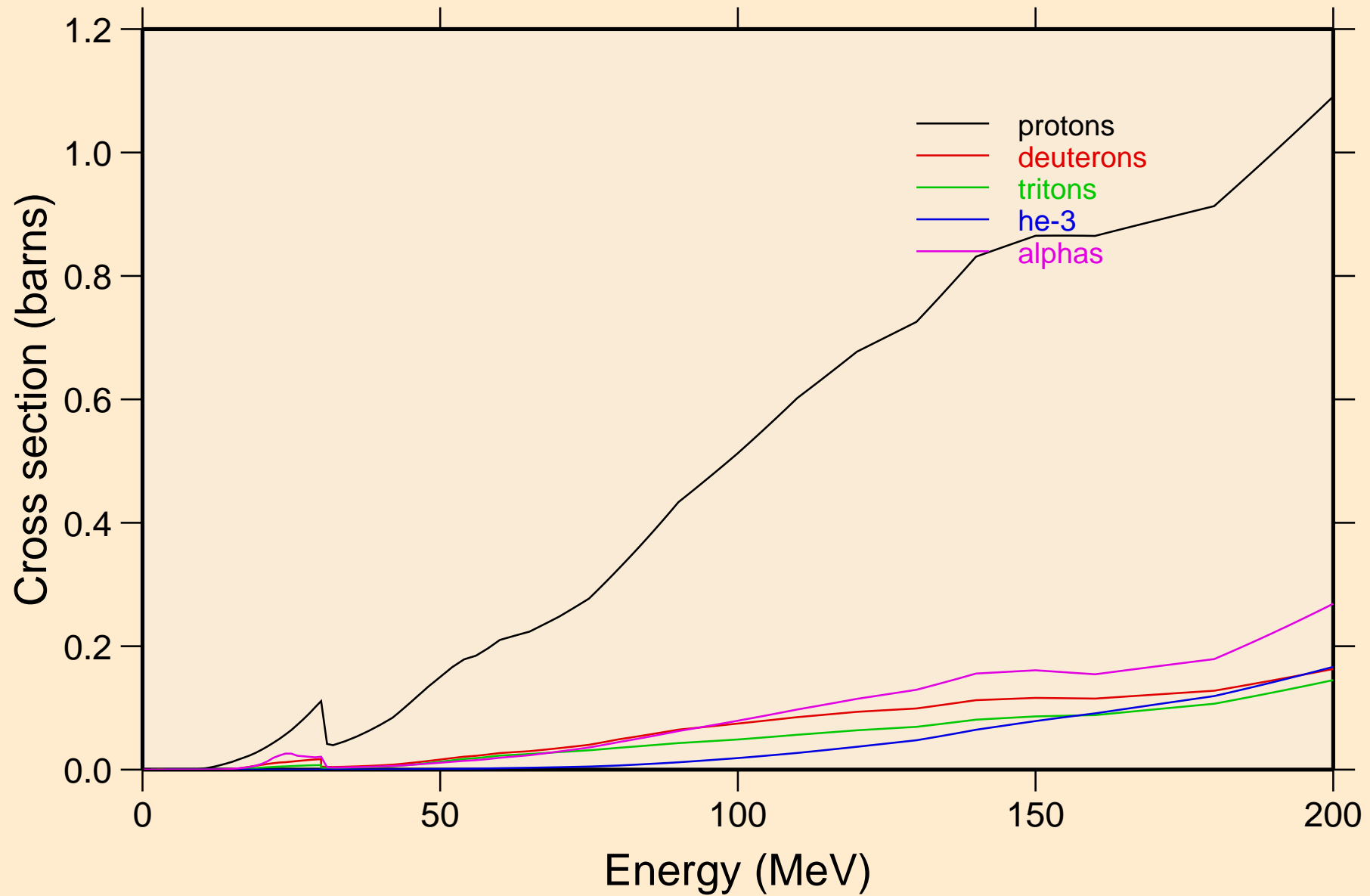

NP236M NEUTRON ACER TENDL-2021 LIBRARY; T=293.6K
protons from (n,x)

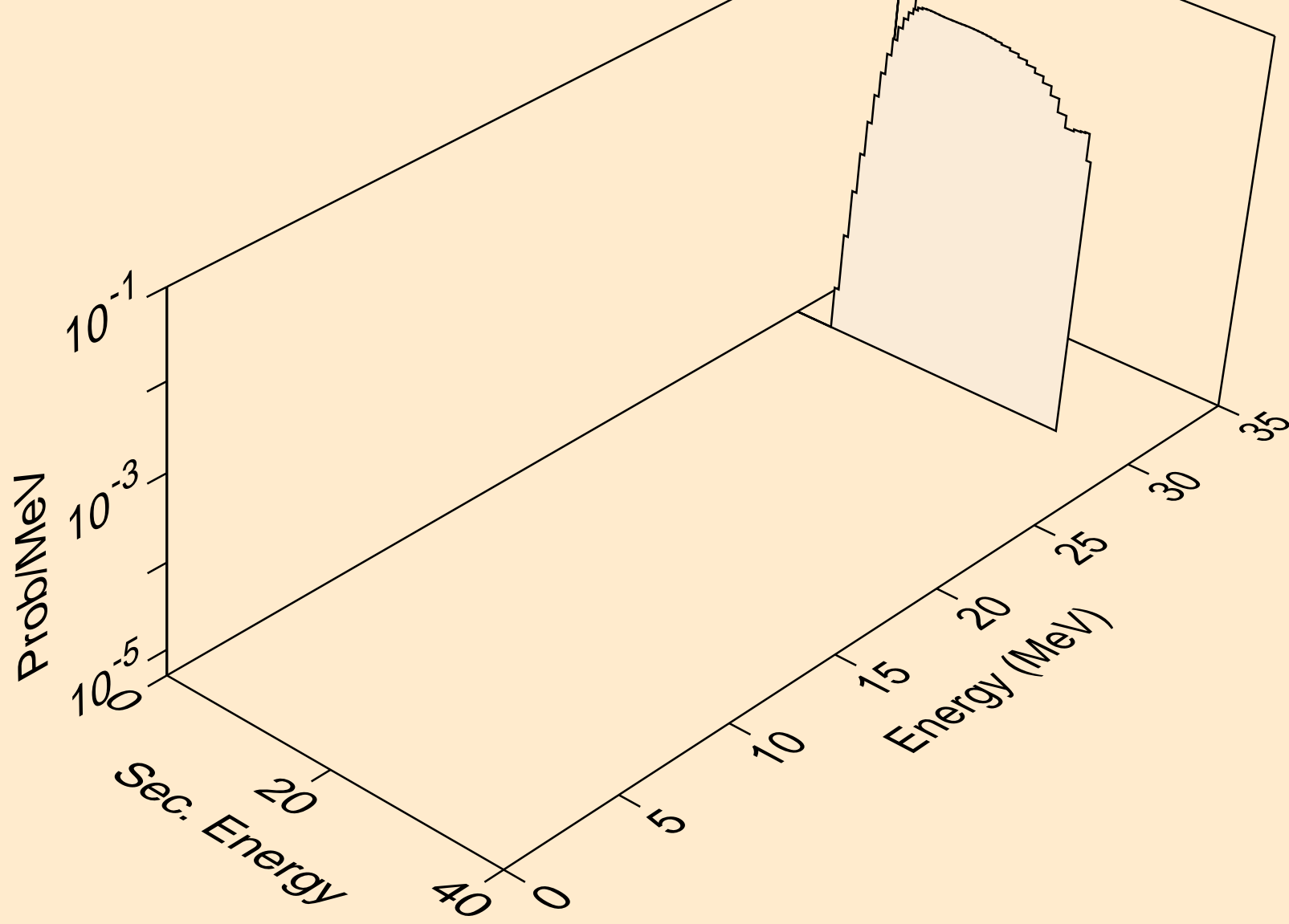

NP236M NEUTRON ACER TENDL-2021 LIBRARY; T=293.6K
protons from (n,n*)p

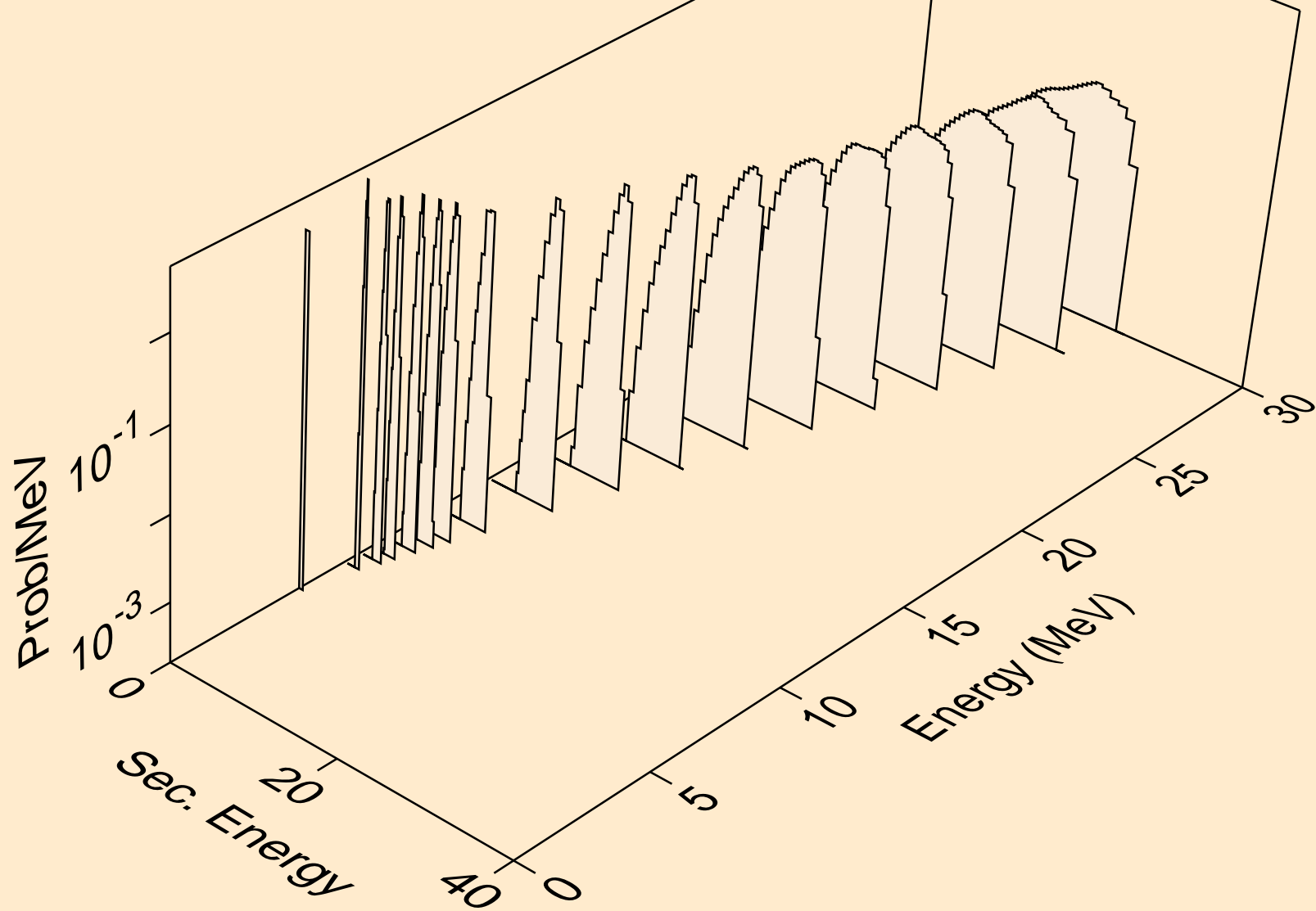

NP236M NEUTRON ACER TENDL-2021 LIBRARY; T=293.6K
protons from (n,2np)

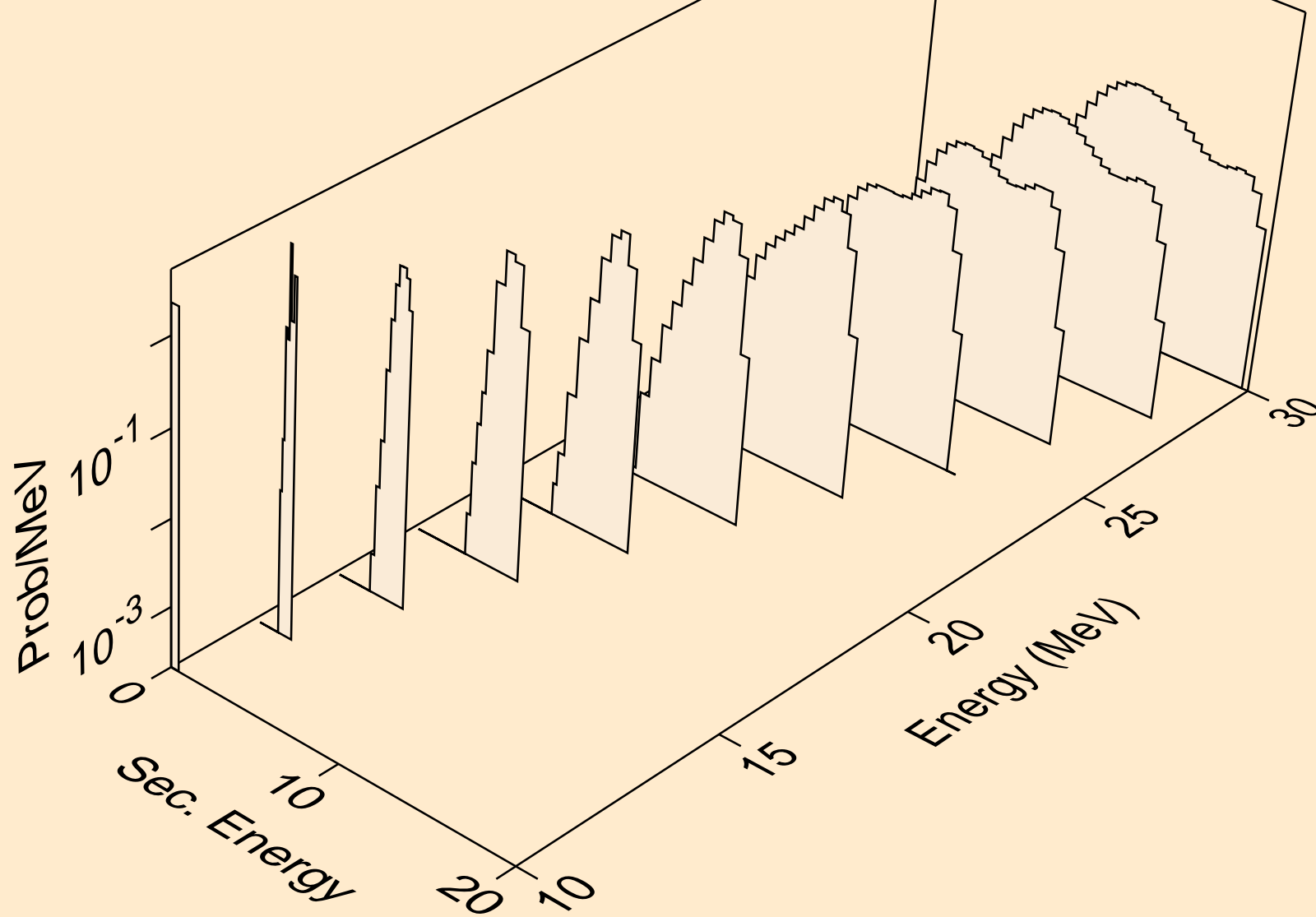

NP236M NEUTRON ACER TENDL-2021 LIBRARY; T=293.6K
protons from (n,3np)

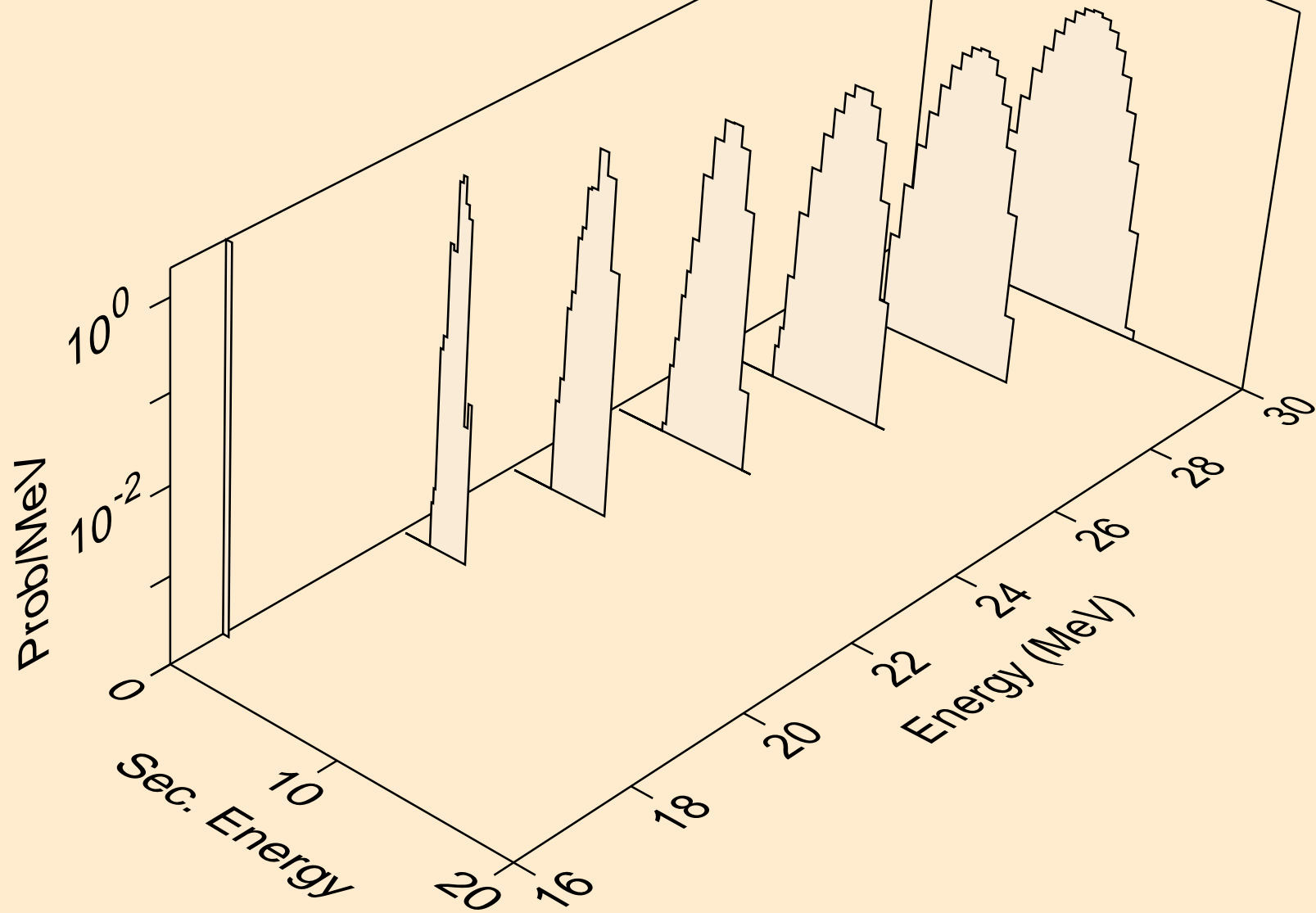

NP236M NEUTRON ACER TENDL-2021 LIBRARY; T=293.6K
protons from (n,2np)

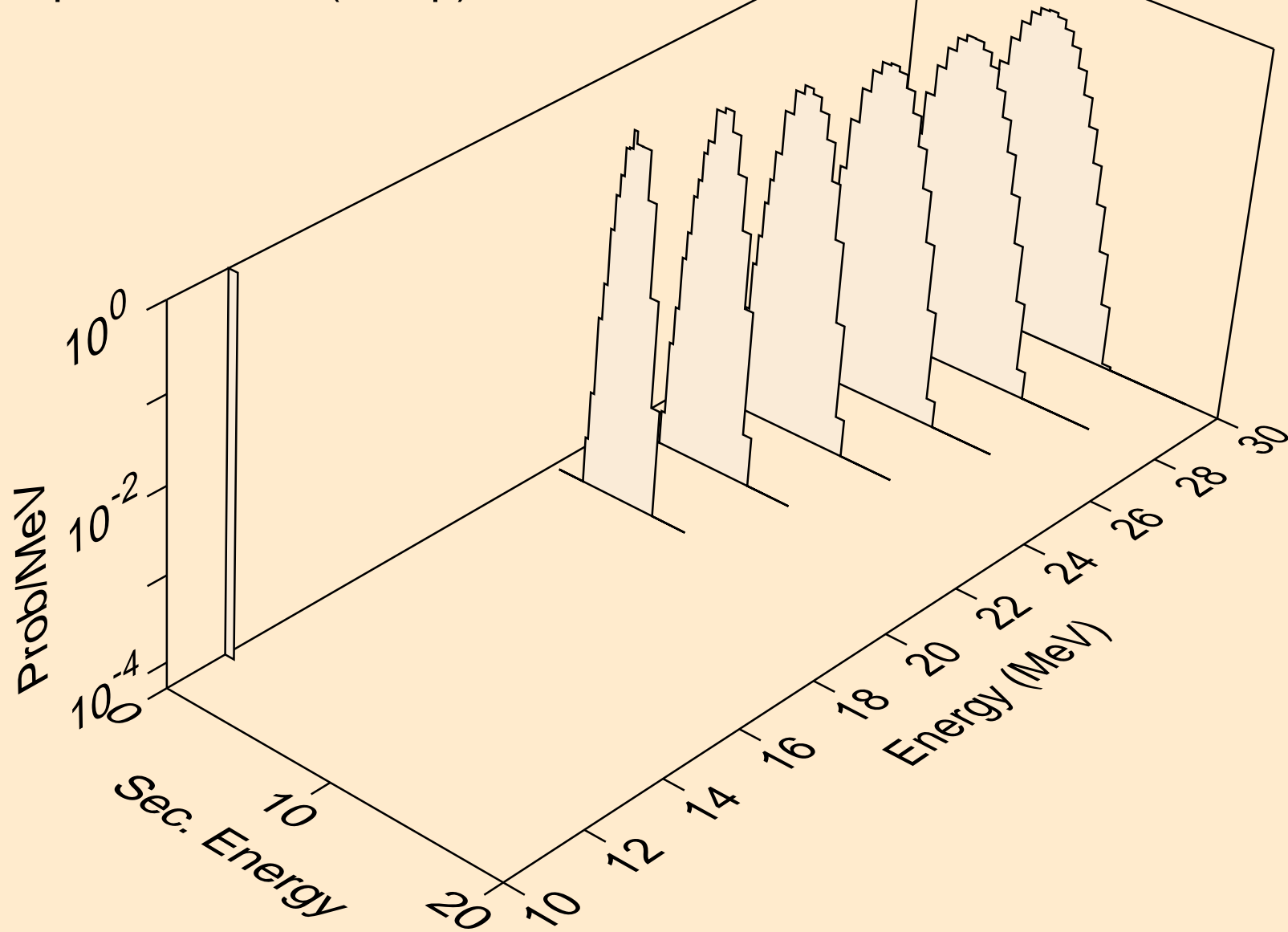

NP236M NEUTRON ACER TENDL-2021 LIBRARY; T=293.6K
protons from (n,npa)

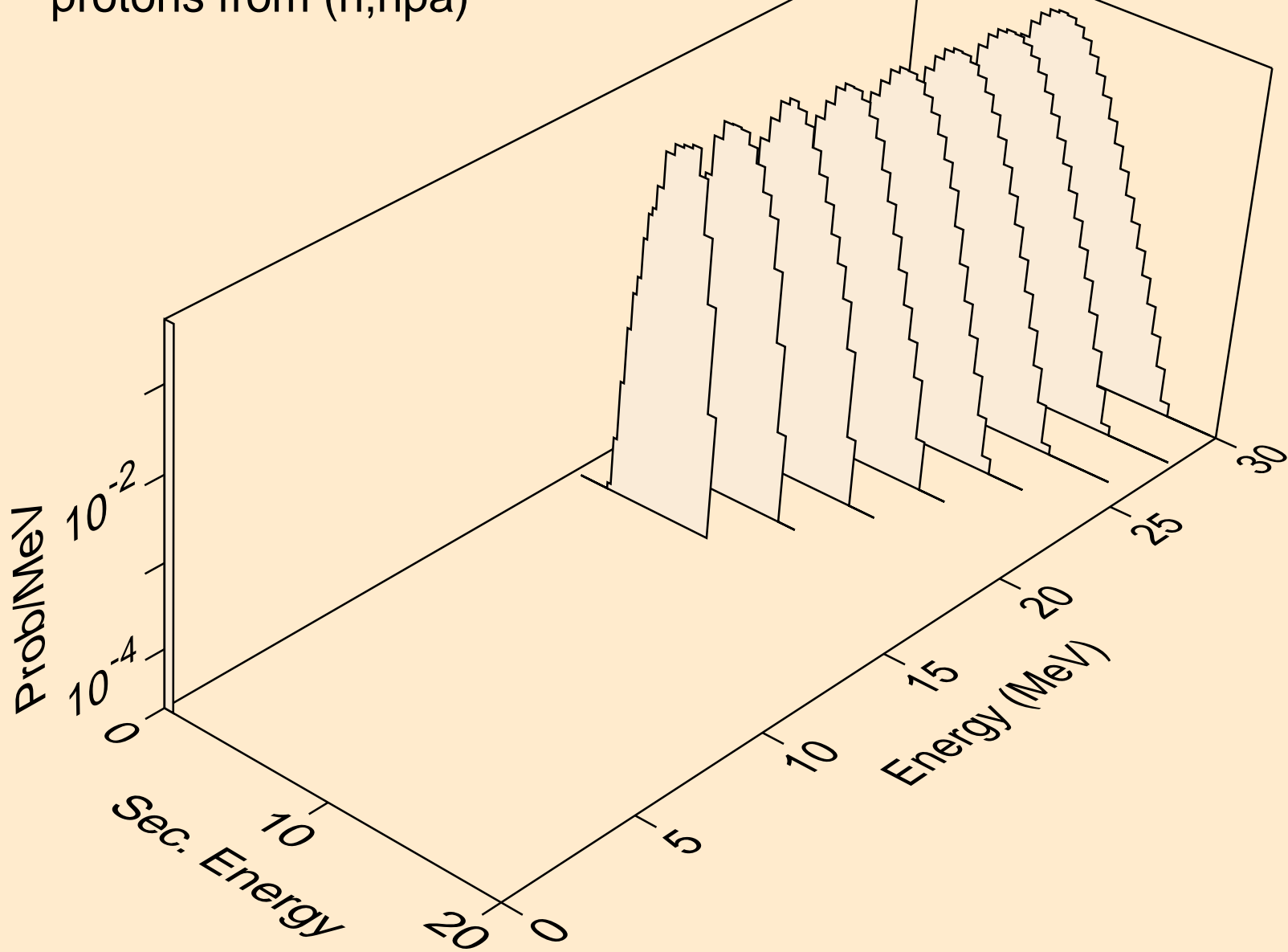

NP236M NEUTRON ACER TENDL-2021 LIBRARY; T=293.6K
protons from (n,p)

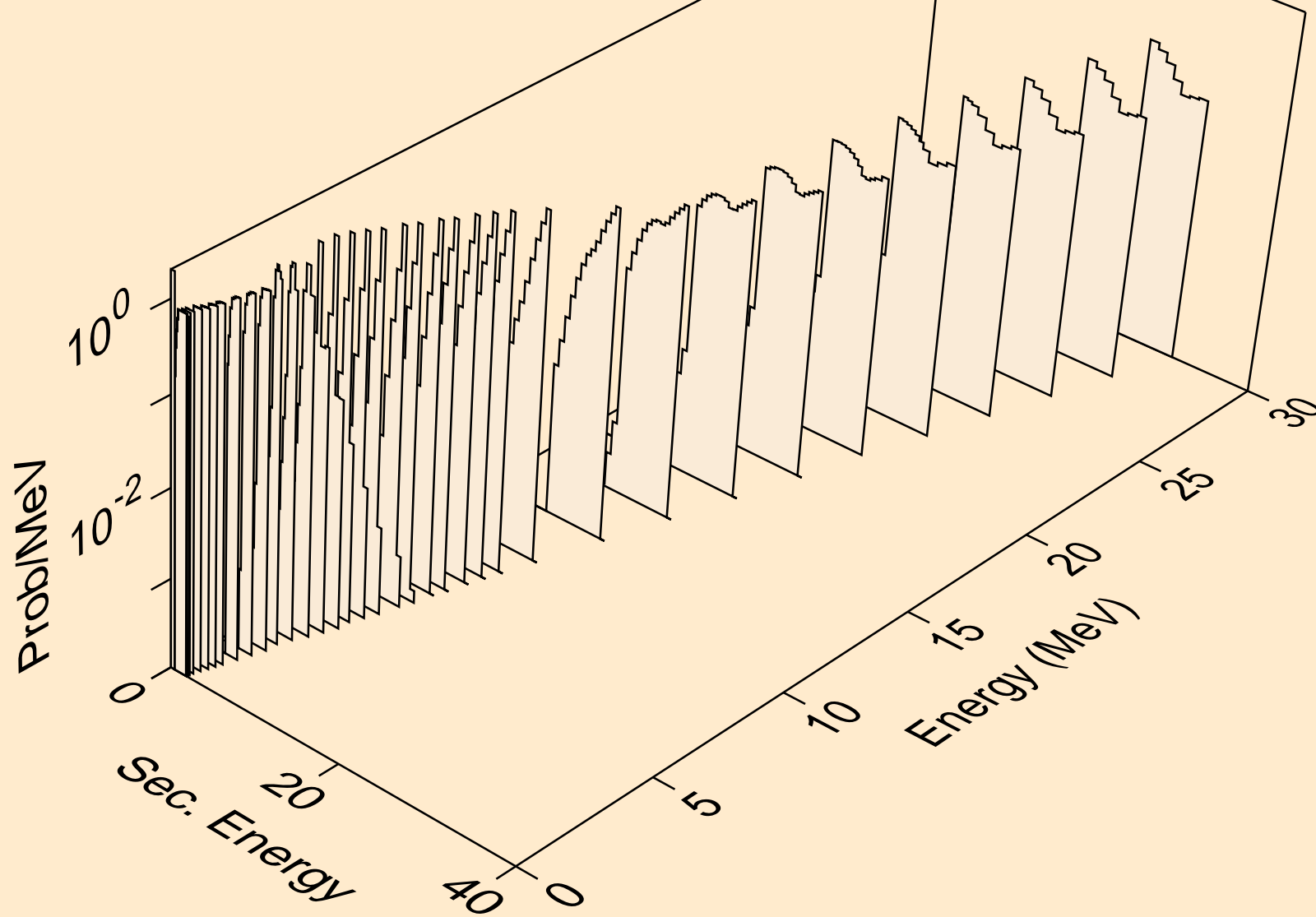

NP236M NEUTRON ACER TENDL-2021 LIBRARY; T=293.6K
protons from (n,2p)

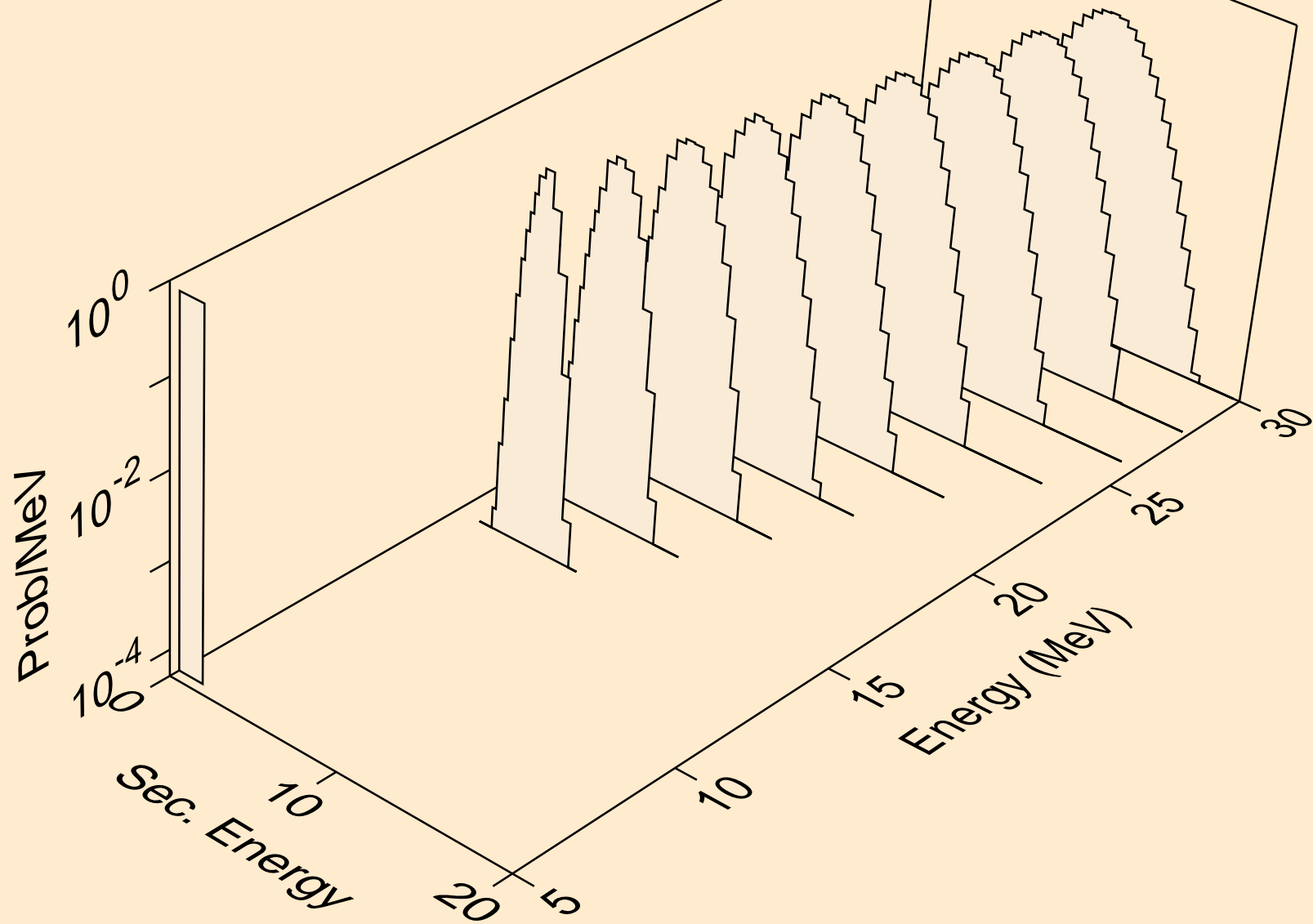

NP236M NEUTRON ACER TENDL-2021 LIBRARY; T=293.6K
protons from (n,p)

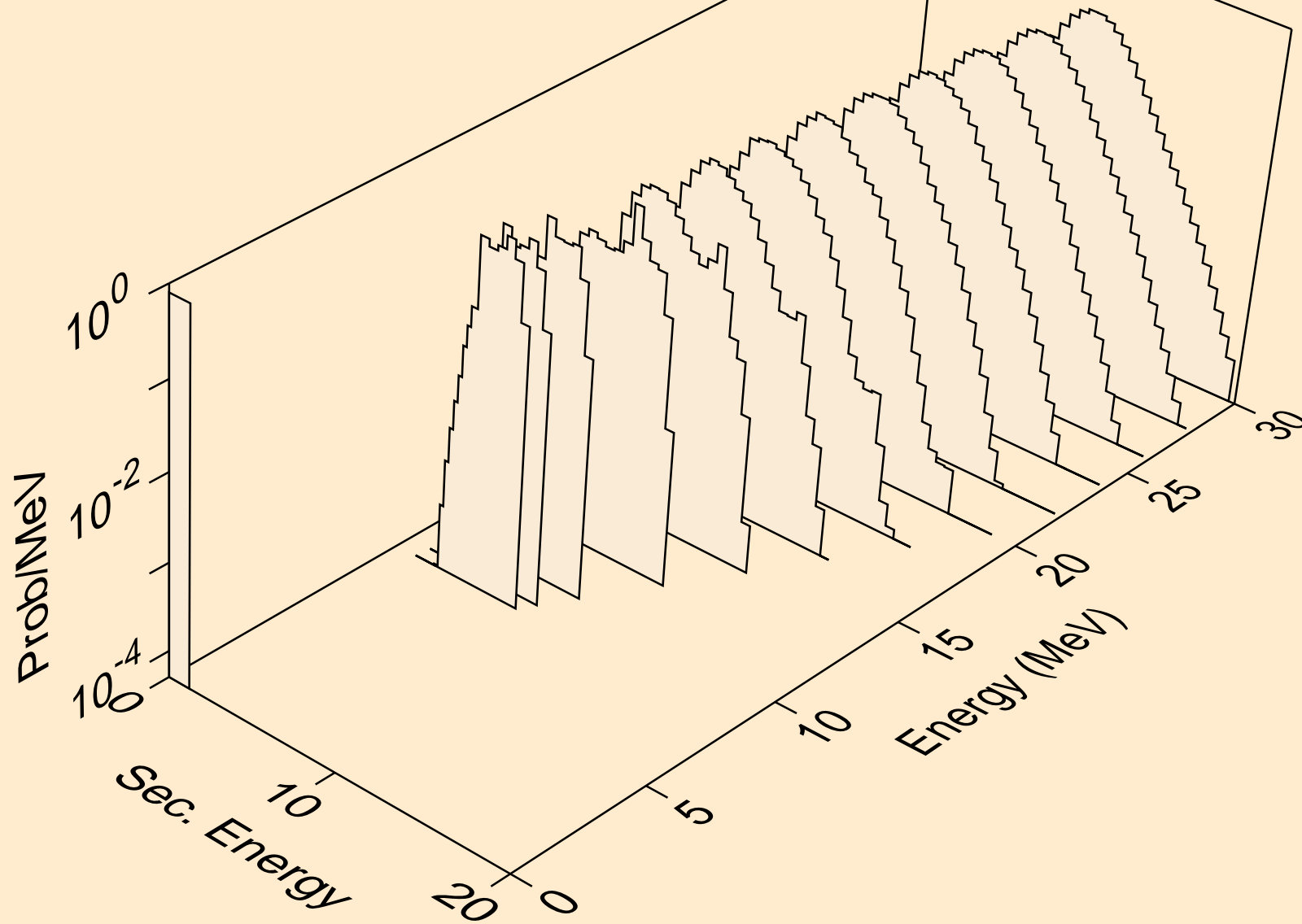

NP236M NEUTRON ACER TENDL-2021 LIBRARY; T=293.6K
deuterons from (n,x)

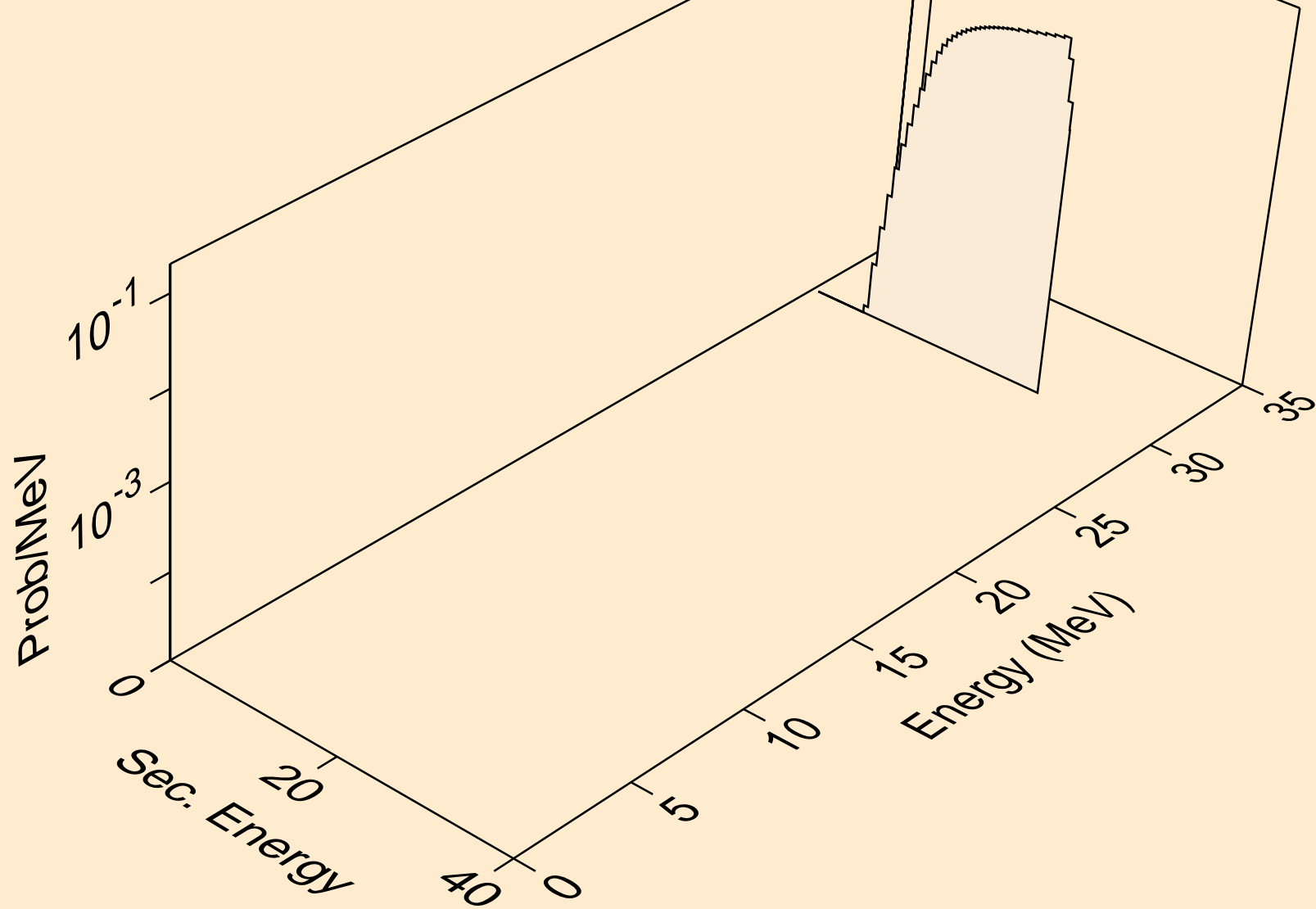

NP236M NEUTRON ACER TENDL-2021 LIBRARY; T=293.6K
deuterons from (n,2nd)

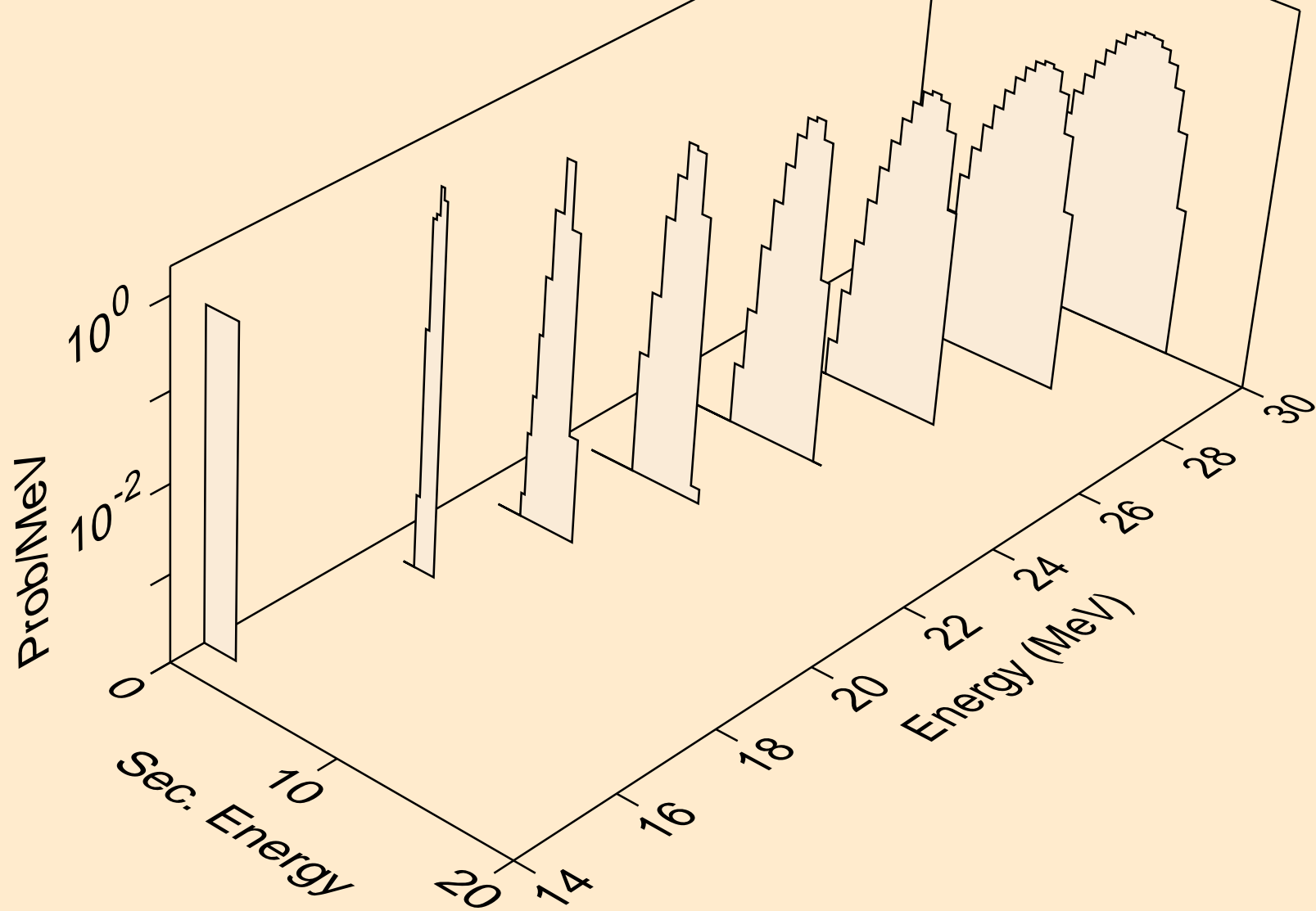

NP236M NEUTRON ACER TENDL-2021 LIBRARY; T=293.6K
deuterons from (n,n*)d

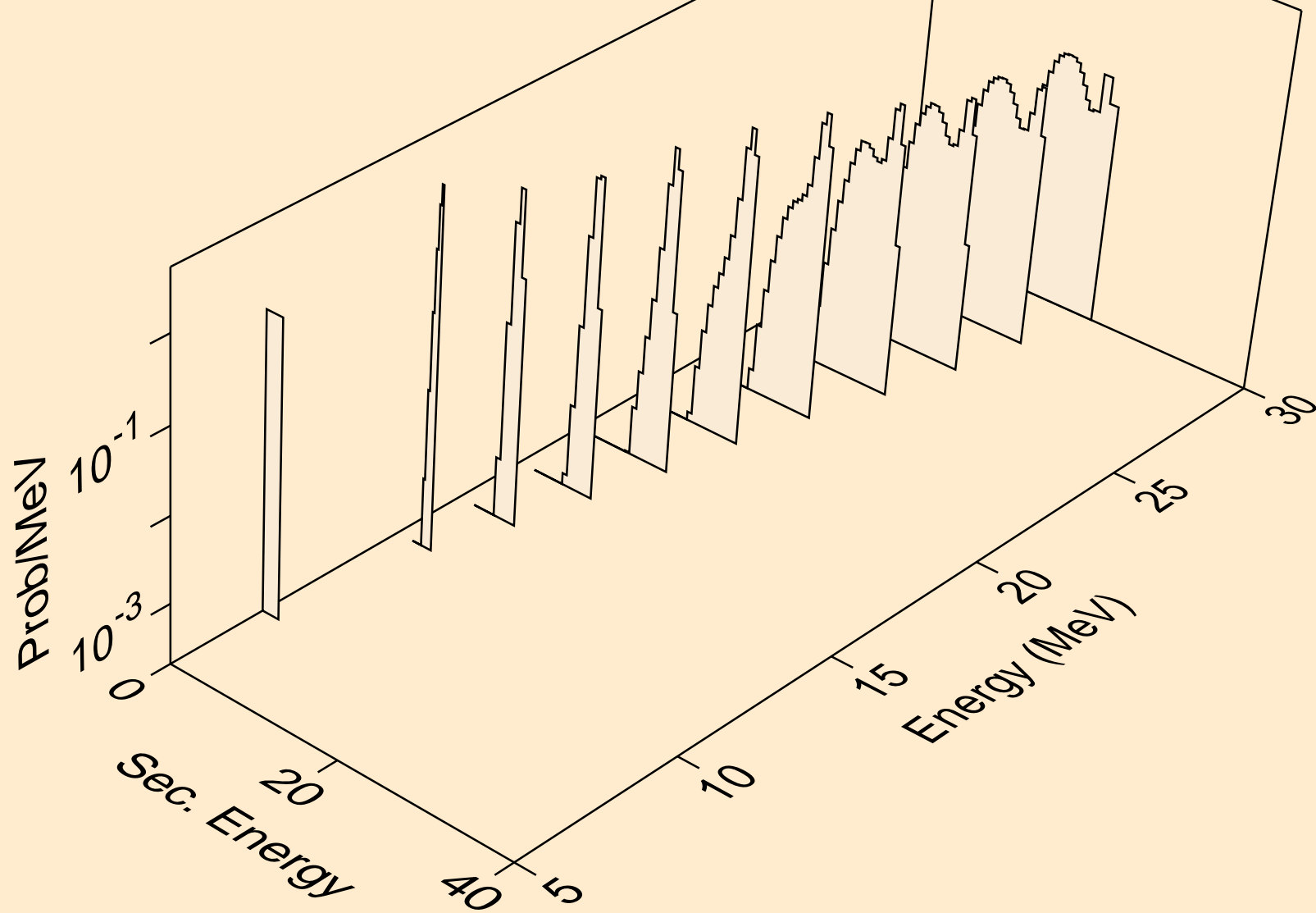

NP236M NEUTRON ACER TENDL-2021 LIBRARY; T=293.6K
deuterons from (n,d)

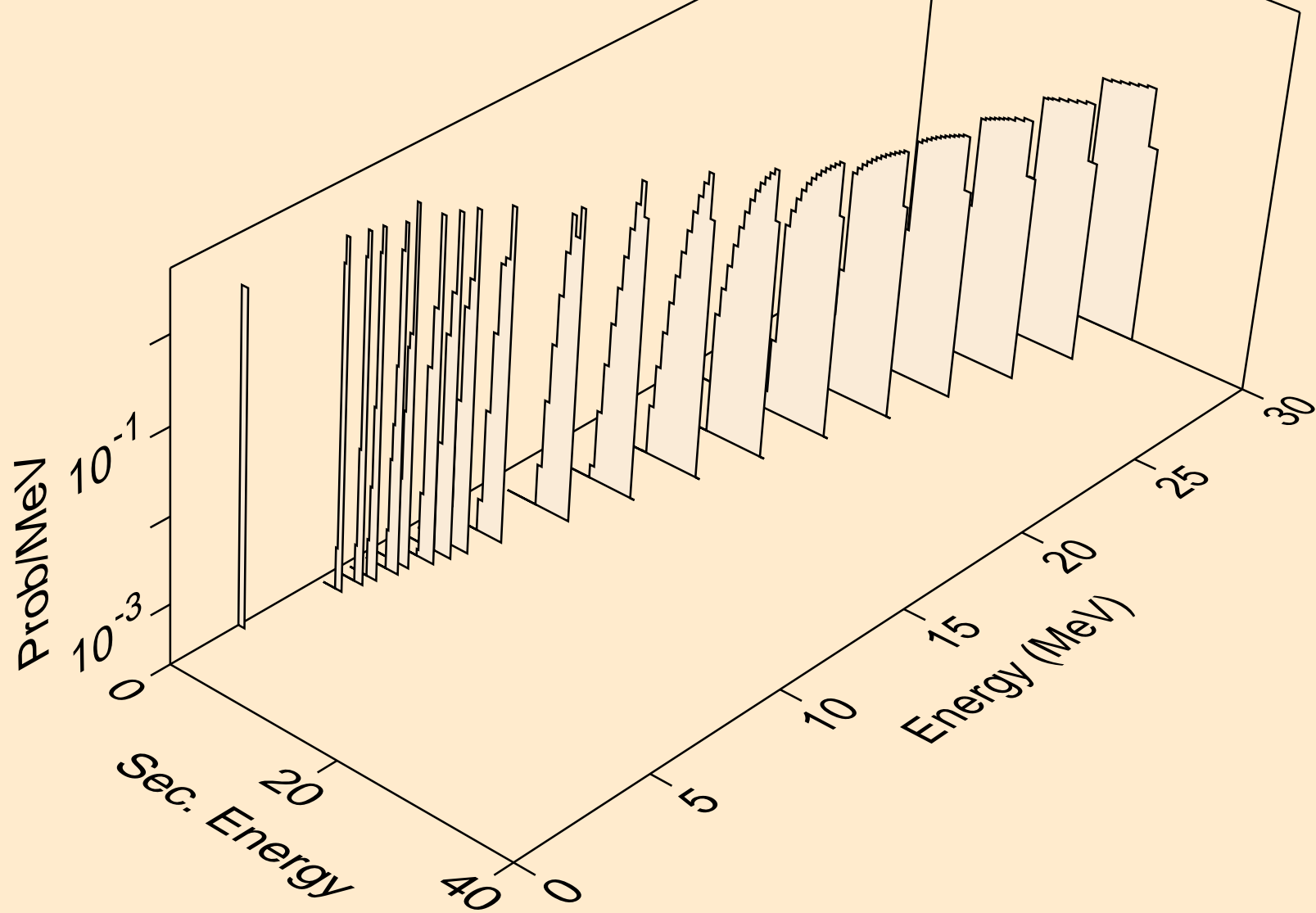

NP236M NEUTRON ACER TENDL-2021 LIBRARY; T=293.6K
tritons from (n,x)

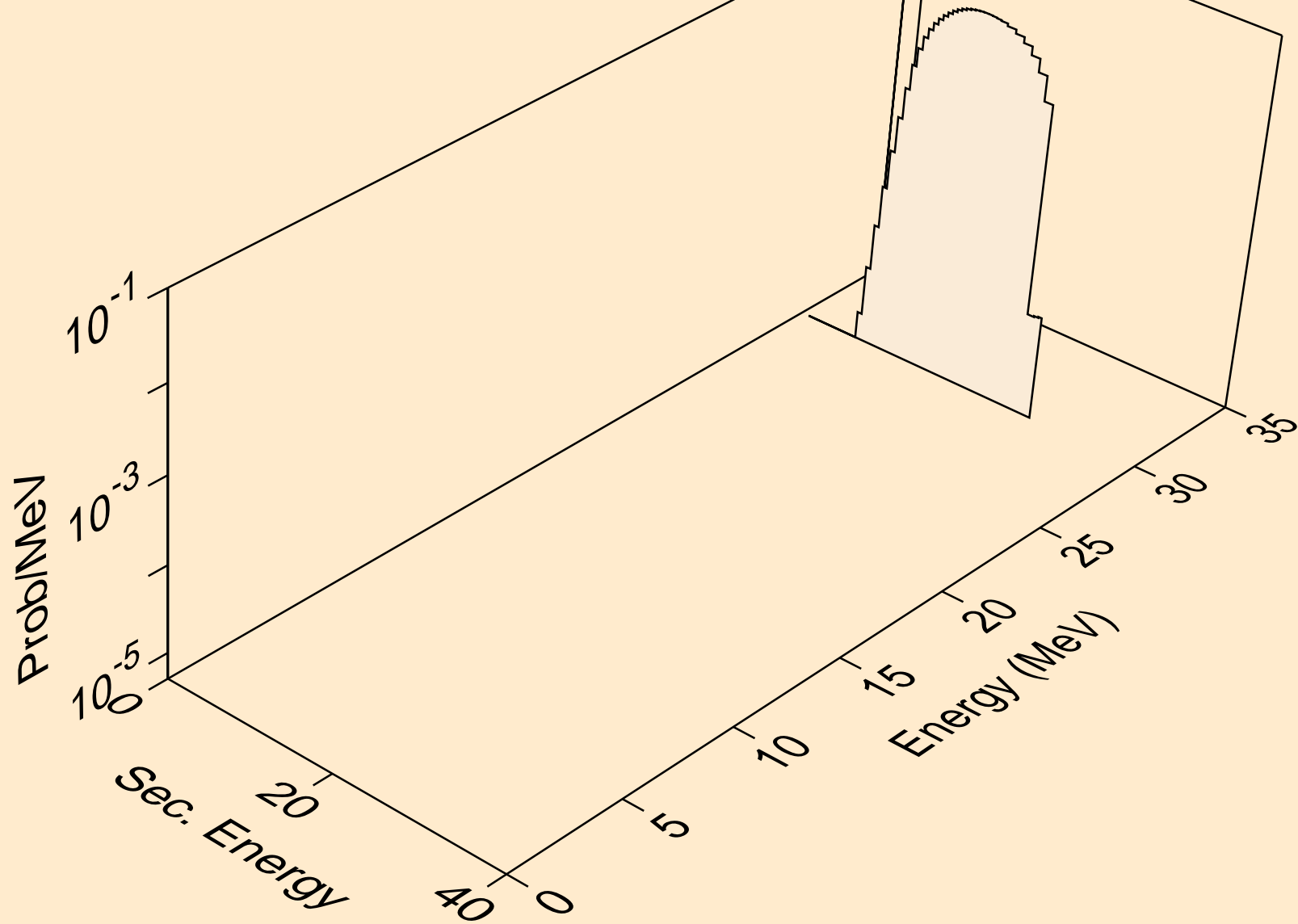

NP236M NEUTRON ACER TENDL-2021 LIBRARY; T=293.6K
tritons from (n,n*)t

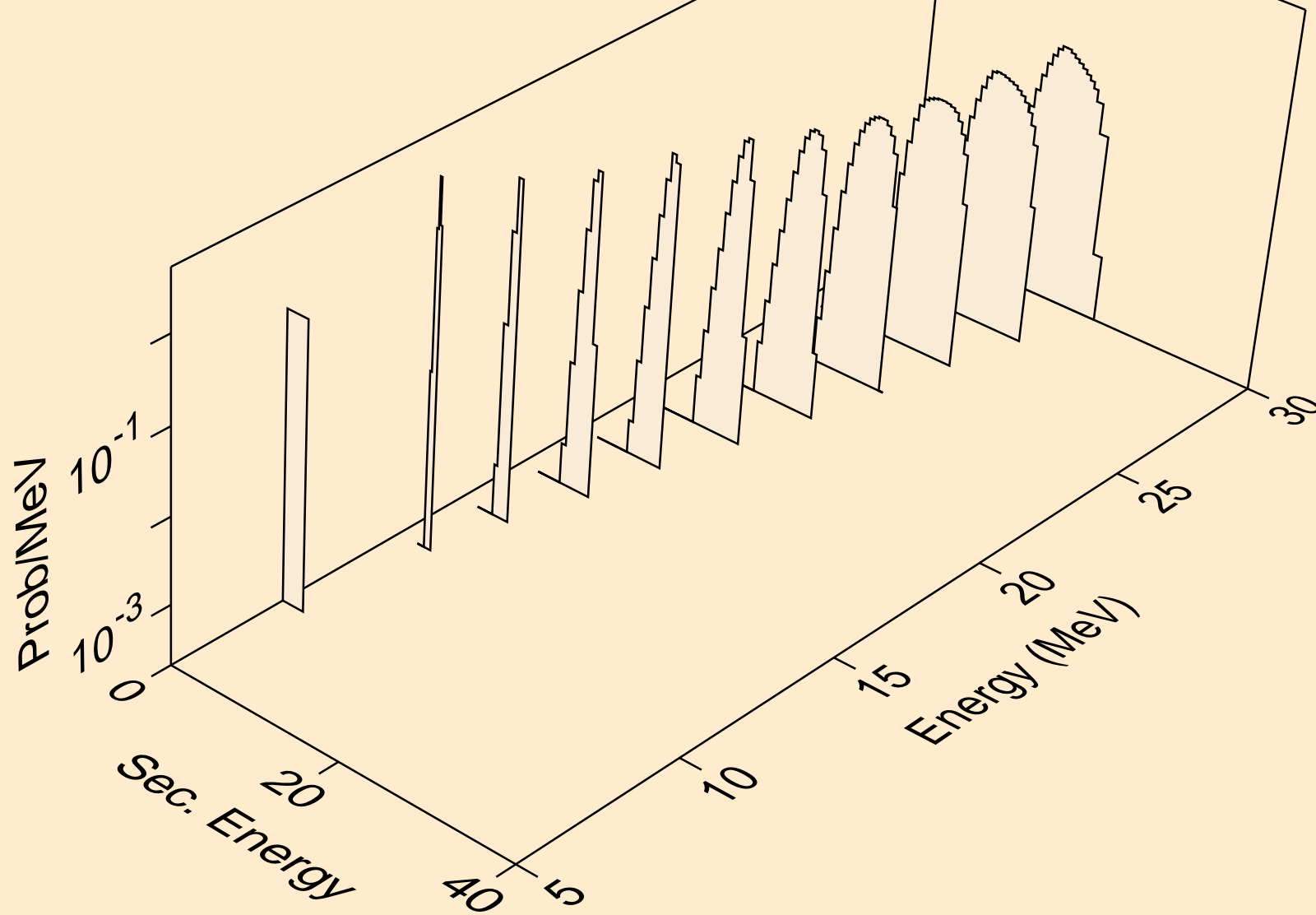

NP236M NEUTRON ACER TENDL-2021 LIBRARY; T=293.6K
tritons from (n,t)

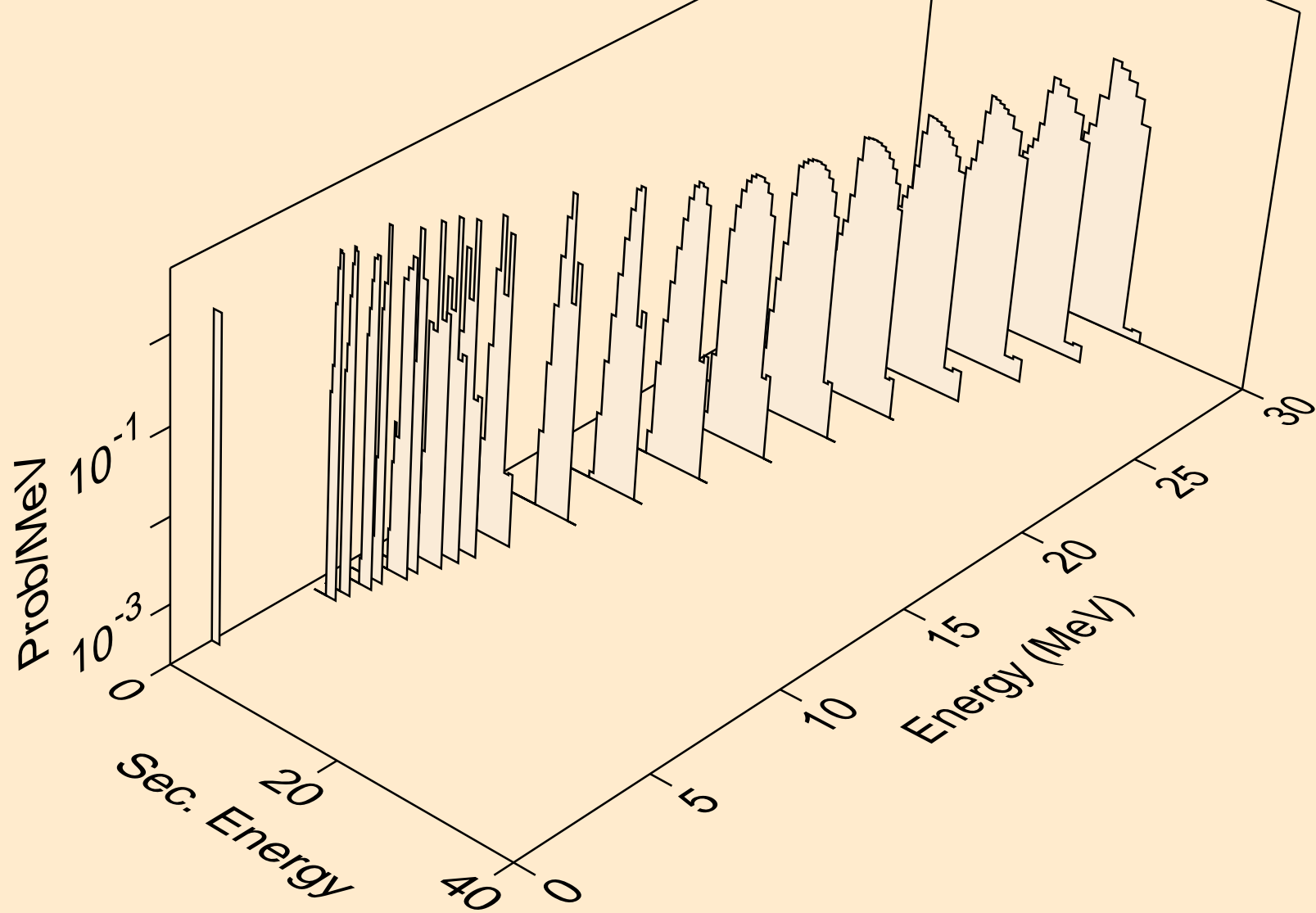

NP236M NEUTRON ACER TENDL-2021 LIBRARY; T=293.6K
he3s from (n,x)

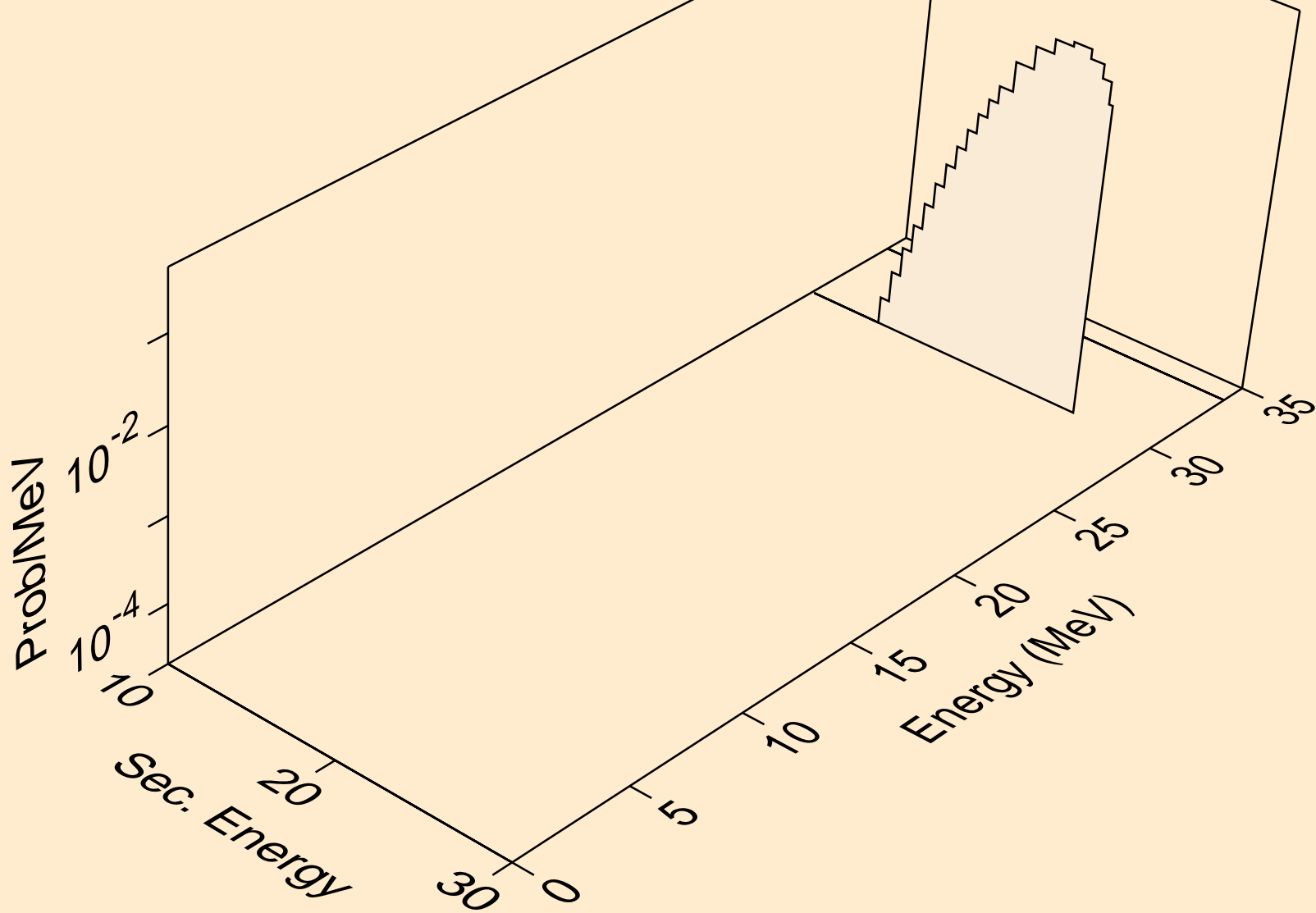

NP236M NEUTRON ACER TENDL-2021 LIBRARY; T=293.6K
he3s from (n,n*)he3

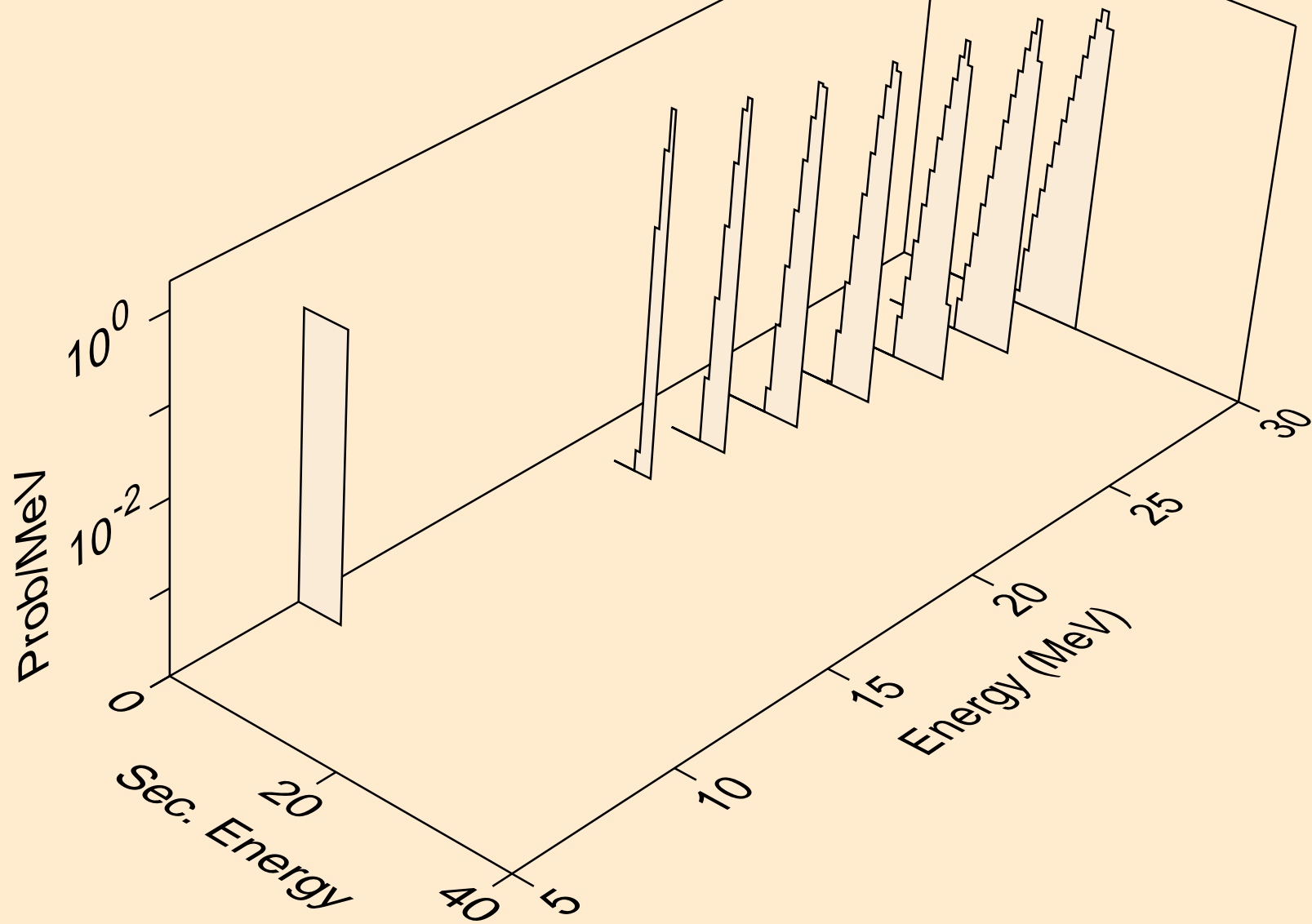

NP236M NEUTRON ACER TENDL-2021 LIBRARY; T=293.6K
he3s from (n,he3)

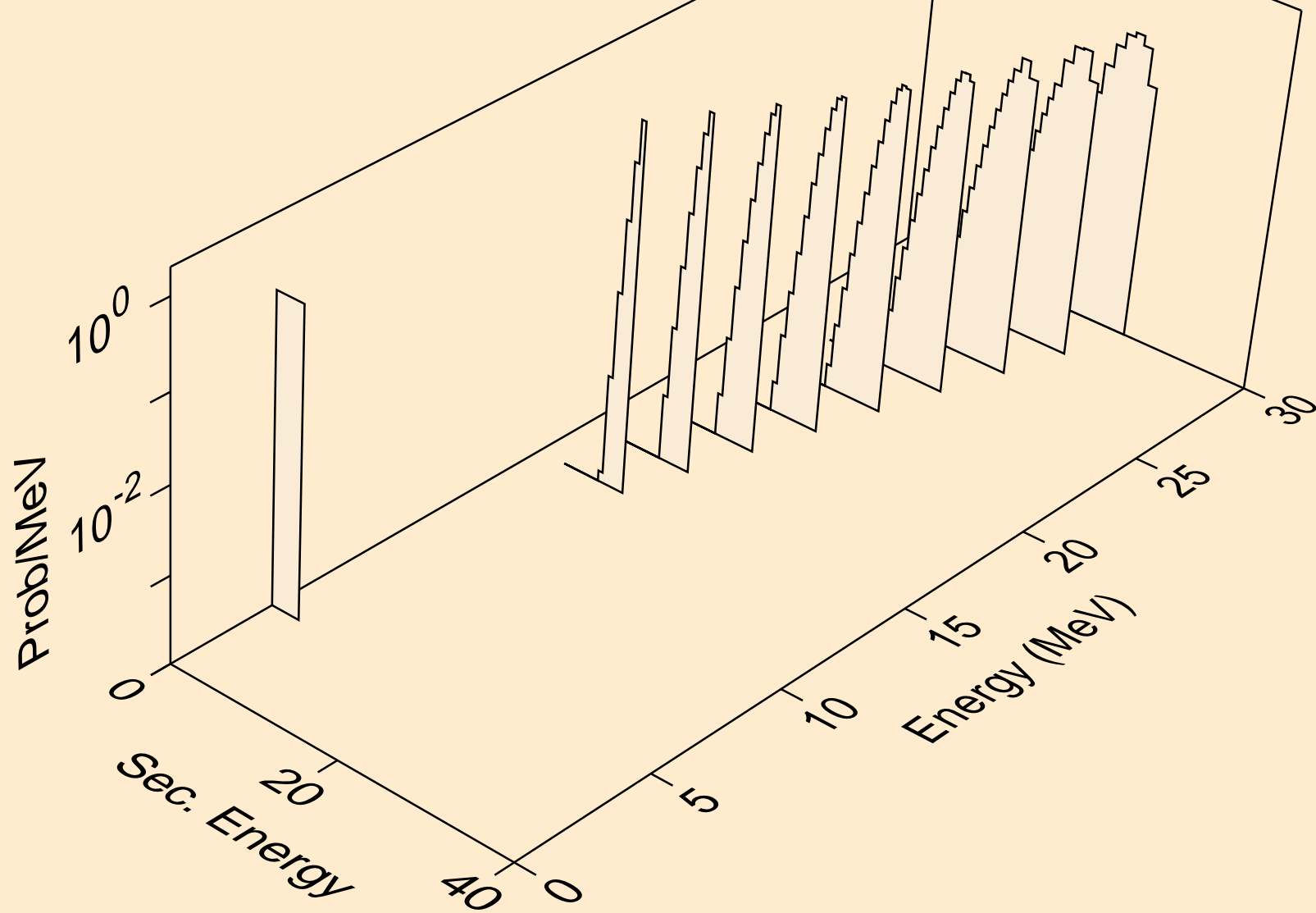

NP236M NEUTRON ACER TENDL-2021 LIBRARY; T=293.6K
alphas from (n,x)

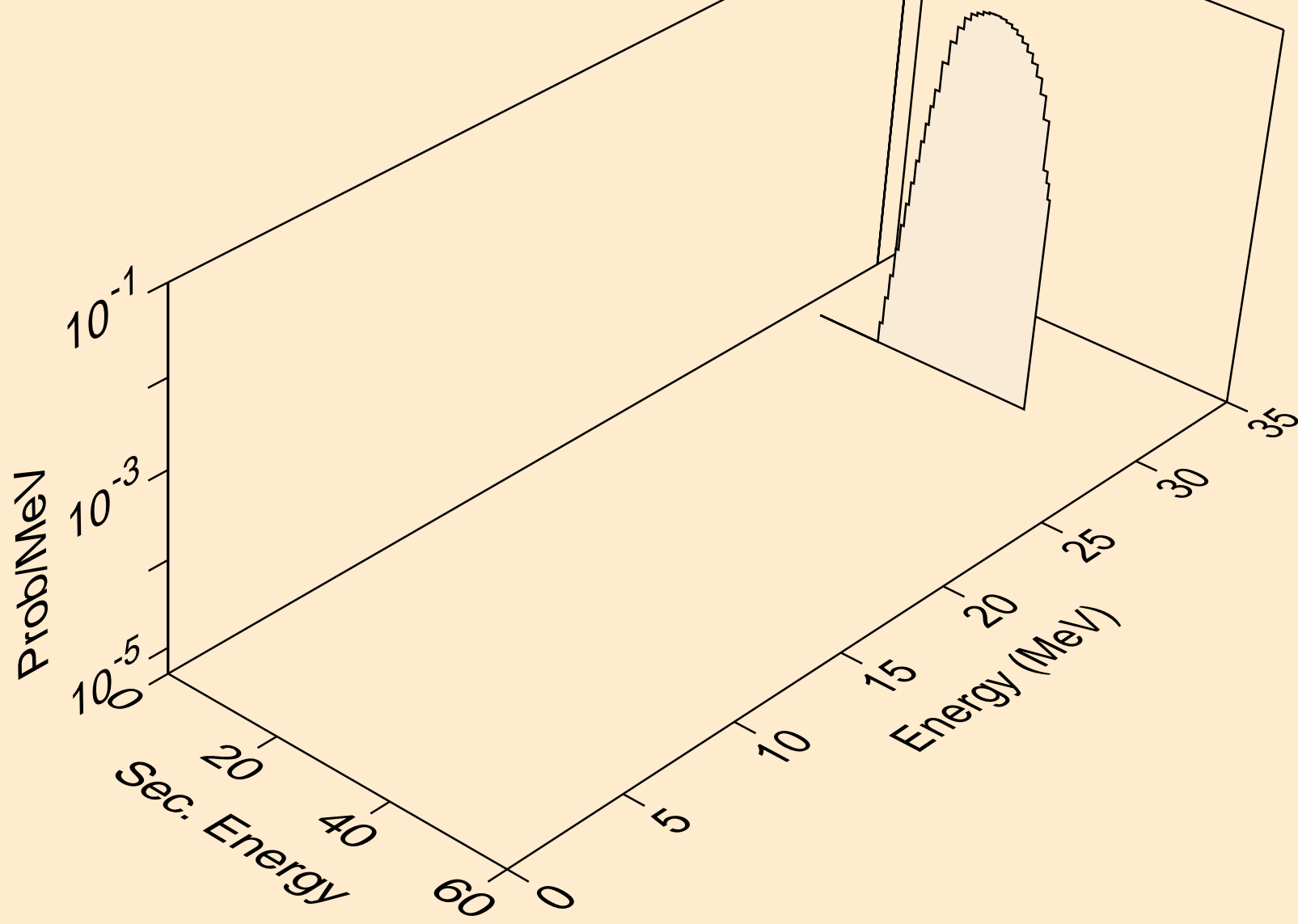

NP236M NEUTRON ACER TENDL-2021 LIBRARY; T=293.6K
alphas from (n,n*)a

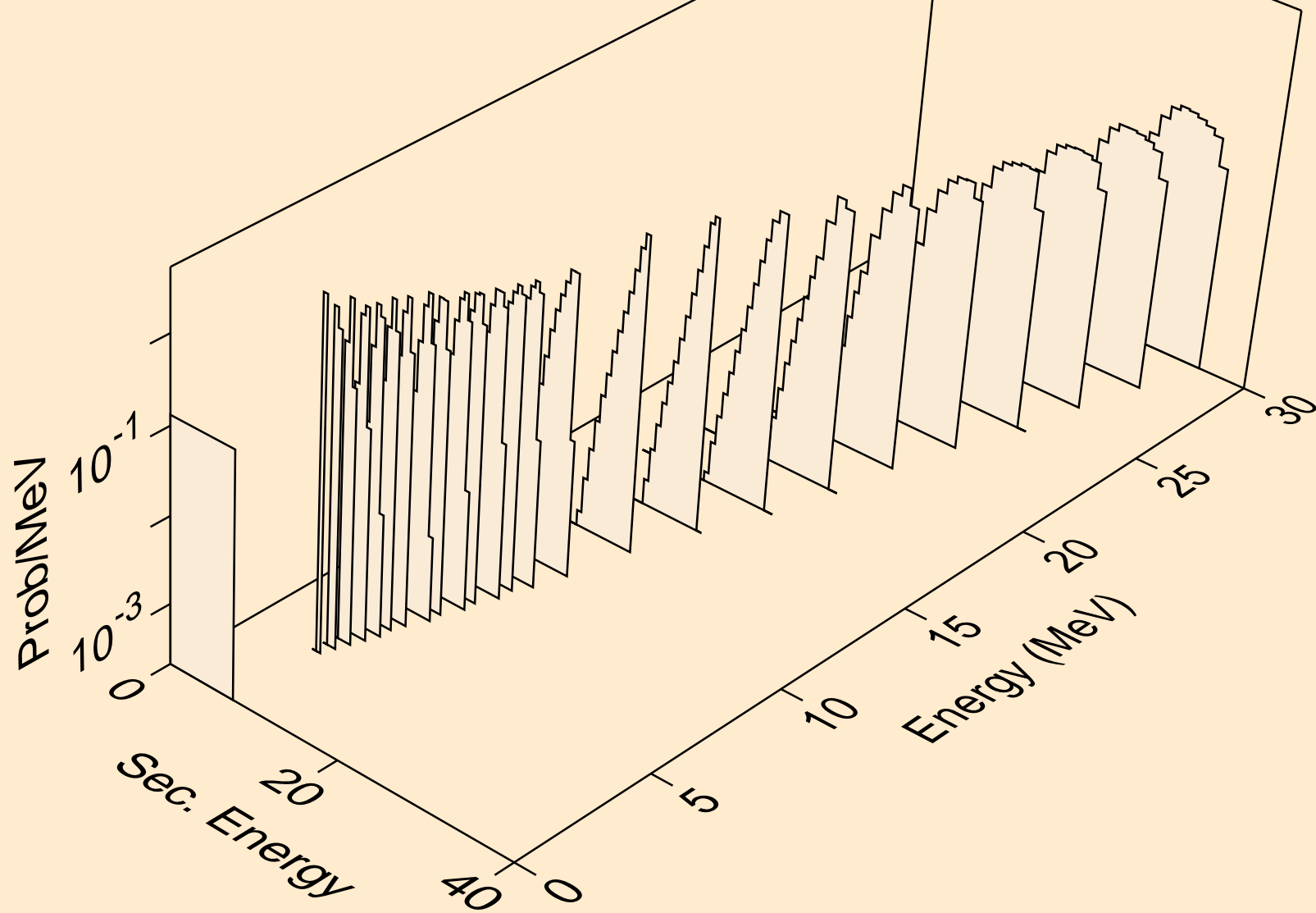

NP236M NEUTRON ACER TENDL-2021 LIBRARY; T=293.6K
alphas from (n,2n)a

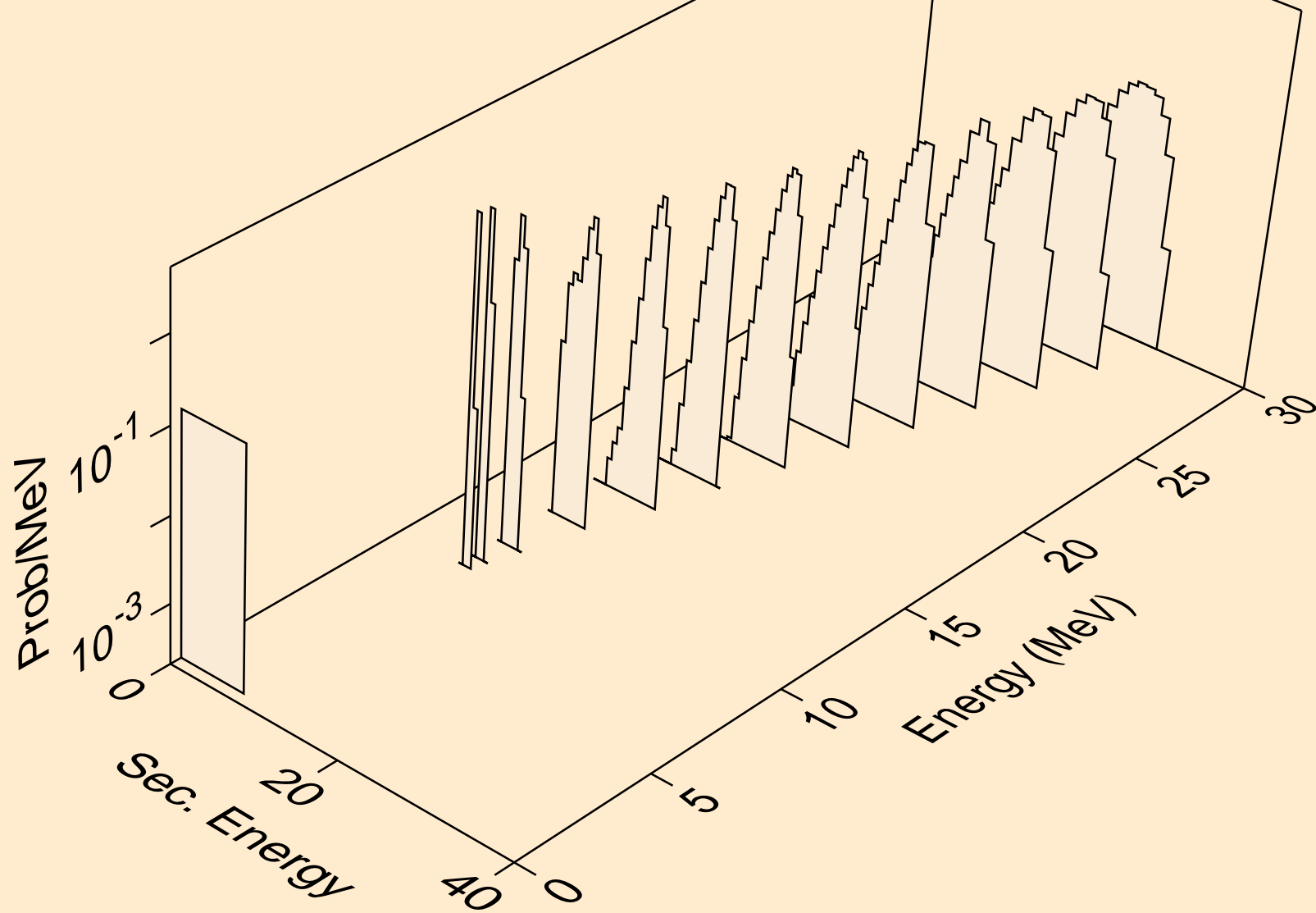

NP236M NEUTRON ACER TENDL-2021 LIBRARY; T=293.6K
alphas from (n,3n)a

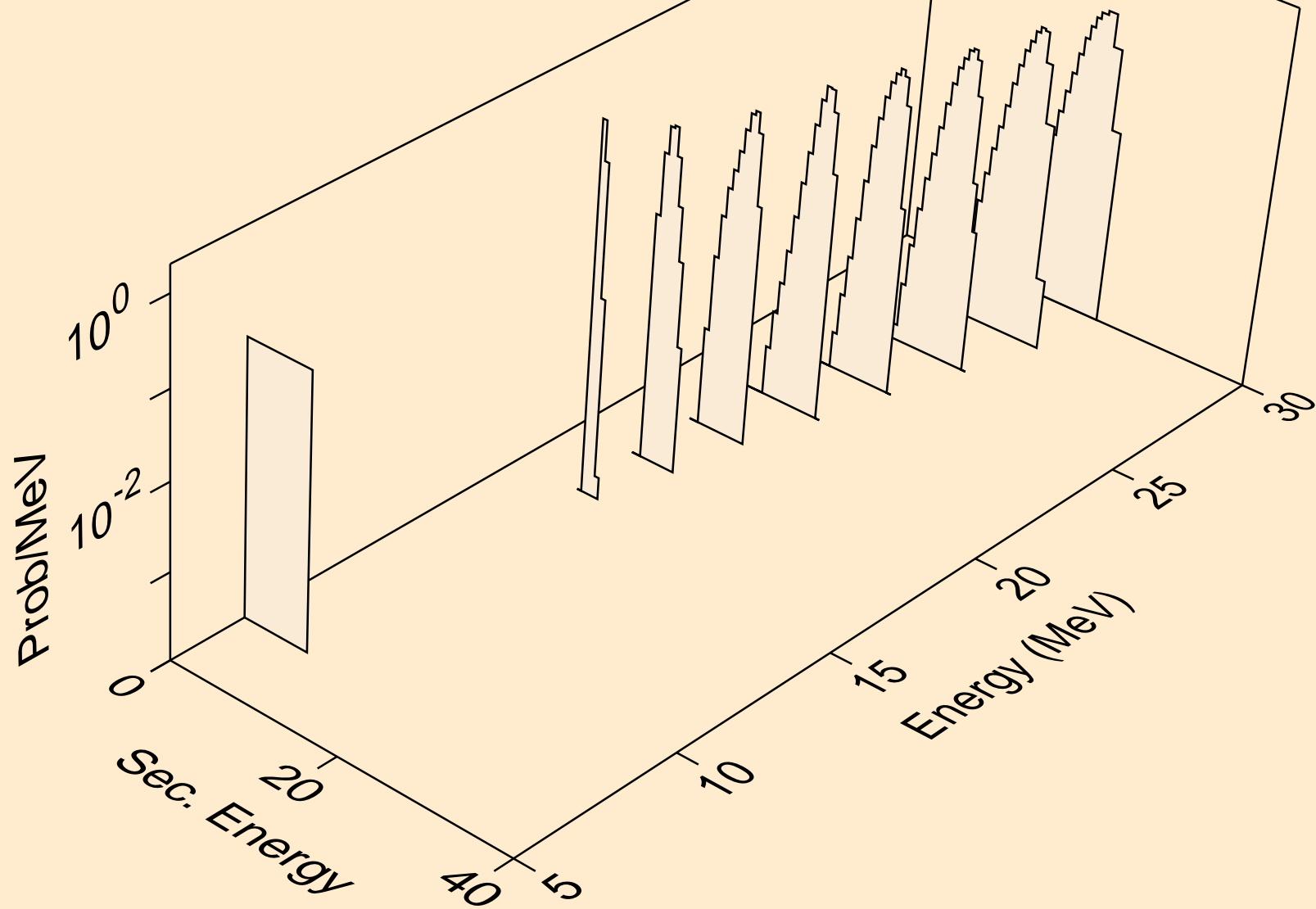

NP236M NEUTRON ACER TENDL-2021 LIBRARY; T=293.6K
alphas from (n,n*)2a

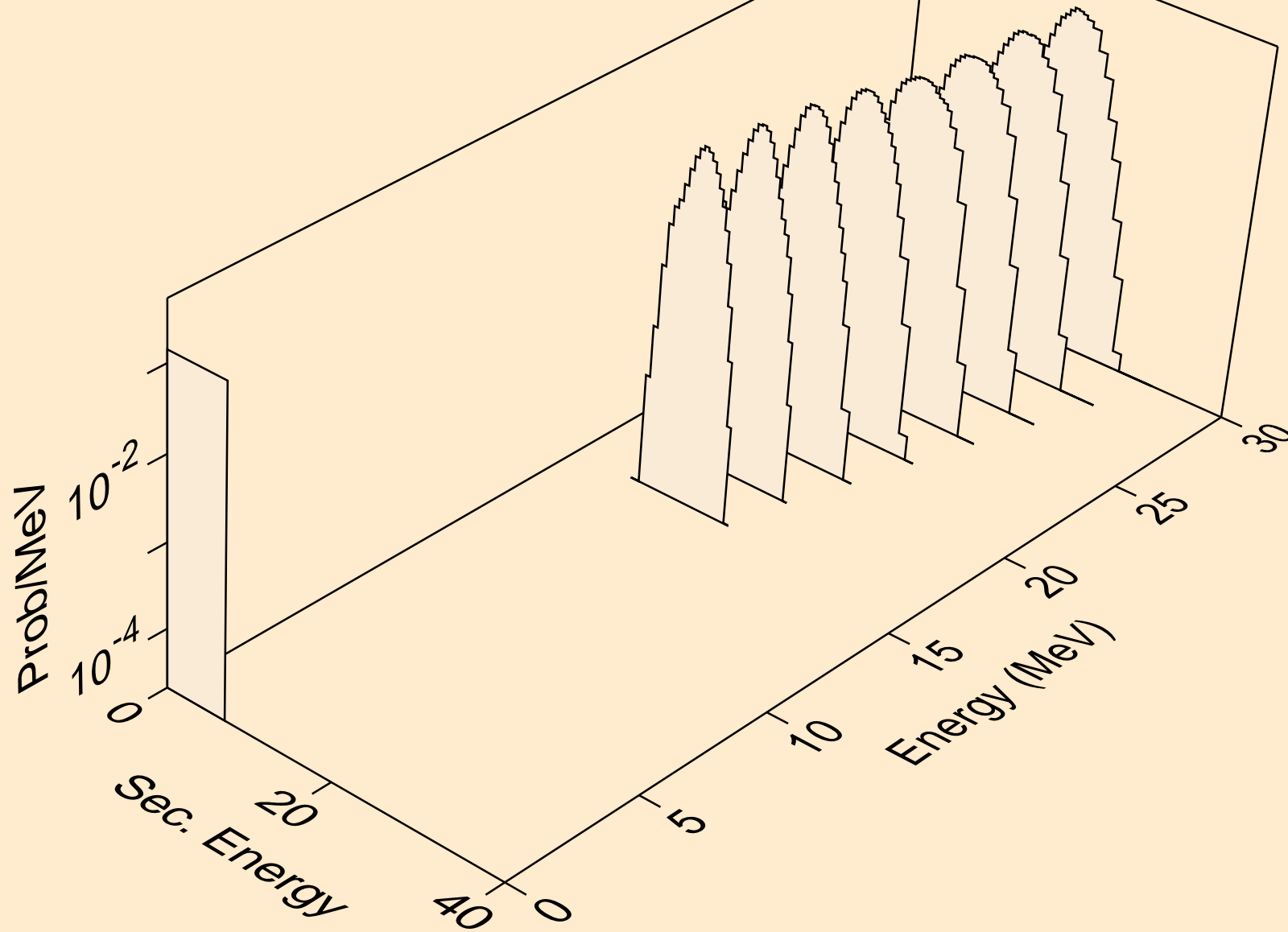

NP236M NEUTRON ACER TENDL-2021 LIBRARY; T=293.6K
alphas from (n,npa)

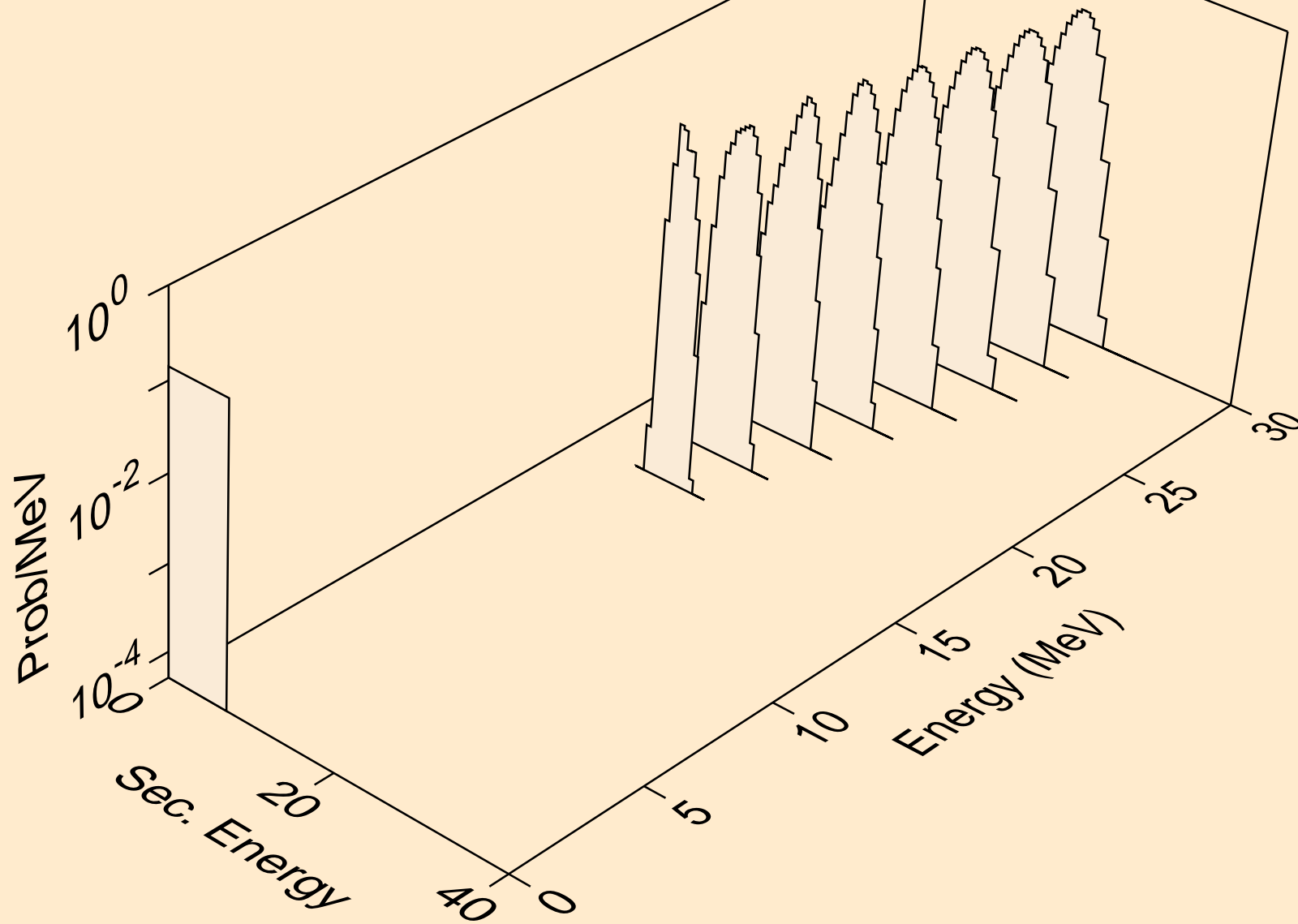

NP236M NEUTRON ACER TENDL-2021 LIBRARY; T=293.6K
alphas from (n,a)

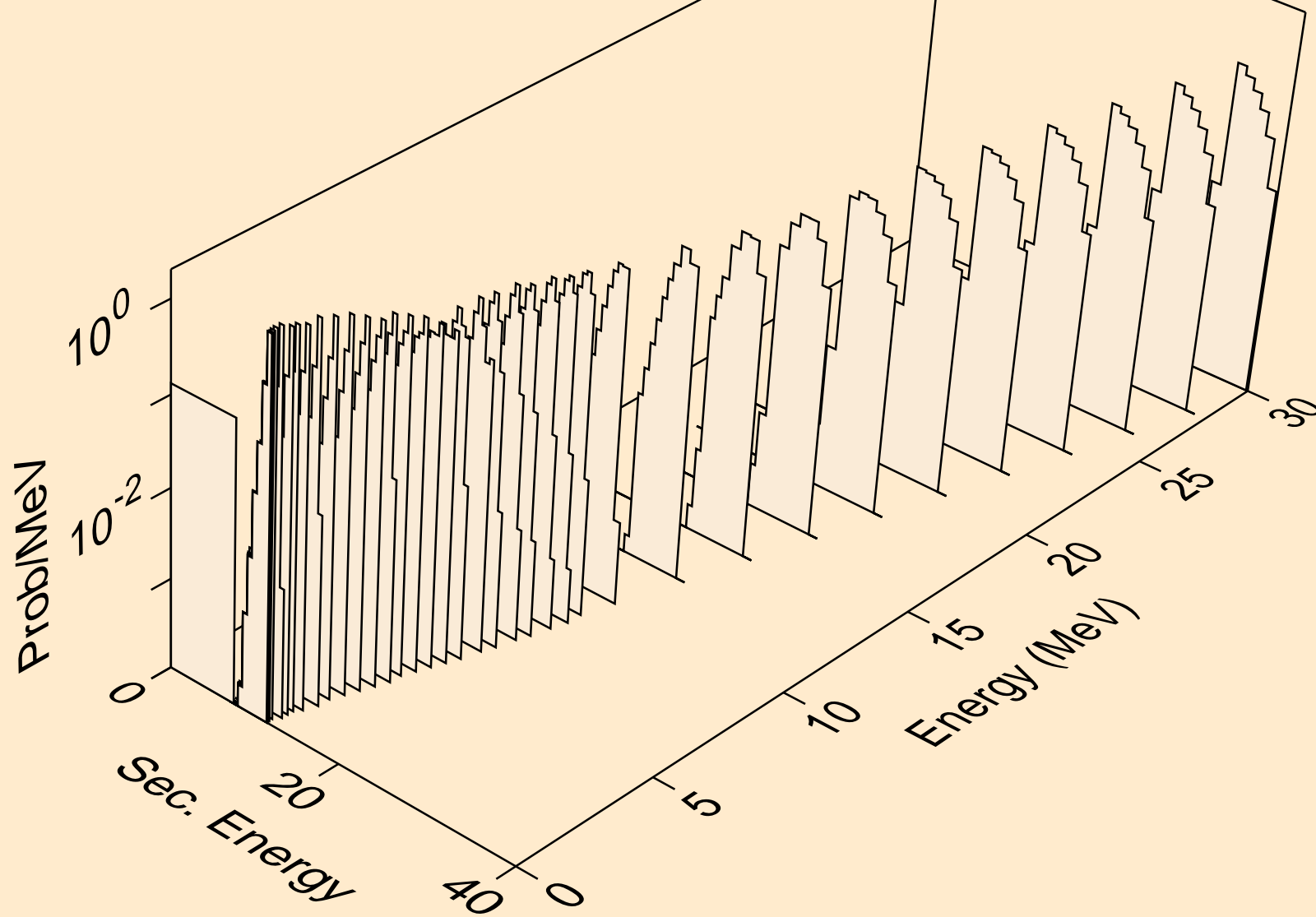

NP236M NEUTRON ACER TENDL-2021 LIBRARY; T=293.6K
alphas from (n,2a)

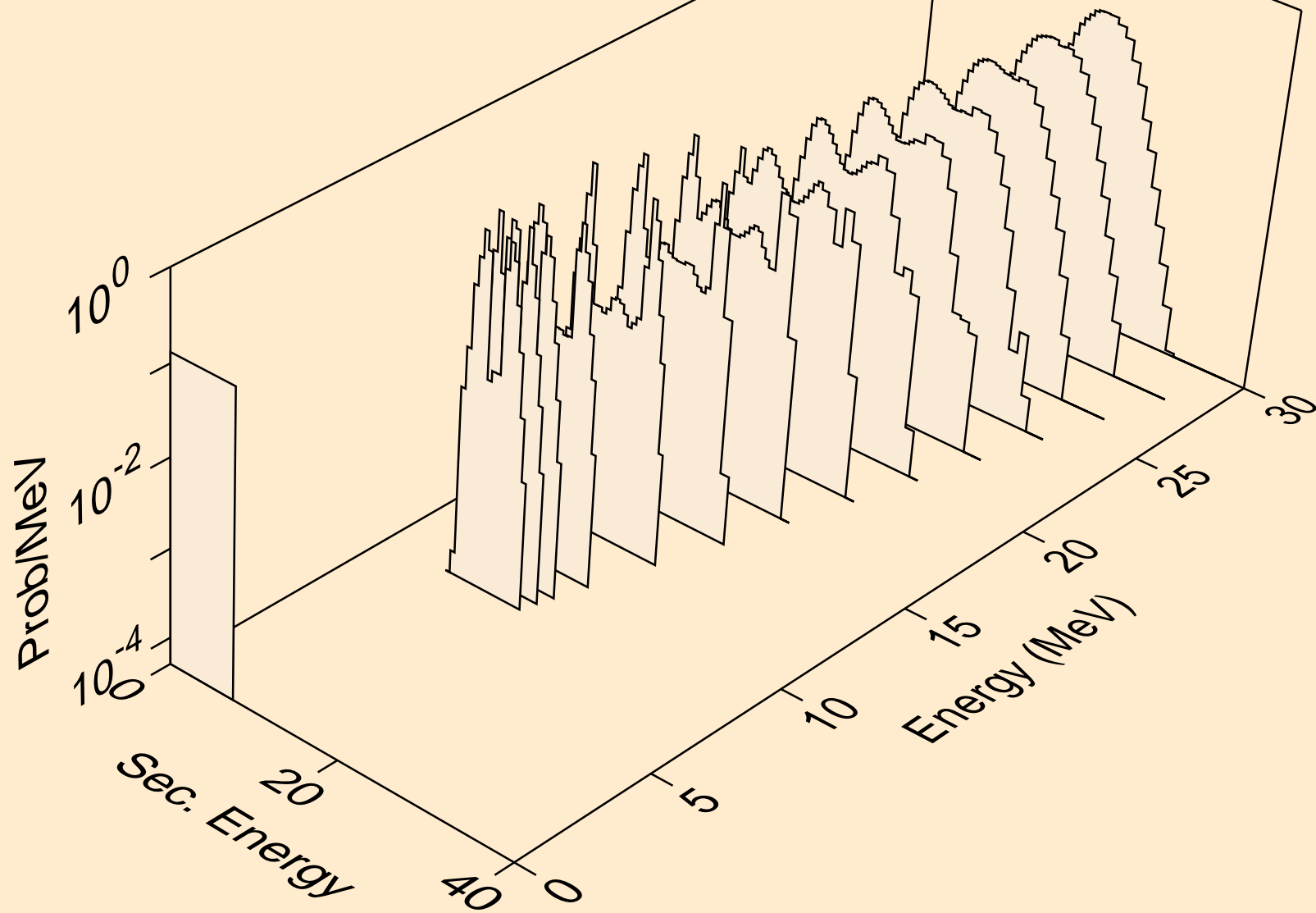

NP236M NEUTRON ACER TENDL-2021 LIBRARY; T=293.6K
alphas from (n,pa)

