

NP244 NEUTRON ACER TENDL-2021 LIBRARY; T=293.6K

Principal cross sections

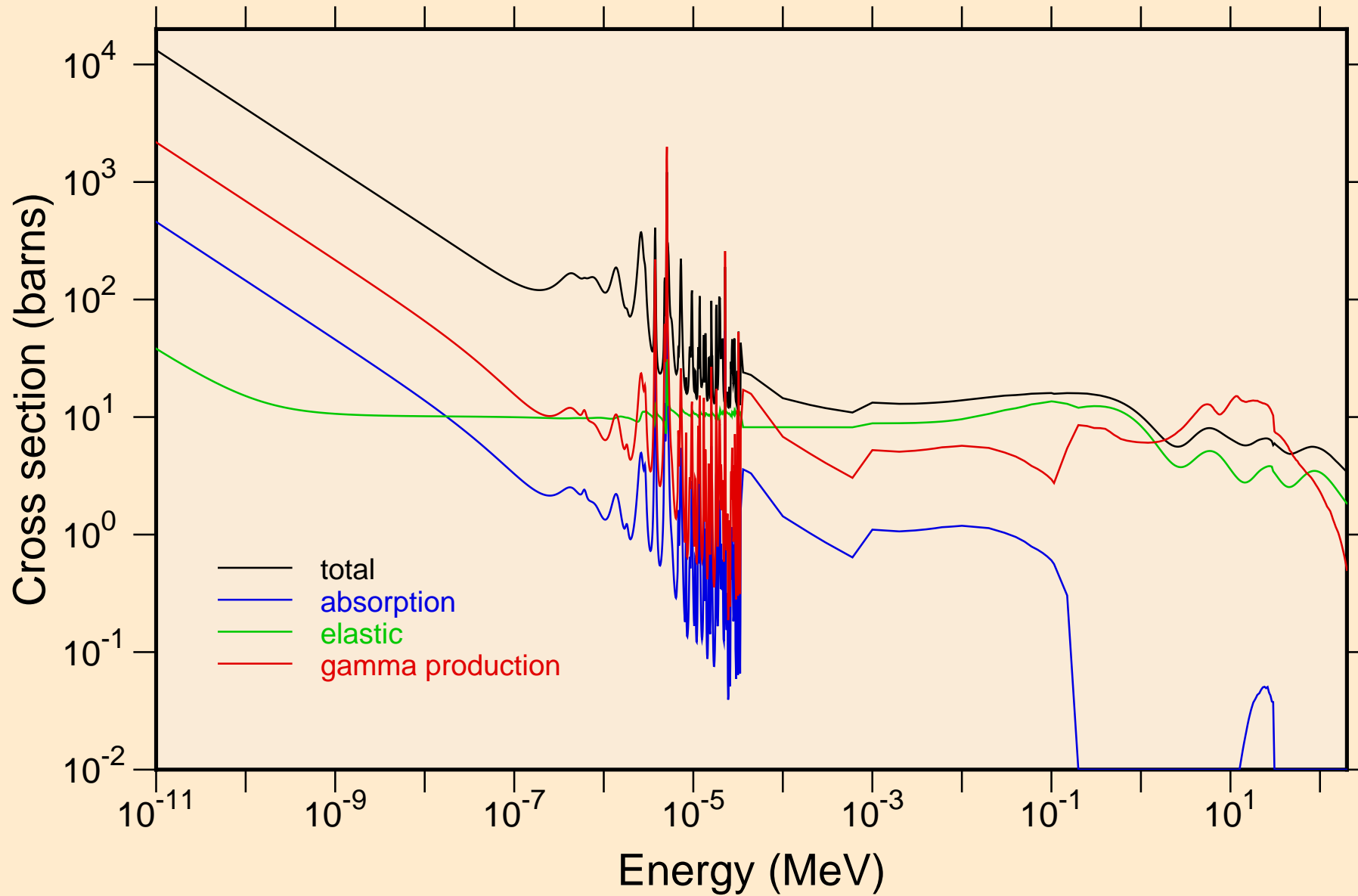

NP244 NEUTRON ACER TENDL-2021 LIBRARY; T=293.6K
resonance total cross section

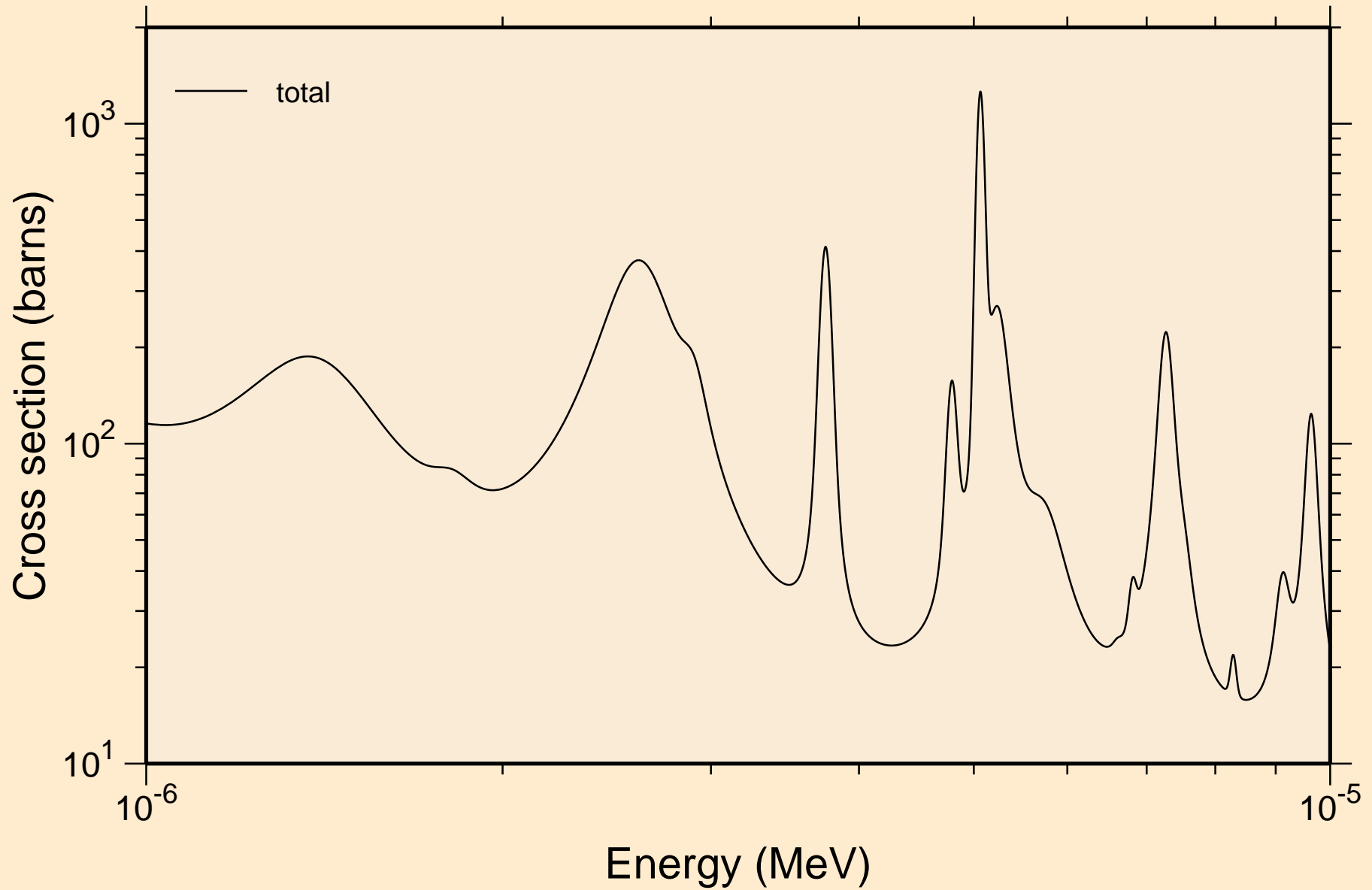

NP244 NEUTRON ACER TENDL-2021 LIBRARY; T=293.6K
resonance total cross section

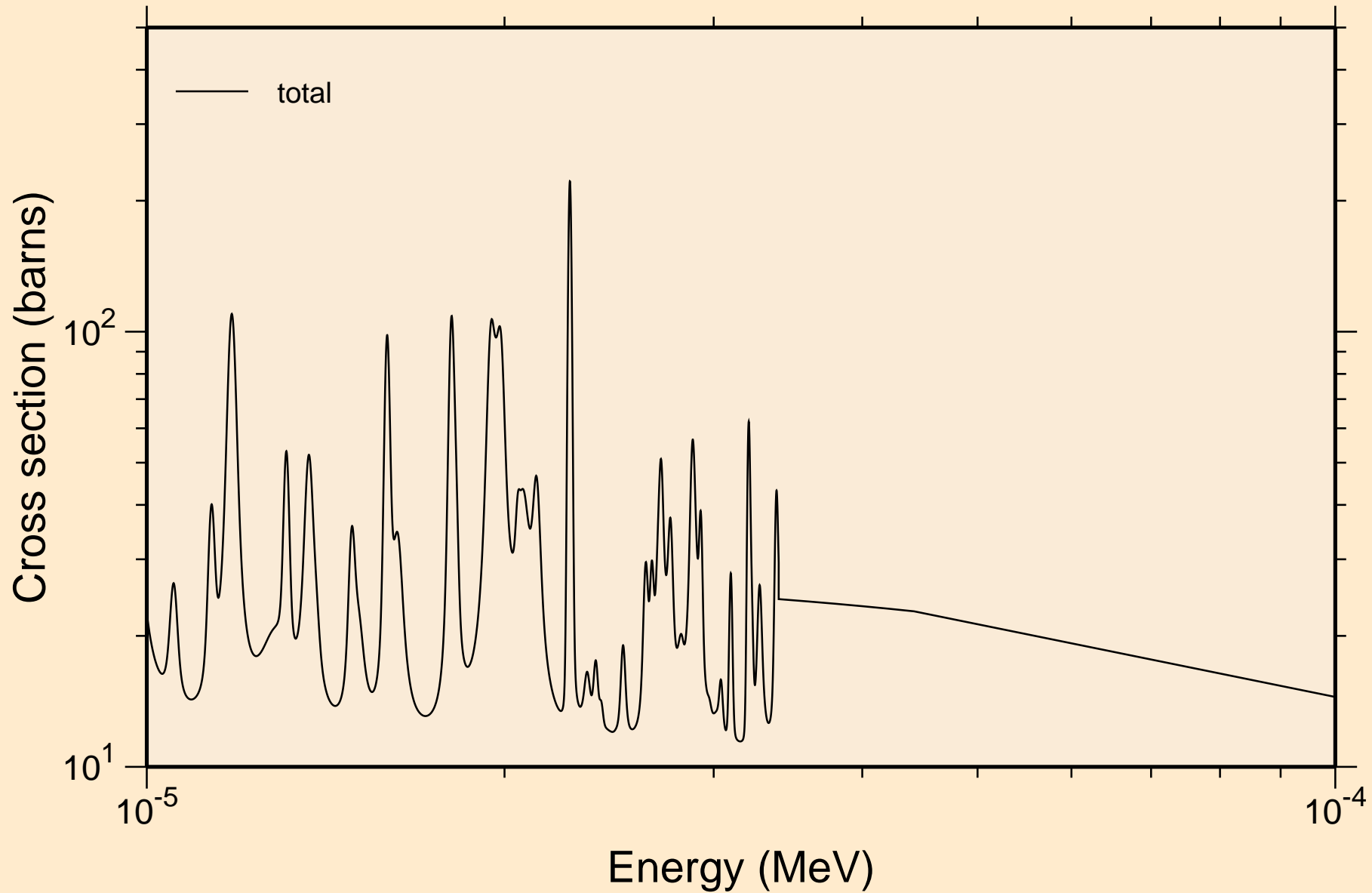

NP244 NEUTRON ACER TENDL-2021 LIBRARY; T=293.6K
resonance total cross section

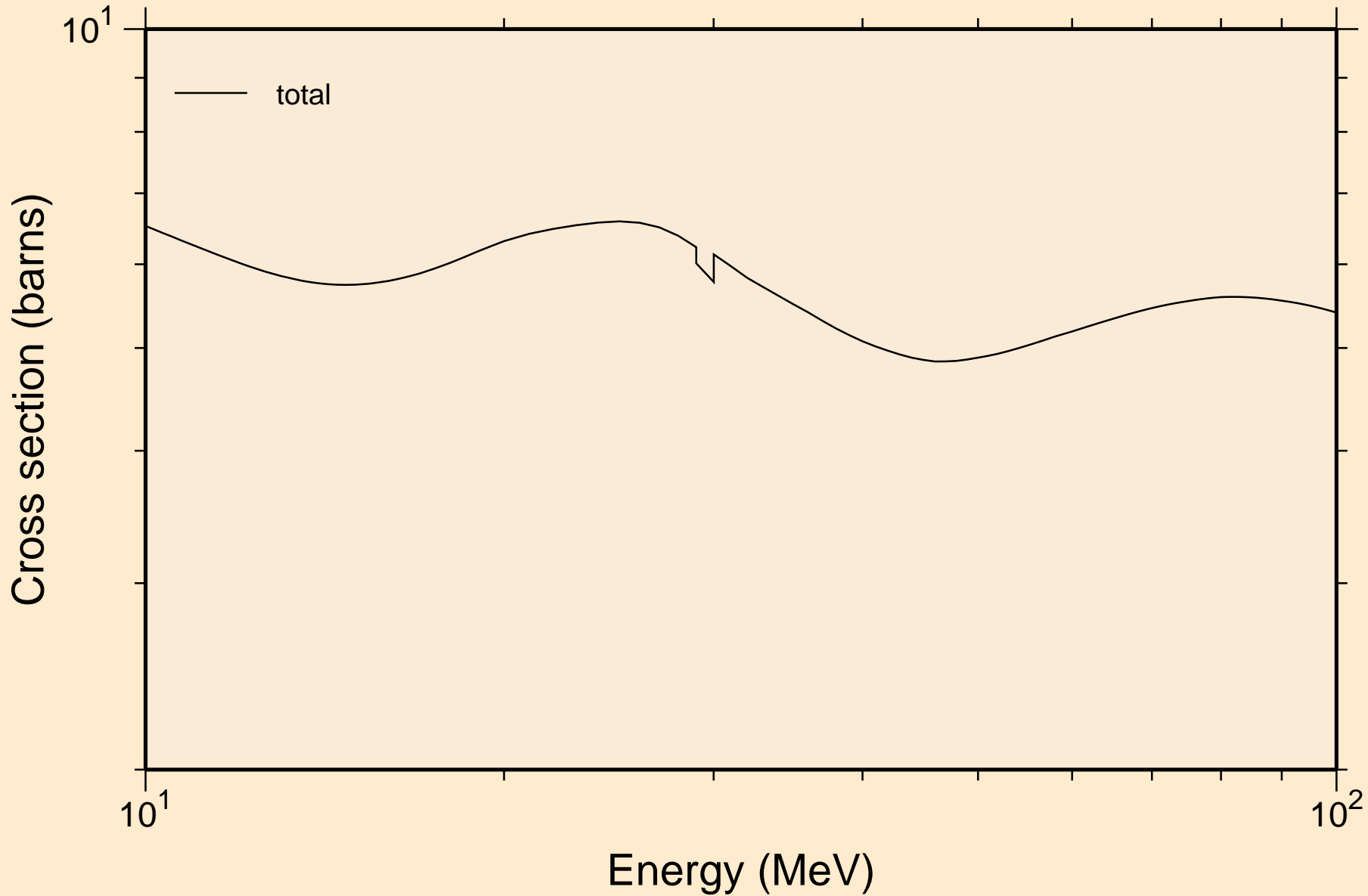

NP244 NEUTRON ACER TENDL-2021 LIBRARY; T=293.6K
resonance absorption cross sections

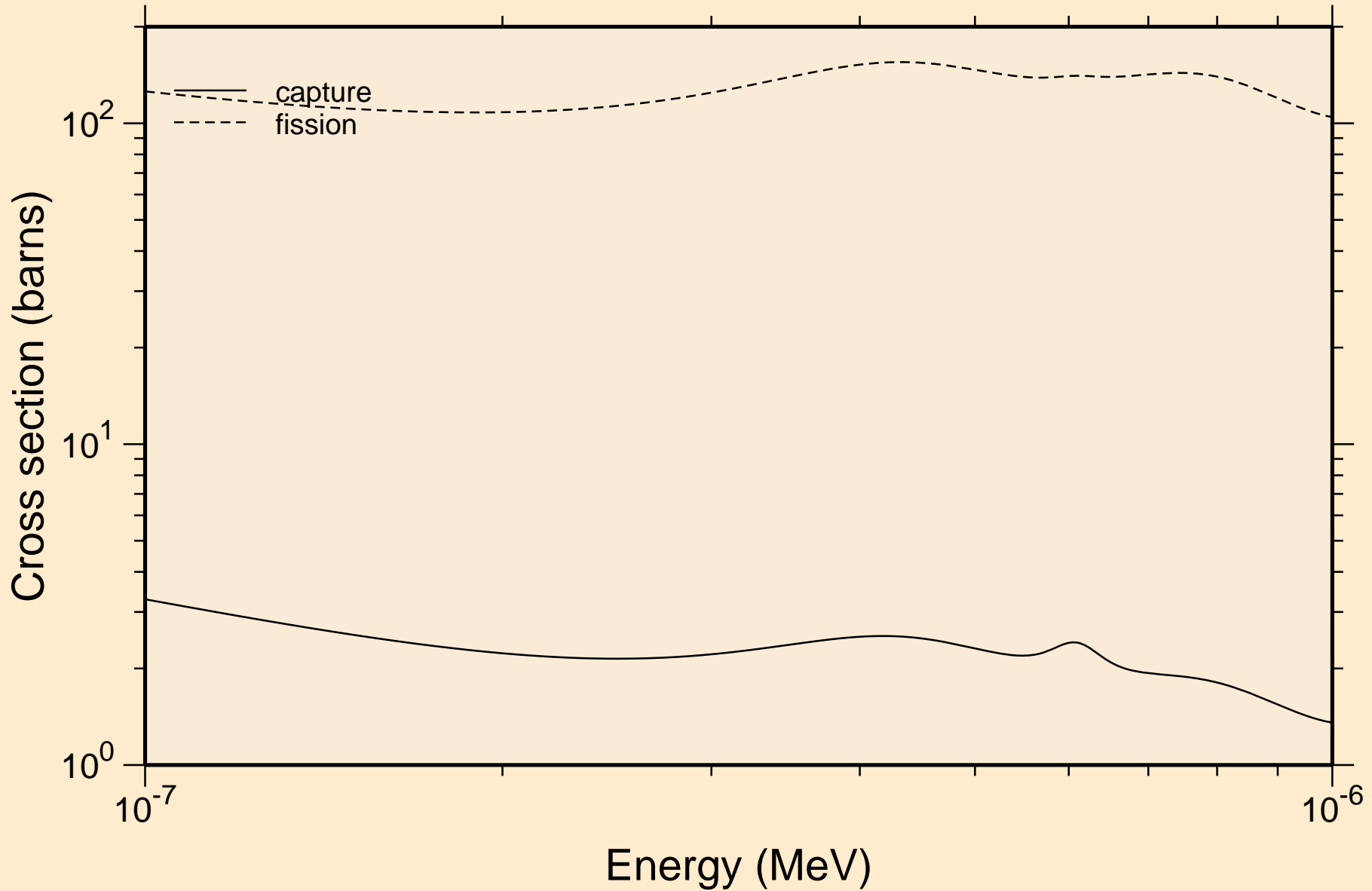

NP244 NEUTRON ACER TENDL-2021 LIBRARY; T=293.6K
resonance absorption cross sections

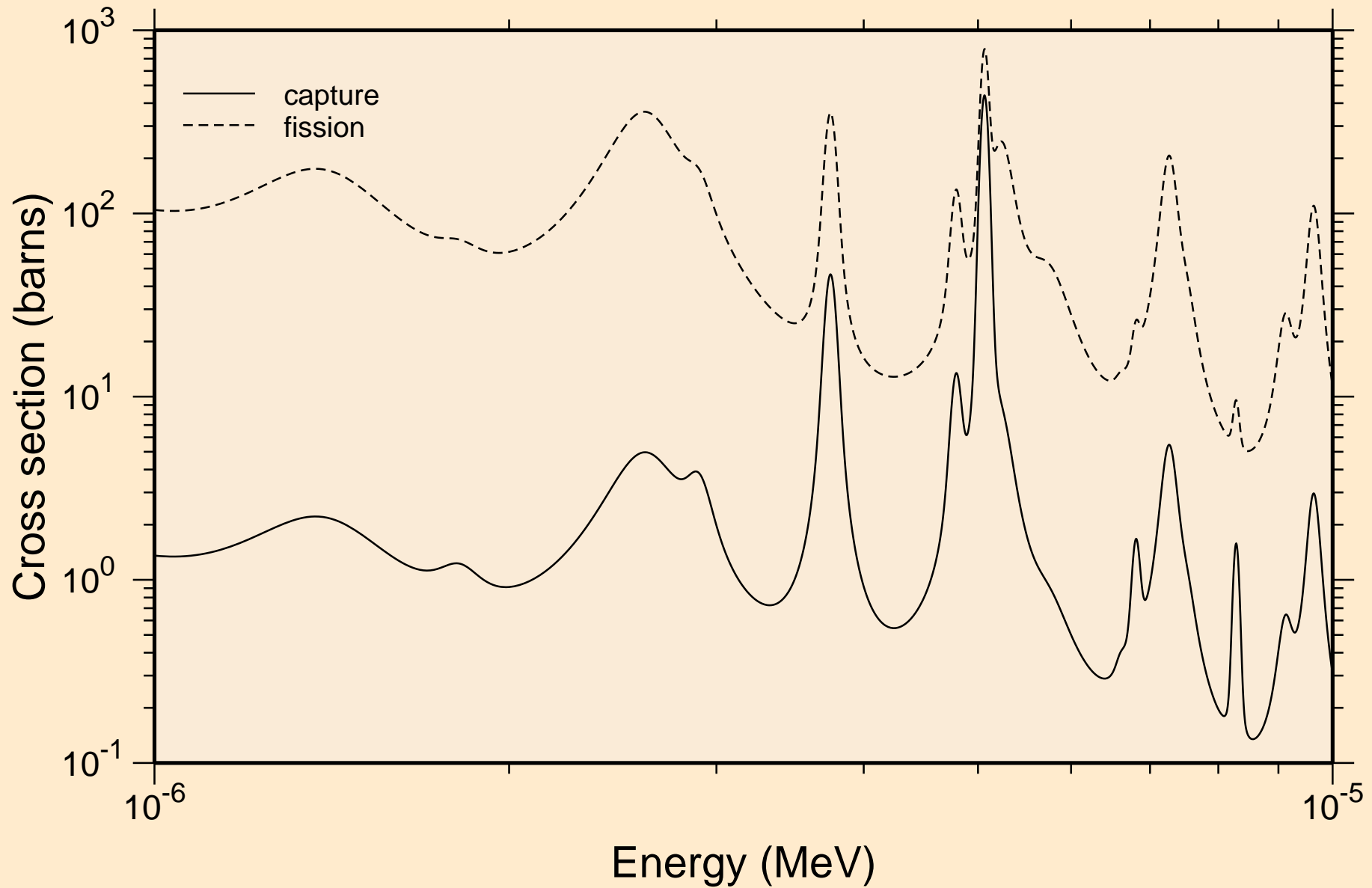

NP244 NEUTRON ACER TENDL-2021 LIBRARY; T=293.6K
resonance absorption cross sections

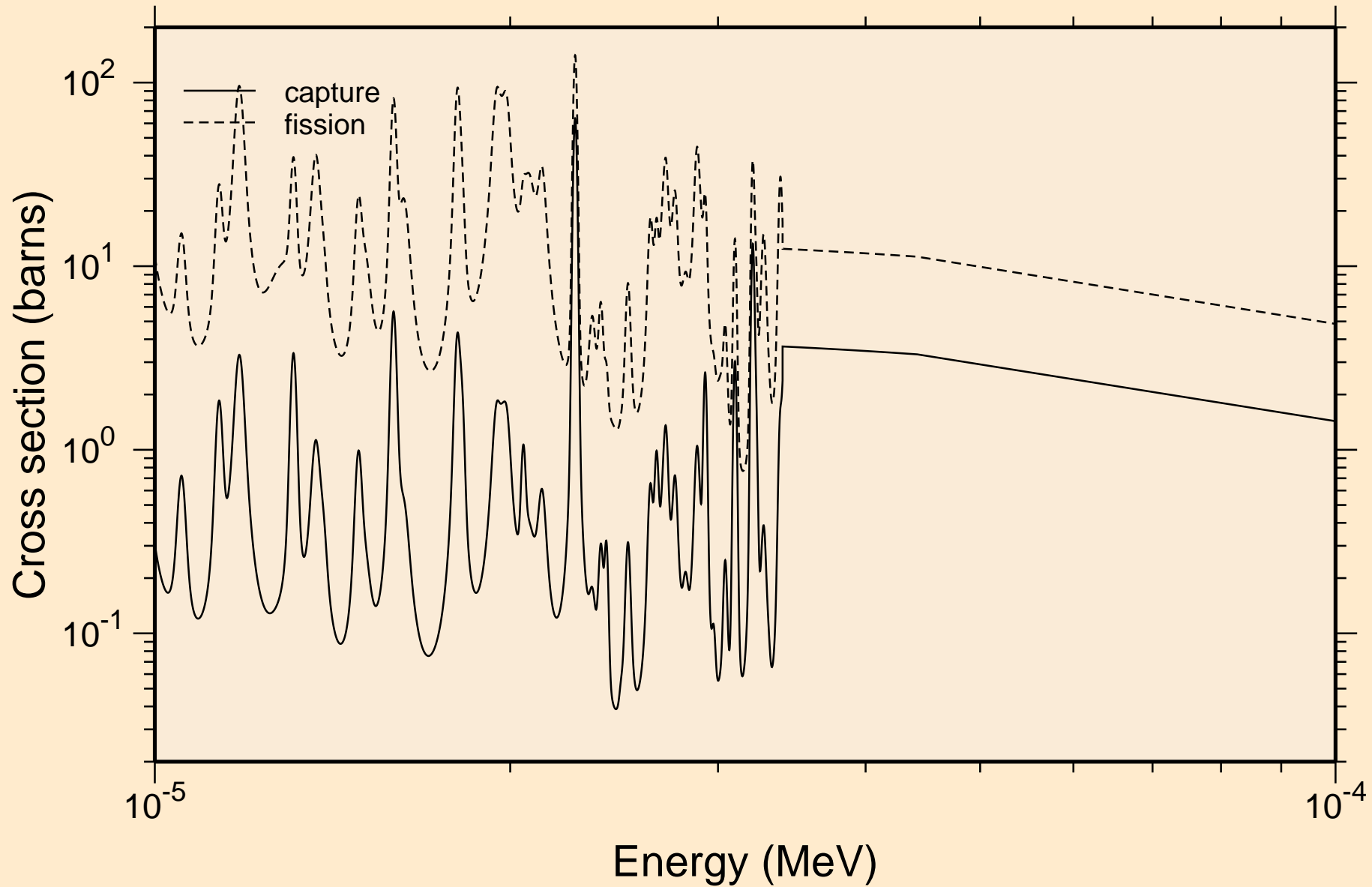

NP244 NEUTRON ACER TENDL-2021 LIBRARY; T=293.6K
resonance absorption cross sections

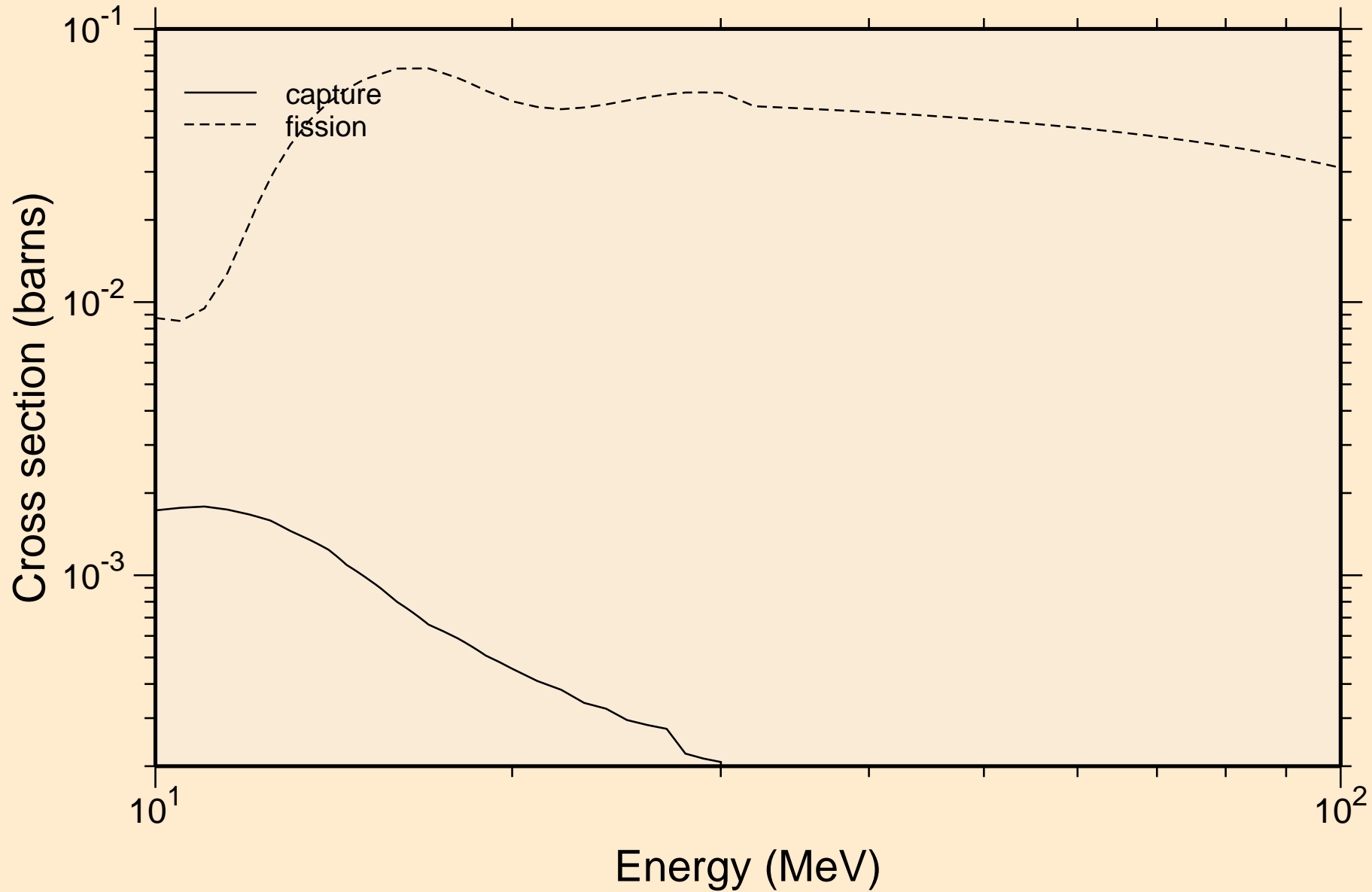

NP244 NEUTRON ACER TENDL-2021 LIBRARY; T=293.6K
Heating

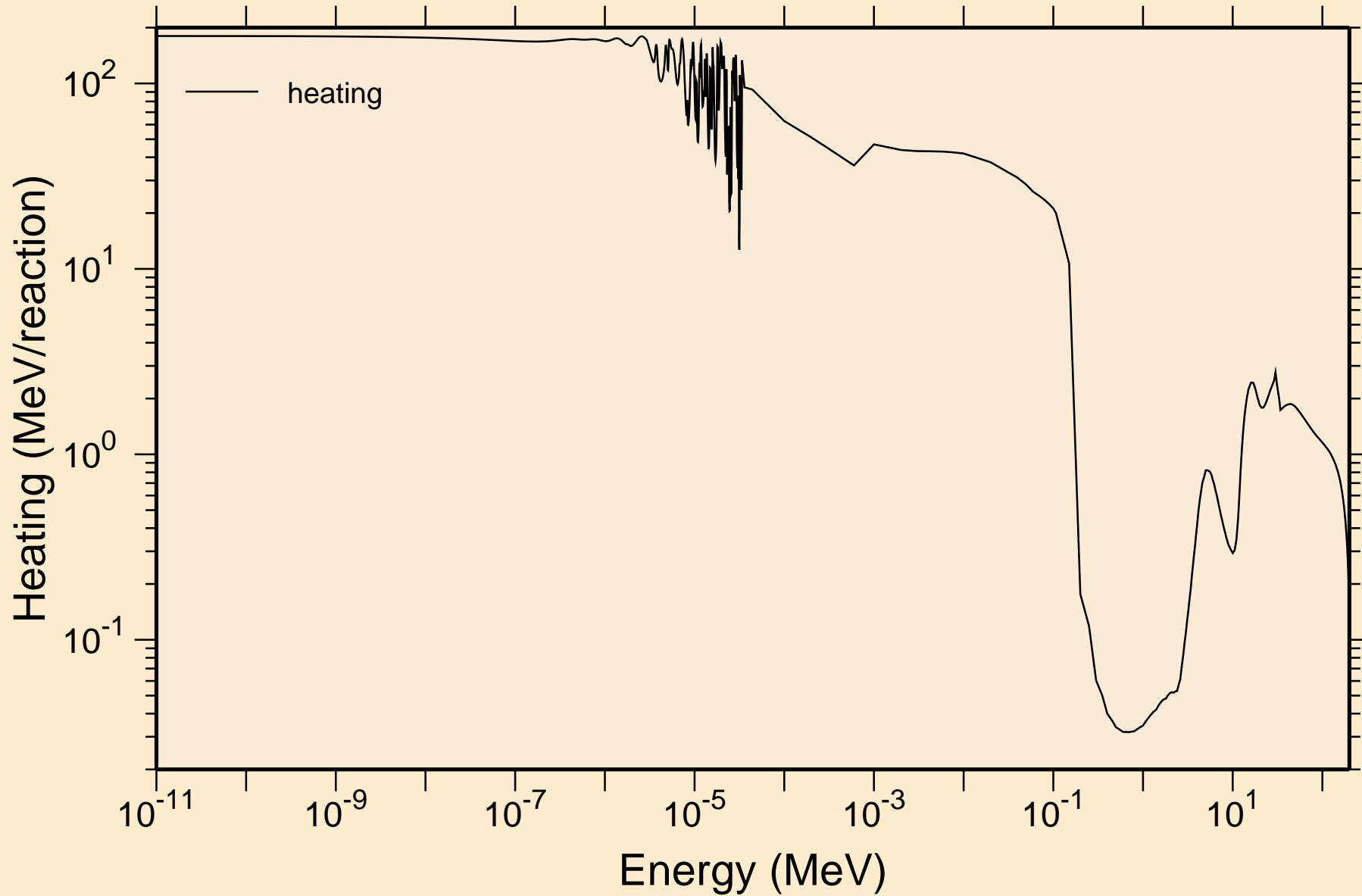

NP244 NEUTRON ACER TENDL-2021 LIBRARY; T=293.6K

Damage

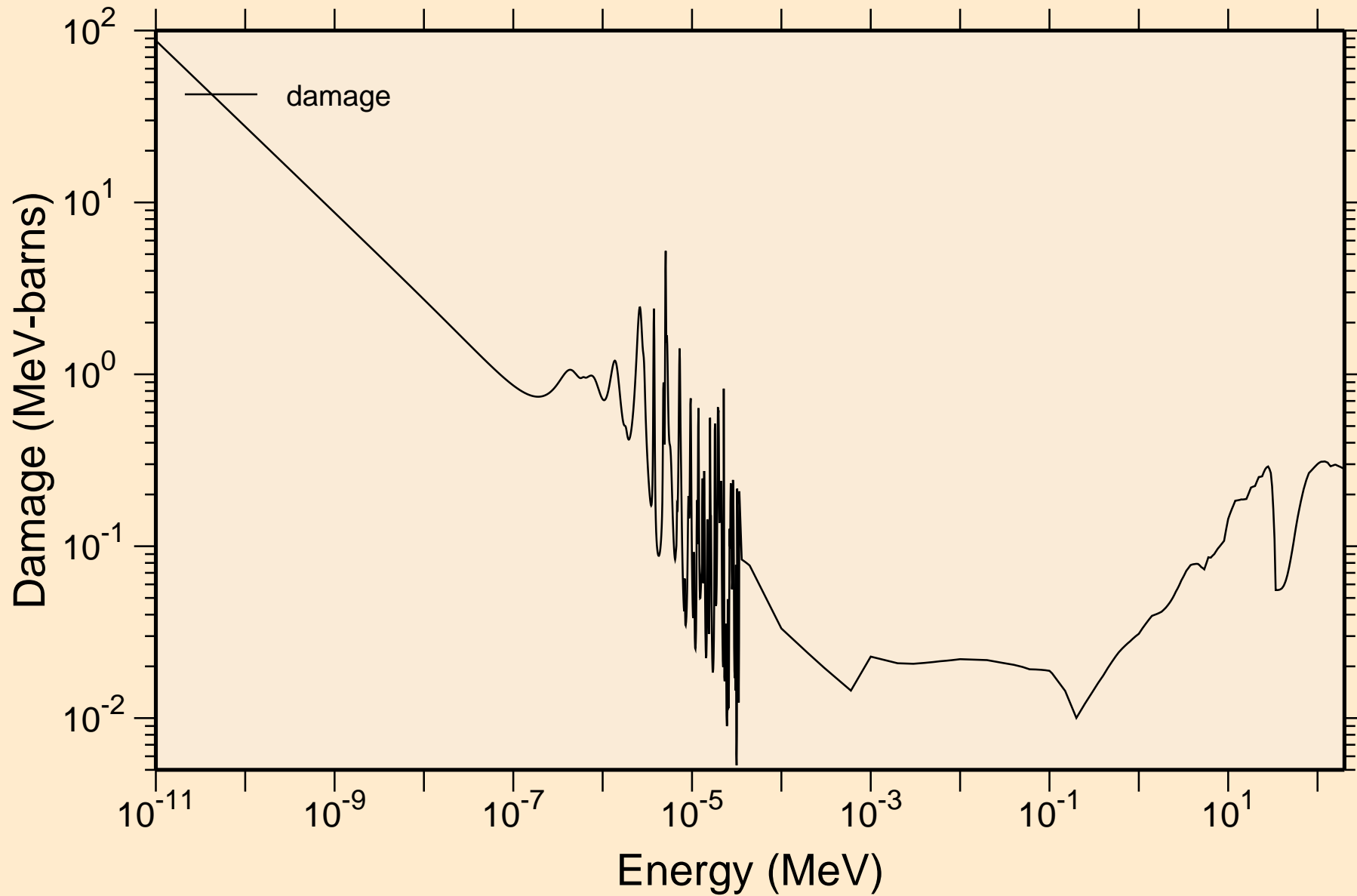

NP244 NEUTRON ACER TENDL-2021 LIBRARY; T=293.6K
Non-threshold reactions

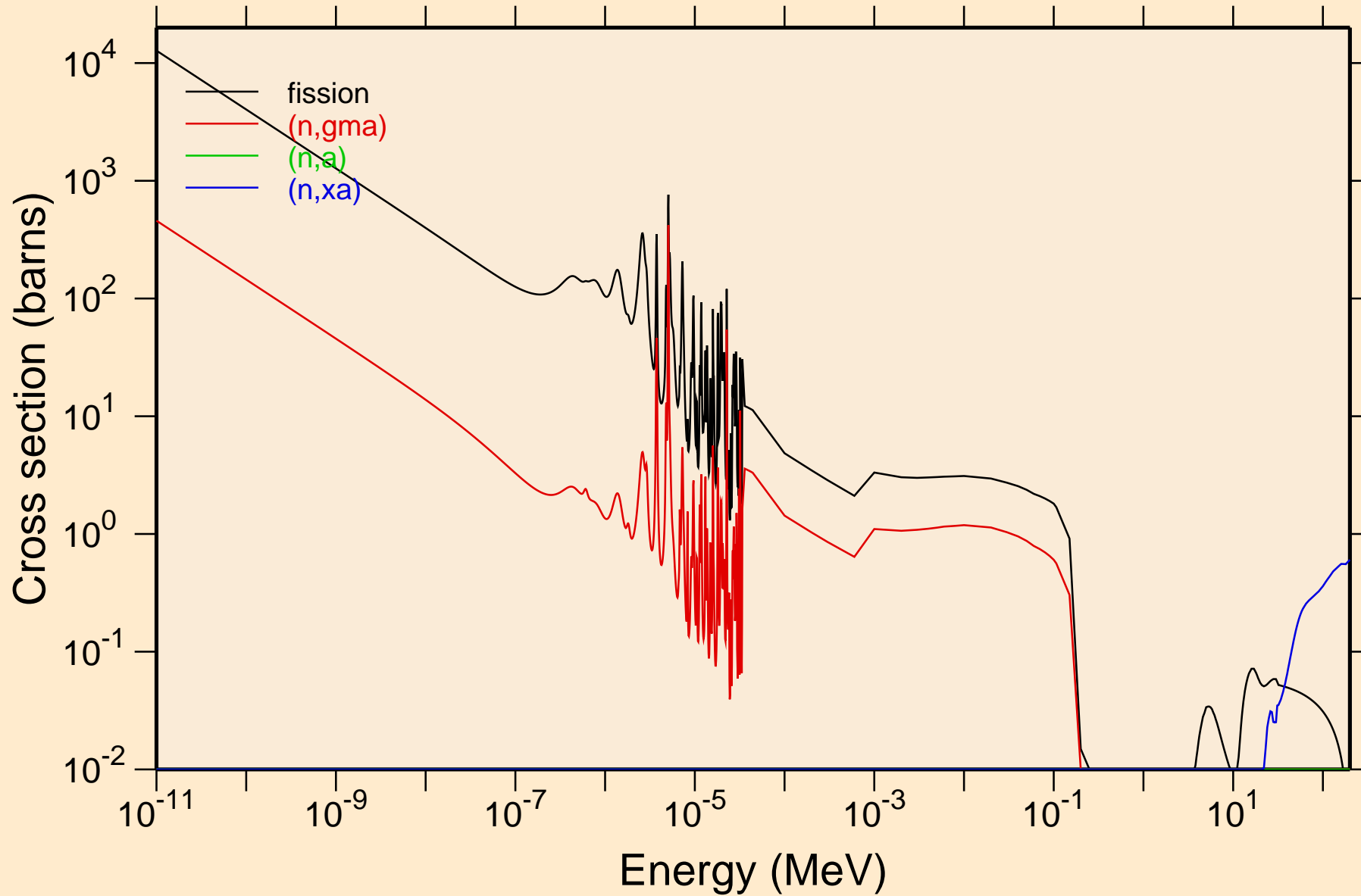

NP244 NEUTRON ACER TENDL-2021 LIBRARY; T=293.6K

Principal cross sections

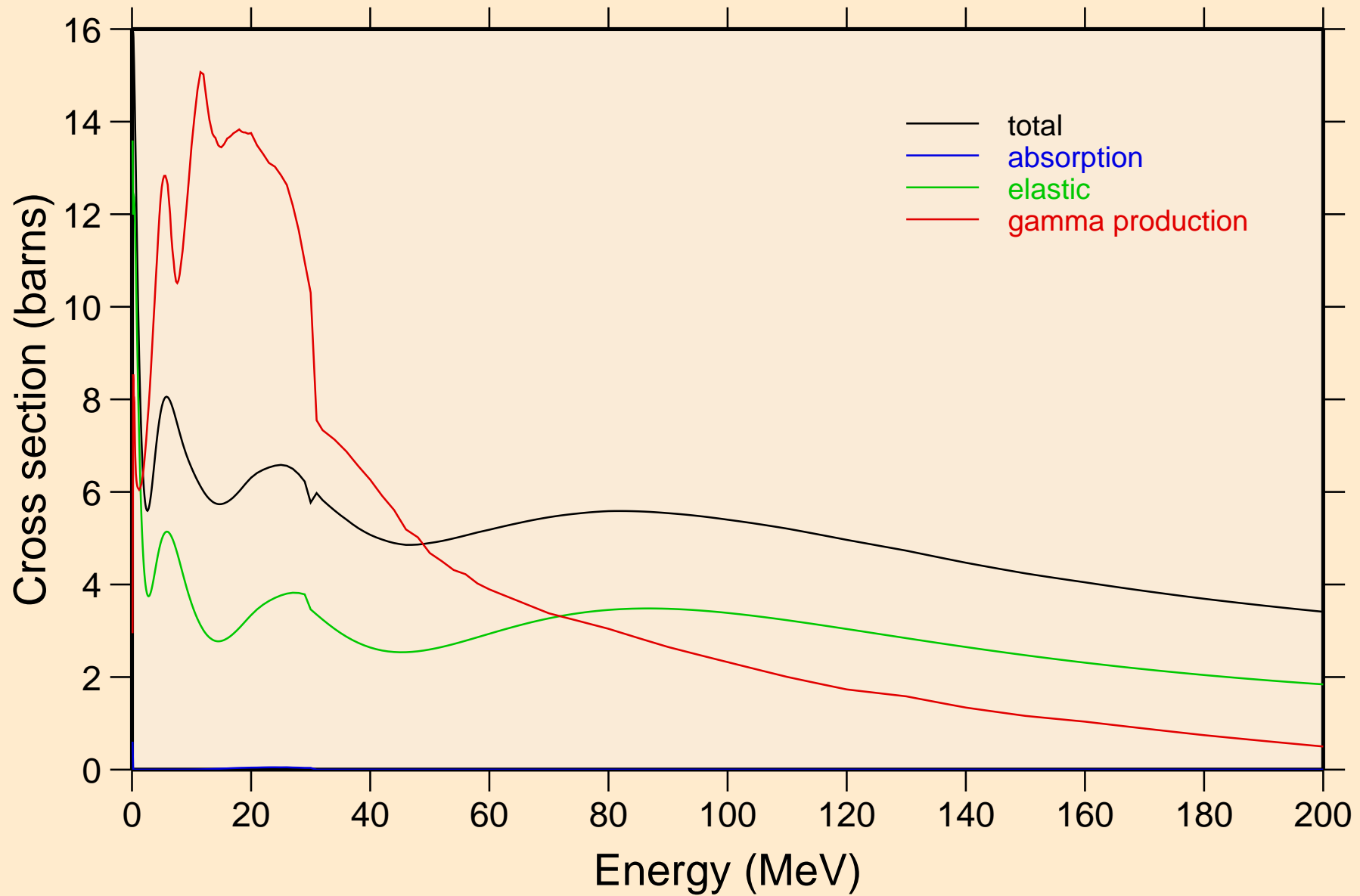

NP244 NEUTRON ACER TENDL-2021 LIBRARY; T=293.6K
Heating

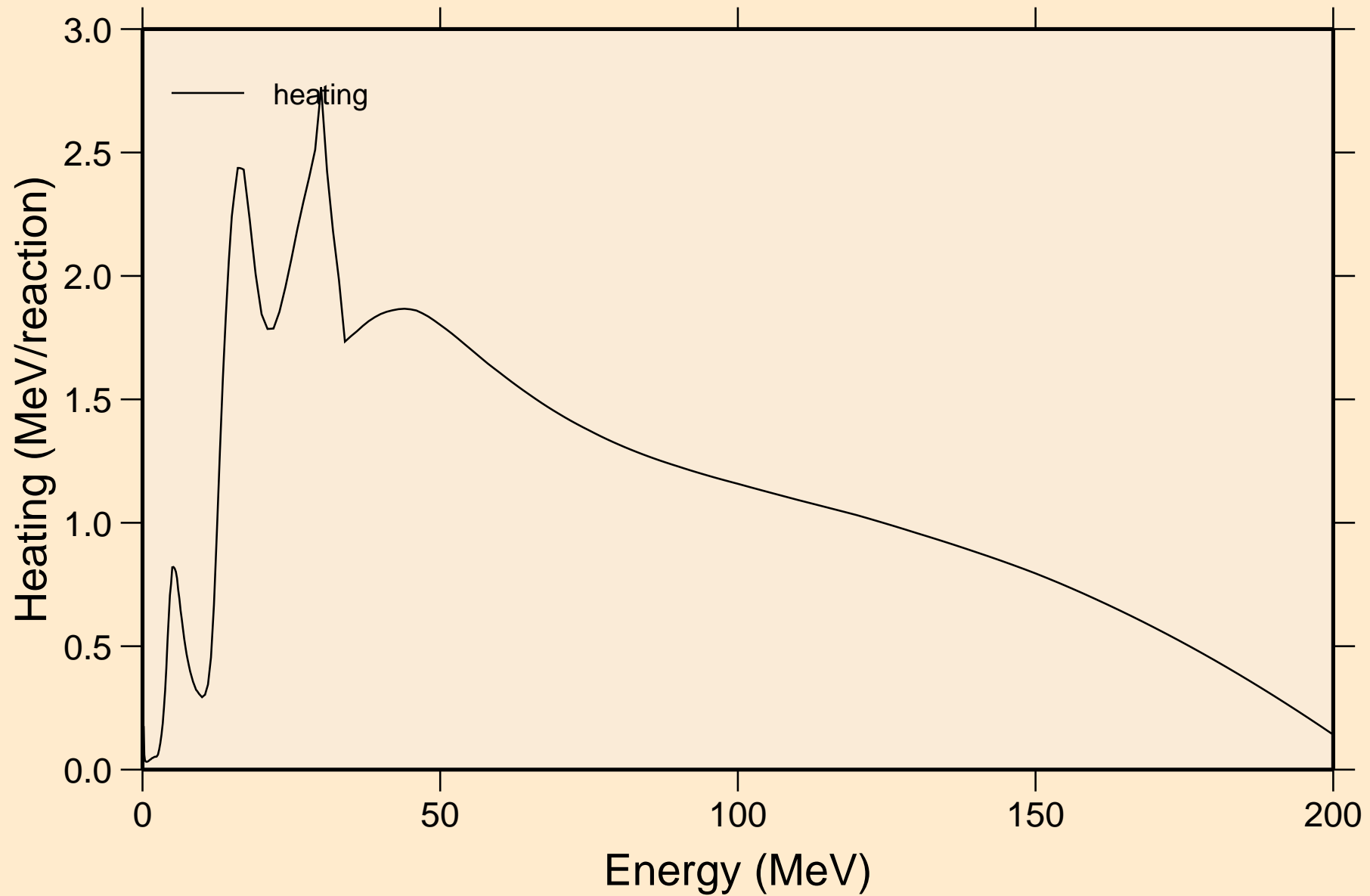

NP244 NEUTRON ACER TENDL-2021 LIBRARY; T=293.6K
Damage

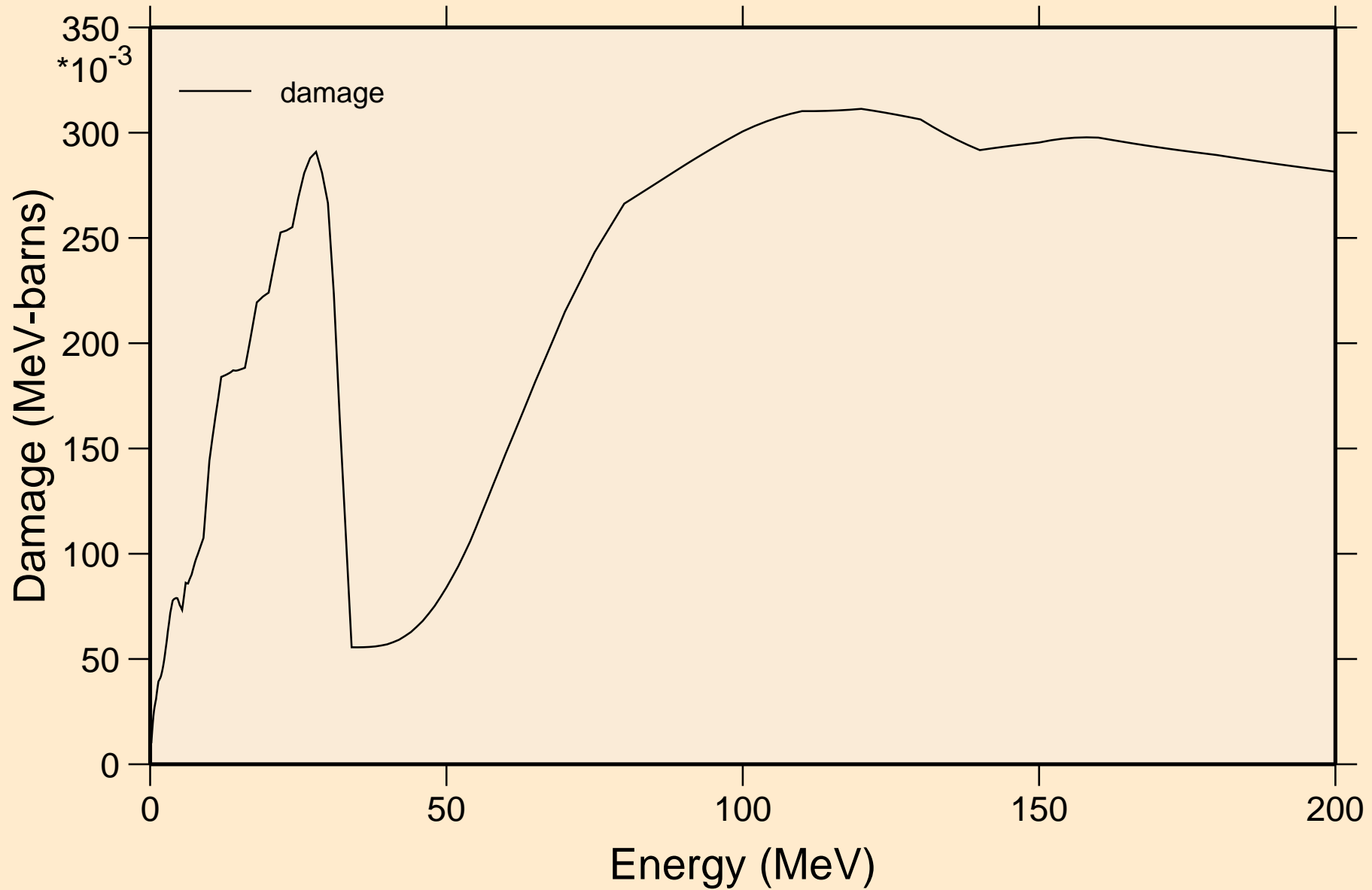

NP244 NEUTRON ACER TENDL-2021 LIBRARY; T=293.6K
Non-threshold reactions

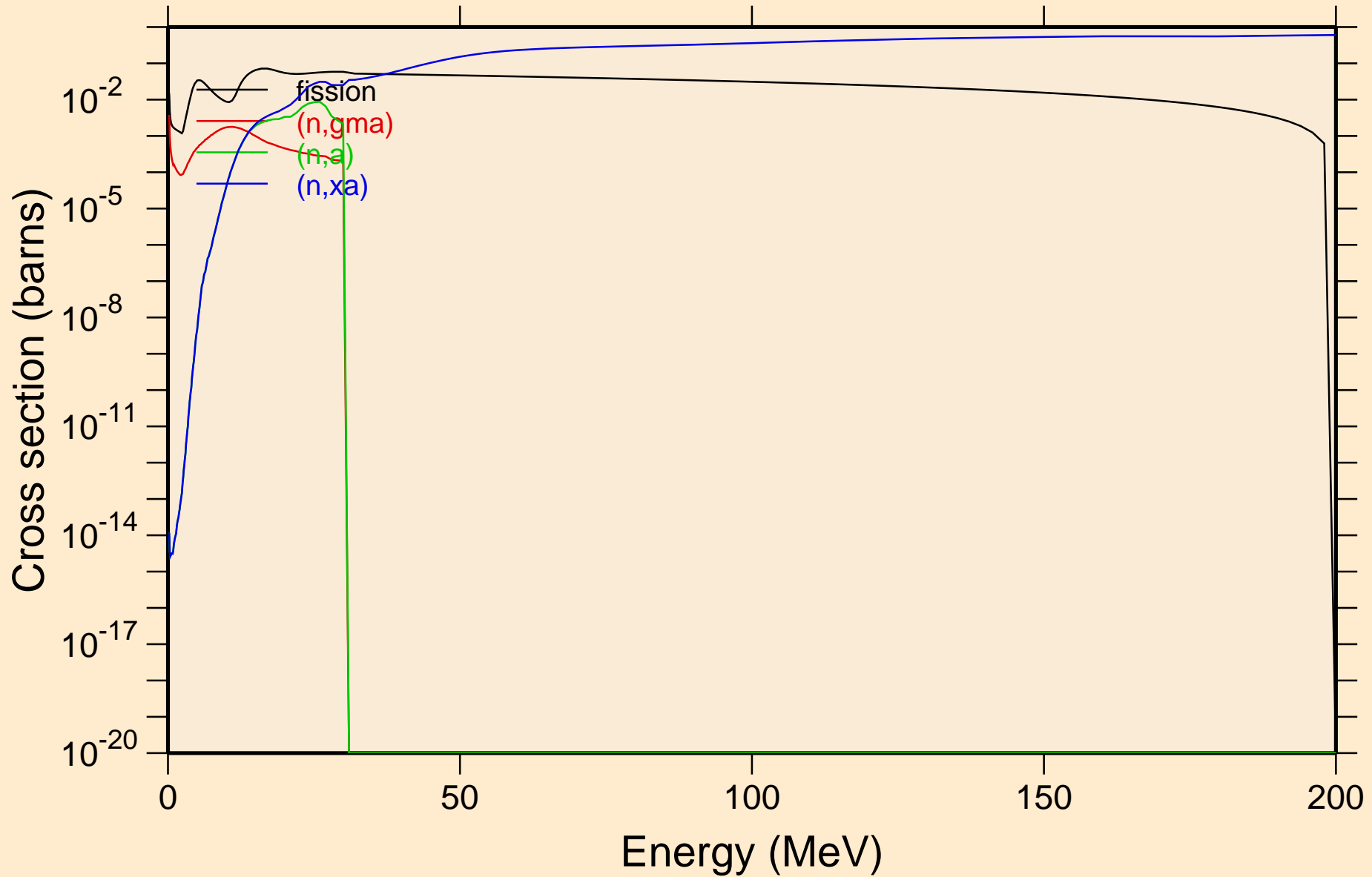

NP244 NEUTRON ACER TENDL-2021 LIBRARY; T=293.6K
Inelastic levels

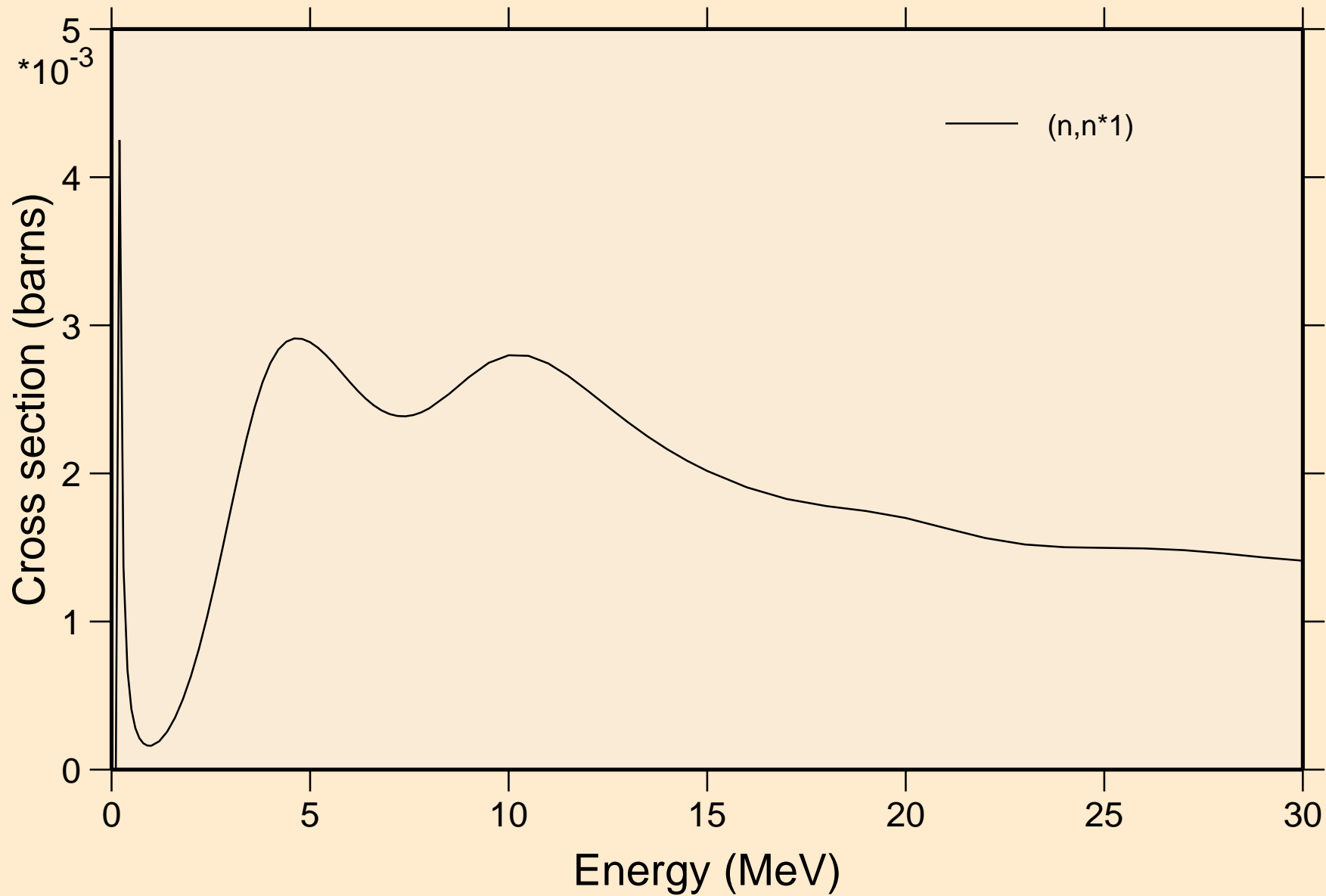

NP244 NEUTRON ACER TENDL-2021 LIBRARY; T=293.6K

Threshold reactions

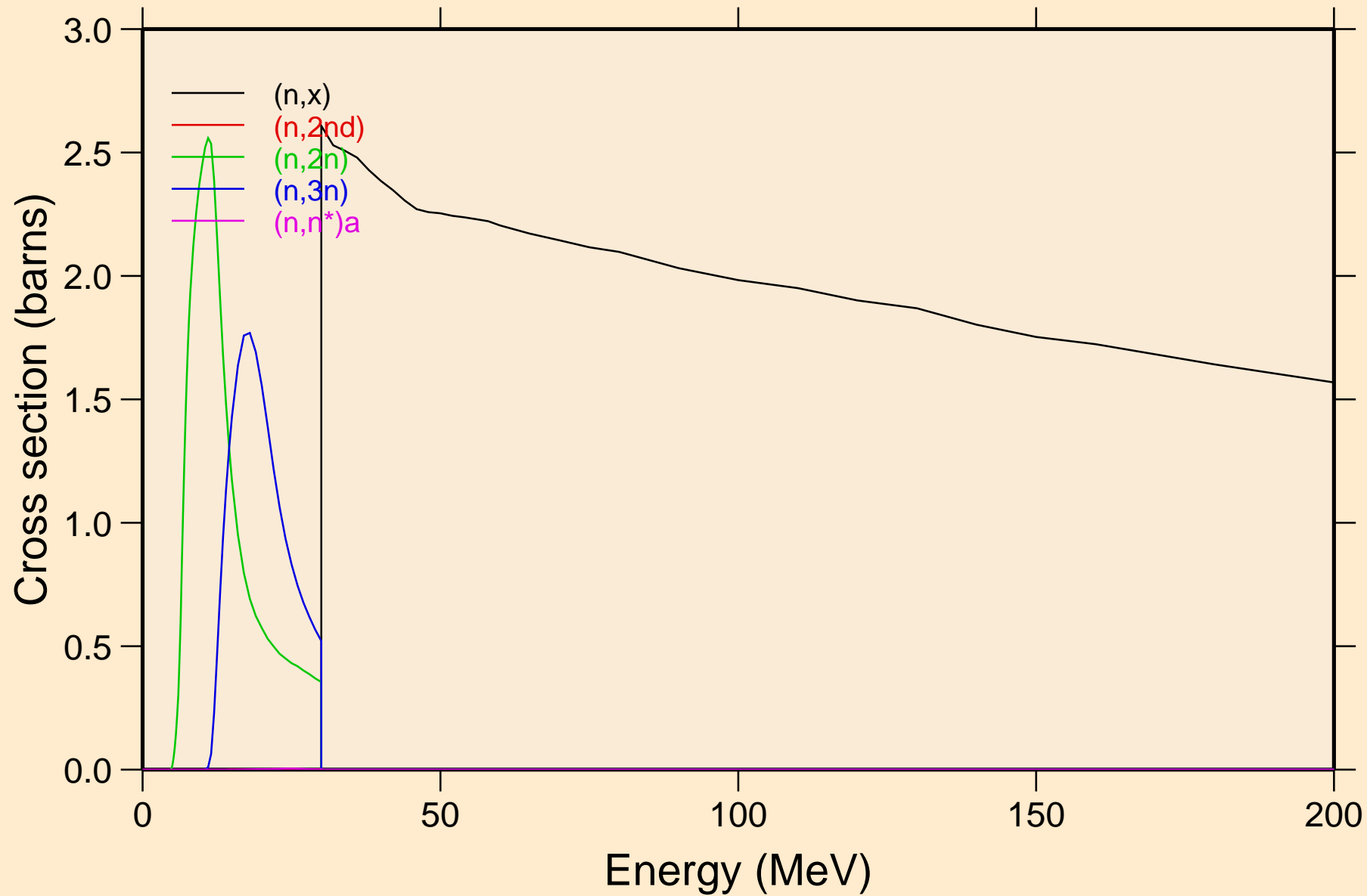

NP244 NEUTRON ACER TENDL-2021 LIBRARY; T=293.6K
Threshold reactions

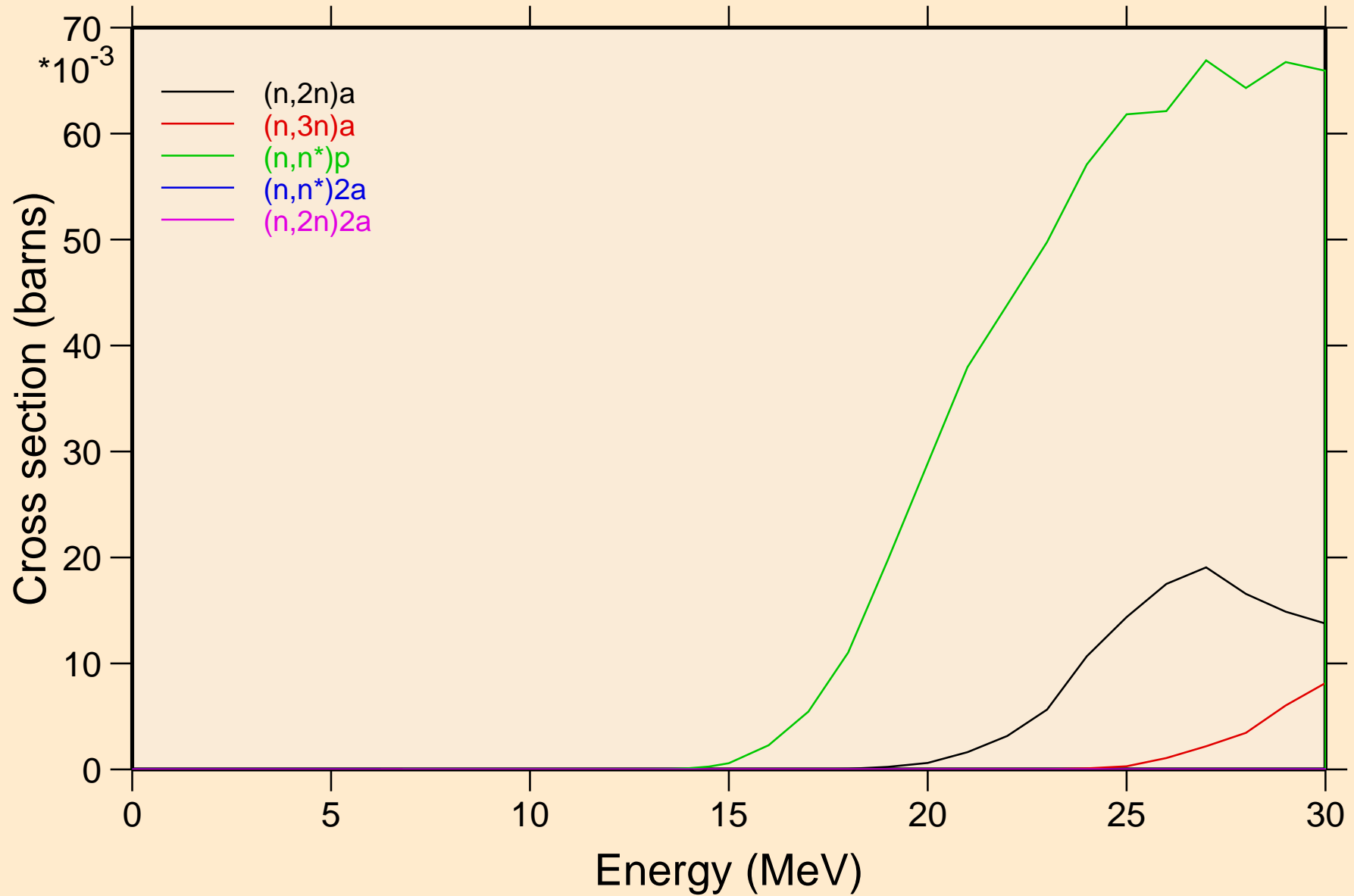

NP244 NEUTRON ACER TENDL-2021 LIBRARY; T=293.6K
Threshold reactions

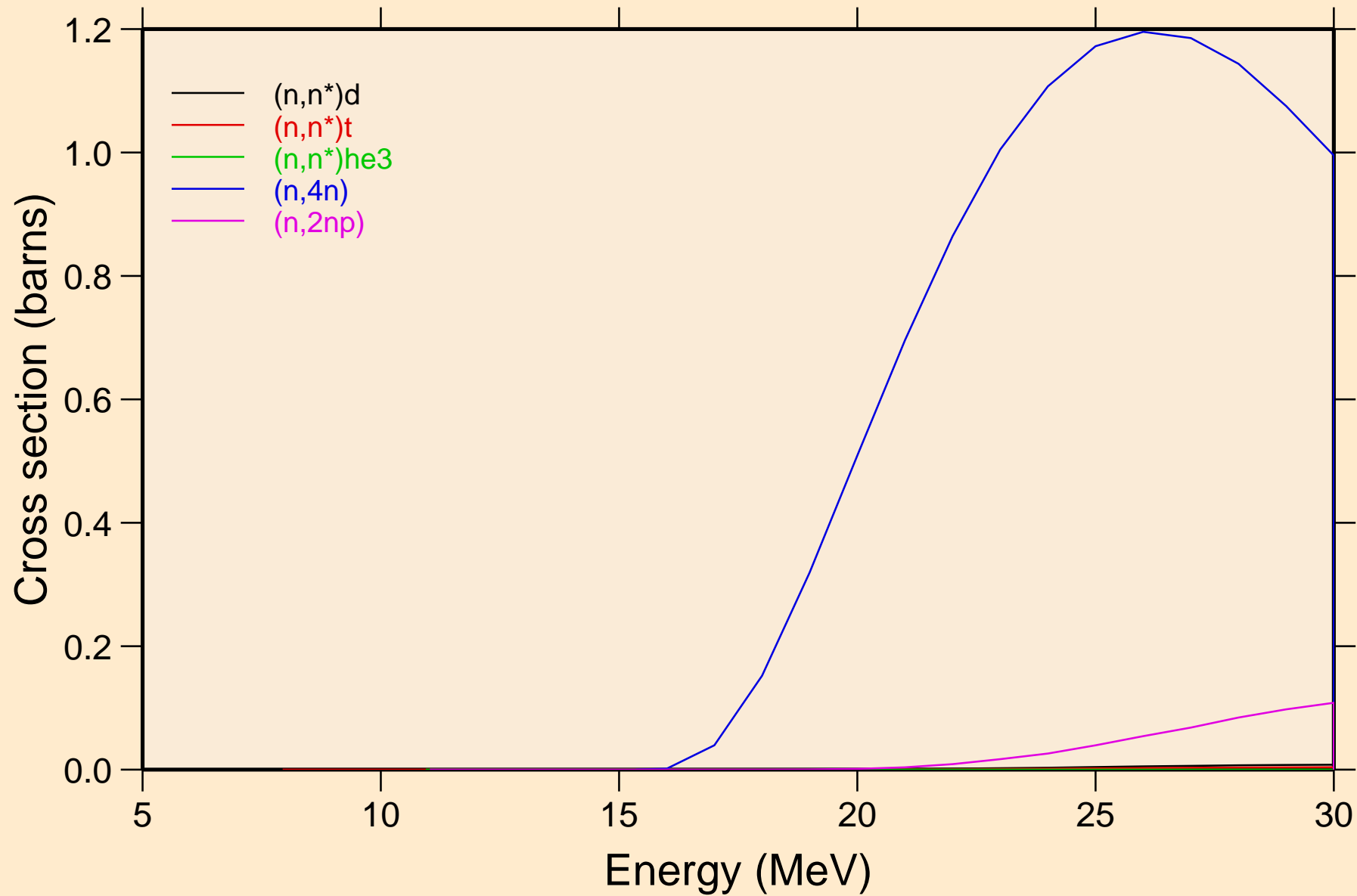

NP244 NEUTRON ACER TENDL-2021 LIBRARY; T=293.6K
Threshold reactions

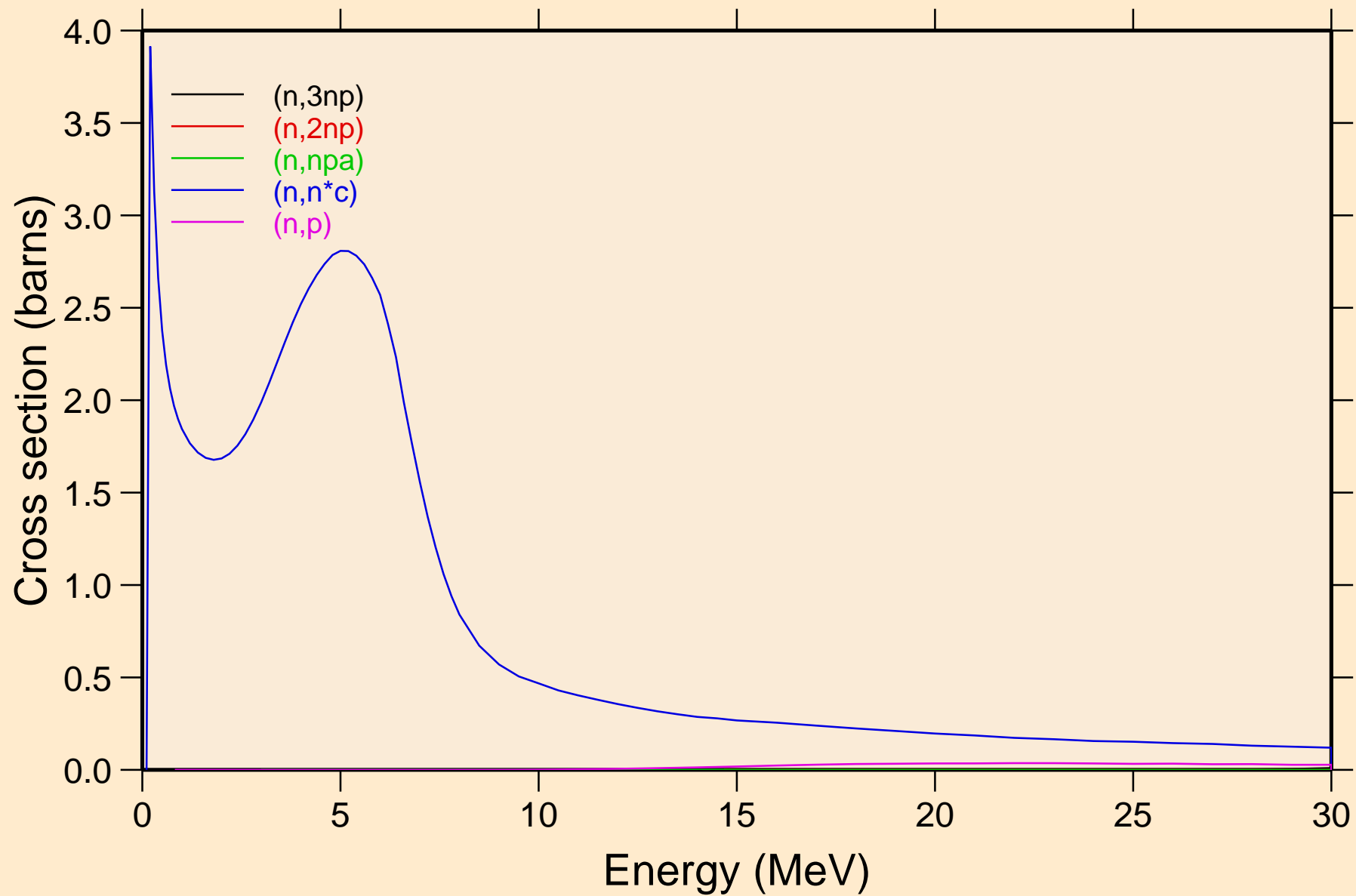

NP244 NEUTRON ACER TENDL-2021 LIBRARY; T=293.6K
Threshold reactions

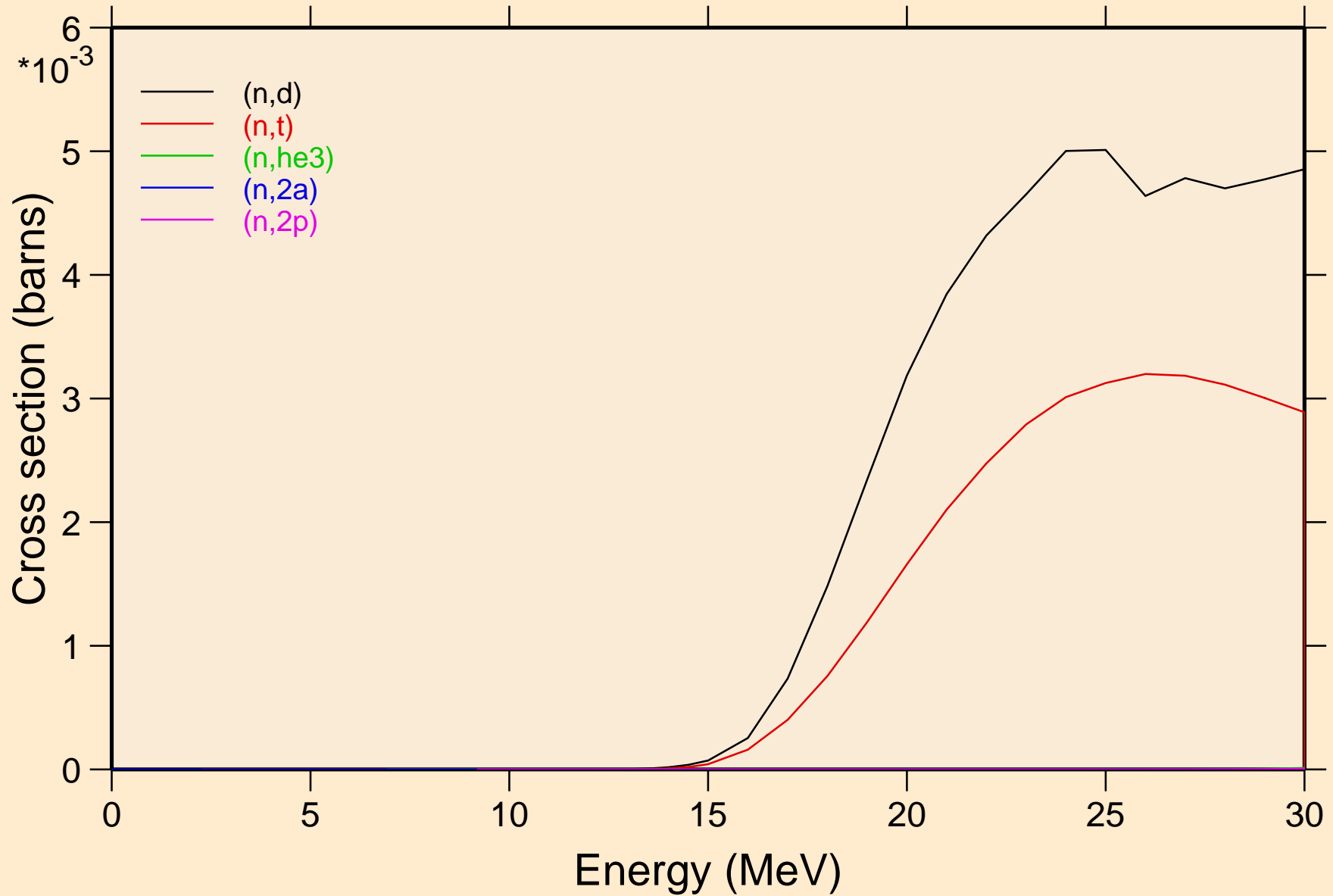

NP244 NEUTRON ACER TENDL-2021 LIBRARY; T=293.6K
Threshold reactions

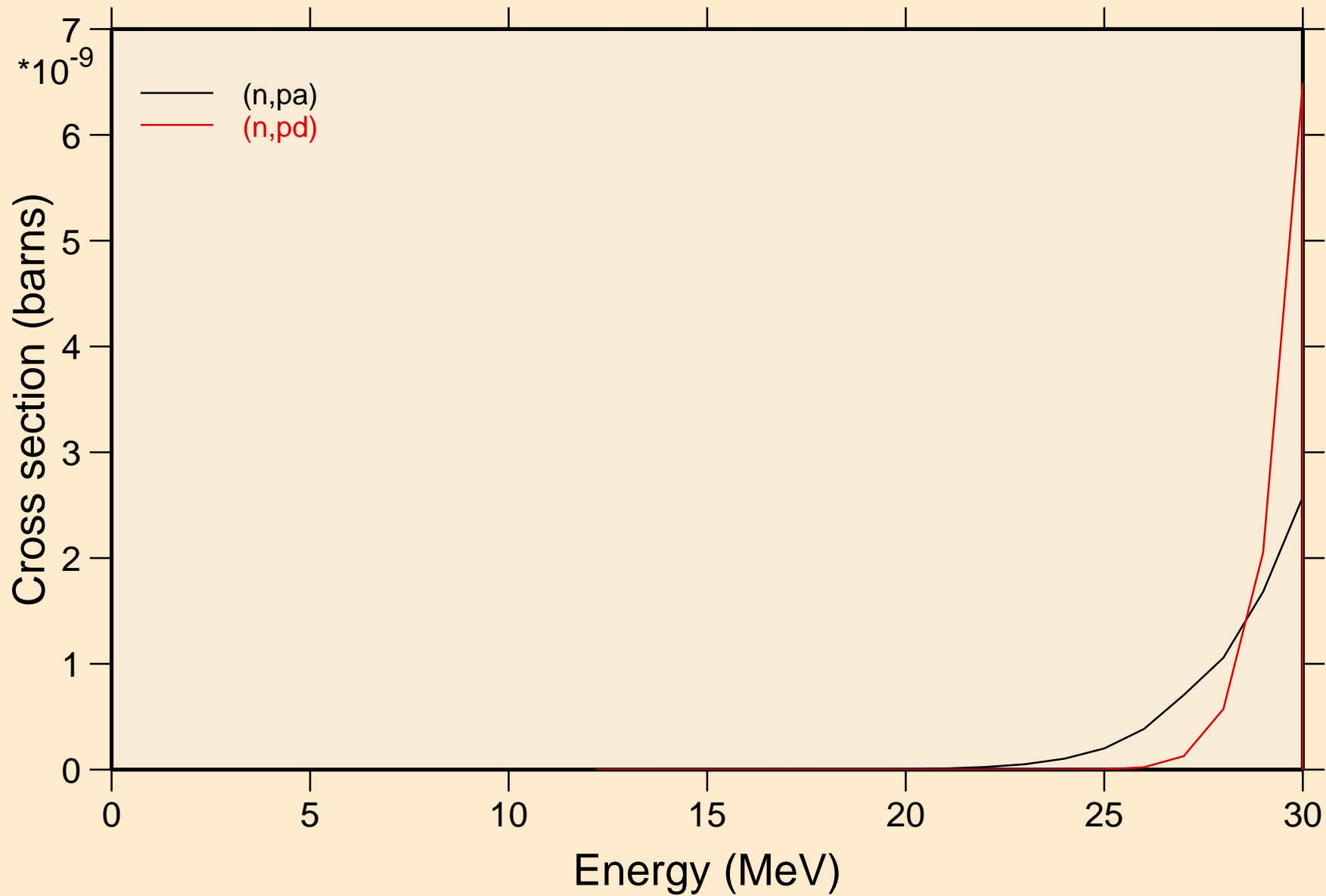

NP244 NEUTRON ACER TENDL-2021 LIBRARY; T=293.6K
Threshold reactions

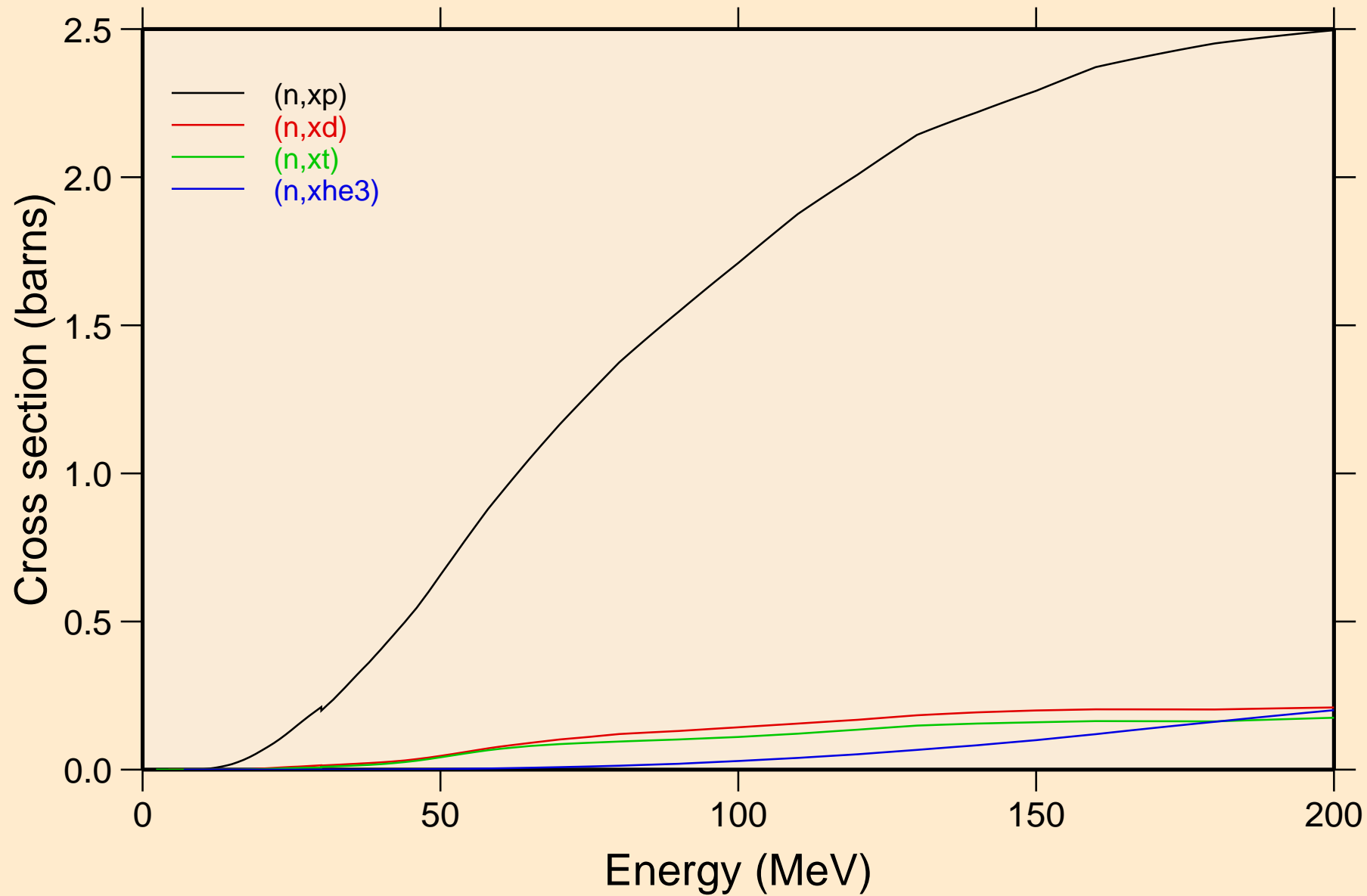

NP244 NEUTRON ACER TENDL-2021 LIBRARY; T=293.6K
angular distribution for elastic

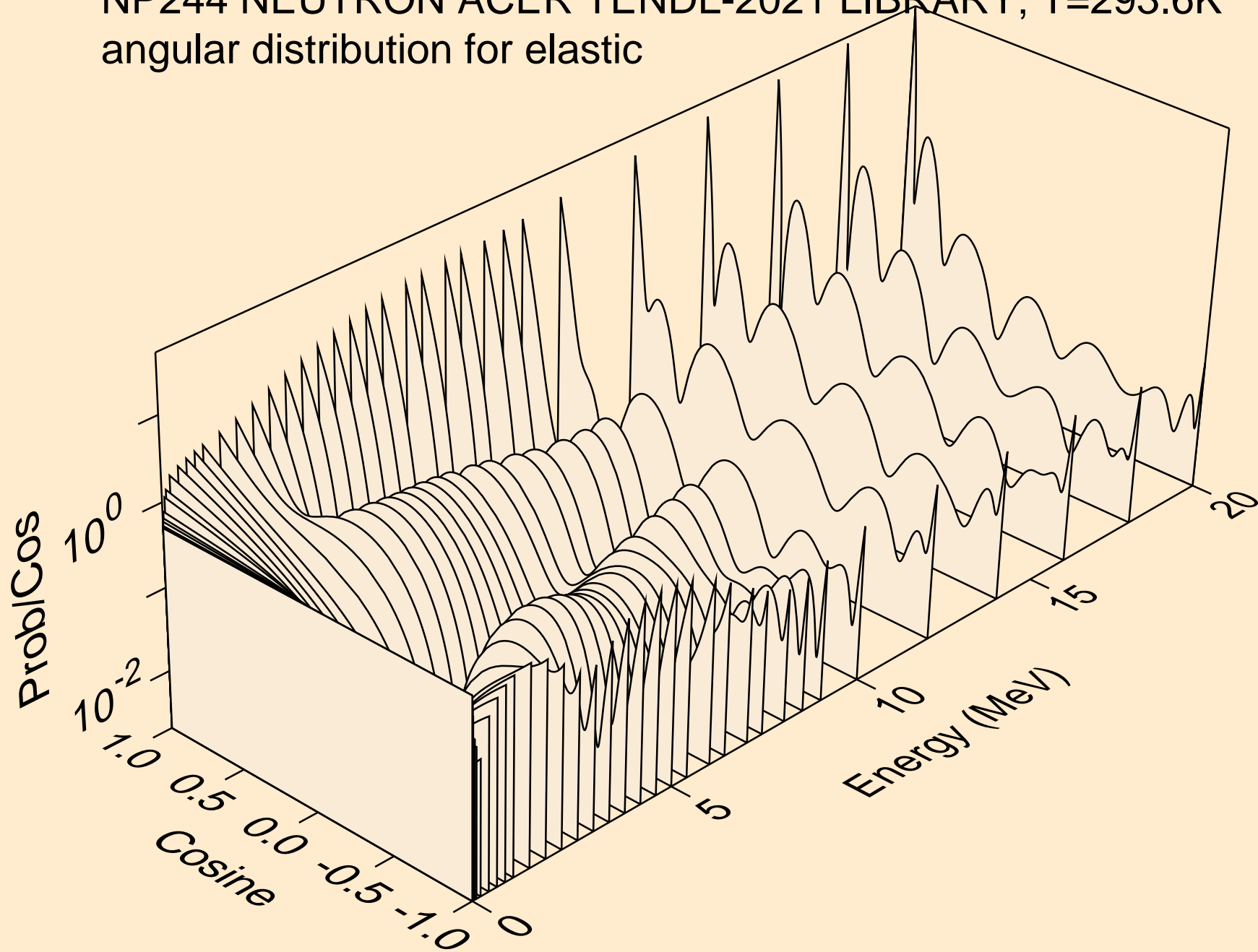

NP244 NEUTRON ACER TENDL-2021 LIBRARY; T=293.6K
angular distribution for elastic

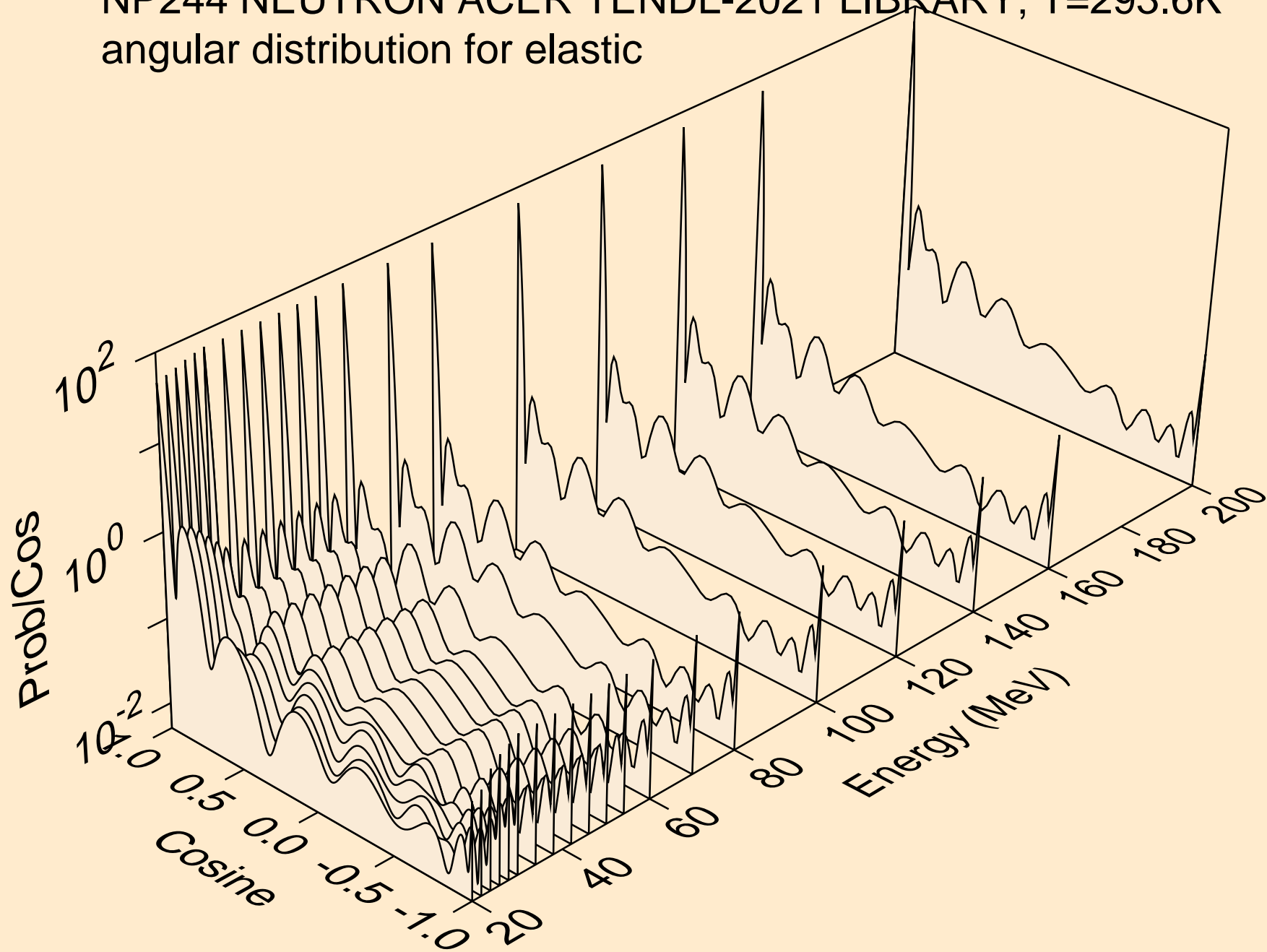

NP244 NEUTRON ACER TENDL-2021 LIBRARY; T=293.6K
angular distribution for (n,n*1)

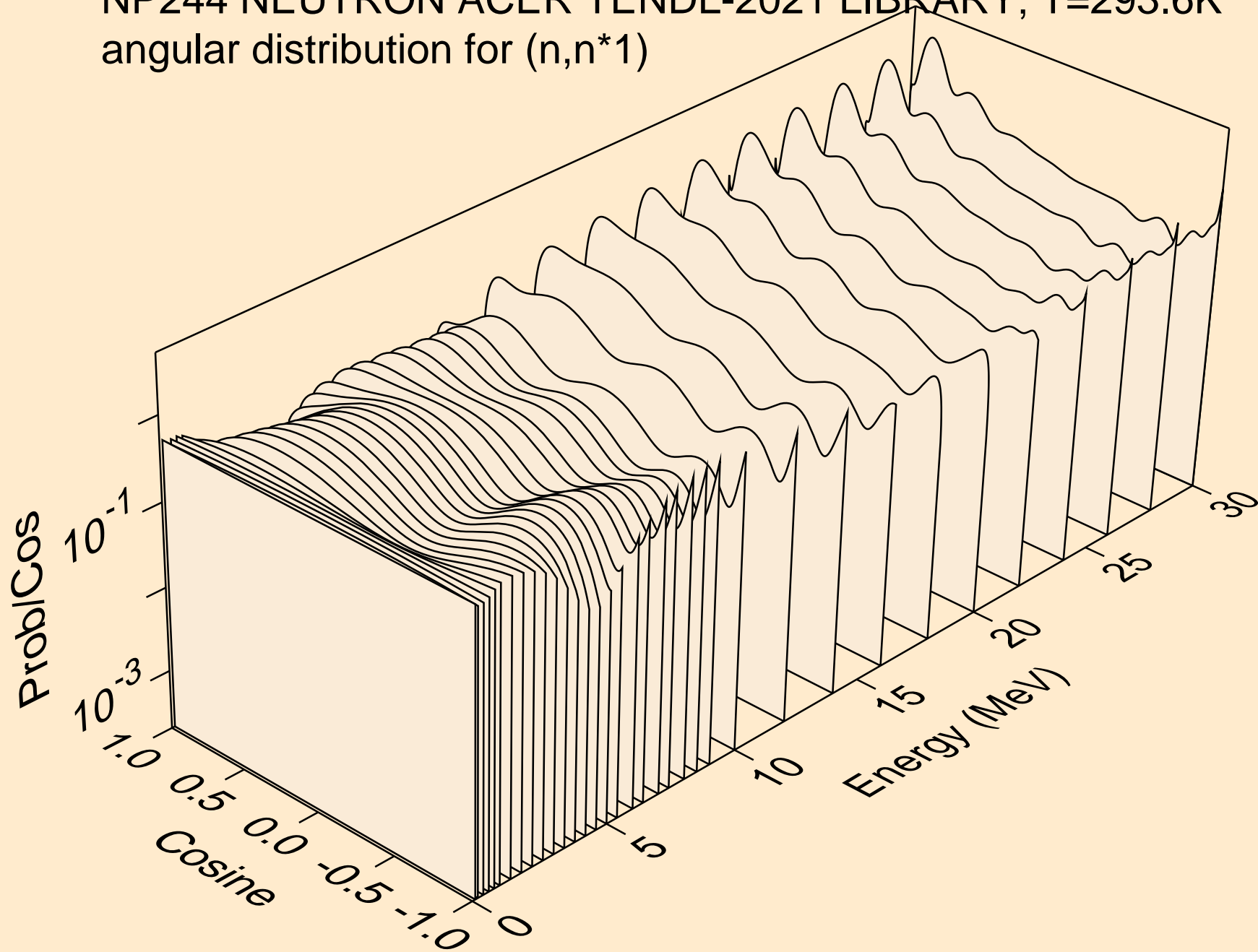

NP244 NEUTRON ACER TENDL-2021 LIBRARY; T=293.6K
Total fission nubar

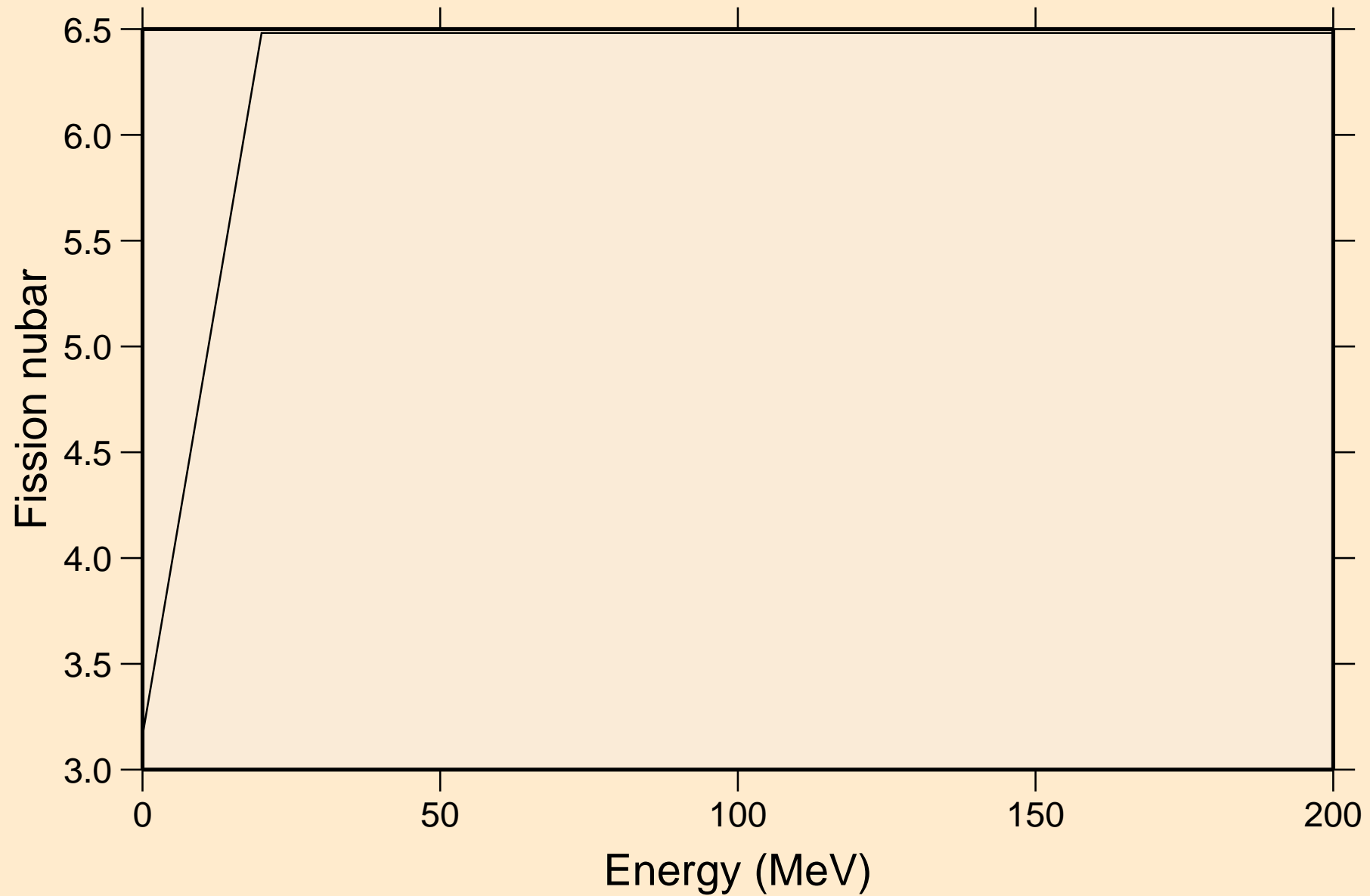

NP244 NEUTRON ACER TENDL-2021 LIBRARY; T=293.6K
Neutron emission for (n,x)

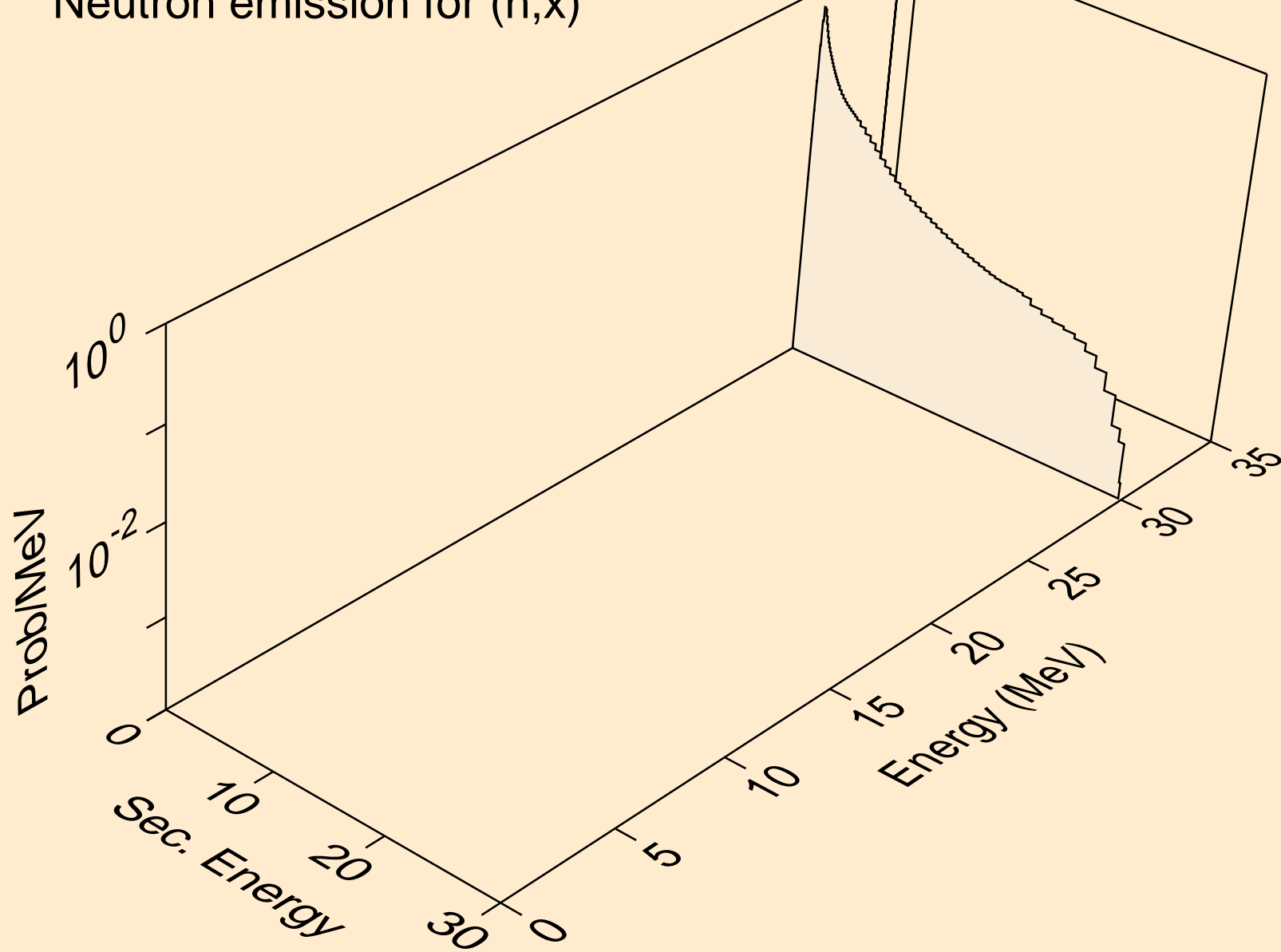

NP244 NEUTRON ACER TENDL-2021 LIBRARY; T=293.6K
Neutron emission for (n,2nd)

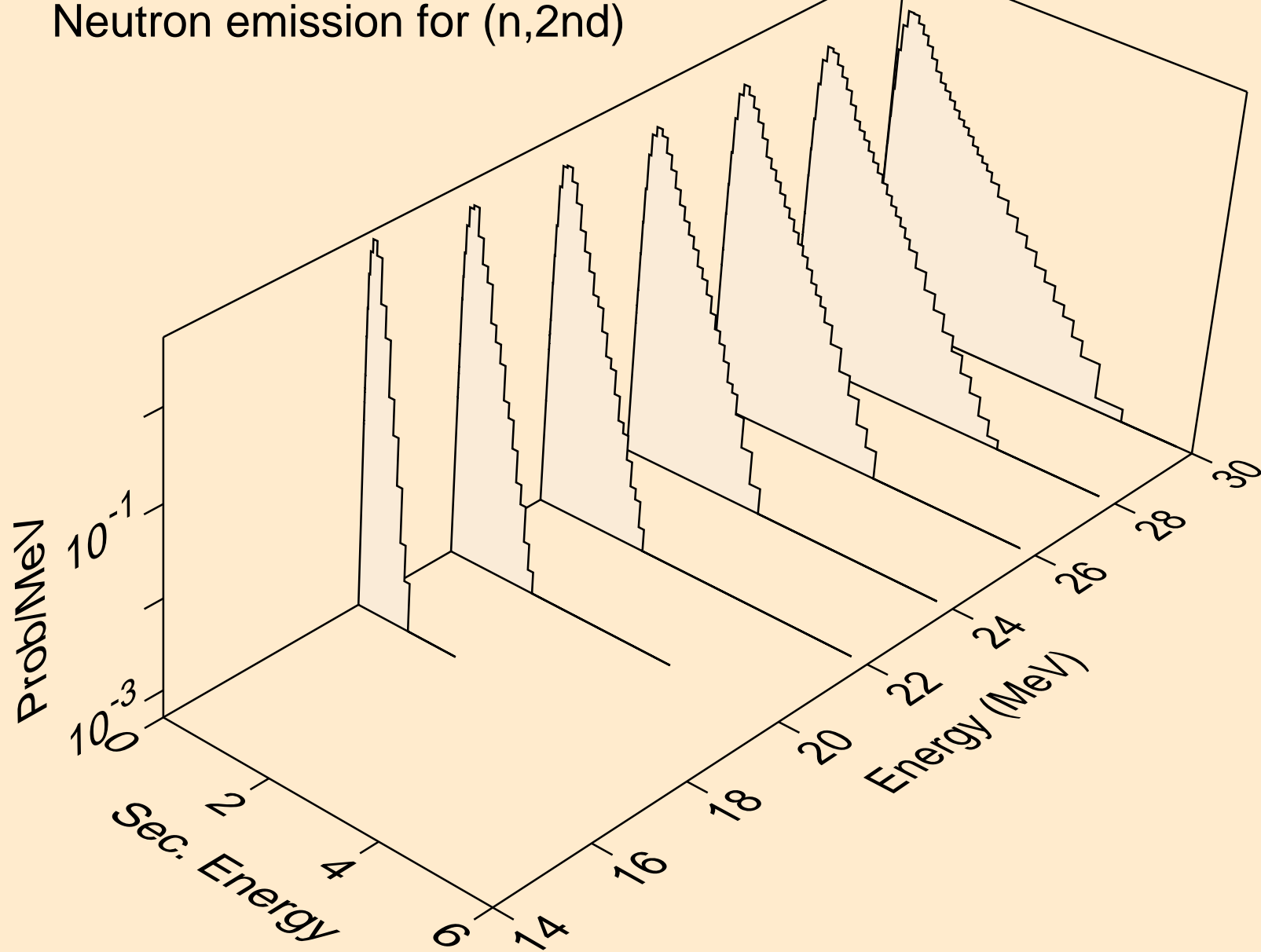

NP244 NEUTRON ACER TENDL-2021 LIBRARY; T=293.6K
Neutron emission for (n,2n)

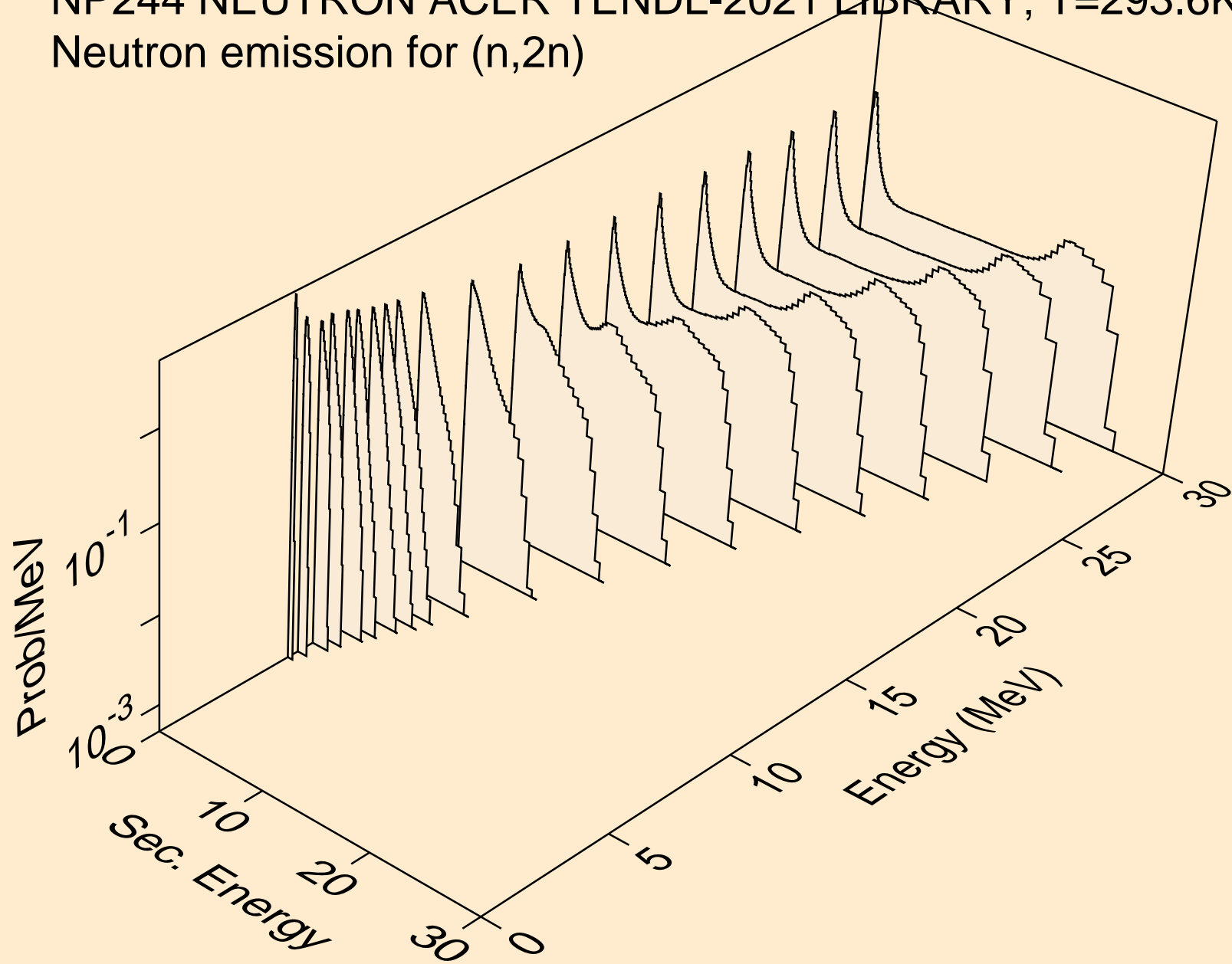

NP244 NEUTRON ACER TENDL-2021 LIBRARY; T=293.6K
Neutron emission for (n,3n)

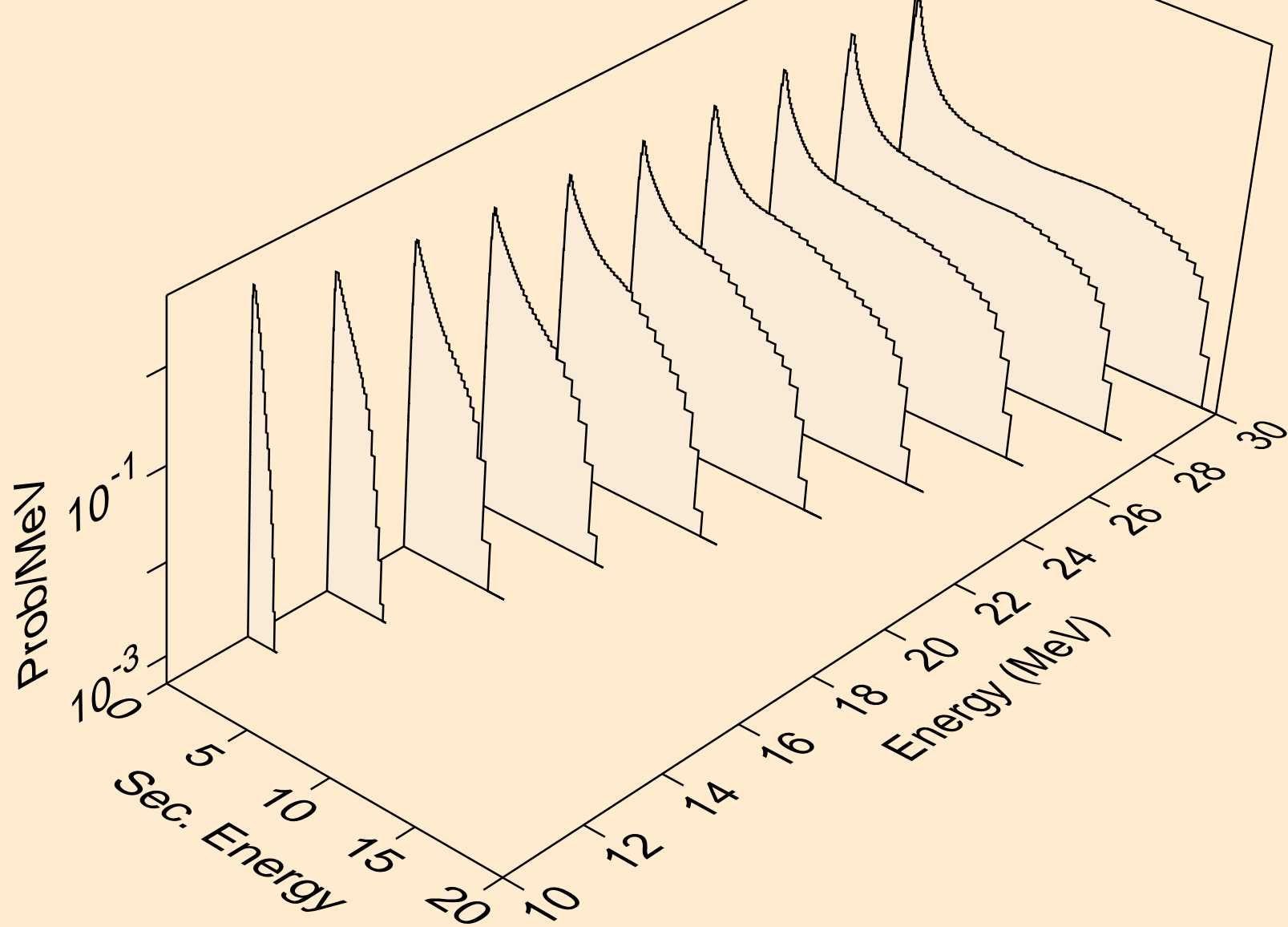

NP244 NEUTRON ACER TENDL-2021 LIBRARY; T=293.6K
Neutron emission for fission

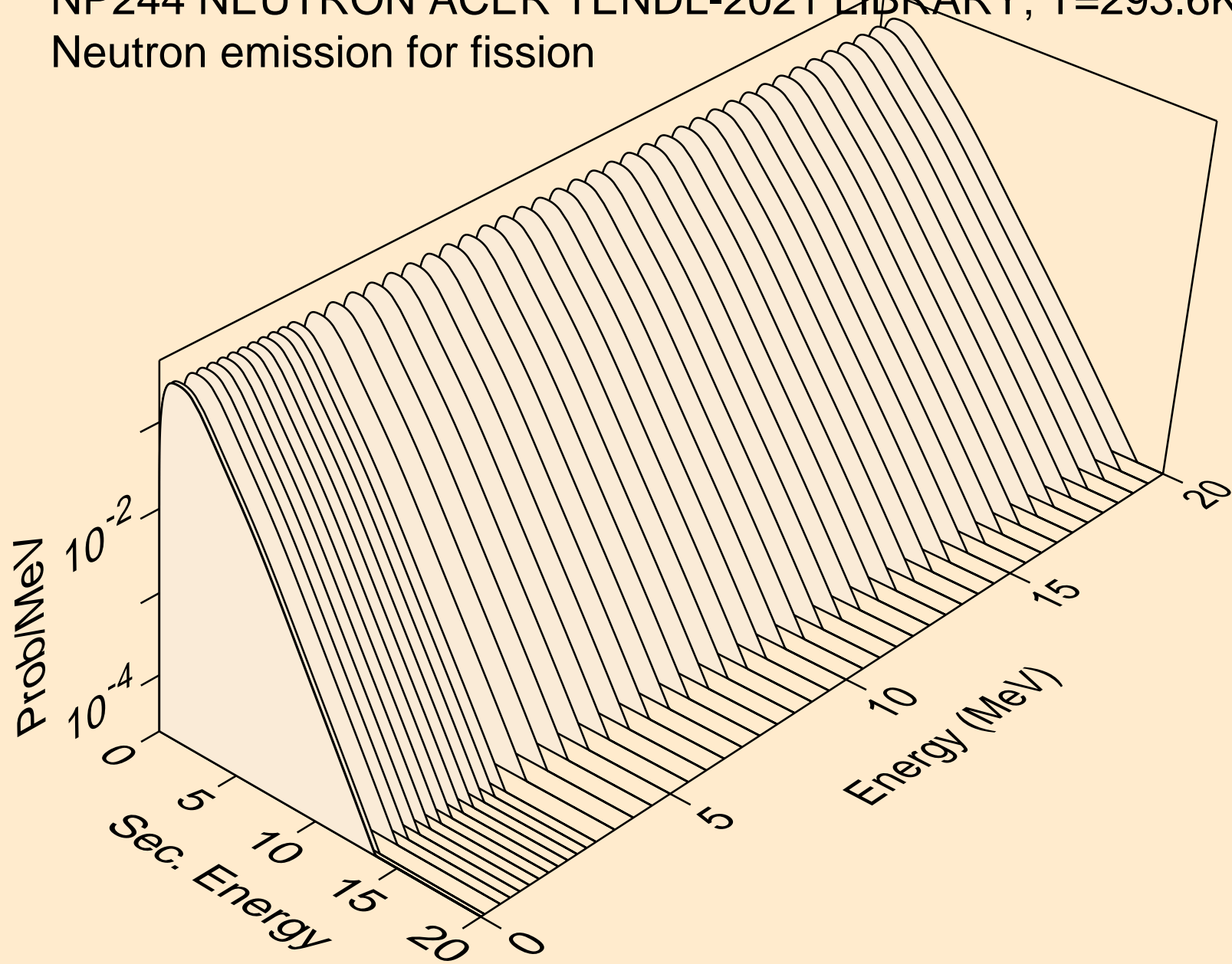

NP244 NEUTRON ACER TENDL-2021 LIBRARY; T=293.6K
Neutron emission for (n,n*)a

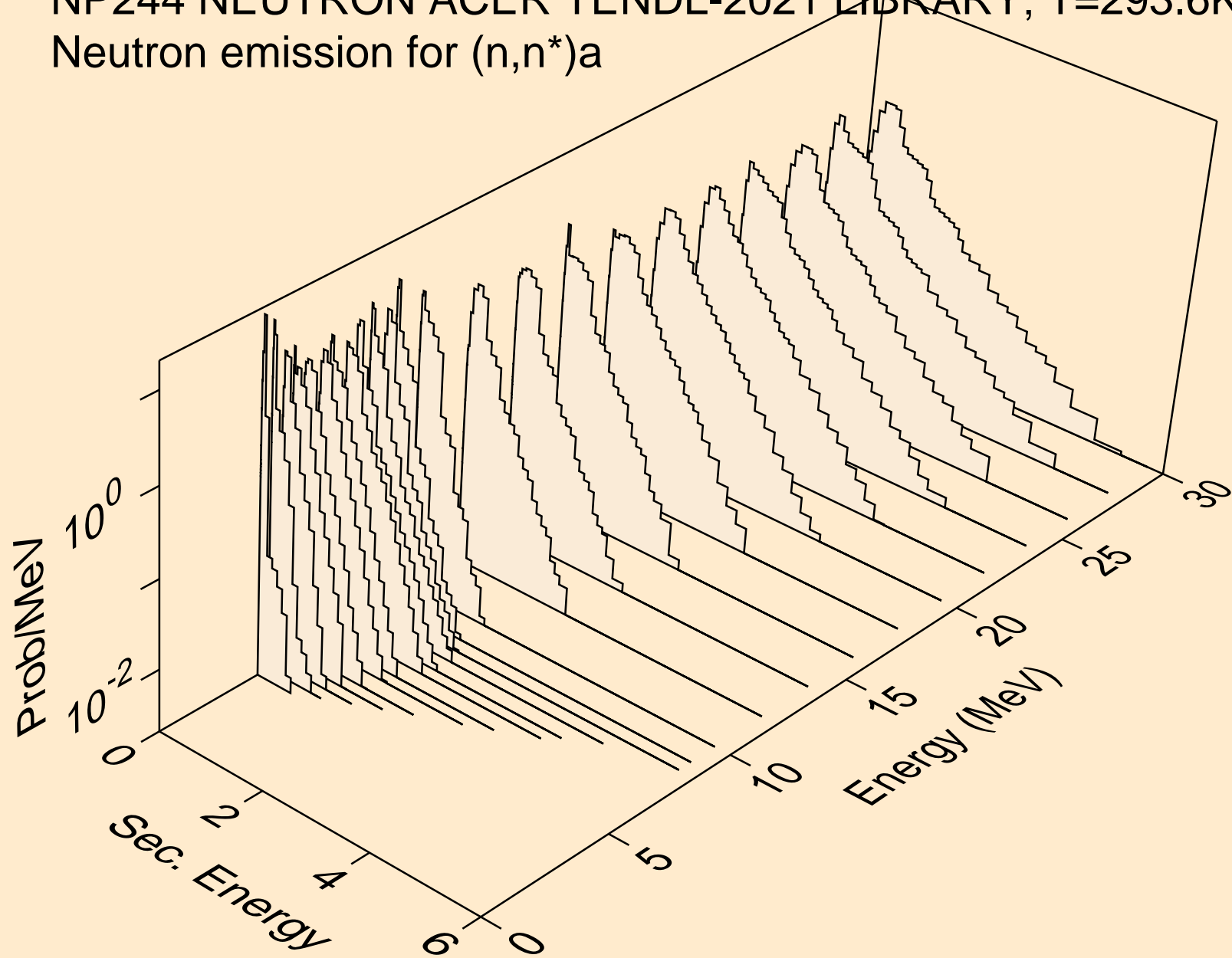

NP244 NEUTRON ACER TENDL-2021 LIBRARY; T=293.6K
Neutron emission for (n,2n)_a

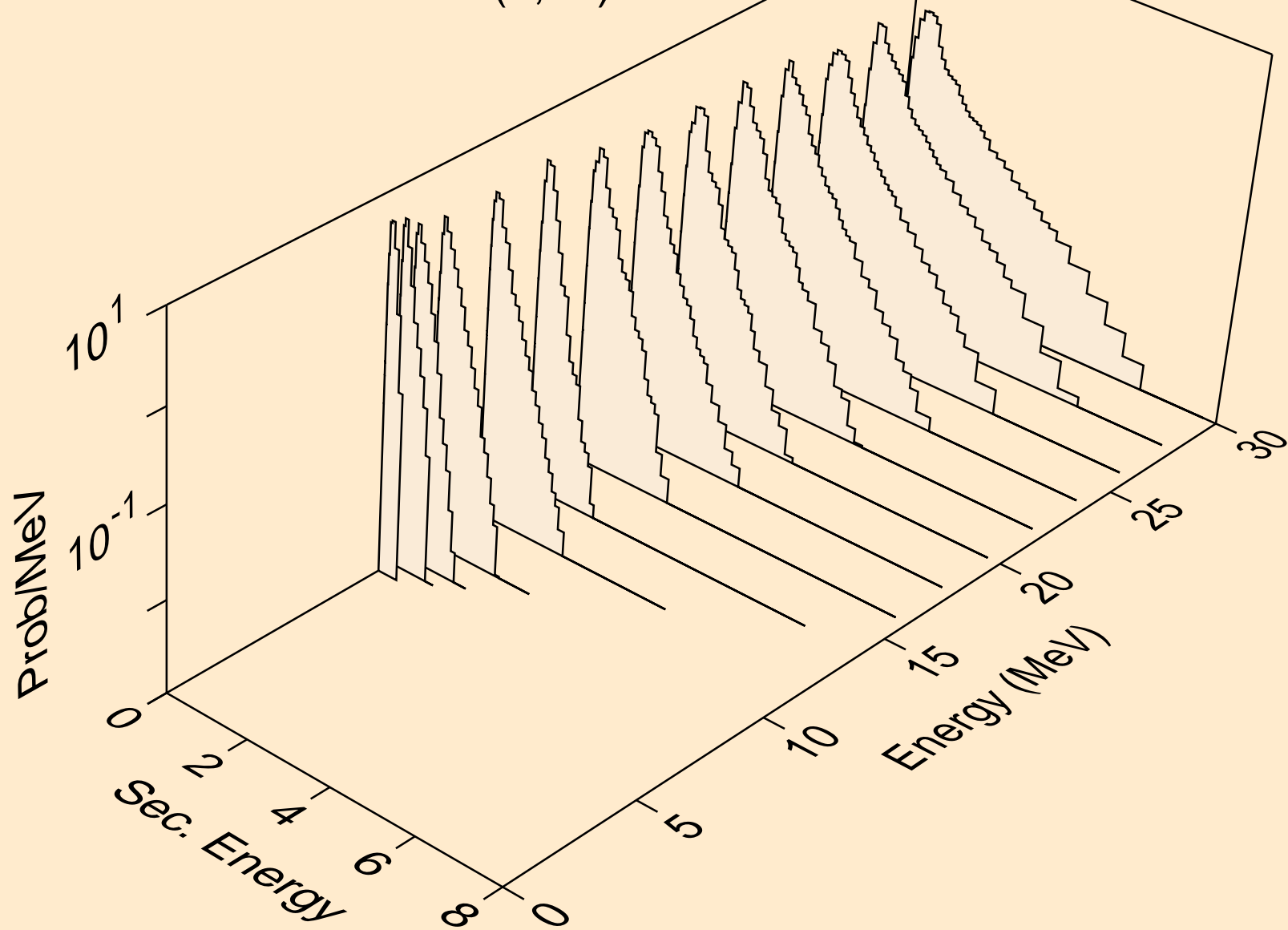

NP244 NEUTRON ACER TENDL-2021 LIBRARY; T=293.6K
Neutron emission for (n,3n)_a

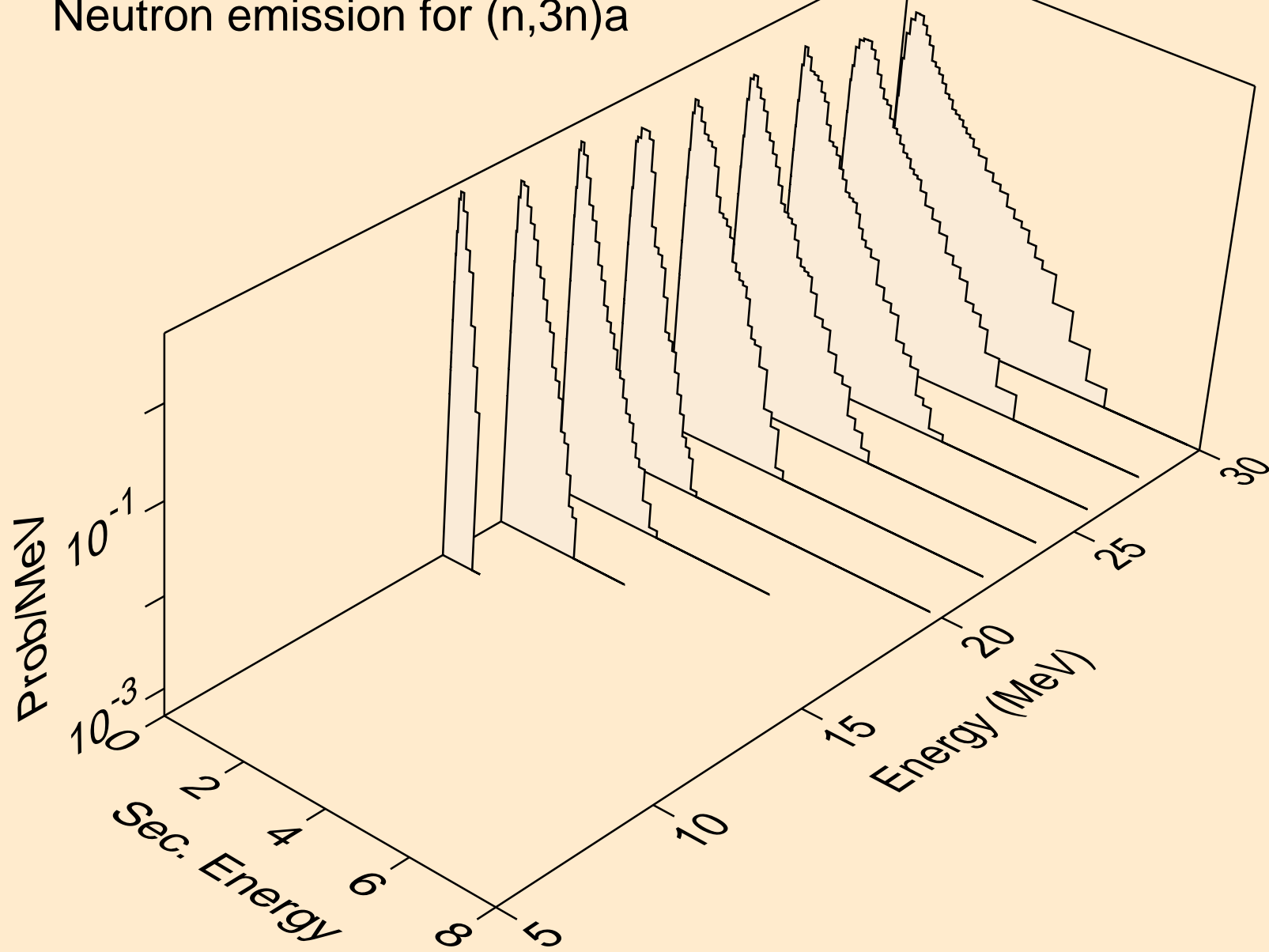

NP244 NEUTRON ACER TENDL-2021 LIBRARY; T=293.6K
Neutron emission for (n,n*)p

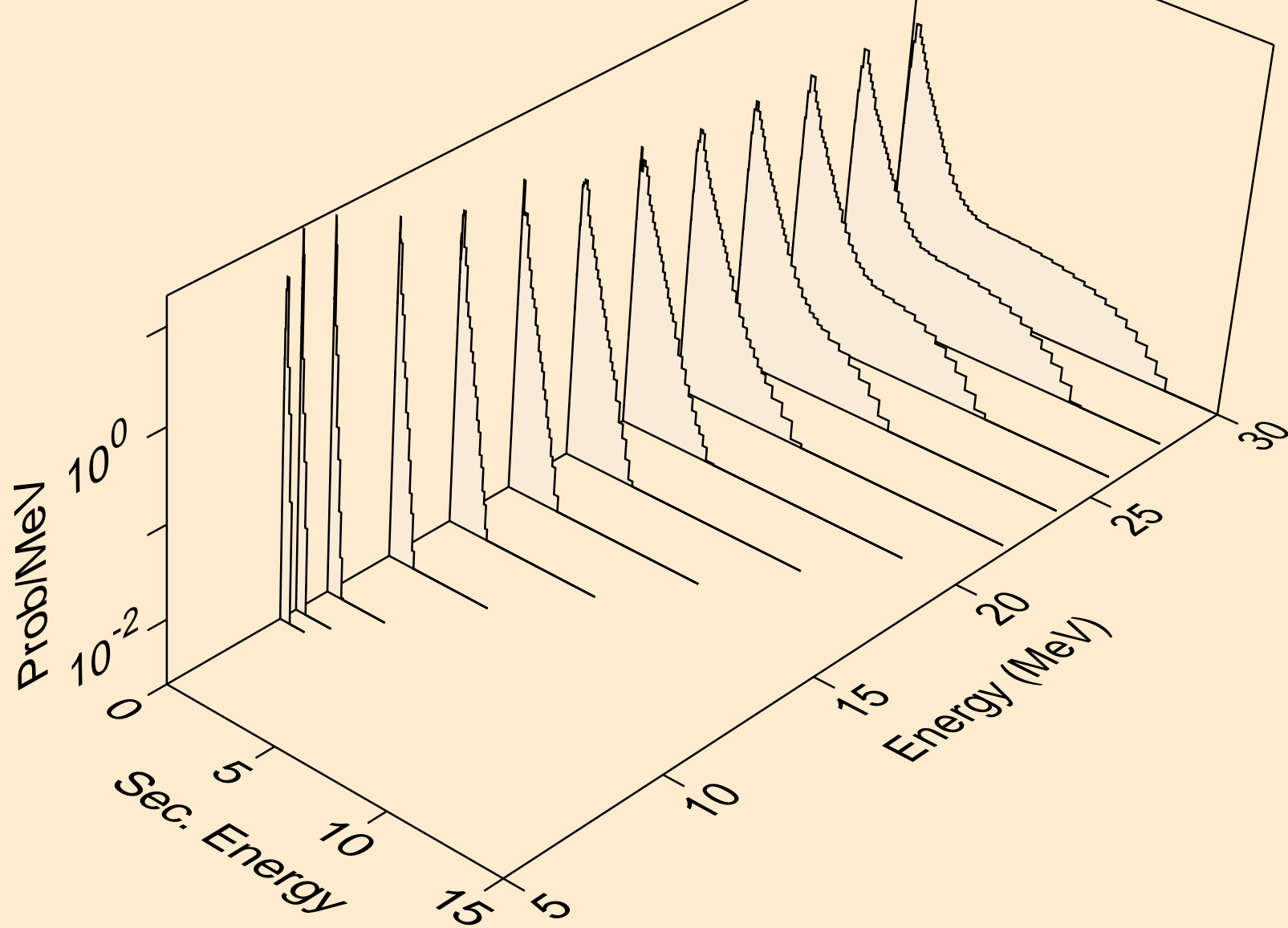

NP244 NEUTRON ACER TENDL-2021 LIBRARY; T=293.6K
Neutron emission for (n,n*)2a

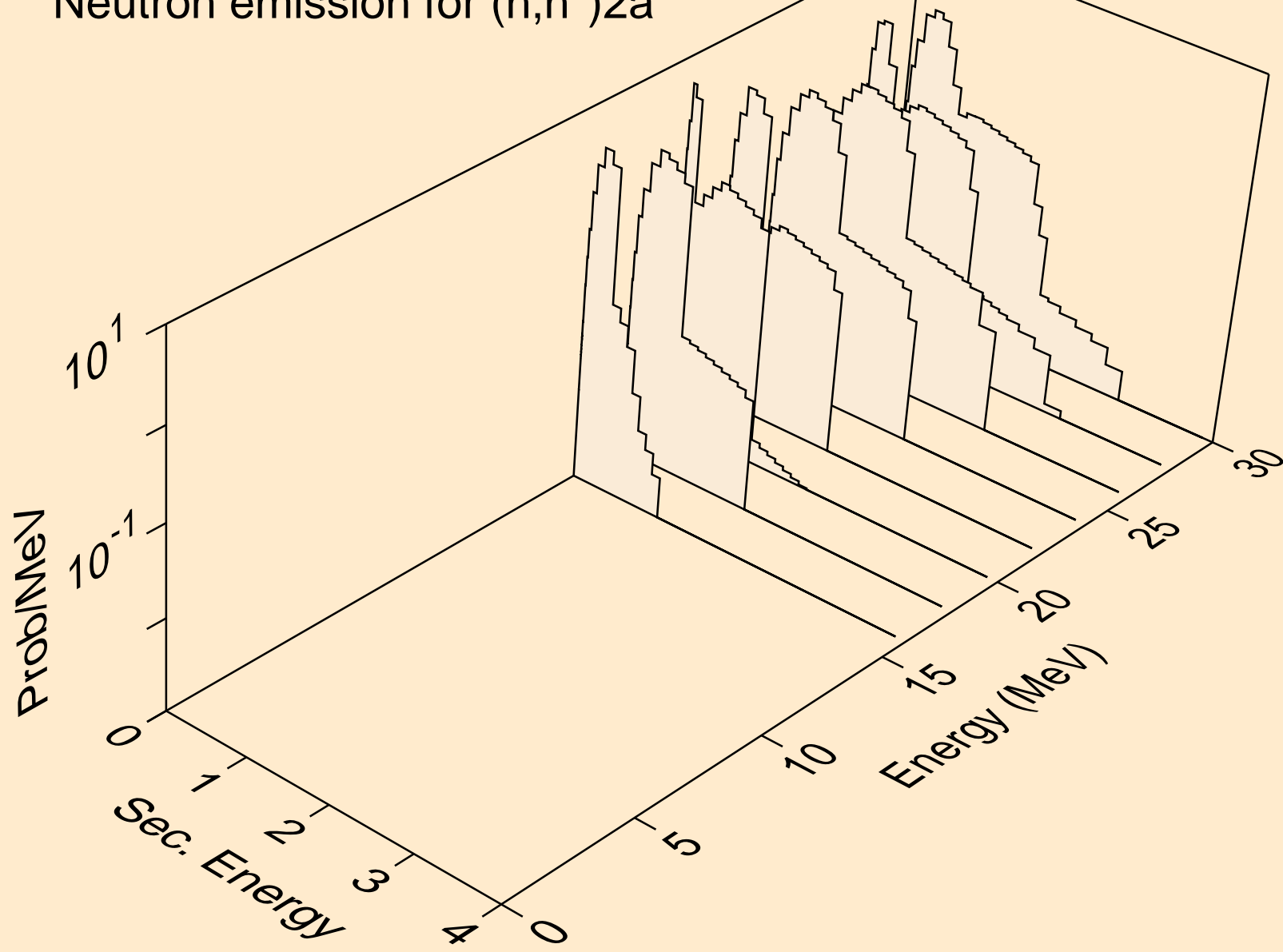

NP244 NEUTRON ACER TENDL-2021 LIBRARY; T=293.6K
Neutron emission for (n,2n)2a

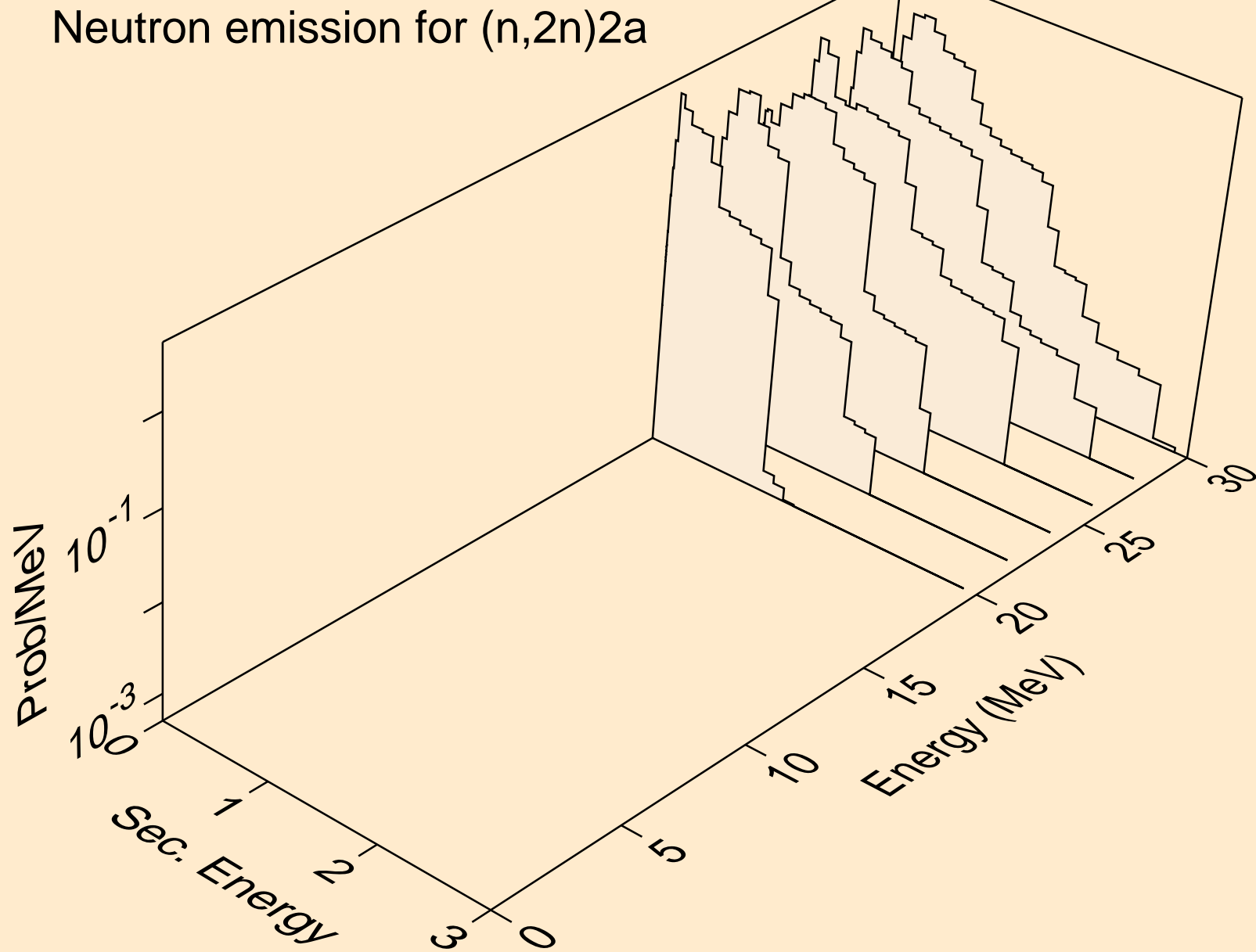

NP244 NEUTRON ACER TENDL-2021 LIBRARY; T=293.6K
Neutron emission for (n,n*)d

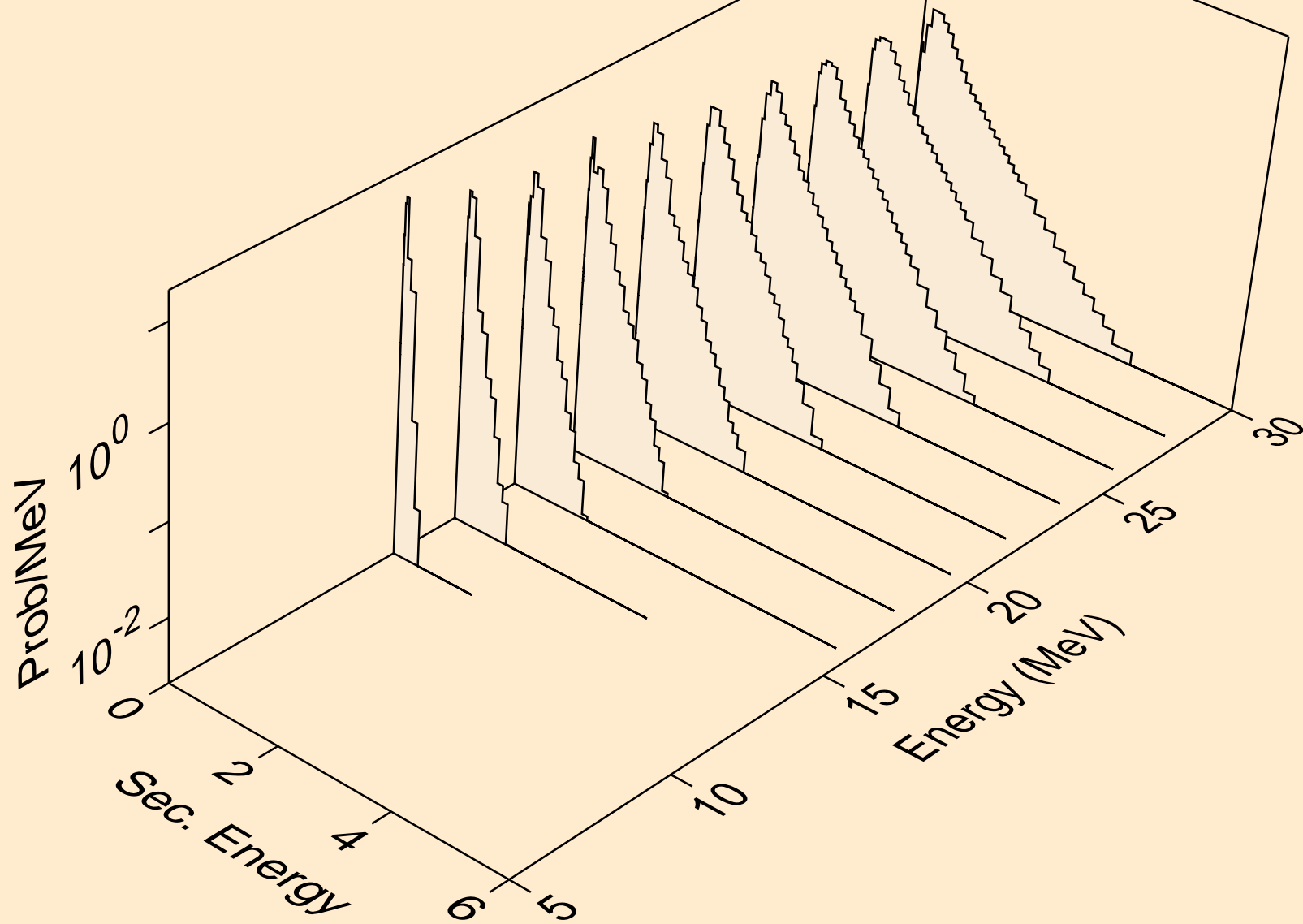

NP244 NEUTRON ACER TENDL-2021 LIBRARY; T=293.6K
Neutron emission for (n,n*)t

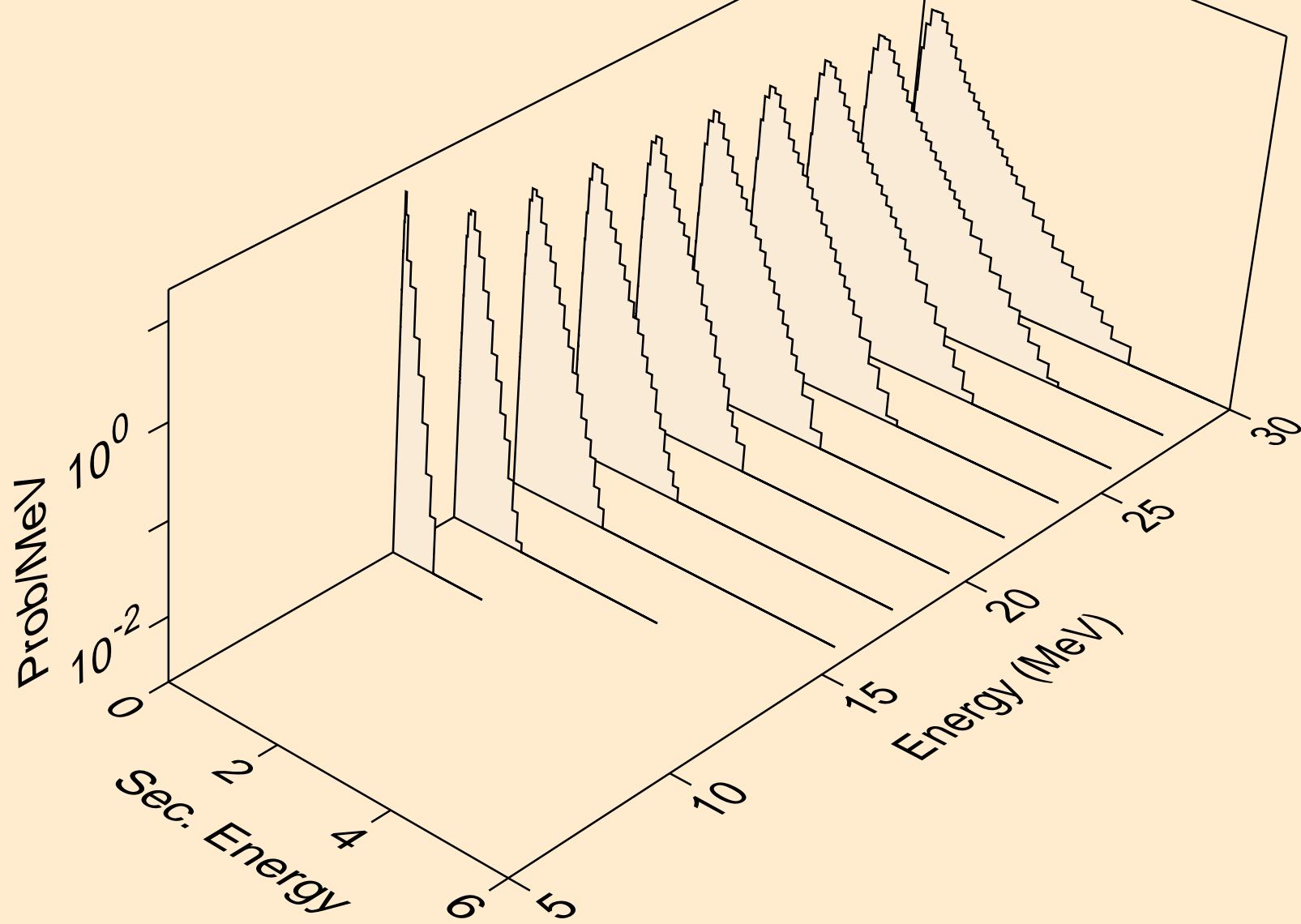

NP244 NEUTRON ACER TENDL-2021 LIBRARY; T=293.6K
Neutron emission for (n,n*)he3

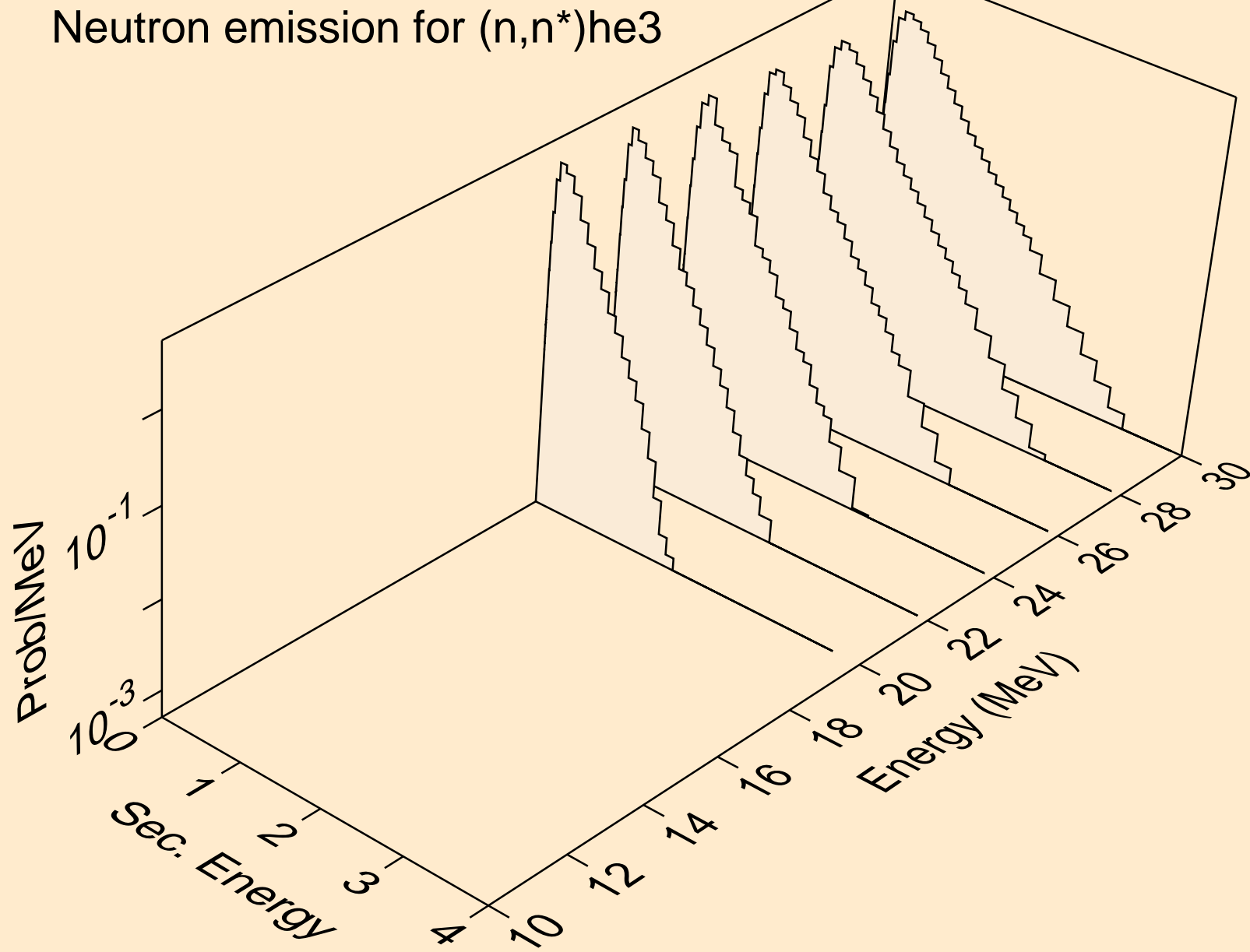

NP244 NEUTRON ACER TENDL-2021 LIBRARY; T=293.6K
Neutron emission for (n,4n)

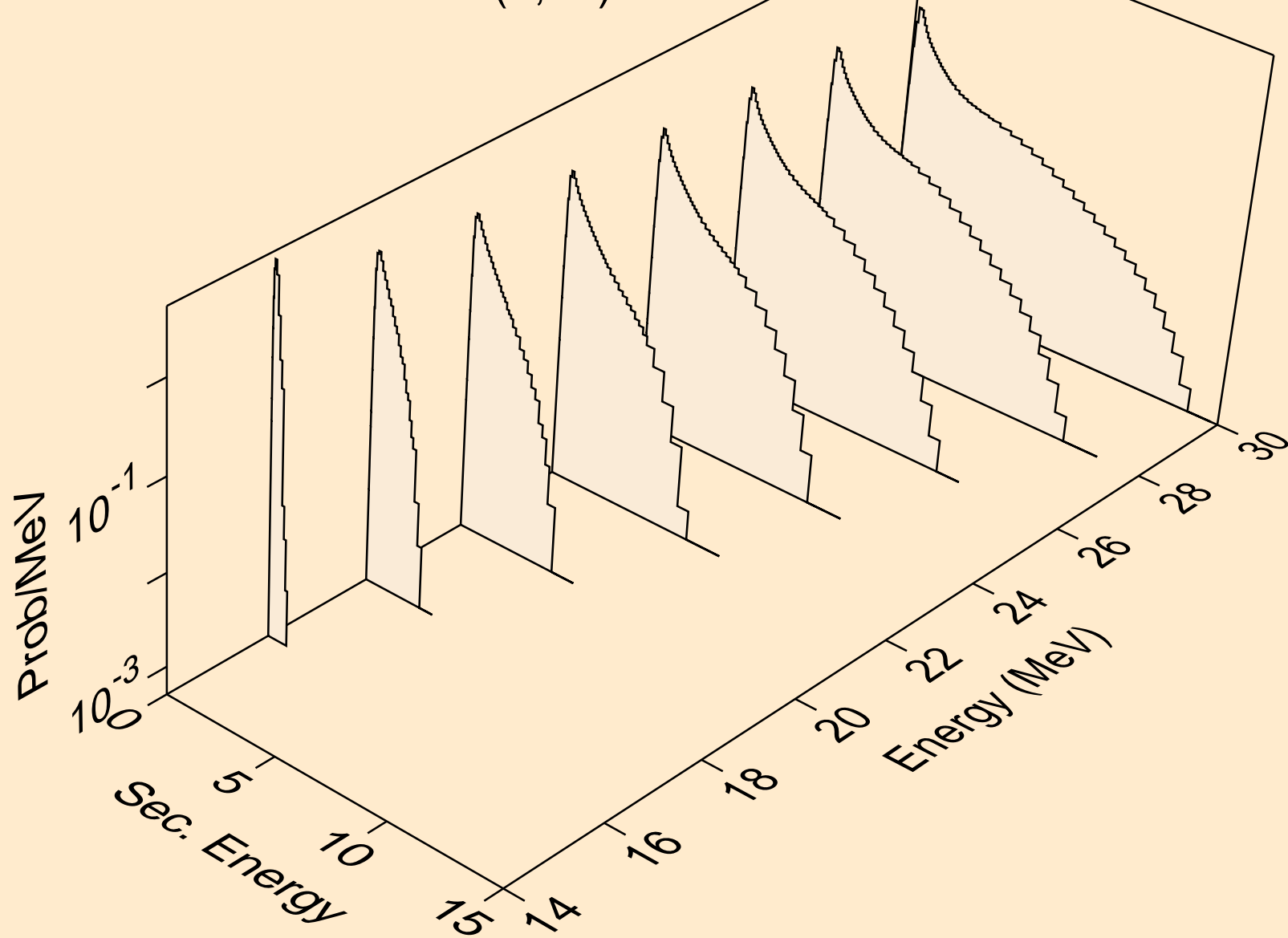

NP244 NEUTRON ACER TENDL-2021 LIBRARY; T=293.6K
Neutron emission for (n,2np)

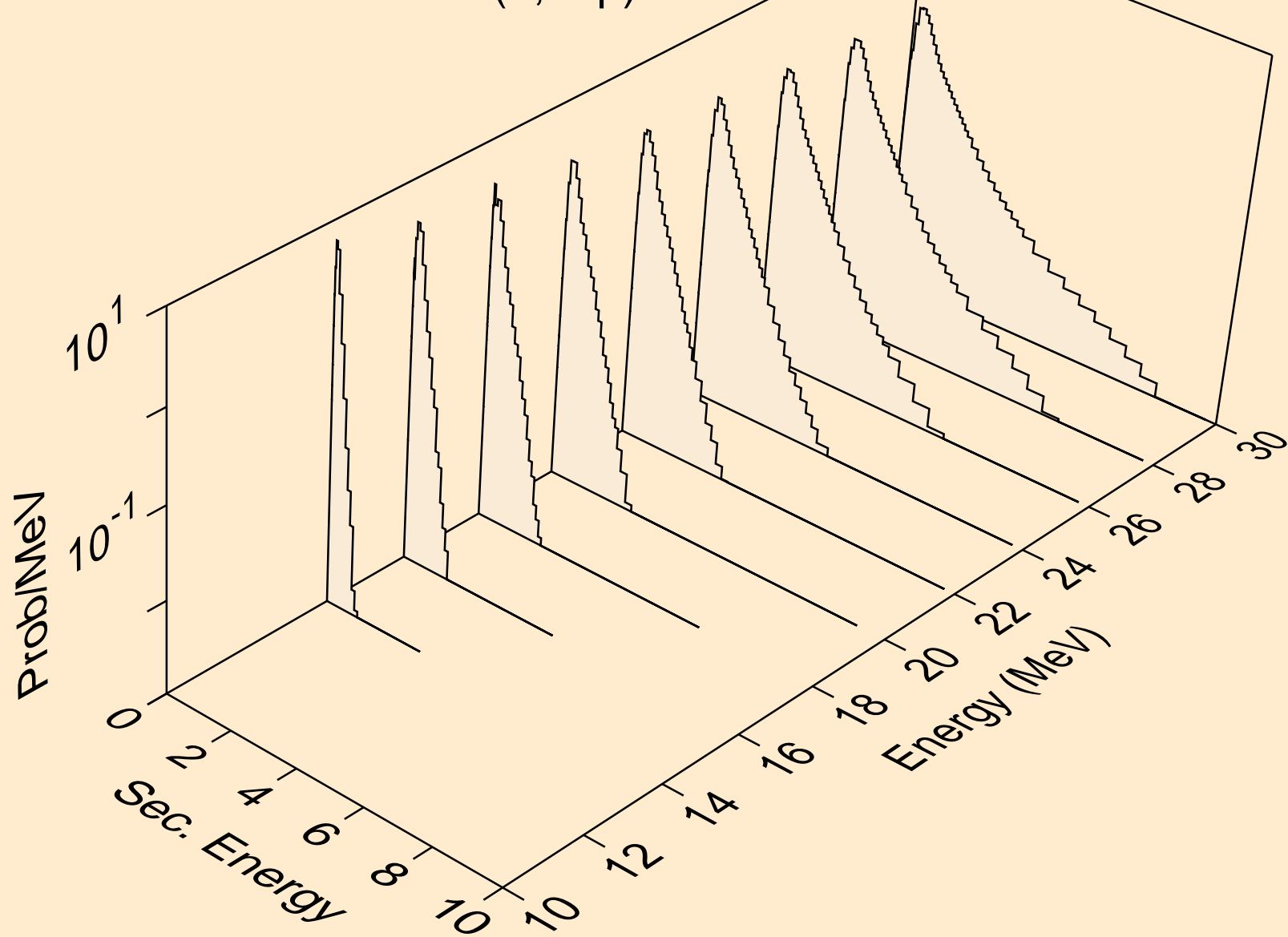

NP244 NEUTRON ACER TENDL-2021 LIBRARY; T=293.6K
Neutron emission for (n,3np)

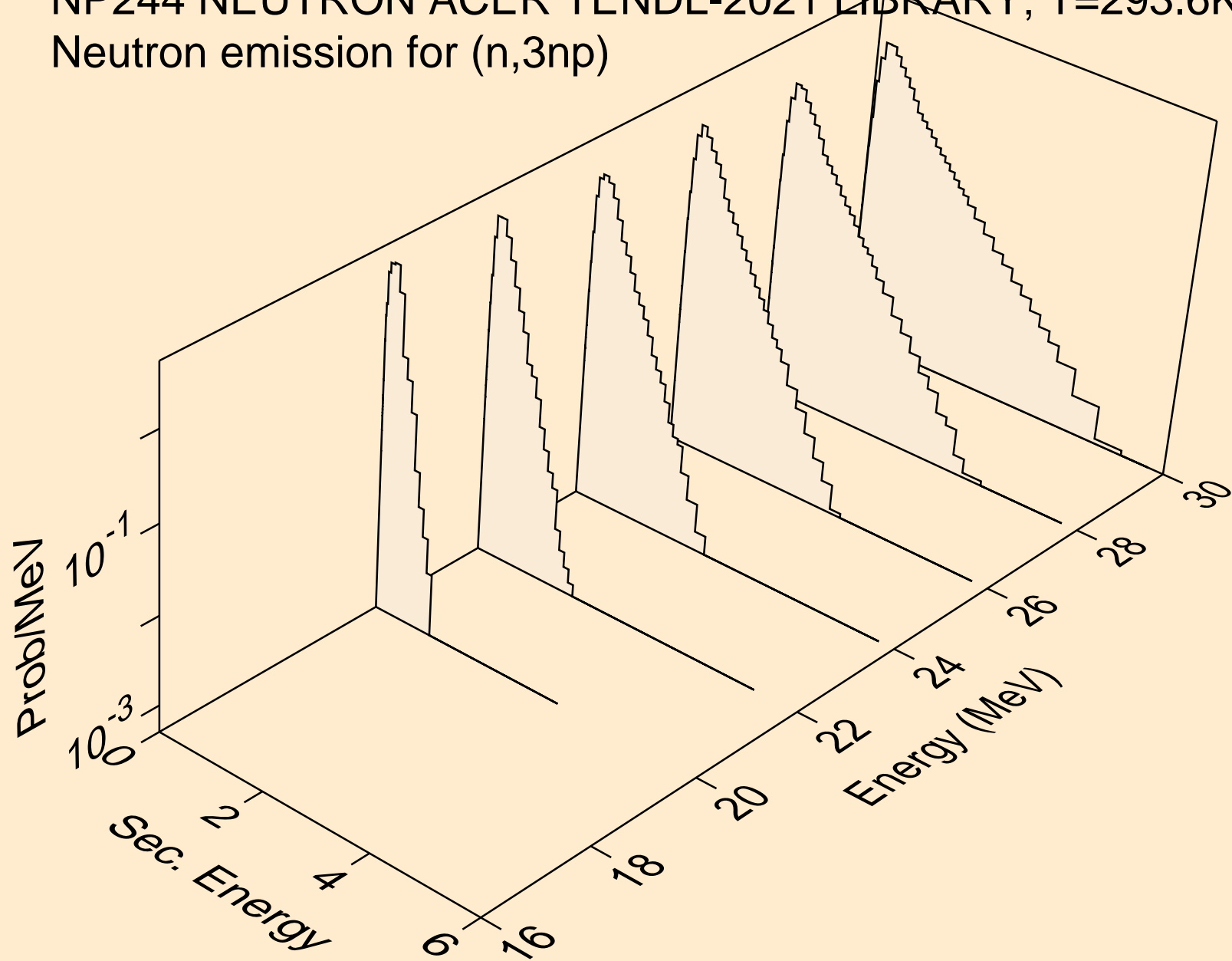

NP244 NEUTRON ACER TENDL-2021 LIBRARY; T=293.6K
Neutron emission for (n,2np)

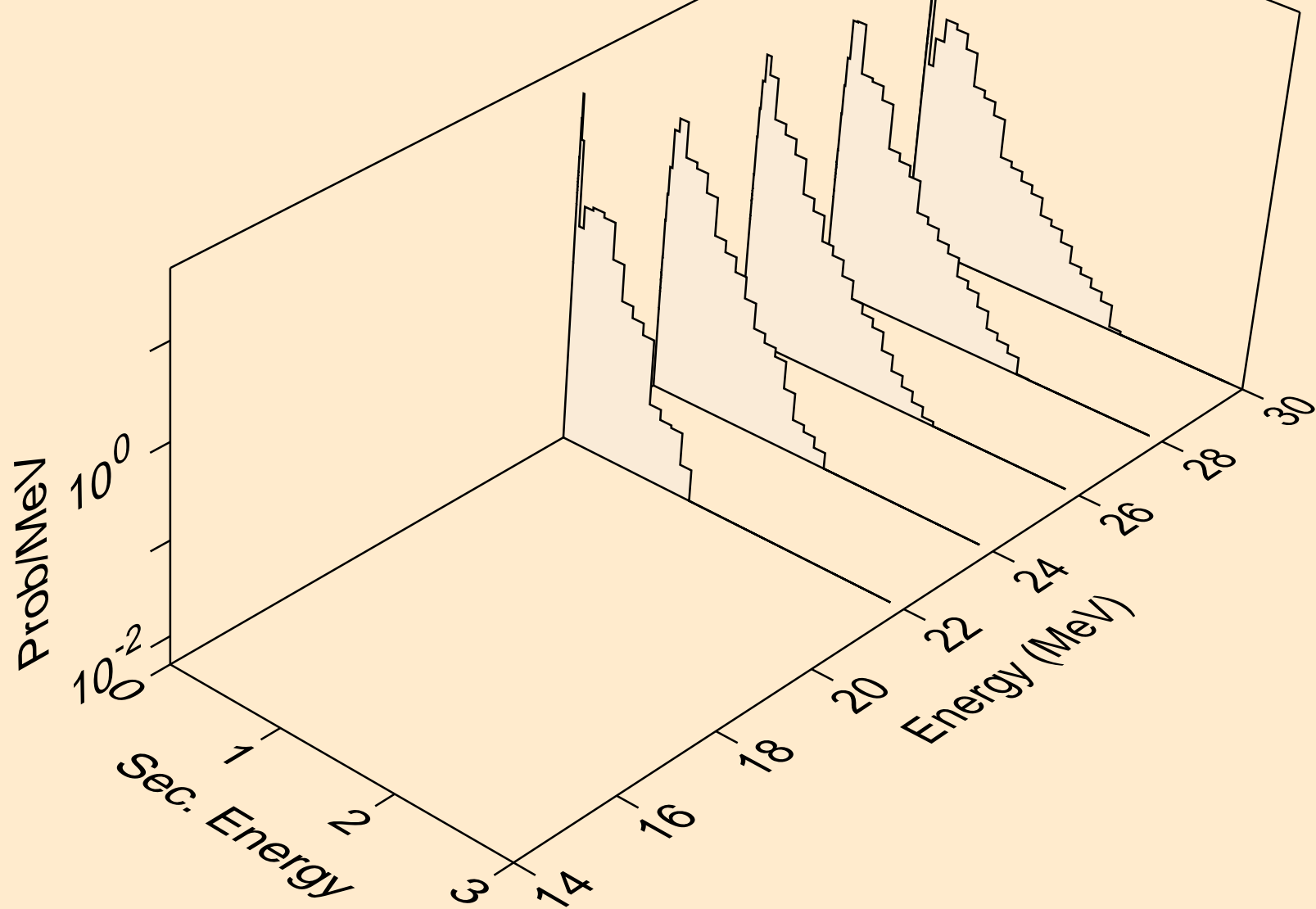

NP244 NEUTRON ACER TENDL-2021 LIBRARY; T=293.6K
Neutron emission for (n,npa)

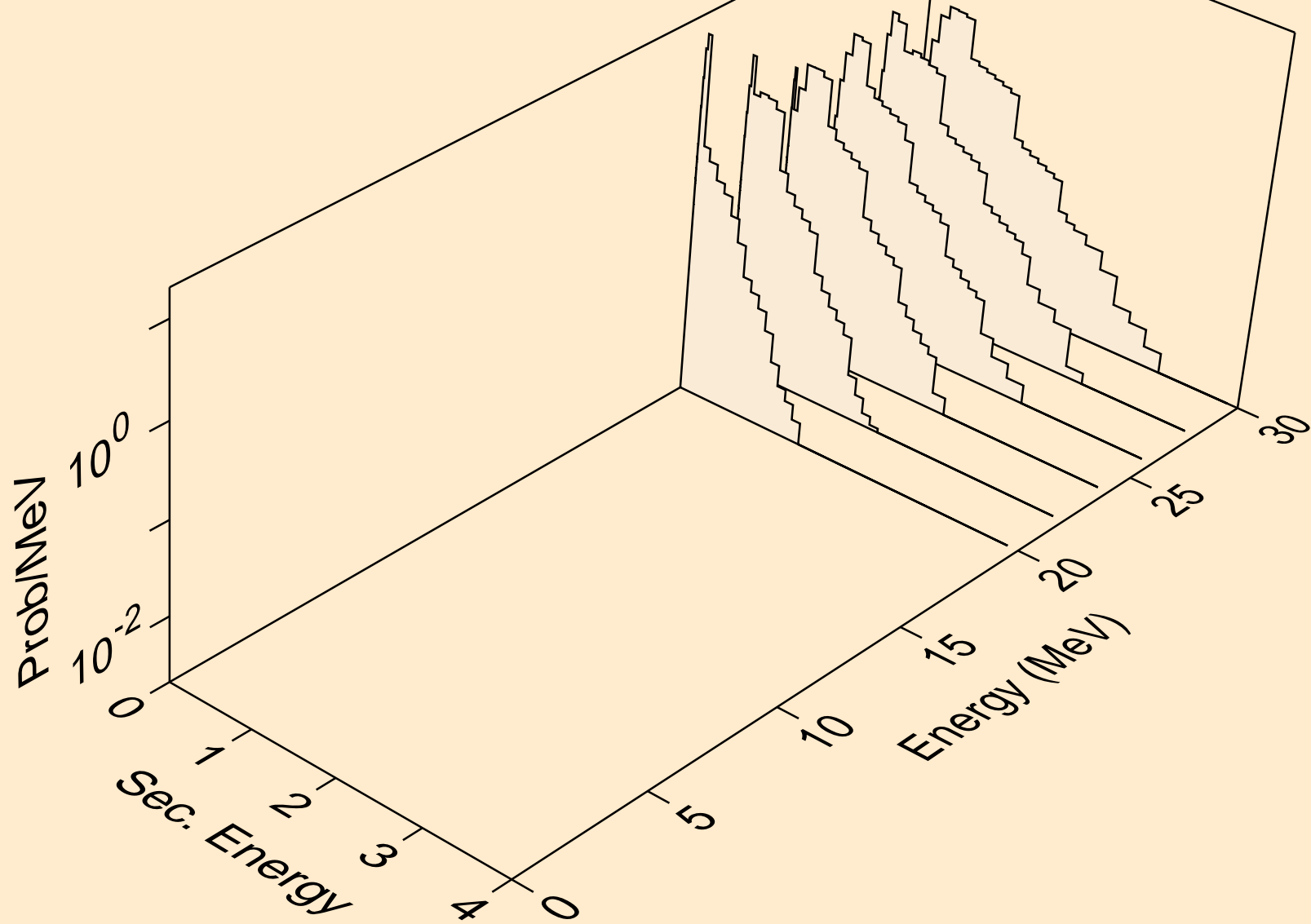

NP244 NEUTRON ACER TENDL-2021 LIBRARY; T=293.6K
Neutron emission for (n,n*c)

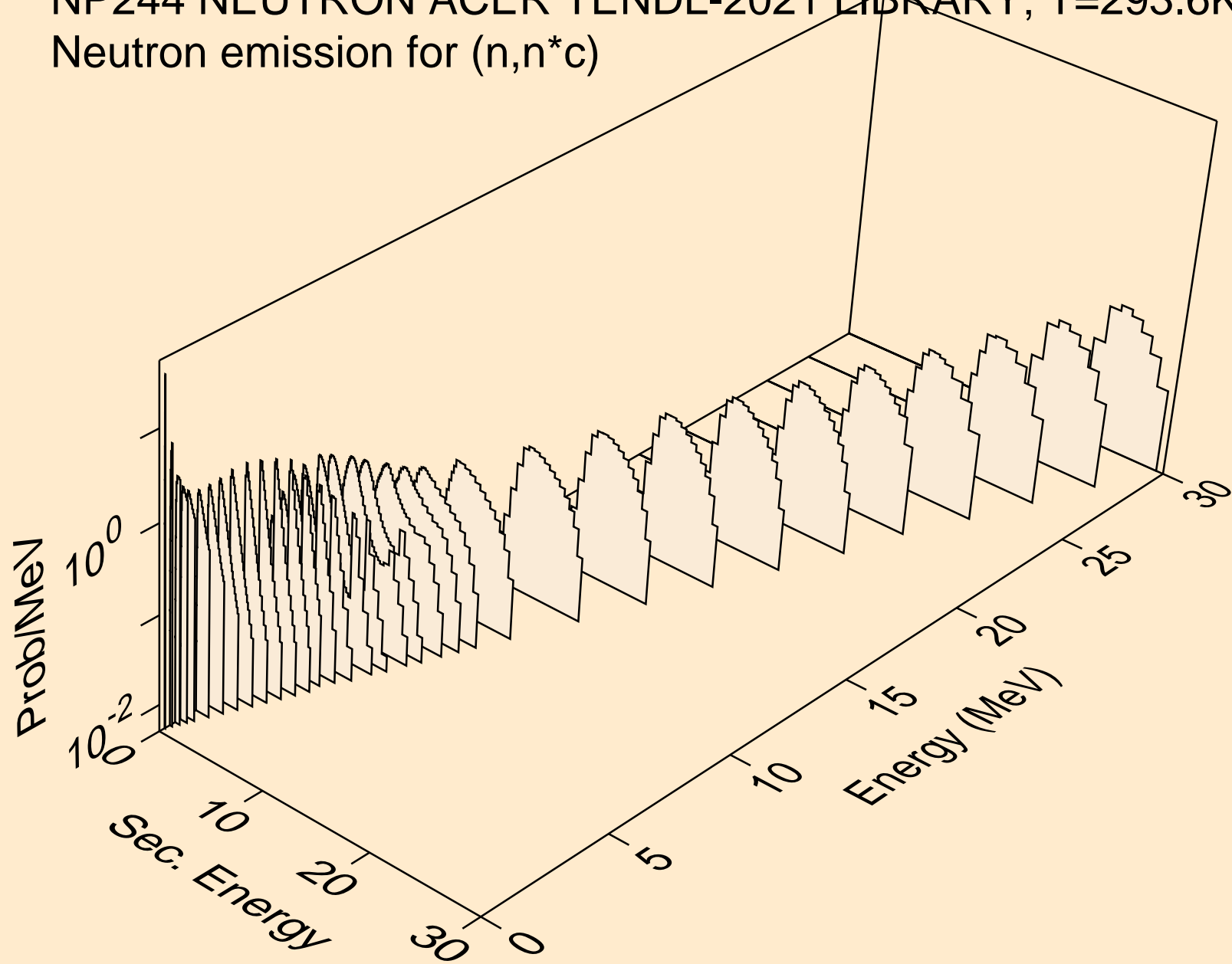

NP244 NEUTRON ACER TENDL-2021 LIBRARY; T=293.6K
Delayed nubar

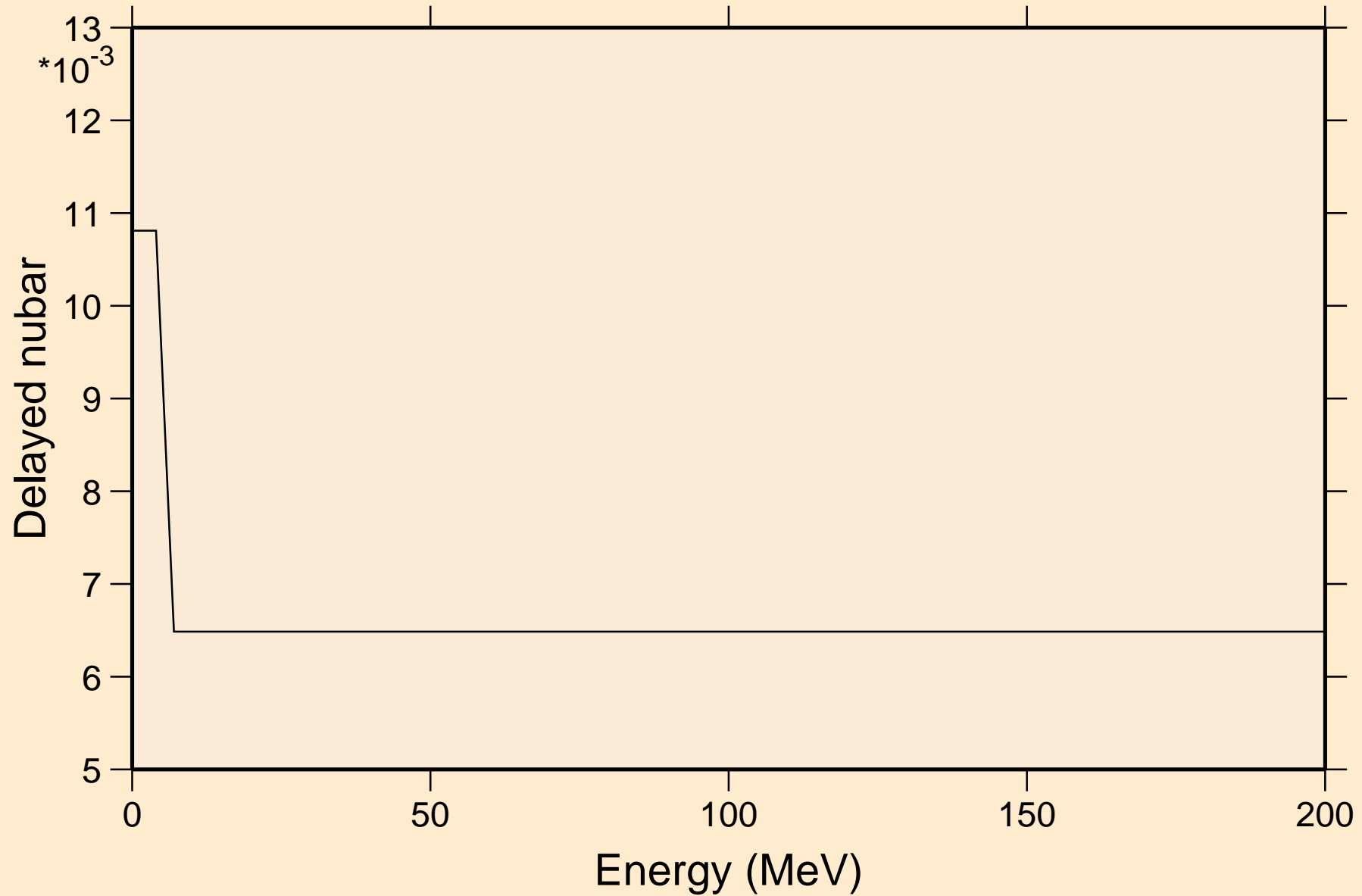

NP244 NEUTRON ACER TENDL-2021 LIBRARY; T=293.6K

Delayed neutron spectra

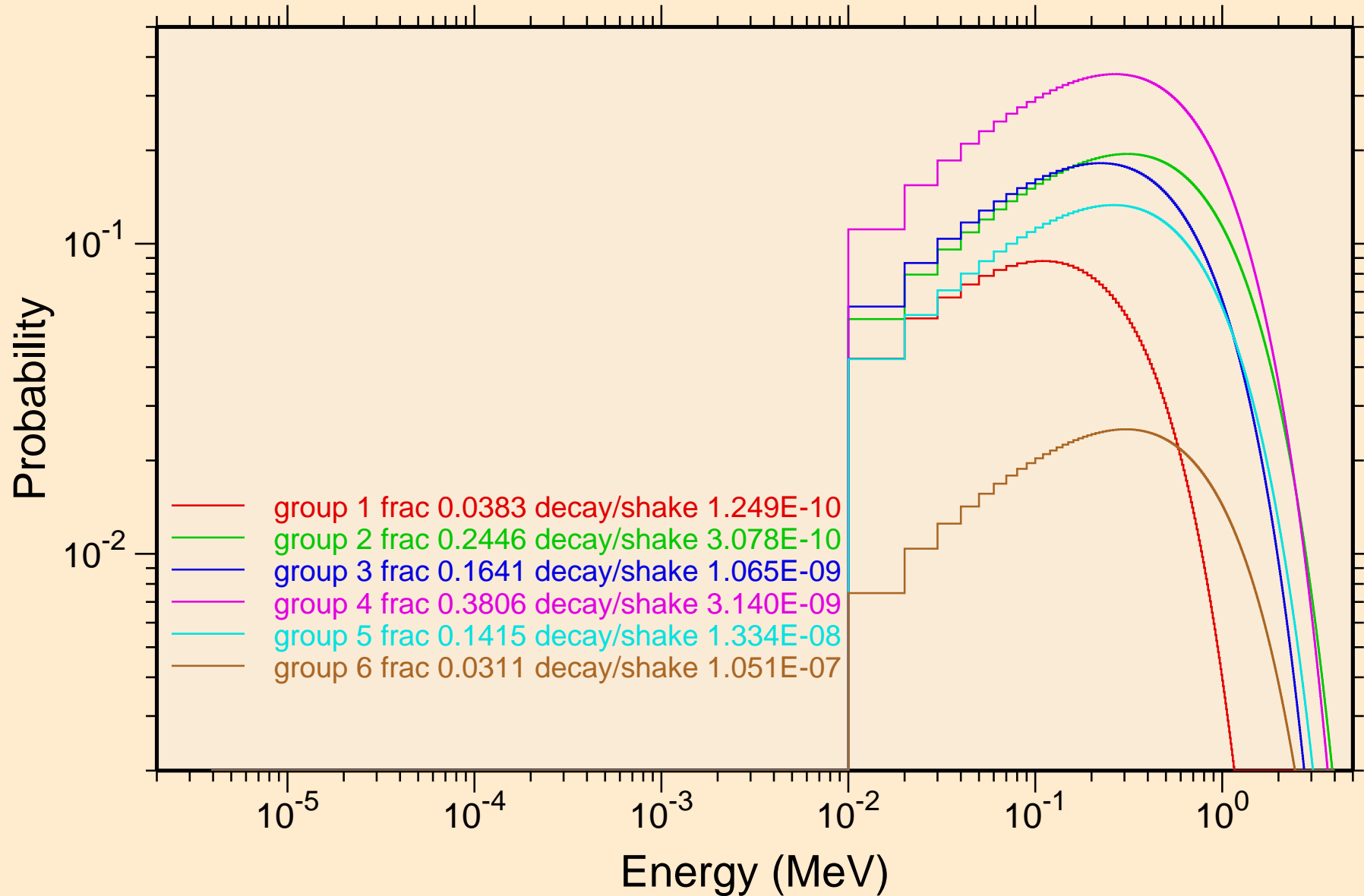

NP244 NEUTRON ACER TENDL-2021 LIBRARY; T=293.6K
Photon emission for (n,x)

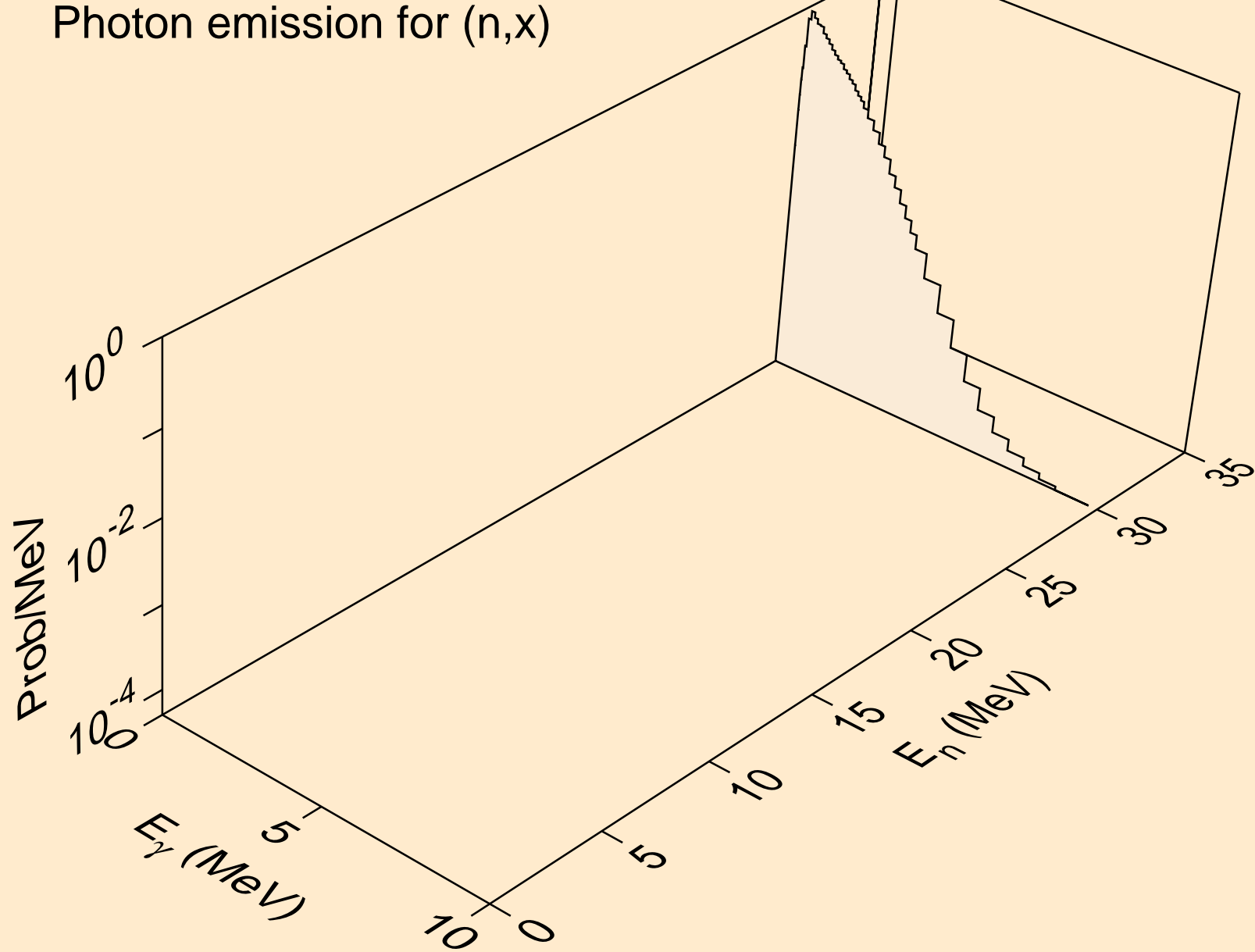

NP244 NEUTRON ACER TENDL-2021 LIBRARY; T=293.6K
Photon emission for (n,2nd)

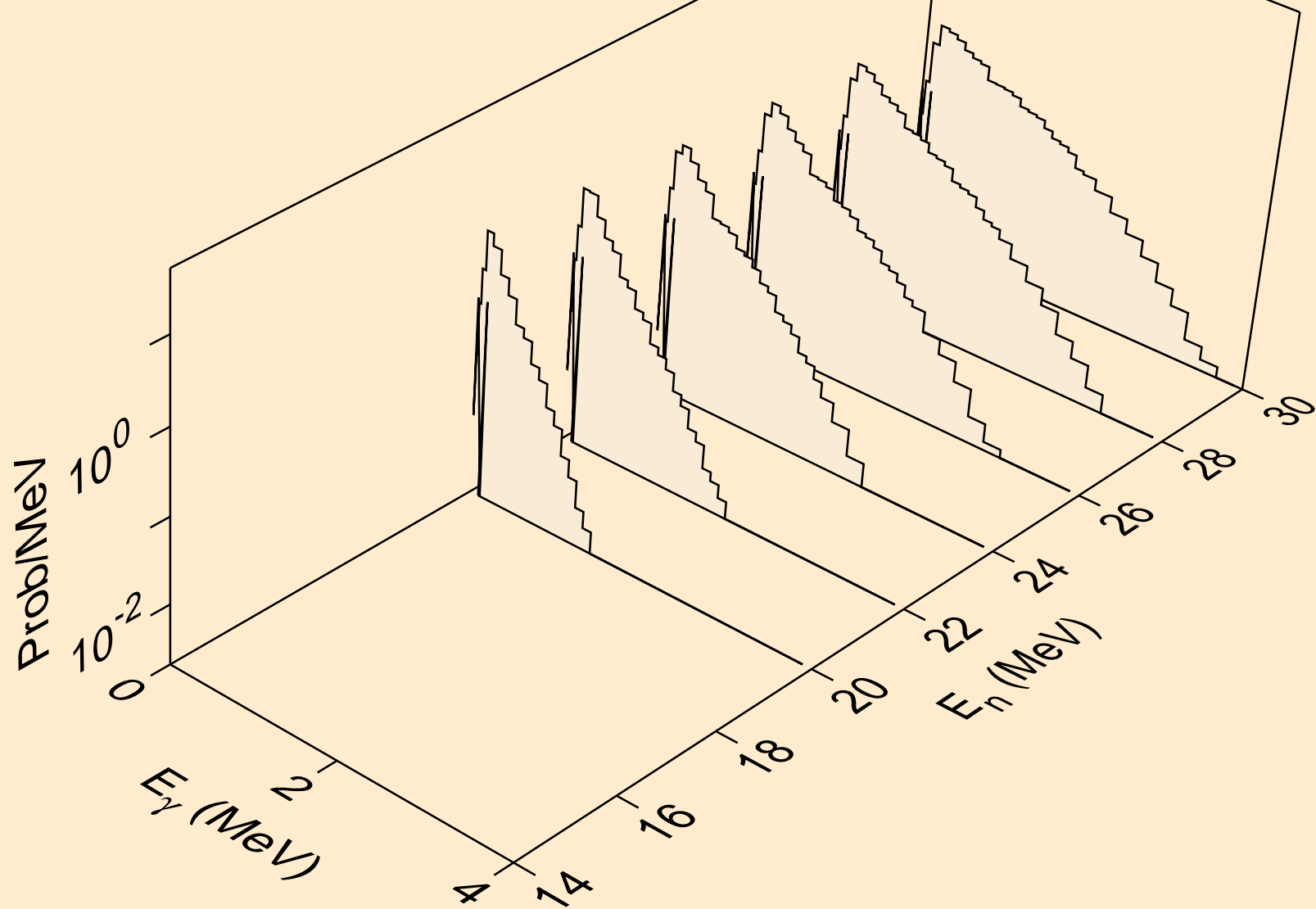

NP244 NEUTRON ACER TENDL-2021 LIBRARY; T=293.6K
Photon emission for (n,2n)

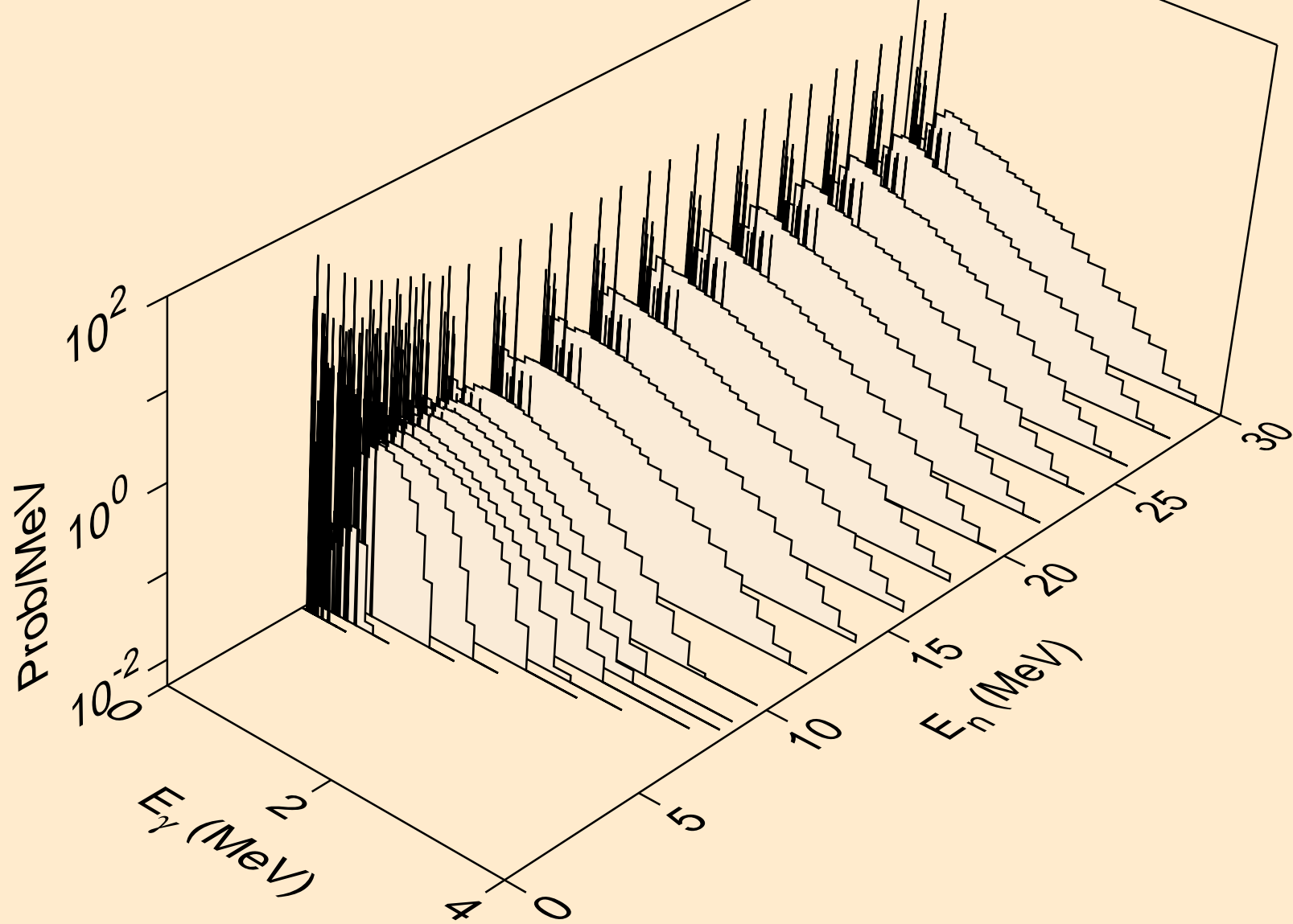

NP244 NEUTRON ACER TENDL-2021 LIBRARY; T=293.6K
Photon emission for (n,3n)

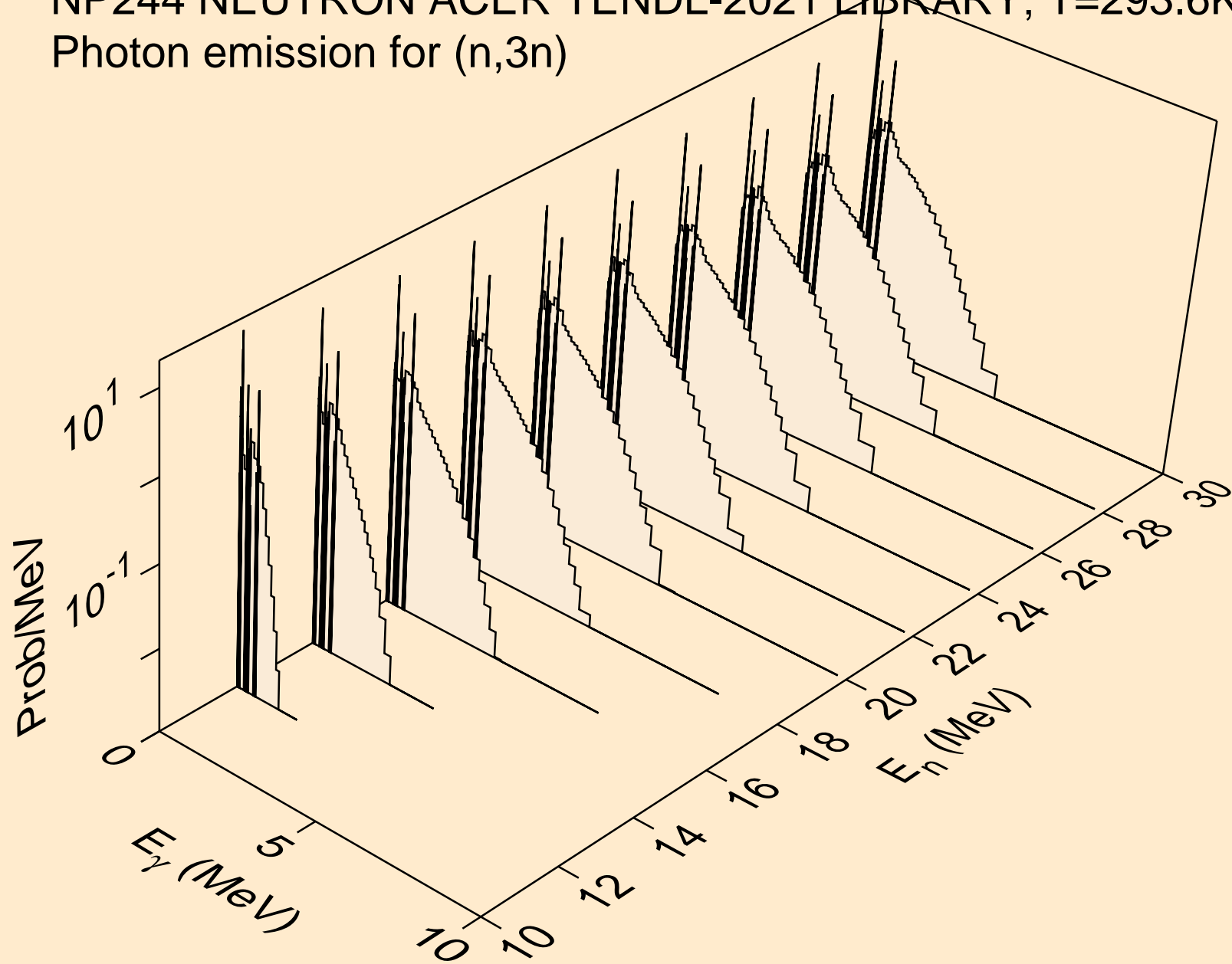

NP244 NEUTRON ACER TENDL-2021 LIBRARY; T=293.6K
Photon emission for (n,n*)a

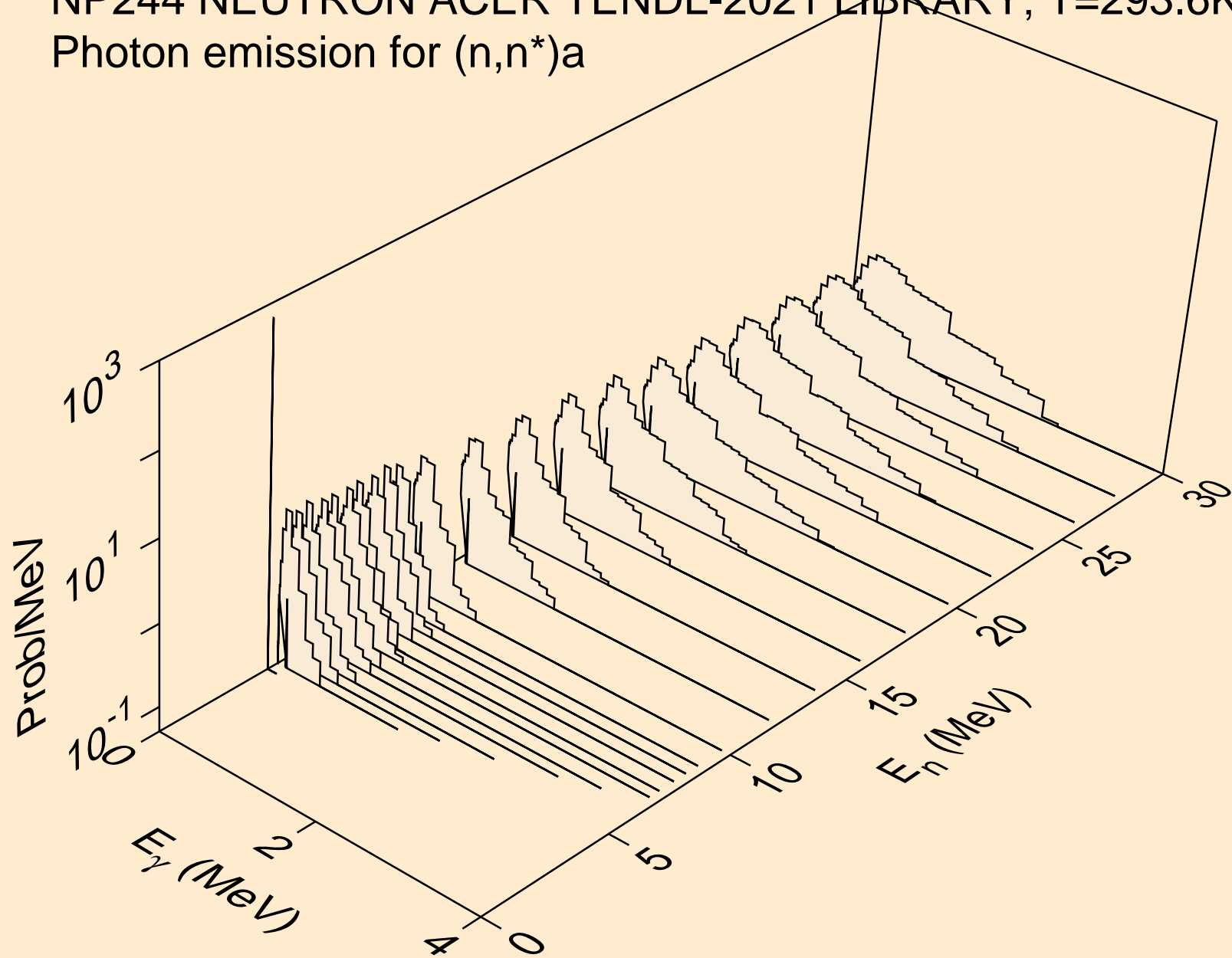

NP244 NEUTRON ACER TENDL-2021 LIBRARY; T=293.6K
Photon emission for (n,2n)a

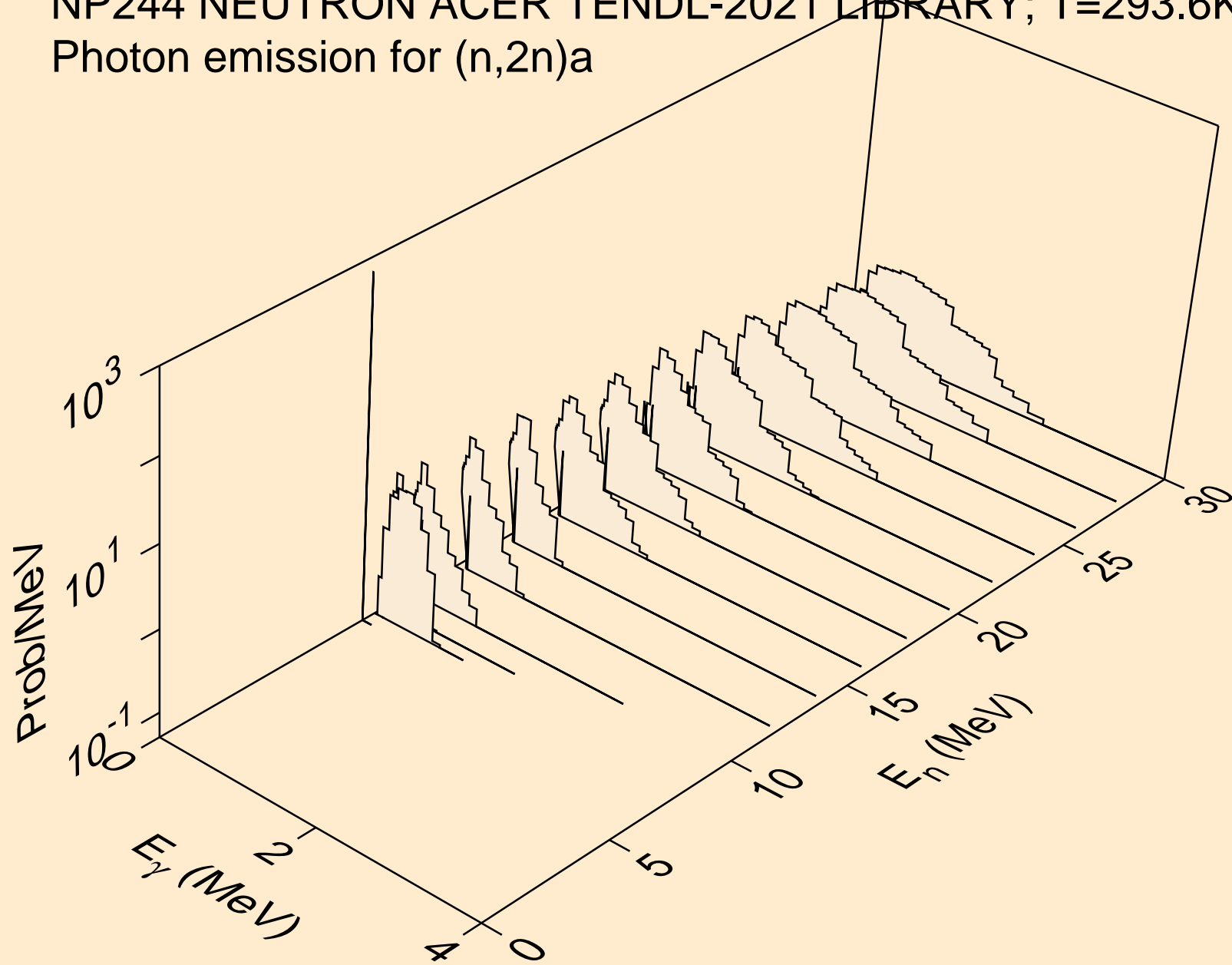

NP244 NEUTRON ACER TENDL-2021 LIBRARY; T=293.6K
Photon emission for (n,3n)a

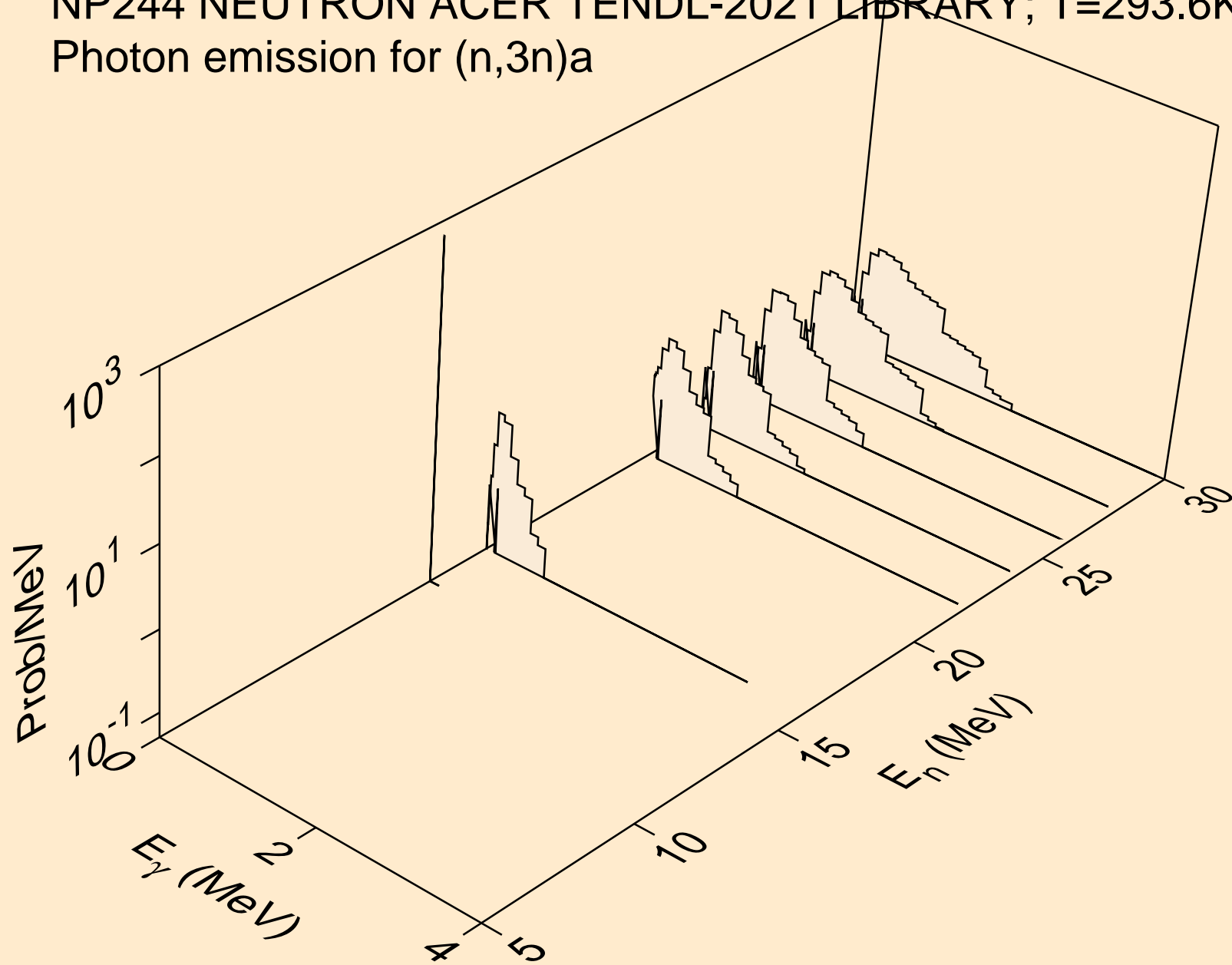

NP244 NEUTRON ACER TENDL-2021 LIBRARY; T=293.6K
Photon emission for (n,n*)p

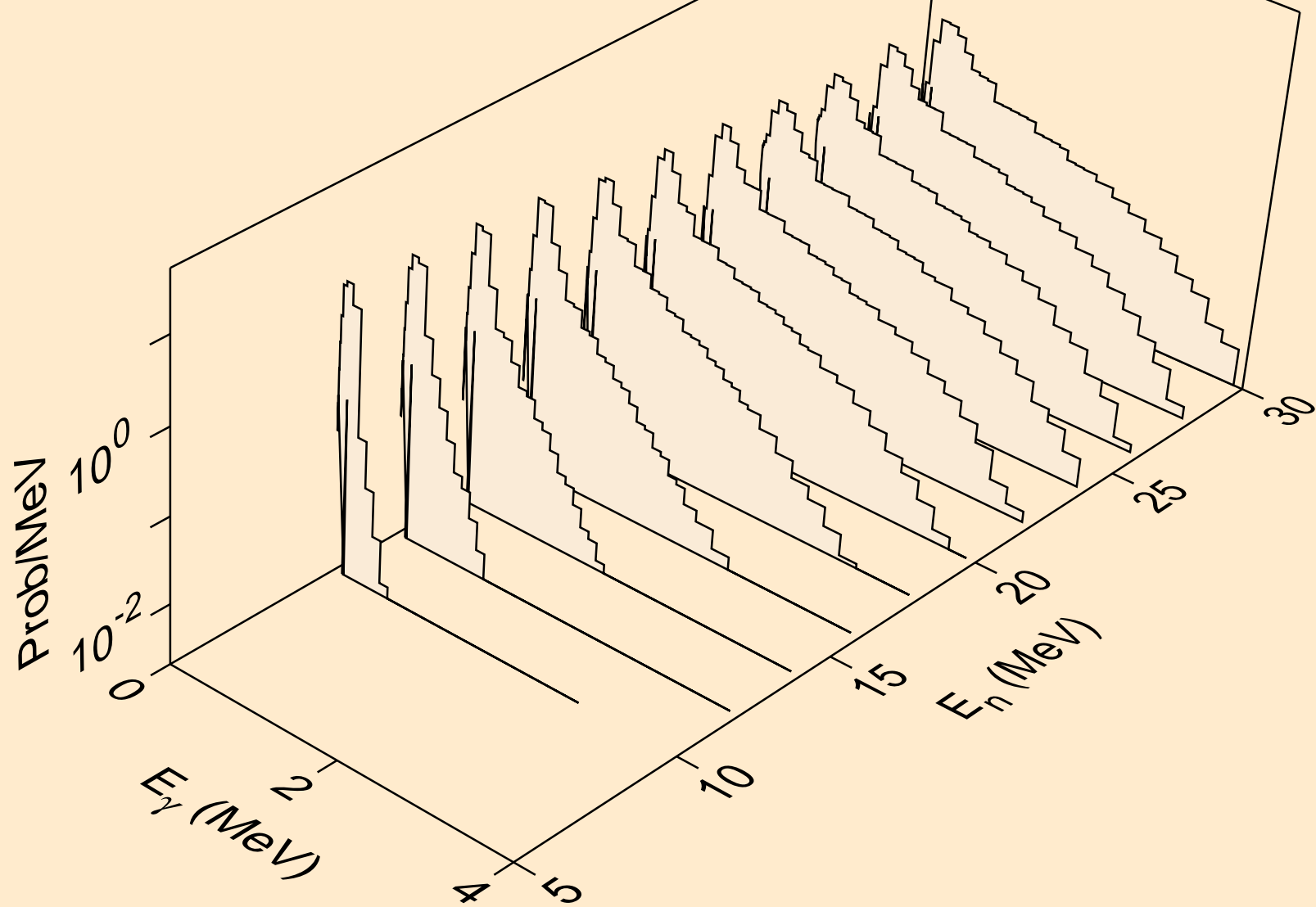

NP244 NEUTRON ACER TENDL-2021 LIBRARY; T=293.6K
Photon emission for (n,n*)2a

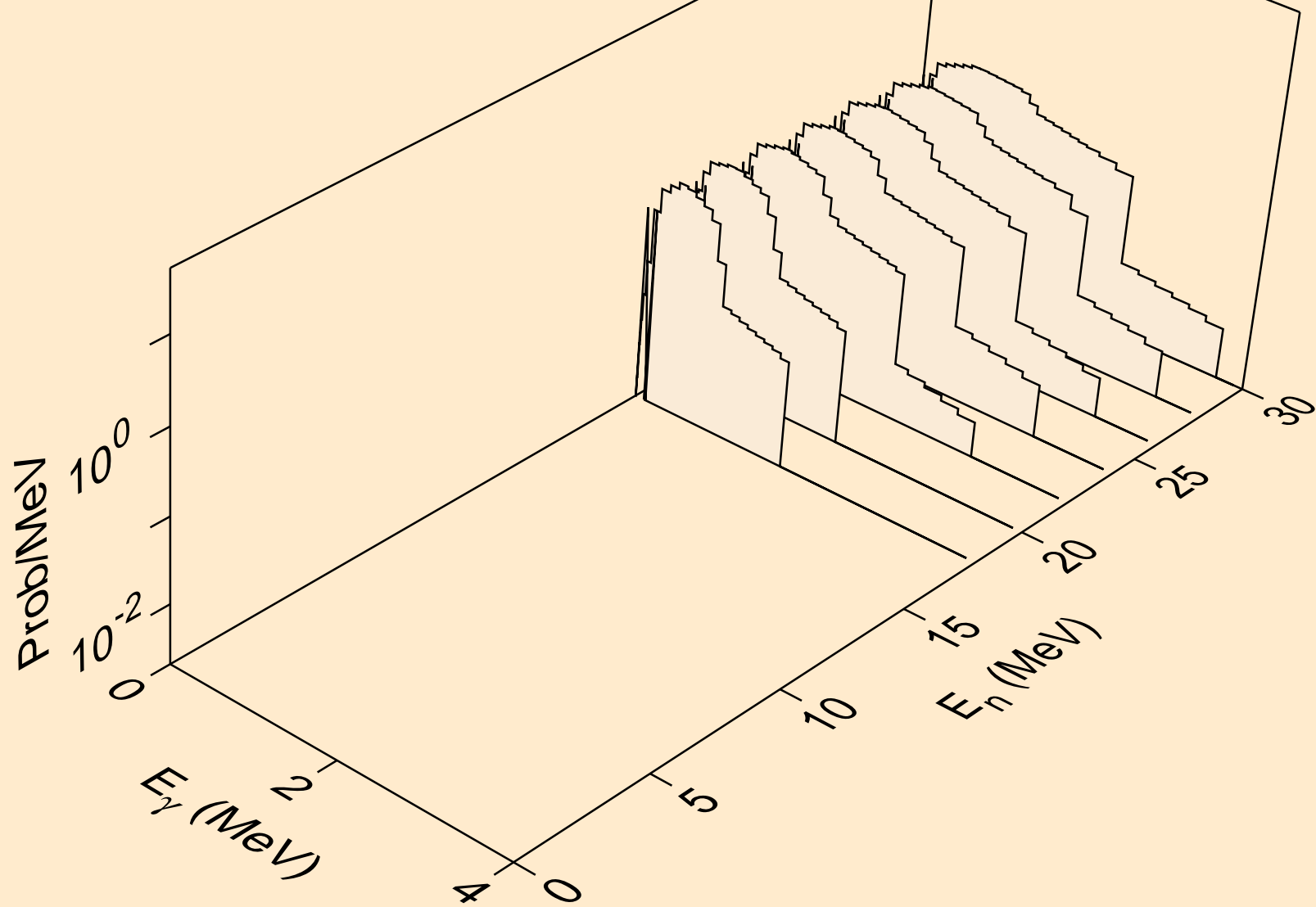

NP244 NEUTRON ACER TENDL-2021 LIBRARY; T=293.6K
Photon emission for (n,2n)2a

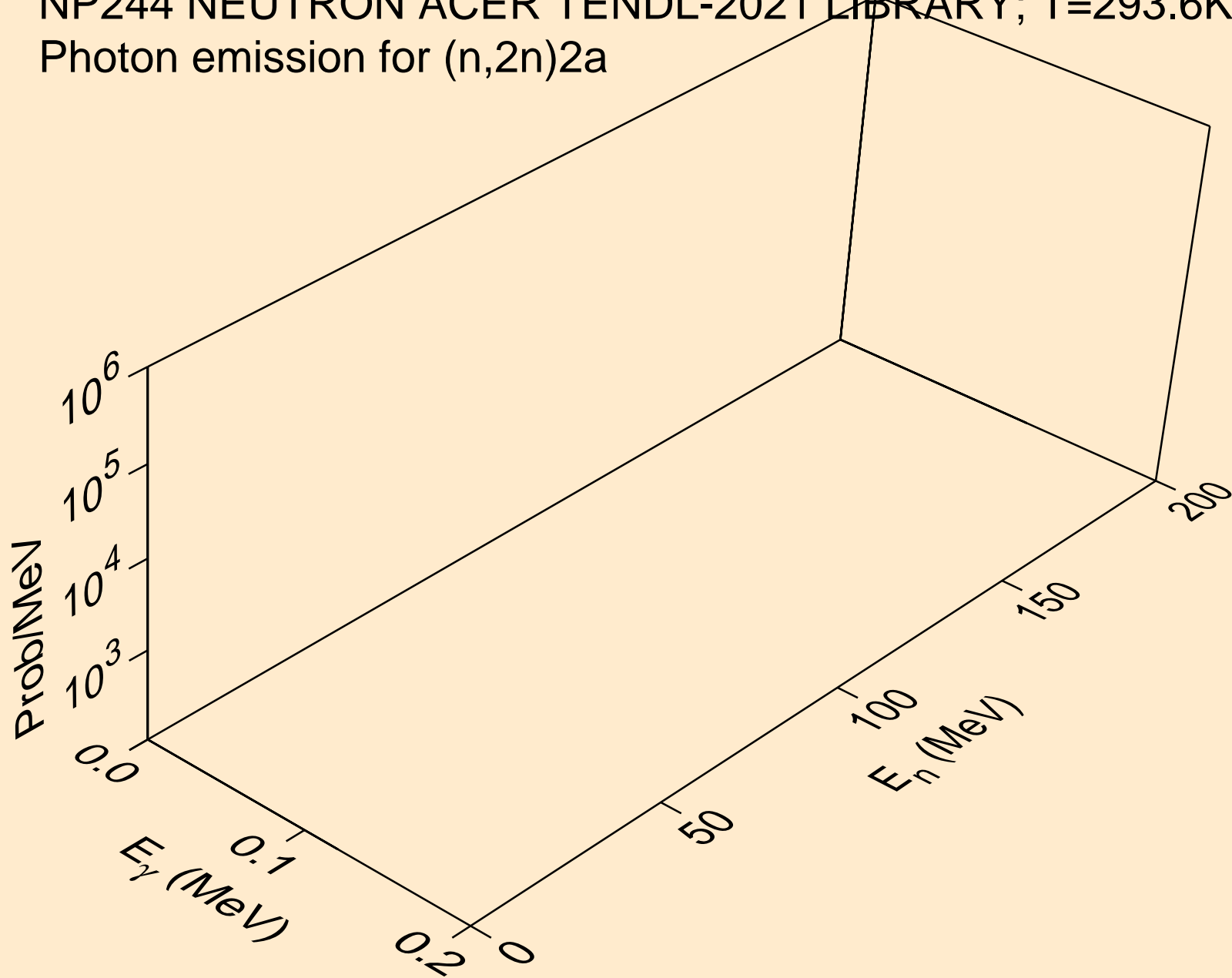

NP244 NEUTRON ACER TENDL-2021 LIBRARY; T=293.6K
Photon emission for (n,n*)d

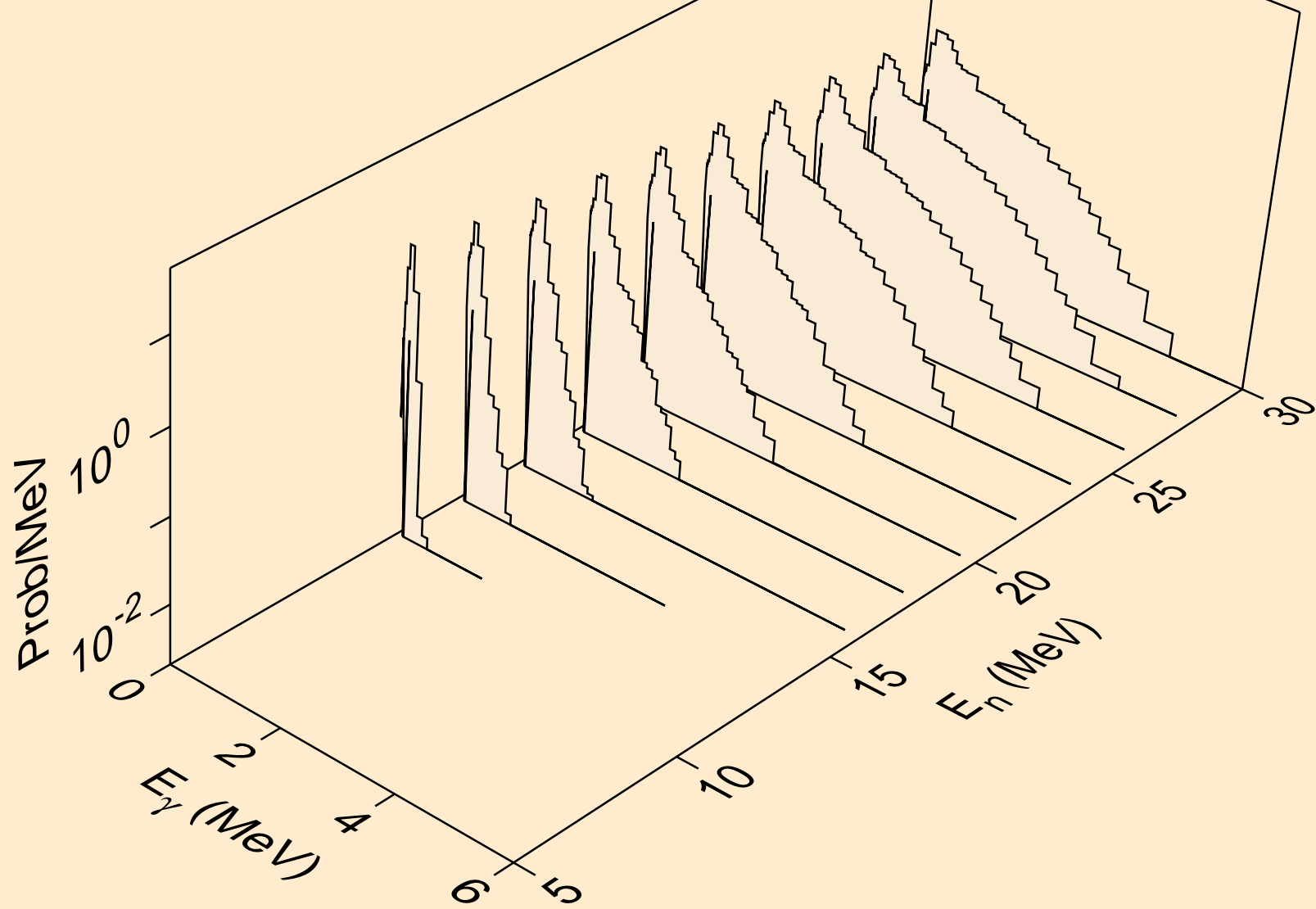

NP244 NEUTRON ACER TENDL-2021 LIBRARY; T=293.6K
Photon emission for (n,n*)t

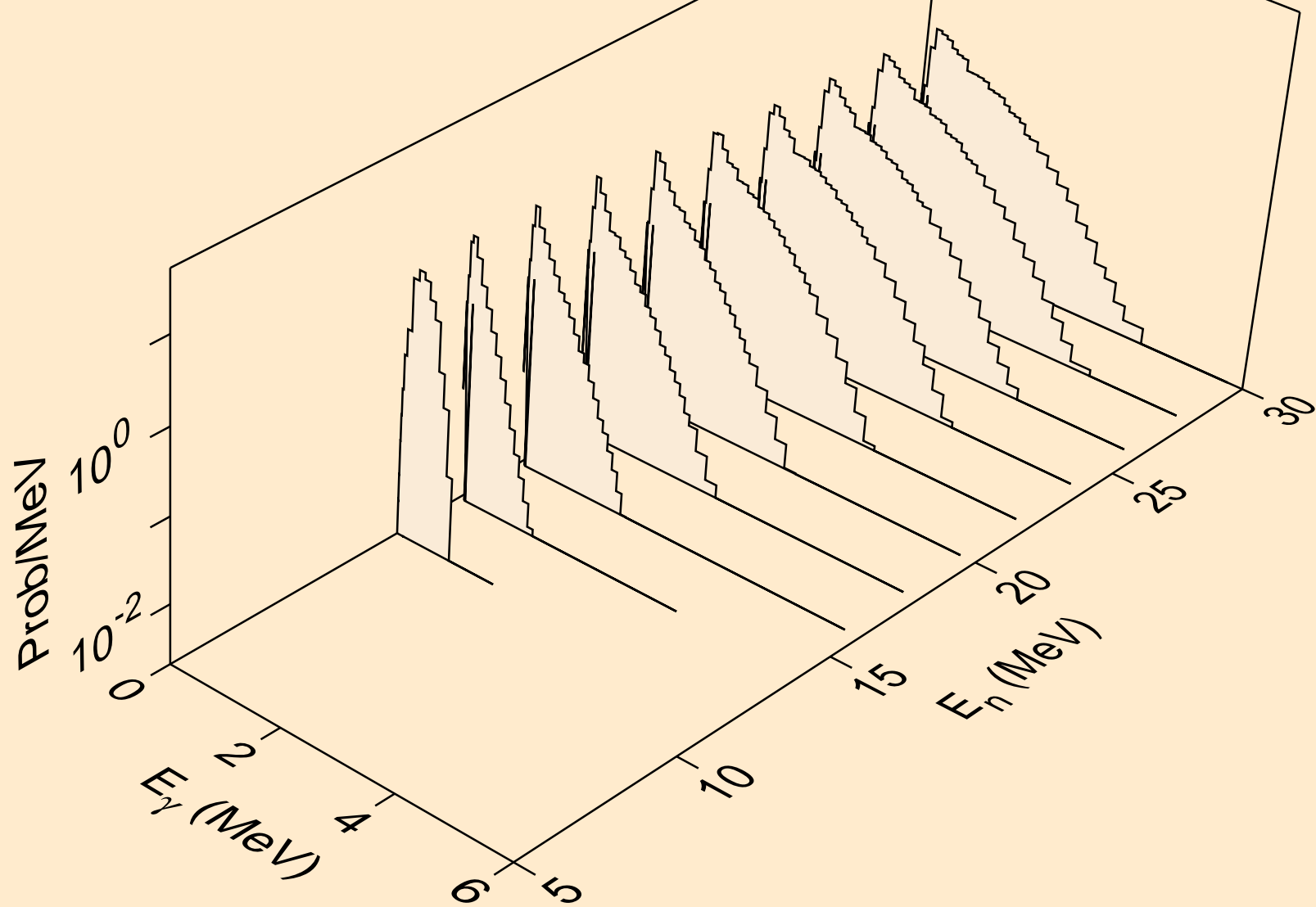

NP244 NEUTRON ACER TENDL-2021 LIBRARY; T=293.6K
Photon emission for (n,n*)he3

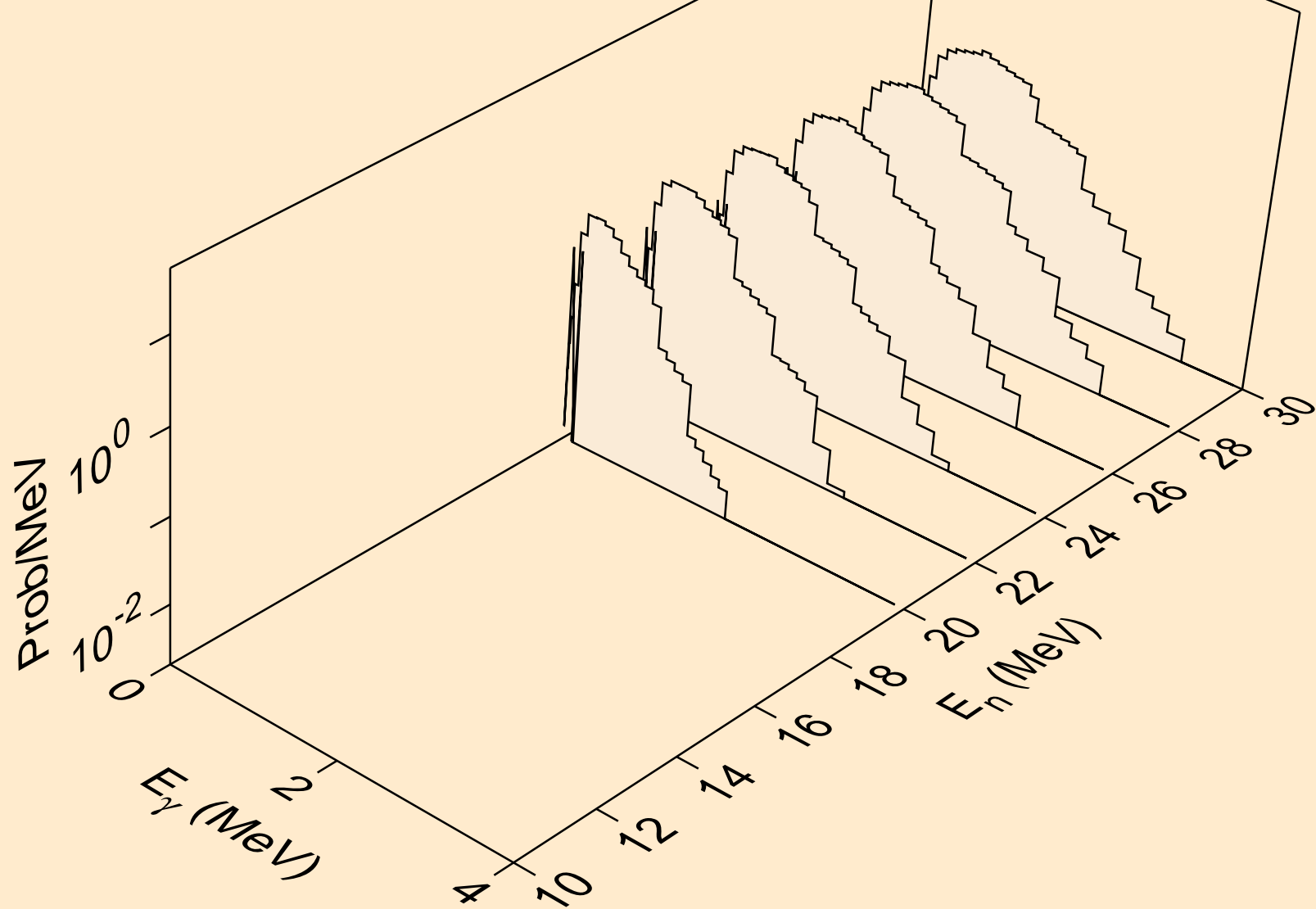

NP244 NEUTRON ACER TENDL-2021 LIBRARY; T=293.6K
Photon emission for (n,4n)

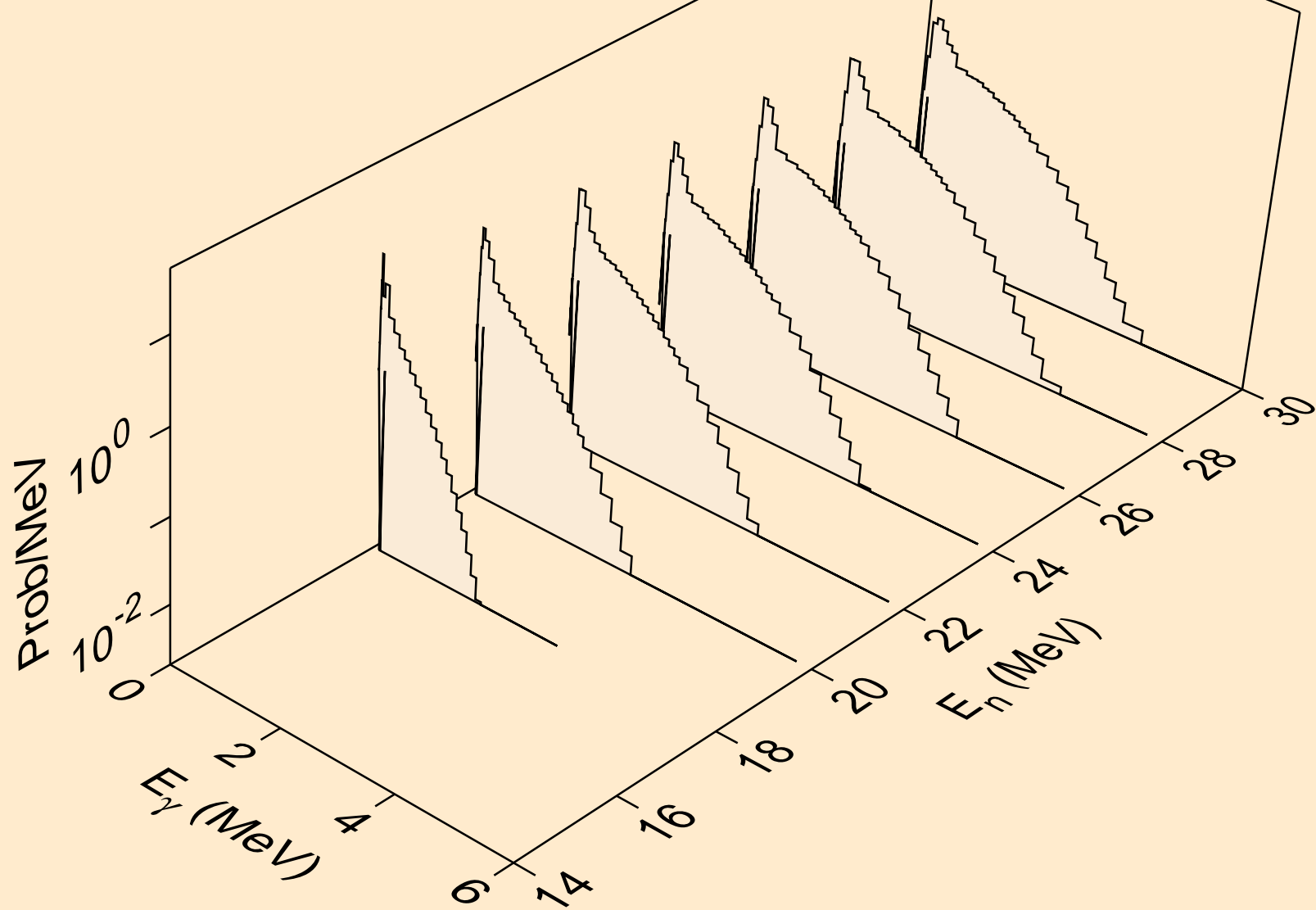

NP244 NEUTRON ACER TENDL-2021 LIBRARY; T=293.6K
Photon emission for (n,2np)

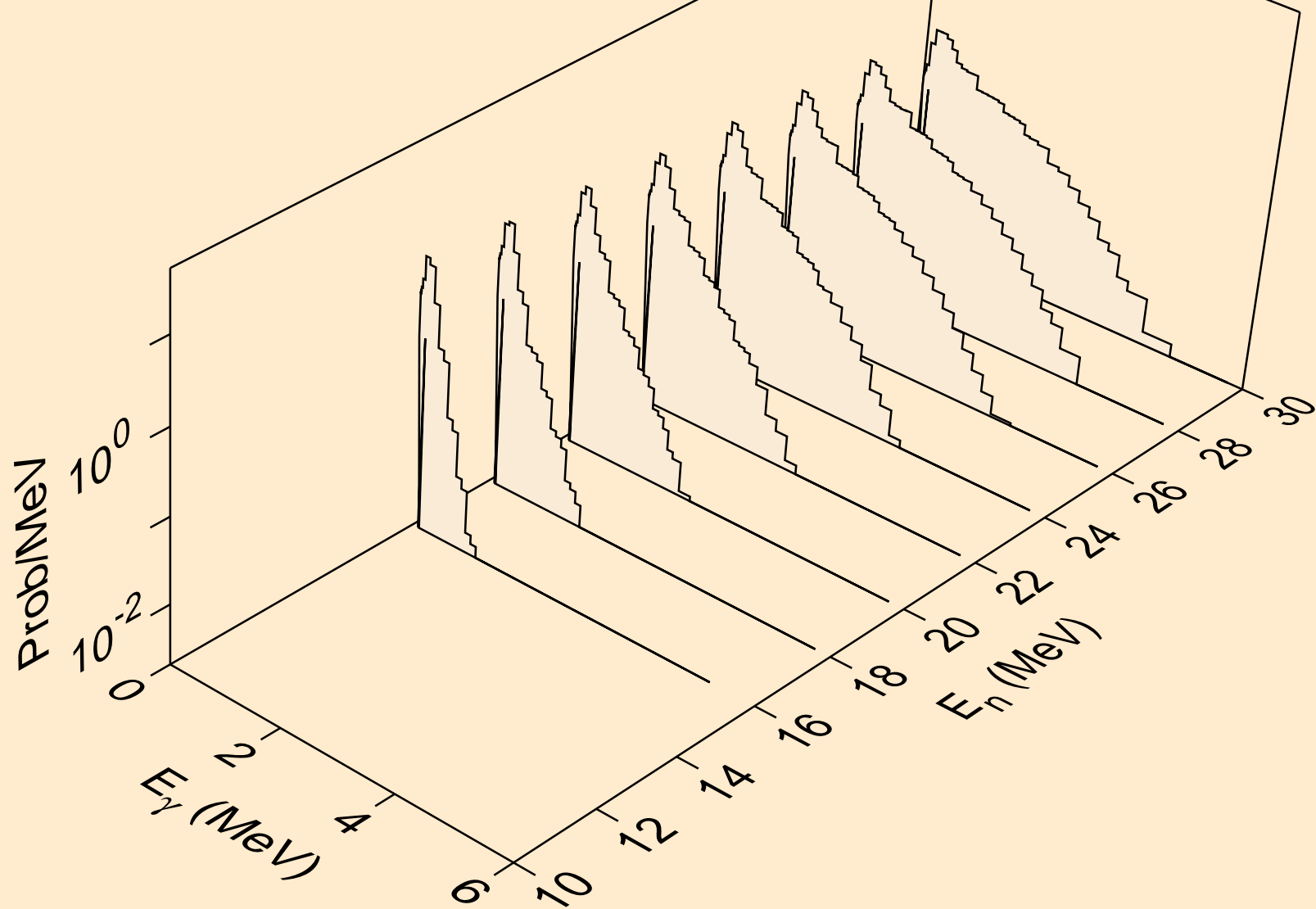

NP244 NEUTRON ACER TENDL-2021 LIBRARY; T=293.6K
Photon emission for (n,3np)

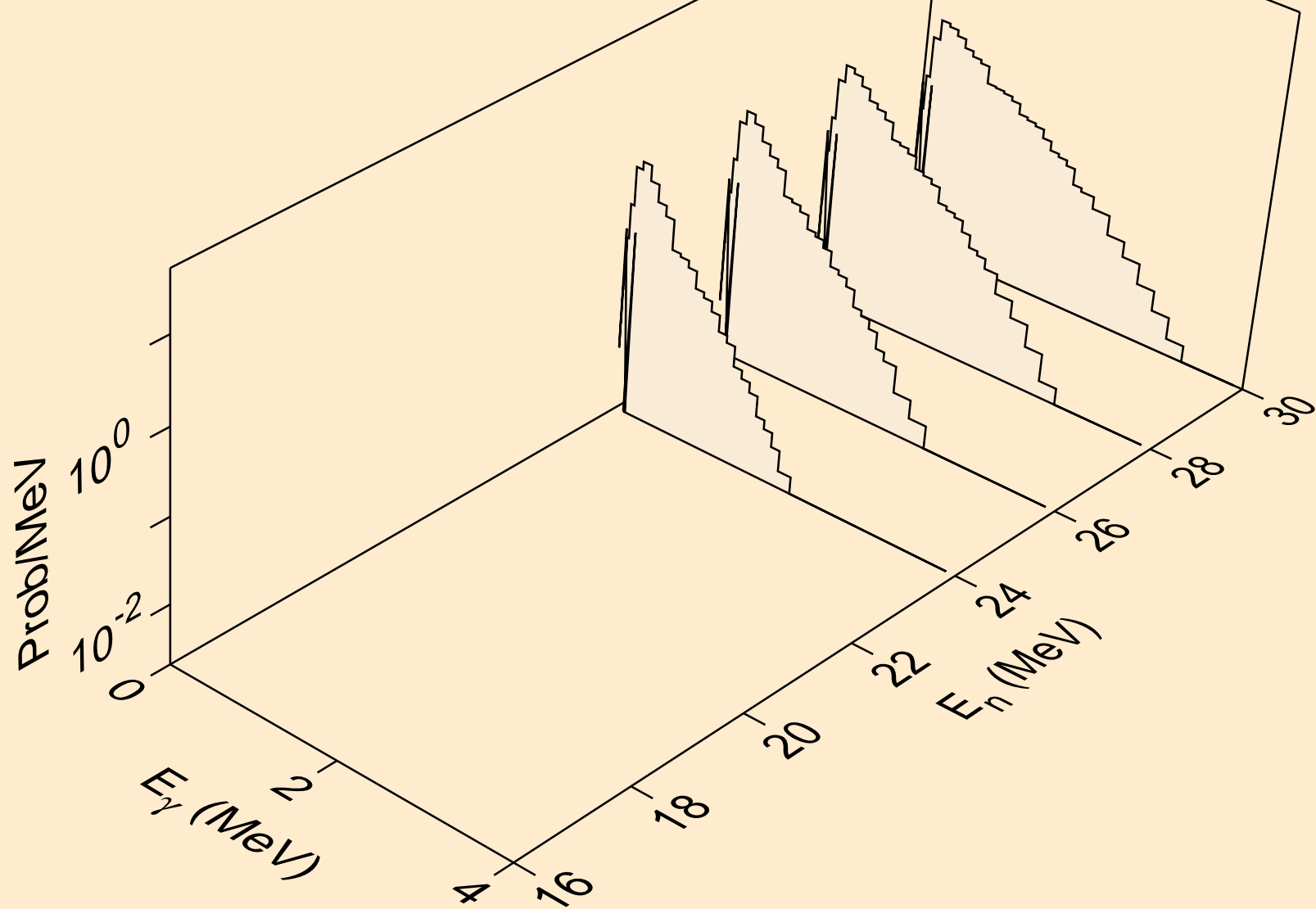

NP244 NEUTRON ACER TENDL-2021 LIBRARY; T=293.6K
Photon emission for (n,2np)

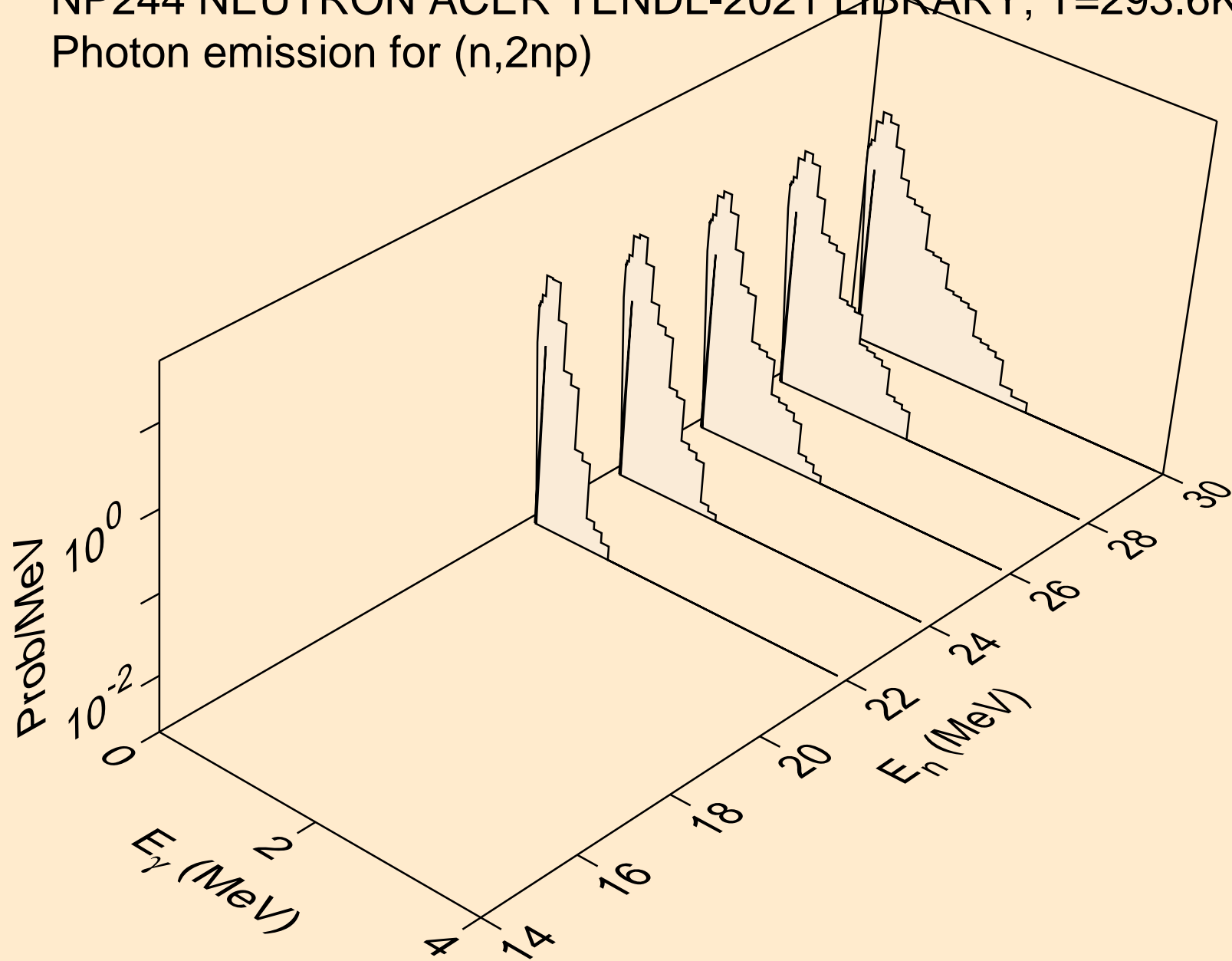

NP244 NEUTRON ACER TENDL-2021 LIBRARY; T=293.6K
Photon emission for (n,npa)

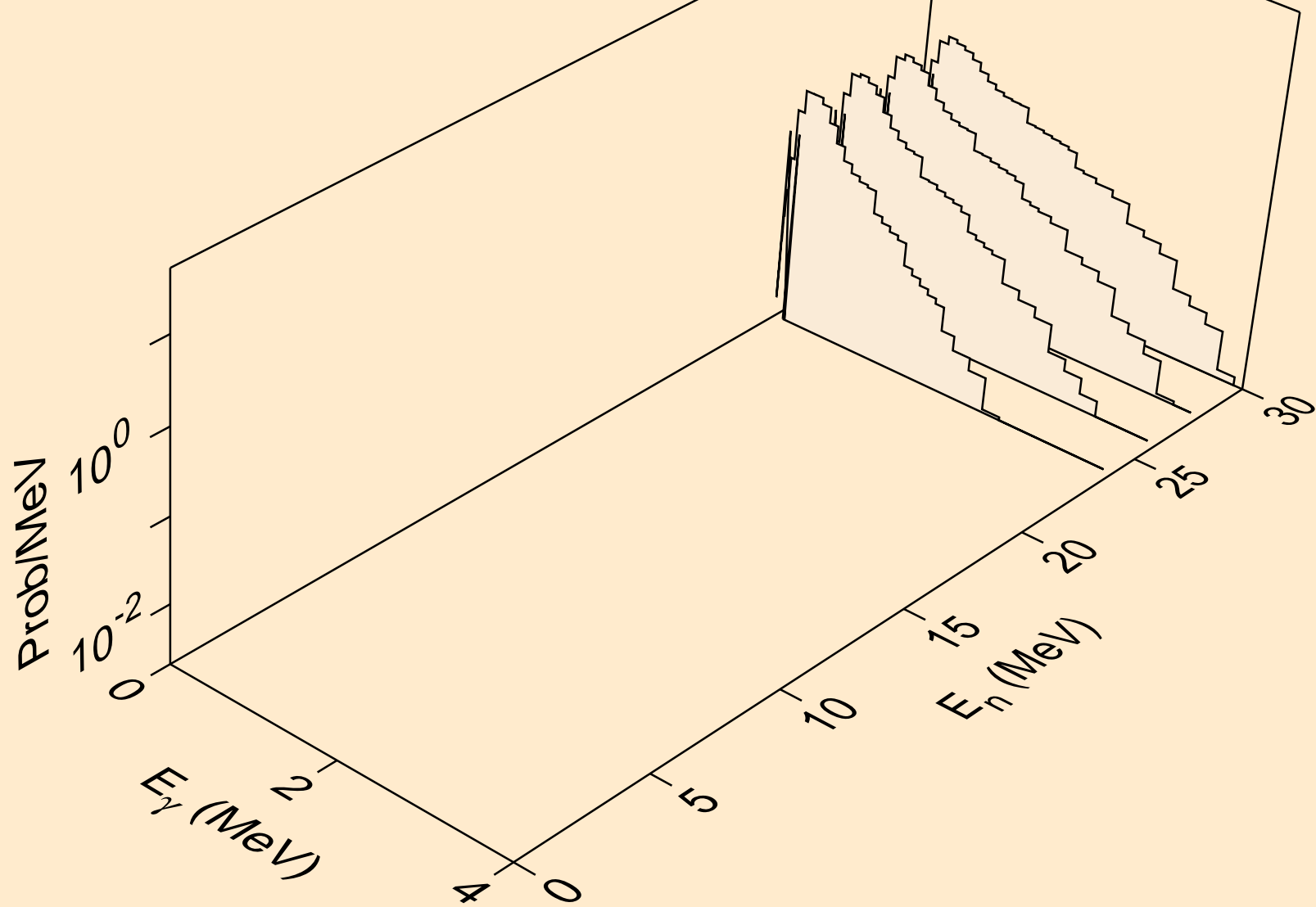

NP244 NEUTRON ACER TENDL-2021 LIBRARY; T=293.6K
Photon emission for (n,n*c)

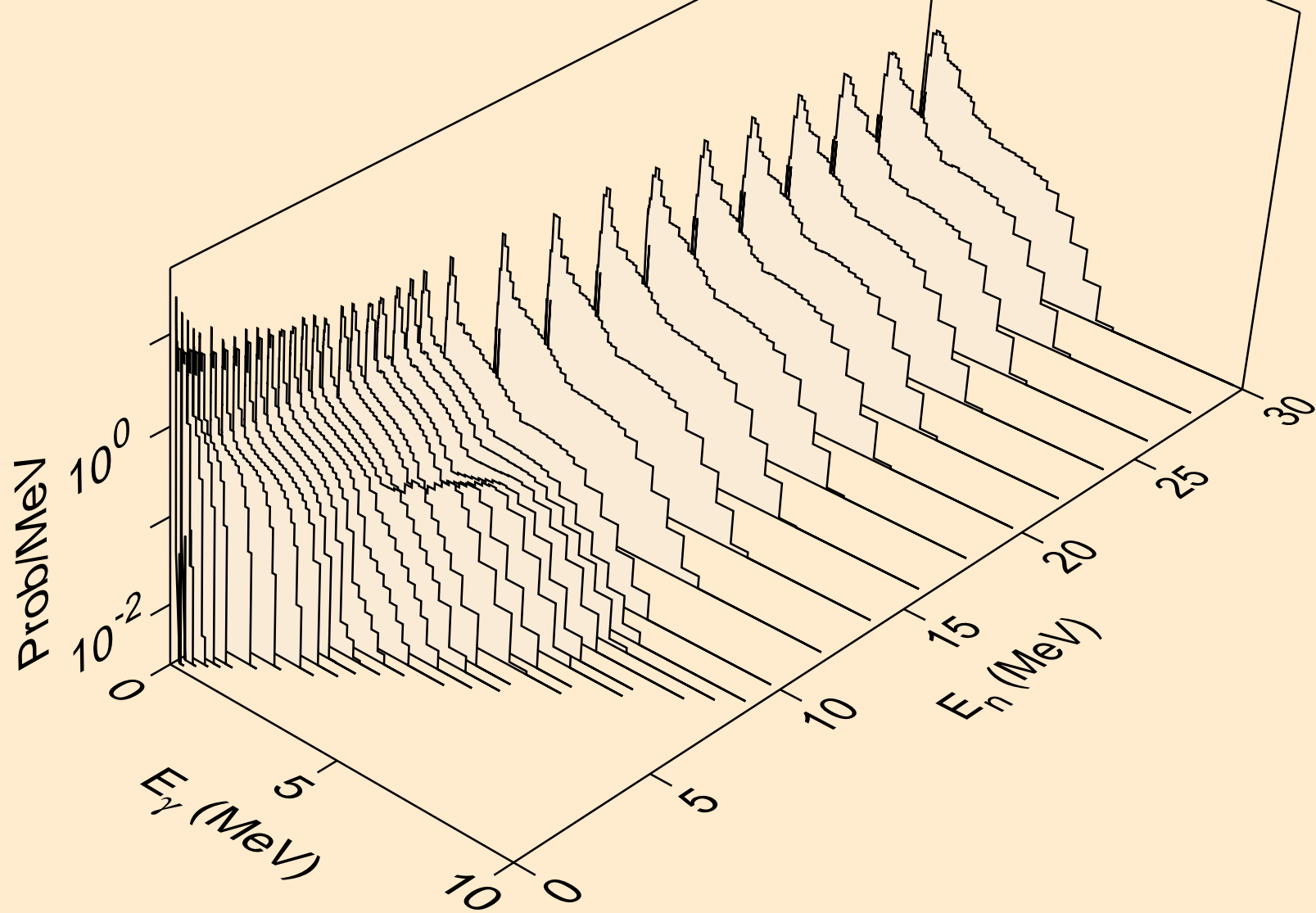

NP244 NEUTRON ACER TENDL-2021 LIBRARY; T=293.6K
Photon emission for (n,gma)

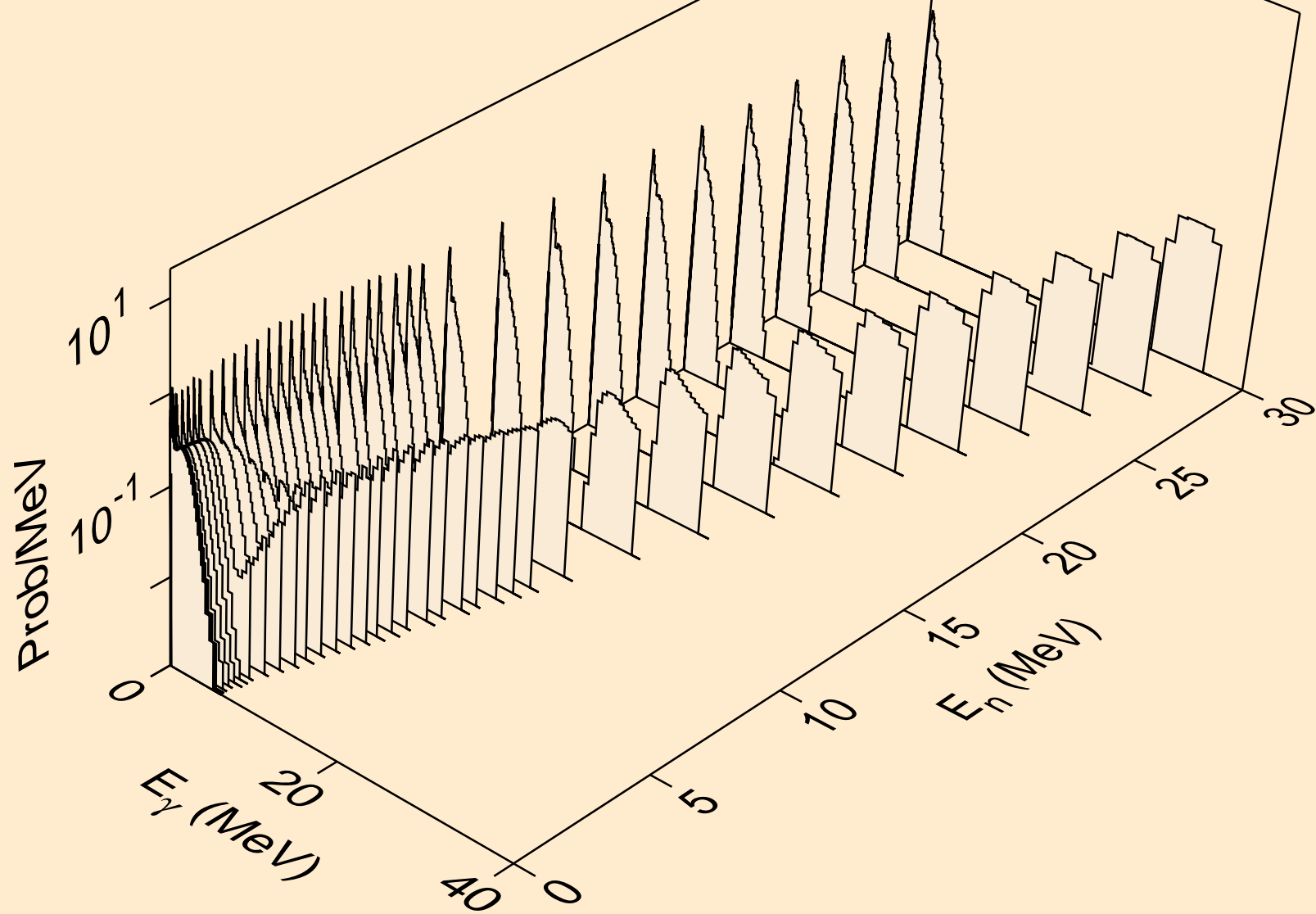

NP244 NEUTRON ACER TENDL-2021 LIBRARY; T=293.6K
Photon emission for (n,p)

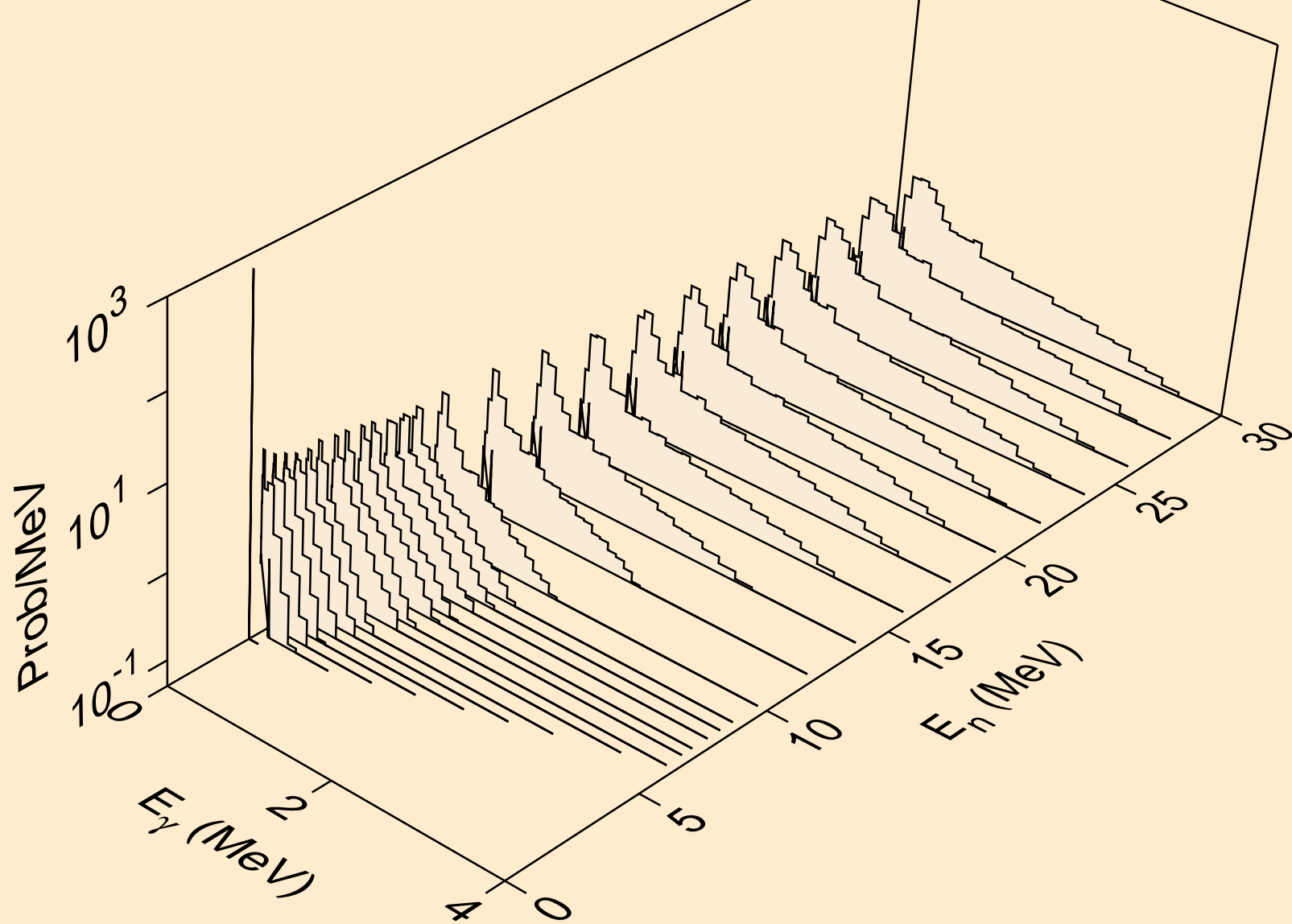

NP244 NEUTRON ACER TENDL-2021 LIBRARY; T=293.6K
Photon emission for (n,d)

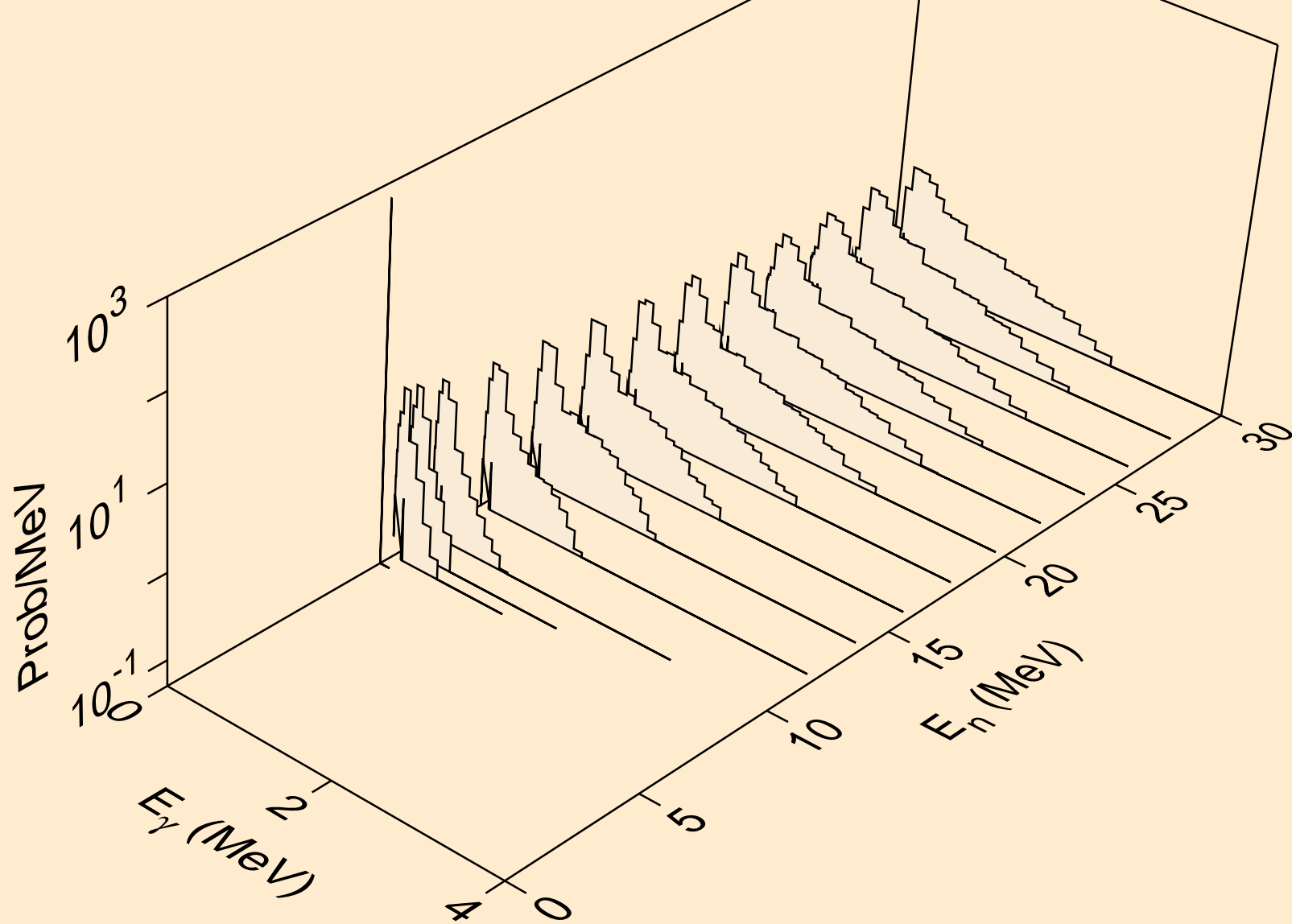

NP244 NEUTRON ACER TENDL-2021 LIBRARY; T=293.6K
Photon emission for (n,t)

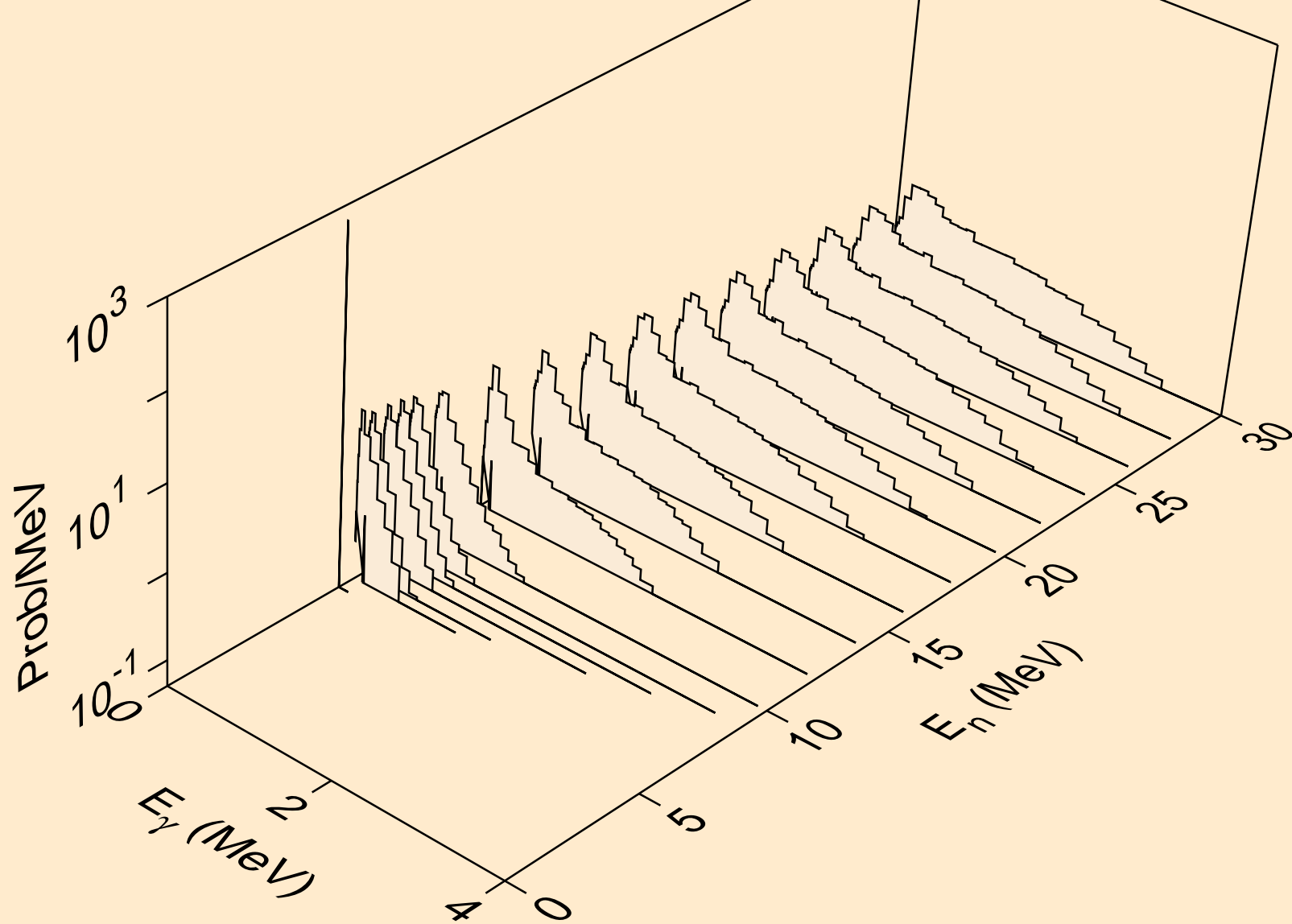

NP244 NEUTRON ACER TENDL-2021 LIBRARY; T=293.6K
Photon emission for (n,he3)

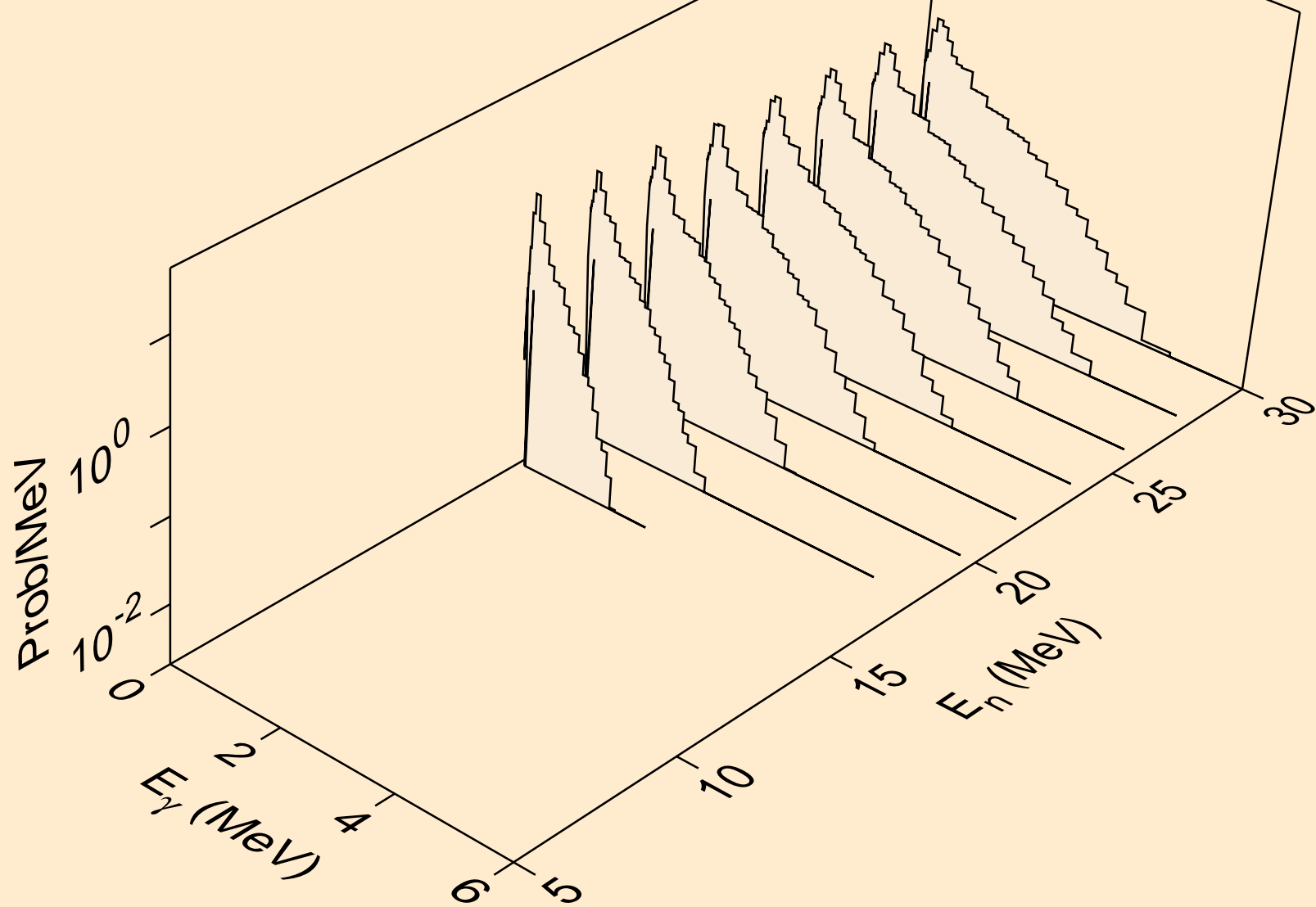

NP244 NEUTRON ACER TENDL-2021 LIBRARY; T=293.6K
Photon emission for (n,a)

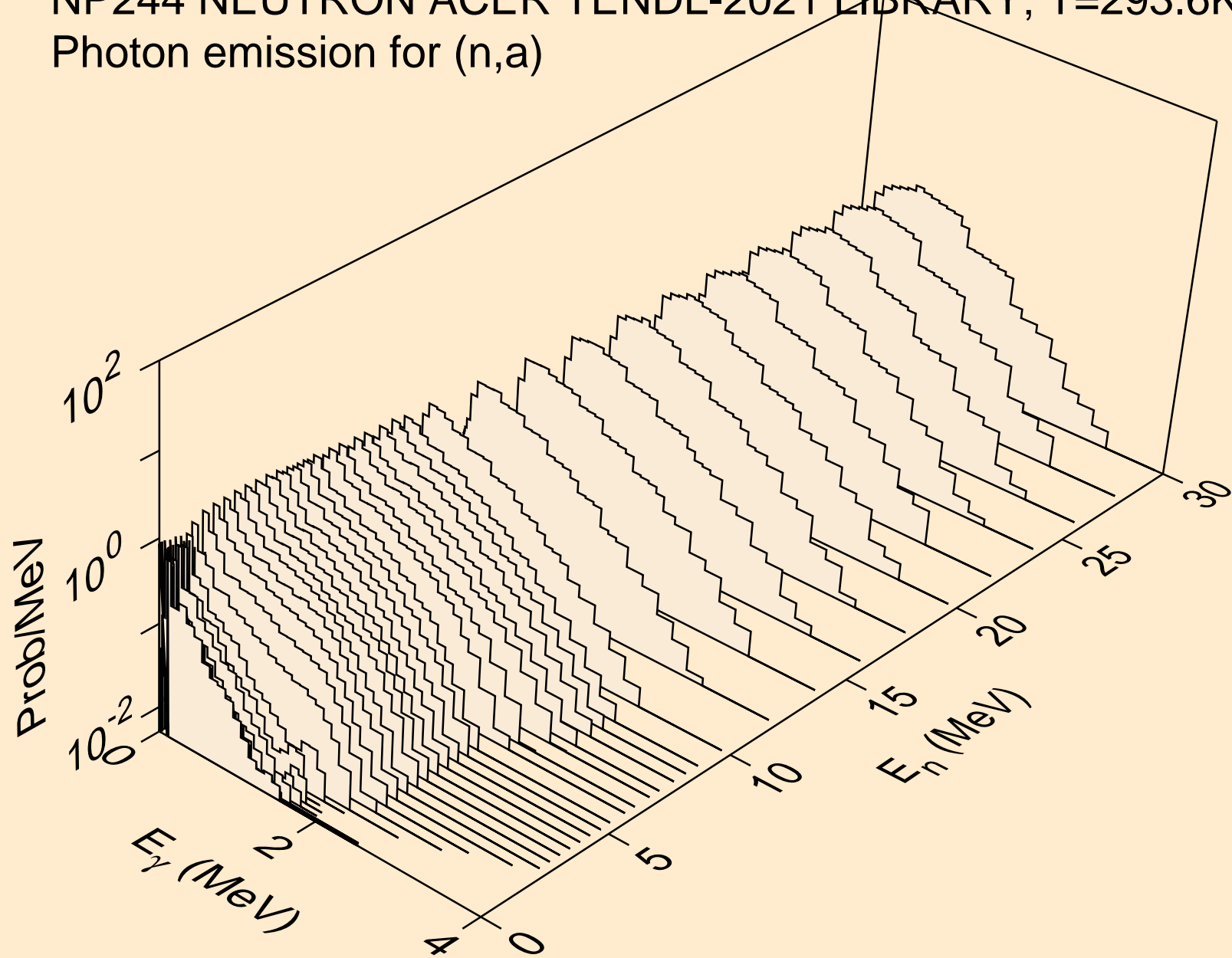

NP244 NEUTRON ACER TENDL-2021 LIBRARY; T=293.6K
Photon emission for (n,2a)

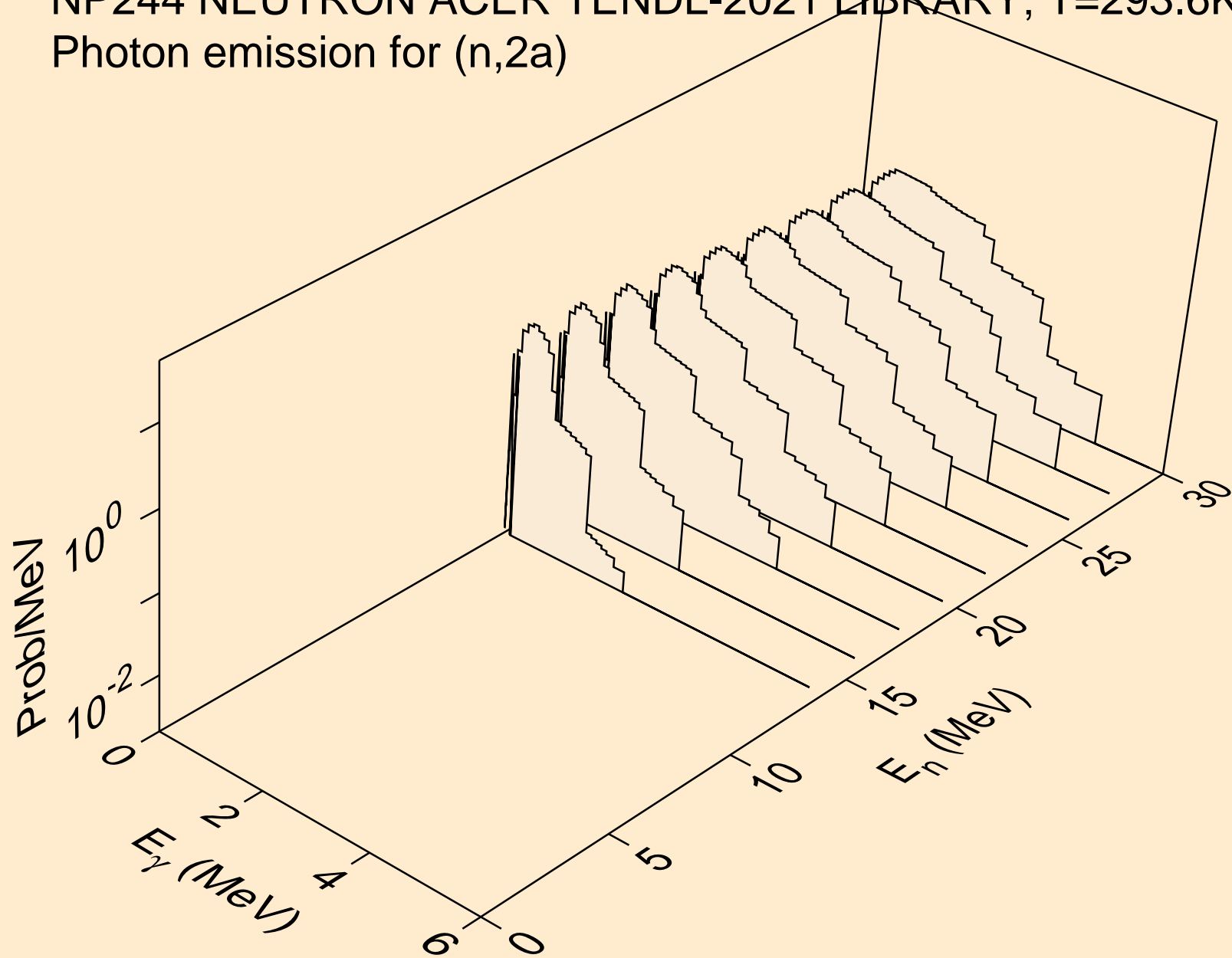

NP244 NEUTRON ACER TENDL-2021 LIBRARY; T=293.6K
Photon emission for (n,2p)

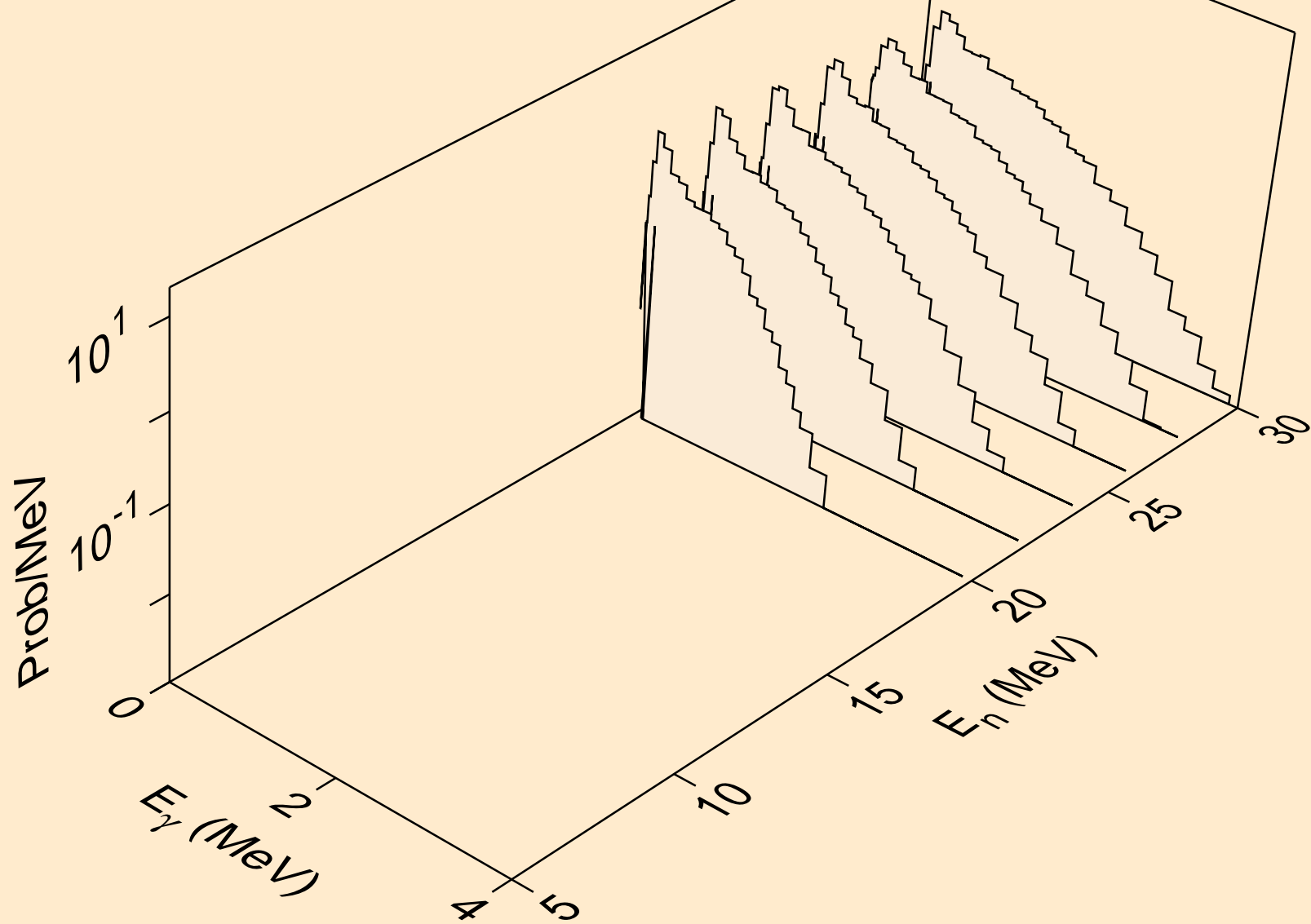

NP244 NEUTRON ACER TENDL-2021 LIBRARY; T=293.6K
Photon emission for (n,p)

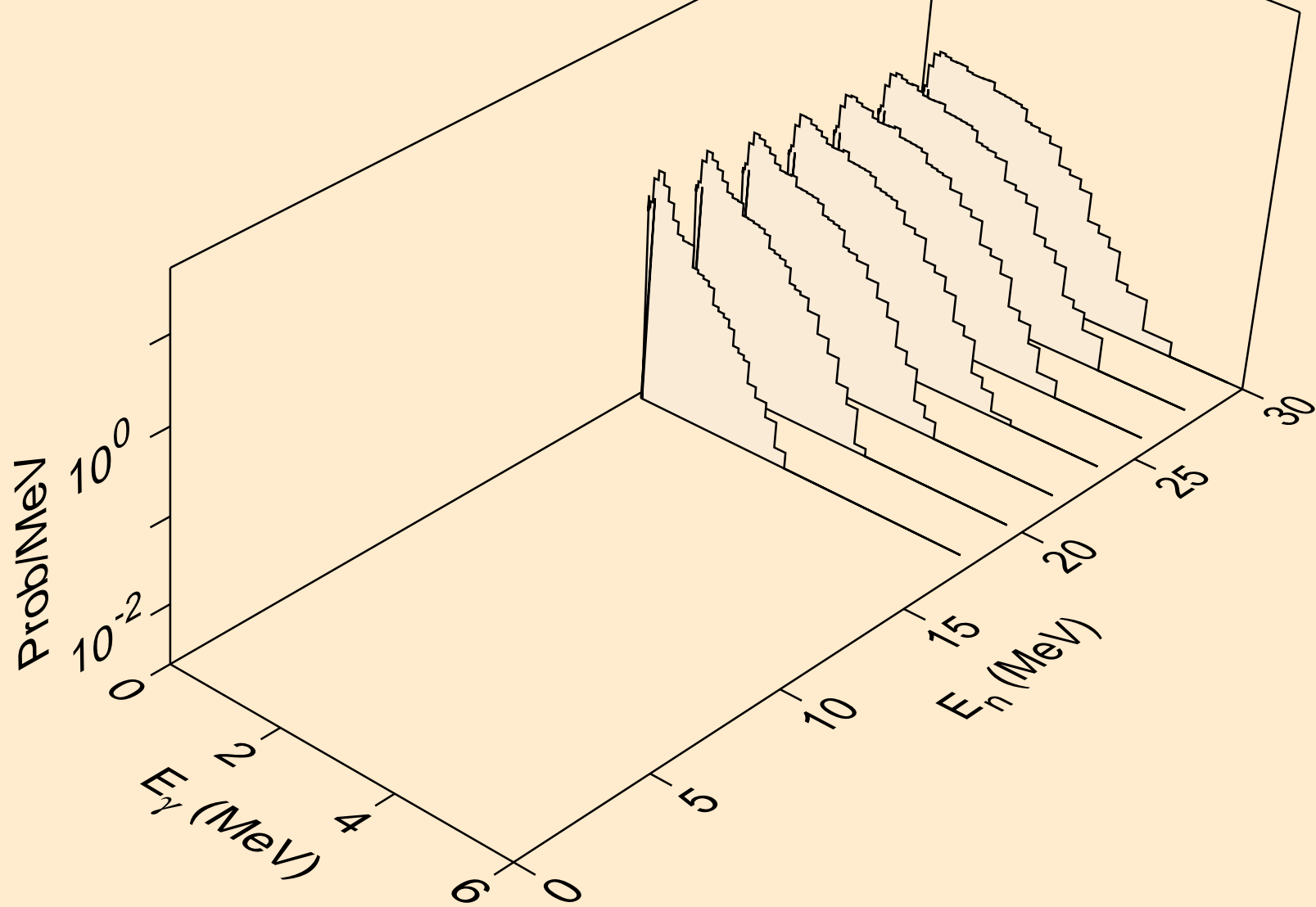

NP244 NEUTRON ACER TENDL-2021 LIBRARY; T=293.6K
Photon emission for (n,pd)

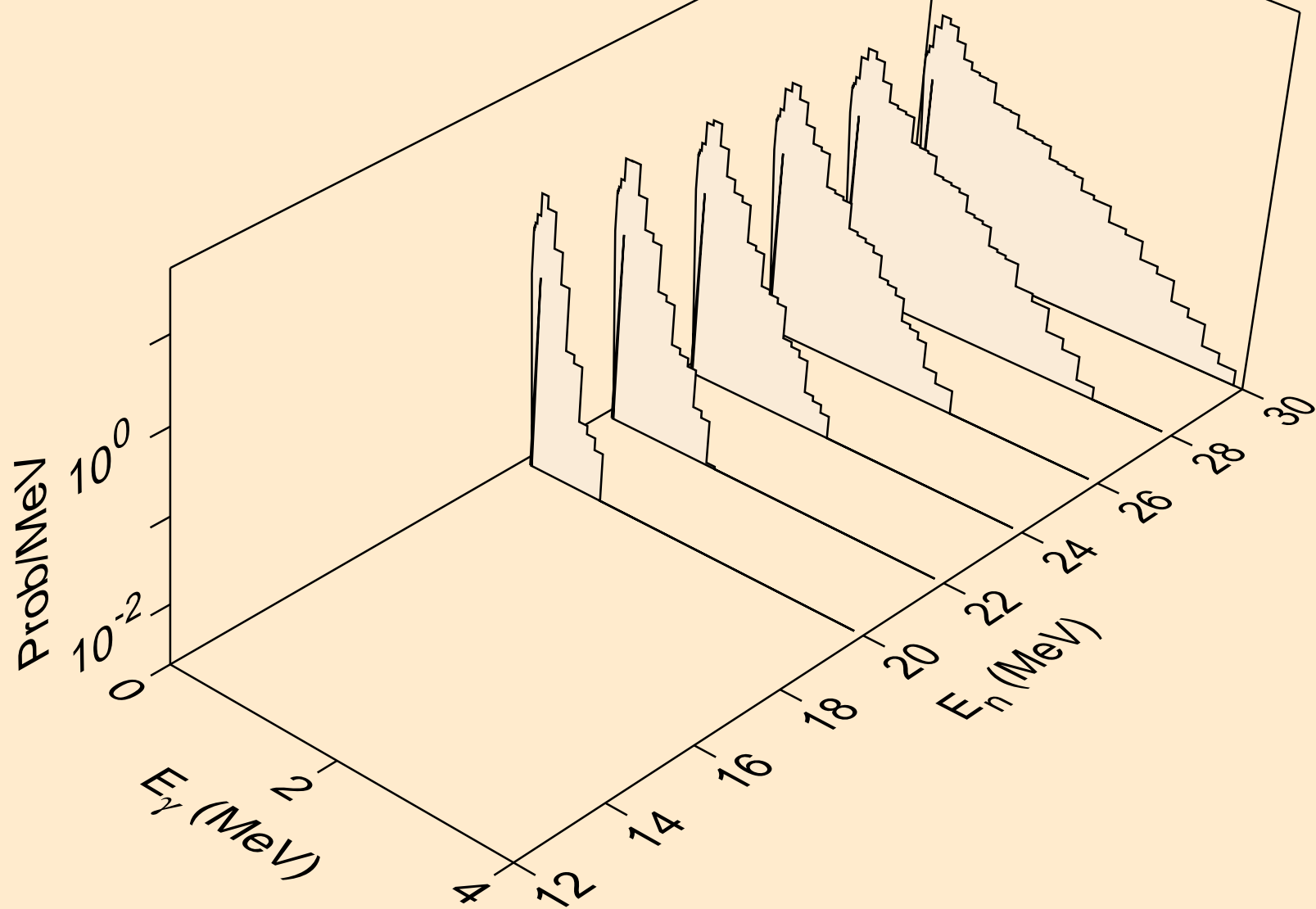

NP244 NEUTRON ACER TENDL-2021 LIBRARY; T=293.6K
thermal capture photon spectrum

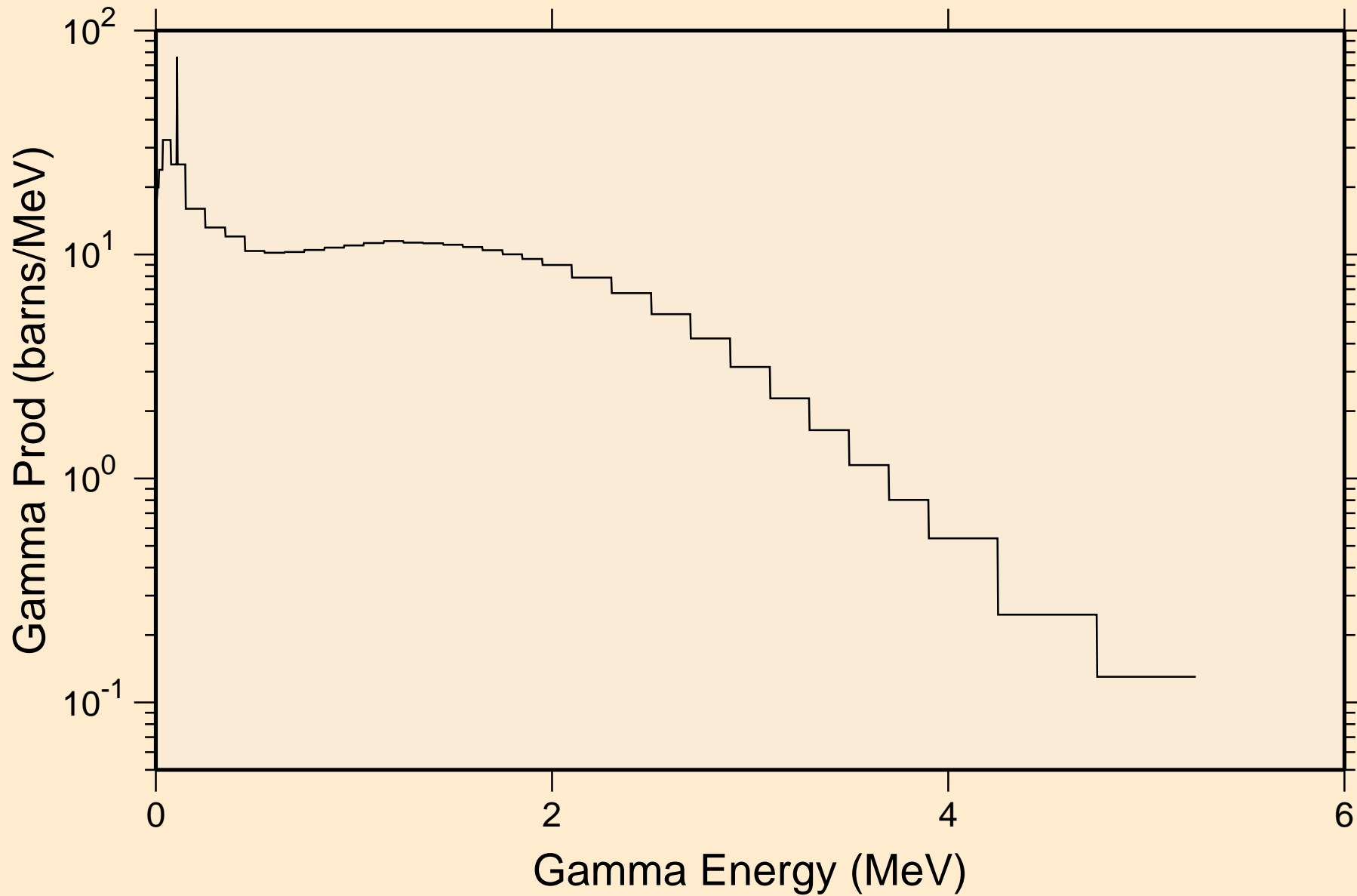

NP244 NEUTRON ACER TENDL-2021 LIBRARY; T=293.6K
14 MeV photon spectrum

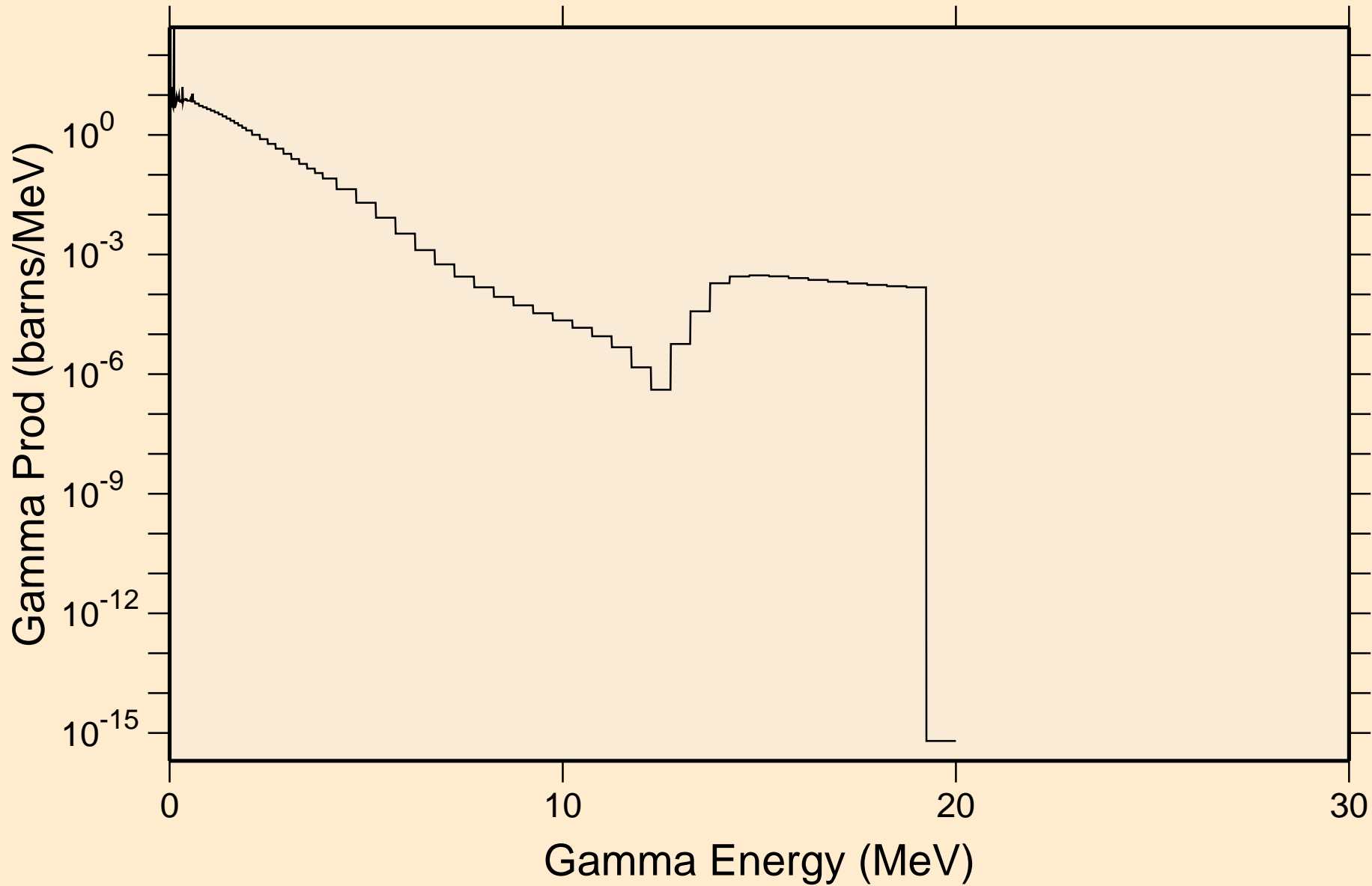

NP244 NEUTRON ACER TENDL-2021 LIBRARY; T=293.6K
Particle heating contributions

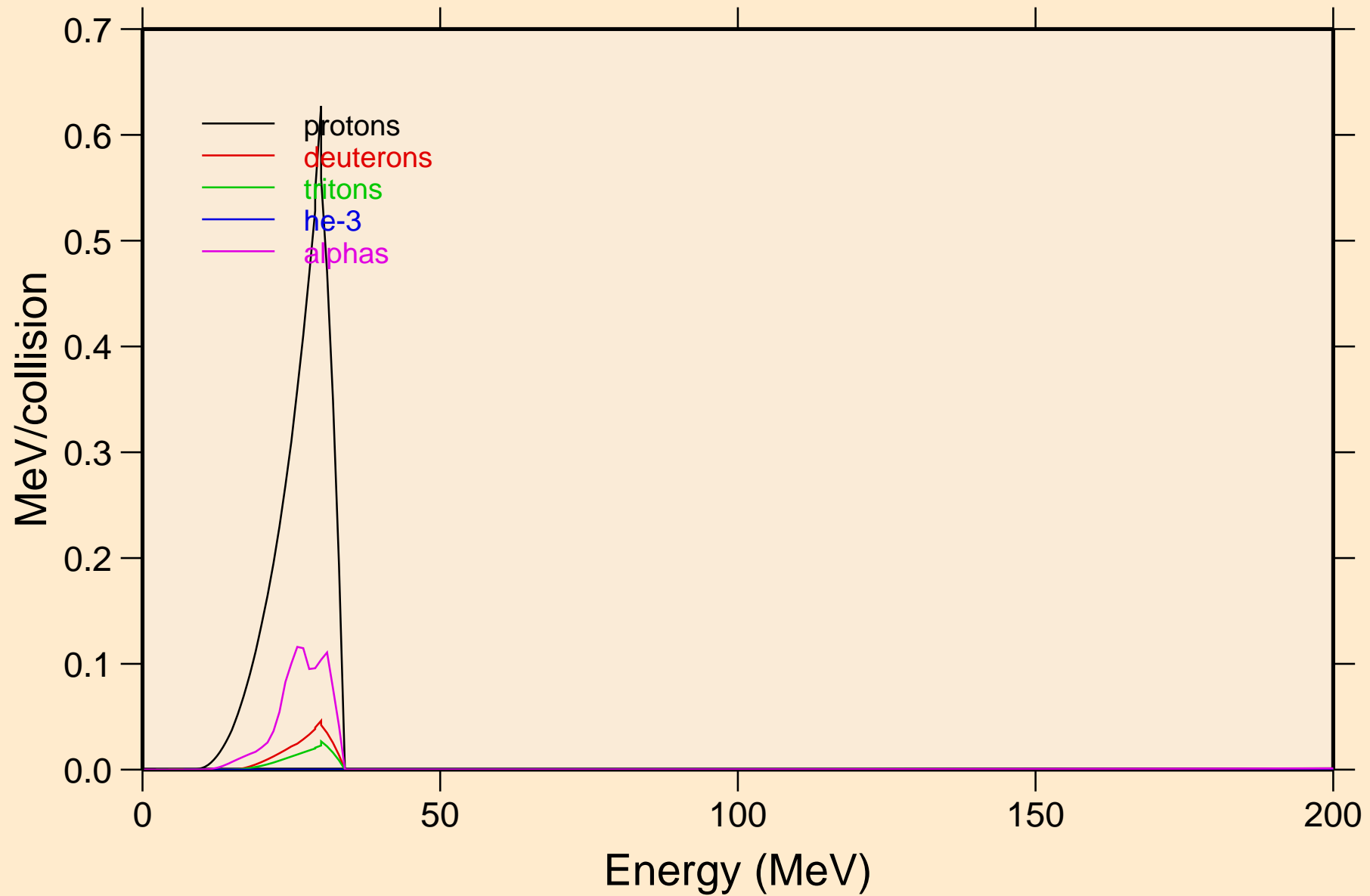

NP244 NEUTRON ACER TENDL-2021 LIBRARY; T=293.6K
Recoil Heating

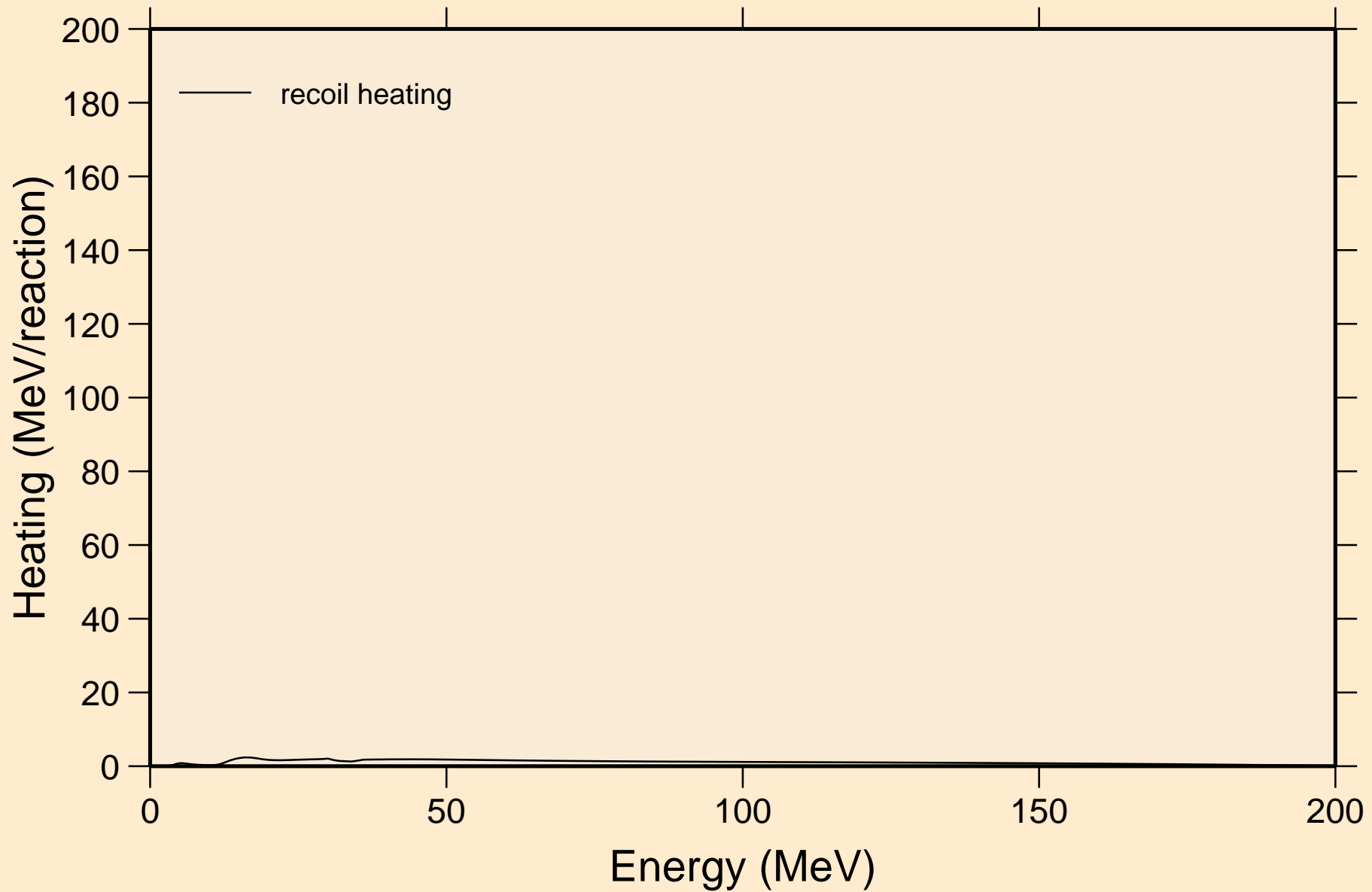

NP244 NEUTRON ACER TENDL-2021 LIBRARY; T=293.6K
Particle production cross sections

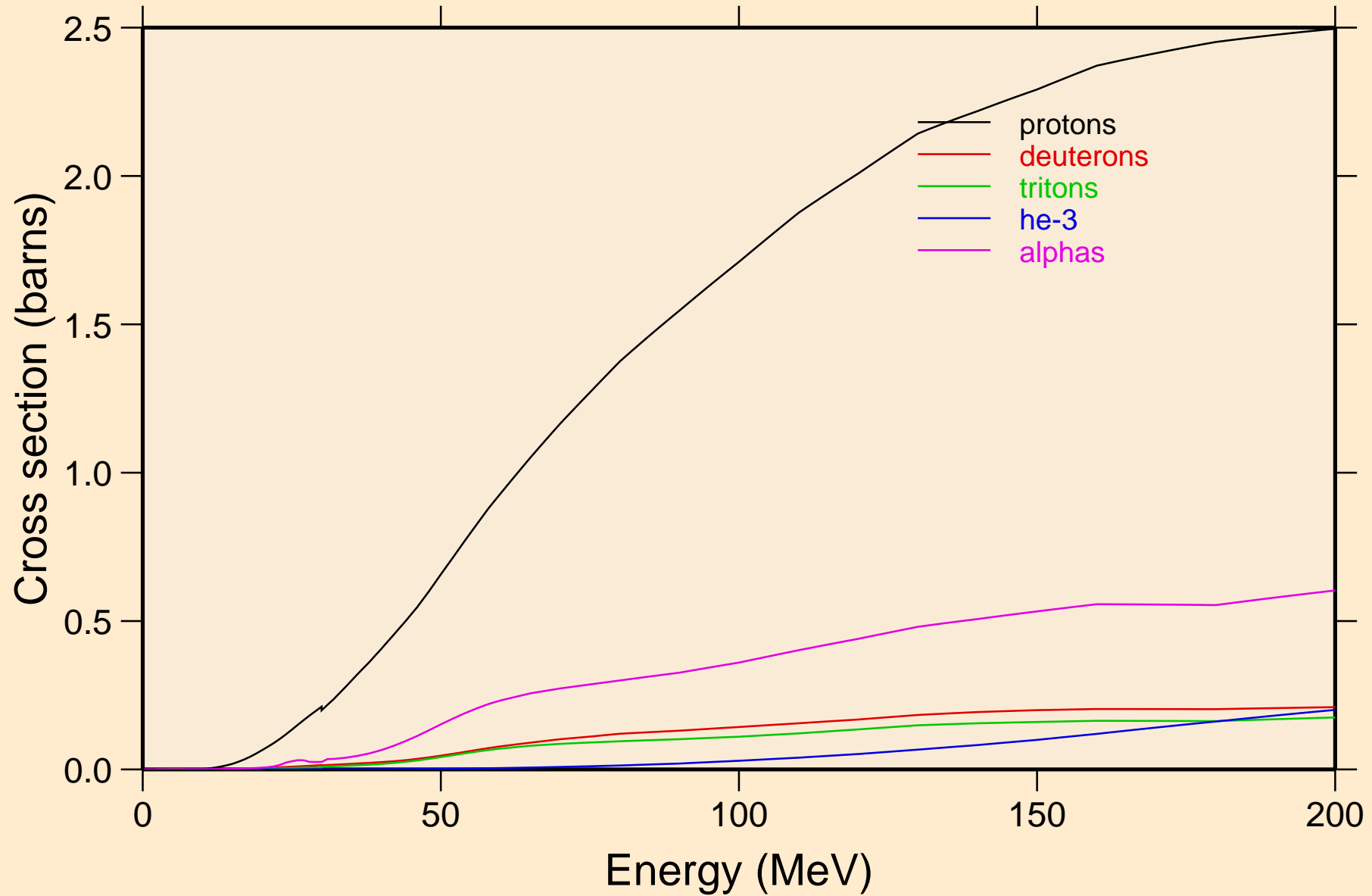

NP244 NEUTRON ACER TENDL-2021 LIBRARY; T=293.6K
protons from (n,x)

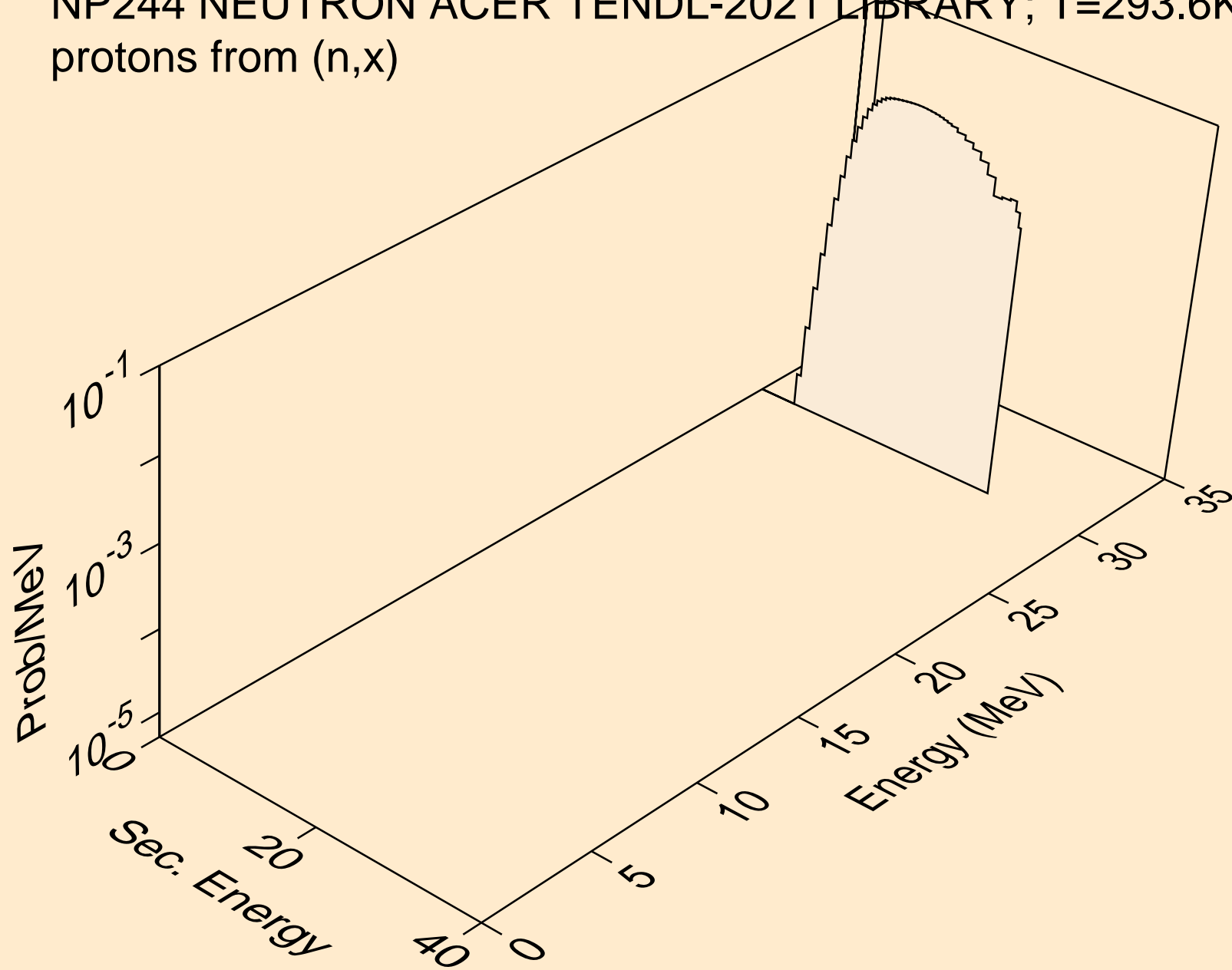

NP244 NEUTRON ACER TENDL-2021 LIBRARY; T=293.6K
protons from (n,n*)p

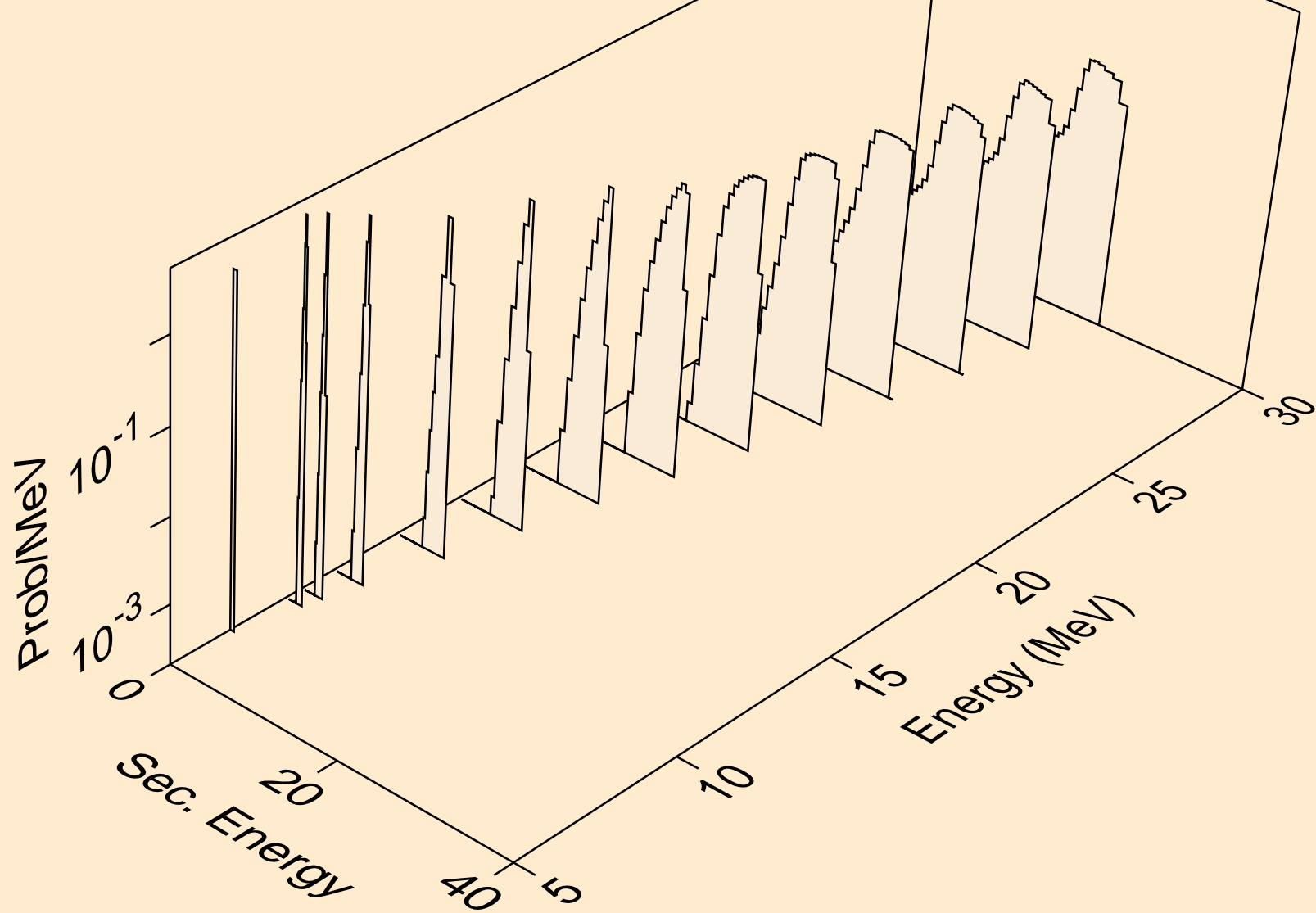

NP244 NEUTRON ACER TENDL-2021 LIBRARY; T=293.6K
protons from (n,2np)

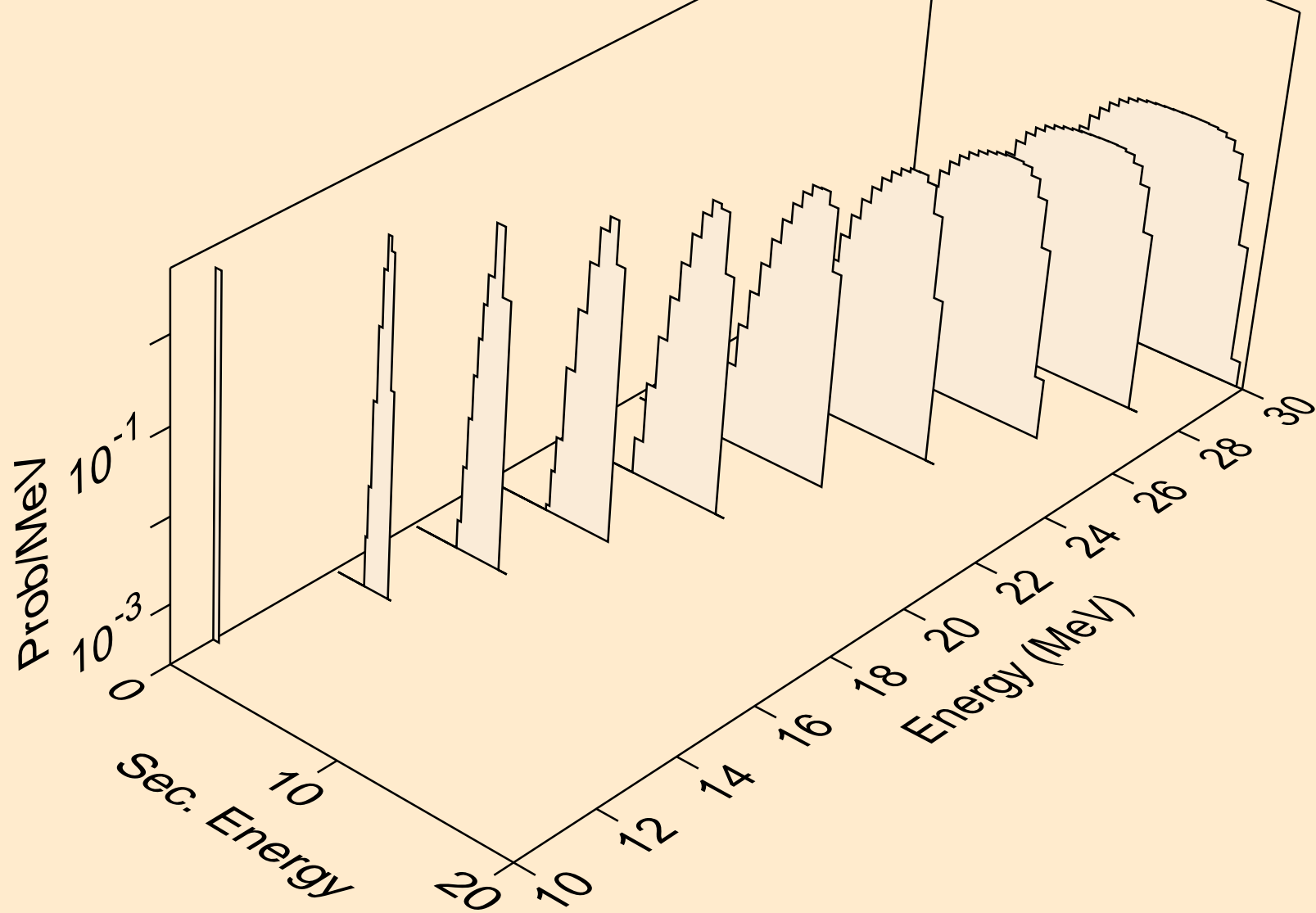

NP244 NEUTRON ACER TENDL-2021 LIBRARY; T=293.6K
protons from (n,3np)

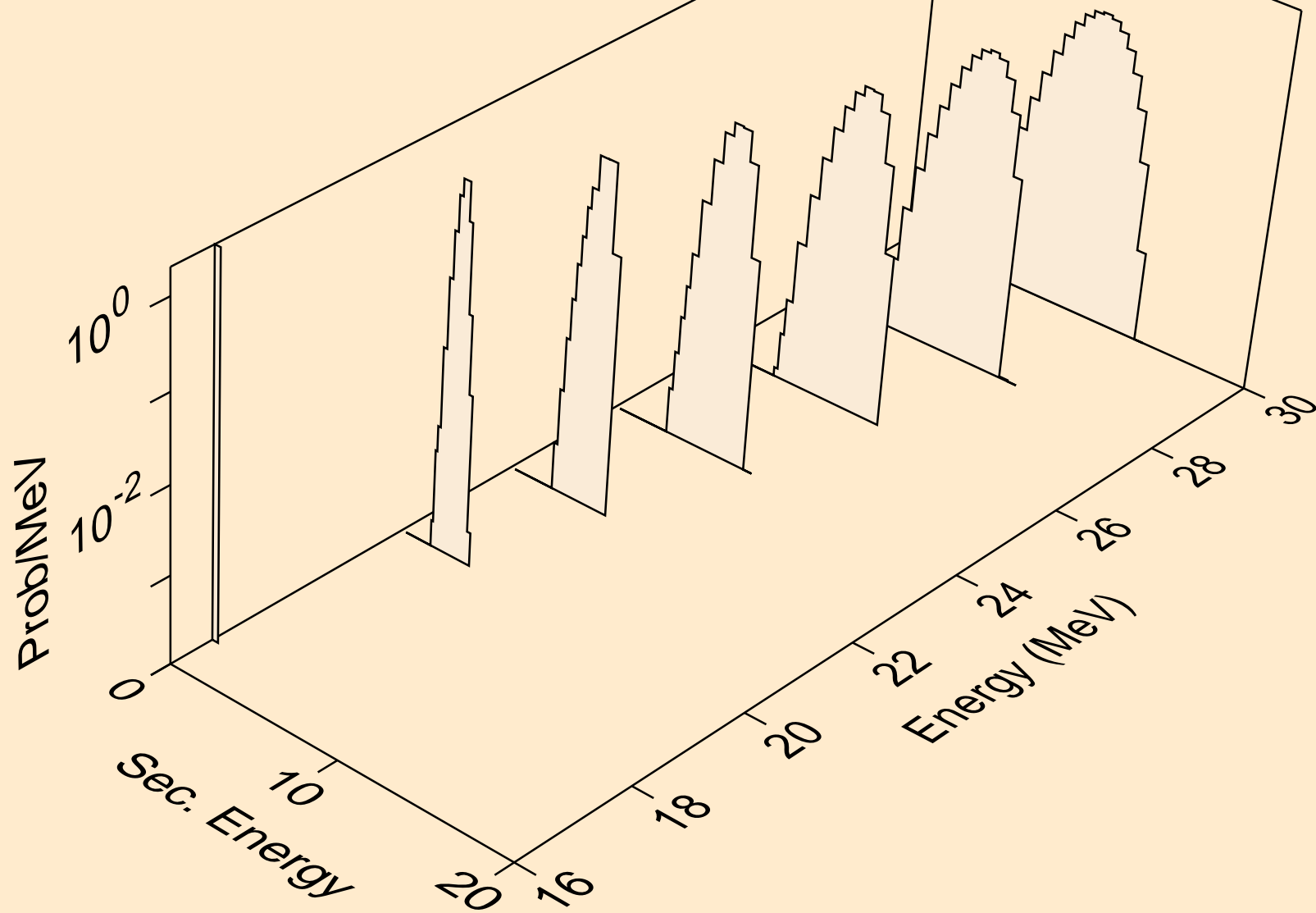

NP244 NEUTRON ACER TENDL-2021 LIBRARY; T=293.6K
protons from (n,2np)

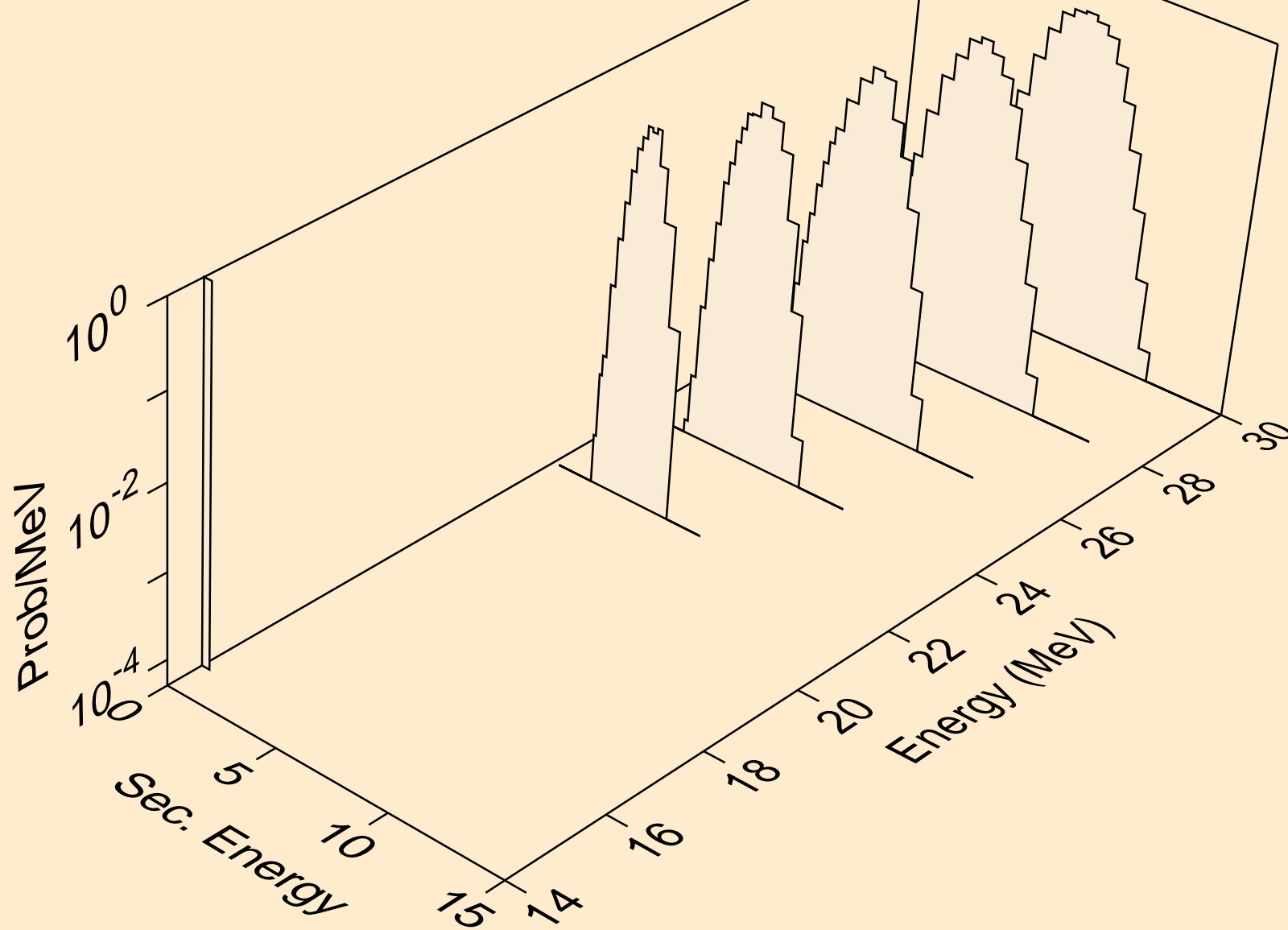

NP244 NEUTRON ACER TENDL-2021 LIBRARY; T=293.6K
protons from (n,npa)

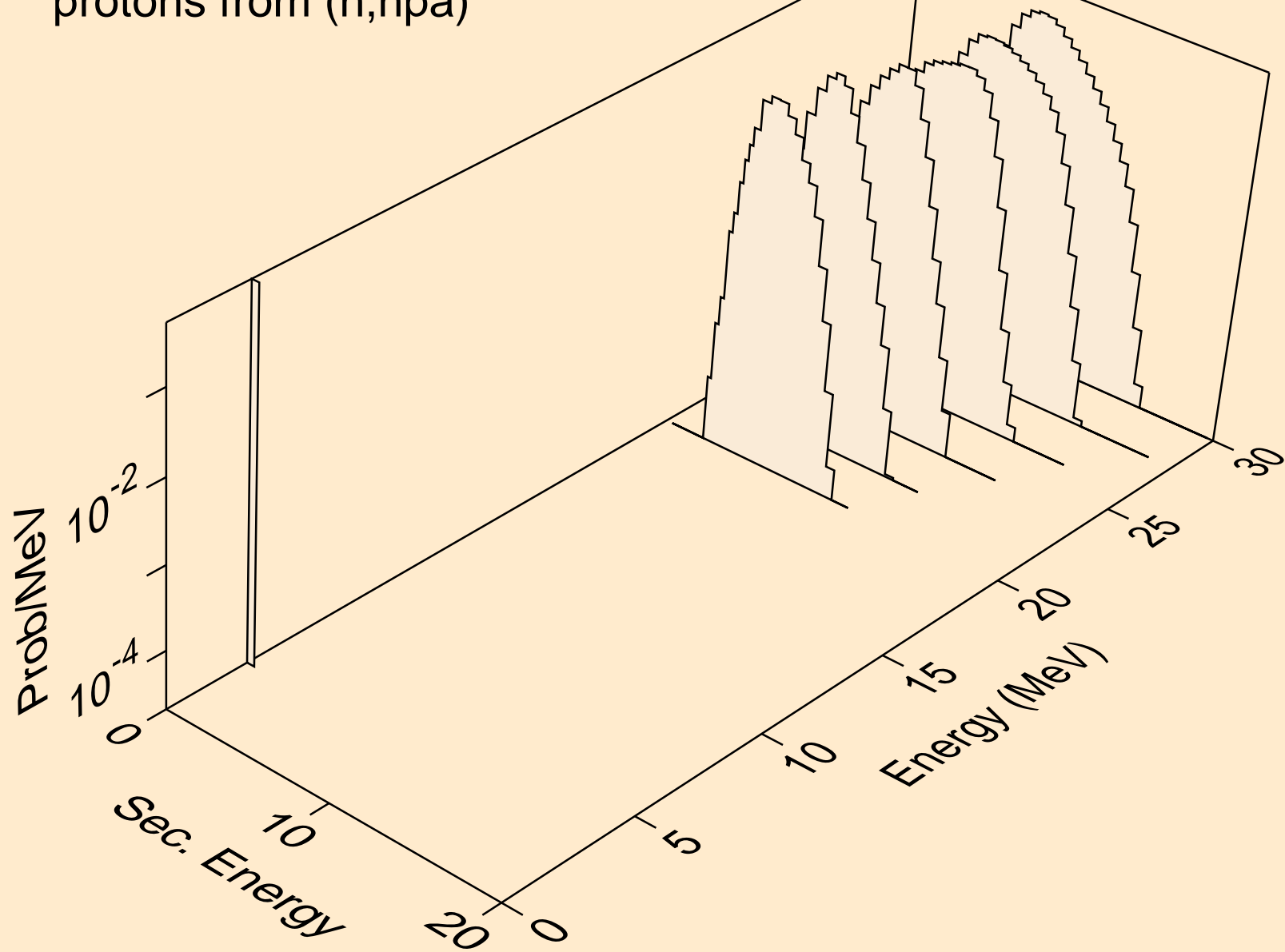

NP244 NEUTRON ACER TENDL-2021 LIBRARY; T=293.6K
protons from (n,p)

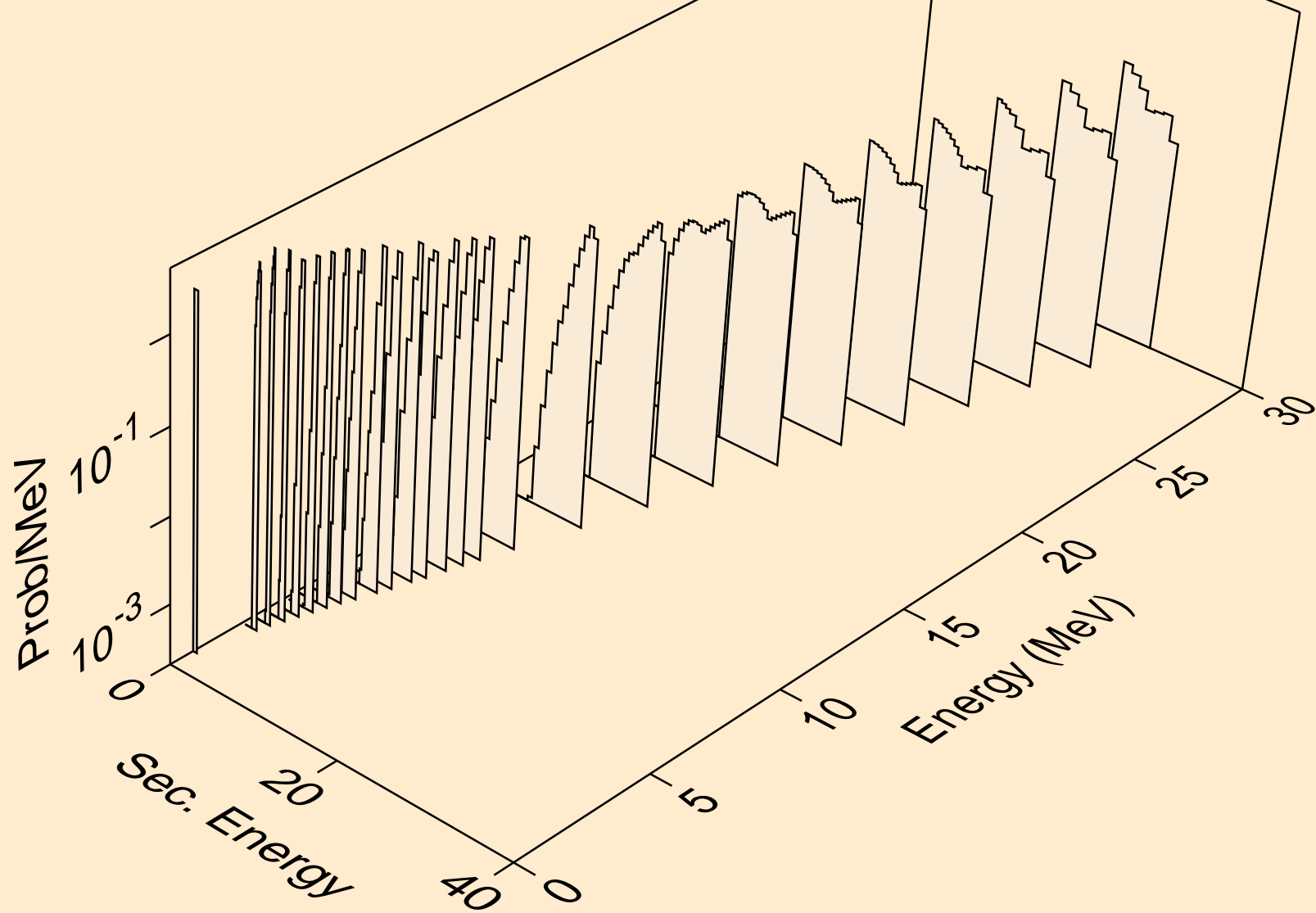

NP244 NEUTRON ACER TENDL-2021 LIBRARY; T=293.6K
protons from (n,2p)

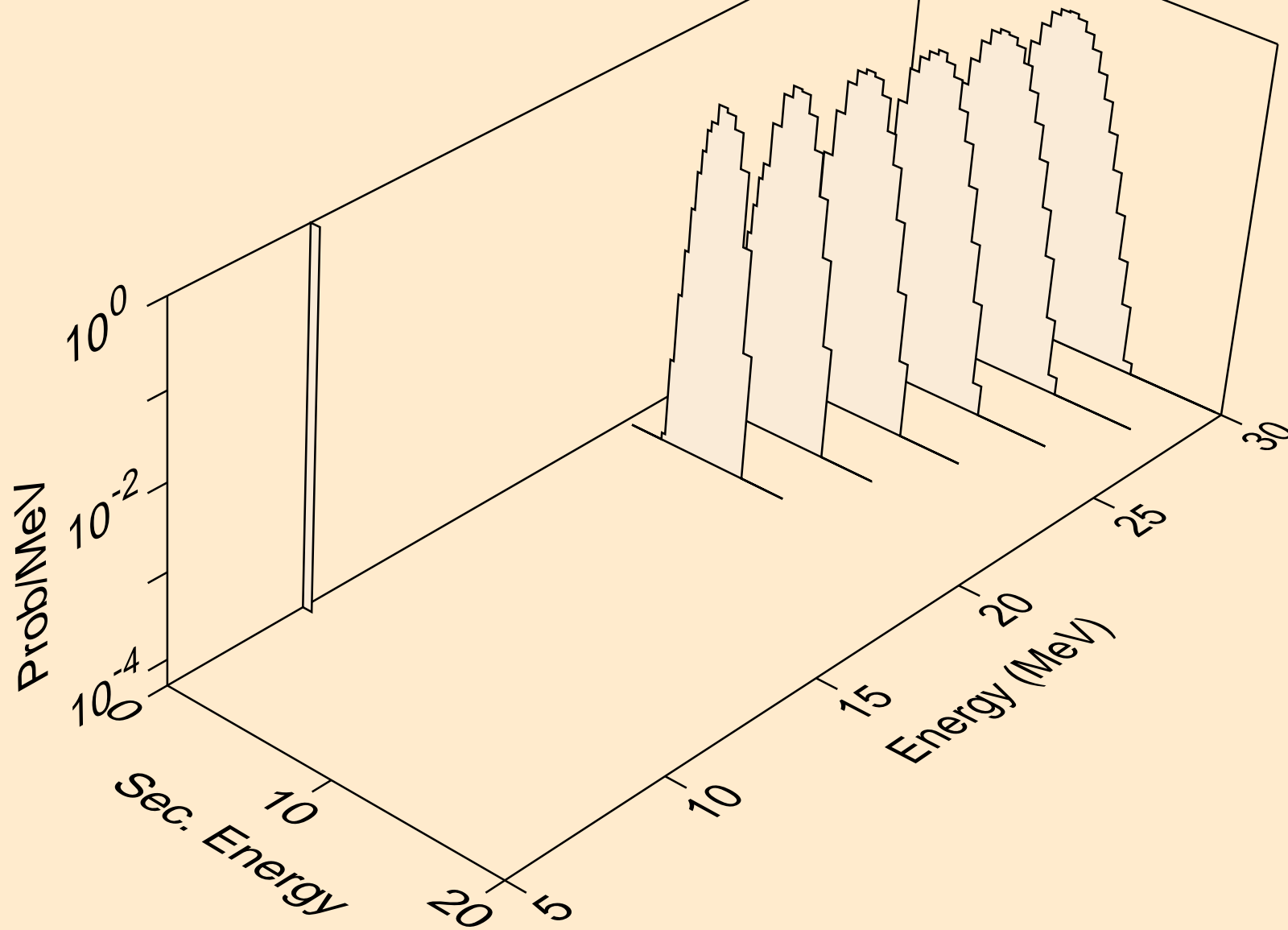

NP244 NEUTRON ACER TENDL-2021 LIBRARY; T=293.6K
protons from (n,p)

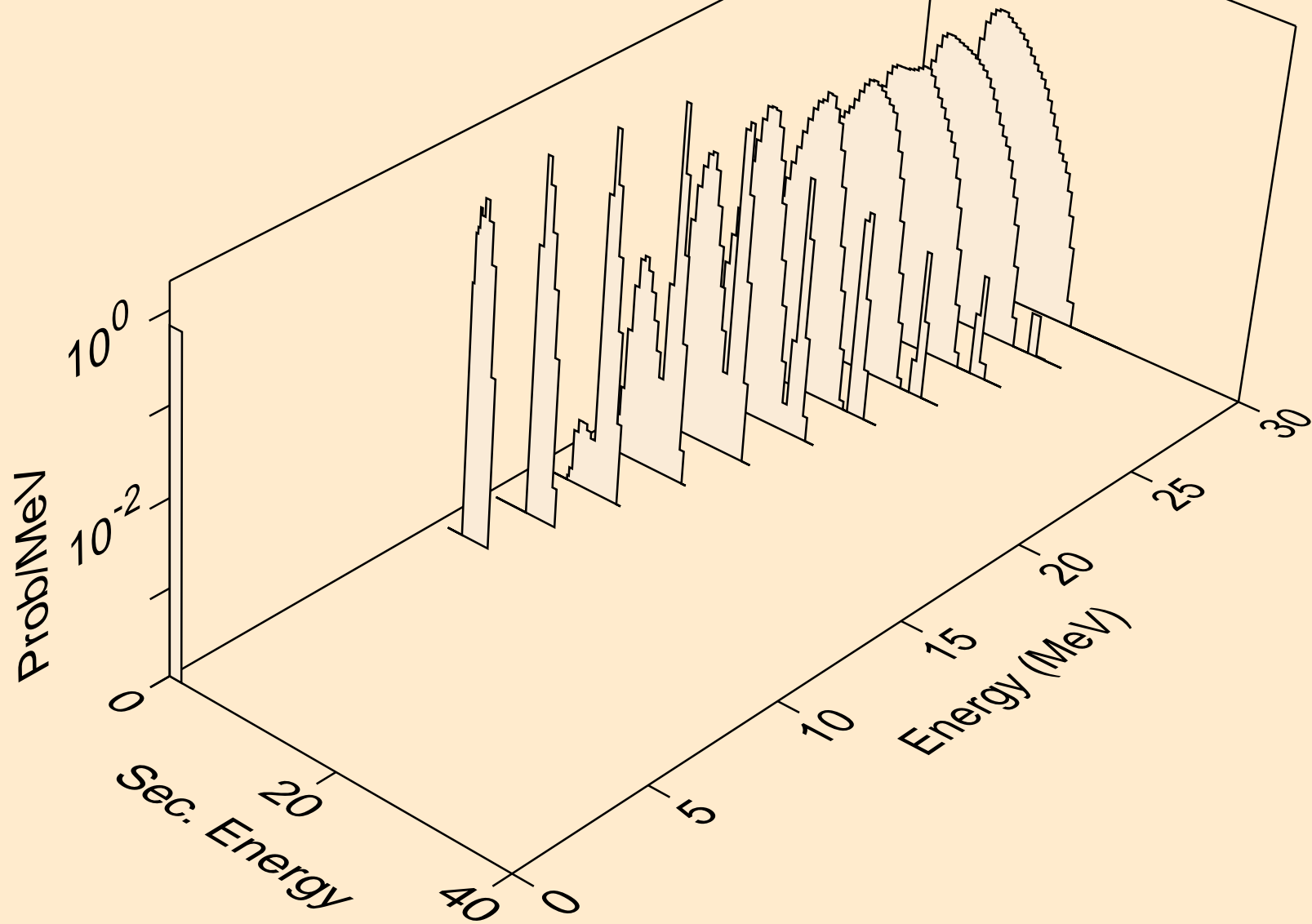

NP244 NEUTRON ACER TENDL-2021 LIBRARY; T=293.6K
protons from (n,pd)

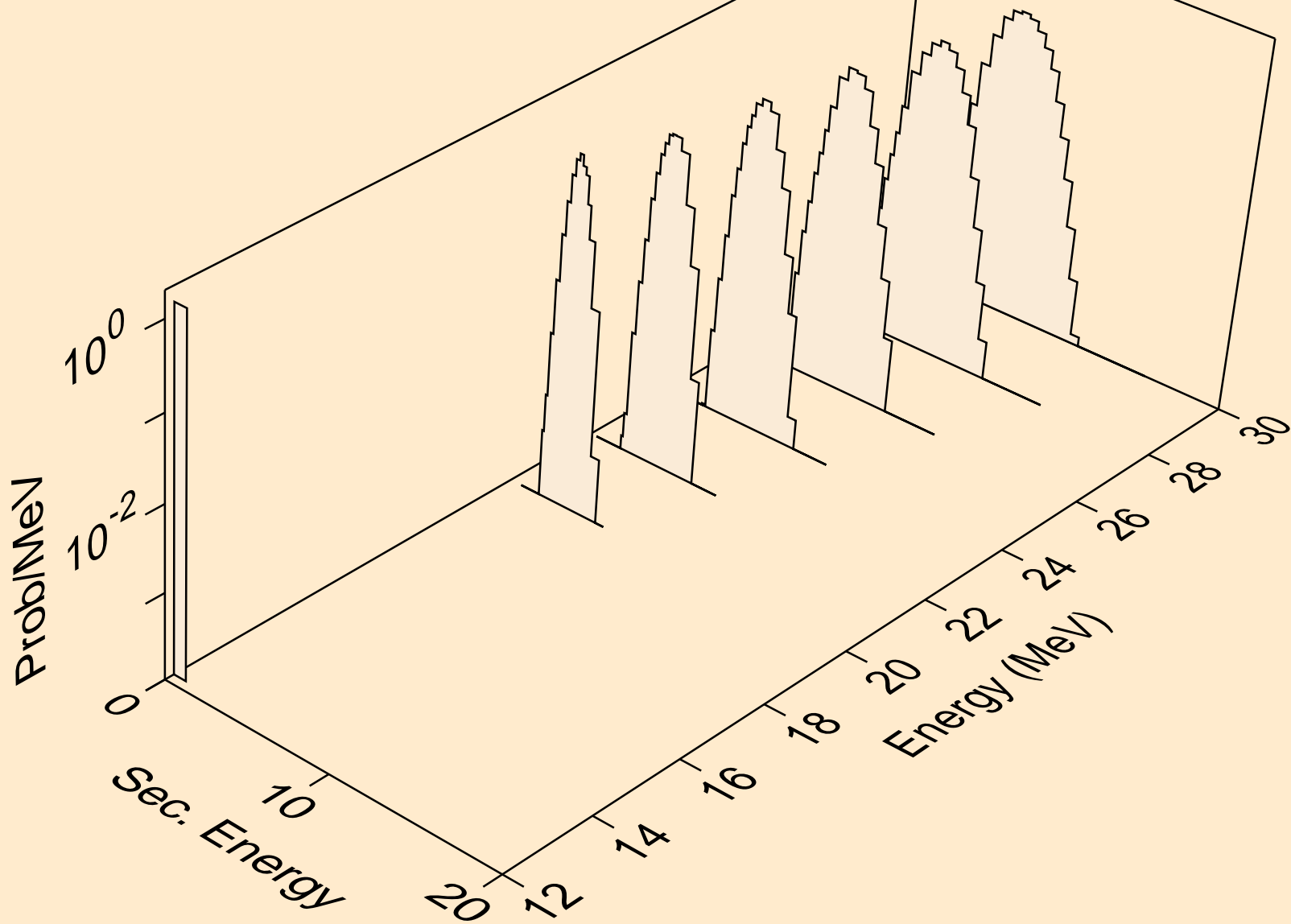

NP244 NEUTRON ACER TENDL-2021 LIBRARY; T=293.6K
deuterons from (n,x)

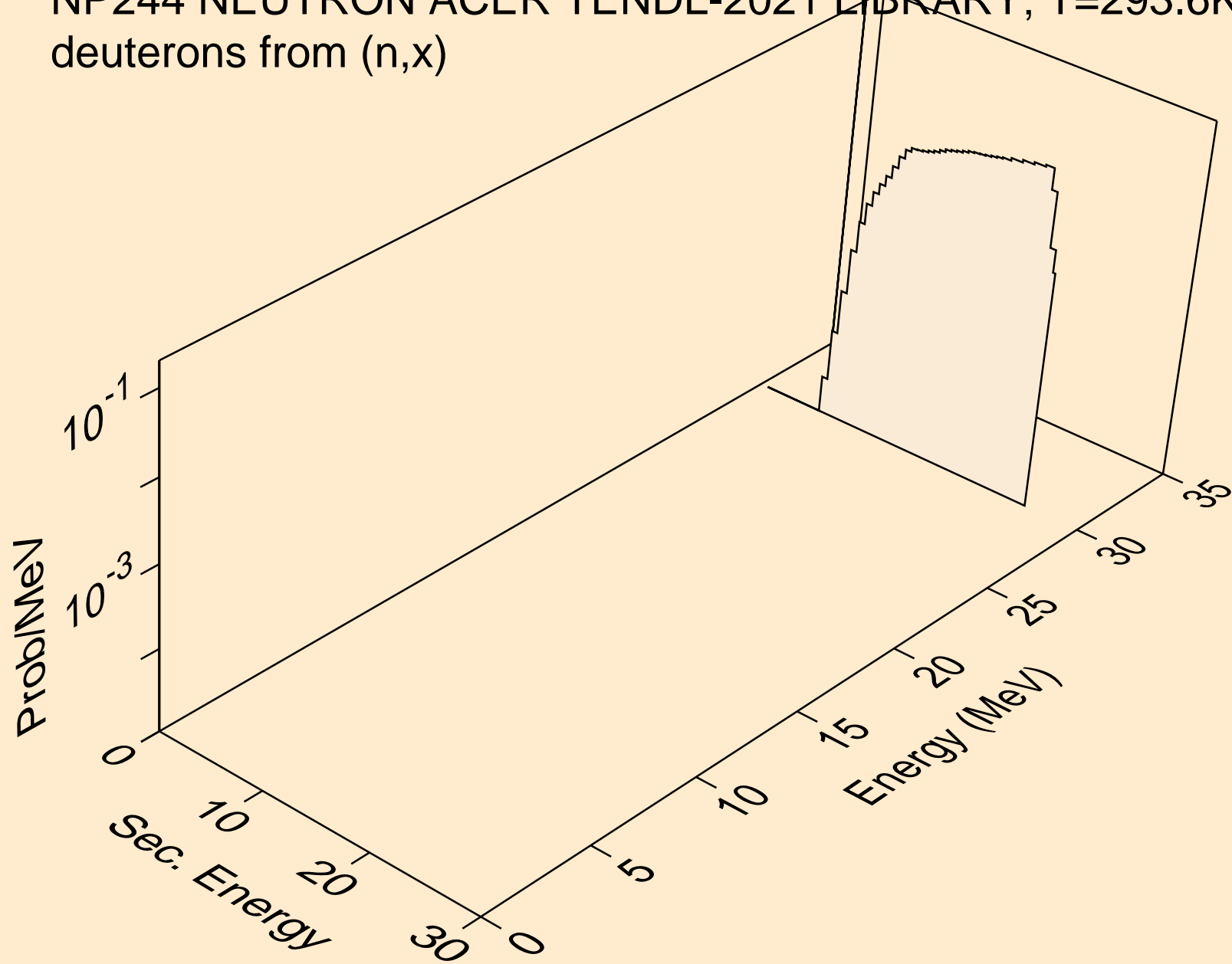

NP244 NEUTRON ACER TENDL-2021 LIBRARY; T=293.6K
deuterons from (n,2nd)

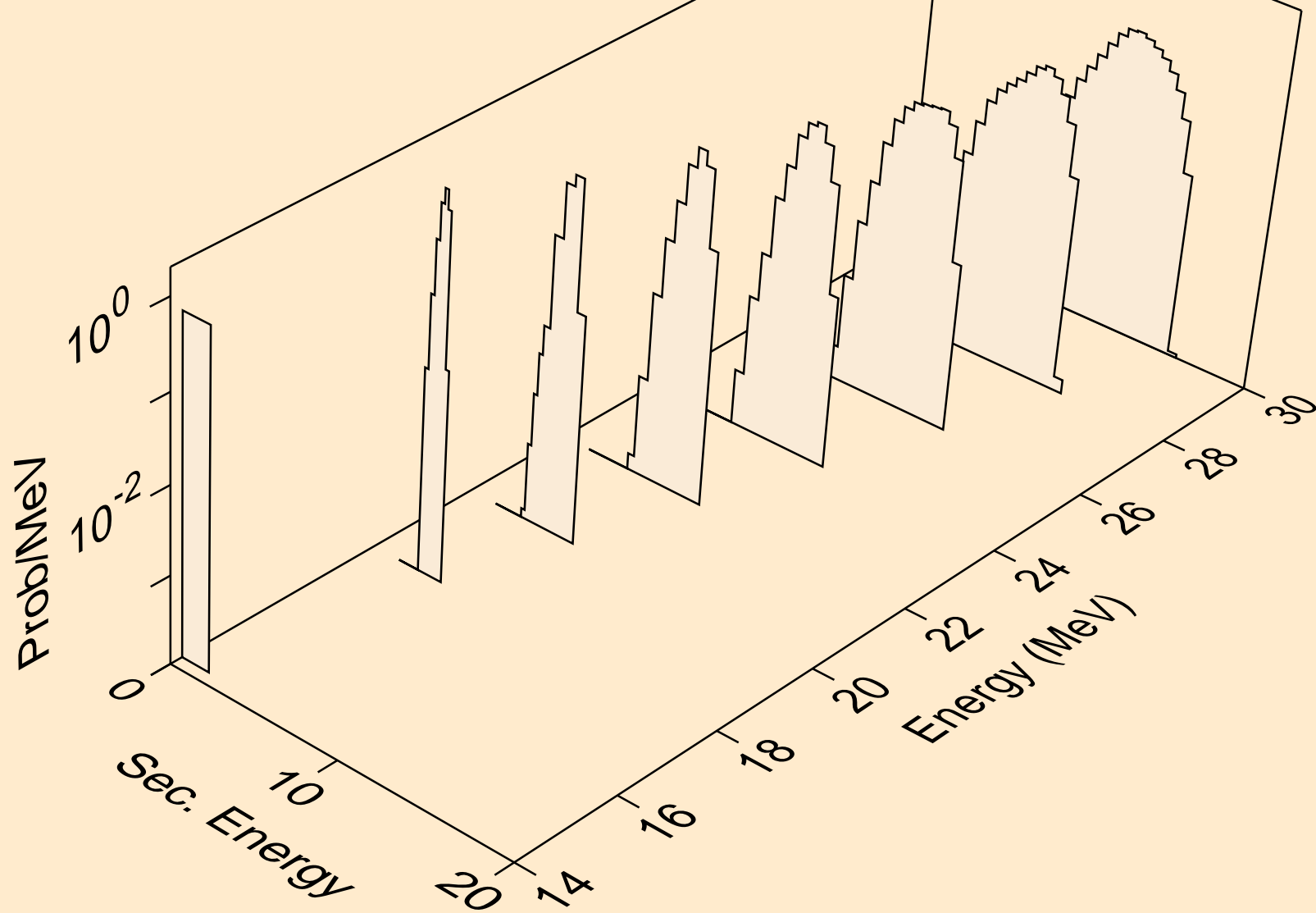

NP244 NEUTRON ACER TENDL-2021 LIBRARY; T=293.6K
deuterons from (n,n*)d

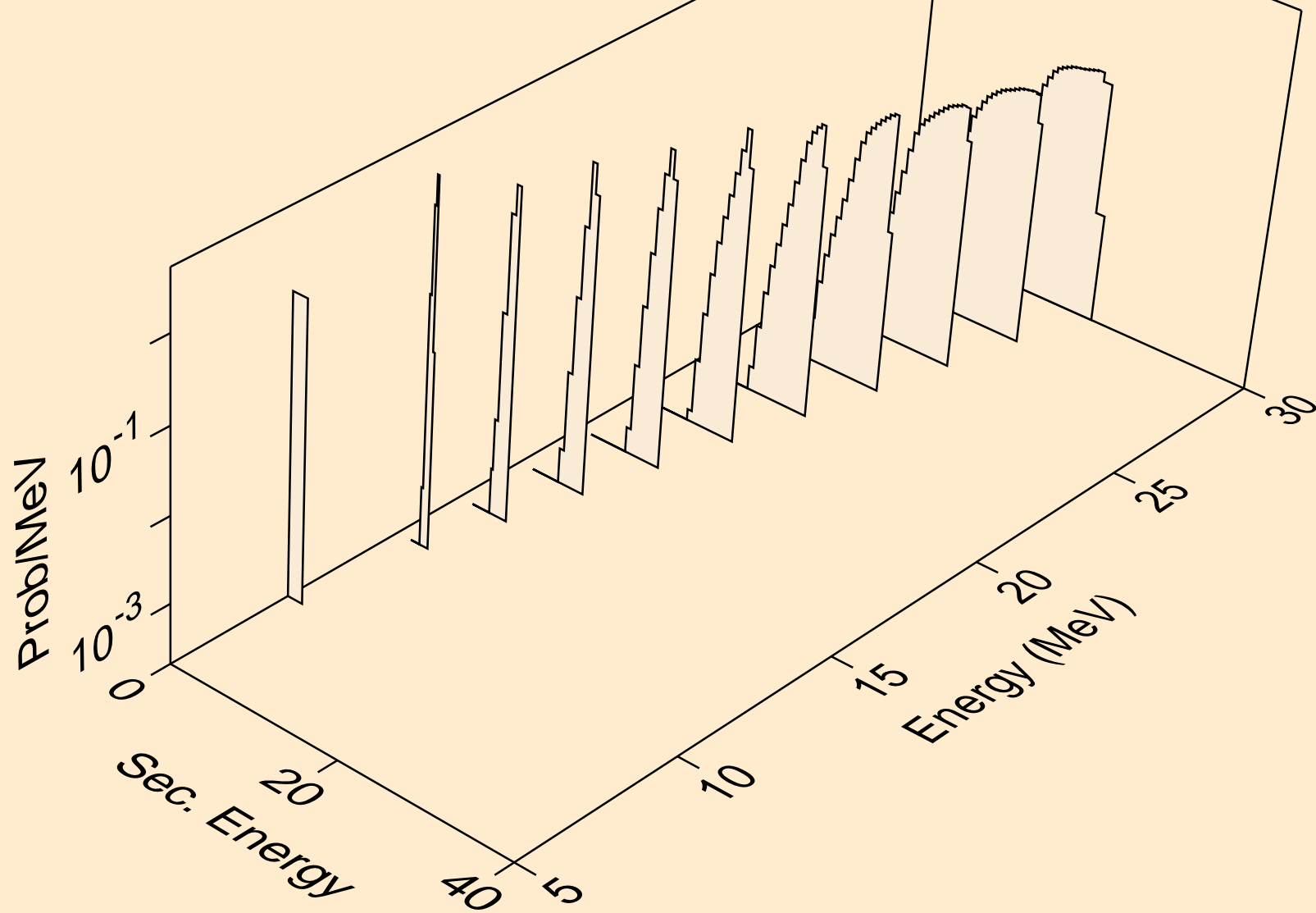

NP244 NEUTRON ACER TENDL-2021 LIBRARY; T=293.6K
deuterons from (n,d)

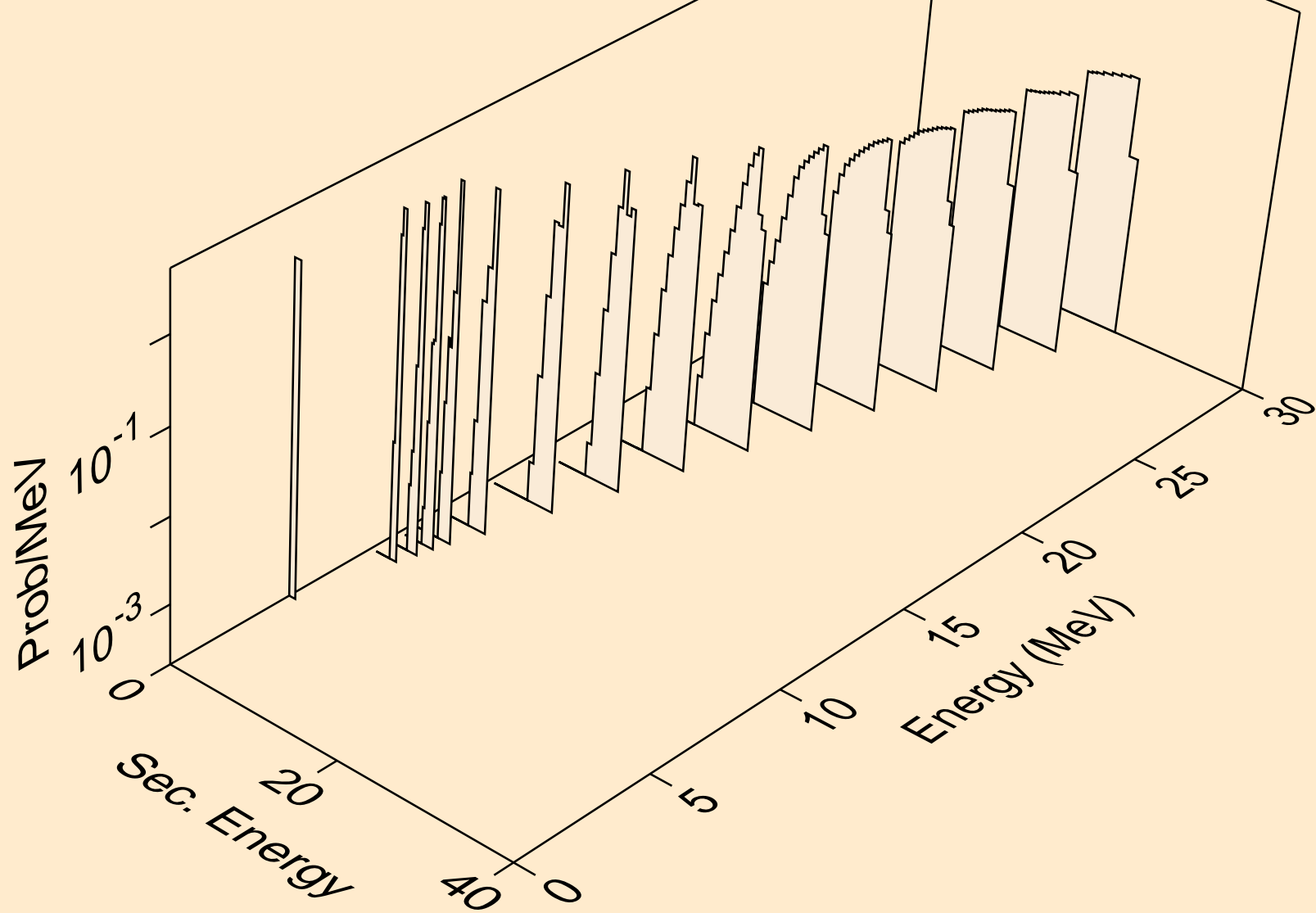

NP244 NEUTRON ACER TENDL-2021 LIBRARY; T=293.6K
deuterons from (n,pd)

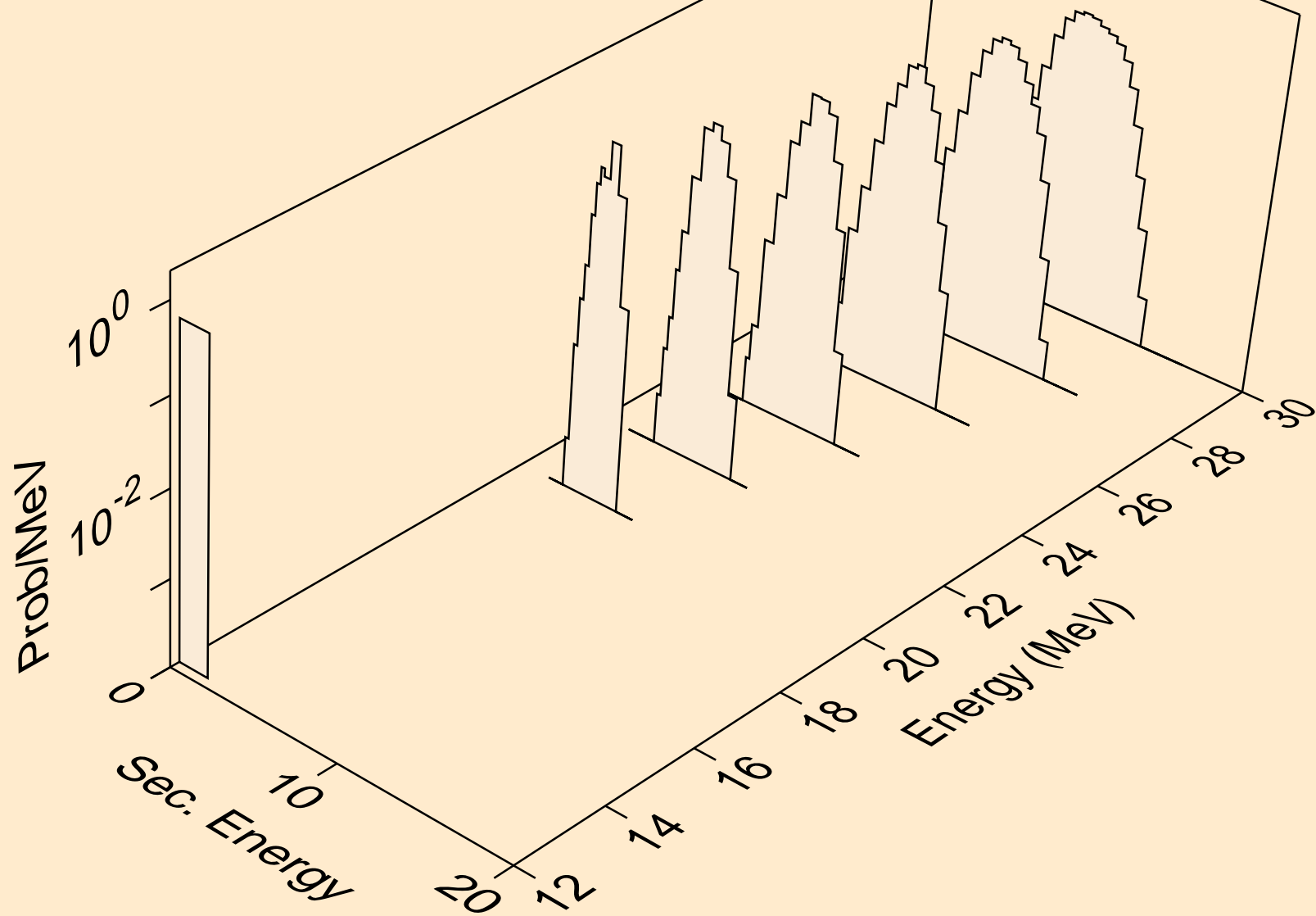

NP244 NEUTRON ACER TENDL-2021 LIBRARY; T=293.6K
tritons from (n,x)

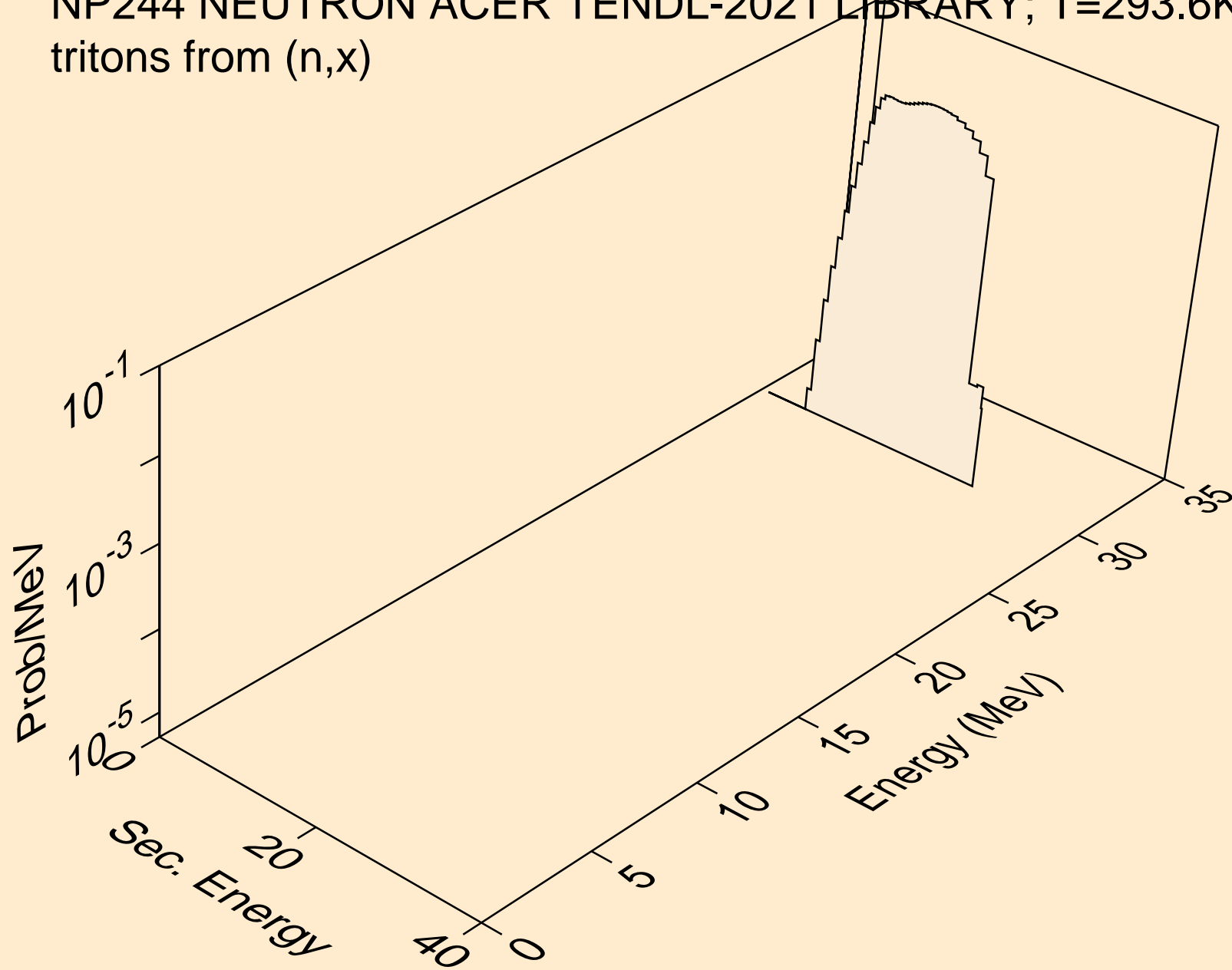

NP244 NEUTRON ACER TENDL-2021 LIBRARY; T=293.6K
tritons from (n,n*)t

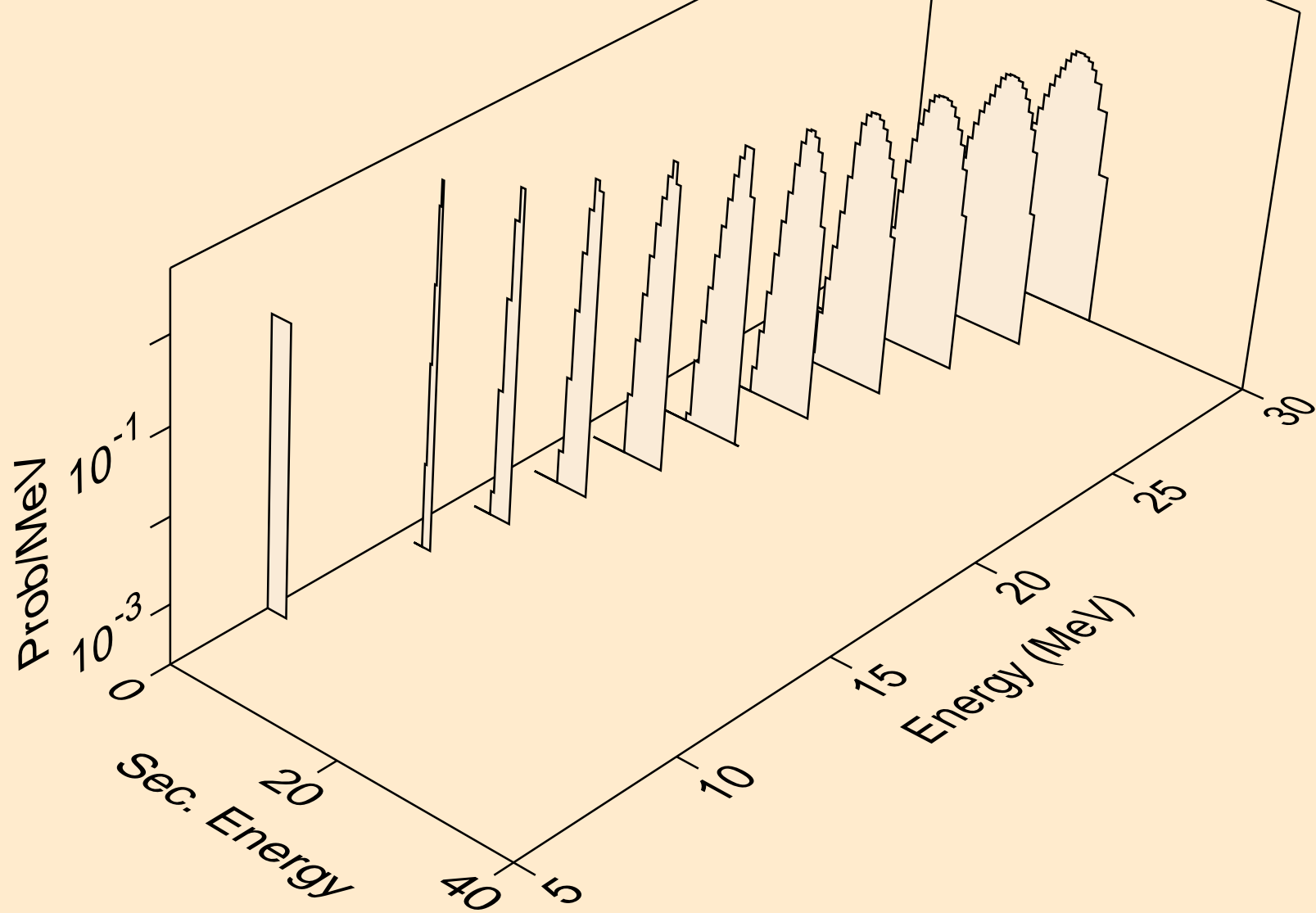

NP244 NEUTRON ACER TENDL-2021 LIBRARY; T=293.6K
tritons from (n,t)

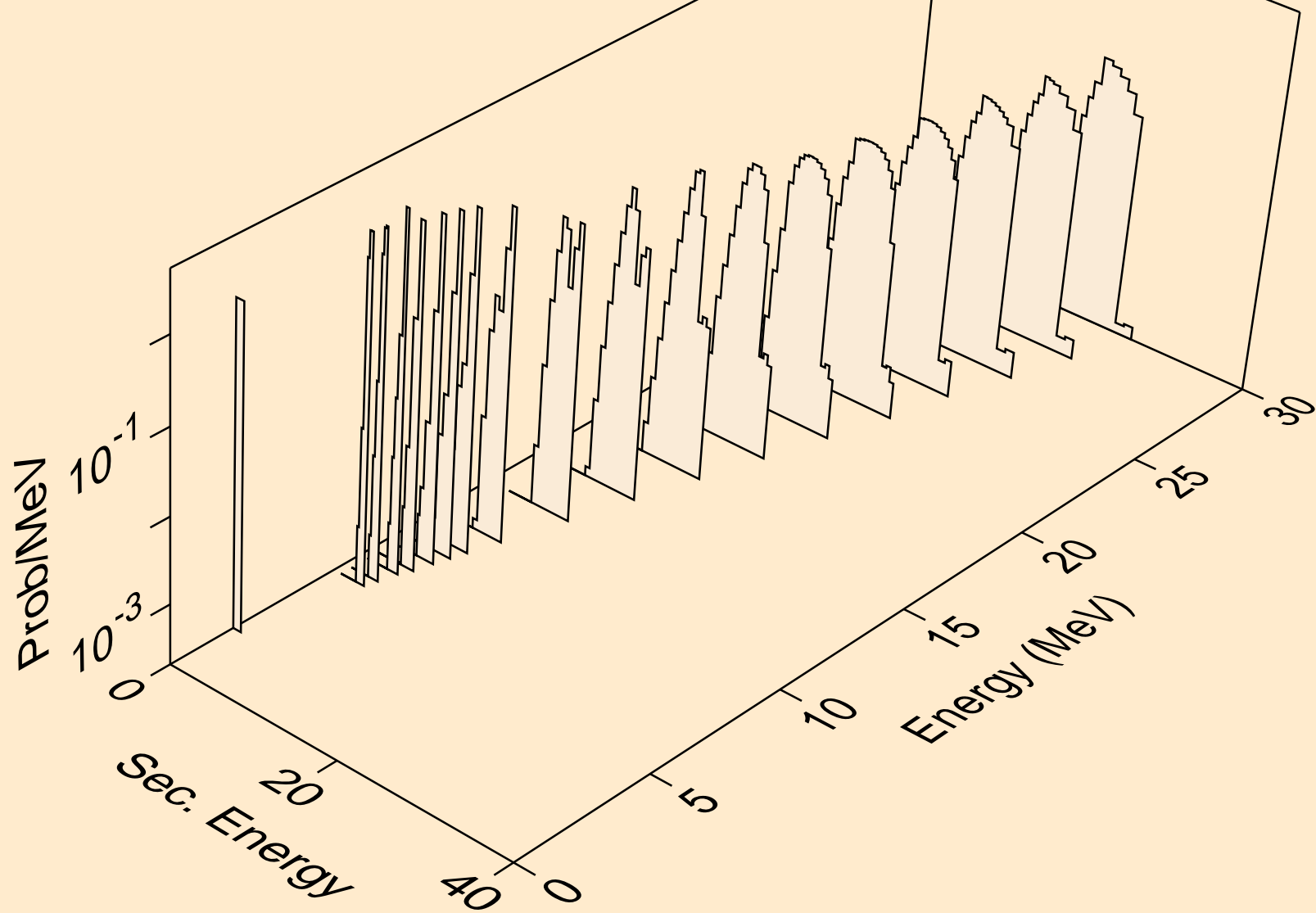

NP244 NEUTRON ACER TENDL-2021 LIBRARY; T=293.6K
he3s from (n,x)

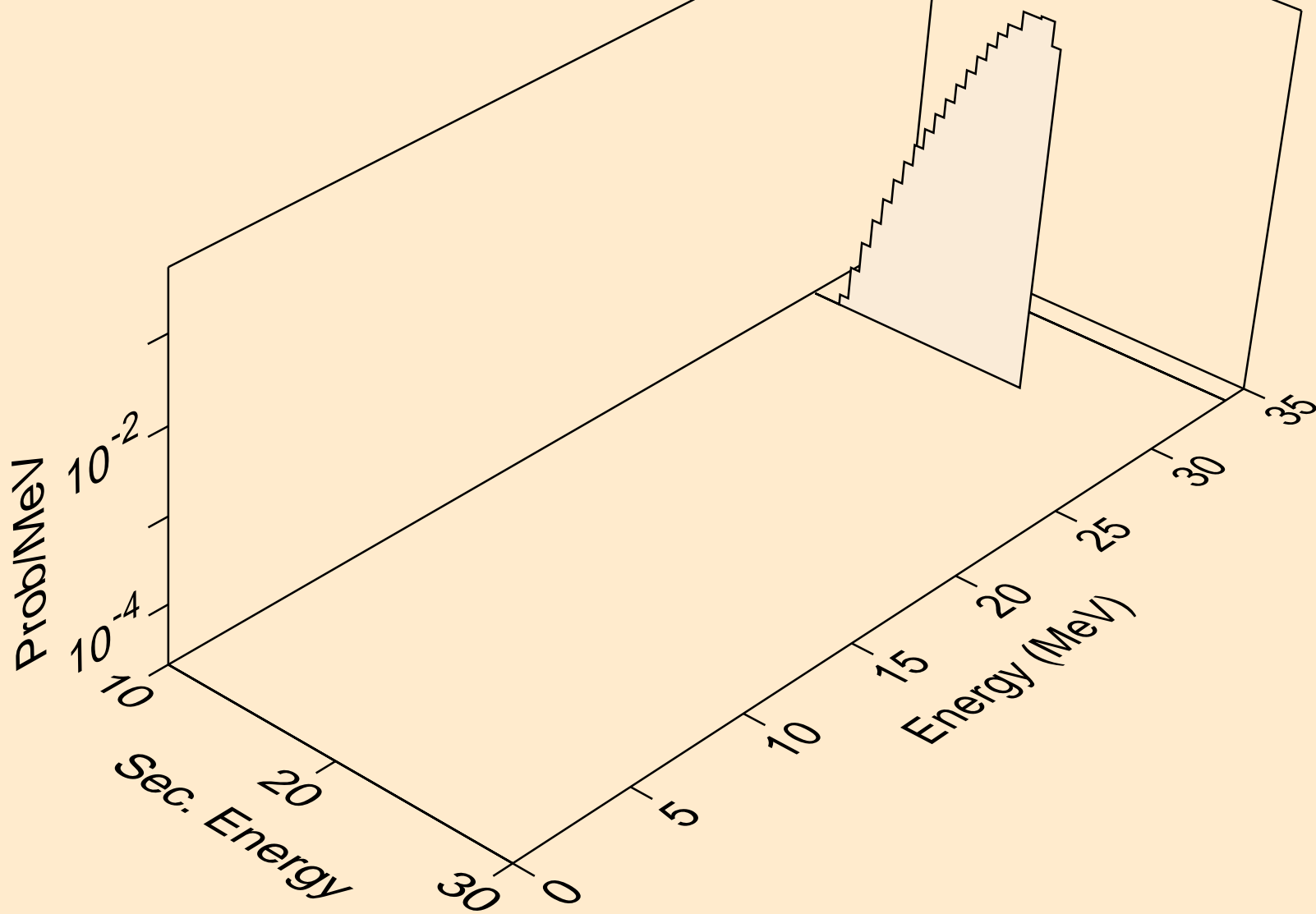

NP244 NEUTRON ACER TENDL-2021 LIBRARY; T=293.6K
he3s from (n,n*)he3

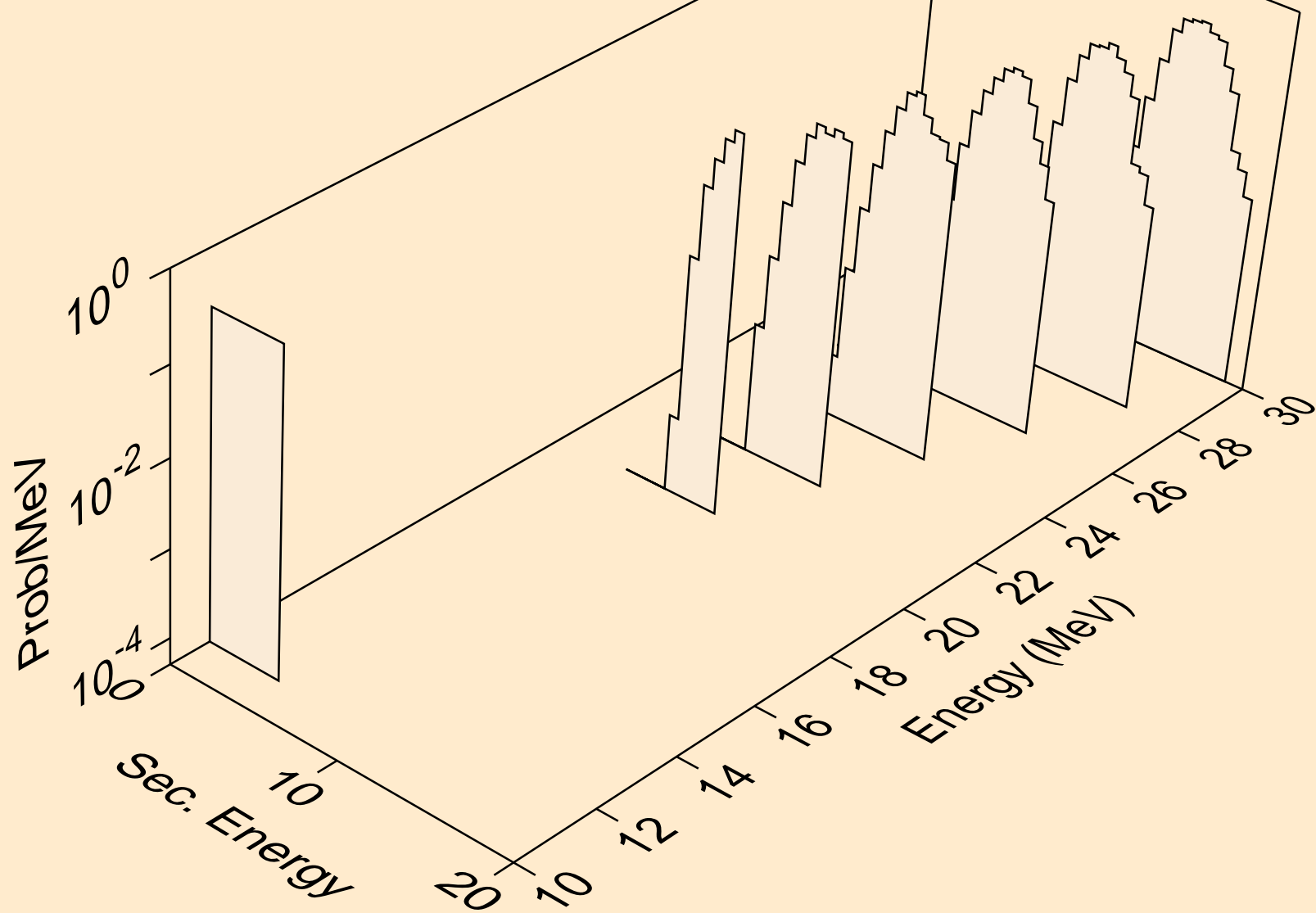

NP244 NEUTRON ACER TENDL-2021 LIBRARY; T=293.6K
he3s from (n,he3)

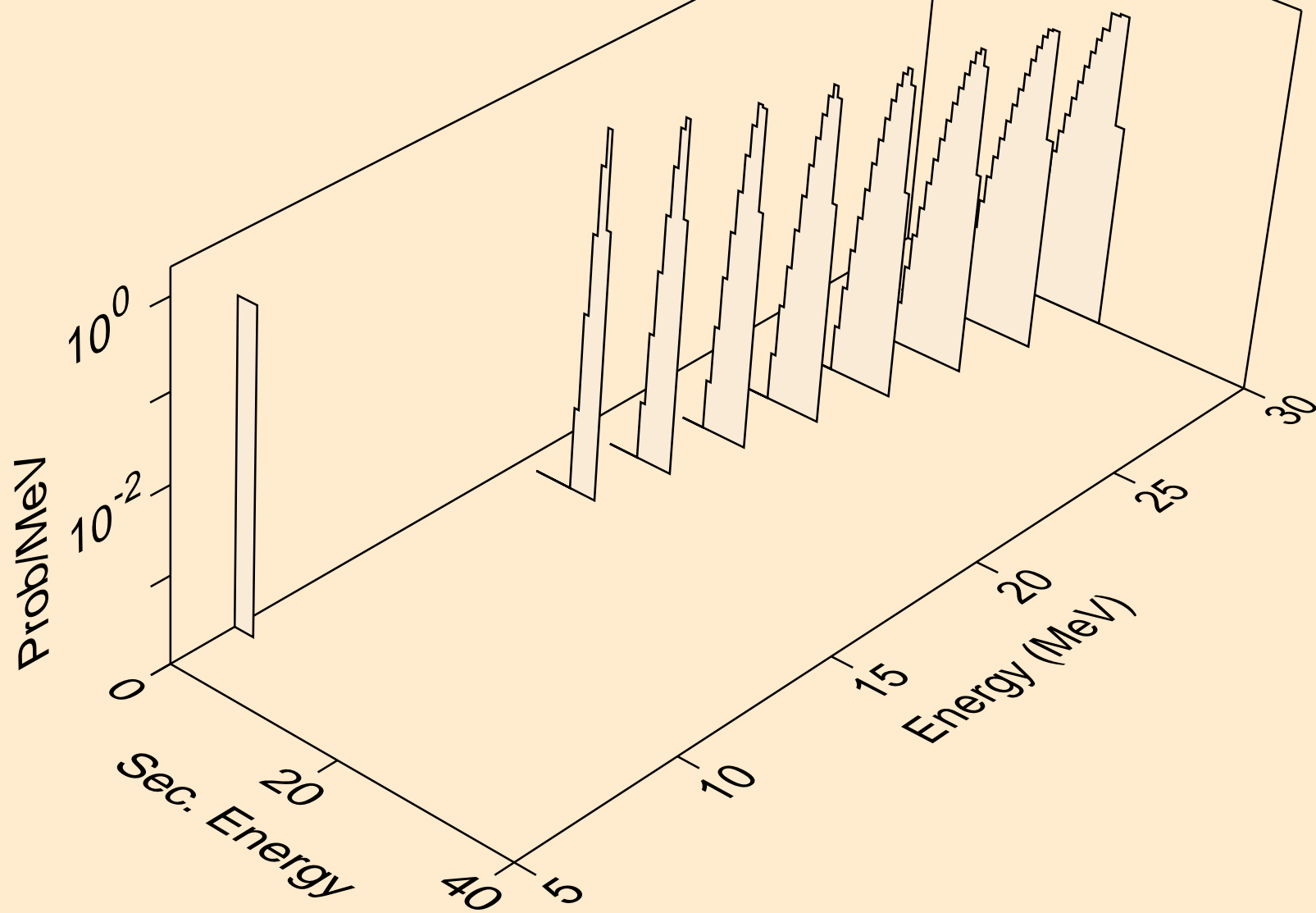

NP244 NEUTRON ACER TENDL-2021 LIBRARY; T=293.6K
alphas from (n,x)

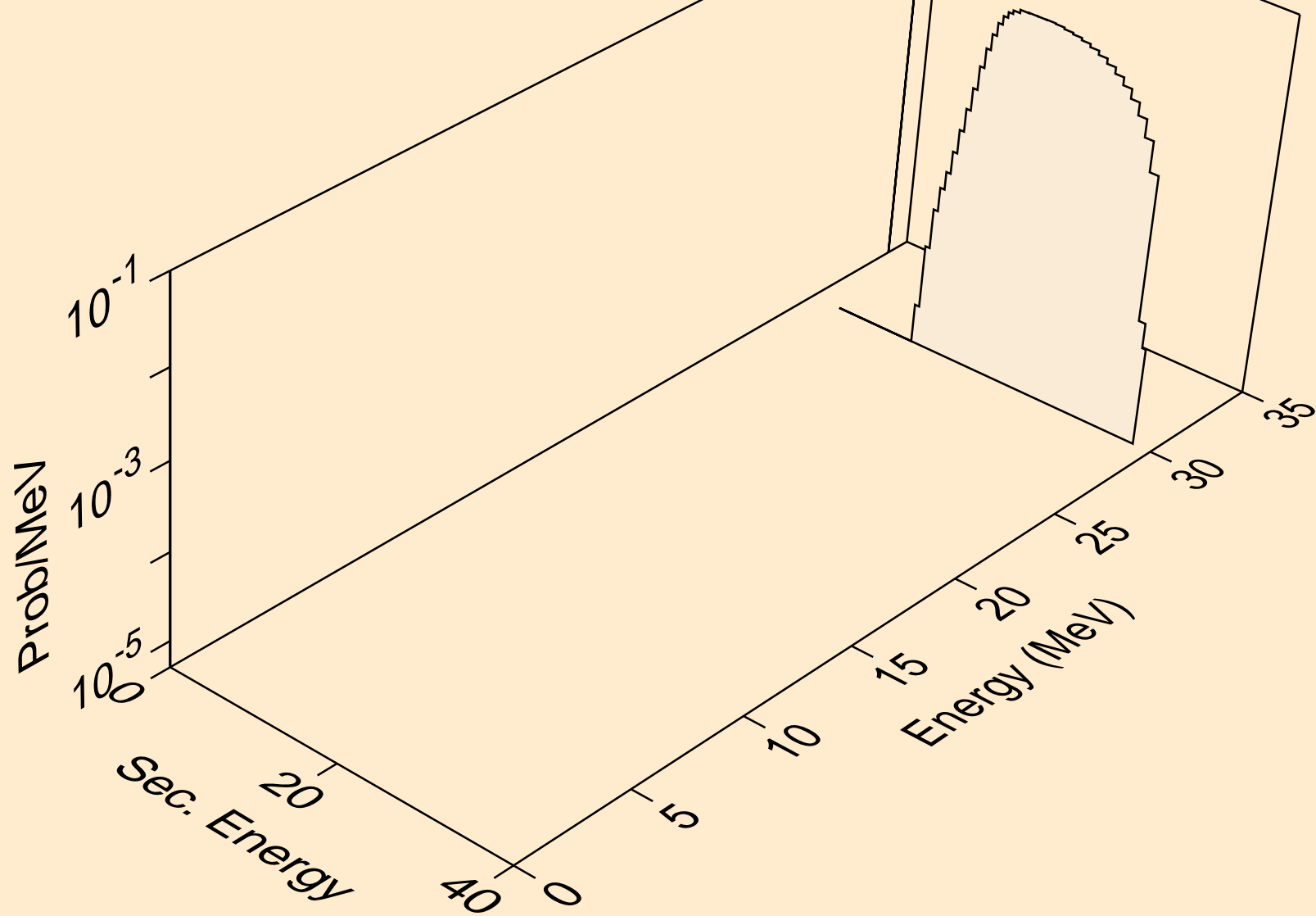

NP244 NEUTRON ACER TENDL-2021 LIBRARY; T=293.6K
alphas from (n,n*)a

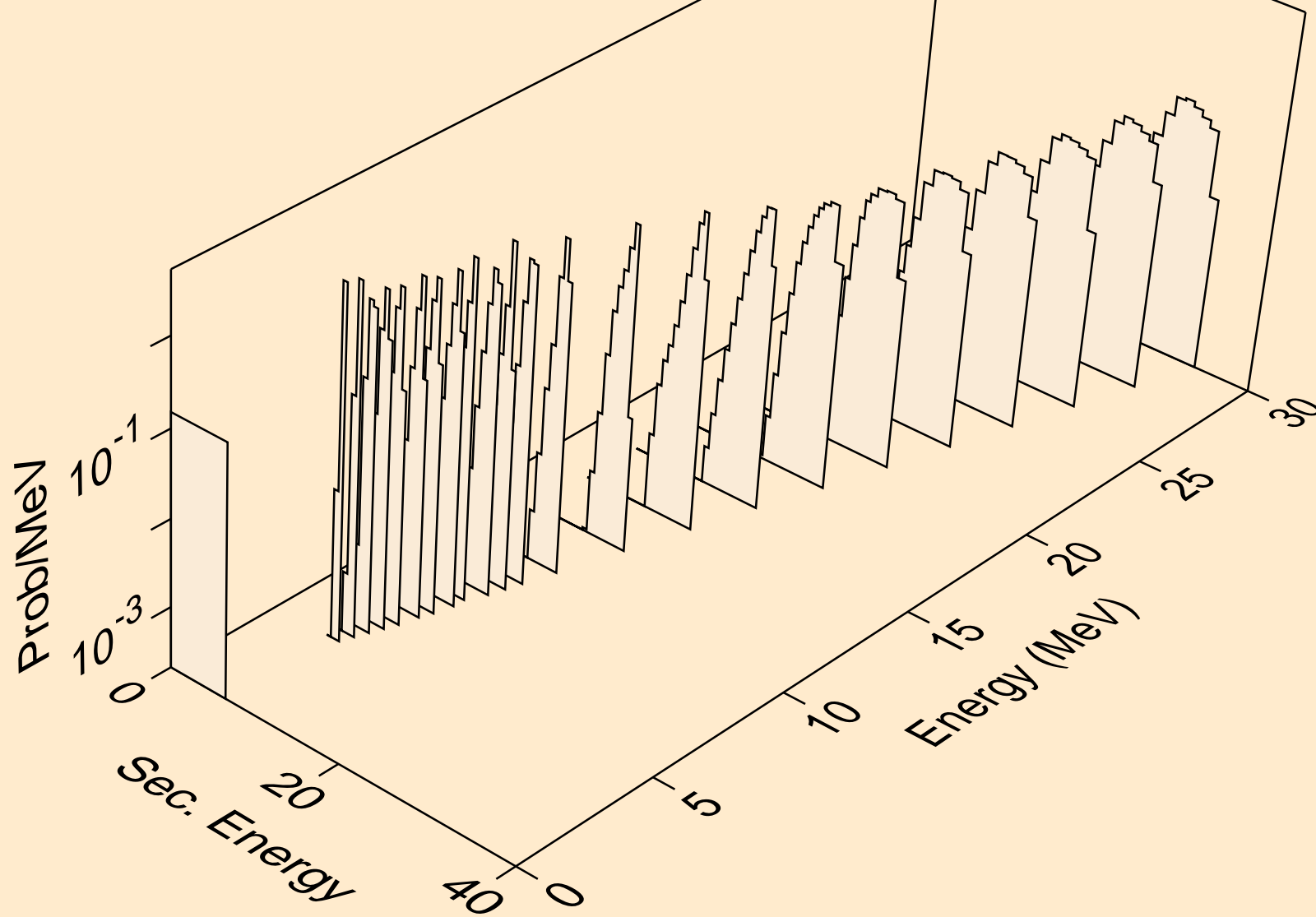

NP244 NEUTRON ACER TENDL-2021 LIBRARY; T=293.6K
alphas from (n,2n)a

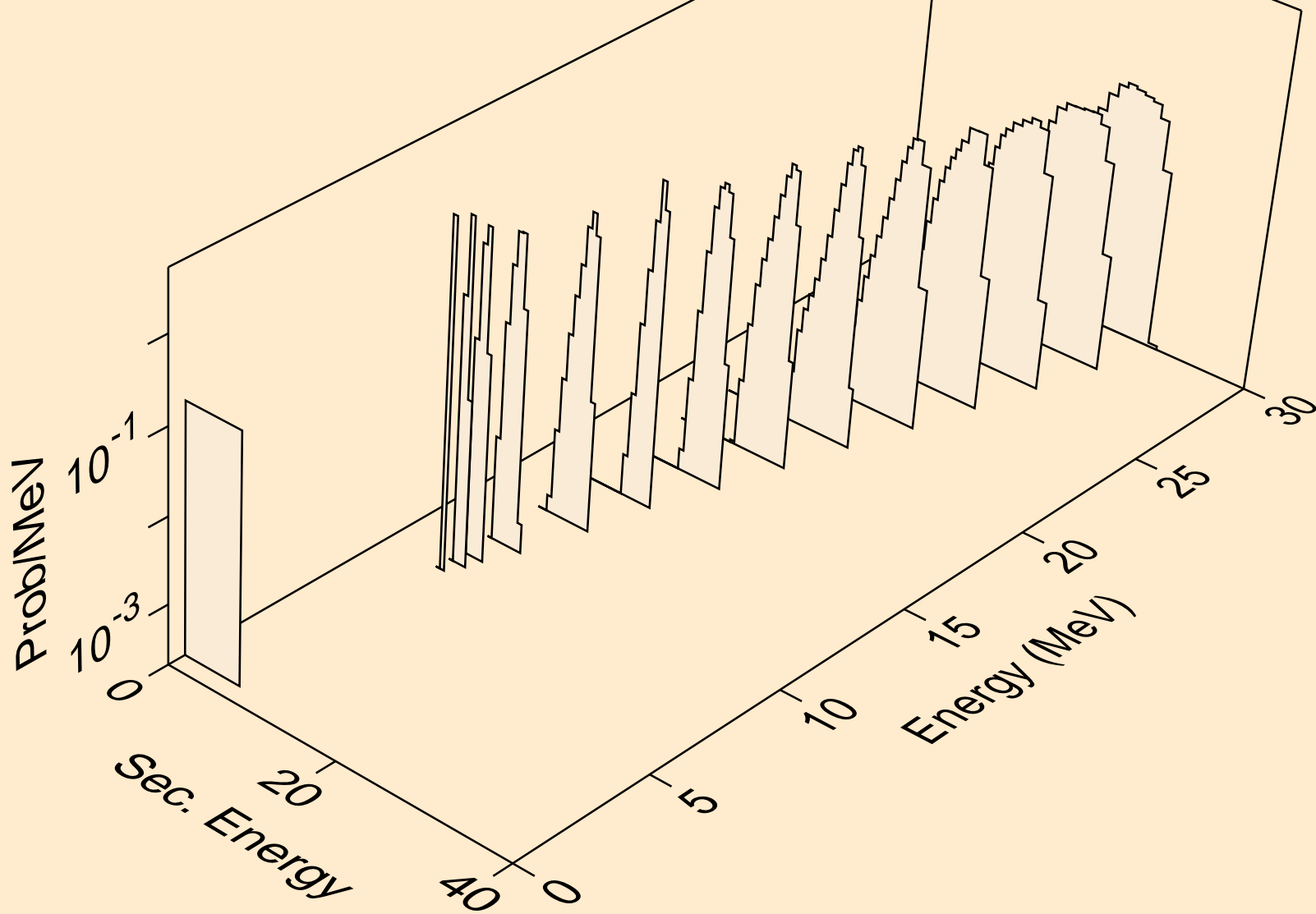

NP244 NEUTRON ACER TENDL-2021 LIBRARY; T=293.6K
alphas from (n,3n)a

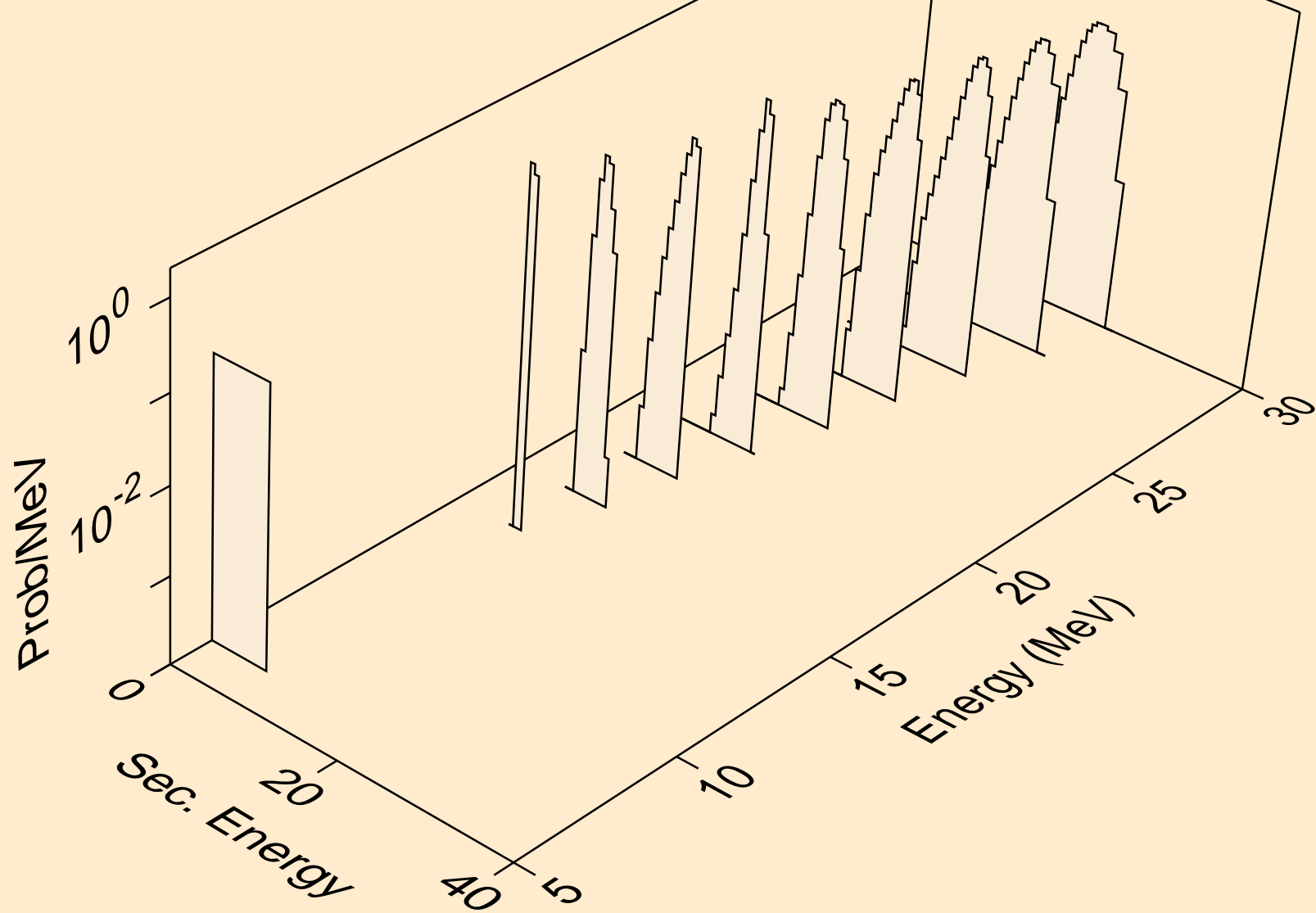

NP244 NEUTRON ACER TENDL-2021 LIBRARY; T=293.6K
alphas from (n,n*)2a

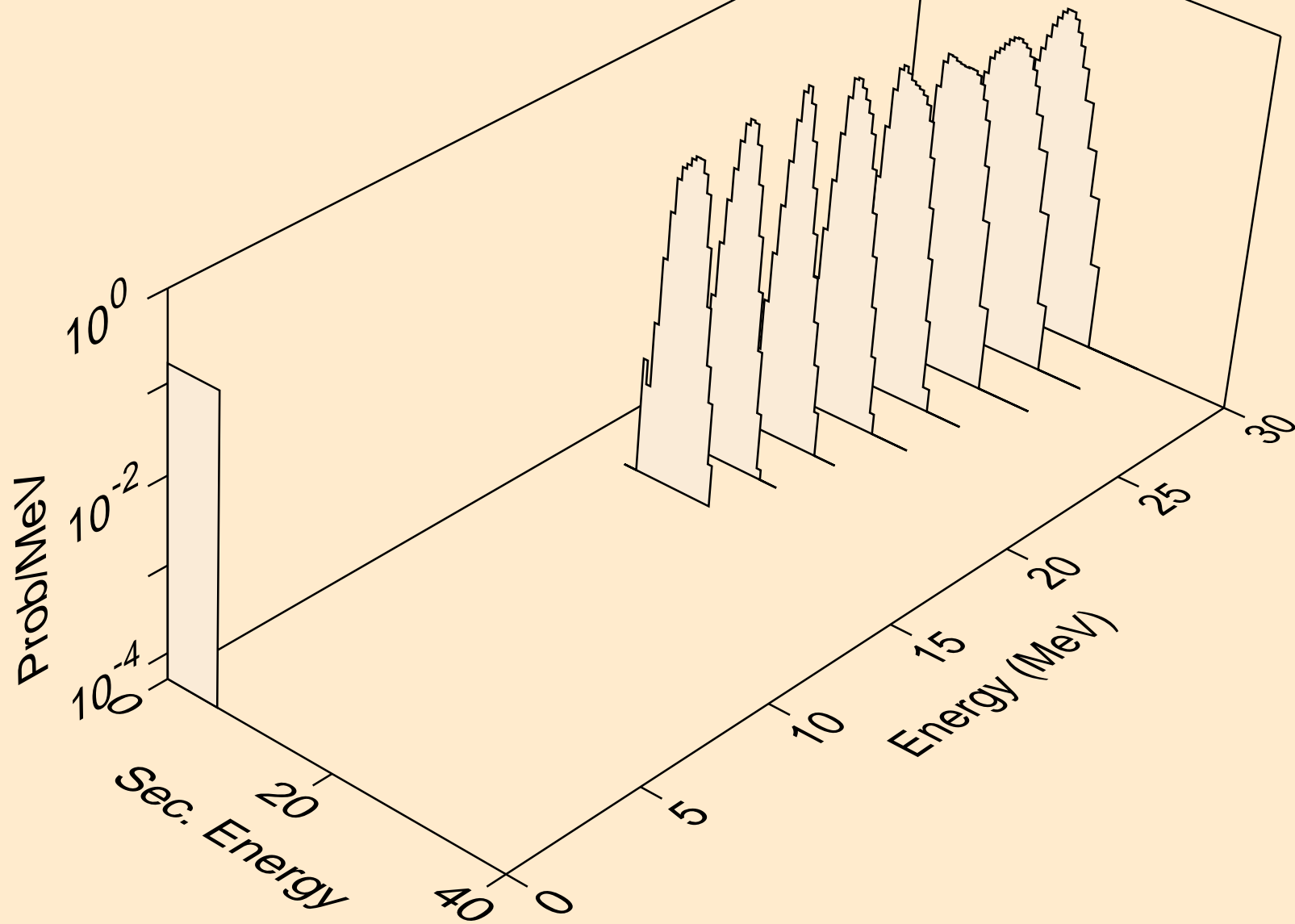

NP244 NEUTRON ACER TENDL-2021 LIBRARY; T=293.6K
alphas from (n,2n)2a

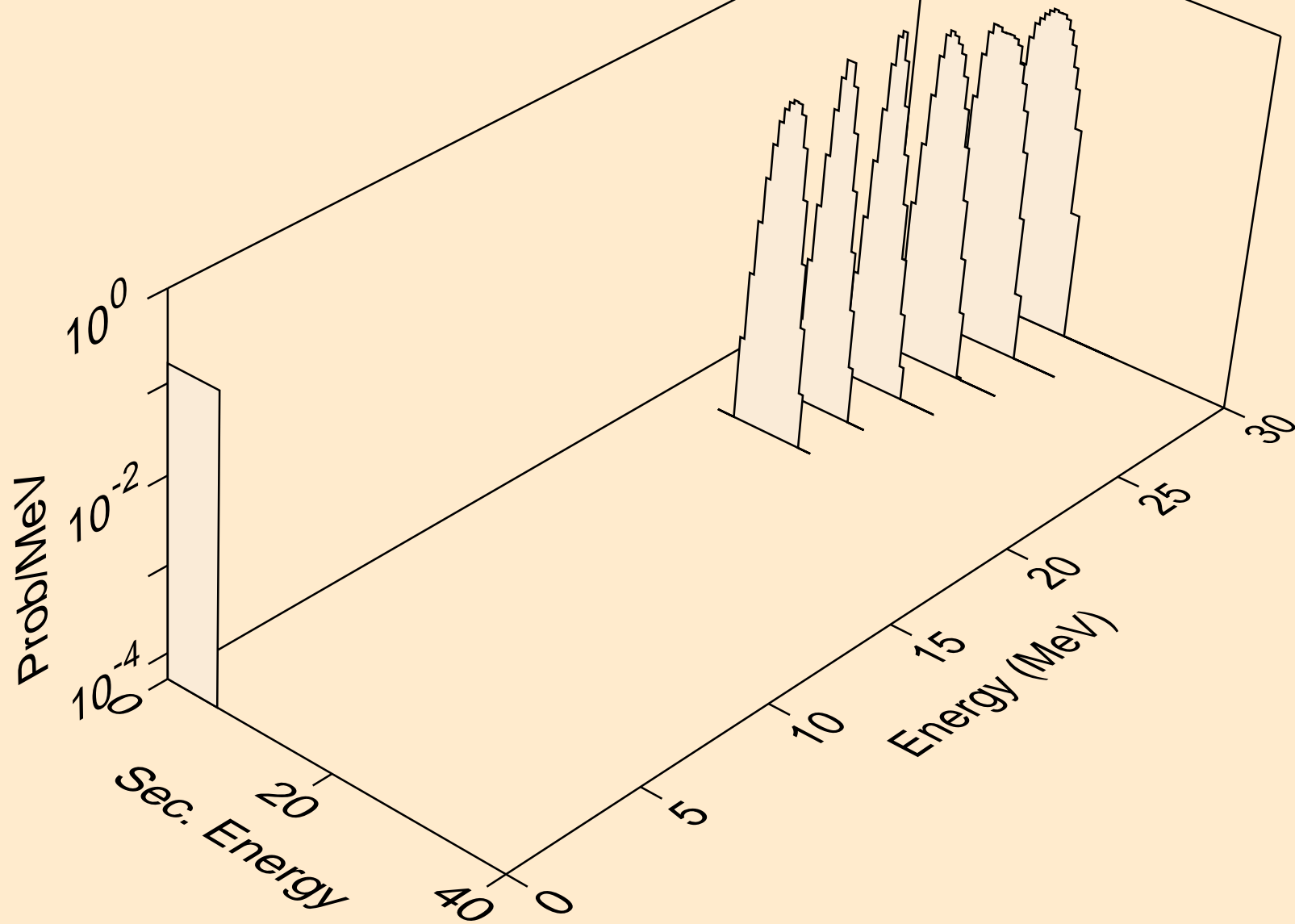

NP244 NEUTRON ACER TENDL-2021 LIBRARY; T=293.6K
alphas from (n,npa)

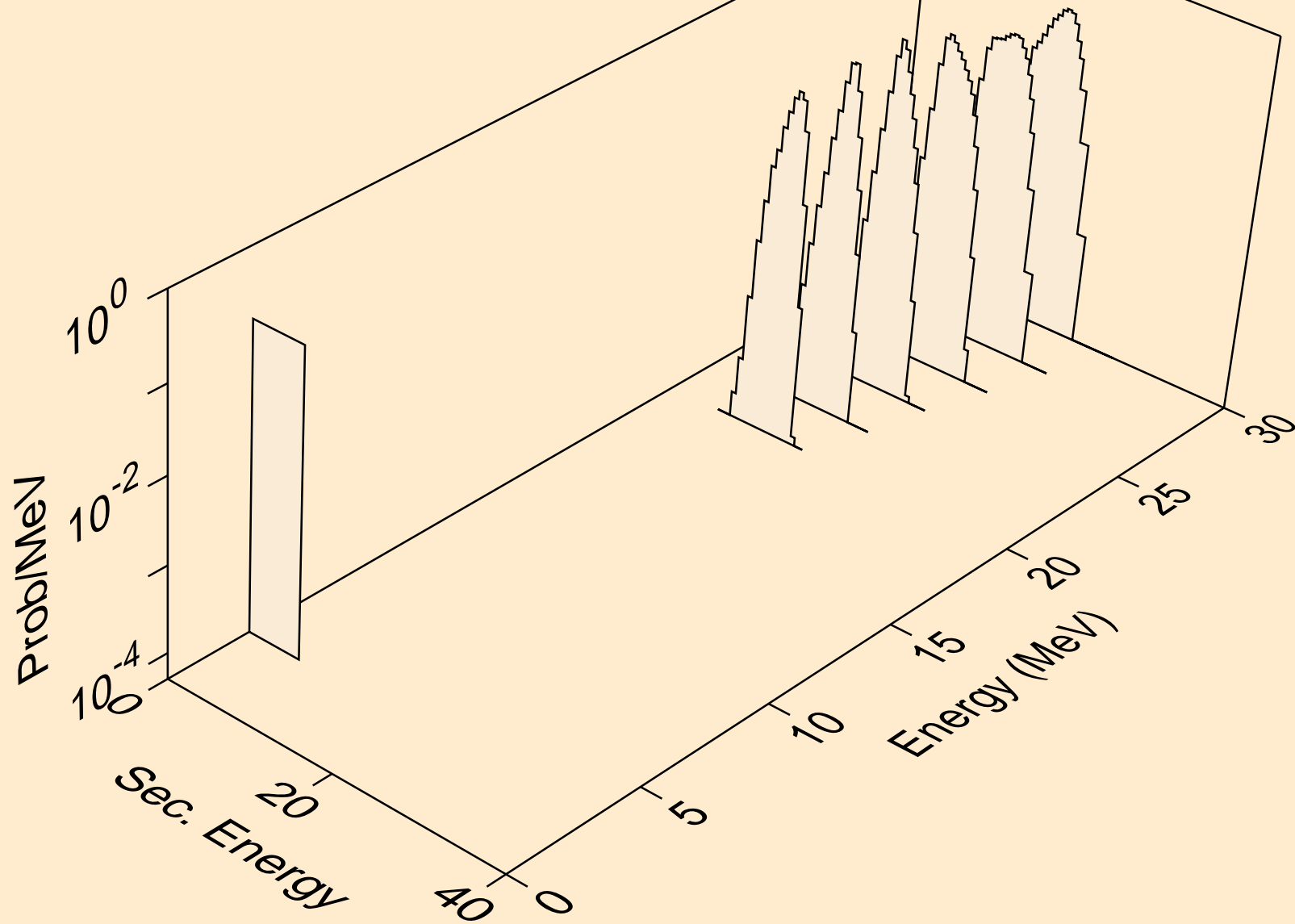

NP244 NEUTRON ACER TENDL-2021 LIBRARY; T=293.6K
alphas from (n,a)

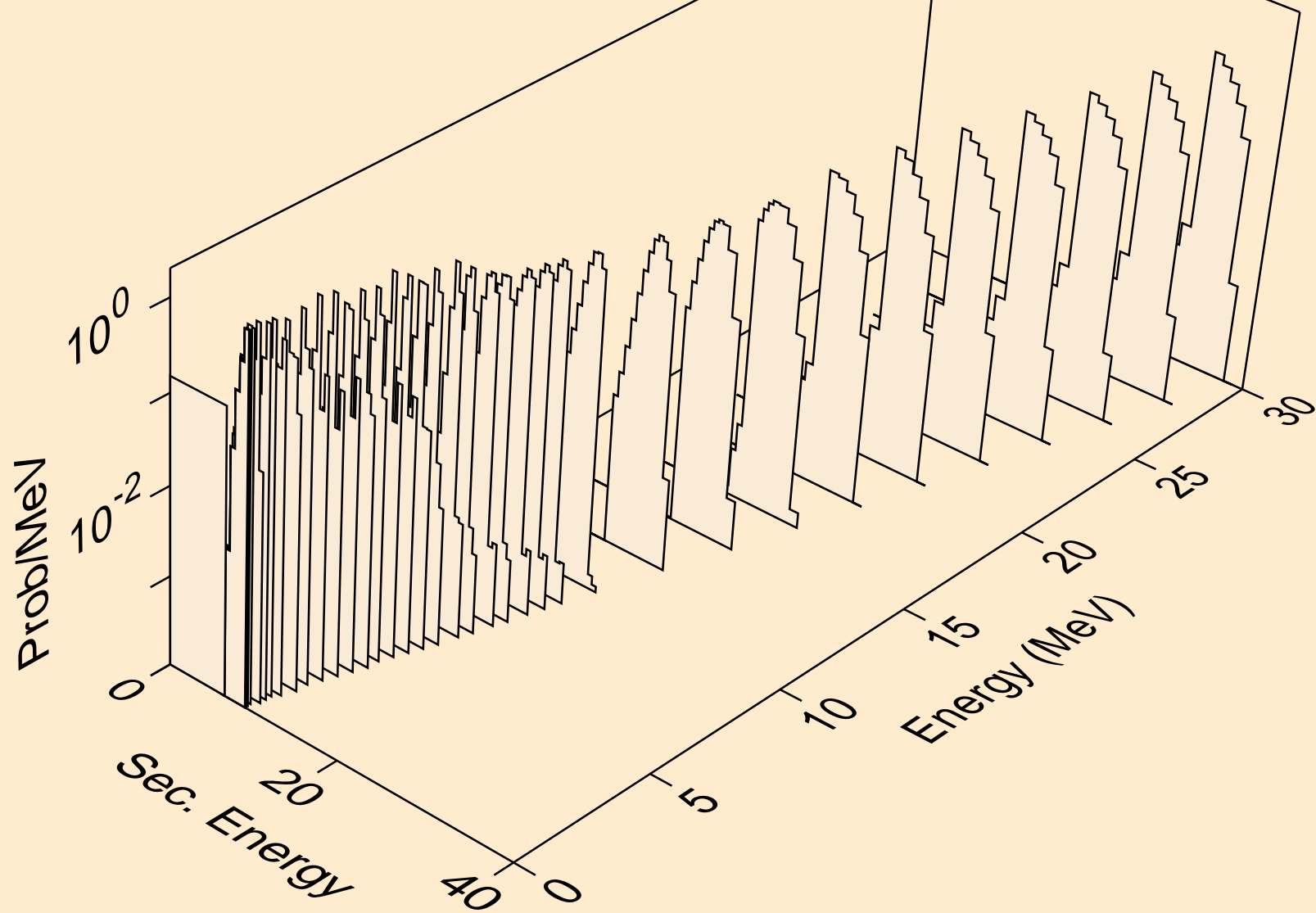

NP244 NEUTRON ACER TENDL-2021 LIBRARY; T=293.6K
alphas from (n,2a)

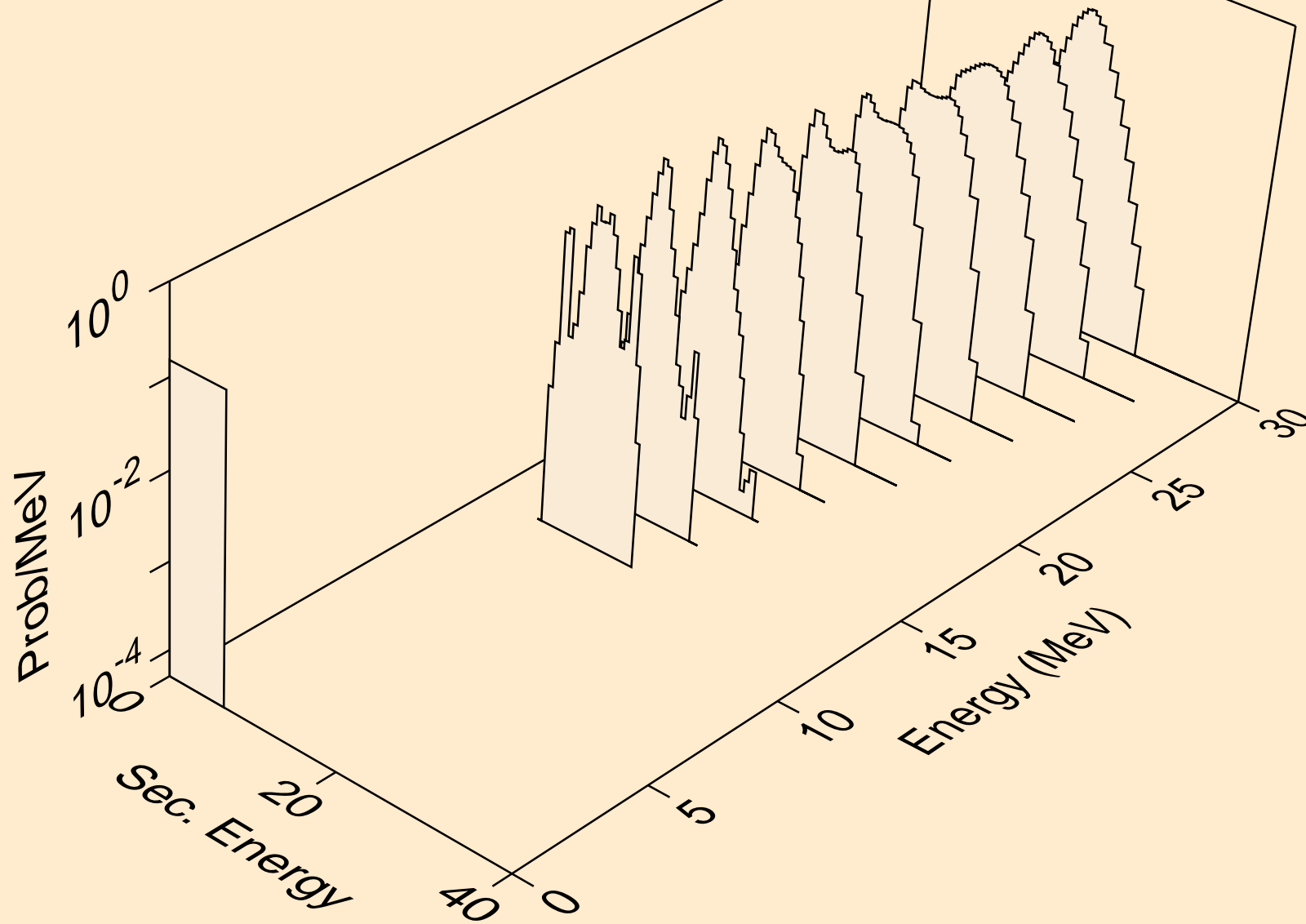

NP244 NEUTRON ACER TENDL-2021 LIBRARY; T=293.6K
alphas from (n,pa)

