

OS181M NEUTRON ACER TENDL-2021 LIBRARY; T=293.6K  
Principal cross sections

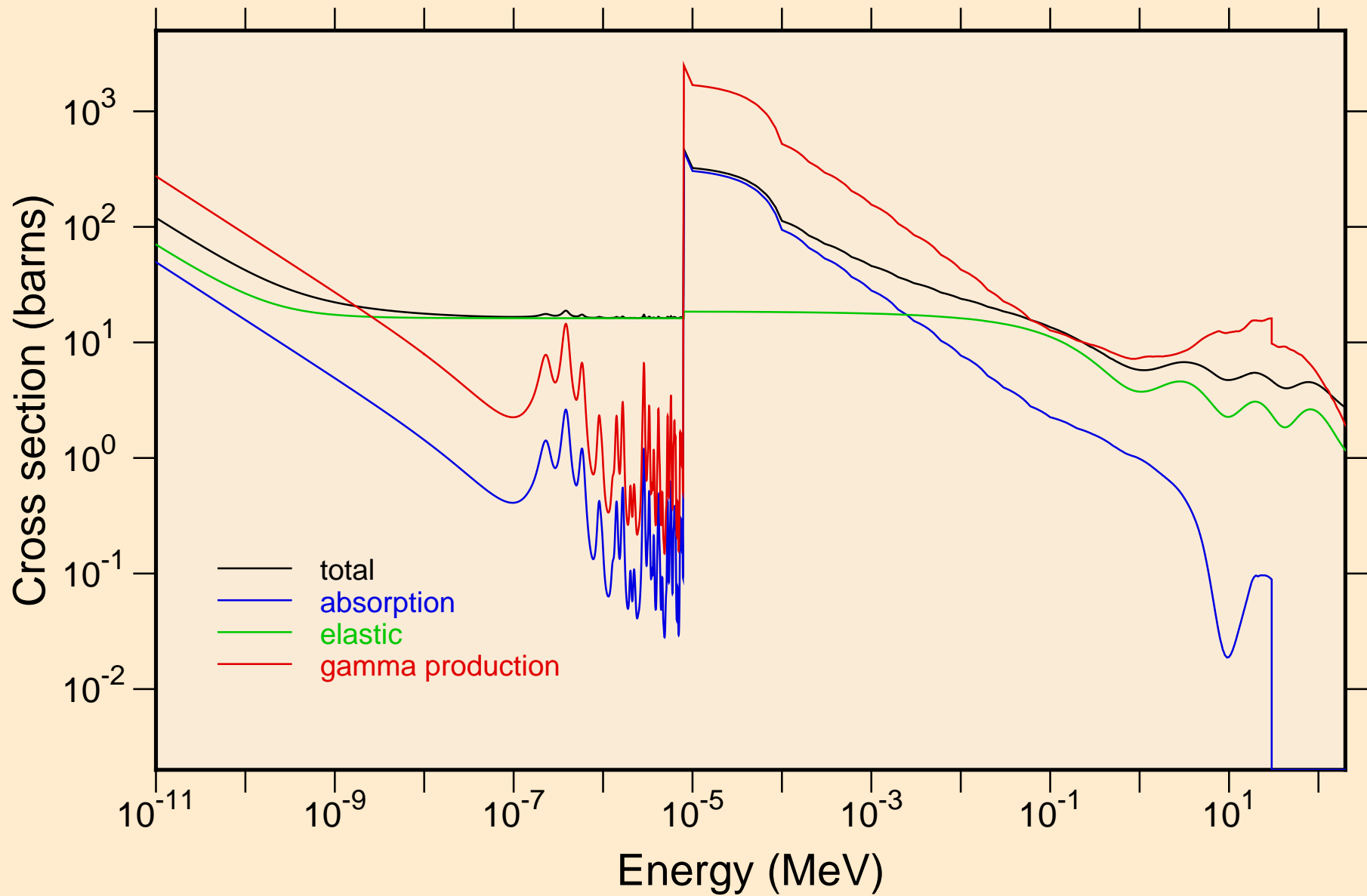

OS181M NEUTRON ACER TENDL-2021 LIBRARY; T=293.6K  
resonance total cross section

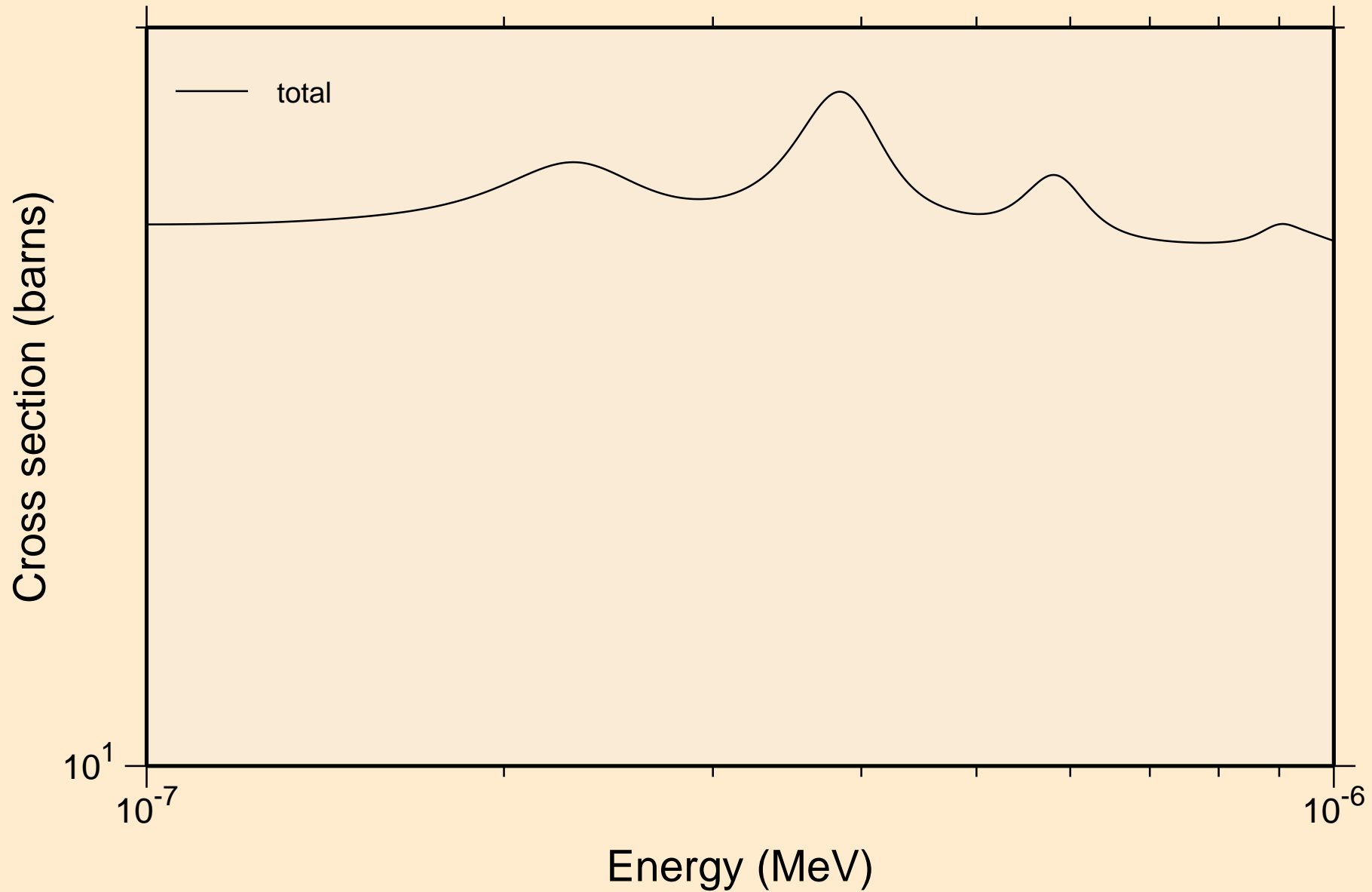

OS181M NEUTRON ACER TENDL-2021 LIBRARY; T=293.6K  
resonance total cross section

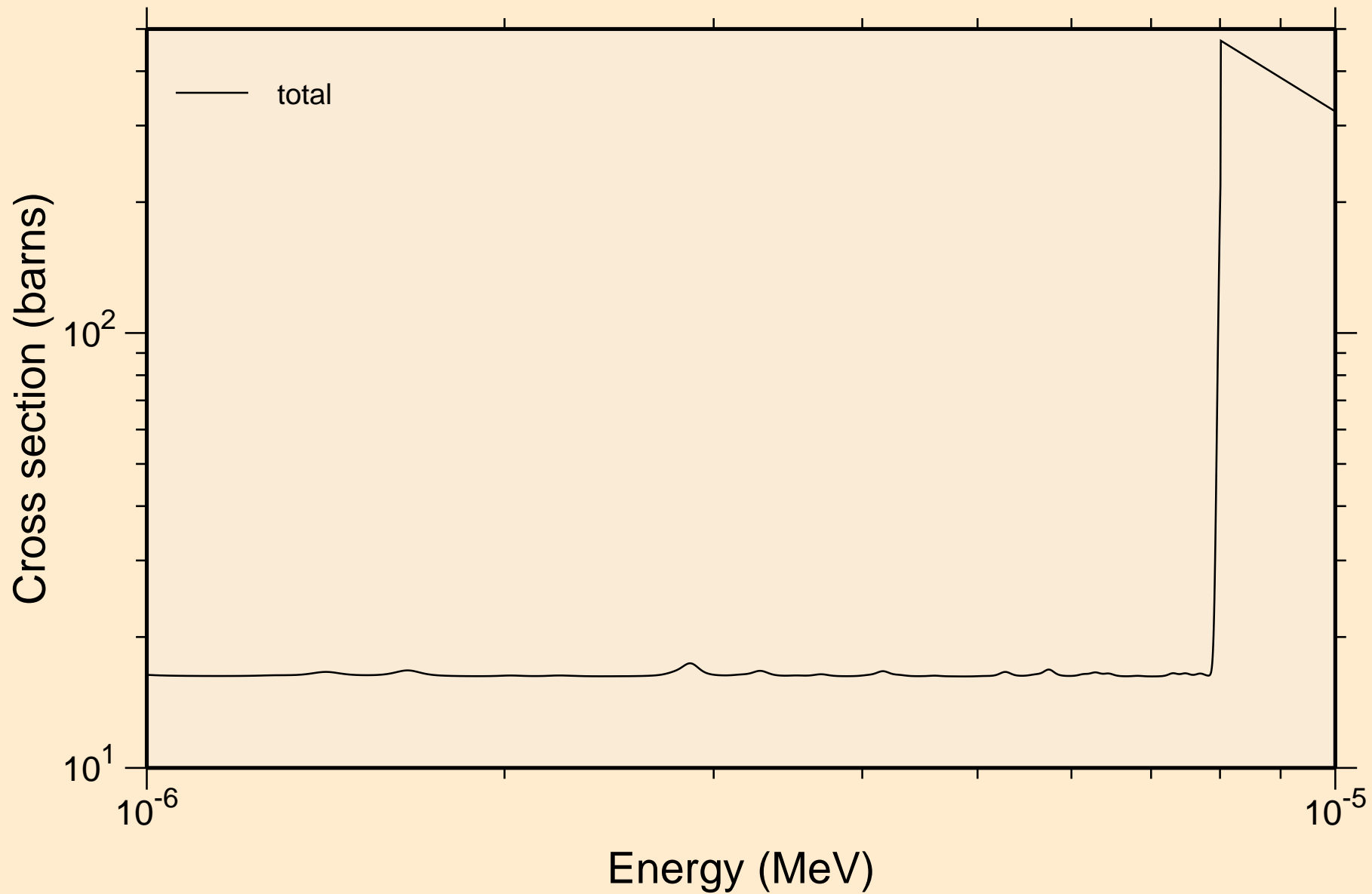

OS181M NEUTRON ACER TENDL-2021 LIBRARY; T=293.6K  
resonance total cross section

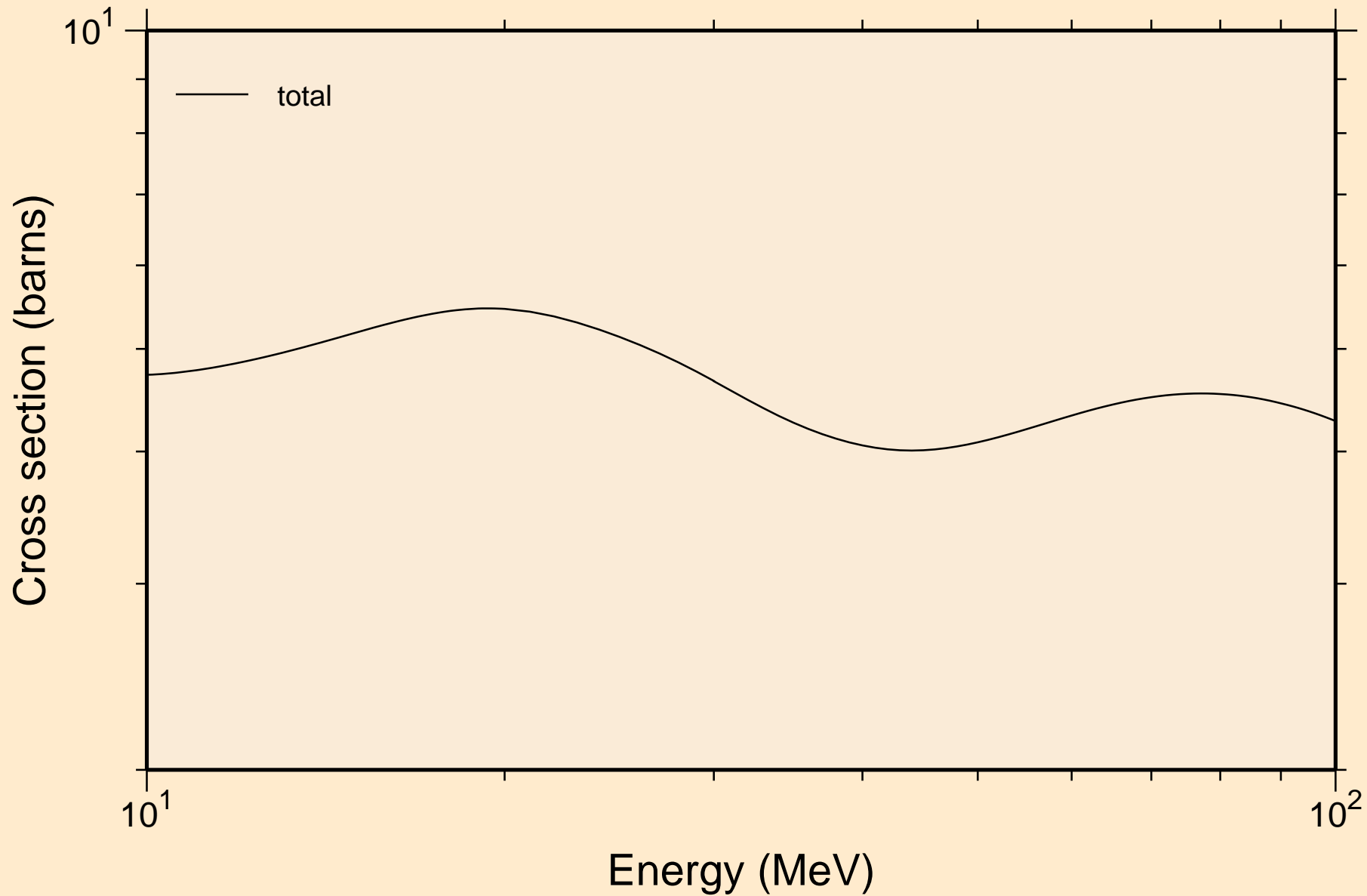

OS181M NEUTRON ACER TENDL-2021 LIBRARY; T=293.6K  
resonance absorption cross sections

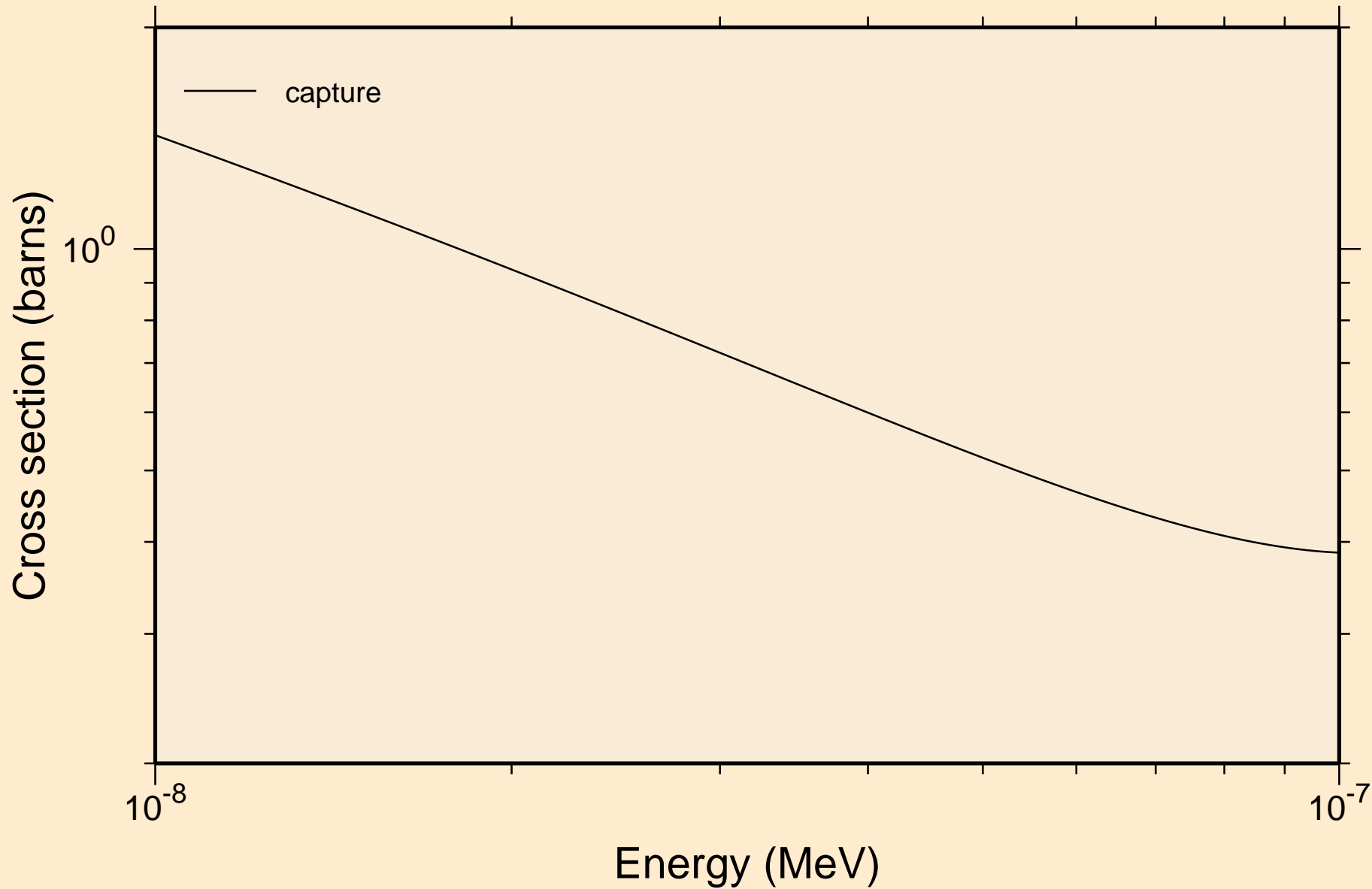

OS181M NEUTRON ACER TENDL-2021 LIBRARY; T=293.6K  
resonance absorption cross sections

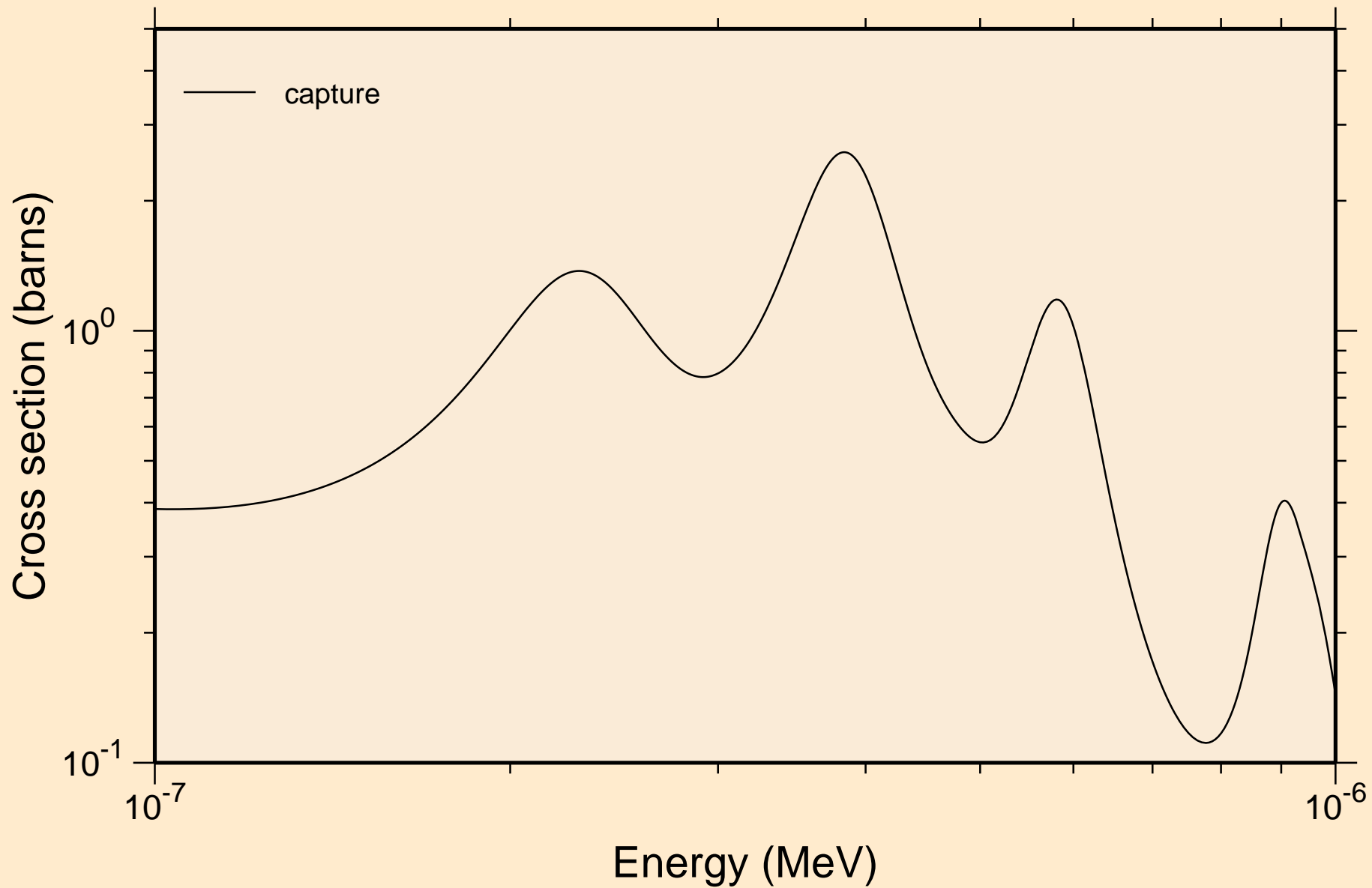

OS181M NEUTRON ACER TENDL-2021 LIBRARY; T=293.6K  
resonance absorption cross sections

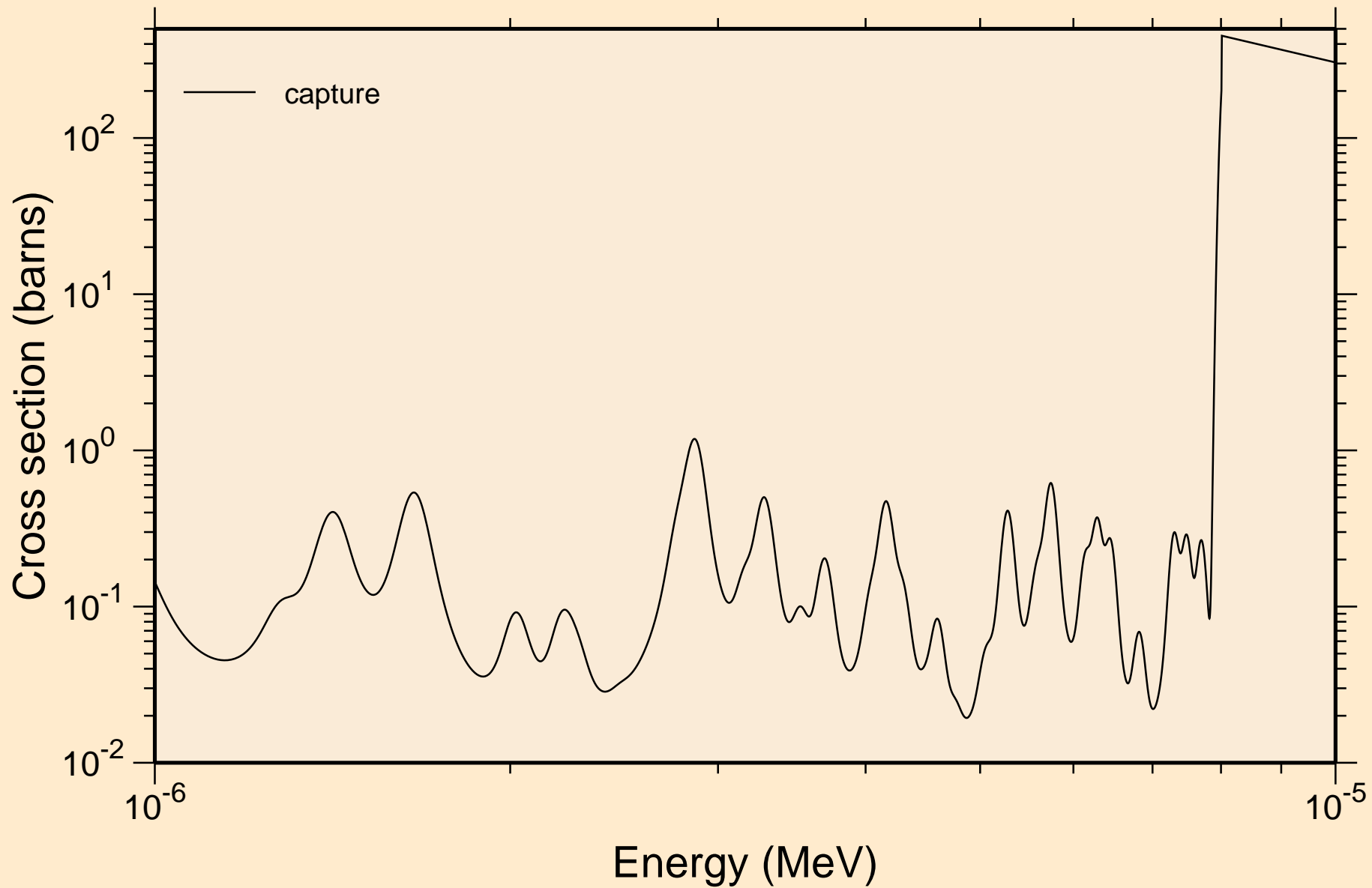

OS181M NEUTRON ACER TENDL-2021 LIBRARY; T=293.6K  
resonance absorption cross sections

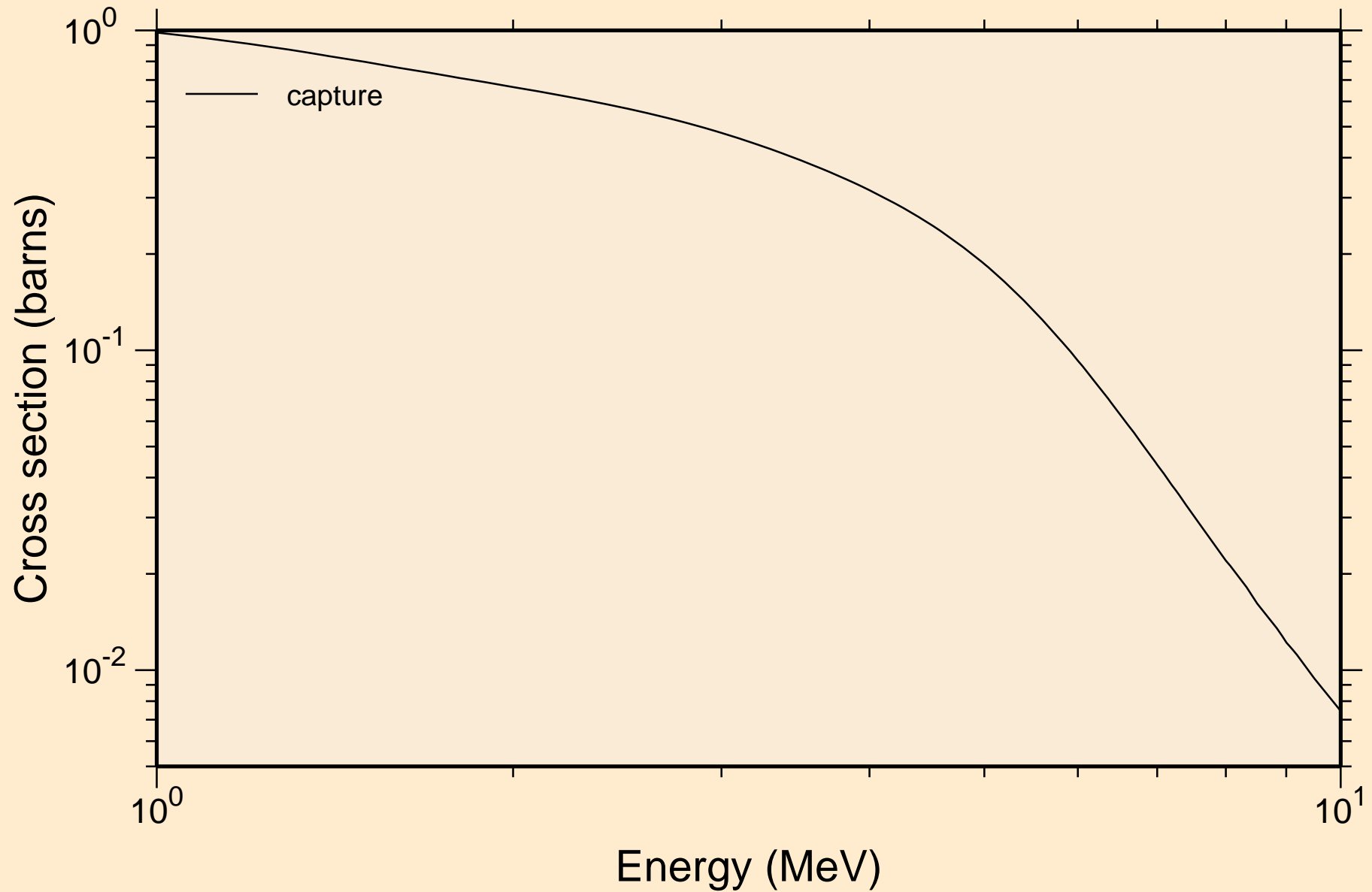



OS181M NEUTRON ACER TENDL-2021 LIBRARY; T=293.6K  
Heating

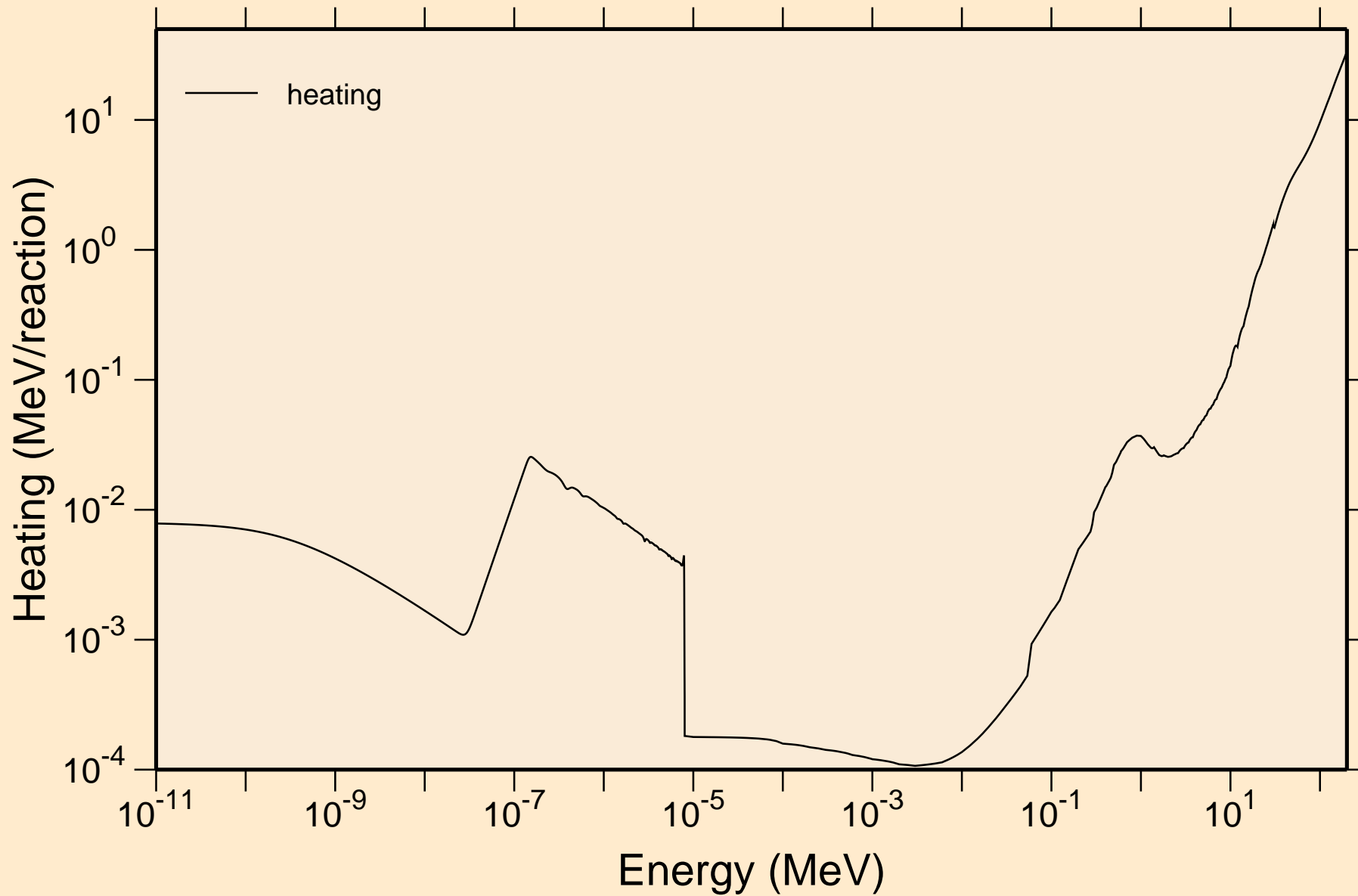

OS181M NEUTRON ACER TENDL-2021 LIBRARY; T=293.6K  
Damage

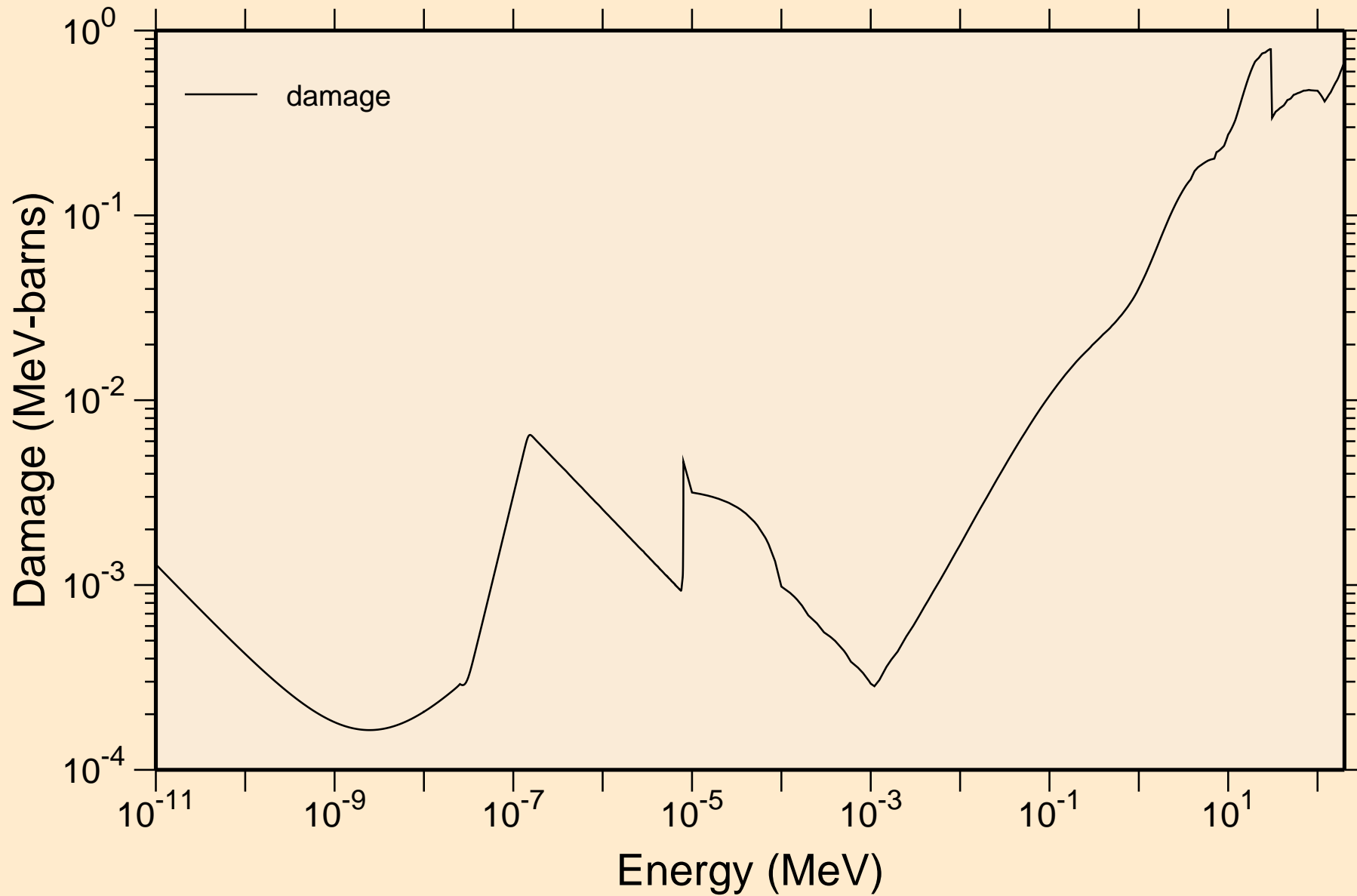

OS181M NEUTRON ACER TENDL-2021 LIBRARY; T=293.6K  
Non-threshold reactions

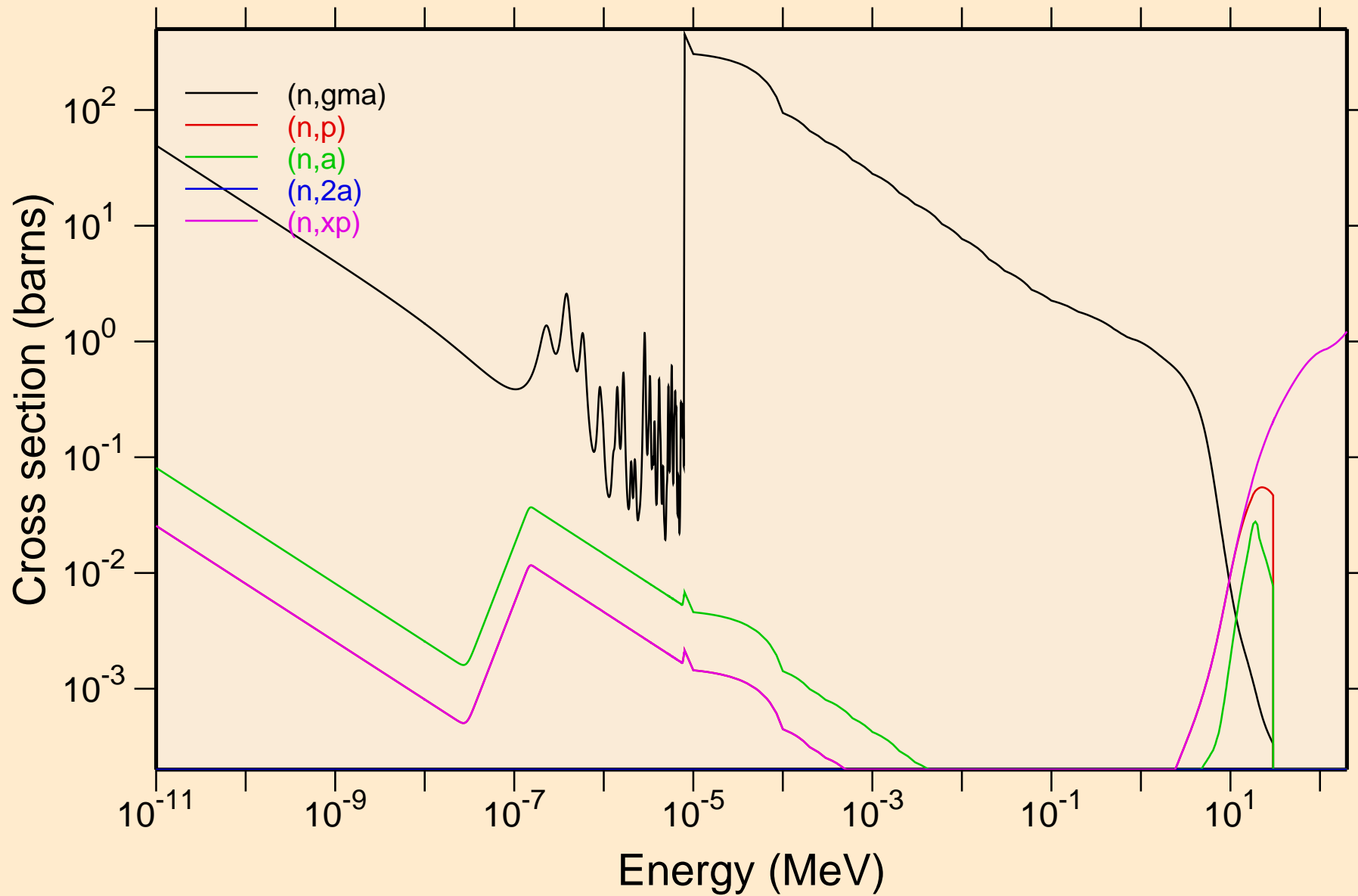

OS181M NEUTRON ACER TENDL-2021 LIBRARY; T=293.6K  
Non-threshold reactions

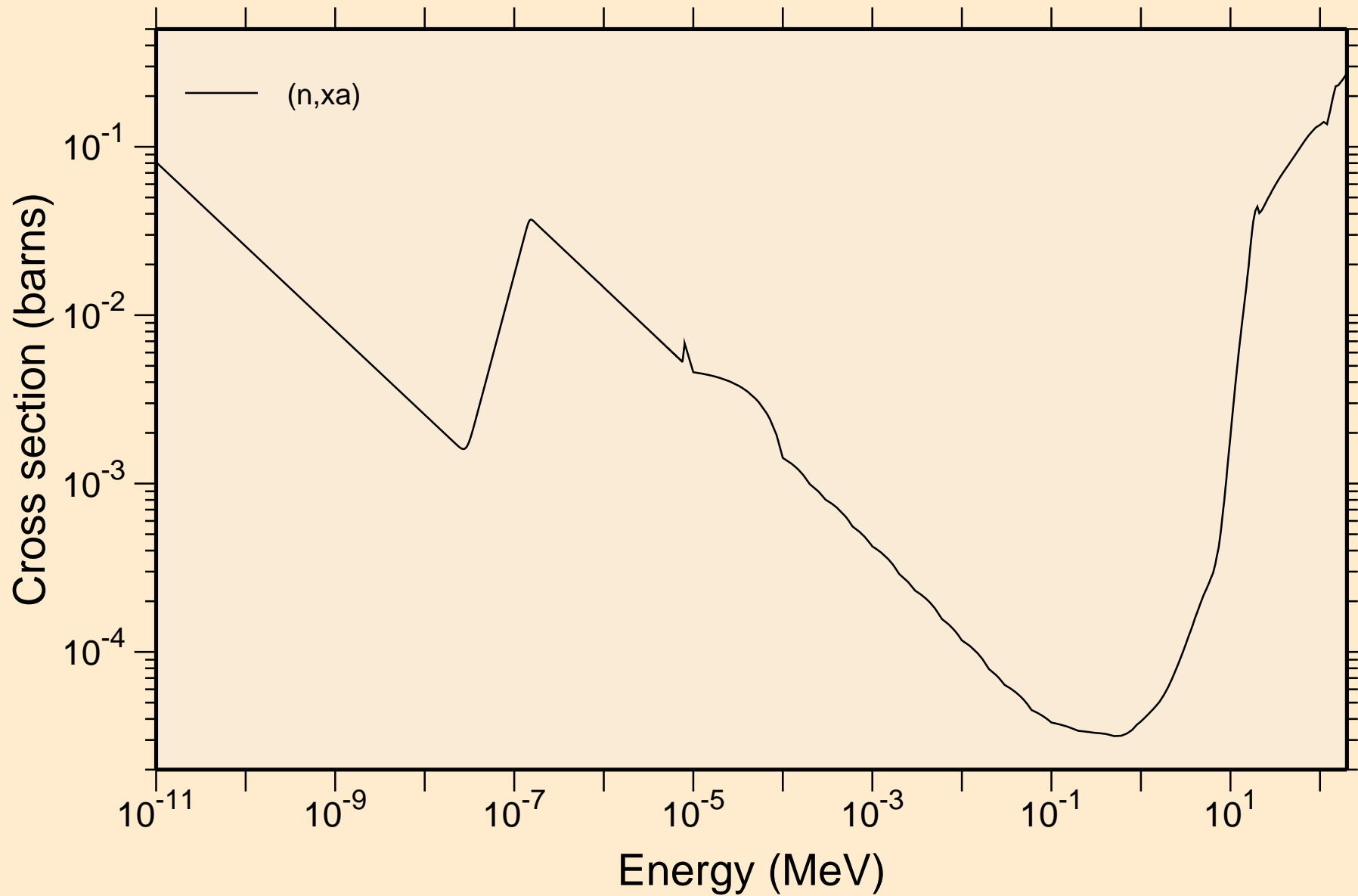

# OS181M NEUTRON ACER TENDL-2021 LIBRARY; T=293.6K

## Principal cross sections

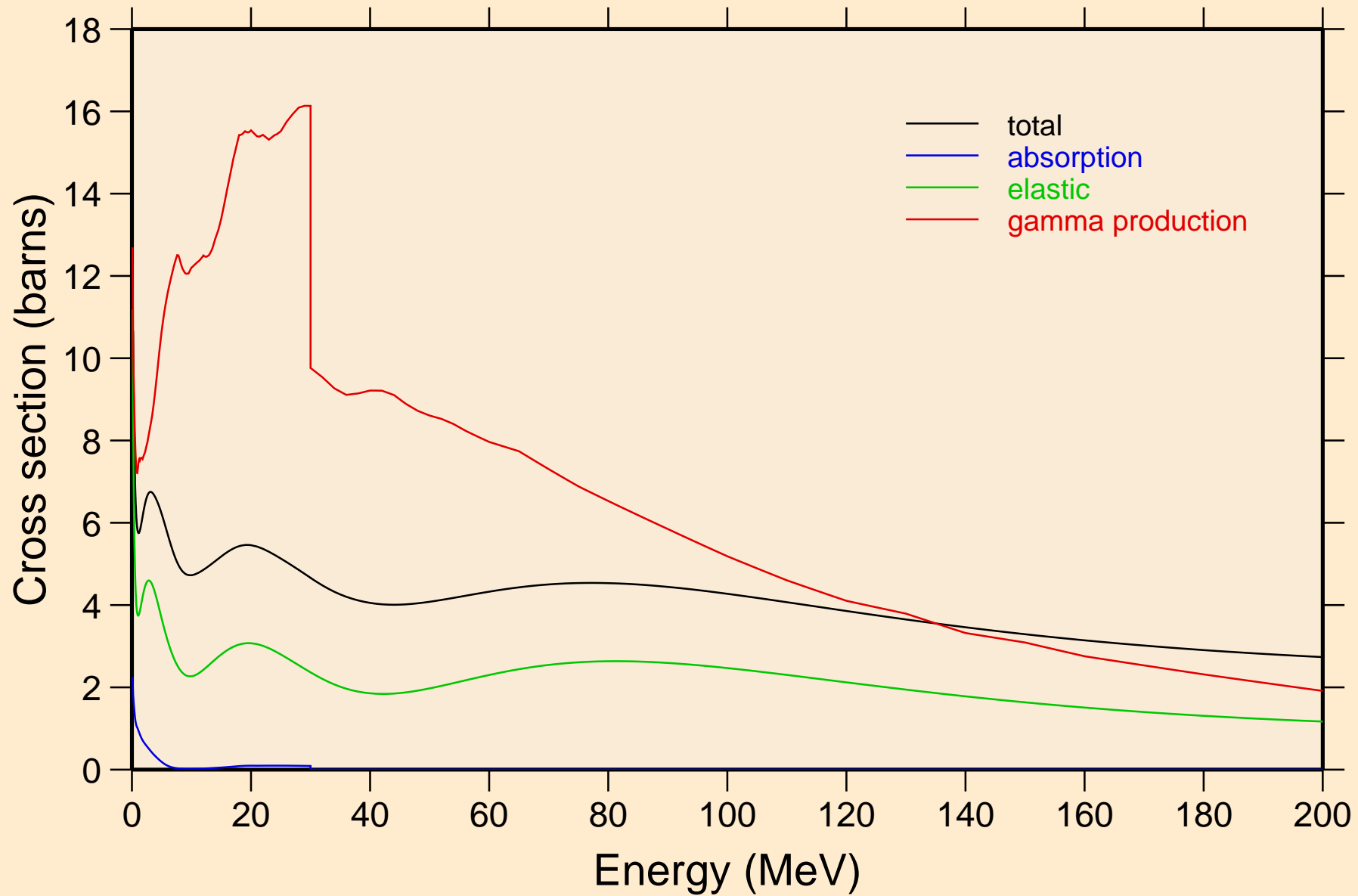

OS181M NEUTRON ACER TENDL-2021 LIBRARY; T=293.6K  
Heating

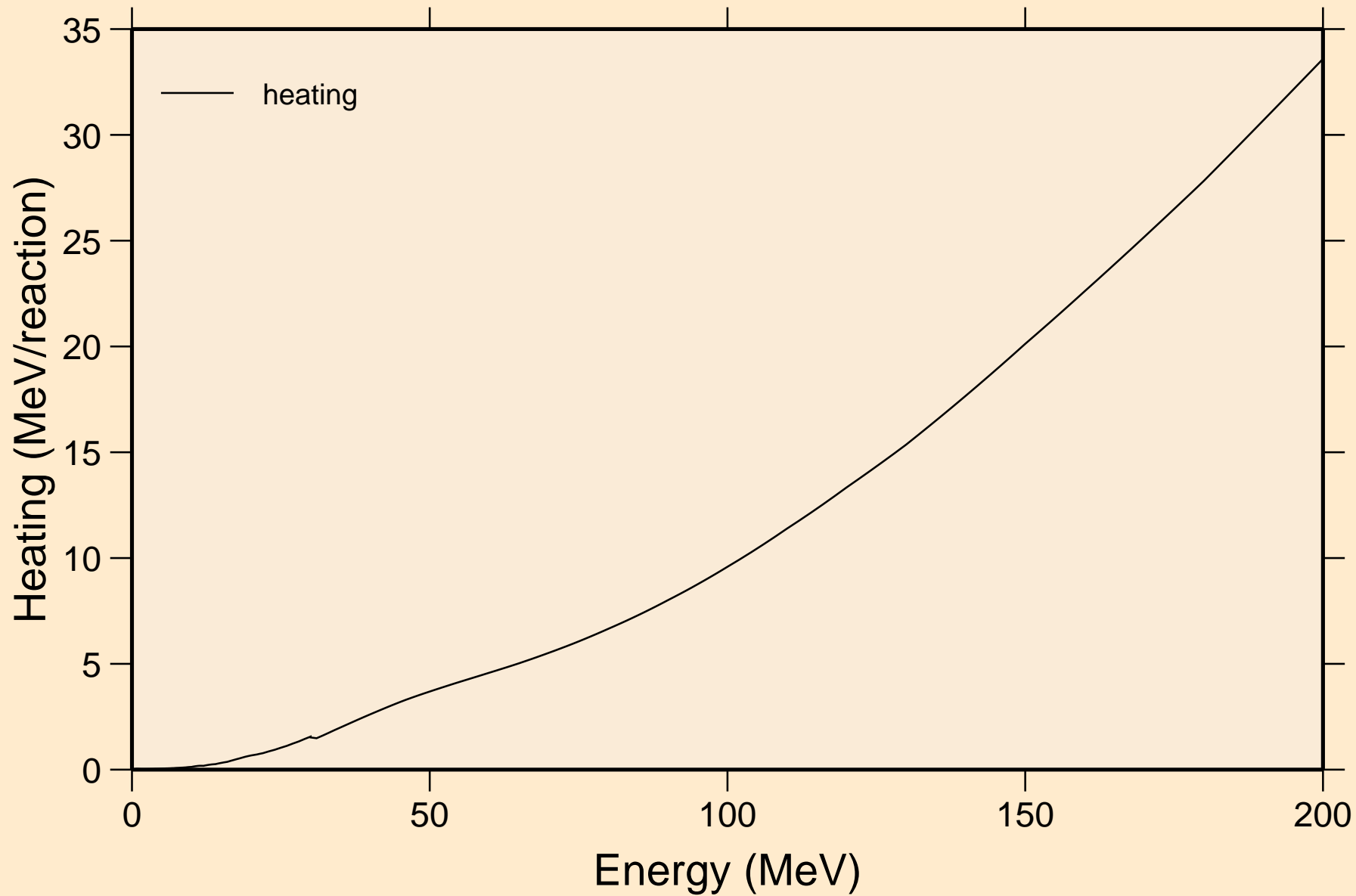

OS181M NEUTRON ACER TENDL-2021 LIBRARY; T=293.6K  
Damage

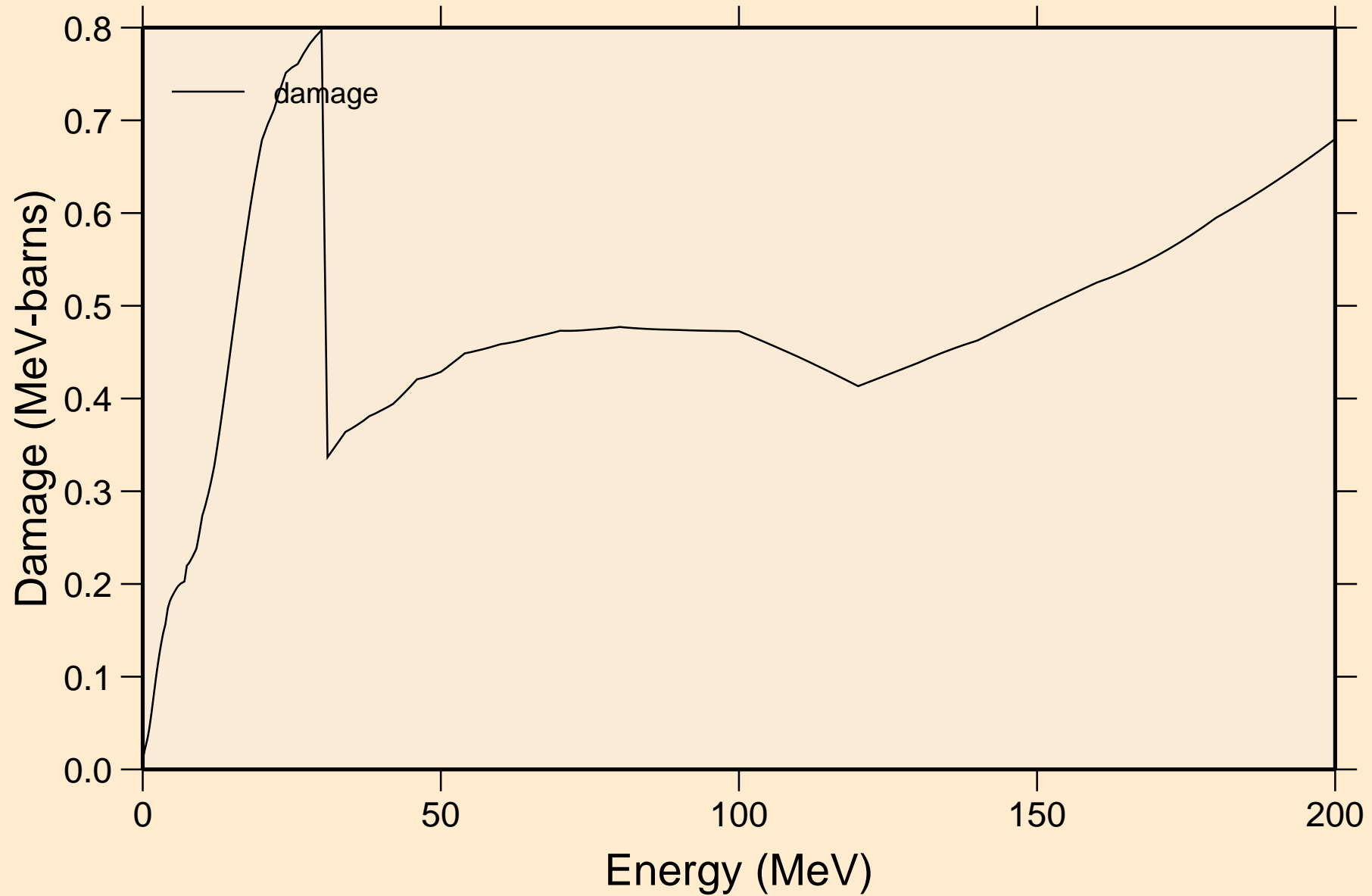

OS181M NEUTRON ACER TENDL-2021 LIBRARY; T=293.6K  
Non-threshold reactions

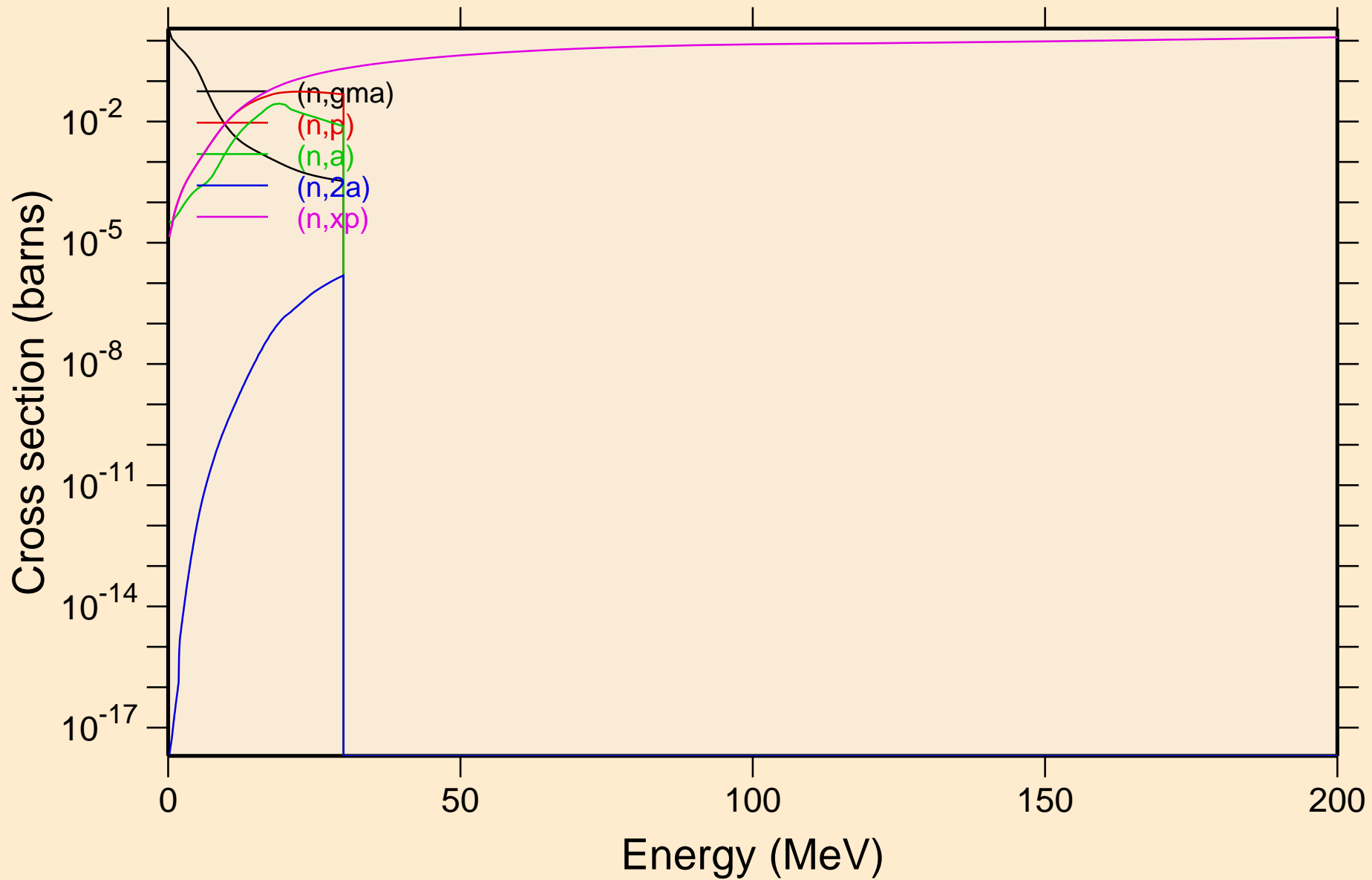



OS181M NEUTRON ACER TENDL-2021 LIBRARY; T=293.6K  
Non-threshold reactions

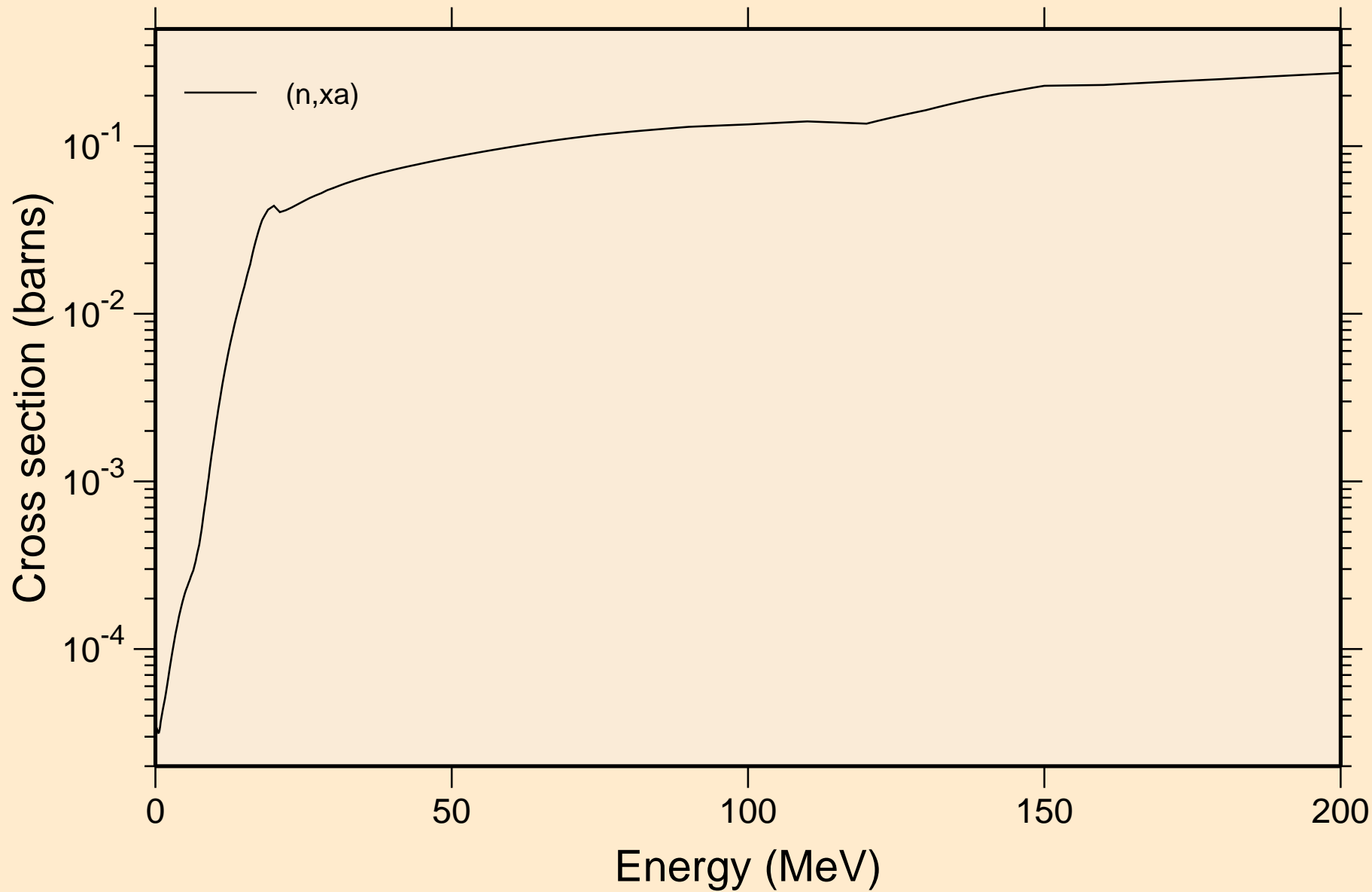

OS181M NEUTRON ACER TENDL-2021 LIBRARY; T=293.6K  
Inelastic levels

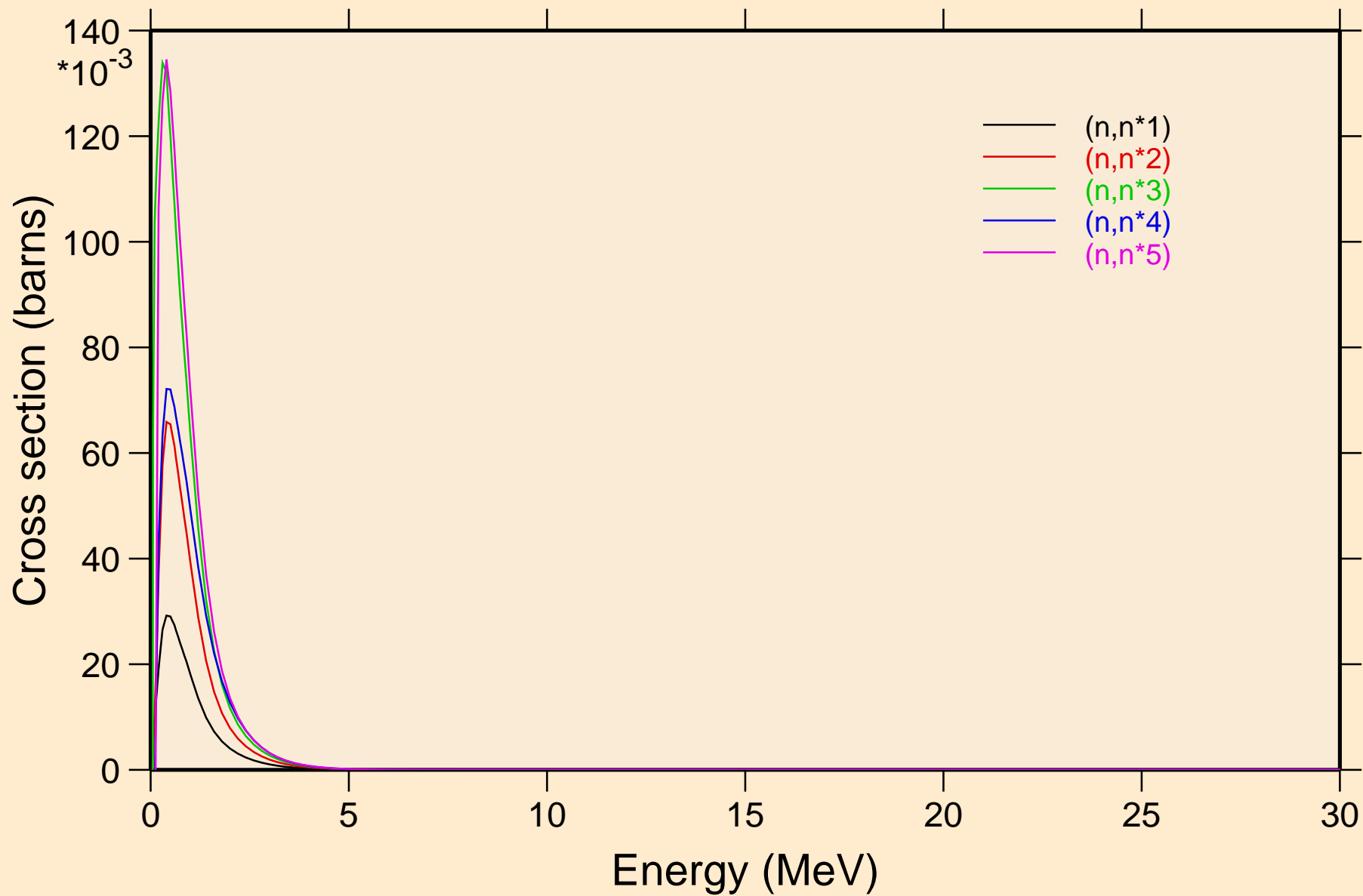

OS181M NEUTRON ACER TENDL-2021 LIBRARY; T=293.6K  
Inelastic levels

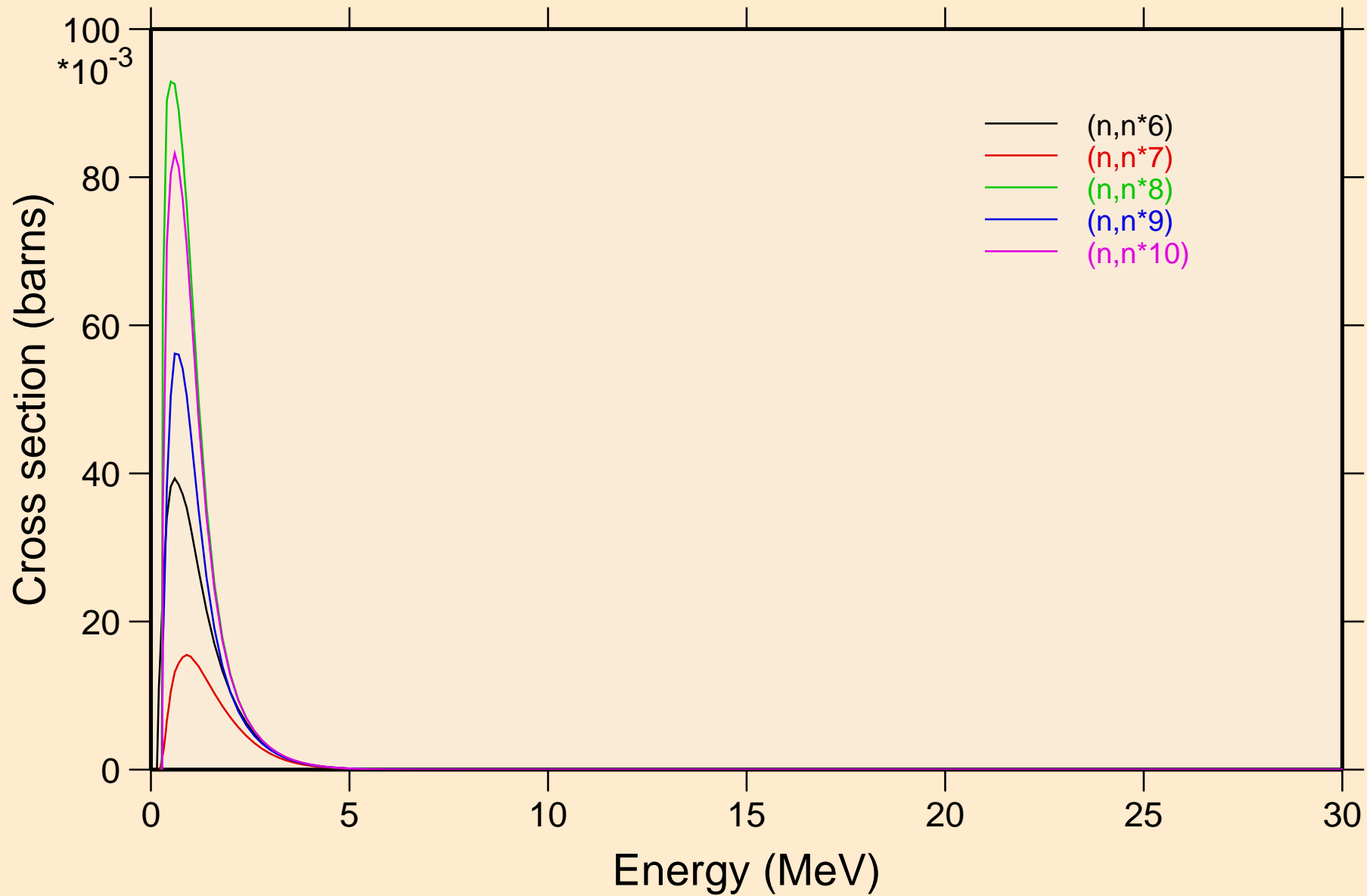

OS181M NEUTRON ACER TENDL-2021 LIBRARY; T=293.6K  
Inelastic levels

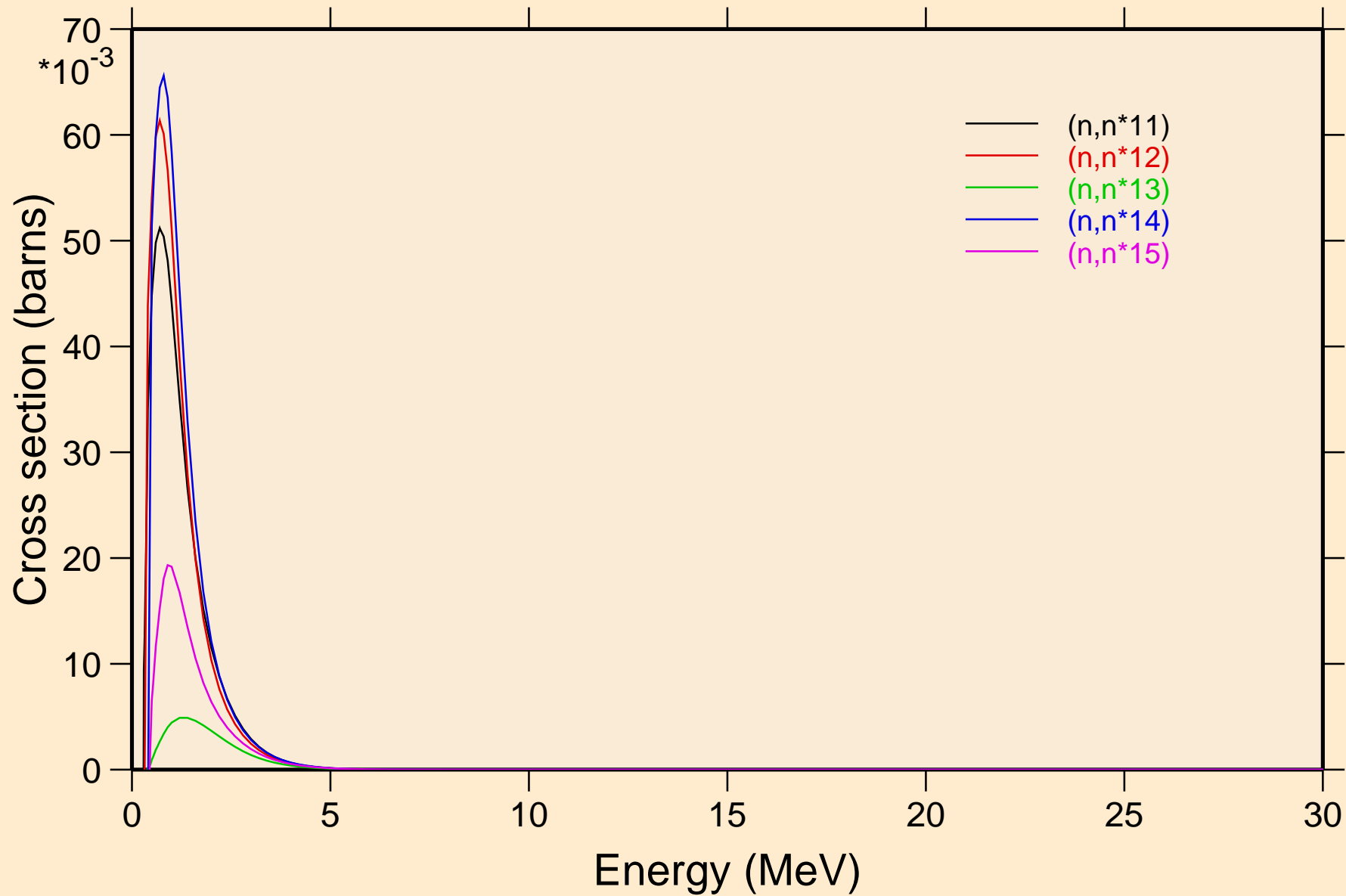

OS181M NEUTRON ACER TENDL-2021 LIBRARY; T=293.6K  
Inelastic levels

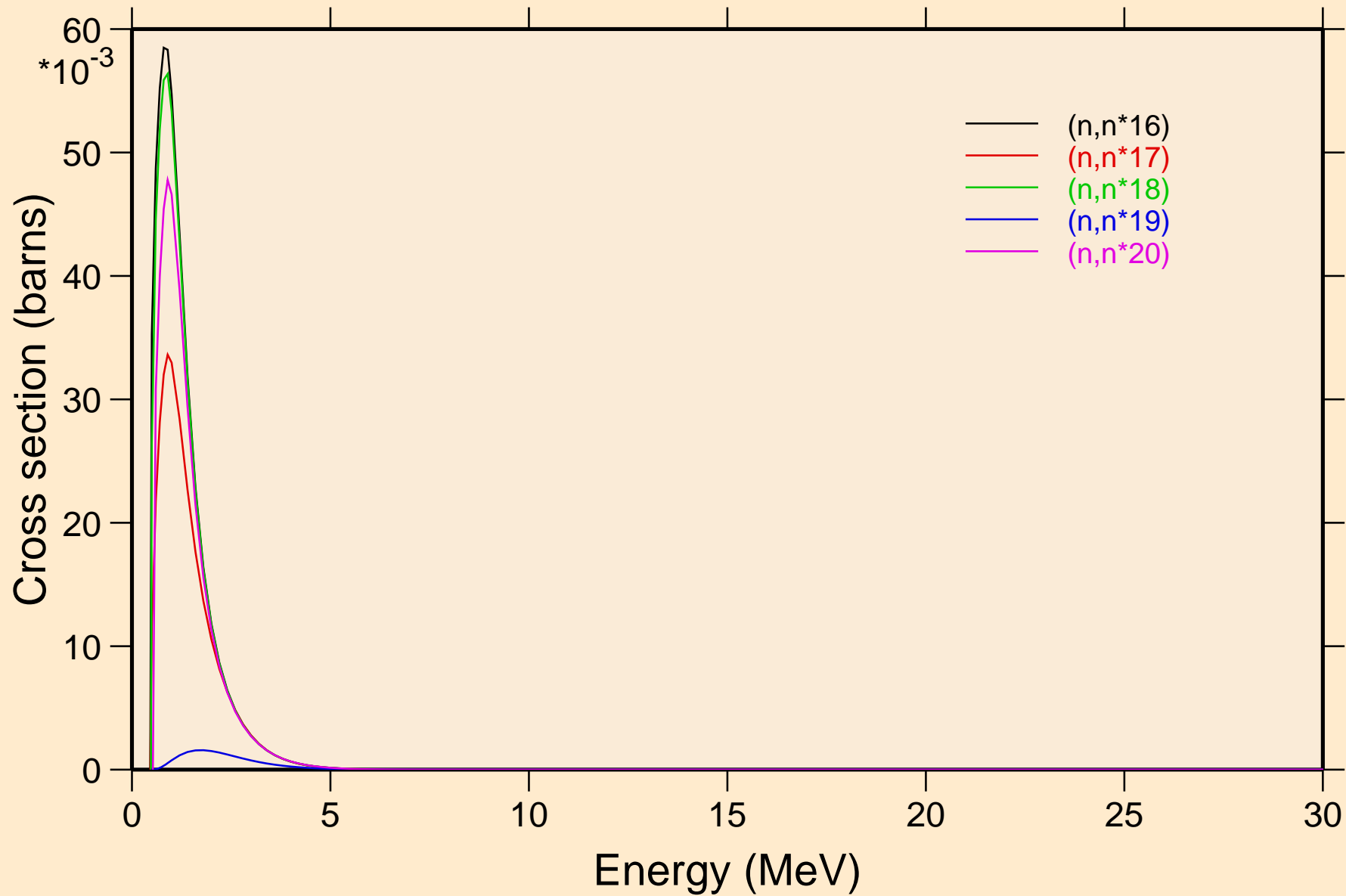

OS181M NEUTRON ACER TENDL-2021 LIBRARY; T=293.6K  
Inelastic levels

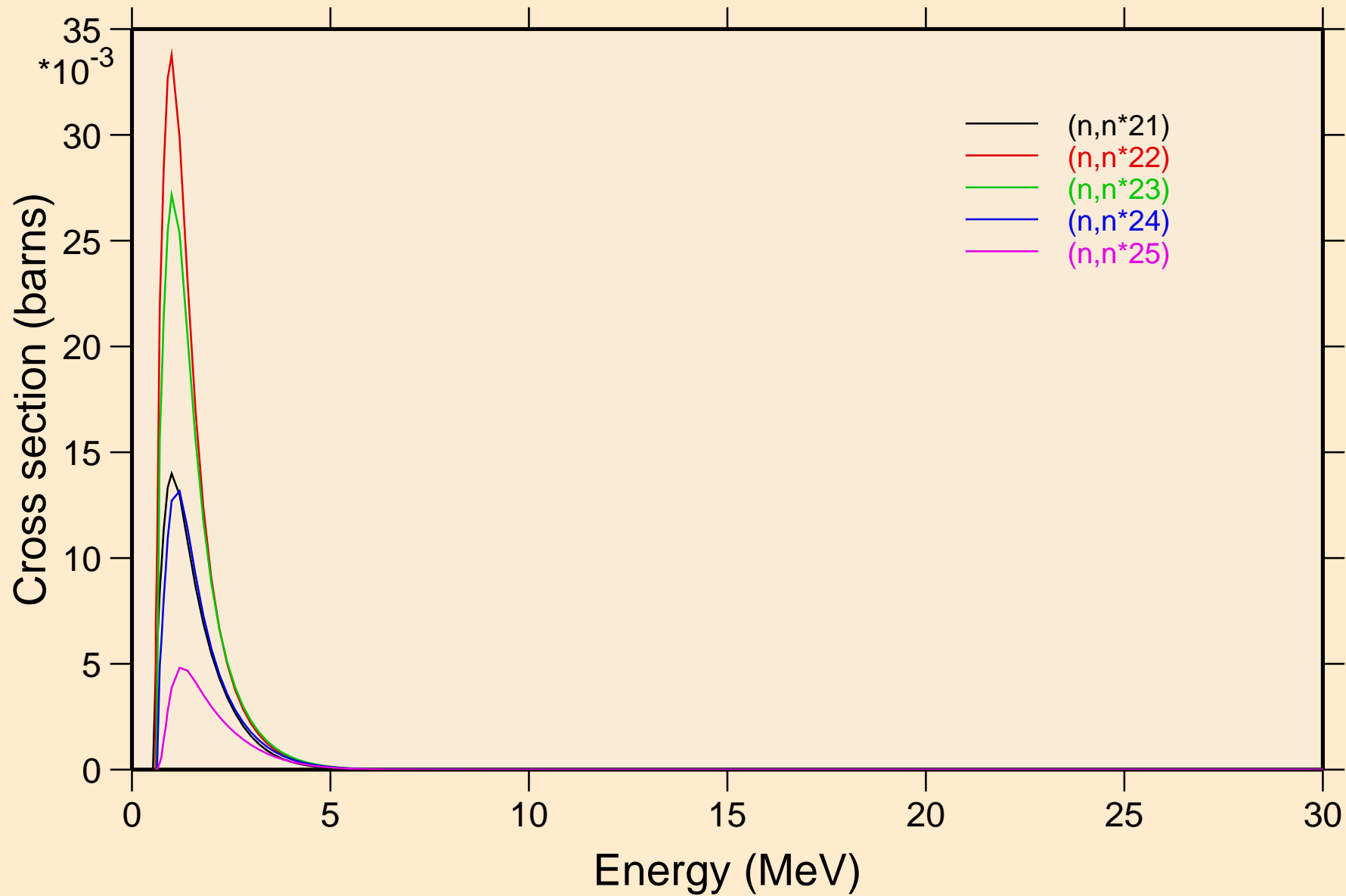

OS181M NEUTRON ACER TENDL-2021 LIBRARY; T=293.6K  
Inelastic levels

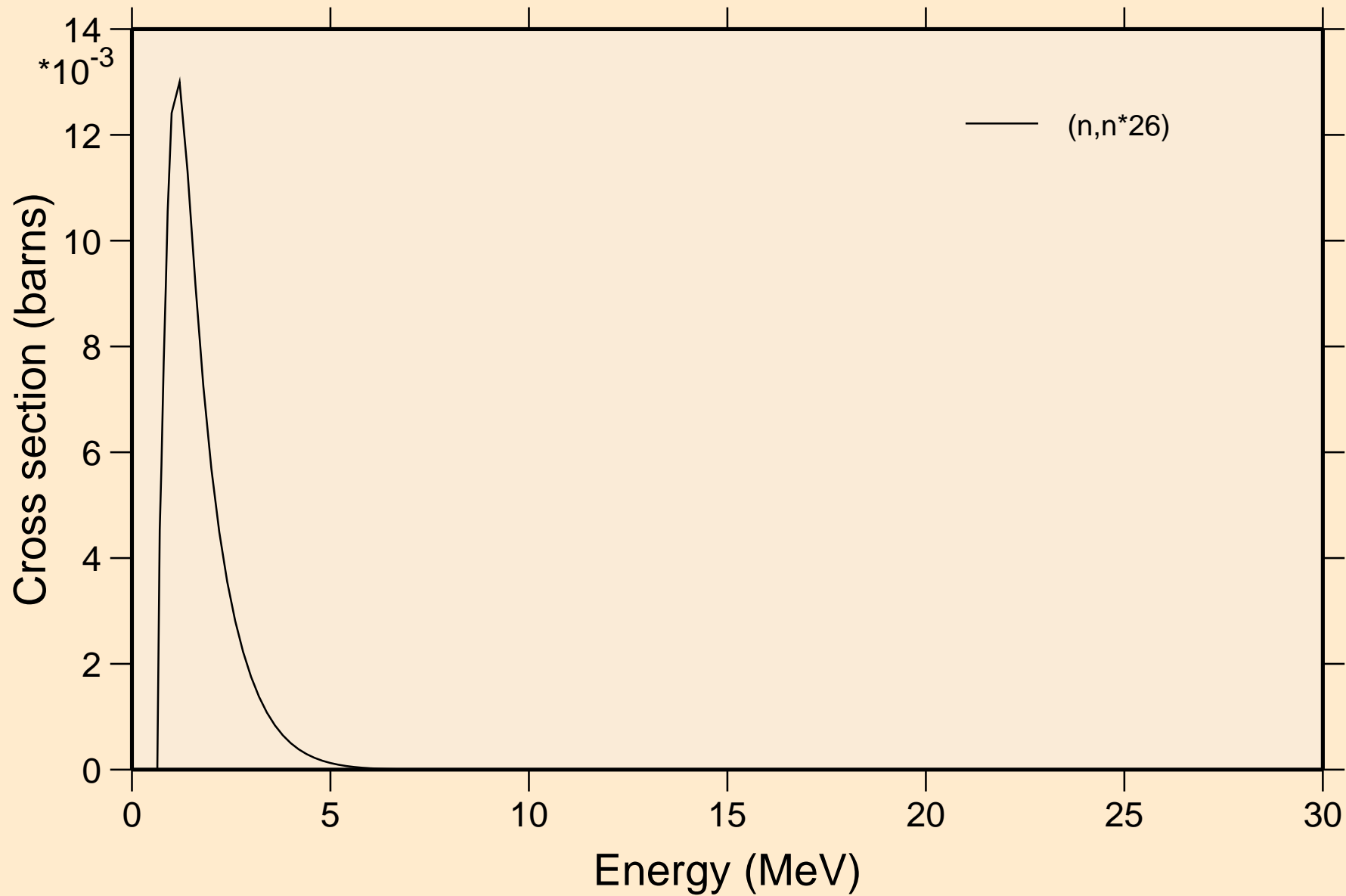

OS181M NEUTRON ACER TENDL-2021 LIBRARY; T=293.6K  
Threshold reactions

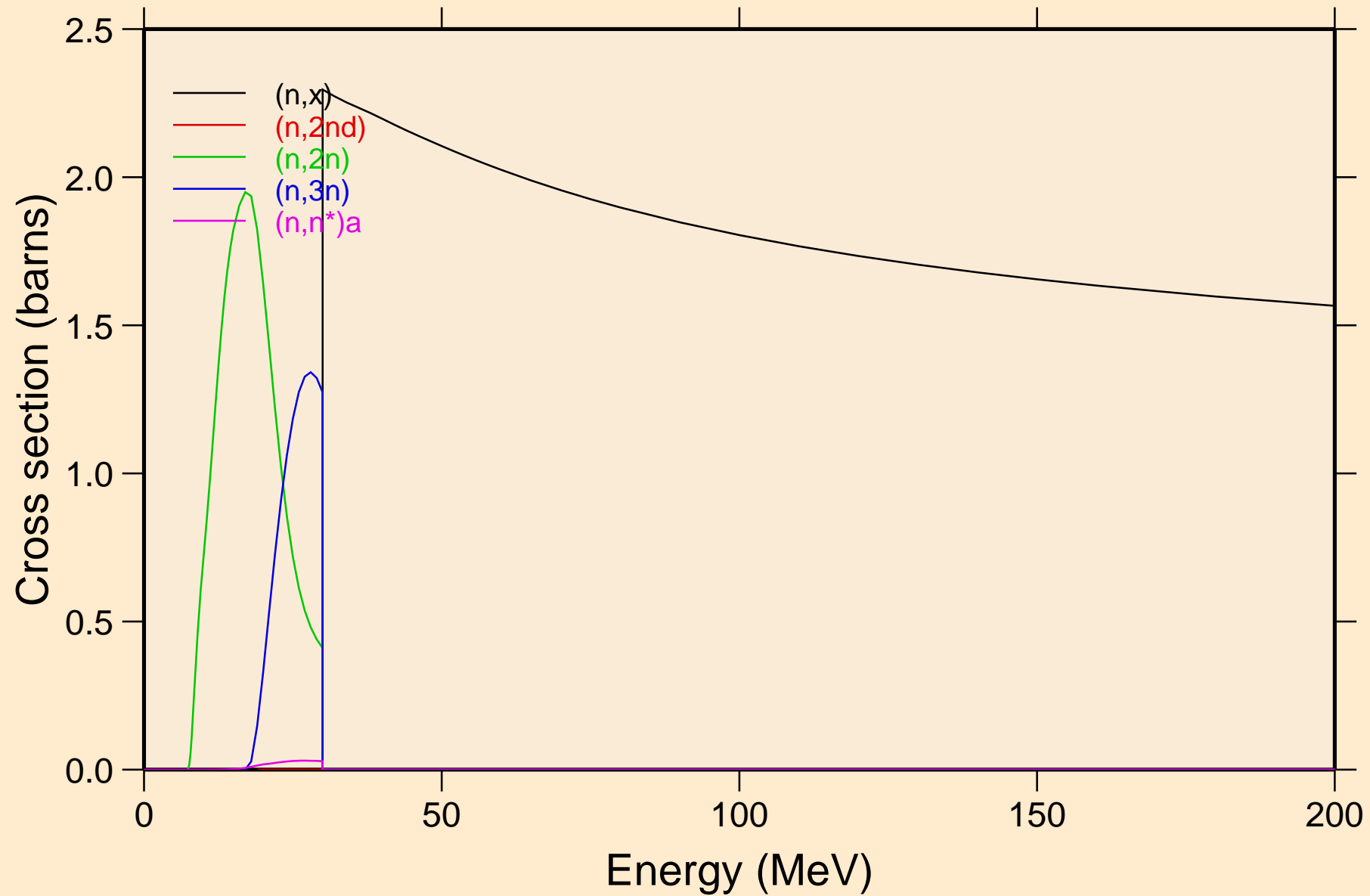



OS181M NEUTRON ACER TENDL-2021 LIBRARY; T=293.6K  
Threshold reactions

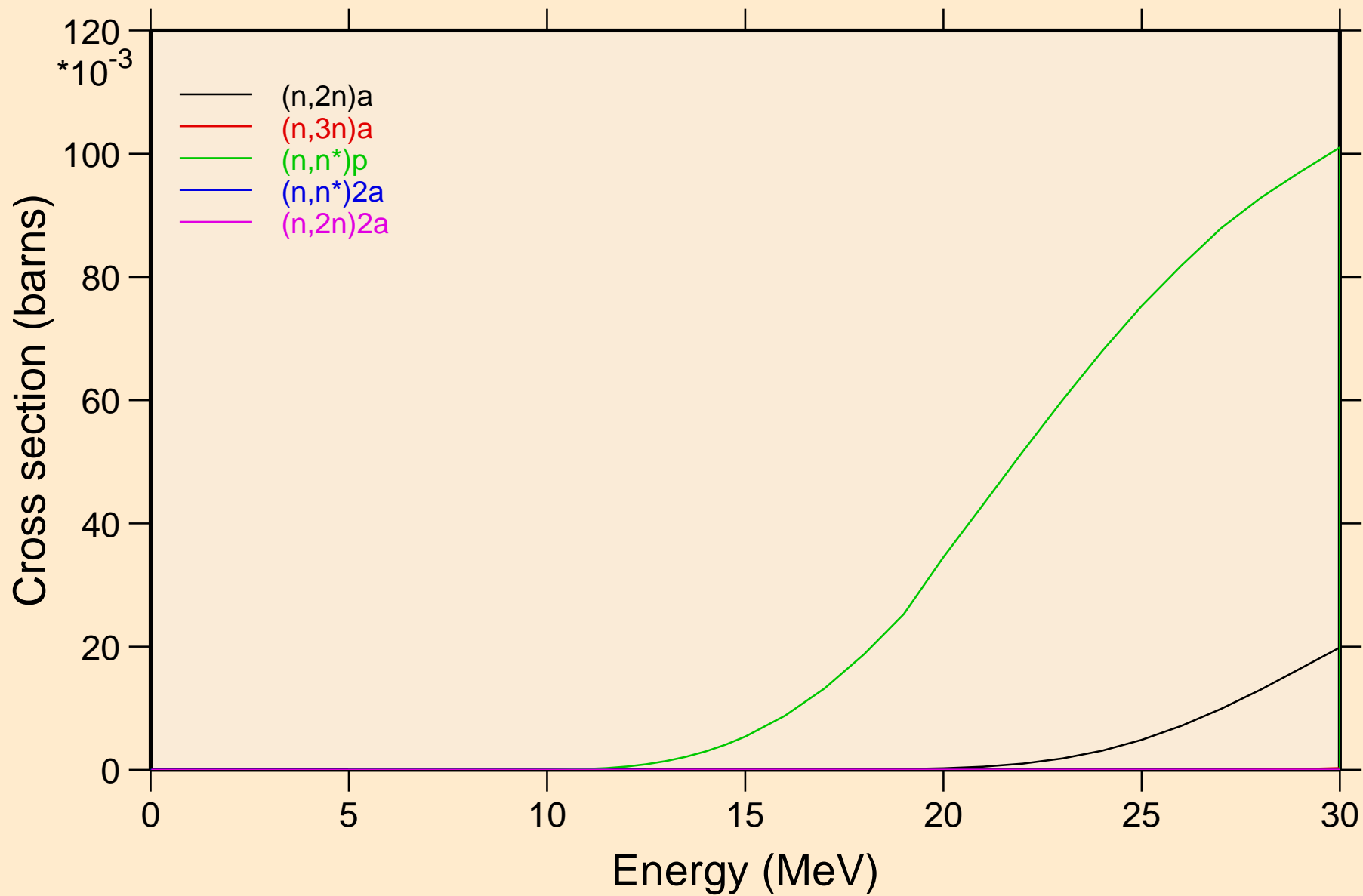

OS181M NEUTRON ACER TENDL-2021 LIBRARY; T=293.6K  
Threshold reactions

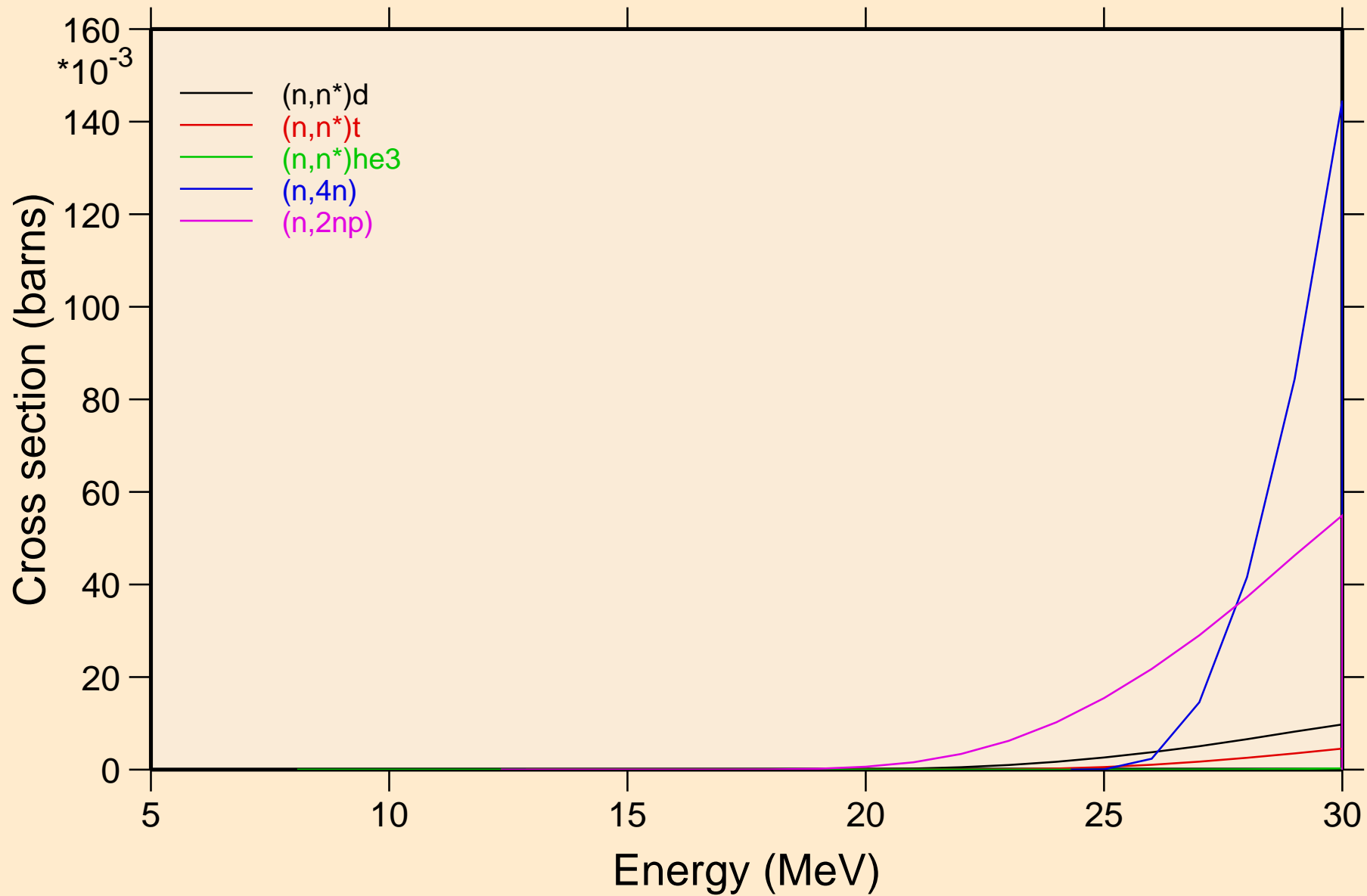

OS181M NEUTRON ACER TENDL-2021 LIBRARY; T=293.6K  
Threshold reactions

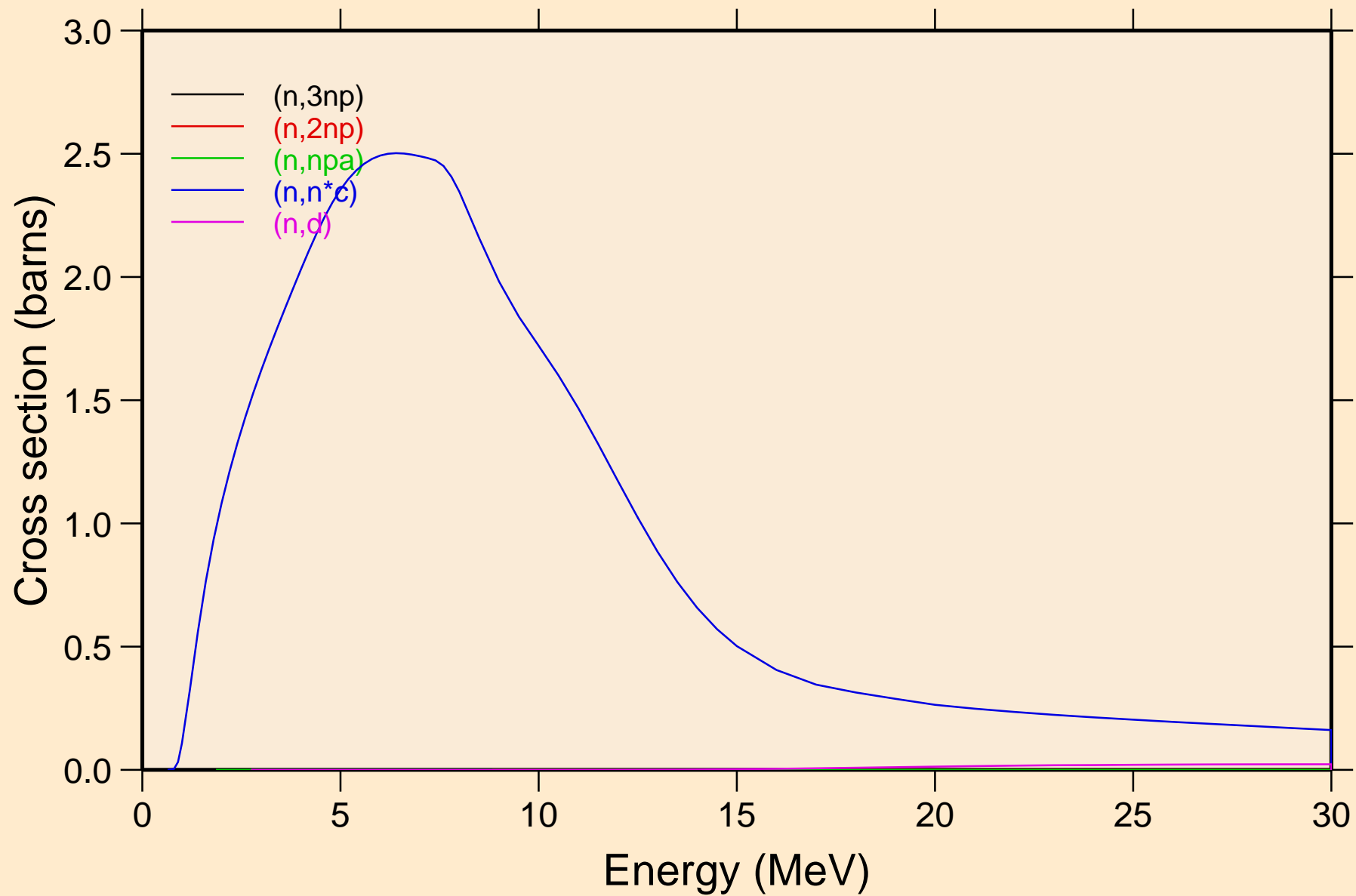

OS181M NEUTRON ACER TENDL-2021 LIBRARY; T=293.6K  
Threshold reactions

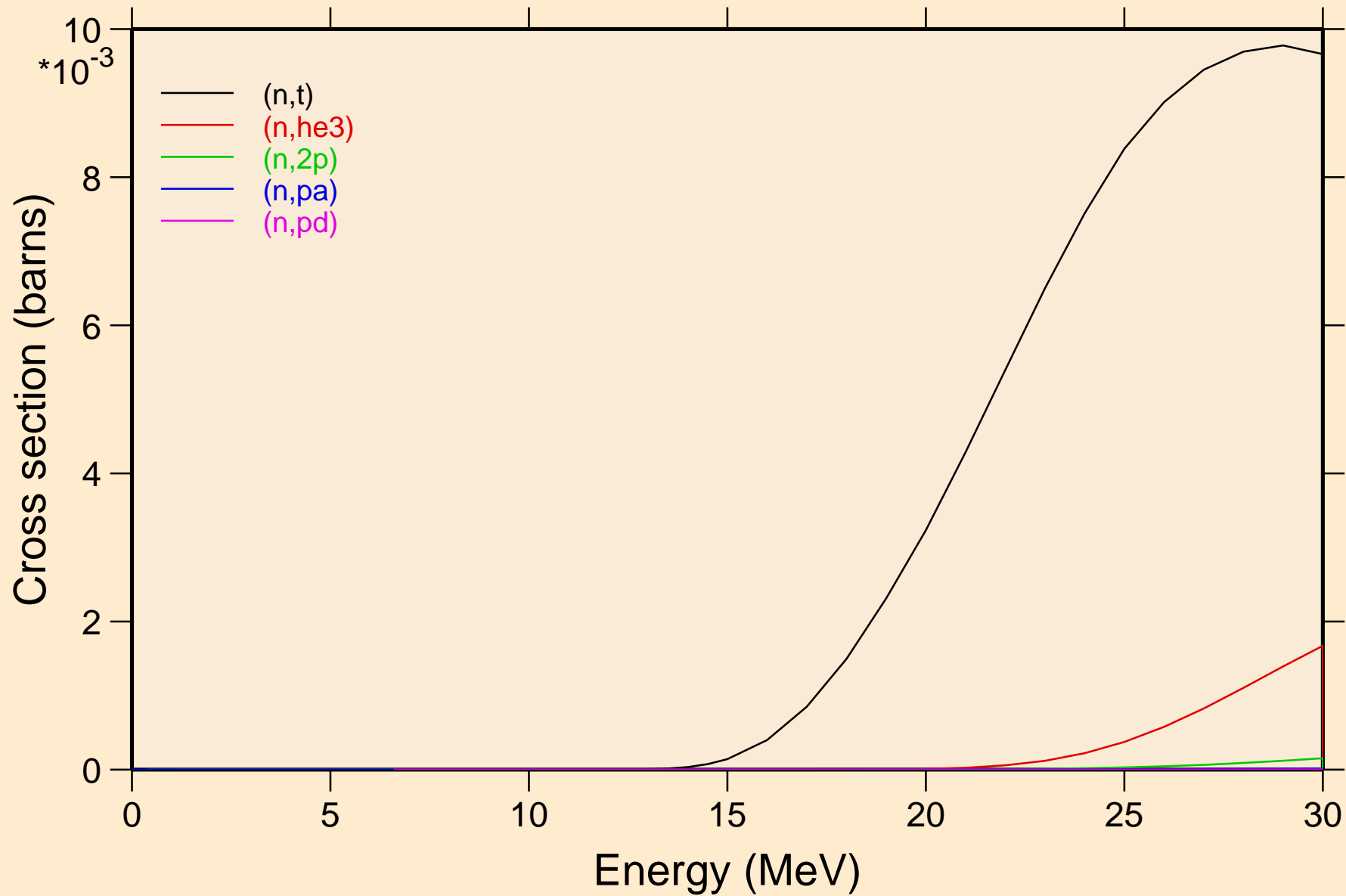

OS181M NEUTRON ACER TENDL-2021 LIBRARY; T=293.6K  
Threshold reactions

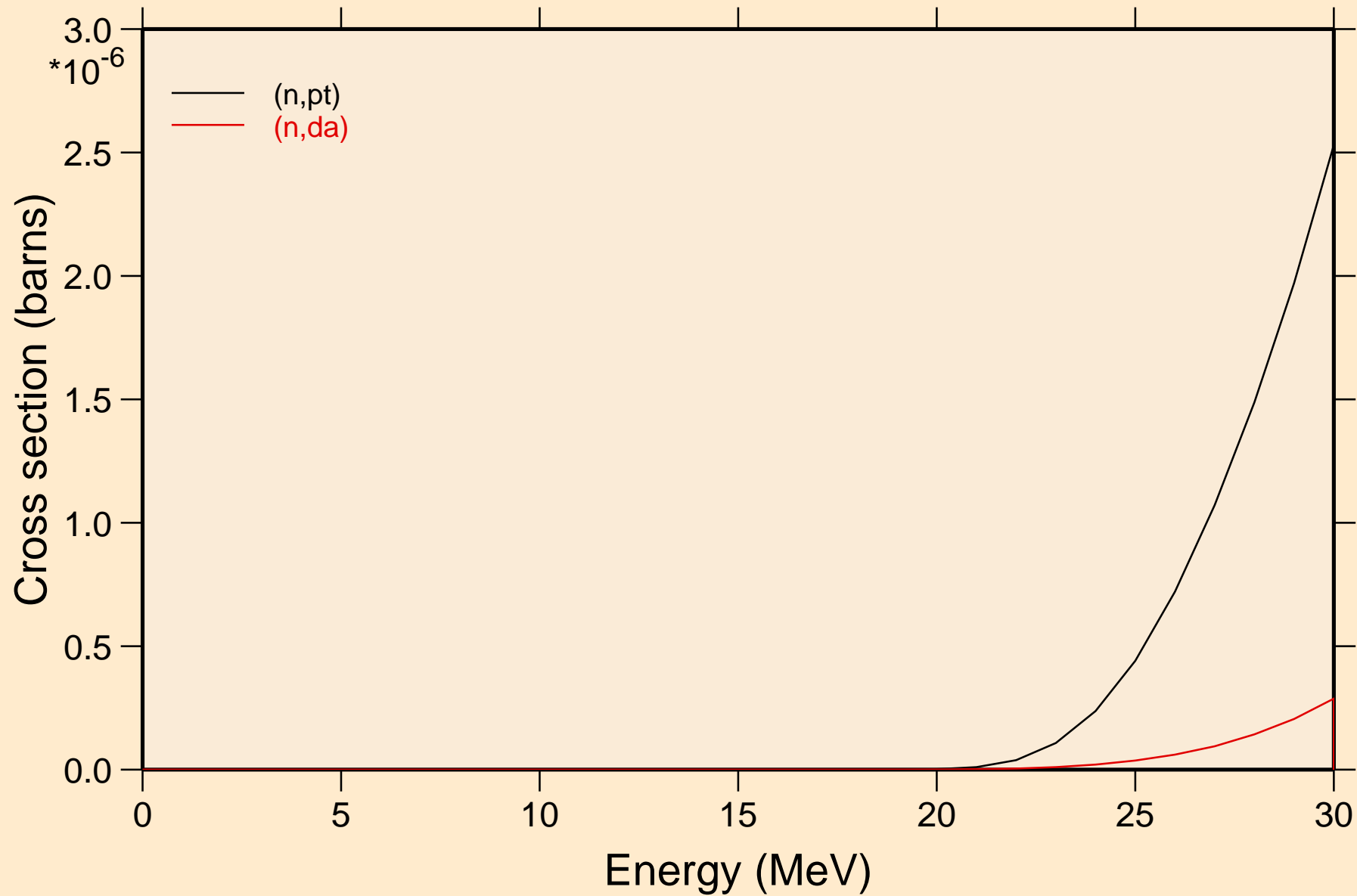

OS181M NEUTRON ACER TENDL-2021 LIBRARY; T=293.6K  
Threshold reactions

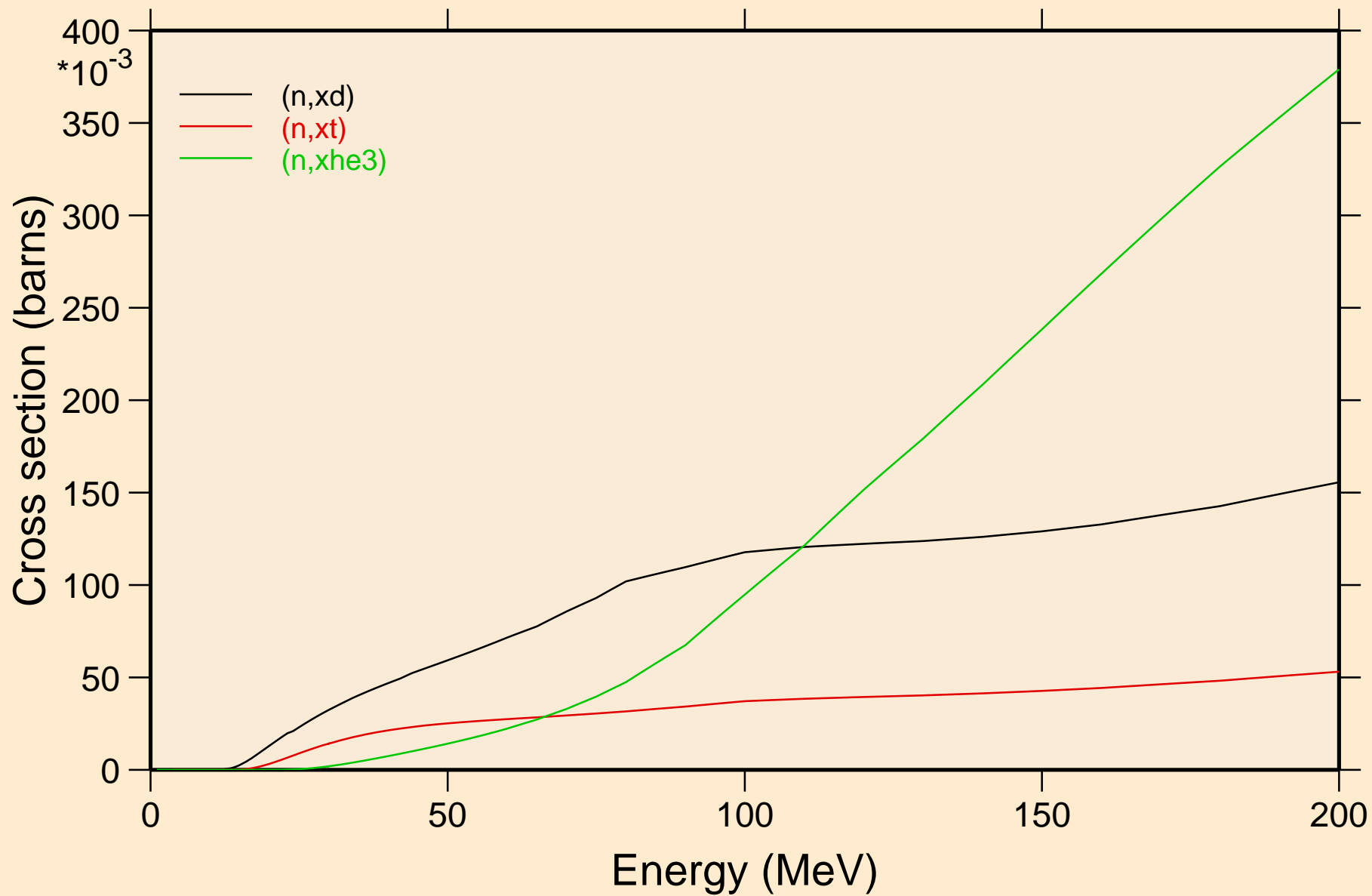

OS181M NEUTRON ACER TENDL-2021 LIBRARY; T=293.6K  
angular distribution for elastic

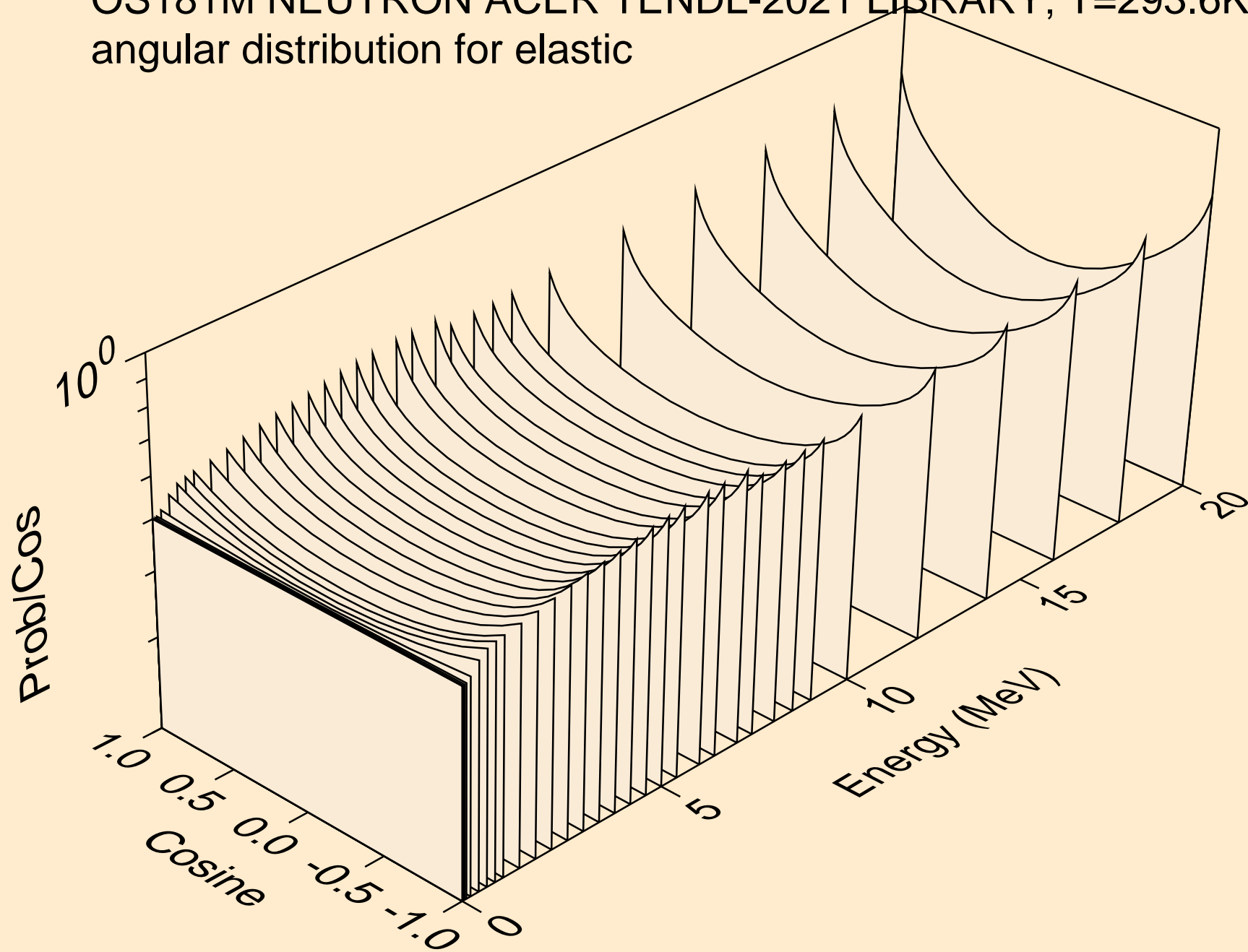

OS181M NEUTRON ACER TENDL-2021 LIBRARY; T=293.6K  
angular distribution for elastic

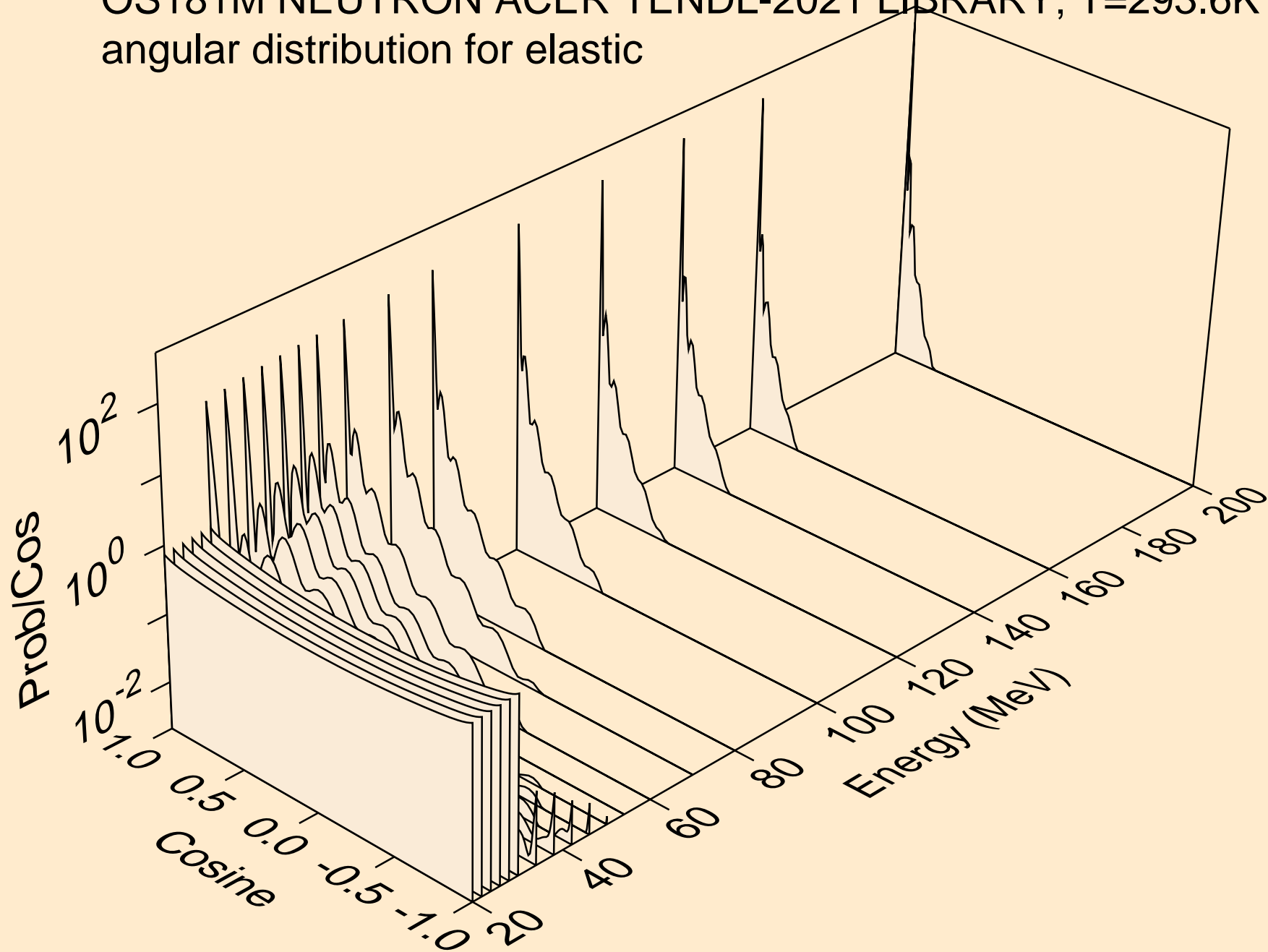



OS181M NEUTRON ACER TENDL-2021 LIBRARY; T=293.6K  
angular distribution for (n,n\*1)

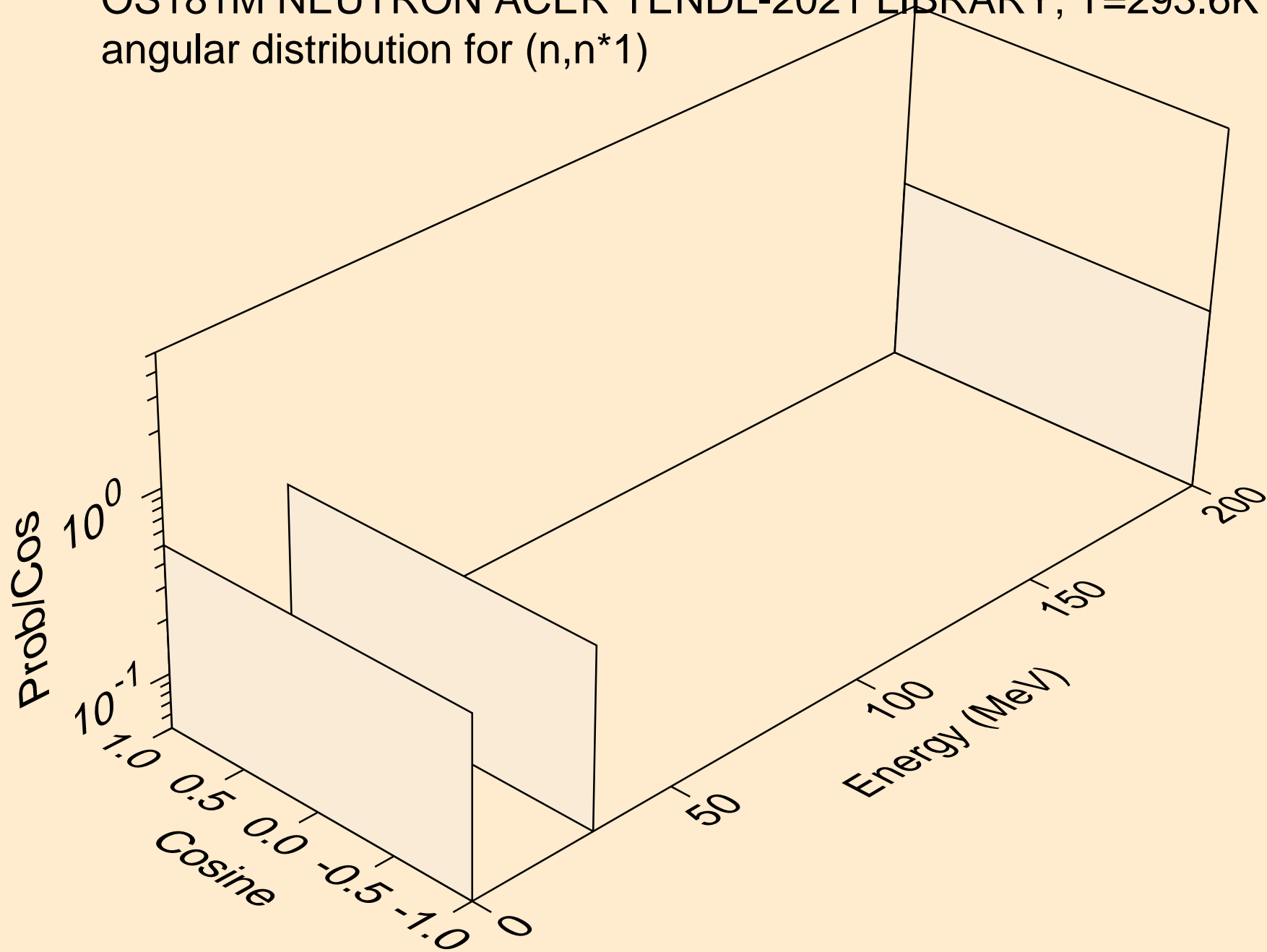

OS181M NEUTRON ACER TENDL-2021 LIBRARY; T=293.6K  
angular distribution for (n,n\*2)

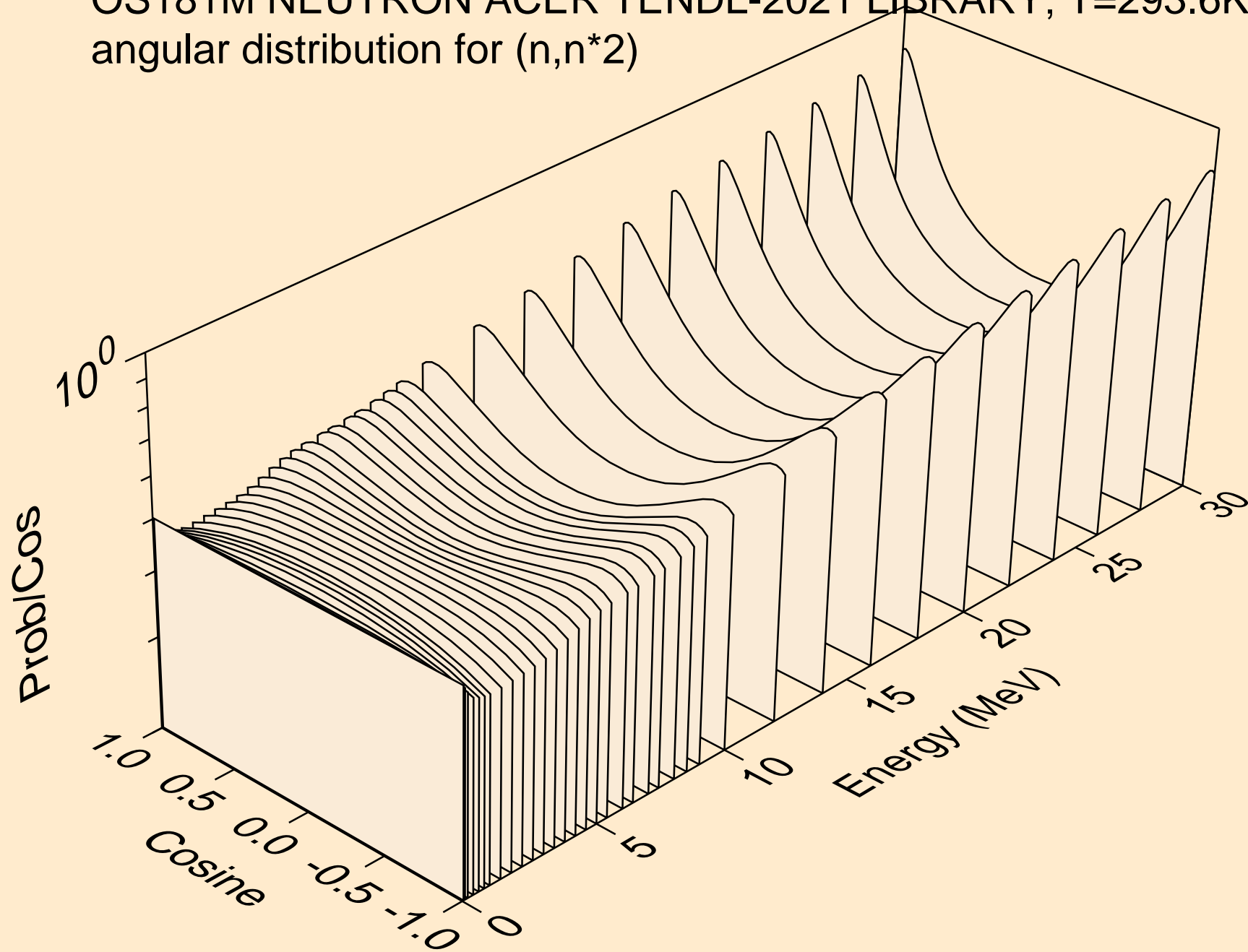

OS181M NEUTRON ACER TENDL-2021 LIBRARY; T=293.6K  
angular distribution for (n,n\*3)

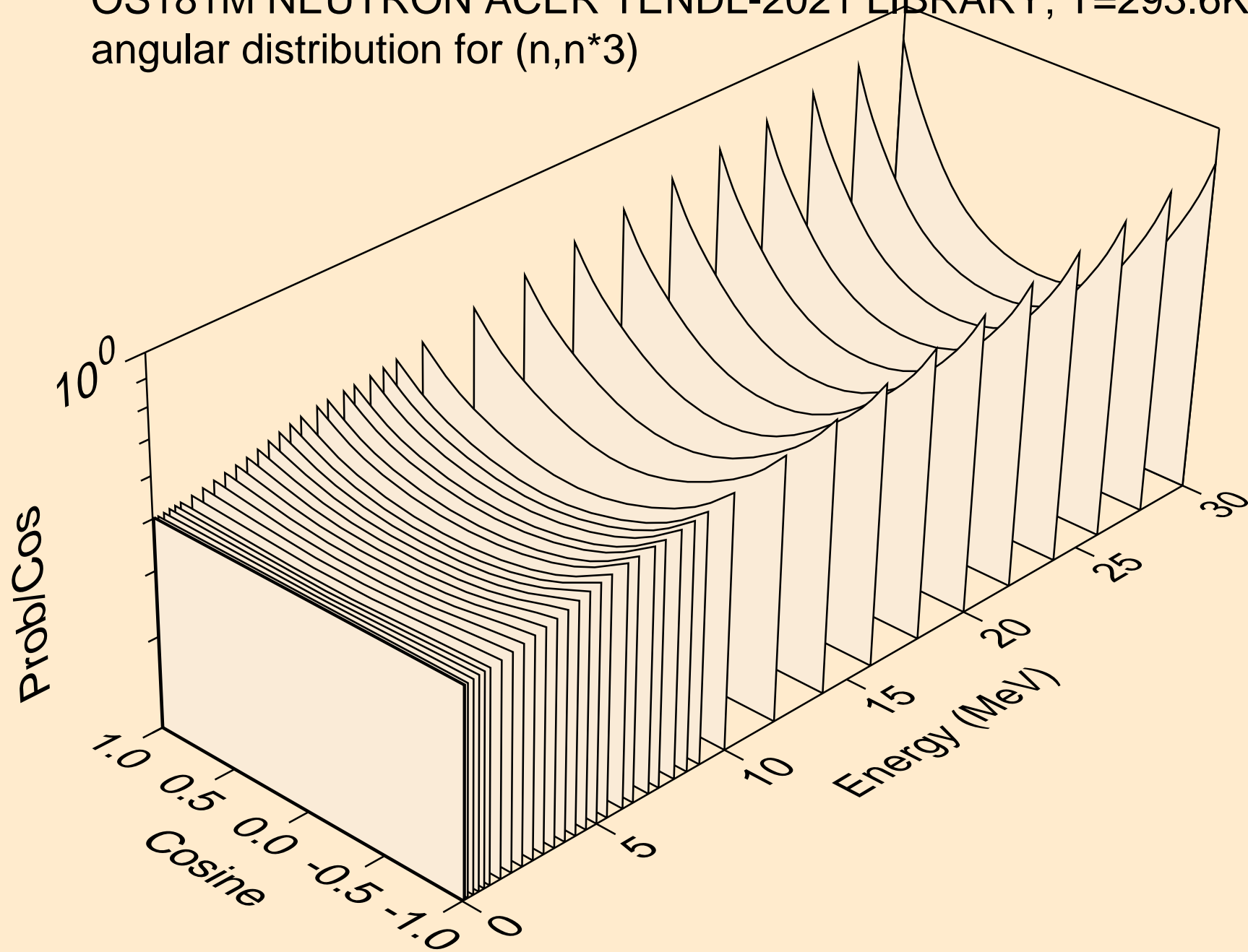

OS181M NEUTRON ACER TENDL-2021 LIBRARY; T=293.6K  
angular distribution for (n,n\*4)

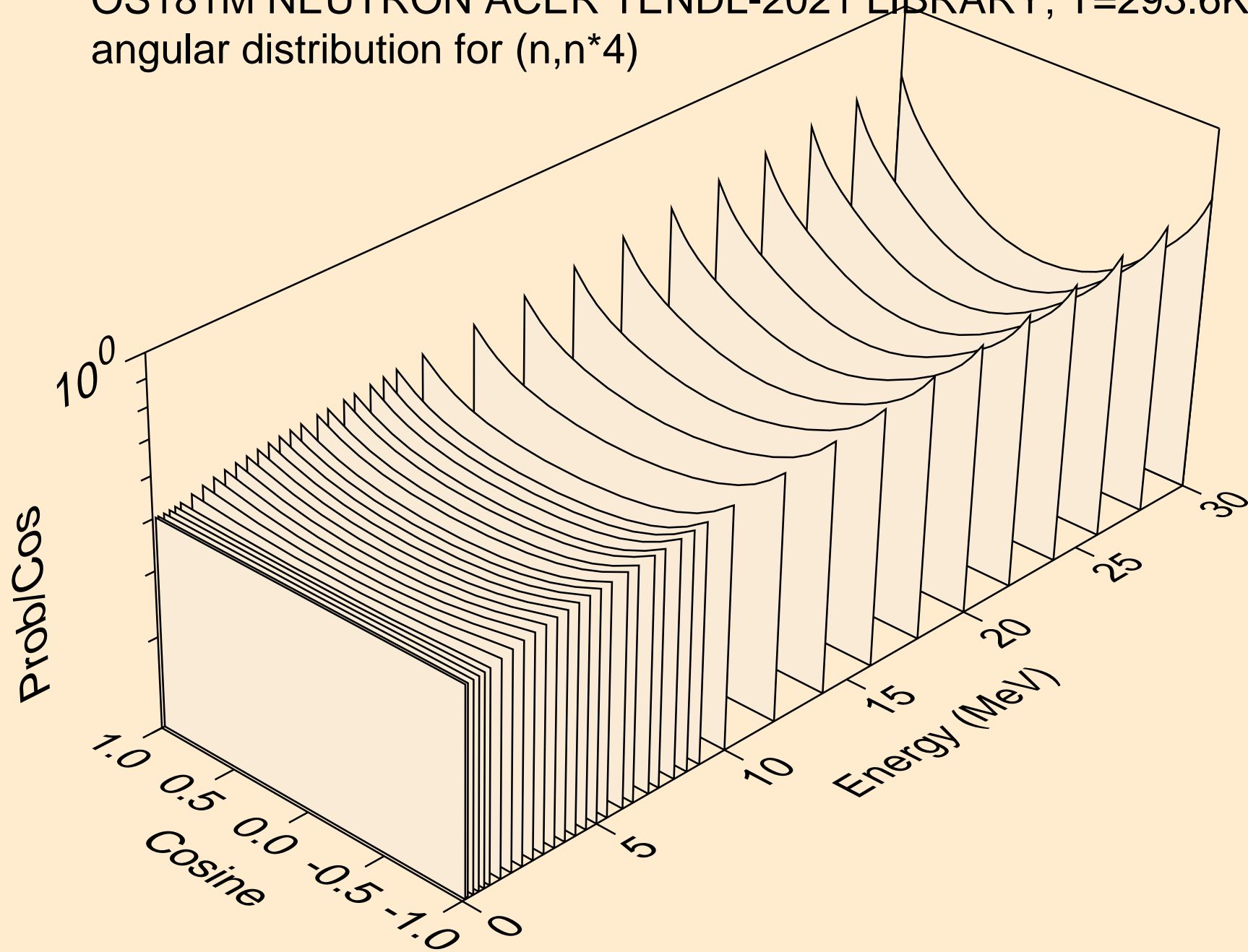

OS181M NEUTRON ACER TENDL-2021 LIBRARY; T=293.6K  
angular distribution for (n,n\*5)

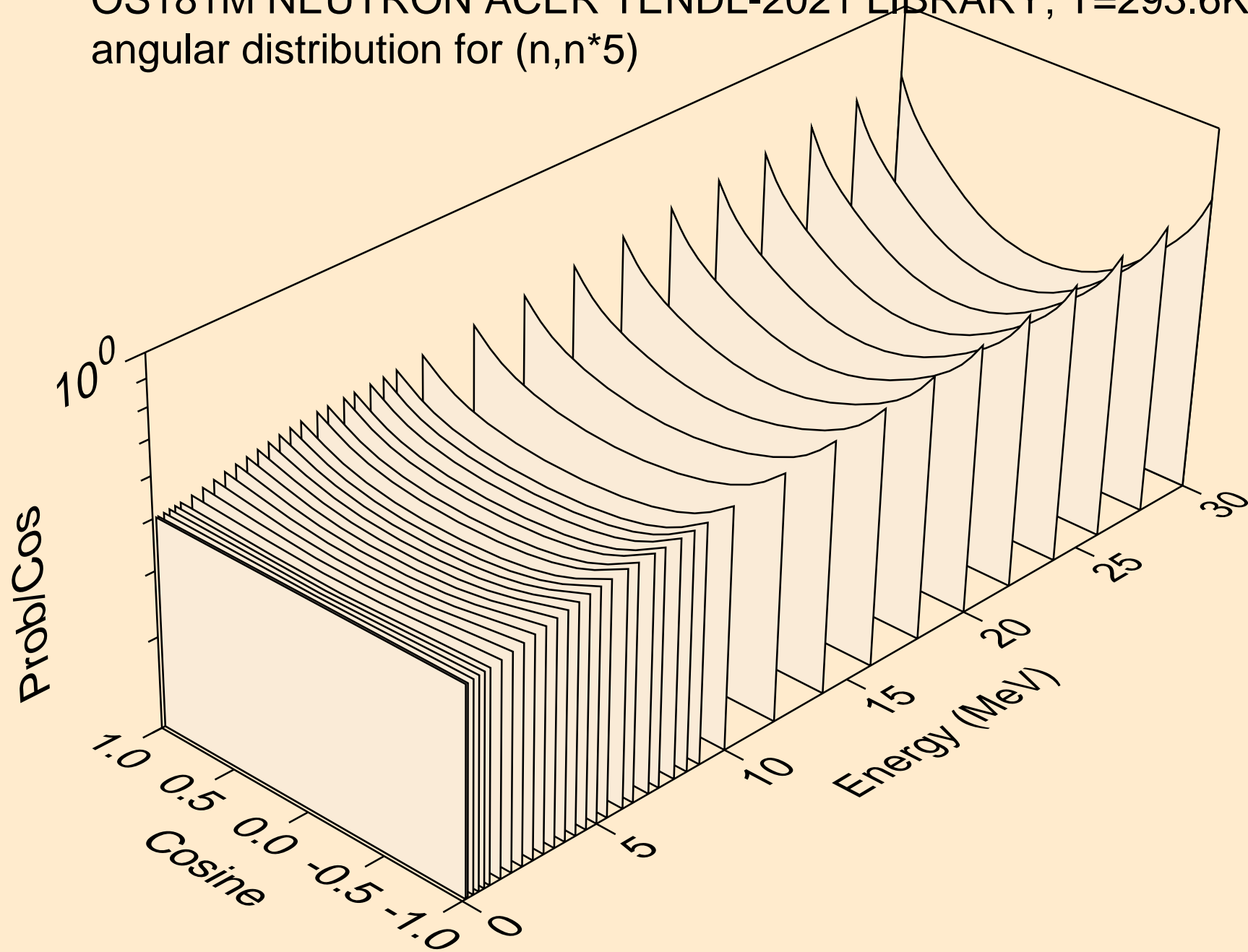

OS181M NEUTRON ACER TENDL-2021 LIBRARY; T=293.6K  
angular distribution for (n,n\*6)

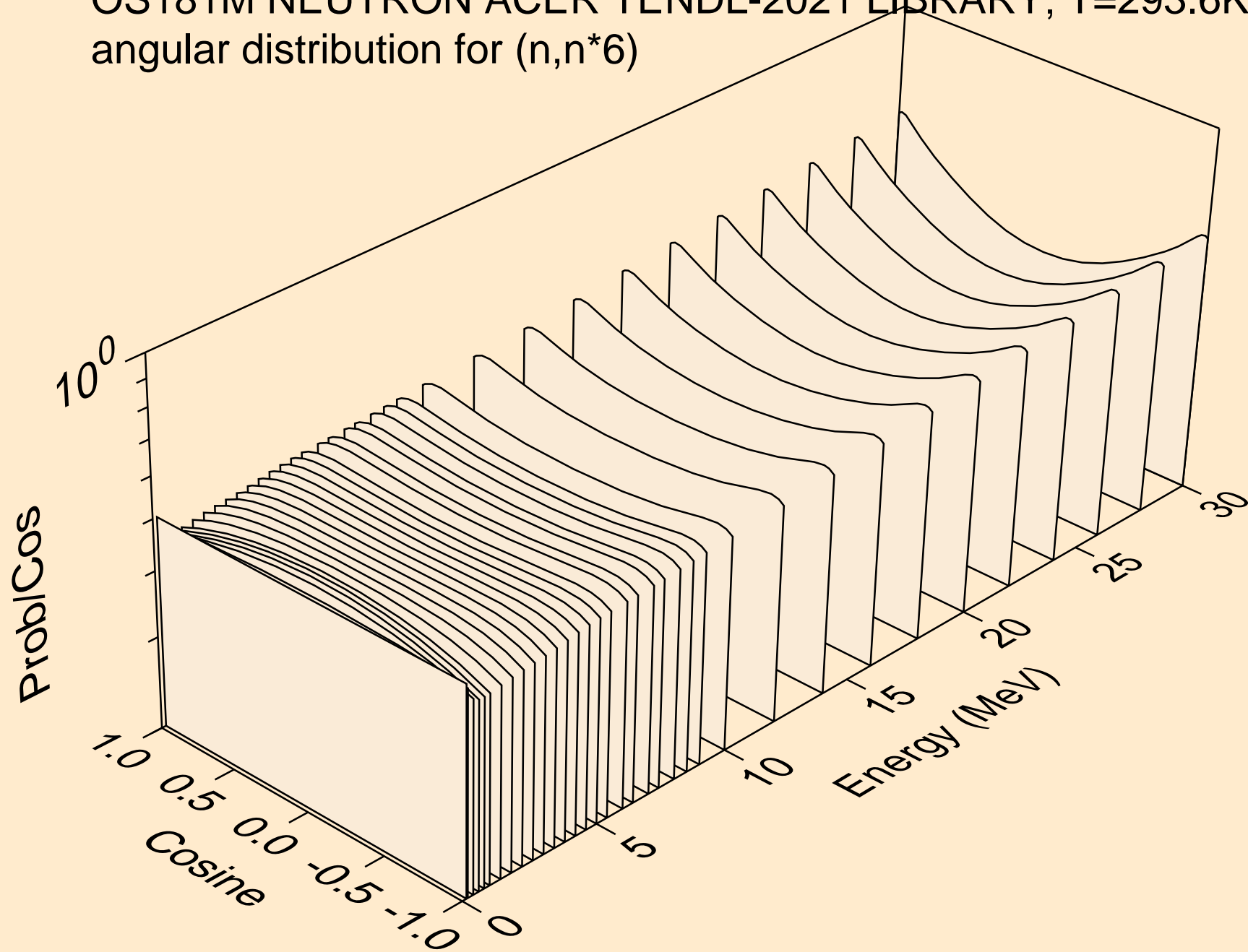

OS181M NEUTRON ACER TENDL-2021 LIBRARY; T=293.6K  
angular distribution for (n,n\*7)

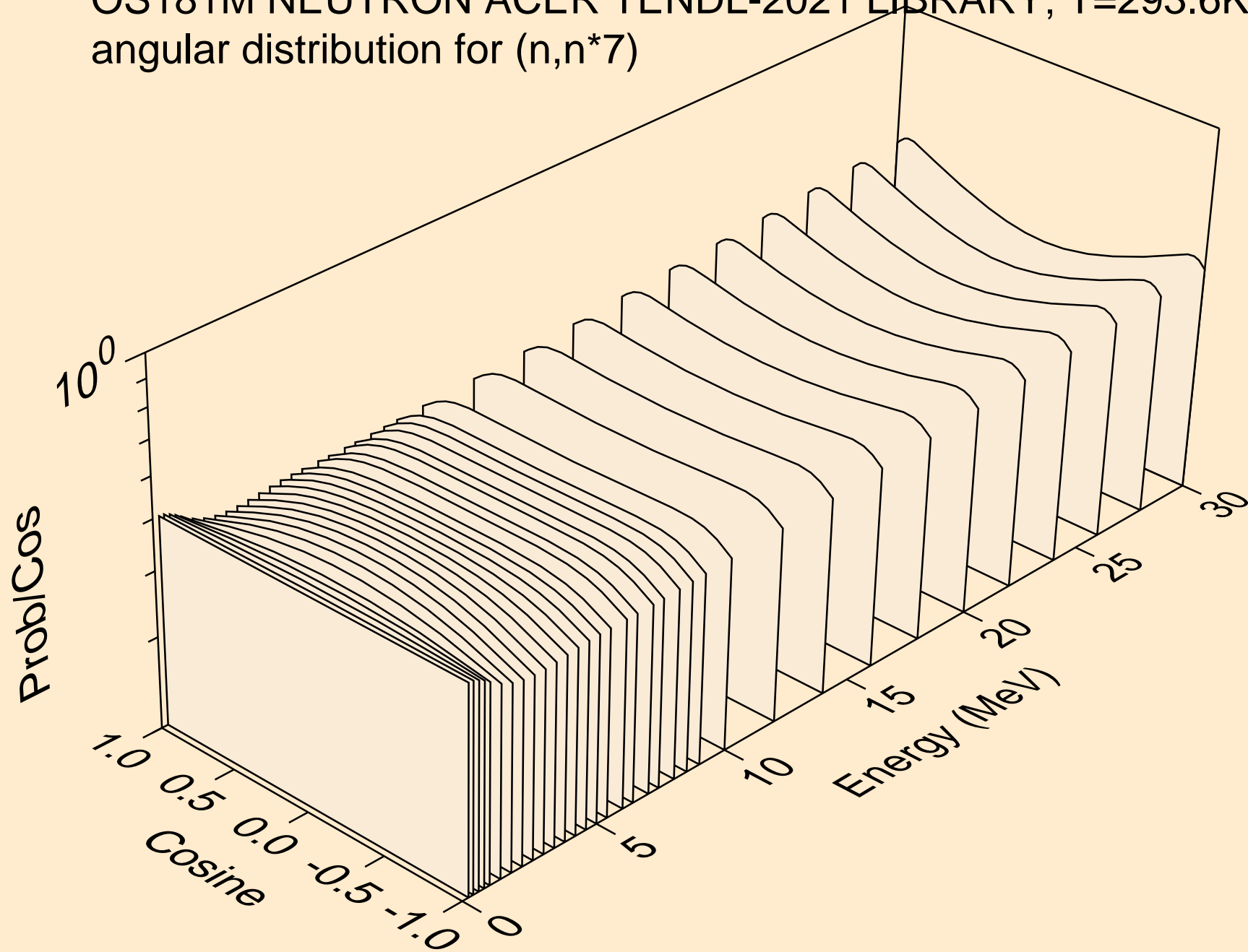

OS181M NEUTRON ACER TENDL-2021 LIBRARY; T=293.6K  
angular distribution for (n,n\*8)

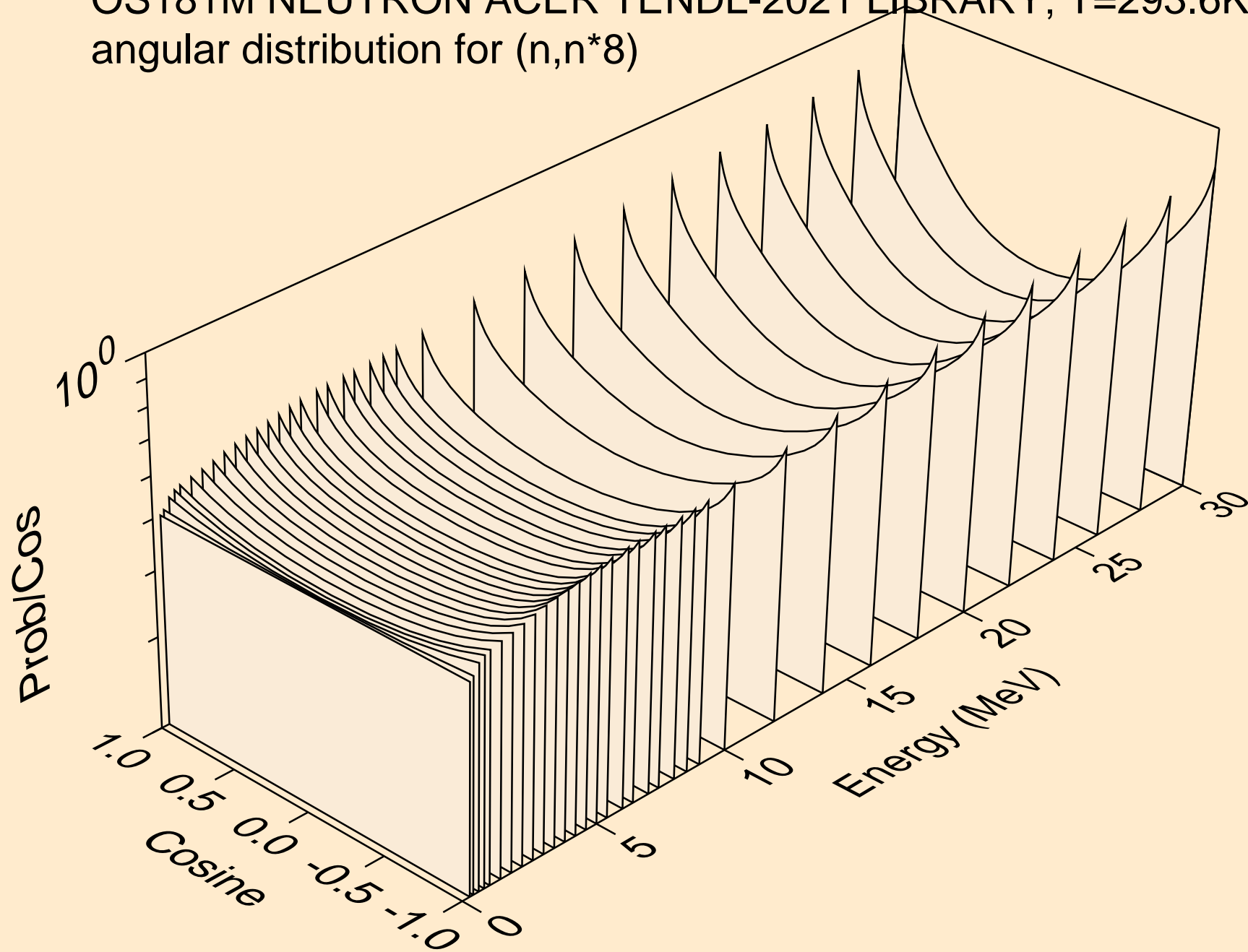



OS181M NEUTRON ACER TENDL-2021 LIBRARY; T=293.6K  
angular distribution for (n,n\*9)

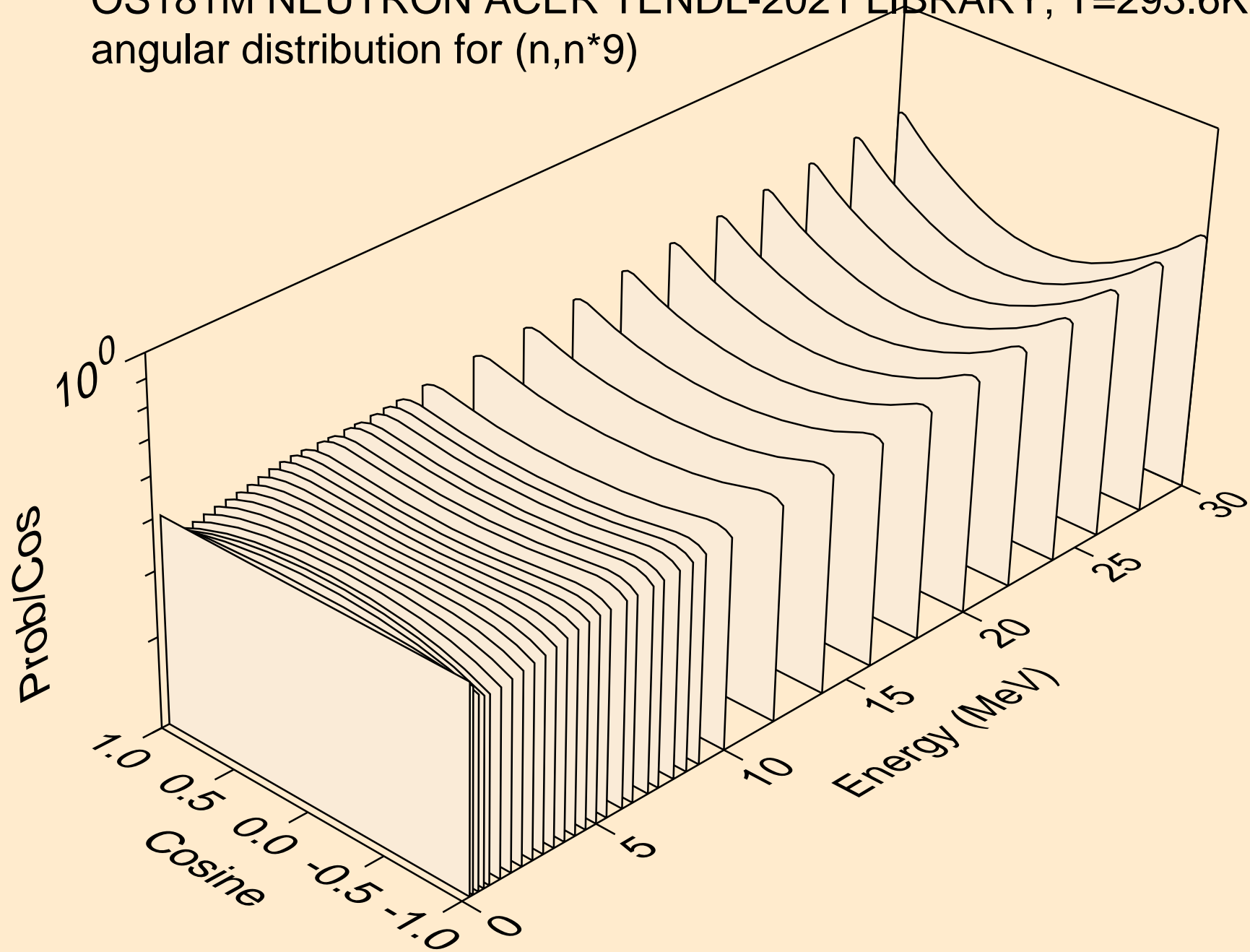

OS181M NEUTRON ACER TENDL-2021 LIBRARY; T=293.6K  
angular distribution for (n,n\*10)

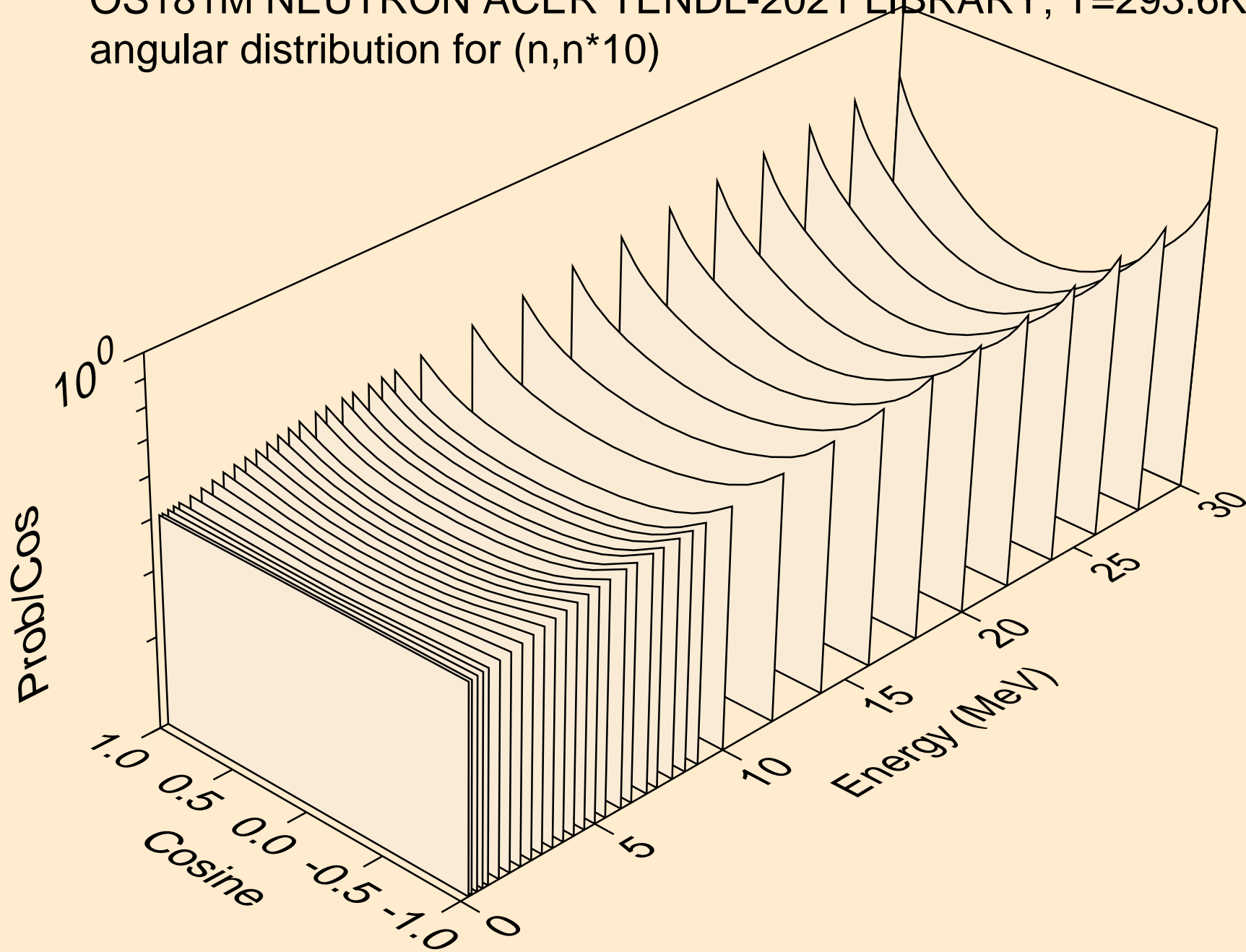

OS181M NEUTRON ACER TENDL-2021 LIBRARY; T=293.6K  
angular distribution for (n,n\*11)

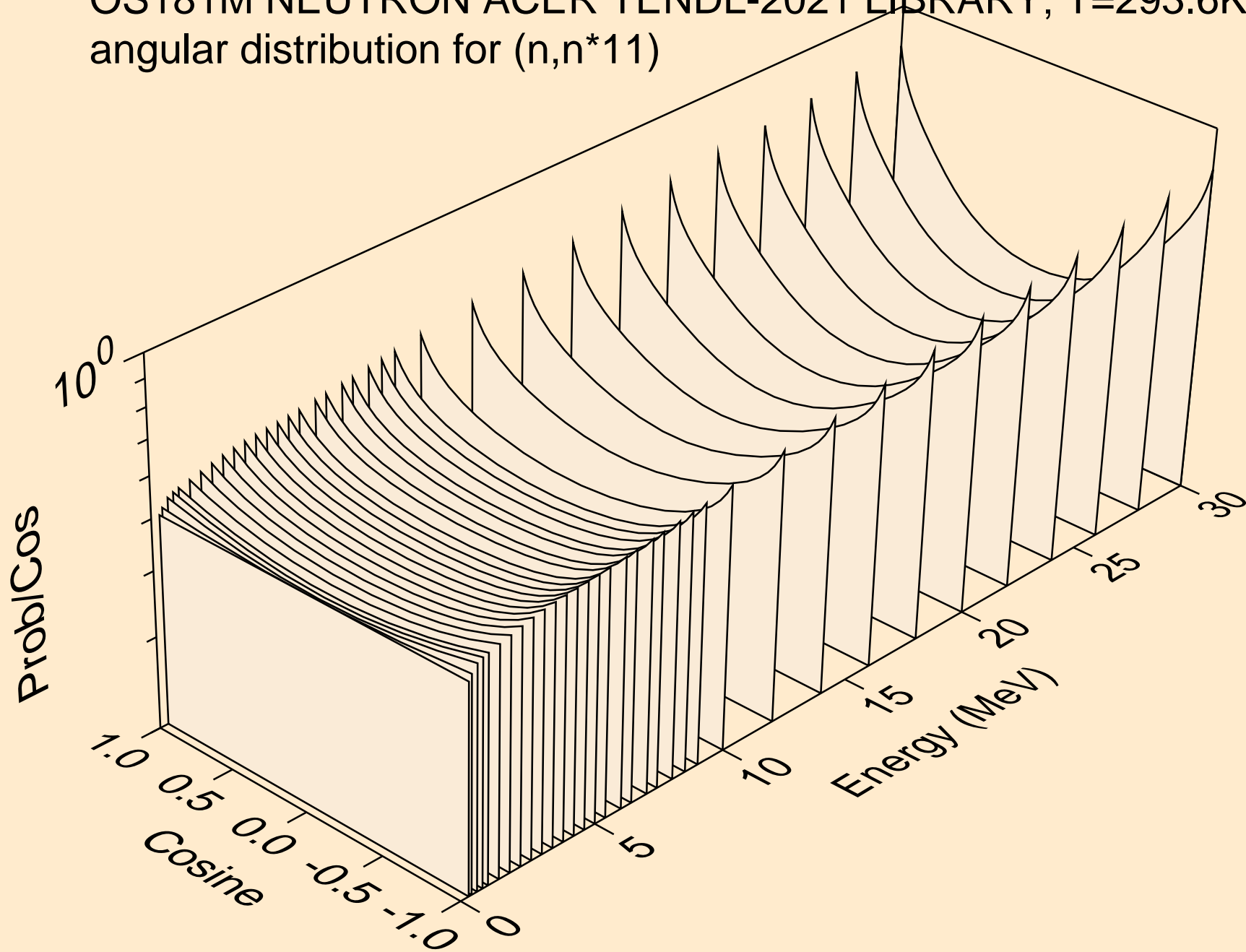

OS181M NEUTRON ACER TENDL-2021 LIBRARY; T=293.6K  
angular distribution for (n,n\*12)

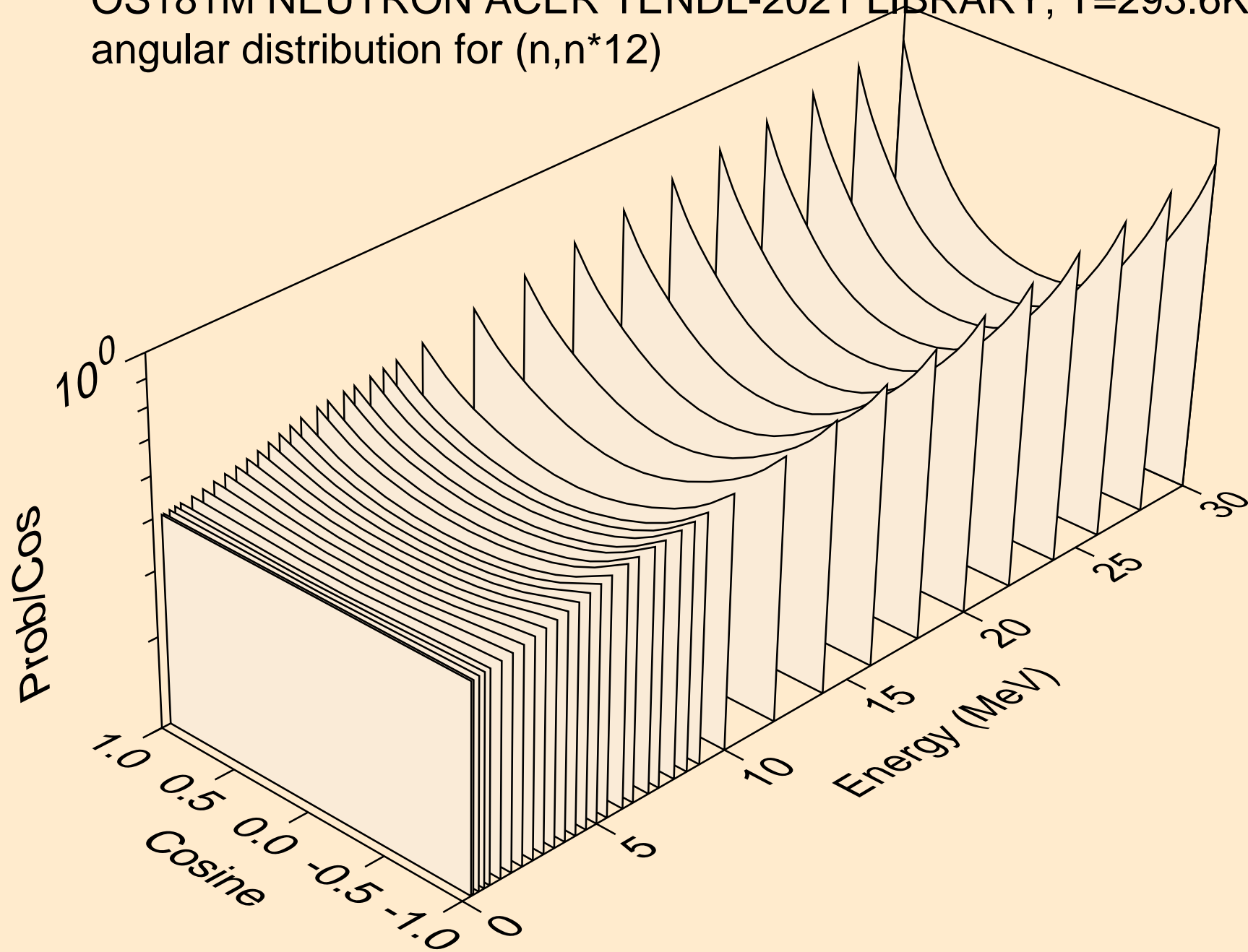

OS181M NEUTRON ACER TENDL-2021 LIBRARY; T=293.6K  
angular distribution for (n,n\*13)

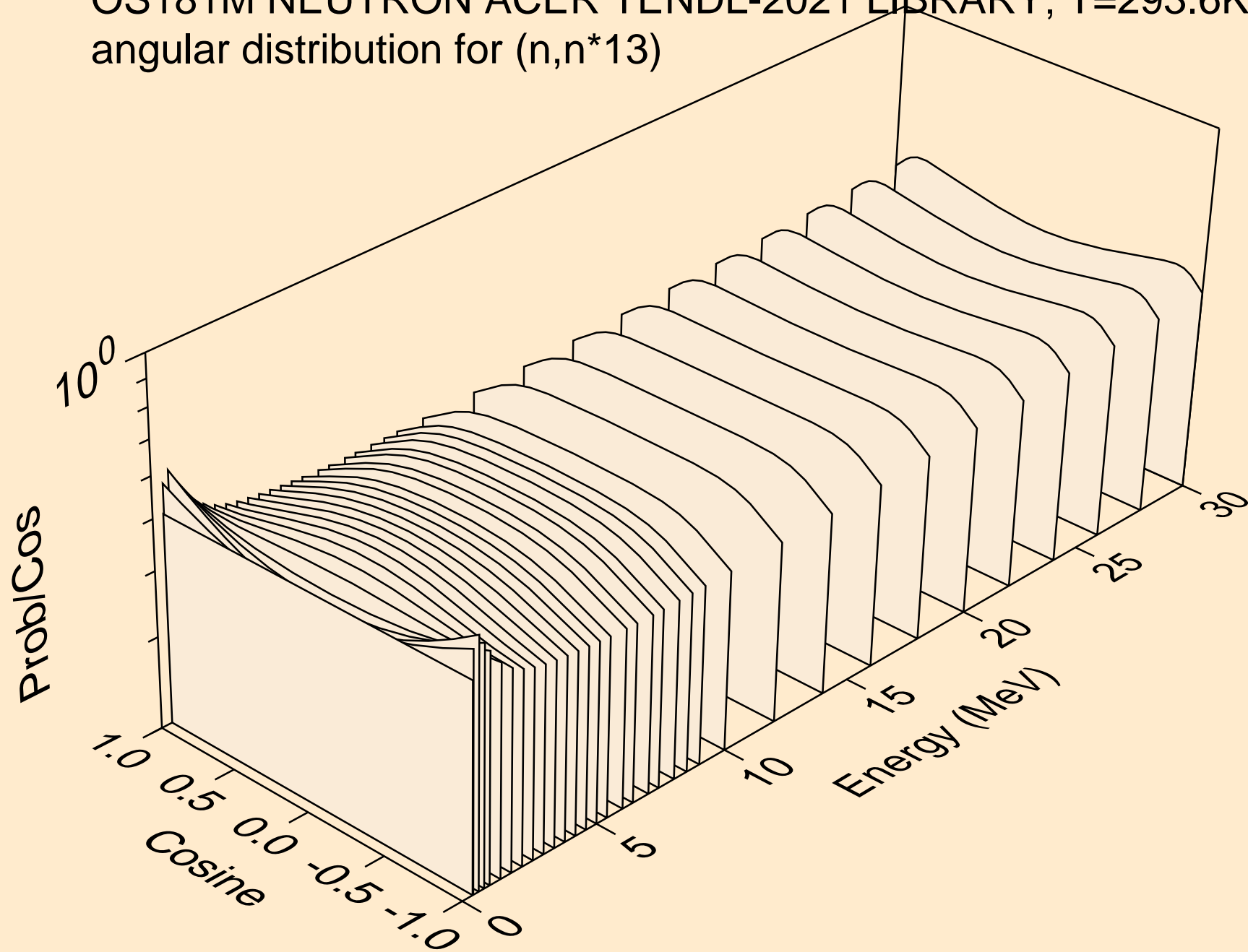

OS181M NEUTRON ACER TENDL-2021 LIBRARY; T=293.6K  
angular distribution for (n,n\*14)

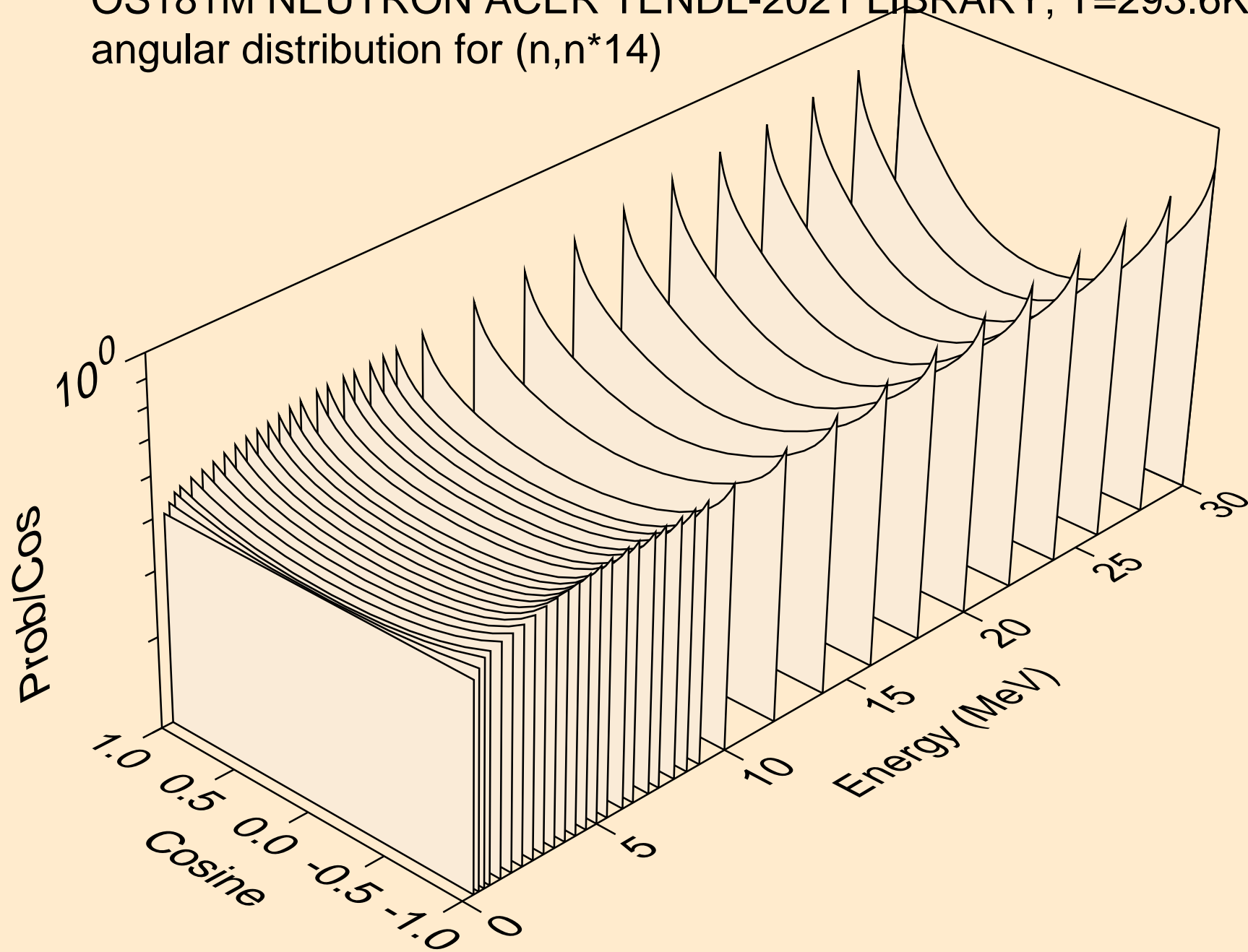

OS181M NEUTRON ACER TENDL-2021 LIBRARY; T=293.6K  
angular distribution for (n,n\*15)

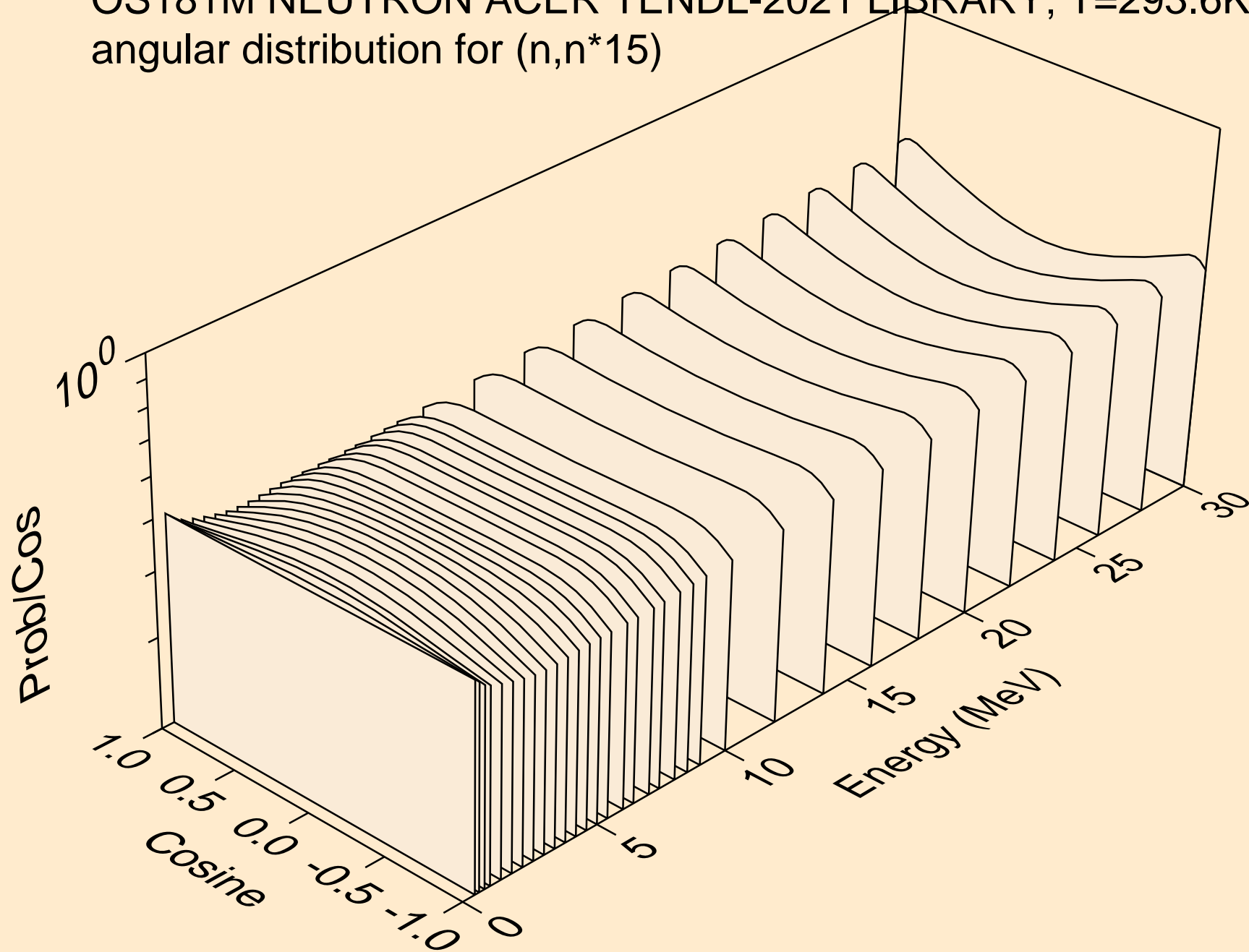

OS181M NEUTRON ACER TENDL-2021 LIBRARY; T=293.6K  
angular distribution for (n,n\*16)

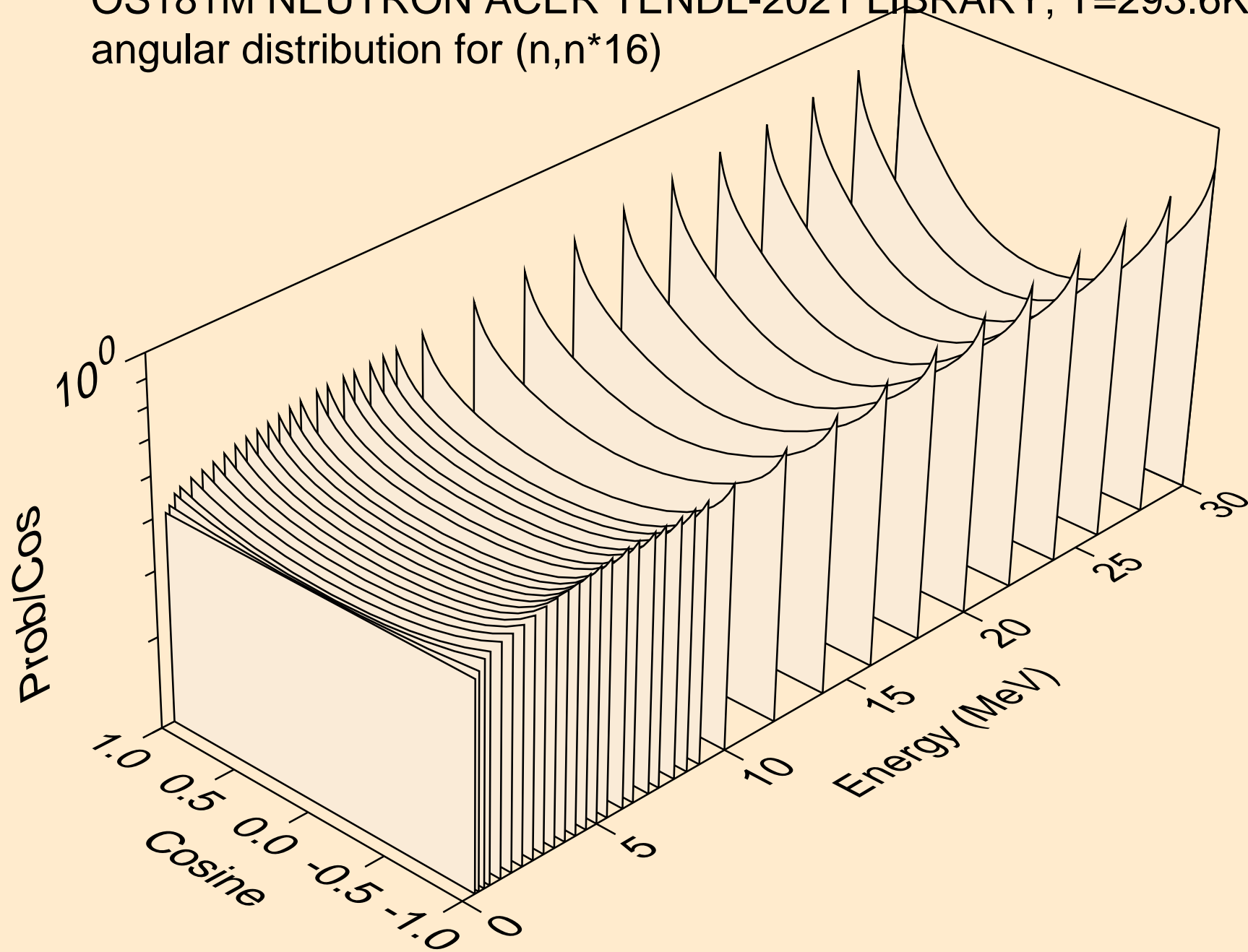



OS181M NEUTRON ACER TENDL-2021 LIBRARY; T=293.6K  
angular distribution for (n,n\*17)

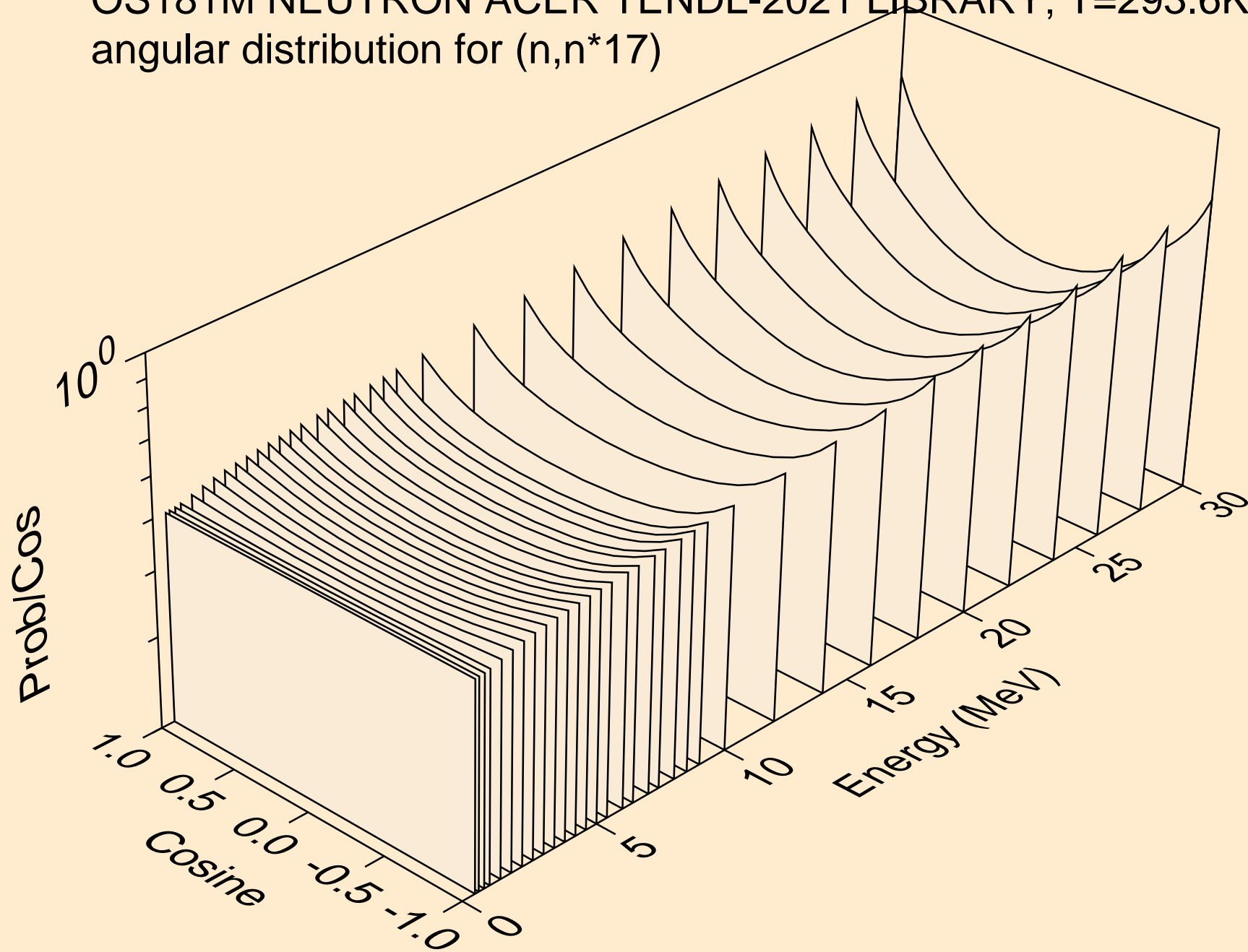

OS181M NEUTRON ACER TENDL-2021 LIBRARY; T=293.6K  
angular distribution for (n,n\*18)

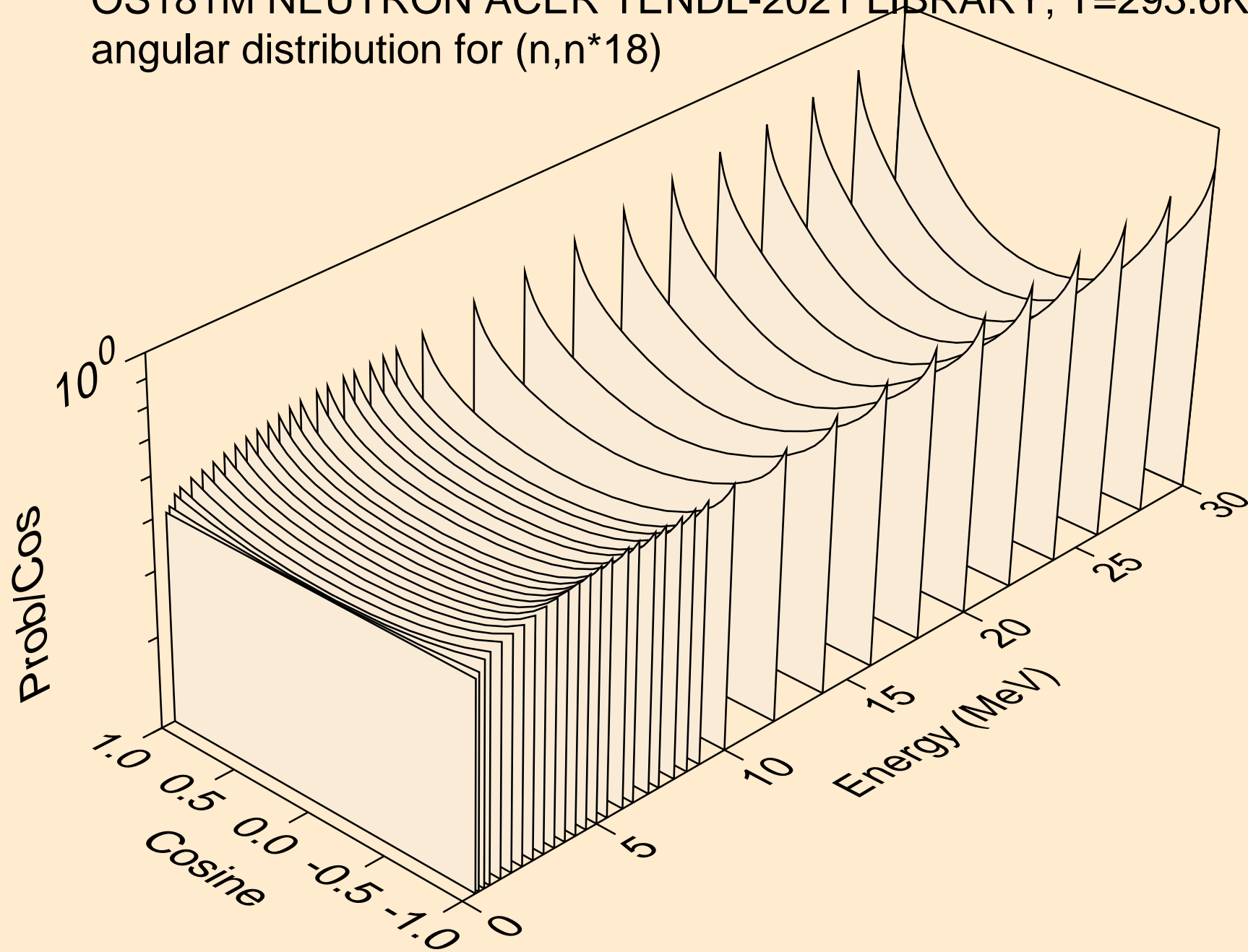

OS181M NEUTRON ACER TENDL-2021 LIBRARY; T=293.6K  
angular distribution for (n,n\*19)

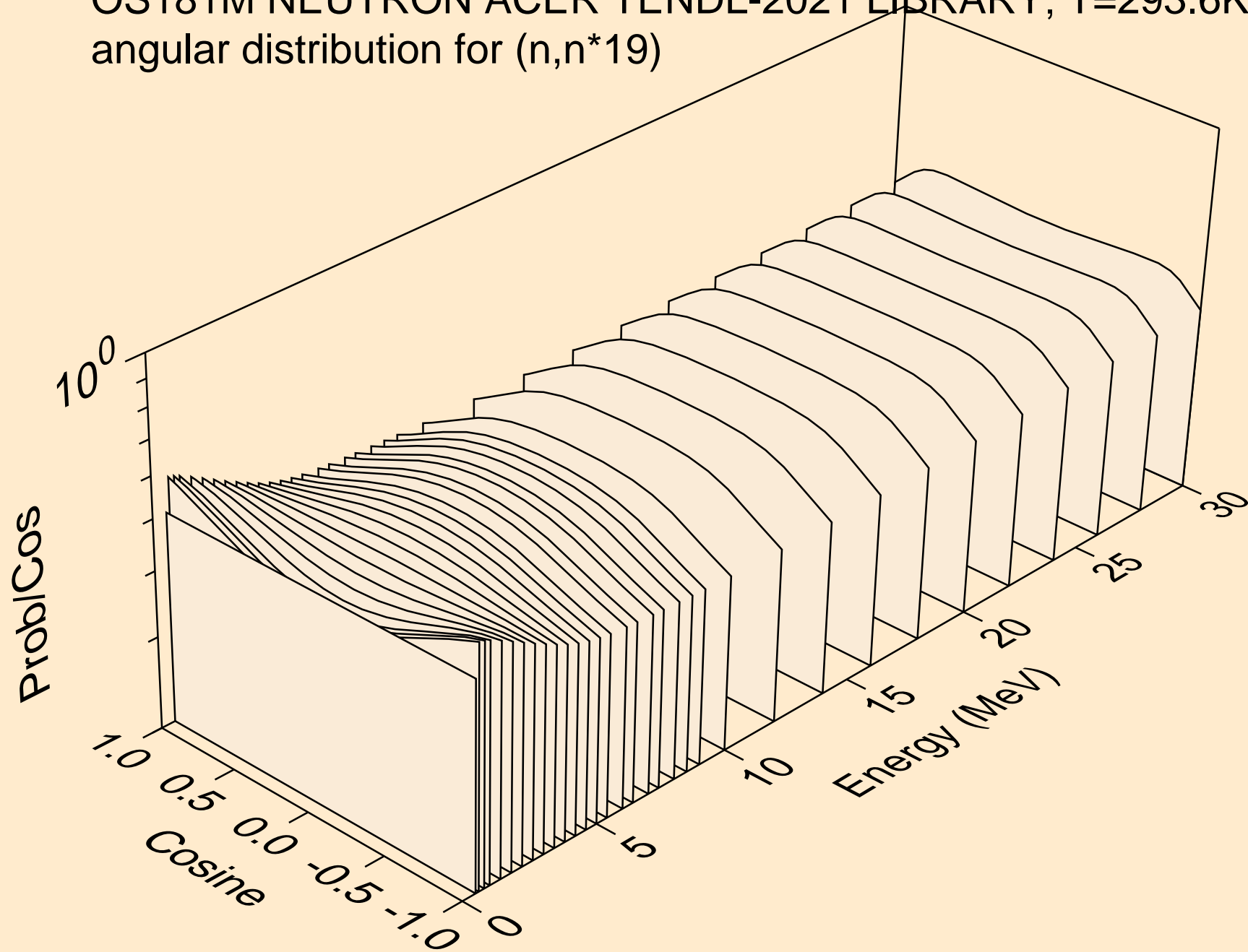

OS181M NEUTRON ACER TENDL-2021 LIBRARY; T=293.6K  
angular distribution for (n,n\*20)

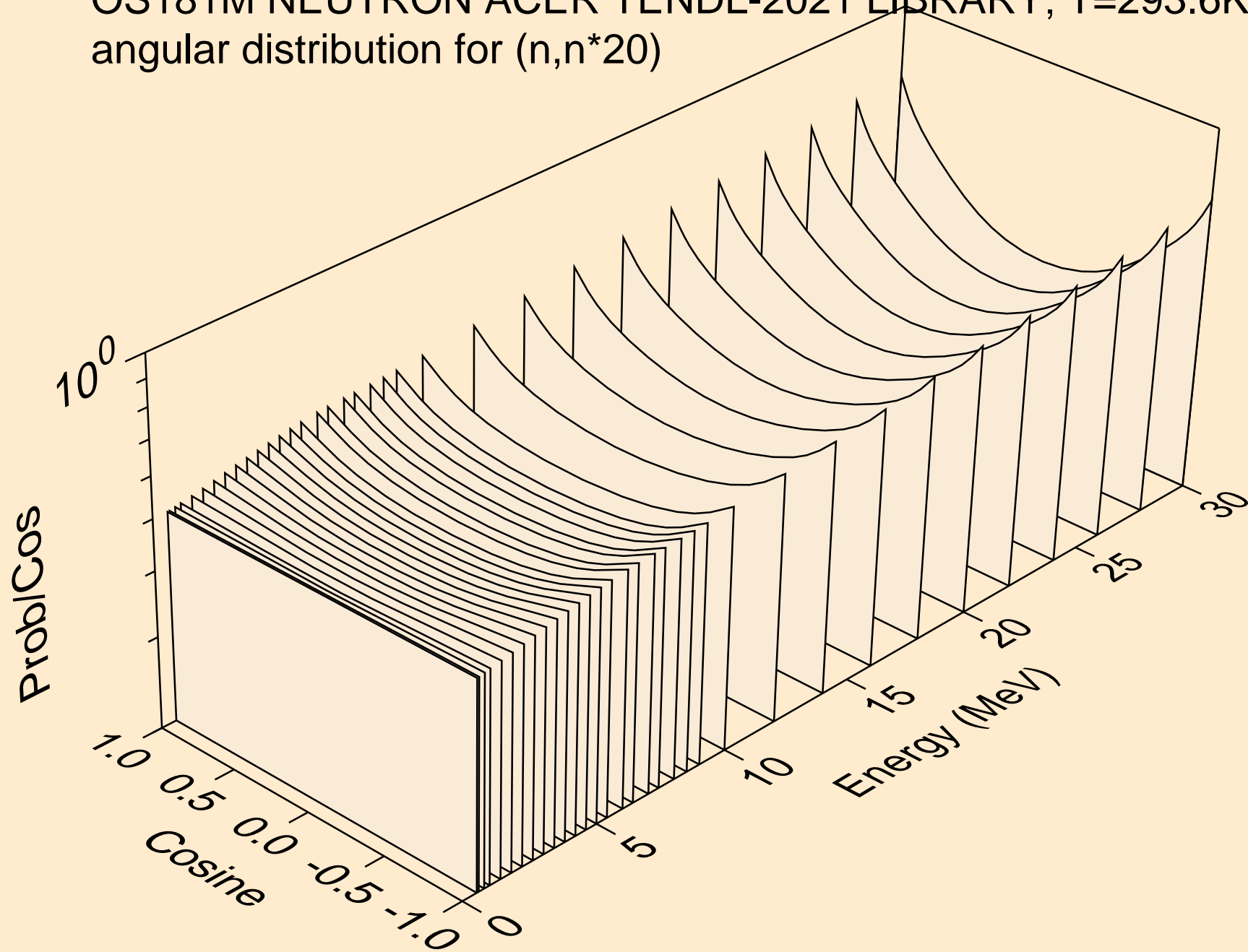

OS181M NEUTRON ACER TENDL-2021 LIBRARY; T=293.6K  
angular distribution for (n,n\*21)

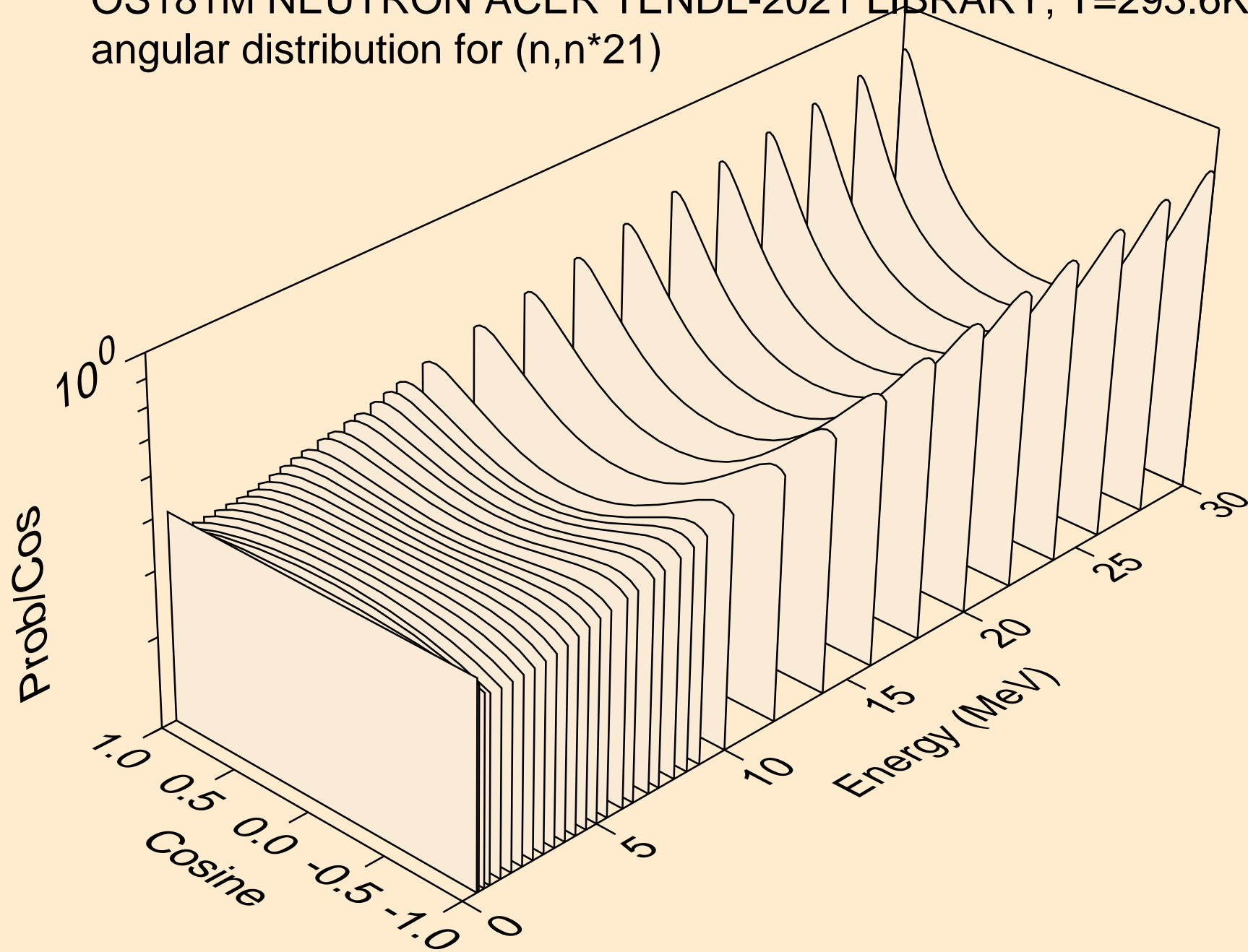

OS181M NEUTRON ACER TENDL-2021 LIBRARY; T=293.6K  
angular distribution for (n,n\*22)

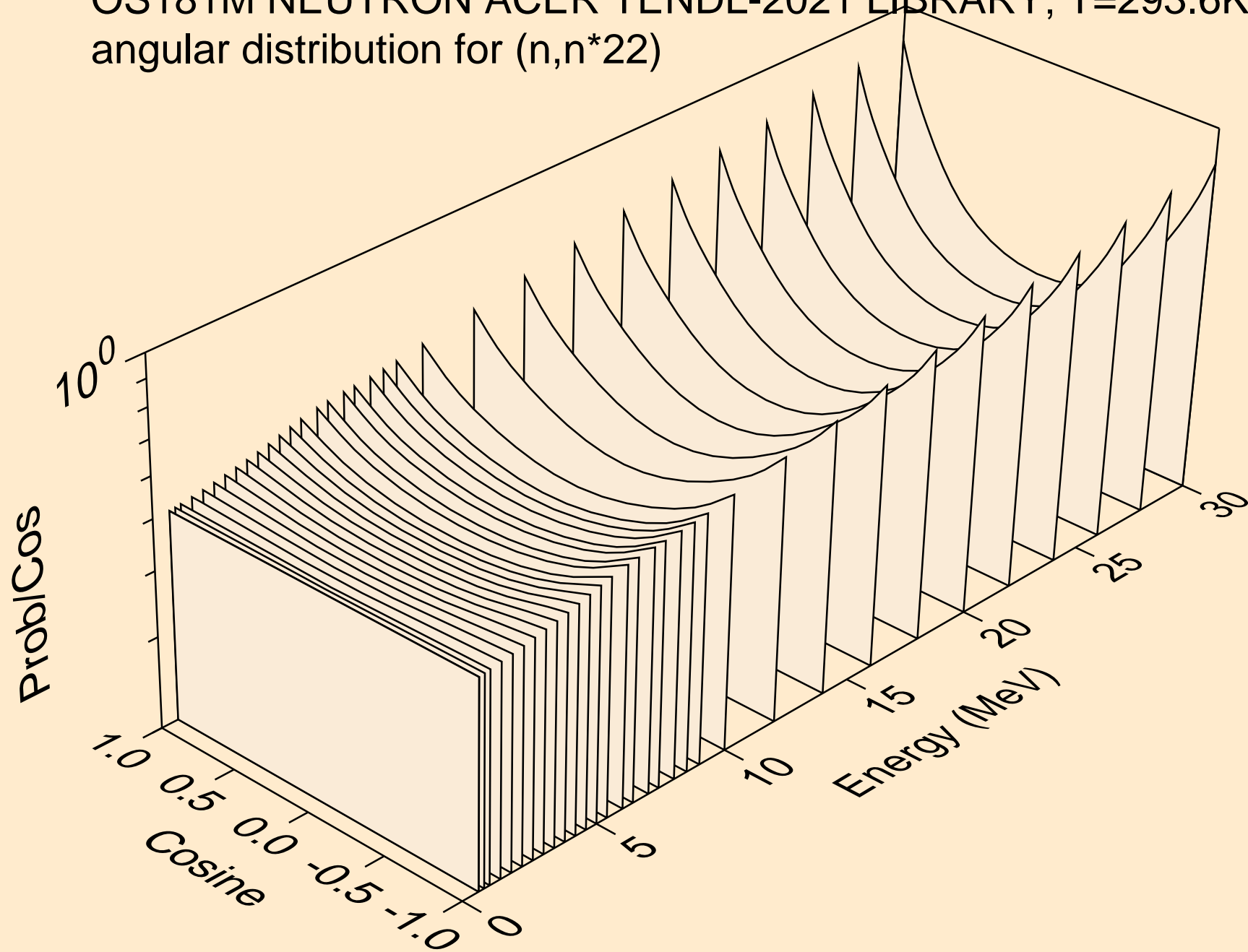

OS181M NEUTRON ACER TENDL-2021 LIBRARY; T=293.6K  
angular distribution for (n,n\*23)

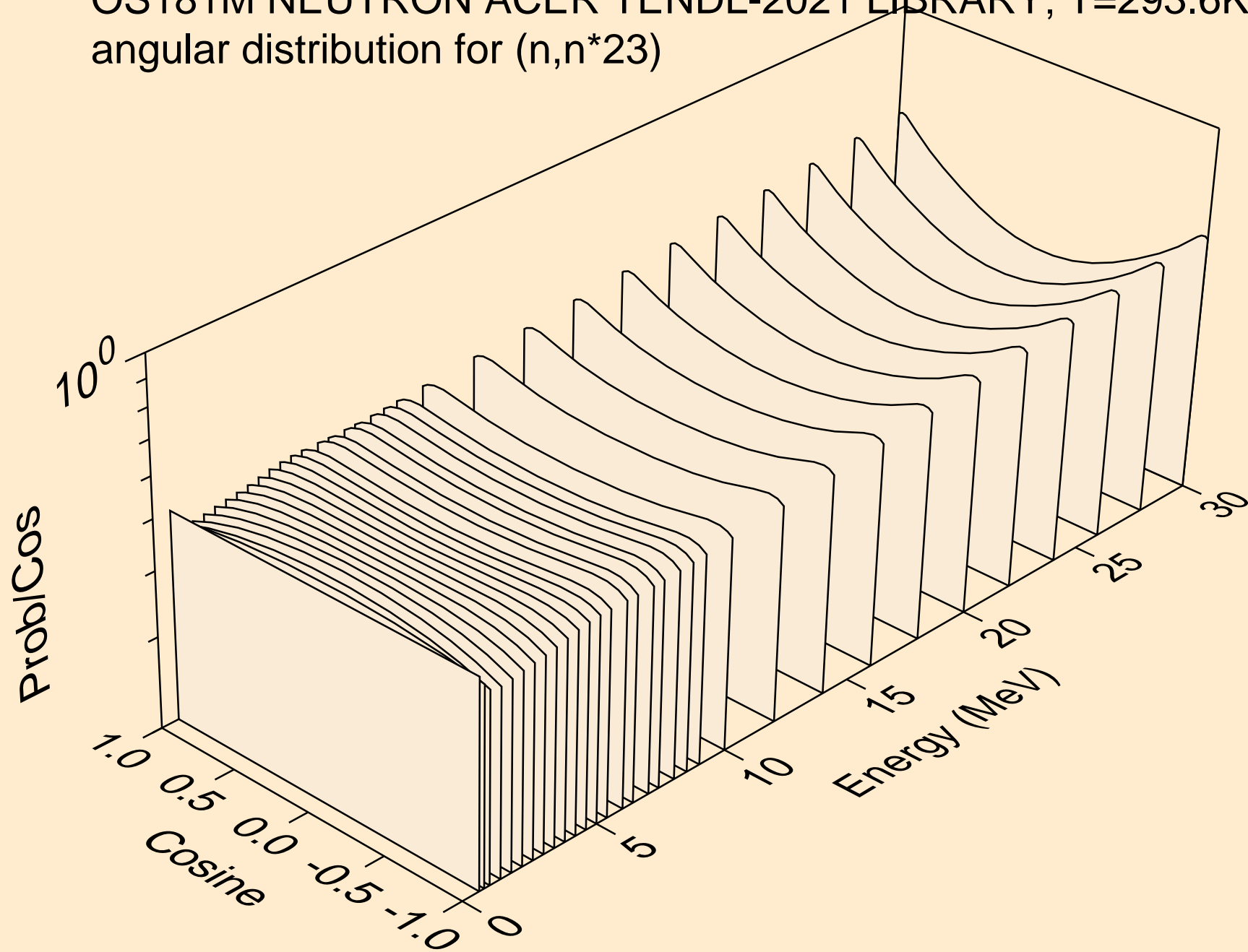

OS181M NEUTRON ACER TENDL-2021 LIBRARY; T=293.6K  
angular distribution for (n,n\*24)

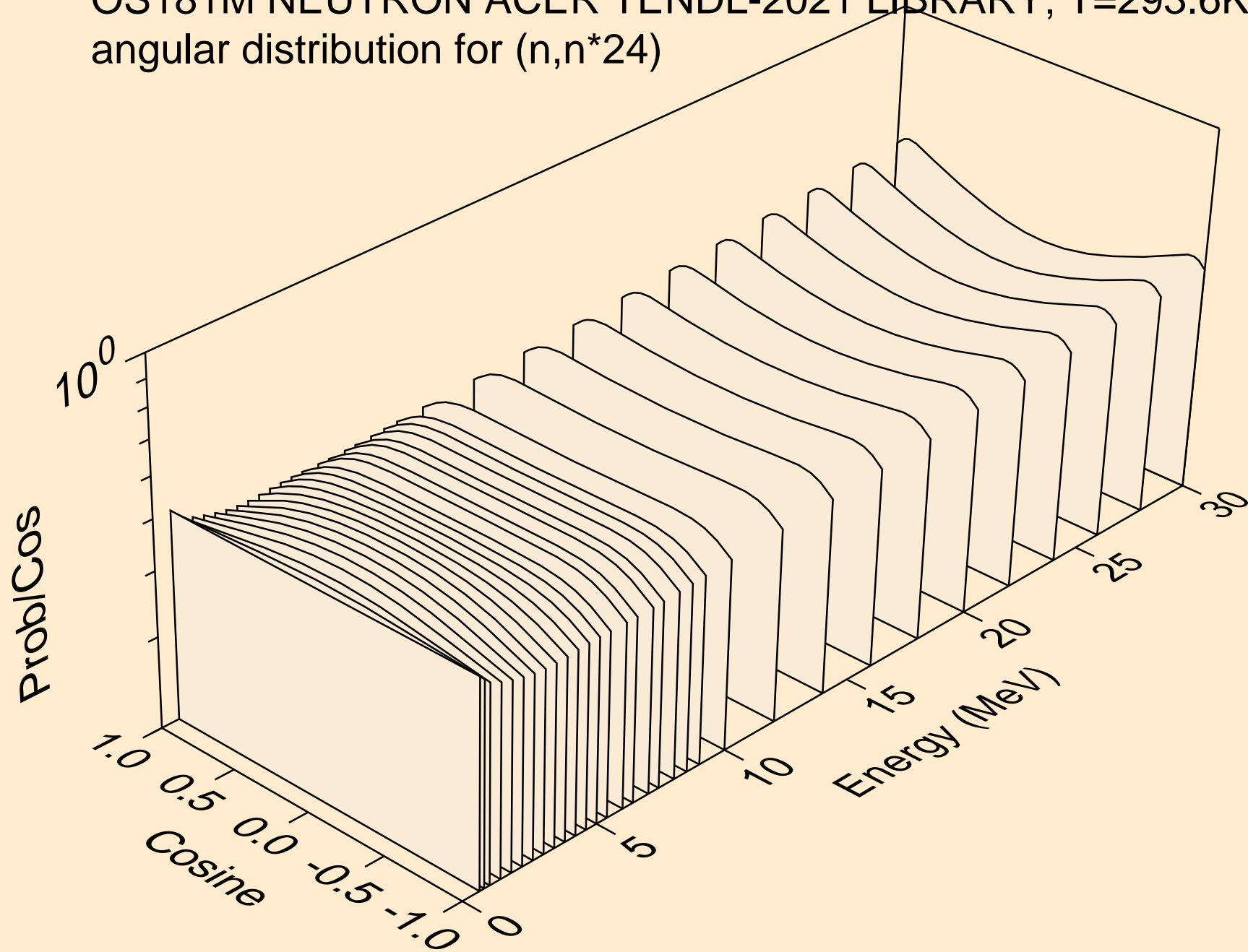



OS181M NEUTRON ACER TENDL-2021 LIBRARY; T=293.6K  
angular distribution for (n,n\*25)

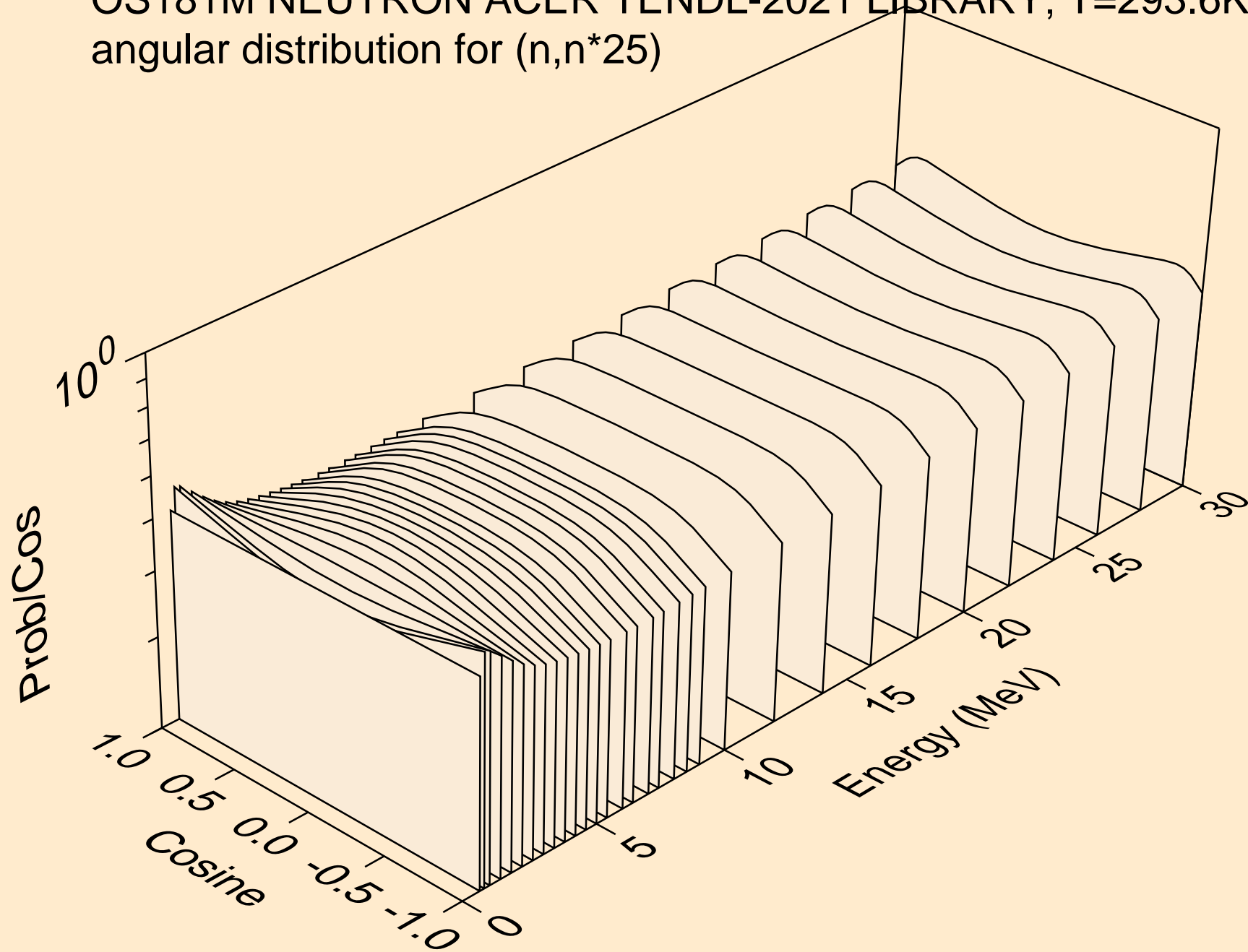

OS181M NEUTRON ACER TENDL-2021 LIBRARY; T=293.6K  
angular distribution for (n,n\*26)

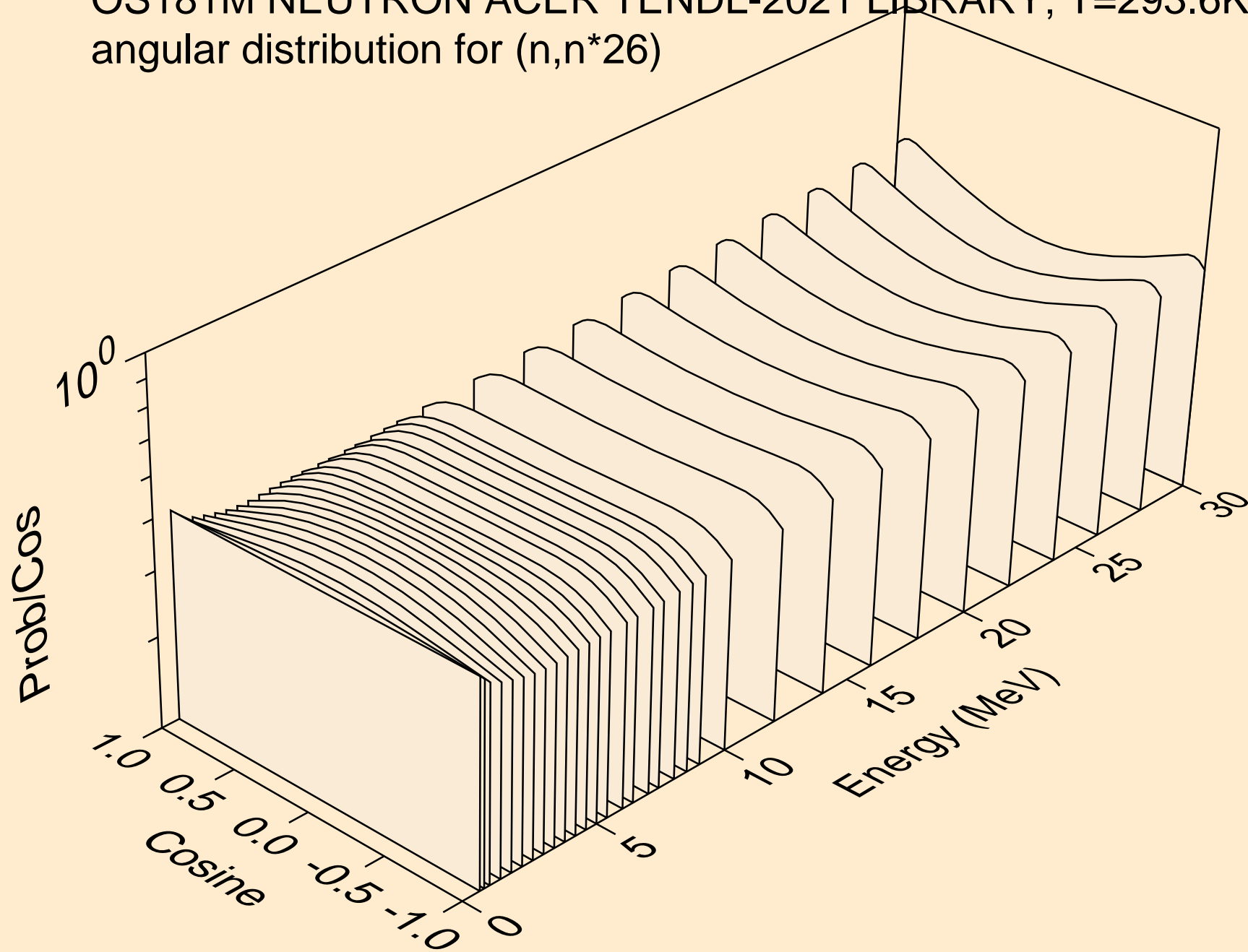

OS181M NEUTRON ACER TENDL-2021 LIBRARY; T=293.6K  
Neutron emission for (n,x)

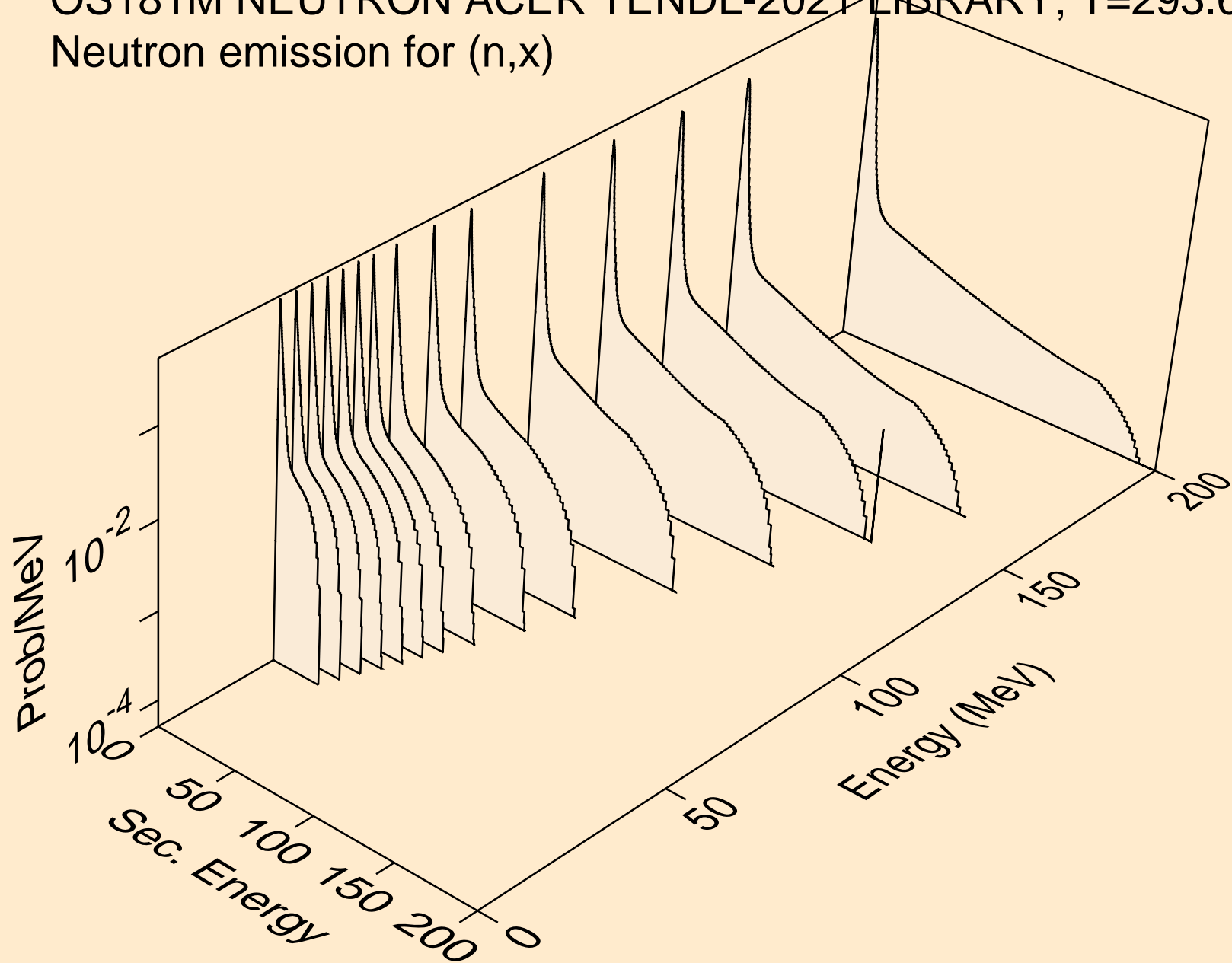

OS181M NEUTRON ACER TENDL-2021 LIBRARY; T=293.6K  
Neutron emission for (n,2nd)

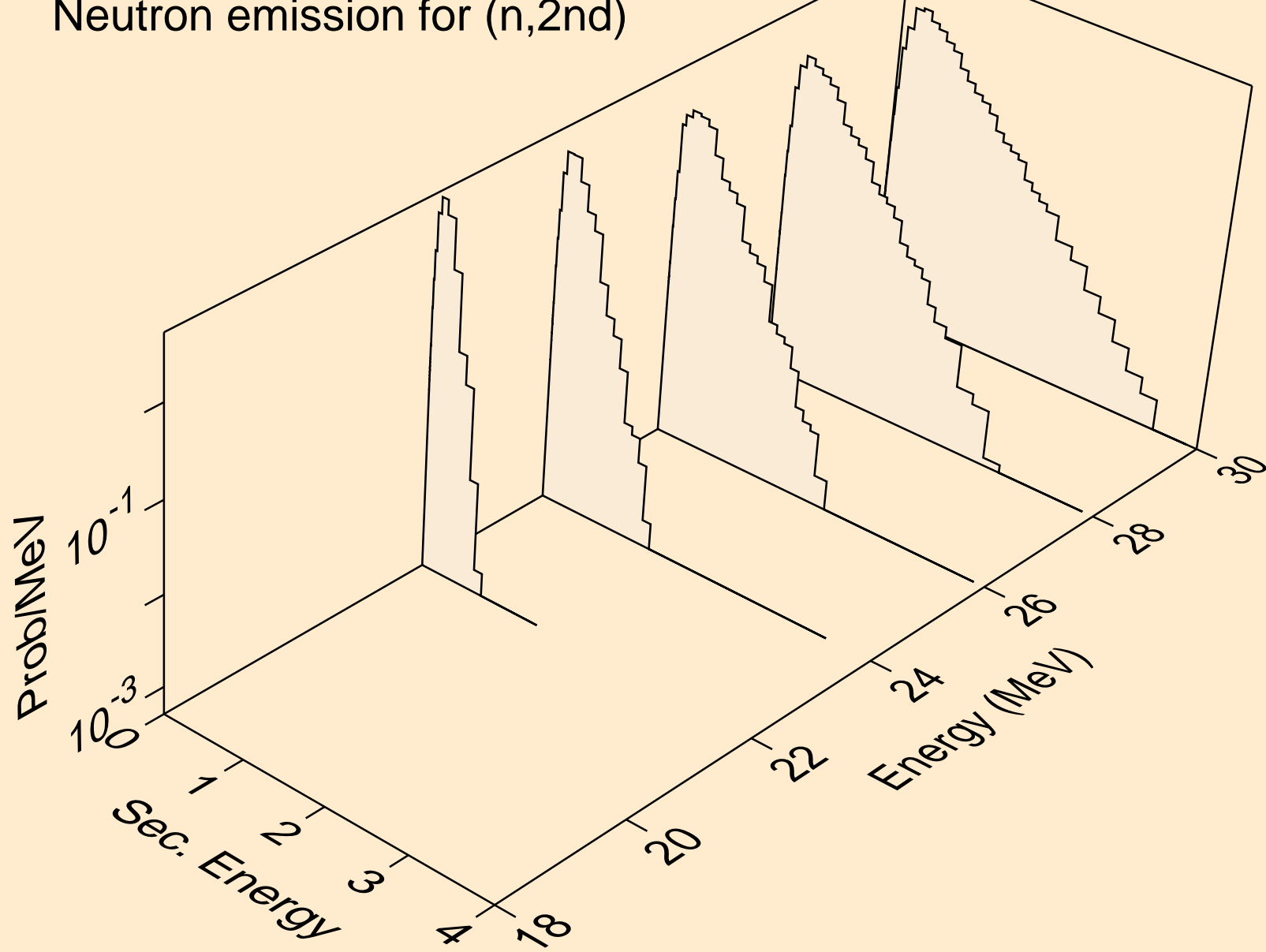

OS181M NEUTRON ACER TENDL-2021 LIBRARY; T=293.6K  
Neutron emission for (n,2n)

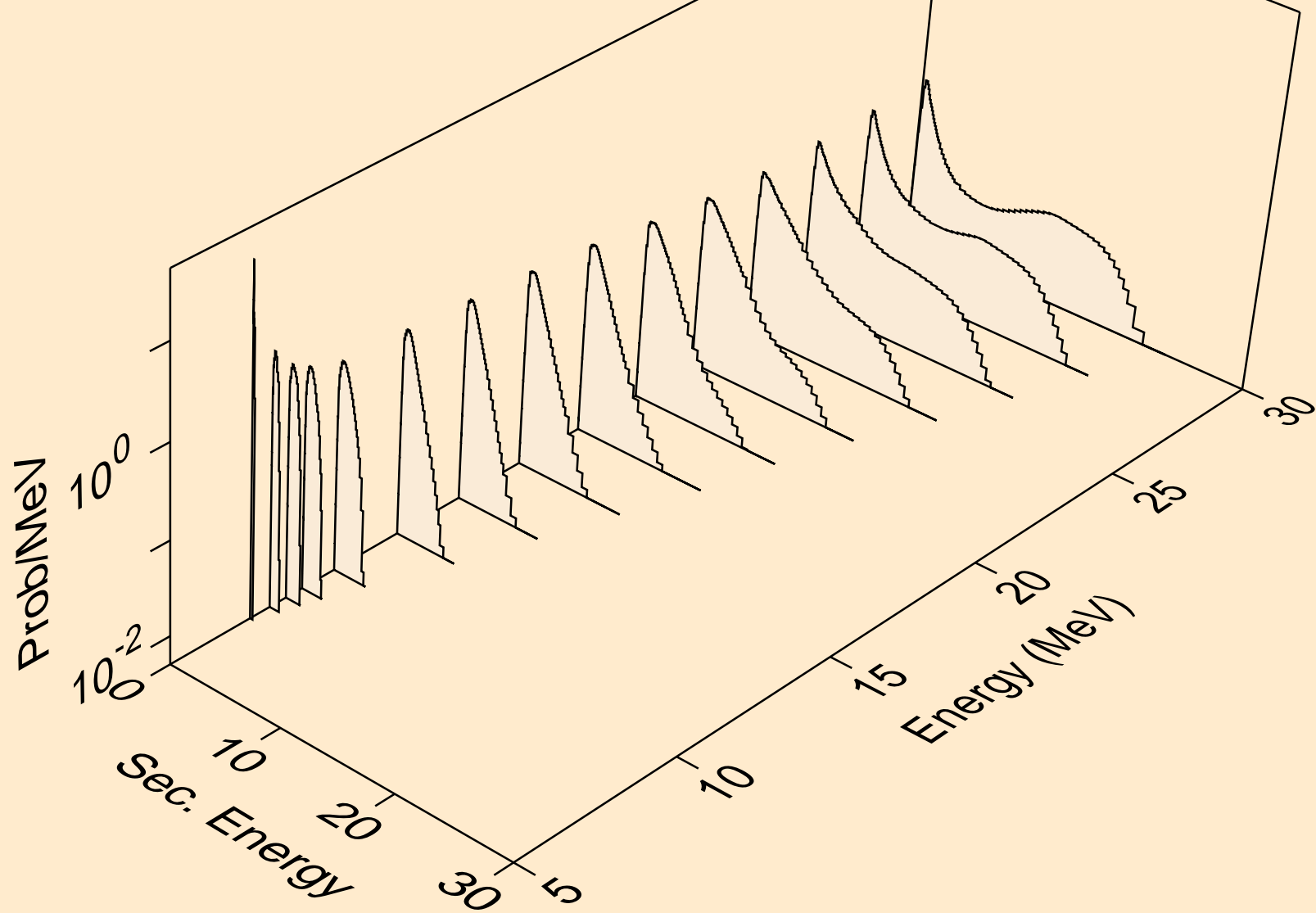

OS181M NEUTRON ACER TENDL-2021 LIBRARY; T=293.6K  
Neutron emission for (n,3n)

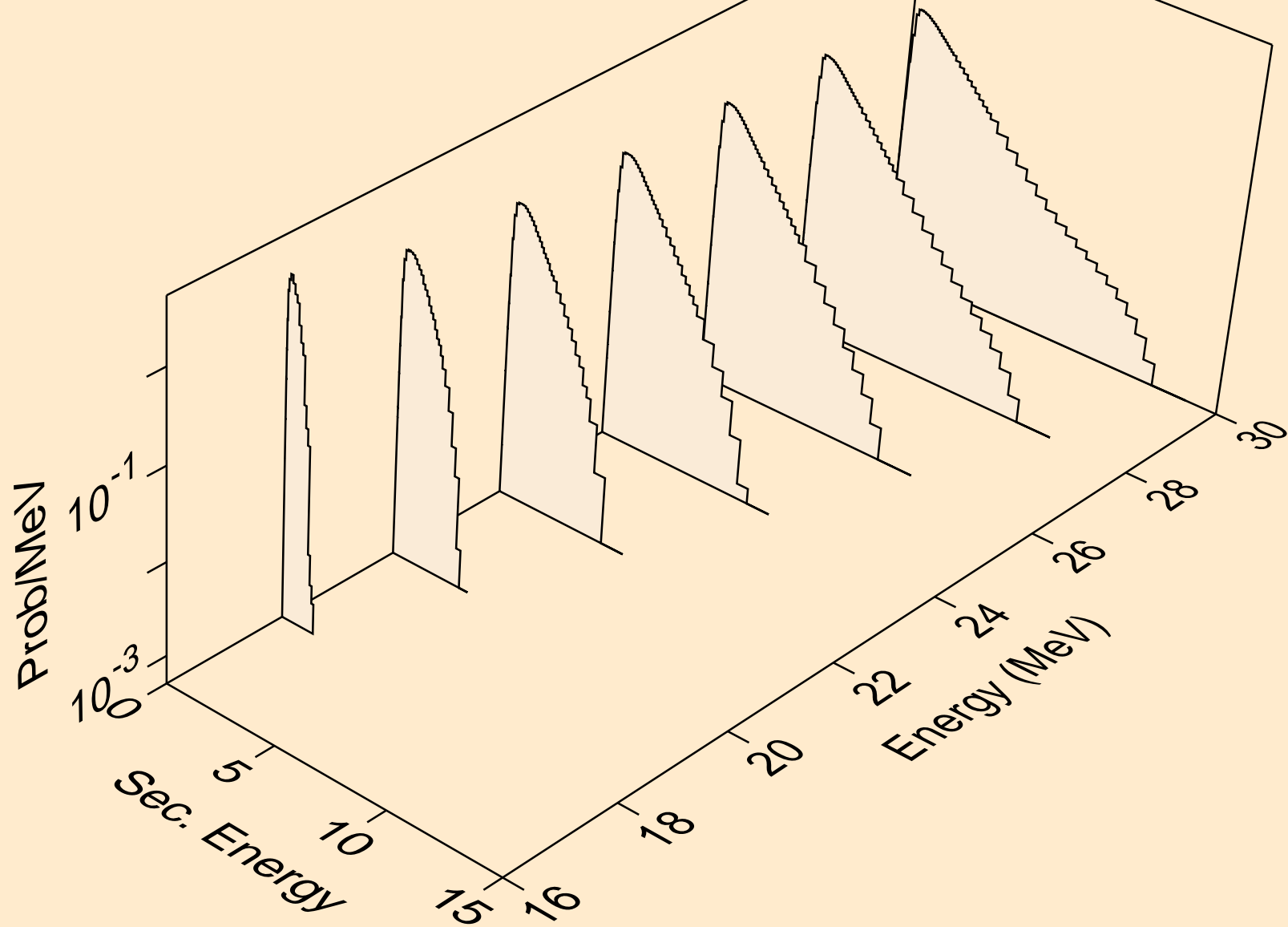

OS181M NEUTRON ACER TENDL-2021 LIBRARY; T=293.6K  
Neutron emission for (n,n\*)a

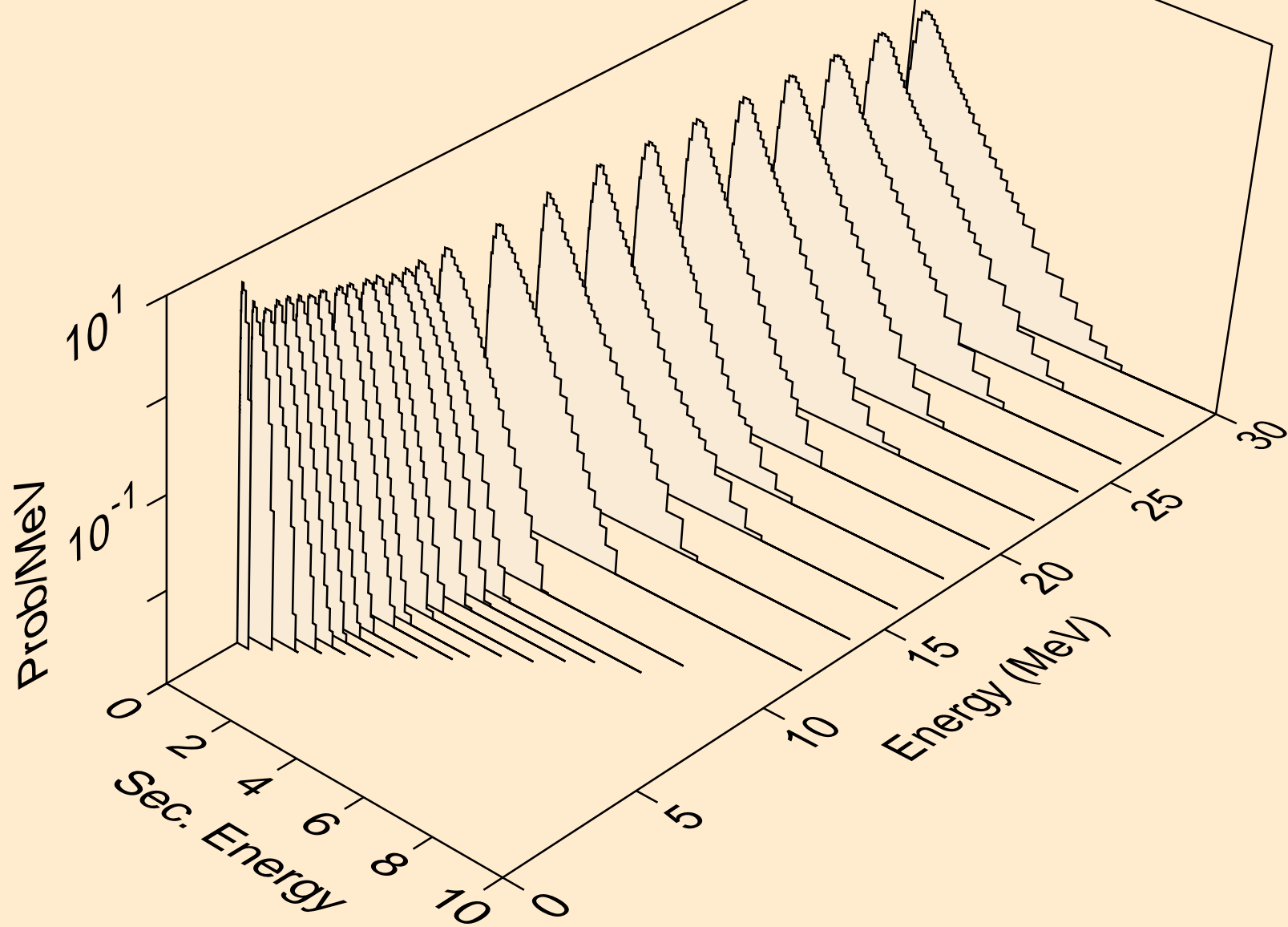

OS181M NEUTRON ACER TENDL-2021 LIBRARY; T=293.6K  
Neutron emission for (n,2n)a

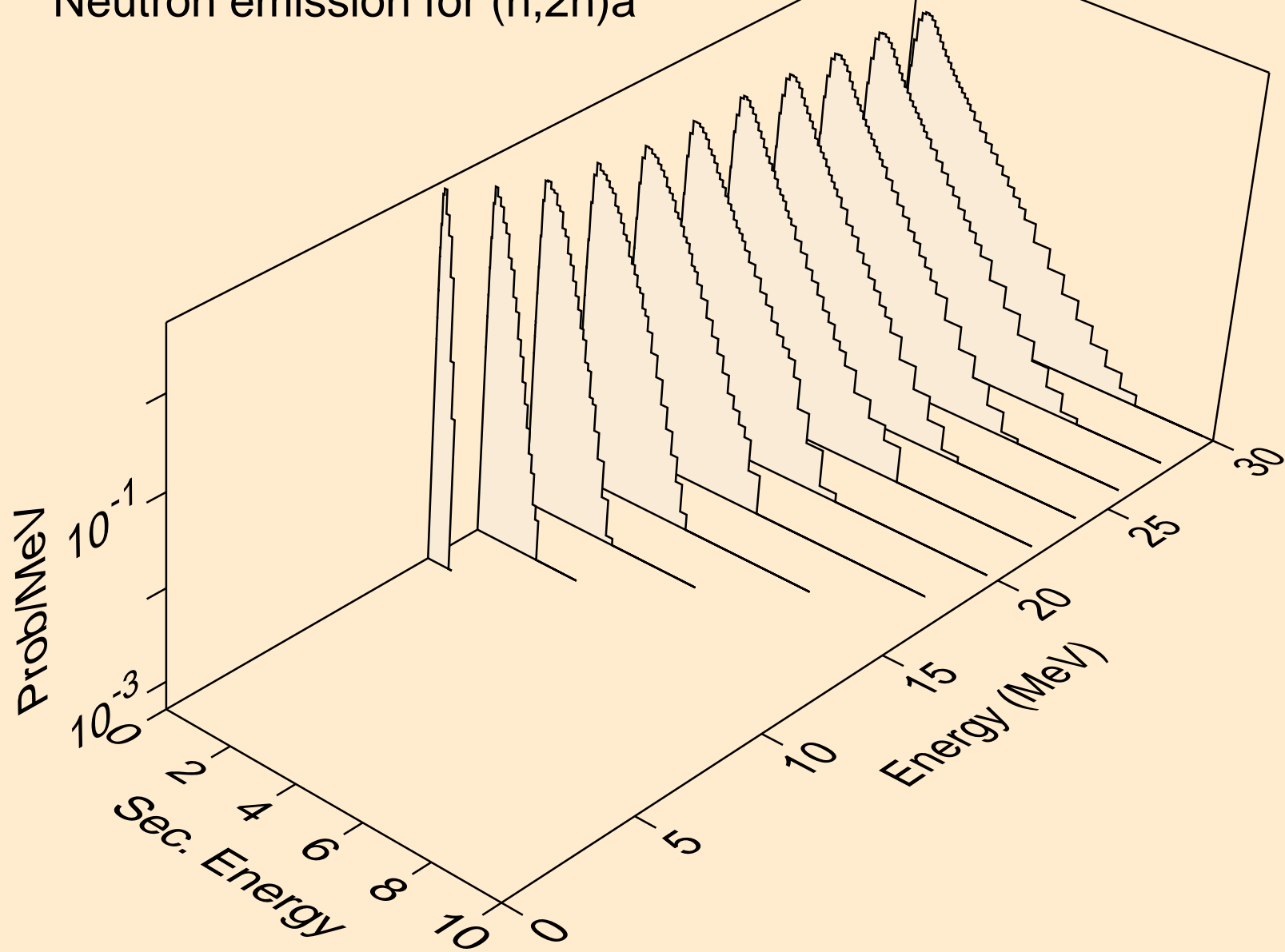



OS181M NEUTRON ACER TENDL-2021 LIBRARY; T=293.6K  
Neutron emission for (n,3n)a

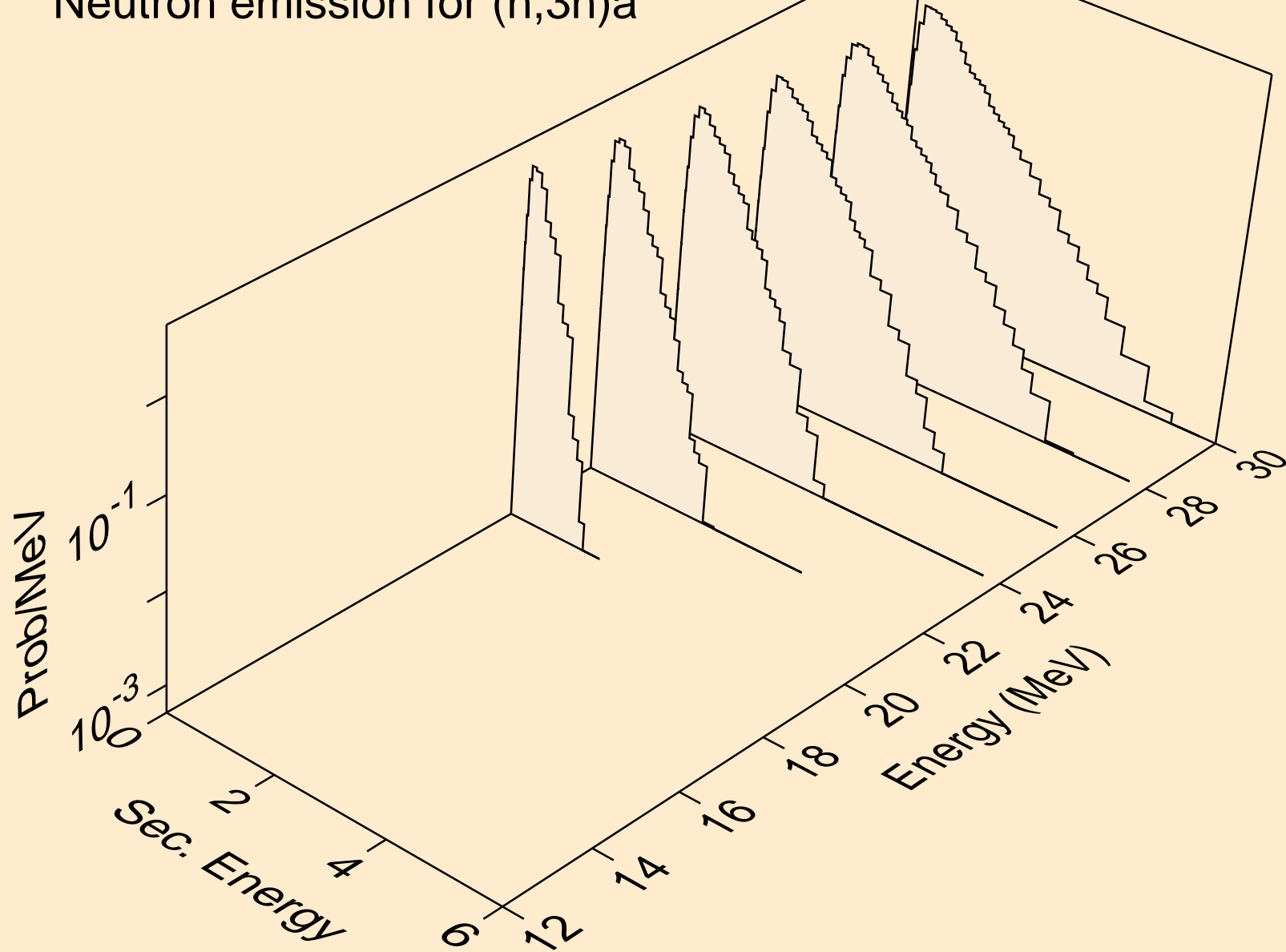

OS181M NEUTRON ACER TENDL-2021 LIBRARY; T=293.6K  
Neutron emission for (n,n\*)p

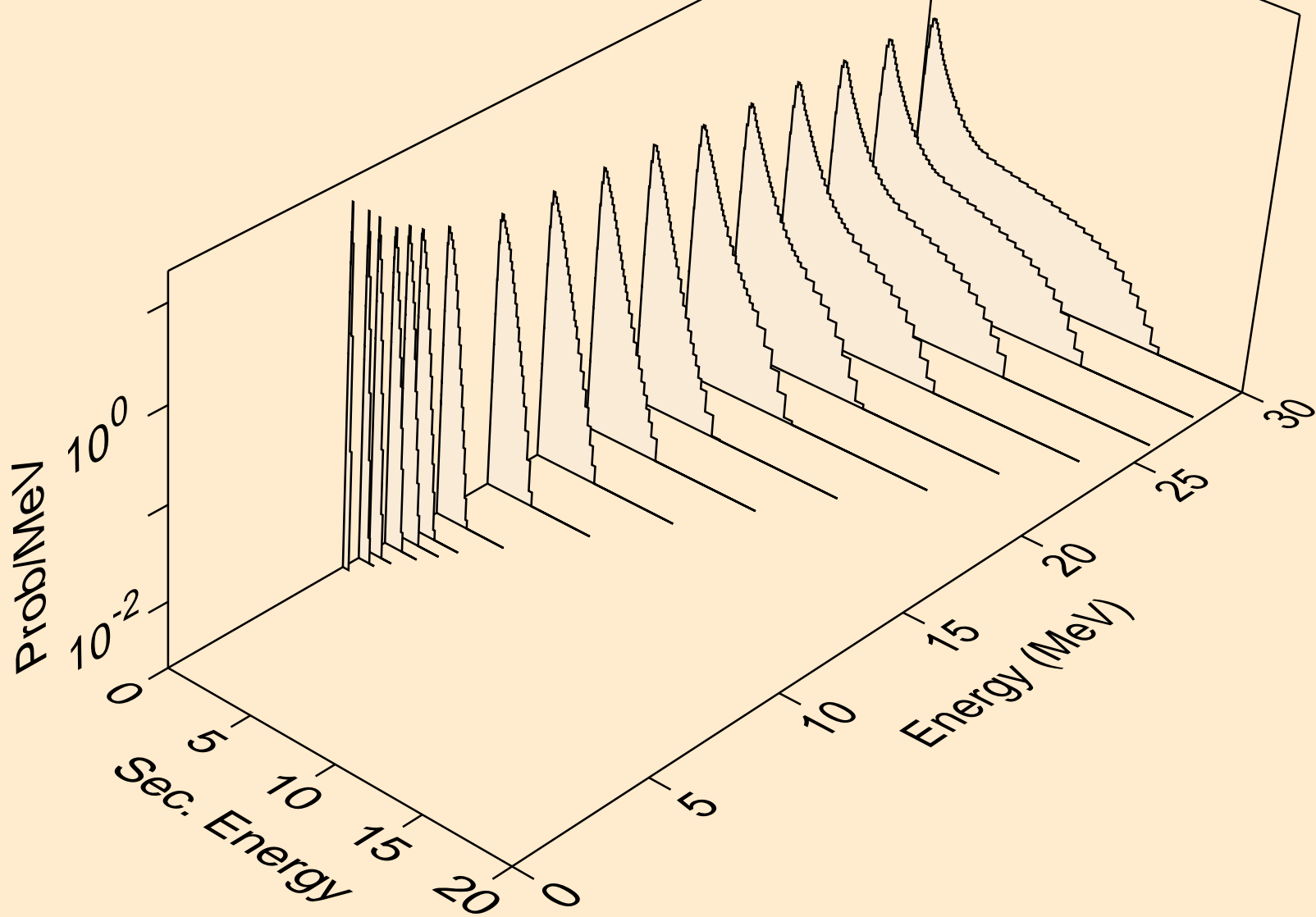

OS181M NEUTRON ACER TENDL-2021 LIBRARY; T=293.6K  
Neutron emission for (n,n\*)2a

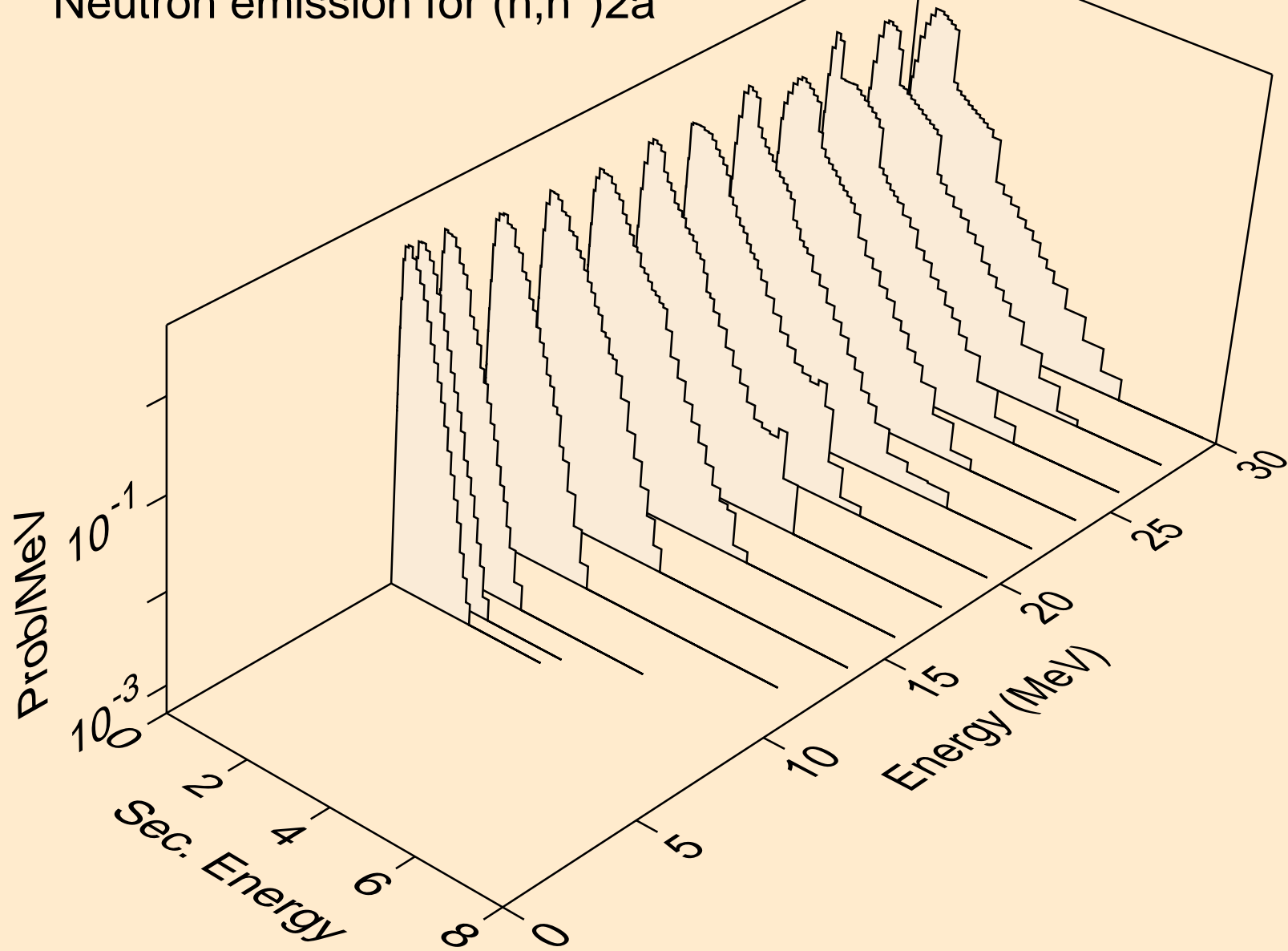

OS181M NEUTRON ACER TENDL-2021 LIBRARY; T=293.6K  
Neutron emission for (n,2n)2a

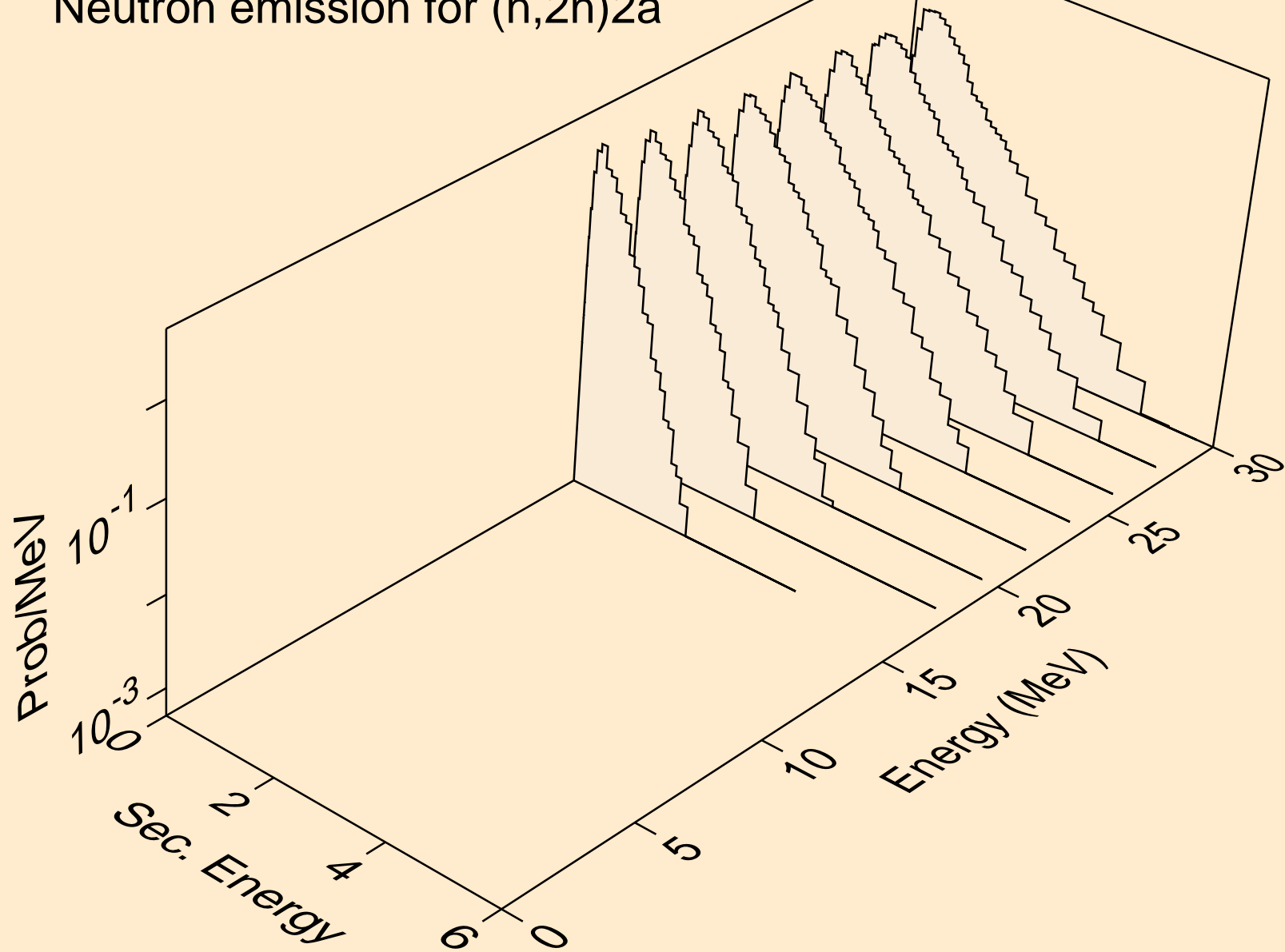

OS181M NEUTRON ACER TENDL-2021 LIBRARY; T=293.6K  
Neutron emission for (n,n\*)d

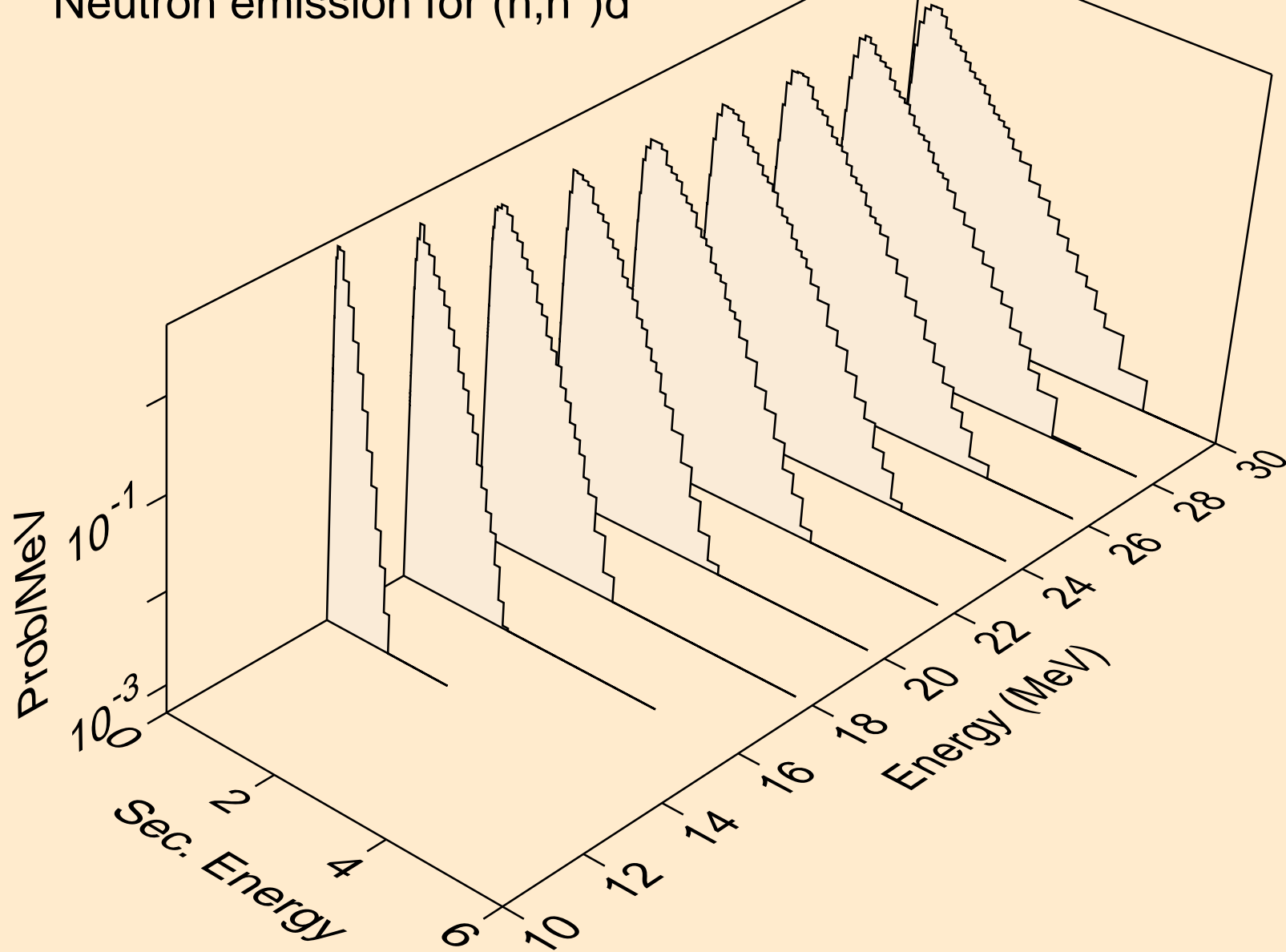

OS181M NEUTRON ACER TENDL-2021 LIBRARY; T=293.6K  
Neutron emission for (n,n\*)t

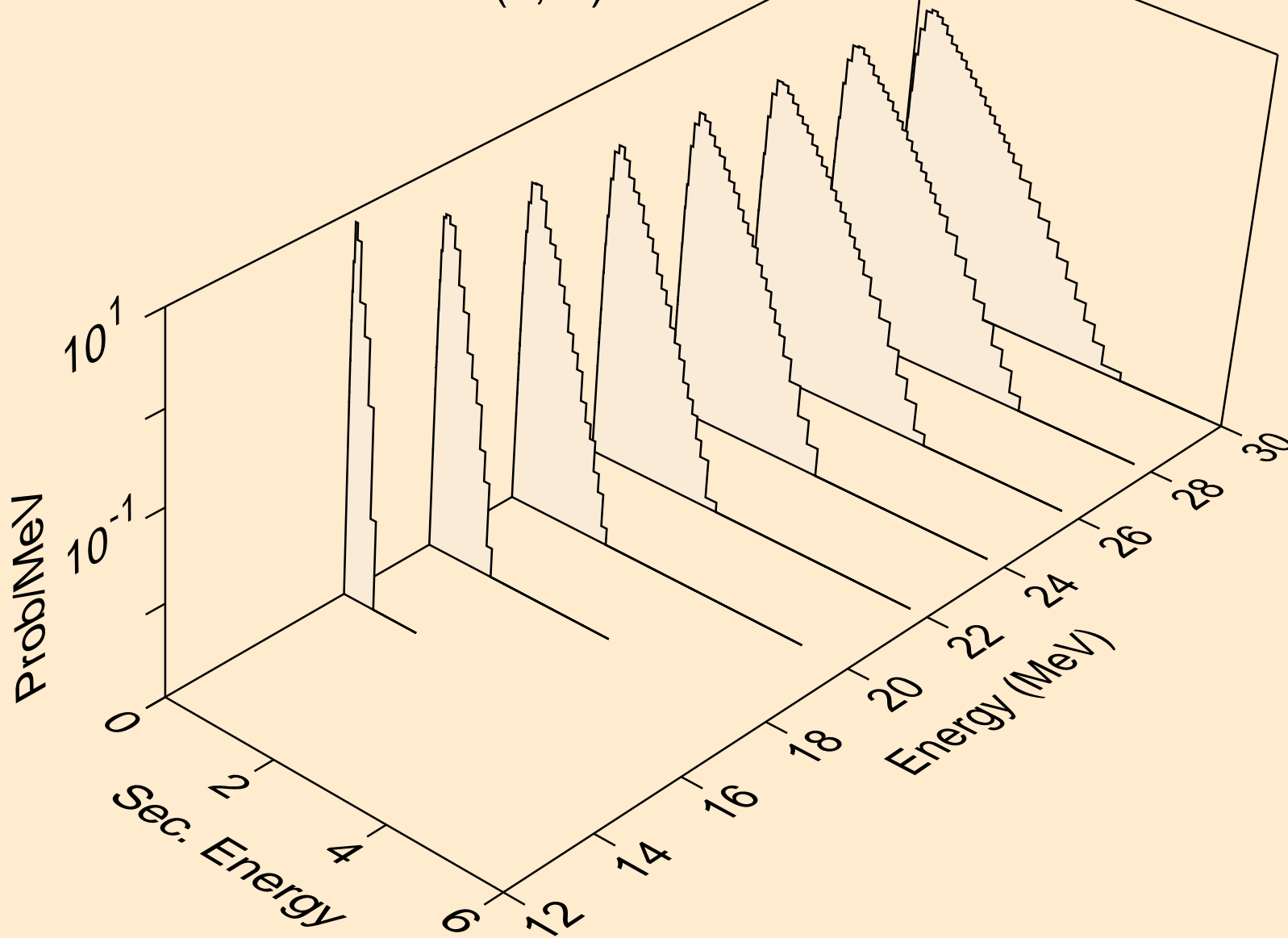

OS181M NEUTRON ACER TENDL-2021 LIBRARY; T=293.6K  
Neutron emission for (n,n\*)he3

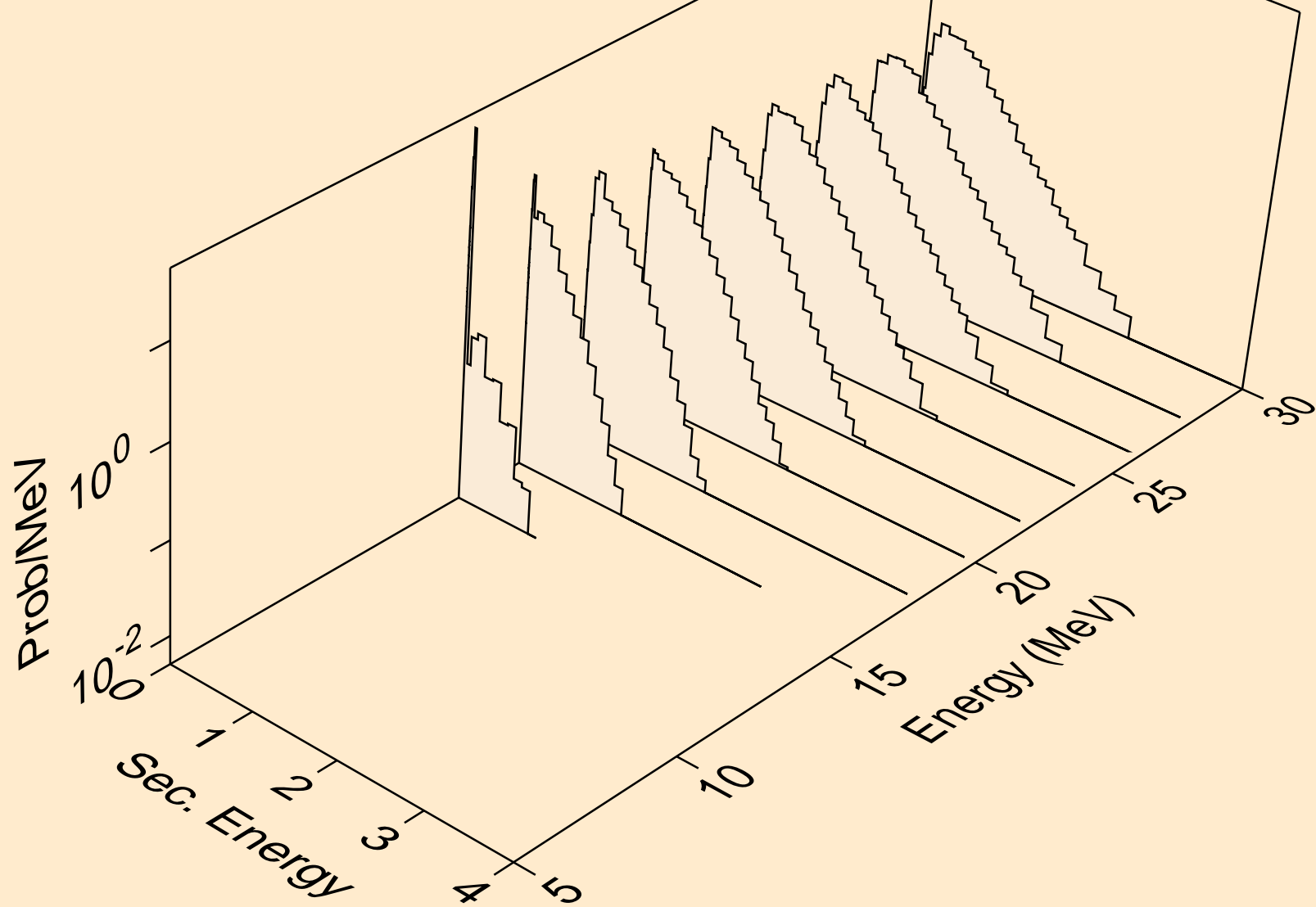

OS181M NEUTRON ACER TENDL-2021 LIBRARY; T=293.6K  
Neutron emission for (n,4n)

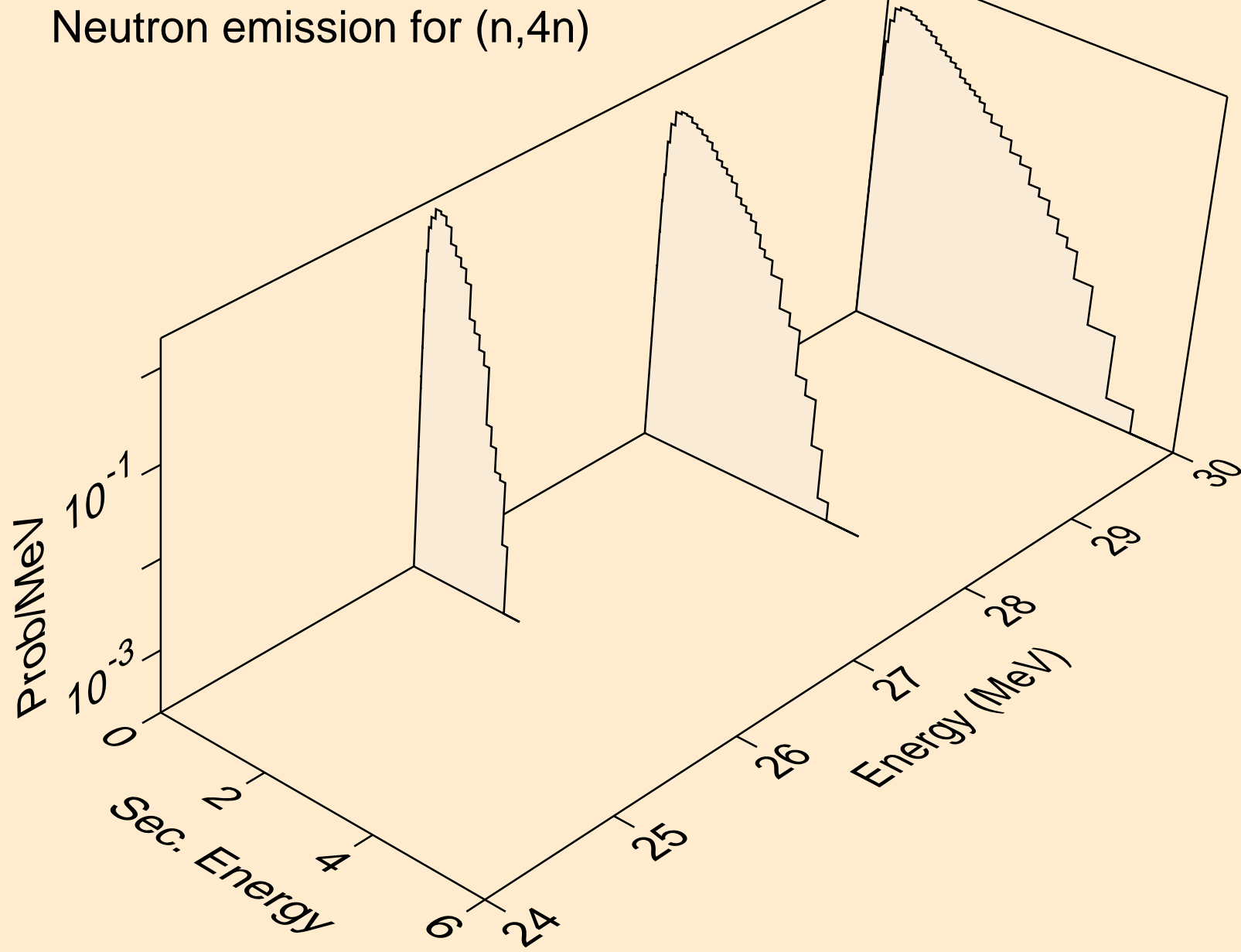



OS181M NEUTRON ACER TENDL-2021 LIBRARY; T=293.6K  
Neutron emission for (n,2np)

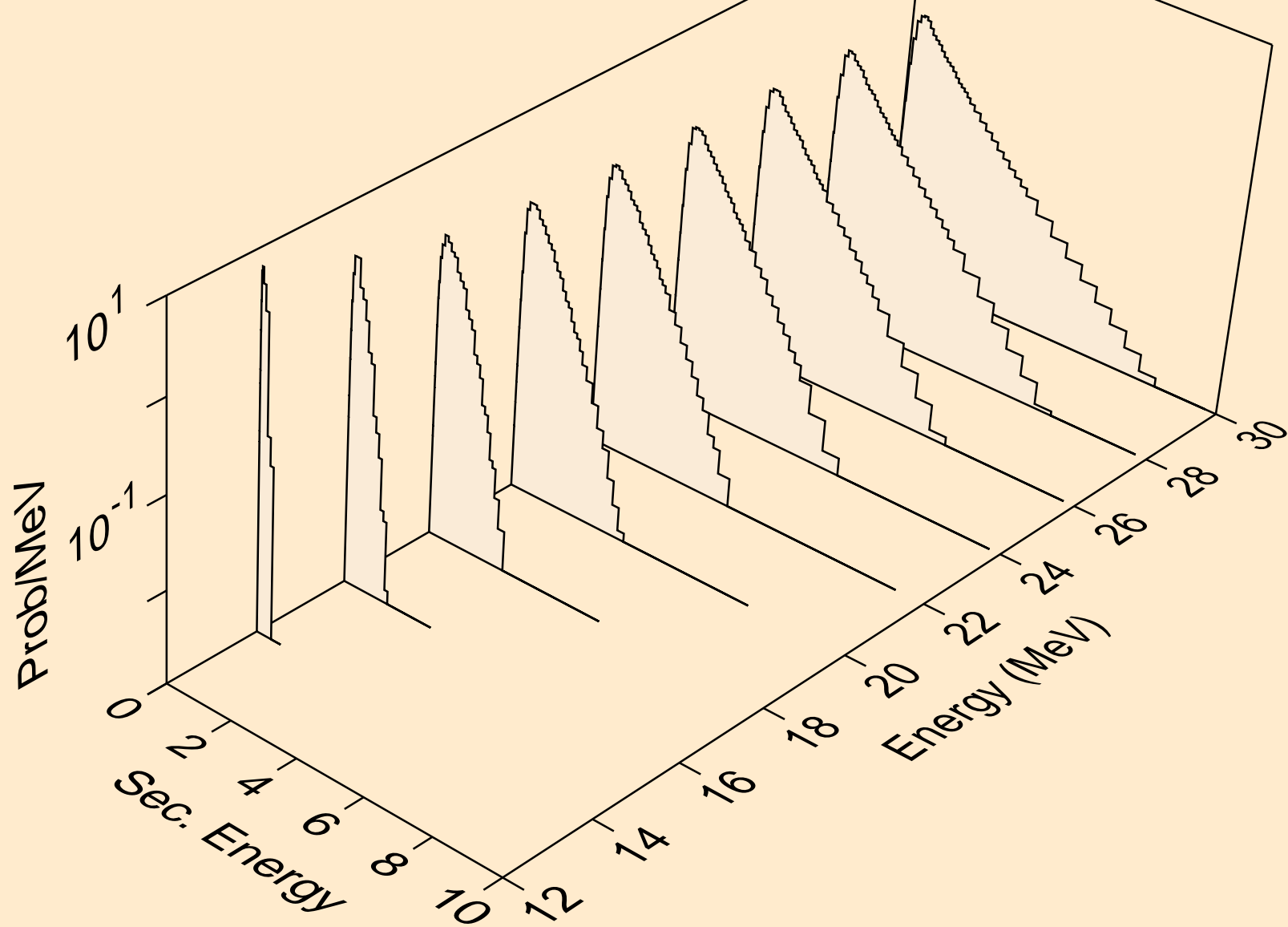

OS181M NEUTRON ACER TENDL-2021 LIBRARY; T=293.6K  
Neutron emission for (n,3np)

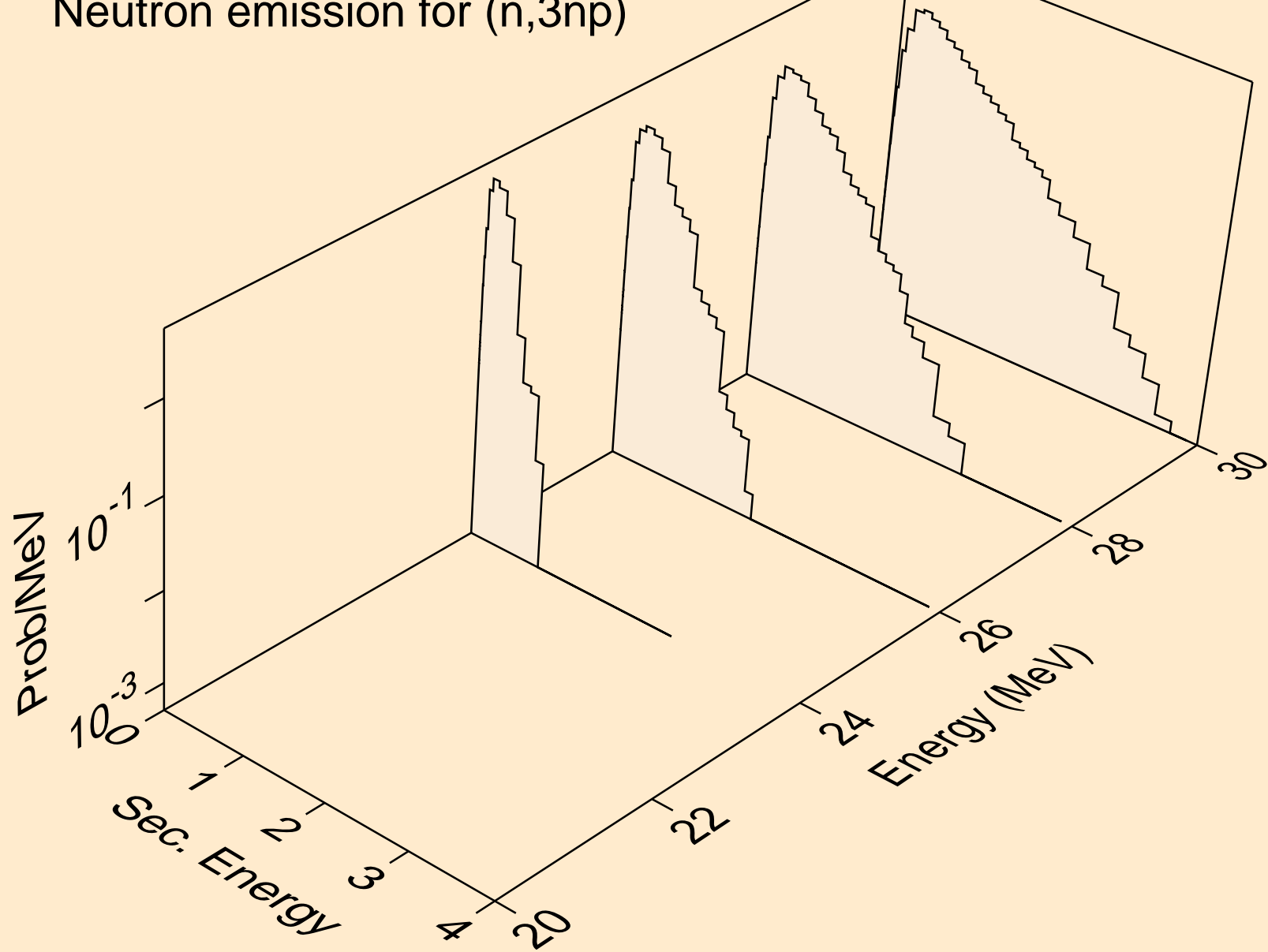

OS181M NEUTRON ACER TENDL-2021 LIBRARY; T=293.6K  
Neutron emission for (n,2np)

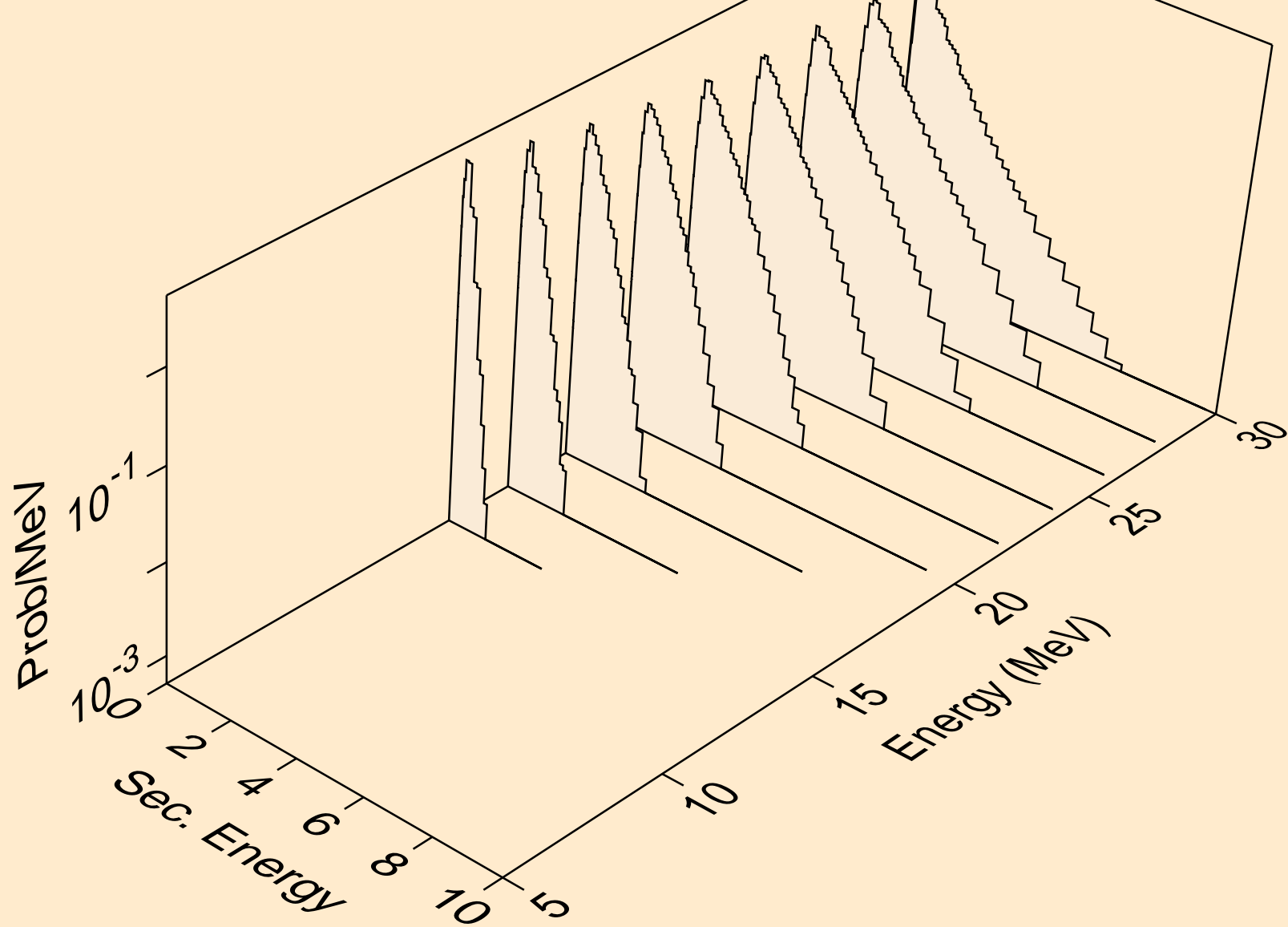

OS181M NEUTRON ACER TENDL-2021 LIBRARY; T=293.6K  
Neutron emission for (n,npa)

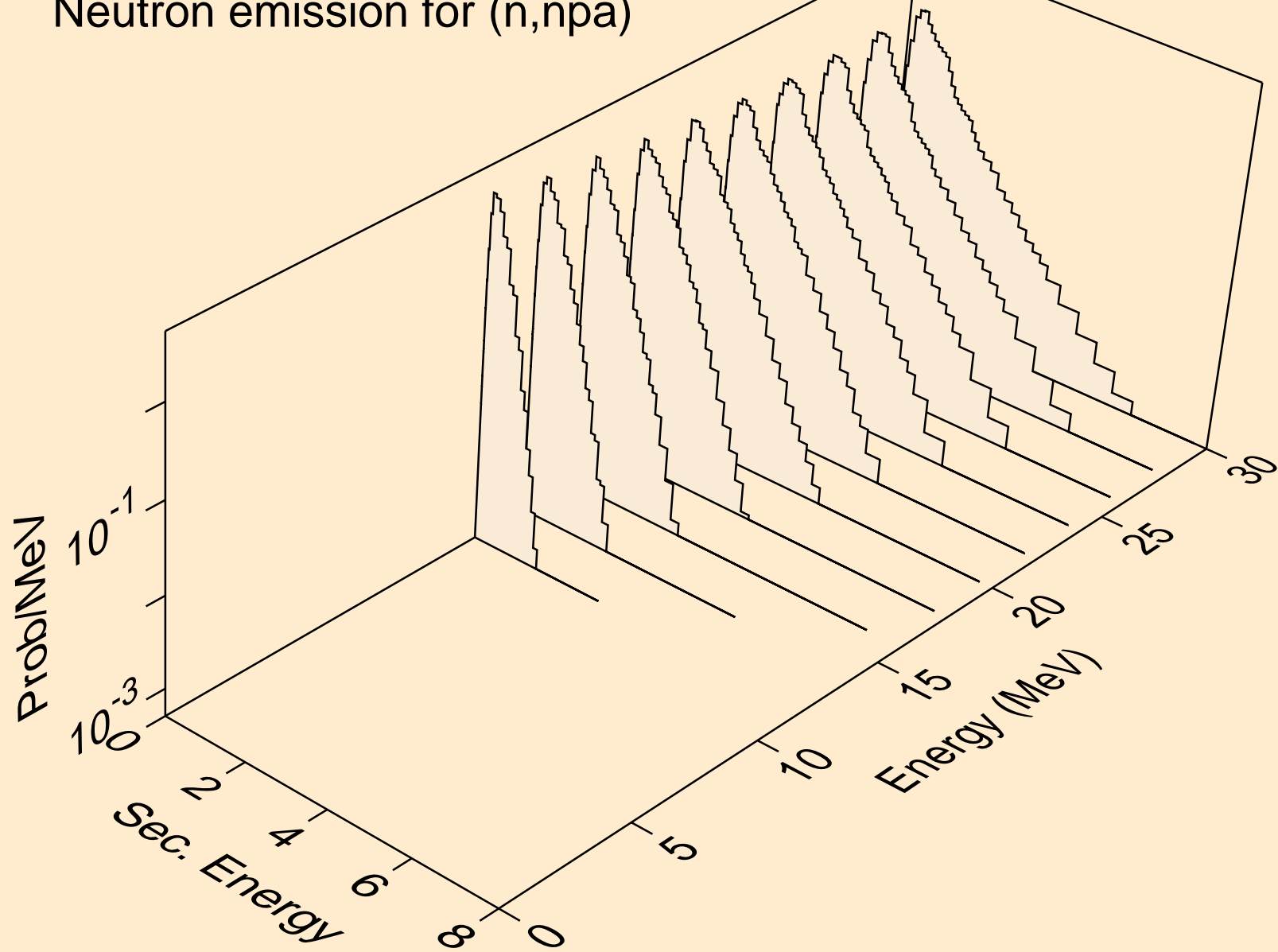

OS181M NEUTRON ACER TENDL-2021 LIBRARY; T=293.6K  
Neutron emission for (n,n\*c)

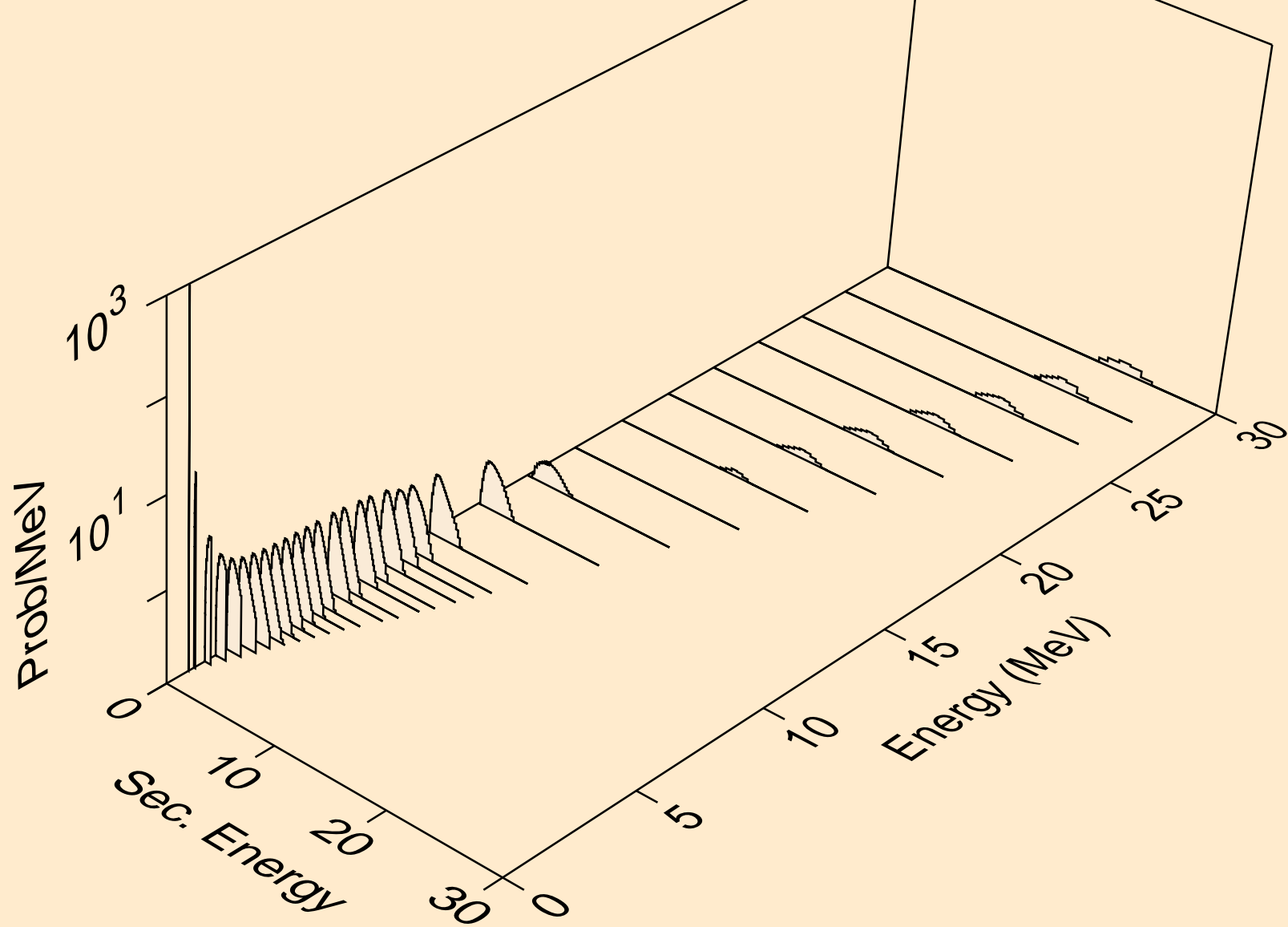

OS181M NEUTRON ACER TENDL-2021 LIBRARY; T=293.6K  
Photon emission for (n,x)

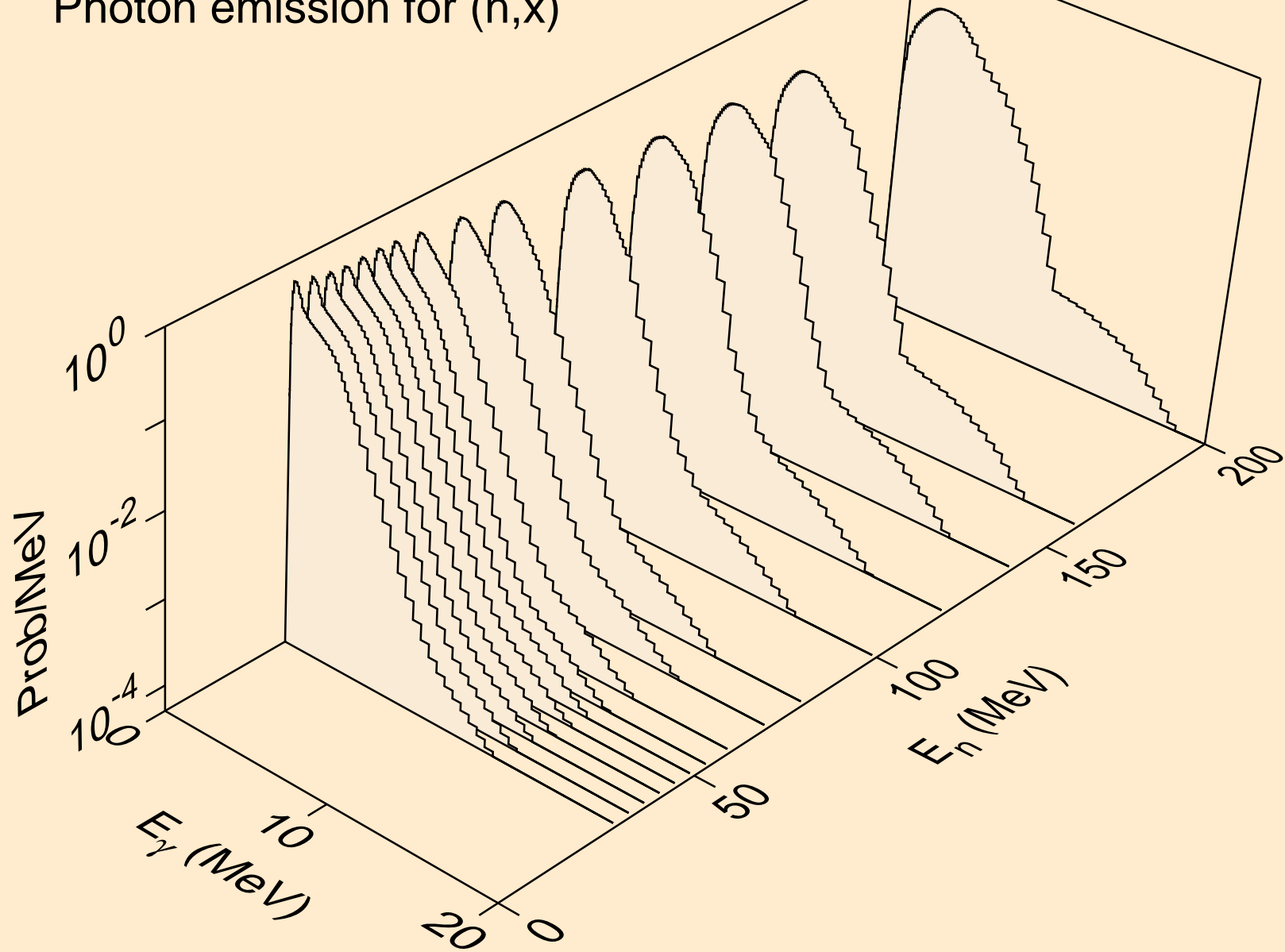

OS181M NEUTRON ACER TENDL-2021 LIBRARY; T=293.6K  
Photon emission for (n,2nd)

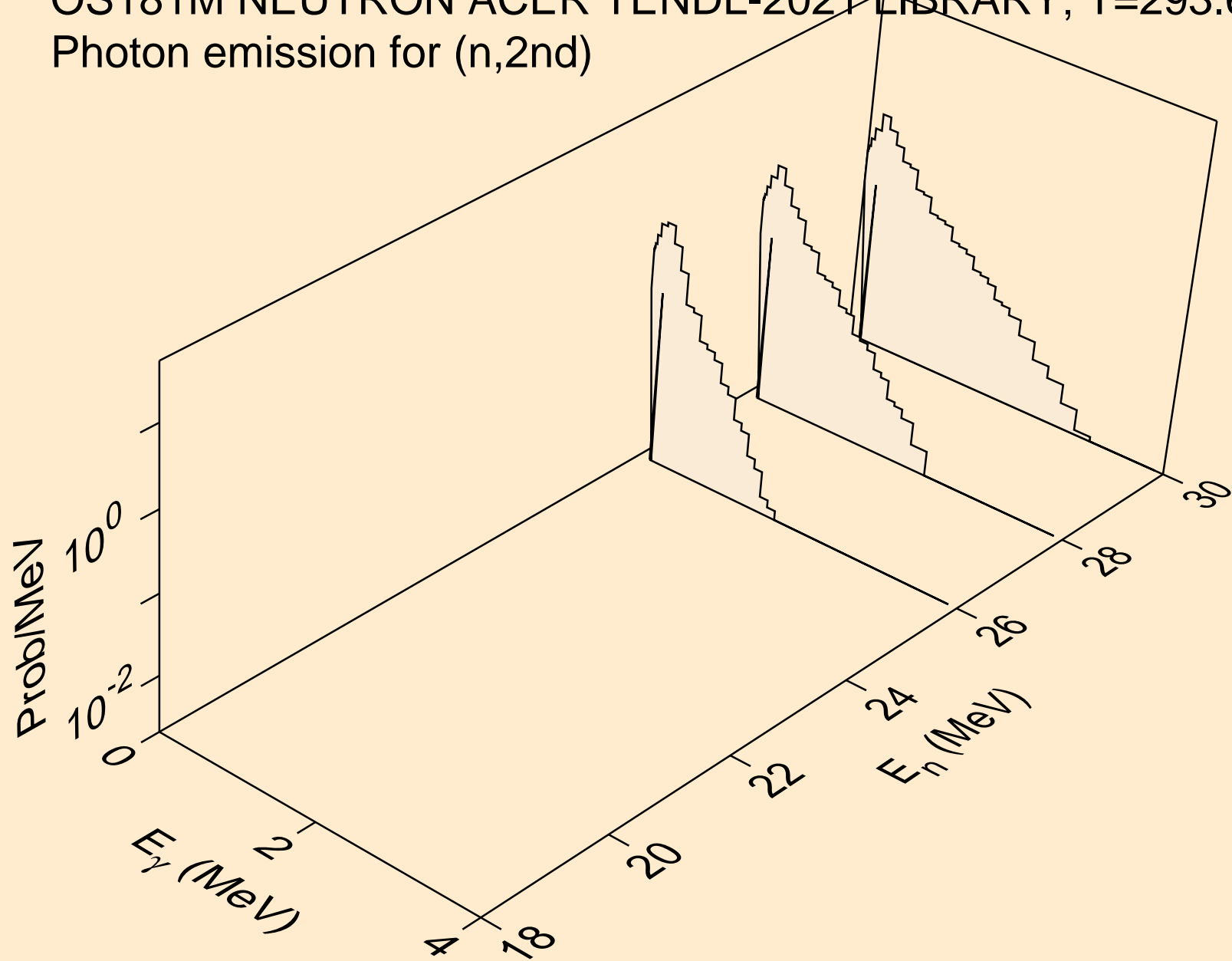

OS181M NEUTRON ACER TENDL-2021 LIBRARY; T=293.6K  
Photon emission for (n,2n)

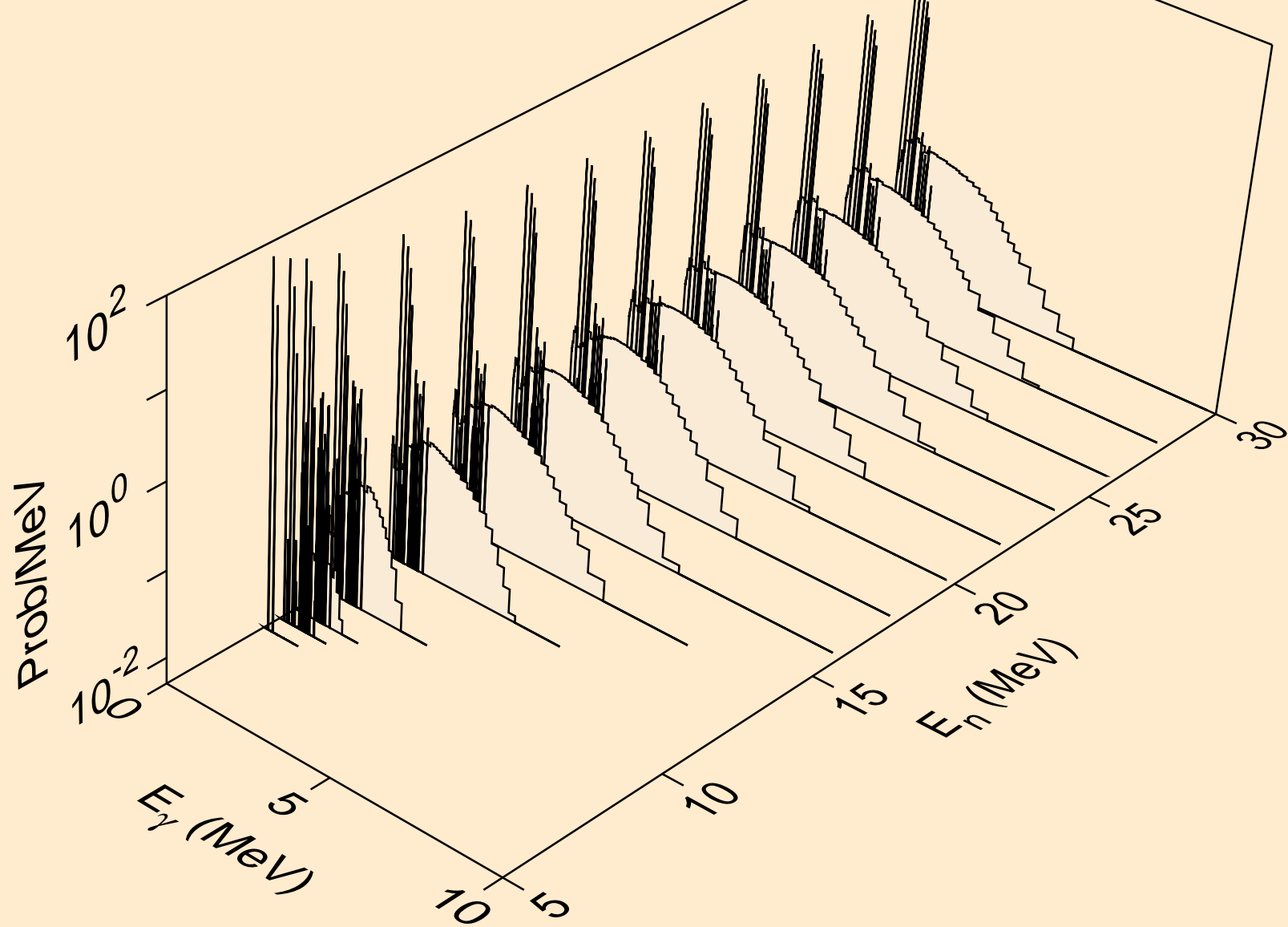



OS181M NEUTRON ACER TENDL-2021 LIBRARY; T=293.6K  
Photon emission for (n,3n)

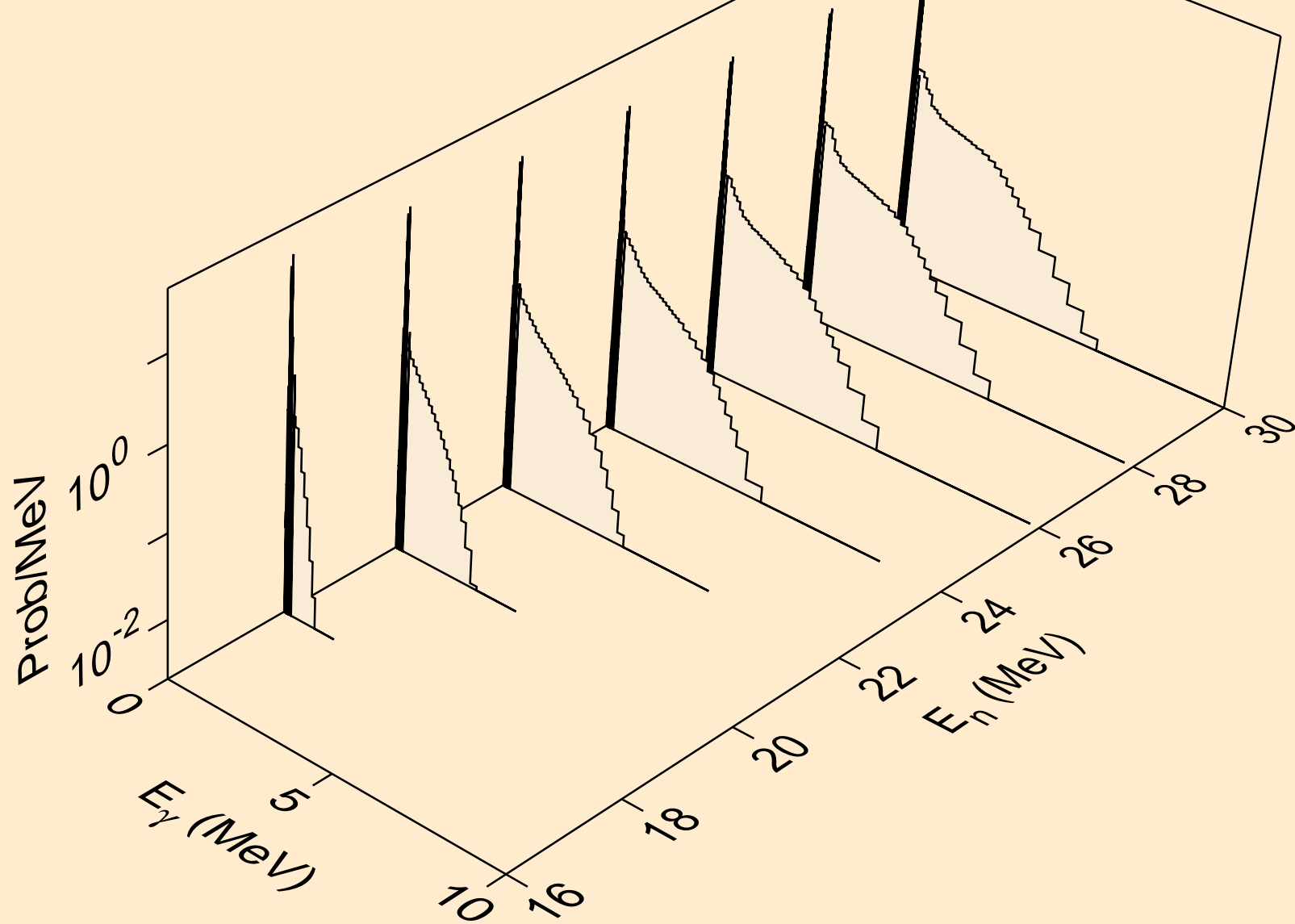

OS181M NEUTRON ACER TENDL-2021 LIBRARY; T=293.6K  
Photon emission for (n,n\*)a

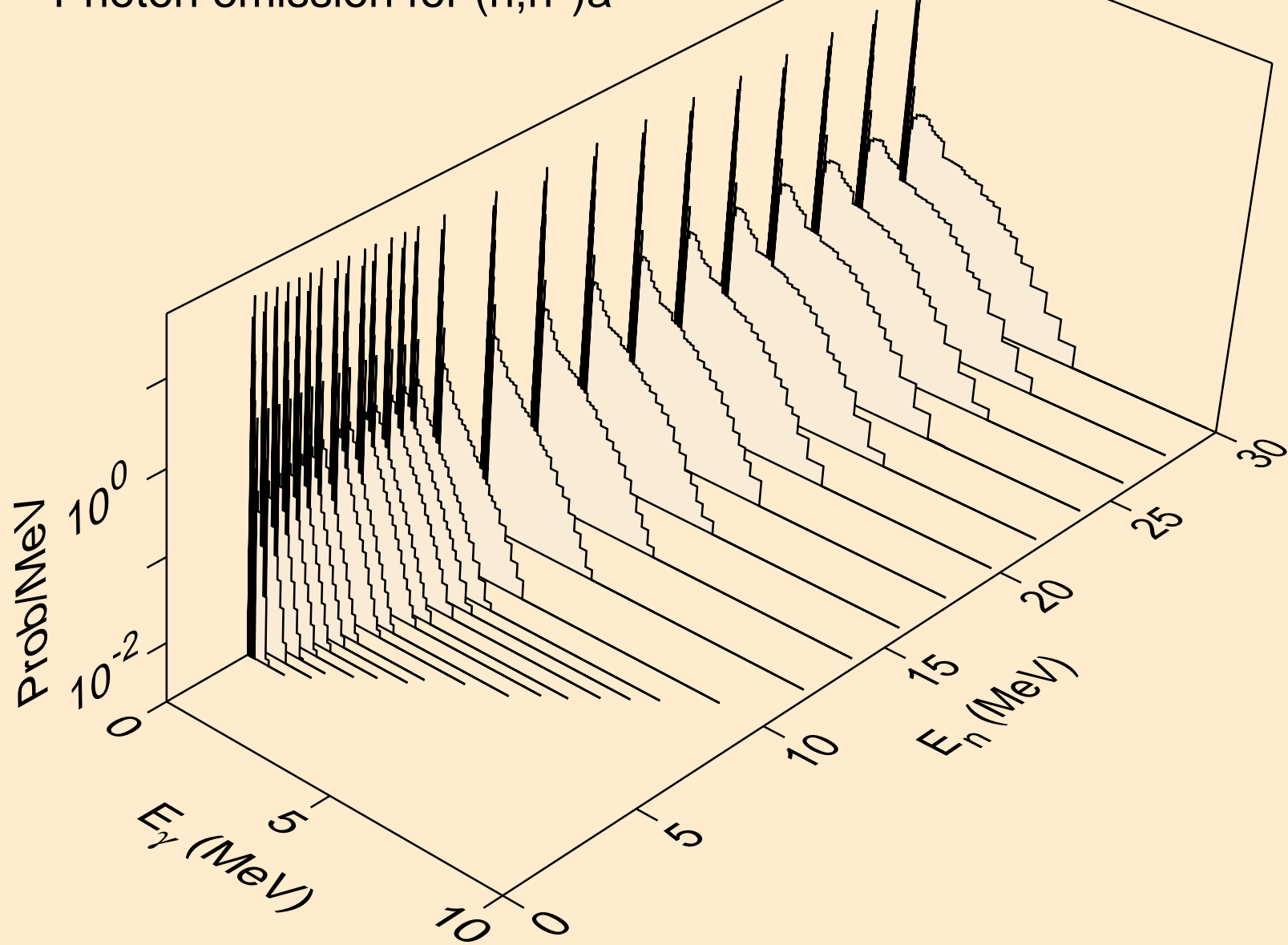

OS181M NEUTRON ACER TENDL-2021 LIBRARY; T=293.6K  
Photon emission for (n,2n)a

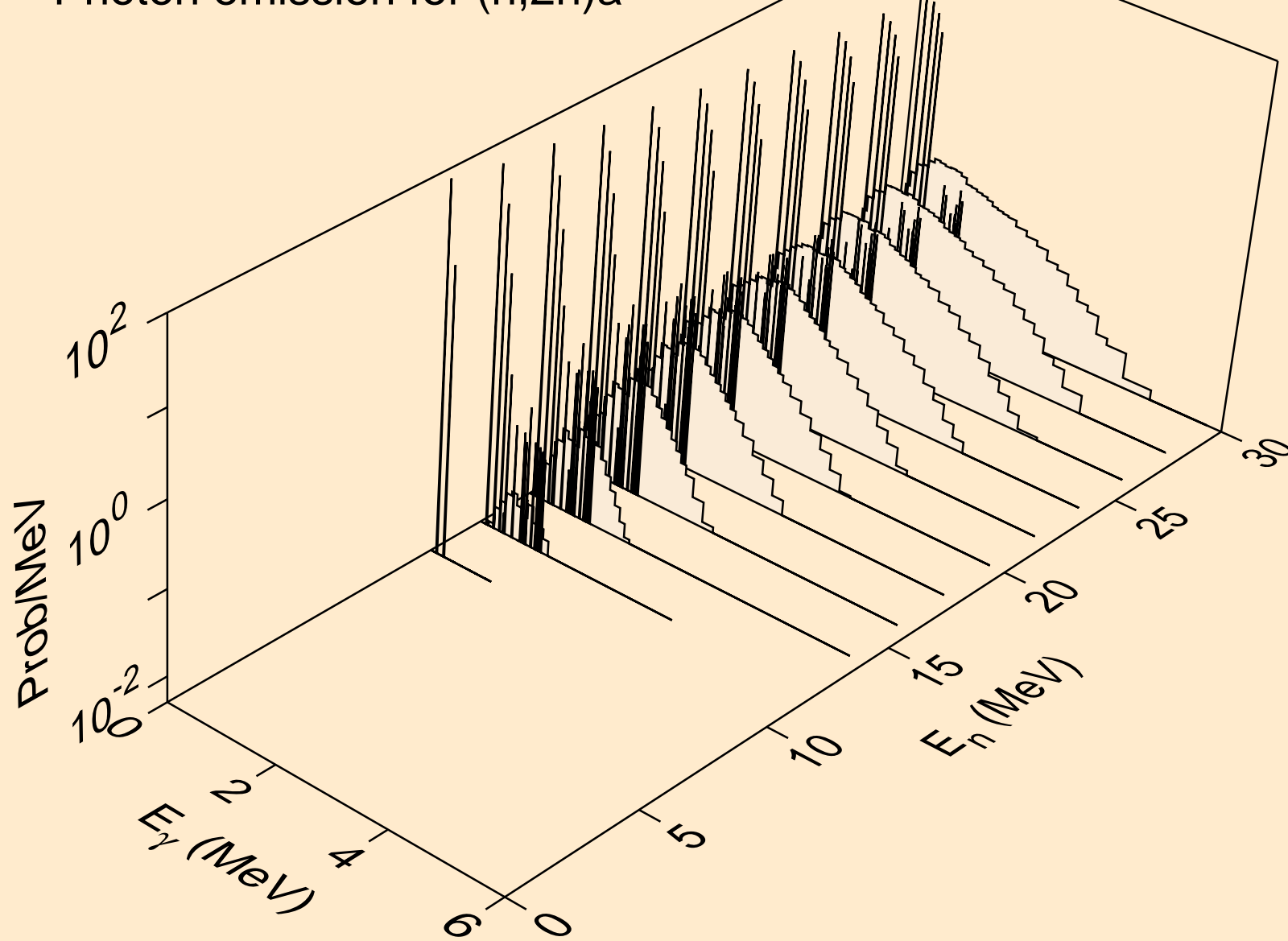

OS181M NEUTRON ACER TENDL-2021 LIBRARY; T=293.6K  
Photon emission for (n,3n)a

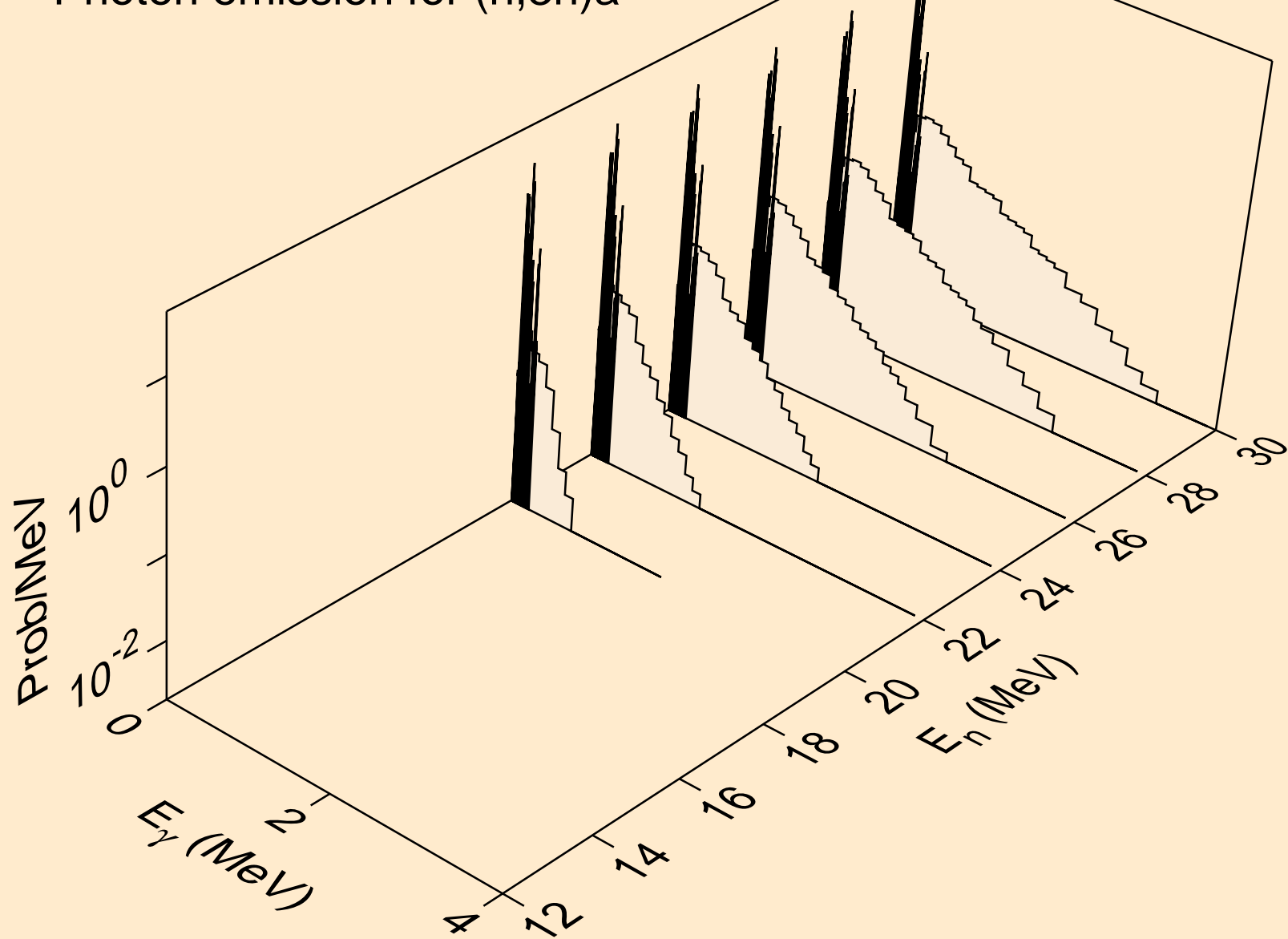

OS181M NEUTRON ACER TENDL-2021 LIBRARY; T=293.6K  
Photon emission for (n,n\*)p

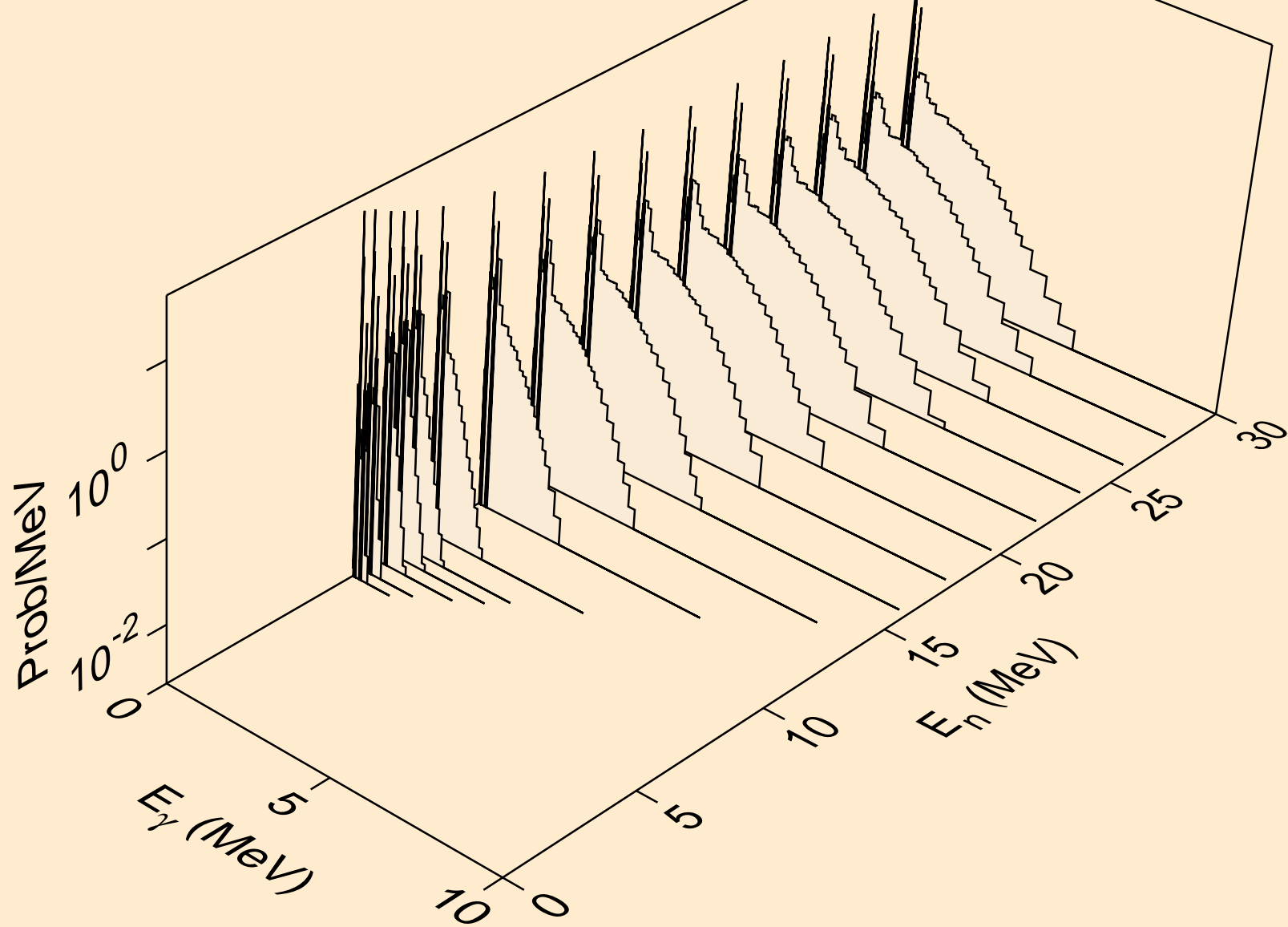

OS181M NEUTRON ACER TENDL-2021 LIBRARY; T=293.6K  
Photon emission for (n,n\*)2a

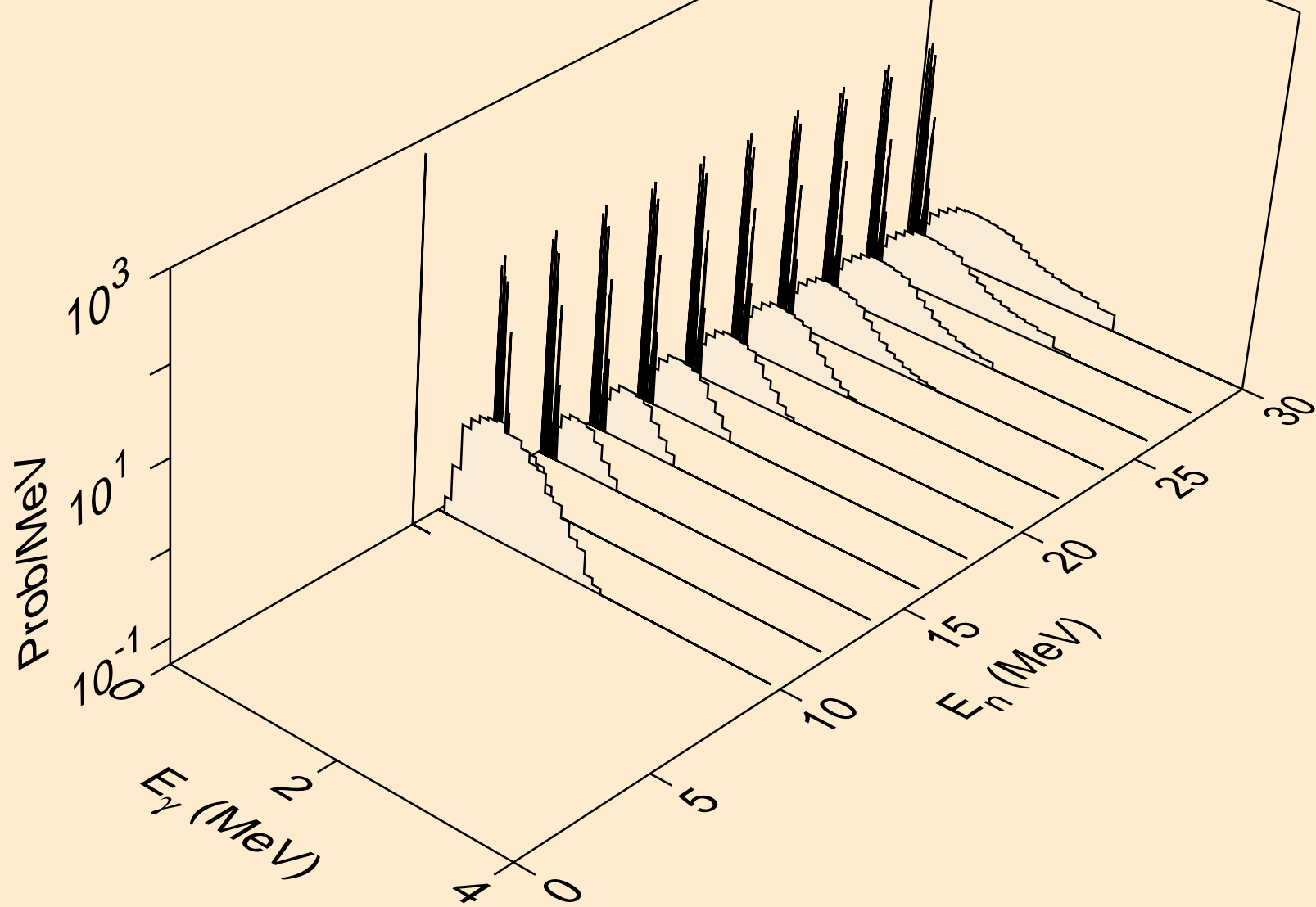

OS181M NEUTRON ACER TENDL-2021 LIBRARY; T=293.6K  
Photon emission for (n,2n)2a

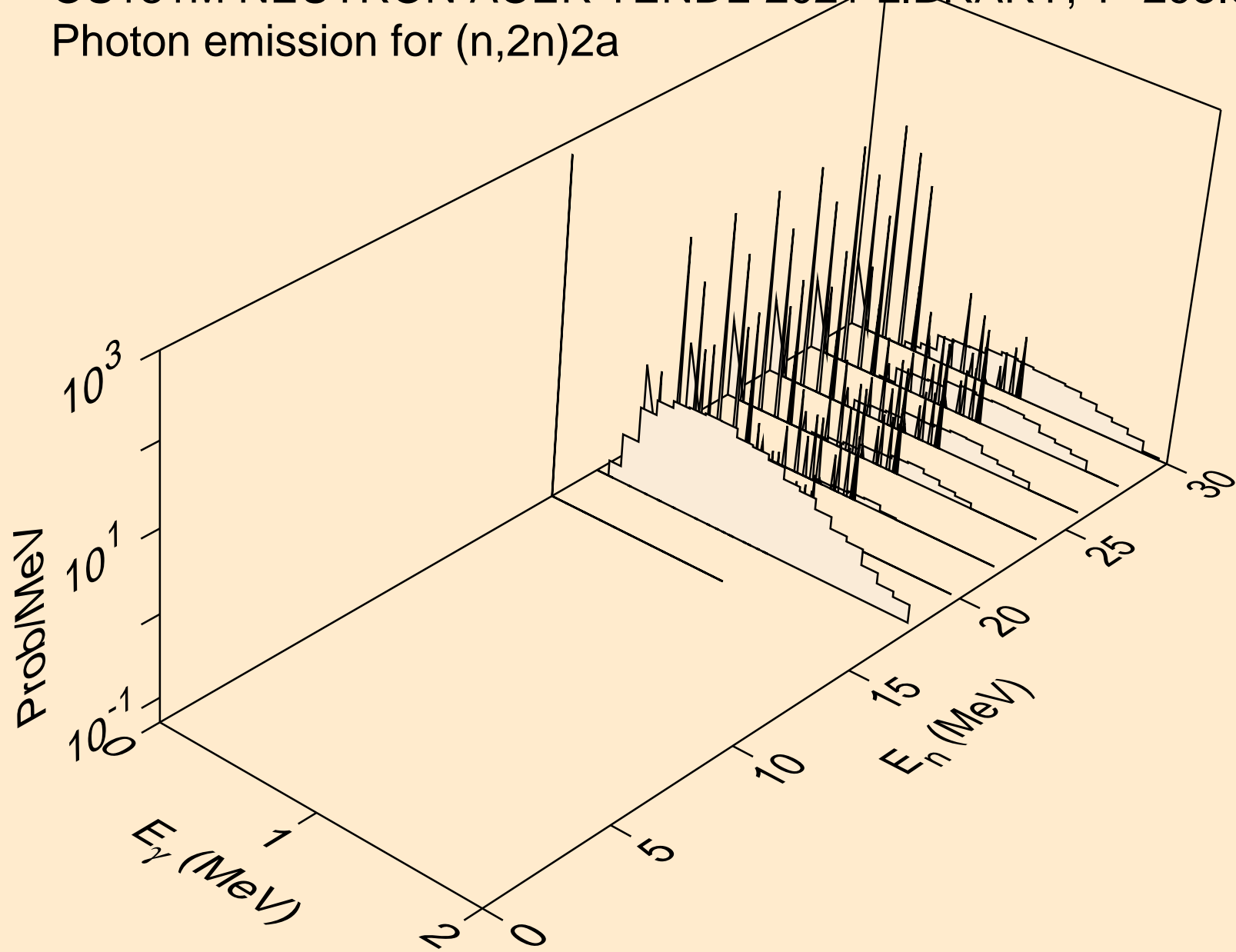

OS181M NEUTRON ACER TENDL-2021 LIBRARY; T=293.6K  
Photon emission for (n,n\*)d

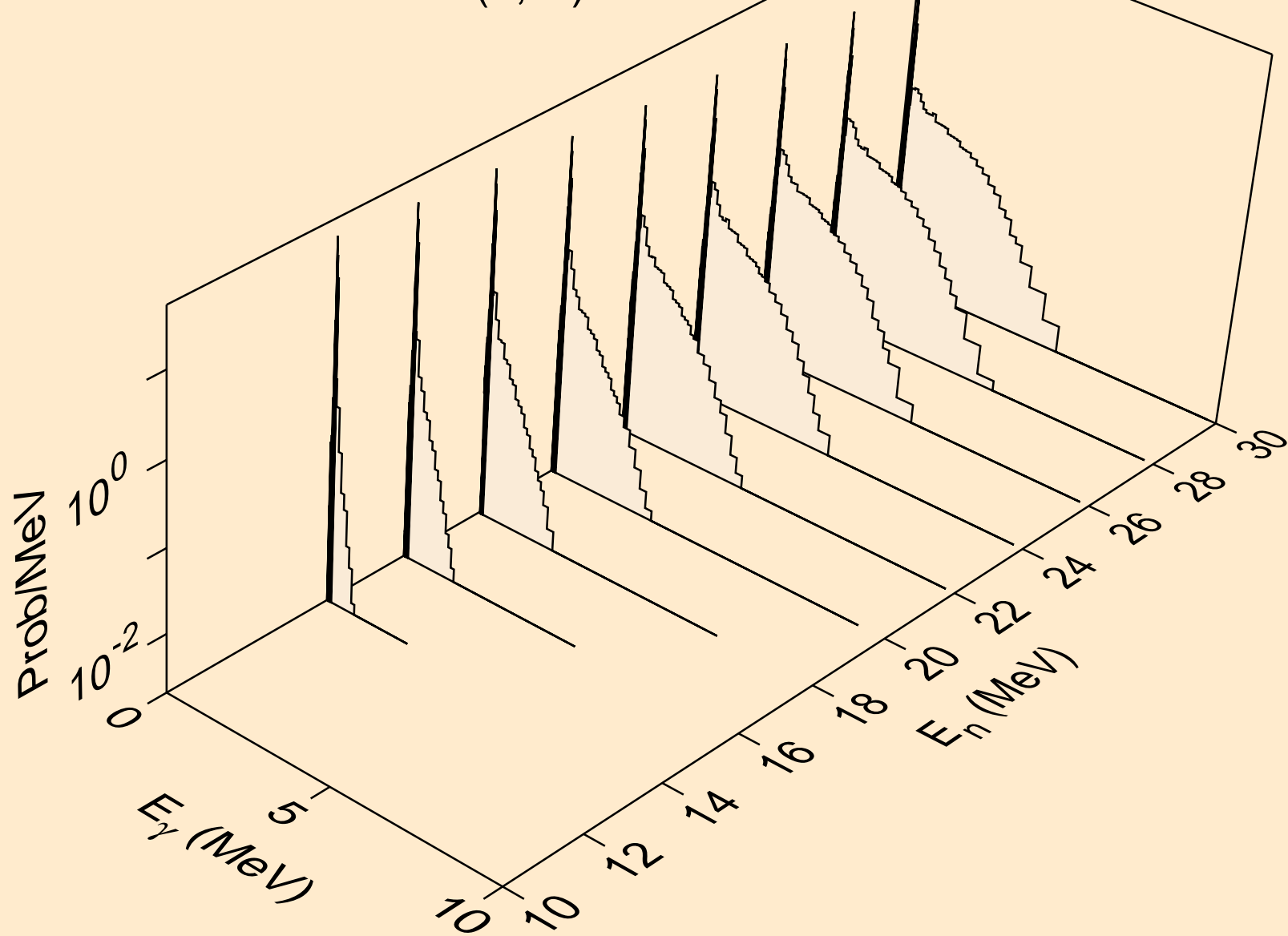



OS181M NEUTRON ACER TENDL-2021 LIBRARY; T=293.6K  
Photon emission for (n,n\*)t

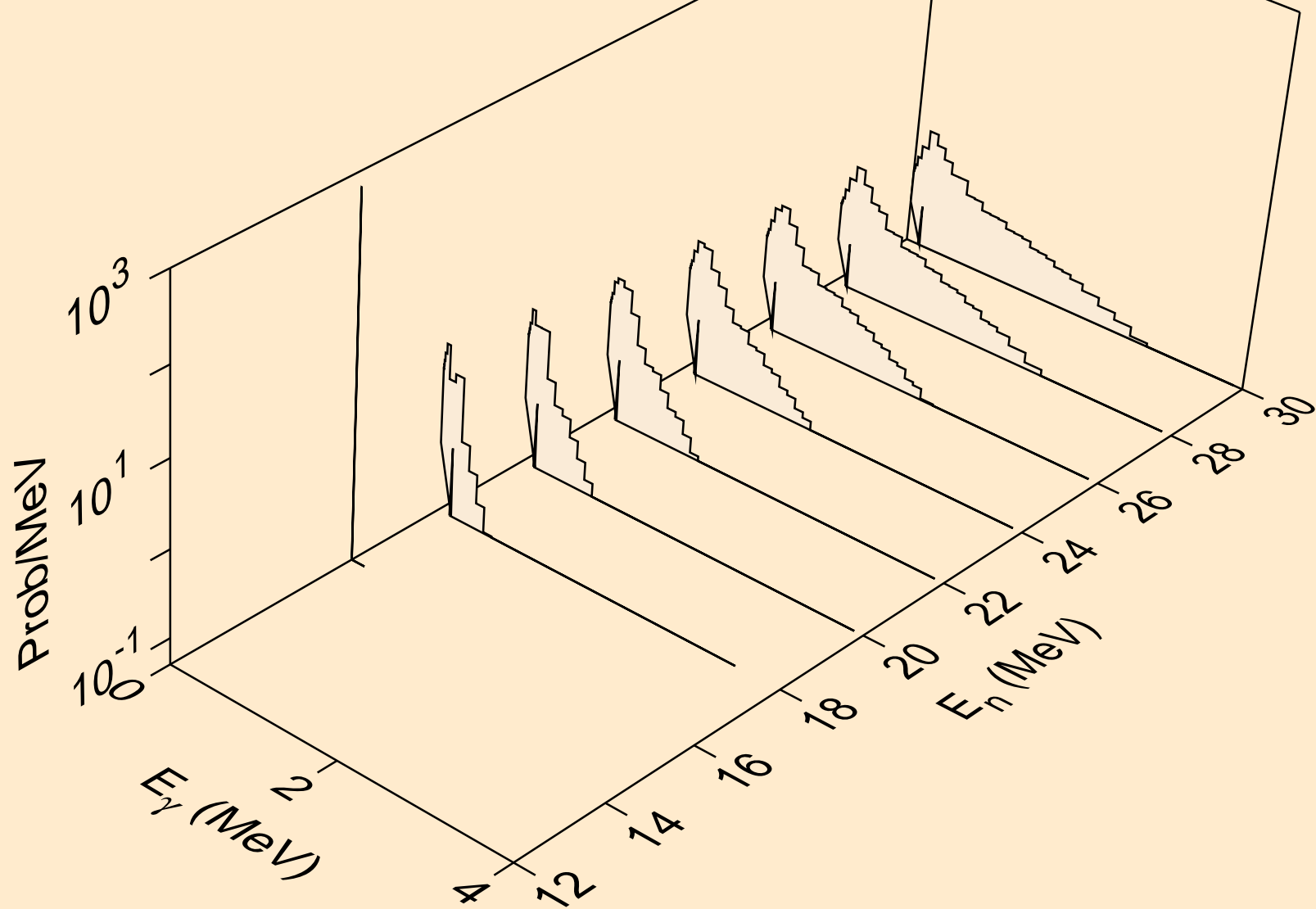

OS181M NEUTRON ACER TENDL-2021 LIBRARY; T=293.6K  
Photon emission for (n,n\*)he3

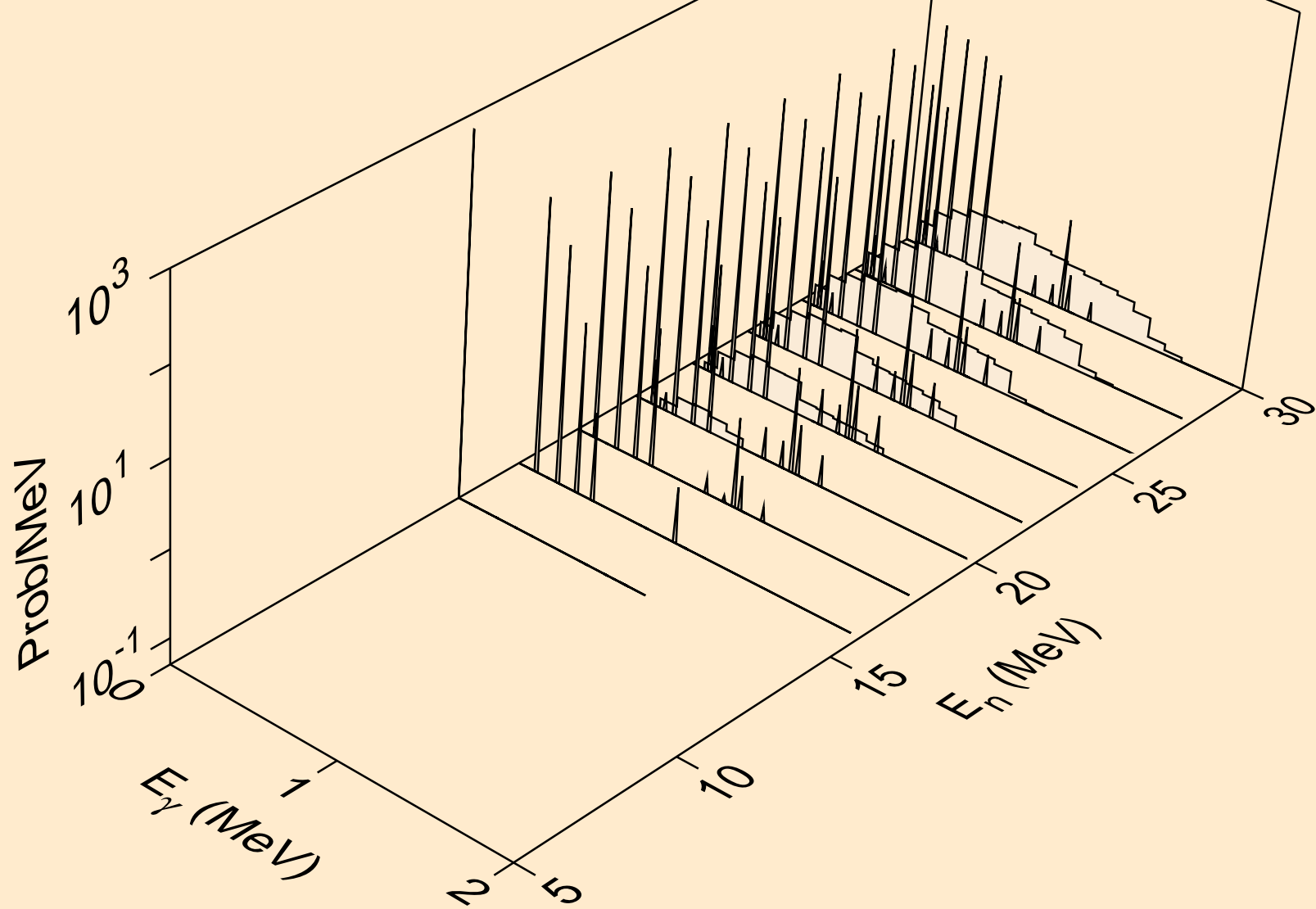

OS181M NEUTRON ACER TENDL-2021 LIBRARY; T=293.6K  
Photon emission for (n,4n)

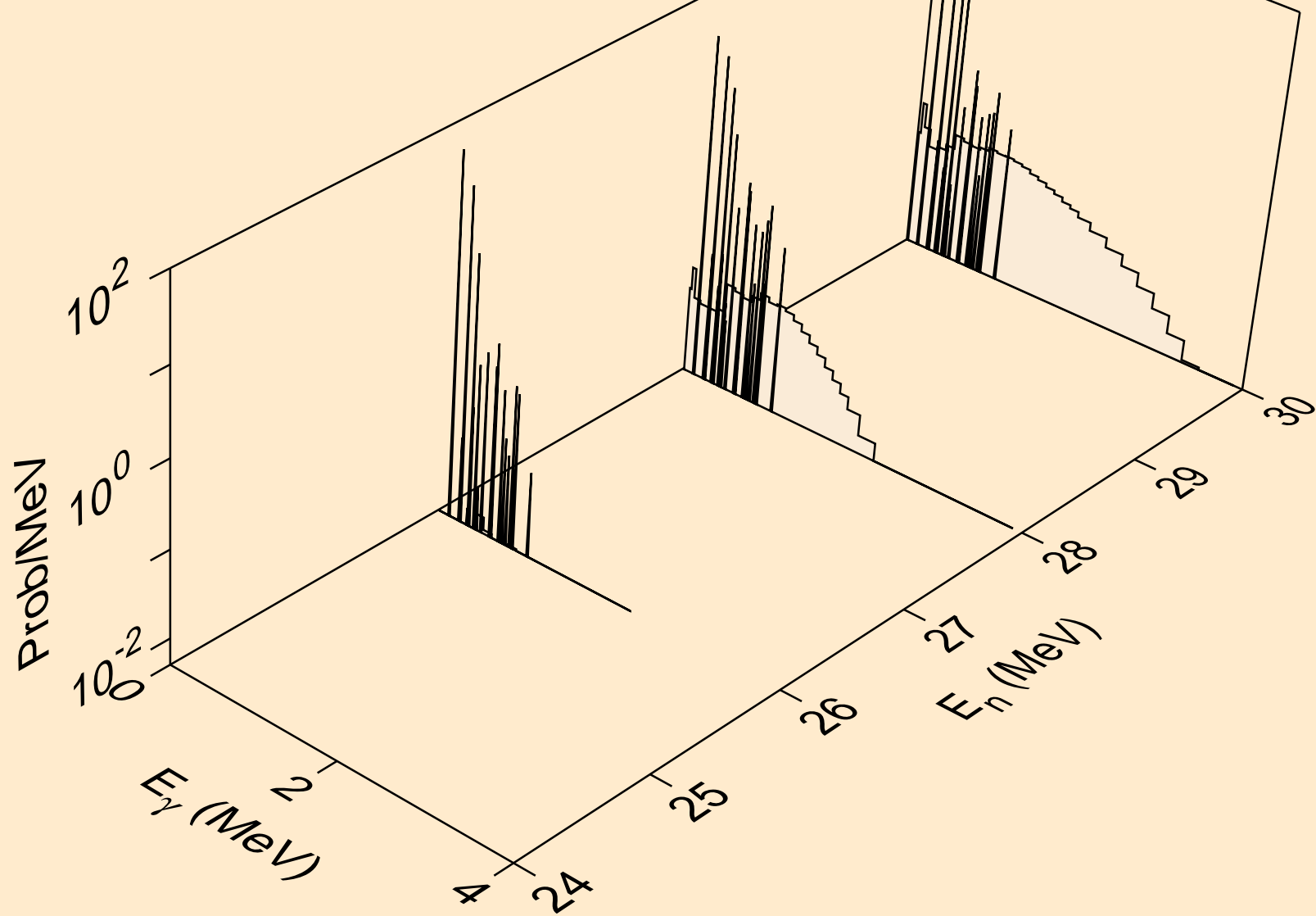

OS181M NEUTRON ACER TENDL-2021 LIBRARY; T=293.6K  
Photon emission for (n,2np)

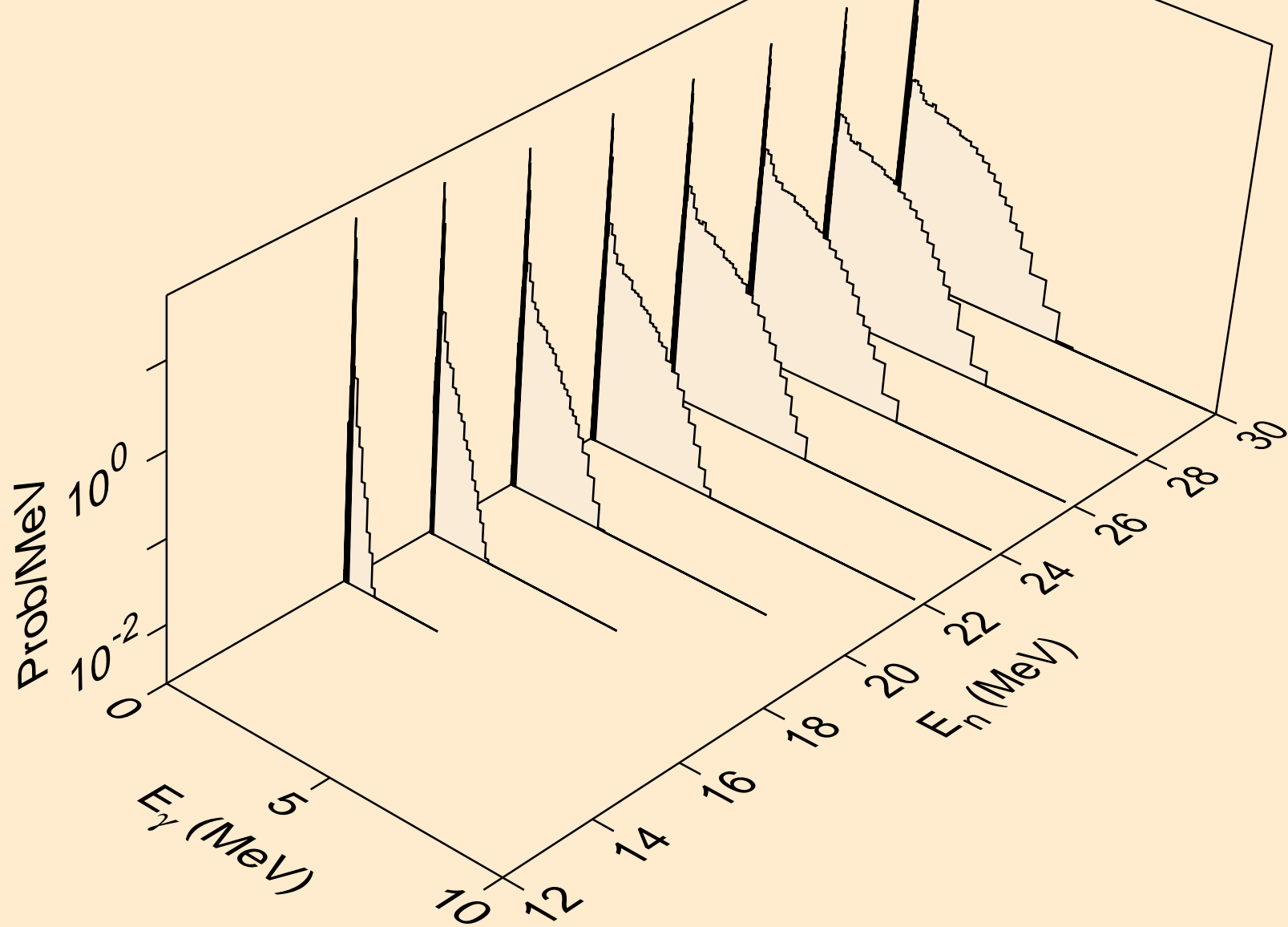

OS181M NEUTRON ACER TENDL-2021 LIBRARY; T=293.6K  
Photon emission for (n,3np)

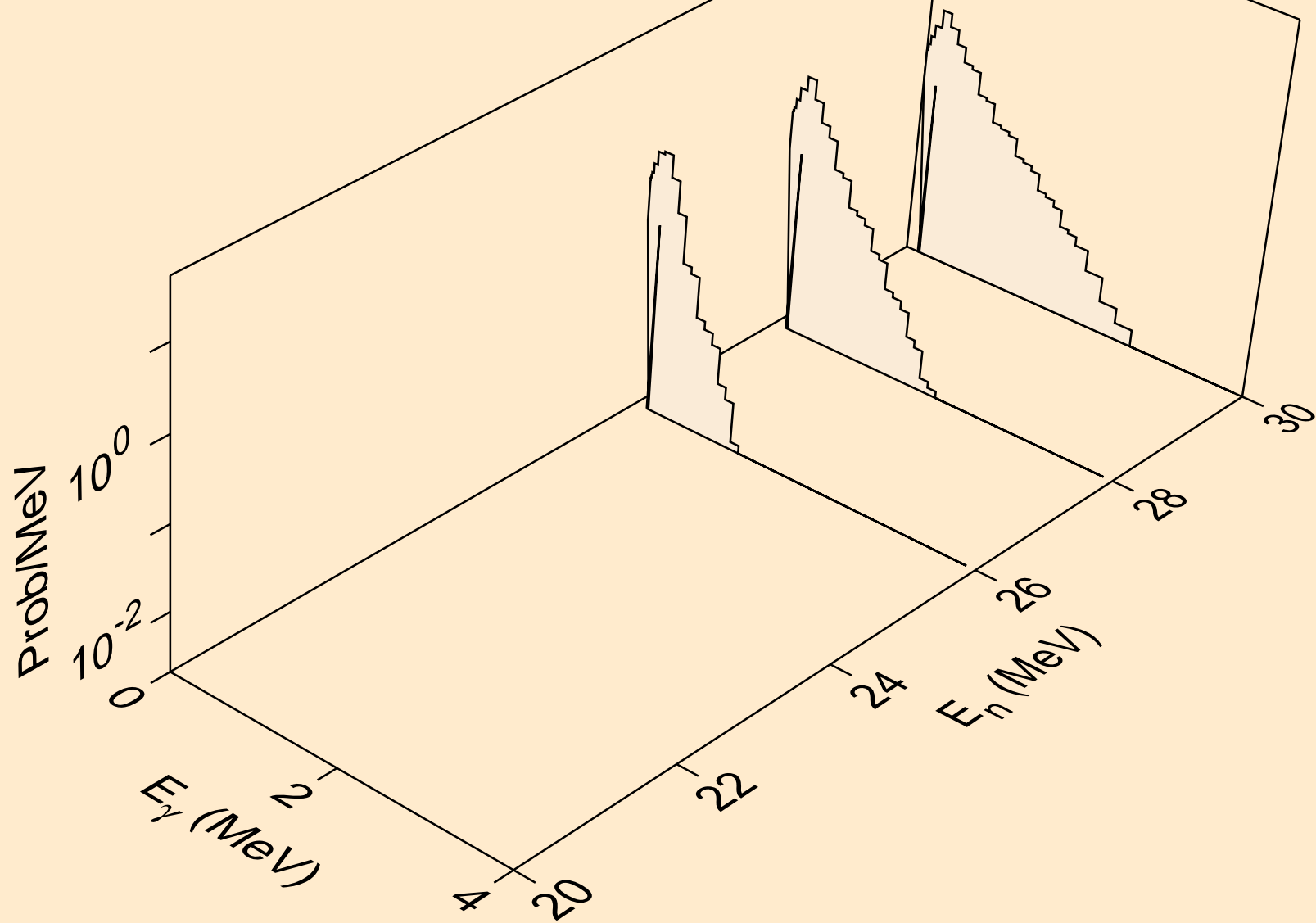

OS181M NEUTRON ACER TENDL-2021 LIBRARY; T=293.6K  
Photon emission for (n,2np)

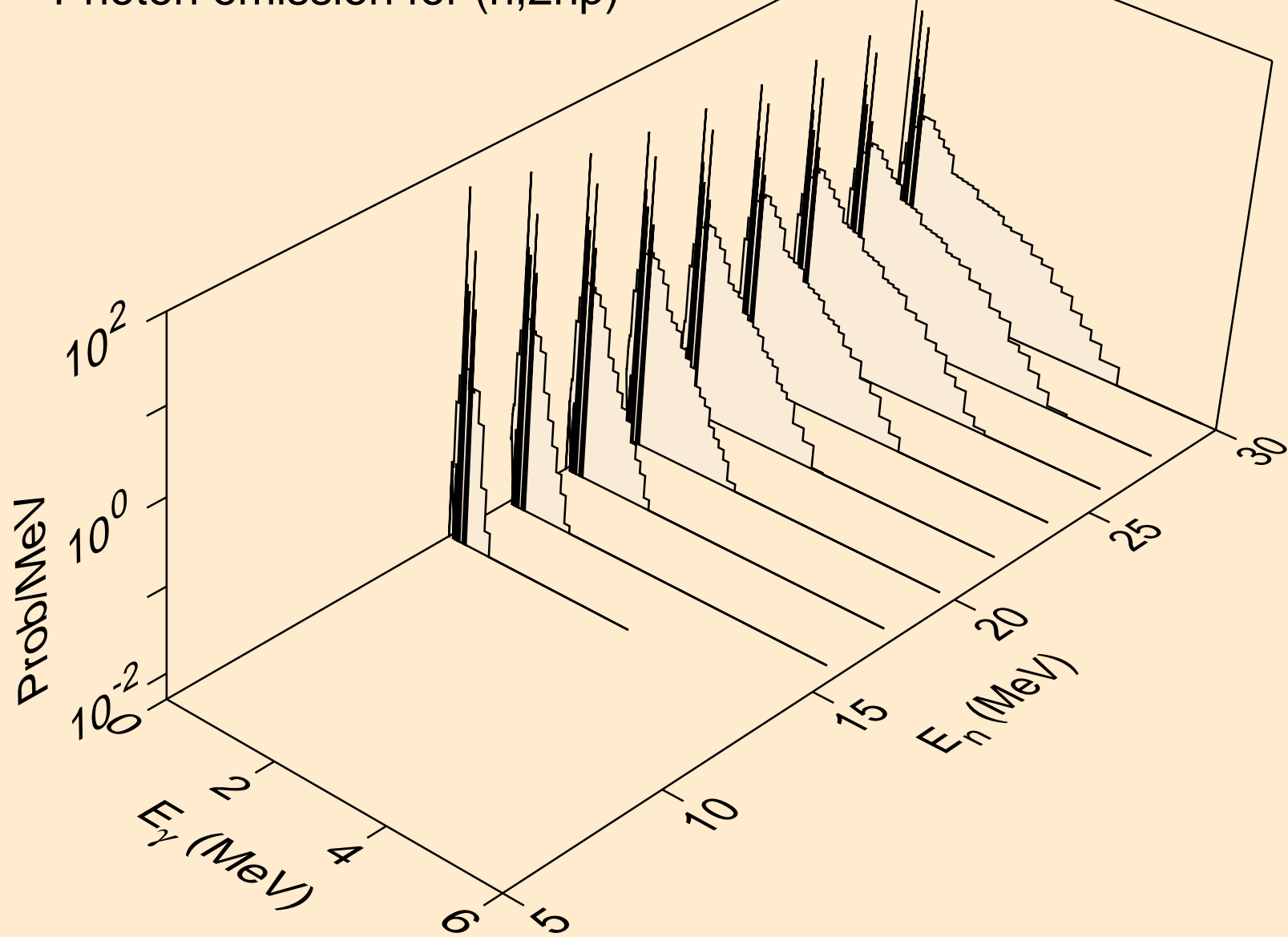

OS181M NEUTRON ACER TENDL-2021 LIBRARY; T=293.6K  
Photon emission for (n,npa)

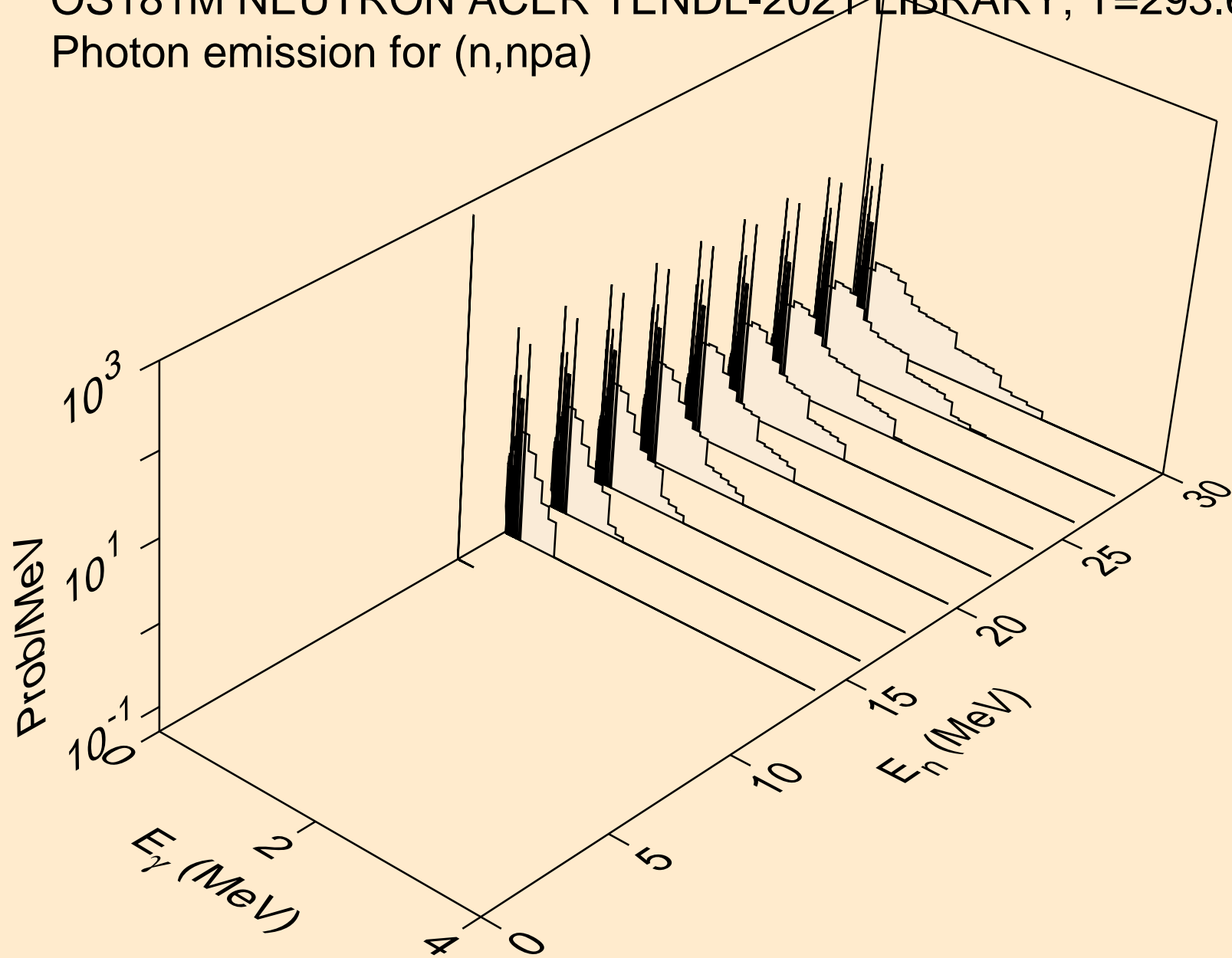

OS181M NEUTRON ACER TENDL-2021 LIBRARY; T=293.6K  
Photon emission for (n,n\*2)

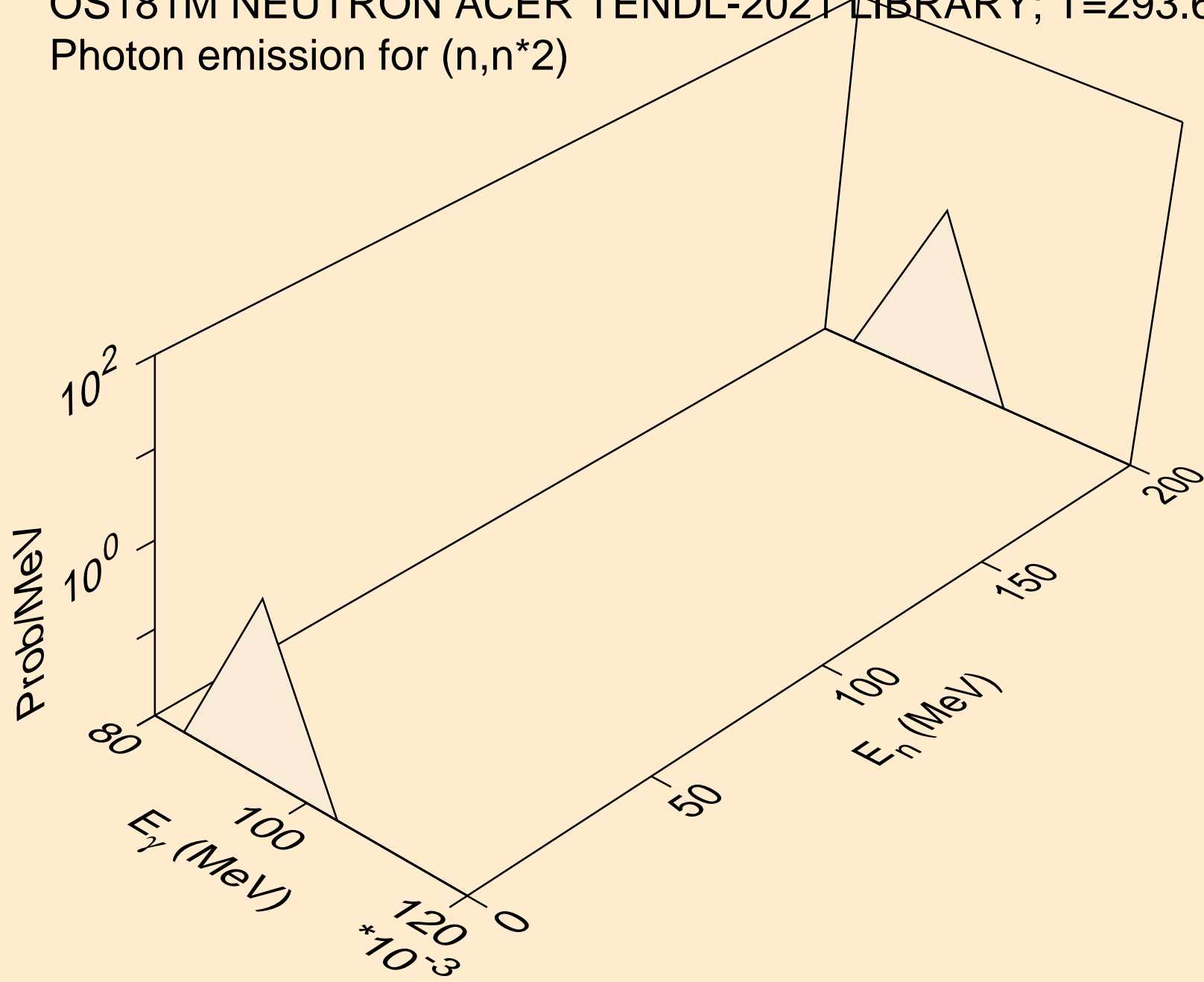



OS181M NEUTRON ACER TENDL-2021 LIBRARY; T=293.6K  
Photon emission for (n,n\*3)

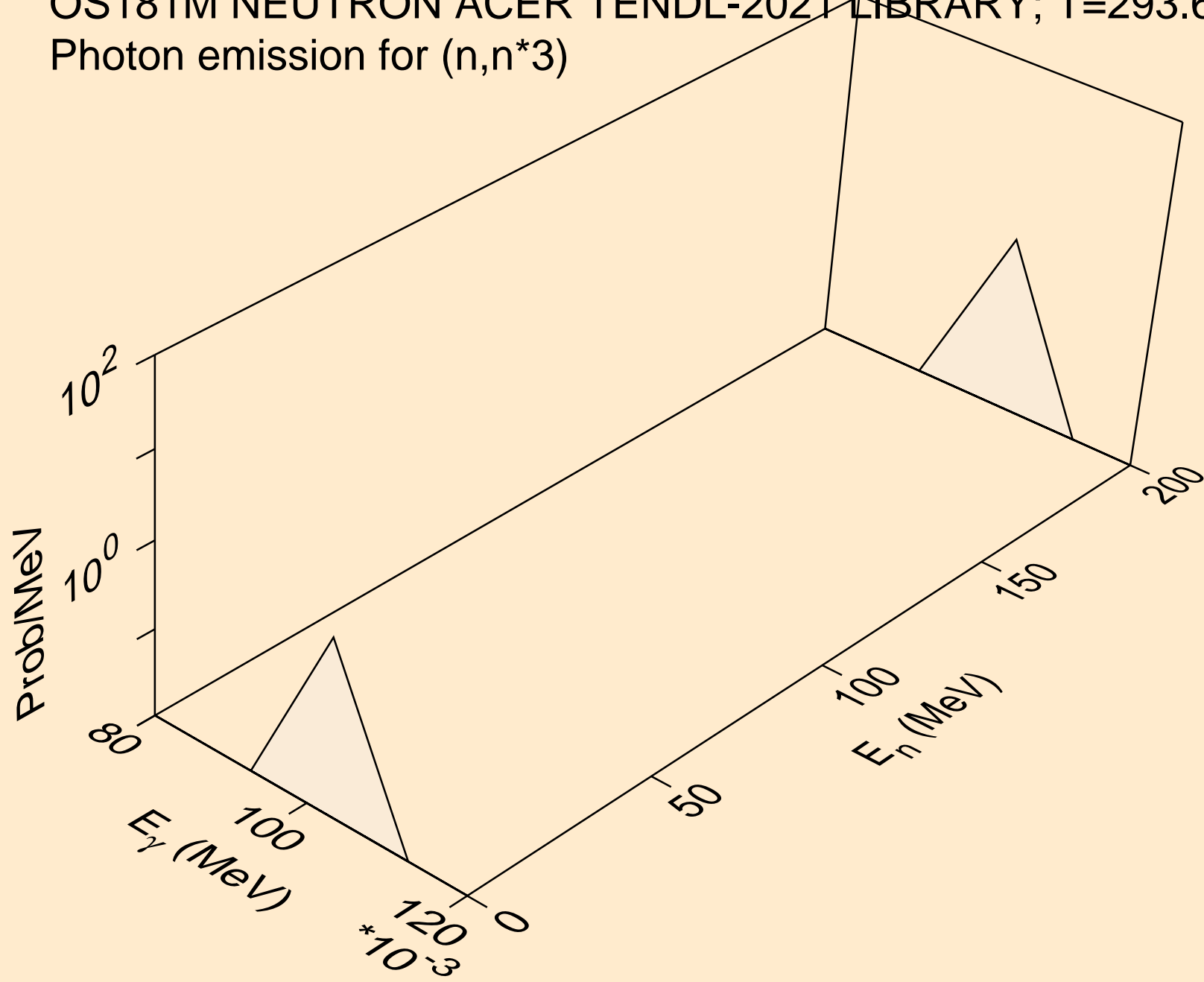

OS181M NEUTRON ACER TENDL-2021 LIBRARY; T=293.6K  
Photon emission for (n,n\*4)

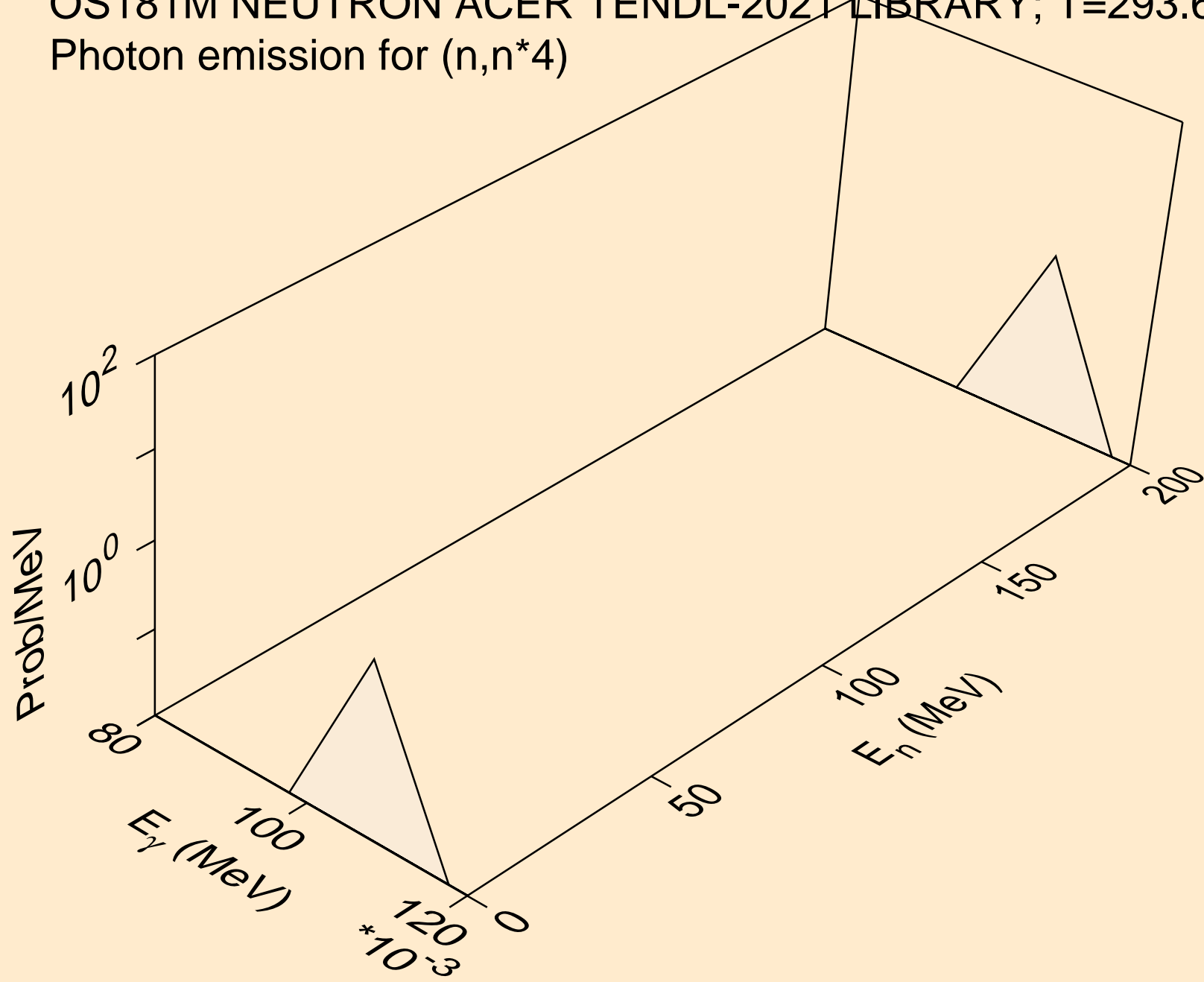

OS181M NEUTRON ACER TENDL-2021 LIBRARY; T=293.6K  
Photon emission for (n,n\*5)

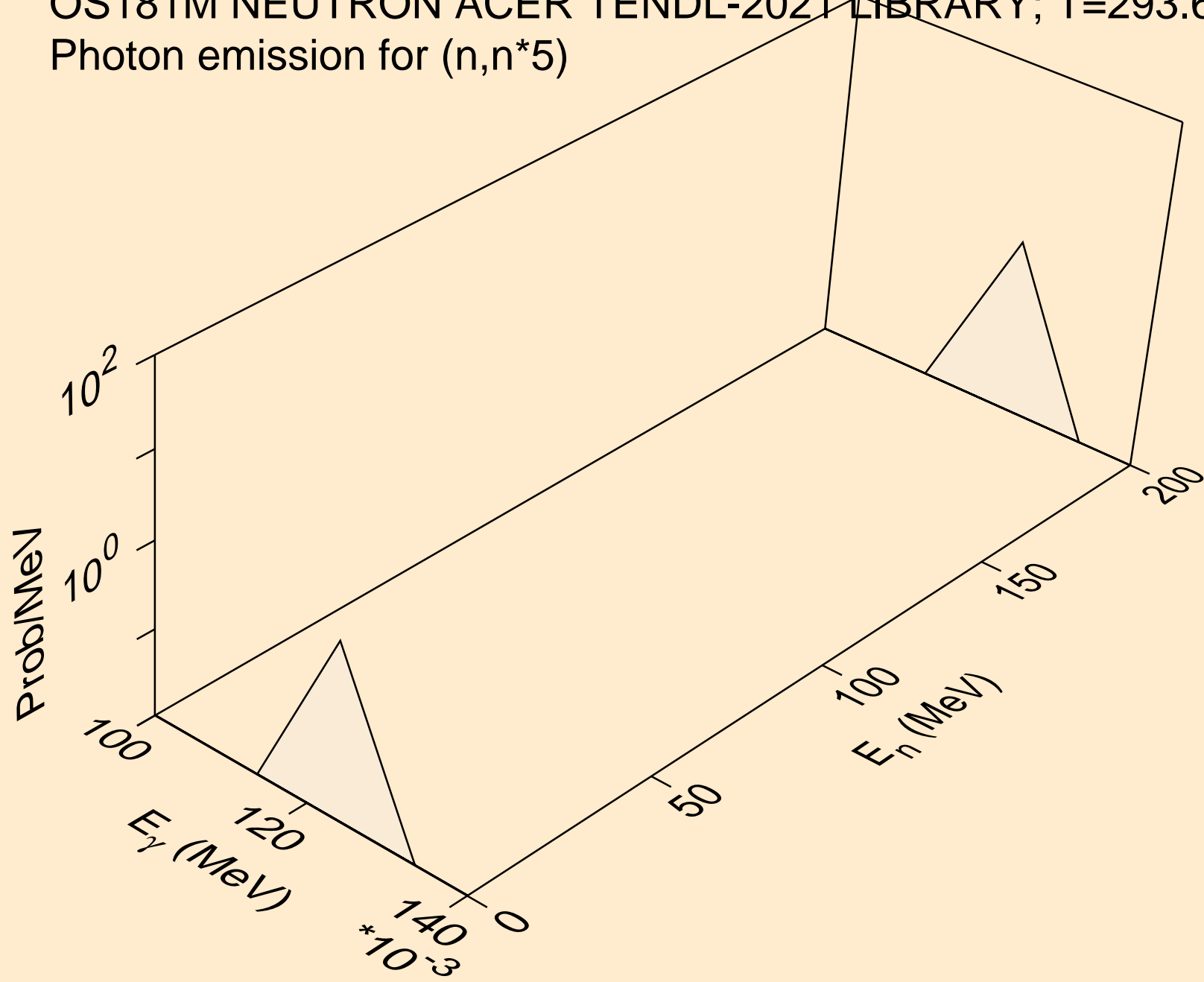

OS181M NEUTRON ACER TENDL-2021 LIBRARY; T=293.6K  
Photon emission for (n,n\*6)

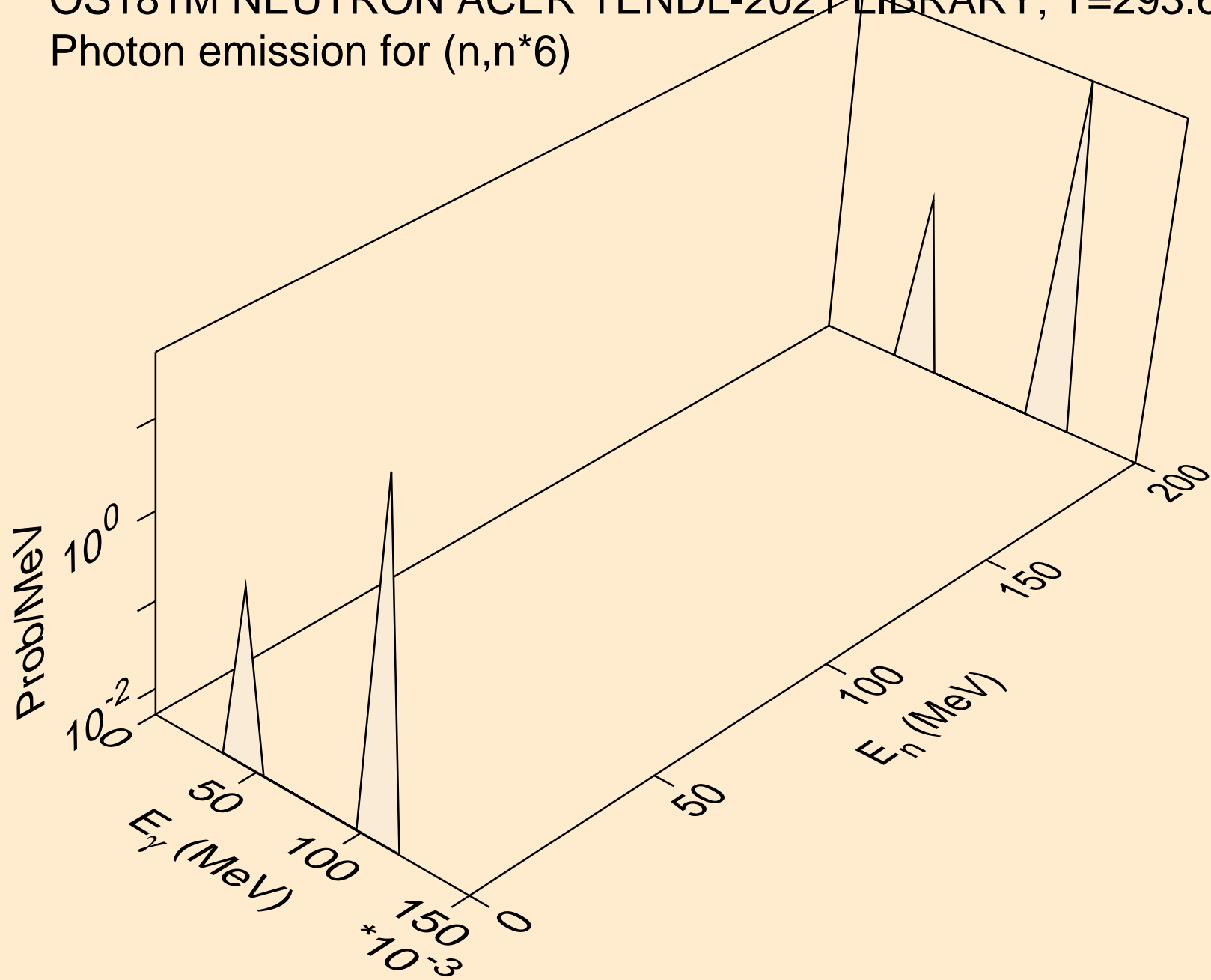

OS181M NEUTRON ACER TENDL-2021 LIBRARY; T=293.6K  
Photon emission for (n,n\*7)

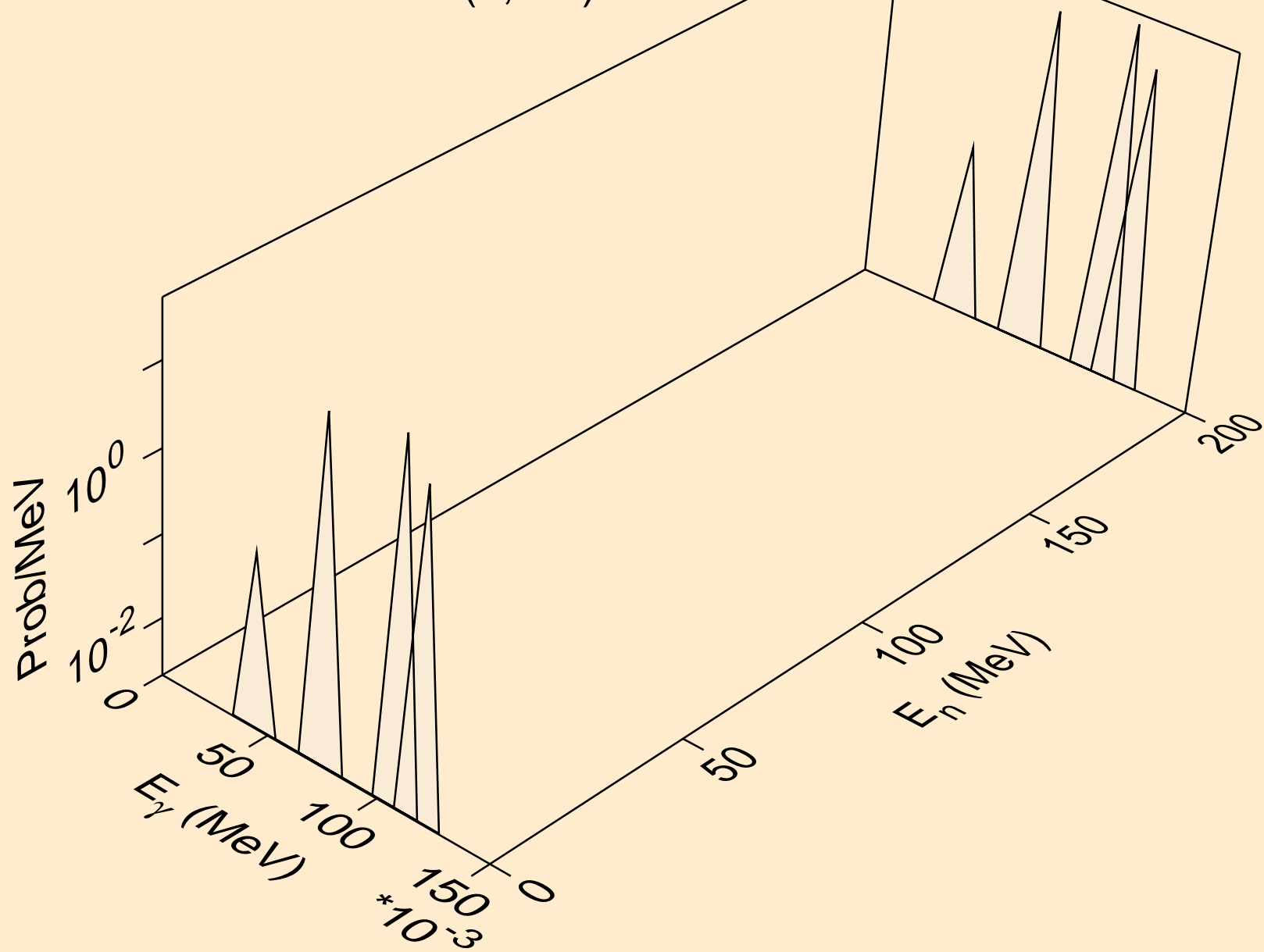

OS181M NEUTRON ACER TENDL-2021 LIBRARY; T=293.6K  
Photon emission for (n,n\*8)

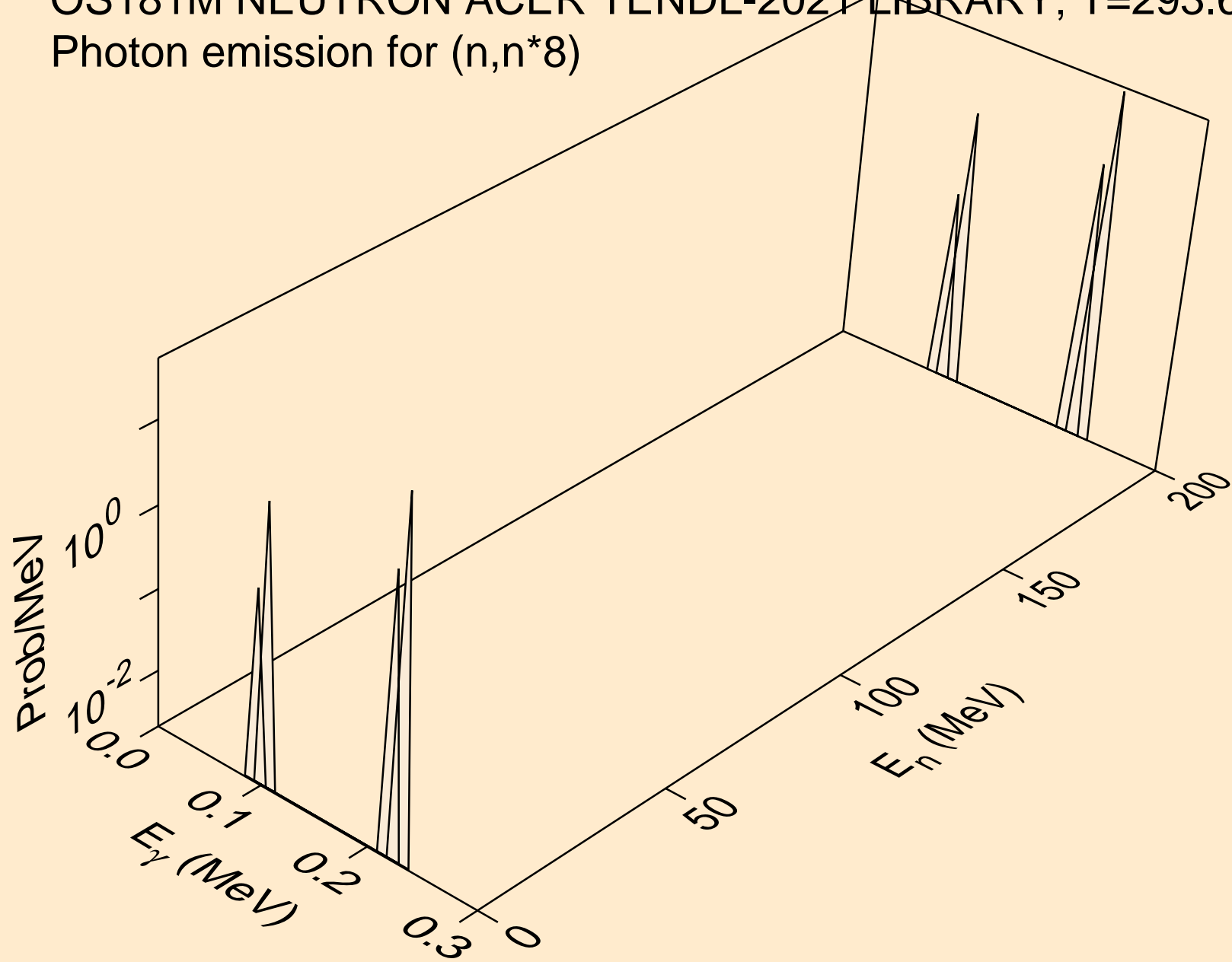

OS181M NEUTRON ACER TENDL-2021 LIBRARY; T=293.6K  
Photon emission for (n,n\*9)

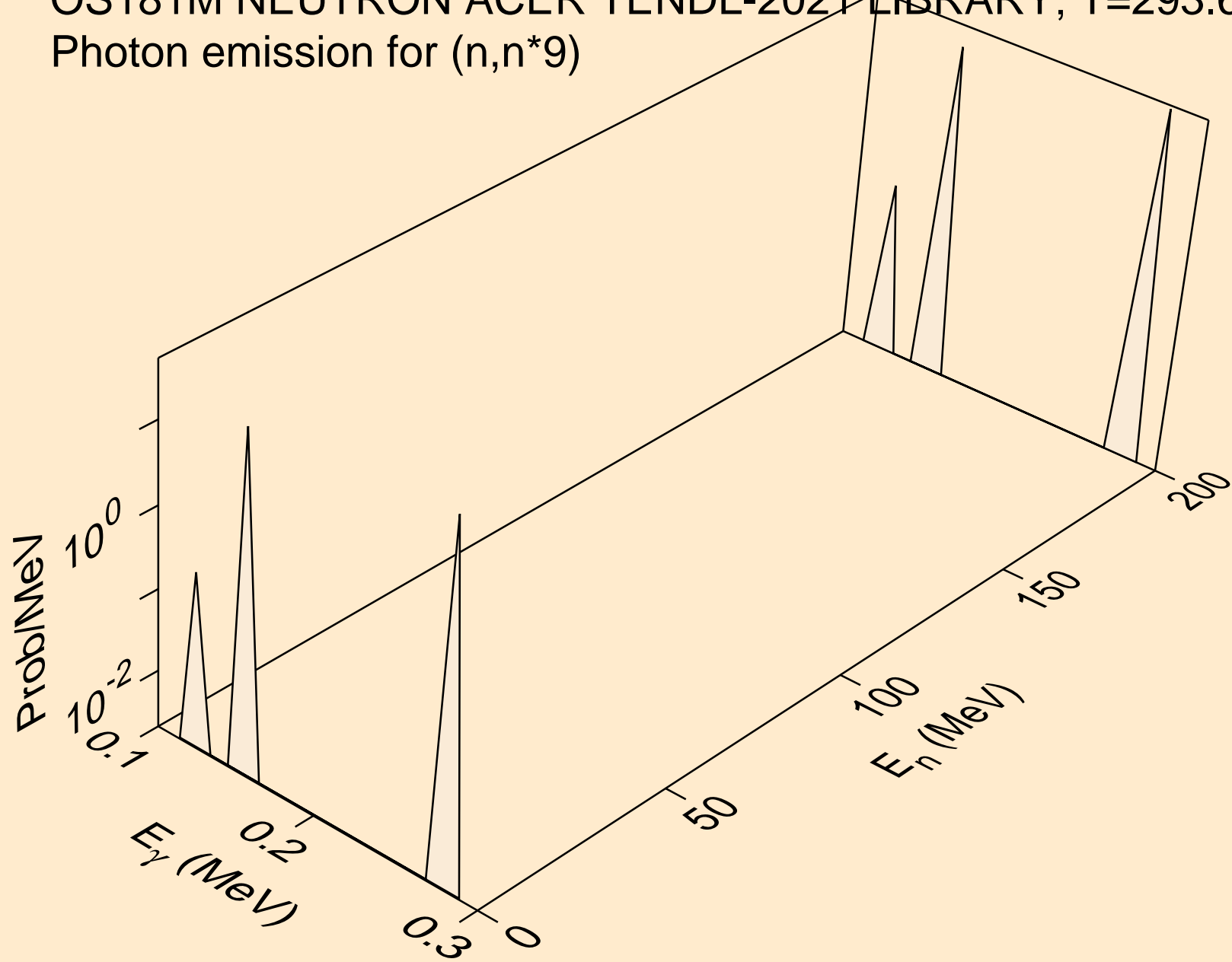

OS181M NEUTRON ACER TENDL-2021 LIBRARY; T=293.6K  
Photon emission for (n,n\*10)

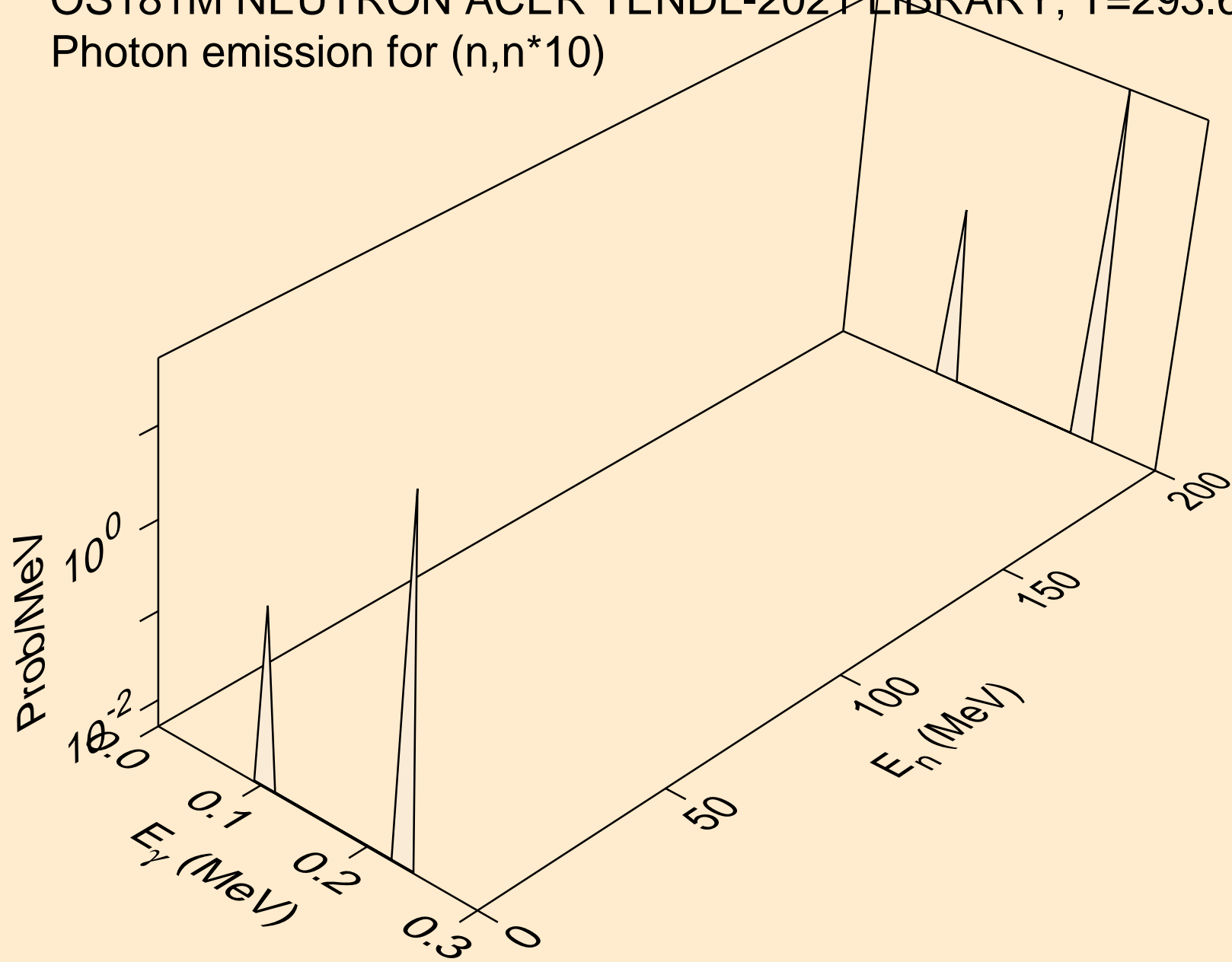



OS181M NEUTRON ACER TENDL-2021 LIBRARY; T=293.6K  
Photon emission for (n,n\*11)

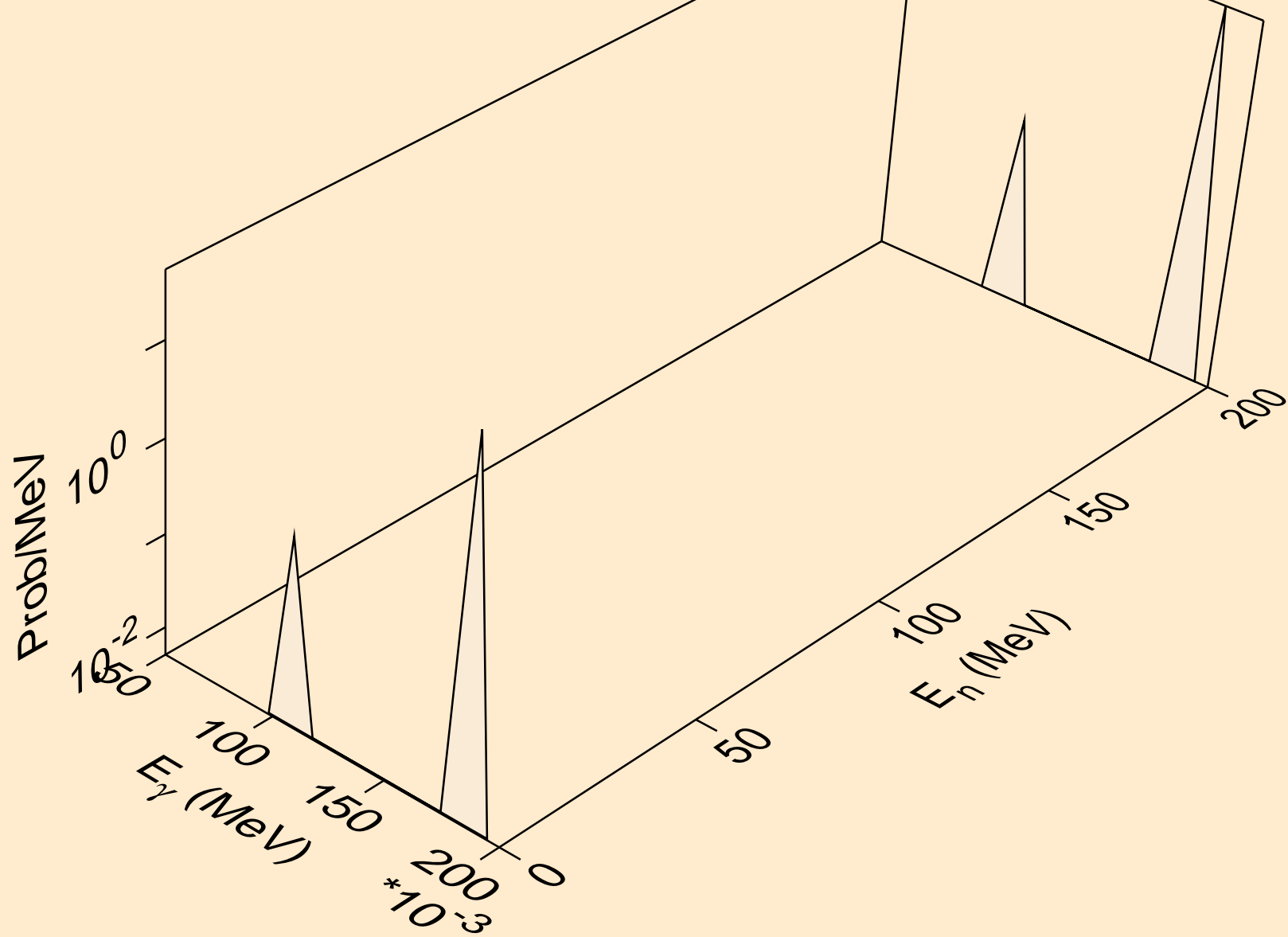

OS181M NEUTRON ACER TENDL-2021 LIBRARY; T=293.6K  
Photon emission for (n,n\*12)

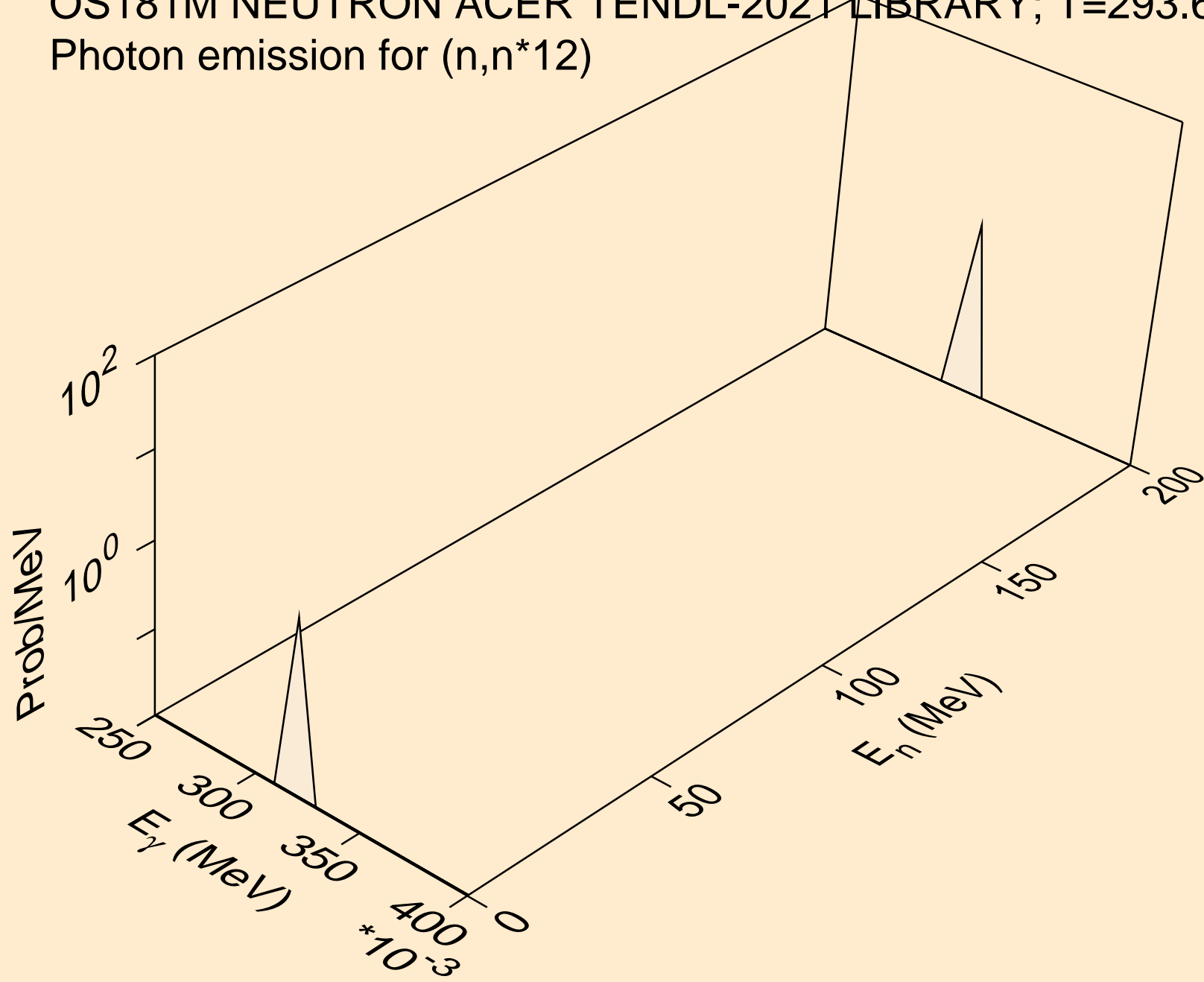

OS181M NEUTRON ACER TENDL-2021 LIBRARY; T=293.6K  
Photon emission for (n,n\*13)

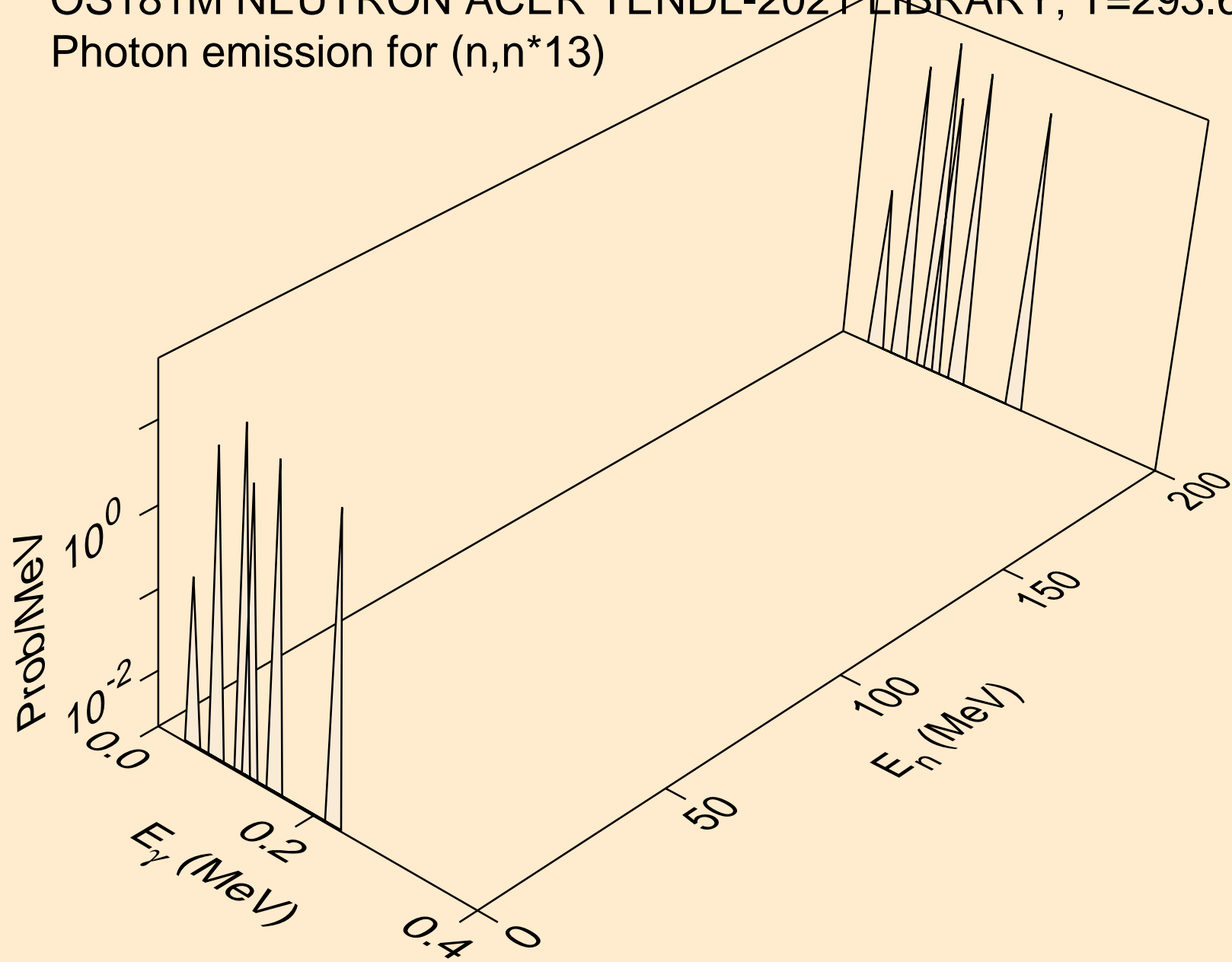

OS181M NEUTRON ACER TENDL-2021 LIBRARY; T=293.6K  
Photon emission for (n,n\*14)

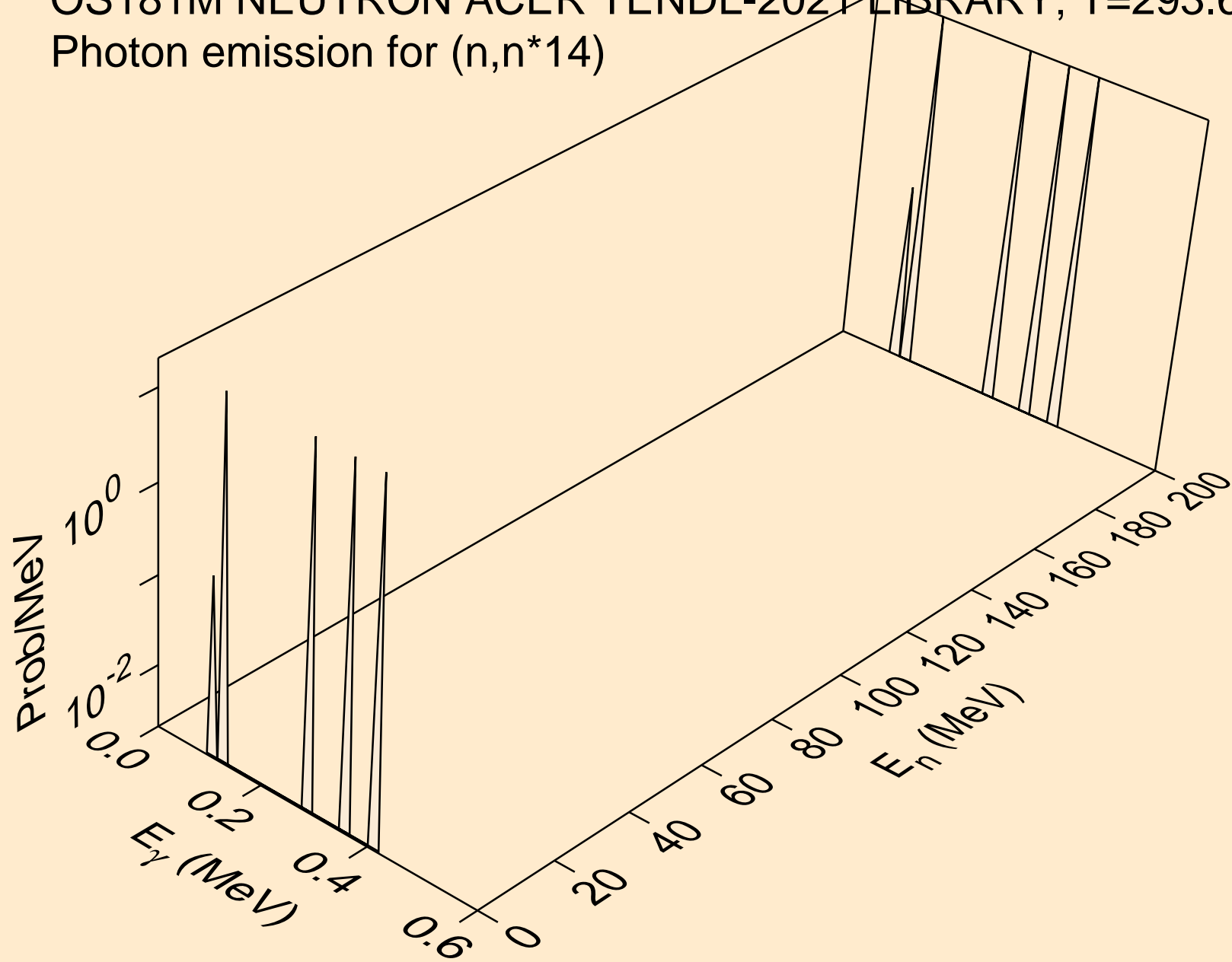

OS181M NEUTRON ACER TENDL-2021 LIBRARY; T=293.6K  
Photon emission for (n,n\*15)

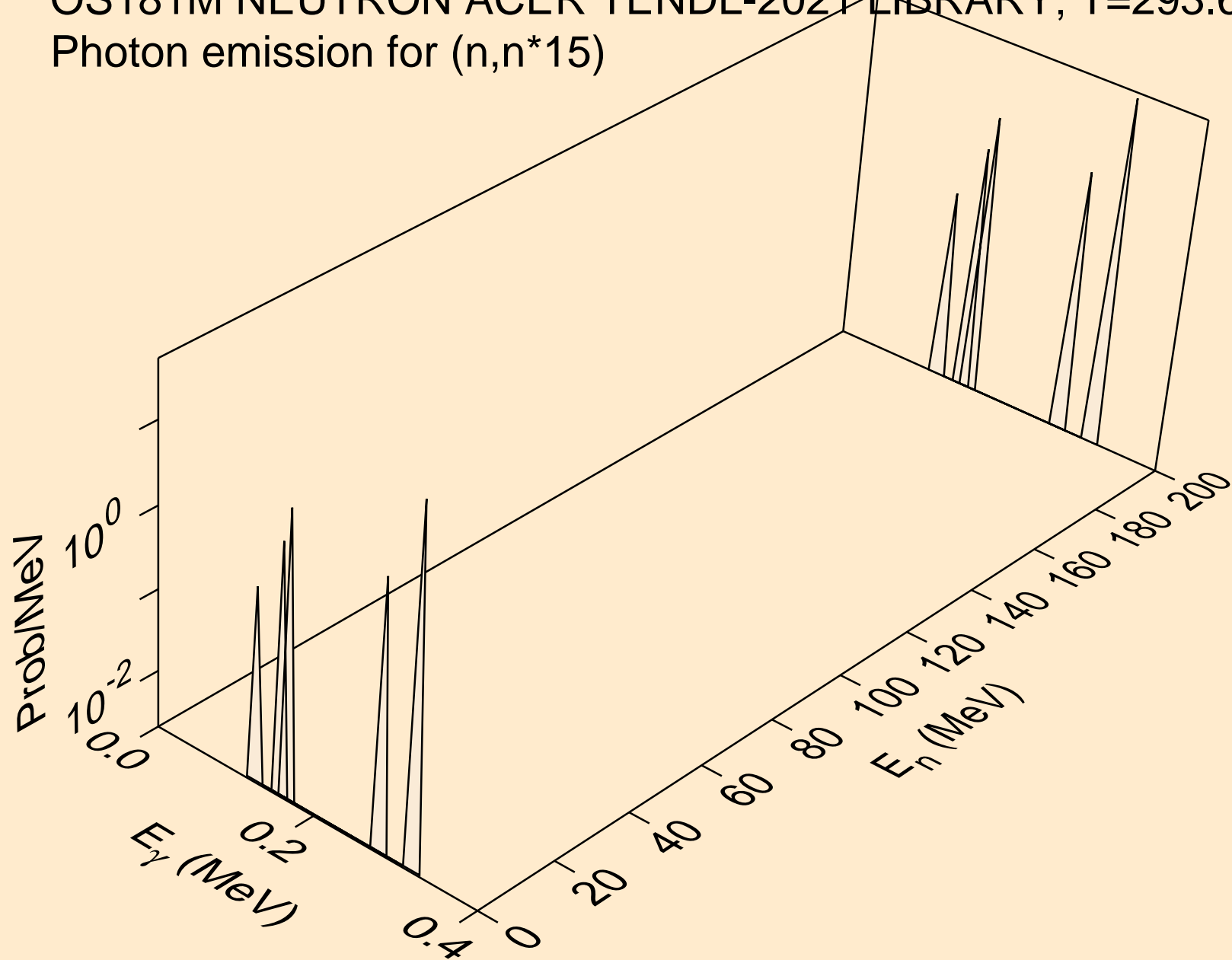

OS181M NEUTRON ACER TENDL-2021 LIBRARY; T=293.6K  
Photon emission for (n,n\*16)

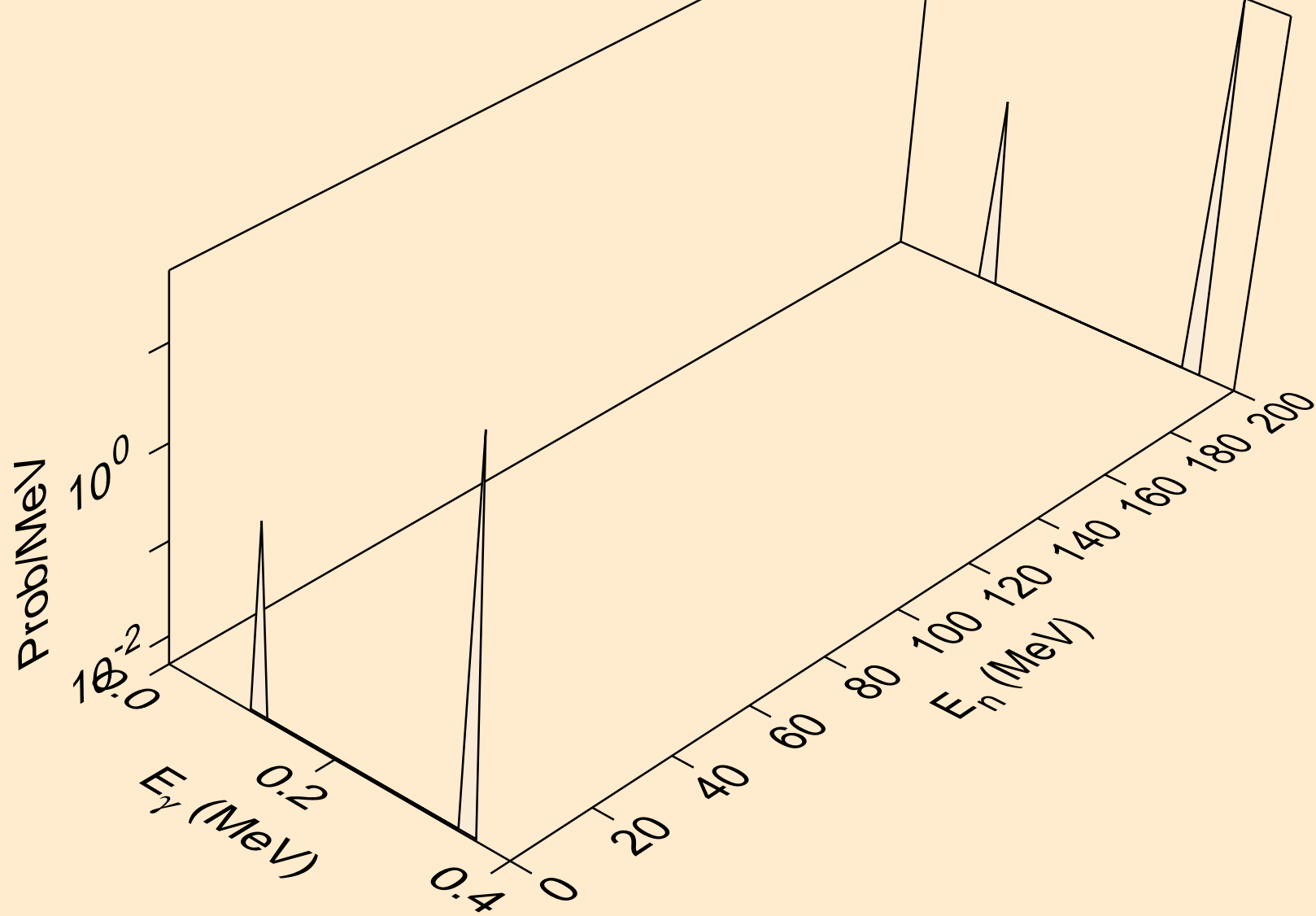

OS181M NEUTRON ACER TENDL-2021 LIBRARY; T=293.6K  
Photon emission for (n,n\*17)

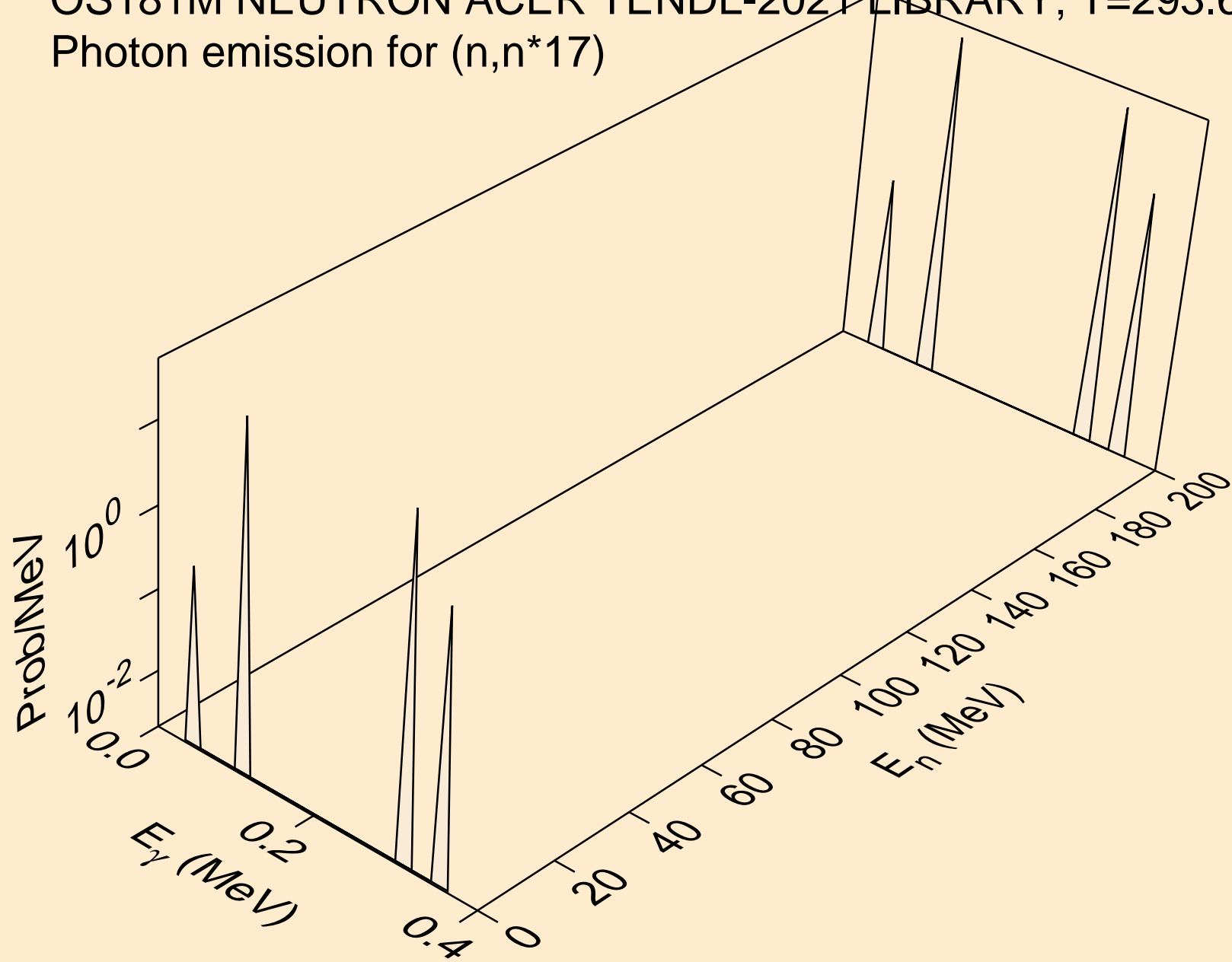

OS181M NEUTRON ACER TENDL-2021 LIBRARY; T=293.6K  
Photon emission for (n,n\*18)

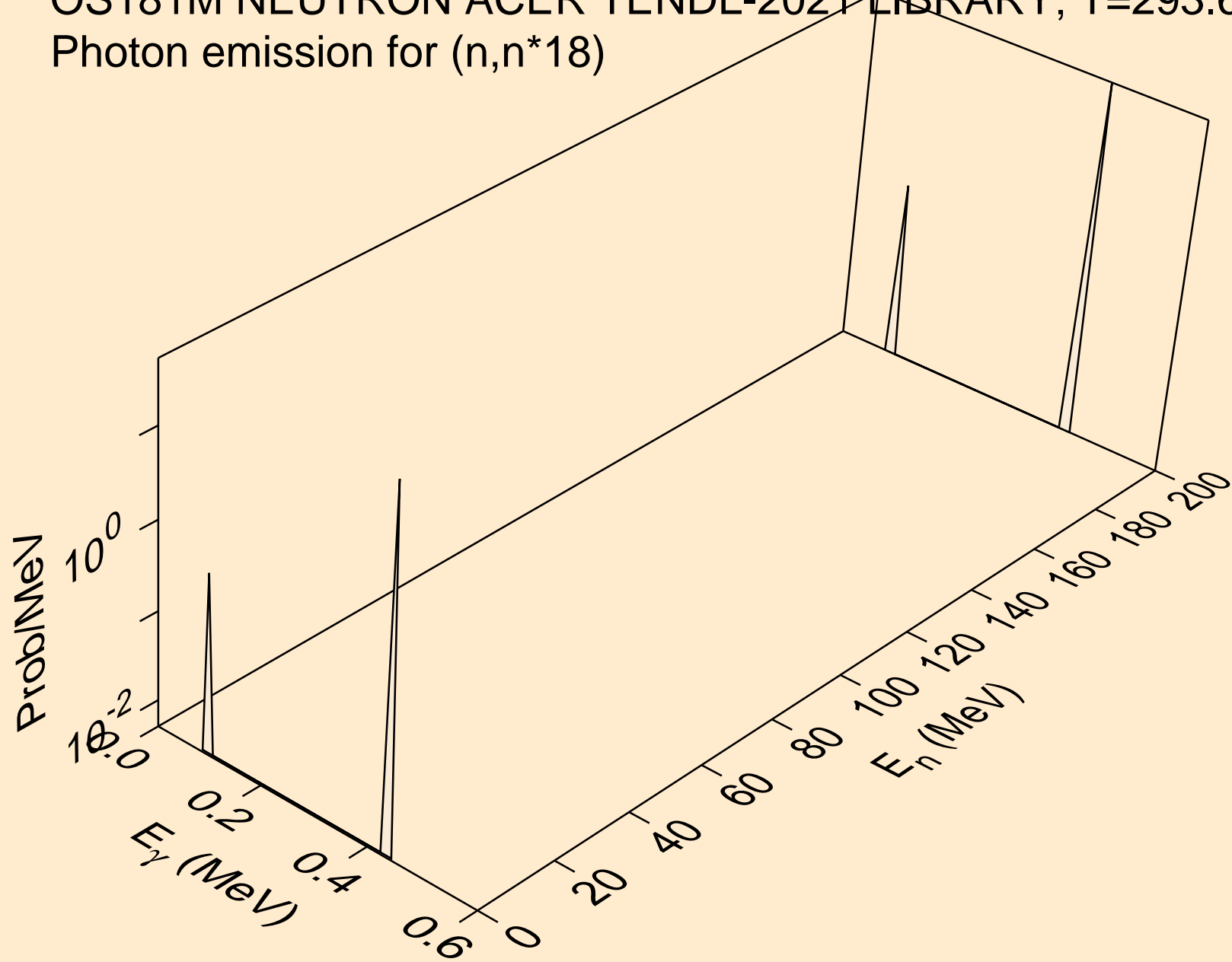



OS181M NEUTRON ACER TENDL-2021 LIBRARY; T=293.6K  
Photon emission for (n,n\*19)

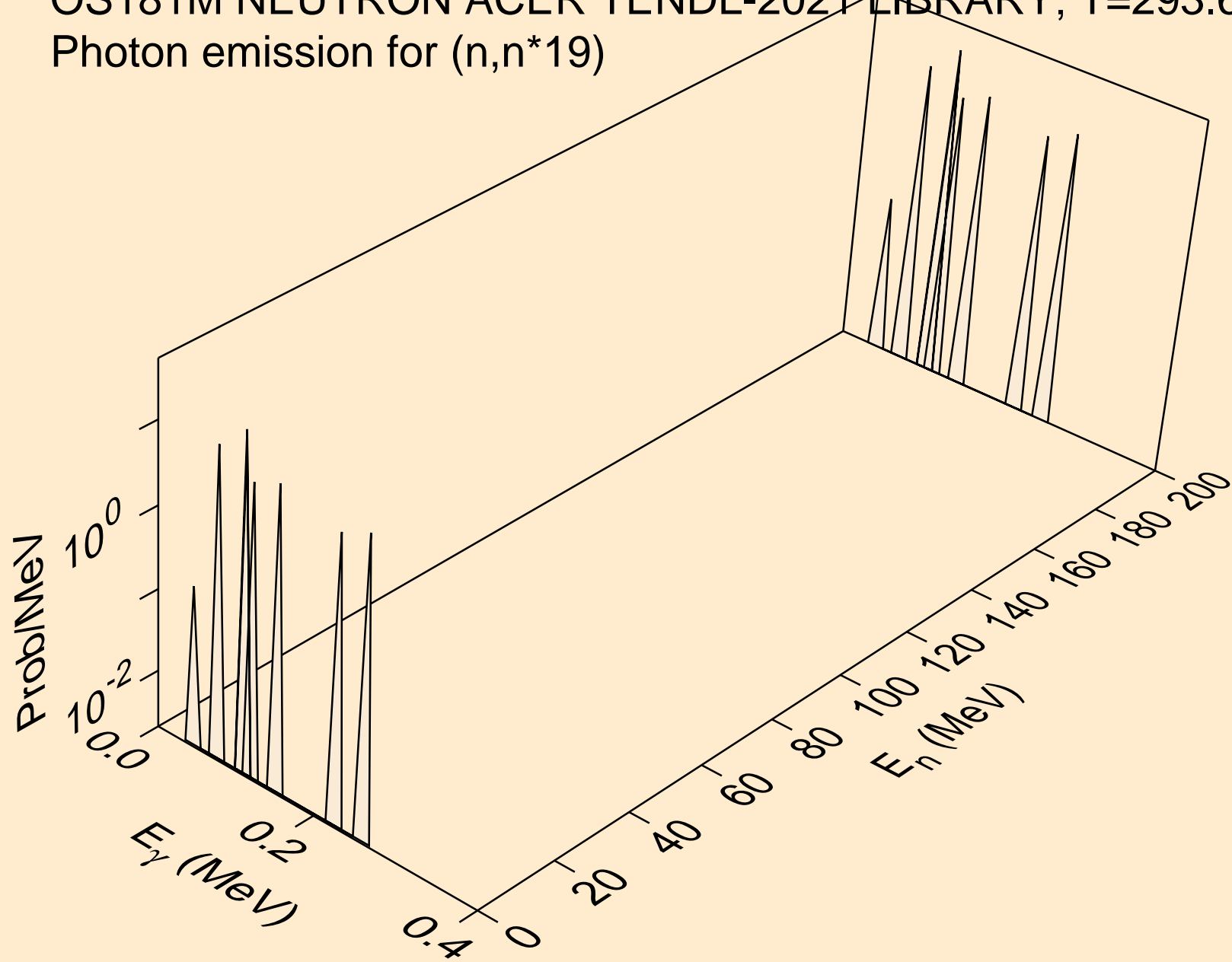

OS181M NEUTRON ACER TENDL-2021 LIBRARY; T=293.6K  
Photon emission for (n,n\*20)

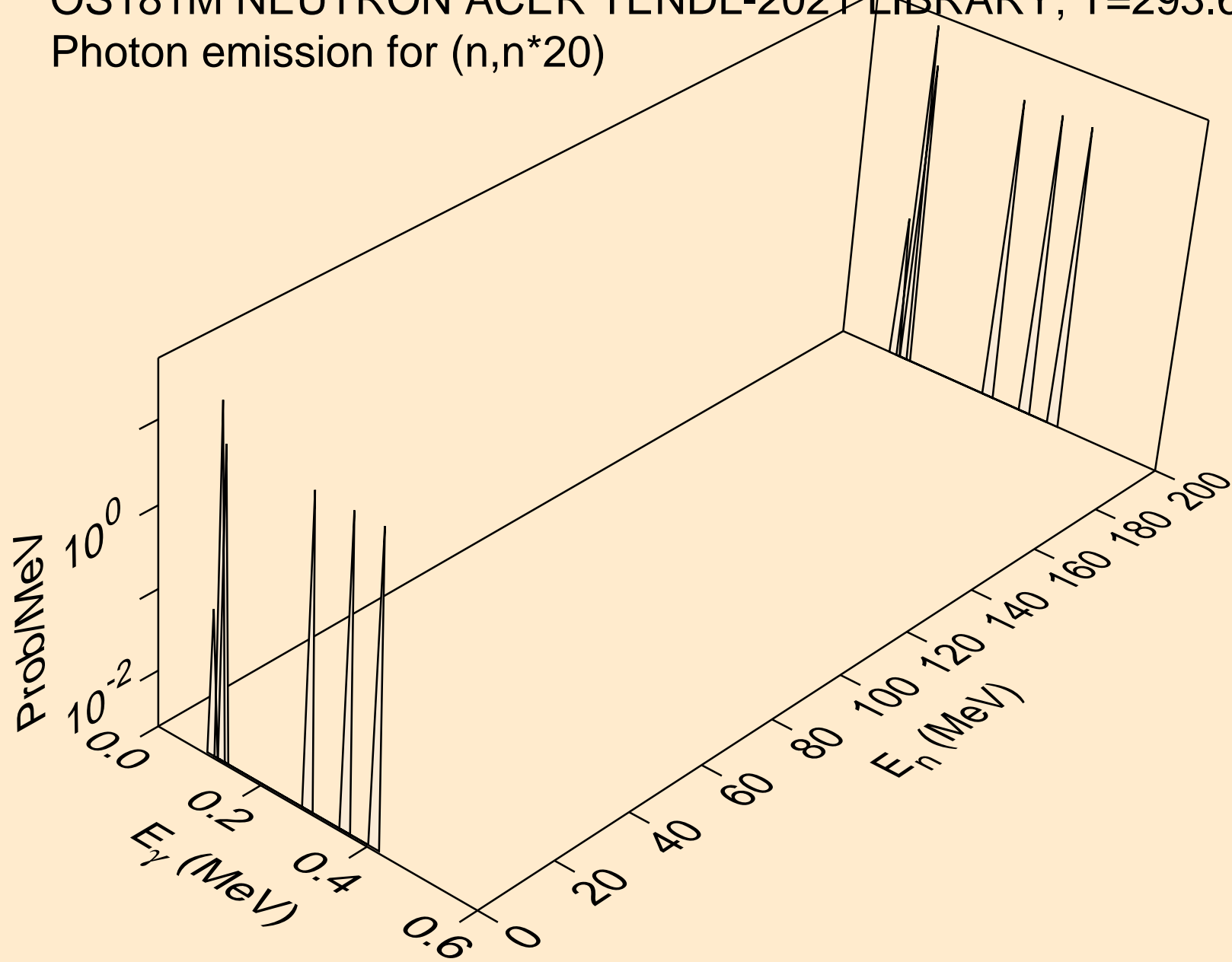

OS181M NEUTRON ACER TENDL-2021 LIBRARY; T=293.6K  
Photon emission for (n,n\*21)

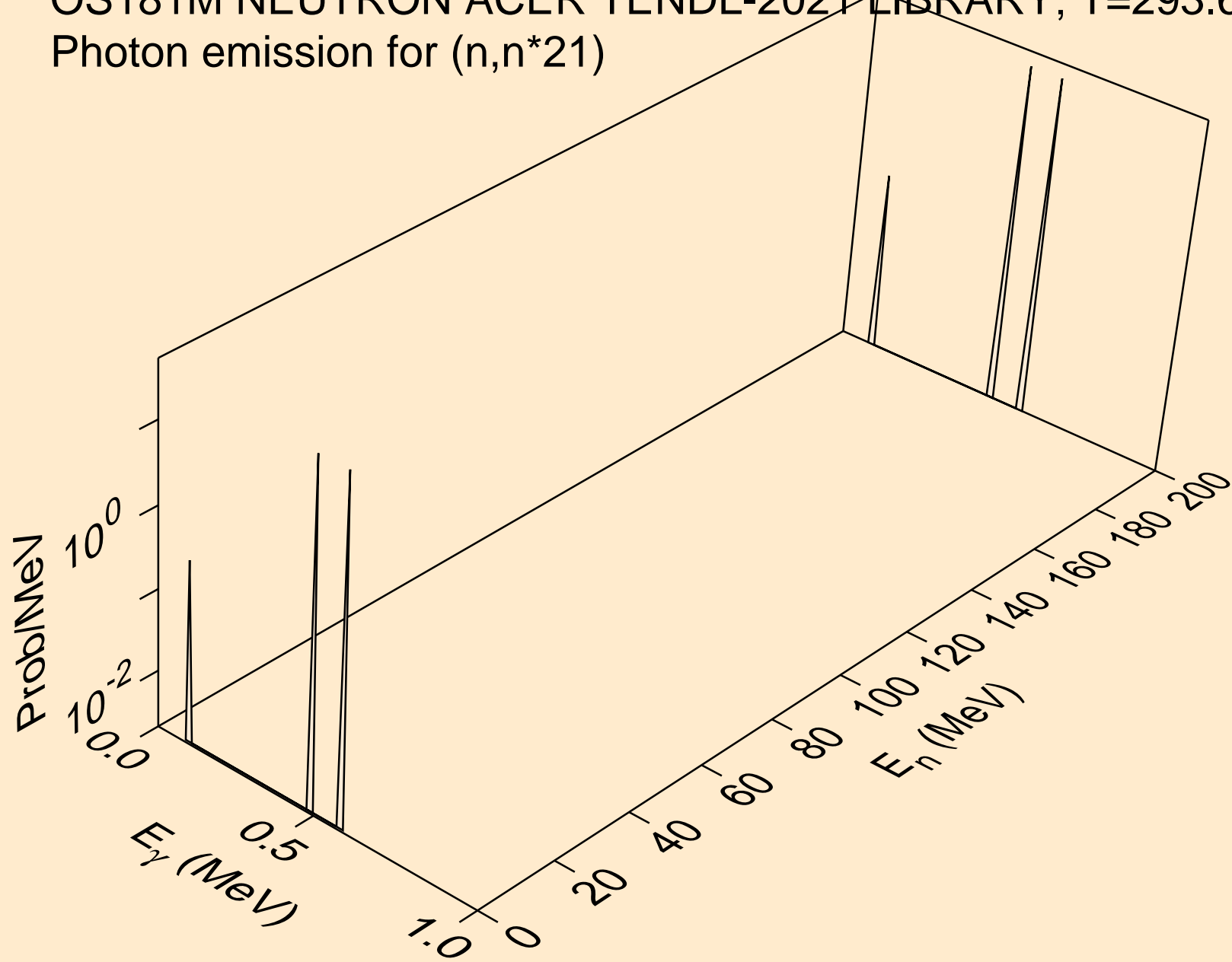

OS181M NEUTRON ACER TENDL-2021 LIBRARY; T=293.6K  
Photon emission for (n,n\*22)

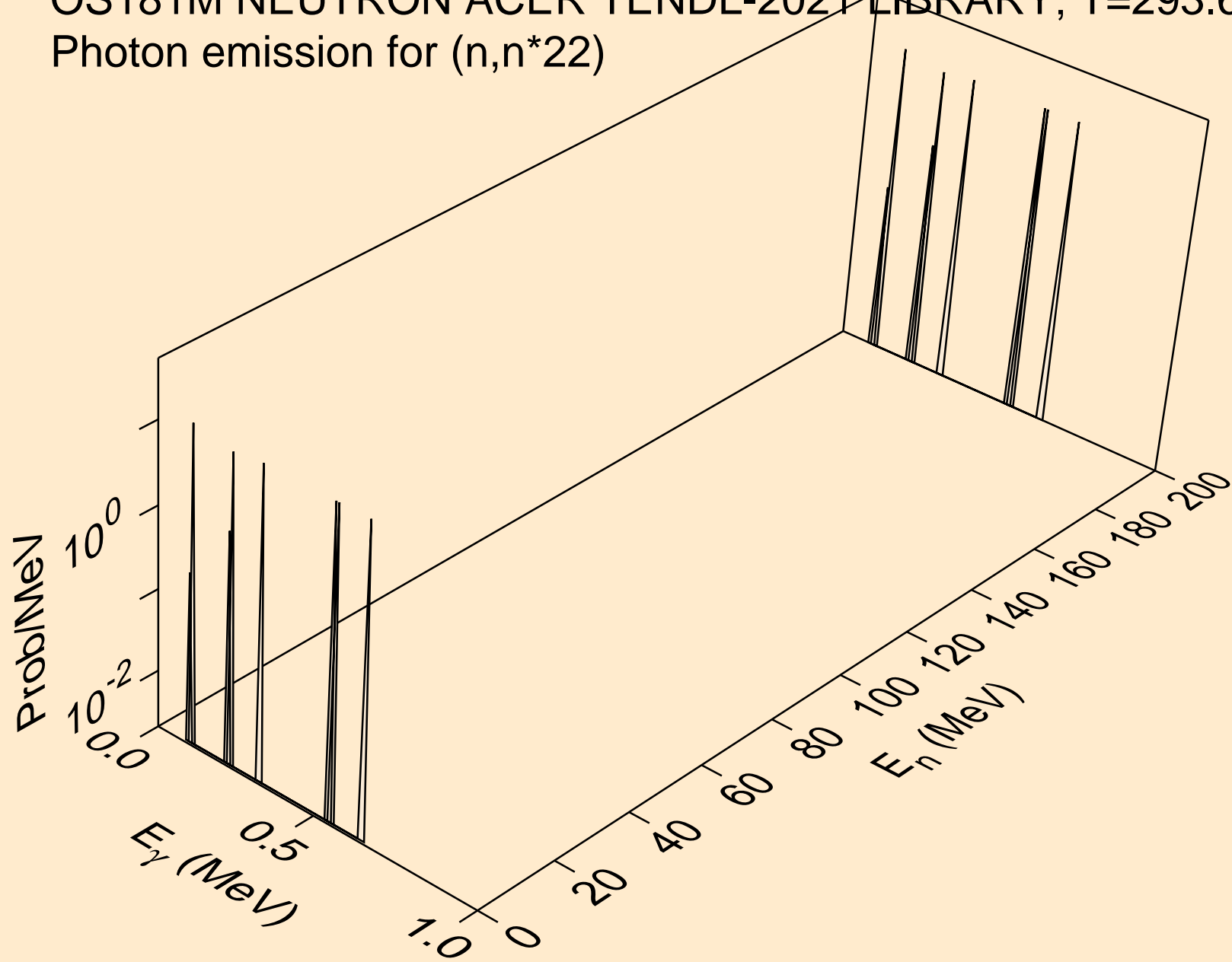

OS181M NEUTRON ACER TENDL-2021 LIBRARY; T=293.6K  
Photon emission for (n,n\*23)

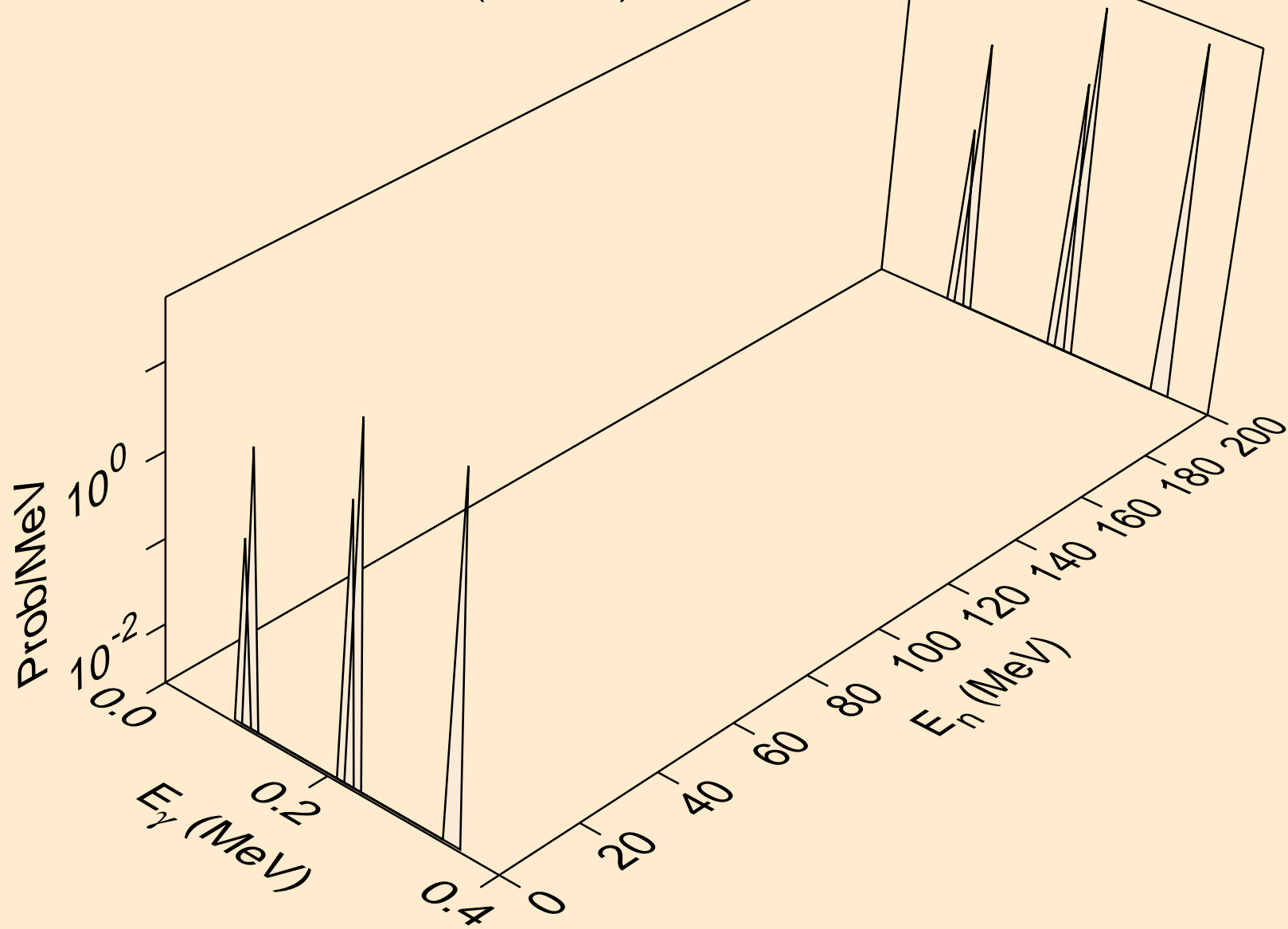

OS181M NEUTRON ACER TENDL-2021 LIBRARY; T=293.6K  
Photon emission for (n,n\*24)

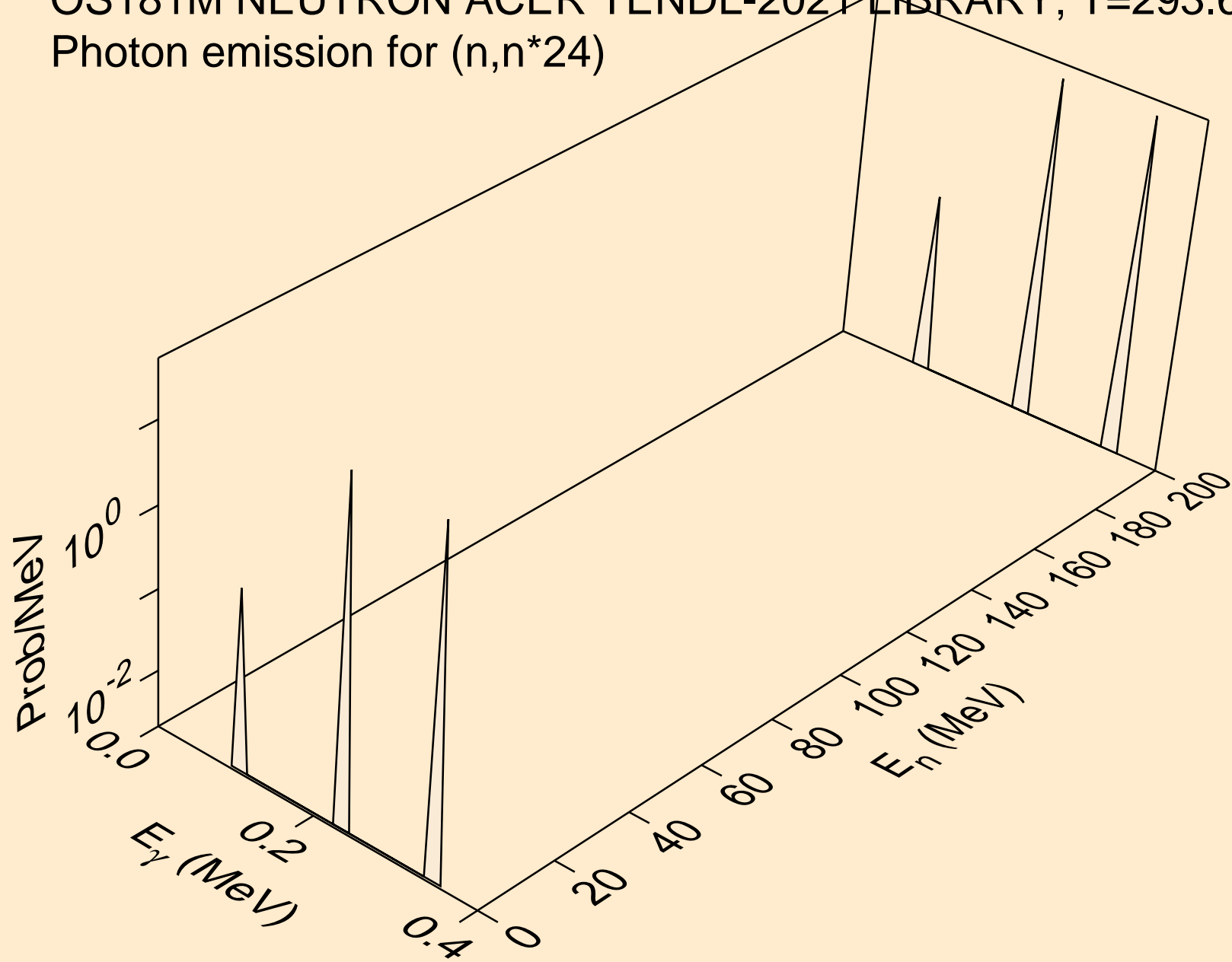

OS181M NEUTRON ACER TENDL-2021 LIBRARY; T=293.6K  
Photon emission for (n,n\*25)

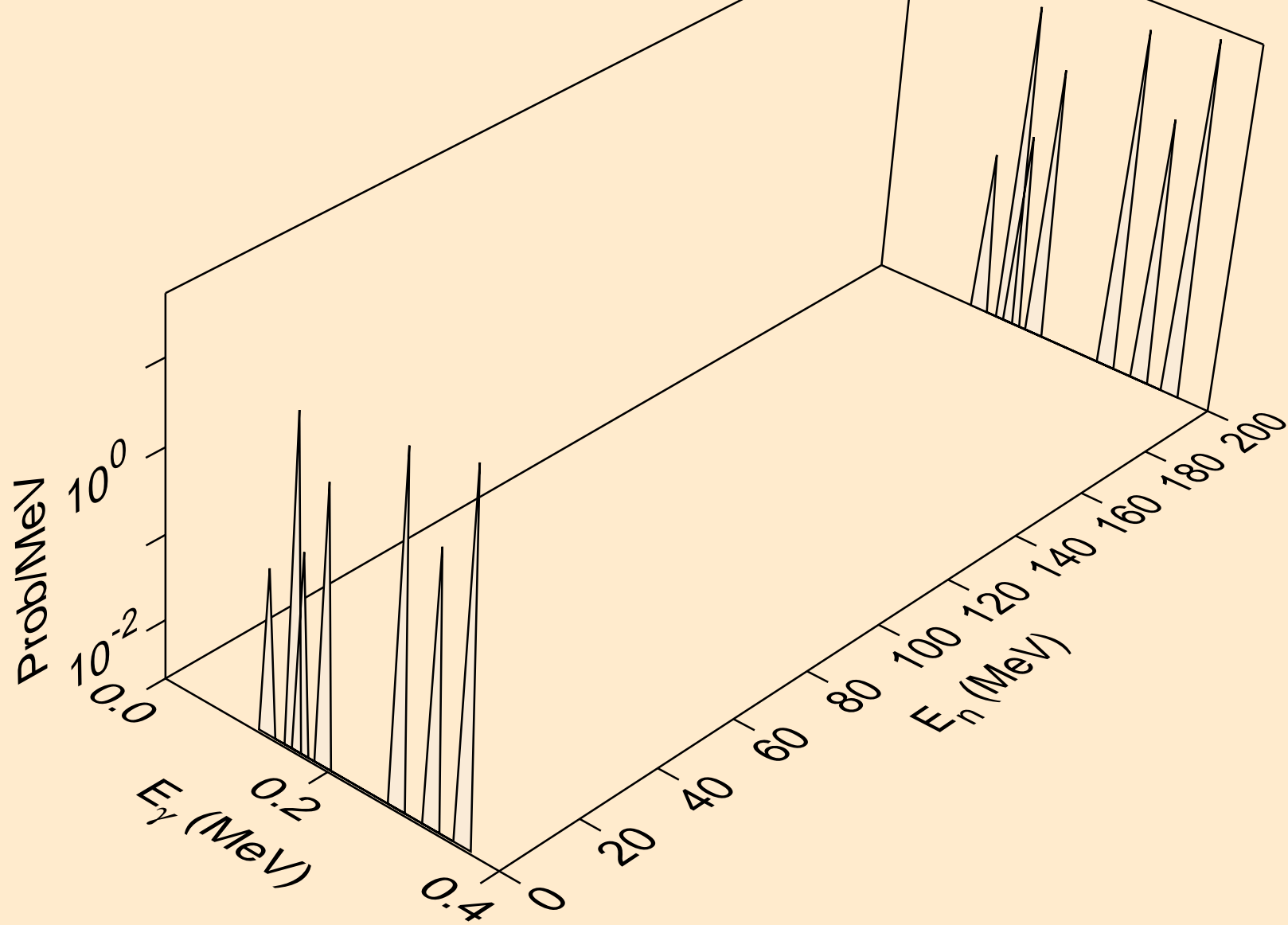

OS181M NEUTRON ACER TENDL-2021 LIBRARY; T=293.6K  
Photon emission for (n,n\*26)

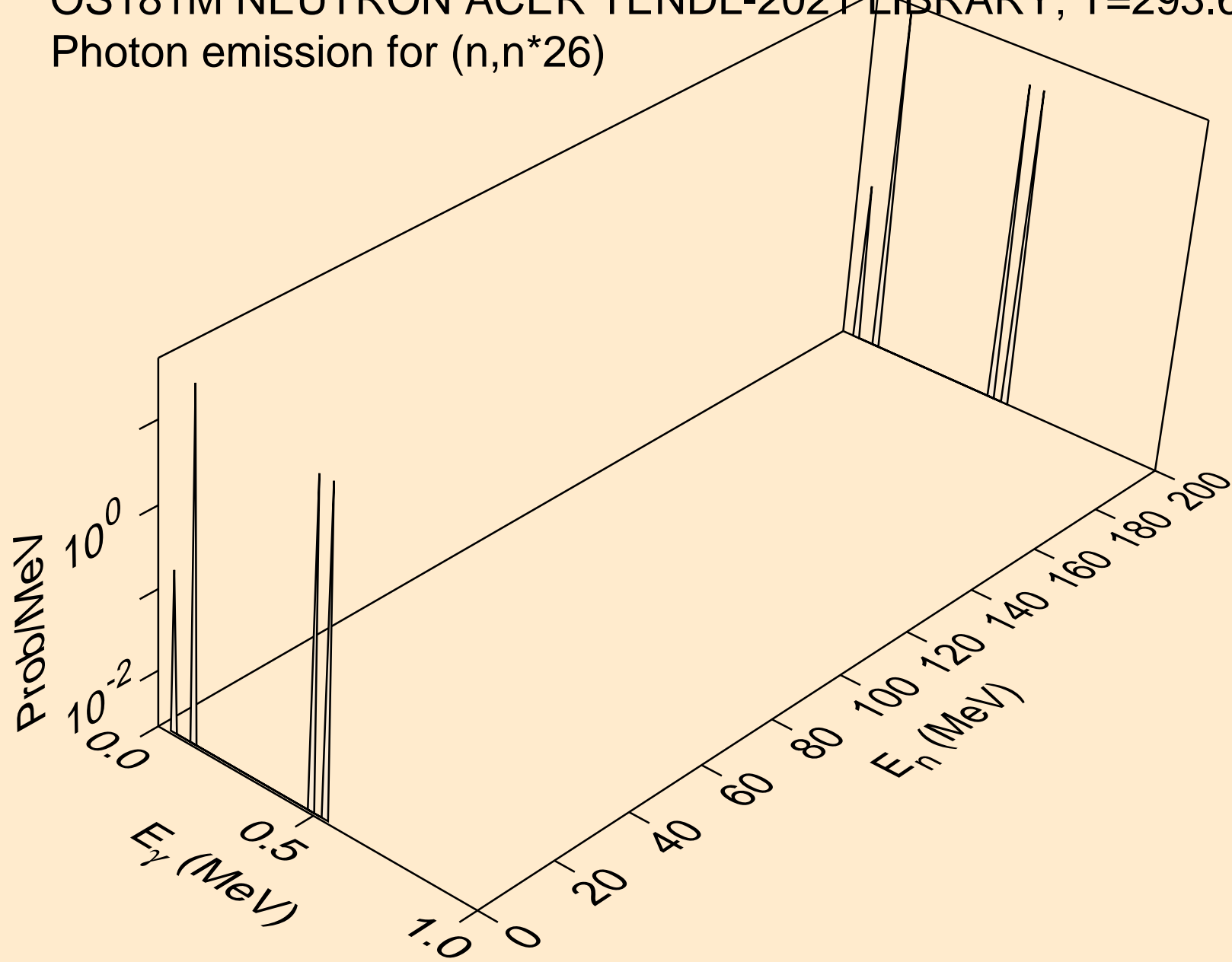



OS181M NEUTRON ACER TENDL-2021 LIBRARY; T=293.6K  
Photon emission for (n,n\*c)

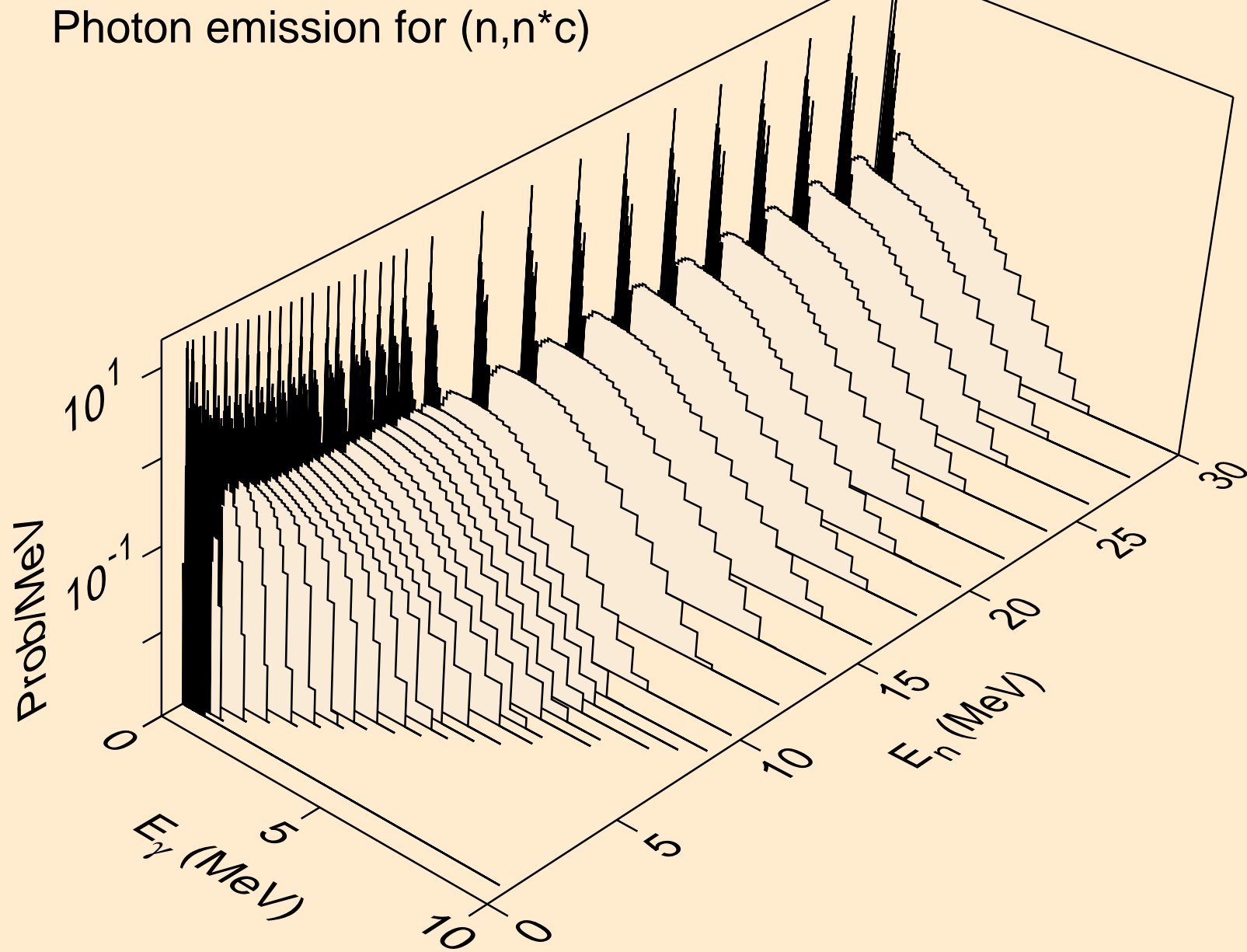

OS181M NEUTRON ACER TENDL-2021 LIBRARY; T=293.6K  
Photon emission for (n,gma)

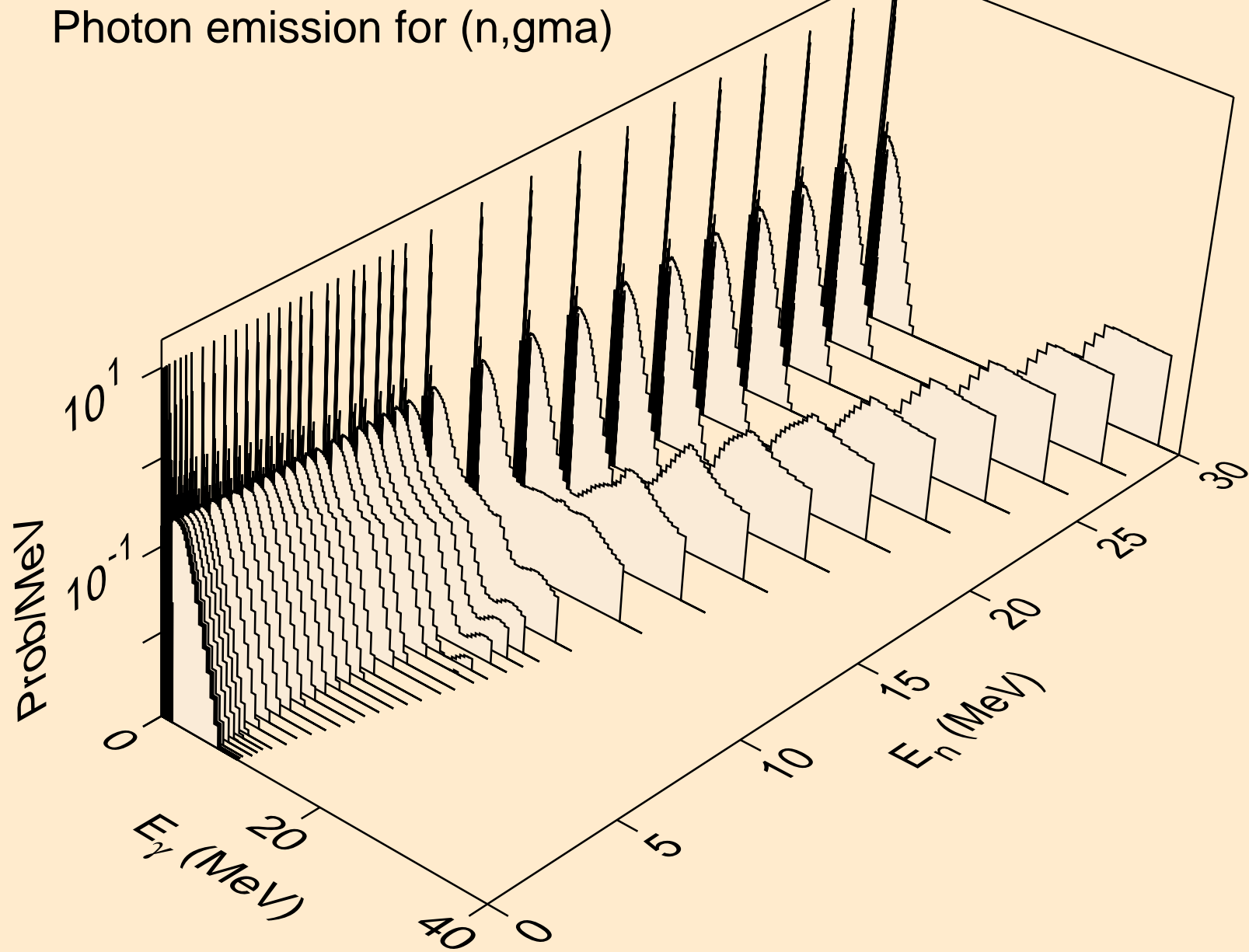

OS181M NEUTRON ACER TENDL-2021 LIBRARY; T=293.6K  
Photon emission for (n,p)

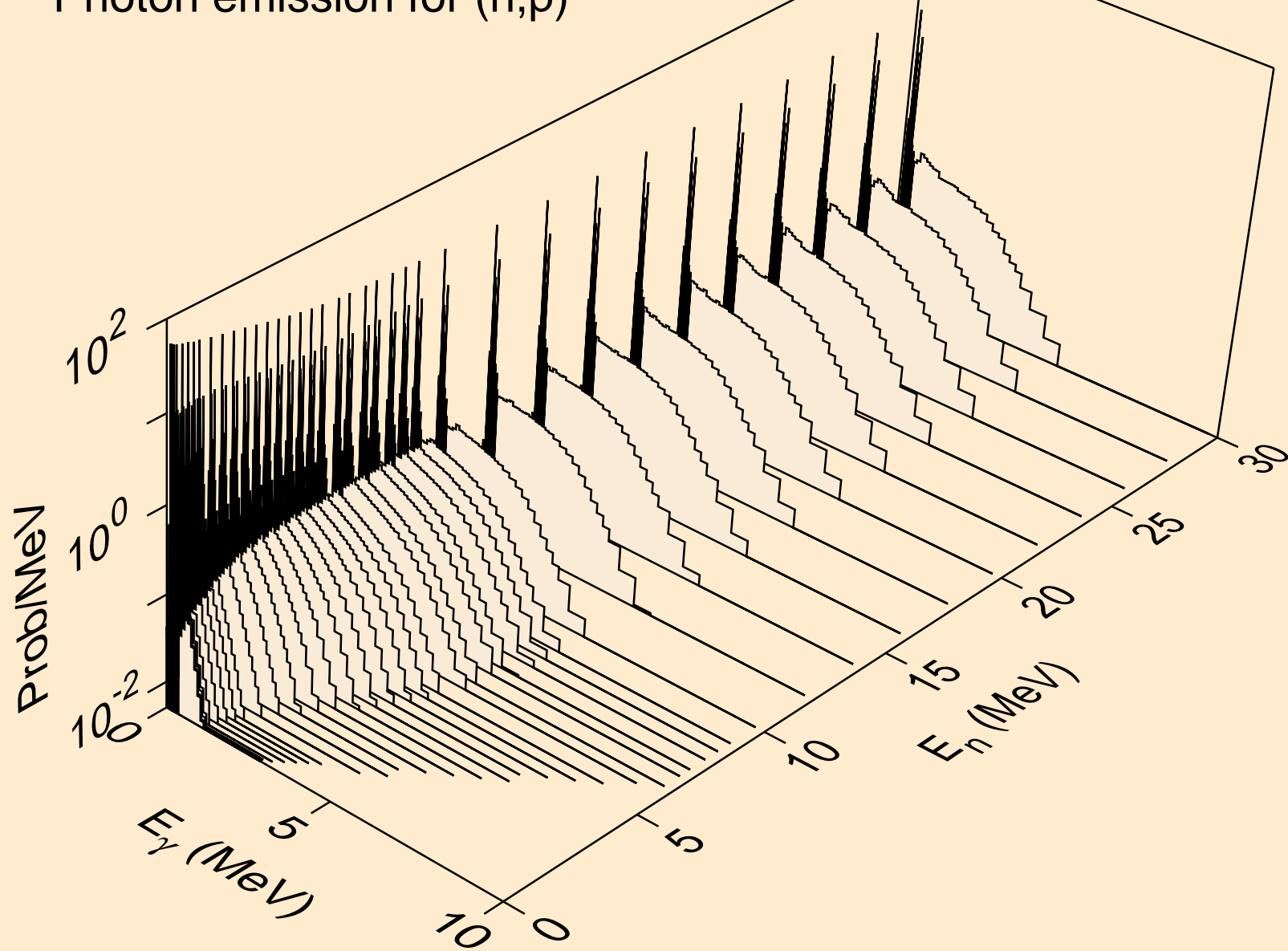

OS181M NEUTRON ACER TENDL-2021 LIBRARY; T=293.6K  
Photon emission for (n,d)

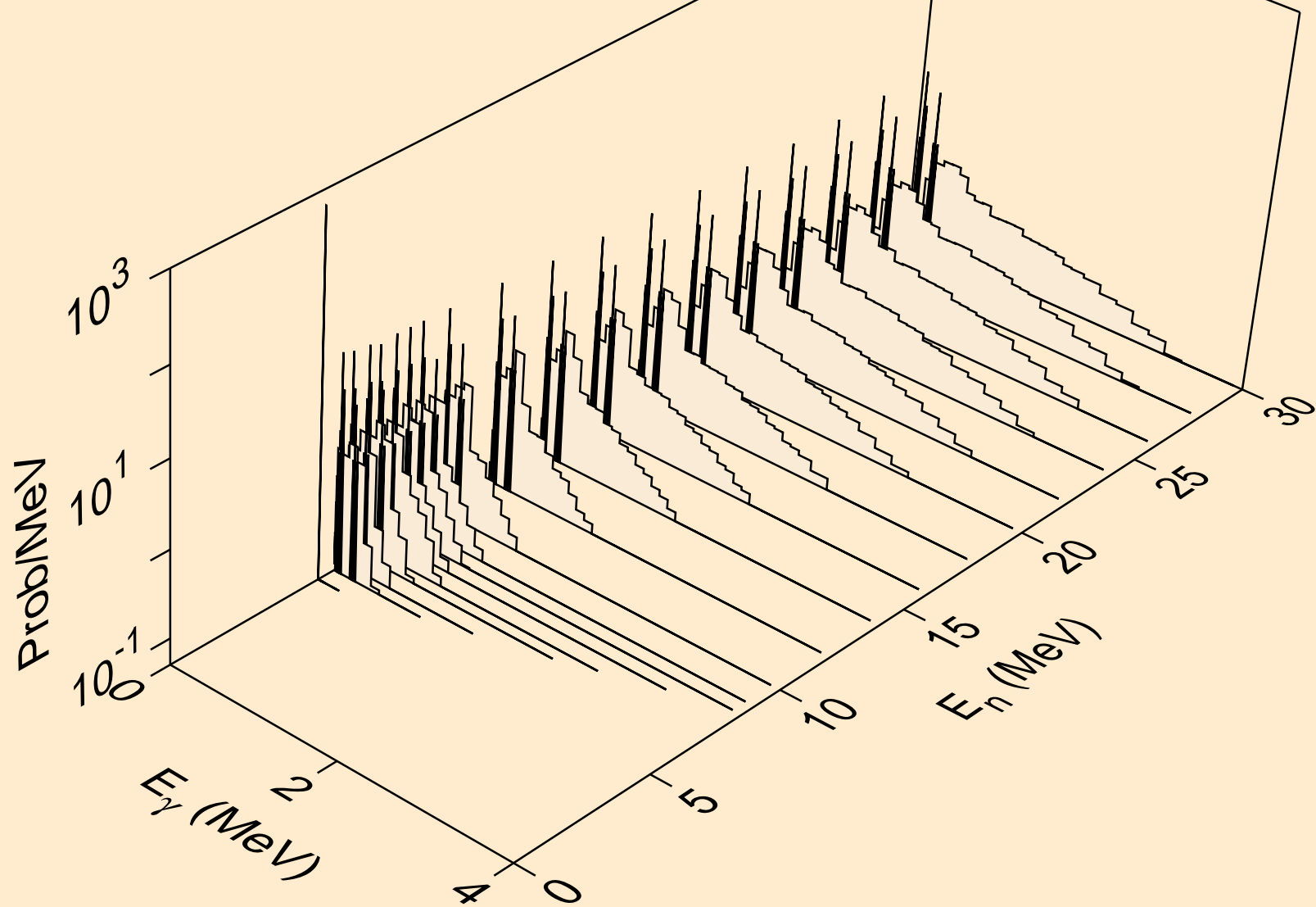

OS181M NEUTRON ACER TENDL-2021 LIBRARY; T=293.6K  
Photon emission for (n,t)

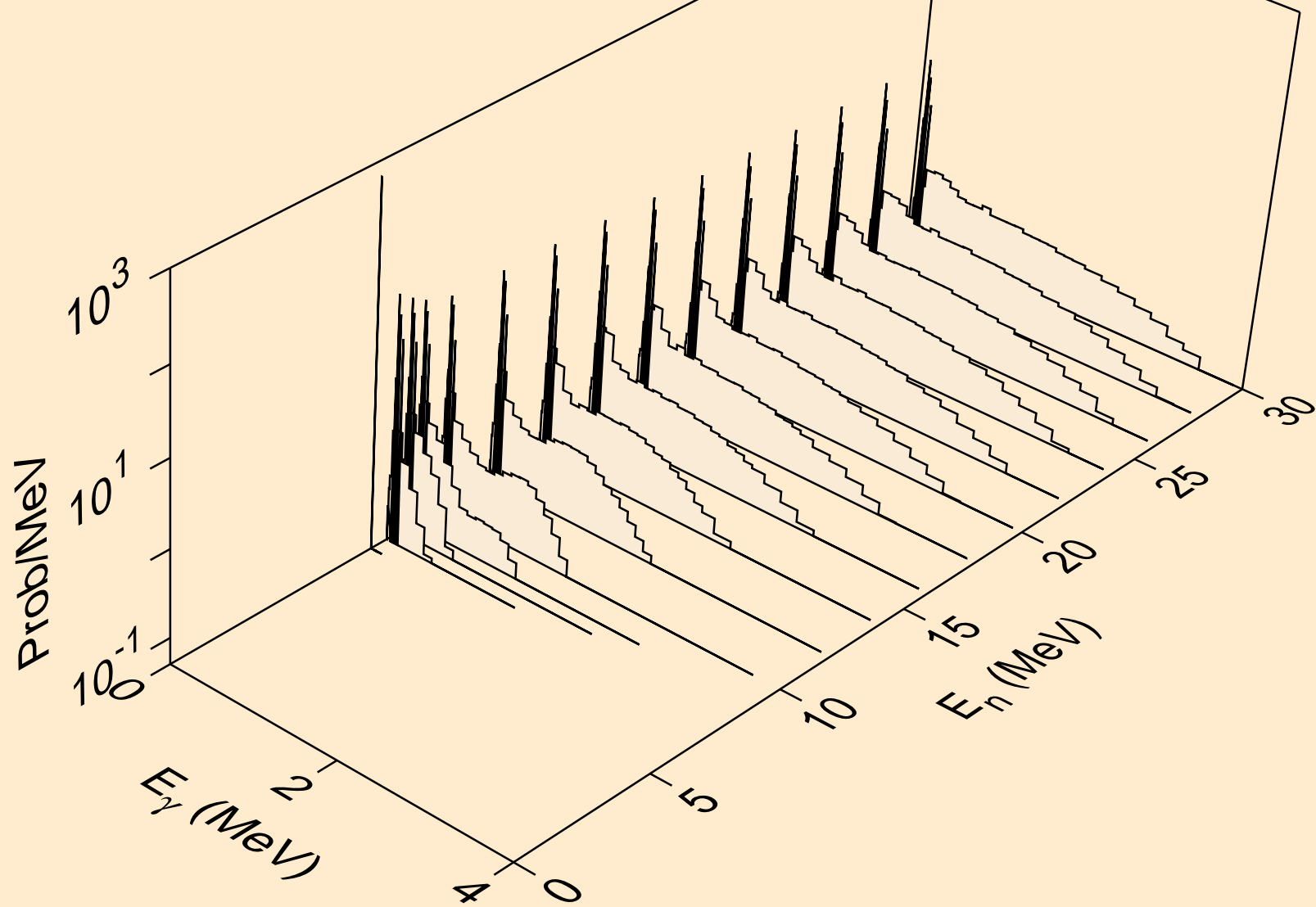

OS181M NEUTRON ACER TENDL-2021 LIBRARY; T=293.6K  
Photon emission for (n,he3)

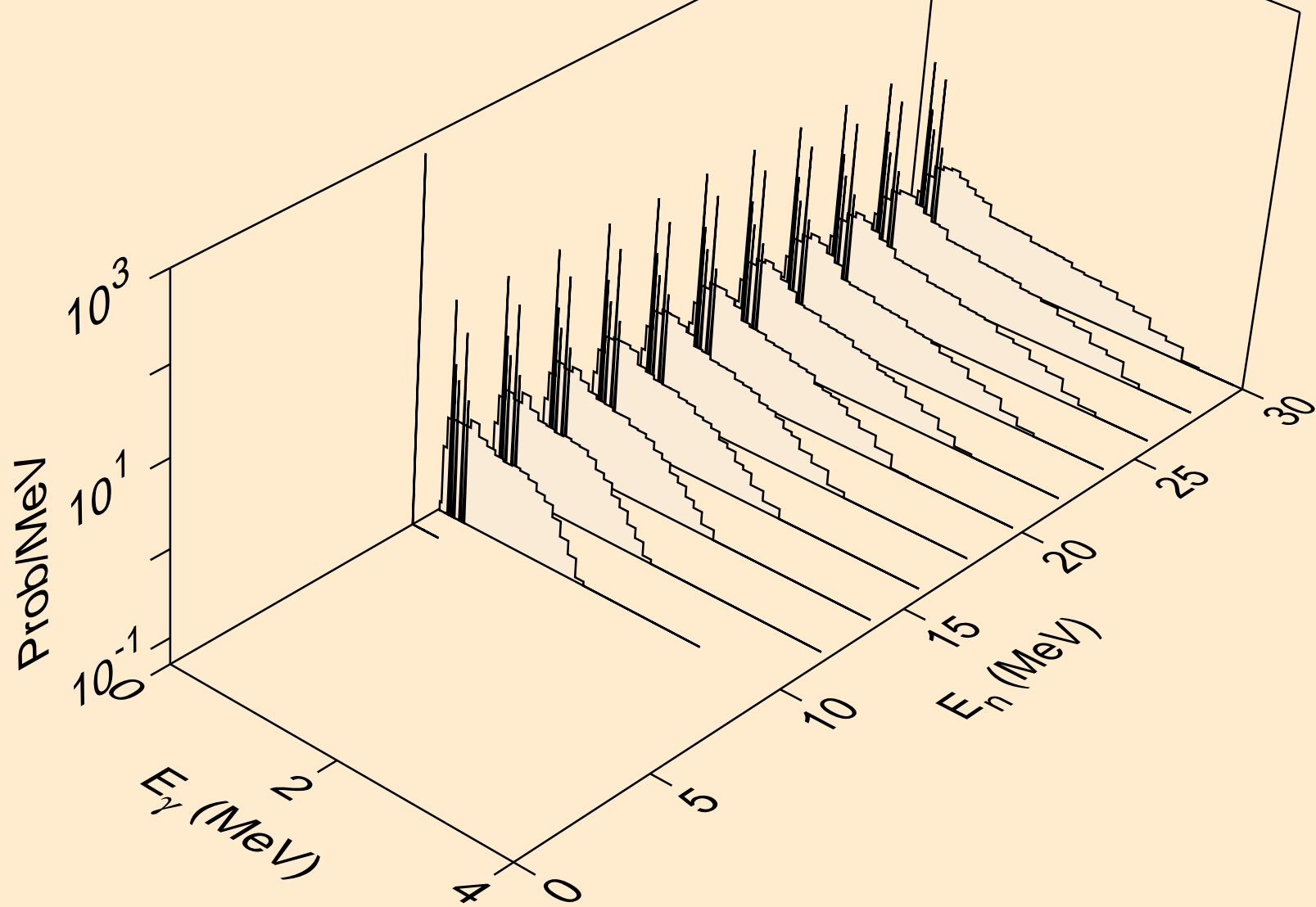

OS181M NEUTRON ACER TENDL-2021 LIBRARY; T=293.6K  
Photon emission for (n,a)

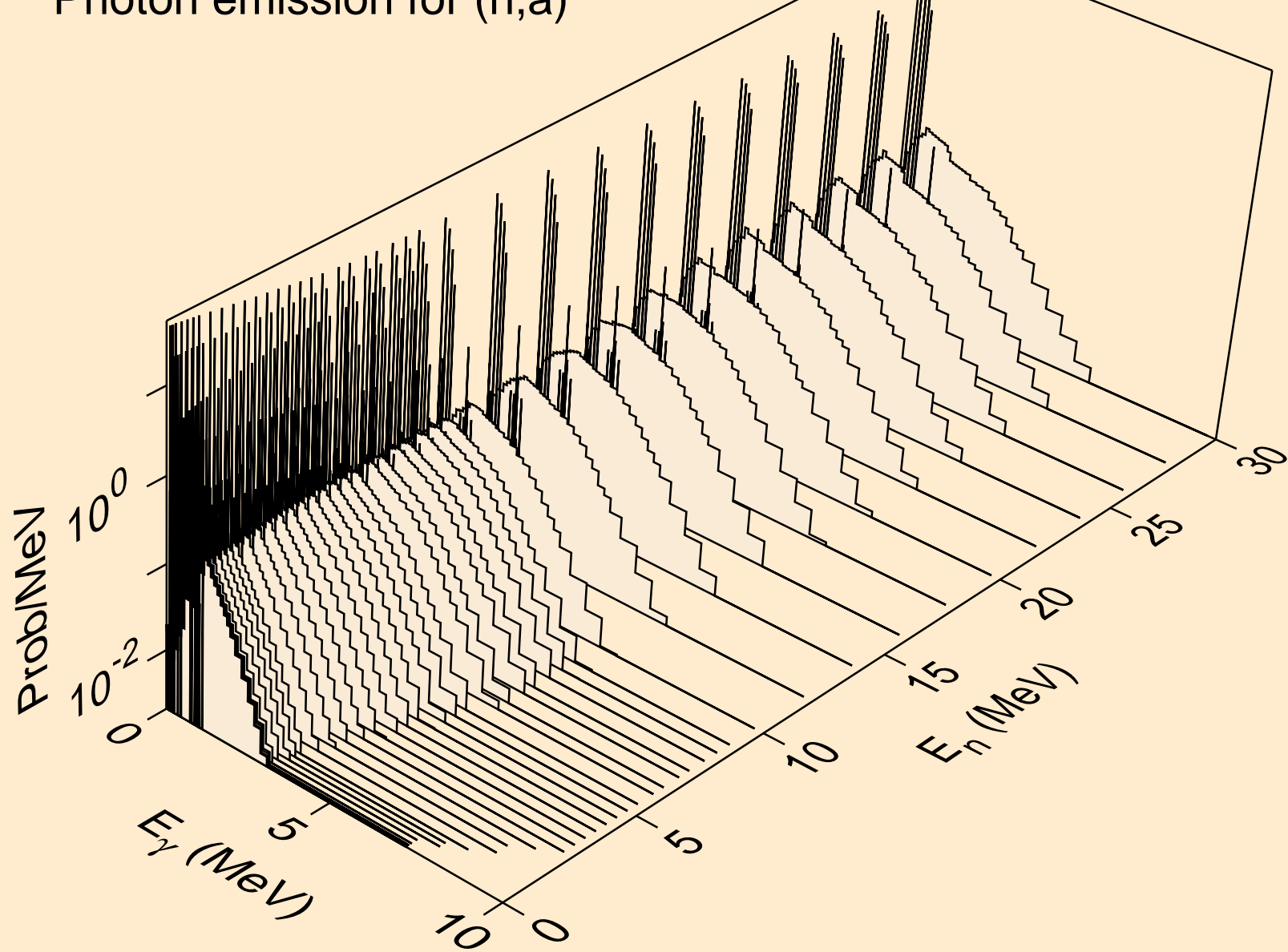

OS181M NEUTRON ACER TENDL-2021 LIBRARY; T=293.6K  
Photon emission for (n,2a)

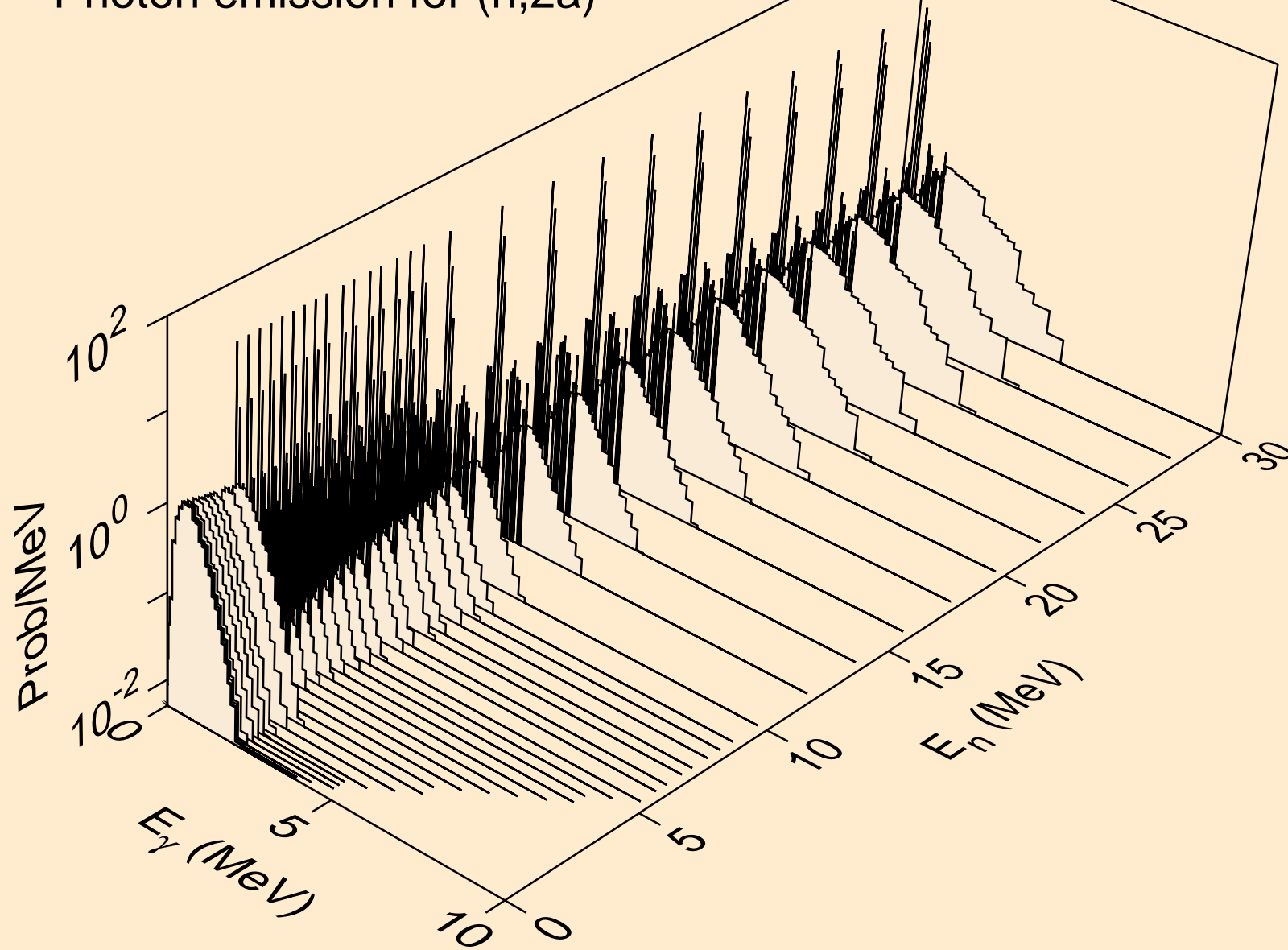



OS181M NEUTRON ACER TENDL-2021 LIBRARY; T=293.6K  
Photon emission for (n,2p)

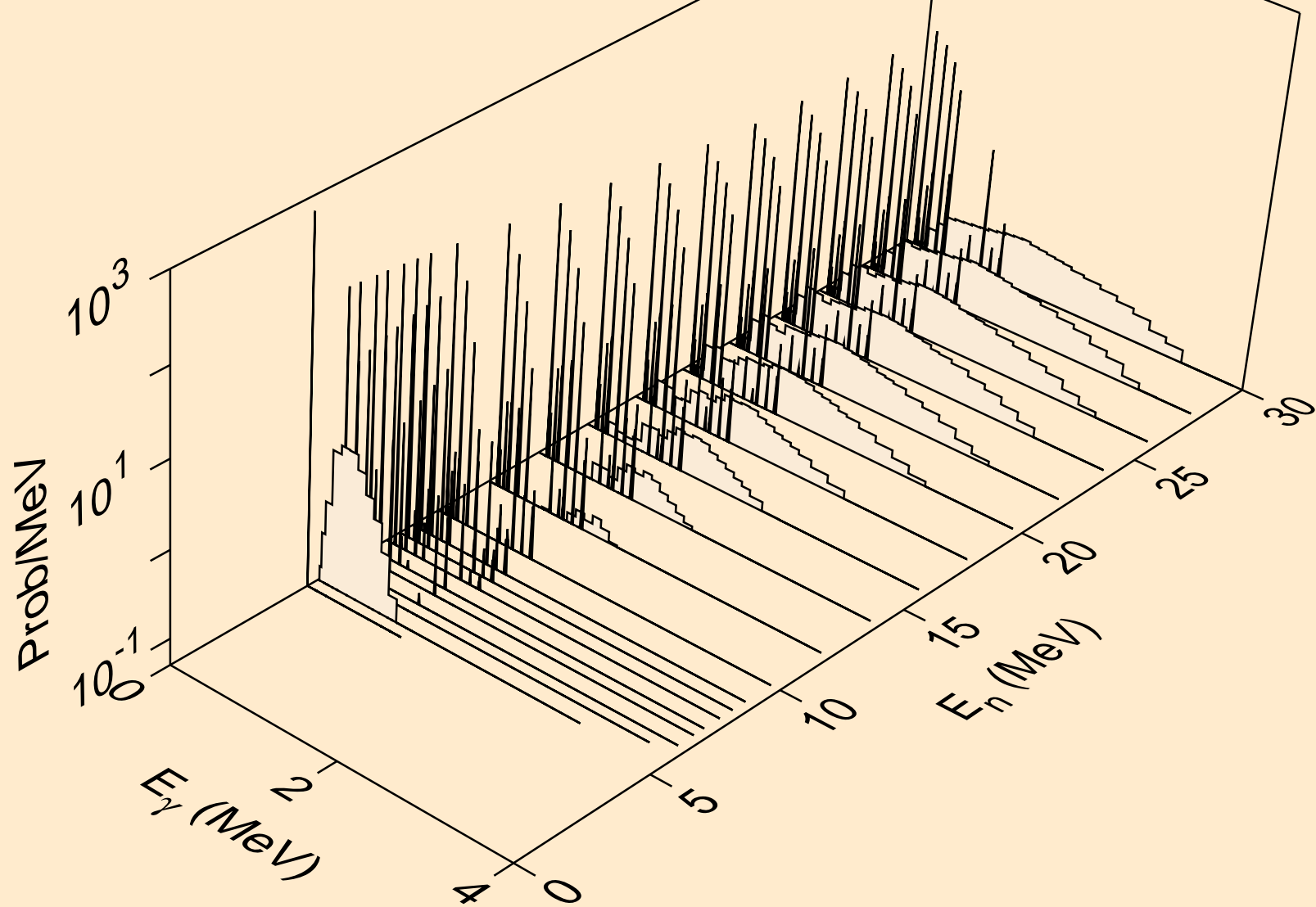

OS181M NEUTRON ACER TENDL-2021 LIBRARY; T=293.6K  
Photon emission for (n,p $\alpha$ )

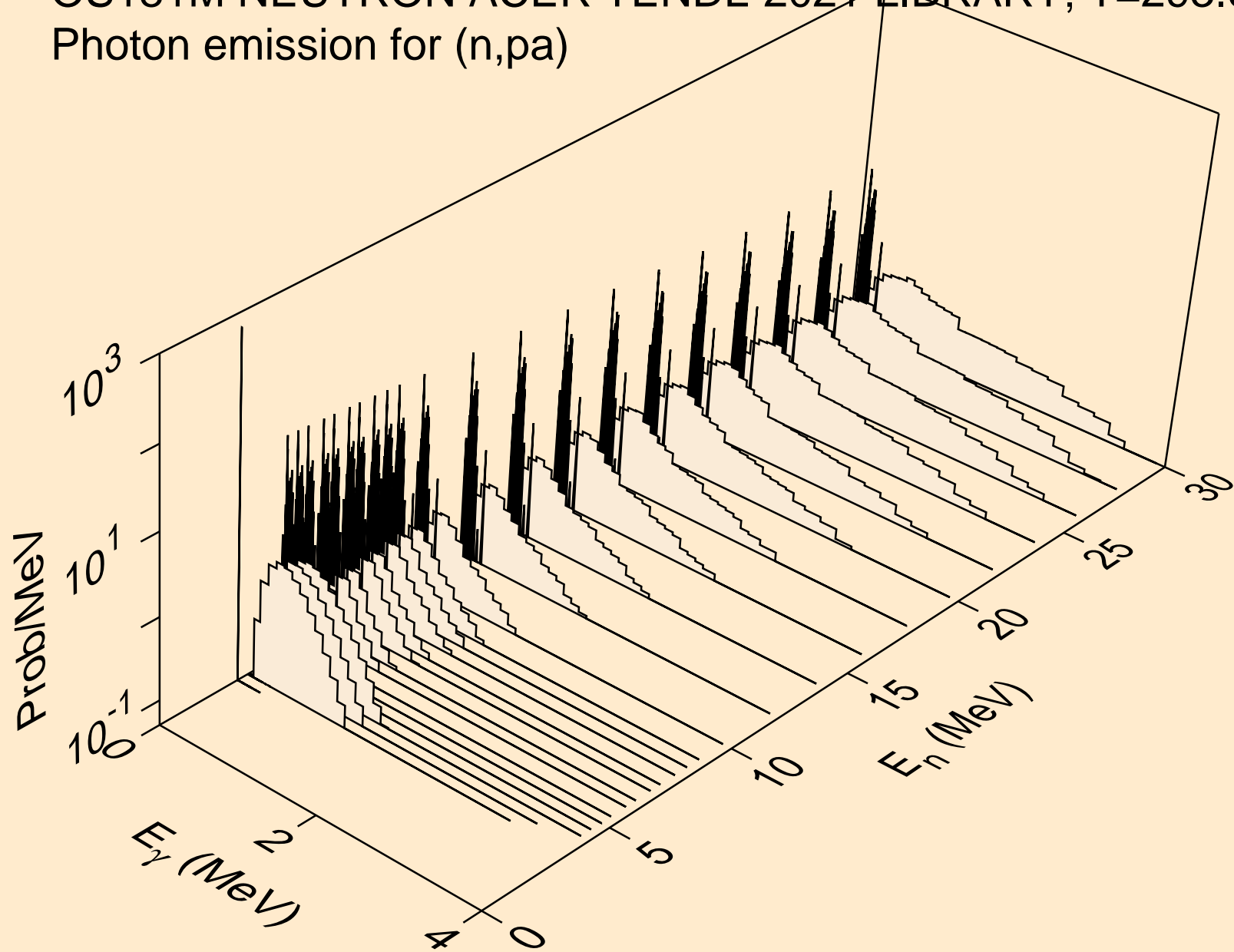

OS181M NEUTRON ACER TENDL-2021 LIBRARY; T=293.6K  
Photon emission for (n,pd)

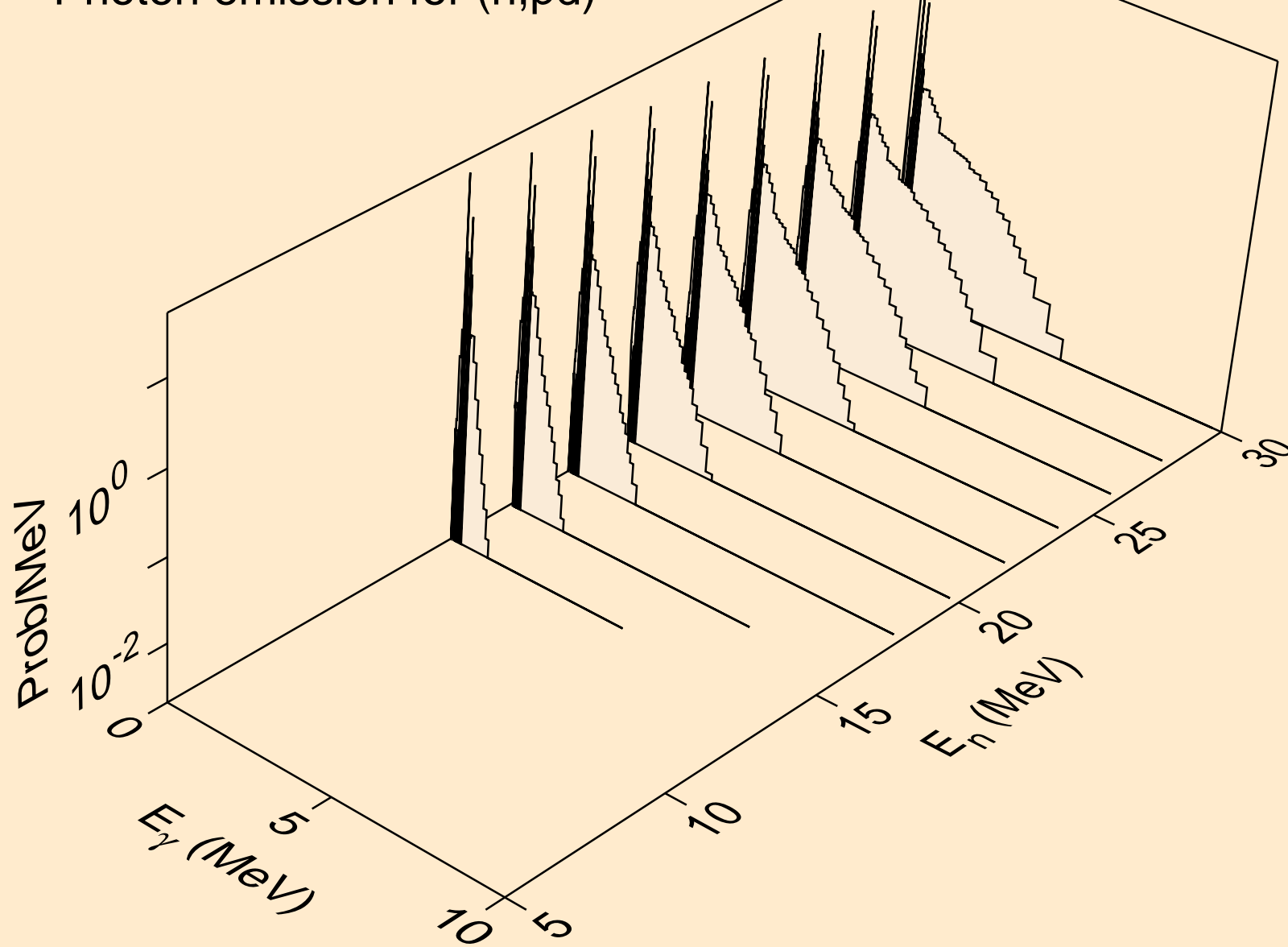

OS181M NEUTRON ACER TENDL-2021 LIBRARY; T=293.6K  
Photon emission for (n,pt)

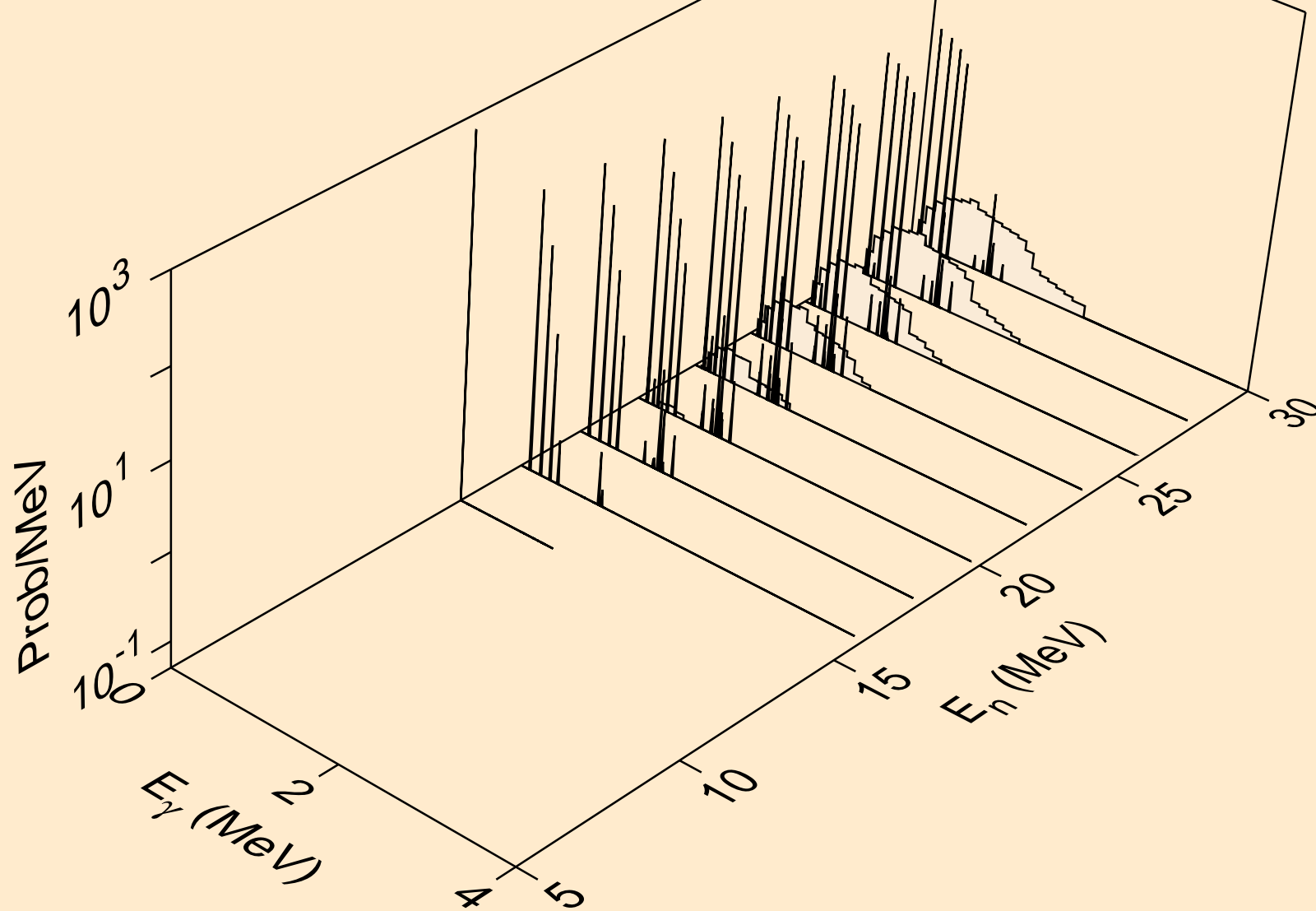

OS181M NEUTRON ACER TENDL-2021 LIBRARY; T=293.6K  
Photon emission for (n,da)

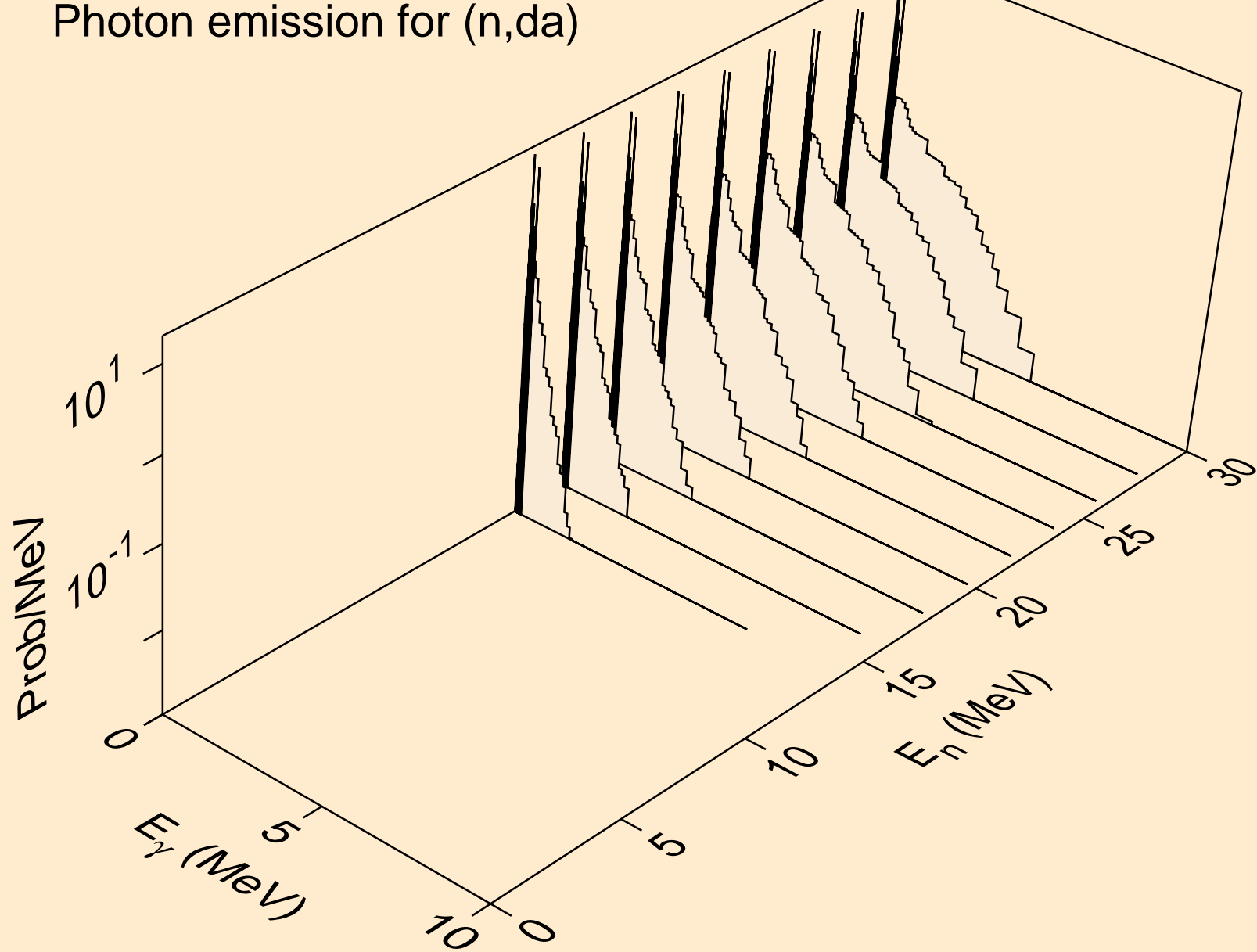

OS181M NEUTRON ACER TENDL-2021 LIBRARY; T=293.6K  
thermal capture photon spectrum

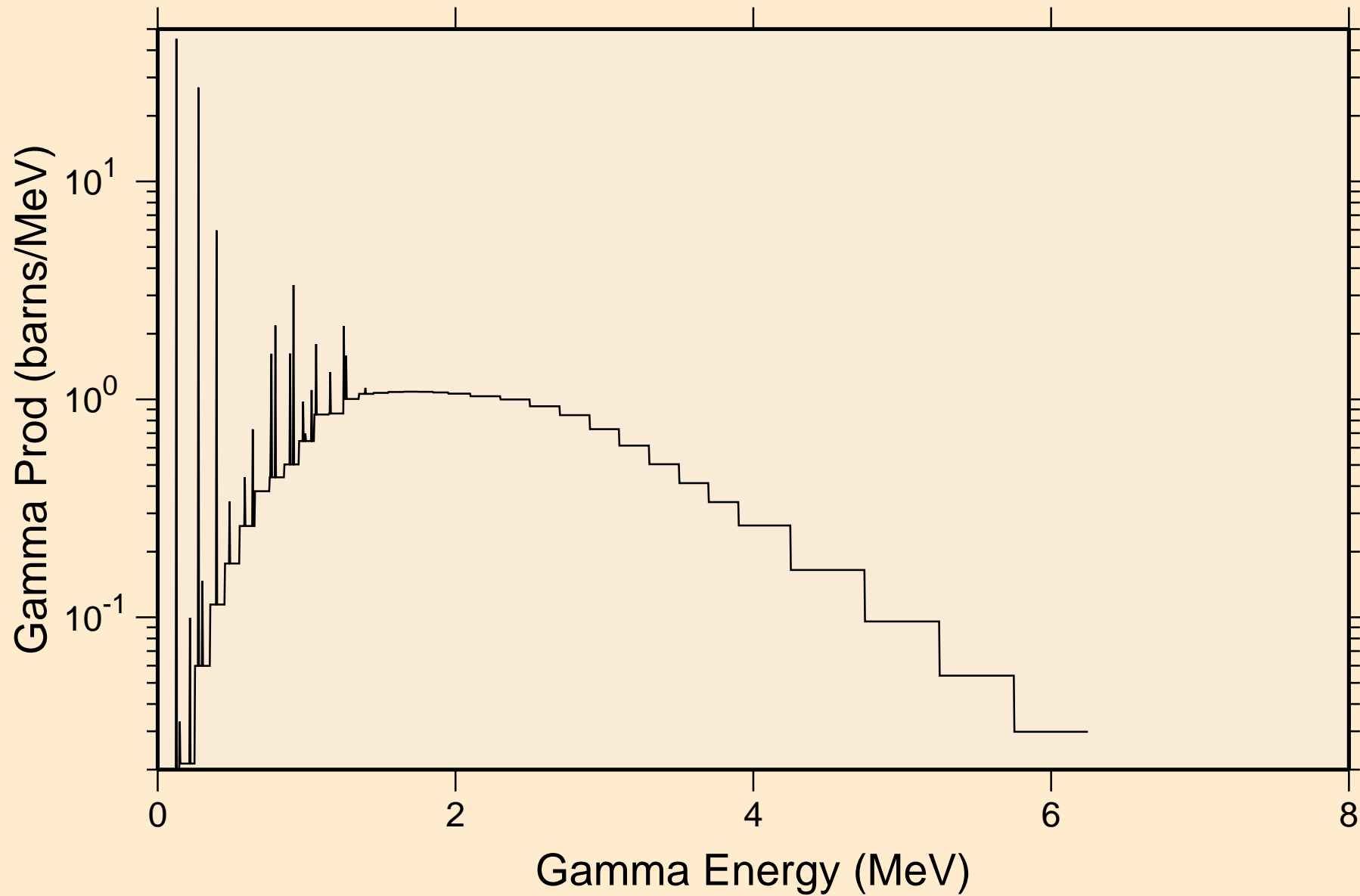

OS181M NEUTRON ACER TENDL-2021 LIBRARY; T=293.6K  
14 MeV photon spectrum

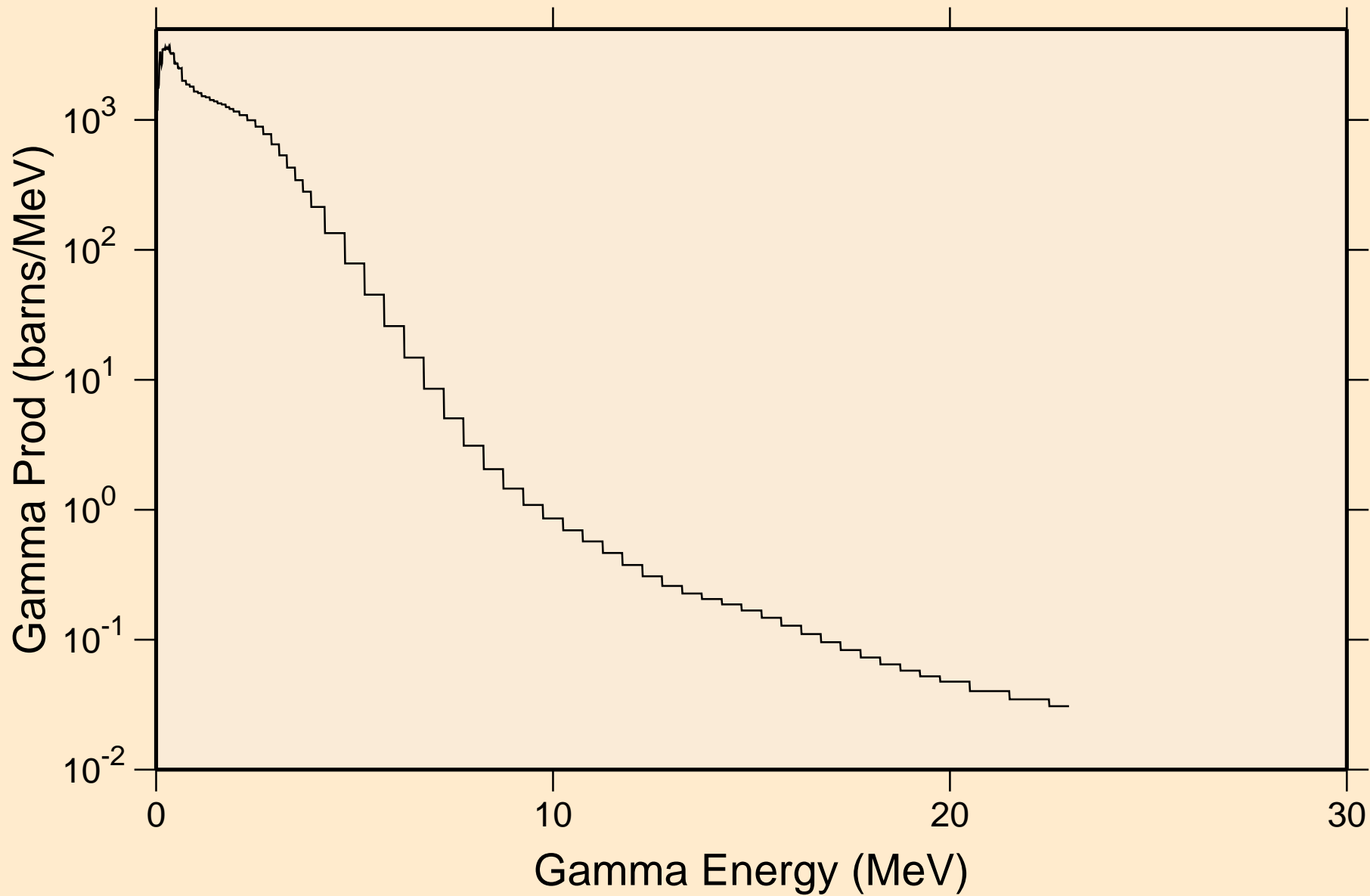

OS181M NEUTRON ACER TENDL-2021 LIBRARY; T=293.6K  
Particle heating contributions

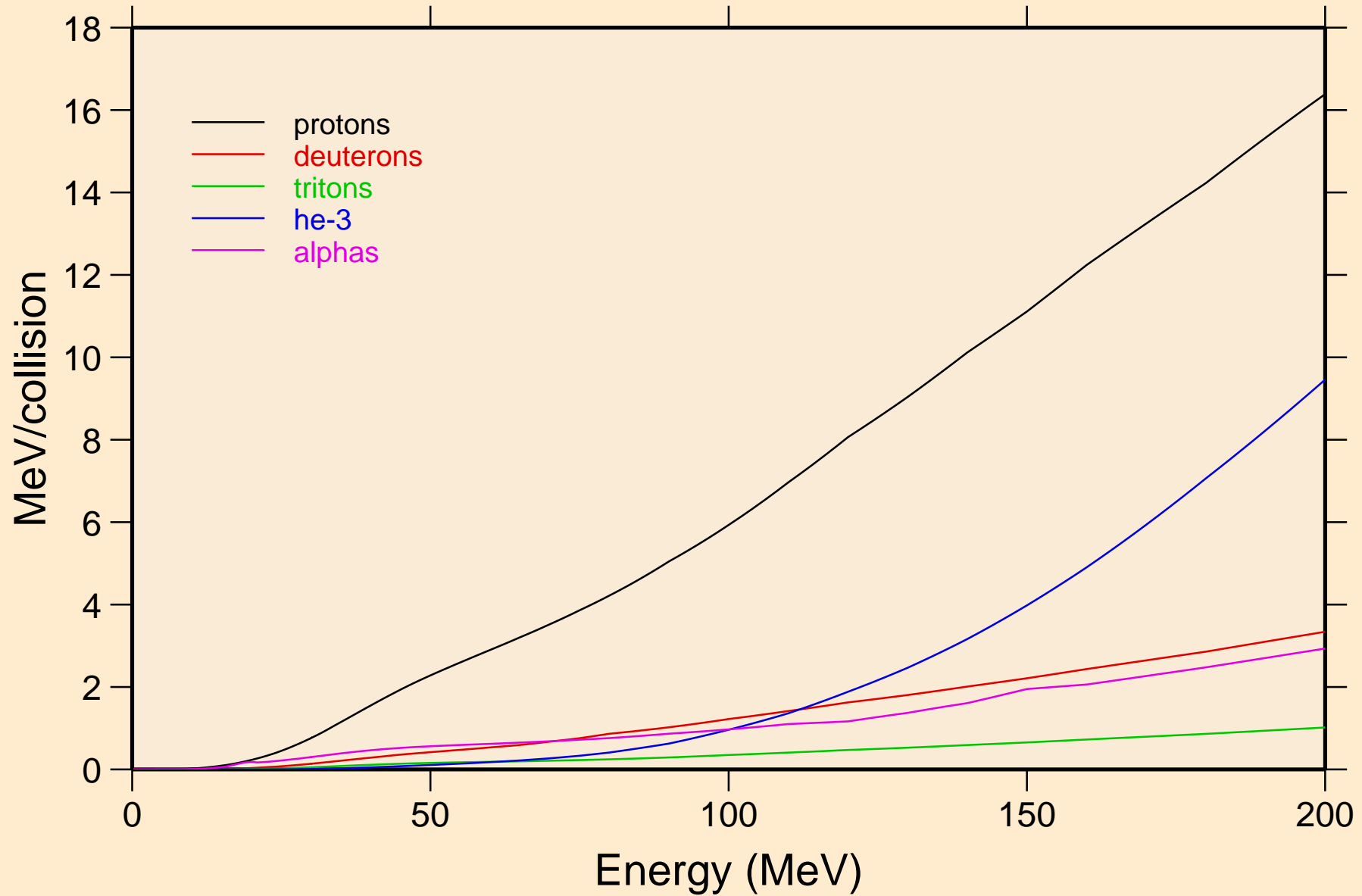



OS181M NEUTRON ACER TENDL-2021 LIBRARY; T=293.6K  
Recoil Heating

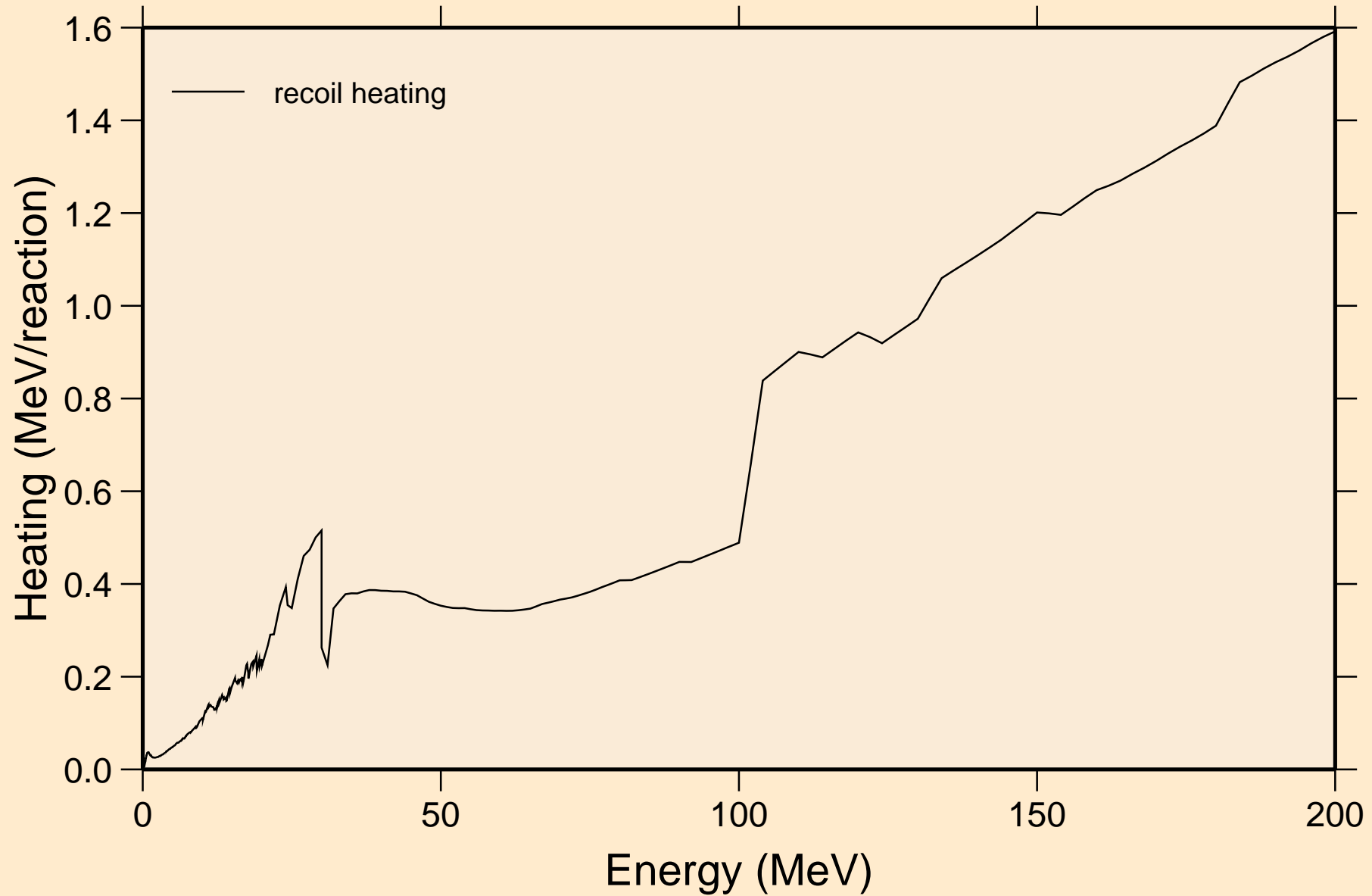

OS181M NEUTRON ACER TENDL-2021 LIBRARY; T=293.6K  
Particle production cross sections

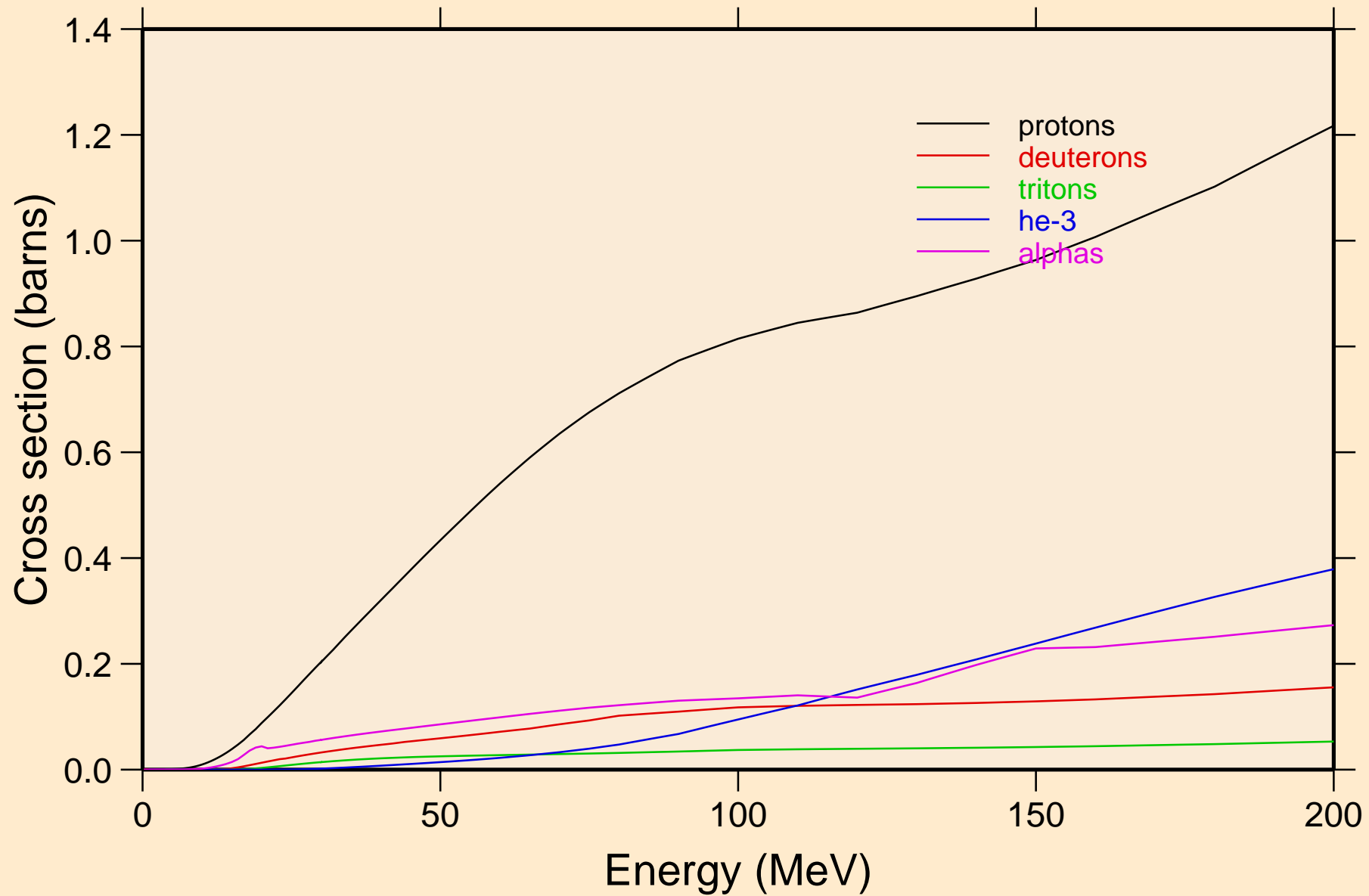

OS181M NEUTRON ACER TENDL-2021 LIBRARY; T=293.6K  
protons from (n,x)

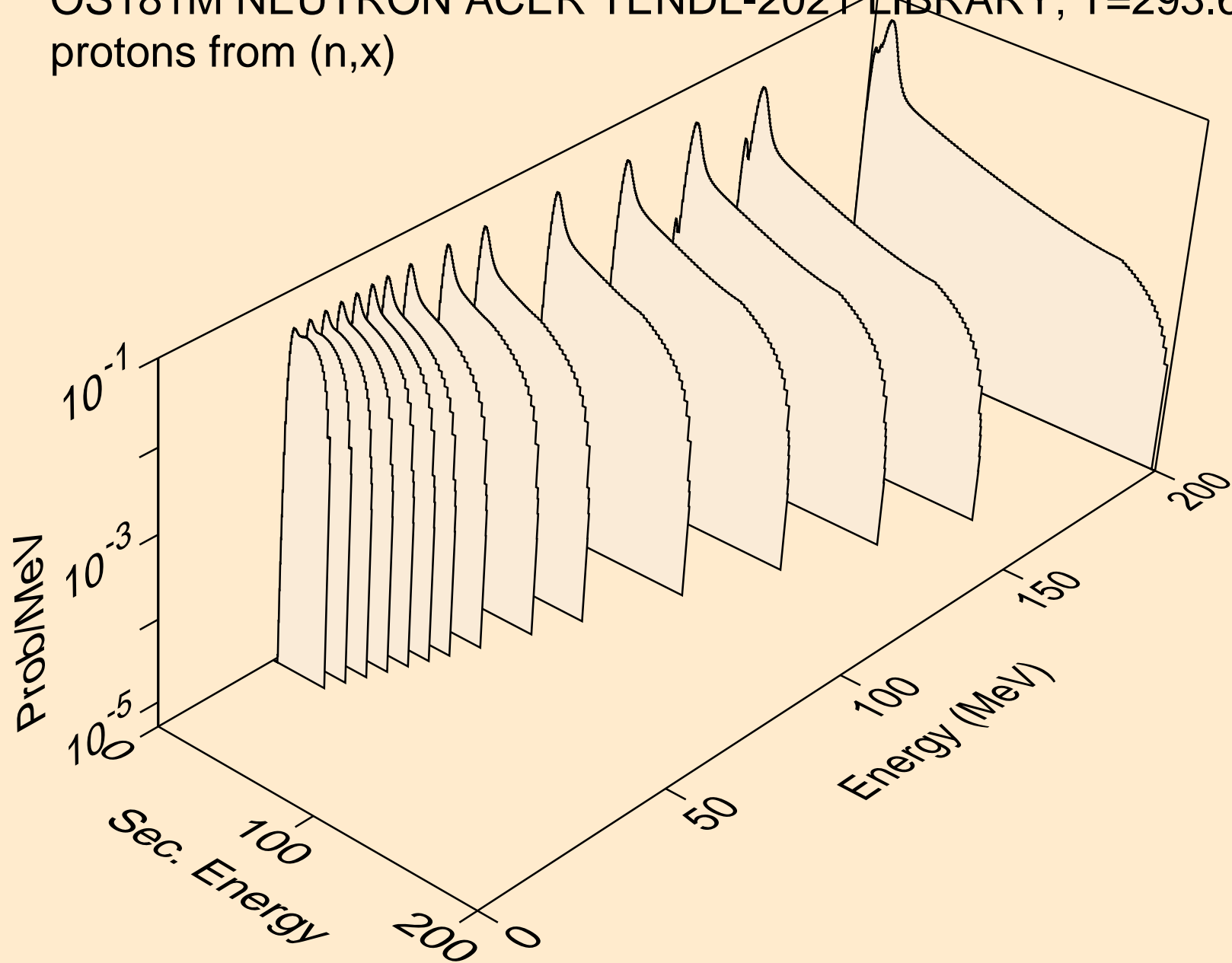

OS181M NEUTRON ACER TENDL-2021 LIBRARY; T=293.6K  
protons from (n,n\*)p

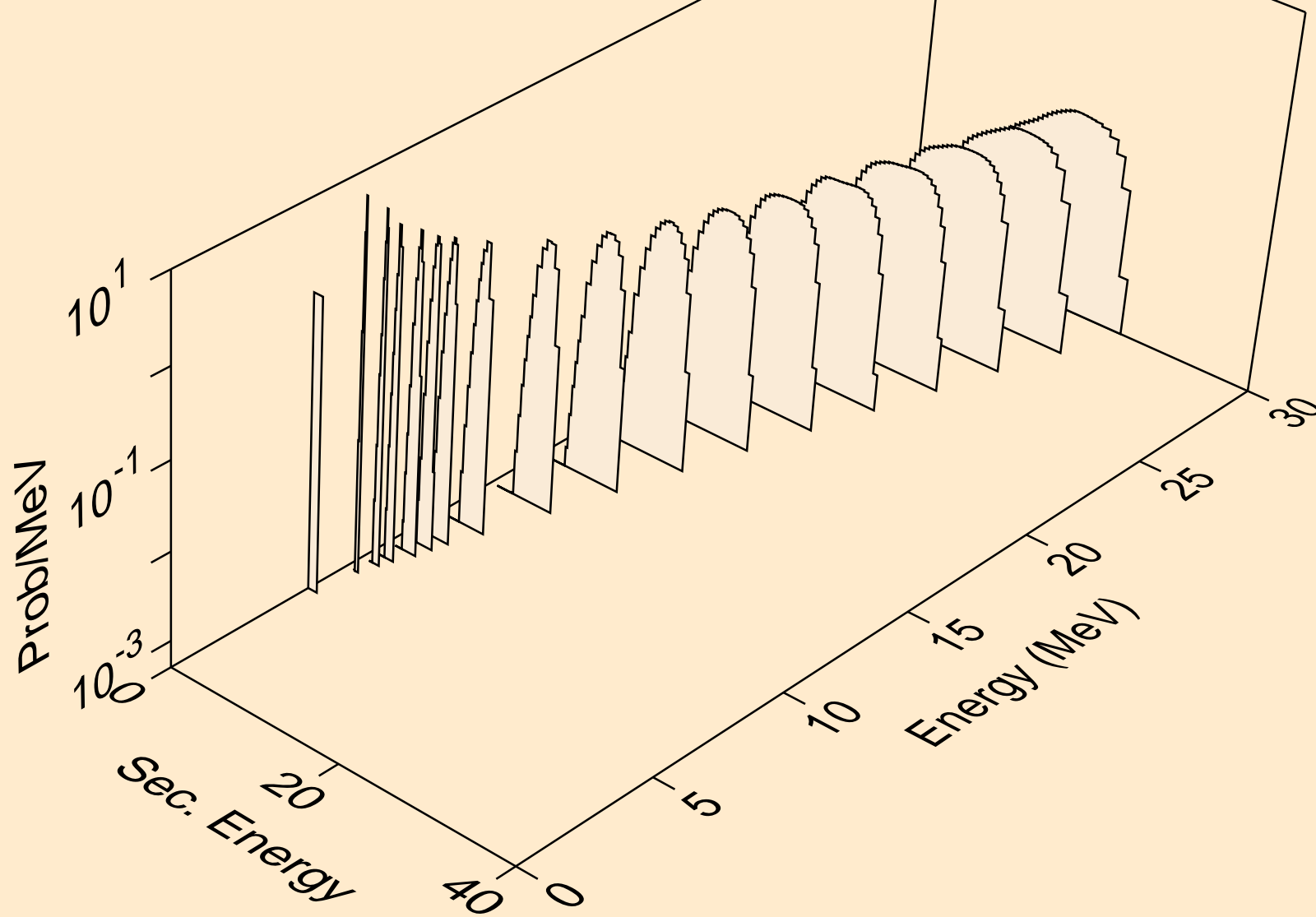

OS181M NEUTRON ACER TENDL-2021 LIBRARY; T=293.6K  
protons from (n,2np)

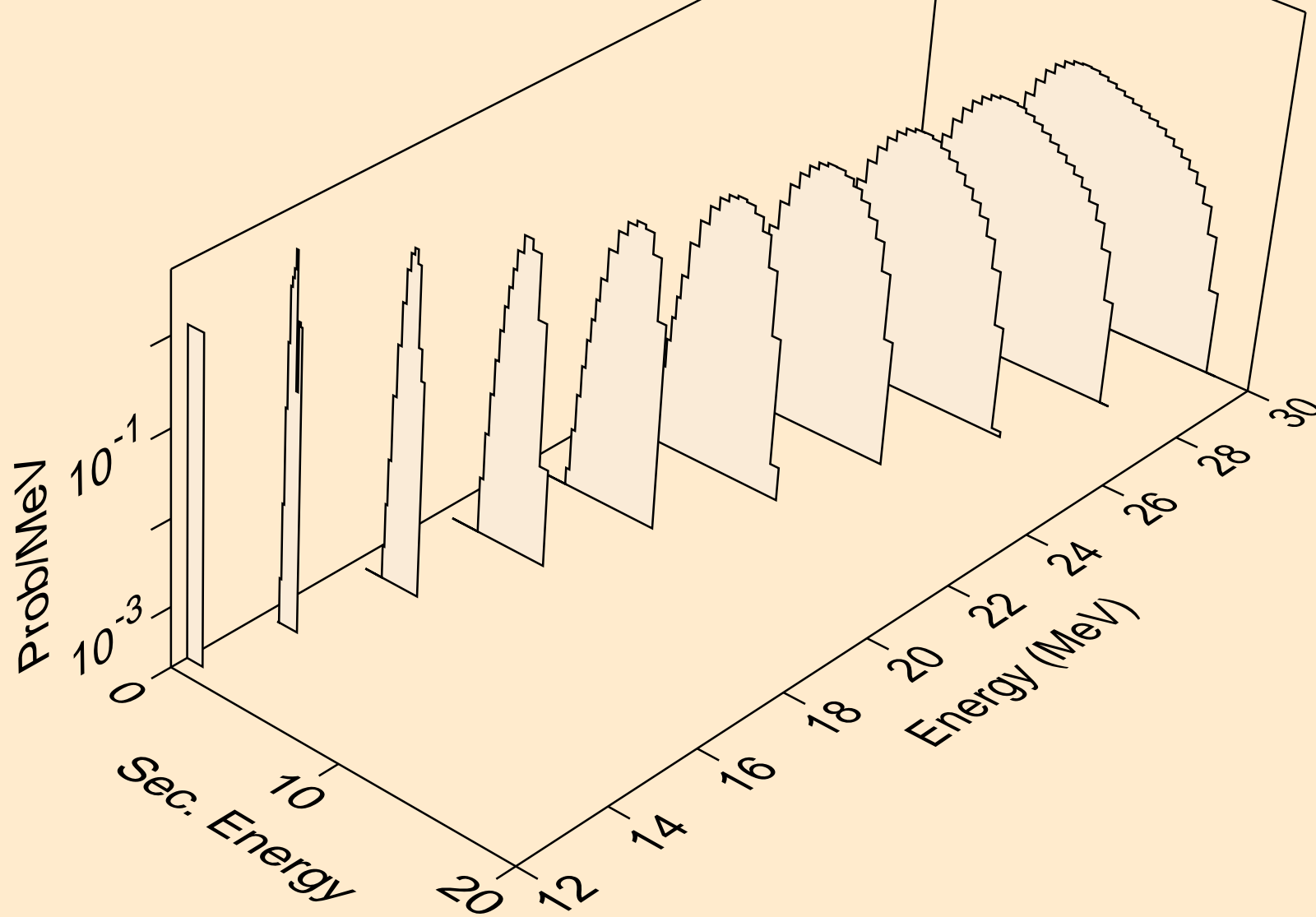

OS181M NEUTRON ACER TENDL-2021 LIBRARY; T=293.6K  
protons from (n,3np)

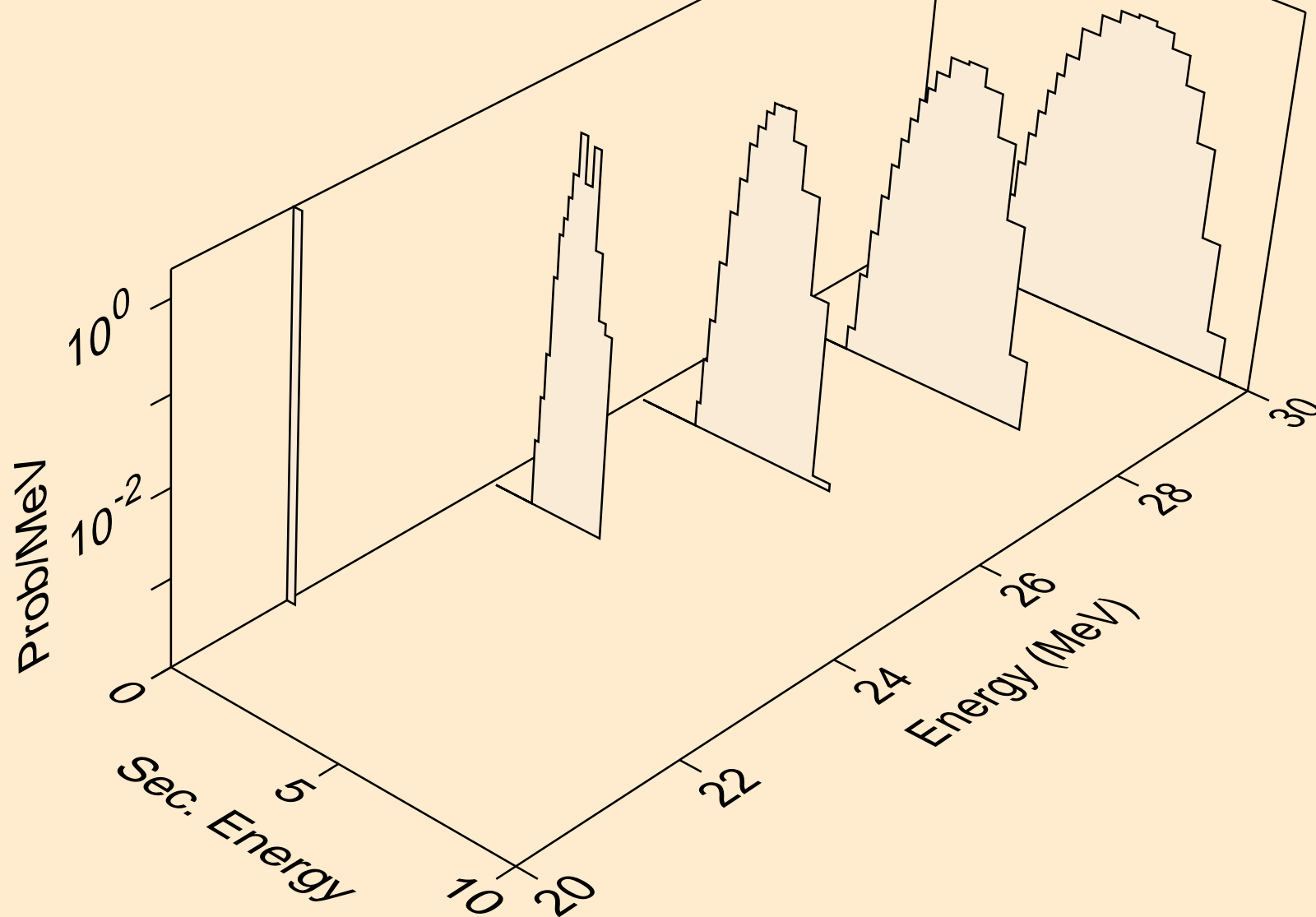

OS181M NEUTRON ACER TENDL-2021 LIBRARY; T=293.6K  
protons from (n,2np)

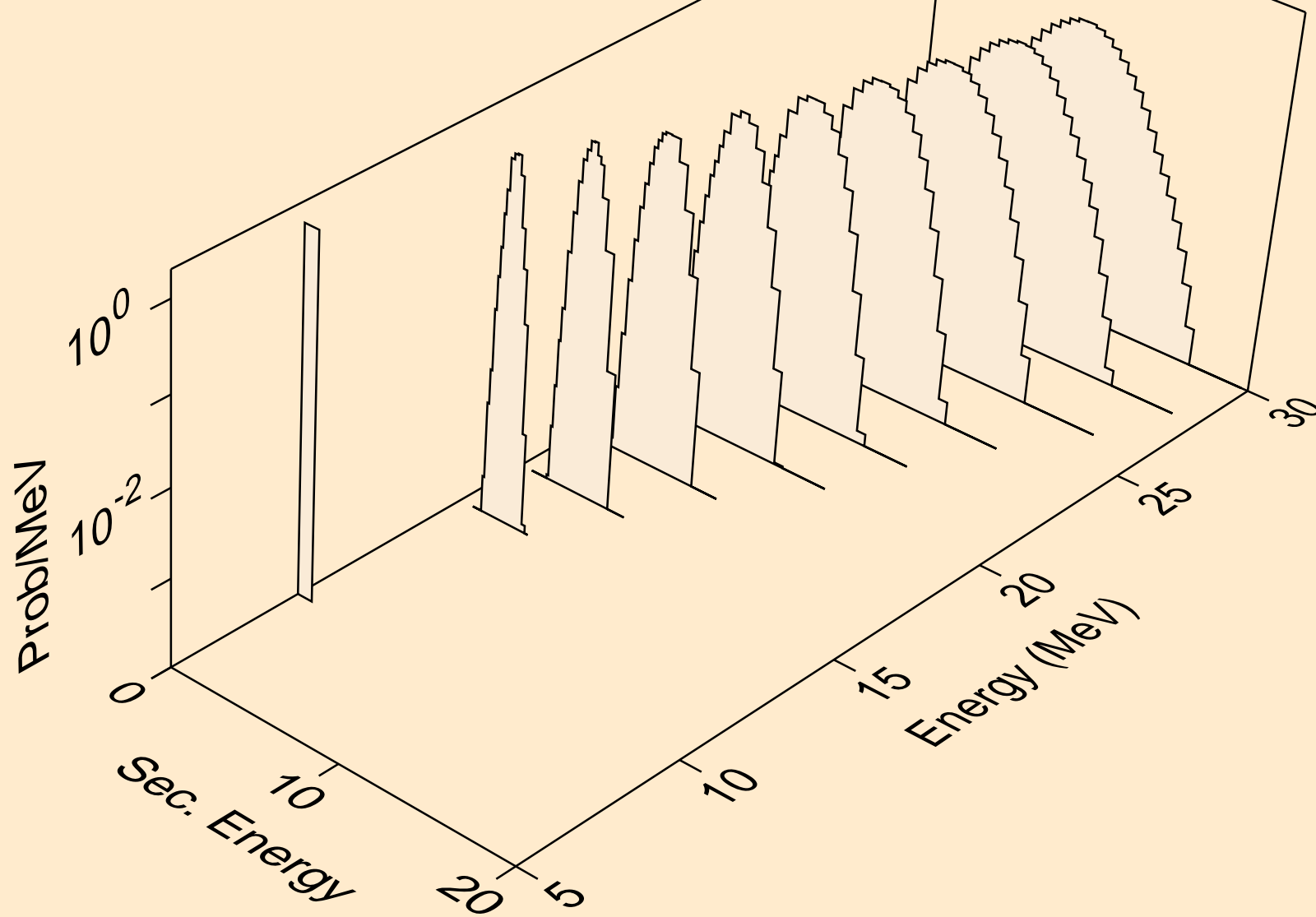

OS181M NEUTRON ACER TENDL-2021 LIBRARY; T=293.6K  
protons from (n,npa)

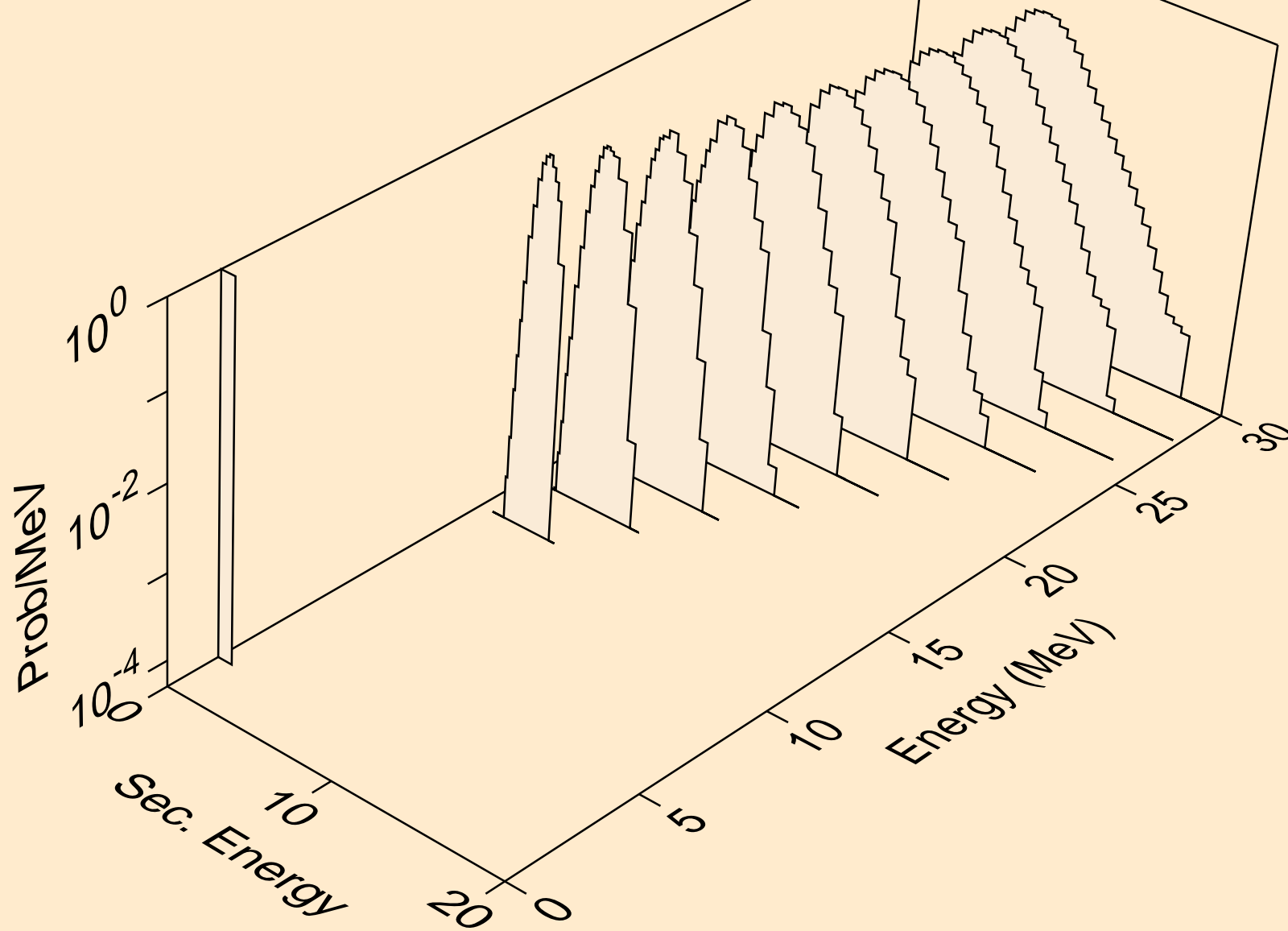



OS181M NEUTRON ACER TENDL-2021 LIBRARY; T=293.6K  
protons from (n,p)

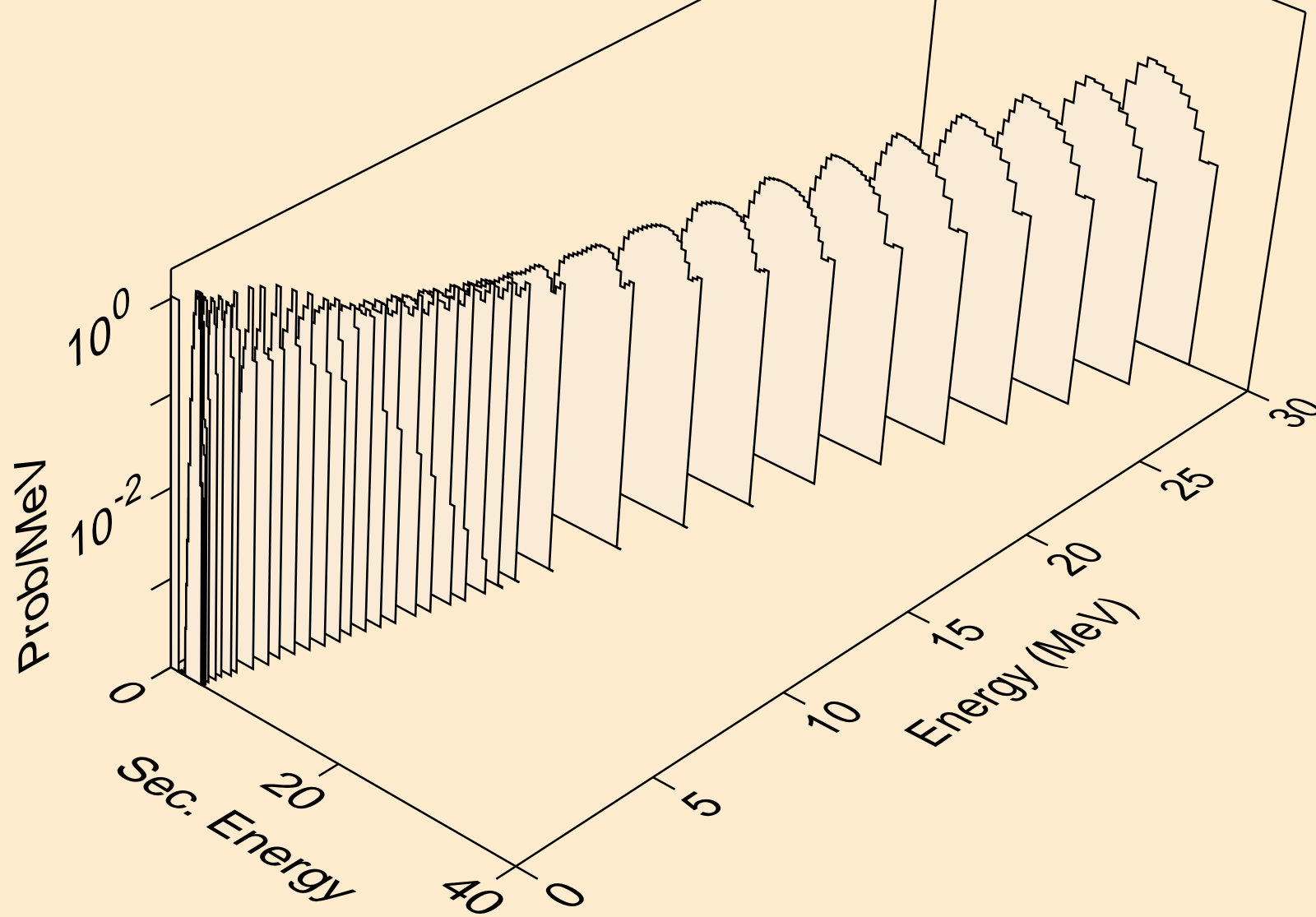

OS181M NEUTRON ACER TENDL-2021 LIBRARY; T=293.6K  
protons from (n,2p)

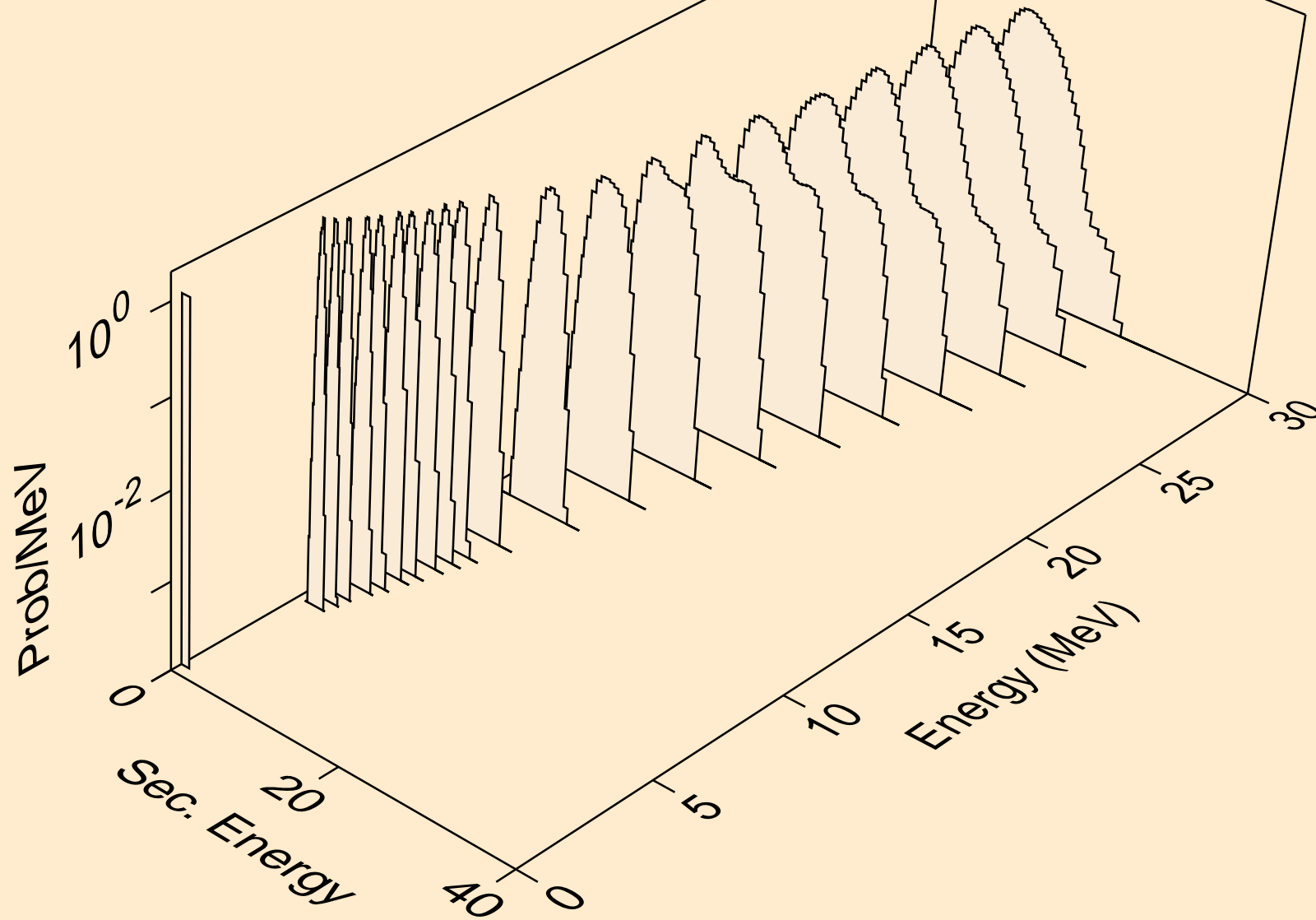

OS181M NEUTRON ACER TENDL-2021 LIBRARY; T=293.6K  
protons from (n,p)

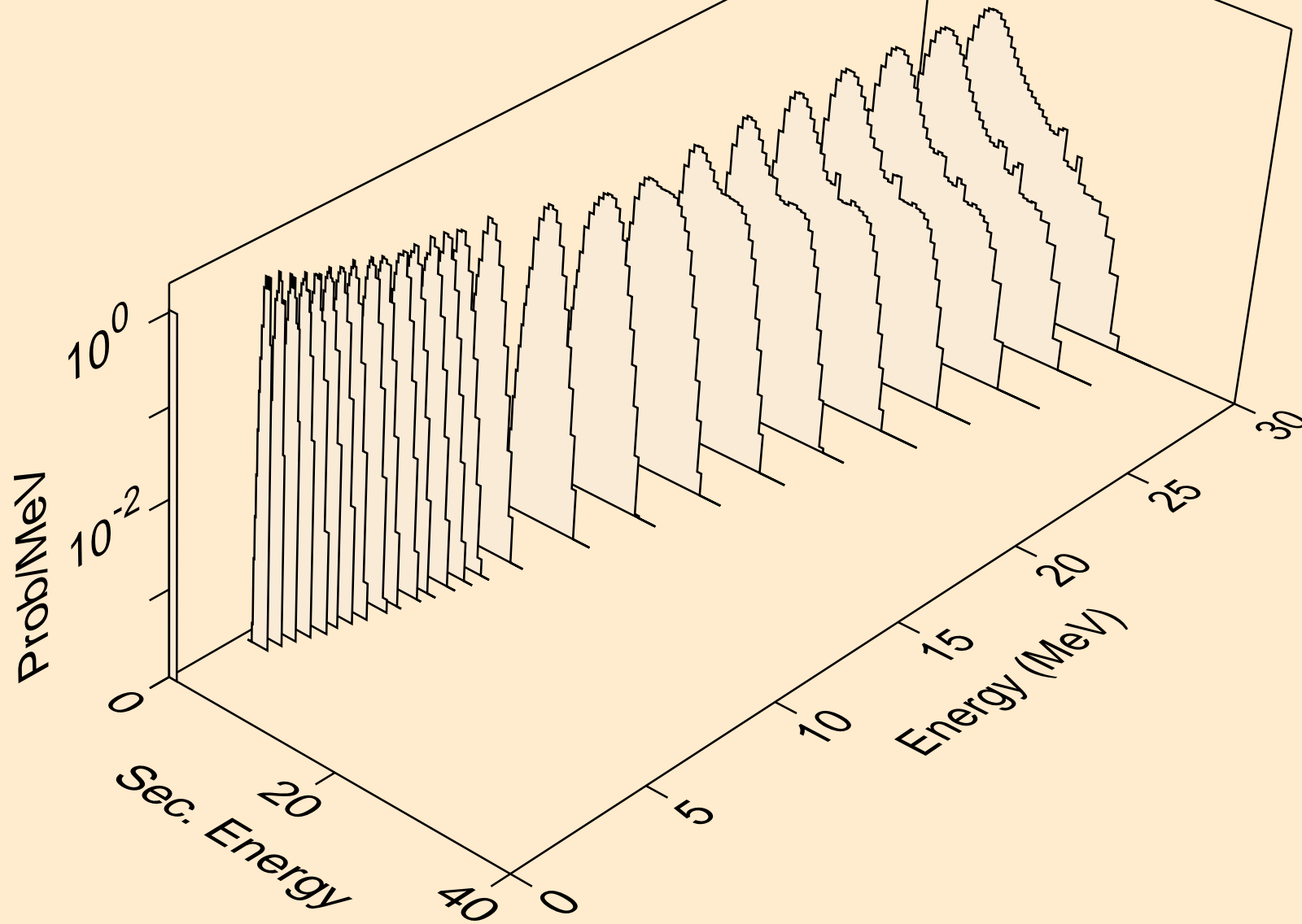

OS181M NEUTRON ACER TENDL-2021 LIBRARY; T=293.6K  
protons from (n,pd)

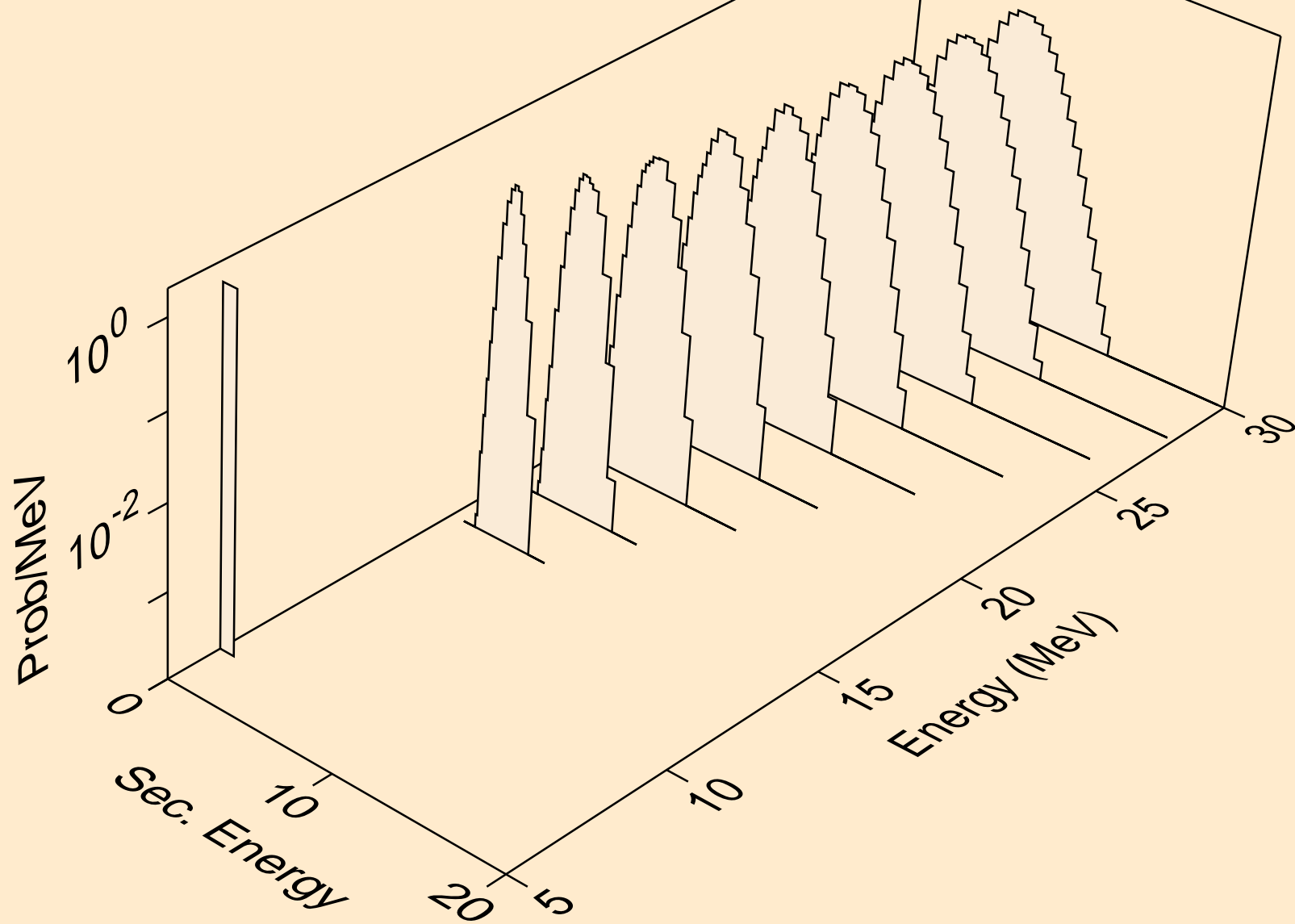

OS181M NEUTRON ACER TENDL-2021 LIBRARY; T=293.6K  
protons from (n,pt)

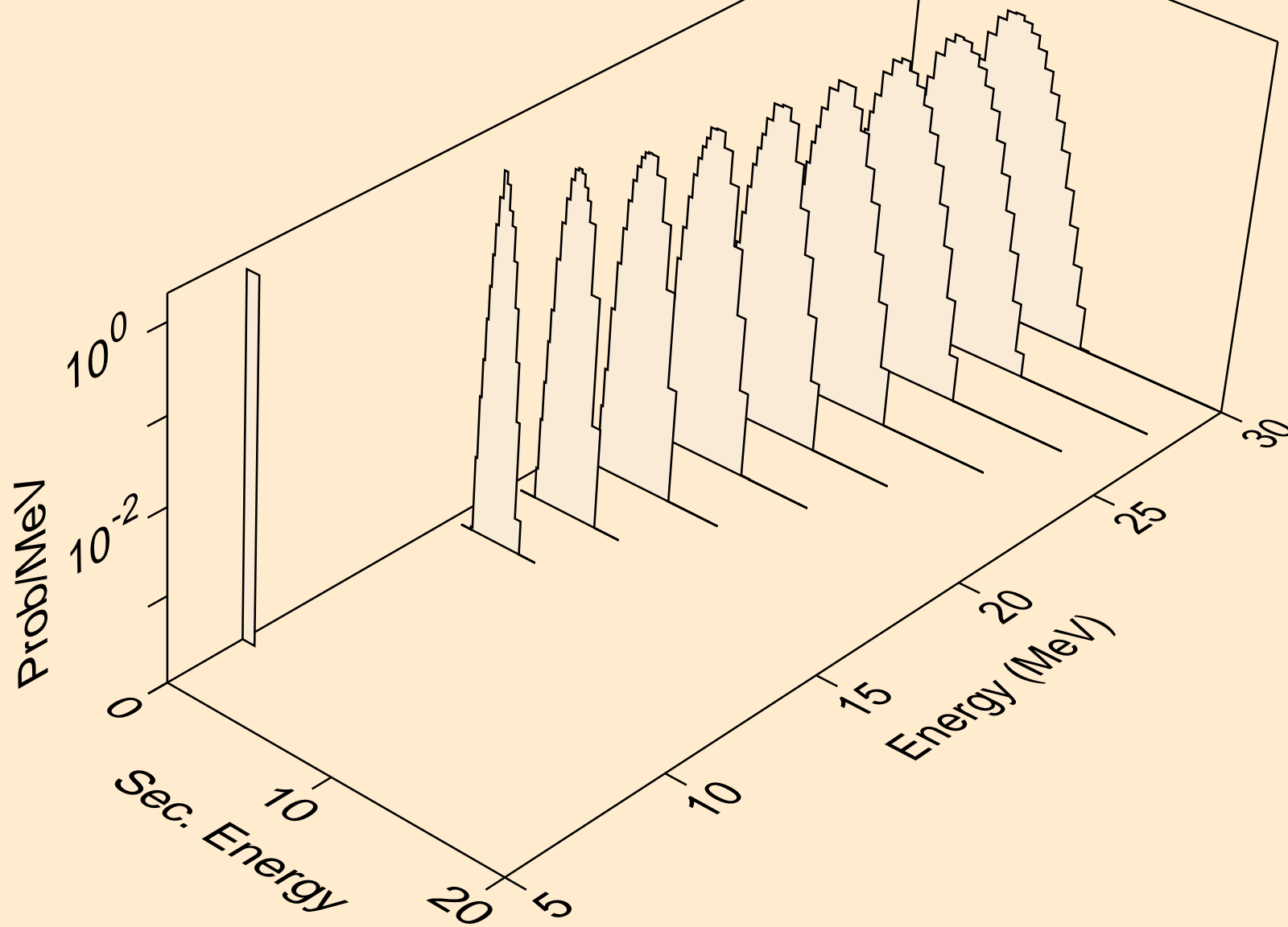

OS181M NEUTRON ACER TENDL-2021 LIBRARY; T=293.6K  
deuterons from (n,x)

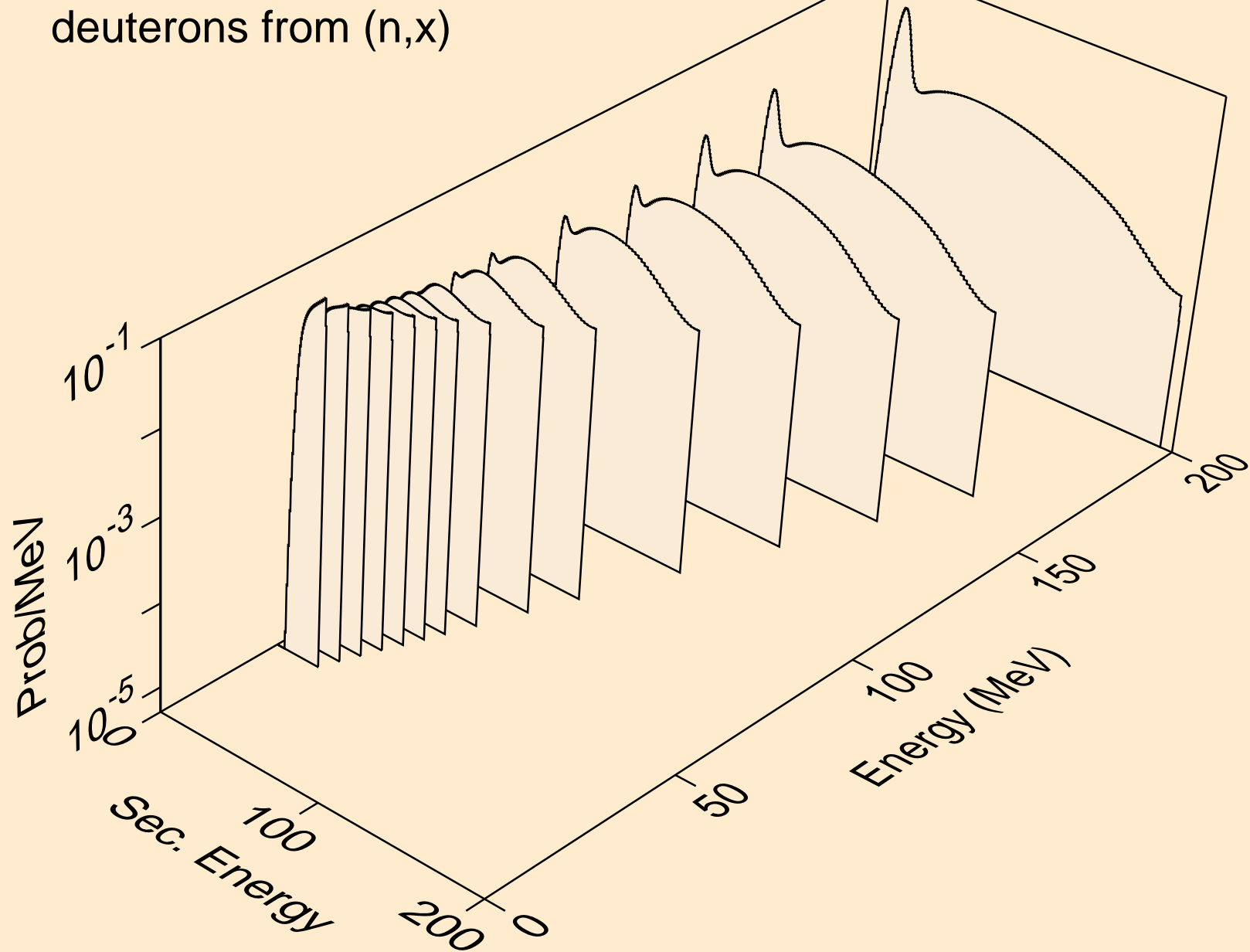

OS181M NEUTRON ACER TENDL-2021 LIBRARY; T=293.6K  
deuterons from (n,2nd)

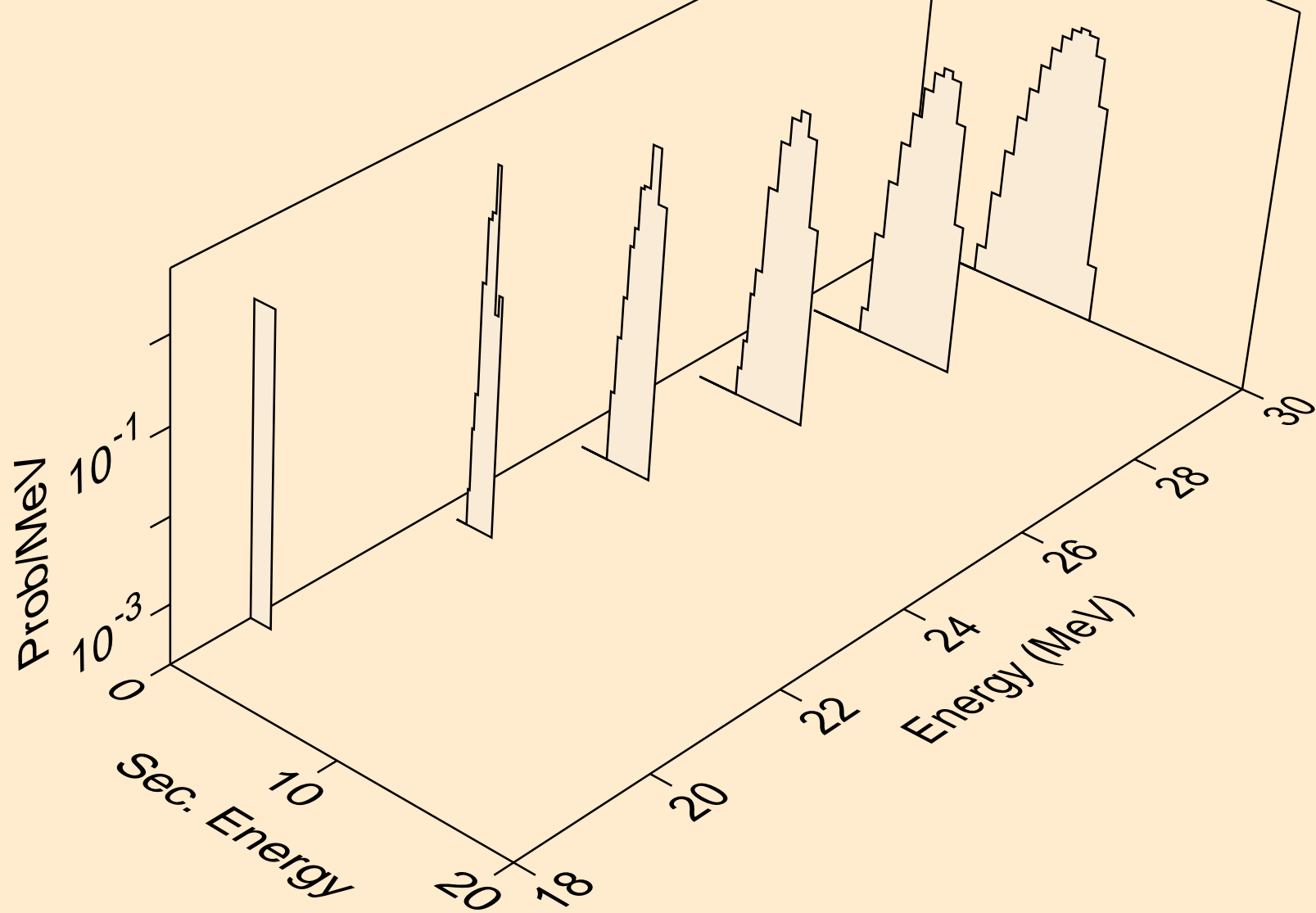

OS181M NEUTRON ACER TENDL-2021 LIBRARY; T=293.6K  
deuterons from (n,n\*)d

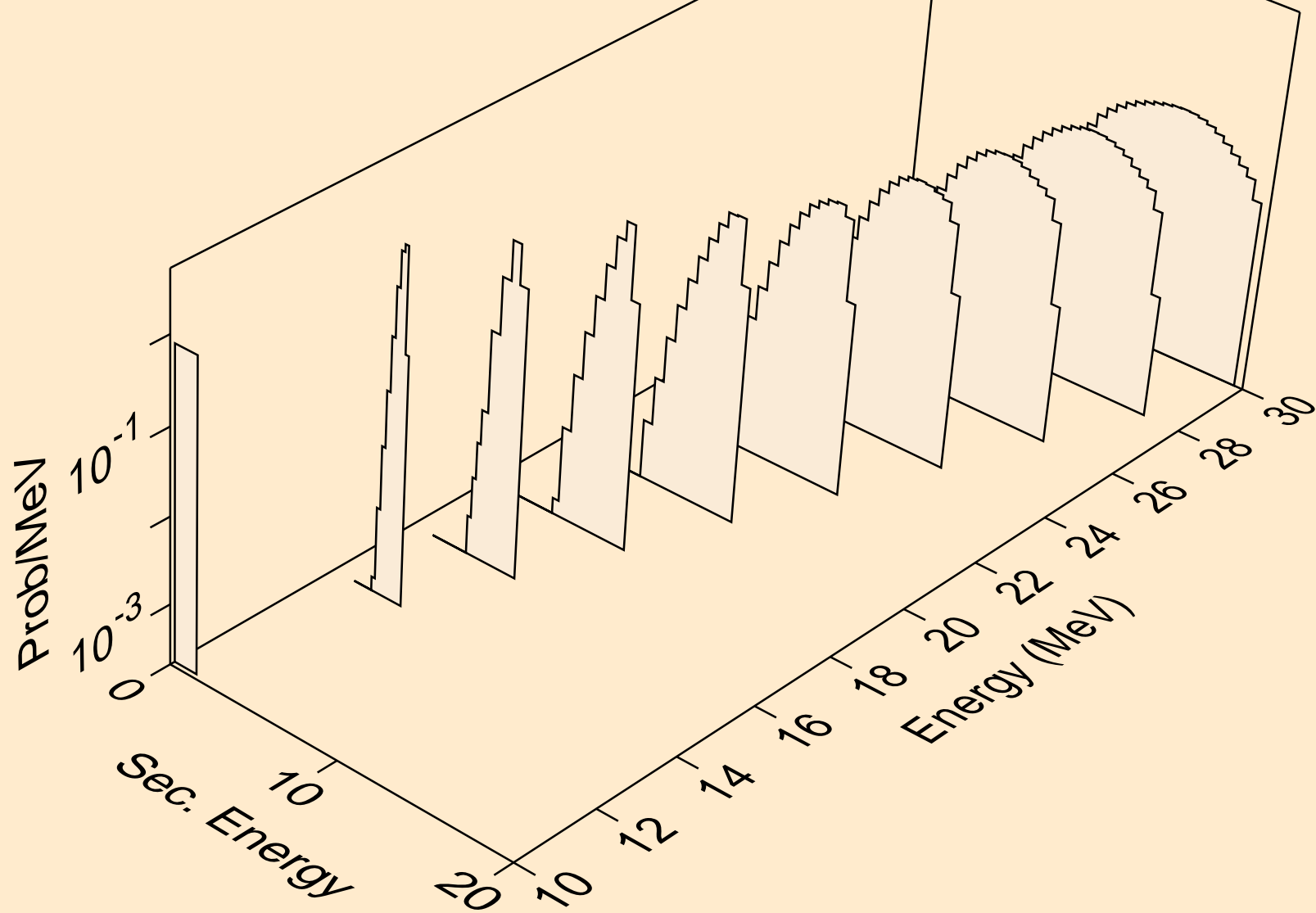



OS181M NEUTRON ACER TENDL-2021 LIBRARY; T=293.6K  
deuterons from (n,d)

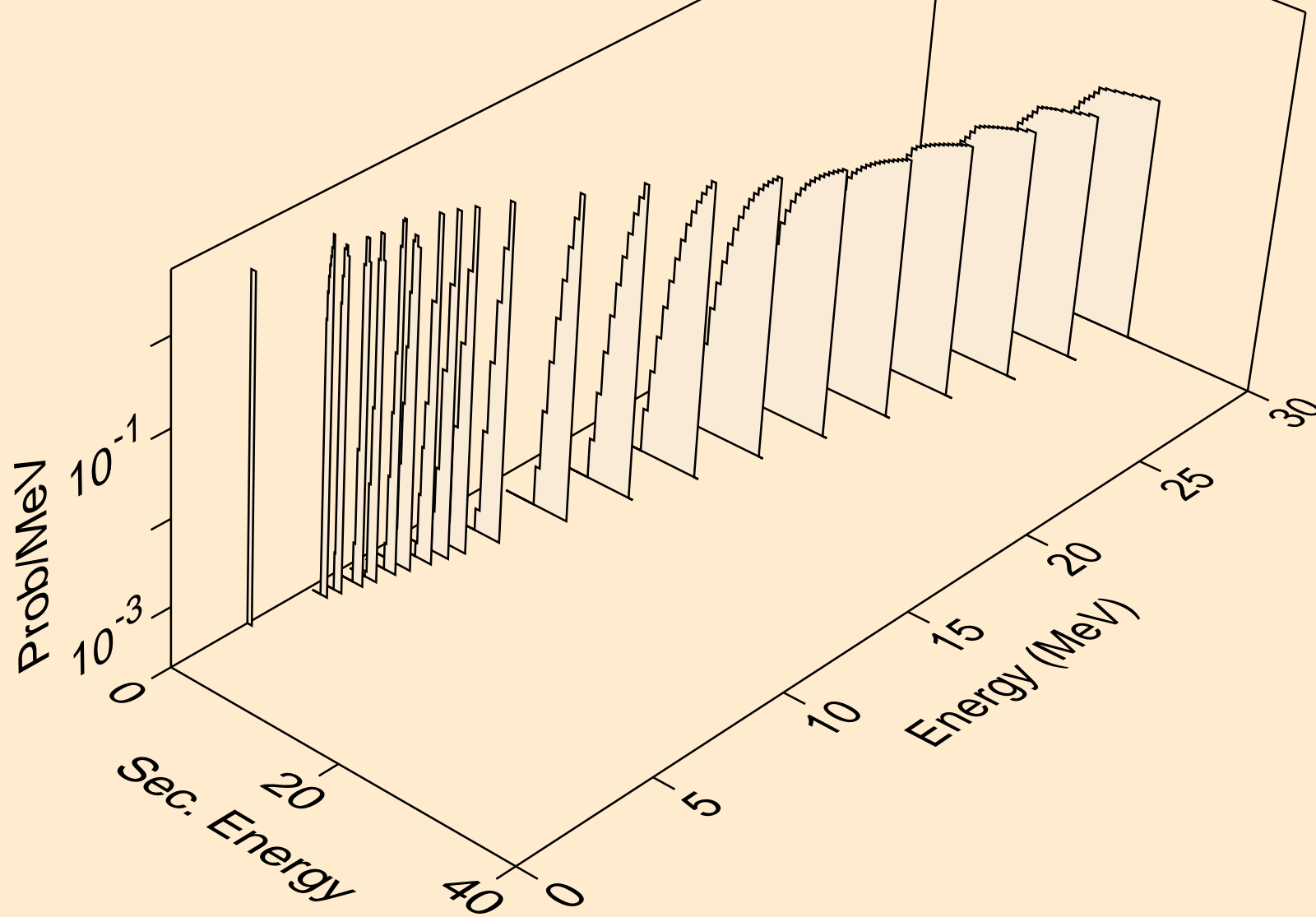

OS181M NEUTRON ACER TENDL-2021 LIBRARY; T=293.6K  
deuterons from (n,pd)

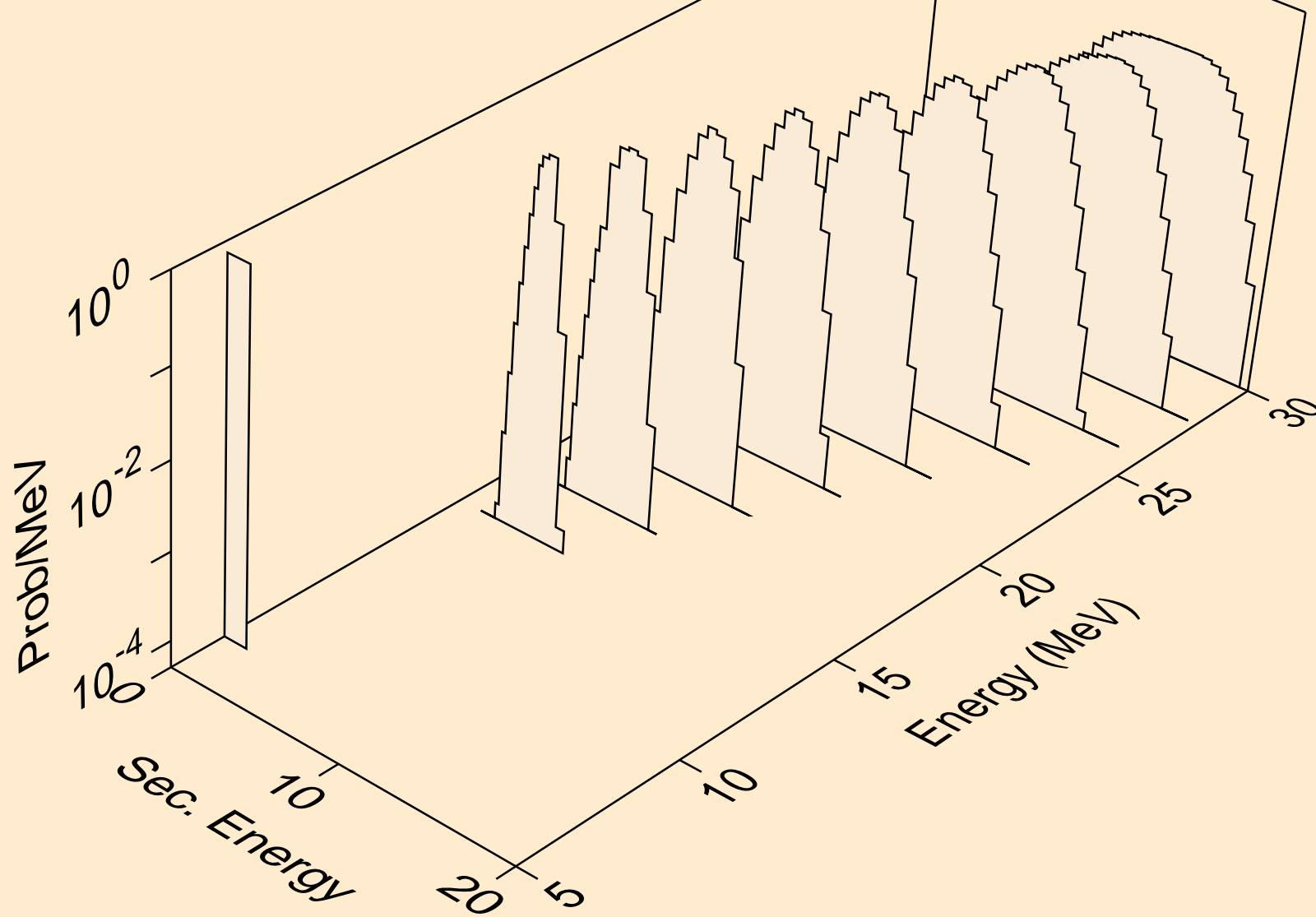

OS181M NEUTRON ACER TENDL-2021 LIBRARY; T=293.6K  
deuterons from (n,da)

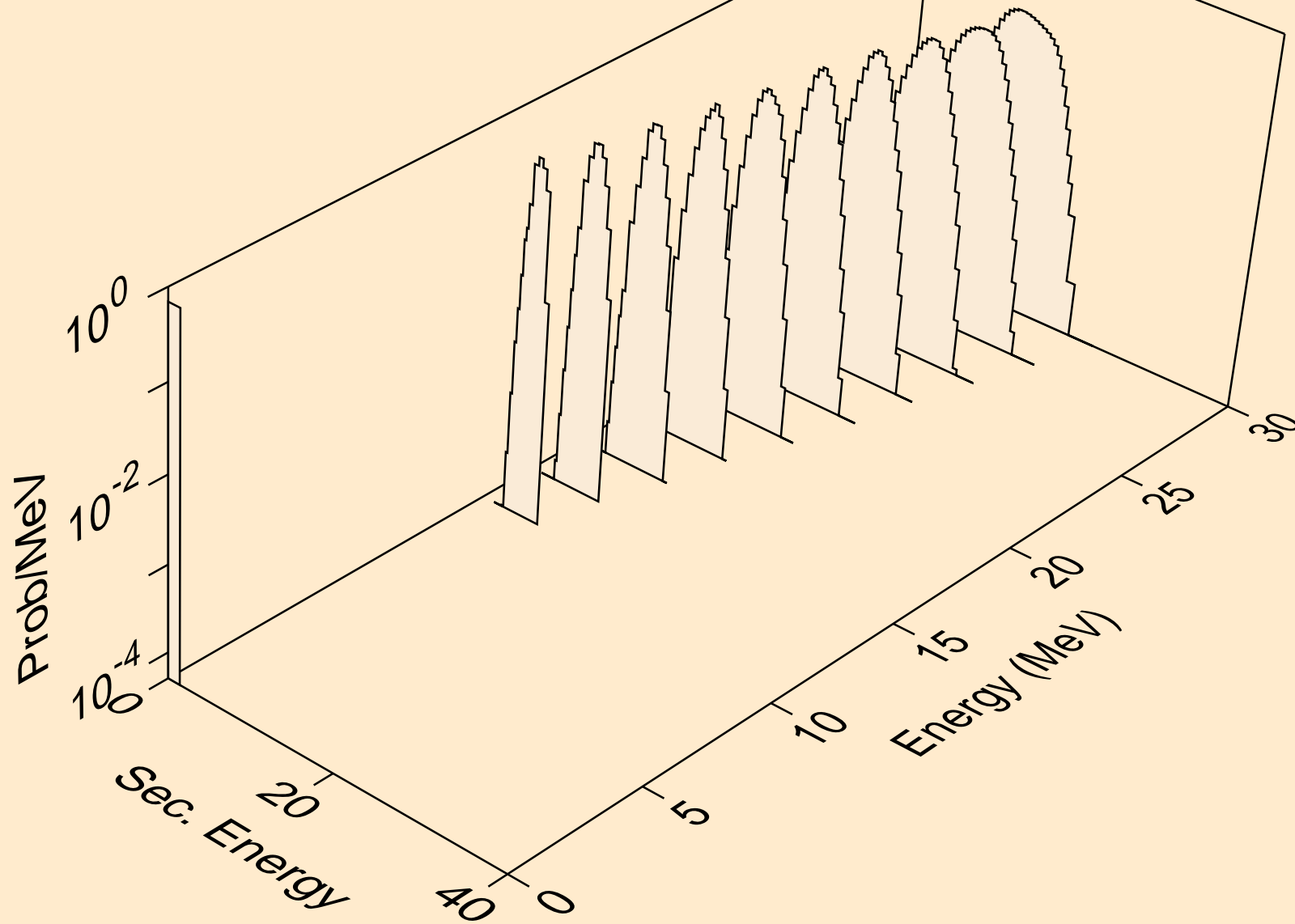

OS181M NEUTRON ACER TENDL-2021 LIBRARY; T=293.6K  
tritons from (n,x)

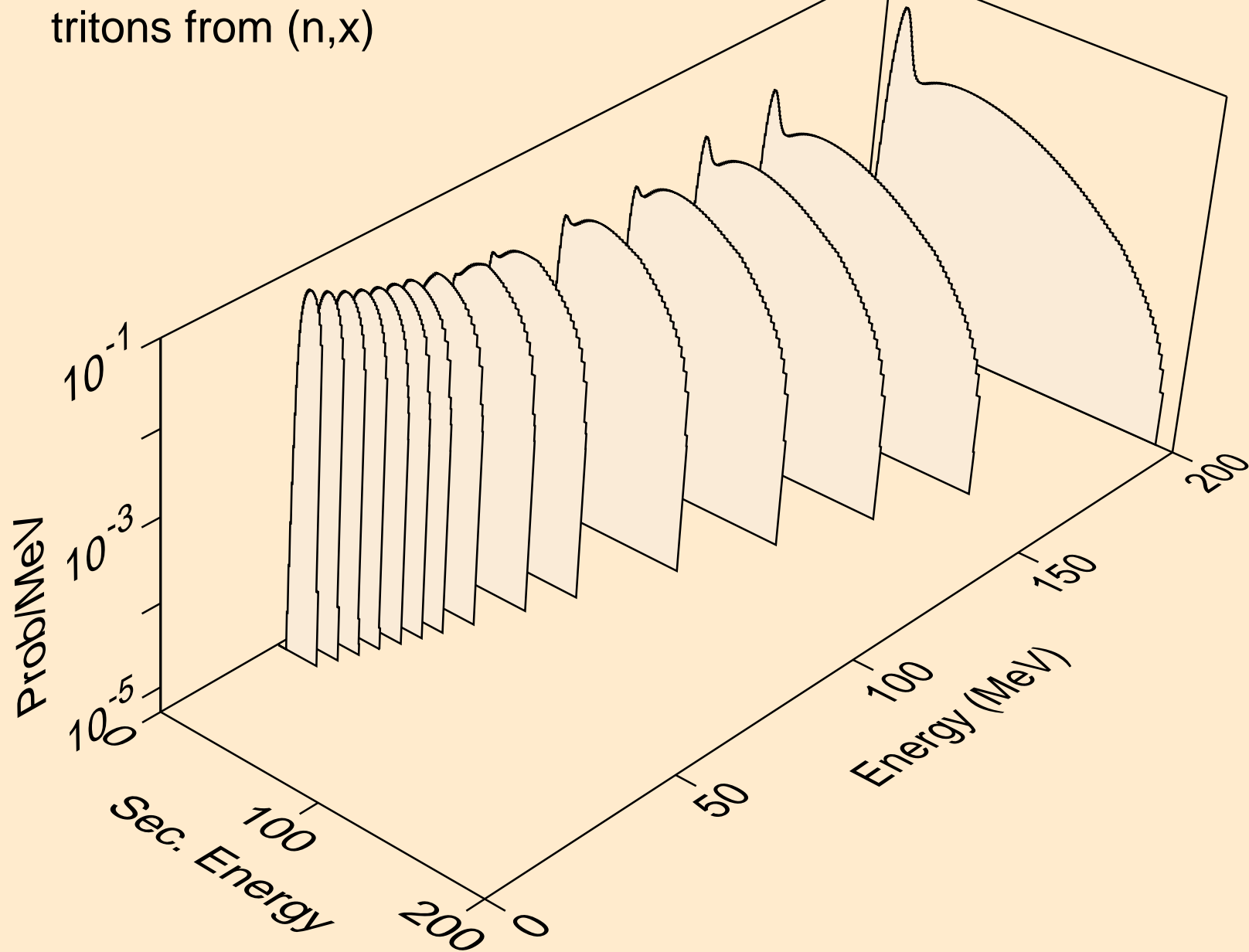

OS181M NEUTRON ACER TENDL-2021 LIBRARY; T=293.6K  
tritons from (n,n\*)t

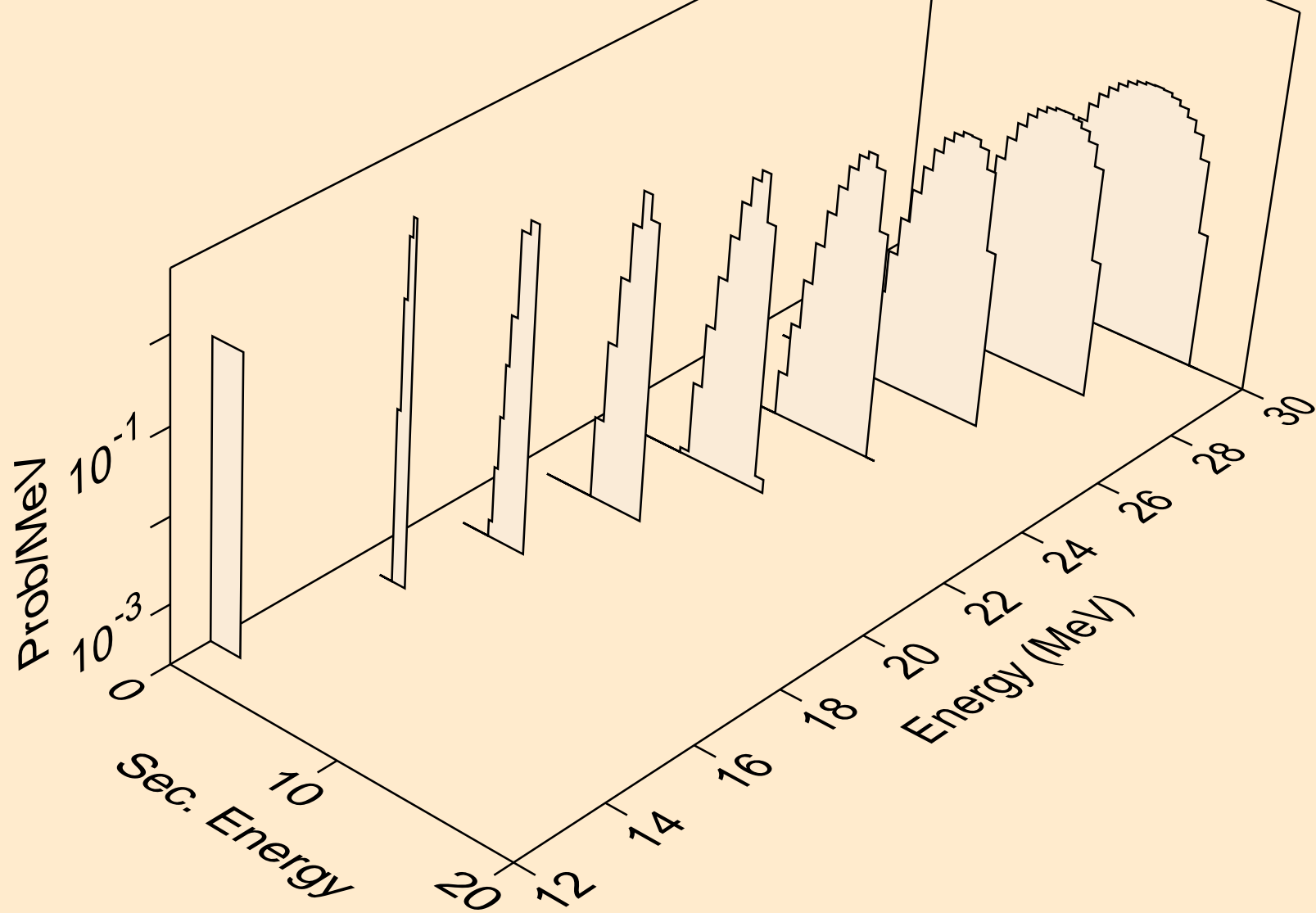

OS181M NEUTRON ACER TENDL-2021 LIBRARY; T=293.6K  
tritons from (n,t)

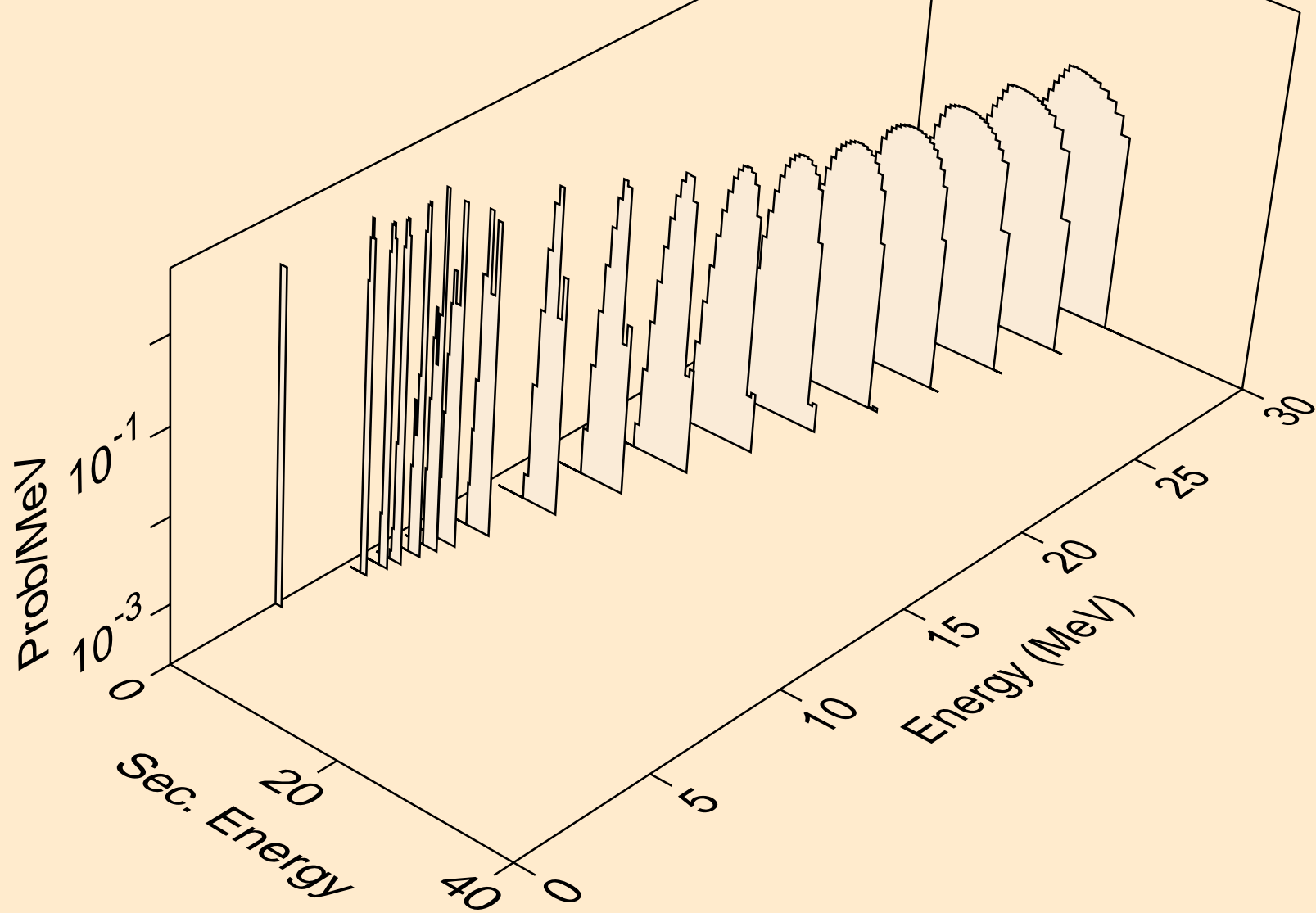

OS181M NEUTRON ACER TENDL-2021 LIBRARY; T=293.6K  
tritons from (n,pt)

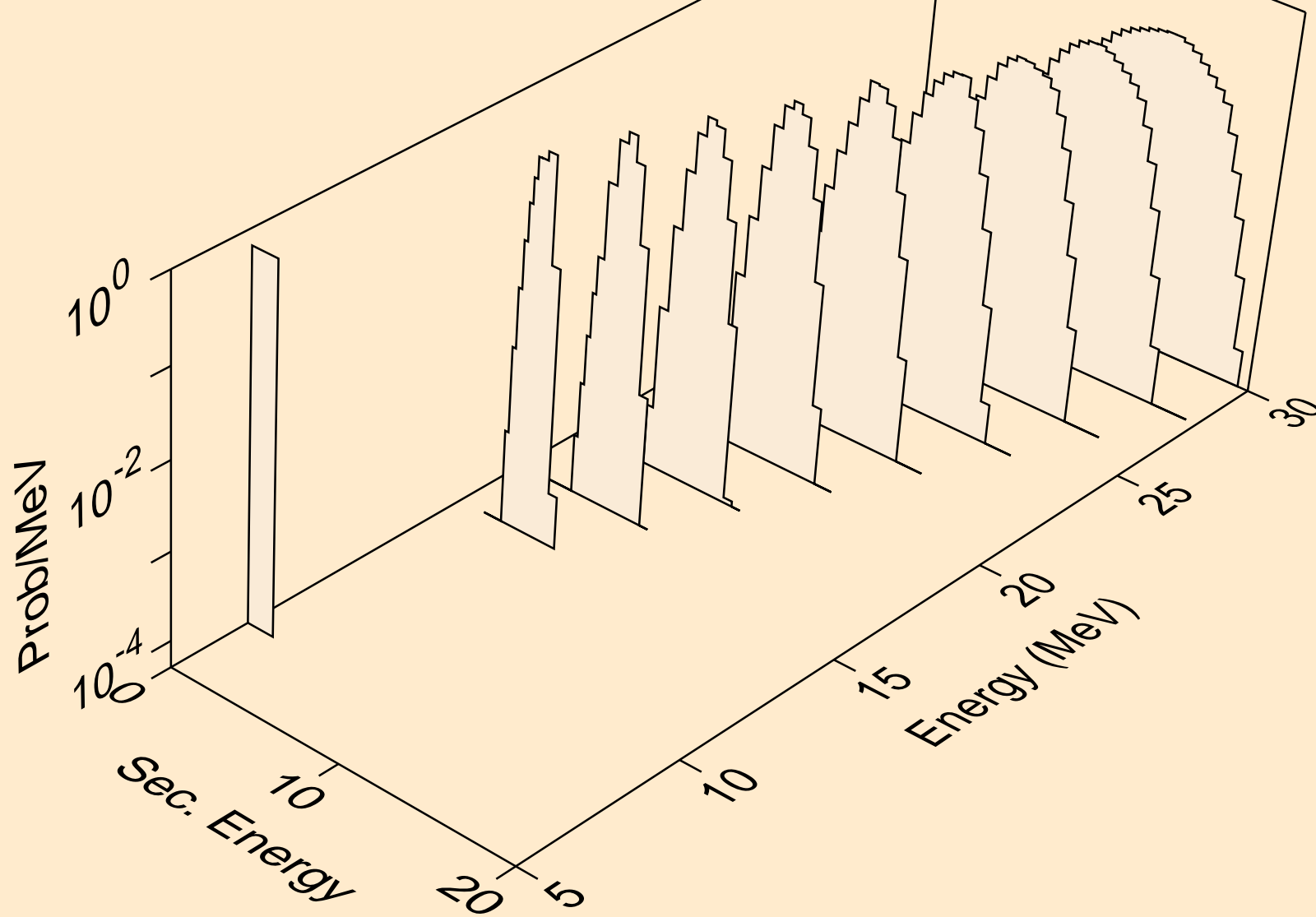

OS181M NEUTRON ACER TENDL-2021 LIBRARY; T=293.6K  
he3s from (n,x)

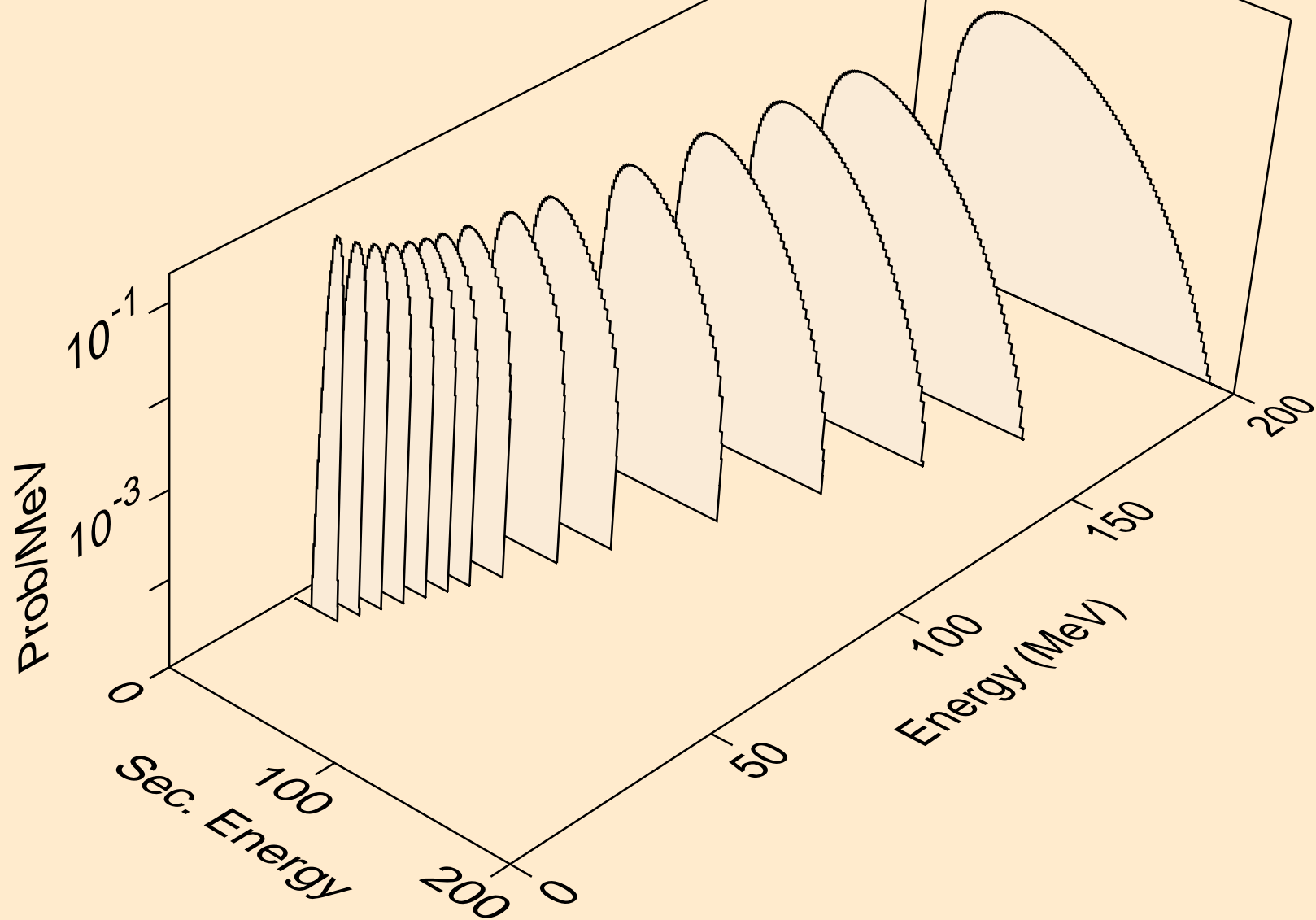



OS181M NEUTRON ACER TENDL-2021 LIBRARY; T=293.6K  
he3s from (n,n\*)he3

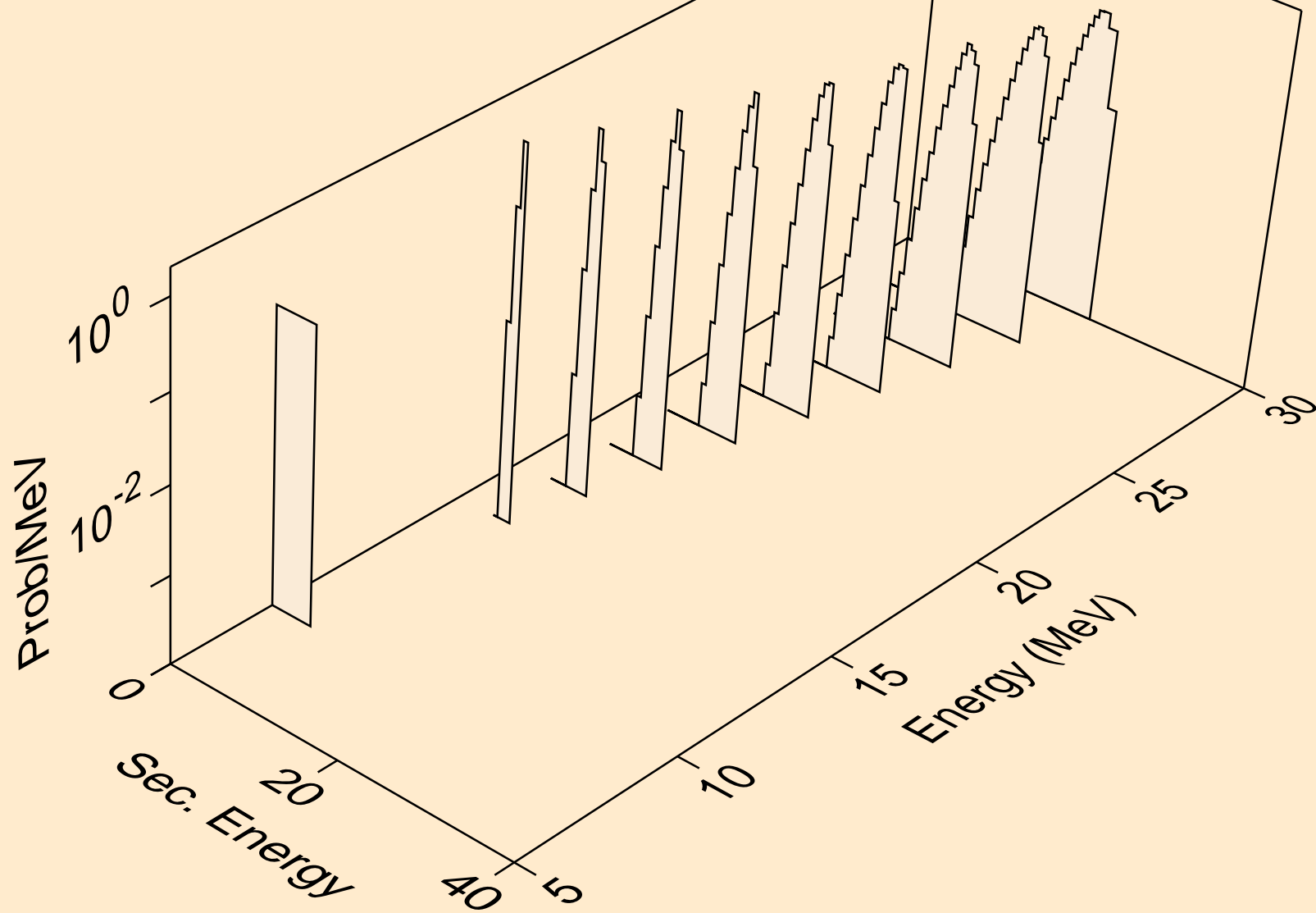

OS181M NEUTRON ACER TENDL-2021 LIBRARY; T=293.6K  
he3s from (n,he3)

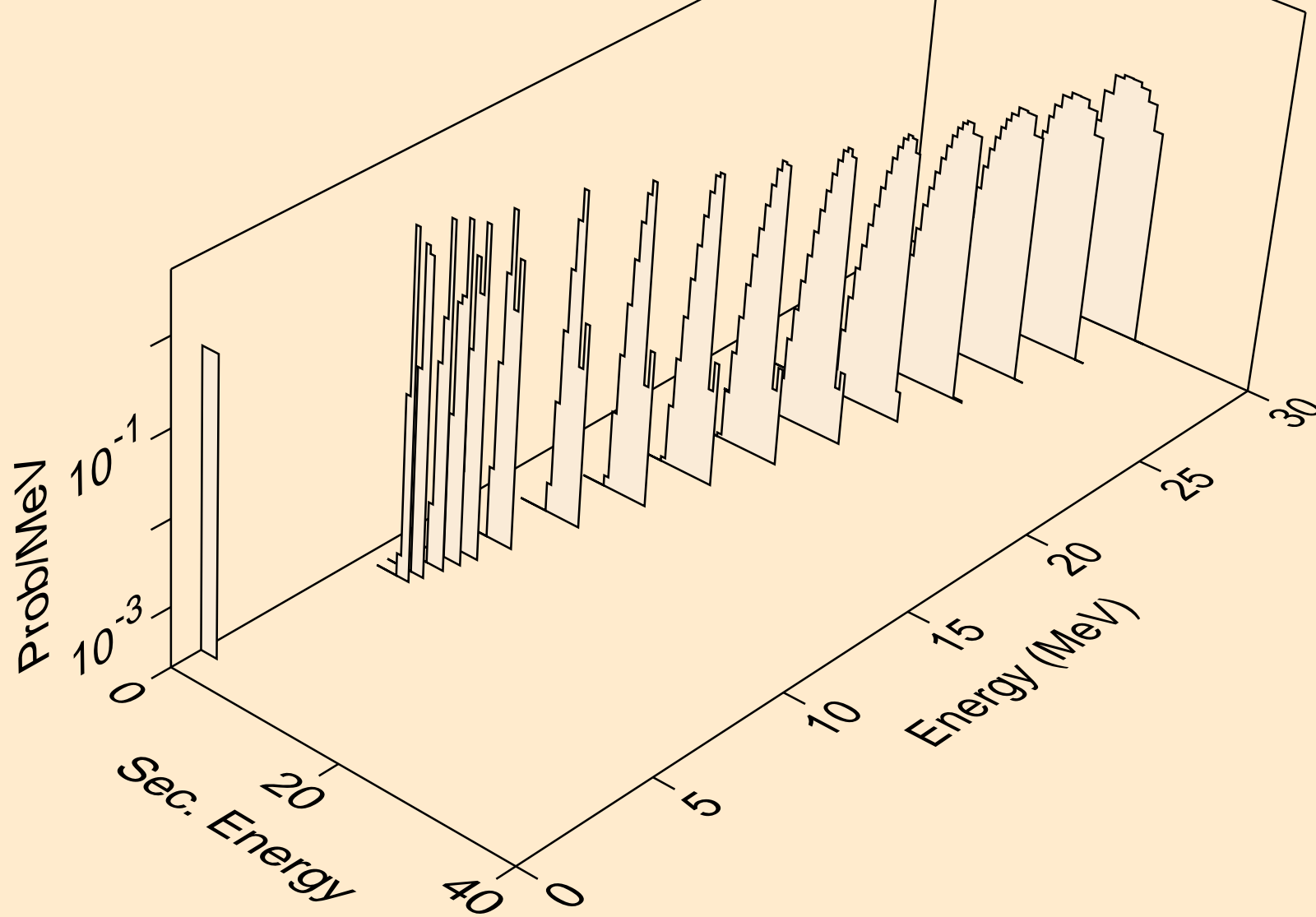

OS181M NEUTRON ACER TENDL-2021 LIBRARY; T=293.6K  
alphas from (n,x)

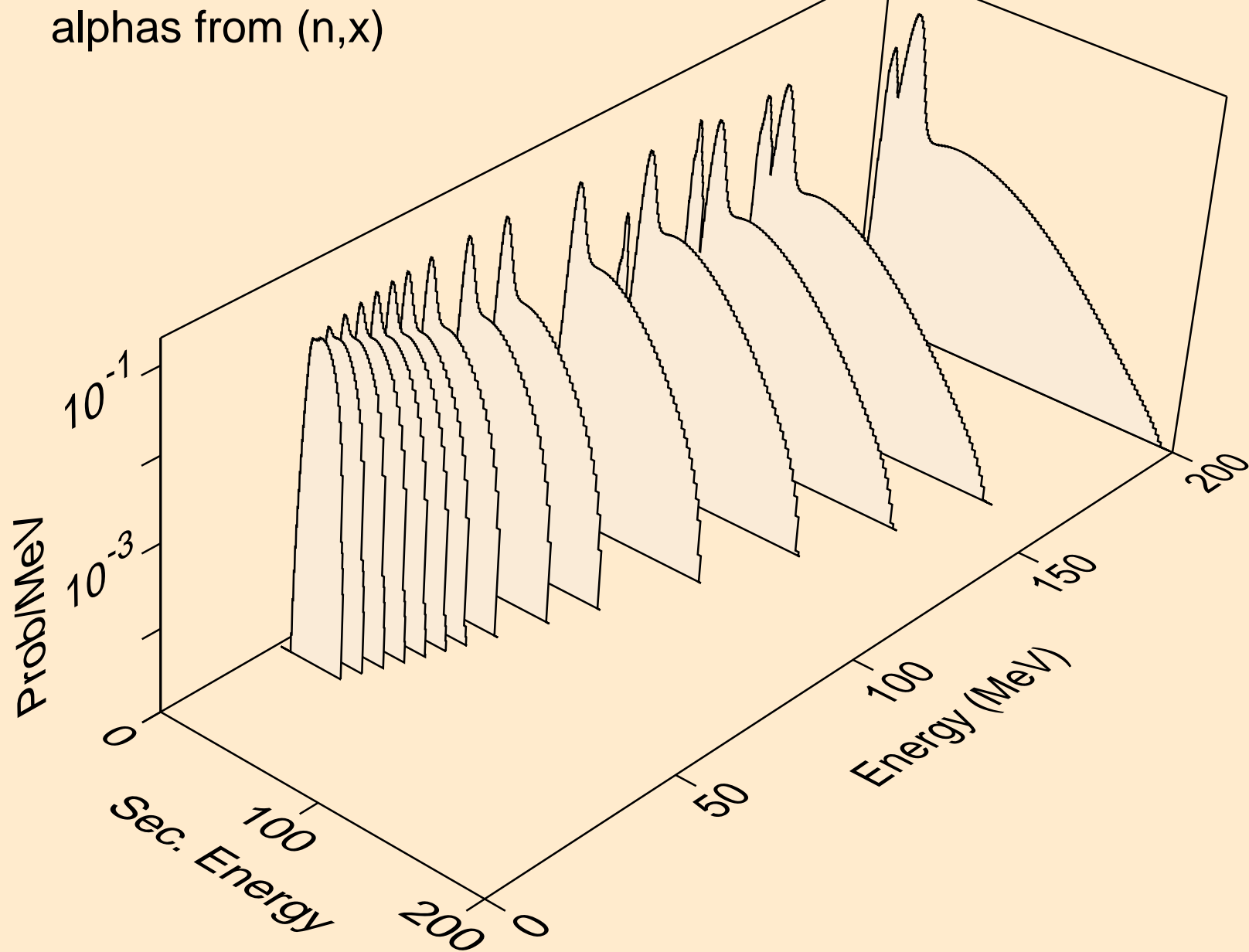

OS181M NEUTRON ACER TENDL-2021 LIBRARY; T=293.6K  
alphas from (n,n\*)a

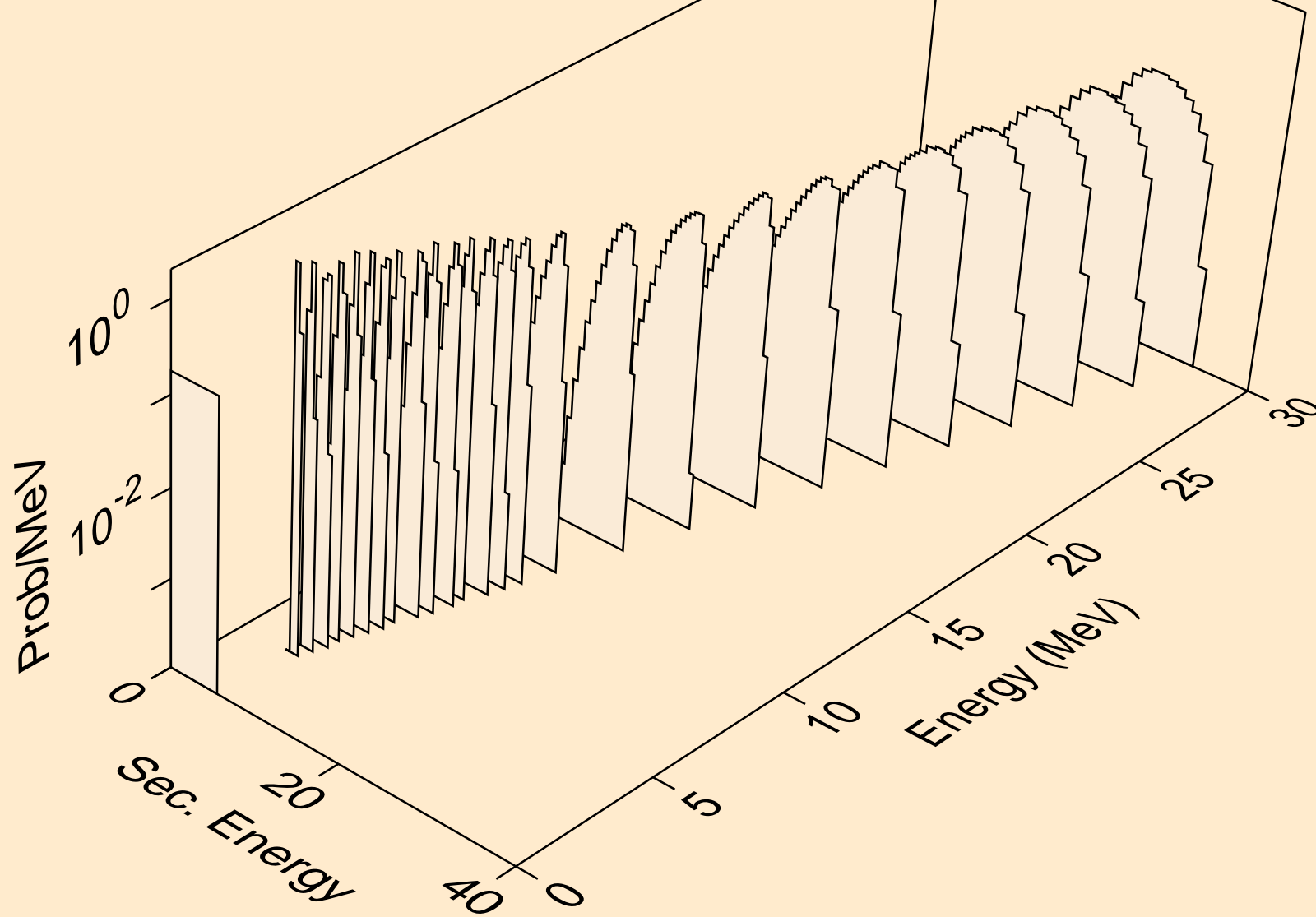

OS181M NEUTRON ACER TENDL-2021 LIBRARY; T=293.6K  
alphas from (n,2n)a

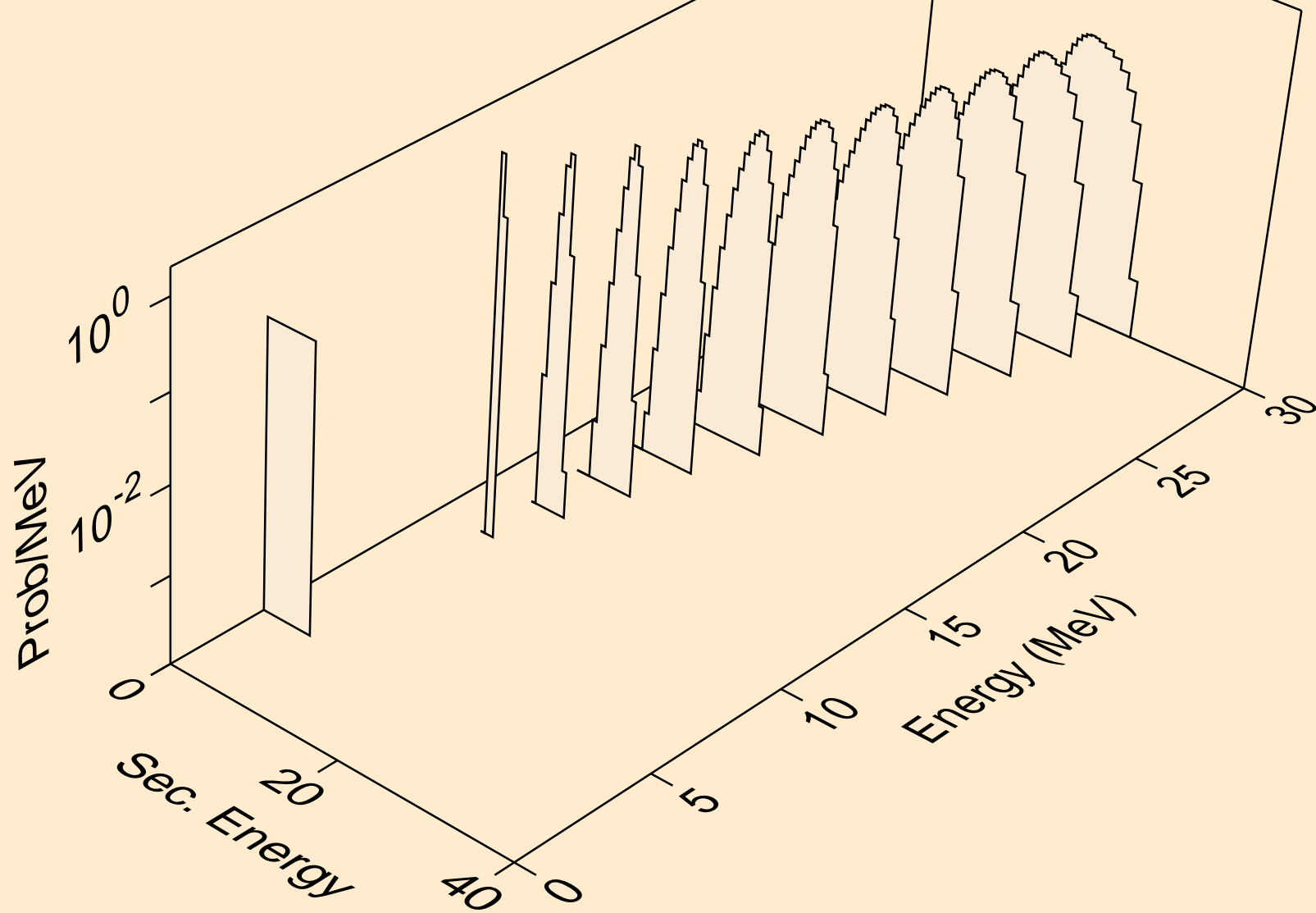

OS181M NEUTRON ACER TENDL-2021 LIBRARY; T=293.6K  
alphas from (n,3n)a

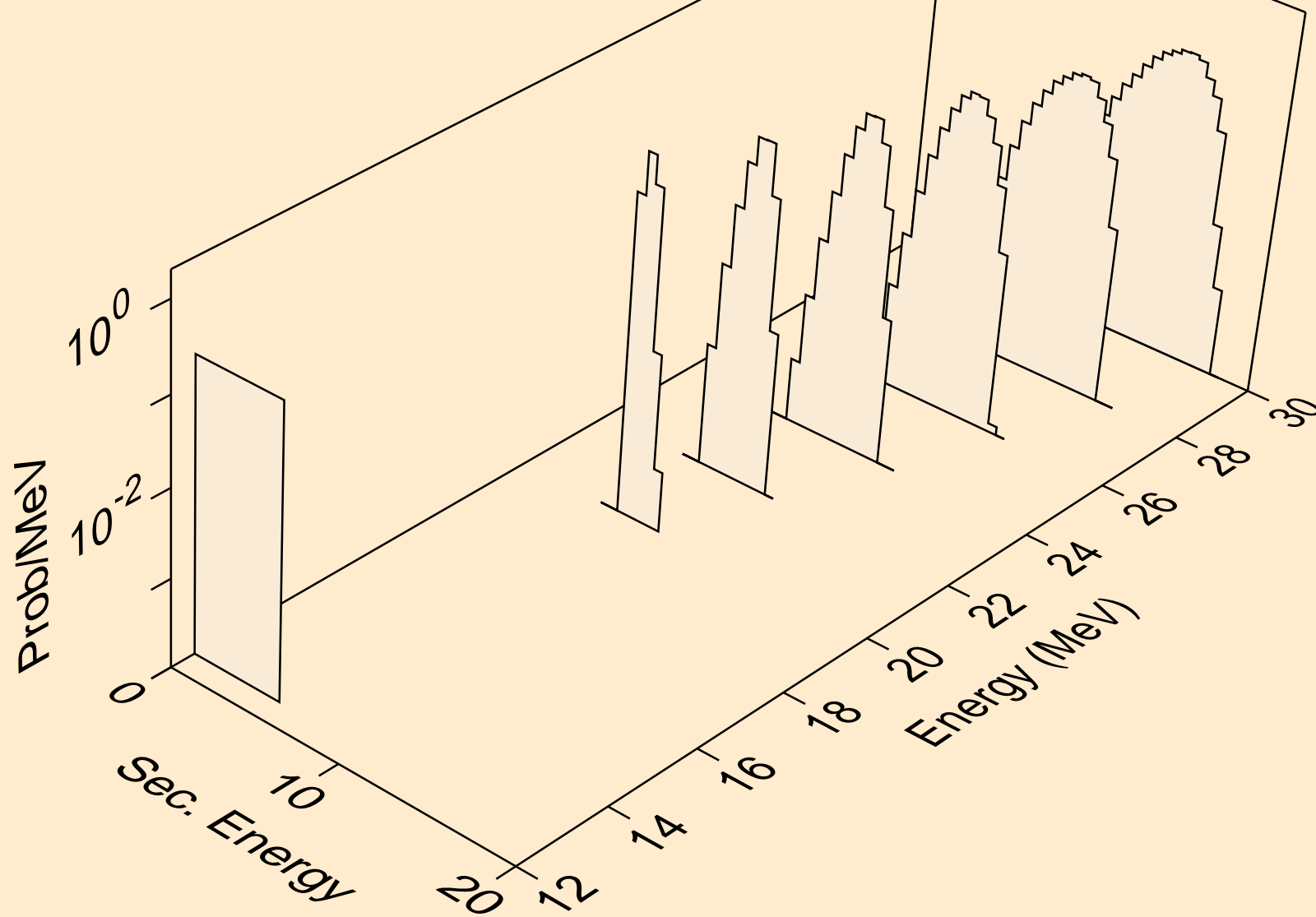

OS181M NEUTRON ACER TENDL-2021 LIBRARY; T=293.6K  
alphas from (n,n\*)2a

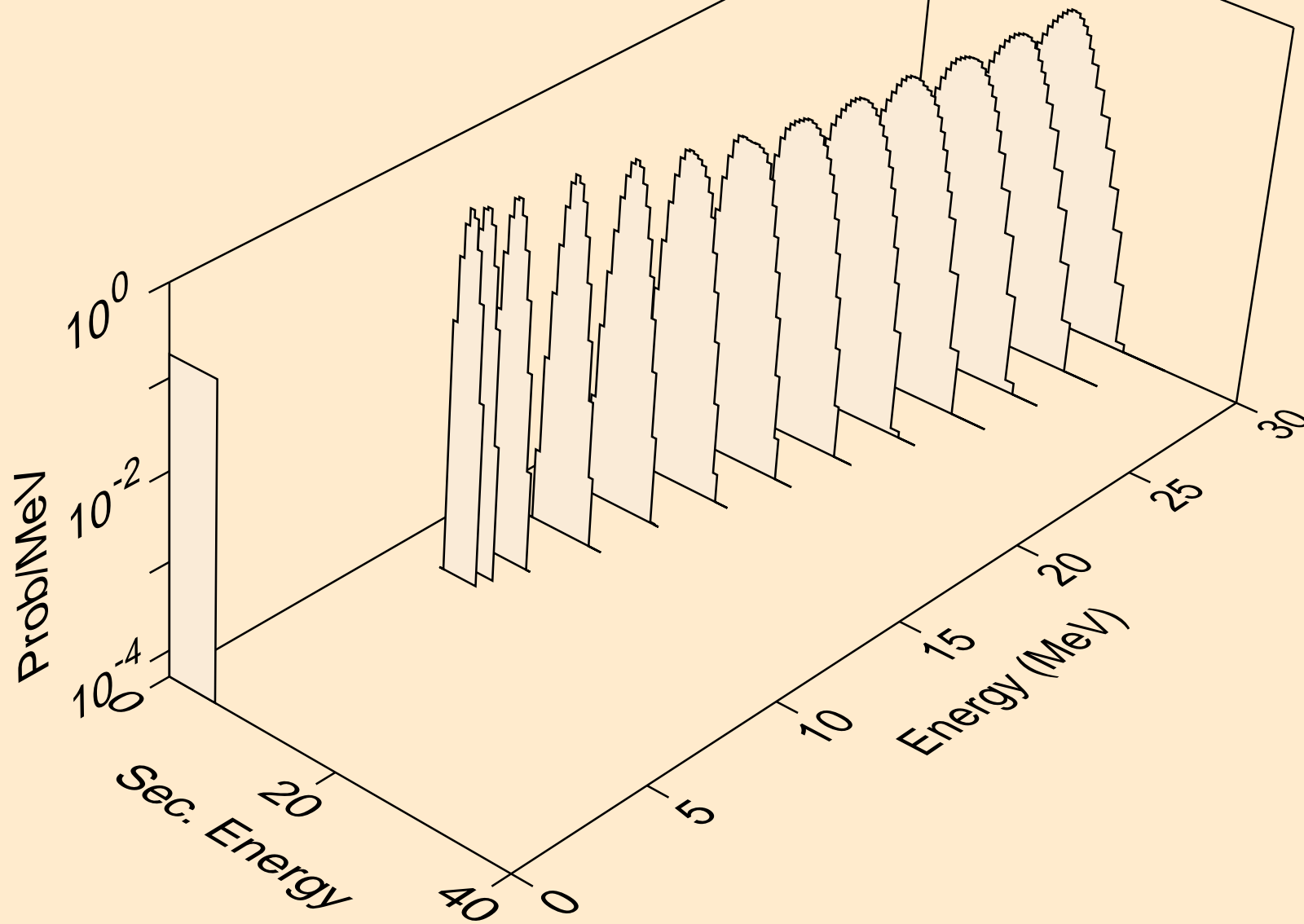

OS181M NEUTRON ACER TENDL-2021 LIBRARY; T=293.6K  
alphas from (n,2n)2a

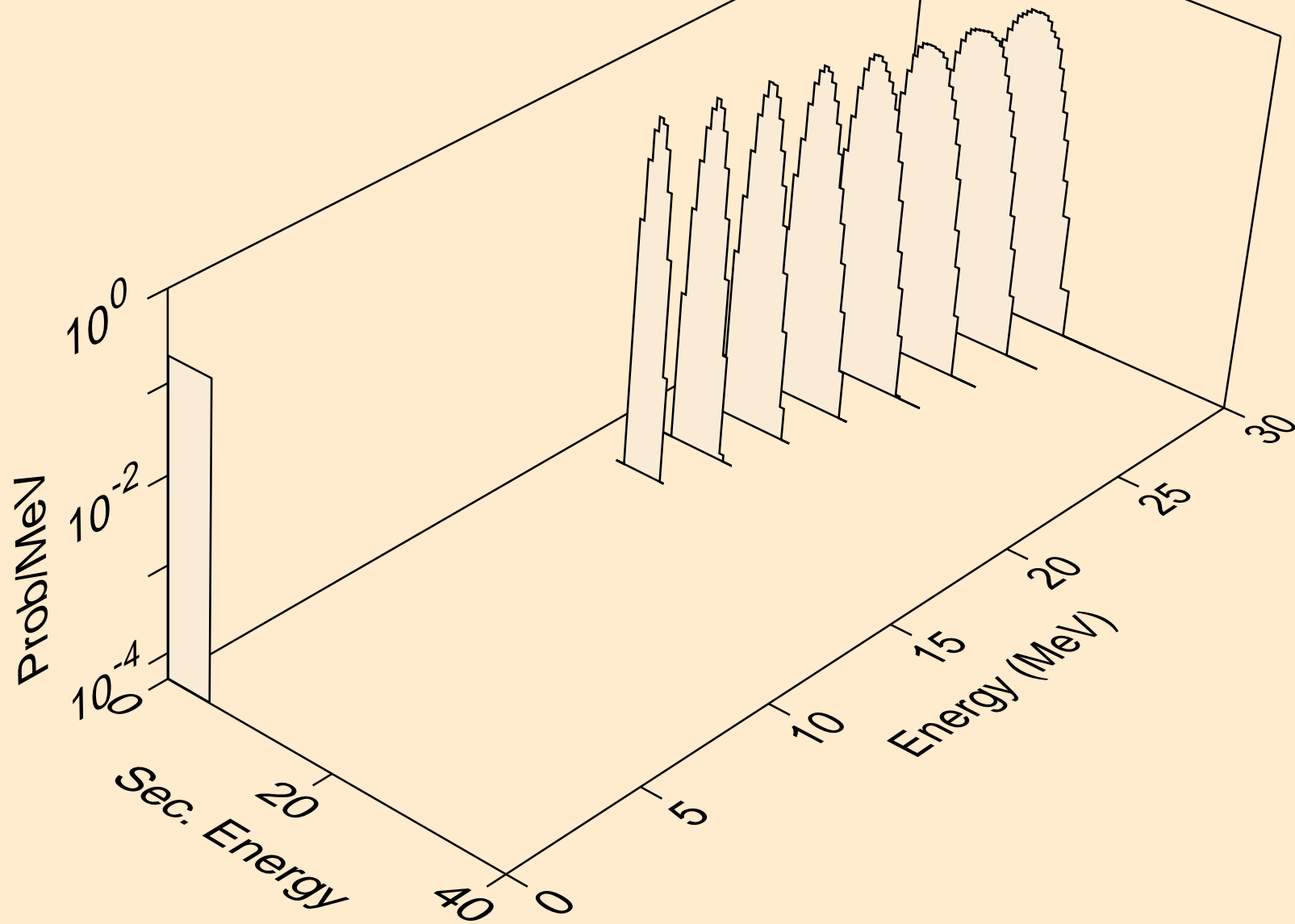



OS181M NEUTRON ACER TENDL-2021 LIBRARY; T=293.6K  
alphas from (n,npa)

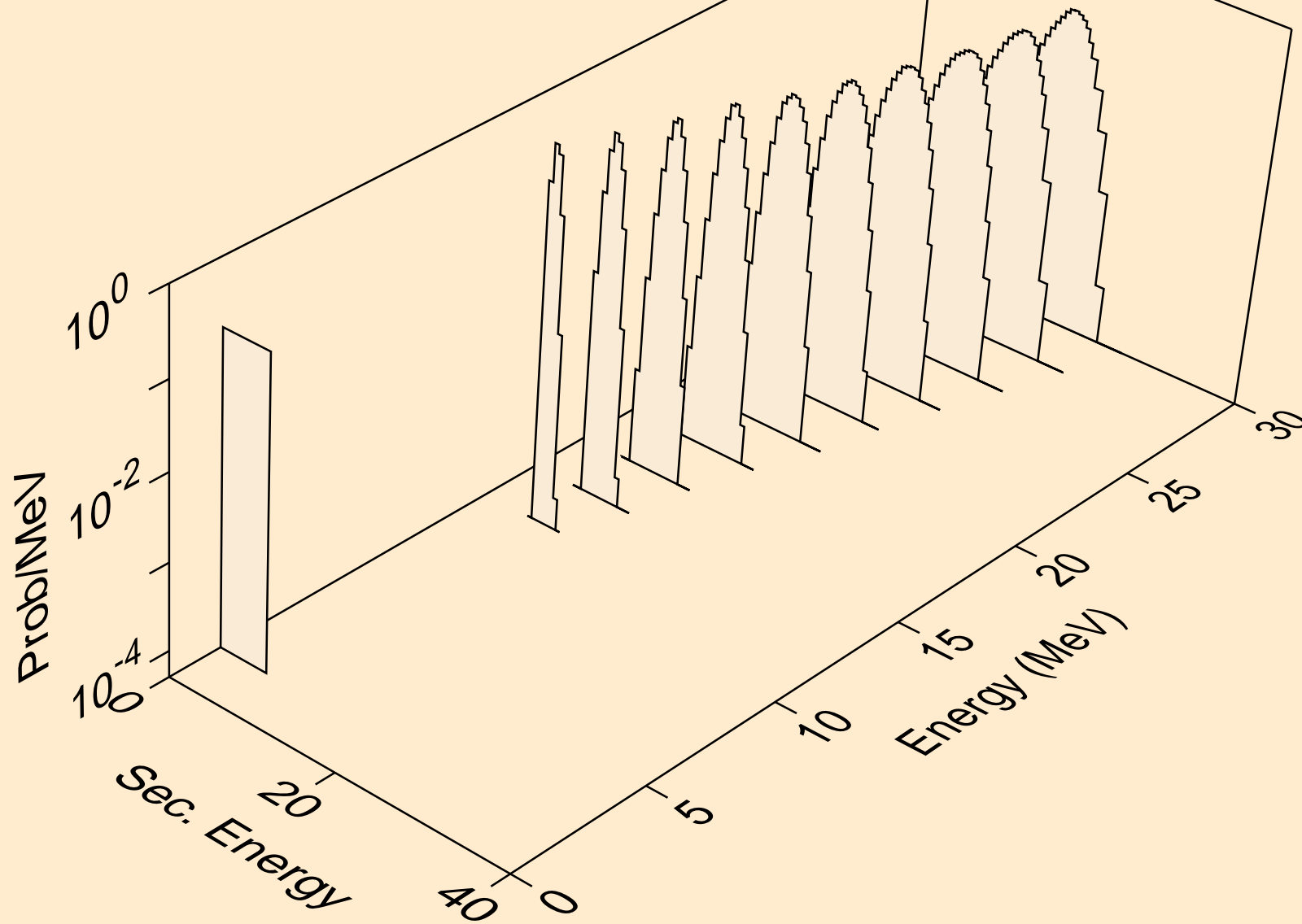

OS181M NEUTRON ACER TENDL-2021 LIBRARY; T=293.6K  
alphas from (n,a)

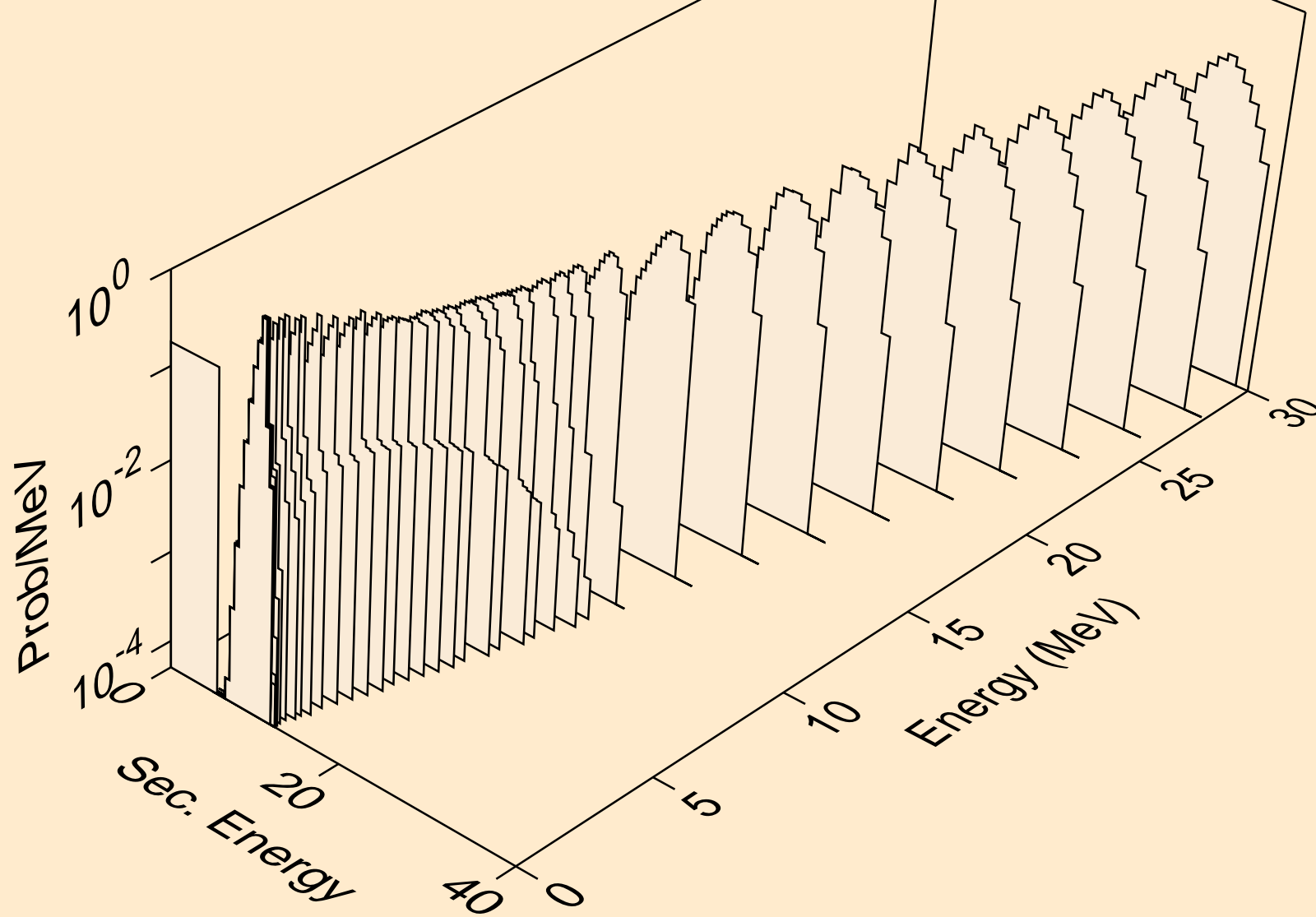

OS181M NEUTRON ACER TENDL-2021 LIBRARY; T=293.6K  
alphas from (n,2a)

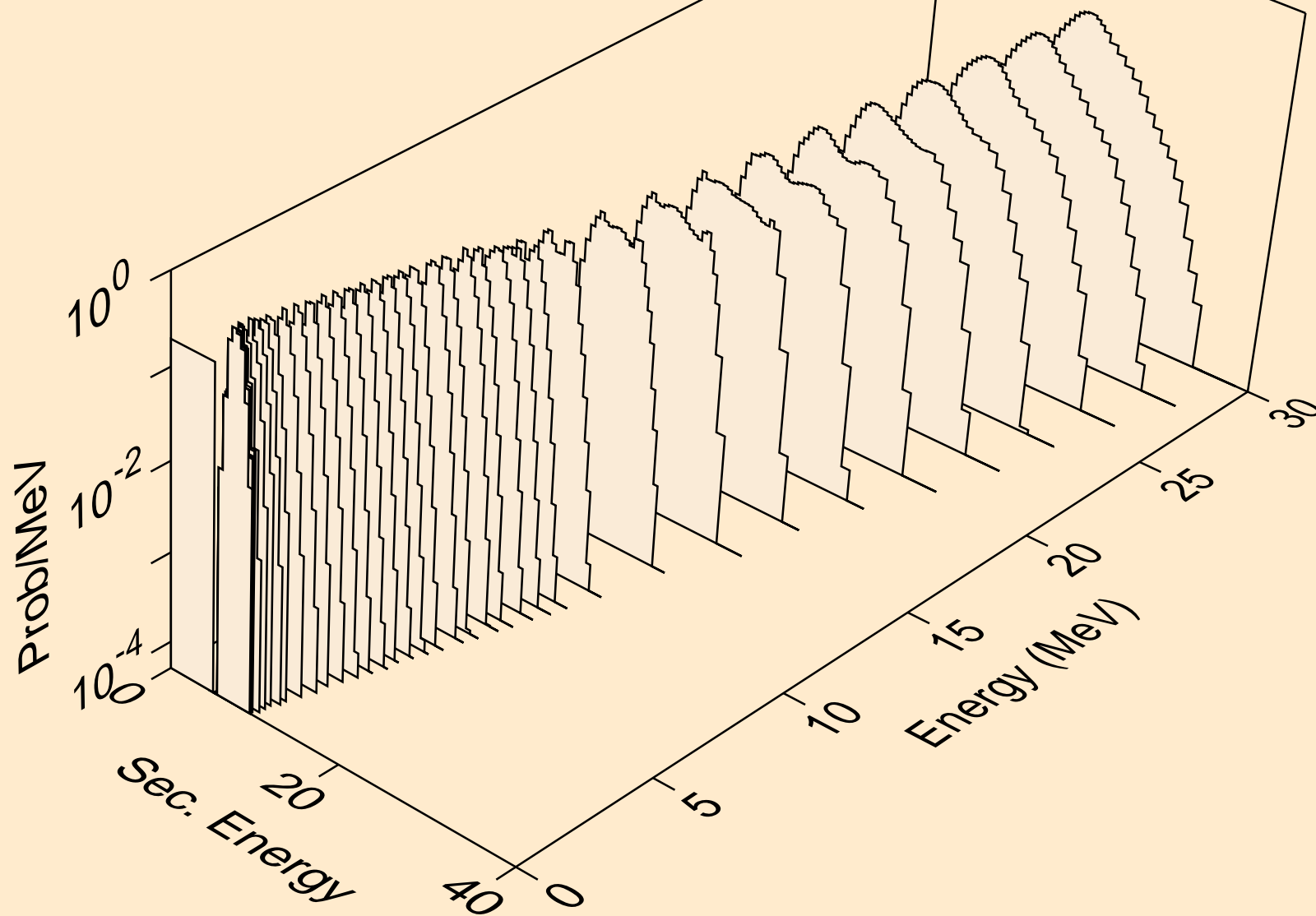

OS181M NEUTRON ACER TENDL-2021 LIBRARY; T=293.6K  
alphas from (n,pa)

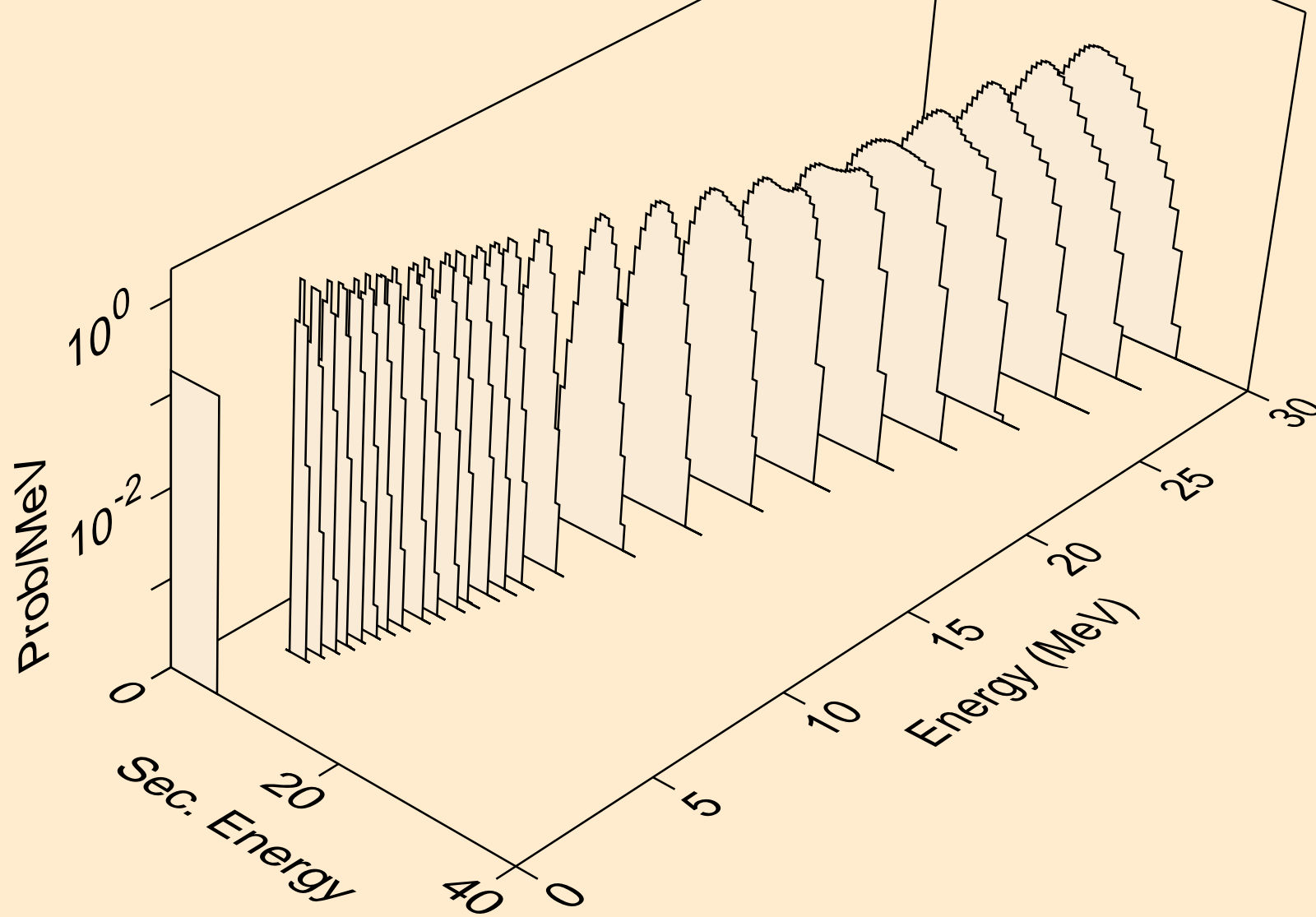

OS181M NEUTRON ACER TENDL-2021 LIBRARY; T=293.6K  
alphas from (n,da)

