

OS191 NEUTRON ACER TENDL-2021 LIBRARY; T=293.6K

Principal cross sections

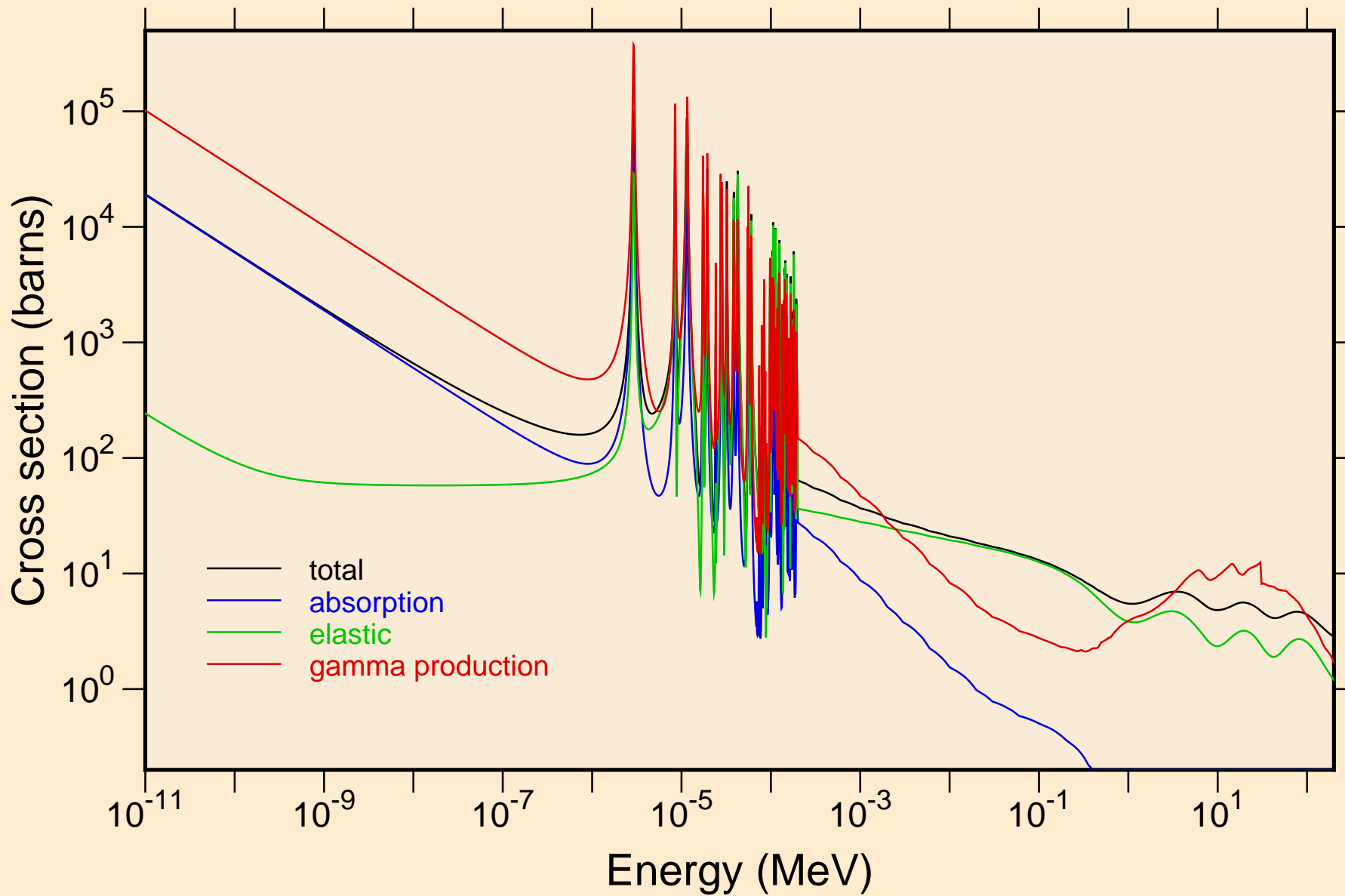

OS191 NEUTRON ACER TENDL-2021 LIBRARY; T=293.6K
resonance total cross section

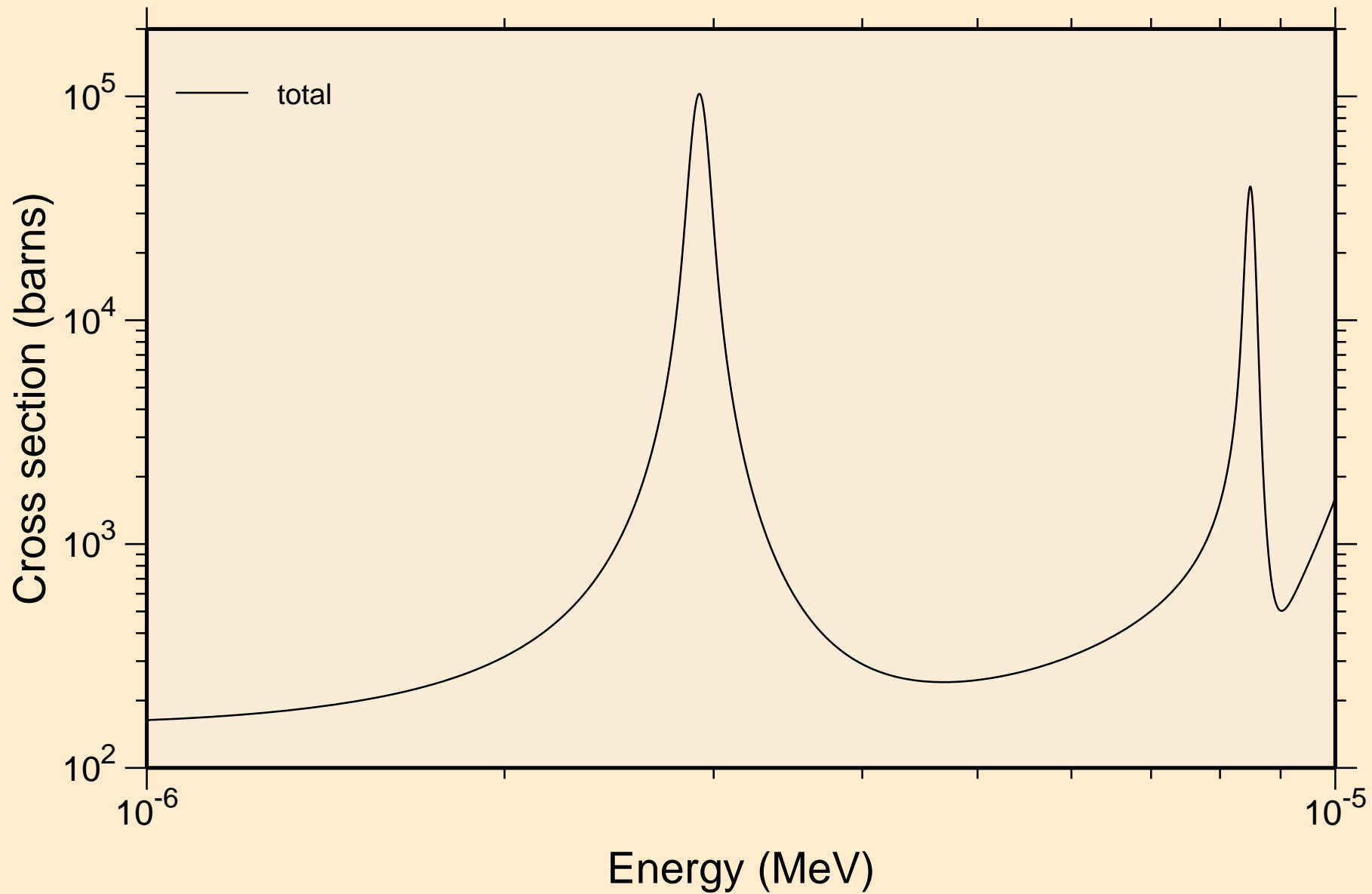

OS191 NEUTRON ACER TENDL-2021 LIBRARY; T=293.6K
resonance total cross section

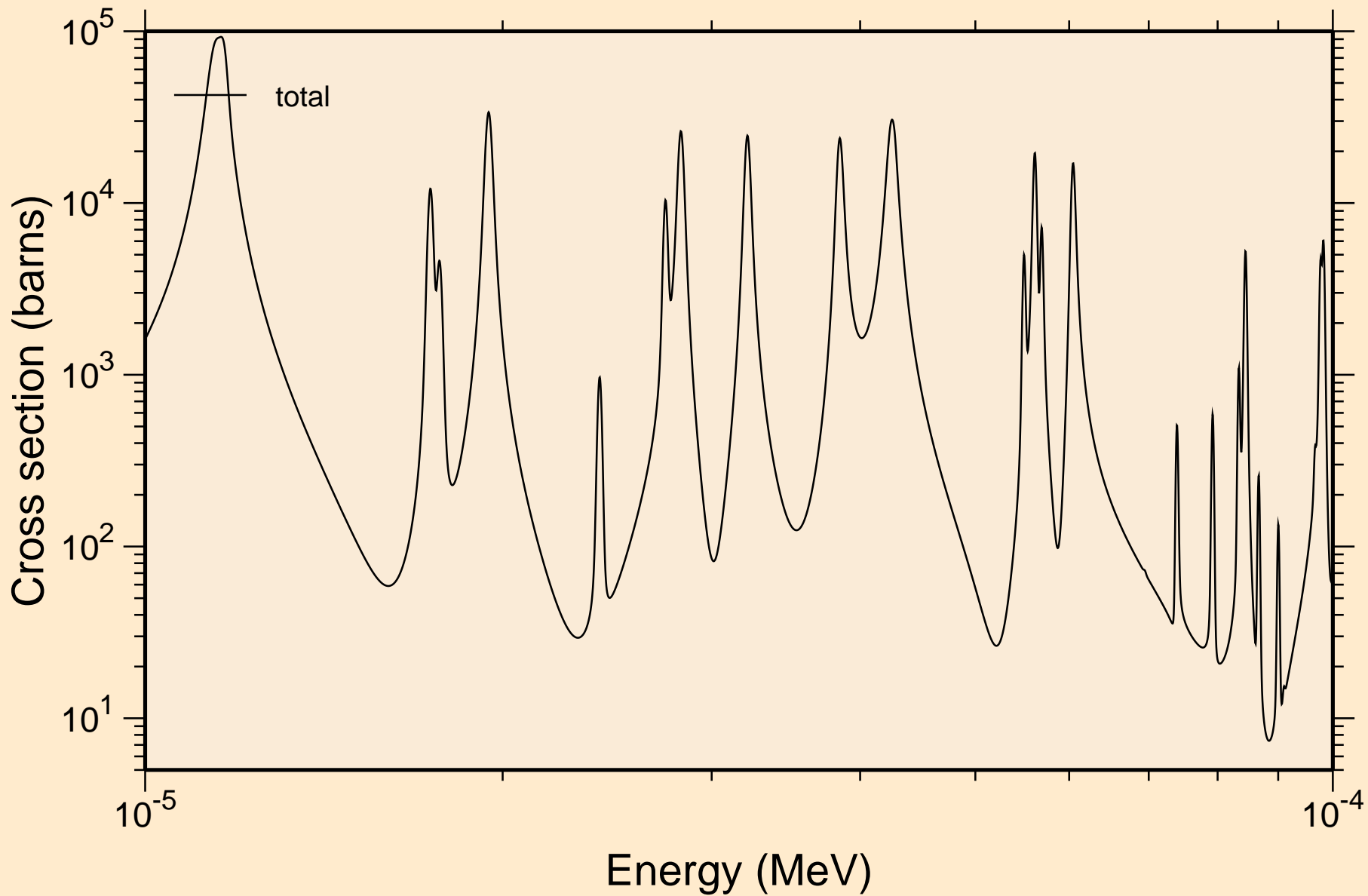

OS191 NEUTRON ACER TENDL-2021 LIBRARY; T=293.6K
resonance total cross section

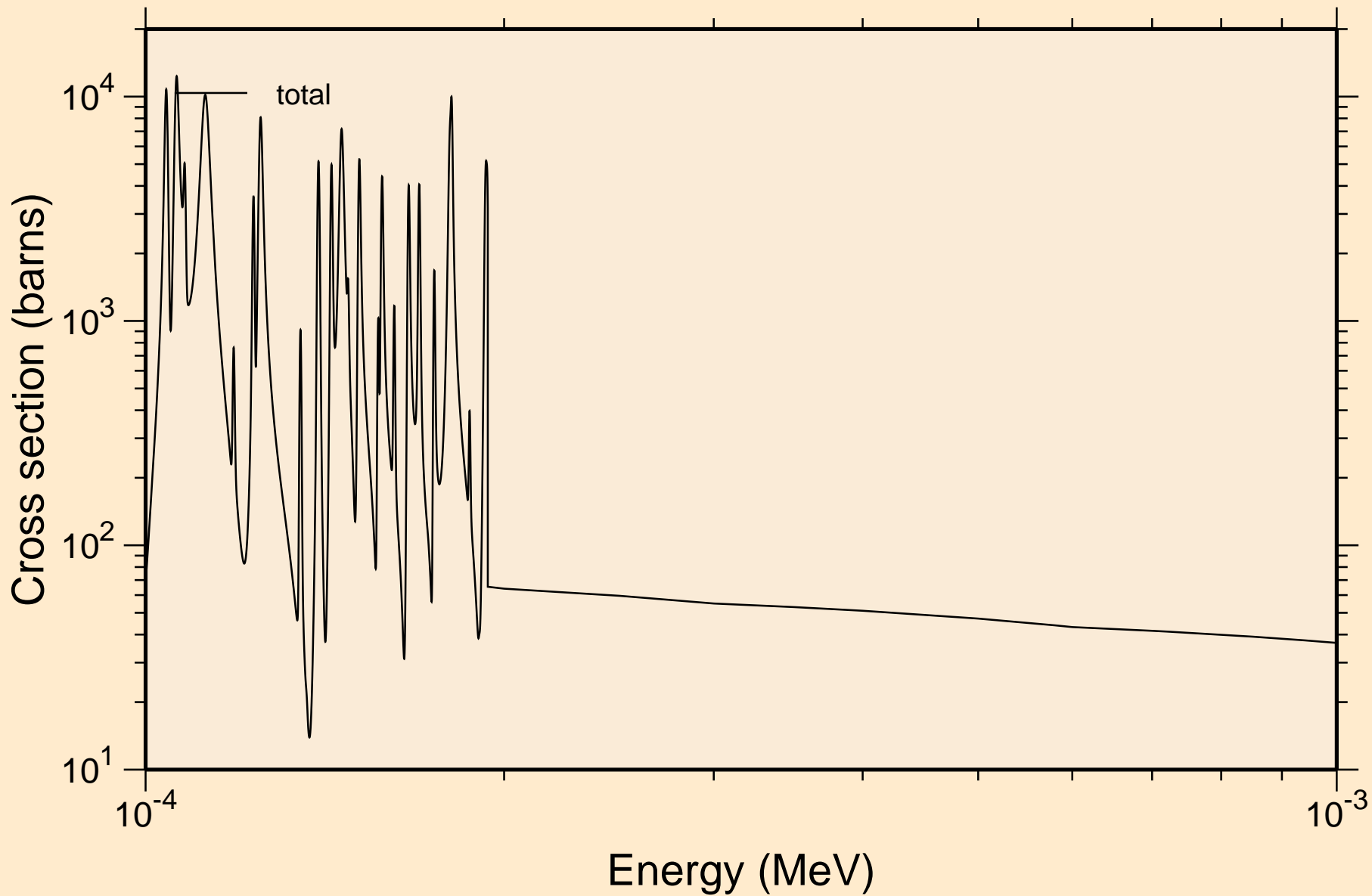

OS191 NEUTRON ACER TENDL-2021 LIBRARY; T=293.6K
resonance total cross section

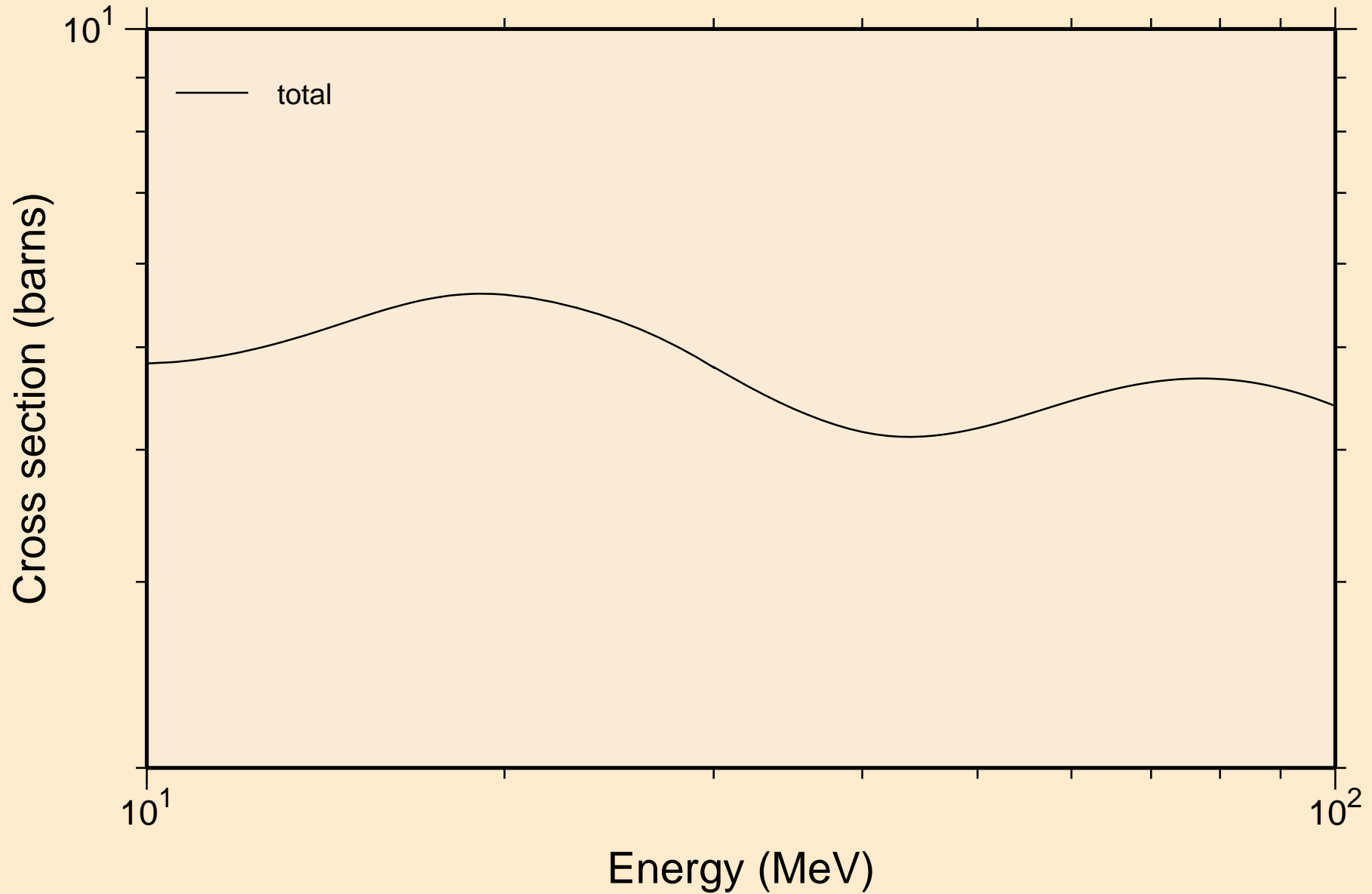

OS191 NEUTRON ACER TENDL-2021 LIBRARY; T=293.6K
resonance absorption cross sections

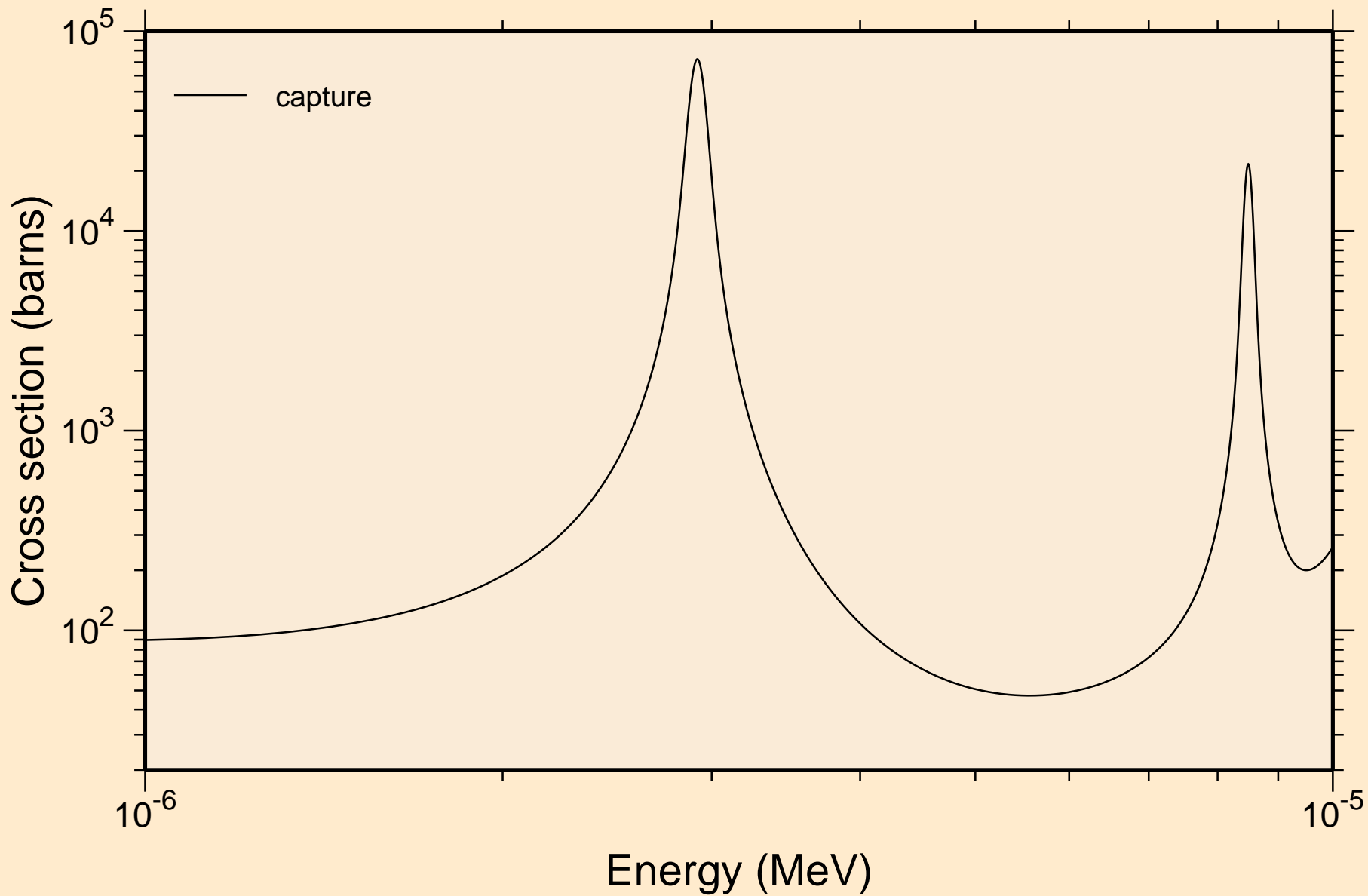

OS191 NEUTRON ACER TENDL-2021 LIBRARY; T=293.6K
resonance absorption cross sections

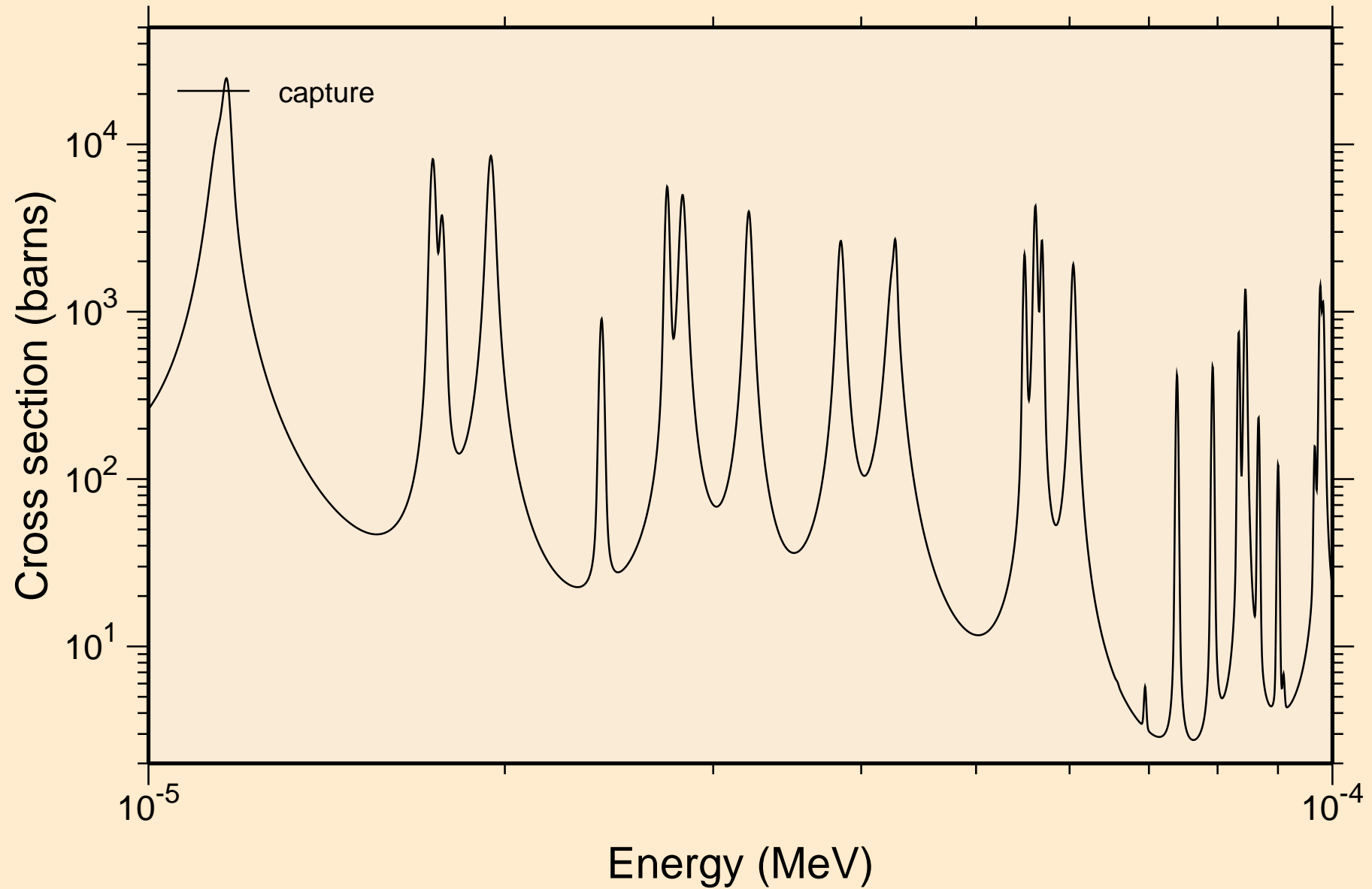

OS191 NEUTRON ACER TENDL-2021 LIBRARY; T=293.6K
resonance absorption cross sections

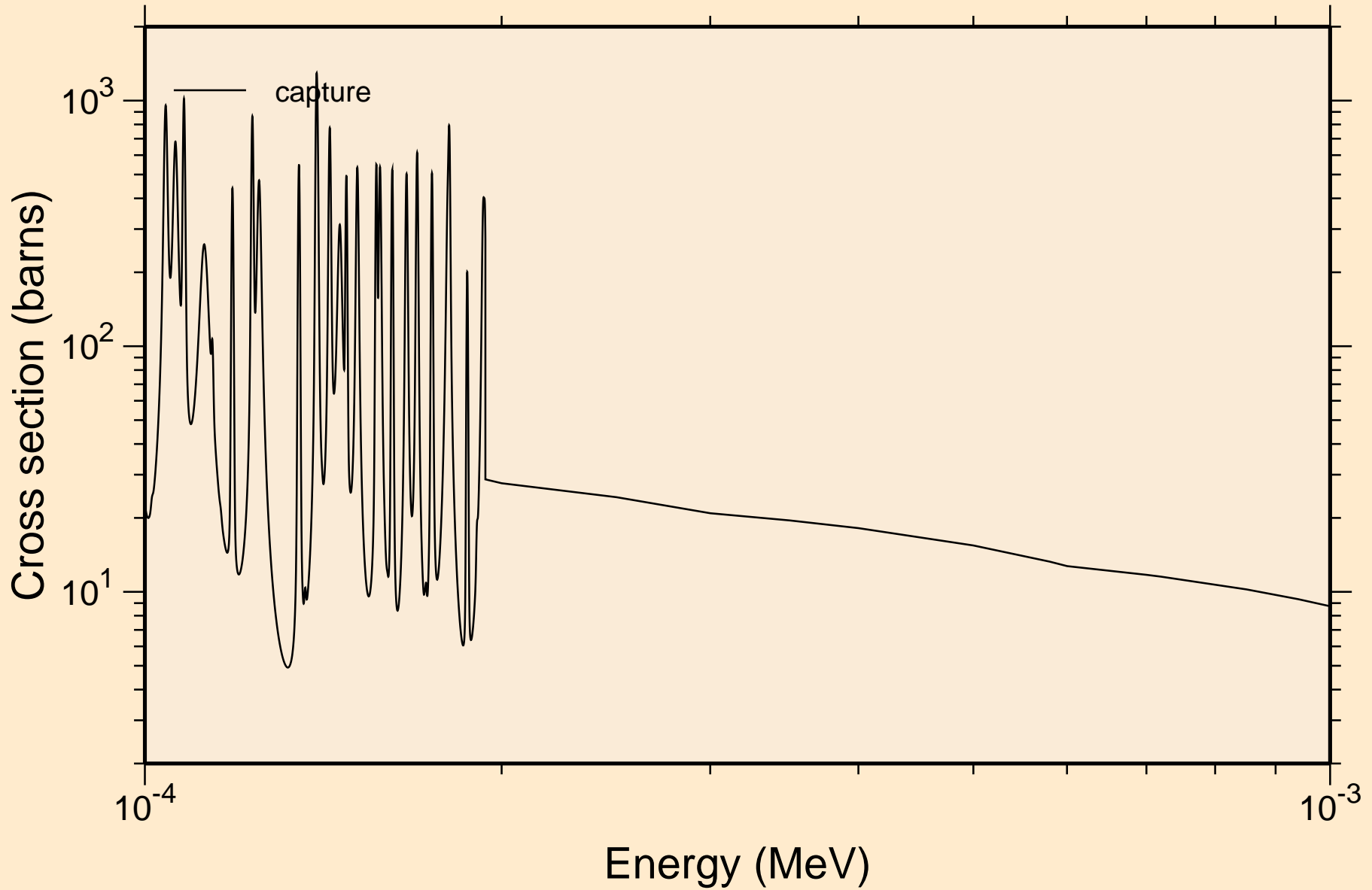

OS191 NEUTRON ACER TENDL-2021 LIBRARY; T=293.6K
resonance absorption cross sections

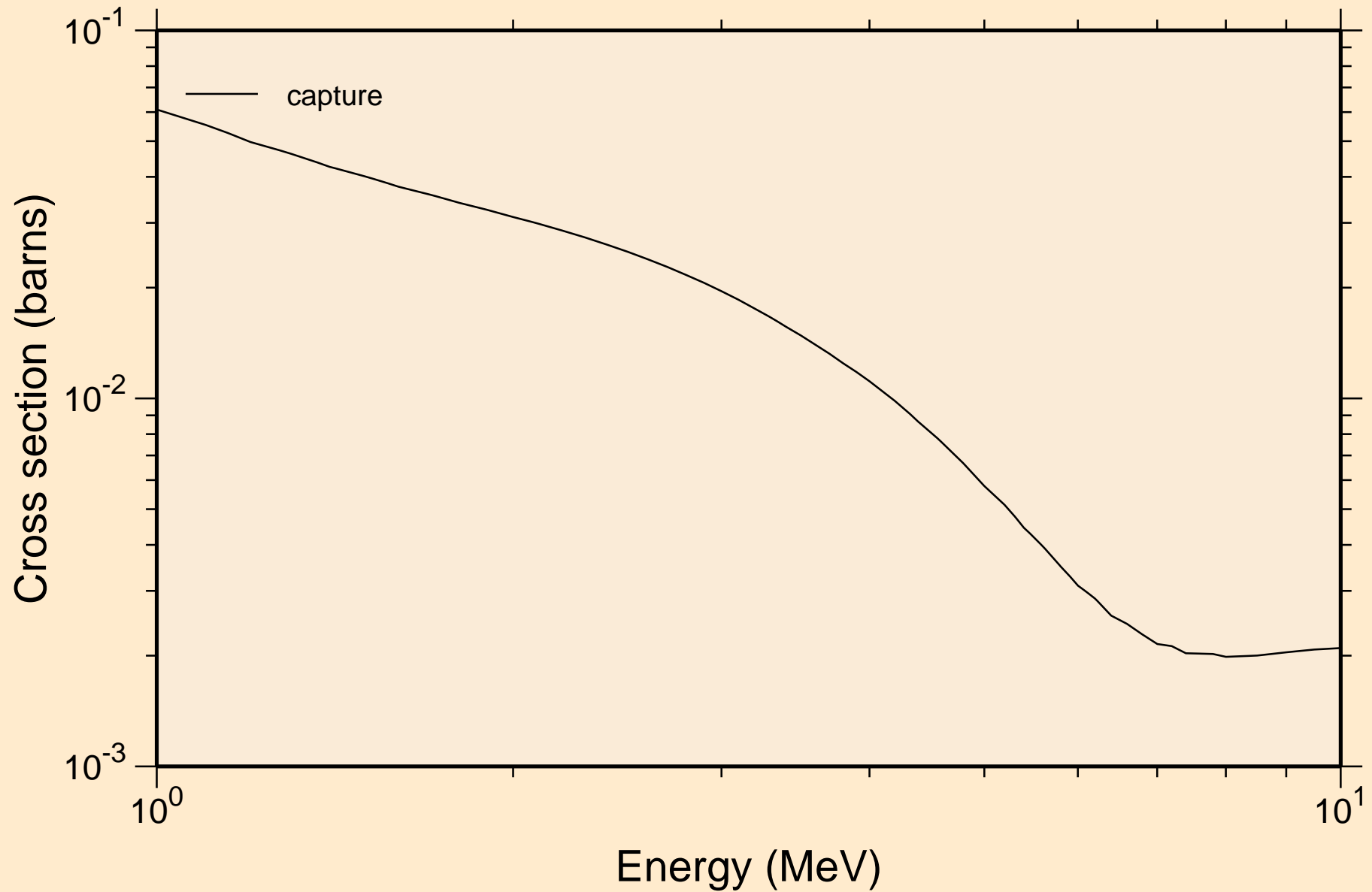

OS191 NEUTRON ACER TENDL-2021 LIBRARY; T=293.6K
Heating

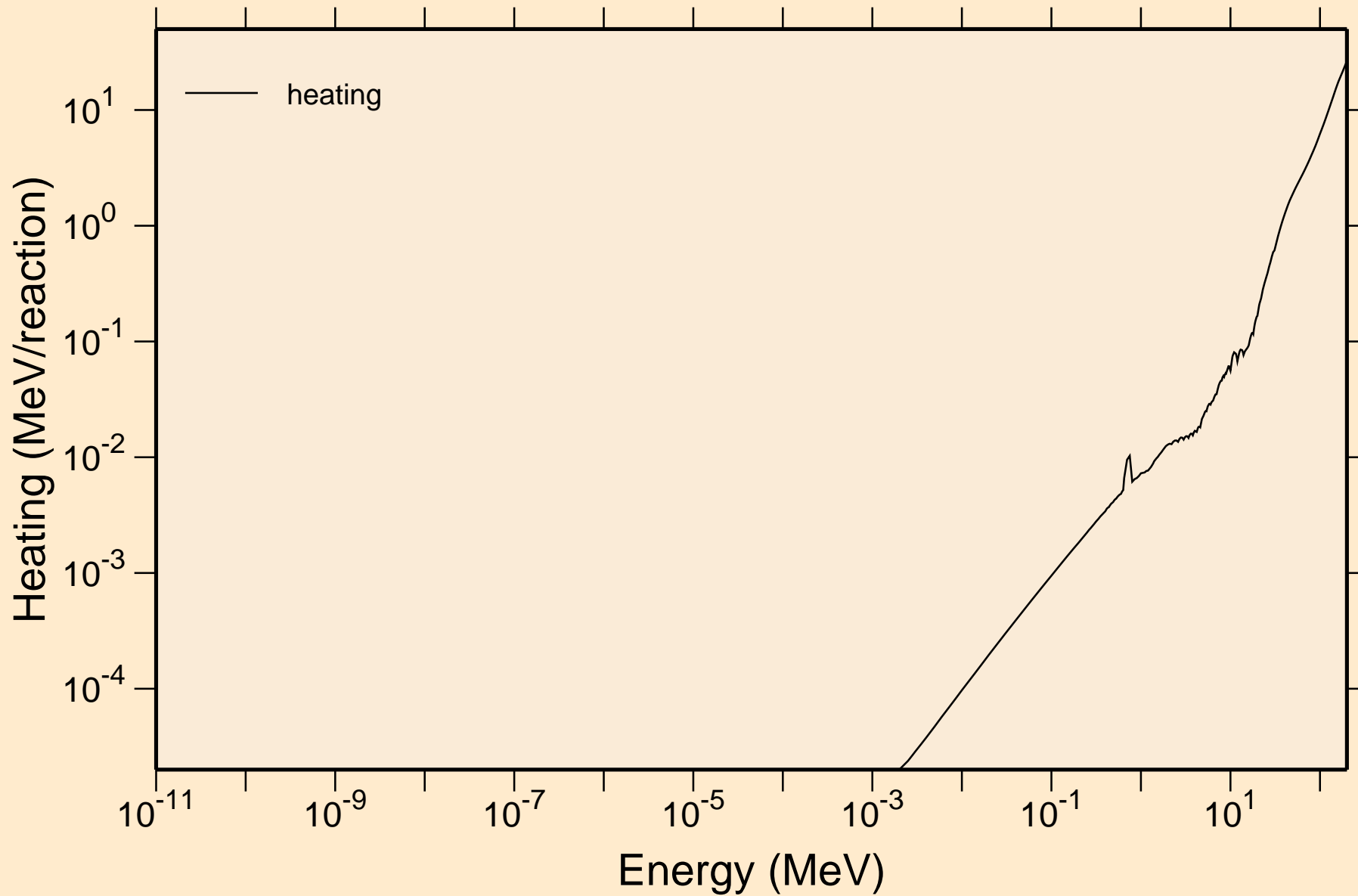

OS191 NEUTRON ACER TENDL-2021 LIBRARY; T=293.6K
Damage

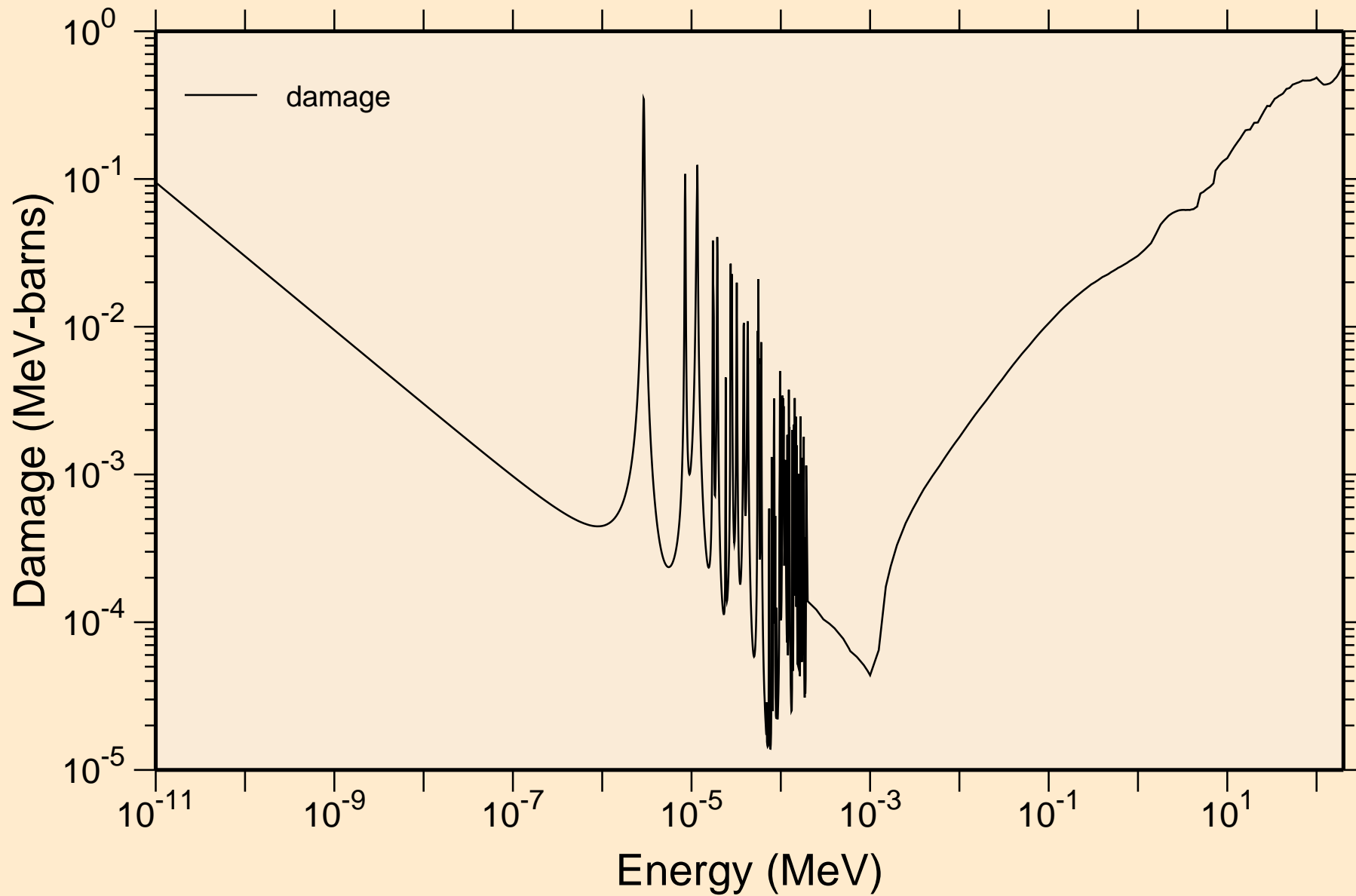

OS191 NEUTRON ACER TENDL-2021 LIBRARY; T=293.6K
Non-threshold reactions

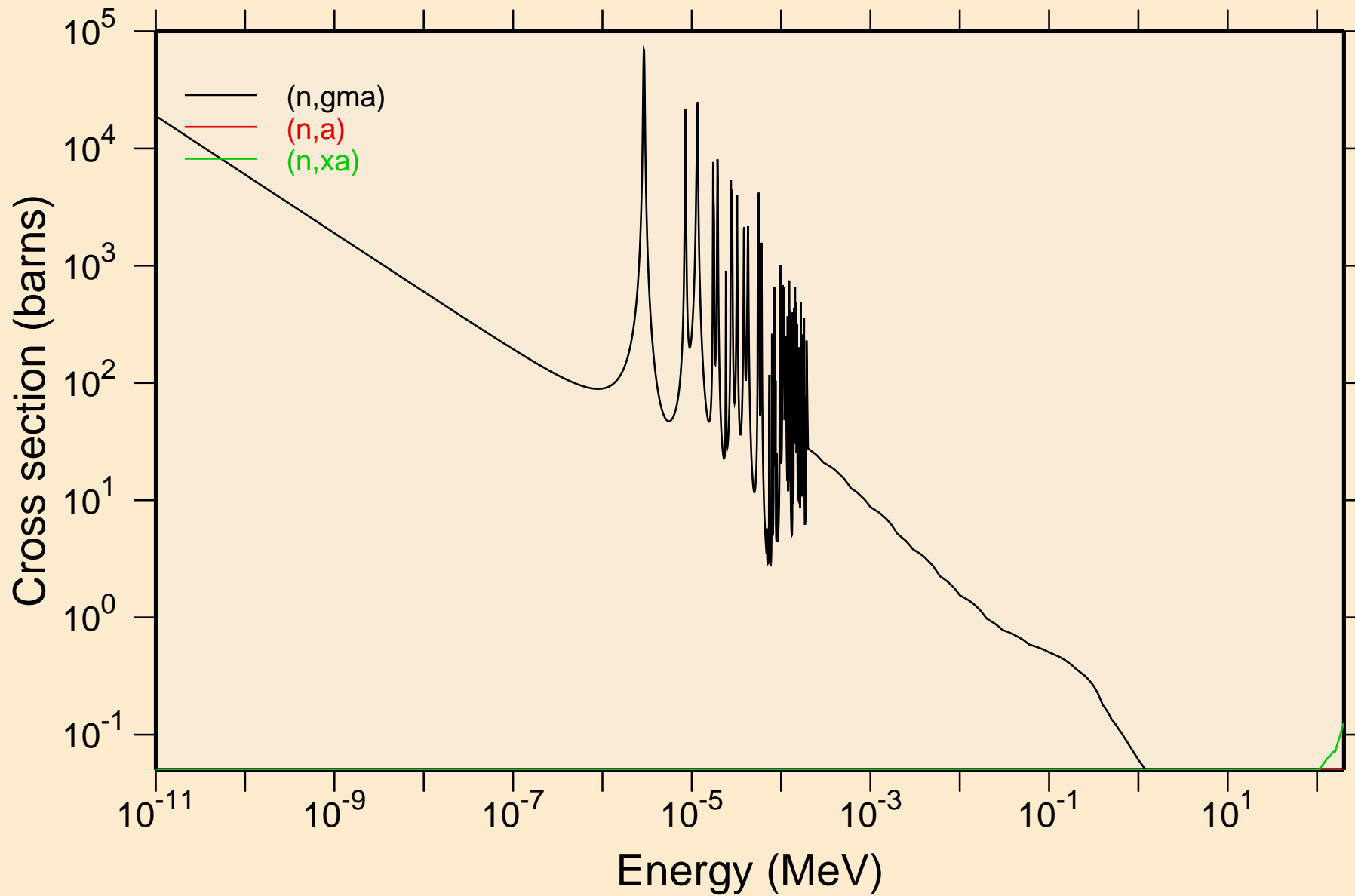

OS191 NEUTRON ACER TENDL-2021 LIBRARY; T=293.6K
Principal cross sections

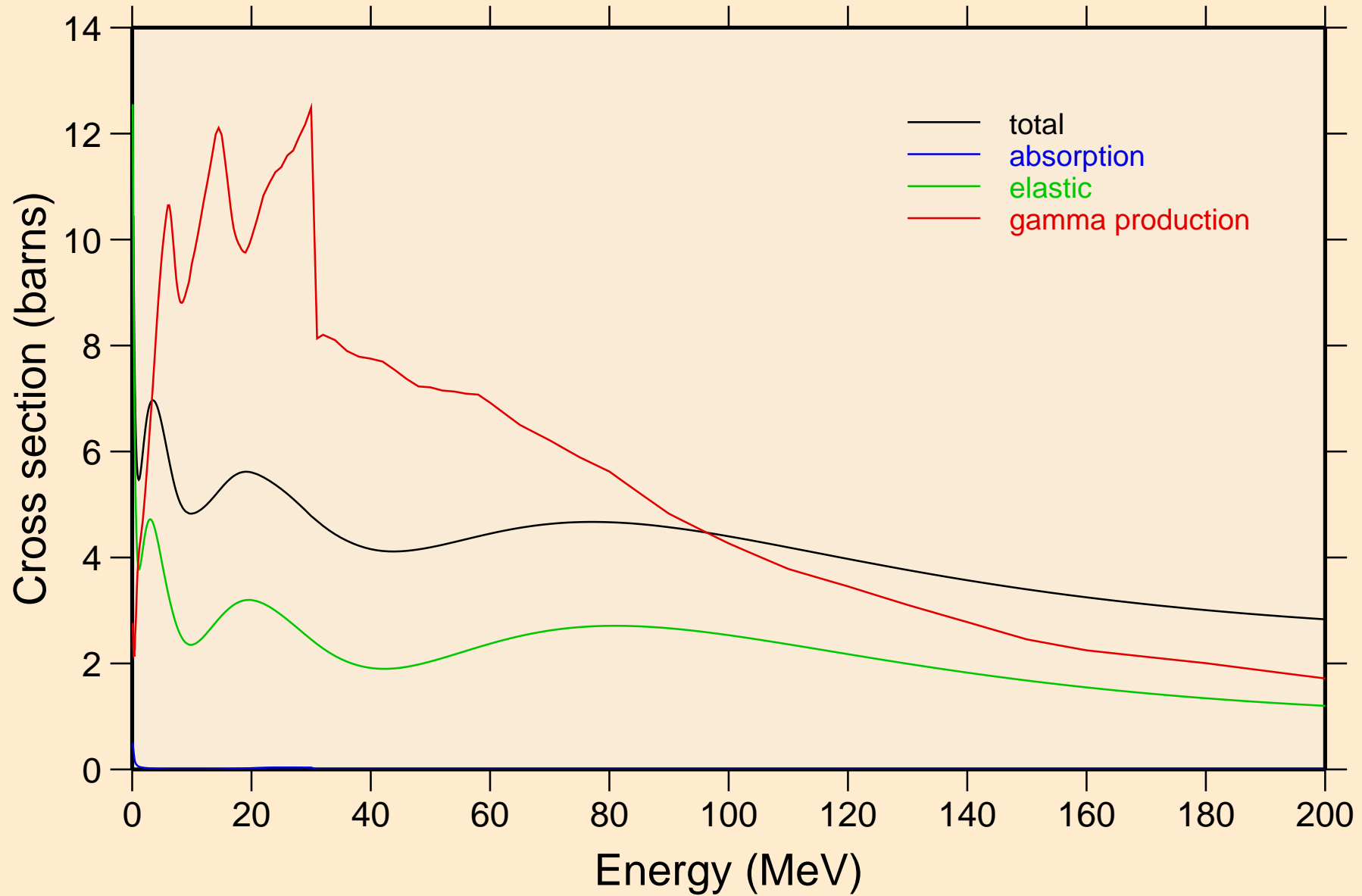

OS191 NEUTRON ACER TENDL-2021 LIBRARY; T=293.6K
Heating

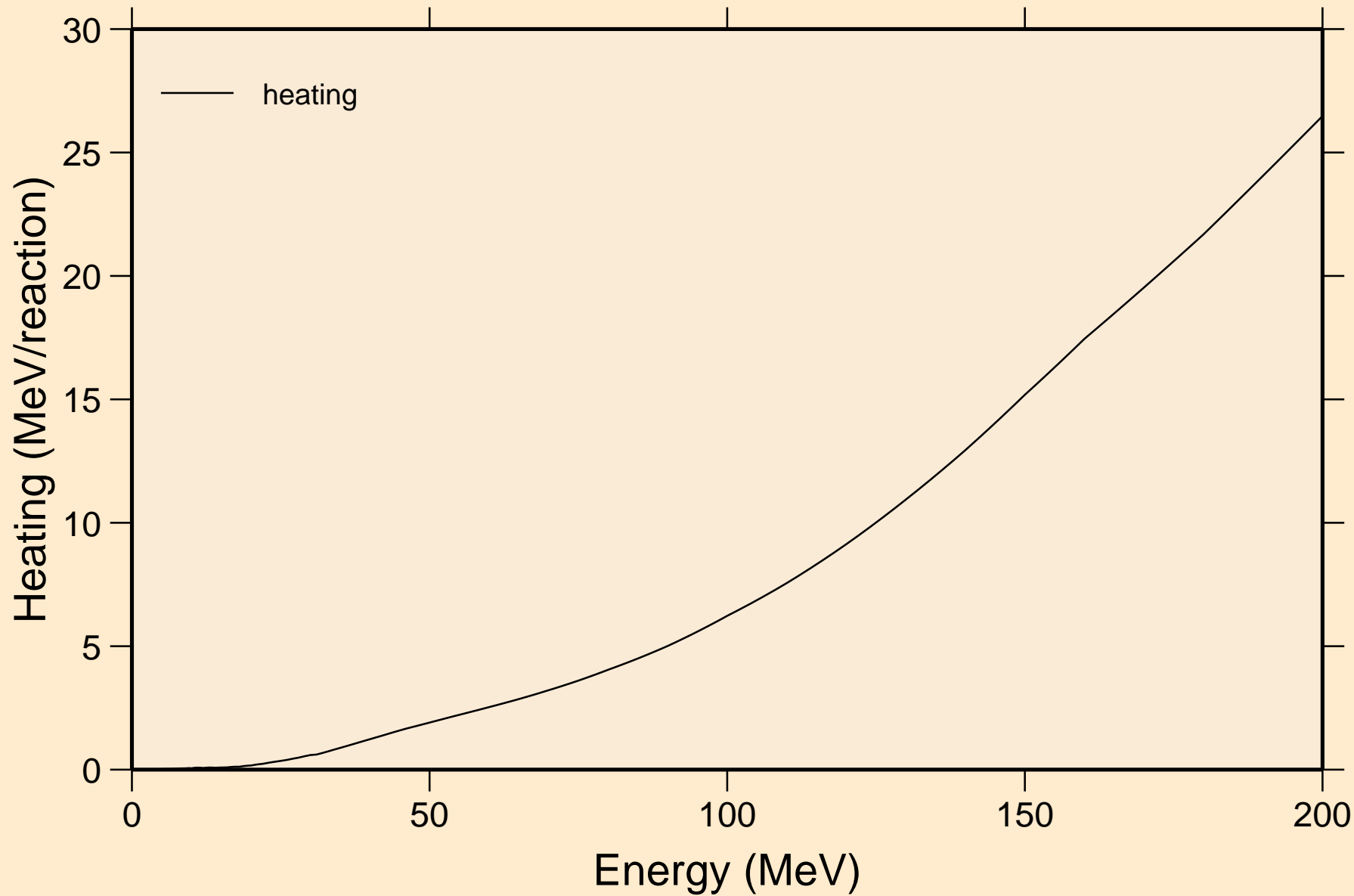

OS191 NEUTRON ACER TENDL-2021 LIBRARY; T=293.6K

Damage

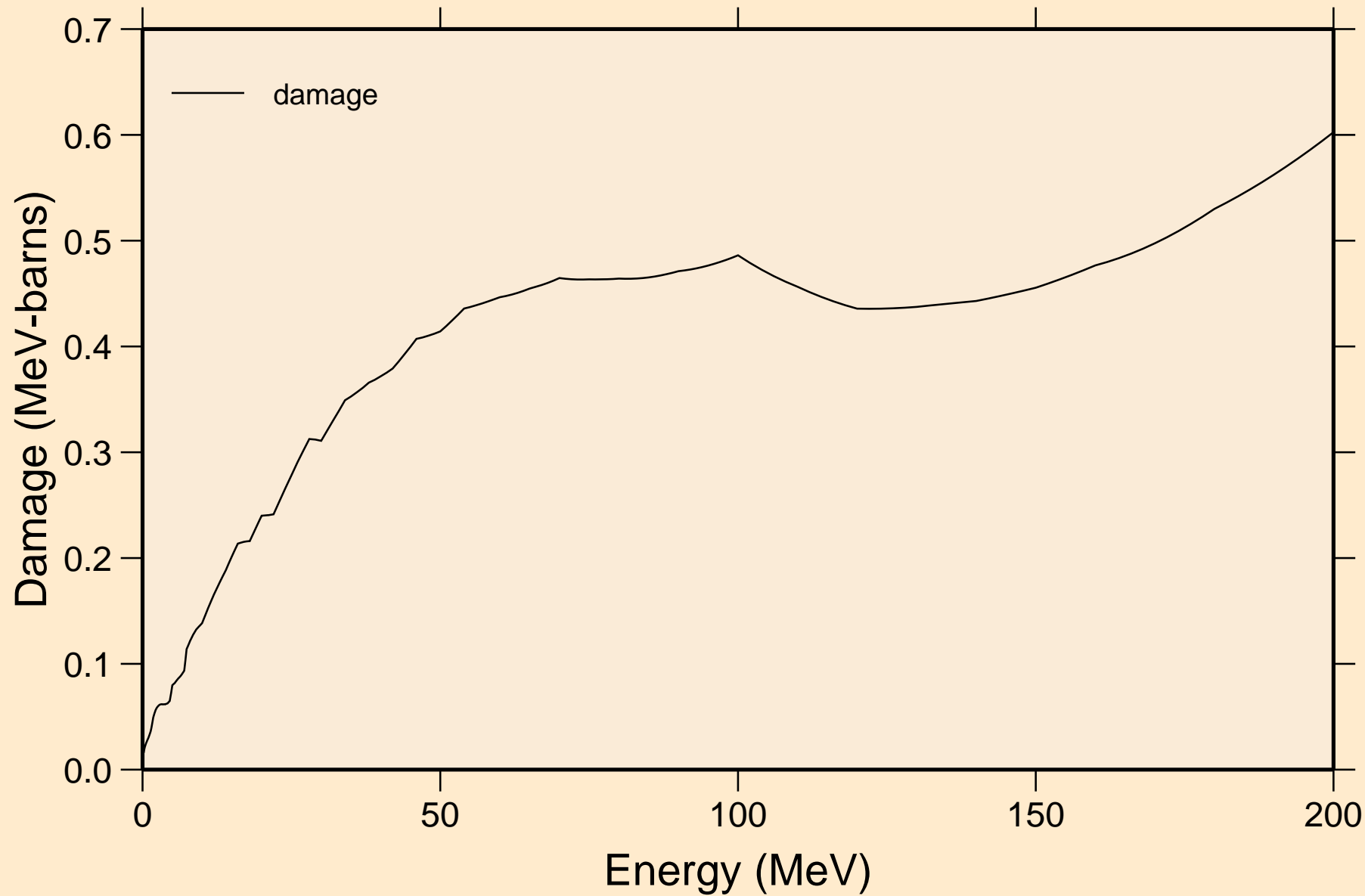

OS191 NEUTRON ACER TENDL-2021 LIBRARY; T=293.6K
Non-threshold reactions

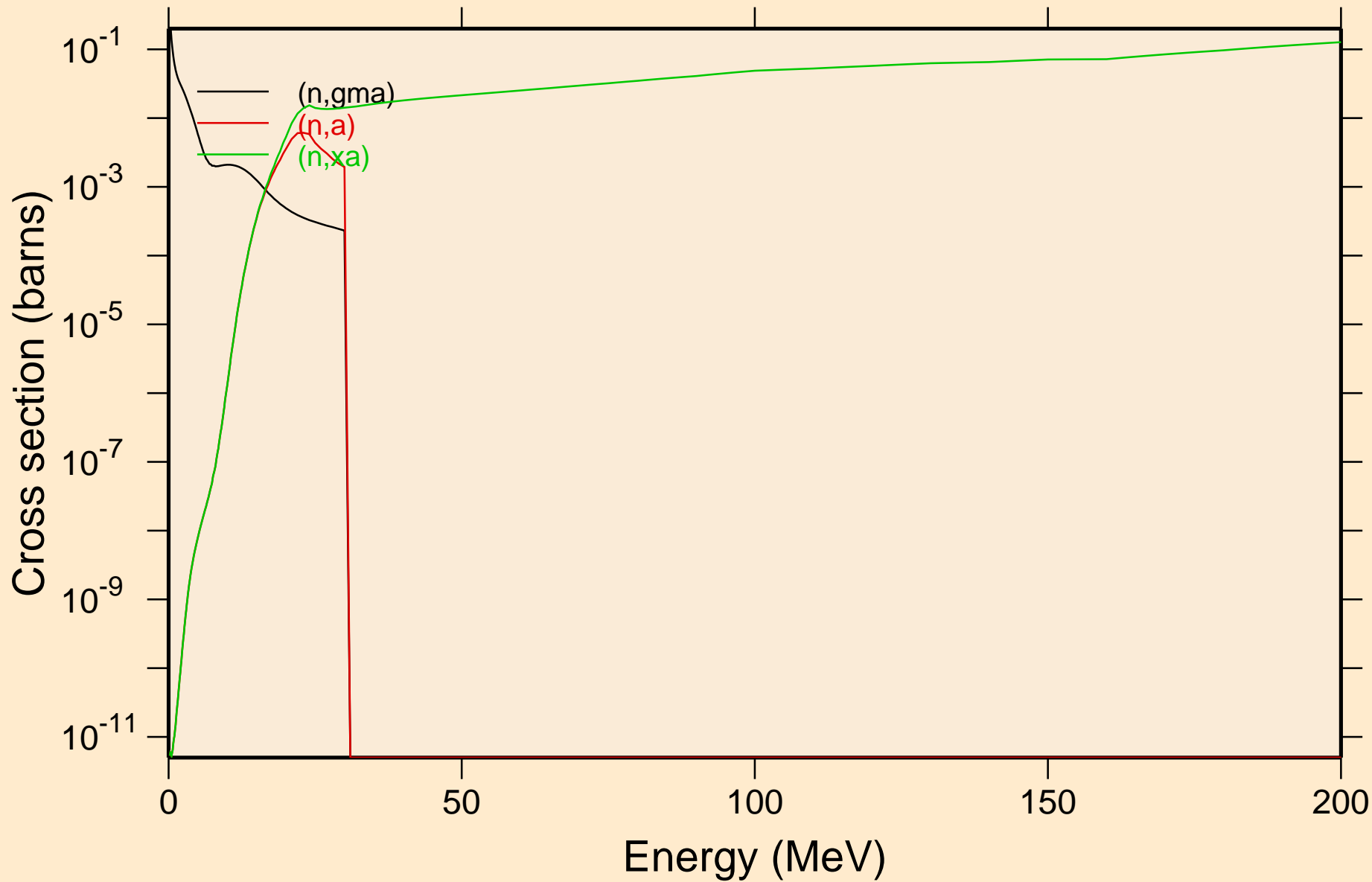

OS191 NEUTRON ACER TENDL-2021 LIBRARY; T=293.6K
Inelastic levels

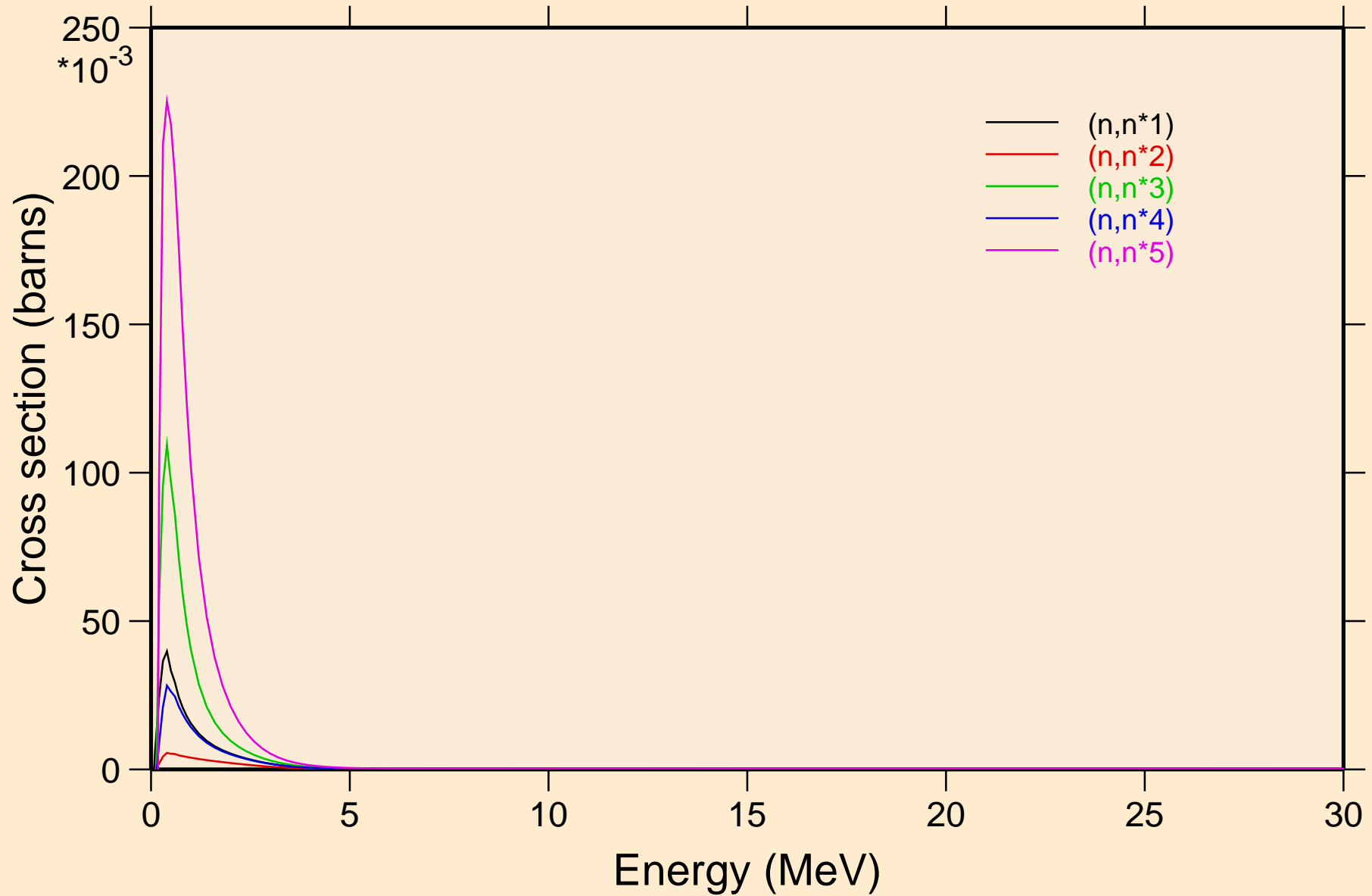

OS191 NEUTRON ACER TENDL-2021 LIBRARY; T=293.6K
Inelastic levels

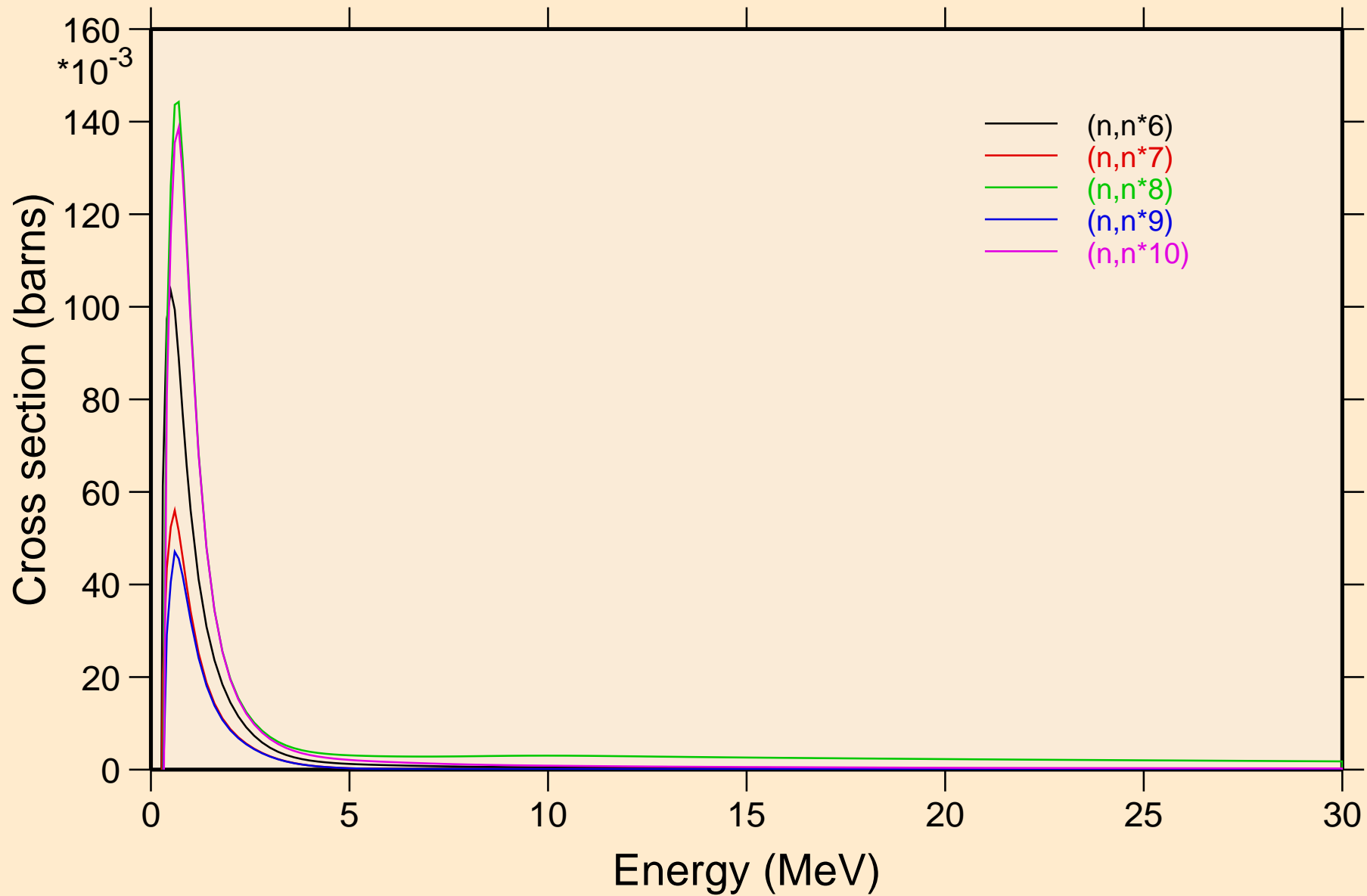

OS191 NEUTRON ACER TENDL-2021 LIBRARY; T=293.6K
Inelastic levels

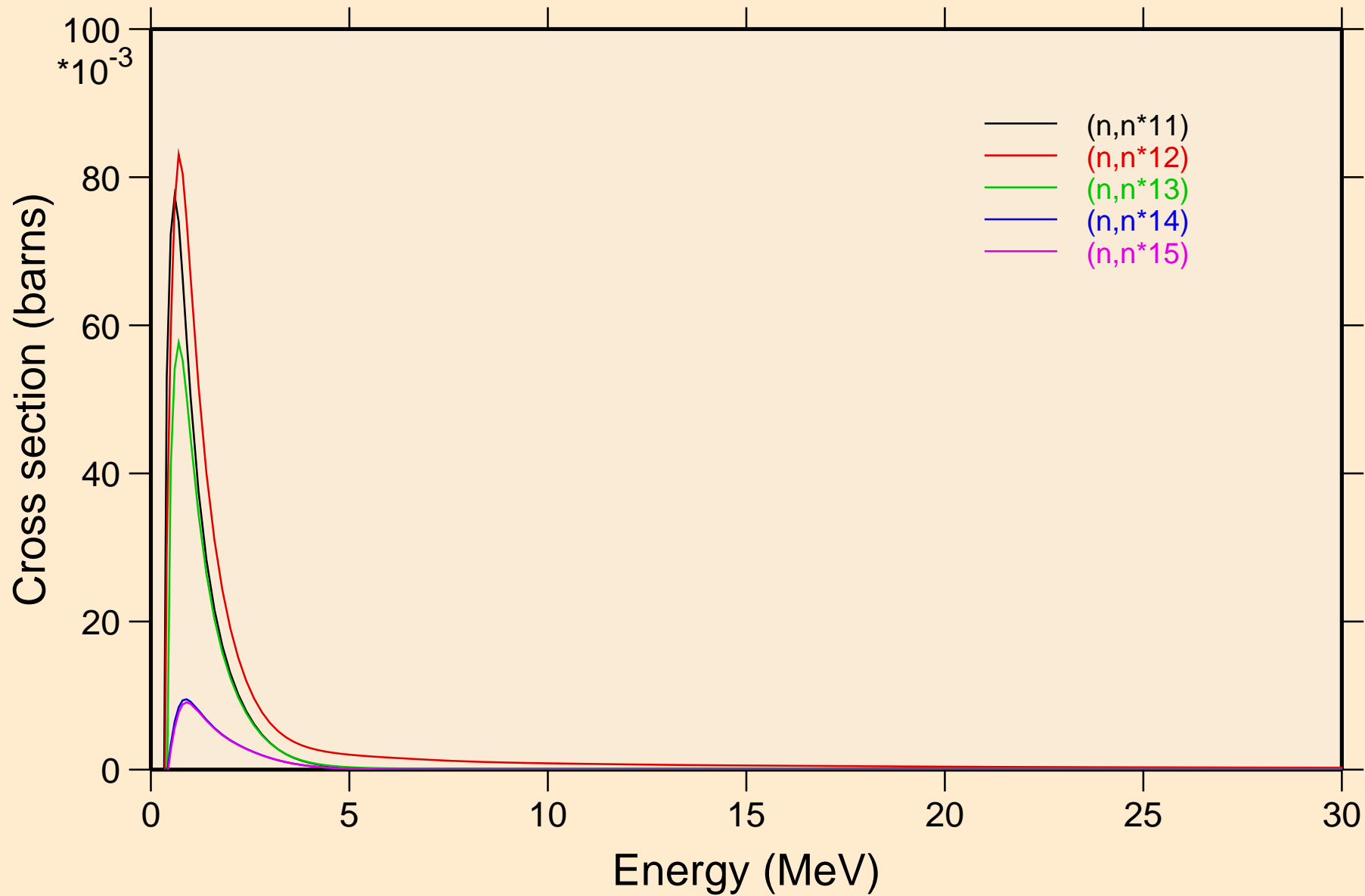

OS191 NEUTRON ACER TENDL-2021 LIBRARY; T=293.6K
Inelastic levels

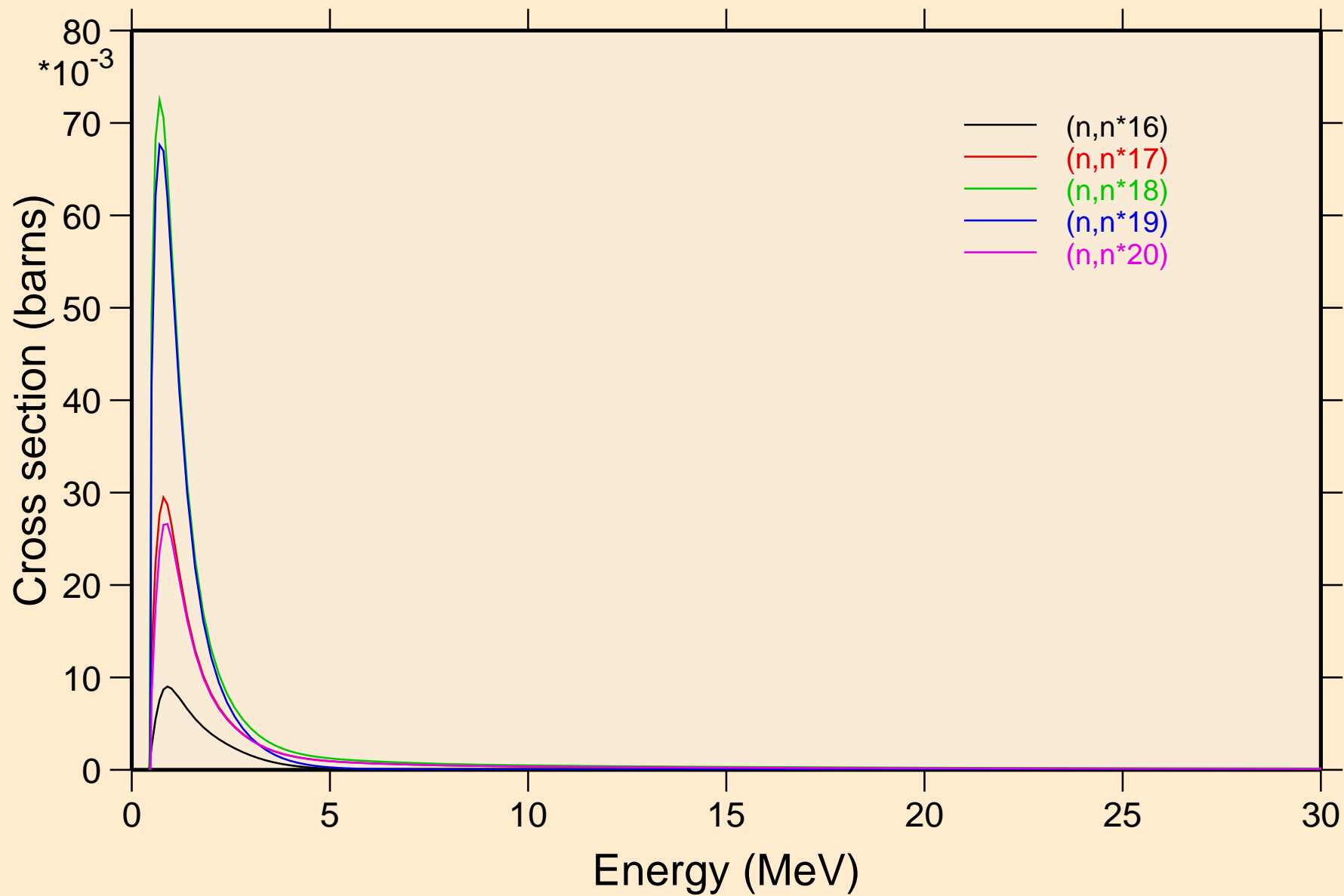

OS191 NEUTRON ACER TENDL-2021 LIBRARY; T=293.6K
Inelastic levels

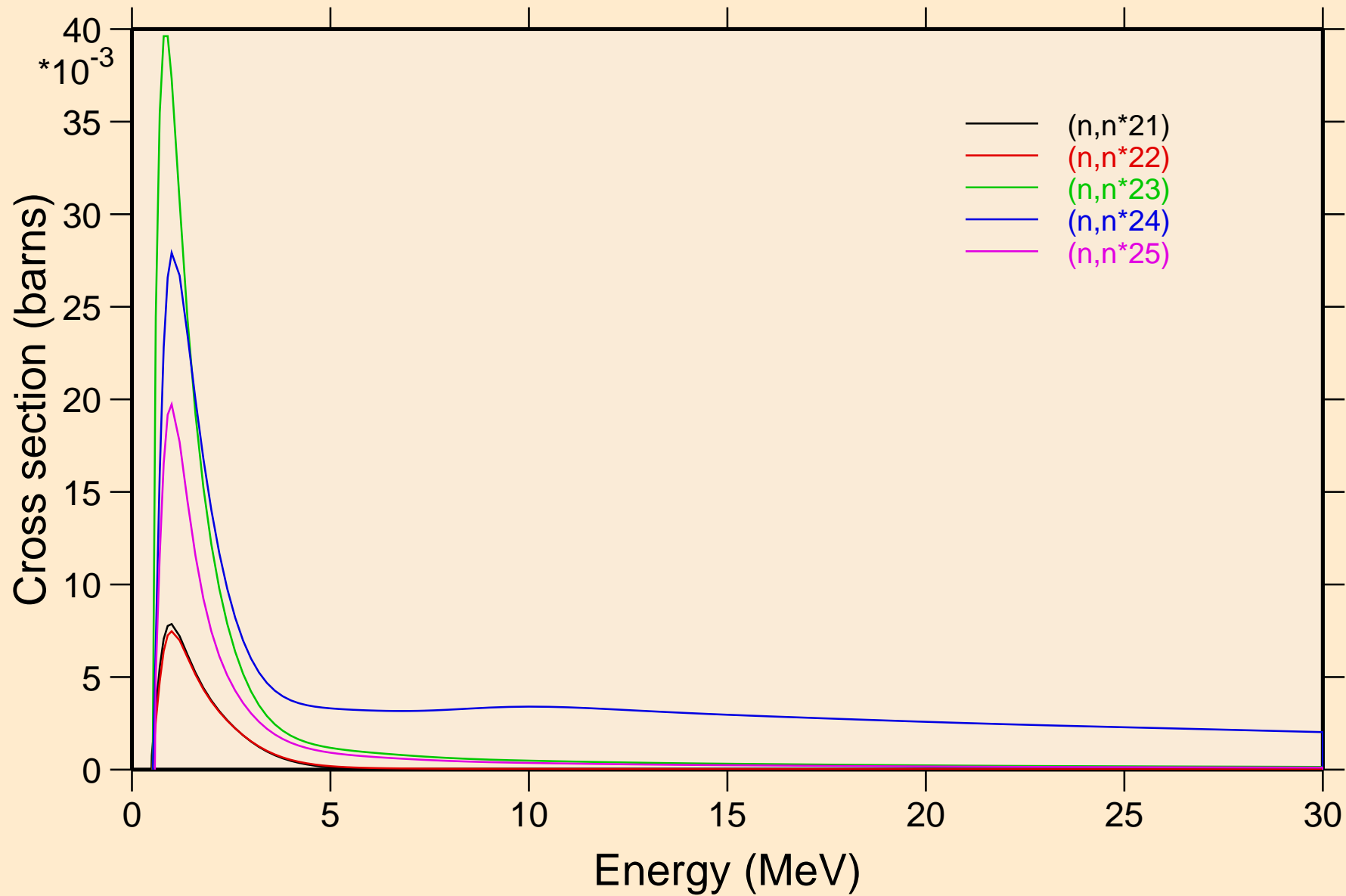

OS191 NEUTRON ACER TENDL-2021 LIBRARY; T=293.6K
Inelastic levels

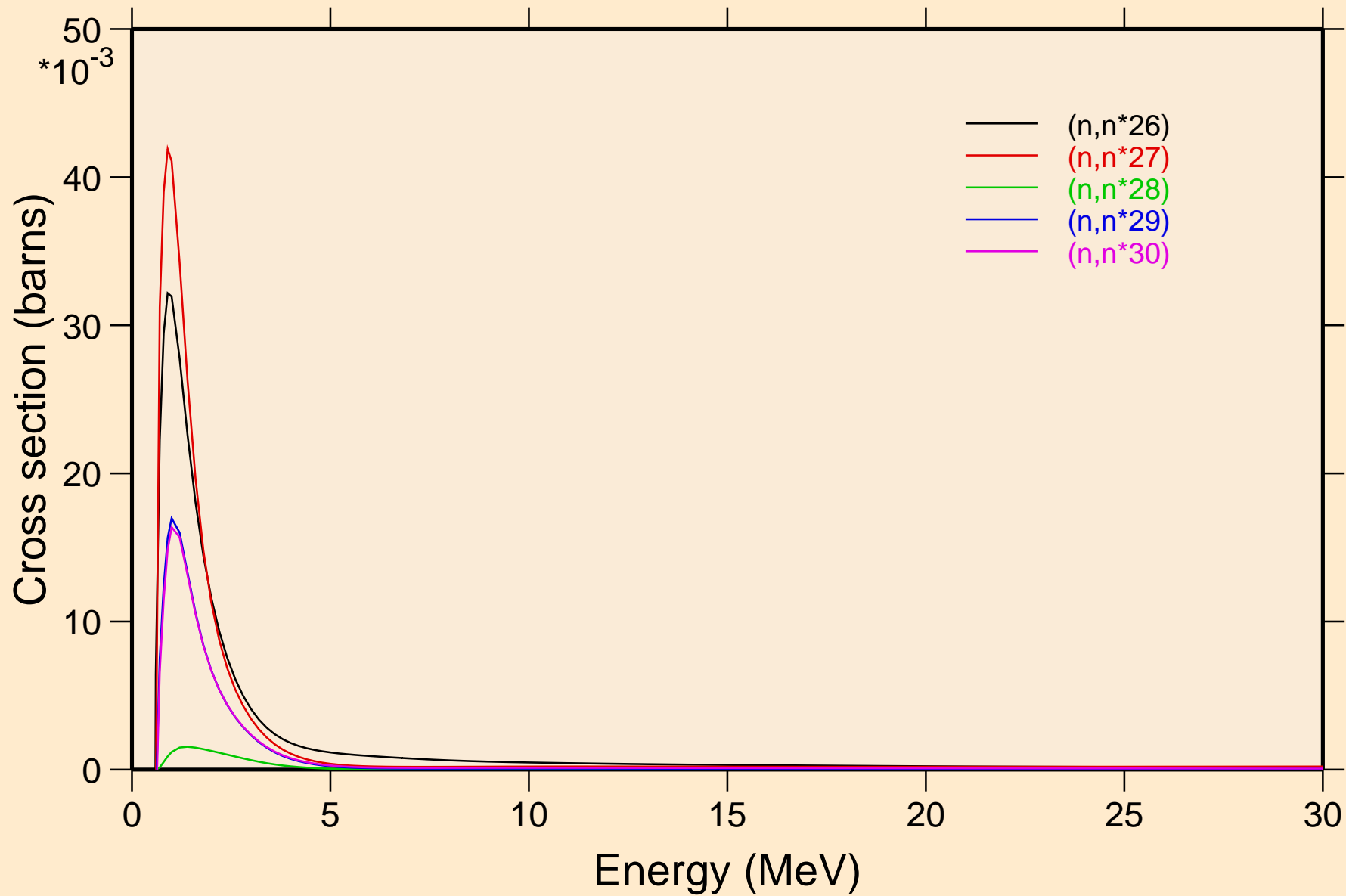

OS191 NEUTRON ACER TENDL-2021 LIBRARY; T=293.6K

Threshold reactions

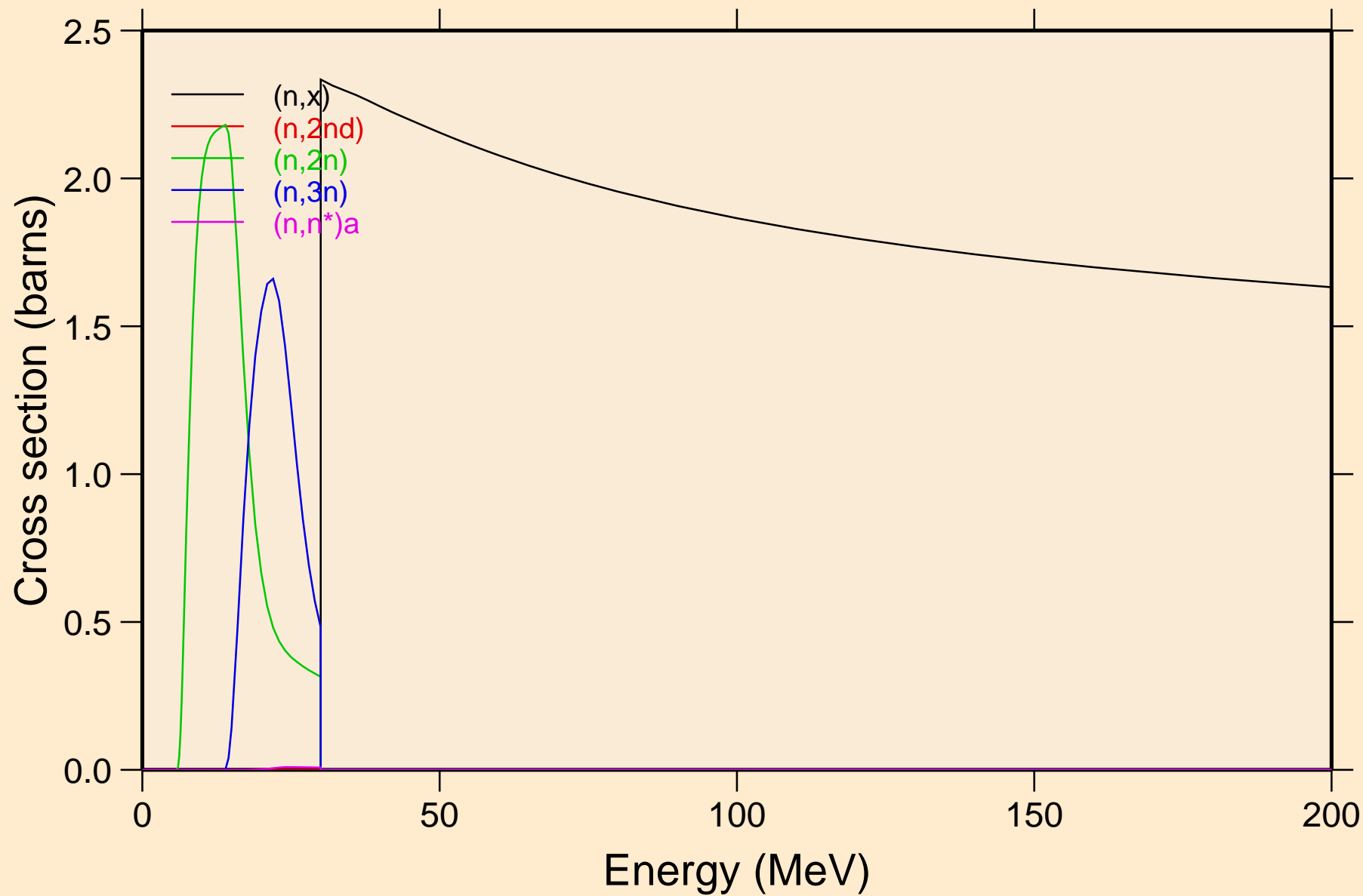

OS191 NEUTRON ACER TENDL-2021 LIBRARY; T=293.6K
Threshold reactions

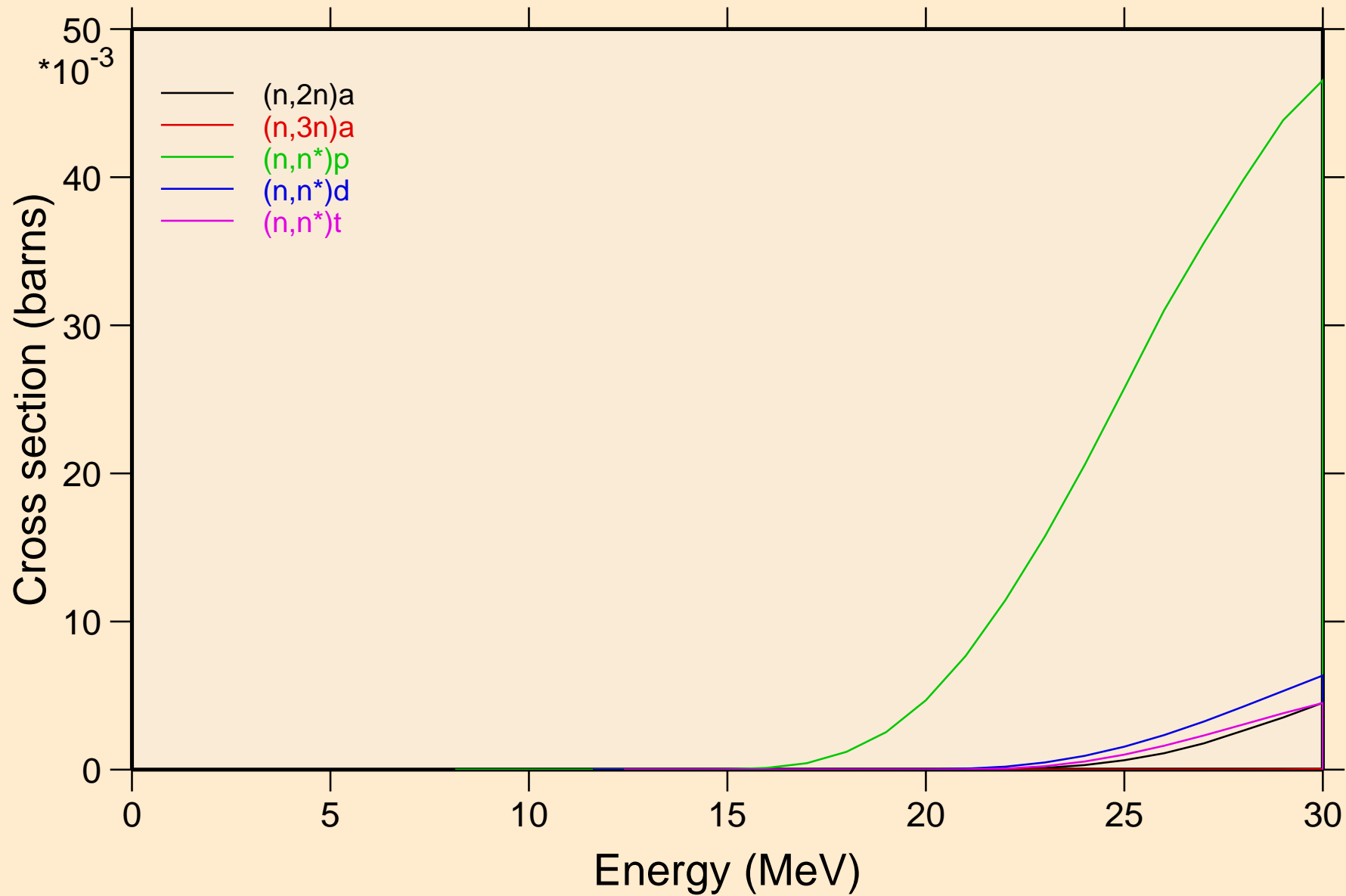

OS191 NEUTRON ACER TENDL-2021 LIBRARY; T=293.6K
Threshold reactions

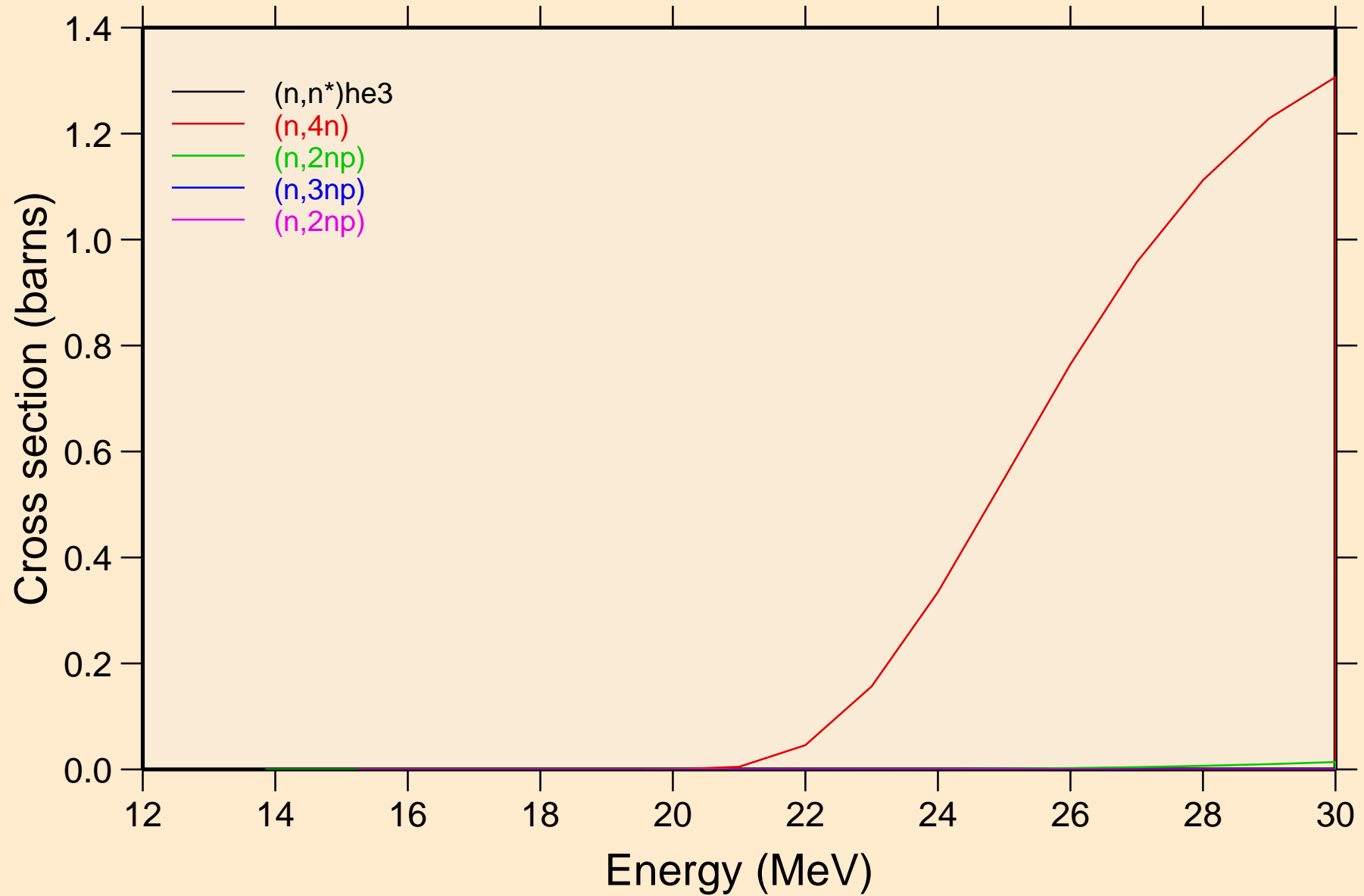

OS191 NEUTRON ACER TENDL-2021 LIBRARY; T=293.6K
Threshold reactions

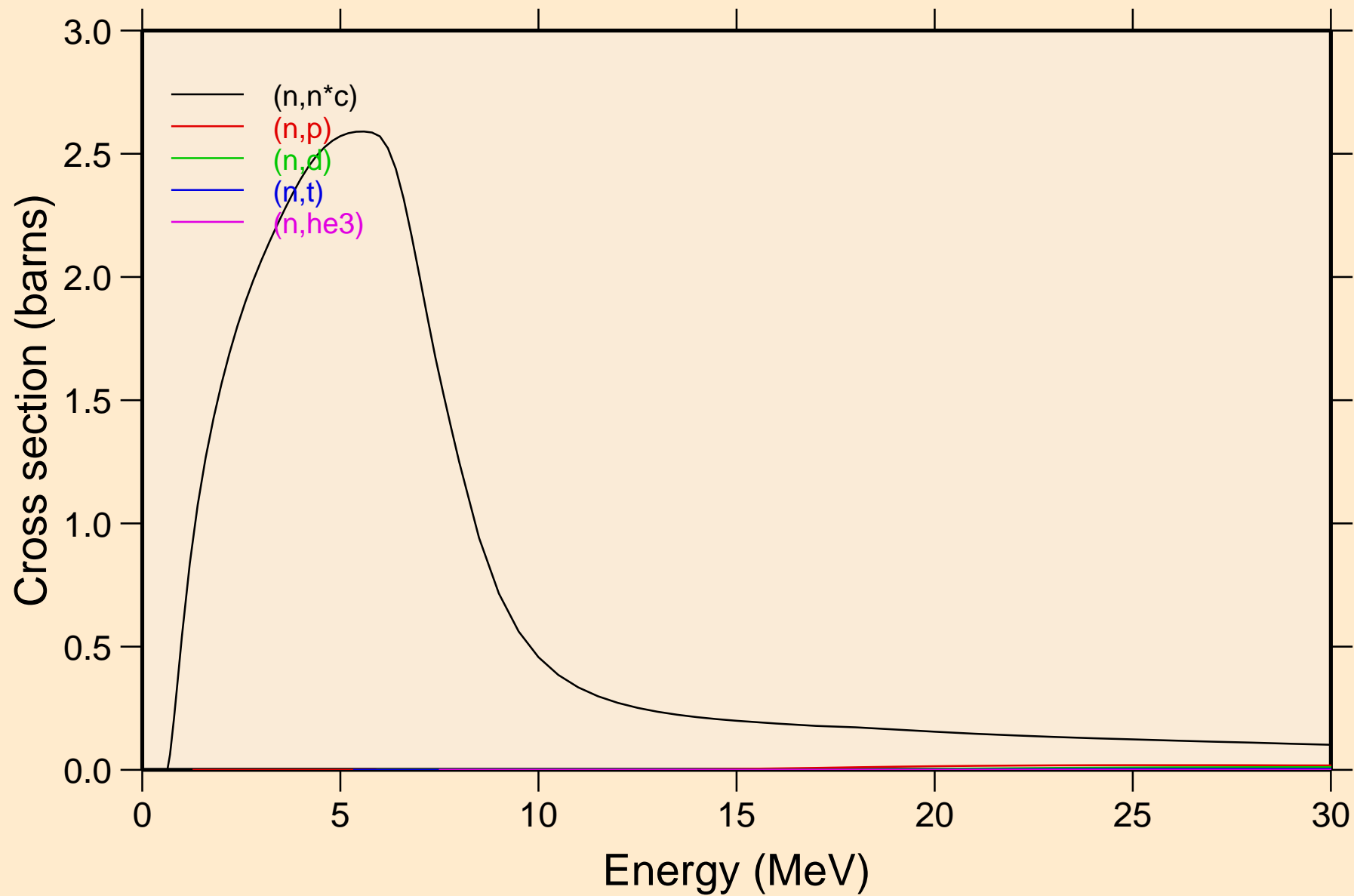

OS191 NEUTRON ACER TENDL-2021 LIBRARY; T=293.6K
Threshold reactions

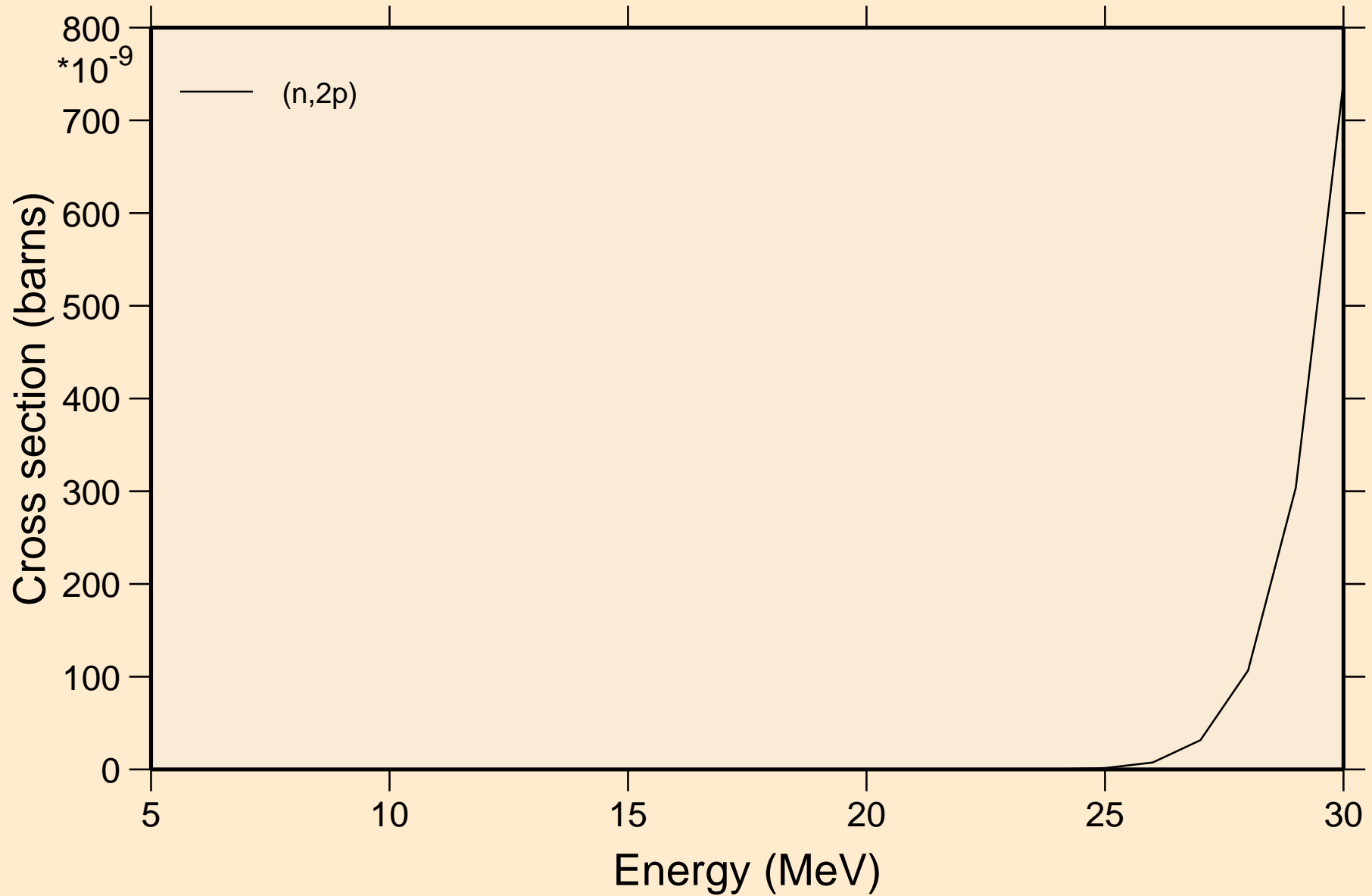

OS191 NEUTRON ACER TENDL-2021 LIBRARY; T=293.6K
Threshold reactions

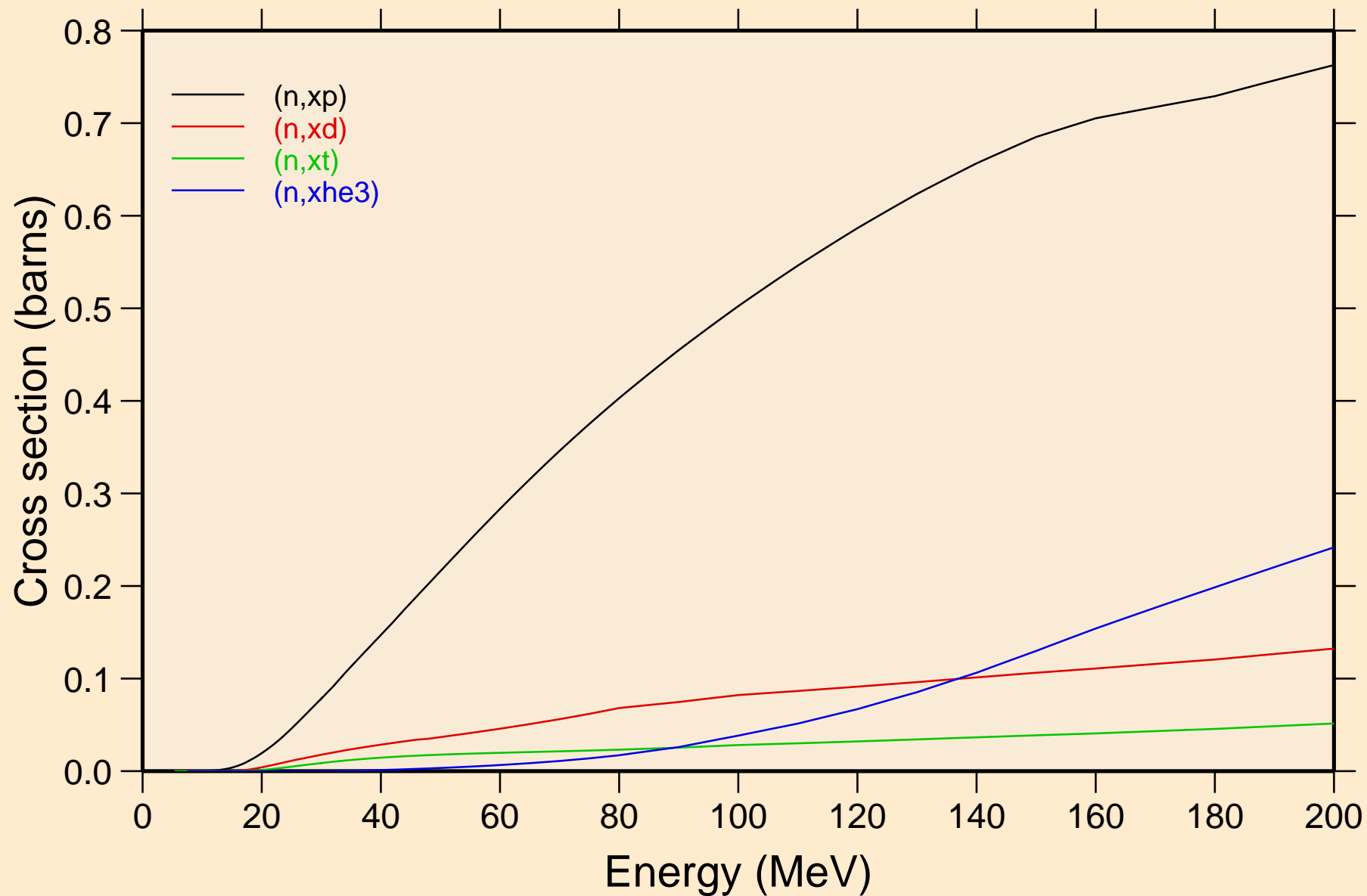

OS191 NEUTRON ACER TENDL-2021 LIBRARY; T=293.6K
angular distribution for elastic

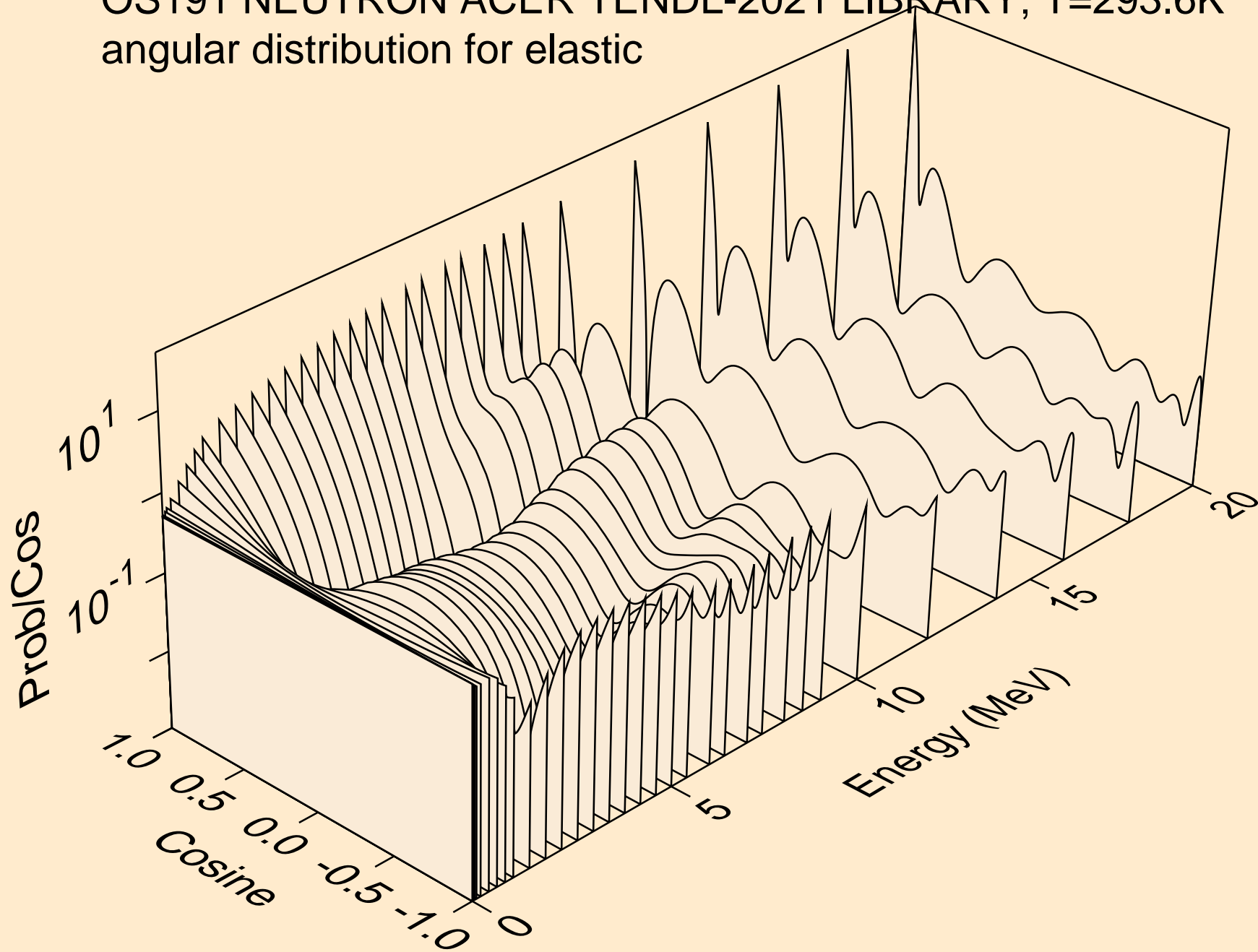

OS191 NEUTRON ACER TENDL-2021 LIBRARY; T=293.6K
angular distribution for elastic

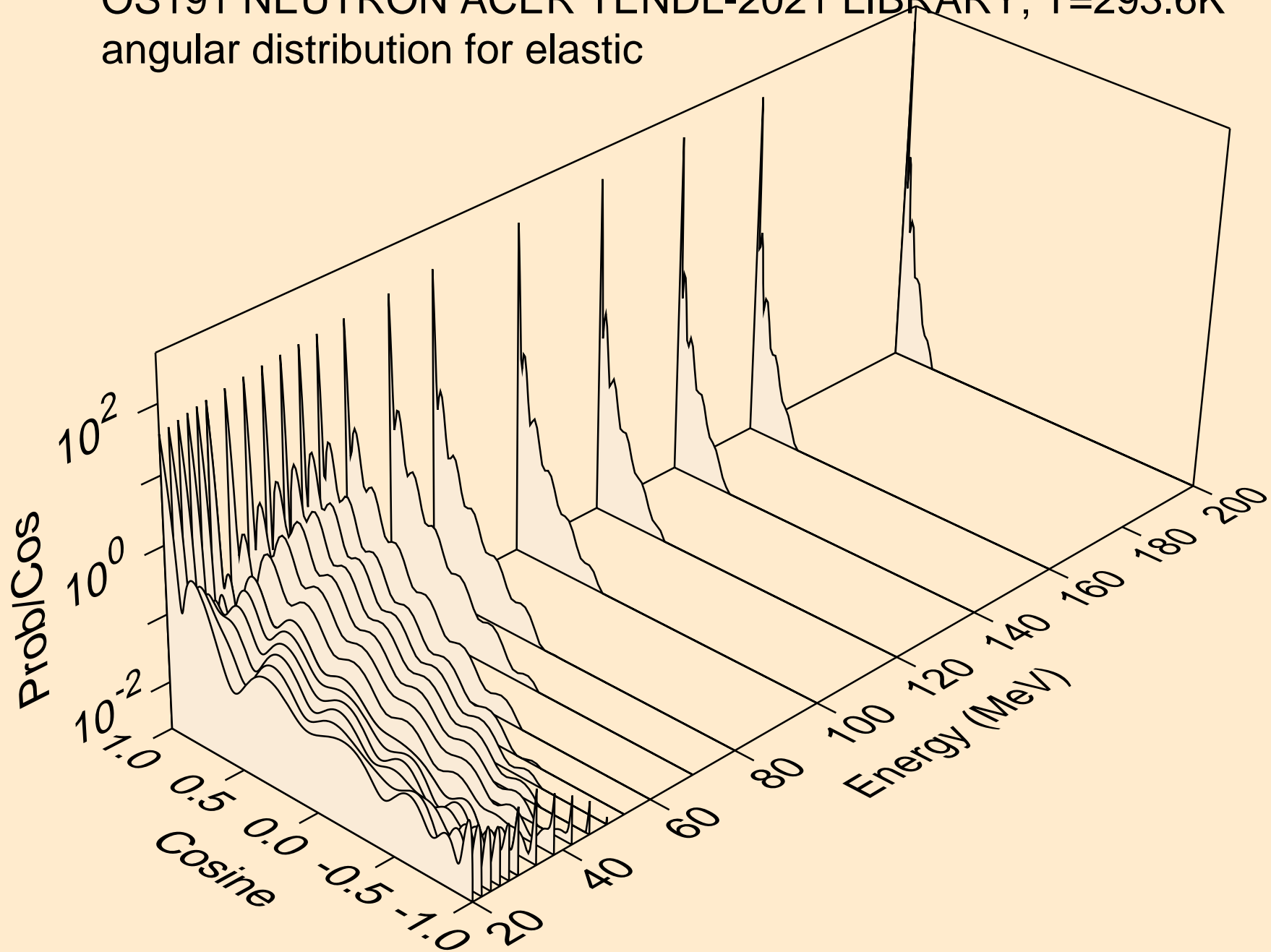

OS191 NEUTRON ACER TENDL-2021 LIBRARY; T=293.6K
angular distribution for (n,n*1)

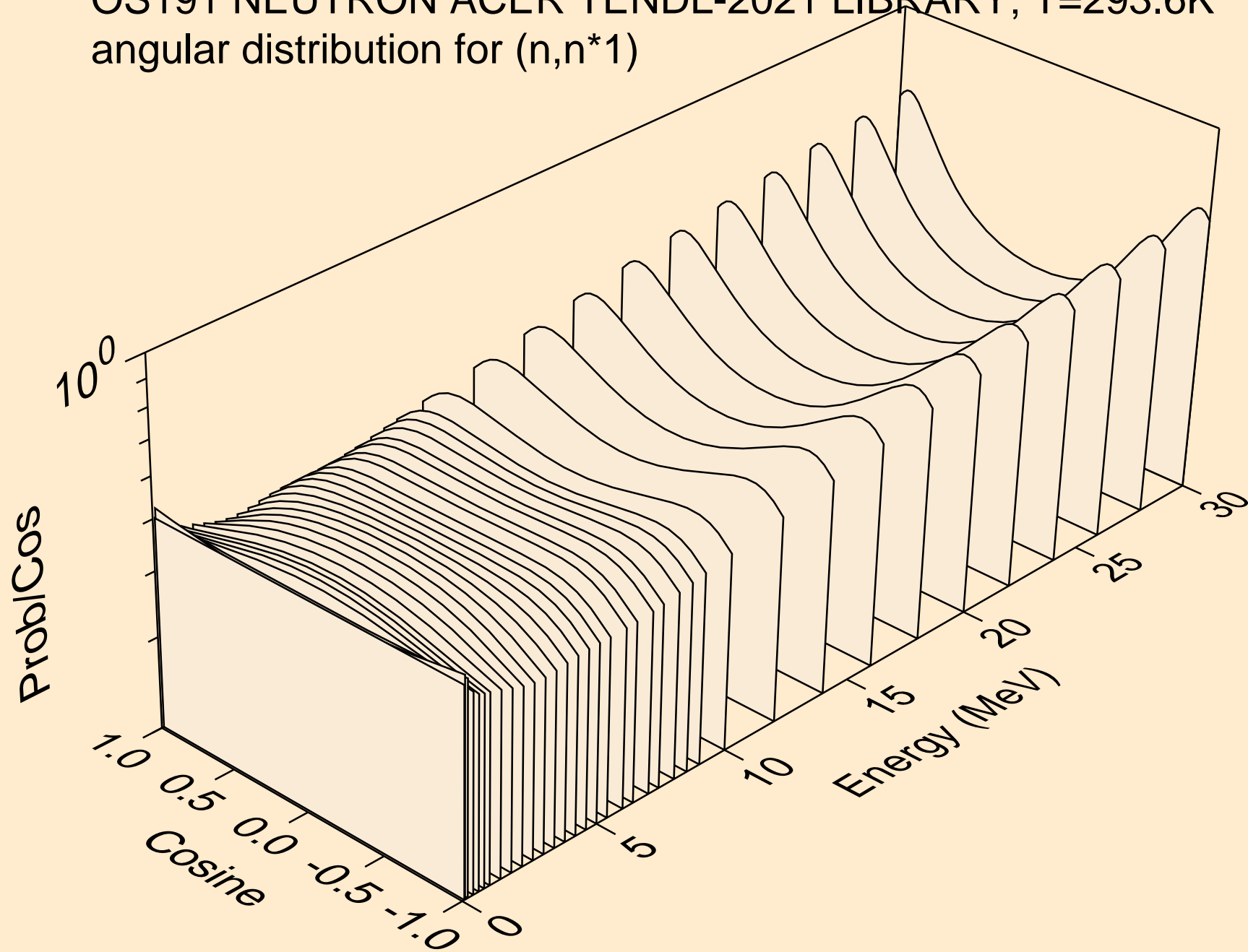

OS191 NEUTRON ACER TENDL-2021 LIBRARY; T=293.6K
angular distribution for (n,n*2)

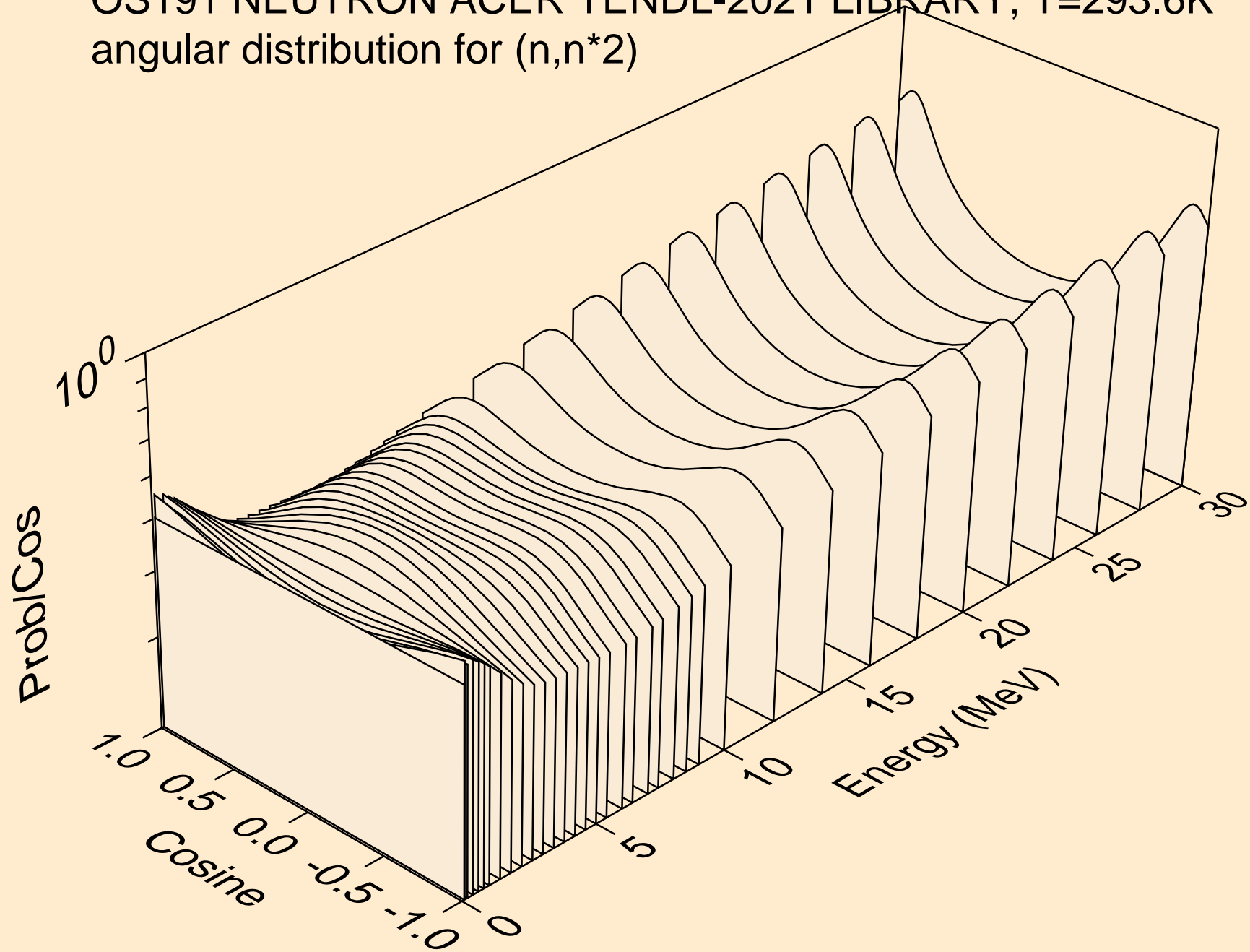

OS191 NEUTRON ACER TENDL-2021 LIBRARY; T=293.6K
angular distribution for (n,n*3)

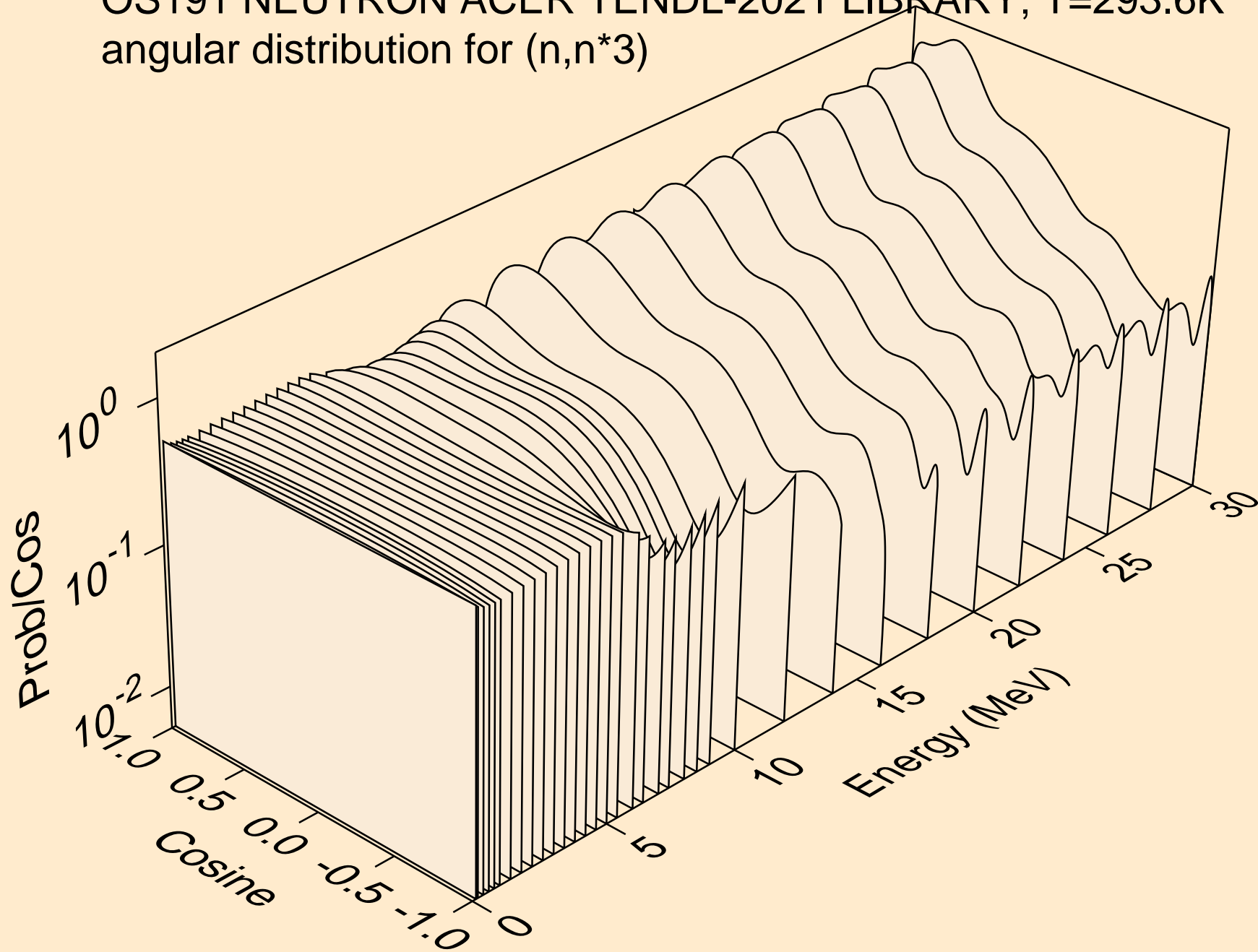

OS191 NEUTRON ACER TENDL-2021 LIBRARY; T=293.6K
angular distribution for (n,n*4)

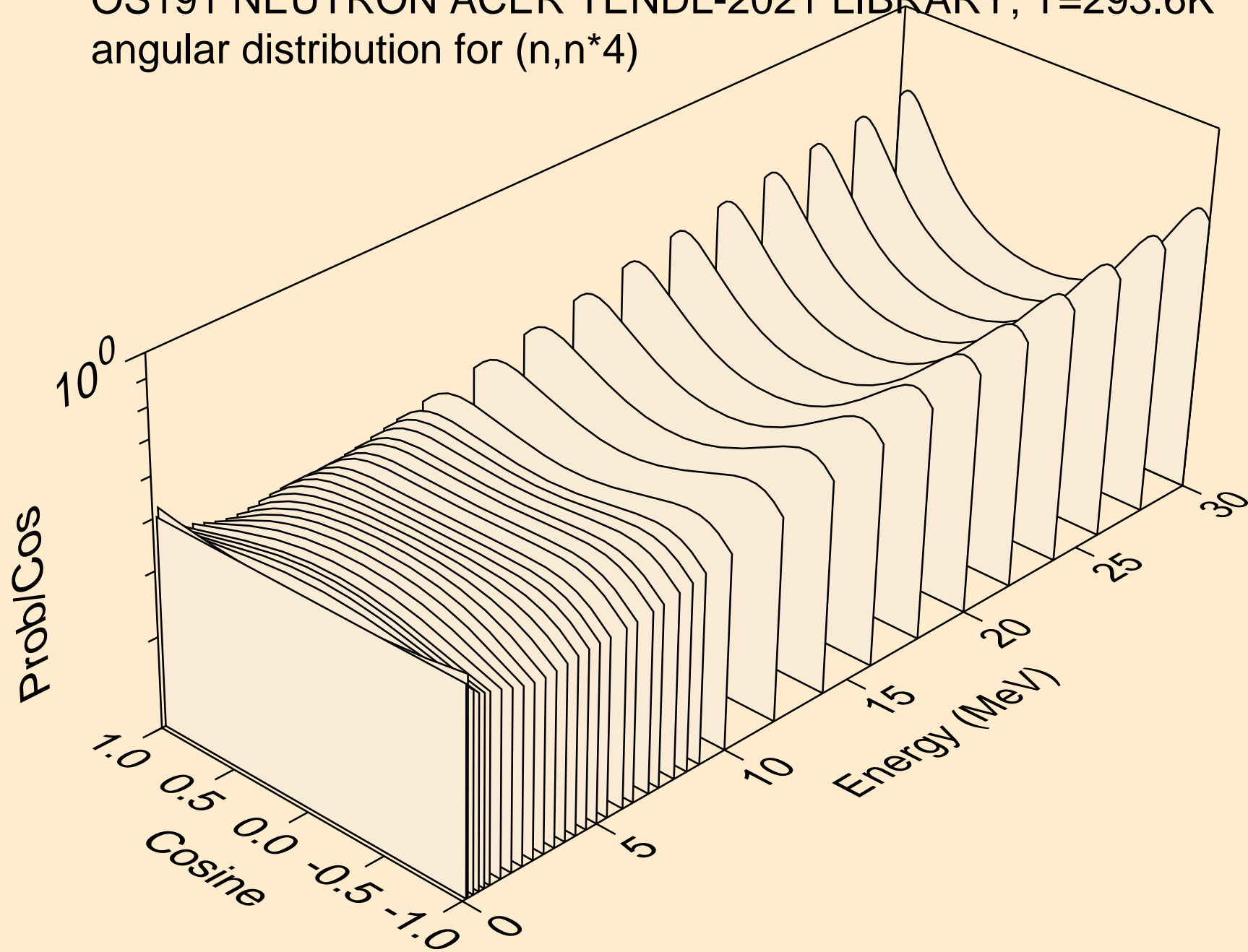

OS191 NEUTRON ACER TENDL-2021 LIBRARY; T=293.6K
angular distribution for (n,n*5)

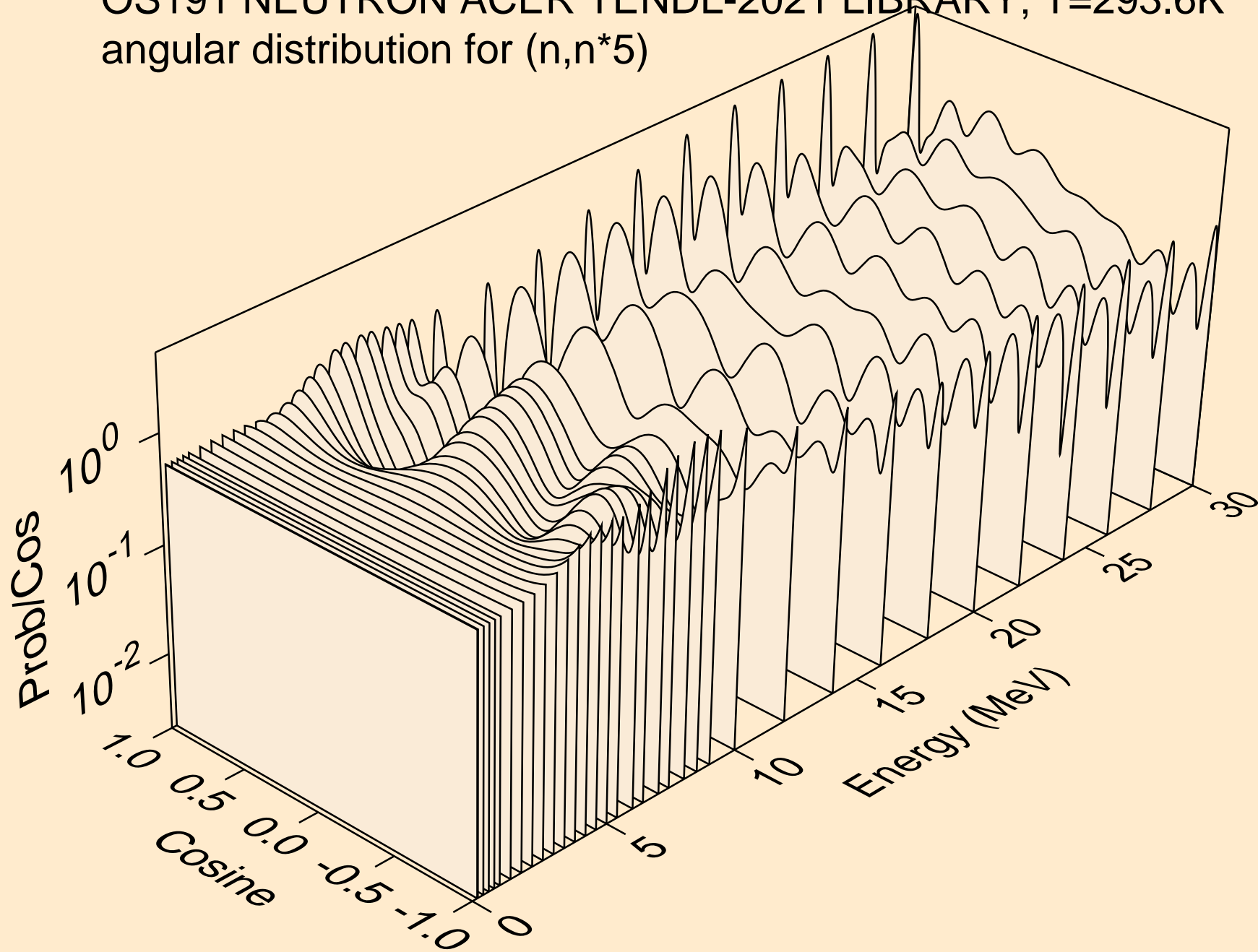

OS191 NEUTRON ACER TENDL-2021 LIBRARY; T=293.6K
angular distribution for (n,n*6)

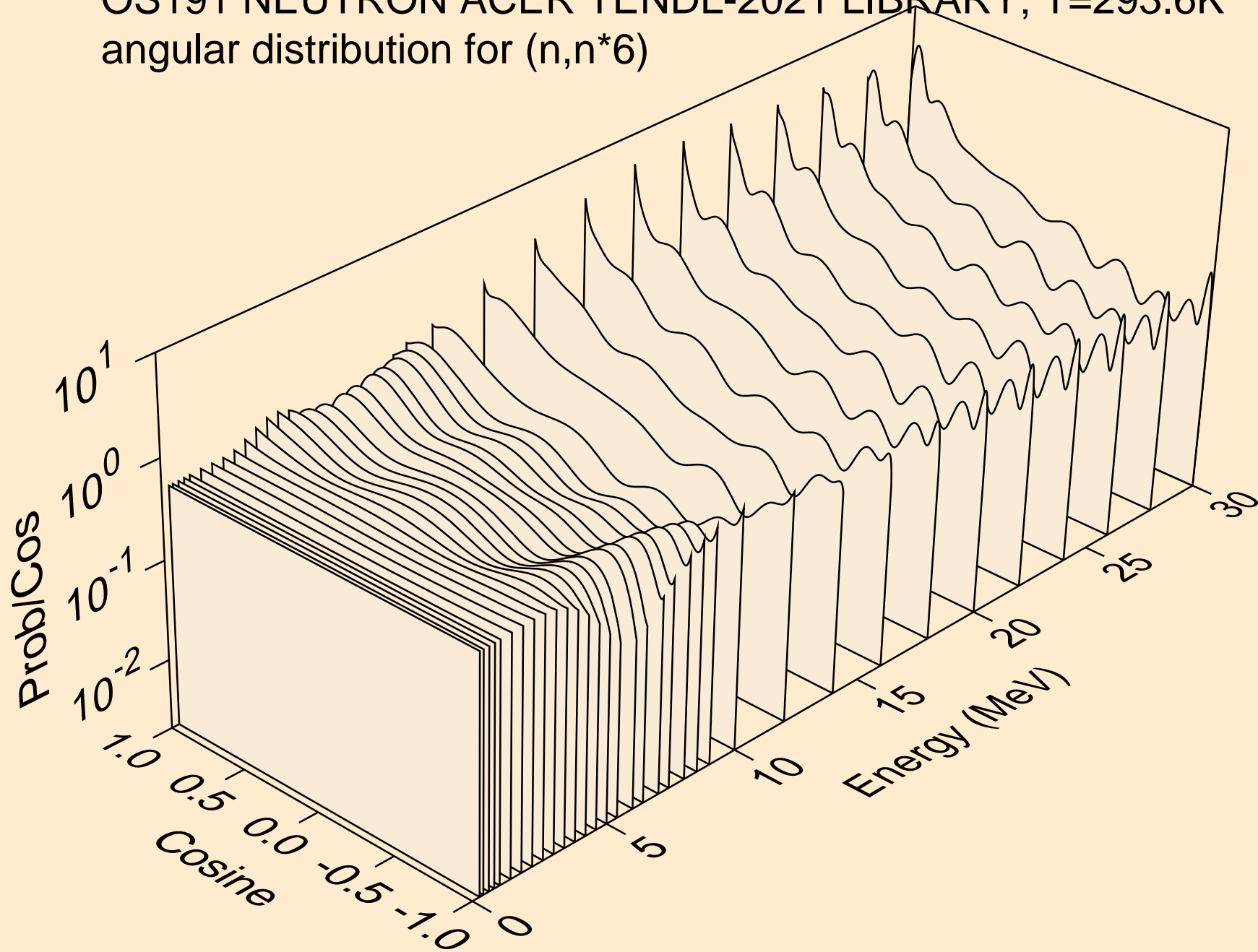

OS191 NEUTRON ACER TENDL-2021 LIBRARY; T=293.6K
angular distribution for (n,n*7)

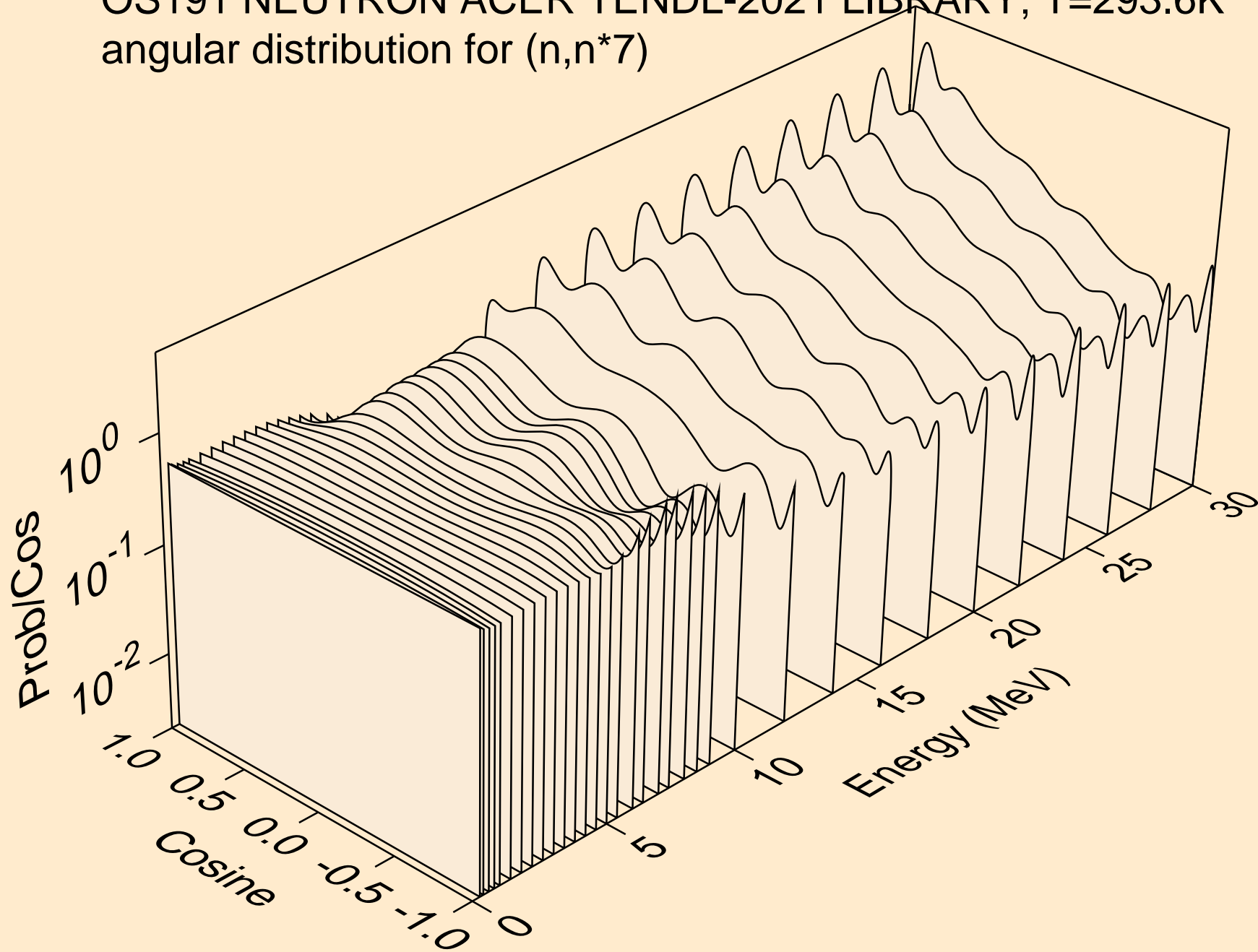

OS191 NEUTRON ACER TENDL-2021 LIBRARY; T=293.6K
angular distribution for (n,n*8)

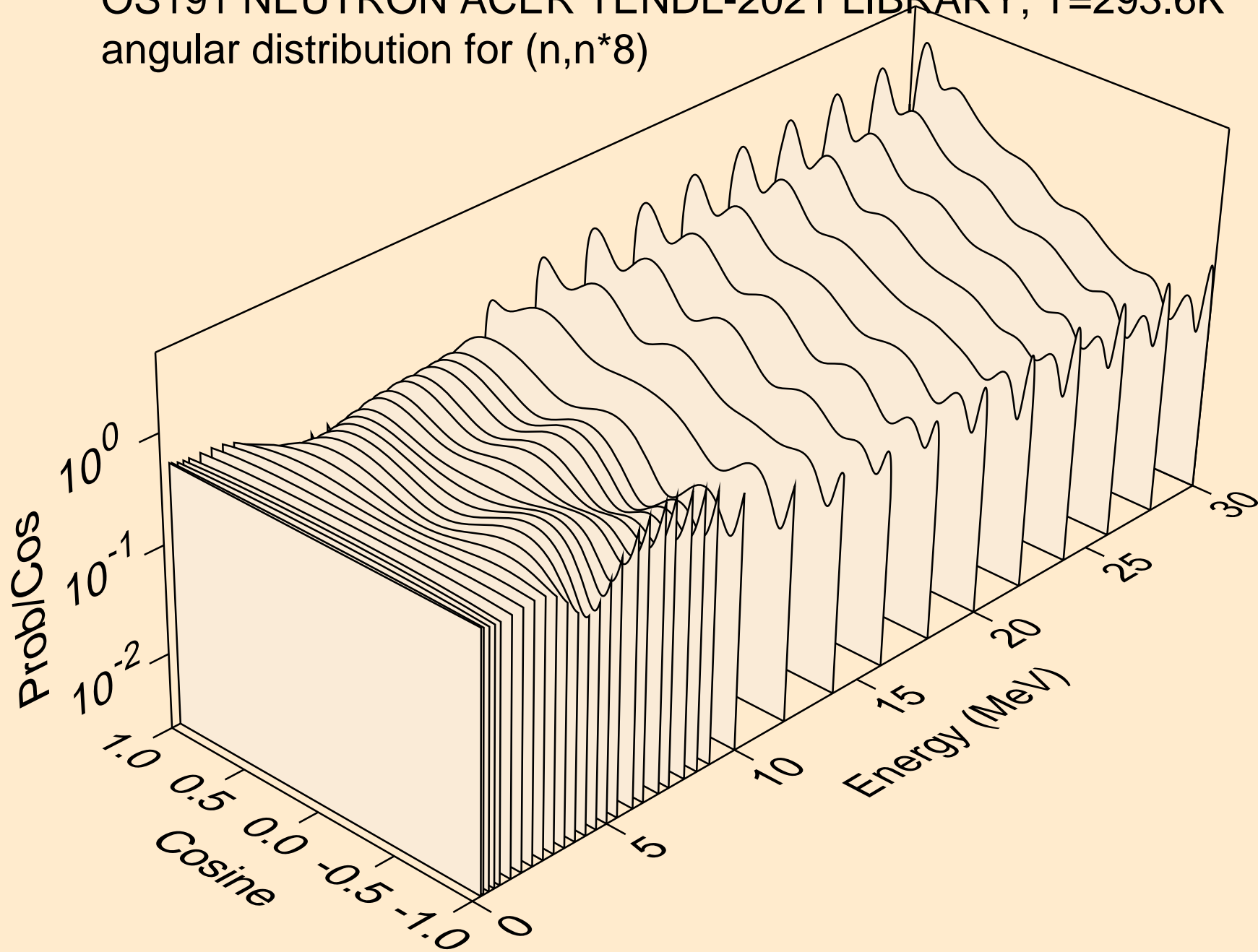

OS191 NEUTRON ACER TENDL-2021 LIBRARY; T=293.6K
angular distribution for (n,n*9)

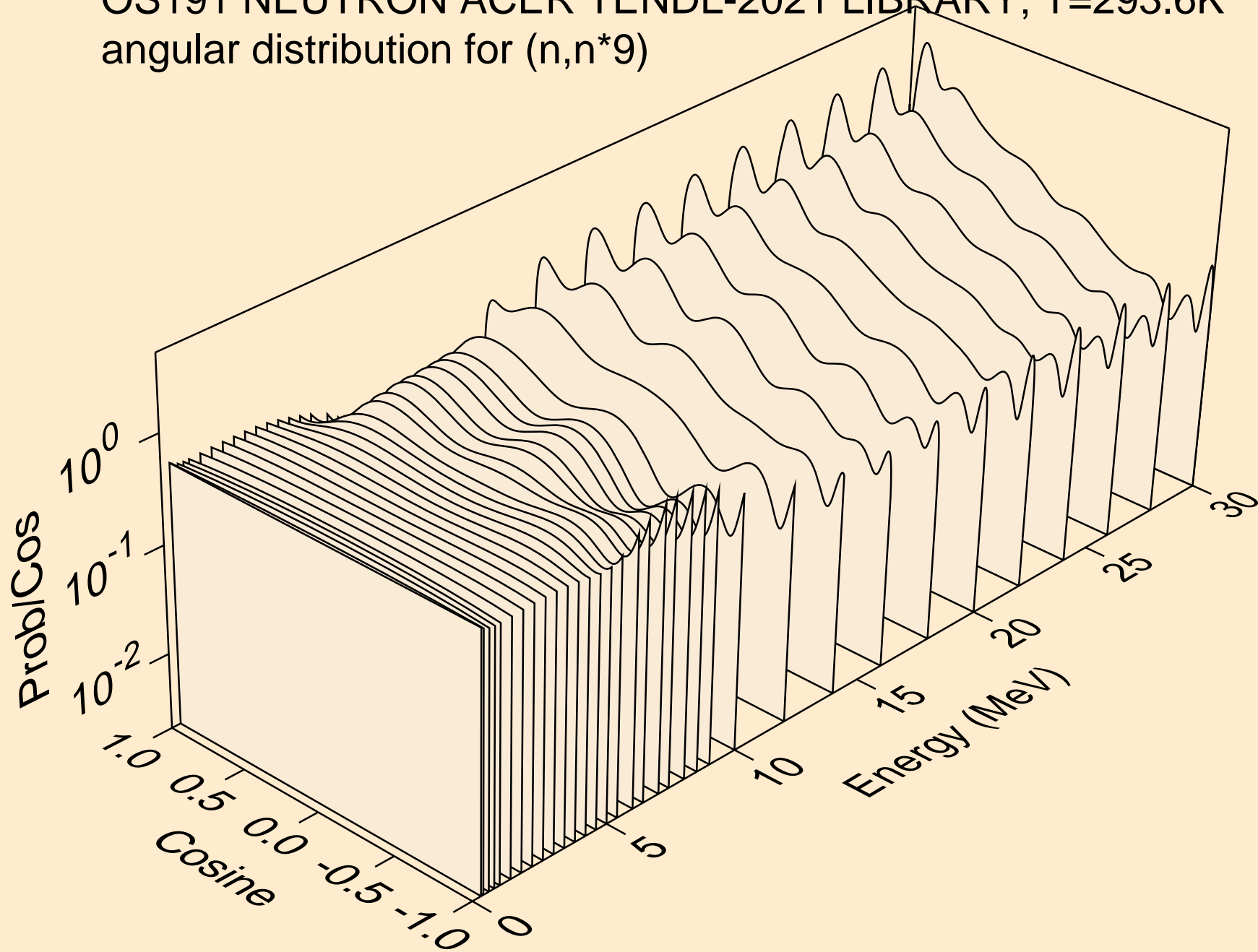

OS191 NEUTRON ACER TENDL-2021 LIBRARY; T=293.6K
angular distribution for (n,n*10)

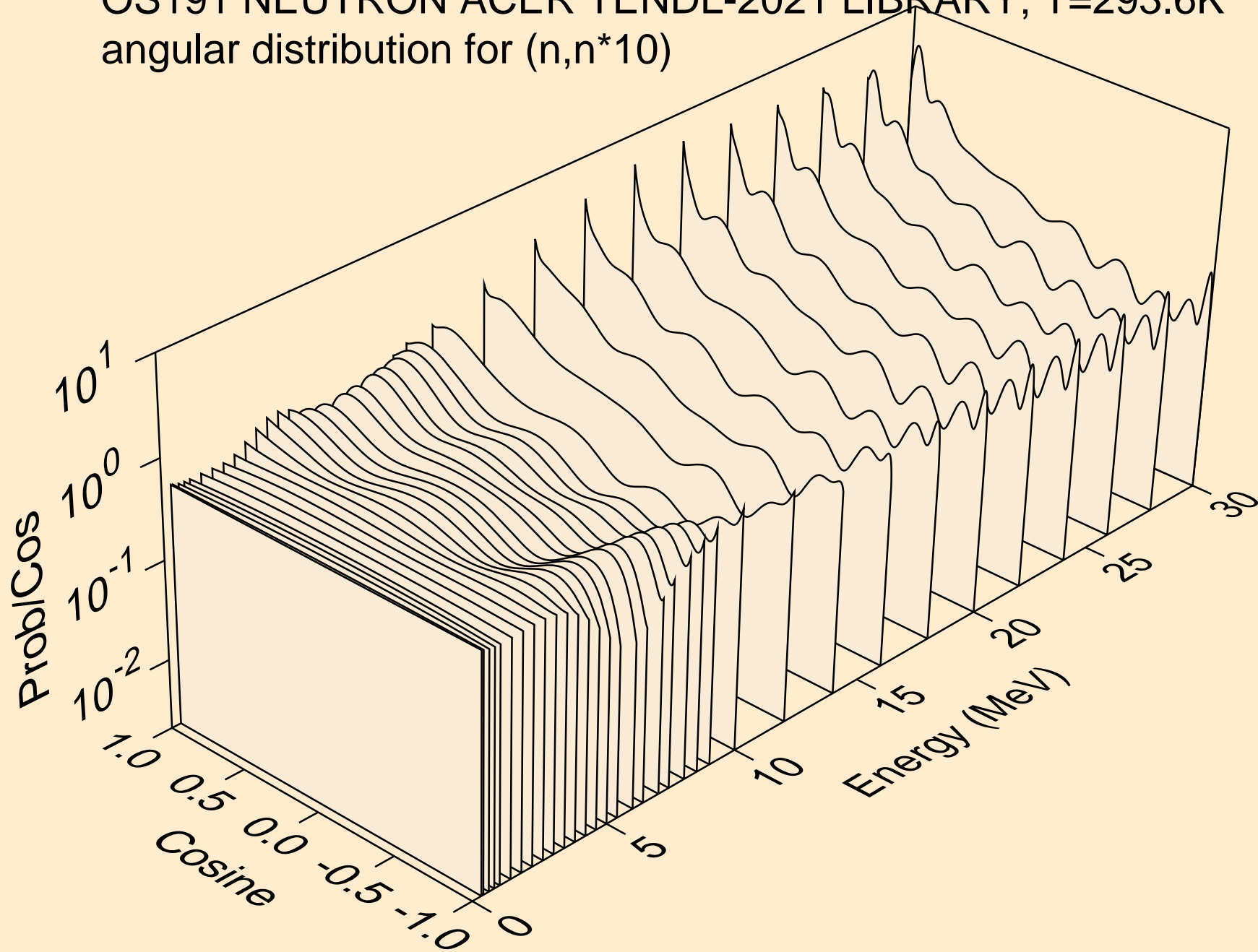

OS191 NEUTRON ACER TENDL-2021 LIBRARY; T=293.6K
angular distribution for (n,n*11)

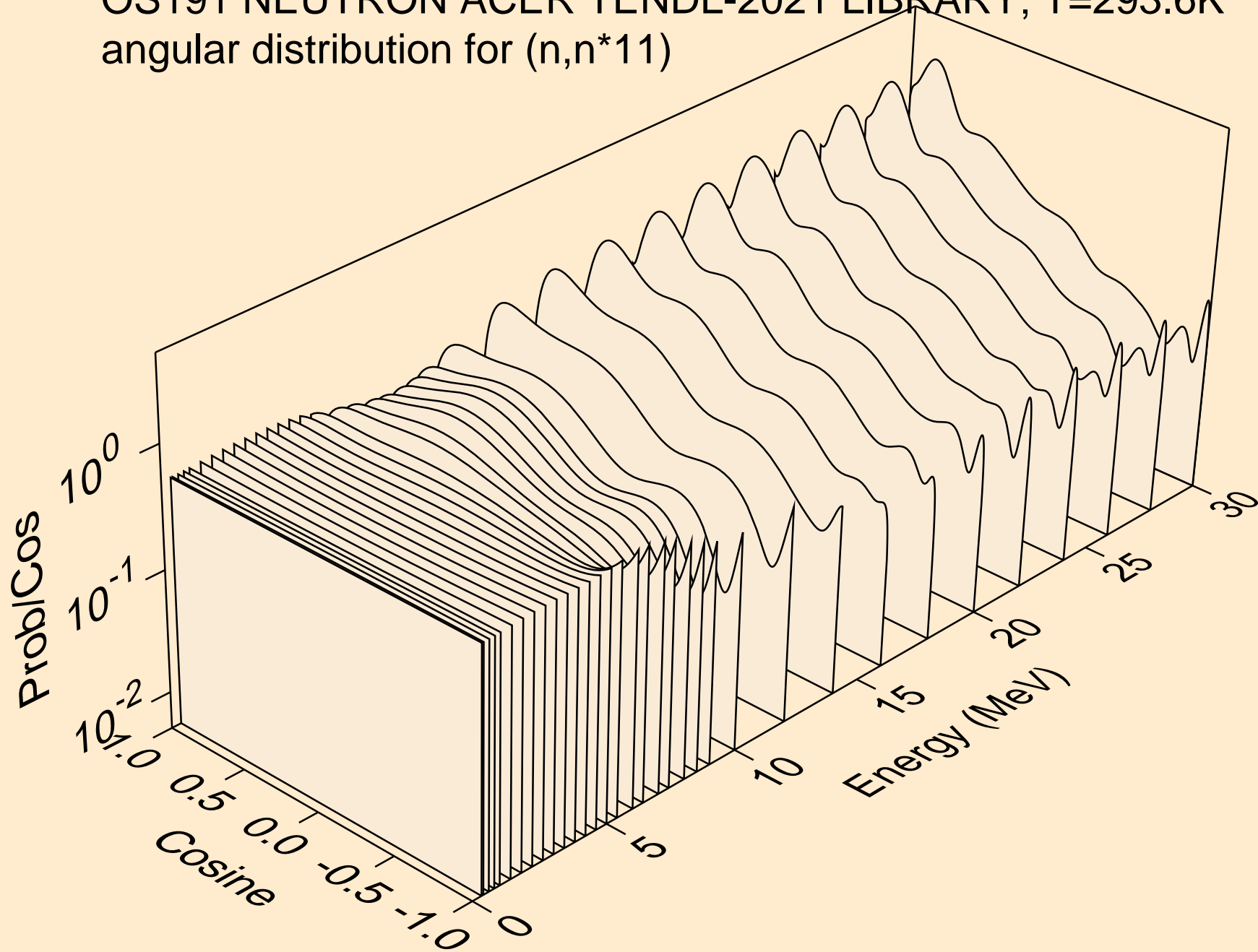

OS191 NEUTRON ACER TENDL-2021 LIBRARY; T=293.6K
angular distribution for (n,n*12)

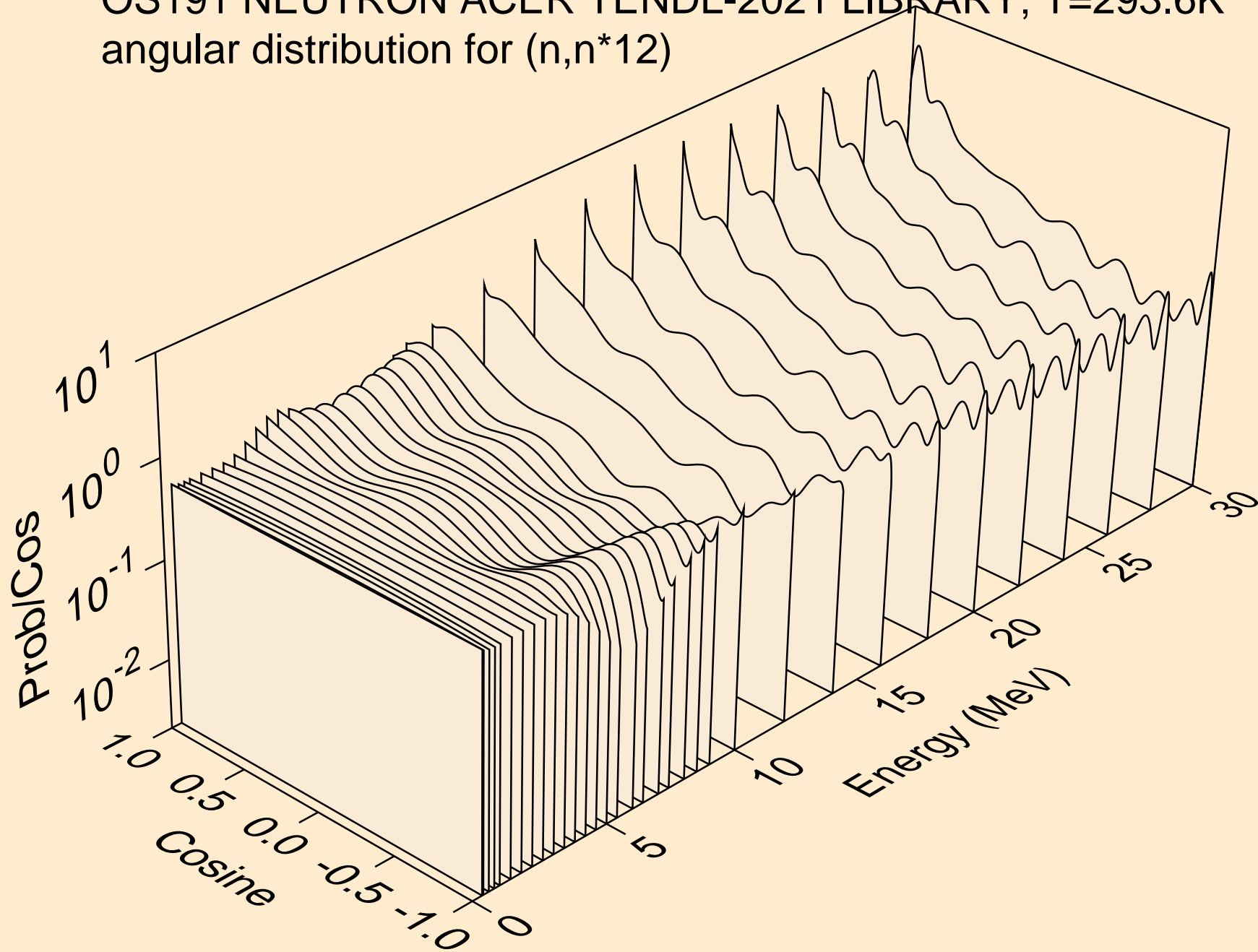

OS191 NEUTRON ACER TENDL-2021 LIBRARY; T=293.6K
angular distribution for (n,n*13)

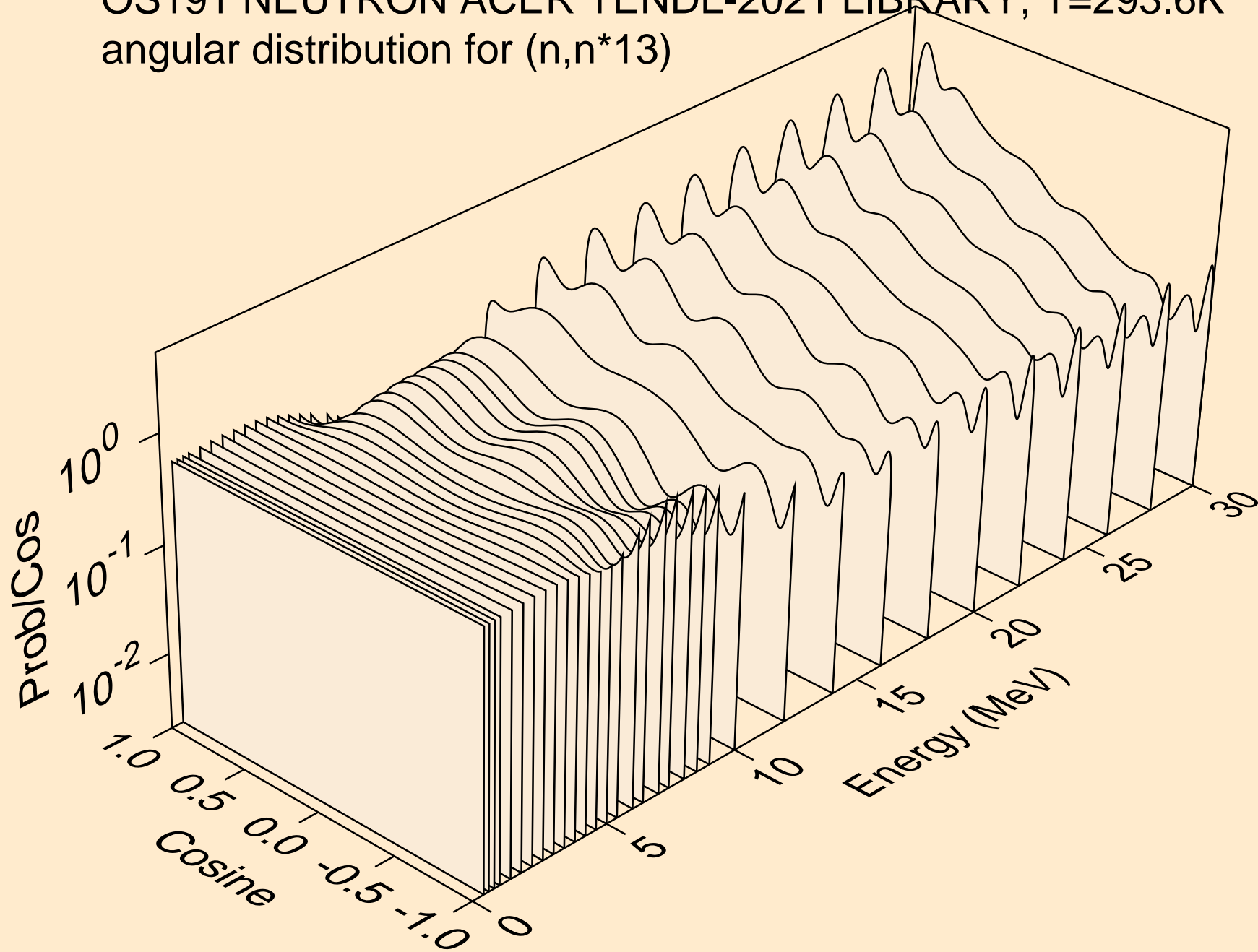

OS191 NEUTRON ACER TENDL-2021 LIBRARY; T=293.6K
angular distribution for (n,n*14)

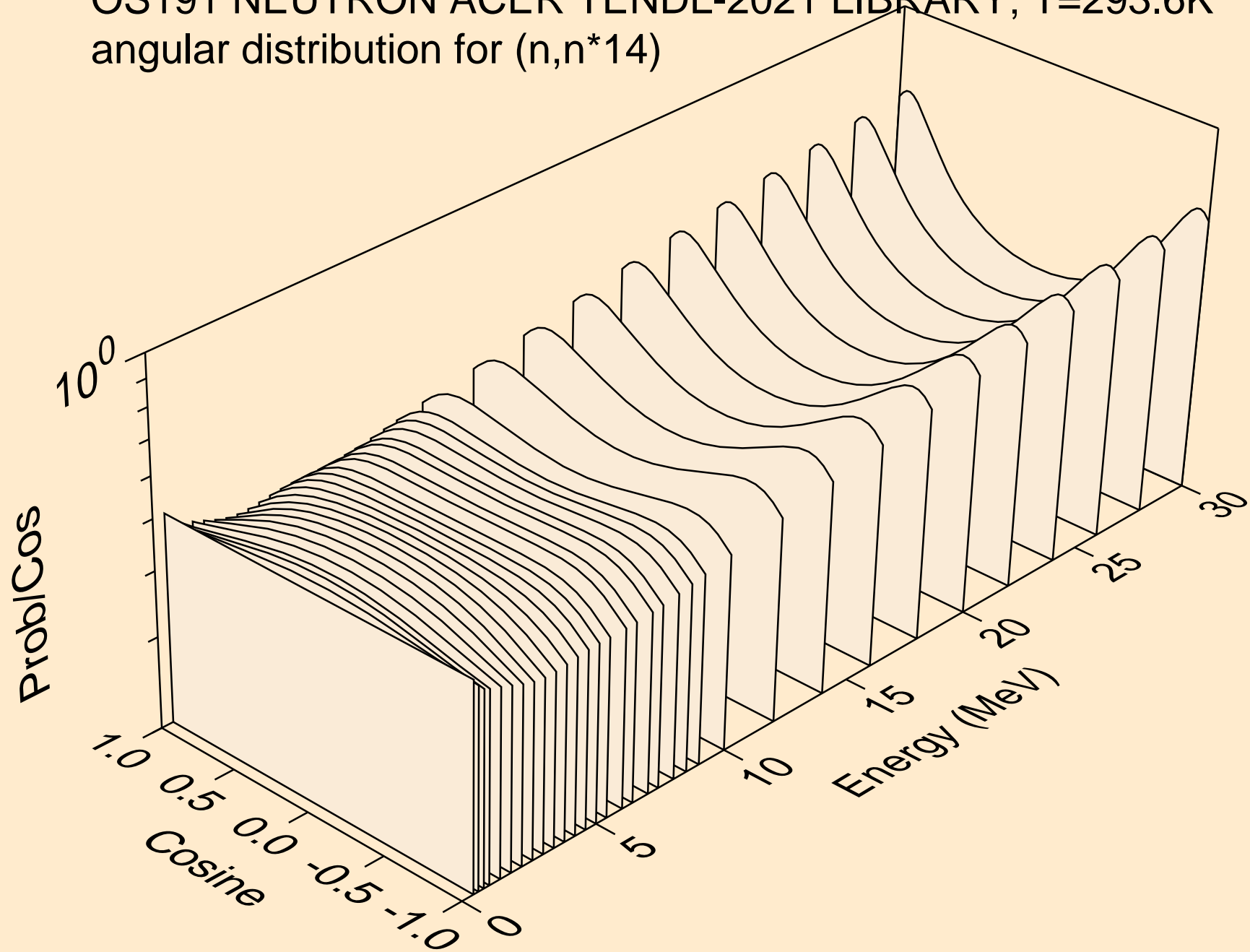

OS191 NEUTRON ACER TENDL-2021 LIBRARY; T=293.6K
angular distribution for (n,n*15)

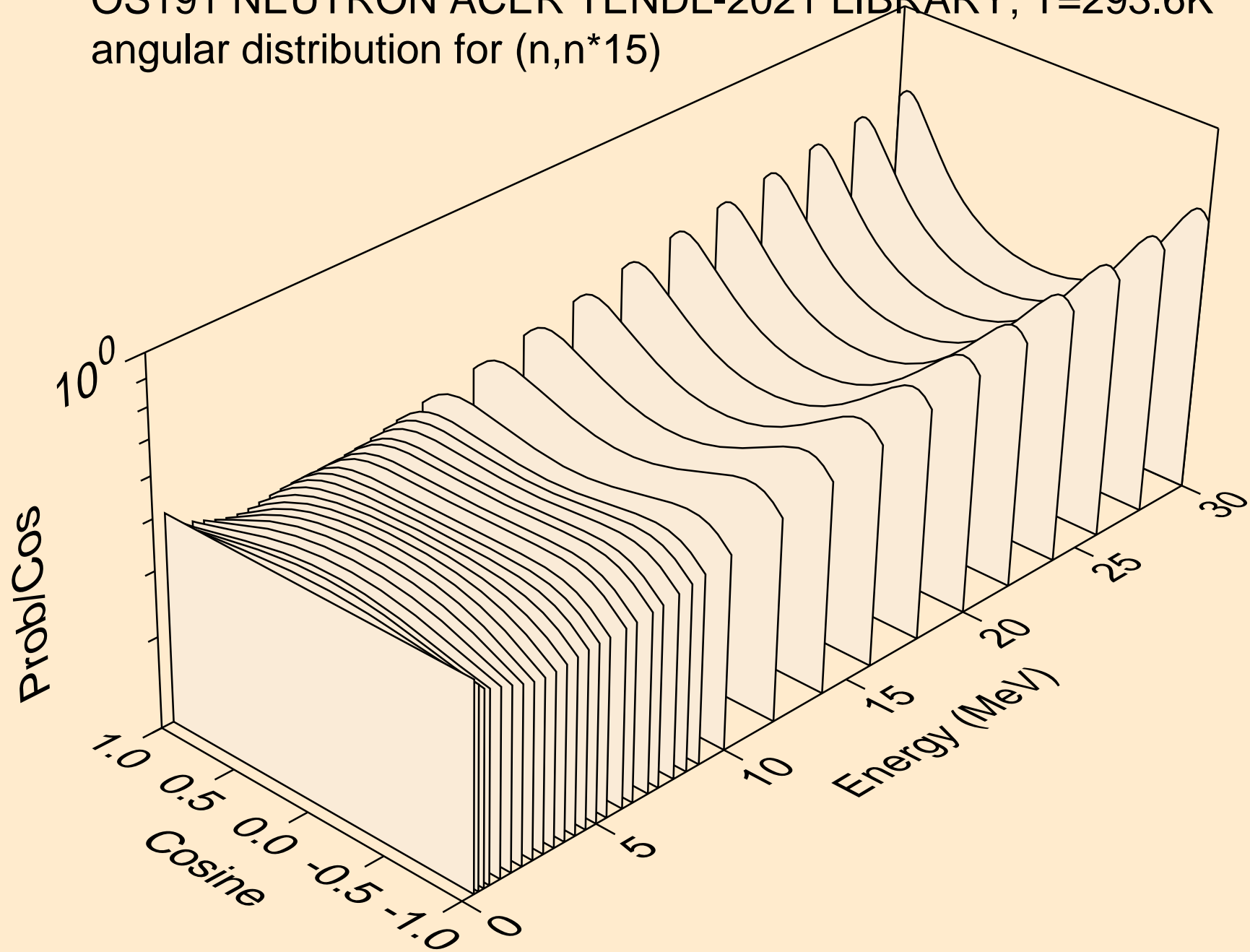

OS191 NEUTRON ACER TENDL-2021 LIBRARY; T=293.6K
angular distribution for (n,n*16)

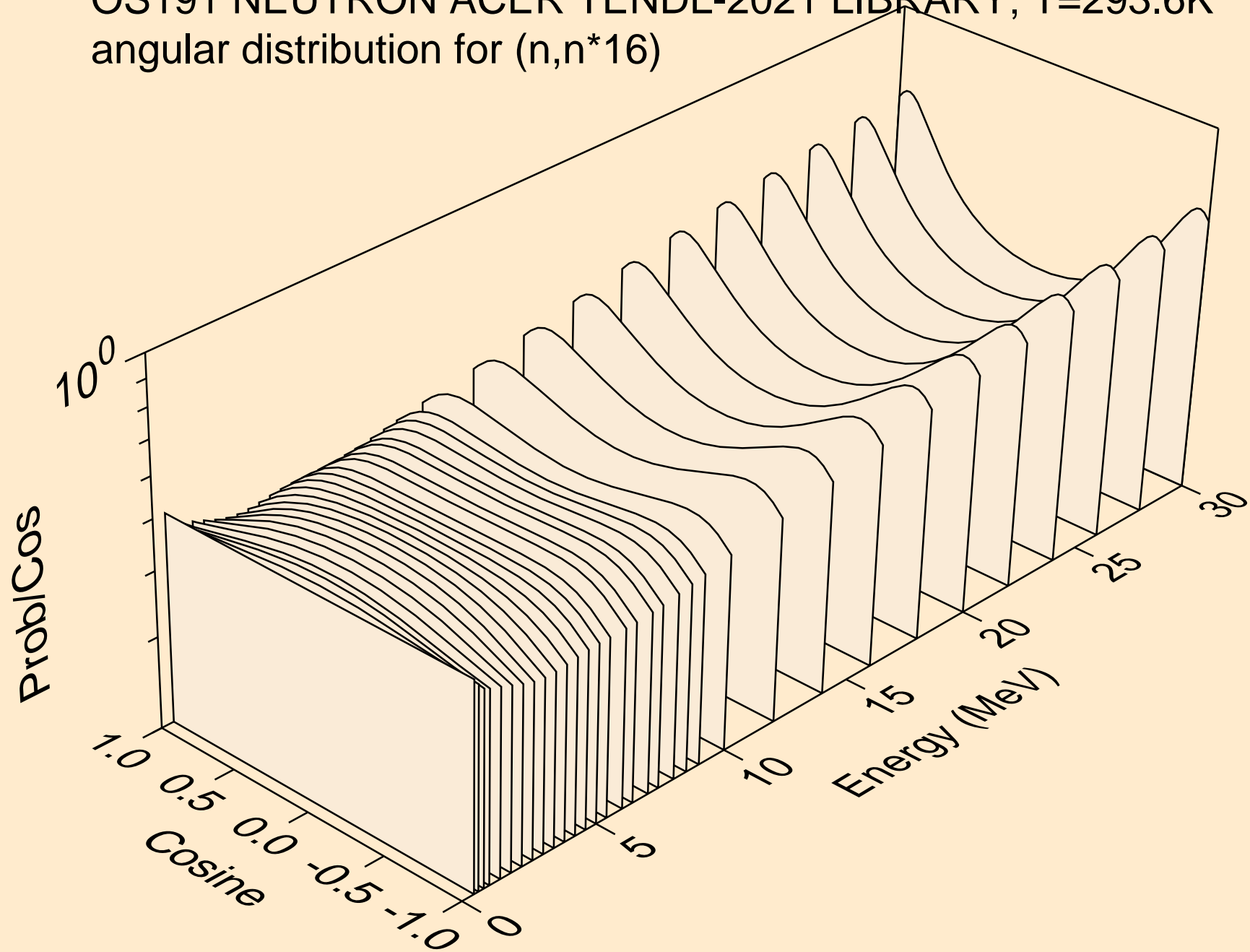

OS191 NEUTRON ACER TENDL-2021 LIBRARY; T=293.6K
angular distribution for (n,n*17)

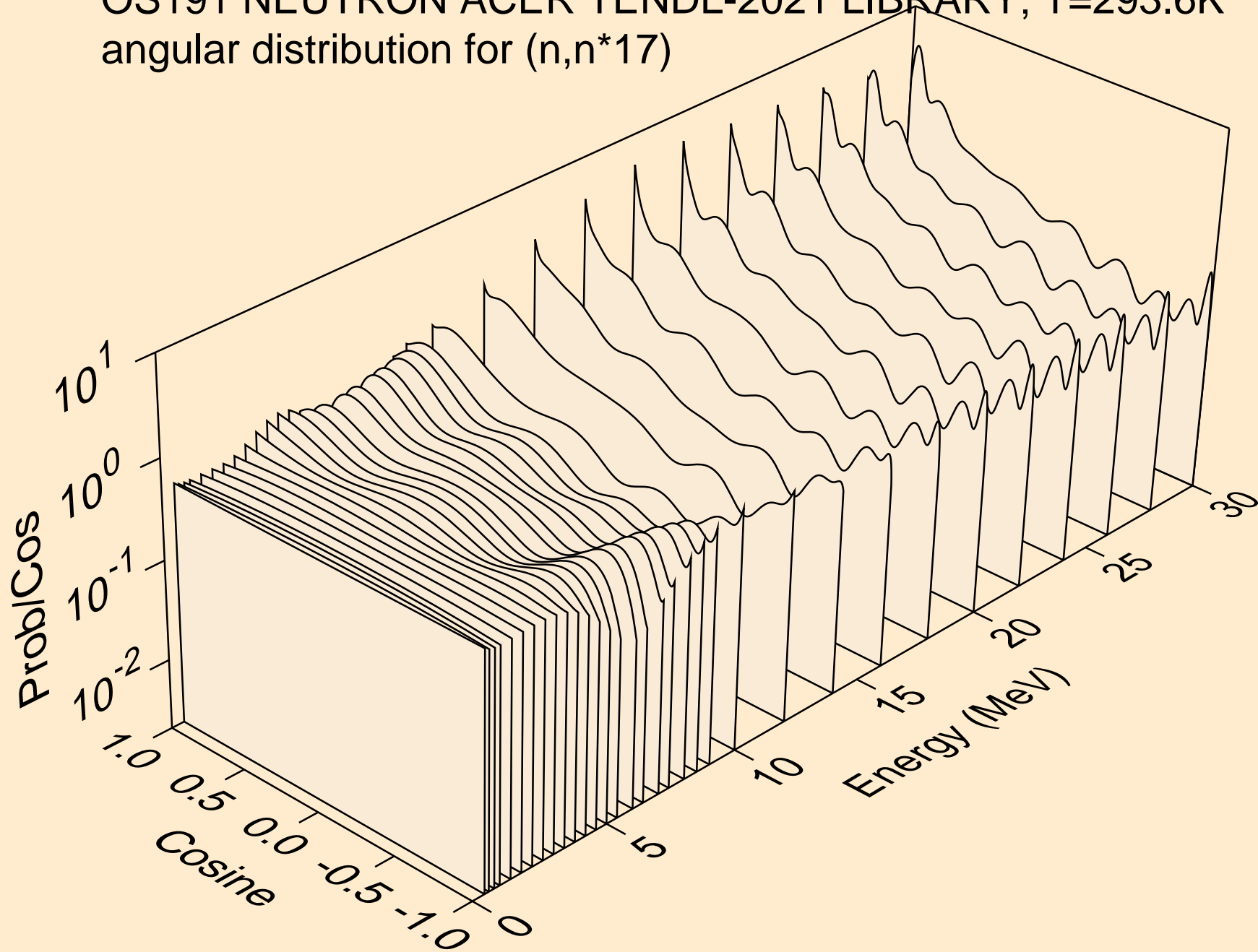

OS191 NEUTRON ACER TENDL-2021 LIBRARY; T=293.6K
angular distribution for (n,n*18)

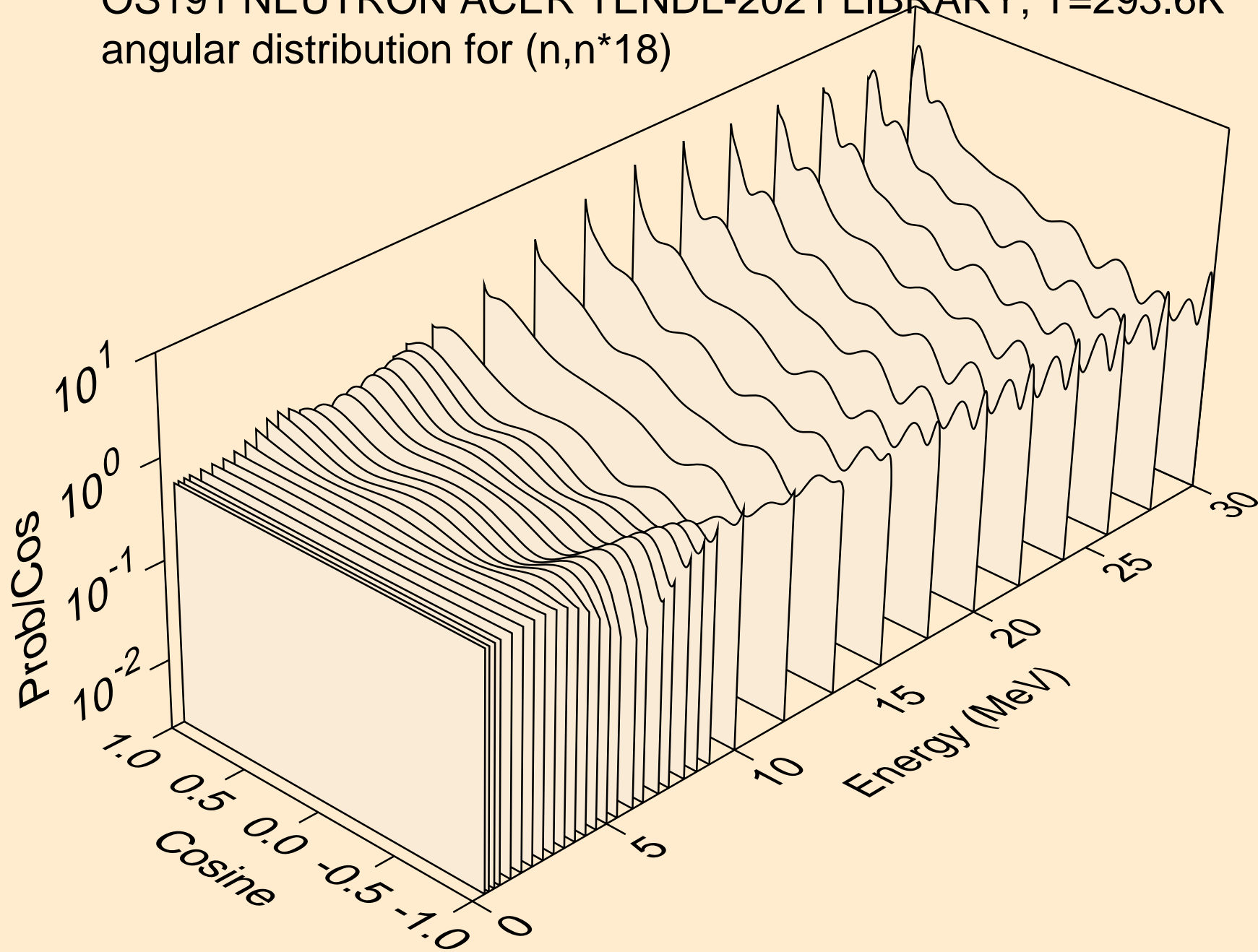

OS191 NEUTRON ACER TENDL-2021 LIBRARY; T=293.6K
angular distribution for (n,n*19)

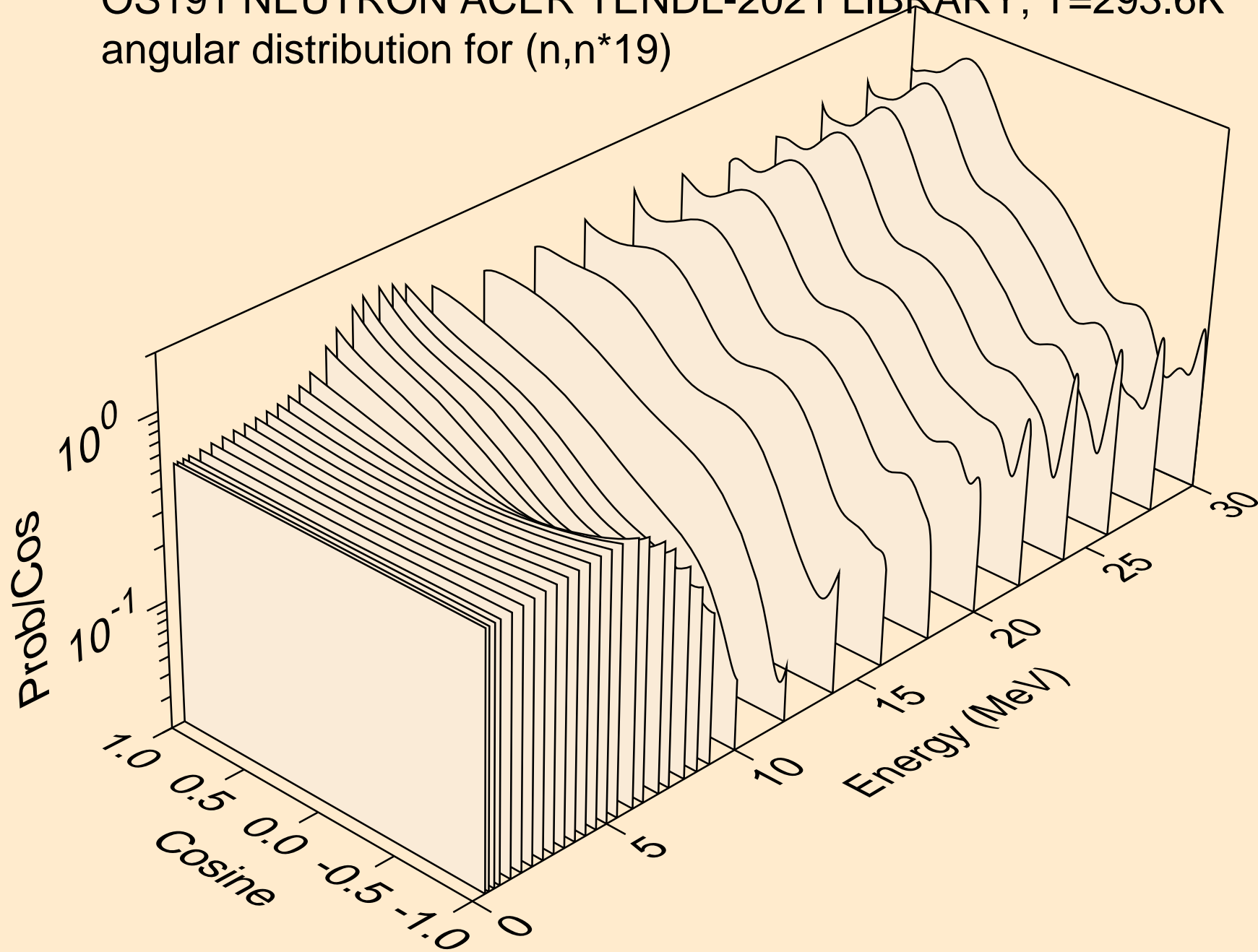

OS191 NEUTRON ACER TENDL-2021 LIBRARY; T=293.6K
angular distribution for (n,n*20)

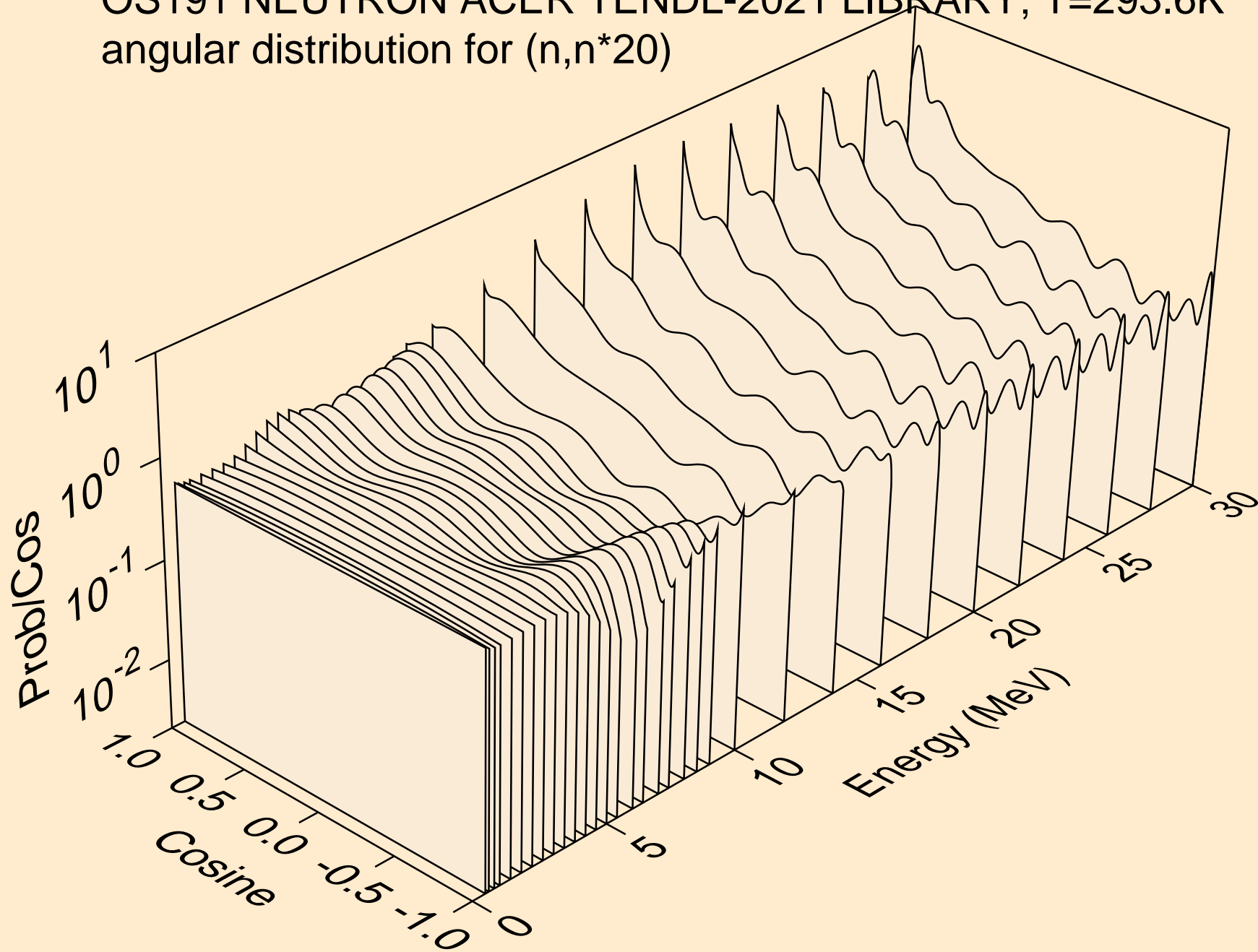

OS191 NEUTRON ACER TENDL-2021 LIBRARY; T=293.6K
angular distribution for (n,n*21)

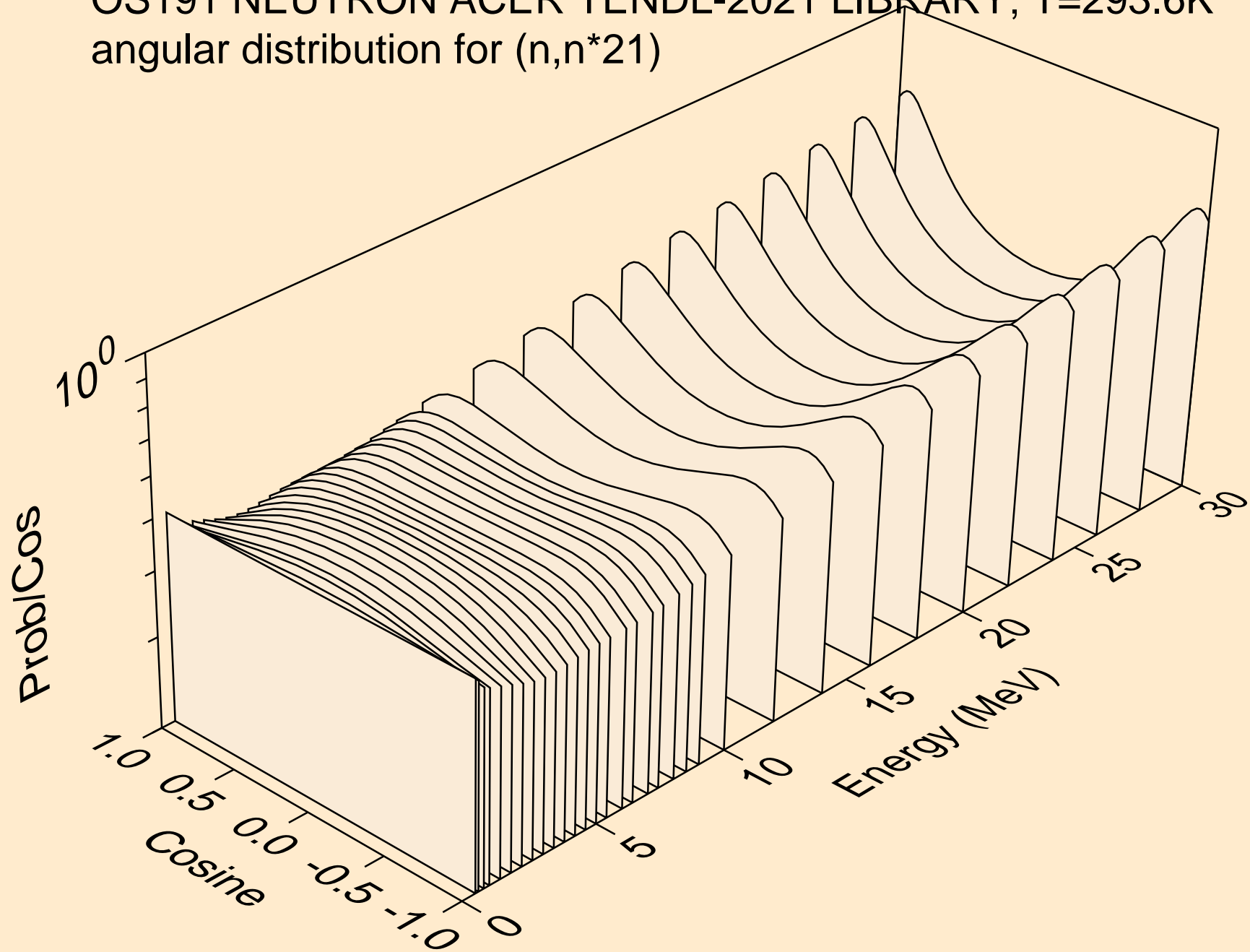

OS191 NEUTRON ACER TENDL-2021 LIBRARY; T=293.6K
angular distribution for (n,n*22)

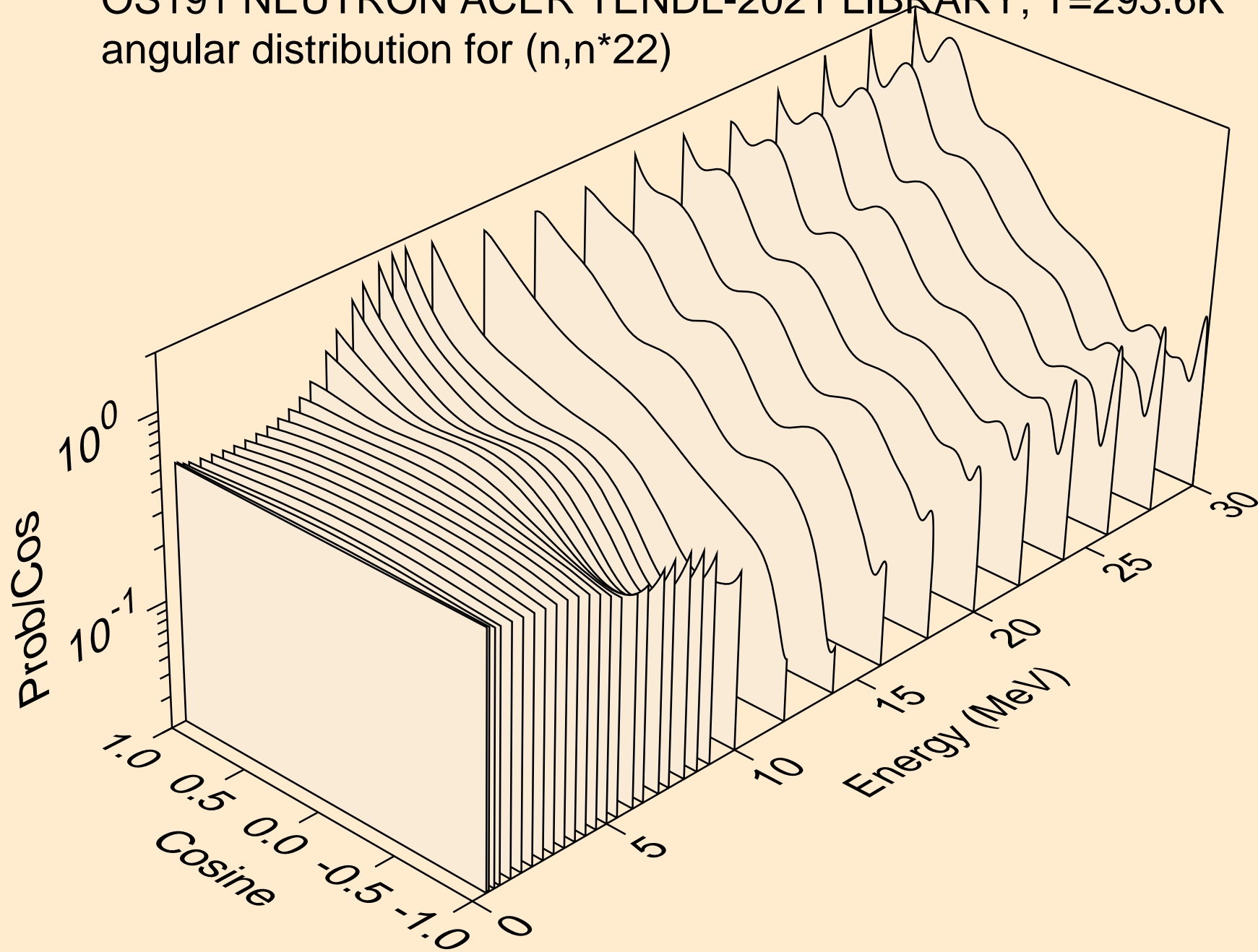

OS191 NEUTRON ACER TENDL-2021 LIBRARY; T=293.6K
angular distribution for (n,n*23)

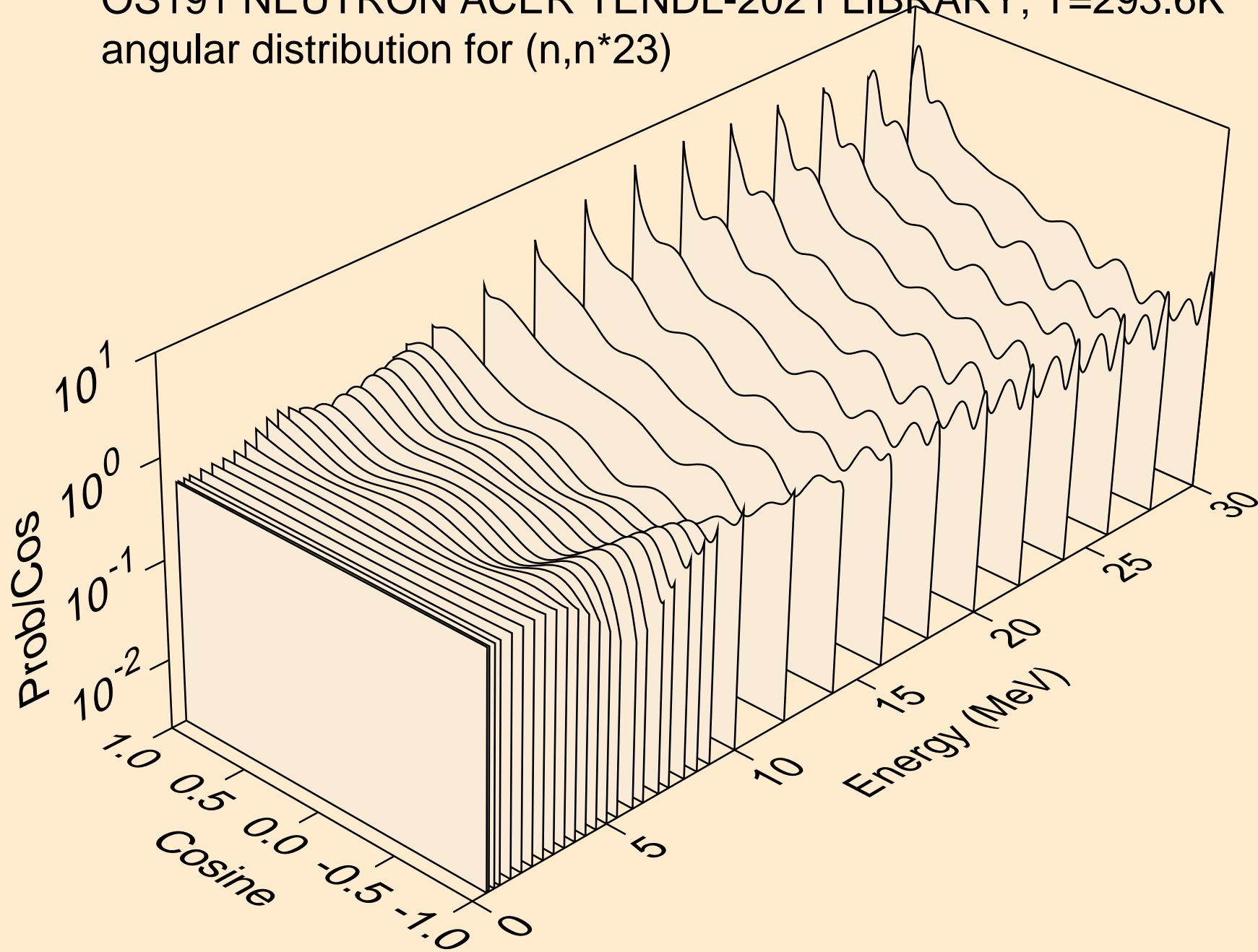

OS191 NEUTRON ACER TENDL-2021 LIBRARY; T=293.6K
angular distribution for (n,n*24)

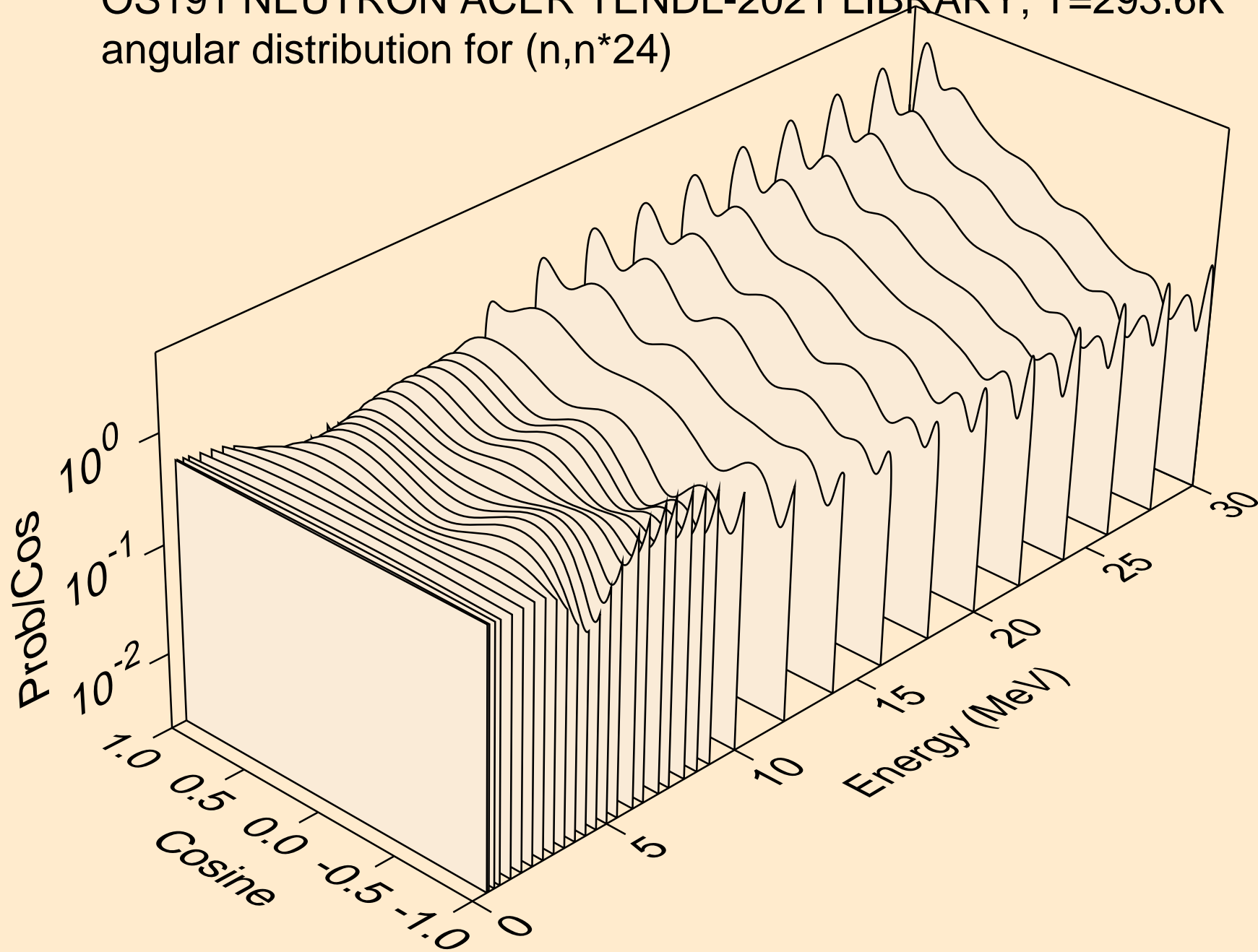

OS191 NEUTRON ACER TENDL-2021 LIBRARY; T=293.6K
angular distribution for (n,n*25)

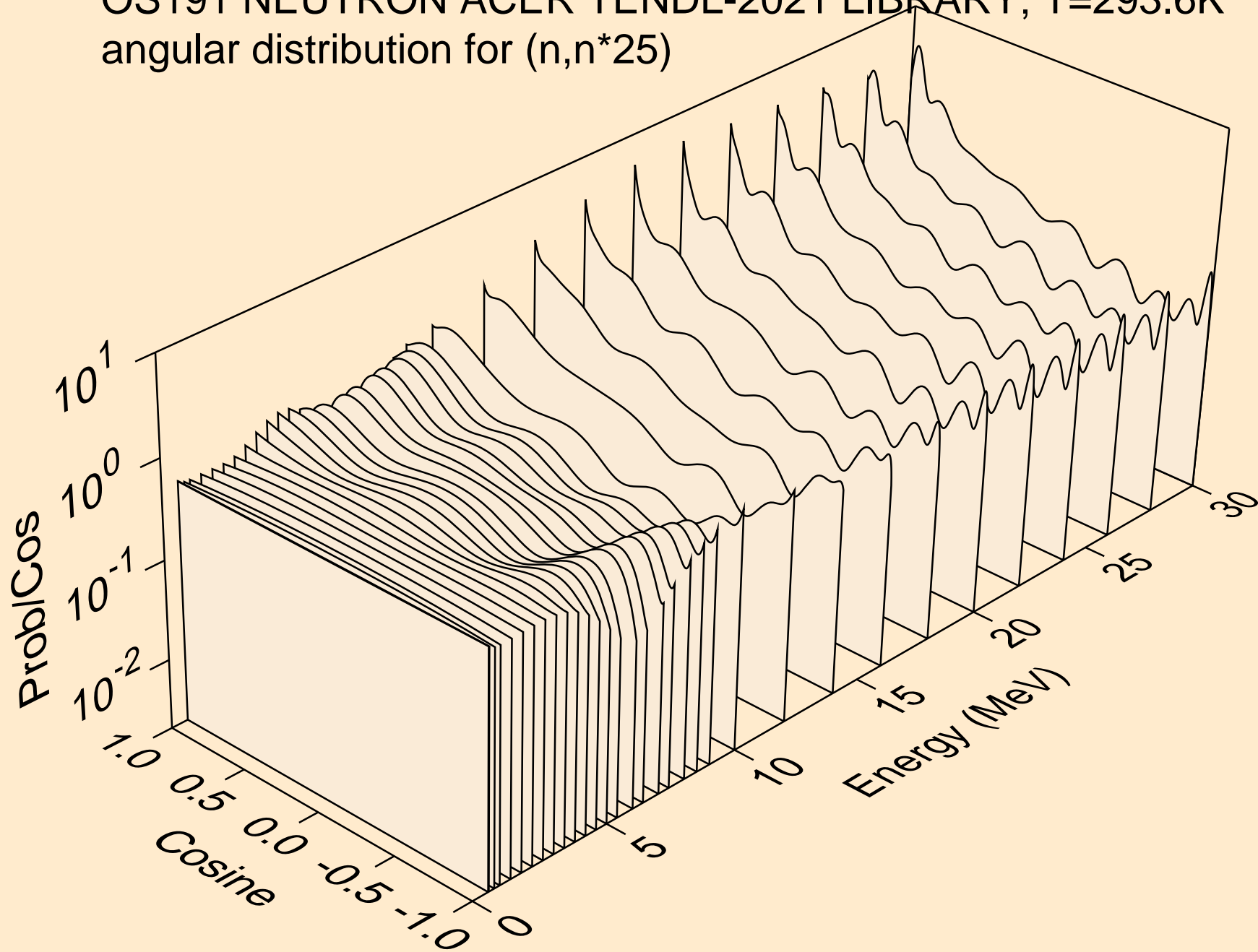

OS191 NEUTRON ACER TENDL-2021 LIBRARY; T=293.6K
angular distribution for (n,n*26)

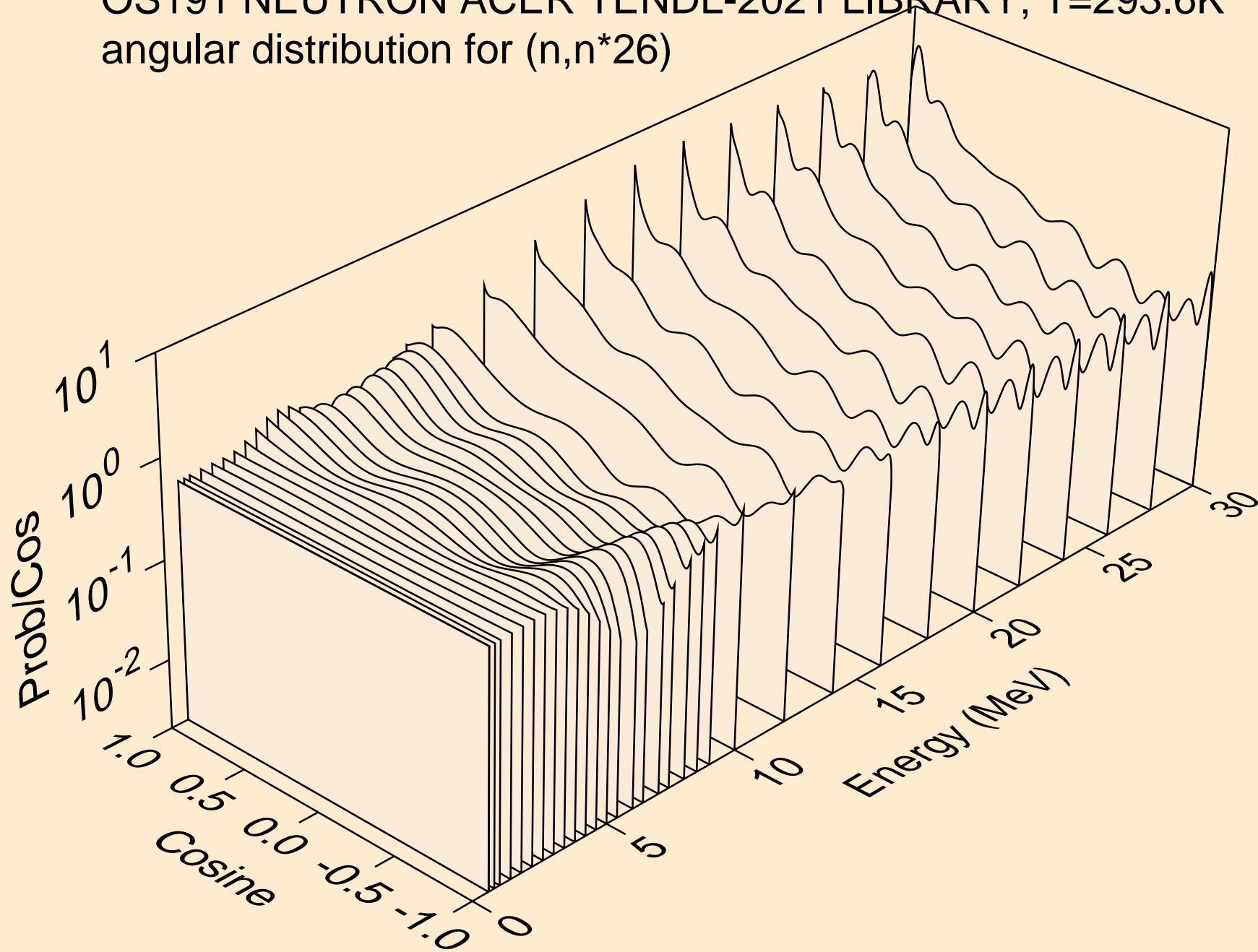

OS191 NEUTRON ACER TENDL-2021 LIBRARY; T=293.6K
angular distribution for (n,n*27)

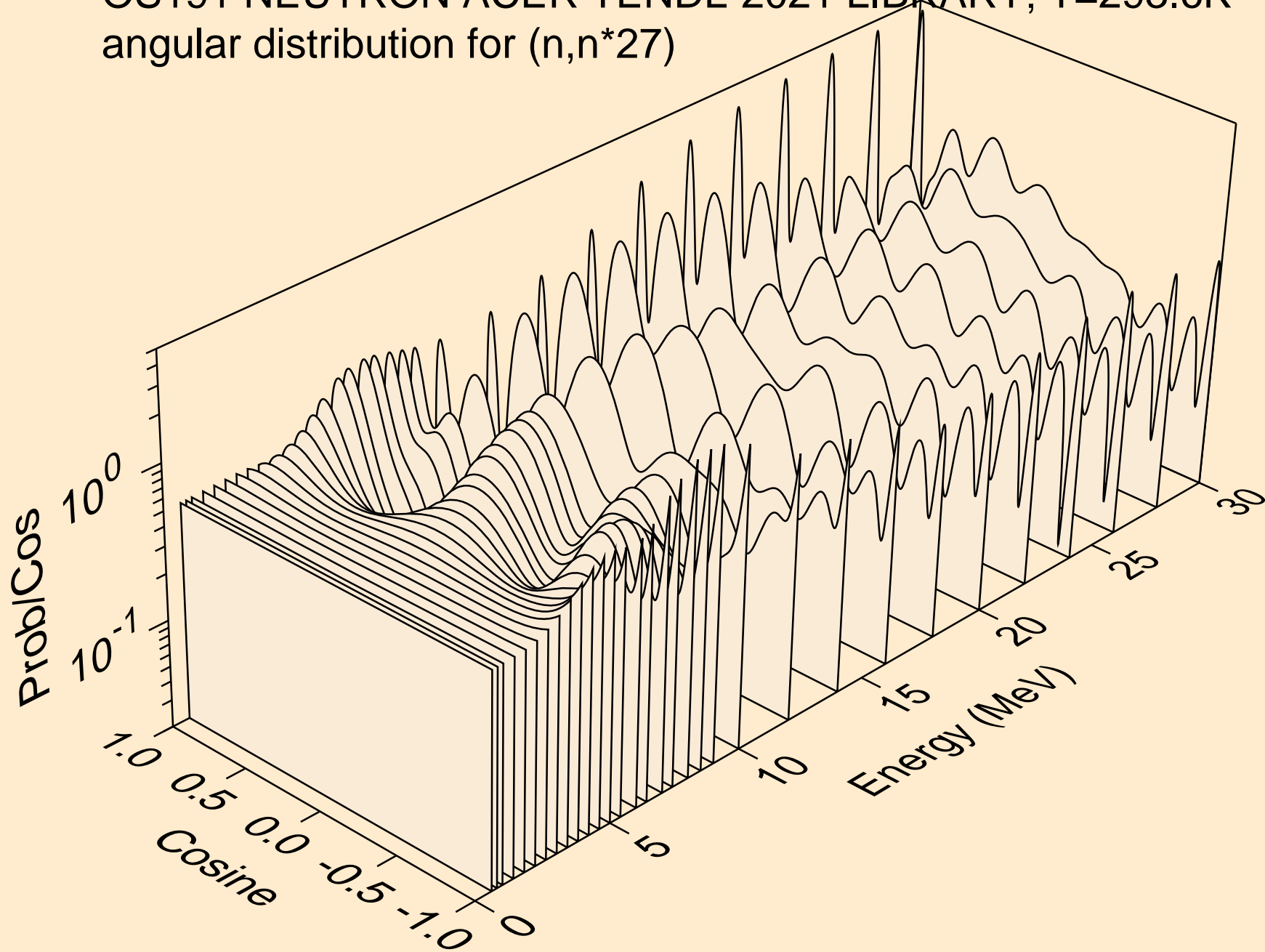

OS191 NEUTRON ACER TENDL-2021 LIBRARY; T=293.6K
angular distribution for (n,n*28)

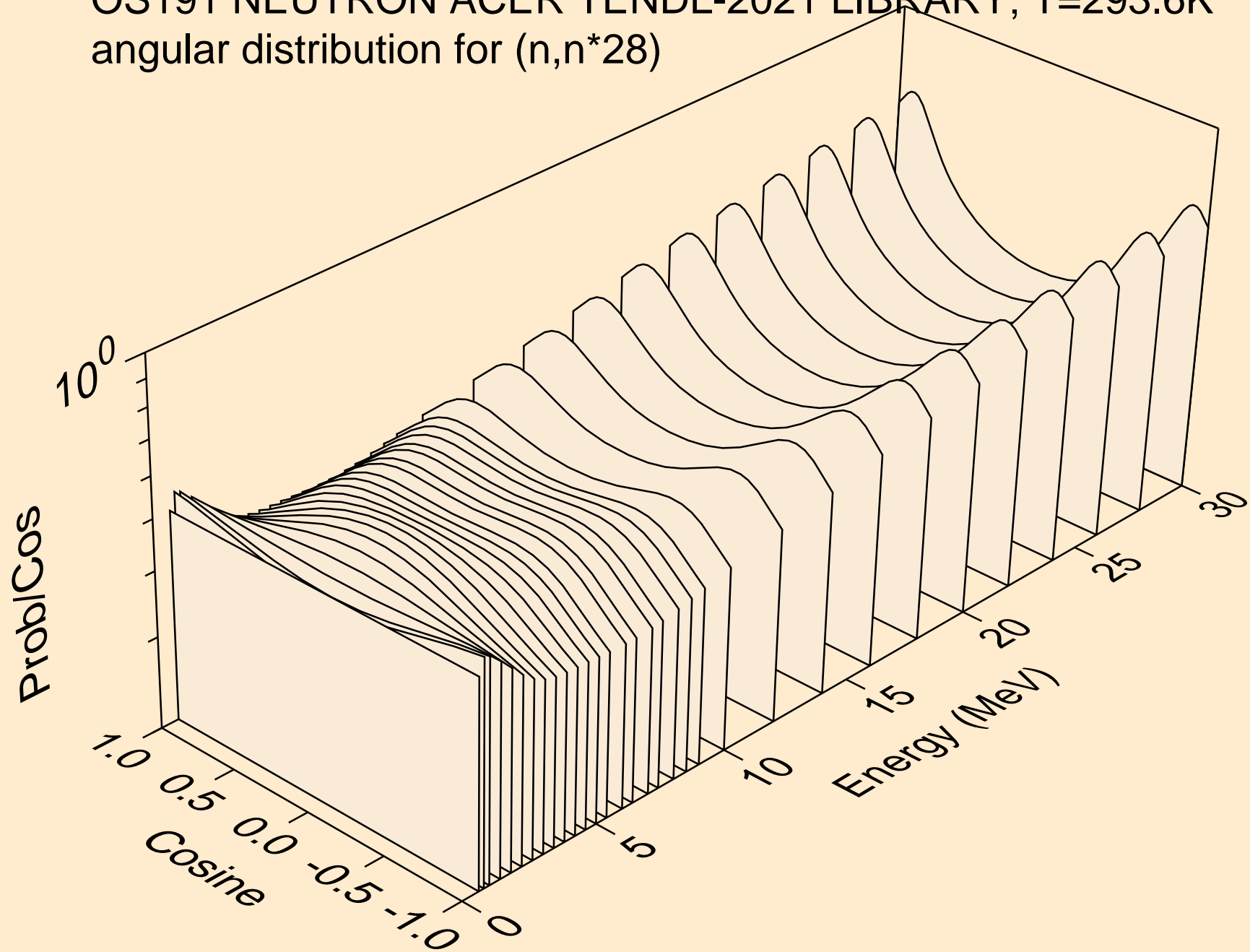

OS191 NEUTRON ACER TENDL-2021 LIBRARY; T=293.6K
angular distribution for (n,n*29)

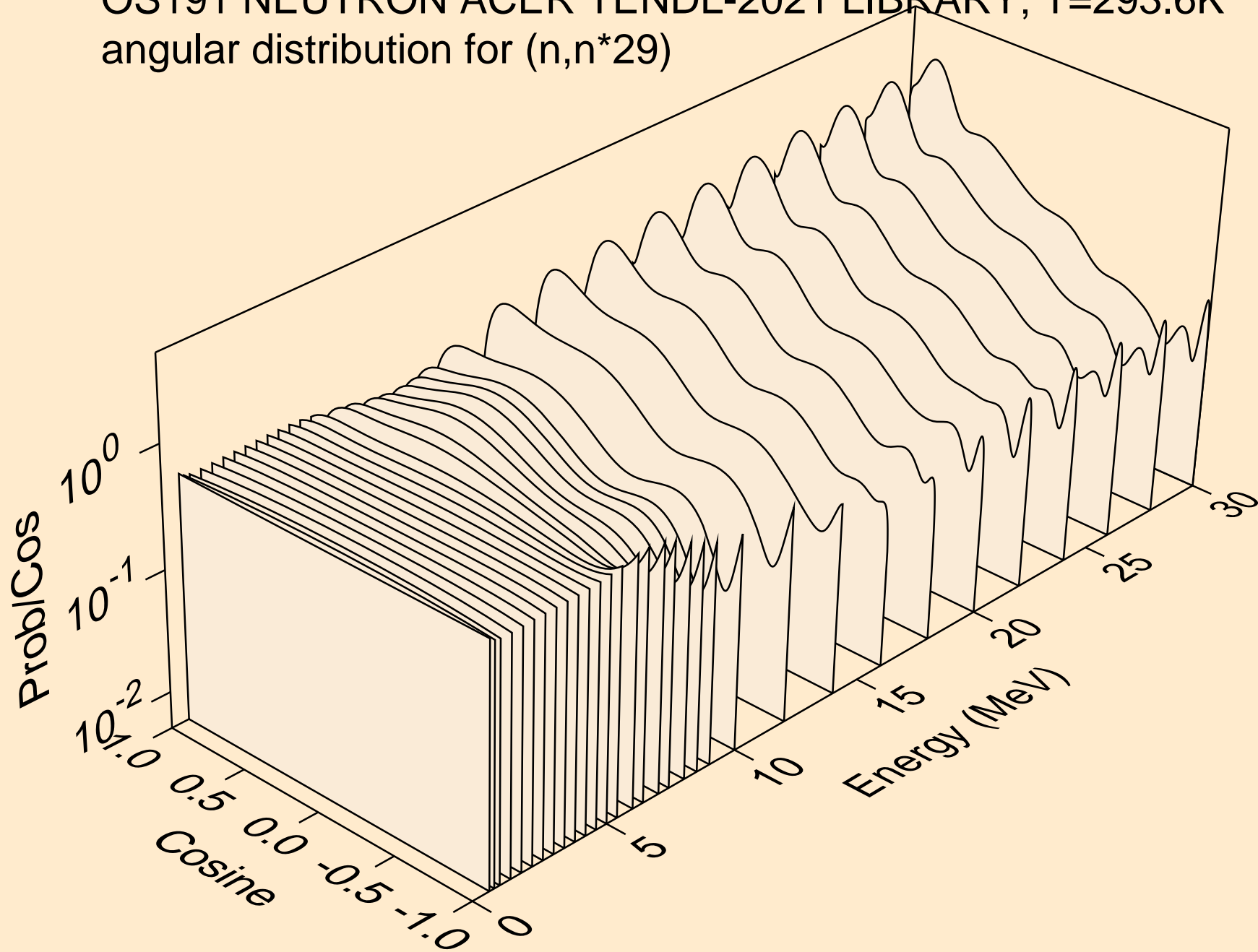

OS191 NEUTRON ACER TENDL-2021 LIBRARY; T=293.6K
angular distribution for (n,n*30)

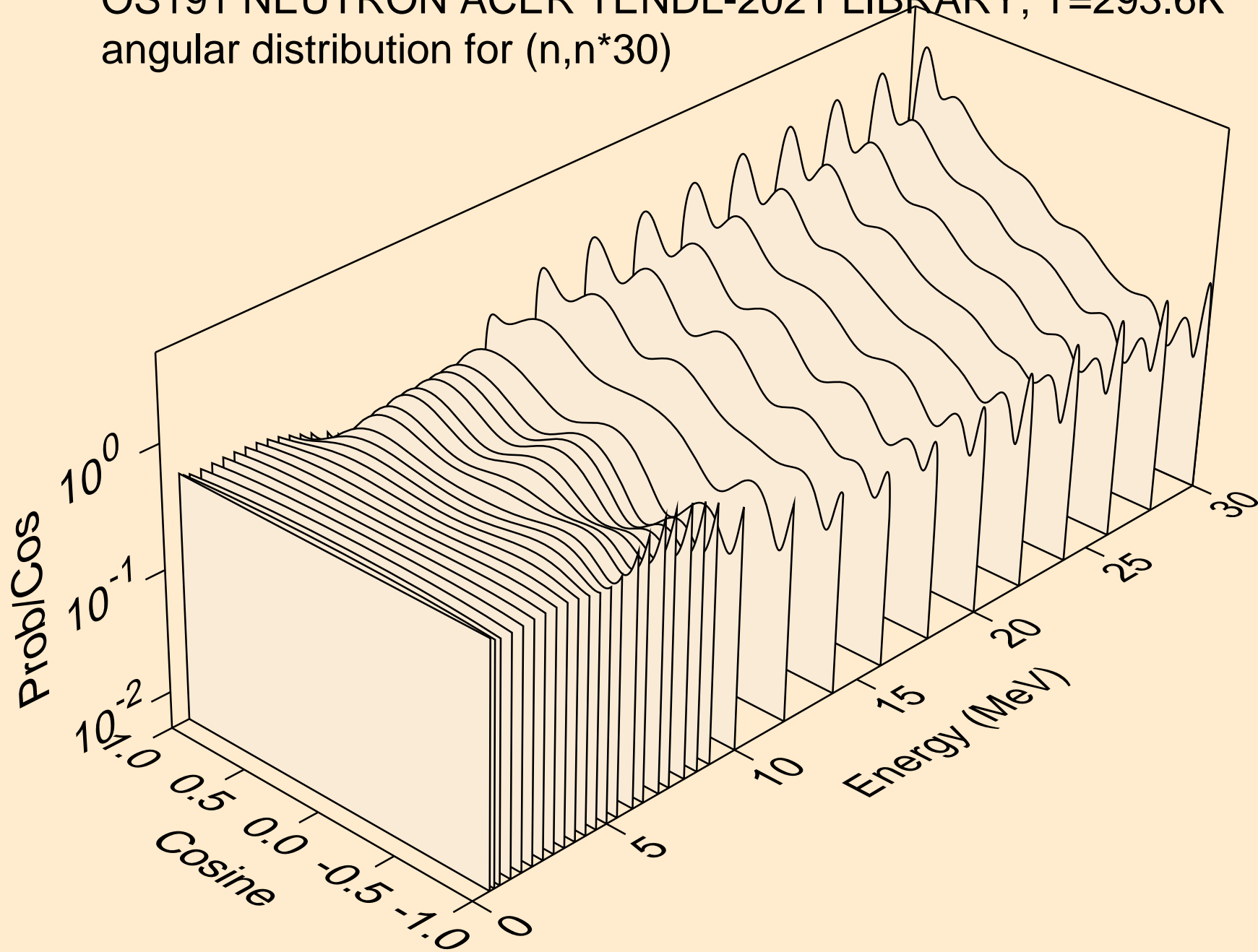

OS191 NEUTRON ACER TENDL-2021 LIBRARY; T=293.6K
Neutron emission for (n,x)

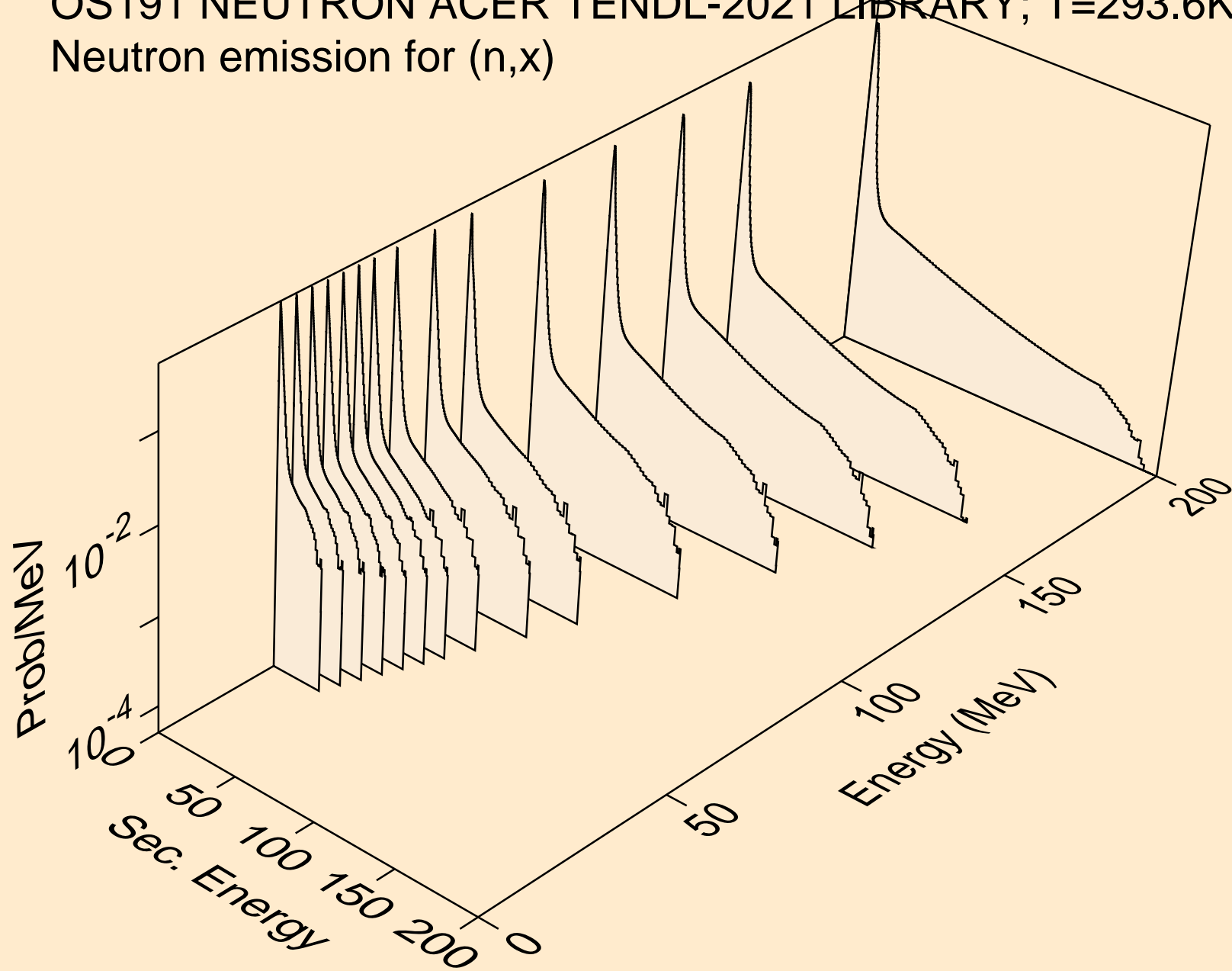

OS191 NEUTRON ACER TENDL-2021 LIBRARY; T=293.6K
Neutron emission for (n,2nd)

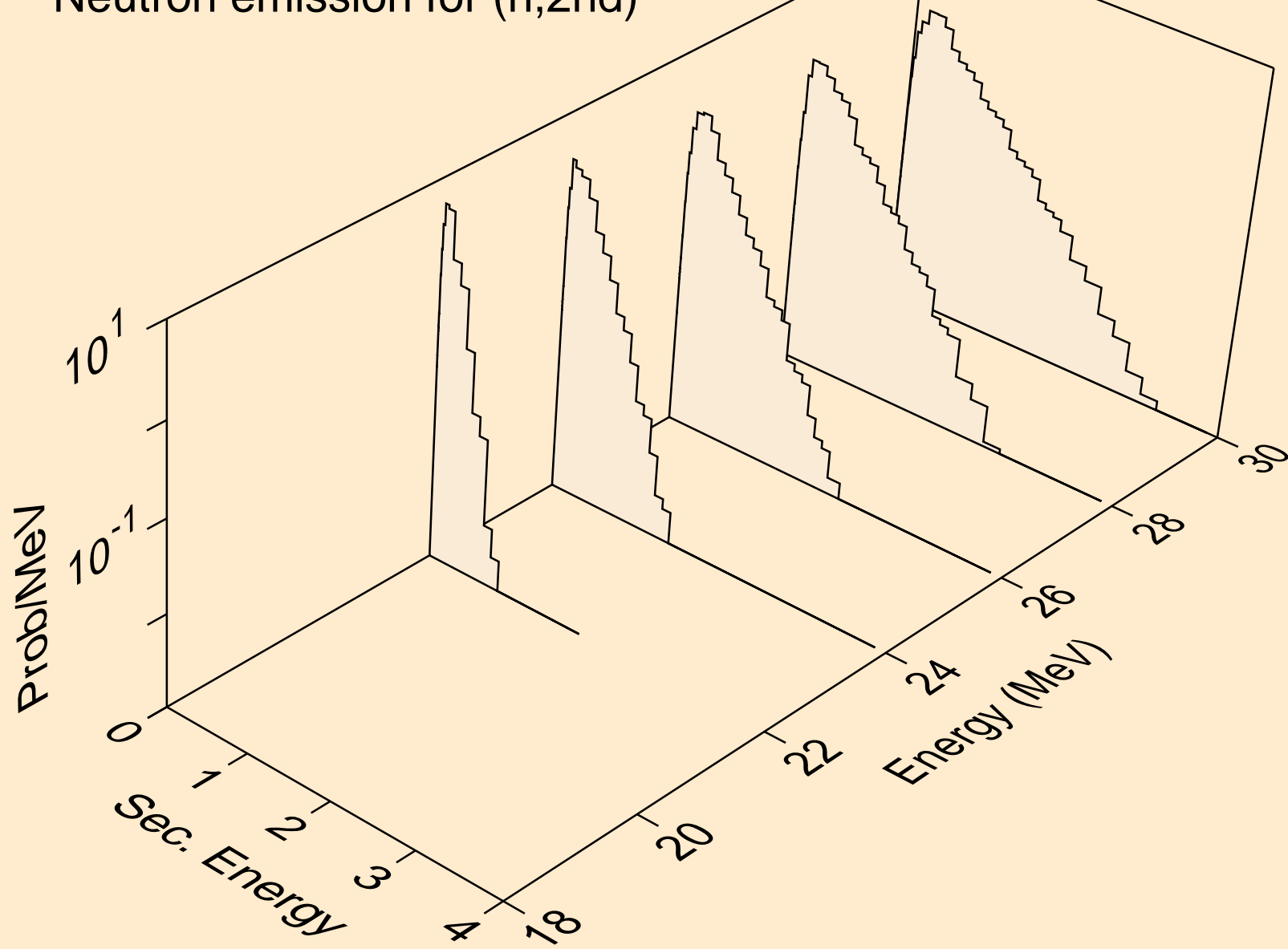

OS191 NEUTRON ACER TENDL-2021 LIBRARY; T=293.6K
Neutron emission for (n,2n)

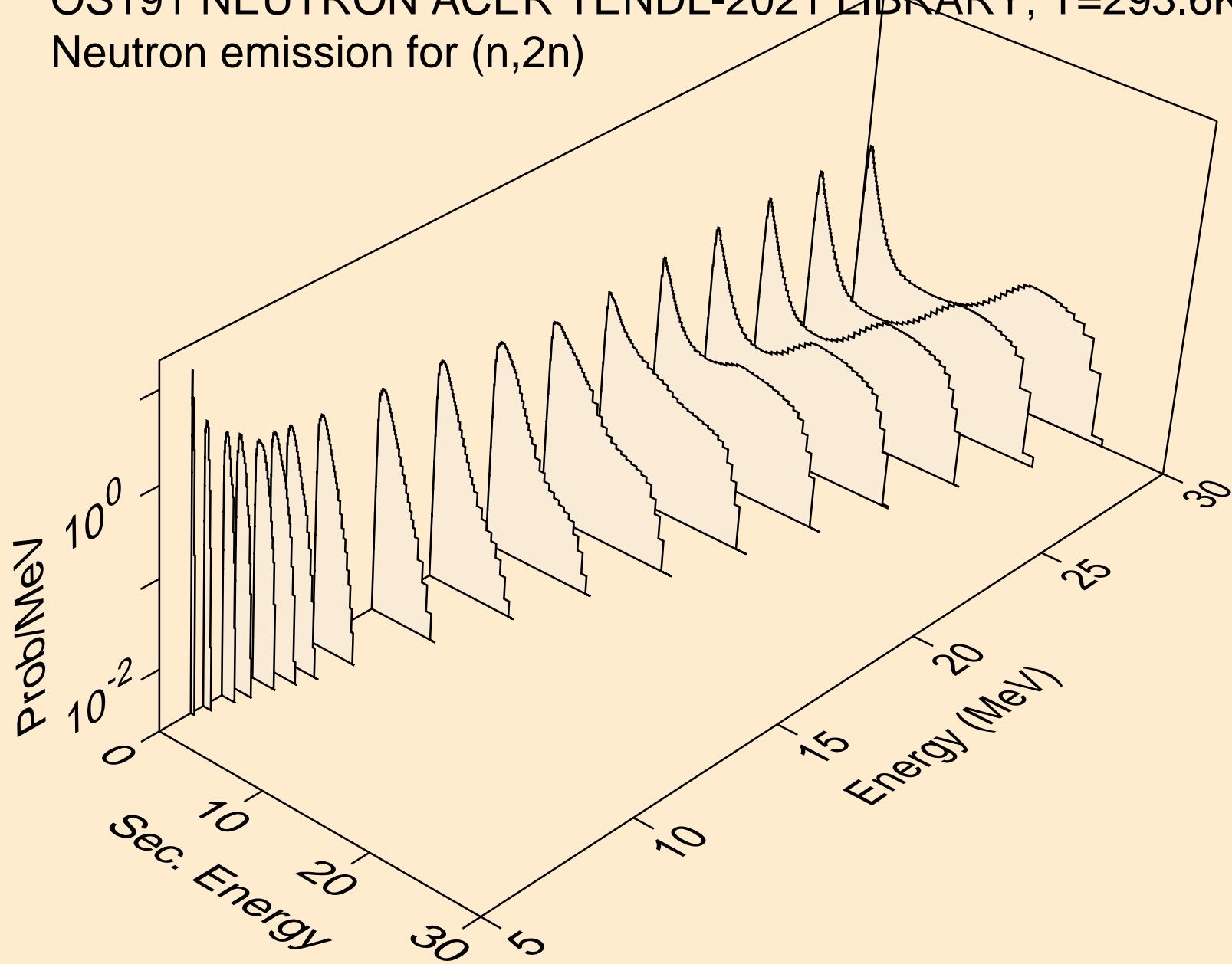

OS191 NEUTRON ACER TENDL-2021 LIBRARY; T=293.6K
Neutron emission for (n,3n)

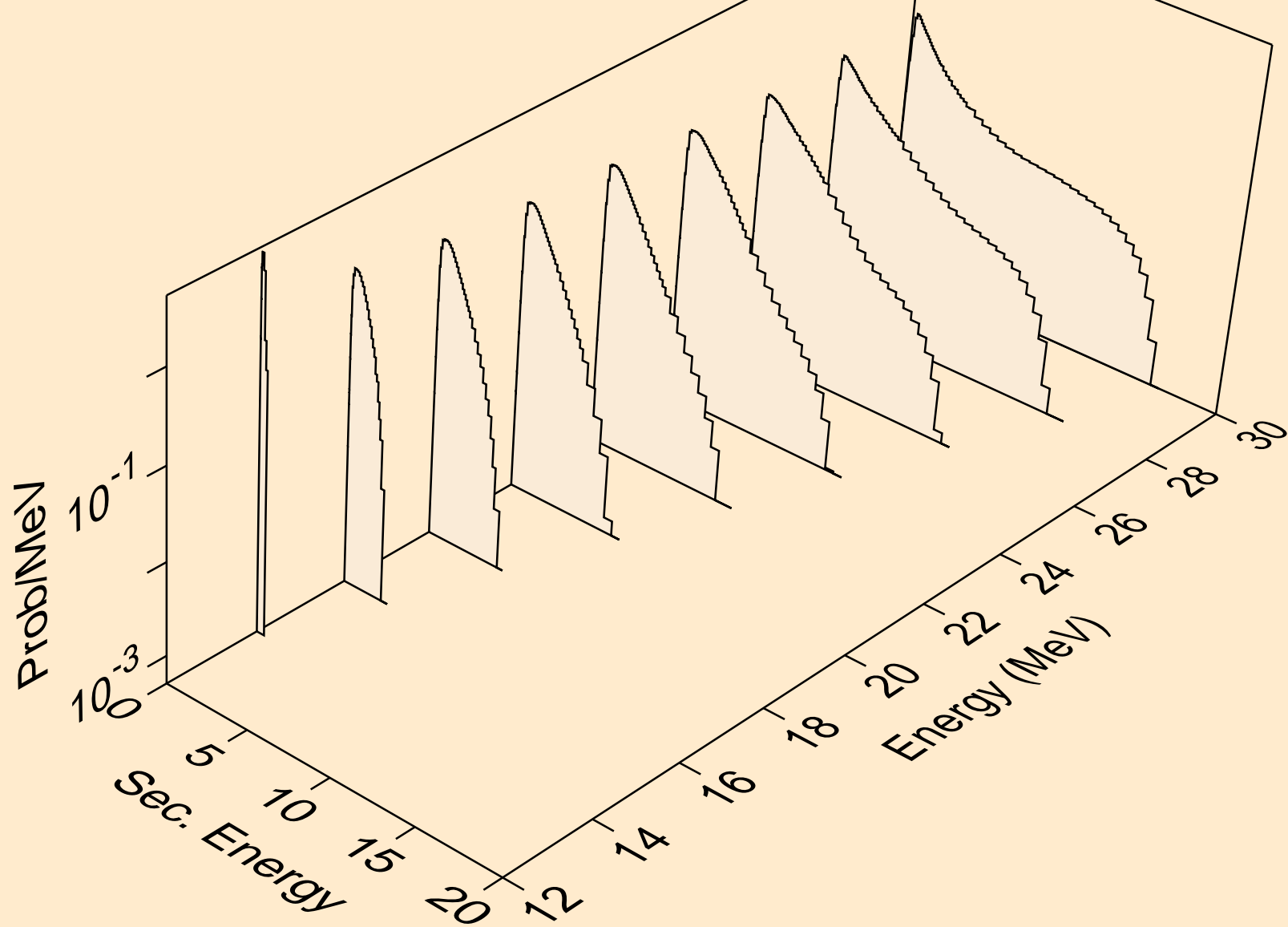

OS191 NEUTRON ACER TENDL-2021 LIBRARY; T=293.6K
Neutron emission for (n,n*)a

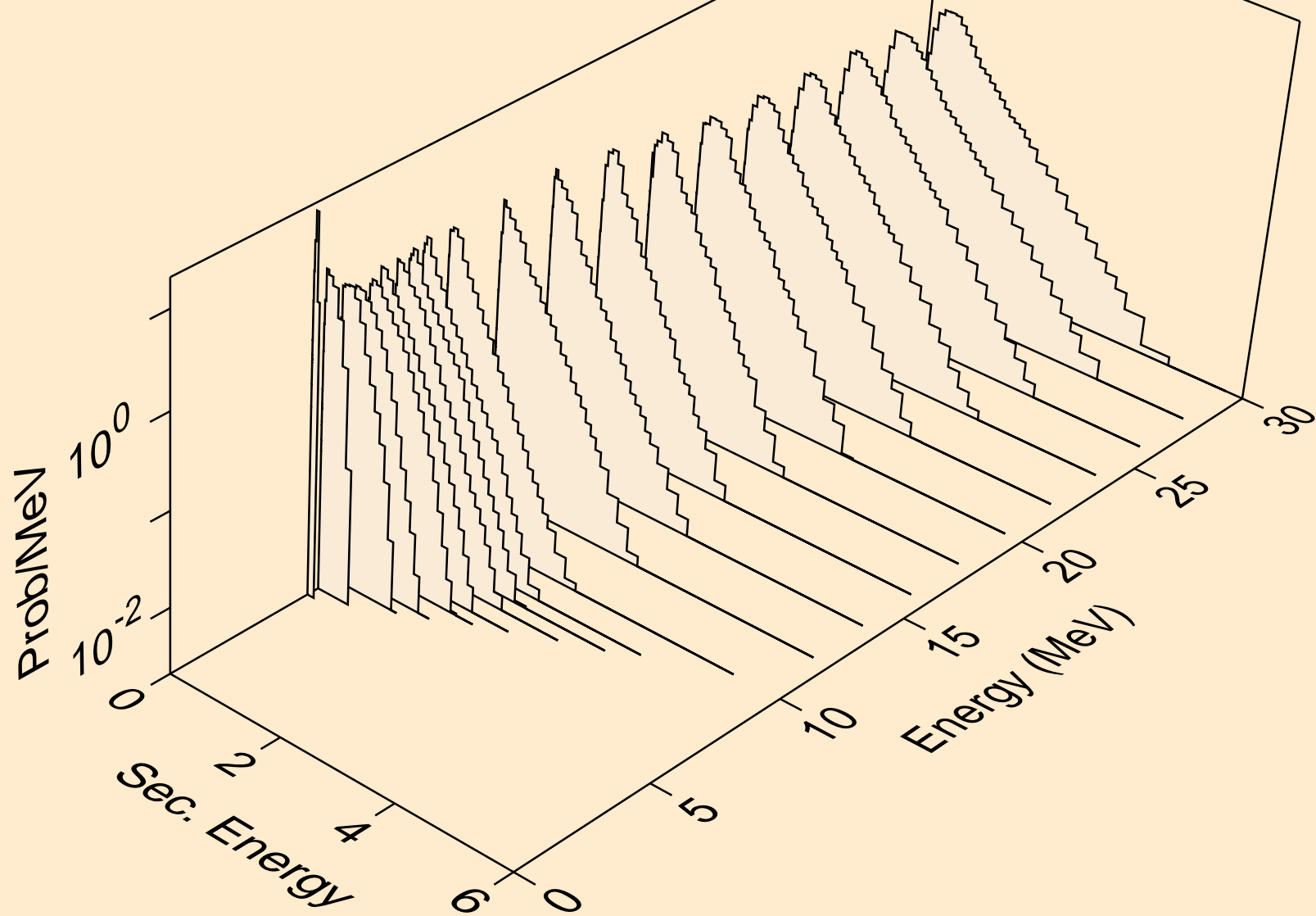

OS191 NEUTRON ACER TENDL-2021 LIBRARY; T=293.6K
Neutron emission for (n,2n)_a

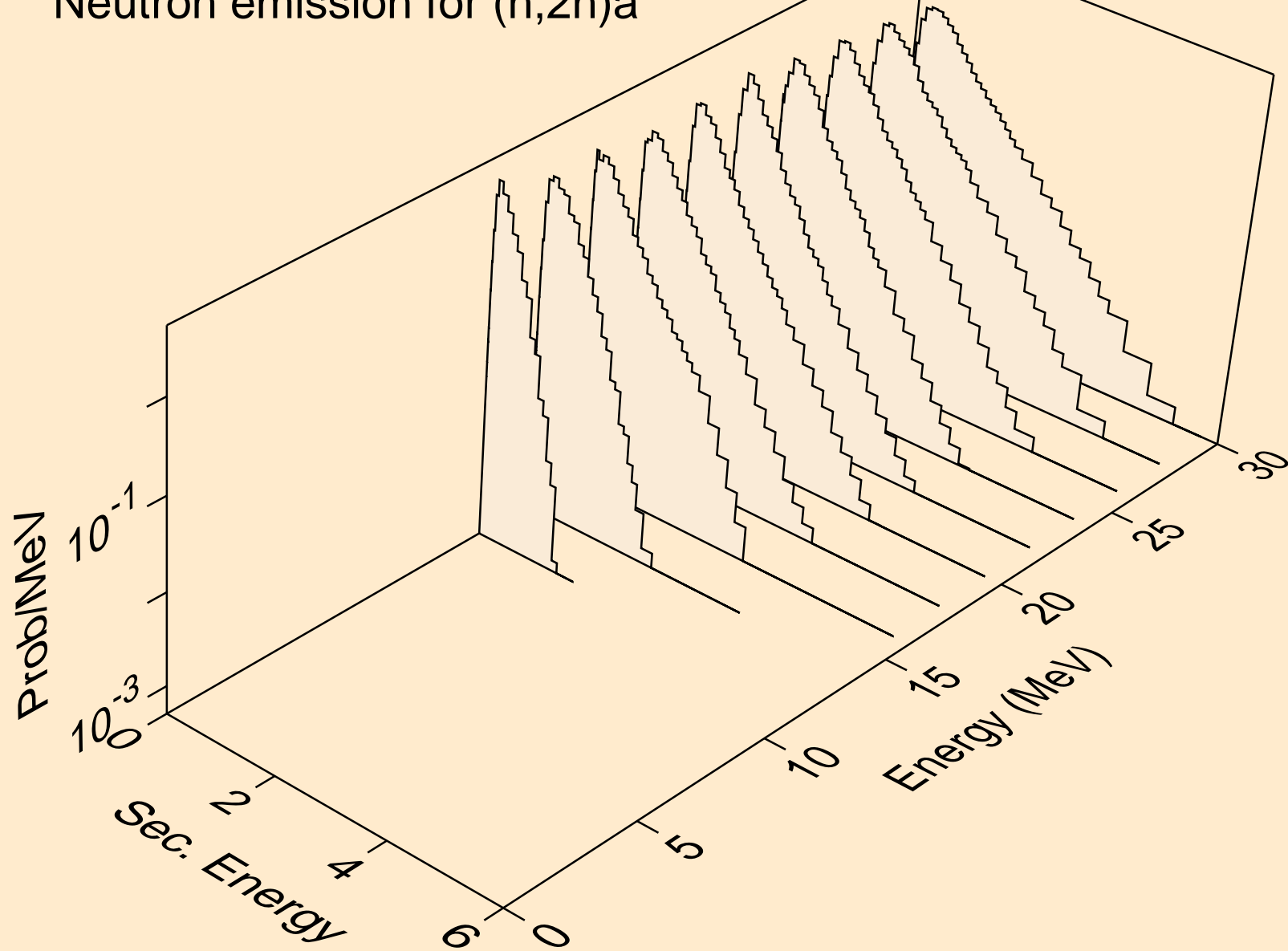

OS191 NEUTRON ACER TENDL-2021 LIBRARY; T=293.6K
Neutron emission for (n,3n)a

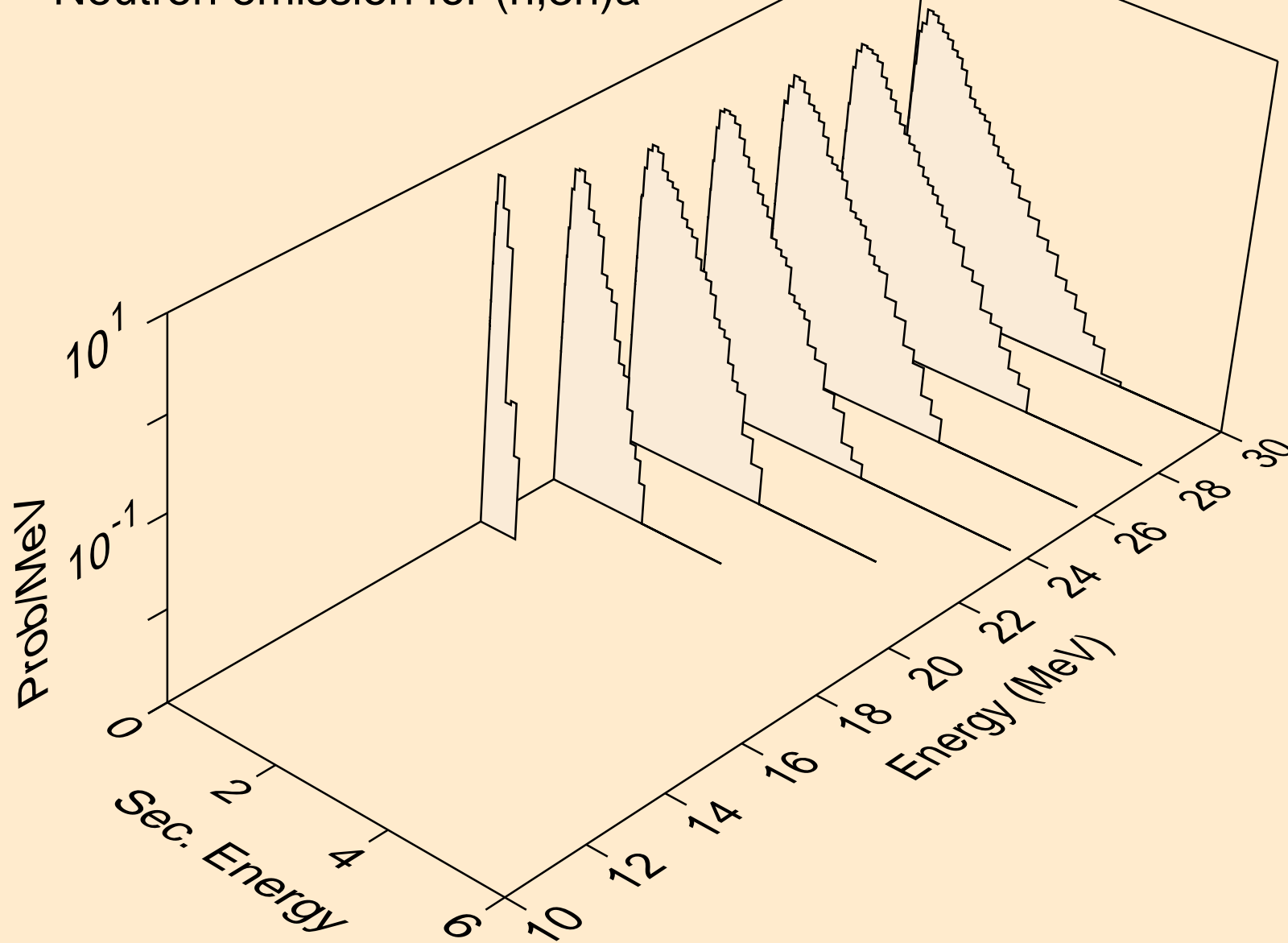

OS191 NEUTRON ACER TENDL-2021 LIBRARY; T=293.6K
Neutron emission for (n,n*)p

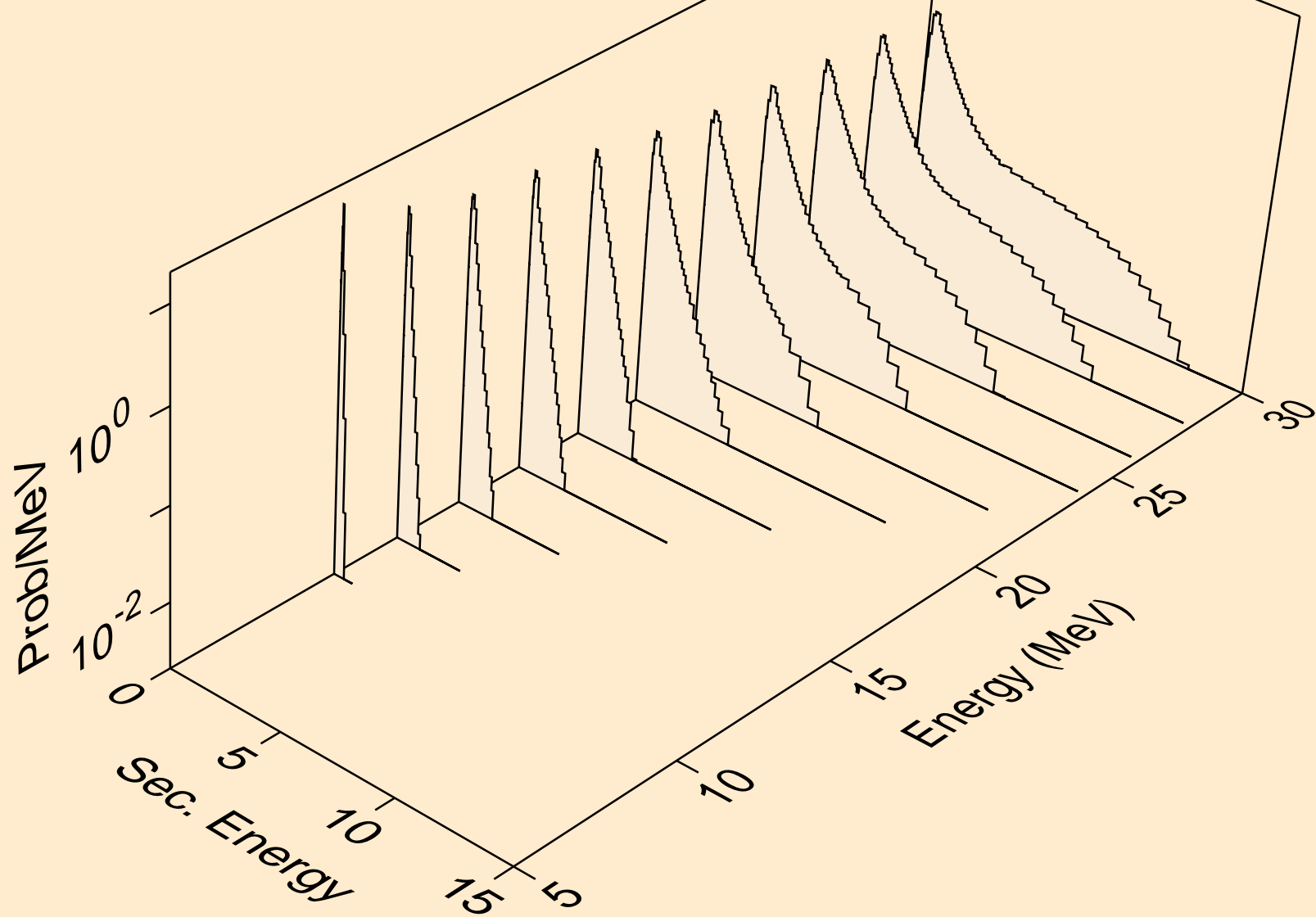

OS191 NEUTRON ACER TENDL-2021 LIBRARY; T=293.6K
Neutron emission for (n,n*)d

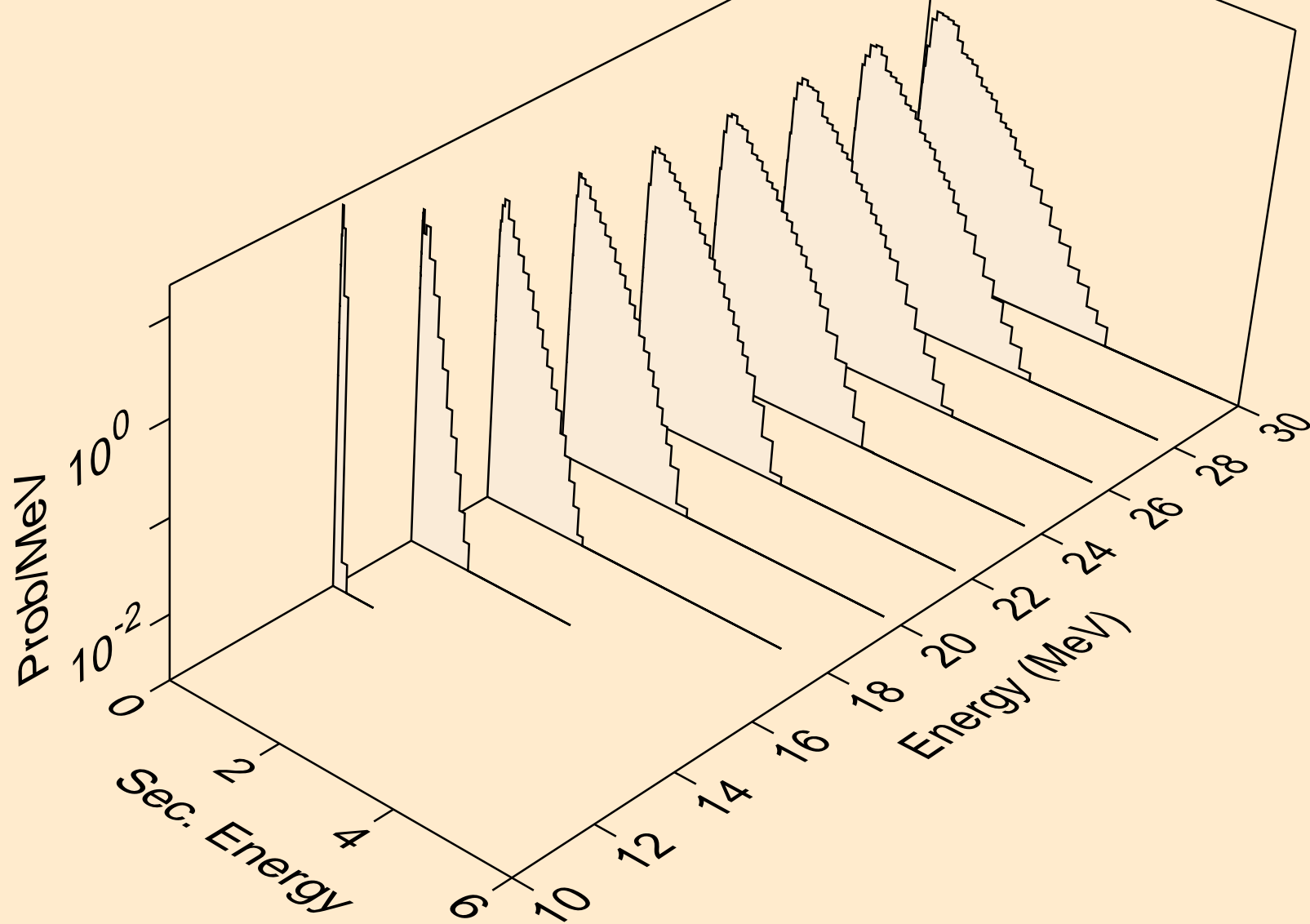

OS191 NEUTRON ACER TENDL-2021 LIBRARY; T=293.6K
Neutron emission for (n,n*)t

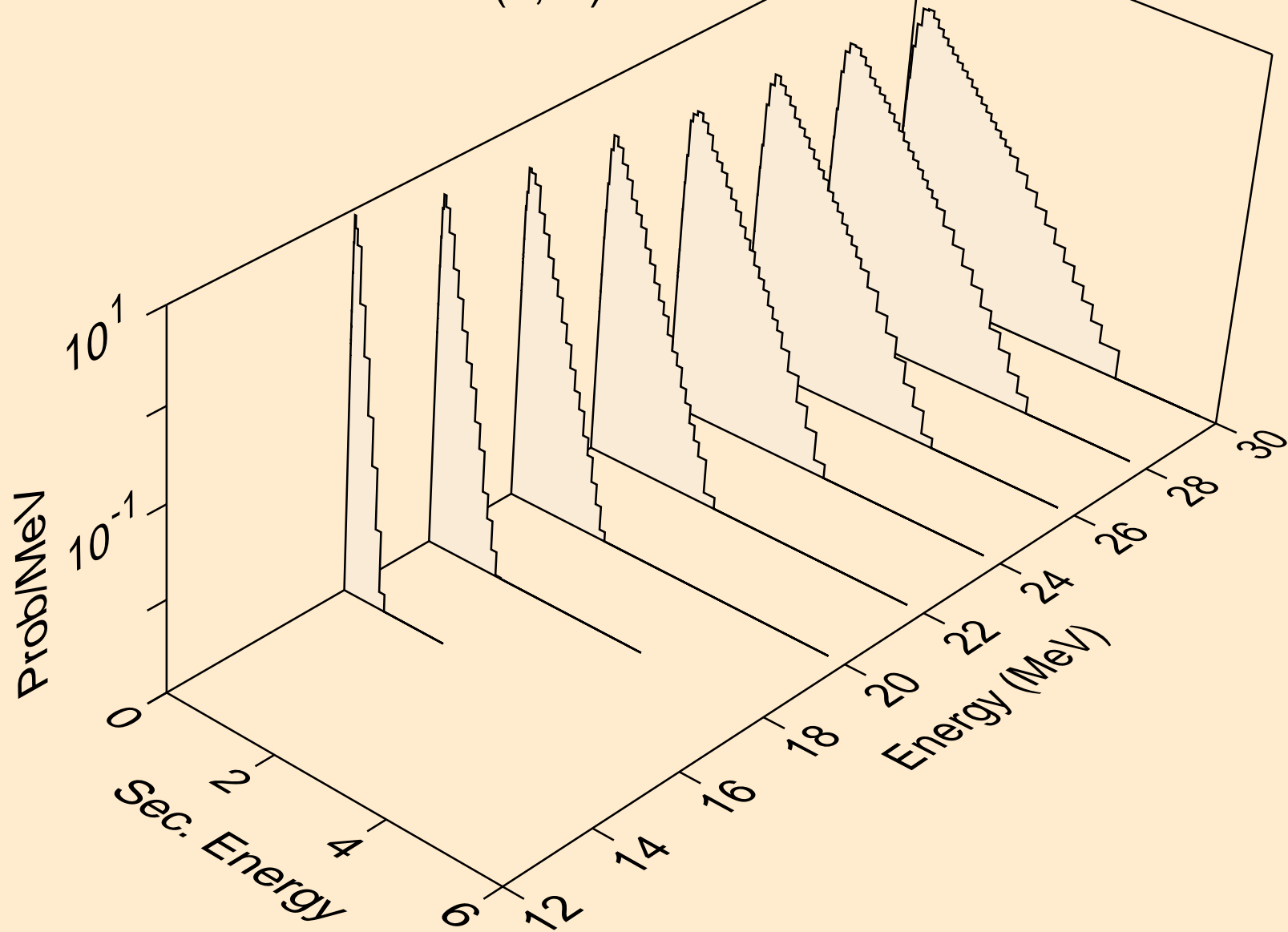

OS191 NEUTRON ACER TENDL-2021 LIBRARY; T=293.6K
Neutron emission for (n,n*)he3

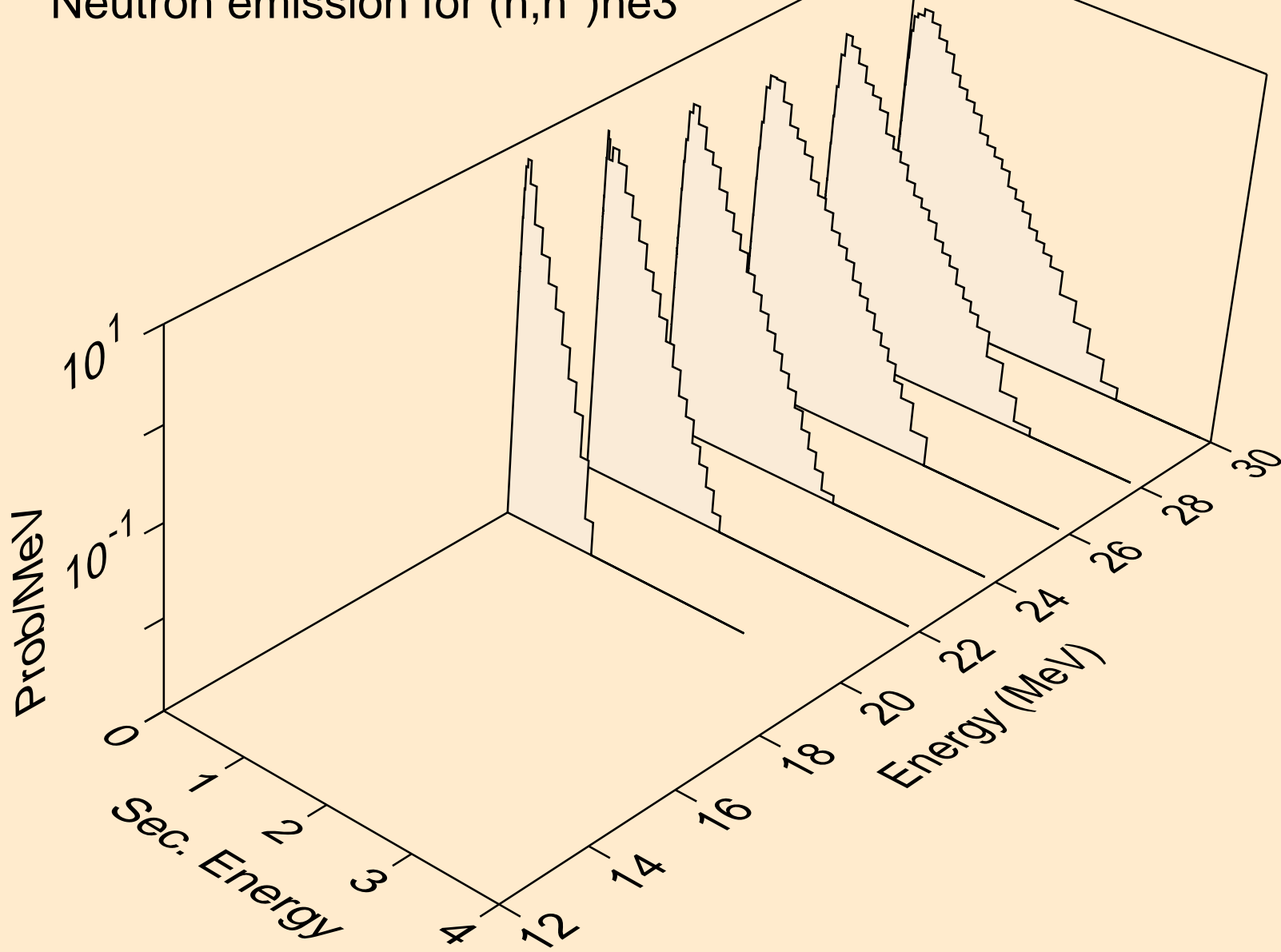

OS191 NEUTRON ACER TENDL-2021 LIBRARY; T=293.6K
Neutron emission for (n,4n)

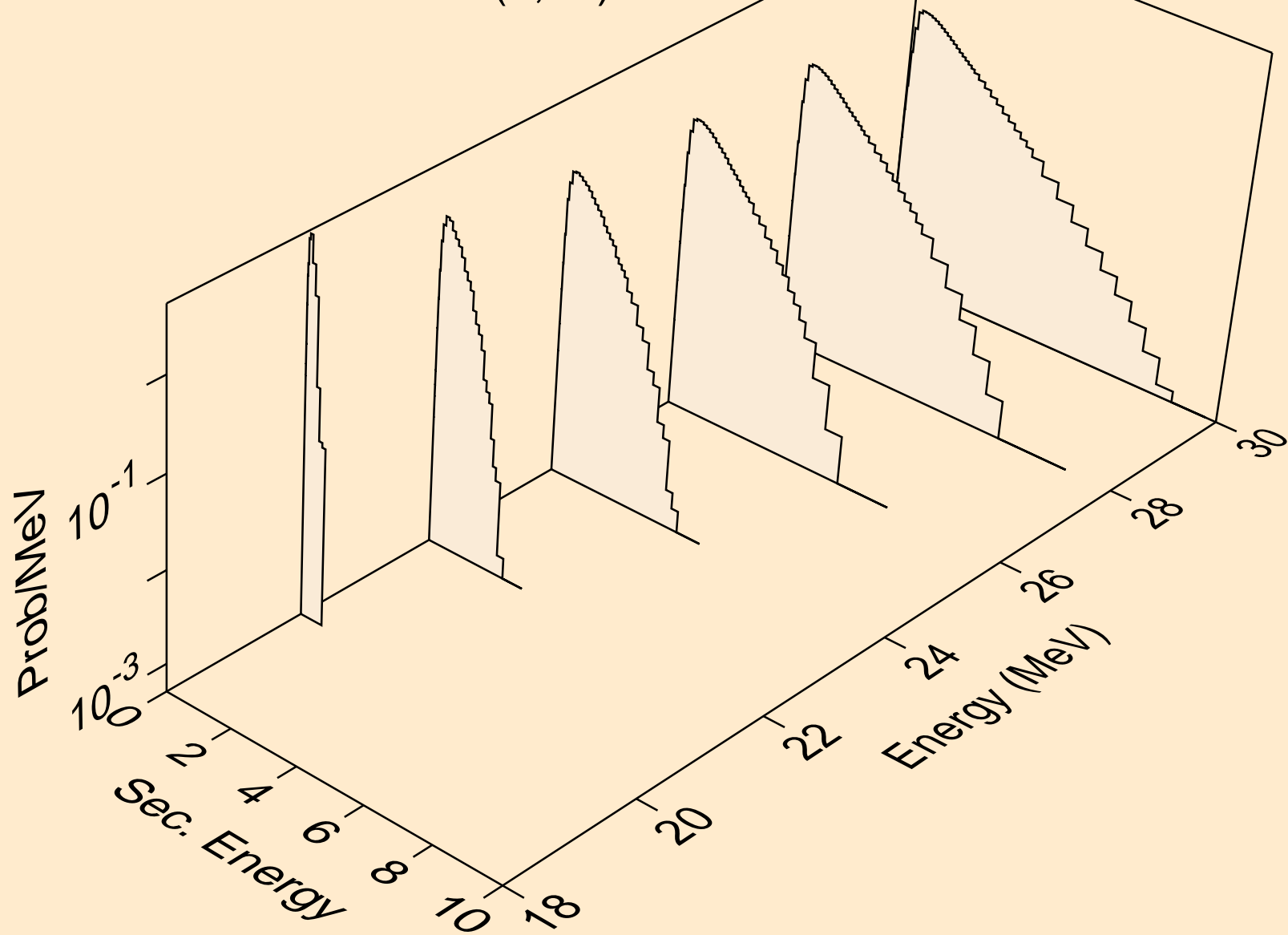

OS191 NEUTRON ACER TENDL-2021 LIBRARY; T=293.6K
Neutron emission for (n,2np)

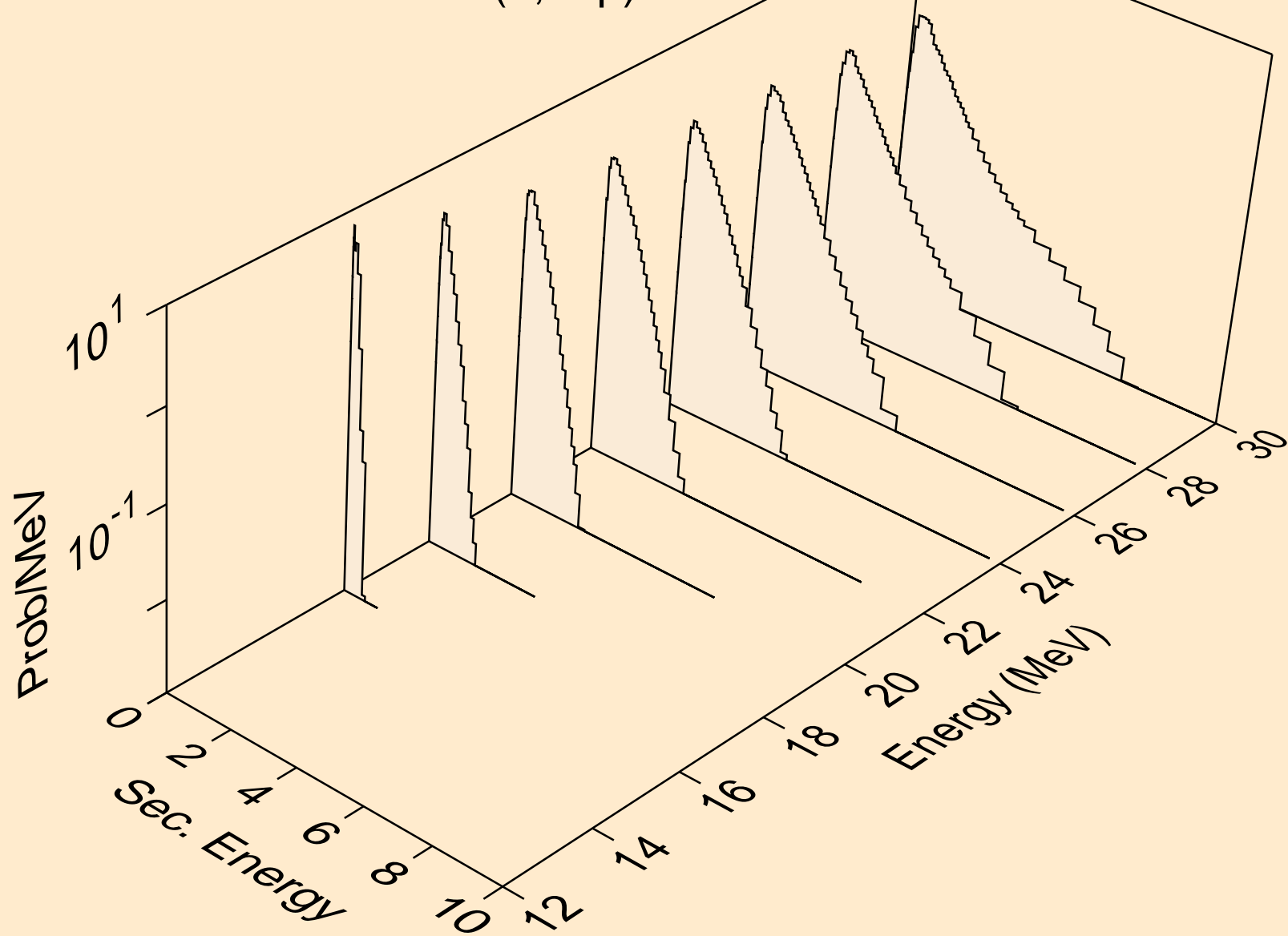

OS191 NEUTRON ACER TENDL-2021 LIBRARY; T=293.6K
Neutron emission for (n,3np)

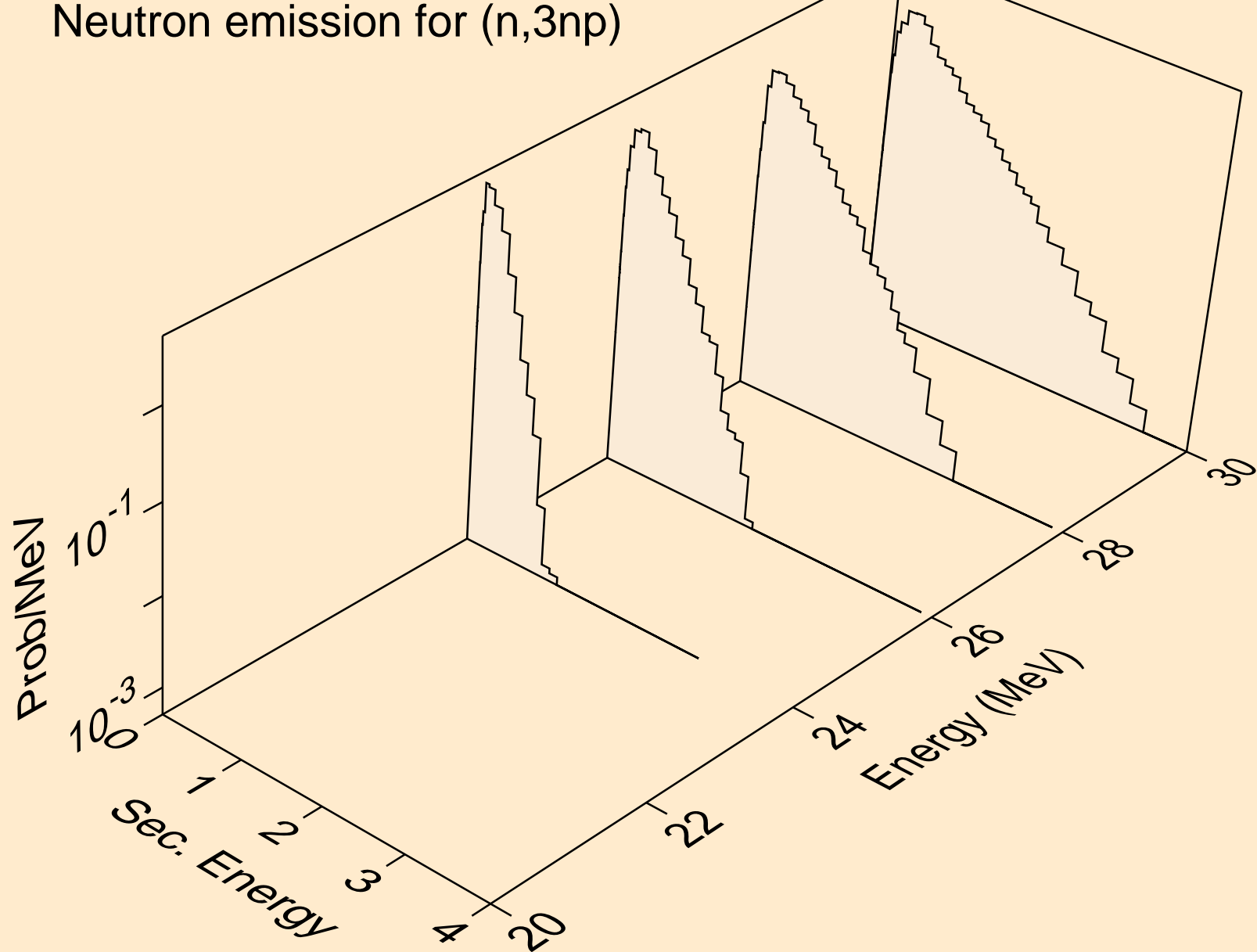

OS191 NEUTRON ACER TENDL-2021 LIBRARY; T=293.6K
Neutron emission for (n,2np)

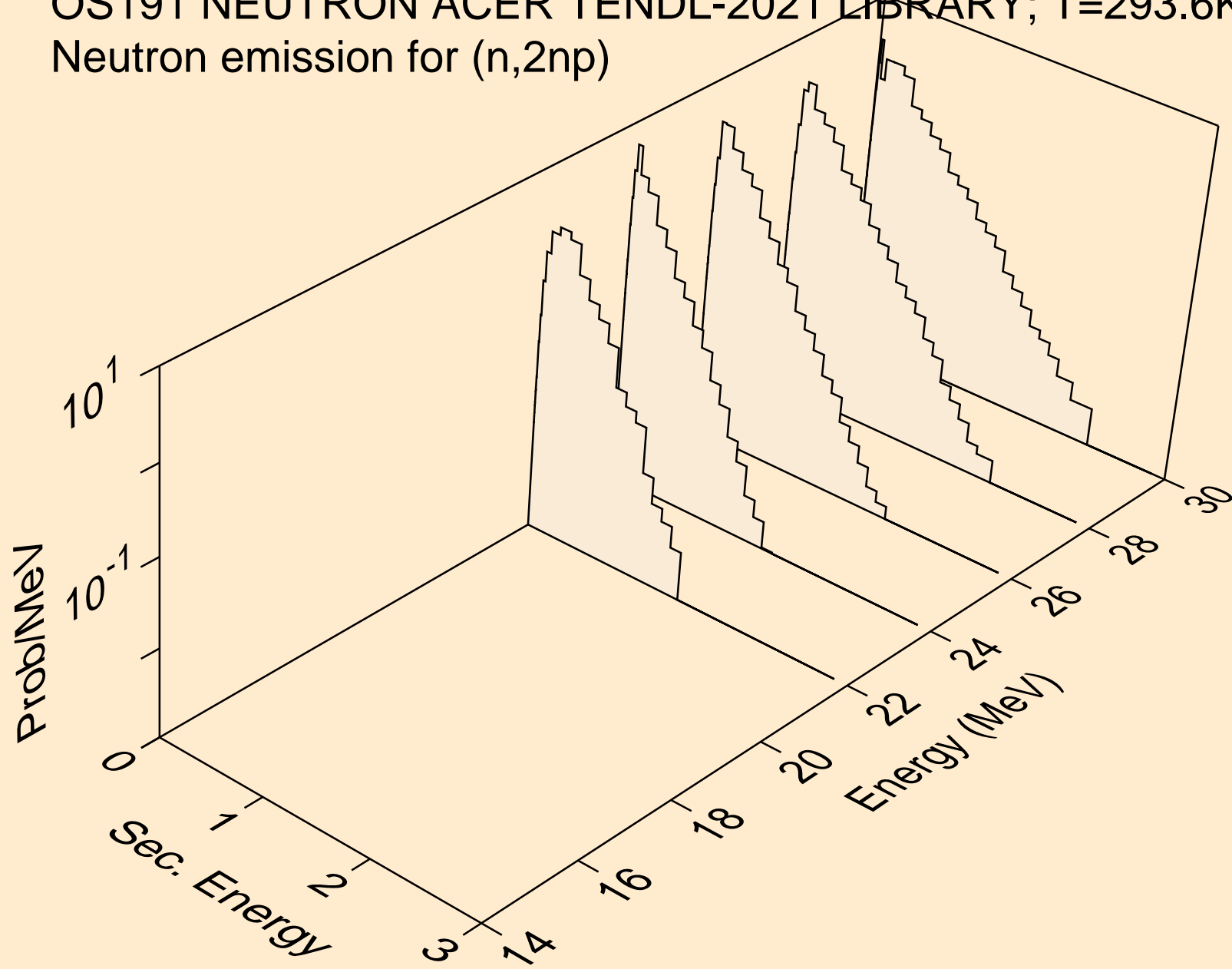

OS191 NEUTRON ACER TENDL-2021 LIBRARY; T=293.6K
Neutron emission for (n,n*c)

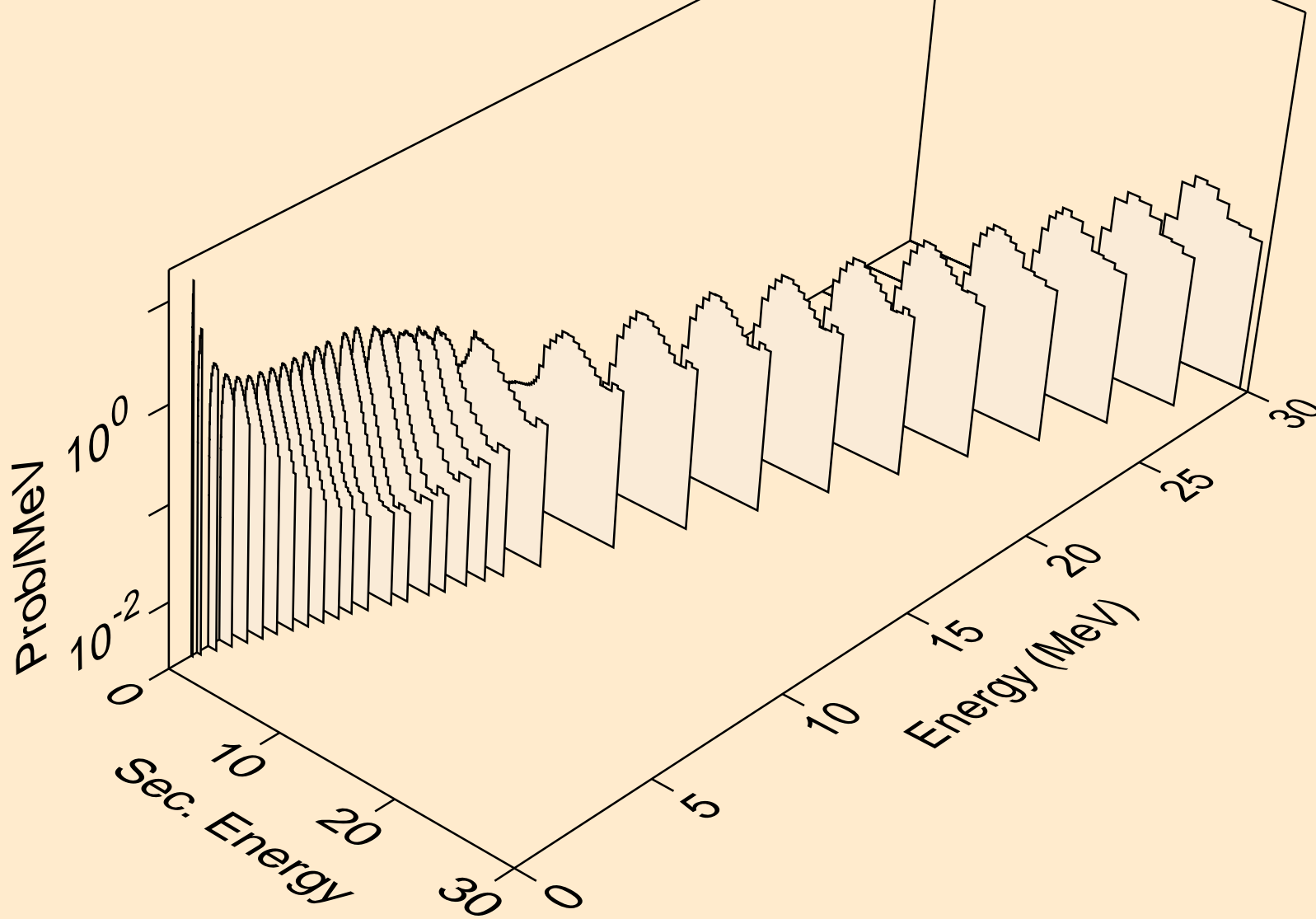

OS191 NEUTRON ACER TENDL-2021 LIBRARY; T=293.6K
Photon emission for (n,x)

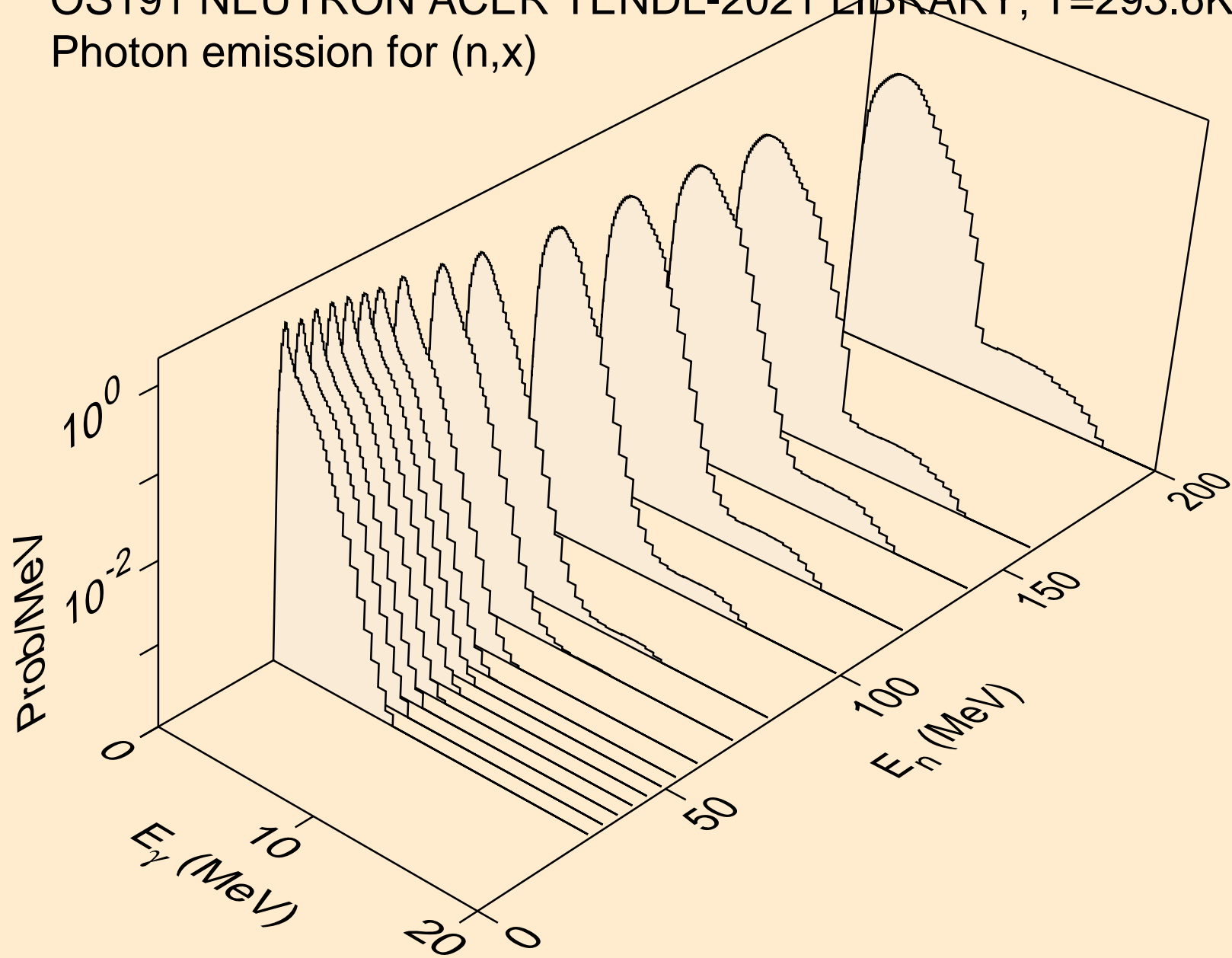

OS191 NEUTRON ACER TENDL-2021 LIBRARY; T=293.6K
Photon emission for (n,2nd)

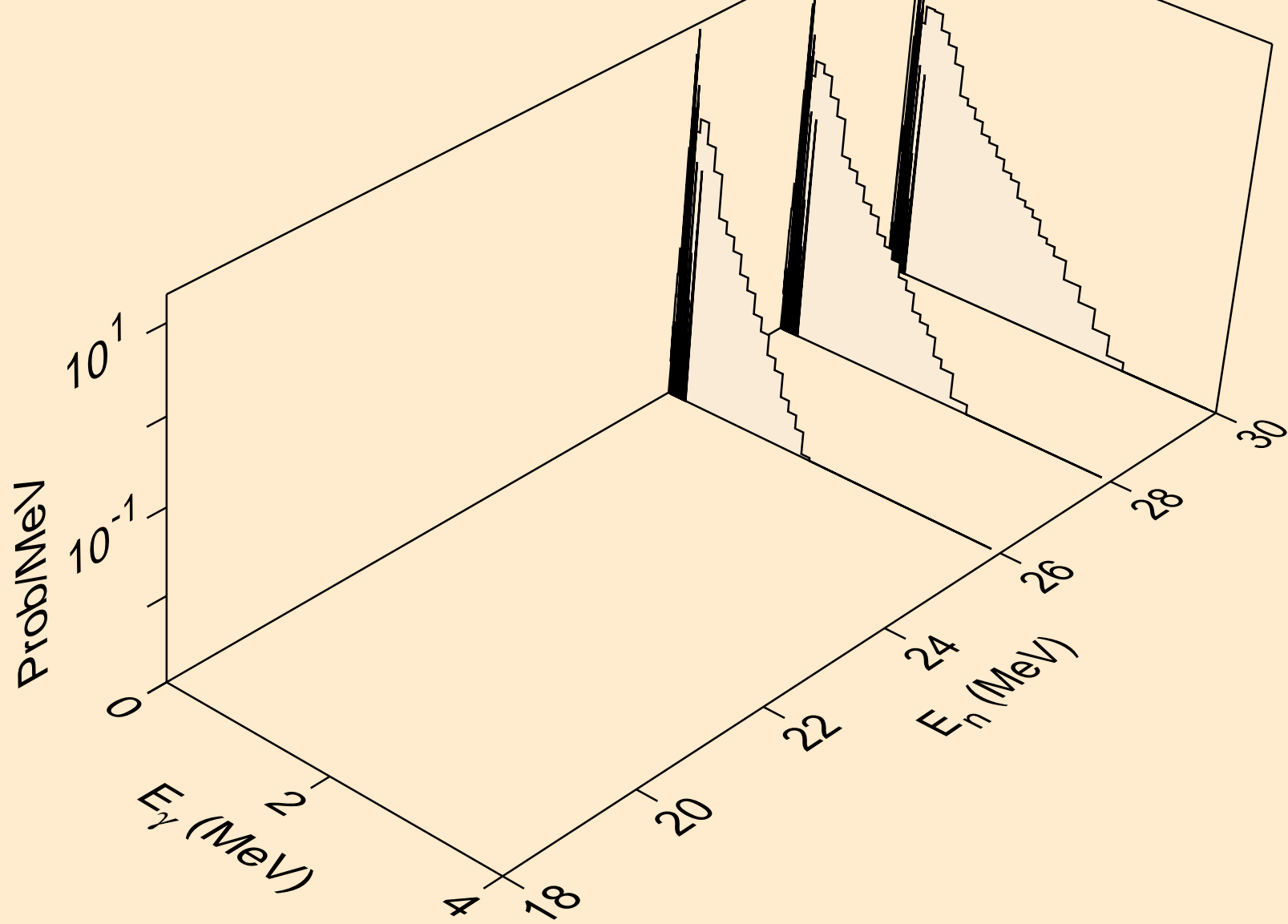

OS191 NEUTRON ACER TENDL-2021 LIBRARY; T=293.6K
Photon emission for (n,2n)

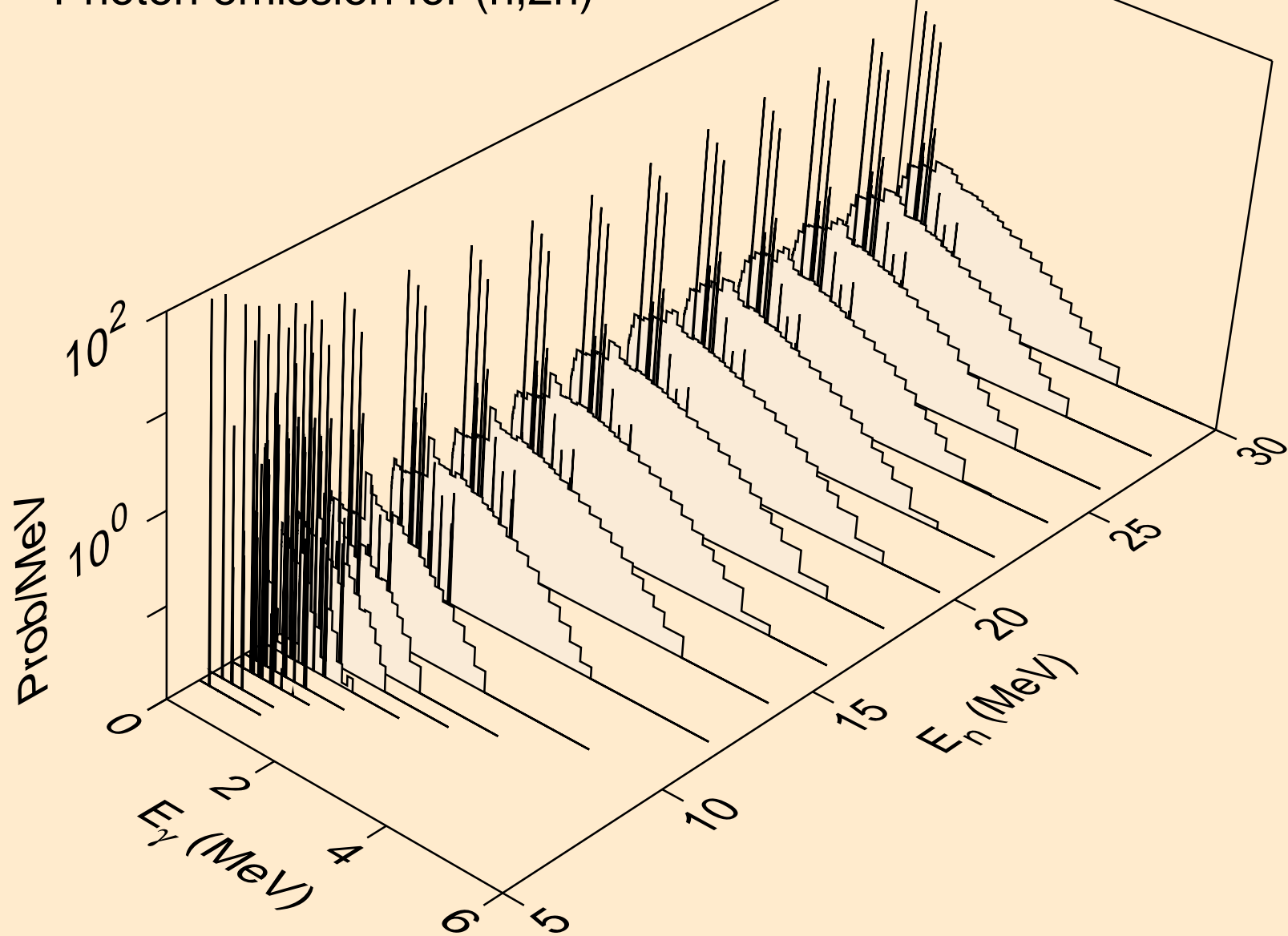

OS191 NEUTRON ACER TENDL-2021 LIBRARY; T=293.6K
Photon emission for (n,3n)

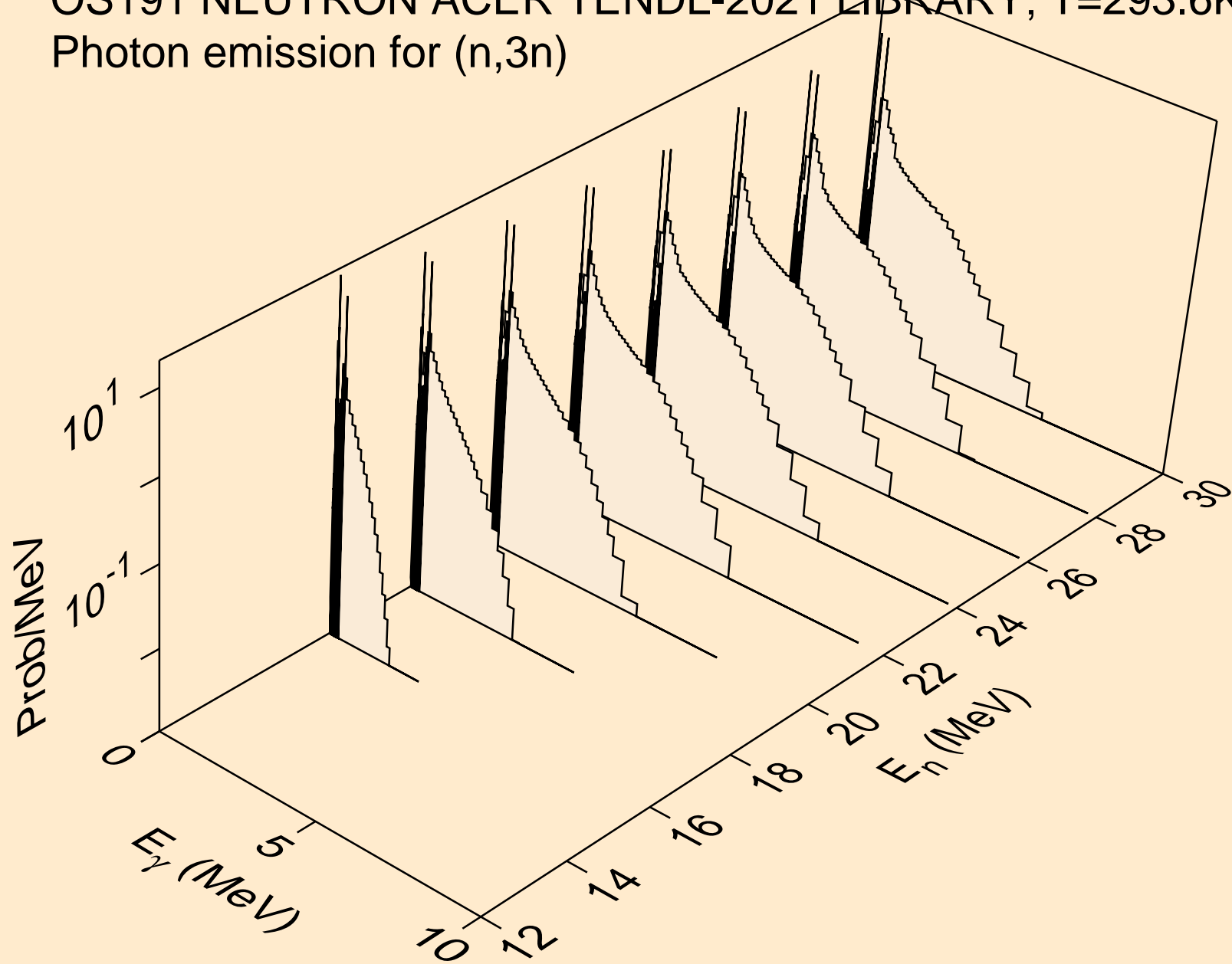

OS191 NEUTRON ACER TENDL-2021 LIBRARY; T=293.6K
Photon emission for (n,n*)a

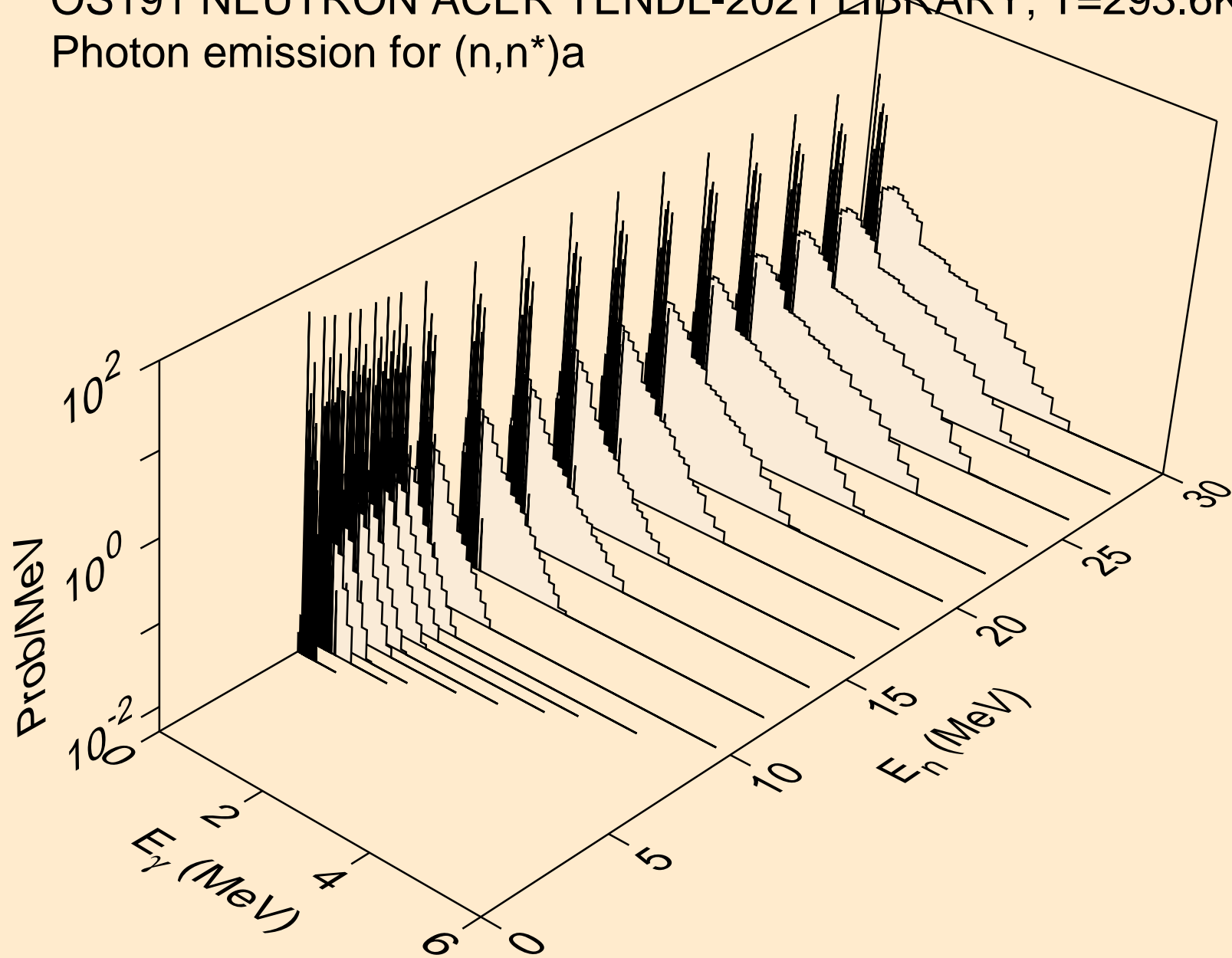

OS191 NEUTRON ACER TENDL-2021 LIBRARY; T=293.6K
Photon emission for (n,2n) α

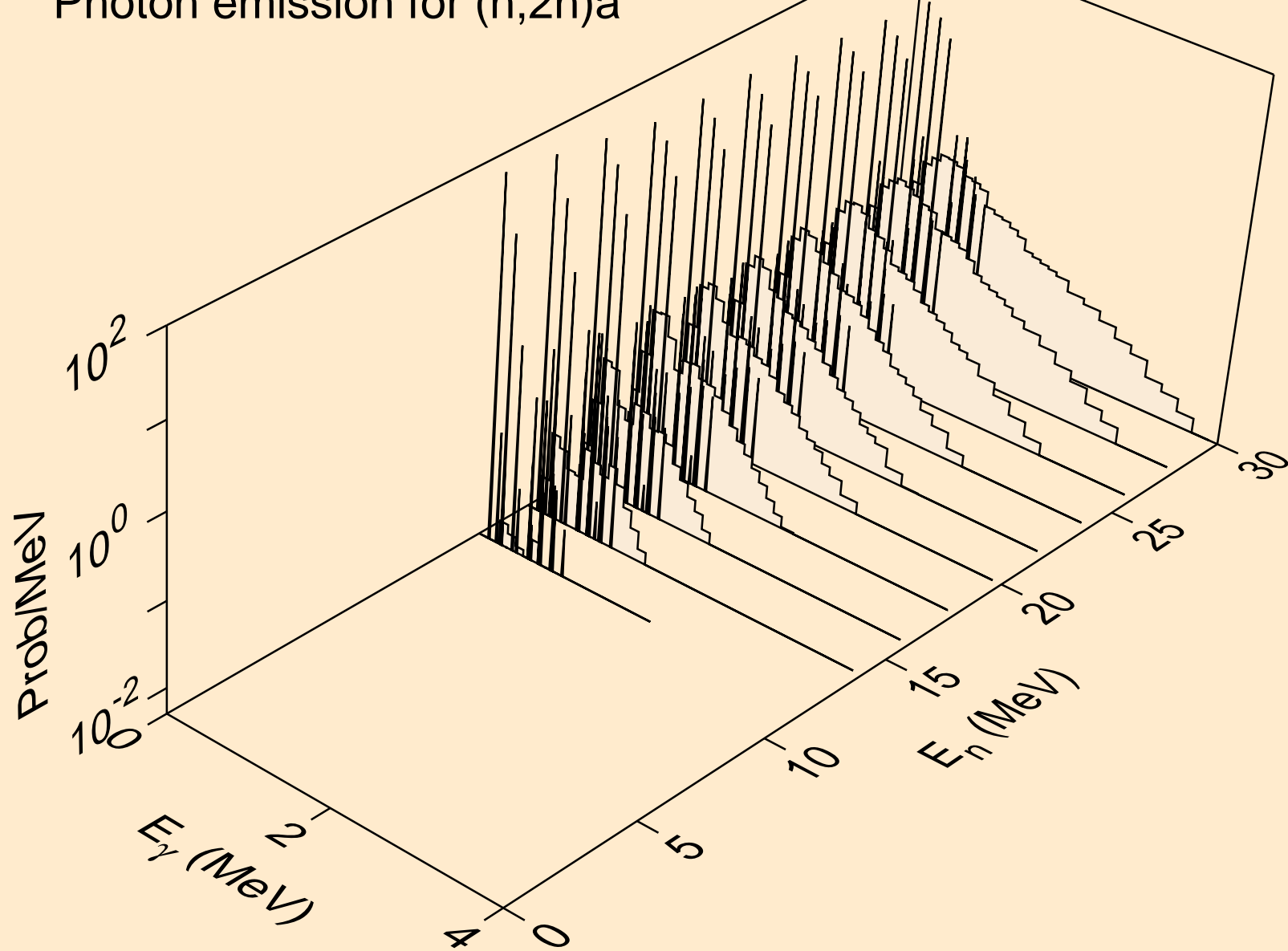

OS191 NEUTRON ACER TENDL-2021 LIBRARY; T=293.6K
Photon emission for (n,3n)a

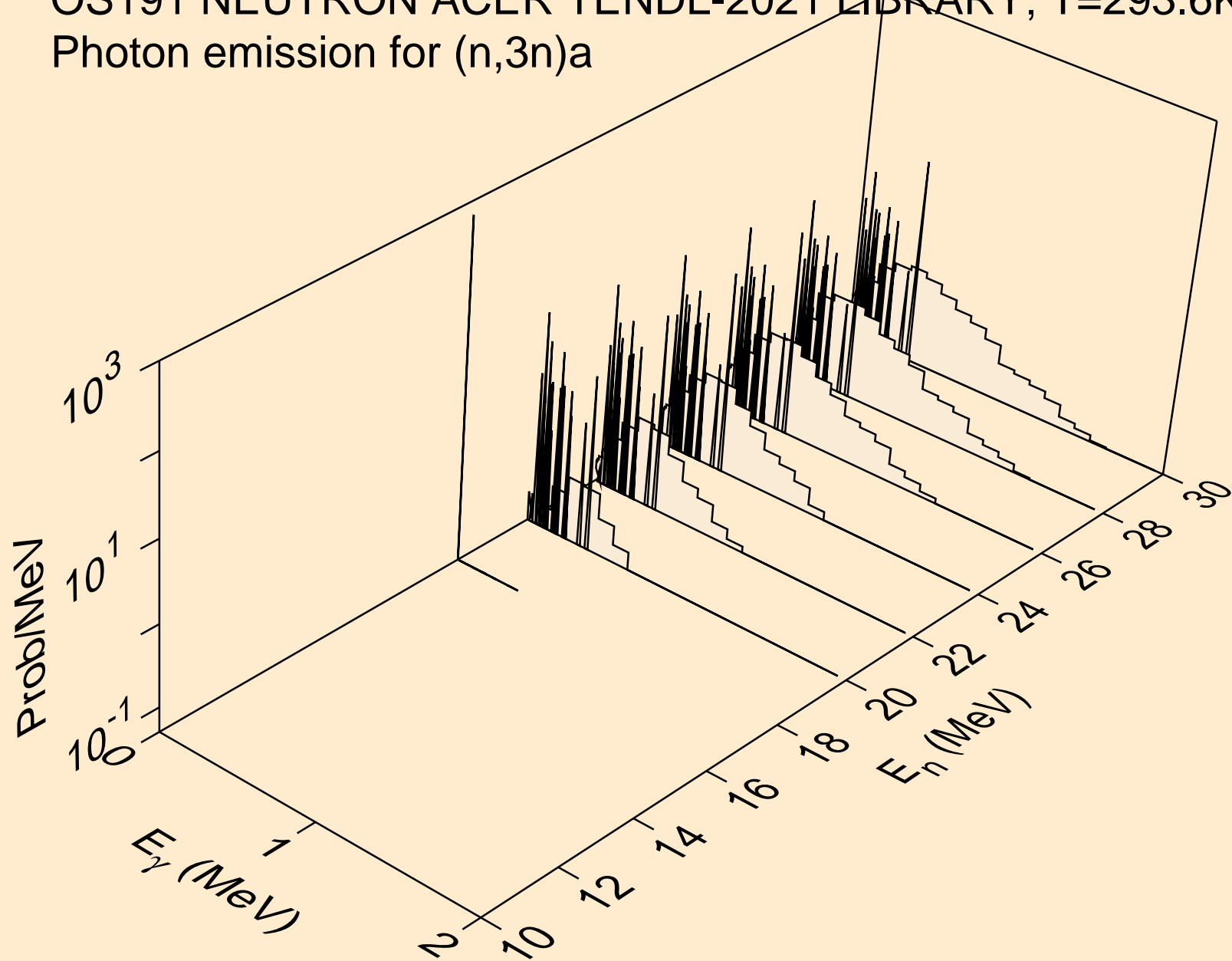

OS191 NEUTRON ACER TENDL-2021 LIBRARY; T=293.6K
Photon emission for (n,n*)p

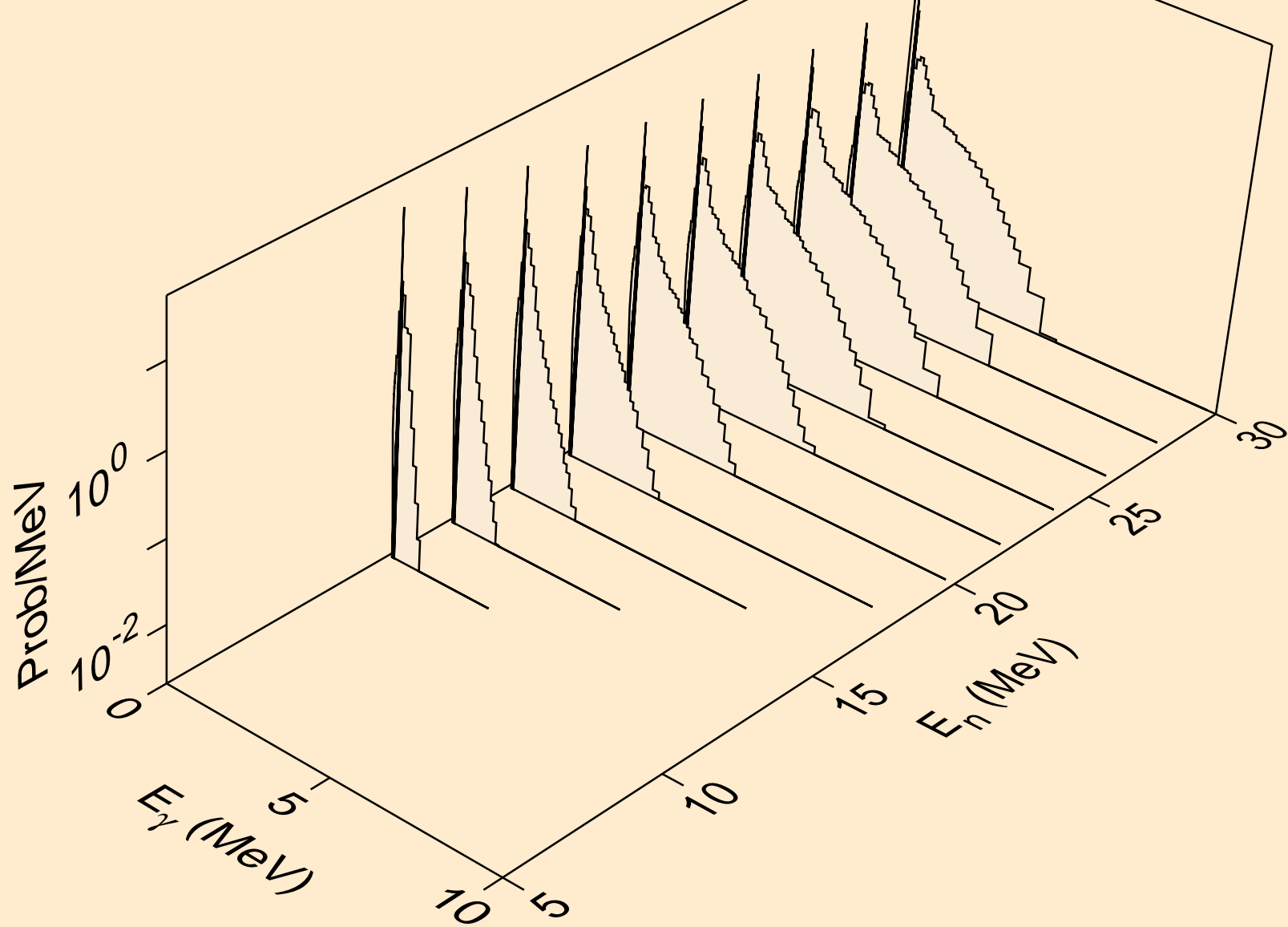

OS191 NEUTRON ACER TENDL-2021 LIBRARY; T=293.6K
Photon emission for (n,n*)d

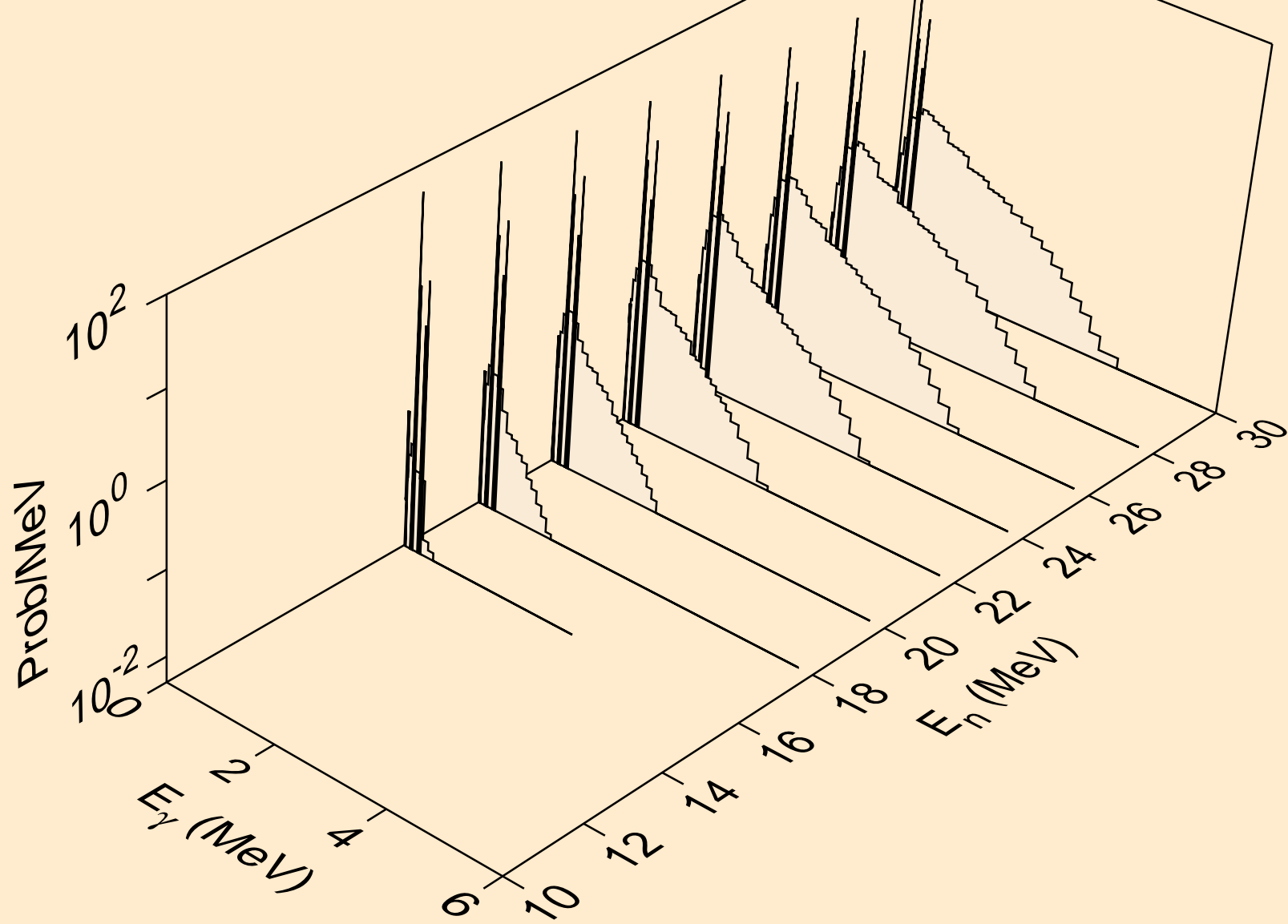

OS191 NEUTRON ACER TENDL-2021 LIBRARY; T=293.6K
Photon emission for (n,n*)t

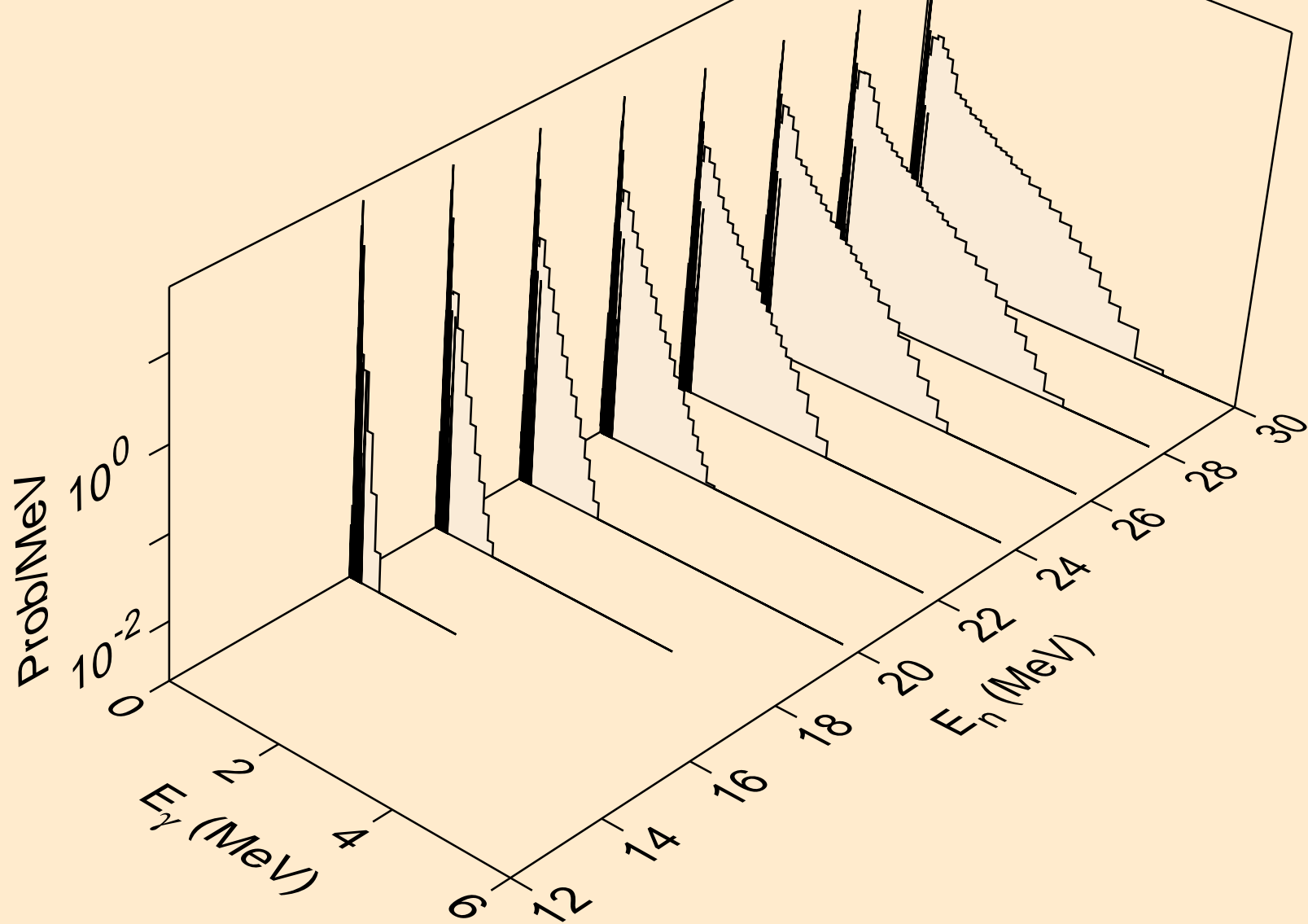

OS191 NEUTRON ACER TENDL-2021 LIBRARY; T=293.6K
Photon emission for (n,n*)he3

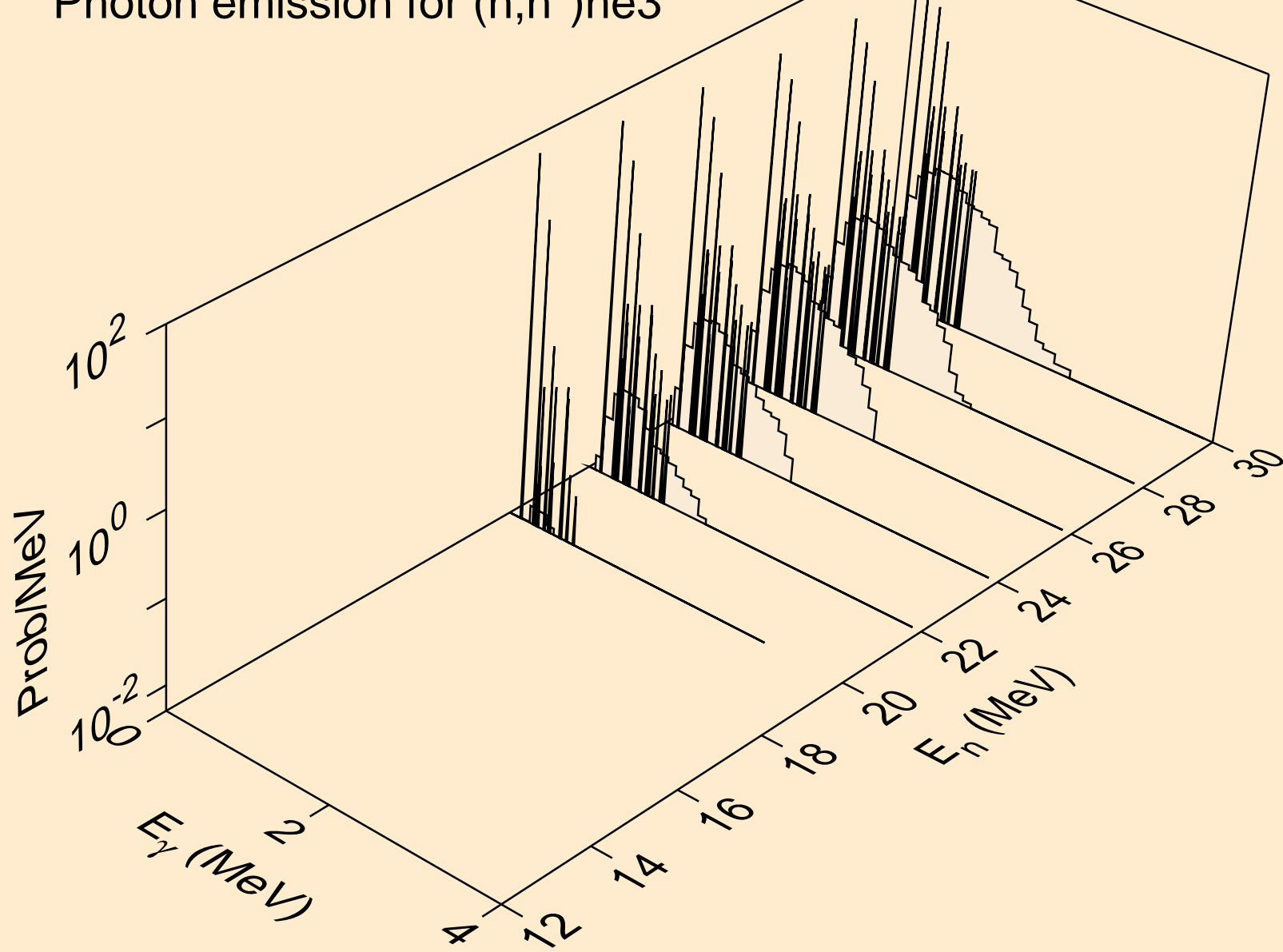

OS191 NEUTRON ACER TENDL-2021 LIBRARY; T=293.6K
Photon emission for (n,4n)

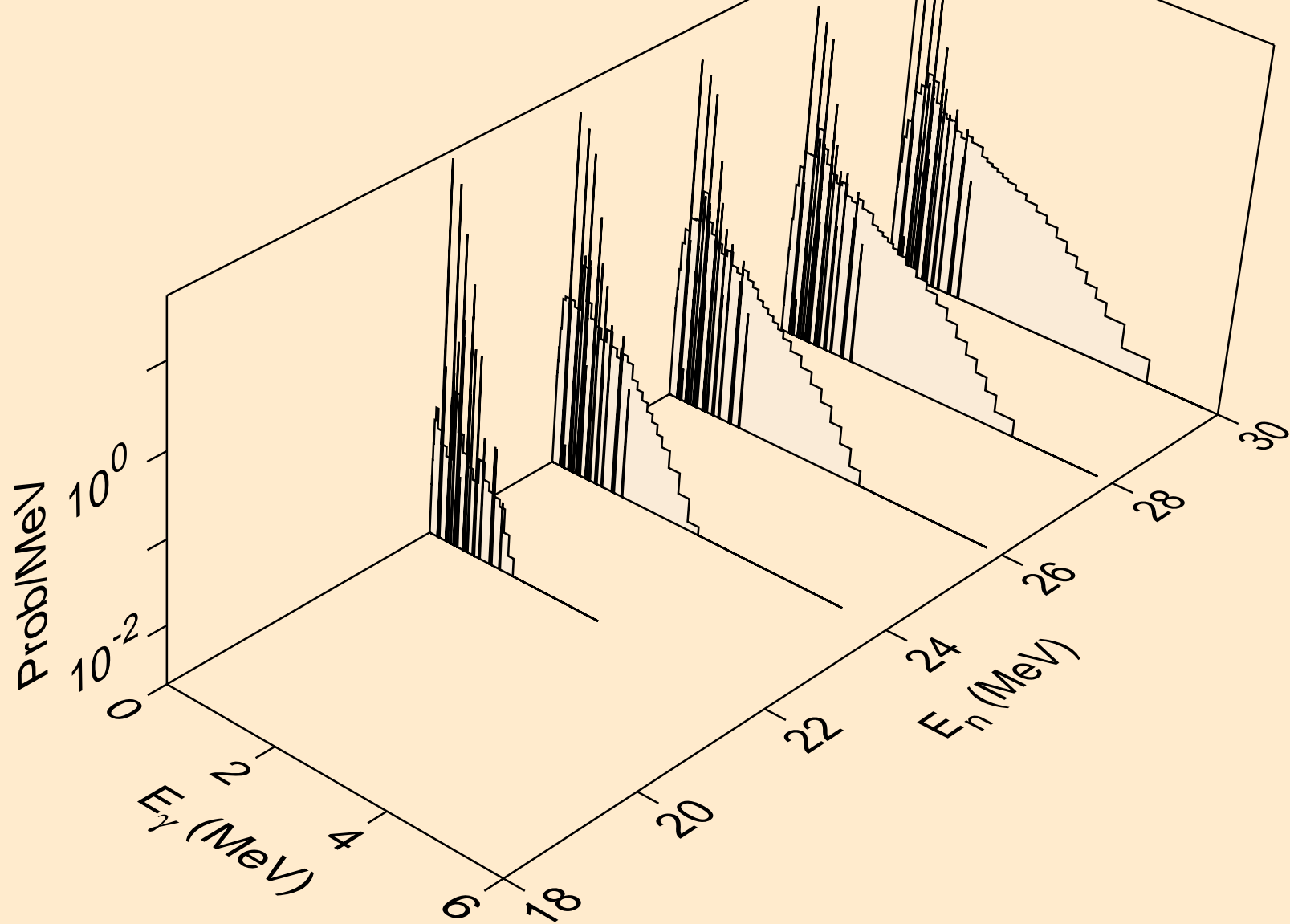

OS191 NEUTRON ACER TENDL-2021 LIBRARY; T=293.6K
Photon emission for (n,2np)

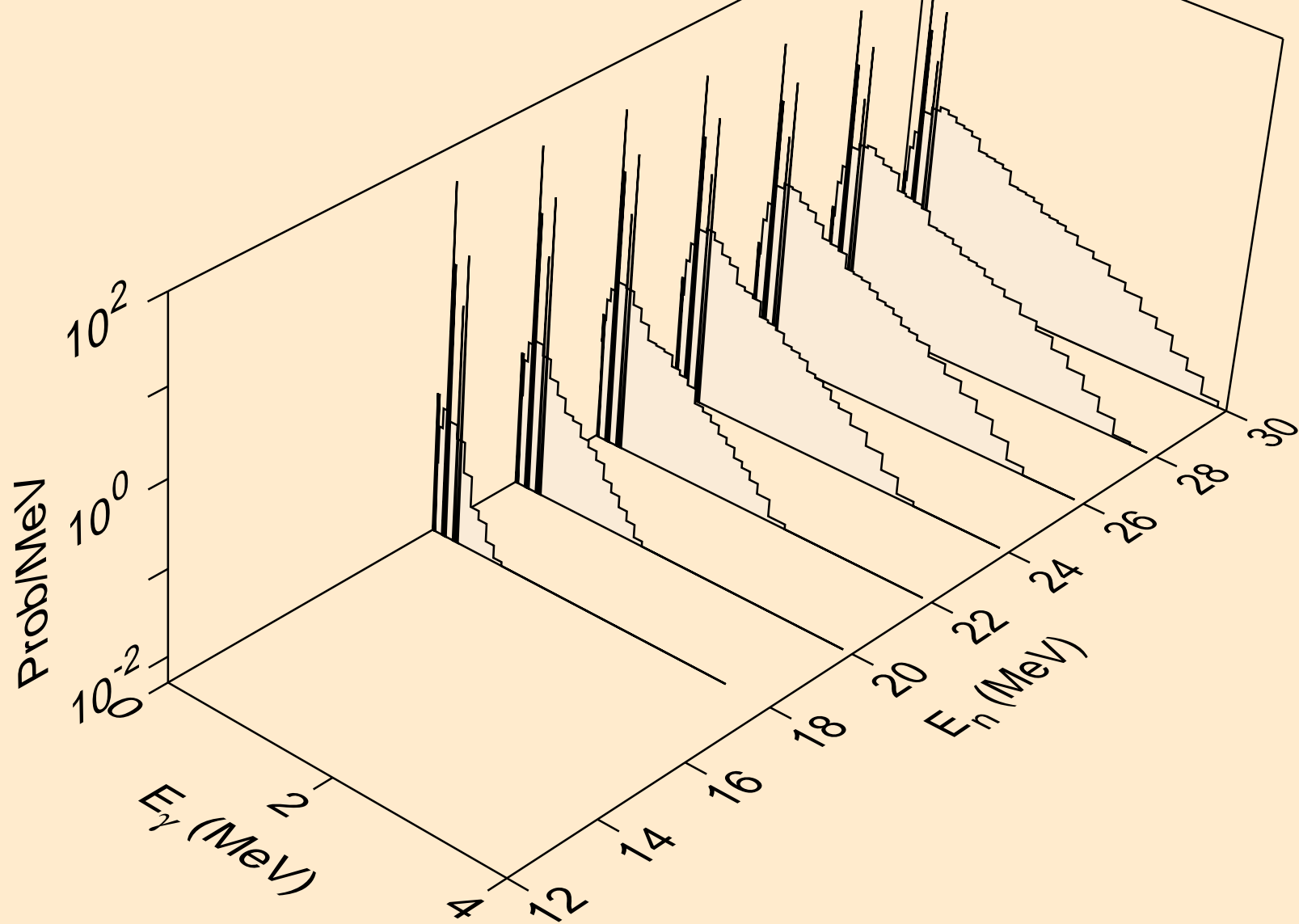

OS191 NEUTRON ACER TENDL-2021 LIBRARY; T=293.6K
Photon emission for (n,3np)

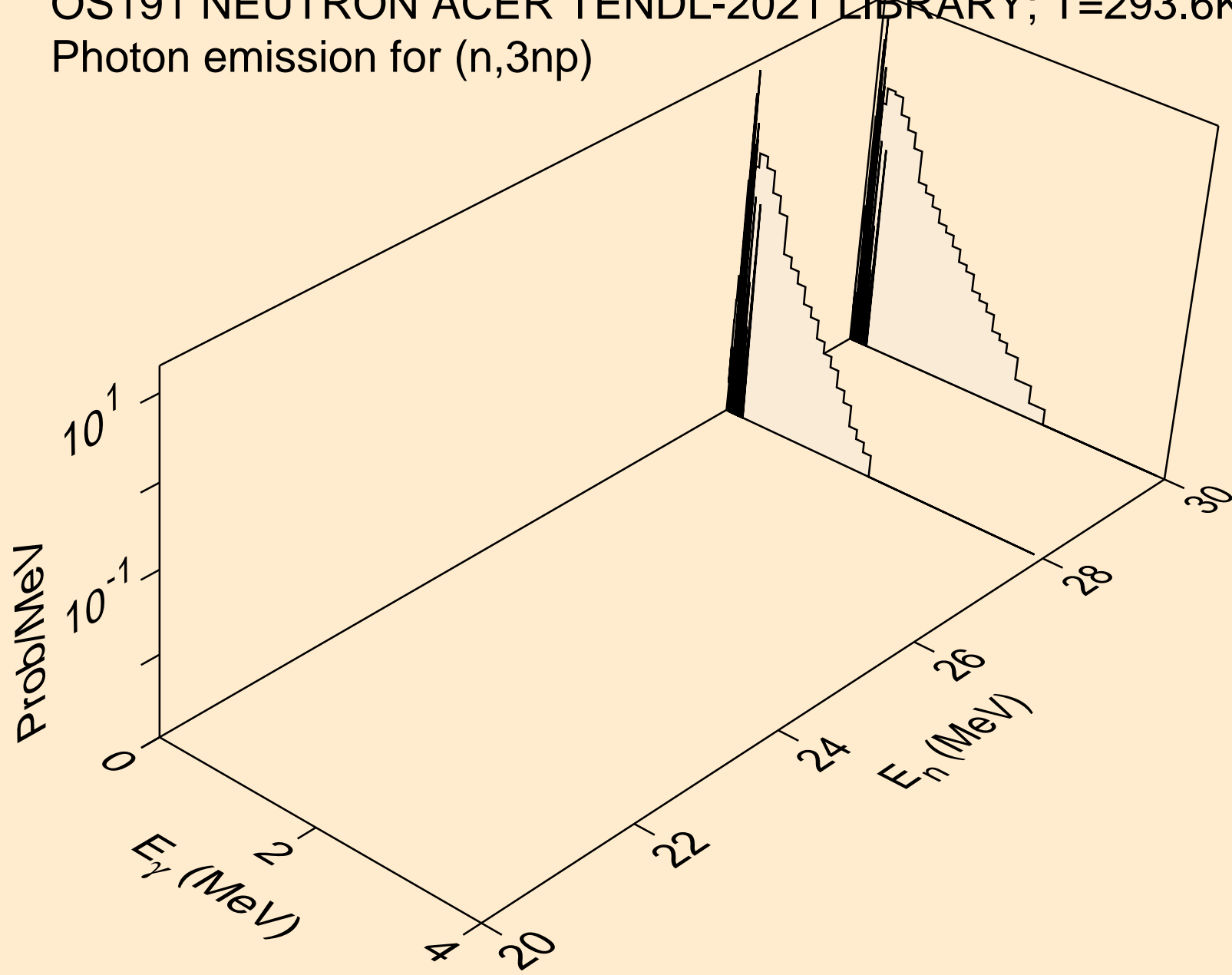

OS191 NEUTRON ACER TENDL-2021 LIBRARY; T=293.6K
Photon emission for (n,2np)

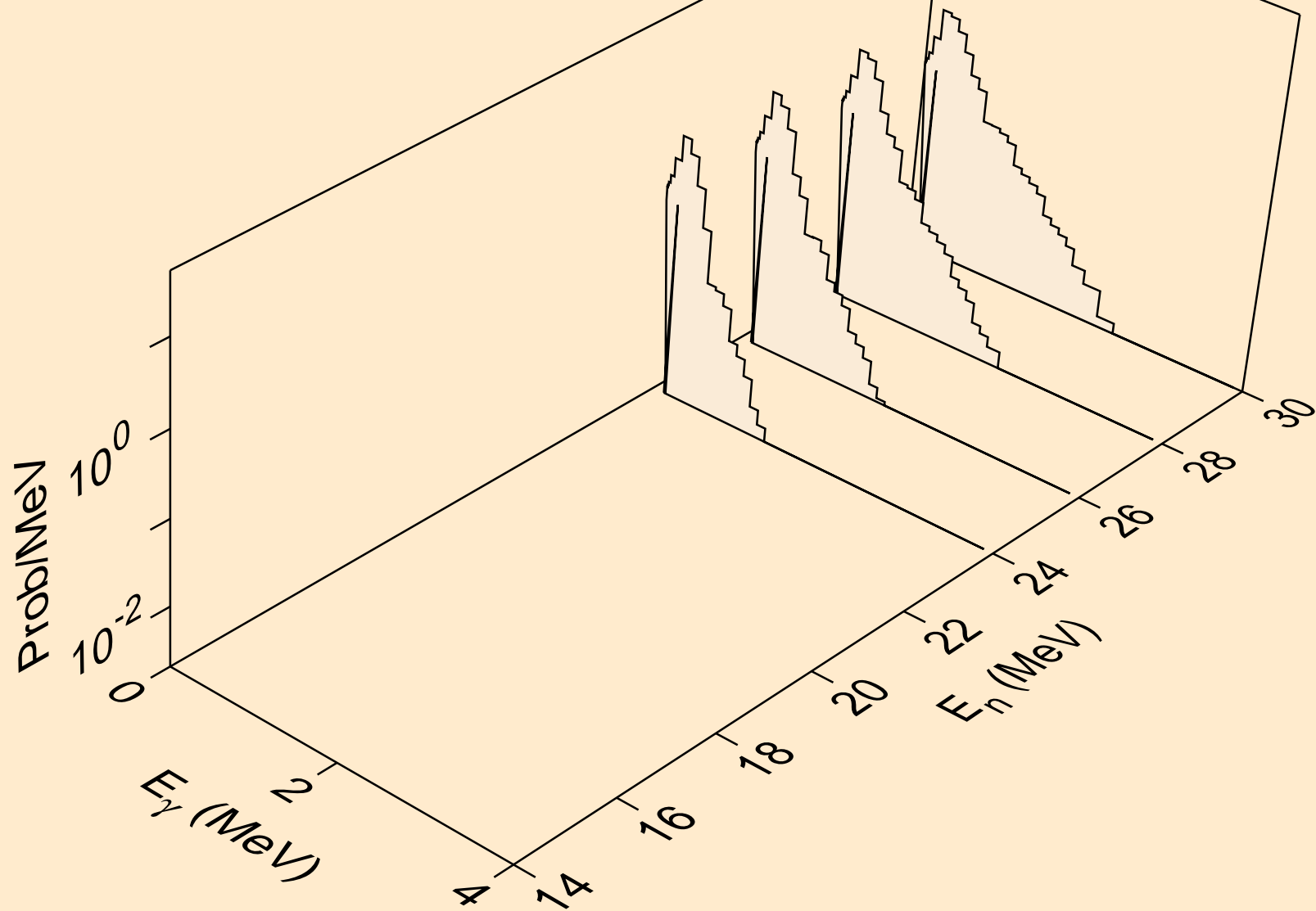

OS191 NEUTRON ACER TENDL-2021 LIBRARY; T=293.6K
Photon emission for (n,n*c)

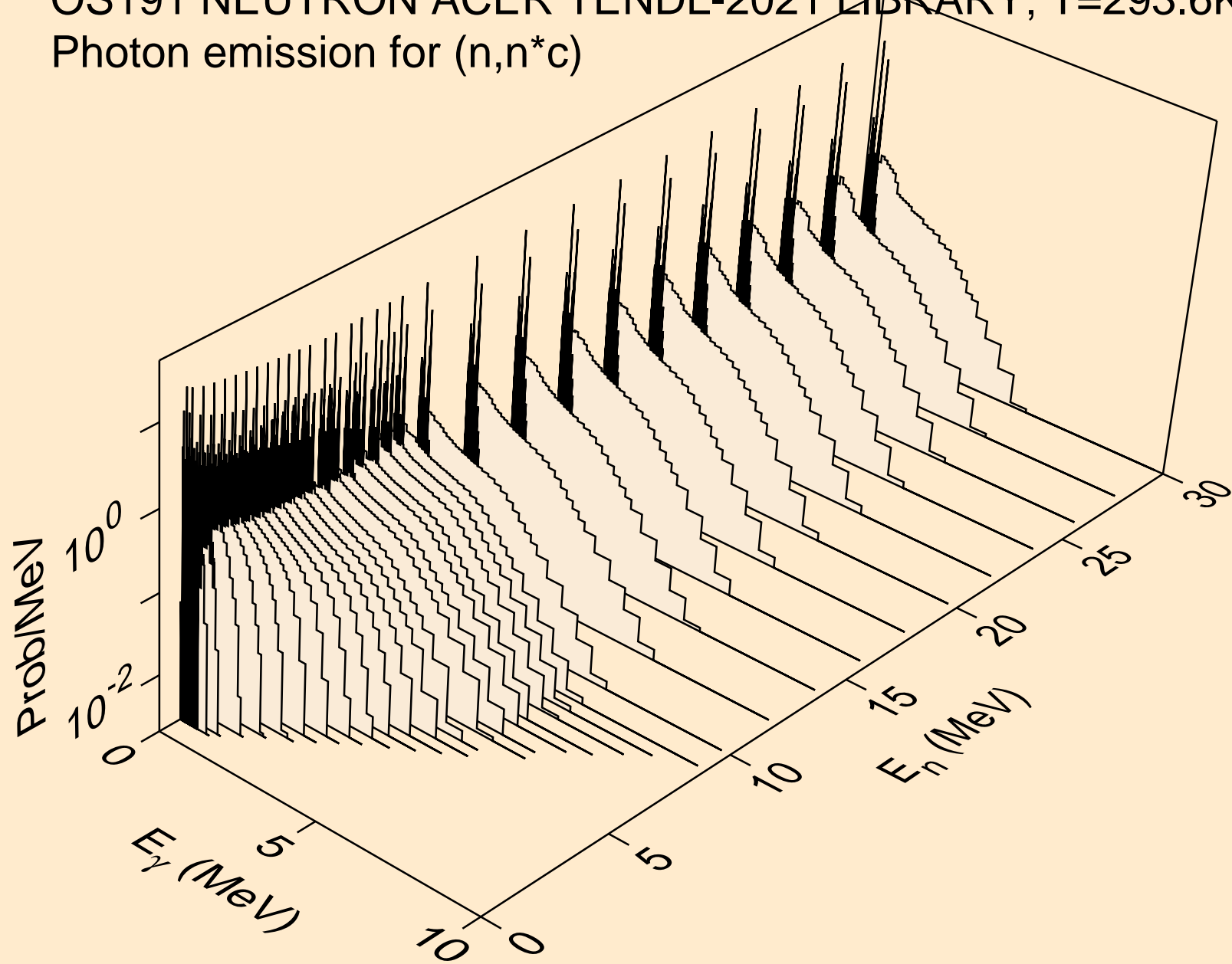

OS191 NEUTRON ACER TENDL-2021 LIBRARY; T=293.6K
Photon emission for (n,gma)

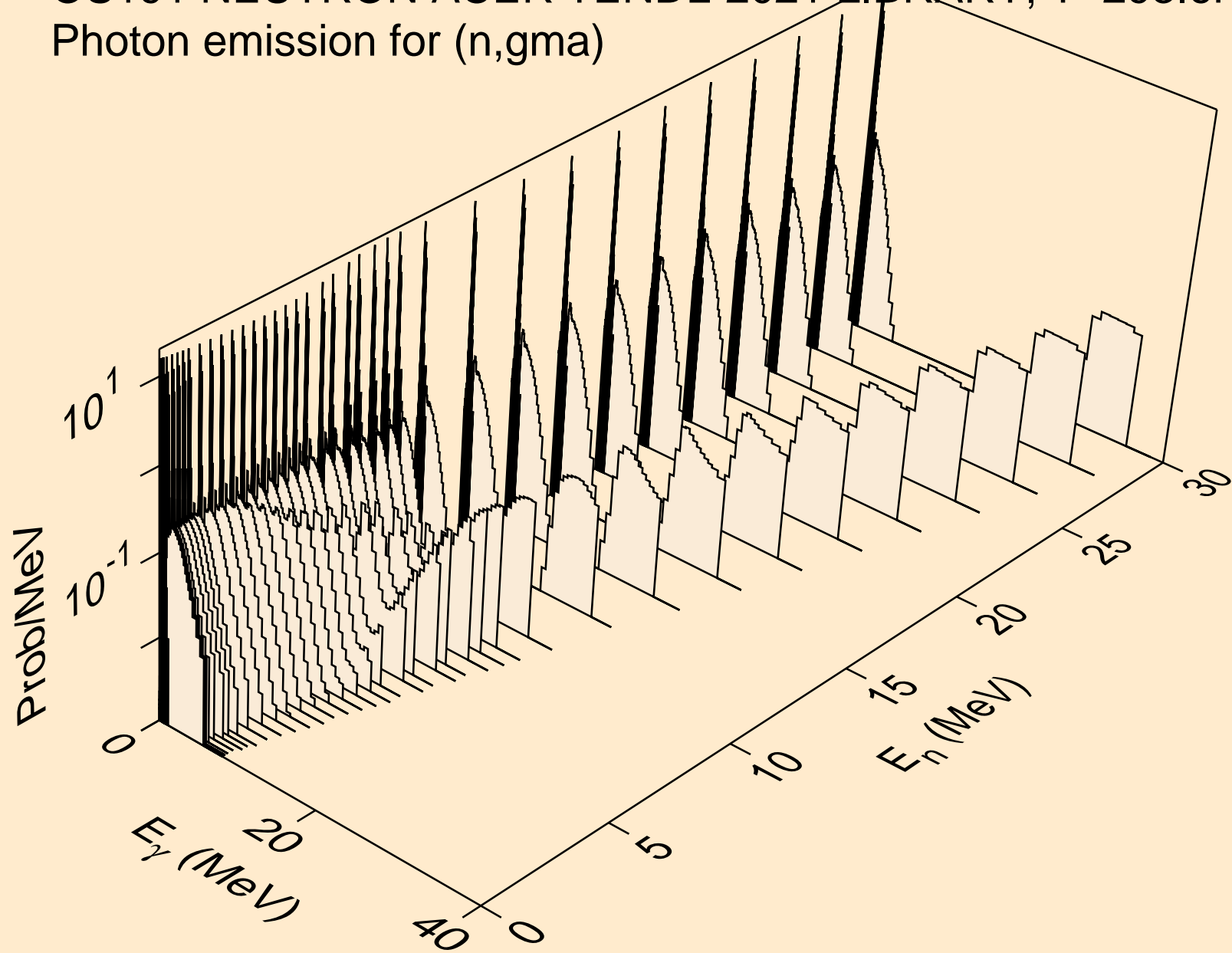

OS191 NEUTRON ACER TENDL-2021 LIBRARY; T=293.6K
Photon emission for (n,p)

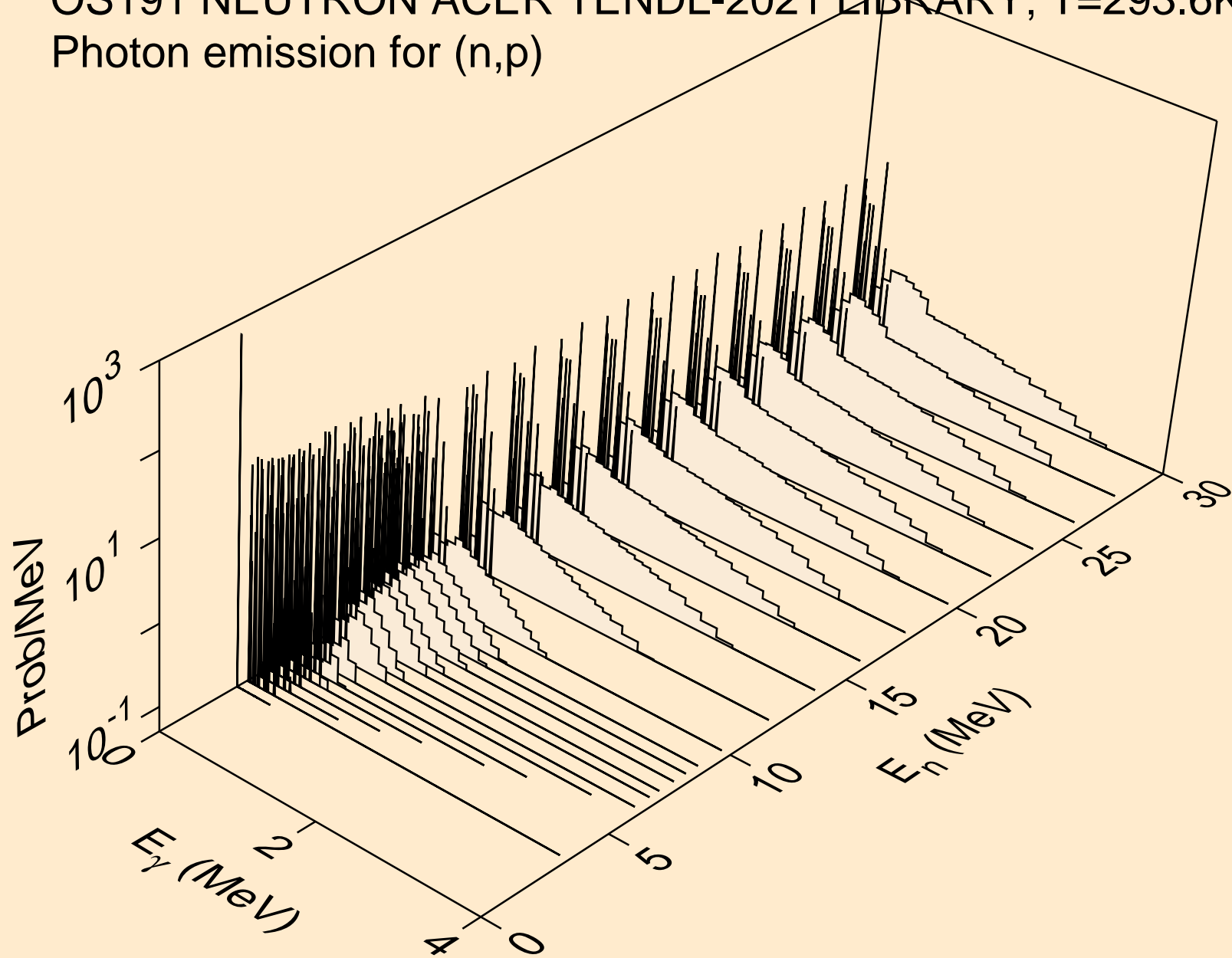

OS191 NEUTRON ACER TENDL-2021 LIBRARY; T=293.6K
Photon emission for (n,d)

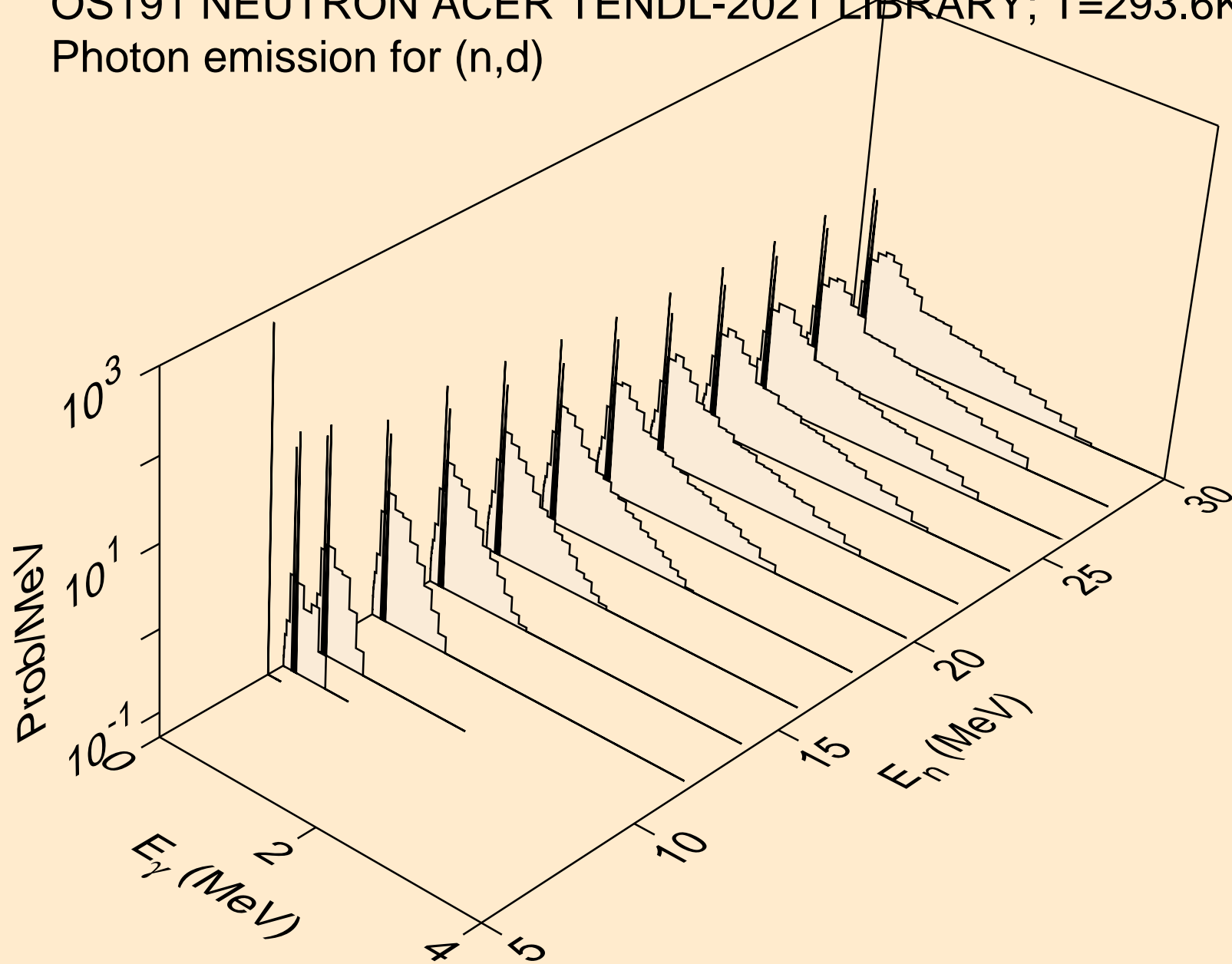

OS191 NEUTRON ACER TENDL-2021 LIBRARY; T=293.6K
Photon emission for (n,t)

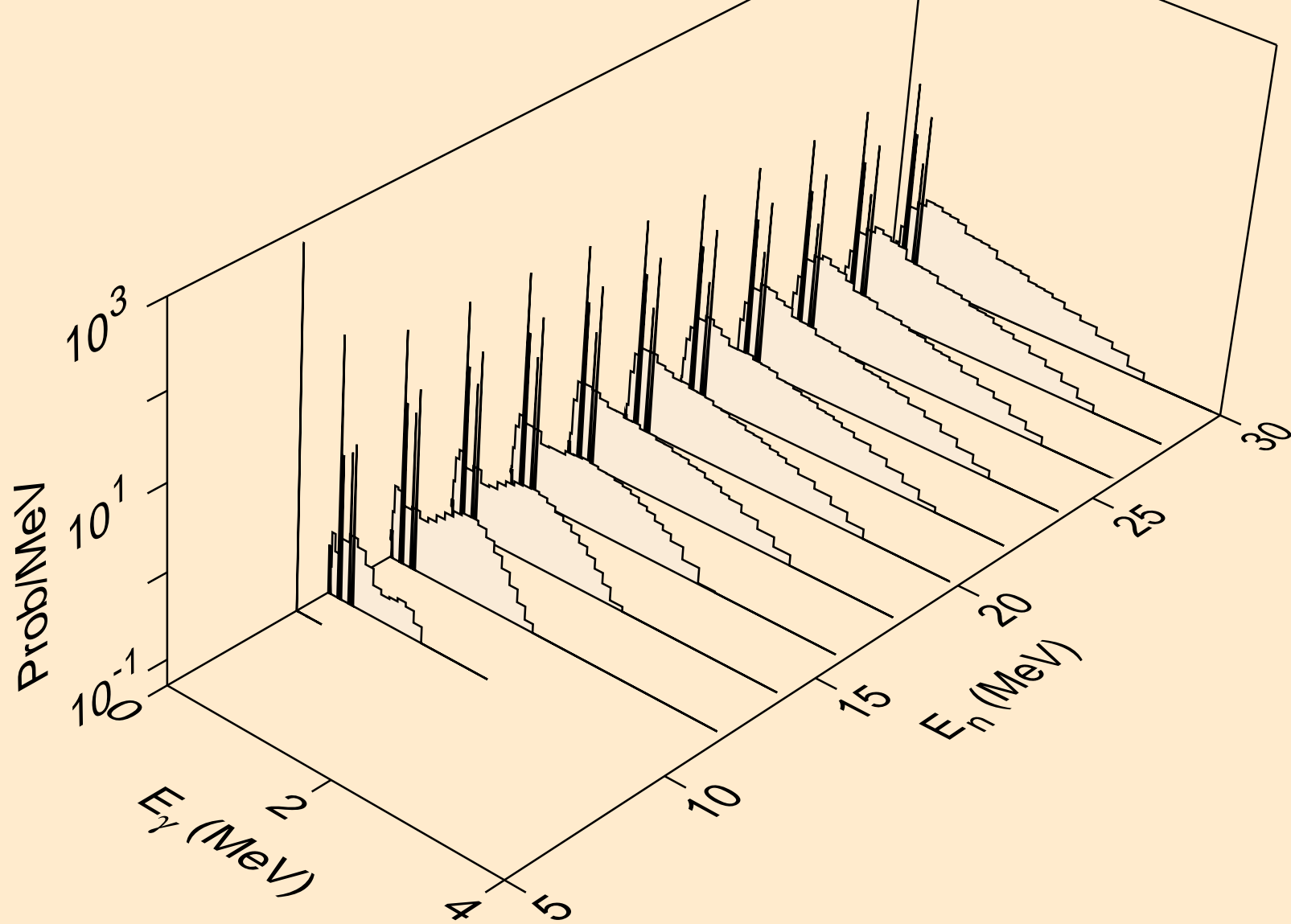

OS191 NEUTRON ACER TENDL-2021 LIBRARY; T=293.6K
Photon emission for (n,he3)

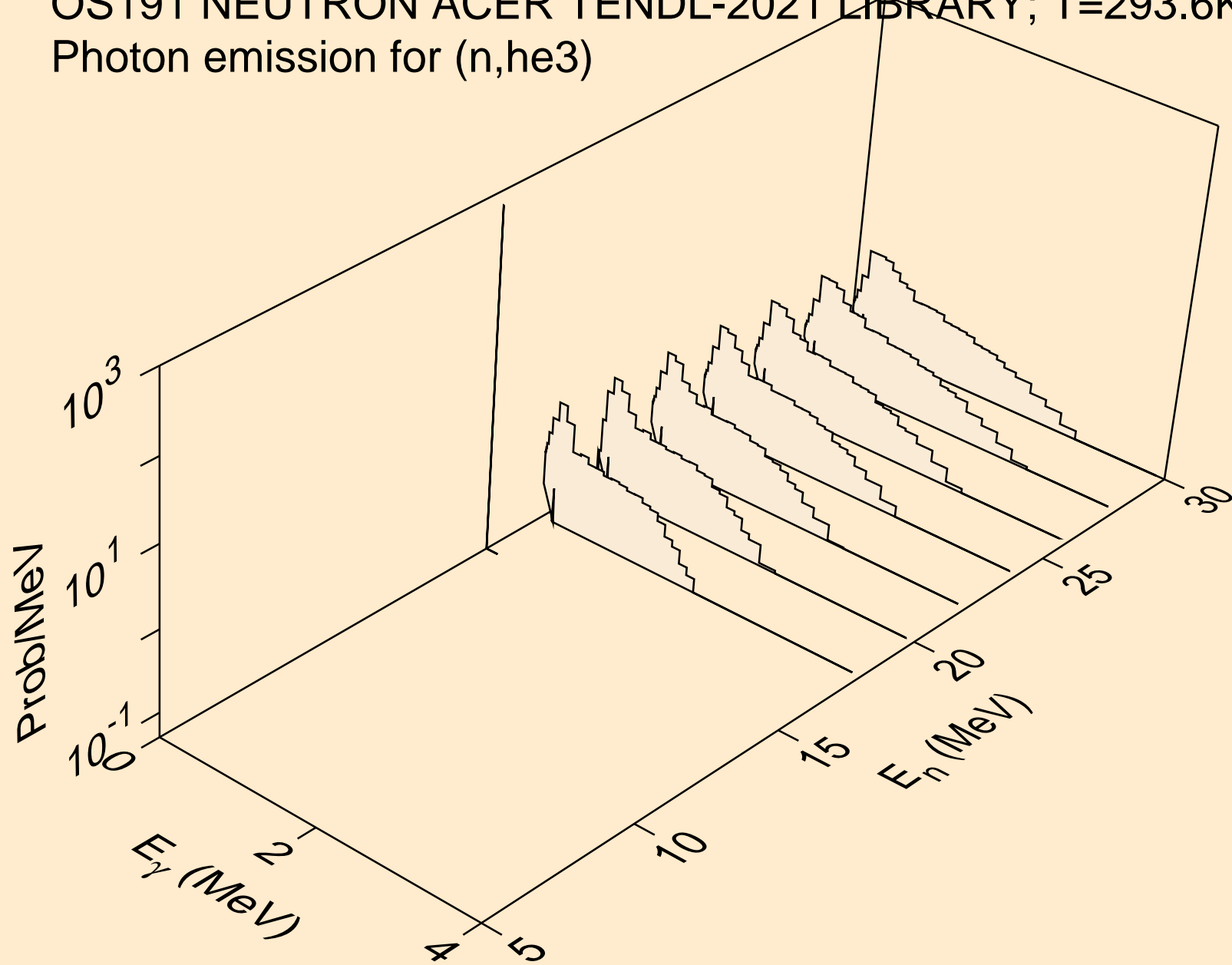

OS191 NEUTRON ACER TENDL-2021 LIBRARY; T=293.6K
Photon emission for (n,a)

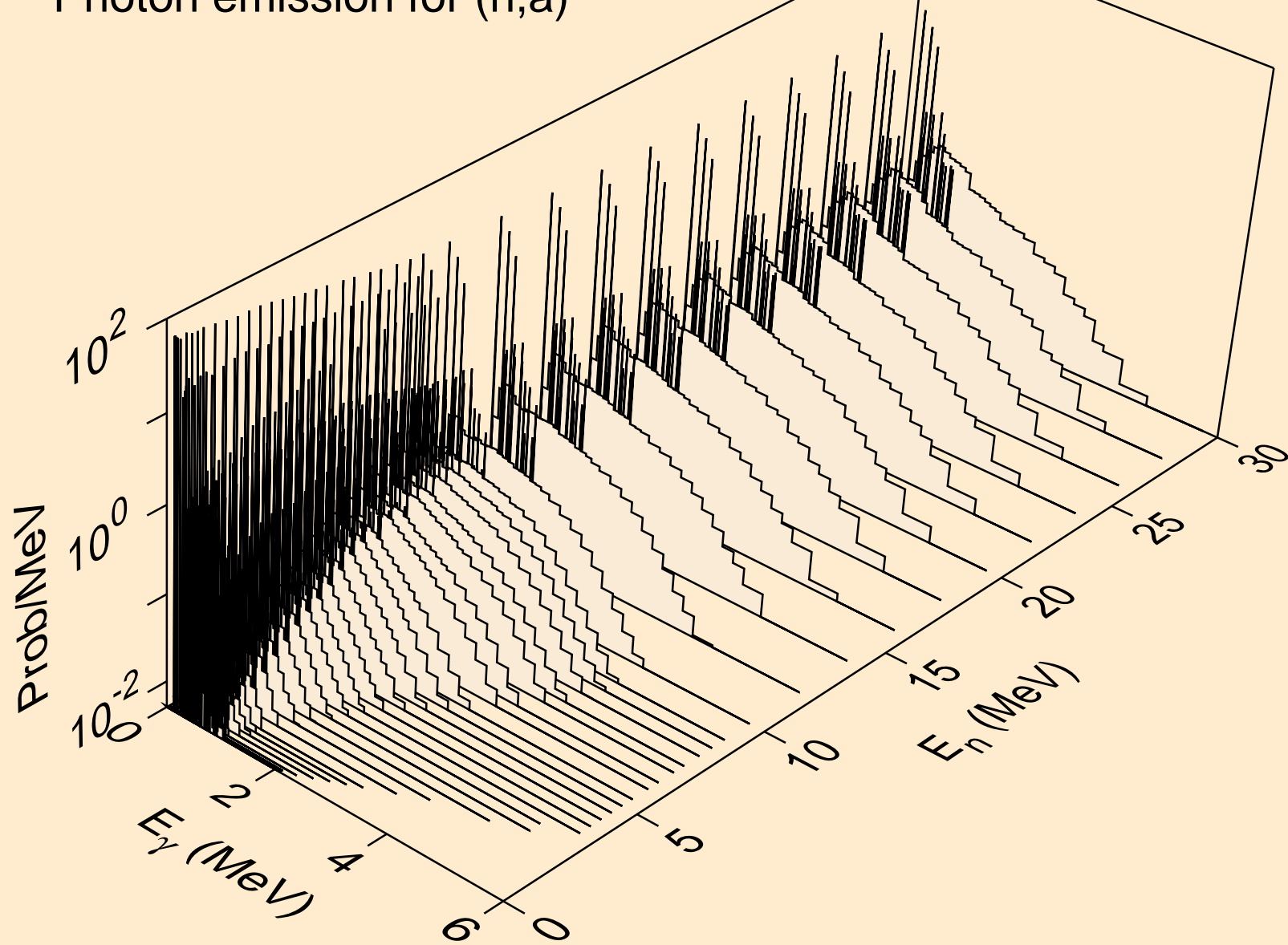

OS191 NEUTRON ACER TENDL-2021 LIBRARY; T=293.6K
Photon emission for (n,2p)

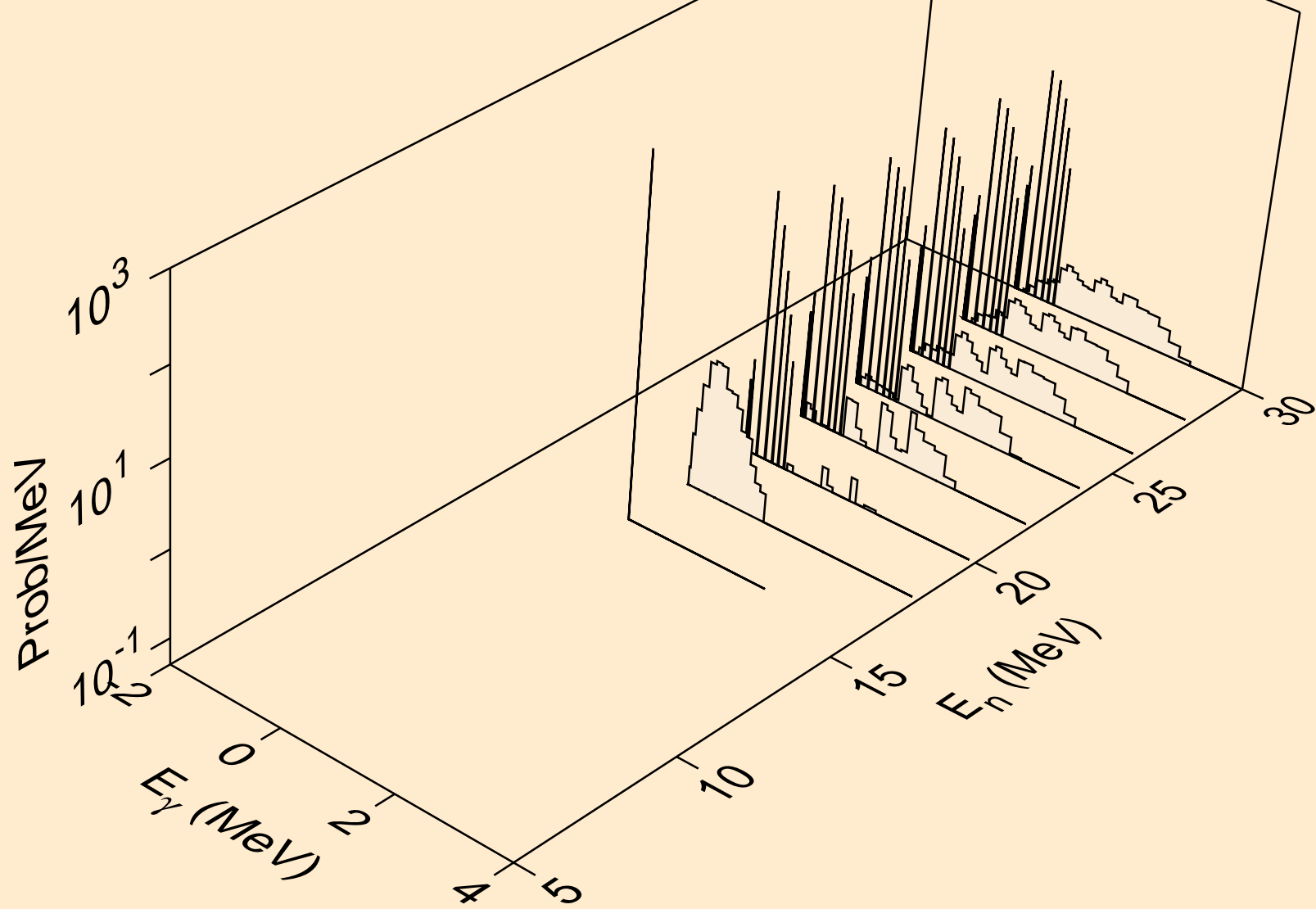

OS191 NEUTRON ACER TENDL-2021 LIBRARY; T=293.6K
thermal capture photon spectrum

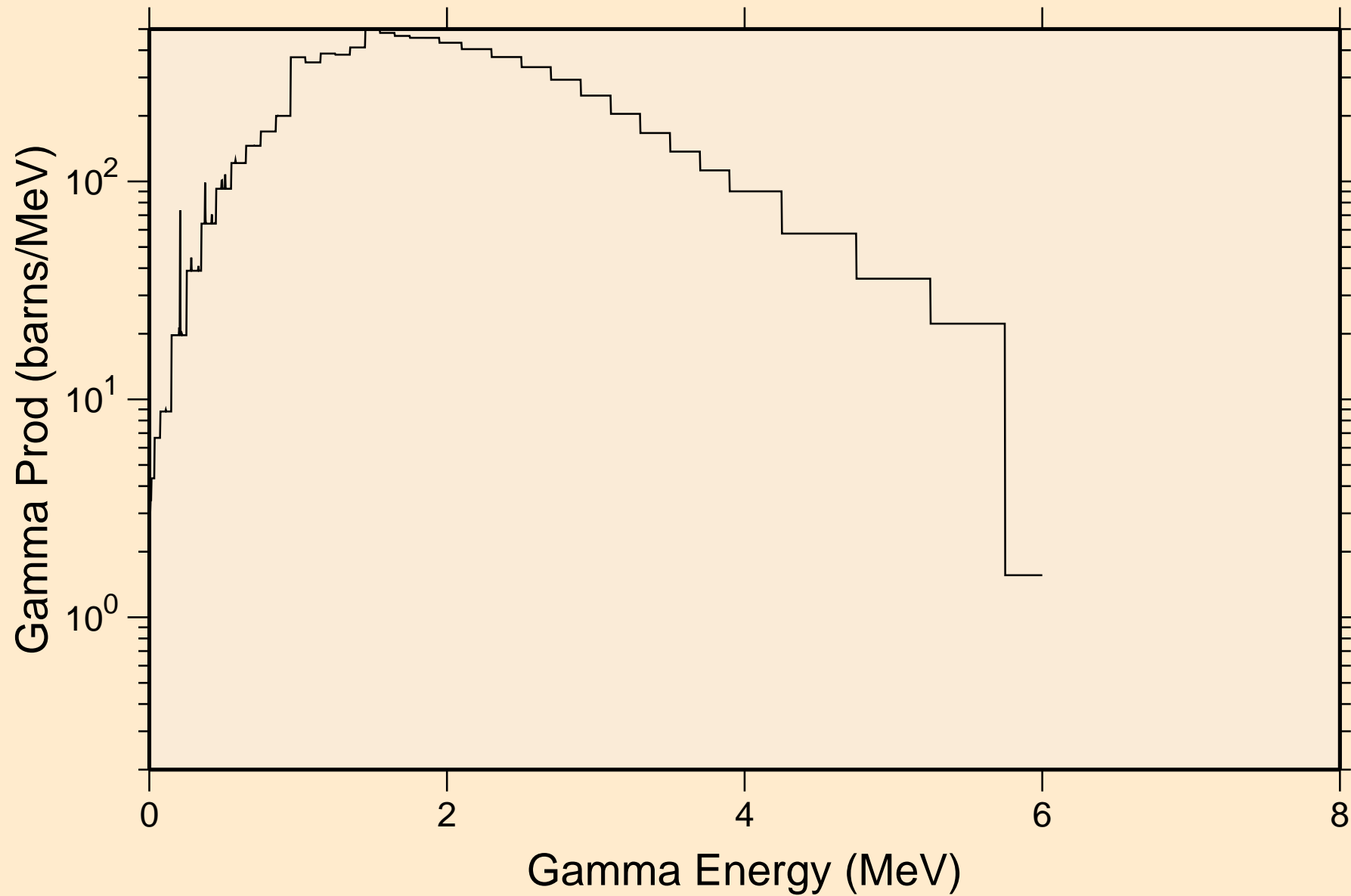

OS191 NEUTRON ACER TENDL-2021 LIBRARY; T=293.6K
14 MeV photon spectrum

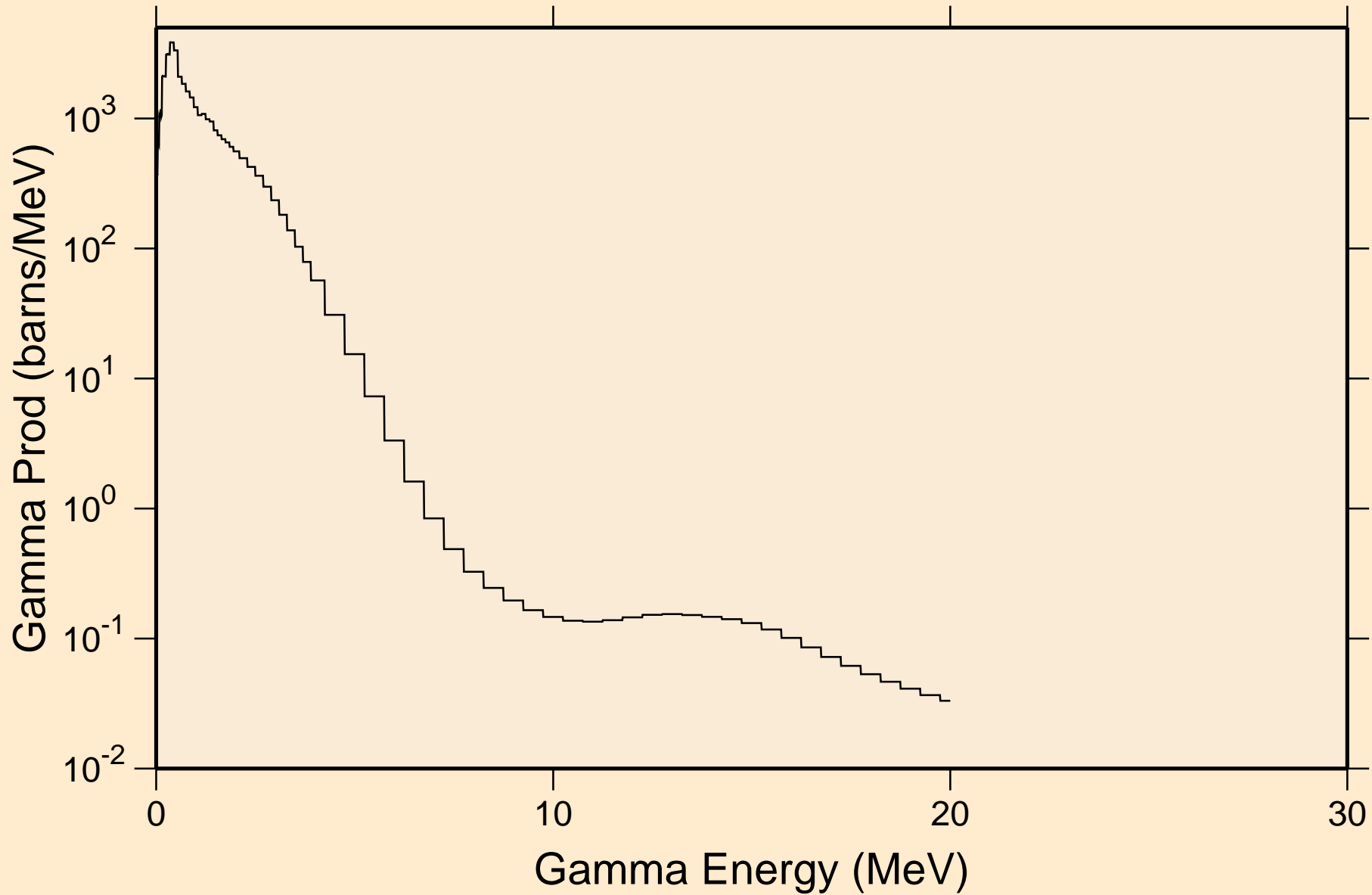

OS191 NEUTRON ACER TENDL-2021 LIBRARY; T=293.6K
Particle heating contributions

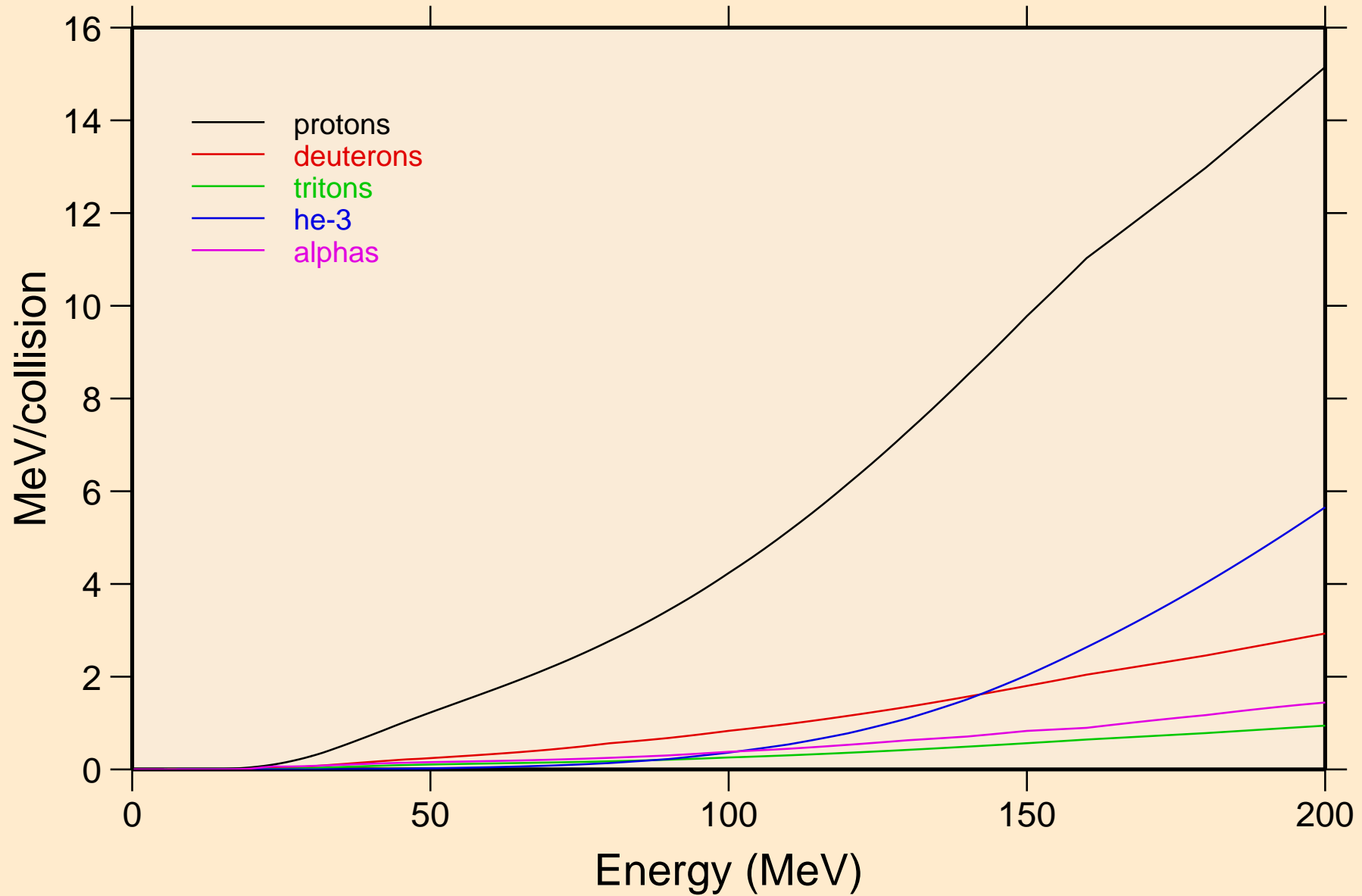

OS191 NEUTRON ACER TENDL-2021 LIBRARY; T=293.6K
Recoil Heating

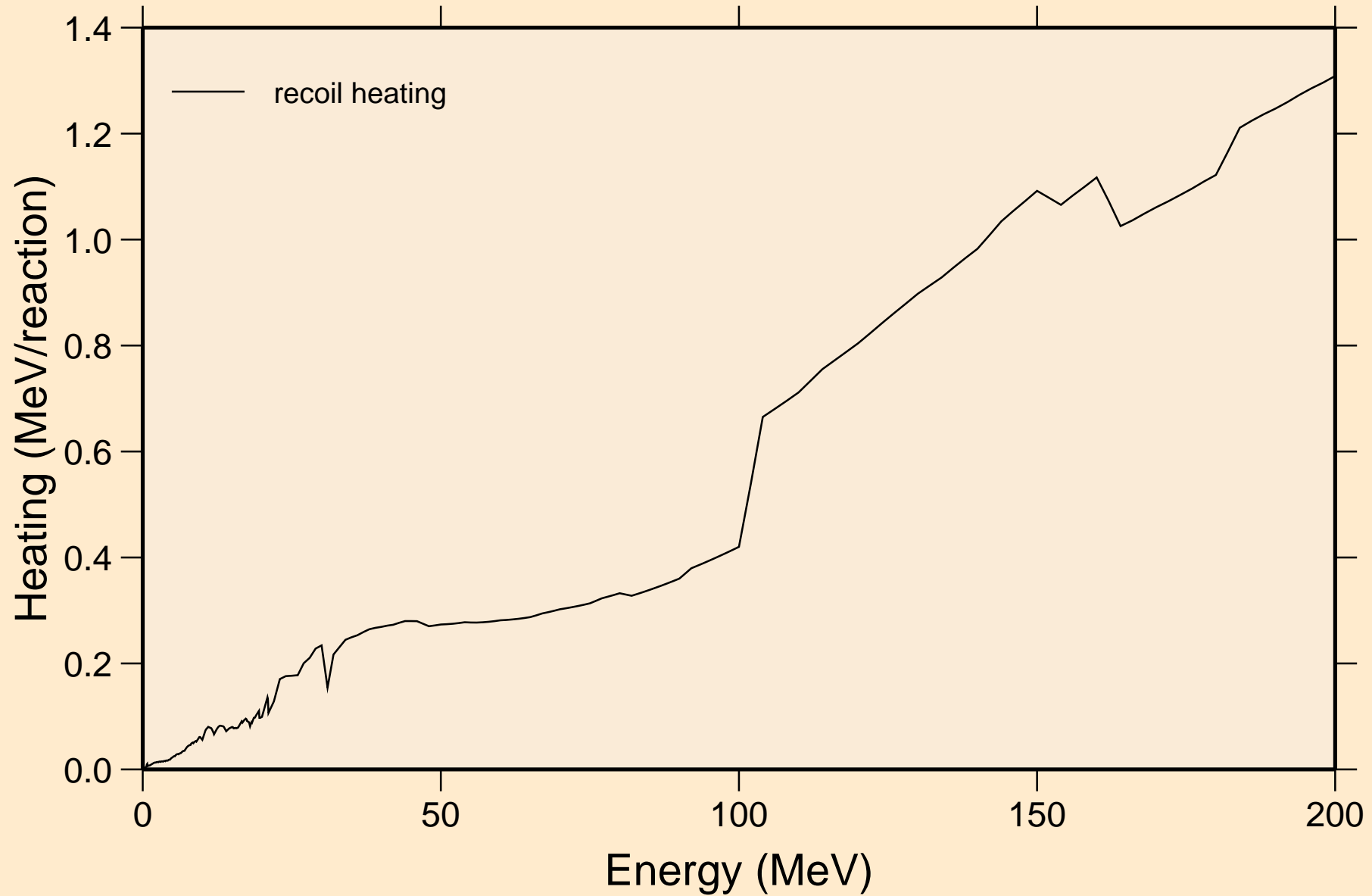

OS191 NEUTRON ACER TENDL-2021 LIBRARY; T=293.6K
Particle production cross sections

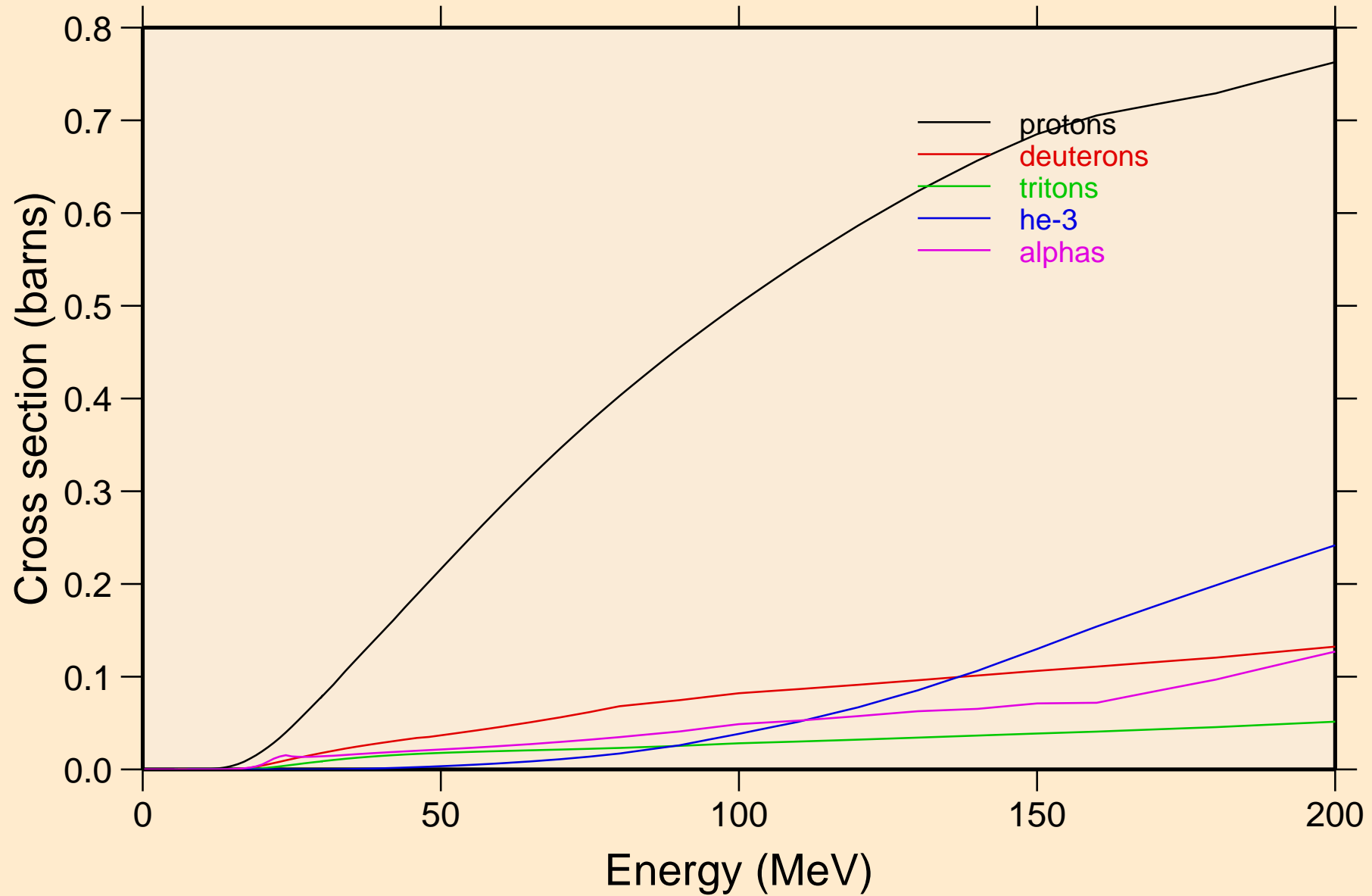

OS191 NEUTRON ACER TENDL-2021 LIBRARY; T=293.6K
protons from (n,x)

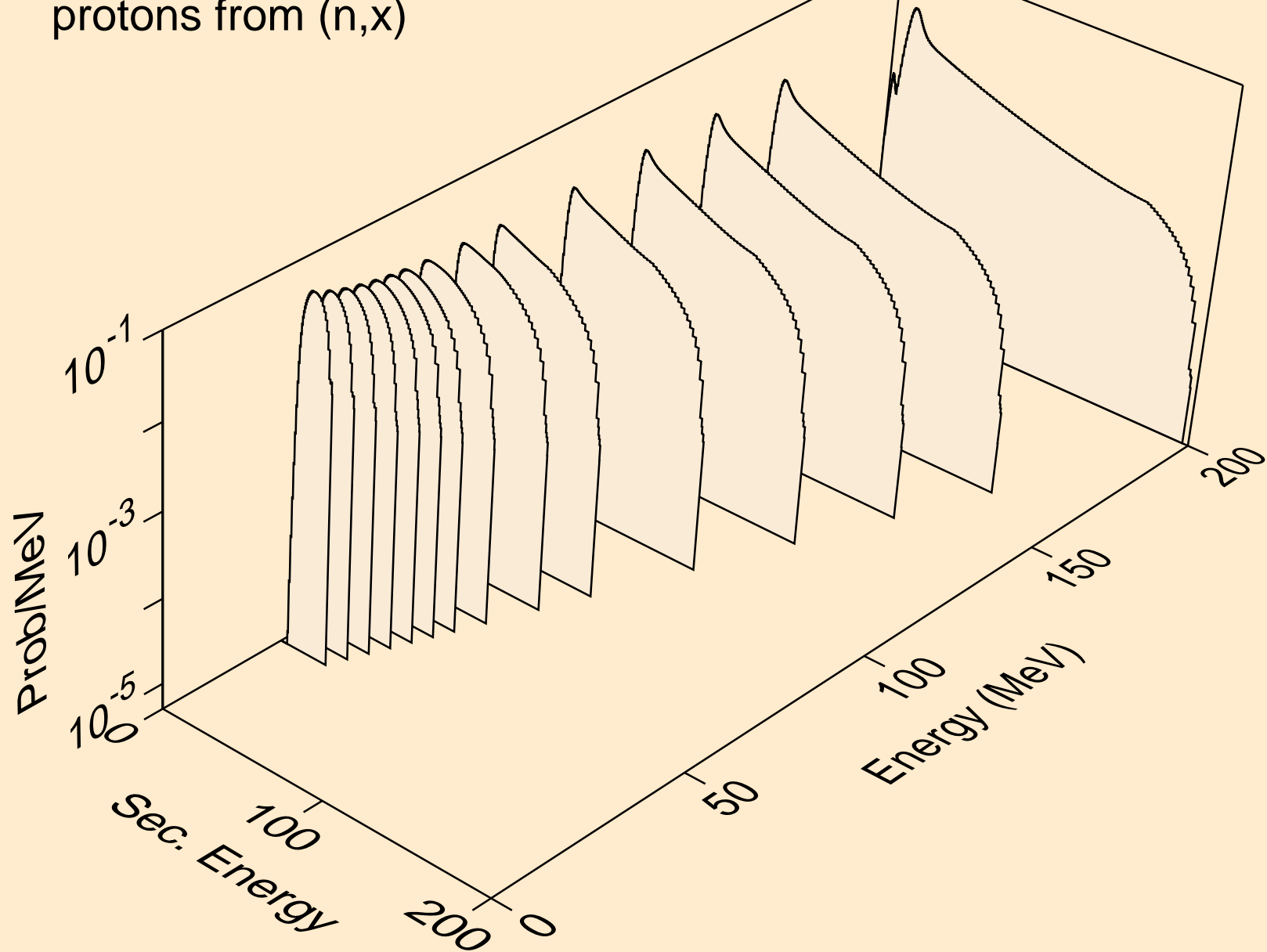

OS191 NEUTRON ACER TENDL-2021 LIBRARY; T=293.6K
protons from (n,n*)p

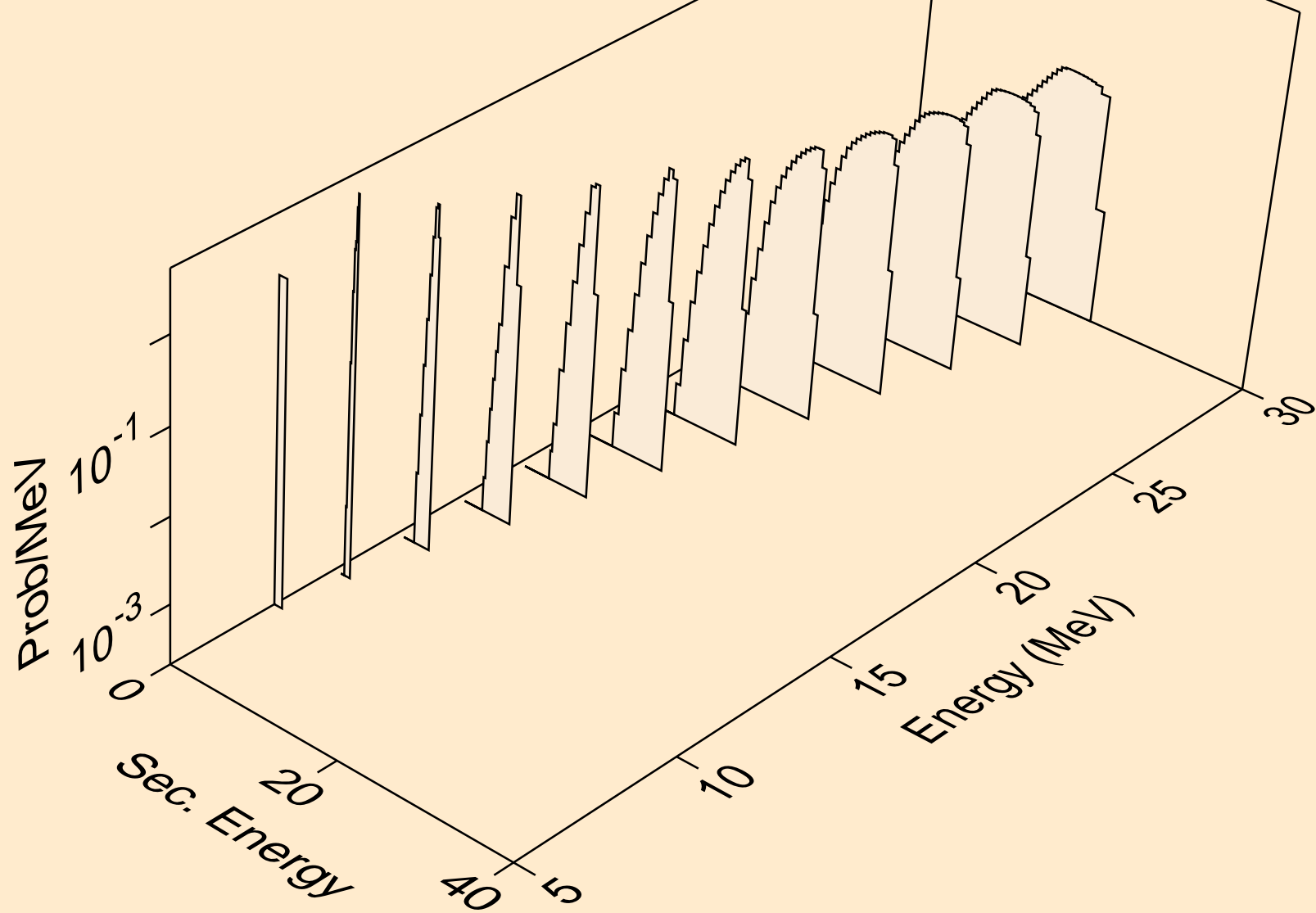

OS191 NEUTRON ACER TENDL-2021 LIBRARY; T=293.6K
protons from (n,2np)

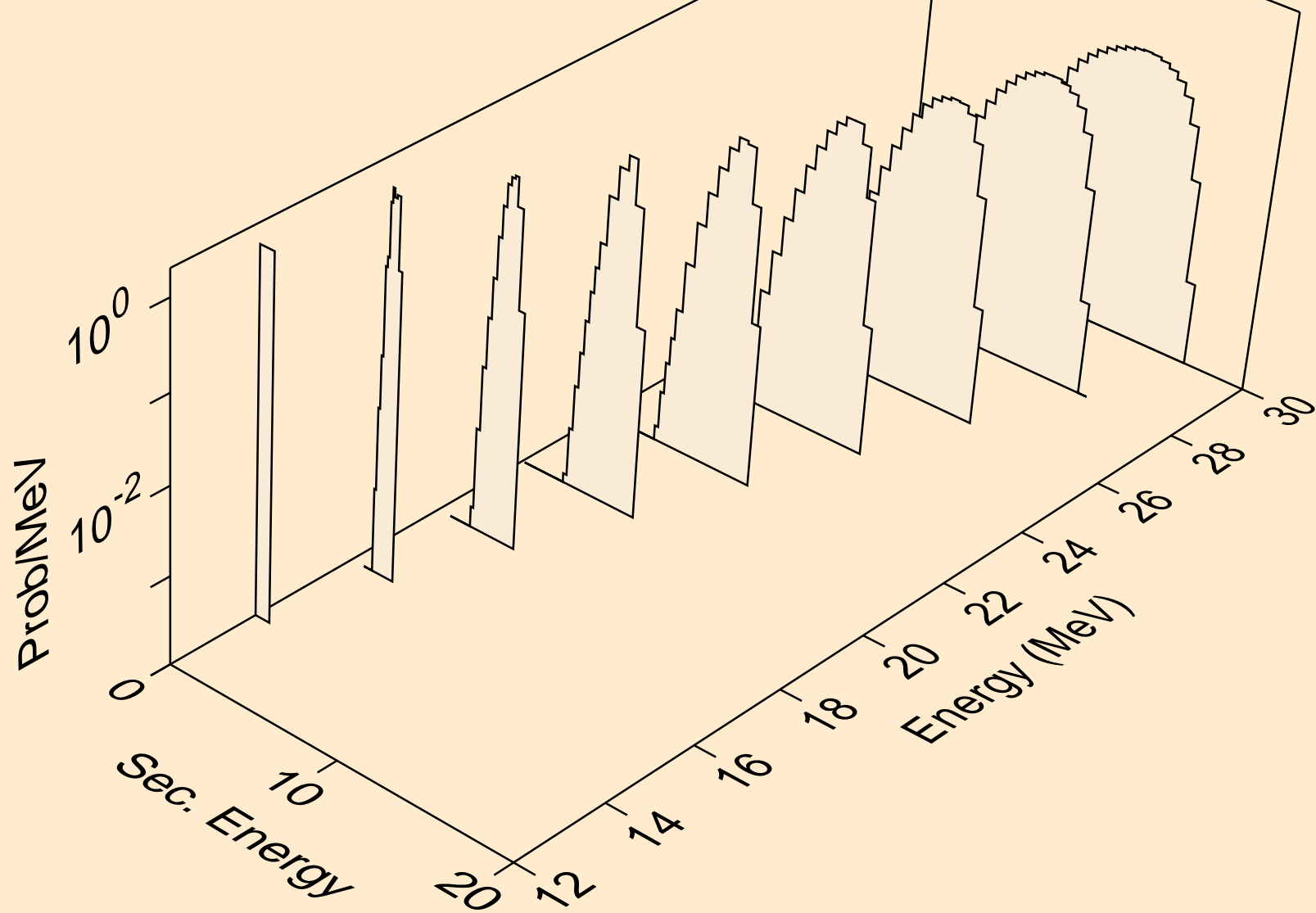

OS191 NEUTRON ACER TENDL-2021 LIBRARY; T=293.6K
protons from (n,3np)

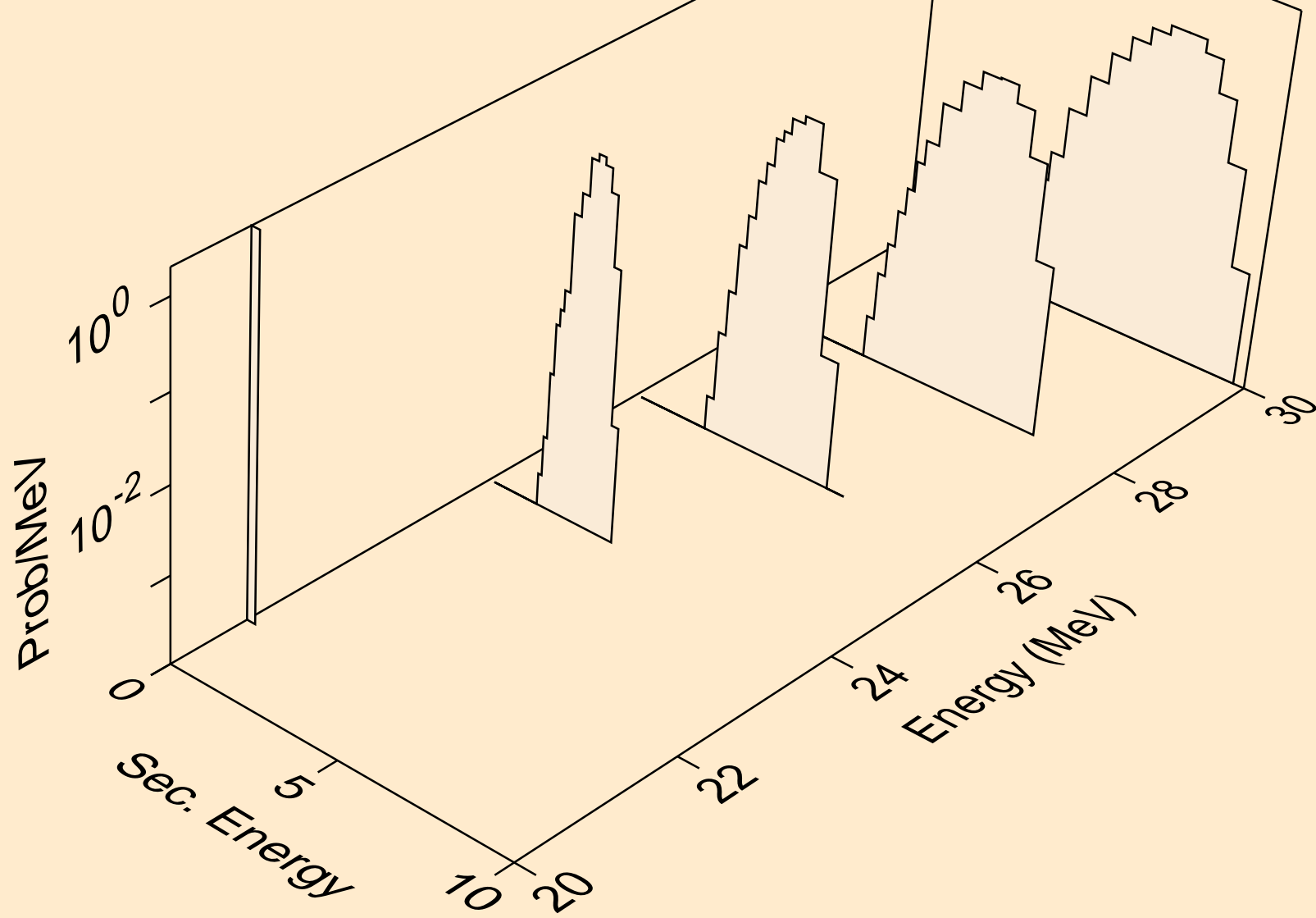

OS191 NEUTRON ACER TENDL-2021 LIBRARY; T=293.6K
protons from (n,2np)

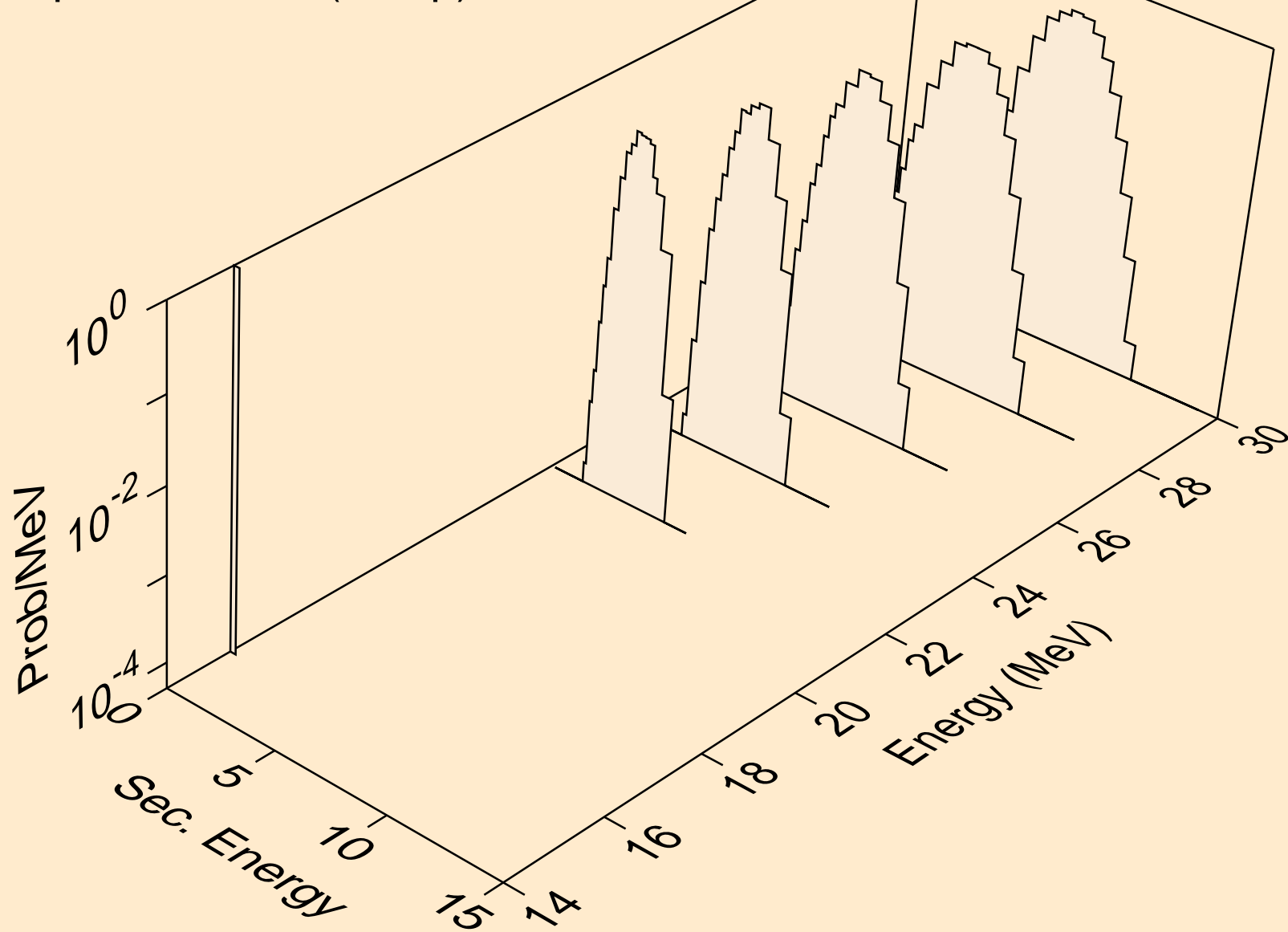

OS191 NEUTRON ACER TENDL-2021 LIBRARY; T=293.6K
protons from (n,p)

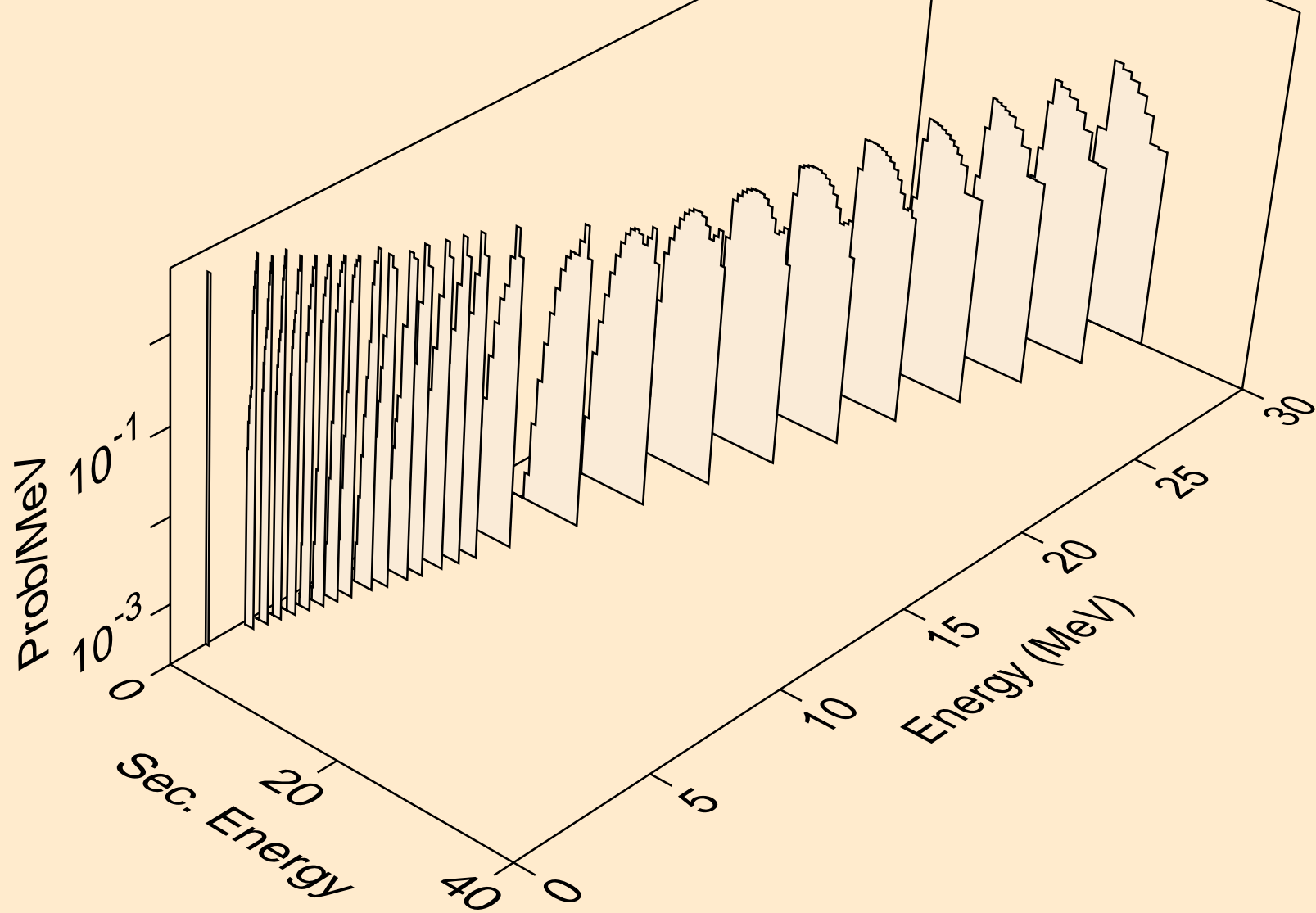

OS191 NEUTRON ACER TENDL-2021 LIBRARY; T=293.6K
protons from (n,2p)

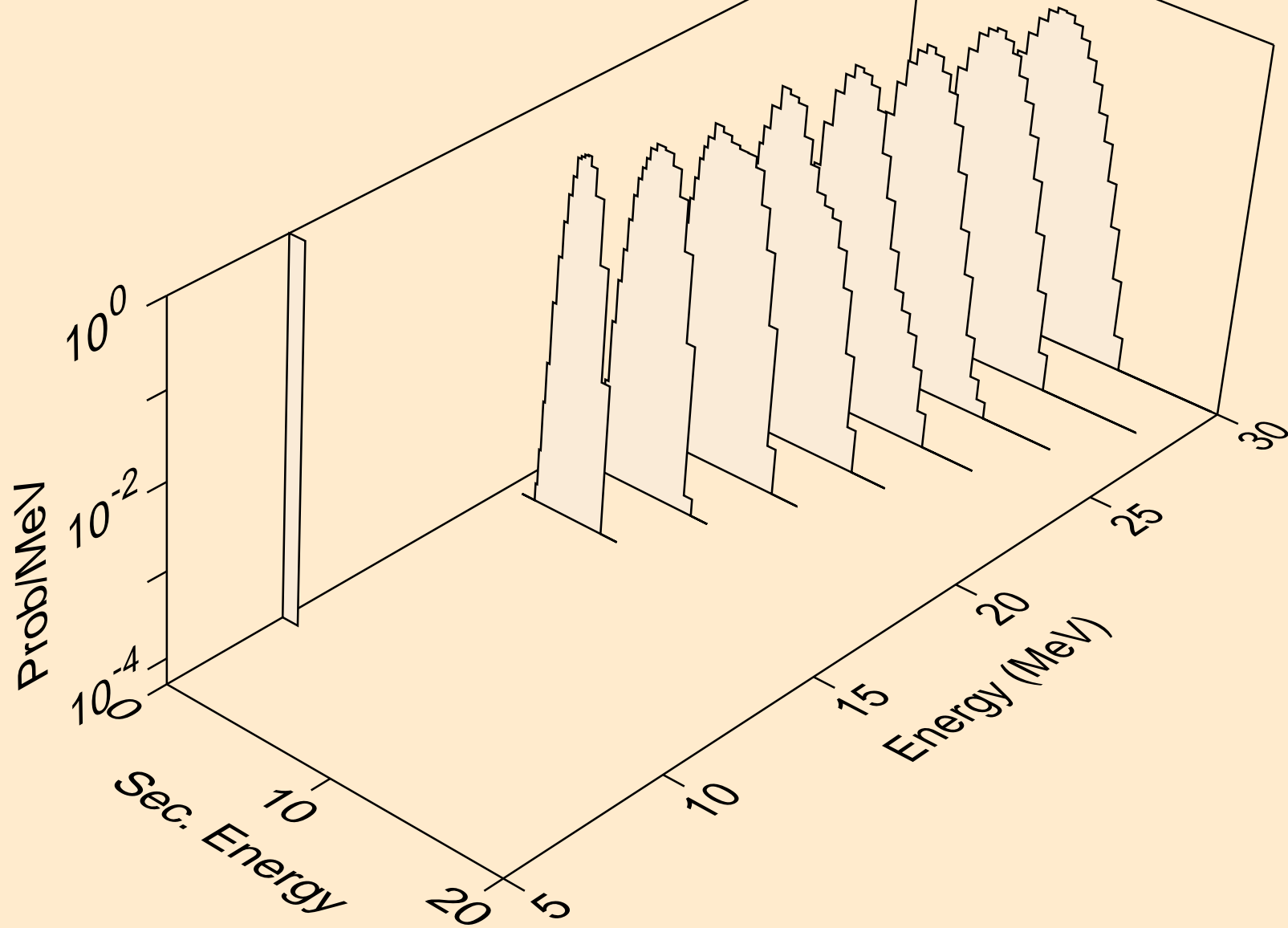

OS191 NEUTRON ACER TENDL-2021 LIBRARY; T=293.6K
deuterons from (n,x)

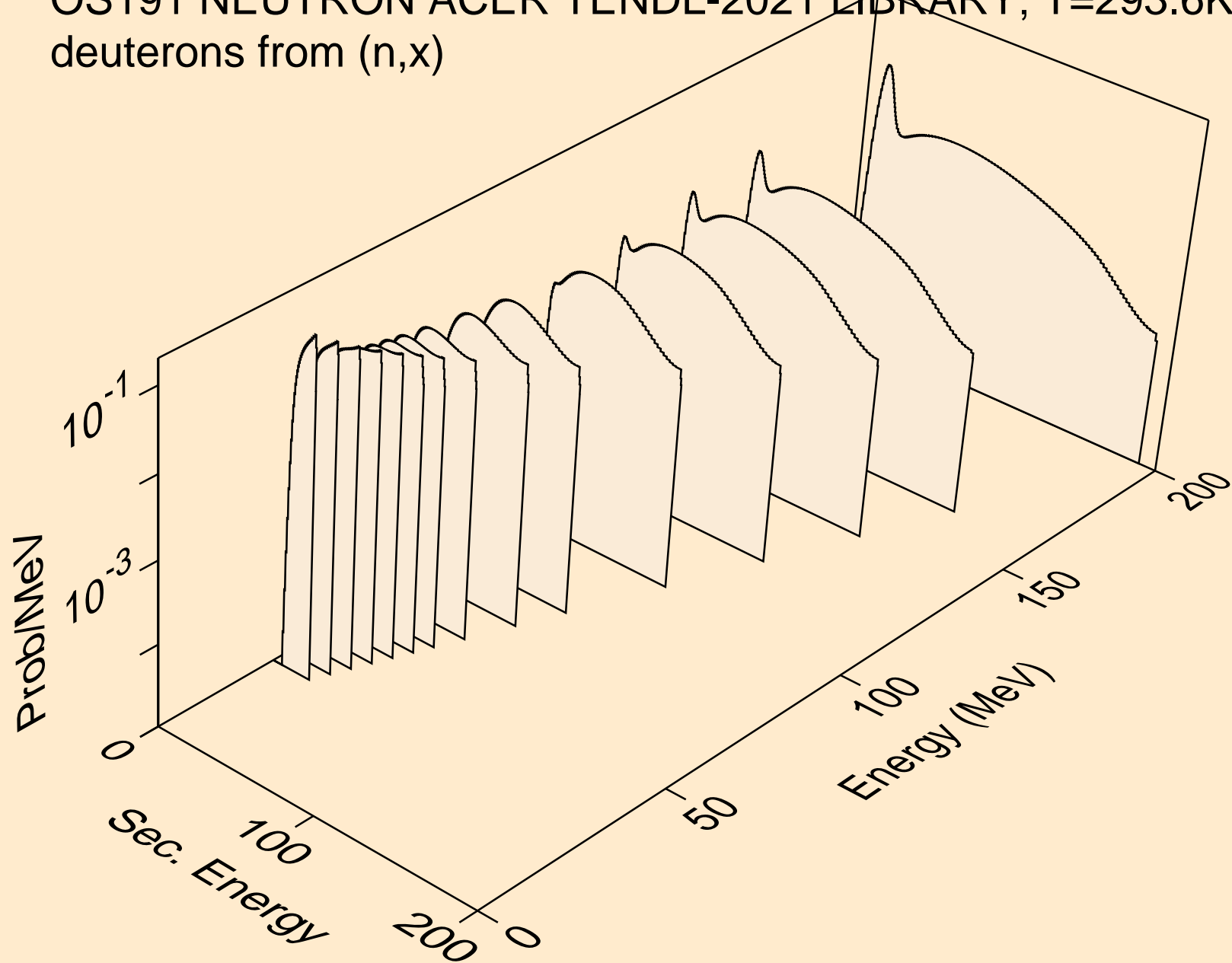

OS191 NEUTRON ACER TENDL-2021 LIBRARY; T=293.6K
deuterons from (n,2nd)

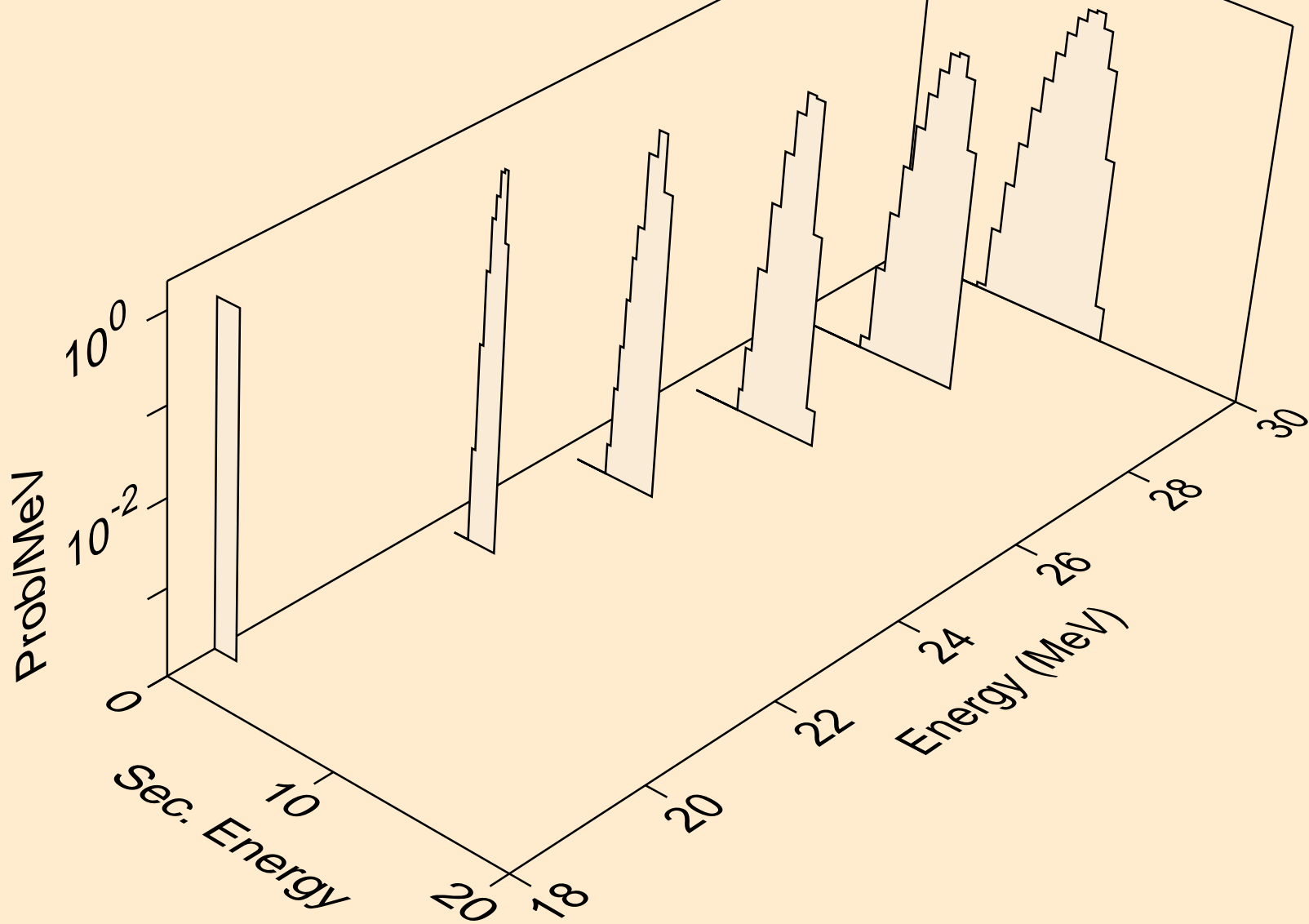

OS191 NEUTRON ACER TENDL-2021 LIBRARY; T=293.6K
deuterons from (n,n*)d

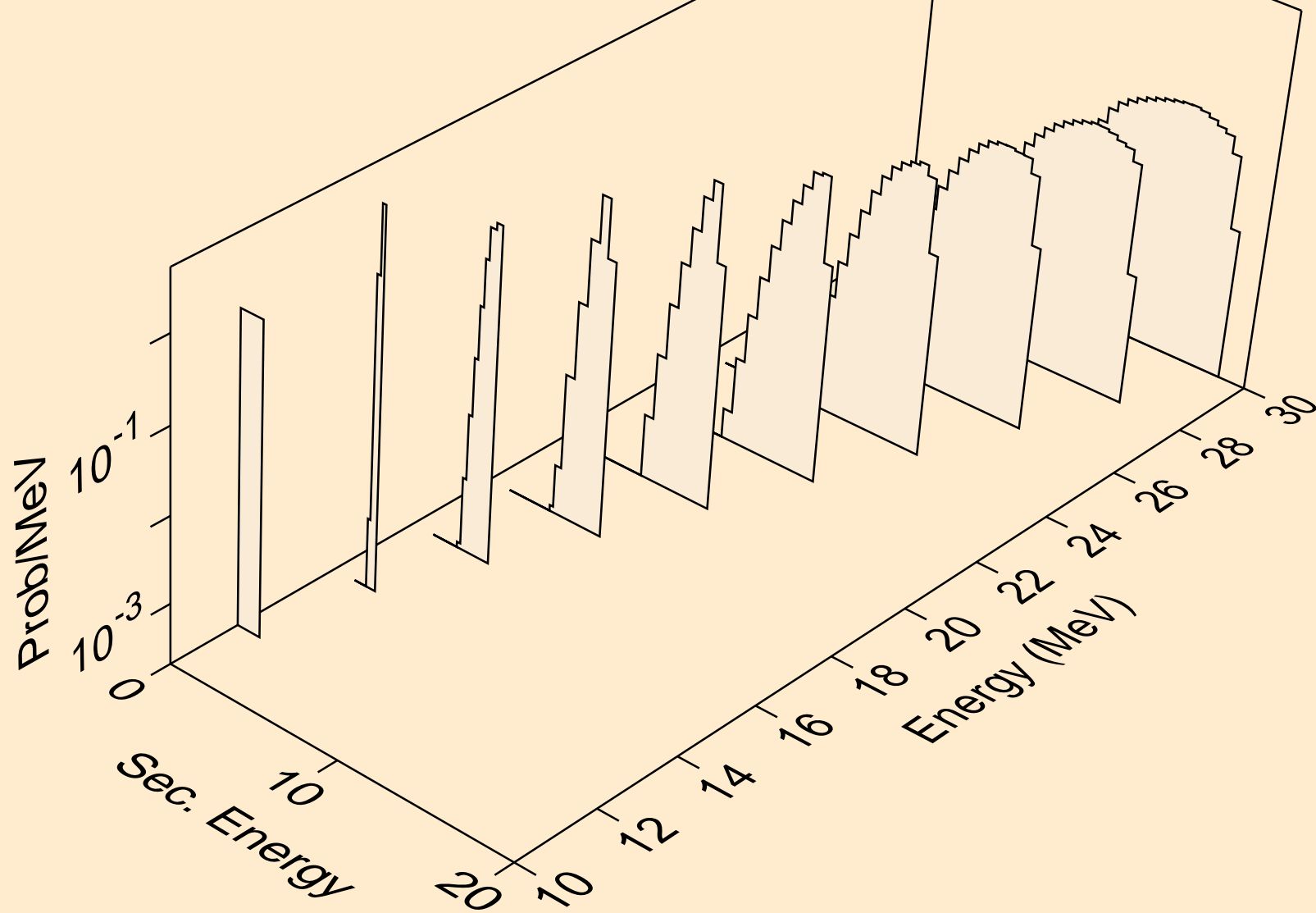

OS191 NEUTRON ACER TENDL-2021 LIBRARY; T=293.6K
deuterons from (n,d)

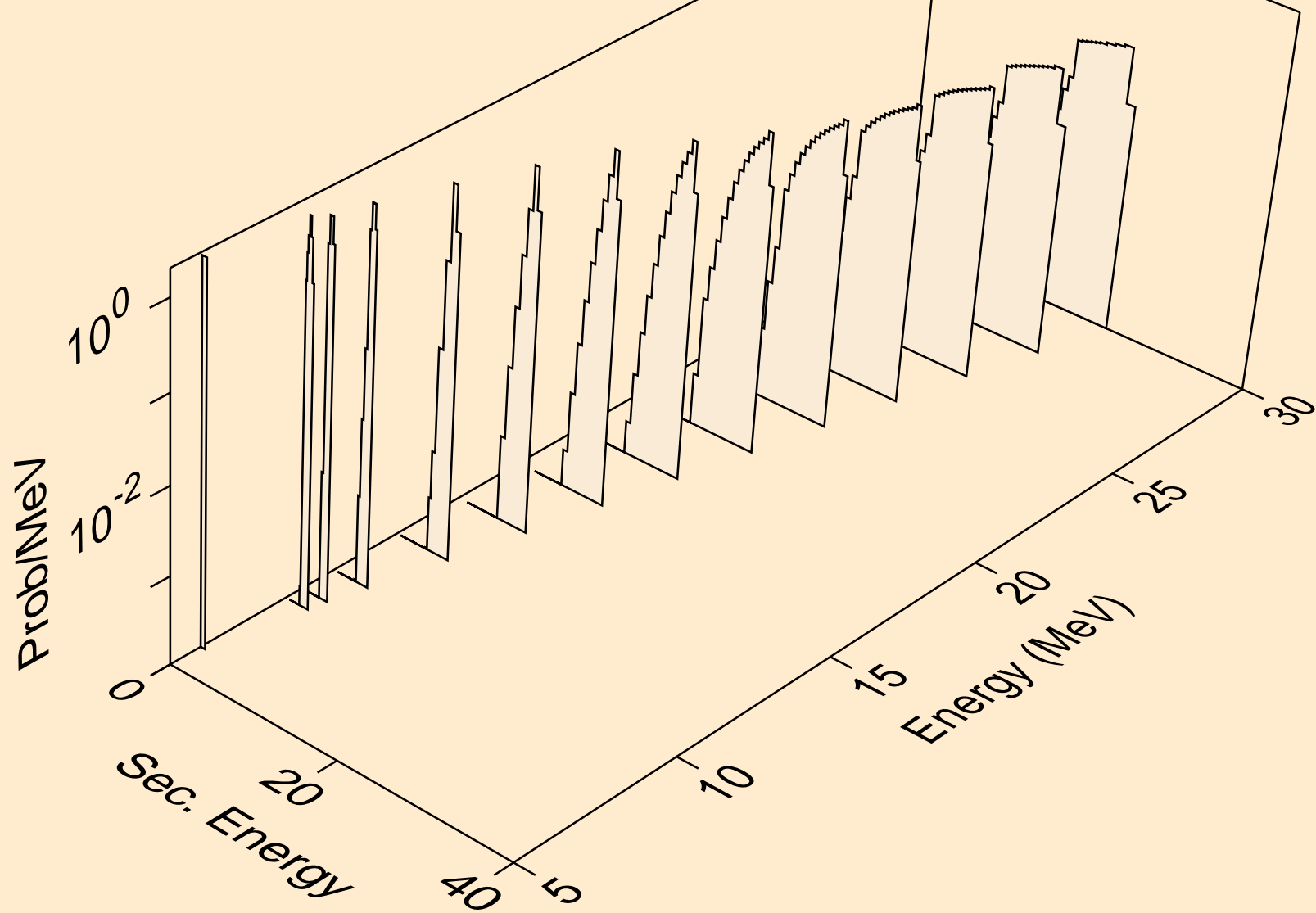

OS191 NEUTRON ACER TENDL-2021 LIBRARY; T=293.6K
tritons from (n,x)

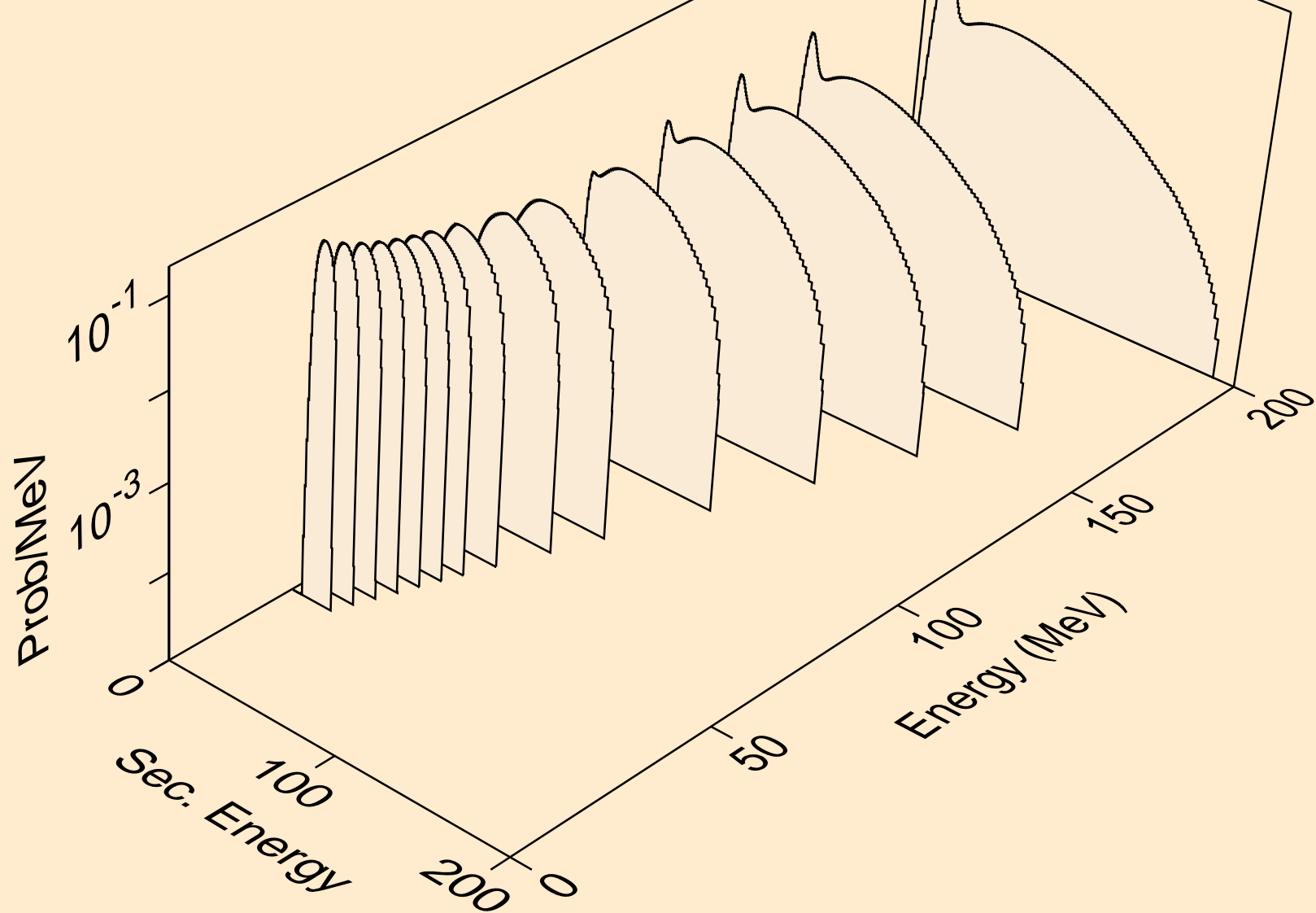

OS191 NEUTRON ACER TENDL-2021 LIBRARY; T=293.6K
tritons from (n,n*)t

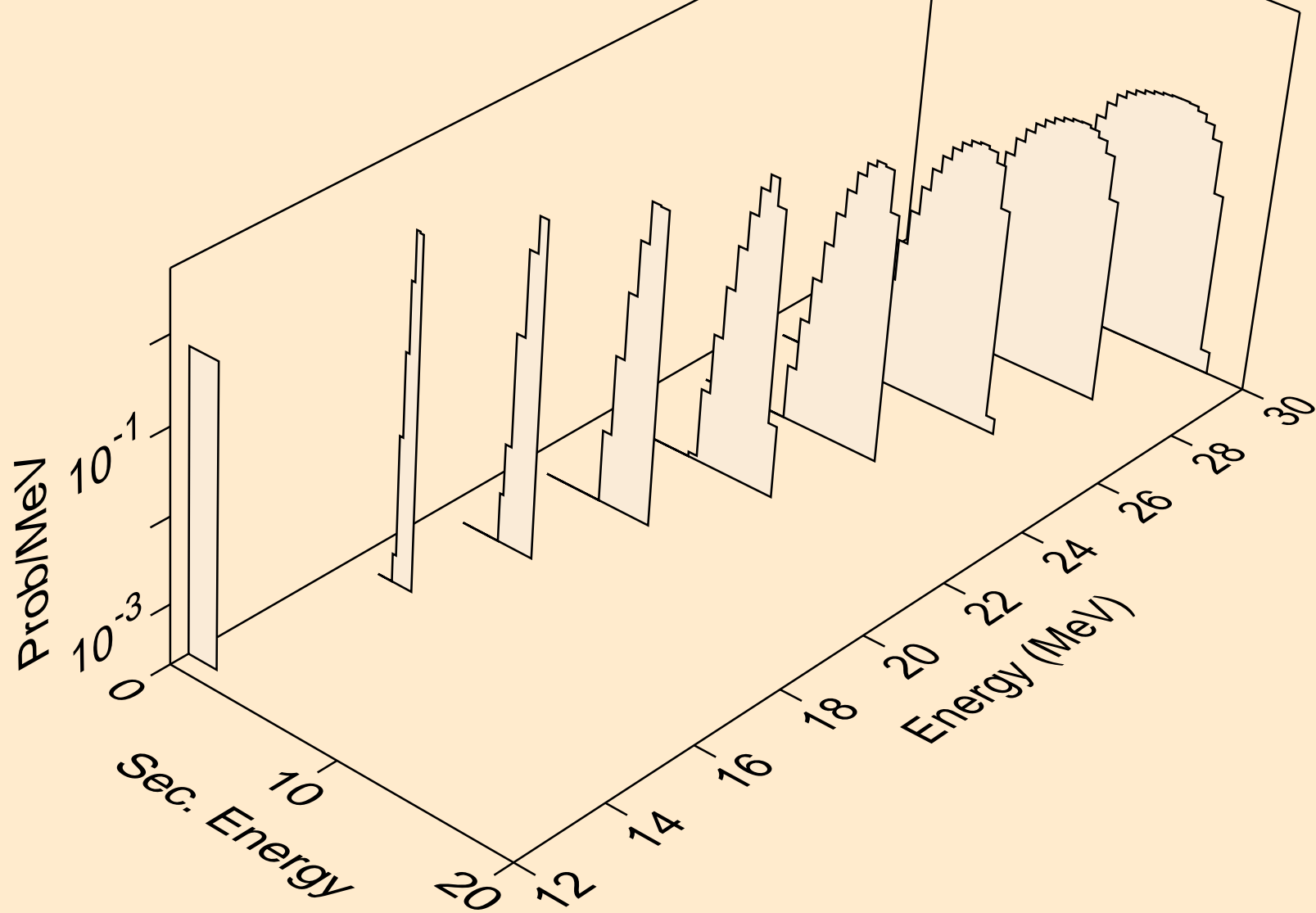

OS191 NEUTRON ACER TENDL-2021 LIBRARY; T=293.6K
tritons from (n,t)

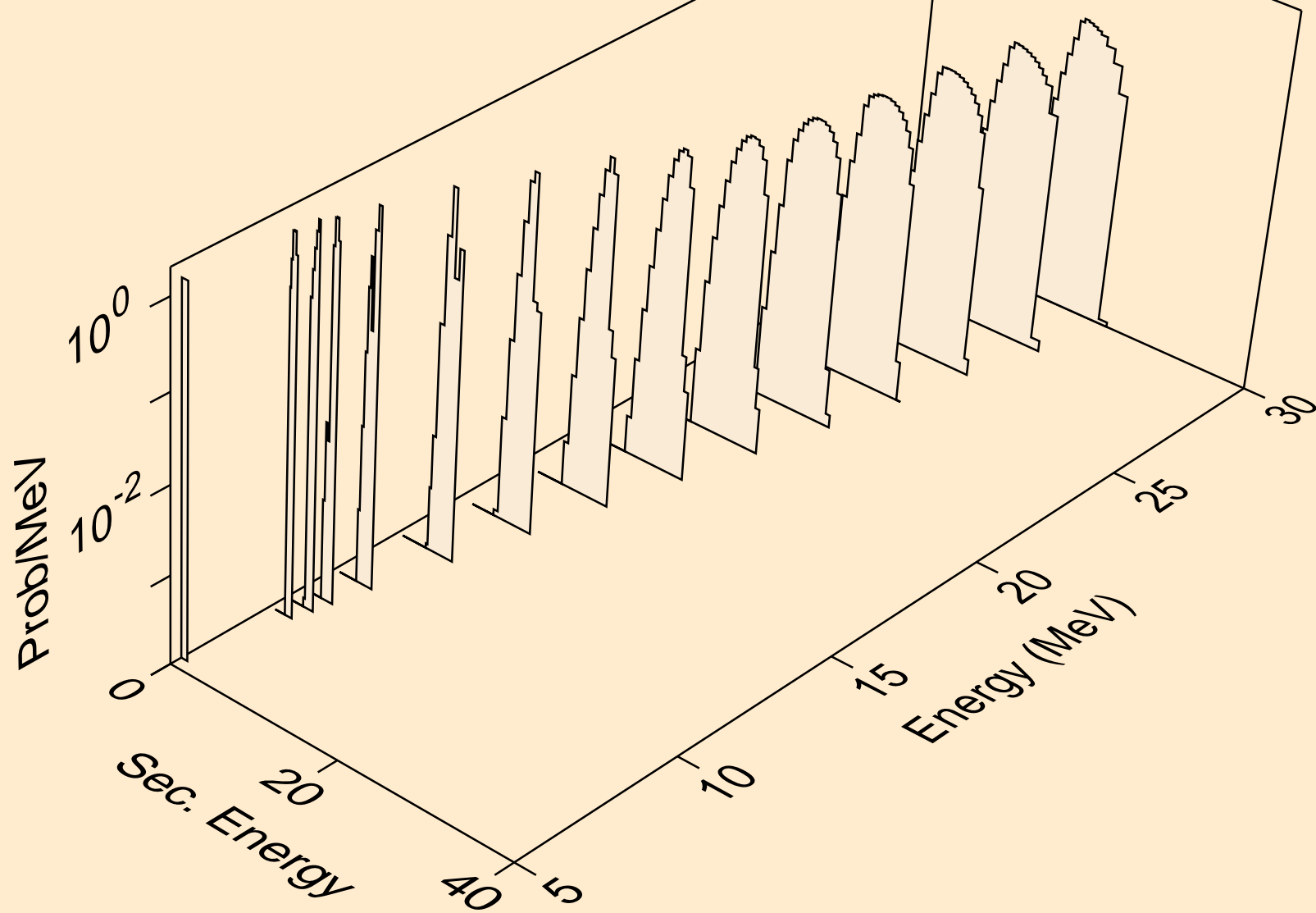

OS191 NEUTRON ACER TENDL-2021 LIBRARY; T=293.6K
he3s from (n,x)

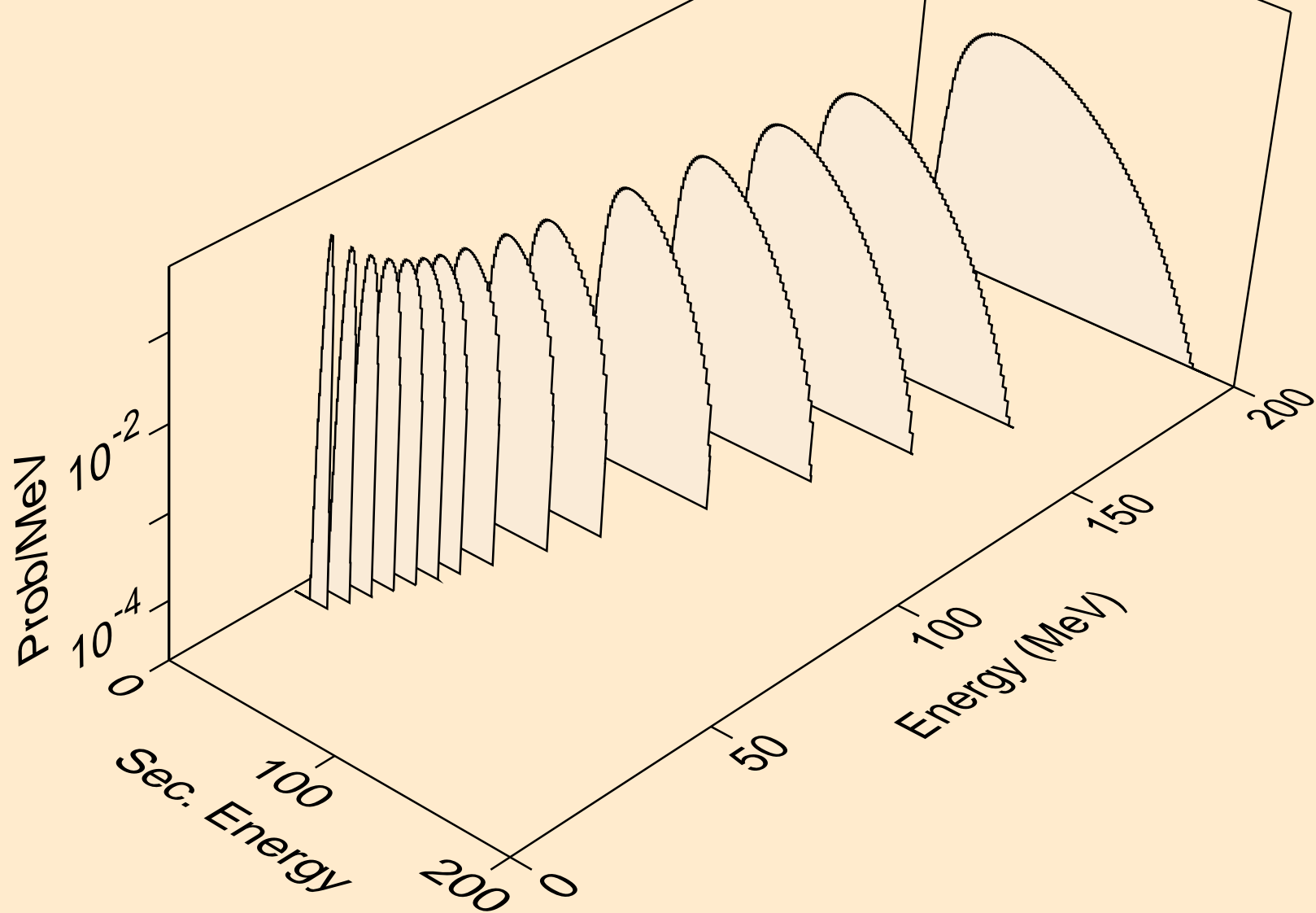

OS191 NEUTRON ACER TENDL-2021 LIBRARY; T=293.6K
he3s from (n,n*)he3

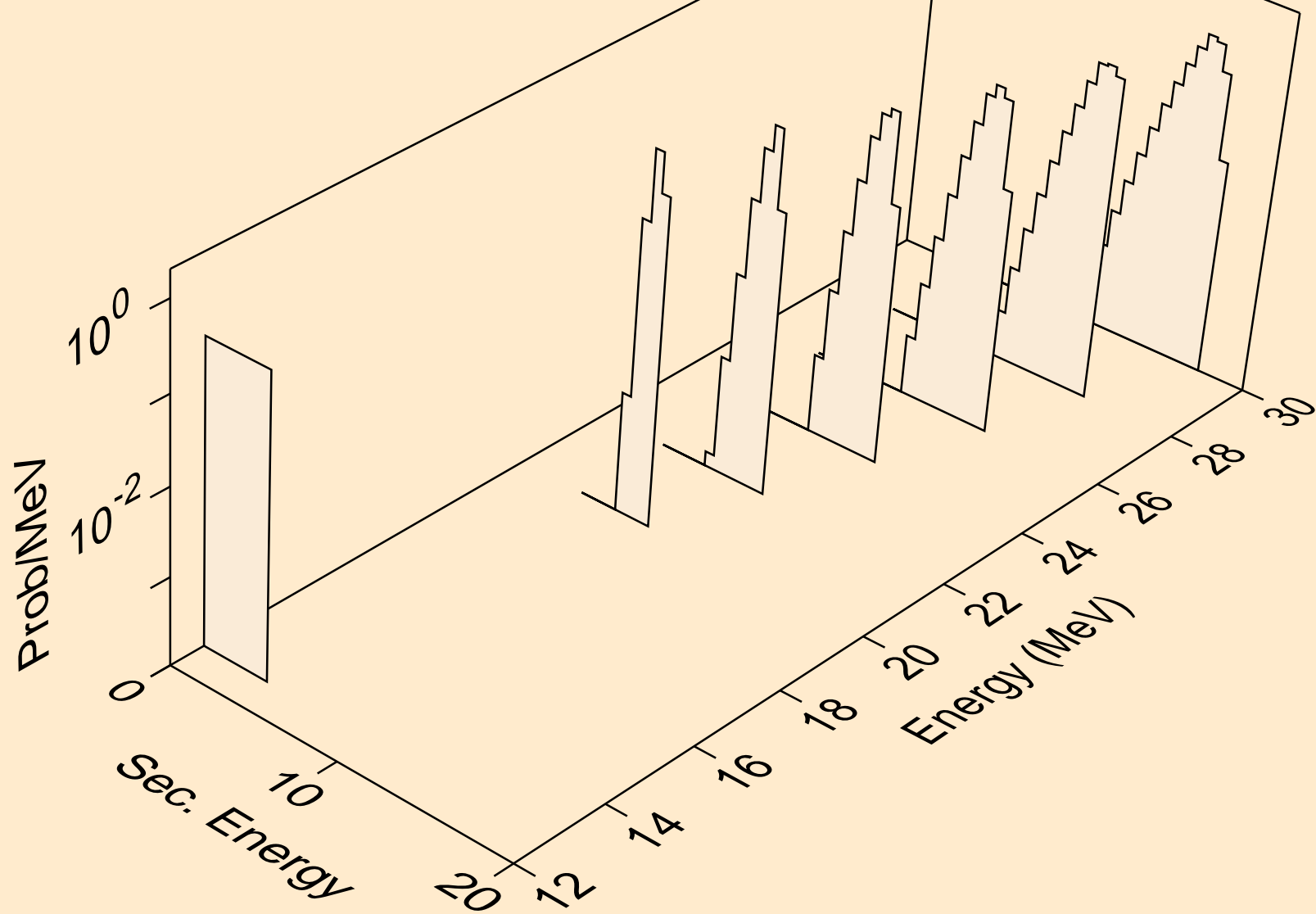

OS191 NEUTRON ACER TENDL-2021 LIBRARY; T=293.6K
he3s from (n,he3)

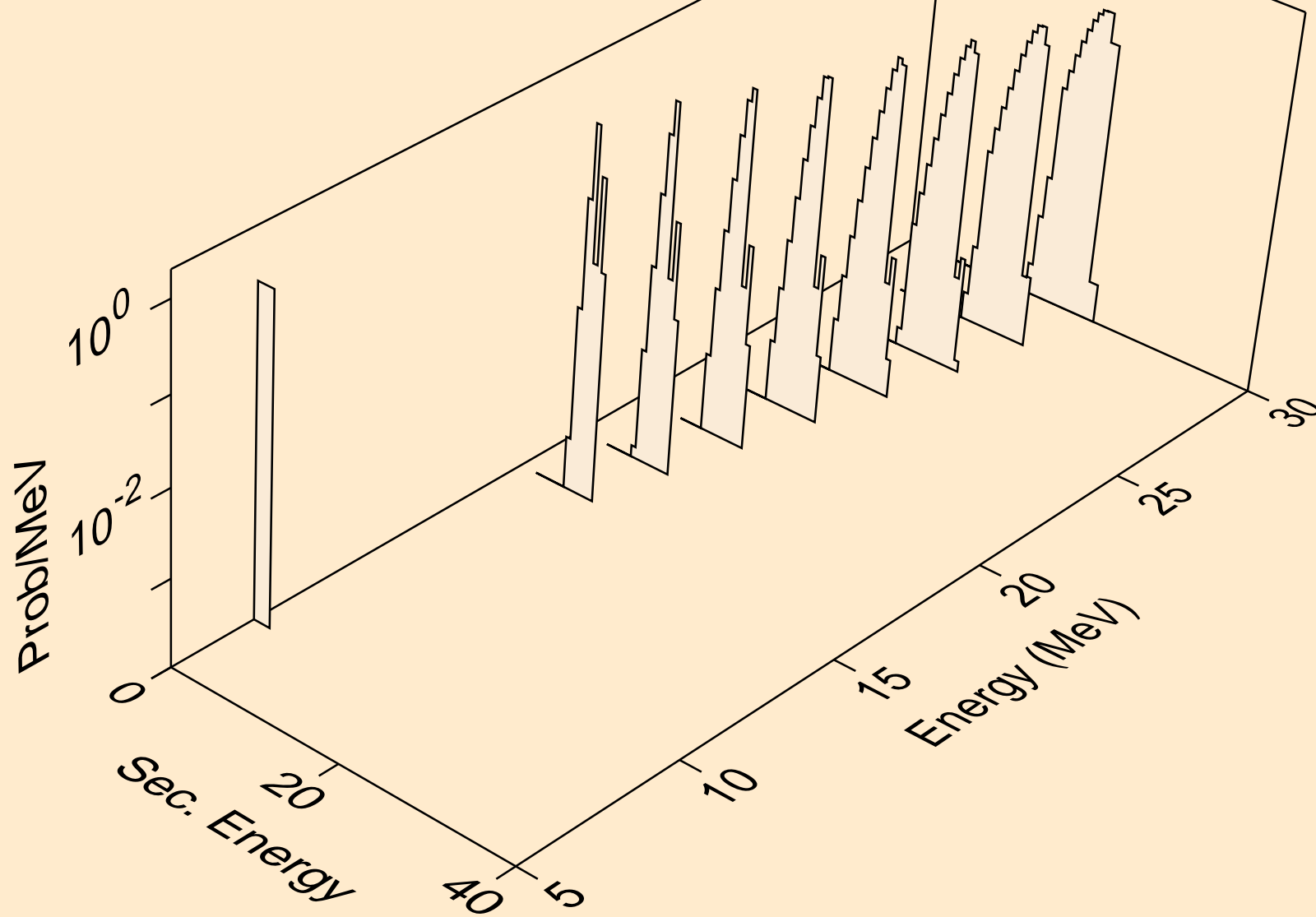

OS191 NEUTRON ACER TENDL-2021 LIBRARY; T=293.6K
alphas from (n,x)

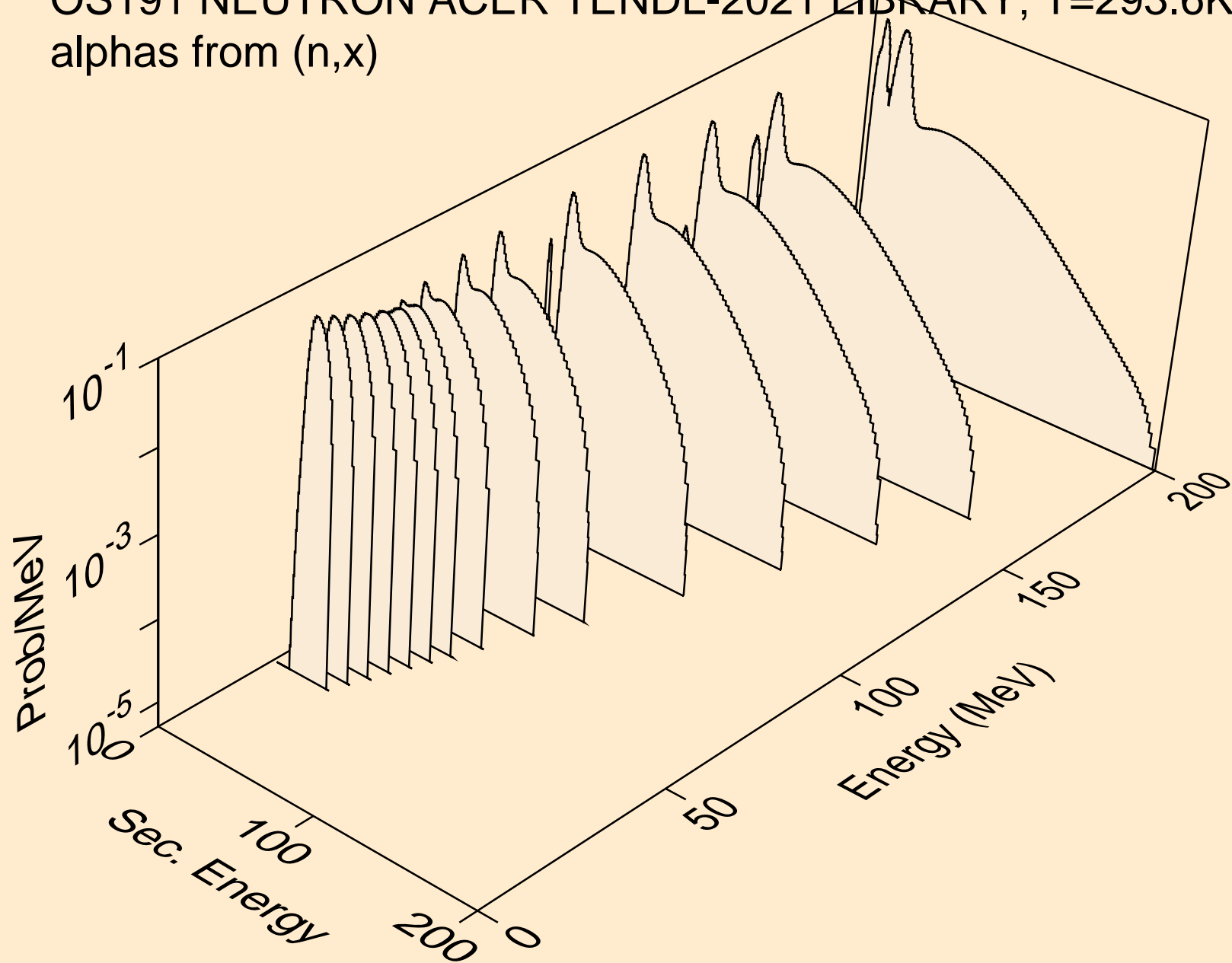

OS191 NEUTRON ACER TENDL-2021 LIBRARY; T=293.6K
alphas from (n,n*)a

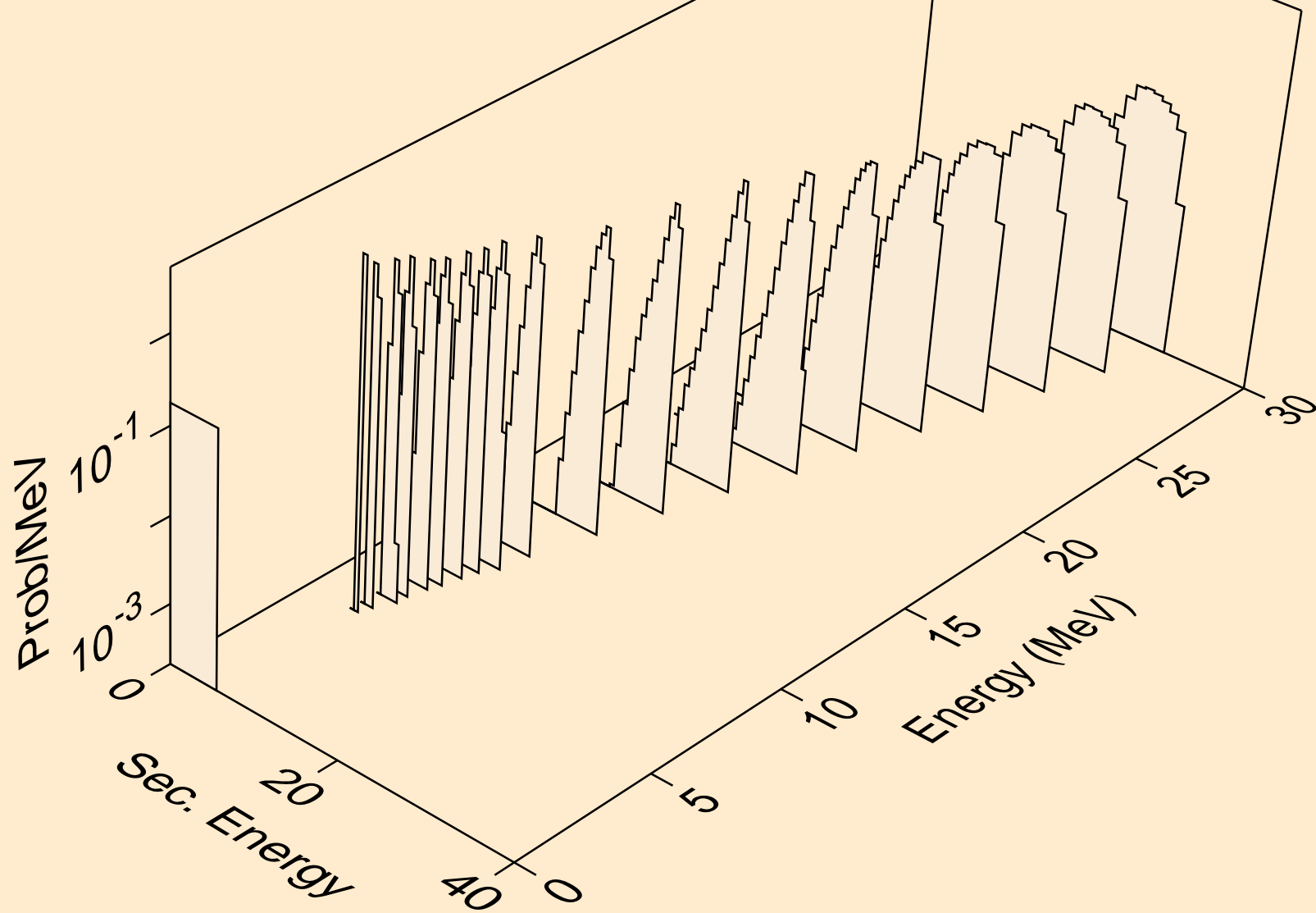

OS191 NEUTRON ACER TENDL-2021 LIBRARY; T=293.6K
alphas from (n,2n)a

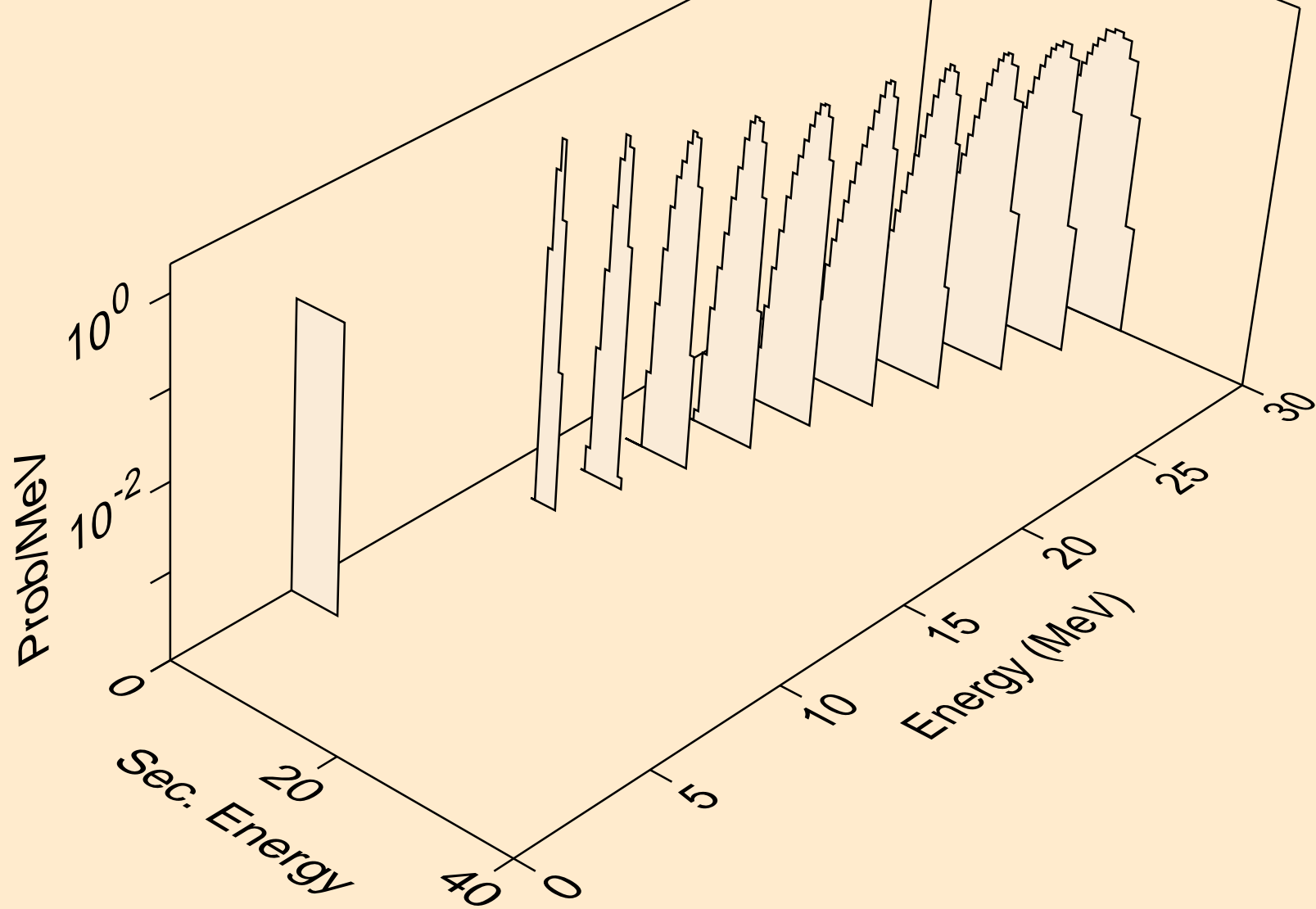

OS191 NEUTRON ACER TENDL-2021 LIBRARY; T=293.6K
alphas from (n,3n)a

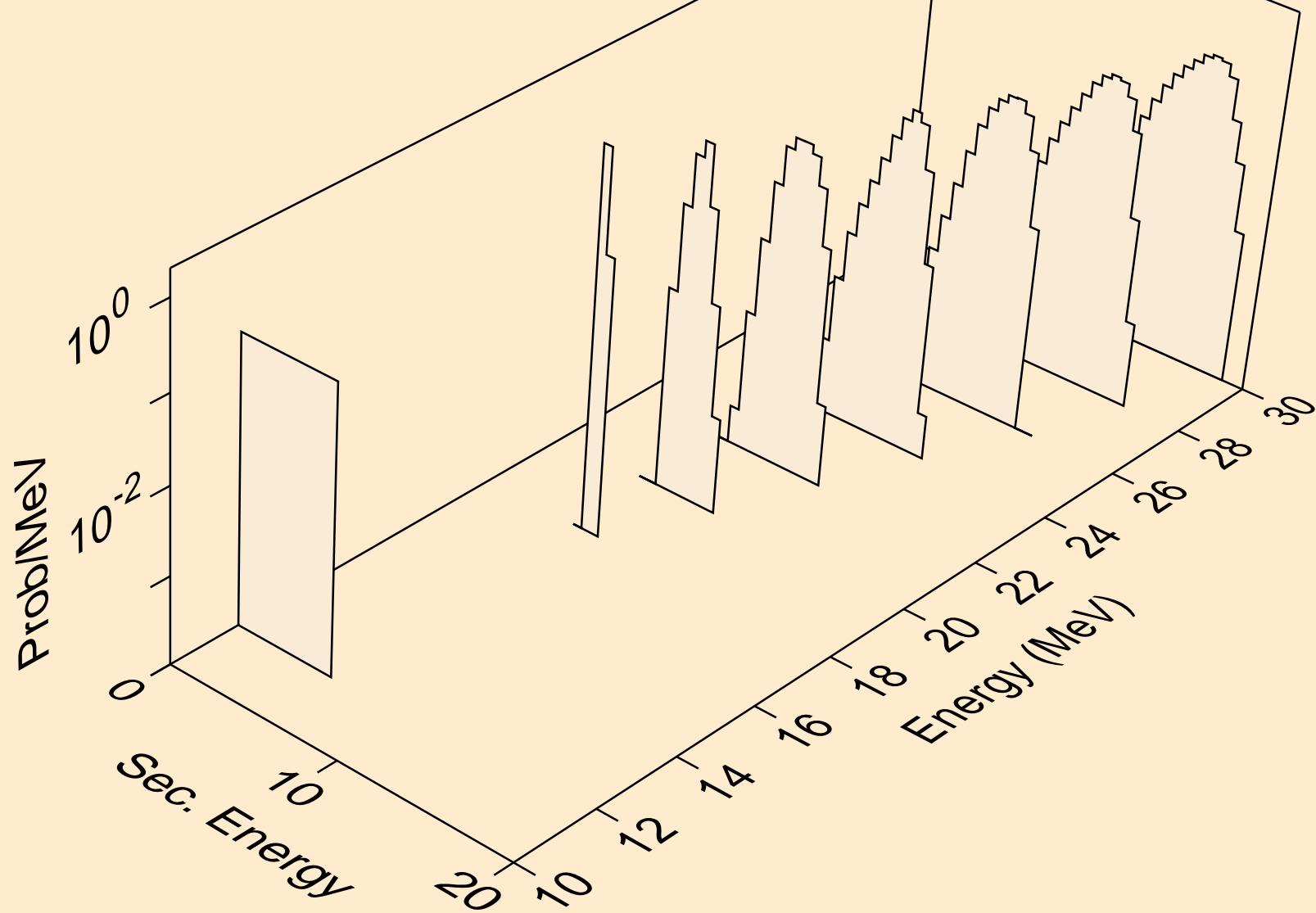

OS191 NEUTRON ACER TENDL-2021 LIBRARY; T=293.6K
alphas from (n,a)

