

# OS195 NEUTRON ACER TENDL-2021 LIBRARY; T=293.6K

## Principal cross sections

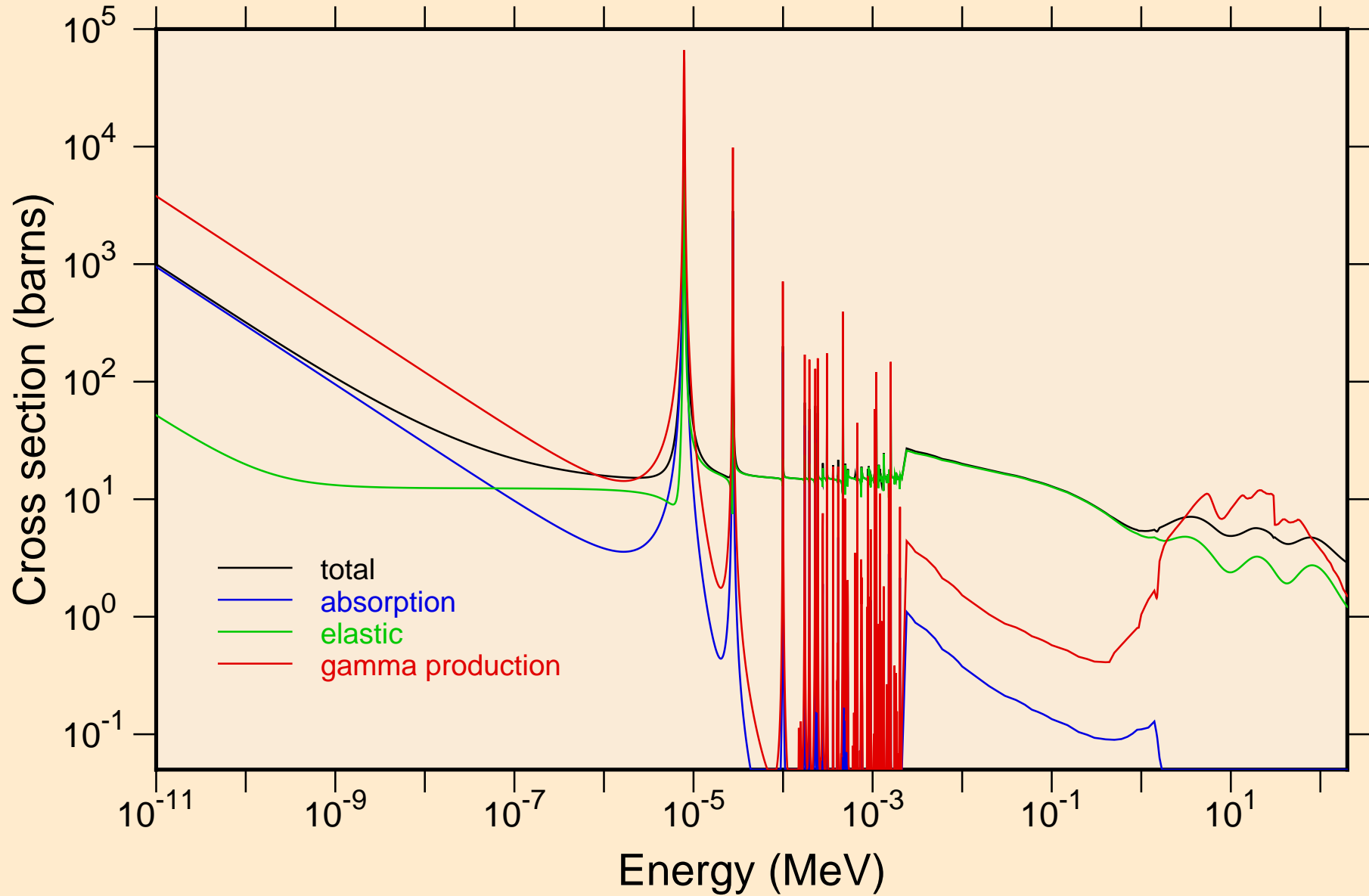

OS195 NEUTRON ACER TENDL-2021 LIBRARY; T=293.6K  
resonance total cross section

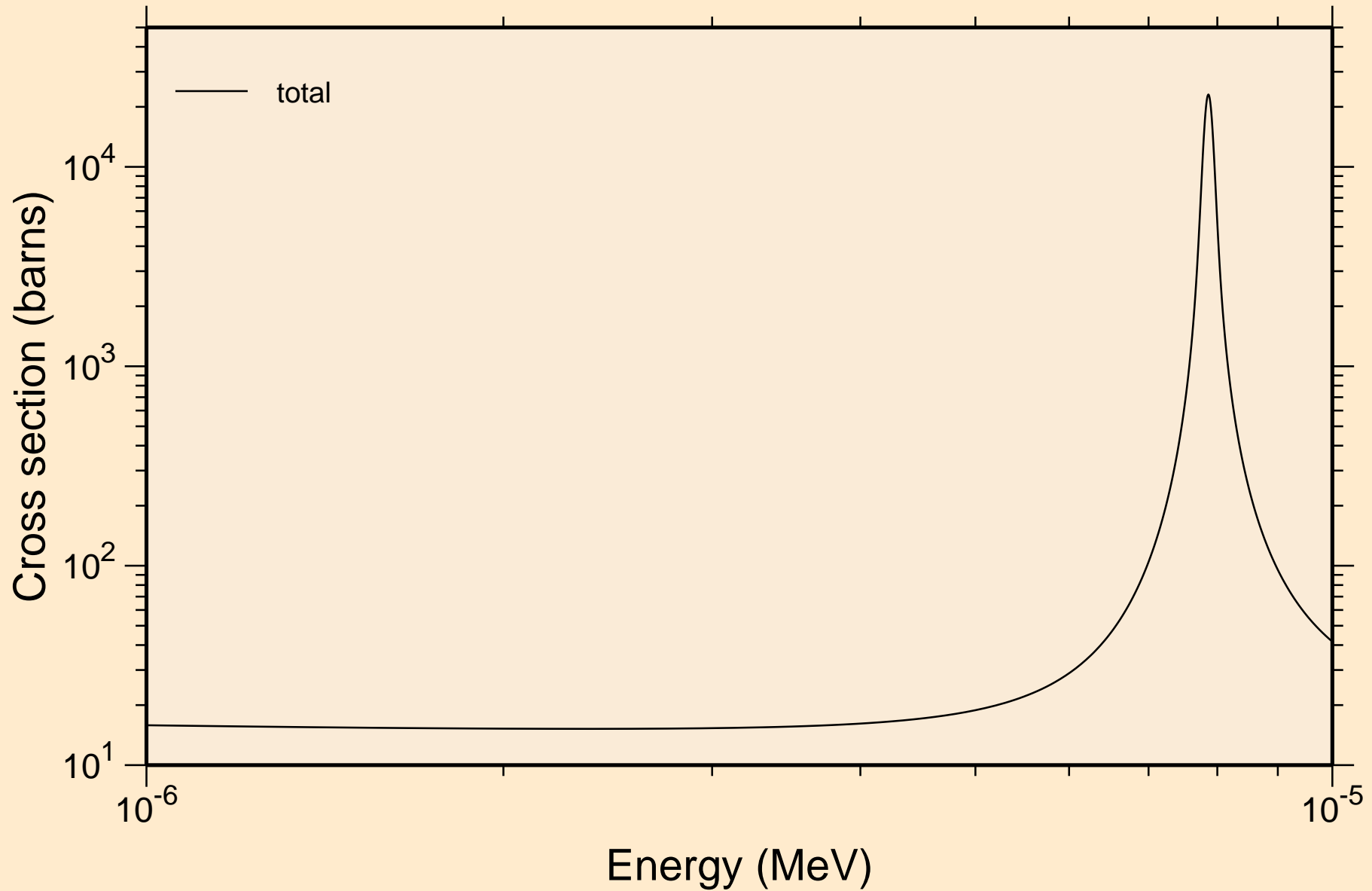

OS195 NEUTRON ACER TENDL-2021 LIBRARY; T=293.6K  
resonance total cross section

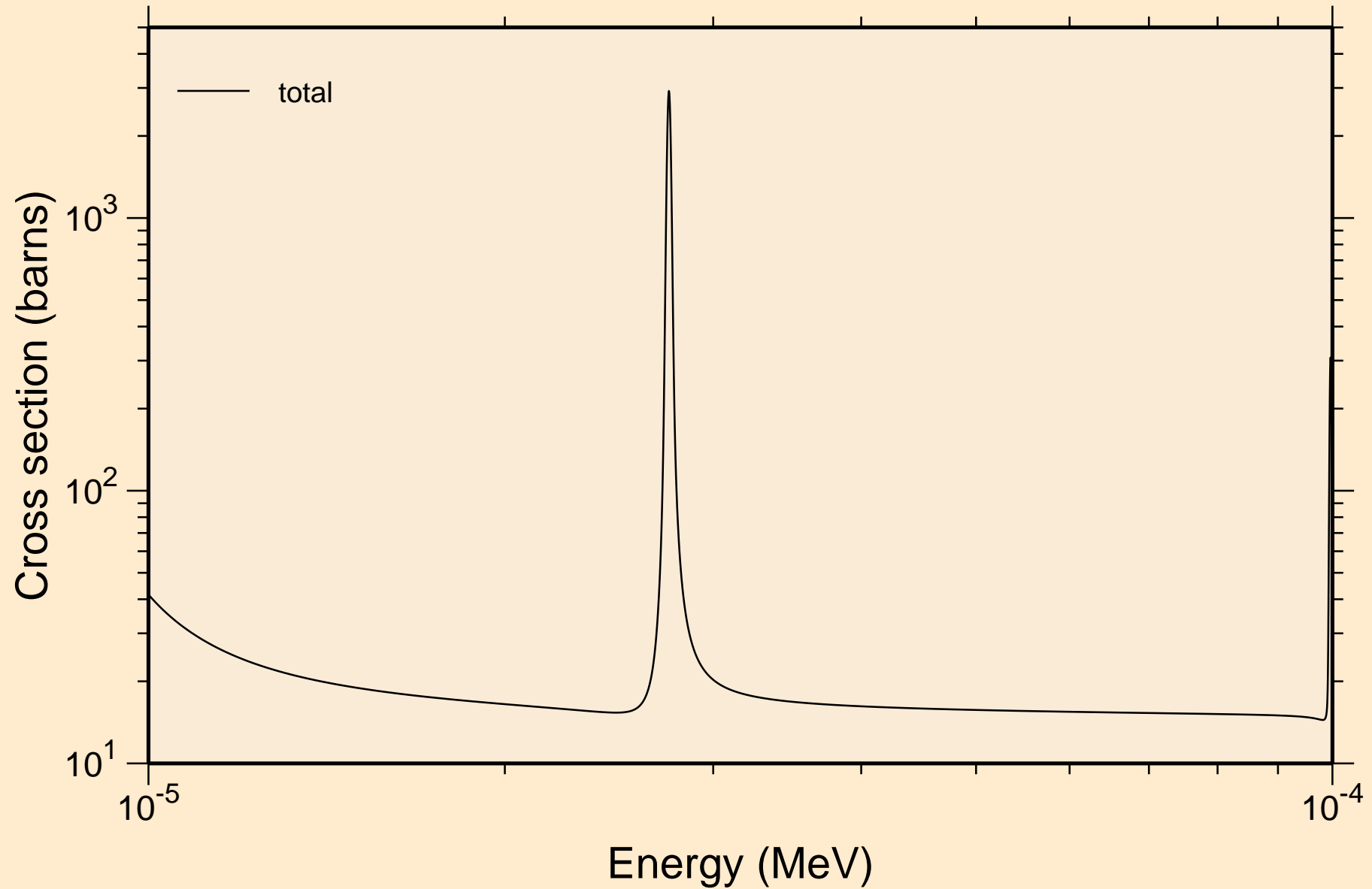

OS195 NEUTRON ACER TENDL-2021 LIBRARY; T=293.6K  
resonance total cross section

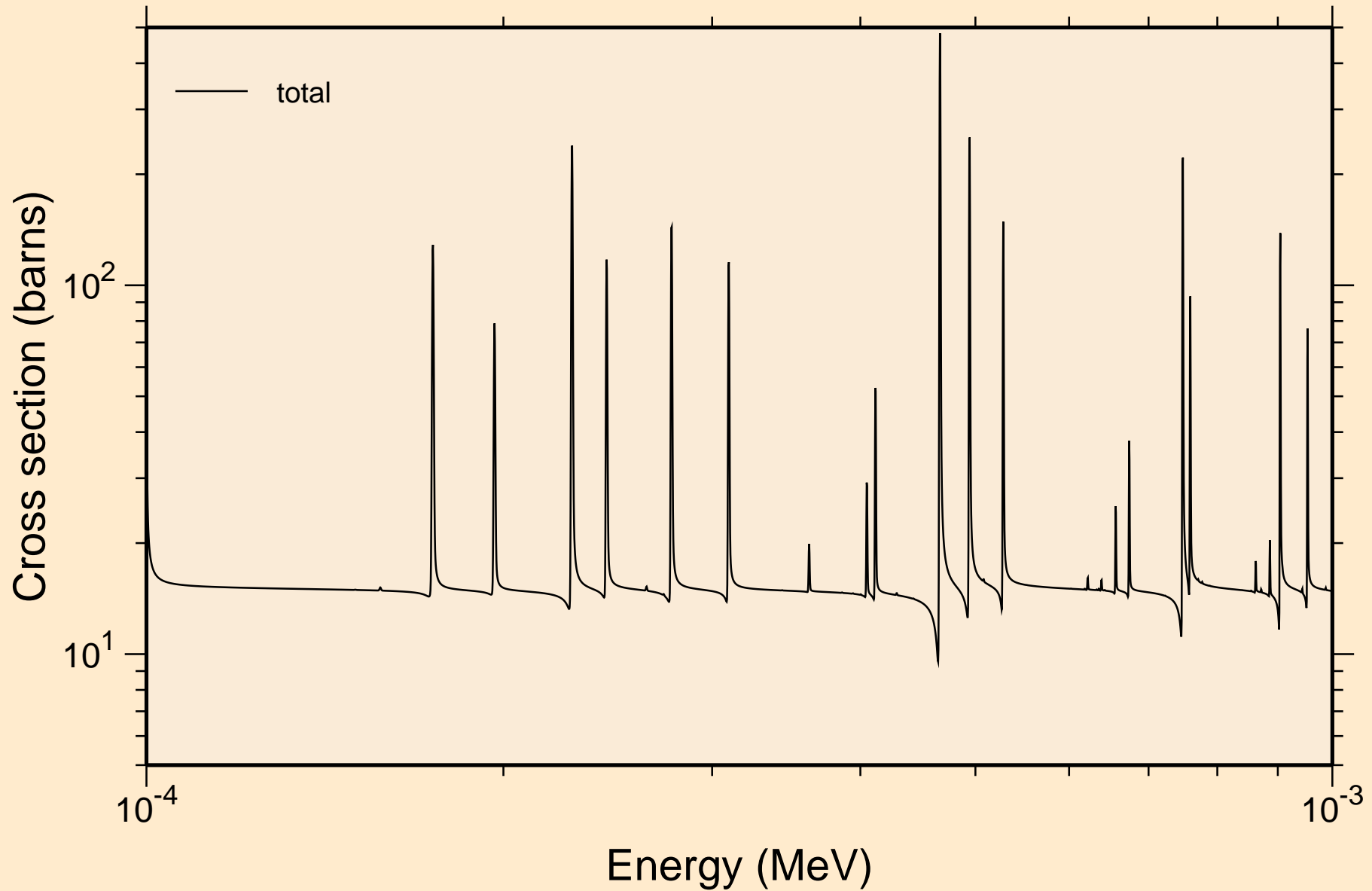

OS195 NEUTRON ACER TENDL-2021 LIBRARY; T=293.6K  
resonance total cross section

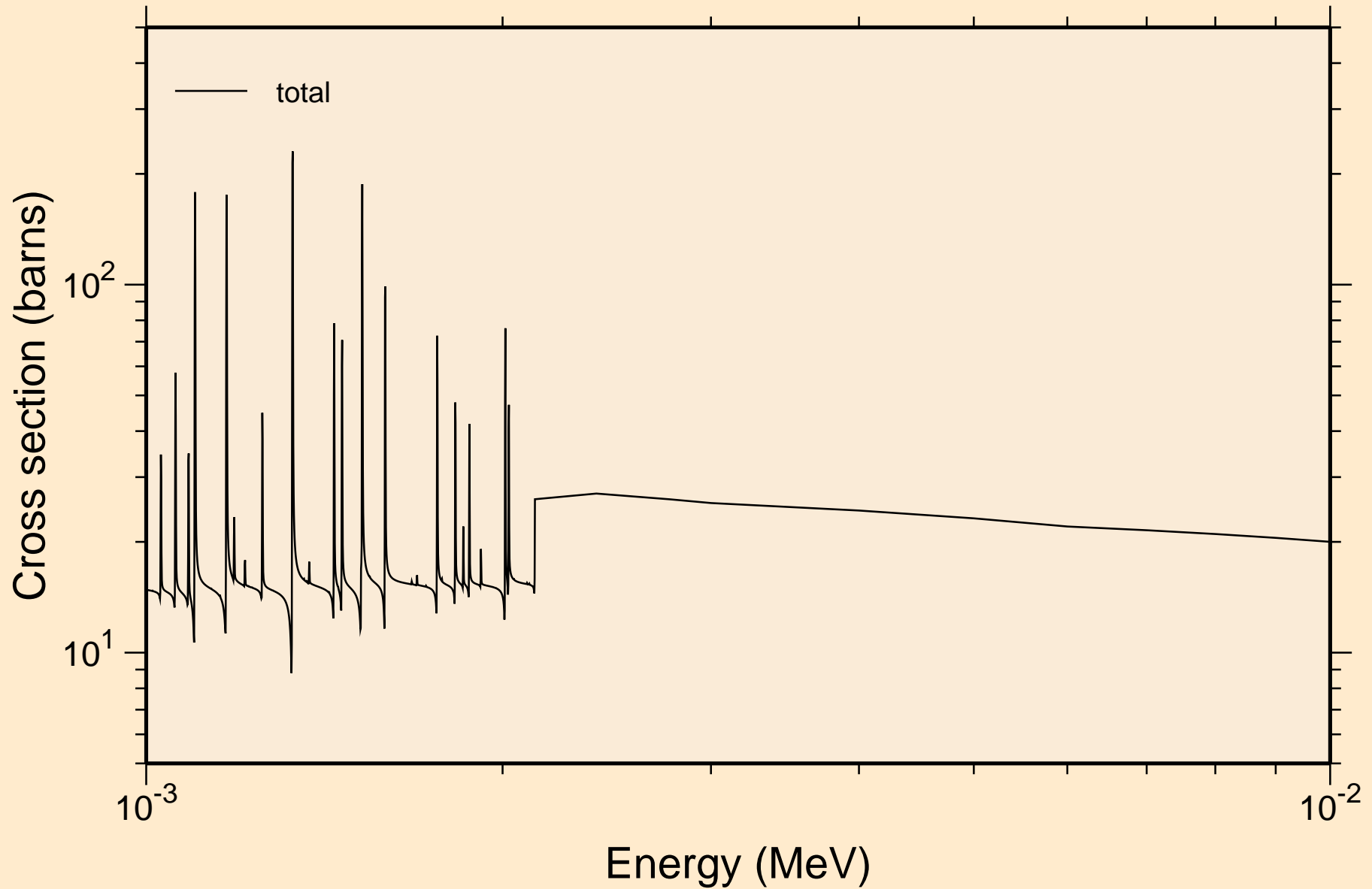

OS195 NEUTRON ACER TENDL-2021 LIBRARY; T=293.6K  
resonance total cross section

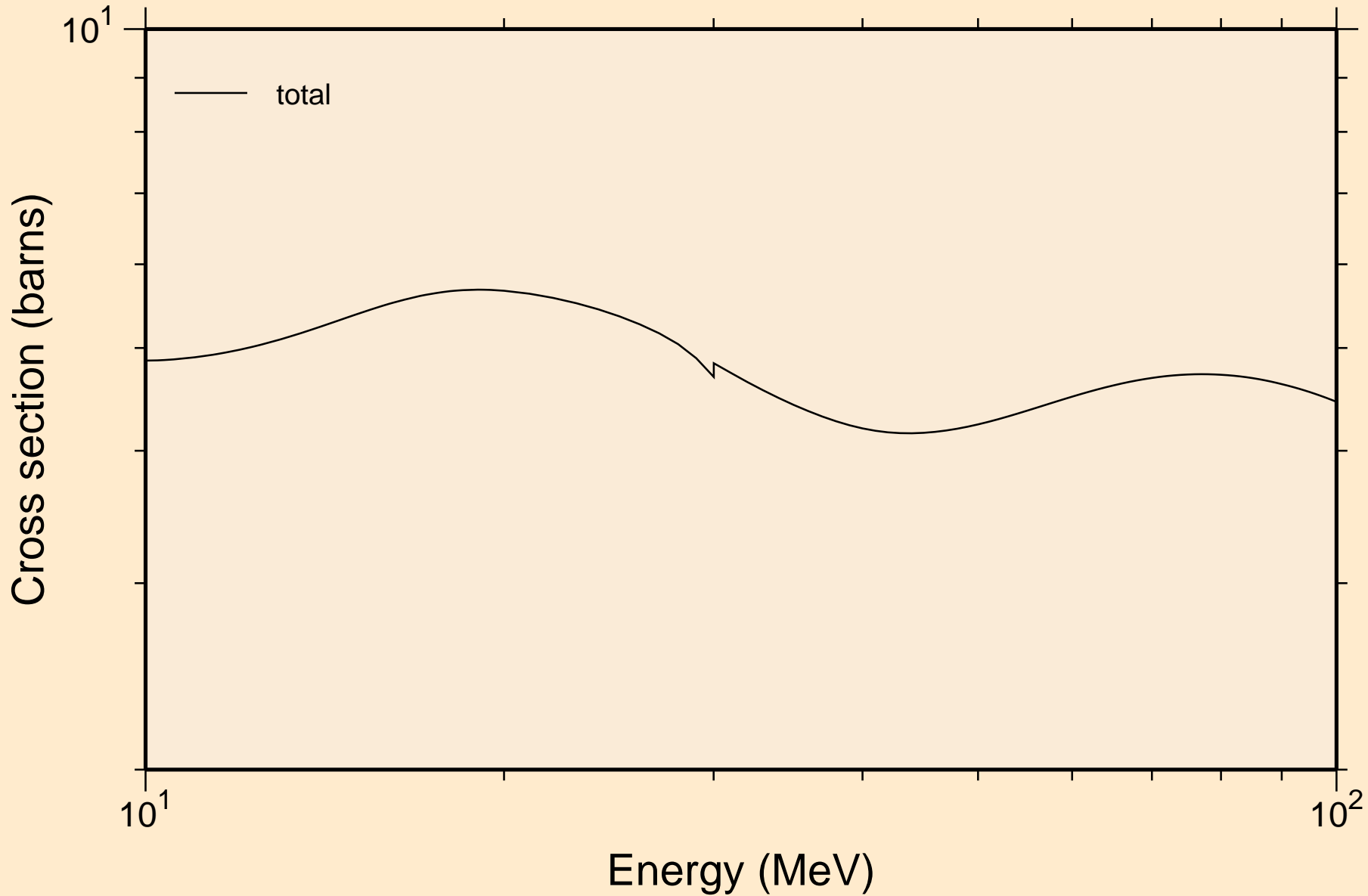

OS195 NEUTRON ACER TENDL-2021 LIBRARY; T=293.6K  
resonance absorption cross sections

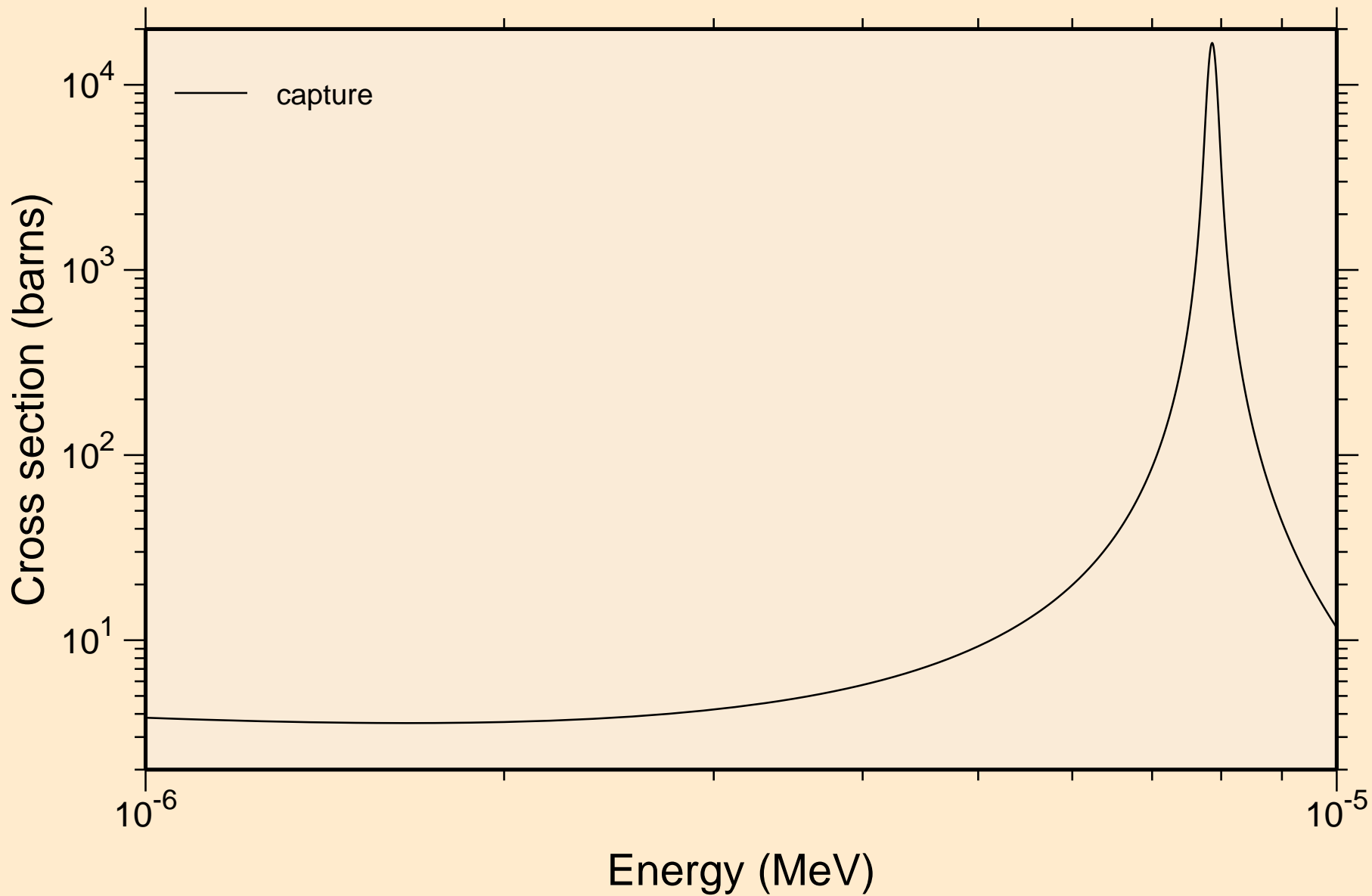

OS195 NEUTRON ACER TENDL-2021 LIBRARY; T=293.6K  
resonance absorption cross sections

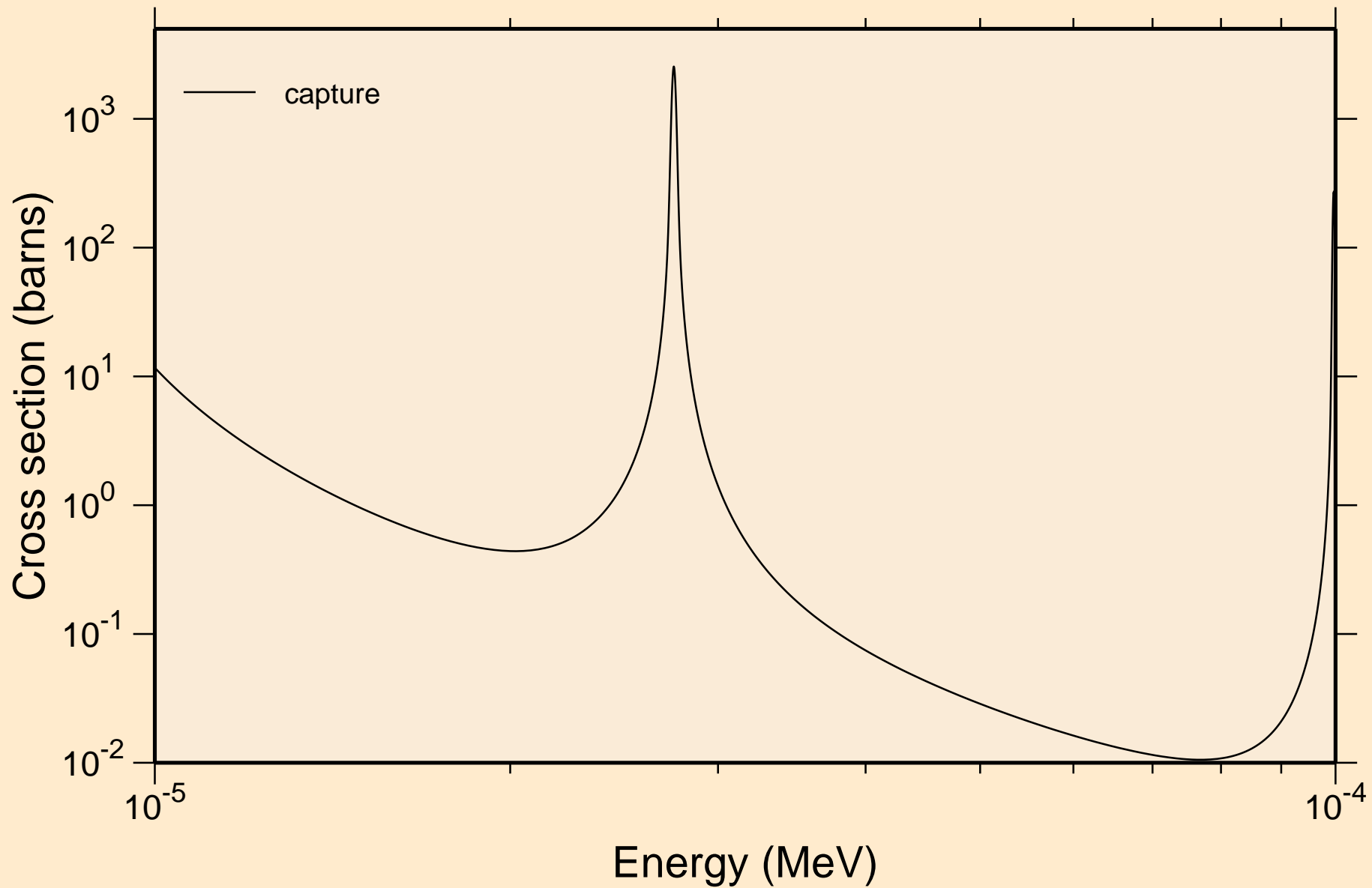



OS195 NEUTRON ACER TENDL-2021 LIBRARY; T=293.6K  
resonance absorption cross sections

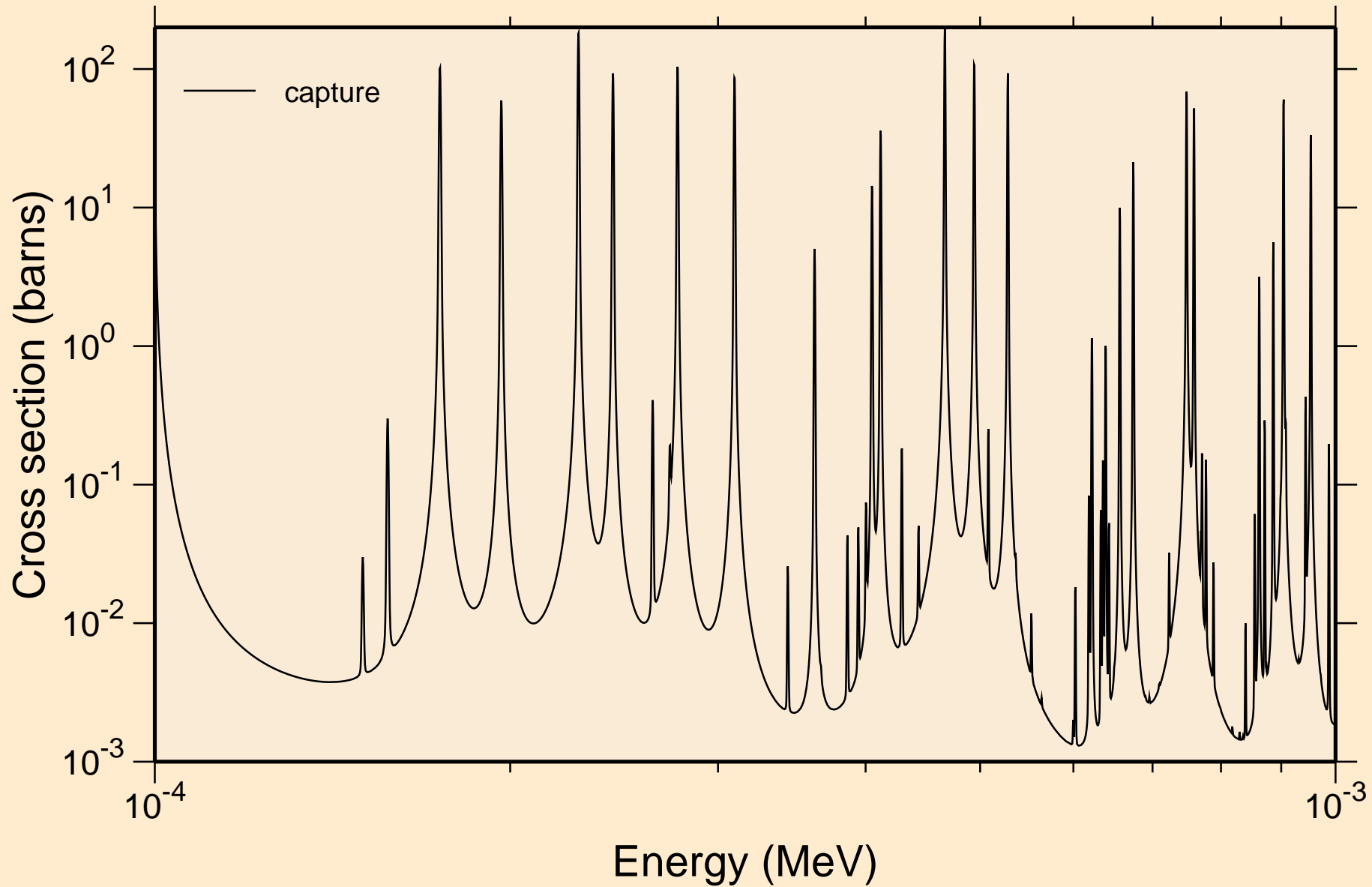

OS195 NEUTRON ACER TENDL-2021 LIBRARY; T=293.6K  
resonance absorption cross sections

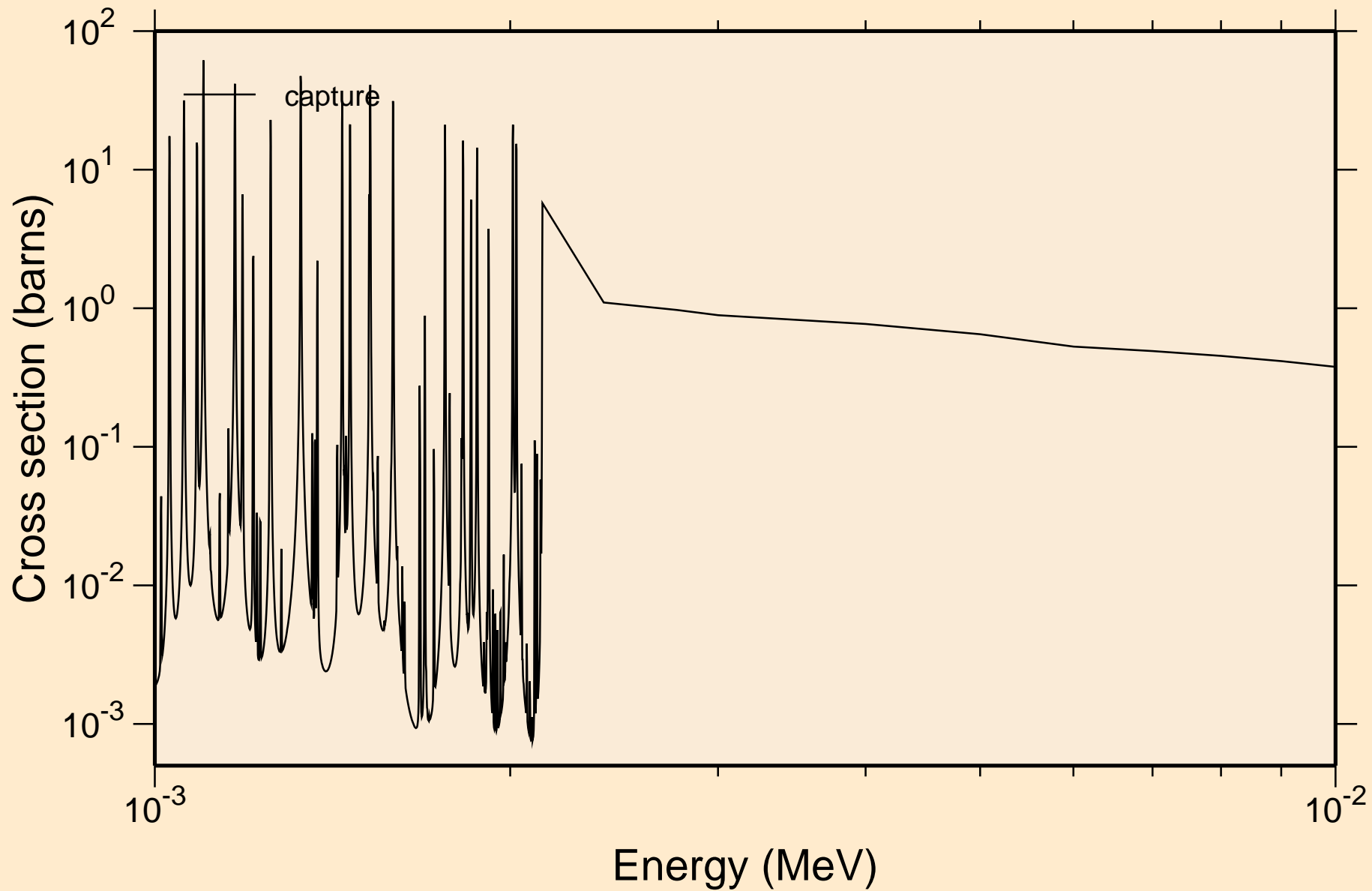

OS195 NEUTRON ACER TENDL-2021 LIBRARY; T=293.6K  
resonance absorption cross sections

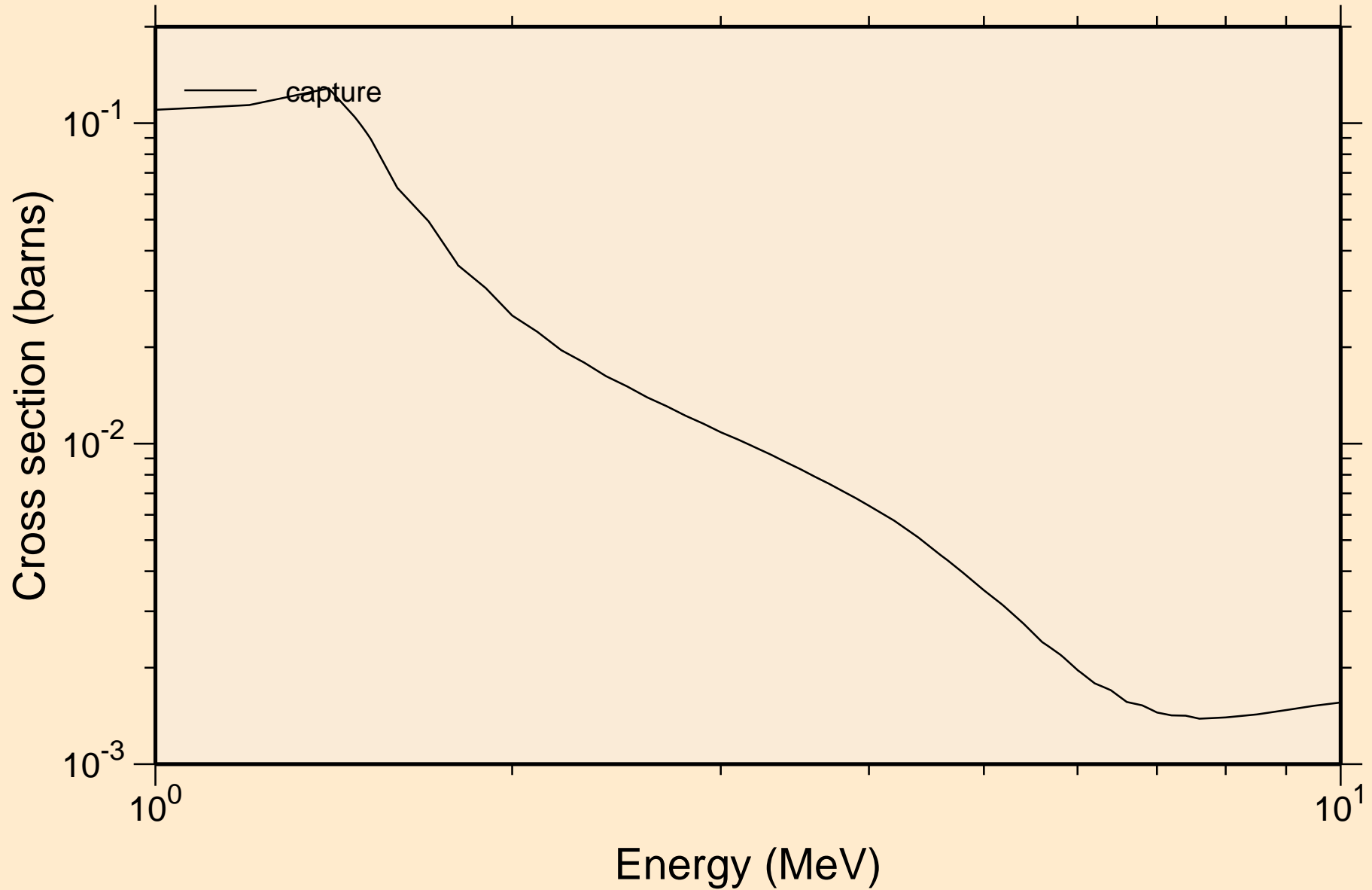

OS195 NEUTRON ACER TENDL-2021 LIBRARY; T=293.6K  
Heating

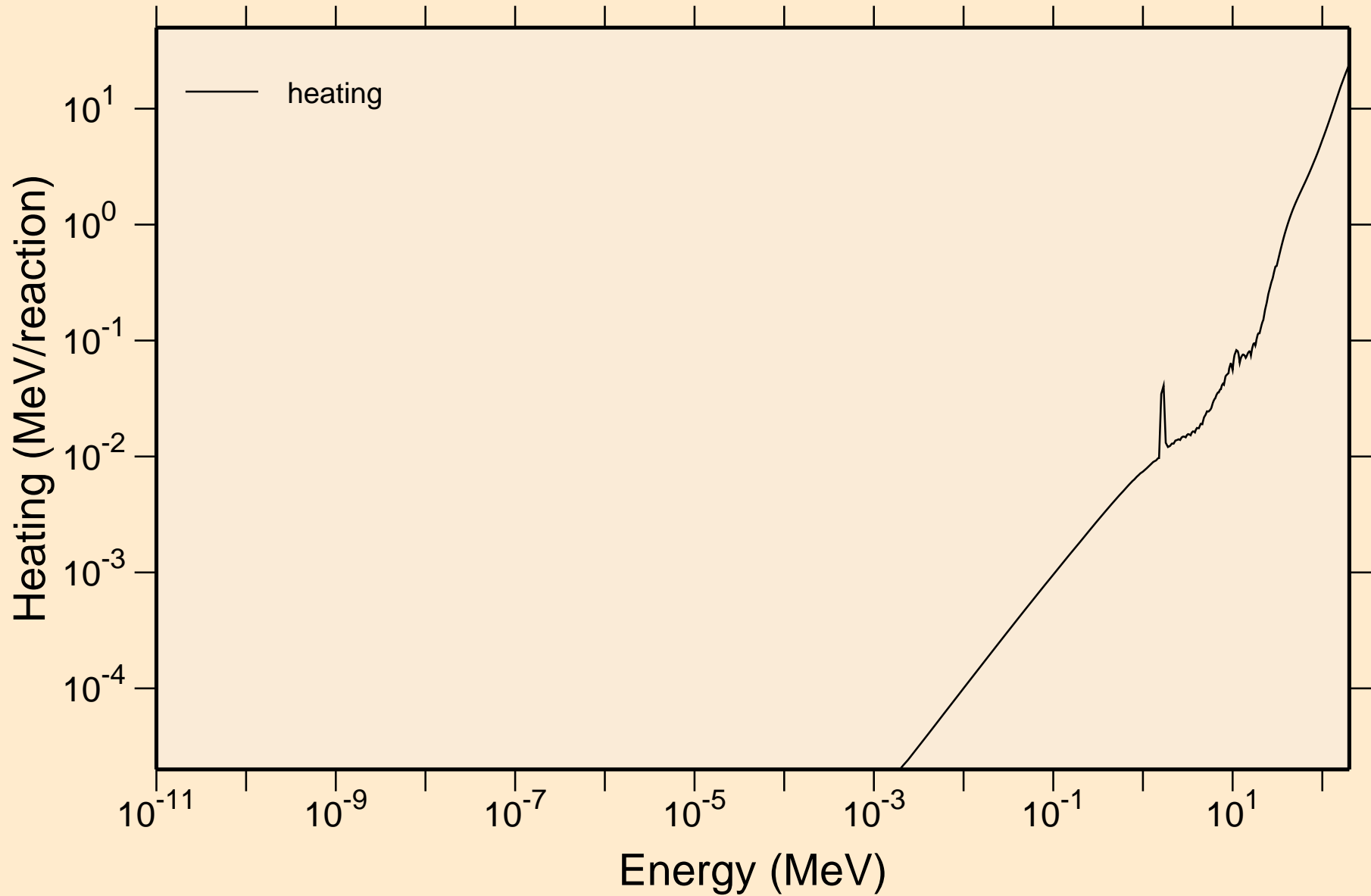

# OS195 NEUTRON ACER TENDL-2021 LIBRARY; T=293.6K

## Damage

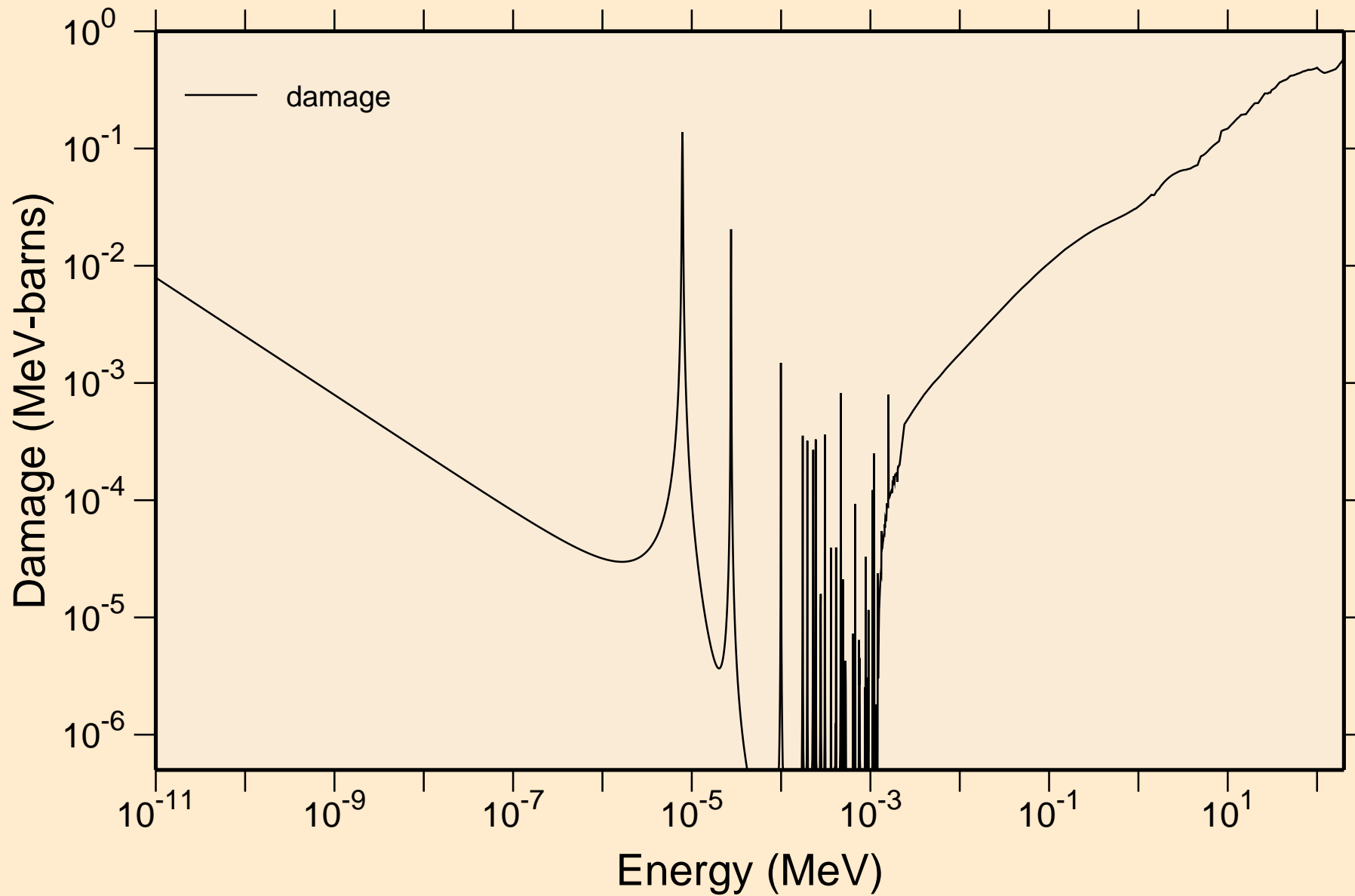

OS195 NEUTRON ACER TENDL-2021 LIBRARY; T=293.6K  
Non-threshold reactions

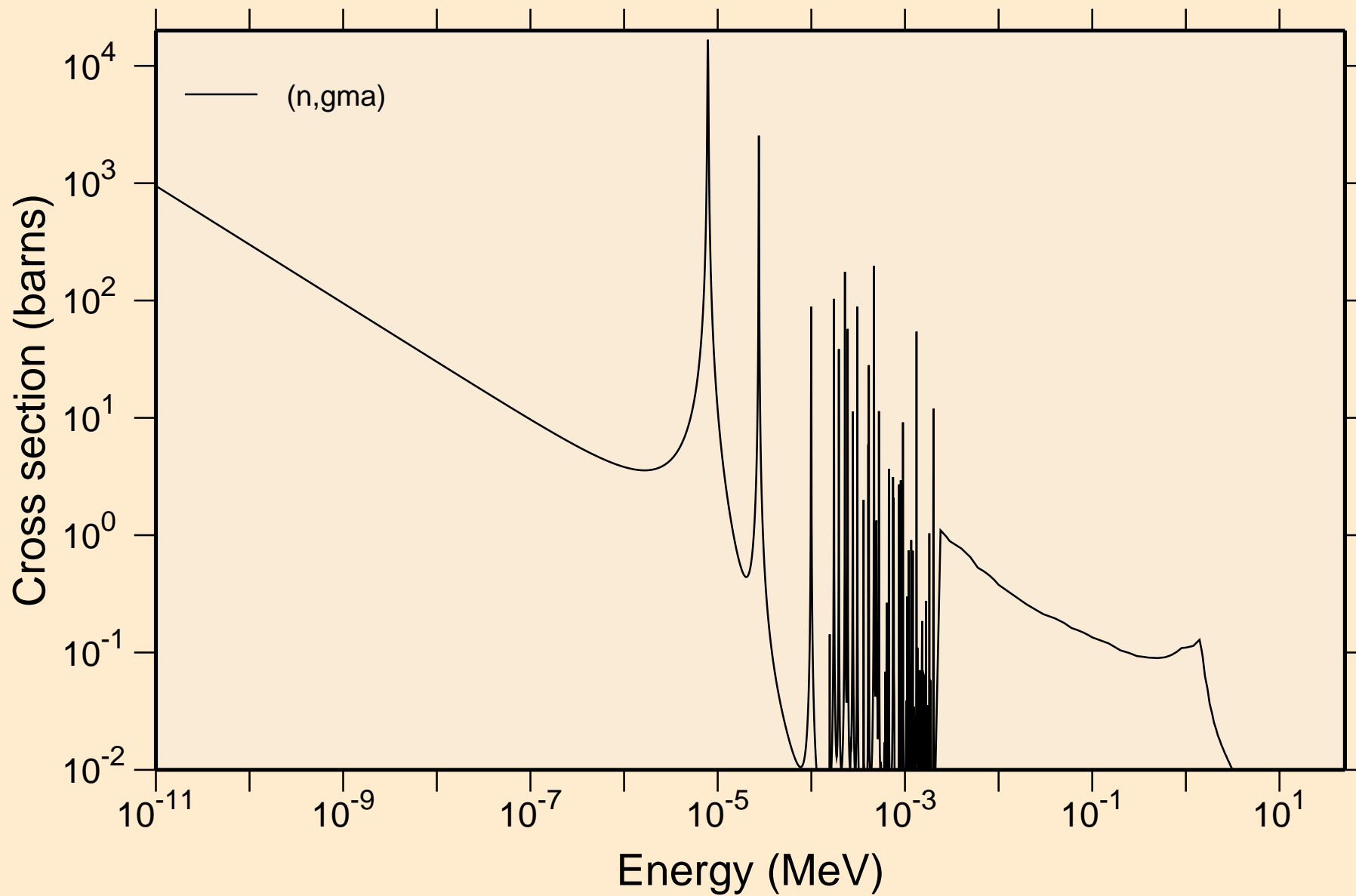

# OS195 NEUTRON ACER TENDL-2021 LIBRARY; T=293.6K

## Principal cross sections

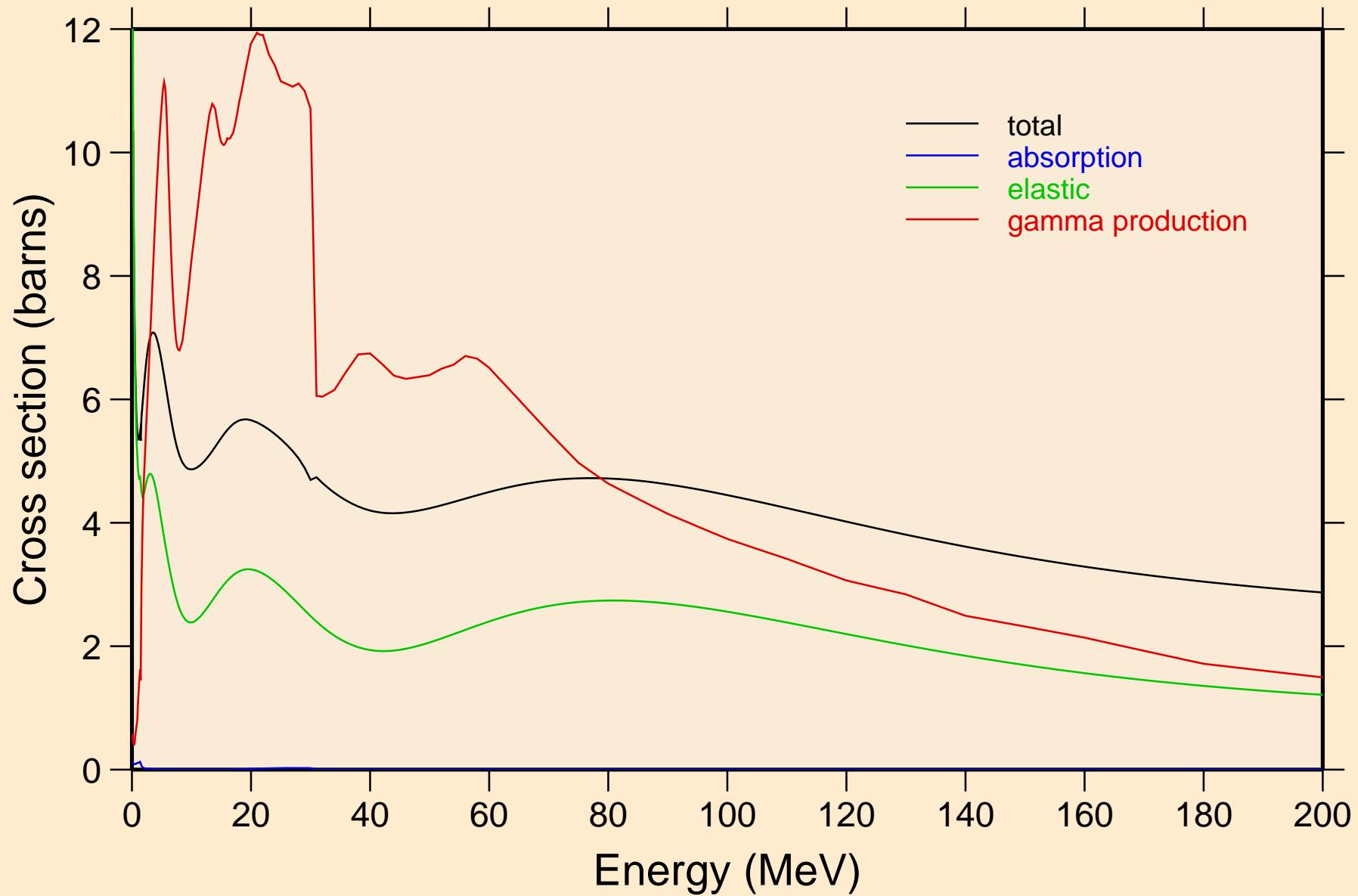

OS195 NEUTRON ACER TENDL-2021 LIBRARY; T=293.6K  
Heating

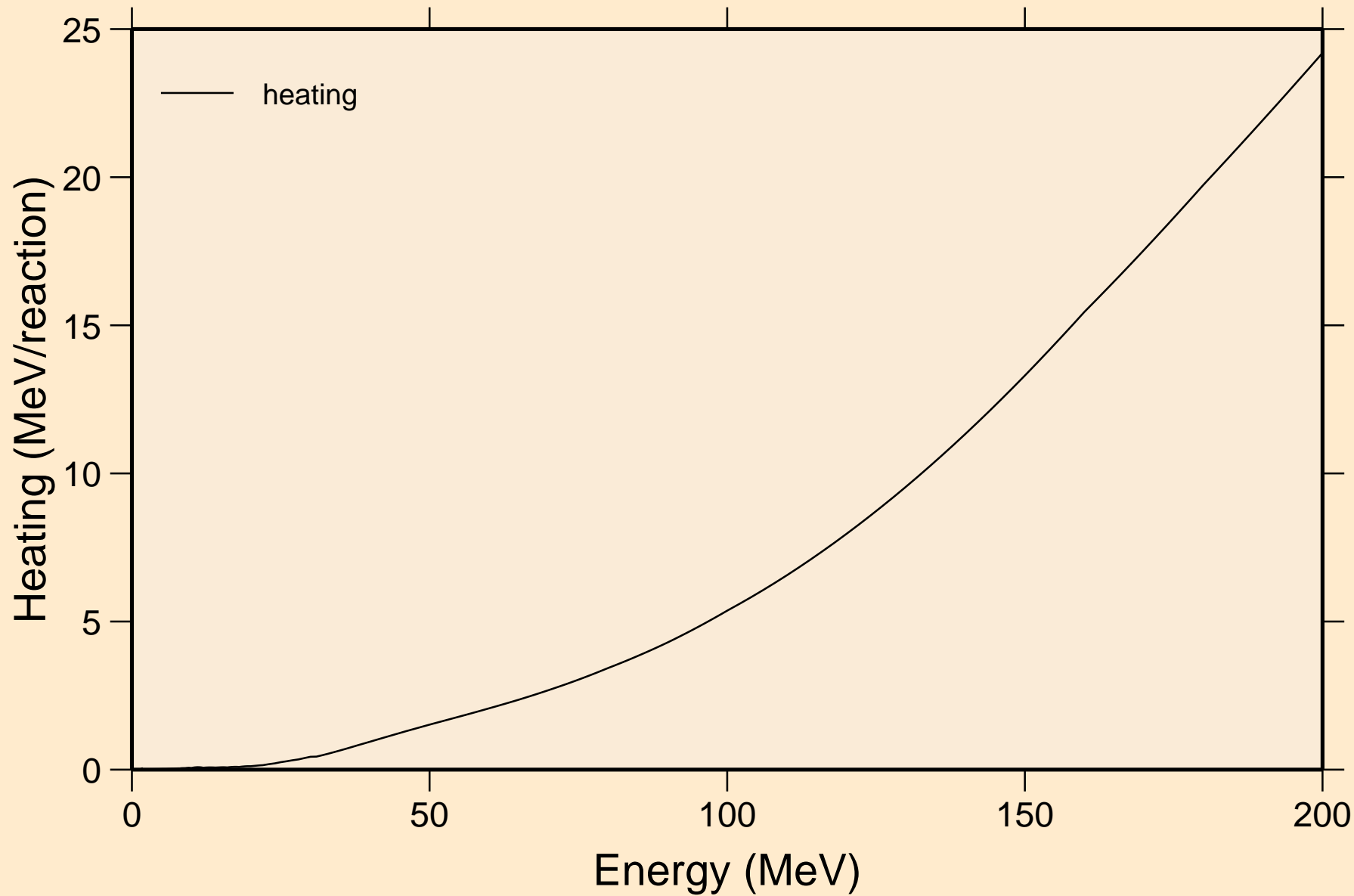



OS195 NEUTRON ACER TENDL-2021 LIBRARY; T=293.6K  
Damage

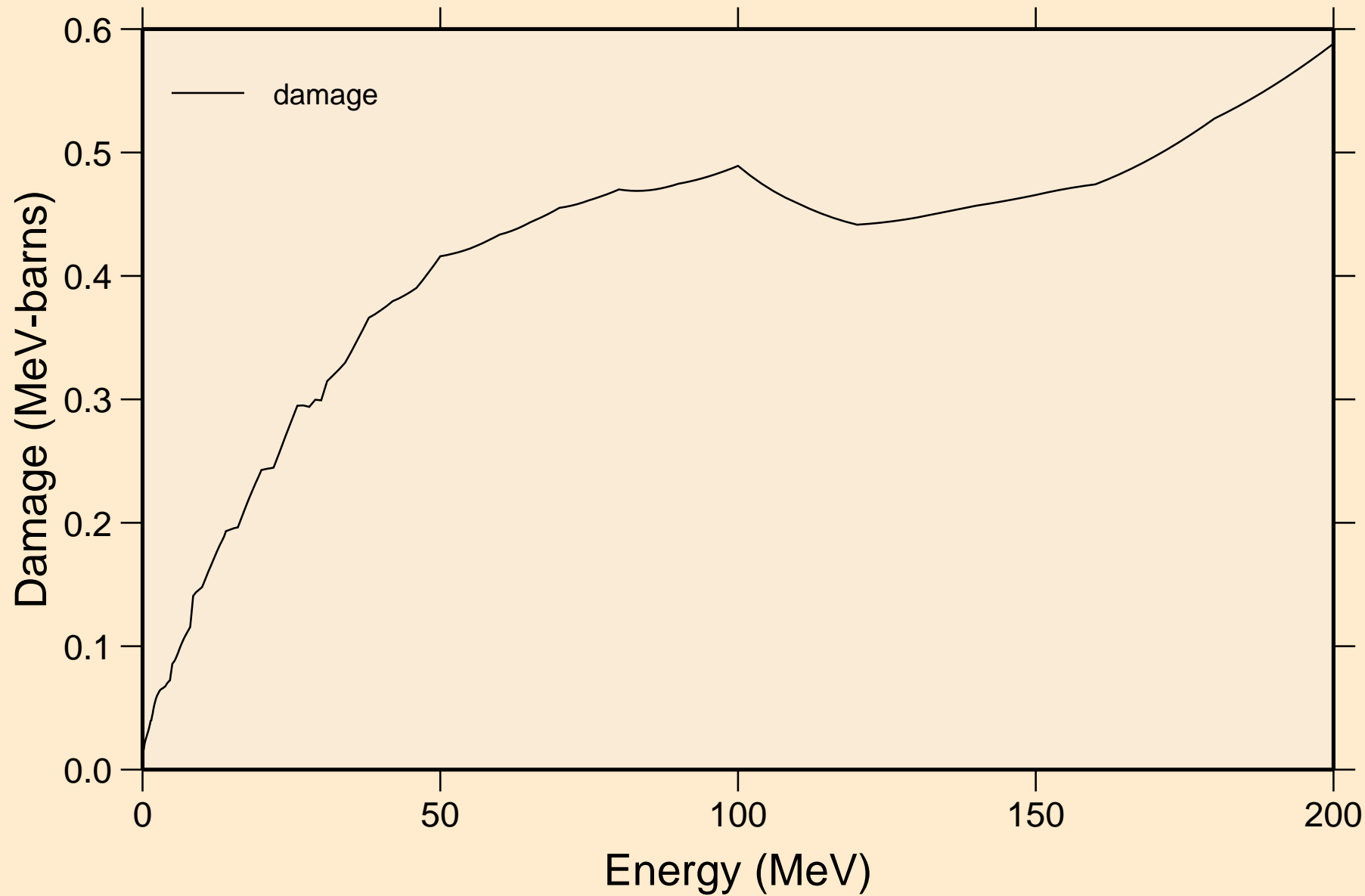

OS195 NEUTRON ACER TENDL-2021 LIBRARY; T=293.6K  
Non-threshold reactions

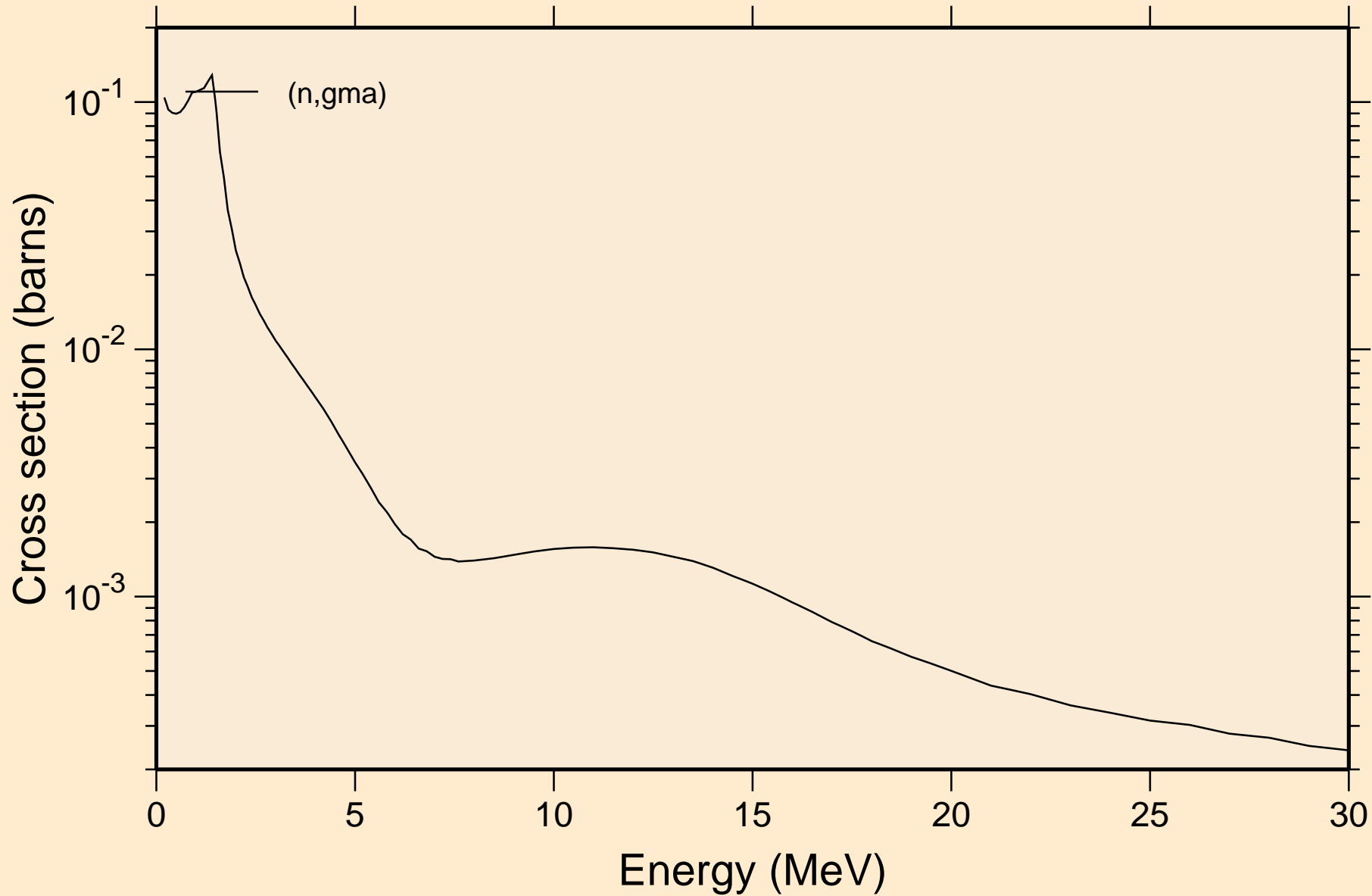

OS195 NEUTRON ACER TENDL-2021 LIBRARY; T=293.6K  
Inelastic levels

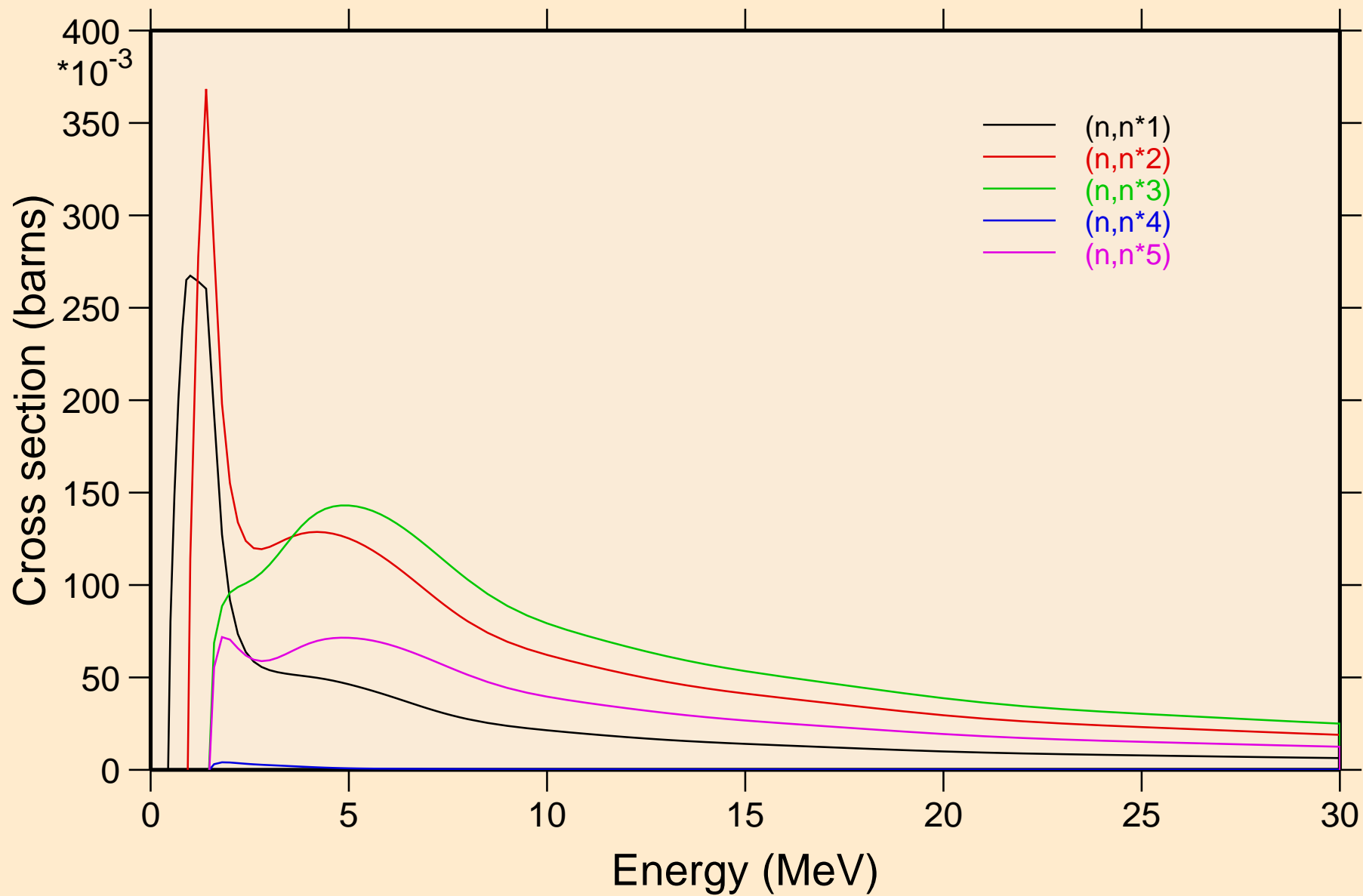

OS195 NEUTRON ACER TENDL-2021 LIBRARY; T=293.6K  
Inelastic levels

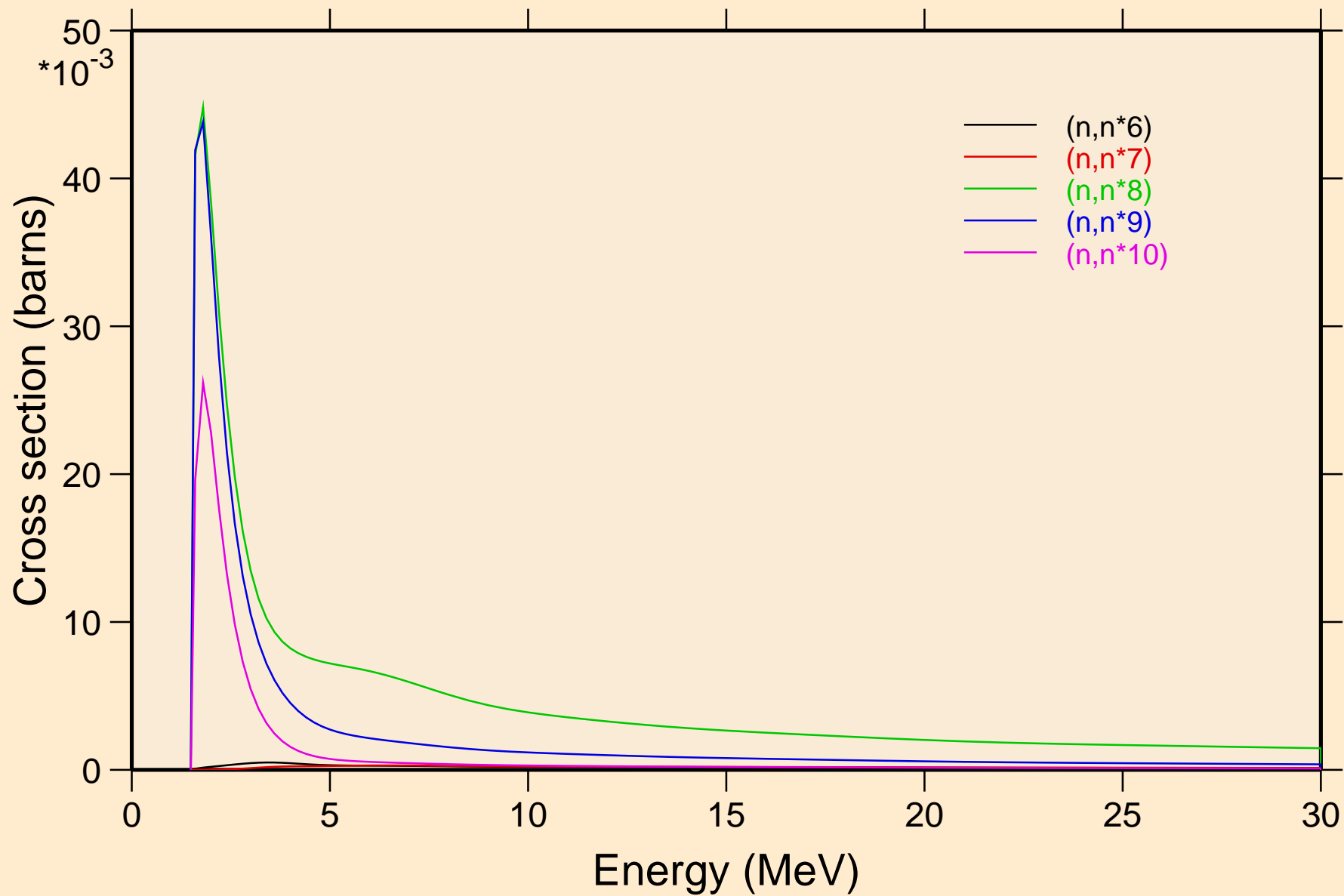

OS195 NEUTRON ACER TENDL-2021 LIBRARY; T=293.6K  
Inelastic levels

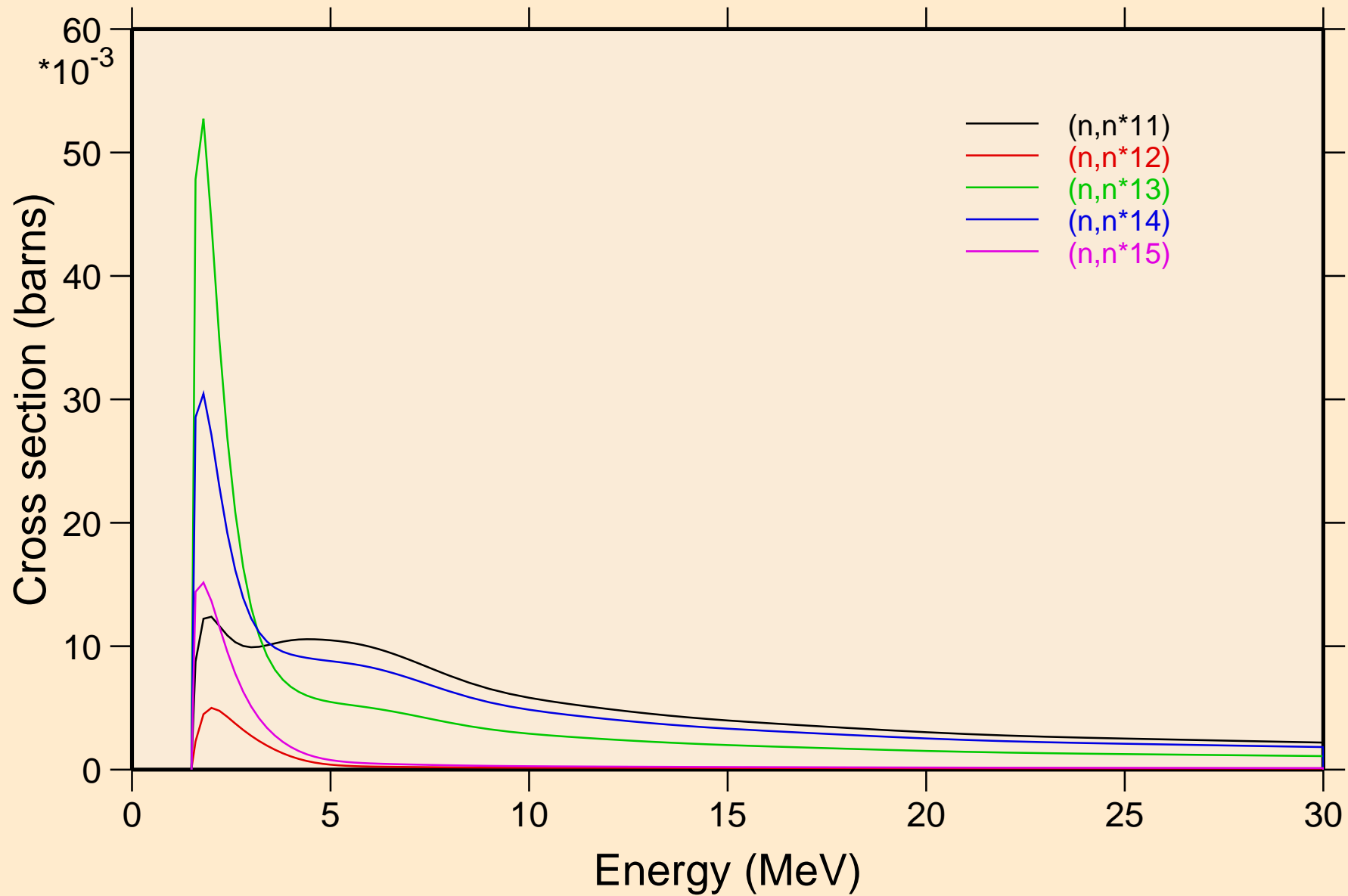

OS195 NEUTRON ACER TENDL-2021 LIBRARY; T=293.6K  
Inelastic levels

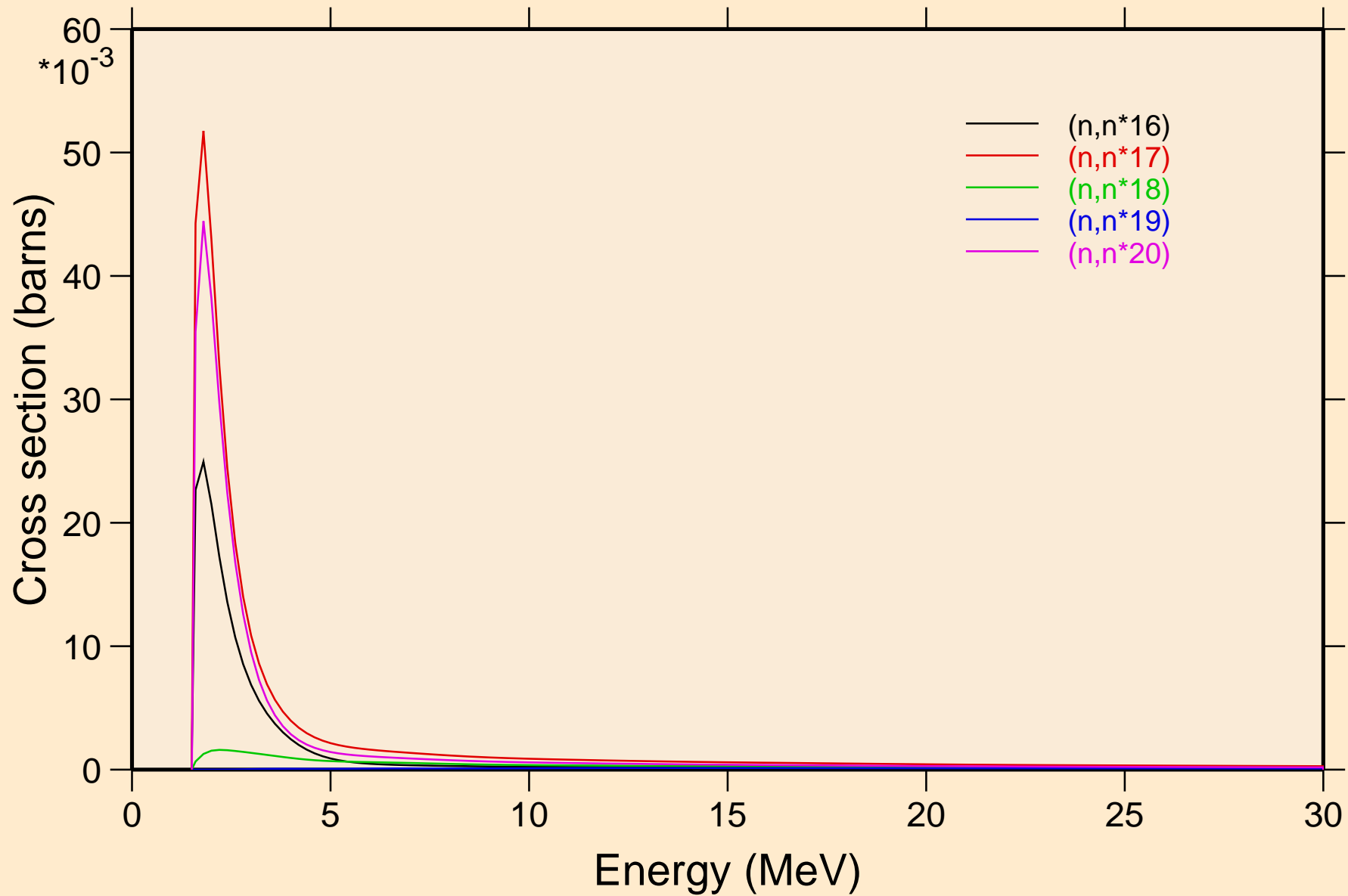

OS195 NEUTRON ACER TENDL-2021 LIBRARY; T=293.6K  
Inelastic levels

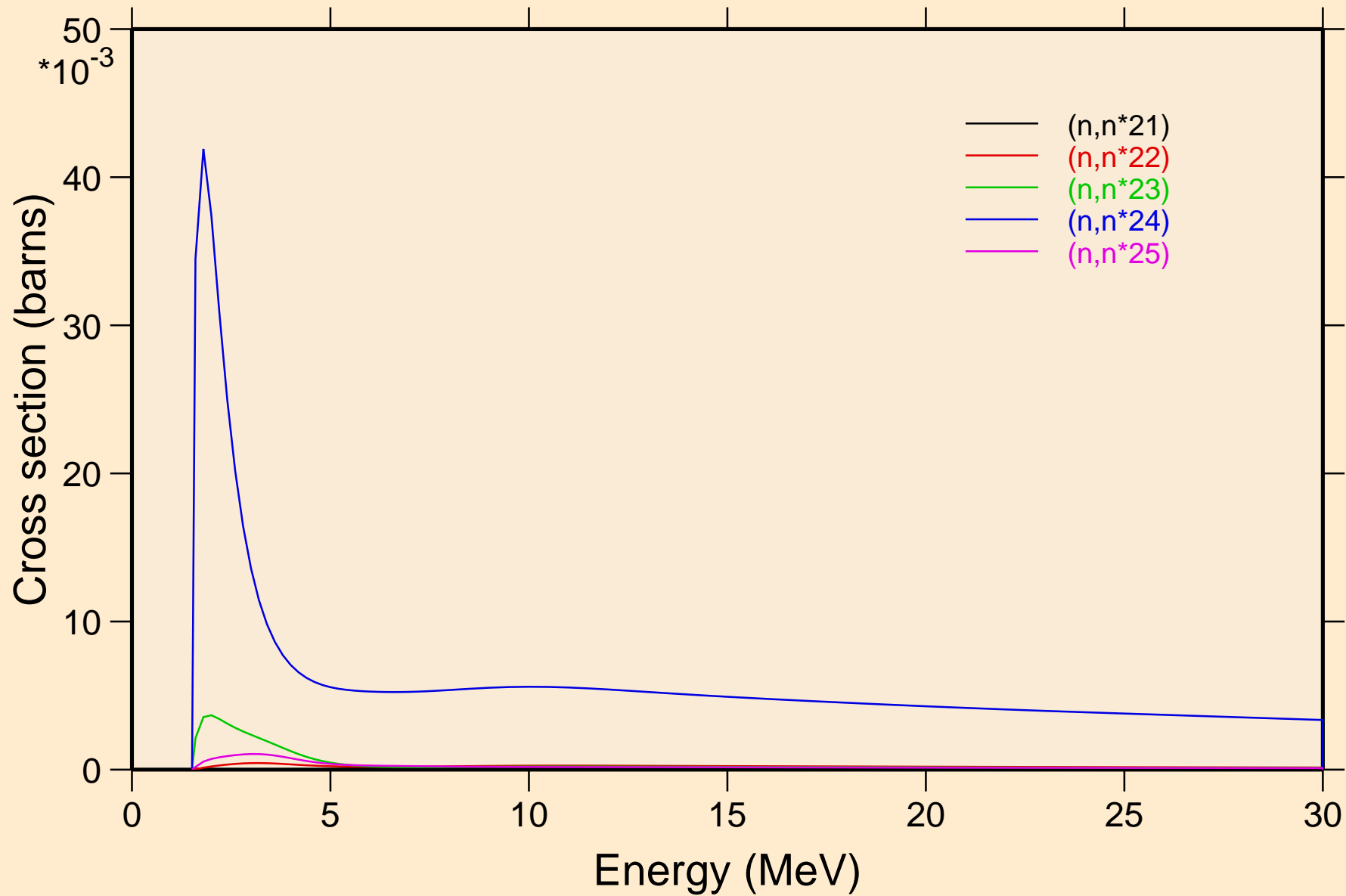

OS195 NEUTRON ACER TENDL-2021 LIBRARY; T=293.6K  
Inelastic levels

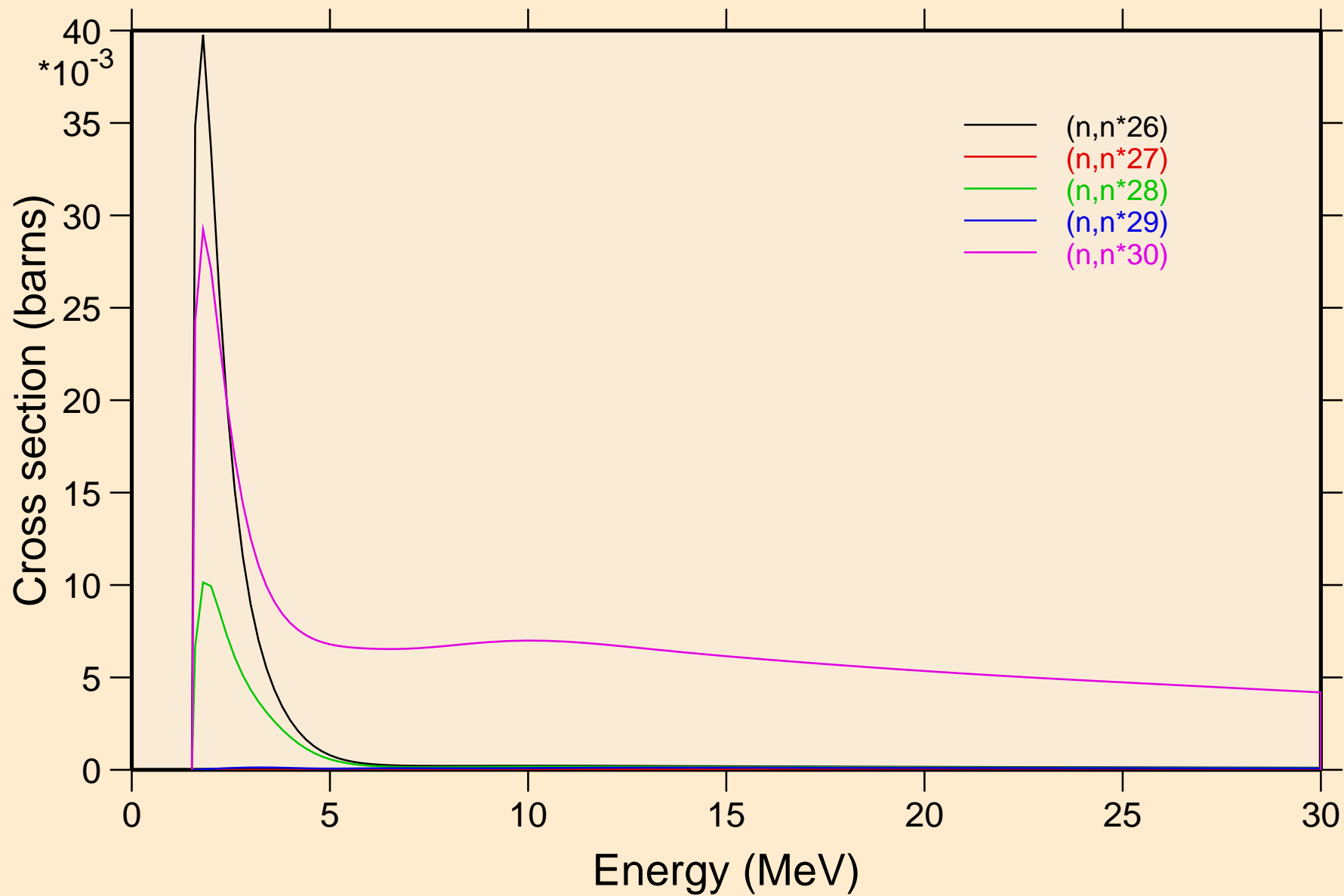



OS195 NEUTRON ACER TENDL-2021 LIBRARY; T=293.6K  
Threshold reactions

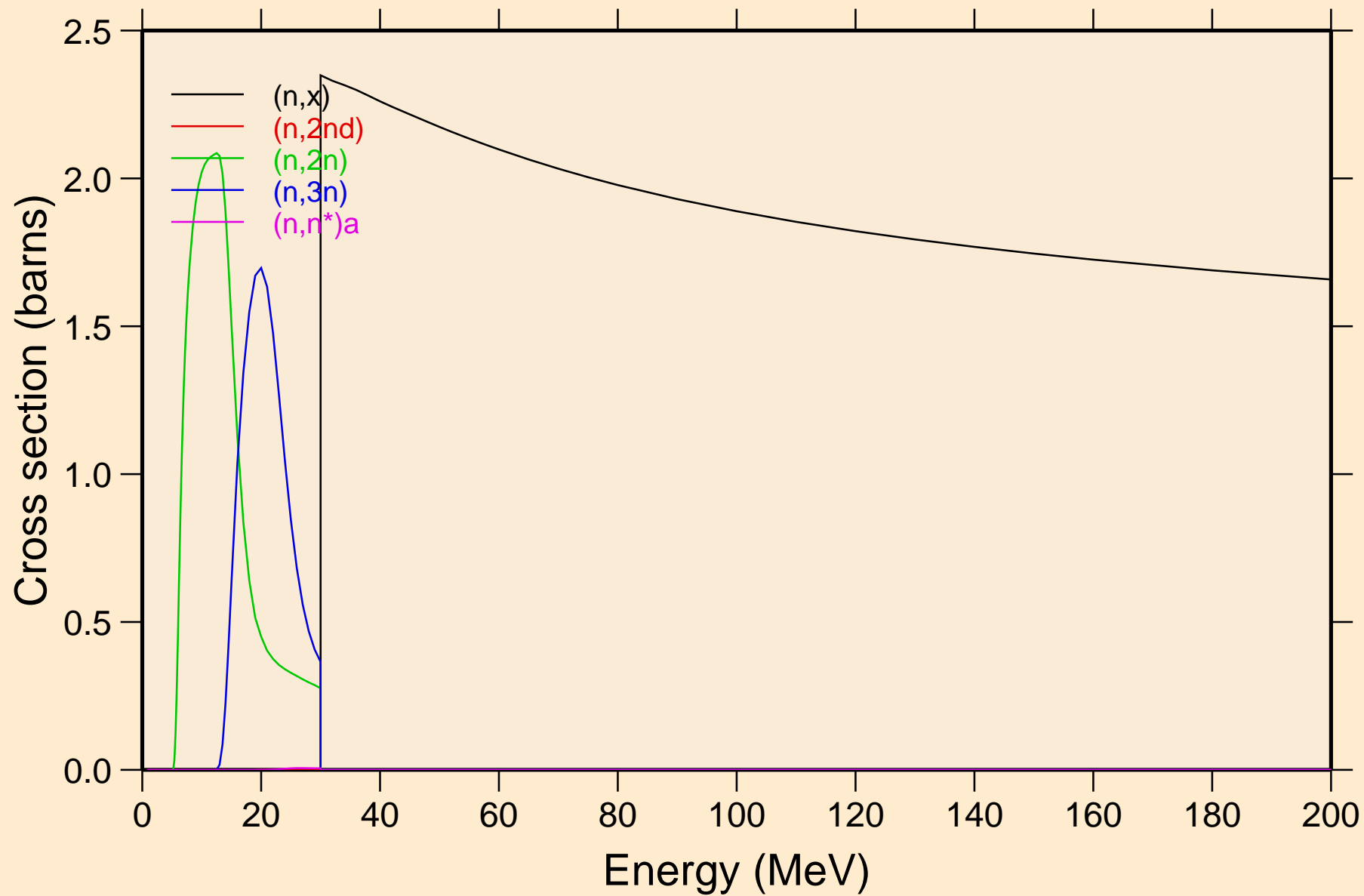

OS195 NEUTRON ACER TENDL-2021 LIBRARY; T=293.6K  
Threshold reactions

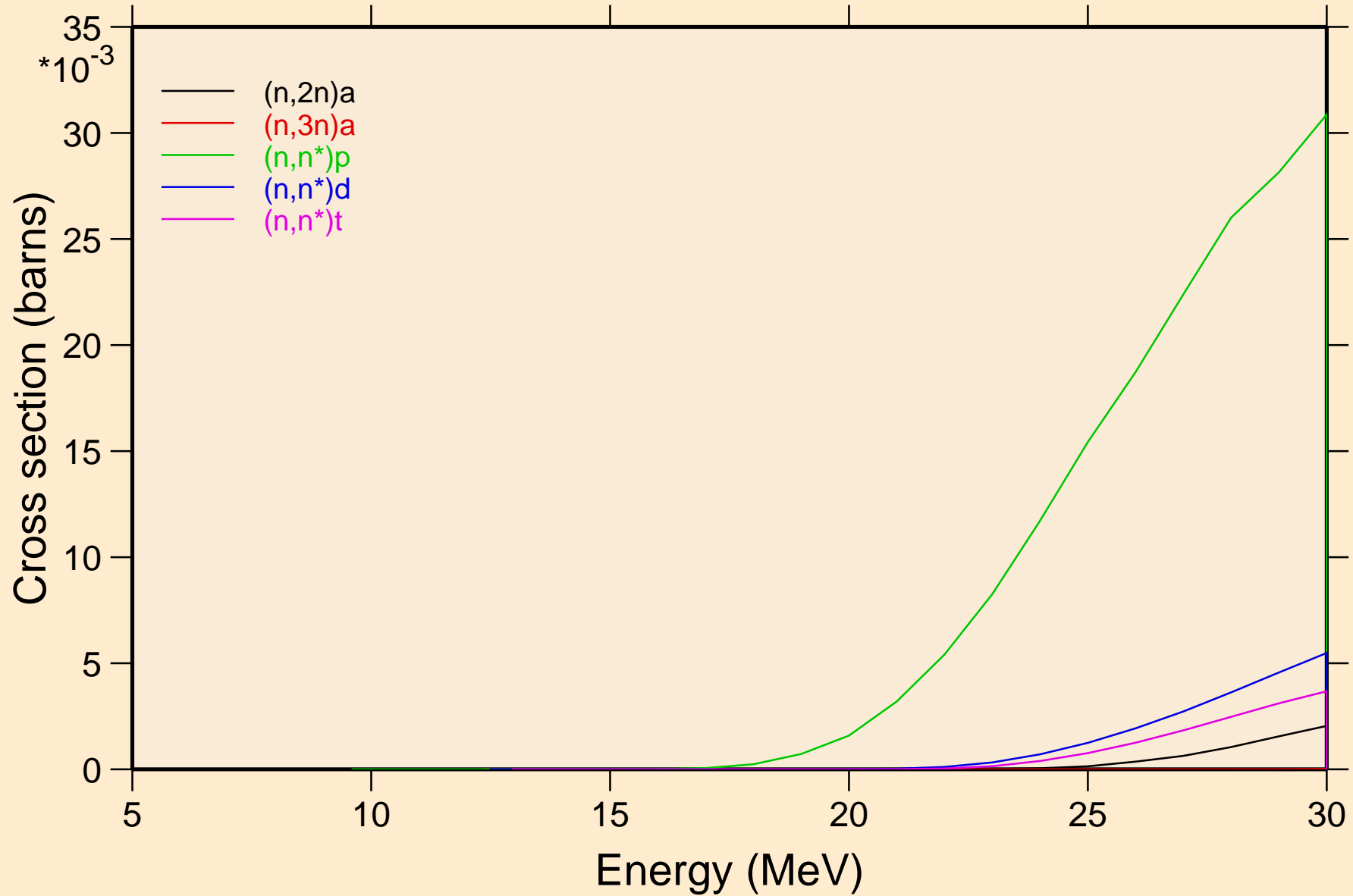

OS195 NEUTRON ACER TENDL-2021 LIBRARY; T=293.6K  
Threshold reactions

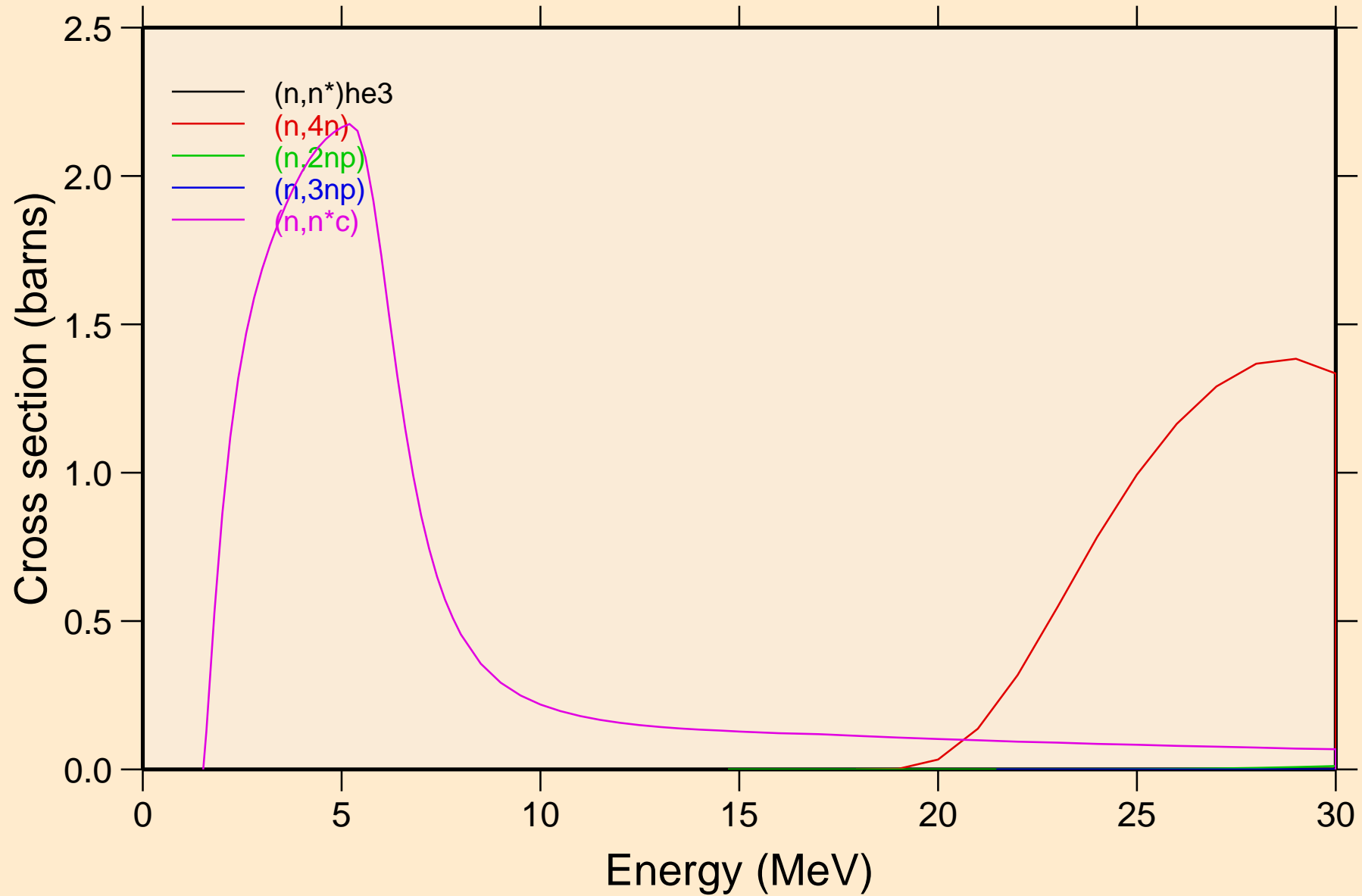

OS195 NEUTRON ACER TENDL-2021 LIBRARY; T=293.6K  
Threshold reactions

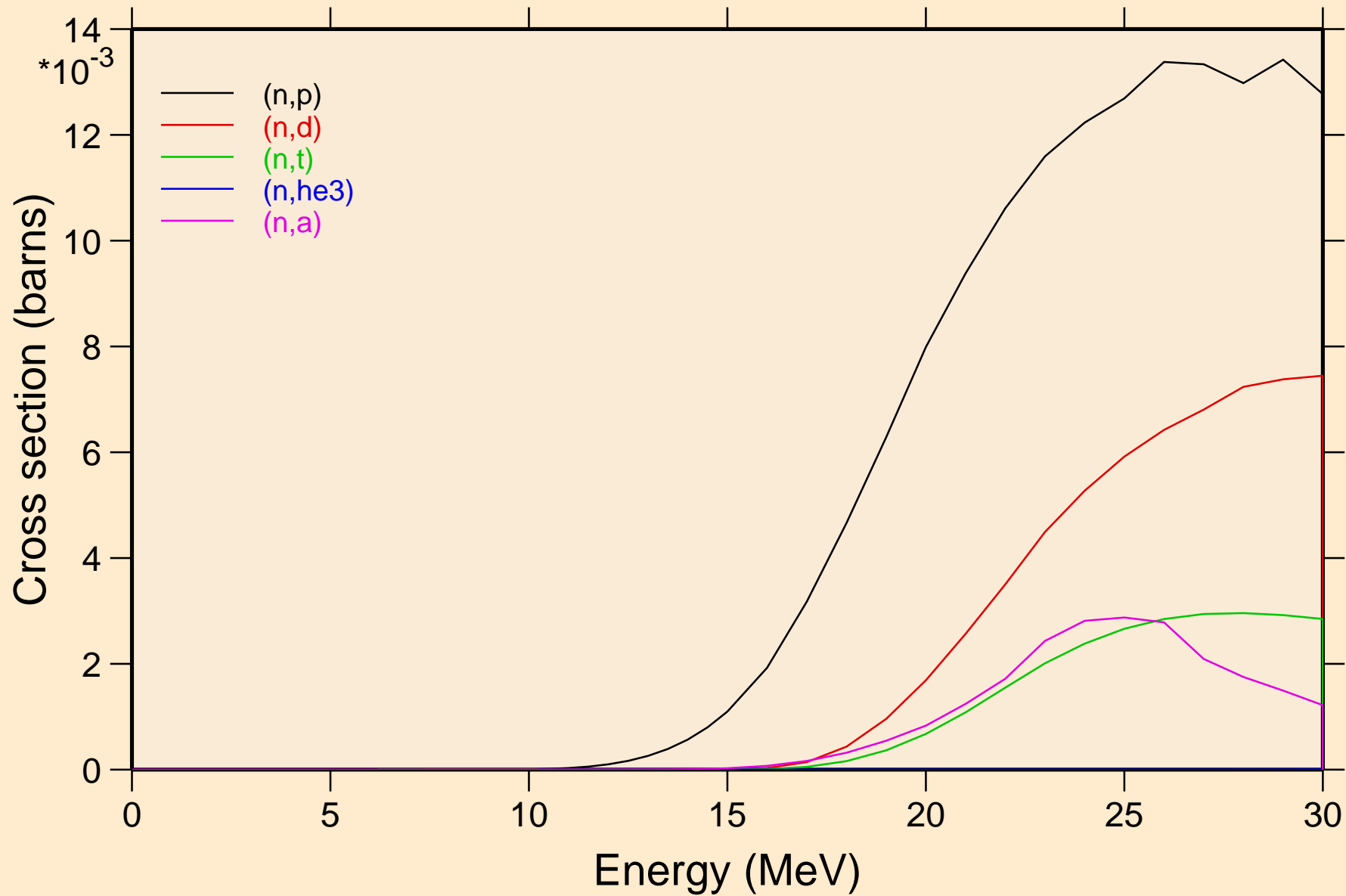

OS195 NEUTRON ACER TENDL-2021 LIBRARY; T=293.6K  
Threshold reactions

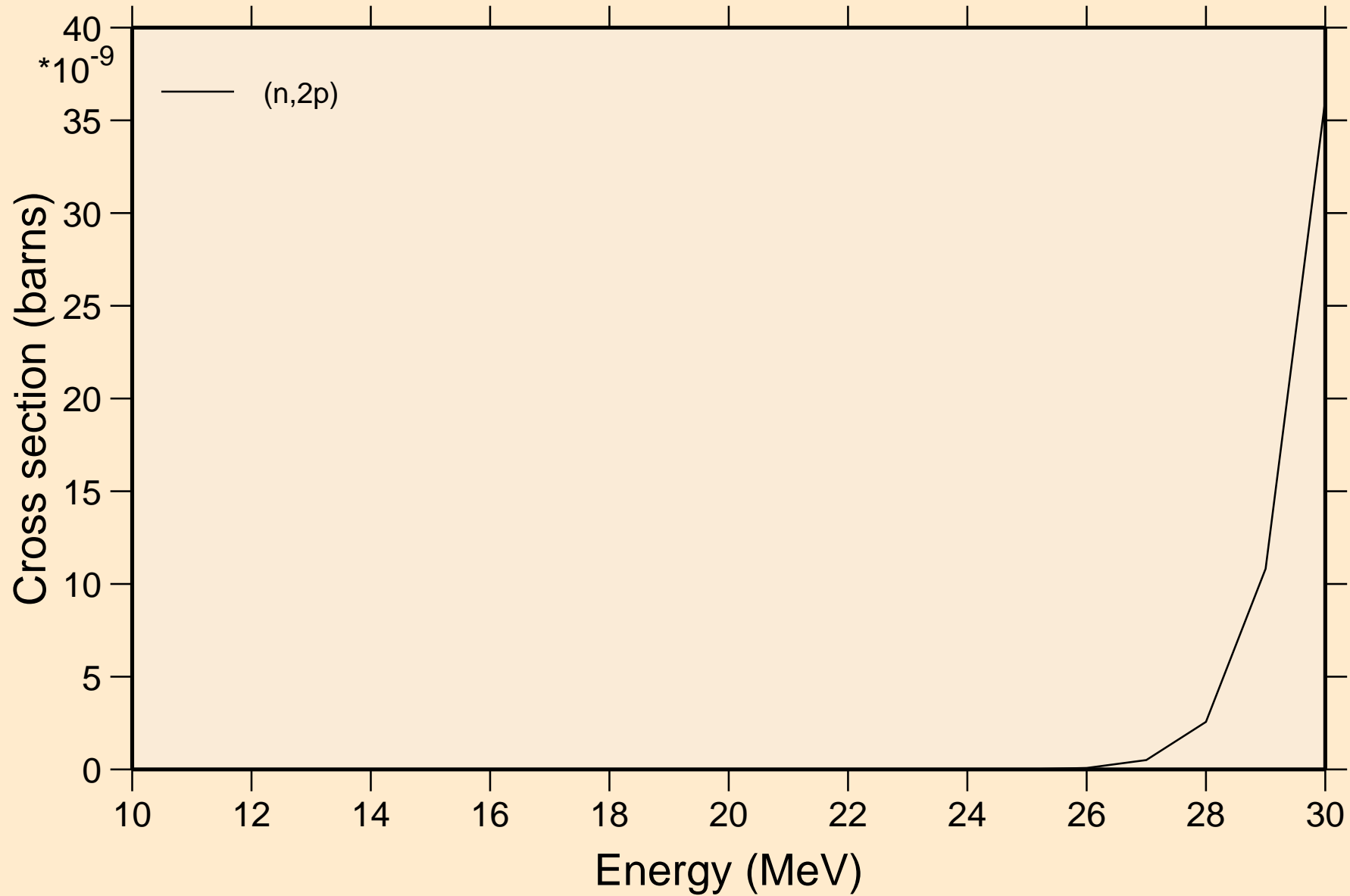

OS195 NEUTRON ACER TENDL-2021 LIBRARY; T=293.6K  
Threshold reactions

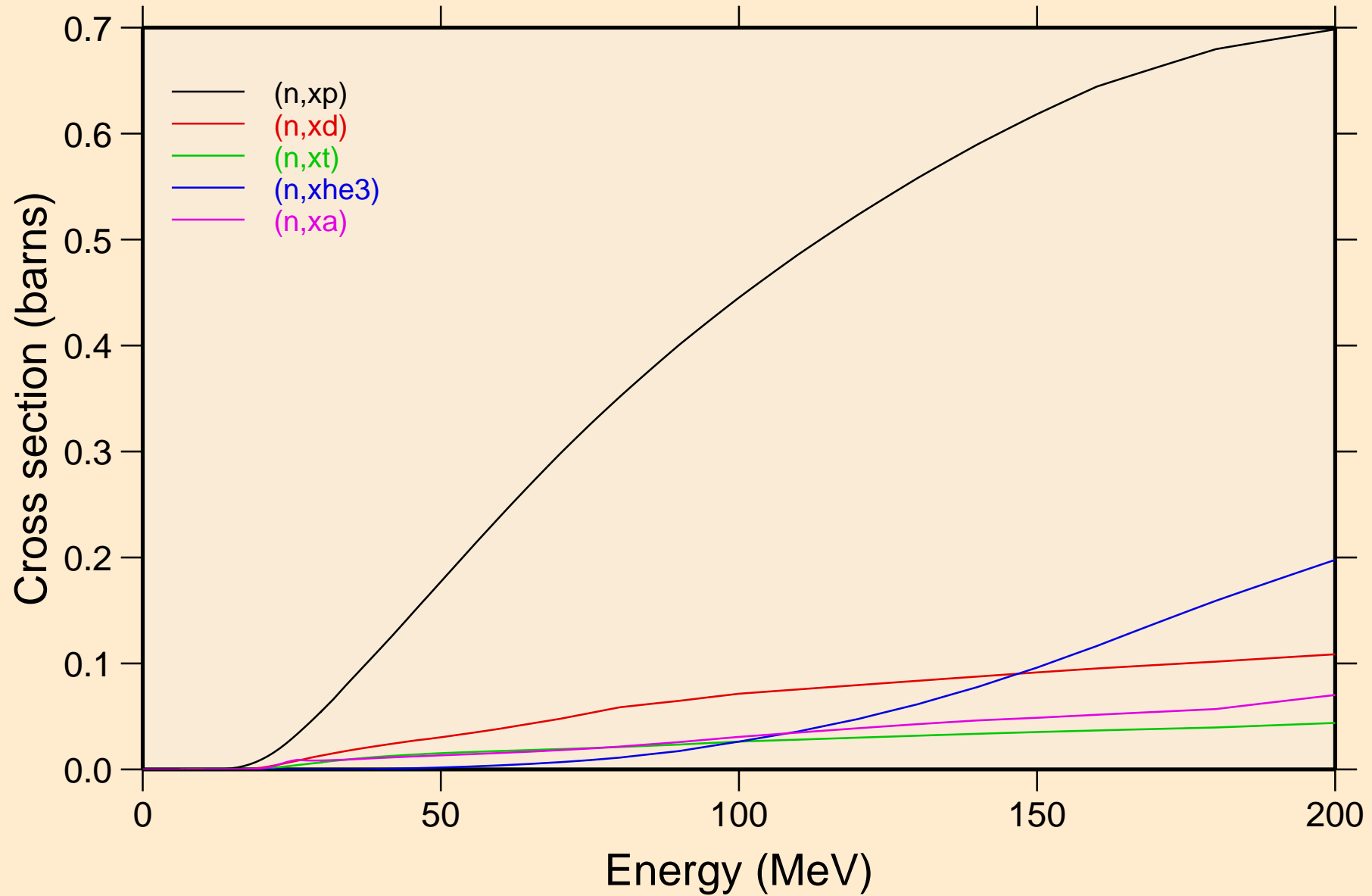

OS195 NEUTRON ACER TENDL-2021 LIBRARY; T=293.6K  
angular distribution for elastic

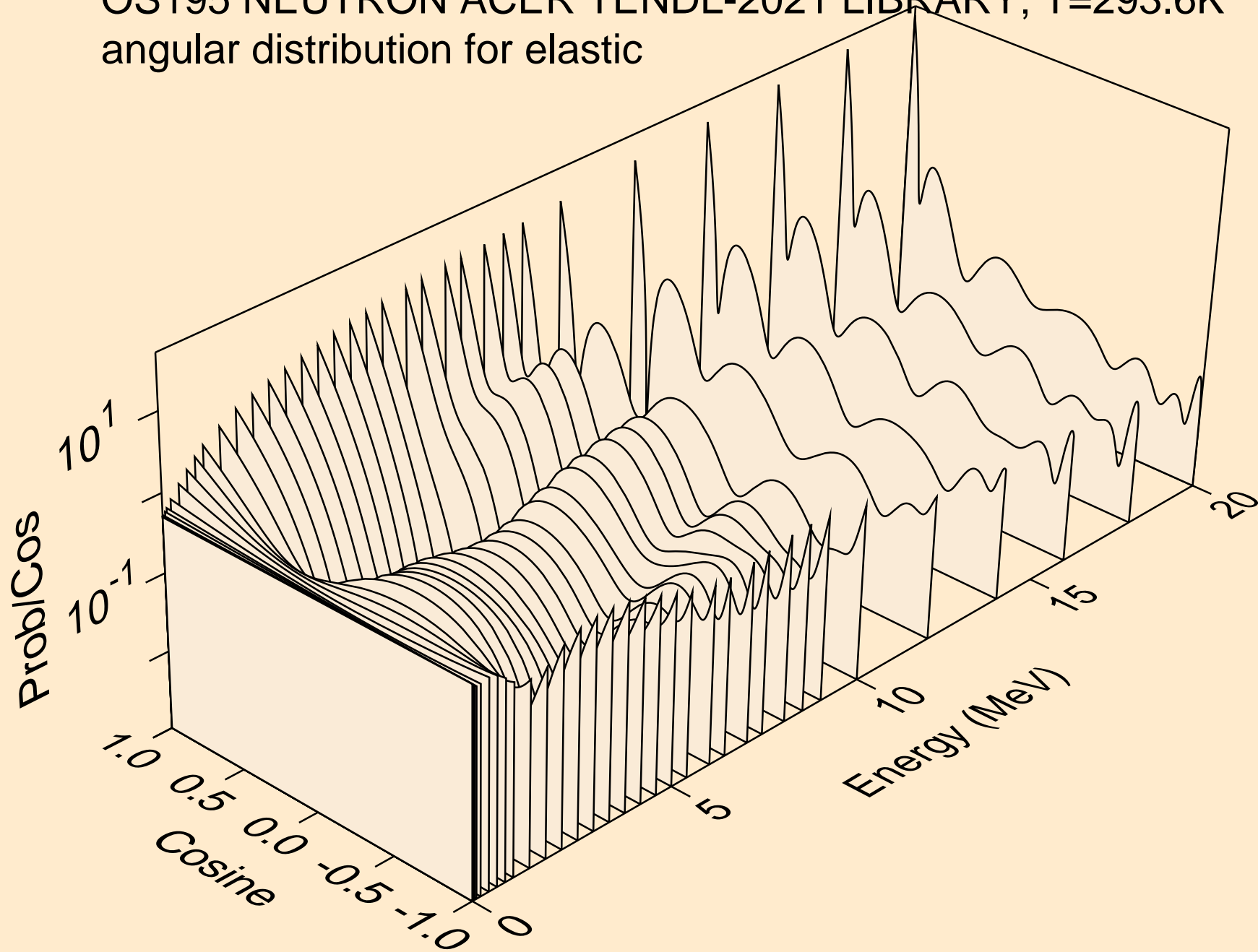

OS195 NEUTRON ACER TENDL-2021 LIBRARY; T=293.6K  
angular distribution for elastic

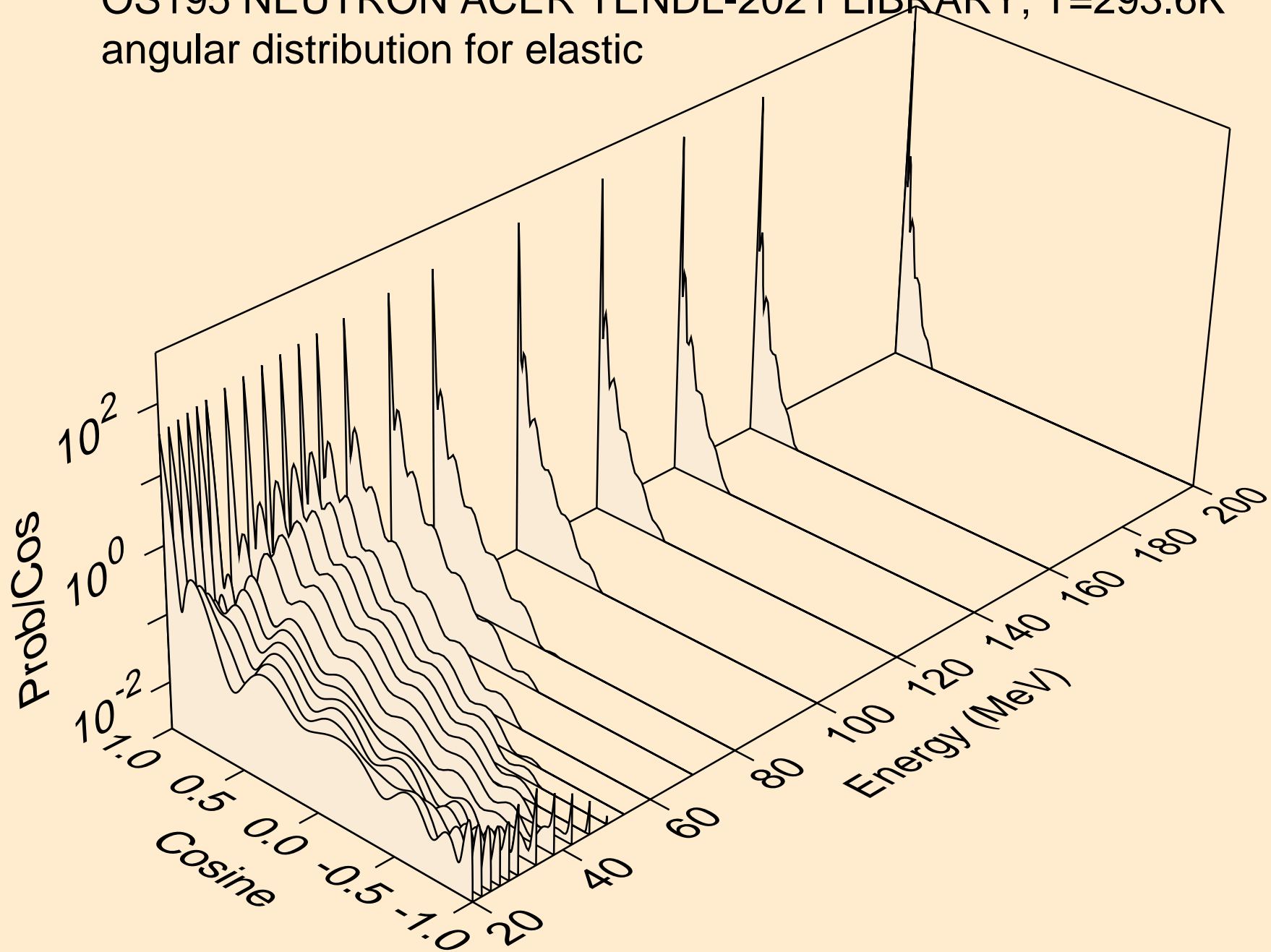



OS195 NEUTRON ACER TENDL-2021 LIBRARY; T=293.6K  
angular distribution for (n,n\*1)

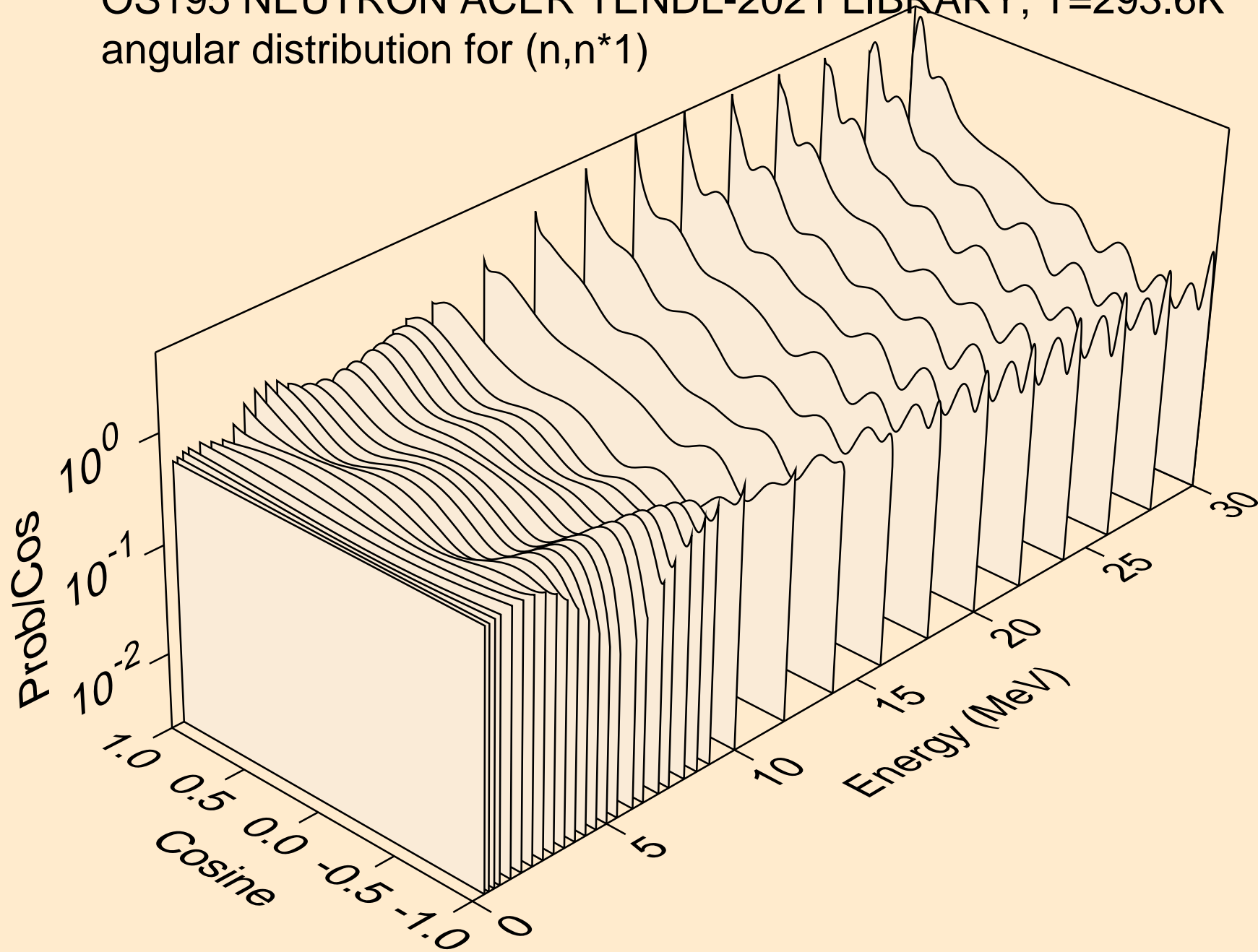

OS195 NEUTRON ACER TENDL-2021 LIBRARY; T=293.6K  
angular distribution for (n,n\*2)

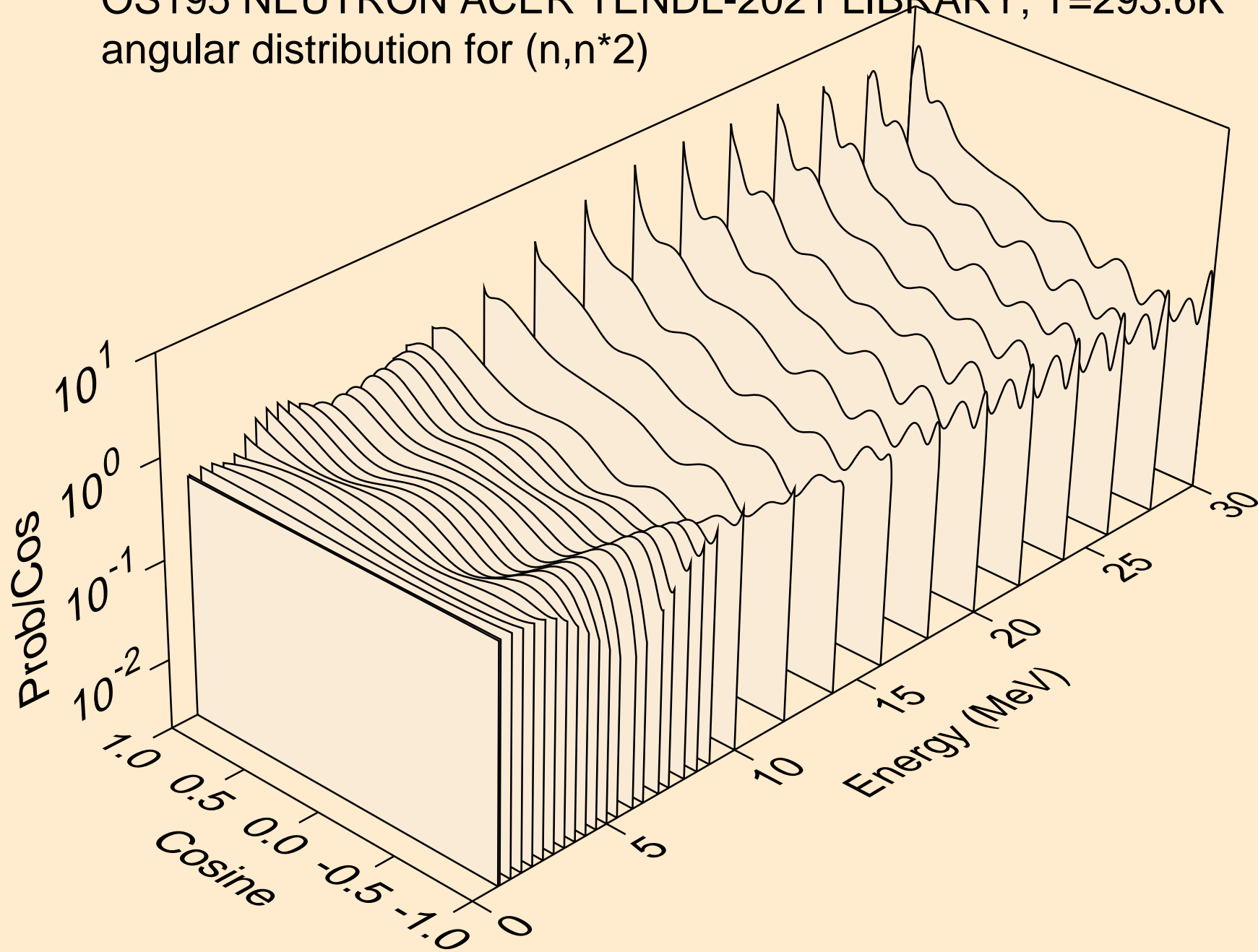

OS195 NEUTRON ACER TENDL-2021 LIBRARY; T=293.6K  
angular distribution for (n,n\*3)

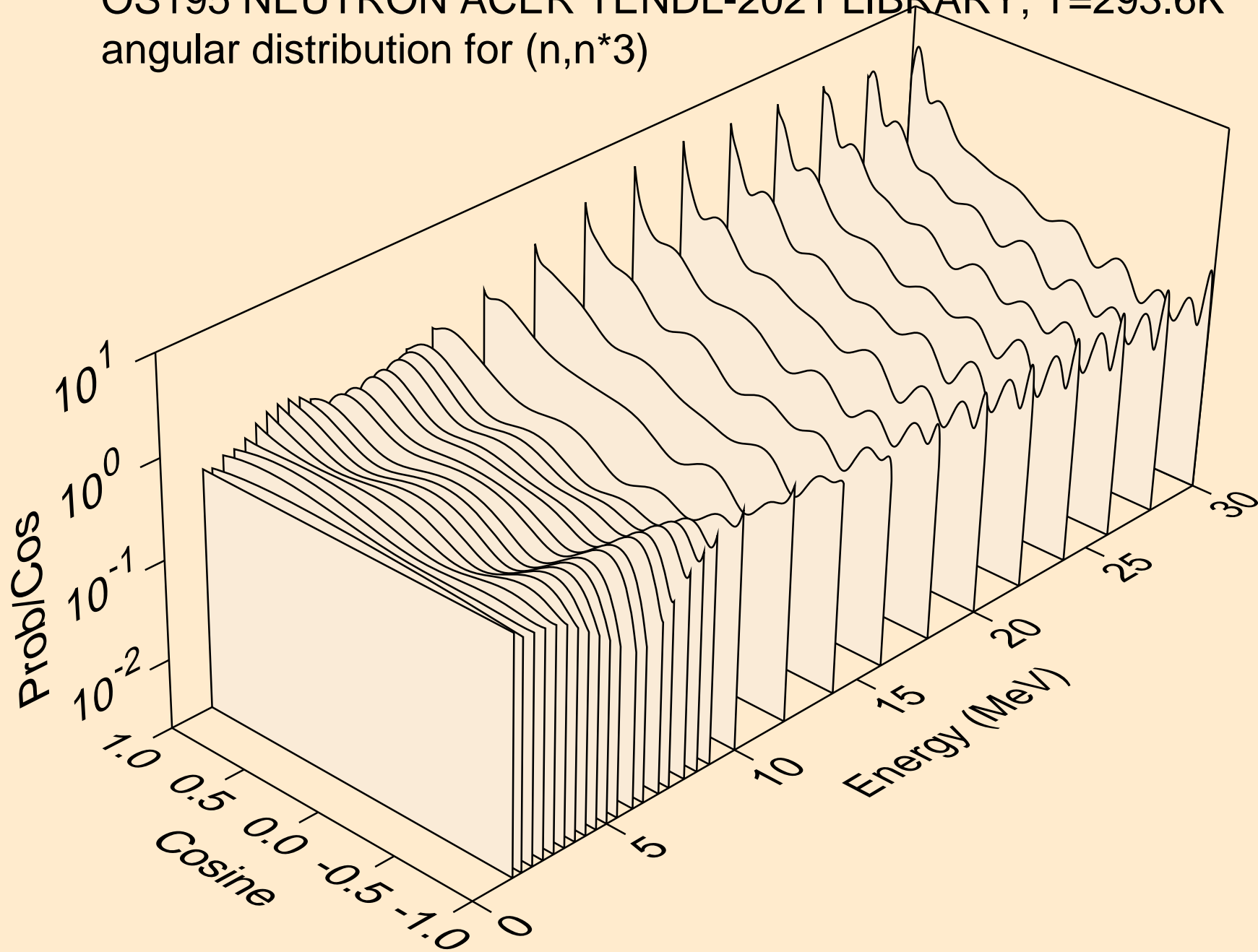

OS195 NEUTRON ACER TENDL-2021 LIBRARY; T=293.6K  
angular distribution for (n,n\*4)

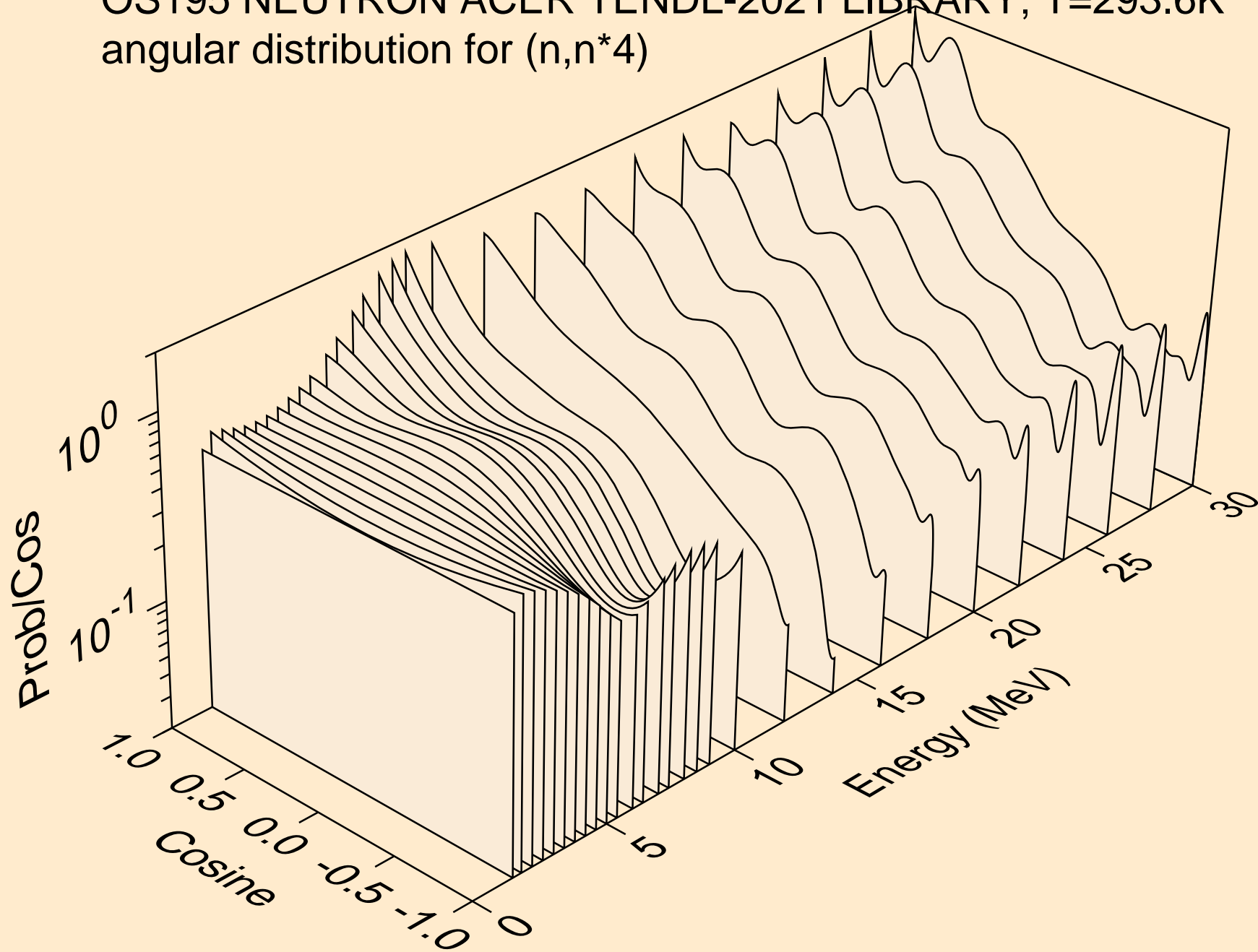

OS195 NEUTRON ACER TENDL-2021 LIBRARY; T=293.6K  
angular distribution for (n,n\*5)

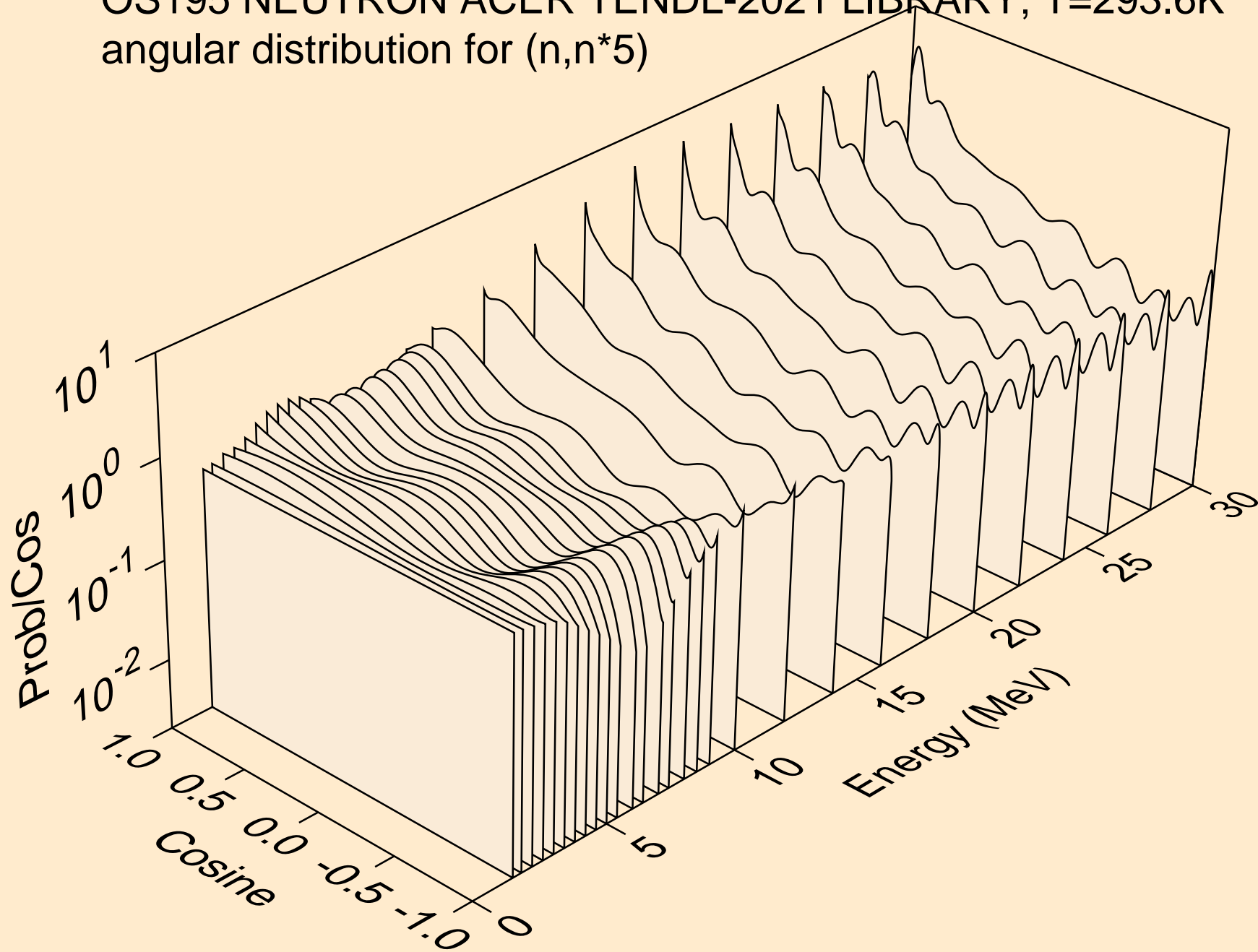

OS195 NEUTRON ACER TENDL-2021 LIBRARY; T=293.6K  
angular distribution for (n,n\*6)

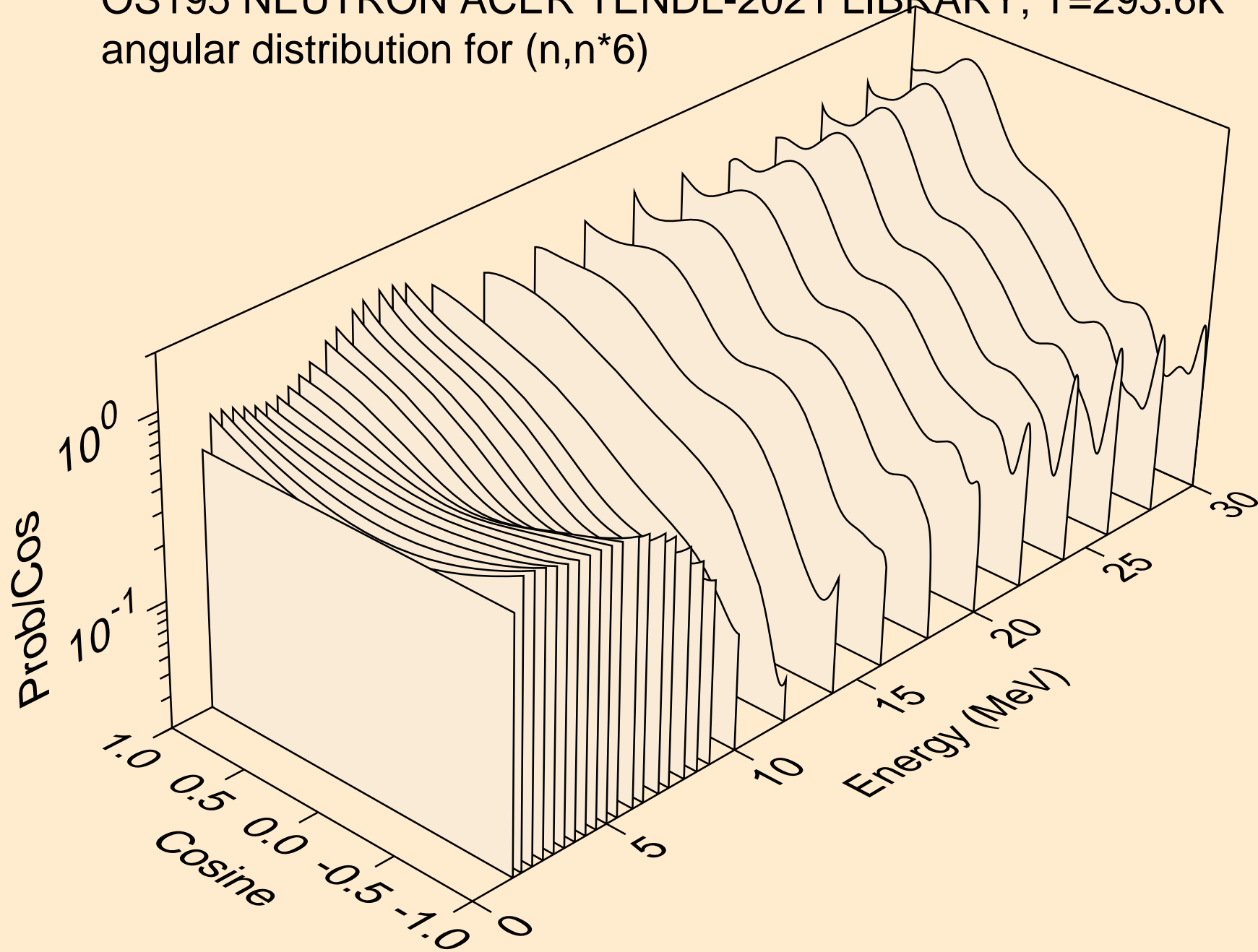

OS195 NEUTRON ACER TENDL-2021 LIBRARY; T=293.6K  
angular distribution for (n,n\*7)

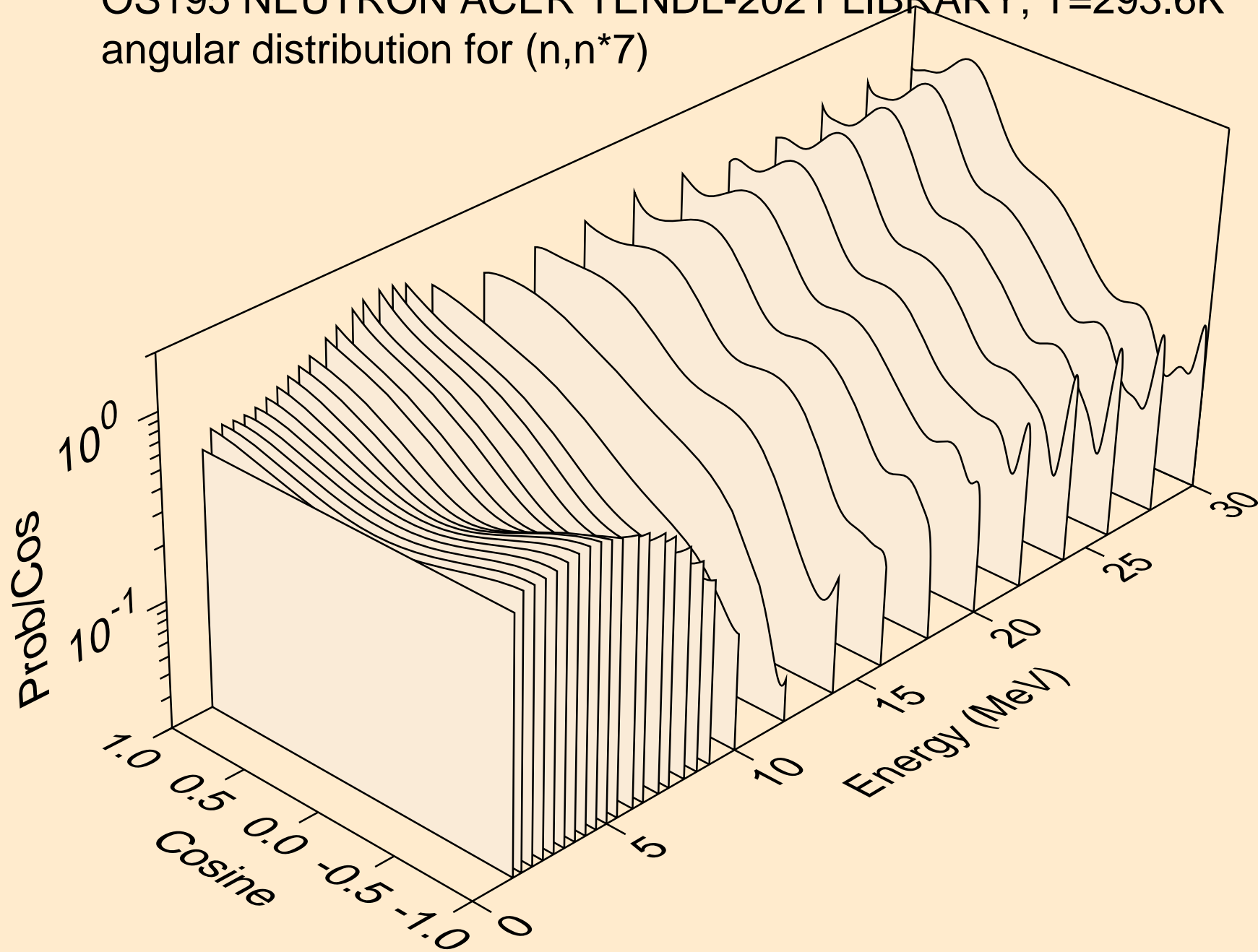

OS195 NEUTRON ACER TENDL-2021 LIBRARY; T=293.6K  
angular distribution for (n,n\*8)

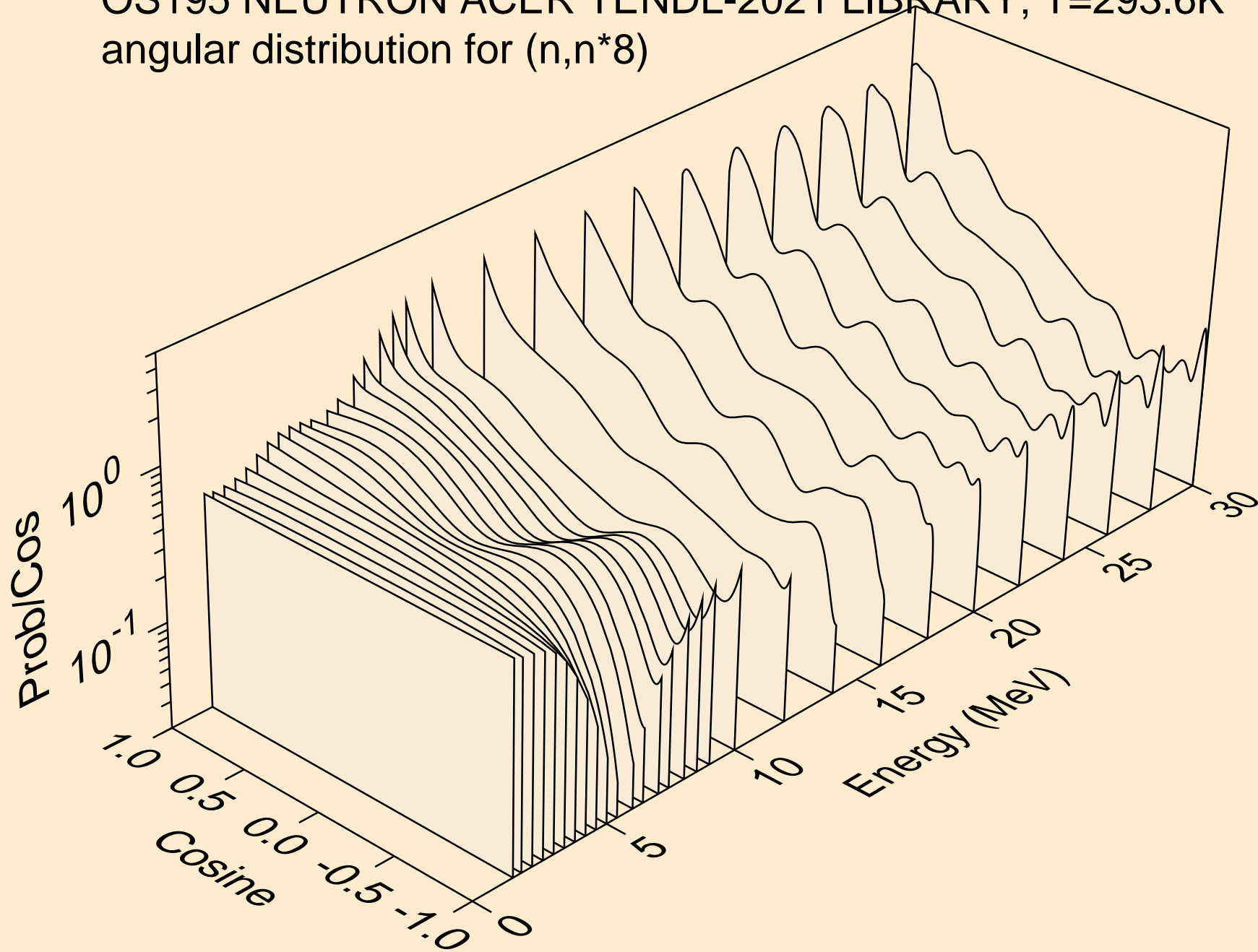



OS195 NEUTRON ACER TENDL-2021 LIBRARY; T=293.6K  
angular distribution for (n,n\*9)

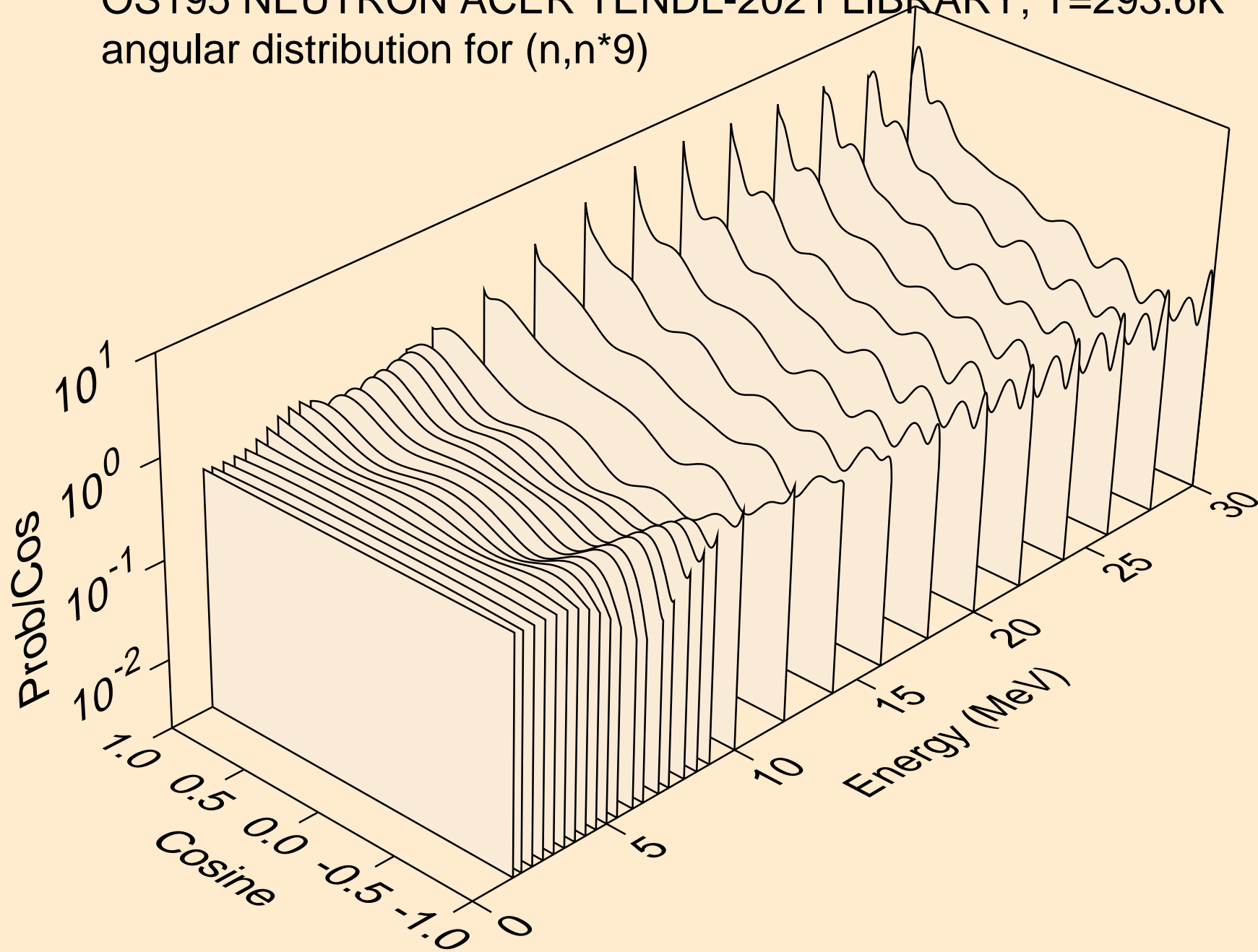

OS195 NEUTRON ACER TENDL-2021 LIBRARY; T=293.6K  
angular distribution for (n,n\*10)

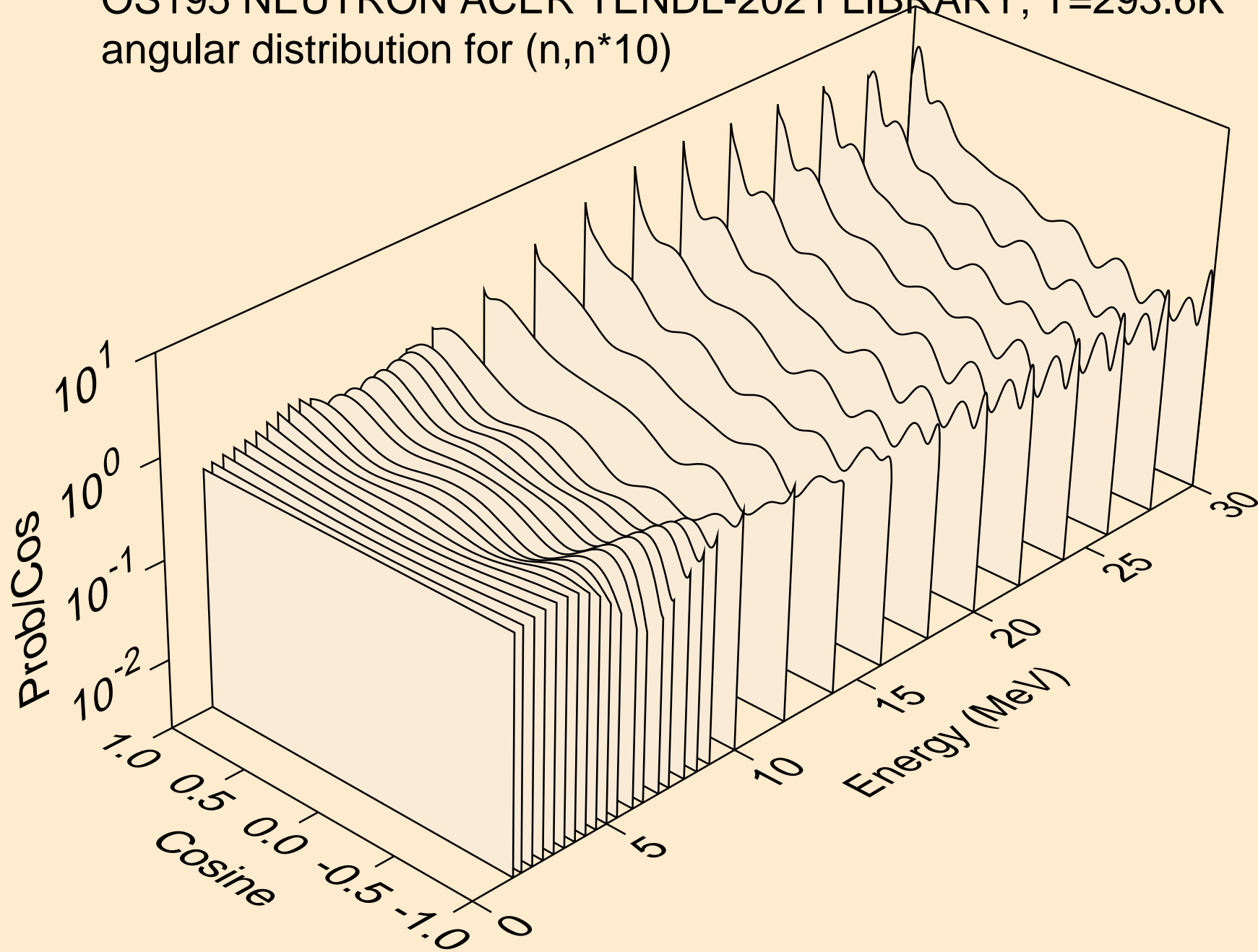

OS195 NEUTRON ACER TENDL-2021 LIBRARY; T=293.6K  
angular distribution for (n,n\*11)

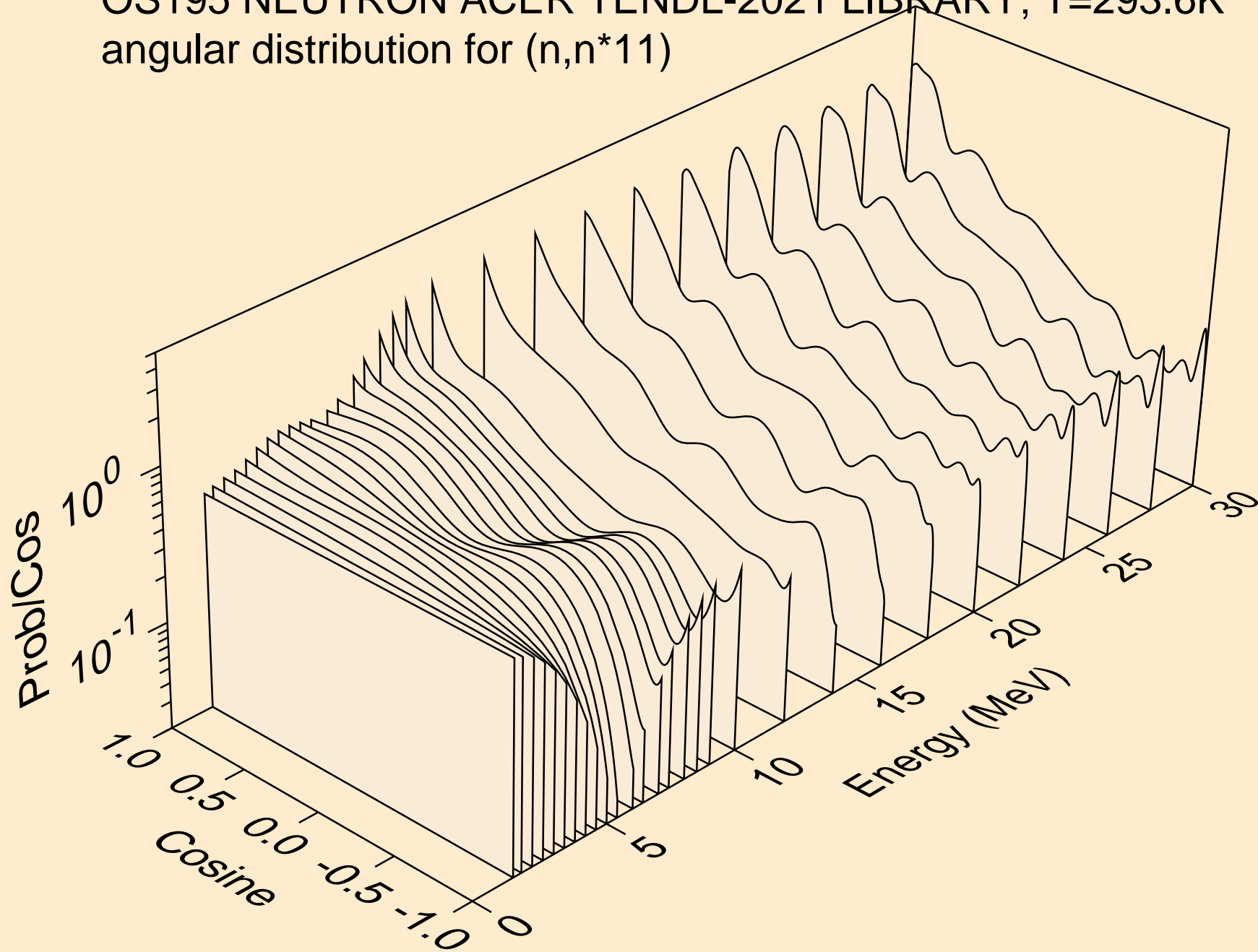

OS195 NEUTRON ACER TENDL-2021 LIBRARY; T=293.6K  
angular distribution for (n,n\*12)

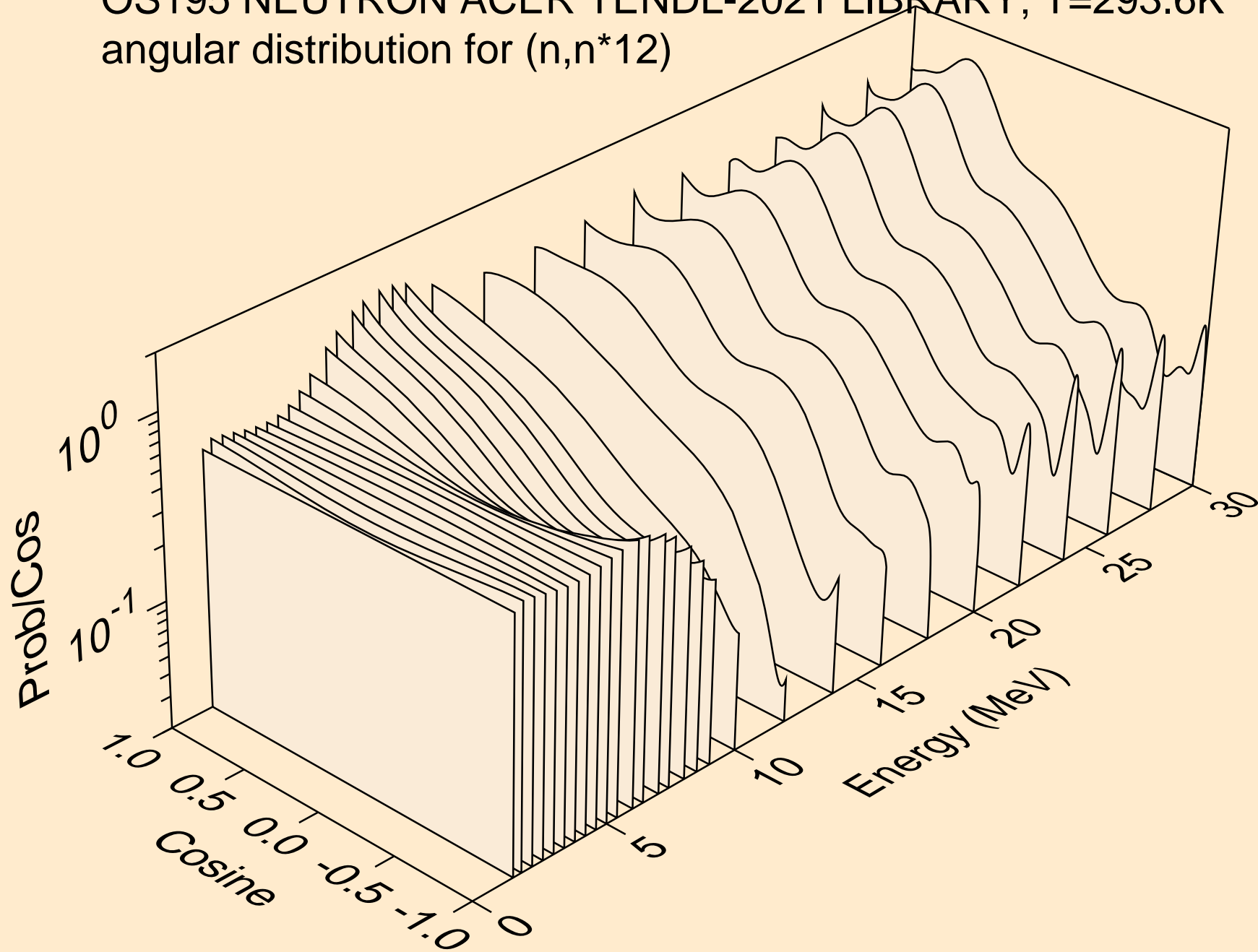

OS195 NEUTRON ACER TENDL-2021 LIBRARY; T=293.6K  
angular distribution for (n,n\*13)

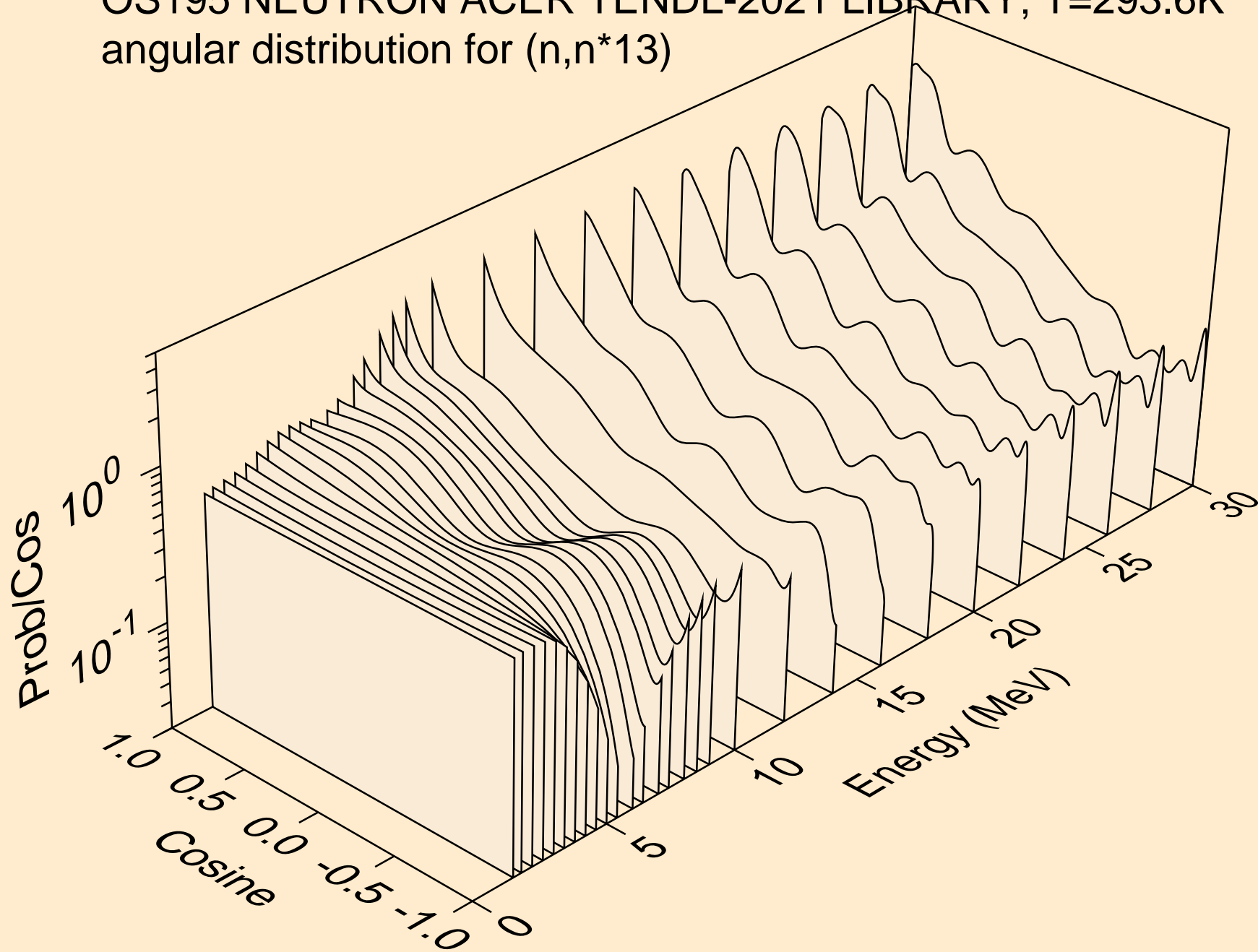

OS195 NEUTRON ACER TENDL-2021 LIBRARY; T=293.6K  
angular distribution for (n,n\*14)

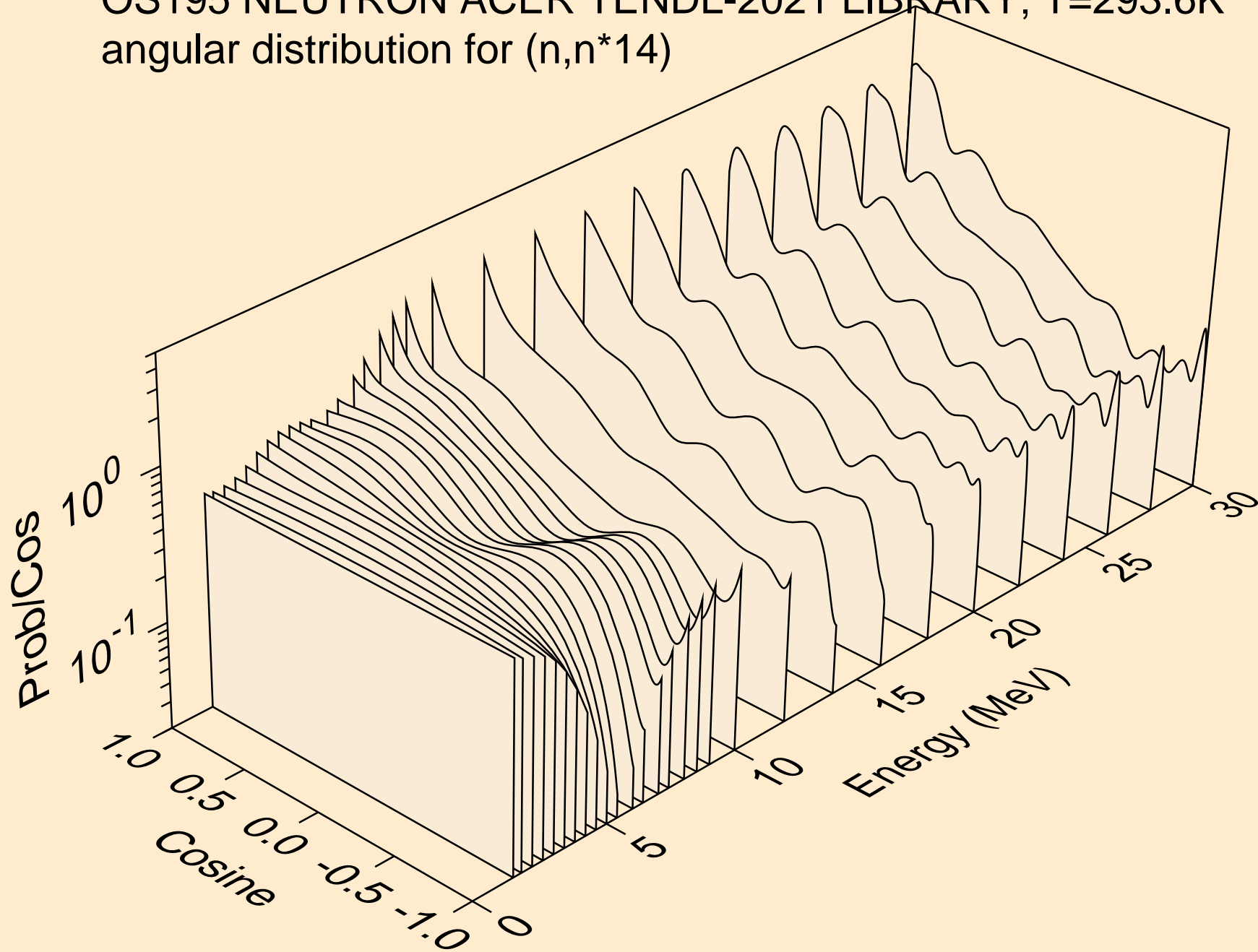

OS195 NEUTRON ACER TENDL-2021 LIBRARY; T=293.6K  
angular distribution for (n,n\*15)

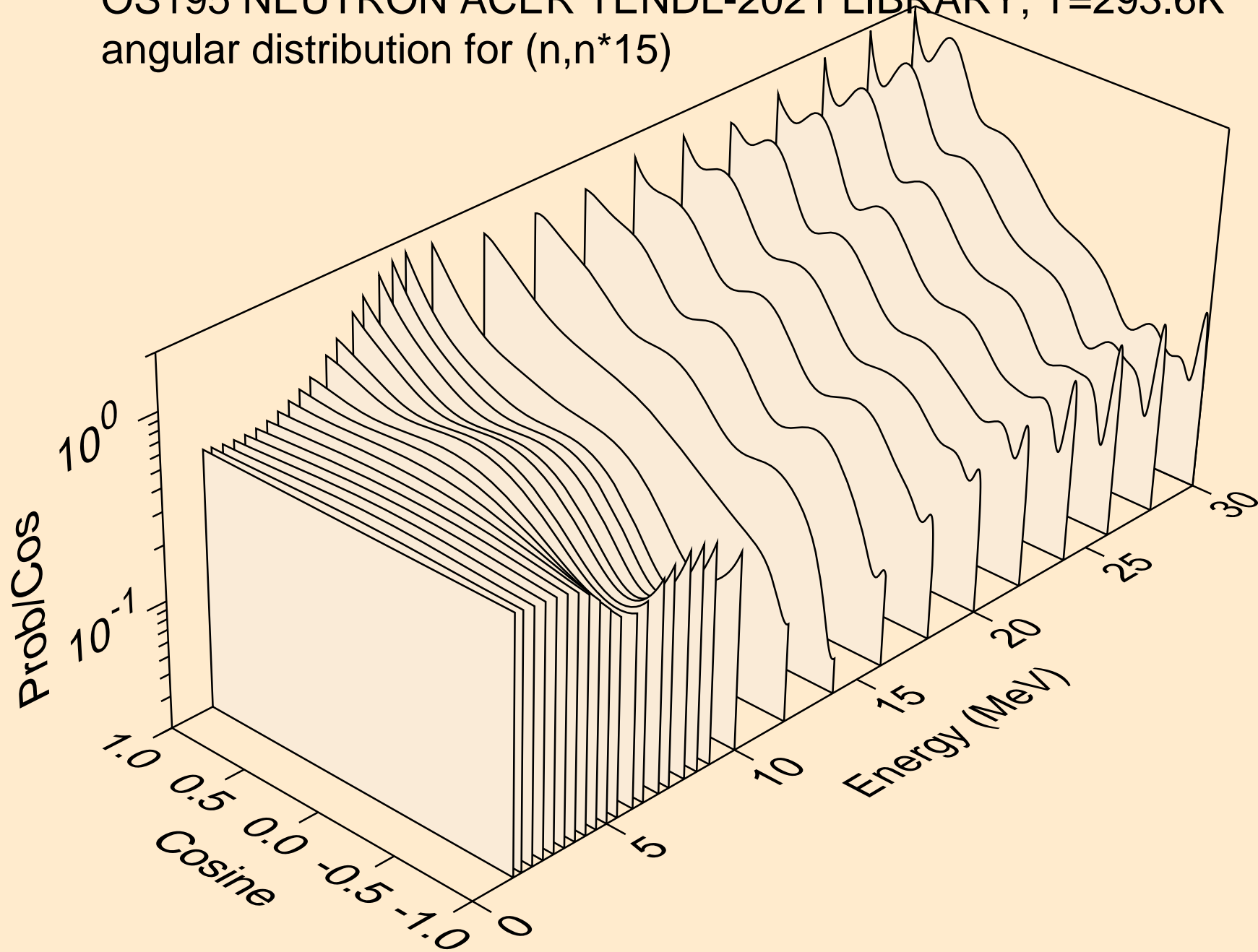

OS195 NEUTRON ACER TENDL-2021 LIBRARY; T=293.6K  
angular distribution for (n,n\*16)

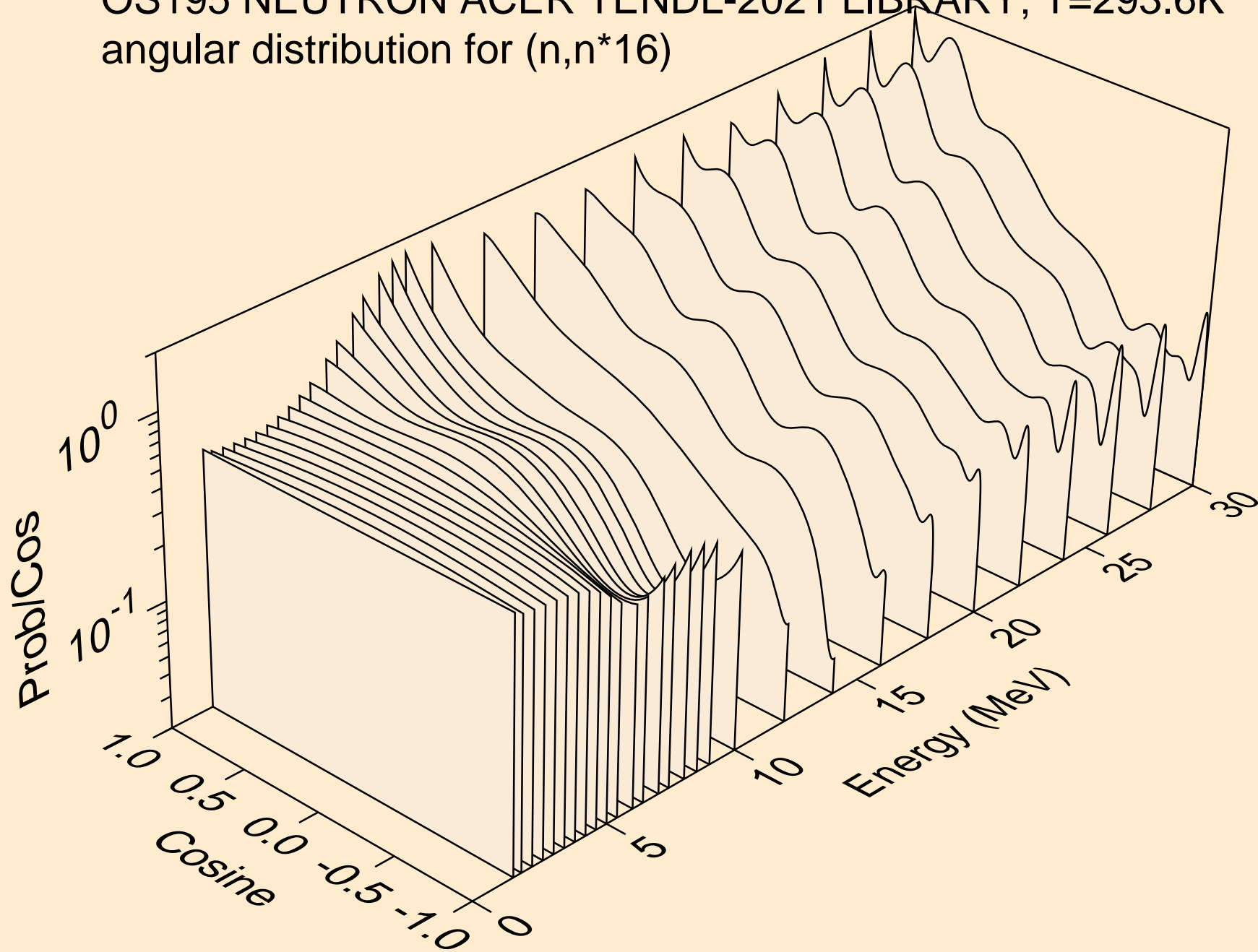



OS195 NEUTRON ACER TENDL-2021 LIBRARY; T=293.6K  
angular distribution for (n,n\*17)

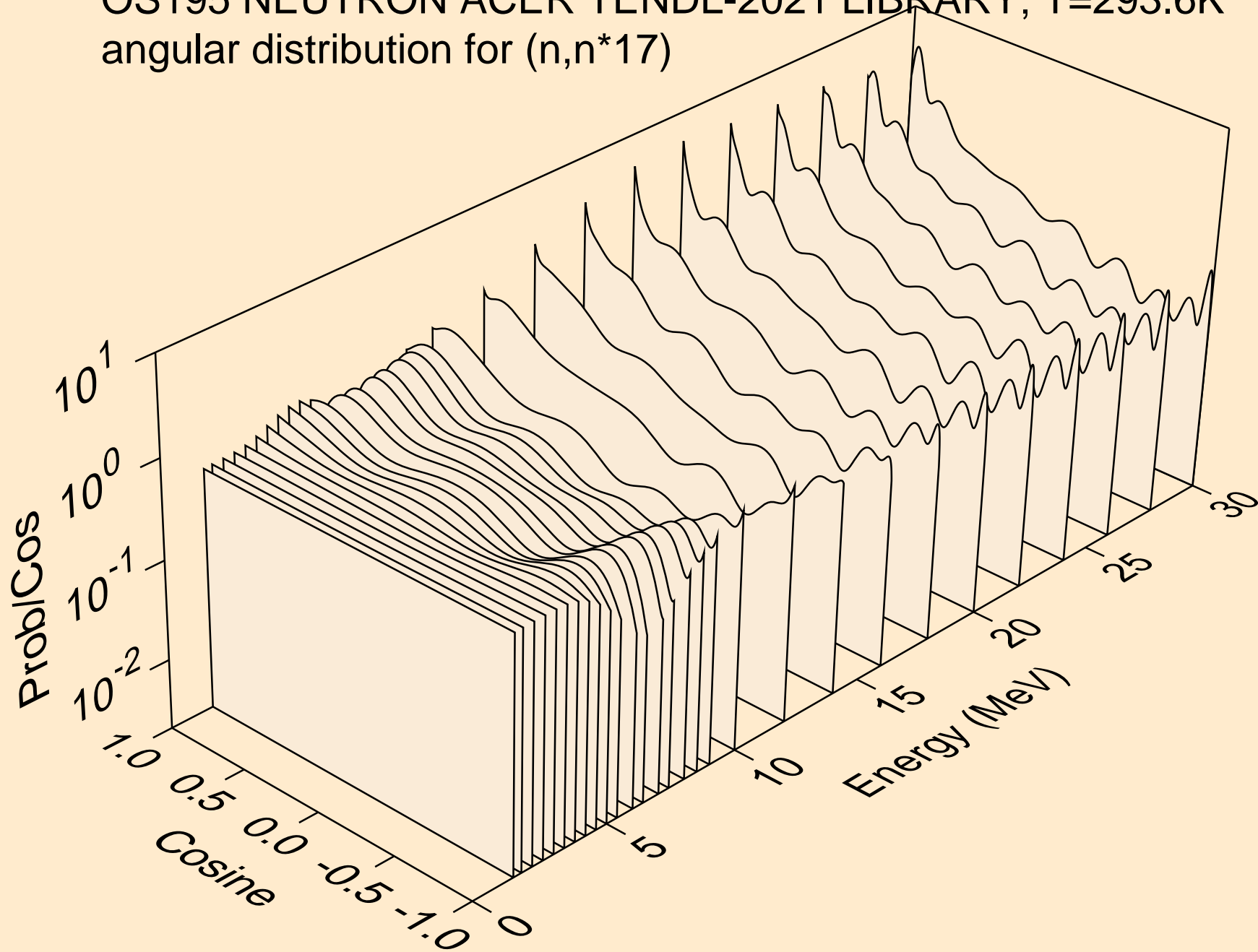

OS195 NEUTRON ACER TENDL-2021 LIBRARY; T=293.6K  
angular distribution for (n,n\*18)

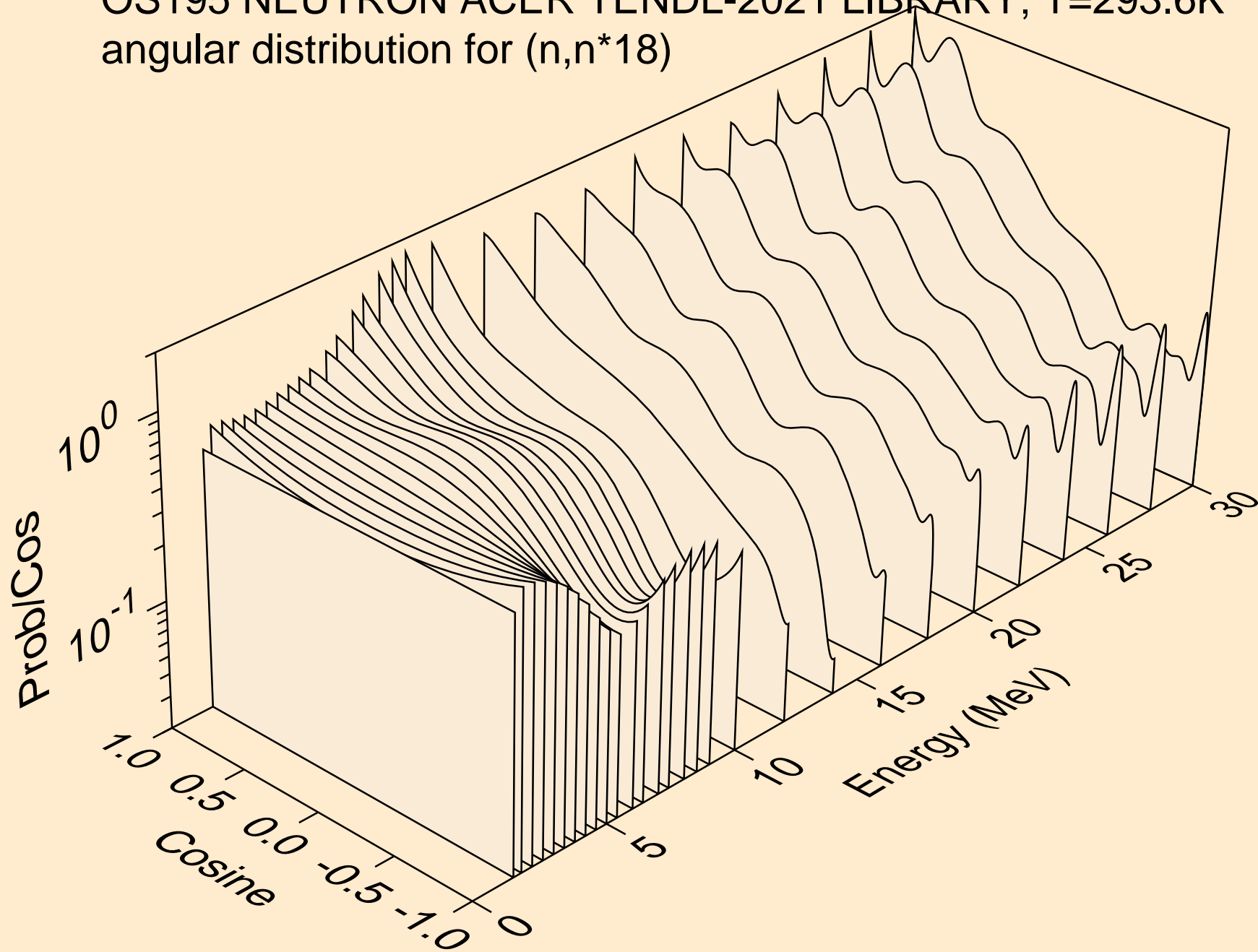

OS195 NEUTRON ACER TENDL-2021 LIBRARY; T=293.6K  
angular distribution for (n,n\*19)

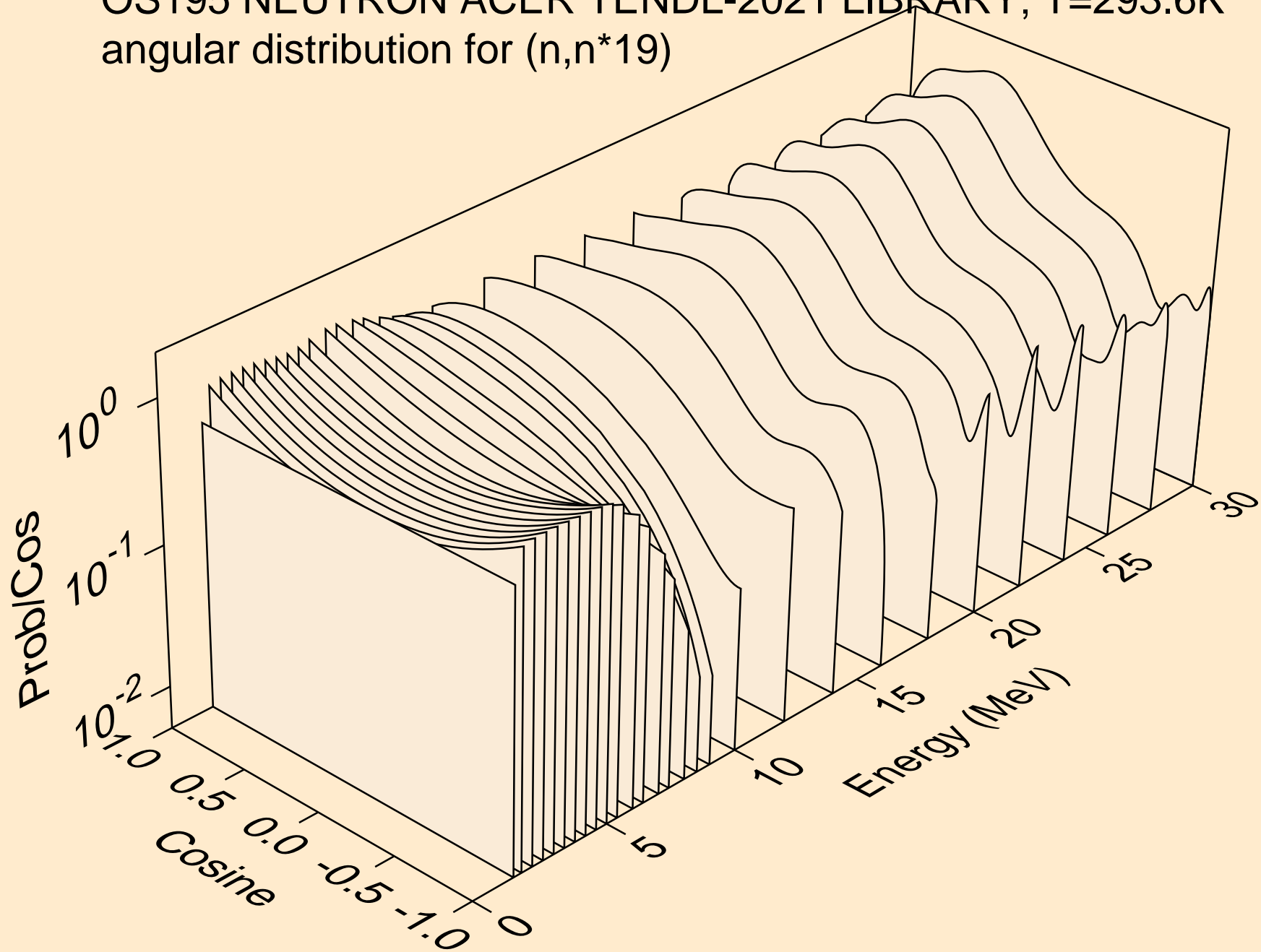

OS195 NEUTRON ACER TENDL-2021 LIBRARY; T=293.6K  
angular distribution for (n,n\*20)

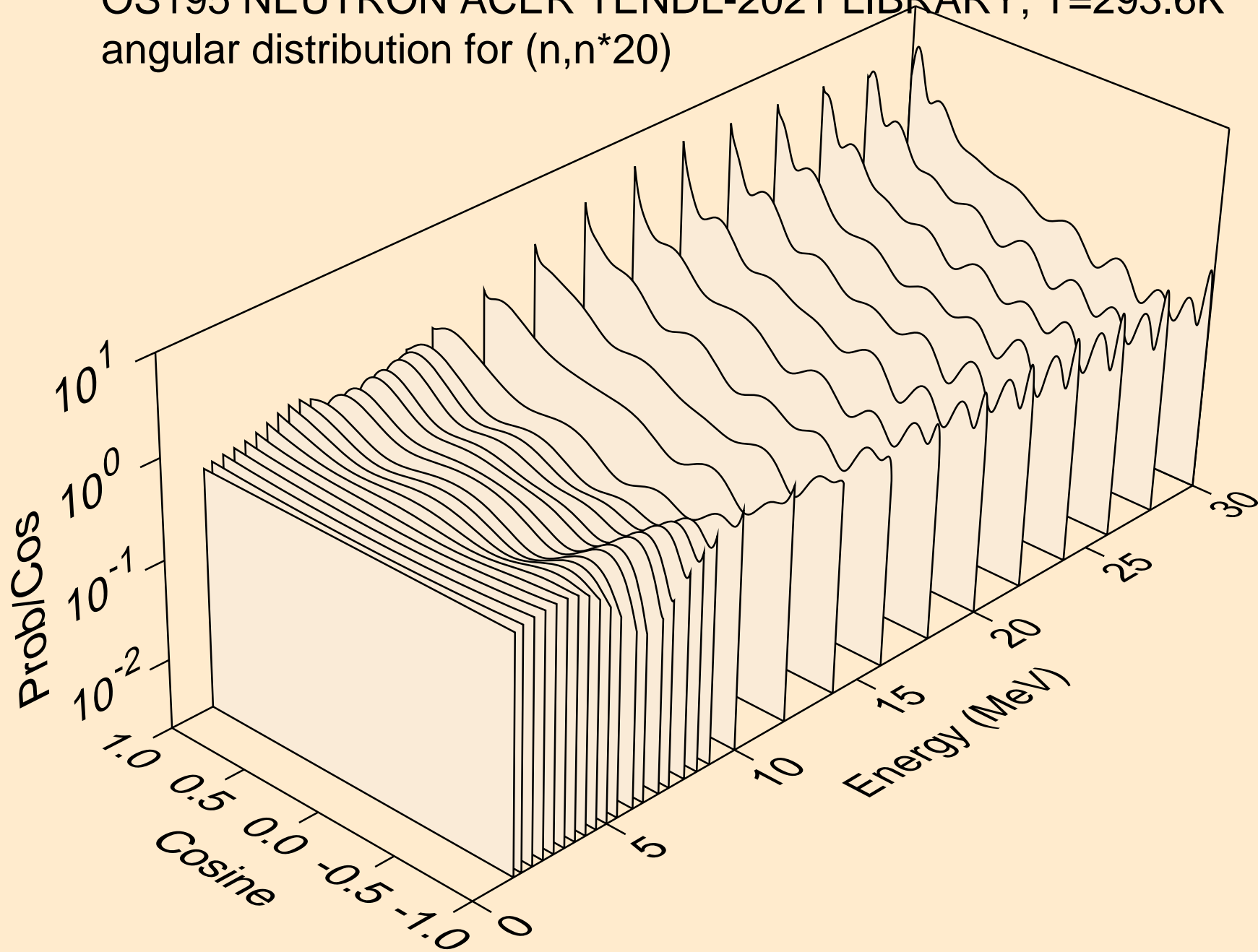

OS195 NEUTRON ACER TENDL-2021 LIBRARY; T=293.6K  
angular distribution for (n,n\*21)

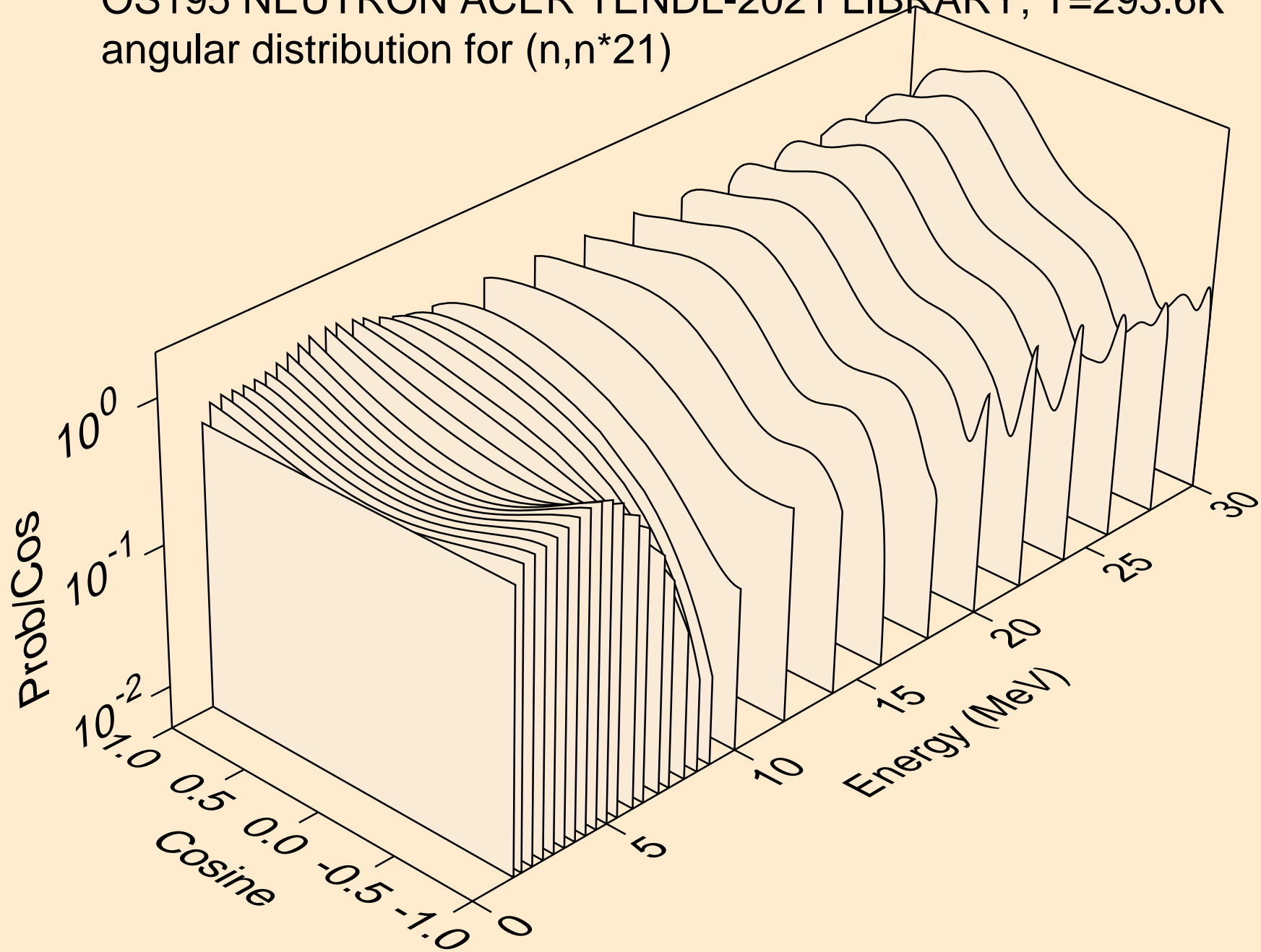

OS195 NEUTRON ACER TENDL-2021 LIBRARY; T=293.6K  
angular distribution for (n,n\*22)

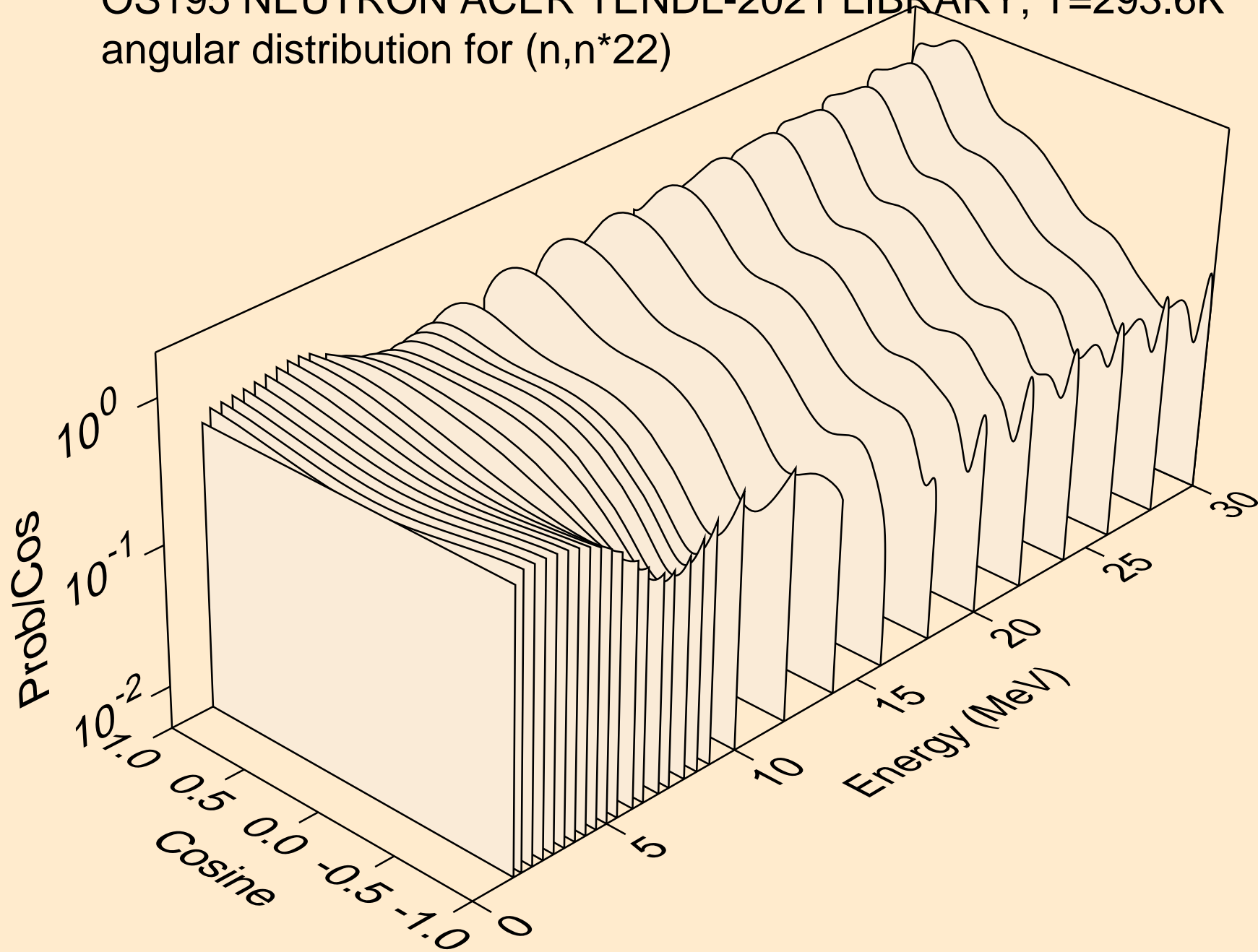

OS195 NEUTRON ACER TENDL-2021 LIBRARY; T=293.6K  
angular distribution for (n,n\*23)

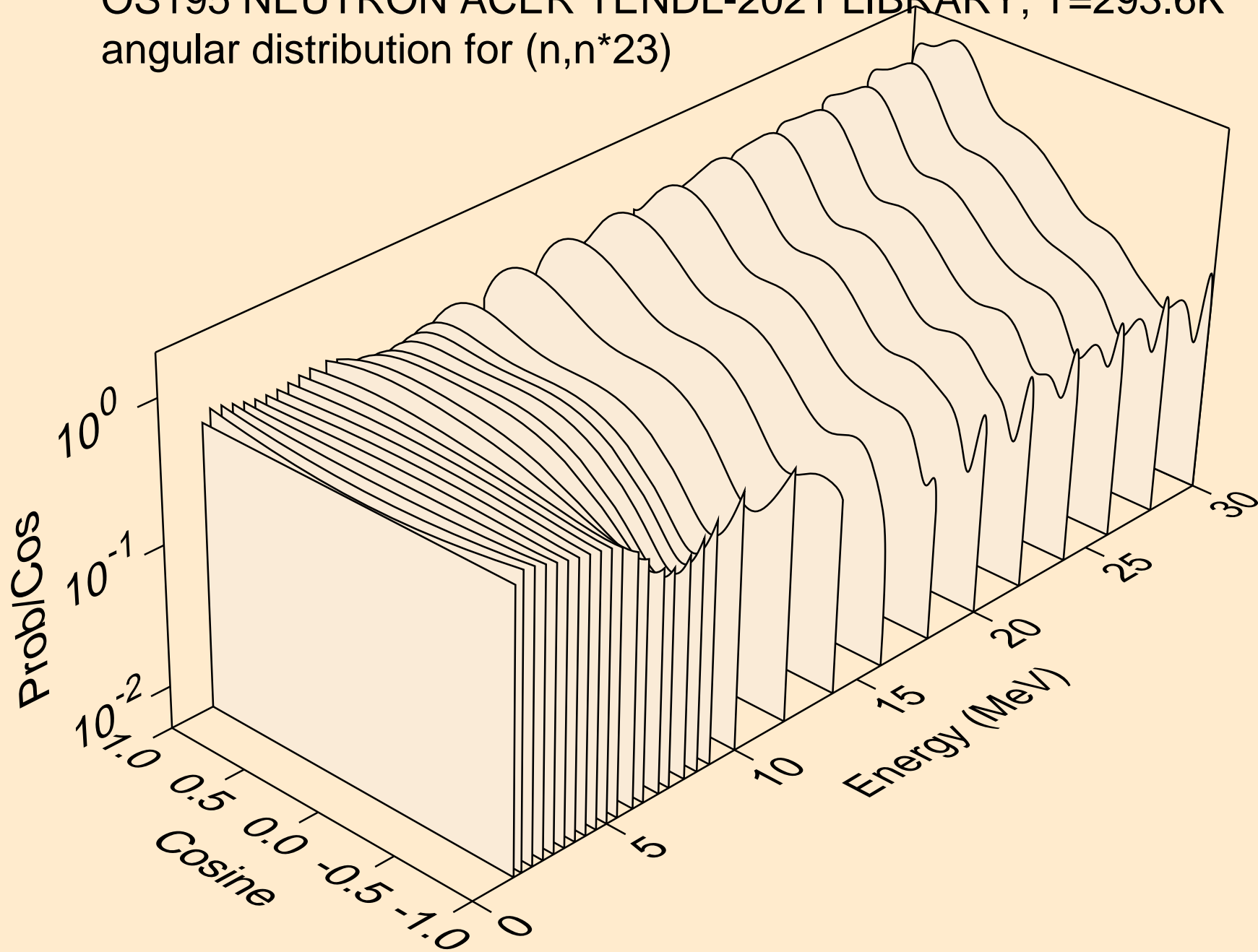

OS195 NEUTRON ACER TENDL-2021 LIBRARY; T=293.6K  
angular distribution for (n,n\*24)

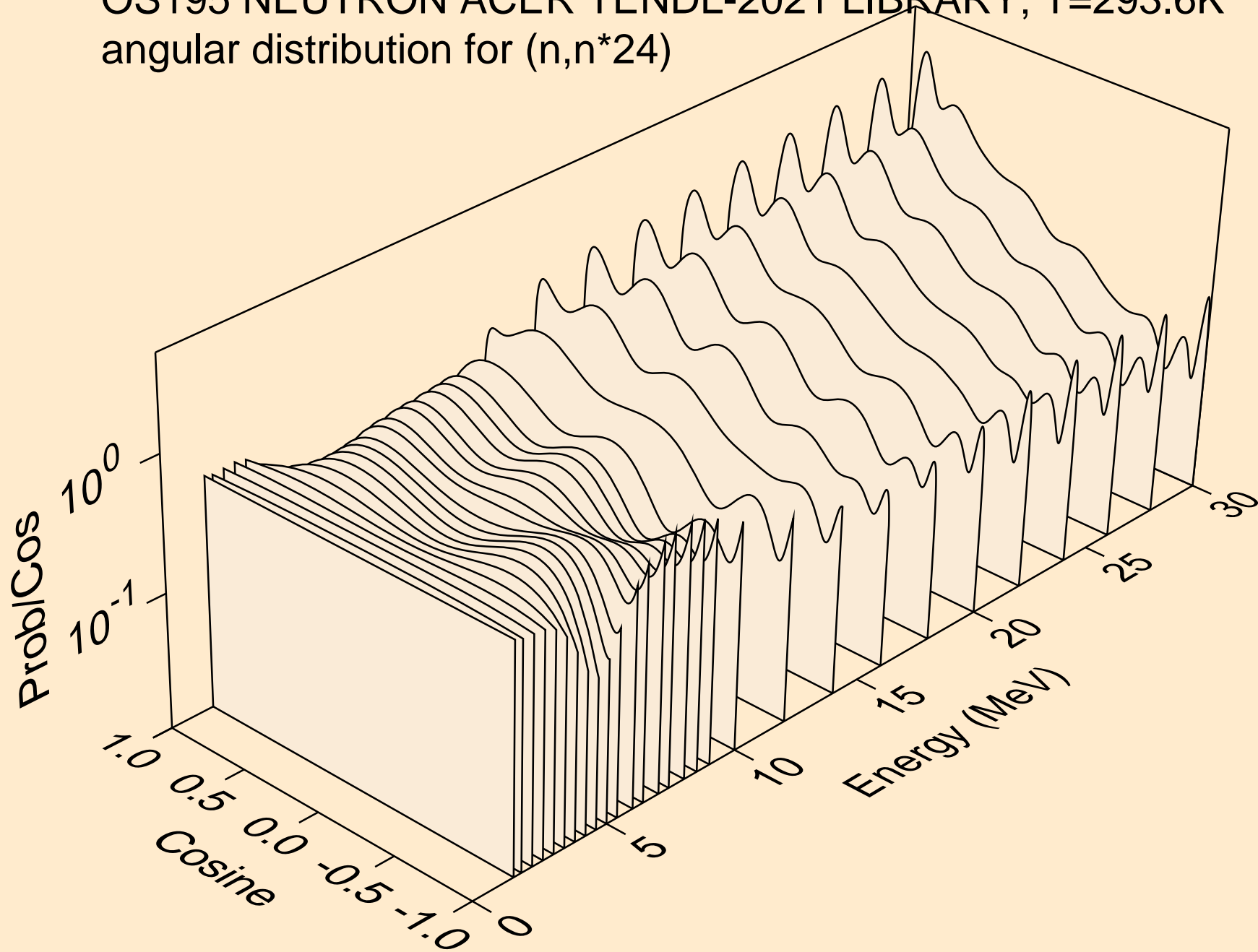



OS195 NEUTRON ACER TENDL-2021 LIBRARY; T=293.6K  
angular distribution for (n,n\*25)

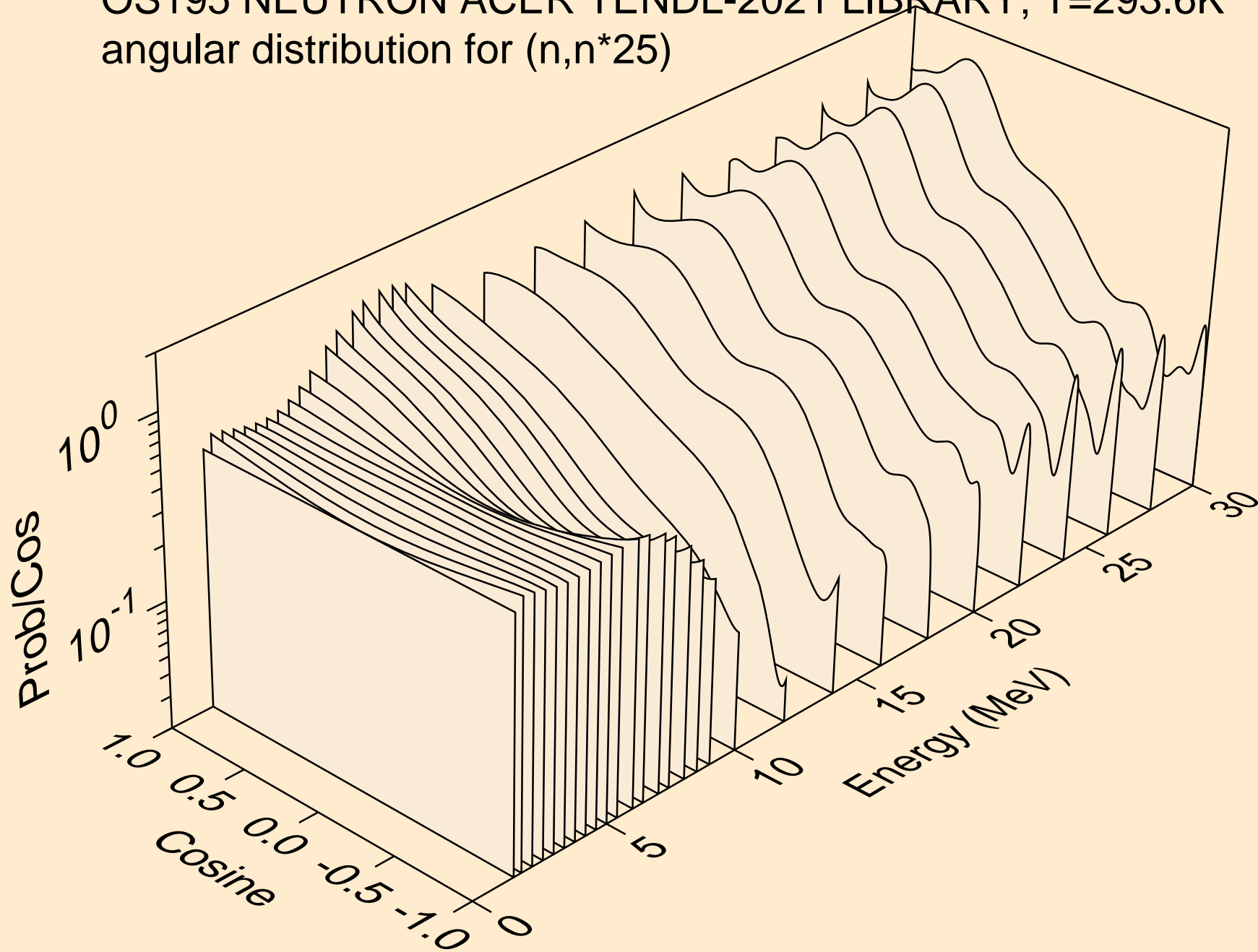

OS195 NEUTRON ACER TENDL-2021 LIBRARY; T=293.6K  
angular distribution for (n,n\*26)

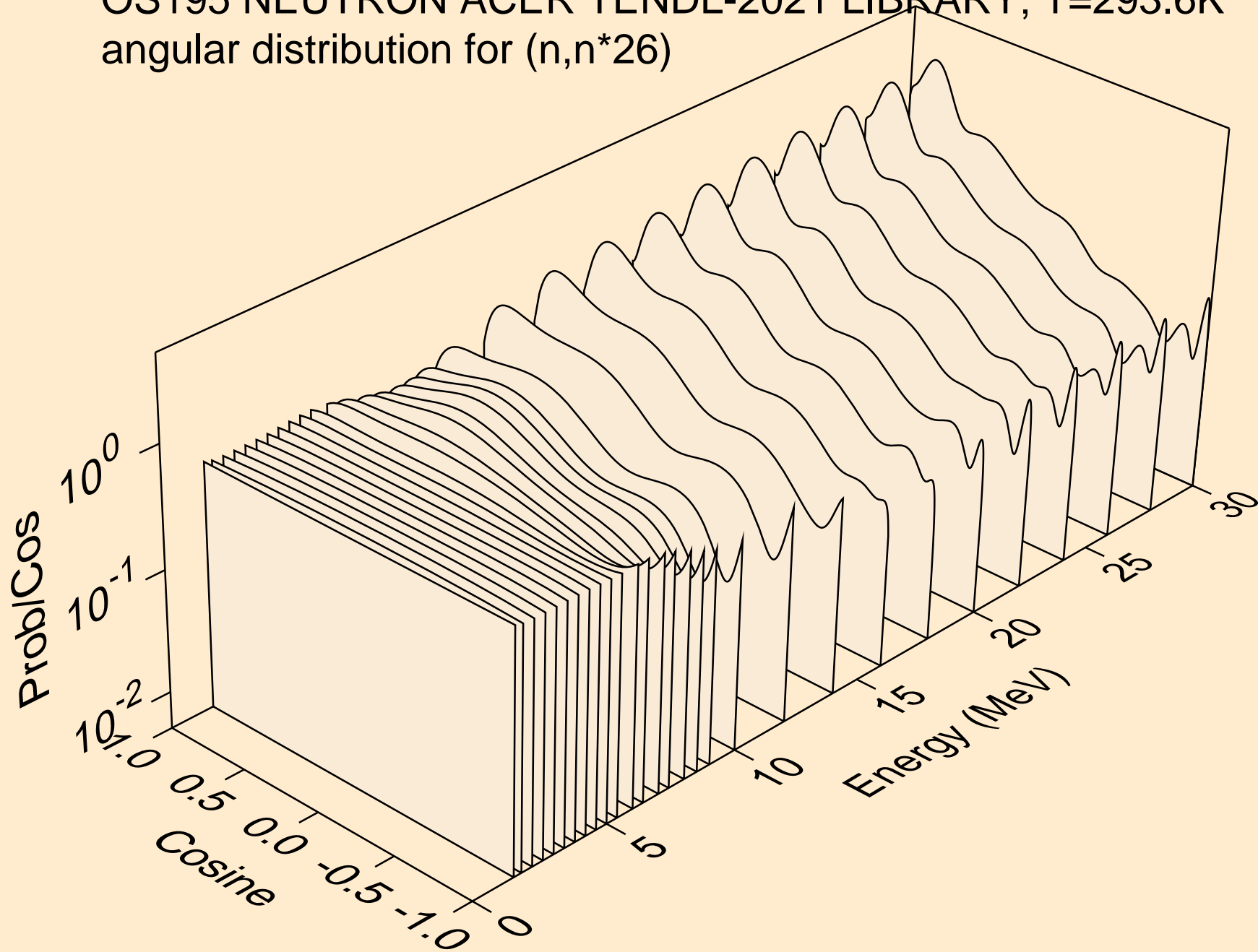

OS195 NEUTRON ACER TENDL-2021 LIBRARY; T=293.6K  
angular distribution for (n,n\*27)

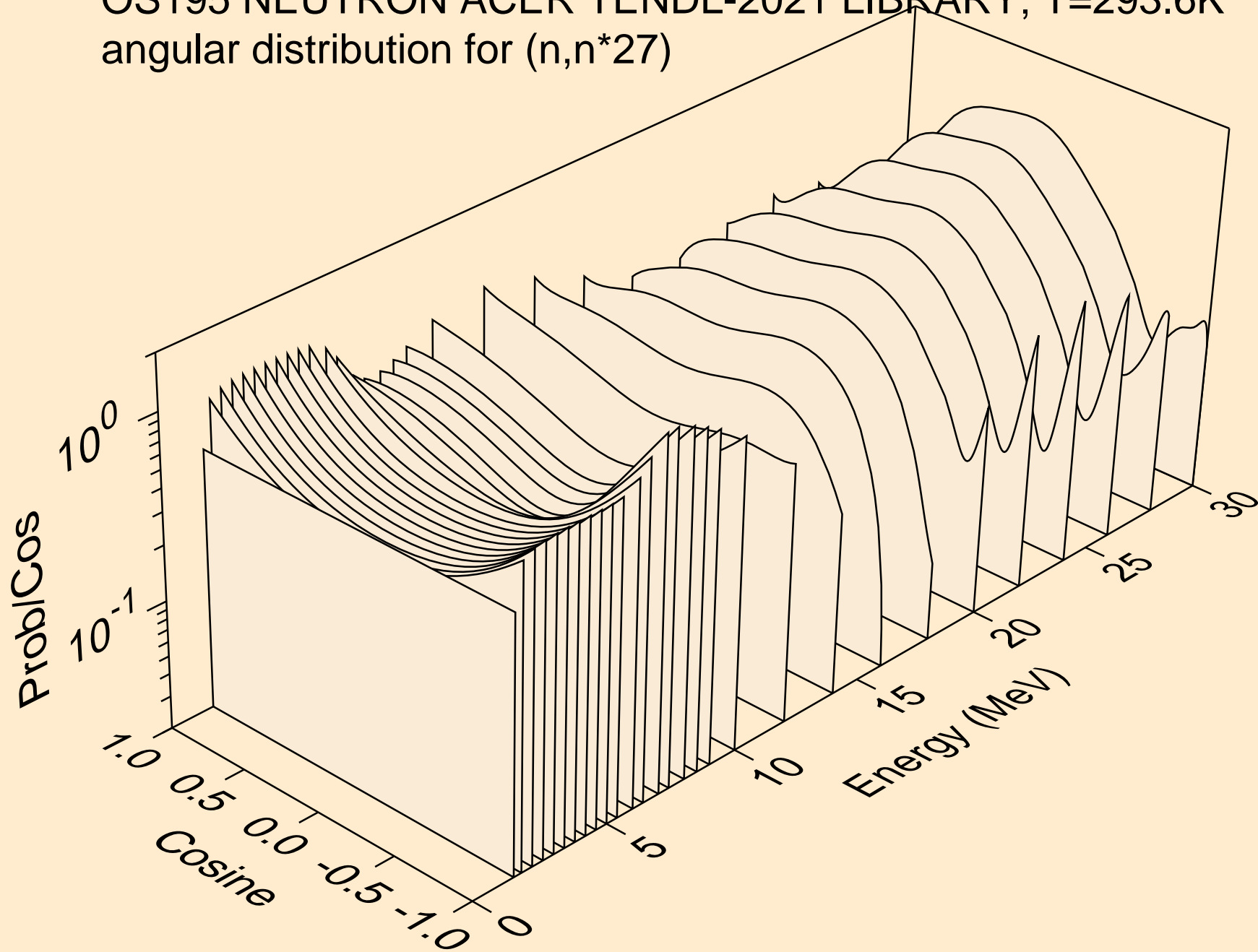

OS195 NEUTRON ACER TENDL-2021 LIBRARY; T=293.6K  
angular distribution for (n,n\*28)

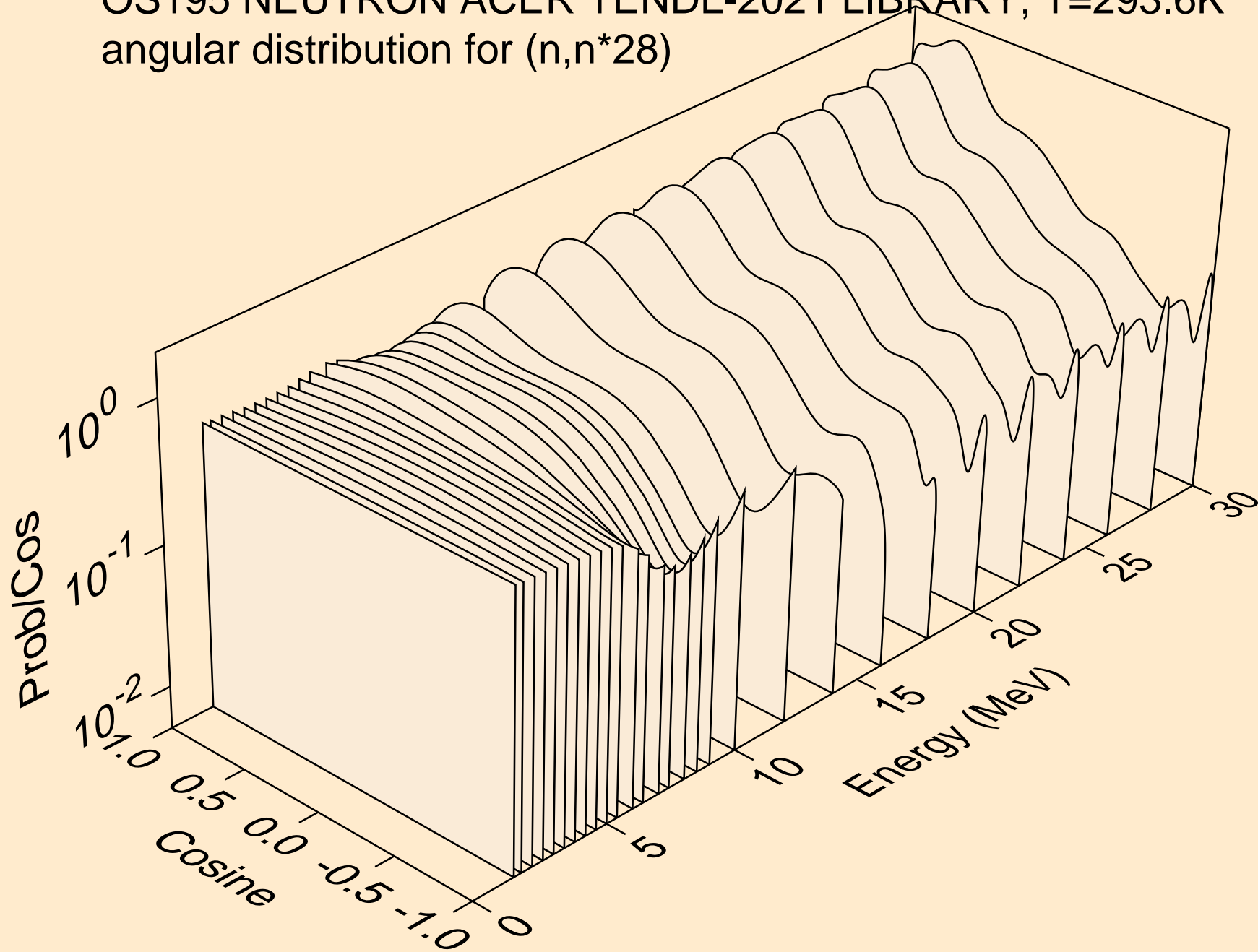

OS195 NEUTRON ACER TENDL-2021 LIBRARY; T=293.6K  
angular distribution for (n,n\*29)

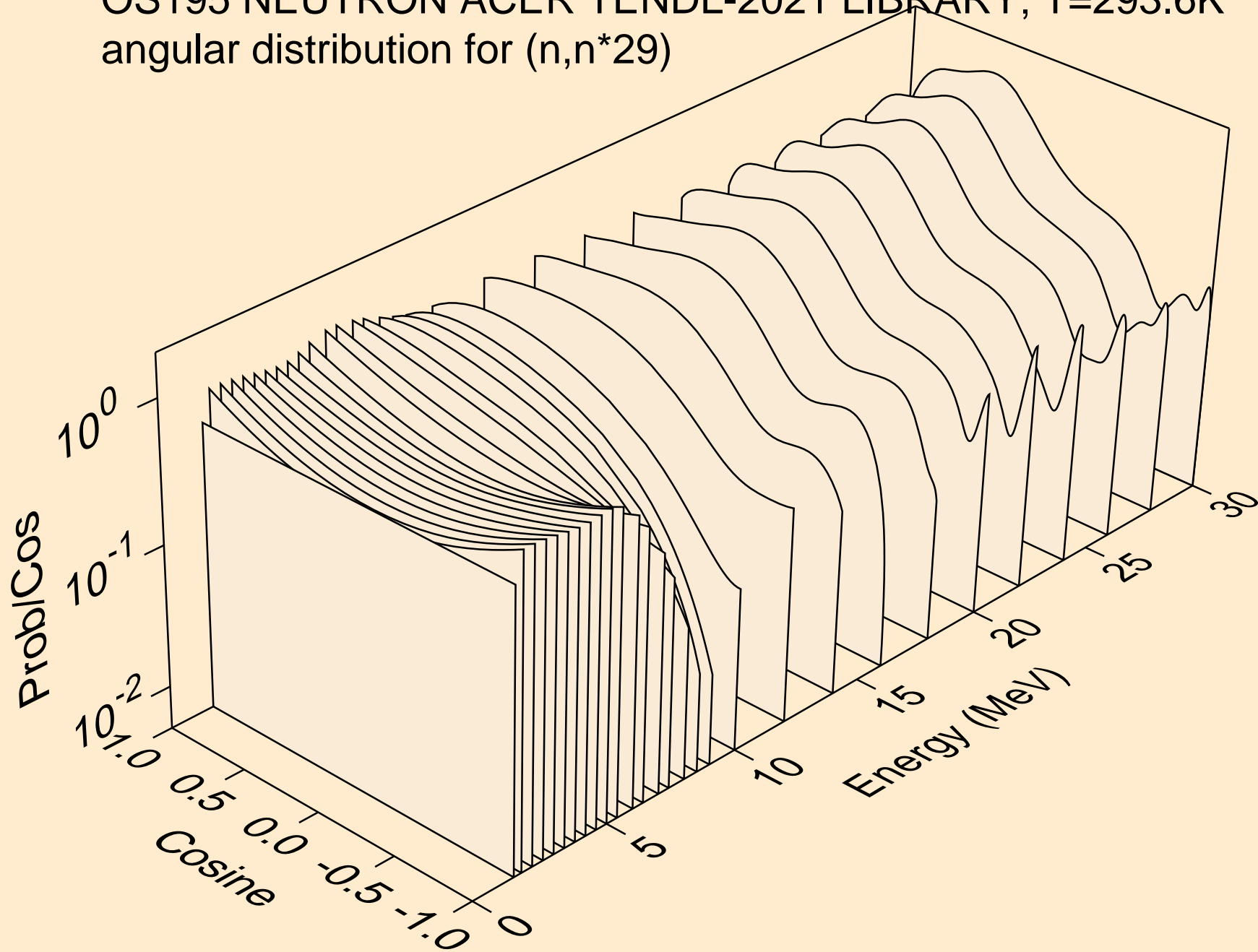

OS195 NEUTRON ACER TENDL-2021 LIBRARY; T=293.6K  
angular distribution for (n,n\*30)

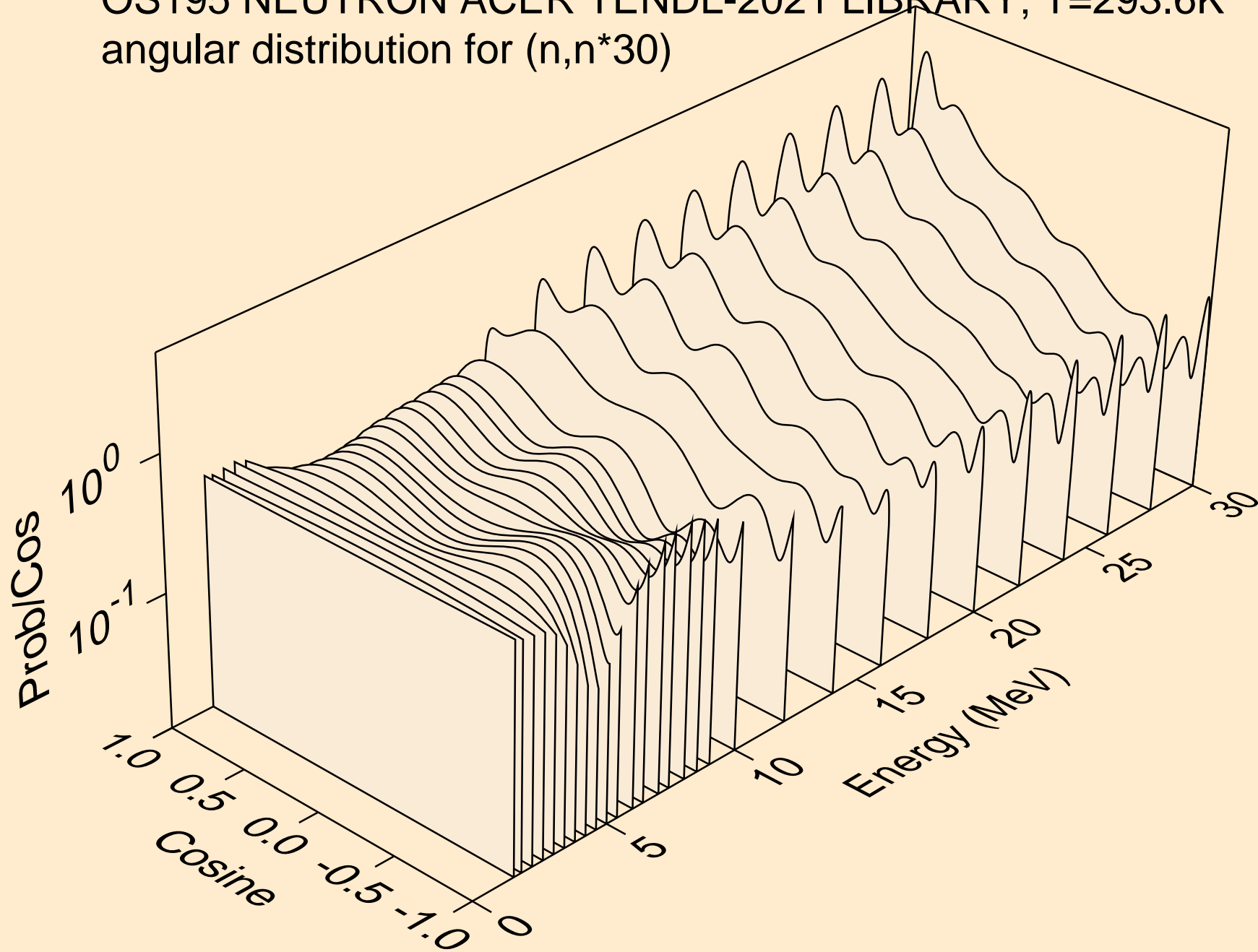

OS195 NEUTRON ACER TENDL-2021 LIBRARY; T=293.6K  
Neutron emission for (n,x)

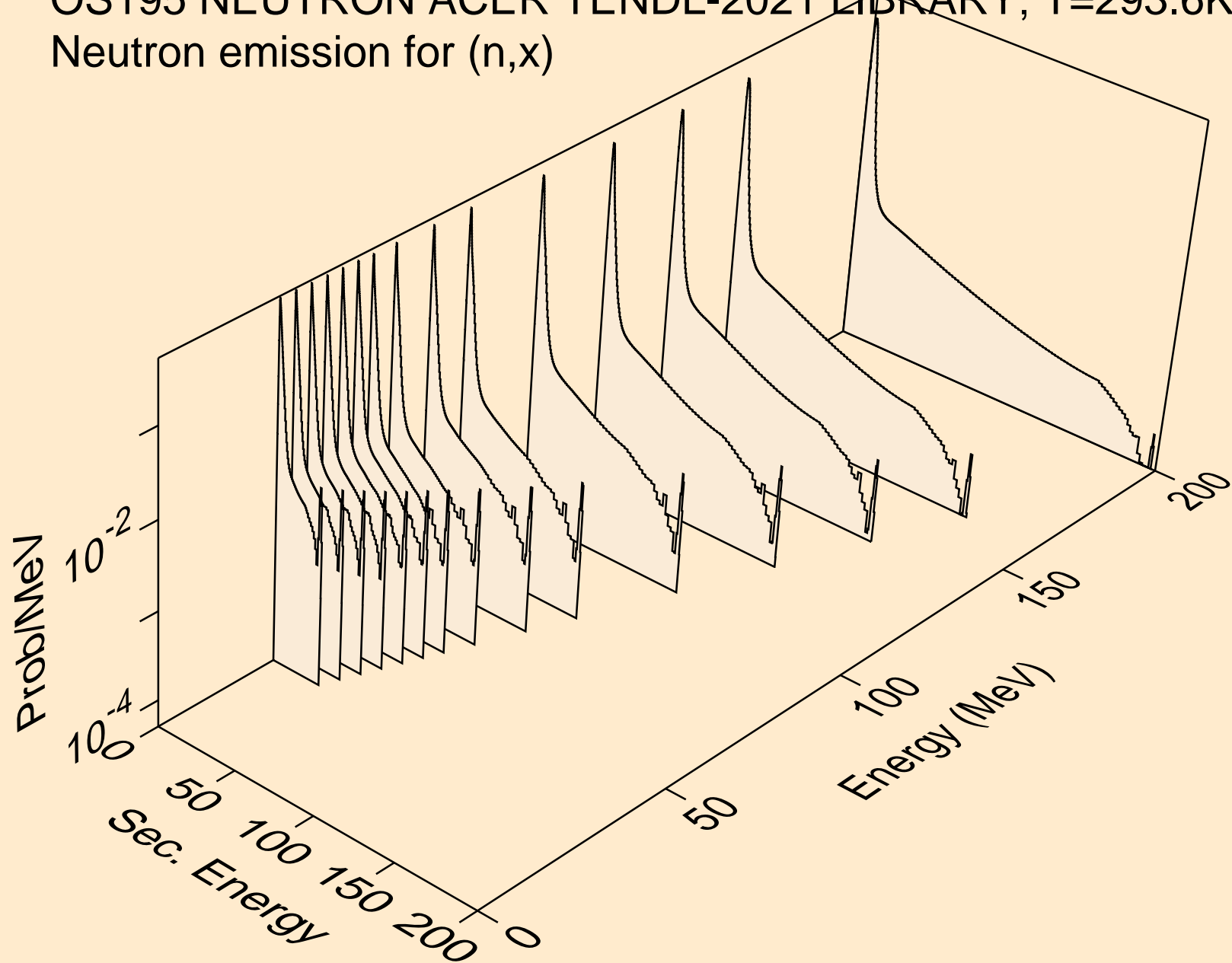

OS195 NEUTRON ACER TENDL-2021 LIBRARY; T=293.6K  
Neutron emission for (n,2nd)

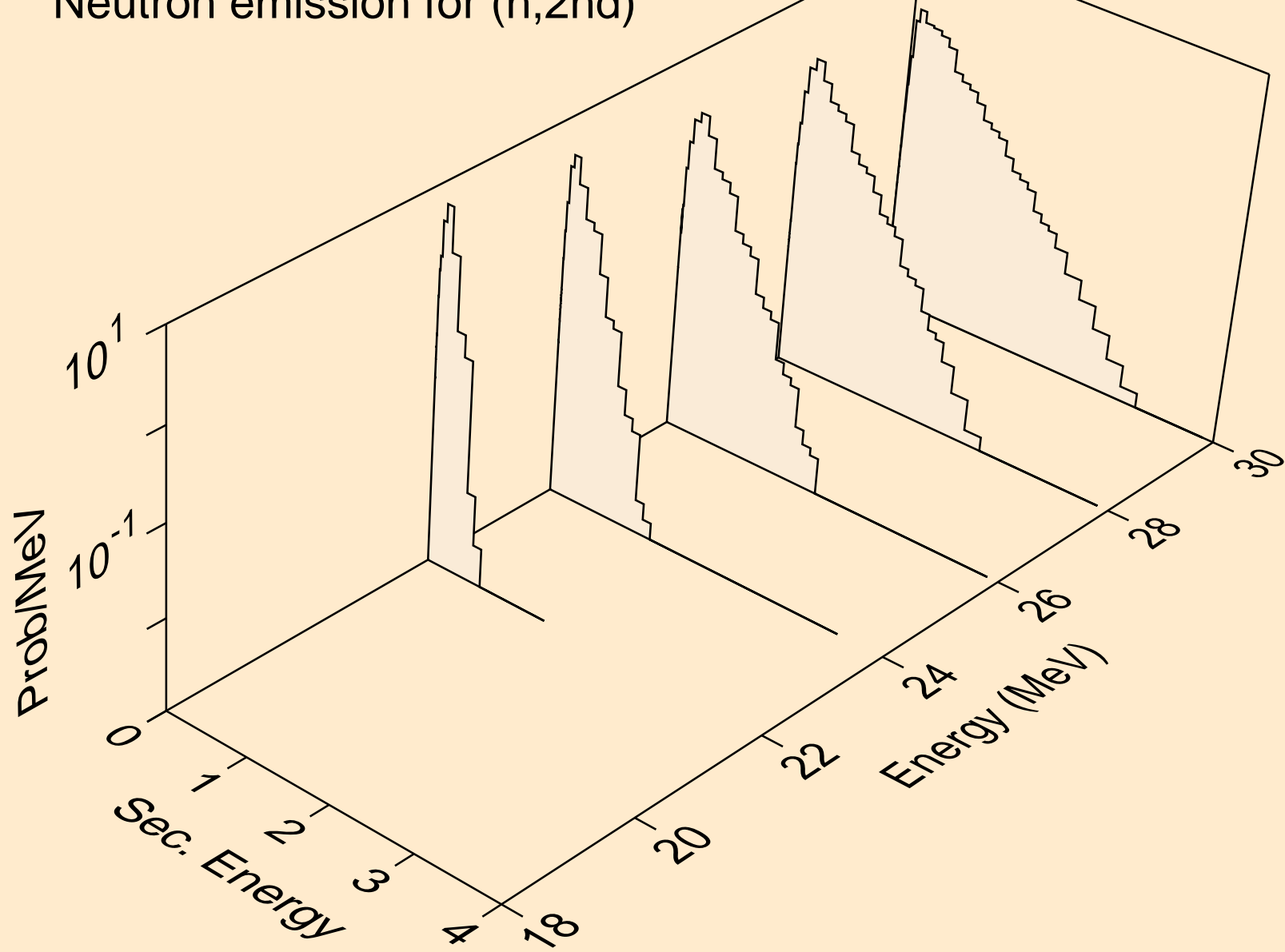



OS195 NEUTRON ACER TENDL-2021 LIBRARY; T=293.6K  
Neutron emission for (n,2n)

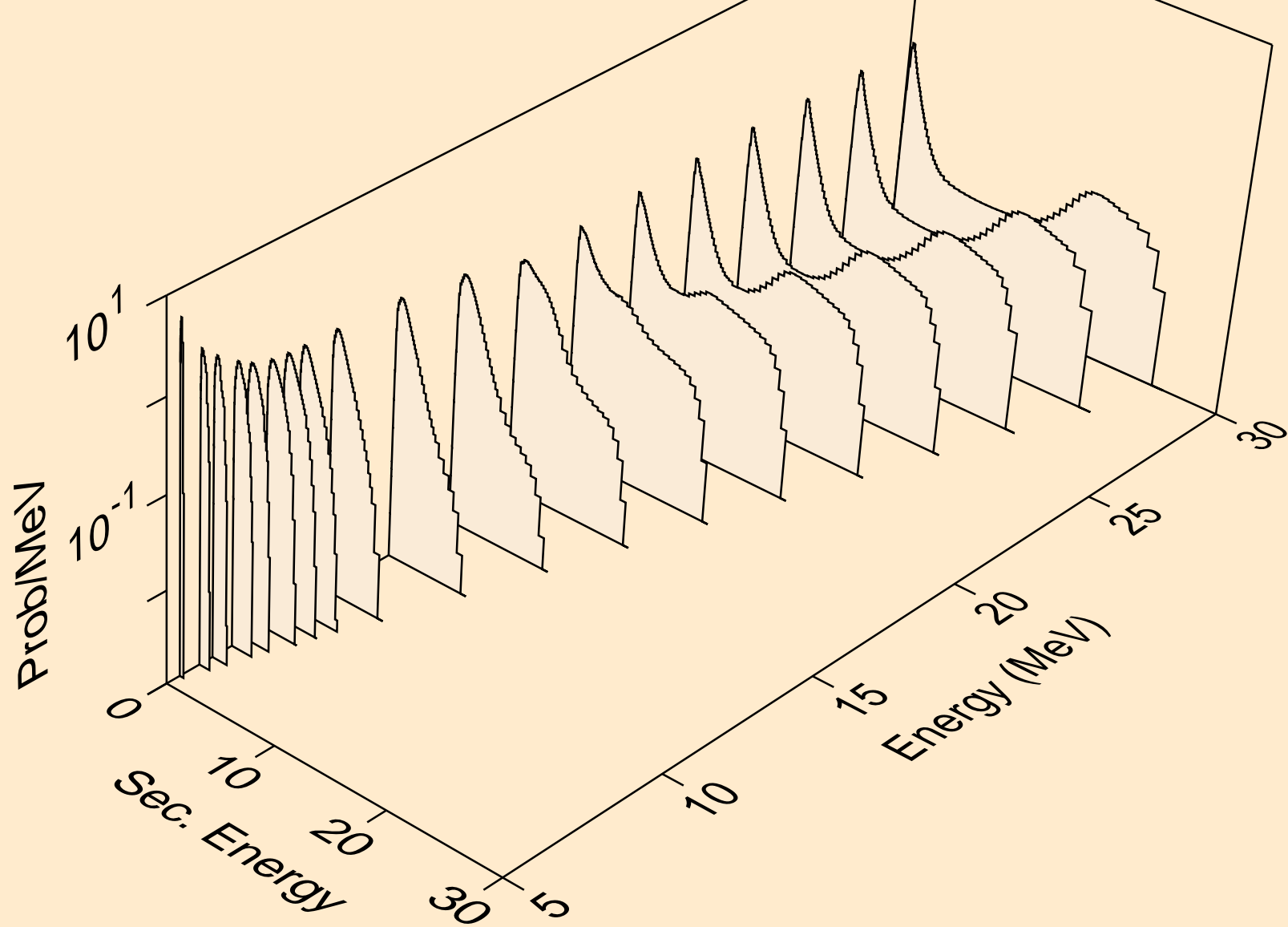

OS195 NEUTRON ACER TENDL-2021 LIBRARY; T=293.6K  
Neutron emission for (n,3n)

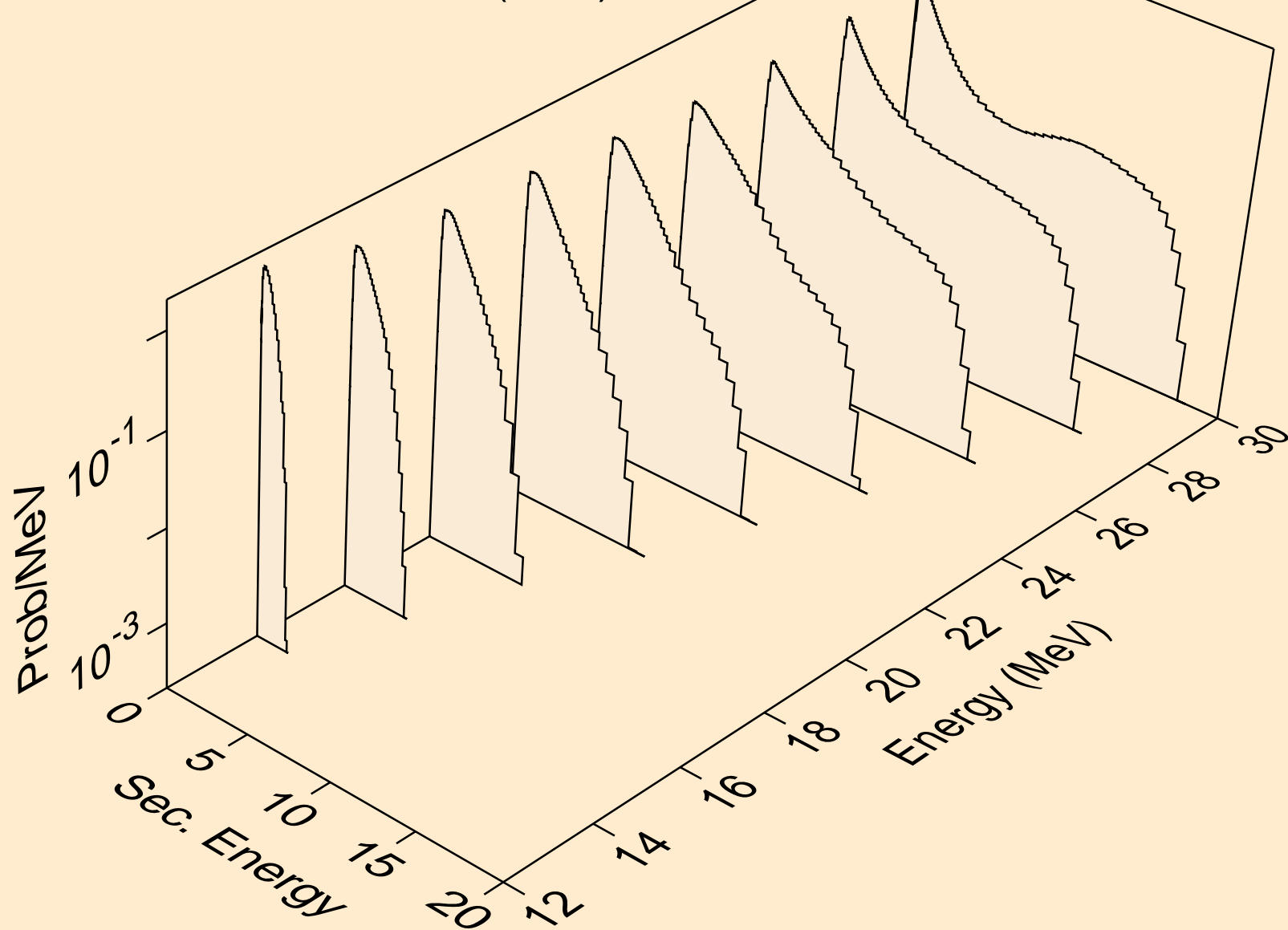

OS195 NEUTRON ACER TENDL-2021 LIBRARY; T=293.6K  
Neutron emission for (n,n\*)a

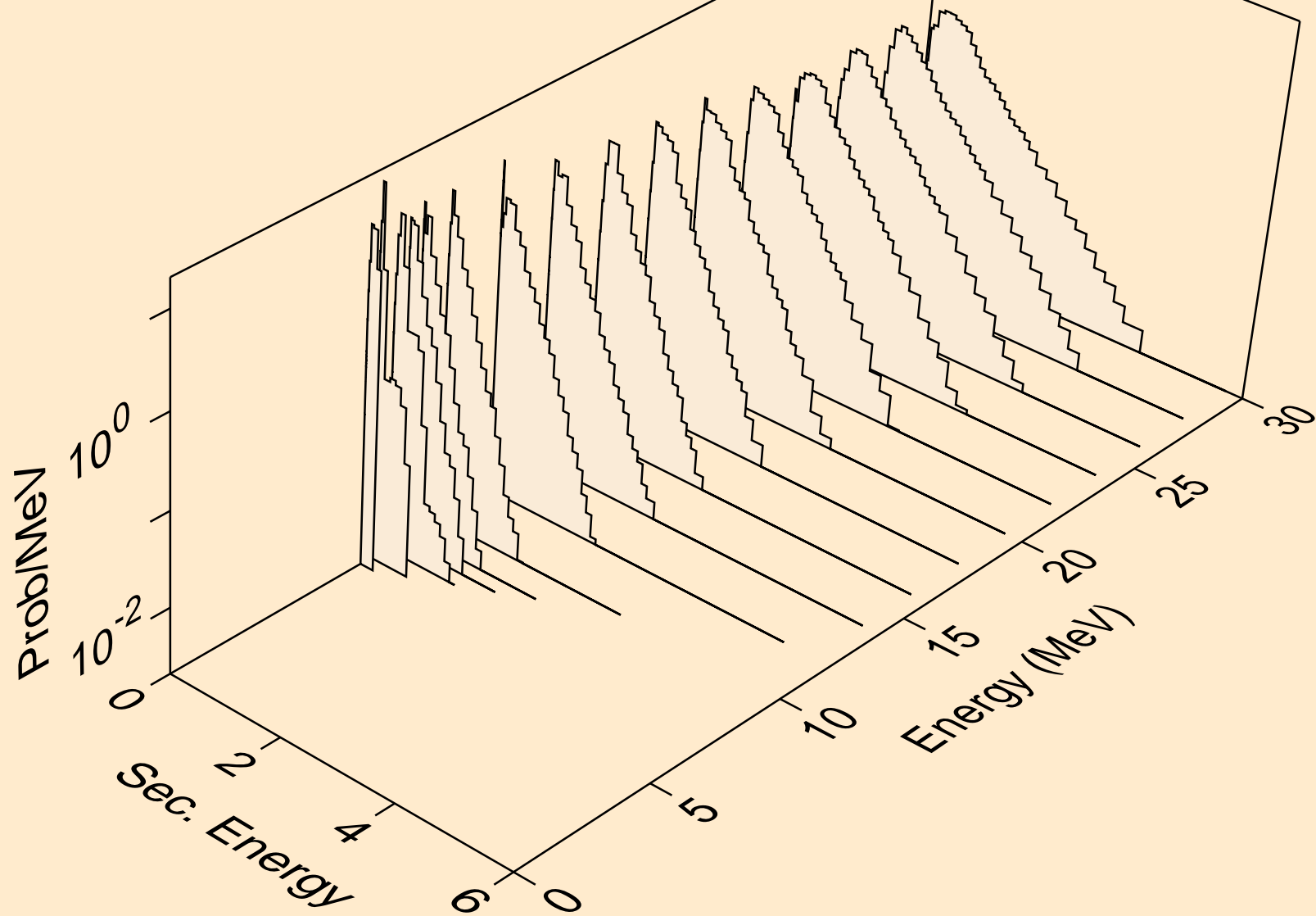

OS195 NEUTRON ACER TENDL-2021 LIBRARY; T=293.6K  
Neutron emission for (n,2n)a

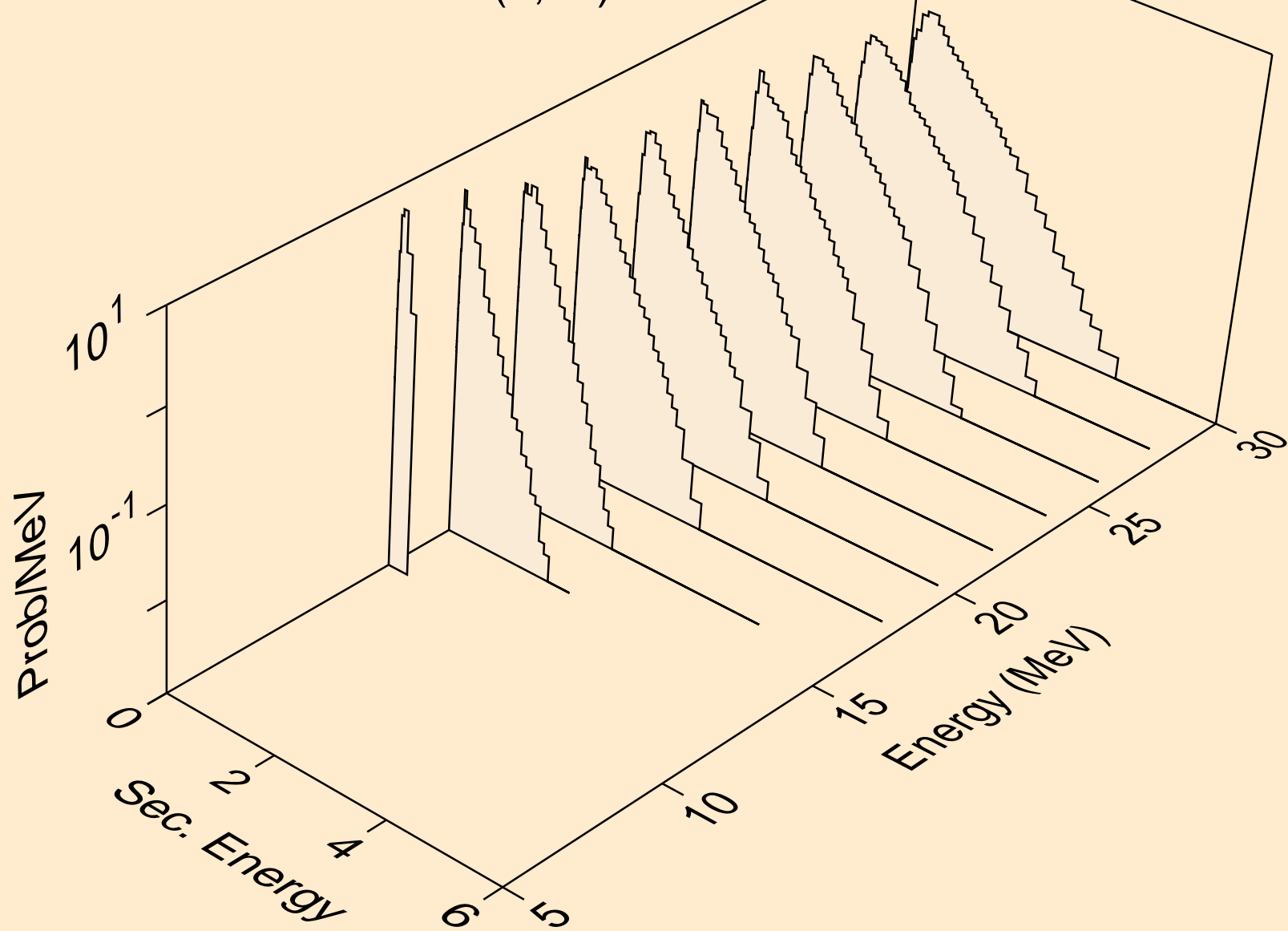

OS195 NEUTRON ACER TENDL-2021 LIBRARY; T=293.6K  
Neutron emission for (n,3n)a

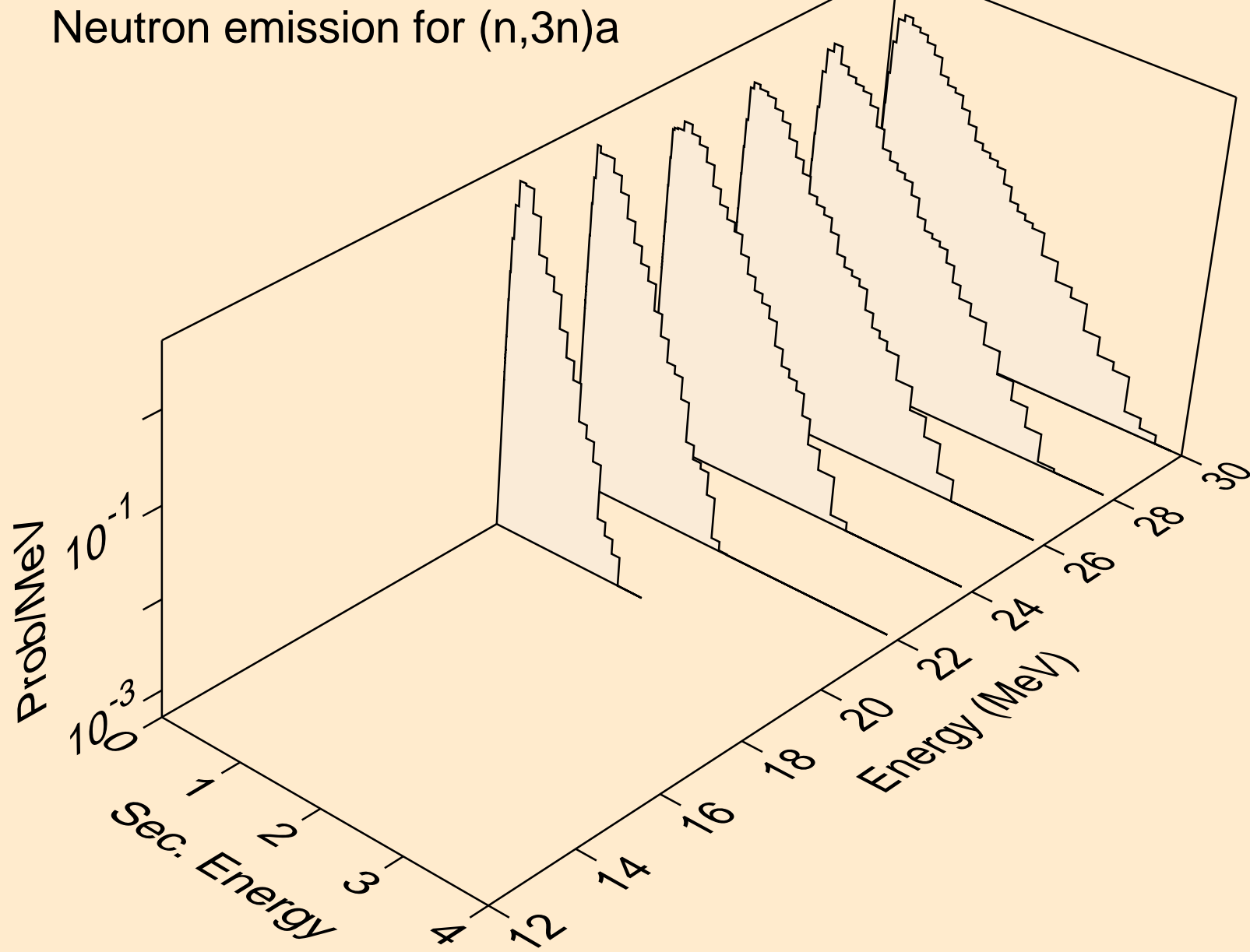

OS195 NEUTRON ACER TENDL-2021 LIBRARY; T=293.6K  
Neutron emission for (n,n\*)p

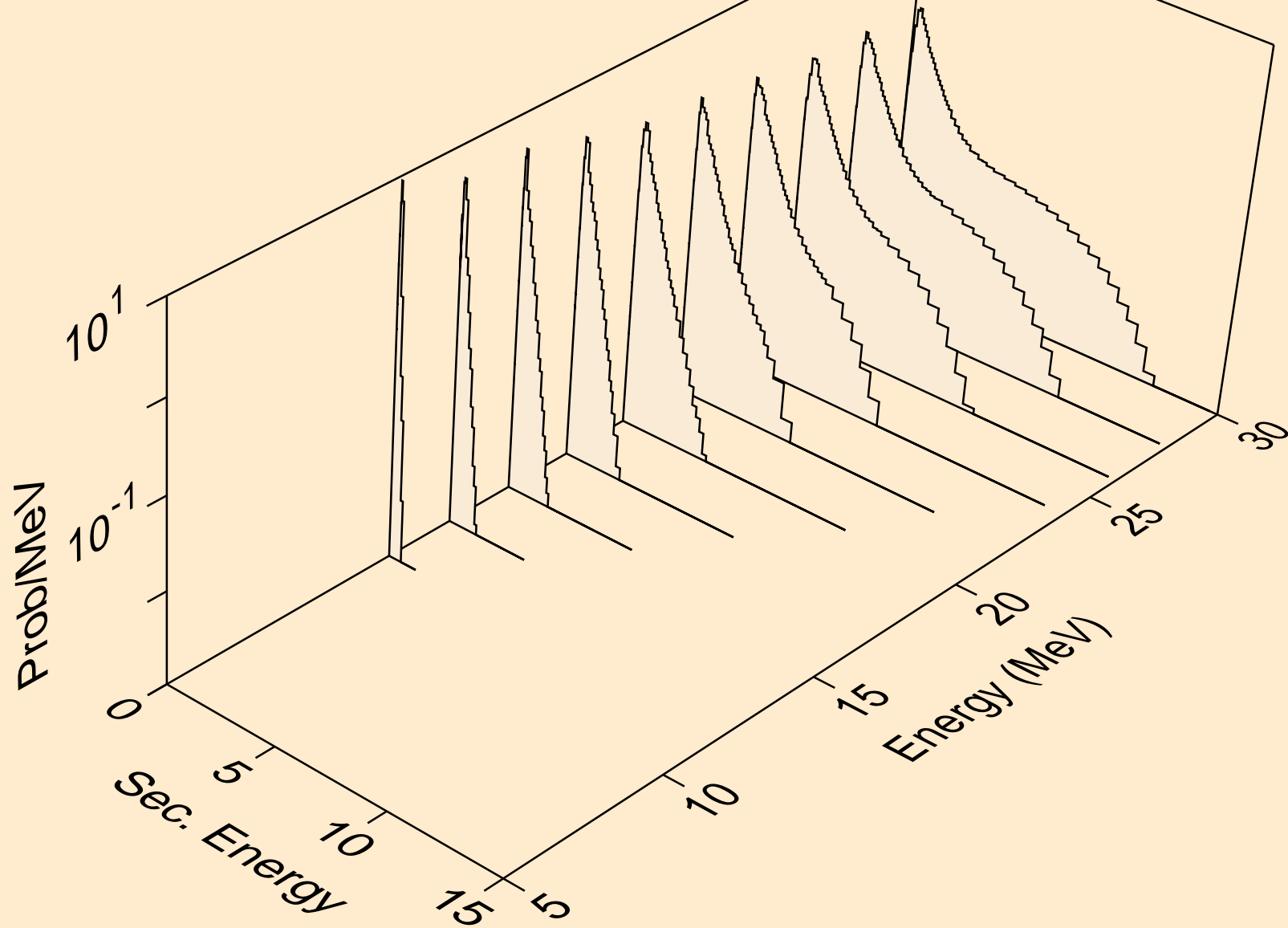

OS195 NEUTRON ACER TENDL-2021 LIBRARY; T=293.6K  
Neutron emission for (n,n\*)d

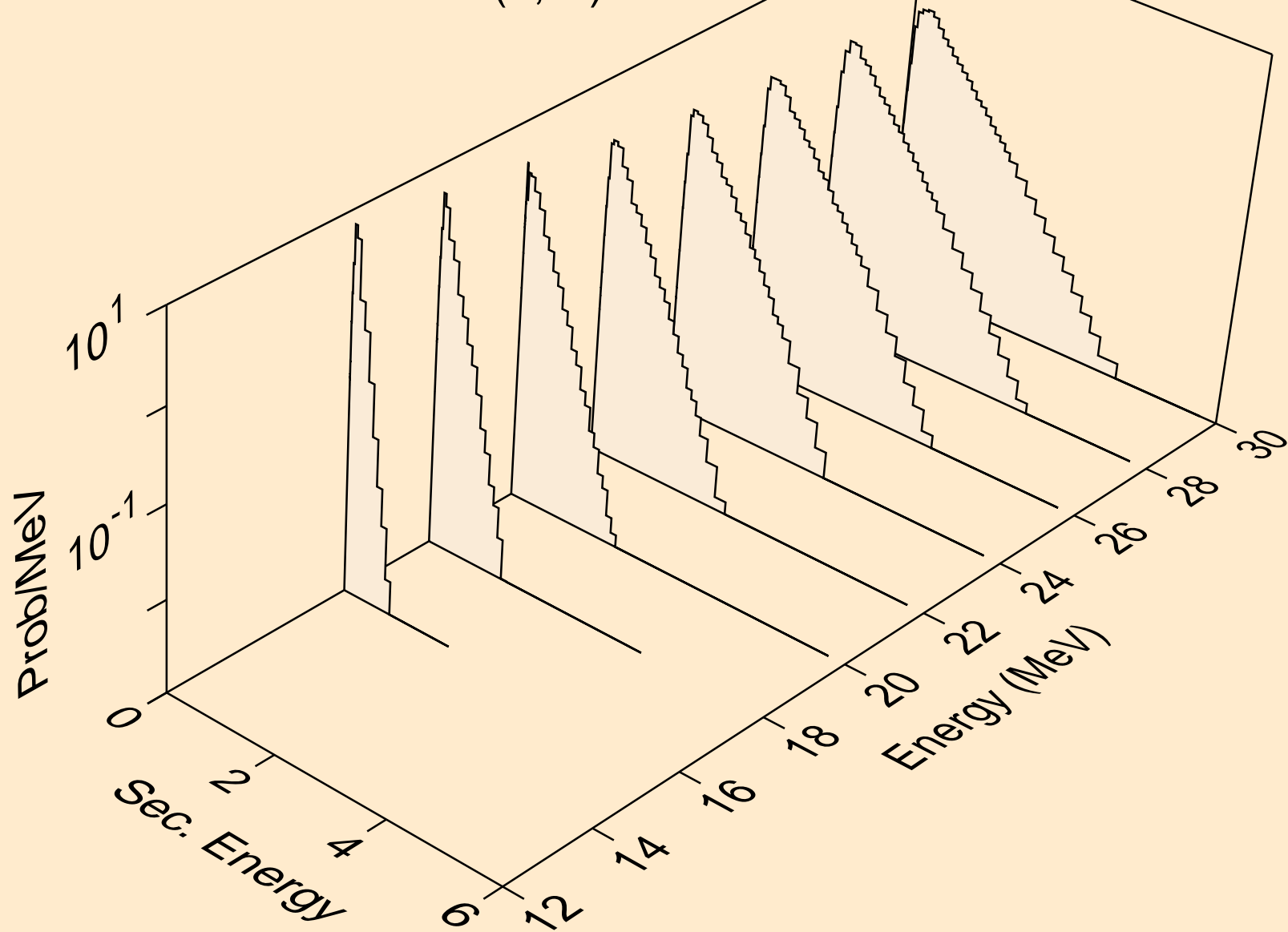

OS195 NEUTRON ACER TENDL-2021 LIBRARY; T=293.6K  
Neutron emission for (n,n\*)t

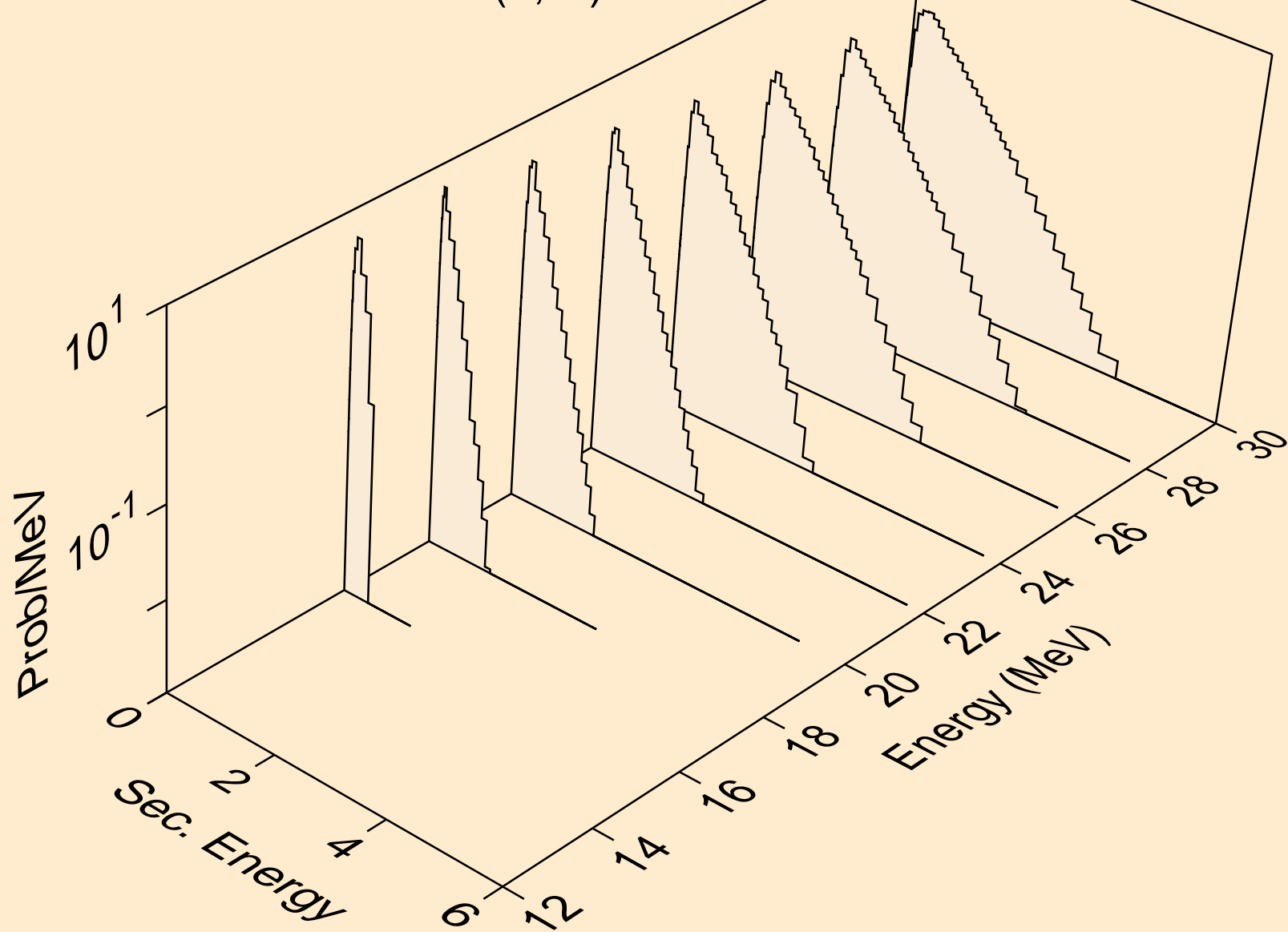



OS195 NEUTRON ACER TENDL-2021 LIBRARY; T=293.6K  
Neutron emission for (n,n\*)he3

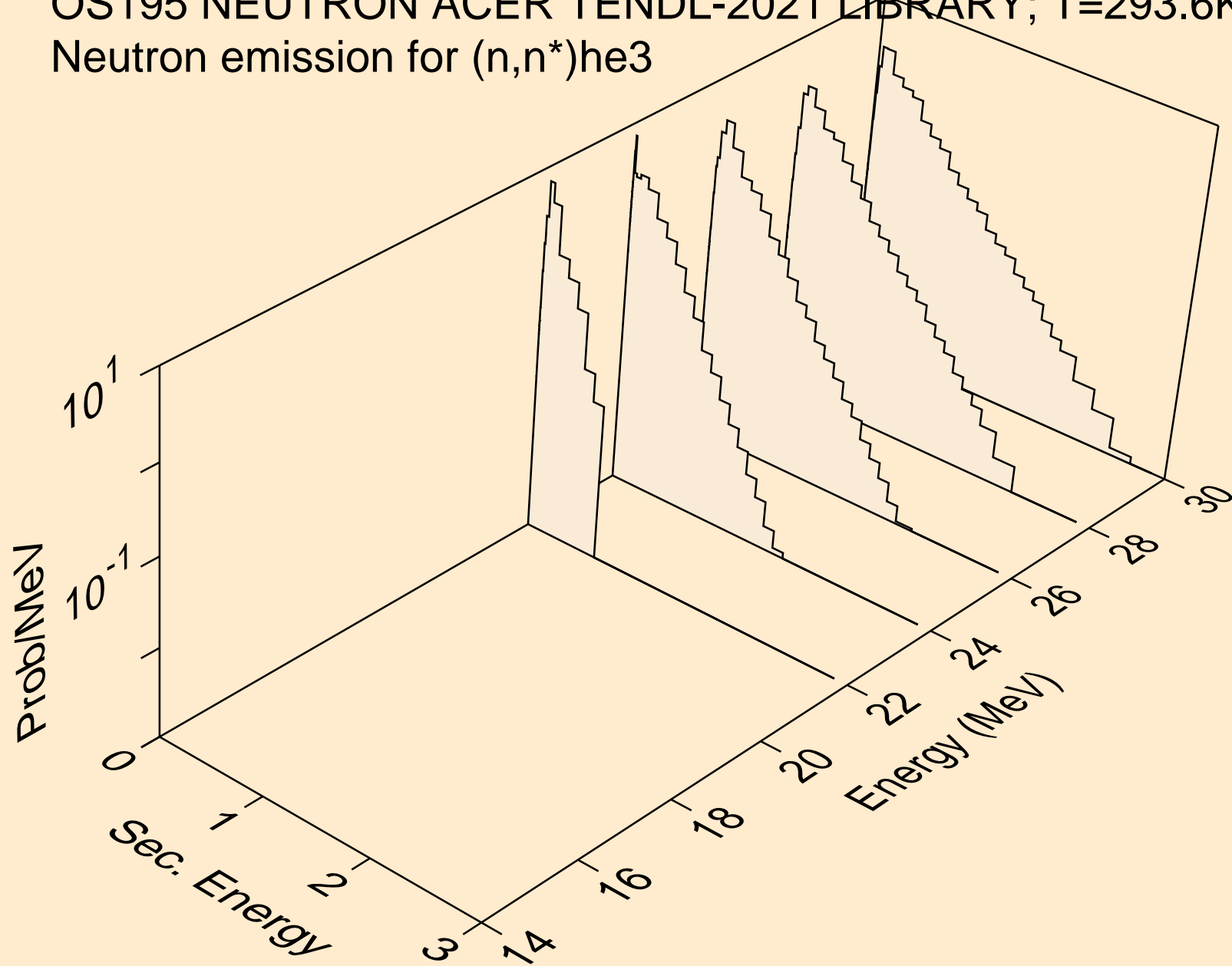

OS195 NEUTRON ACER TENDL-2021 LIBRARY; T=293.6K  
Neutron emission for (n,4n)

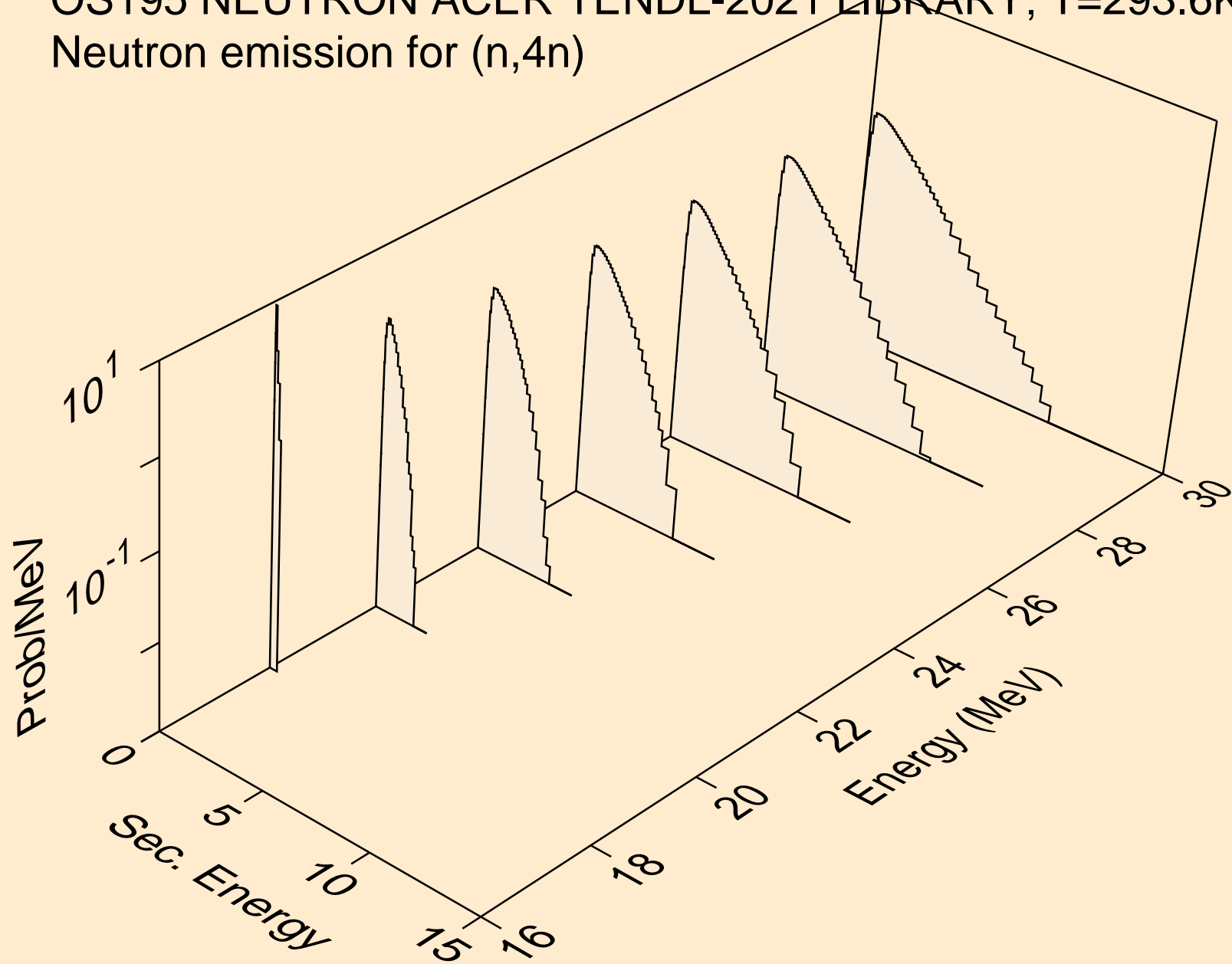

OS195 NEUTRON ACER TENDL-2021 LIBRARY; T=293.6K  
Neutron emission for (n,2np)

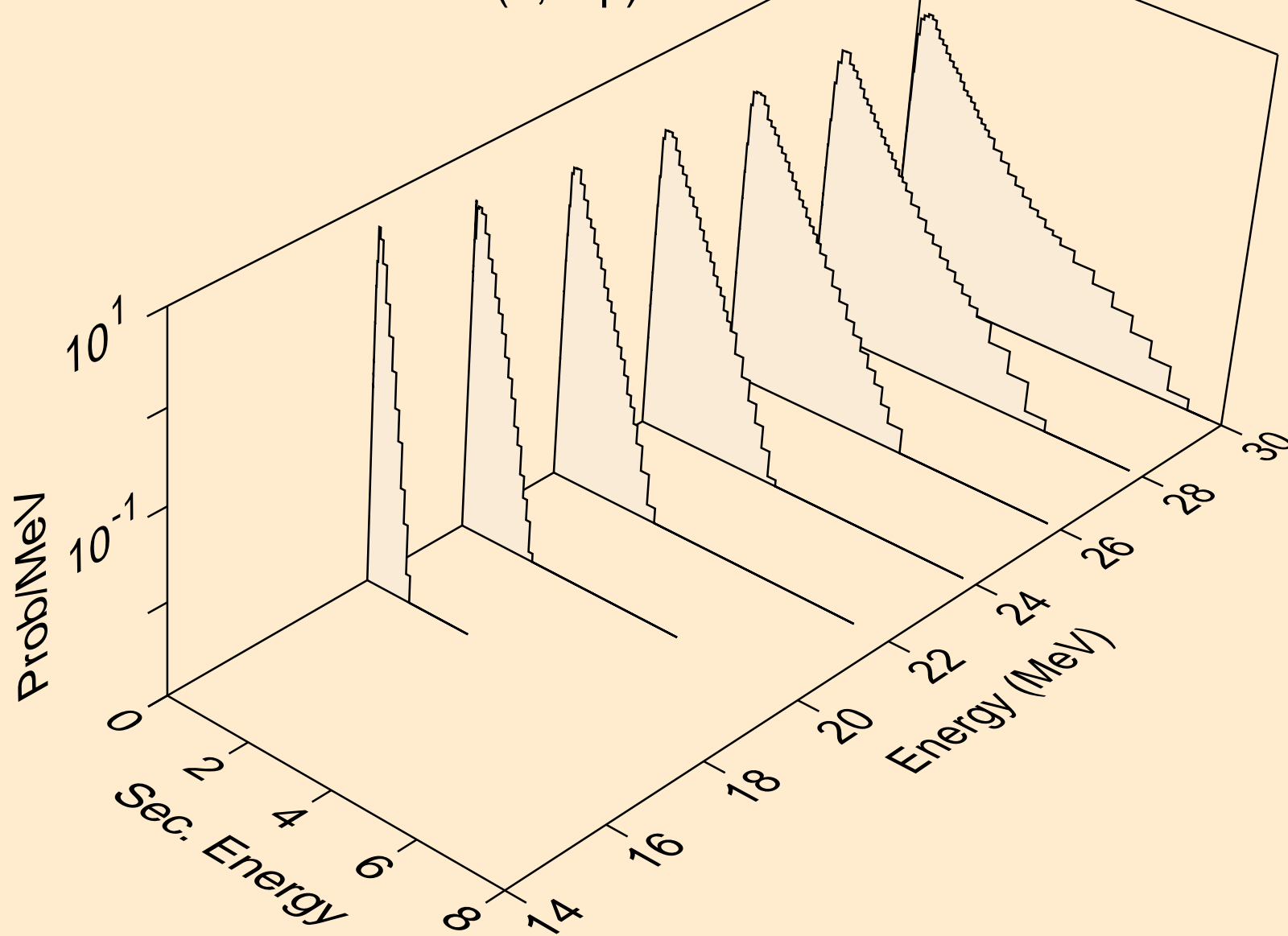

OS195 NEUTRON ACER TENDL-2021 LIBRARY; T=293.6K  
Neutron emission for (n,3np)

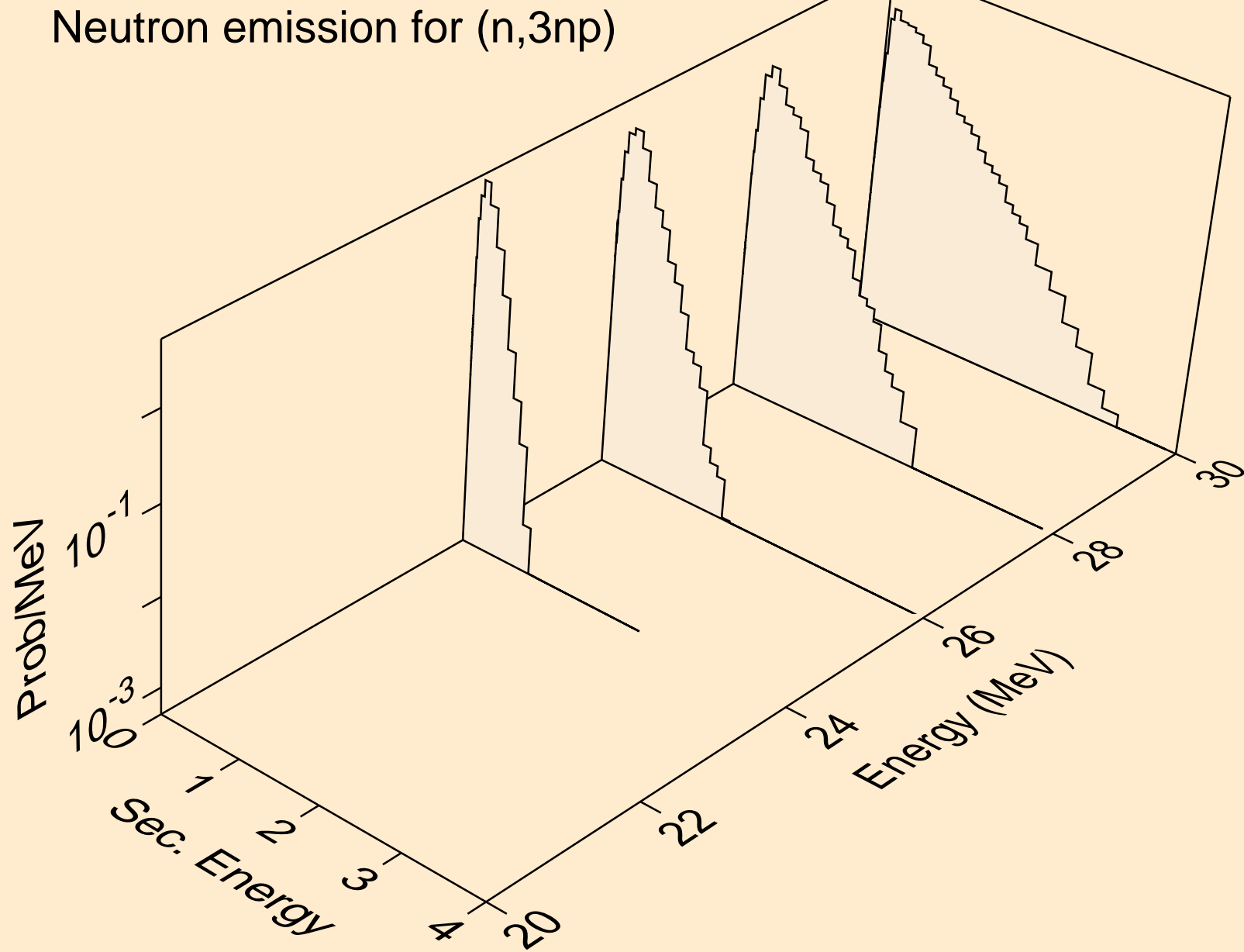

OS195 NEUTRON ACER TENDL-2021 LIBRARY; T=293.6K  
Neutron emission for (n,n\*c)

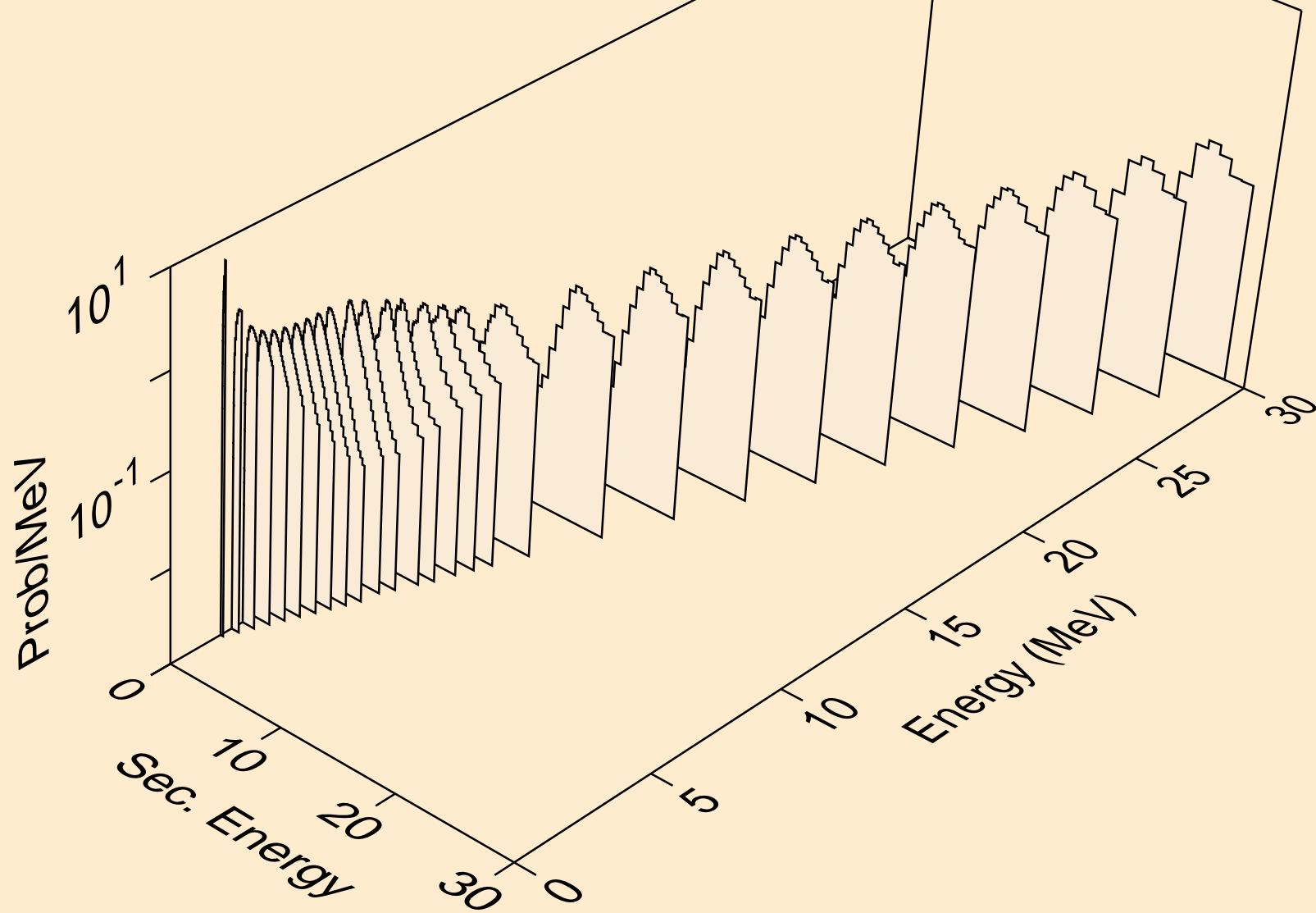

OS195 NEUTRON ACER TENDL-2021 LIBRARY; T=293.6K  
Photon emission for (n,x)

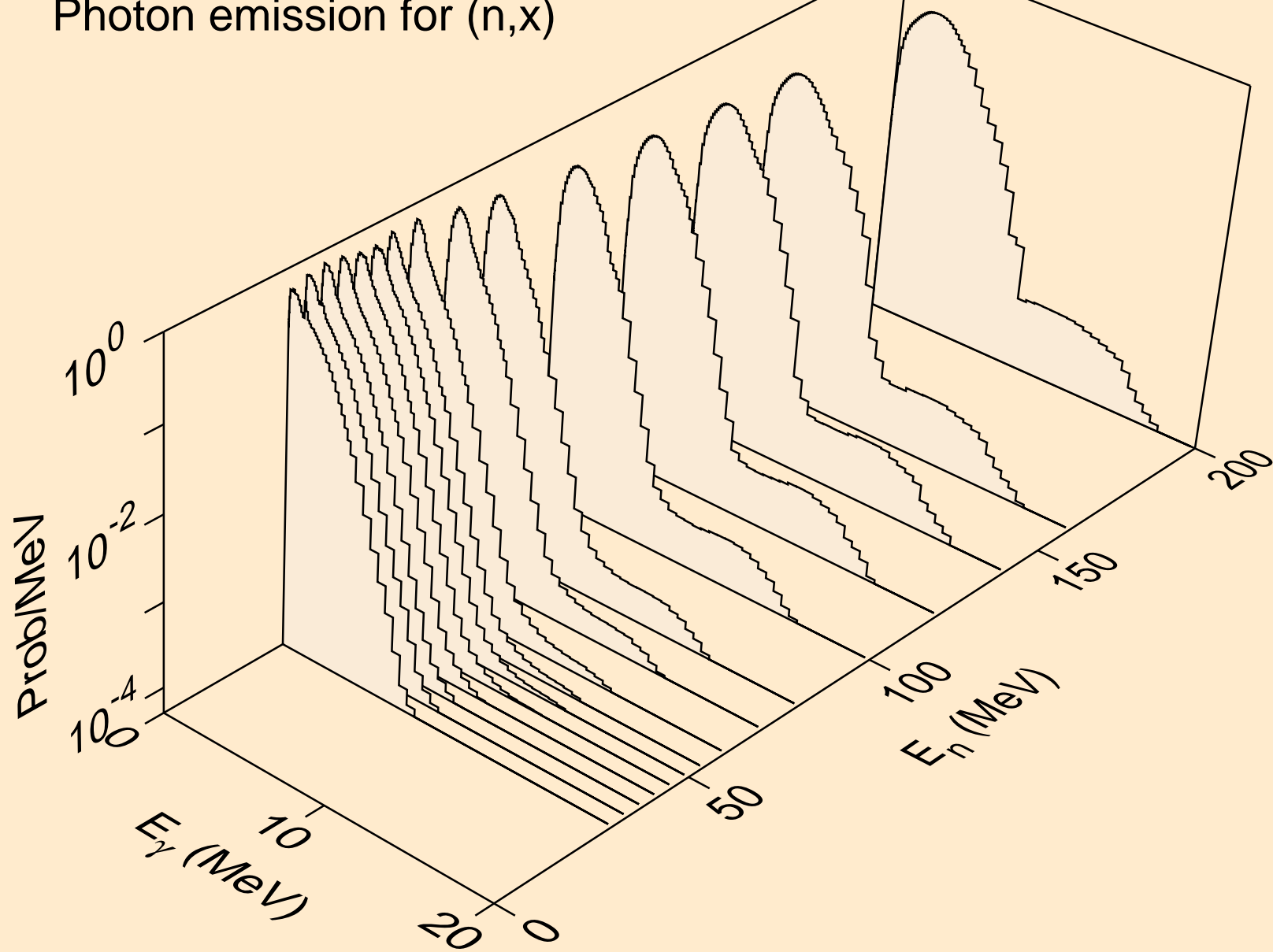

OS195 NEUTRON ACER TENDL-2021 LIBRARY; T=293.6K  
Photon emission for (n,2nd)

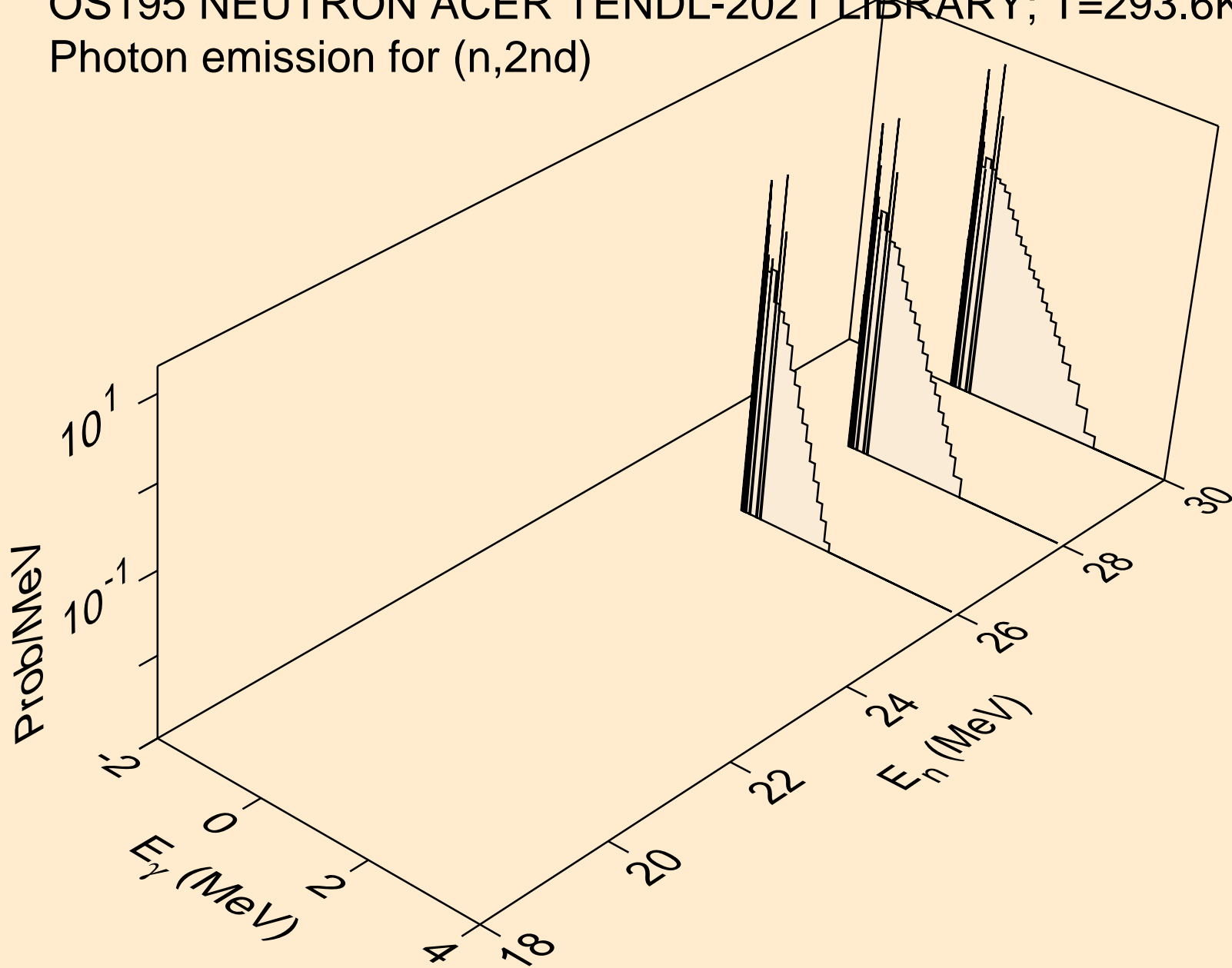

OS195 NEUTRON ACER TENDL-2021 LIBRARY; T=293.6K  
Photon emission for (n,2n)

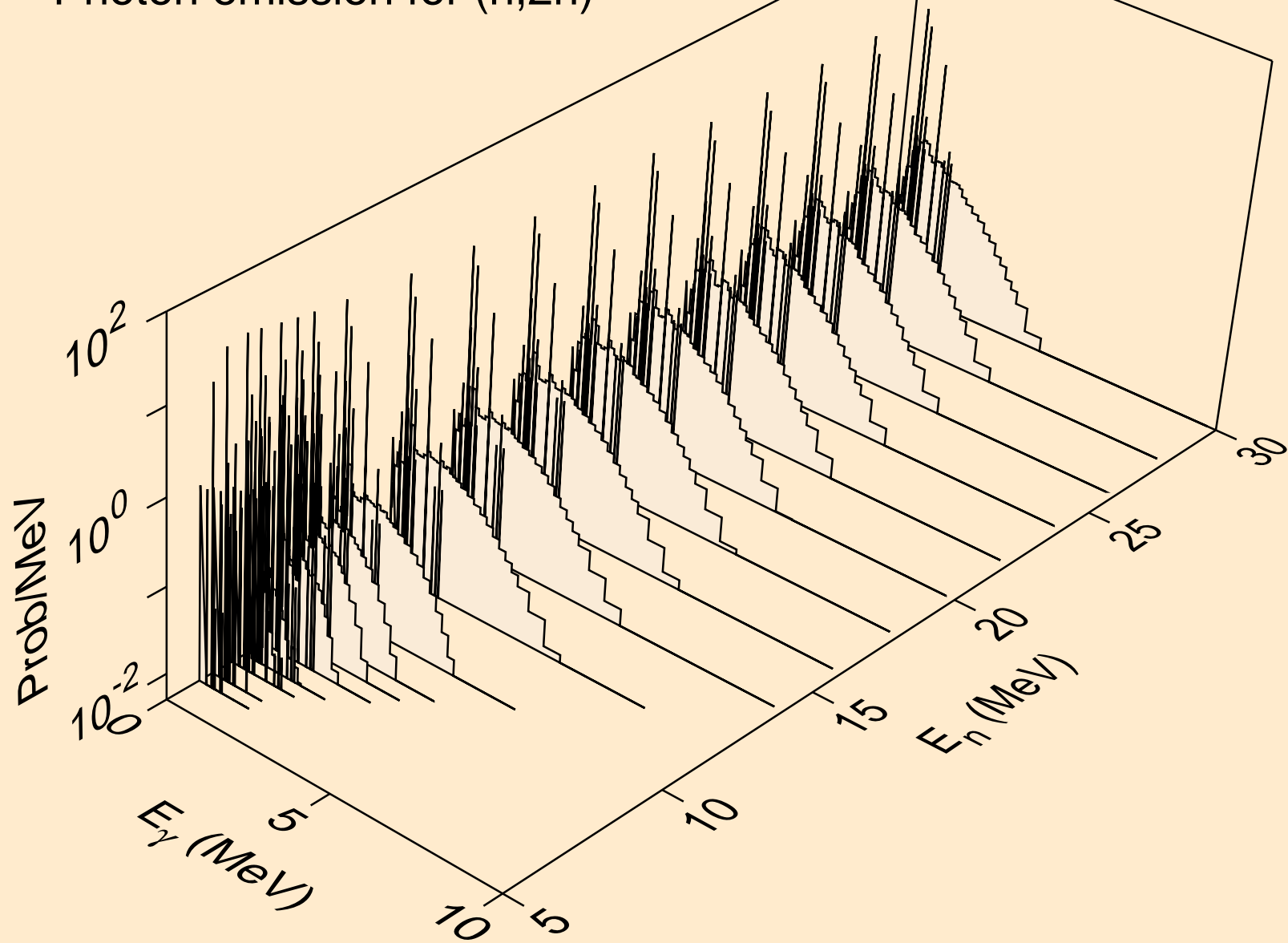



OS195 NEUTRON ACER TENDL-2021 LIBRARY; T=293.6K  
Photon emission for (n,3n)

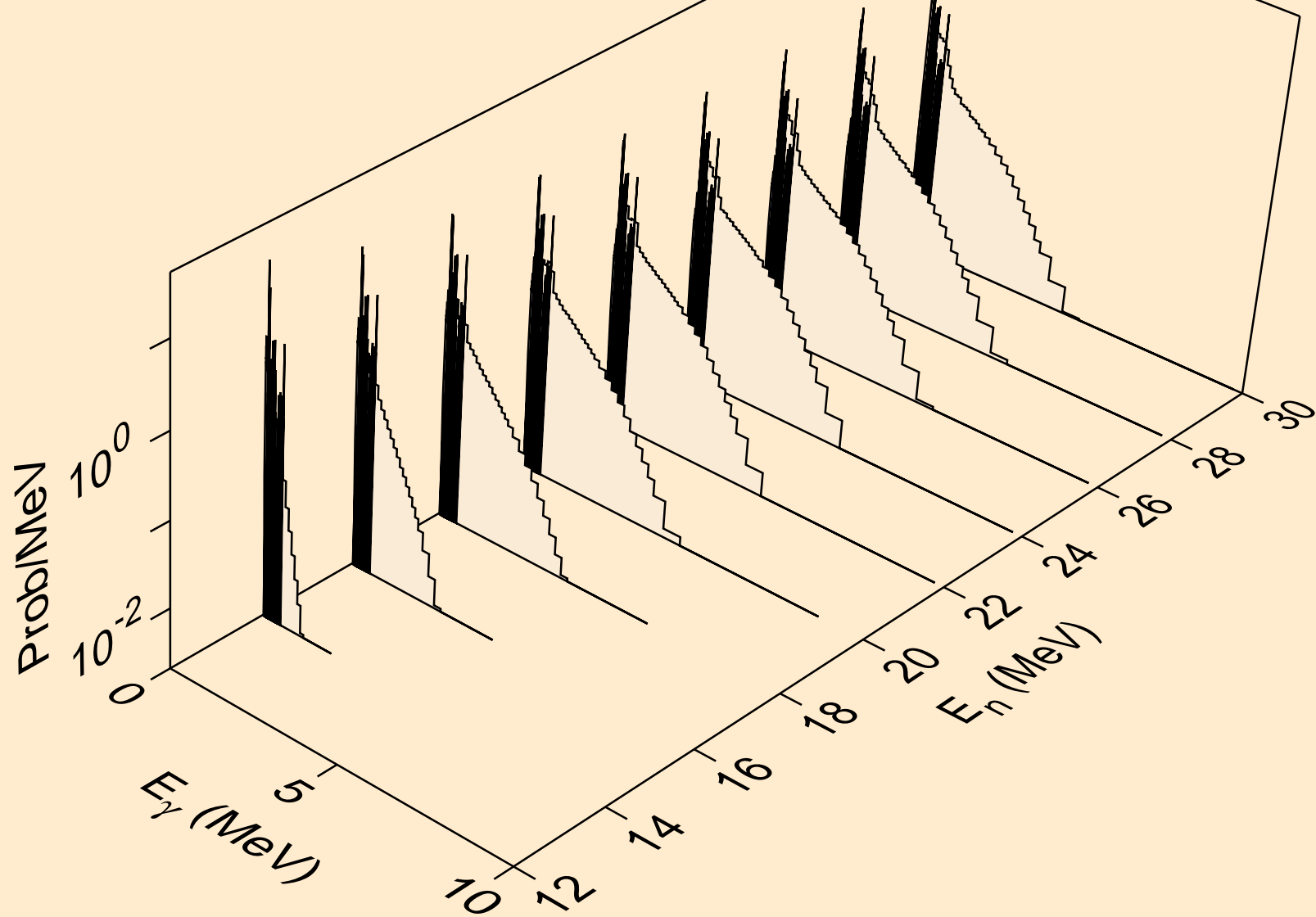

OS195 NEUTRON ACER TENDL-2021 LIBRARY; T=293.6K  
Photon emission for (n,n\*)a

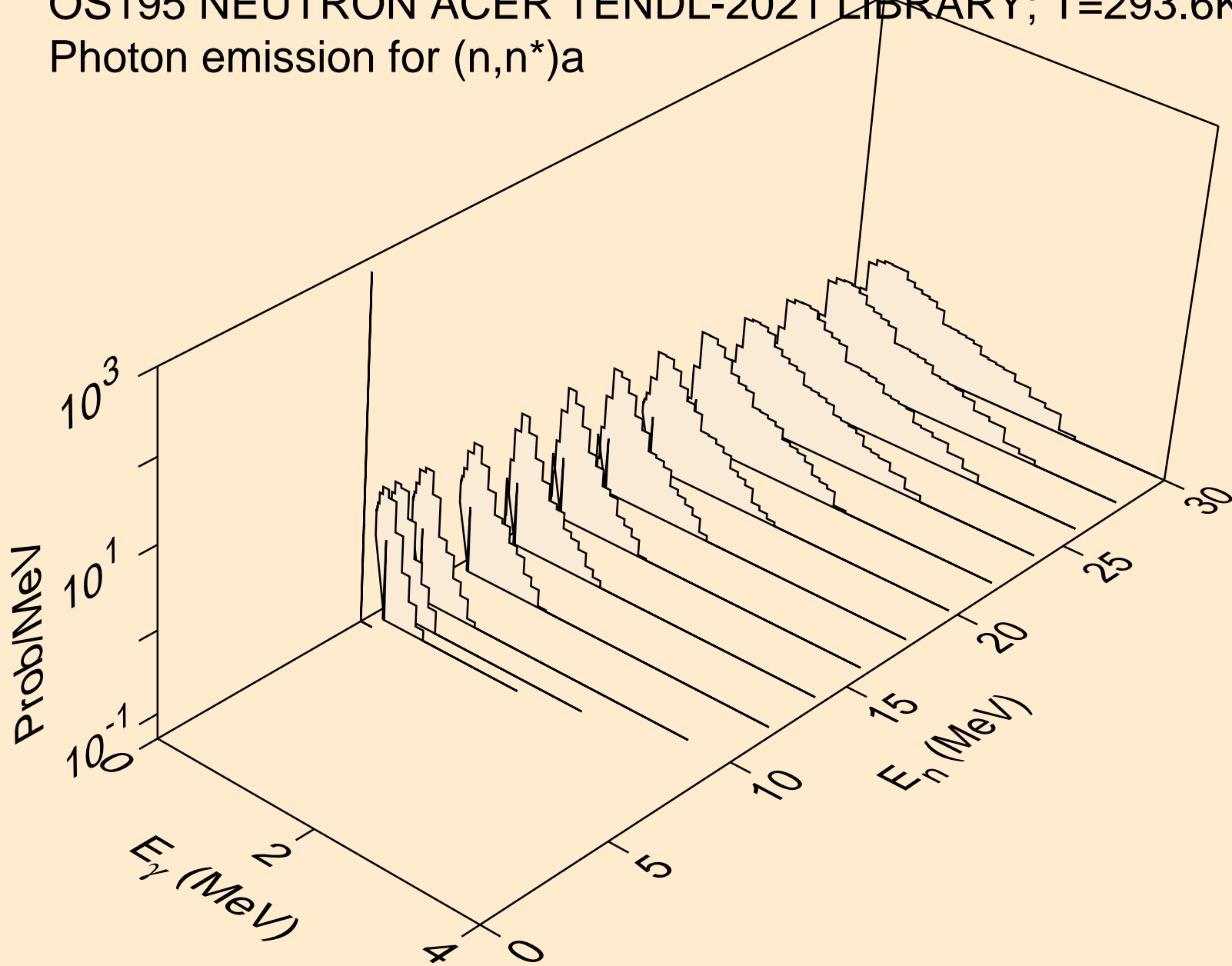

OS195 NEUTRON ACER TENDL-2021 LIBRARY; T=293.6K  
Photon emission for (n,2n)a

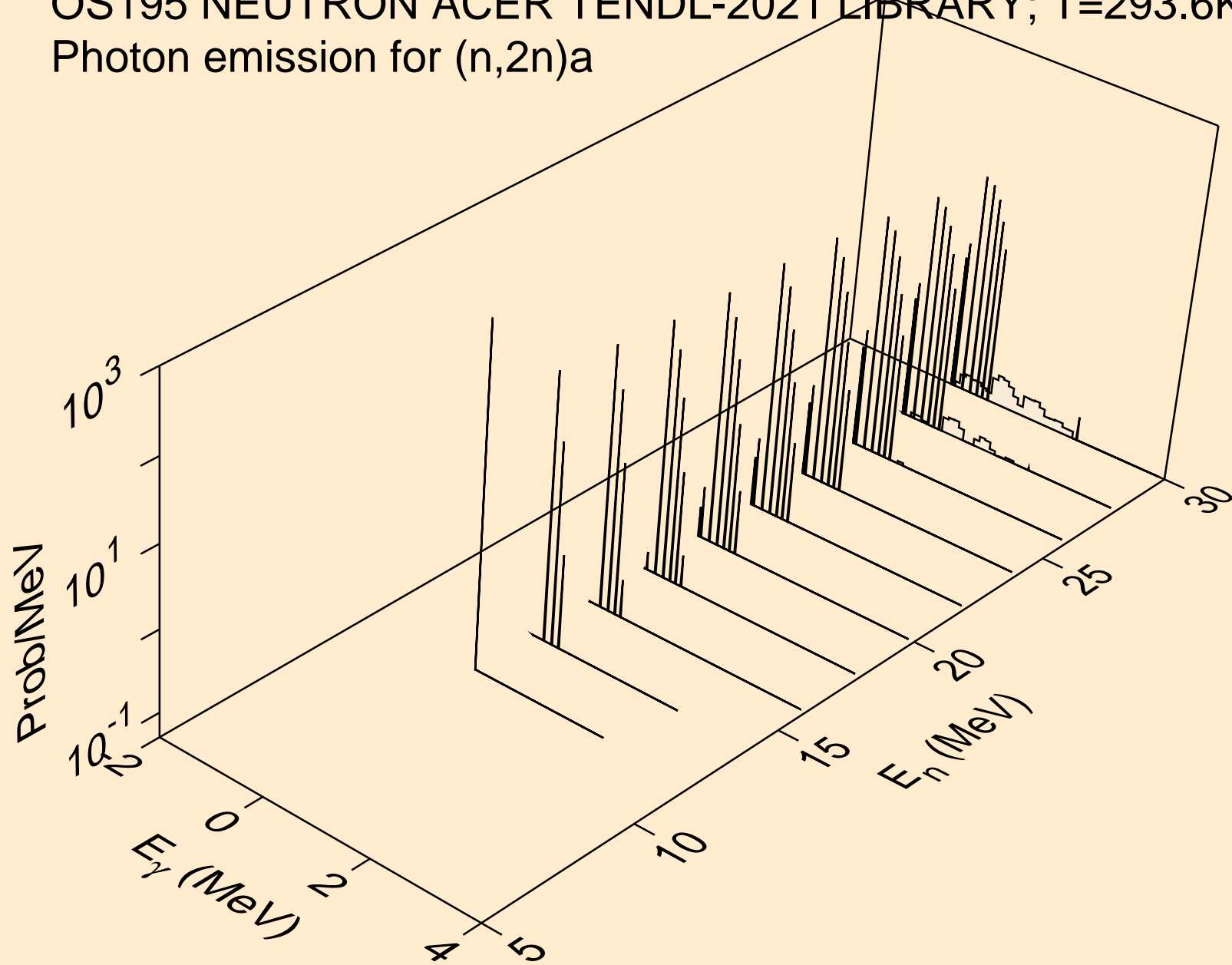

OS195 NEUTRON ACER TENDL-2021 LIBRARY; T=293.6K  
Photon emission for (n,3n)a

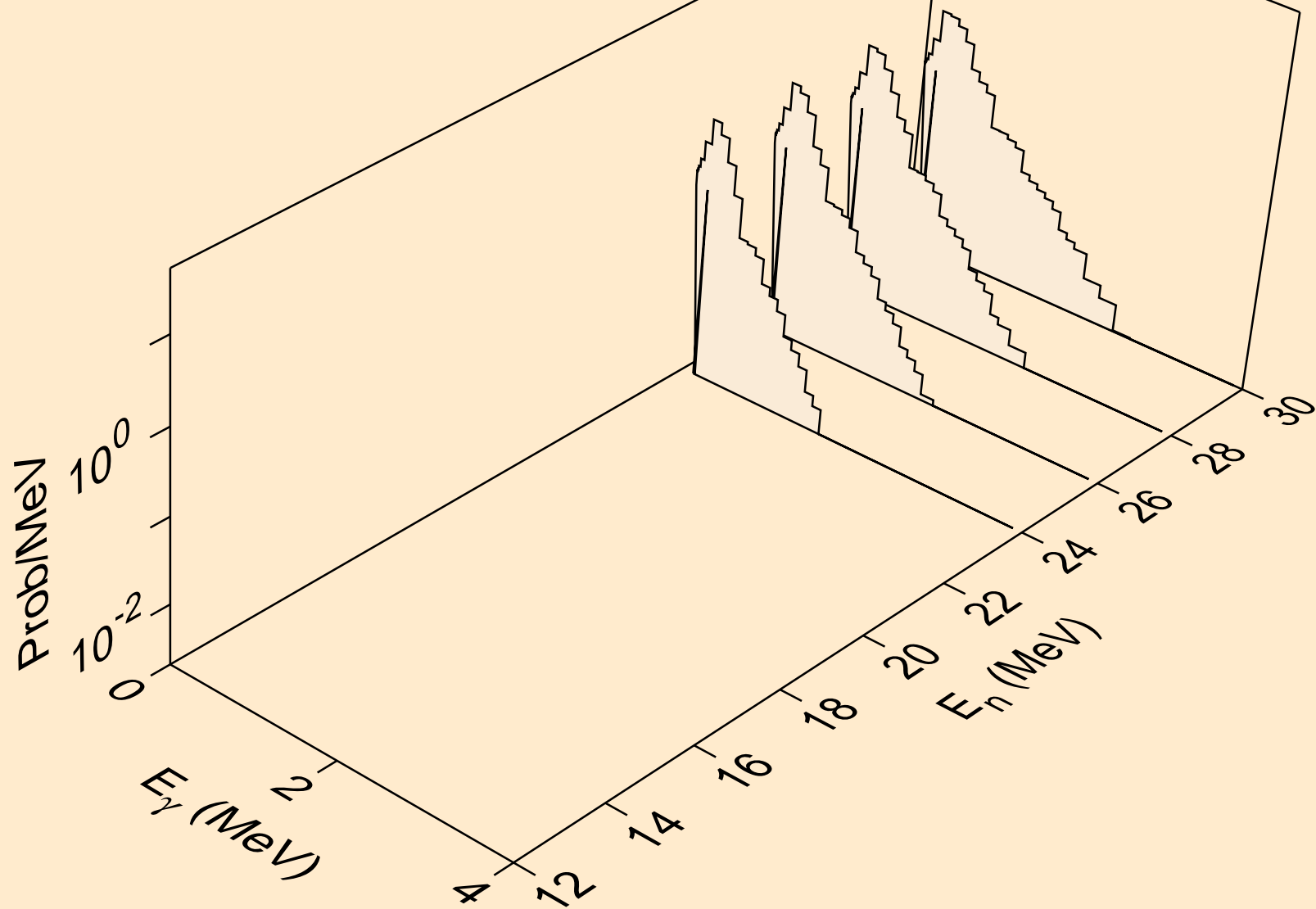

OS195 NEUTRON ACER TENDL-2021 LIBRARY; T=293.6K  
Photon emission for (n,n\*)p

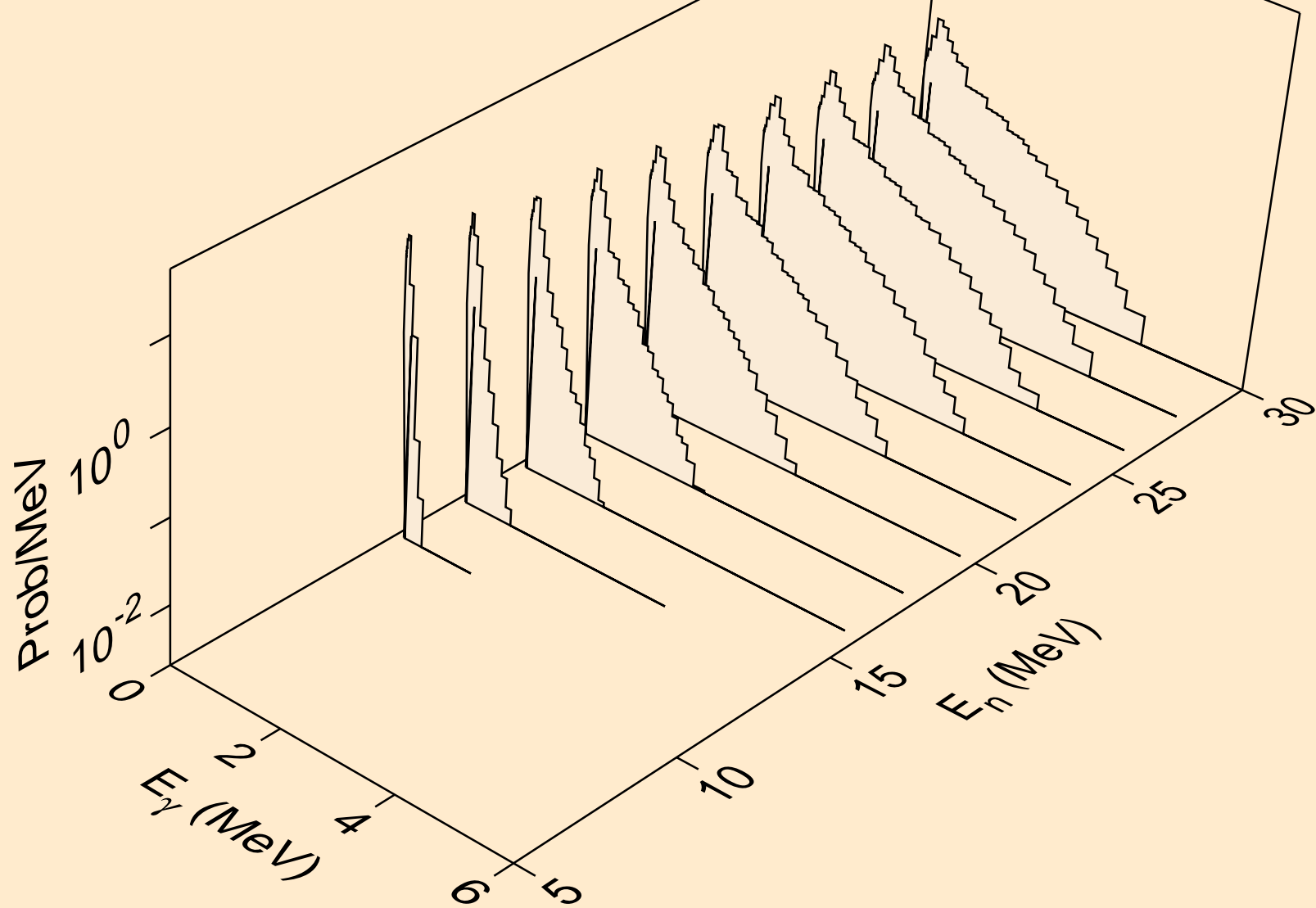

OS195 NEUTRON ACER TENDL-2021 LIBRARY; T=293.6K  
Photon emission for (n,n\*)d

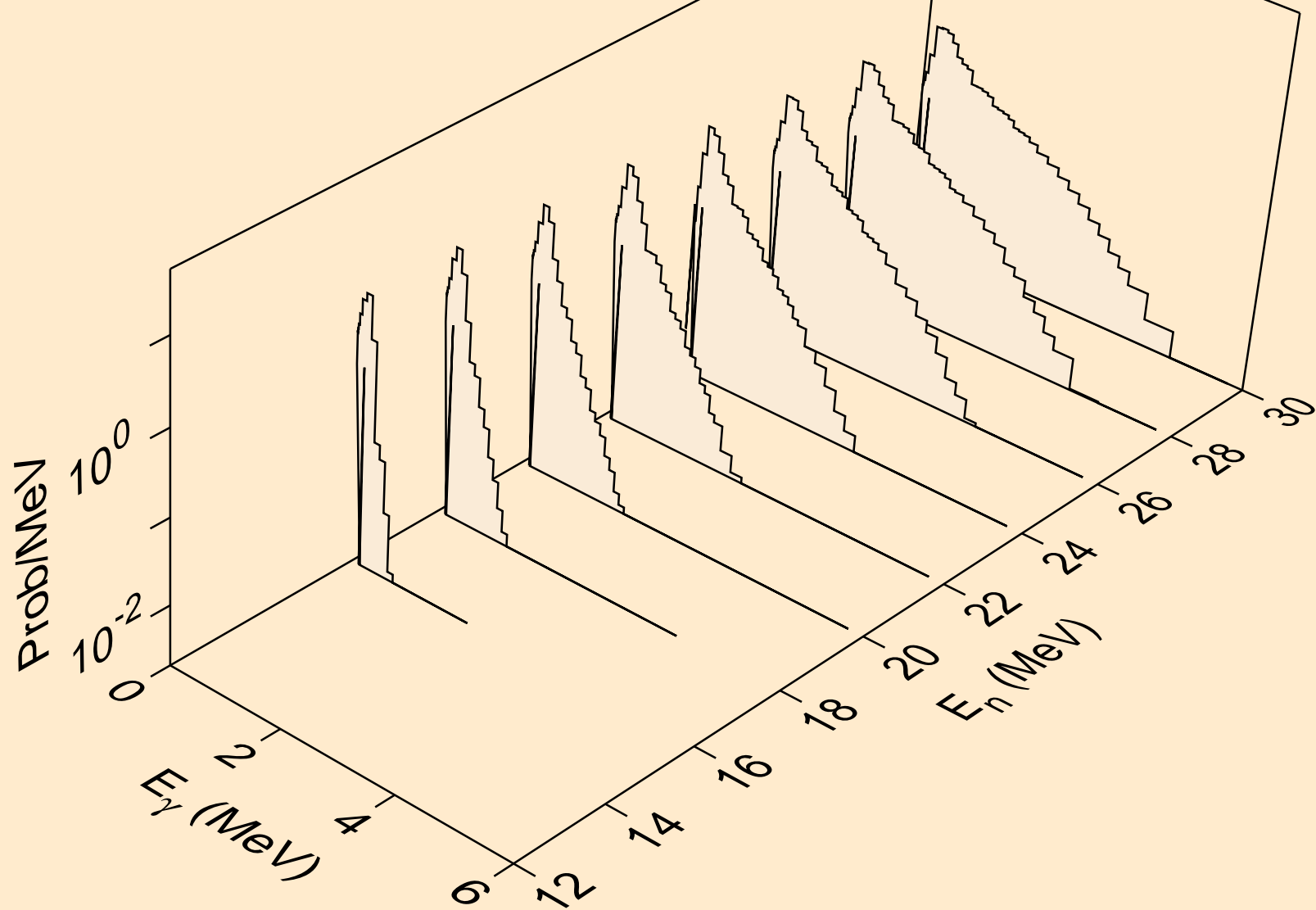

OS195 NEUTRON ACER TENDL-2021 LIBRARY; T=293.6K  
Photon emission for (n,n\*)t

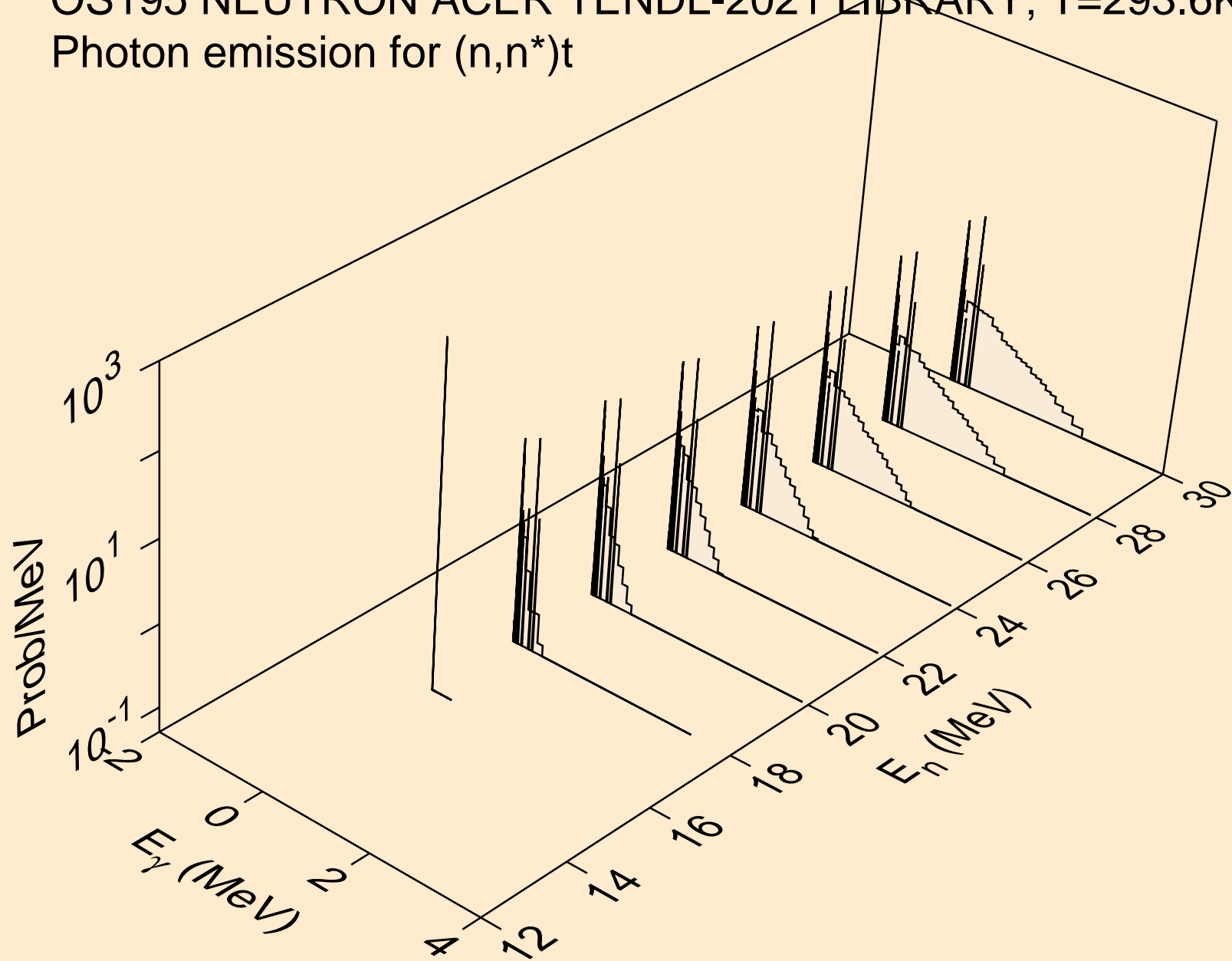

OS195 NEUTRON ACER TENDL-2021 LIBRARY; T=293.6K  
Photon emission for (n,n\*)he3

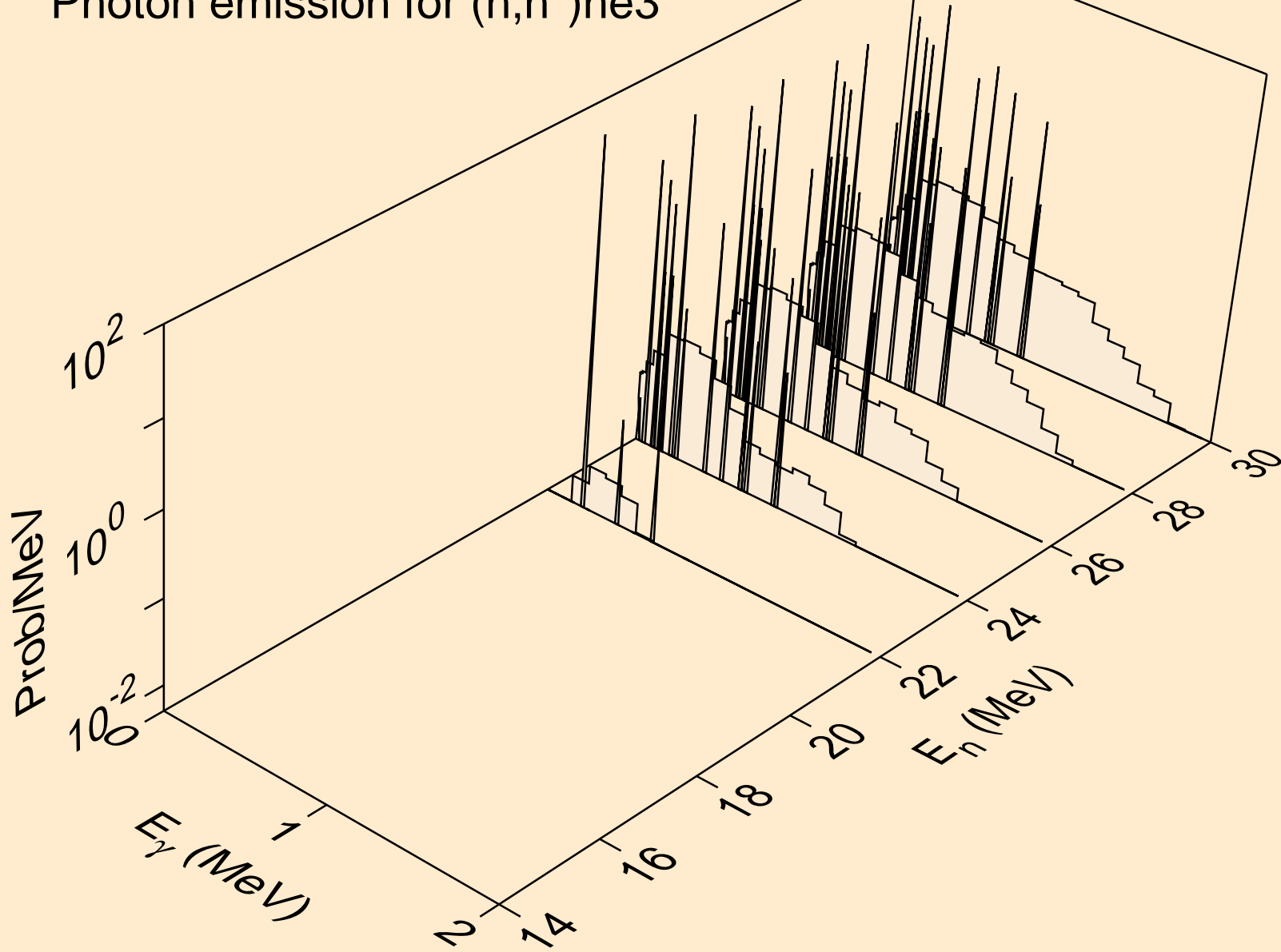



OS195 NEUTRON ACER TENDL-2021 LIBRARY; T=293.6K  
Photon emission for (n,4n)

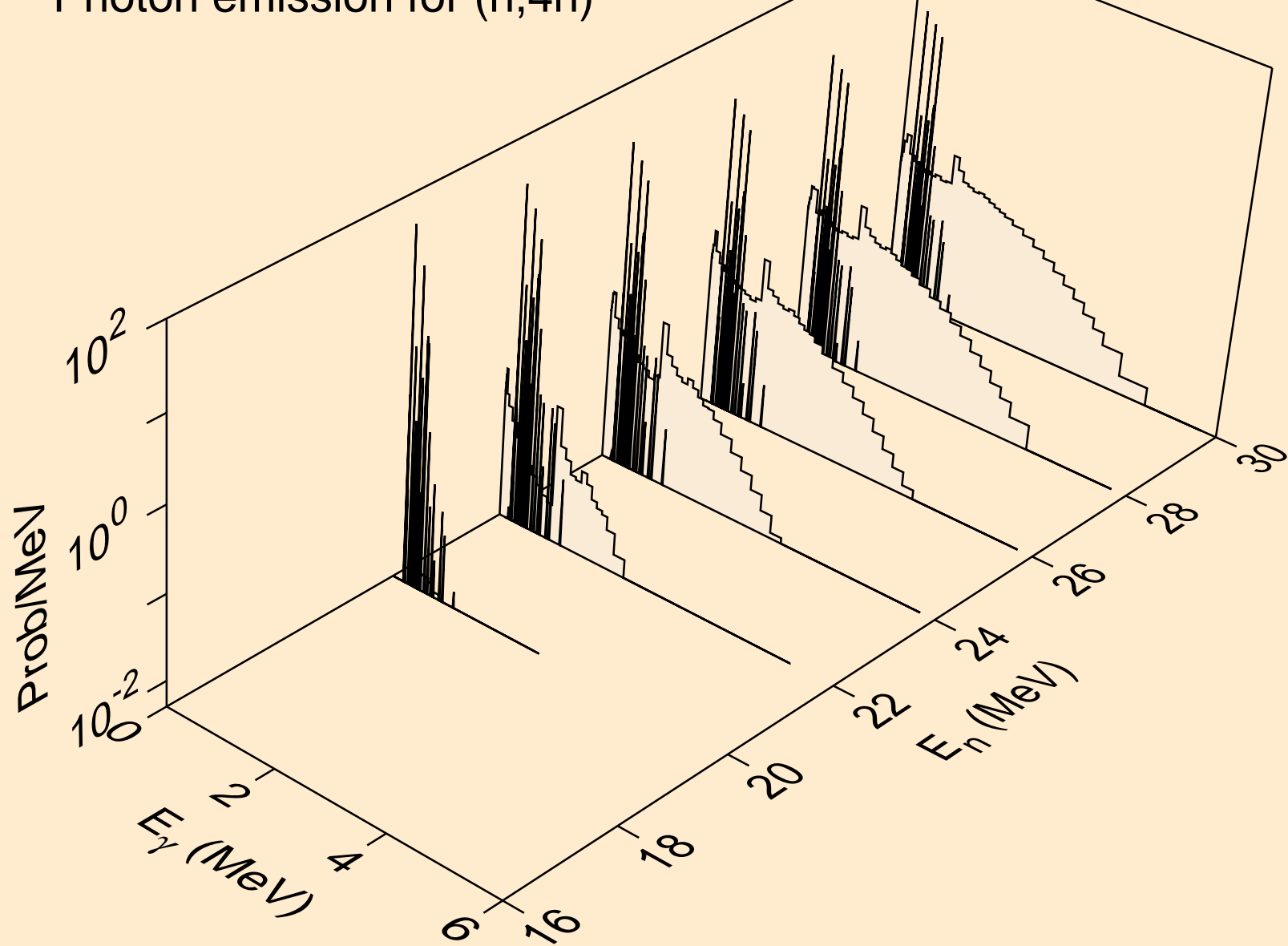

OS195 NEUTRON ACER TENDL-2021 LIBRARY; T=293.6K  
Photon emission for (n,2np)

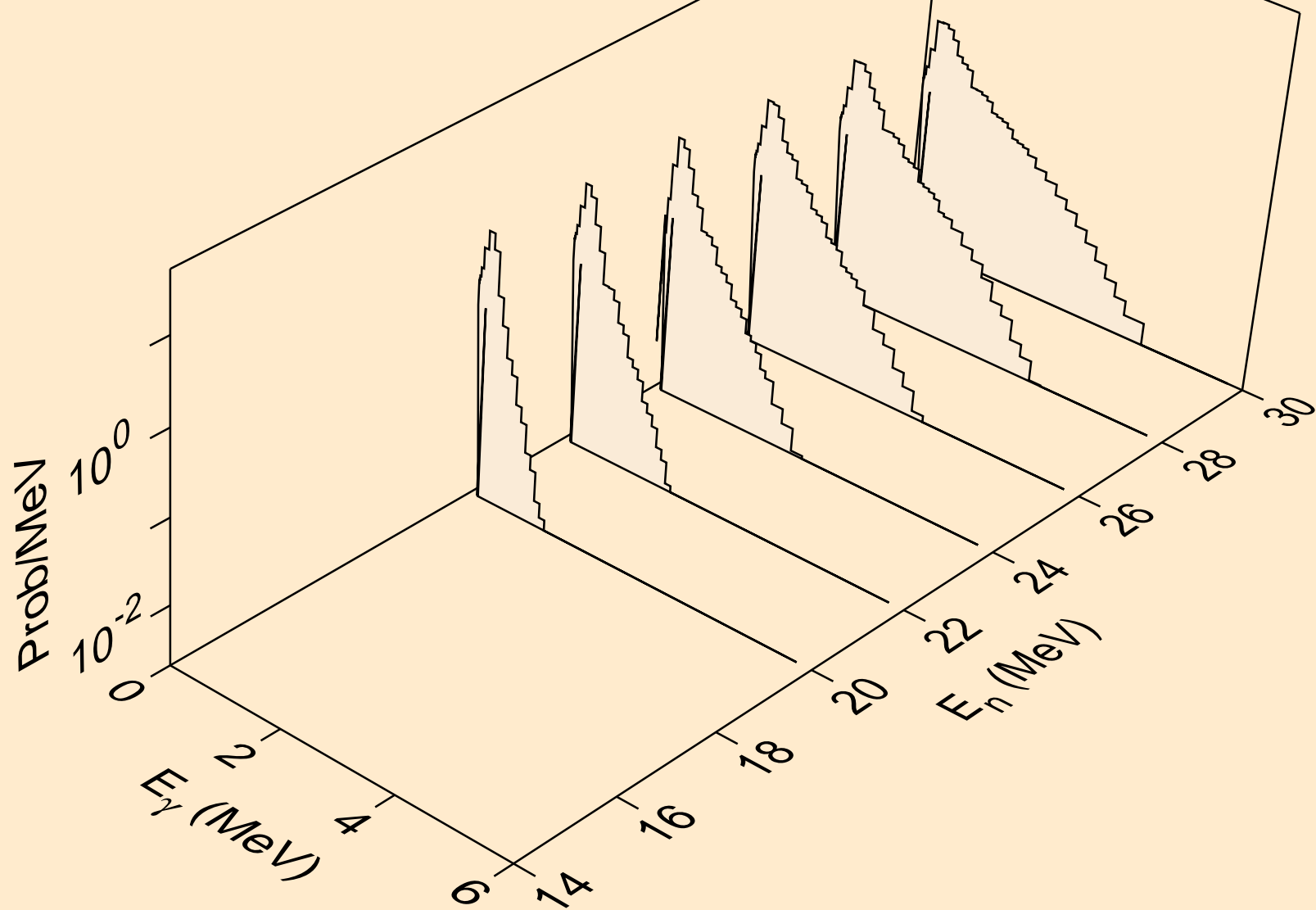

OS195 NEUTRON ACER TENDL-2021 LIBRARY; T=293.6K  
Photon emission for (n,3np)

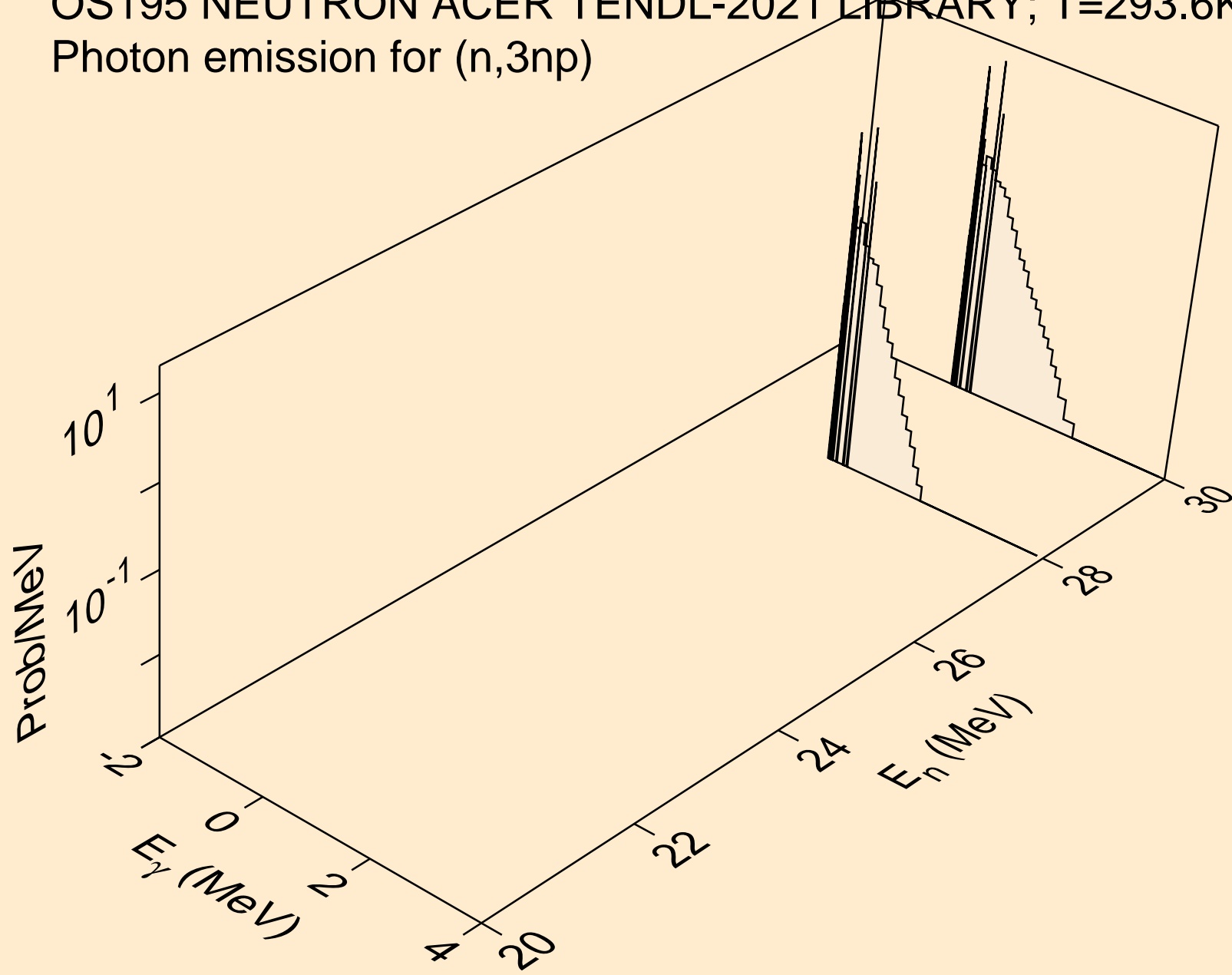

OS195 NEUTRON ACER TENDL-2021 LIBRARY; T=293.6K  
Photon emission for (n,n\*c)

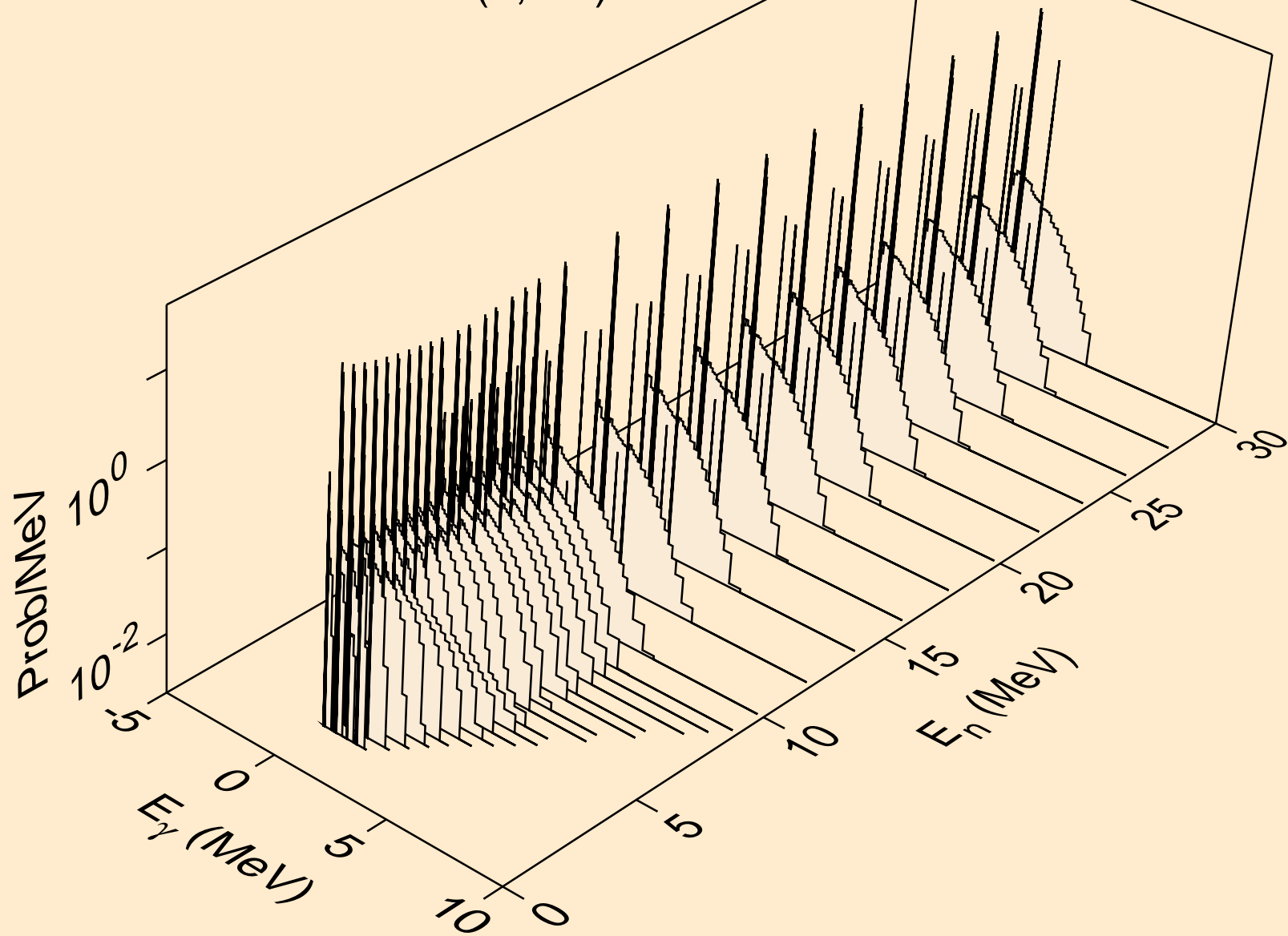

OS195 NEUTRON ACER TENDL-2021 LIBRARY; T=293.6K  
Photon emission for (n,gma)

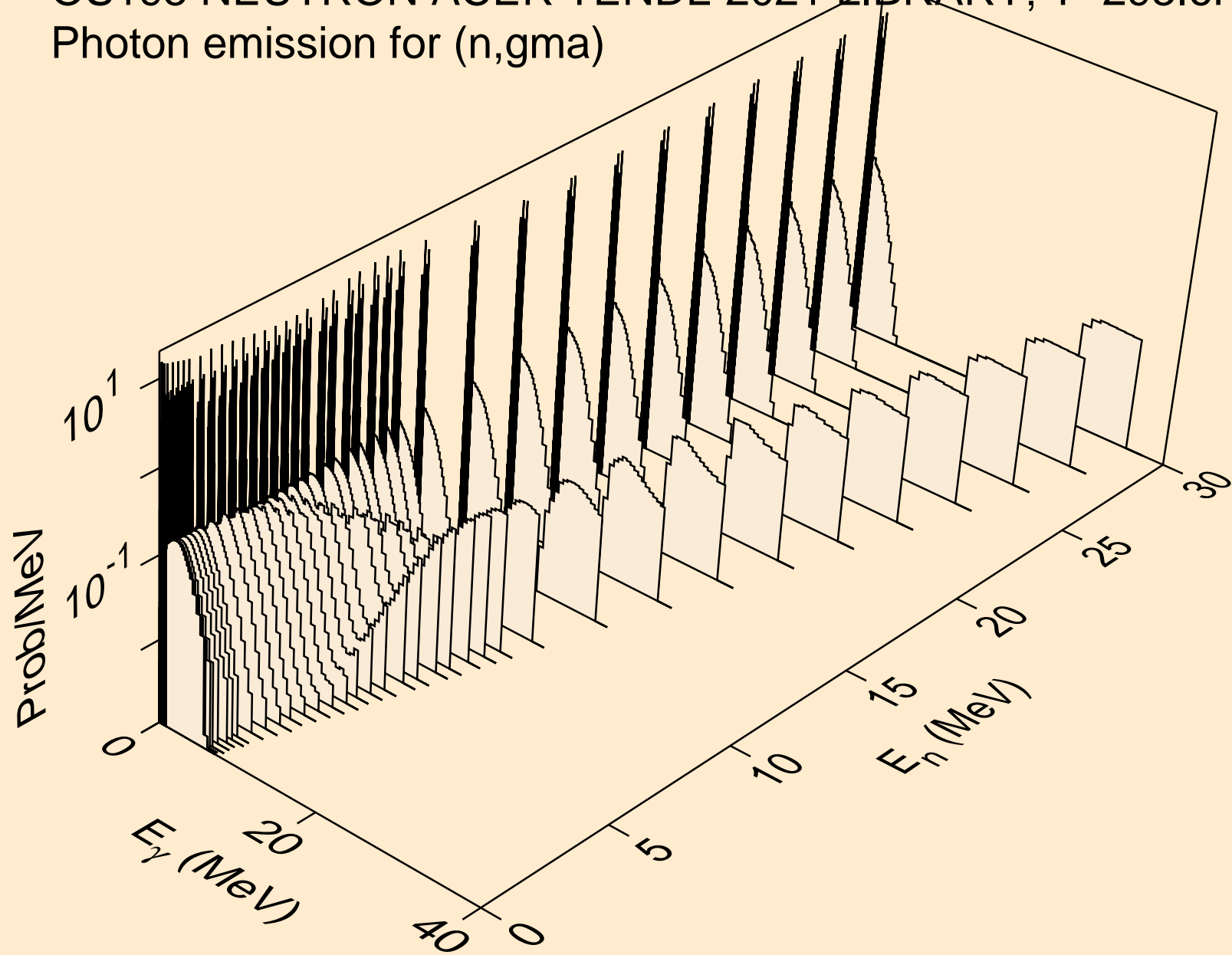

OS195 NEUTRON ACER TENDL-2021 LIBRARY; T=293.6K  
Photon emission for (n,p)

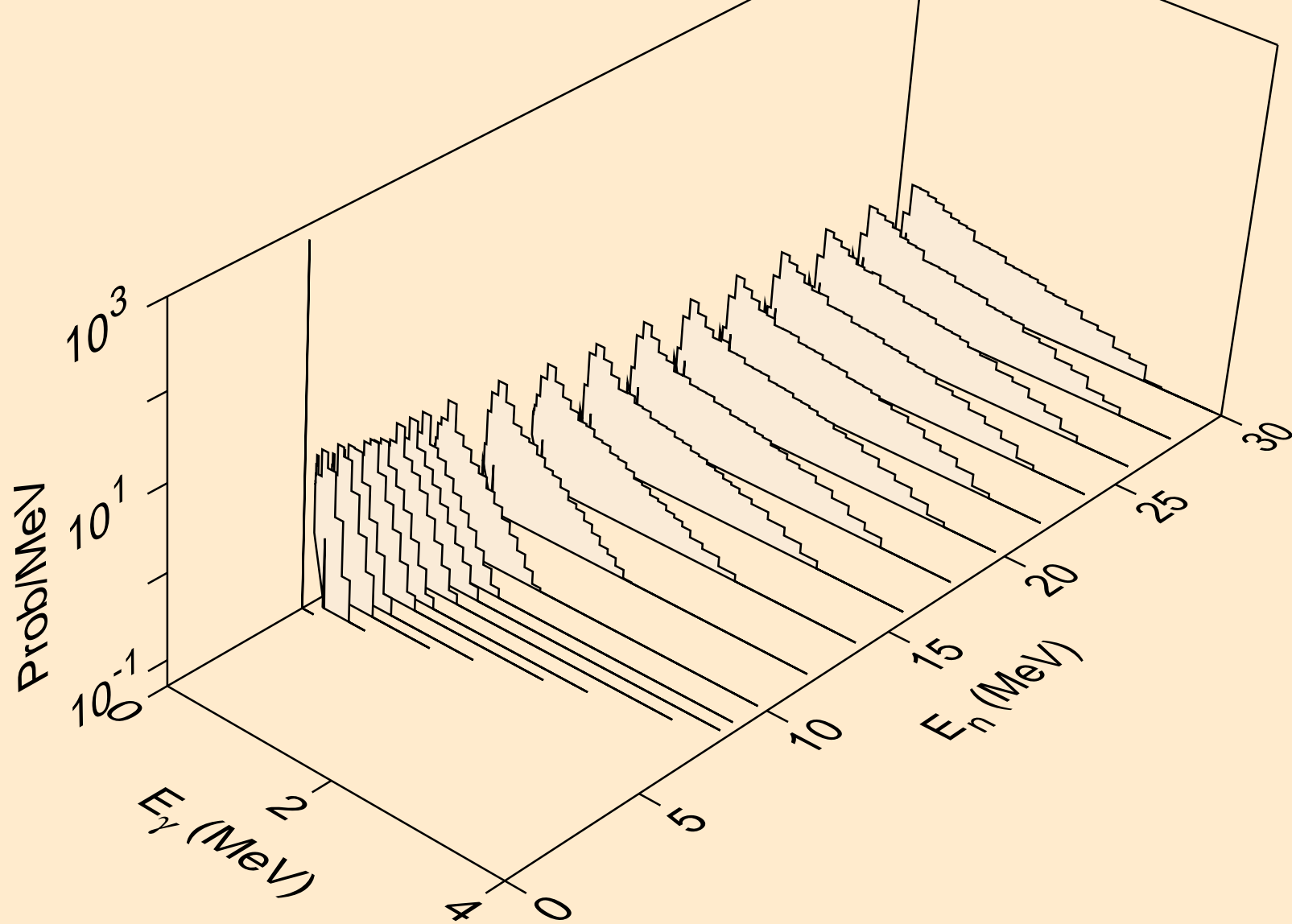

OS195 NEUTRON ACER TENDL-2021 LIBRARY; T=293.6K  
Photon emission for (n,d)

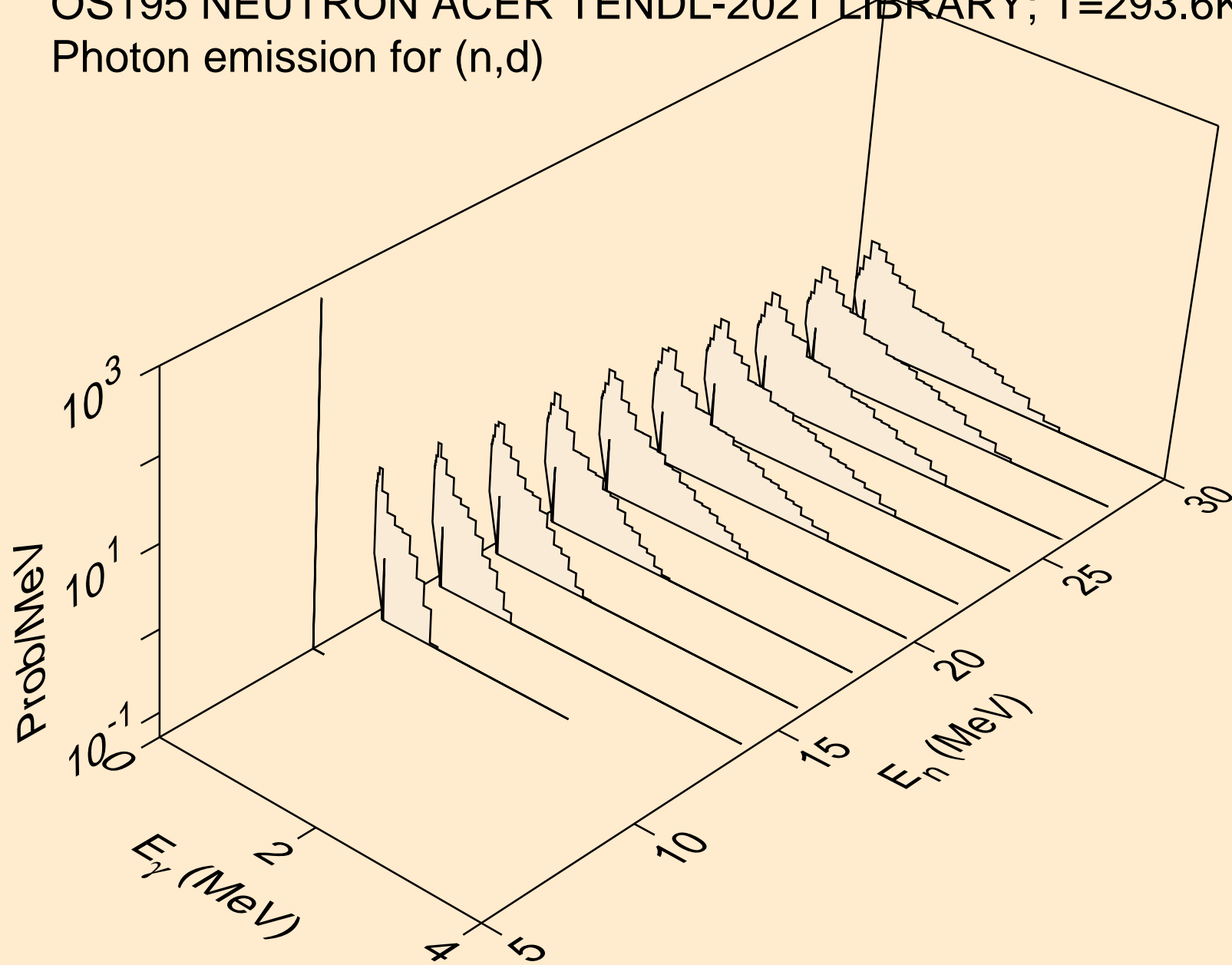

OS195 NEUTRON ACER TENDL-2021 LIBRARY; T=293.6K  
Photon emission for (n,t)

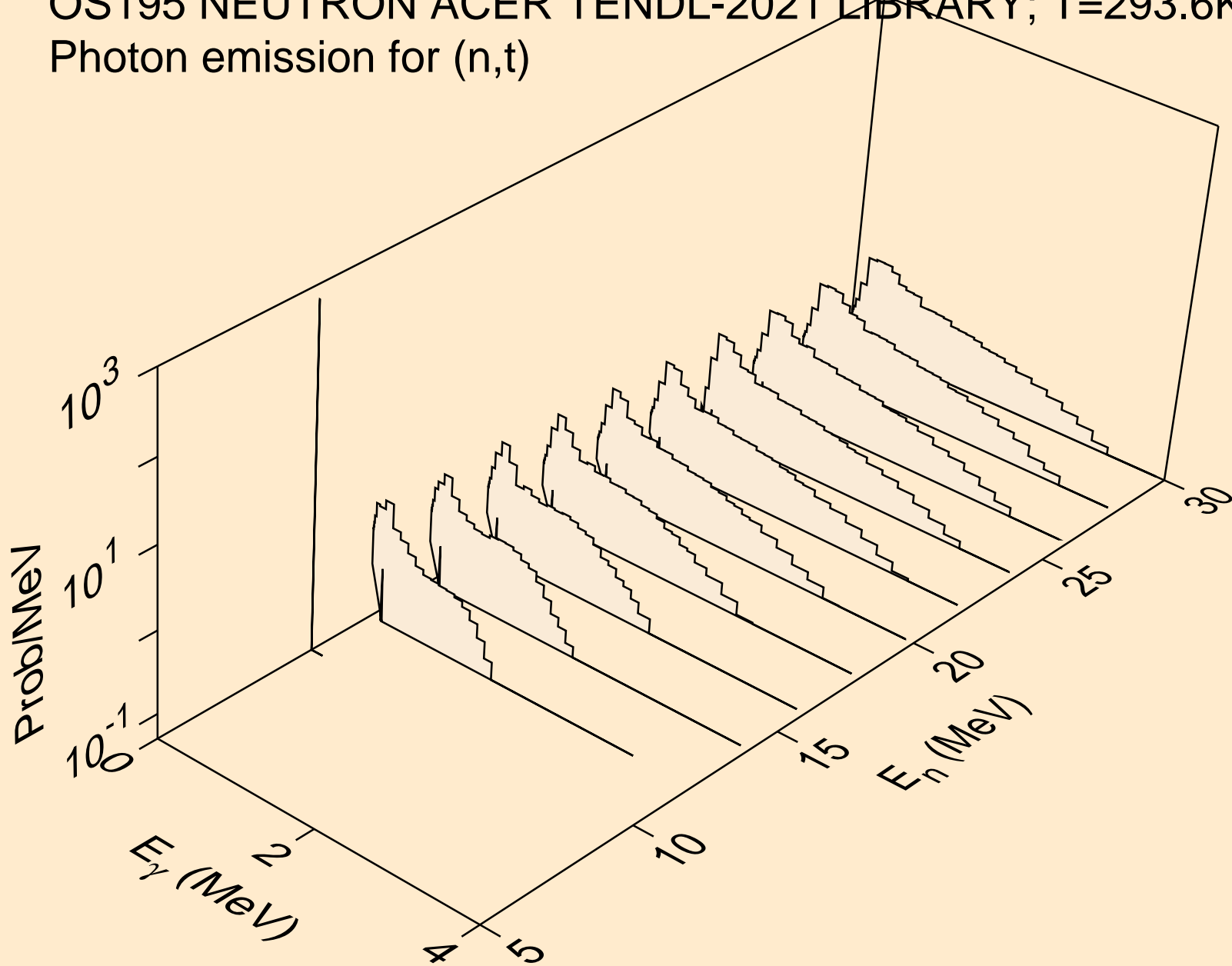



OS195 NEUTRON ACER TENDL-2021 LIBRARY; T=293.6K  
Photon emission for (n,he3)

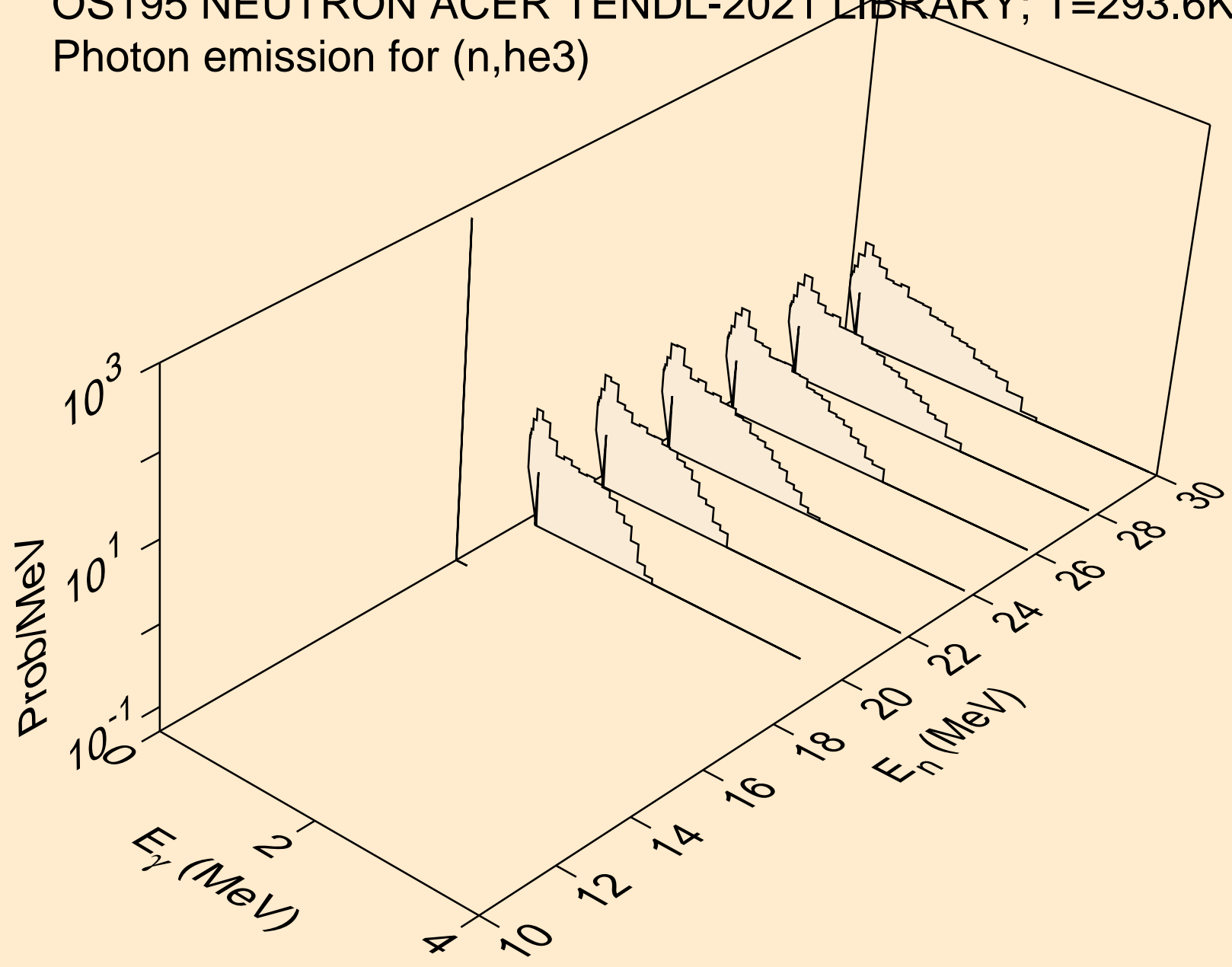

OS195 NEUTRON ACER TENDL-2021 LIBRARY; T=293.6K  
Photon emission for (n,a)

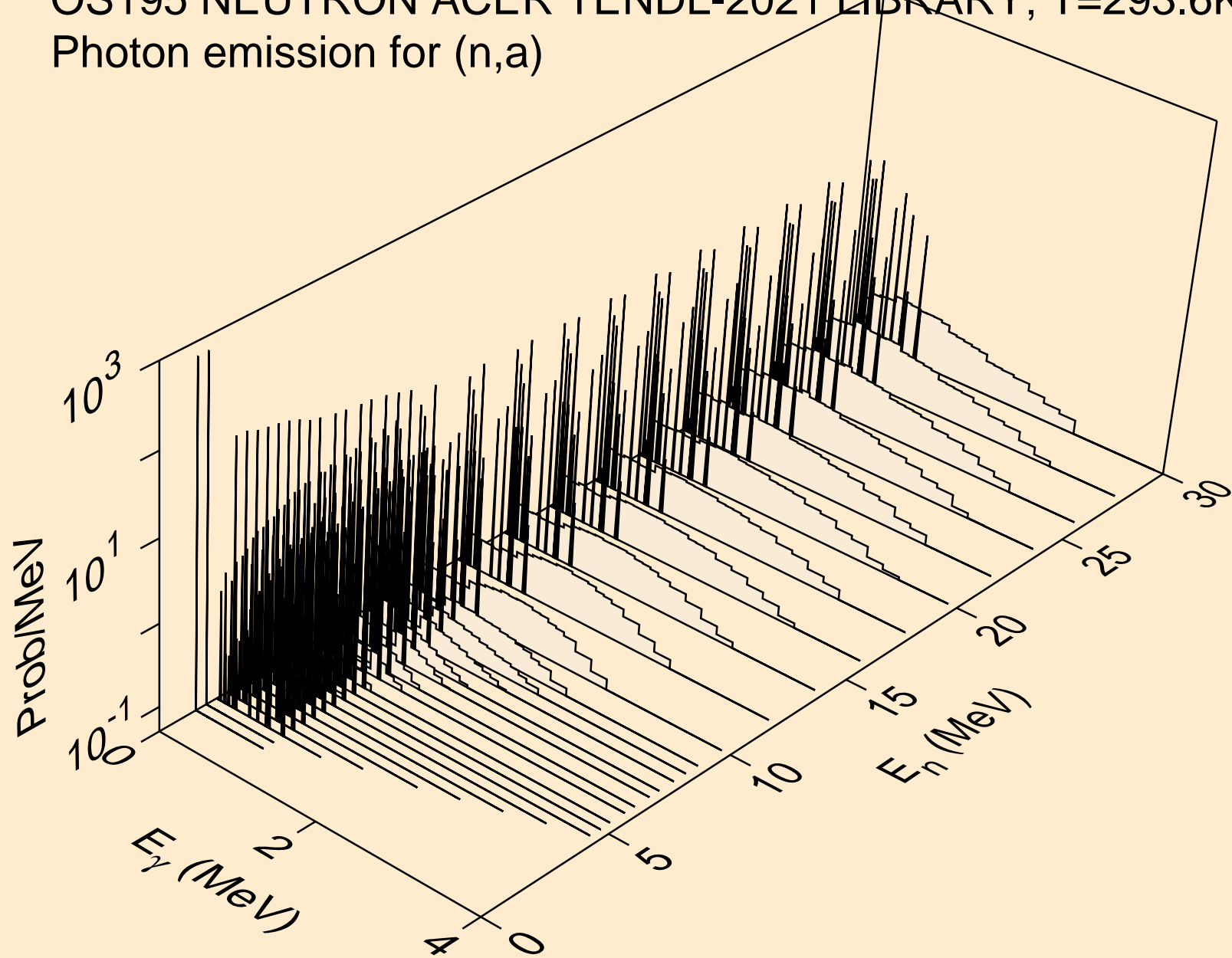

OS195 NEUTRON ACER TENDL-2021 LIBRARY; T=293.6K  
Photon emission for (n,2p)

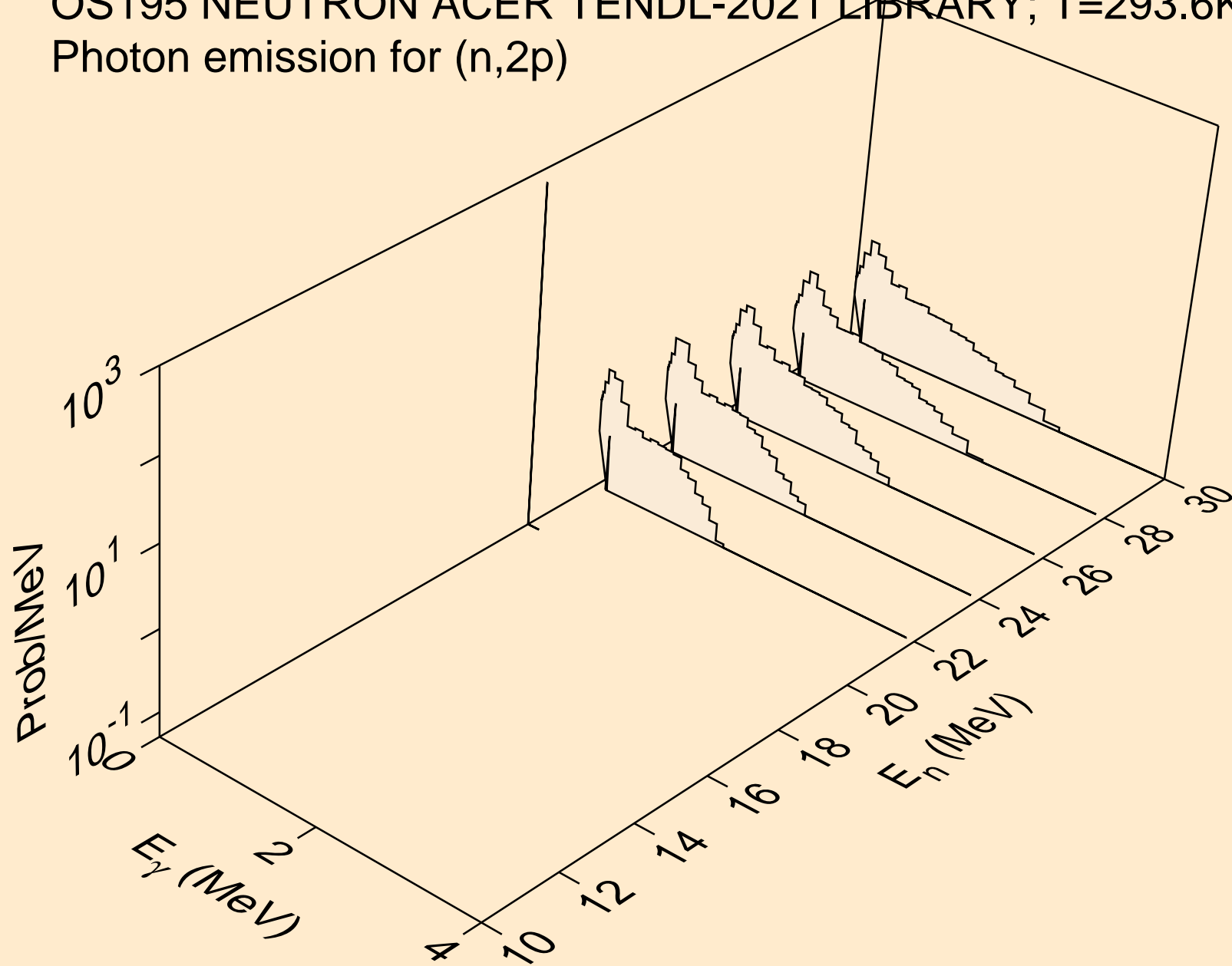

OS195 NEUTRON ACER TENDL-2021 LIBRARY; T=293.6K  
thermal capture photon spectrum

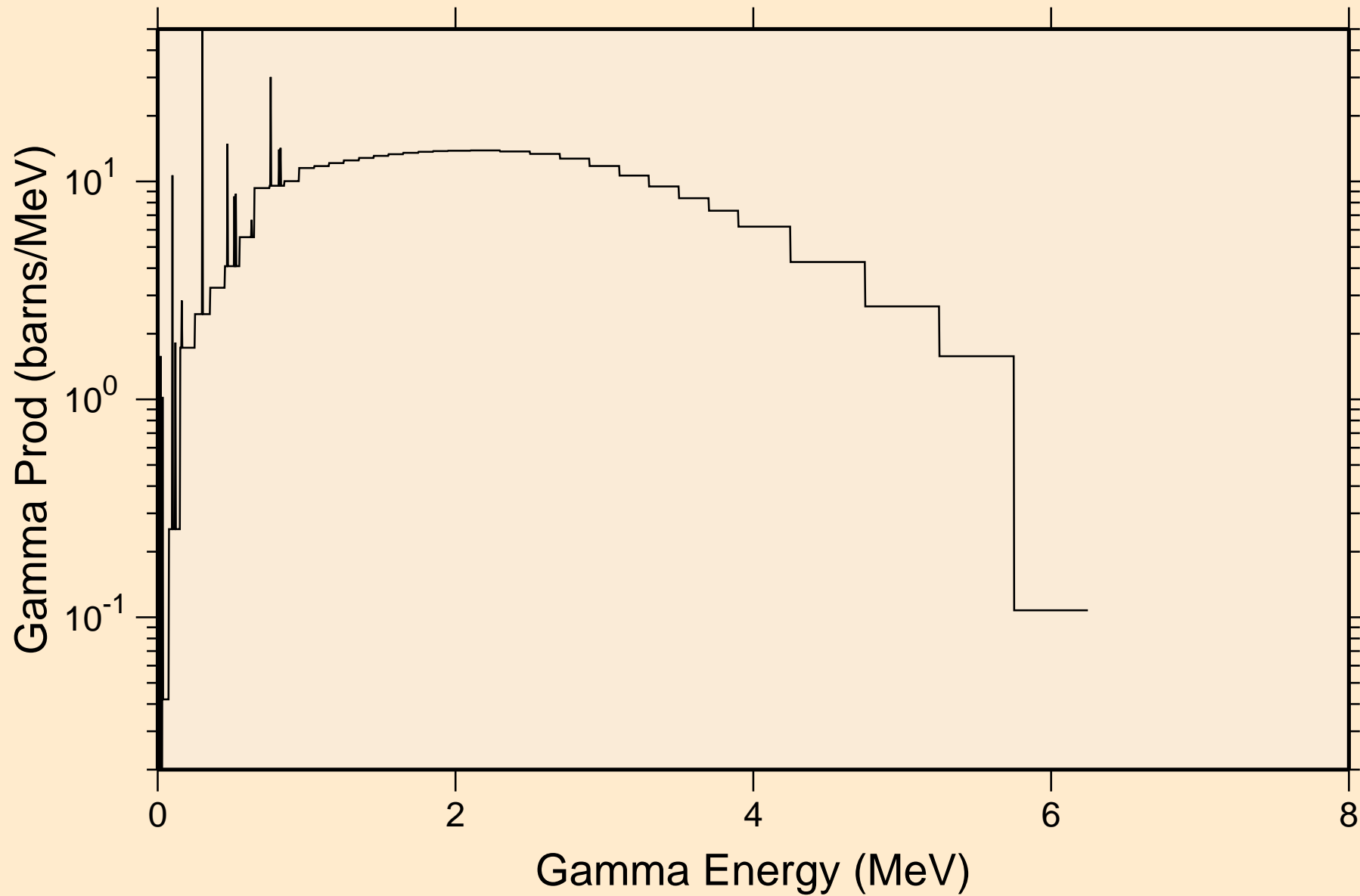

OS195 NEUTRON ACER TENDL-2021 LIBRARY; T=293.6K  
14 MeV photon spectrum

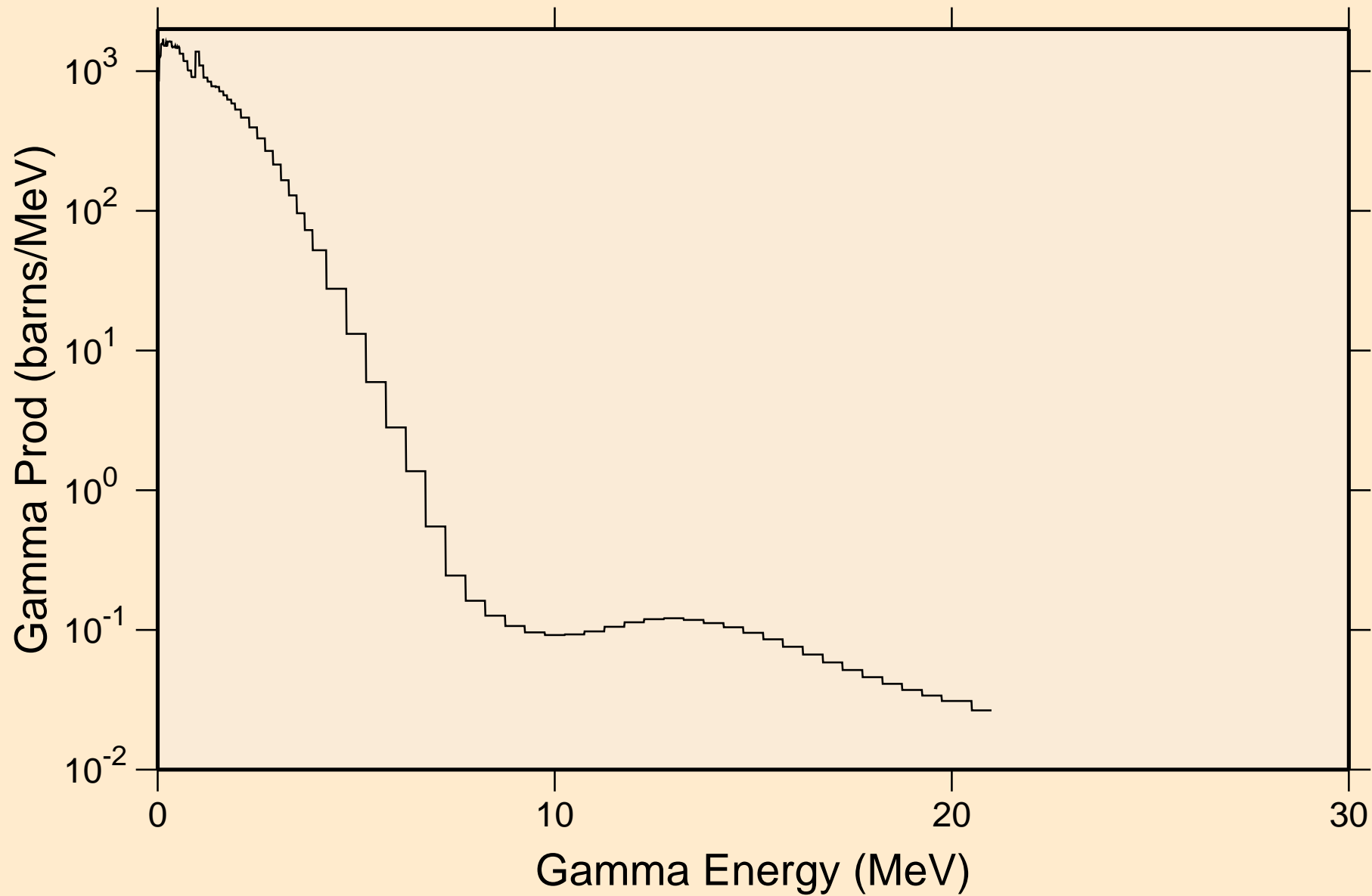

# OS195 NEUTRON ACER TENDL-2021 LIBRARY; T=293.6K

## Particle heating contributions

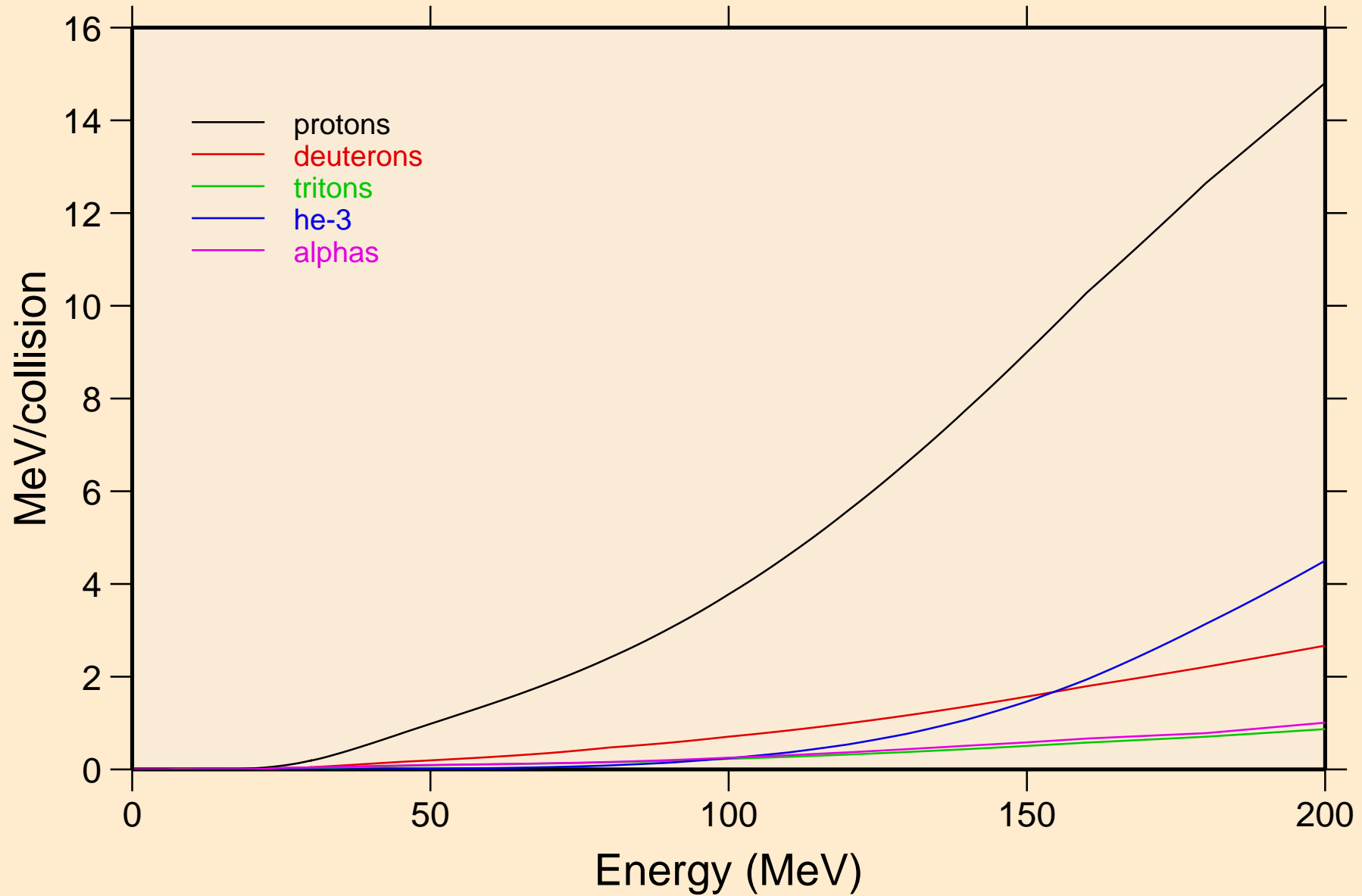

OS195 NEUTRON ACER TENDL-2021 LIBRARY; T=293.6K  
Recoil Heating

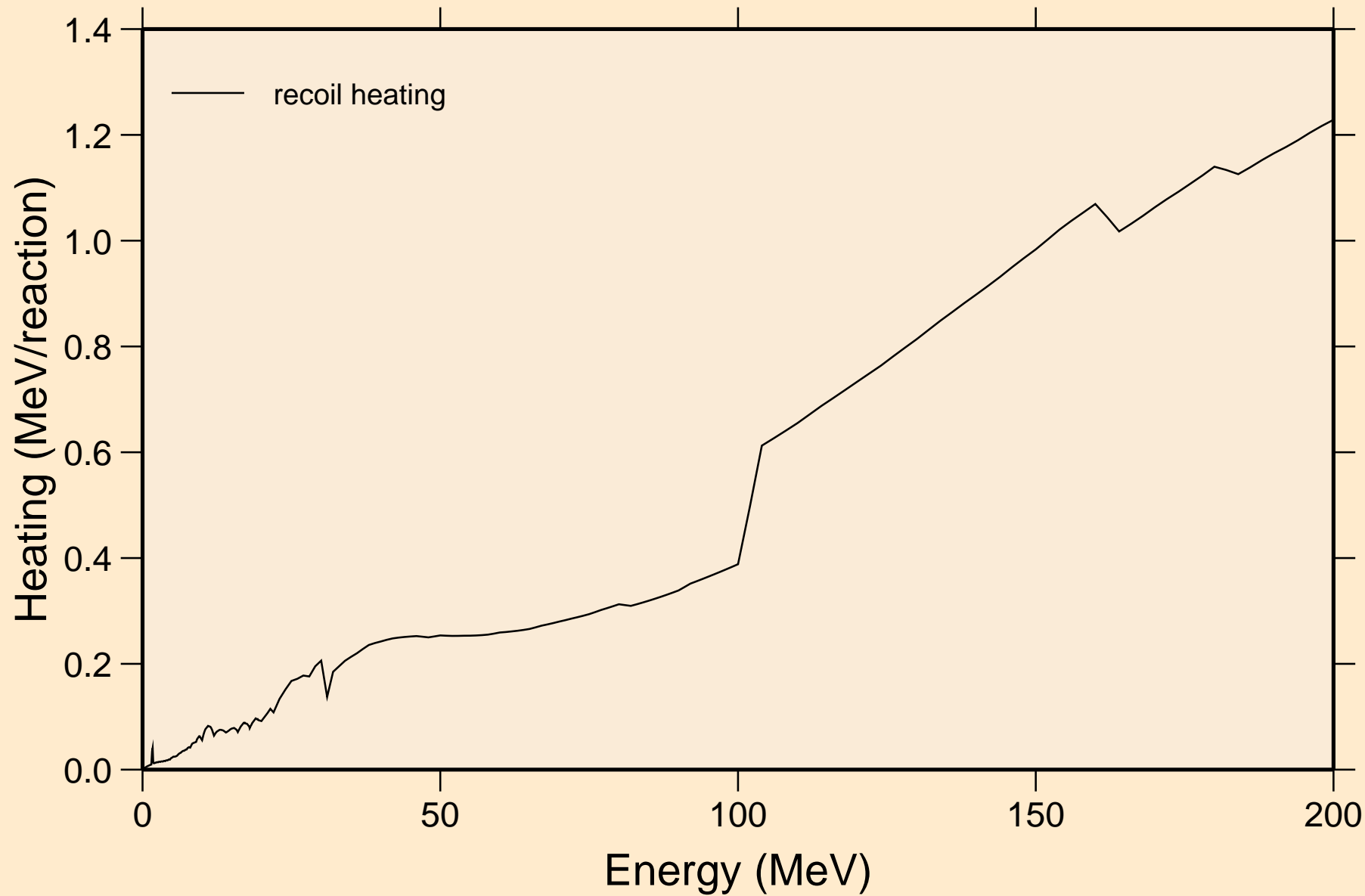

OS195 NEUTRON ACER TENDL-2021 LIBRARY; T=293.6K  
Particle production cross sections

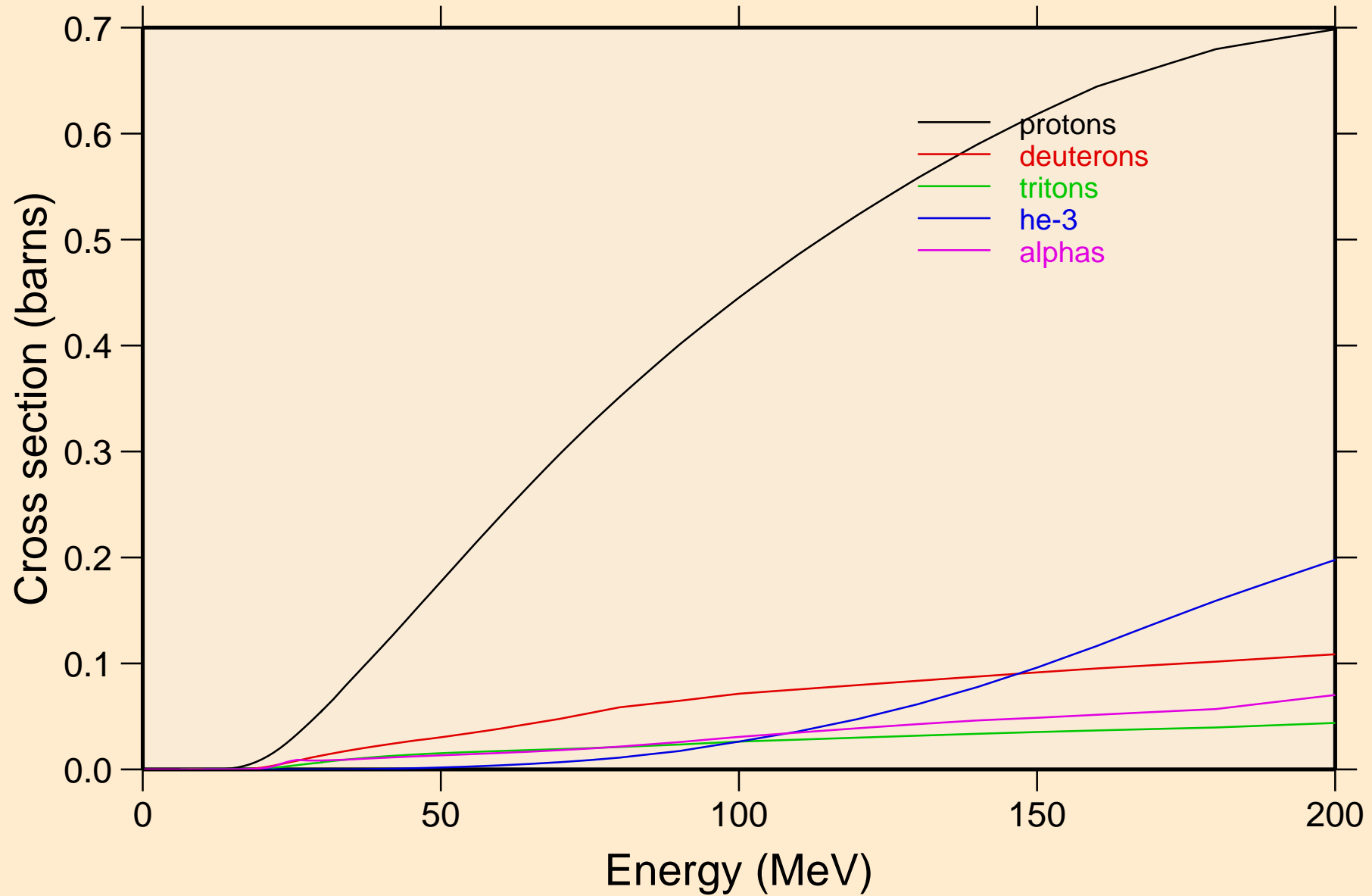



OS195 NEUTRON ACER TENDL-2021 LIBRARY; T=293.6K  
protons from (n,x)

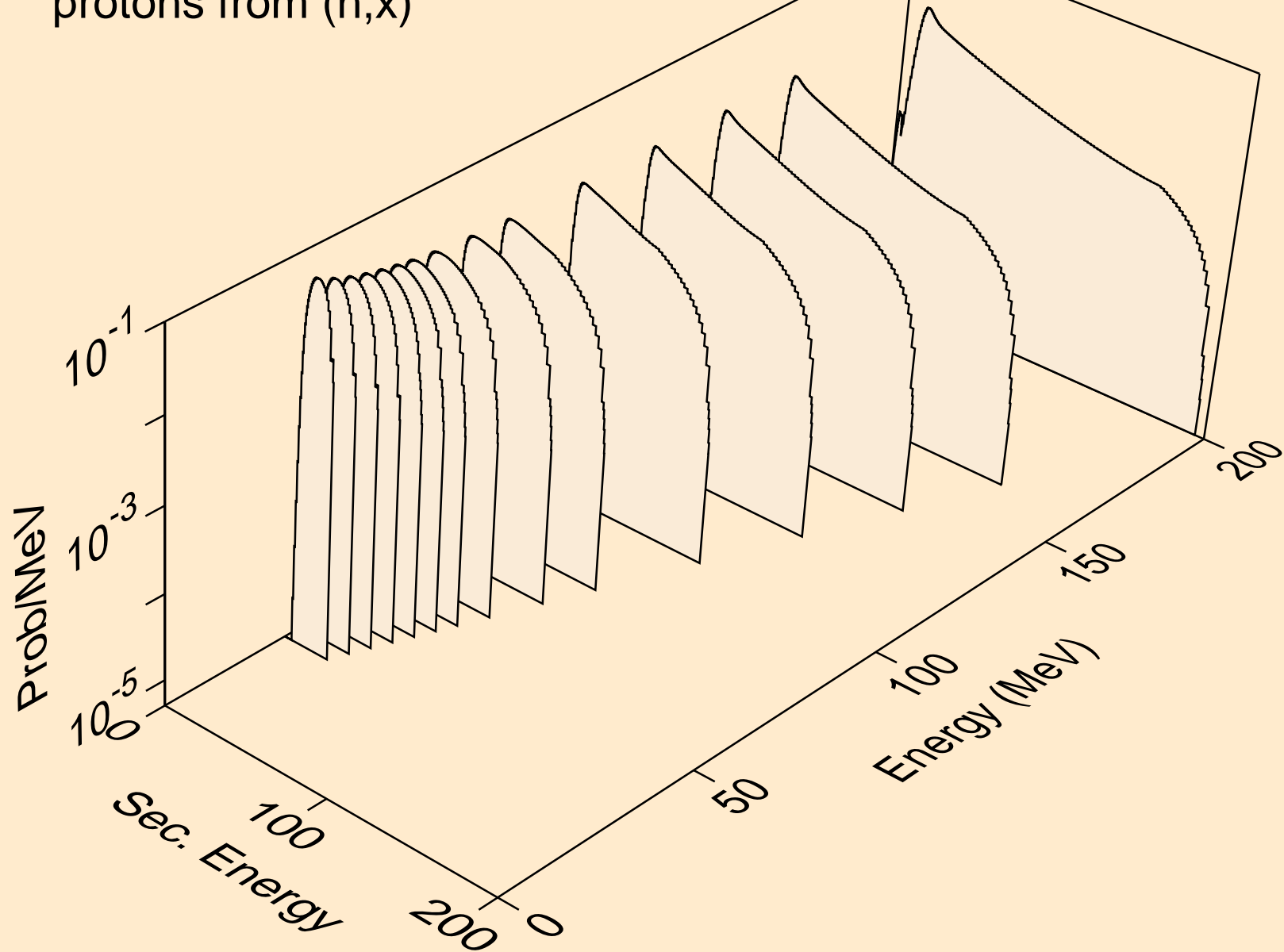

OS195 NEUTRON ACER TENDL-2021 LIBRARY; T=293.6K  
protons from (n,n\*)p

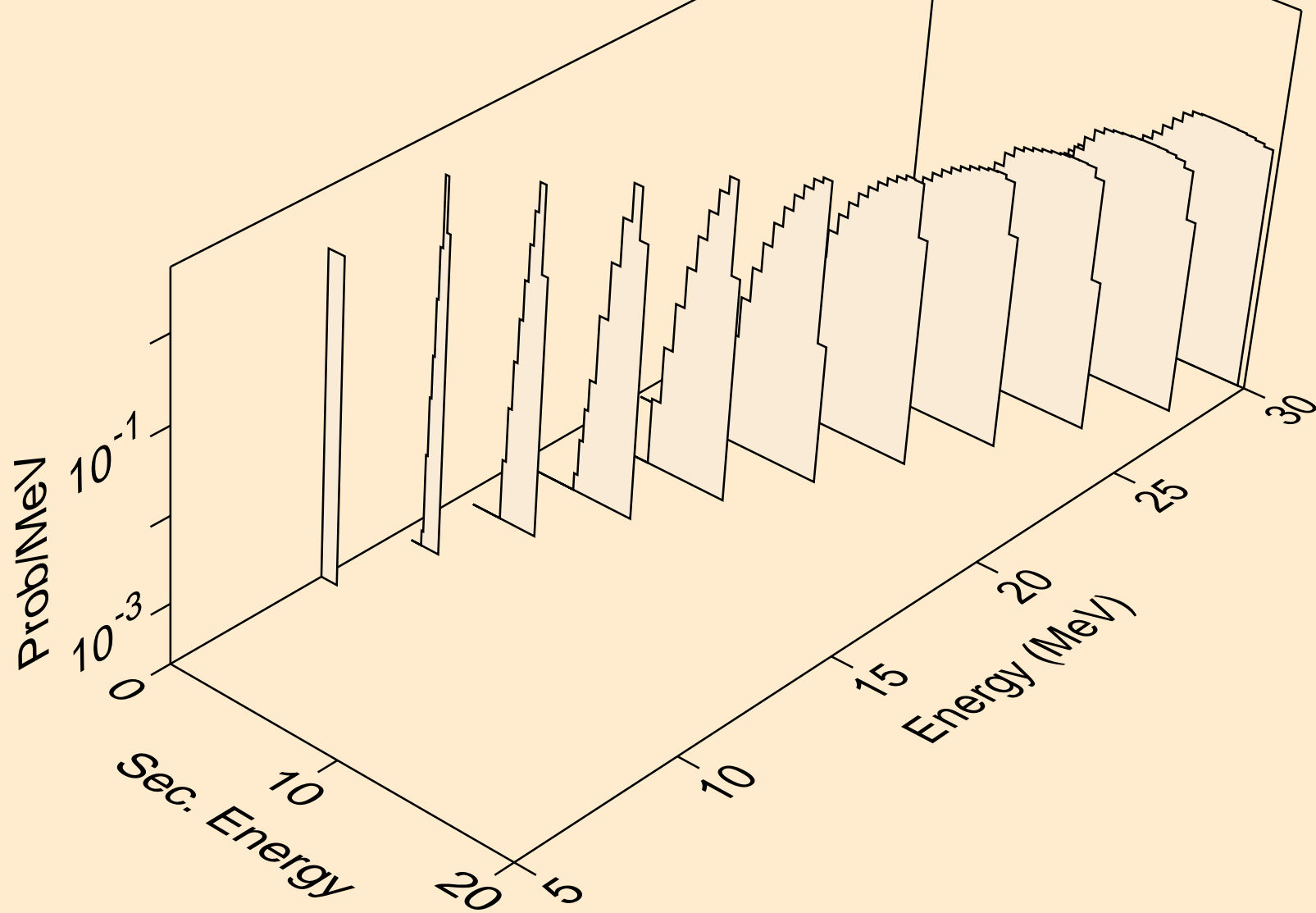

OS195 NEUTRON ACER TENDL-2021 LIBRARY; T=293.6K  
protons from (n,2np)

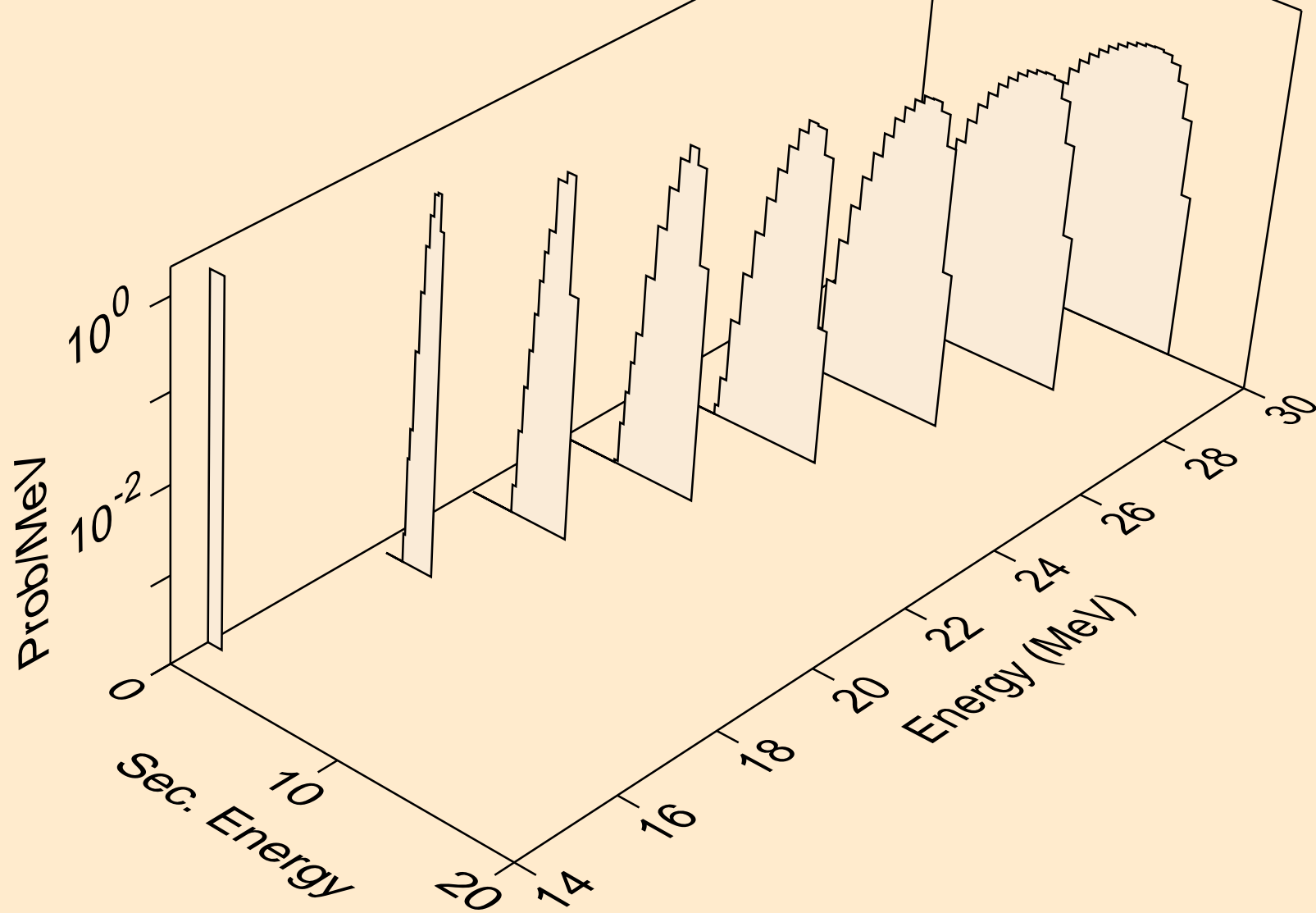

OS195 NEUTRON ACER TENDL-2021 LIBRARY; T=293.6K  
protons from (n,3np)

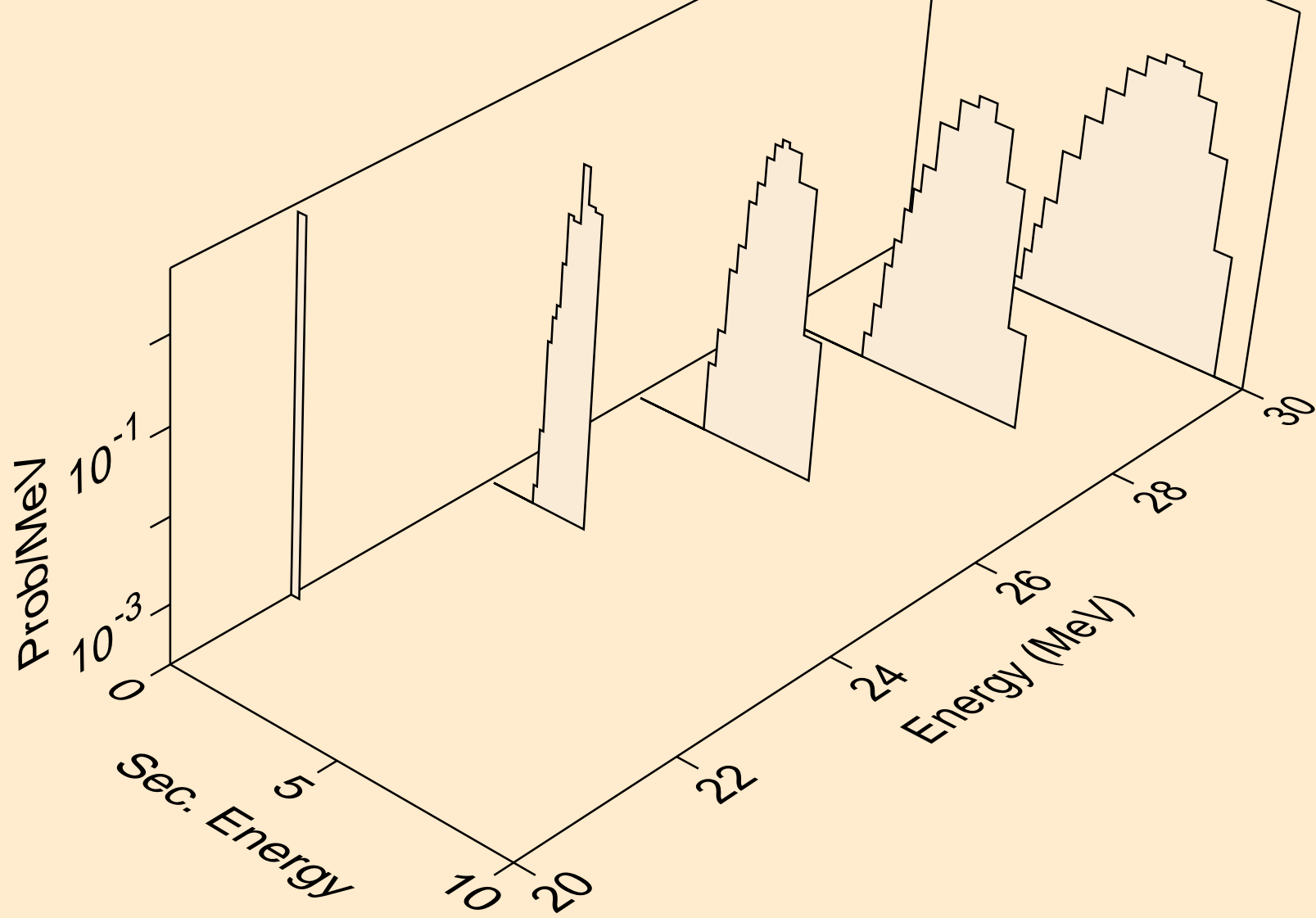

OS195 NEUTRON ACER TENDL-2021 LIBRARY; T=293.6K  
protons from (n,p)

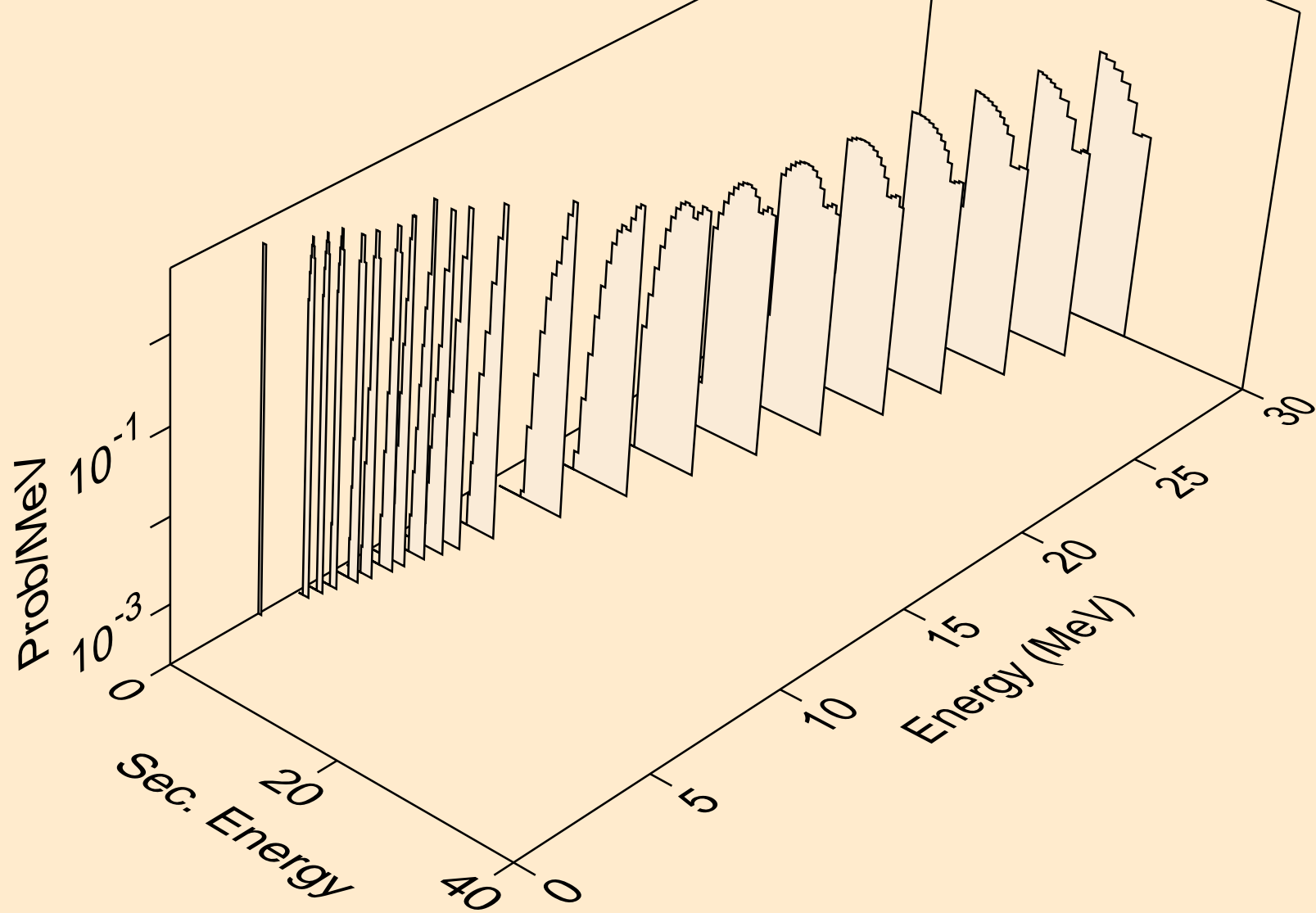

OS195 NEUTRON ACER TENDL-2021 LIBRARY; T=293.6K  
protons from (n,2p)

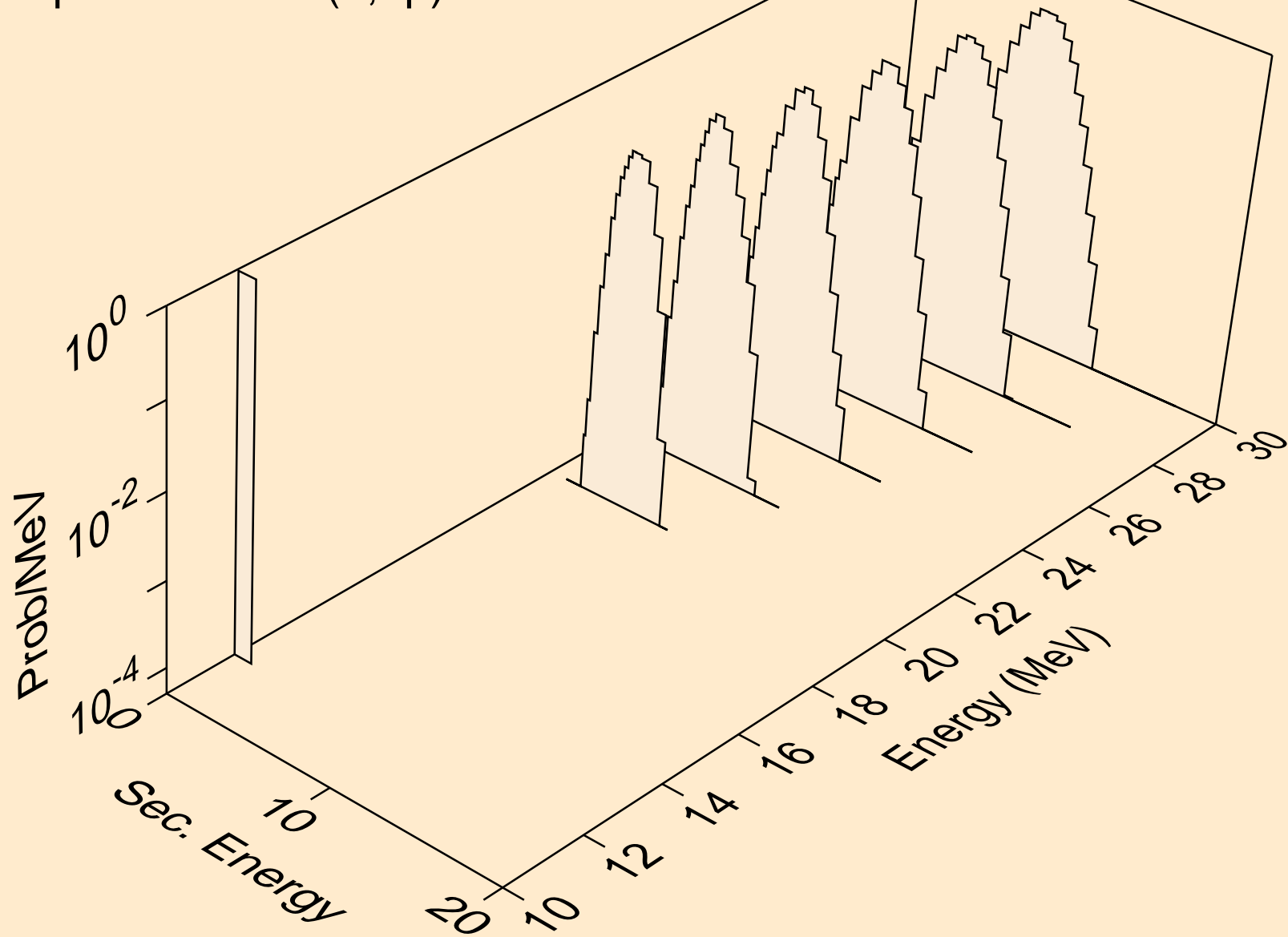

OS195 NEUTRON ACER TENDL-2021 LIBRARY; T=293.6K  
deuterons from (n,x)

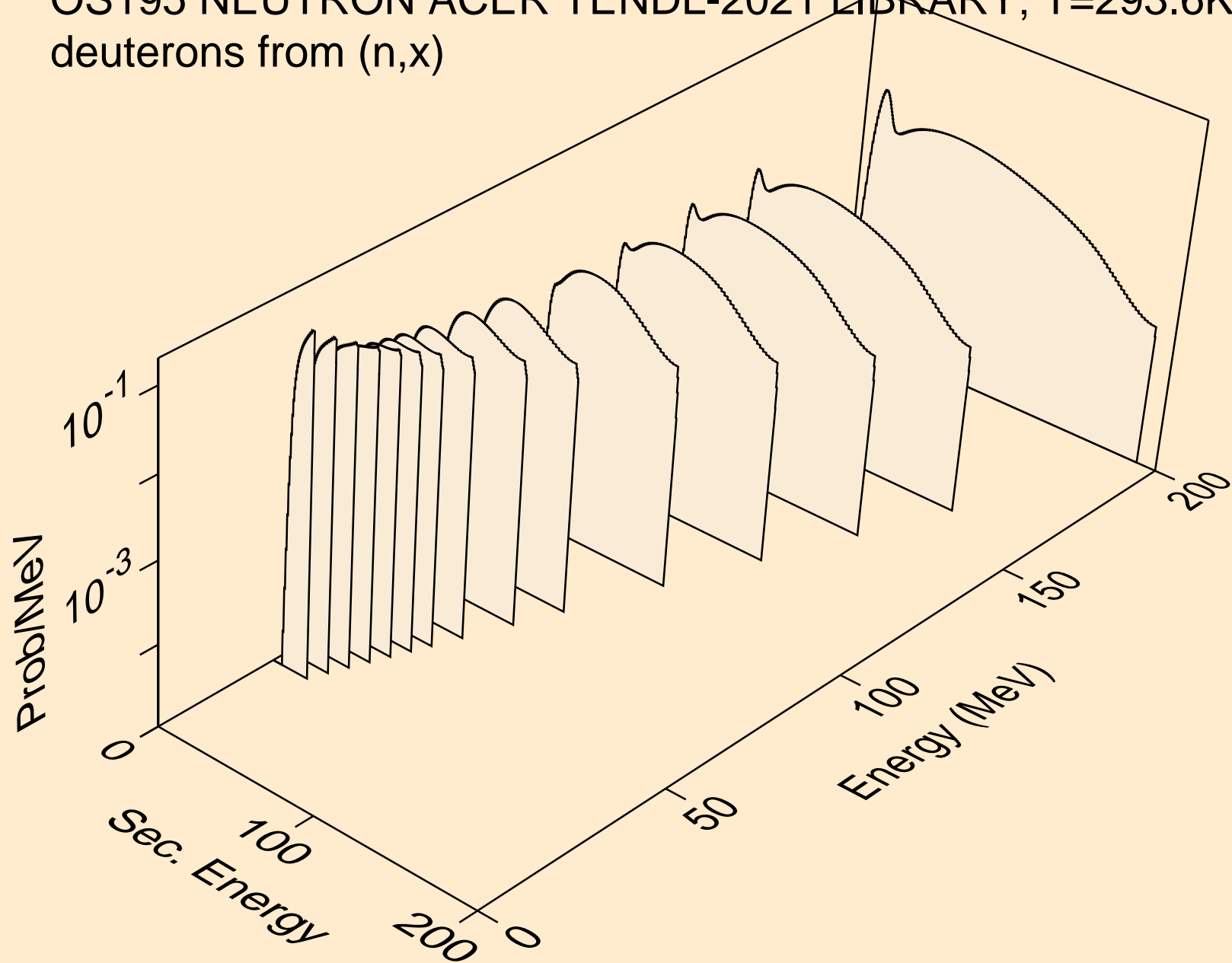

OS195 NEUTRON ACER TENDL-2021 LIBRARY; T=293.6K  
deuterons from (n,2nd)

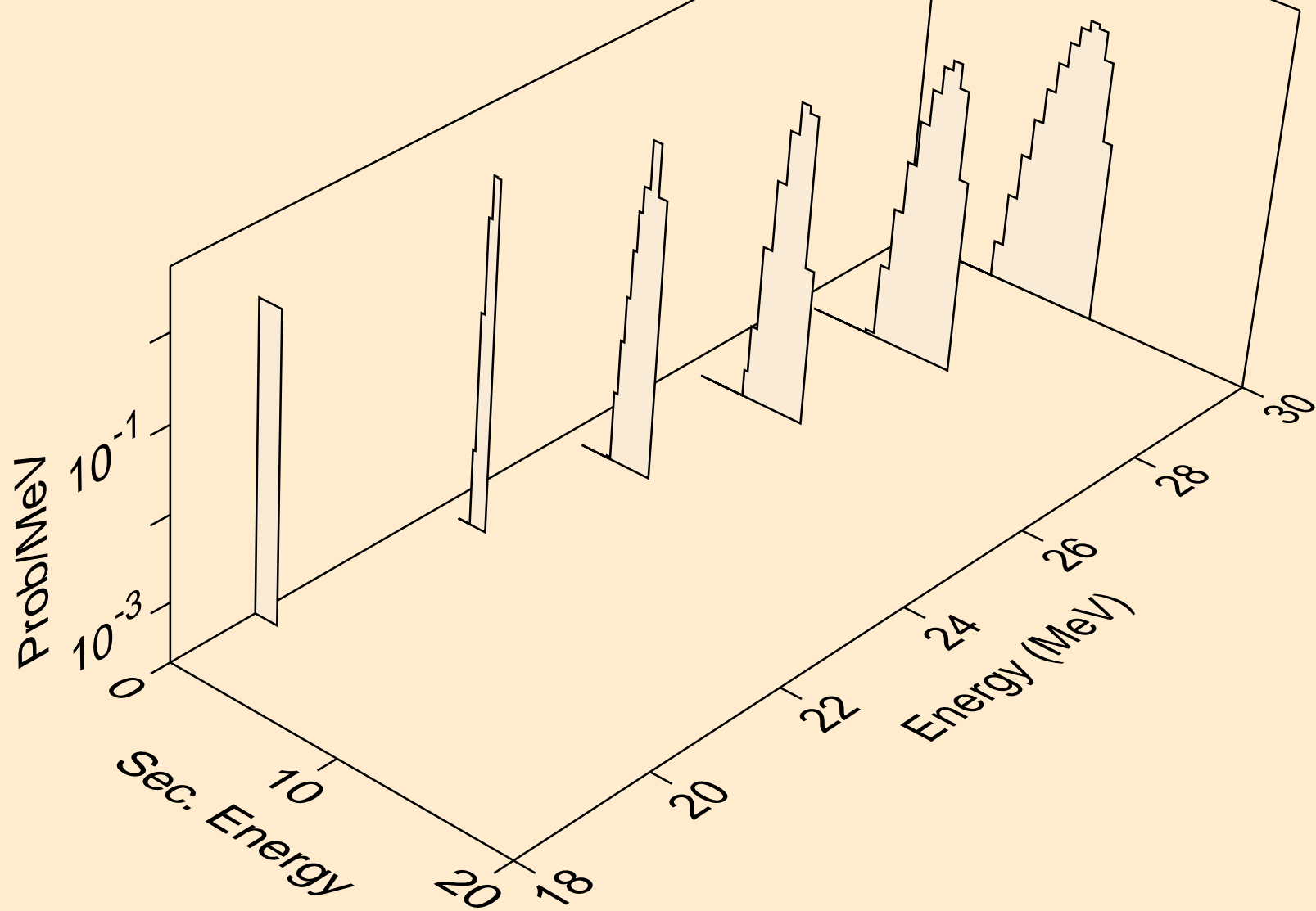



OS195 NEUTRON ACER TENDL-2021 LIBRARY; T=293.6K  
deuterons from (n,n\*)d

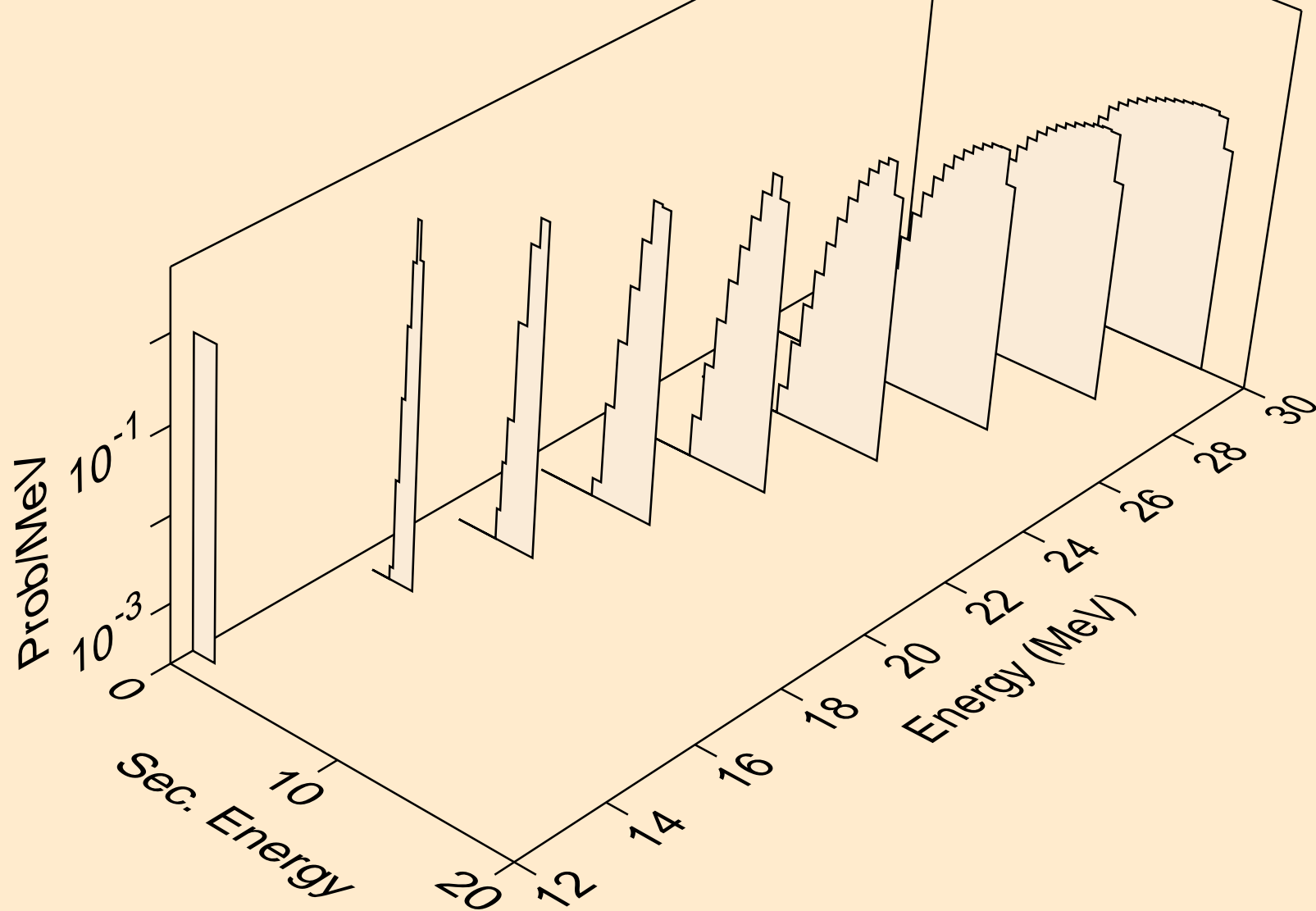

OS195 NEUTRON ACER TENDL-2021 LIBRARY; T=293.6K  
deuterons from (n,d)

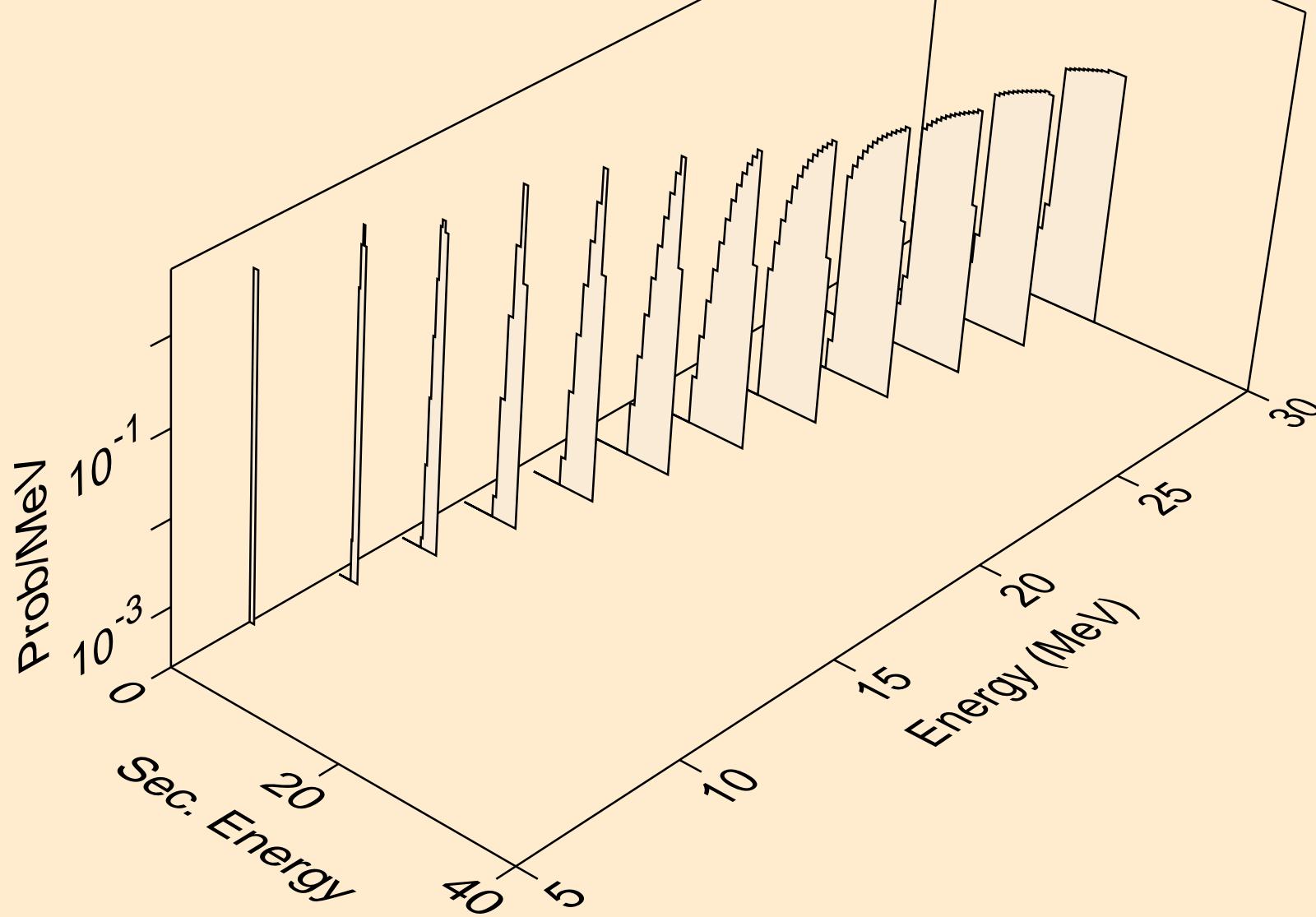

OS195 NEUTRON ACER TENDL-2021 LIBRARY; T=293.6K  
tritons from (n,x)

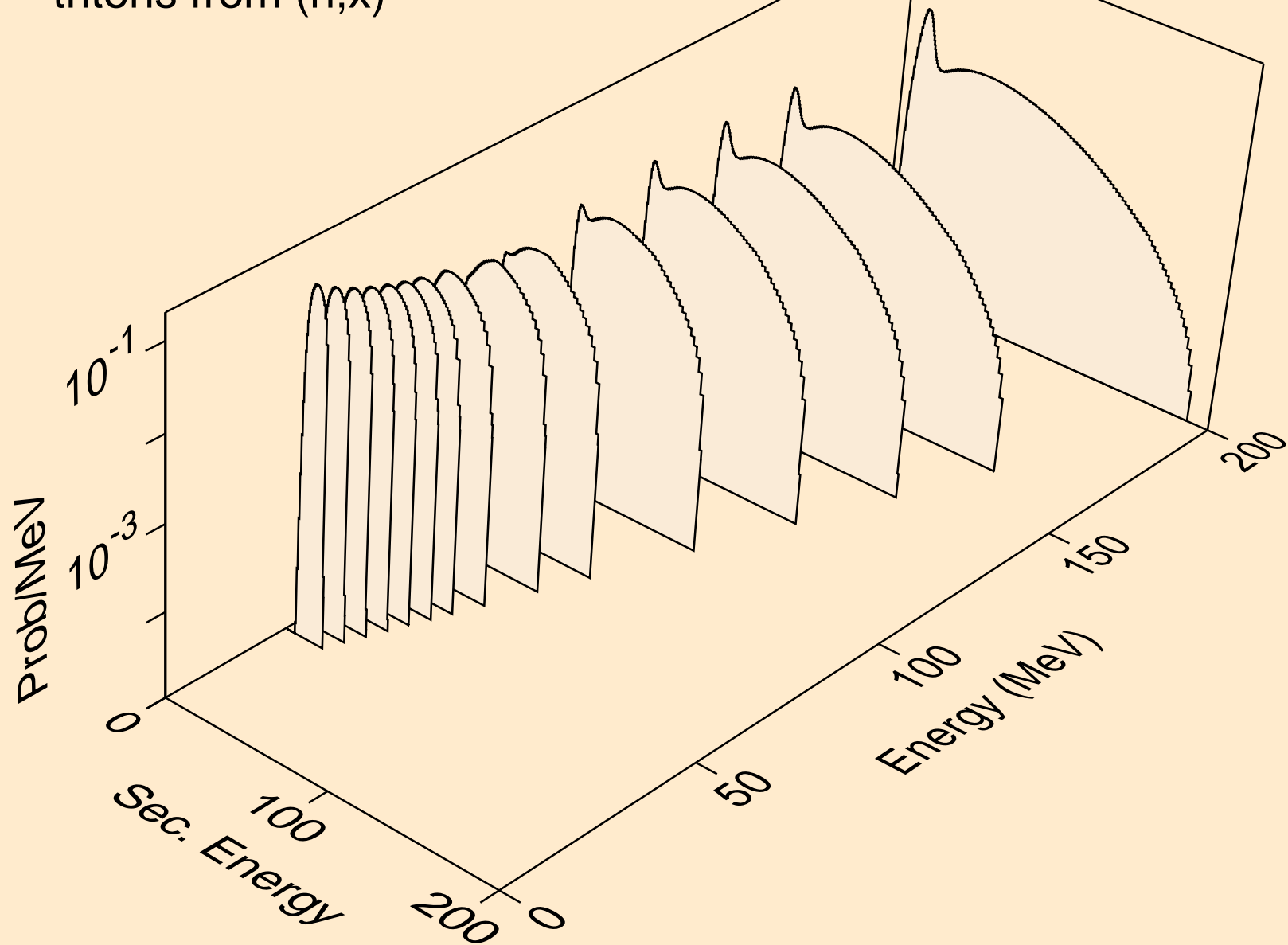

OS195 NEUTRON ACER TENDL-2021 LIBRARY; T=293.6K  
tritons from (n,n\*)t

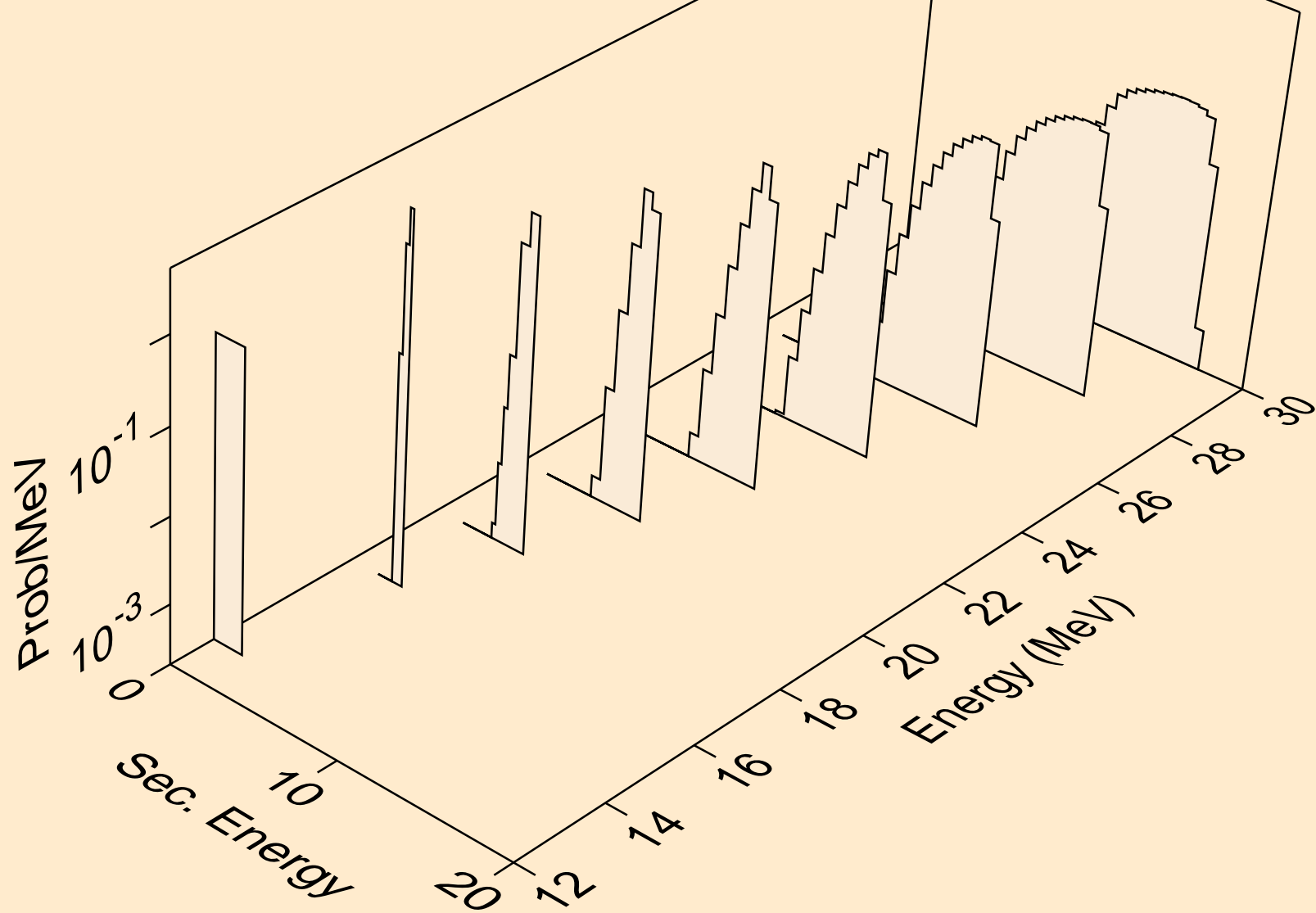

OS195 NEUTRON ACER TENDL-2021 LIBRARY; T=293.6K  
tritons from (n,t)

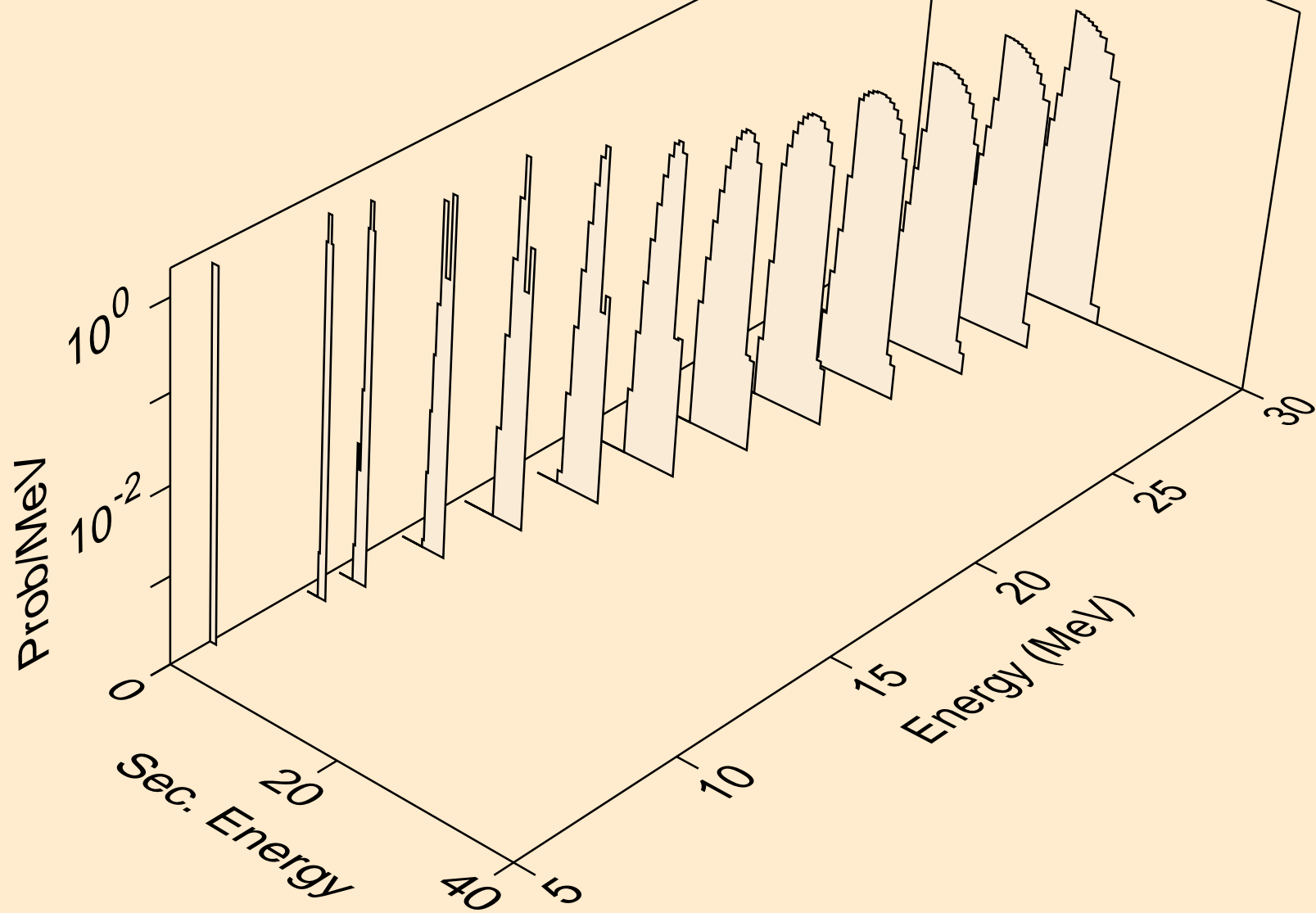

OS195 NEUTRON ACER TENDL-2021 LIBRARY; T=293.6K  
he3s from (n,x)

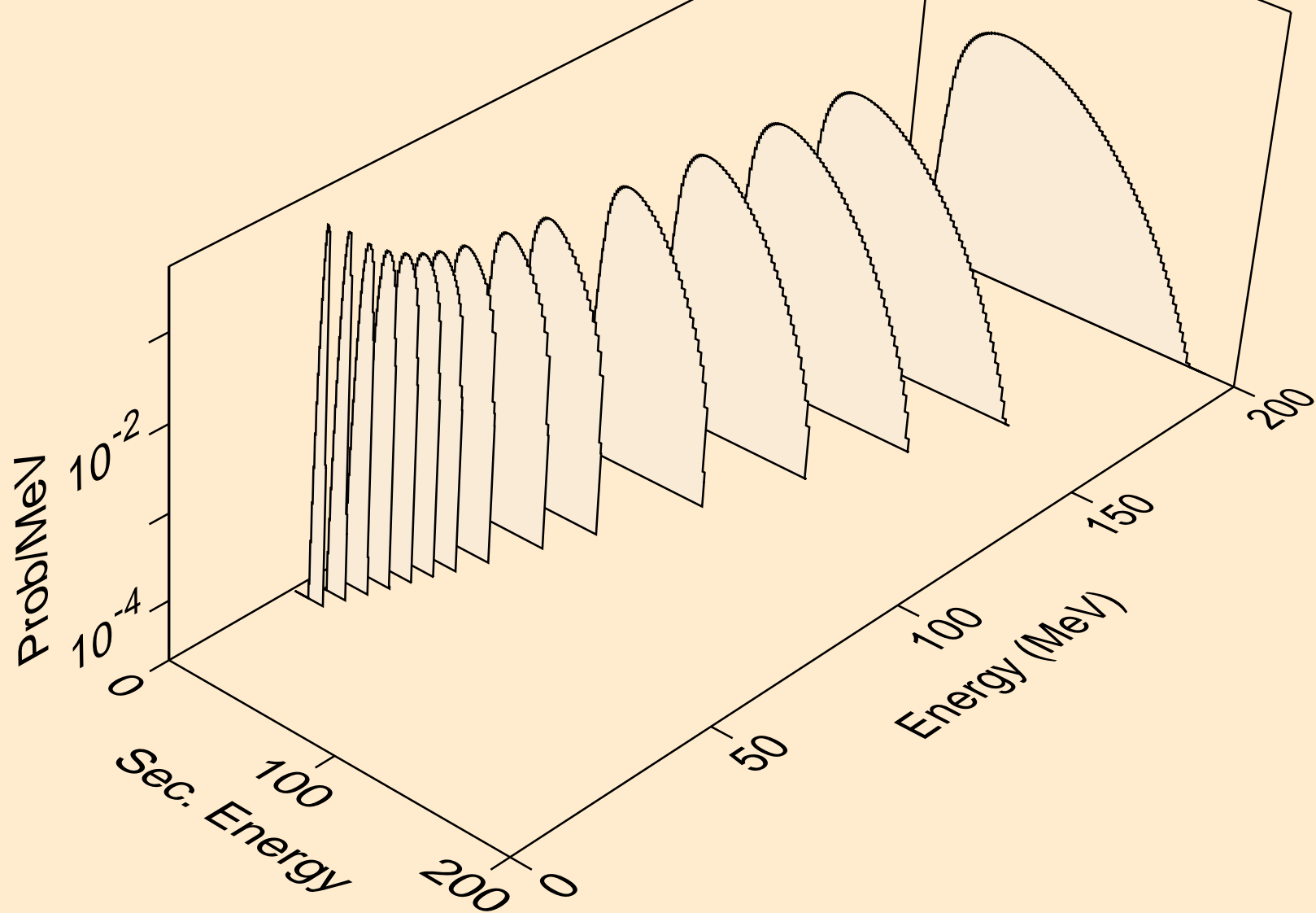

OS195 NEUTRON ACER TENDL-2021 LIBRARY; T=293.6K  
he3s from (n,n\*)he3

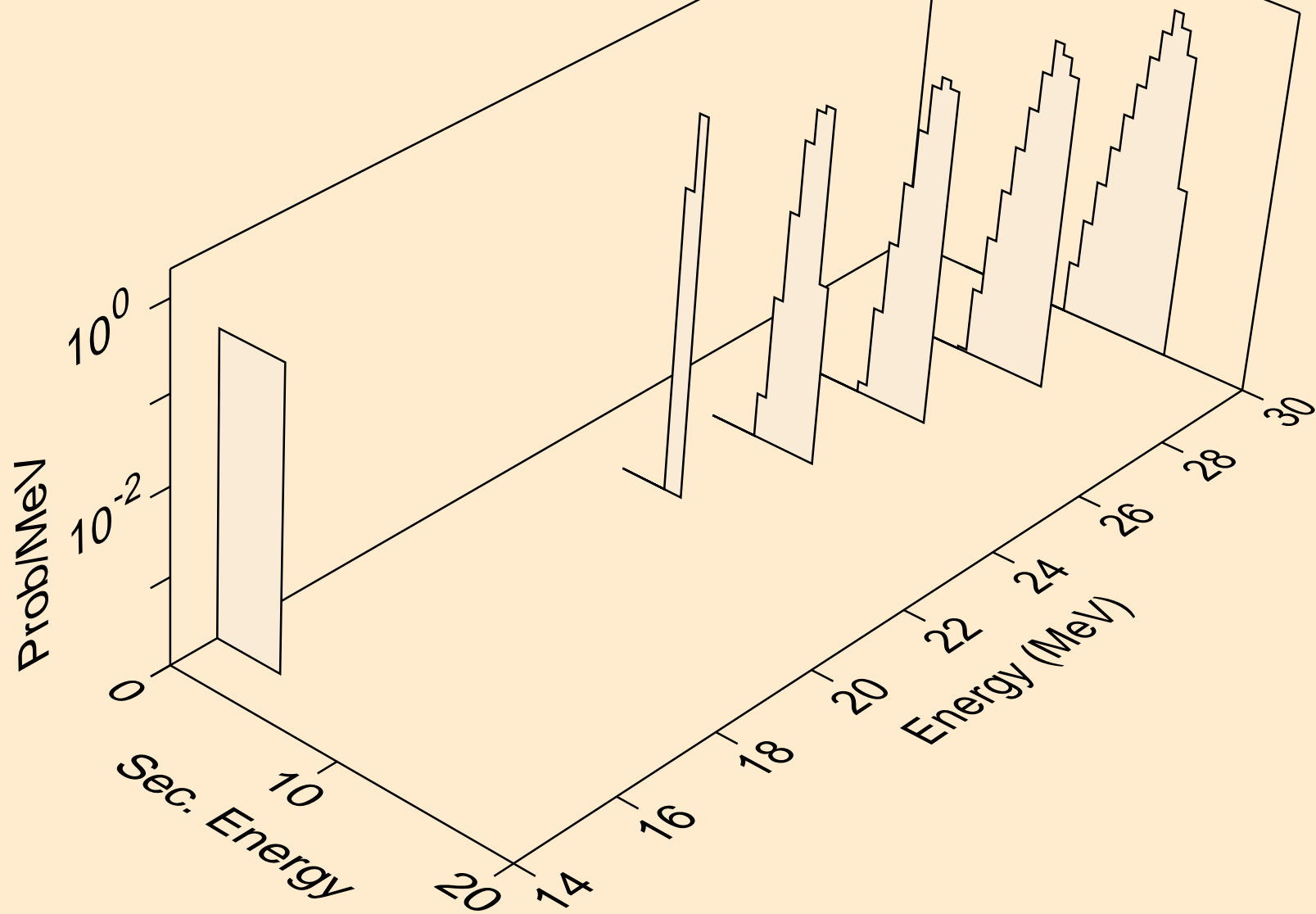

OS195 NEUTRON ACER TENDL-2021 LIBRARY; T=293.6K  
he3s from (n,he3)

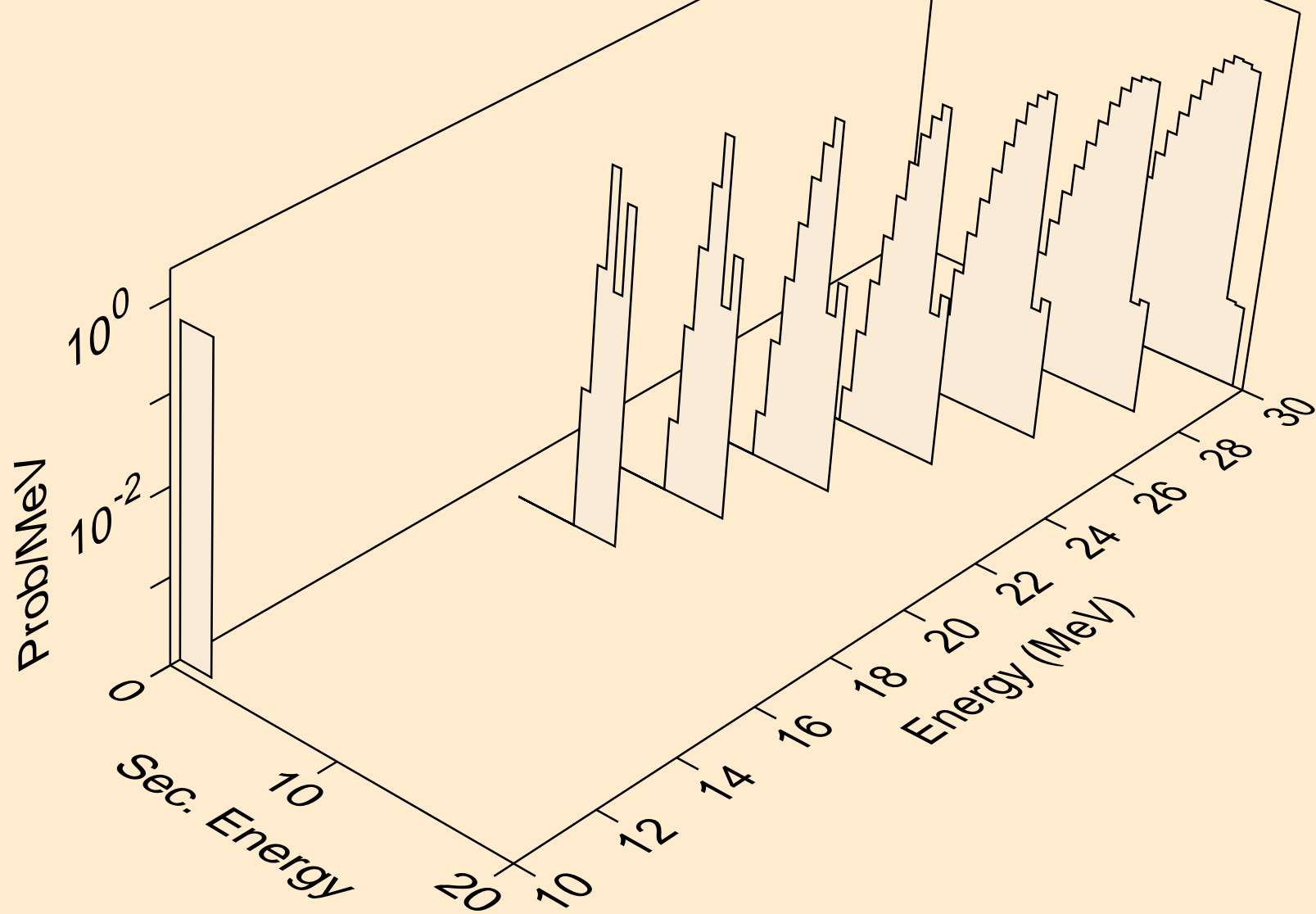



OS195 NEUTRON ACER TENDL-2021 LIBRARY; T=293.6K  
alphas from (n,x)

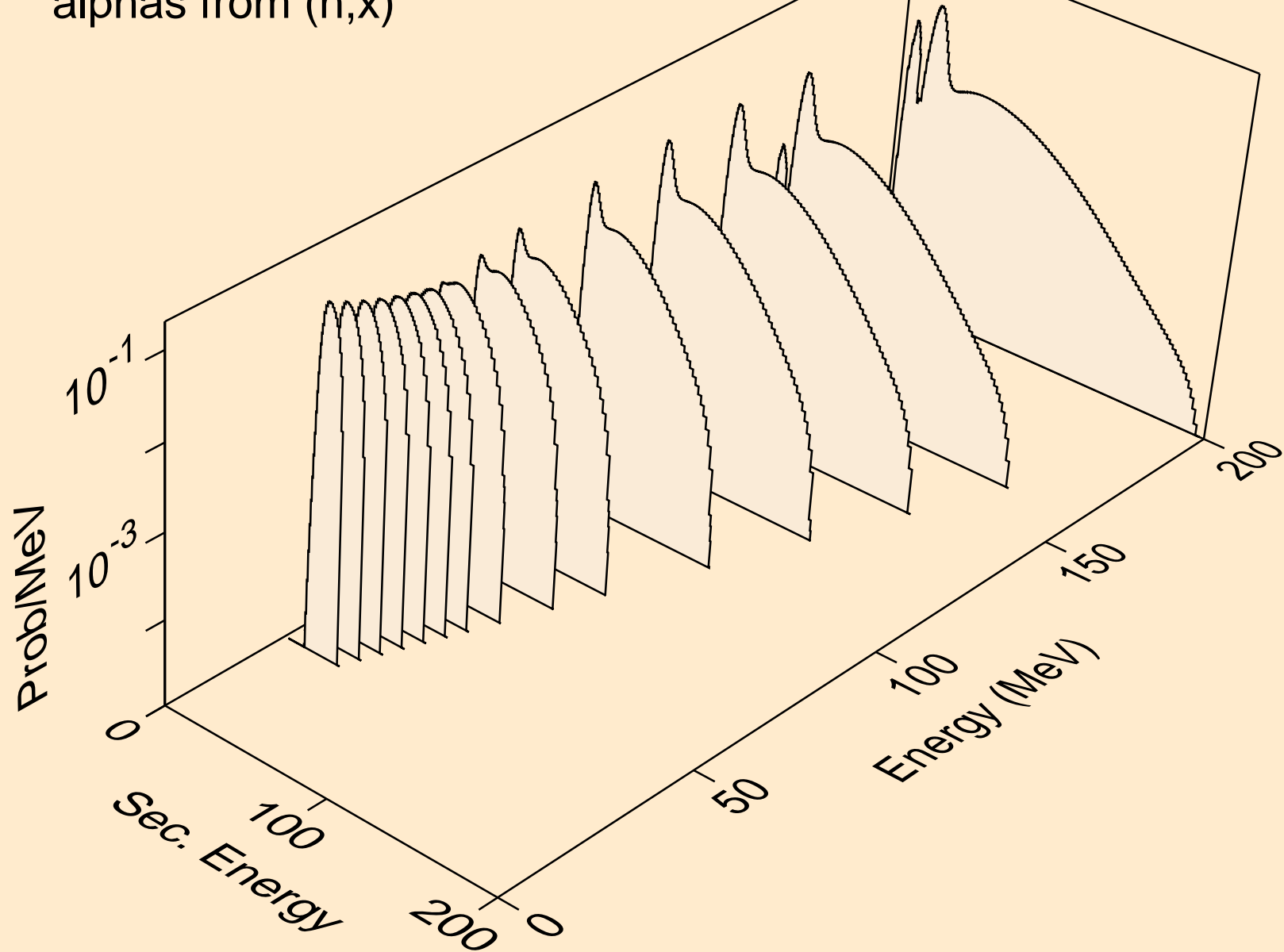

OS195 NEUTRON ACER TENDL-2021 LIBRARY; T=293.6K  
alphas from (n,n\*)a

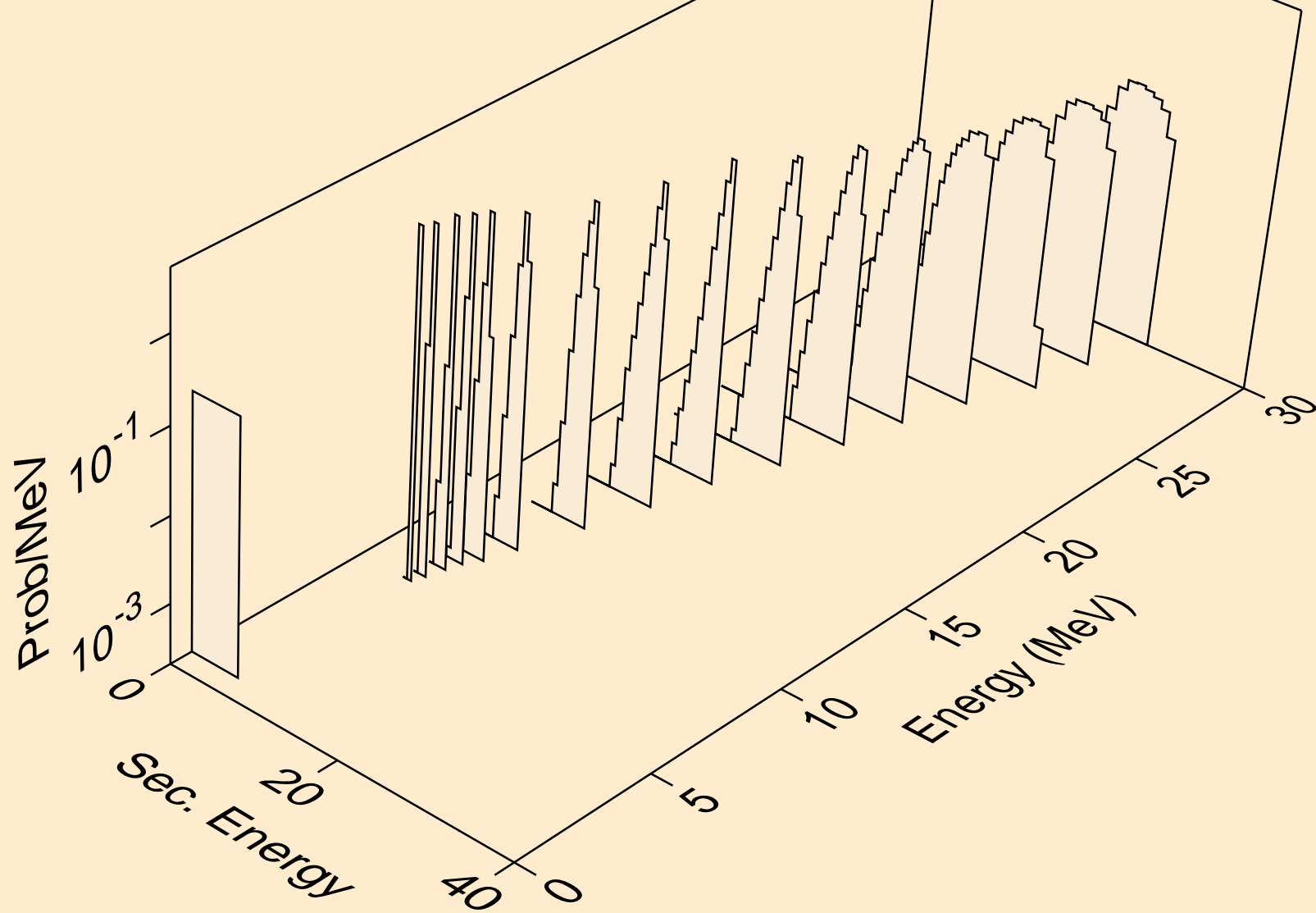

OS195 NEUTRON ACER TENDL-2021 LIBRARY; T=293.6K  
alphas from (n,2n)a

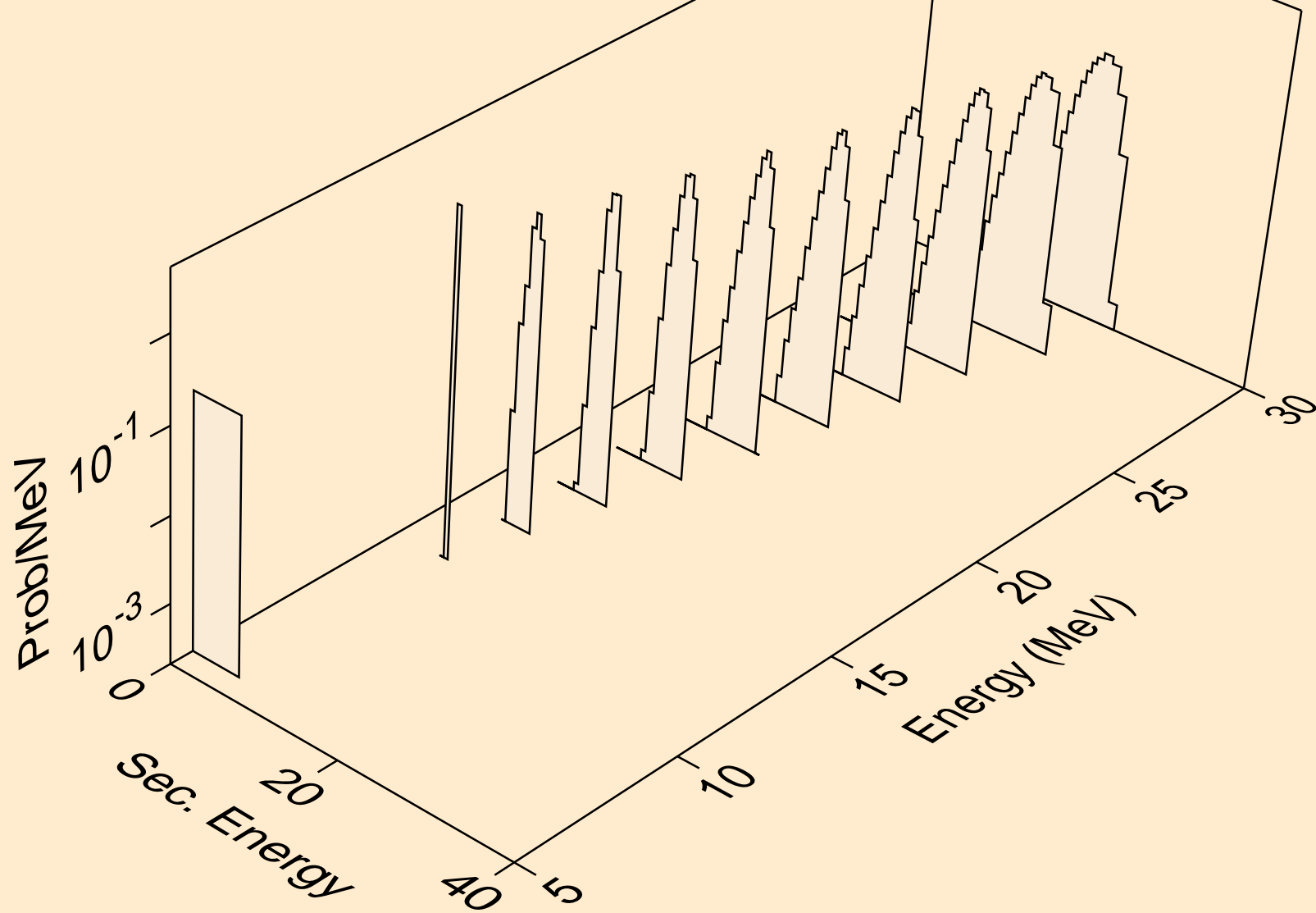

OS195 NEUTRON ACER TENDL-2021 LIBRARY; T=293.6K  
alphas from (n,3n)a

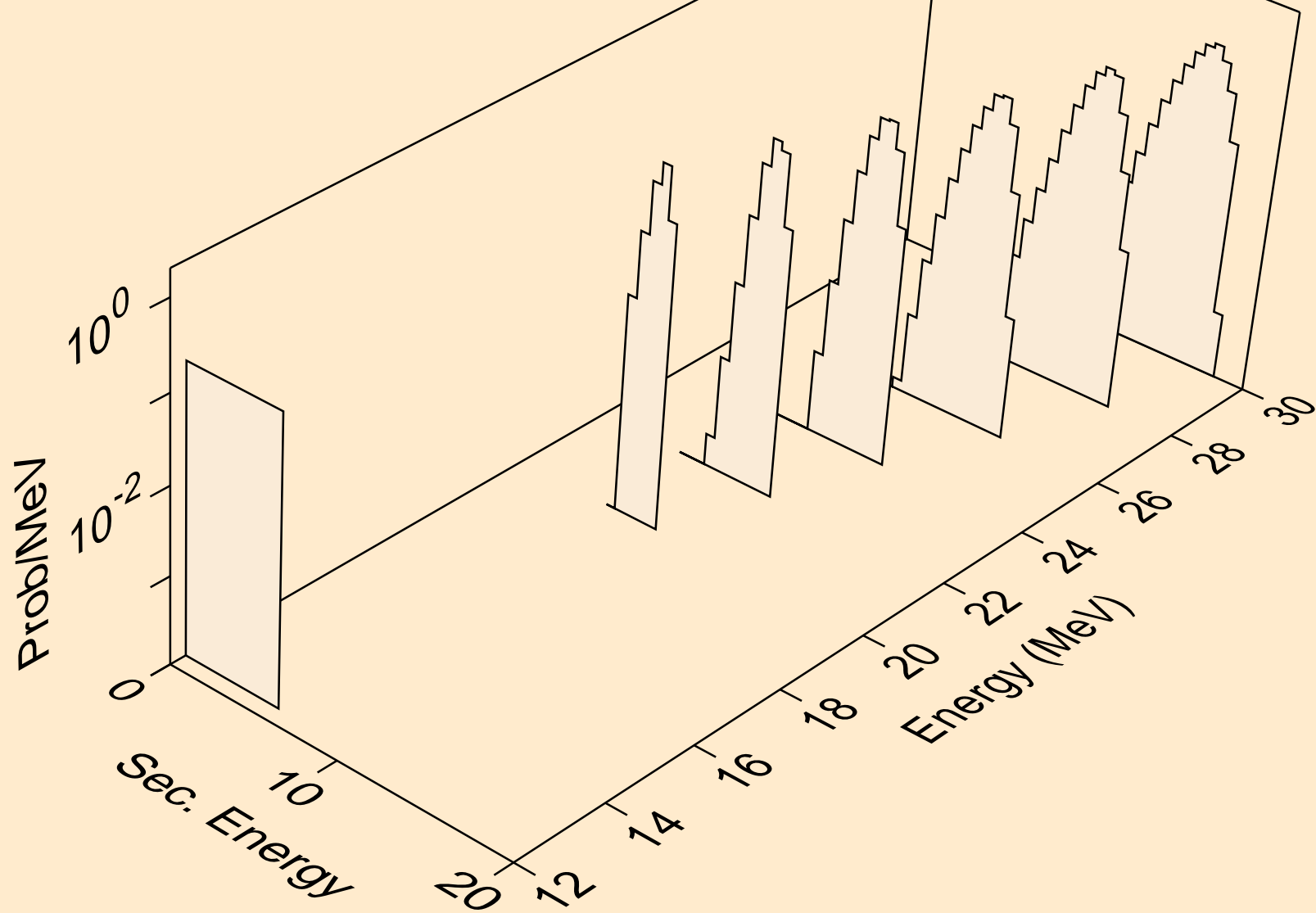

OS195 NEUTRON ACER TENDL-2021 LIBRARY; T=293.6K  
alphas from (n,a)

