

PA226 NEUTRON ACER TENDL-2021 LIBRARY; T=293.6K
Principal cross sections

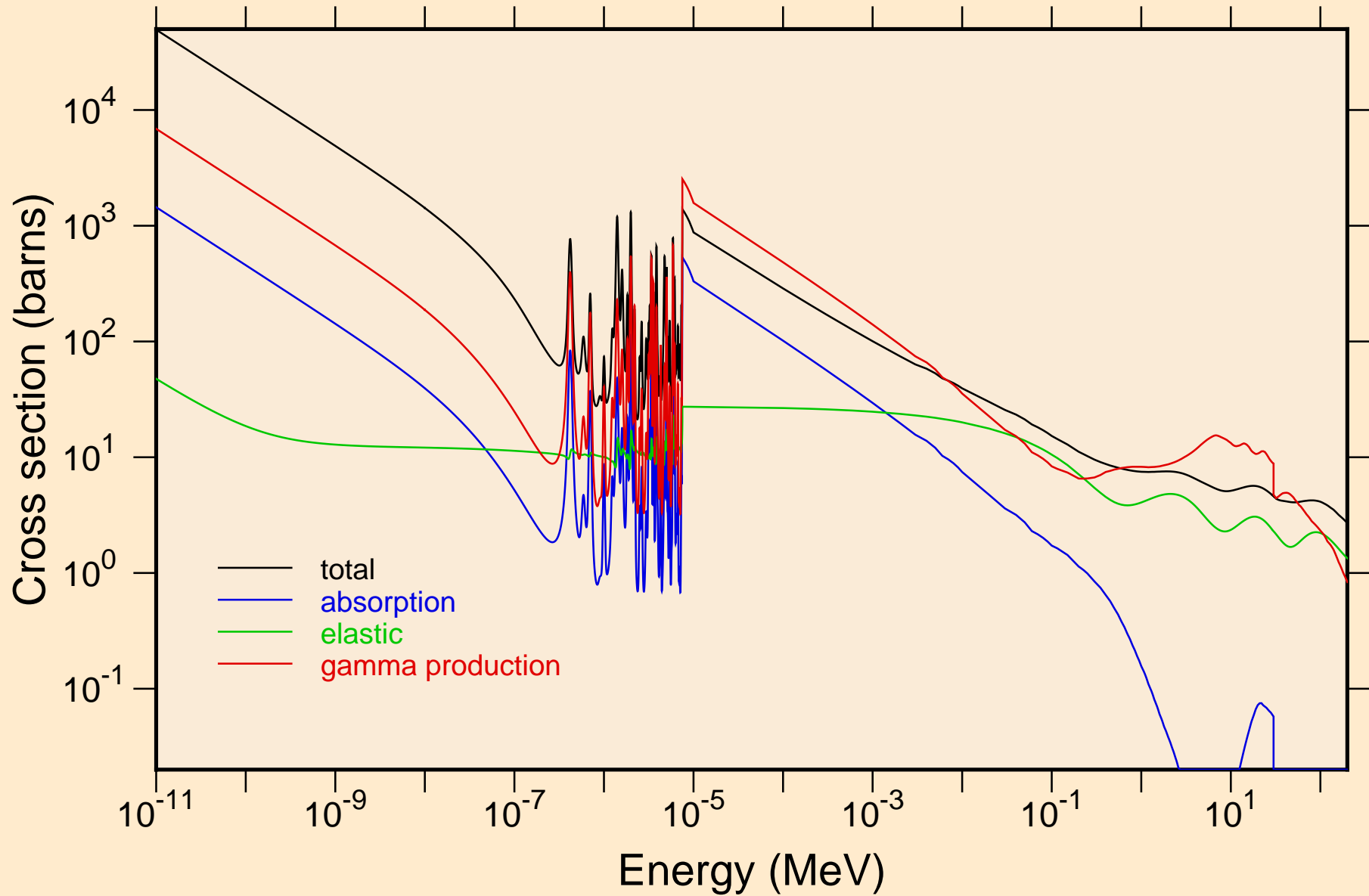

PA226 NEUTRON ACER TENDL-2021 LIBRARY; T=293.6K
resonance total cross section

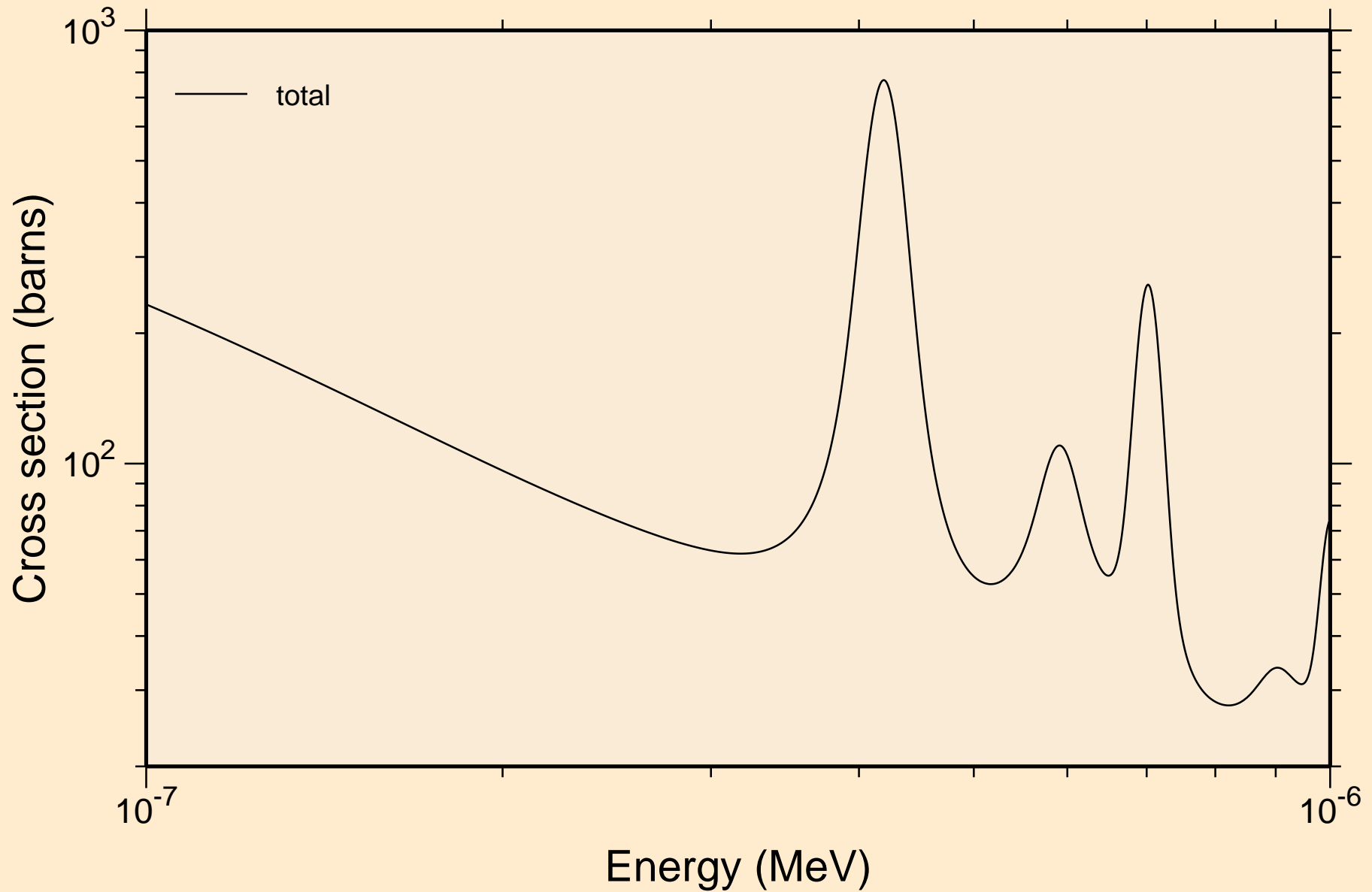

PA226 NEUTRON ACER TENDL-2021 LIBRARY; T=293.6K
resonance total cross section

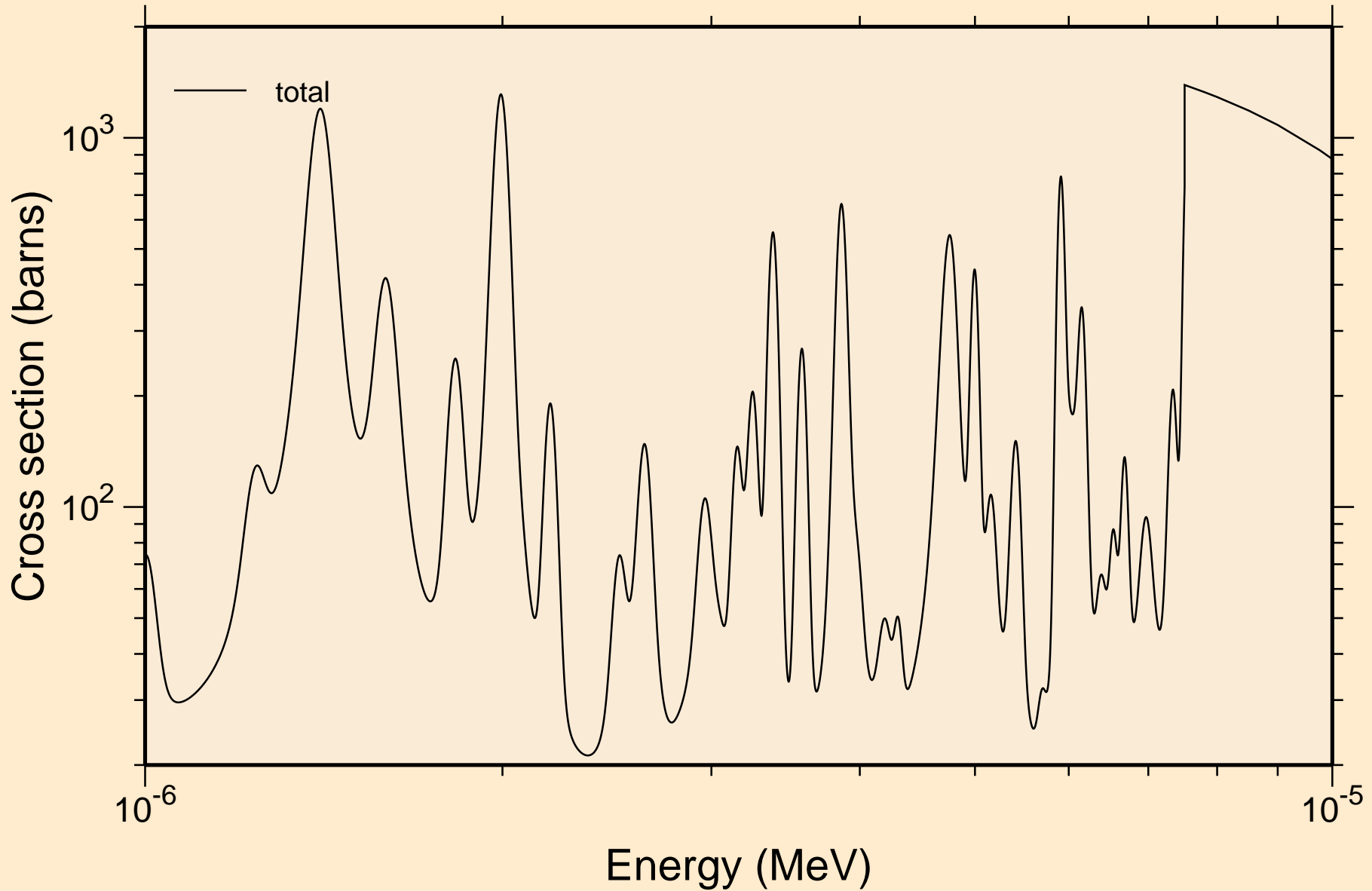

PA226 NEUTRON ACER TENDL-2021 LIBRARY; T=293.6K
resonance total cross section

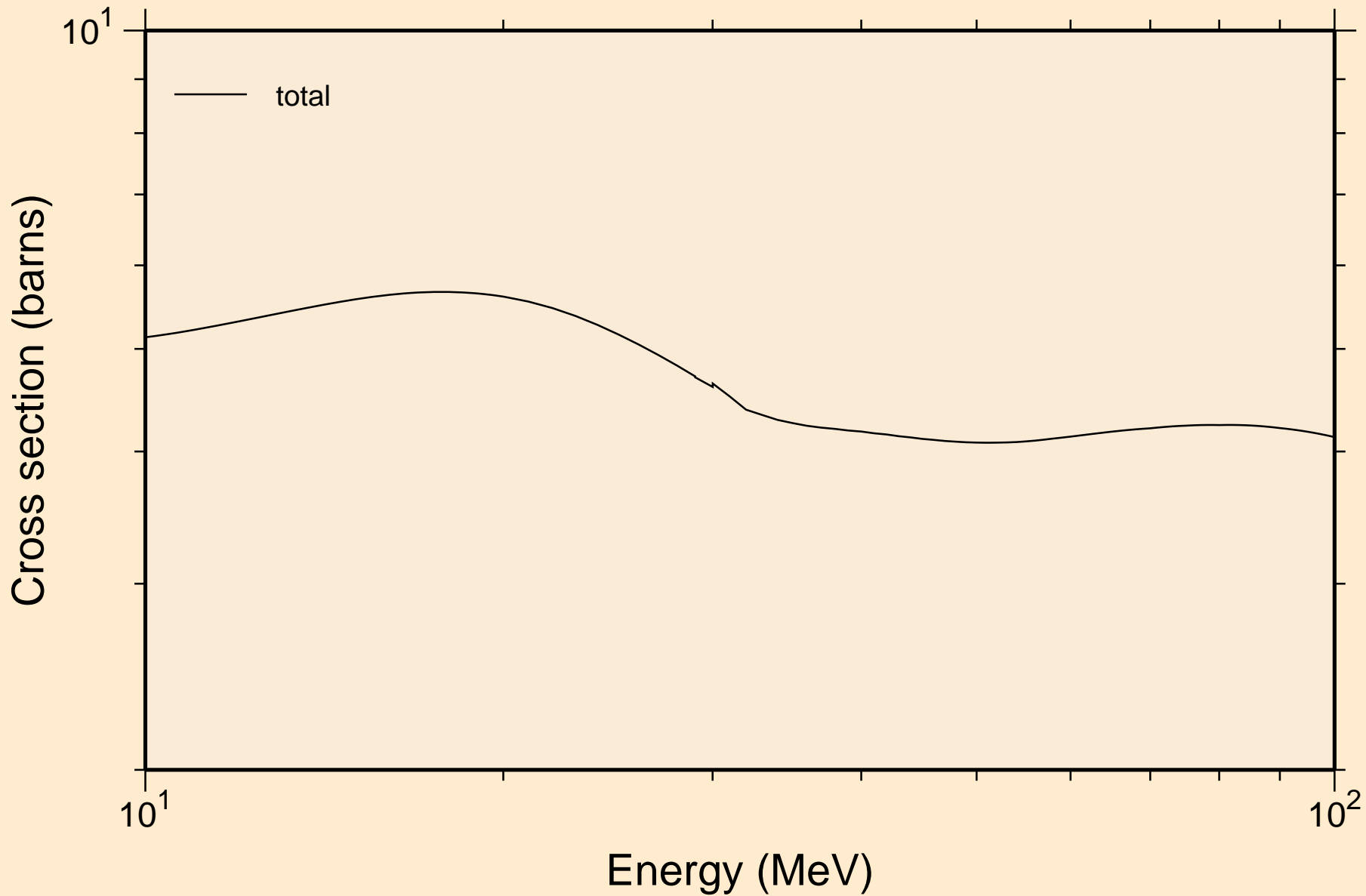

PA226 NEUTRON ACER TENDL-2021 LIBRARY; T=293.6K
resonance absorption cross sections

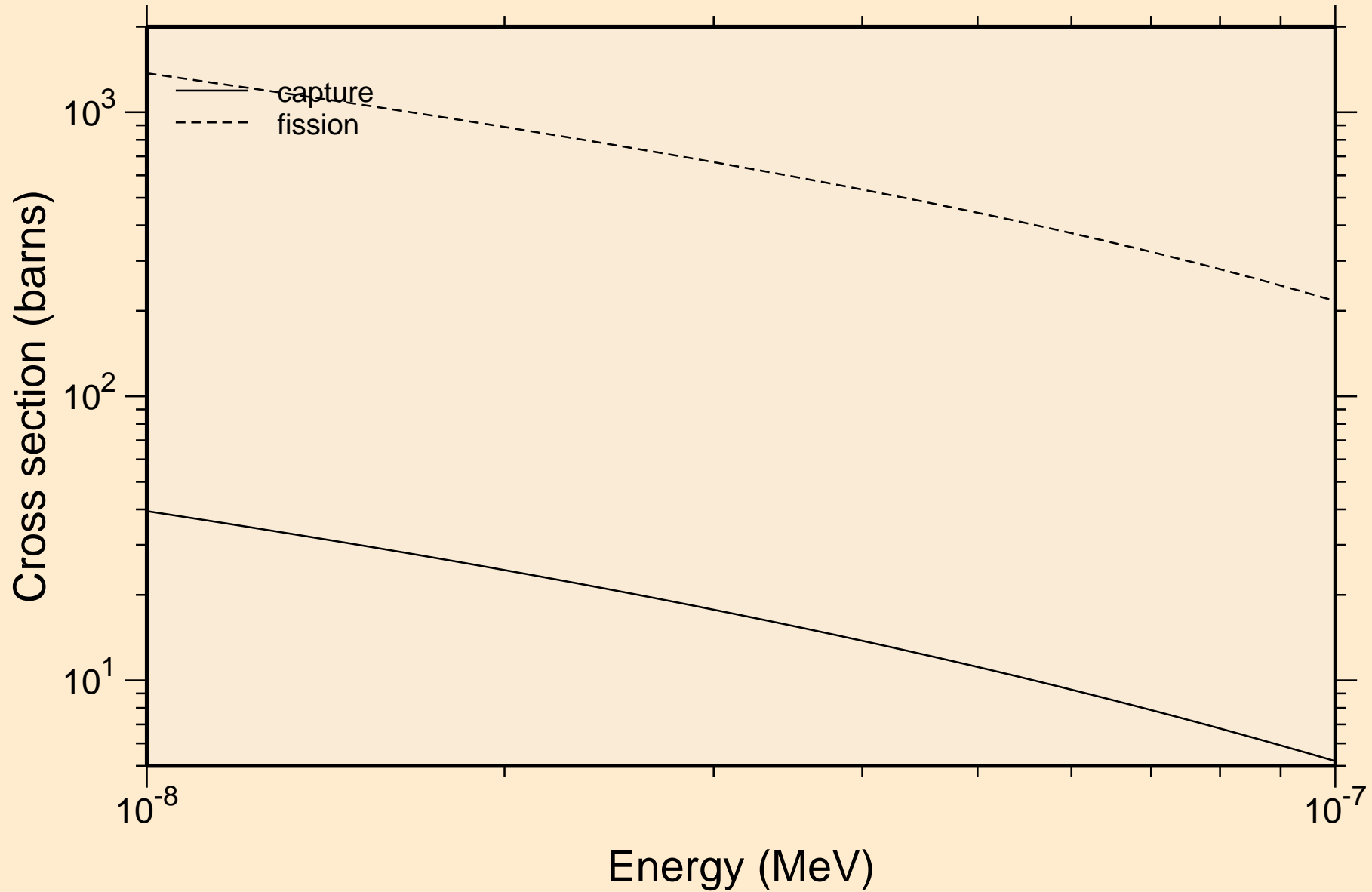

PA226 NEUTRON ACER TENDL-2021 LIBRARY; T=293.6K
resonance absorption cross sections

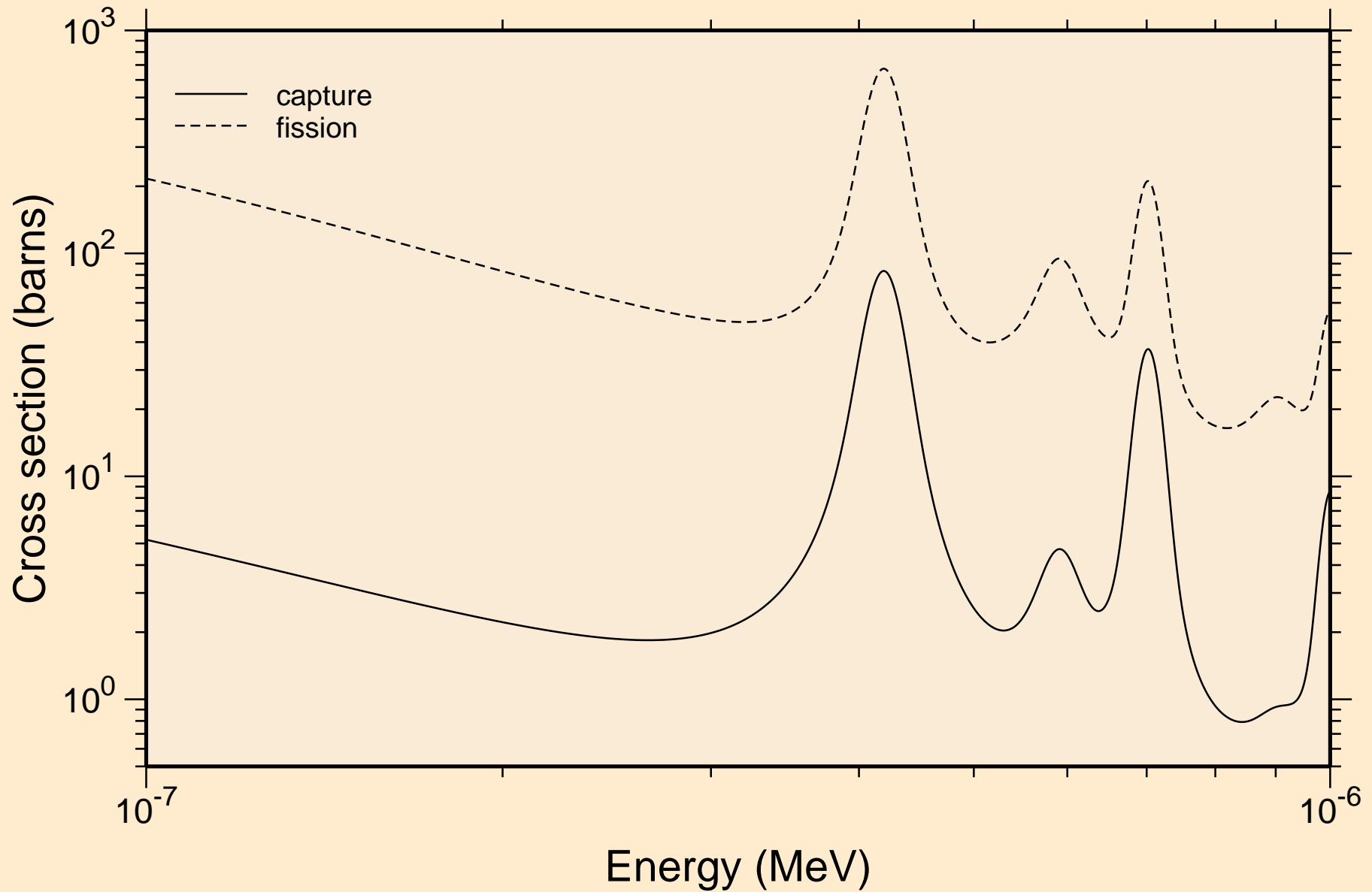

PA226 NEUTRON ACER TENDL-2021 LIBRARY; T=293.6K
resonance absorption cross sections

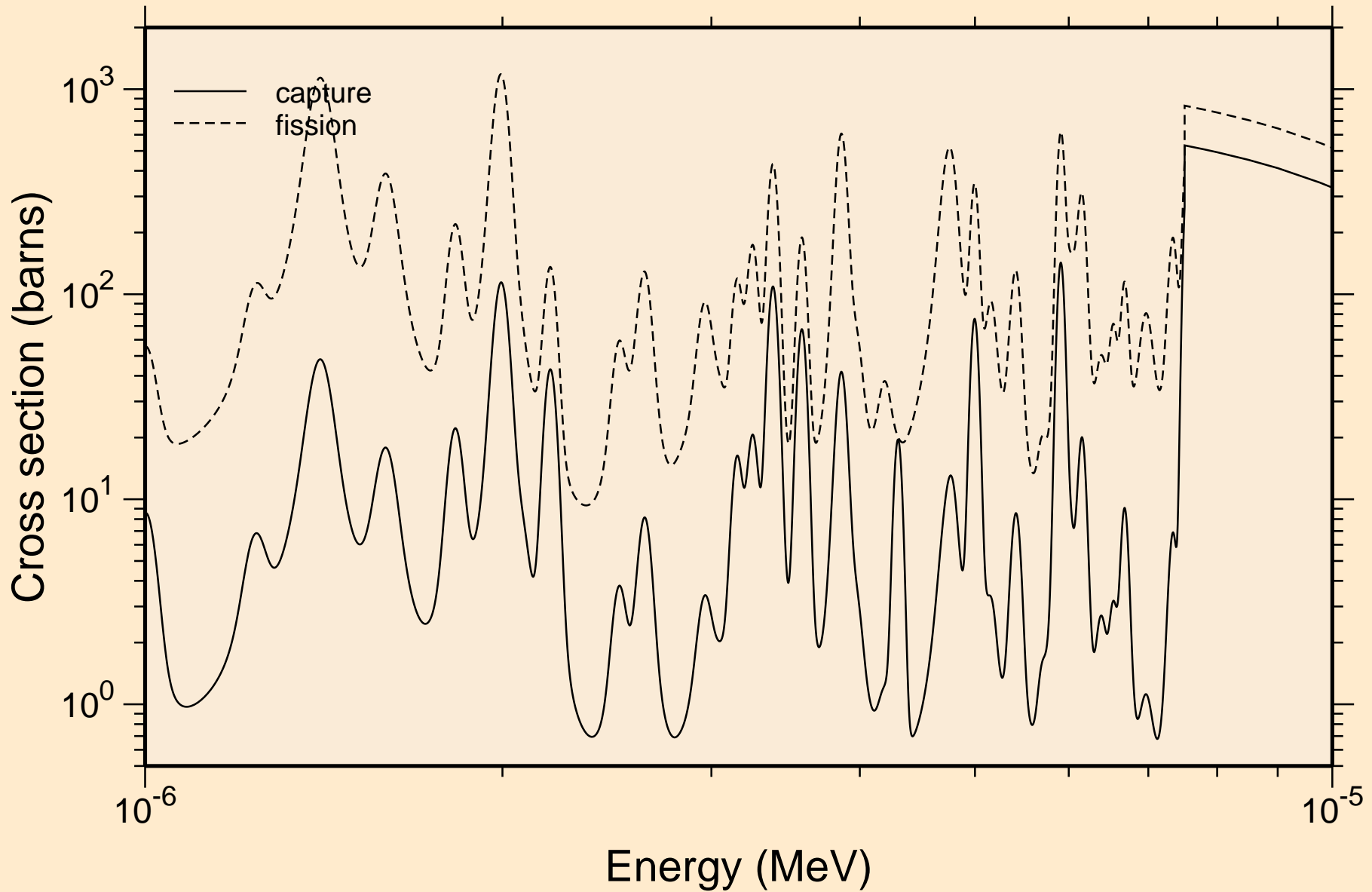

PA226 NEUTRON ACER TENDL-2021 LIBRARY; T=293.6K
resonance absorption cross sections

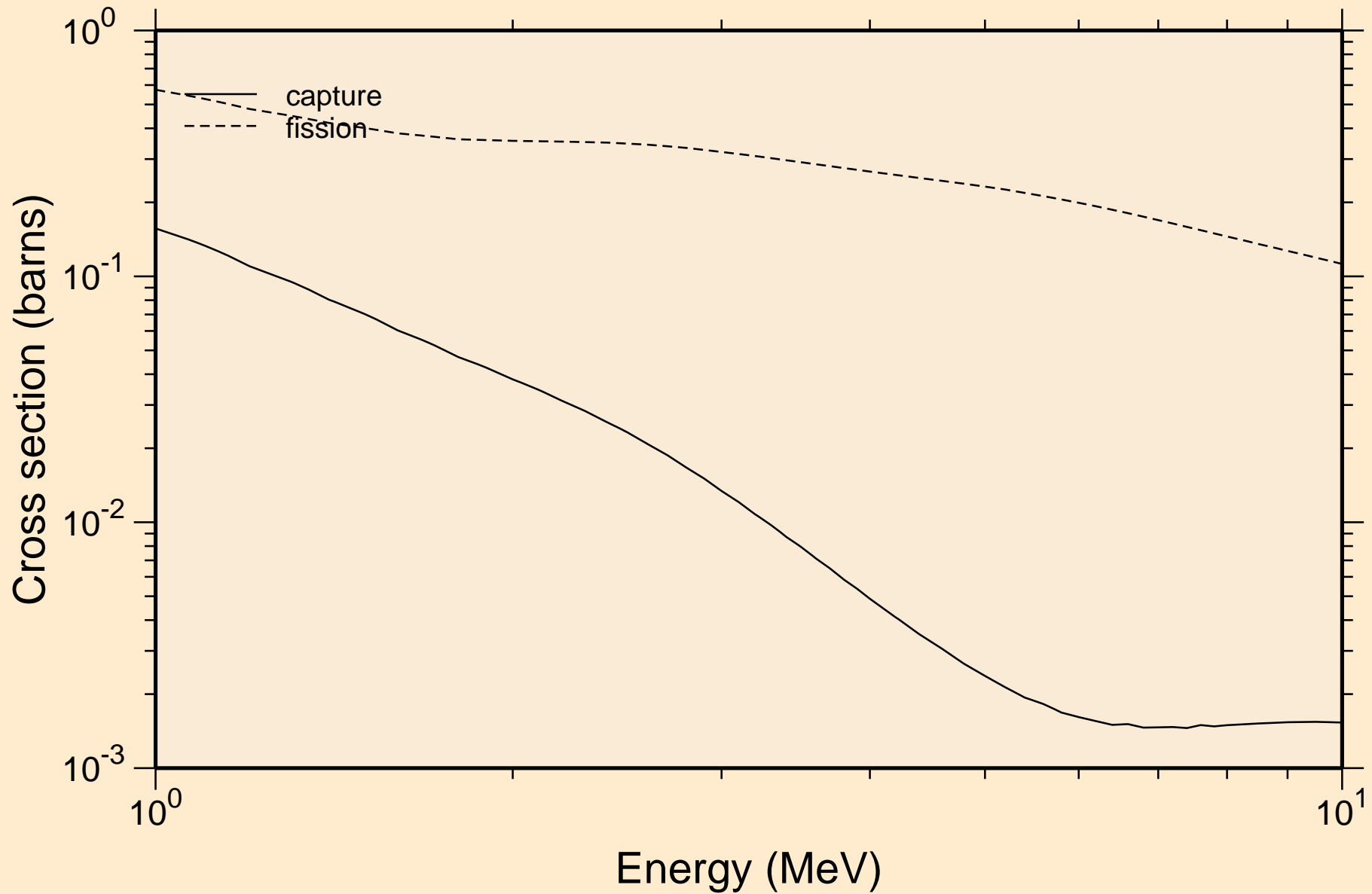

PA226 NEUTRON ACER TENDL-2021 LIBRARY; T=293.6K
Heating

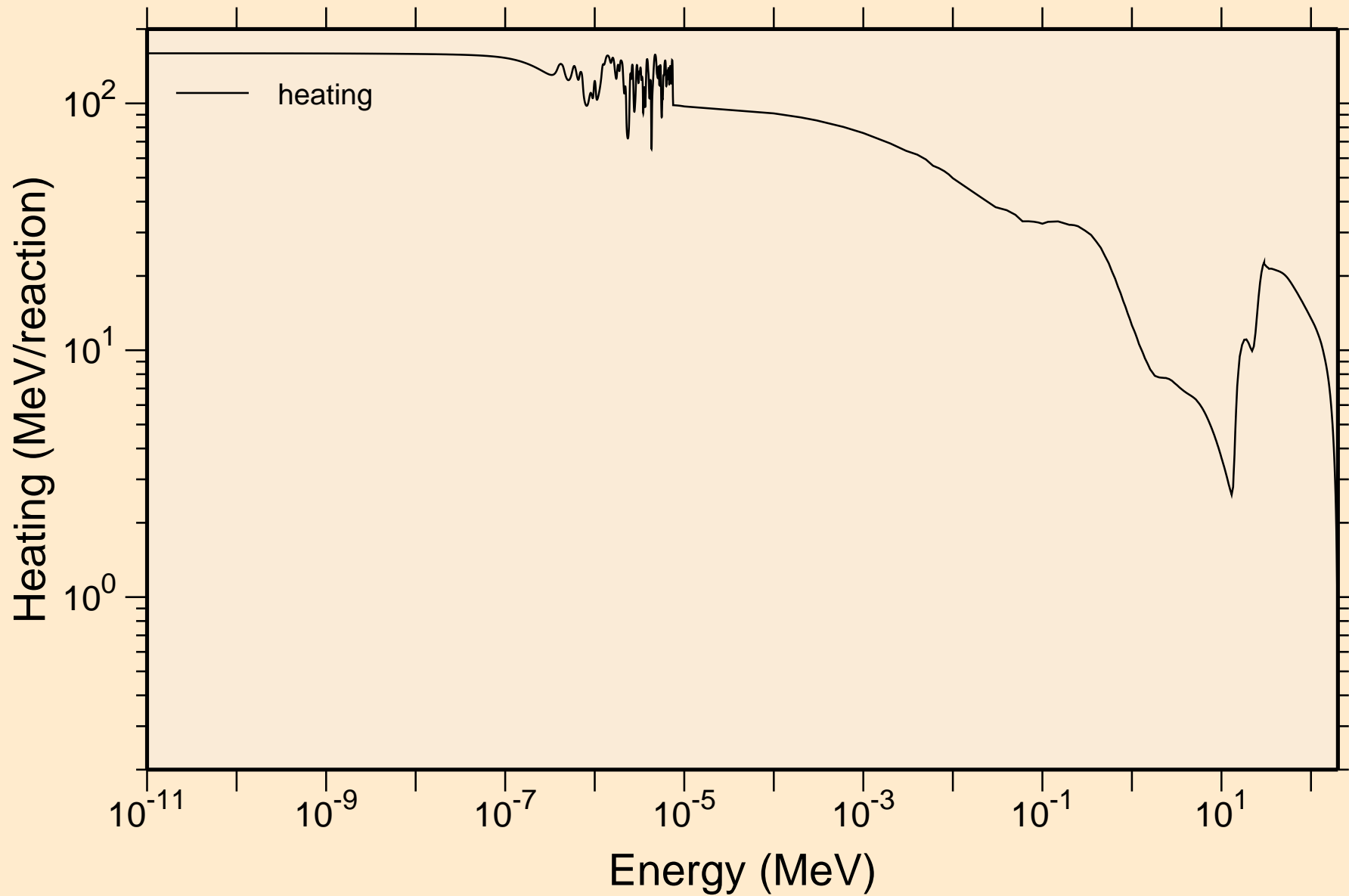

PA226 NEUTRON ACER TENDL-2021 LIBRARY; T=293.6K
Damage

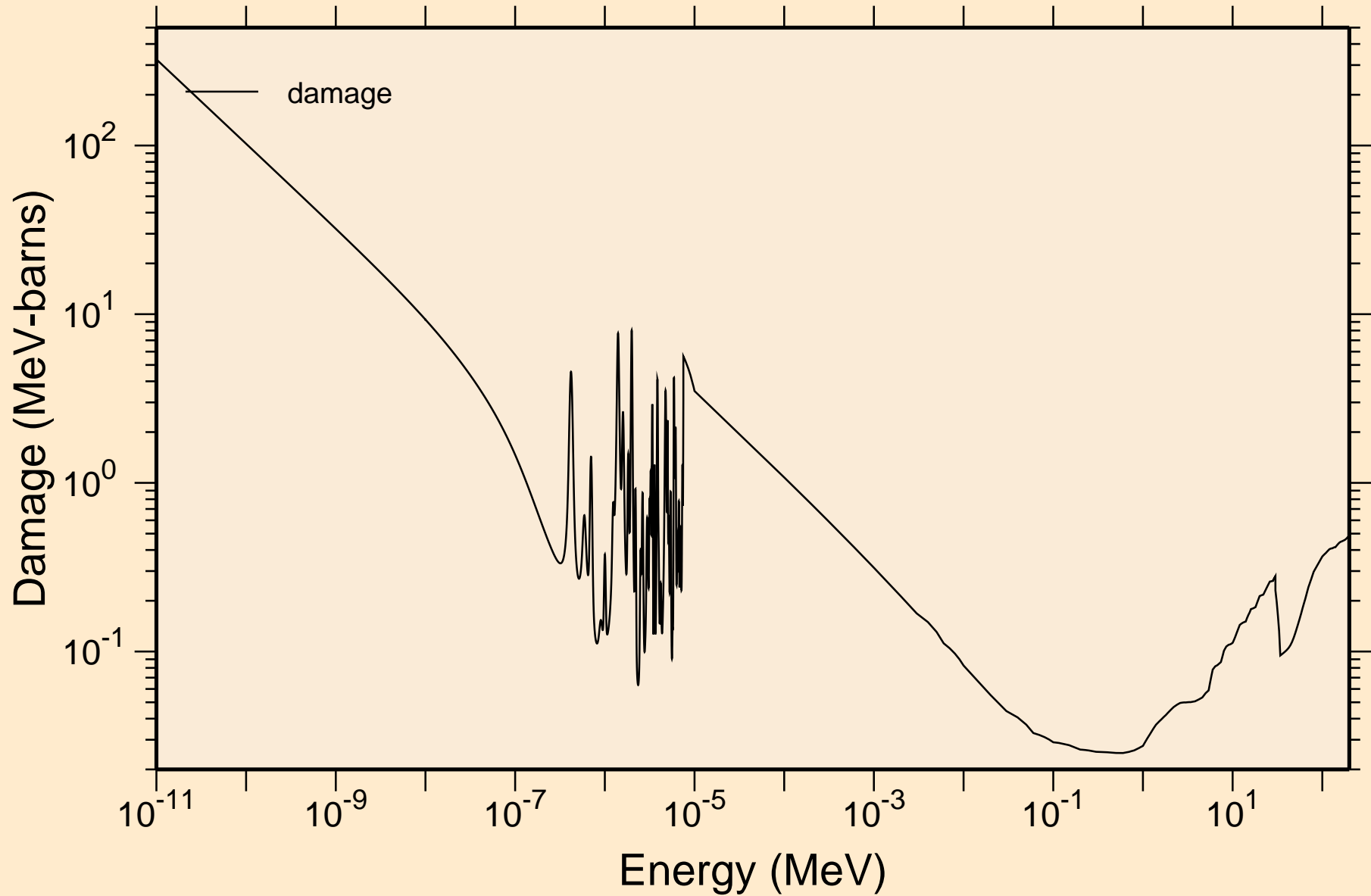

PA226 NEUTRON ACER TENDL-2021 LIBRARY; T=293.6K
Non-threshold reactions

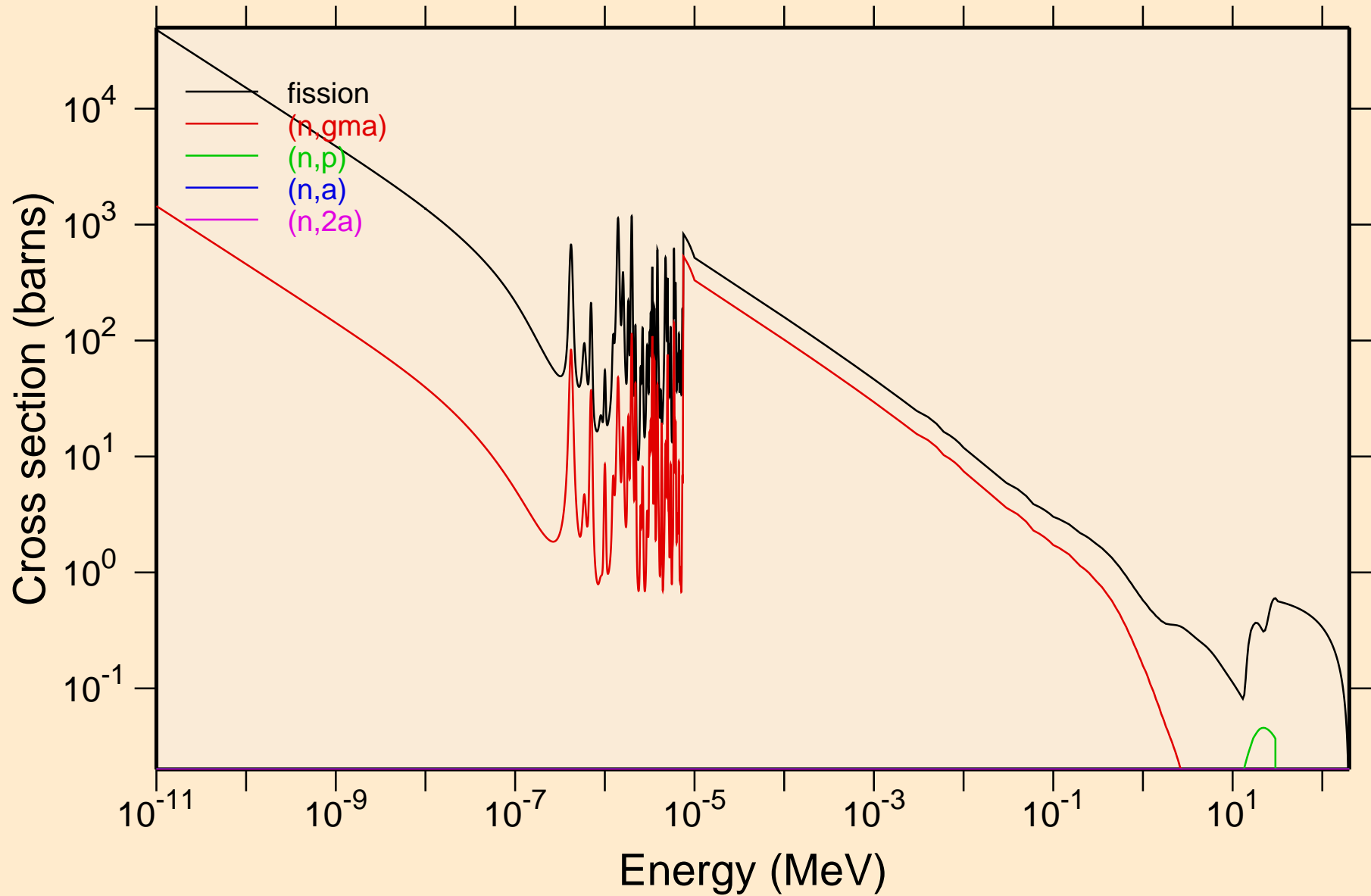

PA226 NEUTRON ACER TENDL-2021 LIBRARY; T=293.6K
Non-threshold reactions

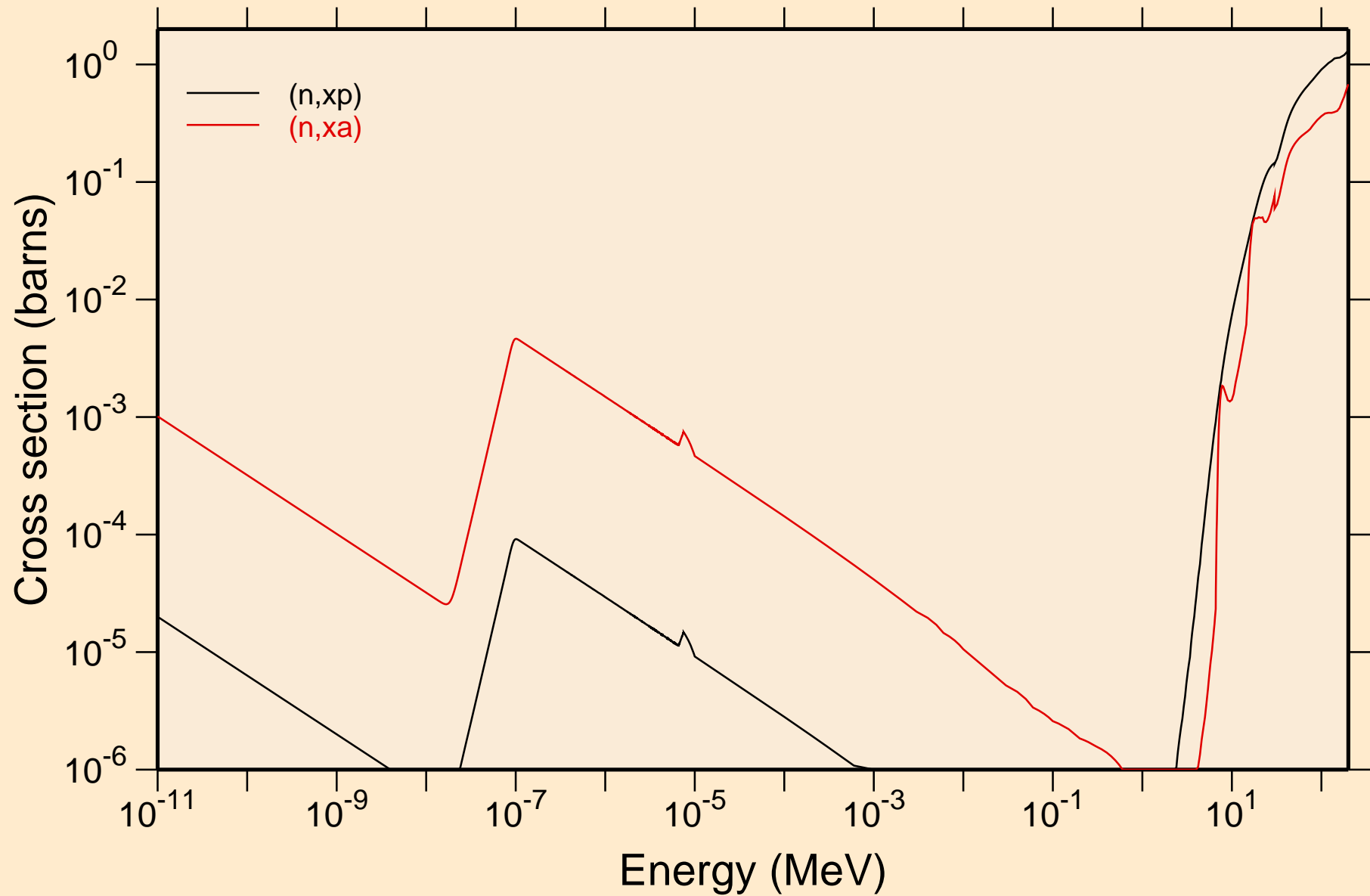

PA226 NEUTRON ACER TENDL-2021 LIBRARY; T=293.6K
Principal cross sections

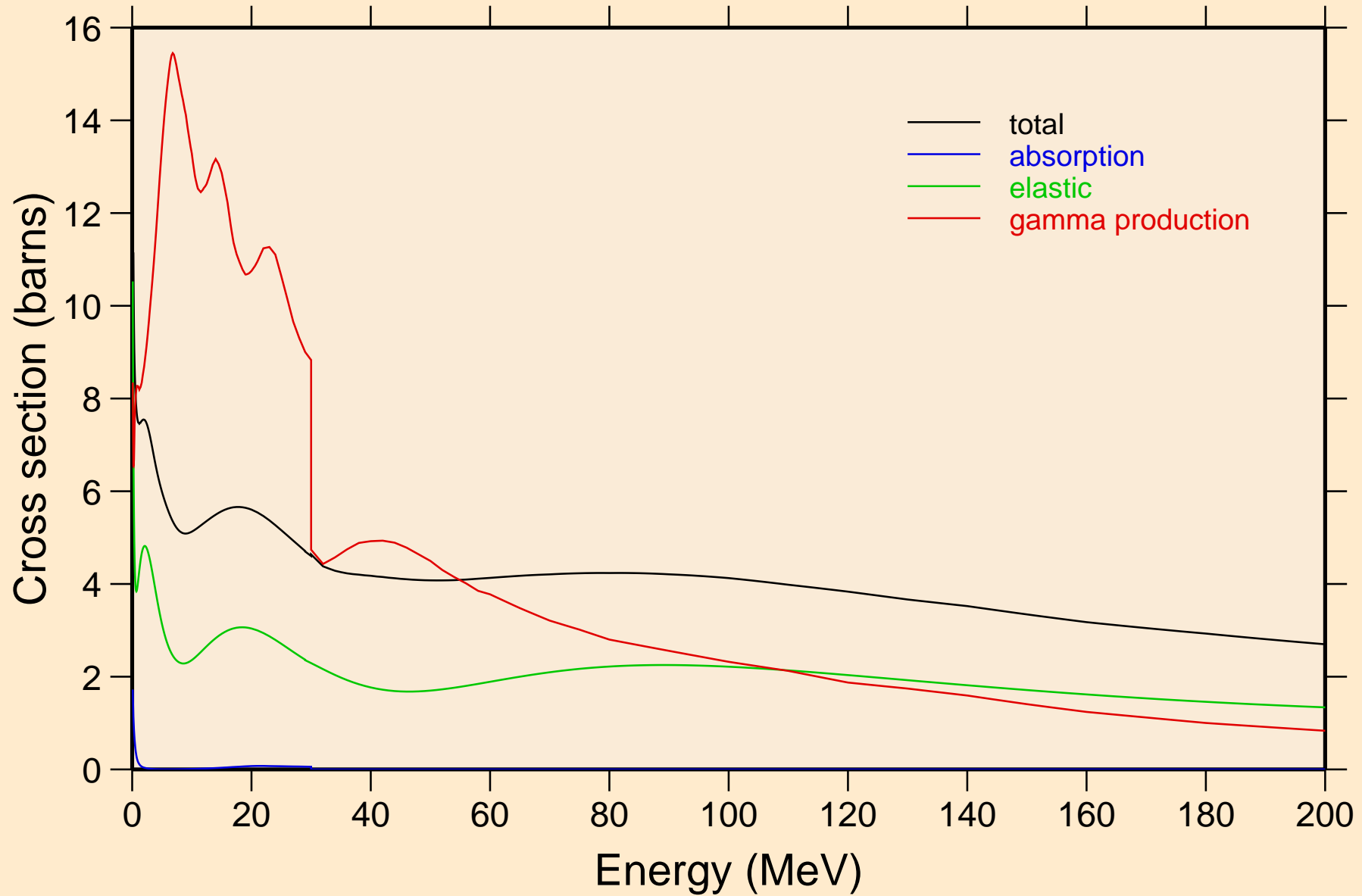

PA226 NEUTRON ACER TENDL-2021 LIBRARY; T=293.6K
Heating

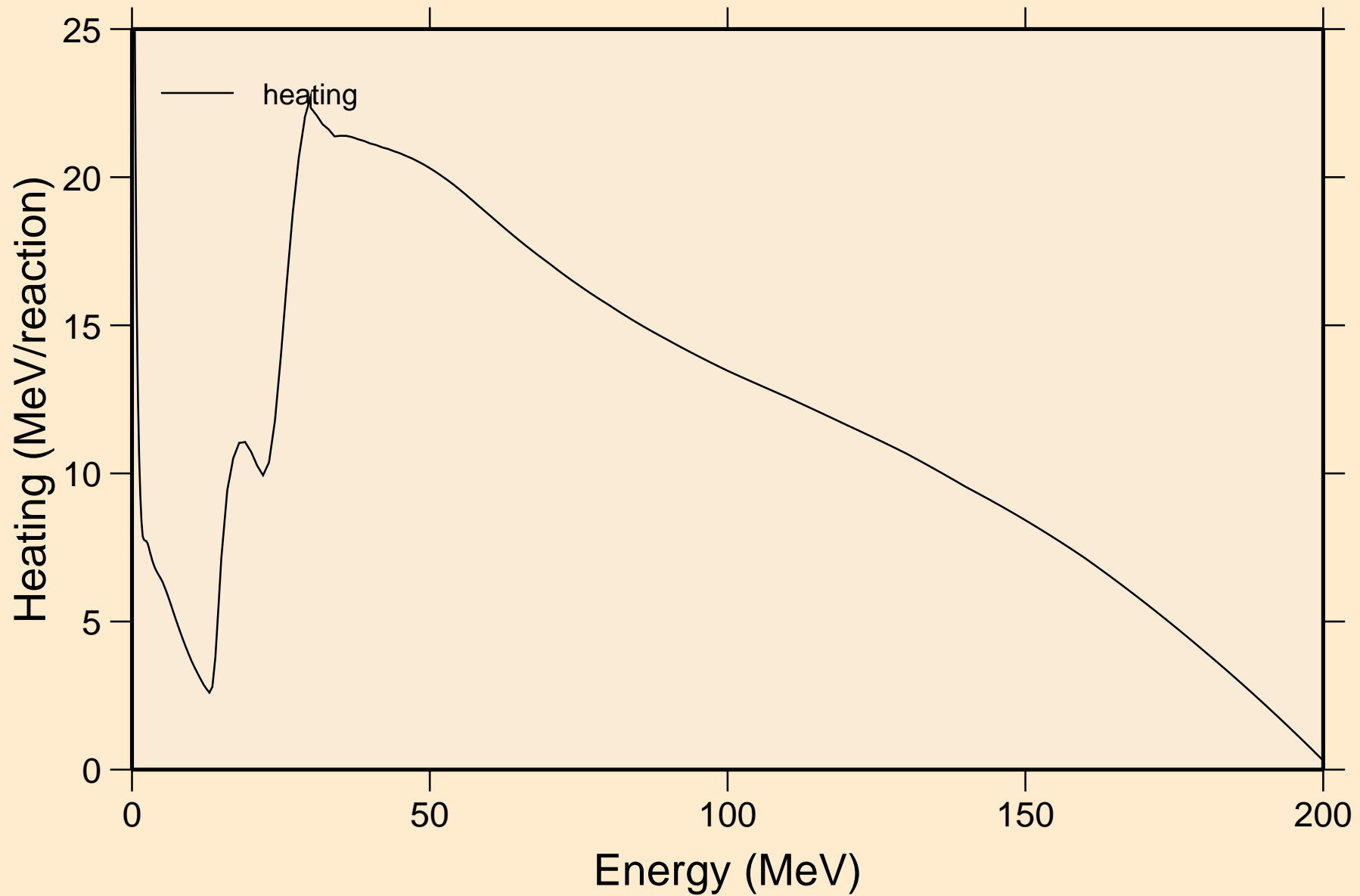

PA226 NEUTRON ACER TENDL-2021 LIBRARY; T=293.6K
Damage

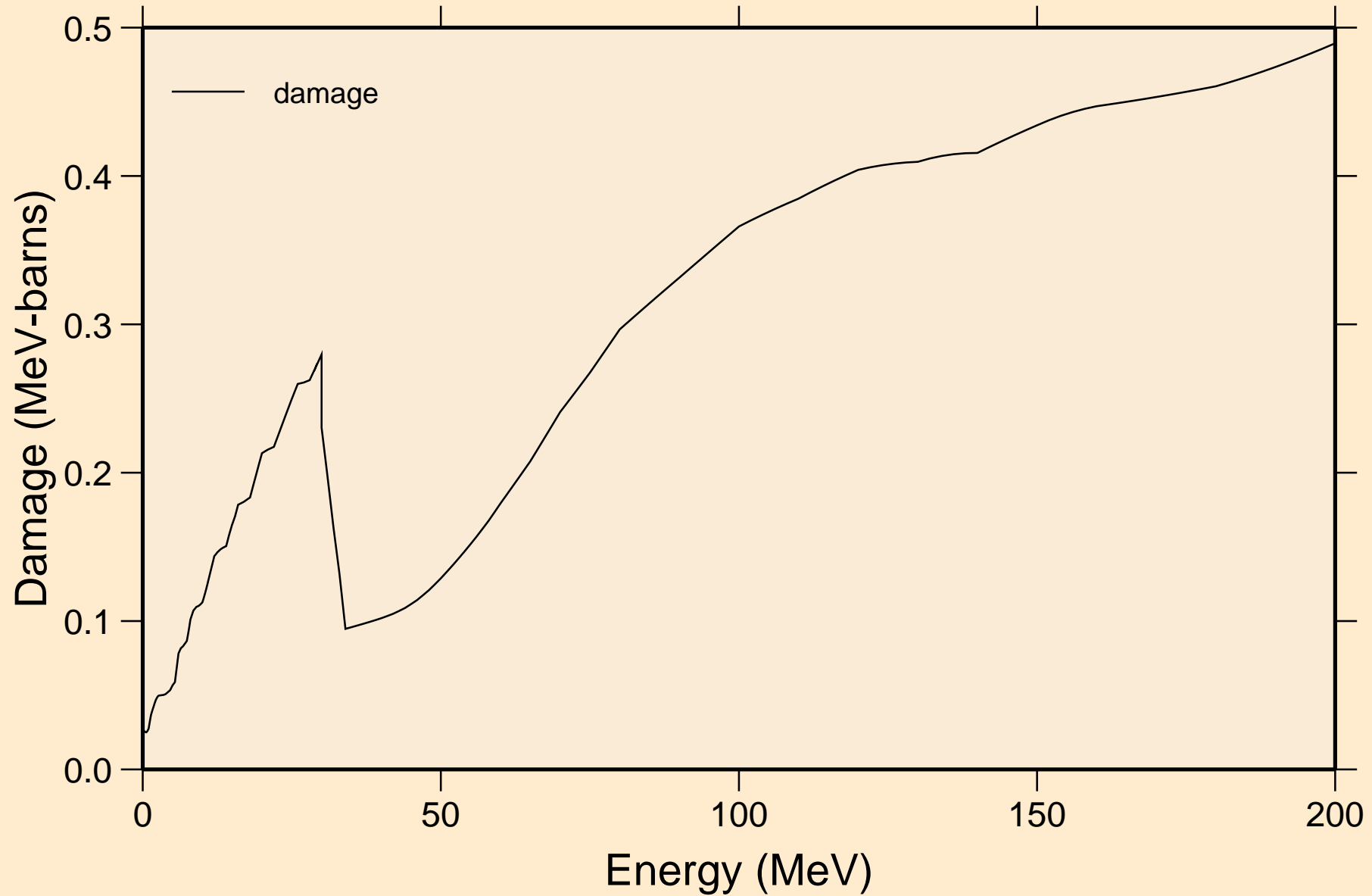

PA226 NEUTRON ACER TENDL-2021 LIBRARY; T=293.6K
Non-threshold reactions

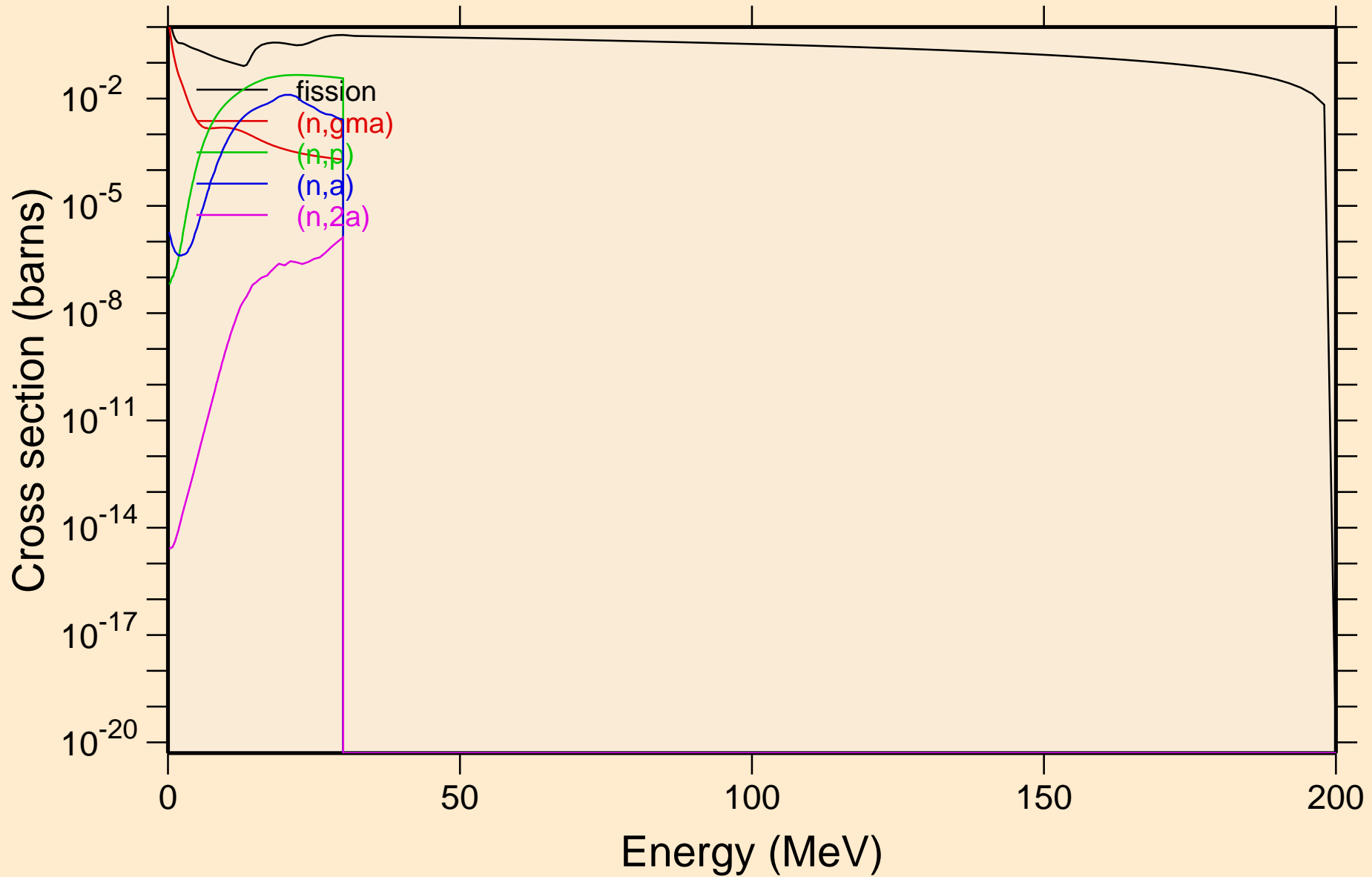

PA226 NEUTRON ACER TENDL-2021 LIBRARY; T=293.6K
Non-threshold reactions

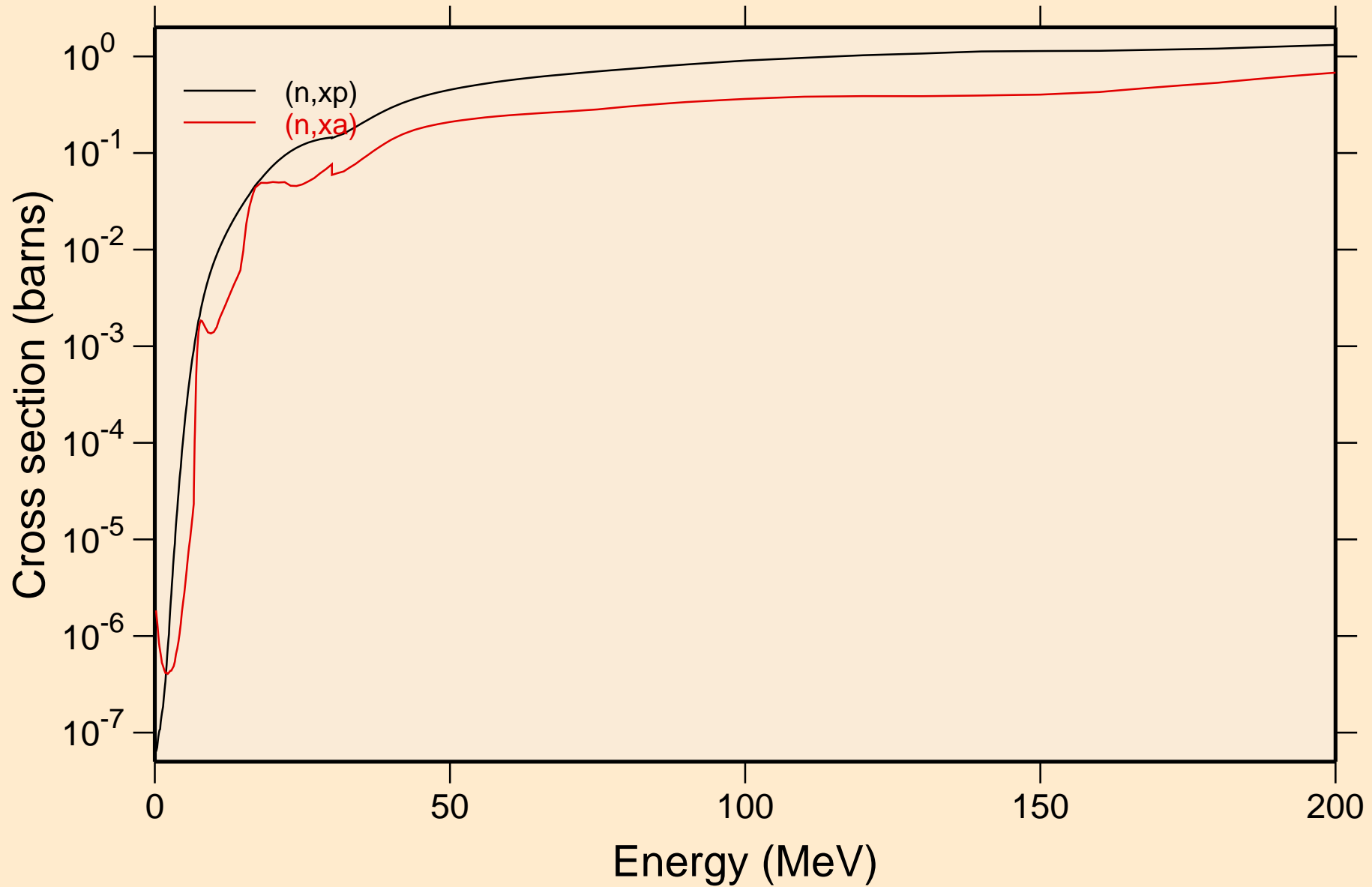

PA226 NEUTRON ACER TENDL-2021 LIBRARY; T=293.6K
Inelastic levels

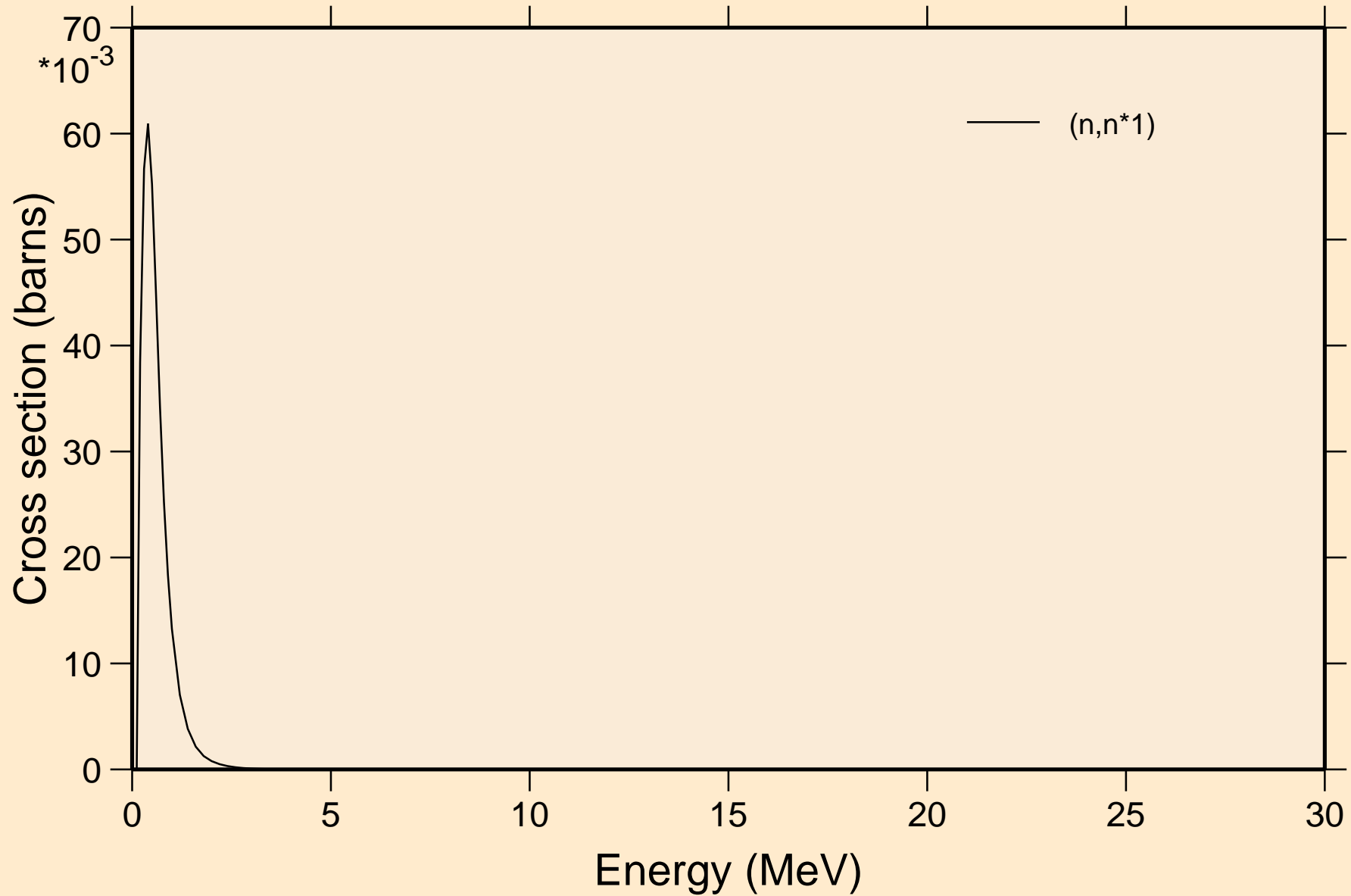

PA226 NEUTRON ACER TENDL-2021 LIBRARY; T=293.6K
Threshold reactions

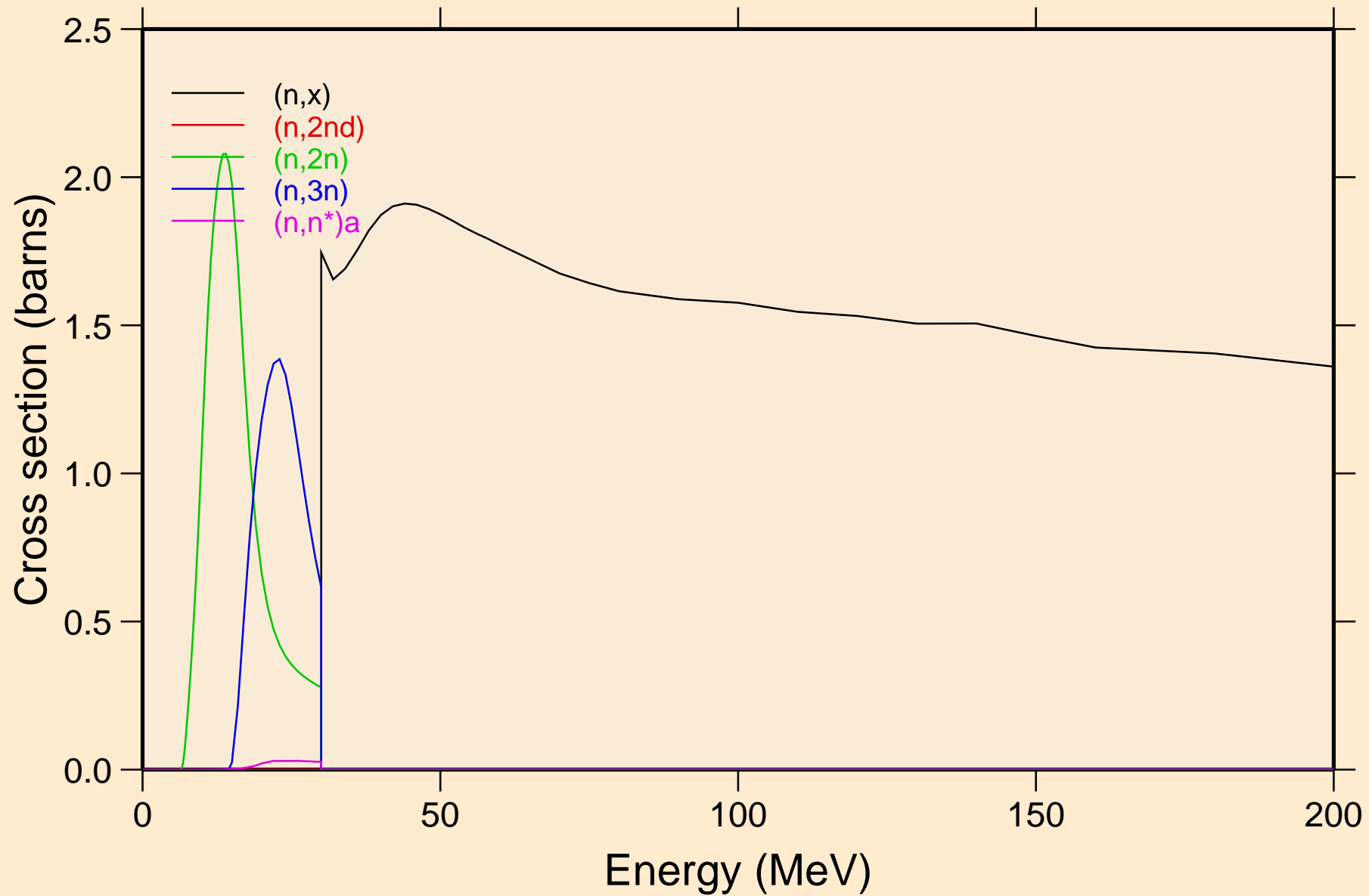

PA226 NEUTRON ACER TENDL-2021 LIBRARY; T=293.6K
Threshold reactions

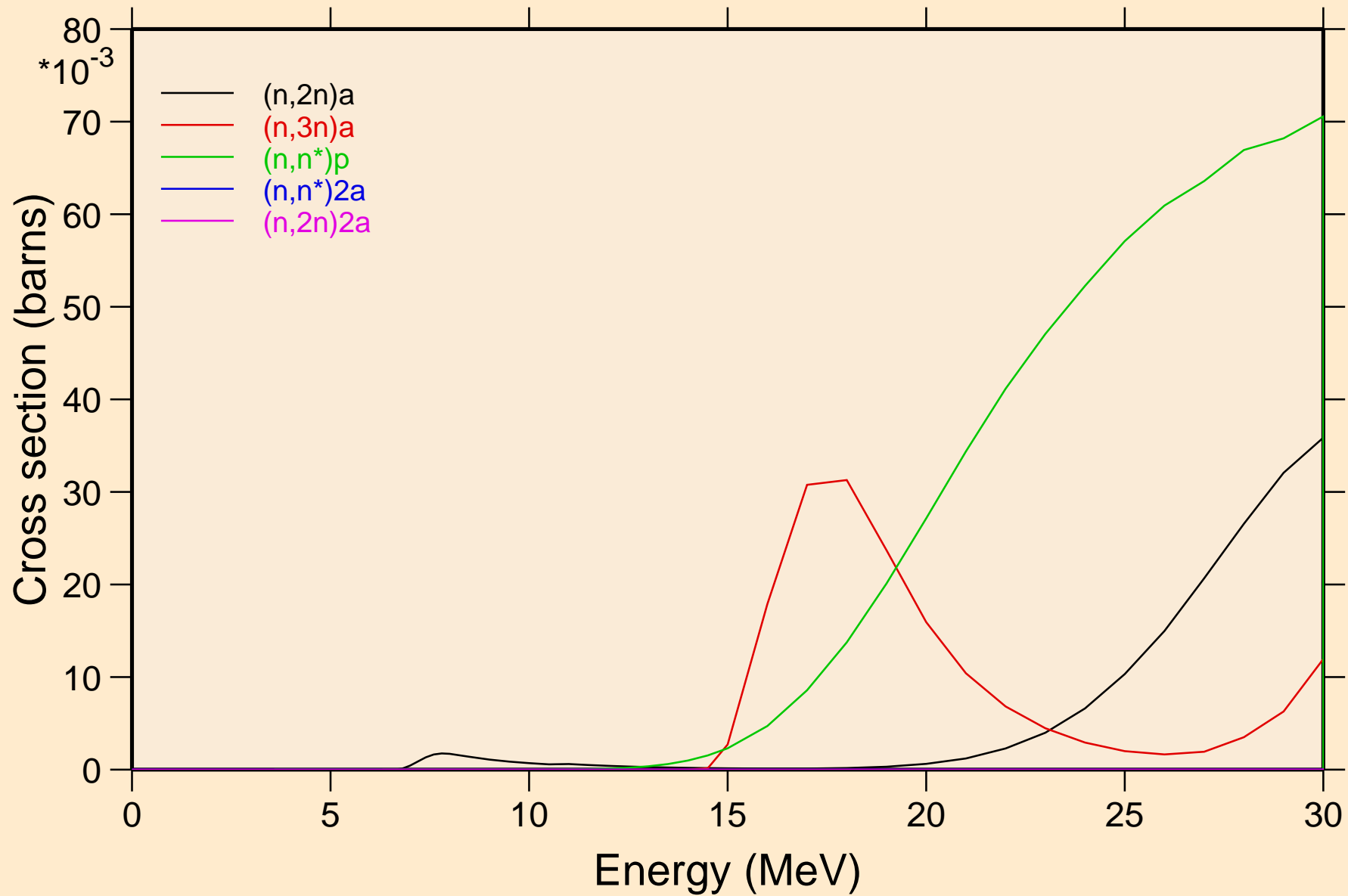

PA226 NEUTRON ACER TENDL-2021 LIBRARY; T=293.6K
Threshold reactions

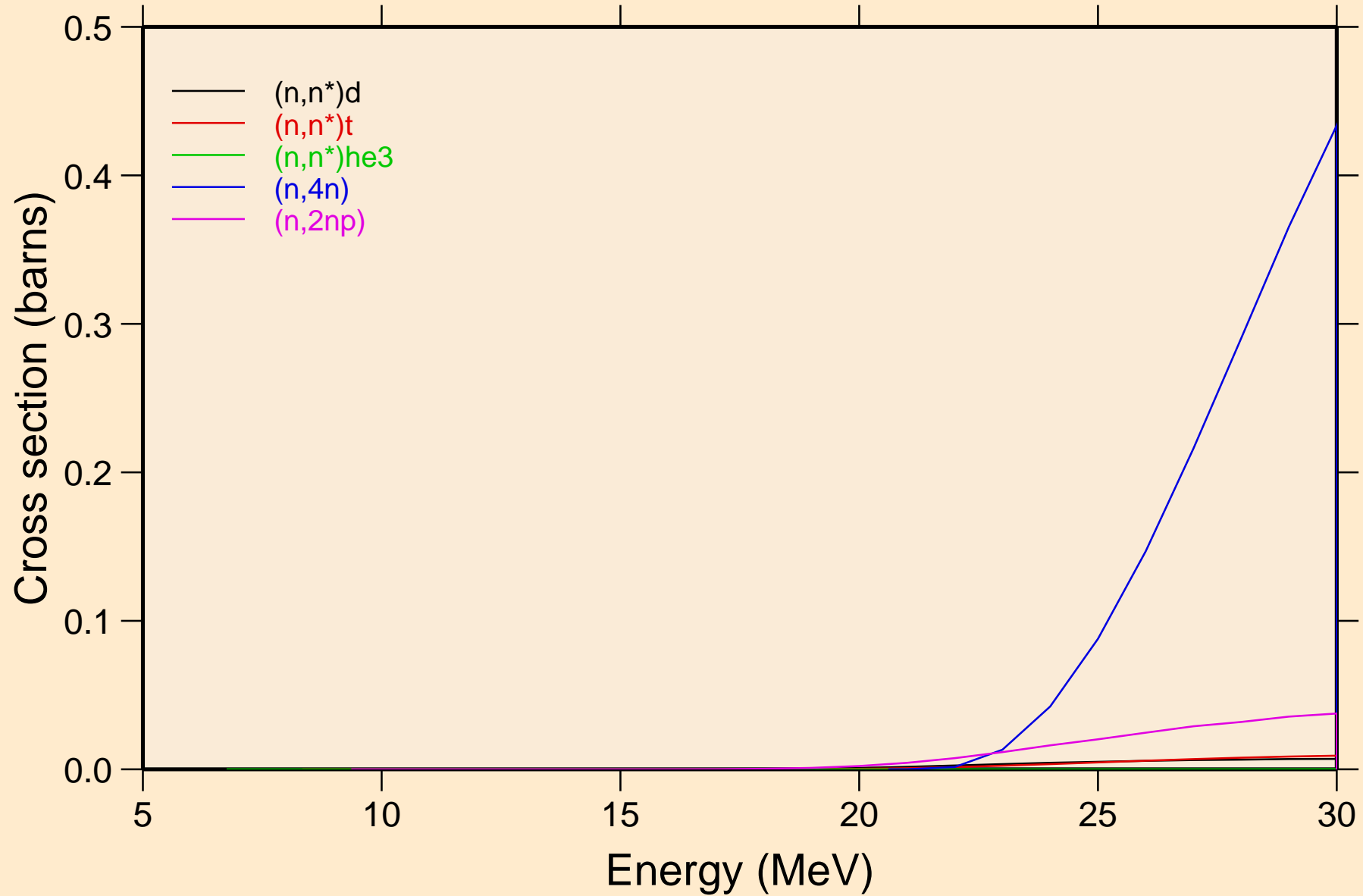

PA226 NEUTRON ACER TENDL-2021 LIBRARY; T=293.6K
Threshold reactions

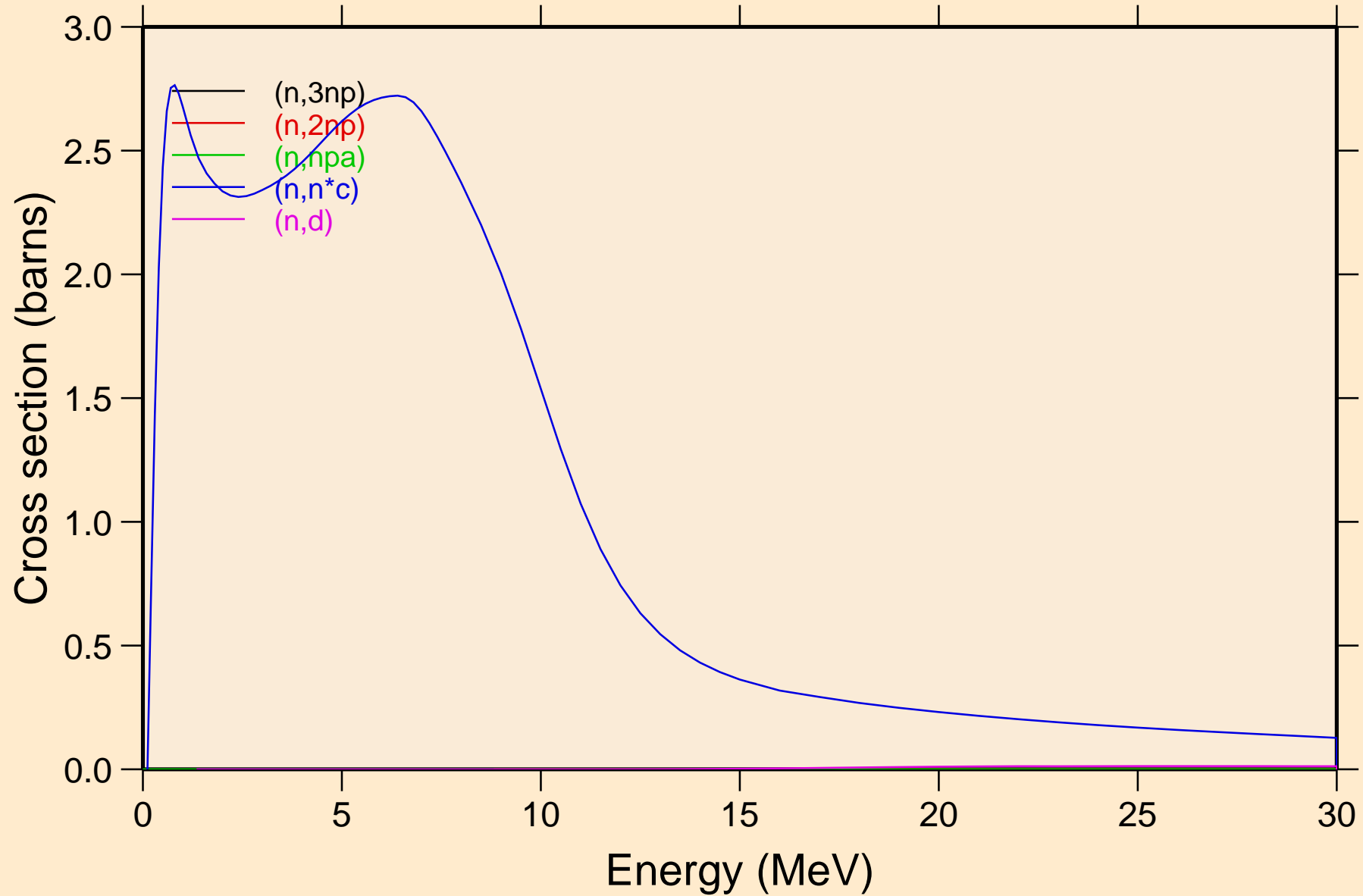

PA226 NEUTRON ACER TENDL-2021 LIBRARY; T=293.6K
Threshold reactions

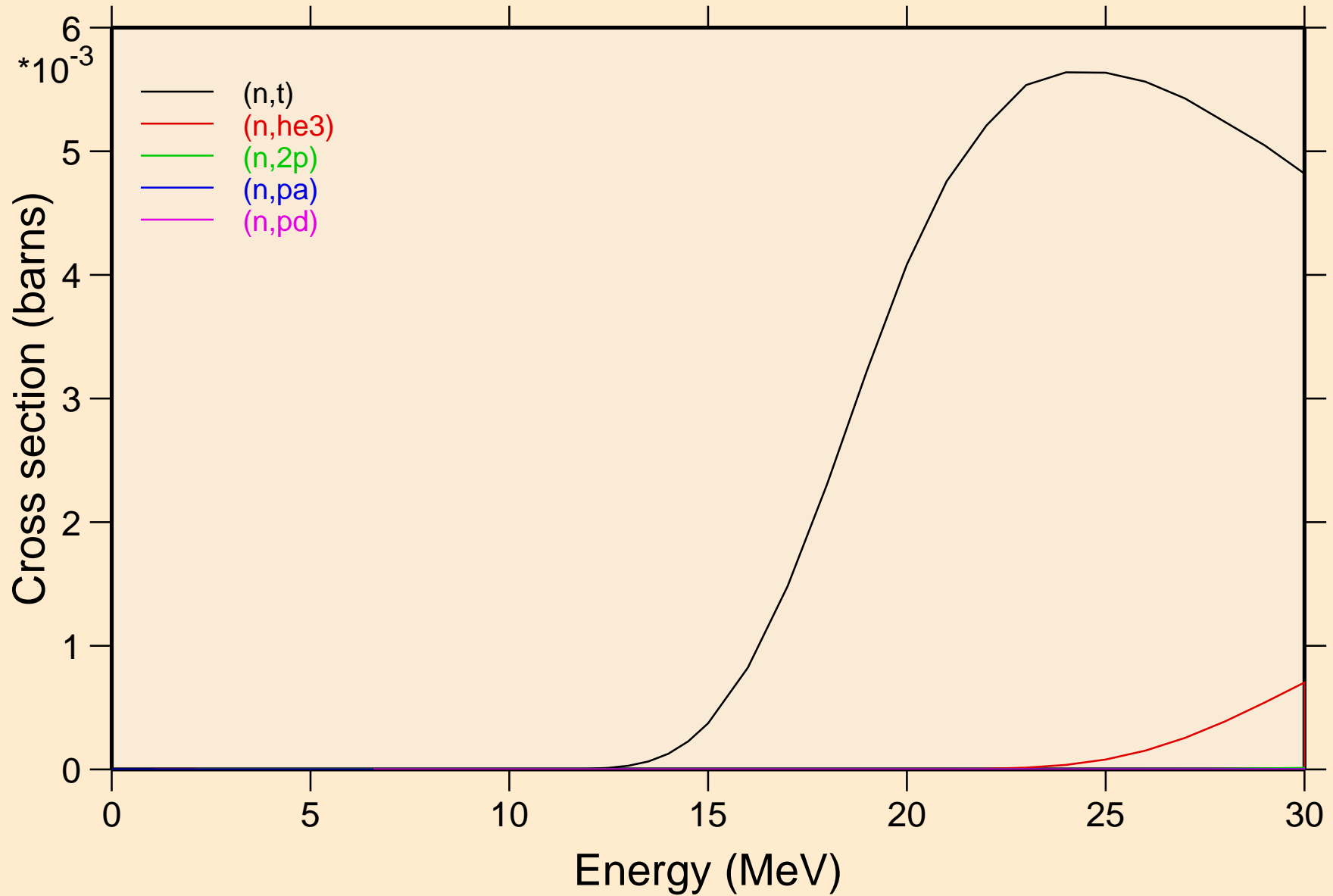

PA226 NEUTRON ACER TENDL-2021 LIBRARY; T=293.6K
Threshold reactions

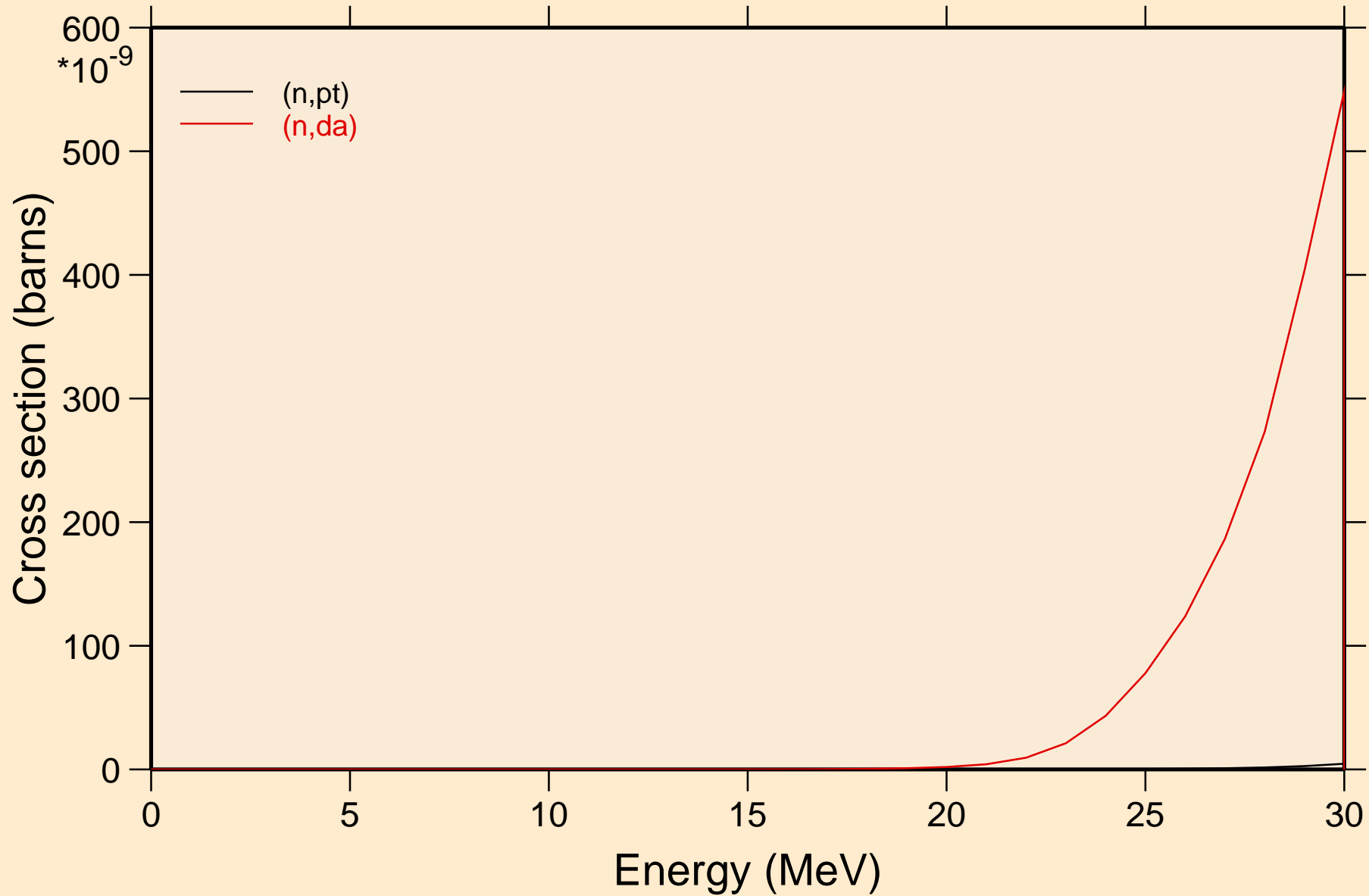

PA226 NEUTRON ACER TENDL-2021 LIBRARY; T=293.6K
Threshold reactions

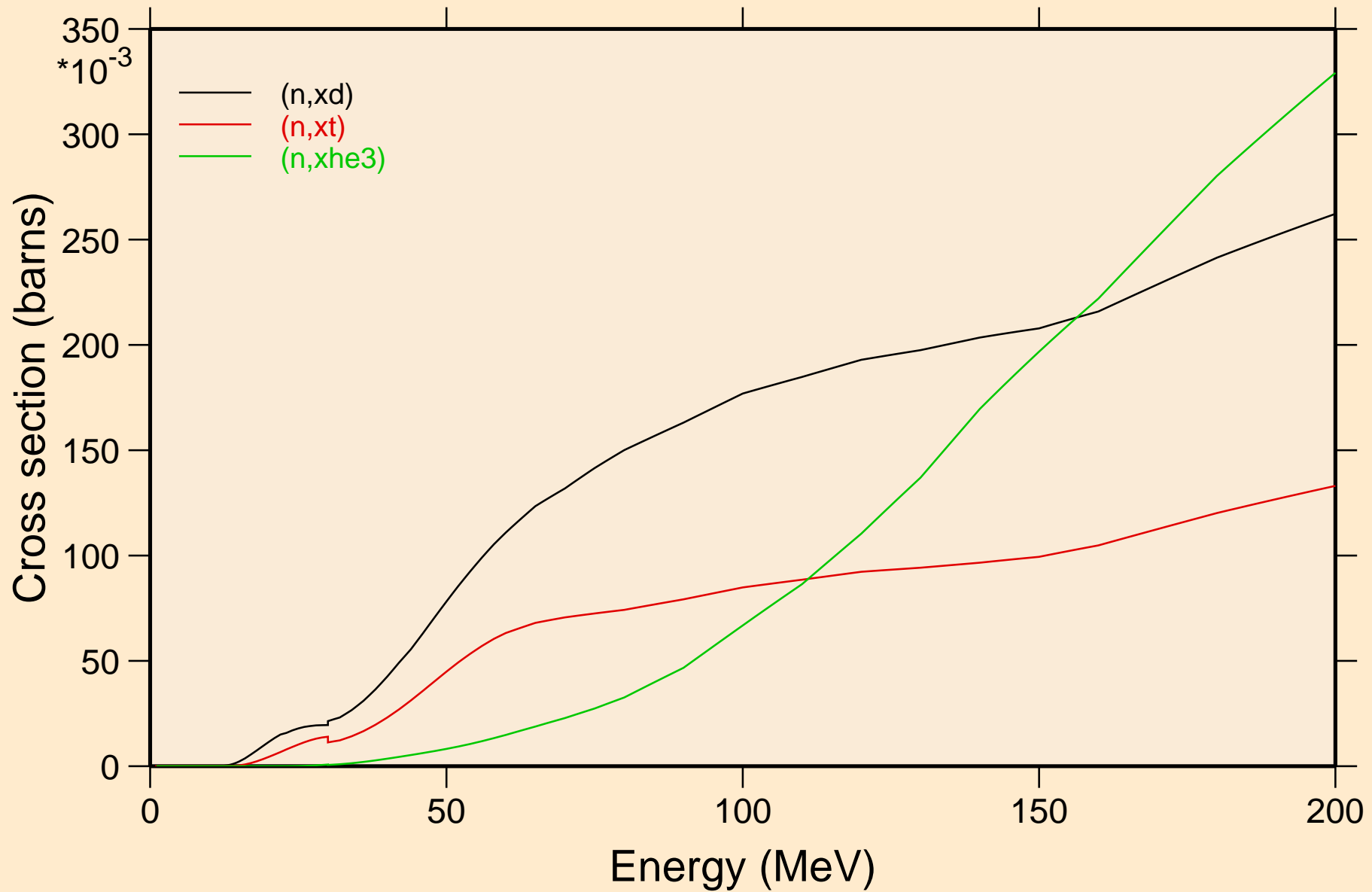

PA226 NEUTRON ACER TENDL-2021 LIBRARY; T=293.6K
angular distribution for elastic

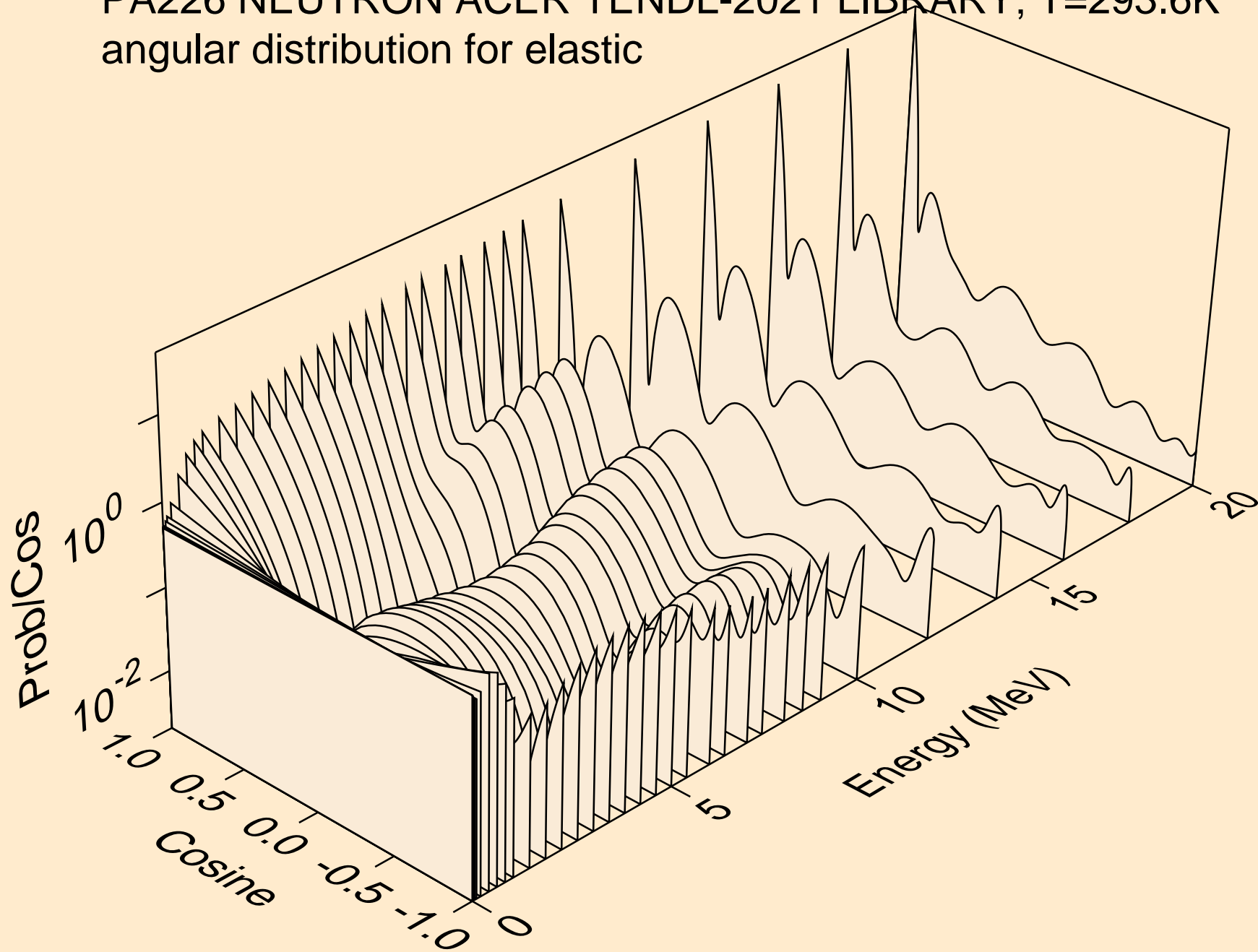

PA226 NEUTRON ACER TENDL-2021 LIBRARY; T=293.6K
angular distribution for elastic

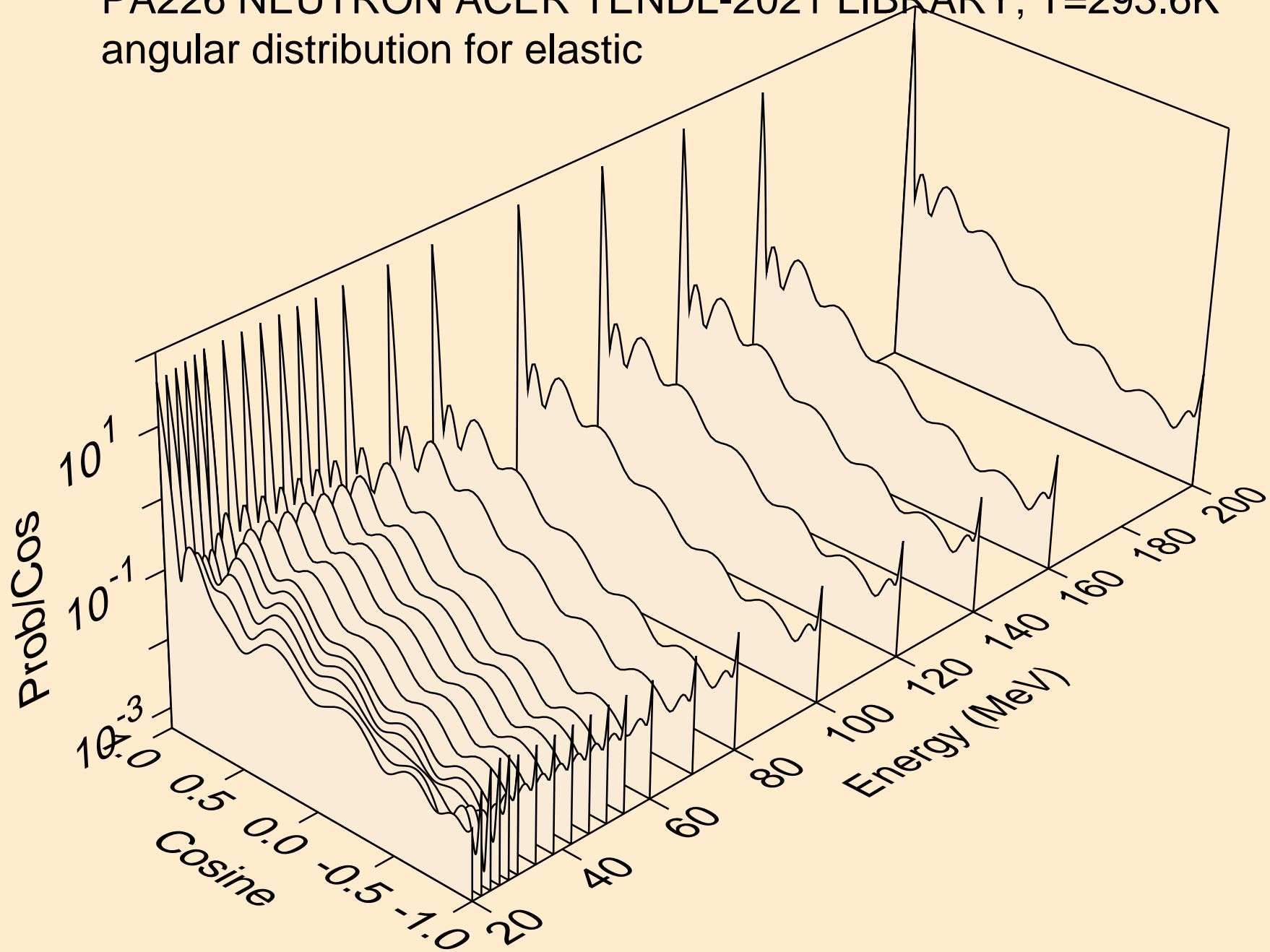

PA226 NEUTRON ACER TENDL-2021 LIBRARY; T=293.6K
angular distribution for (n,n*1)

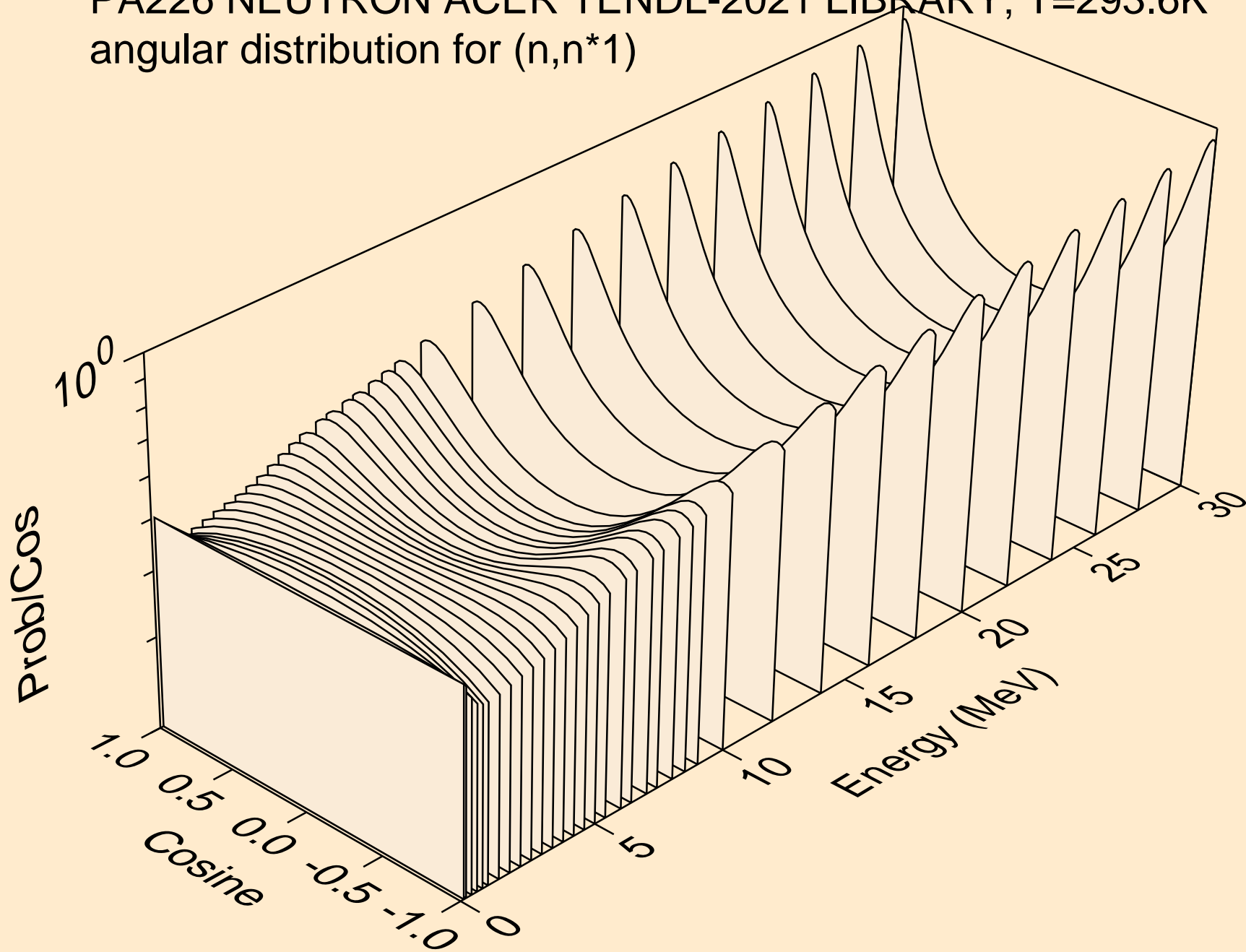

PA226 NEUTRON ACER TENDL-2021 LIBRARY; T=293.6K
Total fission nubar

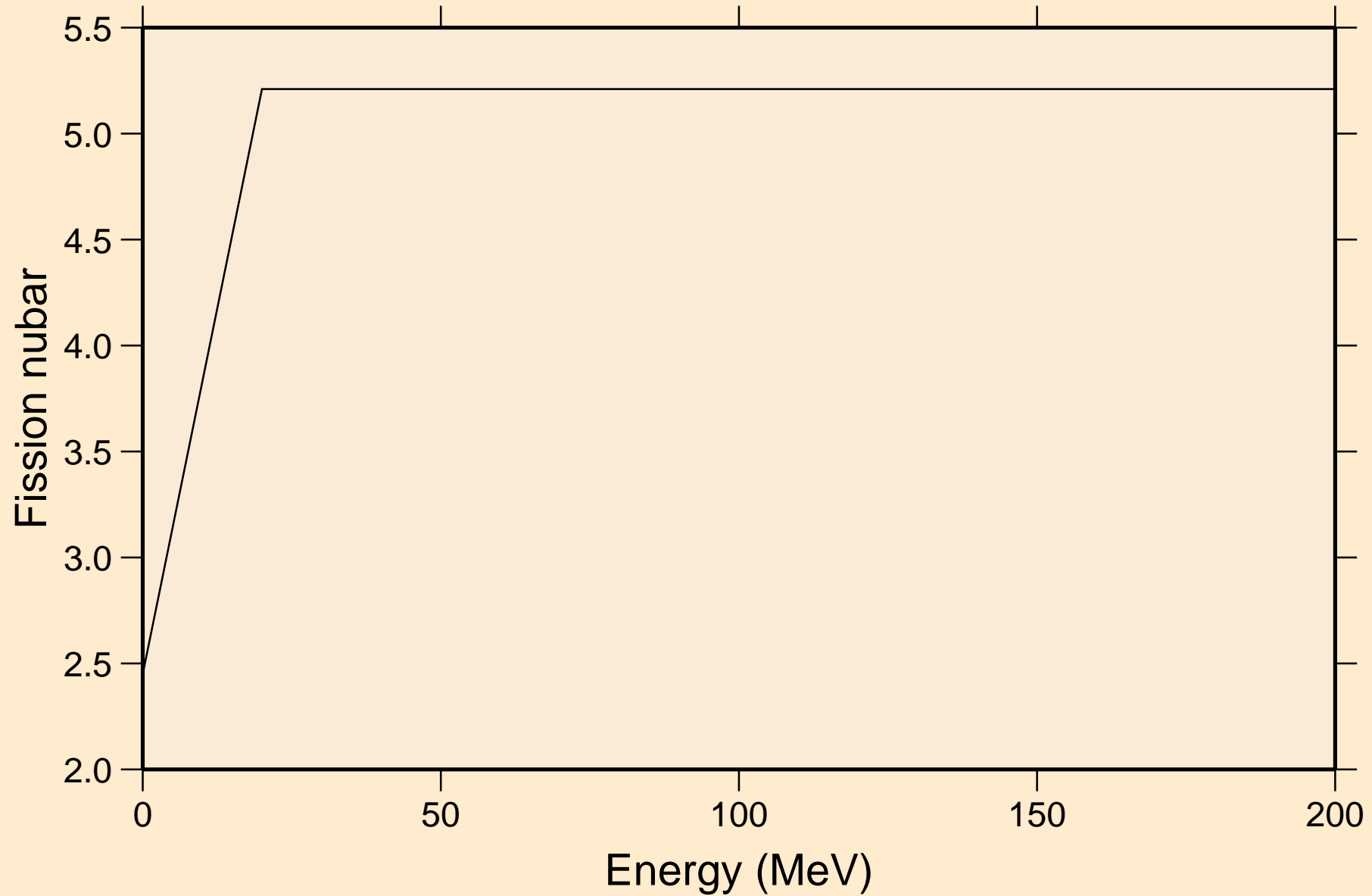

PA226 NEUTRON ACER TENDL-2021 LIBRARY; T=293.6K
Neutron emission for (n,x)

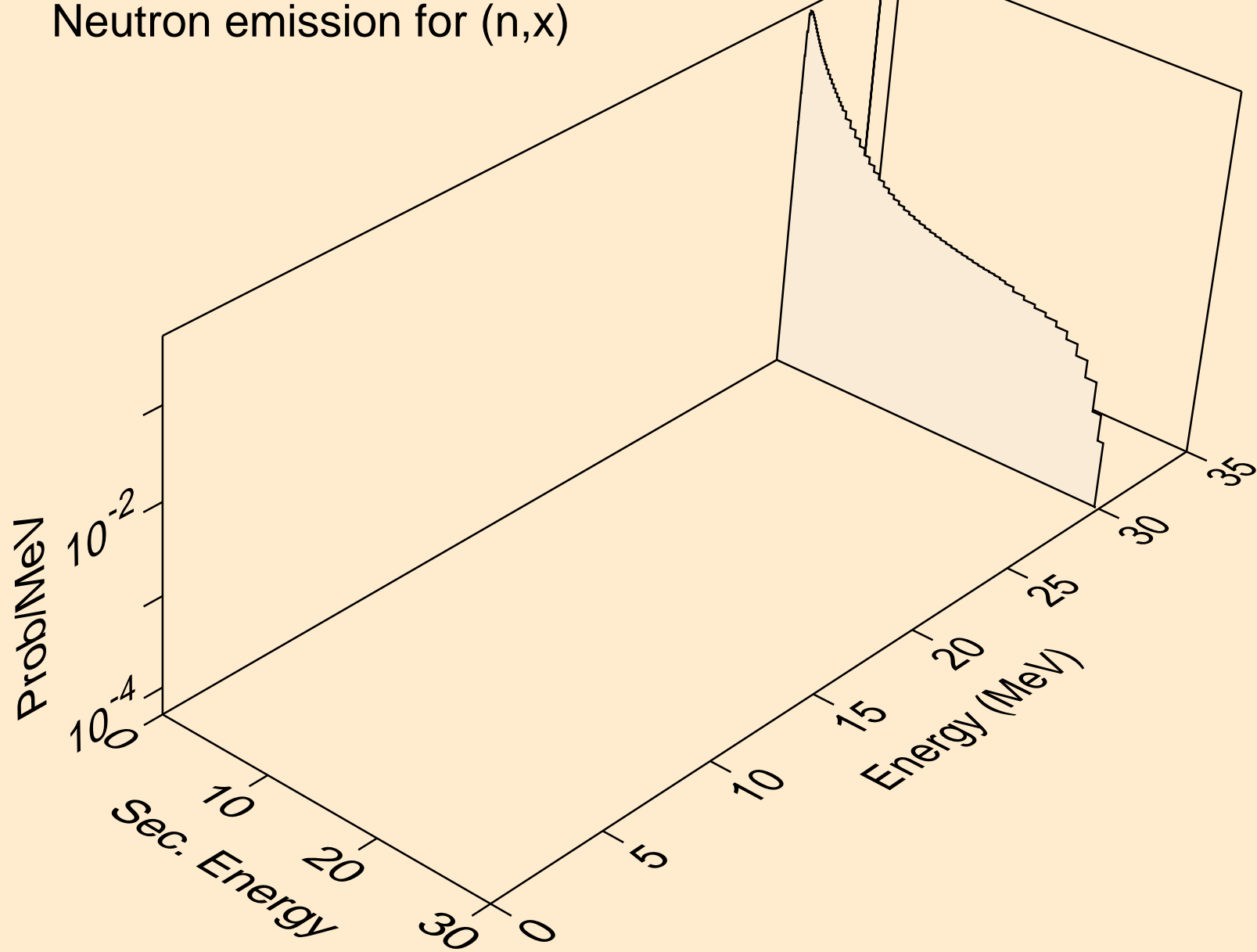

PA226 NEUTRON ACER TENDL-2021 LIBRARY; T=293.6K
Neutron emission for (n,2nd)

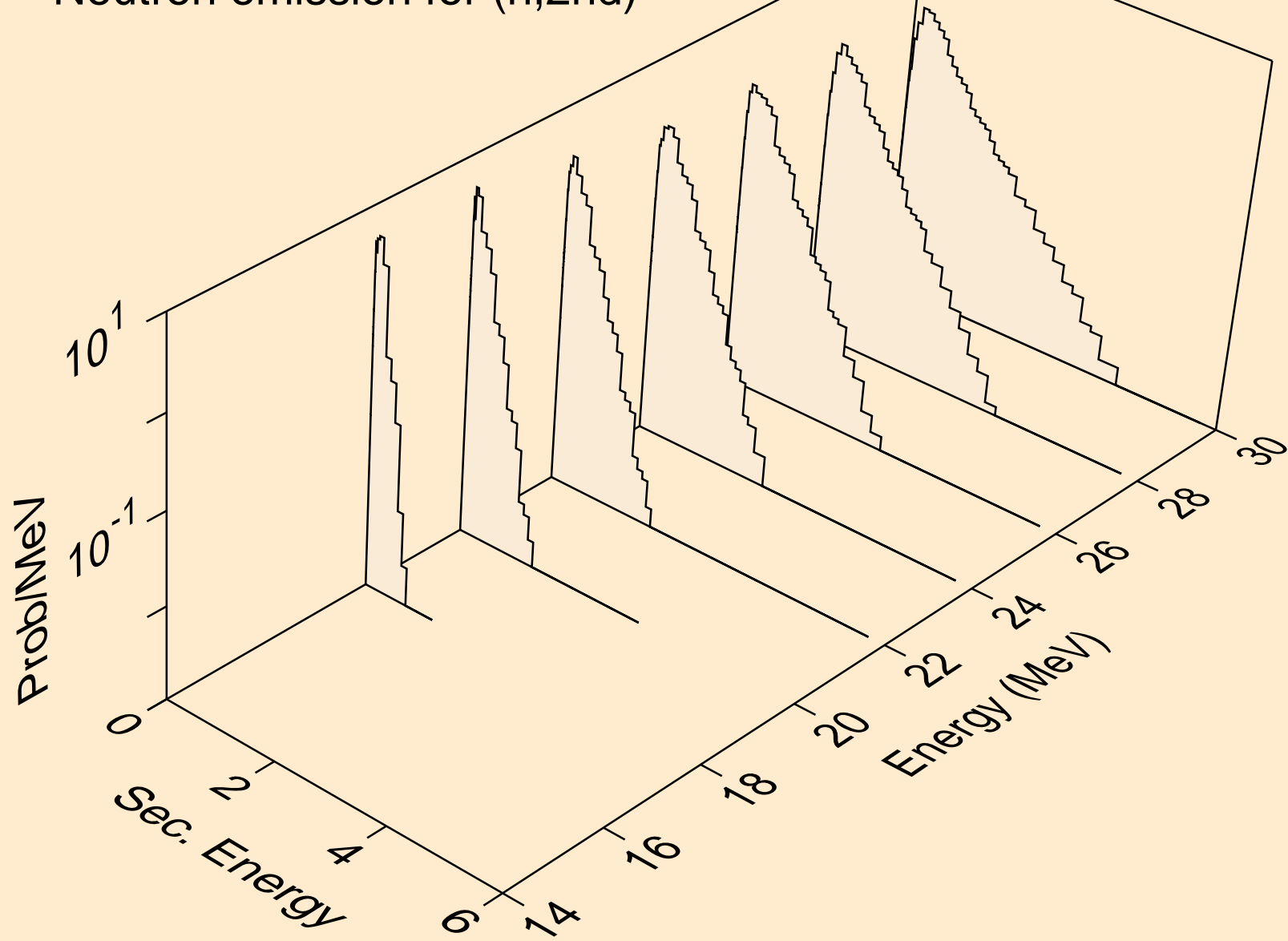

PA226 NEUTRON ACER TENDL-2021 LIBRARY; T=293.6K
Neutron emission for (n,2n)

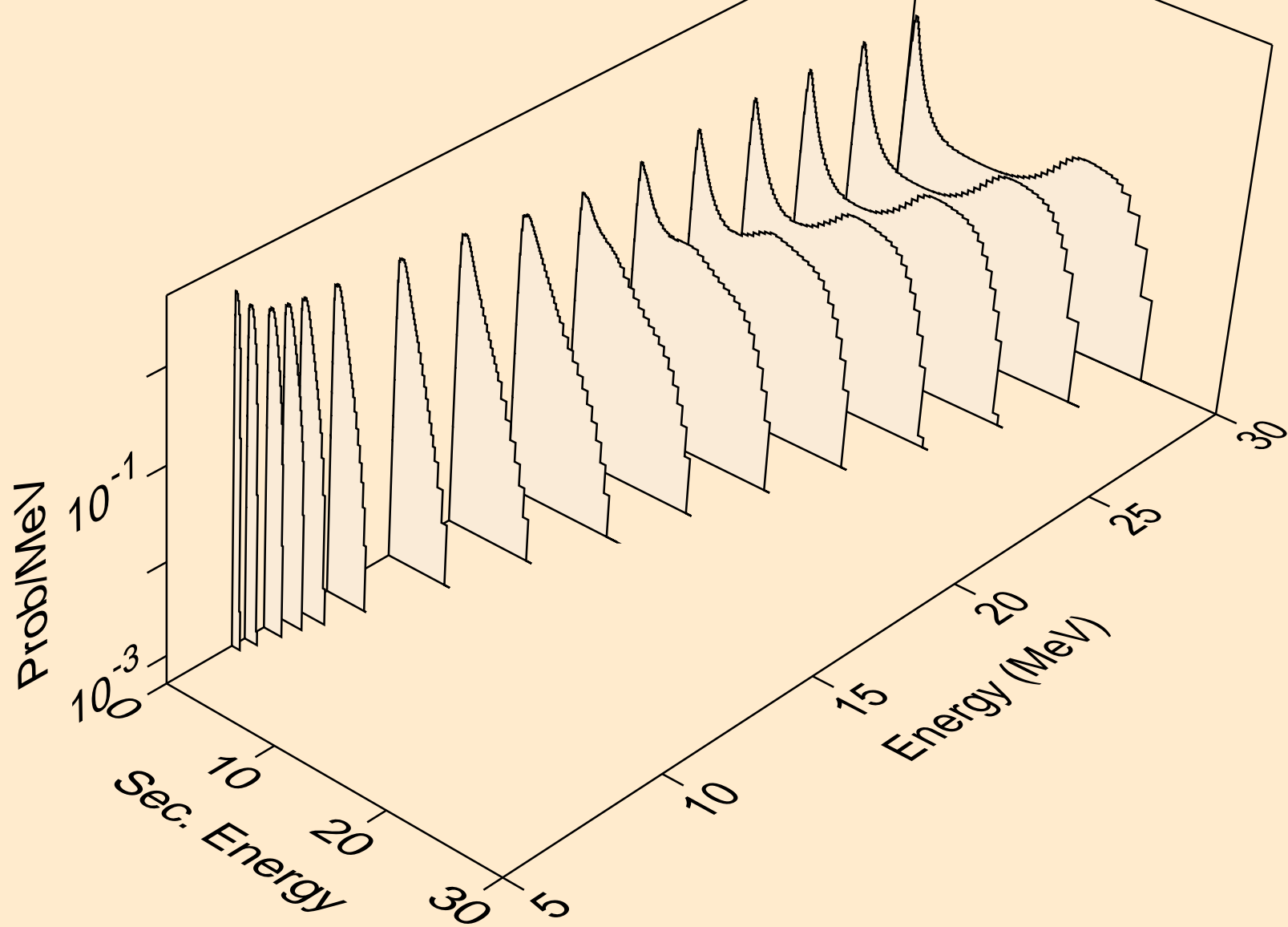

PA226 NEUTRON ACER TENDL-2021 LIBRARY; T=293.6K
Neutron emission for (n,3n)

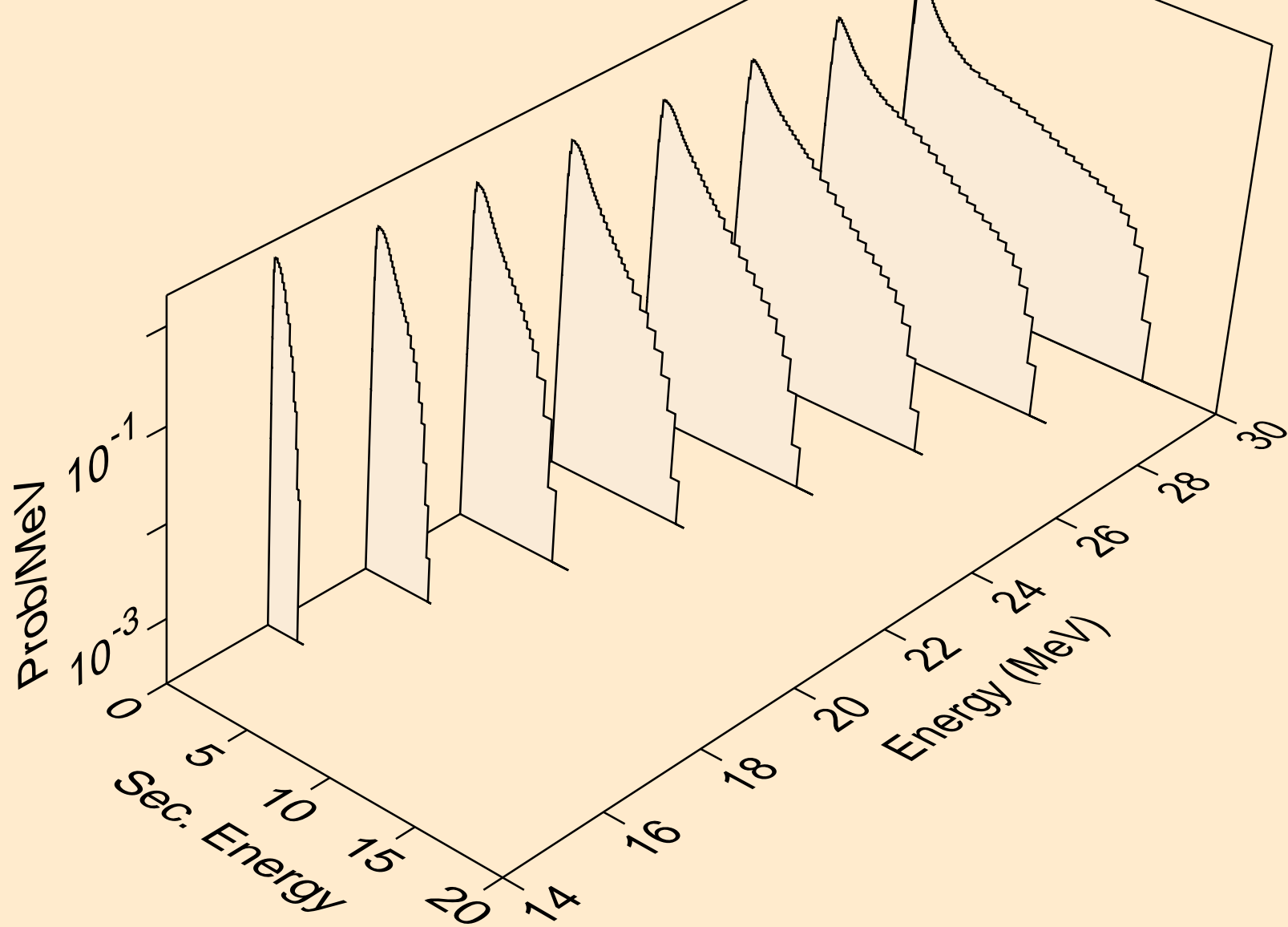

PA226 NEUTRON ACER TENDL-2021 LIBRARY; T=293.6K
Neutron emission for fission

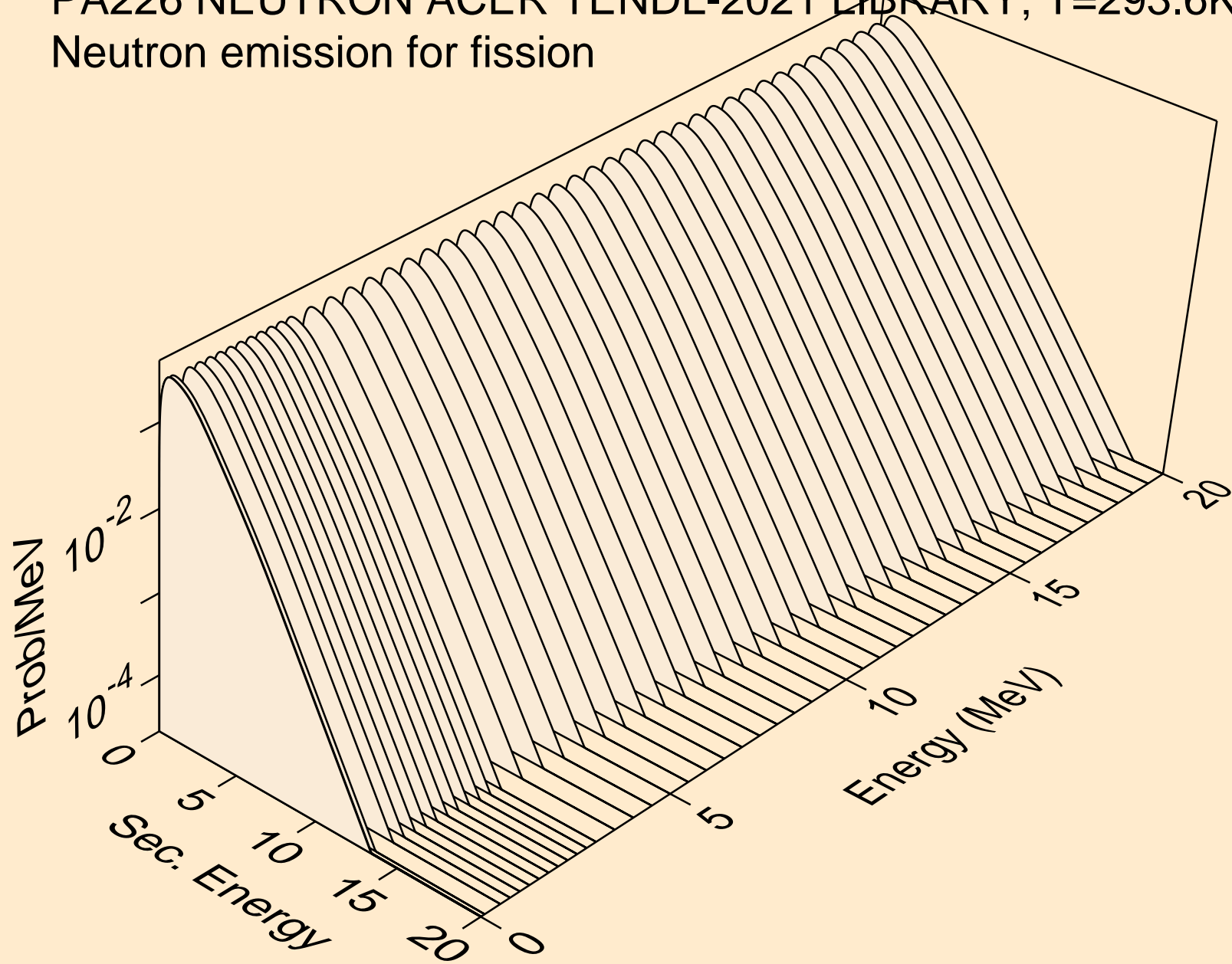

PA226 NEUTRON ACER TENDL-2021 LIBRARY; T=293.6K
Neutron emission for (n,n*)a

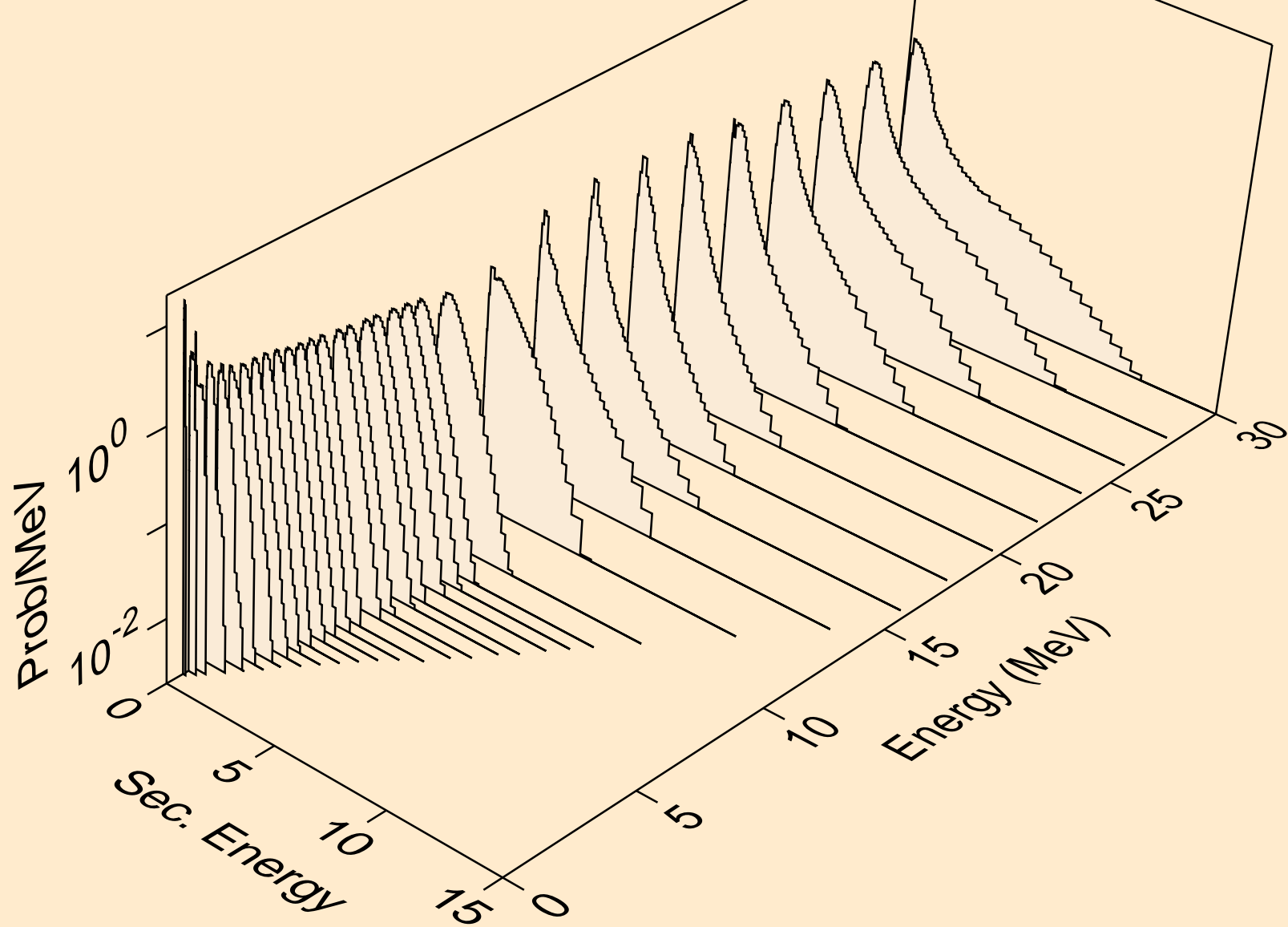

PA226 NEUTRON ACER TENDL-2021 LIBRARY; T=293.6K
Neutron emission for (n,2n)_a

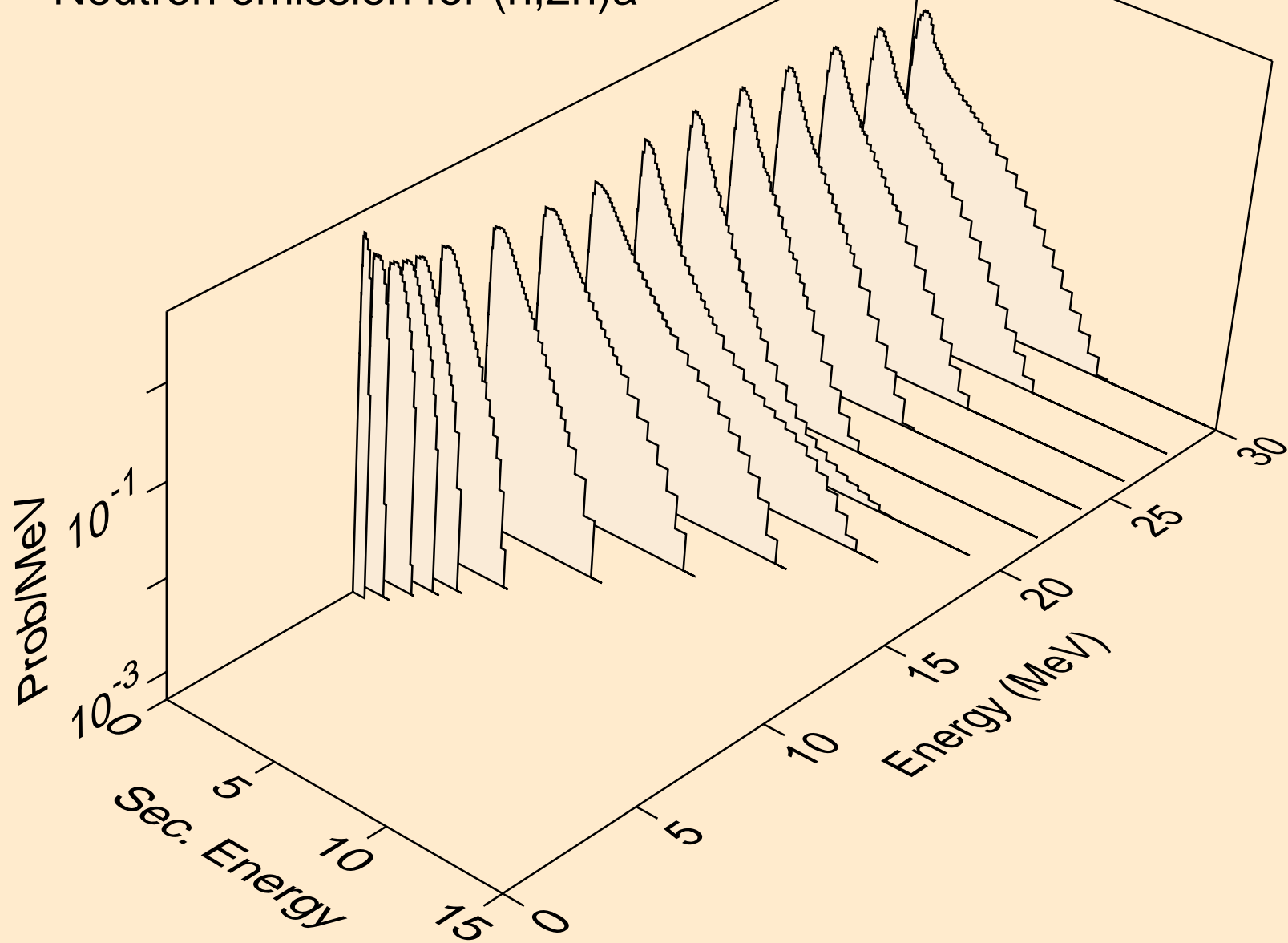

PA226 NEUTRON ACER TENDL-2021 LIBRARY; T=293.6K
Neutron emission for (n,3n)a

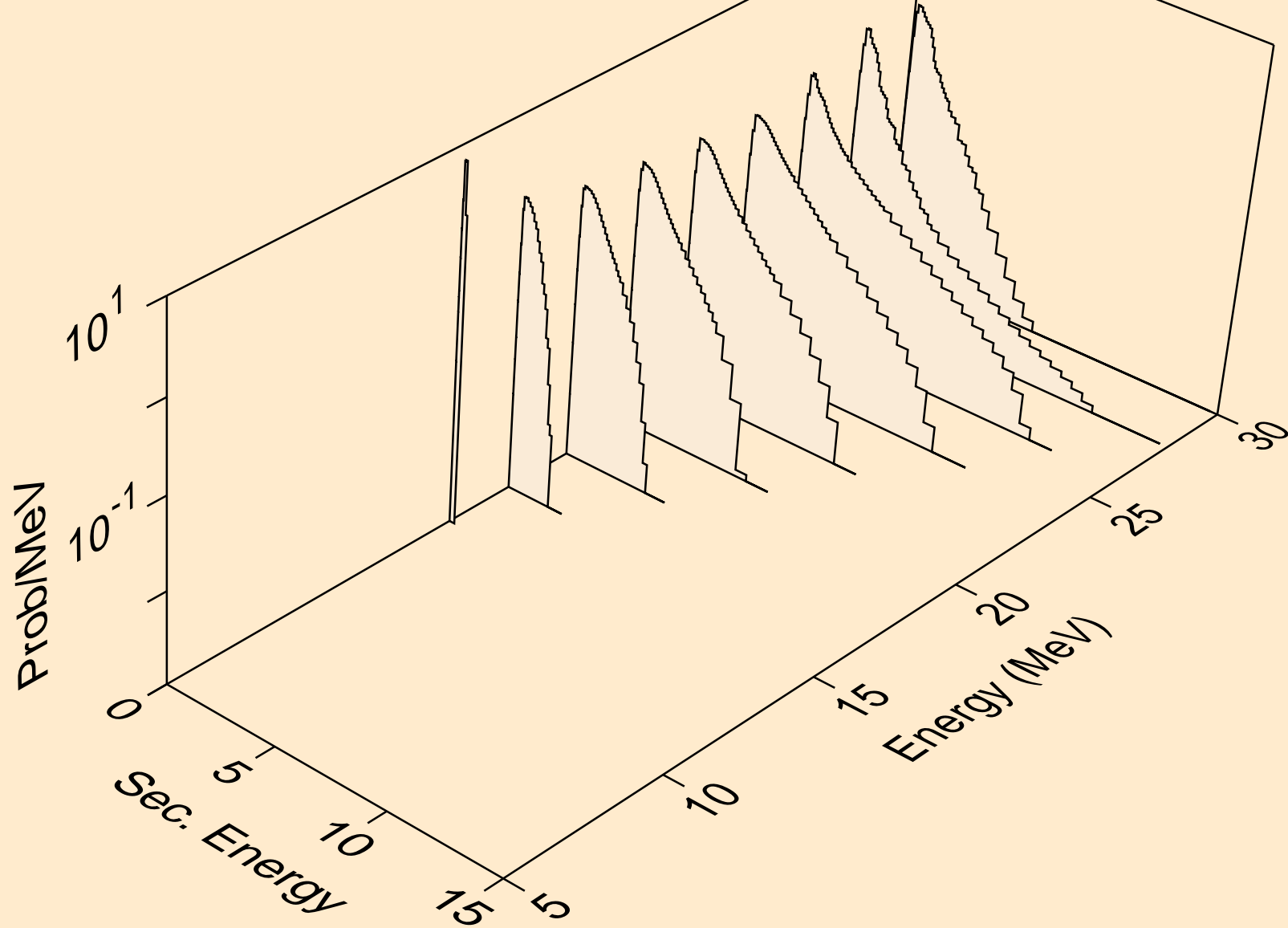

PA226 NEUTRON ACER TENDL-2021 LIBRARY; T=293.6K
Neutron emission for (n,n*)p

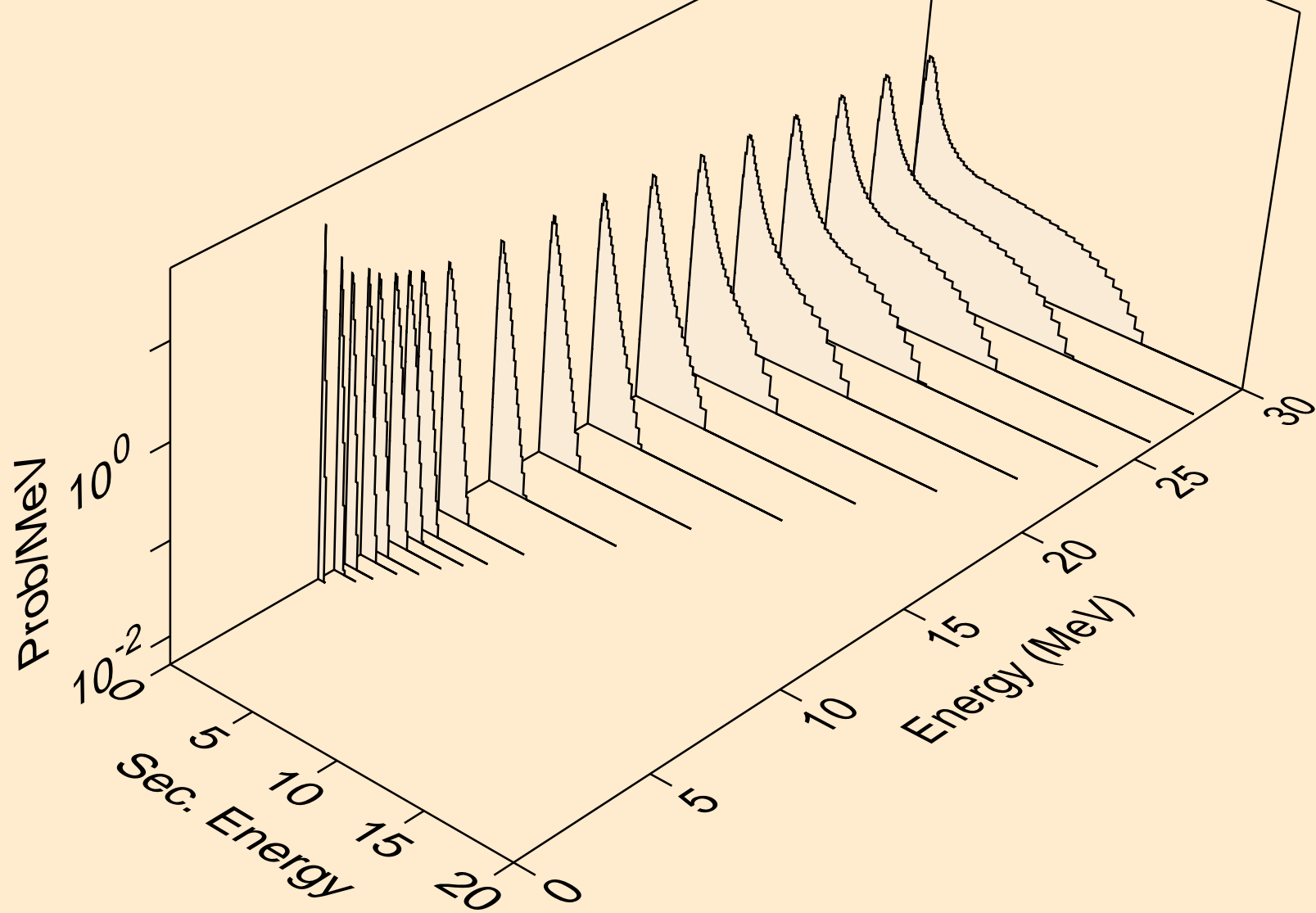

PA226 NEUTRON ACER TENDL-2021 LIBRARY; T=293.6K
Neutron emission for (n,n*)2a

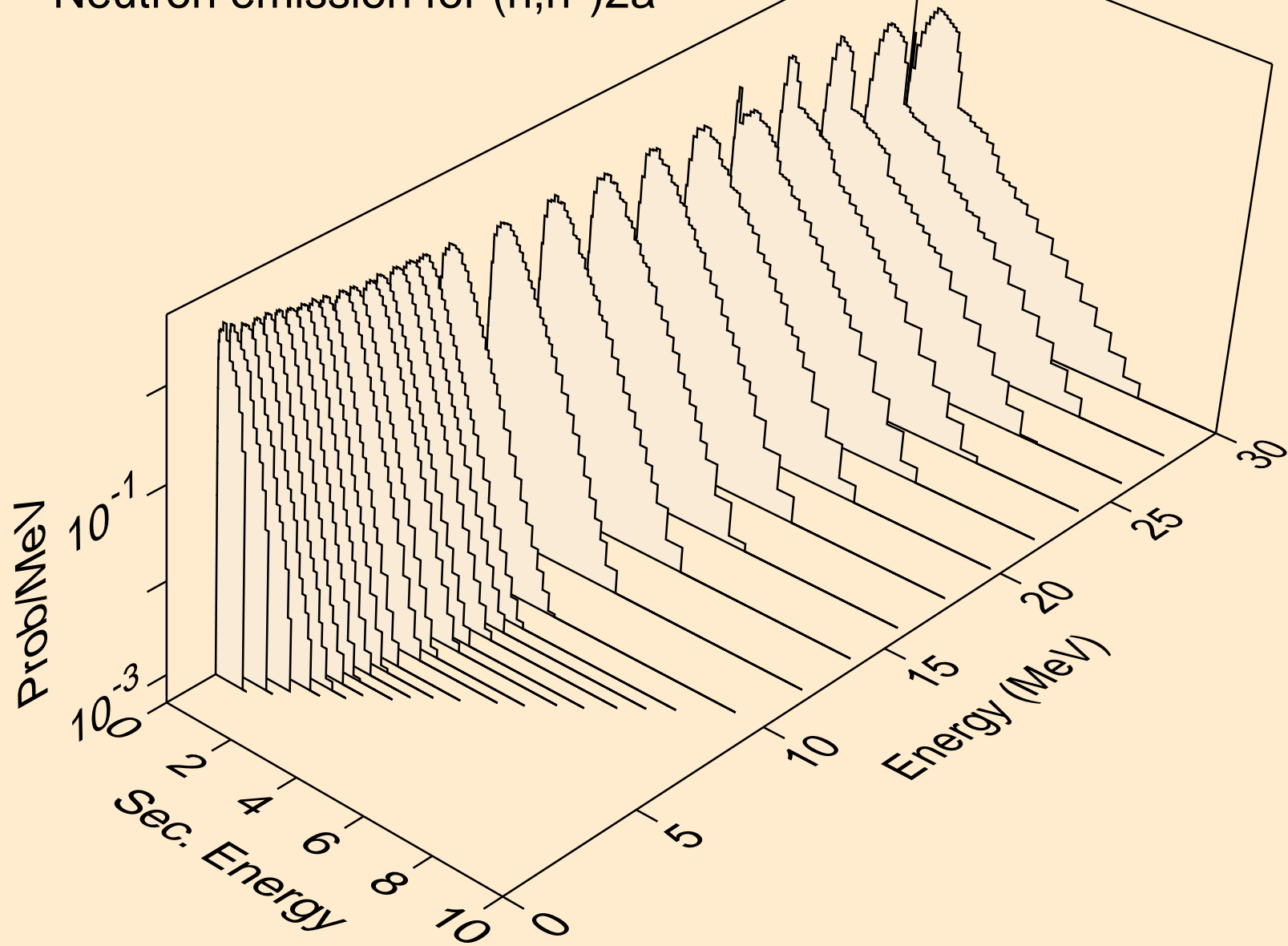

PA226 NEUTRON ACER TENDL-2021 LIBRARY; T=293.6K
Neutron emission for (n,2n)2a

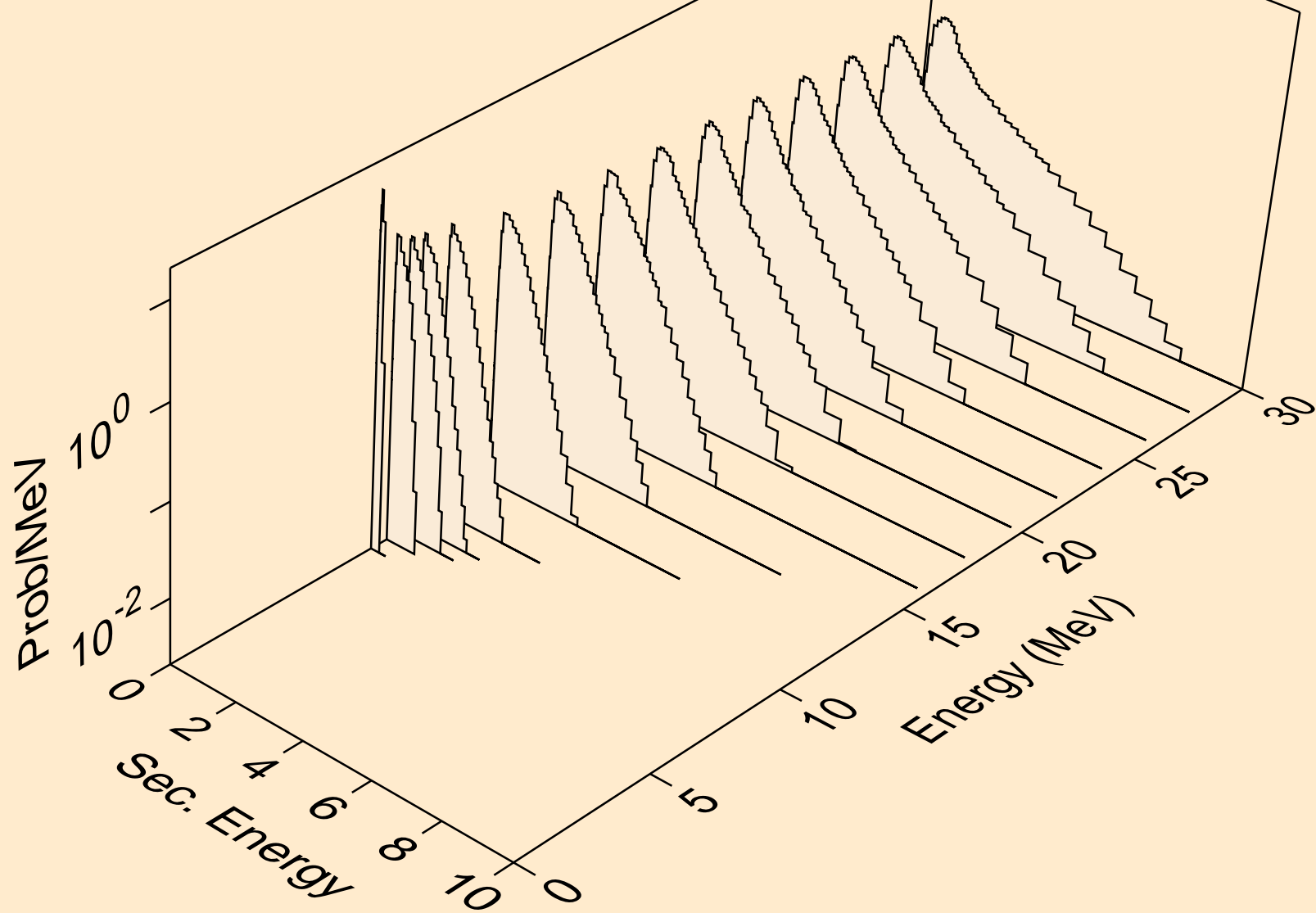

PA226 NEUTRON ACER TENDL-2021 LIBRARY; T=293.6K
Neutron emission for (n,n*)d

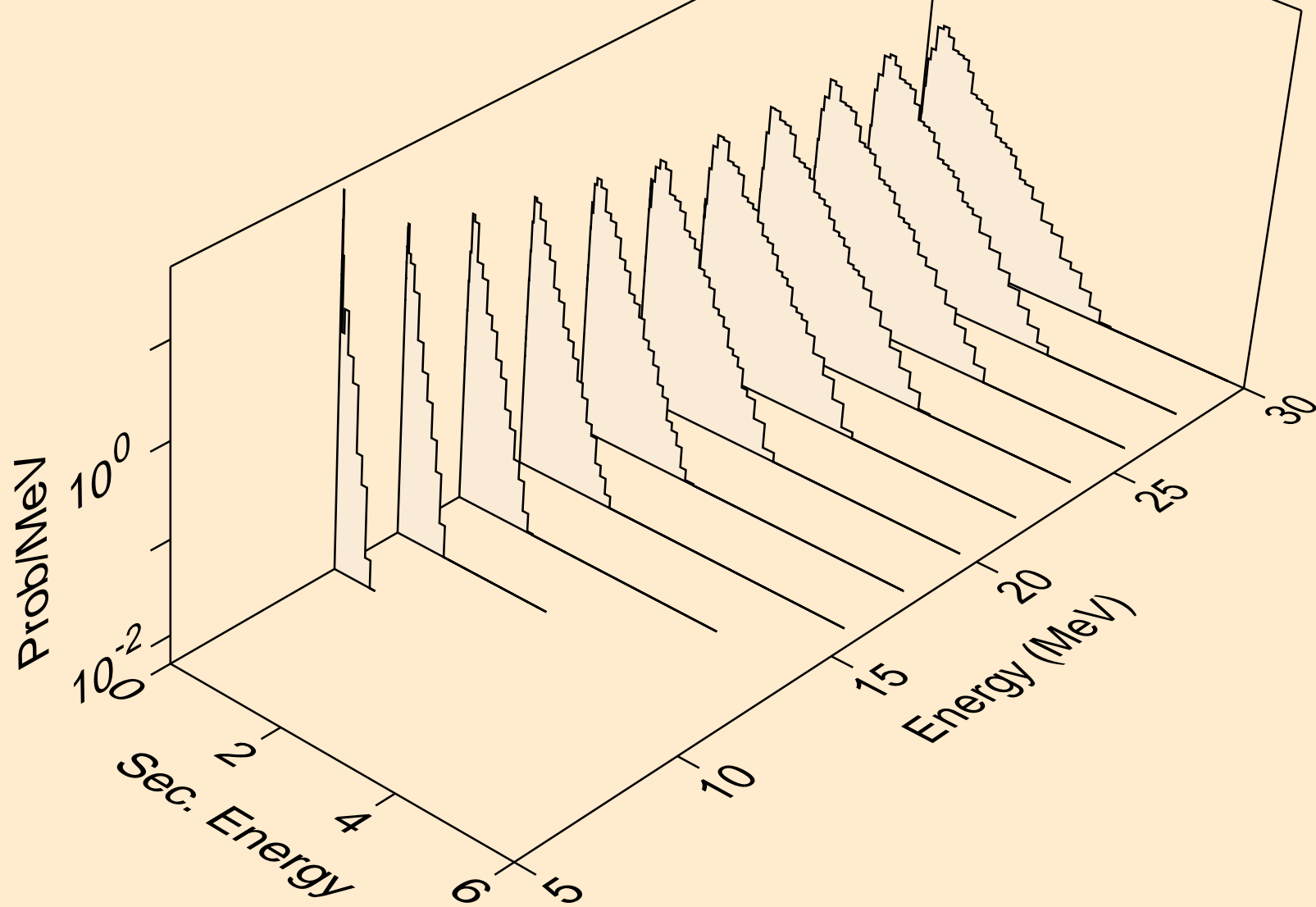

PA226 NEUTRON ACER TENDL-2021 LIBRARY; T=293.6K
Neutron emission for (n,n*)t

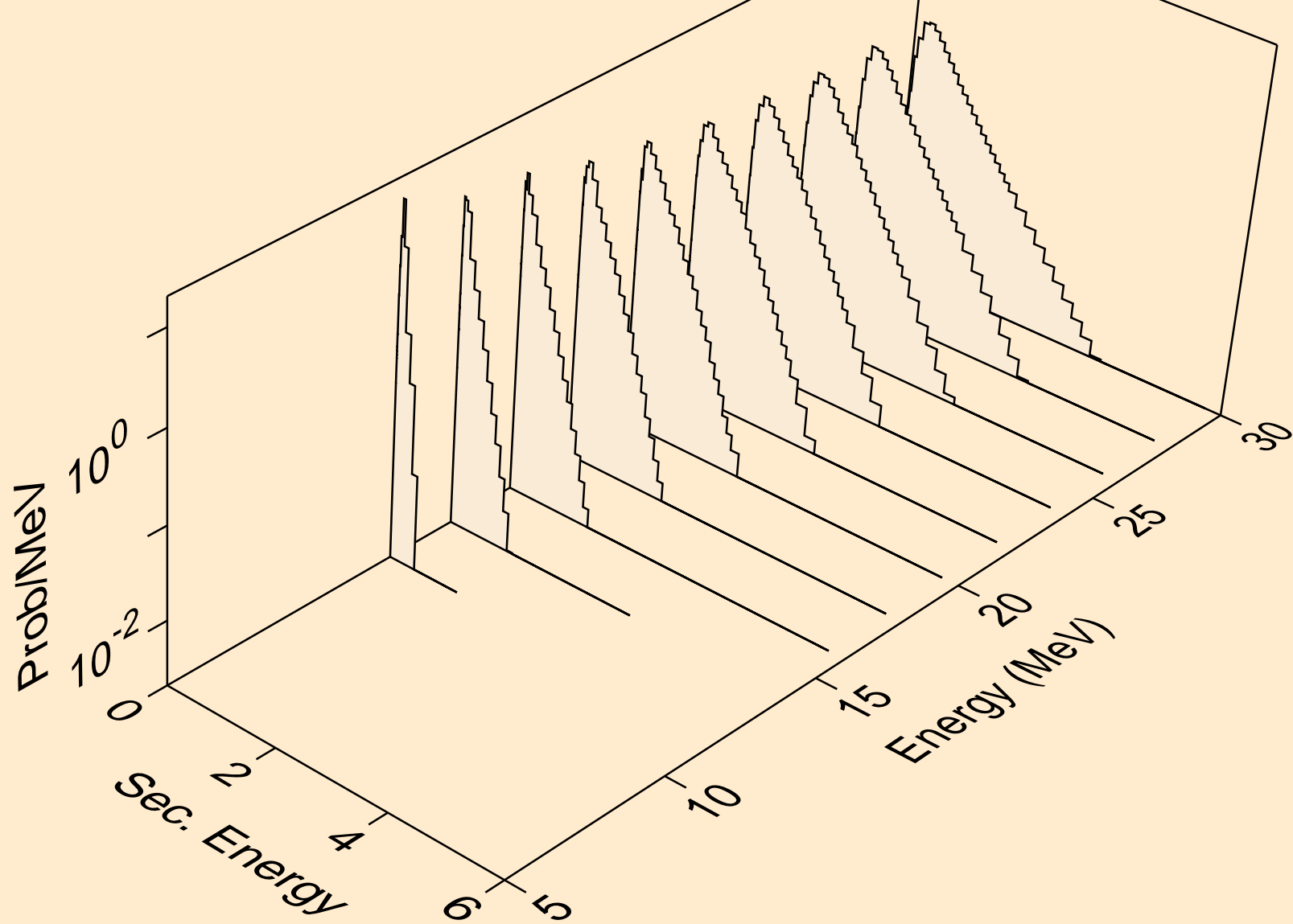

PA226 NEUTRON ACER TENDL-2021 LIBRARY; T=293.6K
Neutron emission for (n,n*)he3

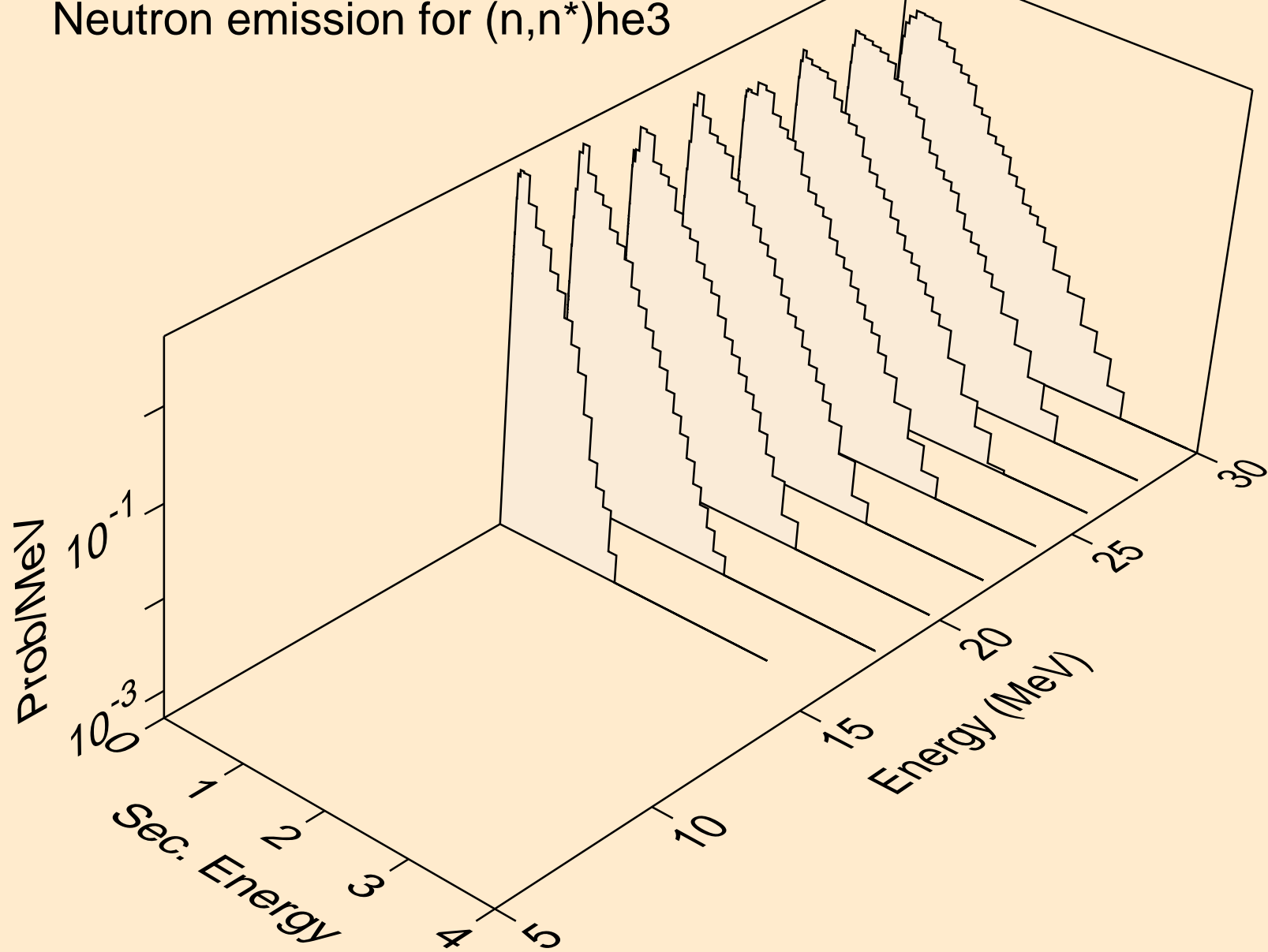

PA226 NEUTRON ACER TENDL-2021 LIBRARY; T=293.6K
Neutron emission for (n,4n)

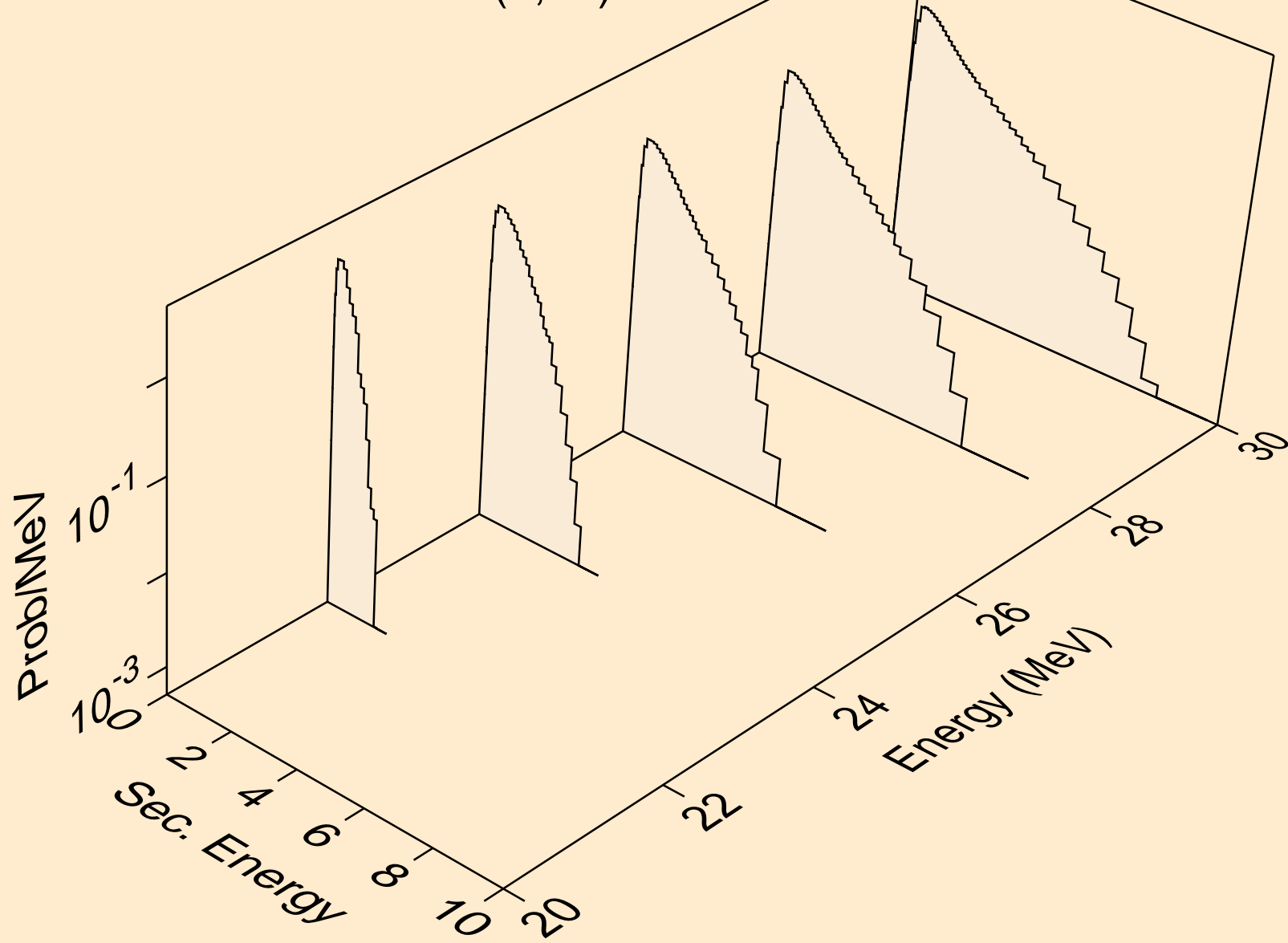

PA226 NEUTRON ACER TENDL-2021 LIBRARY; T=293.6K
Neutron emission for (n,2np)

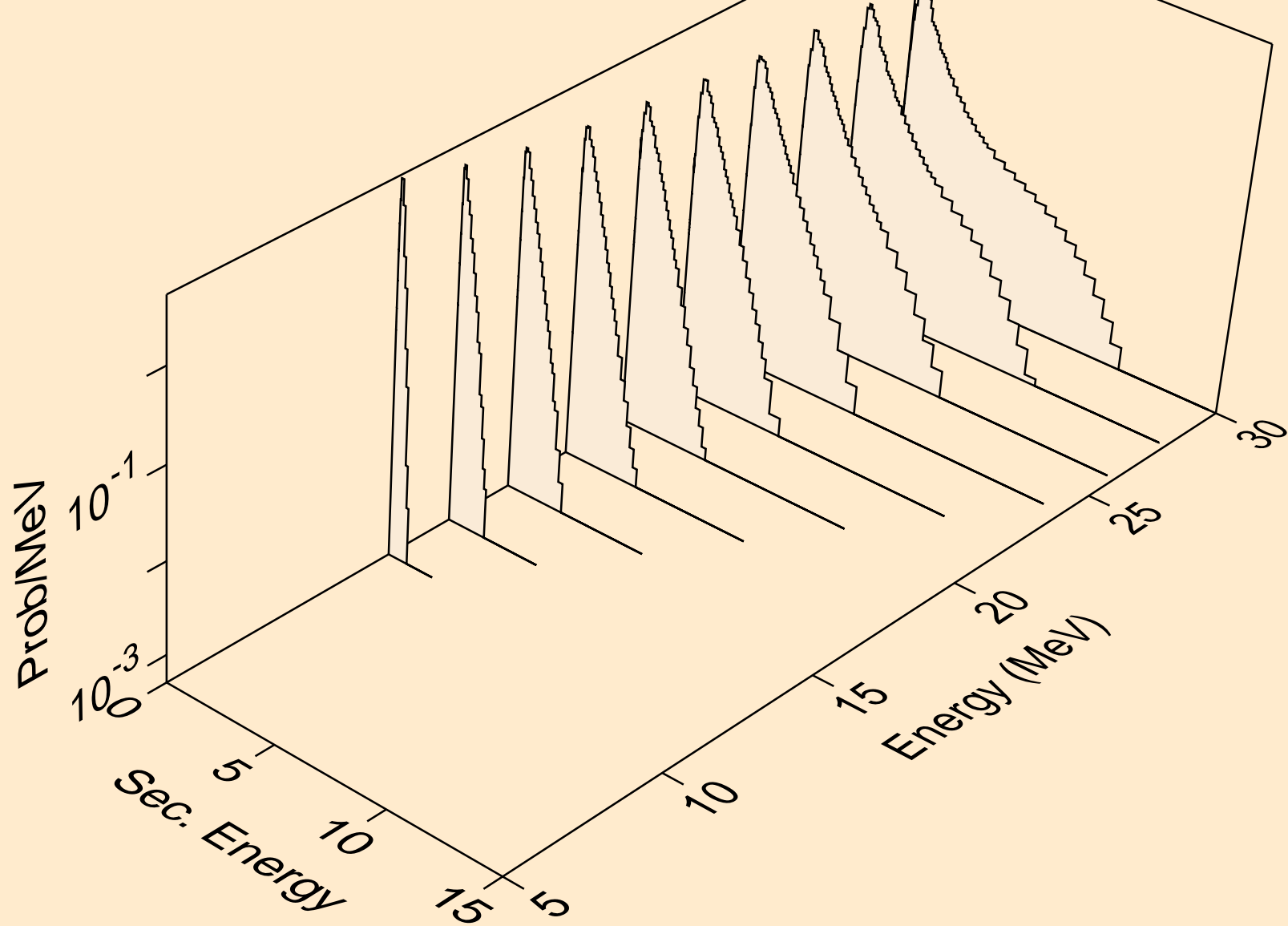

PA226 NEUTRON ACER TENDL-2021 LIBRARY; T=293.6K
Neutron emission for (n,3np)

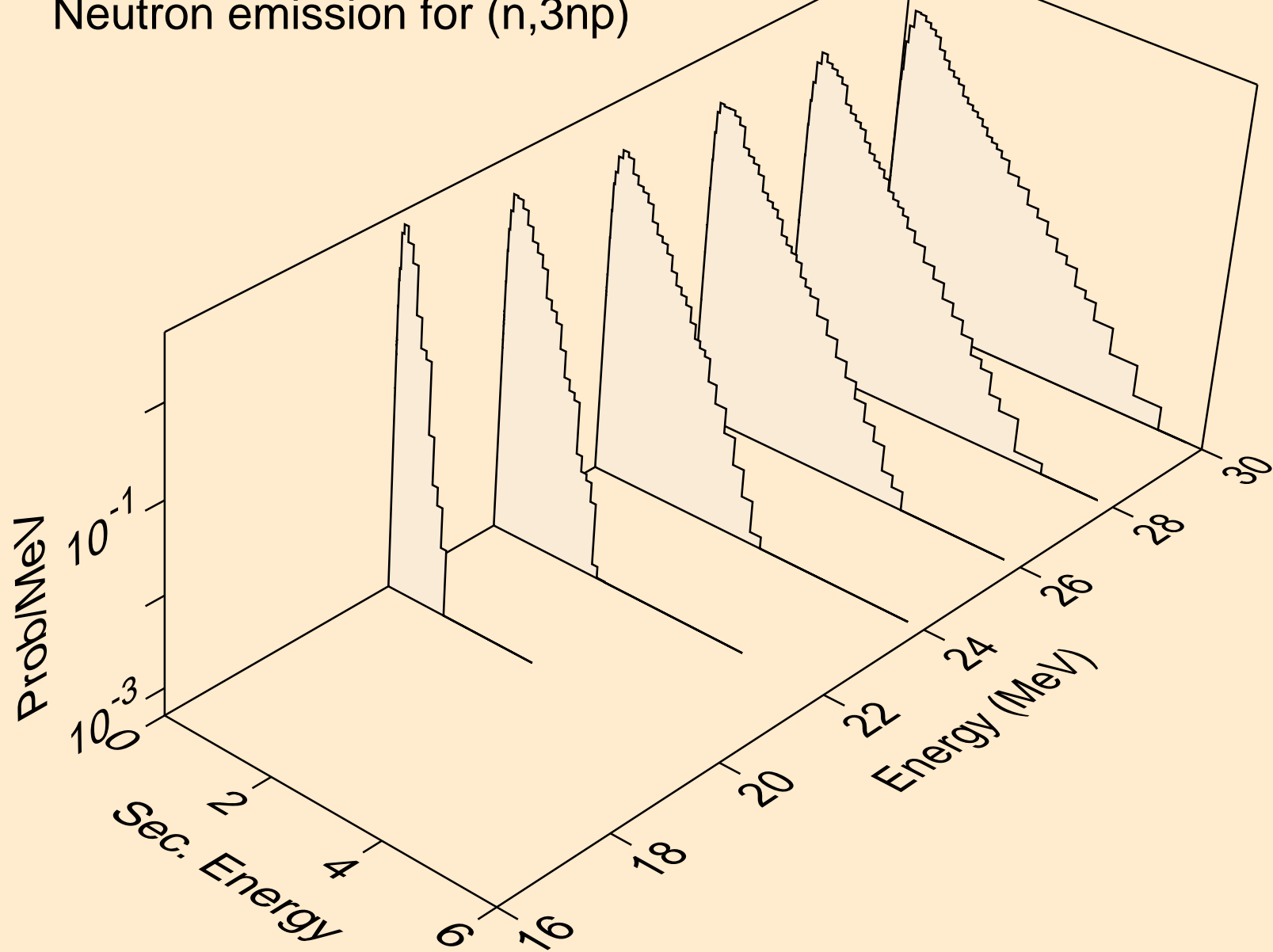

PA226 NEUTRON ACER TENDL-2021 LIBRARY; T=293.6K
Neutron emission for (n,2np)

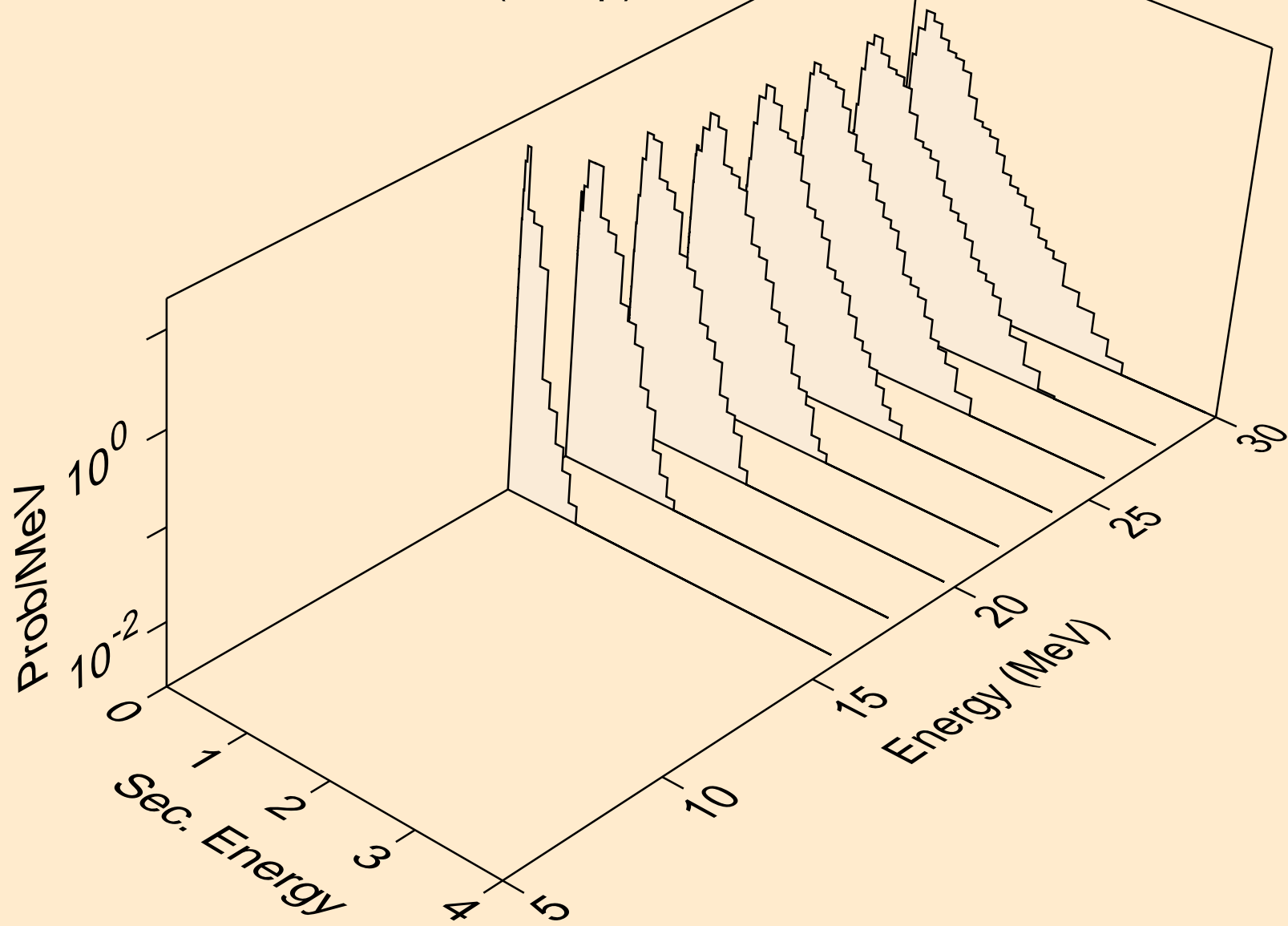

PA226 NEUTRON ACER TENDL-2021 LIBRARY; T=293.6K
Neutron emission for (n,npa)

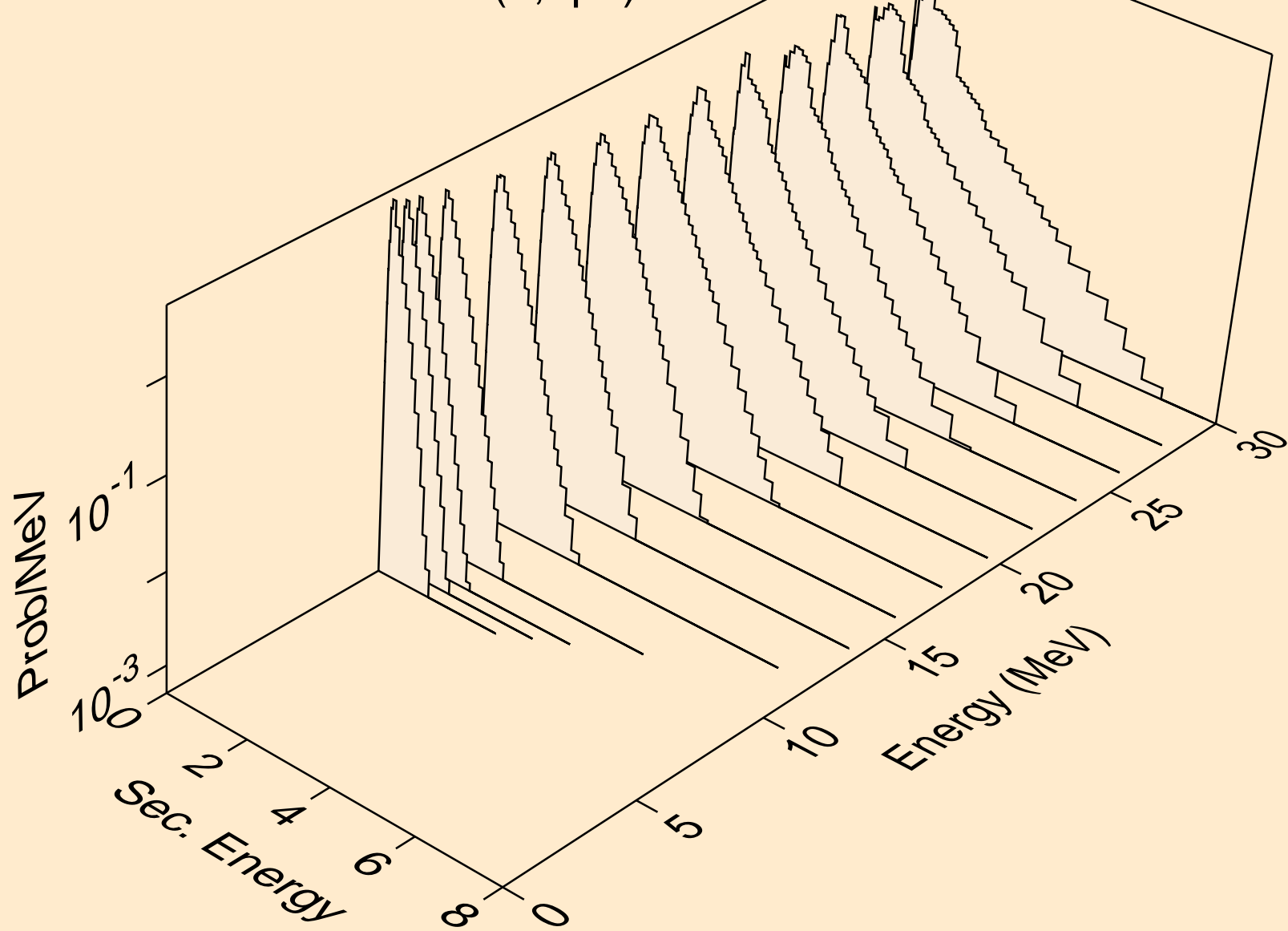

PA226 NEUTRON ACER TENDL-2021 LIBRARY; T=293.6K
Neutron emission for (n,n*c)

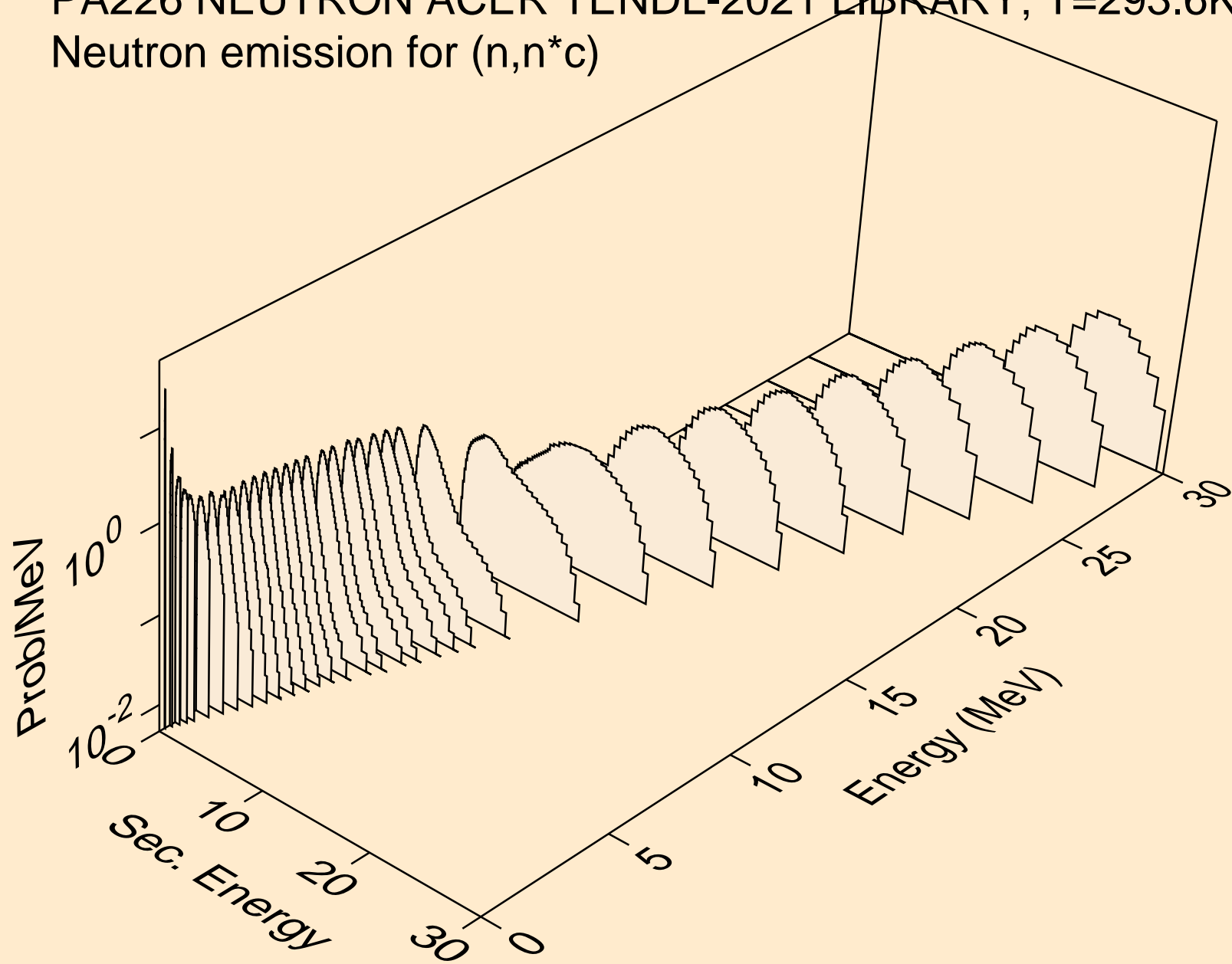

PA226 NEUTRON ACER TENDL-2021 LIBRARY; T=293.6K

Delayed nubar

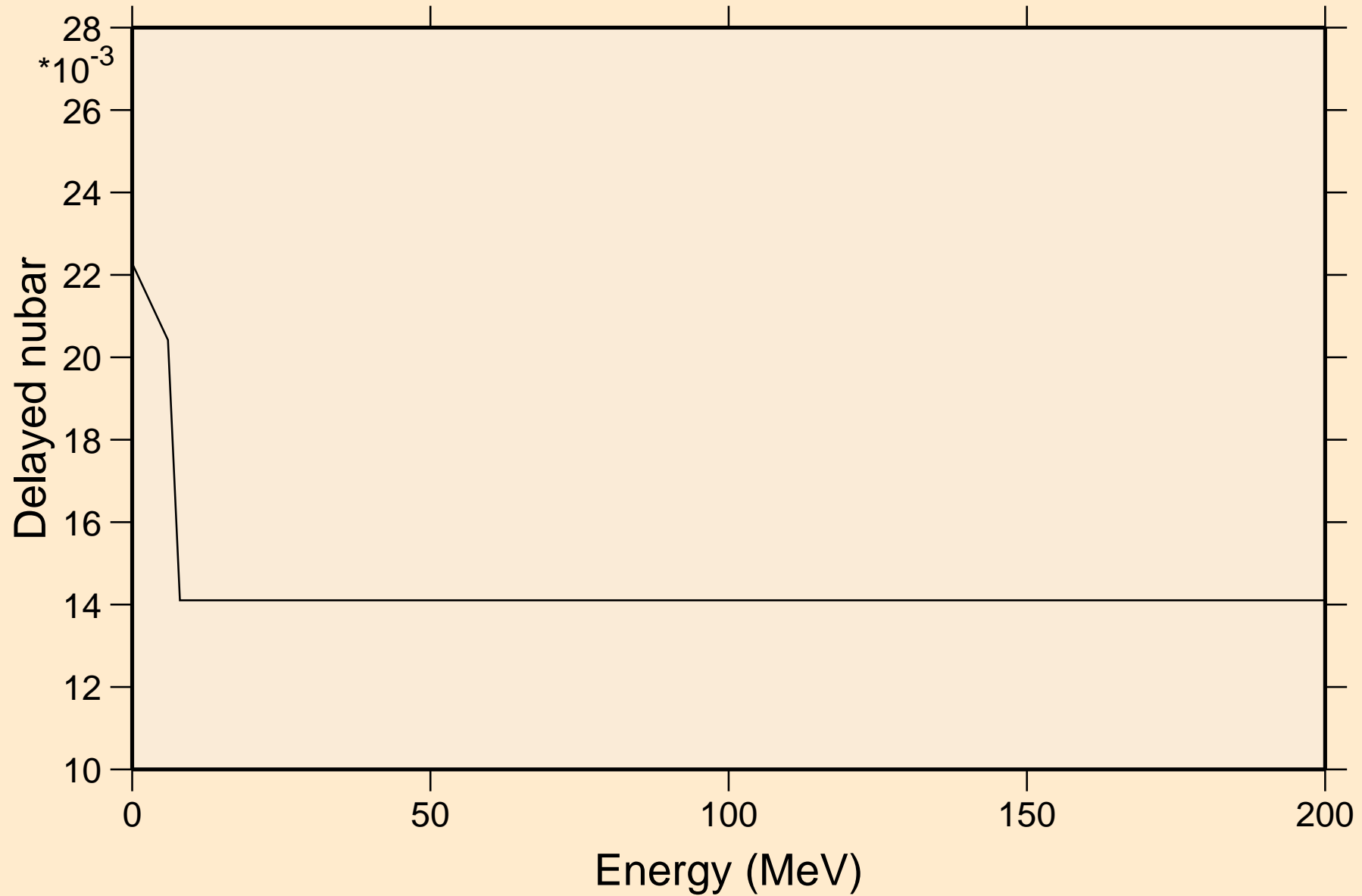

PA226 NEUTRON ACER TENDL-2021 LIBRARY; T=293.6K

Delayed neutron spectra

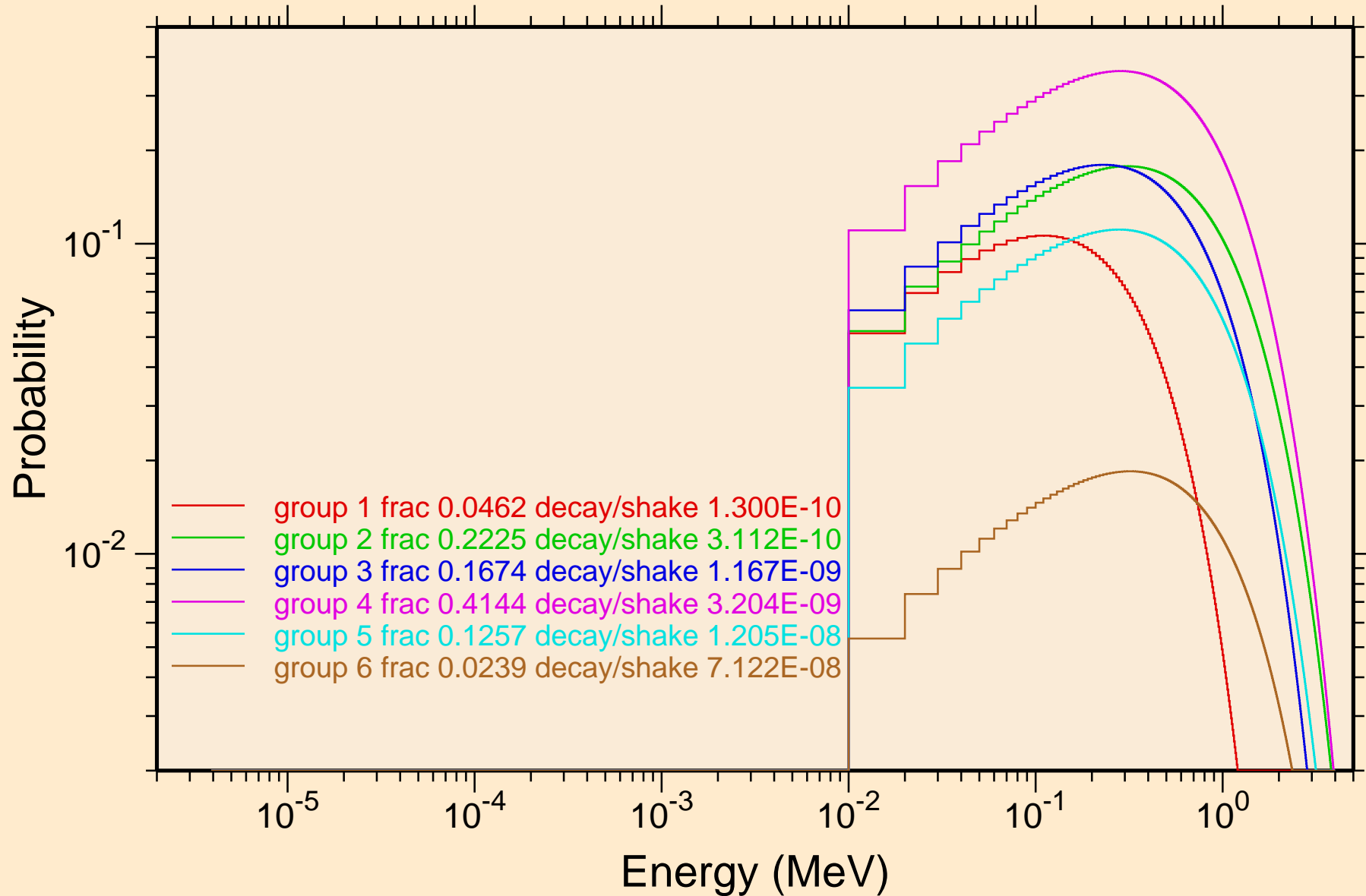

PA226 NEUTRON ACER TENDL-2021 LIBRARY; T=293.6K
Photon emission for (n,x)

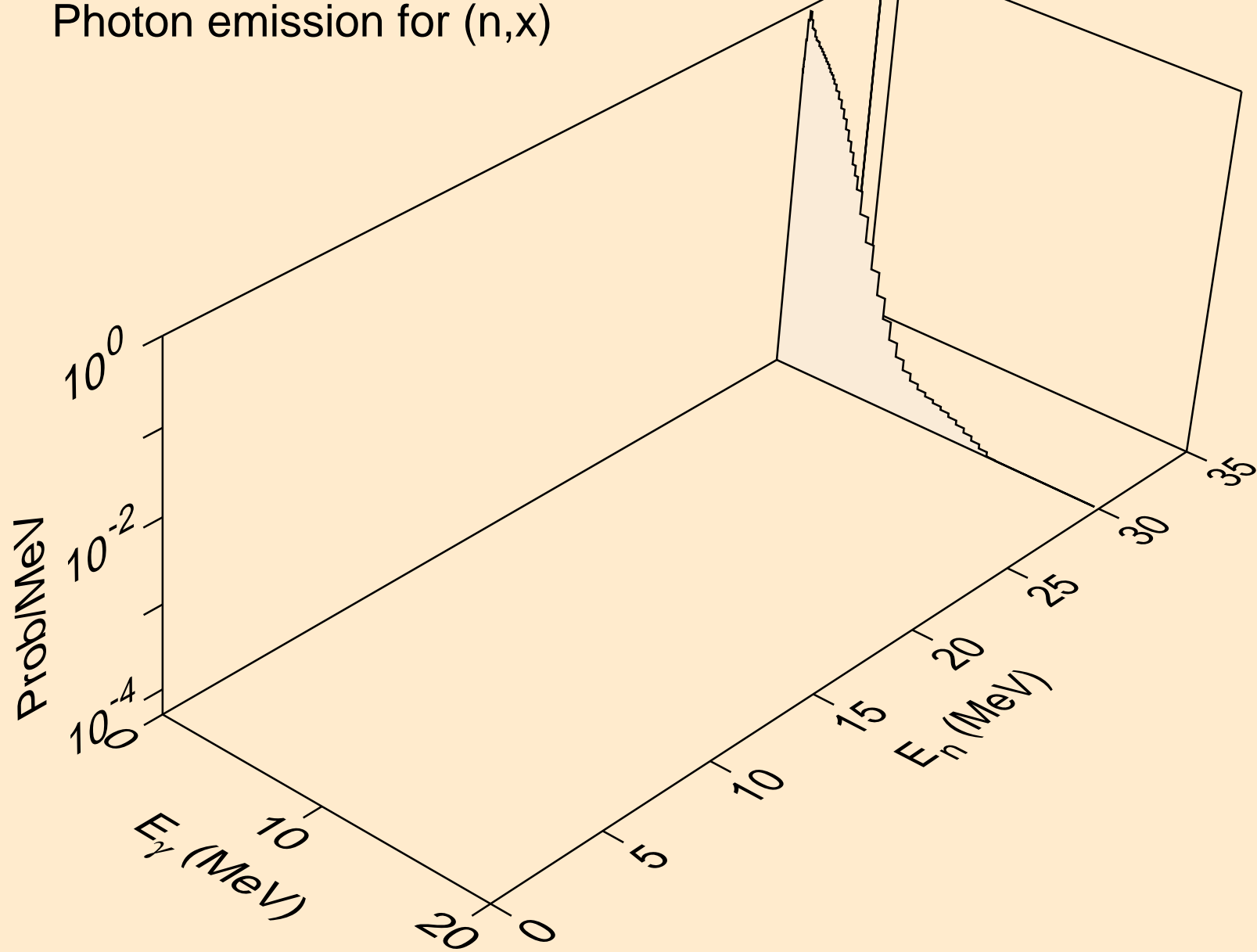

PA226 NEUTRON ACER TENDL-2021 LIBRARY; T=293.6K
Photon emission for (n,2nd)

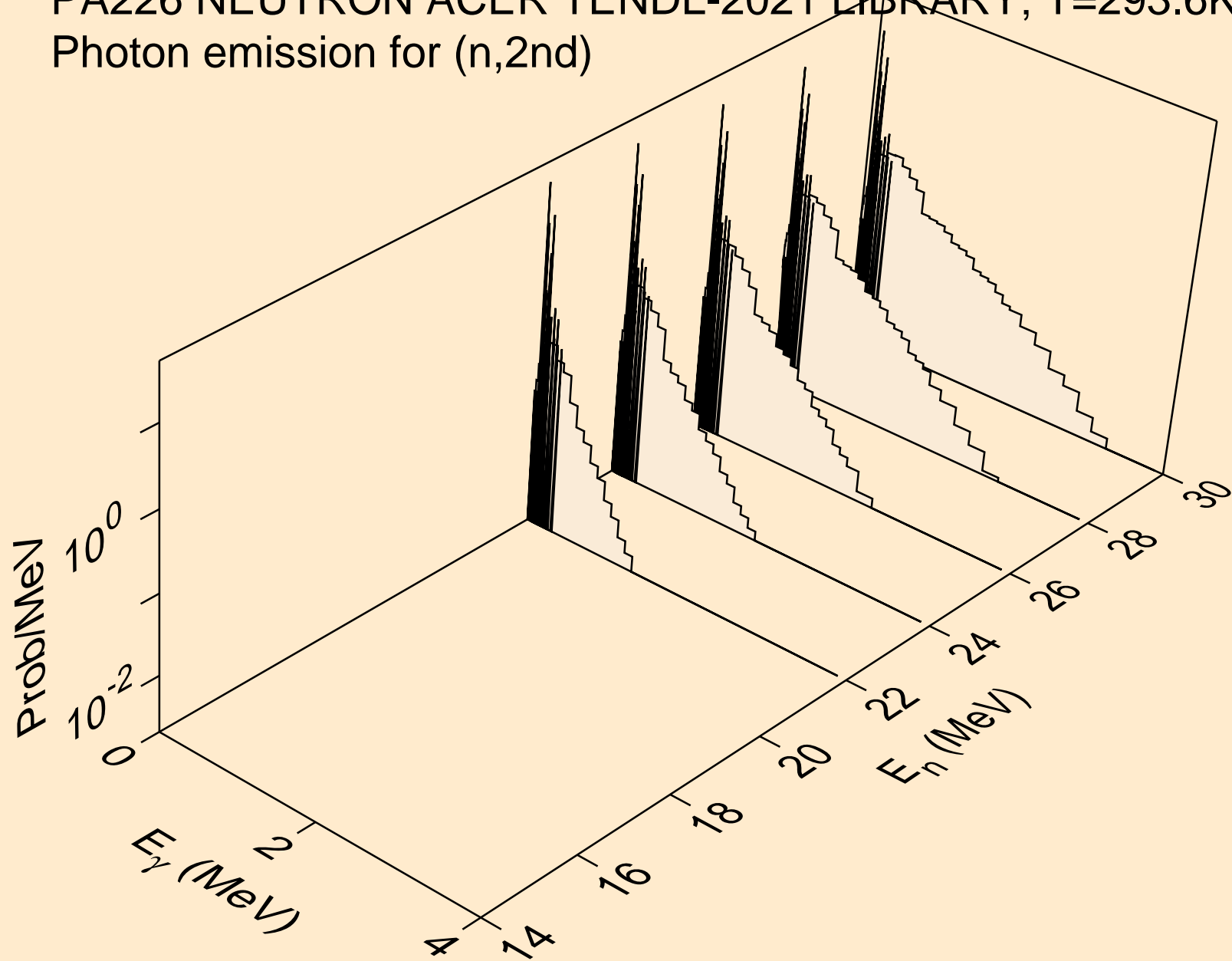

PA226 NEUTRON ACER TENDL-2021 LIBRARY; T=293.6K
Photon emission for (n,2n)

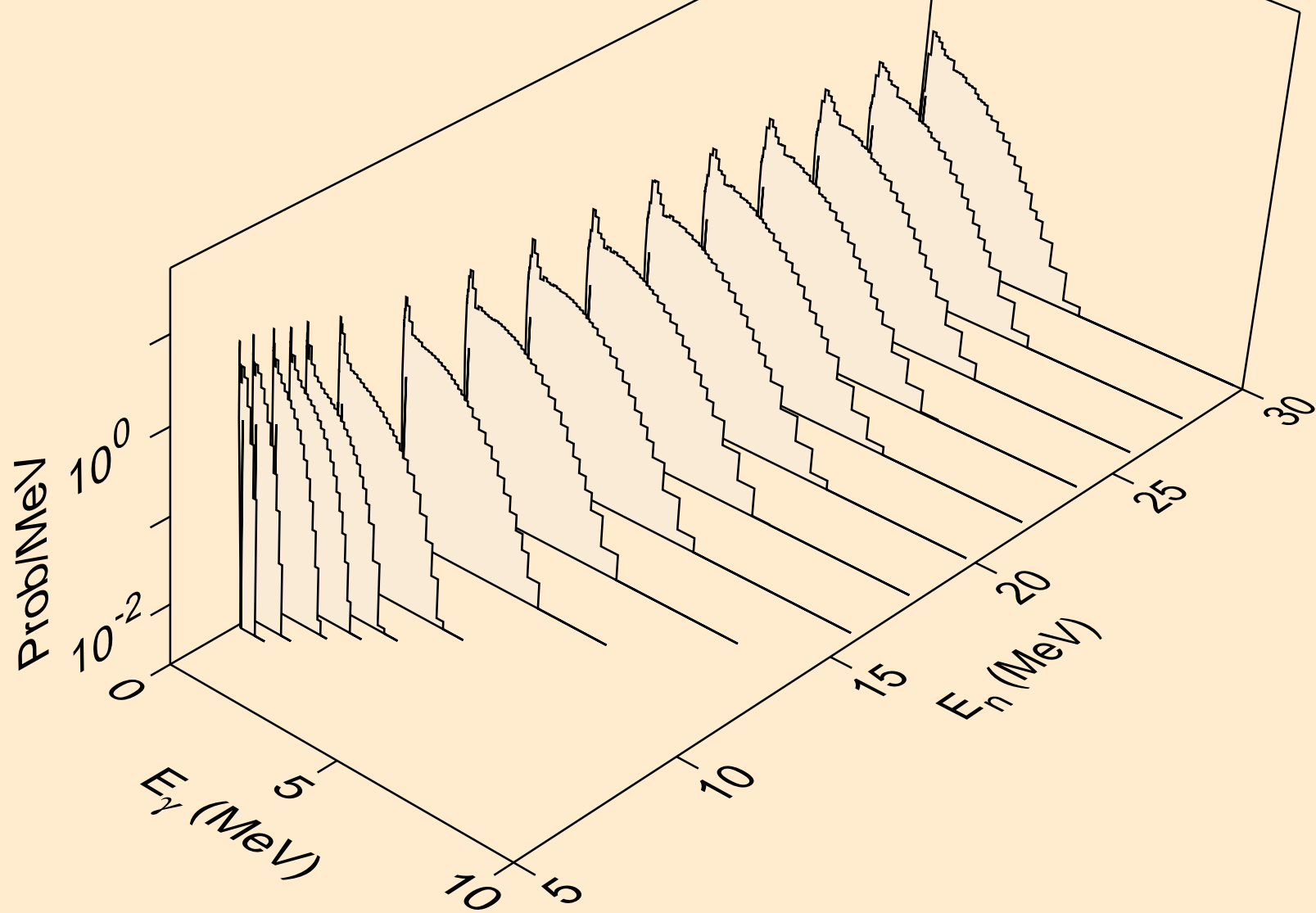

PA226 NEUTRON ACER TENDL-2021 LIBRARY; T=293.6K
Photon emission for (n,3n)

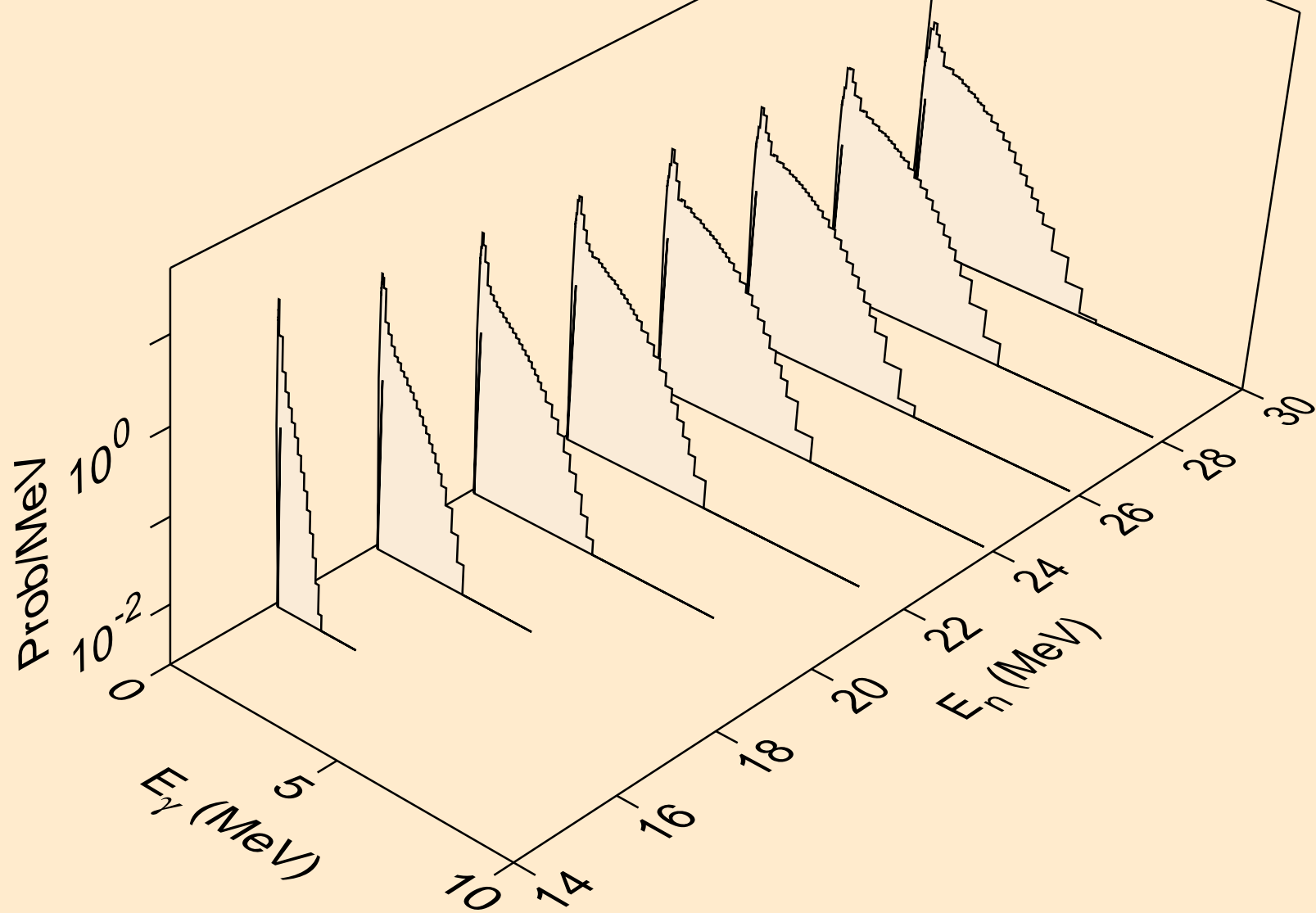

PA226 NEUTRON ACER TENDL-2021 LIBRARY; T=293.6K
Photon emission for (n,n*)a

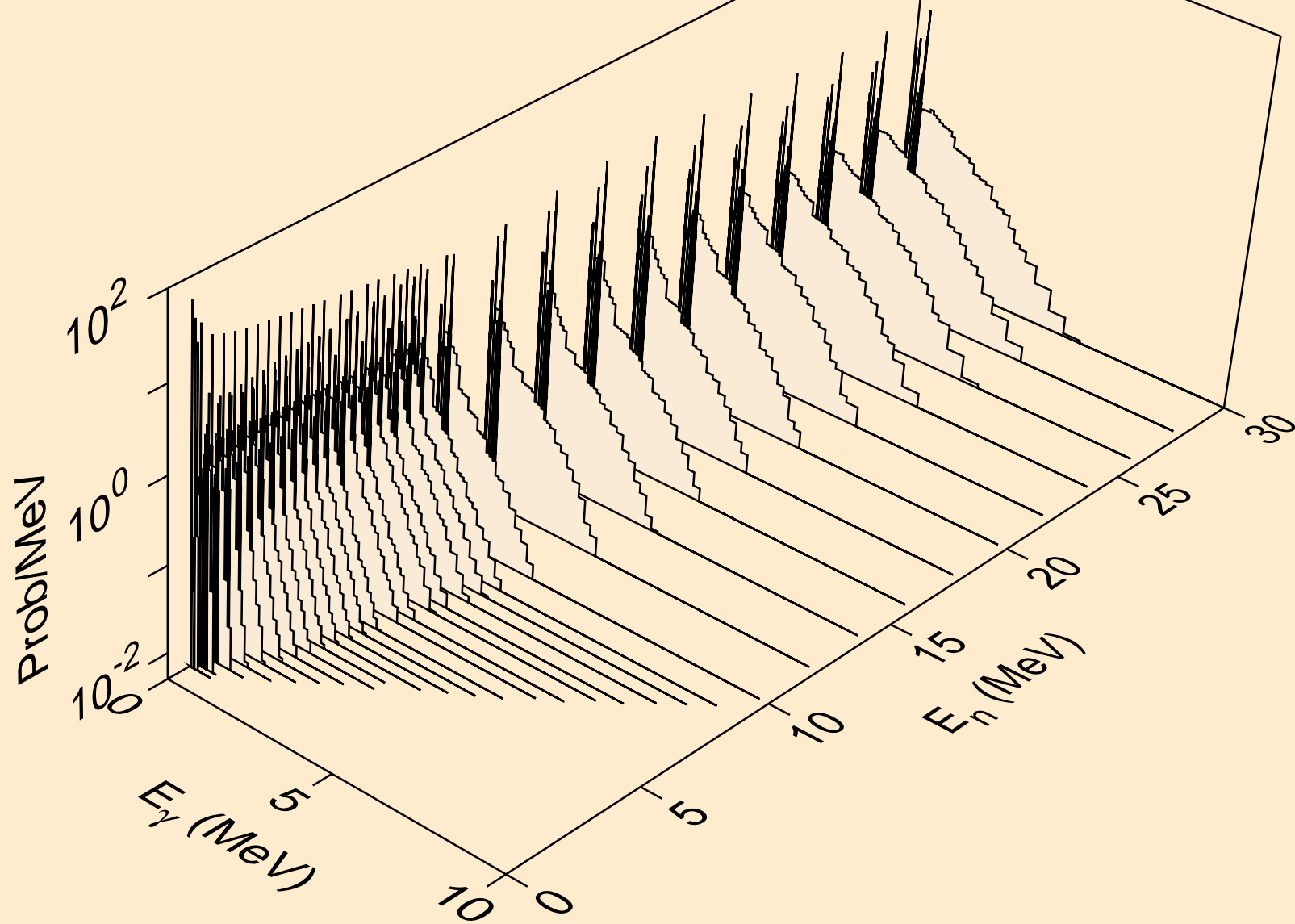

PA226 NEUTRON ACER TENDL-2021 LIBRARY; T=293.6K
Photon emission for (n,2n)a

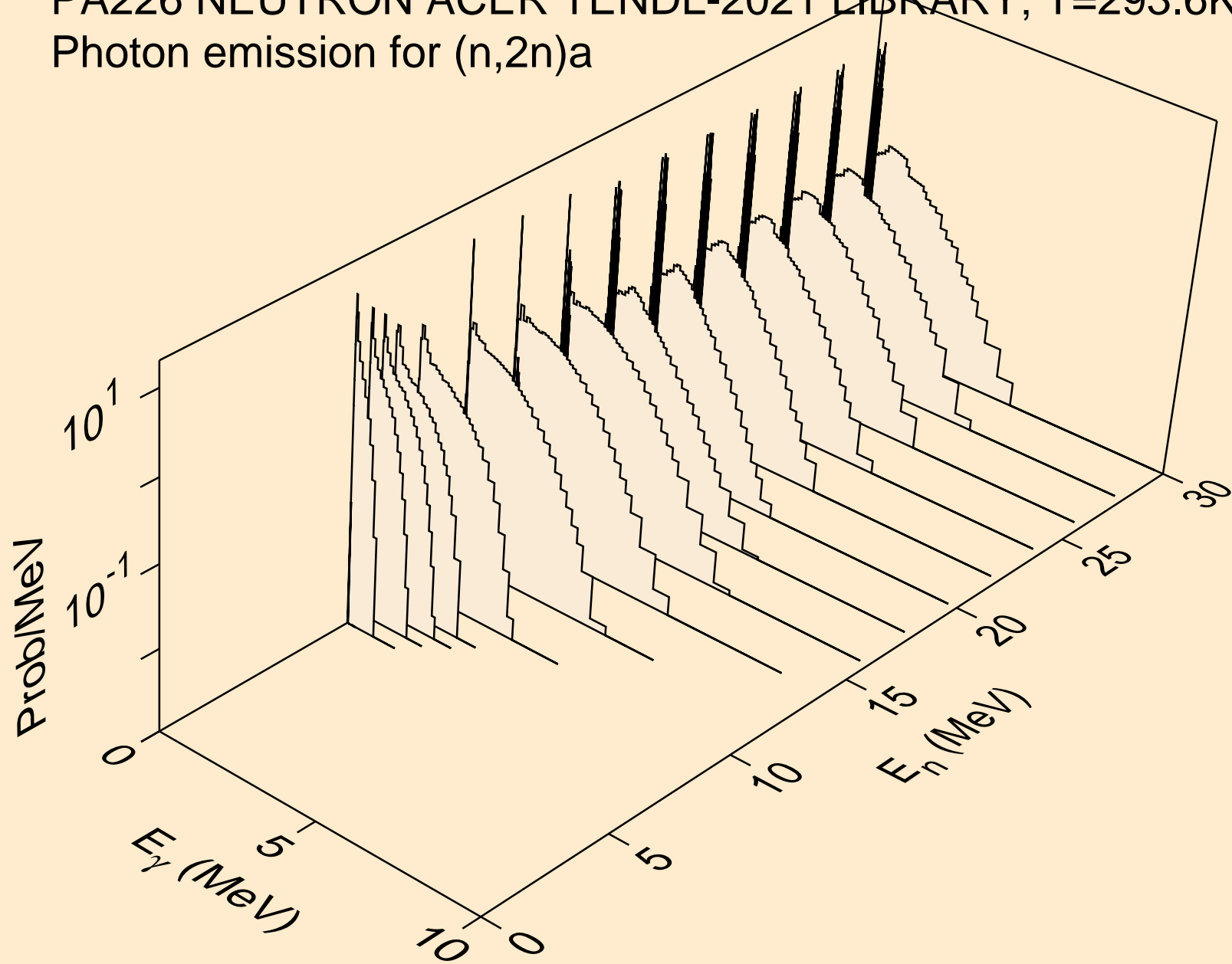

PA226 NEUTRON ACER TENDL-2021 LIBRARY; T=293.6K
Photon emission for (n,3n)a

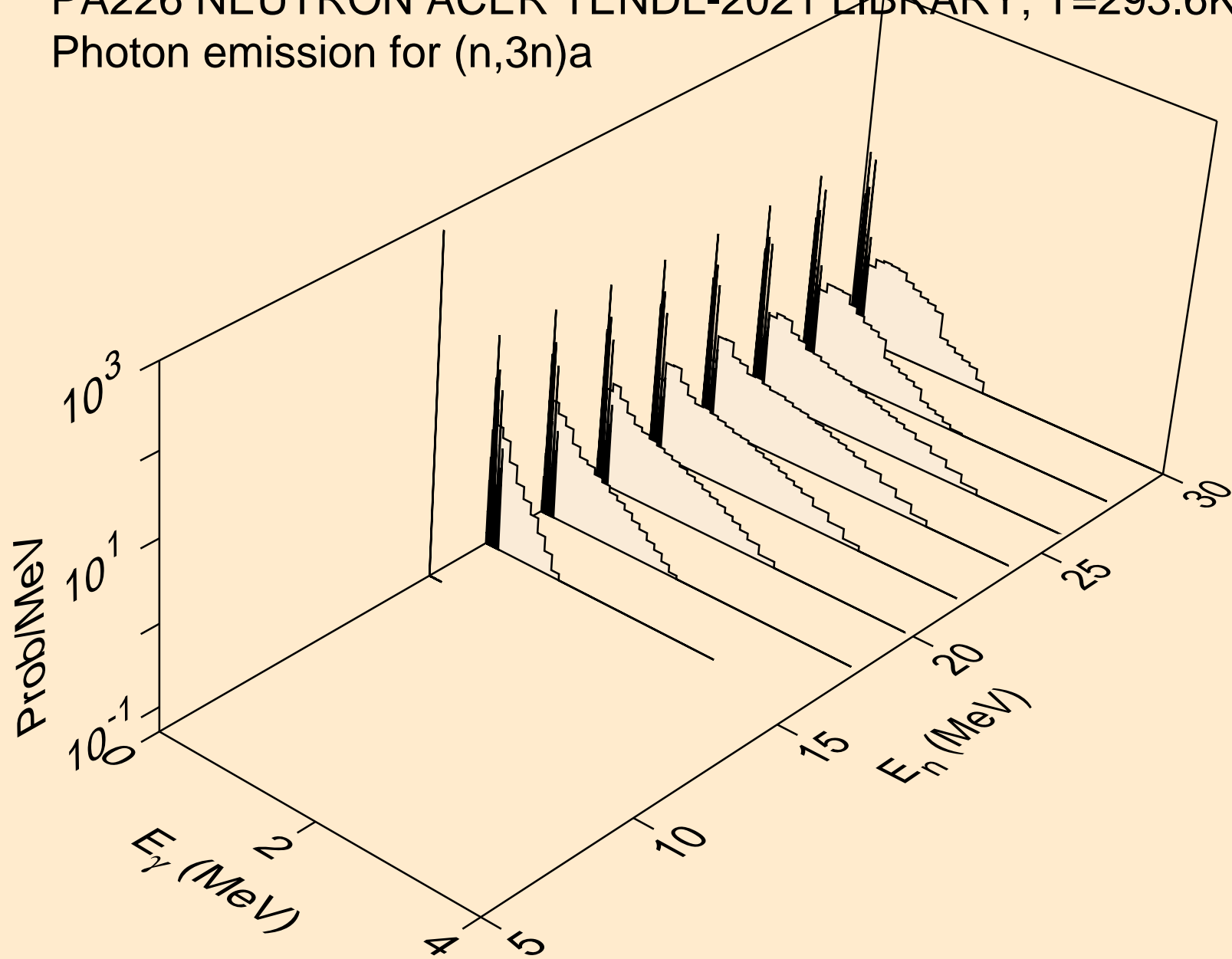

PA226 NEUTRON ACER TENDL-2021 LIBRARY; T=293.6K
Photon emission for (n,n*)p

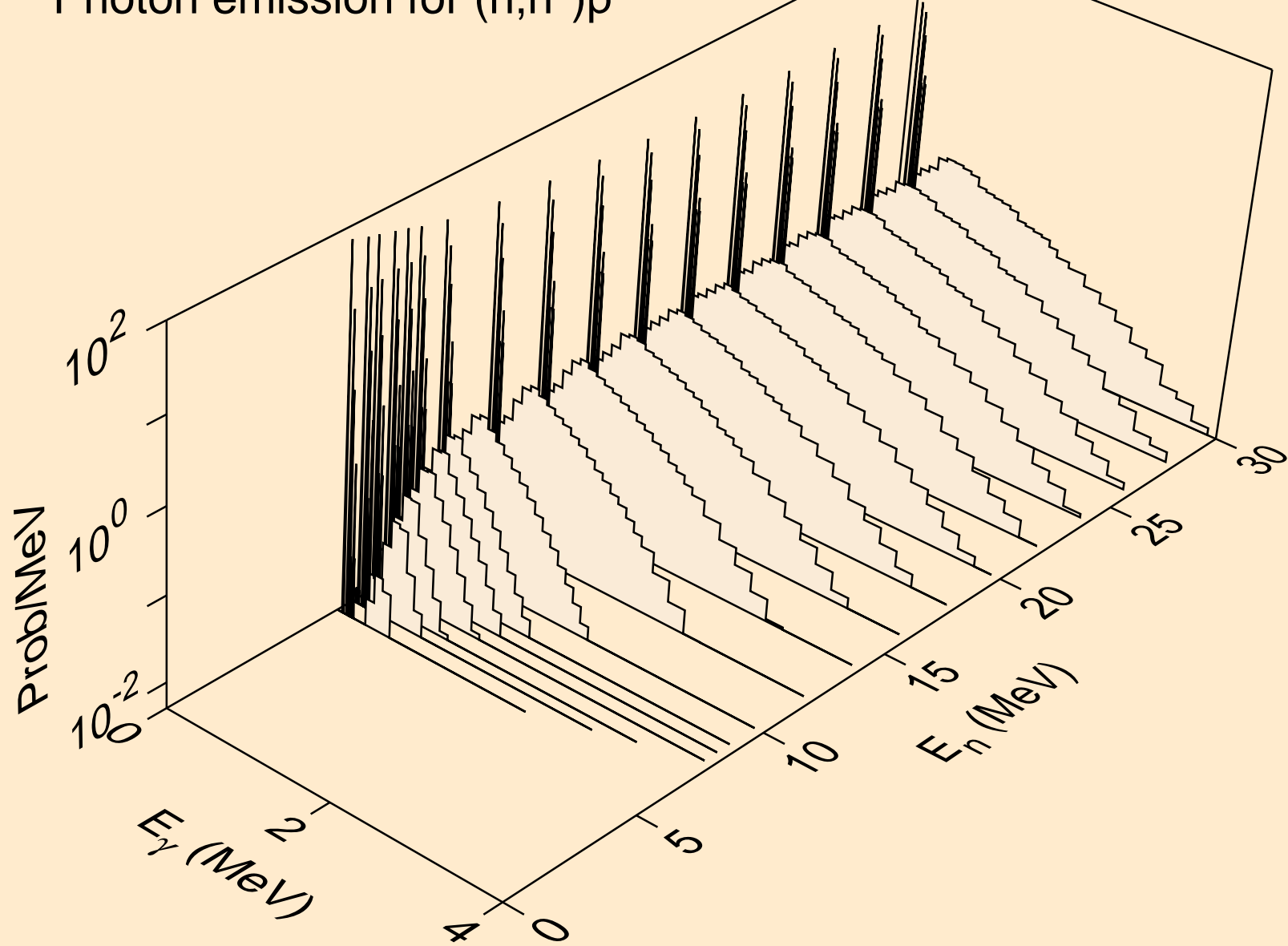

PA226 NEUTRON ACER TENDL-2021 LIBRARY; T=293.6K
Photon emission for (n,n*)2a

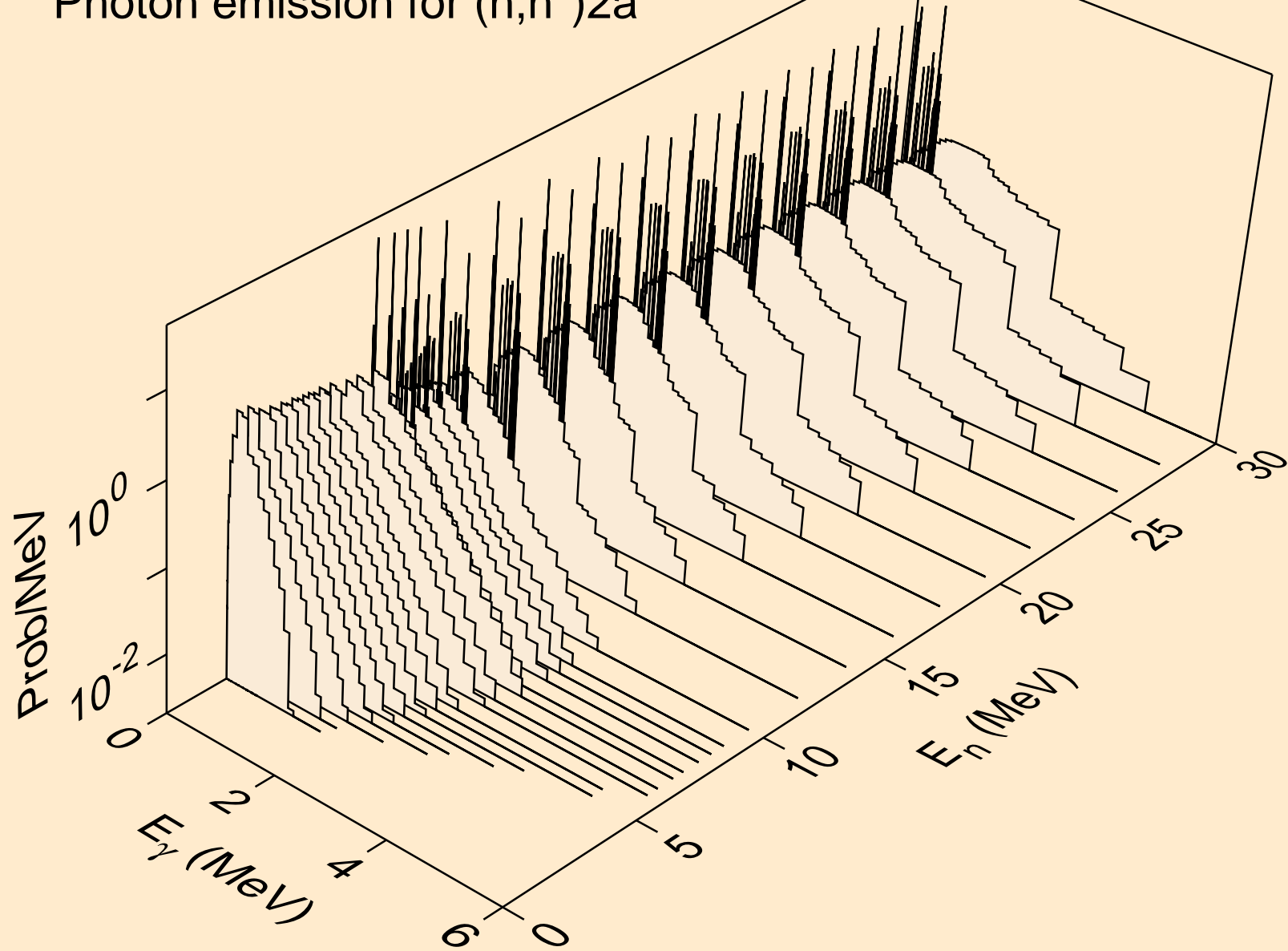

PA226 NEUTRON ACER TENDL-2021 LIBRARY; T=293.6K
Photon emission for (n,2n)2a

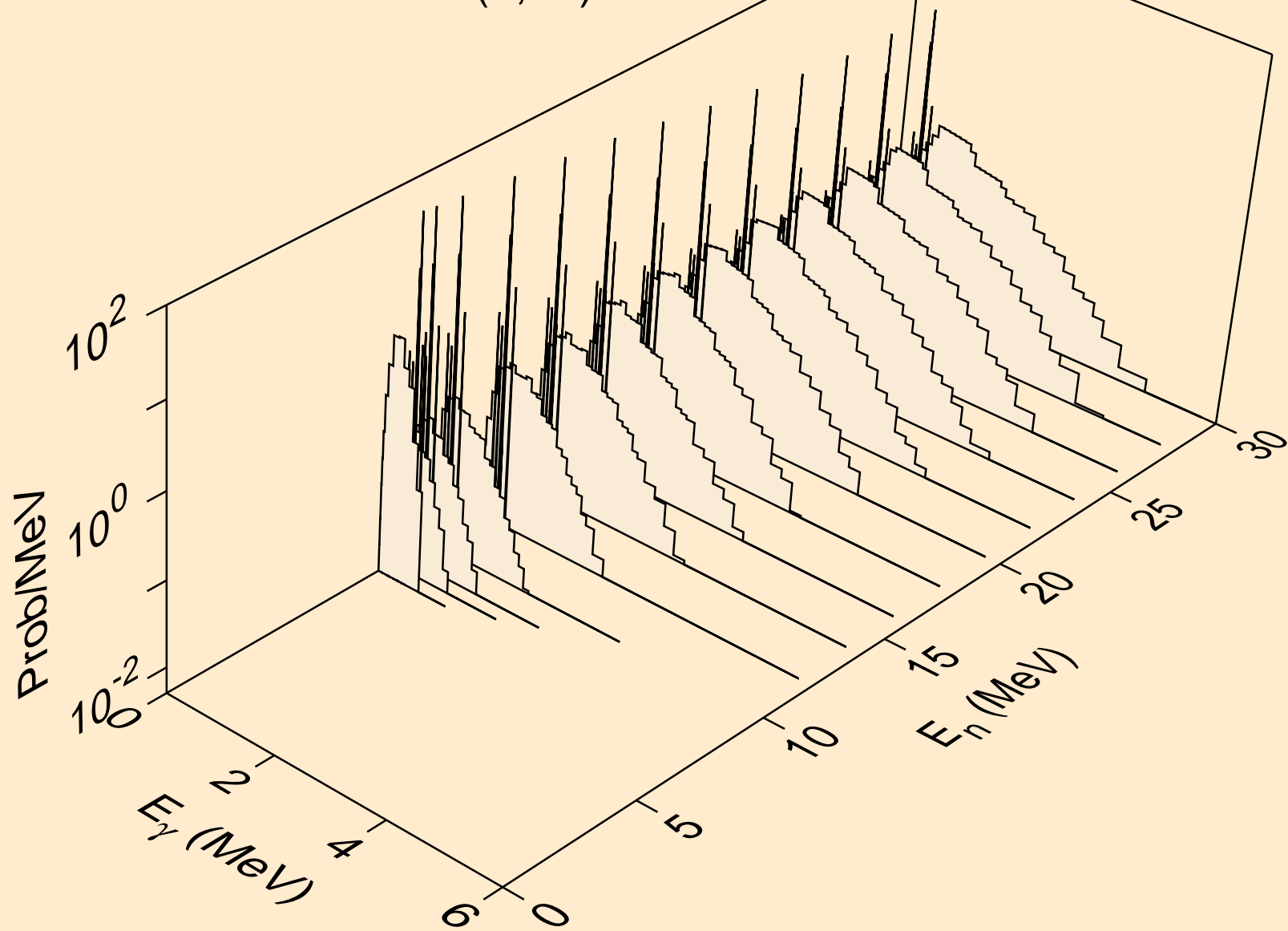

PA226 NEUTRON ACER TENDL-2021 LIBRARY; T=293.6K
Photon emission for (n,n*)d

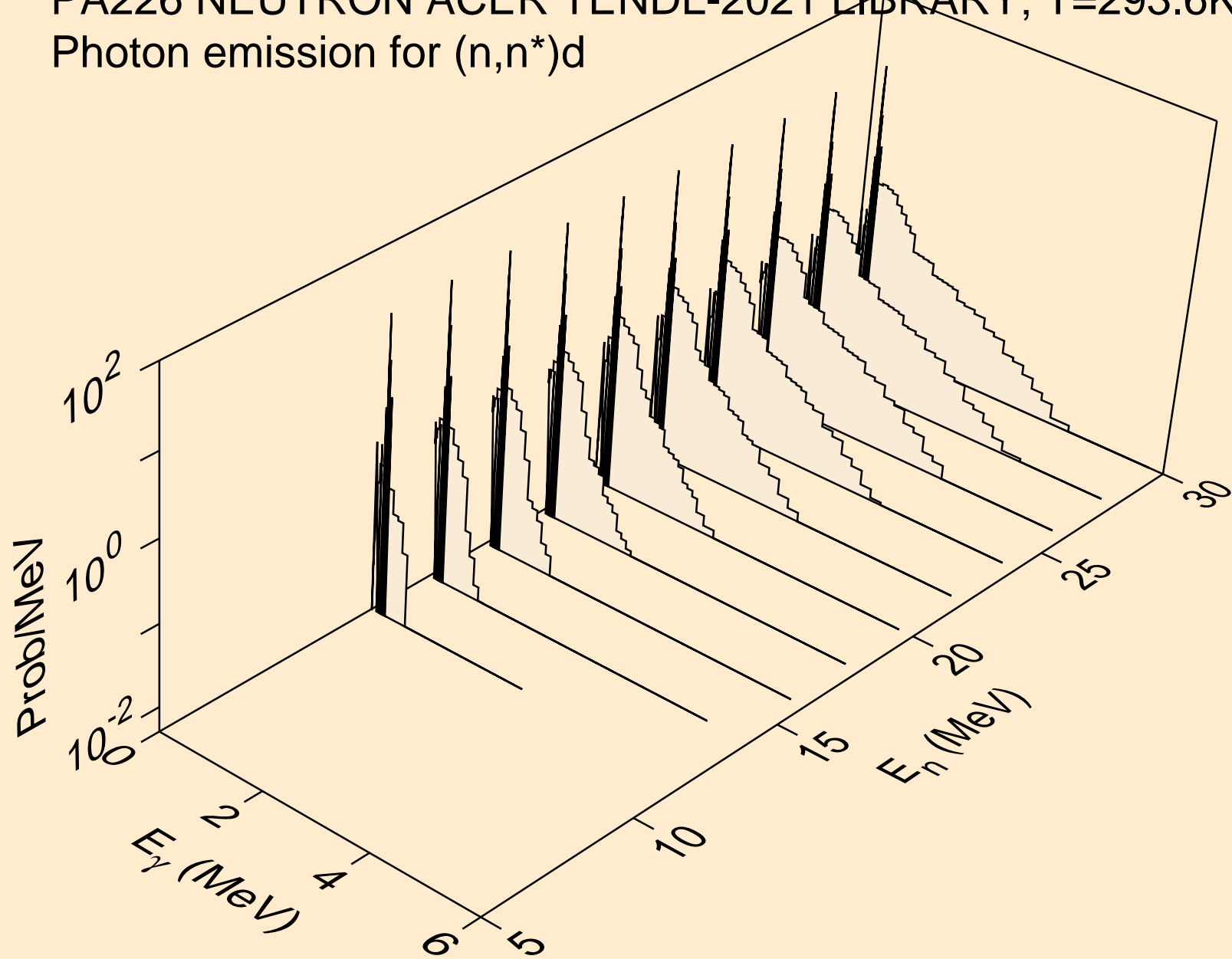

PA226 NEUTRON ACER TENDL-2021 LIBRARY; T=293.6K
Photon emission for (n,n*)t

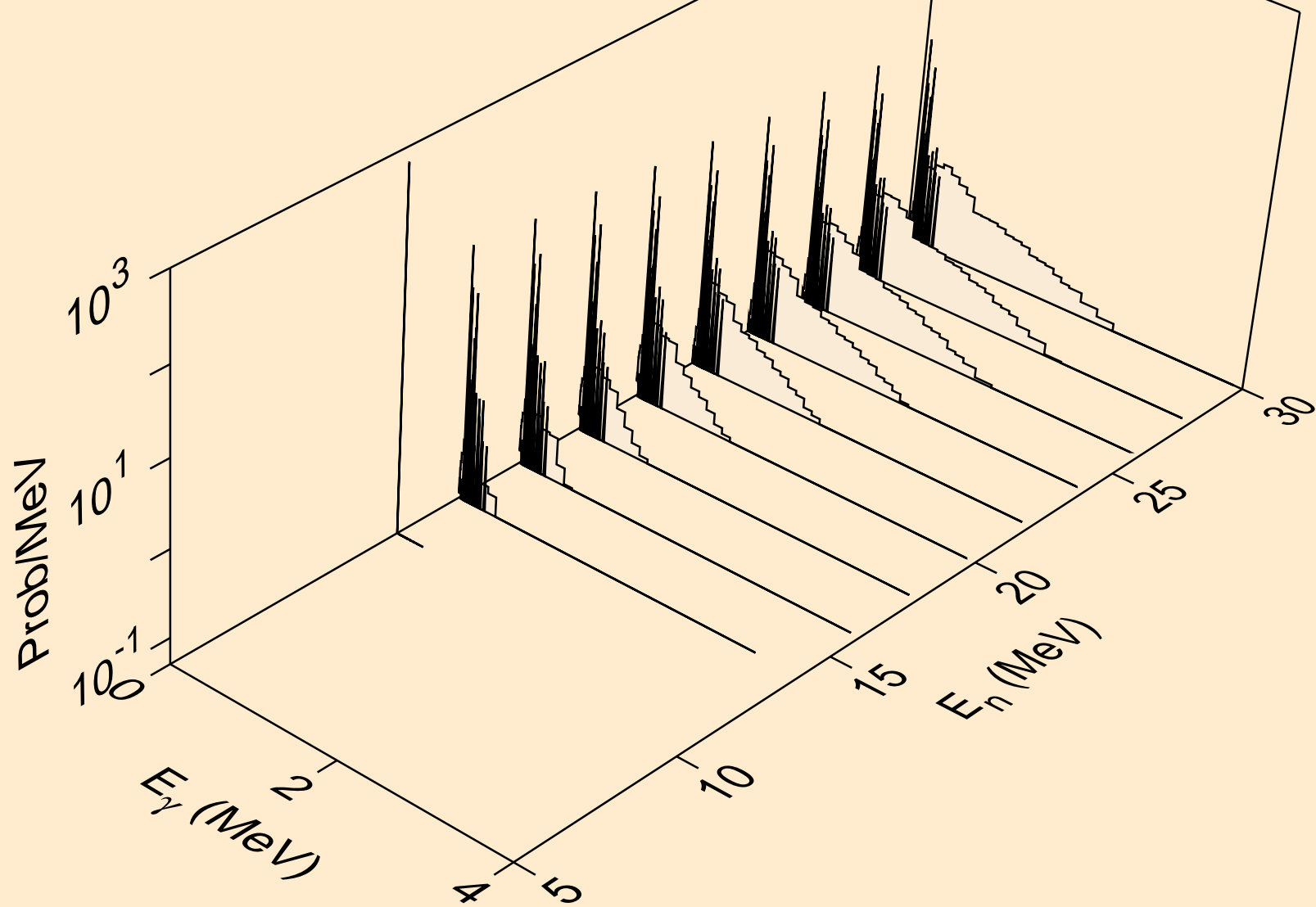

PA226 NEUTRON ACER TENDL-2021 LIBRARY; T=293.6K
Photon emission for (n,n*)he3

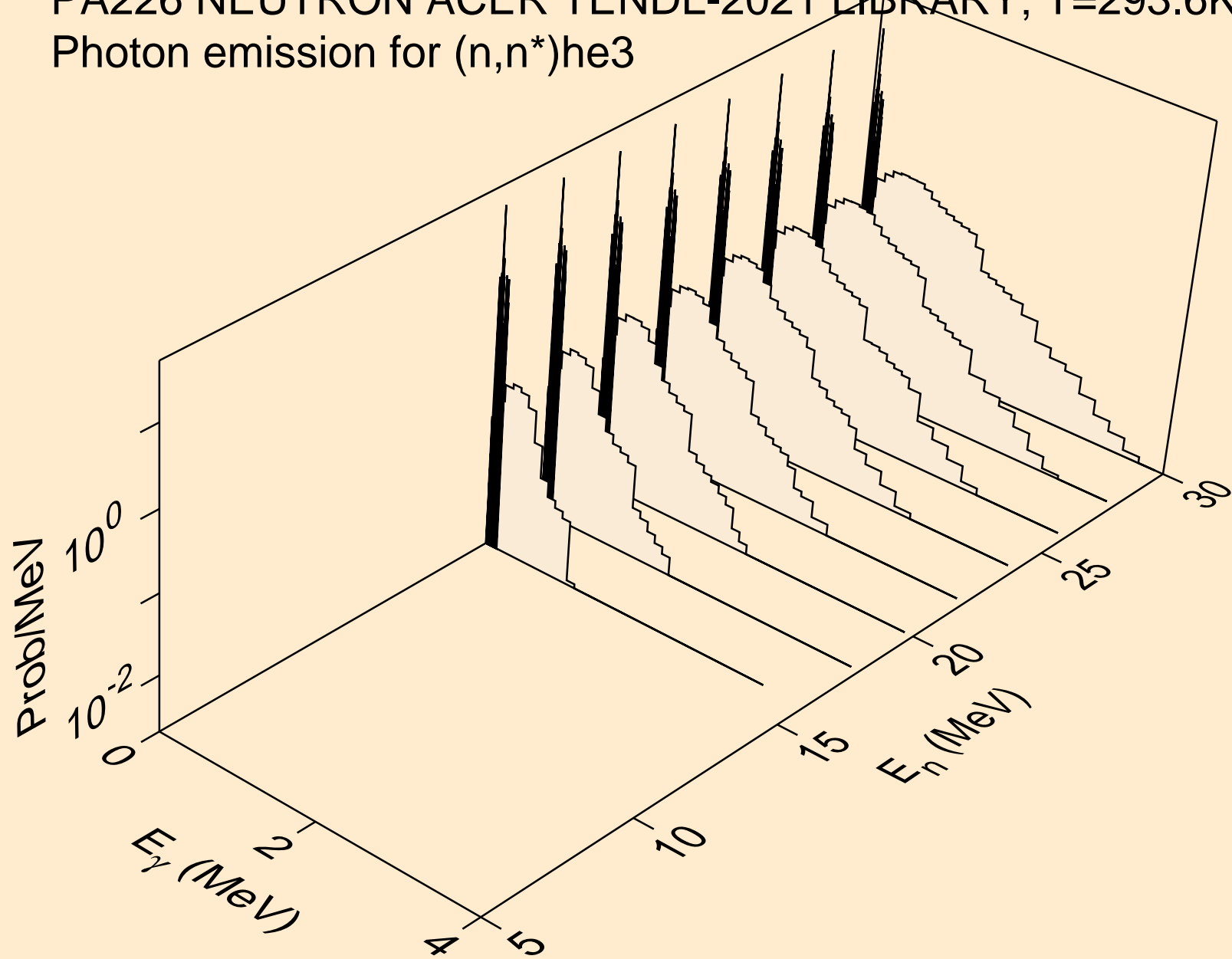

PA226 NEUTRON ACER TENDL-2021 LIBRARY; T=293.6K
Photon emission for (n,4n)

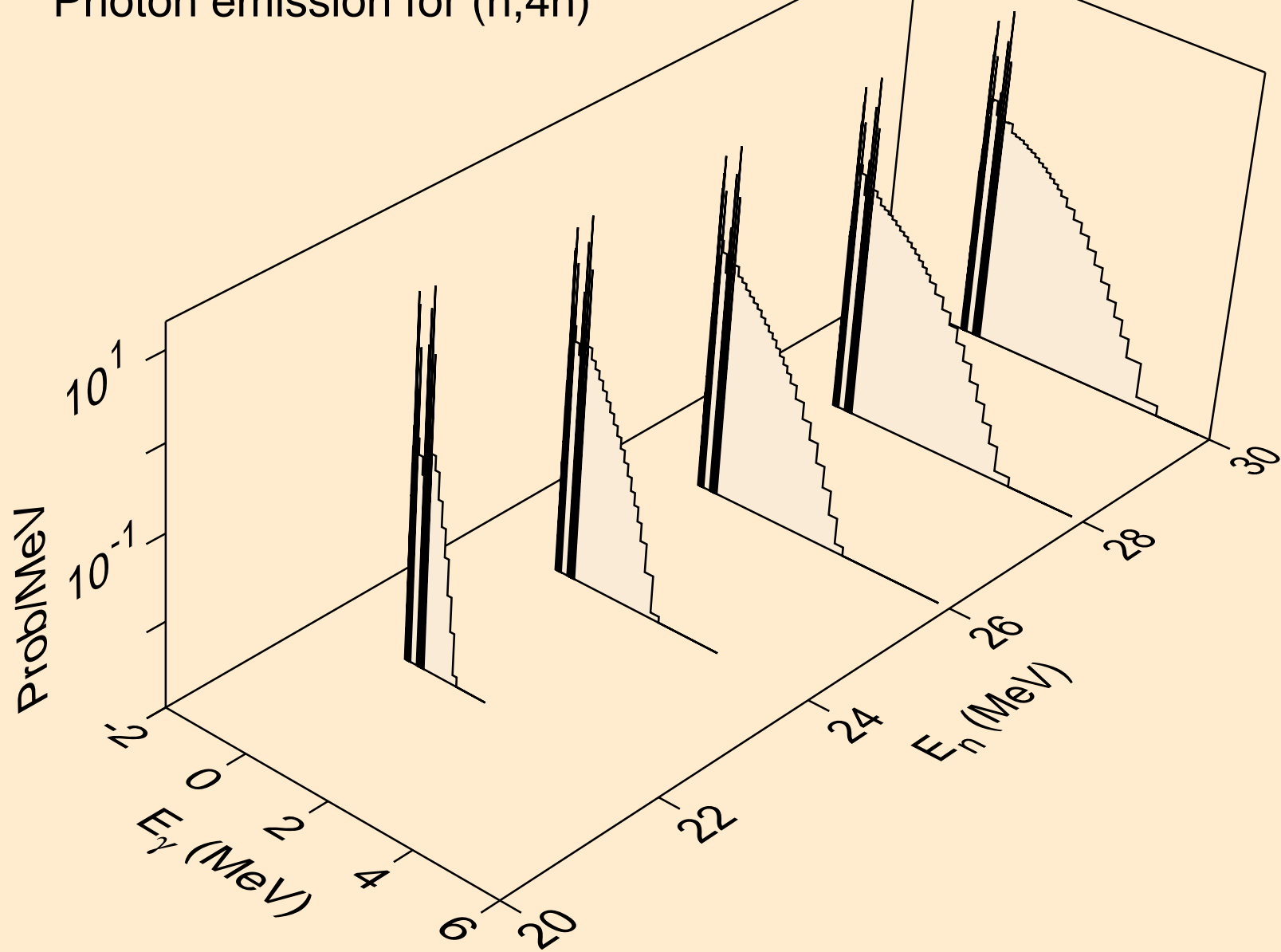

PA226 NEUTRON ACER TENDL-2021 LIBRARY; T=293.6K
Photon emission for (n,2np)

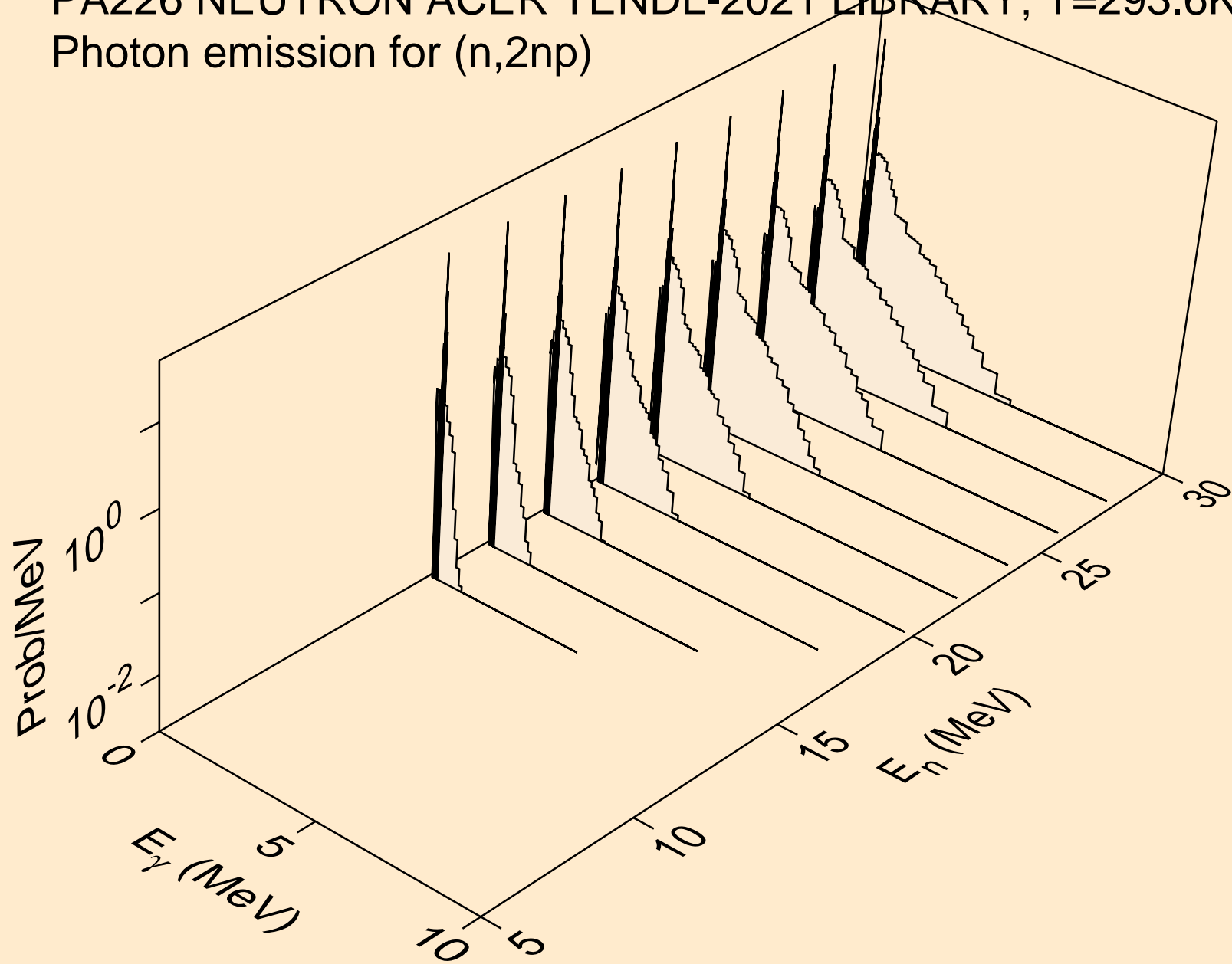

PA226 NEUTRON ACER TENDL-2021 LIBRARY; T=293.6K
Photon emission for (n,3np)

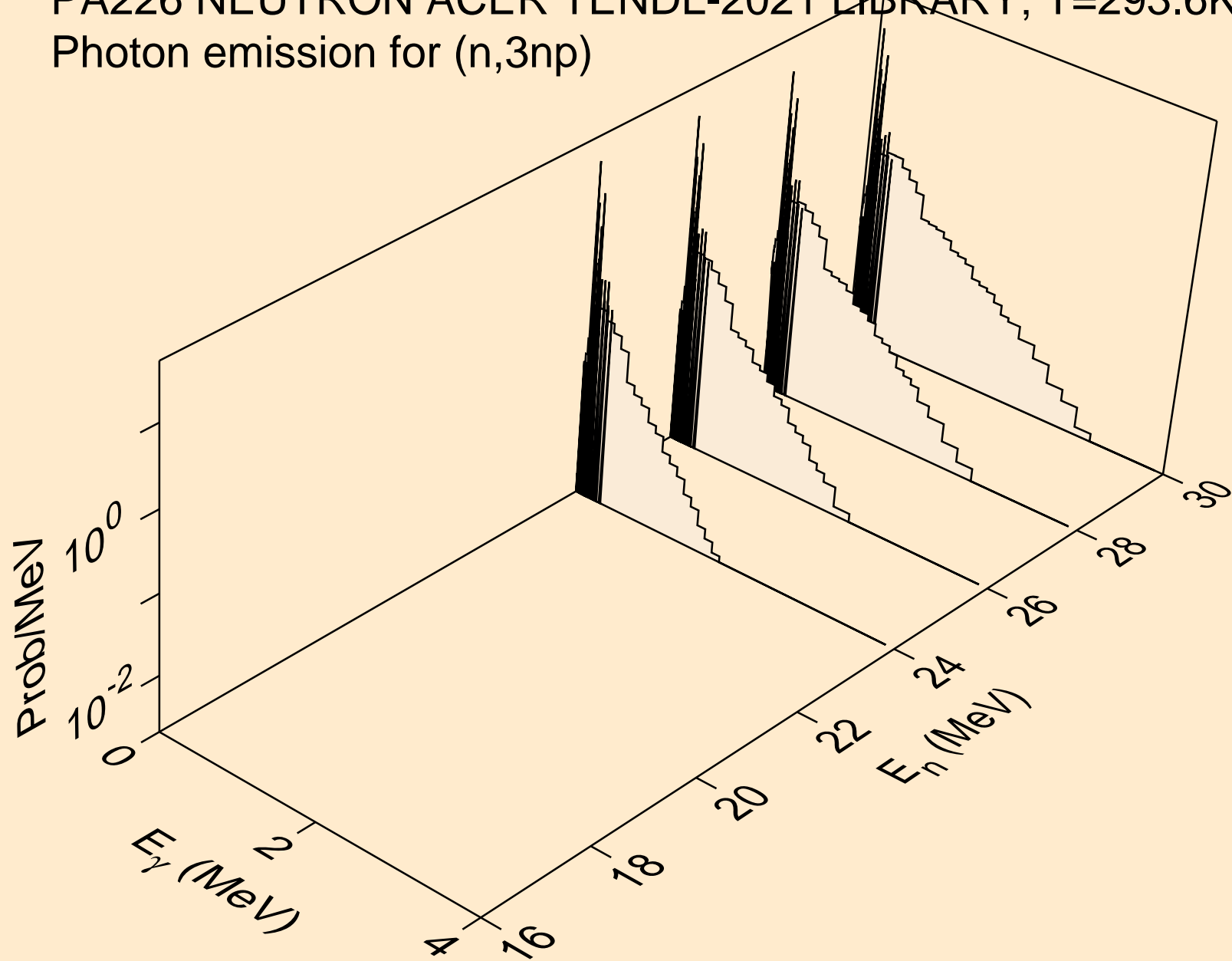

PA226 NEUTRON ACER TENDL-2021 LIBRARY; T=293.6K
Photon emission for (n,2np)

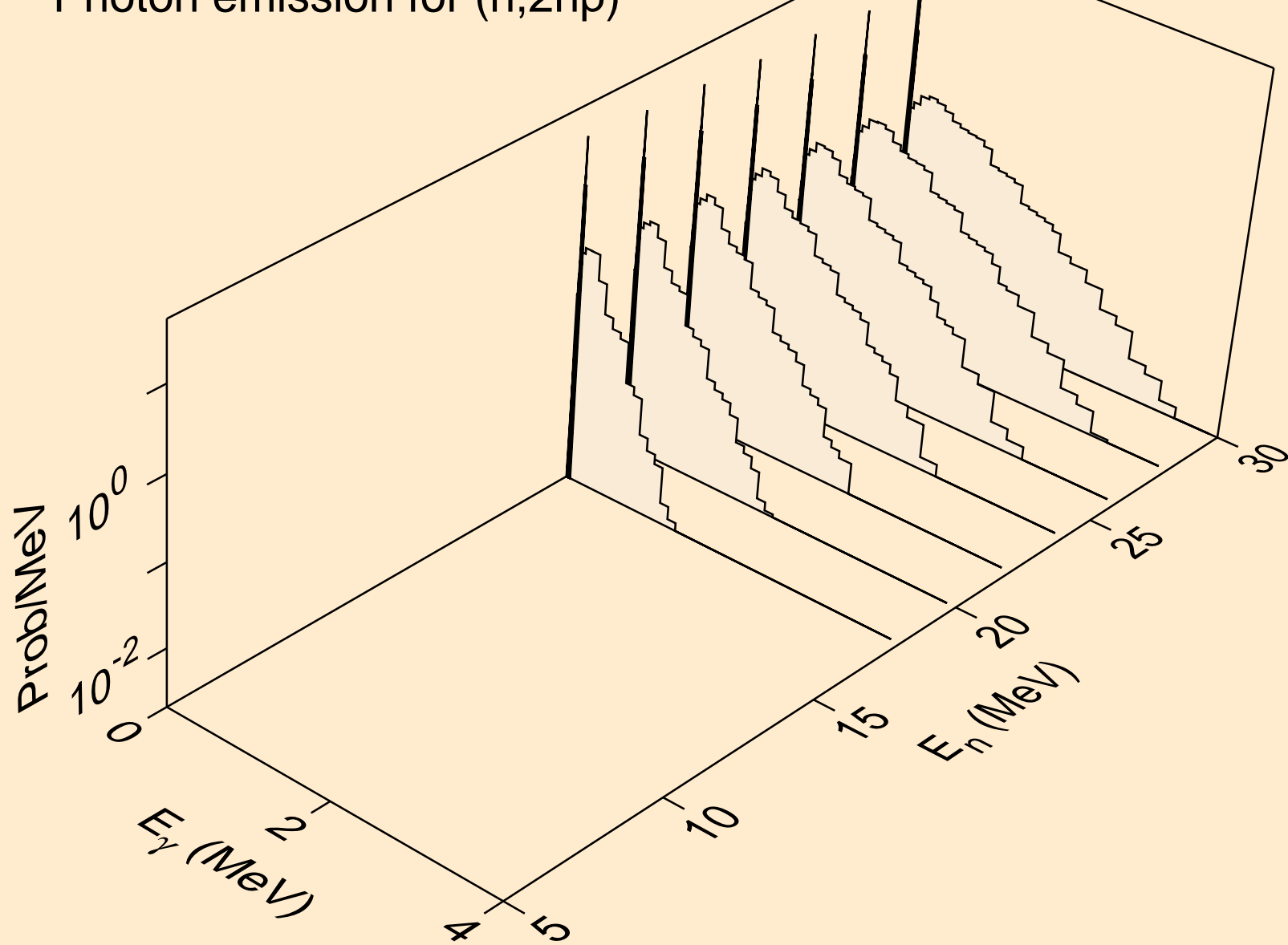

PA226 NEUTRON ACER TENDL-2021 LIBRARY; T=293.6K
Photon emission for (n,npa)

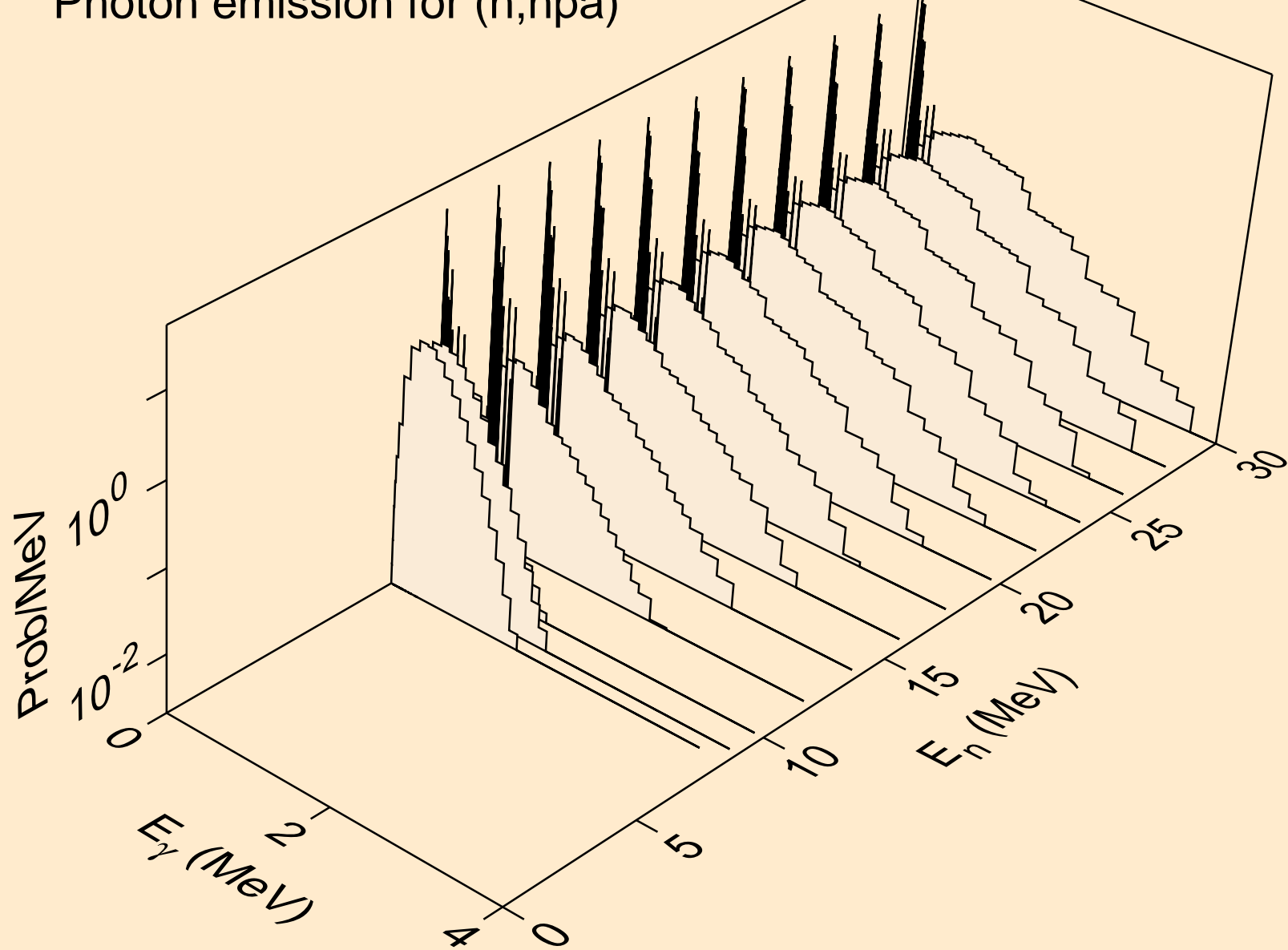

PA226 NEUTRON ACER TENDL-2021 LIBRARY; T=293.6K
Photon emission for (n,n*c)

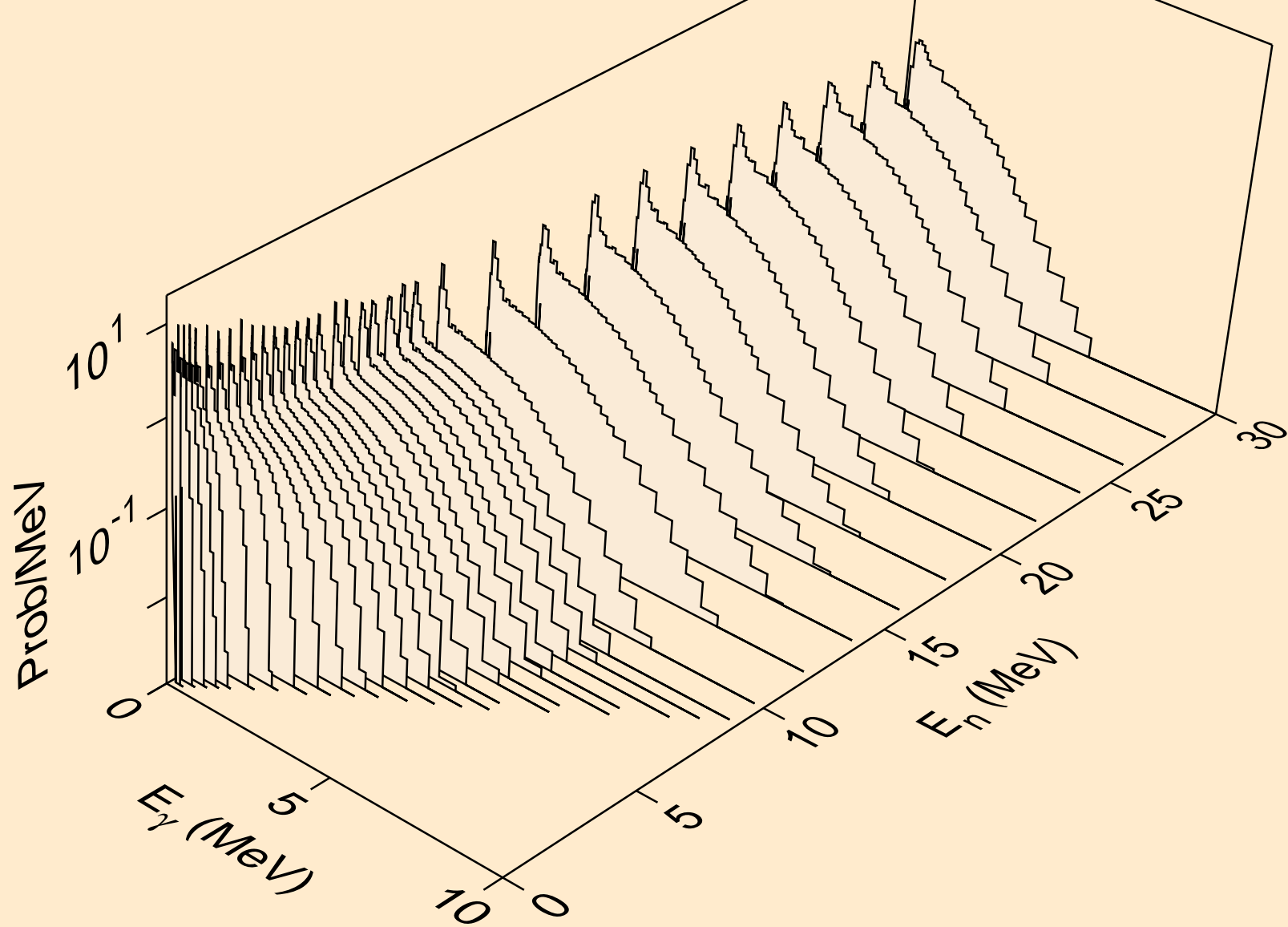

PA226 NEUTRON ACER TENDL-2021 LIBRARY; T=293.6K
Photon emission for (n,gma)

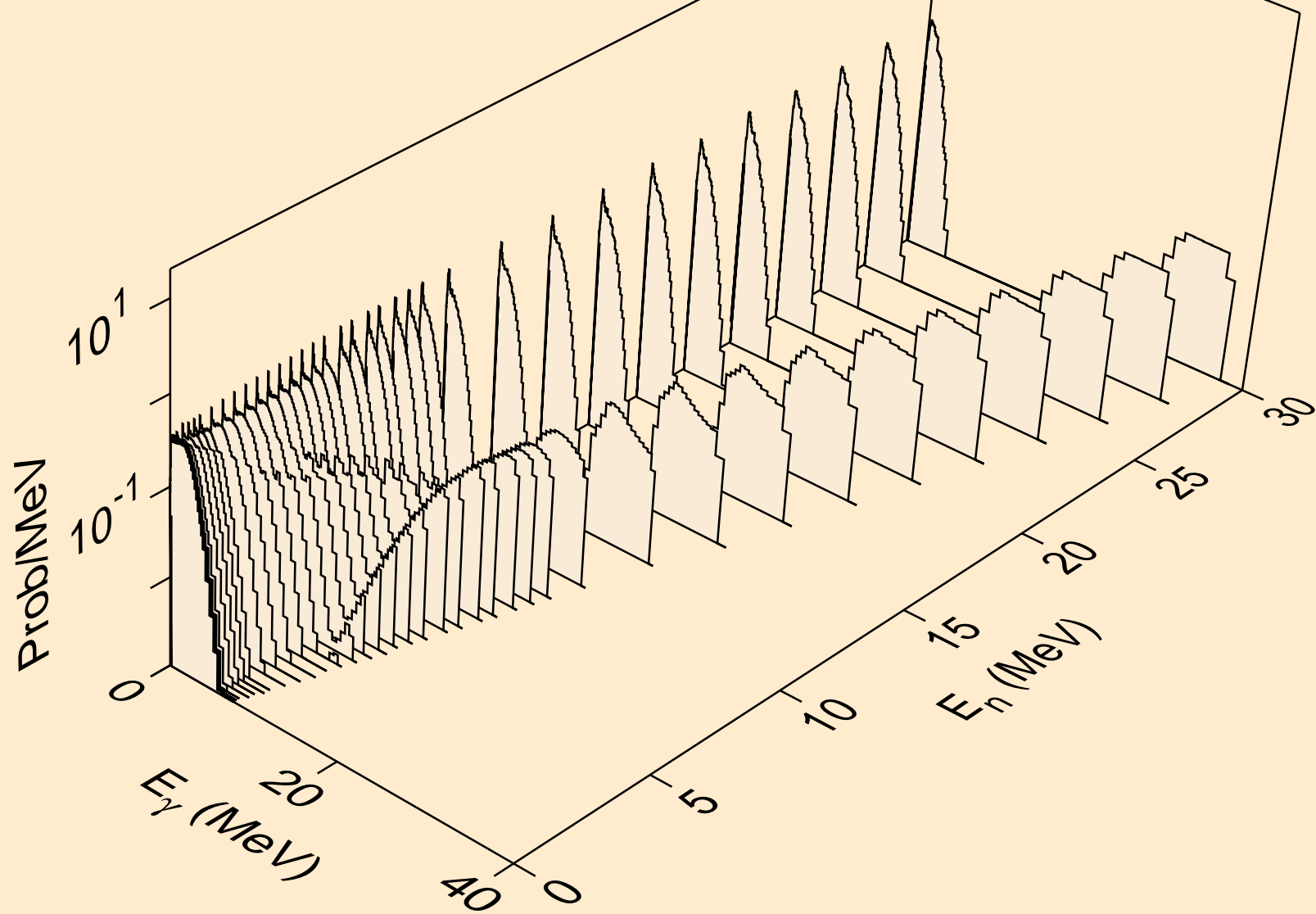

PA226 NEUTRON ACER TENDL-2021 LIBRARY; T=293.6K
Photon emission for (n,p)

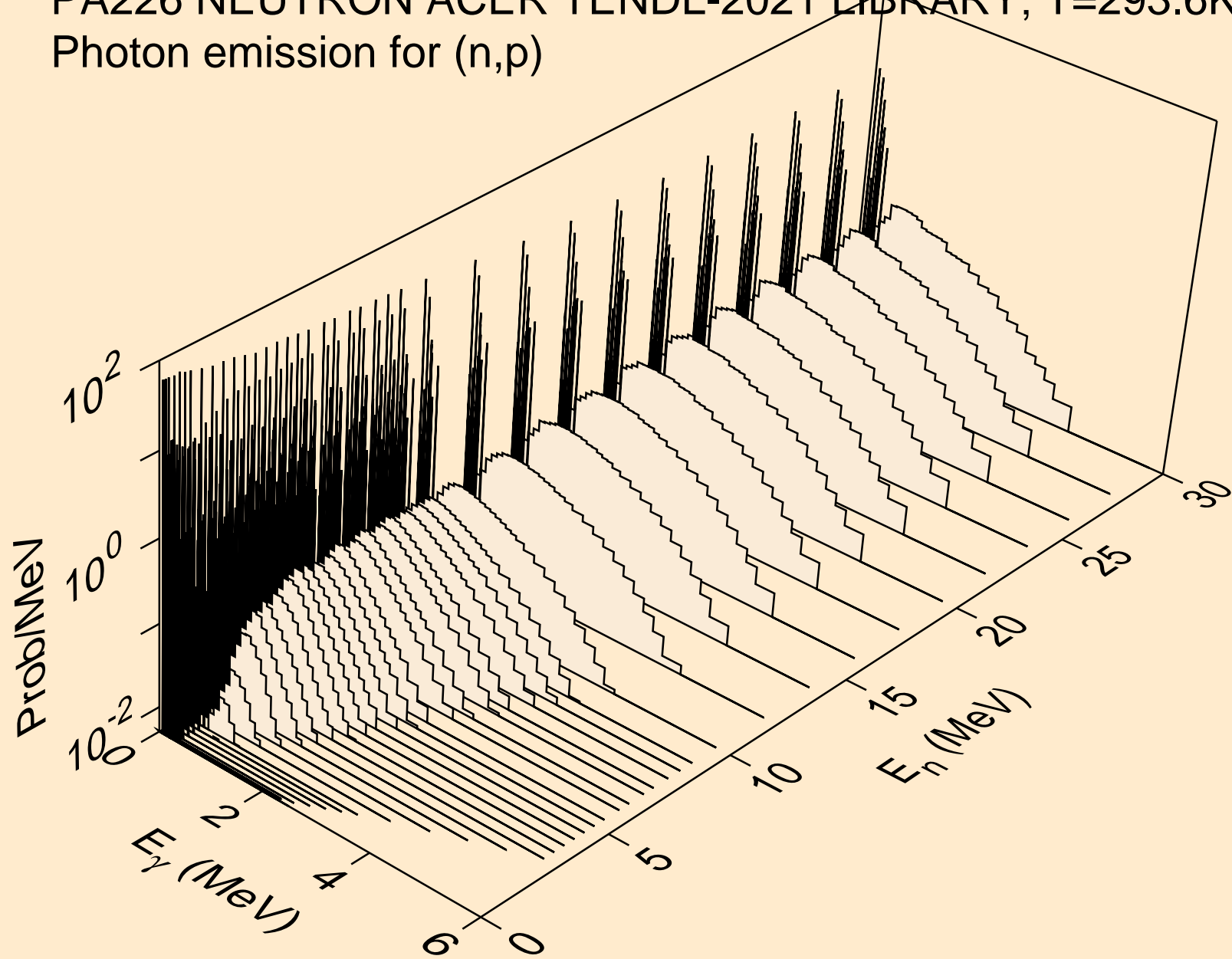

PA226 NEUTRON ACER TENDL-2021 LIBRARY; T=293.6K
Photon emission for (n,d)

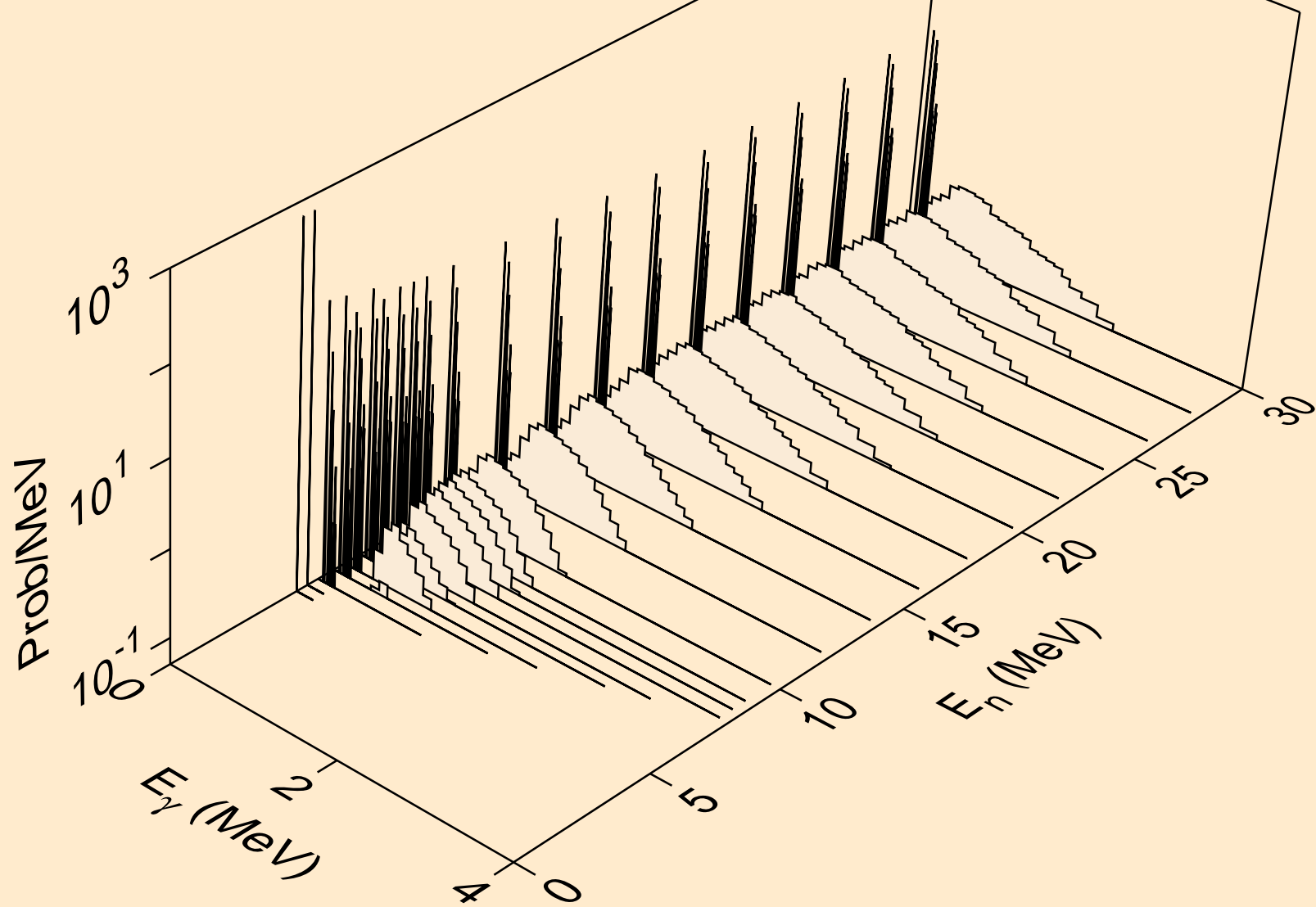

PA226 NEUTRON ACER TENDL-2021 LIBRARY; T=293.6K
Photon emission for (n,t)

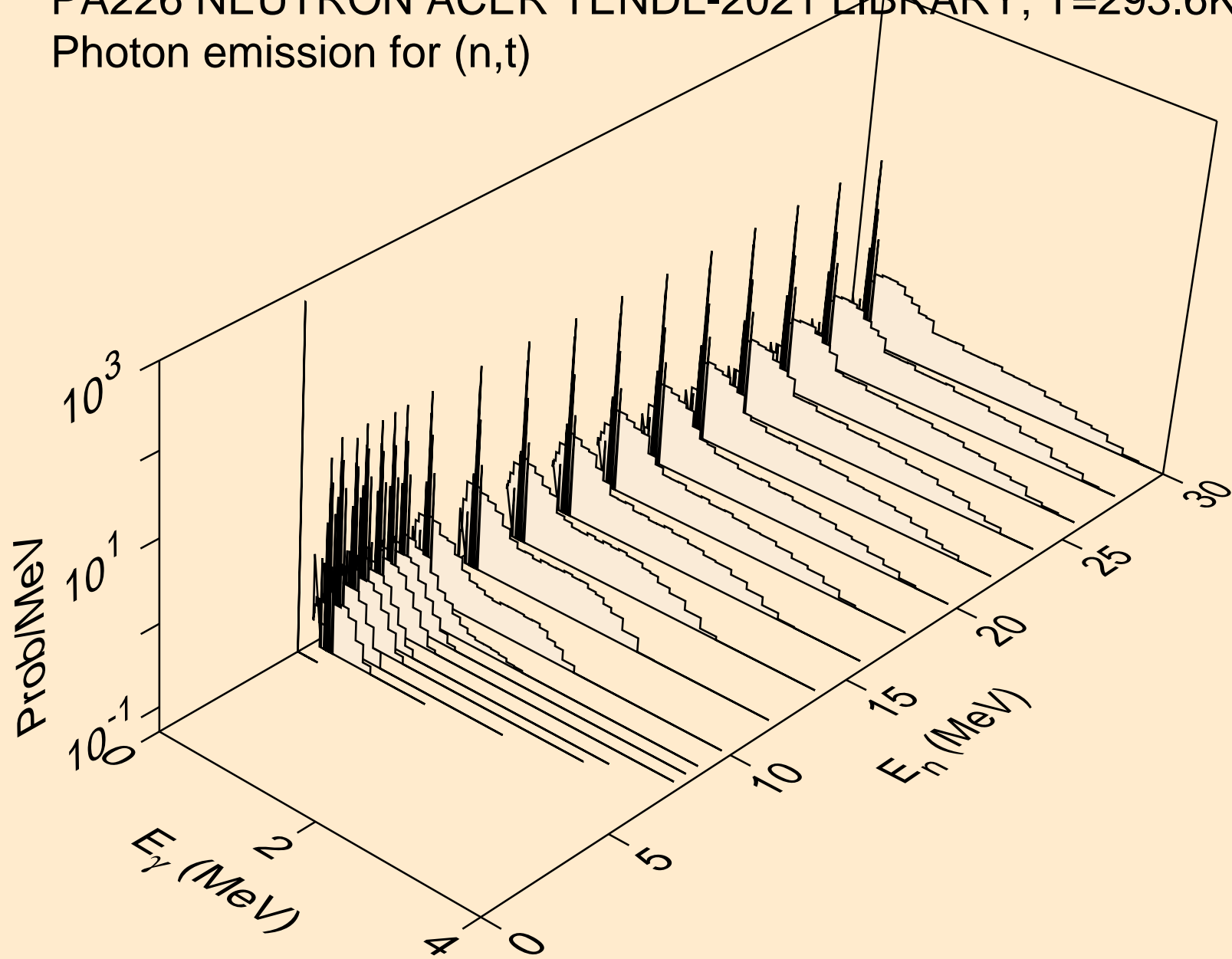

PA226 NEUTRON ACER TENDL-2021 LIBRARY; T=293.6K
Photon emission for (n,he3)

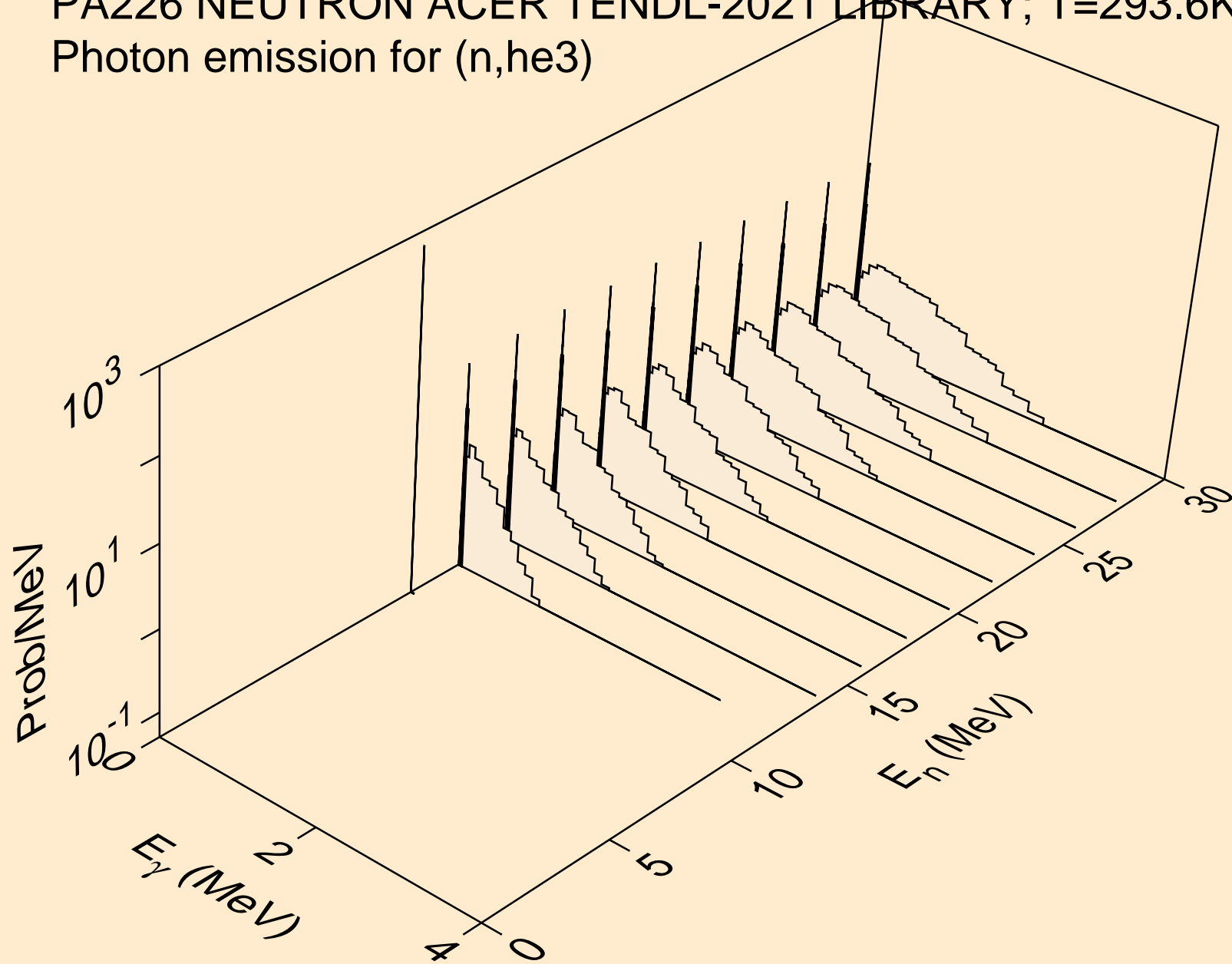

PA226 NEUTRON ACER TENDL-2021 LIBRARY; T=293.6K
Photon emission for (n,a)

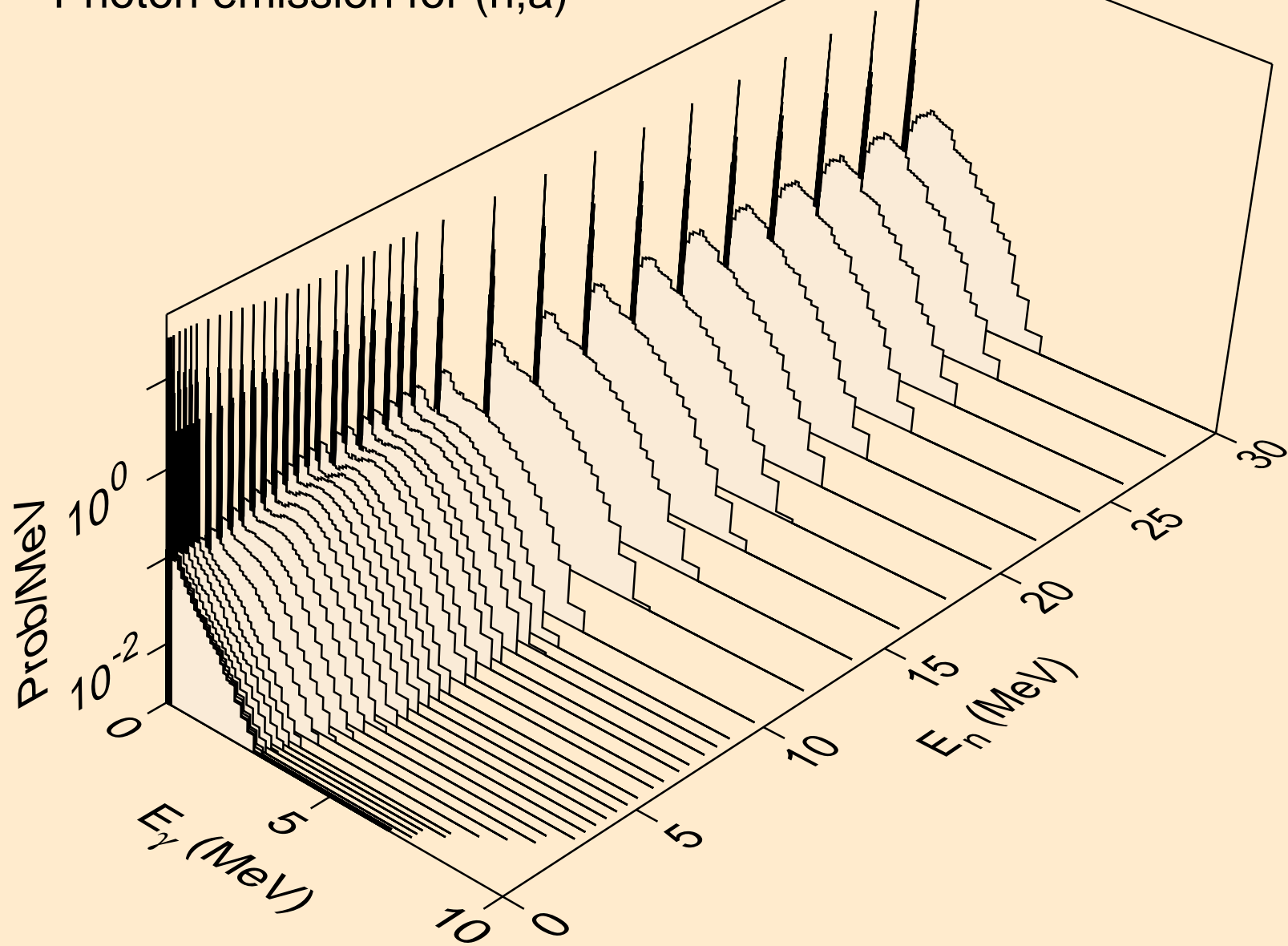

PA226 NEUTRON ACER TENDL-2021 LIBRARY; T=293.6K
Photon emission for (n,2a)

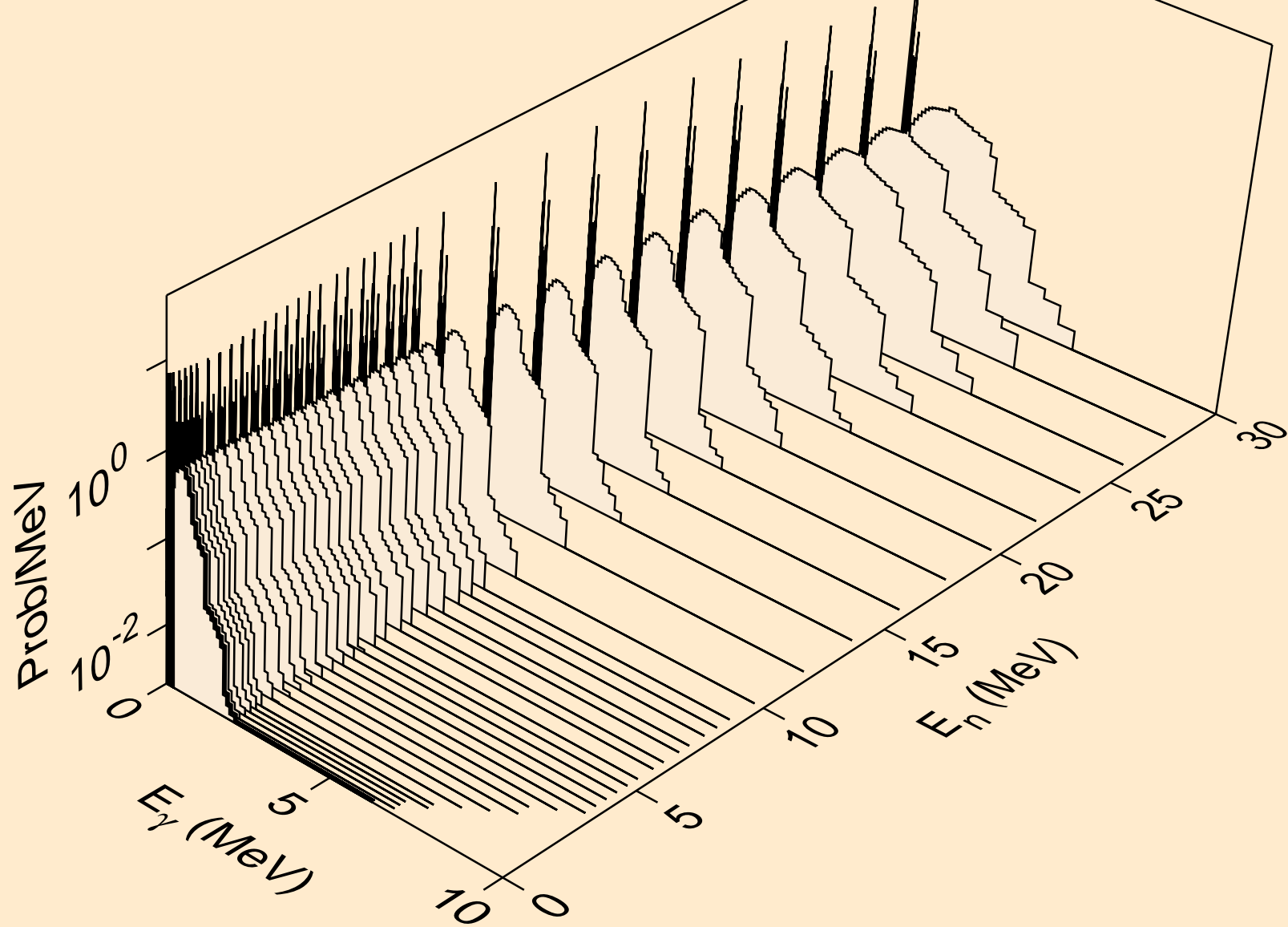

PA226 NEUTRON ACER TENDL-2021 LIBRARY; T=293.6K
Photon emission for (n,2p)

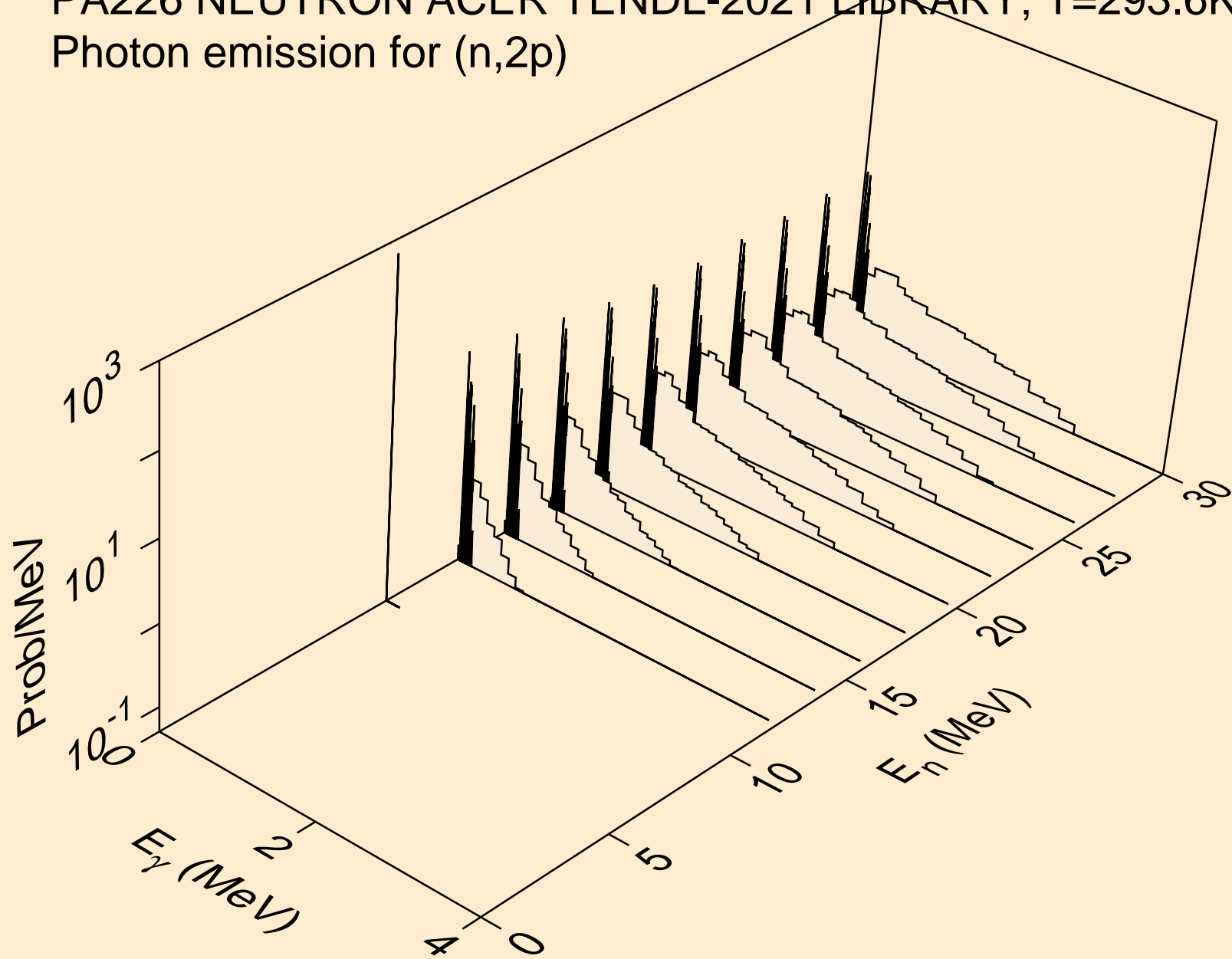

PA226 NEUTRON ACER TENDL-2021 LIBRARY; T=293.6K
Photon emission for (n,p α)

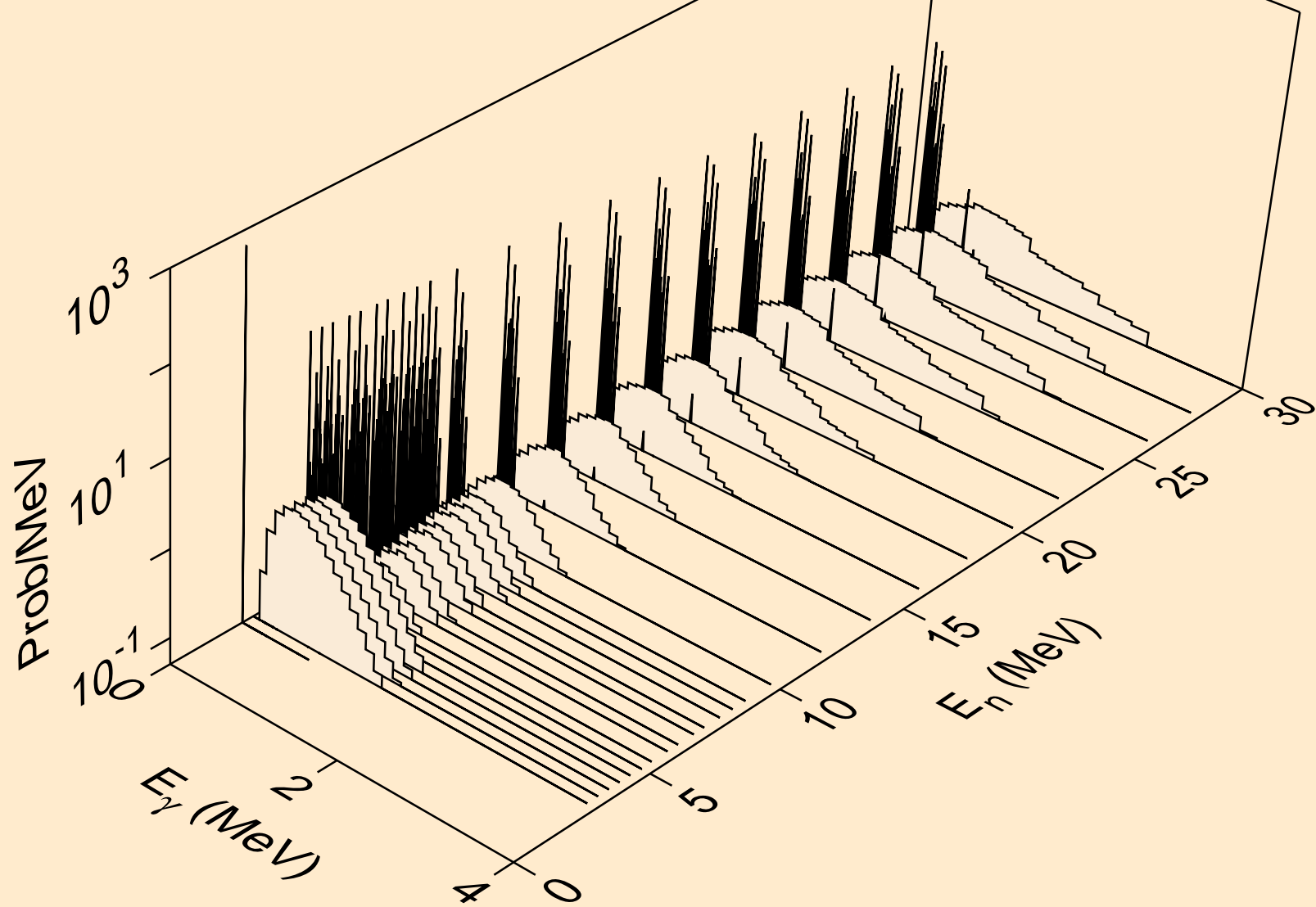

PA226 NEUTRON ACER TENDL-2021 LIBRARY; T=293.6K
Photon emission for (n,pd)

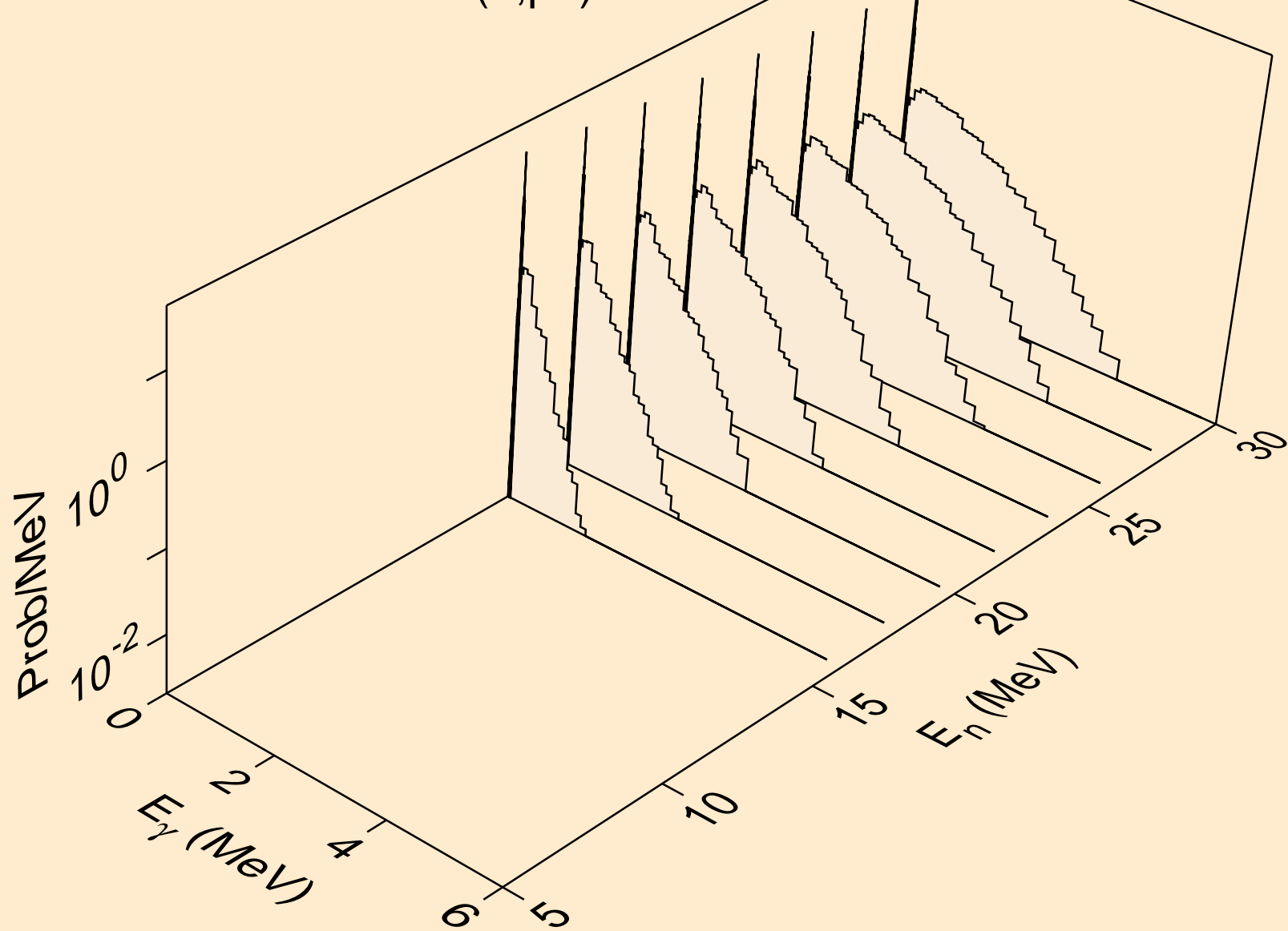

PA226 NEUTRON ACER TENDL-2021 LIBRARY; T=293.6K
Photon emission for (n,pt)

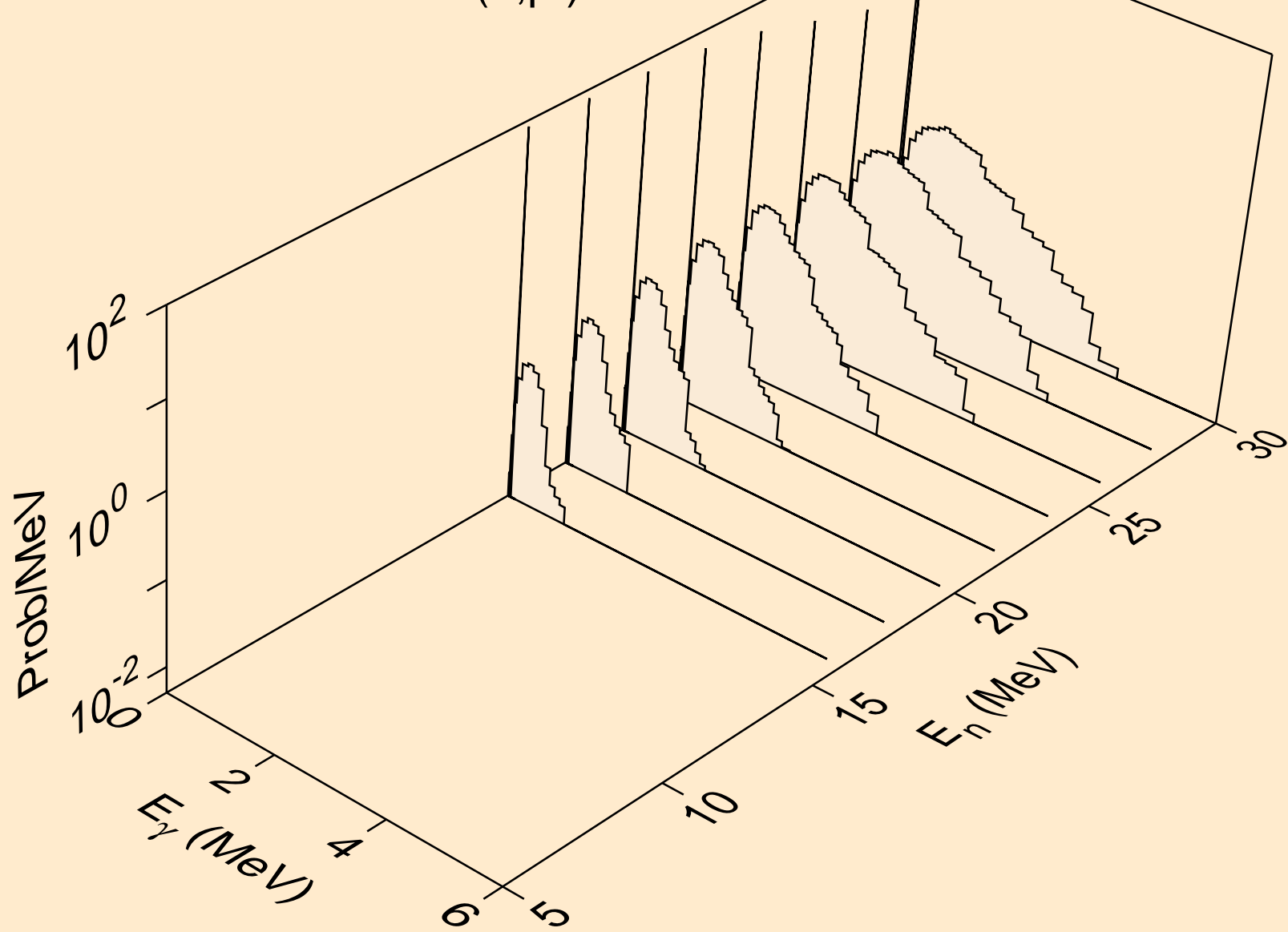

PA226 NEUTRON ACER TENDL-2021 LIBRARY; T=293.6K
Photon emission for (n,da)

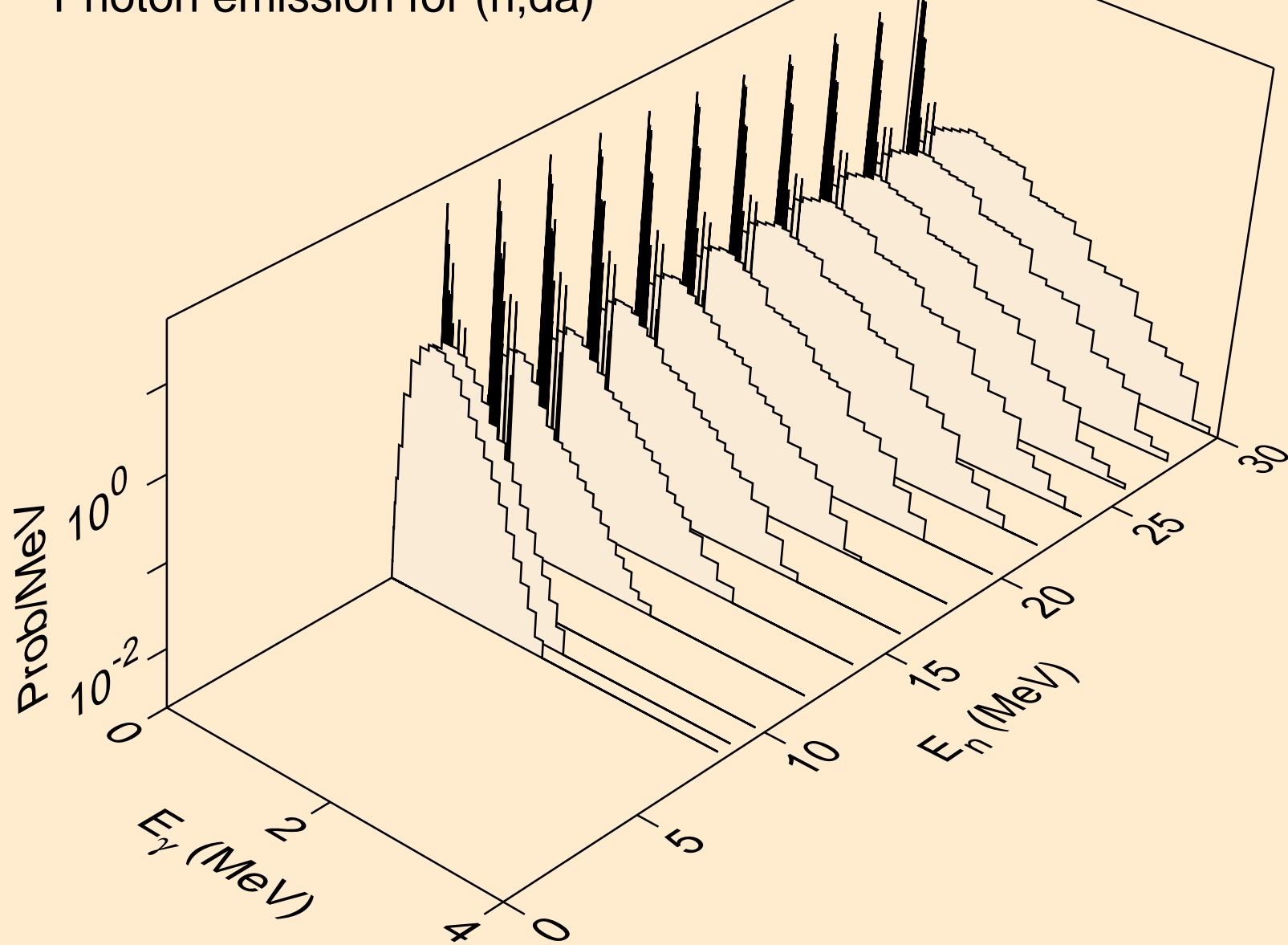

PA226 NEUTRON ACER TENDL-2021 LIBRARY; T=293.6K
thermal capture photon spectrum

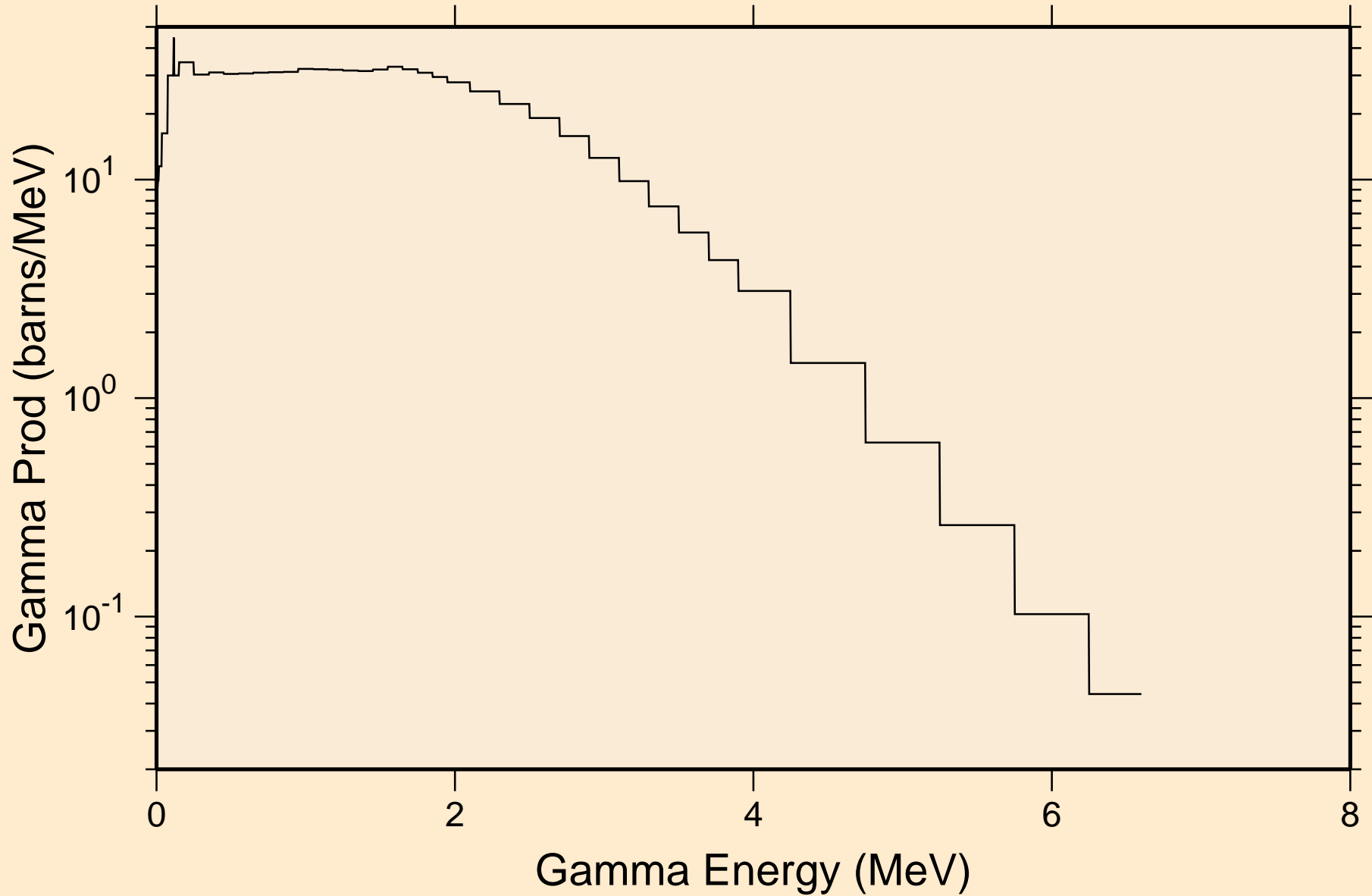

PA226 NEUTRON ACER TENDL-2021 LIBRARY; T=293.6K
14 MeV photon spectrum

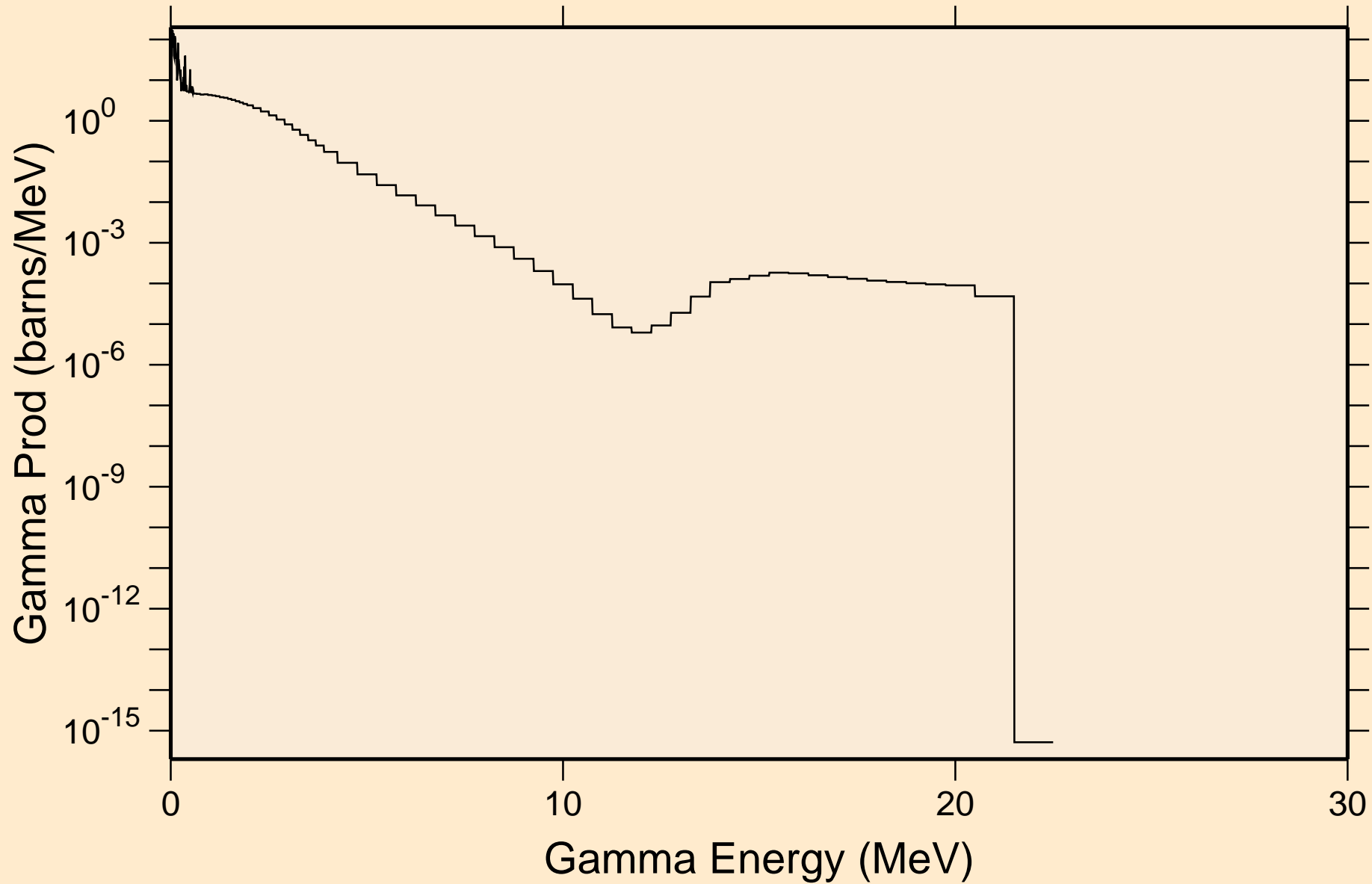

PA226 NEUTRON ACER TENDL-2021 LIBRARY; T=293.6K
Particle heating contributions

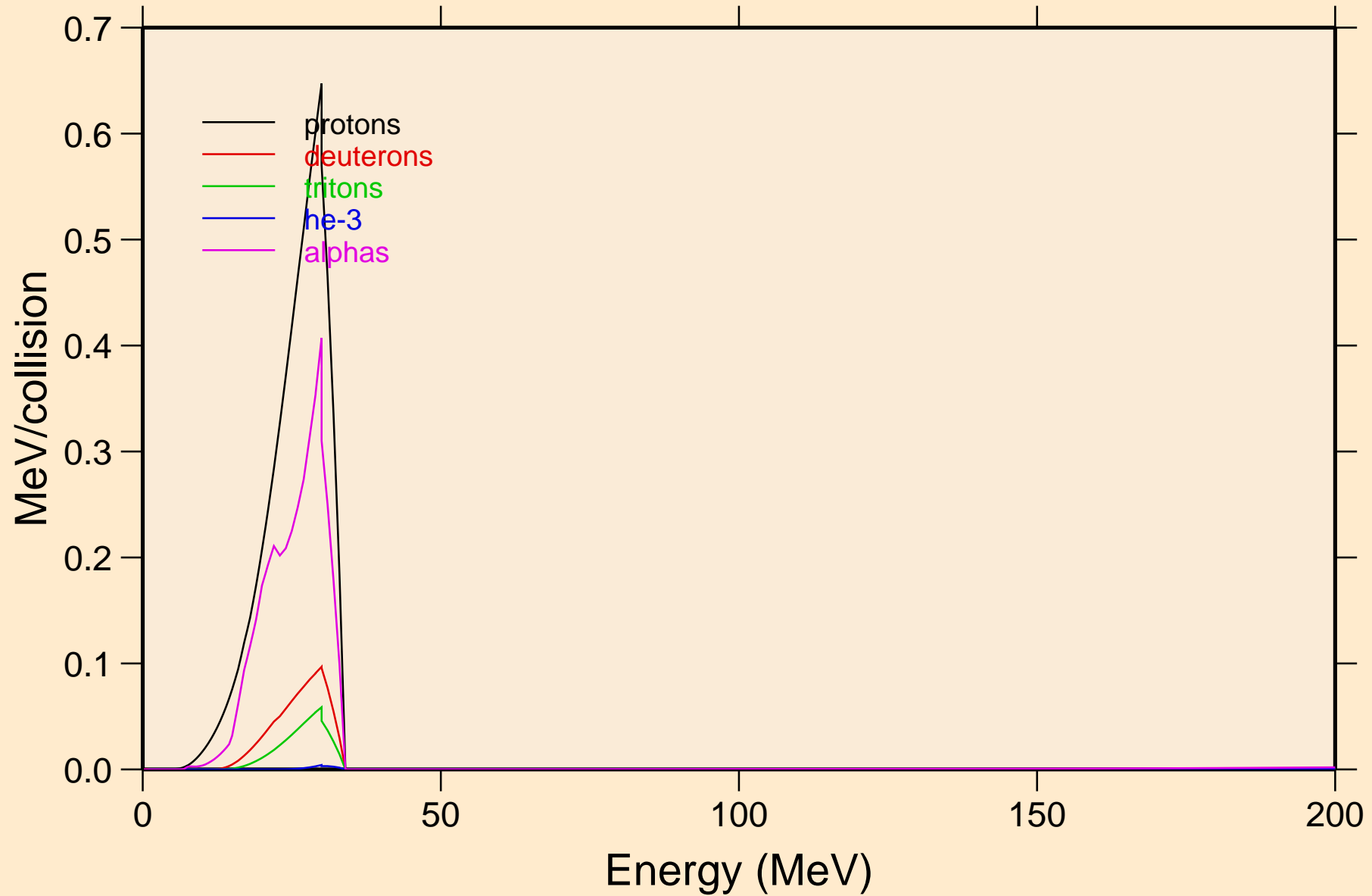

PA226 NEUTRON ACER TENDL-2021 LIBRARY; T=293.6K
Recoil Heating

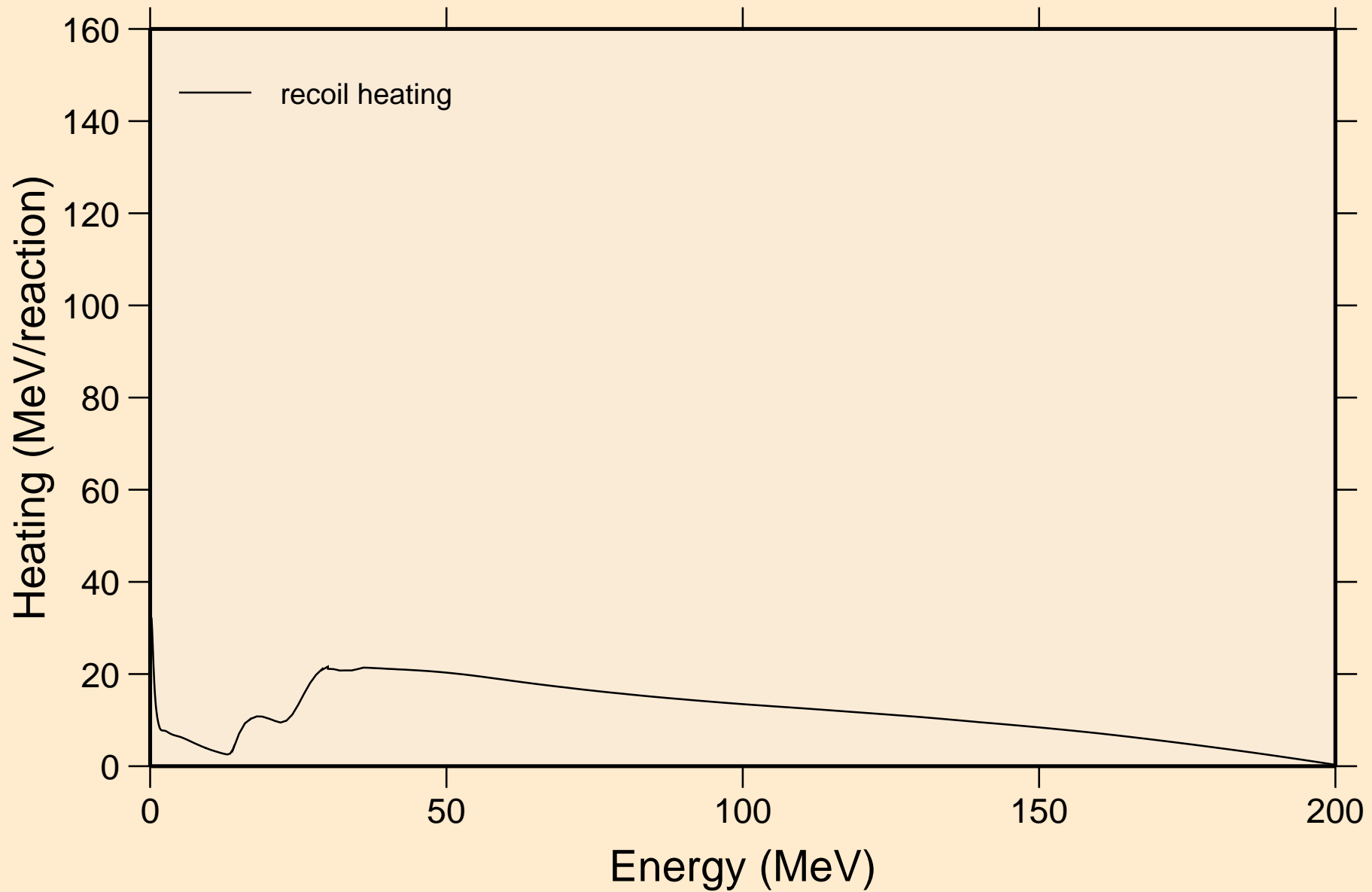

PA226 NEUTRON ACER TENDL-2021 LIBRARY; T=293.6K
Particle production cross sections

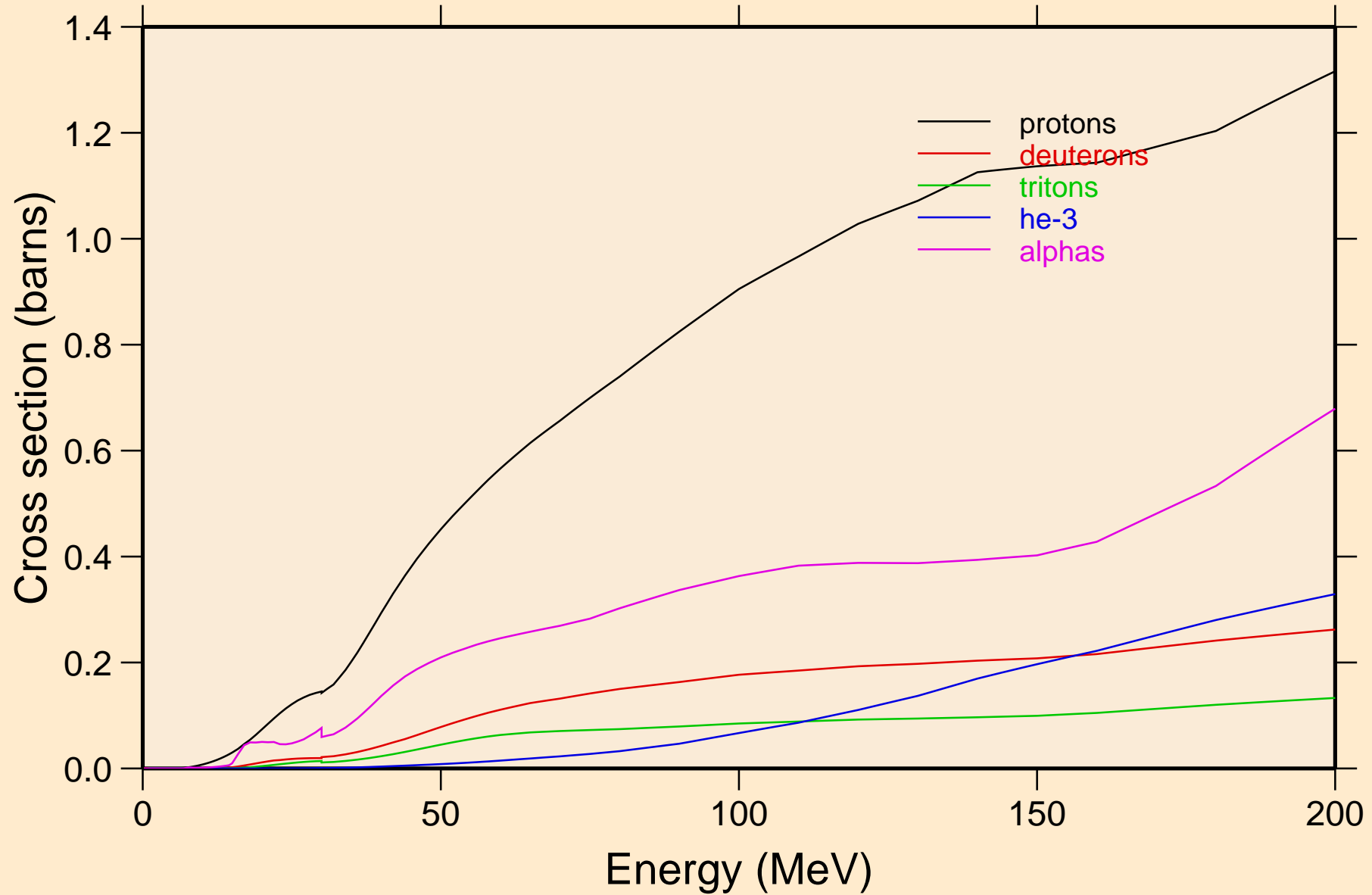

PA226 NEUTRON ACER TENDL-2021 LIBRARY; T=293.6K
protons from (n,x)

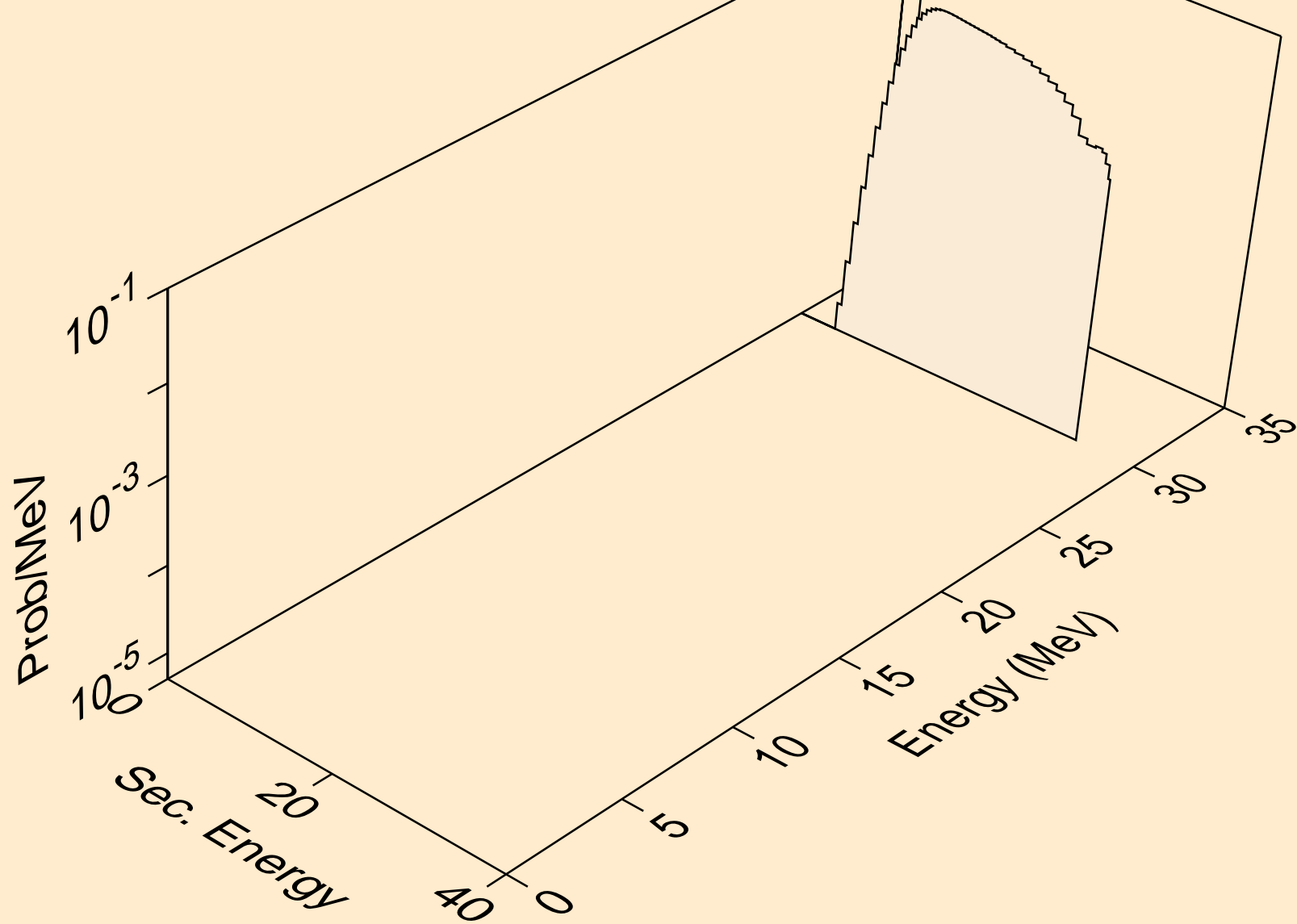

PA226 NEUTRON ACER TENDL-2021 LIBRARY; T=293.6K
protons from (n,n*)p

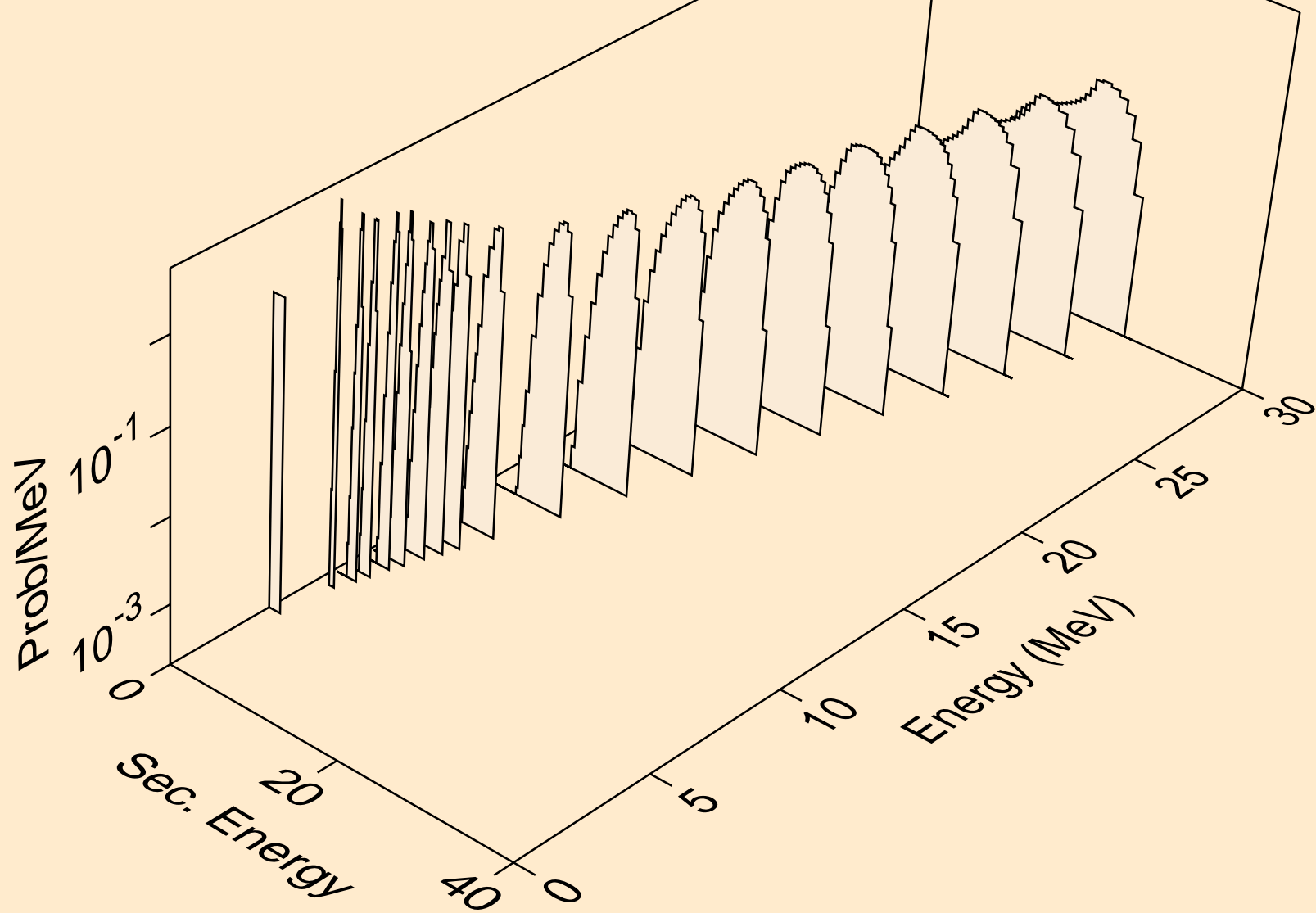

PA226 NEUTRON ACER TENDL-2021 LIBRARY; T=293.6K
protons from (n,2np)

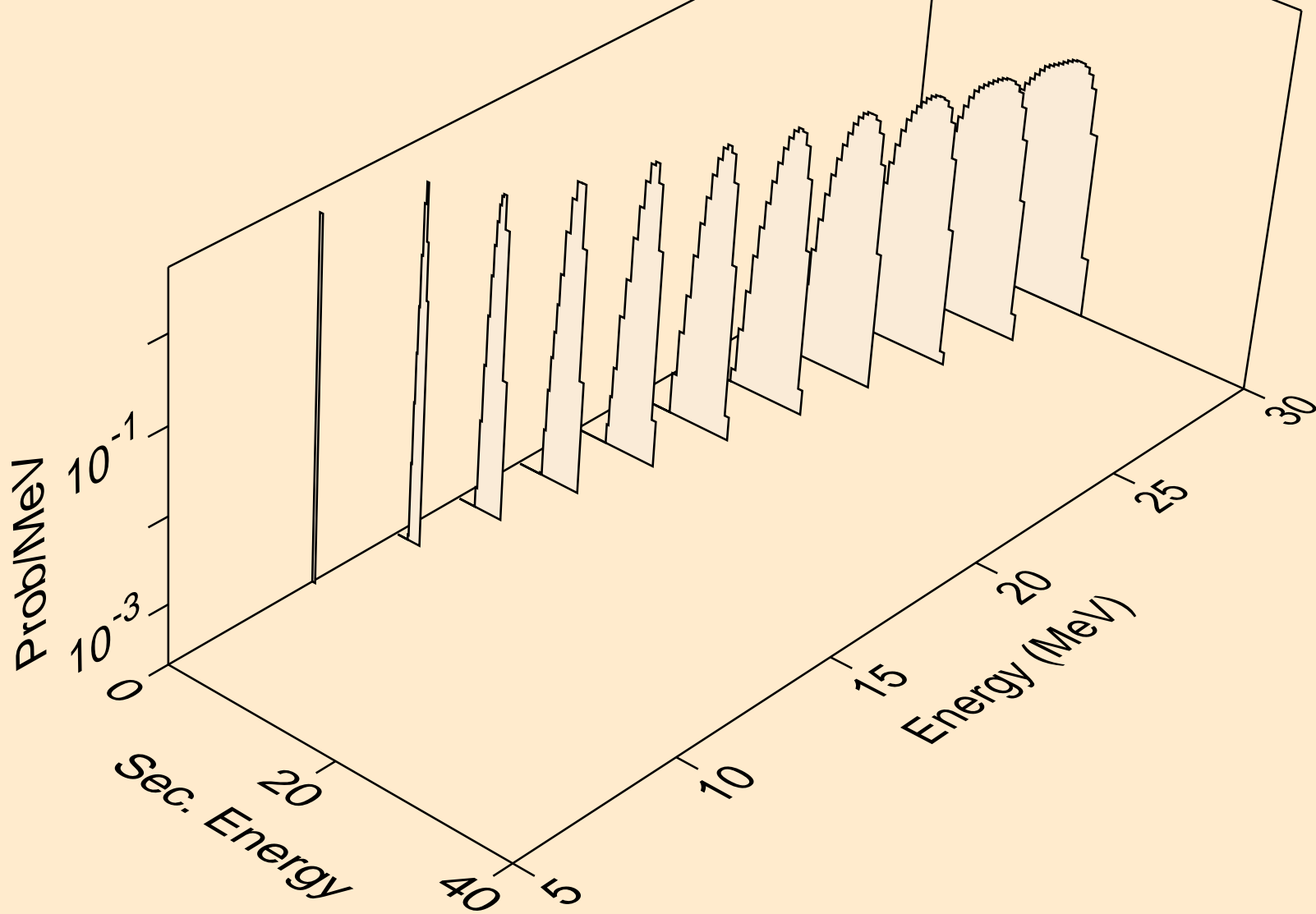

PA226 NEUTRON ACER TENDL-2021 LIBRARY; T=293.6K
protons from (n,3np)

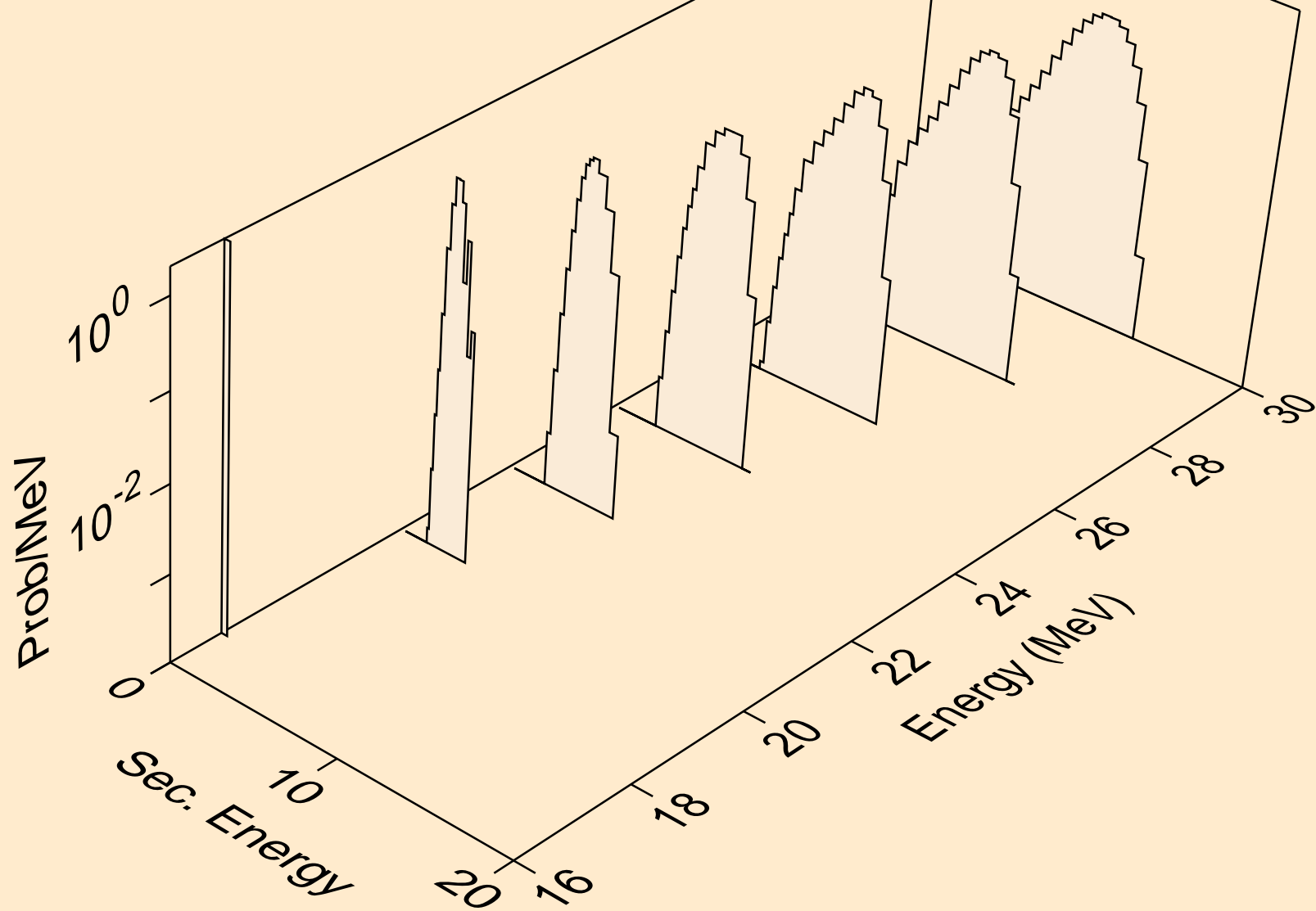

PA226 NEUTRON ACER TENDL-2021 LIBRARY; T=293.6K
protons from (n,2np)

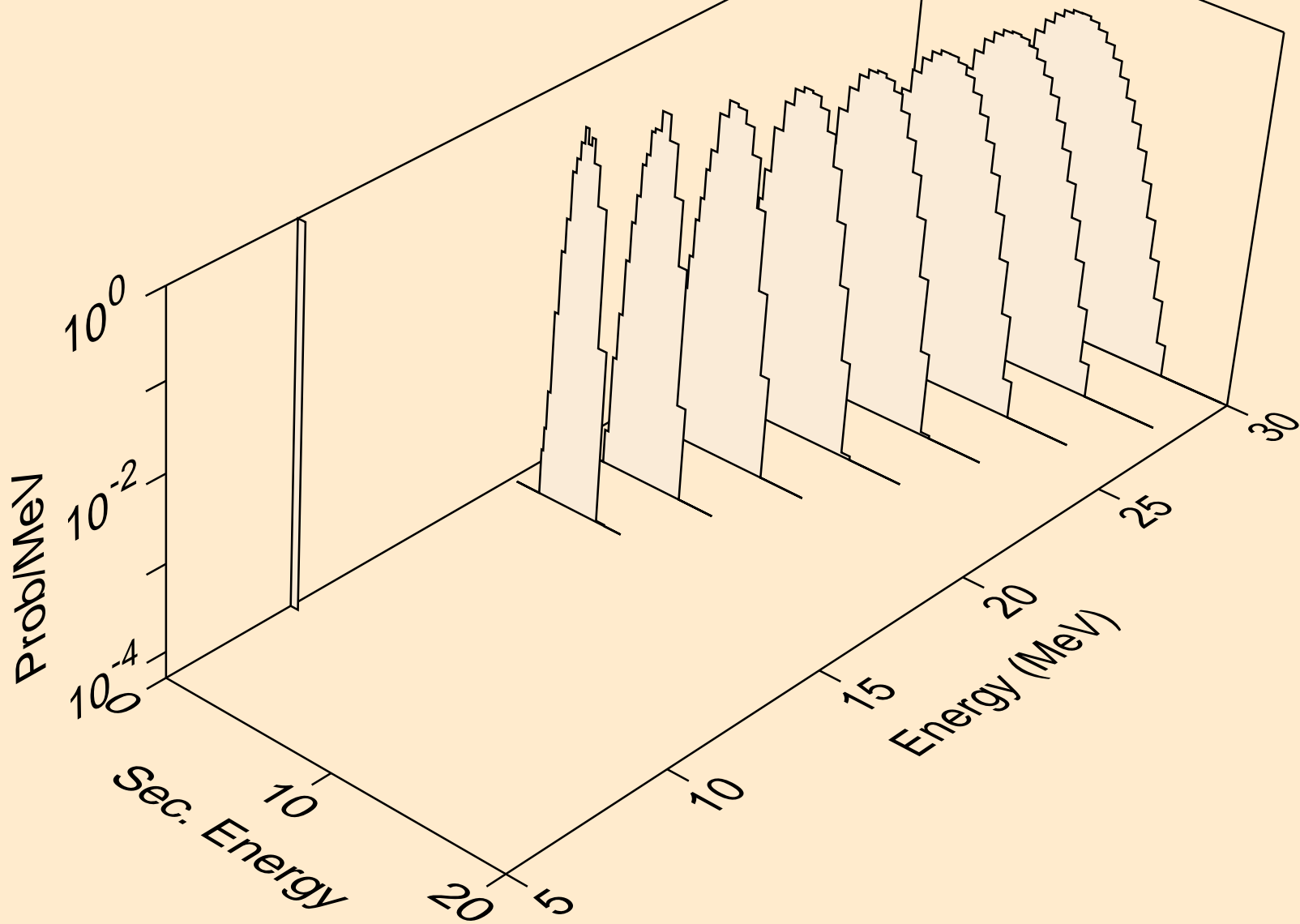

PA226 NEUTRON ACER TENDL-2021 LIBRARY; T=293.6K
protons from (n,npa)

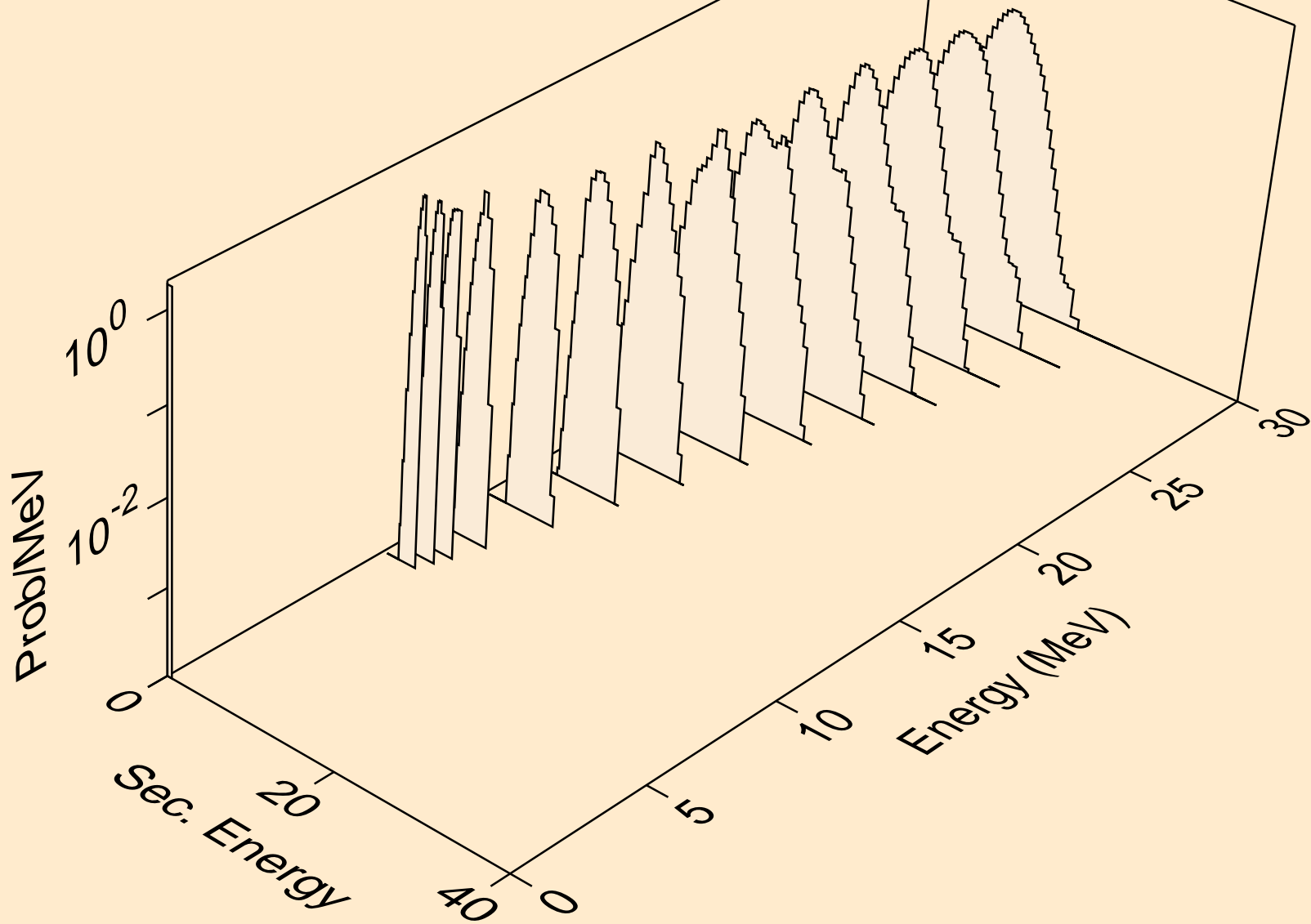

PA226 NEUTRON ACER TENDL-2021 LIBRARY; T=293.6K
protons from (n,p)

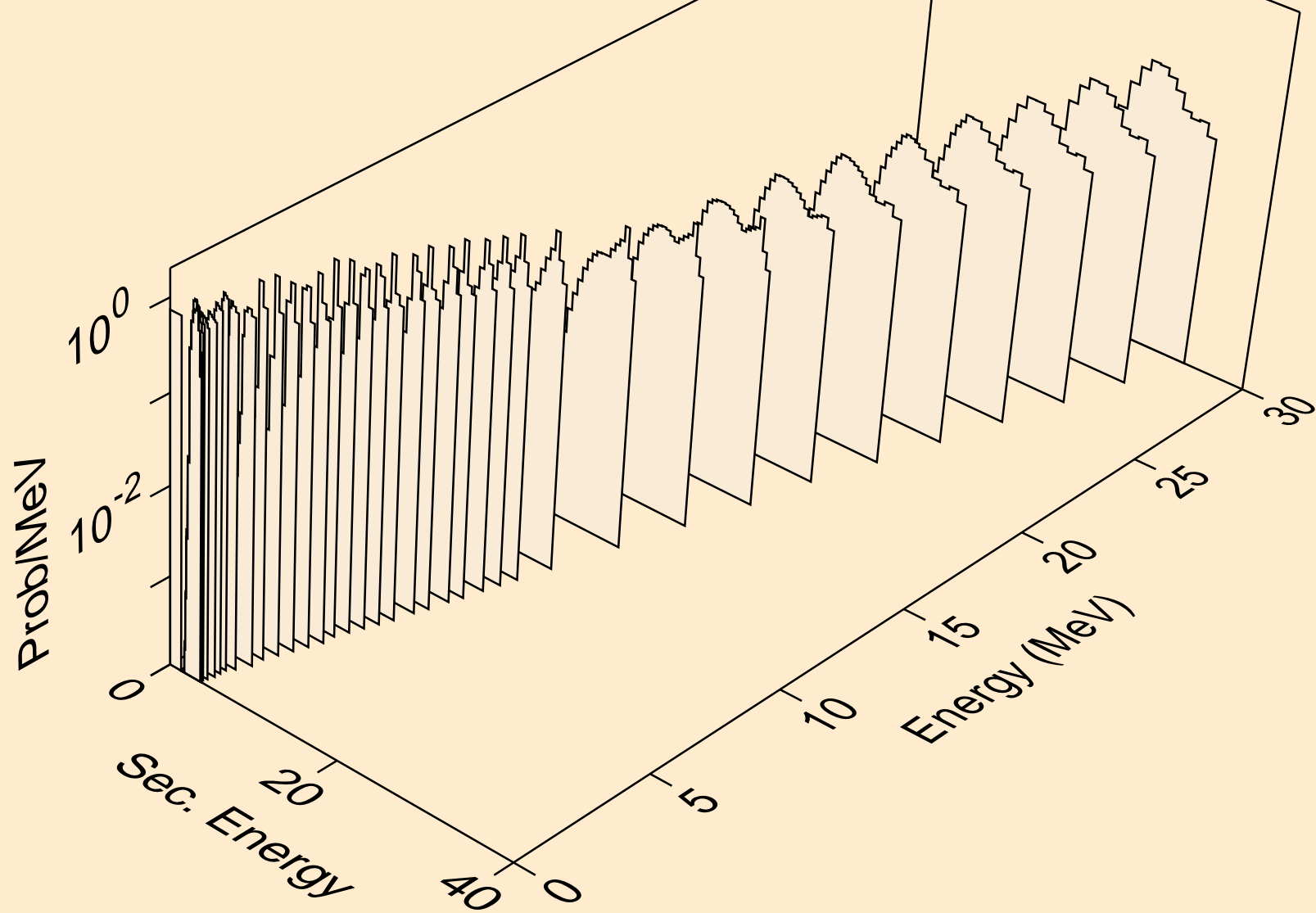

PA226 NEUTRON ACER TENDL-2021 LIBRARY; T=293.6K
protons from (n,2p)

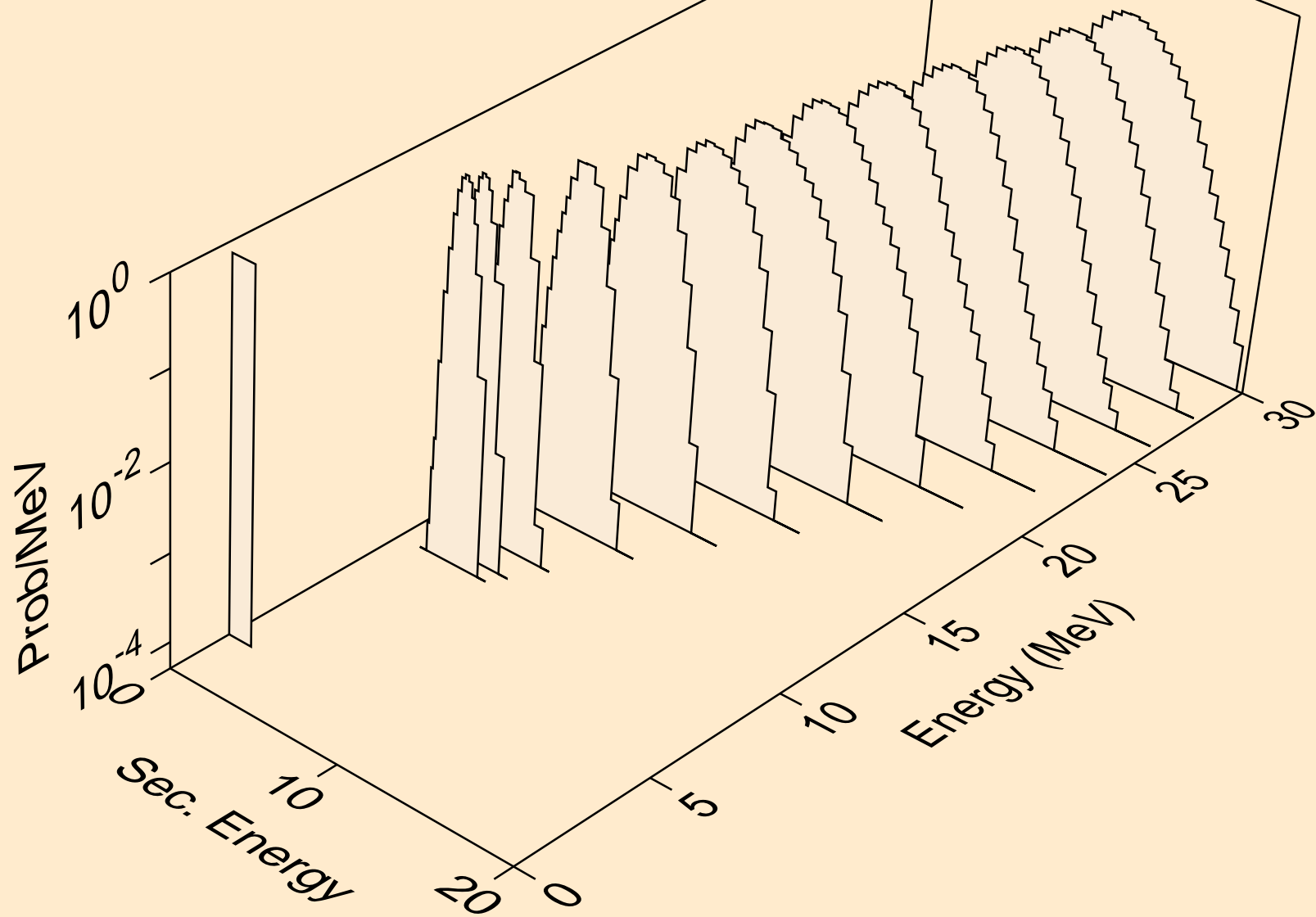

PA226 NEUTRON ACER TENDL-2021 LIBRARY; T=293.6K
protons from (n,pa)

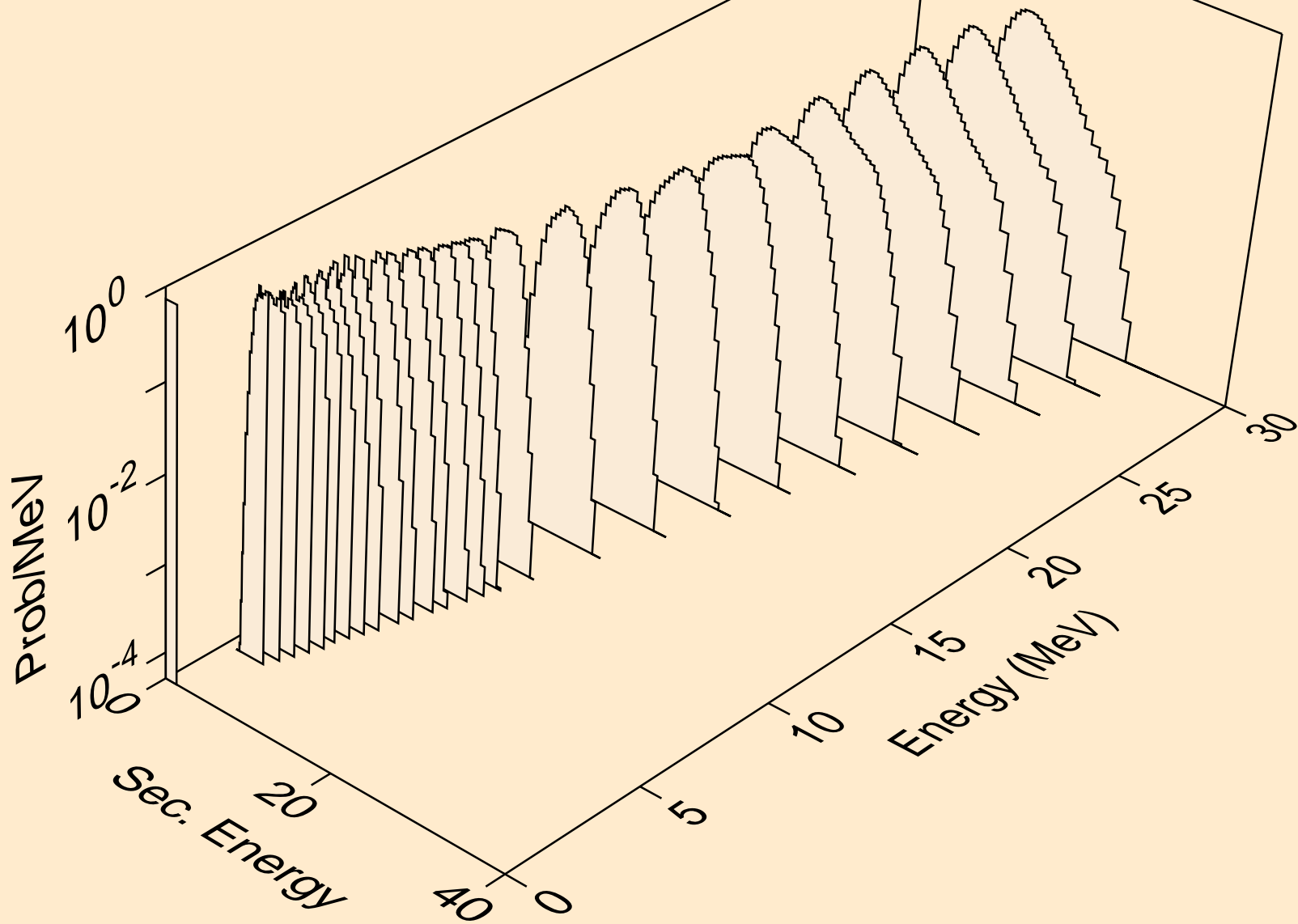

PA226 NEUTRON ACER TENDL-2021 LIBRARY; T=293.6K
protons from (n,pd)

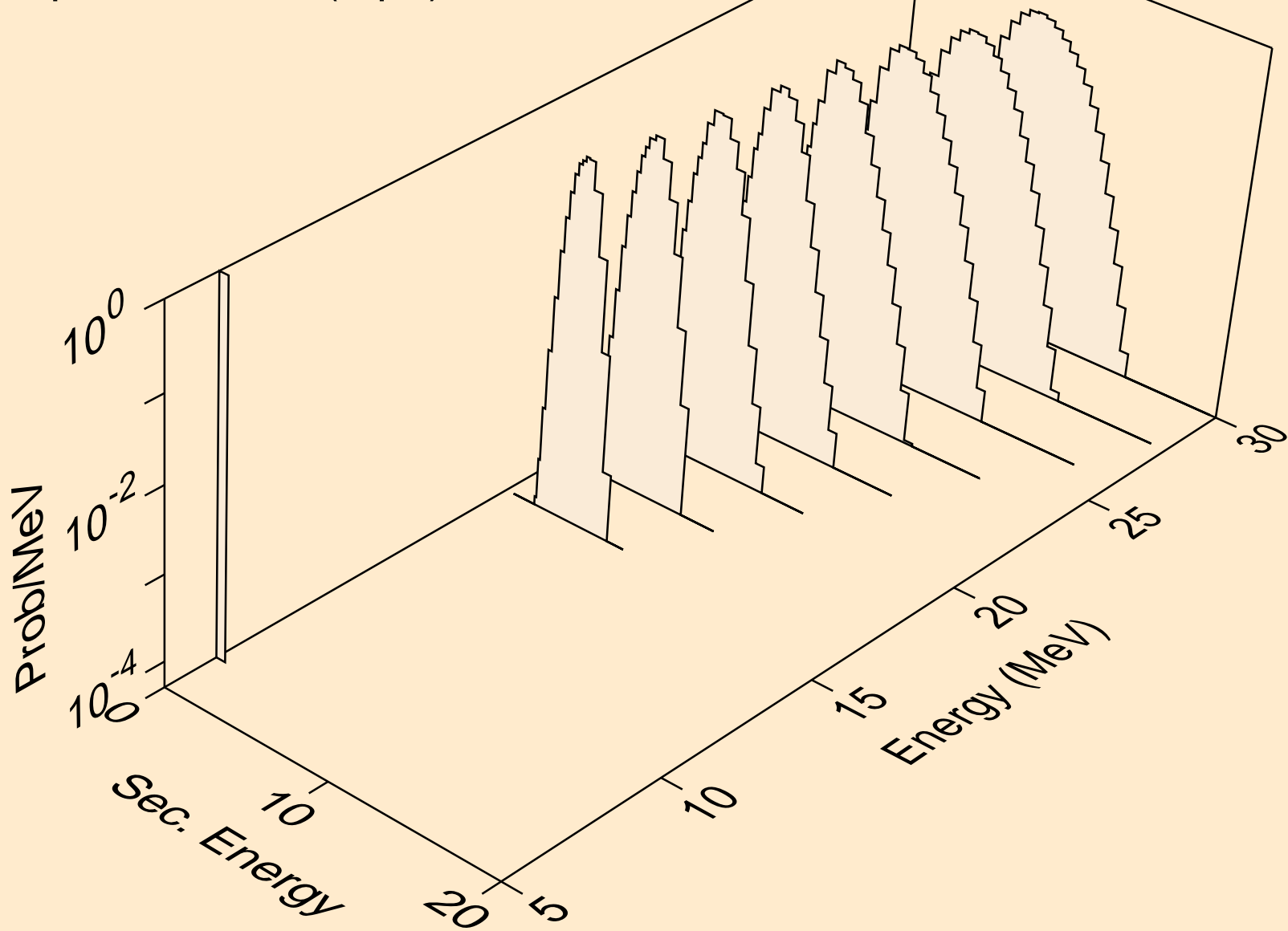

PA226 NEUTRON ACER TENDL-2021 LIBRARY; T=293.6K
protons from (n,pt)

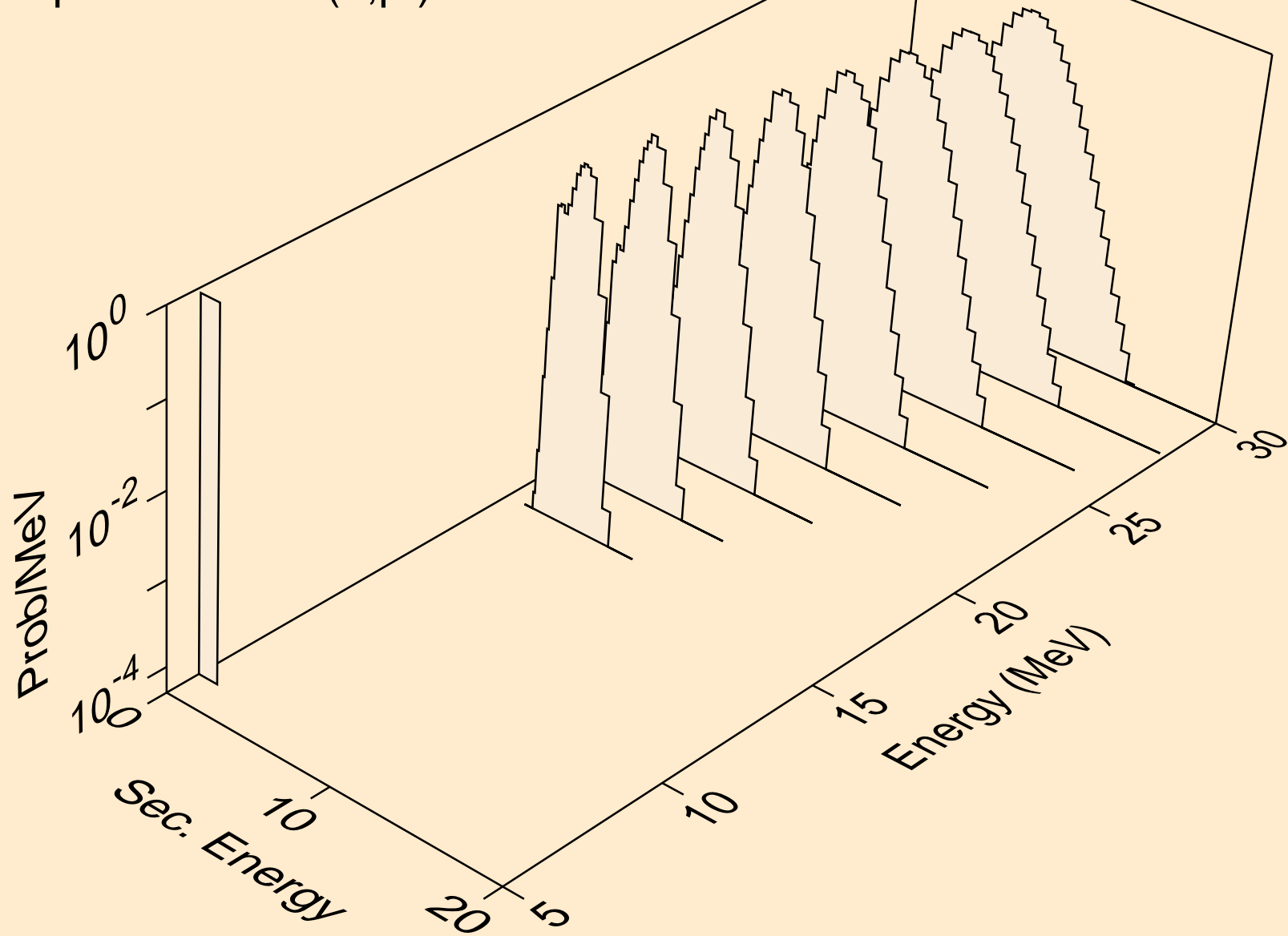

PA226 NEUTRON ACER TENDL-2021 LIBRARY; T=293.6K
deuterons from (n,x)

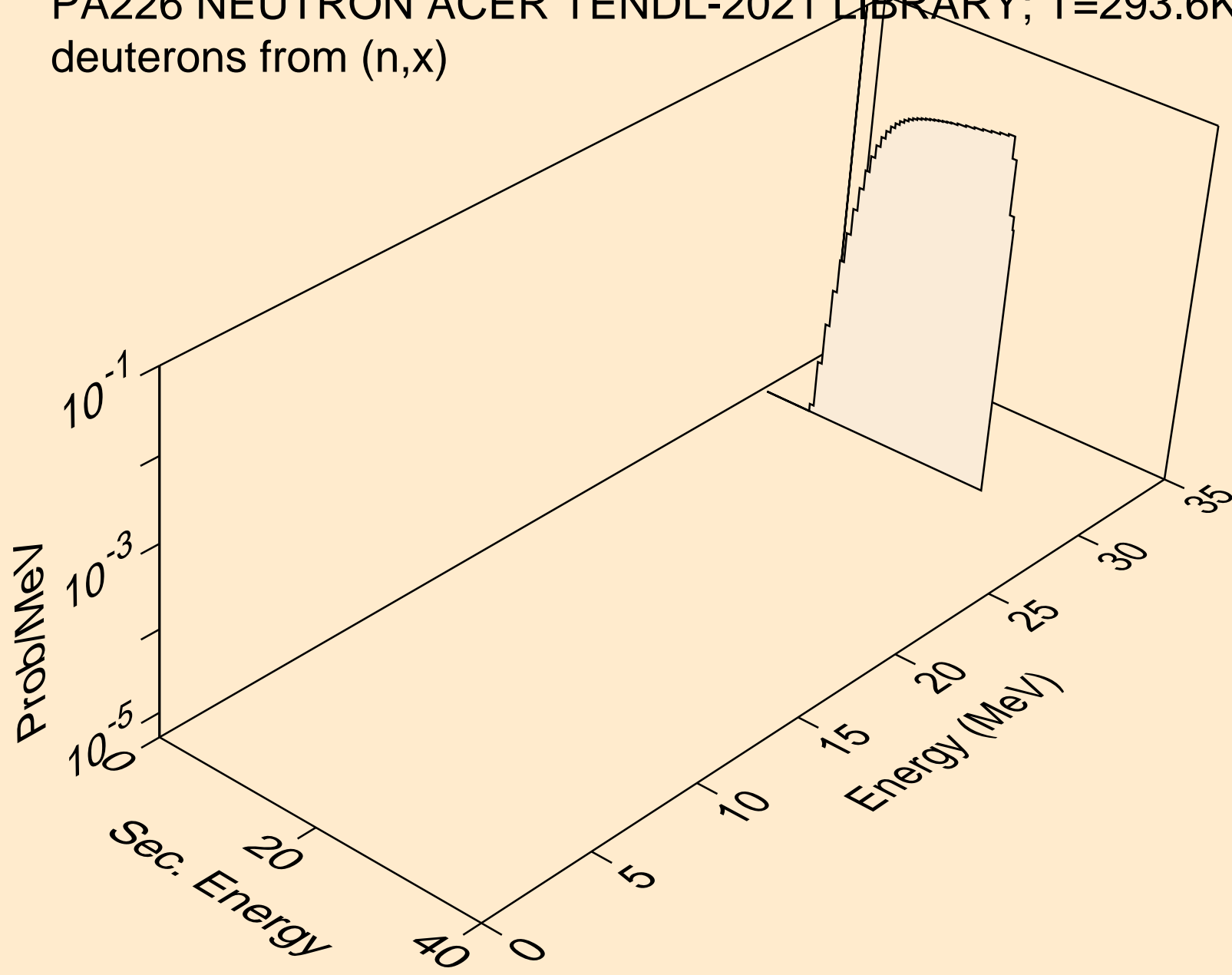

PA226 NEUTRON ACER TENDL-2021 LIBRARY; T=293.6K
deuterons from (n,2nd)

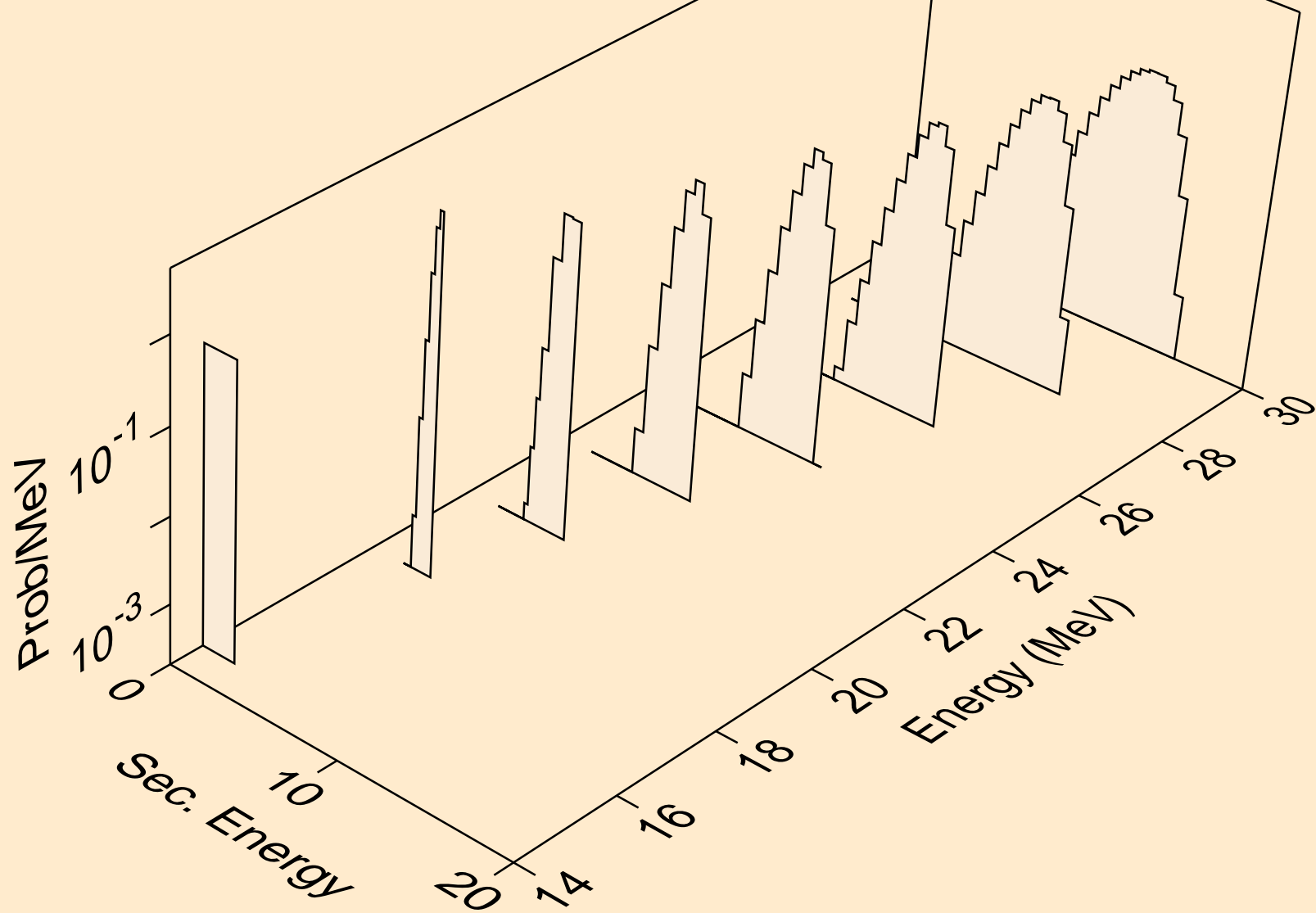

PA226 NEUTRON ACER TENDL-2021 LIBRARY; T=293.6K
deuterons from (n,n*)d

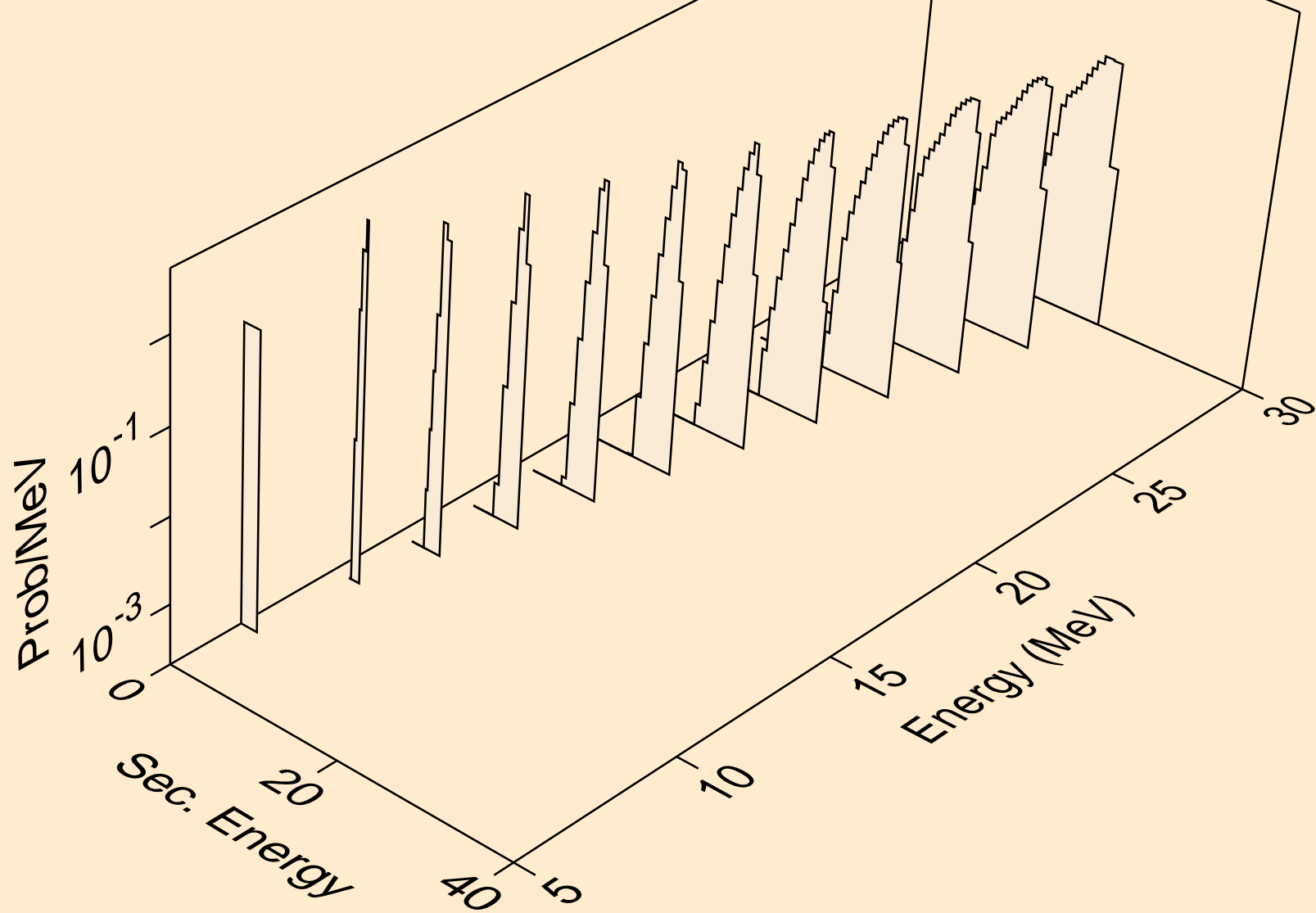

PA226 NEUTRON ACER TENDL-2021 LIBRARY; T=293.6K
deuterons from (n,d)

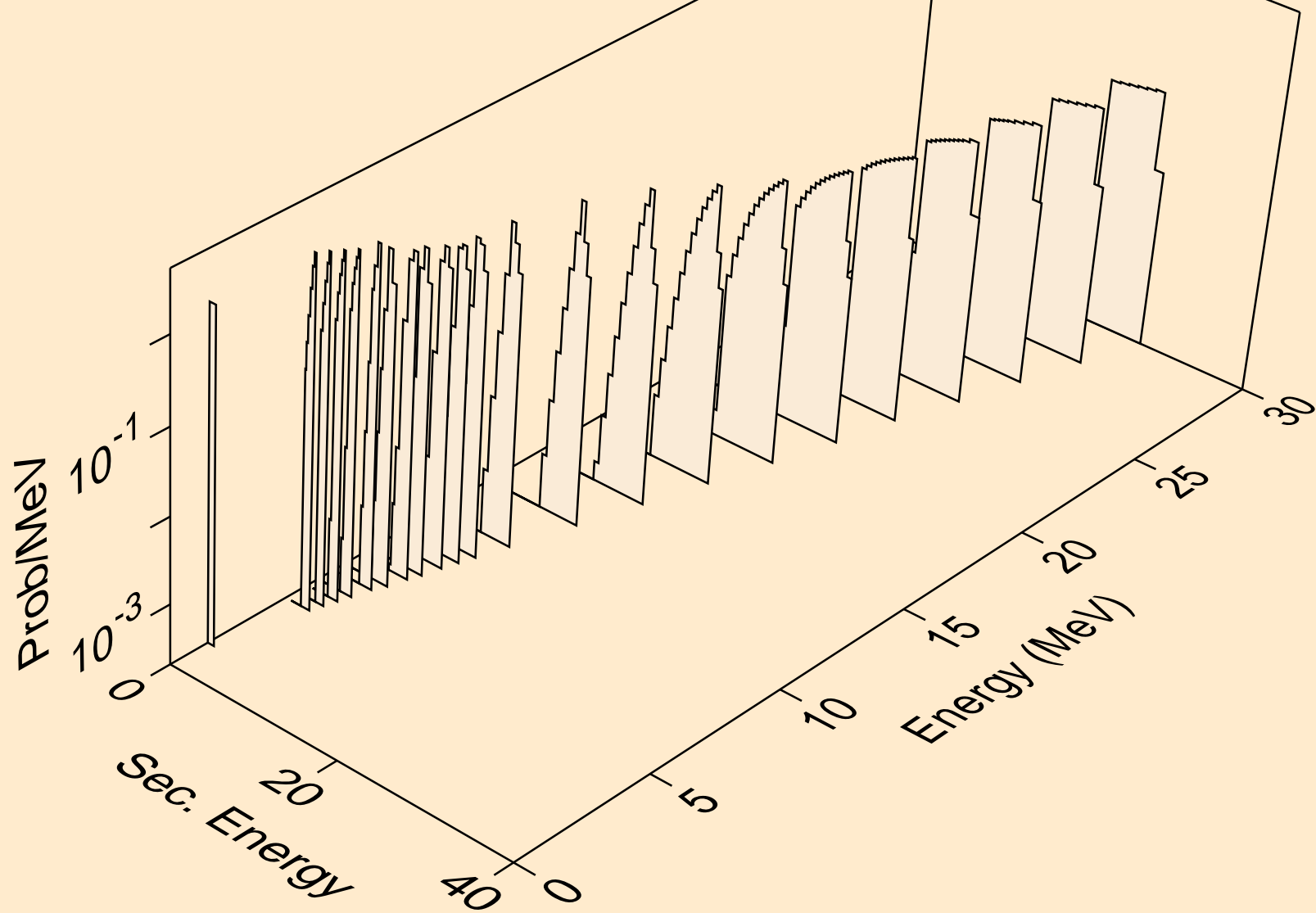

PA226 NEUTRON ACER TENDL-2021 LIBRARY; T=293.6K
deuterons from (n,pd)

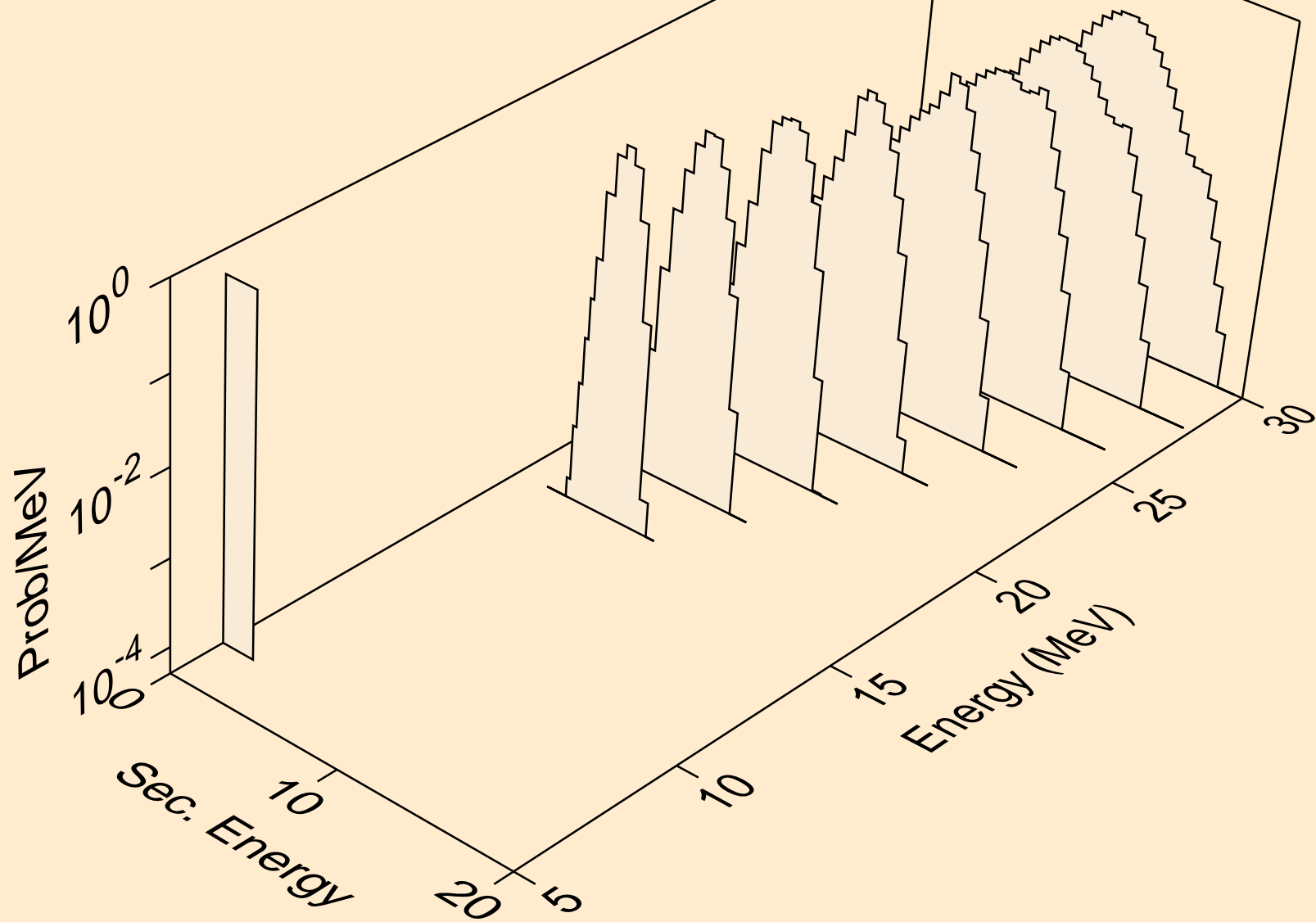

PA226 NEUTRON ACER TENDL-2021 LIBRARY; T=293.6K
deuterons from (n,da)

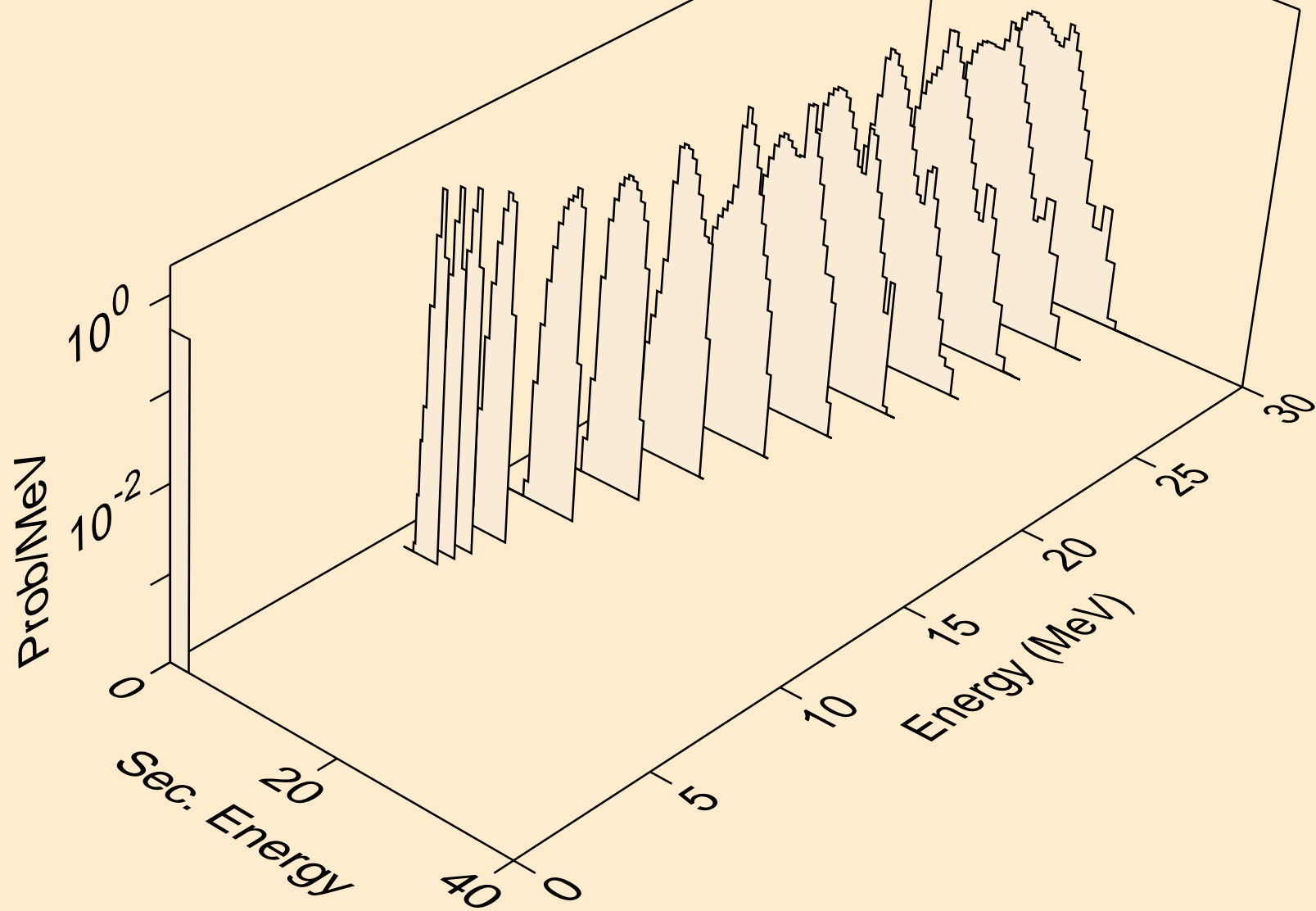

PA226 NEUTRON ACER TENDL-2021 LIBRARY; T=293.6K
tritons from (n,x)

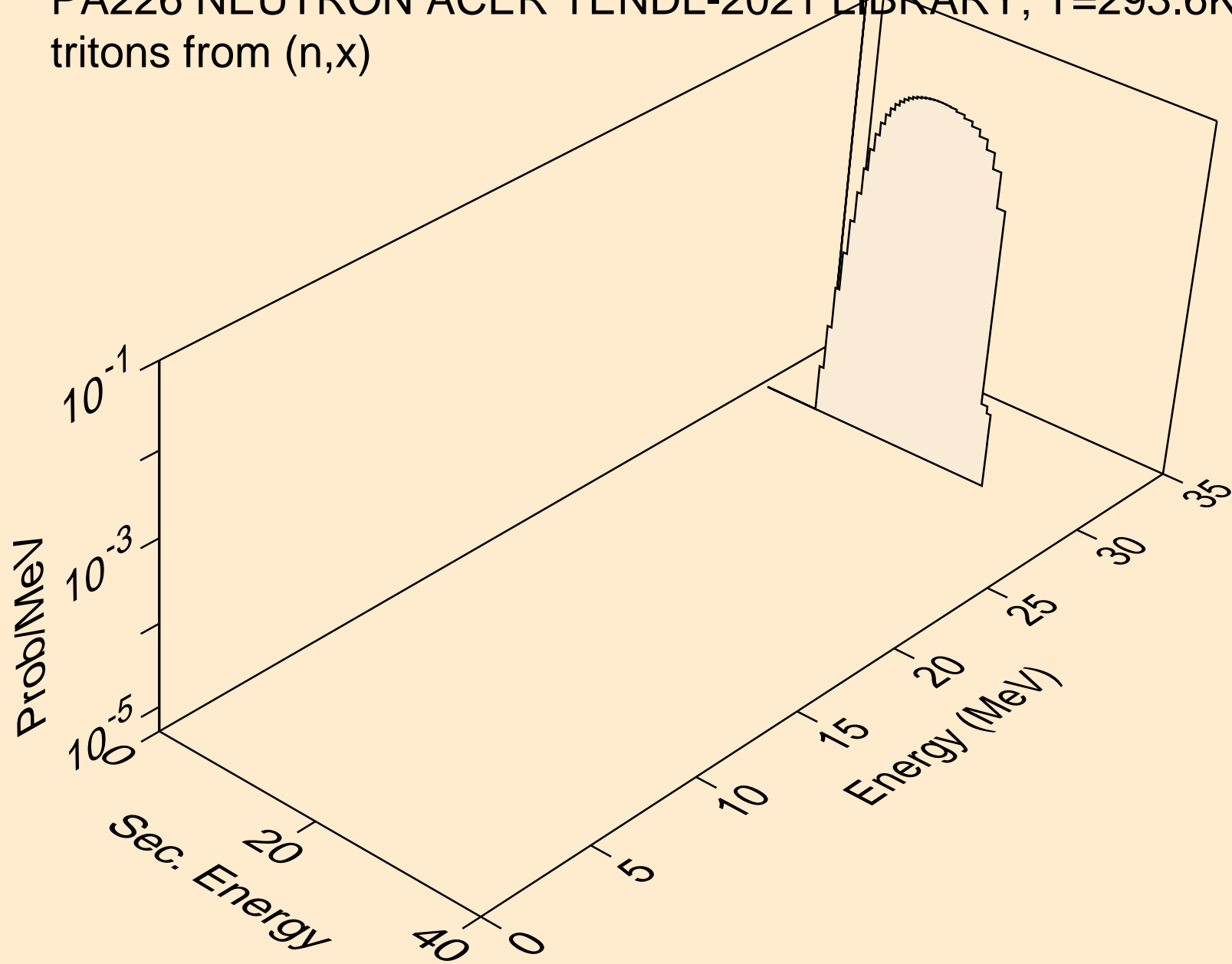

PA226 NEUTRON ACER TENDL-2021 LIBRARY; T=293.6K
tritons from (n,n*)t

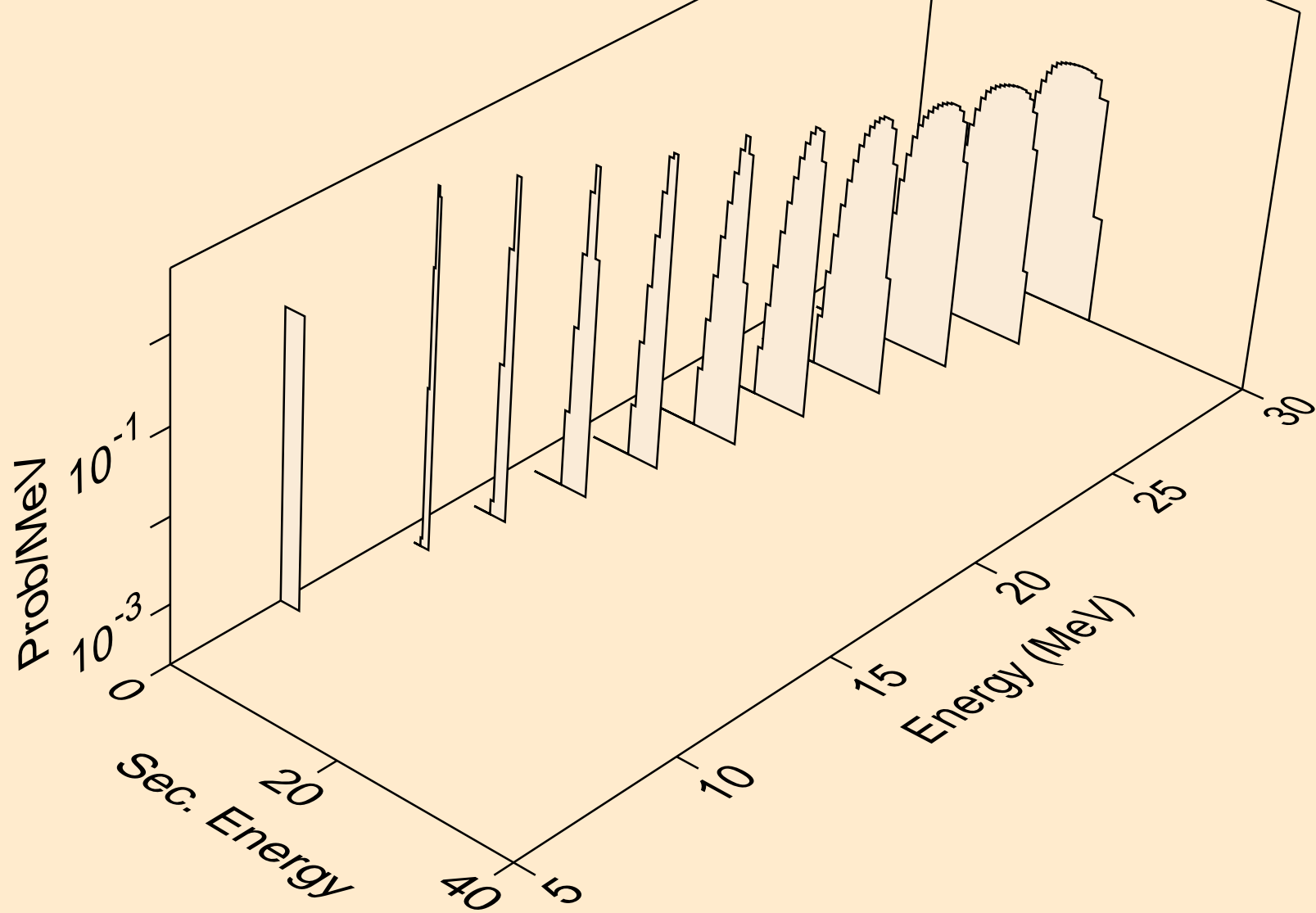

PA226 NEUTRON ACER TENDL-2021 LIBRARY; T=293.6K
tritons from (n,t)

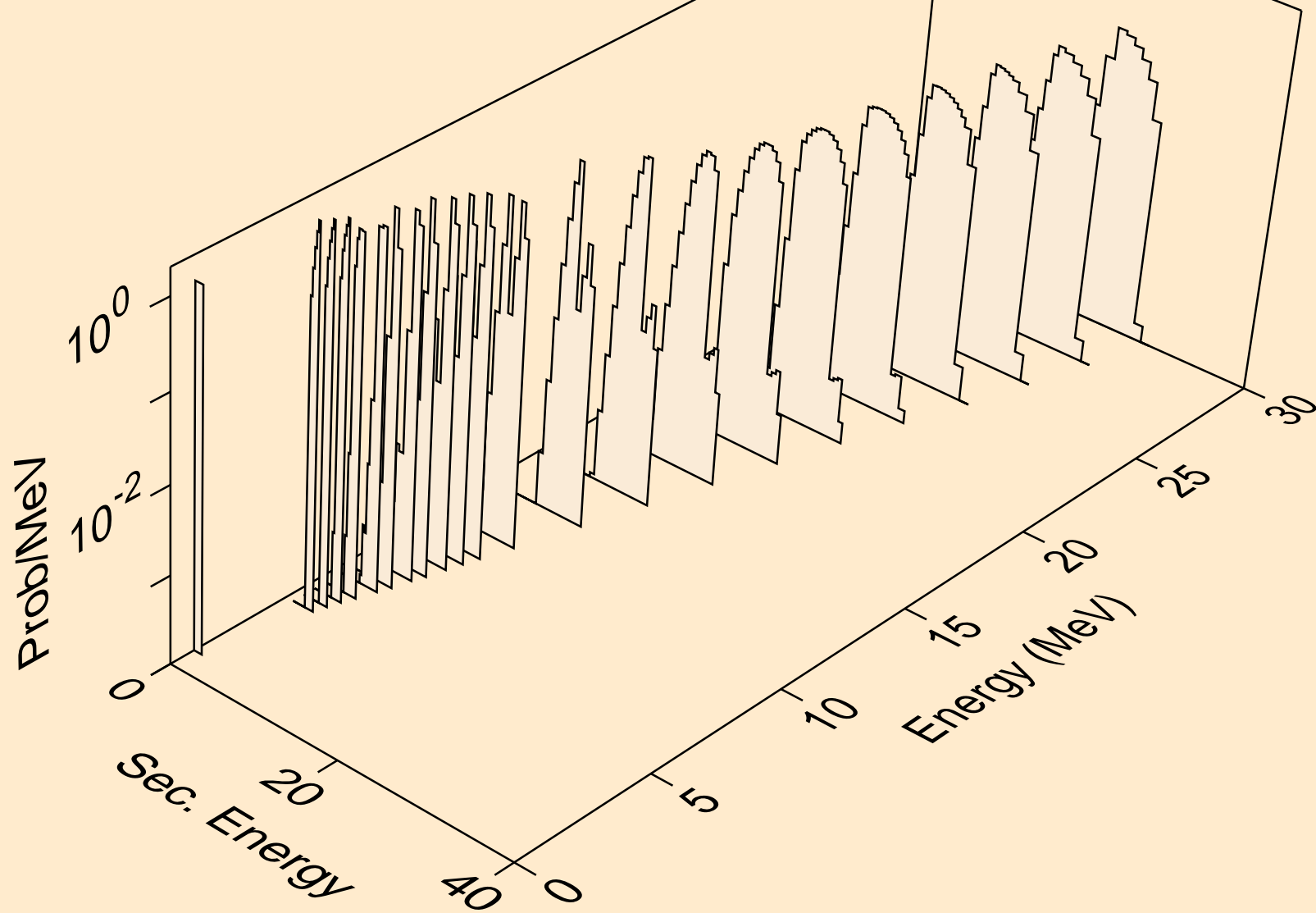

PA226 NEUTRON ACER TENDL-2021 LIBRARY; T=293.6K
tritons from (n,pt)

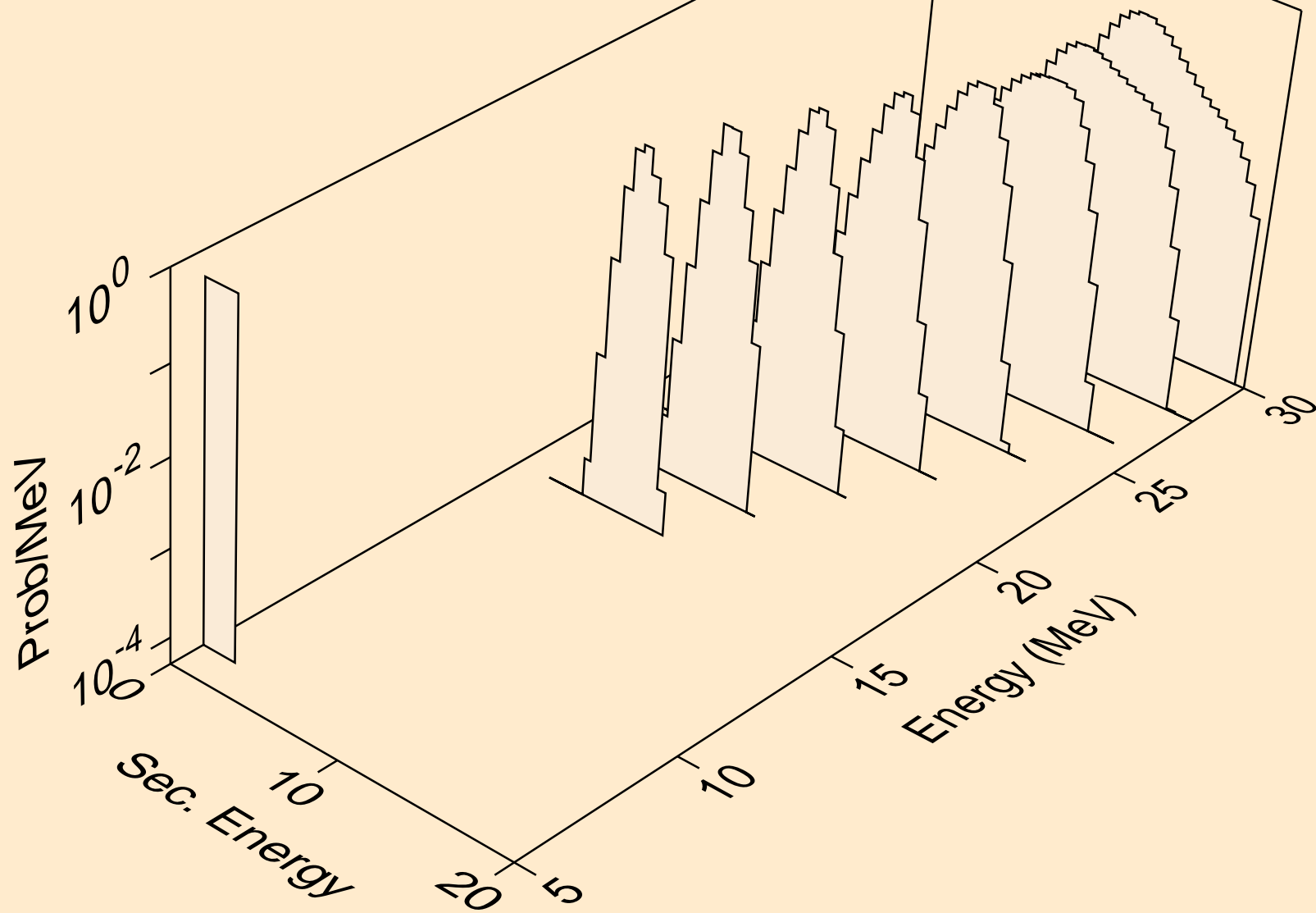

PA226 NEUTRON ACER TENDL-2021 LIBRARY; T=293.6K
he3s from (n,x)

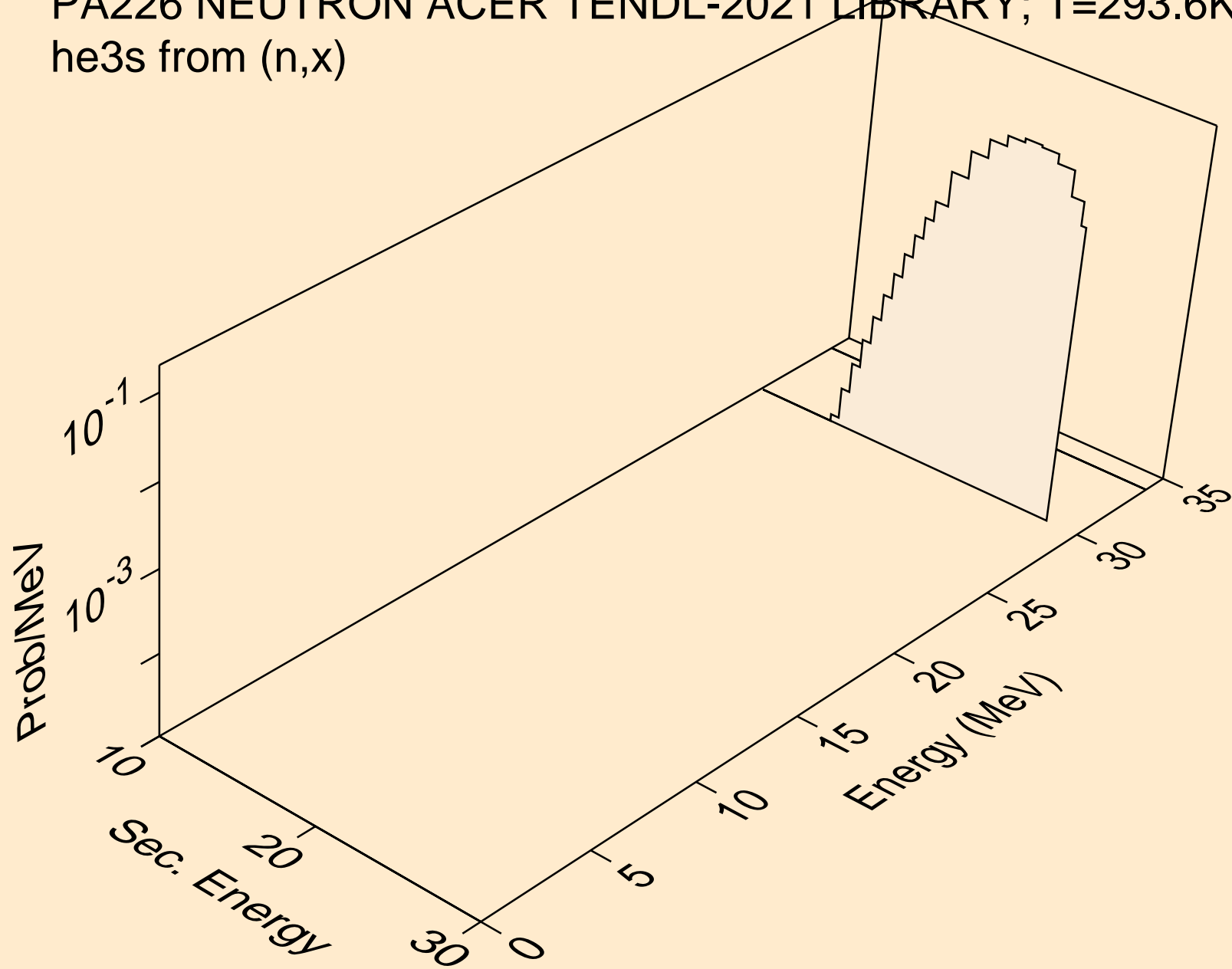

PA226 NEUTRON ACER TENDL-2021 LIBRARY; T=293.6K
he3s from (n,n*)he3

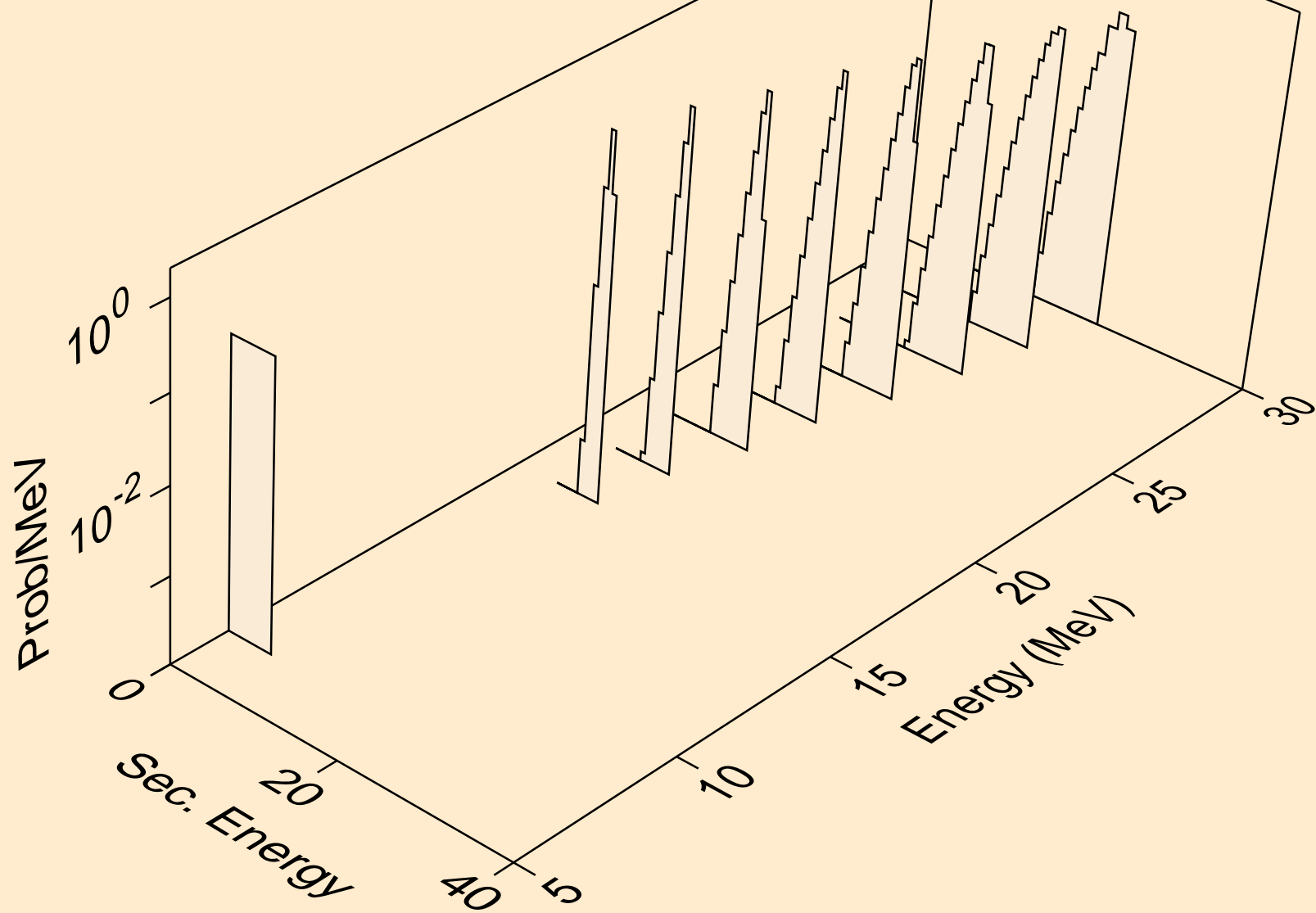

PA226 NEUTRON ACER TENDL-2021 LIBRARY; T=293.6K
he3s from (n,he3)

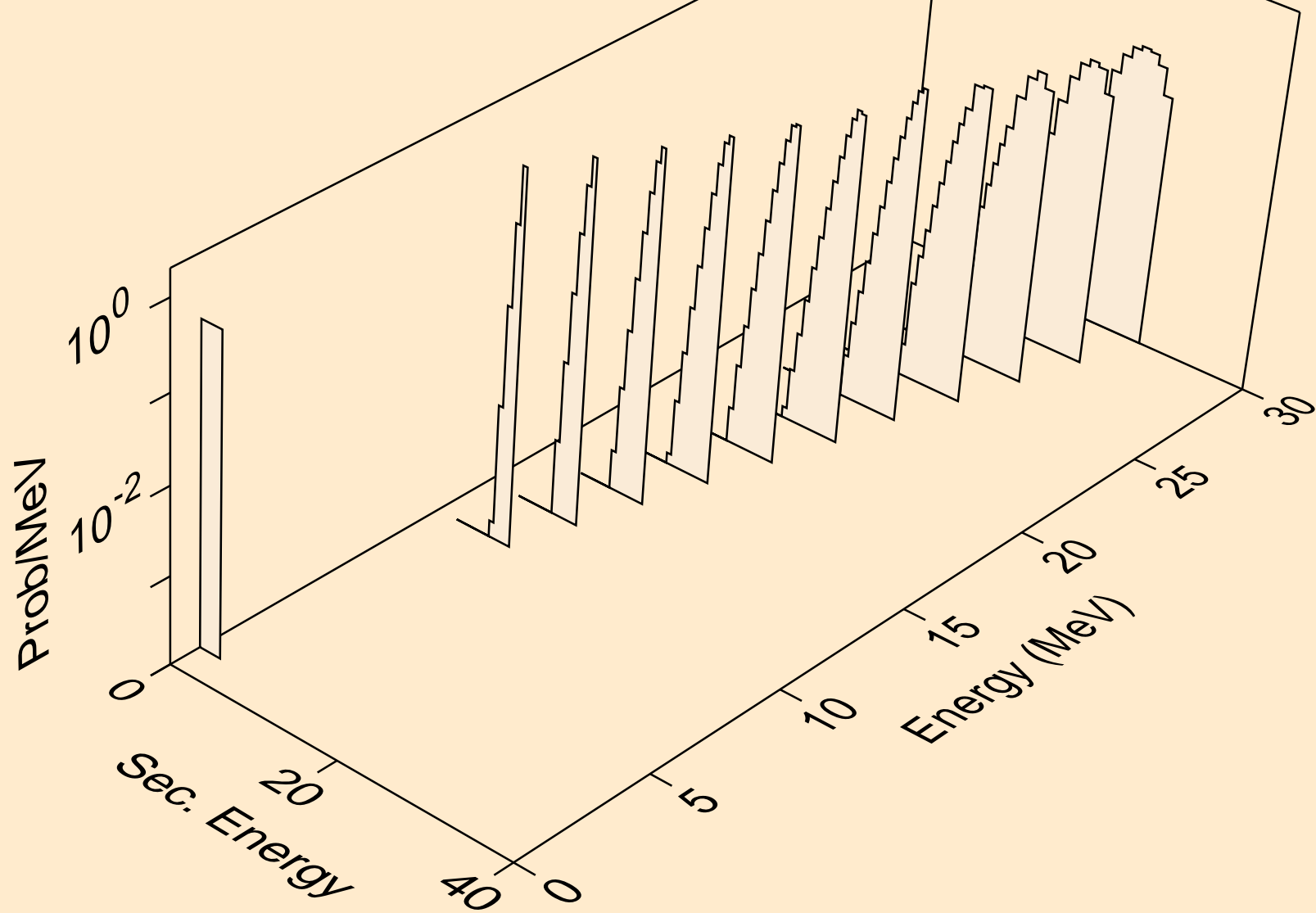

PA226 NEUTRON ACER TENDL-2021 LIBRARY; T=293.6K
alphas from (n,x)

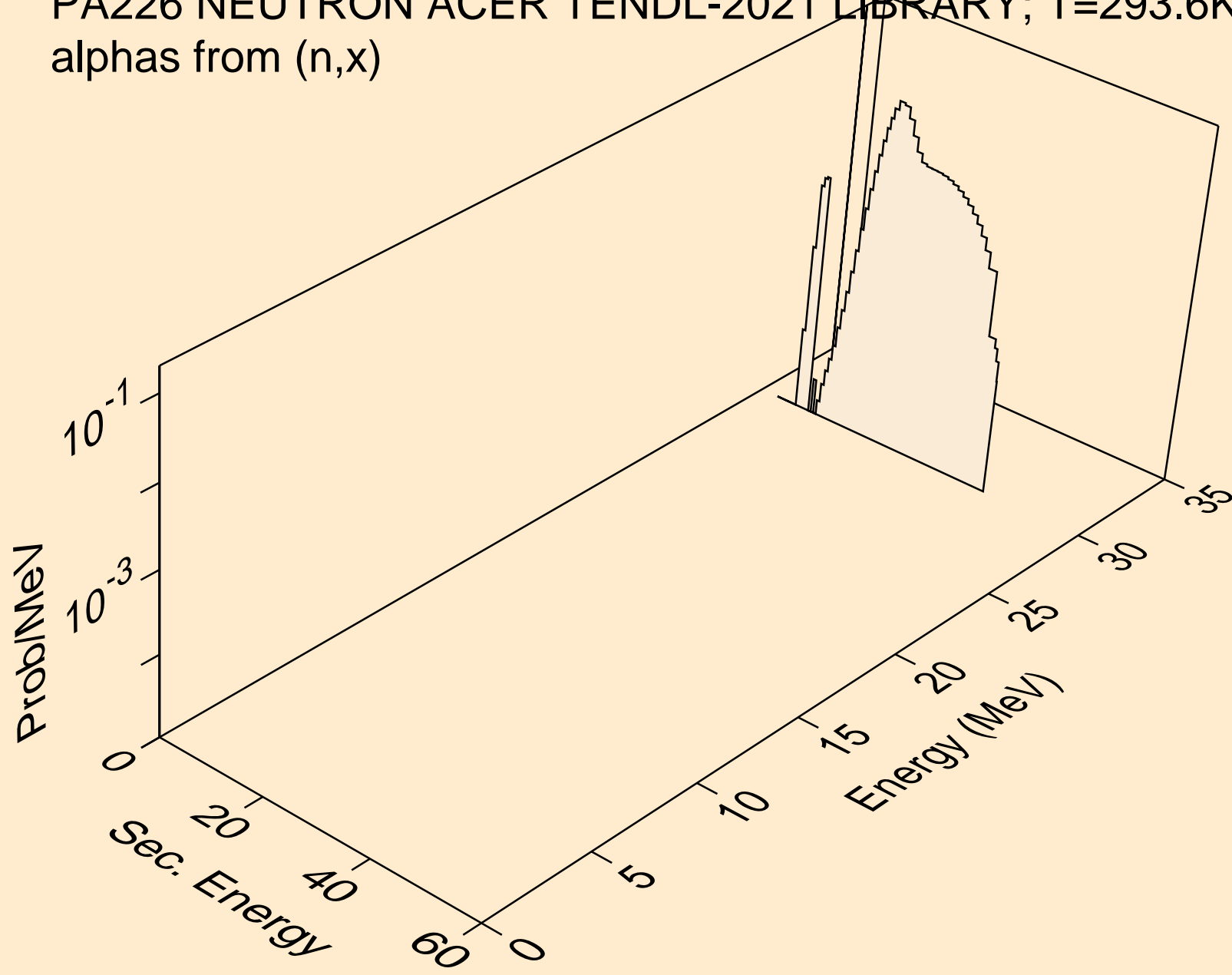

PA226 NEUTRON ACER TENDL-2021 LIBRARY; T=293.6K
alphas from (n,n*)a

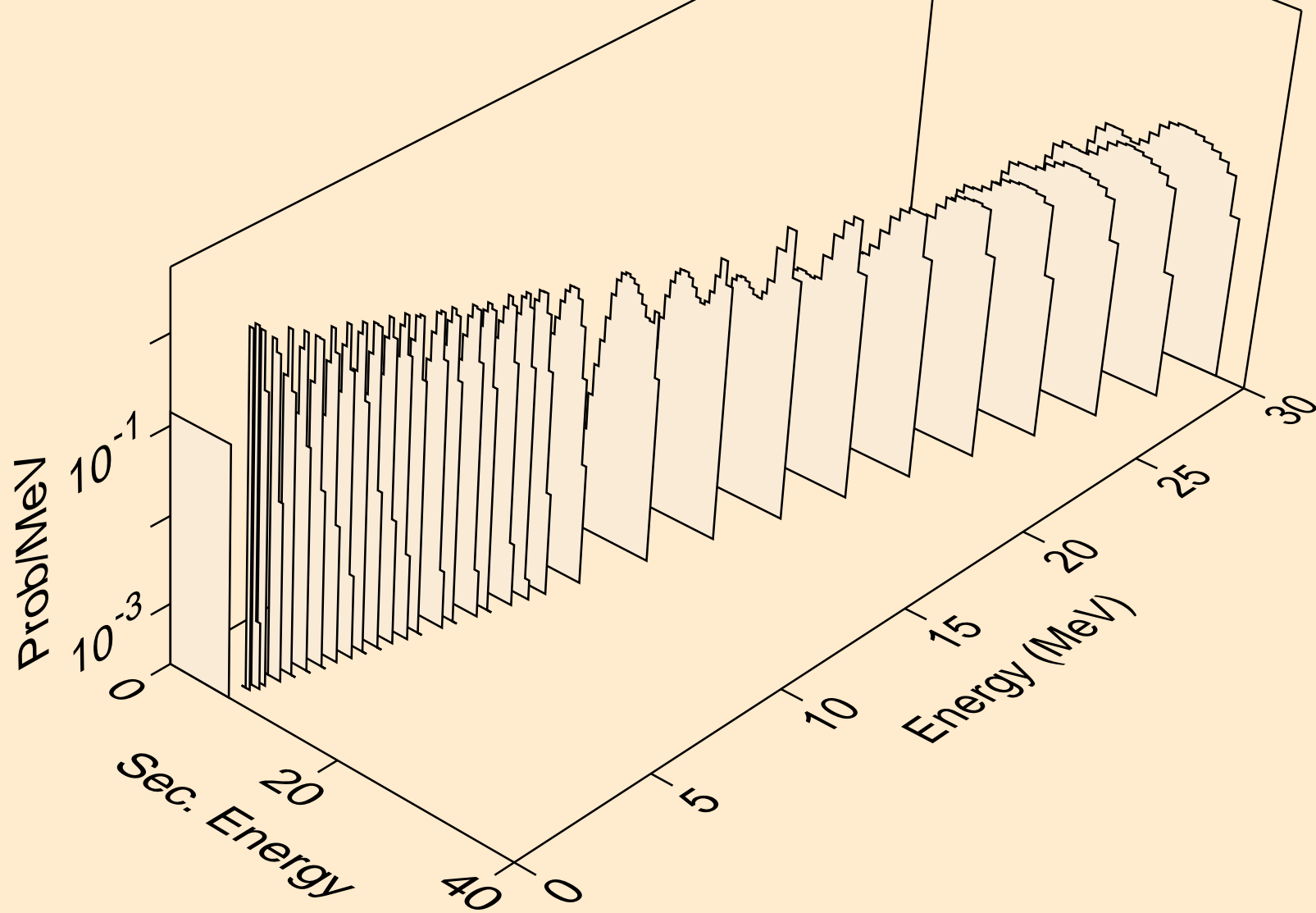

PA226 NEUTRON ACER TENDL-2021 LIBRARY; T=293.6K
alphas from (n,2n)a

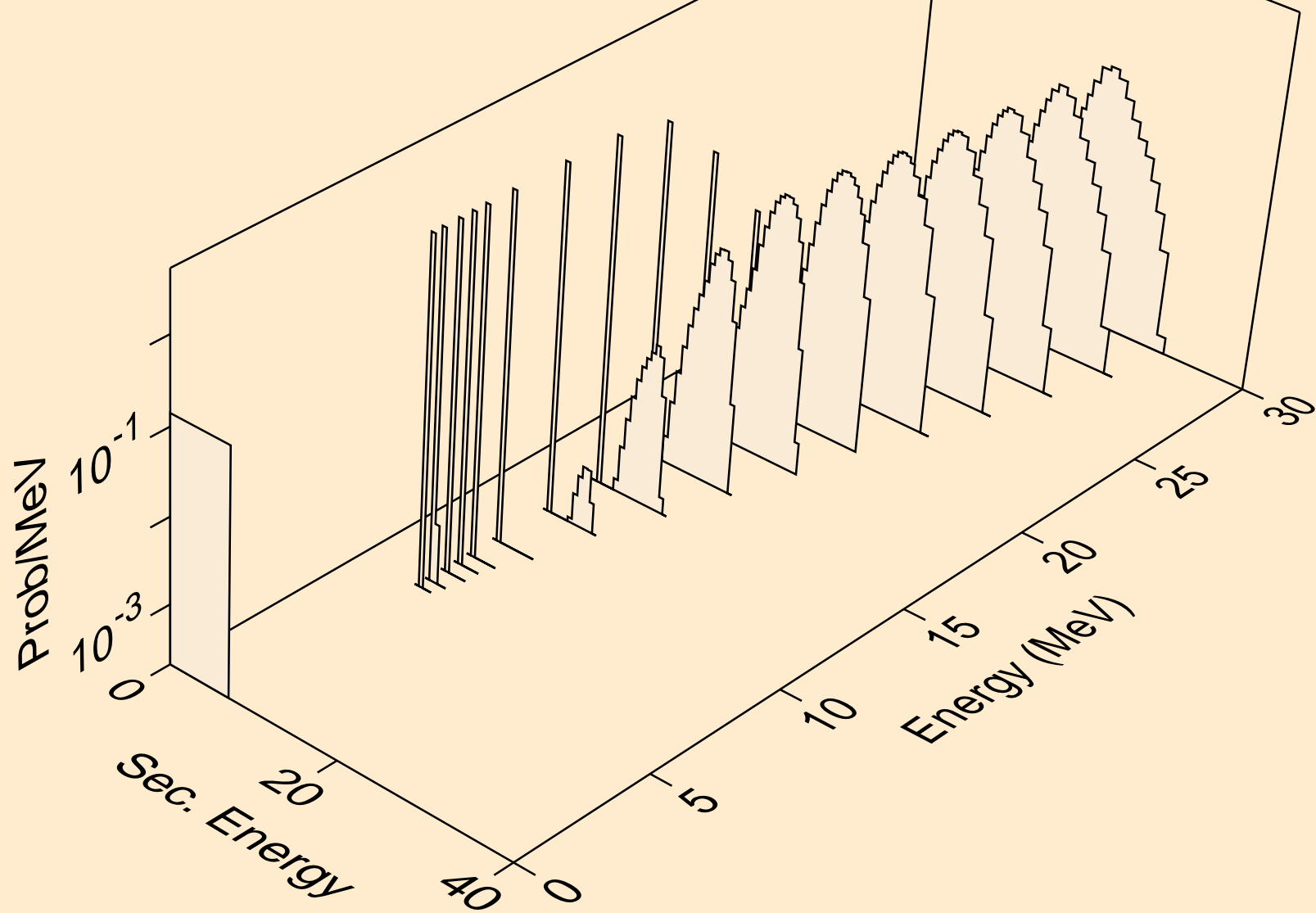

PA226 NEUTRON ACER TENDL-2021 LIBRARY; T=293.6K
alphas from (n,3n)a

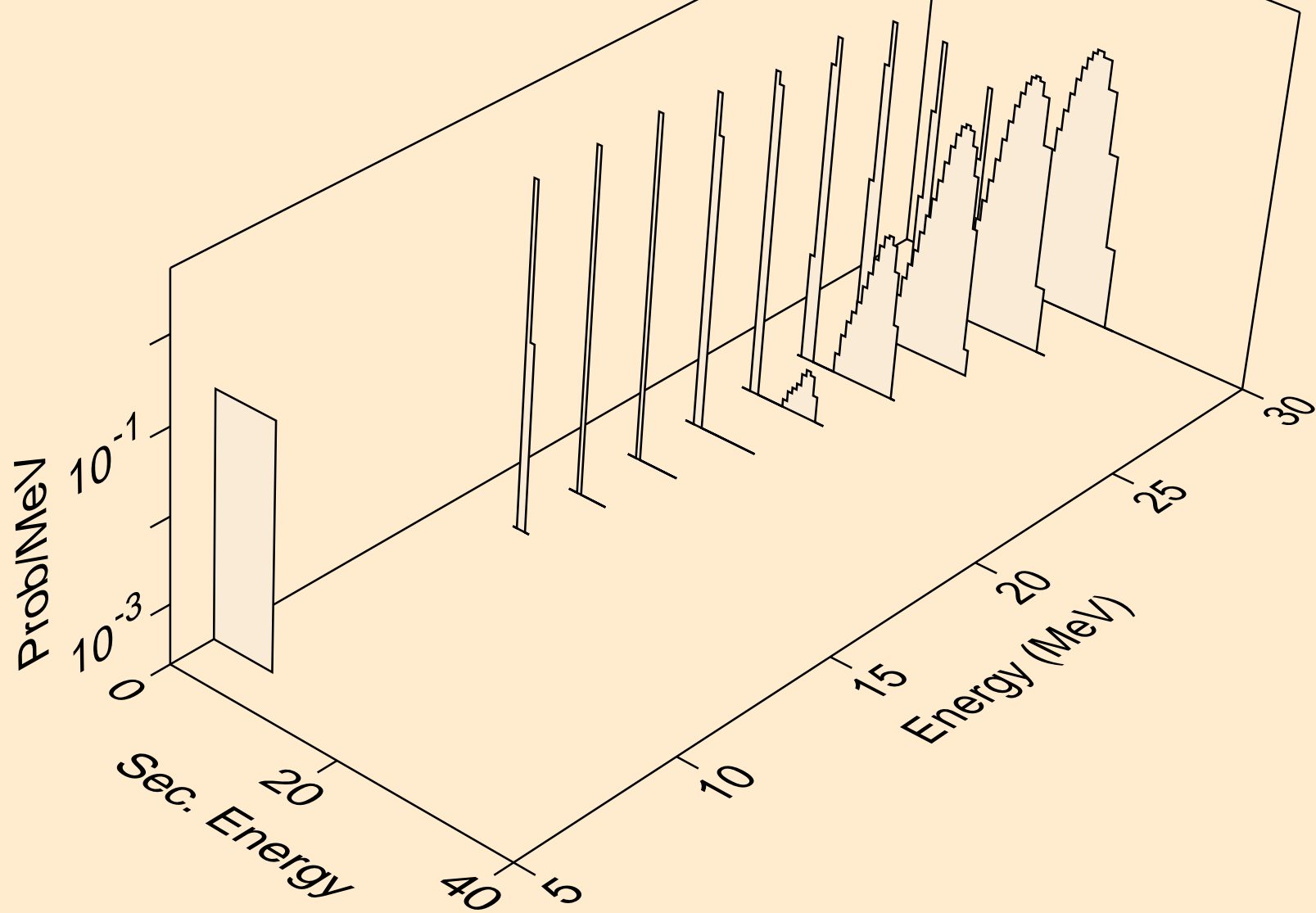

PA226 NEUTRON ACER TENDL-2021 LIBRARY; T=293.6K
alphas from (n,n*)2a

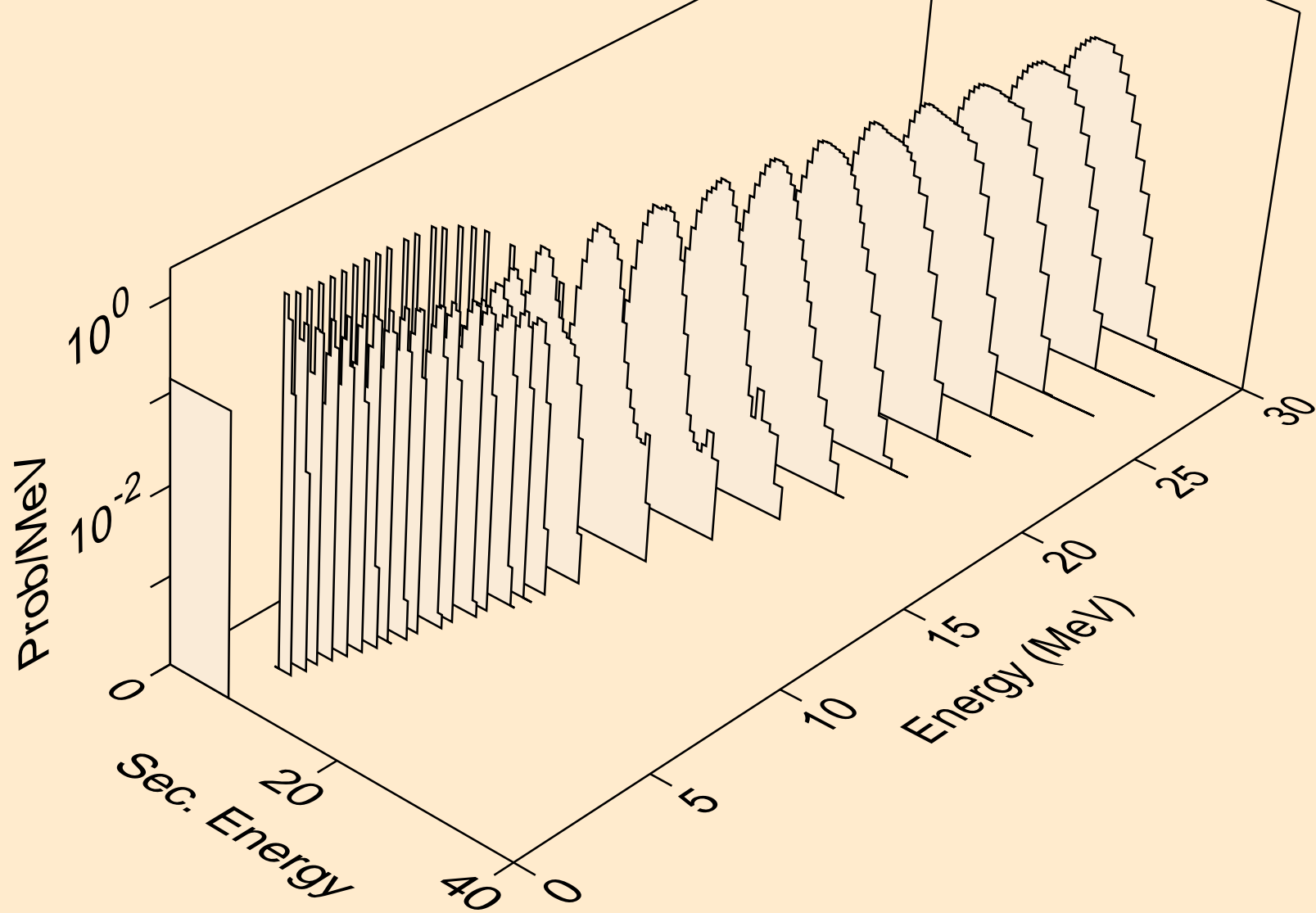

PA226 NEUTRON ACER TENDL-2021 LIBRARY; T=293.6K
alphas from (n,2n)2a

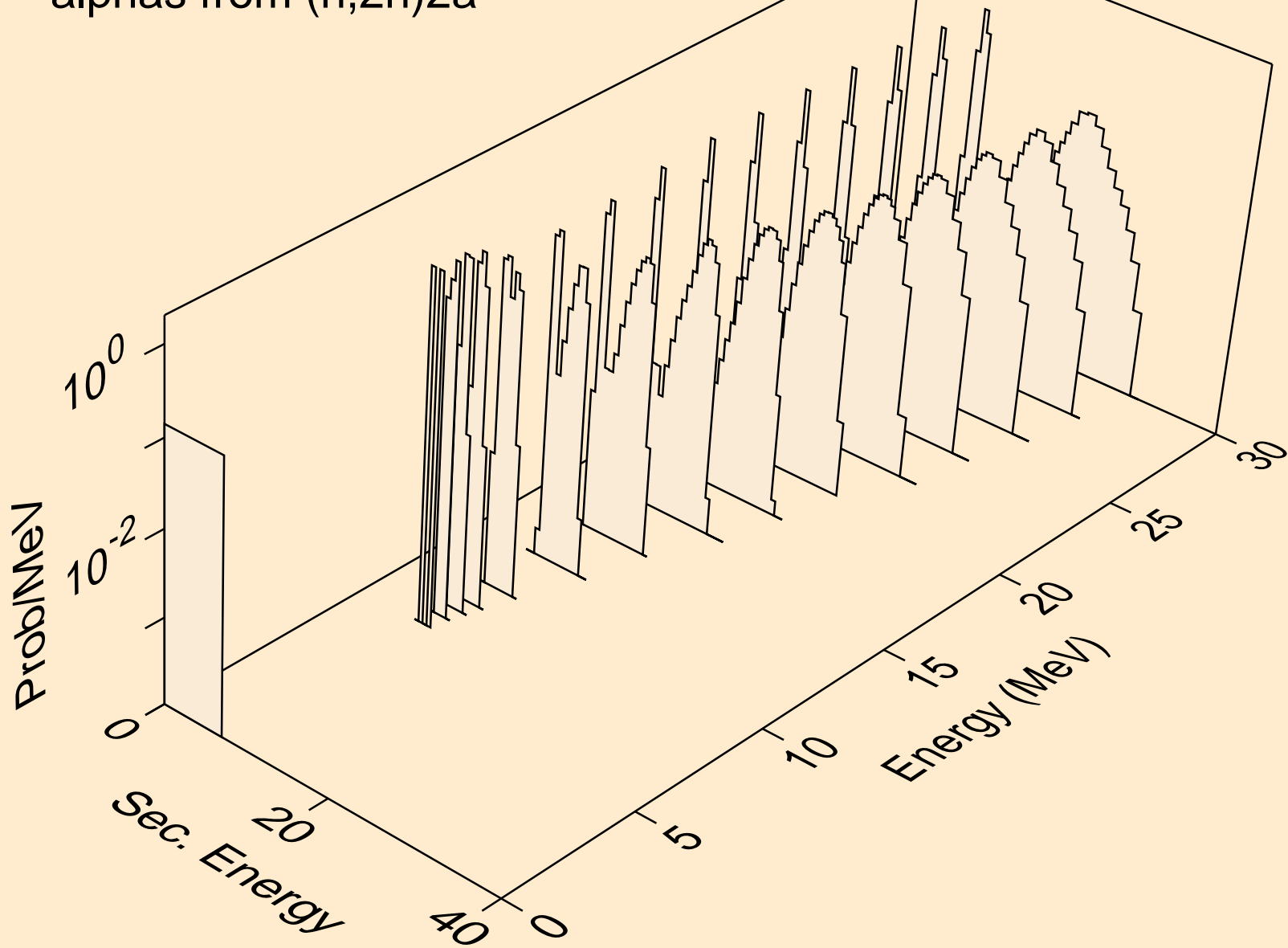

PA226 NEUTRON ACER TENDL-2021 LIBRARY; T=293.6K
alphas from (n,npa)

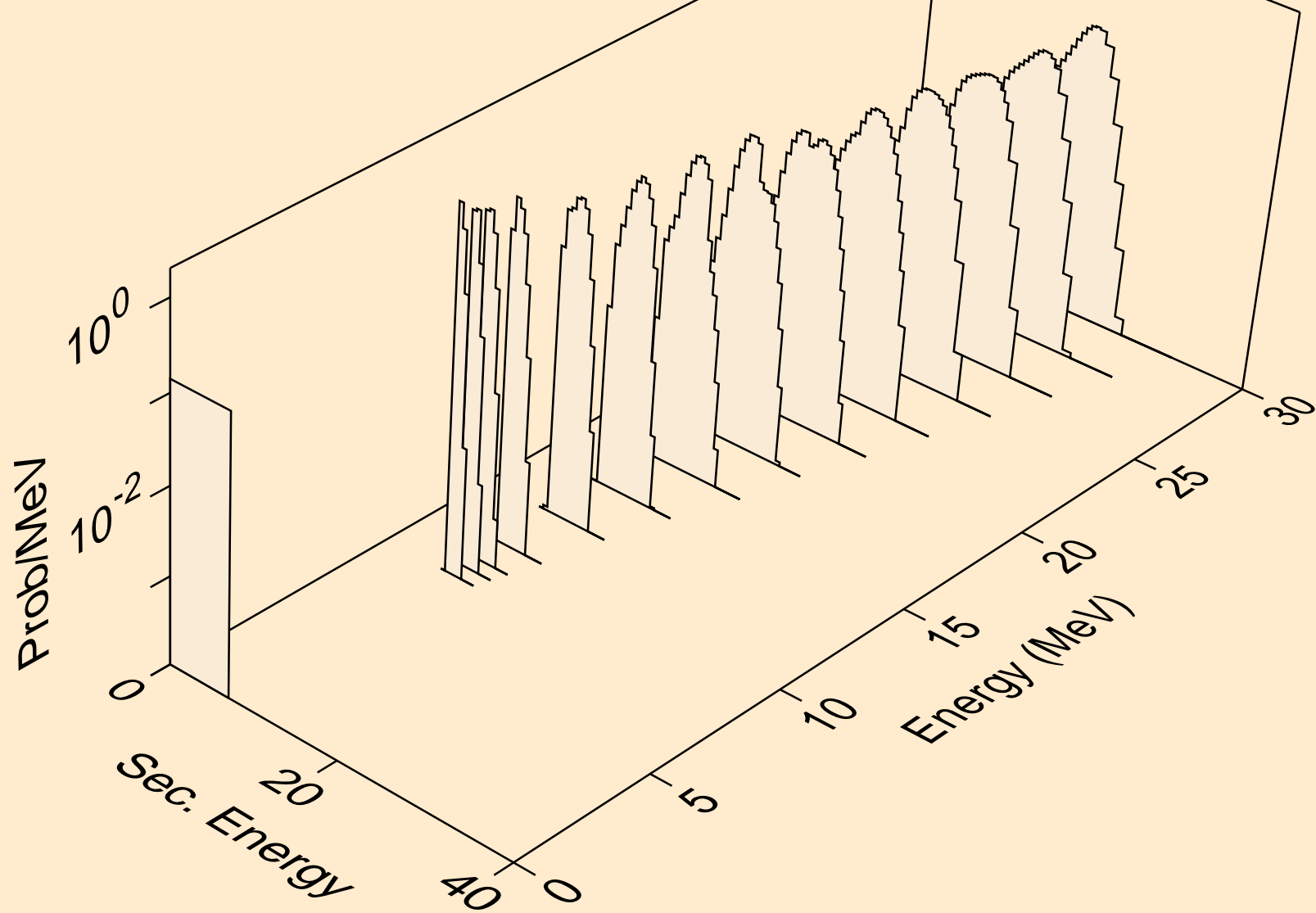

PA226 NEUTRON ACER TENDL-2021 LIBRARY; T=293.6K
alphas from (n,a)

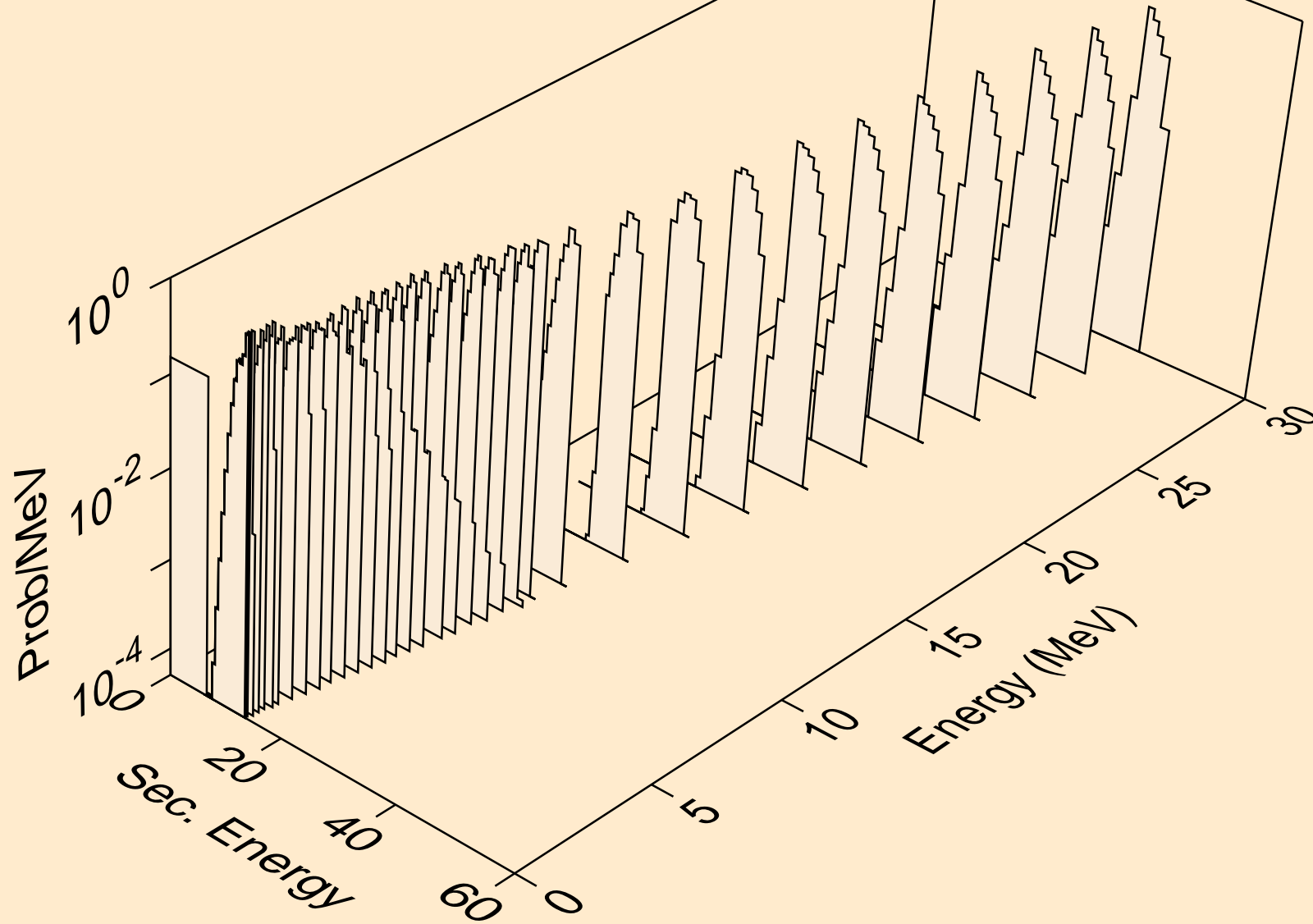

PA226 NEUTRON ACER TENDL-2021 LIBRARY; T=293.6K
alphas from (n,2a)

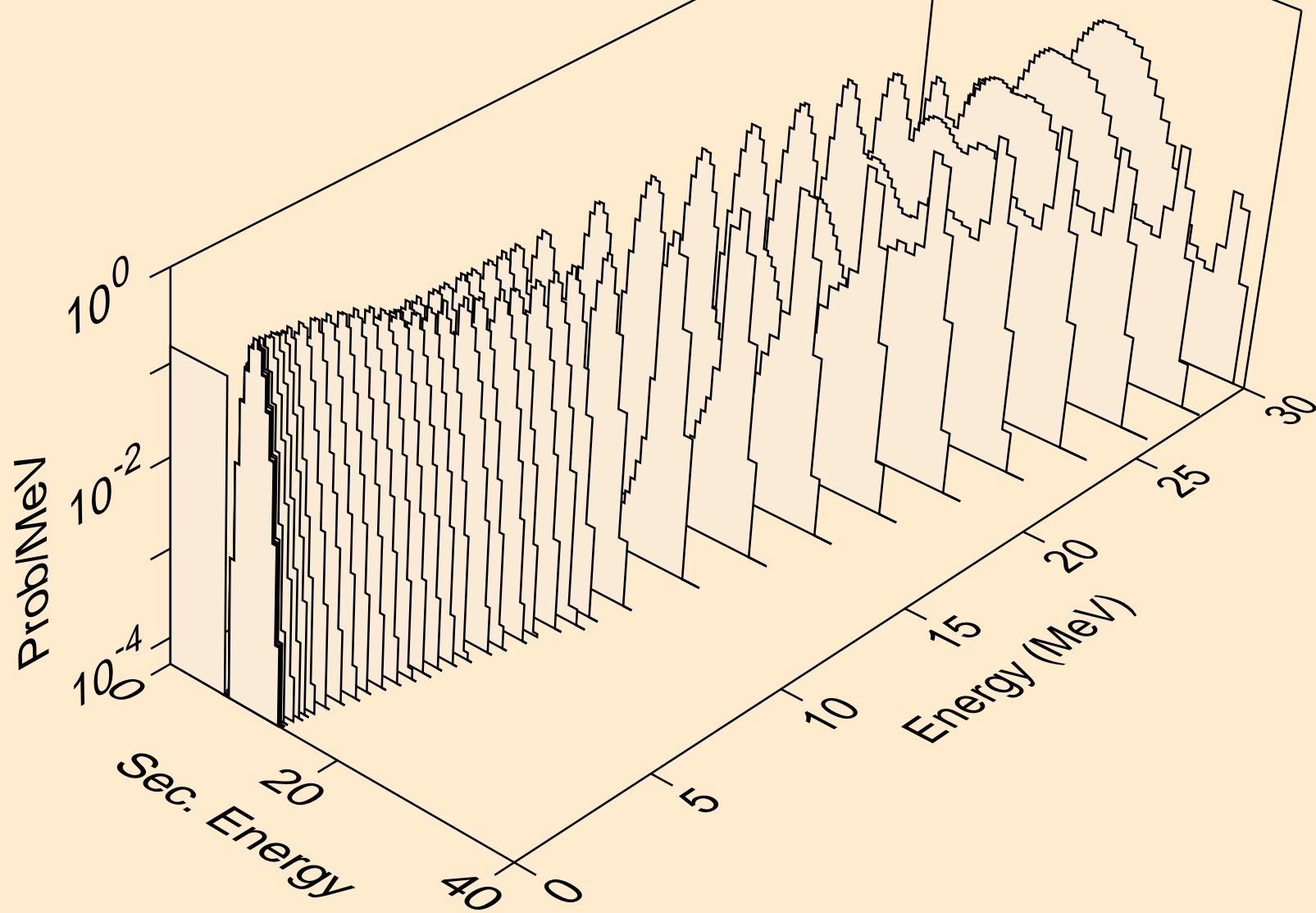

PA226 NEUTRON ACER TENDL-2021 LIBRARY; T=293.6K
alphas from (n,pa)

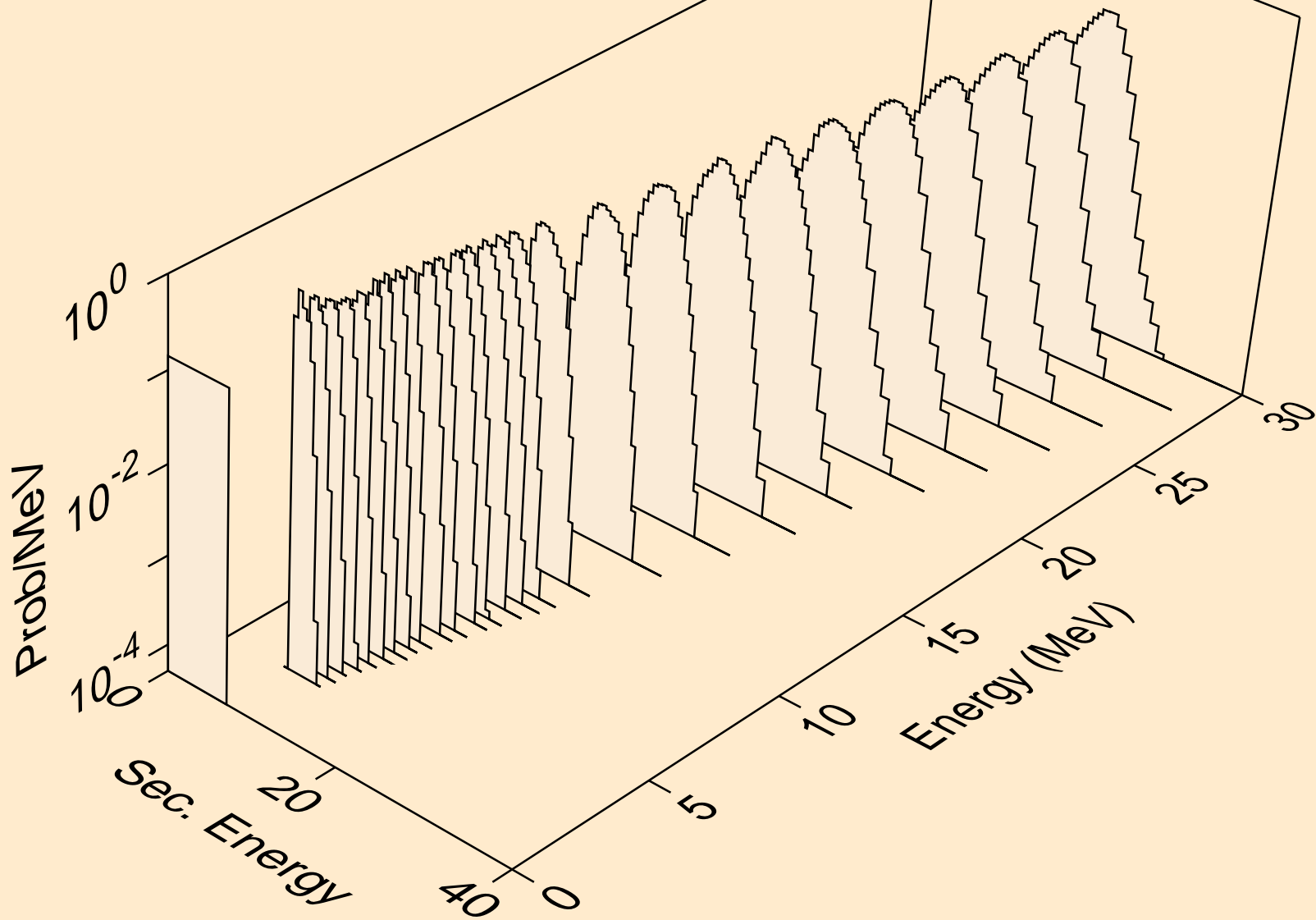

PA226 NEUTRON ACER TENDL-2021 LIBRARY; T=293.6K
alphas from (n,da)

