

PA231 NEUTRON ACER TENDL-2021 LIBRARY; T=293.6K
Principal cross sections

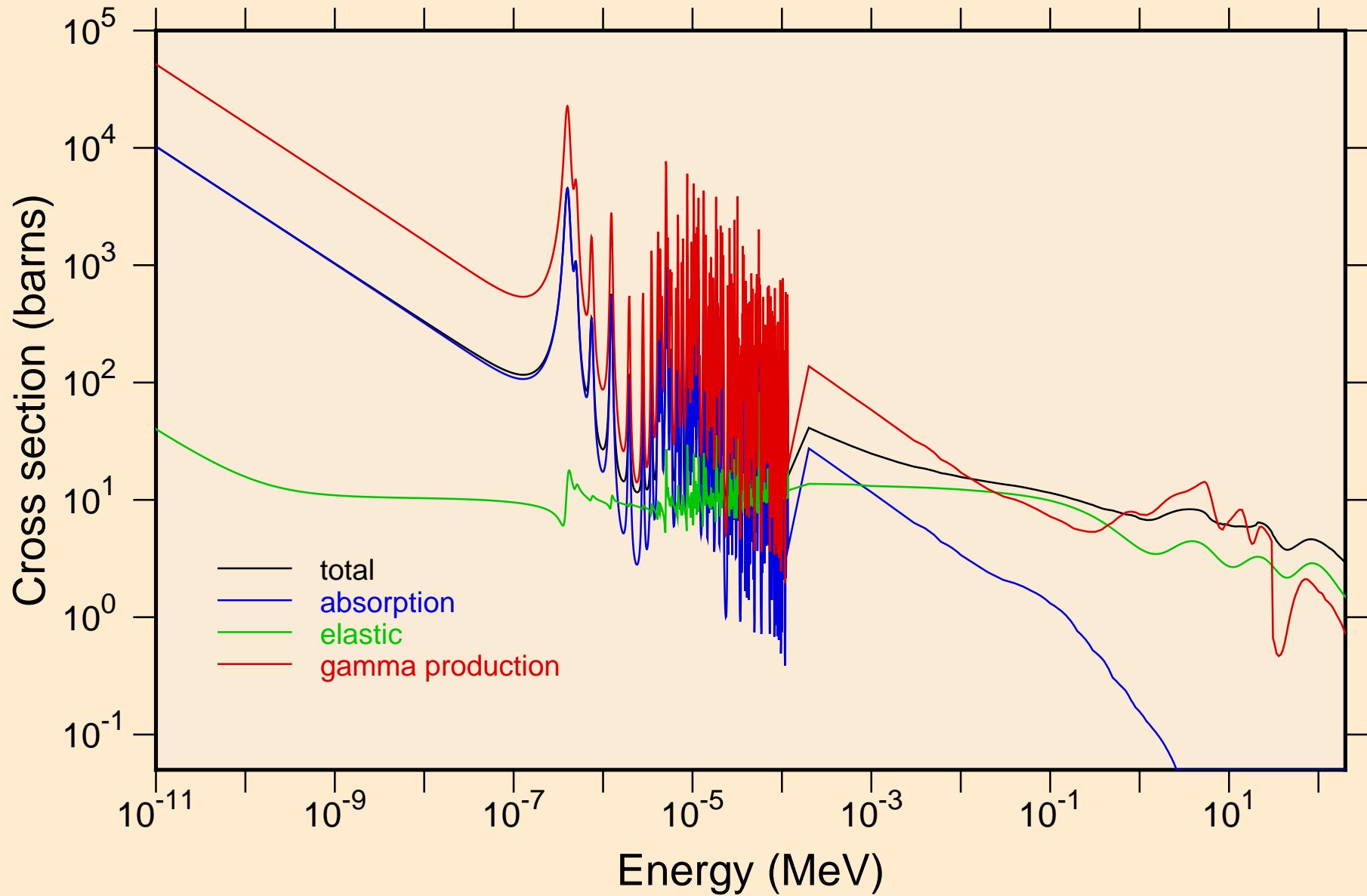

PA231 NEUTRON ACER TENDL-2021 LIBRARY; T=293.6K
resonance total cross section

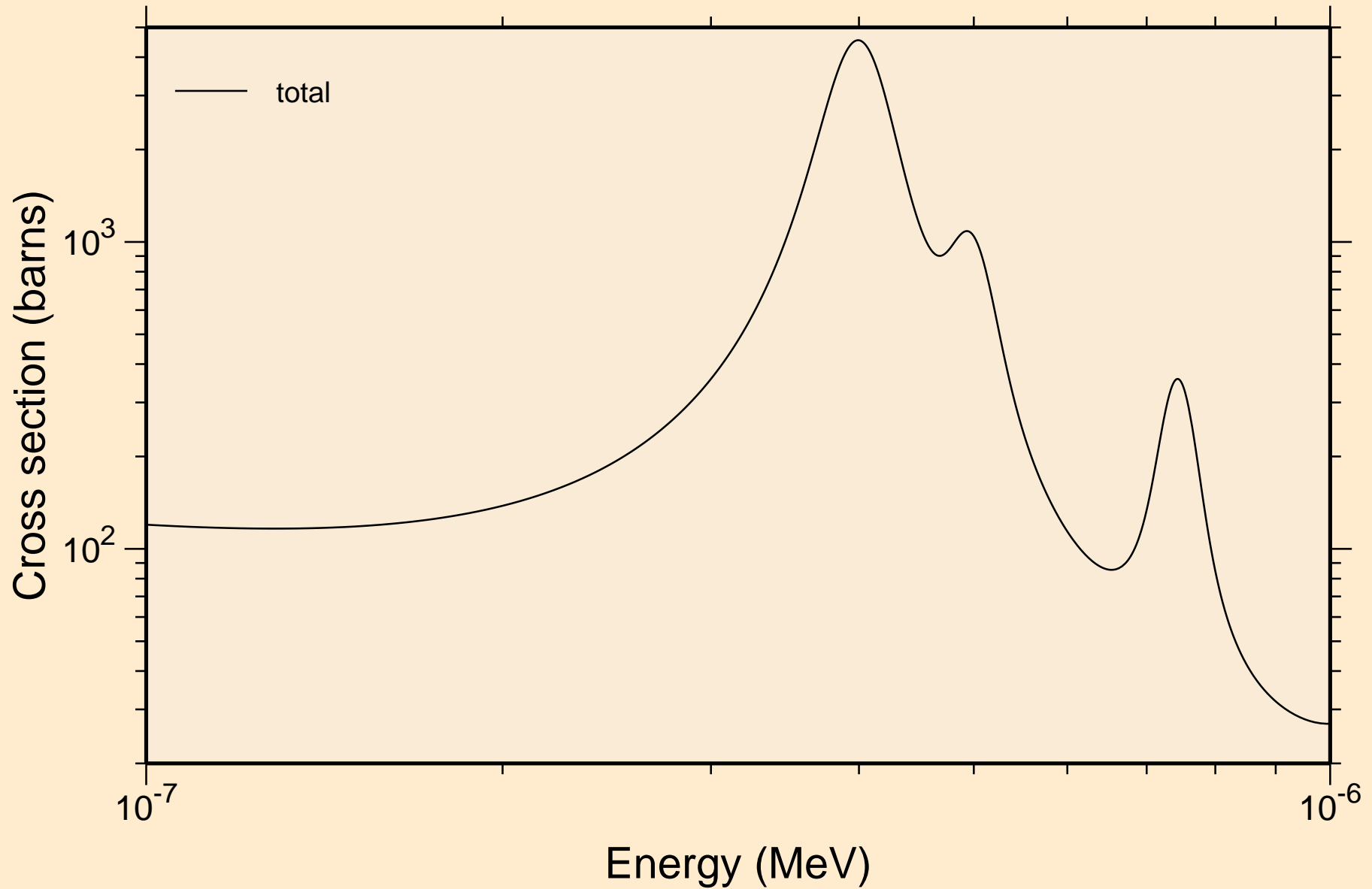

PA231 NEUTRON ACER TENDL-2021 LIBRARY; T=293.6K
resonance total cross section

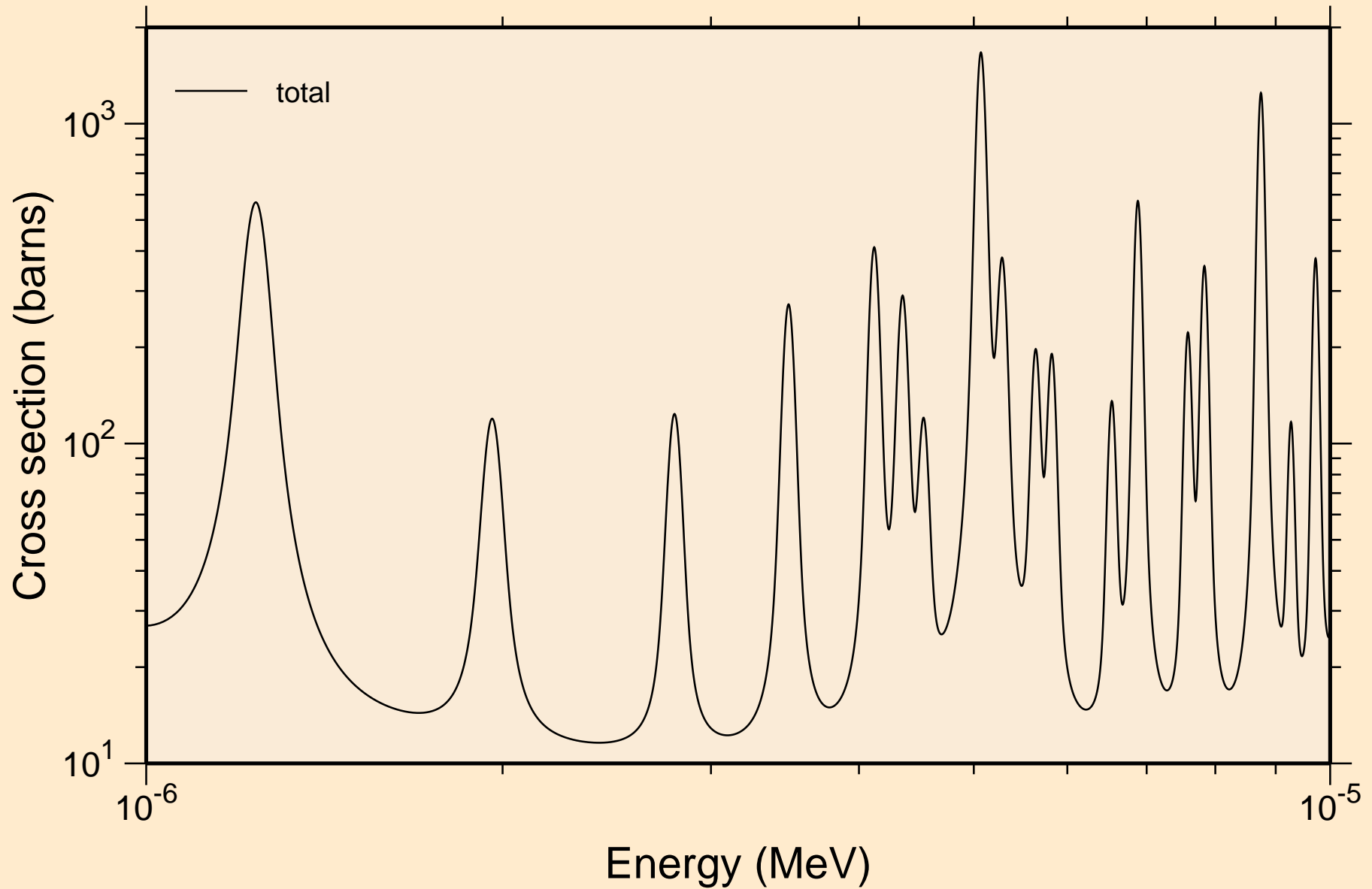

PA231 NEUTRON ACER TENDL-2021 LIBRARY; T=293.6K
resonance total cross section

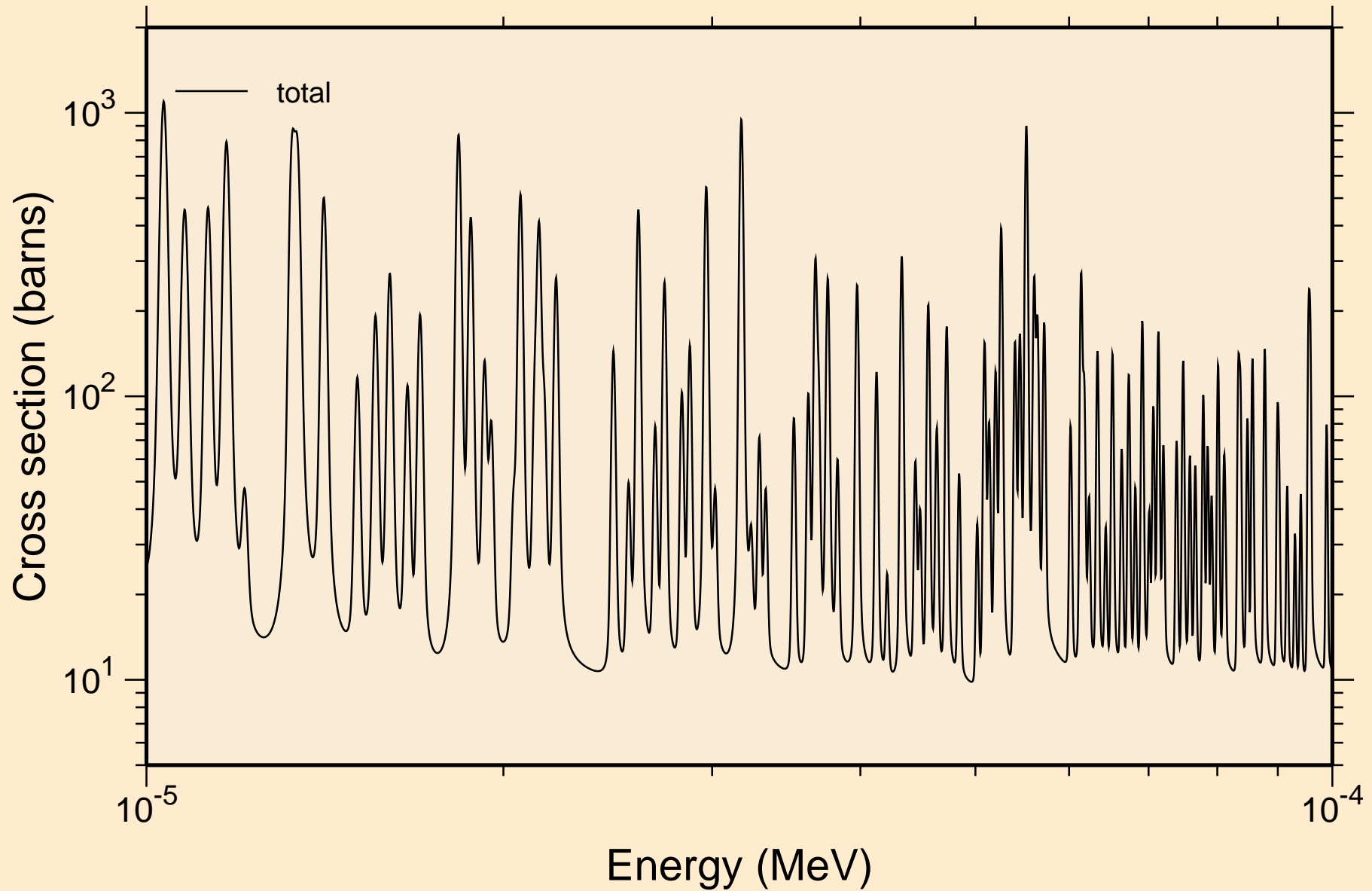

PA231 NEUTRON ACER TENDL-2021 LIBRARY; T=293.6K
resonance total cross section

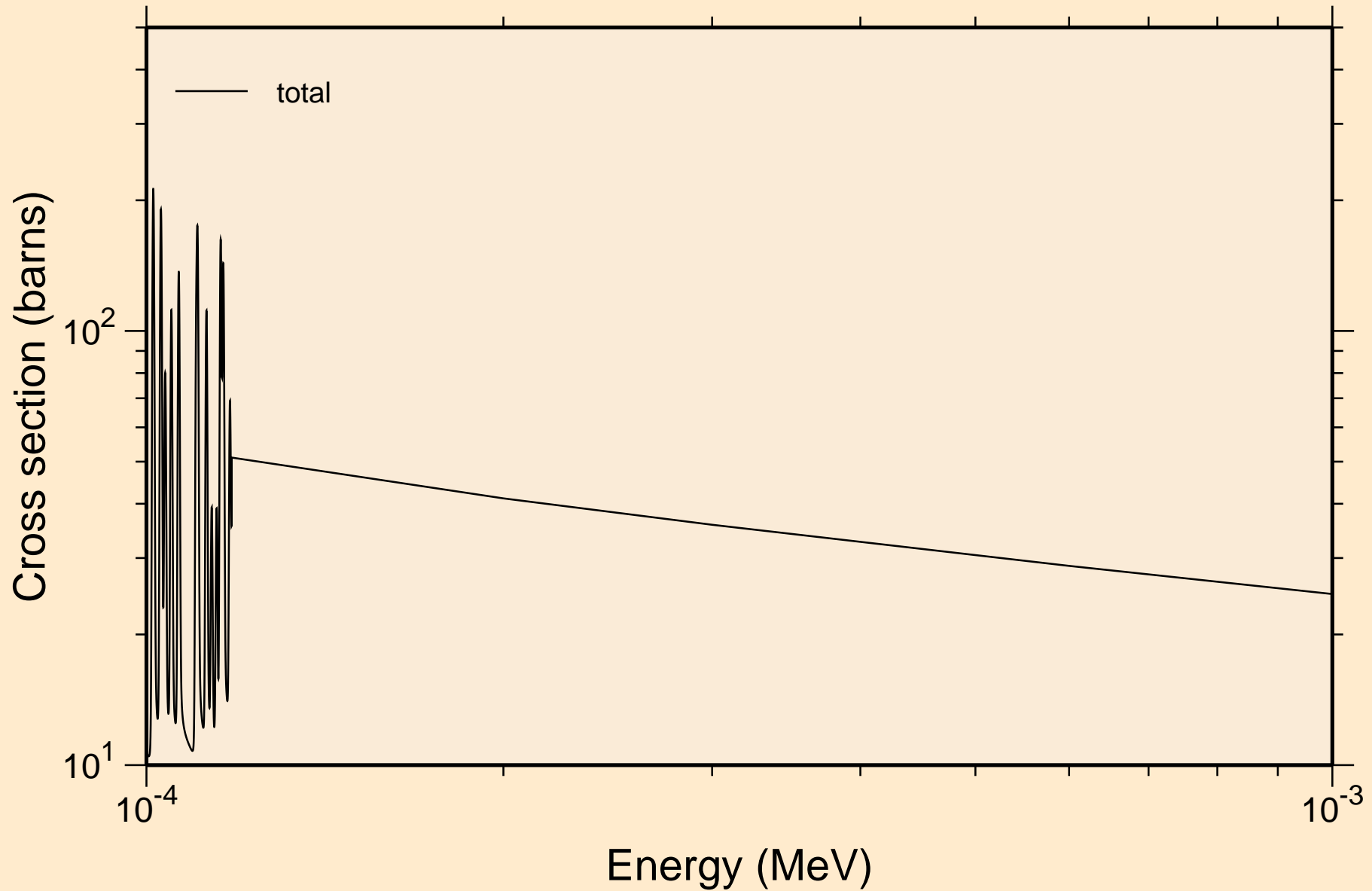

PA231 NEUTRON ACER TENDL-2021 LIBRARY; T=293.6K
resonance total cross section

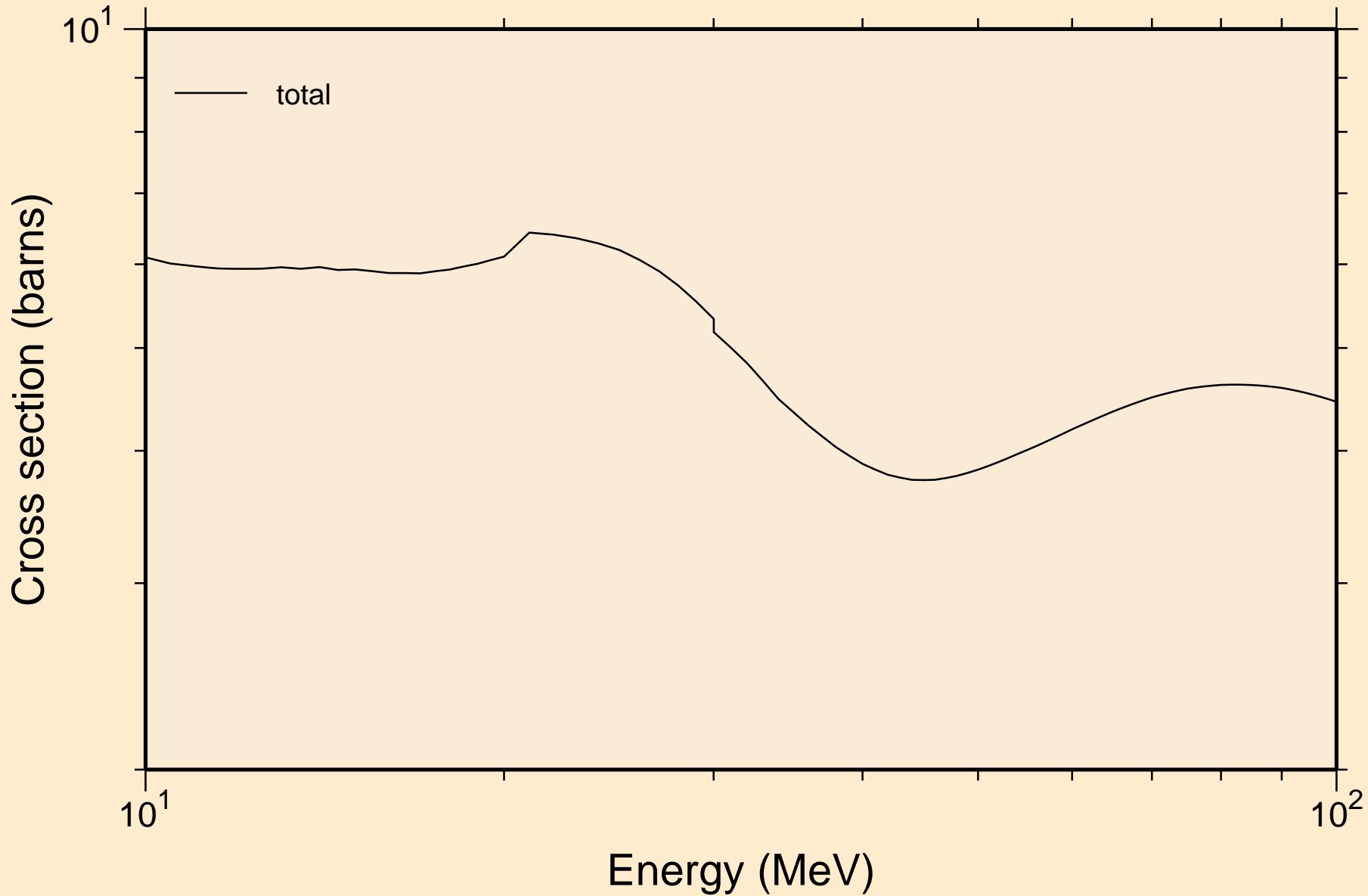

PA231 NEUTRON ACER TENDL-2021 LIBRARY; T=293.6K
resonance absorption cross sections

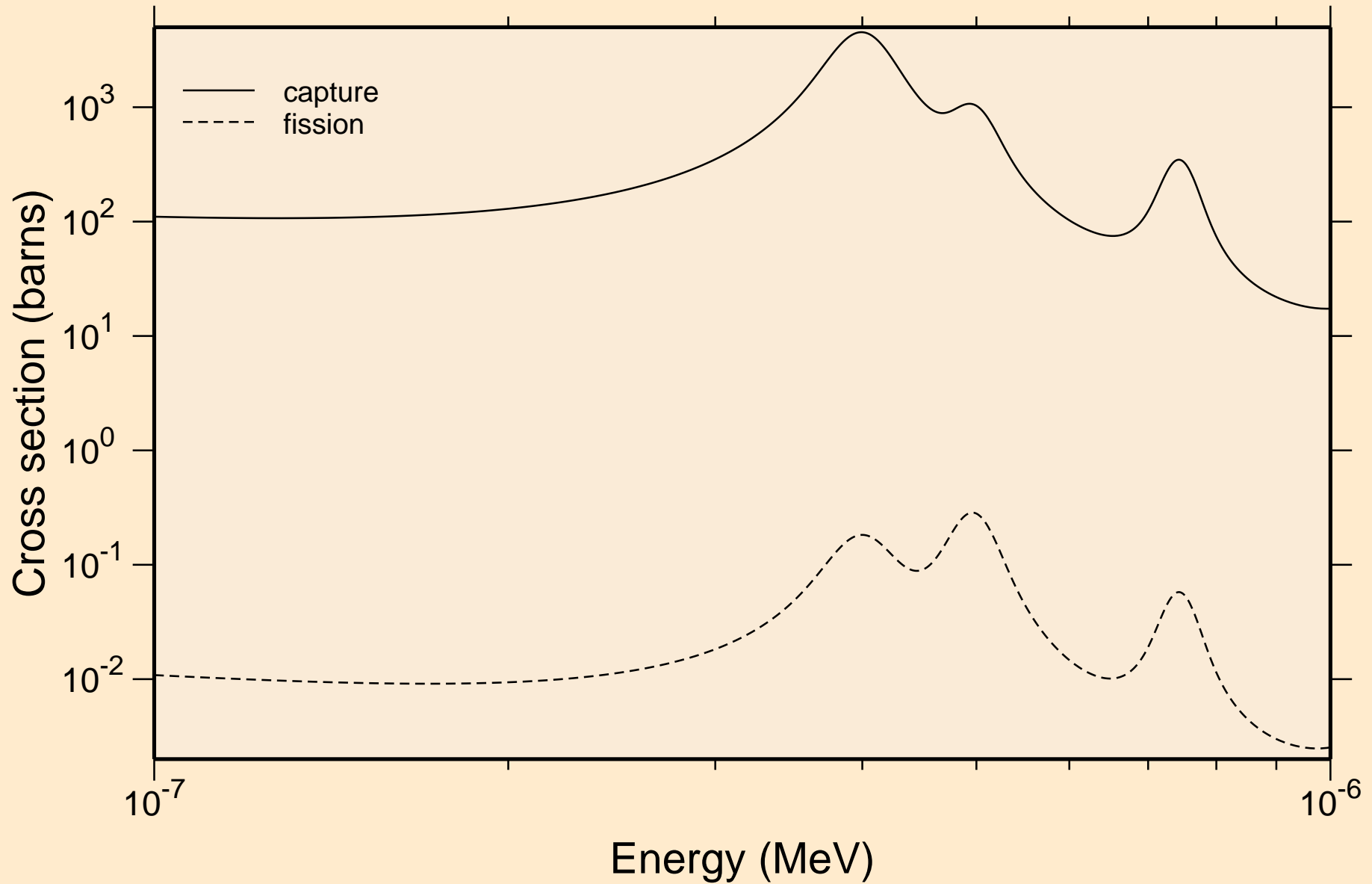

PA231 NEUTRON ACER TENDL-2021 LIBRARY; T=293.6K
resonance absorption cross sections

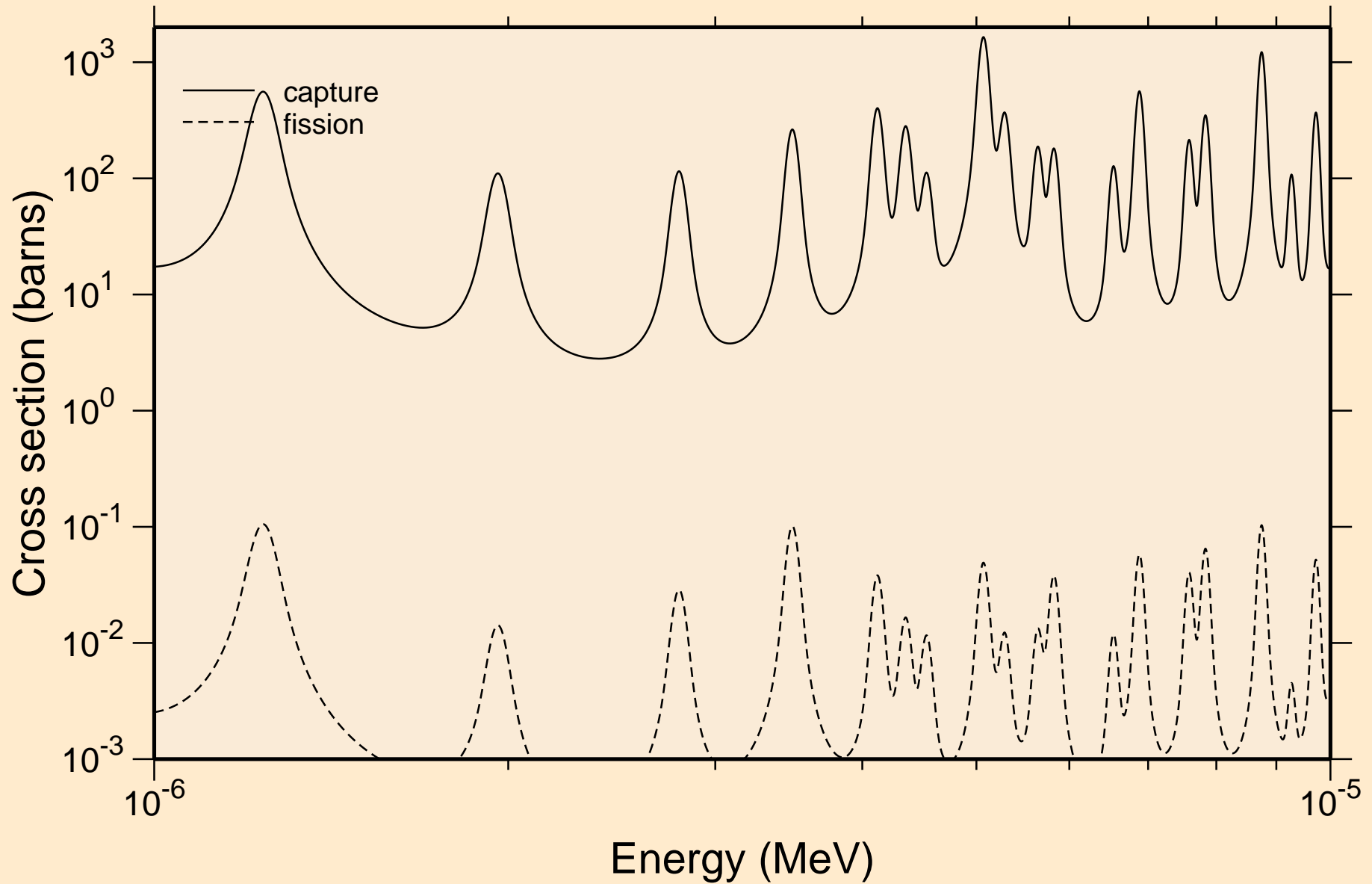

PA231 NEUTRON ACER TENDL-2021 LIBRARY; T=293.6K
resonance absorption cross sections

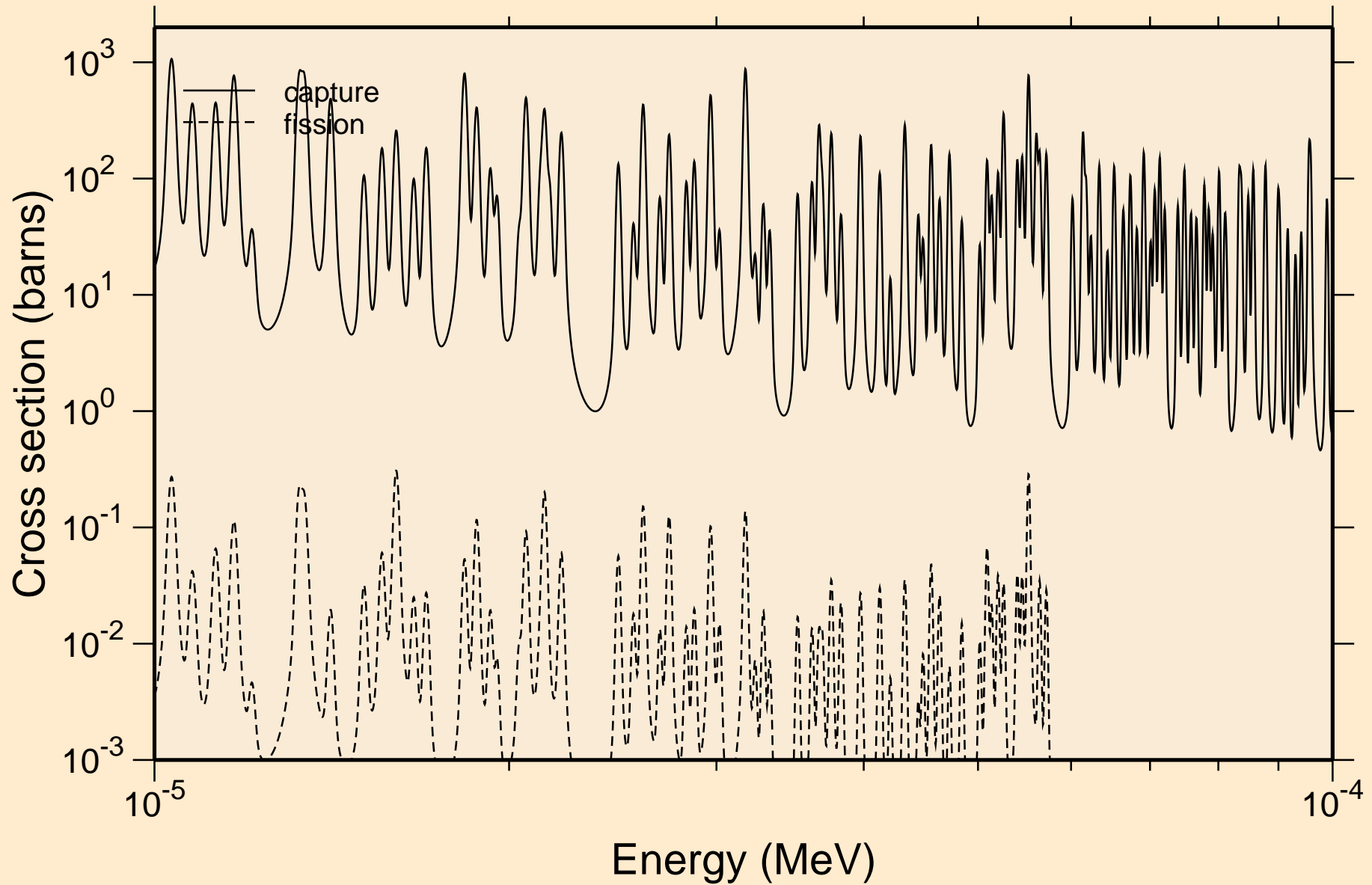

PA231 NEUTRON ACER TENDL-2021 LIBRARY; T=293.6K
resonance absorption cross sections

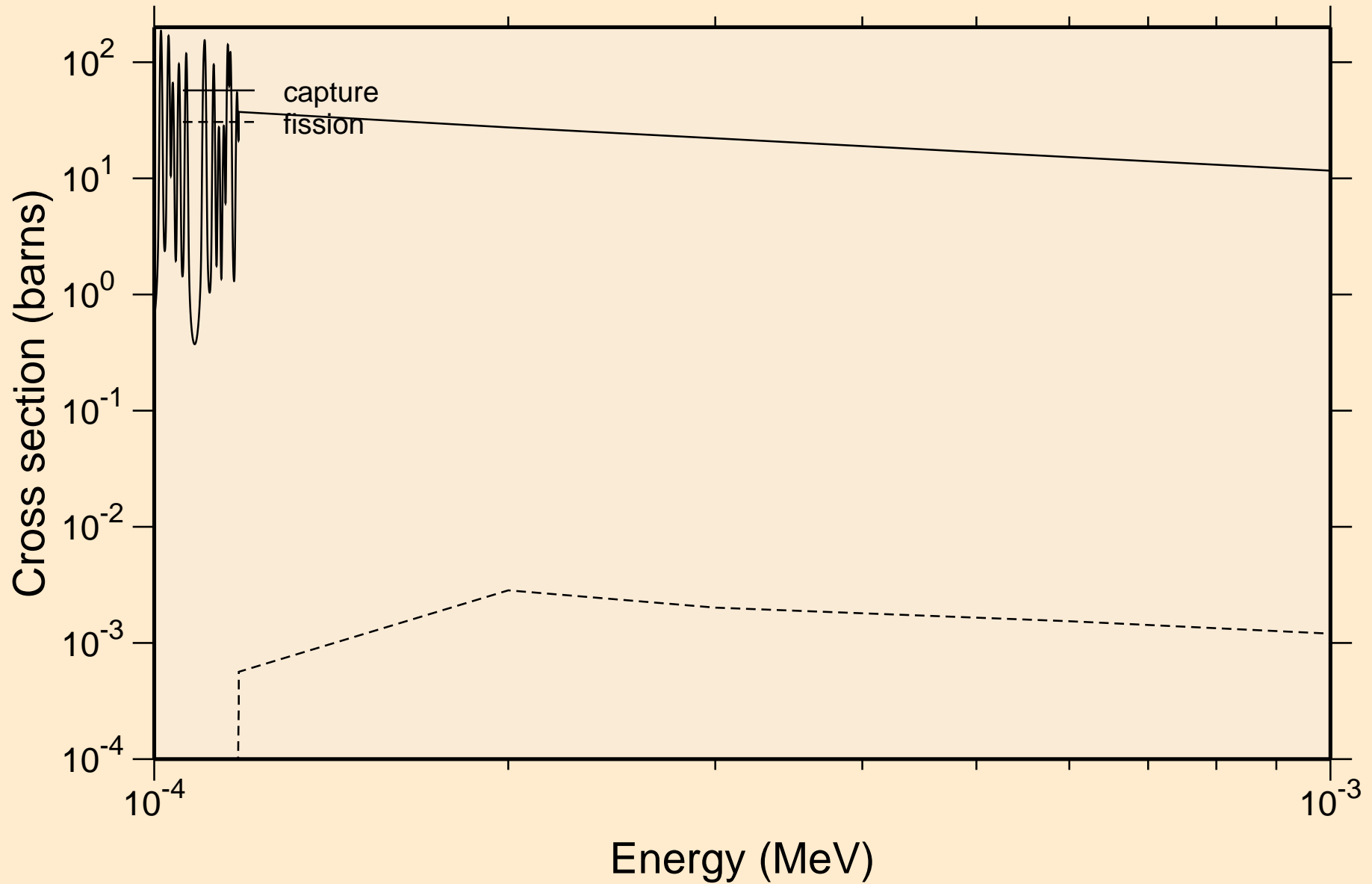

PA231 NEUTRON ACER TENDL-2021 LIBRARY; T=293.6K
resonance absorption cross sections

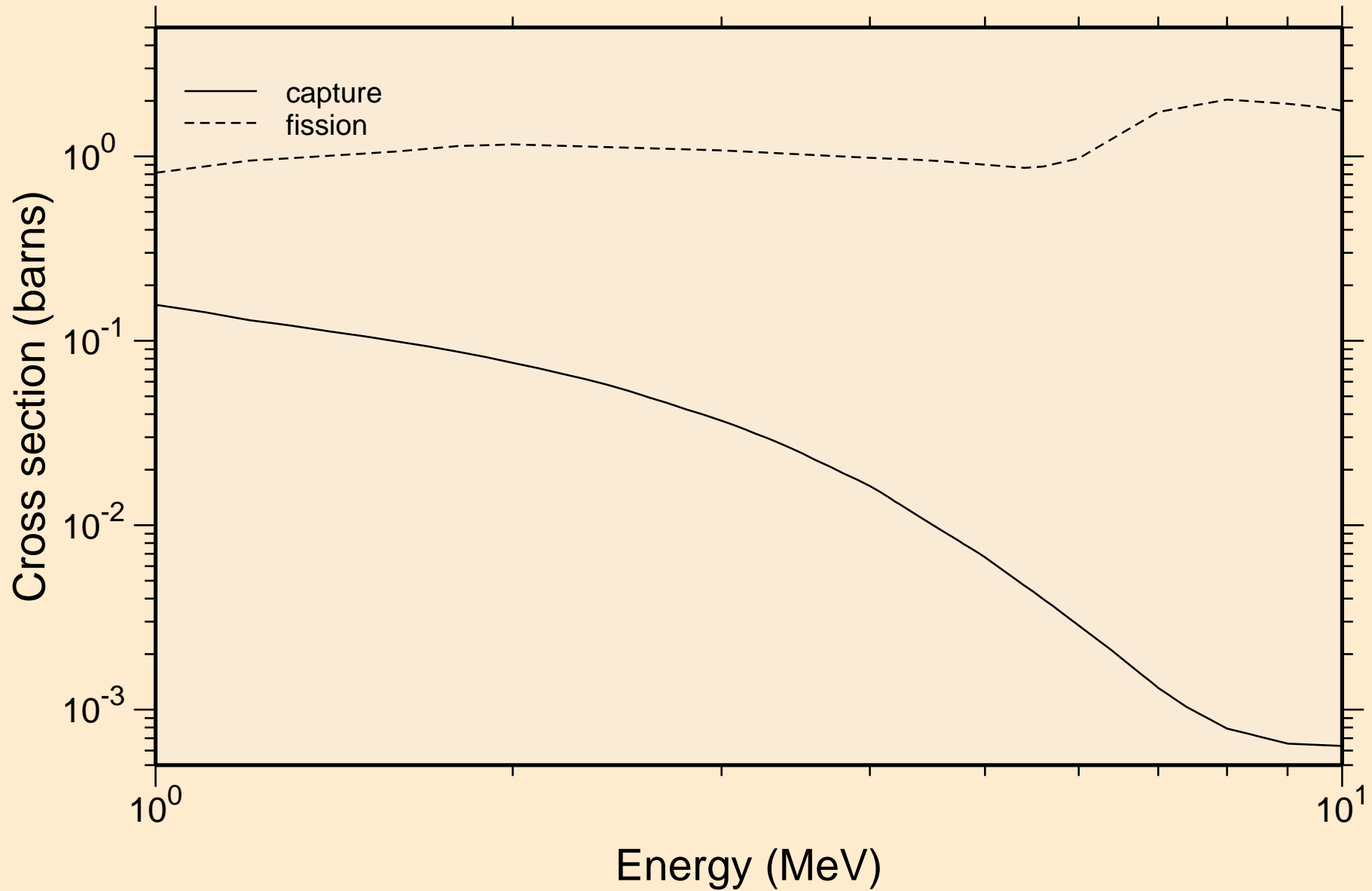

PA231 NEUTRON ACER TENDL-2021 LIBRARY; T=293.6K
Heating

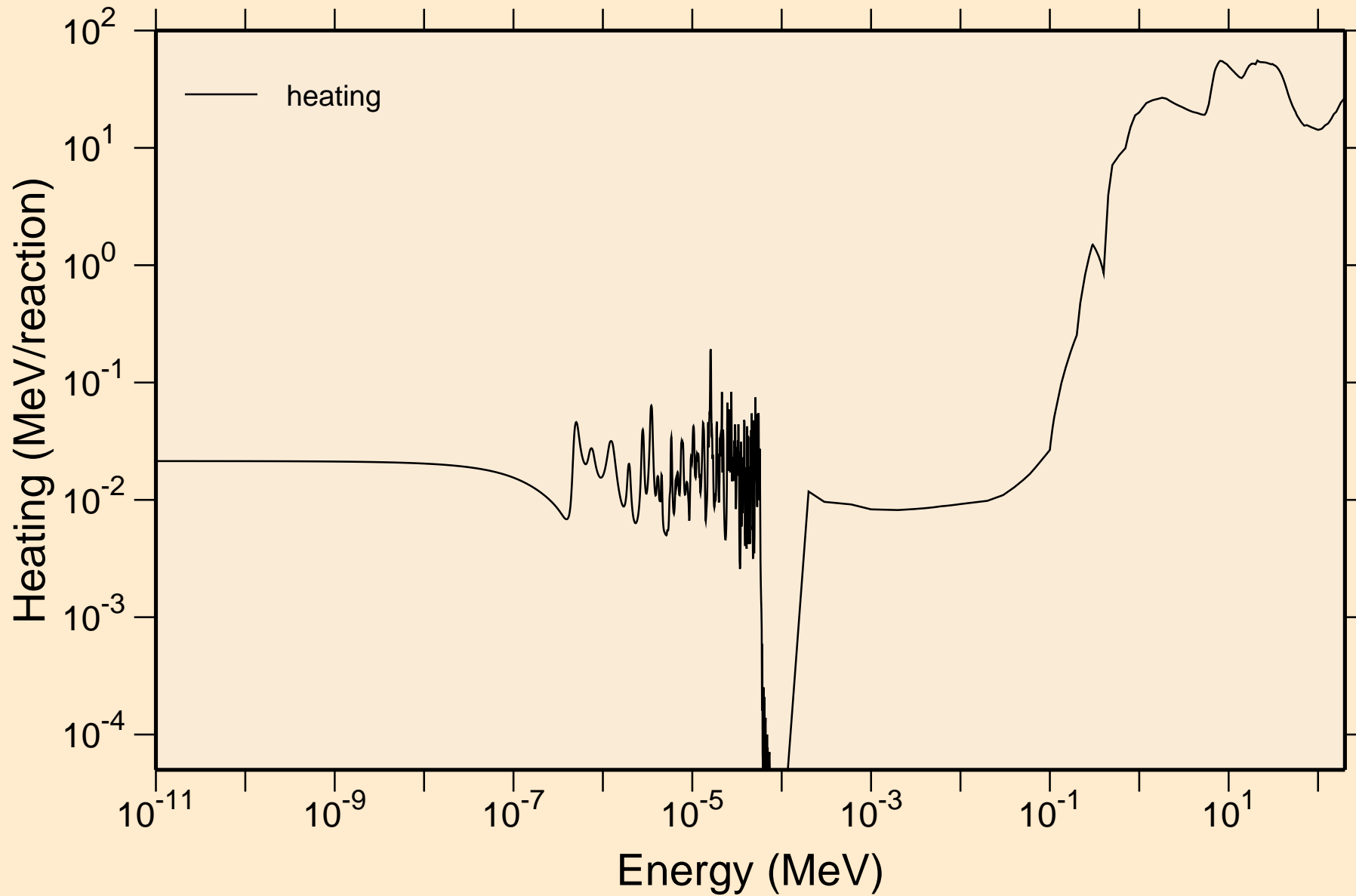

PA231 NEUTRON ACER TENDL-2021 LIBRARY; T=293.6K
Damage

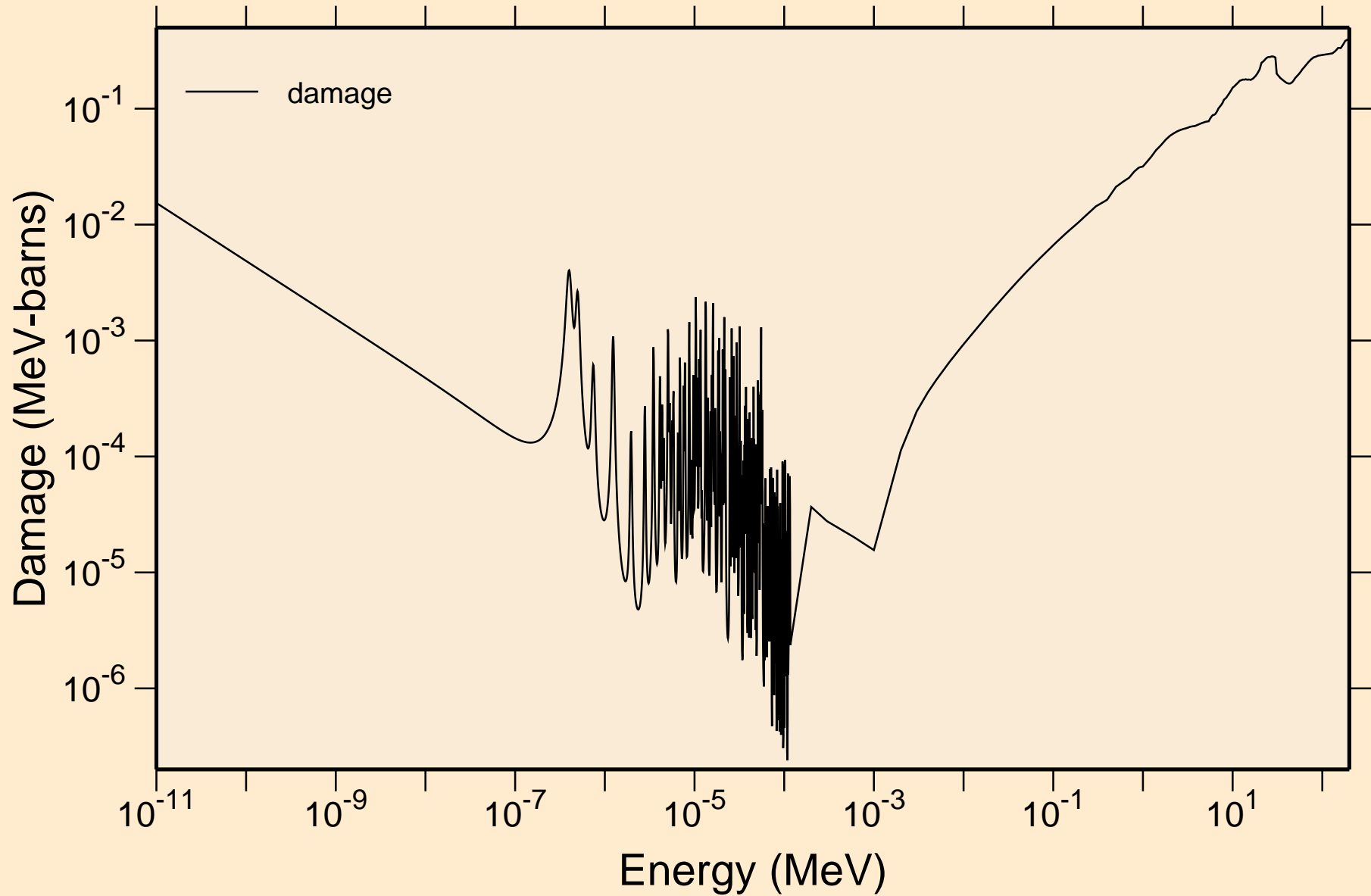

PA231 NEUTRON ACER TENDL-2021 LIBRARY; T=293.6K

Non-threshold reactions

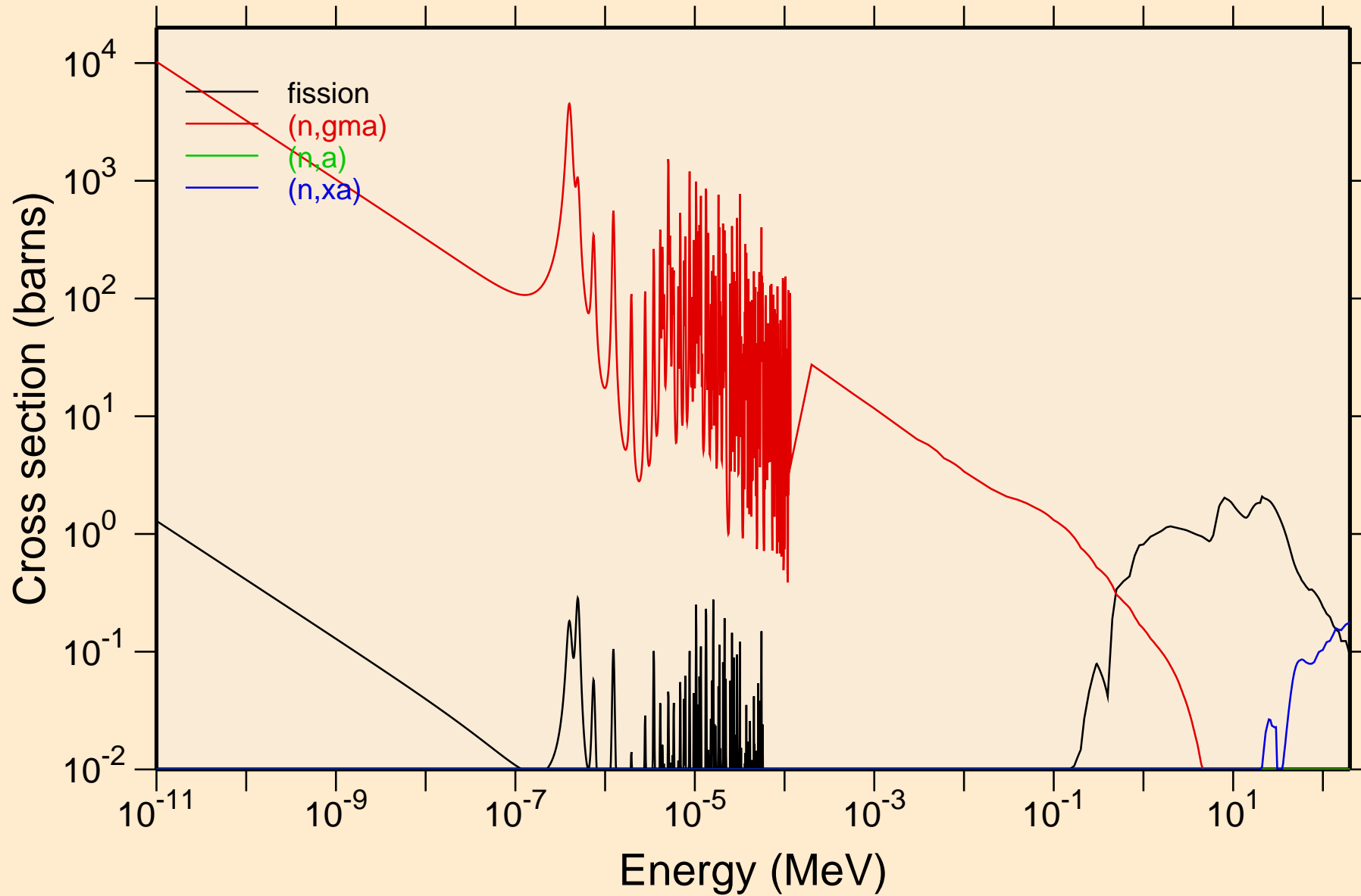

PA231 NEUTRON ACER TENDL-2021 LIBRARY; T=293.6K
Principal cross sections

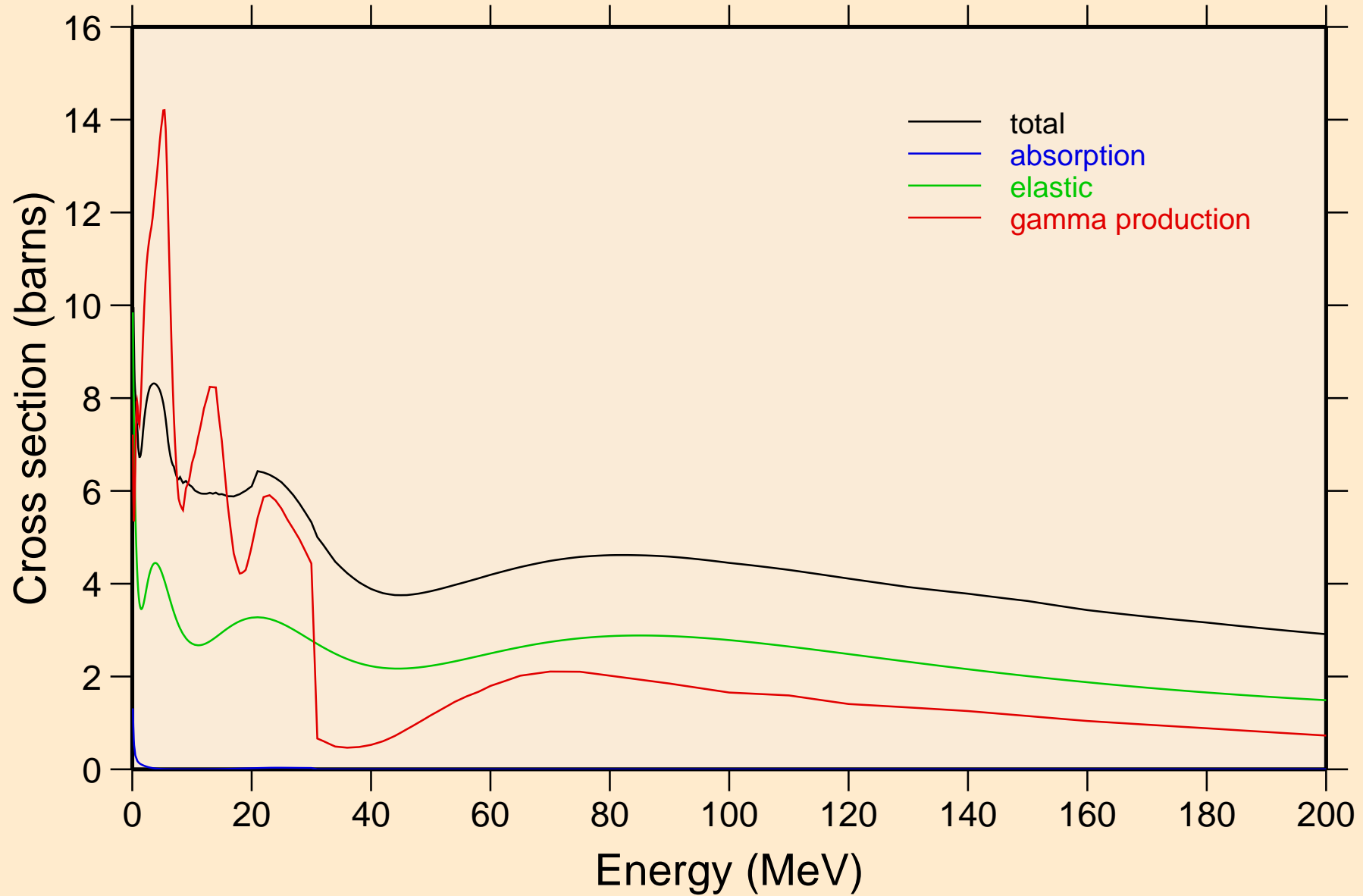

PA231 NEUTRON ACER TENDL-2021 LIBRARY; T=293.6K
Heating

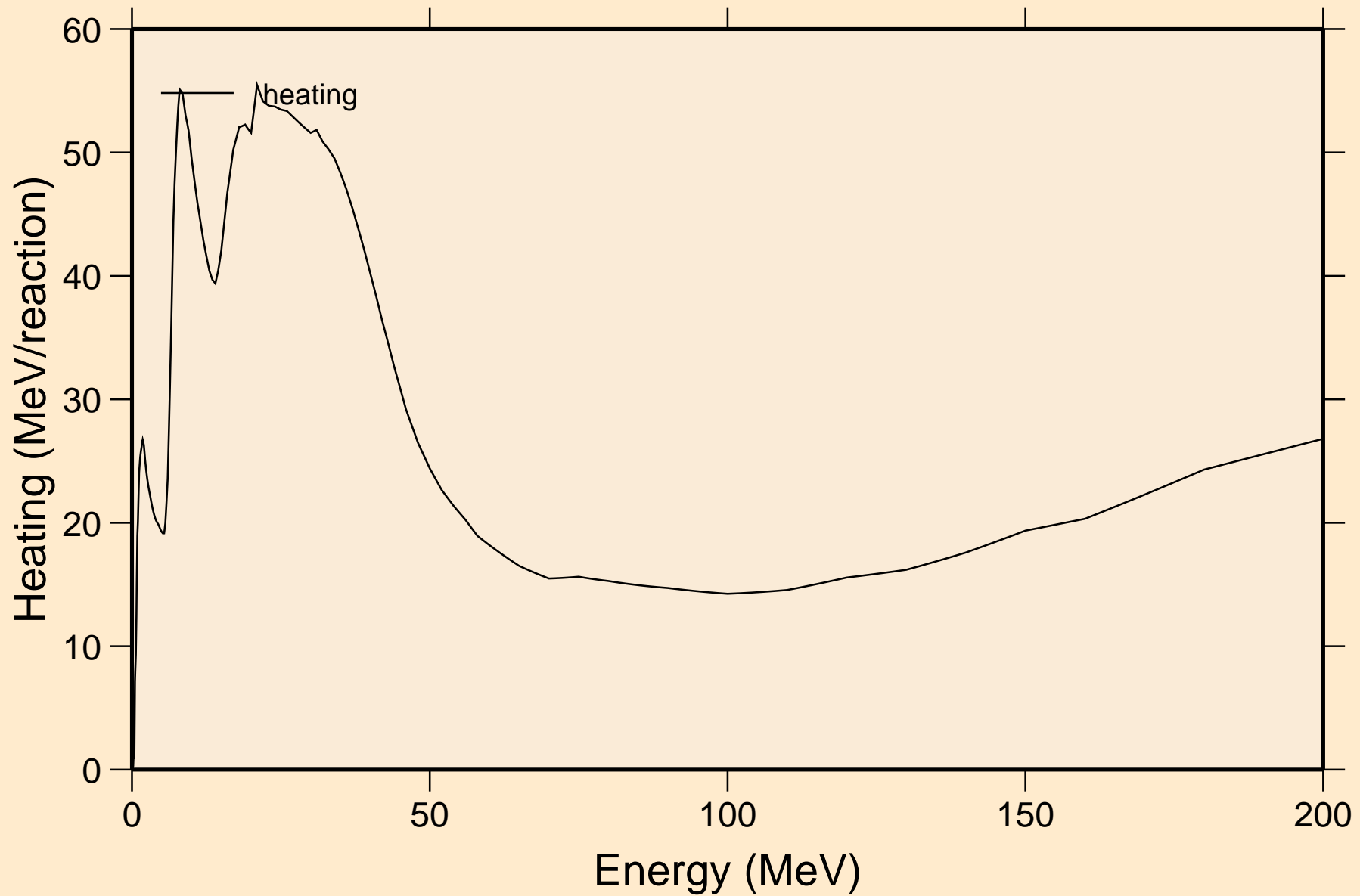

PA231 NEUTRON ACER TENDL-2021 LIBRARY; T=293.6K
Damage

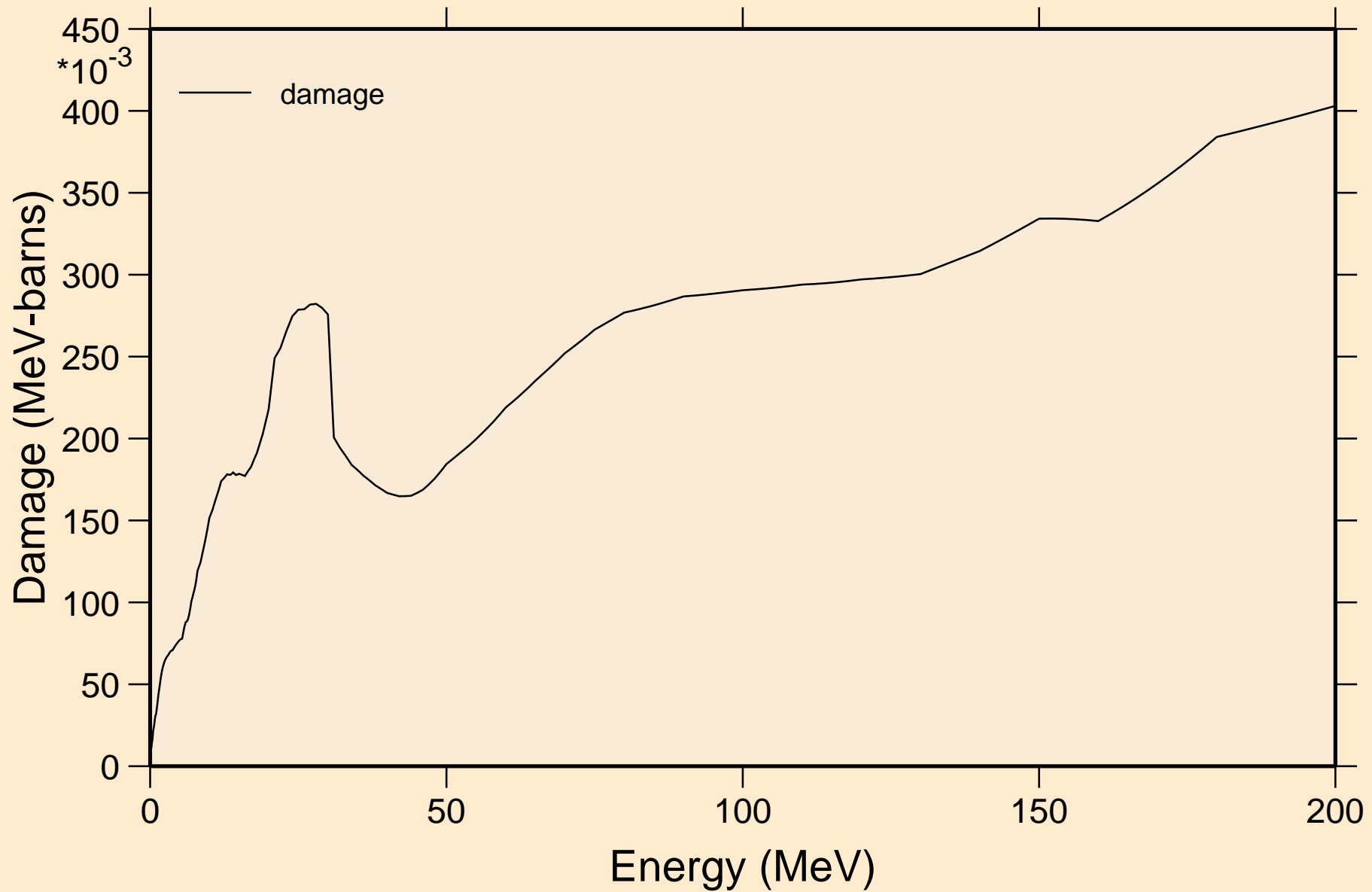

PA231 NEUTRON ACER TENDL-2021 LIBRARY; T=293.6K
Non-threshold reactions

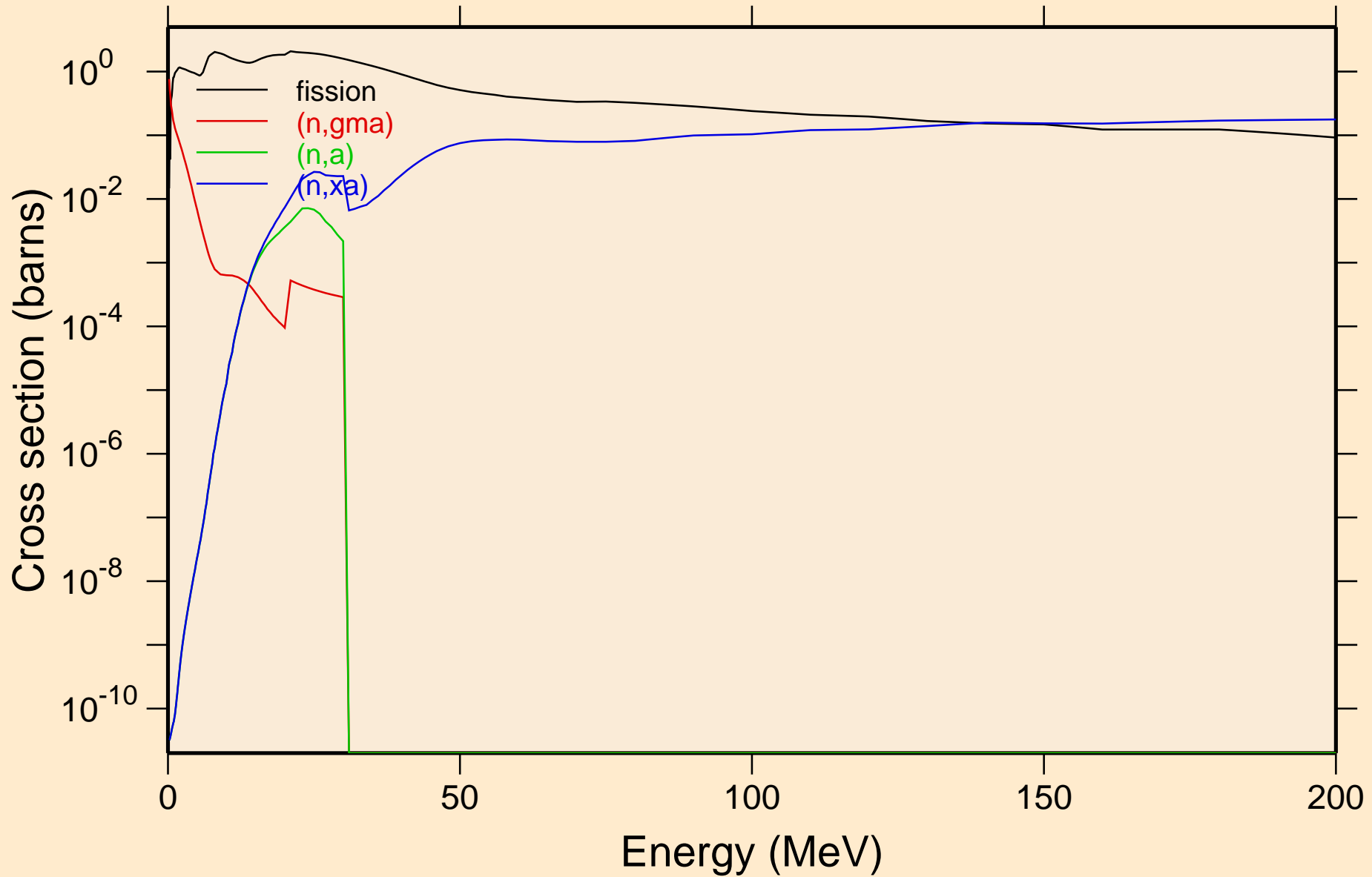

PA231 NEUTRON ACER TENDL-2021 LIBRARY; T=293.6K
Inelastic levels

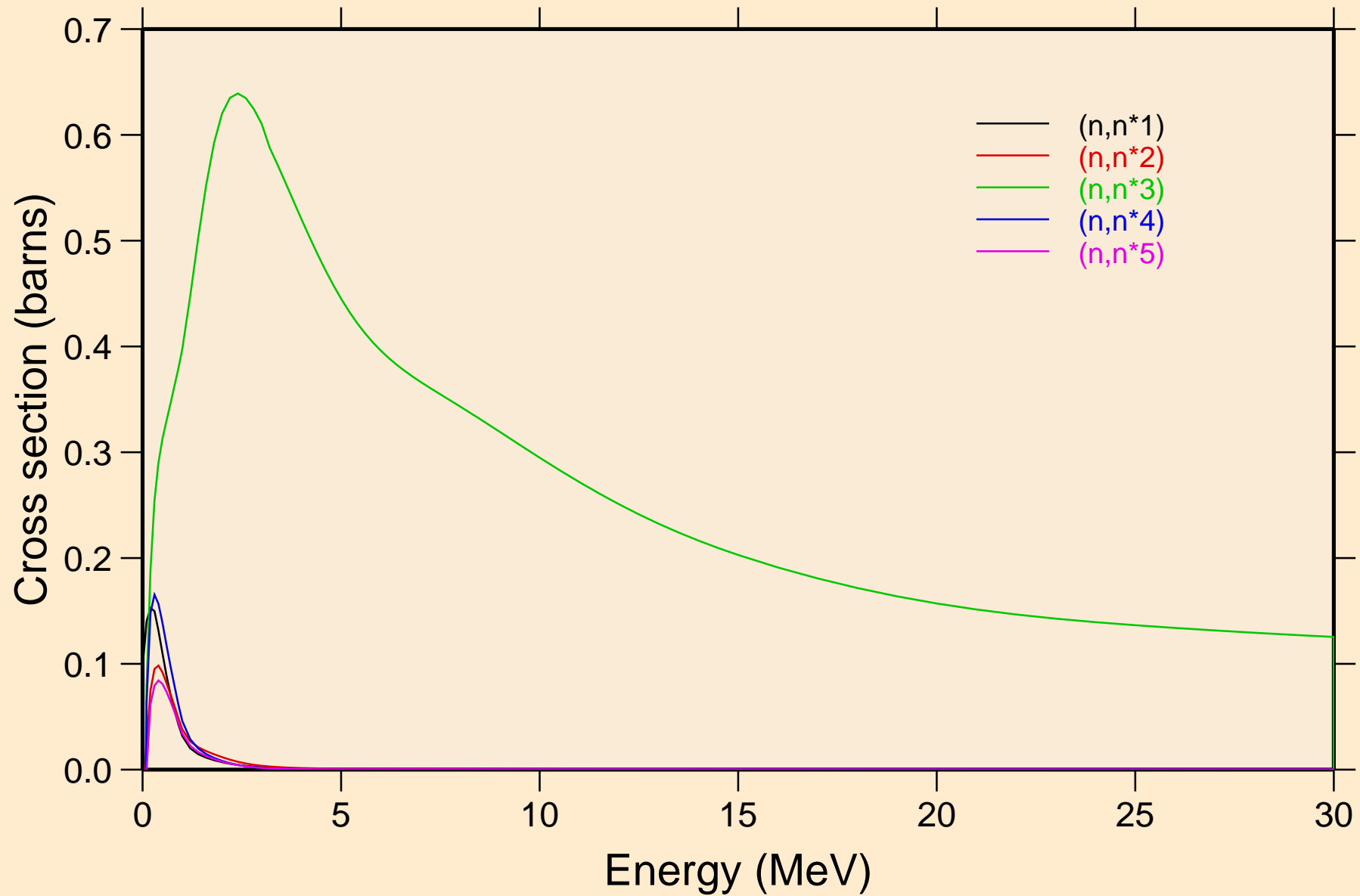

PA231 NEUTRON ACER TENDL-2021 LIBRARY; T=293.6K
Inelastic levels

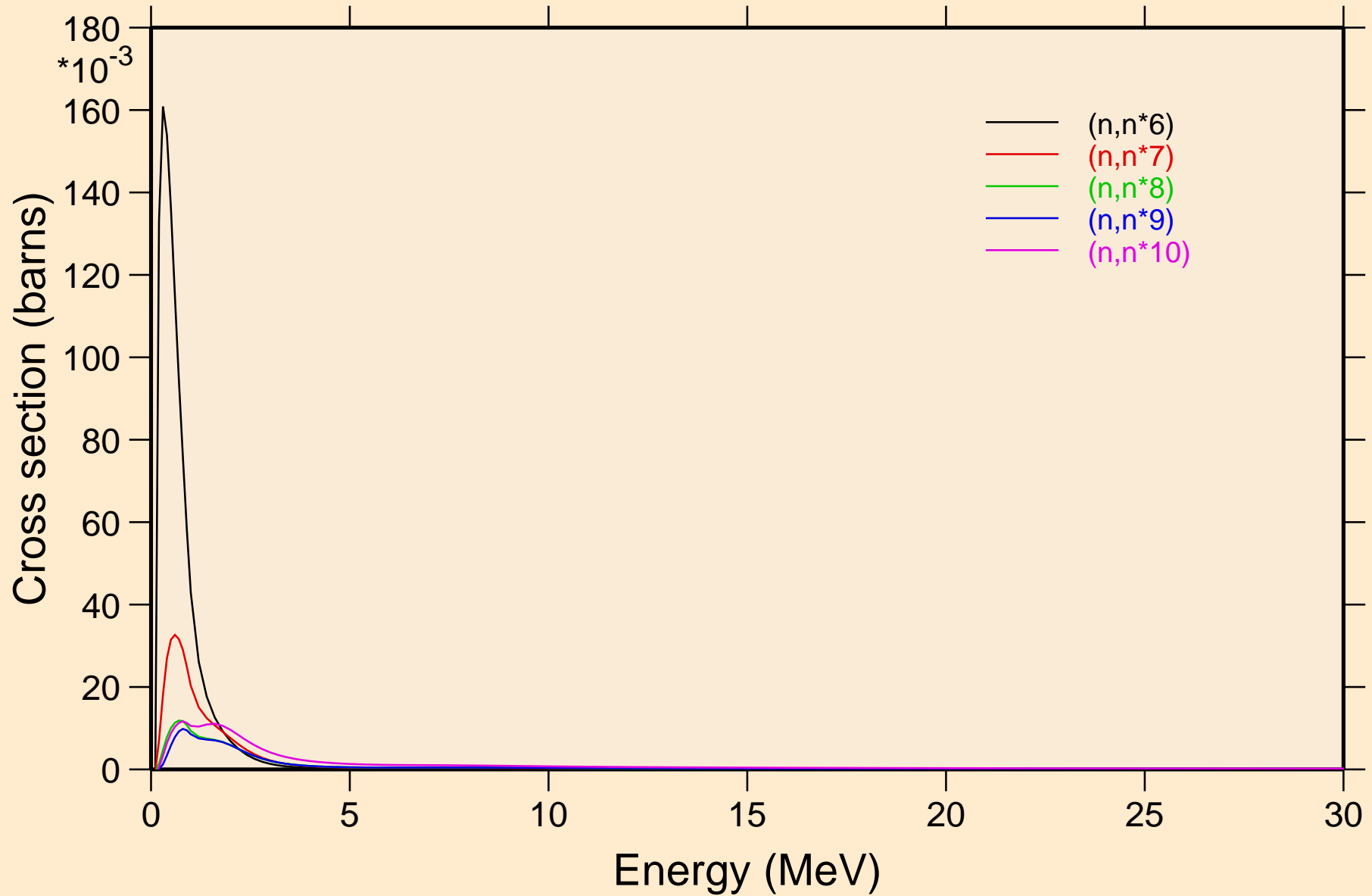

PA231 NEUTRON ACER TENDL-2021 LIBRARY; T=293.6K
Inelastic levels

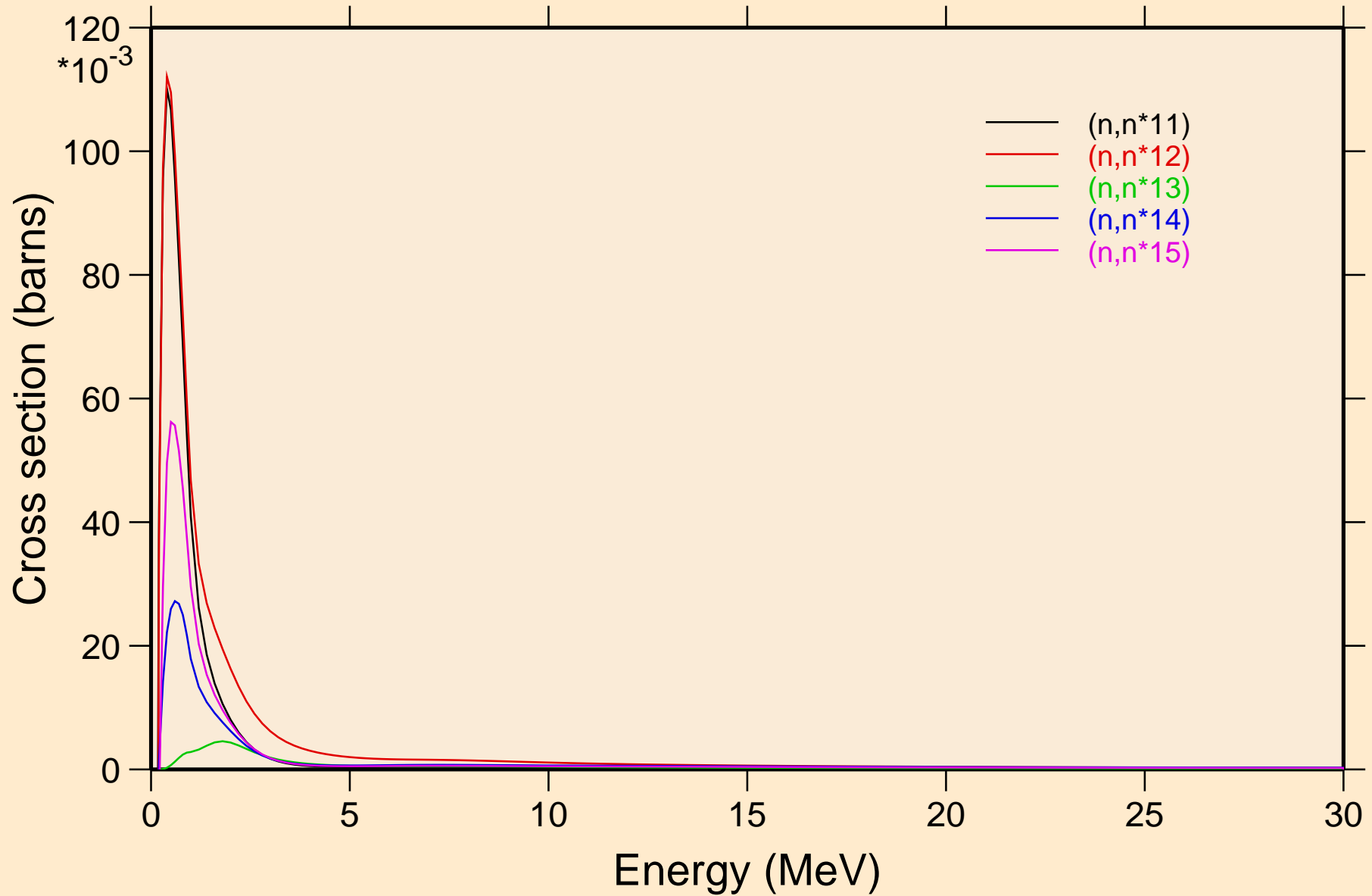

PA231 NEUTRON ACER TENDL-2021 LIBRARY; T=293.6K
Inelastic levels

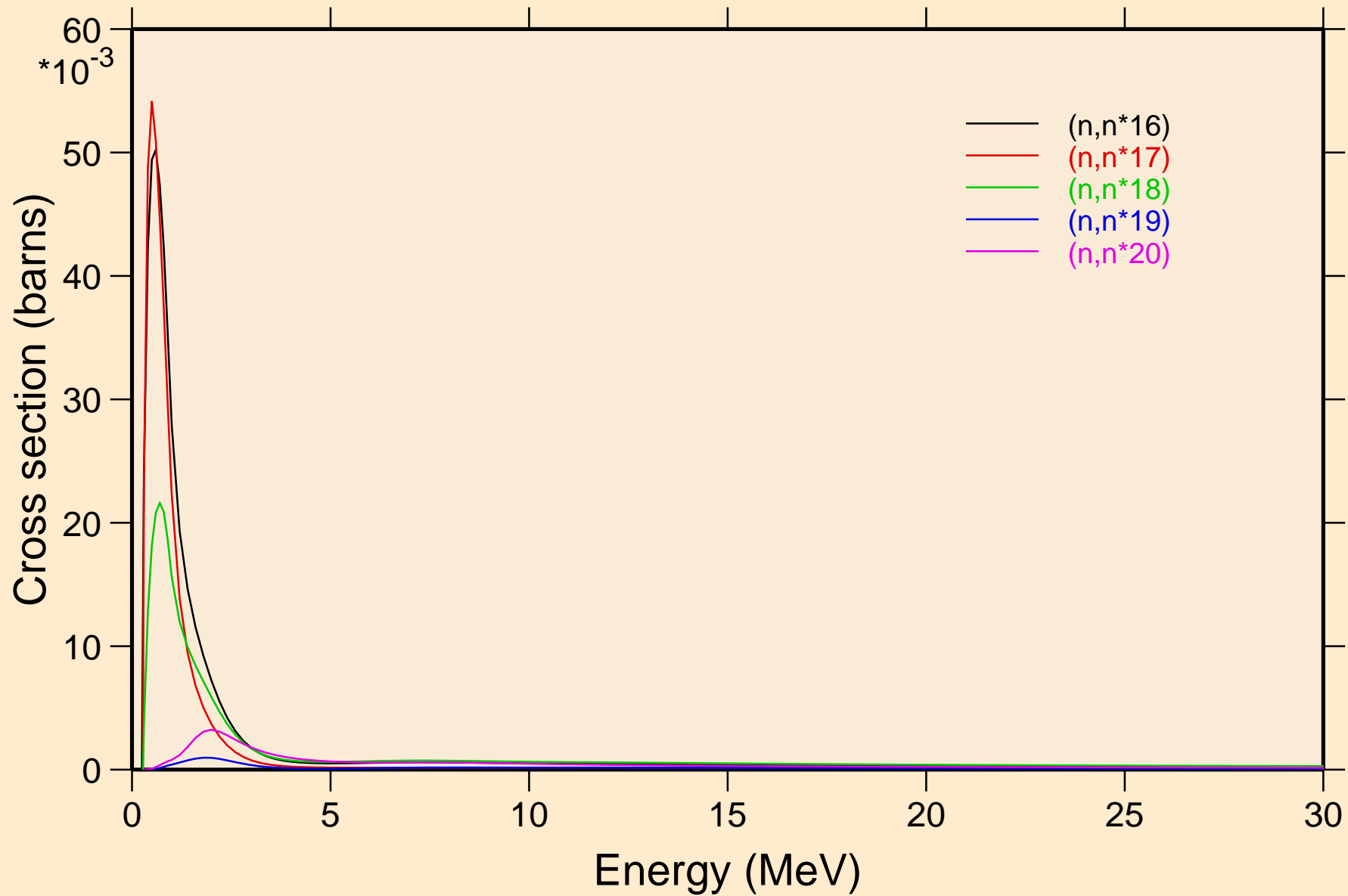

PA231 NEUTRON ACER TENDL-2021 LIBRARY; T=293.6K
Inelastic levels

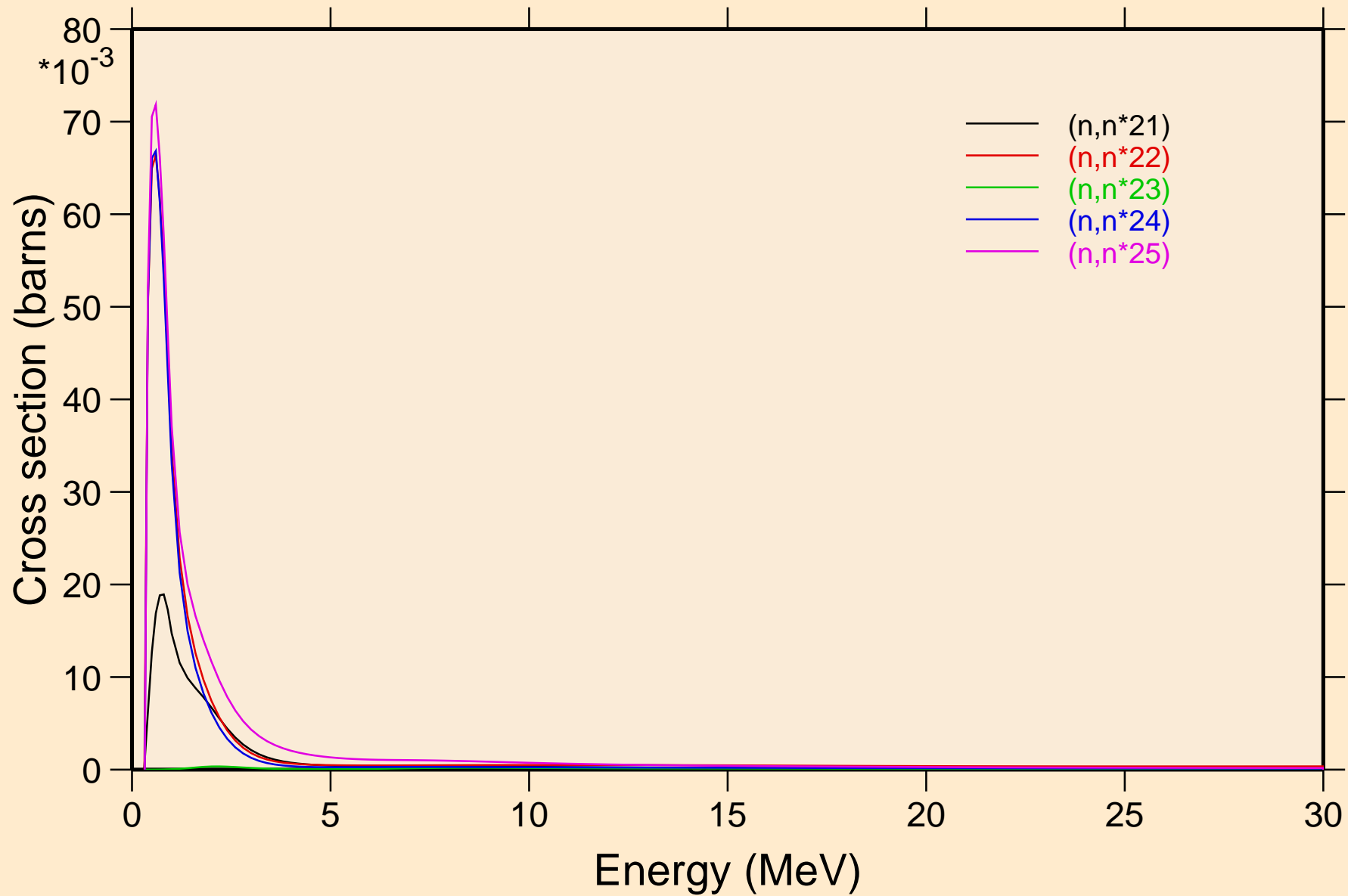

PA231 NEUTRON ACER TENDL-2021 LIBRARY; T=293.6K
Inelastic levels

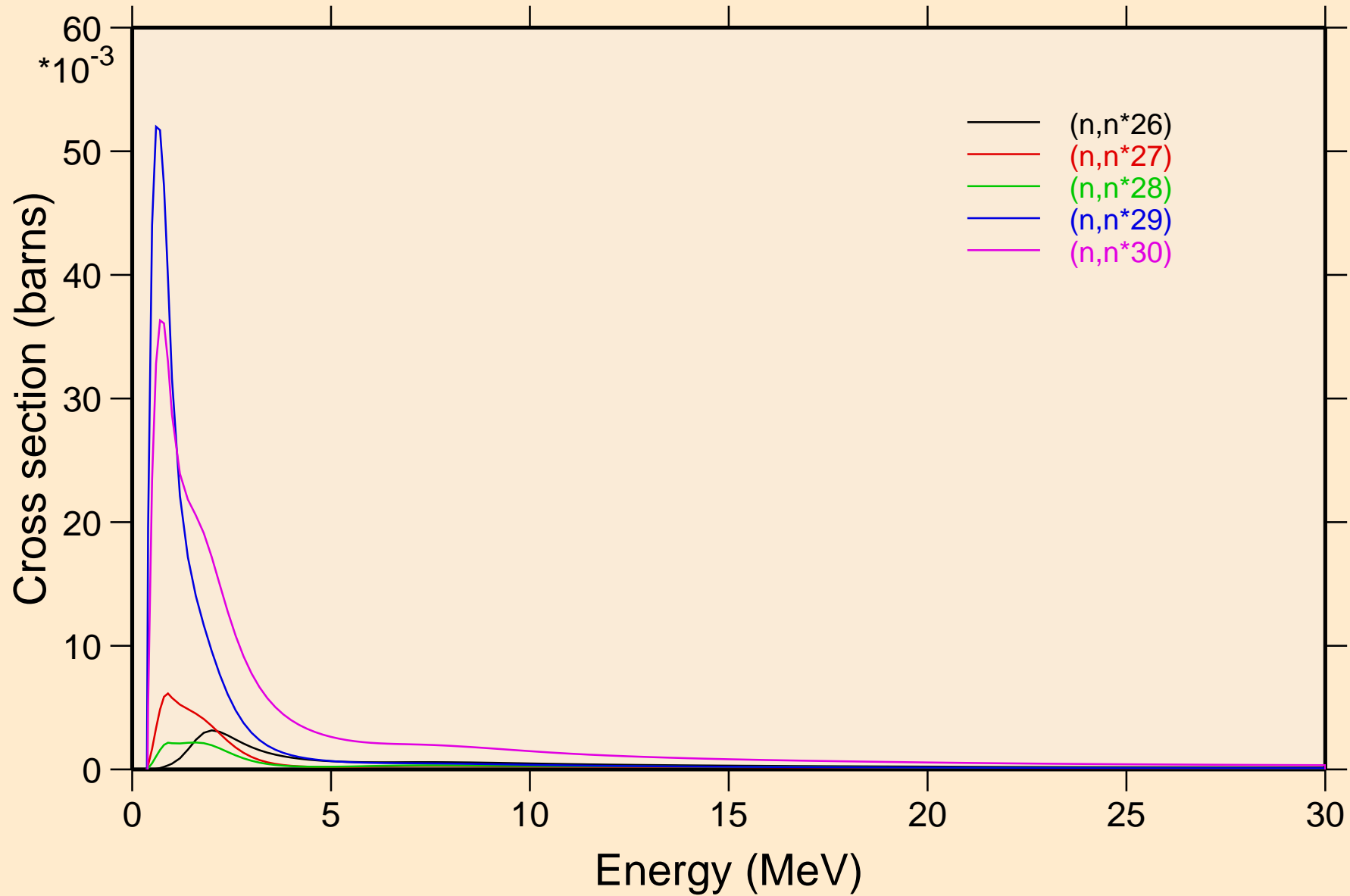

PA231 NEUTRON ACER TENDL-2021 LIBRARY; T=293.6K
Threshold reactions

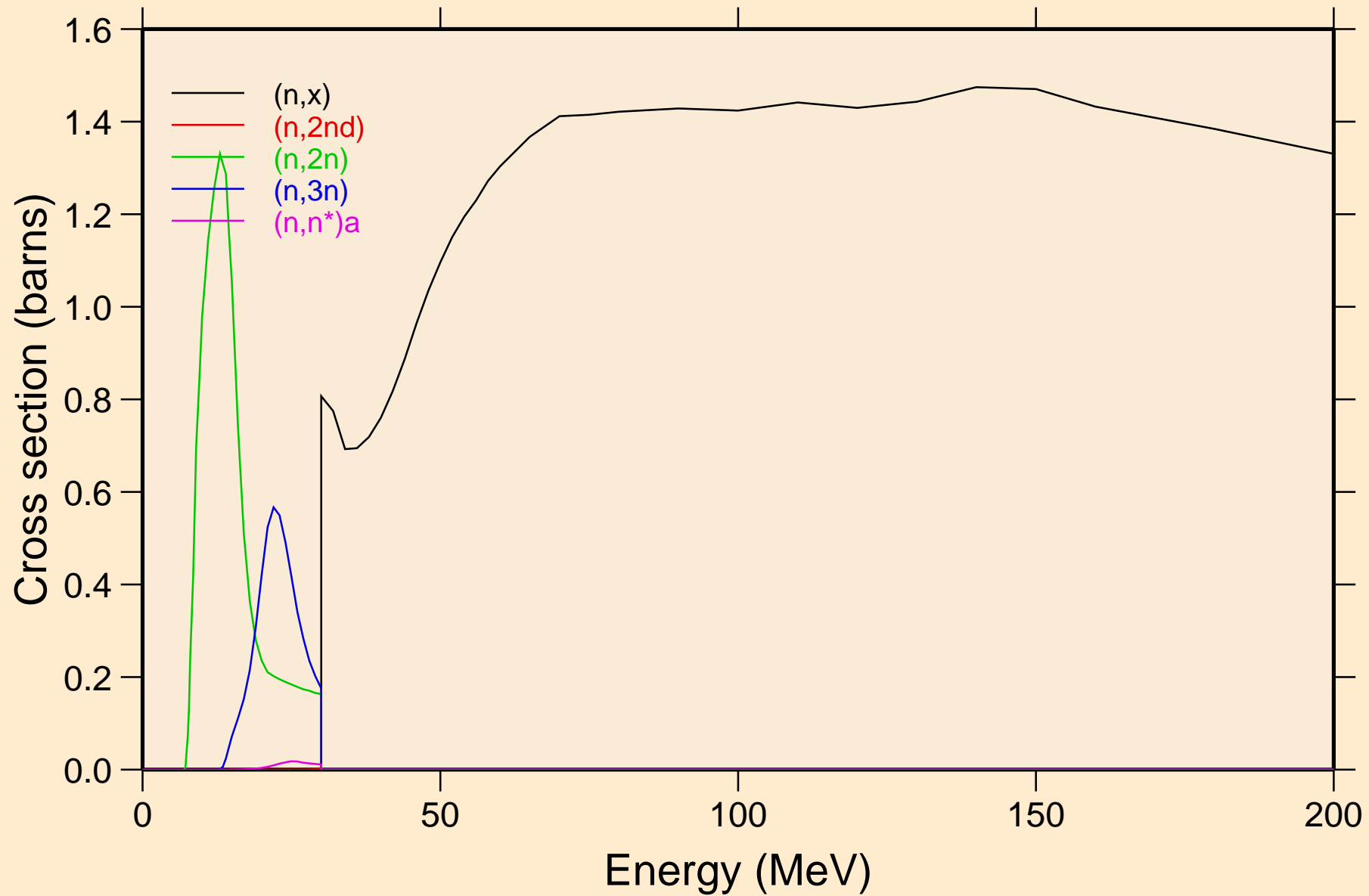

PA231 NEUTRON ACER TENDL-2021 LIBRARY; T=293.6K
Threshold reactions

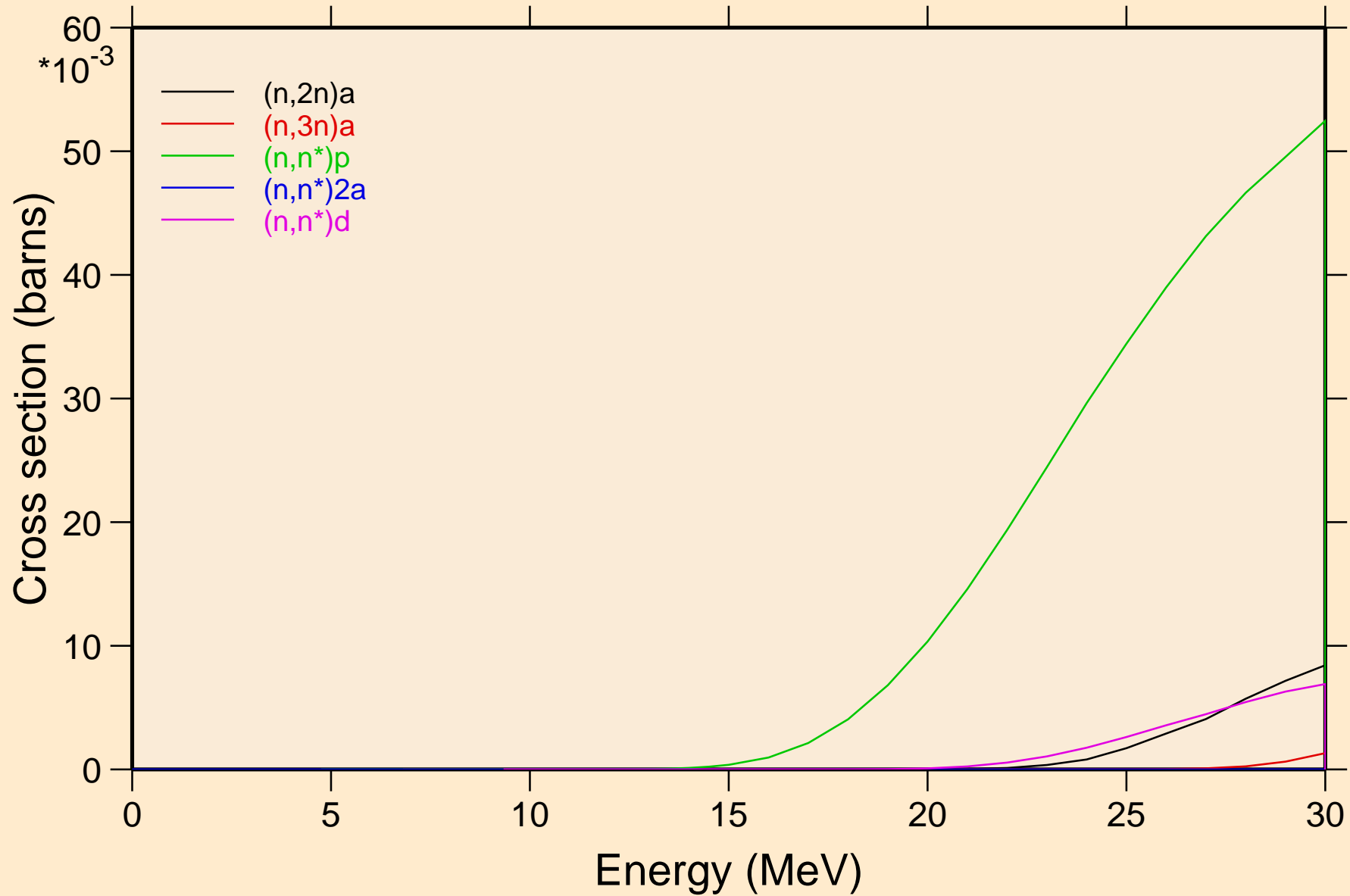

PA231 NEUTRON ACER TENDL-2021 LIBRARY; T=293.6K
Threshold reactions

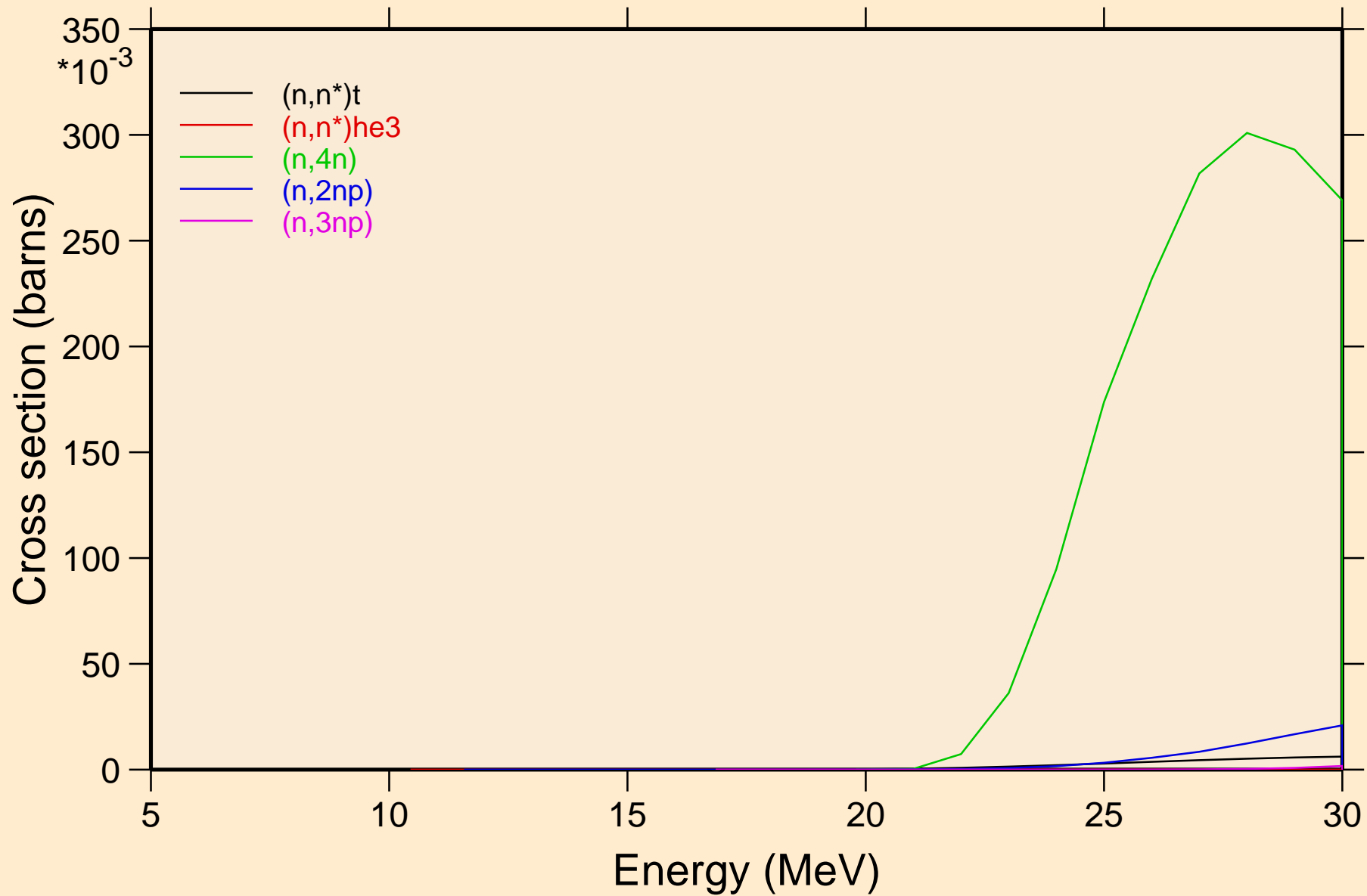

PA231 NEUTRON ACER TENDL-2021 LIBRARY; T=293.6K
Threshold reactions

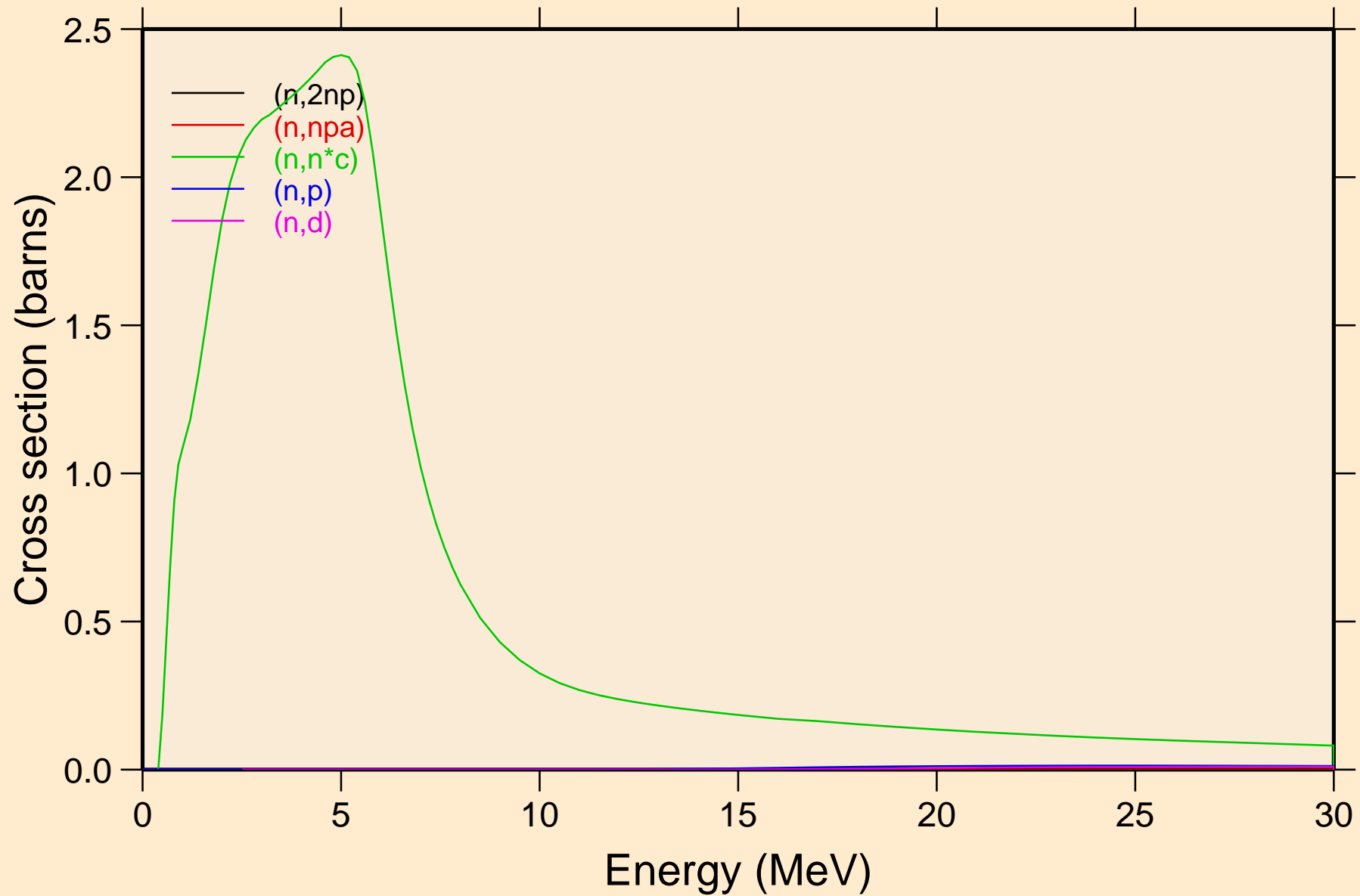

PA231 NEUTRON ACER TENDL-2021 LIBRARY; T=293.6K
Threshold reactions

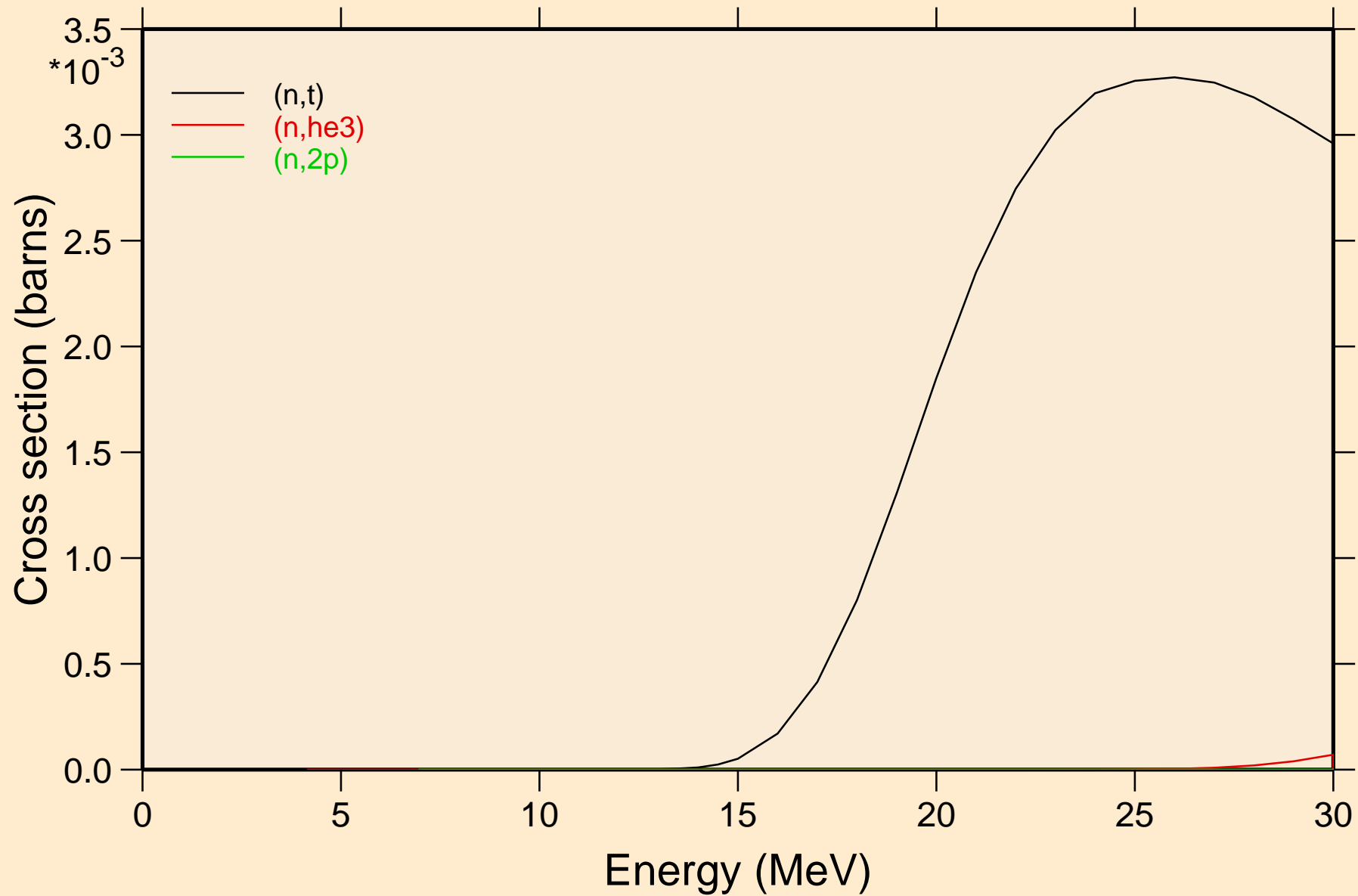

PA231 NEUTRON ACER TENDL-2021 LIBRARY; T=293.6K
Threshold reactions

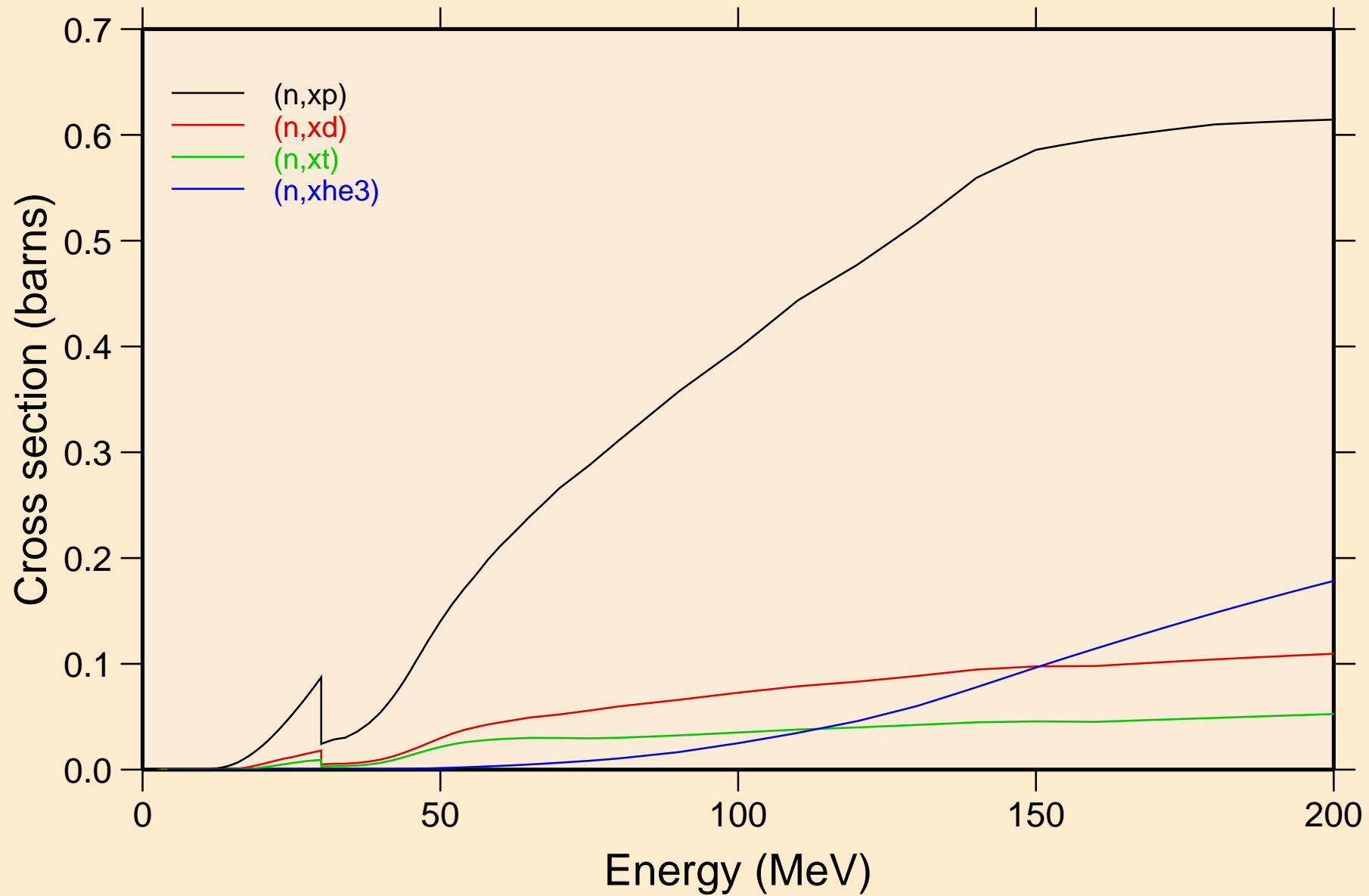

PA231 NEUTRON ACER TENDL-2021 LIBRARY; T=293.6K
angular distribution for elastic

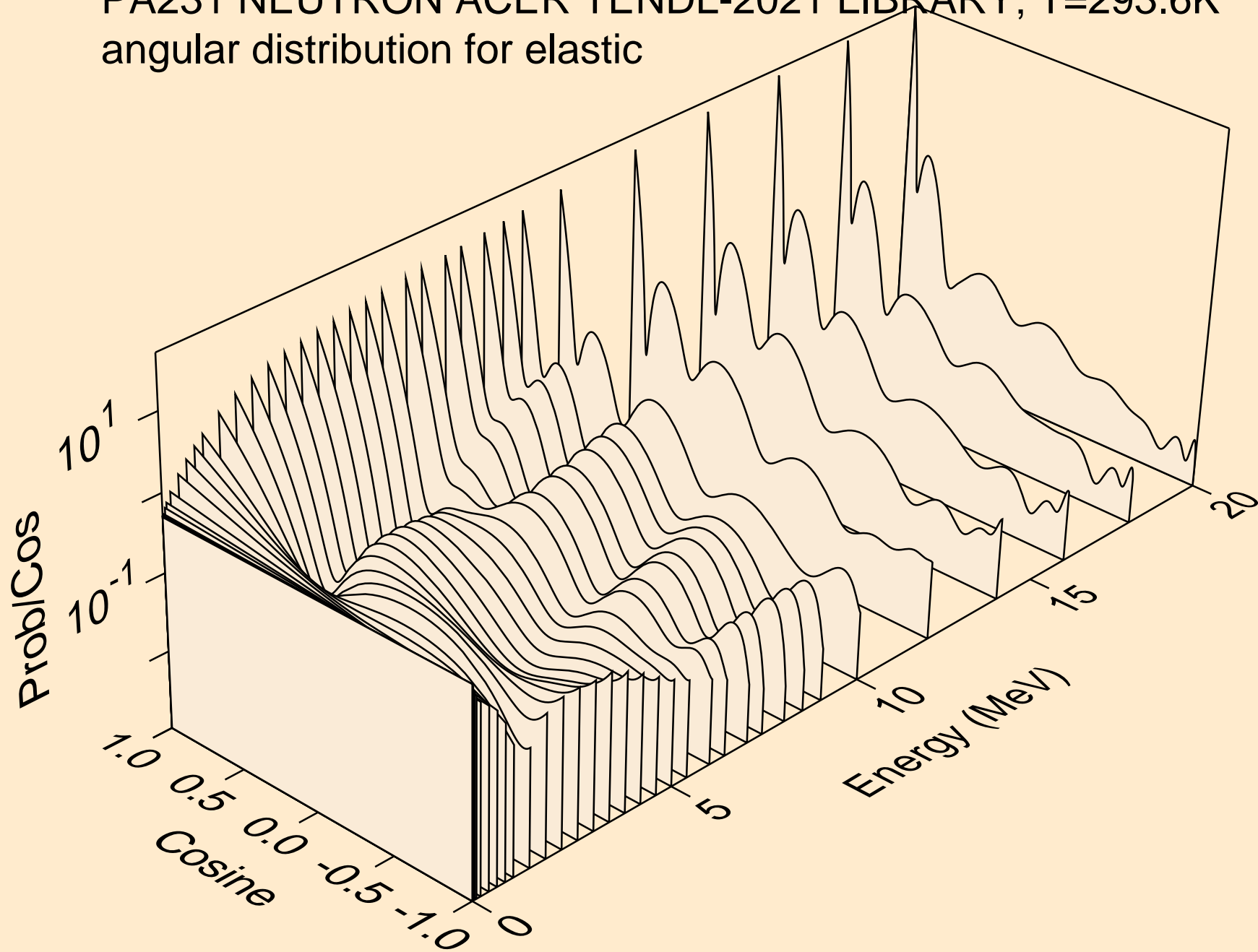

PA231 NEUTRON ACER TENDL-2021 LIBRARY; T=293.6K
angular distribution for elastic

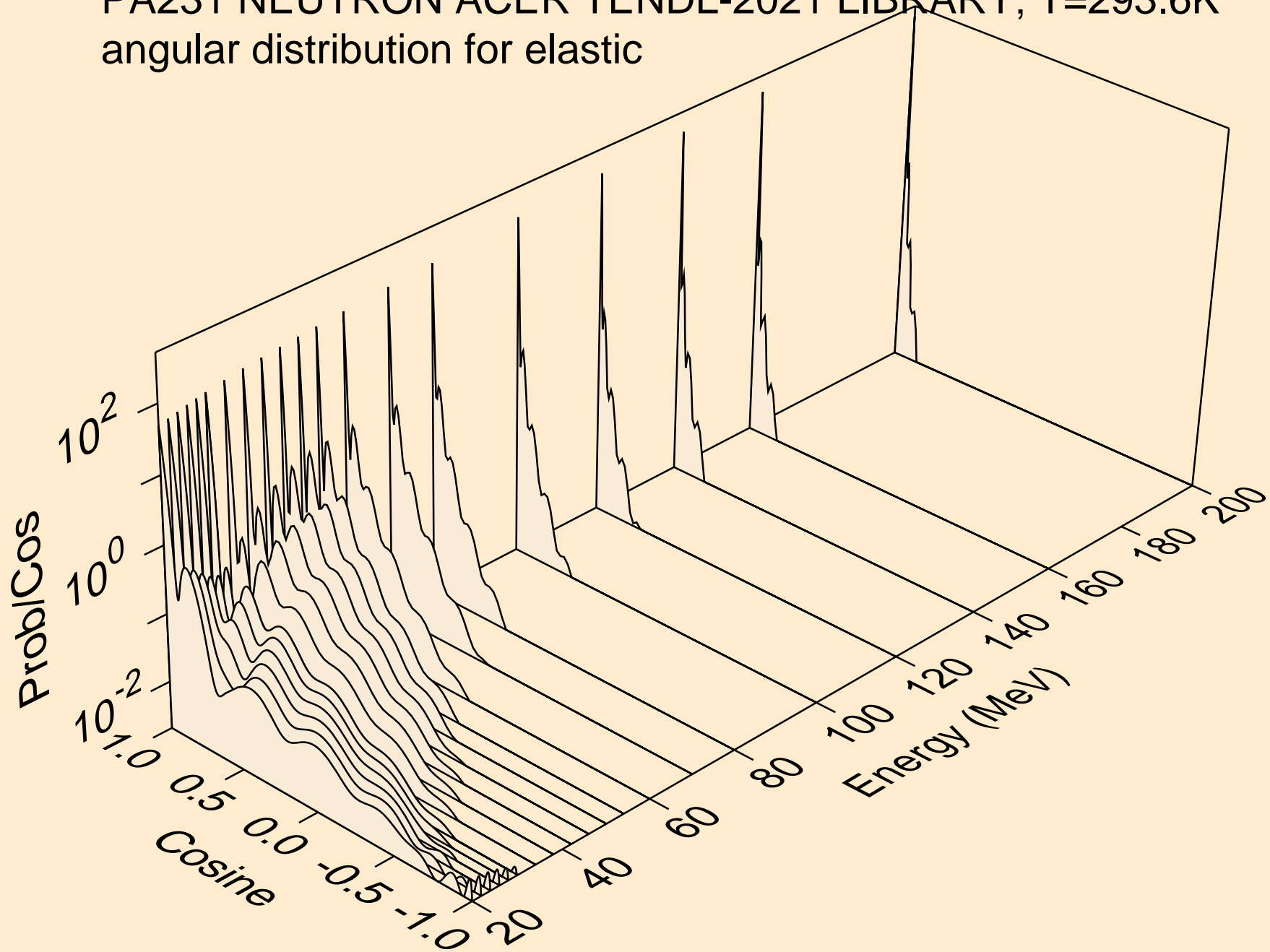

PA231 NEUTRON ACER TENDL-2021 LIBRARY; T=293.6K
angular distribution for (n,n*1)

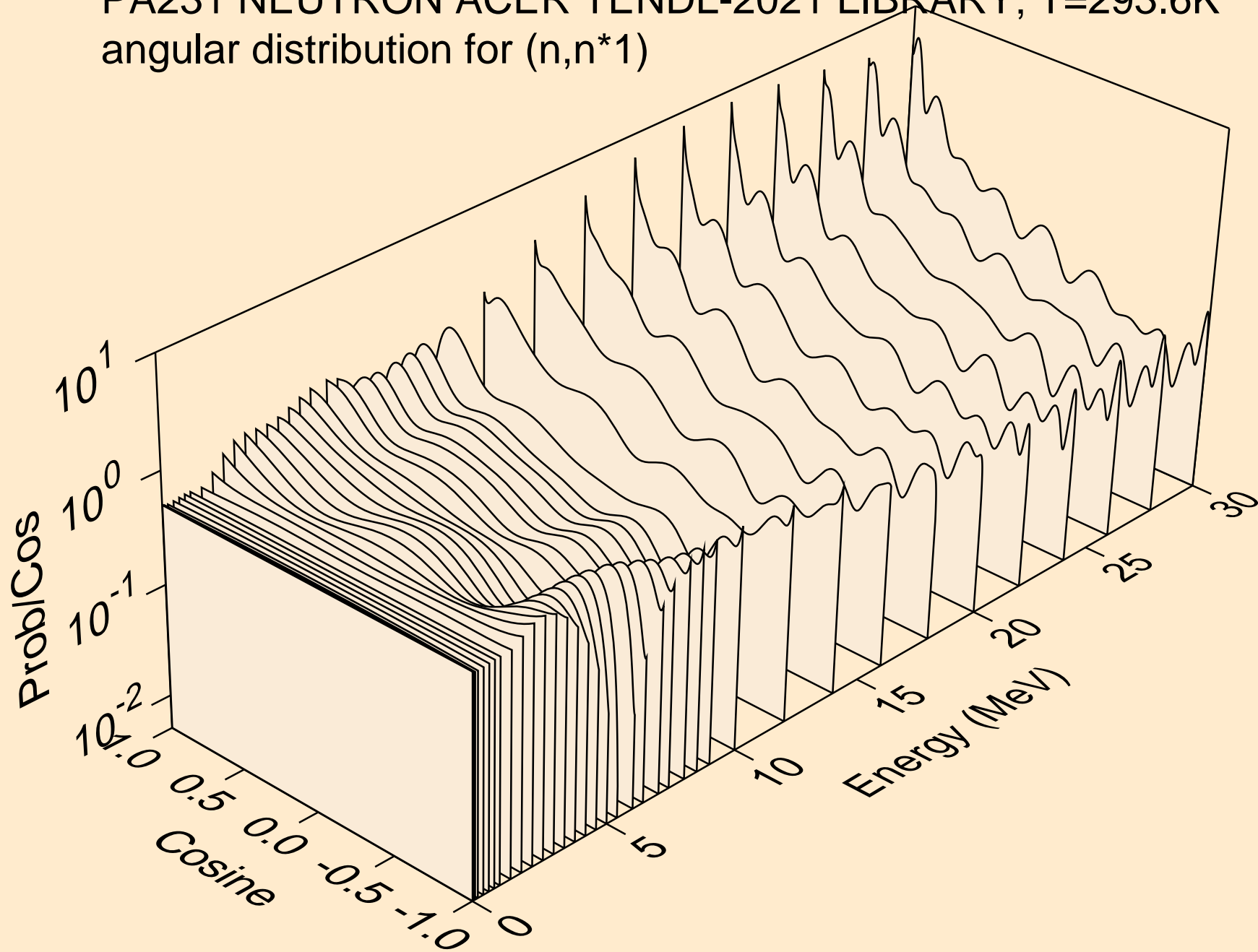

PA231 NEUTRON ACER TENDL-2021 LIBRARY; T=293.6K
angular distribution for (n,n*2)

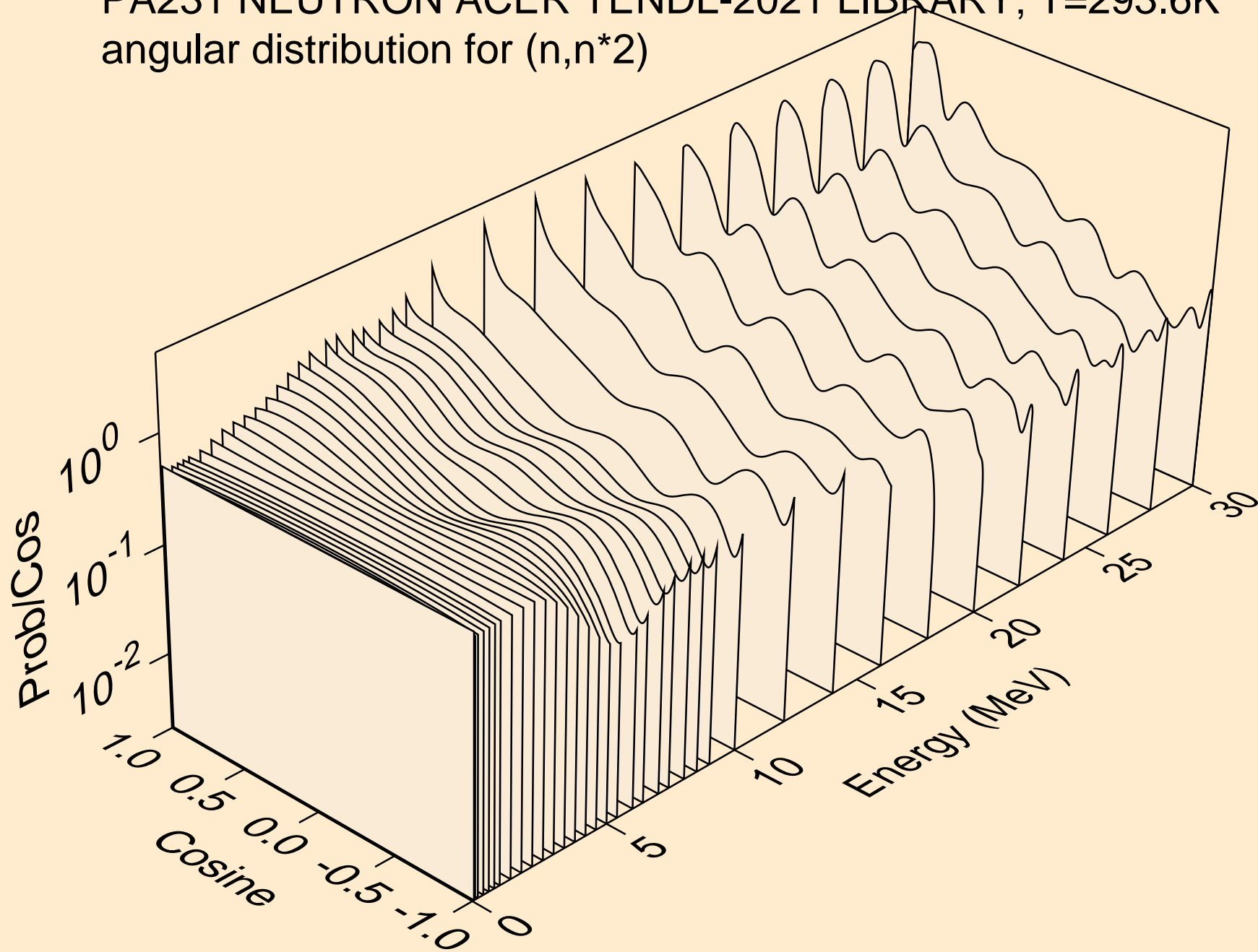

PA231 NEUTRON ACER TENDL-2021 LIBRARY; T=293.6K
angular distribution for (n,n*3)

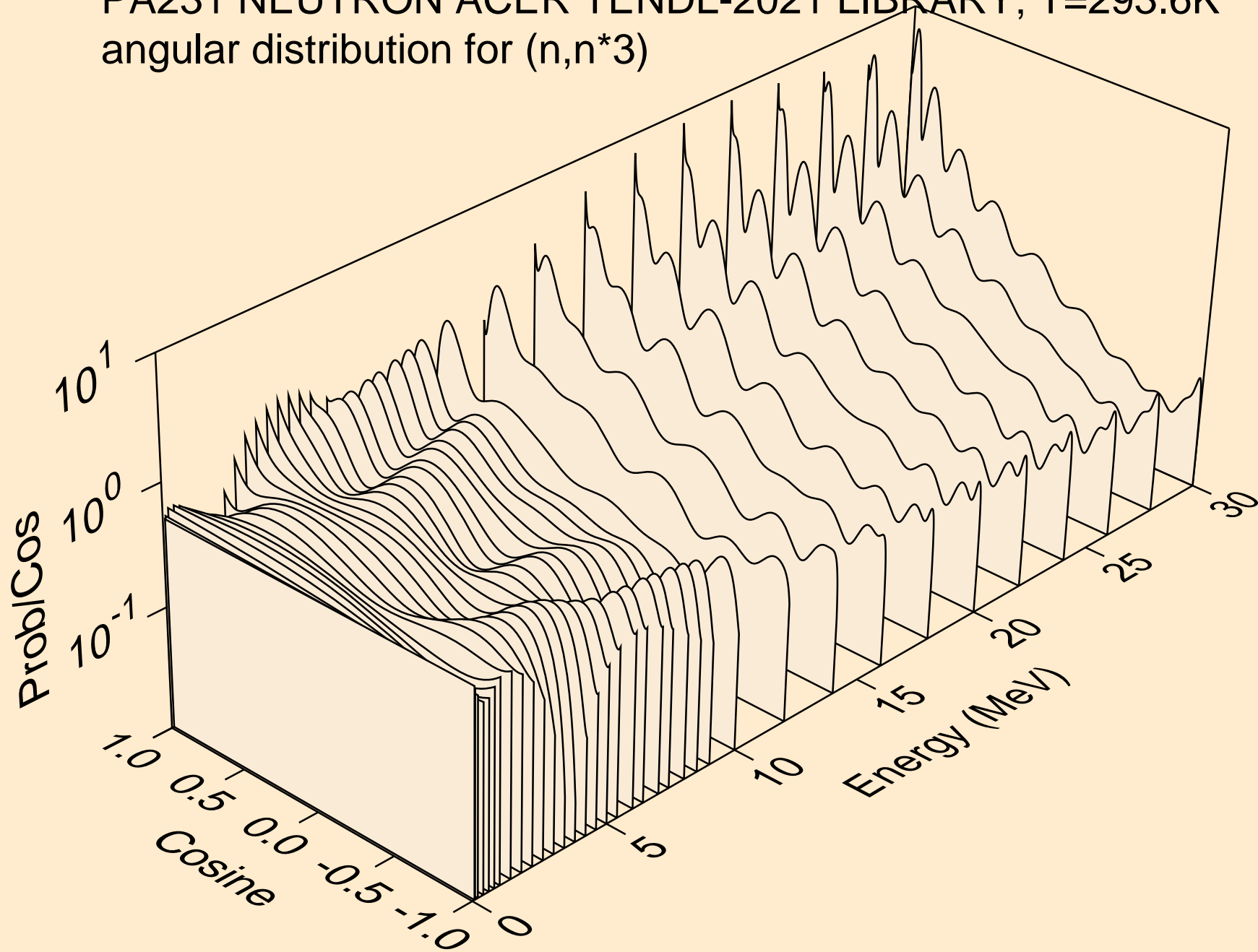

PA231 NEUTRON ACER TENDL-2021 LIBRARY; T=293.6K
angular distribution for (n,n*4)

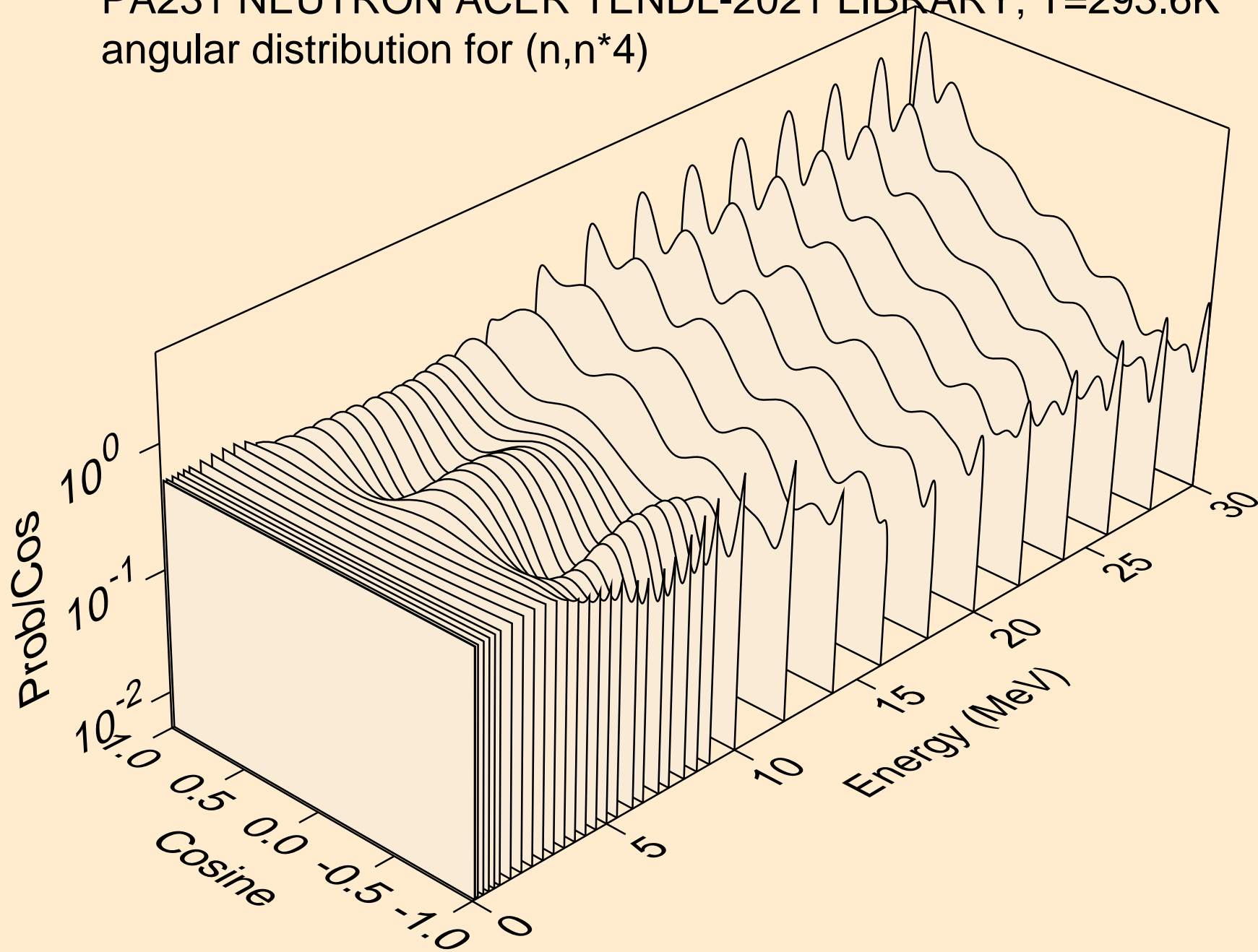

PA231 NEUTRON ACER TENDL-2021 LIBRARY; T=293.6K
angular distribution for (n,n*5)

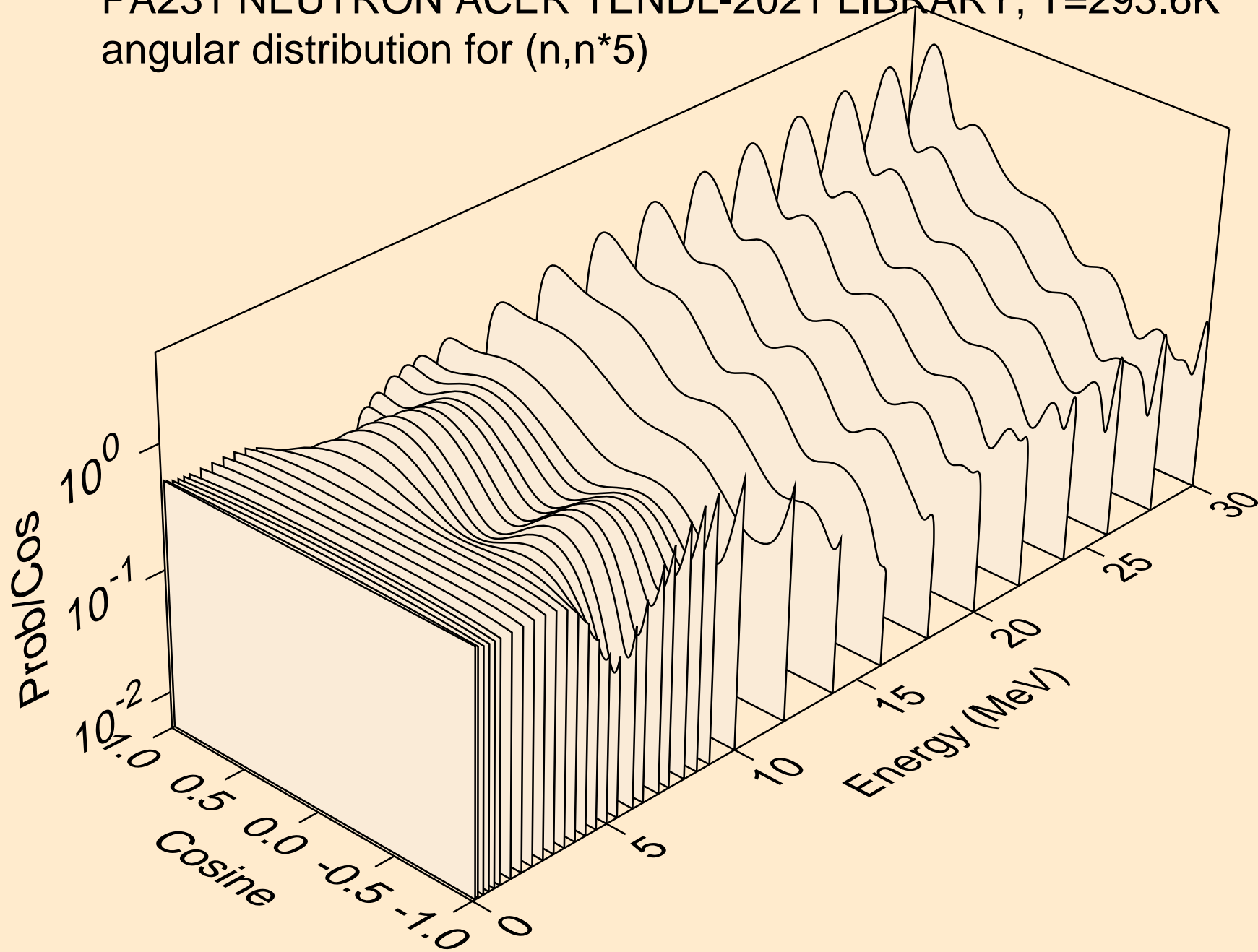

PA231 NEUTRON ACER TENDL-2021 LIBRARY; T=293.6K
angular distribution for (n,n*6)

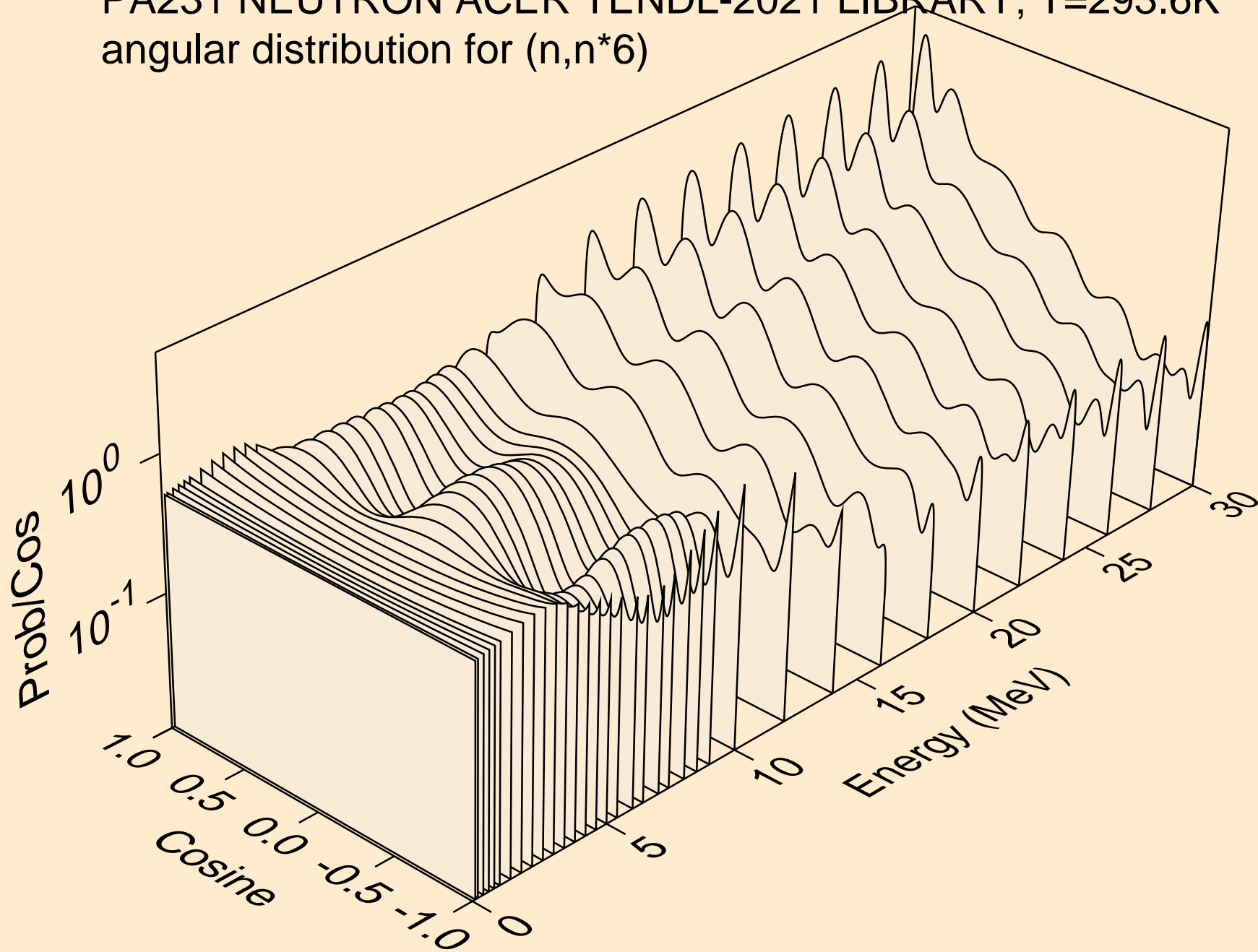

PA231 NEUTRON ACER TENDL-2021 LIBRARY; T=293.6K
angular distribution for (n,n*7)

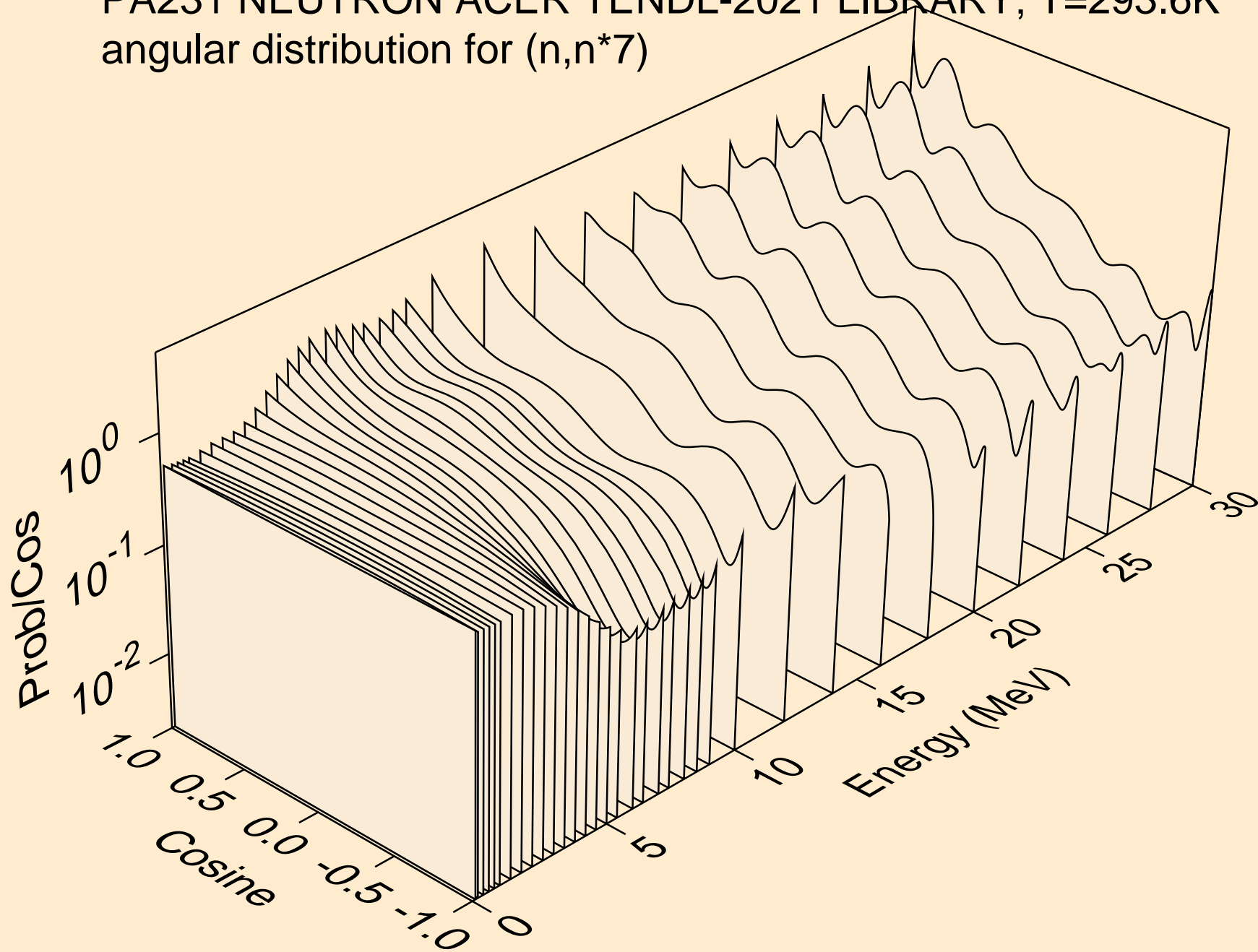

PA231 NEUTRON ACER TENDL-2021 LIBRARY; T=293.6K
angular distribution for (n,n*8)

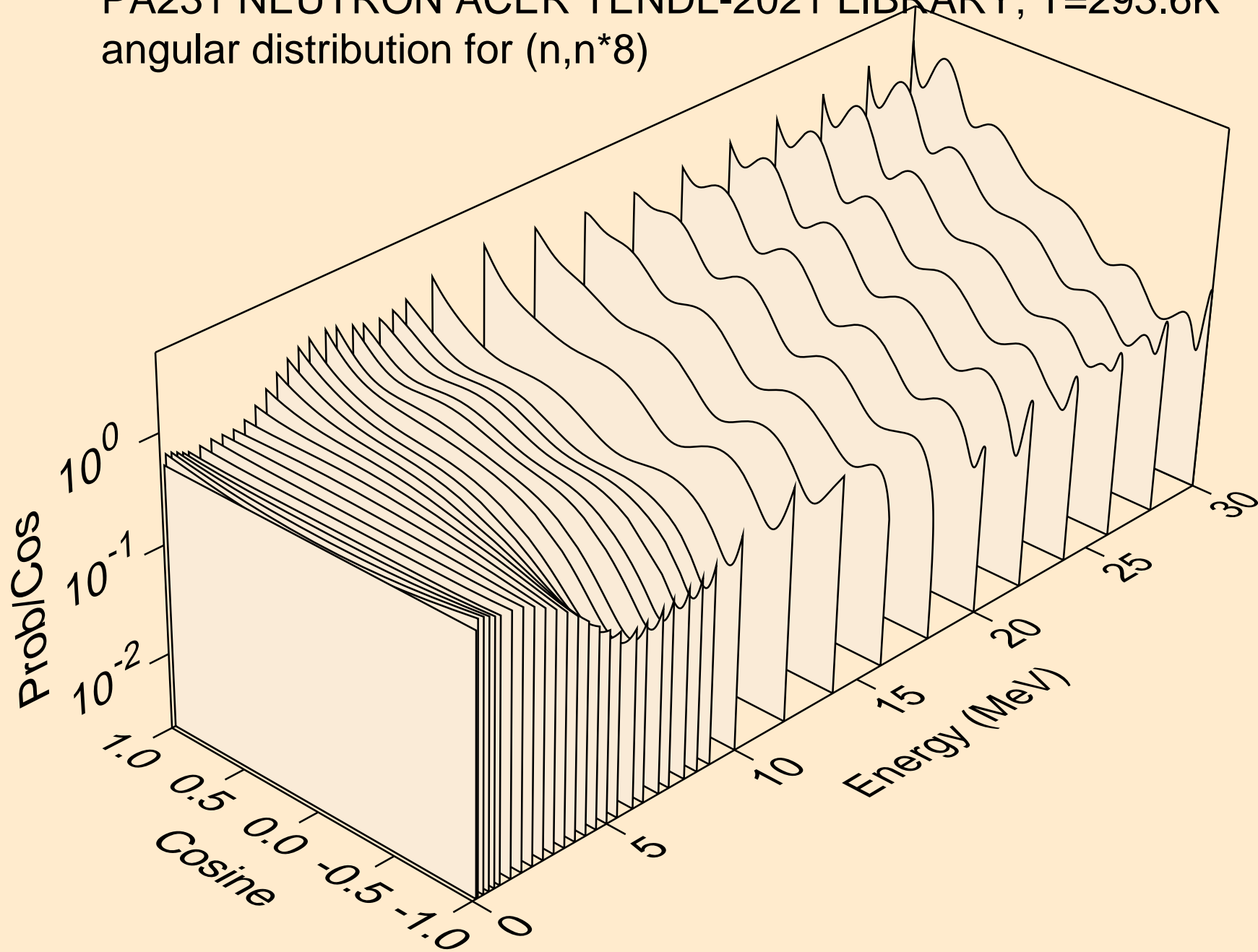

PA231 NEUTRON ACER TENDL-2021 LIBRARY; T=293.6K
angular distribution for (n,n*9)

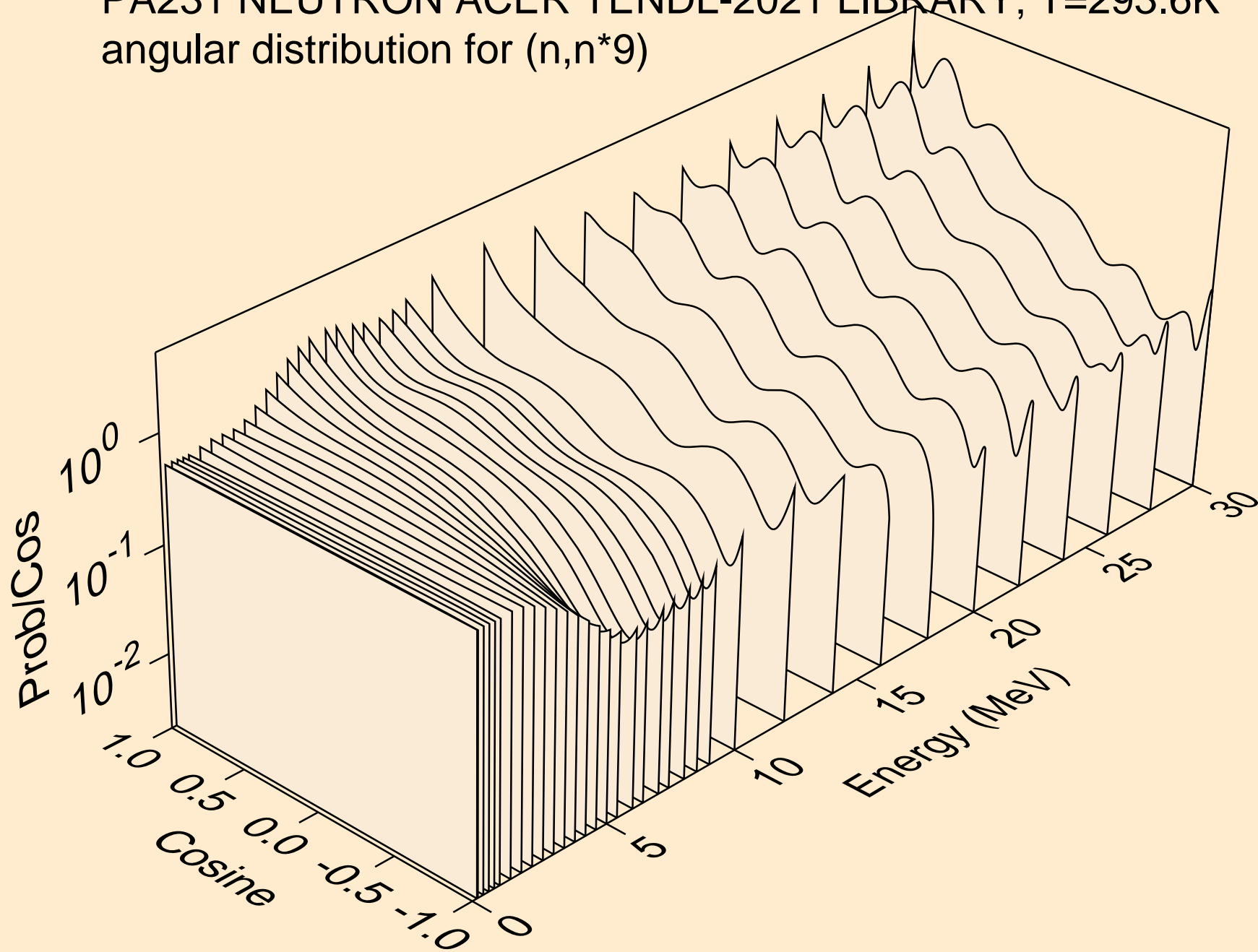

PA231 NEUTRON ACER TENDL-2021 LIBRARY; T=293.6K
angular distribution for (n,n*10)

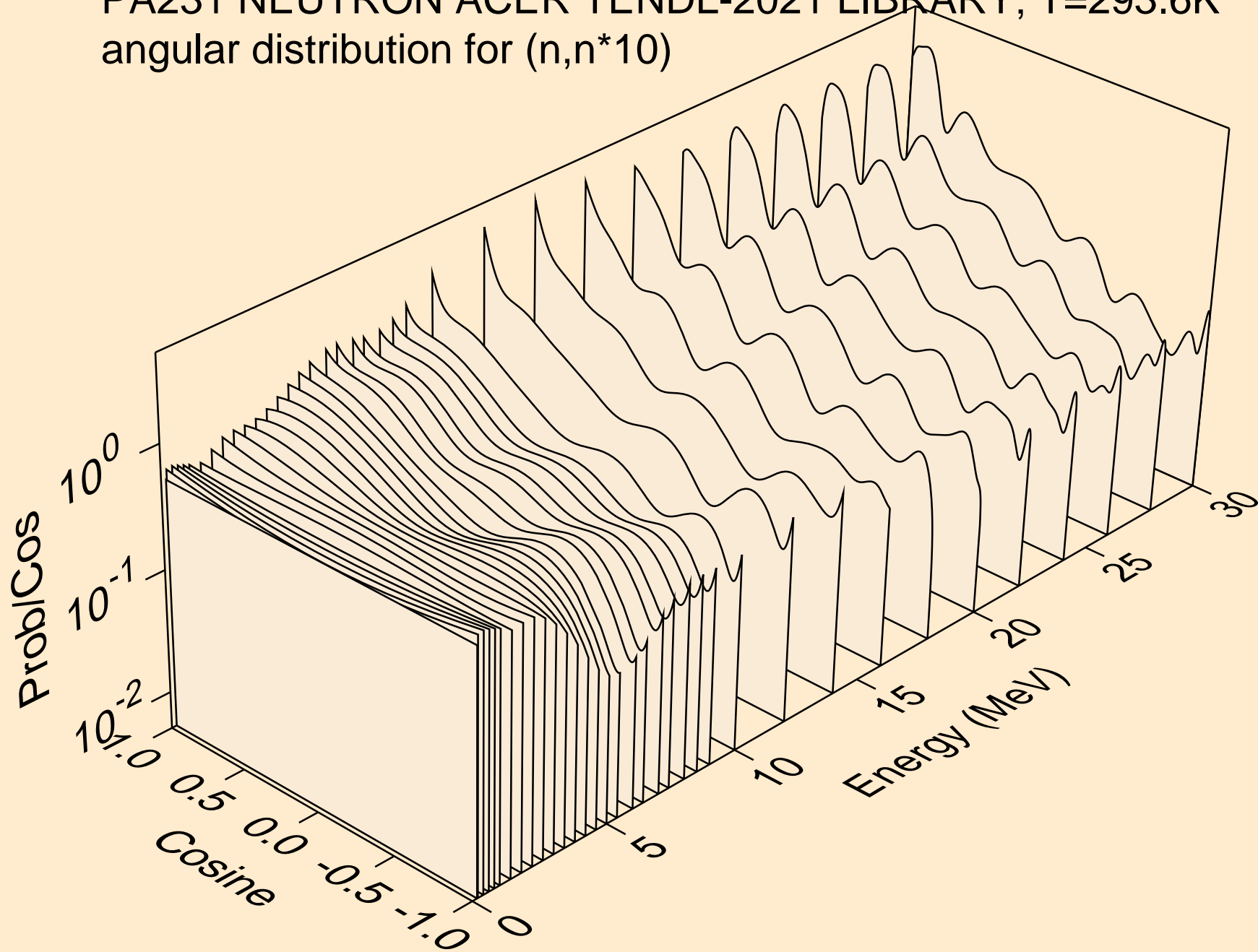

PA231 NEUTRON ACER TENDL-2021 LIBRARY; T=293.6K
angular distribution for (n,n*11)

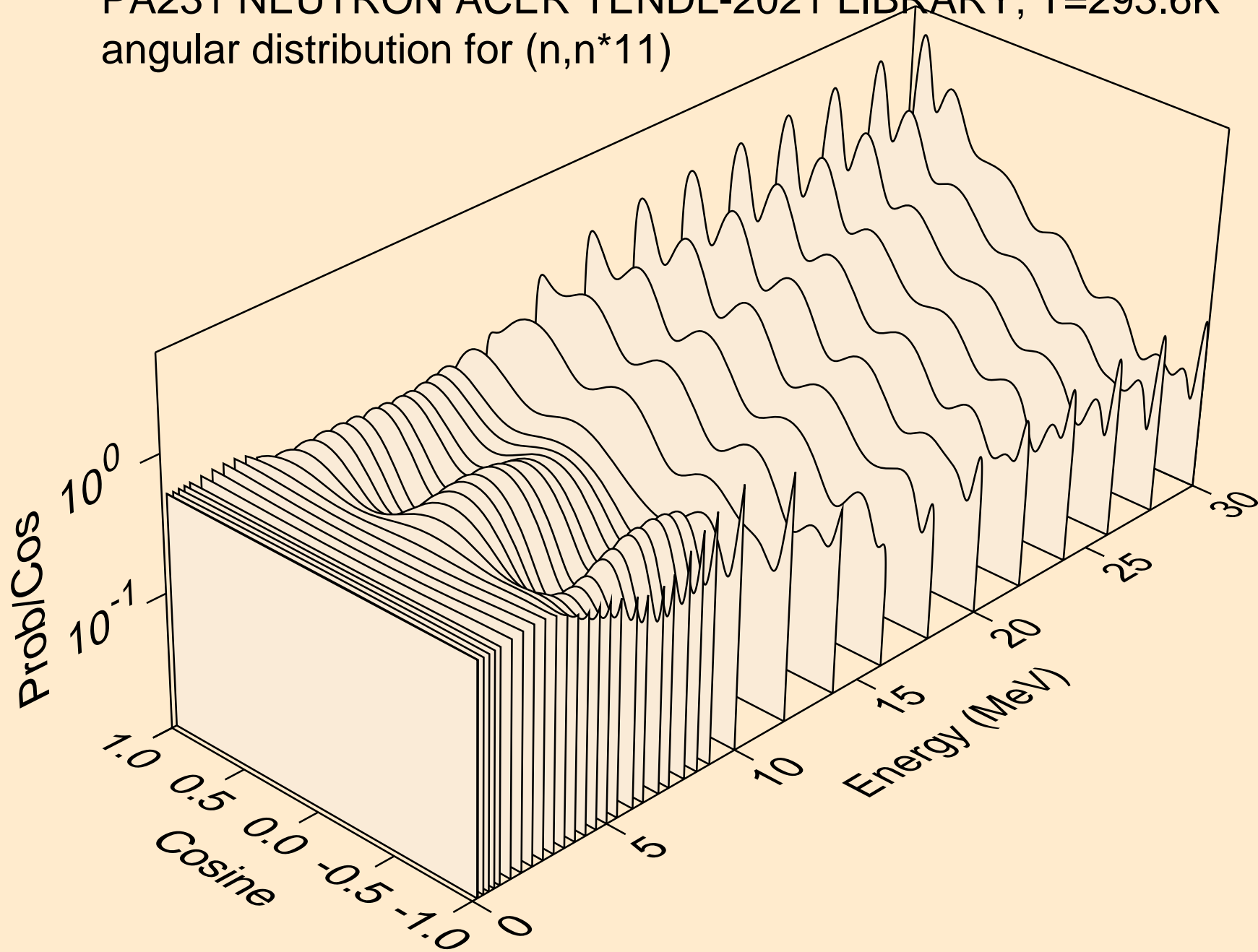

PA231 NEUTRON ACER TENDL-2021 LIBRARY; T=293.6K
angular distribution for (n,n*12)

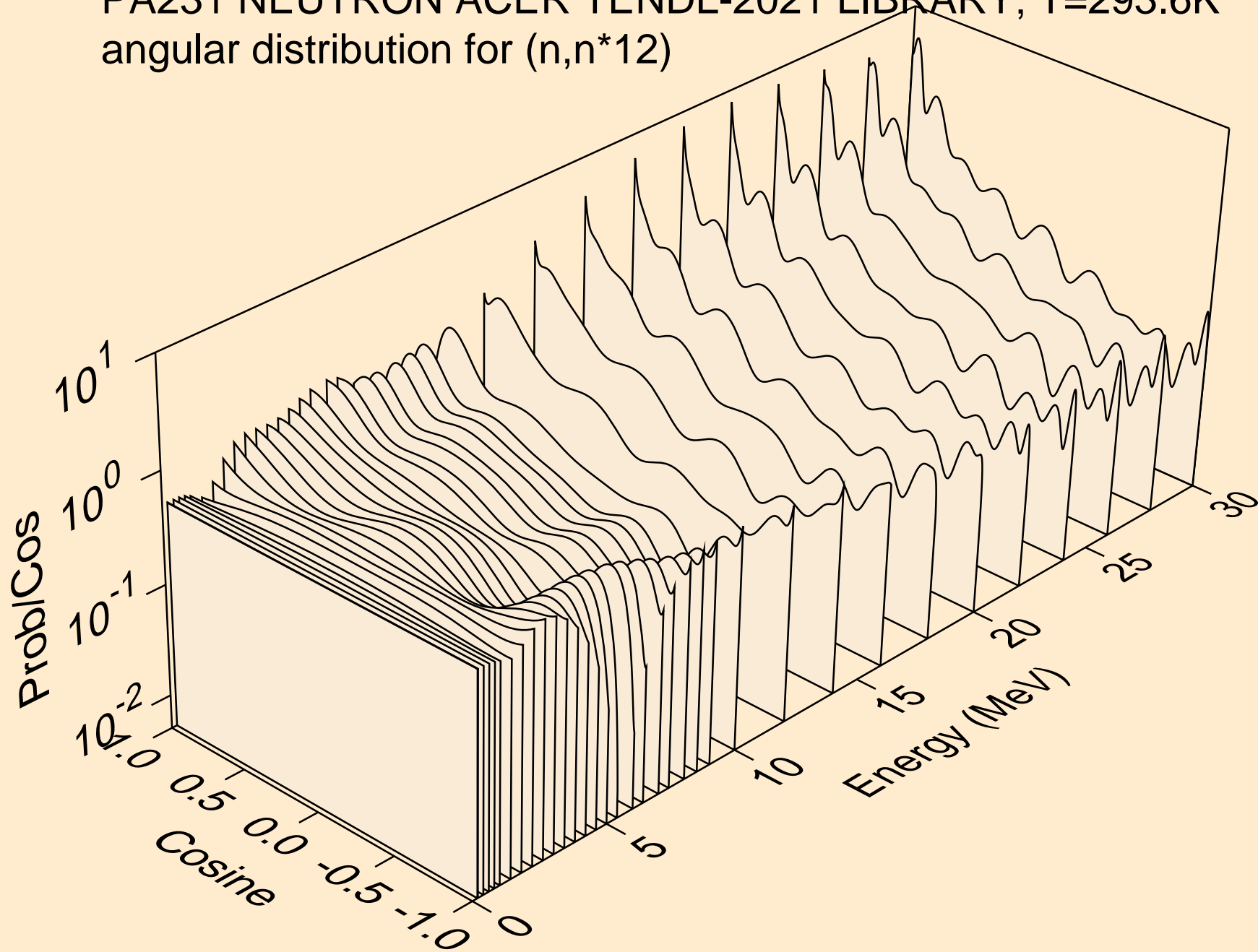

PA231 NEUTRON ACER TENDL-2021 LIBRARY; T=293.6K
angular distribution for (n,n*13)

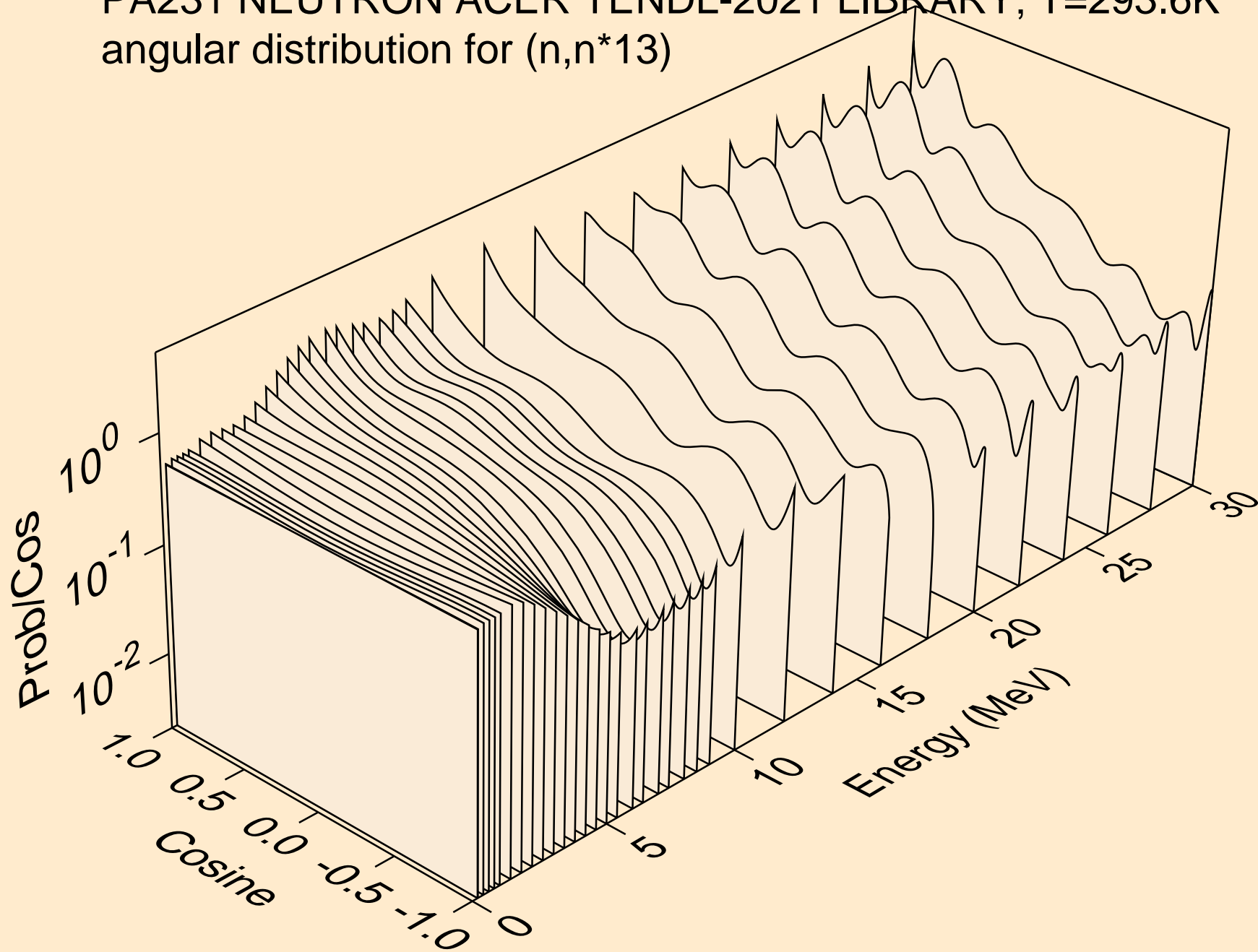

PA231 NEUTRON ACER TENDL-2021 LIBRARY; T=293.6K
angular distribution for (n,n*14)

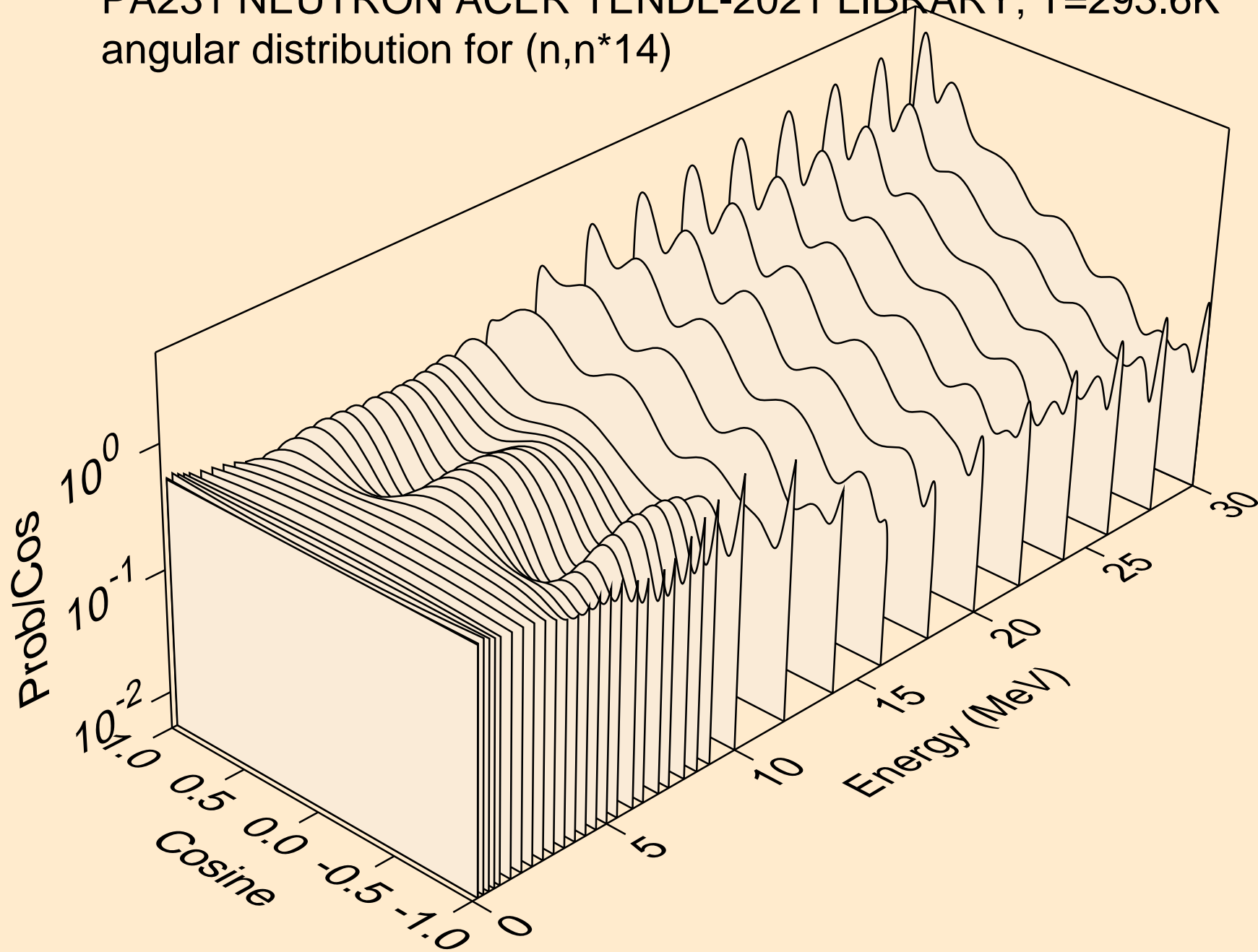

PA231 NEUTRON ACER TENDL-2021 LIBRARY; T=293.6K
angular distribution for (n,n*15)

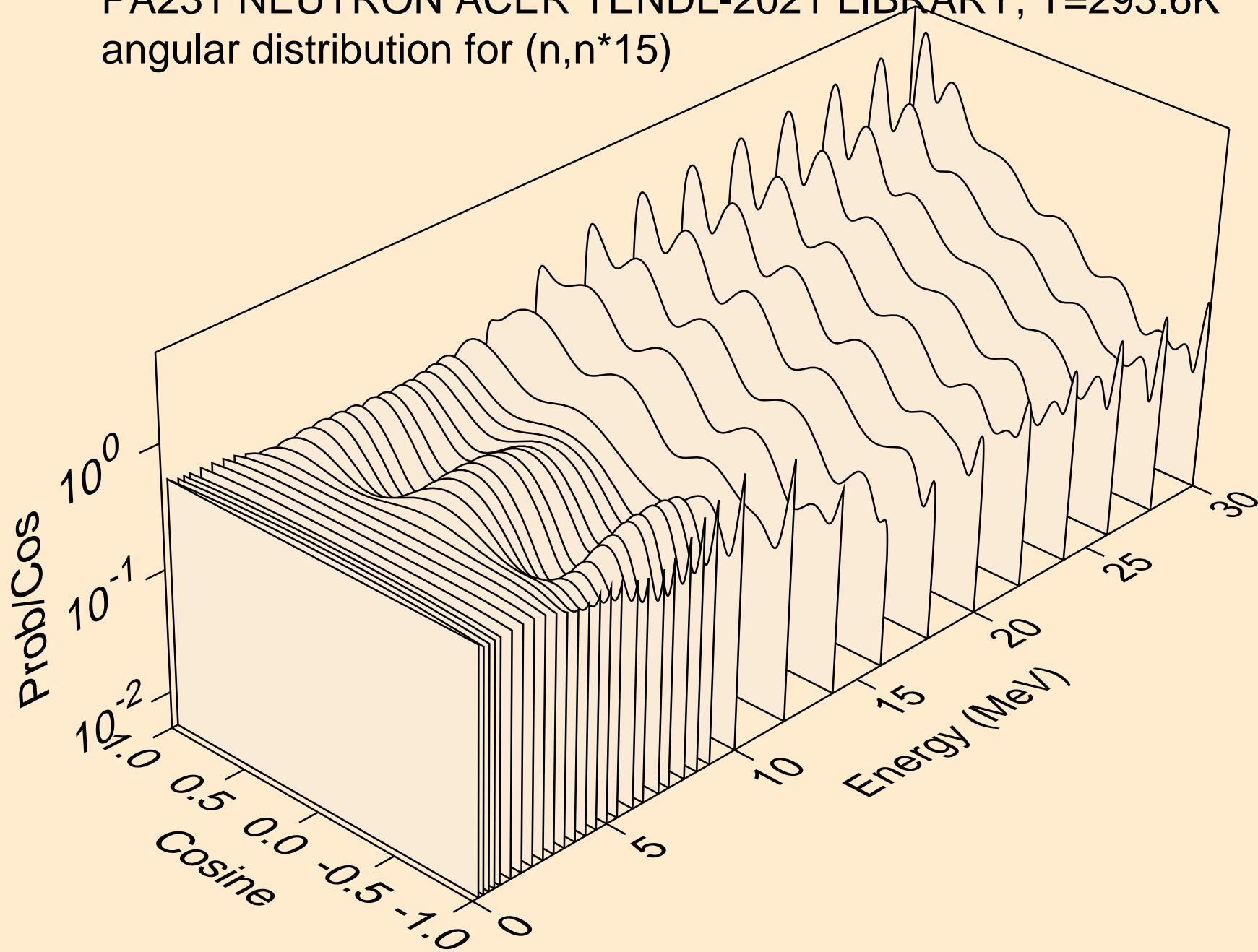

PA231 NEUTRON ACER TENDL-2021 LIBRARY; T=293.6K
angular distribution for (n,n*16)

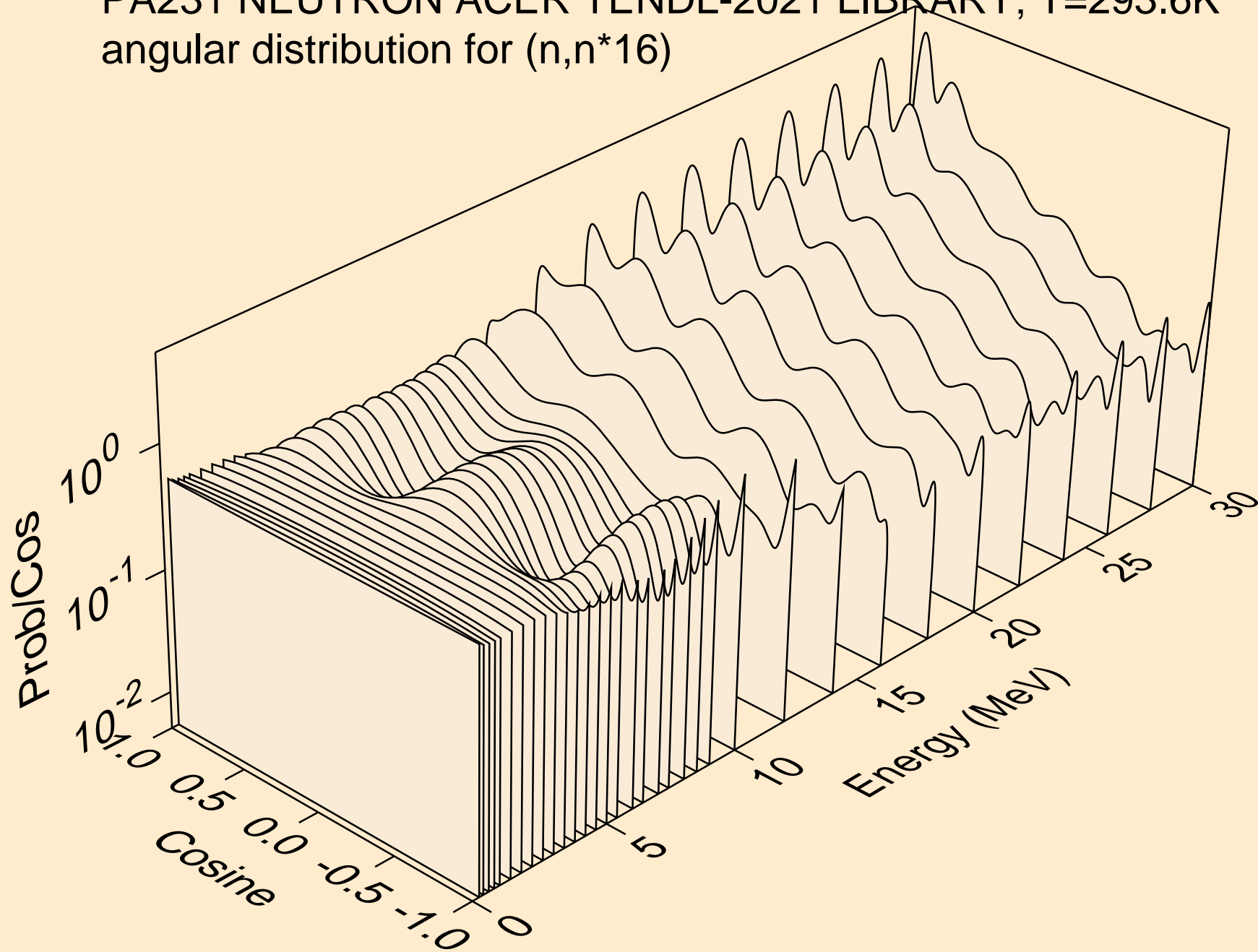

PA231 NEUTRON ACER TENDL-2021 LIBRARY; T=293.6K
angular distribution for (n,n*17)

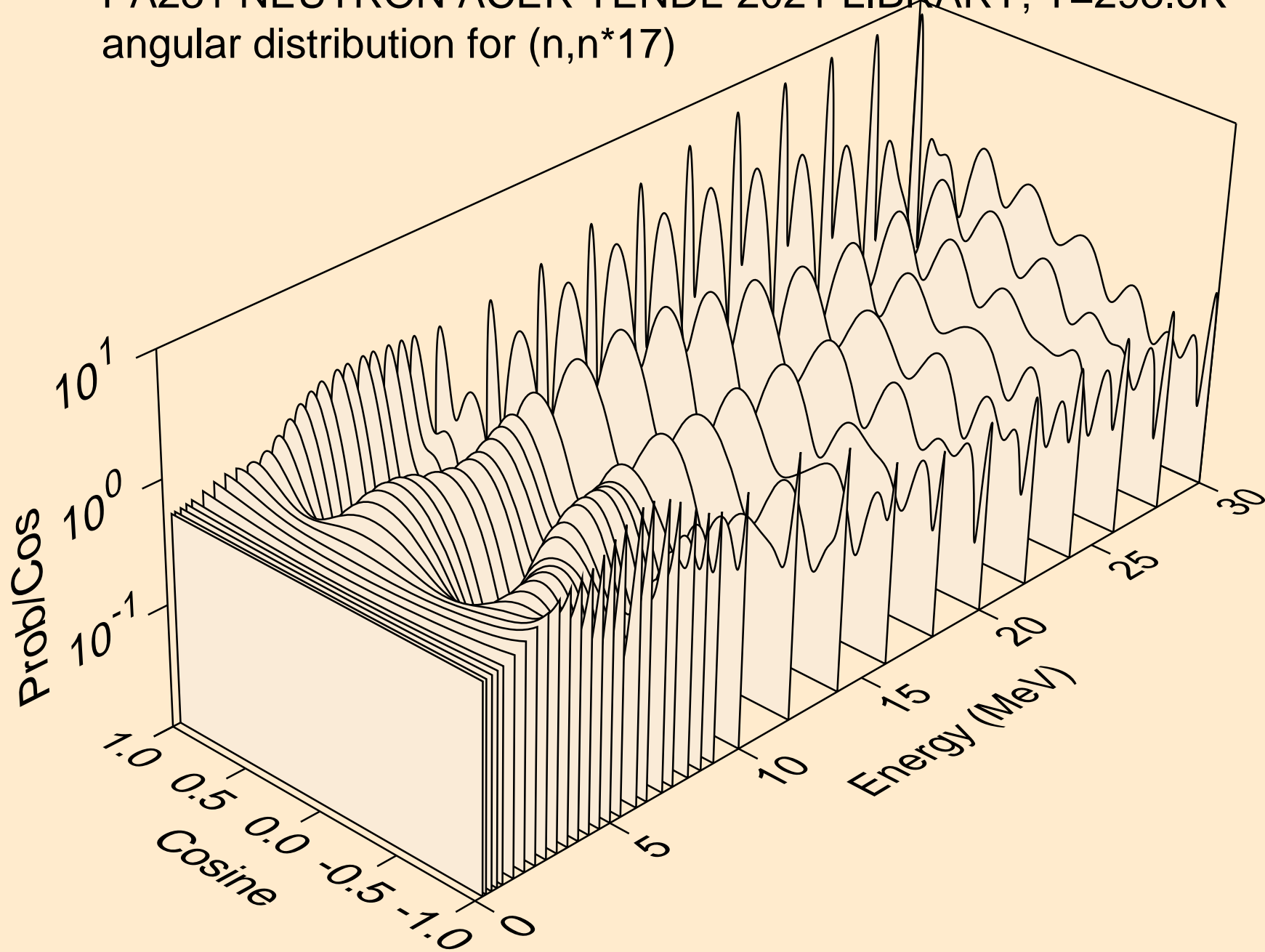

PA231 NEUTRON ACER TENDL-2021 LIBRARY; T=293.6K
angular distribution for (n,n*18)

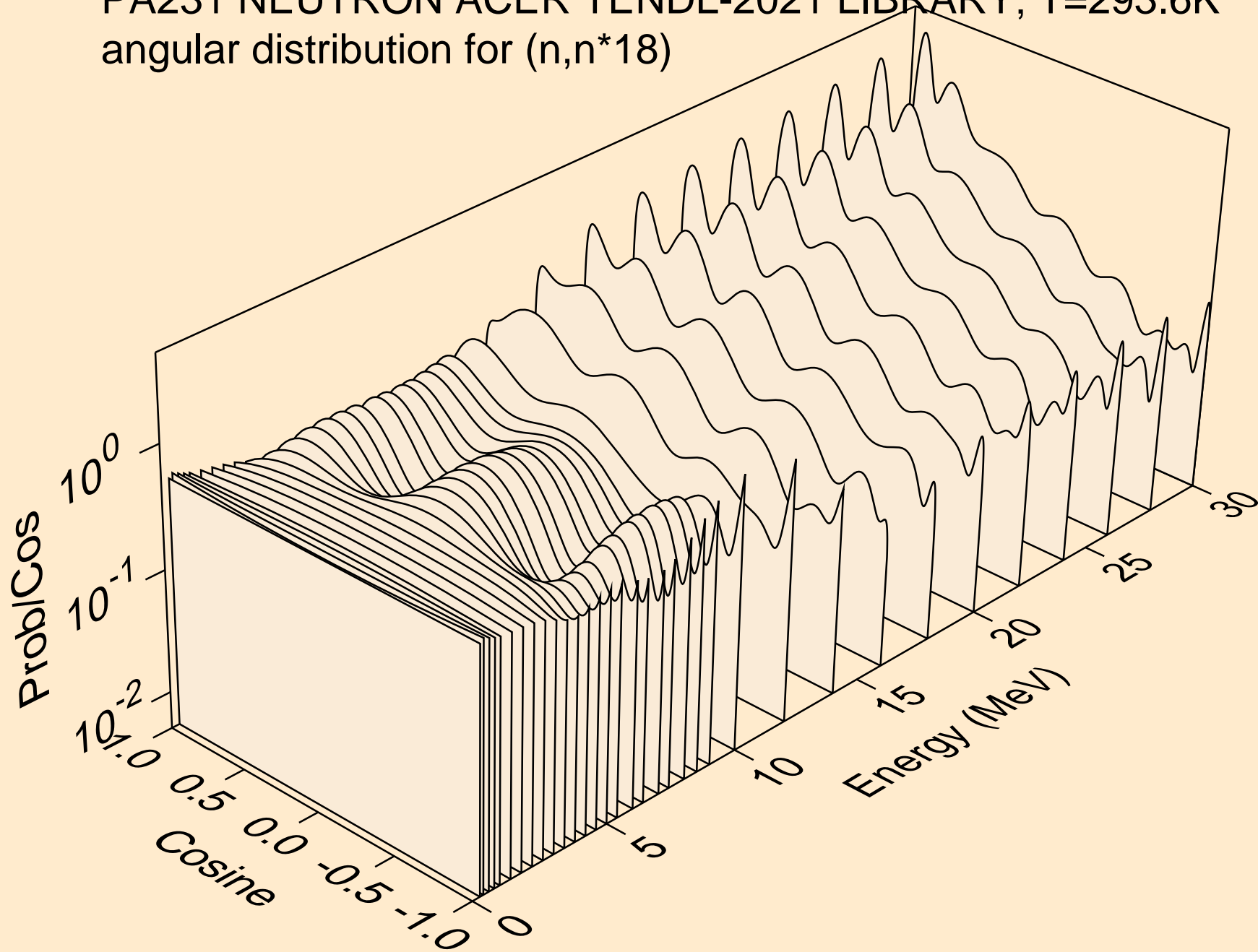

PA231 NEUTRON ACER TENDL-2021 LIBRARY; T=293.6K
angular distribution for (n,n*19)

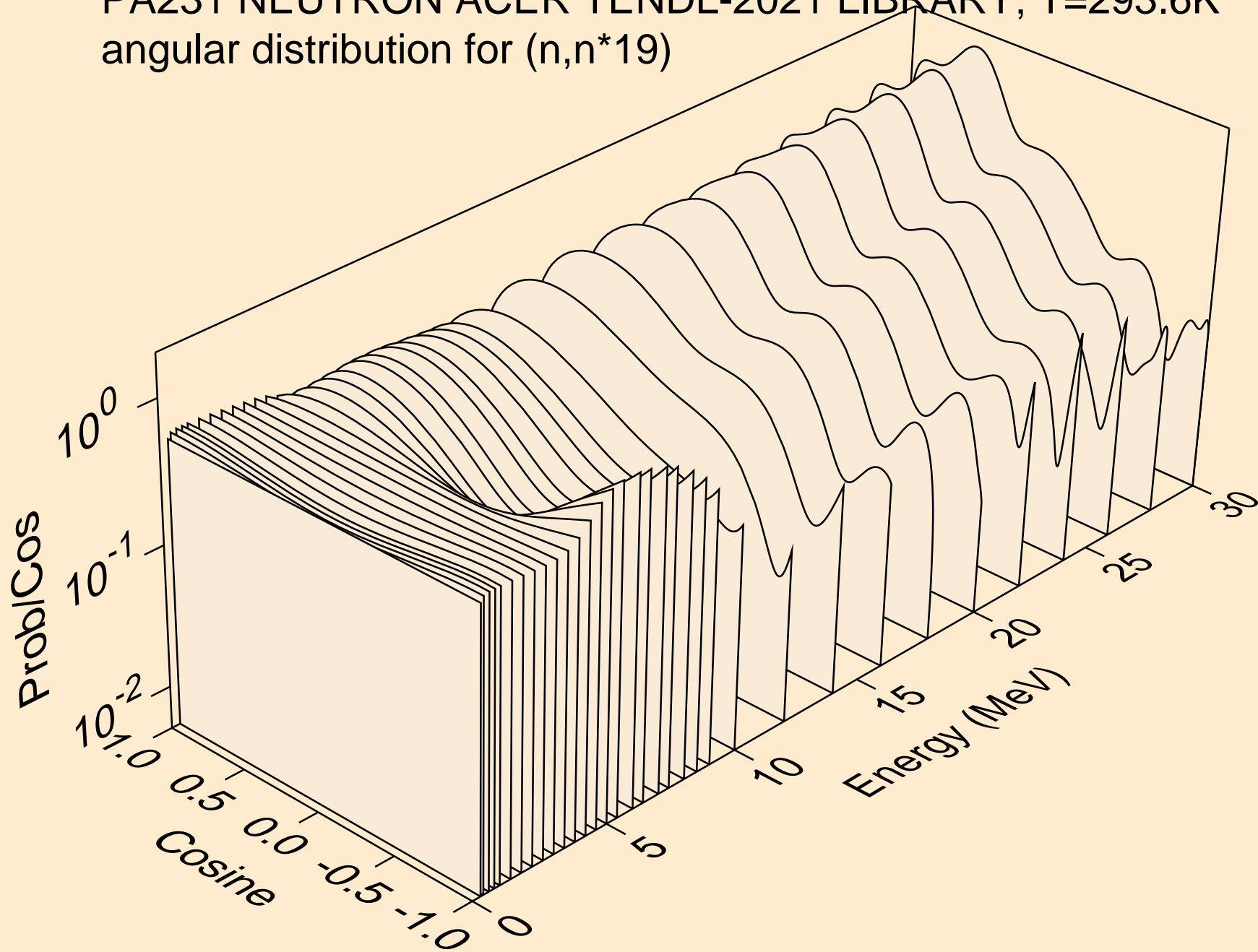

PA231 NEUTRON ACER TENDL-2021 LIBRARY; T=293.6K
angular distribution for (n,n*20)

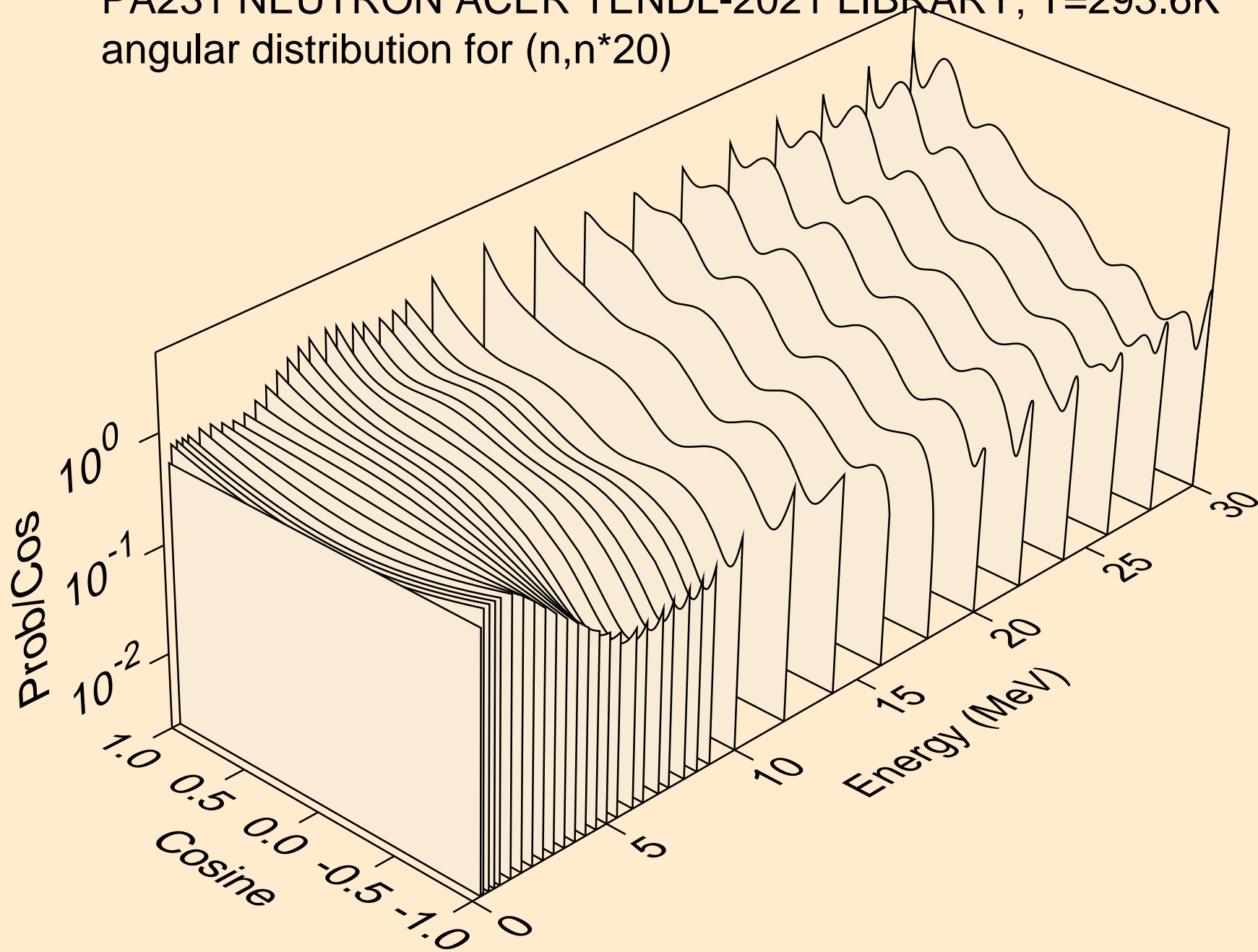

PA231 NEUTRON ACER TENDL-2021 LIBRARY; T=293.6K
angular distribution for (n,n*21)

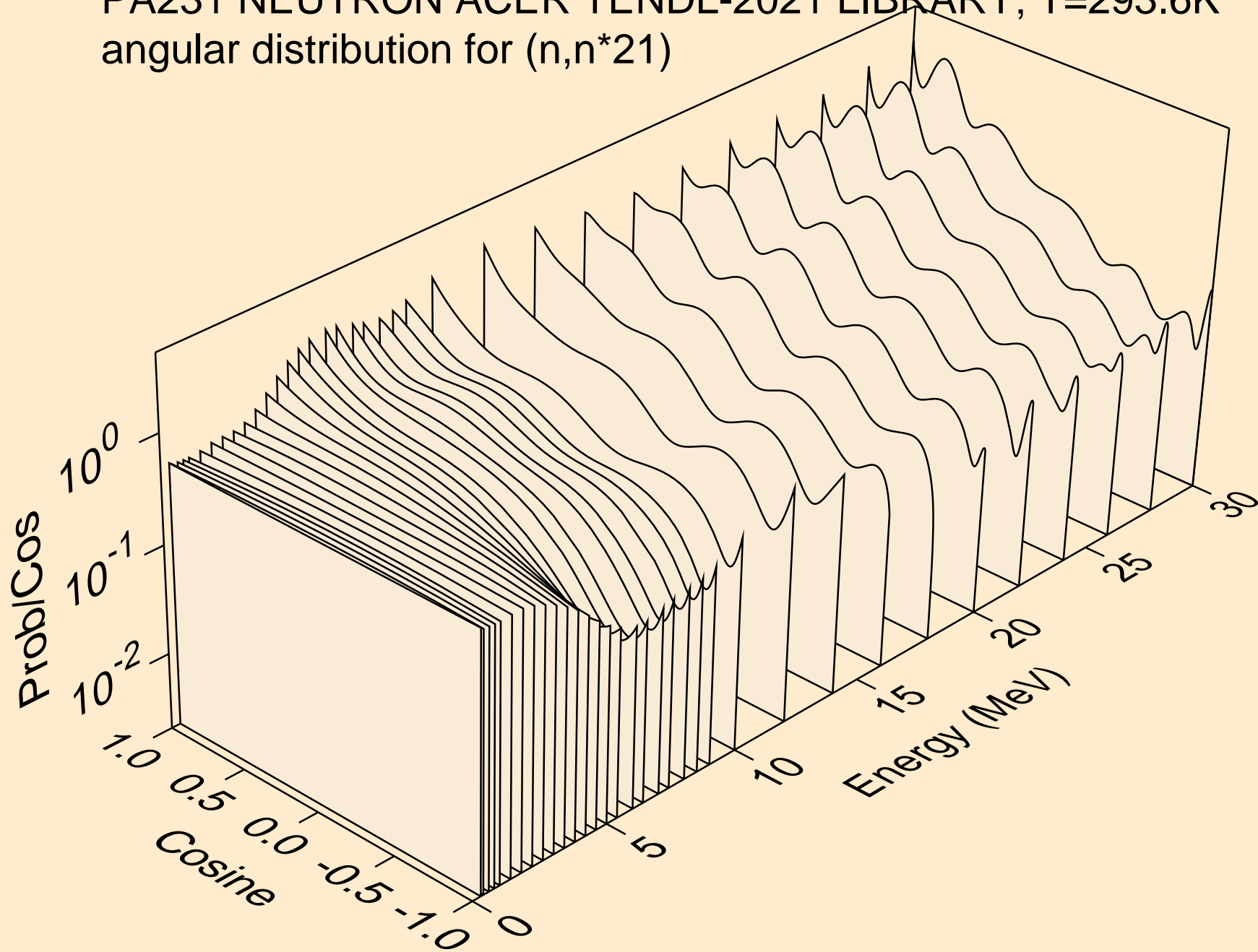

PA231 NEUTRON ACER TENDL-2021 LIBRARY; T=293.6K
angular distribution for (n,n*22)

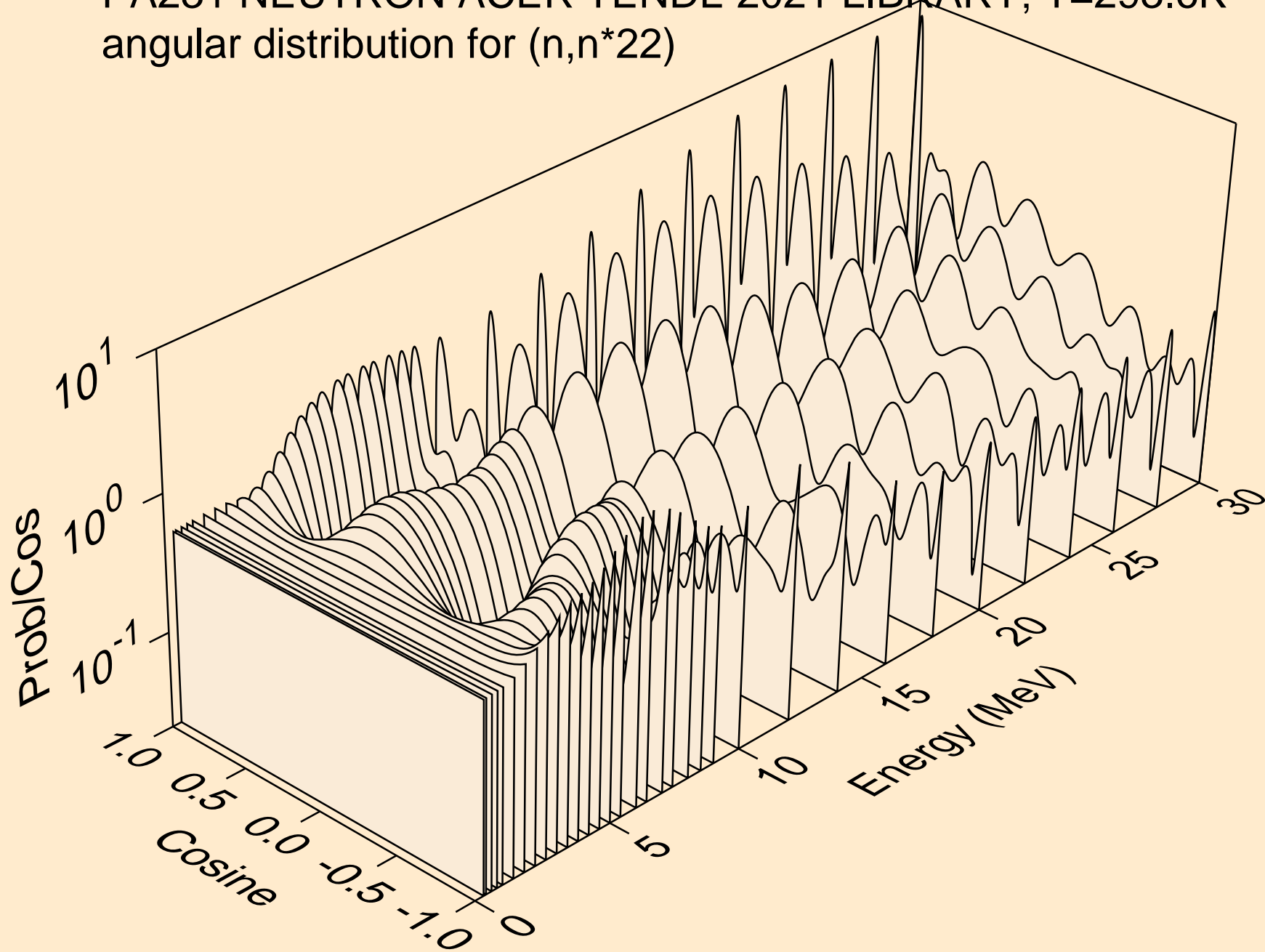

PA231 NEUTRON ACER TENDL-2021 LIBRARY; T=293.6K
angular distribution for (n,n*23)

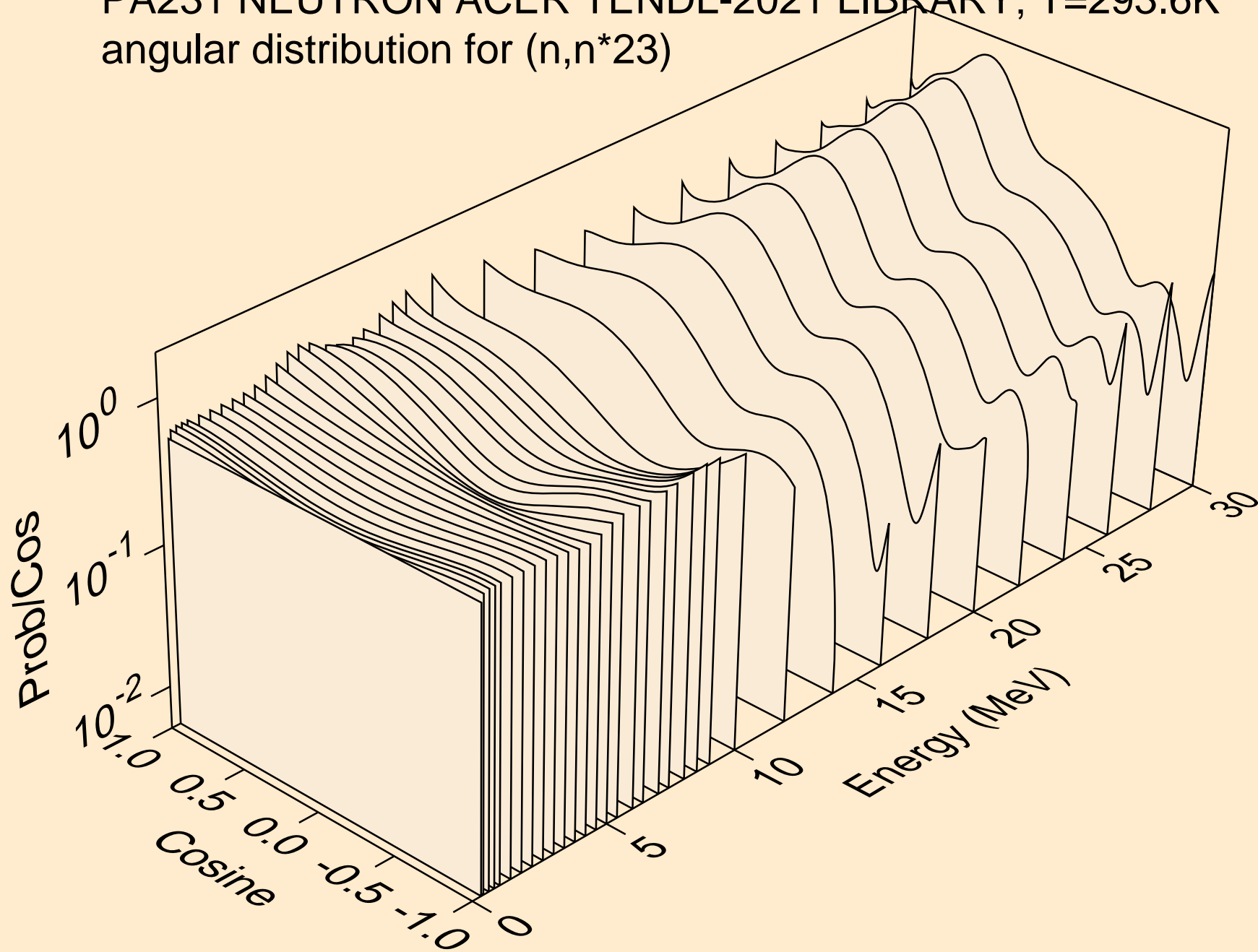

PA231 NEUTRON ACER TENDL-2021 LIBRARY; T=293.6K
angular distribution for (n,n*24)

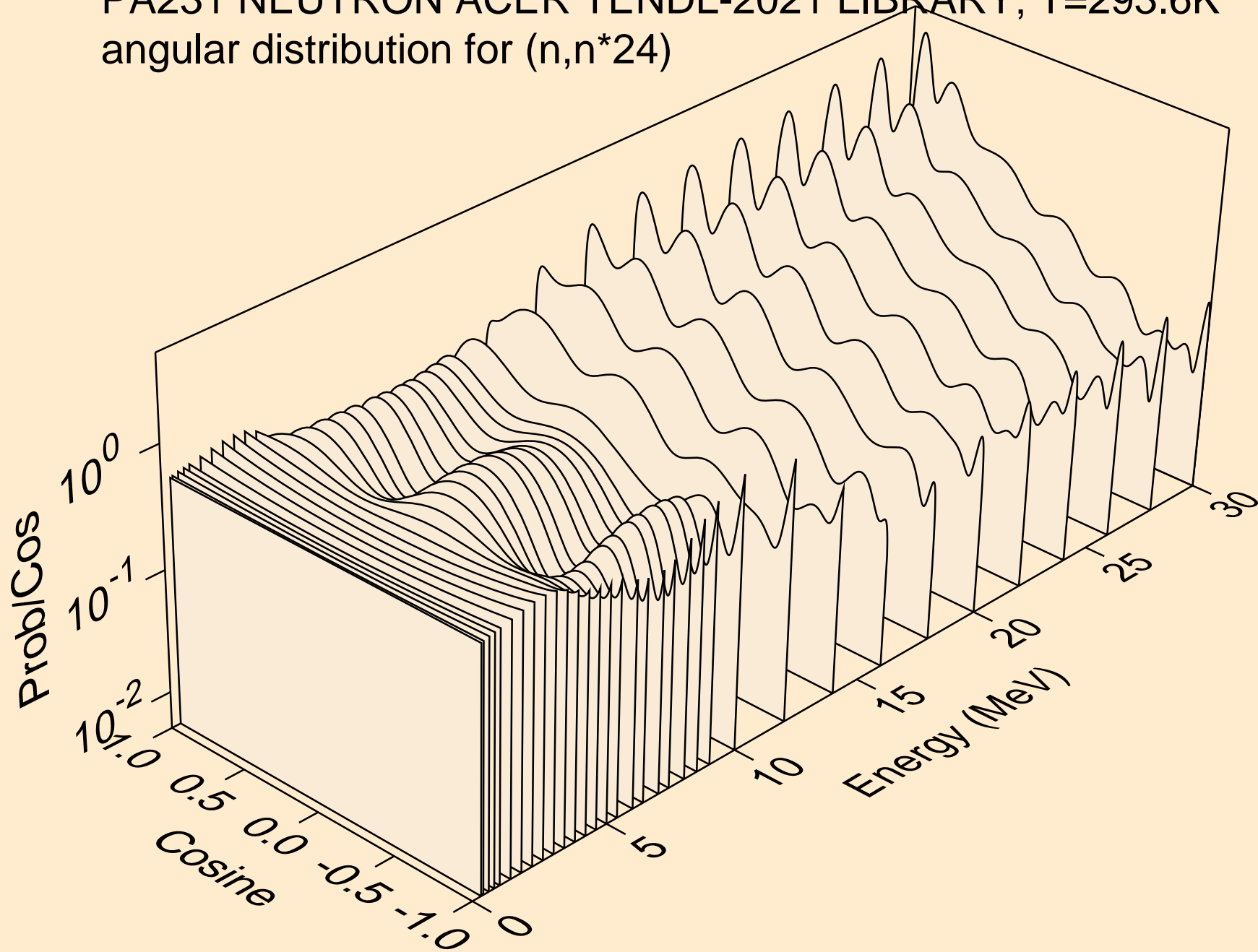

PA231 NEUTRON ACER TENDL-2021 LIBRARY; T=293.6K
angular distribution for (n,n*25)

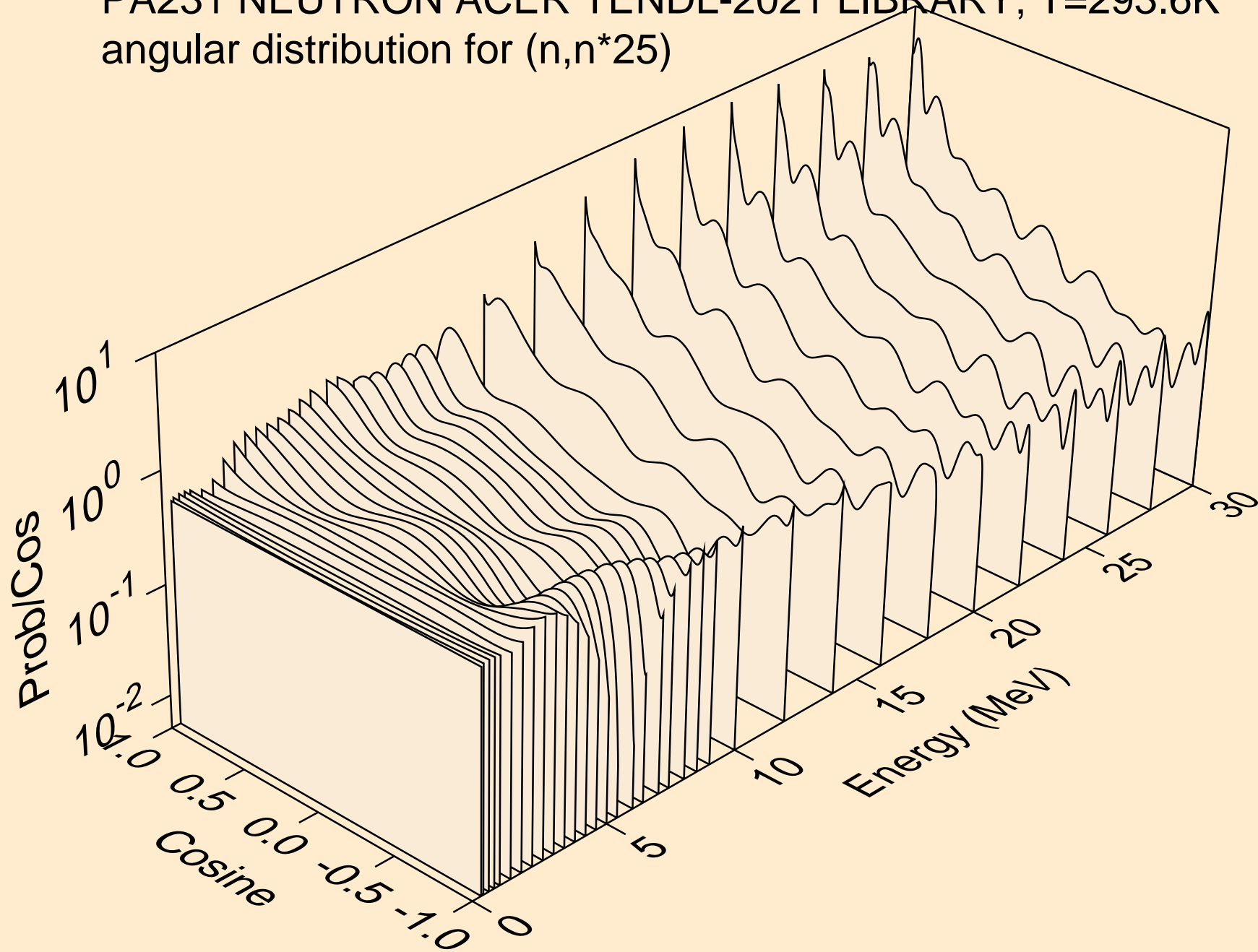

PA231 NEUTRON ACER TENDL-2021 LIBRARY; T=293.6K
angular distribution for (n,n*26)

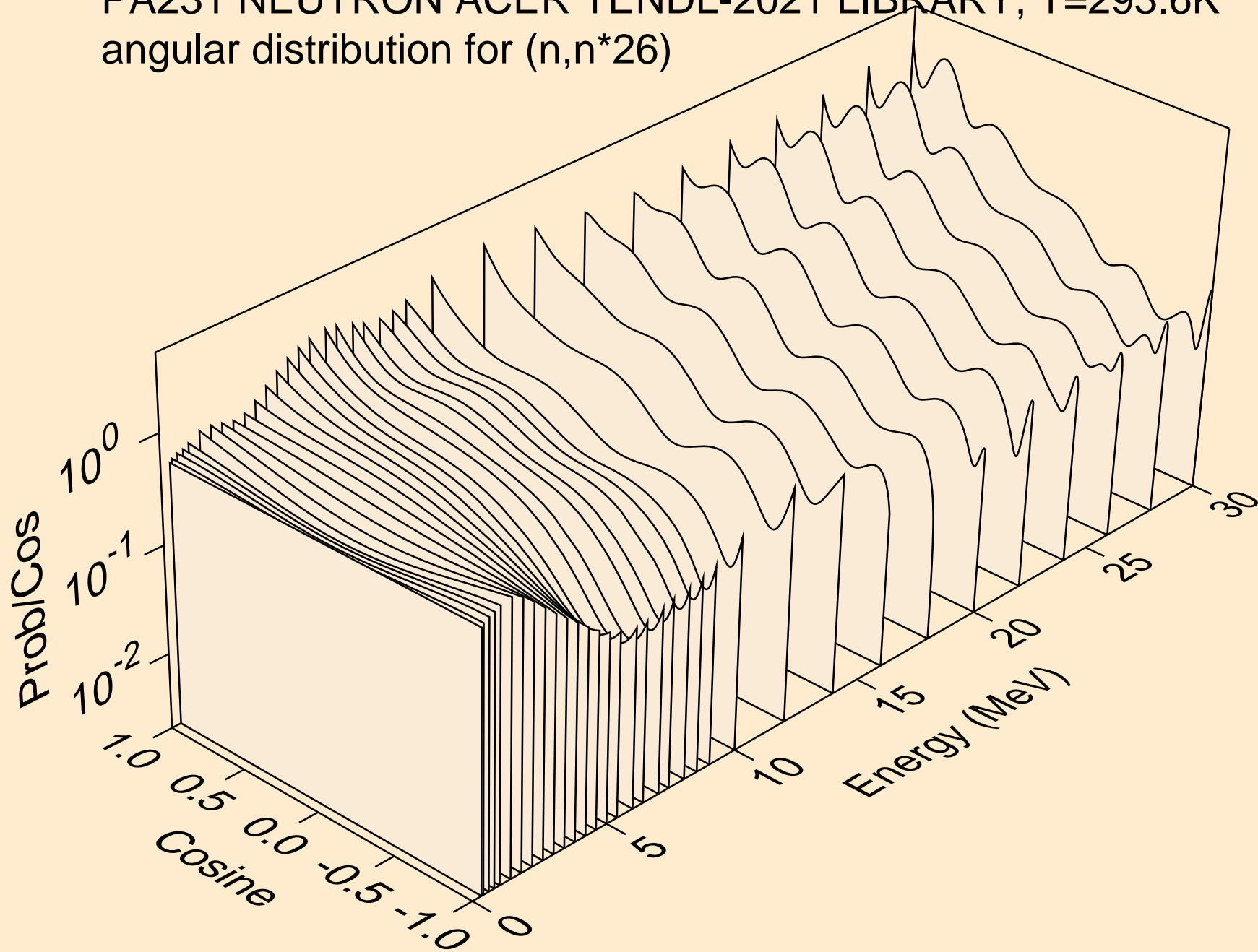

PA231 NEUTRON ACER TENDL-2021 LIBRARY; T=293.6K
angular distribution for (n,n*27)

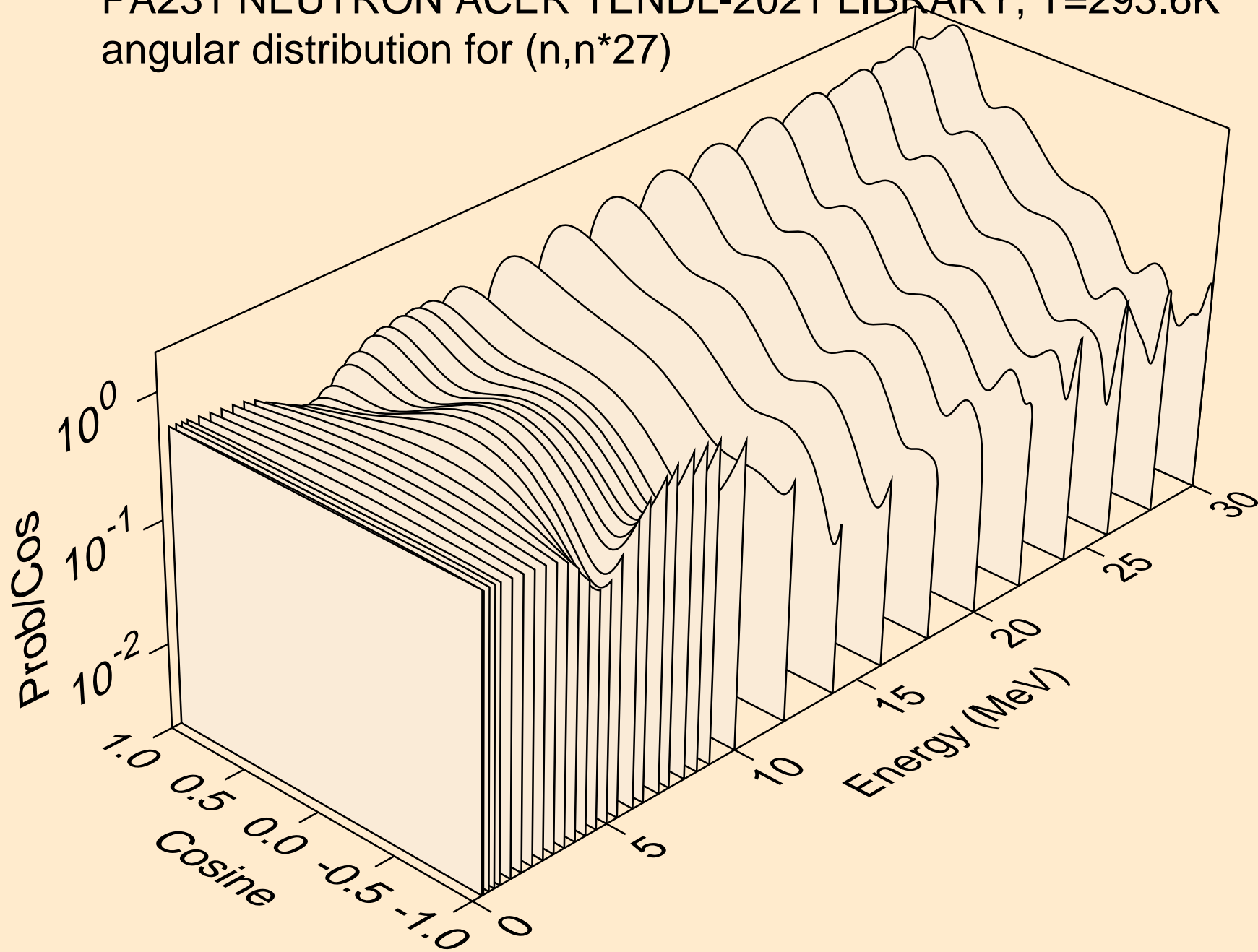

PA231 NEUTRON ACER TENDL-2021 LIBRARY; T=293.6K
angular distribution for (n,n*28)

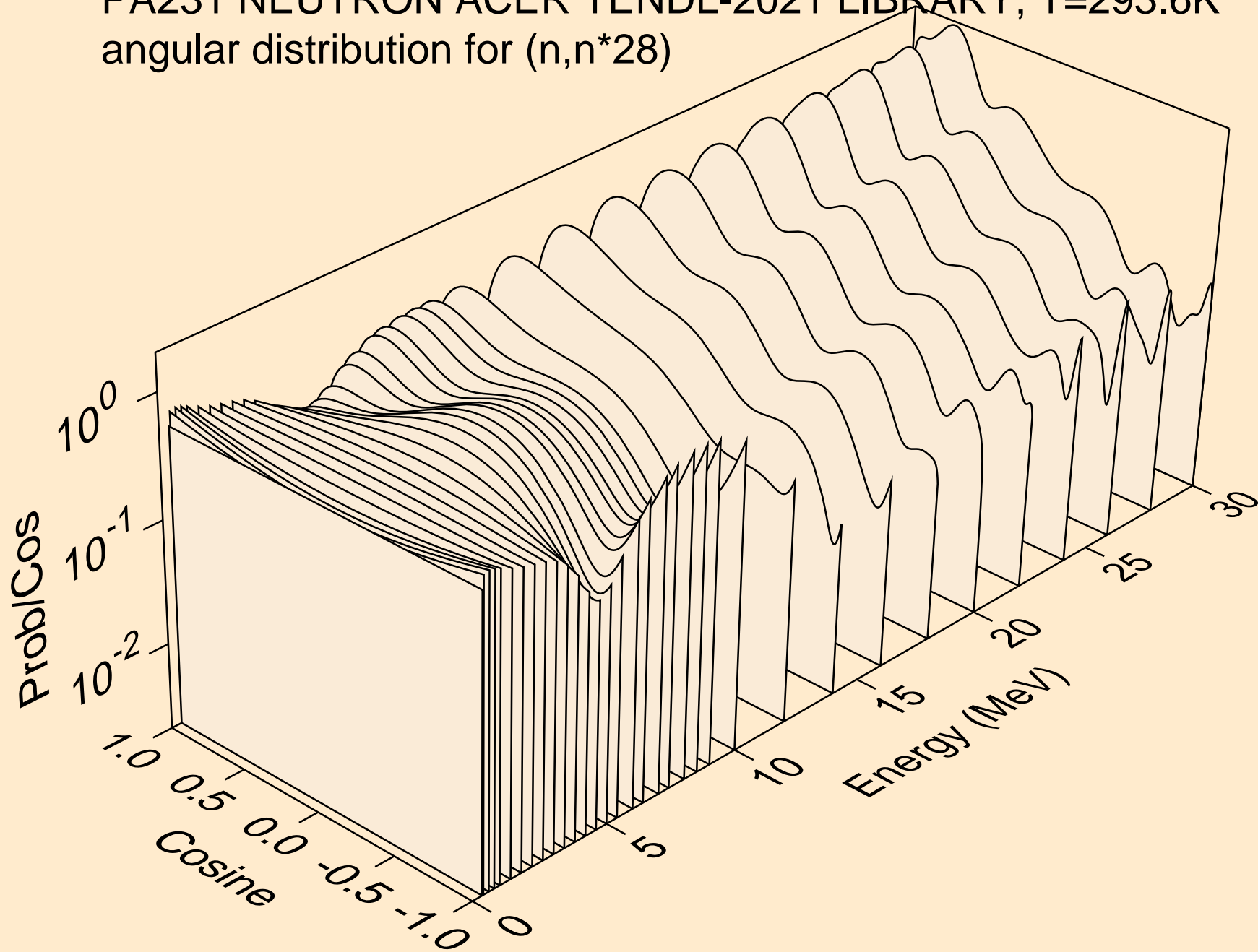

PA231 NEUTRON ACER TENDL-2021 LIBRARY; T=293.6K
angular distribution for (n,n*29)

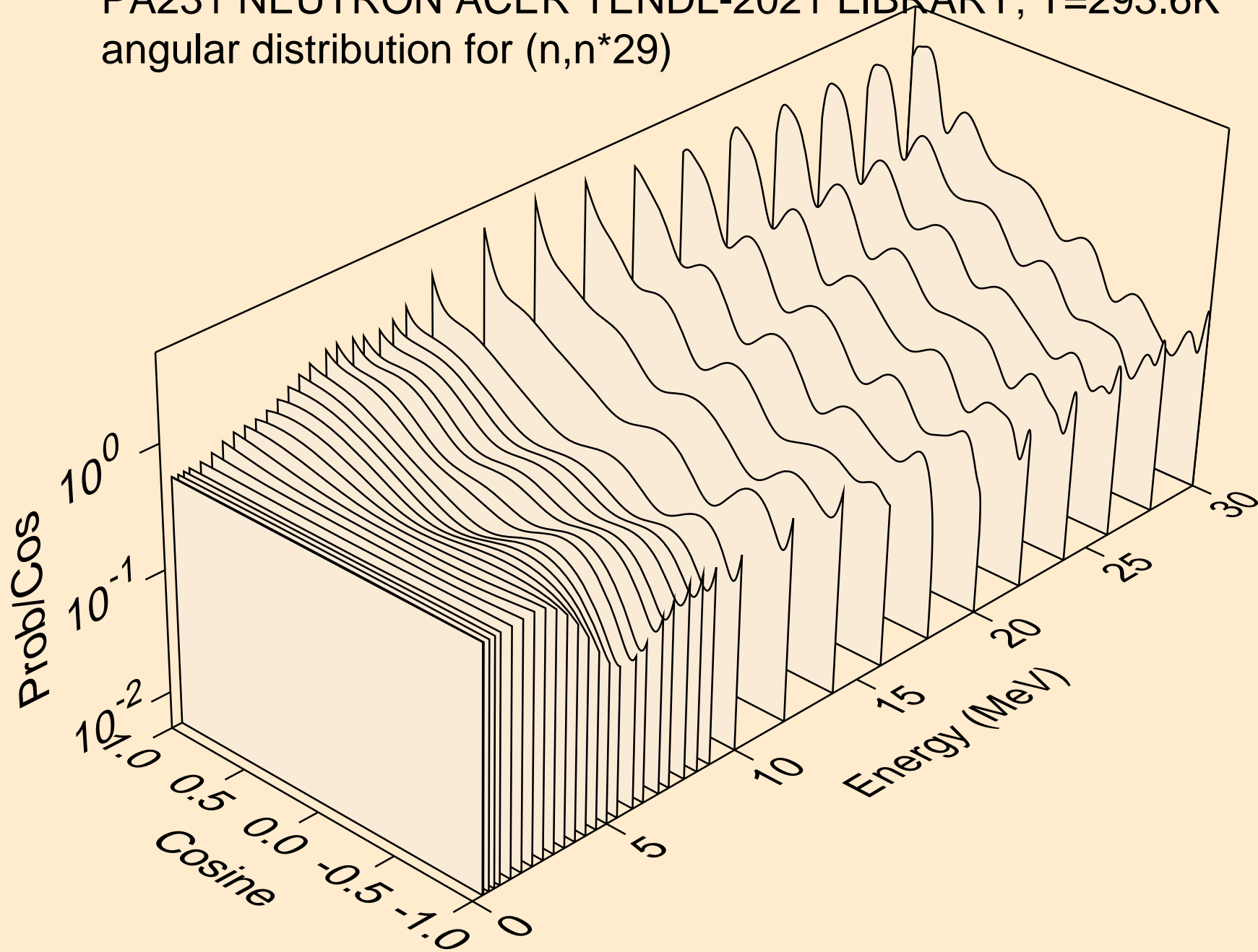

PA231 NEUTRON ACER TENDL-2021 LIBRARY; T=293.6K
angular distribution for (n,n*30)

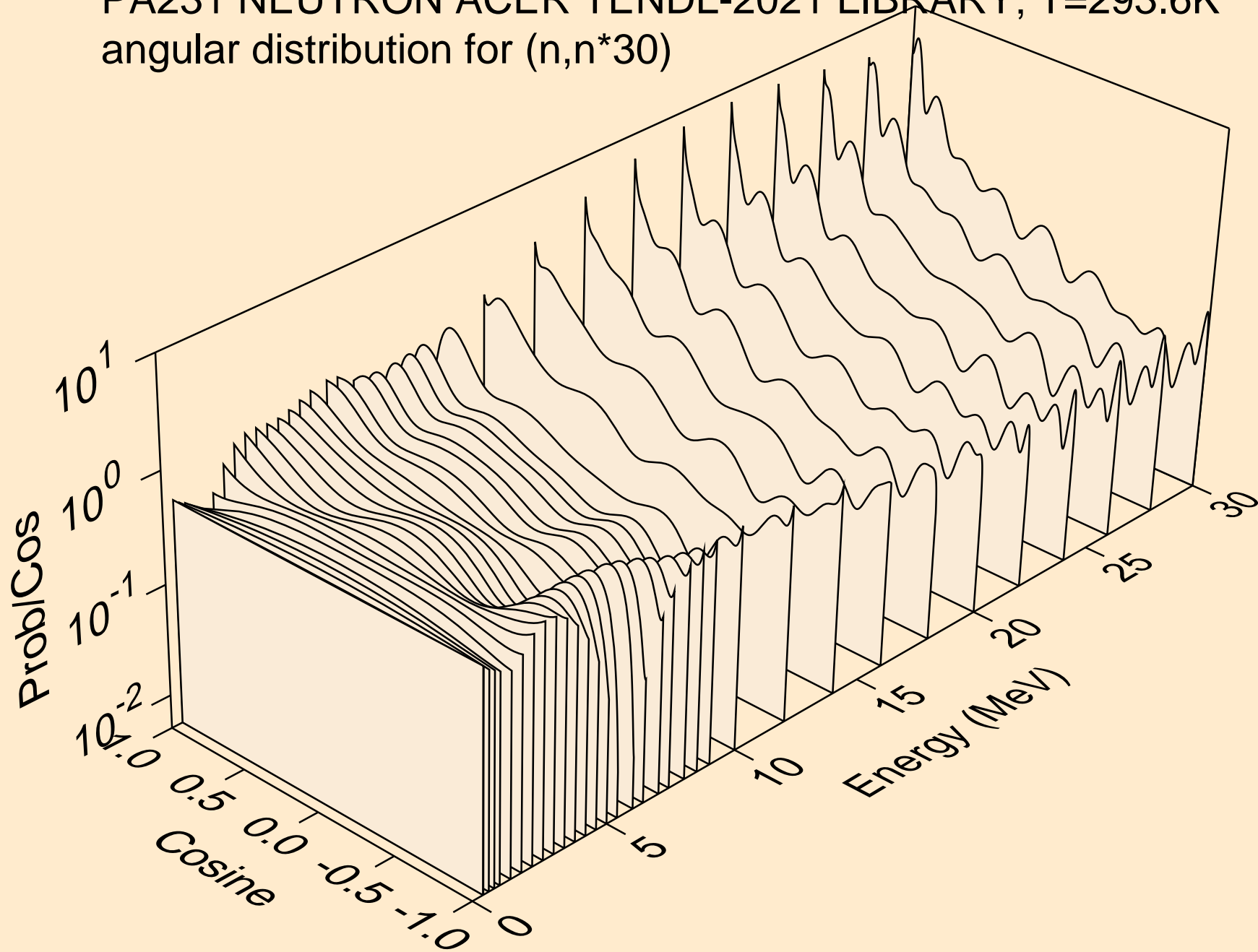

PA231 NEUTRON ACER TENDL-2021 LIBRARY; T=293.6K
Total fission nubar

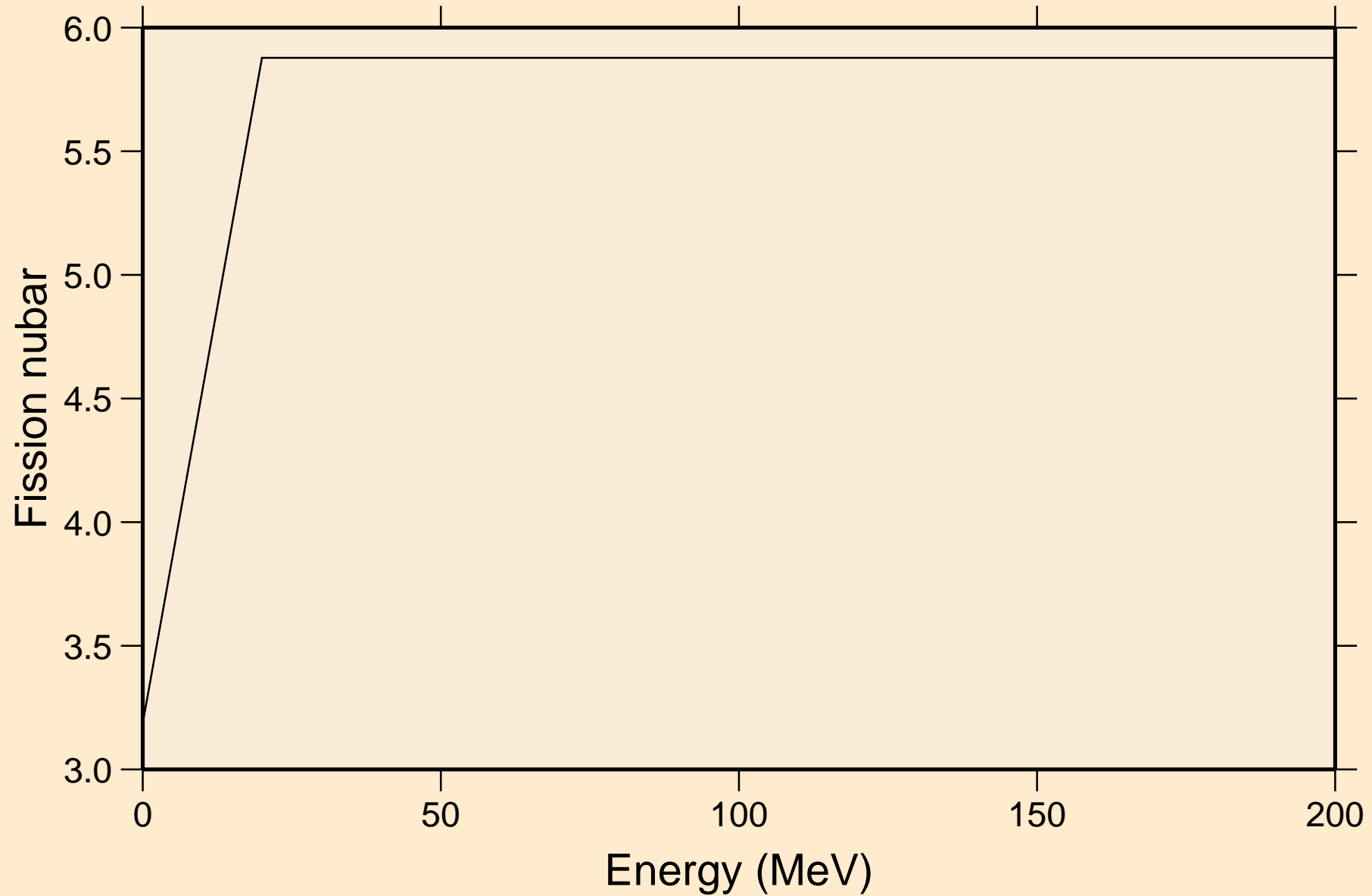

PA231 NEUTRON ACER TENDL-2021 LIBRARY; T=293.6K
Neutron emission for (n,x)

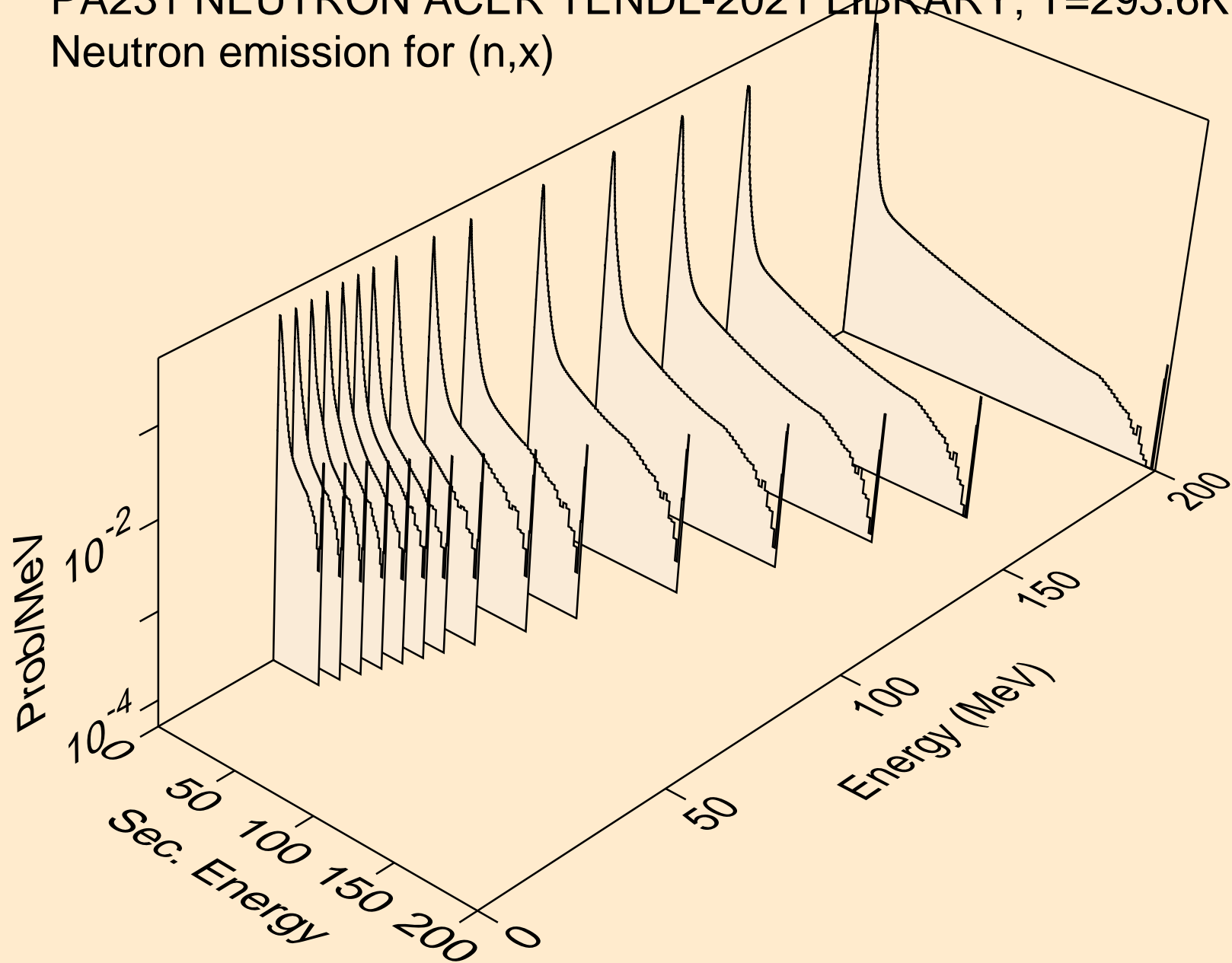

PA231 NEUTRON ACER TENDL-2021 LIBRARY; T=293.6K
Neutron emission for (n,2nd)

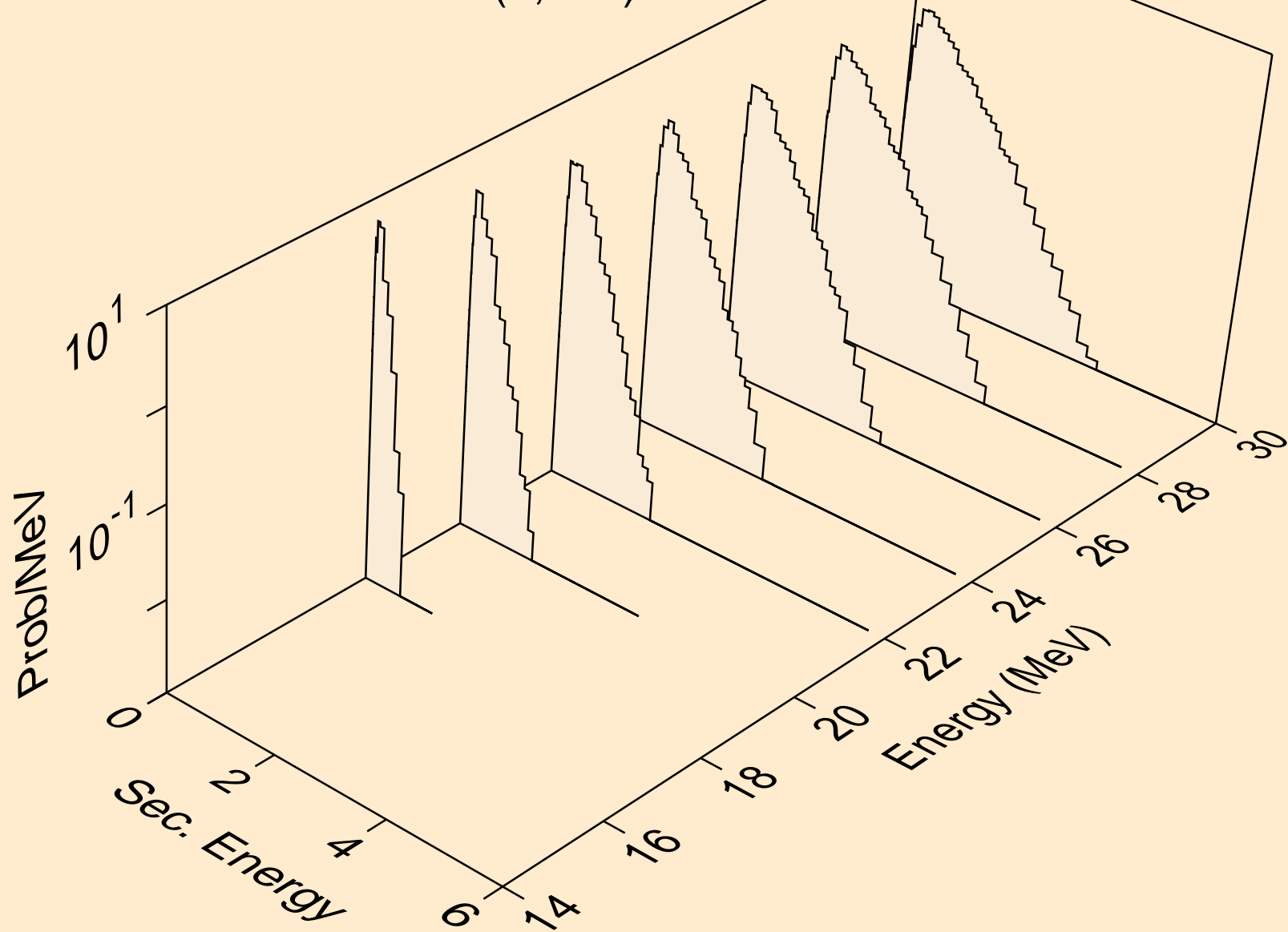

PA231 NEUTRON ACER TENDL-2021 LIBRARY; T=293.6K
Neutron emission for (n,2n)

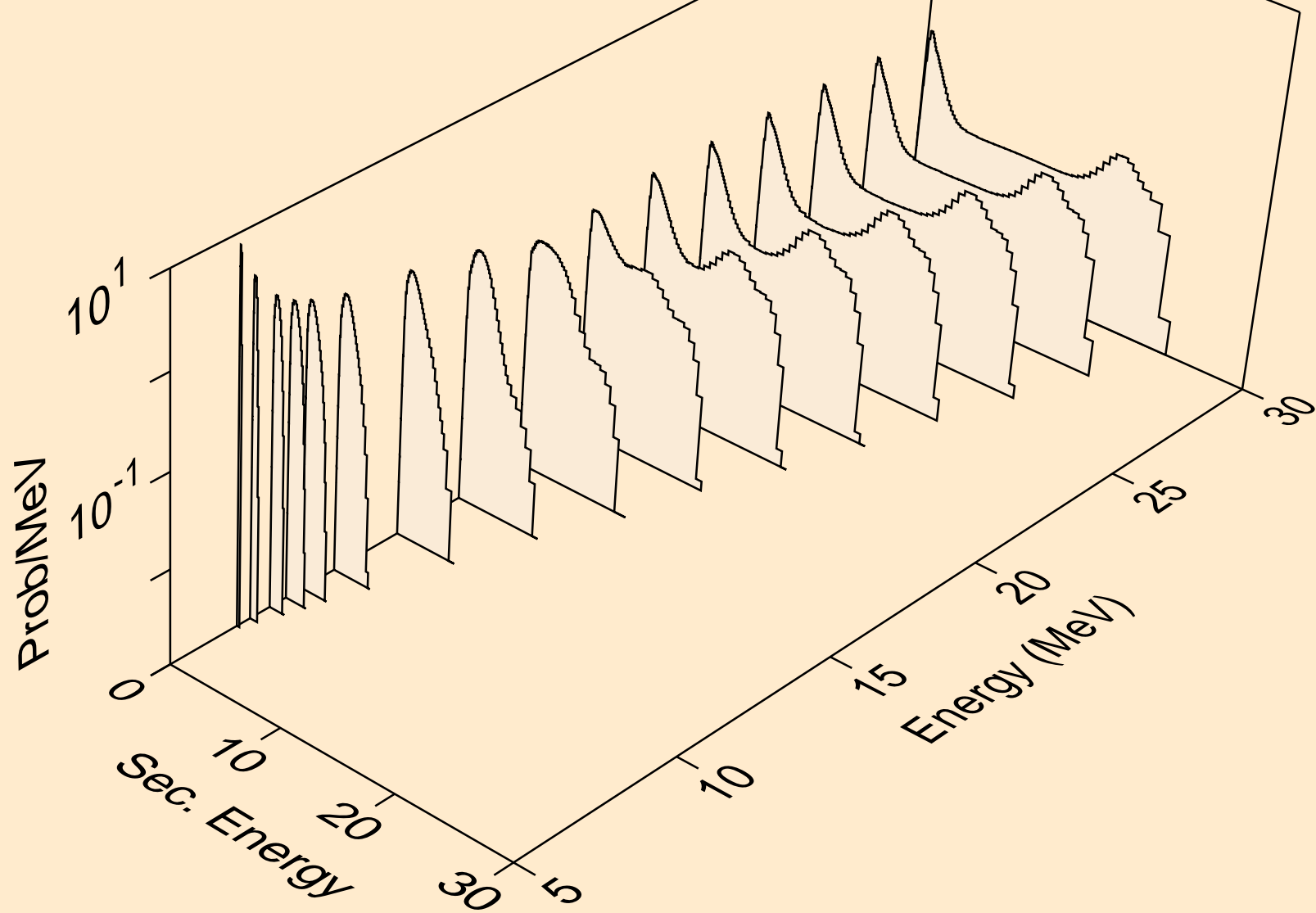

PA231 NEUTRON ACER TENDL-2021 LIBRARY; T=293.6K
Neutron emission for (n,3n)

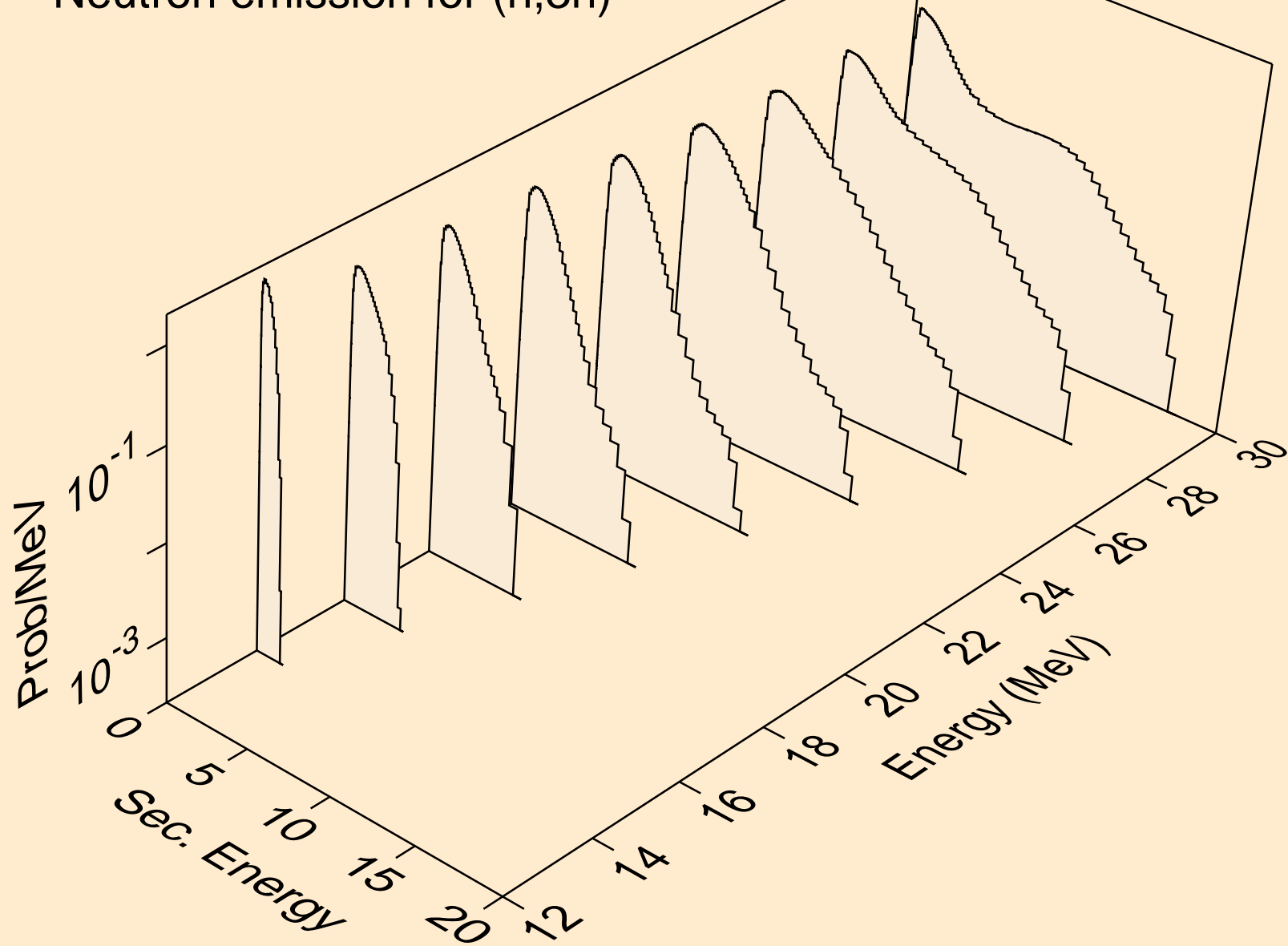

PA231 NEUTRON ACER TENDL-2021 LIBRARY; T=293.6K
Neutron emission for fission

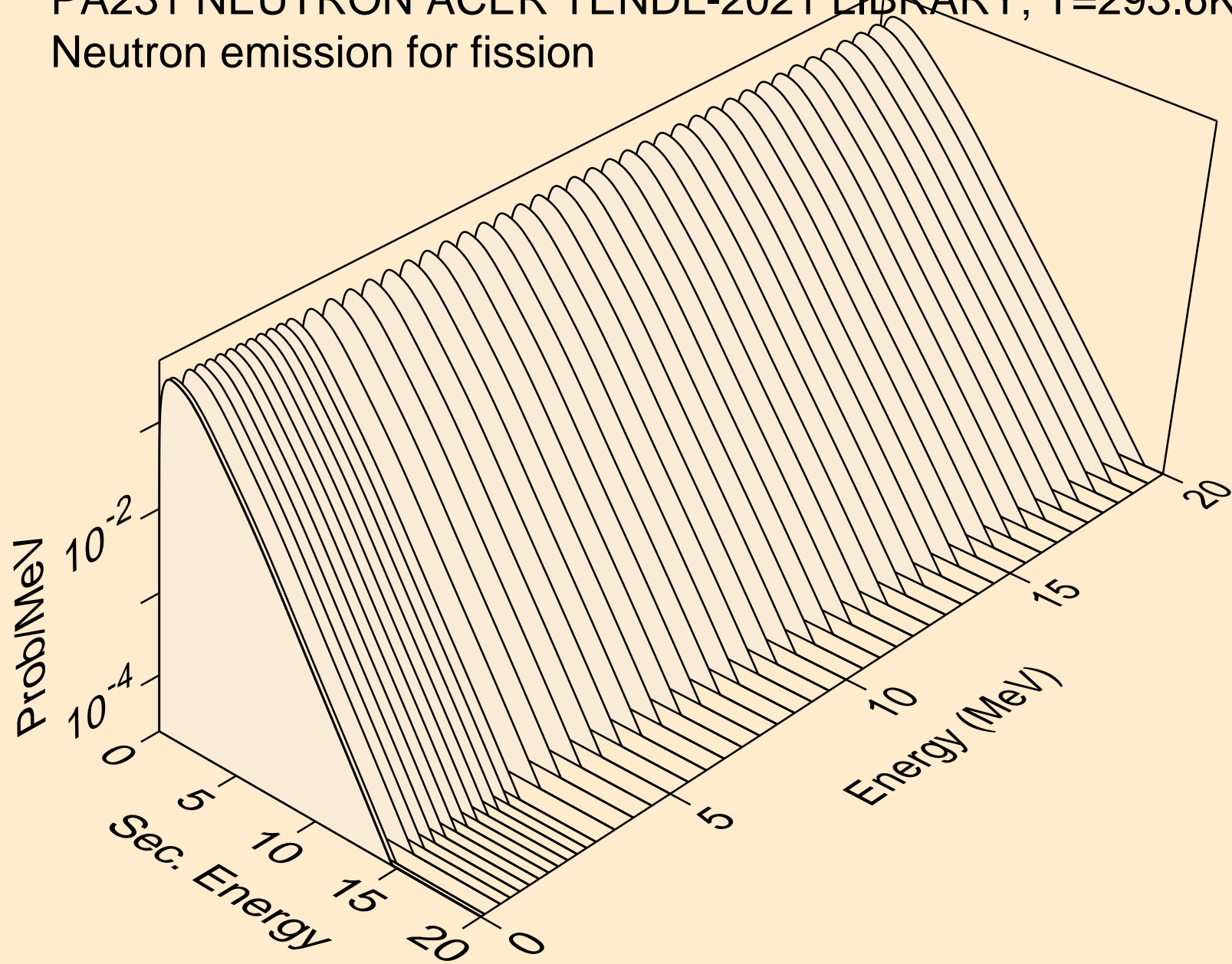

PA231 NEUTRON ACER TENDL-2021 LIBRARY; T=293.6K
Neutron emission for (n,n*)a

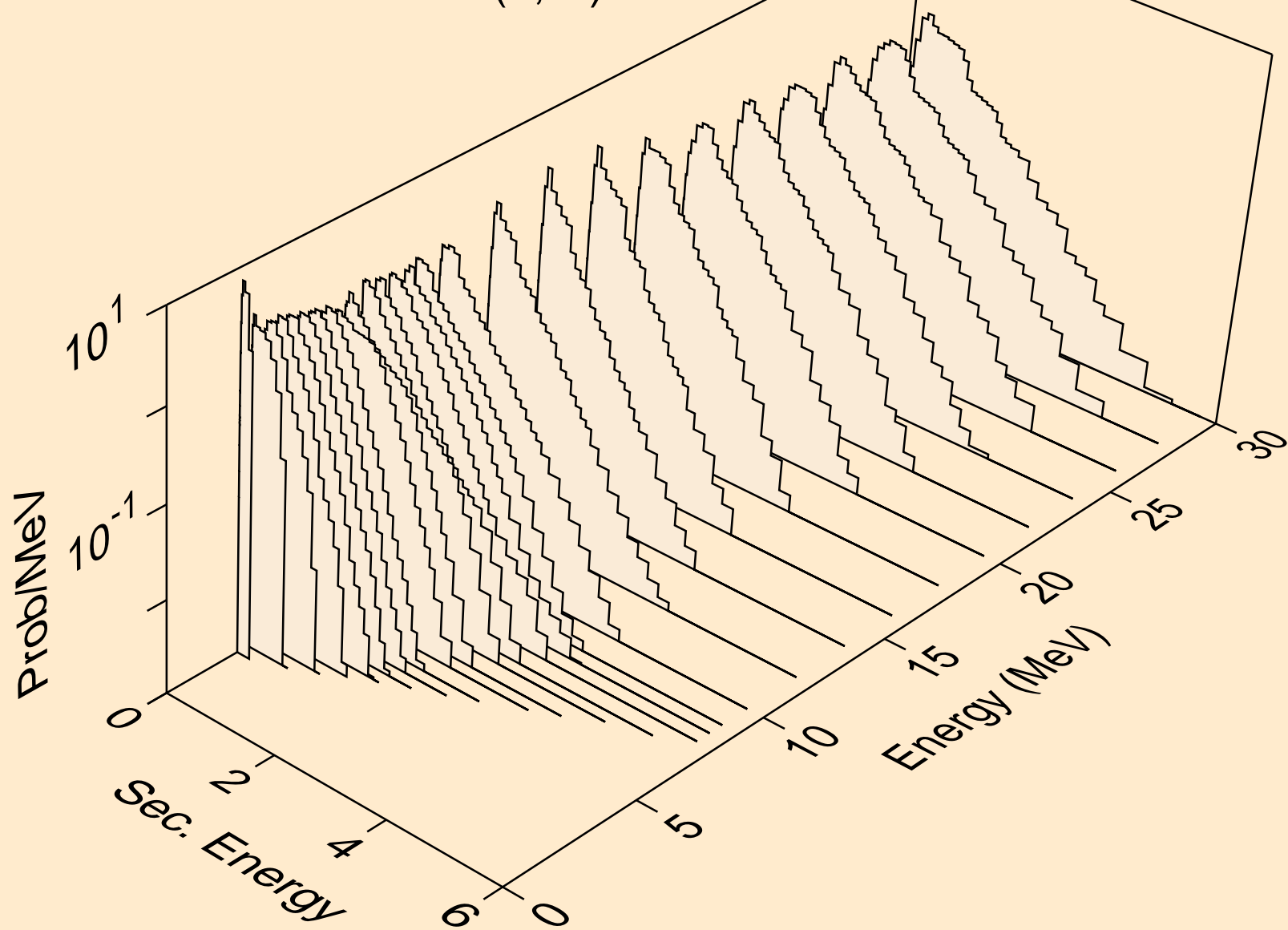

PA231 NEUTRON ACER TENDL-2021 LIBRARY; T=293.6K
Neutron emission for (n,2n)a

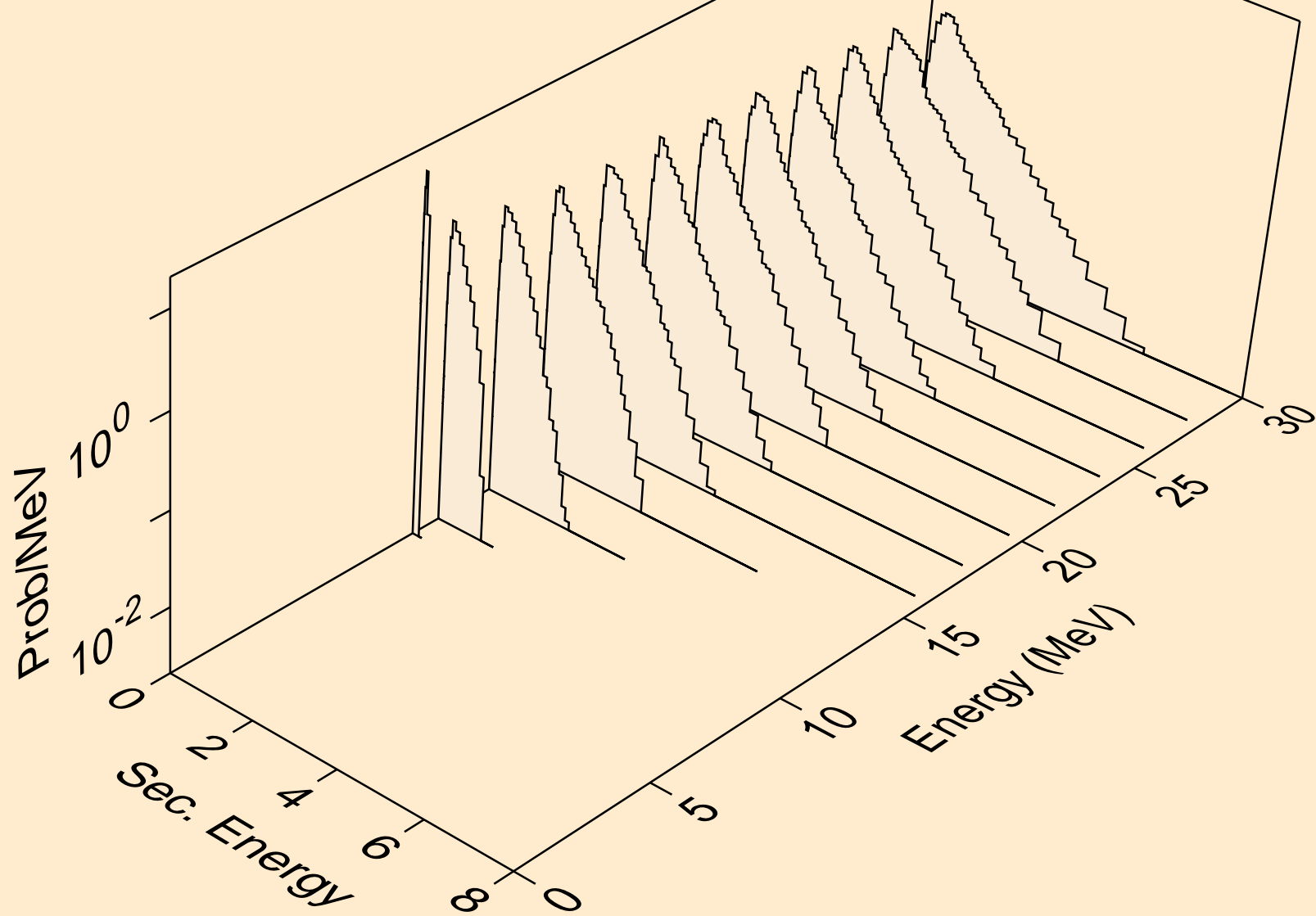

PA231 NEUTRON ACER TENDL-2021 LIBRARY; T=293.6K
Neutron emission for (n,3n)a

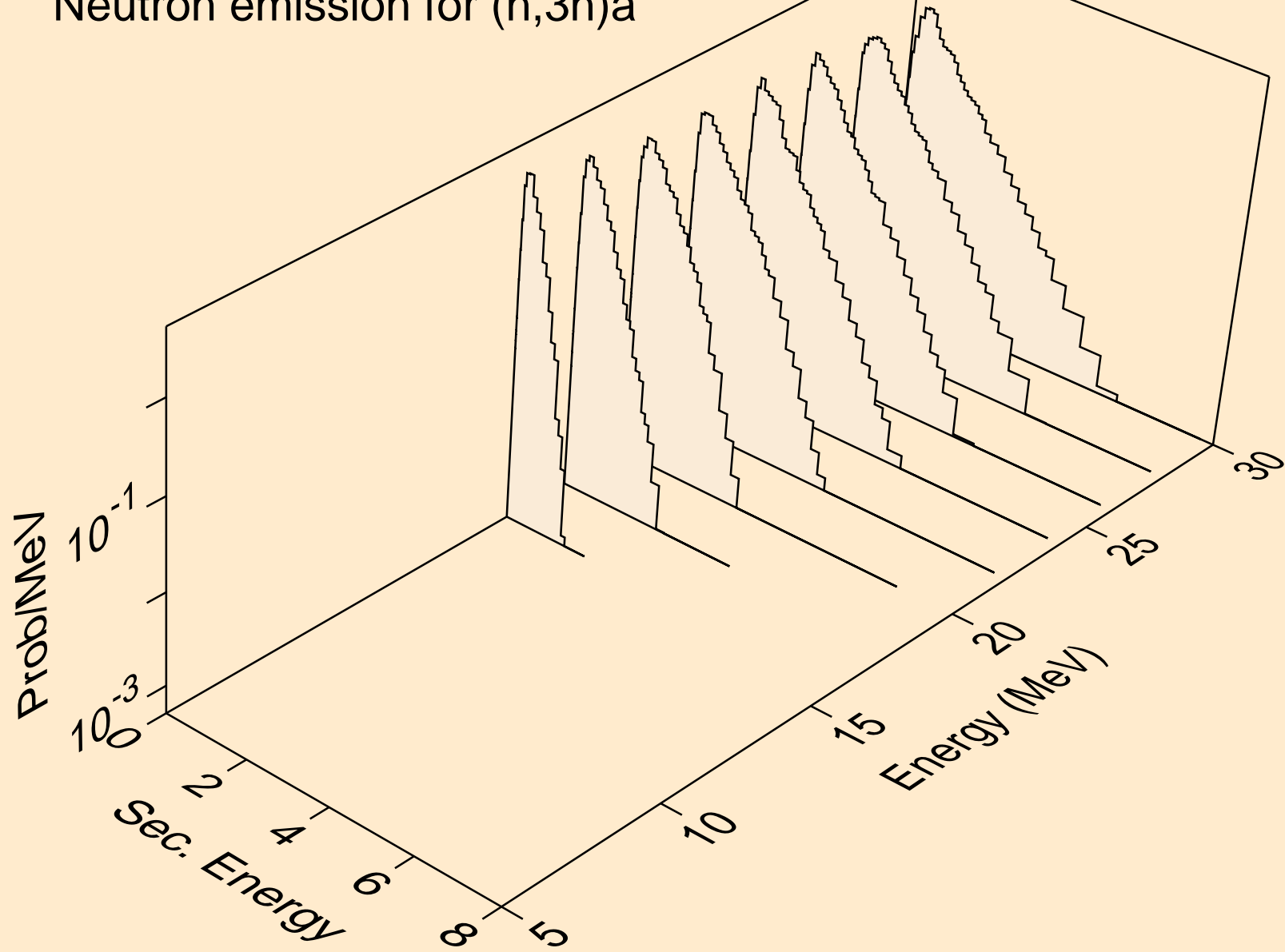

PA231 NEUTRON ACER TENDL-2021 LIBRARY; T=293.6K
Neutron emission for (n,n*)p

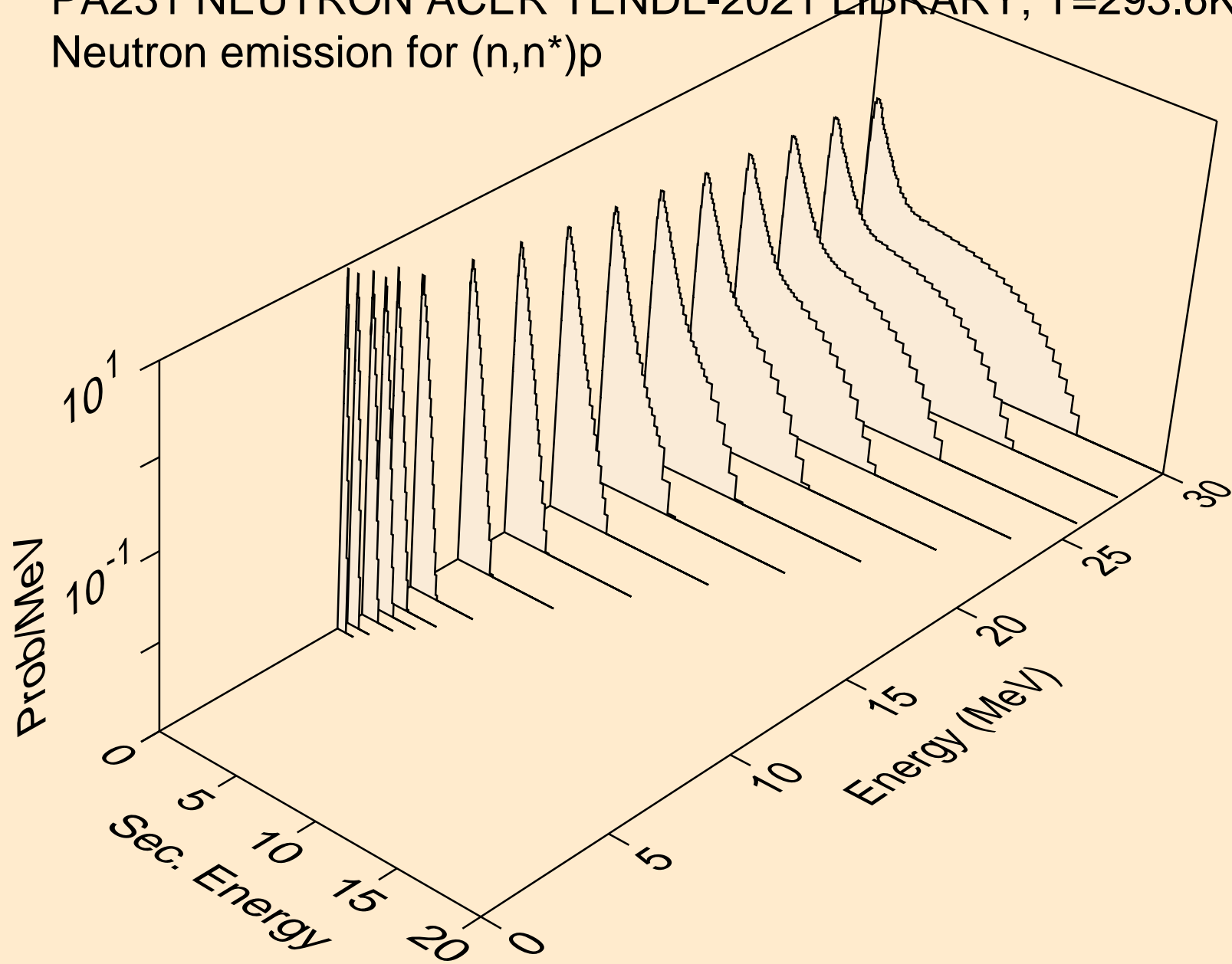

PA231 NEUTRON ACER TENDL-2021 LIBRARY; T=293.6K
Neutron emission for (n,n*)2a

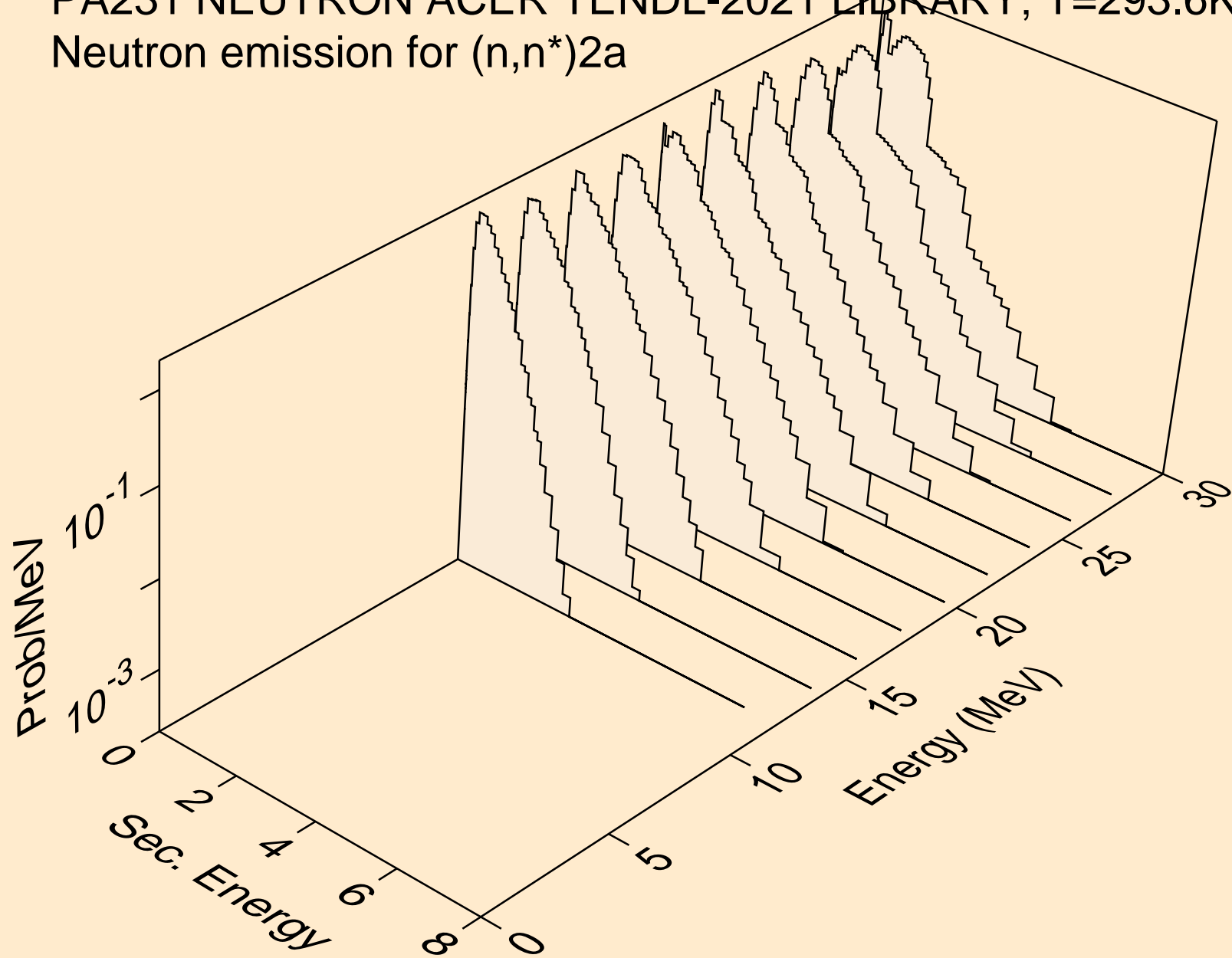

PA231 NEUTRON ACER TENDL-2021 LIBRARY; T=293.6K
Neutron emission for (n,n*)d

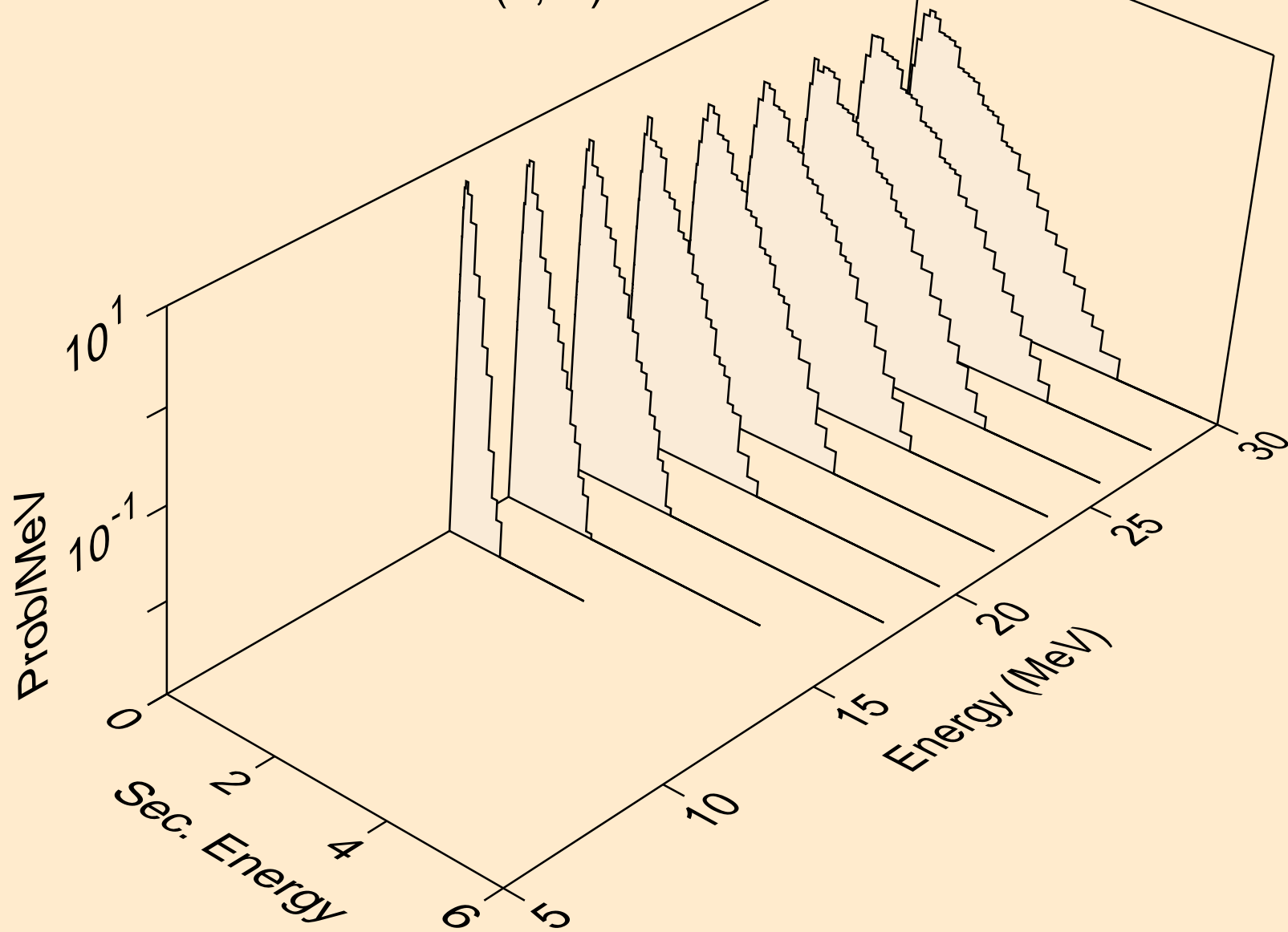

PA231 NEUTRON ACER TENDL-2021 LIBRARY; T=293.6K
Neutron emission for (n,n*)t

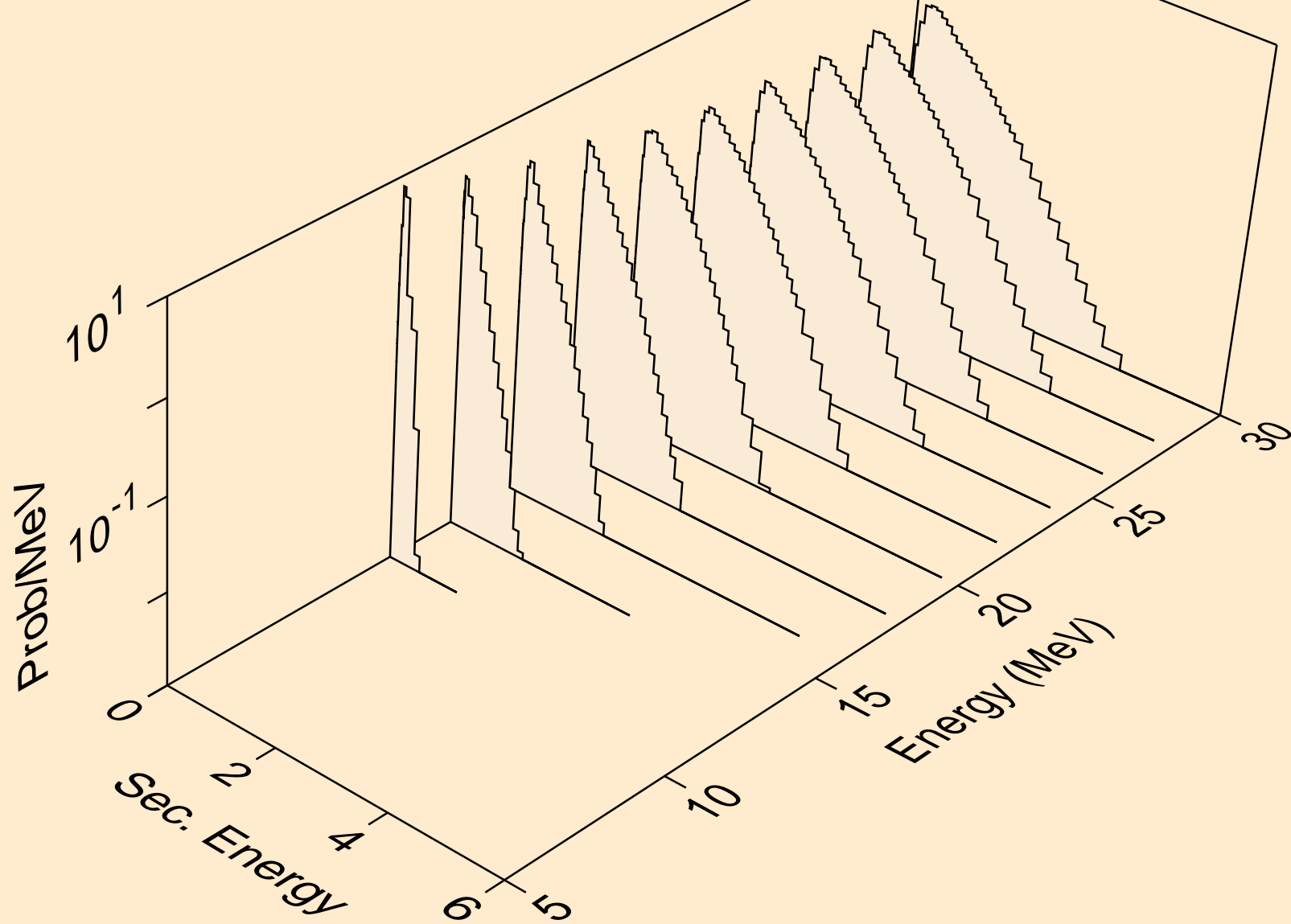

PA231 NEUTRON ACER TENDL-2021 LIBRARY; T=293.6K
Neutron emission for (n,n*)he3

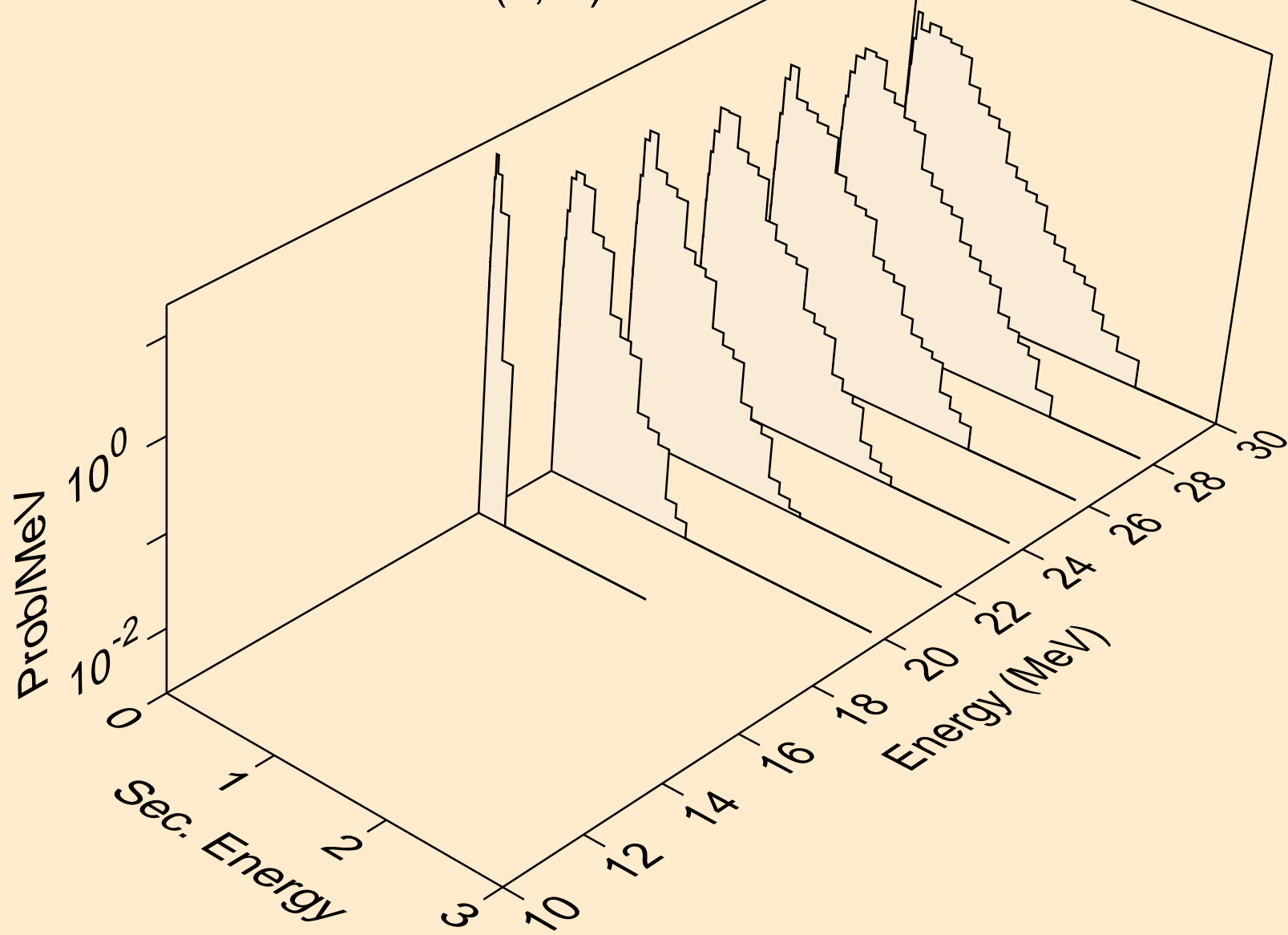

PA231 NEUTRON ACER TENDL-2021 LIBRARY; T=293.6K
Neutron emission for (n,4n)

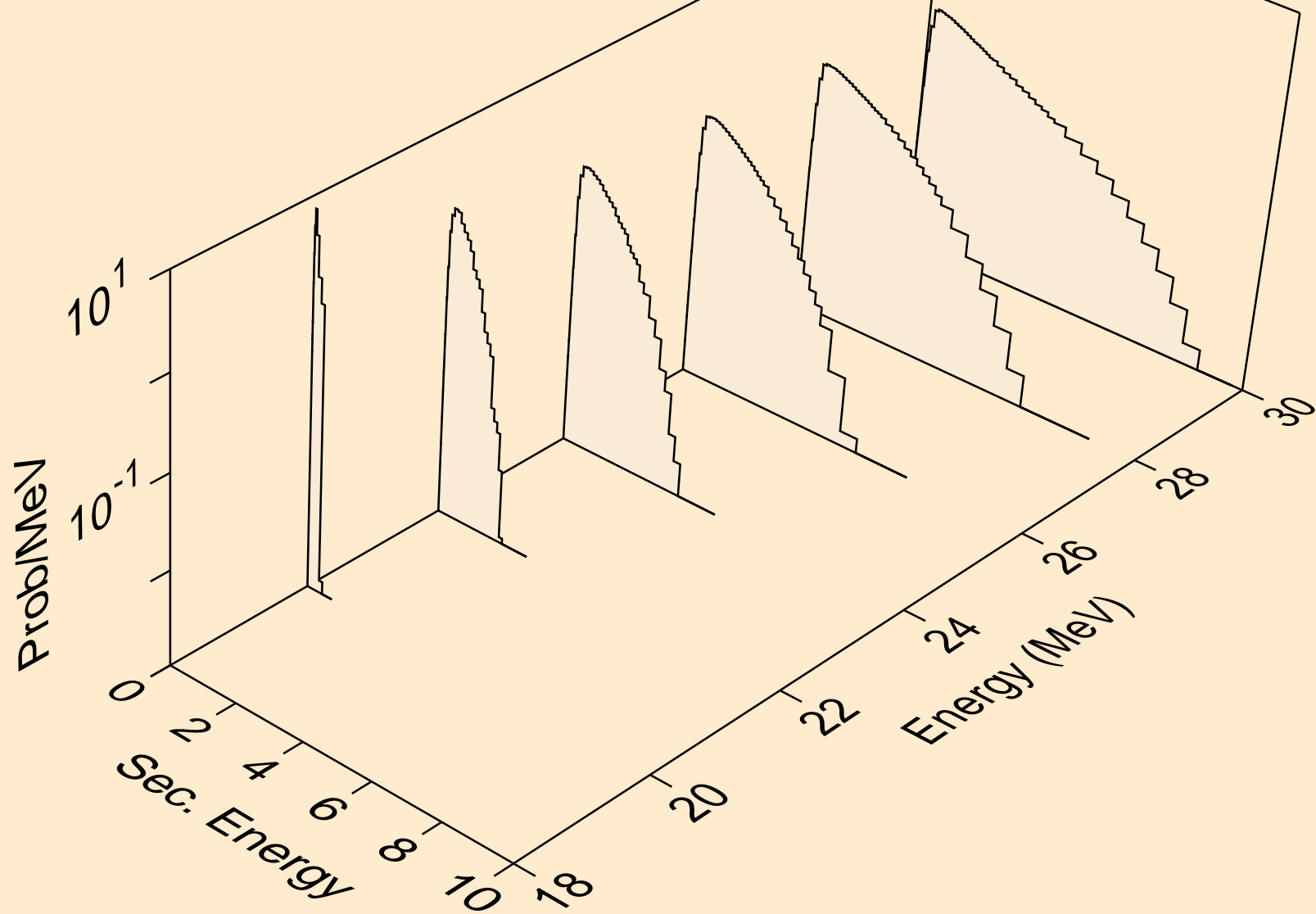

PA231 NEUTRON ACER TENDL-2021 LIBRARY; T=293.6K
Neutron emission for (n,2np)

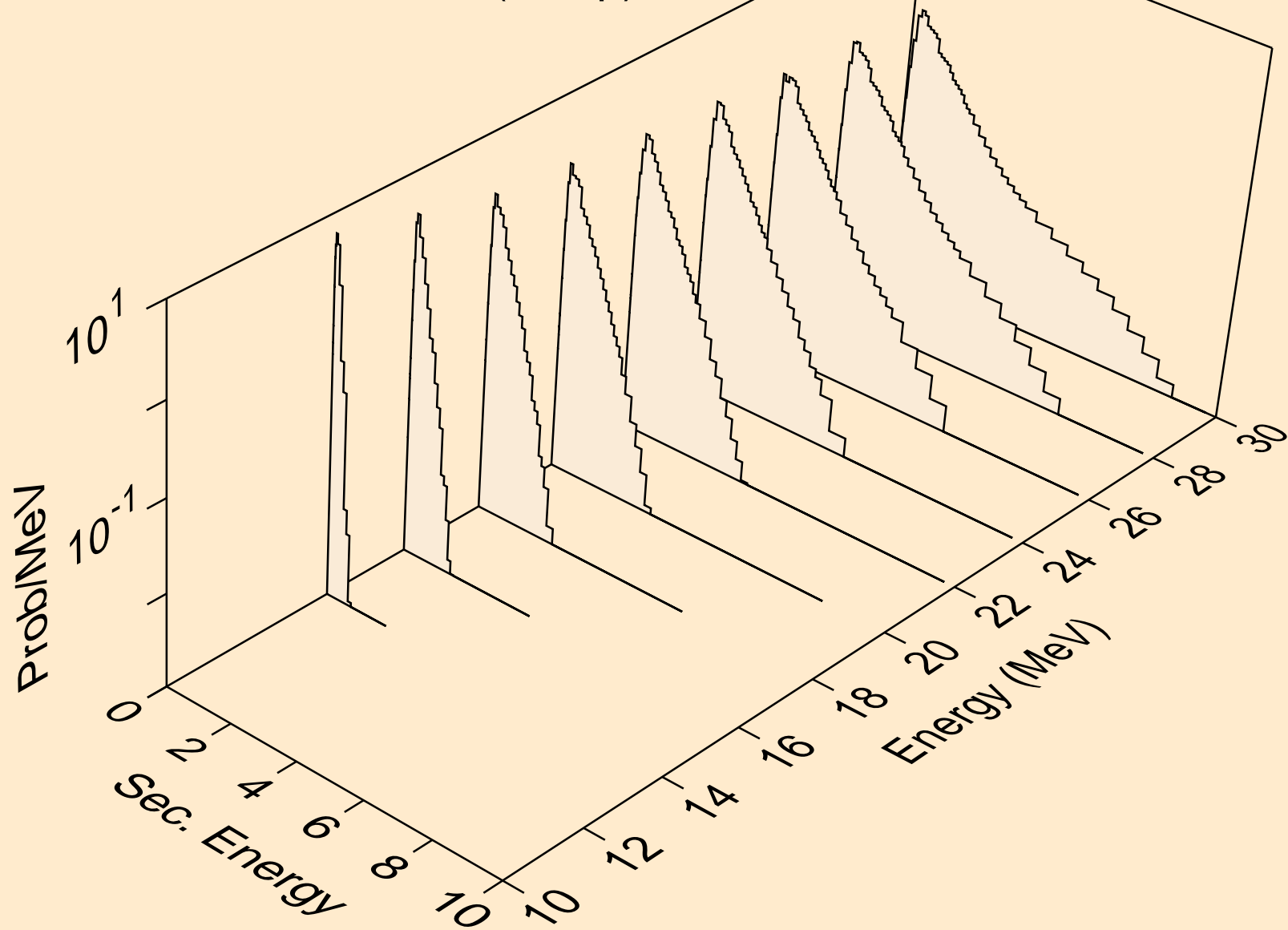

PA231 NEUTRON ACER TENDL-2021 LIBRARY; T=293.6K
Neutron emission for (n,3np)

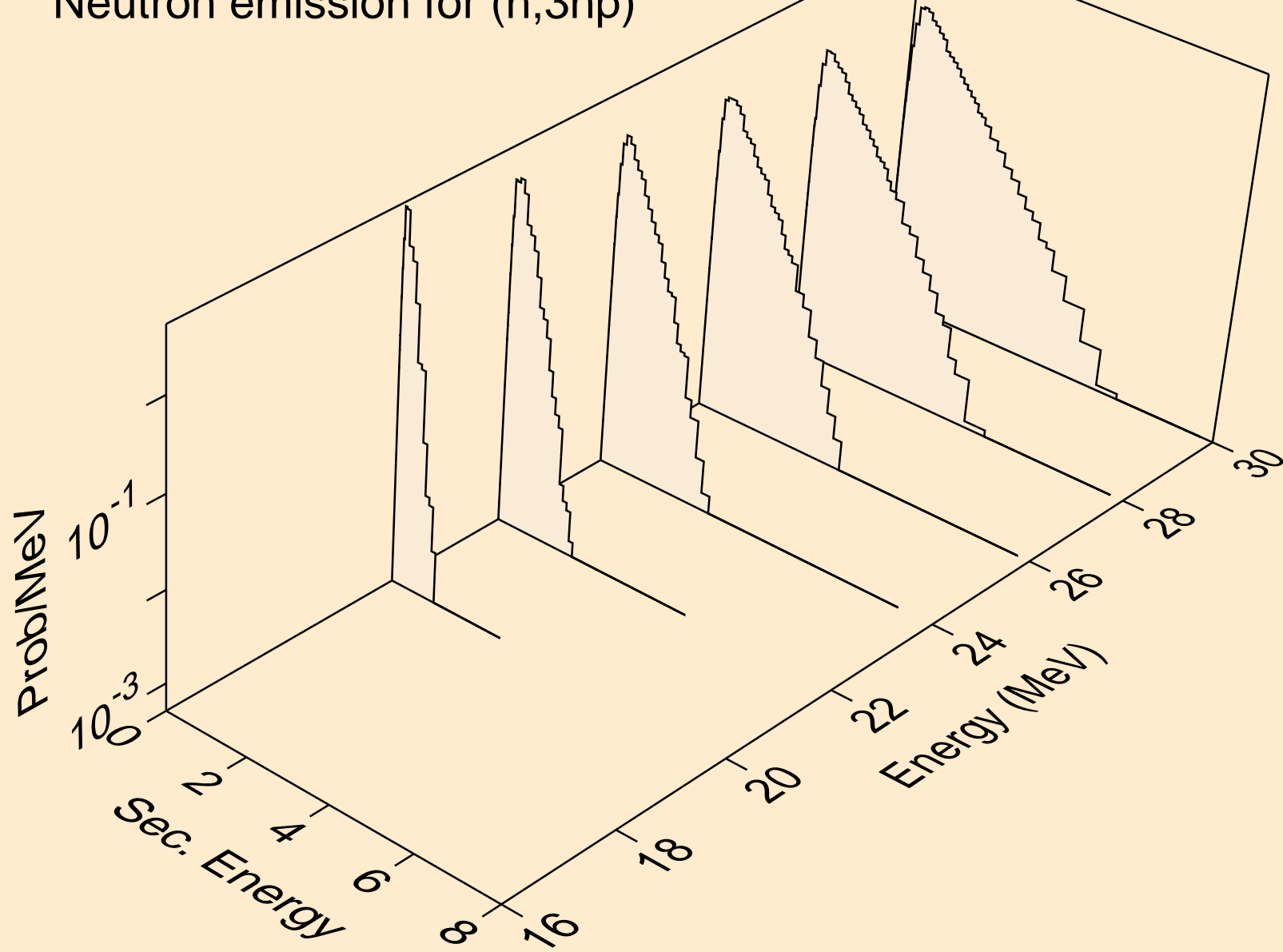

PA231 NEUTRON ACER TENDL-2021 LIBRARY; T=293.6K
Neutron emission for (n,2np)

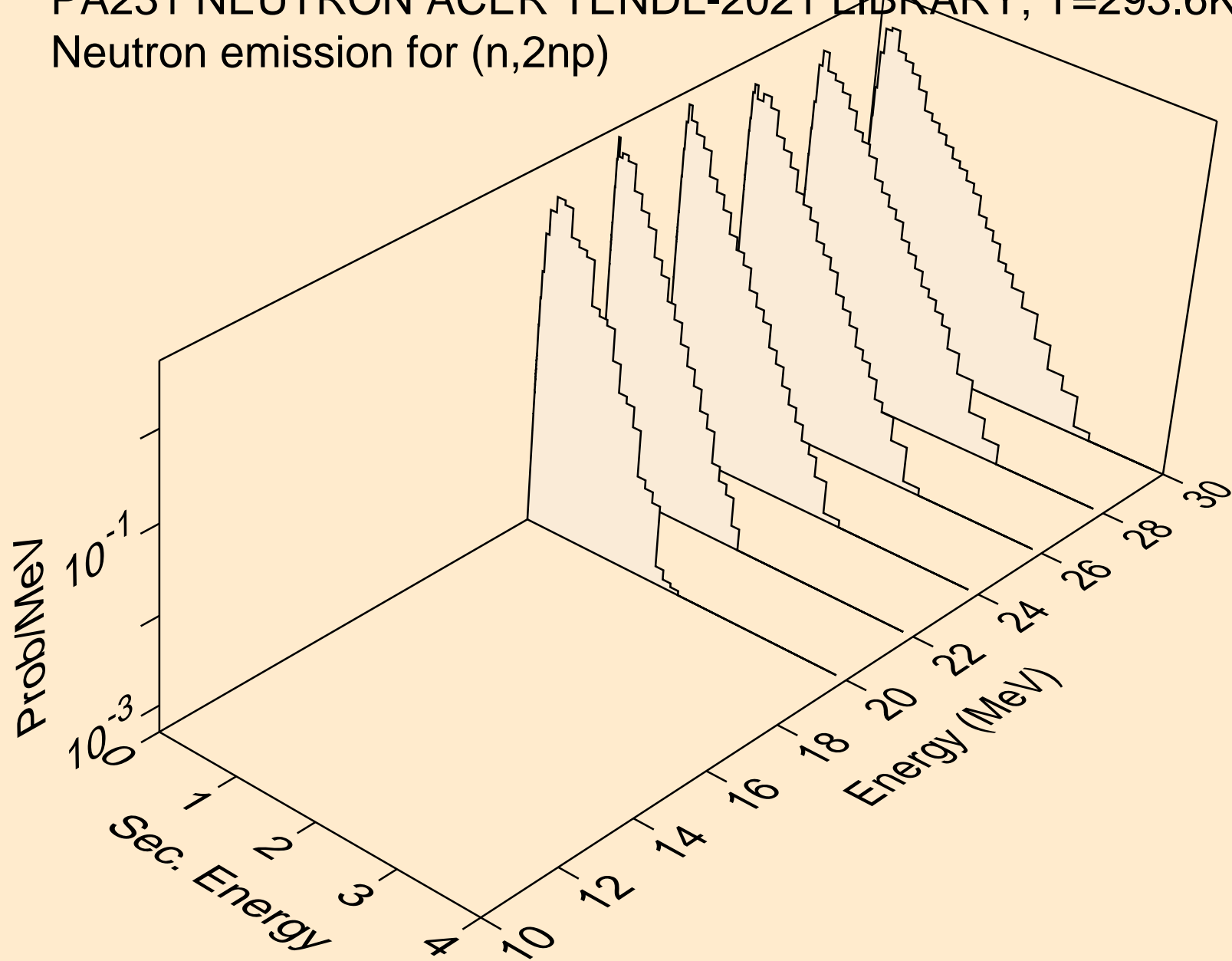

PA231 NEUTRON ACER TENDL-2021 LIBRARY; T=293.6K
Neutron emission for (n,npa)

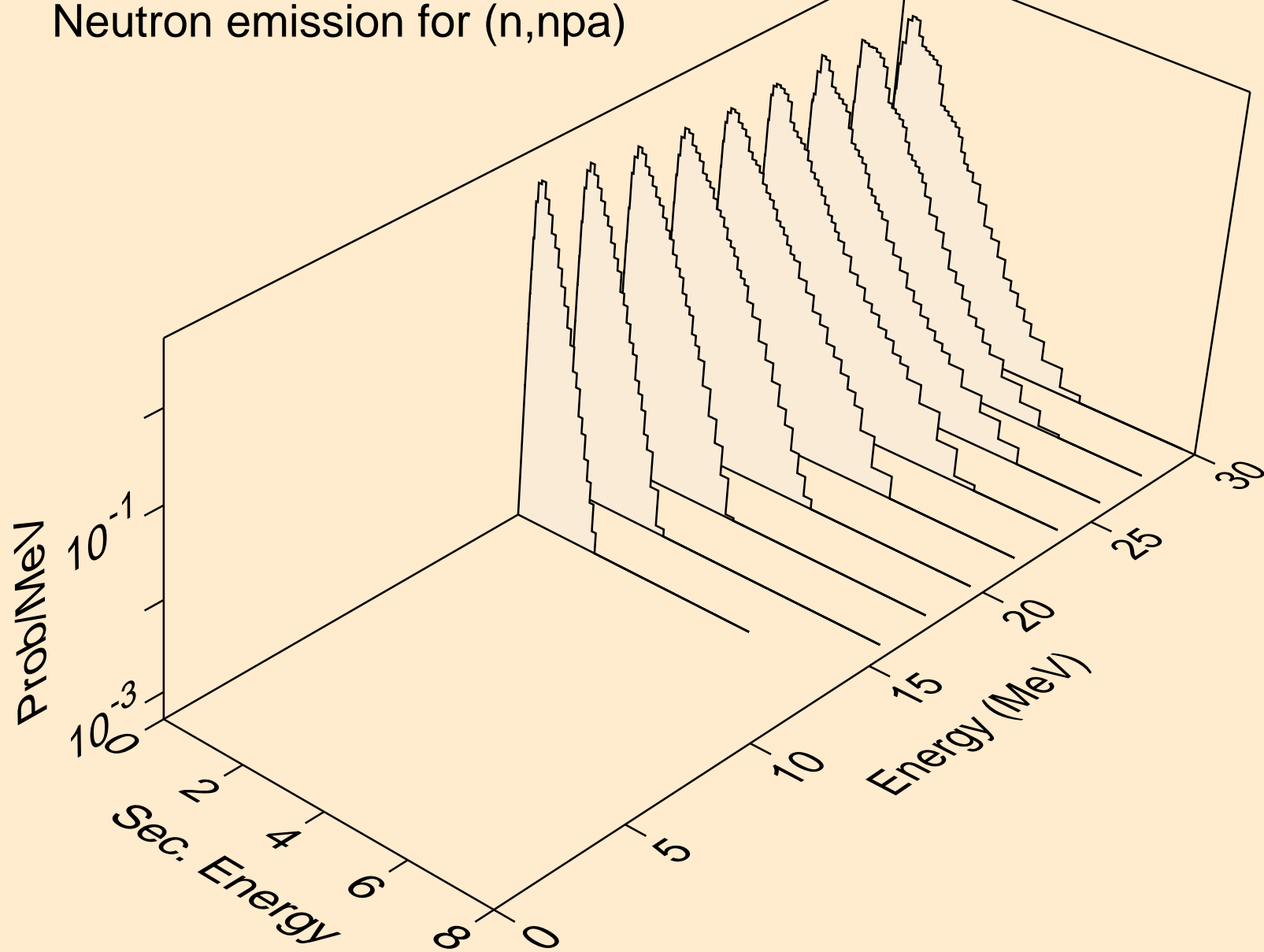

PA231 NEUTRON ACER TENDL-2021 LIBRARY; T=293.6K
Neutron emission for (n,n*c)

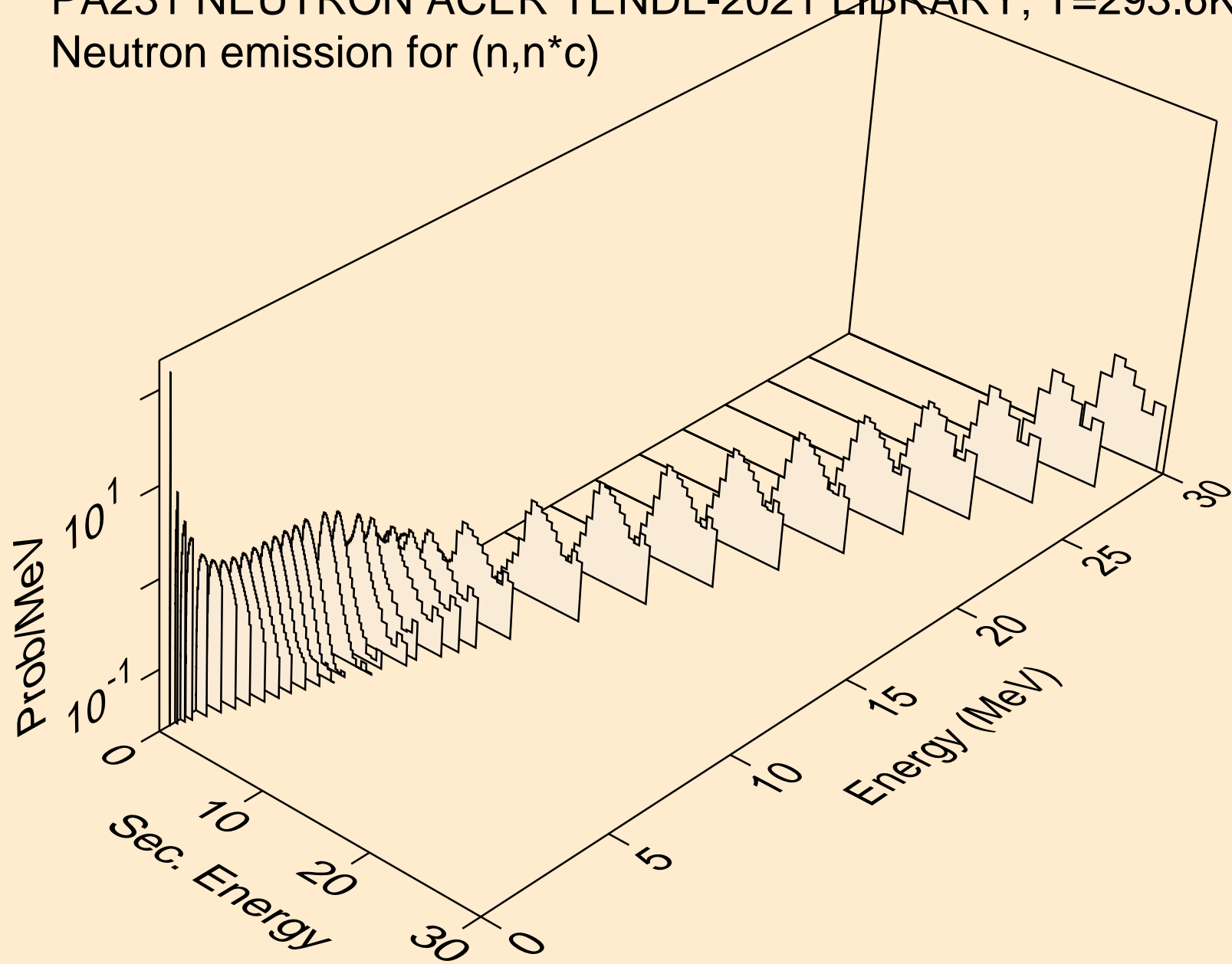

PA231 NEUTRON ACER TENDL-2021 LIBRARY; T=293.6K

Delayed nubar

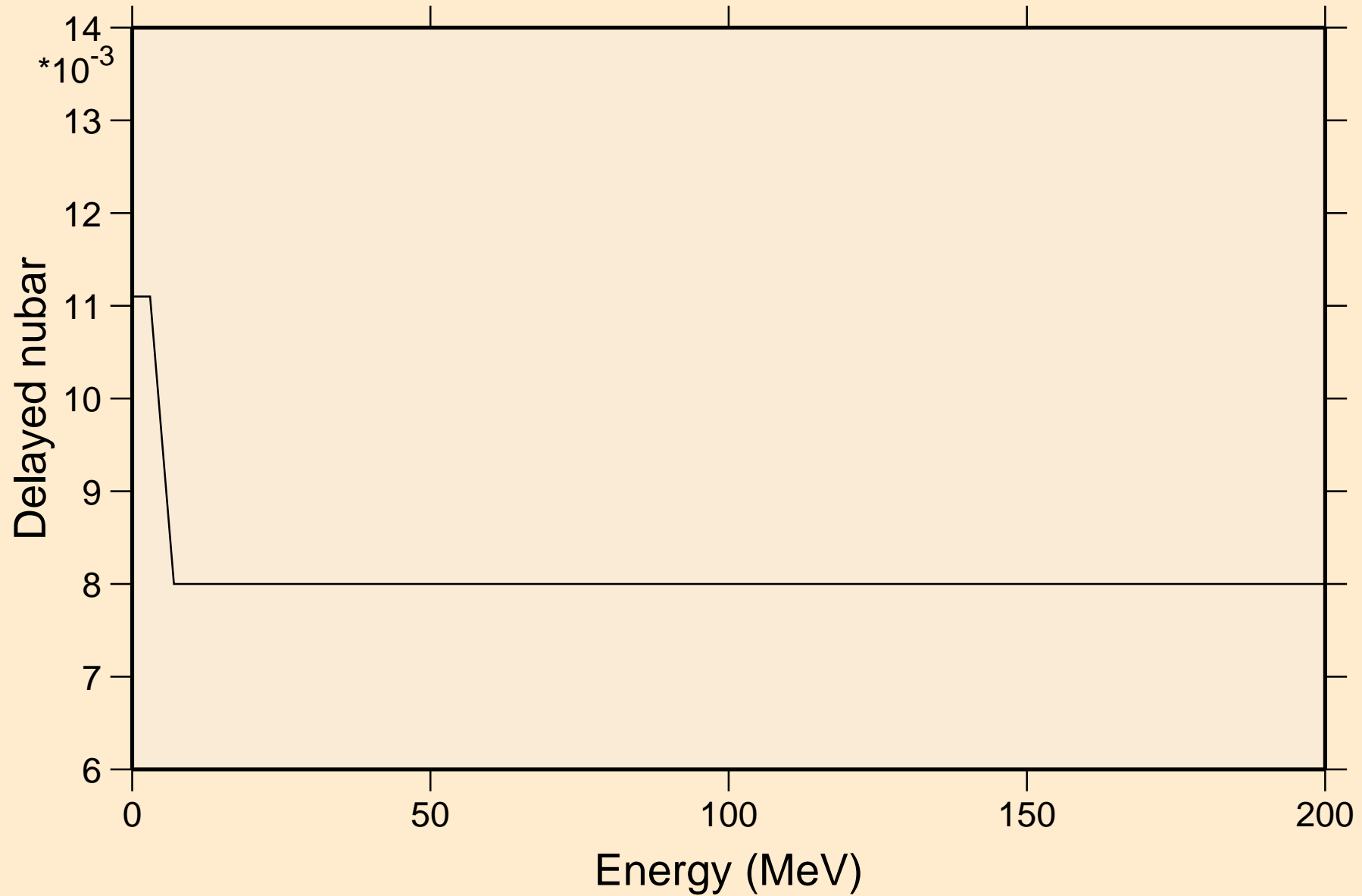

PA231 NEUTRON ACER TENDL-2021 LIBRARY; T=293.6K

Delayed neutron spectra

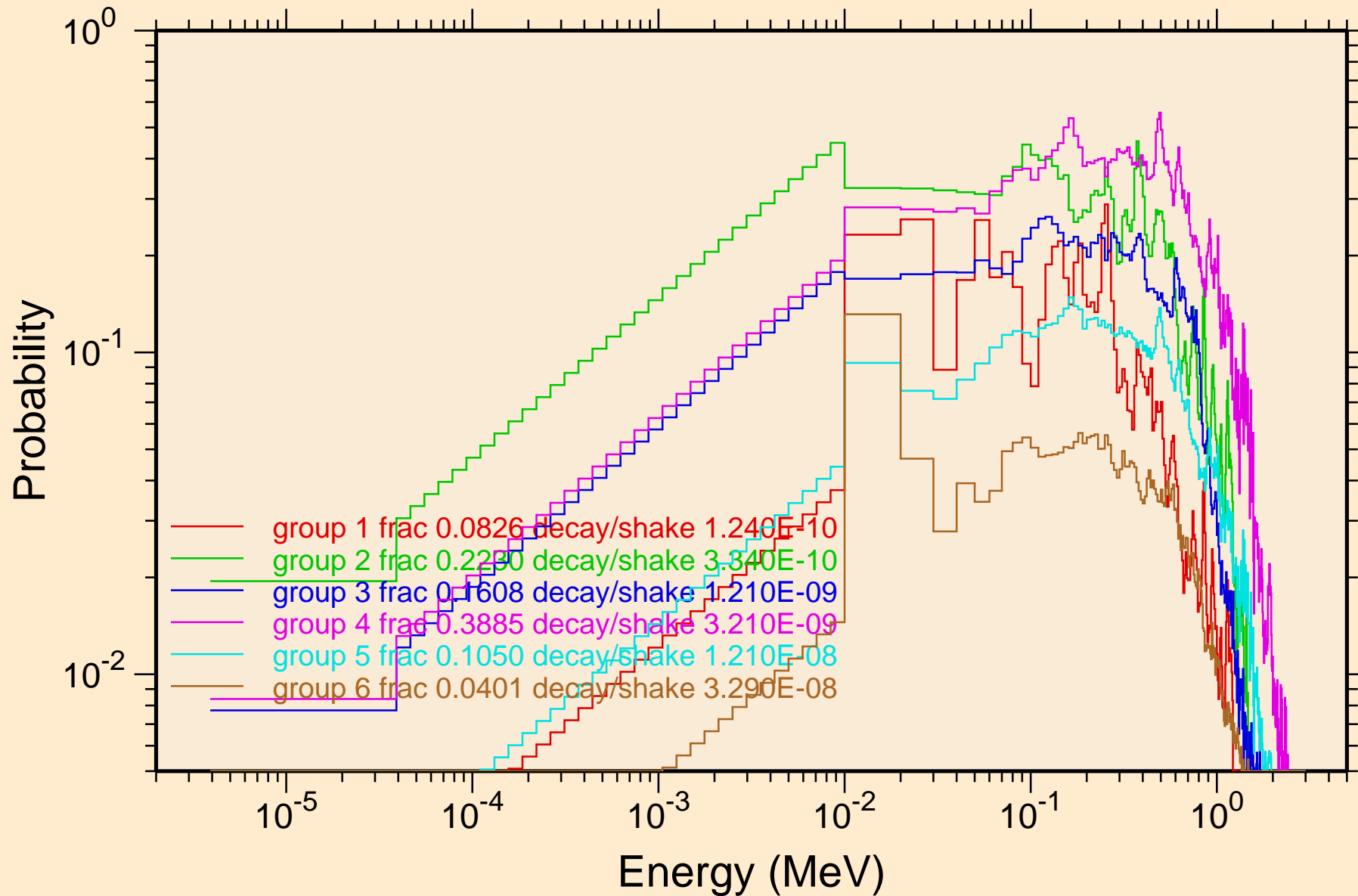

PA231 NEUTRON ACER TENDL-2021 LIBRARY; T=293.6K
Photon emission for (n,x)

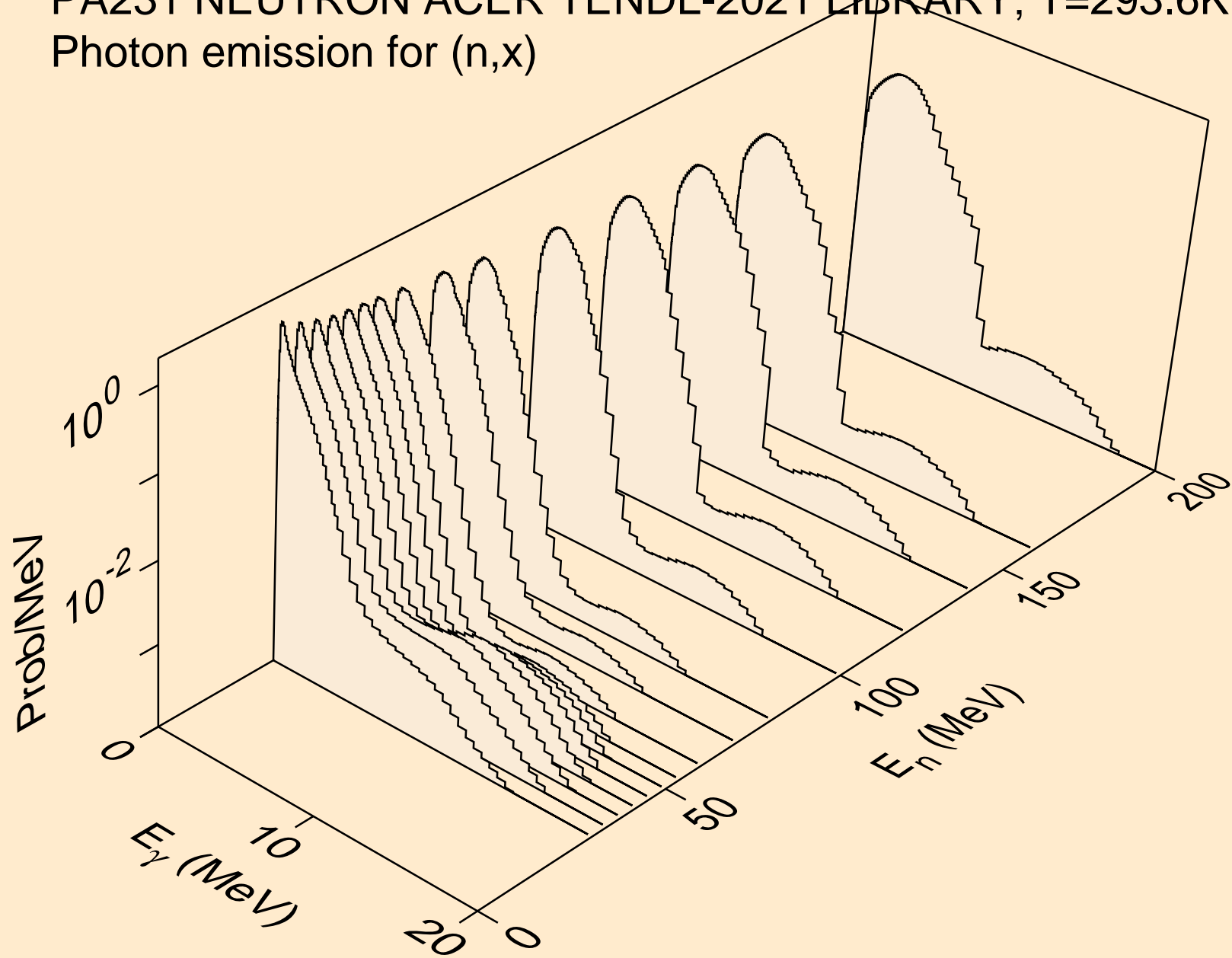

PA231 NEUTRON ACER TENDL-2021 LIBRARY; T=293.6K
Photon emission for (n,2nd)

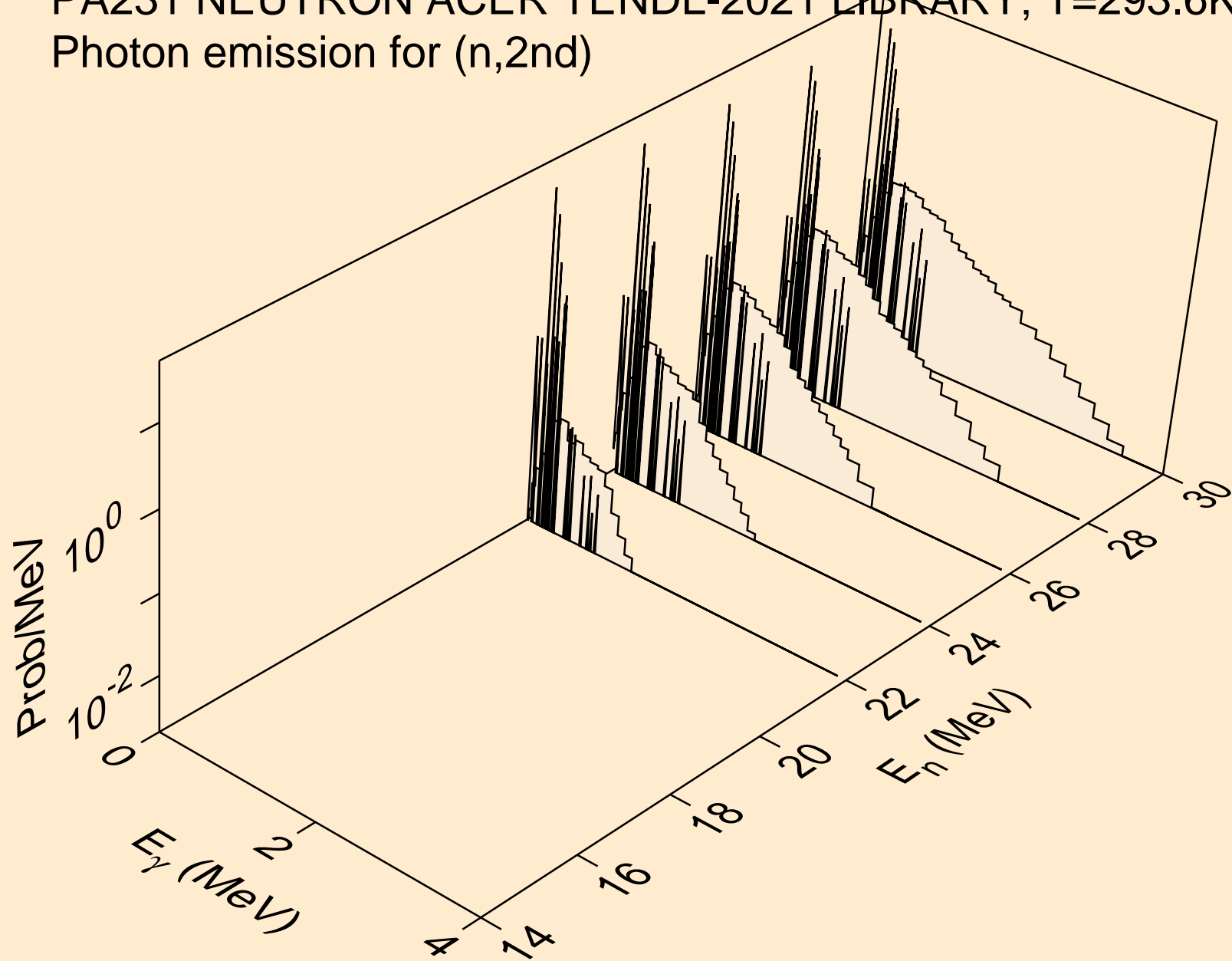

PA231 NEUTRON ACER TENDL-2021 LIBRARY; T=293.6K
Photon emission for (n,2n)

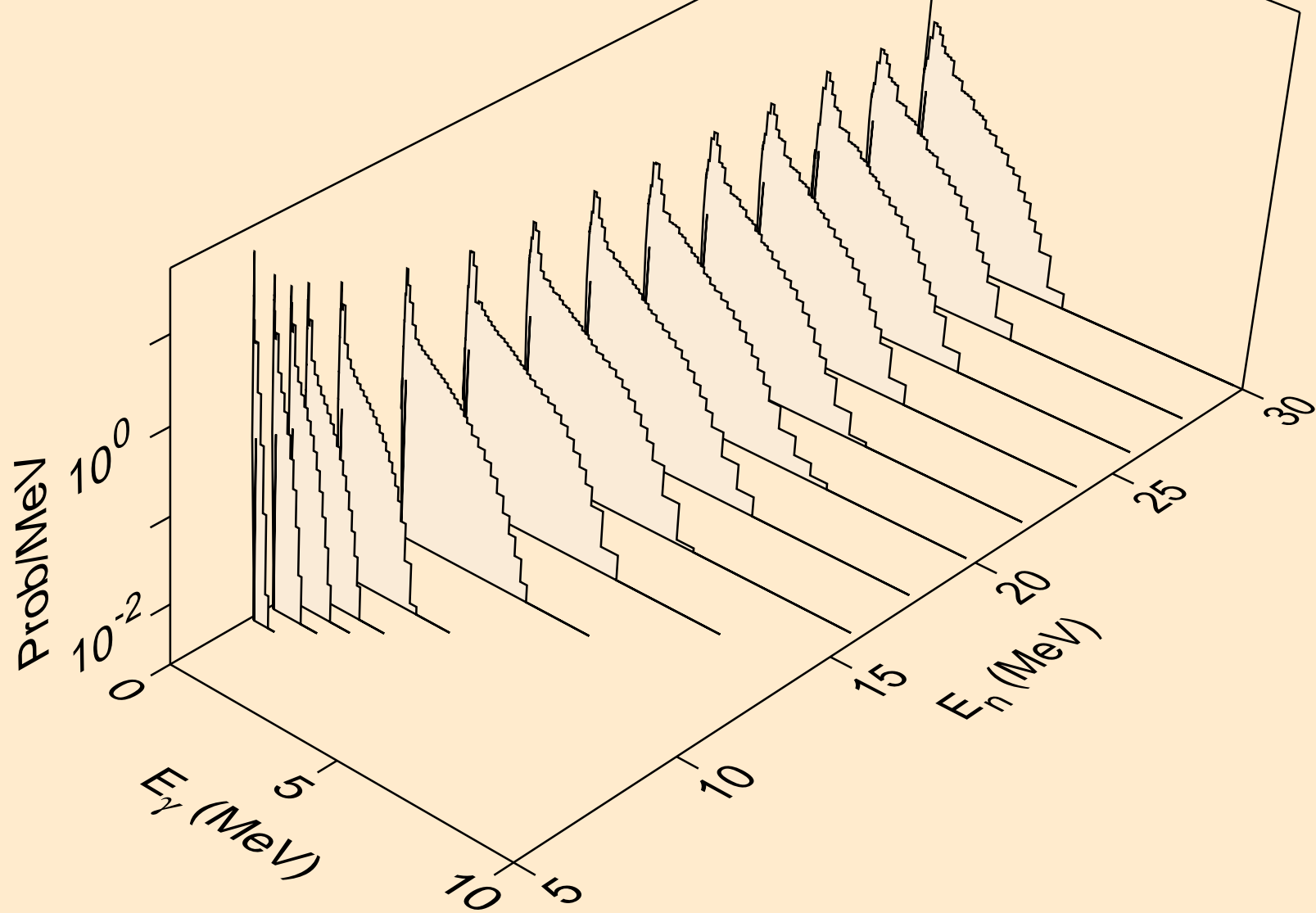

PA231 NEUTRON ACER TENDL-2021 LIBRARY; T=293.6K
Photon emission for (n,3n)

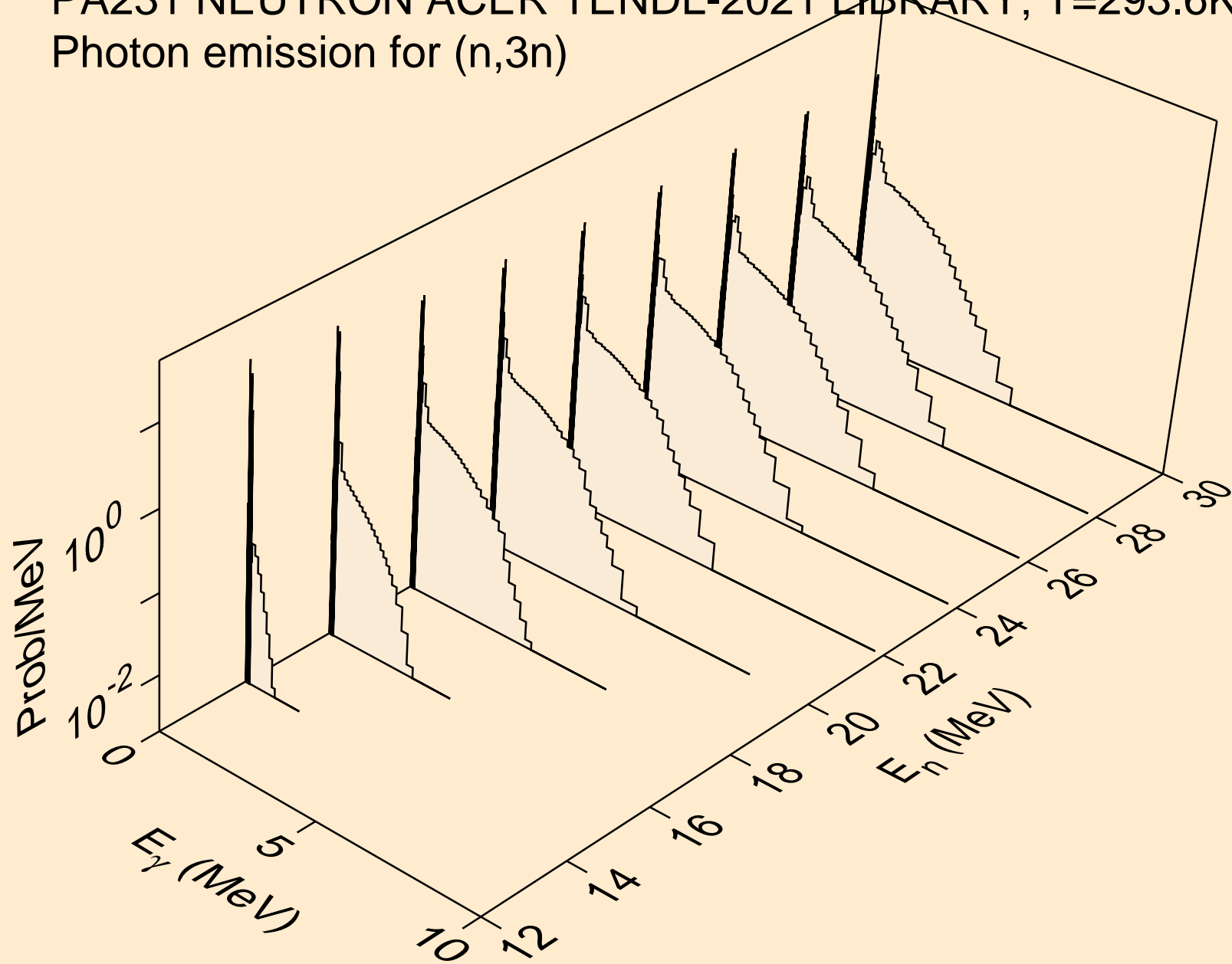

PA231 NEUTRON ACER TENDL-2021 LIBRARY; T=293.6K
Photon emission for (n,n*)a

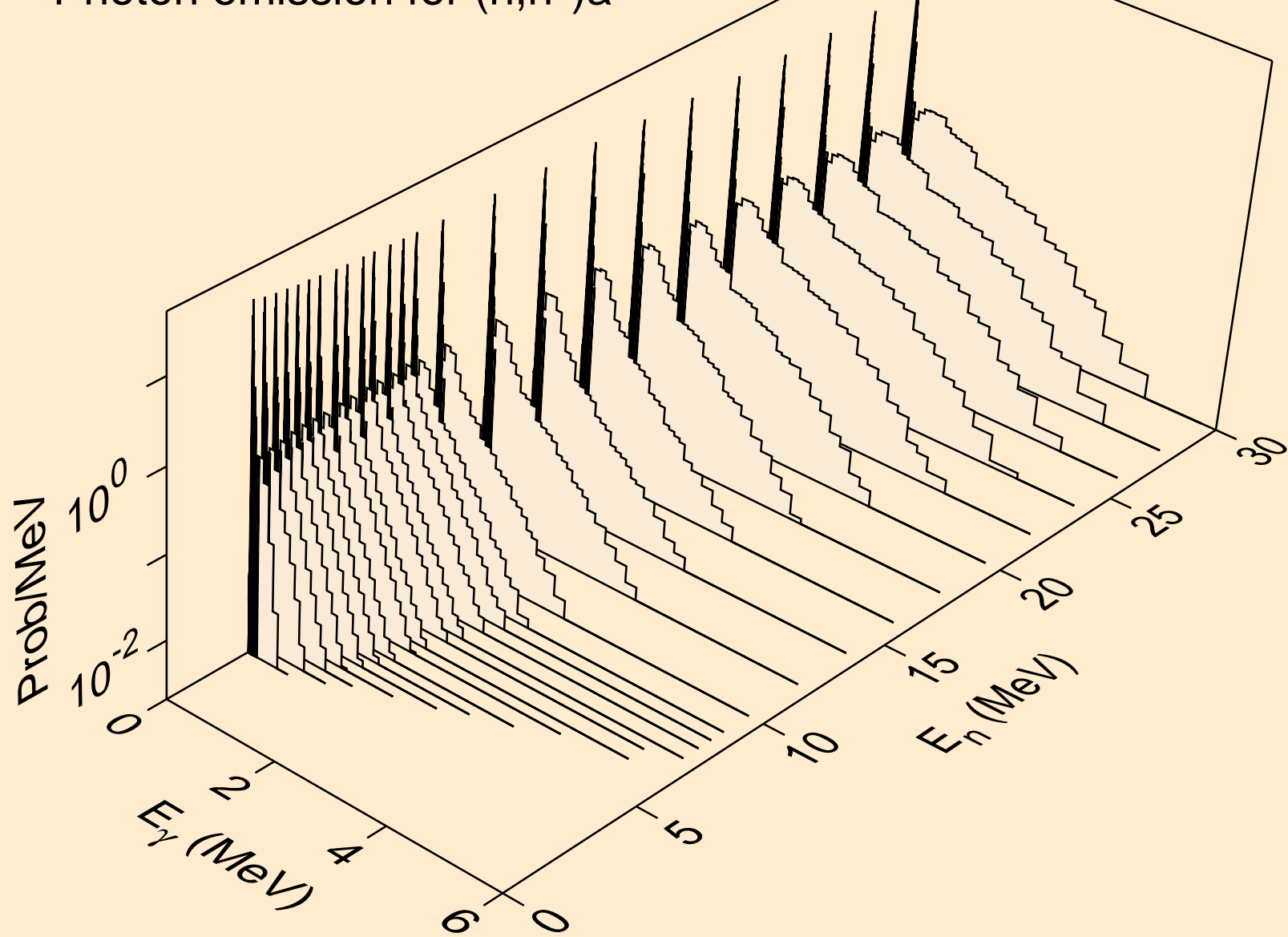

PA231 NEUTRON ACER TENDL-2021 LIBRARY; T=293.6K
Photon emission for (n,2n)a

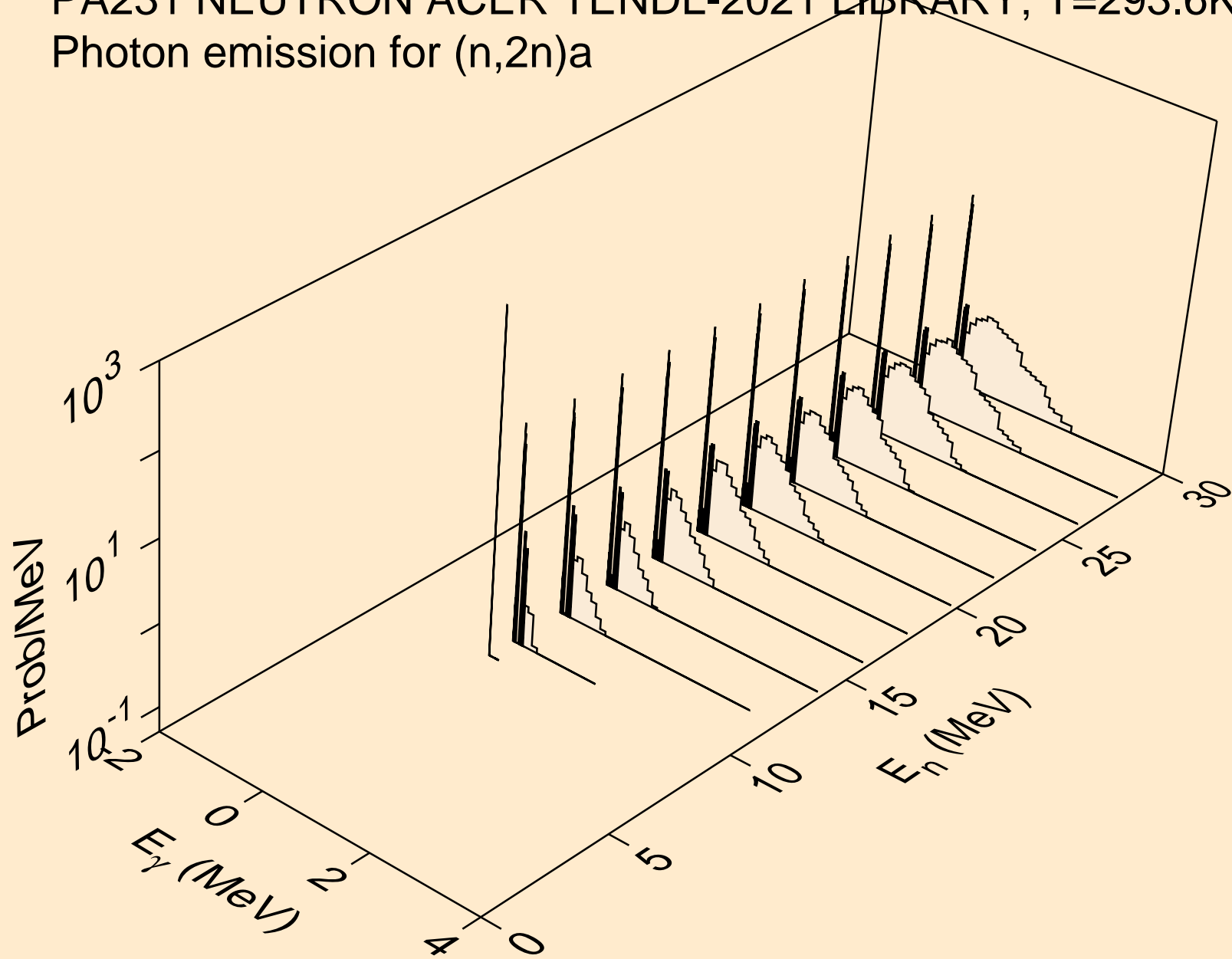

PA231 NEUTRON ACER TENDL-2021 LIBRARY; T=293.6K
Photon emission for (n,3n)a

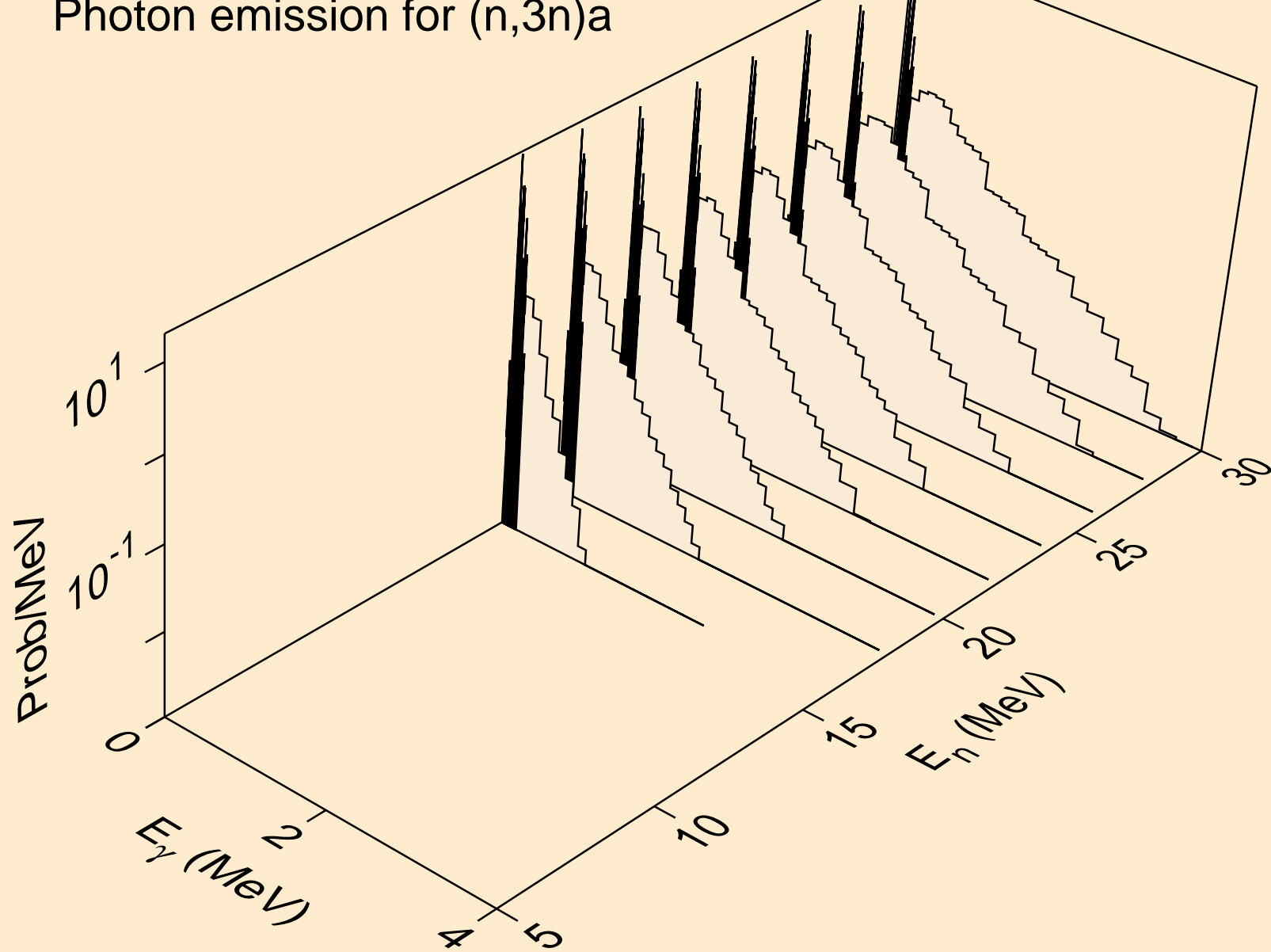

PA231 NEUTRON ACER TENDL-2021 LIBRARY; T=293.6K
Photon emission for (n,n*)p

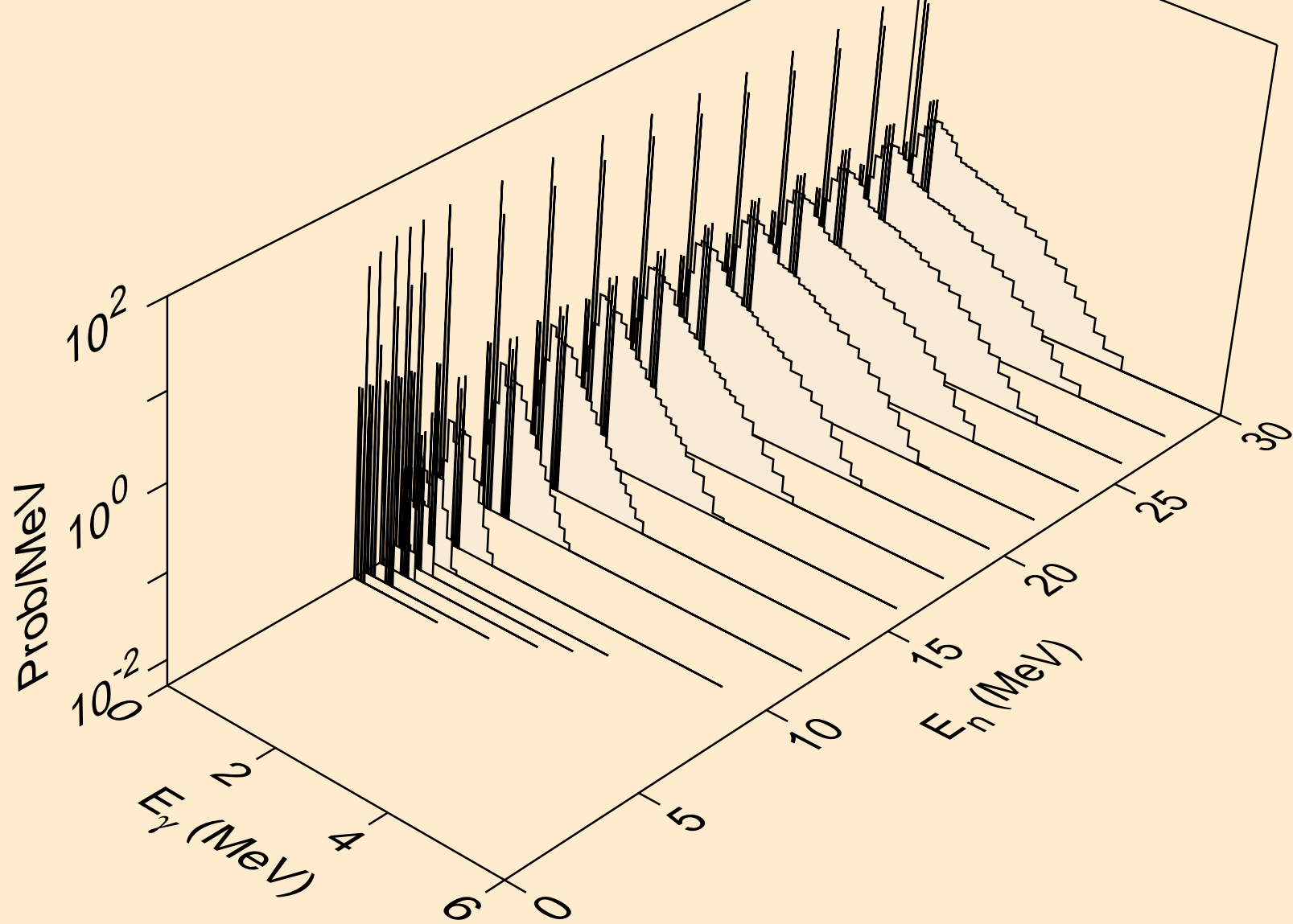

PA231 NEUTRON ACER TENDL-2021 LIBRARY; T=293.6K
Photon emission for (n,n*)2a

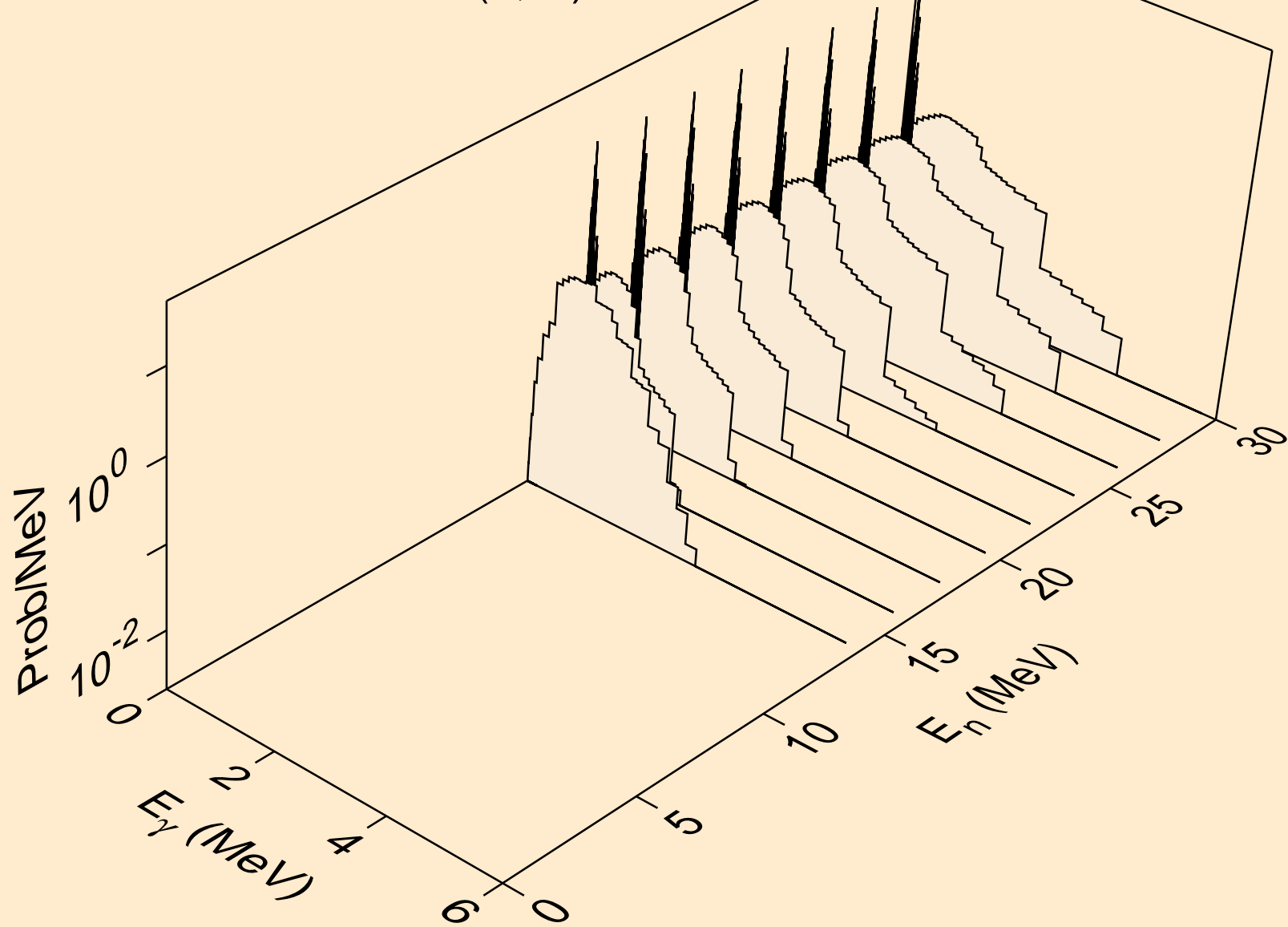

PA231 NEUTRON ACER TENDL-2021 LIBRARY; T=293.6K
Photon emission for (n,n*)d

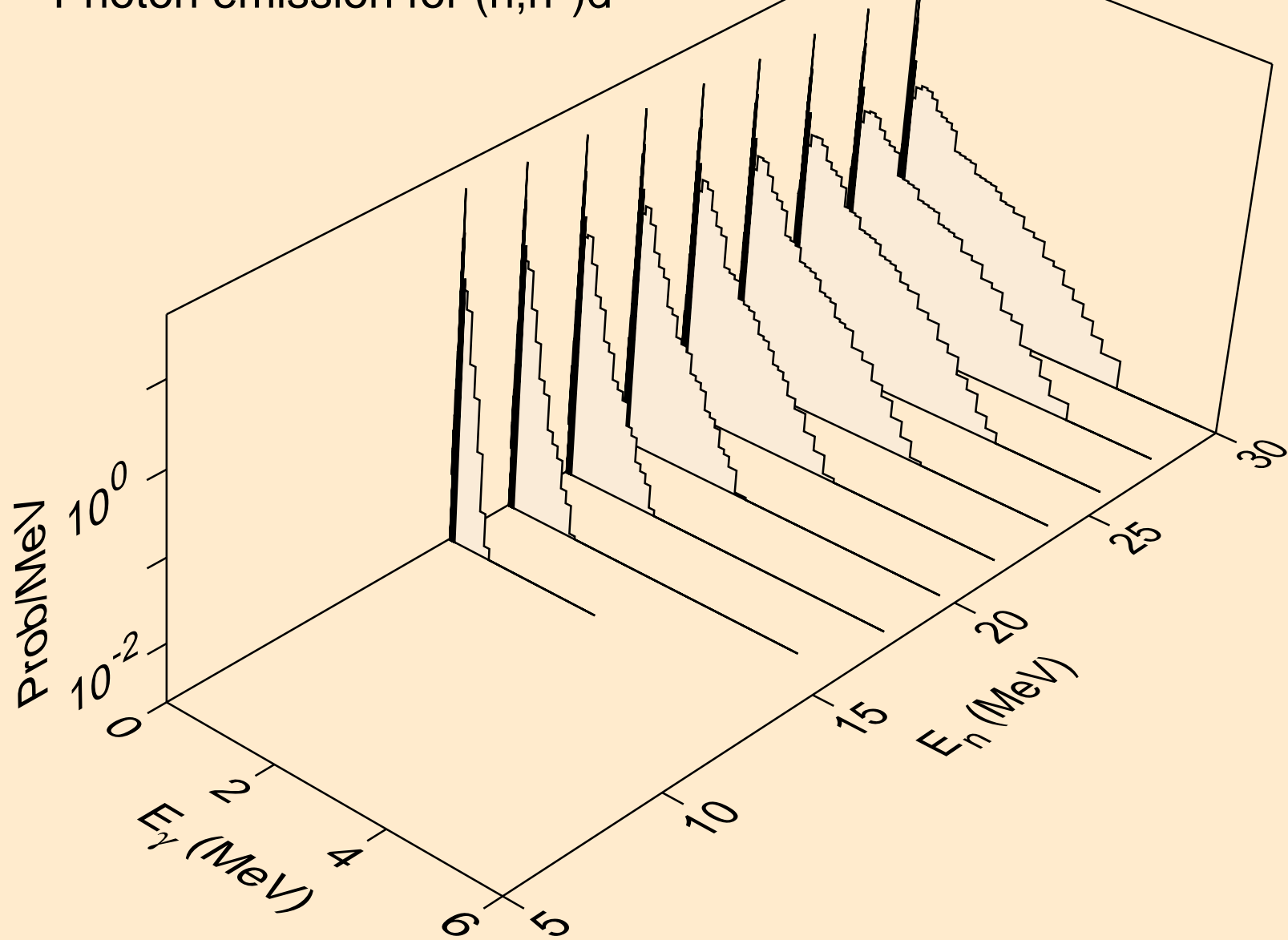

PA231 NEUTRON ACER TENDL-2021 LIBRARY; T=293.6K
Photon emission for (n,n*)t

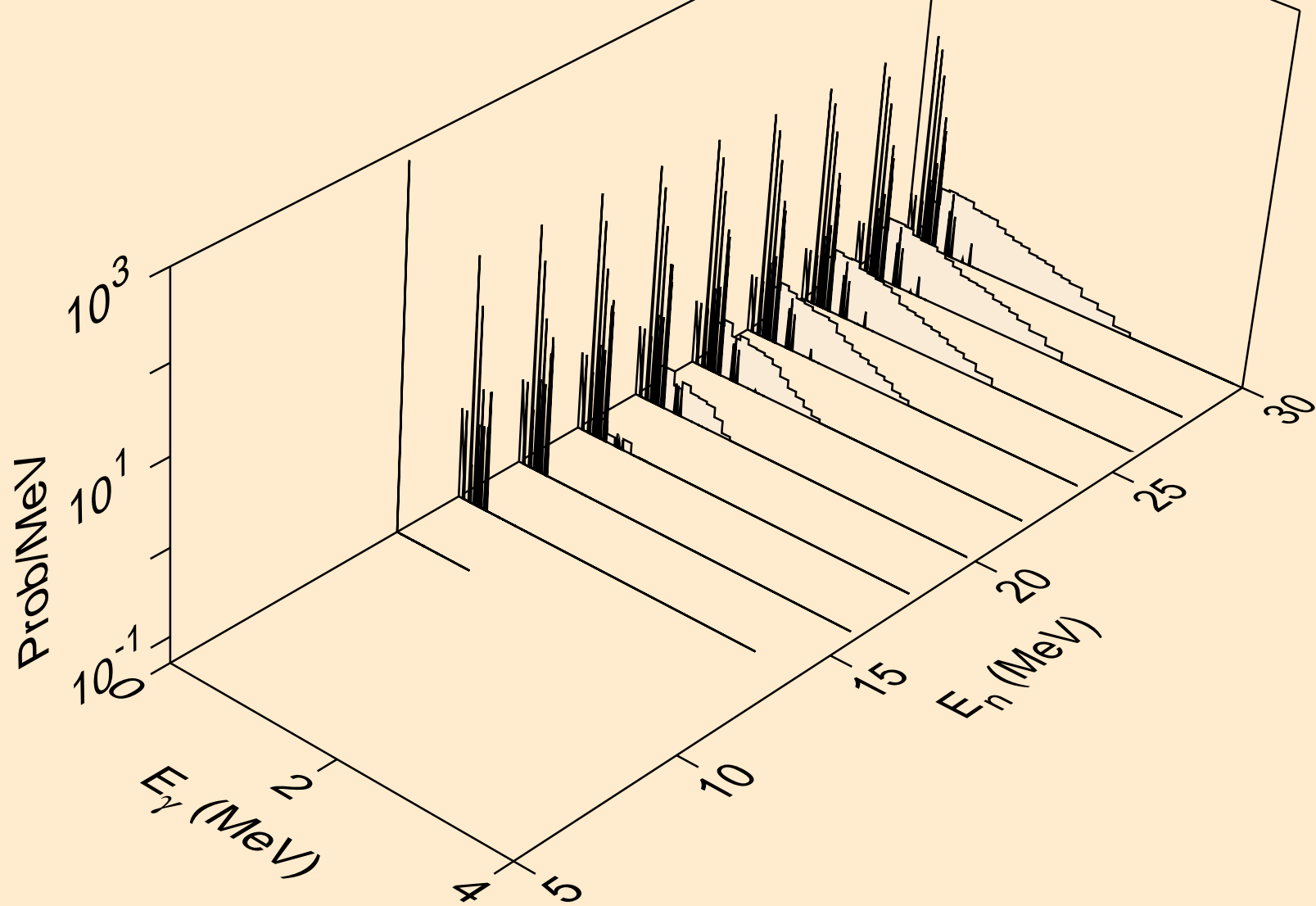

PA231 NEUTRON ACER TENDL-2021 LIBRARY; T=293.6K
Photon emission for (n,n*)he3

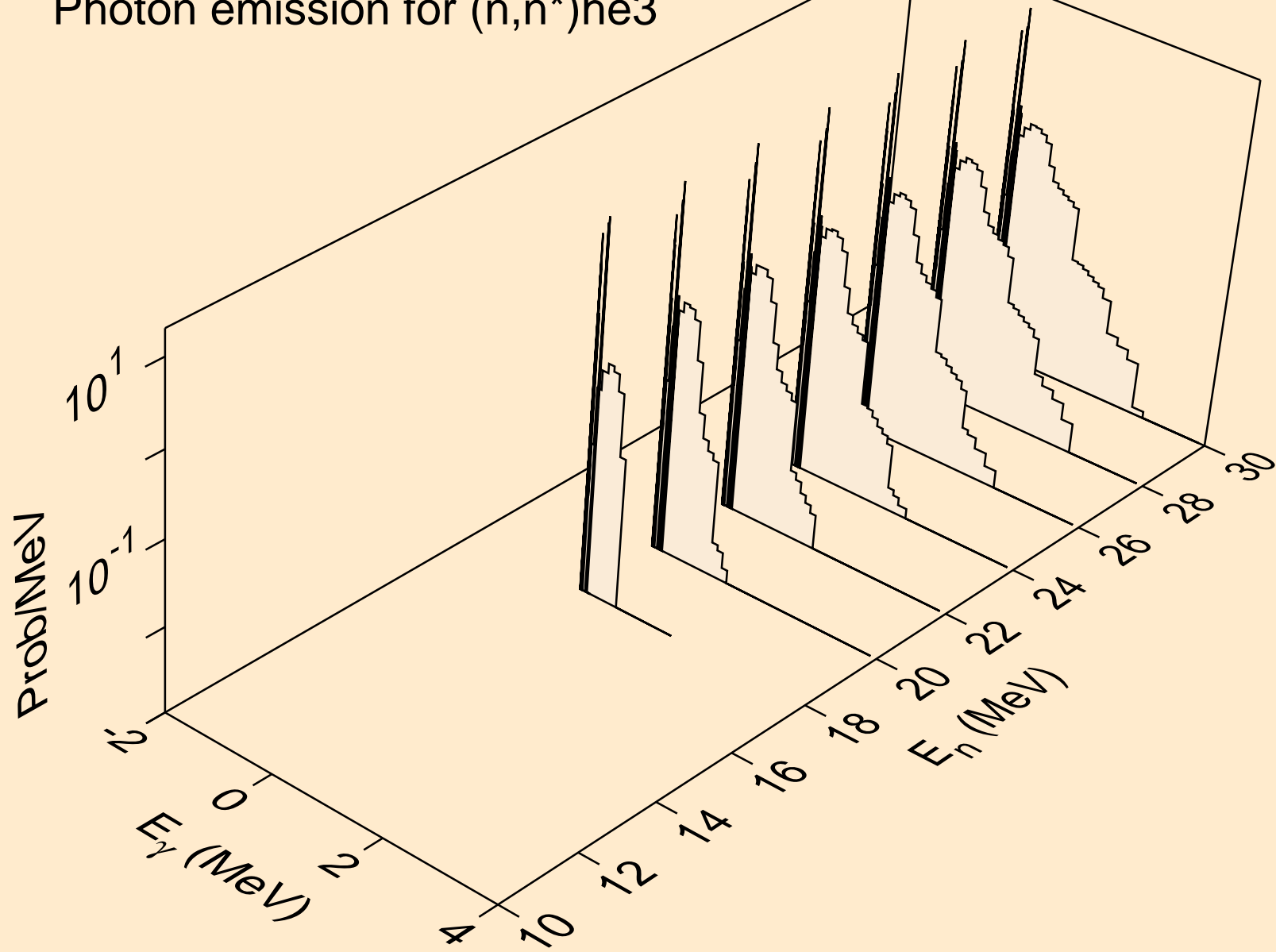

PA231 NEUTRON ACER TENDL-2021 LIBRARY; T=293.6K
Photon emission for (n,4n)

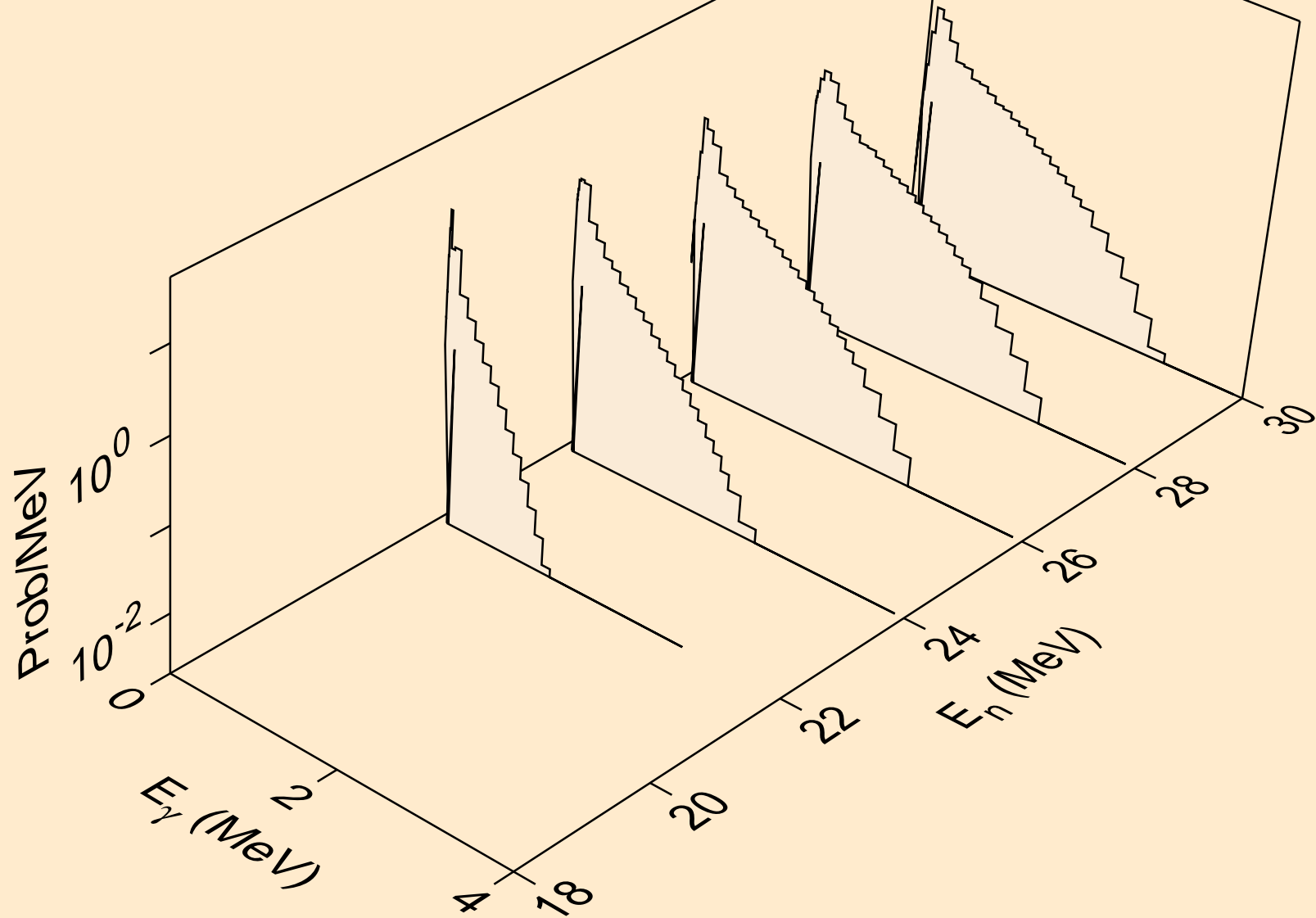

PA231 NEUTRON ACER TENDL-2021 LIBRARY; T=293.6K
Photon emission for (n,2np)

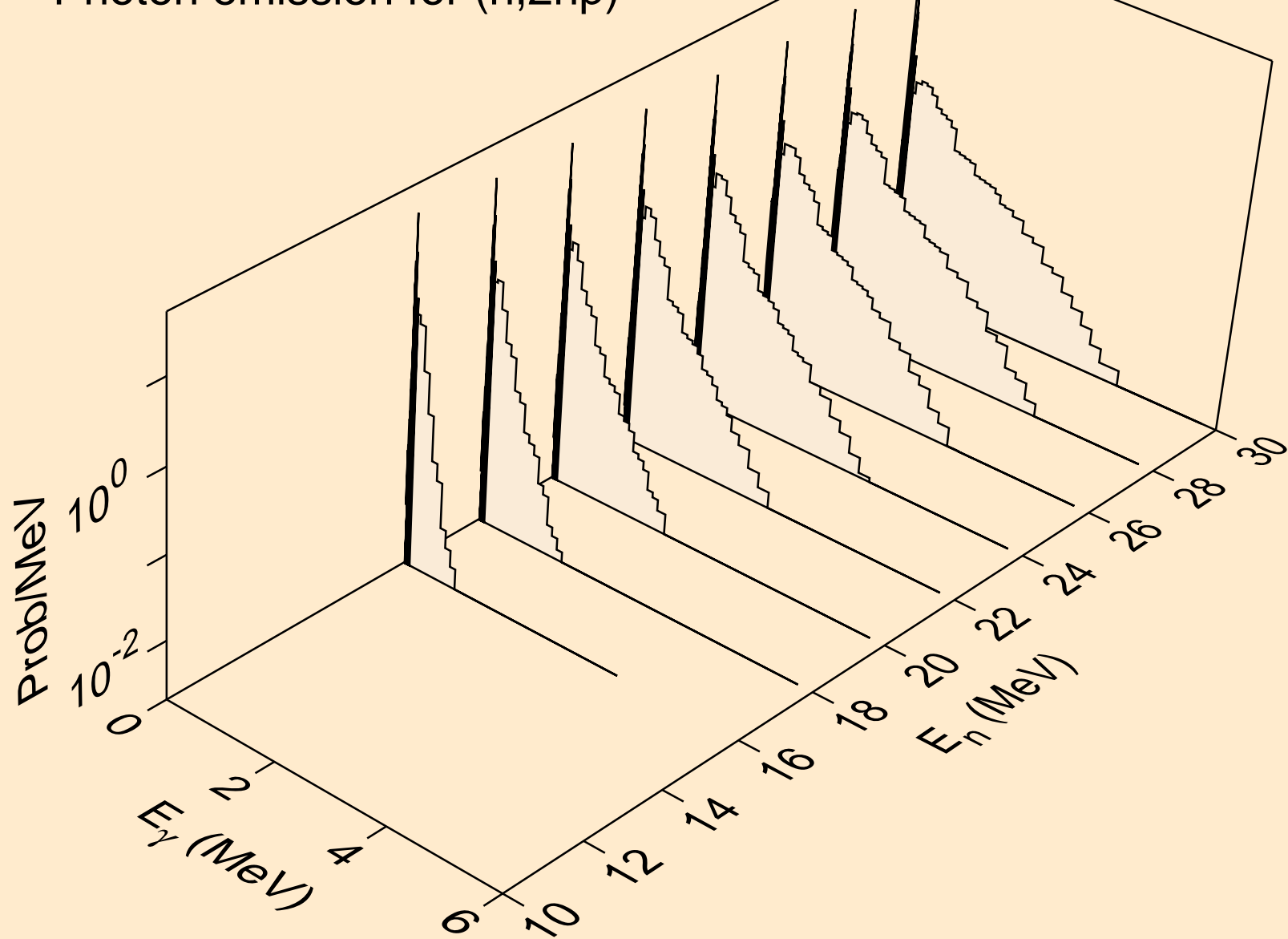

PA231 NEUTRON ACER TENDL-2021 LIBRARY; T=293.6K
Photon emission for (n,3np)

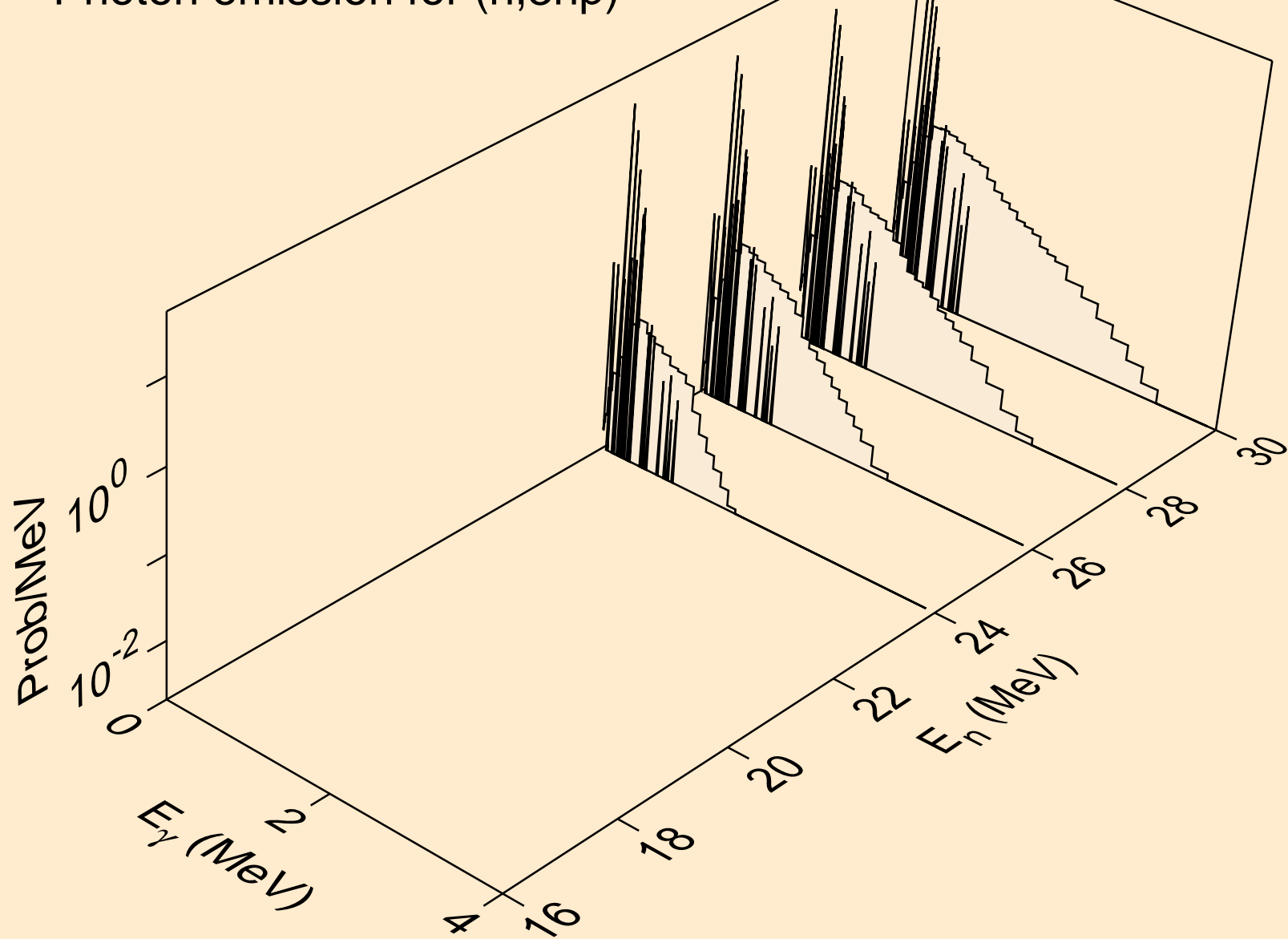

PA231 NEUTRON ACER TENDL-2021 LIBRARY; T=293.6K
Photon emission for (n,2np)

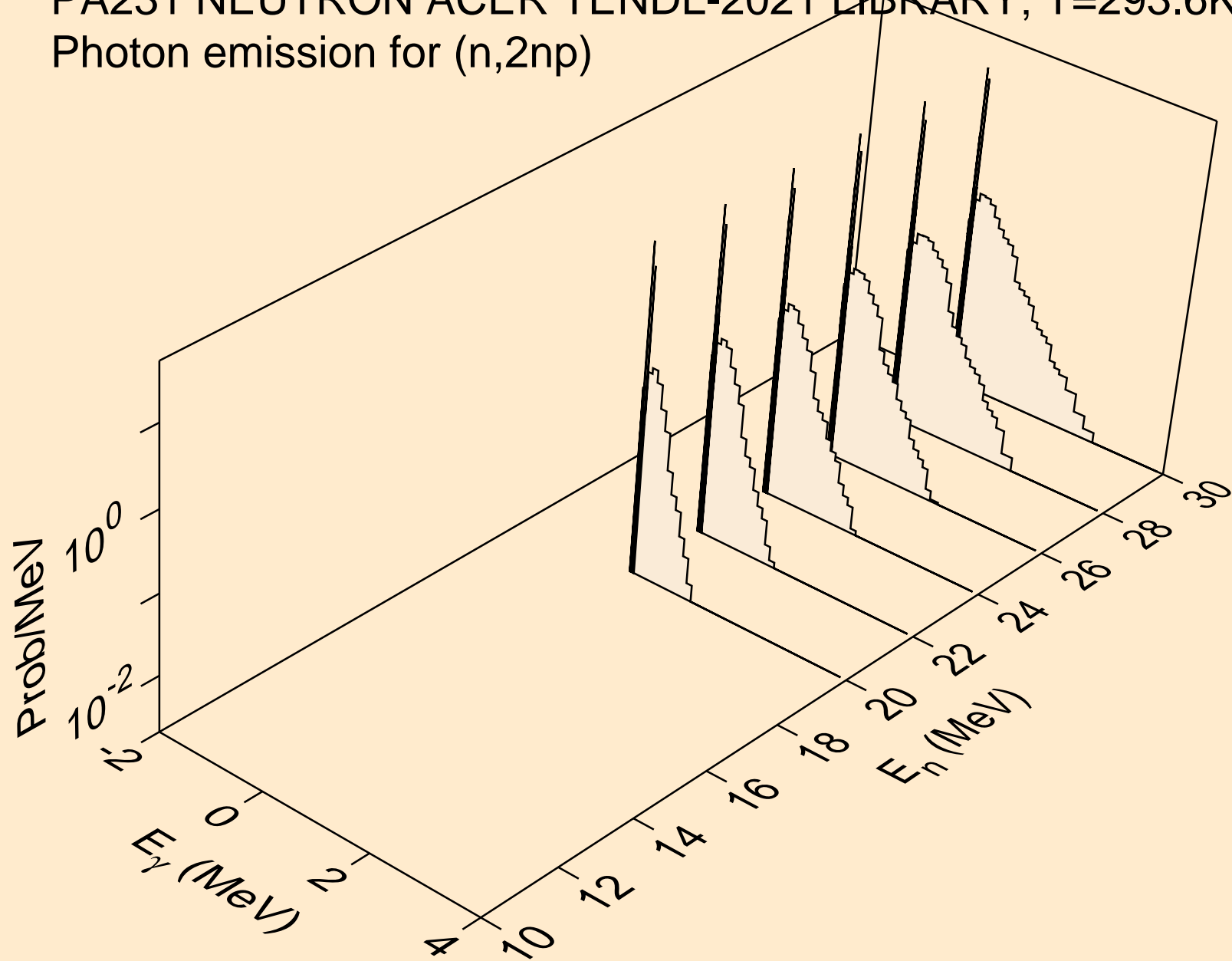

PA231 NEUTRON ACER TENDL-2021 LIBRARY; T=293.6K
Photon emission for (n,npa)

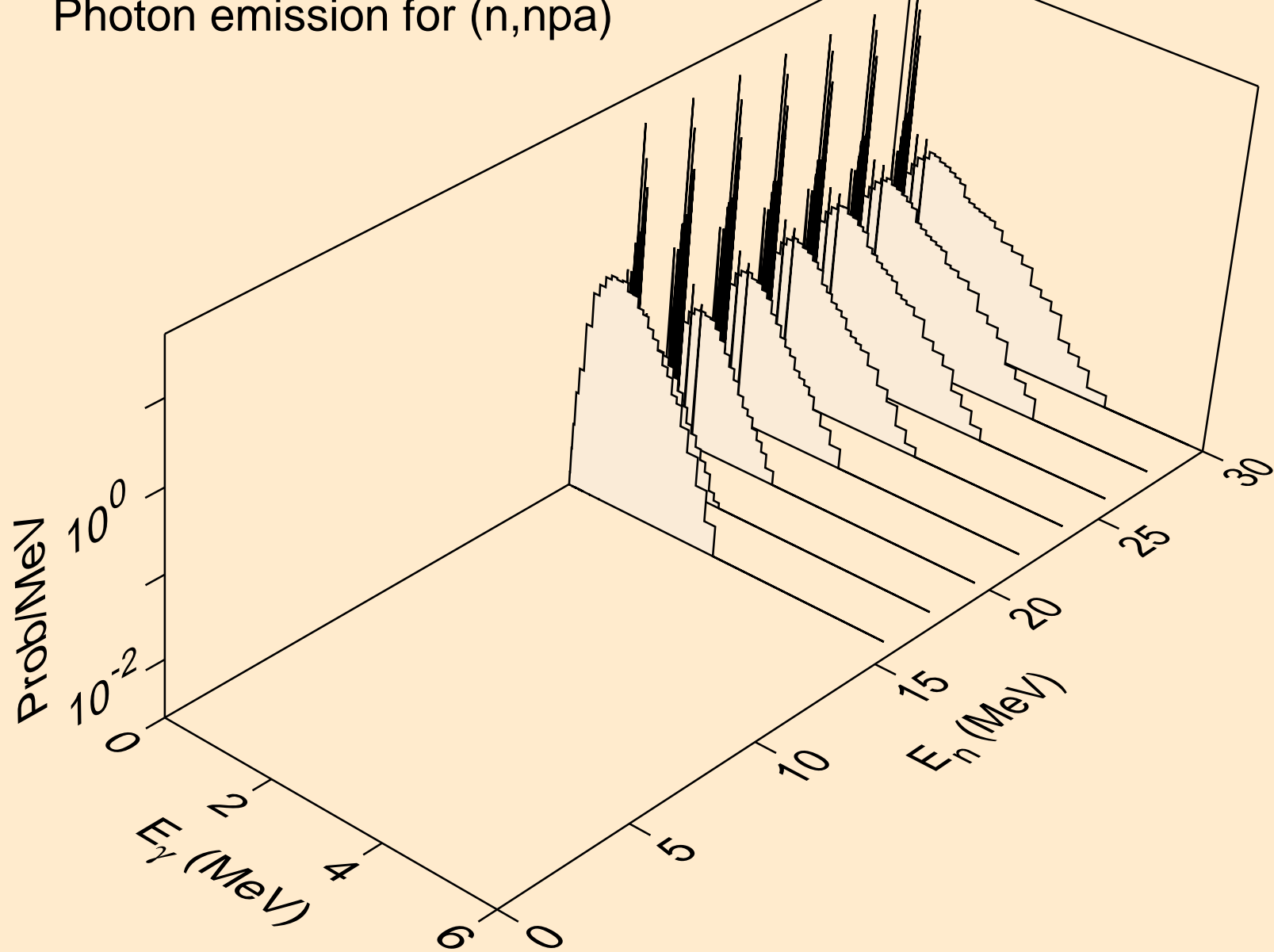

PA231 NEUTRON ACER TENDL-2021 LIBRARY; T=293.6K
Photon emission for (n,n*c)

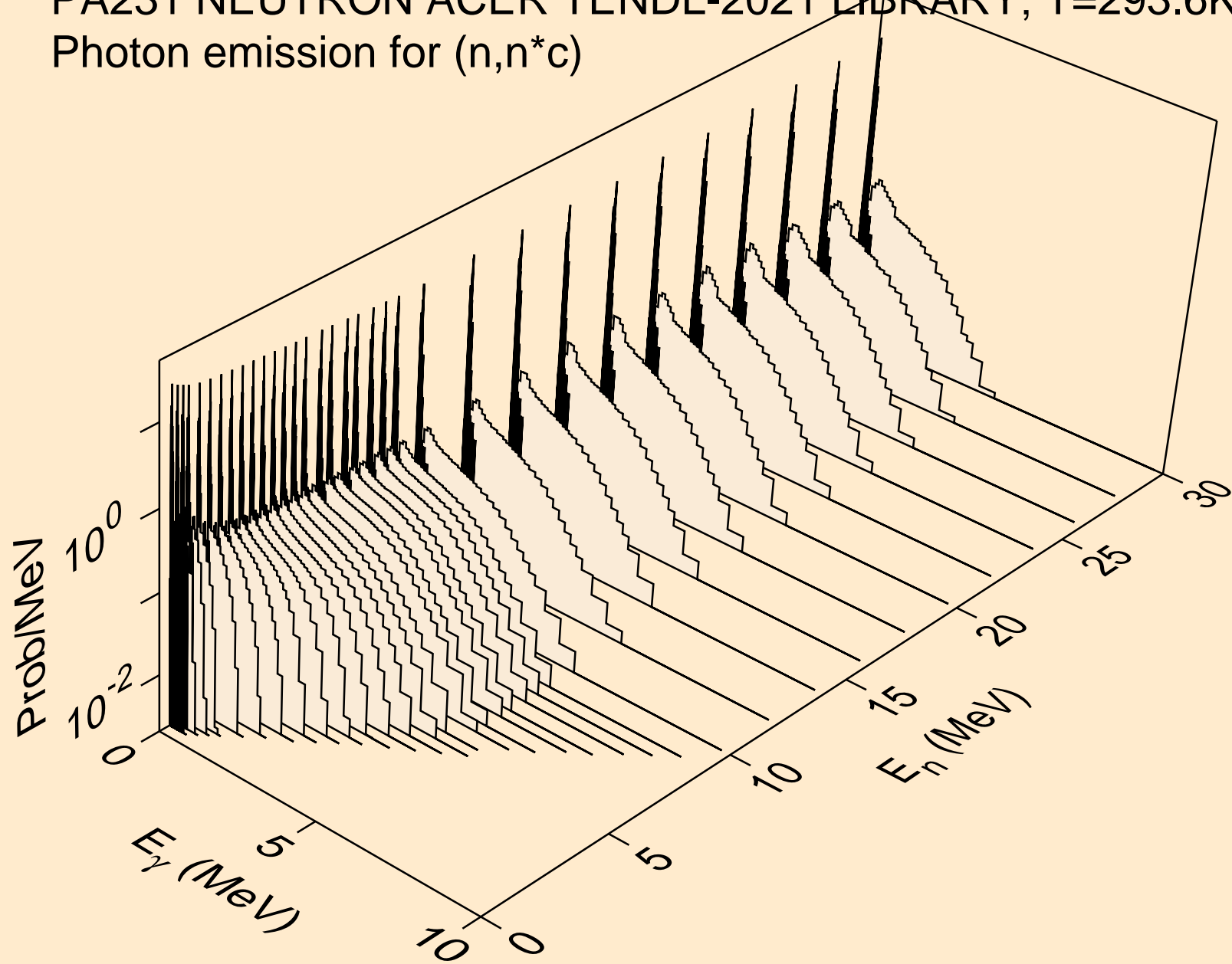

PA231 NEUTRON ACER TENDL-2021 LIBRARY; T=293.6K
Photon emission for (n,gma)

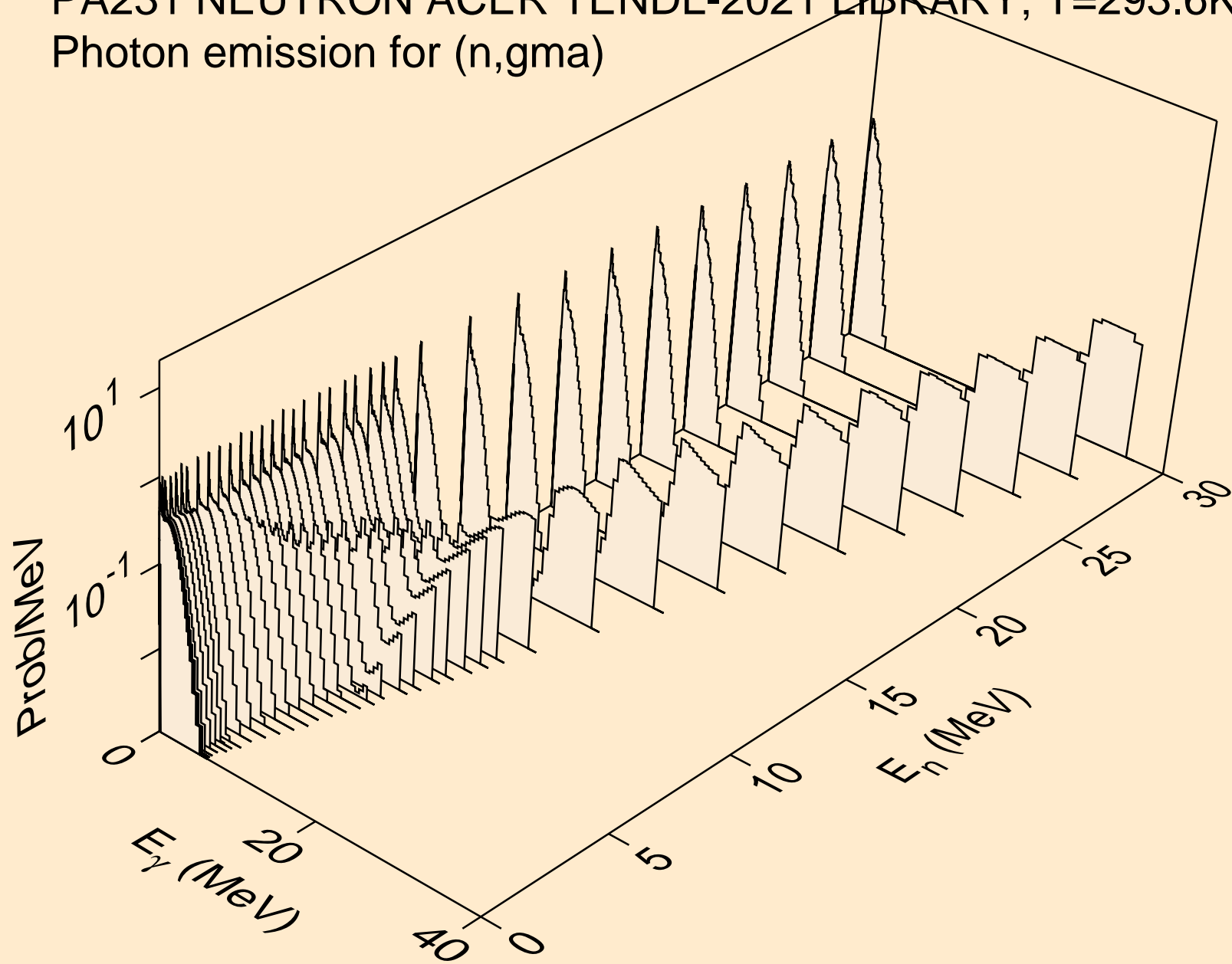

PA231 NEUTRON ACER TENDL-2021 LIBRARY; T=293.6K
Photon emission for (n,p)

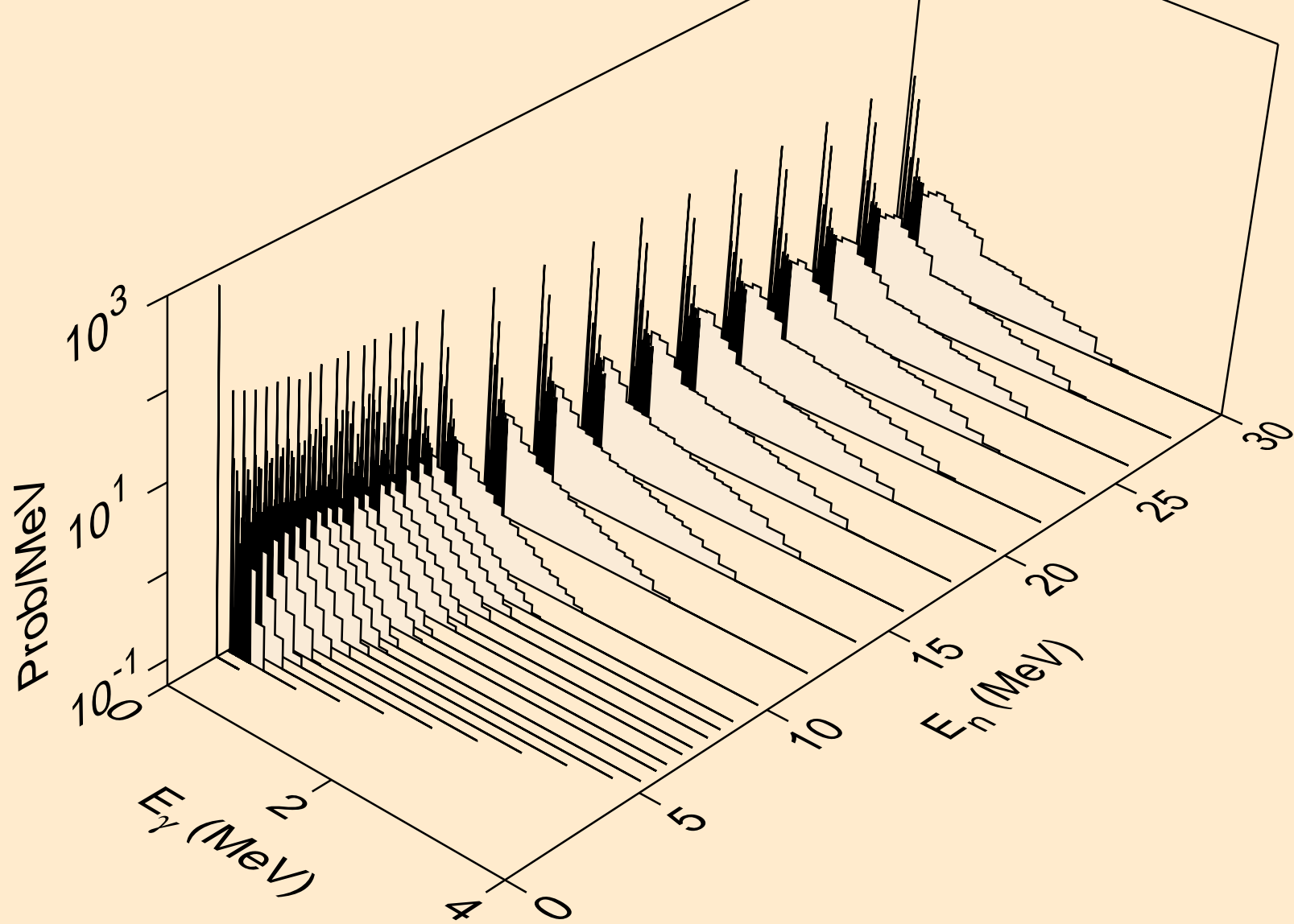

PA231 NEUTRON ACER TENDL-2021 LIBRARY; T=293.6K
Photon emission for (n,d)

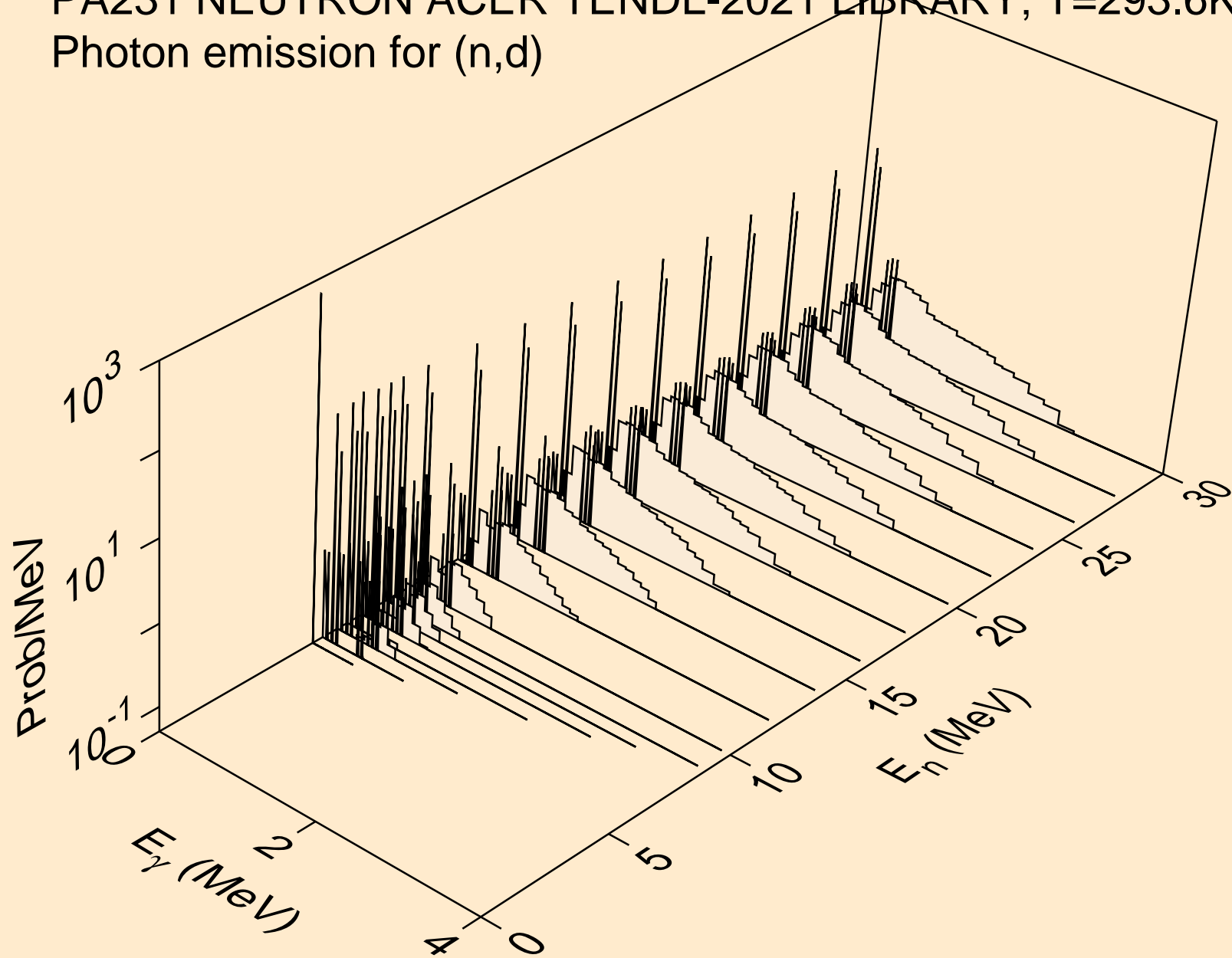

PA231 NEUTRON ACER TENDL-2021 LIBRARY; T=293.6K
Photon emission for (n,t)

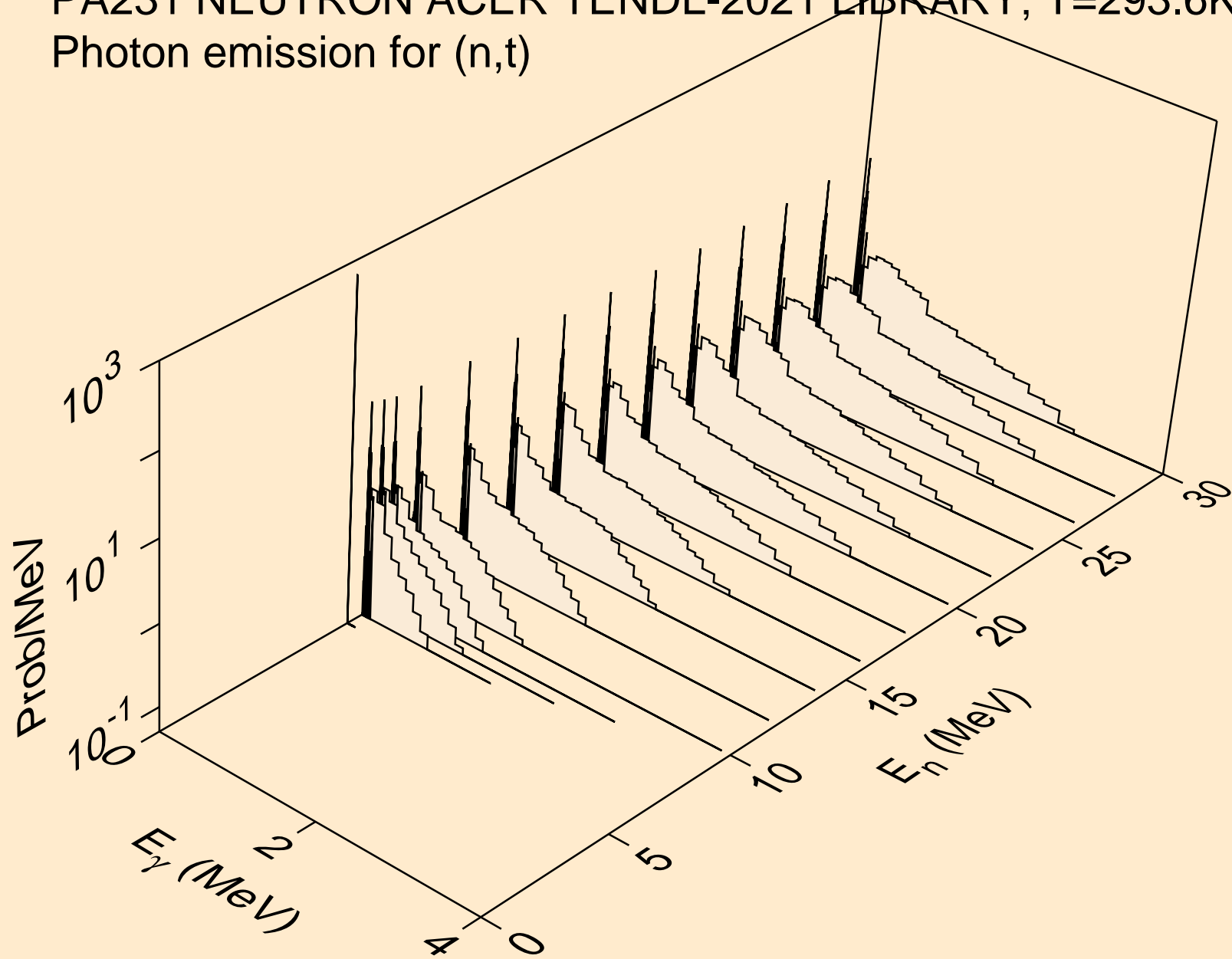

PA231 NEUTRON ACER TENDL-2021 LIBRARY; T=293.6K
Photon emission for (n,he3)

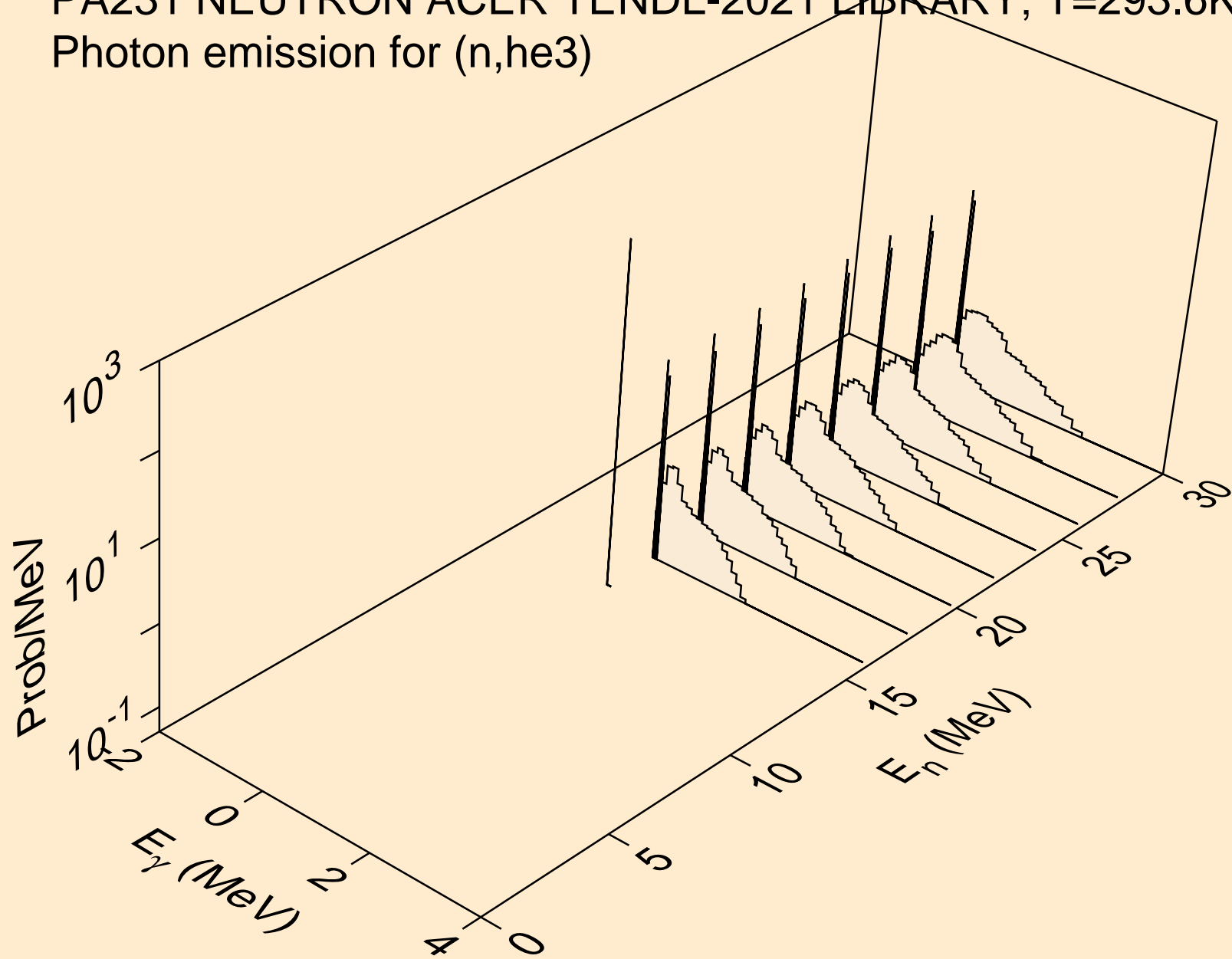

PA231 NEUTRON ACER TENDL-2021 LIBRARY; T=293.6K
Photon emission for (n,a)

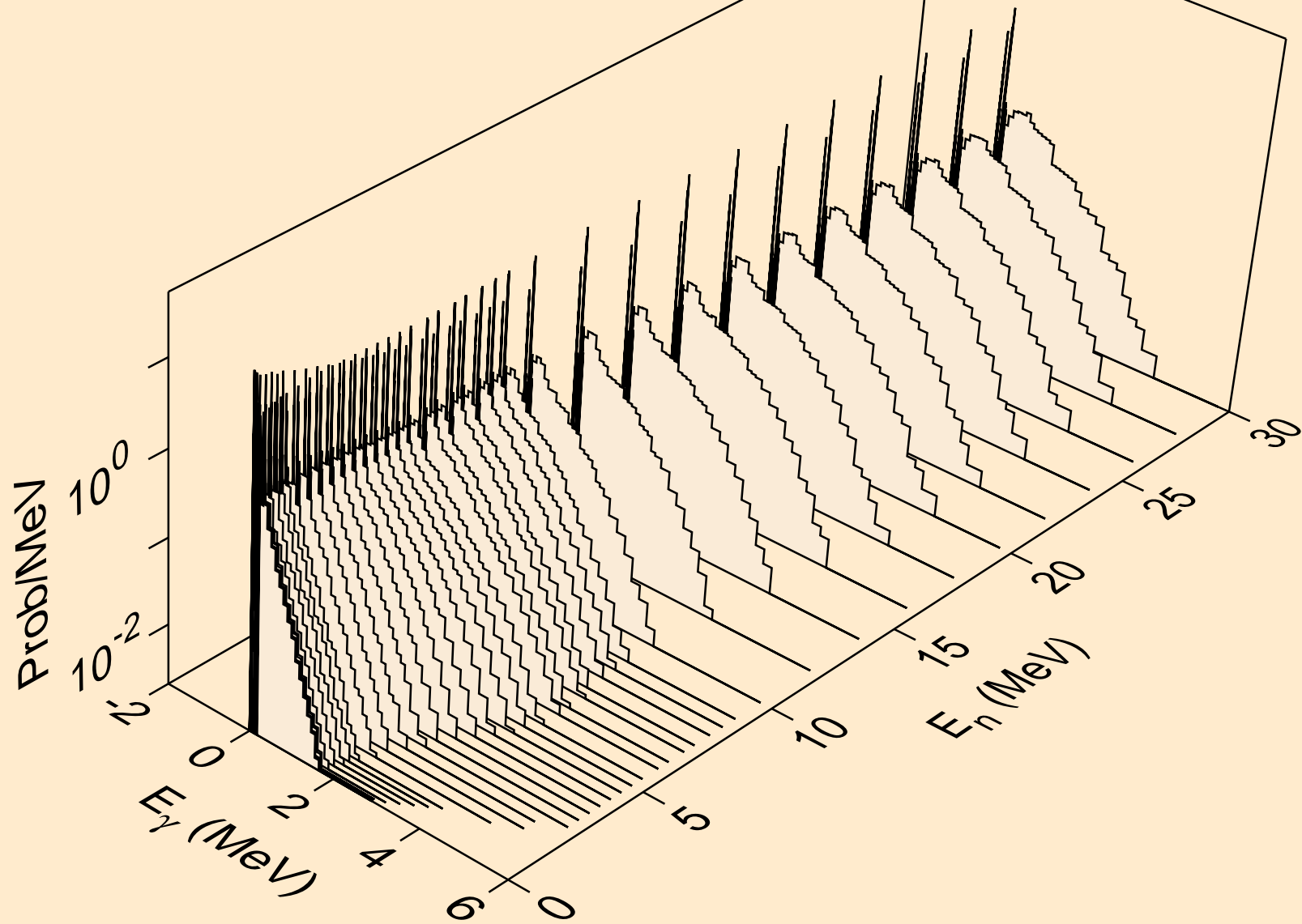

PA231 NEUTRON ACER TENDL-2021 LIBRARY; T=293.6K
Photon emission for (n,2p)

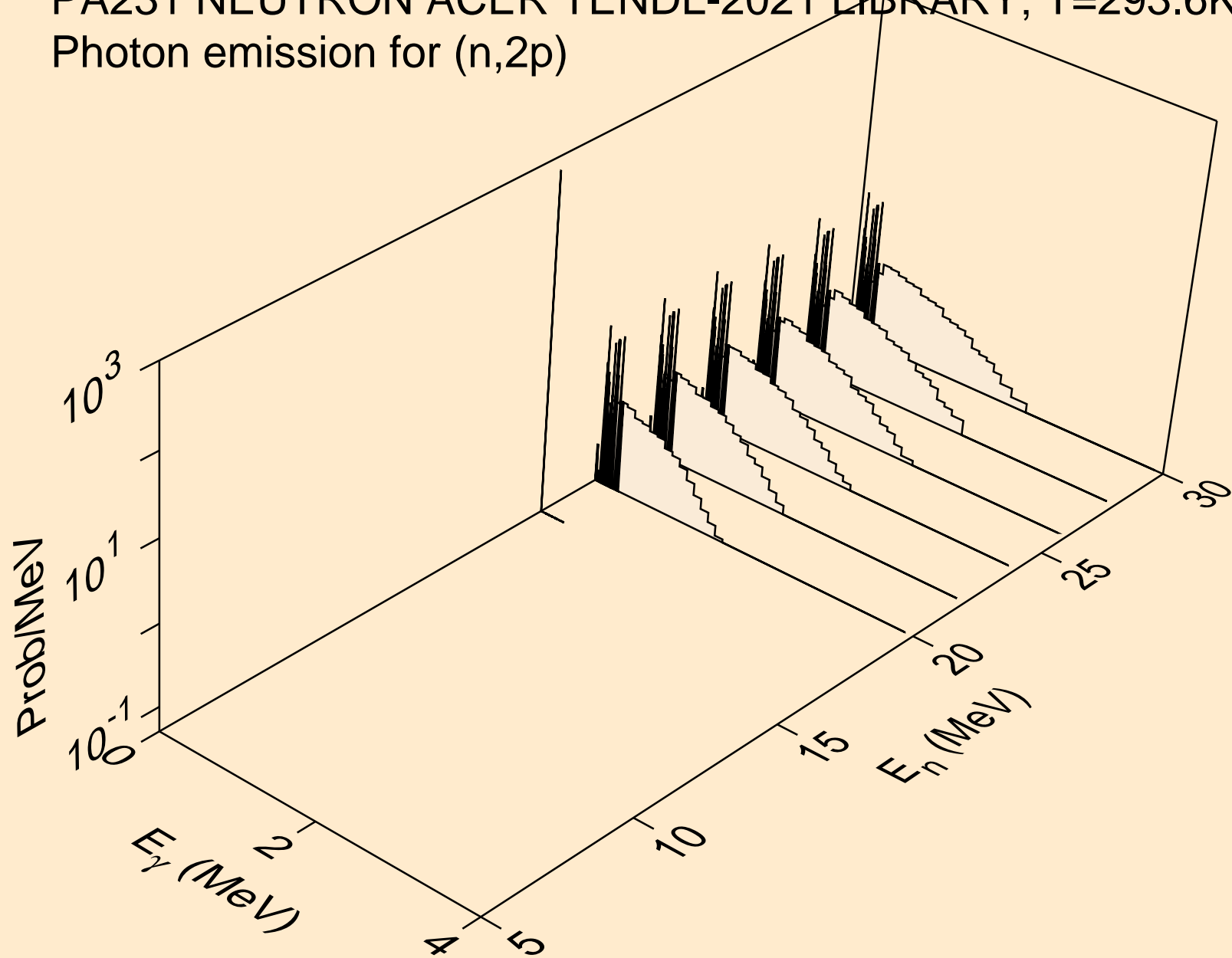

PA231 NEUTRON ACER TENDL-2021 LIBRARY; T=293.6K
thermal capture photon spectrum

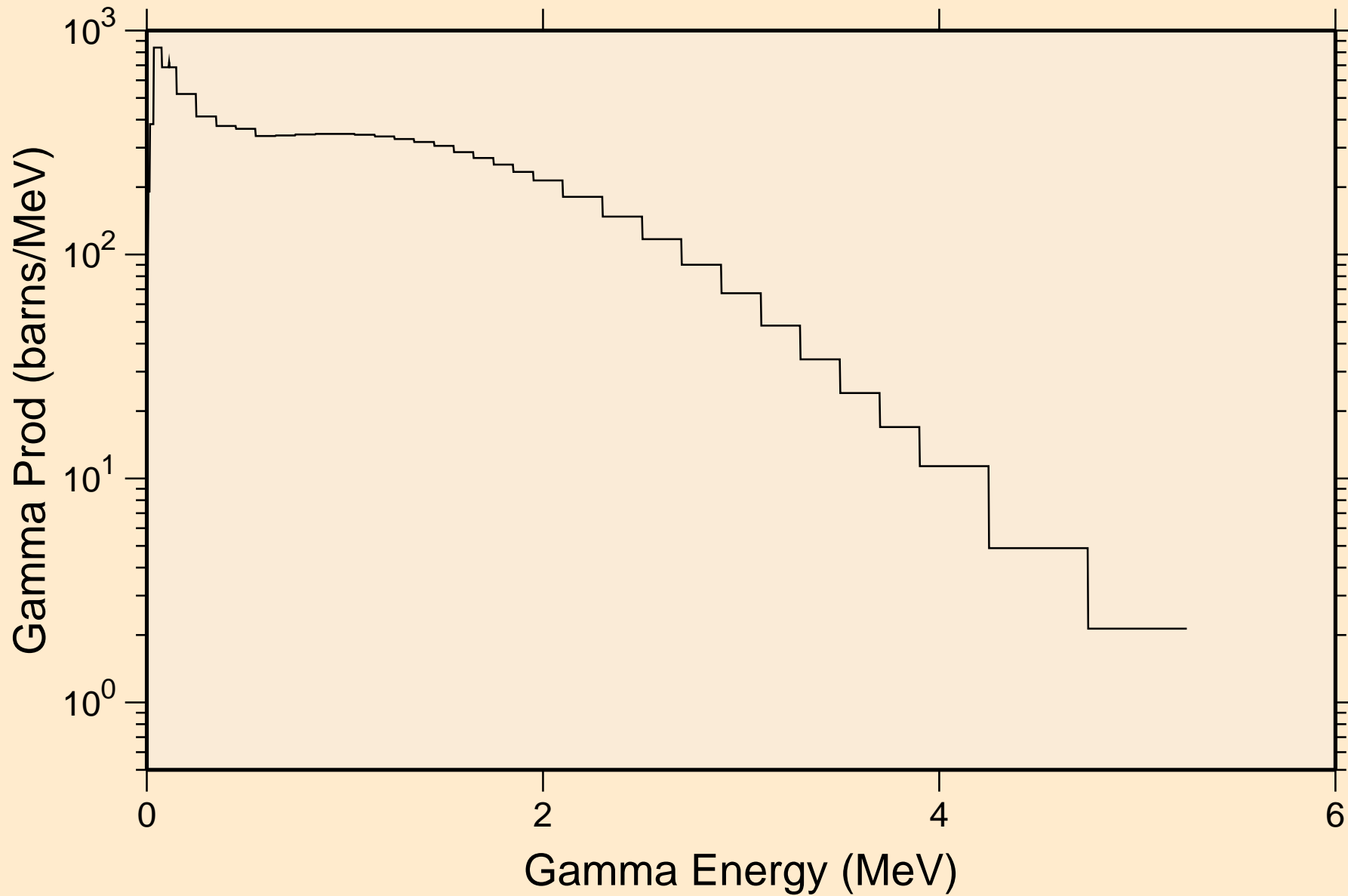

PA231 NEUTRON ACER TENDL-2021 LIBRARY; T=293.6K
14 MeV photon spectrum

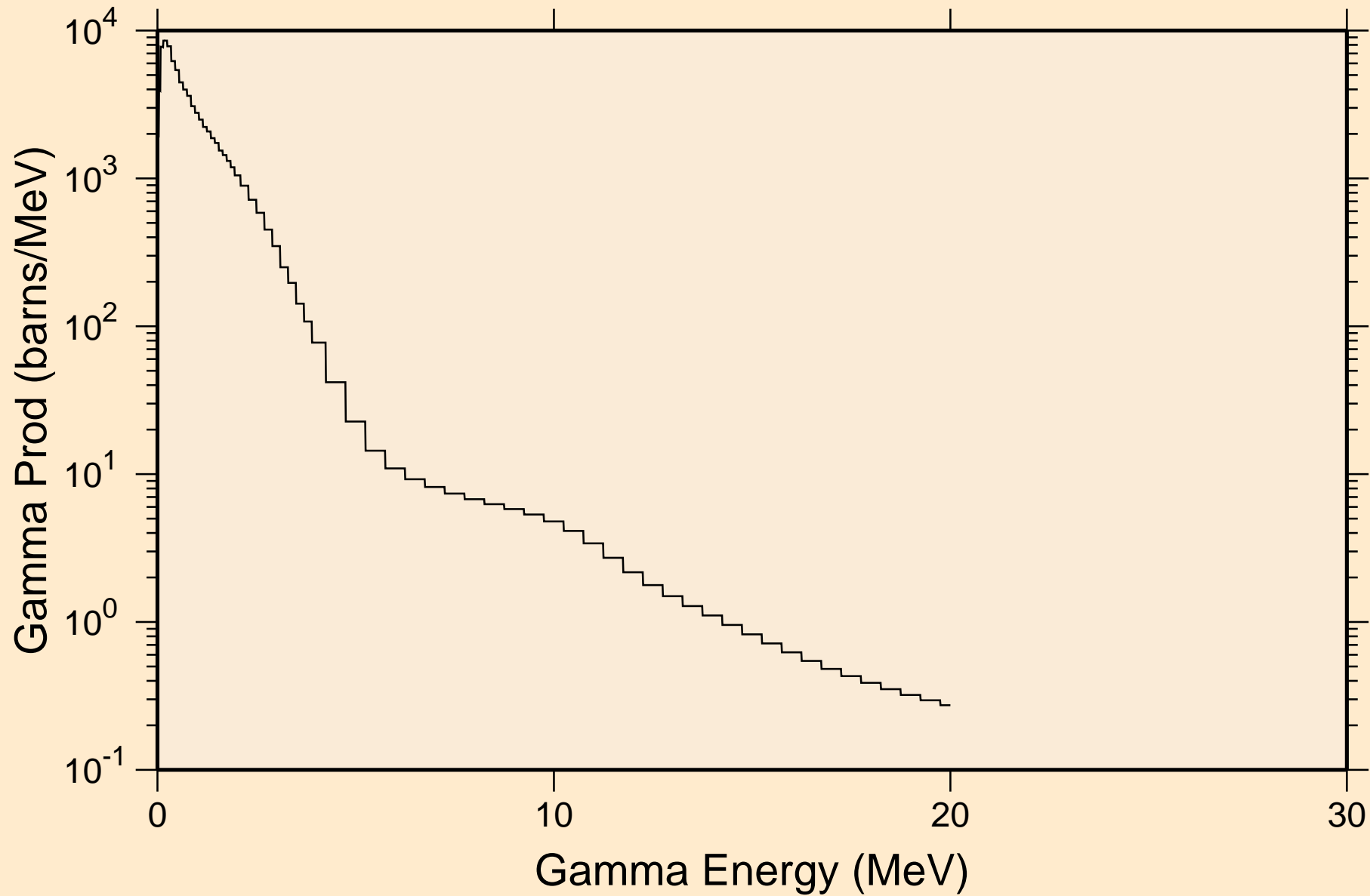

PA231 NEUTRON ACER TENDL-2021 LIBRARY; T=293.6K
Particle heating contributions

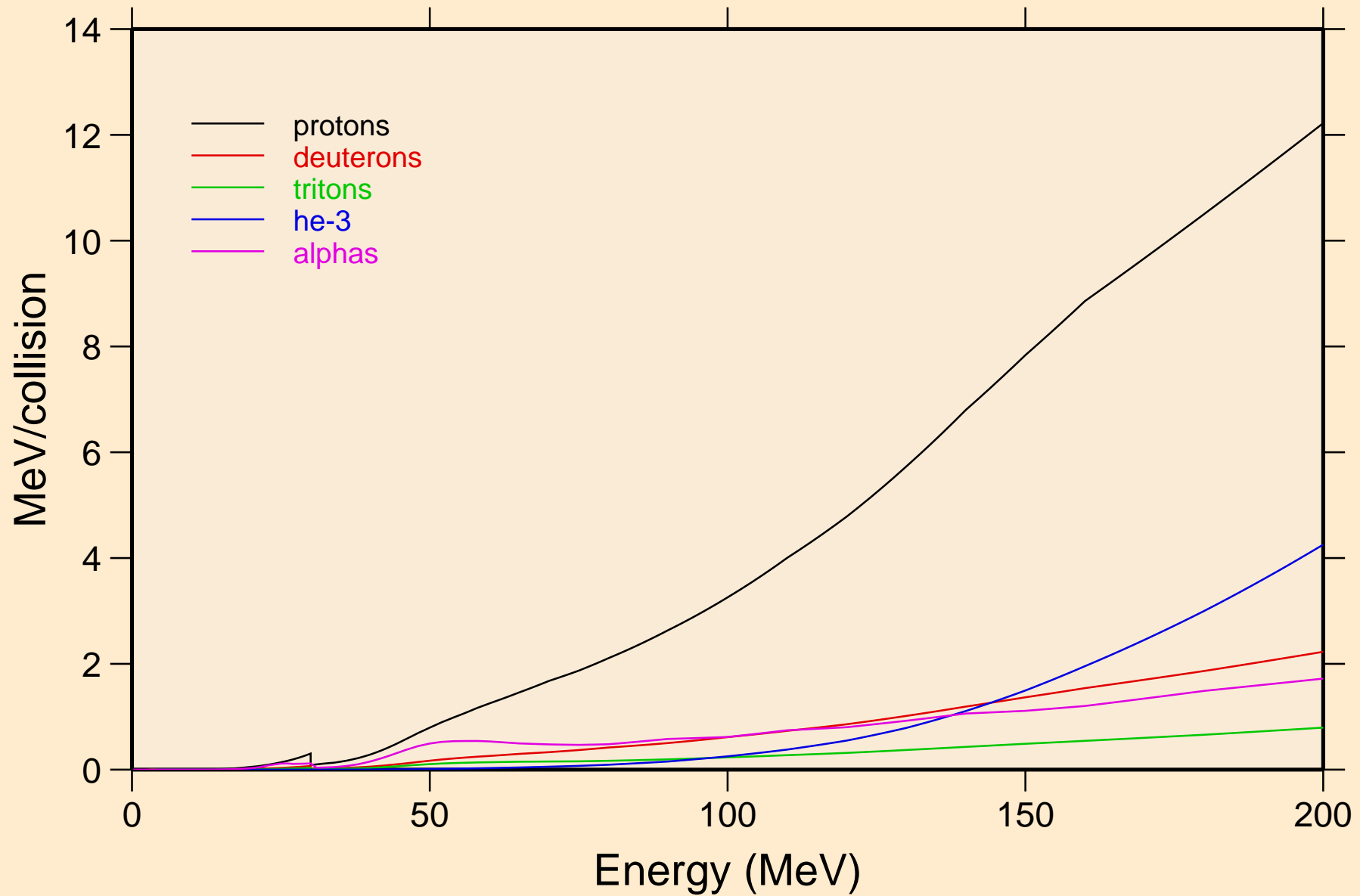

PA231 NEUTRON ACER TENDL-2021 LIBRARY; T=293.6K
Recoil Heating

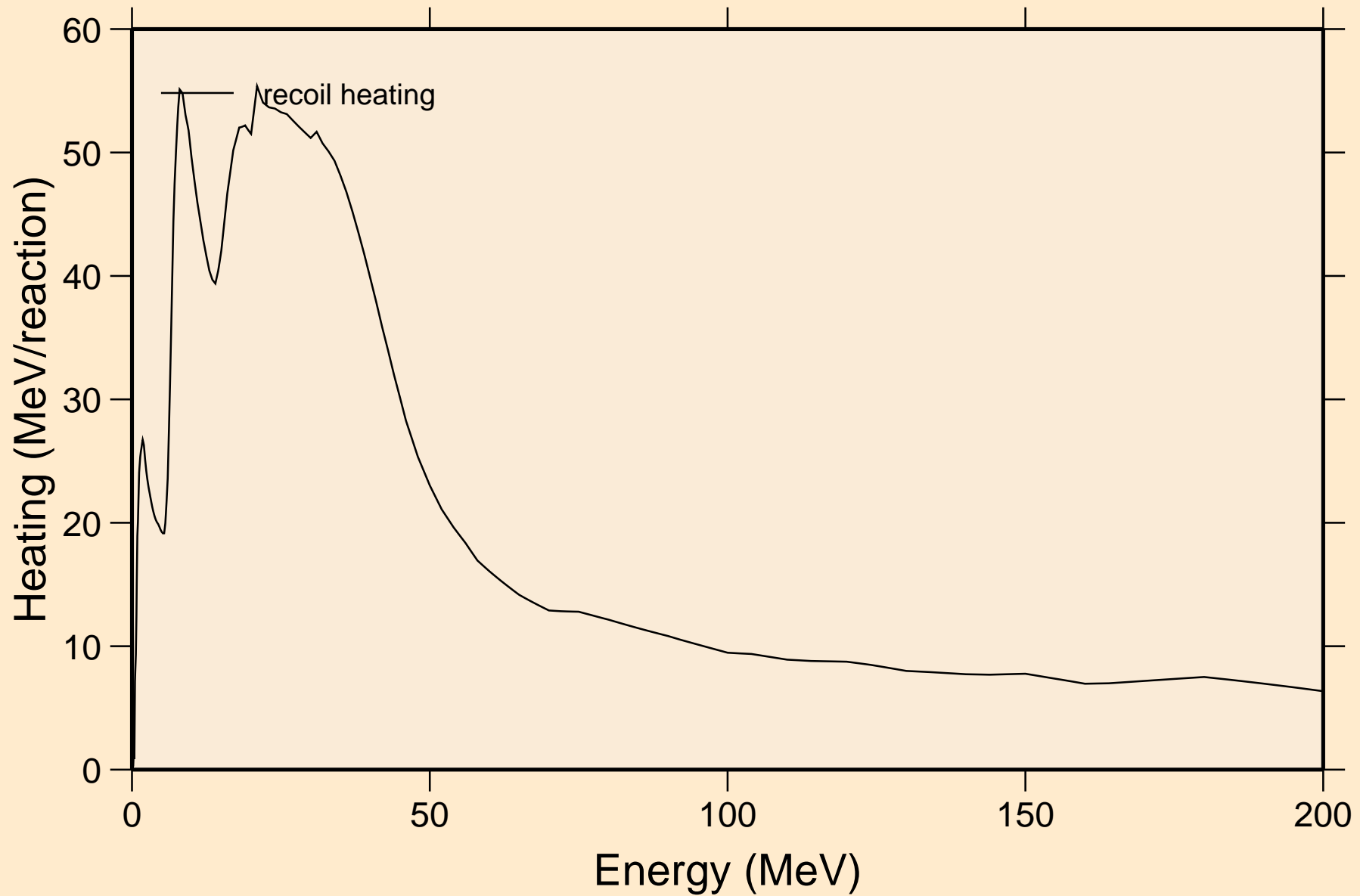

PA231 NEUTRON ACER TENDL-2021 LIBRARY; T=293.6K
Particle production cross sections

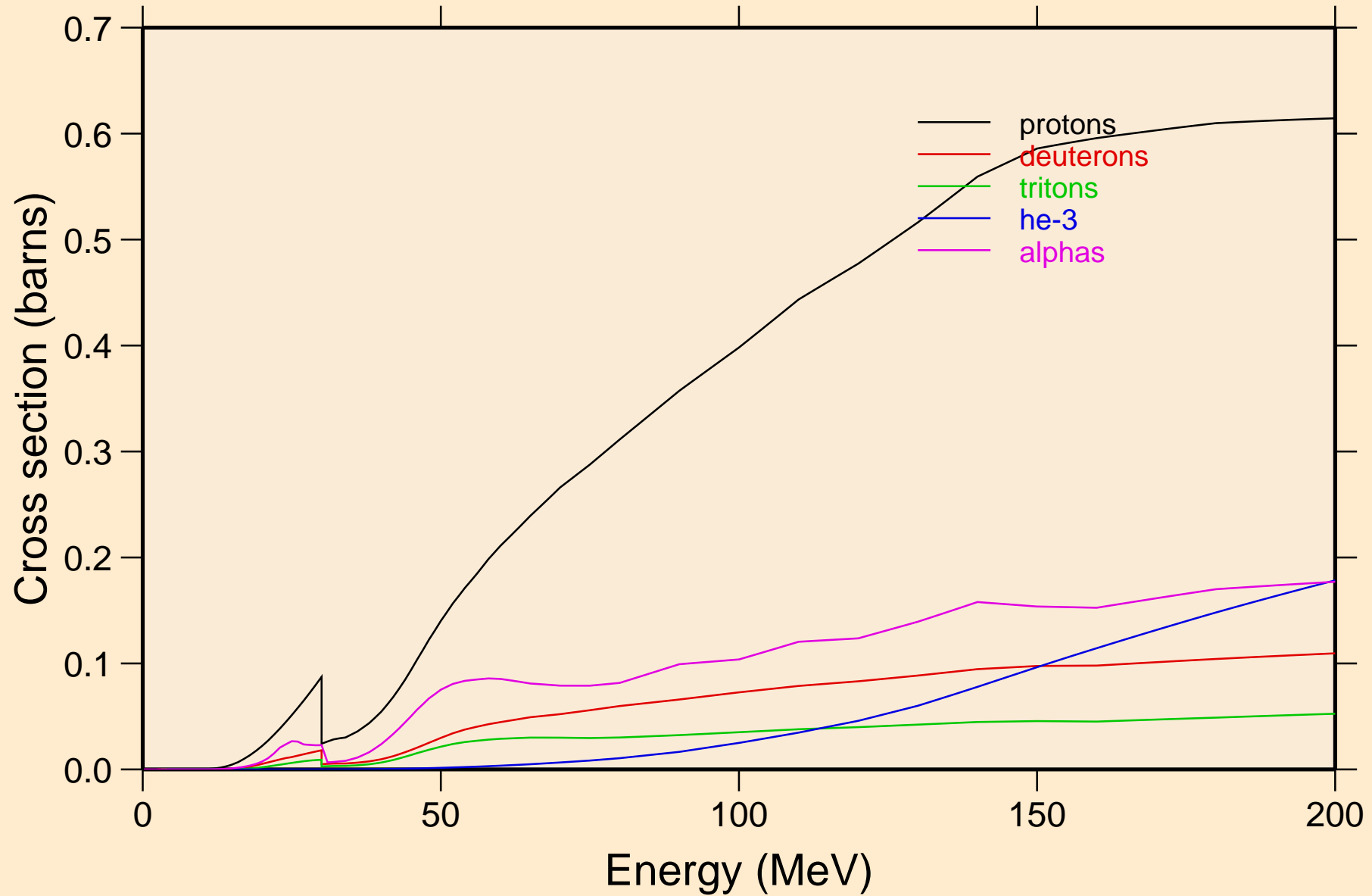

PA231 NEUTRON ACER TENDL-2021 LIBRARY; T=293.6K
protons from (n,x)

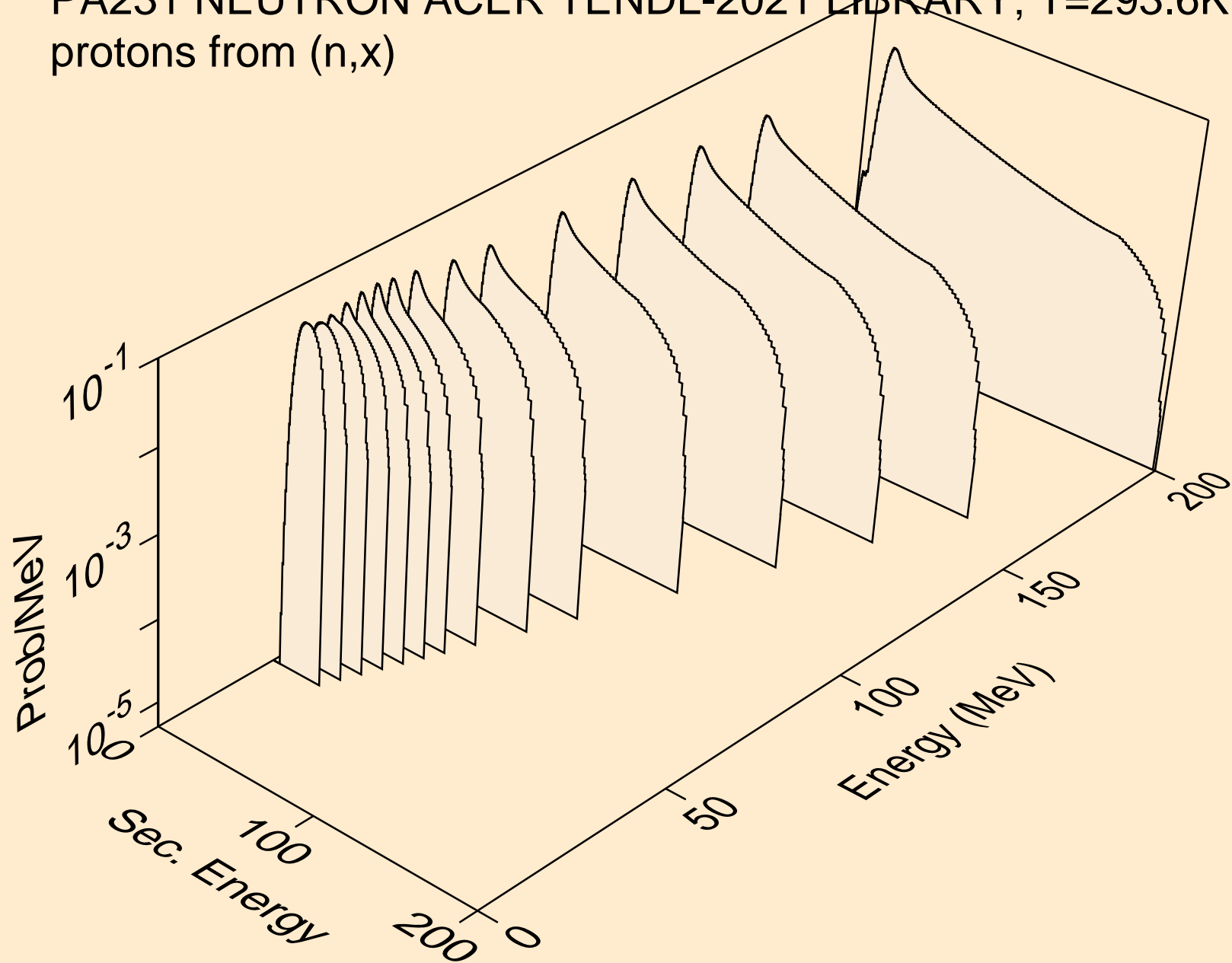

PA231 NEUTRON ACER TENDL-2021 LIBRARY; T=293.6K
protons from (n,n*)p

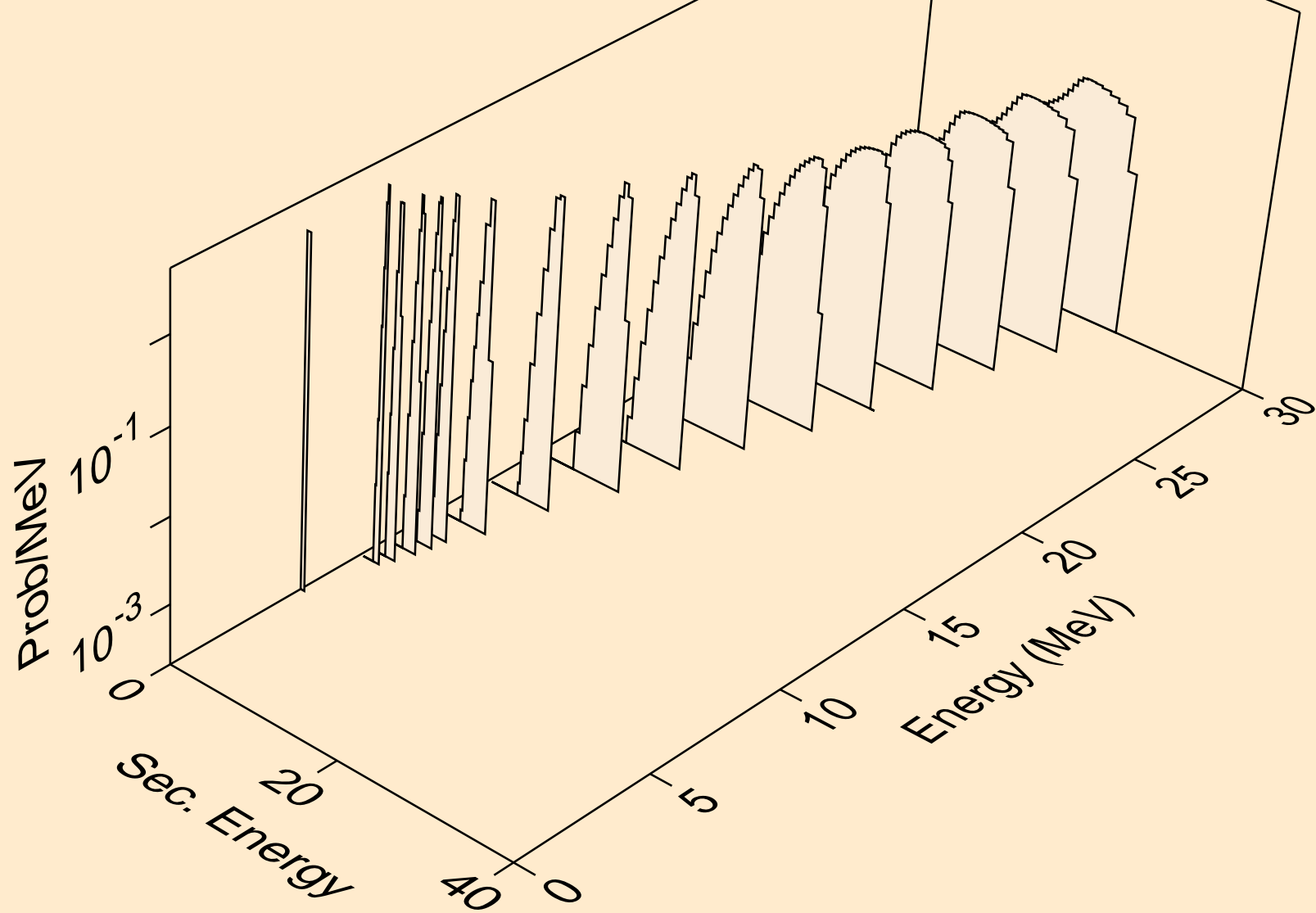

PA231 NEUTRON ACER TENDL-2021 LIBRARY; T=293.6K
protons from (n,2np)

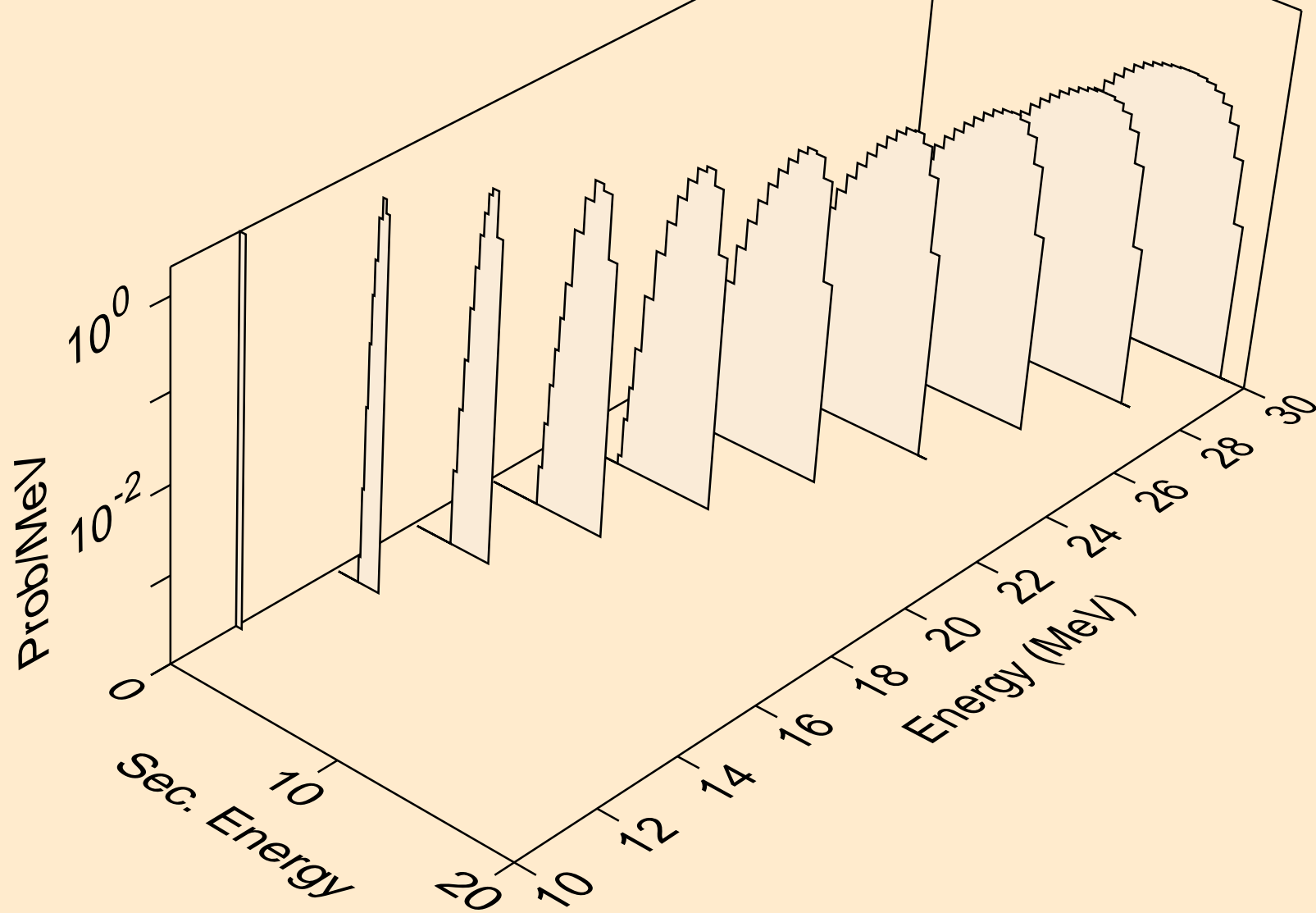

PA231 NEUTRON ACER TENDL-2021 LIBRARY; T=293.6K
protons from (n,3np)

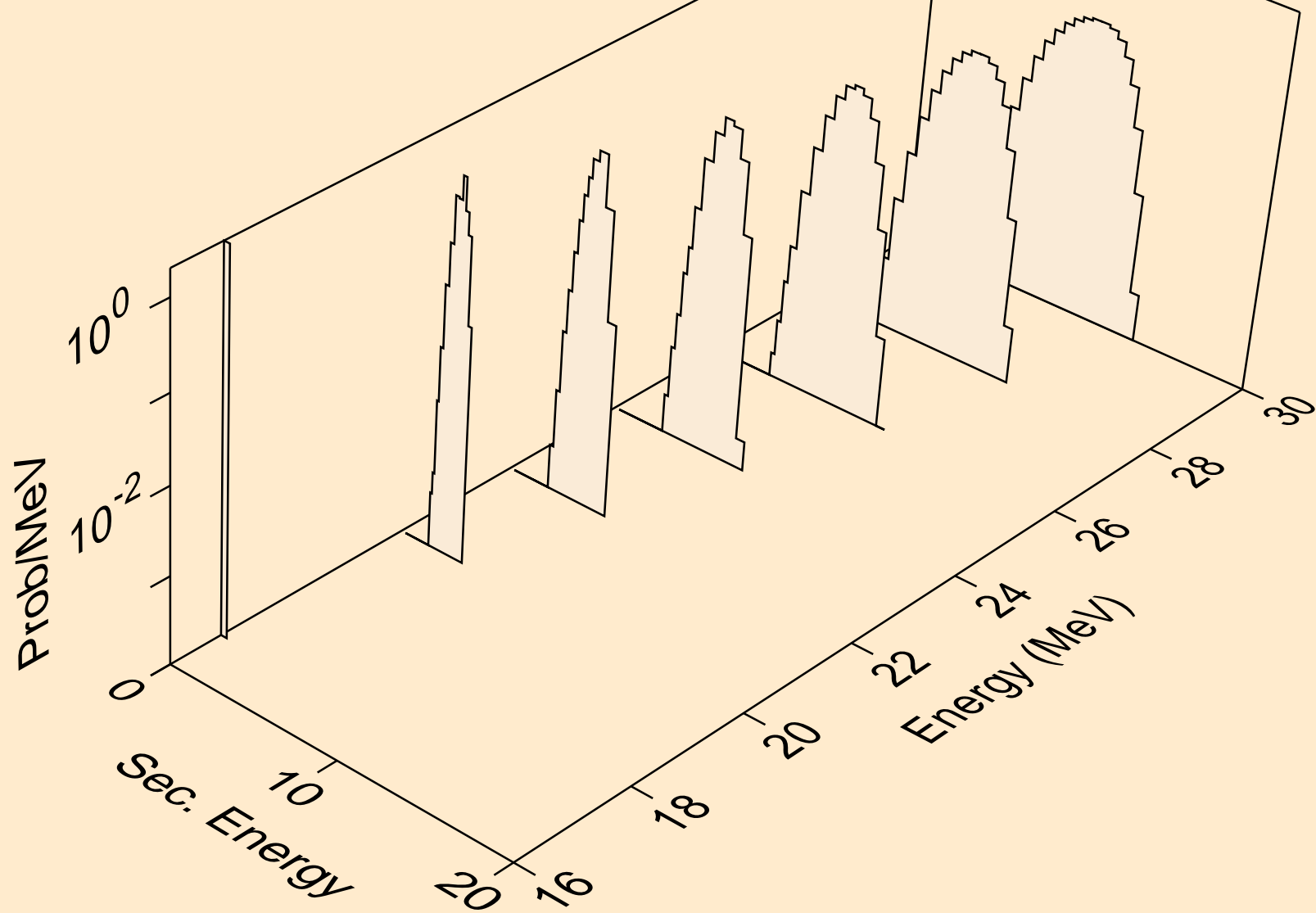

PA231 NEUTRON ACER TENDL-2021 LIBRARY; T=293.6K
protons from (n,2np)

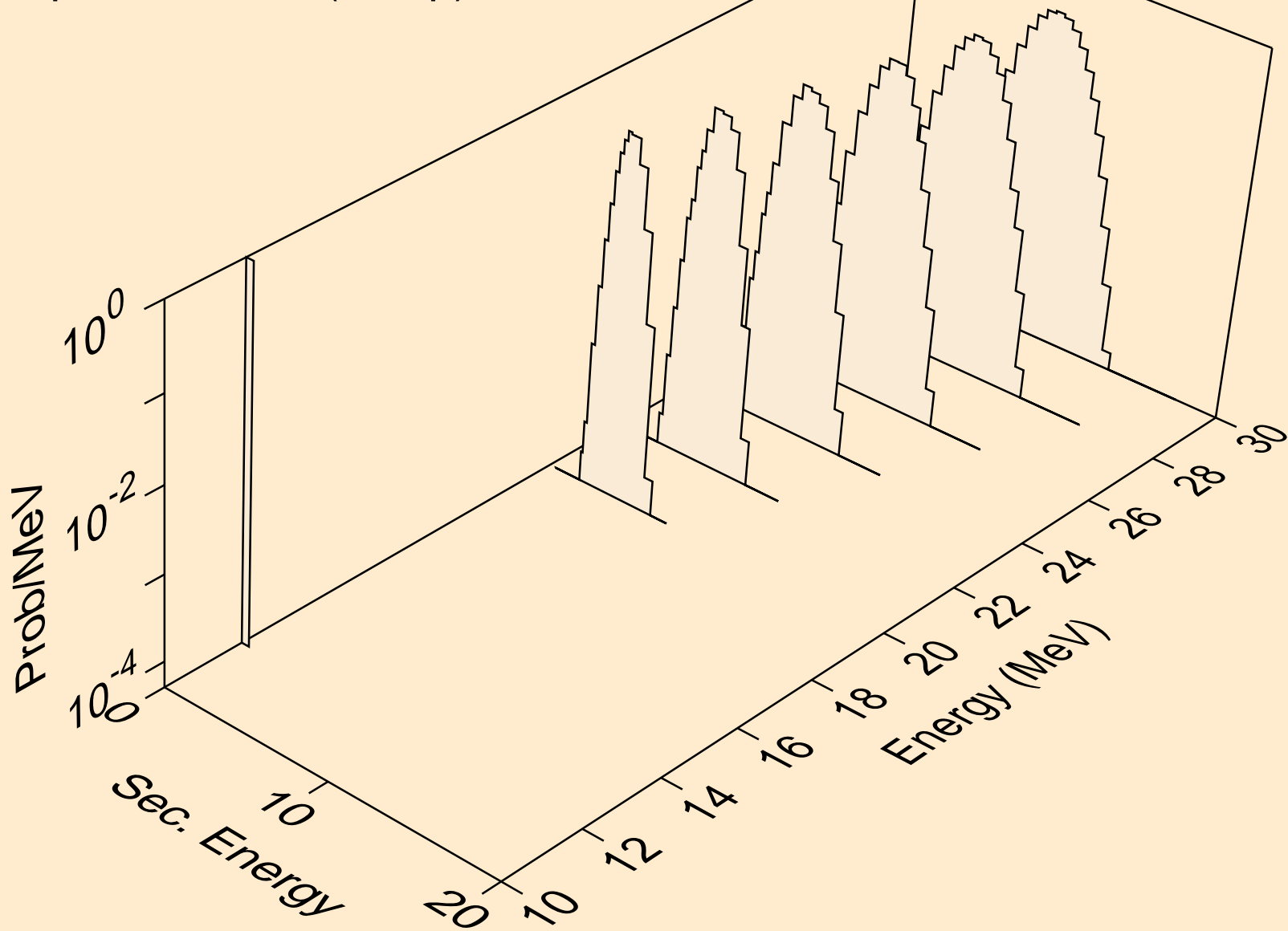

PA231 NEUTRON ACER TENDL-2021 LIBRARY; T=293.6K
protons from (n,npa)

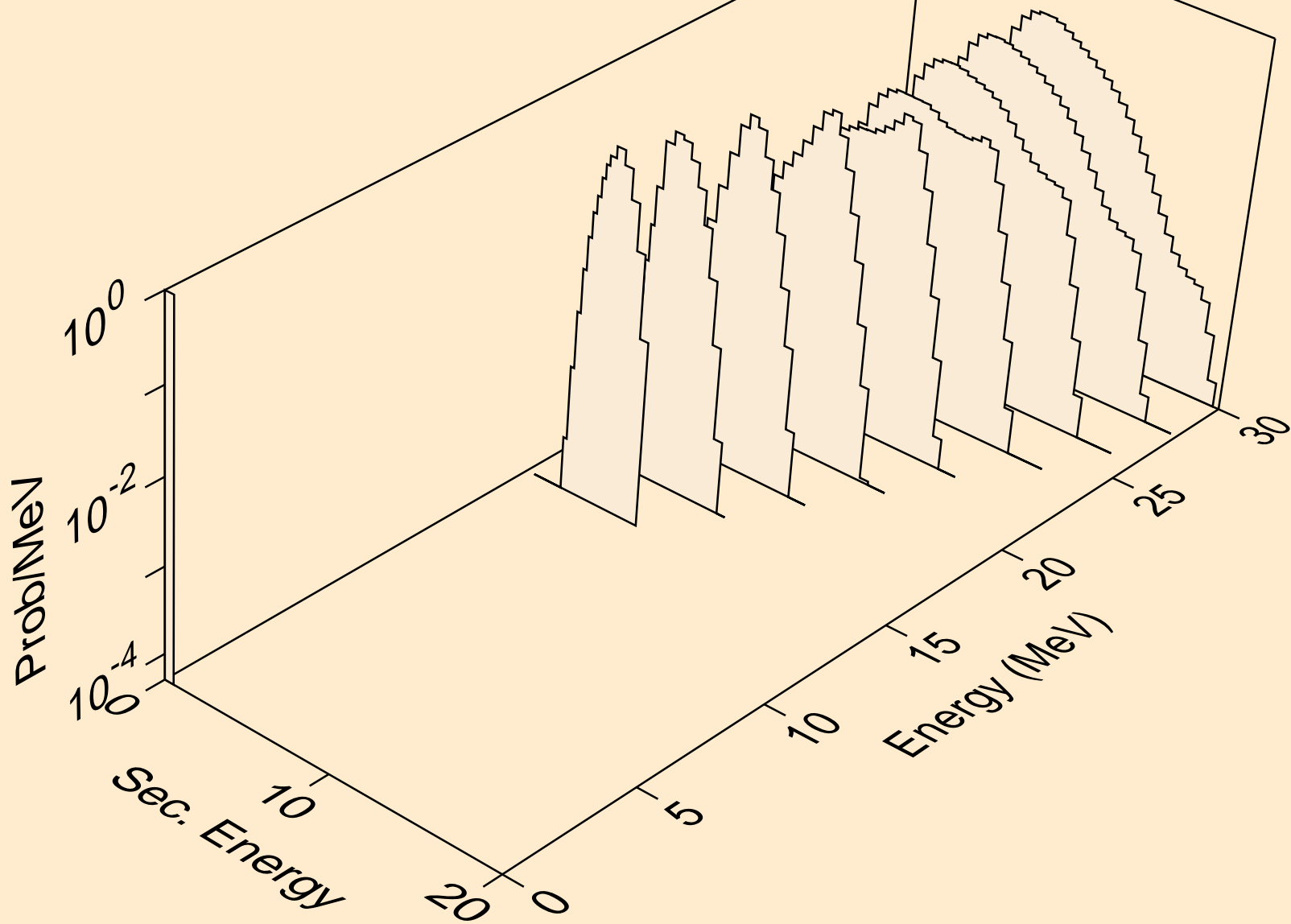

PA231 NEUTRON ACER TENDL-2021 LIBRARY; T=293.6K
protons from (n,p)

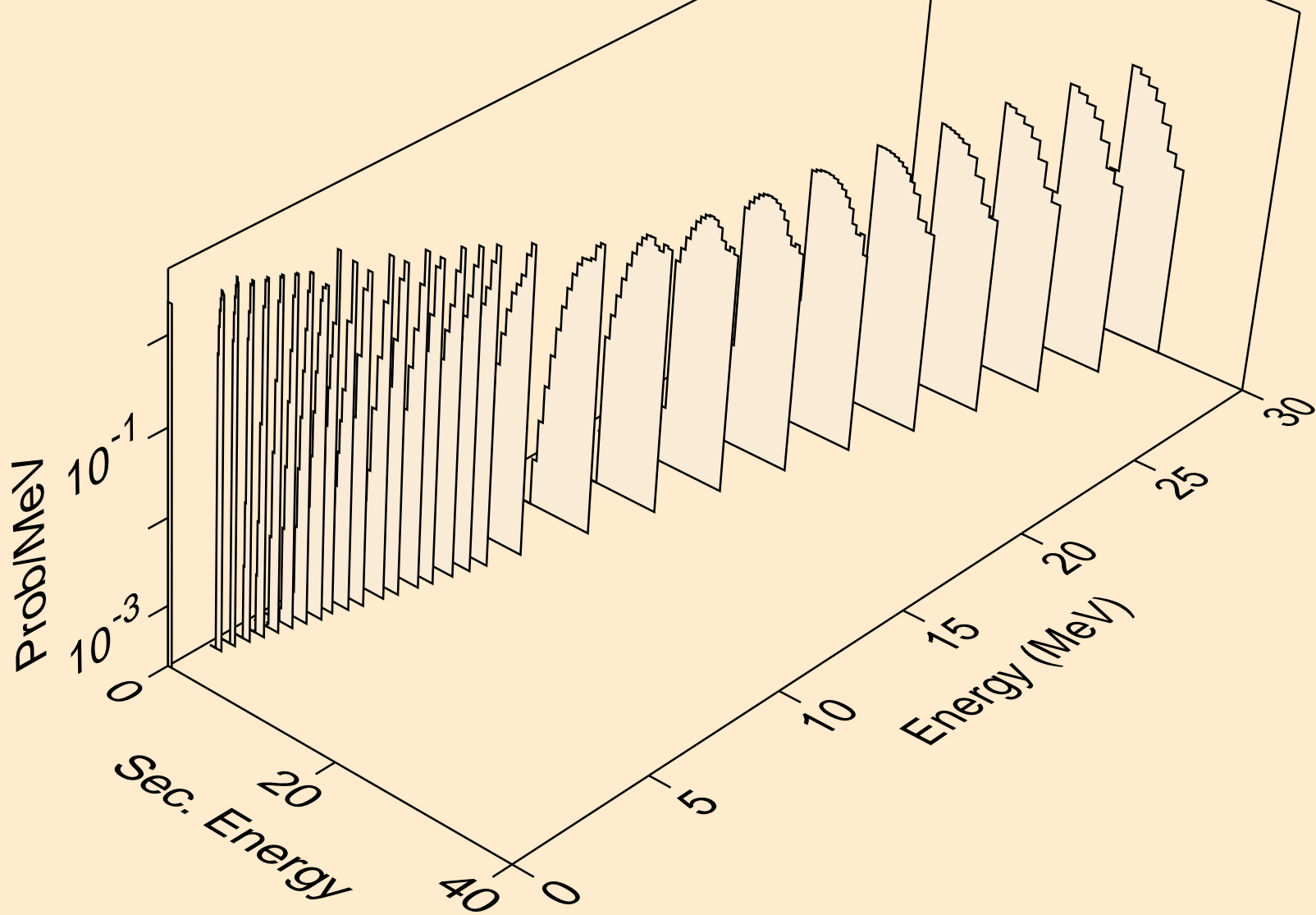

PA231 NEUTRON ACER TENDL-2021 LIBRARY; T=293.6K
protons from (n,2p)

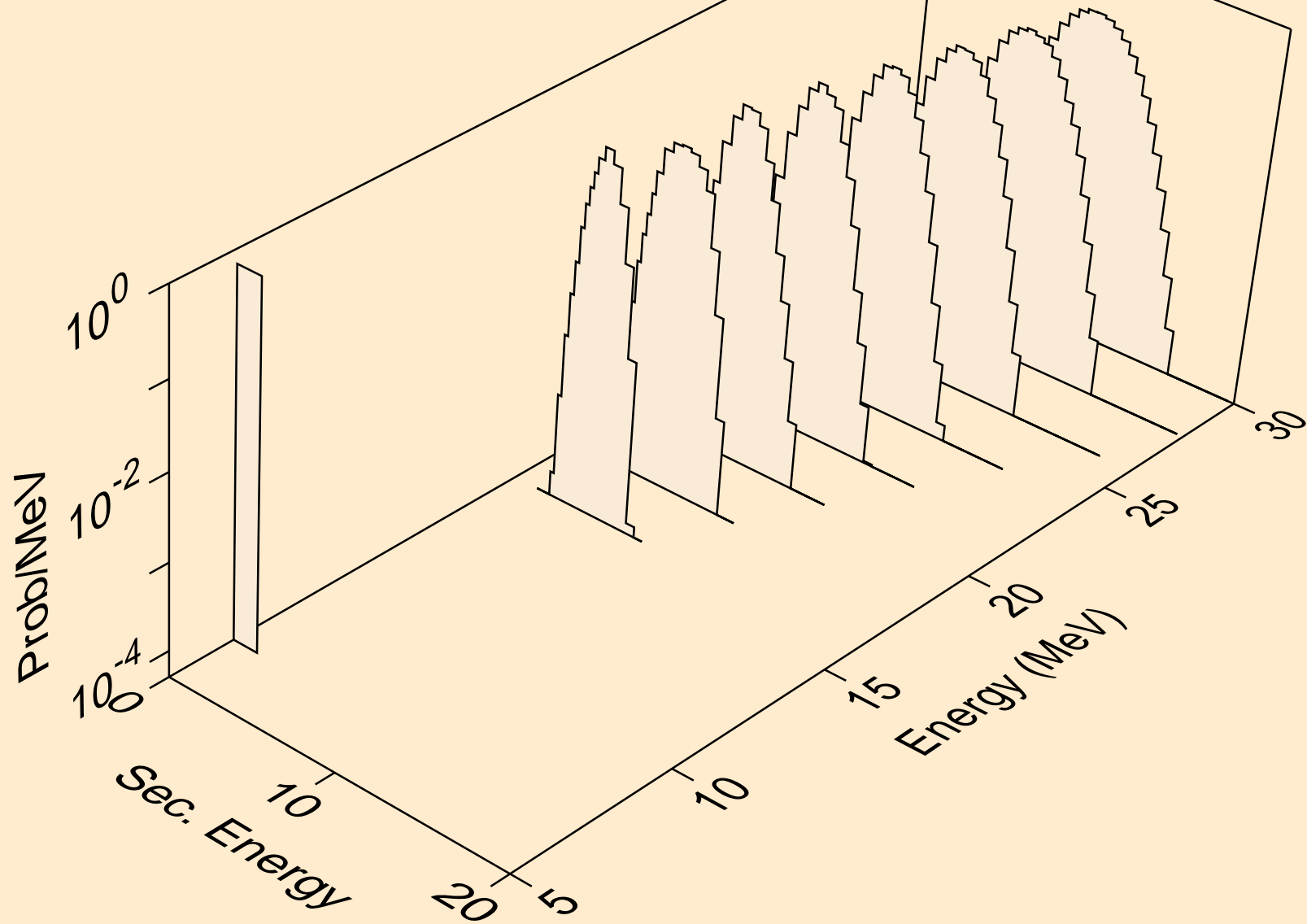

PA231 NEUTRON ACER TENDL-2021 LIBRARY; T=293.6K
deuterons from (n,x)

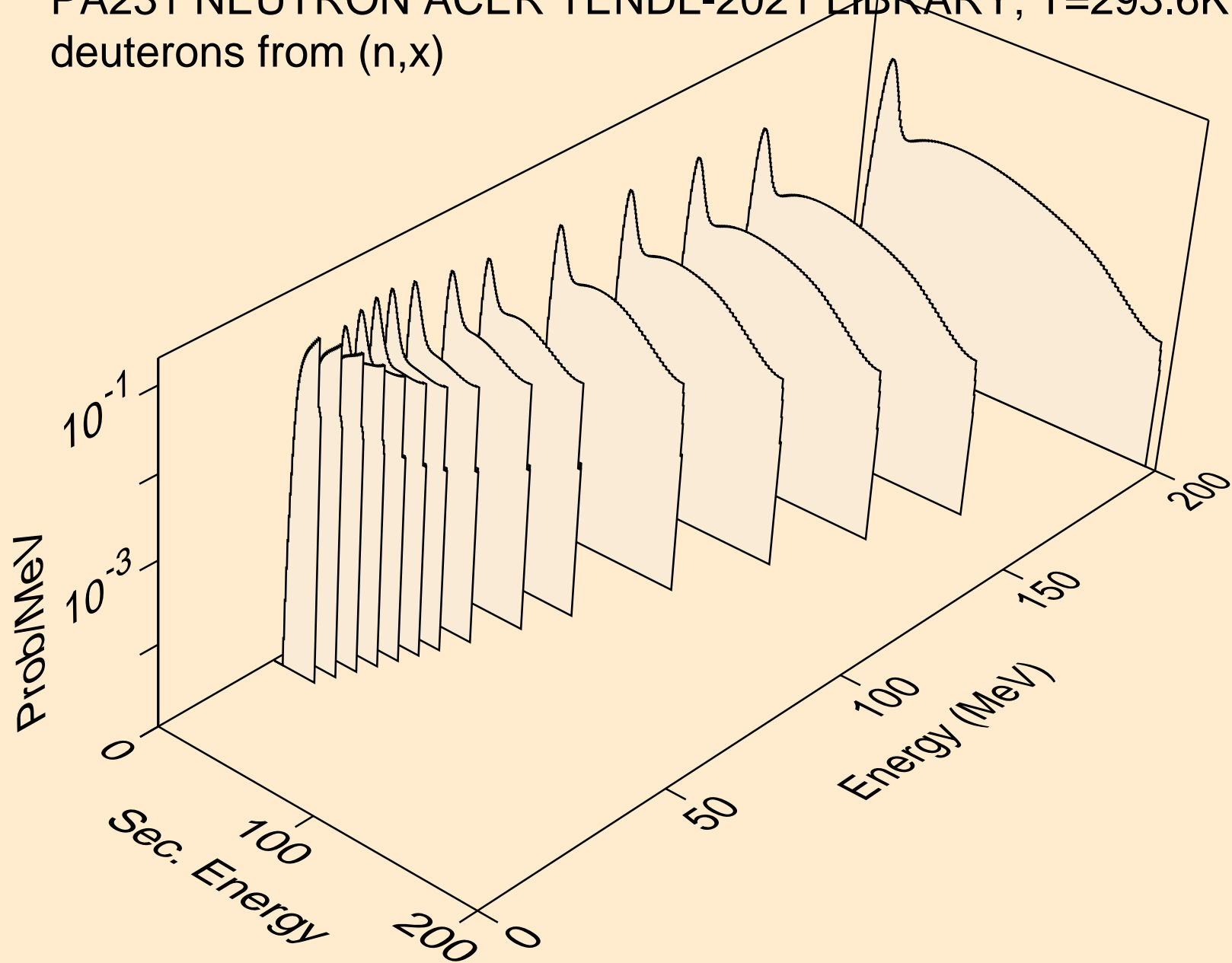

PA231 NEUTRON ACER TENDL-2021 LIBRARY; T=293.6K
deuterons from (n,2nd)

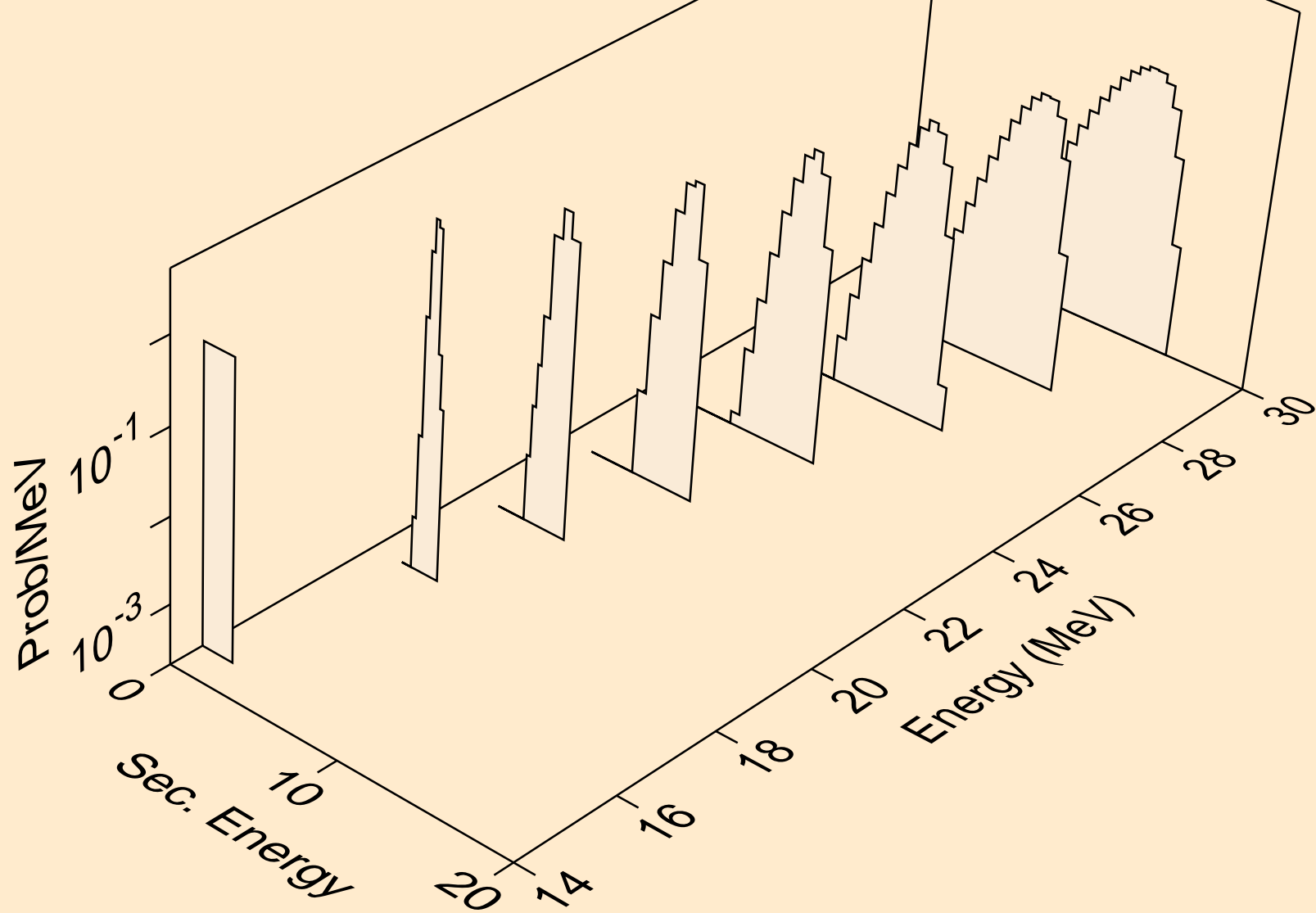

PA231 NEUTRON ACER TENDL-2021 LIBRARY; T=293.6K
deuterons from (n,n*)d

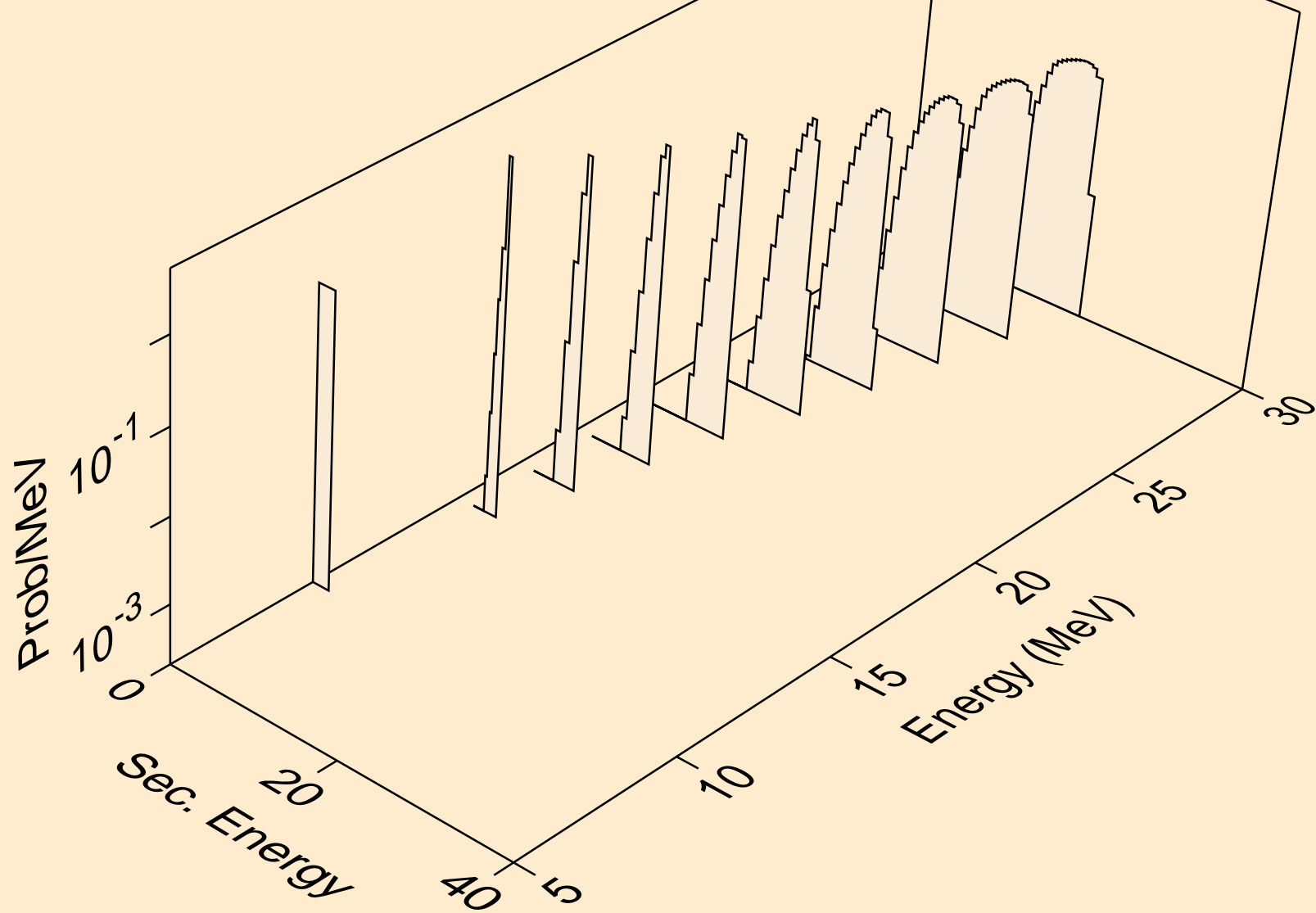

PA231 NEUTRON ACER TENDL-2021 LIBRARY; T=293.6K
deuterons from (n,d)

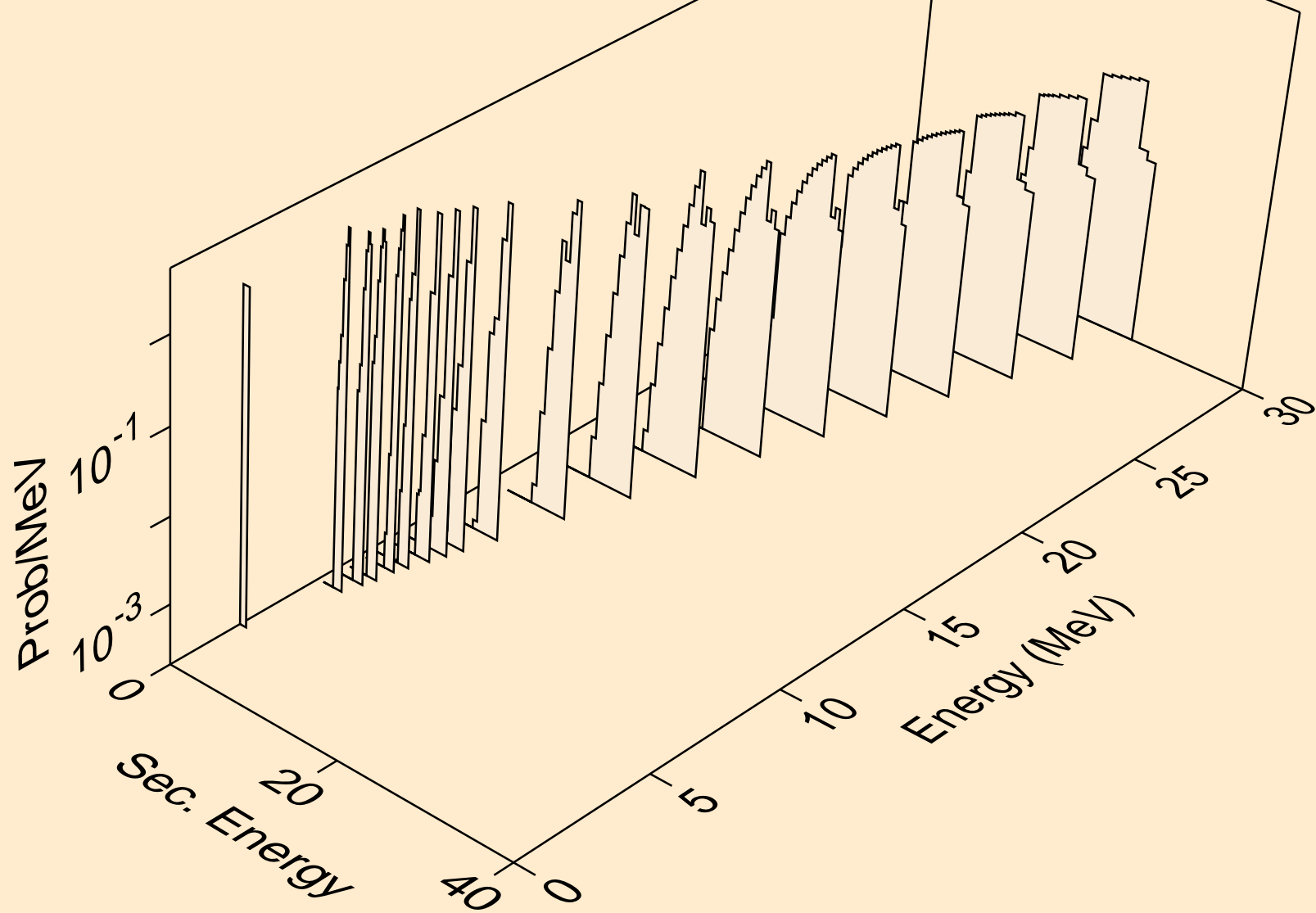

PA231 NEUTRON ACER TENDL-2021 LIBRARY; T=293.6K
tritons from (n,x)

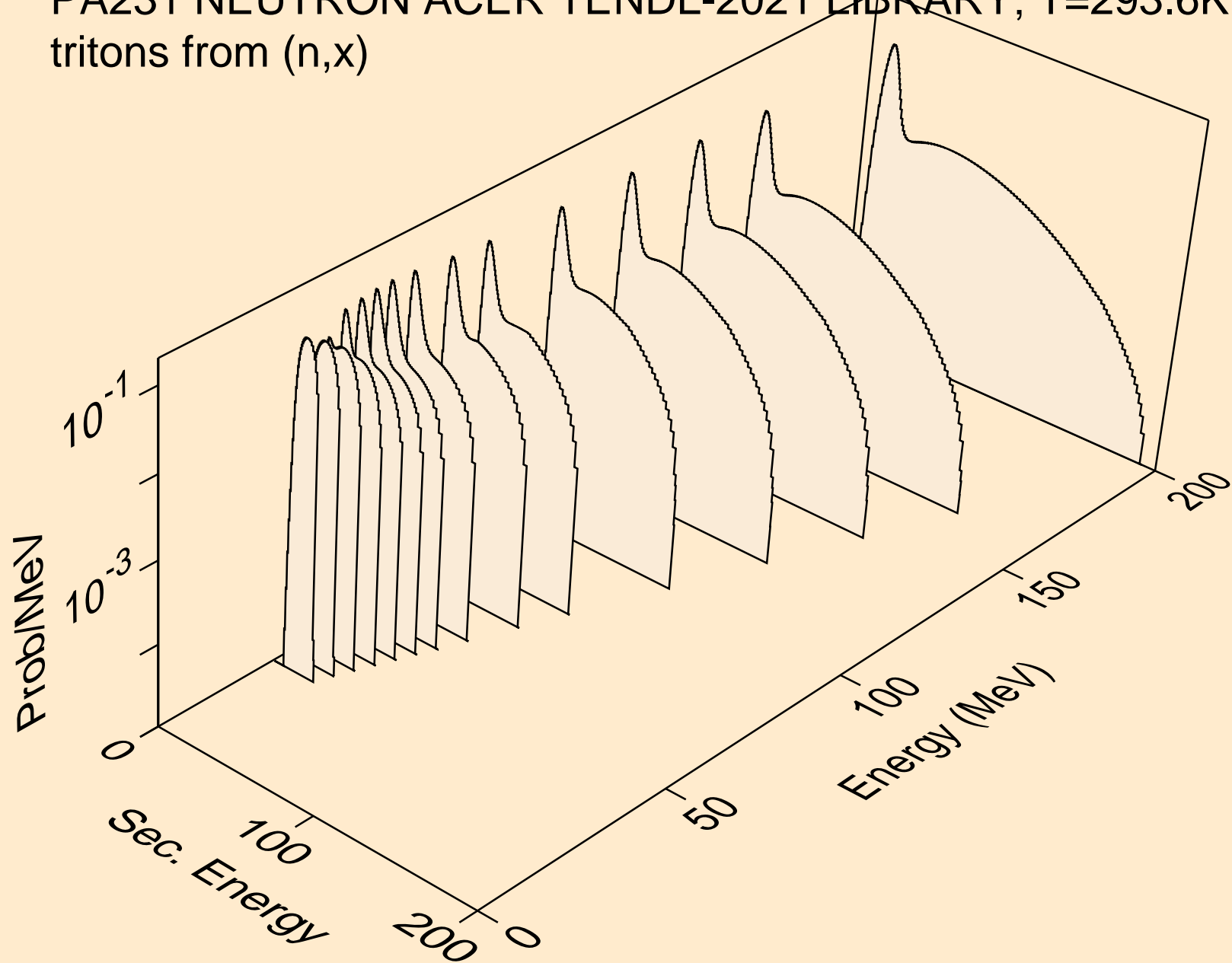

PA231 NEUTRON ACER TENDL-2021 LIBRARY; T=293.6K
tritons from (n,n*)t

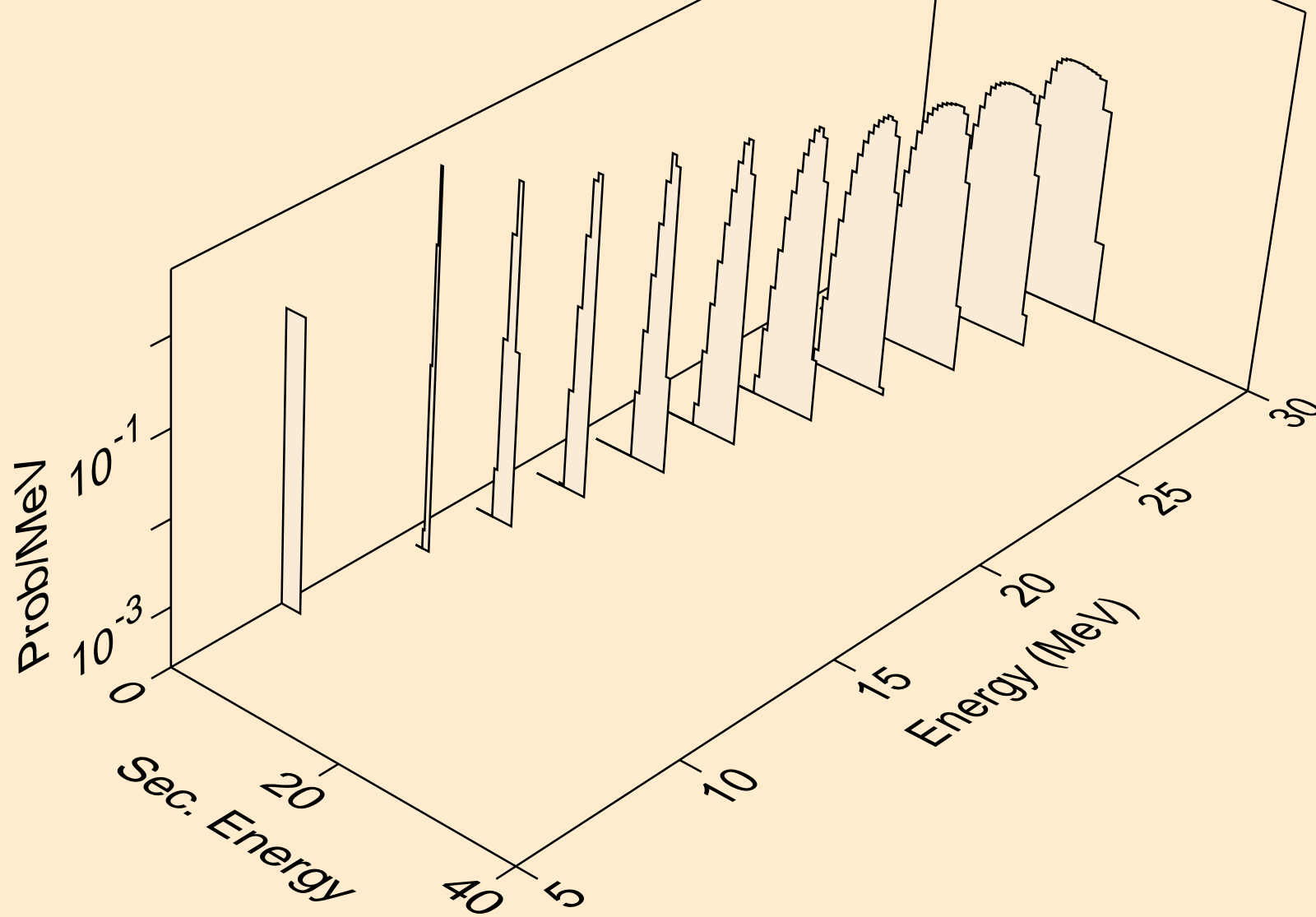

PA231 NEUTRON ACER TENDL-2021 LIBRARY; T=293.6K
tritons from (n,t)

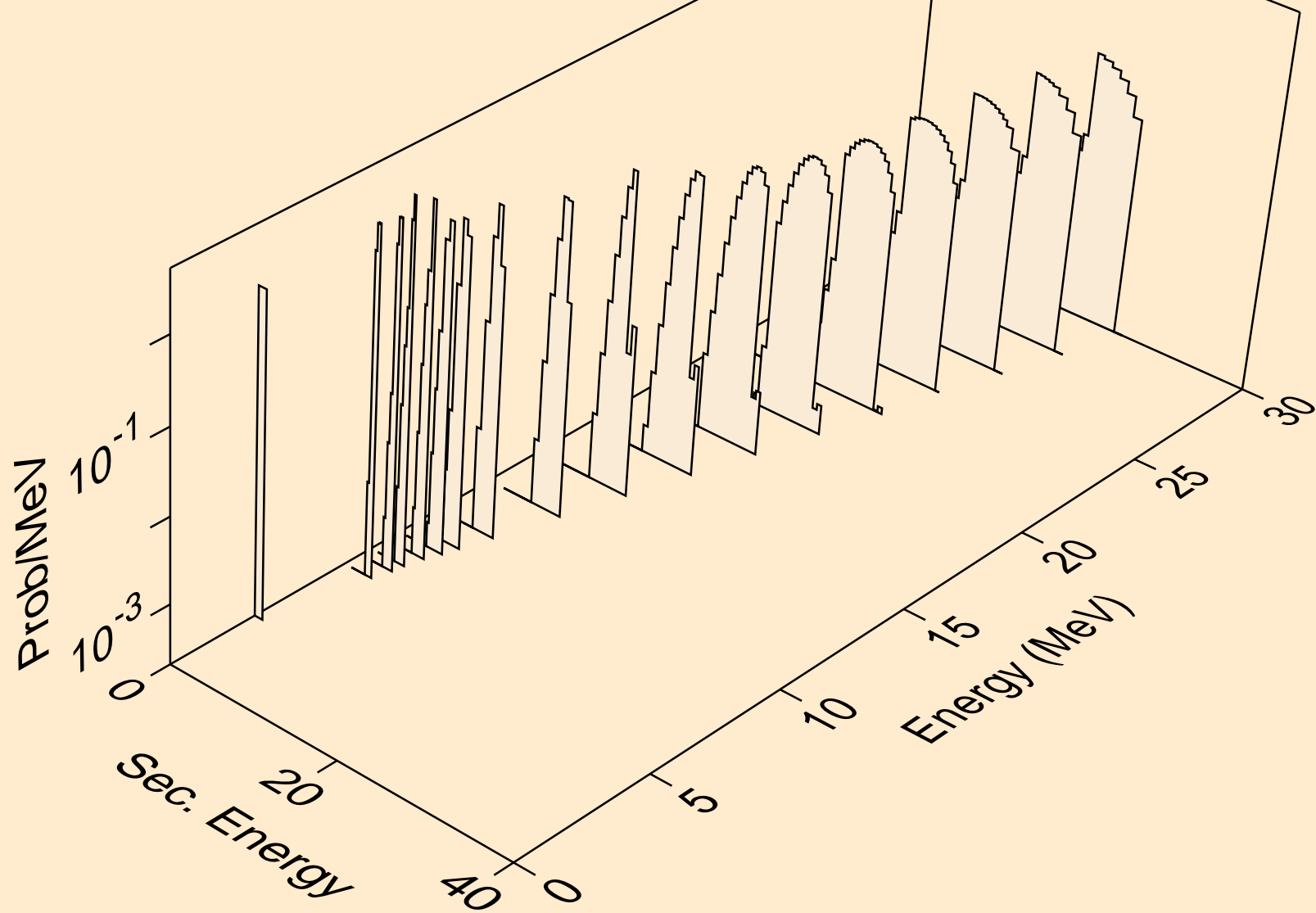

PA231 NEUTRON ACER TENDL-2021 LIBRARY; T=293.6K
he3s from (n,x)

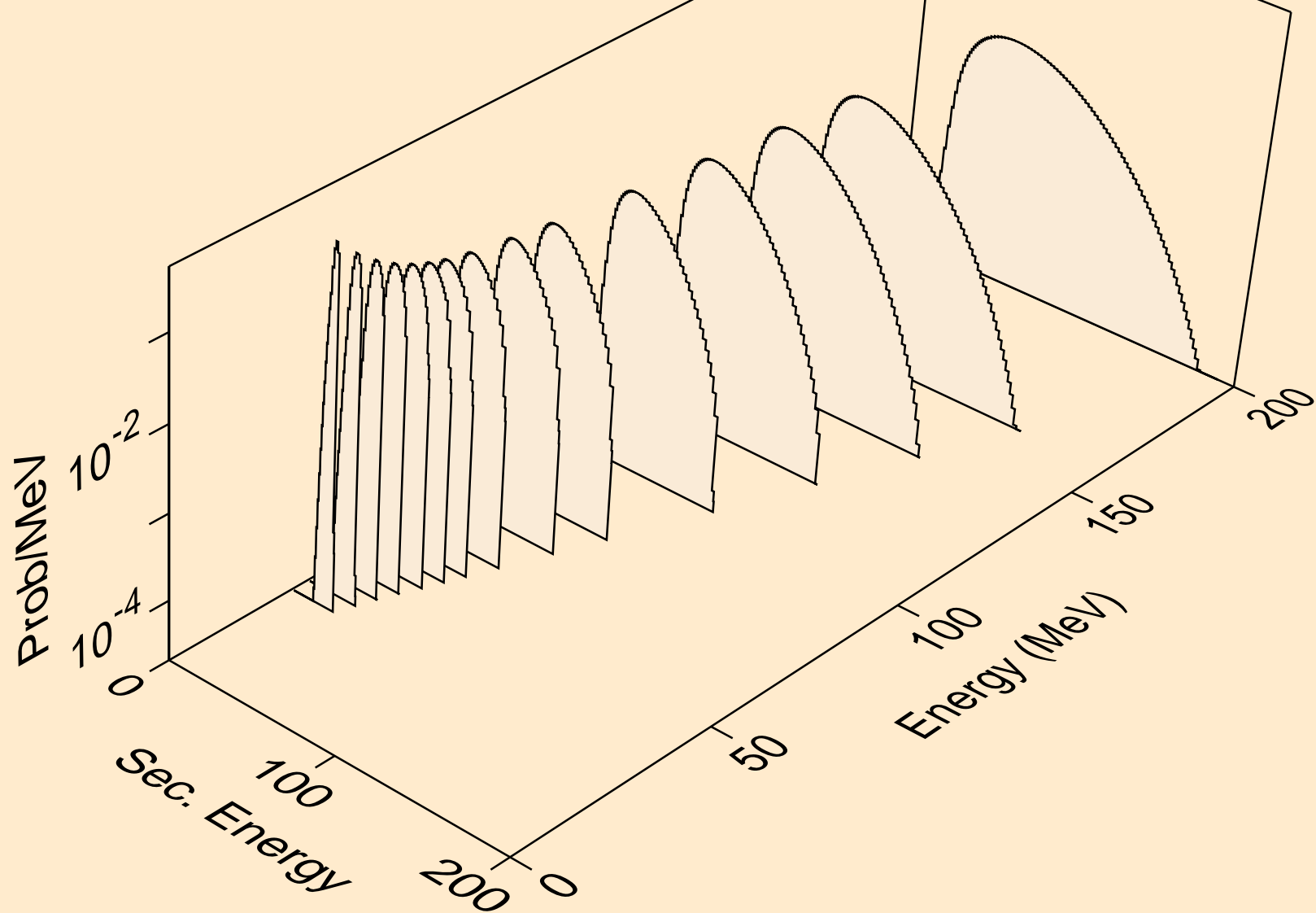

PA231 NEUTRON ACER TENDL-2021 LIBRARY; T=293.6K
he3s from (n,n*)he3

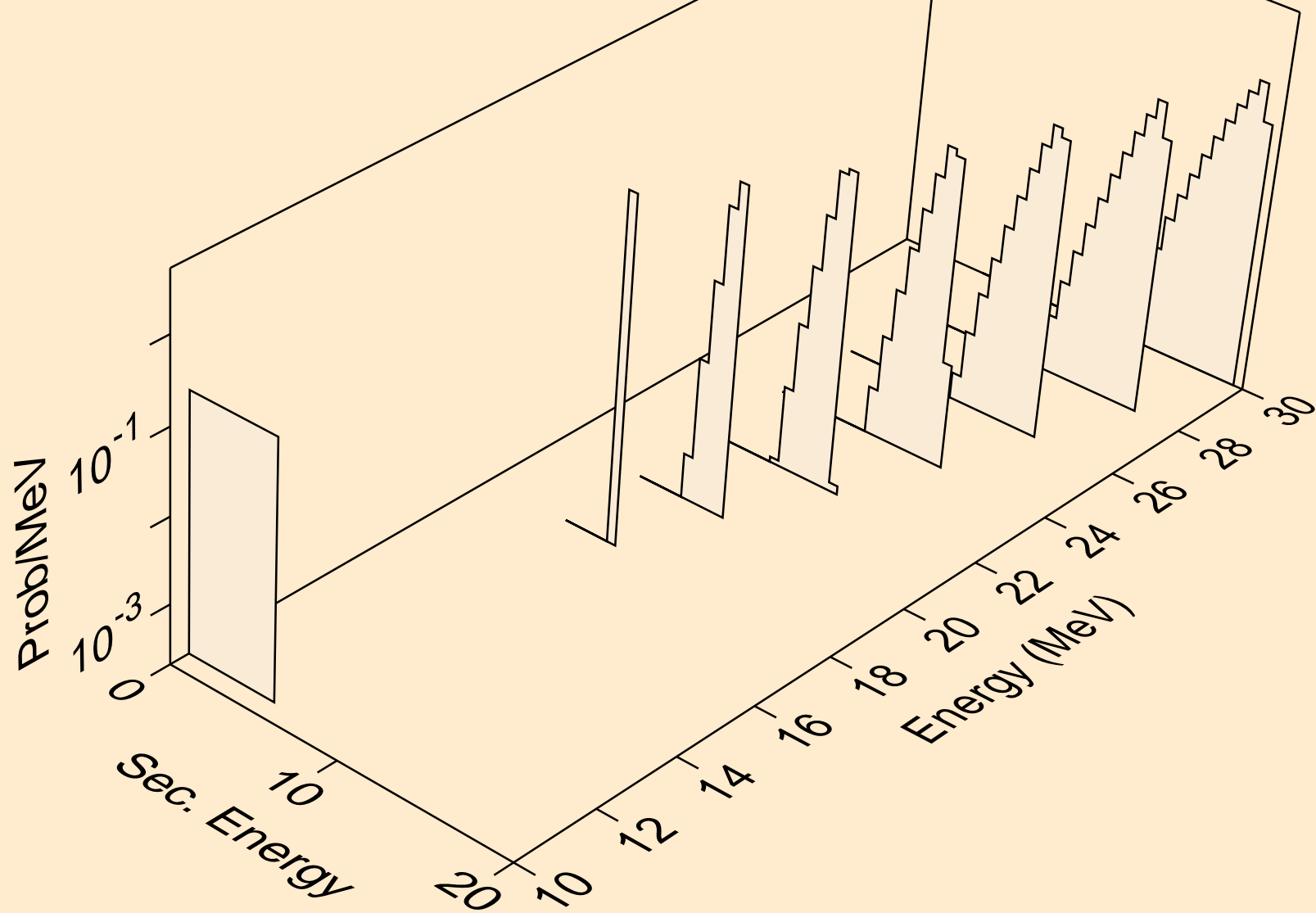

PA231 NEUTRON ACER TENDL-2021 LIBRARY; T=293.6K
he3s from (n,he3)

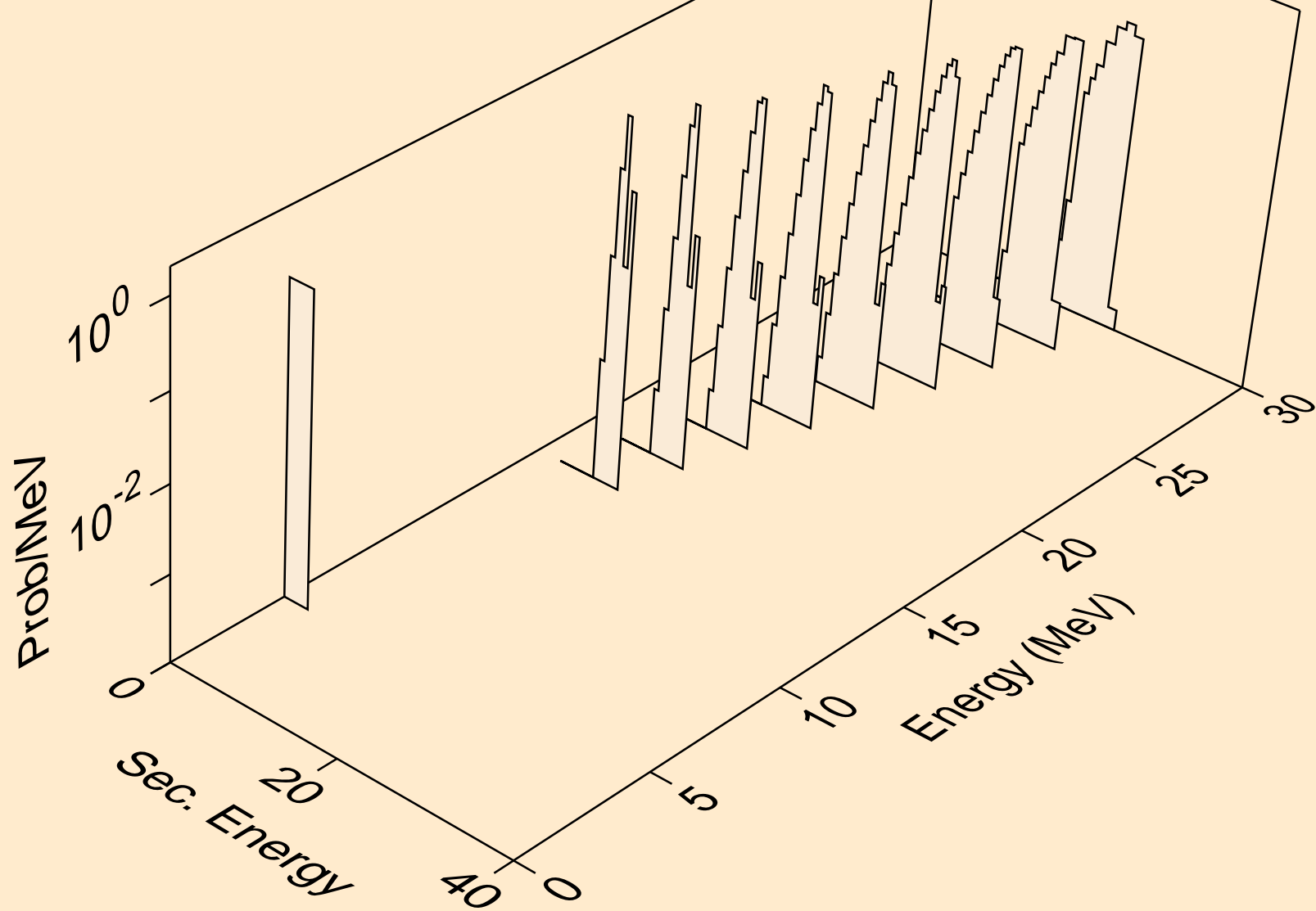

PA231 NEUTRON ACER TENDL-2021 LIBRARY; T=293.6K
alphas from (n,x)

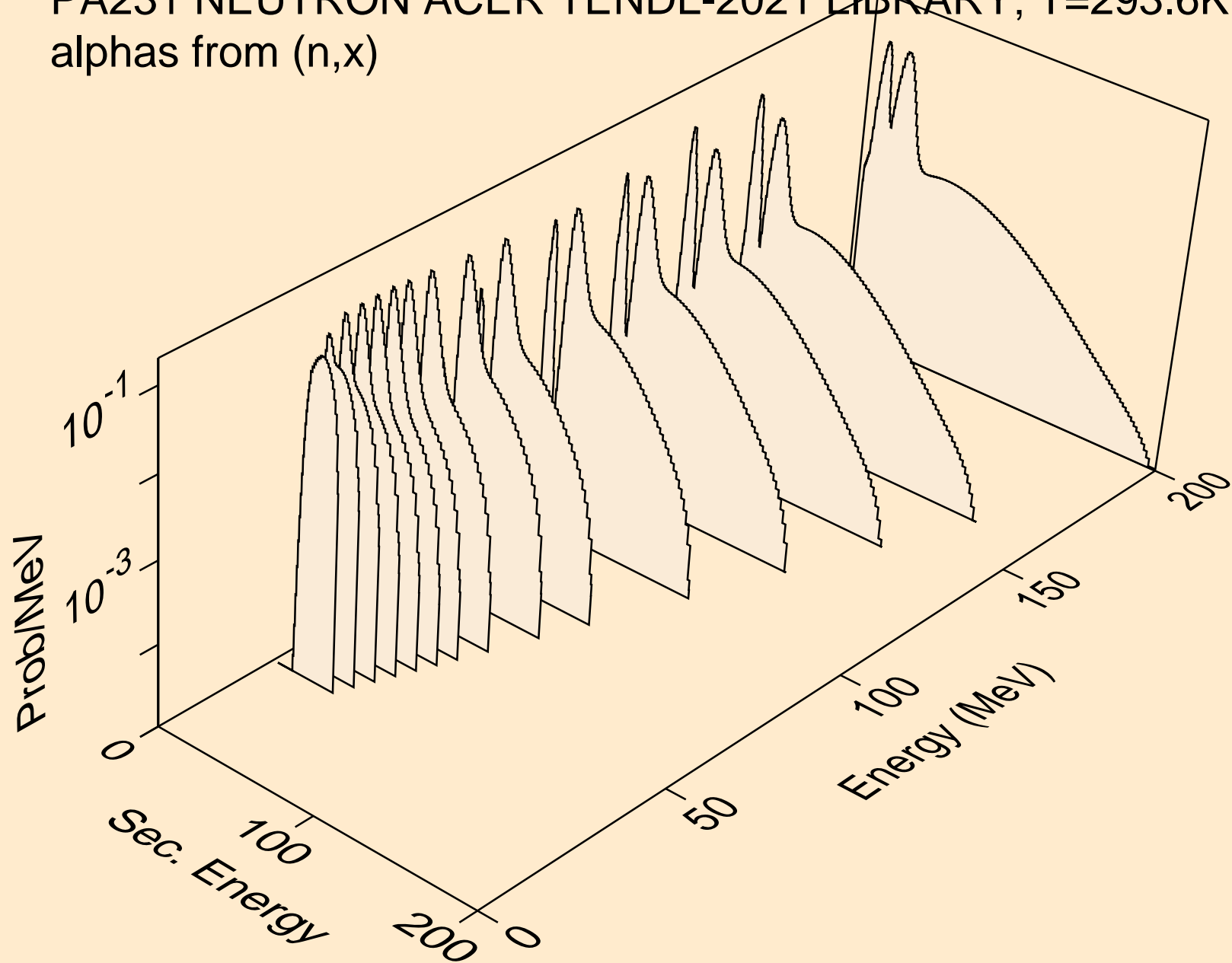

PA231 NEUTRON ACER TENDL-2021 LIBRARY; T=293.6K
alphas from (n,n*)a

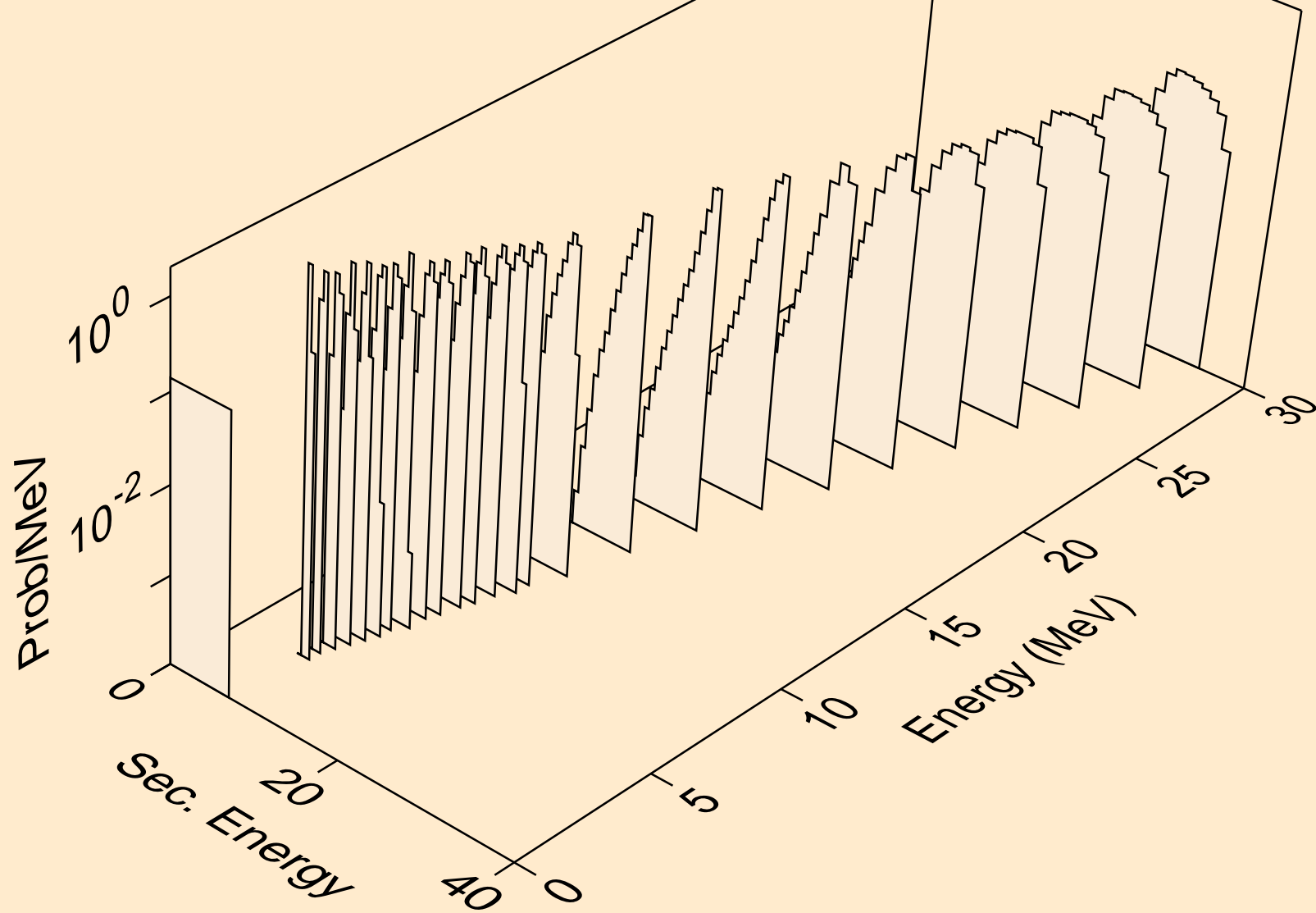

PA231 NEUTRON ACER TENDL-2021 LIBRARY; T=293.6K
alphas from (n,2n)a

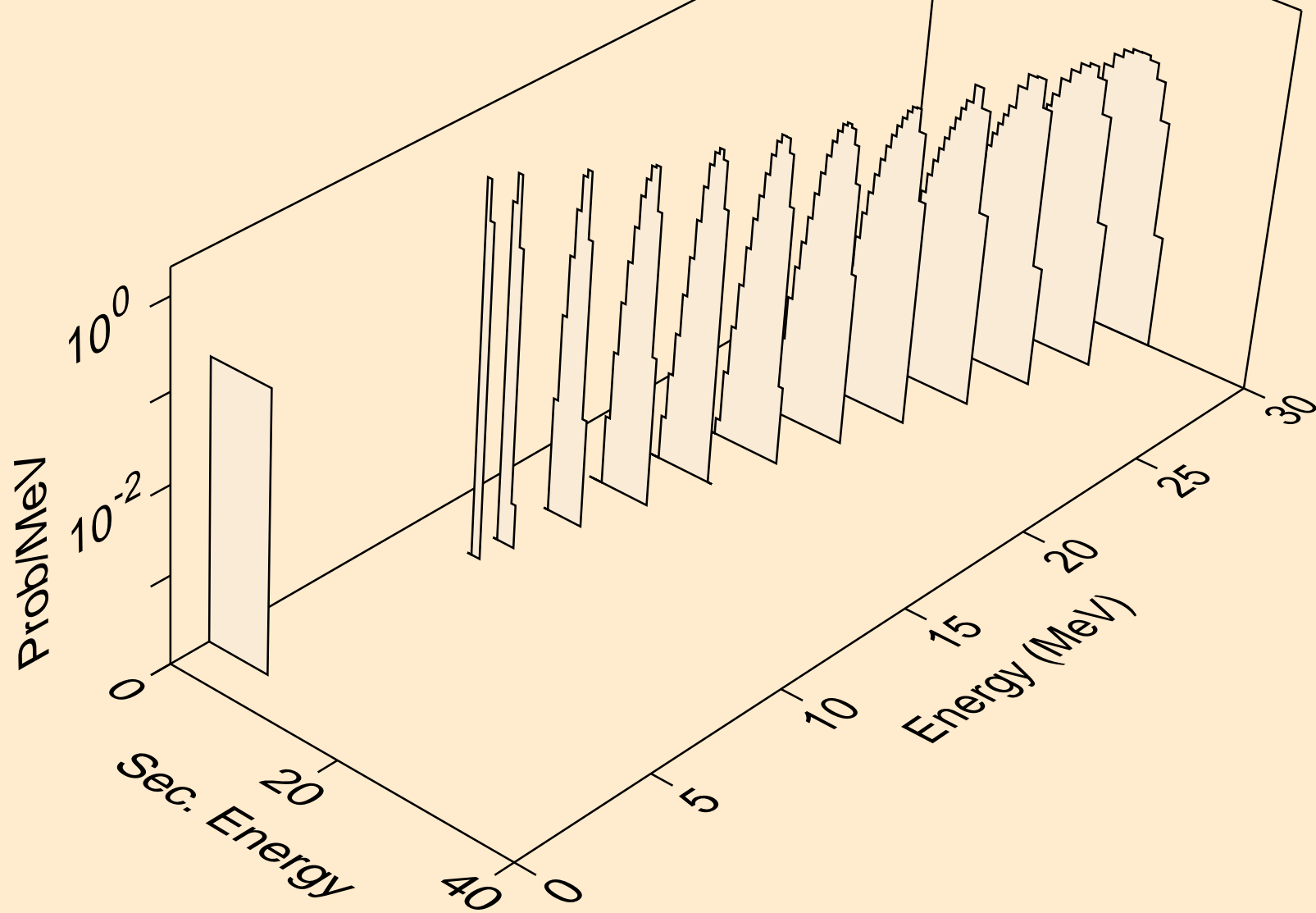

PA231 NEUTRON ACER TENDL-2021 LIBRARY; T=293.6K
alphas from (n,3n)a

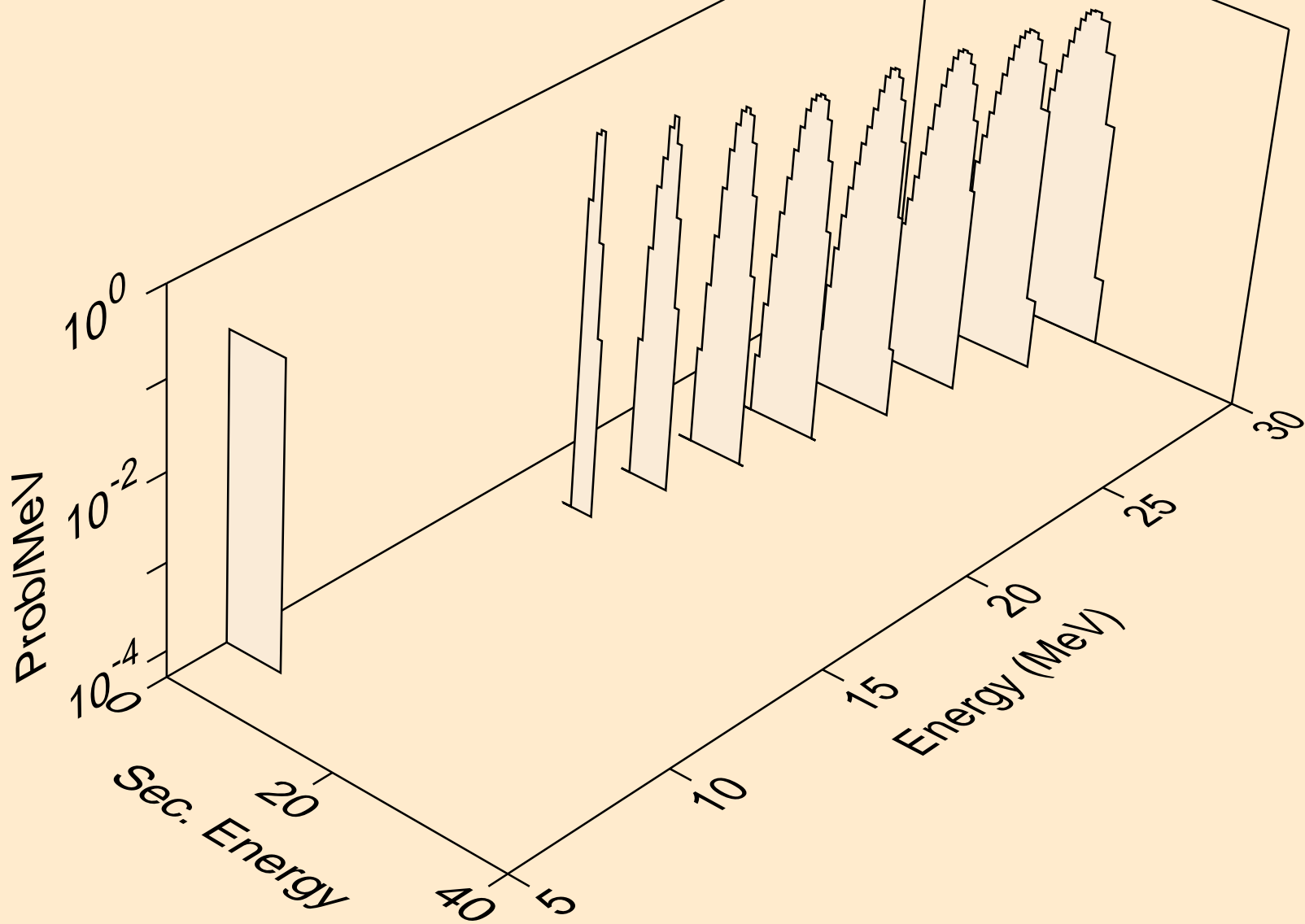

PA231 NEUTRON ACER TENDL-2021 LIBRARY; T=293.6K
alphas from (n,n*)2a

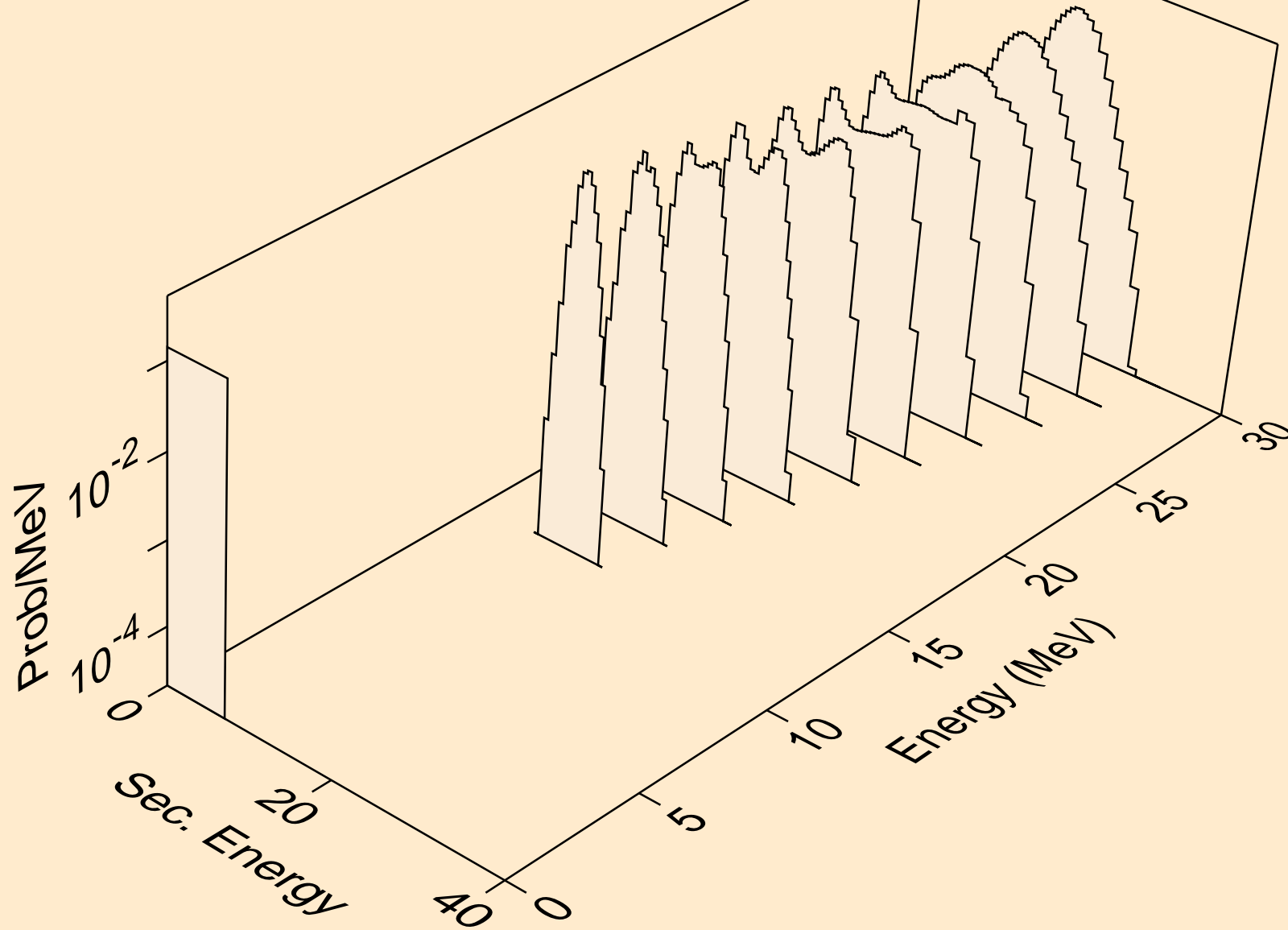

PA231 NEUTRON ACER TENDL-2021 LIBRARY; T=293.6K
alphas from (n,npa)

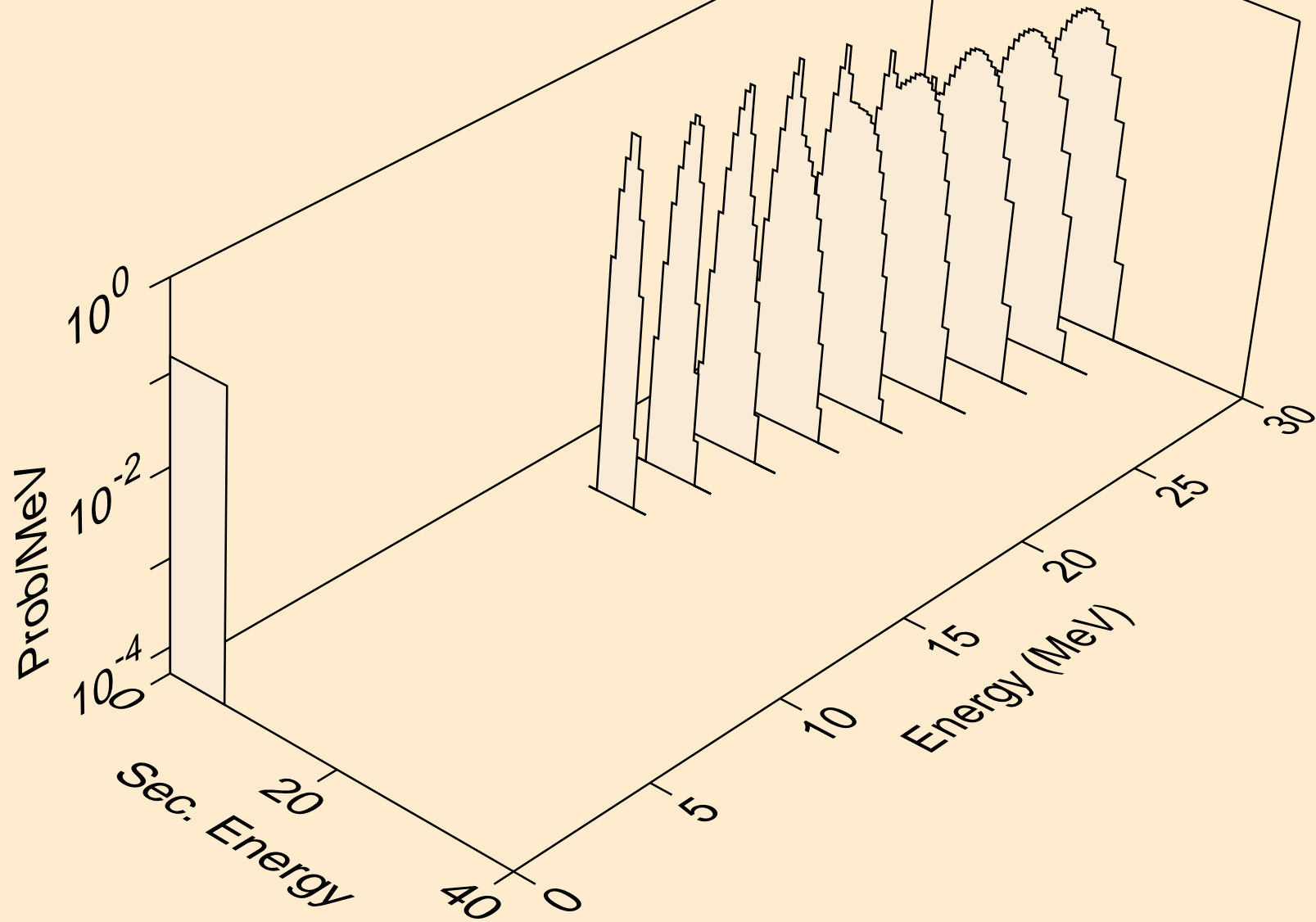

PA231 NEUTRON ACER TENDL-2021 LIBRARY; T=293.6K
alphas from (n,a)

