

PA241 NEUTRON ACER TENDL-2021 LIBRARY; T=293.6K
Principal cross sections

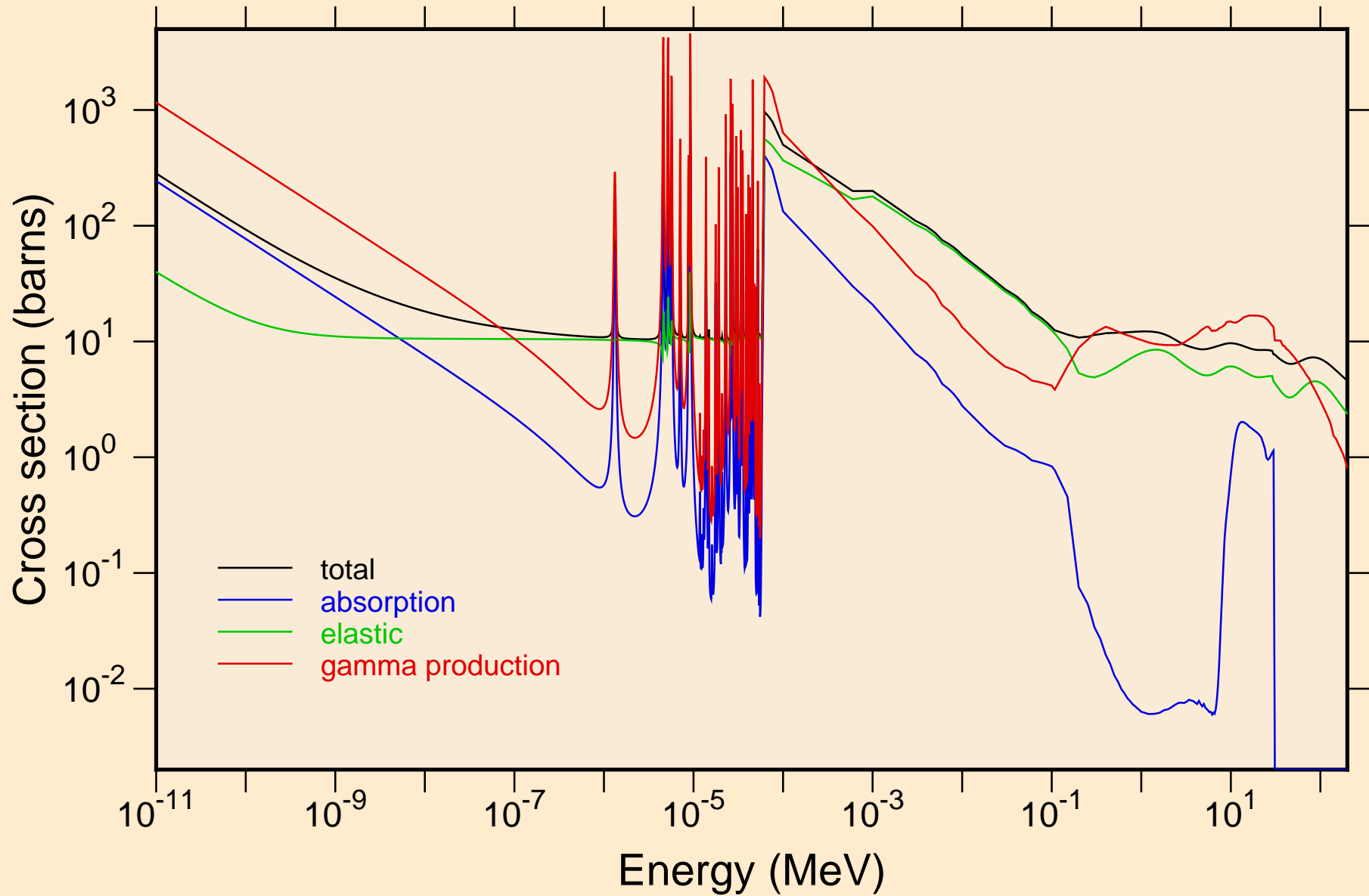

PA241 NEUTRON ACER TENDL-2021 LIBRARY; T=293.6K
resonance total cross section

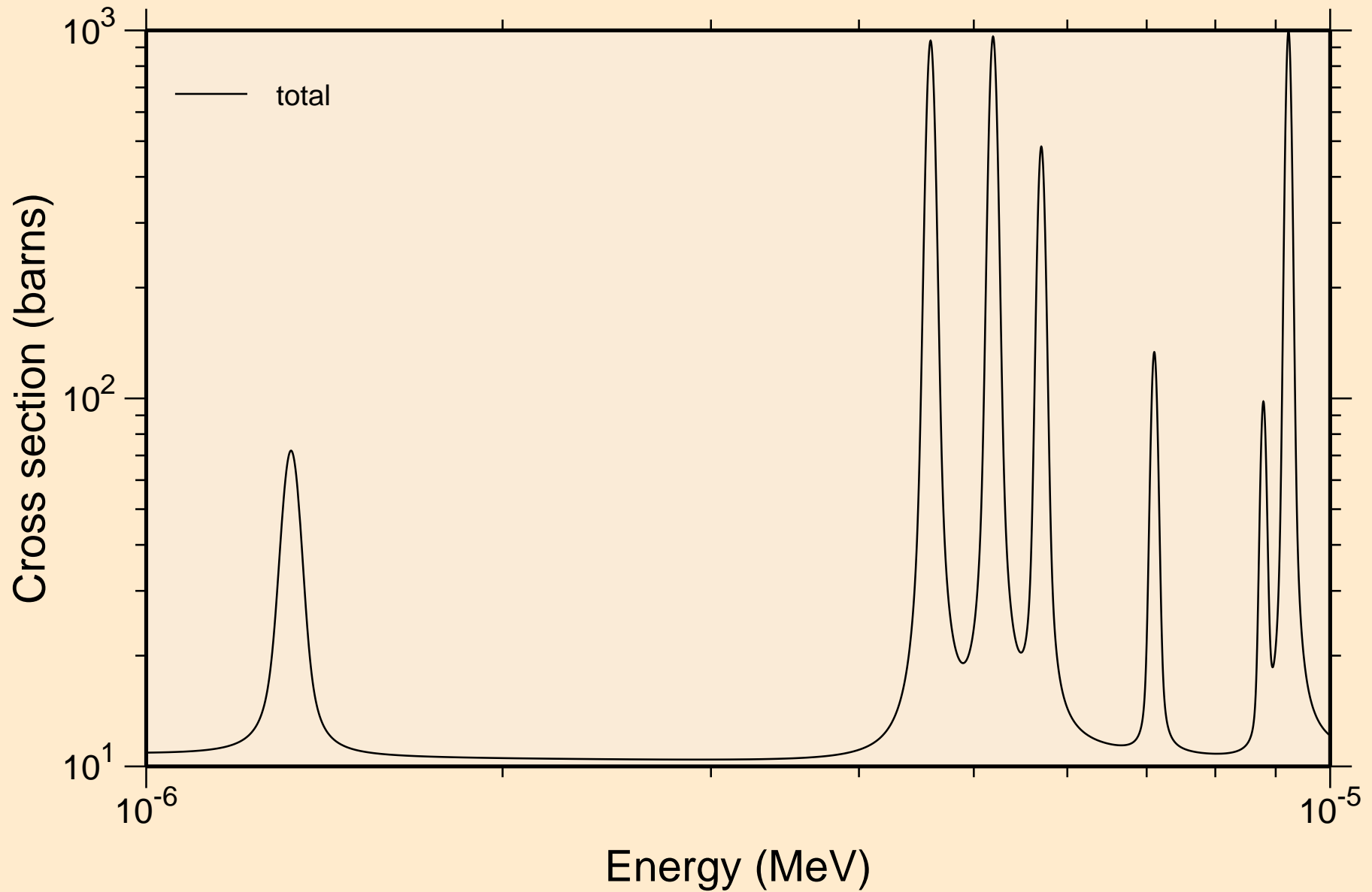

PA241 NEUTRON ACER TENDL-2021 LIBRARY; T=293.6K
resonance total cross section

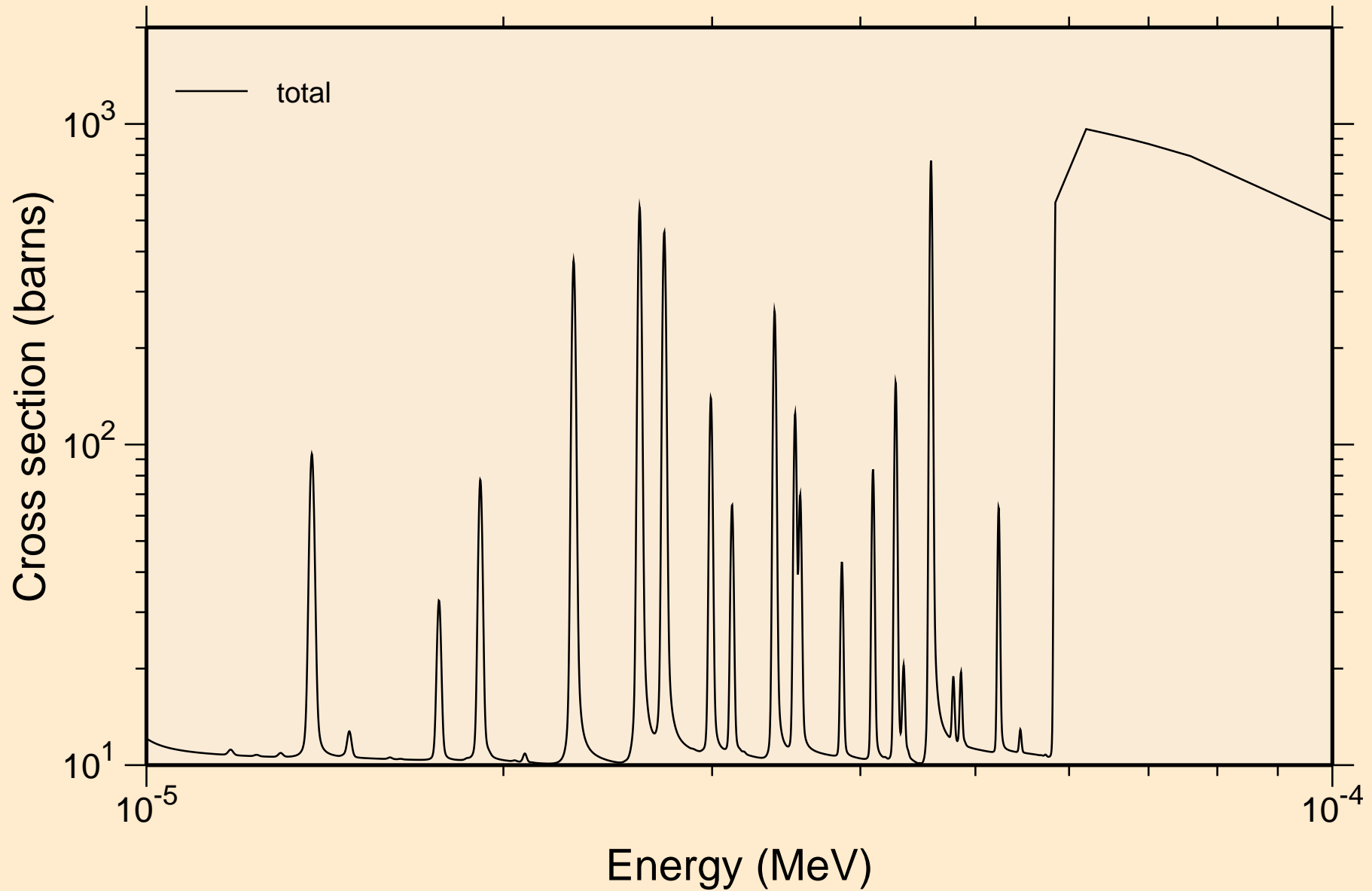

PA241 NEUTRON ACER TENDL-2021 LIBRARY; T=293.6K
resonance total cross section

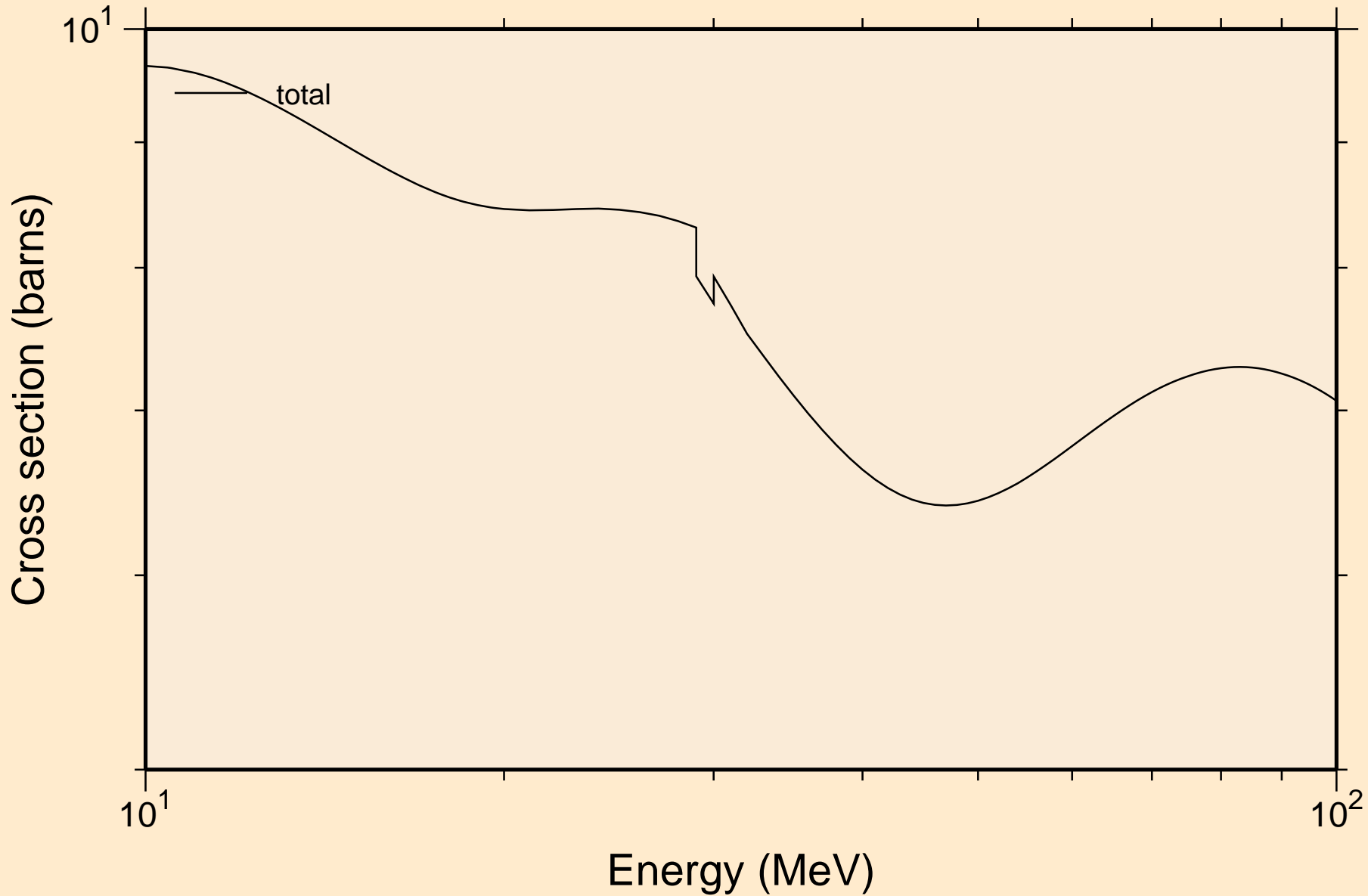

PA241 NEUTRON ACER TENDL-2021 LIBRARY; T=293.6K
resonance absorption cross sections

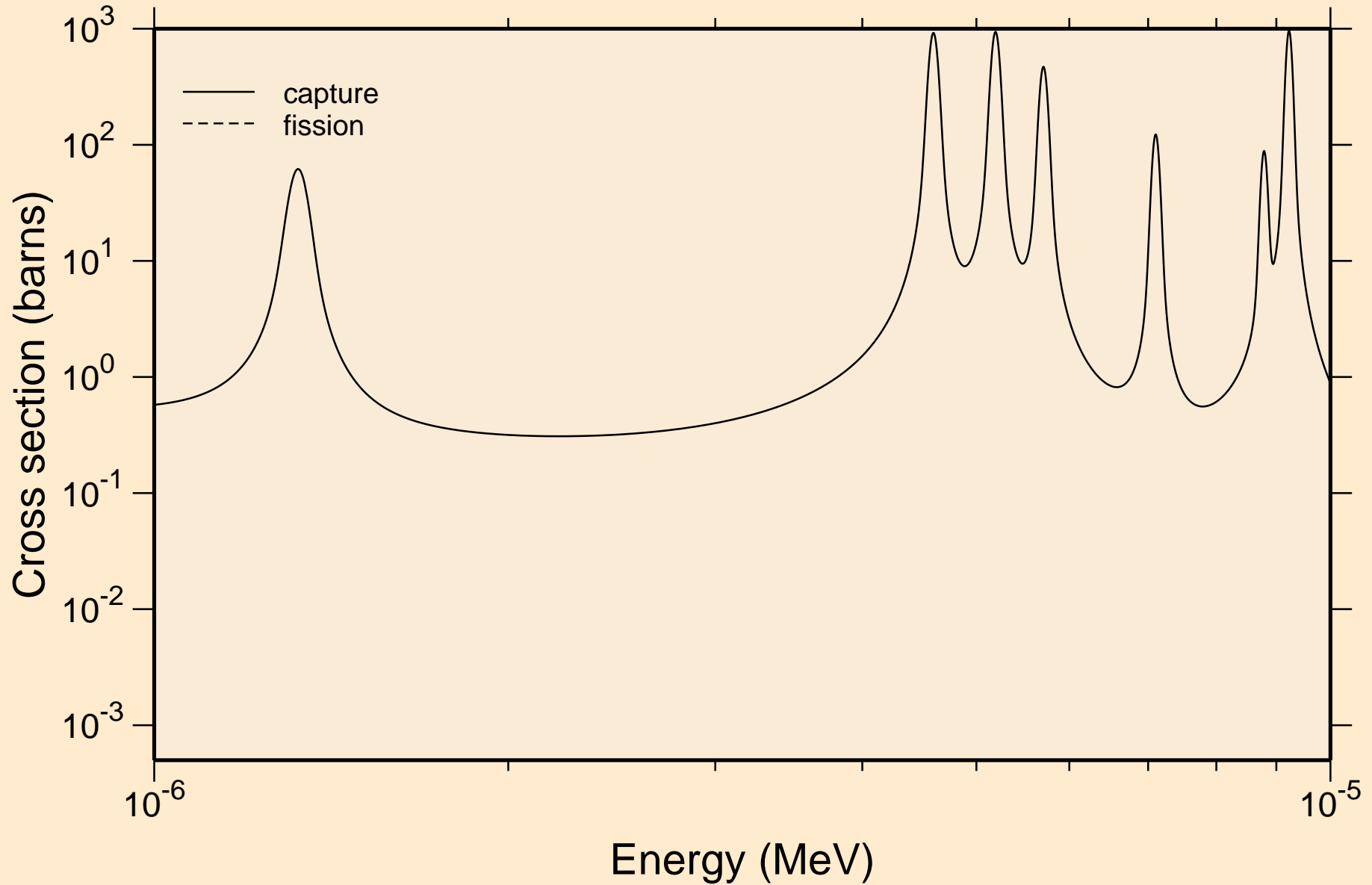

PA241 NEUTRON ACER TENDL-2021 LIBRARY; T=293.6K
resonance absorption cross sections

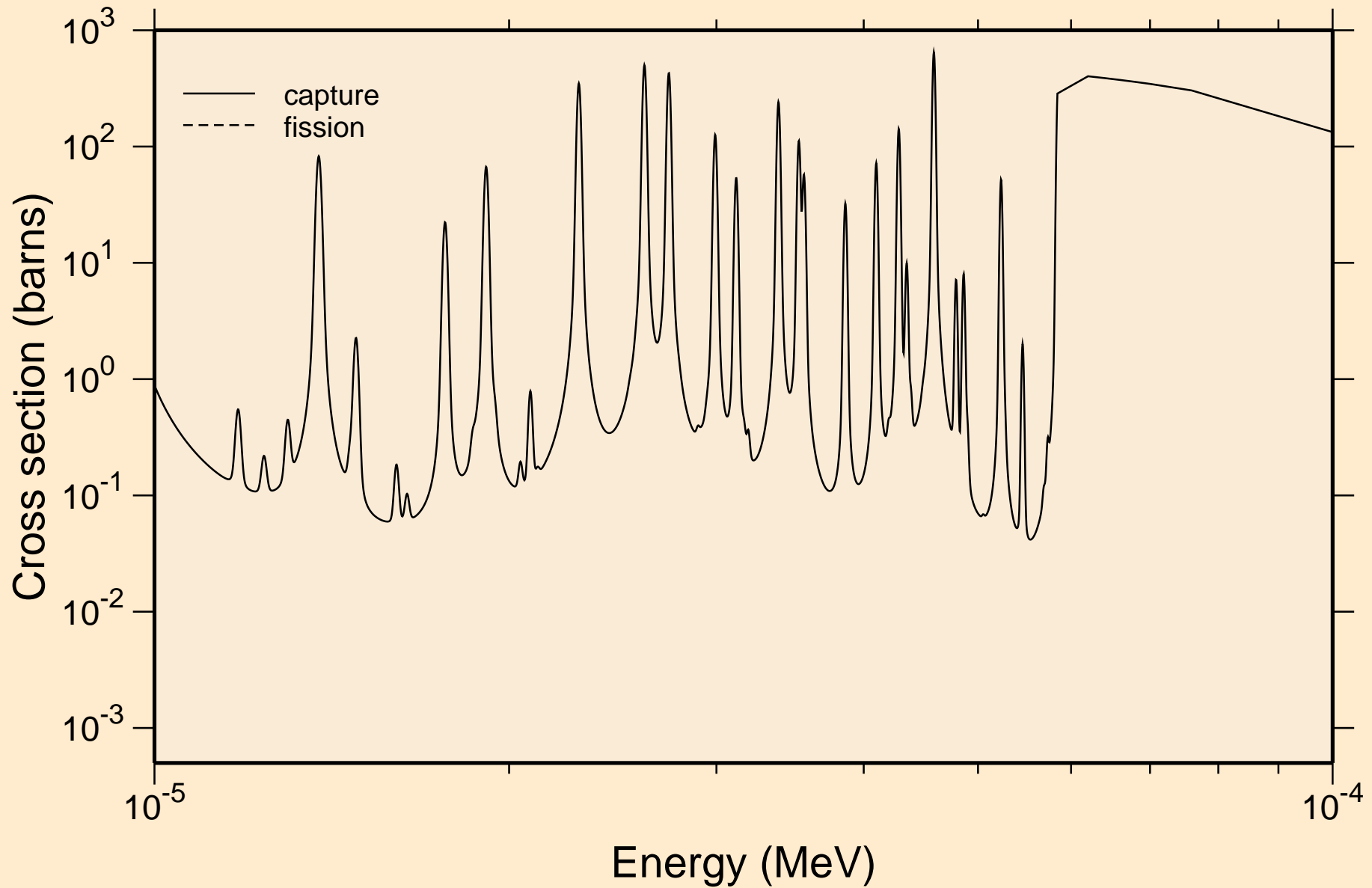

PA241 NEUTRON ACER TENDL-2021 LIBRARY; T=293.6K
resonance absorption cross sections

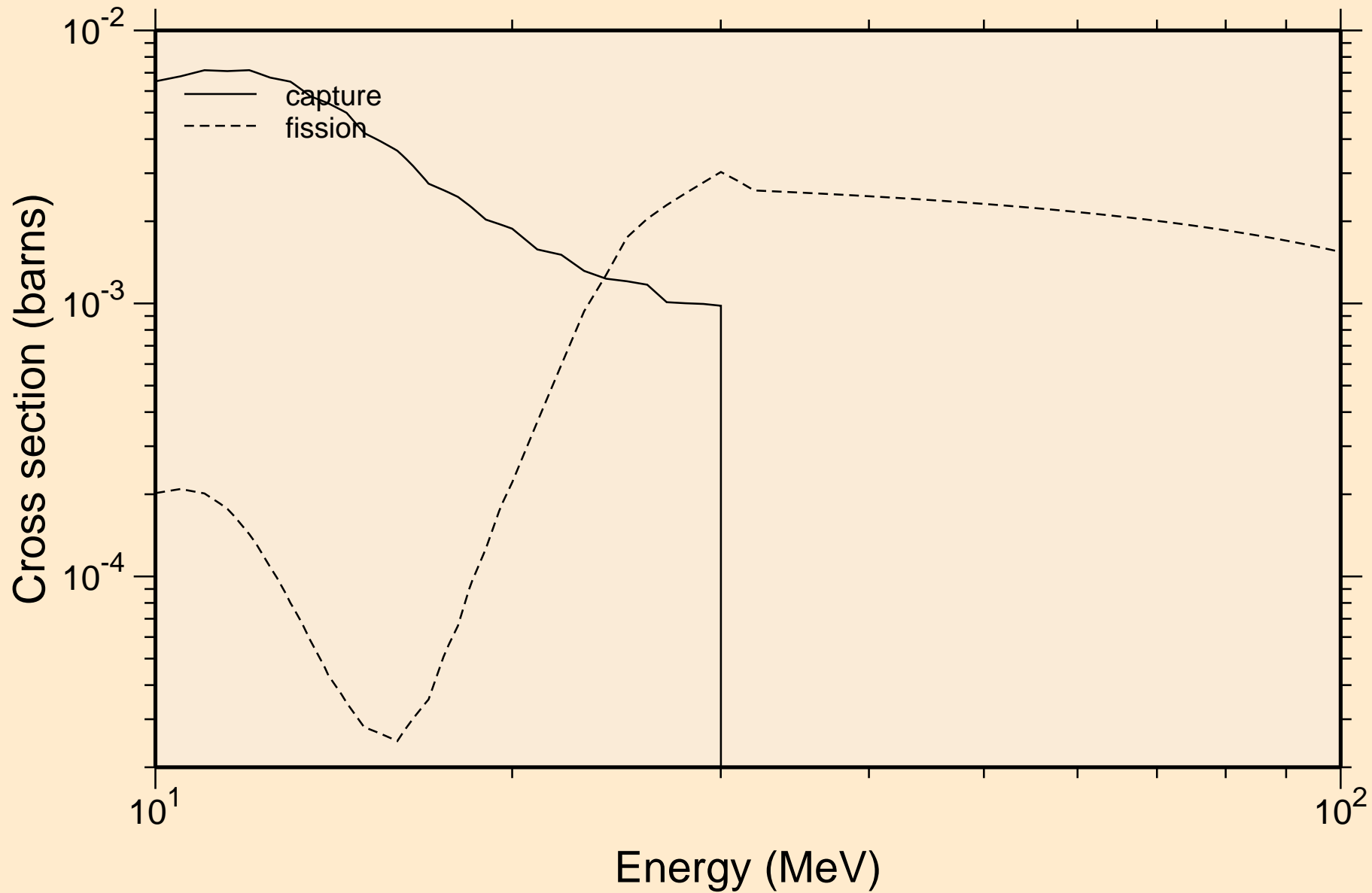

PA241 NEUTRON ACER TENDL-2021 LIBRARY; T=293.6K
Heating

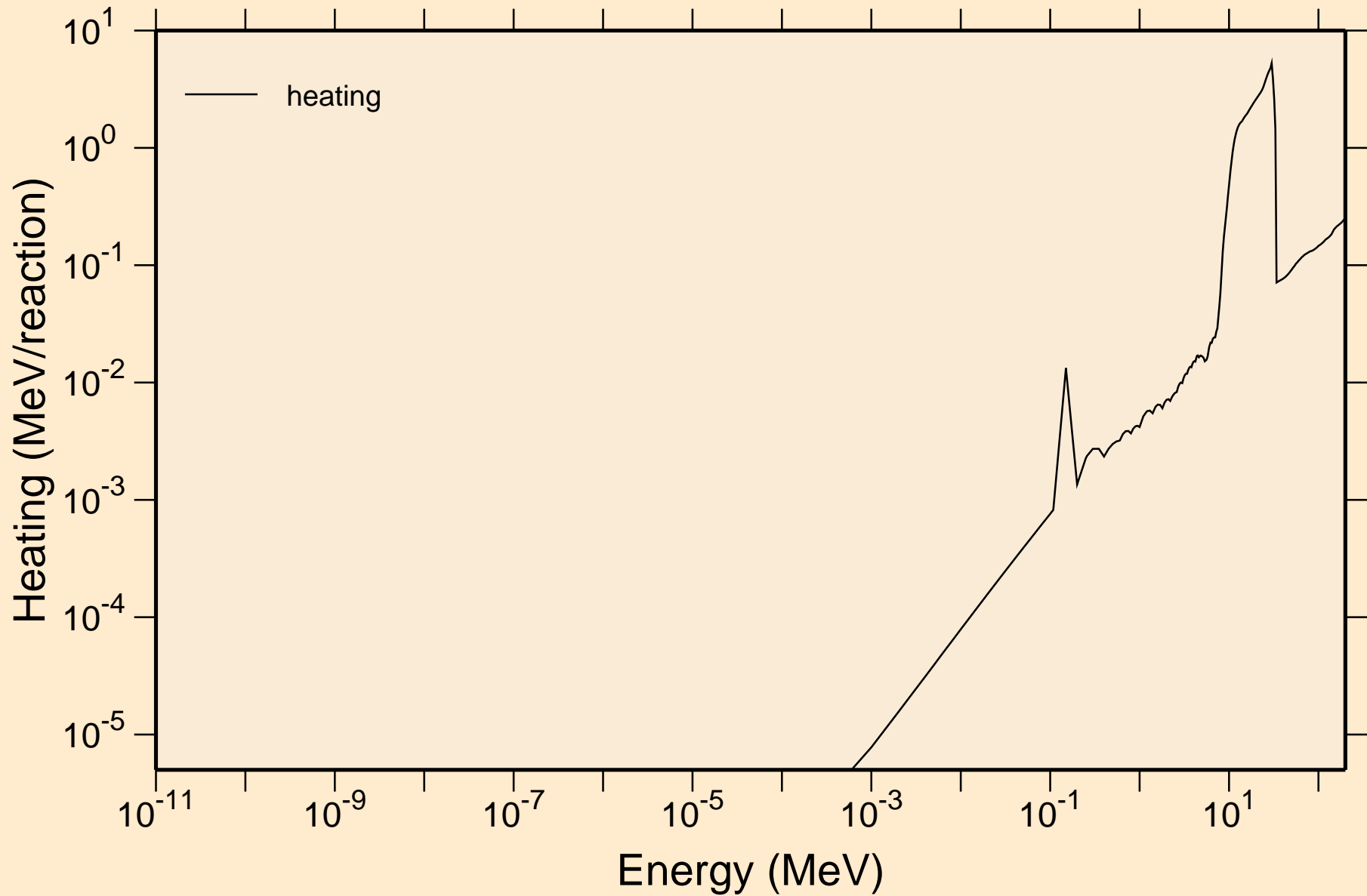

PA241 NEUTRON ACER TENDL-2021 LIBRARY; T=293.6K
Damage

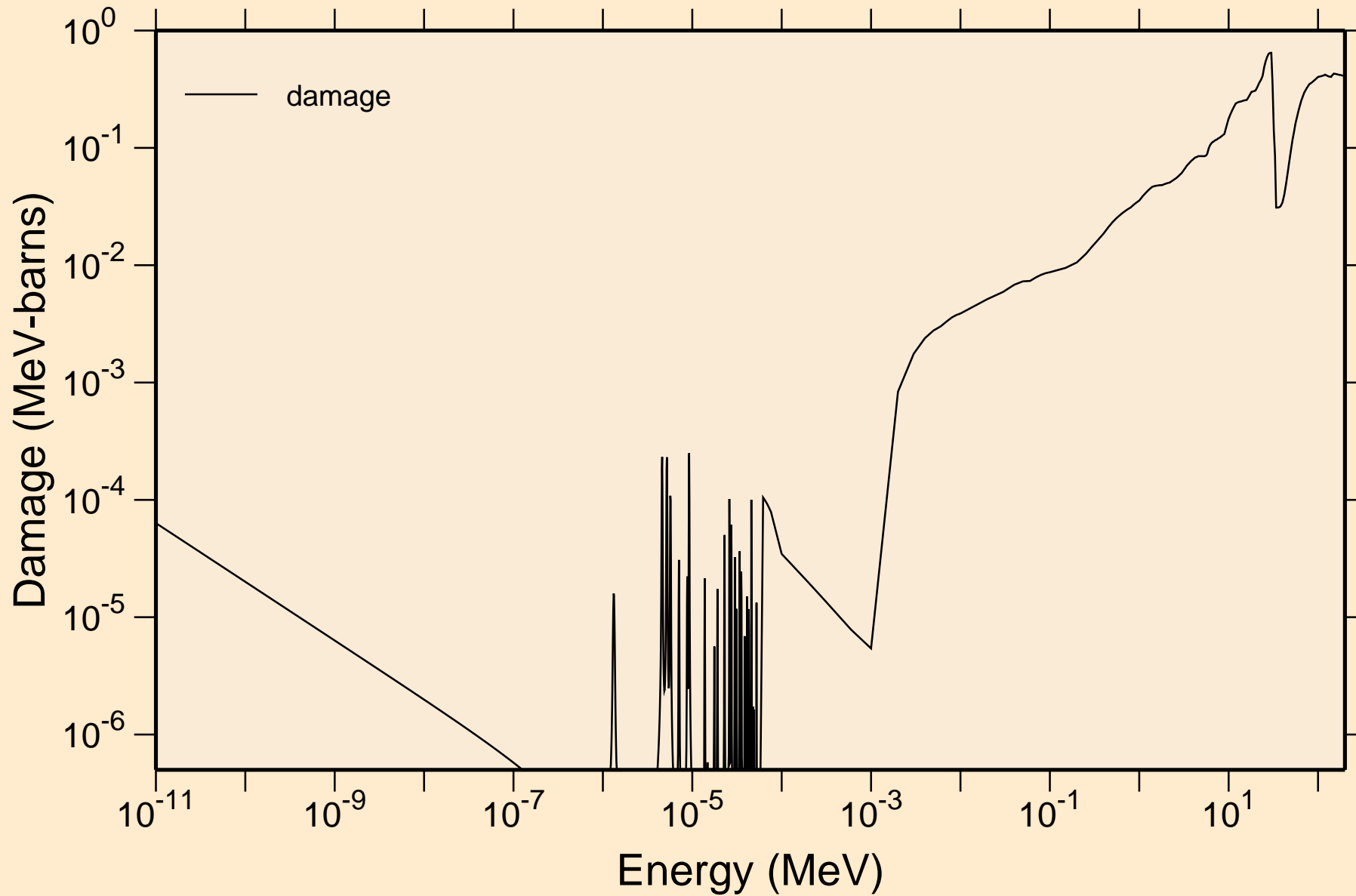

PA241 NEUTRON ACER TENDL-2021 LIBRARY; T=293.6K
Non-threshold reactions

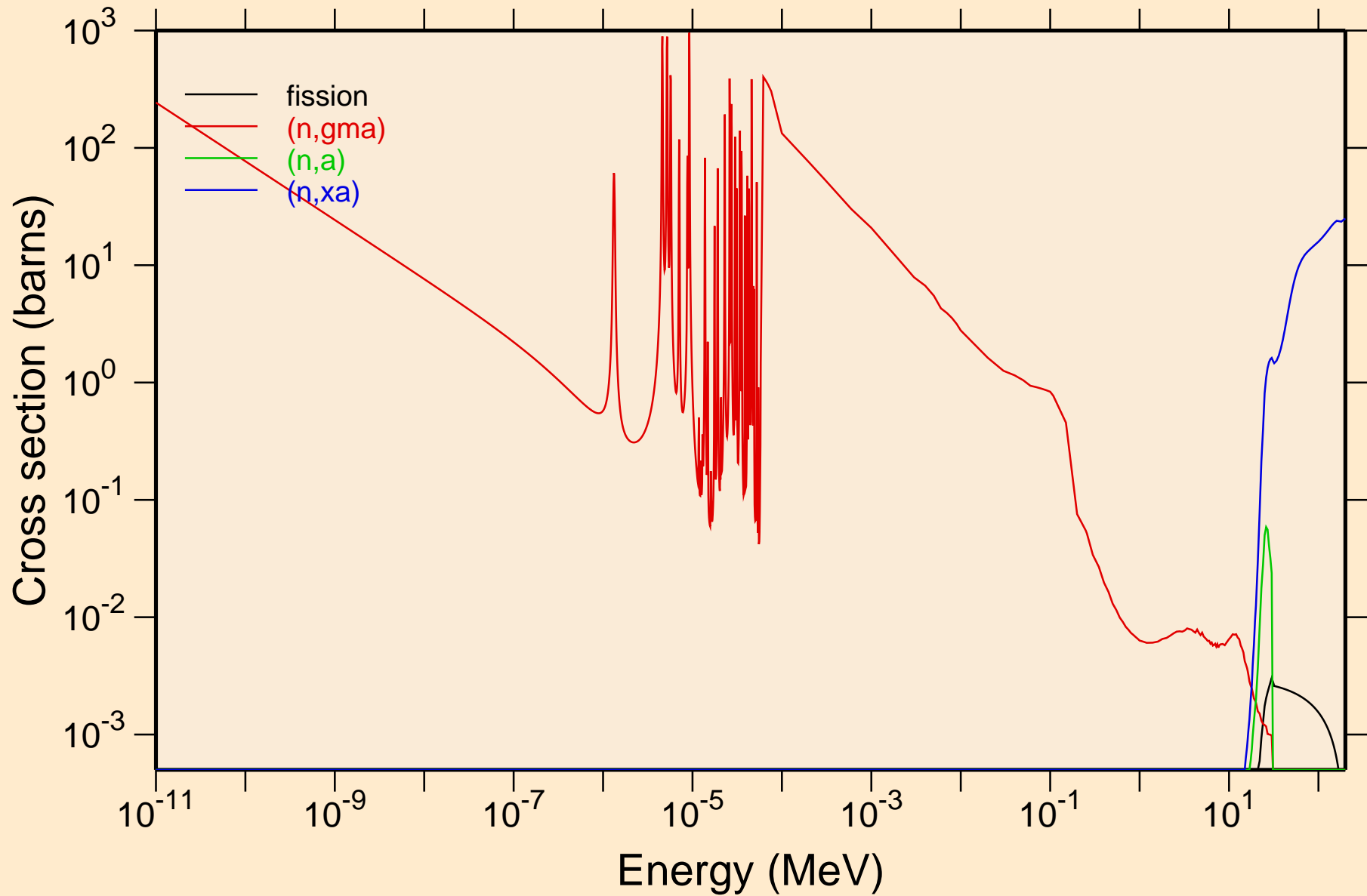

PA241 NEUTRON ACER TENDL-2021 LIBRARY; T=293.6K
Principal cross sections

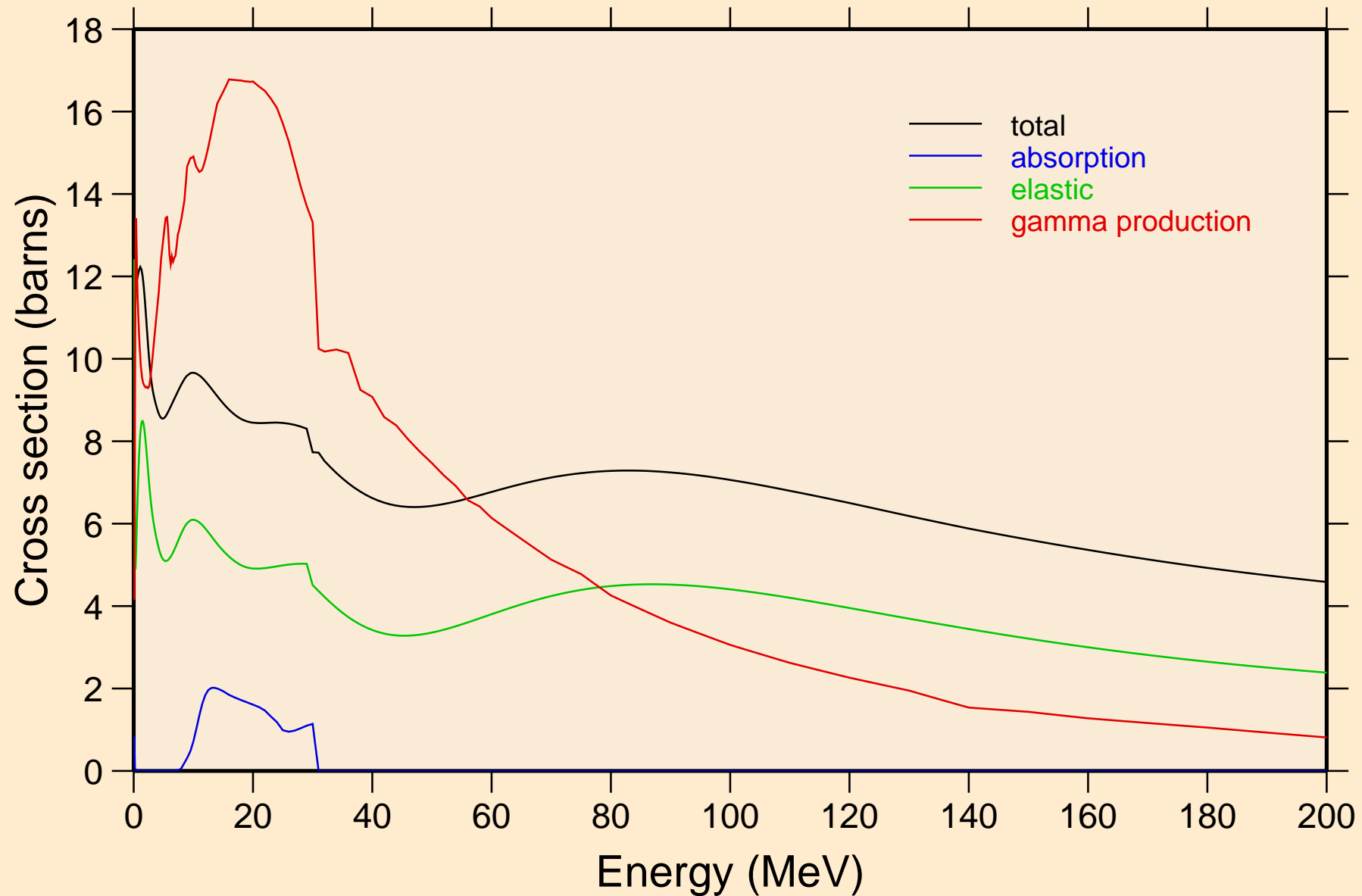

PA241 NEUTRON ACER TENDL-2021 LIBRARY; T=293.6K
Heating

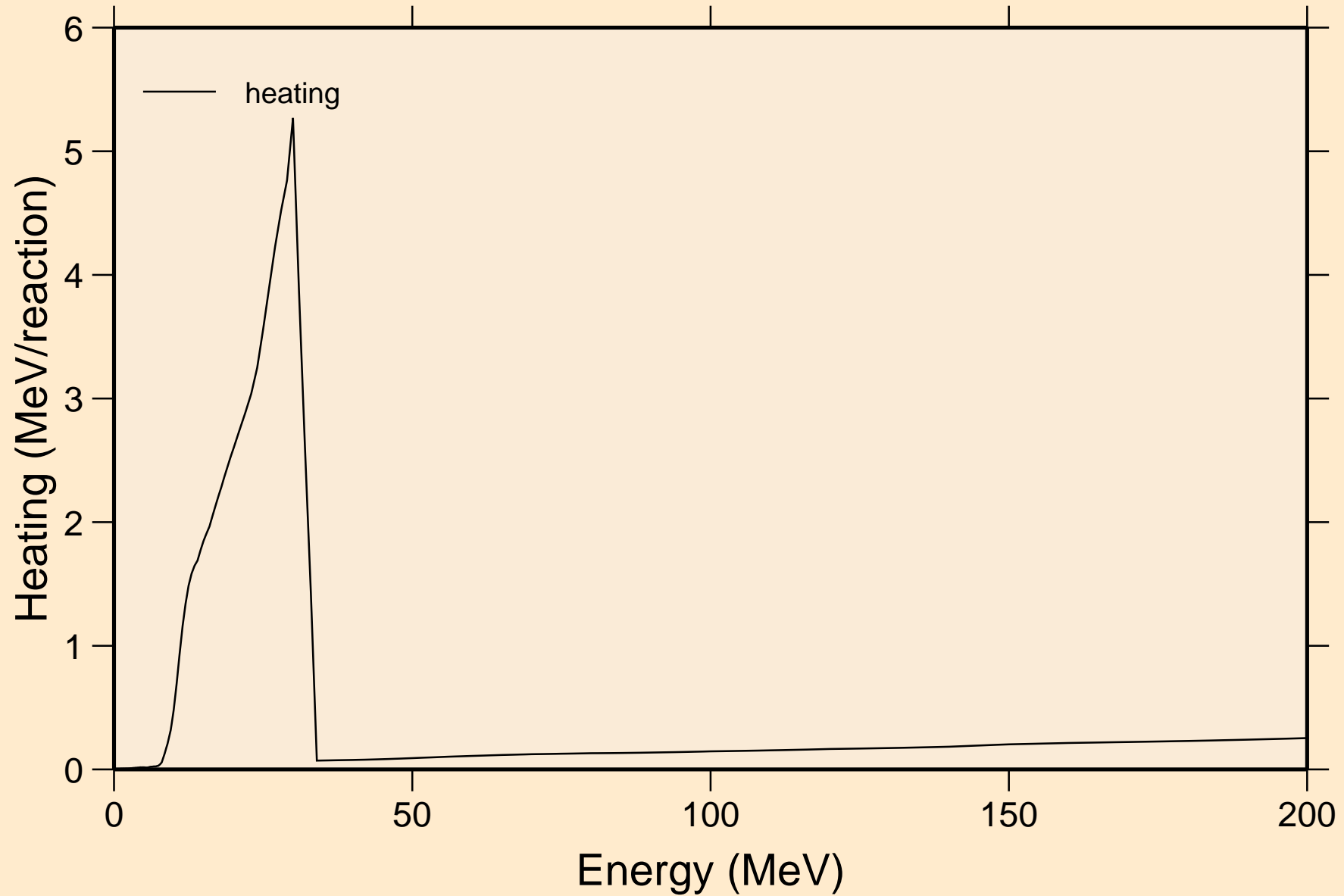

PA241 NEUTRON ACER TENDL-2021 LIBRARY; T=293.6K
Damage

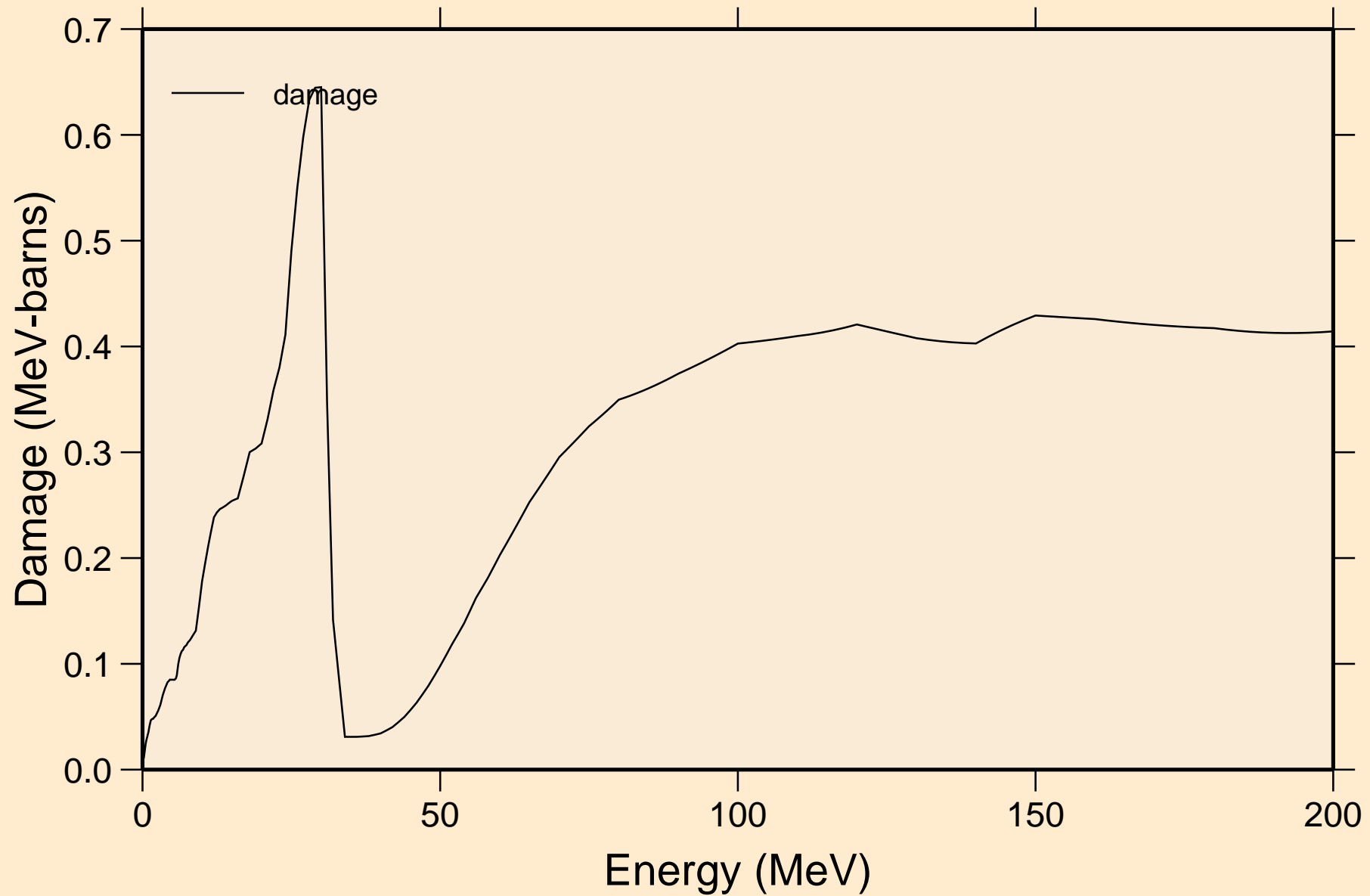

PA241 NEUTRON ACER TENDL-2021 LIBRARY; T=293.6K
Non-threshold reactions

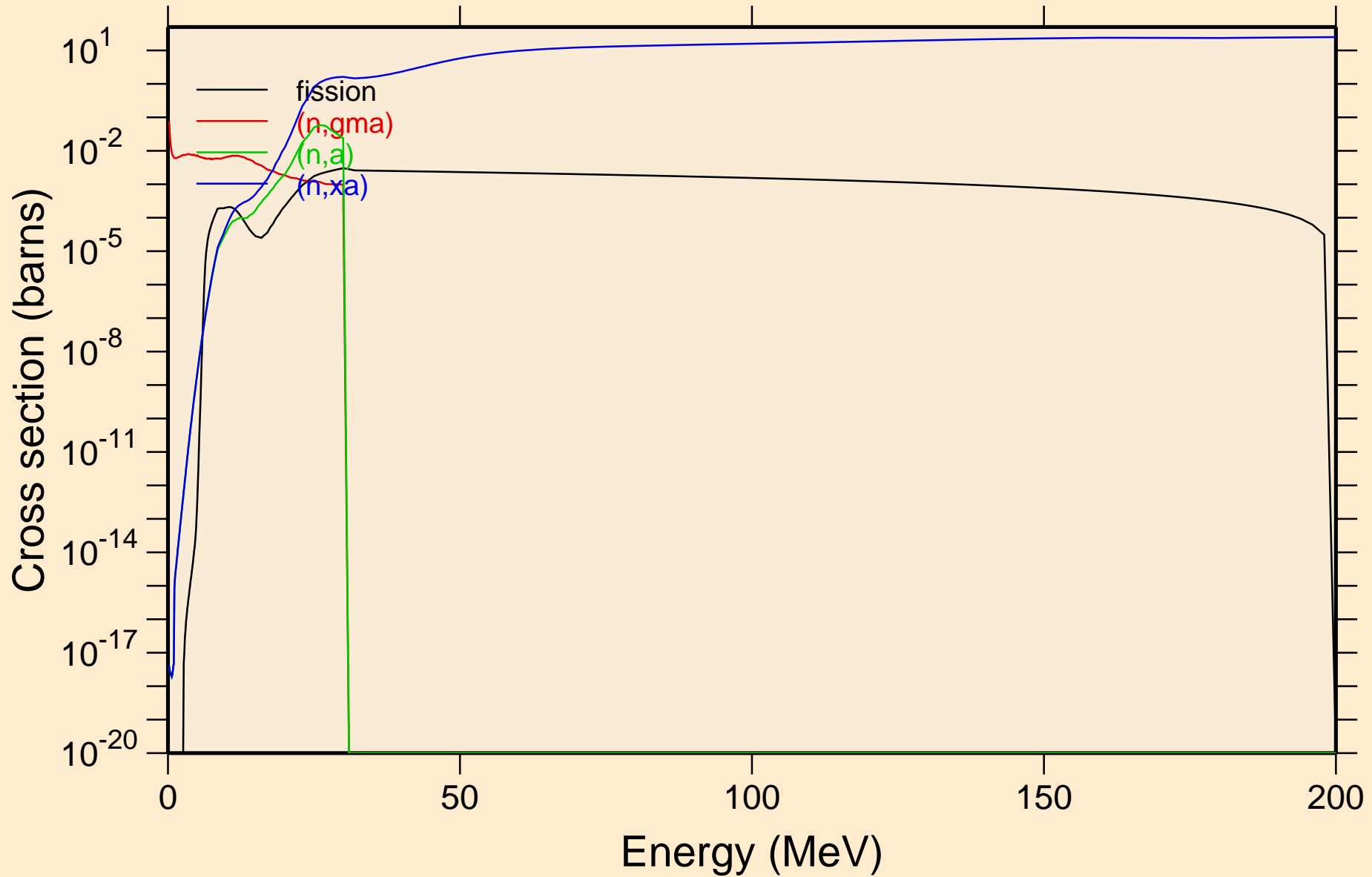

PA241 NEUTRON ACER TENDL-2021 LIBRARY; T=293.6K
Inelastic levels

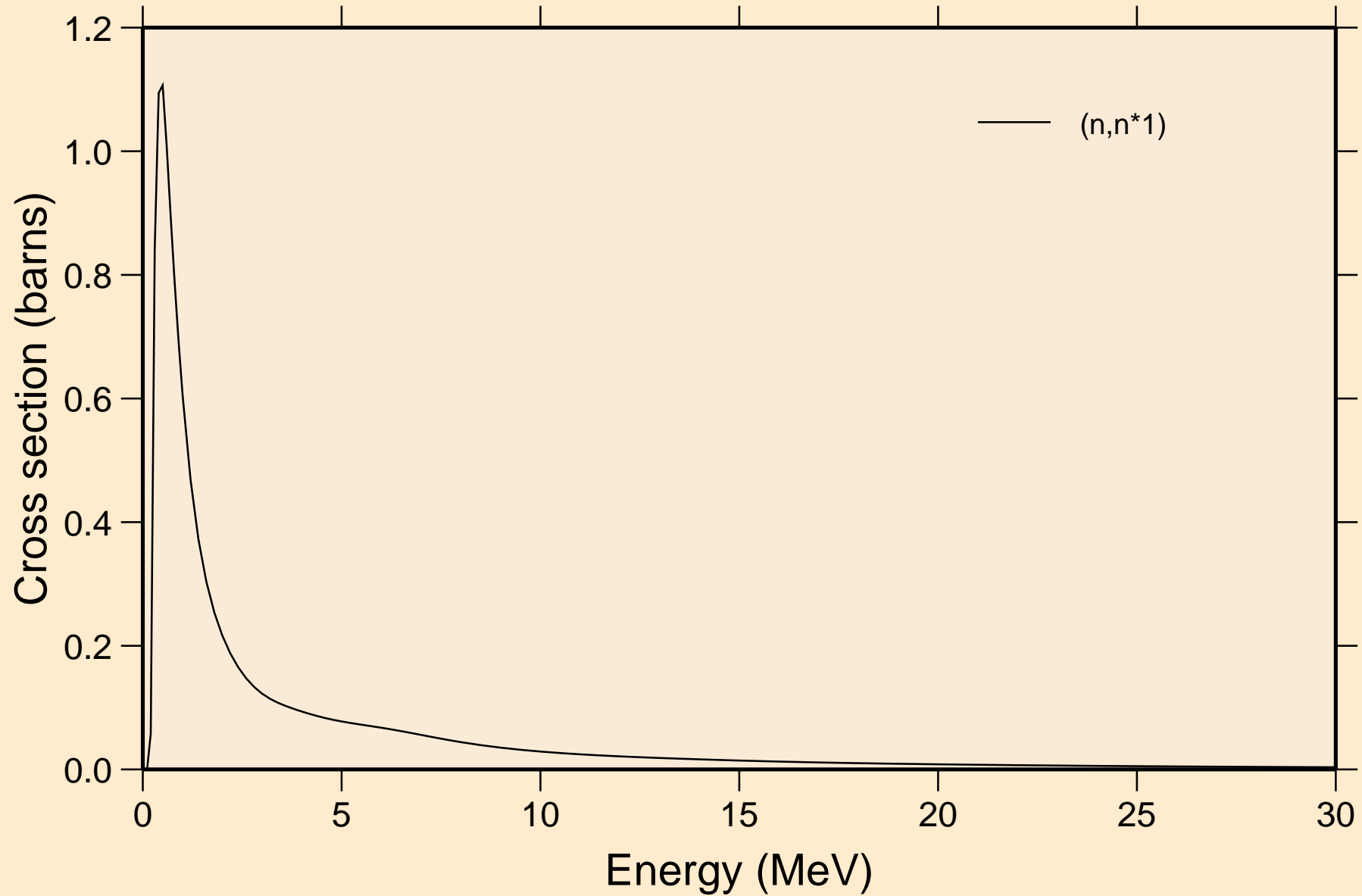

PA241 NEUTRON ACER TENDL-2021 LIBRARY; T=293.6K
Threshold reactions

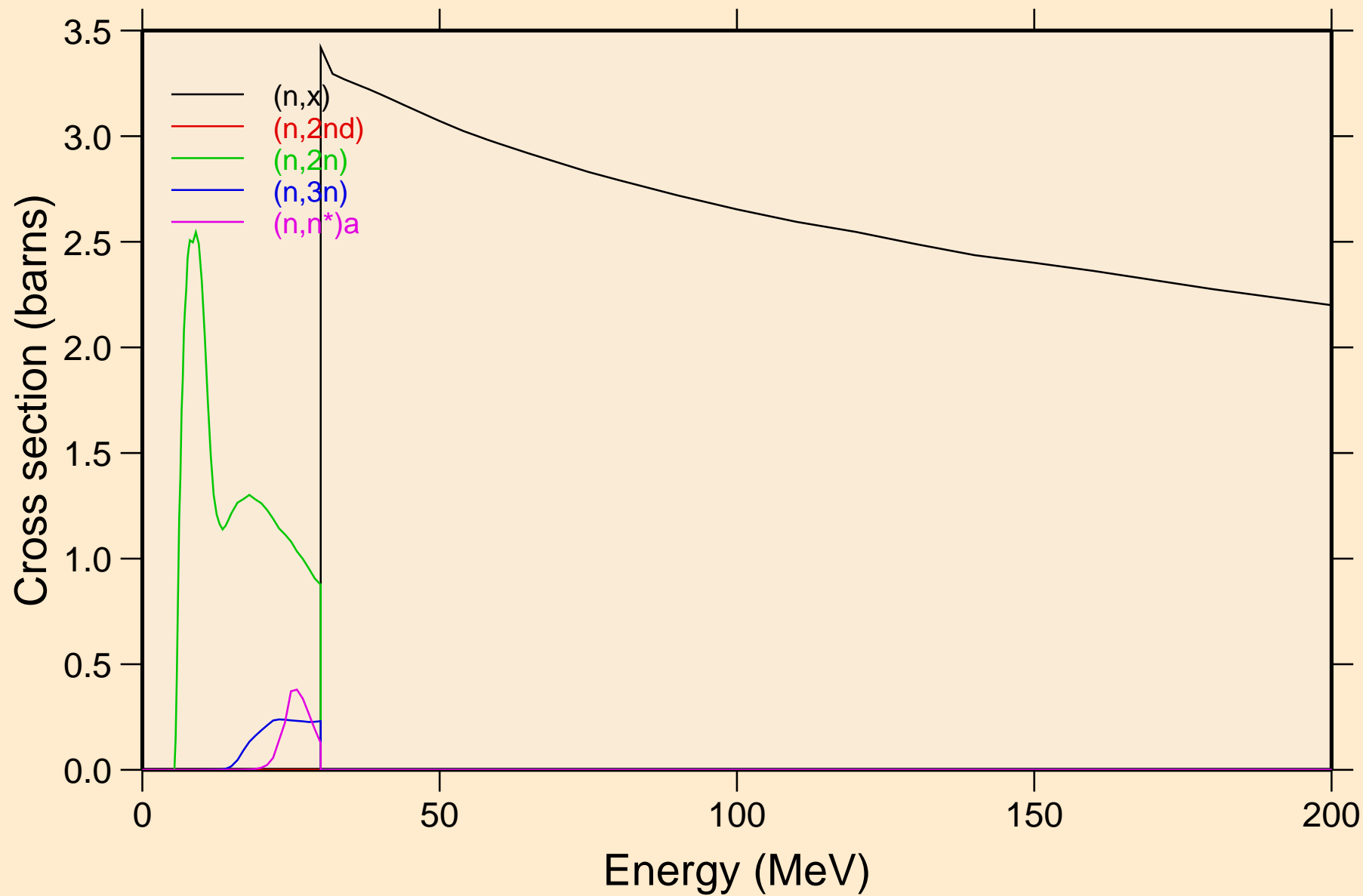

PA241 NEUTRON ACER TENDL-2021 LIBRARY; T=293.6K
Threshold reactions

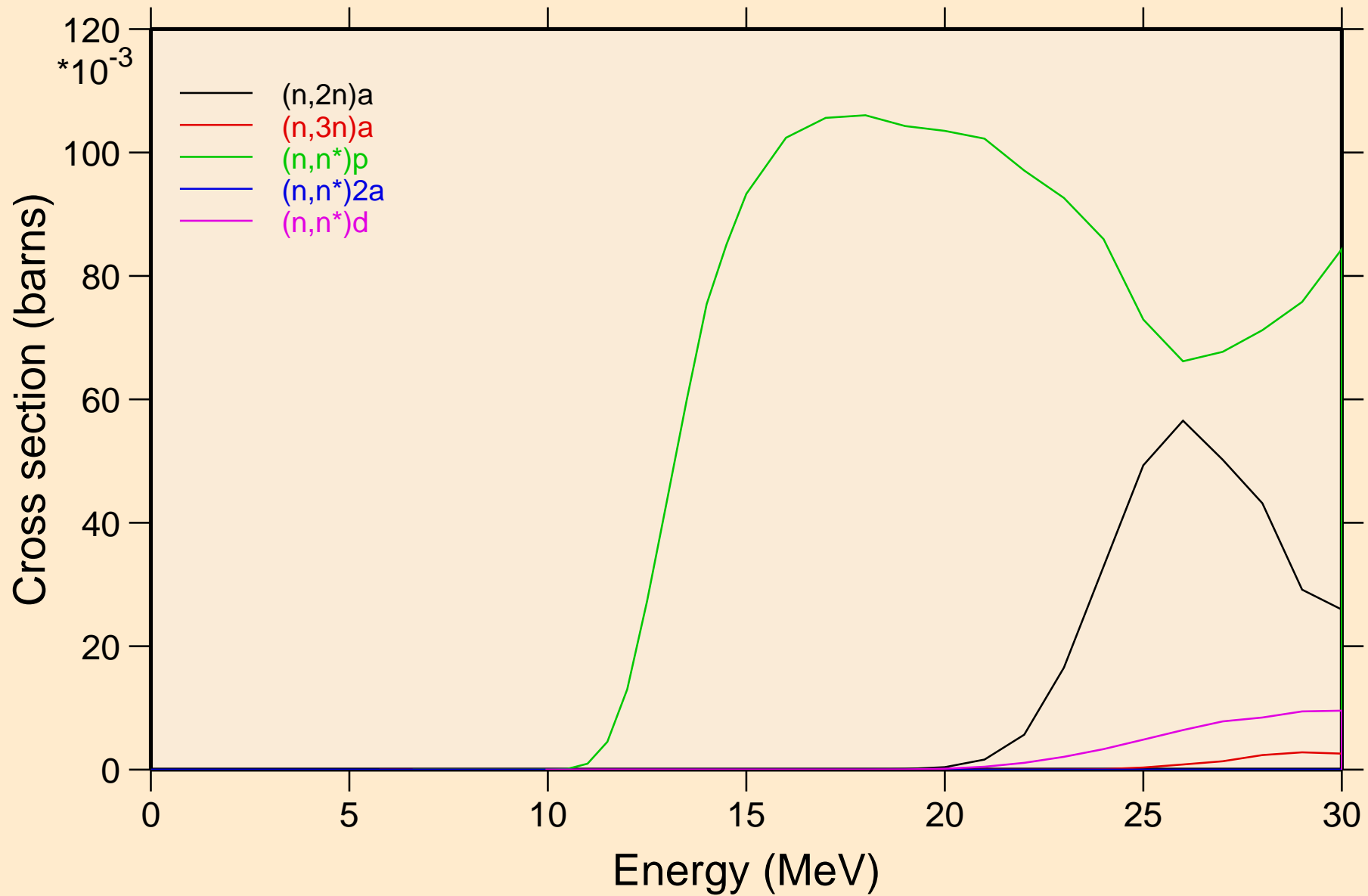

PA241 NEUTRON ACER TENDL-2021 LIBRARY; T=293.6K
Threshold reactions

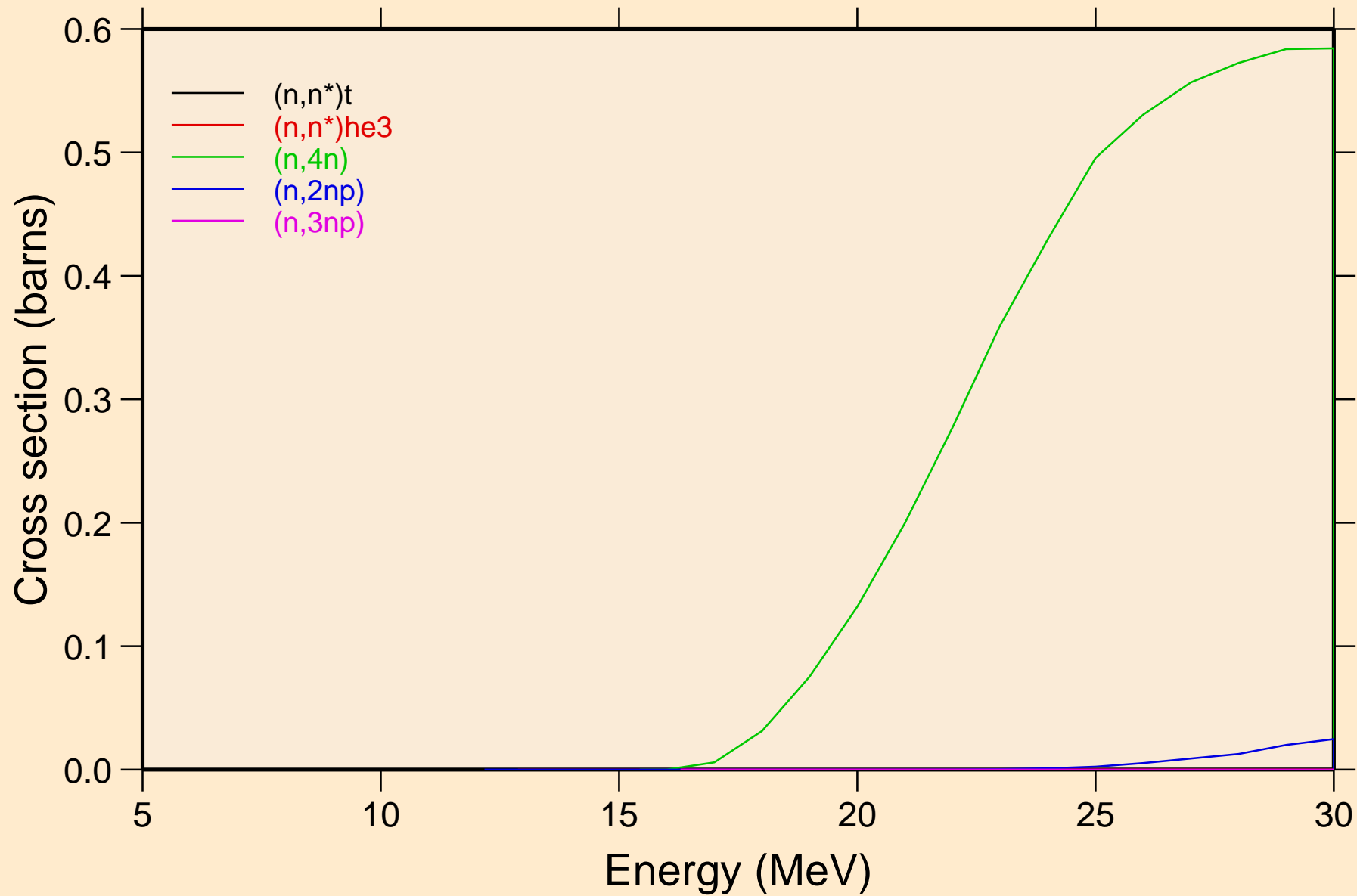

PA241 NEUTRON ACER TENDL-2021 LIBRARY; T=293.6K
Threshold reactions

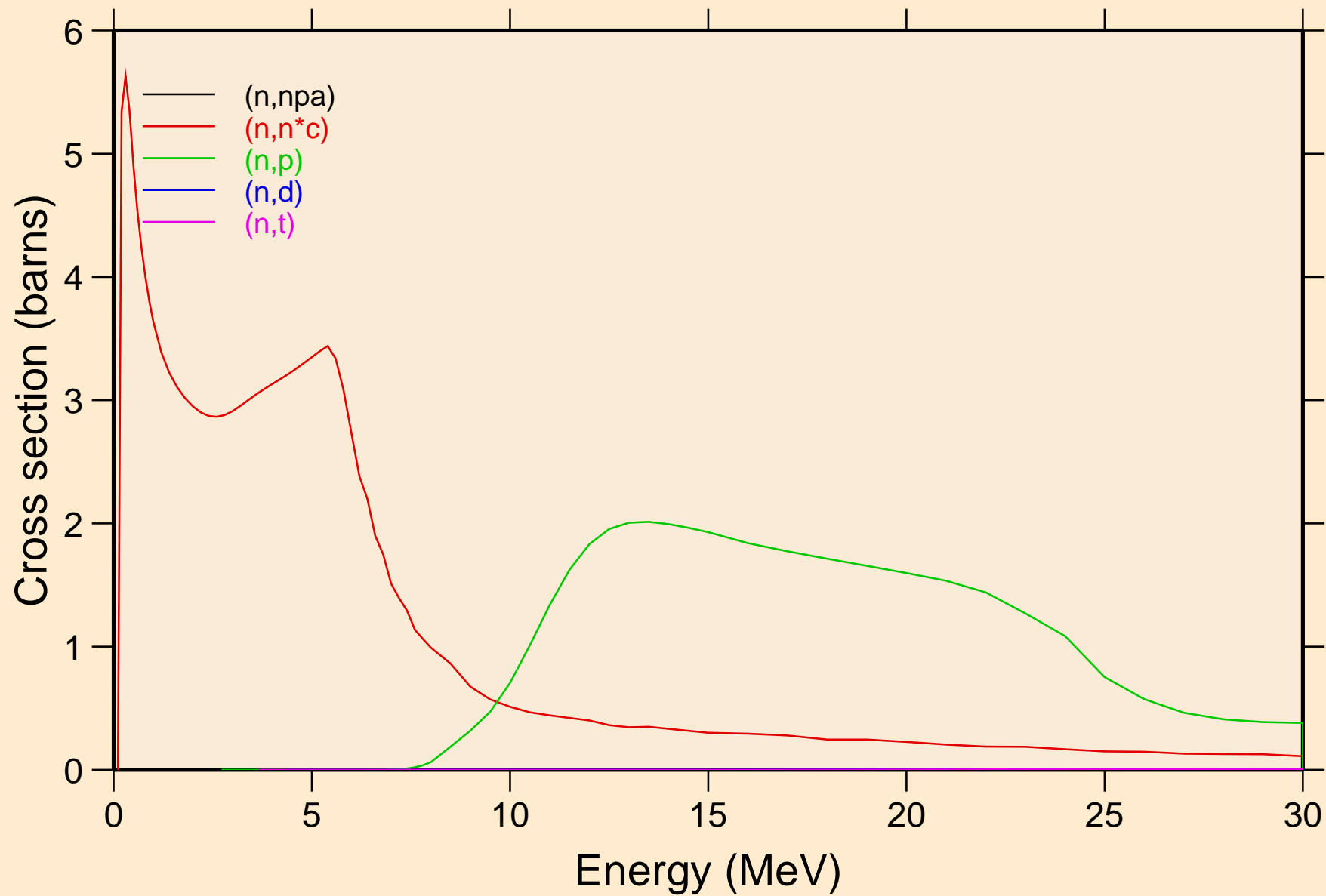

PA241 NEUTRON ACER TENDL-2021 LIBRARY; T=293.6K
Threshold reactions

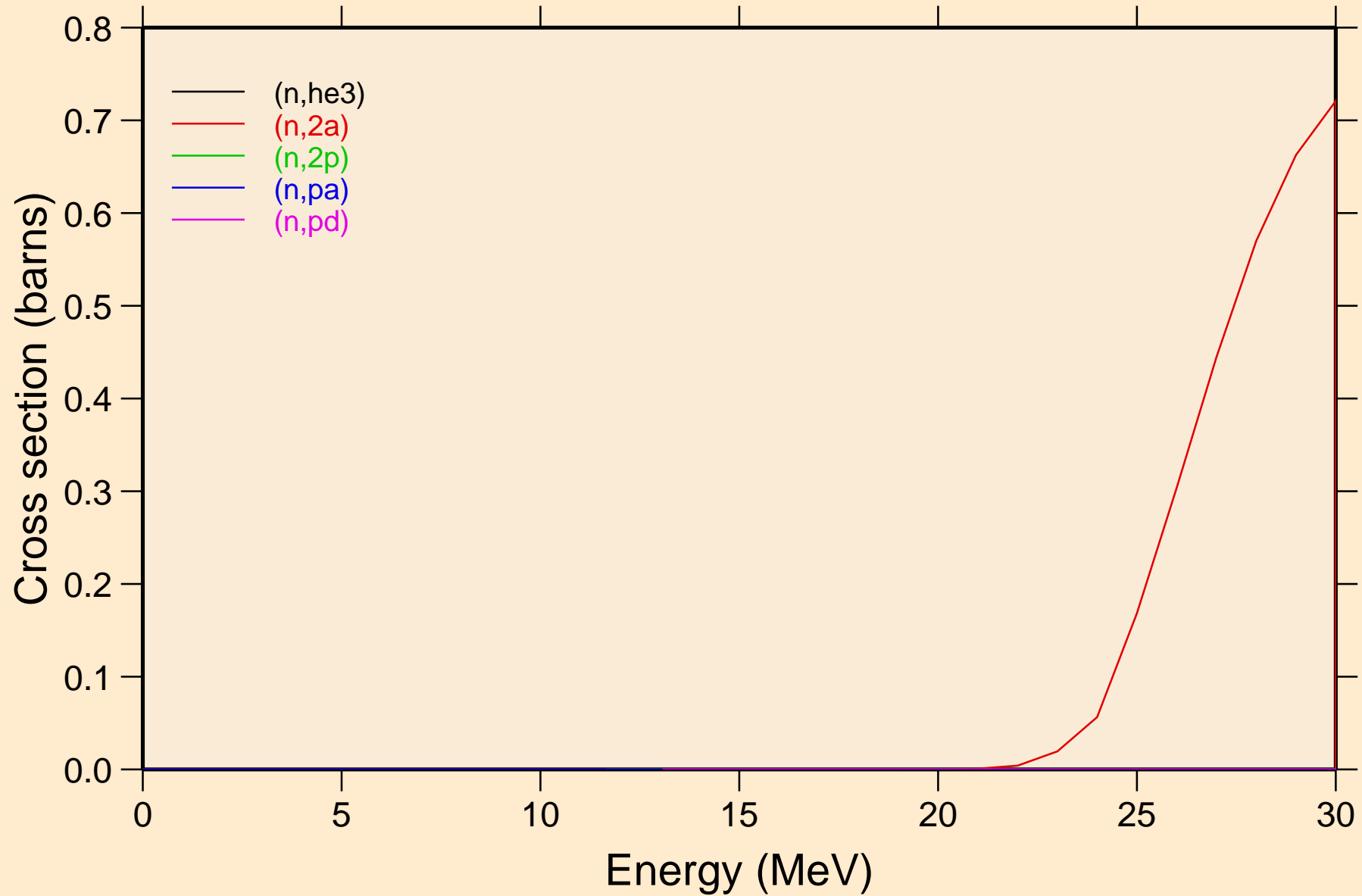

PA241 NEUTRON ACER TENDL-2021 LIBRARY; T=293.6K
Threshold reactions

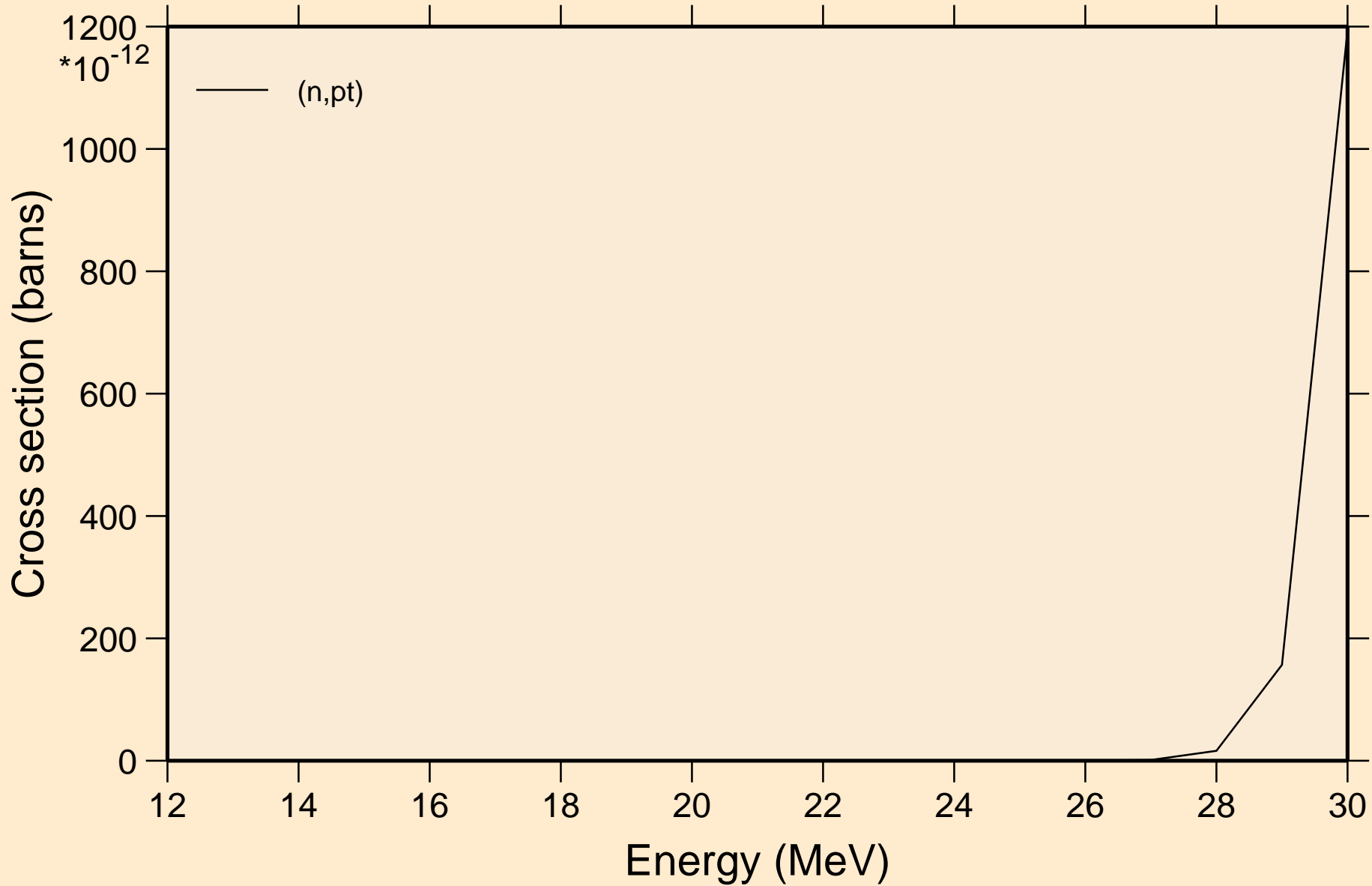

PA241 NEUTRON ACER TENDL-2021 LIBRARY; T=293.6K
Threshold reactions

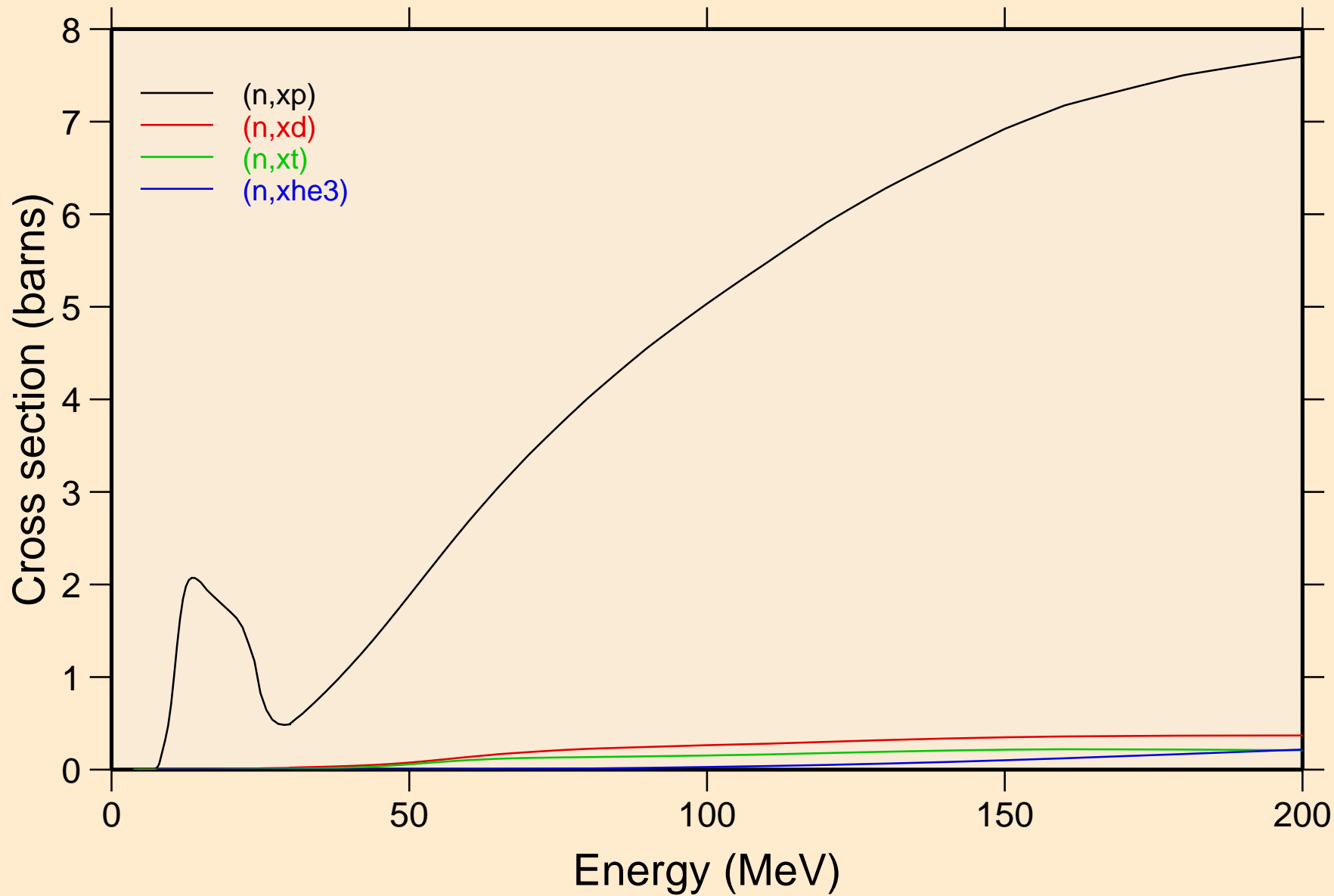

PA241 NEUTRON ACER TENDL-2021 LIBRARY; T=293.6K
angular distribution for elastic

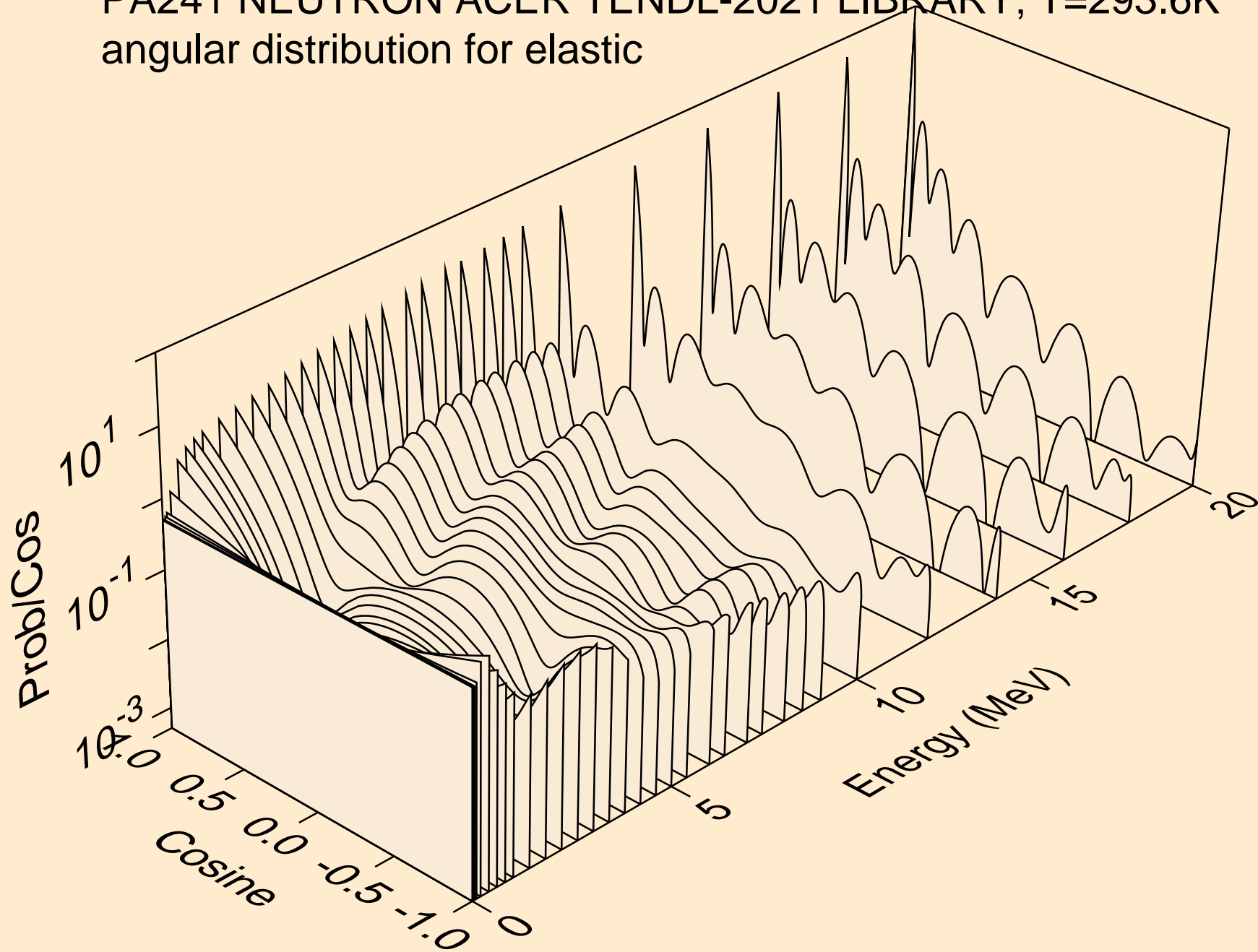

PA241 NEUTRON ACER TENDL-2021 LIBRARY; T=293.6K
angular distribution for elastic

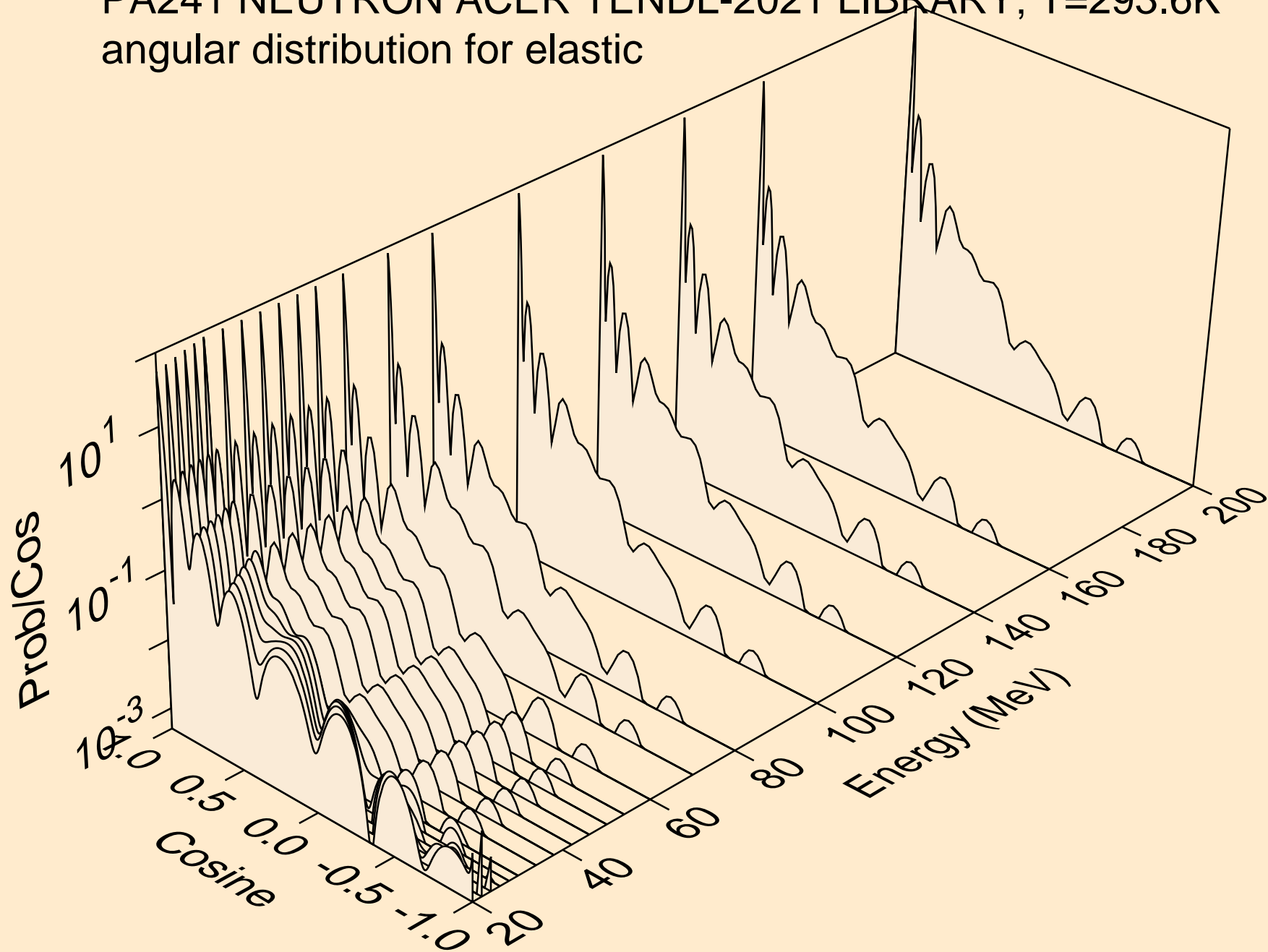

PA241 NEUTRON ACER TENDL-2021 LIBRARY; T=293.6K
angular distribution for (n,n*1)

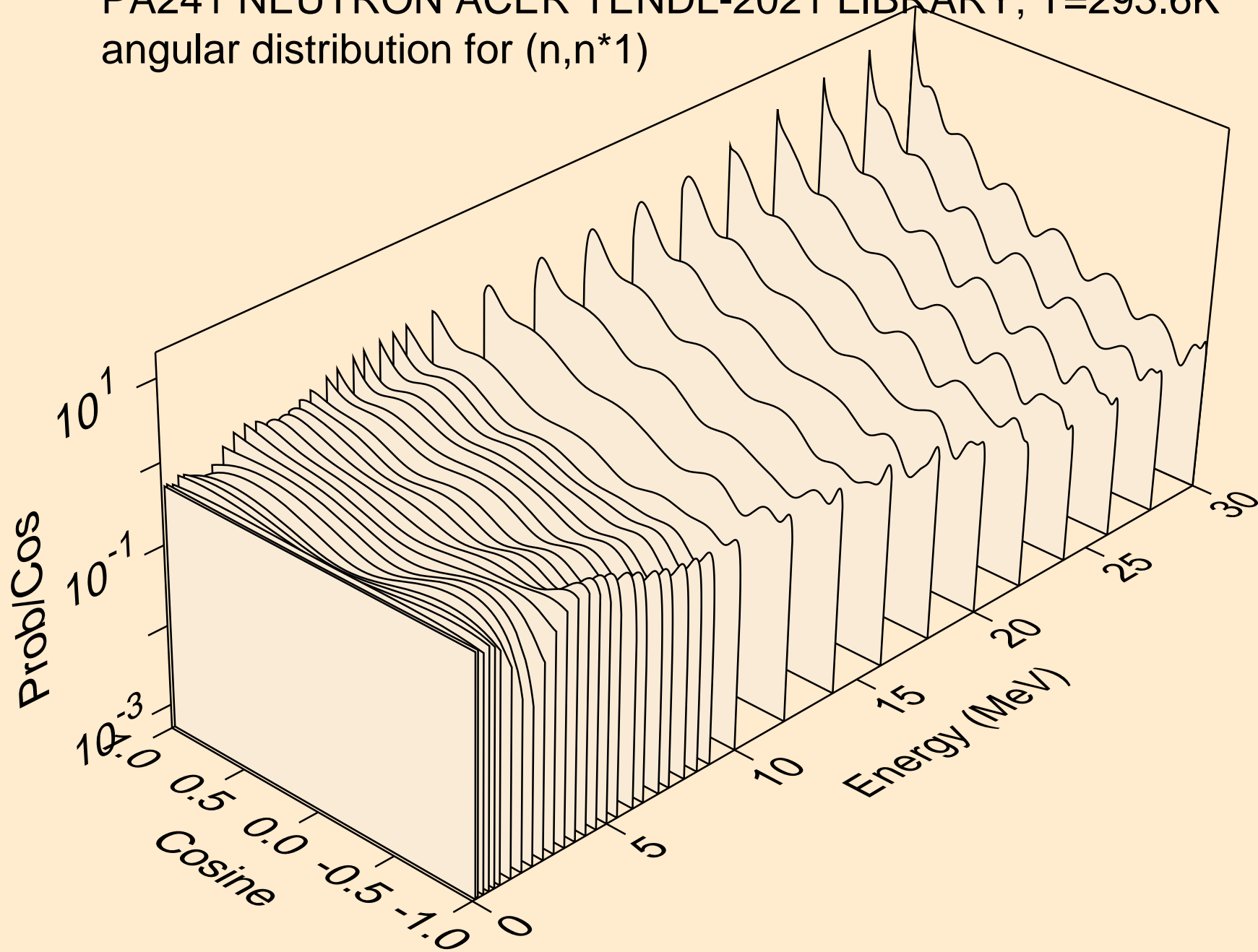

PA241 NEUTRON ACER TENDL-2021 LIBRARY; T=293.6K
Total fission nubar

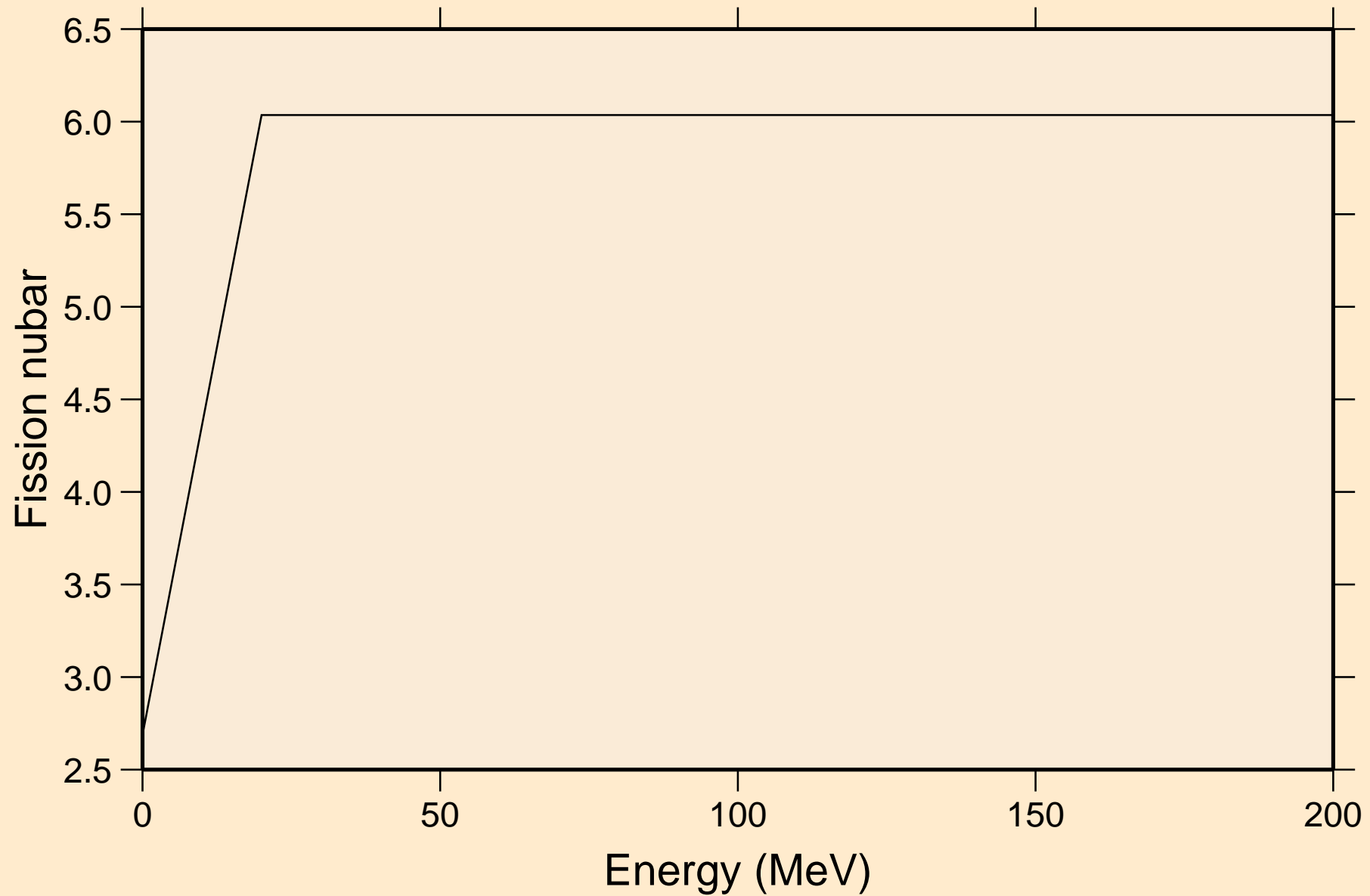

PA241 NEUTRON ACER TENDL-2021 LIBRARY; T=293.6K
Neutron emission for (n,x)

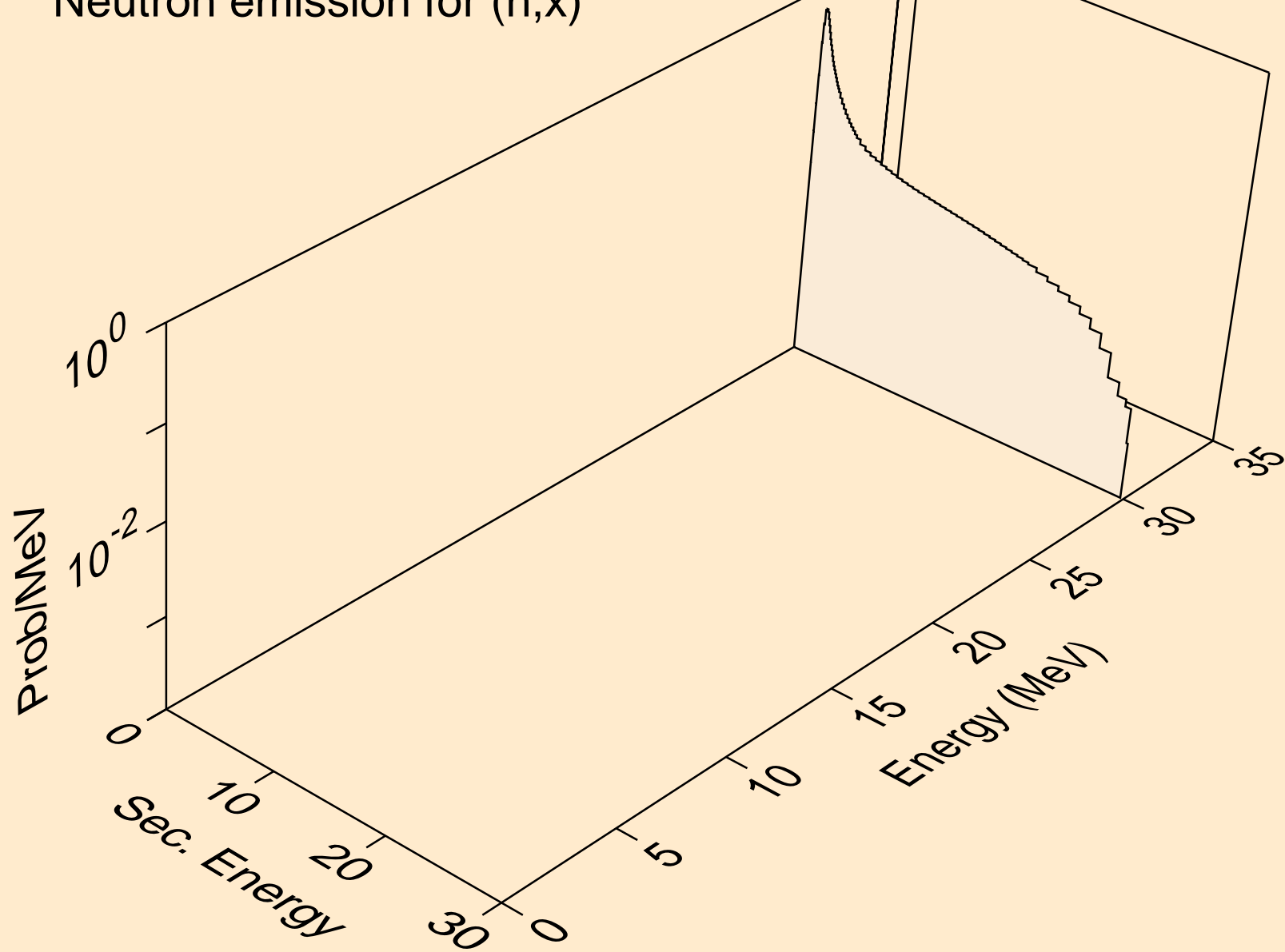

PA241 NEUTRON ACER TENDL-2021 LIBRARY; T=293.6K
Neutron emission for (n,2nd)

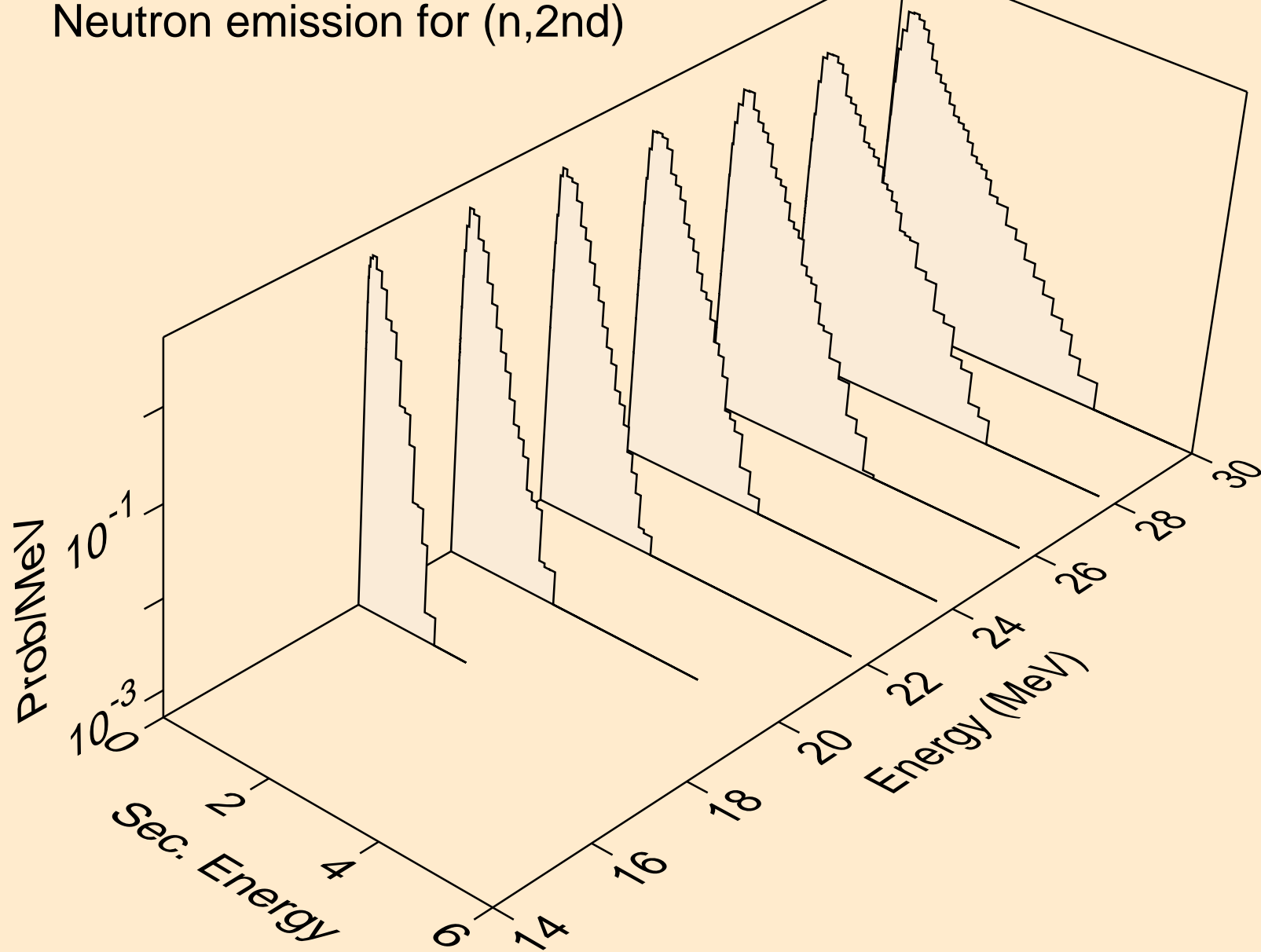

PA241 NEUTRON ACER TENDL-2021 LIBRARY; T=293.6K
Neutron emission for (n,2n)

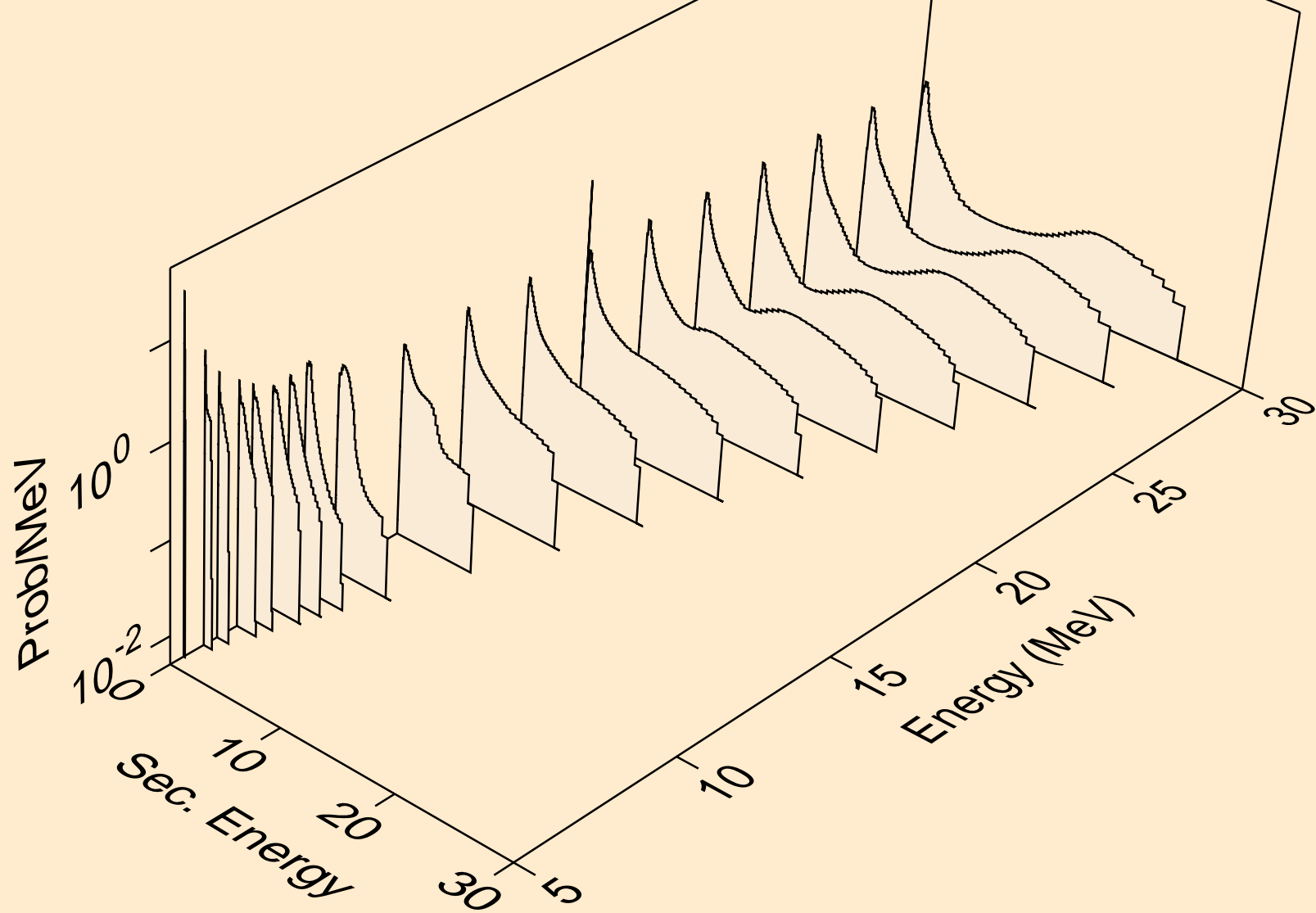

PA241 NEUTRON ACER TENDL-2021 LIBRARY; T=293.6K
Neutron emission for (n,3n)

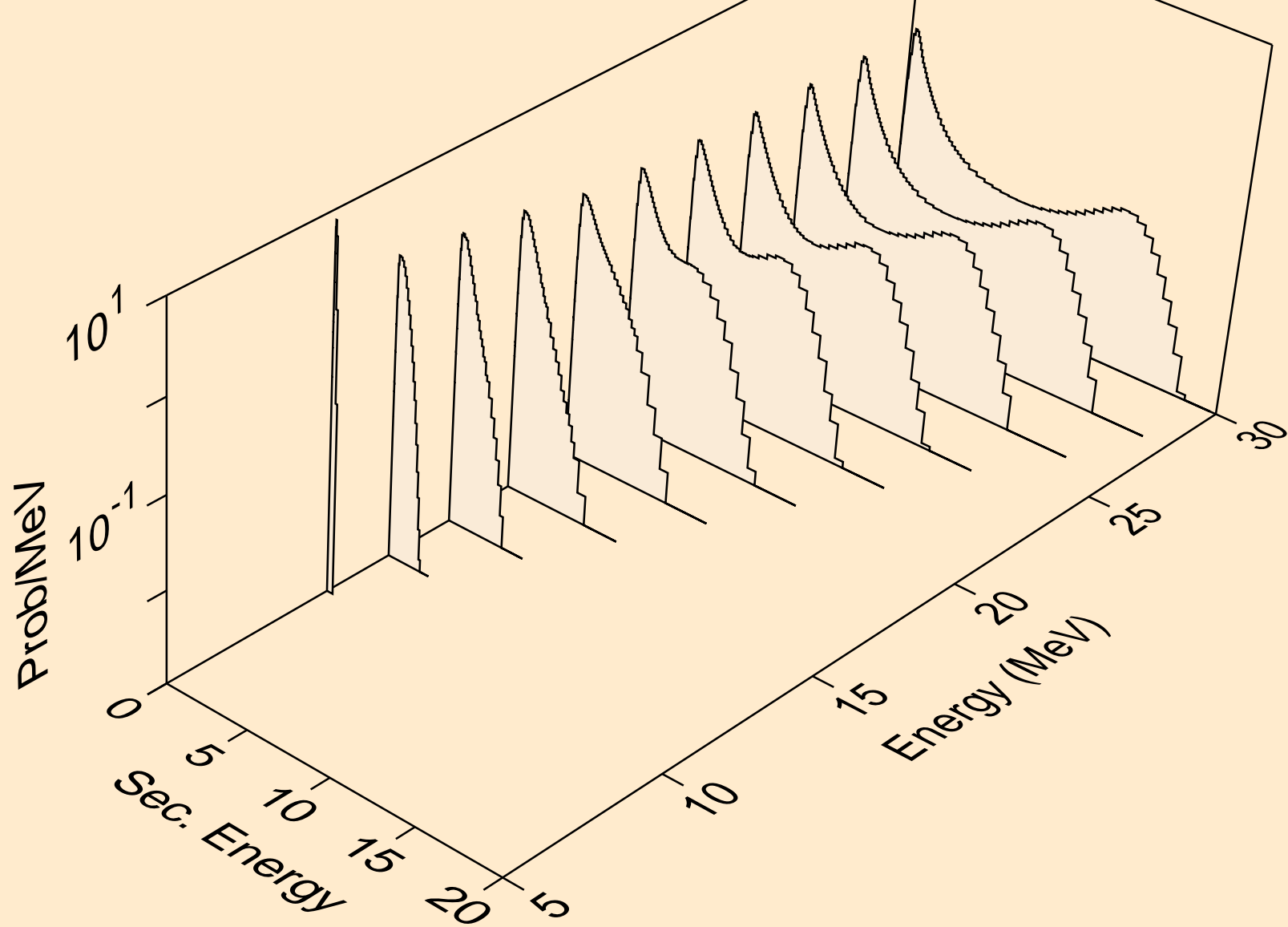

PA241 NEUTRON ACER TENDL-2021 LIBRARY; T=293.6K
Neutron emission for fission

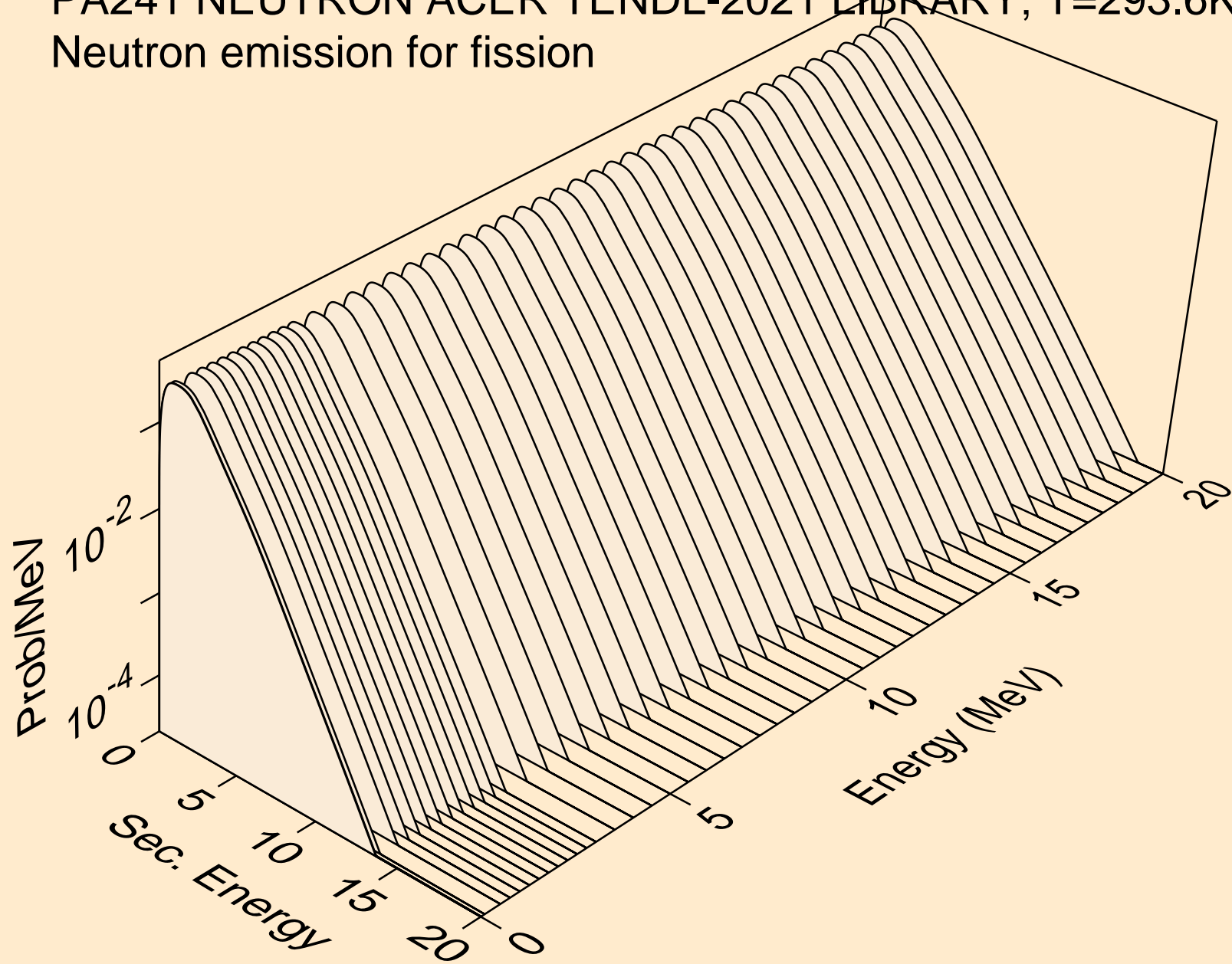

PA241 NEUTRON ACER TENDL-2021 LIBRARY; T=293.6K
Neutron emission for (n,n*)a

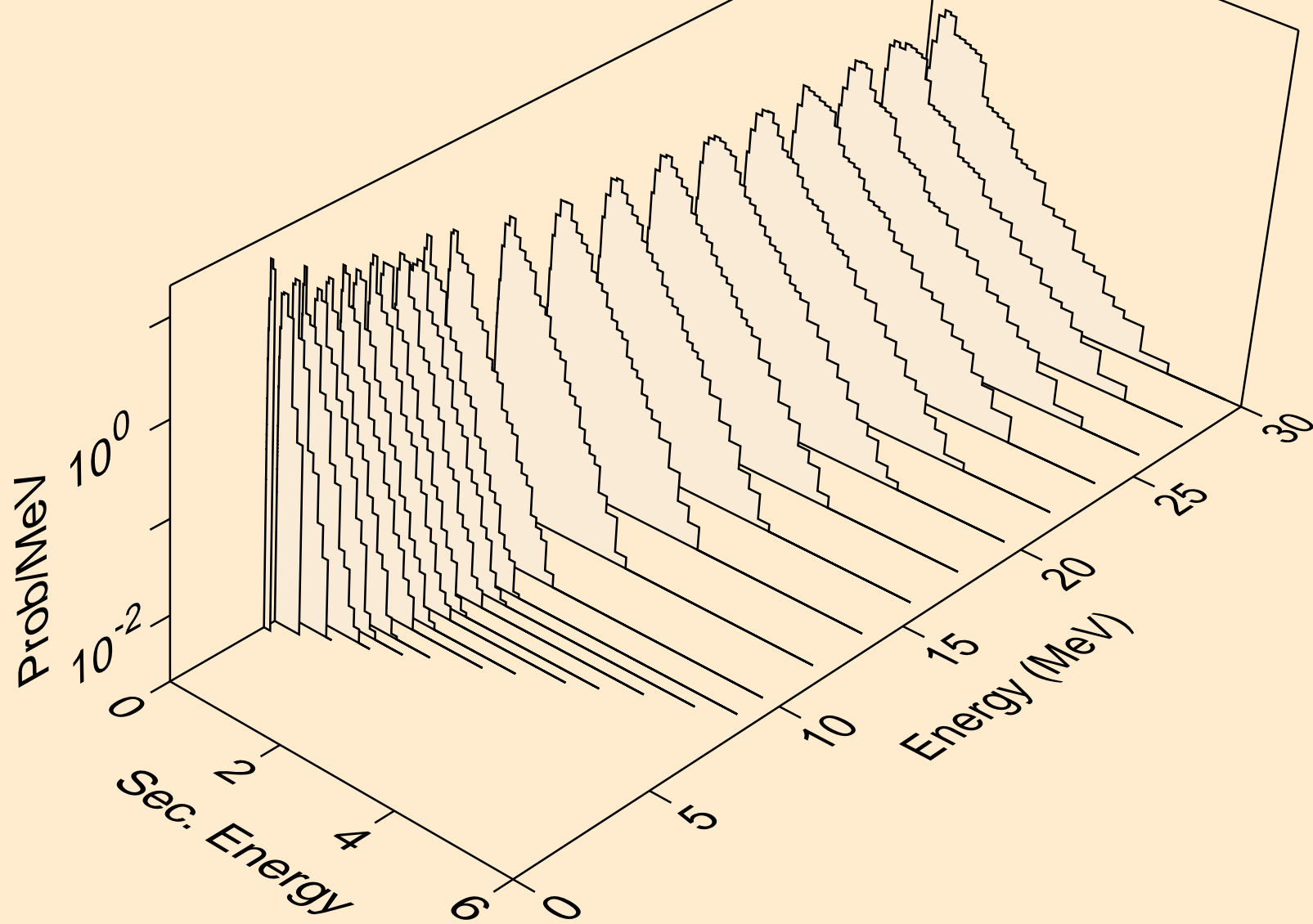

PA241 NEUTRON ACER TENDL-2021 LIBRARY; T=293.6K
Neutron emission for (n,2n)_a

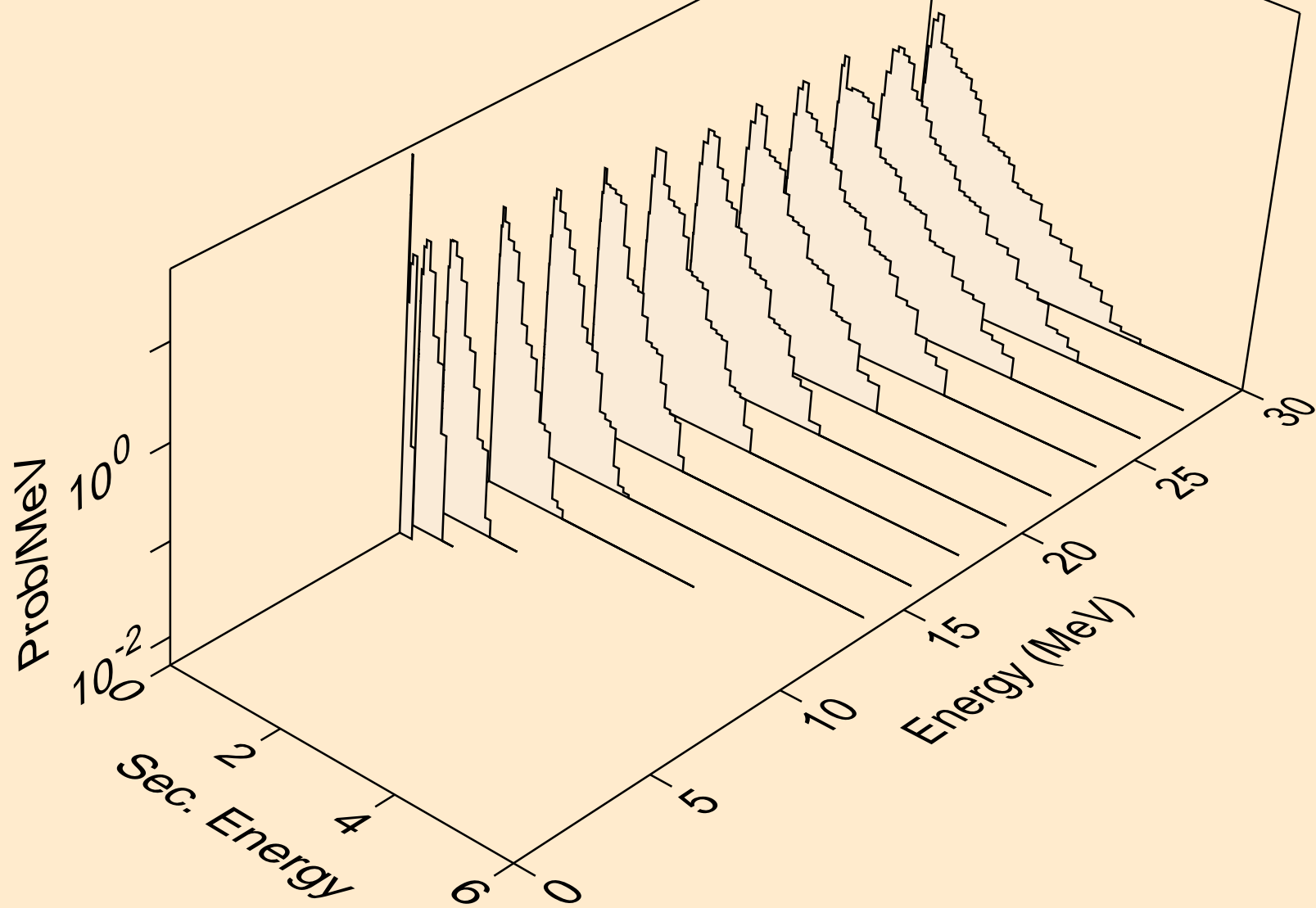

PA241 NEUTRON ACER TENDL-2021 LIBRARY; T=293.6K
Neutron emission for (n,3n)a

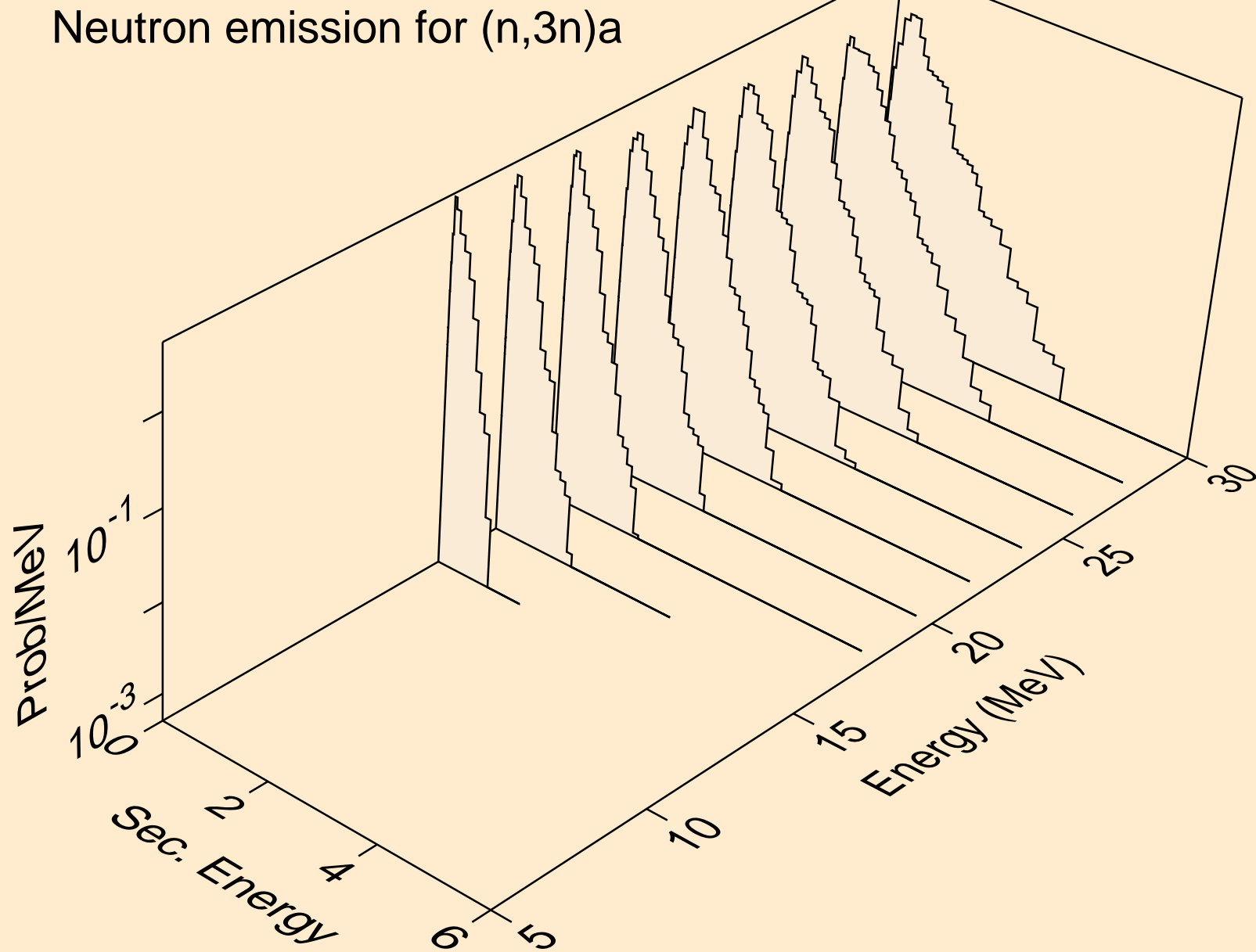

PA241 NEUTRON ACER TENDL-2021 LIBRARY; T=293.6K
Neutron emission for (n,n*)p

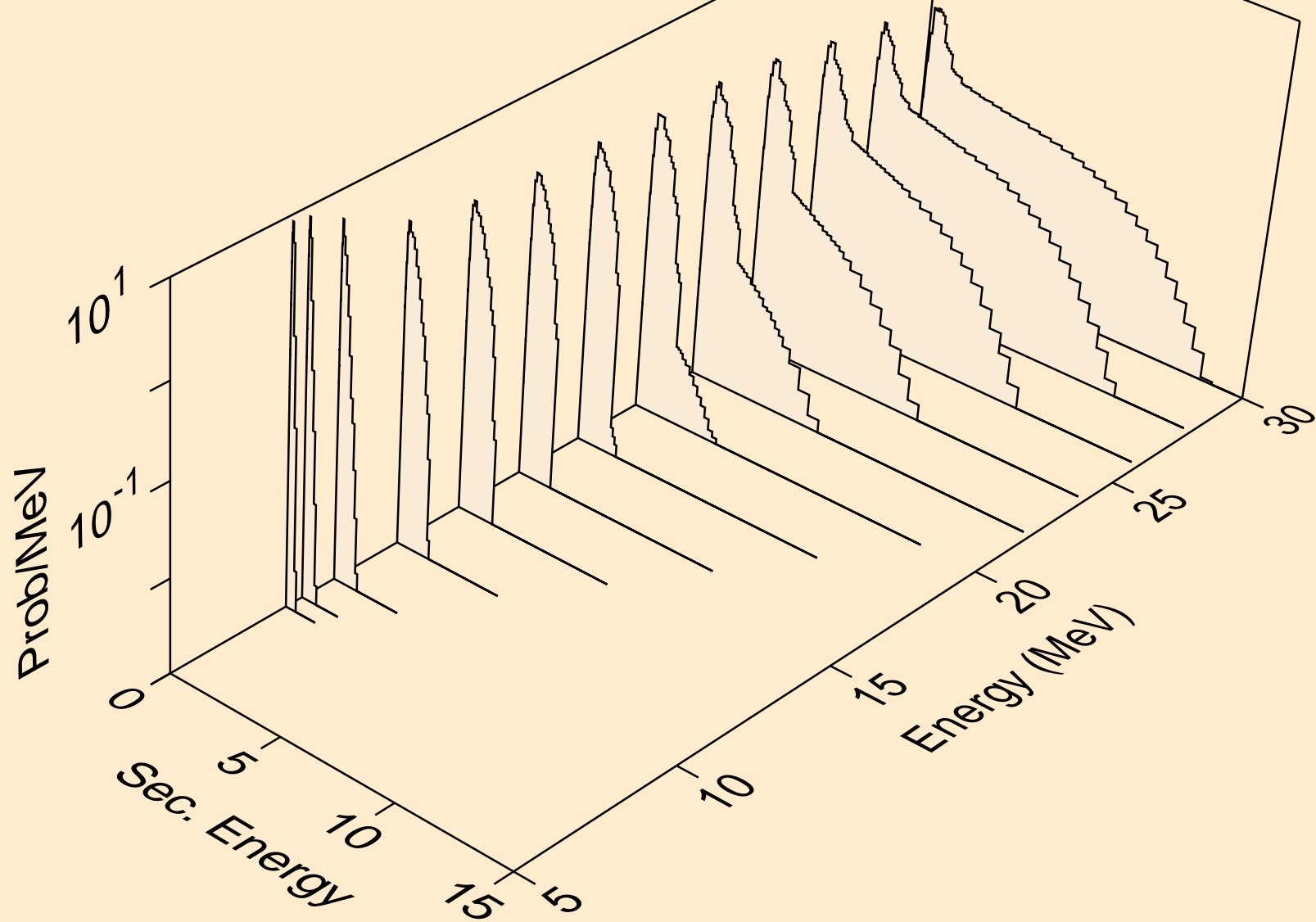

PA241 NEUTRON ACER TENDL-2021 LIBRARY; T=293.6K
Neutron emission for (n,n*)2a

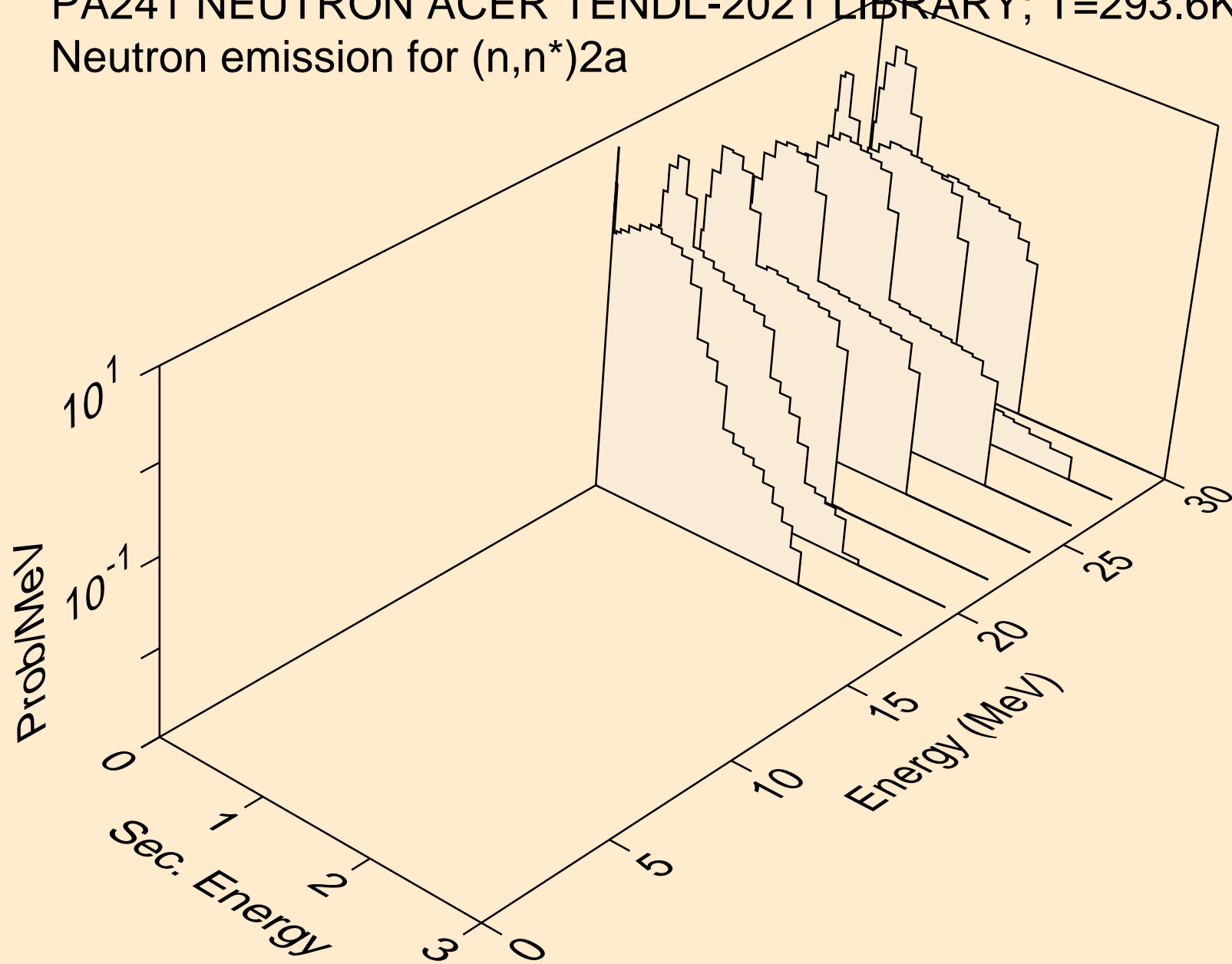

PA241 NEUTRON ACER TENDL-2021 LIBRARY; T=293.6K
Neutron emission for (n,n*)d

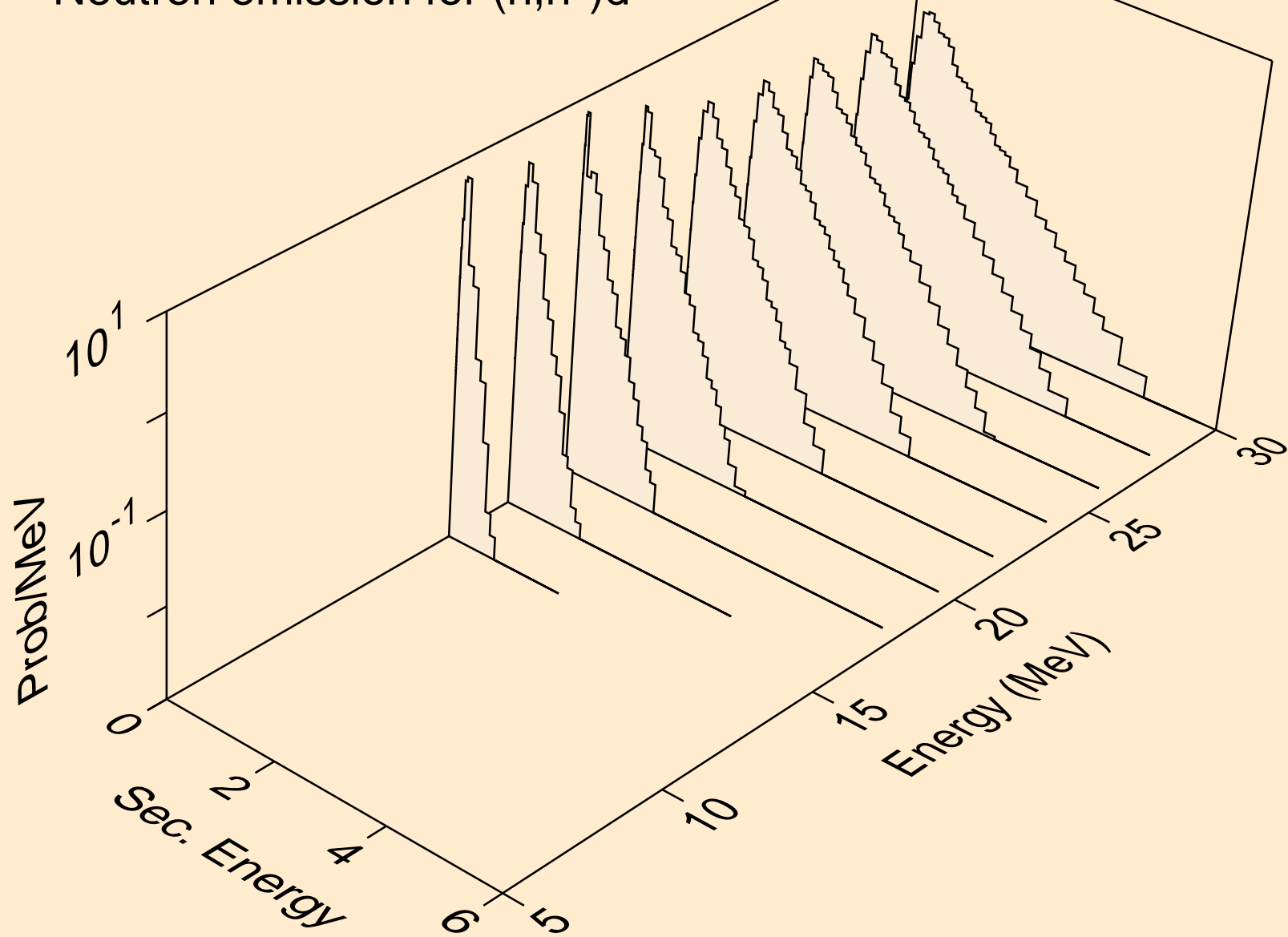

PA241 NEUTRON ACER TENDL-2021 LIBRARY; T=293.6K
Neutron emission for (n,n*)t

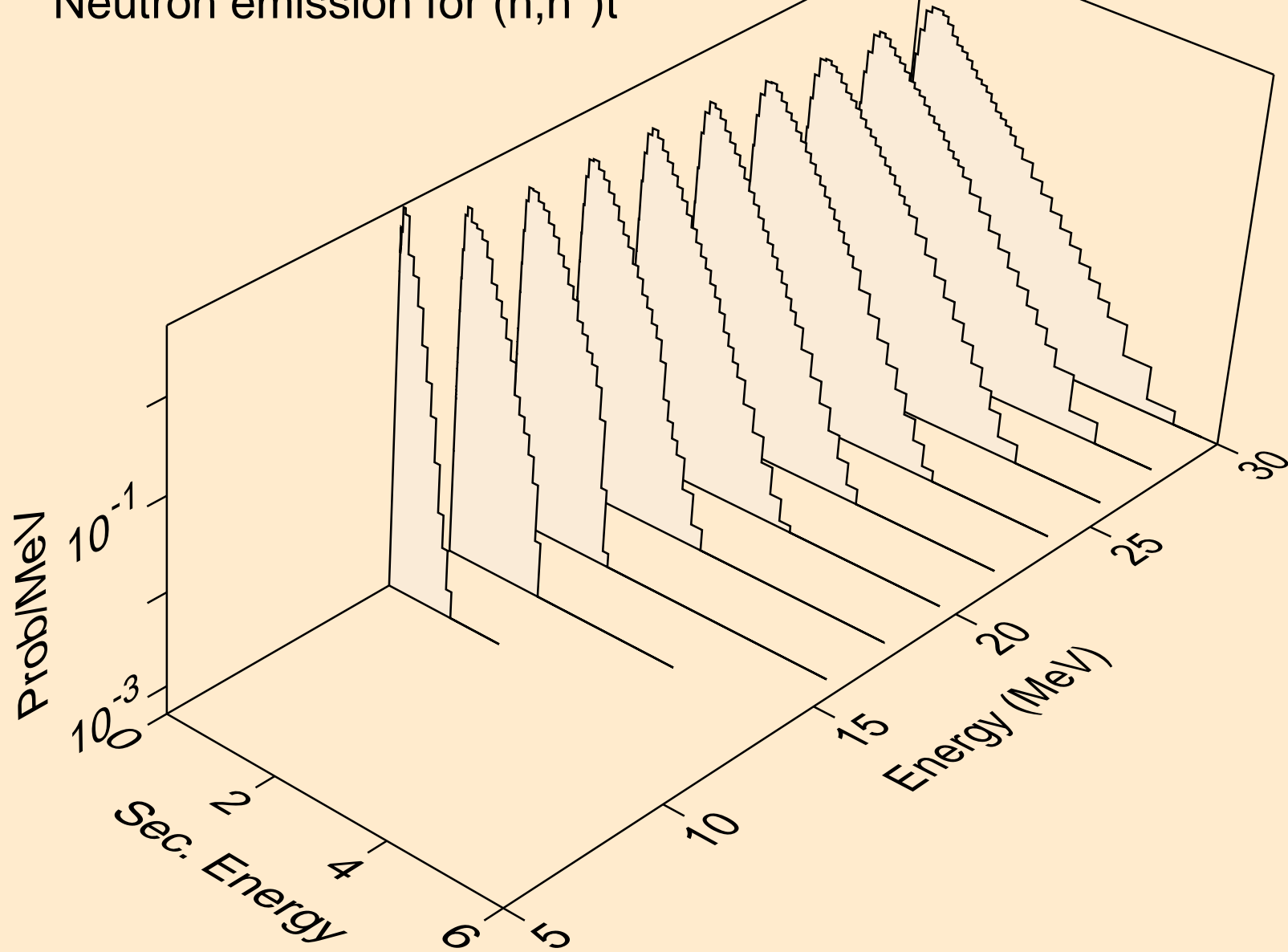

PA241 NEUTRON ACER TENDL-2021 LIBRARY; T=293.6K
Neutron emission for (n,n*)he3

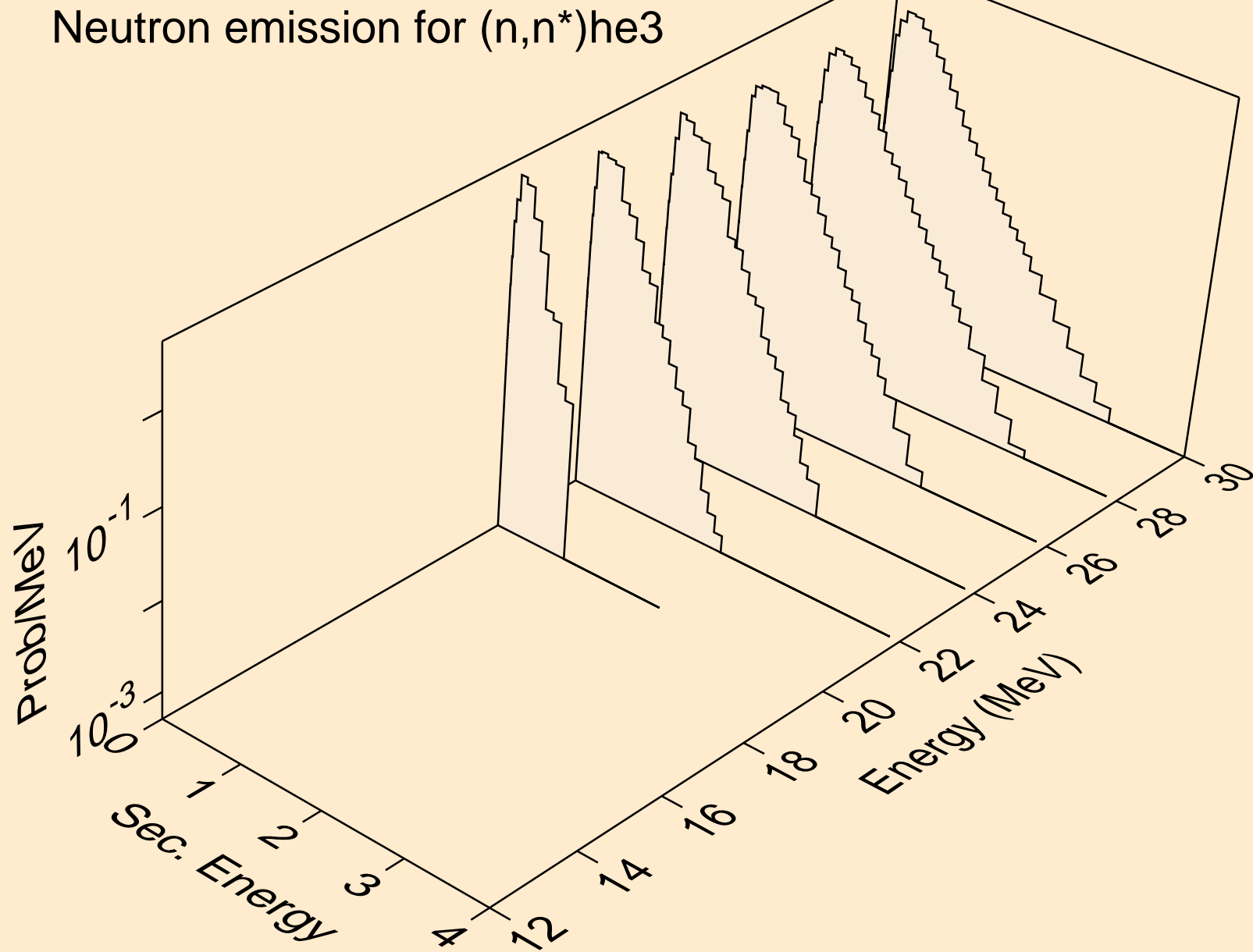

PA241 NEUTRON ACER TENDL-2021 LIBRARY; T=293.6K
Neutron emission for (n,4n)

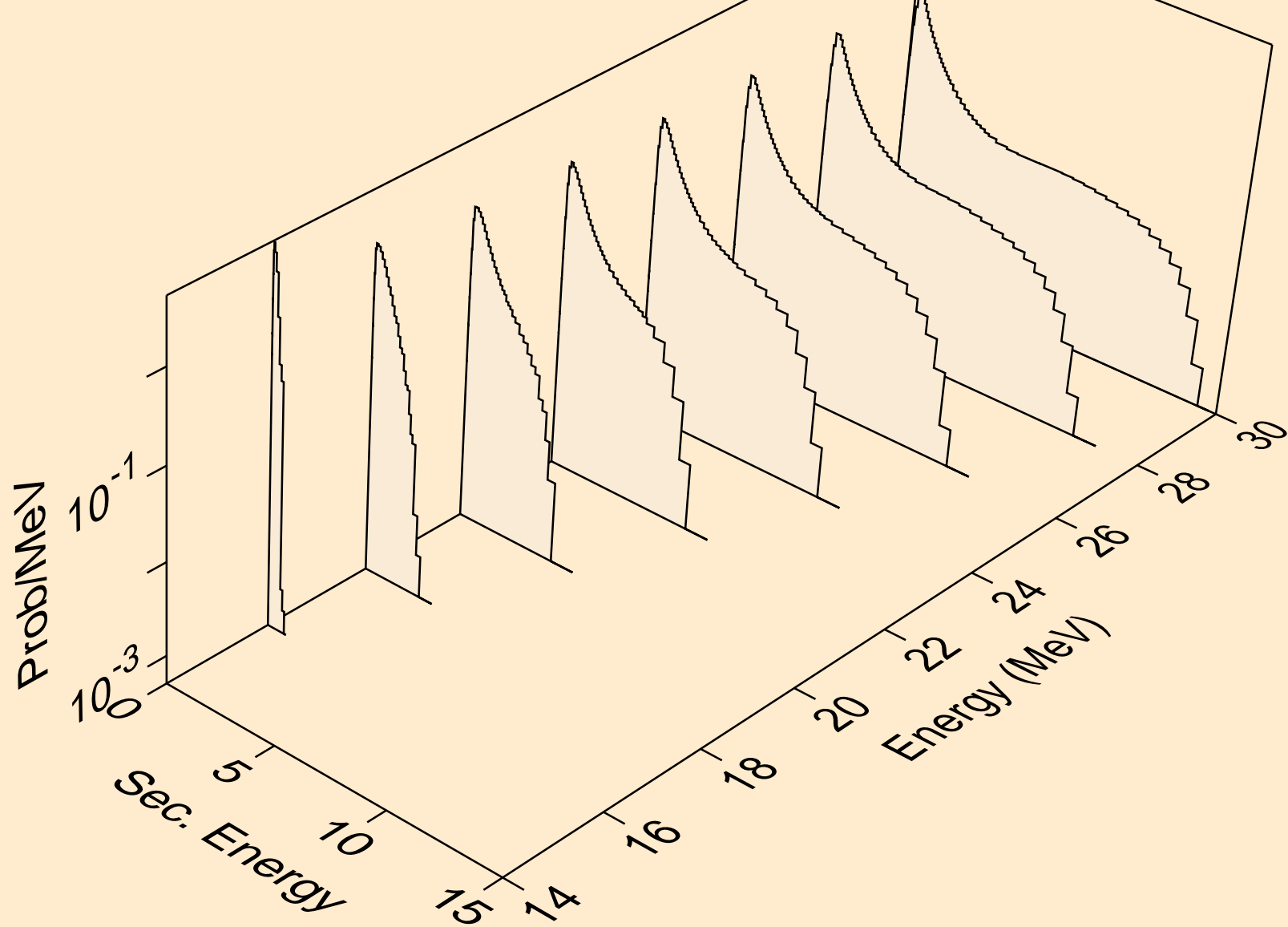

PA241 NEUTRON ACER TENDL-2021 LIBRARY; T=293.6K
Neutron emission for (n,2np)

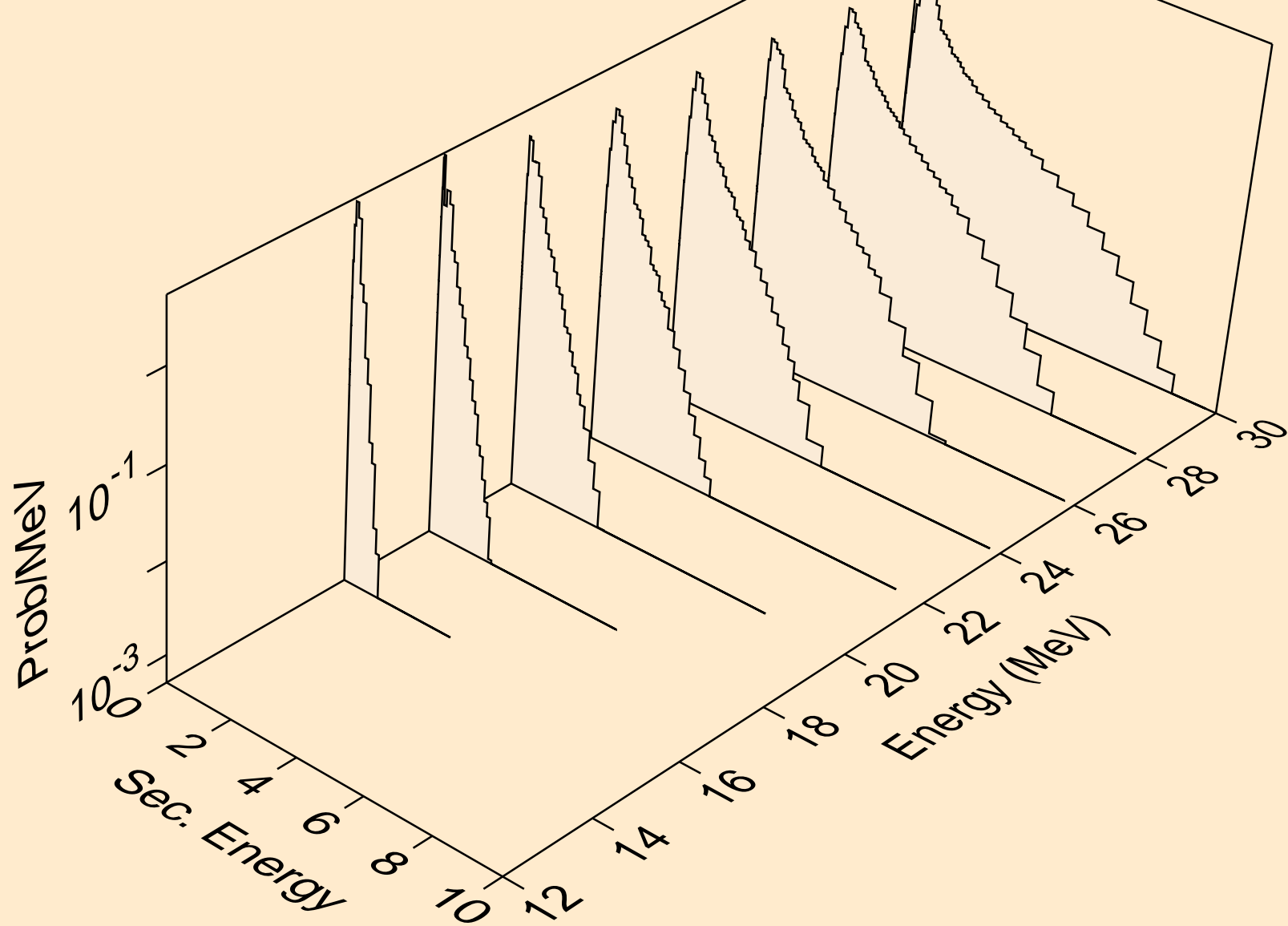

PA241 NEUTRON ACER TENDL-2021 LIBRARY; T=293.6K
Neutron emission for (n,3np)

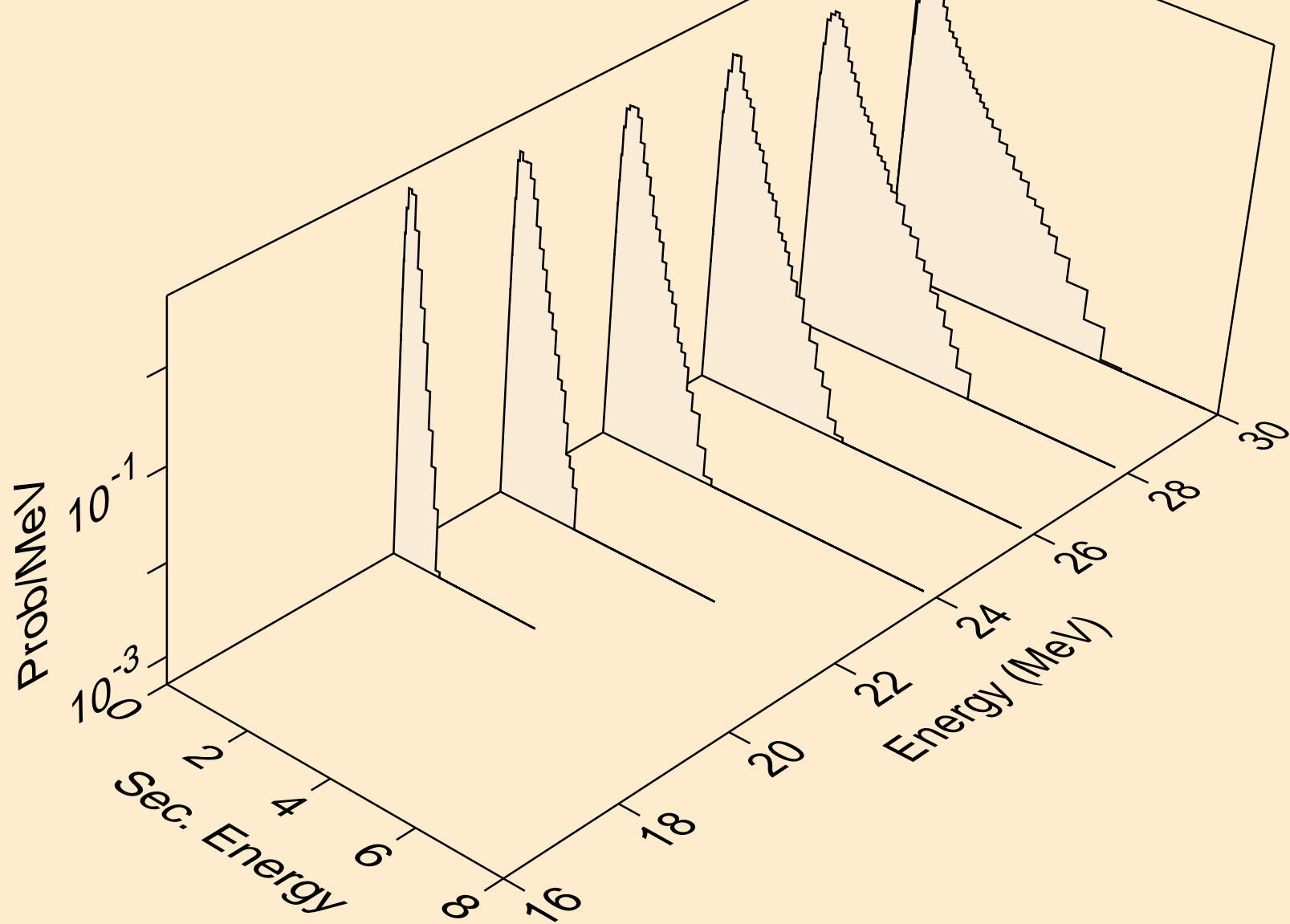

PA241 NEUTRON ACER TENDL-2021 LIBRARY; T=293.6K
Neutron emission for (n,npa)

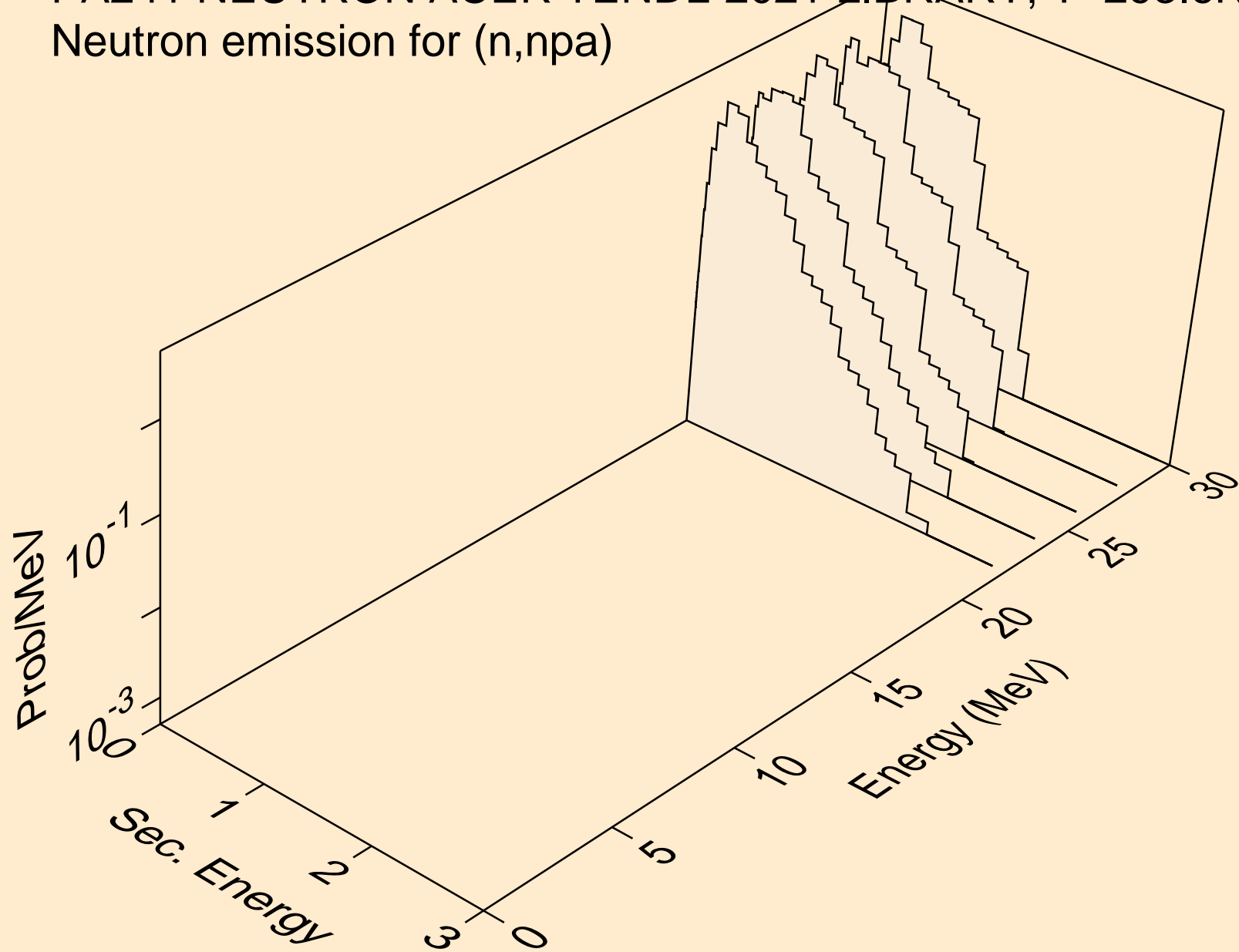

PA241 NEUTRON ACER TENDL-2021 LIBRARY; T=293.6K
Neutron emission for (n,n*c)

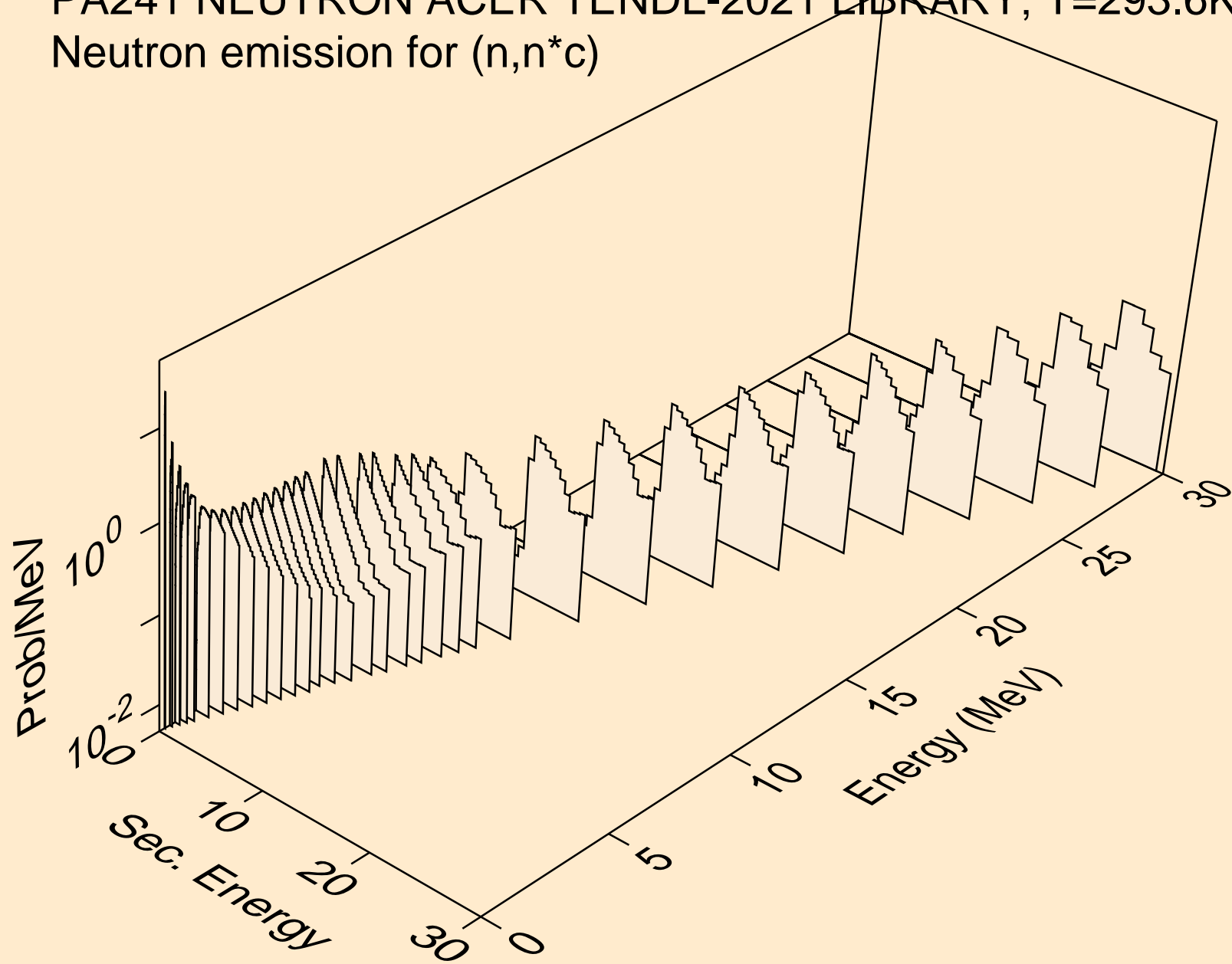

PA241 NEUTRON ACER TENDL-2021 LIBRARY; T=293.6K

Delayed nubar

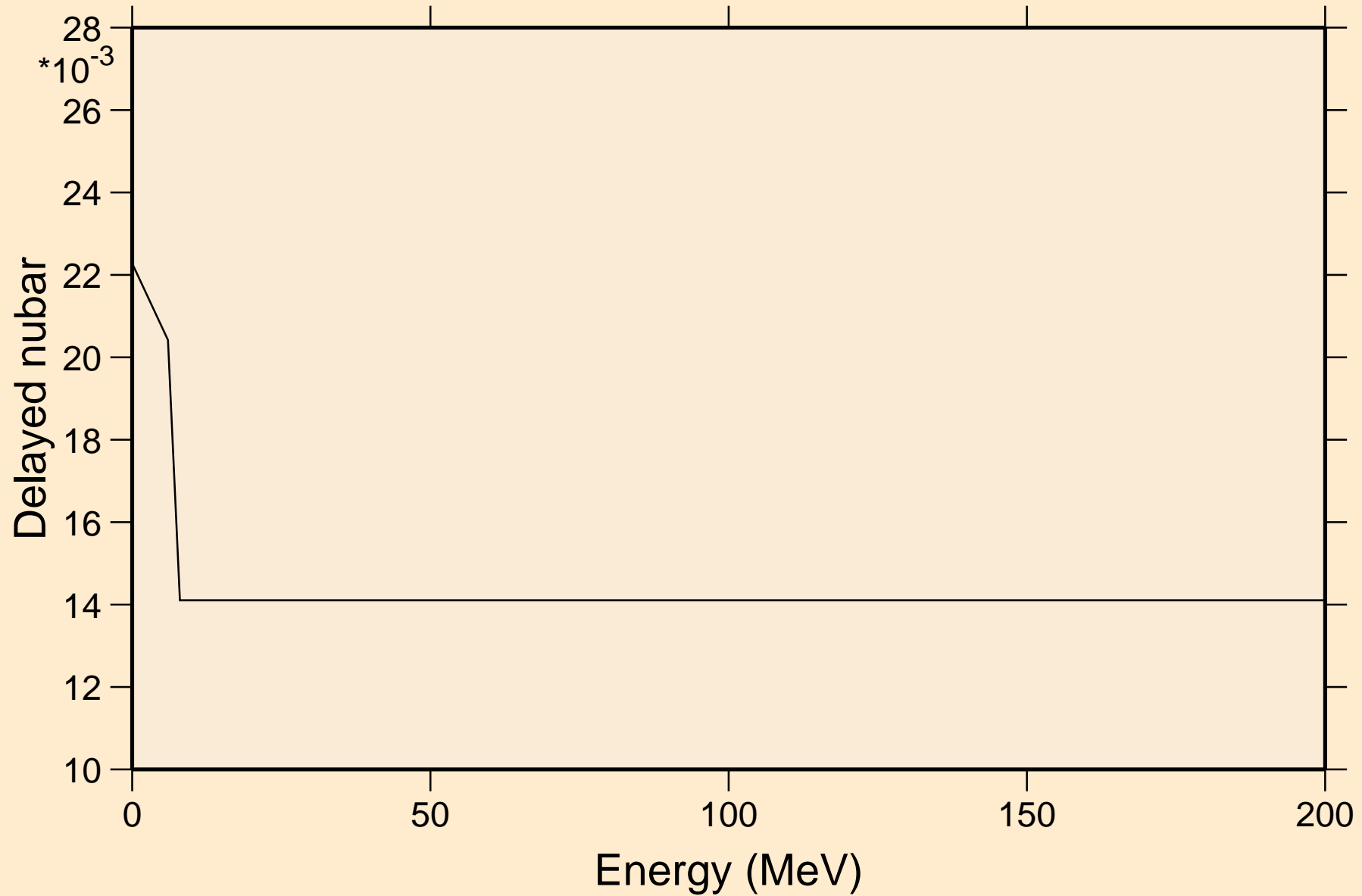

PA241 NEUTRON ACER TENDL-2021 LIBRARY; T=293.6K

Delayed neutron spectra

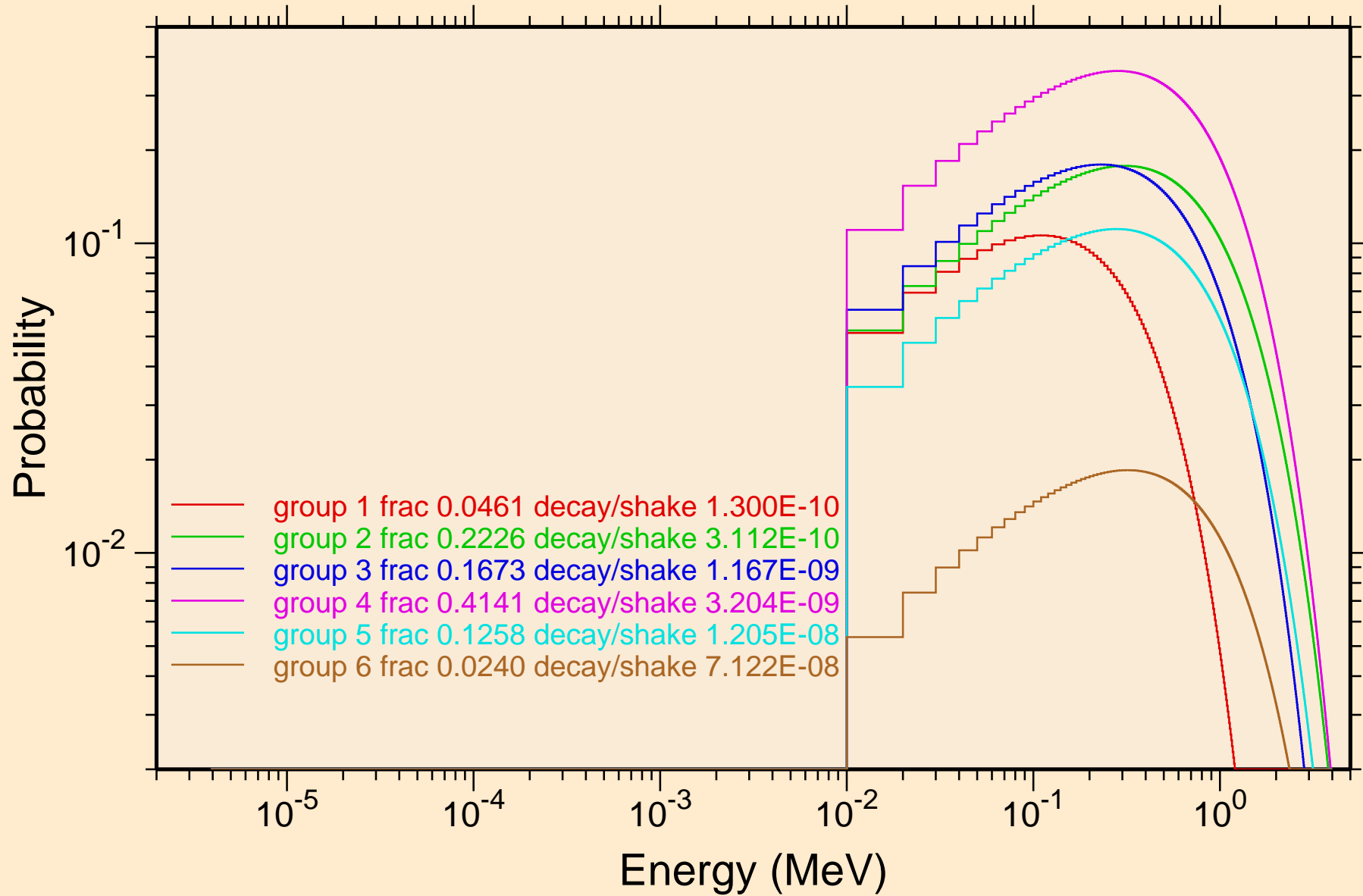

PA241 NEUTRON ACER TENDL-2021 LIBRARY; T=293.6K
Photon emission for (n,x)

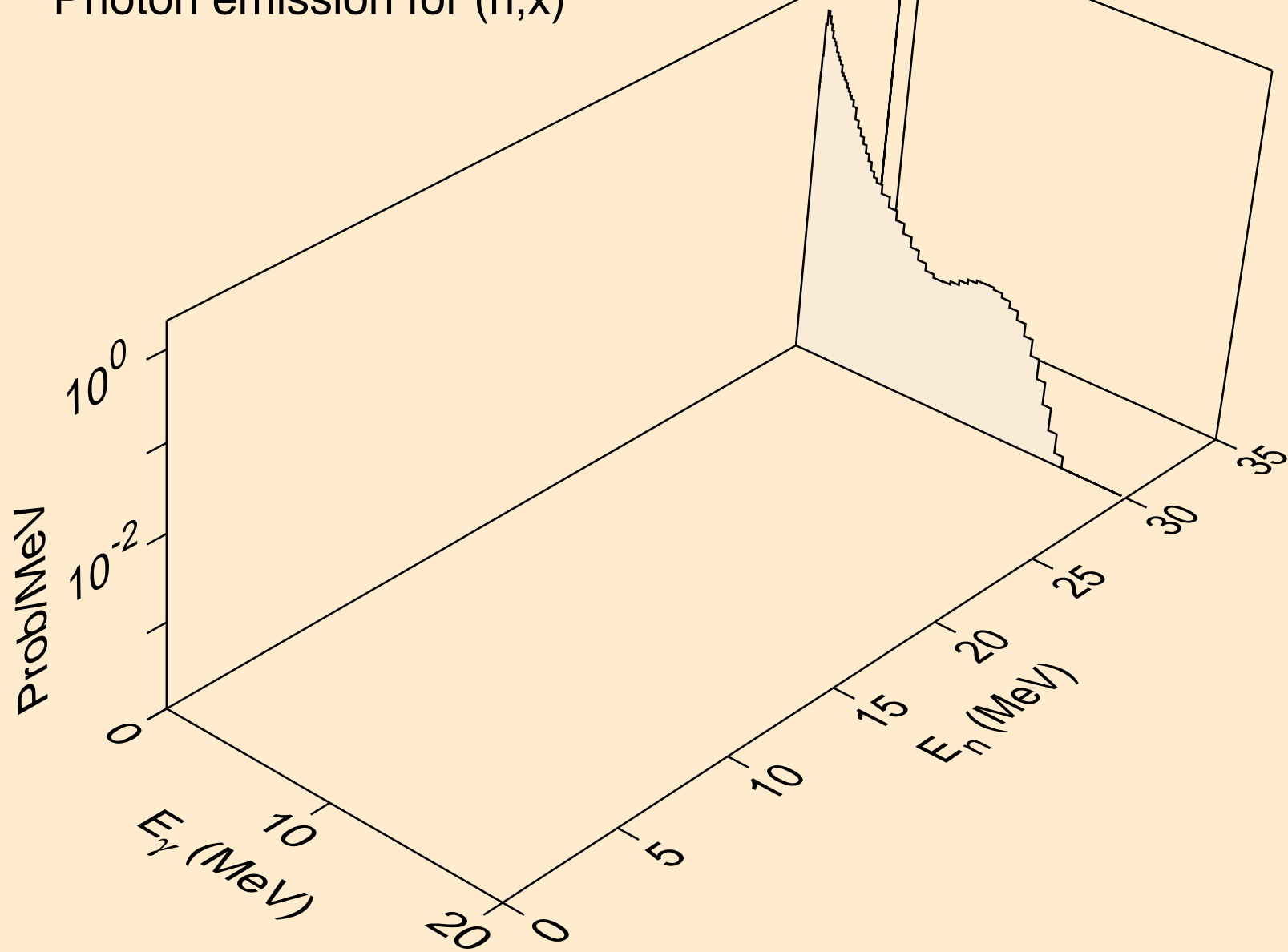

PA241 NEUTRON ACER TENDL-2021 LIBRARY; T=293.6K
Photon emission for (n,2nd)

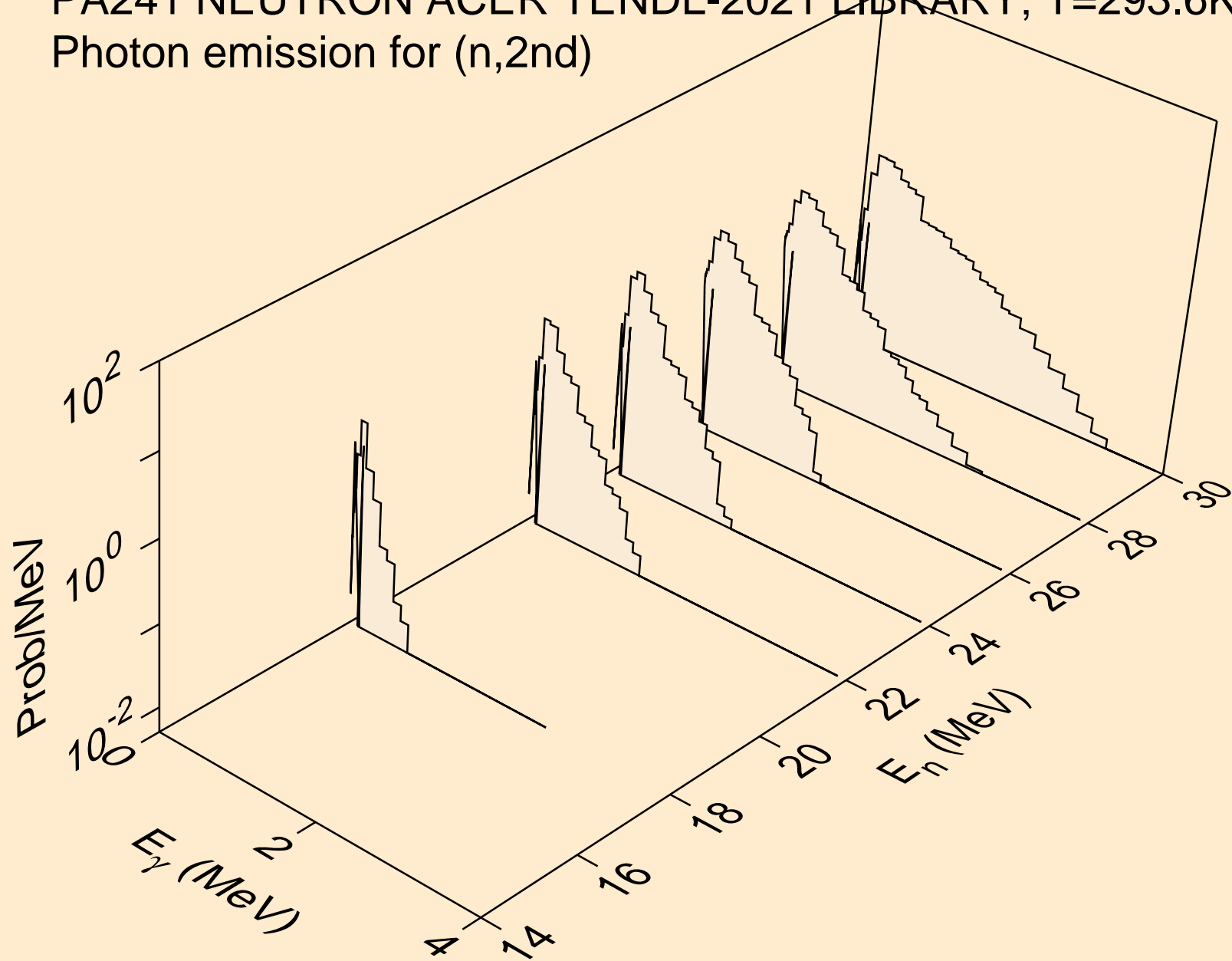

PA241 NEUTRON ACER TENDL-2021 LIBRARY; T=293.6K
Photon emission for (n,2n)

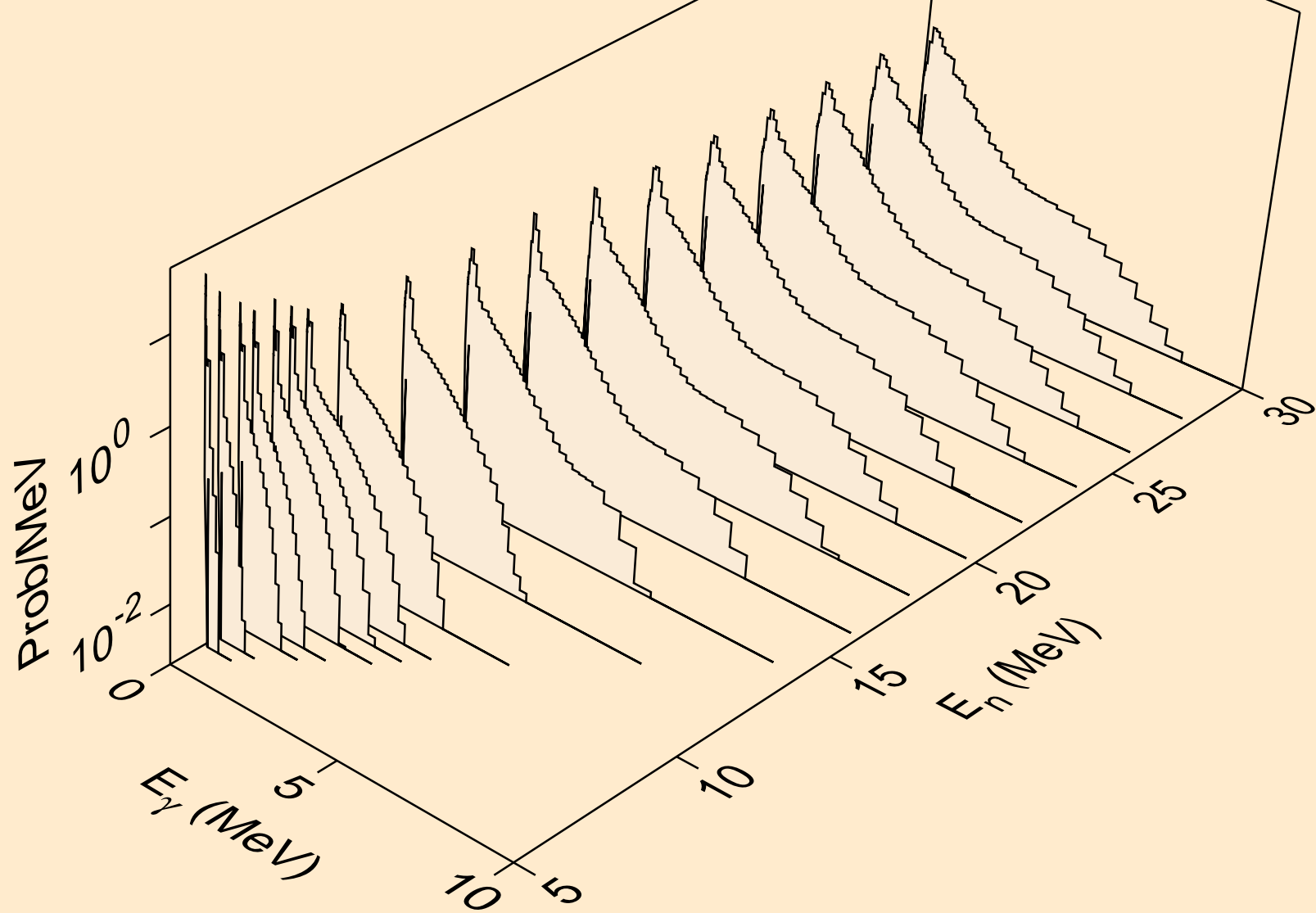

PA241 NEUTRON ACER TENDL-2021 LIBRARY; T=293.6K
Photon emission for (n,3n)

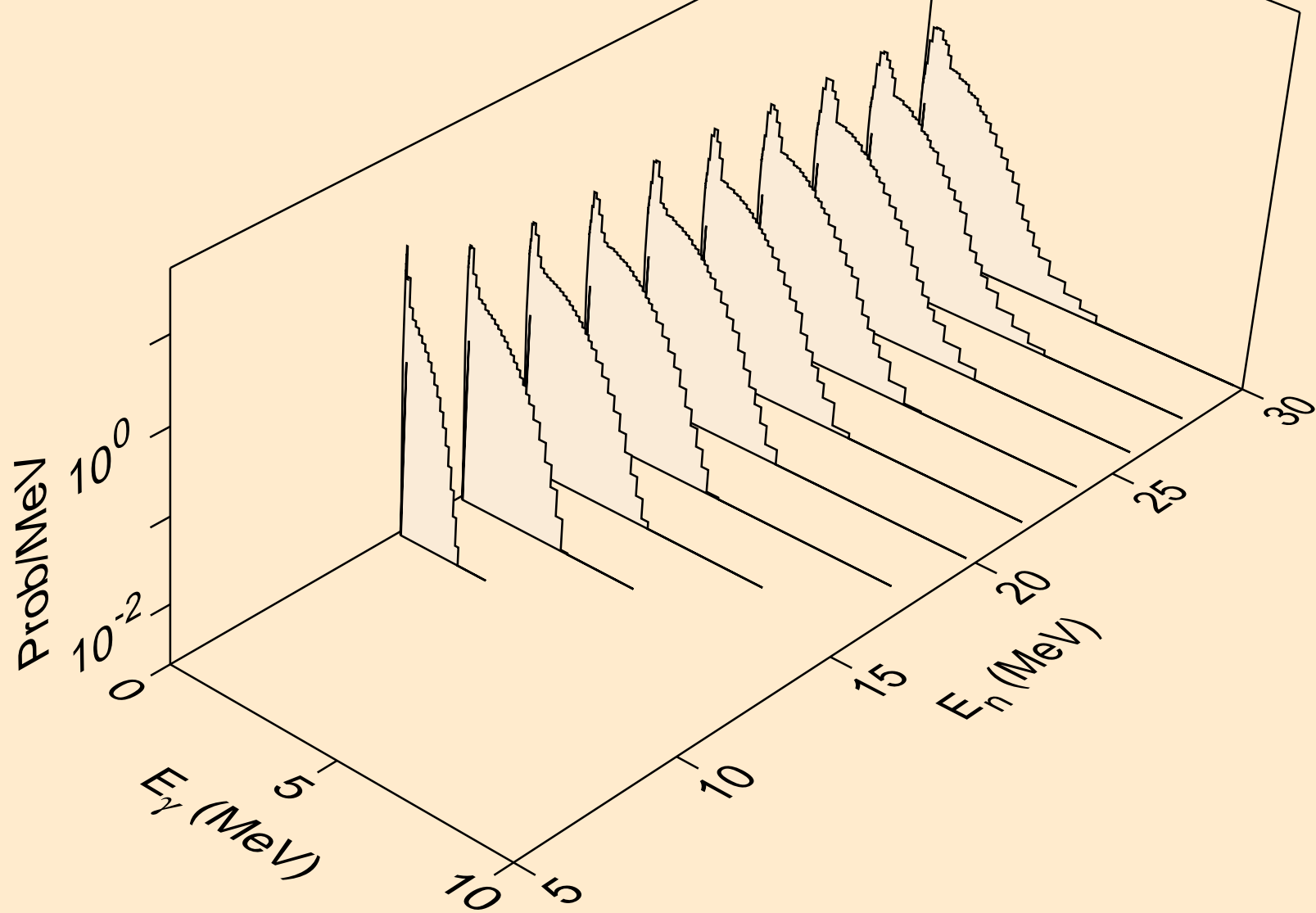

PA241 NEUTRON ACER TENDL-2021 LIBRARY; T=293.6K
Photon emission for (n,n*)a

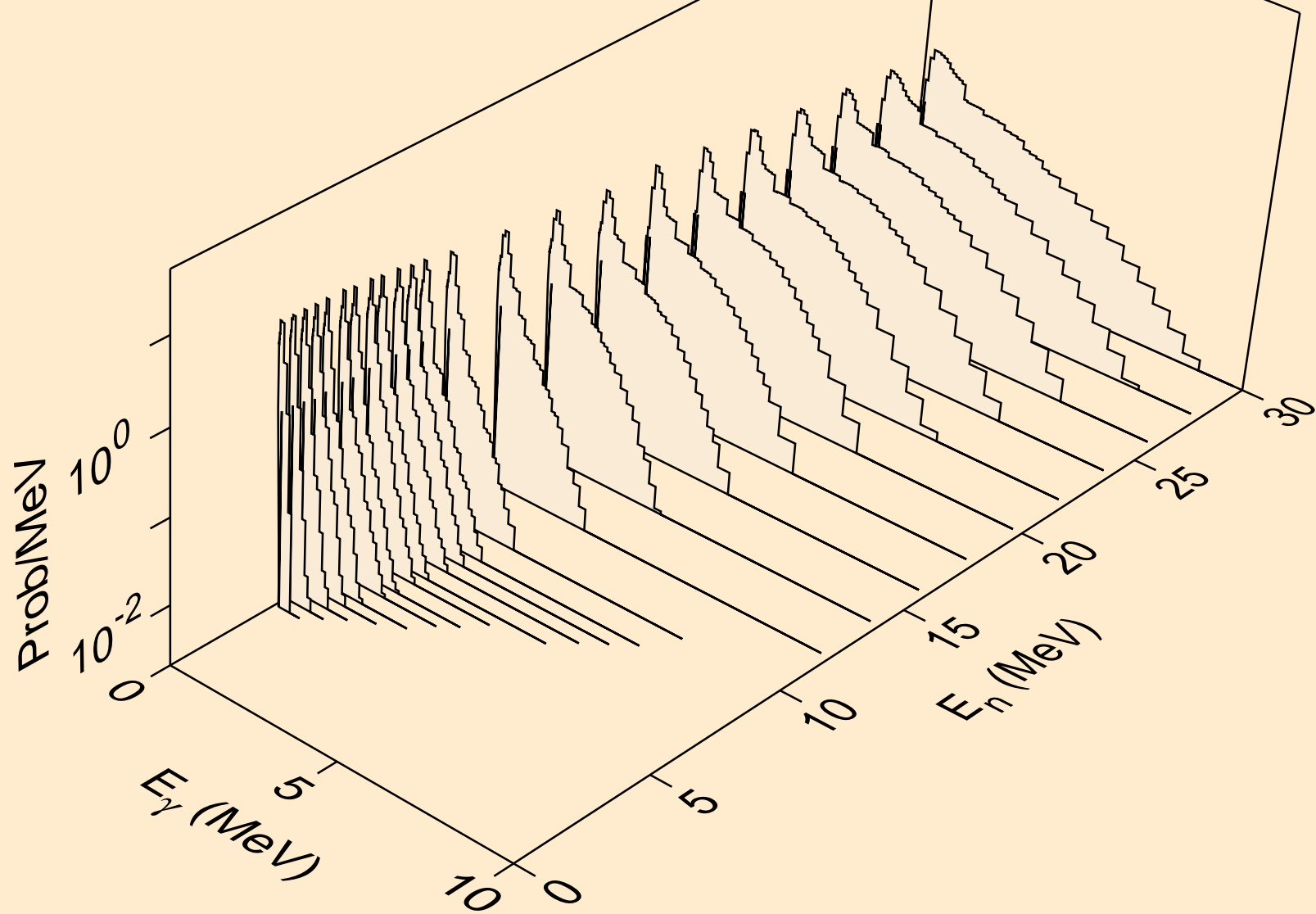

PA241 NEUTRON ACER TENDL-2021 LIBRARY; T=293.6K
Photon emission for (n,2n)a

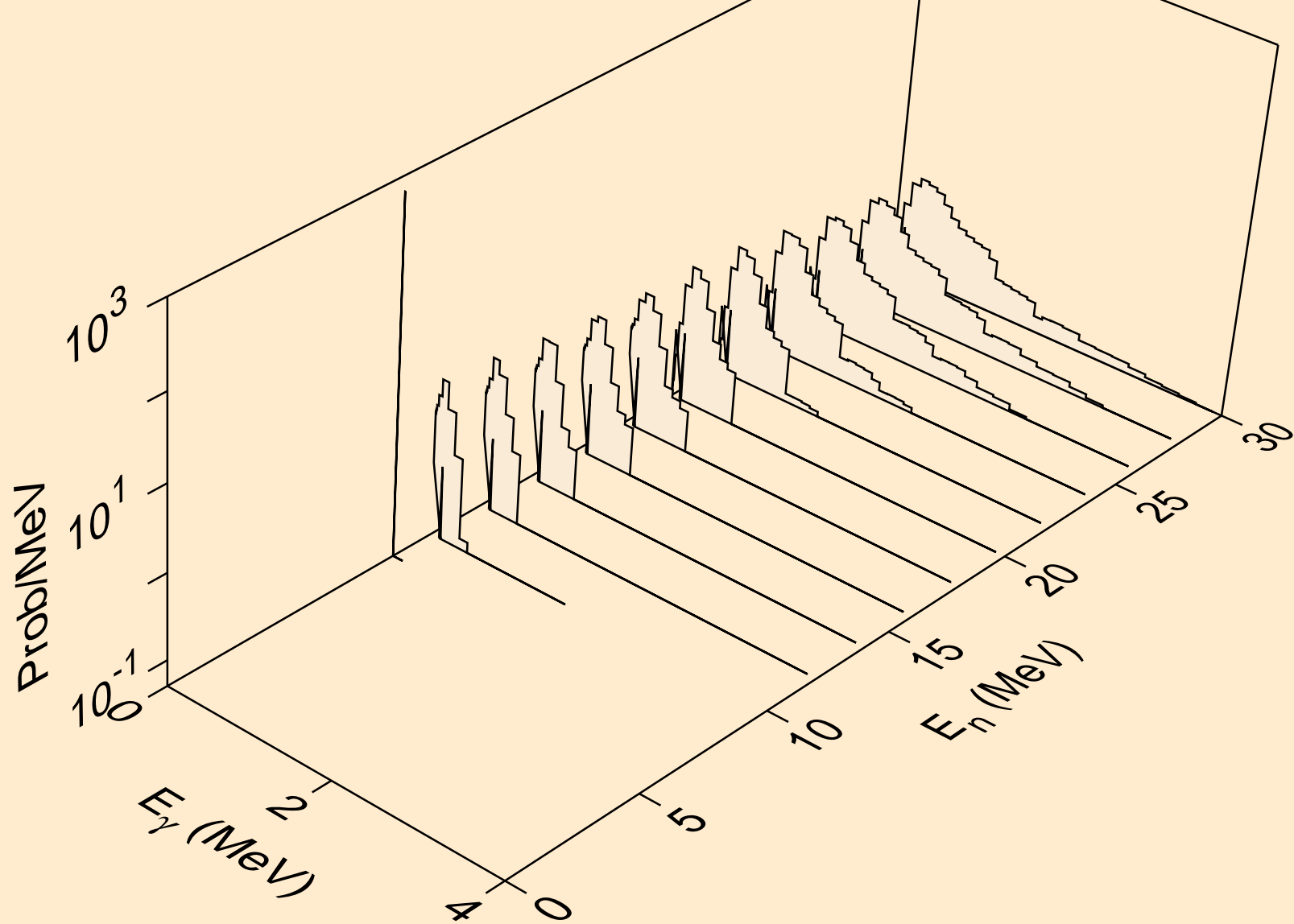

PA241 NEUTRON ACER TENDL-2021 LIBRARY; T=293.6K
Photon emission for (n,3n)a

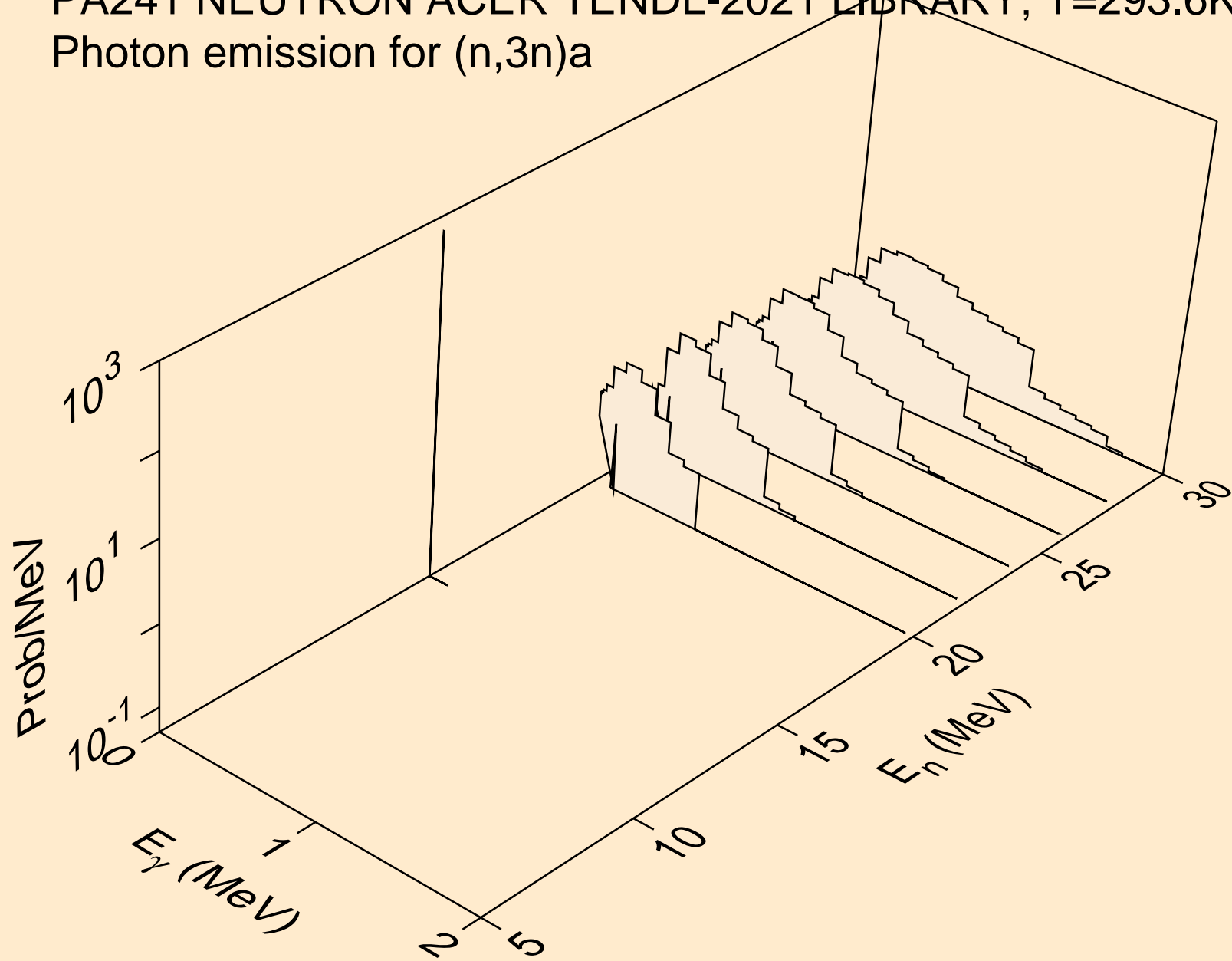

PA241 NEUTRON ACER TENDL-2021 LIBRARY; T=293.6K
Photon emission for (n,n*)p

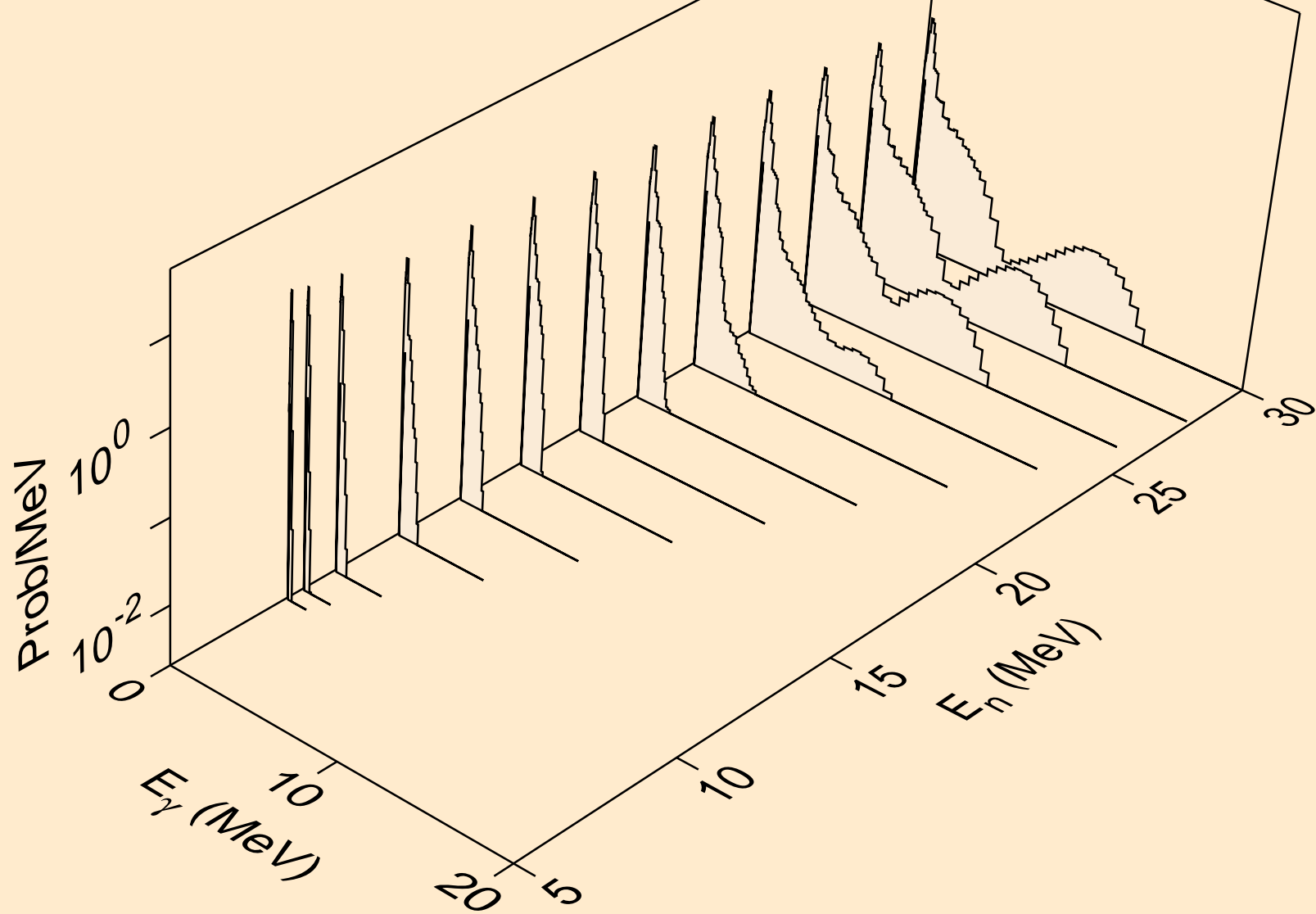

PA241 NEUTRON ACER TENDL-2021 LIBRARY; T=293.6K
Photon emission for (n,n*)2a

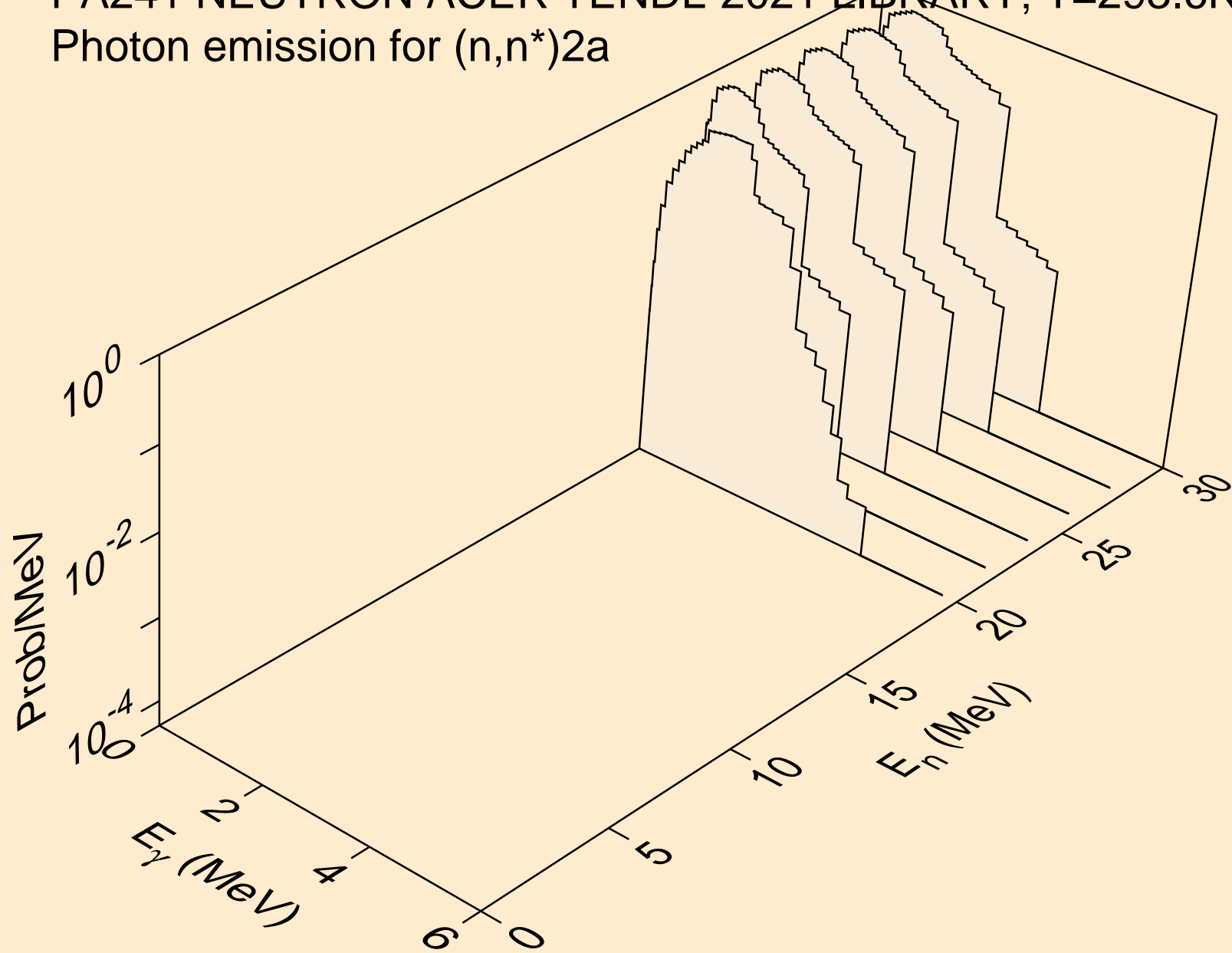

PA241 NEUTRON ACER TENDL-2021 LIBRARY; T=293.6K
Photon emission for (n,n*)d

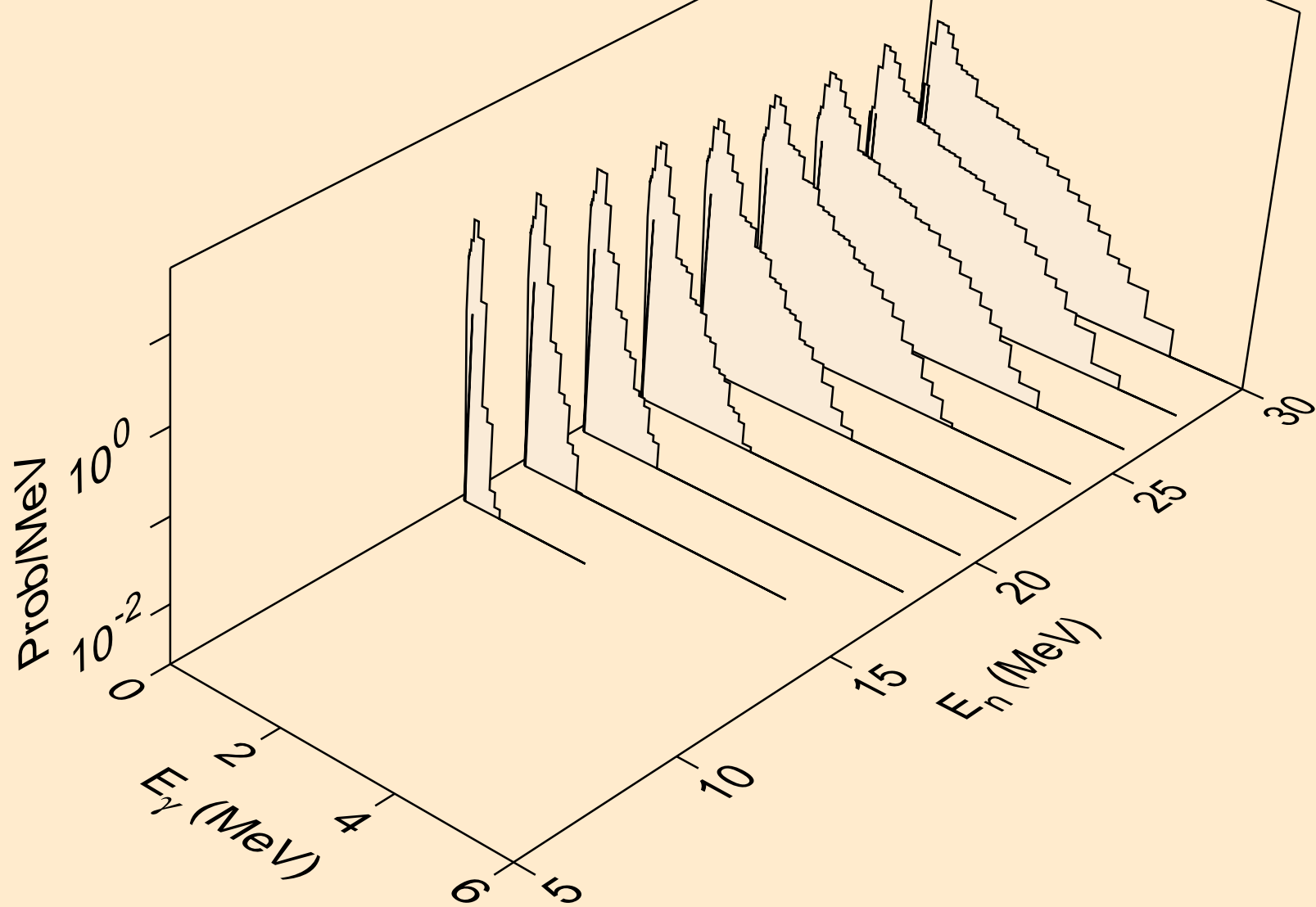

PA241 NEUTRON ACER TENDL-2021 LIBRARY; T=293.6K
Photon emission for (n,n*)t

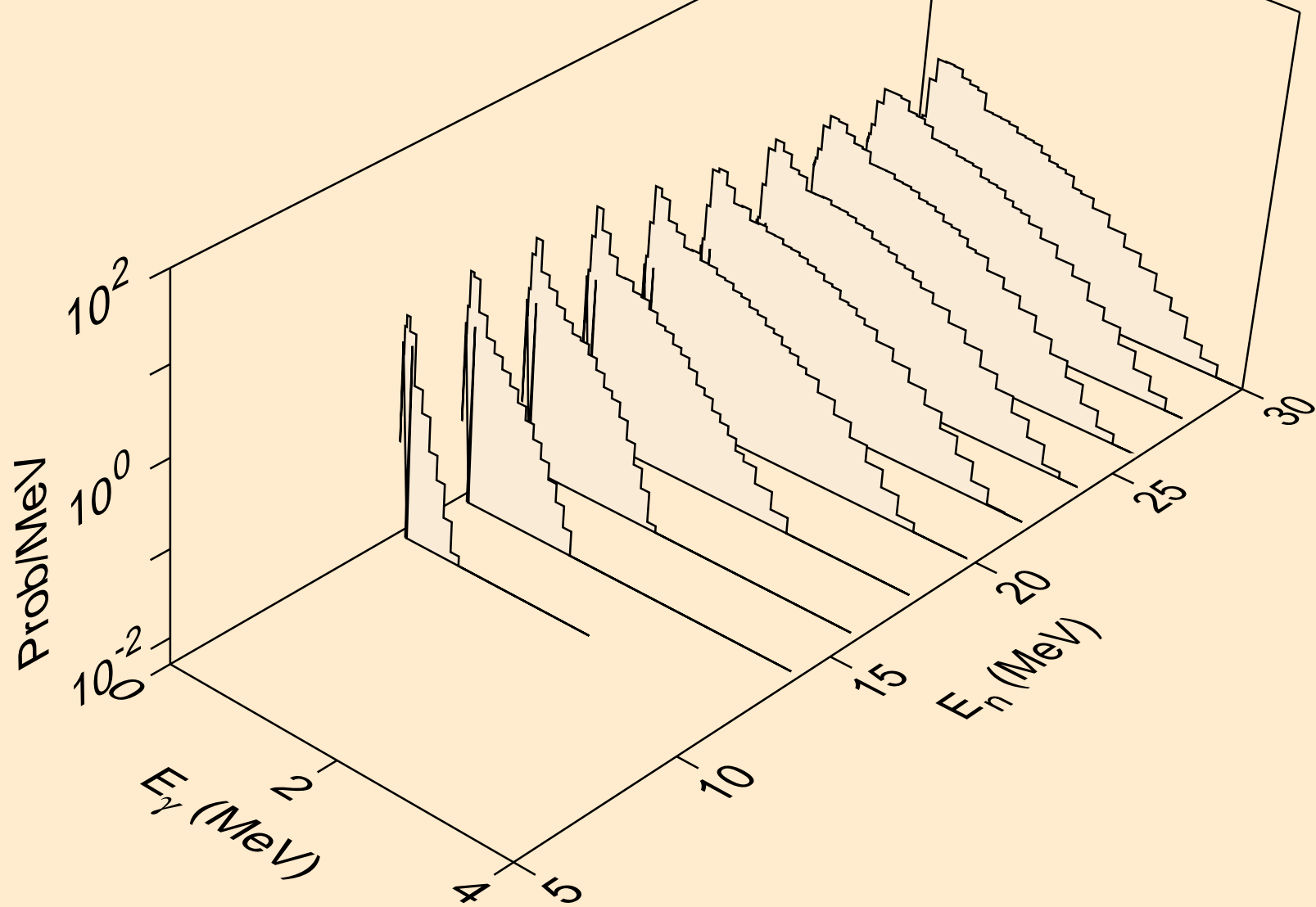

PA241 NEUTRON ACER TENDL-2021 LIBRARY; T=293.6K
Photon emission for (n,n*)he3

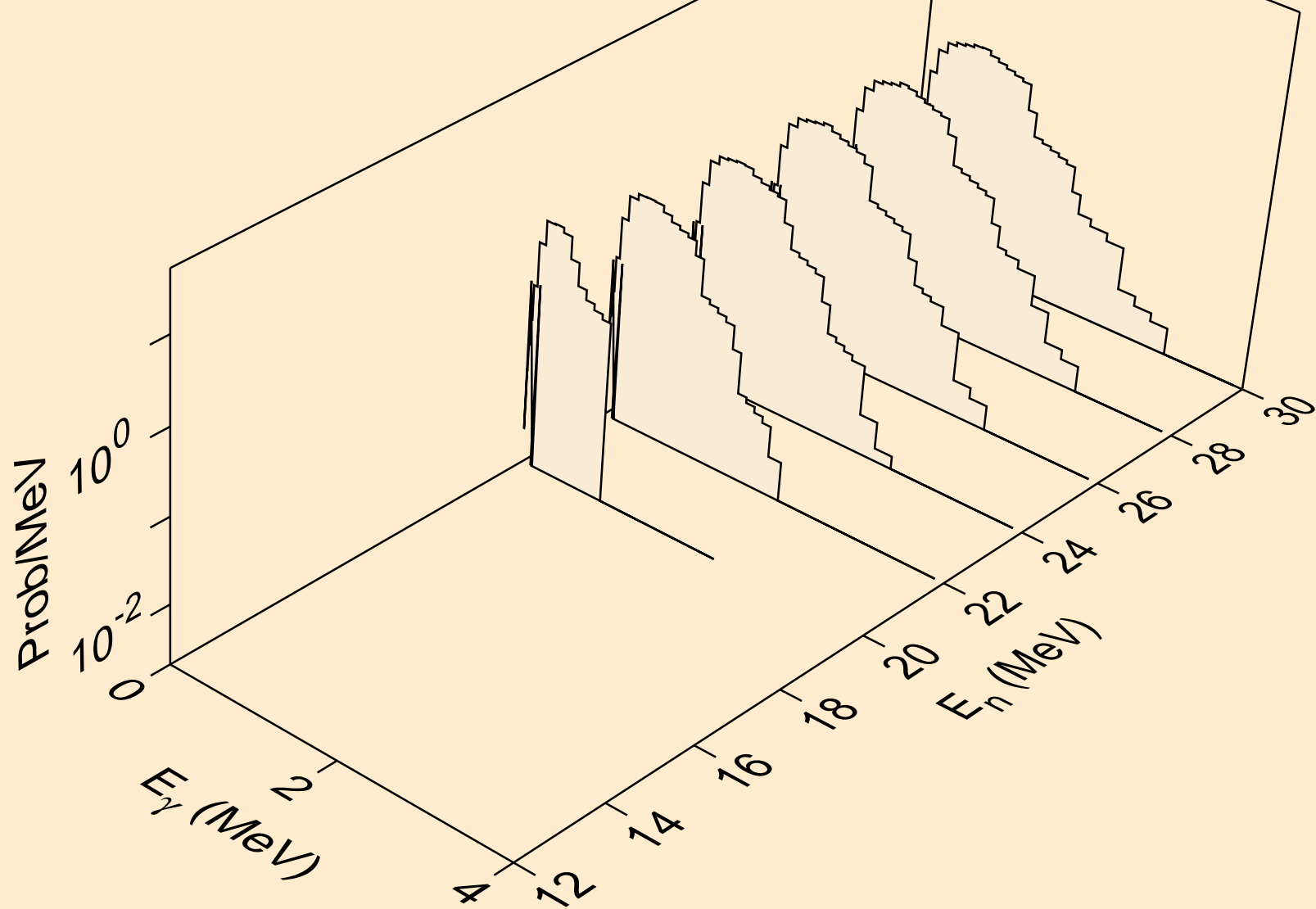

PA241 NEUTRON ACER TENDL-2021 LIBRARY; T=293.6K
Photon emission for (n,4n)

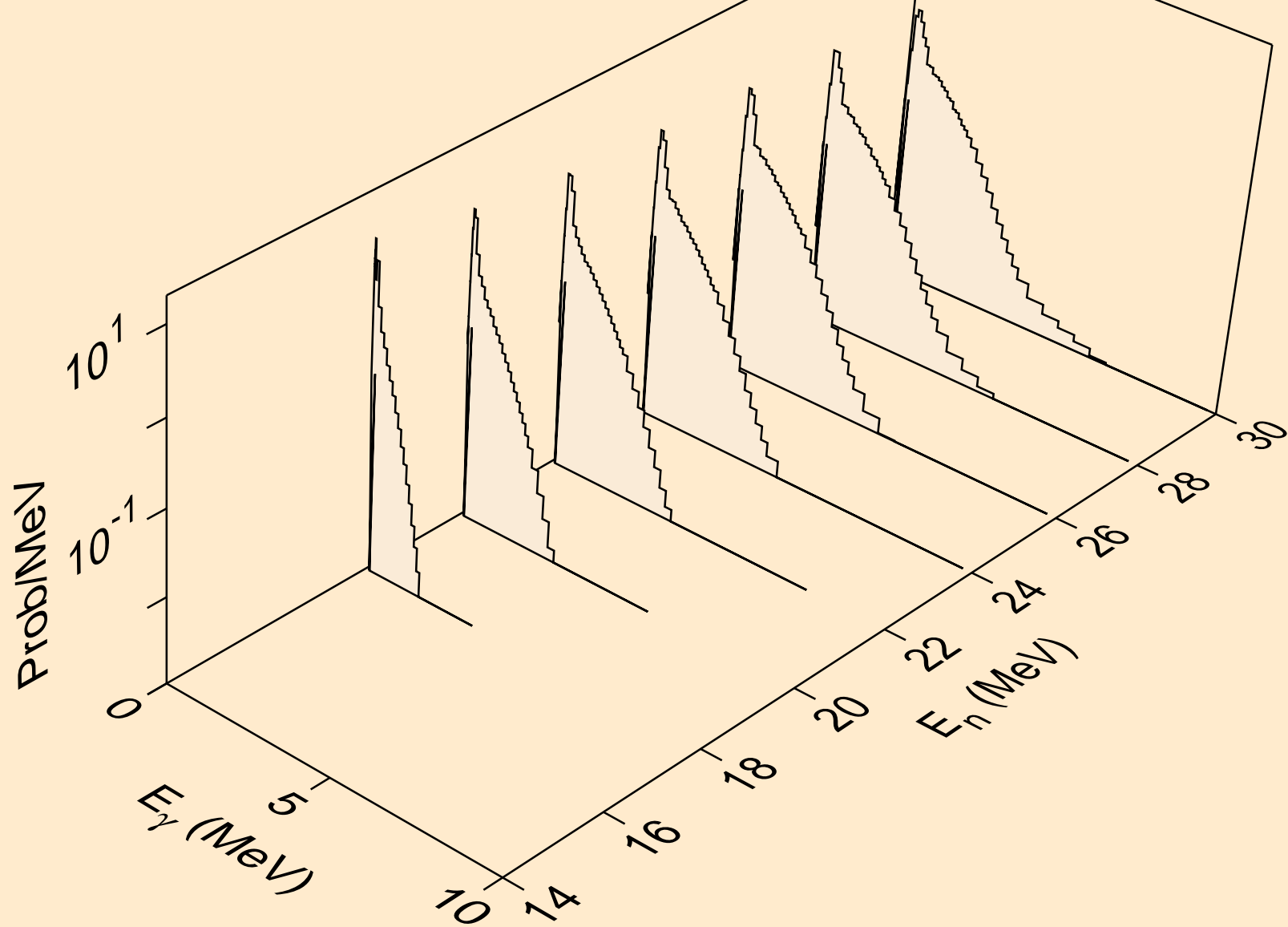

PA241 NEUTRON ACER TENDL-2021 LIBRARY; T=293.6K
Photon emission for (n,2np)

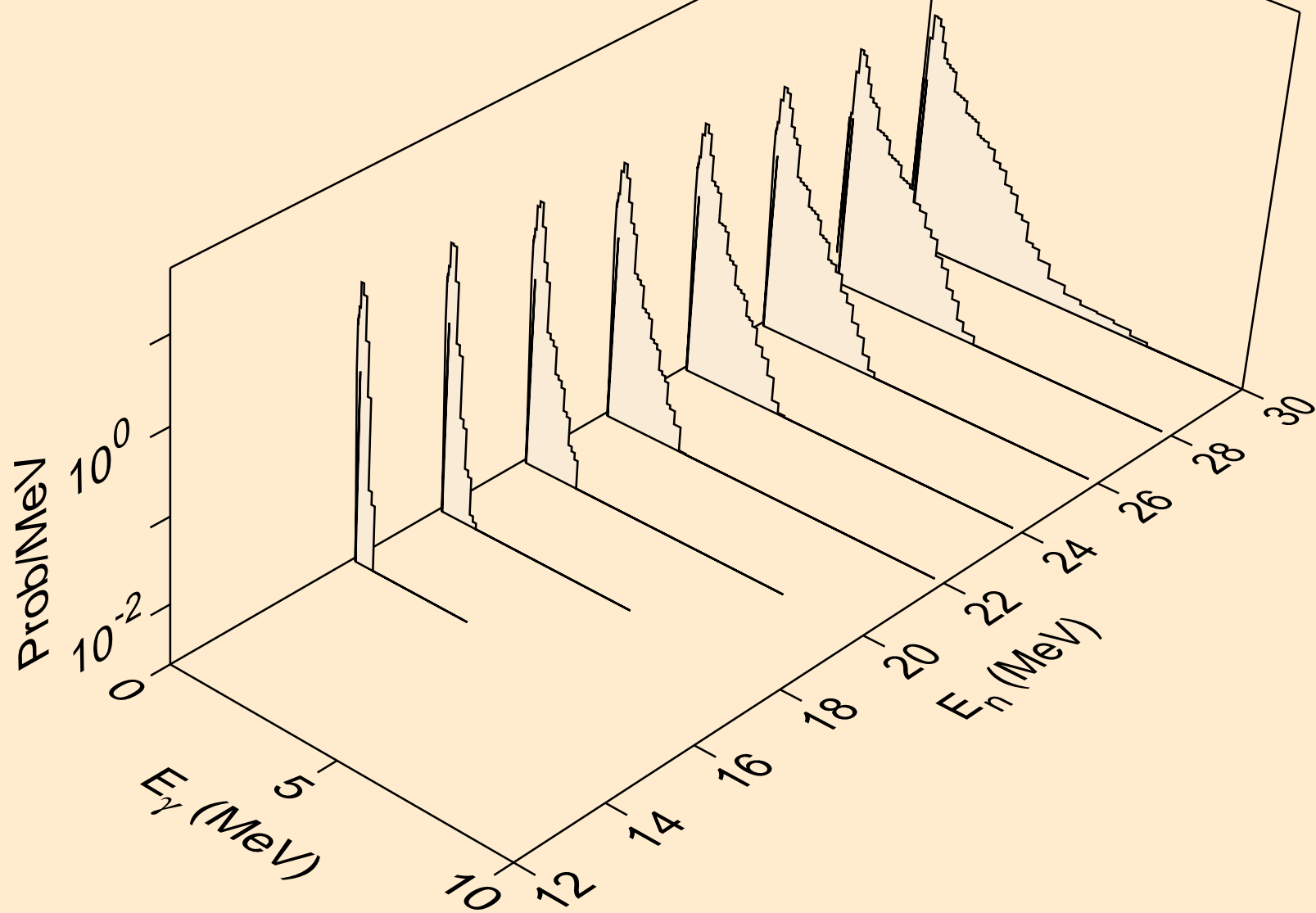

PA241 NEUTRON ACER TENDL-2021 LIBRARY; T=293.6K
Photon emission for (n,3np)

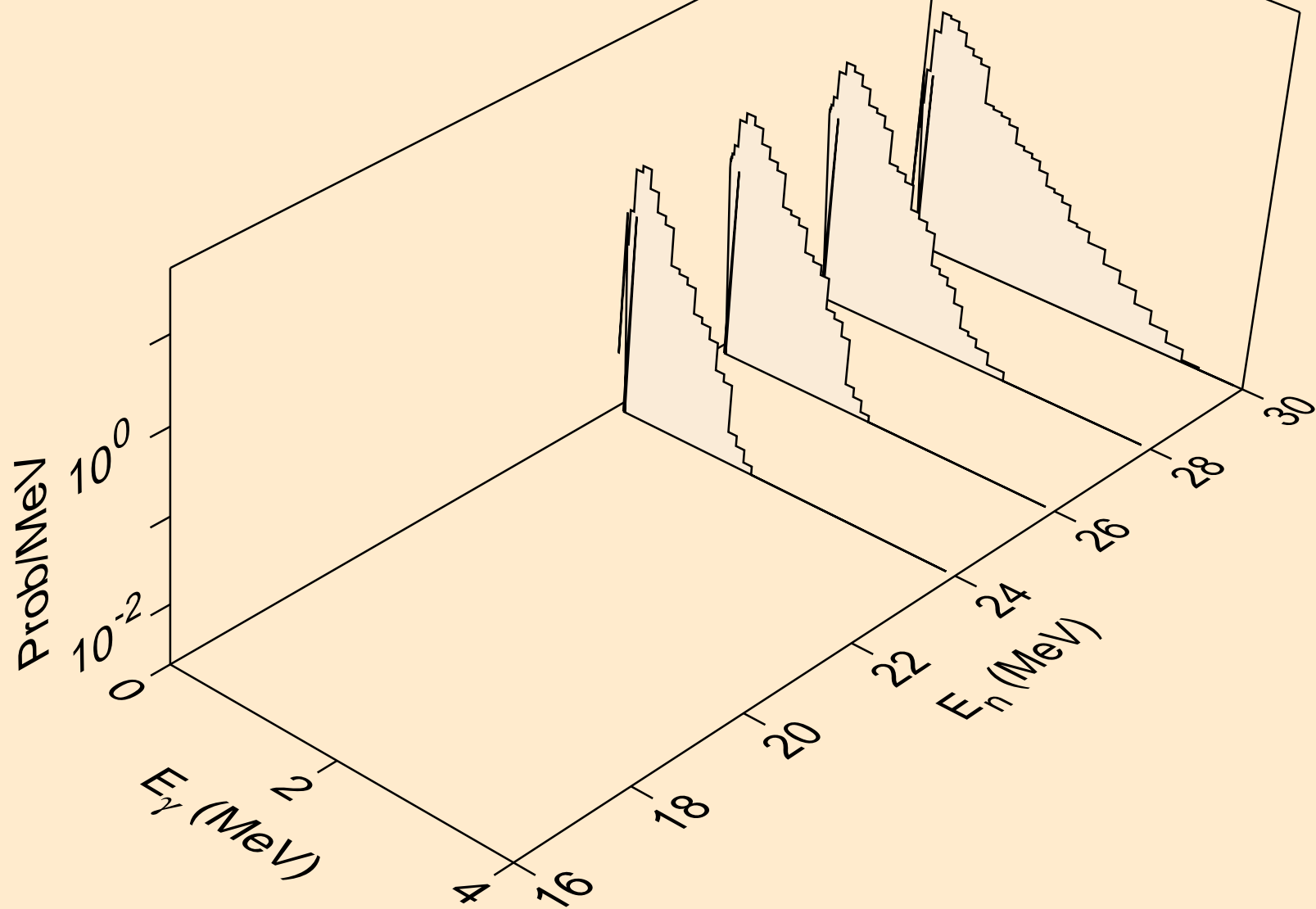

PA241 NEUTRON ACER TENDL-2021 LIBRARY; T=293.6K
Photon emission for (n,npa)

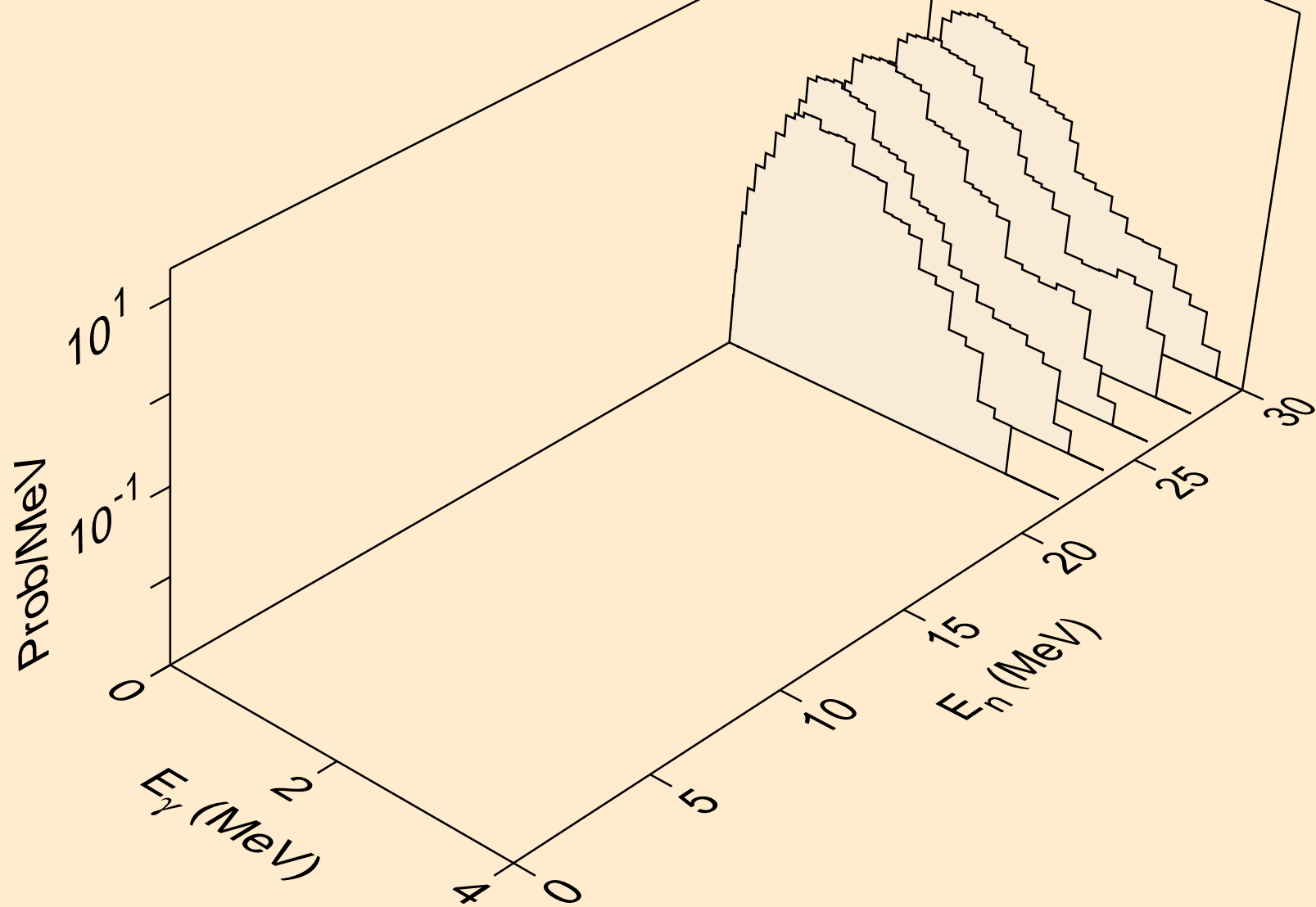

PA241 NEUTRON ACER TENDL-2021 LIBRARY; T=293.6K
Photon emission for (n,n*c)

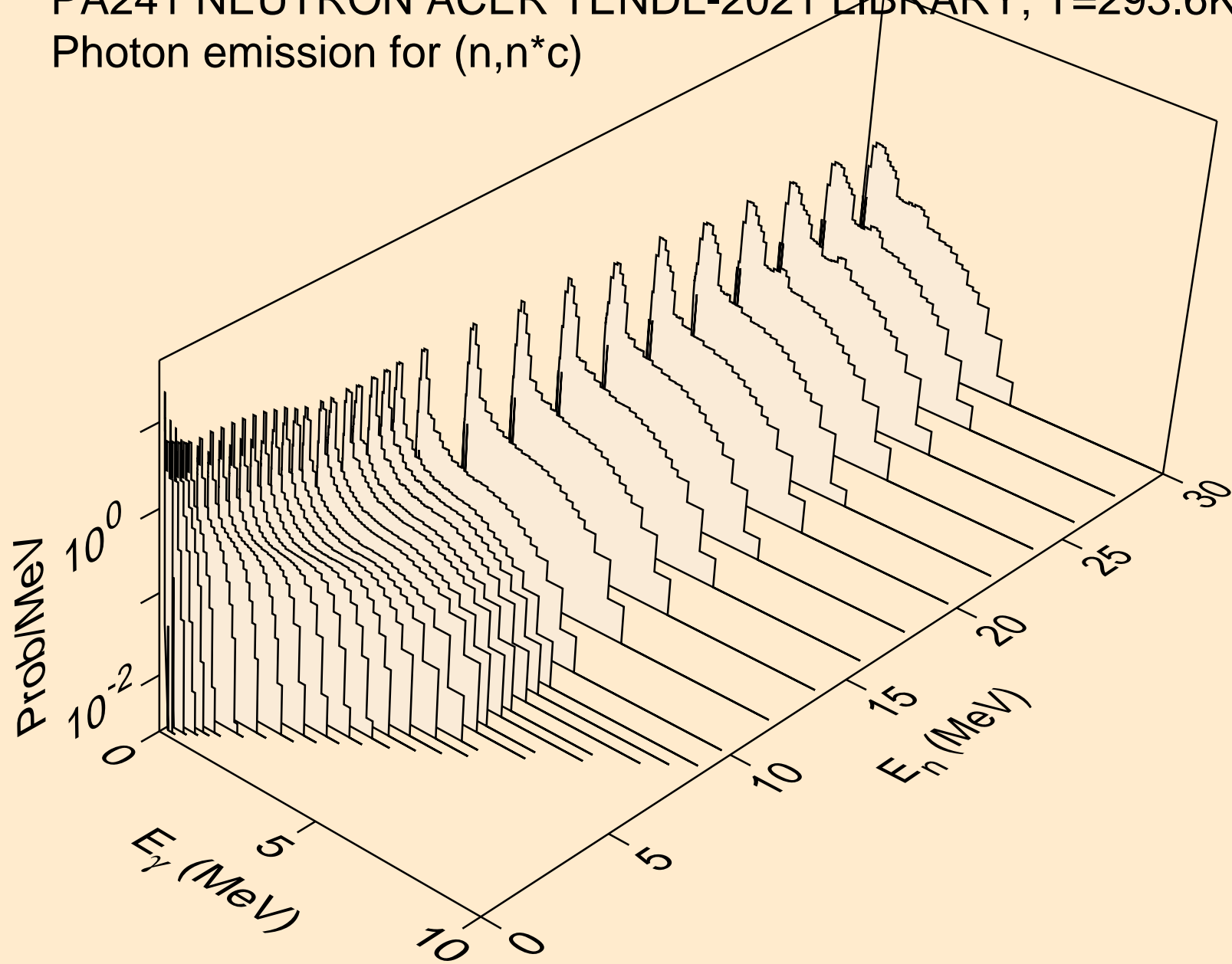

PA241 NEUTRON ACER TENDL-2021 LIBRARY; T=293.6K
Photon emission for (n,gma)

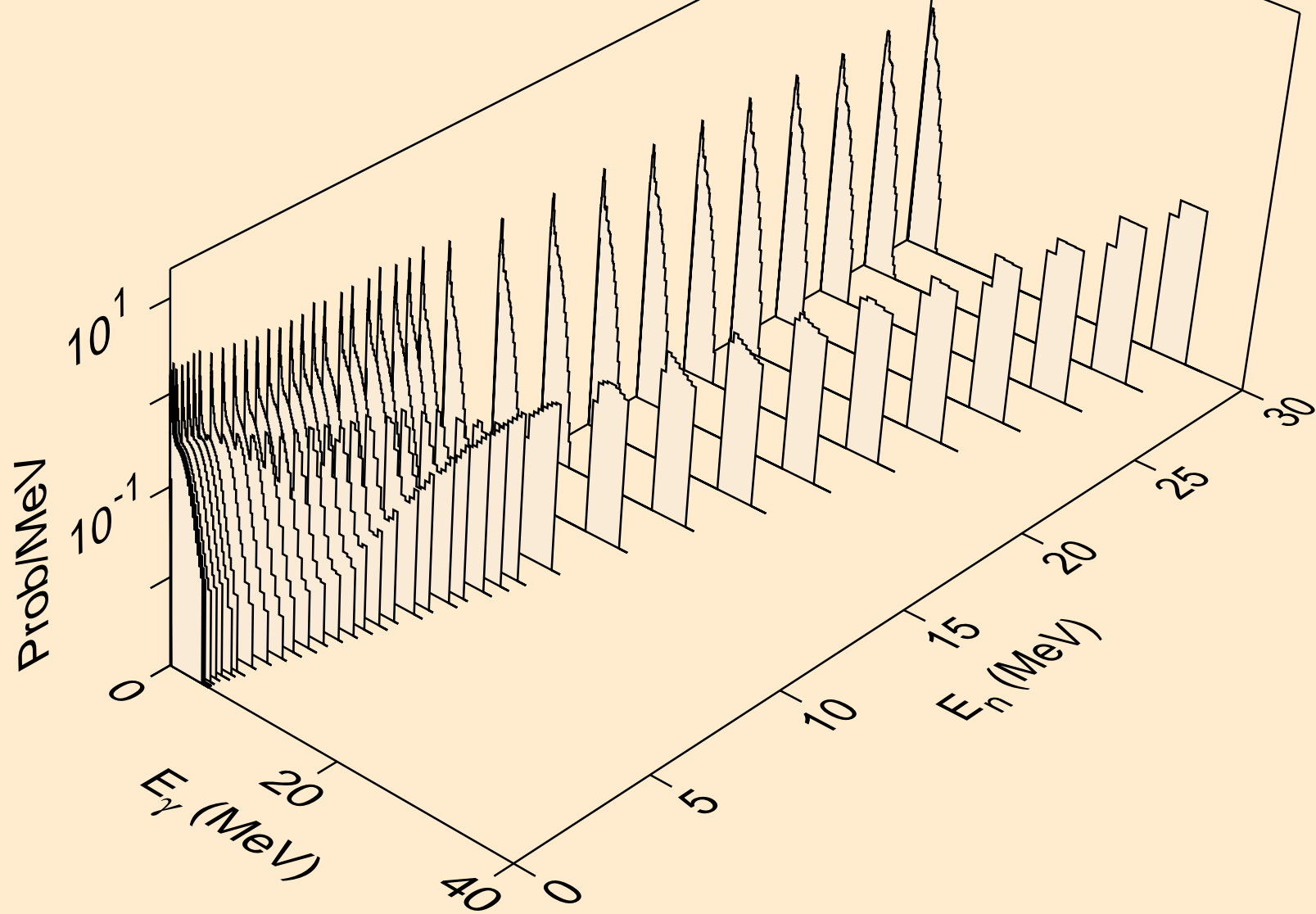

PA241 NEUTRON ACER TENDL-2021 LIBRARY; T=293.6K
Photon emission for (n,p)

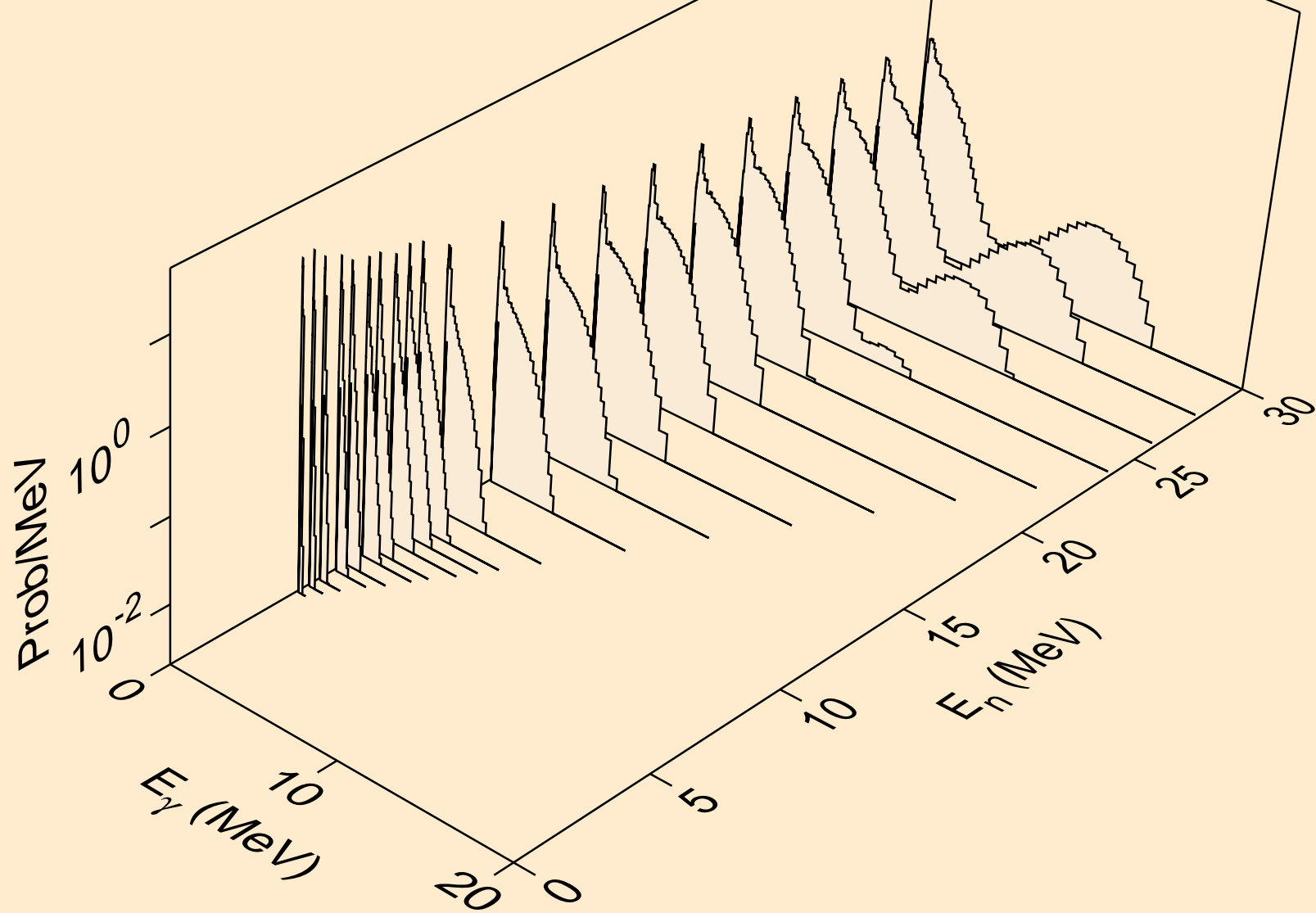

PA241 NEUTRON ACER TENDL-2021 LIBRARY; T=293.6K
Photon emission for (n,d)

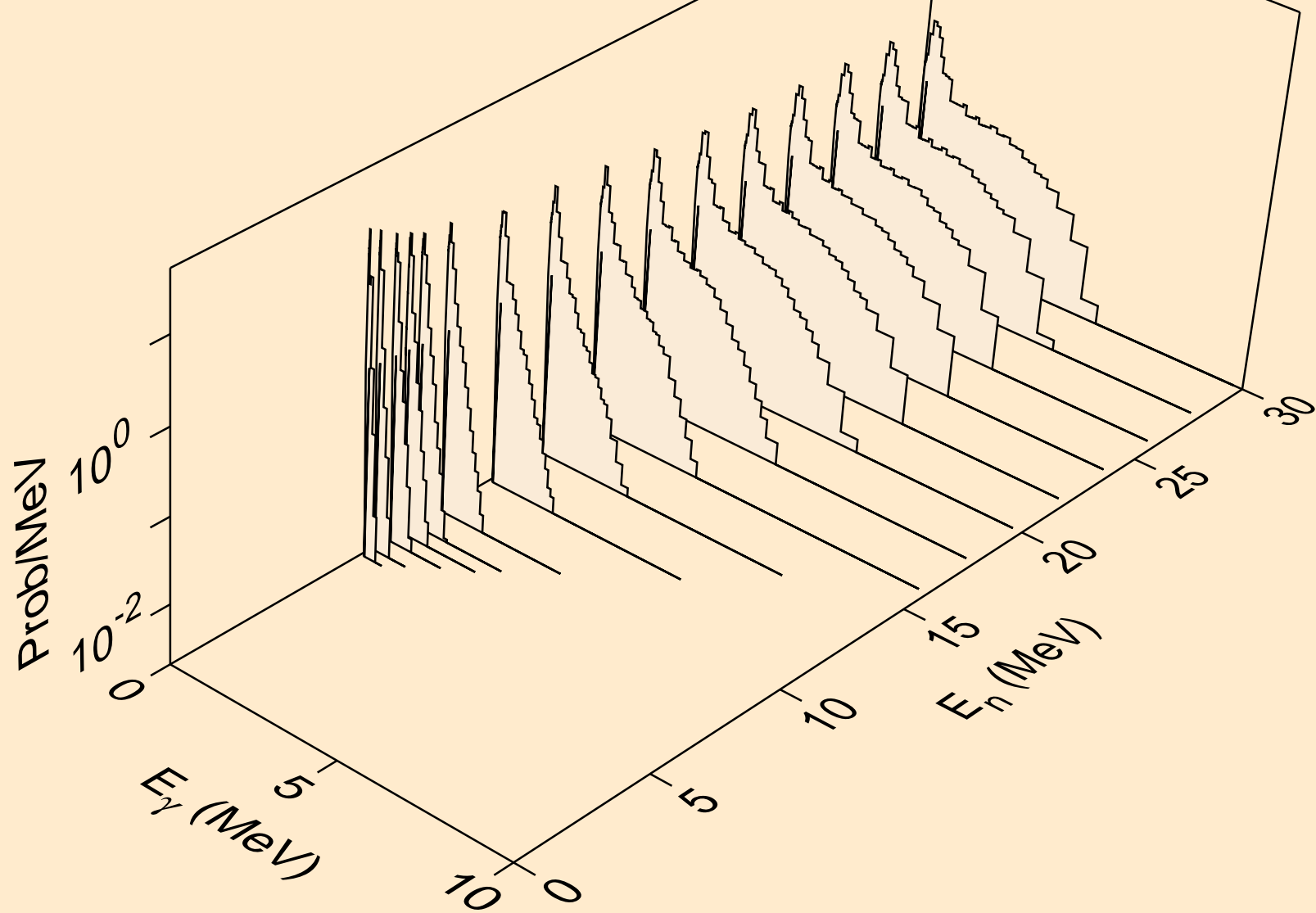

PA241 NEUTRON ACER TENDL-2021 LIBRARY; T=293.6K
Photon emission for (n,t)

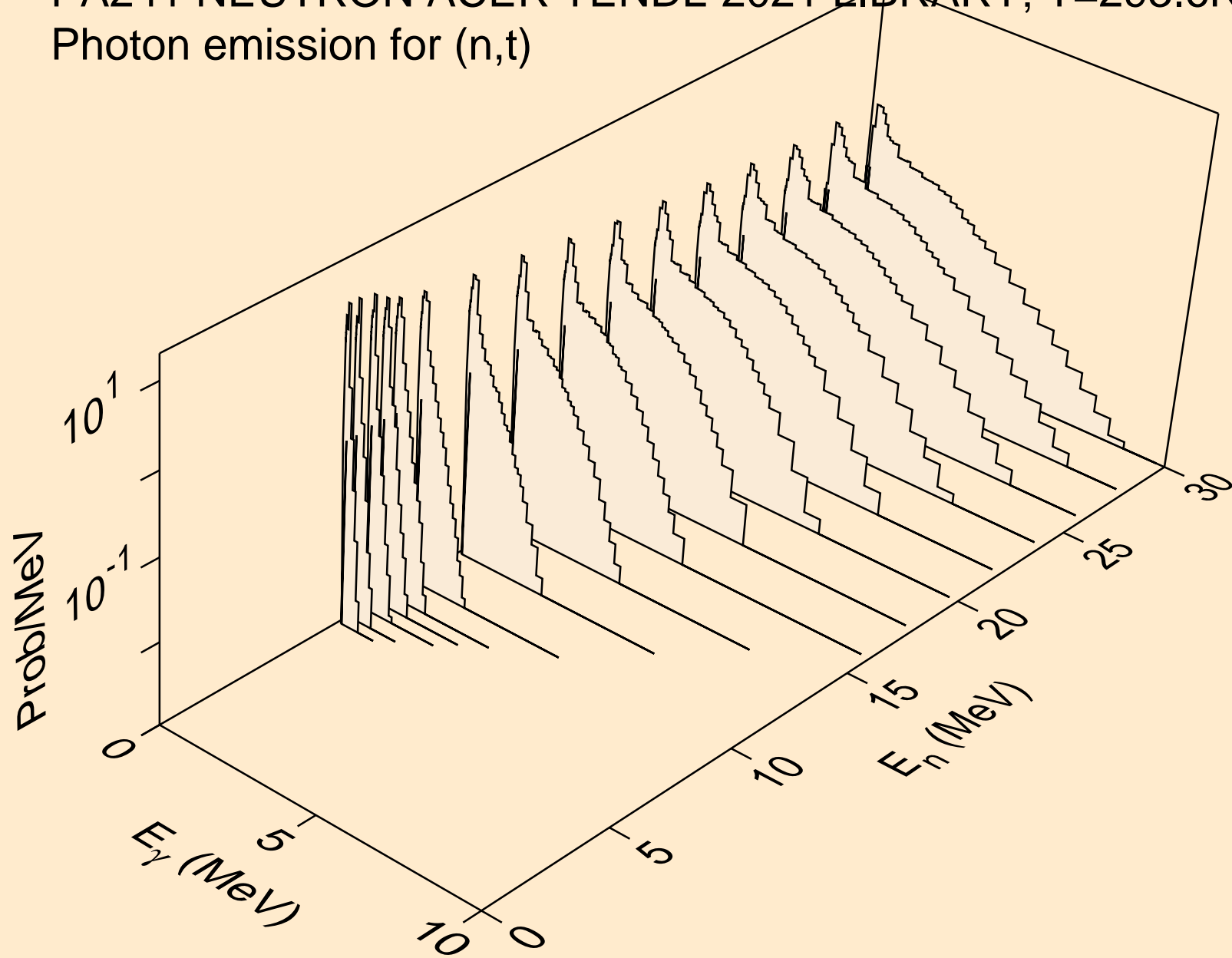

PA241 NEUTRON ACER TENDL-2021 LIBRARY; T=293.6K
Photon emission for (n,he3)

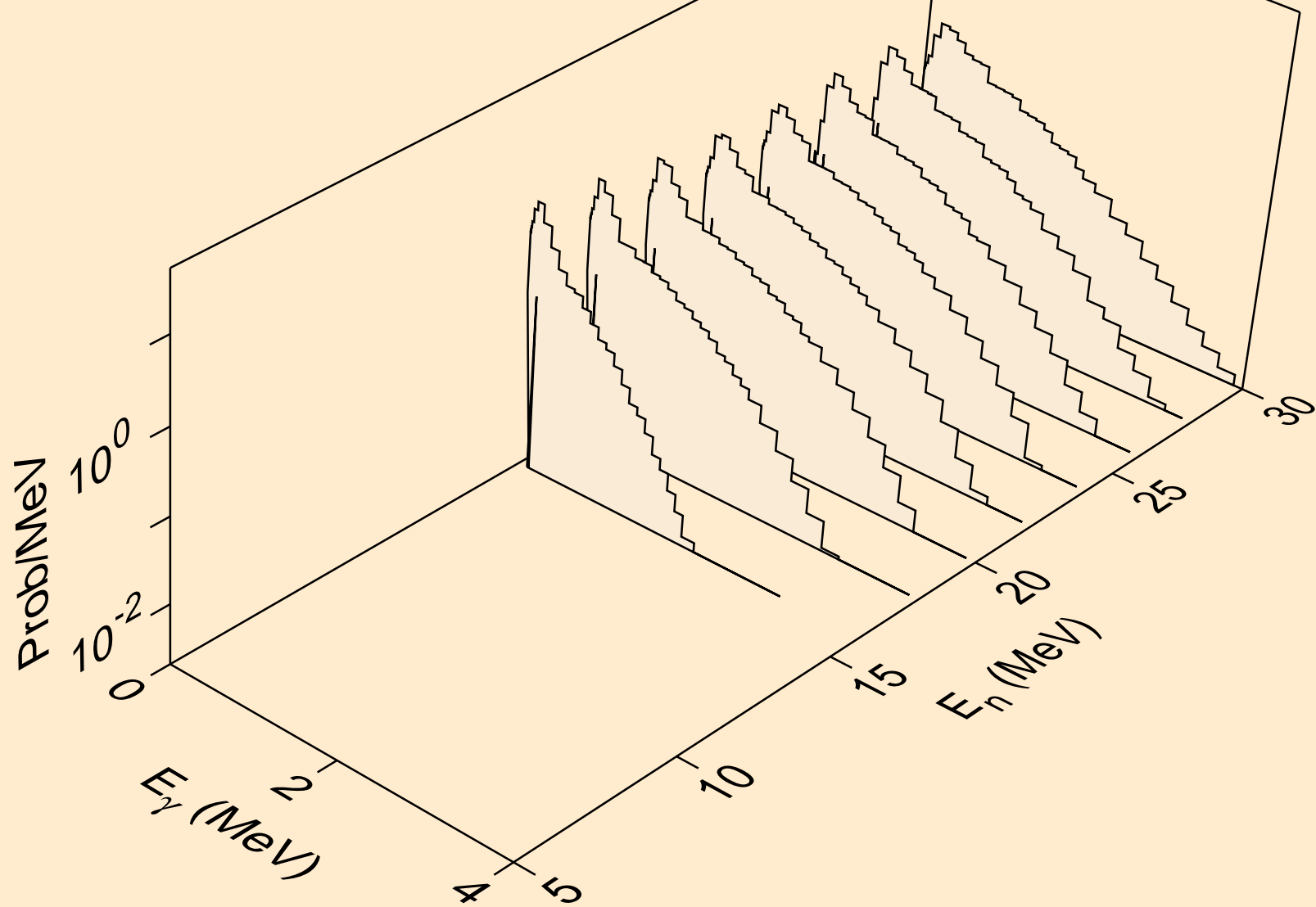

PA241 NEUTRON ACER TENDL-2021 LIBRARY; T=293.6K
Photon emission for (n,a)

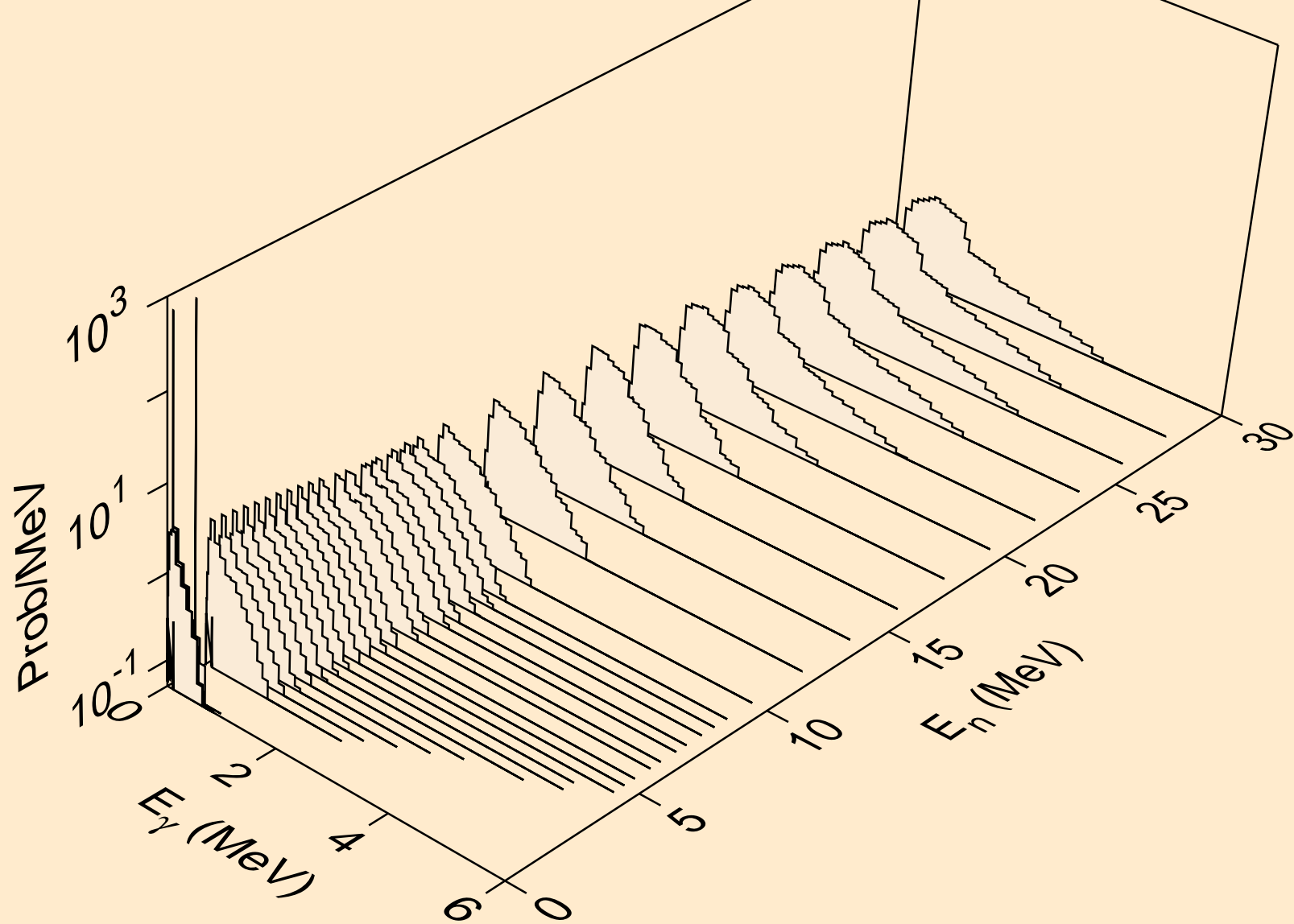

PA241 NEUTRON ACER TENDL-2021 LIBRARY; T=293.6K
Photon emission for (n,2a)

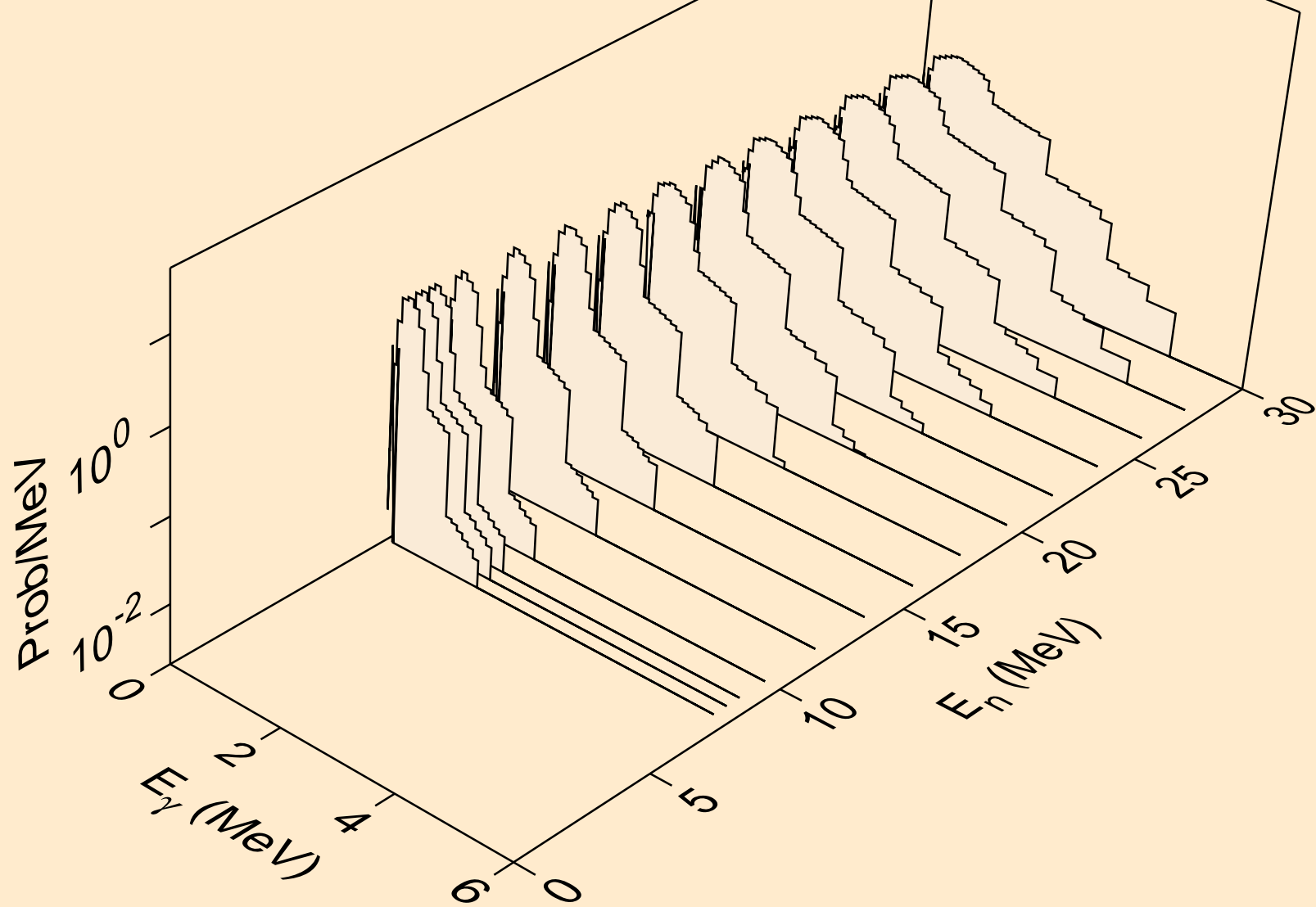

PA241 NEUTRON ACER TENDL-2021 LIBRARY; T=293.6K
Photon emission for (n,2p)

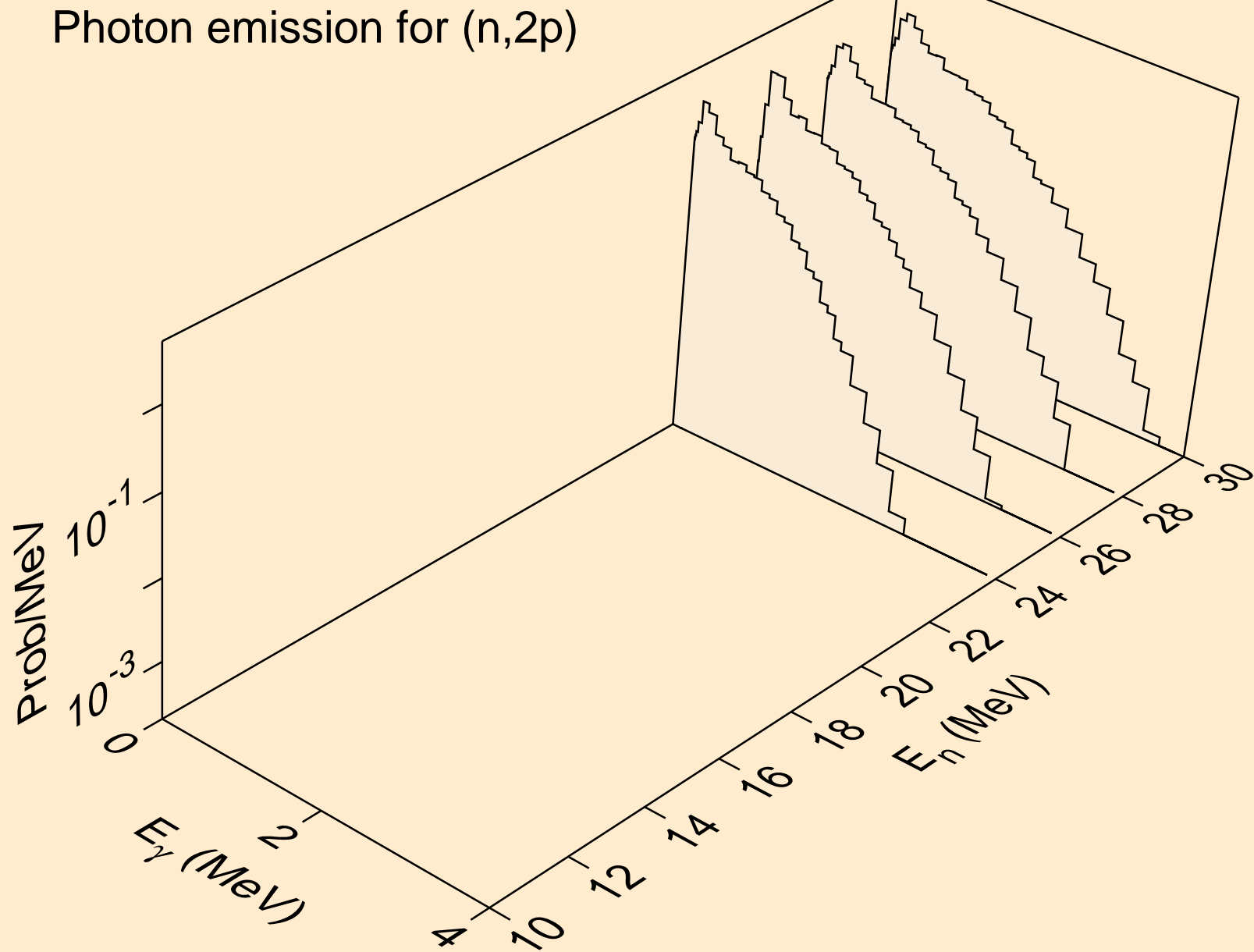

PA241 NEUTRON ACER TENDL-2021 LIBRARY; T=293.6K
Photon emission for (n,p)

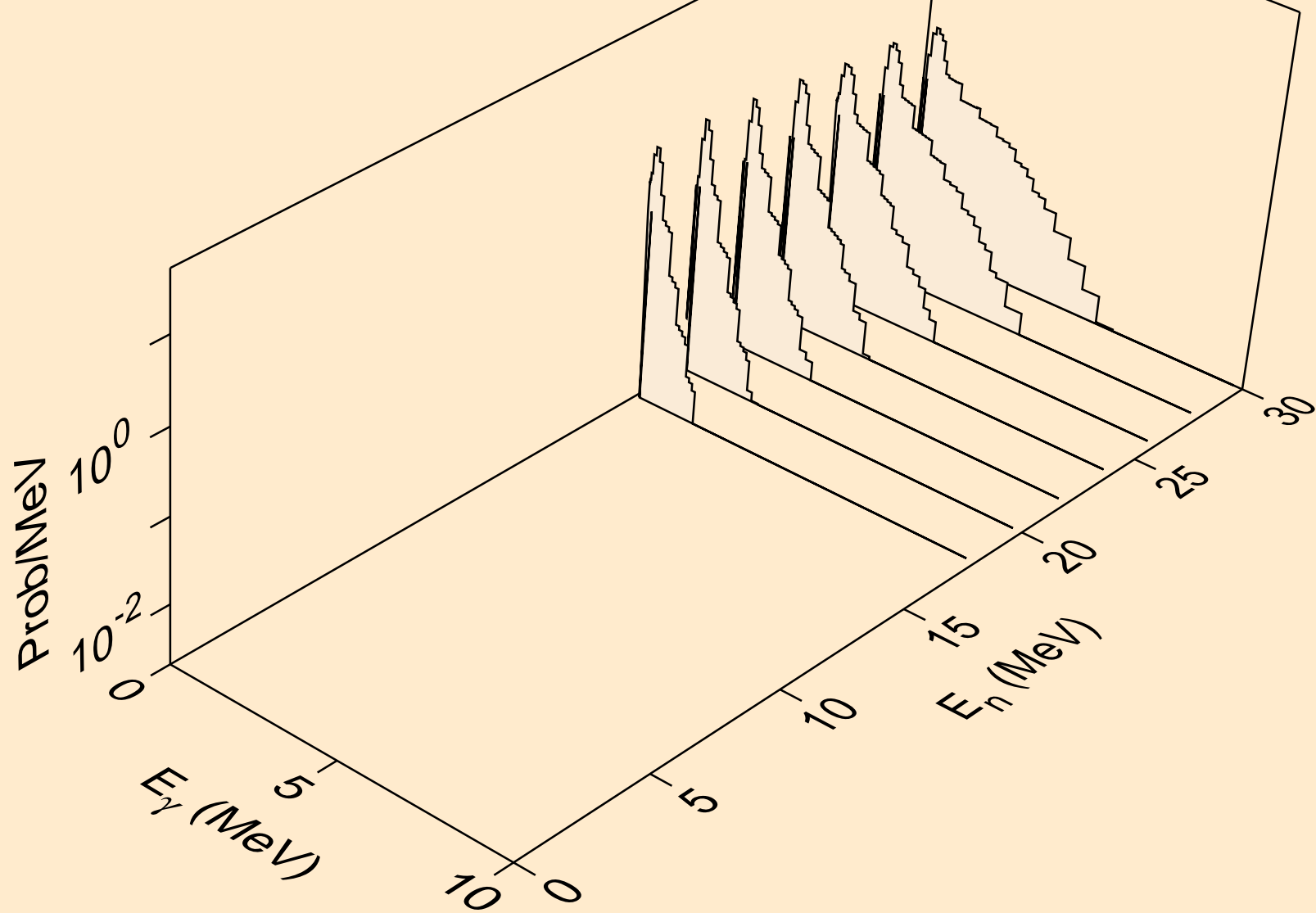

PA241 NEUTRON ACER TENDL-2021 LIBRARY; T=293.6K
Photon emission for (n,pd)

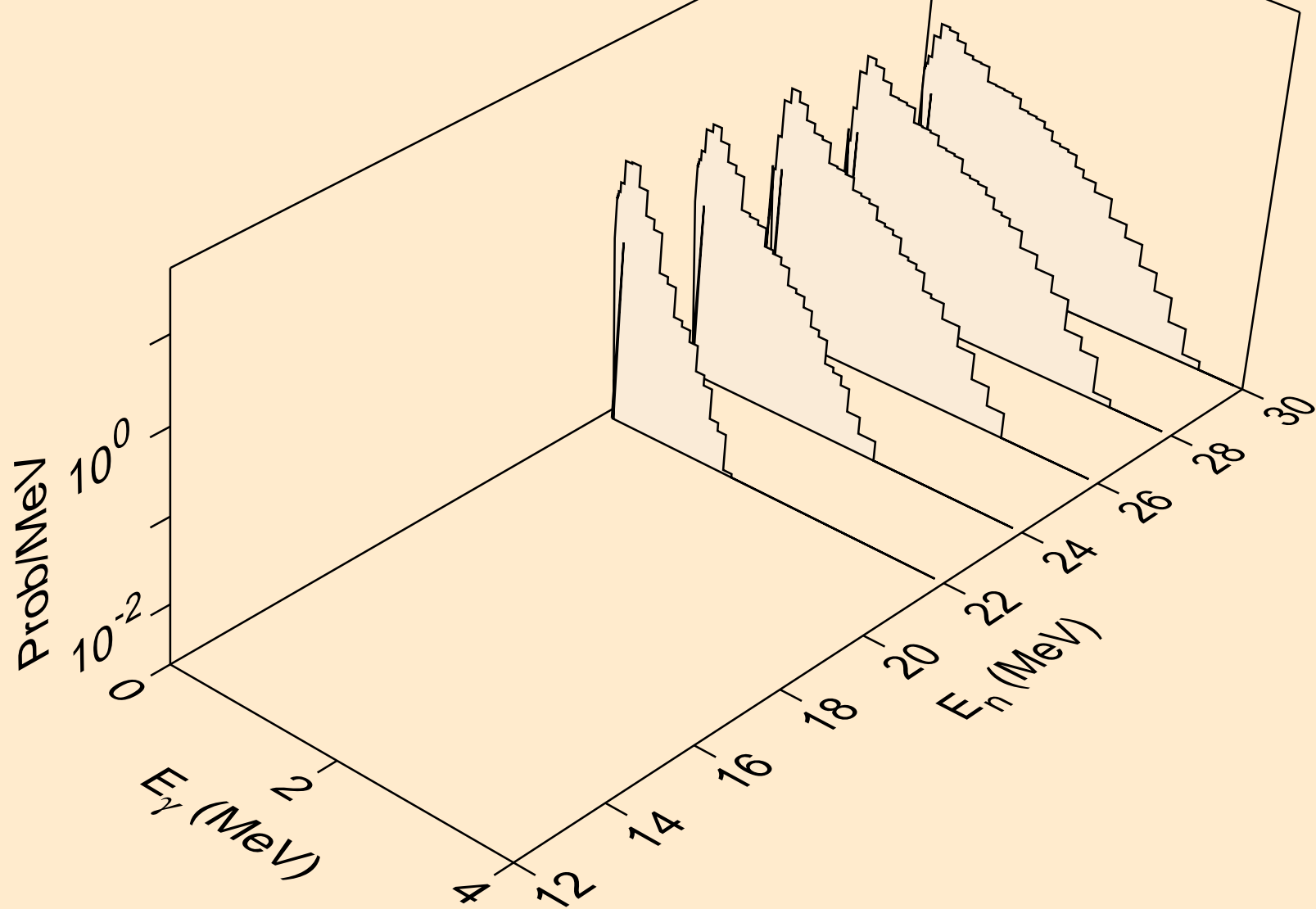

PA241 NEUTRON ACER TENDL-2021 LIBRARY; T=293.6K
Photon emission for (n,pt)

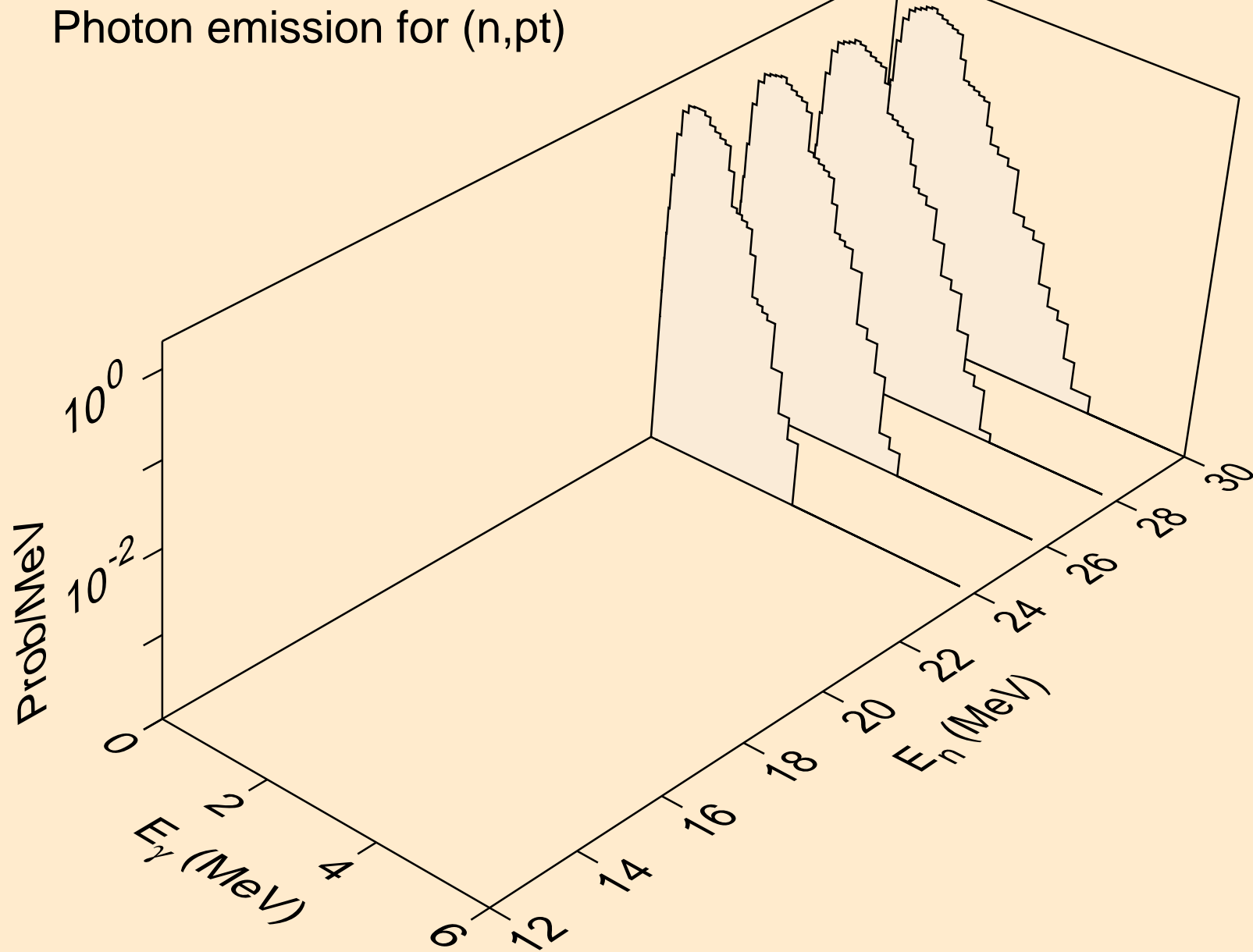

PA241 NEUTRON ACER TENDL-2021 LIBRARY; T=293.6K
thermal capture photon spectrum

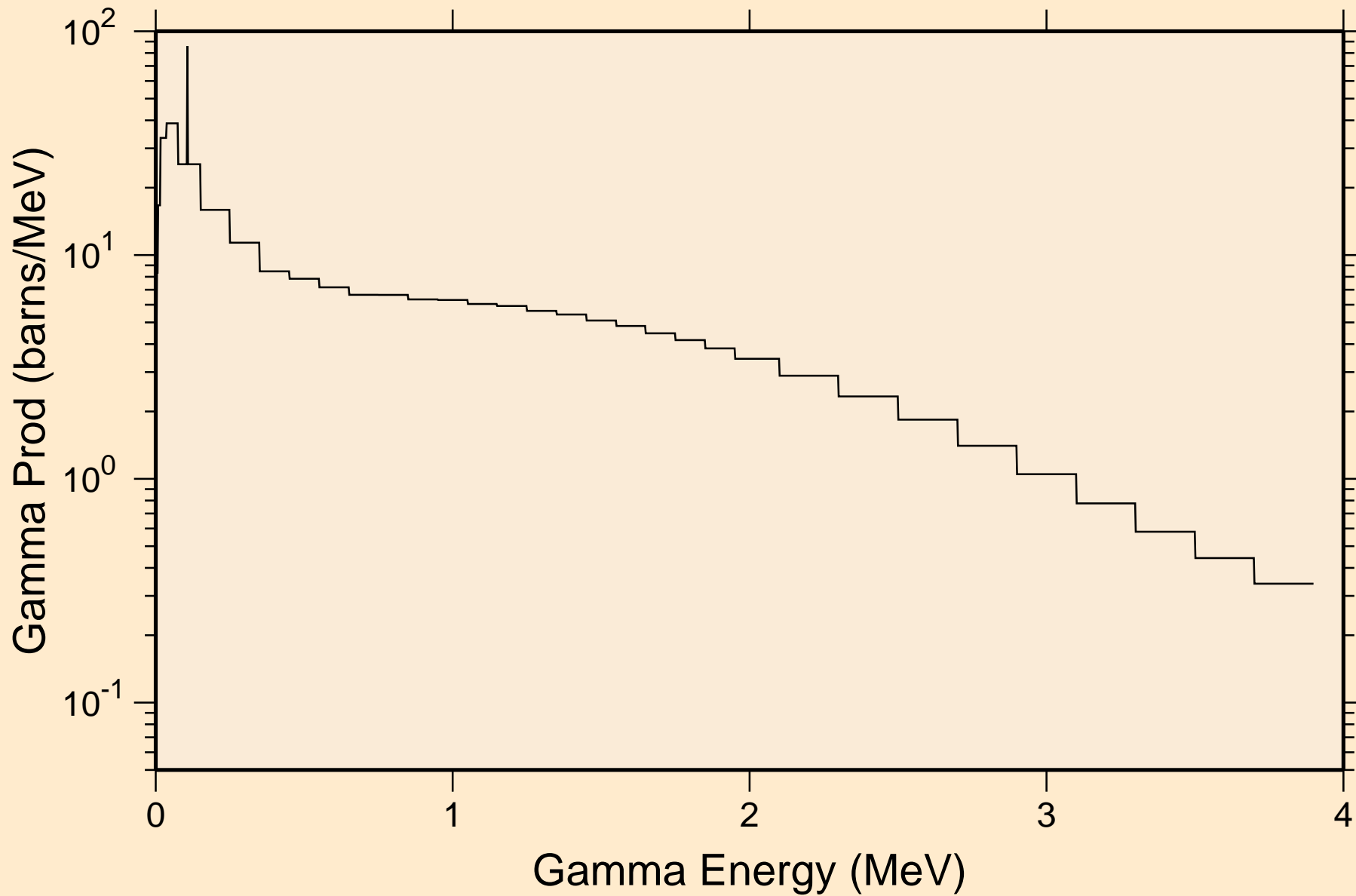

PA241 NEUTRON ACER TENDL-2021 LIBRARY; T=293.6K
14 MeV photon spectrum

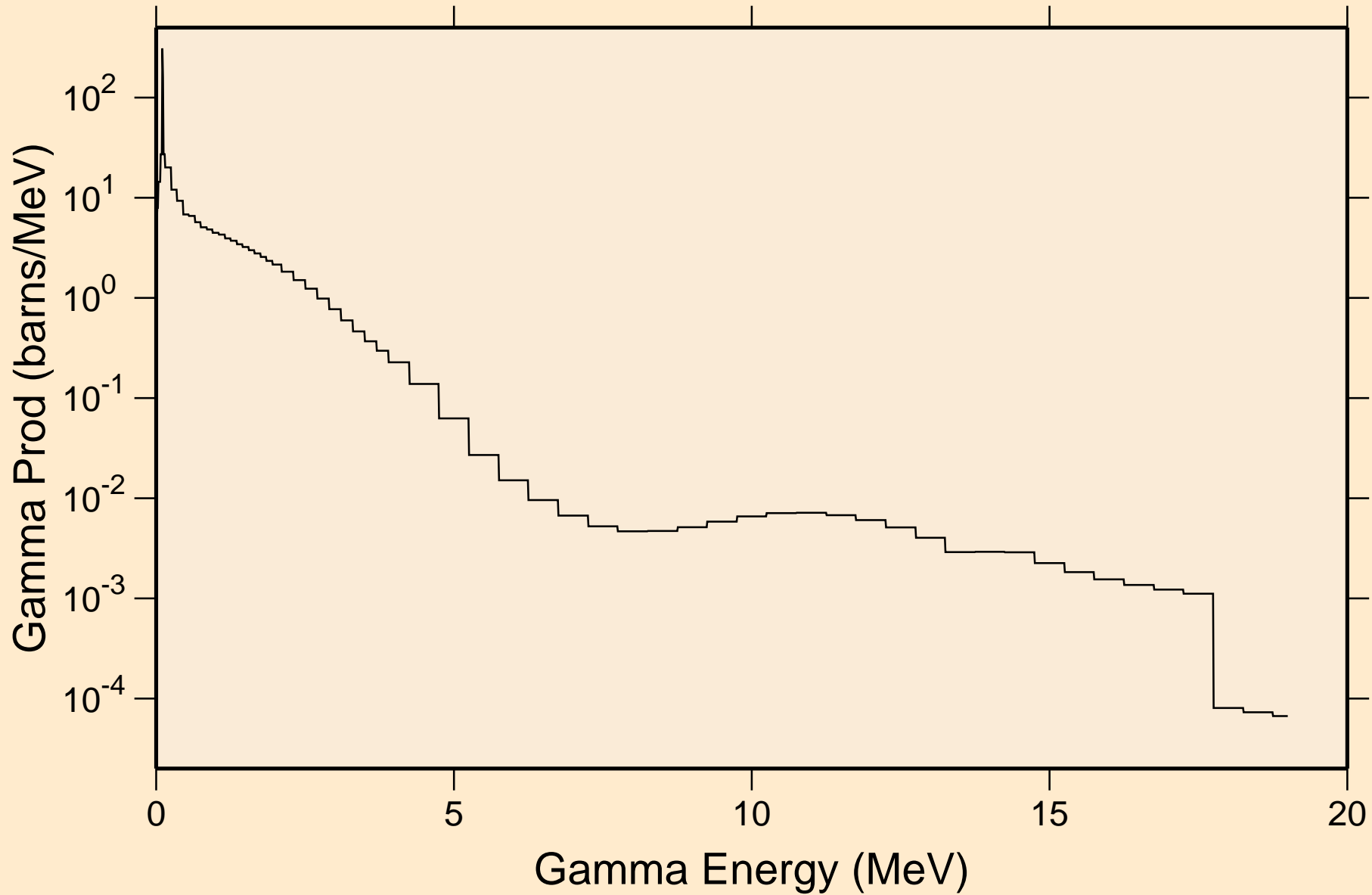

PA241 NEUTRON ACER TENDL-2021 LIBRARY; T=293.6K
Particle heating contributions

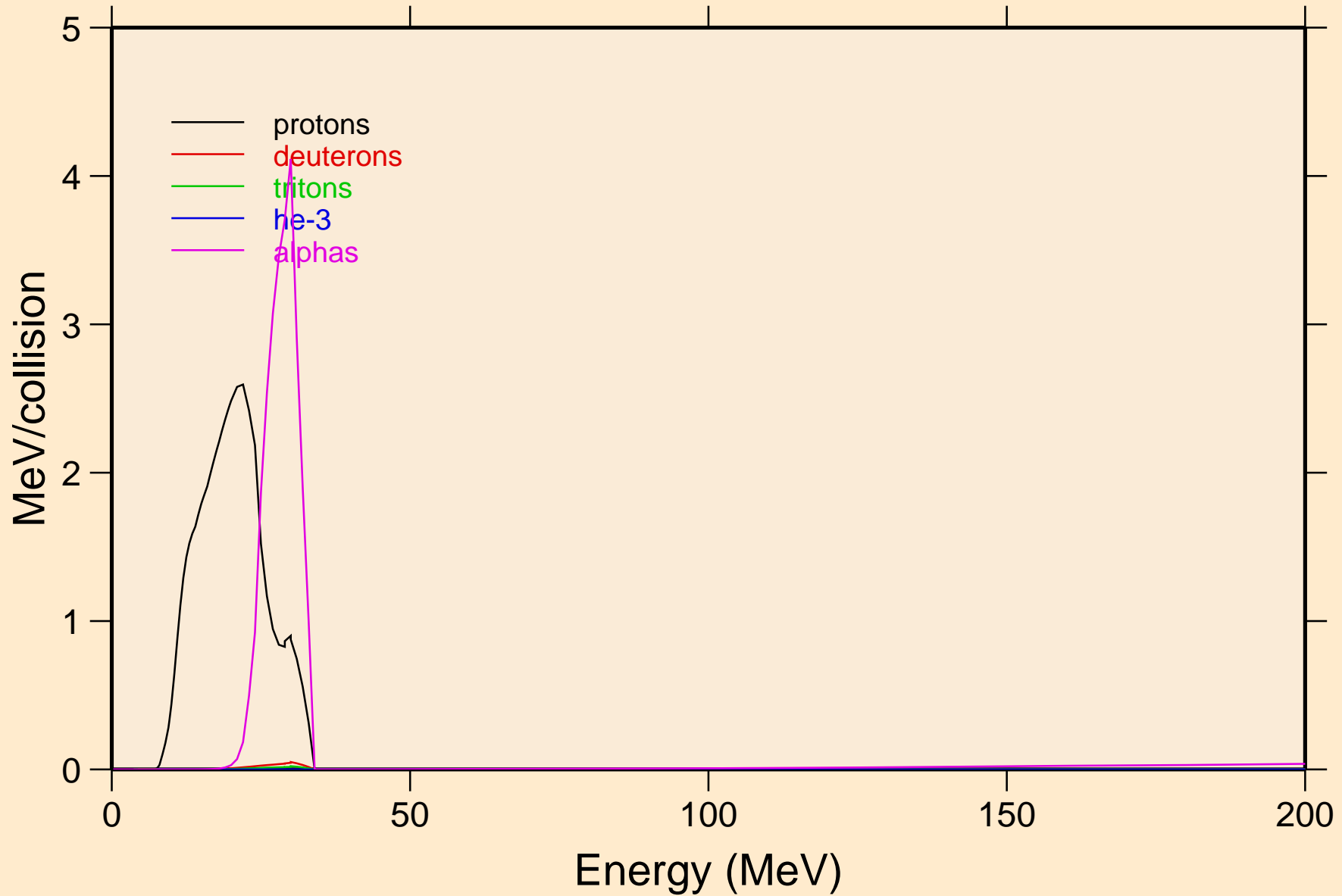

PA241 NEUTRON ACER TENDL-2021 LIBRARY; T=293.6K
Recoil Heating

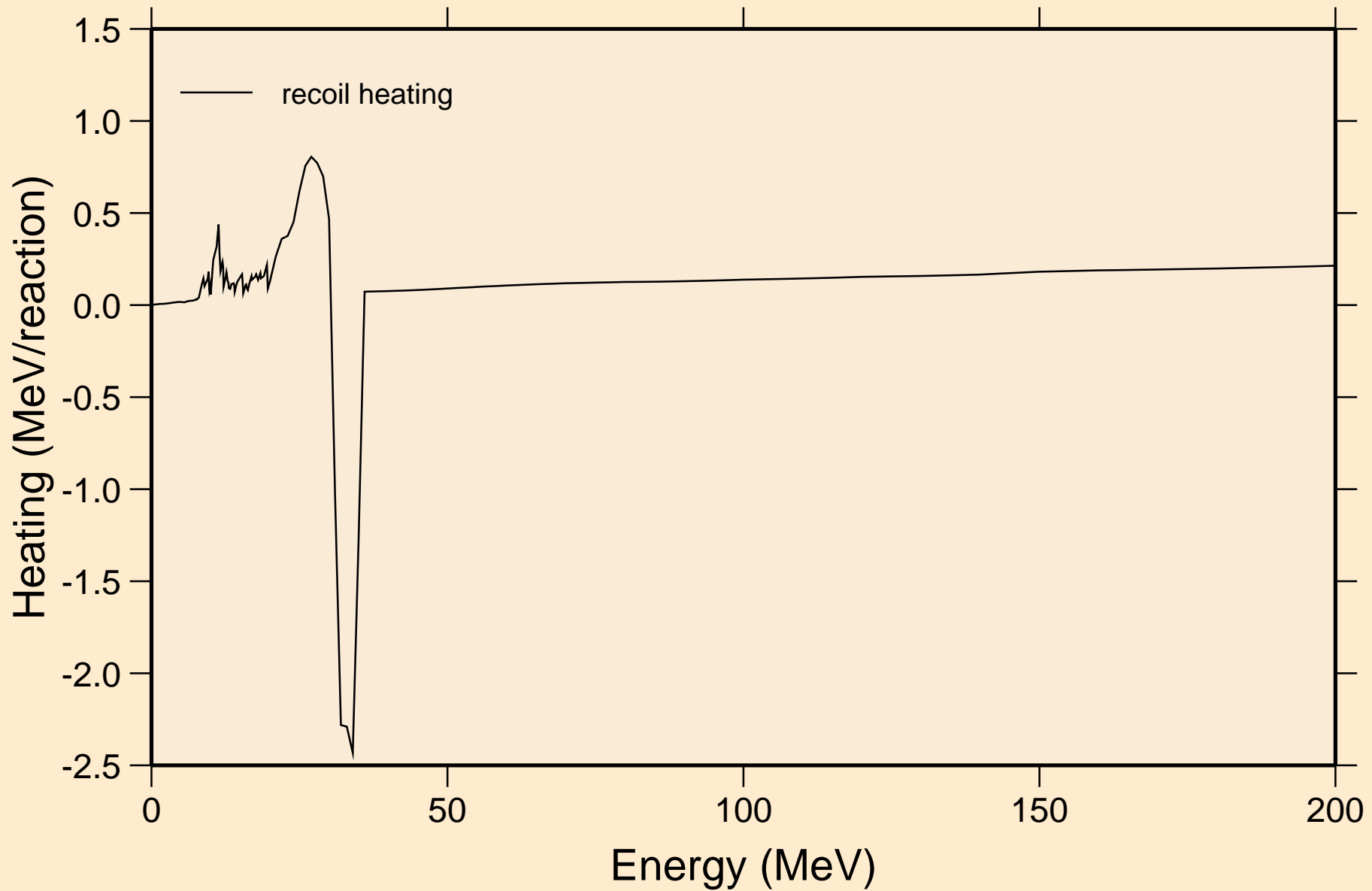

PA241 NEUTRON ACER TENDL-2021 LIBRARY; T=293.6K
Particle production cross sections

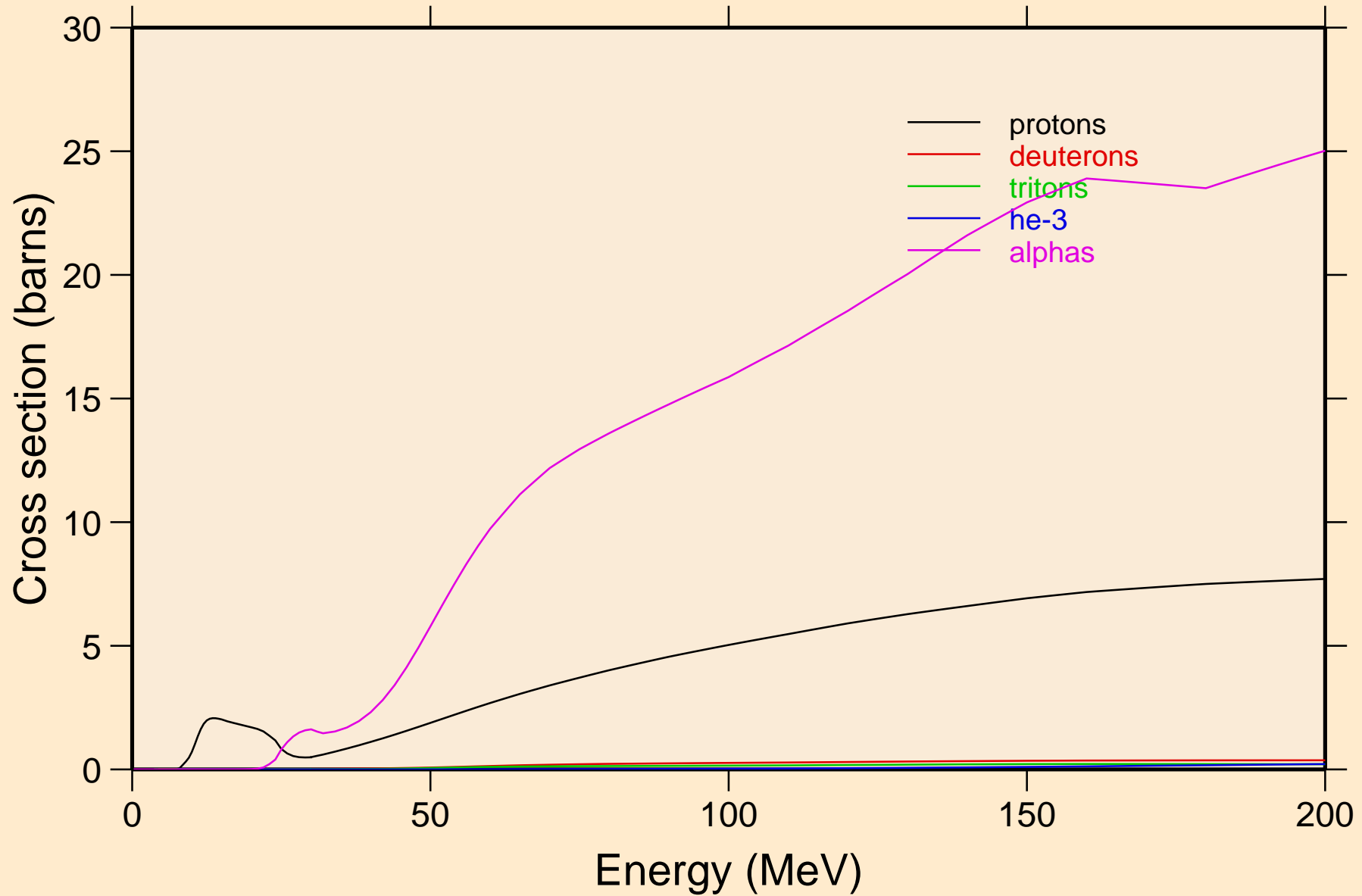

PA241 NEUTRON ACER TENDL-2021 LIBRARY; T=293.6K
protons from (n,x)

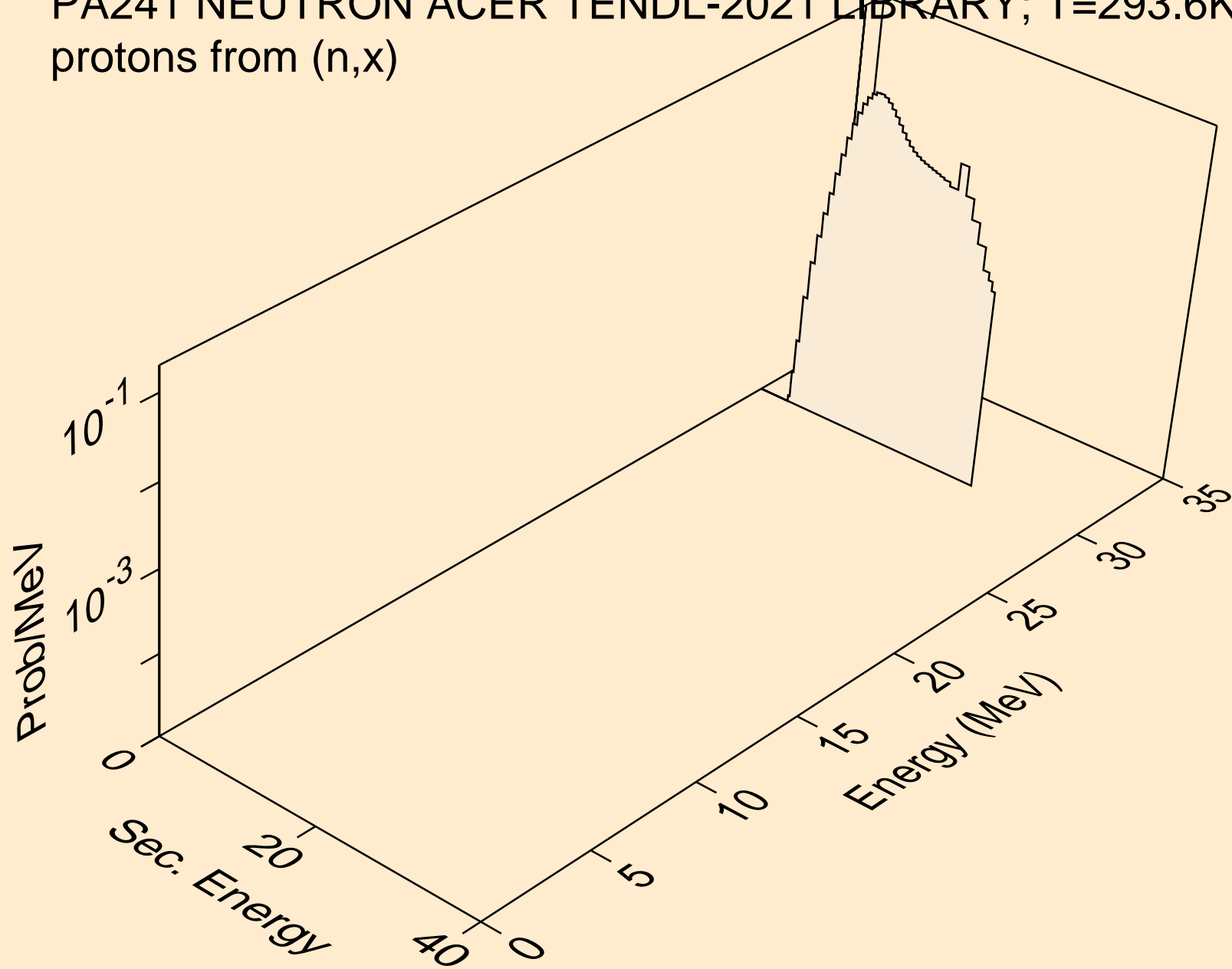

PA241 NEUTRON ACER TENDL-2021 LIBRARY; T=293.6K
protons from (n,n*)p

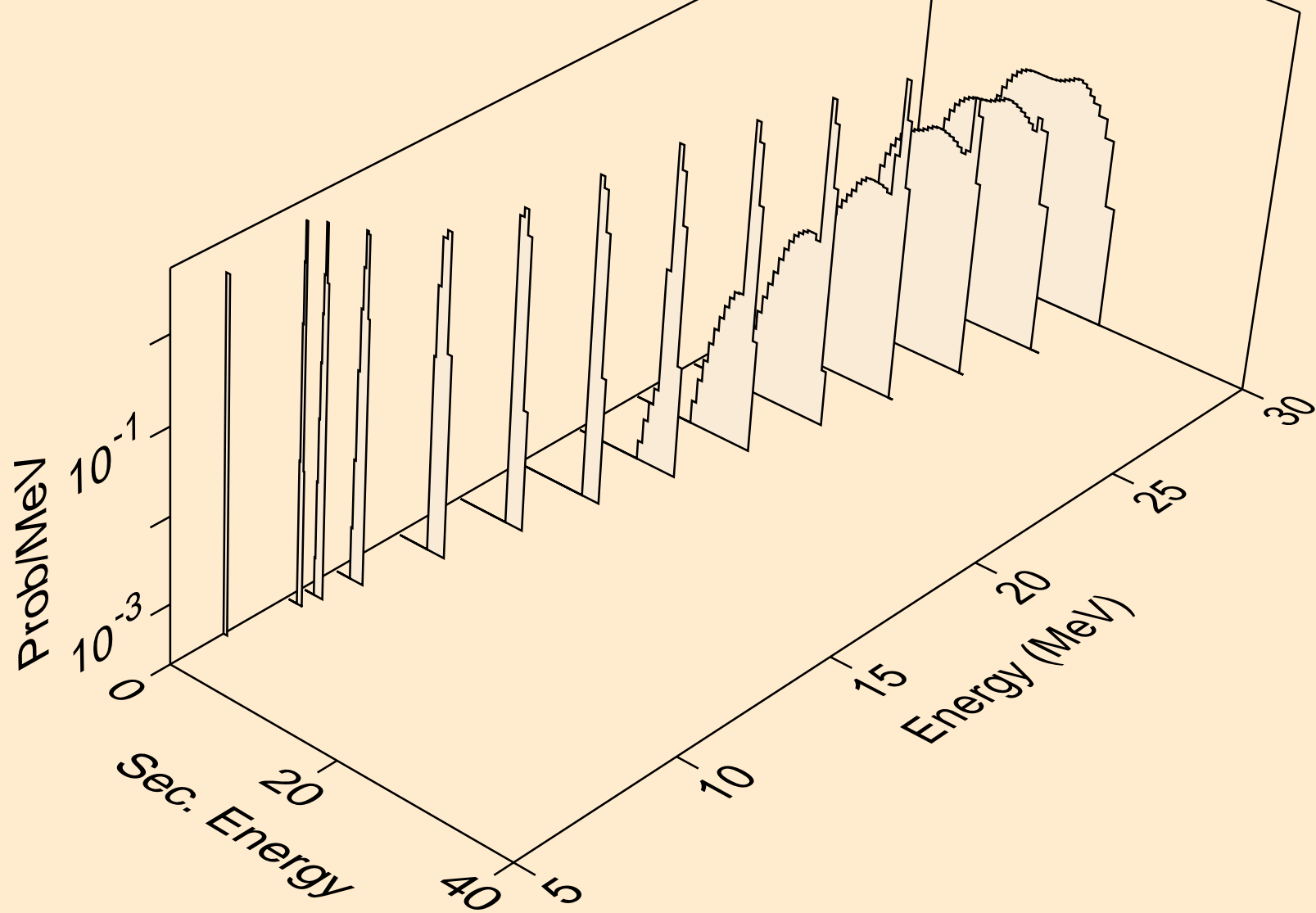

PA241 NEUTRON ACER TENDL-2021 LIBRARY; T=293.6K
protons from (n,2np)

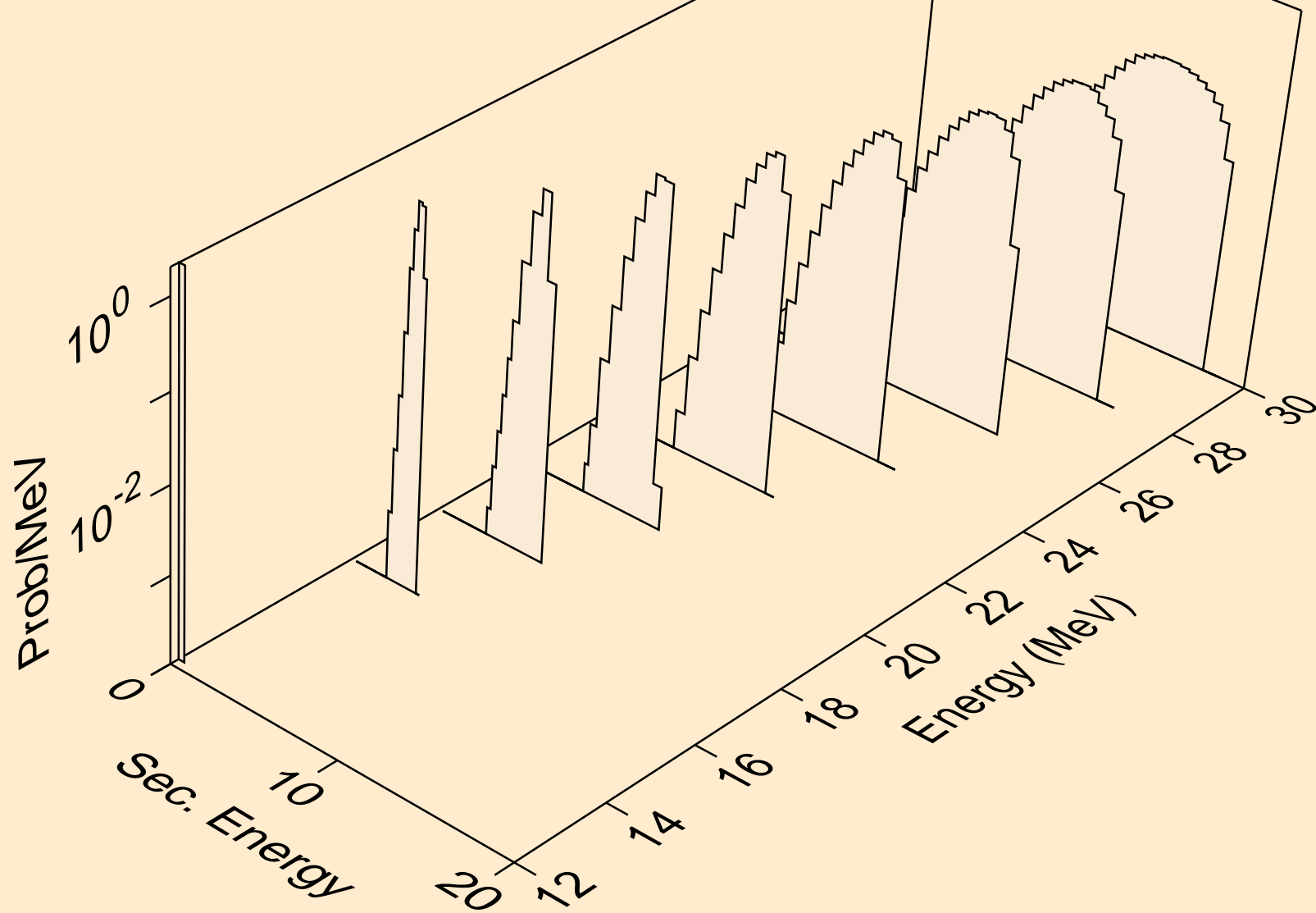

PA241 NEUTRON ACER TENDL-2021 LIBRARY; T=293.6K
protons from (n,3np)

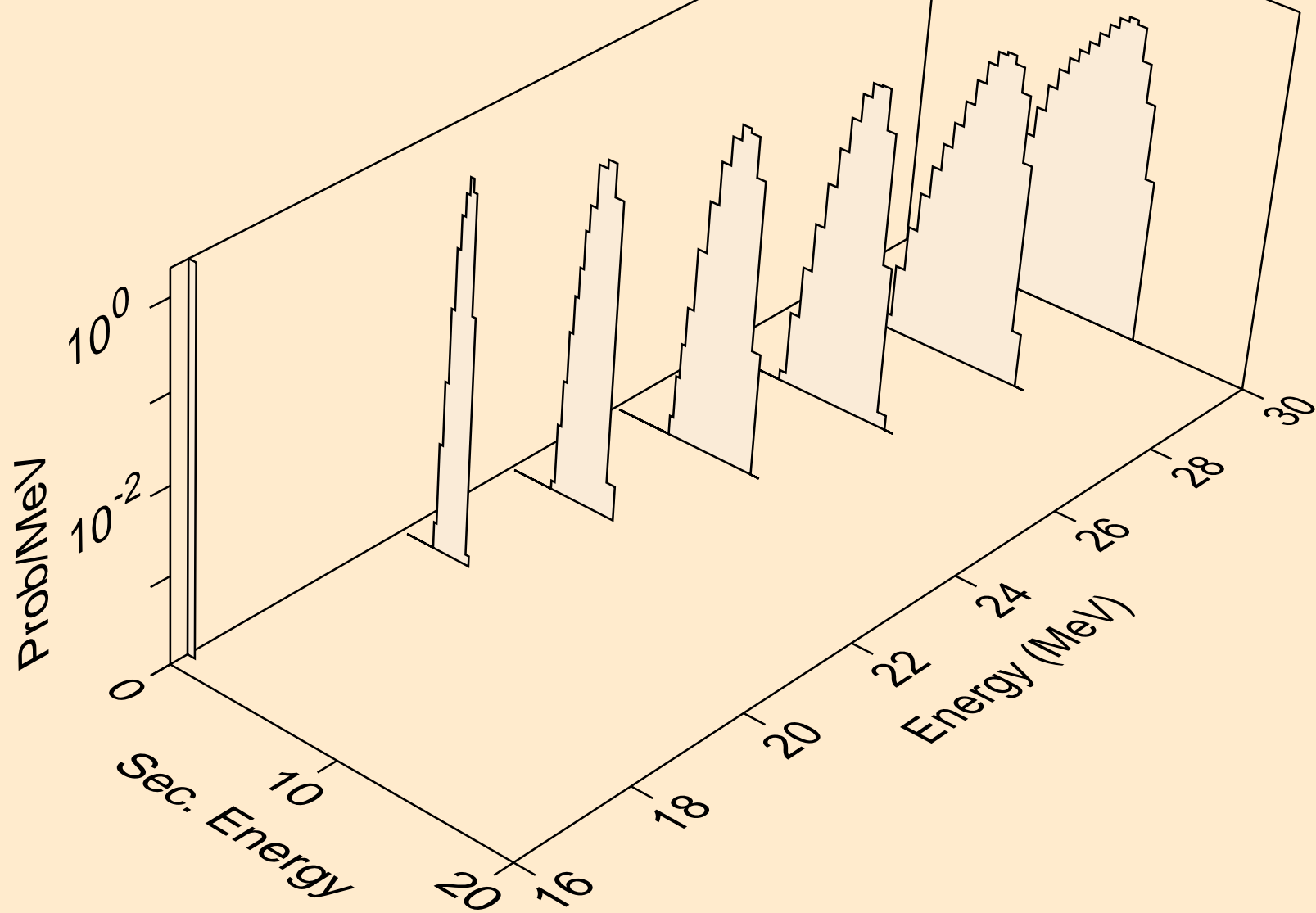

PA241 NEUTRON ACER TENDL-2021 LIBRARY; T=293.6K
protons from (n,npa)

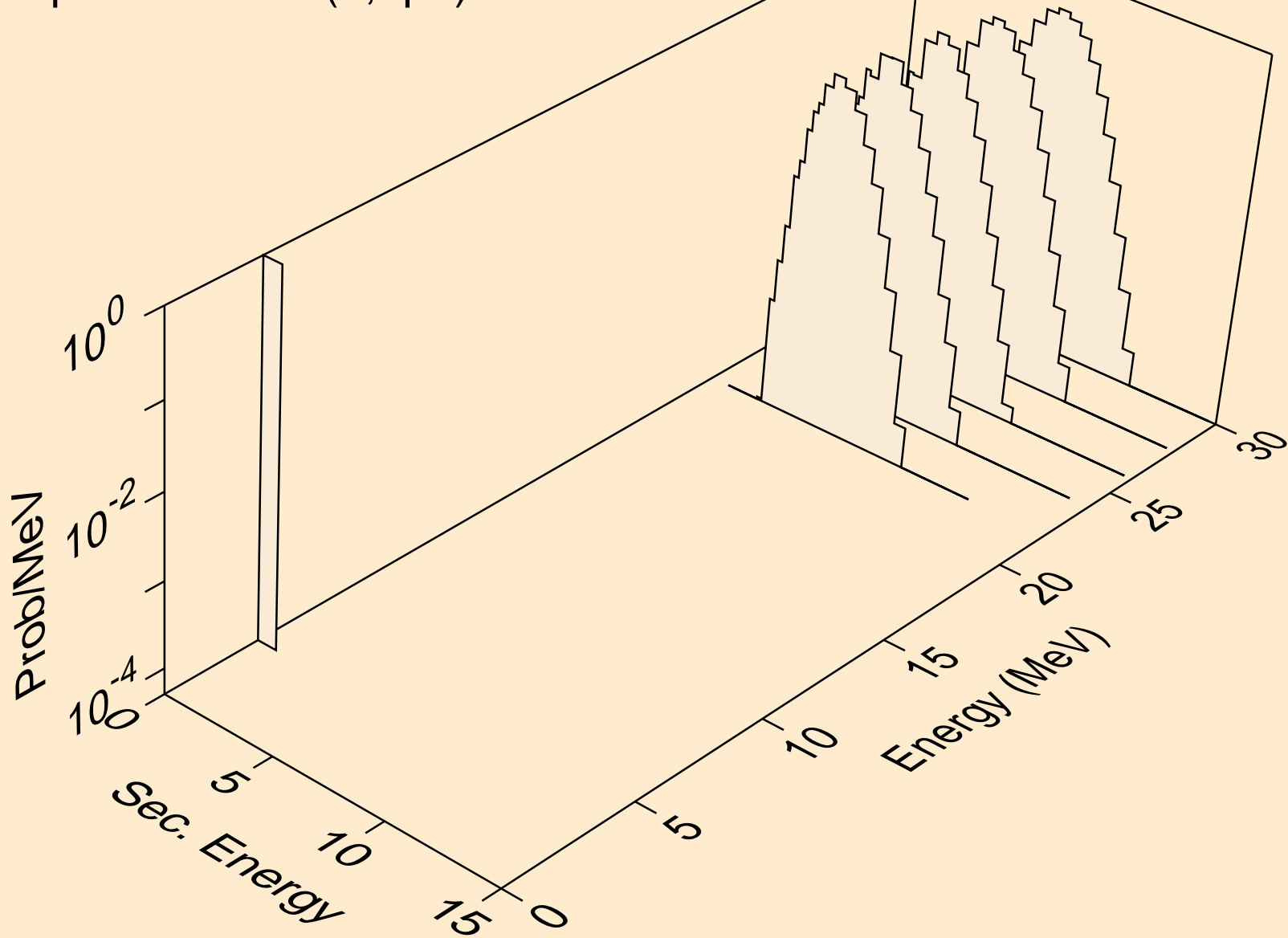

PA241 NEUTRON ACER TENDL-2021 LIBRARY; T=293.6K
protons from (n,p)

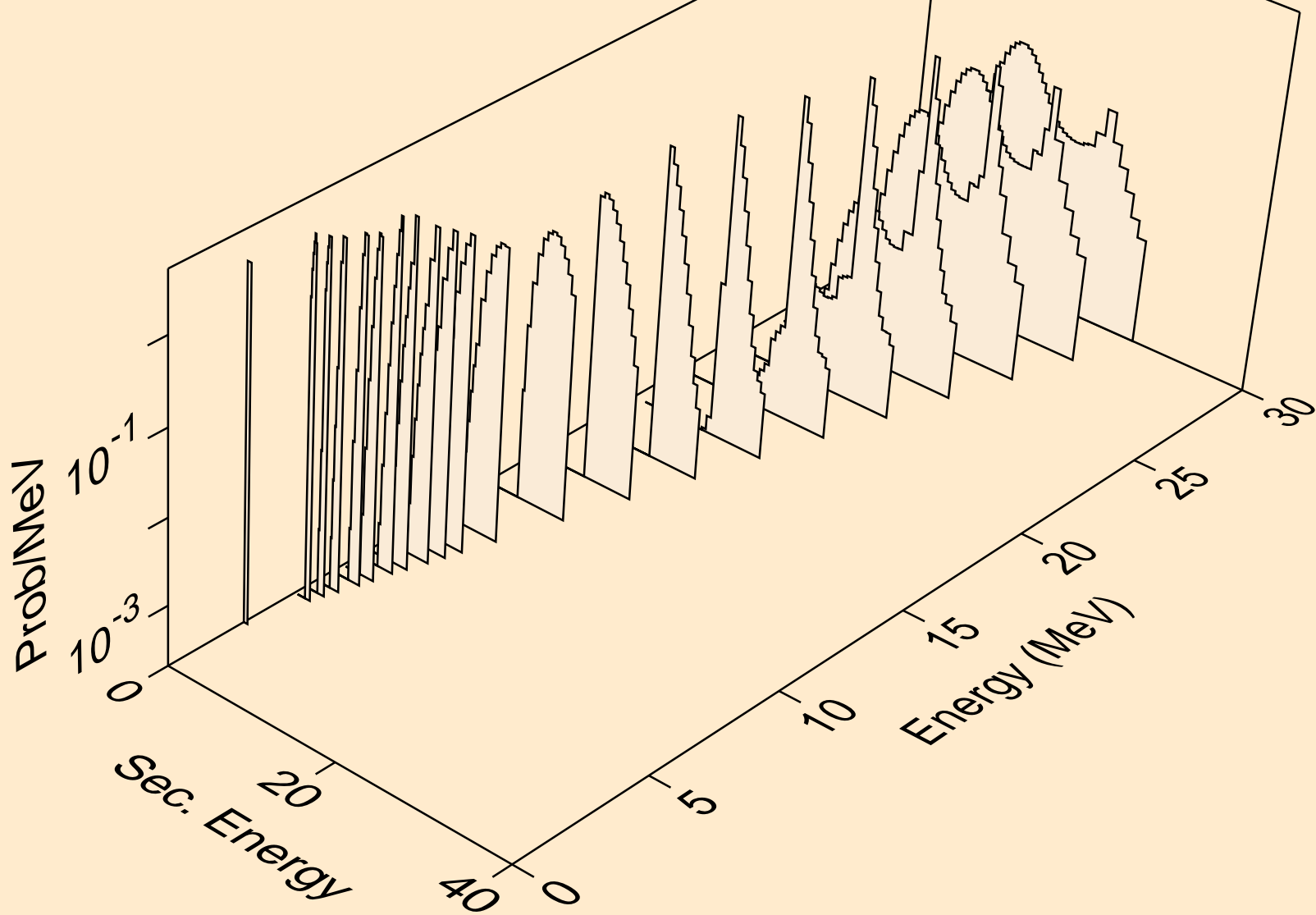

PA241 NEUTRON ACER TENDL-2021 LIBRARY; T=293.6K
protons from (n,2p)

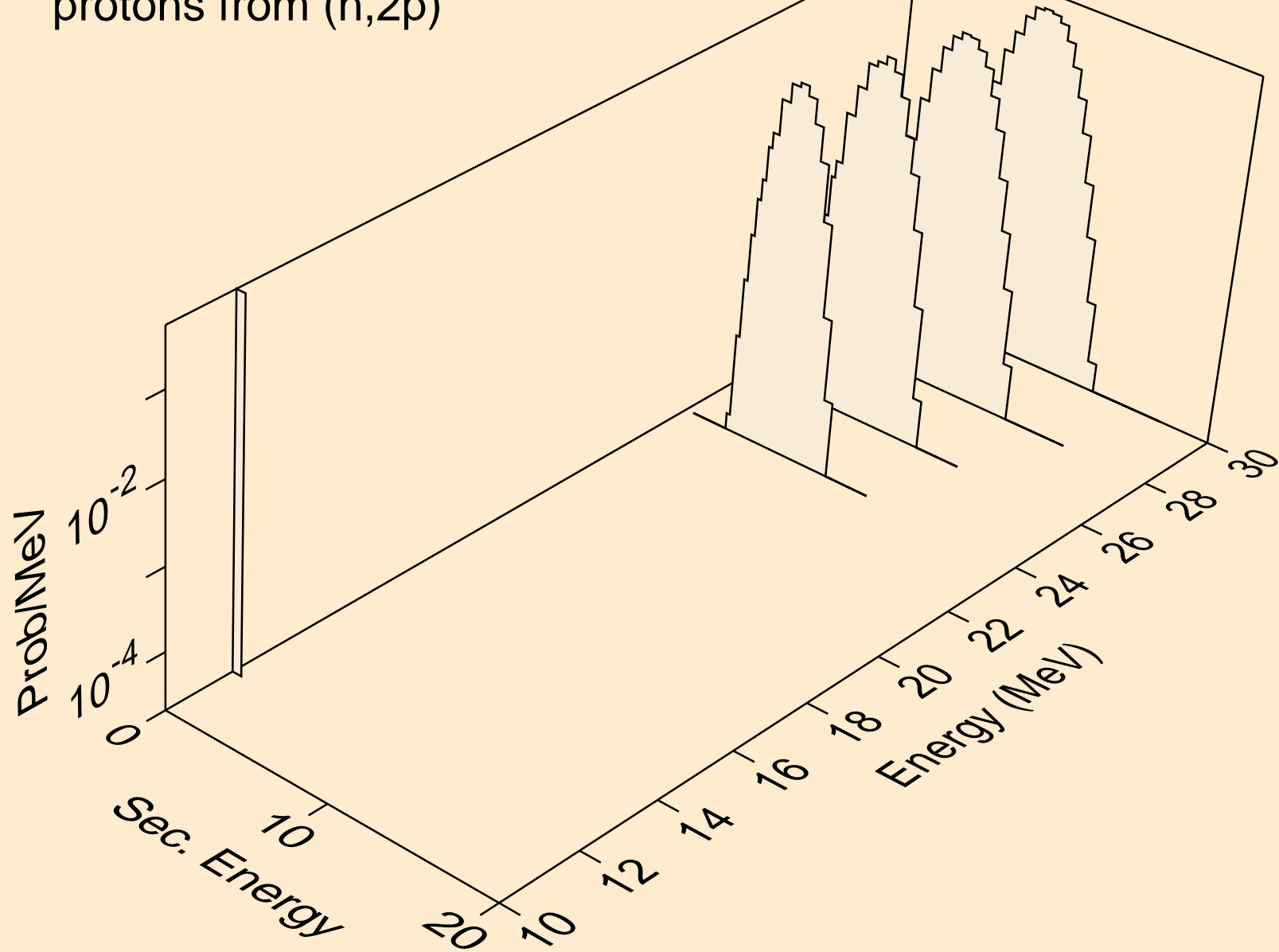

PA241 NEUTRON ACER TENDL-2021 LIBRARY; T=293.6K
protons from (n,p)

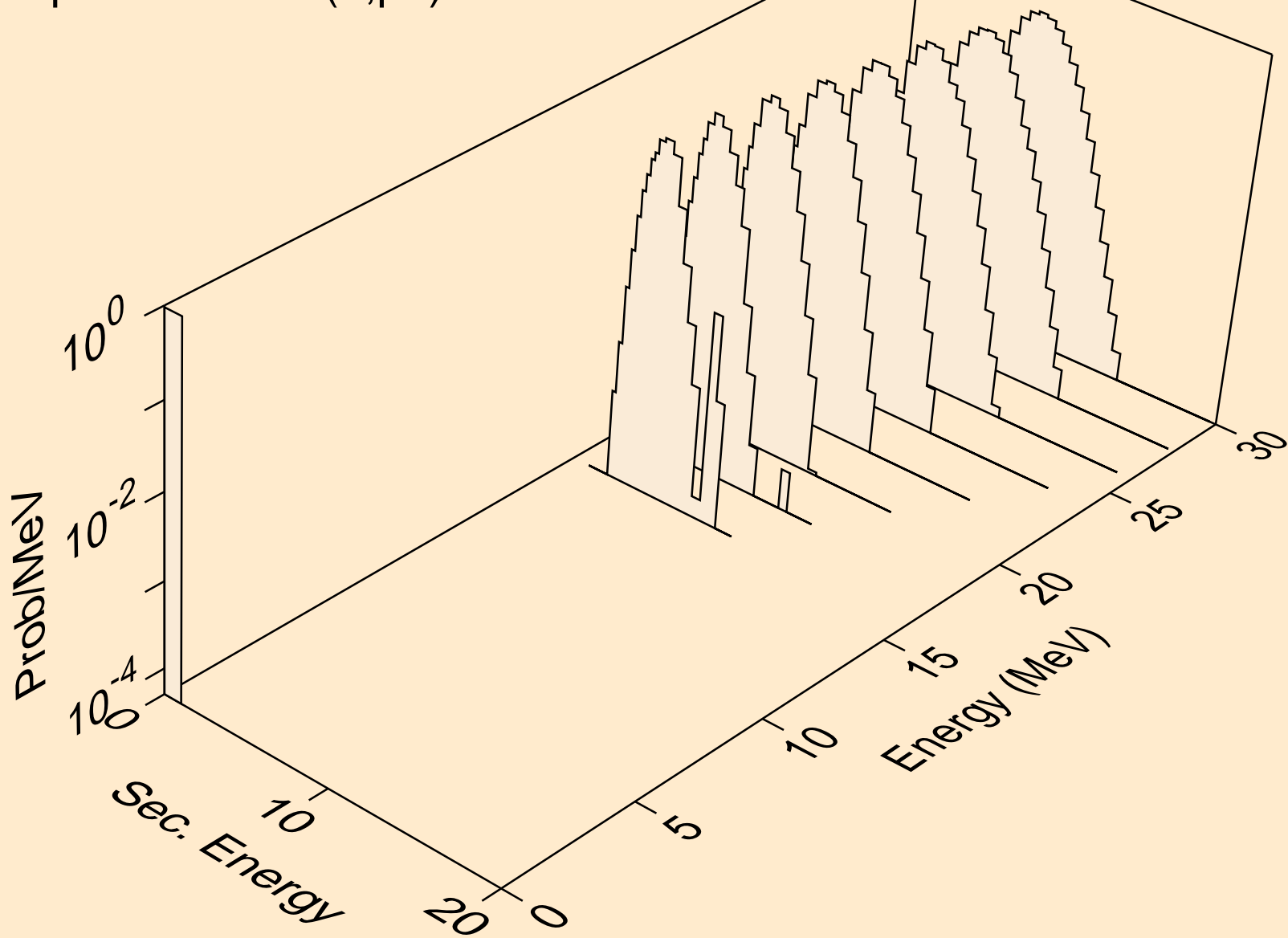

PA241 NEUTRON ACER TENDL-2021 LIBRARY; T=293.6K
protons from (n,pd)

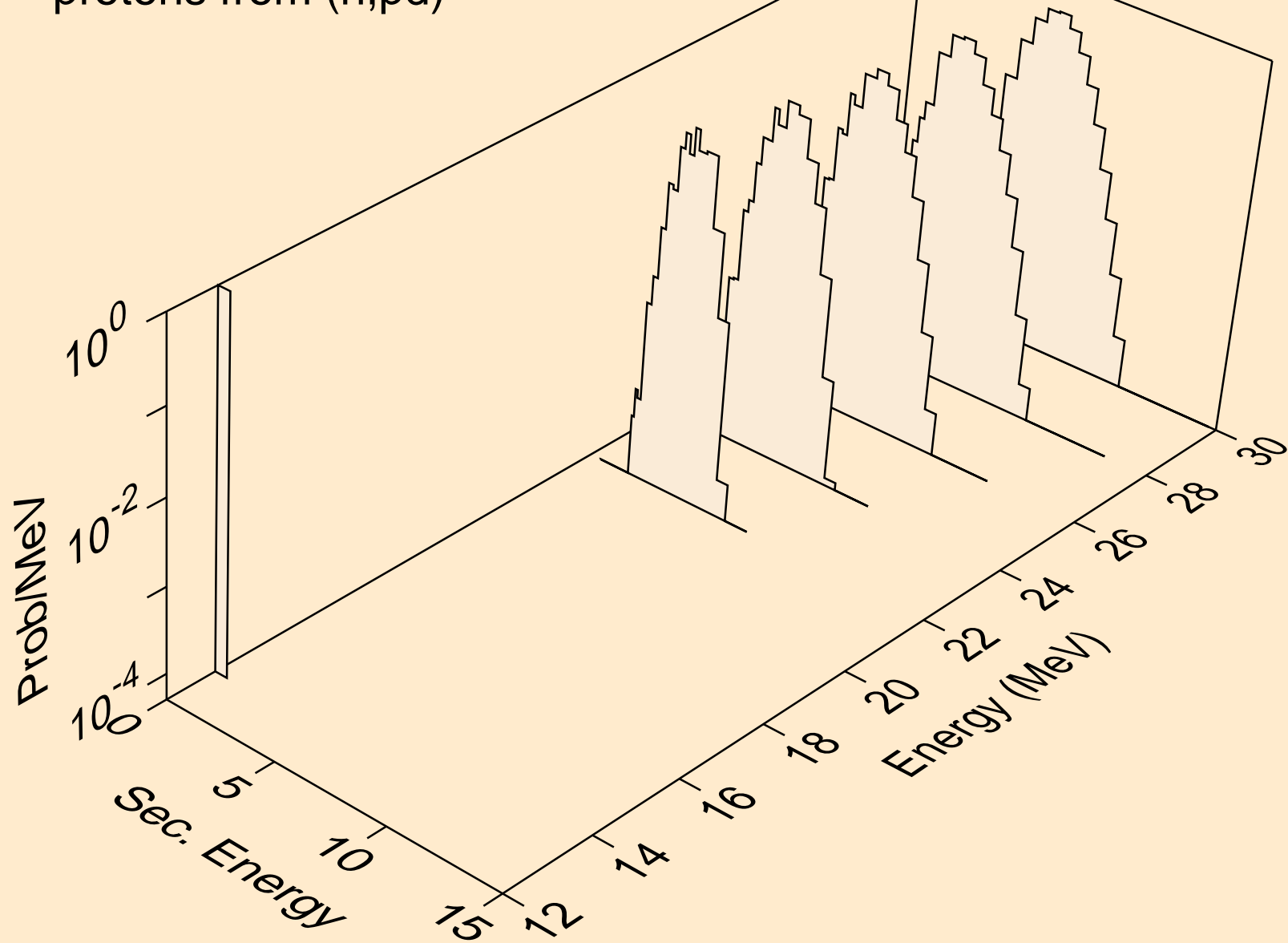

PA241 NEUTRON ACER TENDL-2021 LIBRARY; T=293.6K
protons from (n,pt)

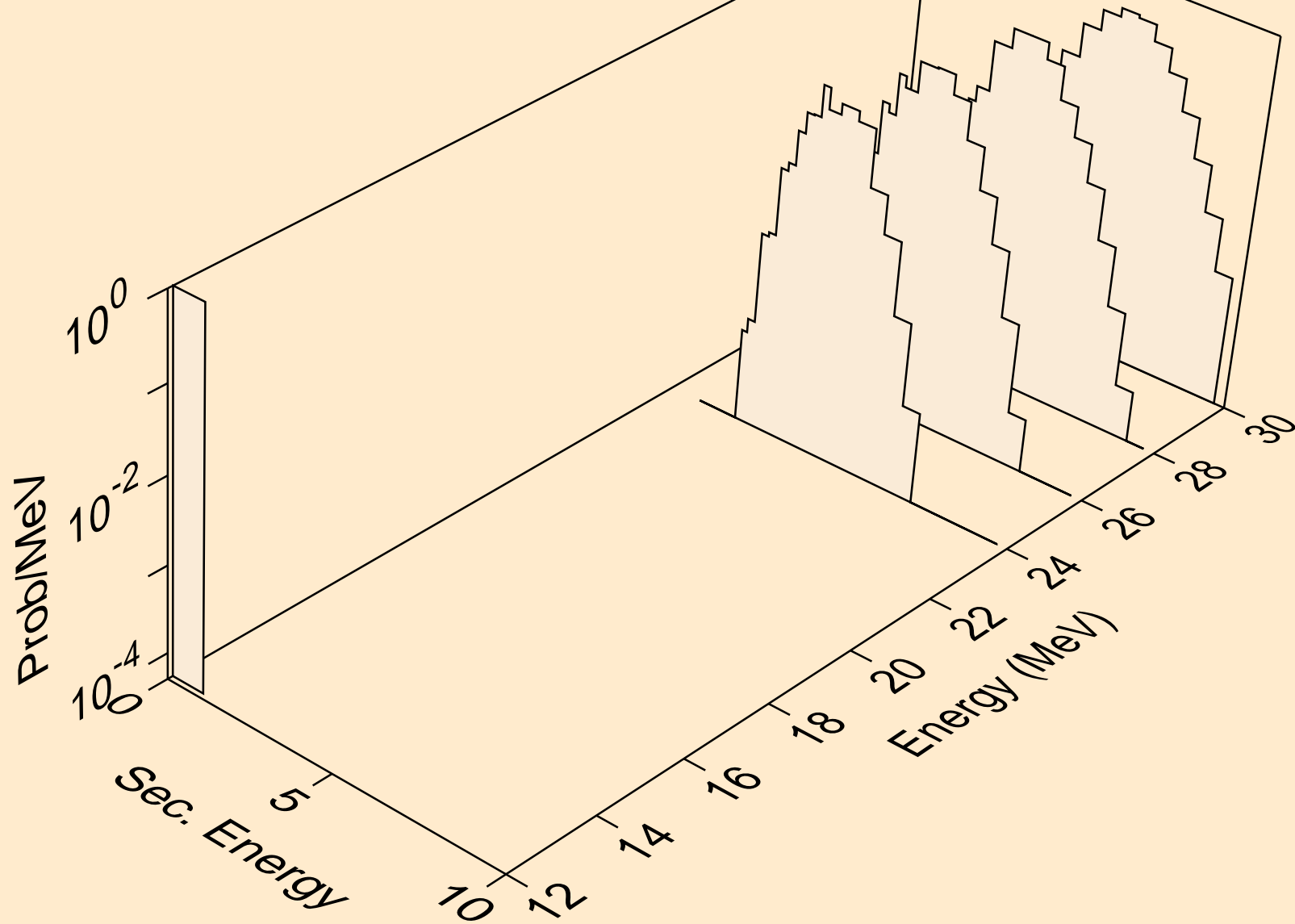

PA241 NEUTRON ACER TENDL-2021 LIBRARY; T=293.6K
deuterons from (n,x)

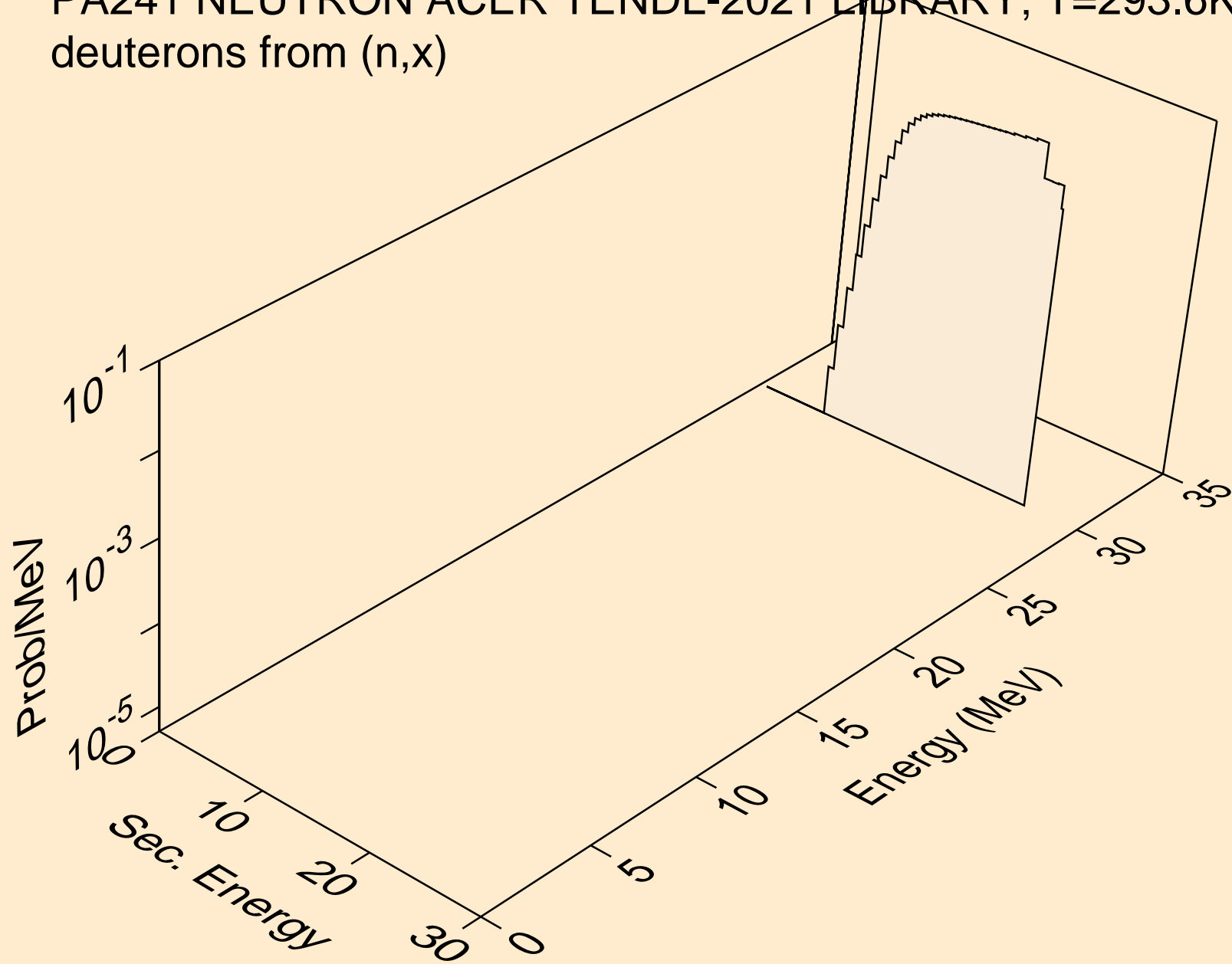

PA241 NEUTRON ACER TENDL-2021 LIBRARY; T=293.6K
deuterons from (n,2nd)

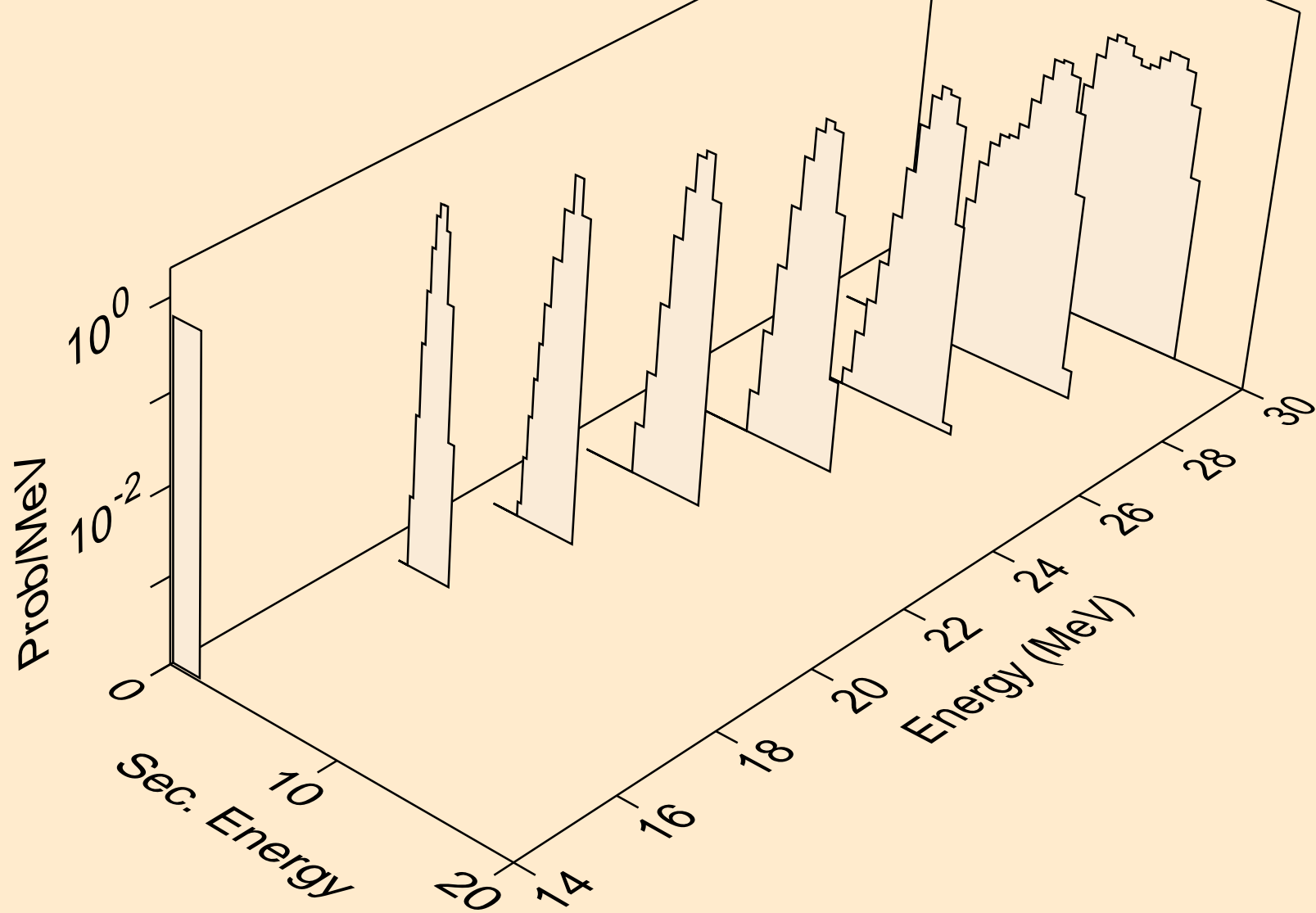

PA241 NEUTRON ACER TENDL-2021 LIBRARY; T=293.6K
deuterons from (n,n*)d

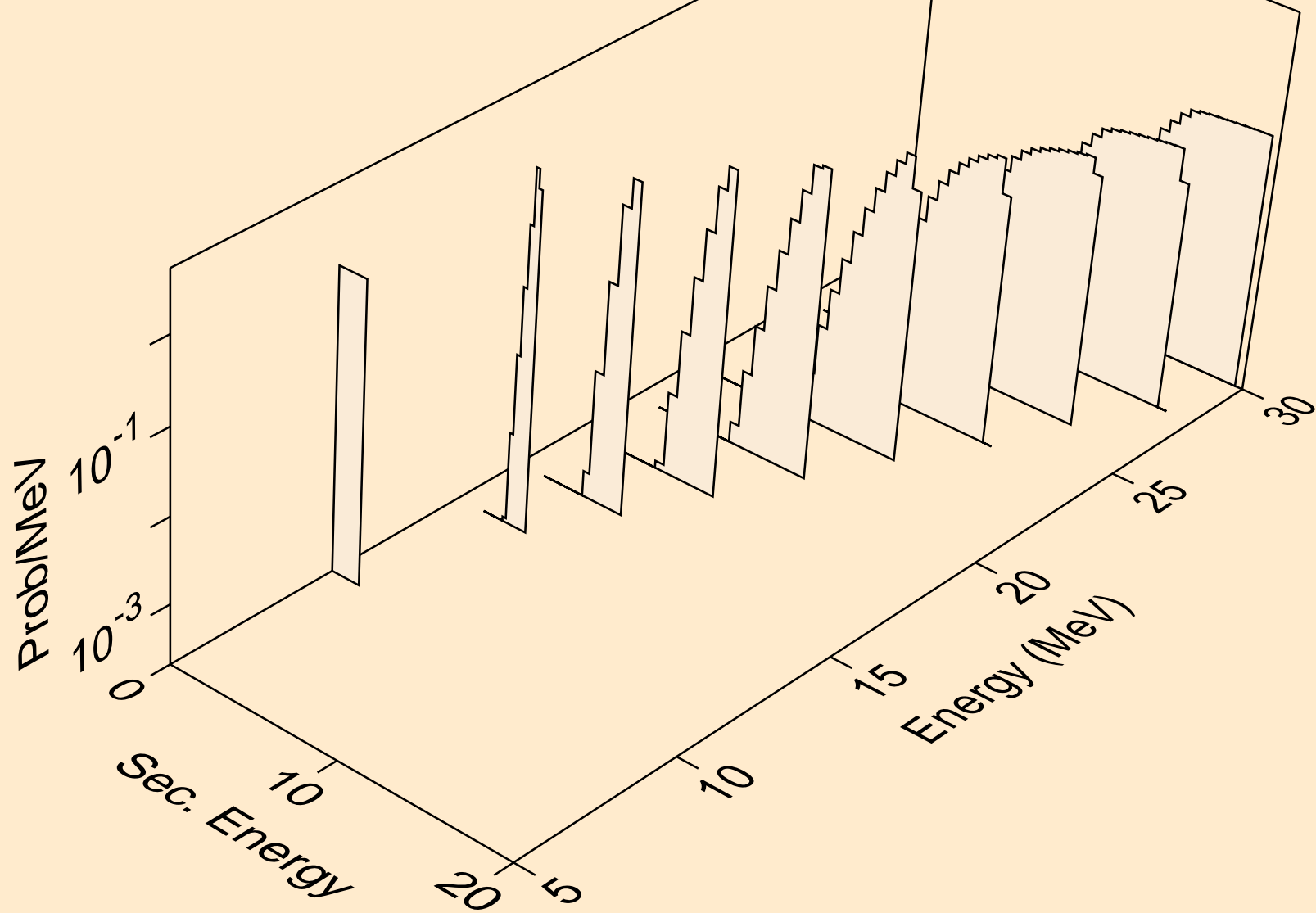

PA241 NEUTRON ACER TENDL-2021 LIBRARY; T=293.6K
deuterons from (n,d)

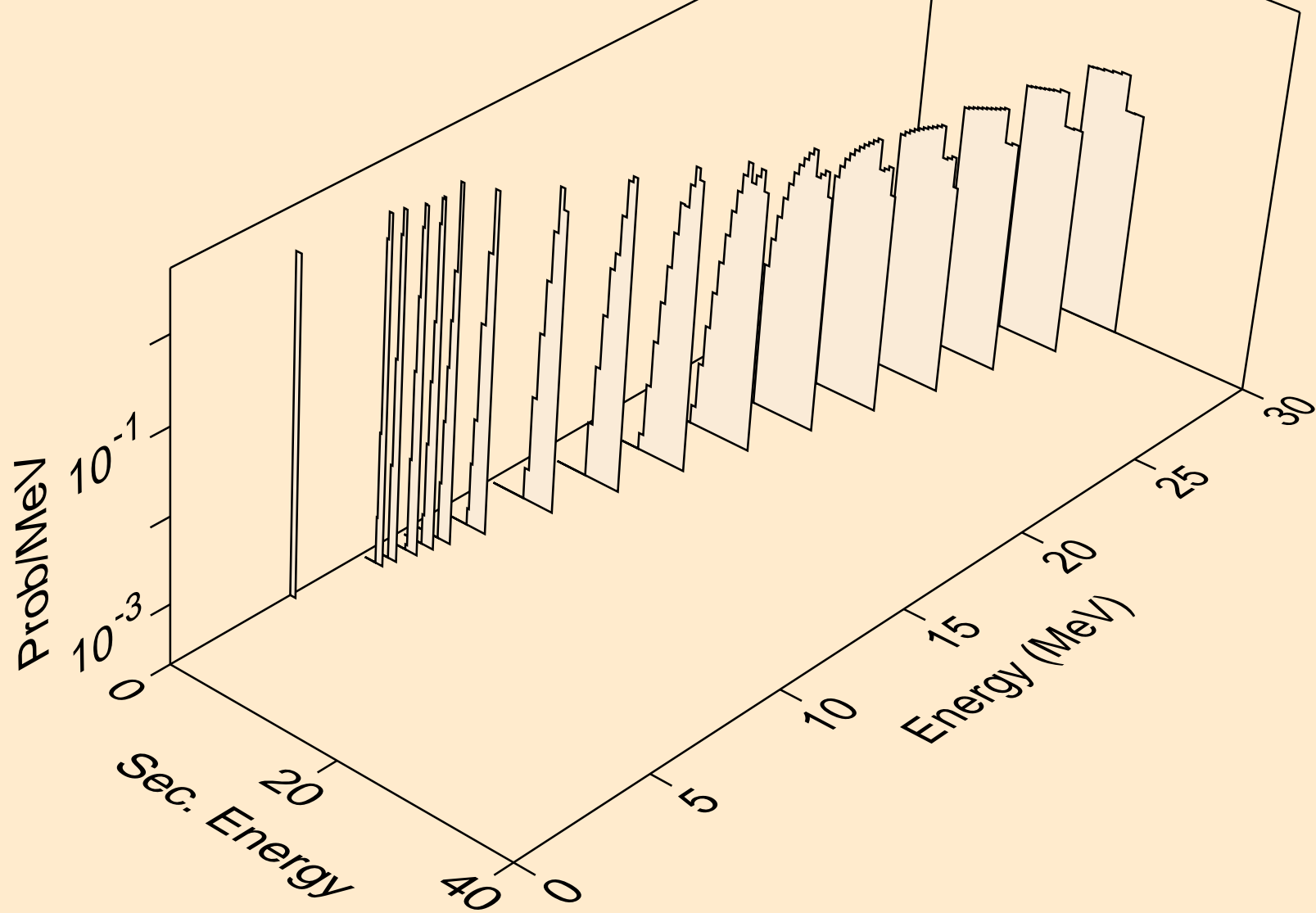

PA241 NEUTRON ACER TENDL-2021 LIBRARY; T=293.6K
deuterons from (n,pd)

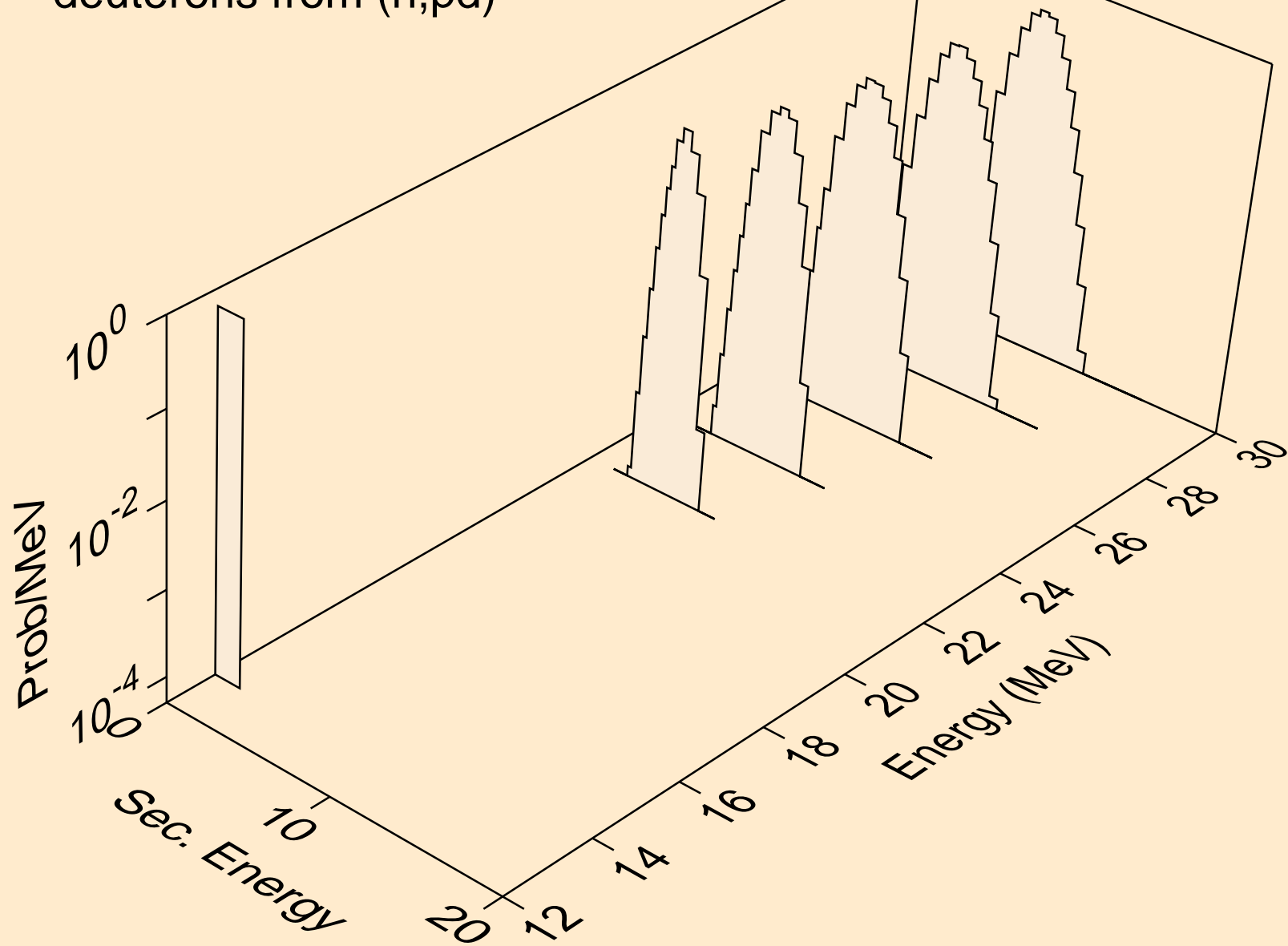

PA241 NEUTRON ACER TENDL-2021 LIBRARY; T=293.6K
tritons from (n,x)

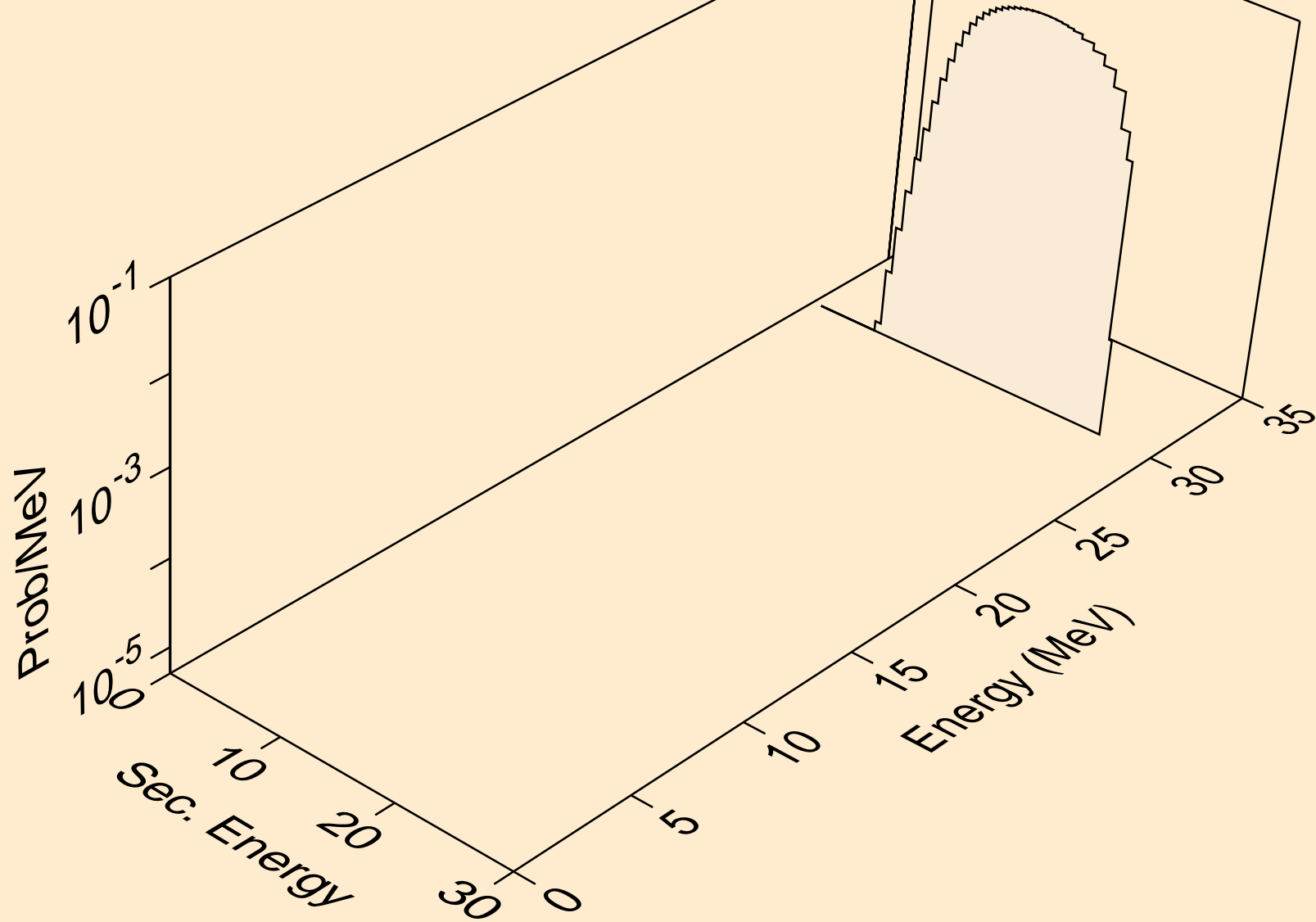

PA241 NEUTRON ACER TENDL-2021 LIBRARY; T=293.6K
tritons from (n,n*)t

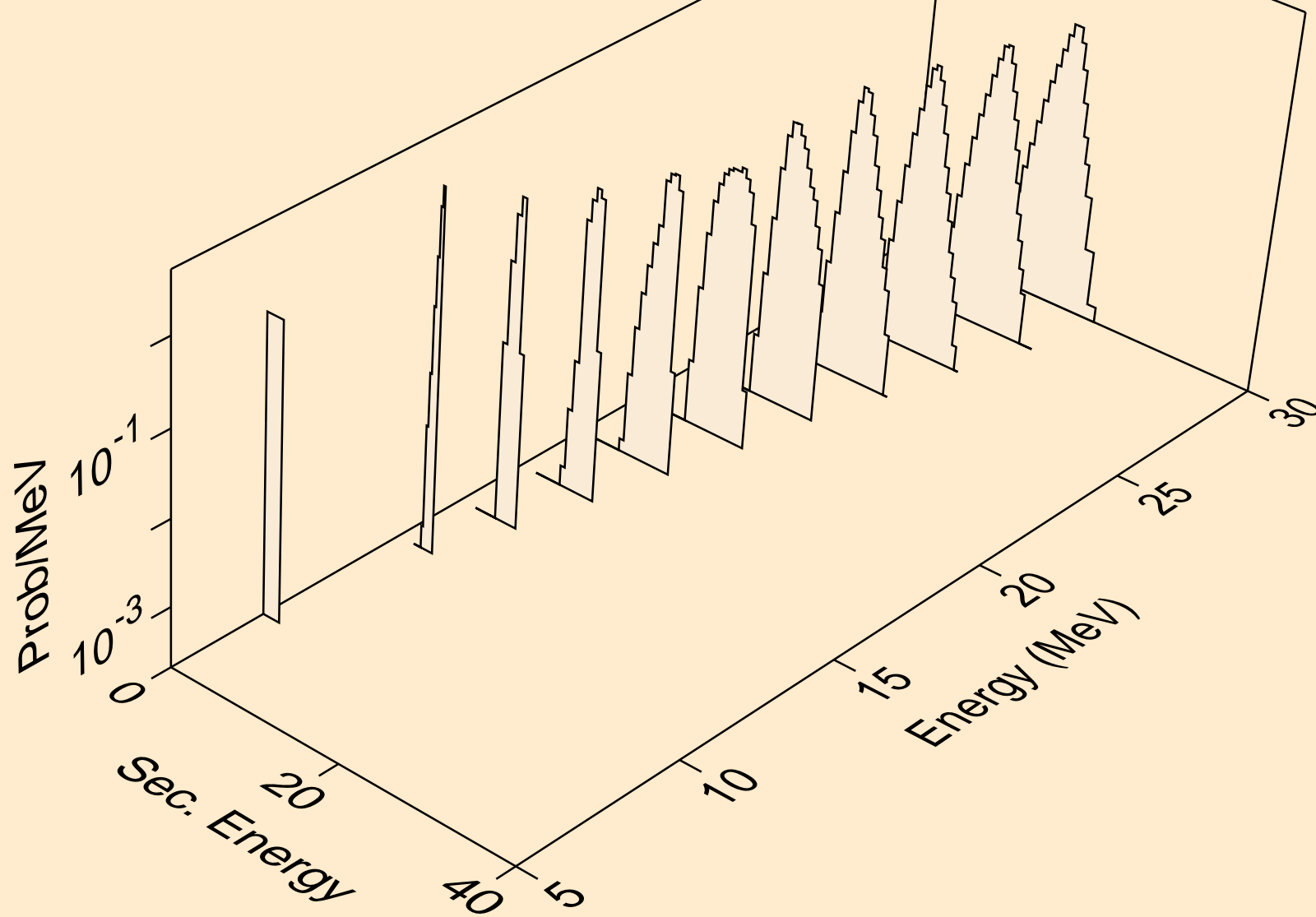

PA241 NEUTRON ACER TENDL-2021 LIBRARY; T=293.6K
tritons from (n,t)

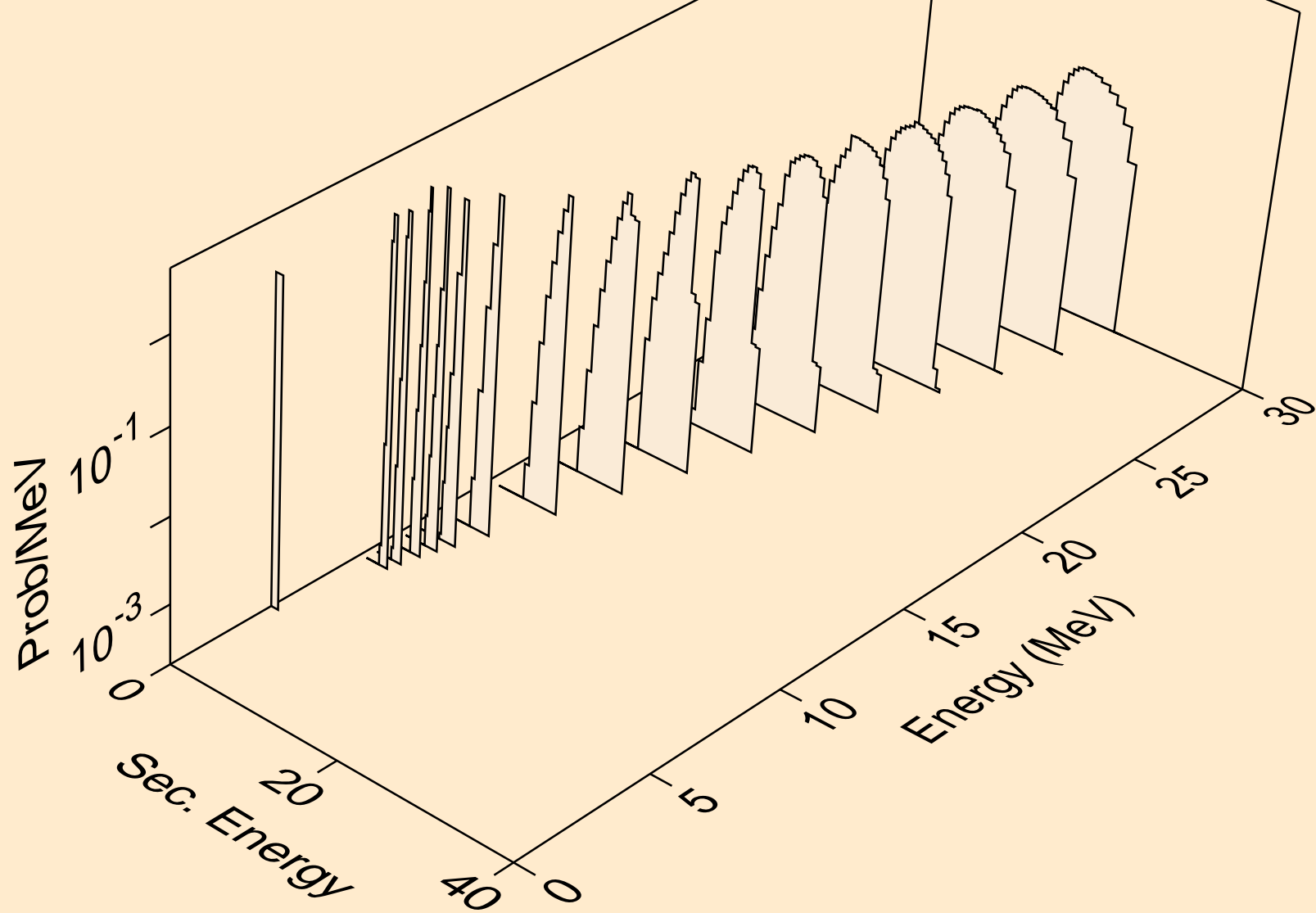

PA241 NEUTRON ACER TENDL-2021 LIBRARY; T=293.6K
tritons from (n,pt)

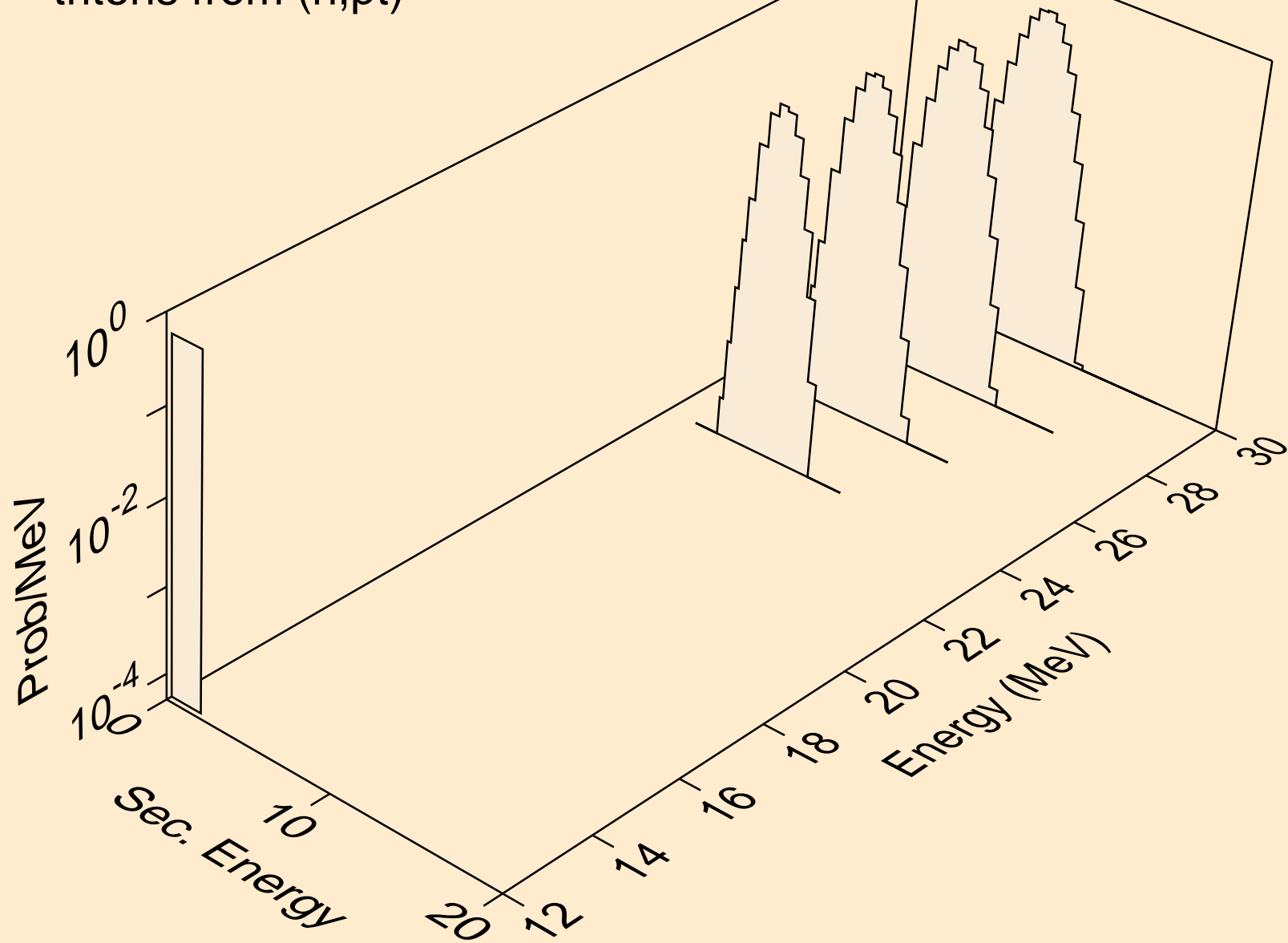

PA241 NEUTRON ACER TENDL-2021 LIBRARY; T=293.6K
he3s from (n,x)

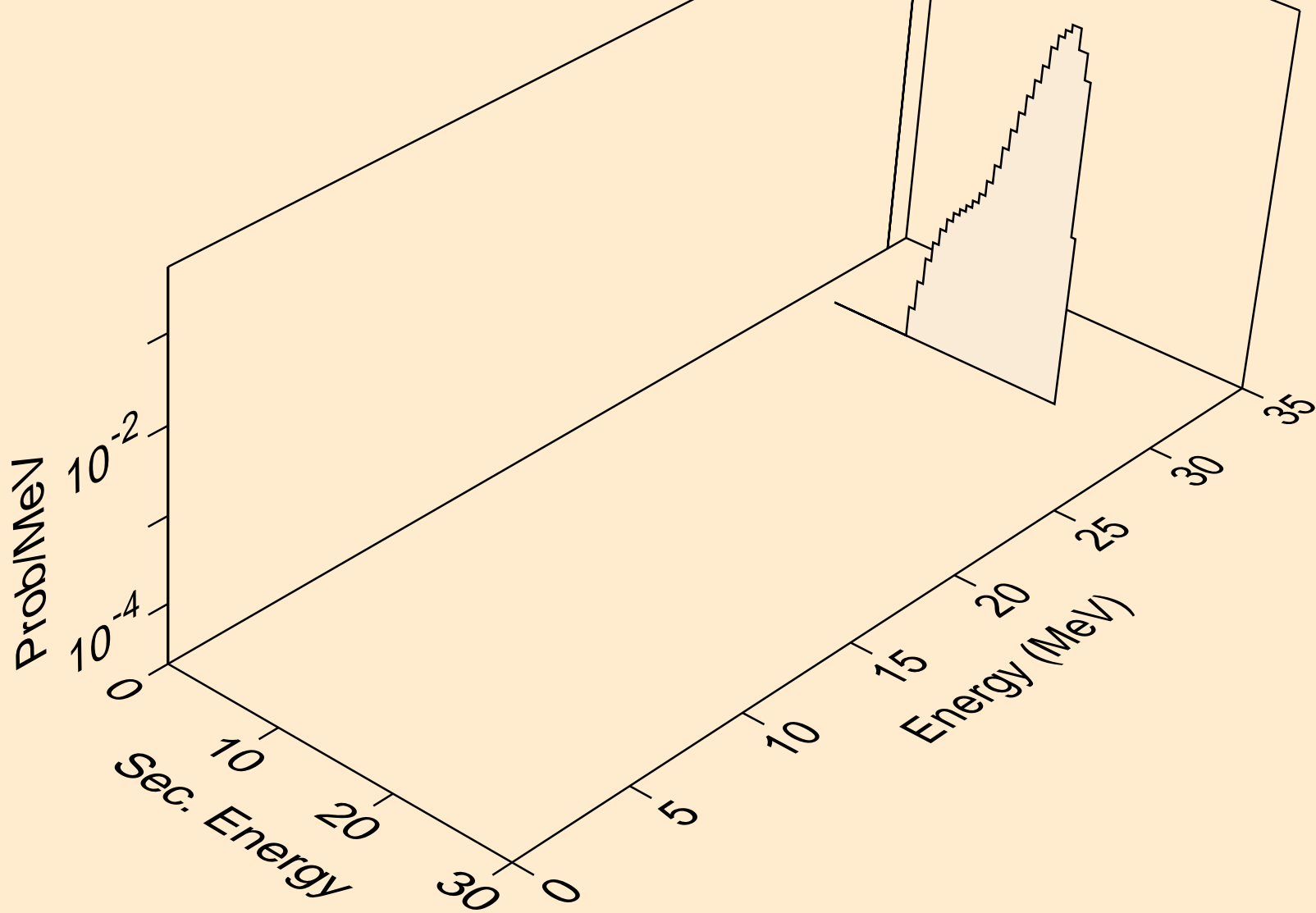

PA241 NEUTRON ACER TENDL-2021 LIBRARY; T=293.6K
he3s from (n,n*)he3

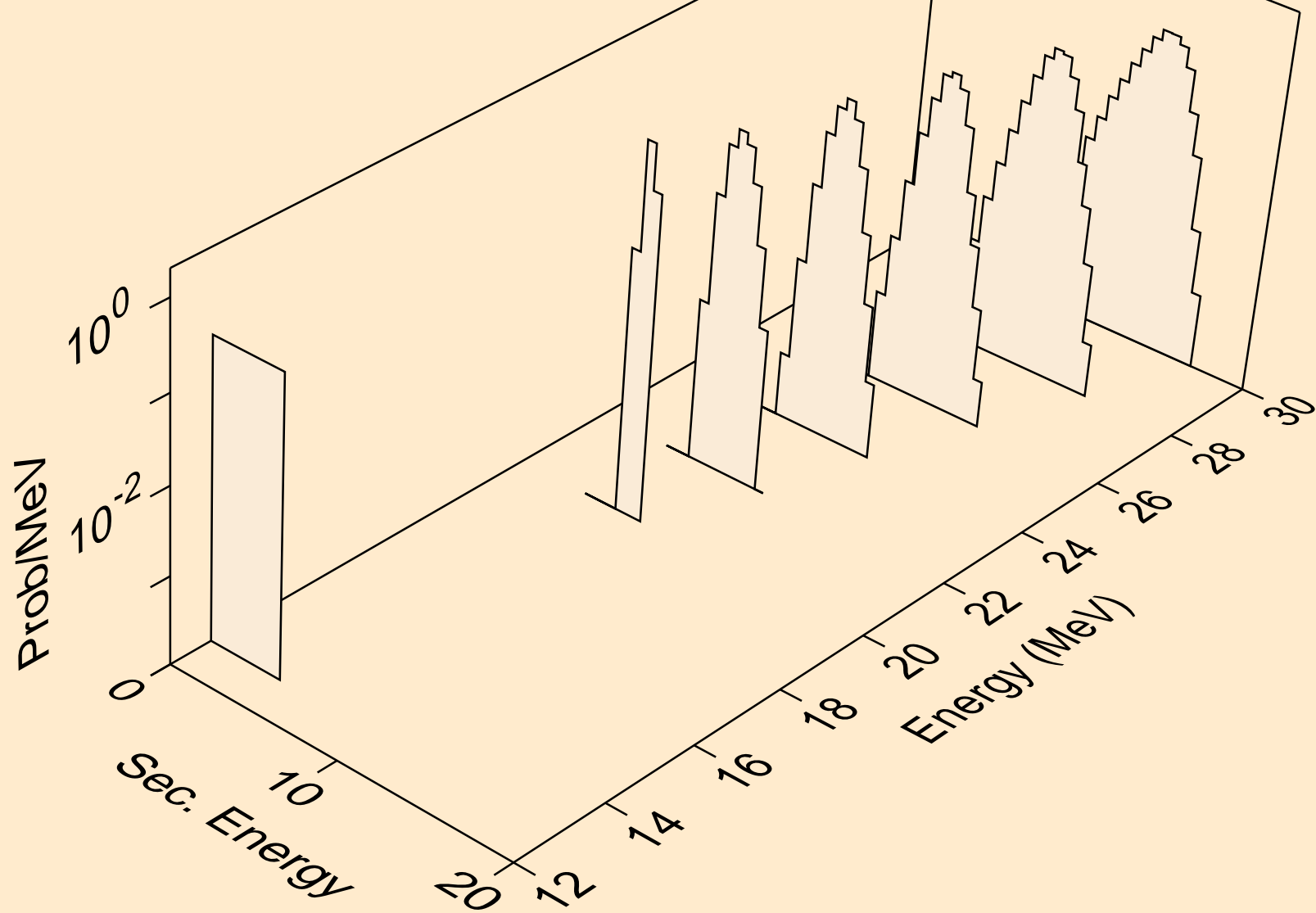

PA241 NEUTRON ACER TENDL-2021 LIBRARY; T=293.6K
he3s from (n,he3)

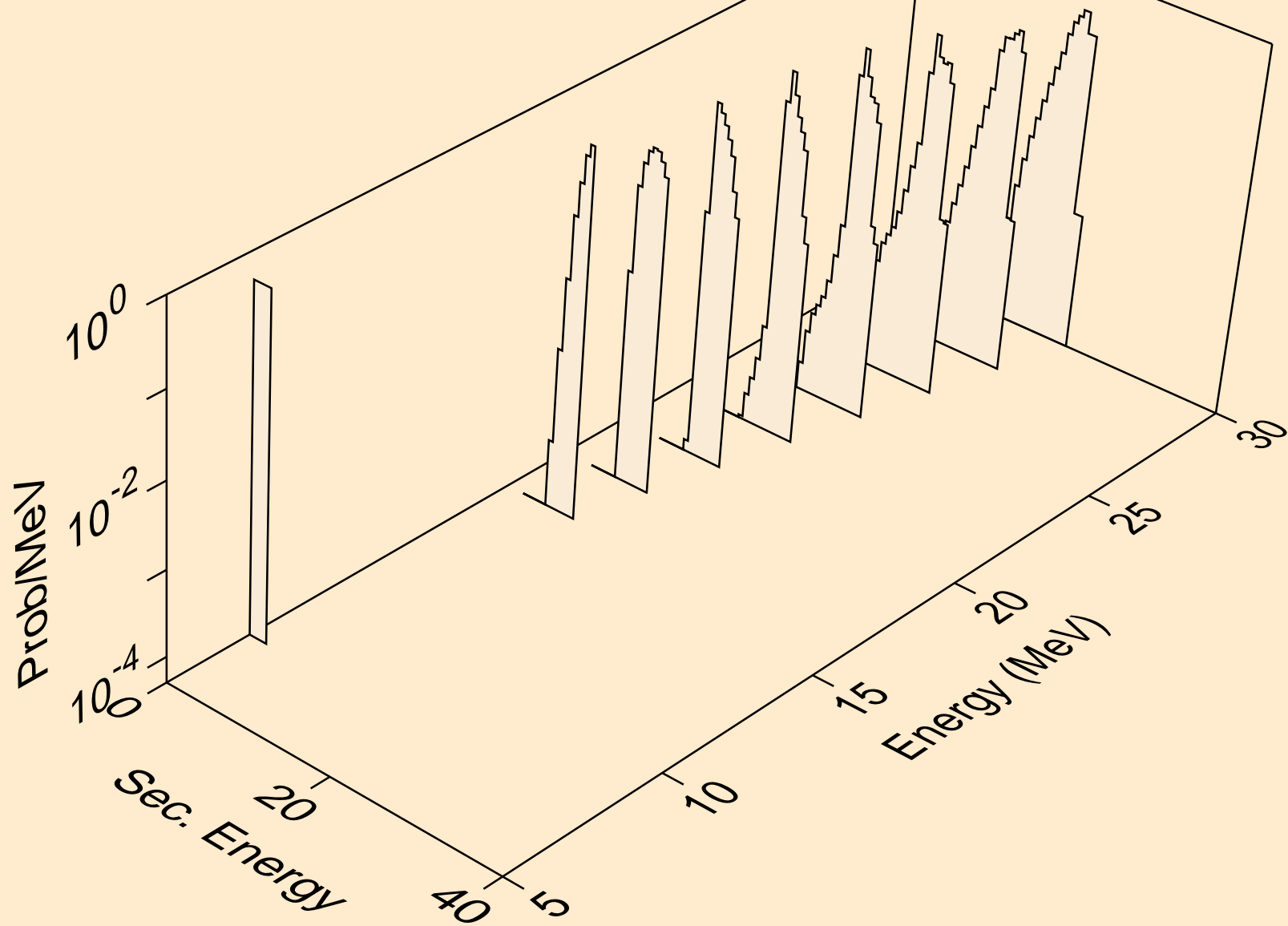

PA241 NEUTRON ACER TENDL-2021 LIBRARY; T=293.6K
alphas from (n,x)

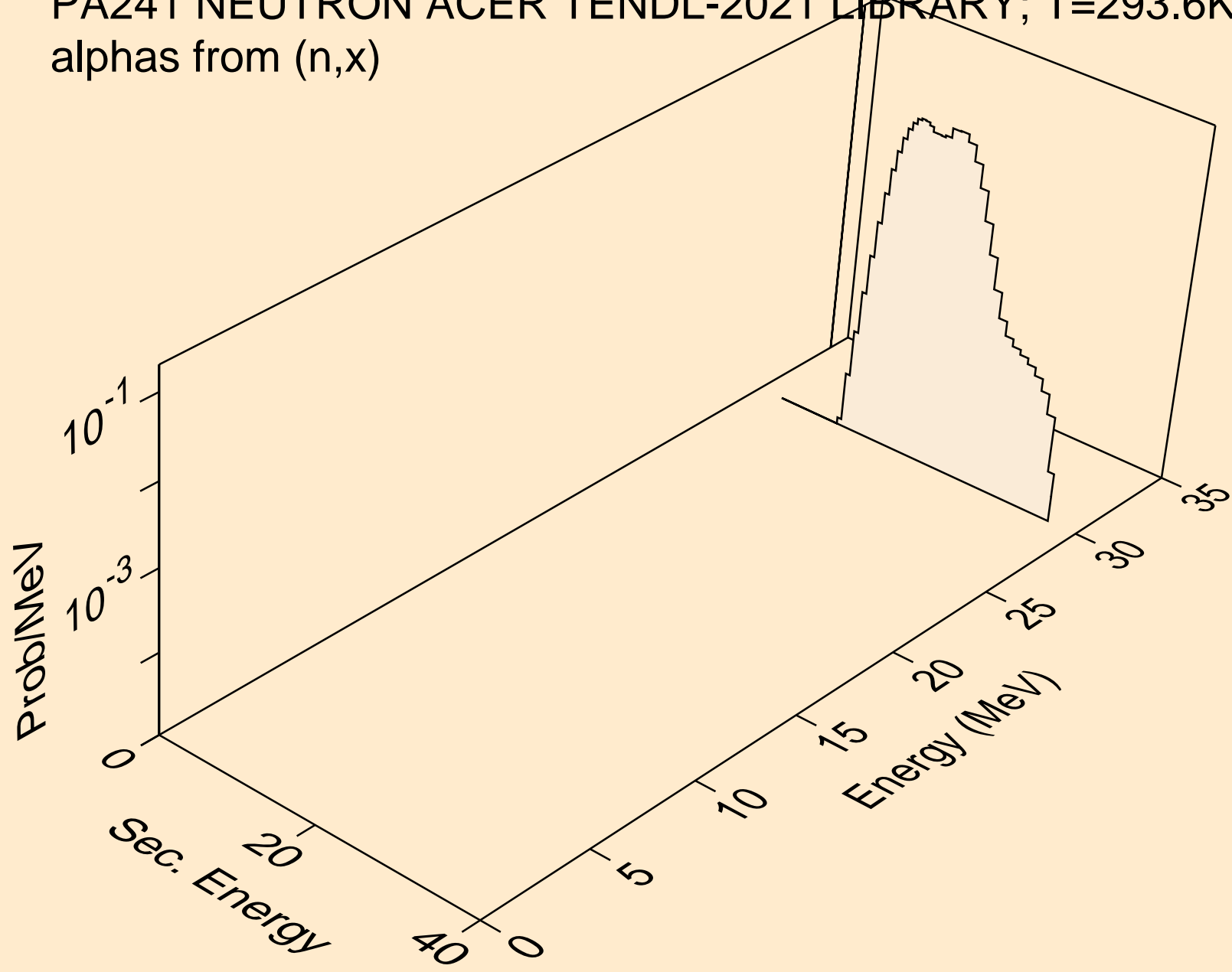

PA241 NEUTRON ACER TENDL-2021 LIBRARY; T=293.6K
alphas from (n,n*)a

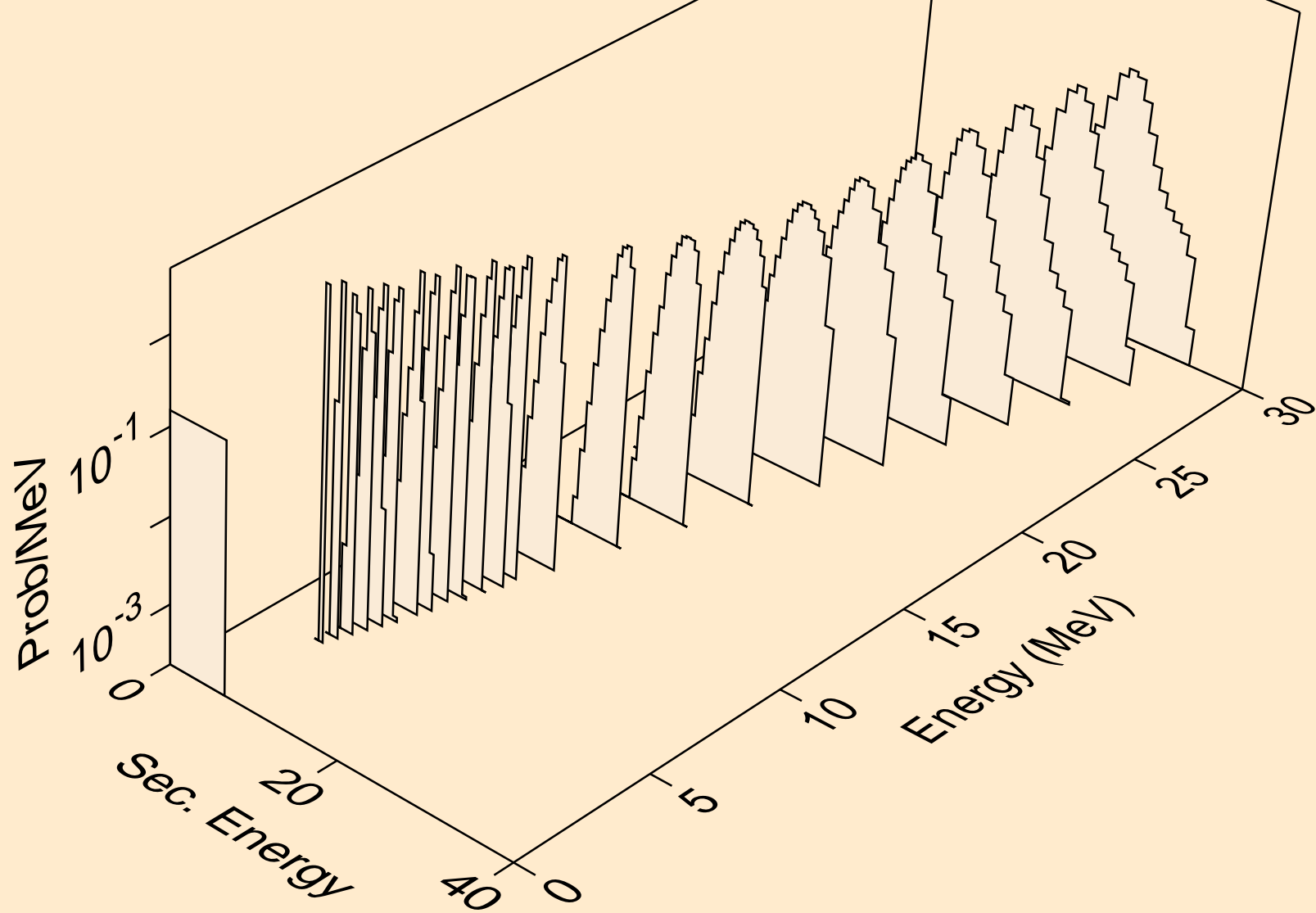

PA241 NEUTRON ACER TENDL-2021 LIBRARY; T=293.6K
alphas from (n,2n)a

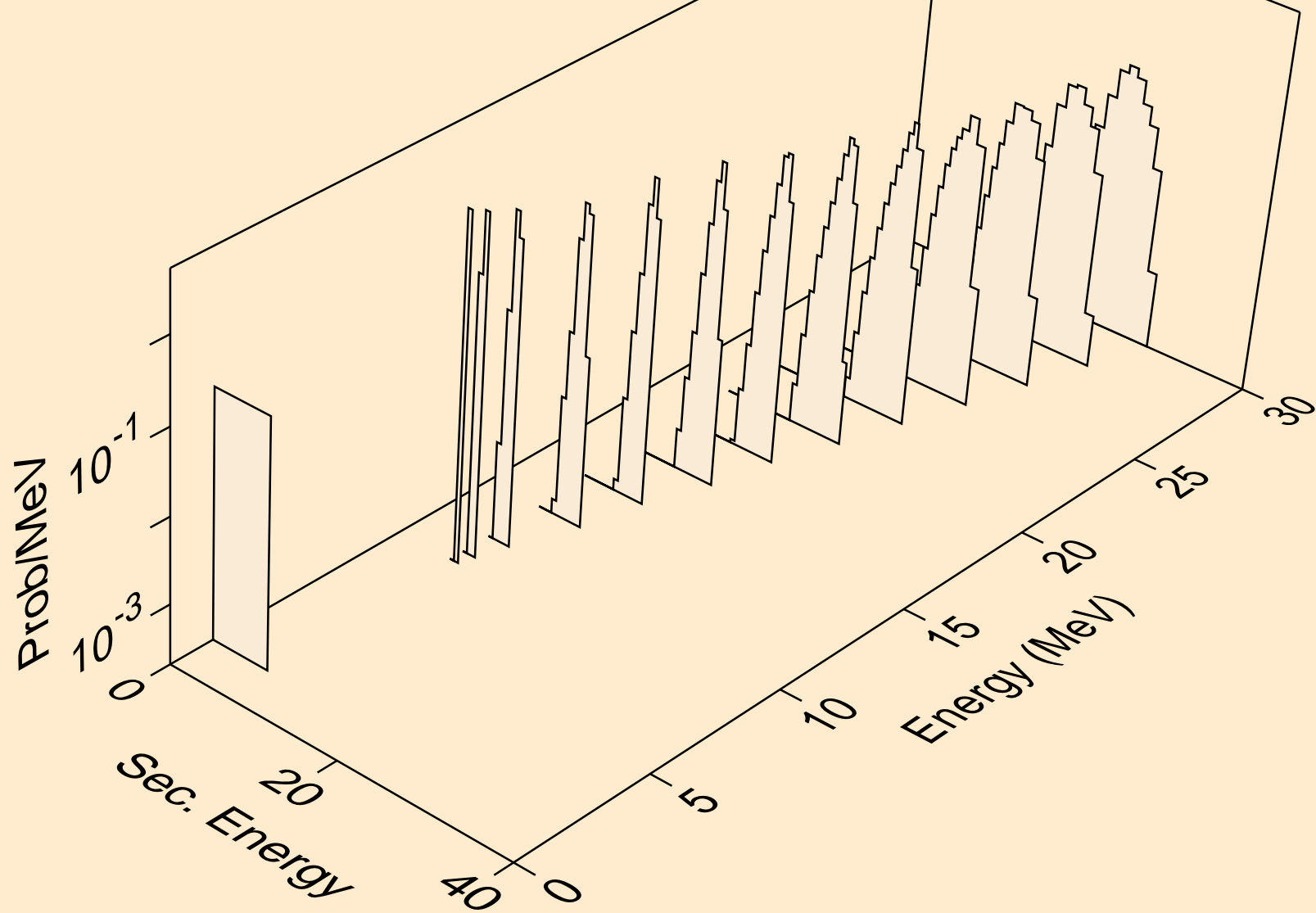

PA241 NEUTRON ACER TENDL-2021 LIBRARY; T=293.6K
alphas from (n,3n)a

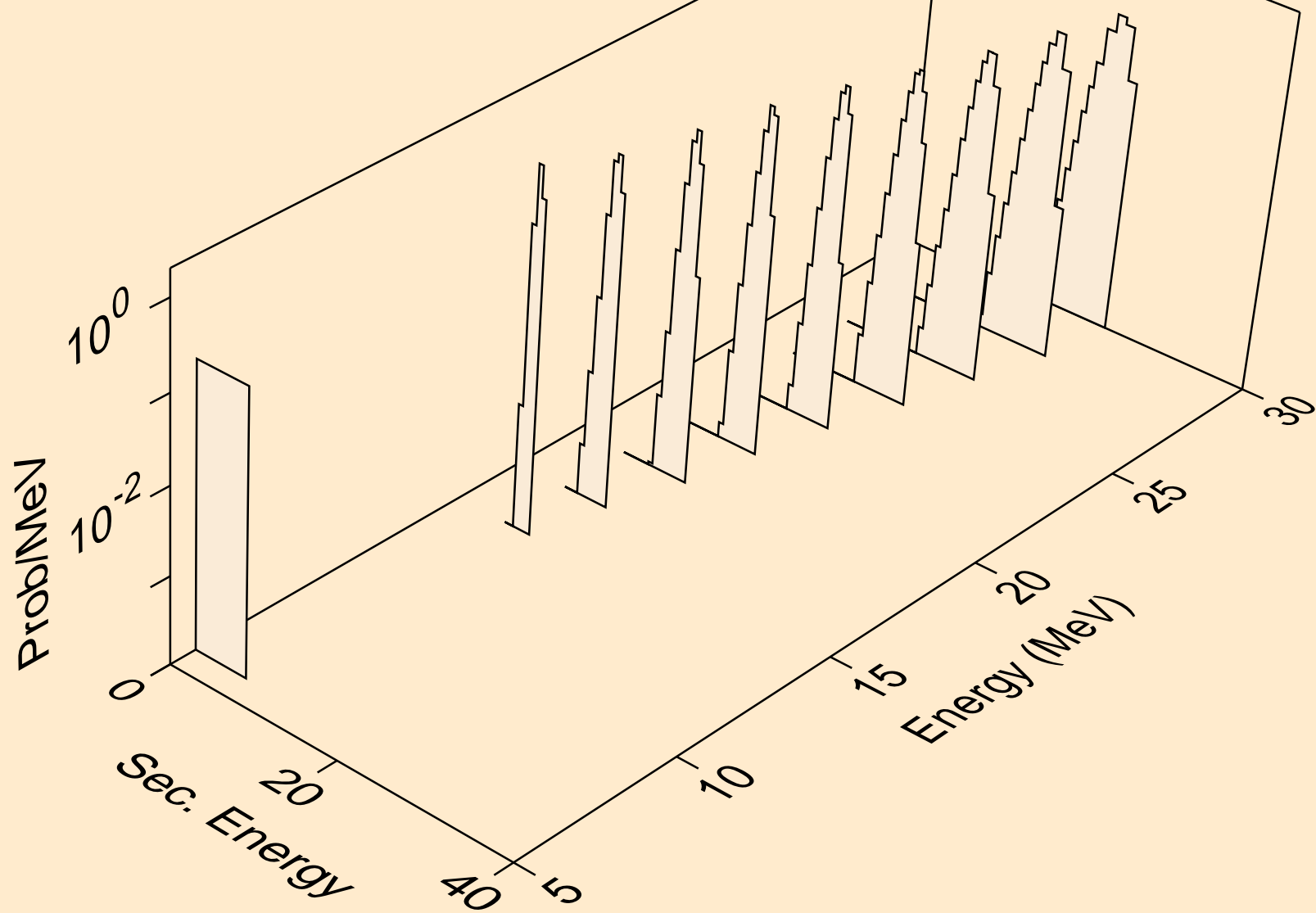

PA241 NEUTRON ACER TENDL-2021 LIBRARY; T=293.6K
alphas from (n,n*)2a

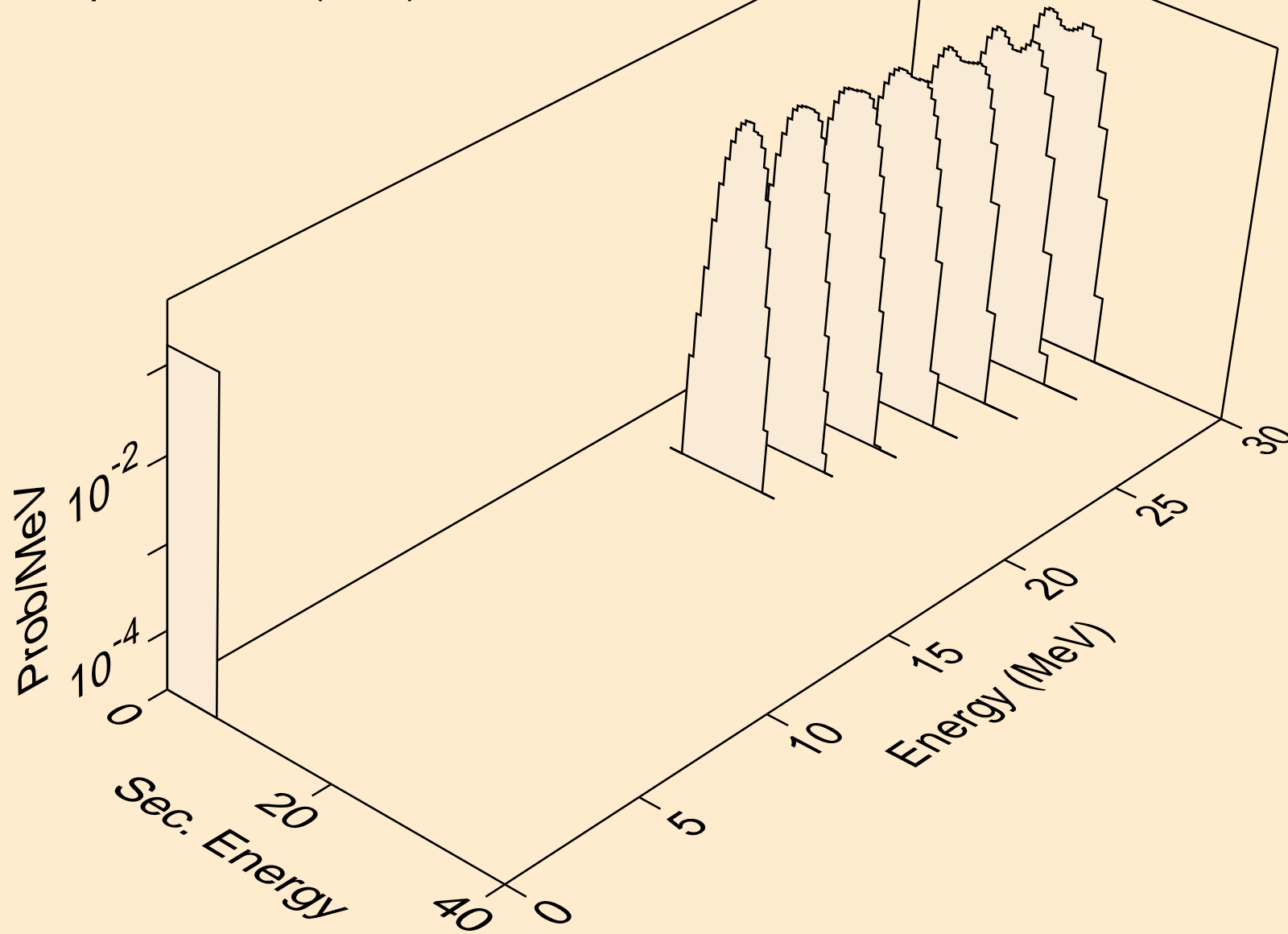

PA241 NEUTRON ACER TENDL-2021 LIBRARY; T=293.6K
alphas from (n,npa)

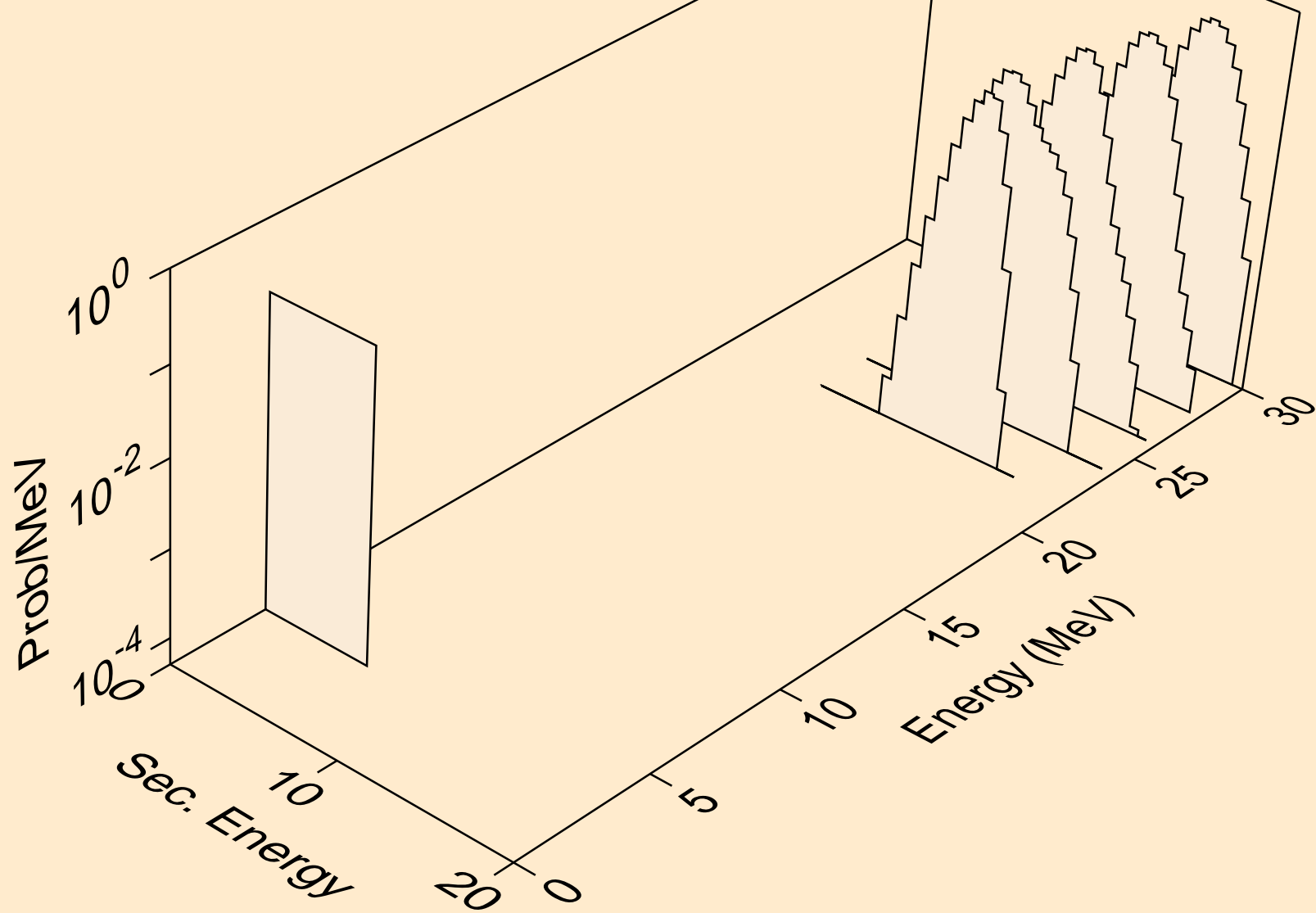

PA241 NEUTRON ACER TENDL-2021 LIBRARY; T=293.6K
alphas from (n,a)

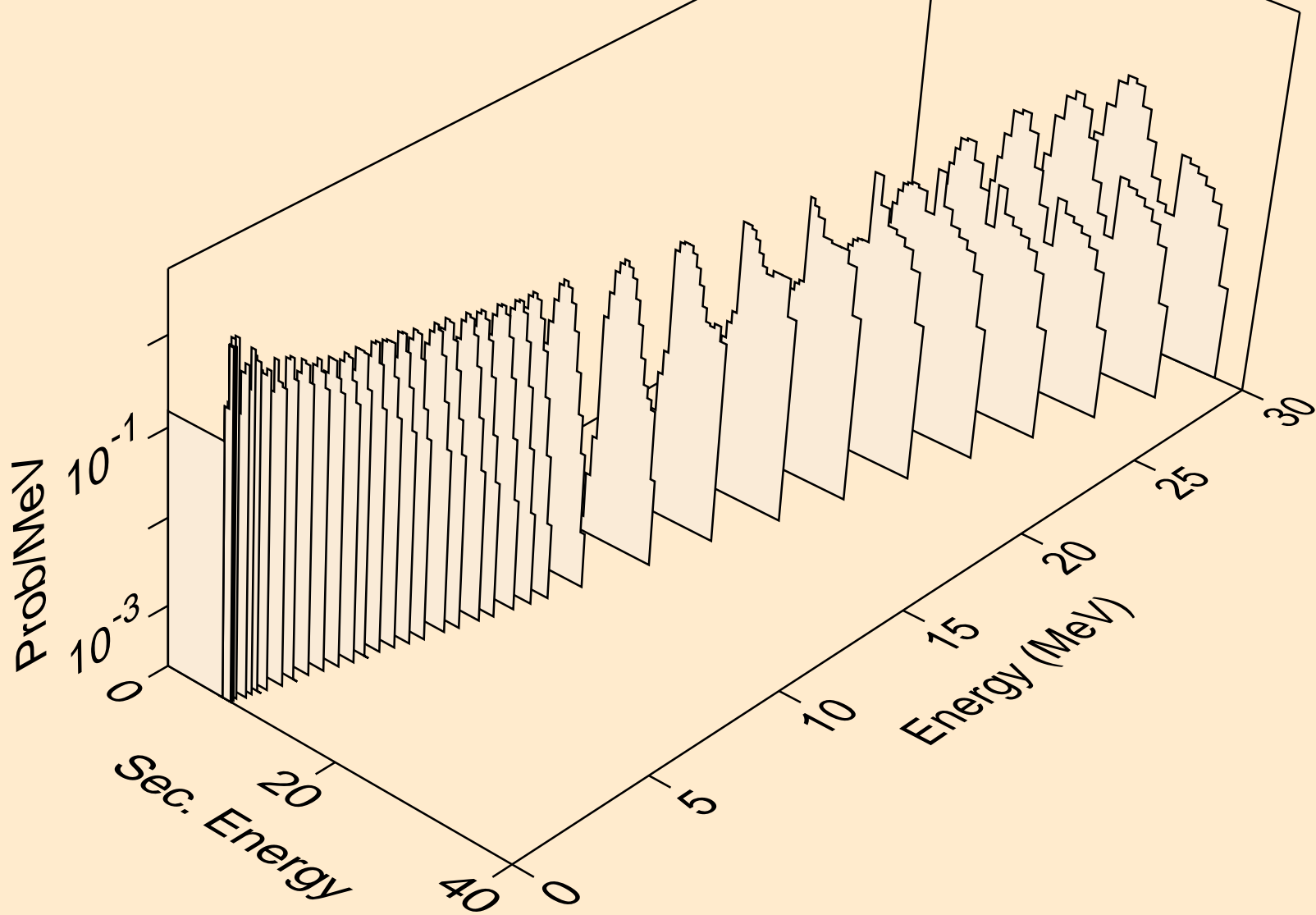

PA241 NEUTRON ACER TENDL-2021 LIBRARY; T=293.6K
alphas from (n,2a)

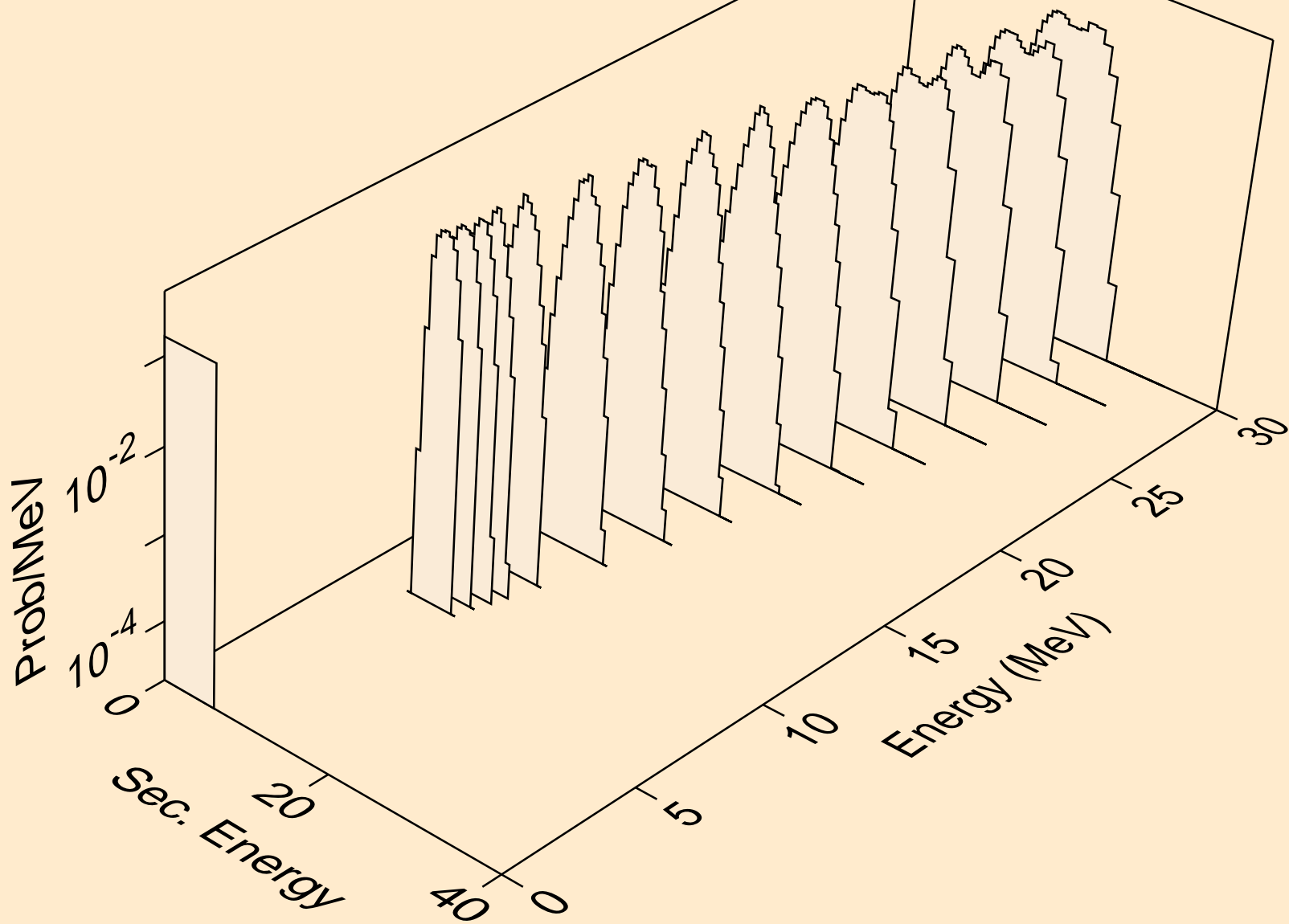

PA241 NEUTRON ACER TENDL-2021 LIBRARY; T=293.6K
alphas from (n,pa)

