

PB193M NEUTRON ACER TENDL-2021 LIBRARY; T=293.6K
Principal cross sections

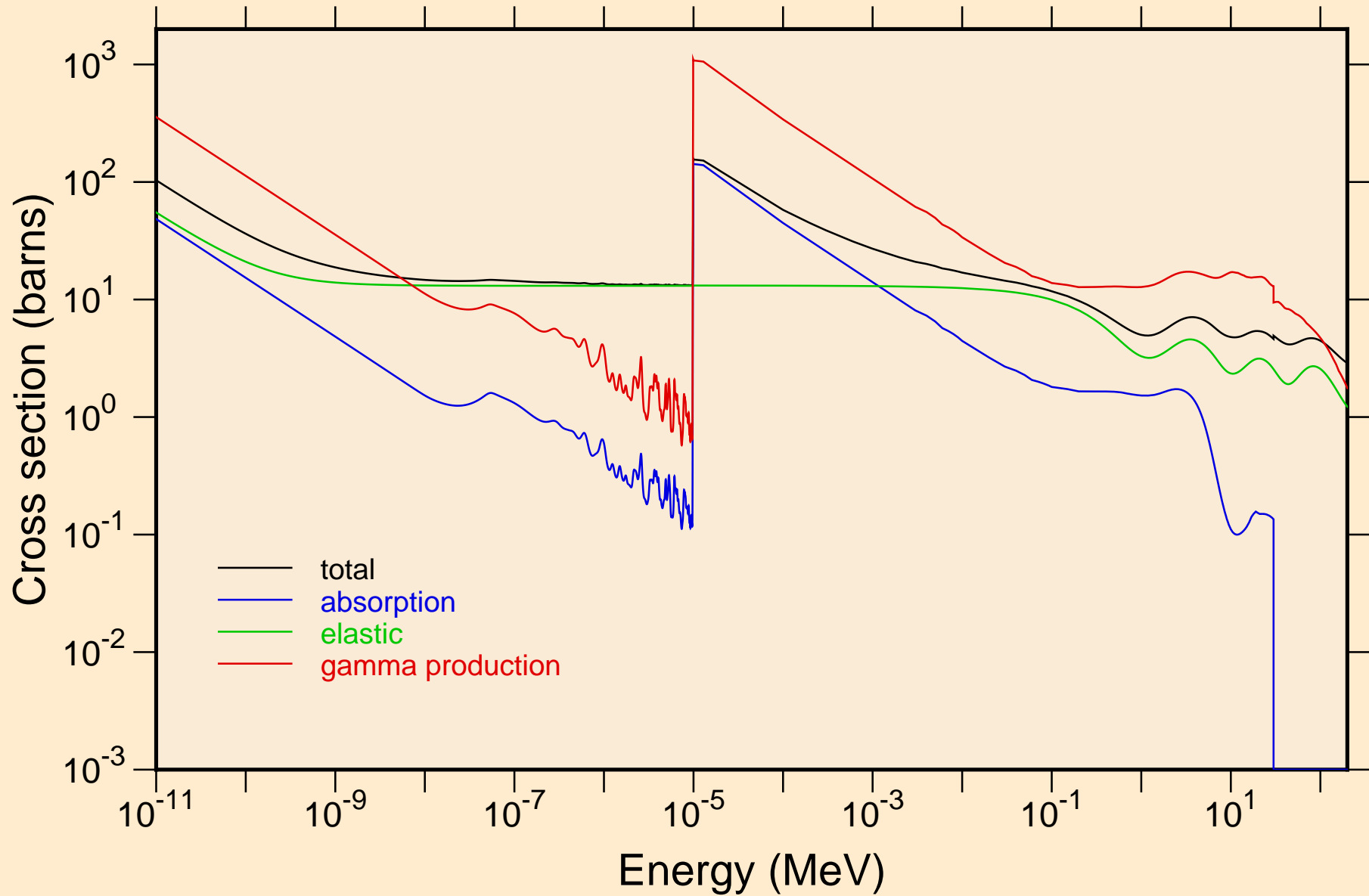

PB193M NEUTRON ACER TENDL-2021 LIBRARY; T=293.6K
resonance total cross section

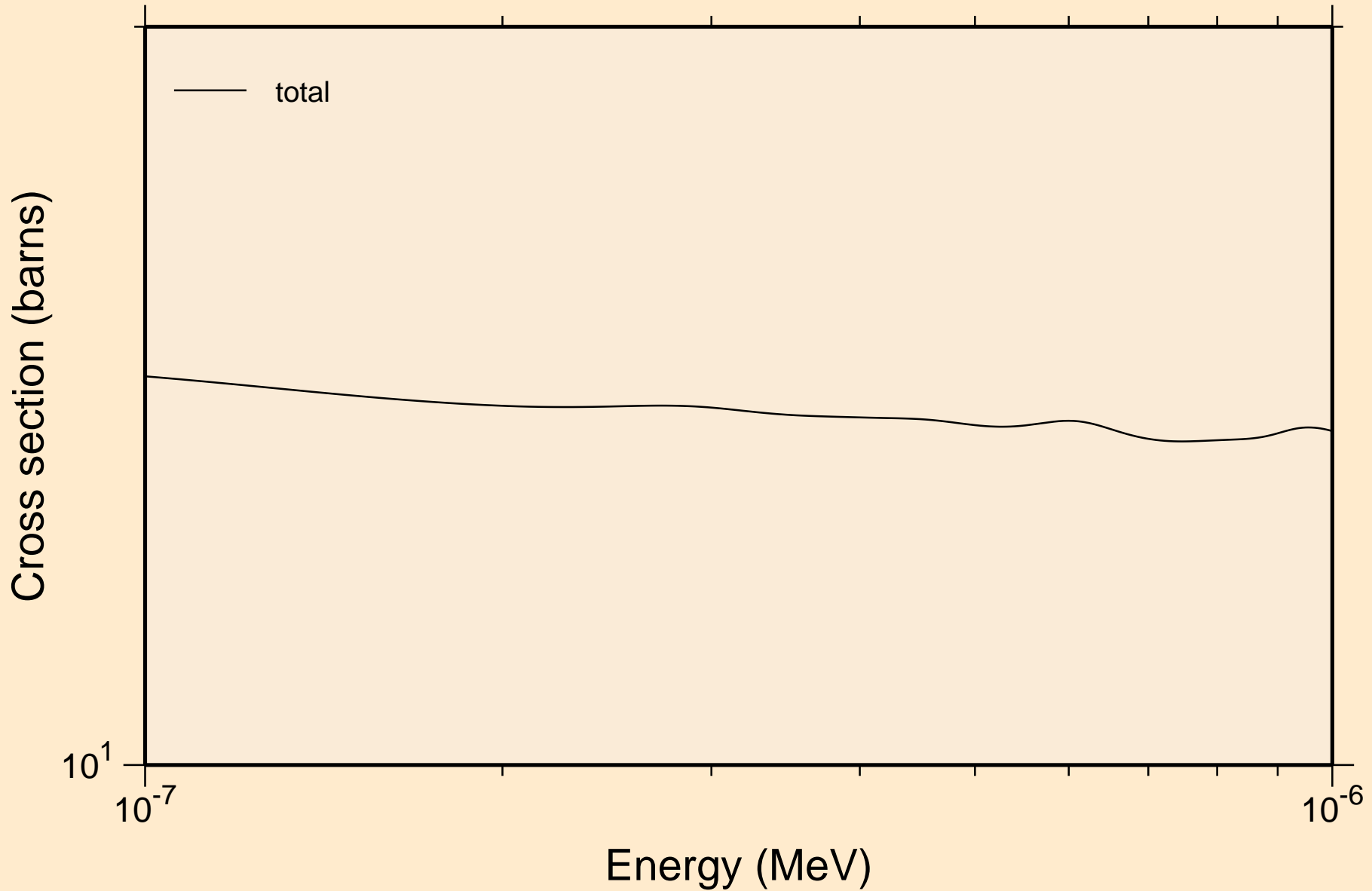

PB193M NEUTRON ACER TENDL-2021 LIBRARY; T=293.6K
resonance total cross section

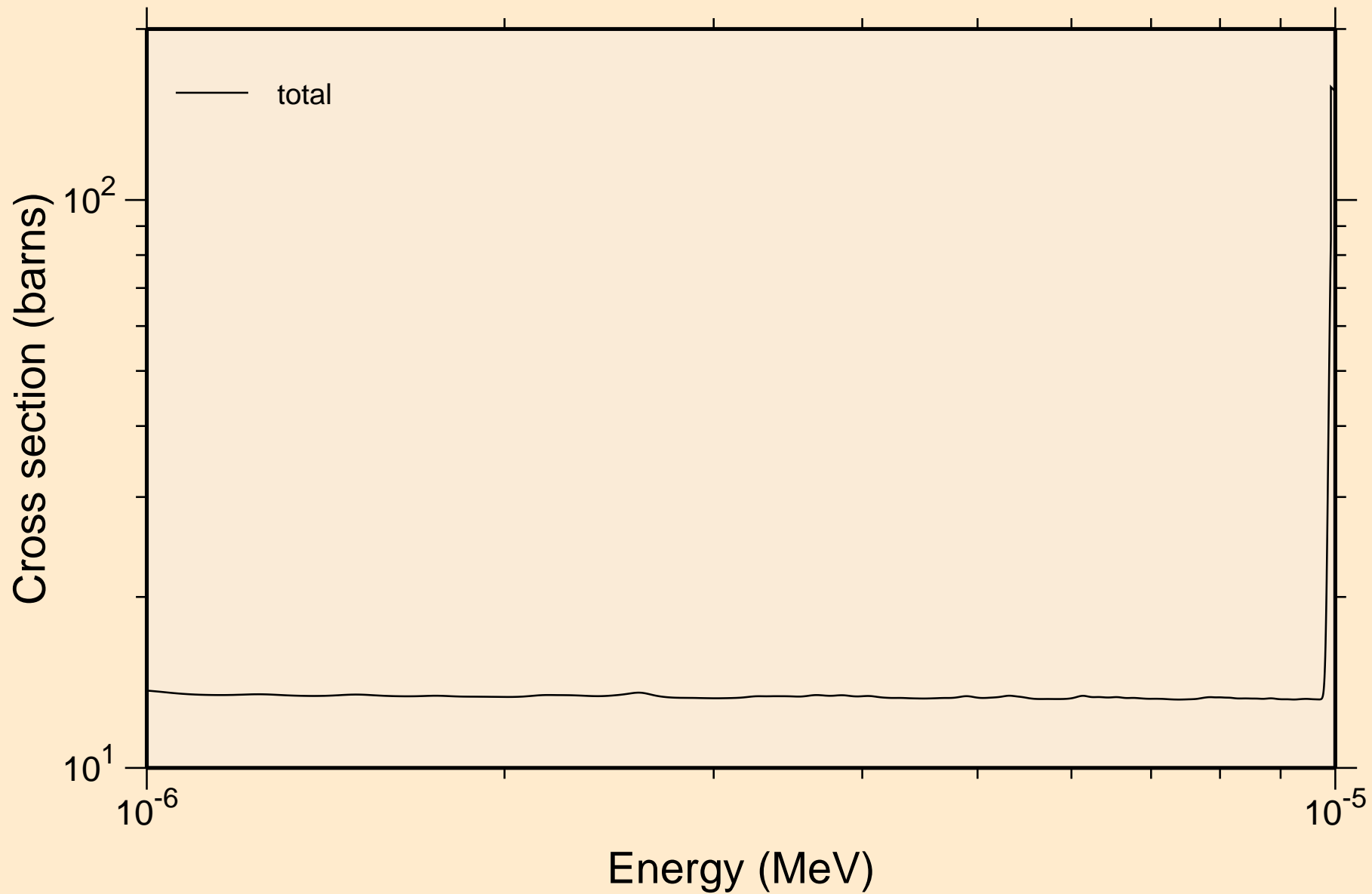

PB193M NEUTRON ACER TENDL-2021 LIBRARY; T=293.6K
resonance total cross section

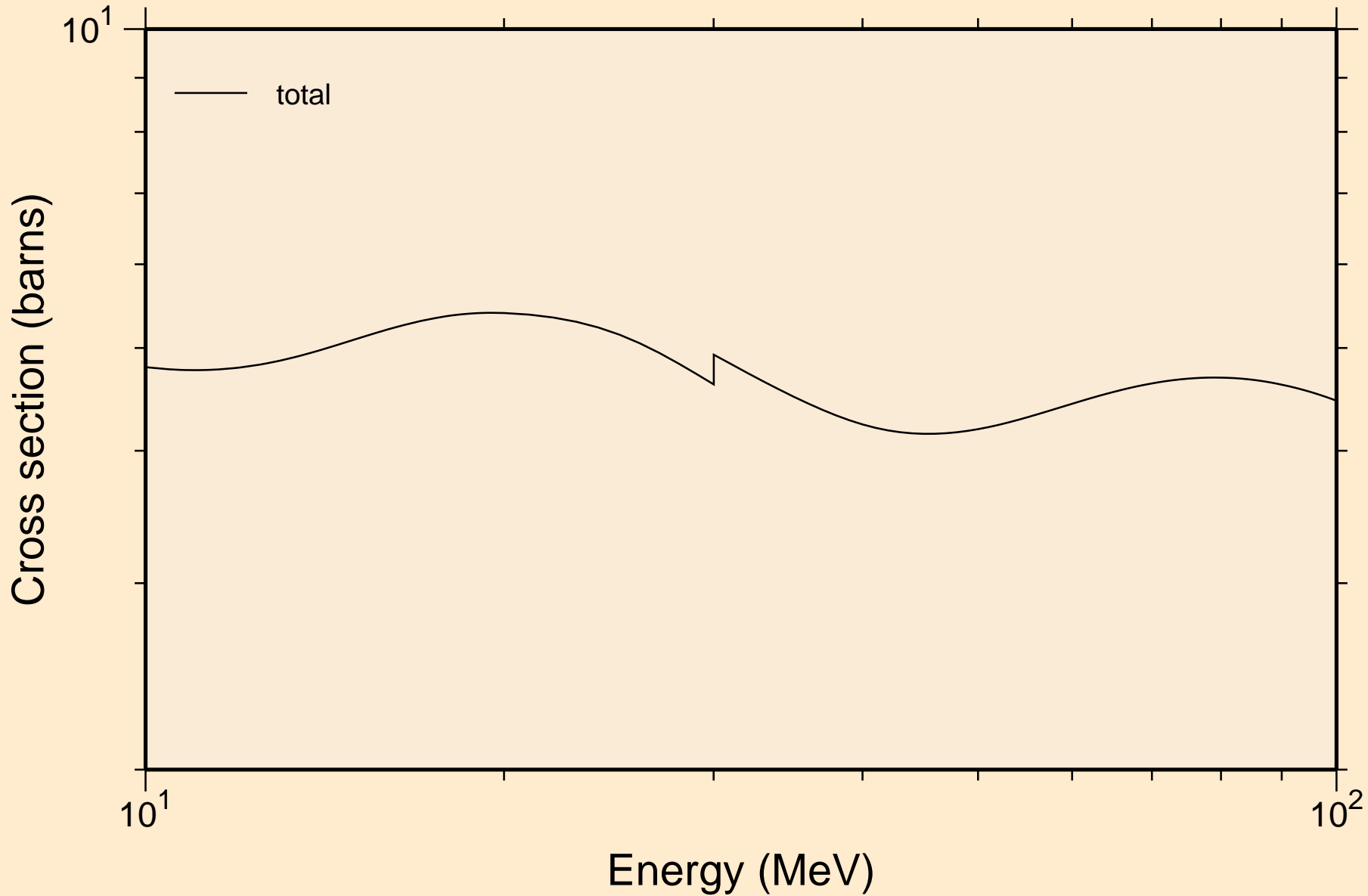

PB193M NEUTRON ACER TENDL-2021 LIBRARY; T=293.6K
resonance absorption cross sections

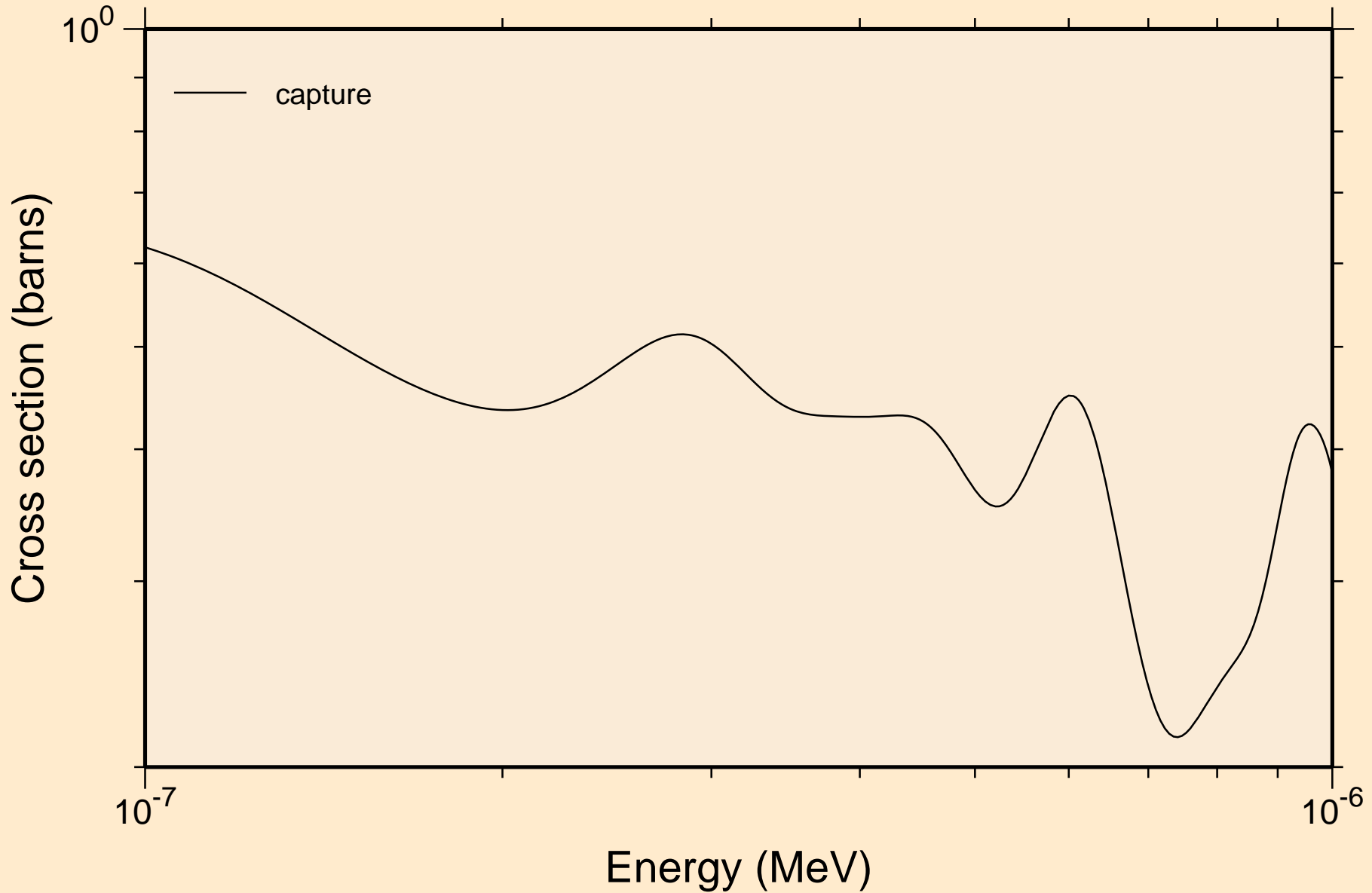

PB193M NEUTRON ACER TENDL-2021 LIBRARY; T=293.6K
resonance absorption cross sections

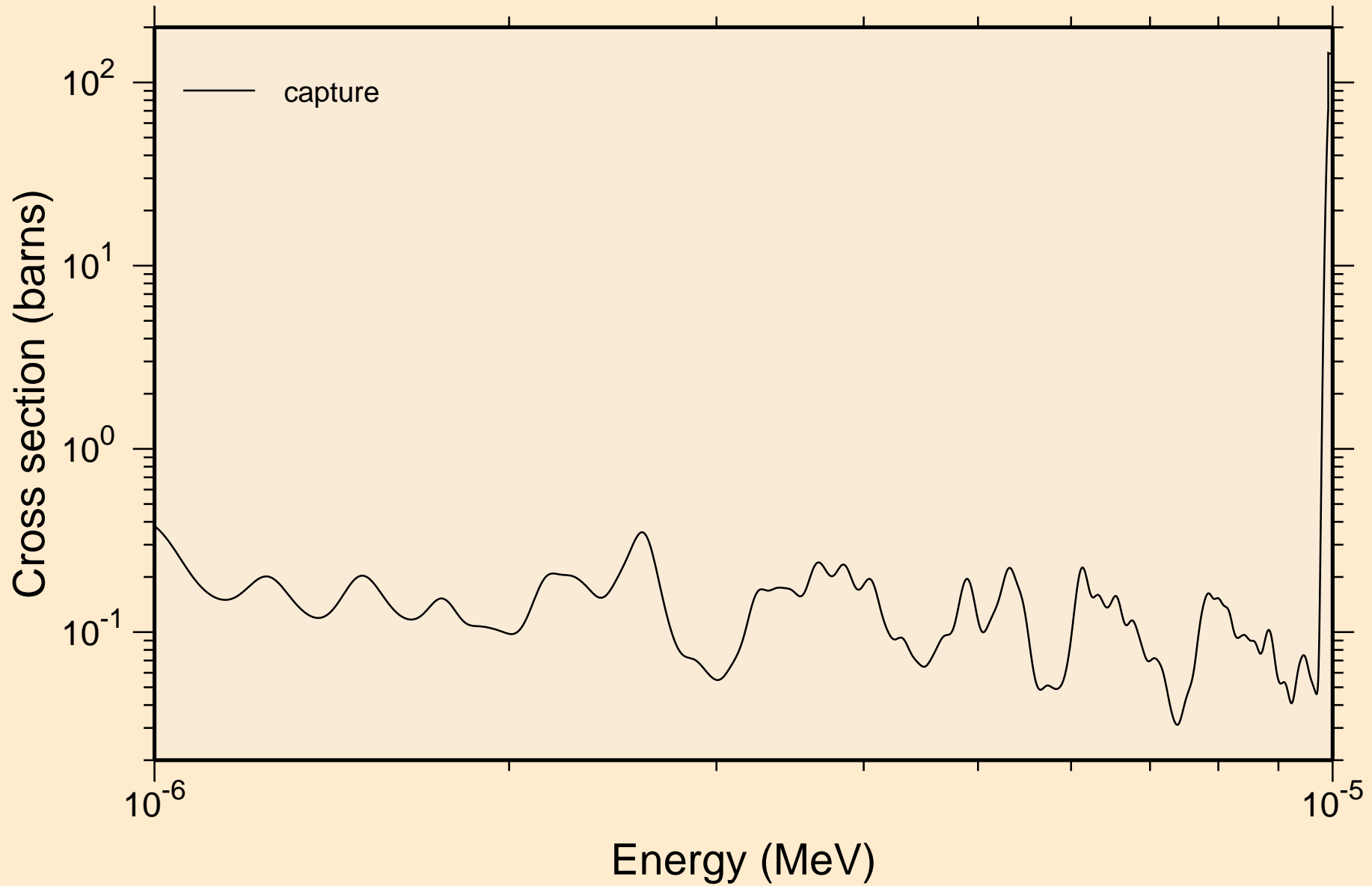

PB193M NEUTRON ACER TENDL-2021 LIBRARY; T=293.6K
resonance absorption cross sections

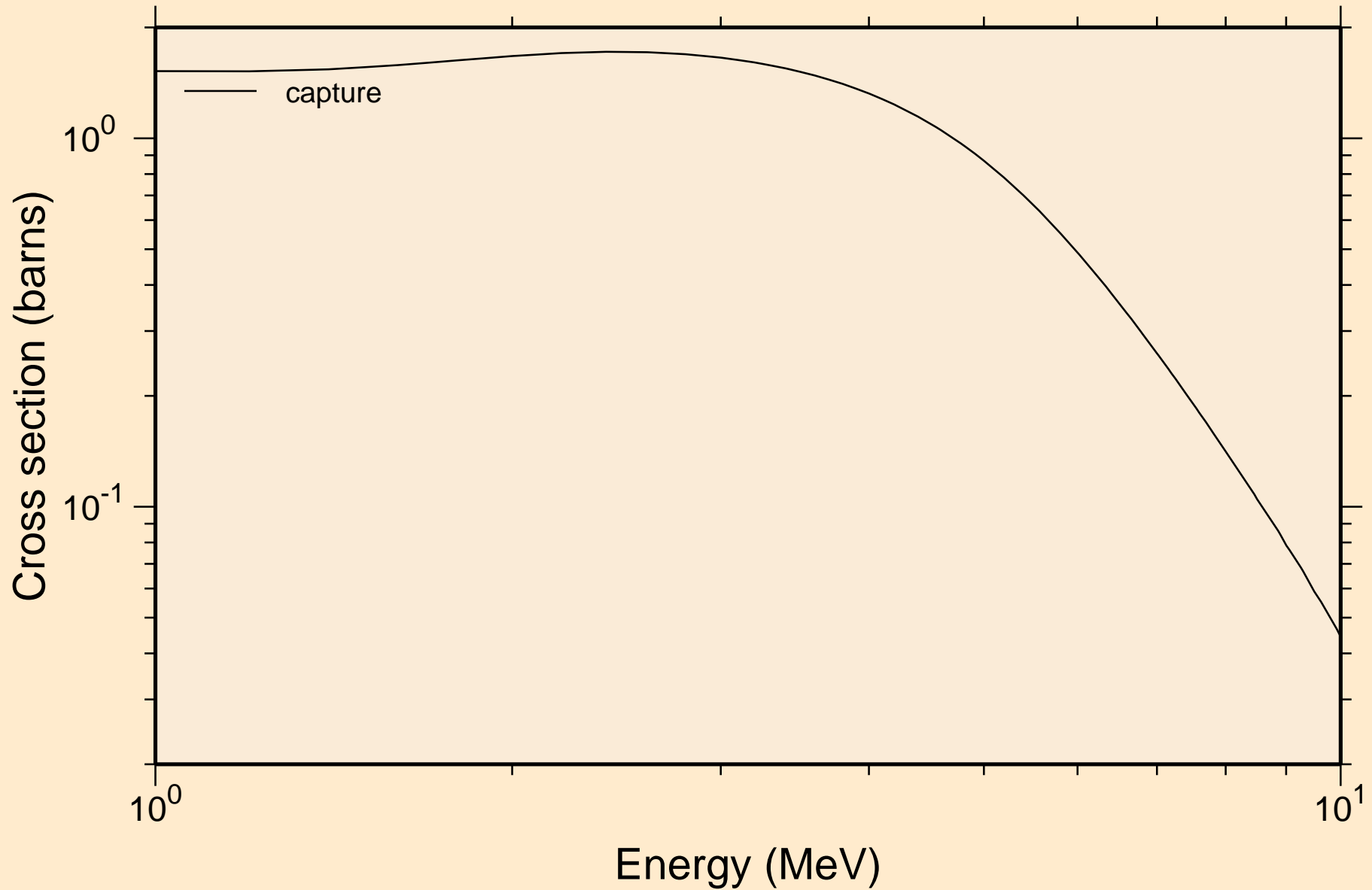

PB193M NEUTRON ACER TENDL-2021 LIBRARY; T=293.6K
Heating

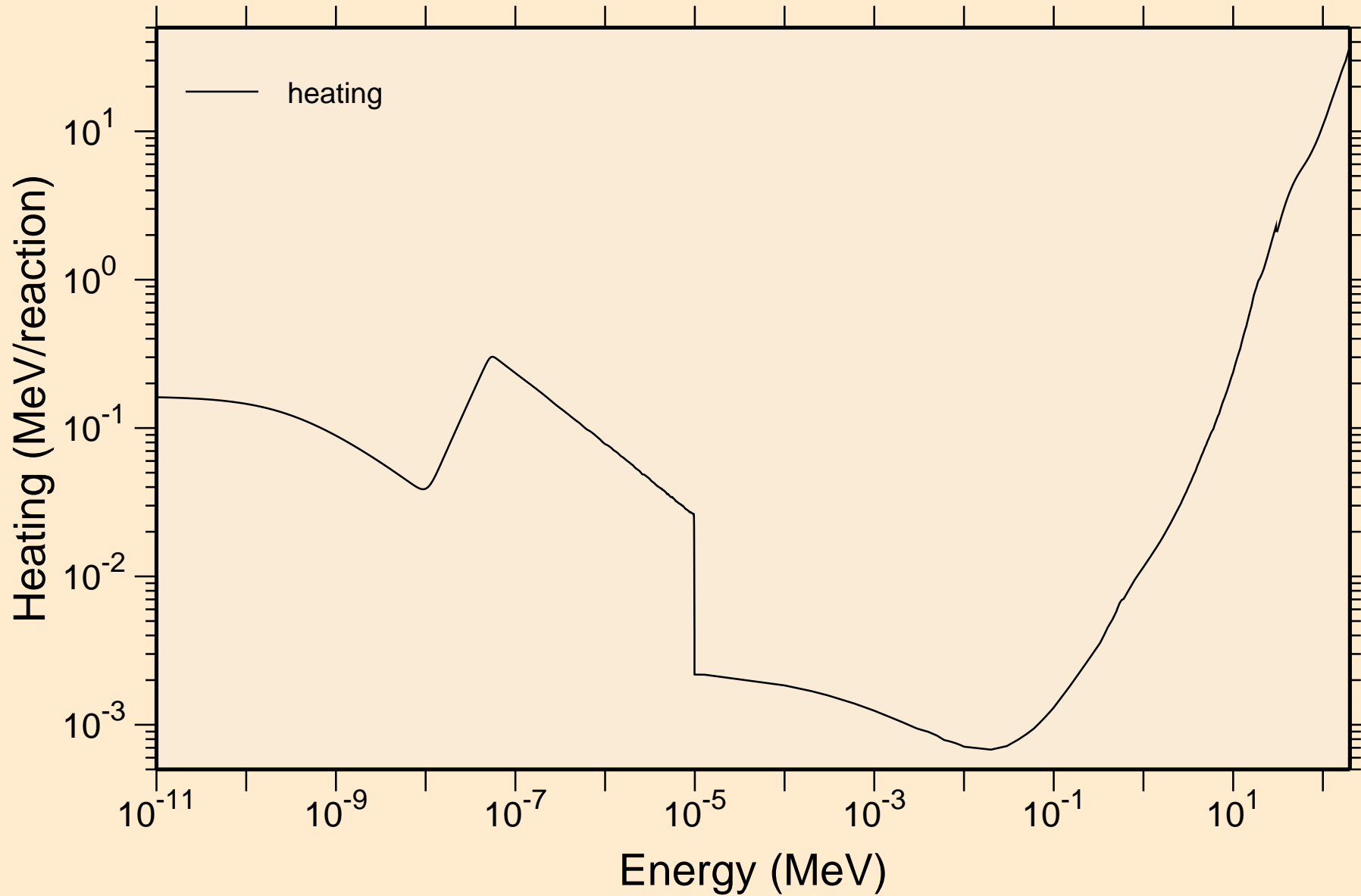

PB193M NEUTRON ACER TENDL-2021 LIBRARY; T=293.6K
Damage

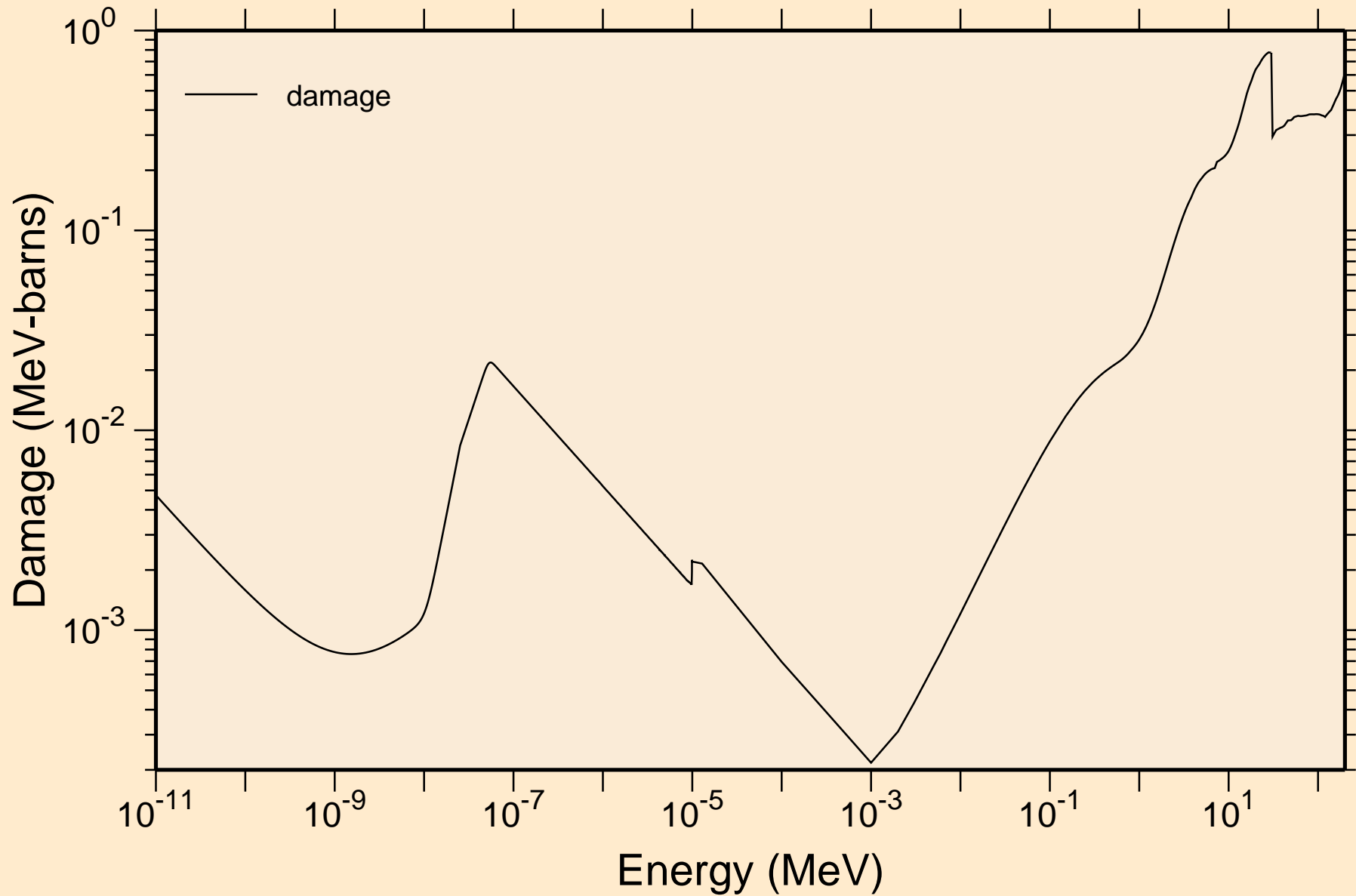

PB193M NEUTRON ACER TENDL-2021 LIBRARY; T=293.6K
Non-threshold reactions

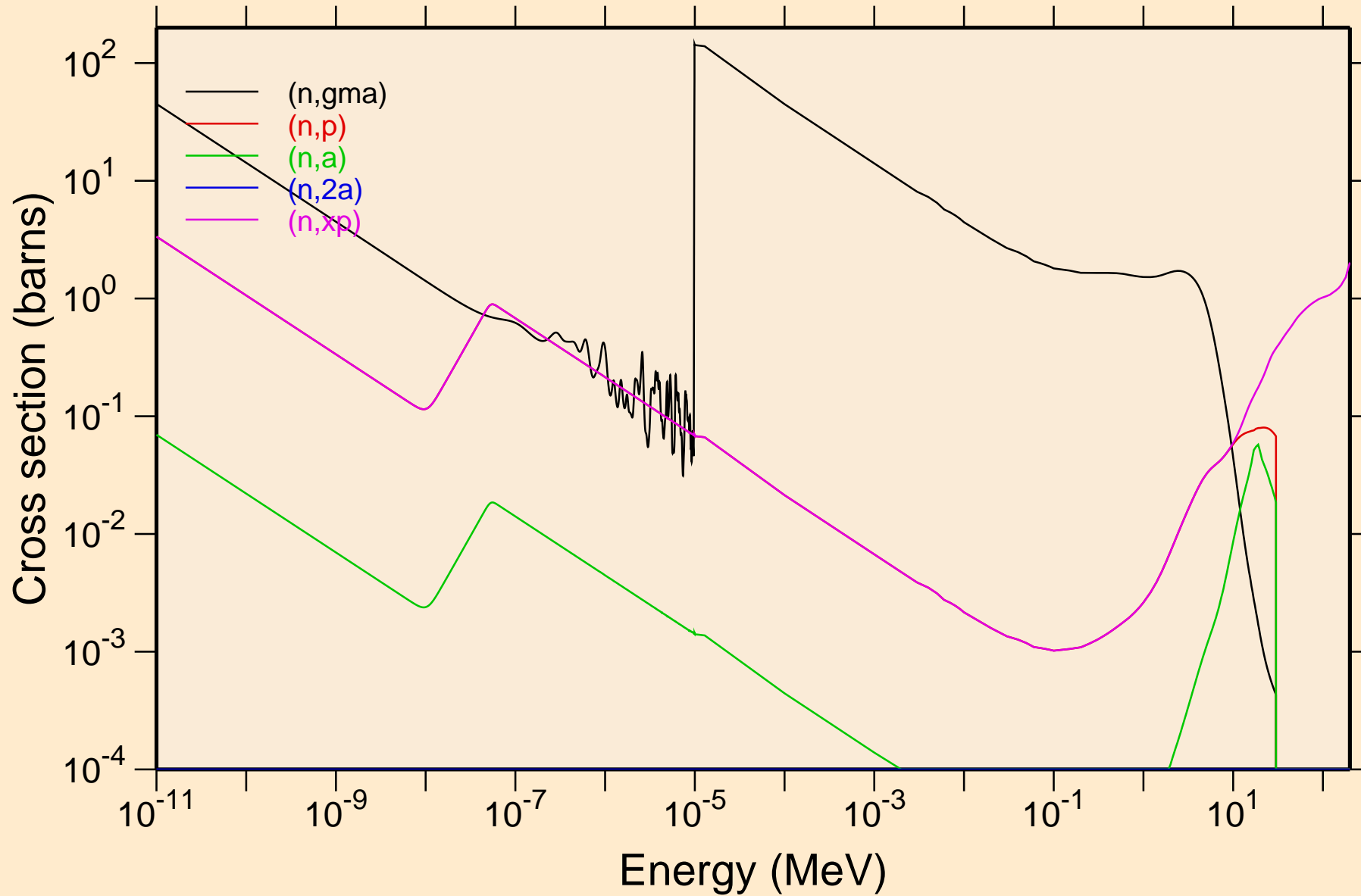

PB193M NEUTRON ACER TENDL-2021 LIBRARY; T=293.6K
Non-threshold reactions

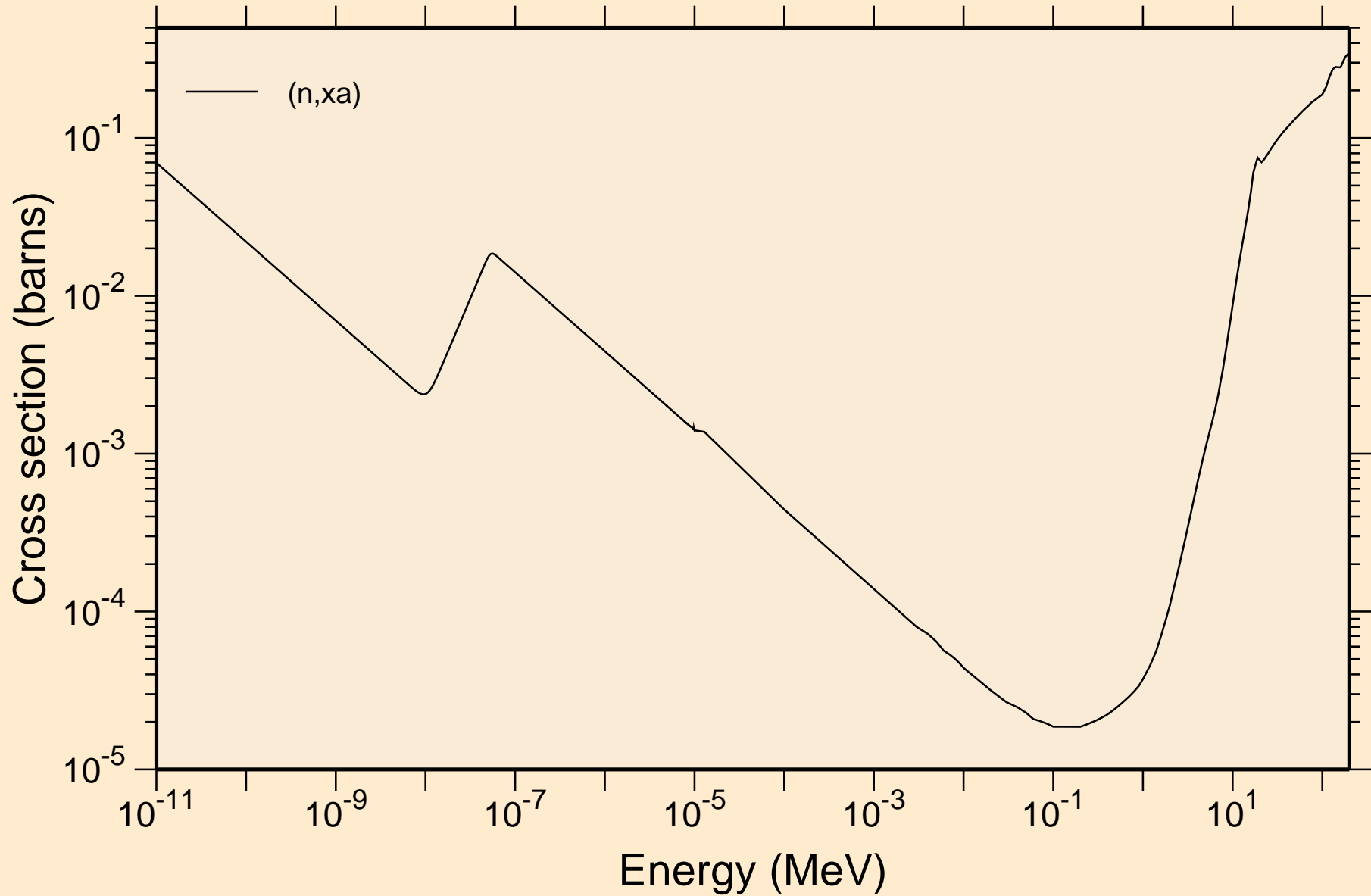

PB193M NEUTRON ACER TENDL-2021 LIBRARY; T=293.6K
Principal cross sections

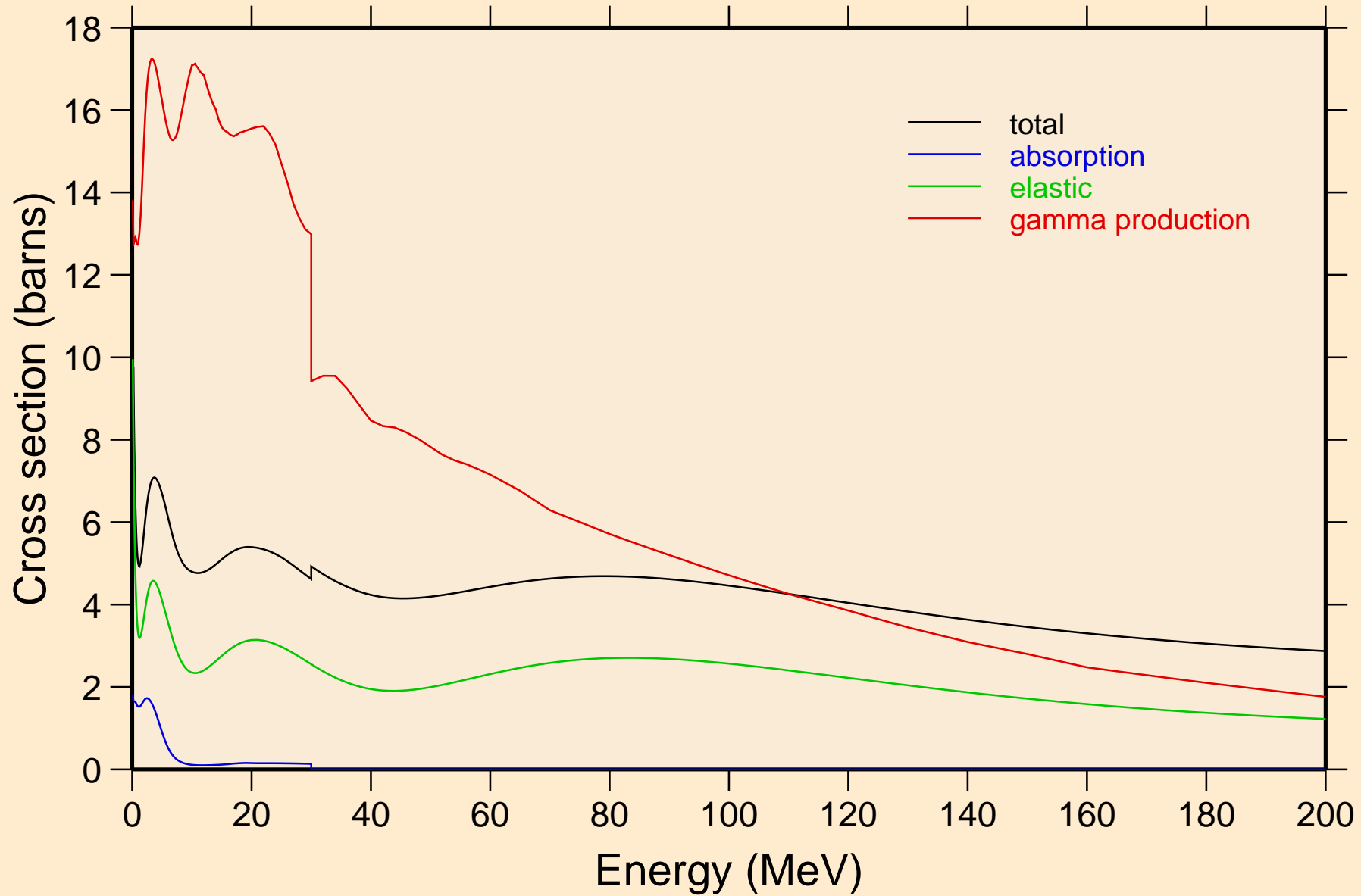

PB193M NEUTRON ACER TENDL-2021 LIBRARY; T=293.6K
Heating

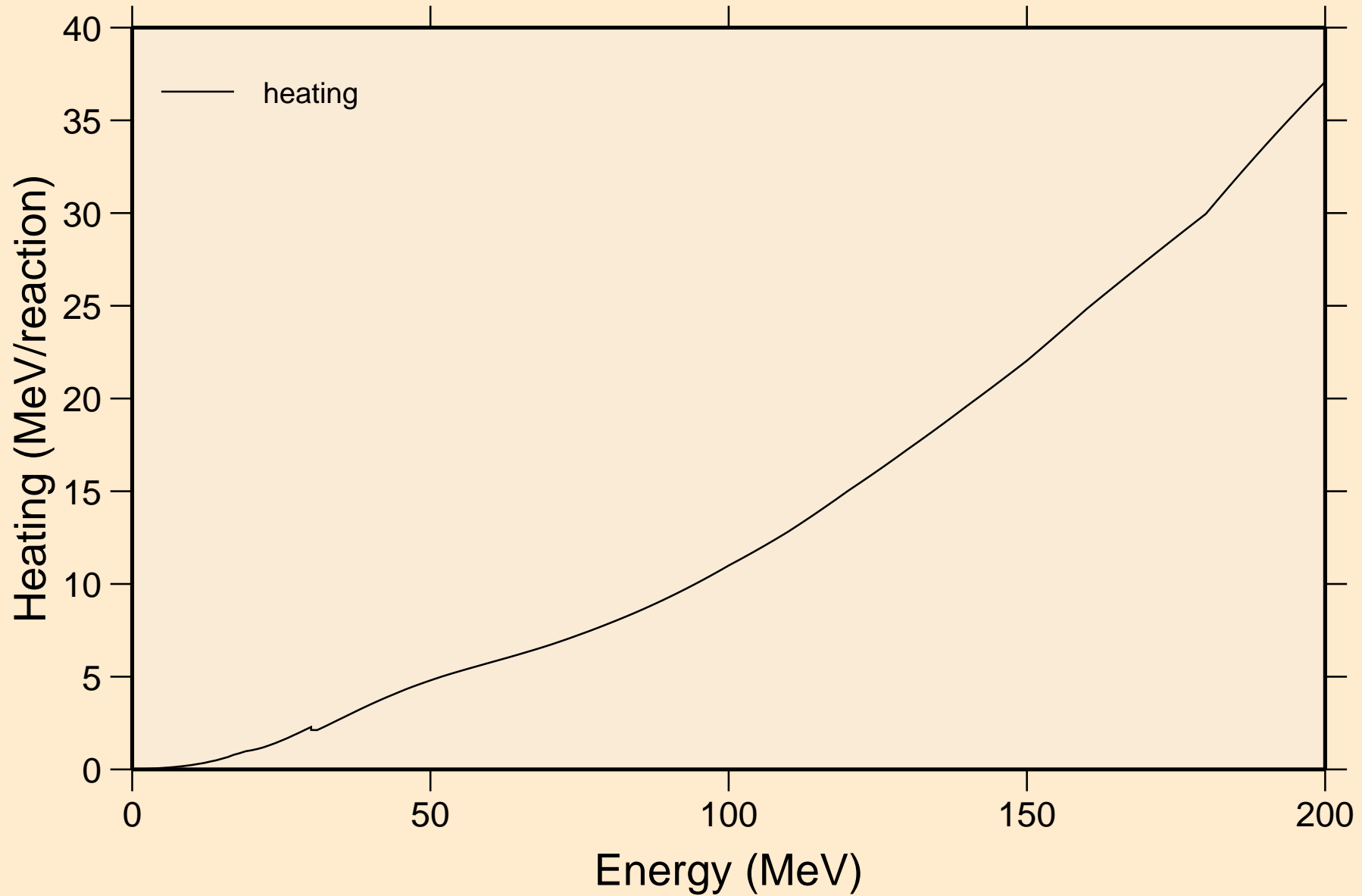

PB193M NEUTRON ACER TENDL-2021 LIBRARY; T=293.6K
Damage

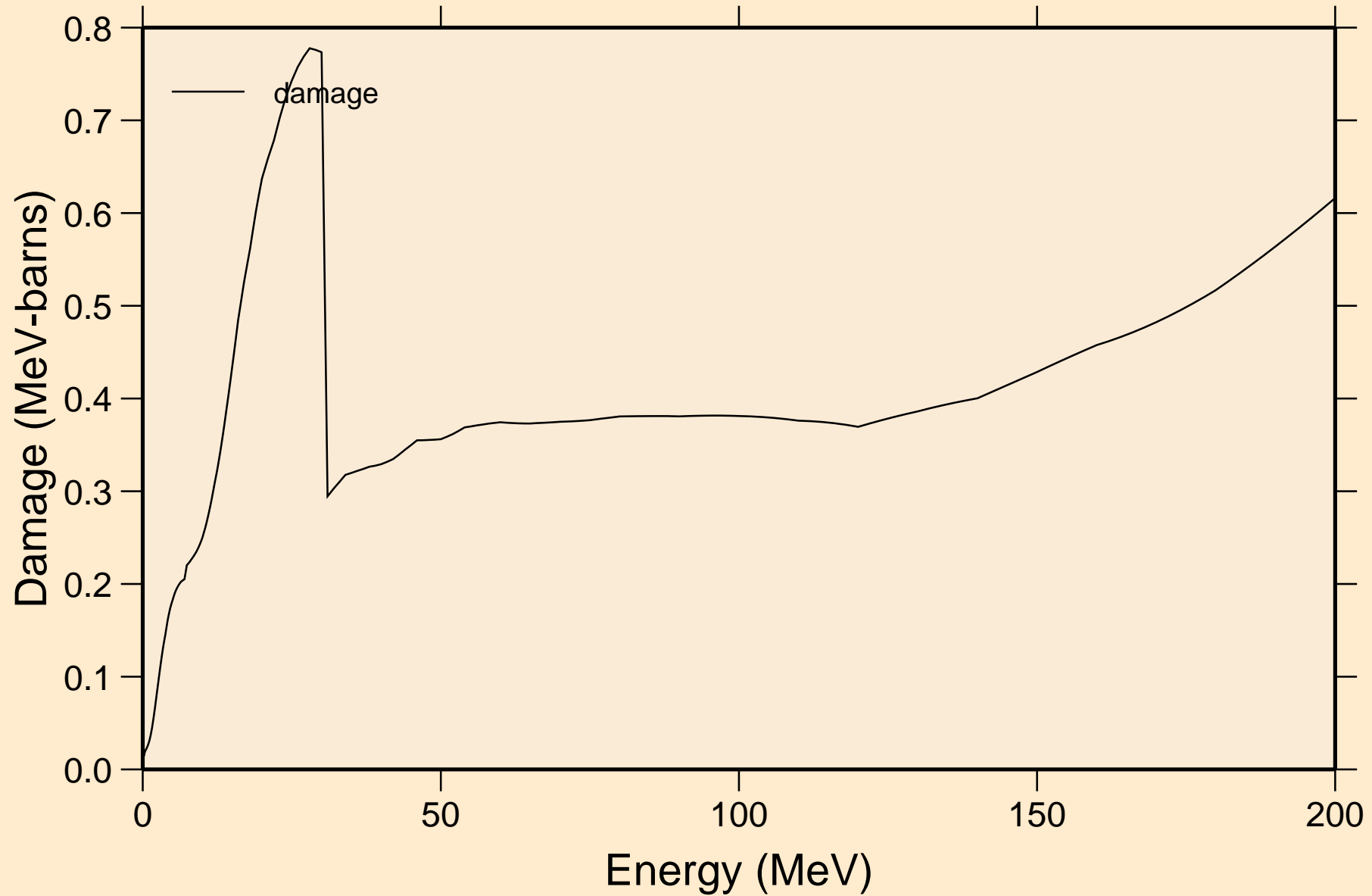

PB193M NEUTRON ACER TENDL-2021 LIBRARY; T=293.6K
Non-threshold reactions

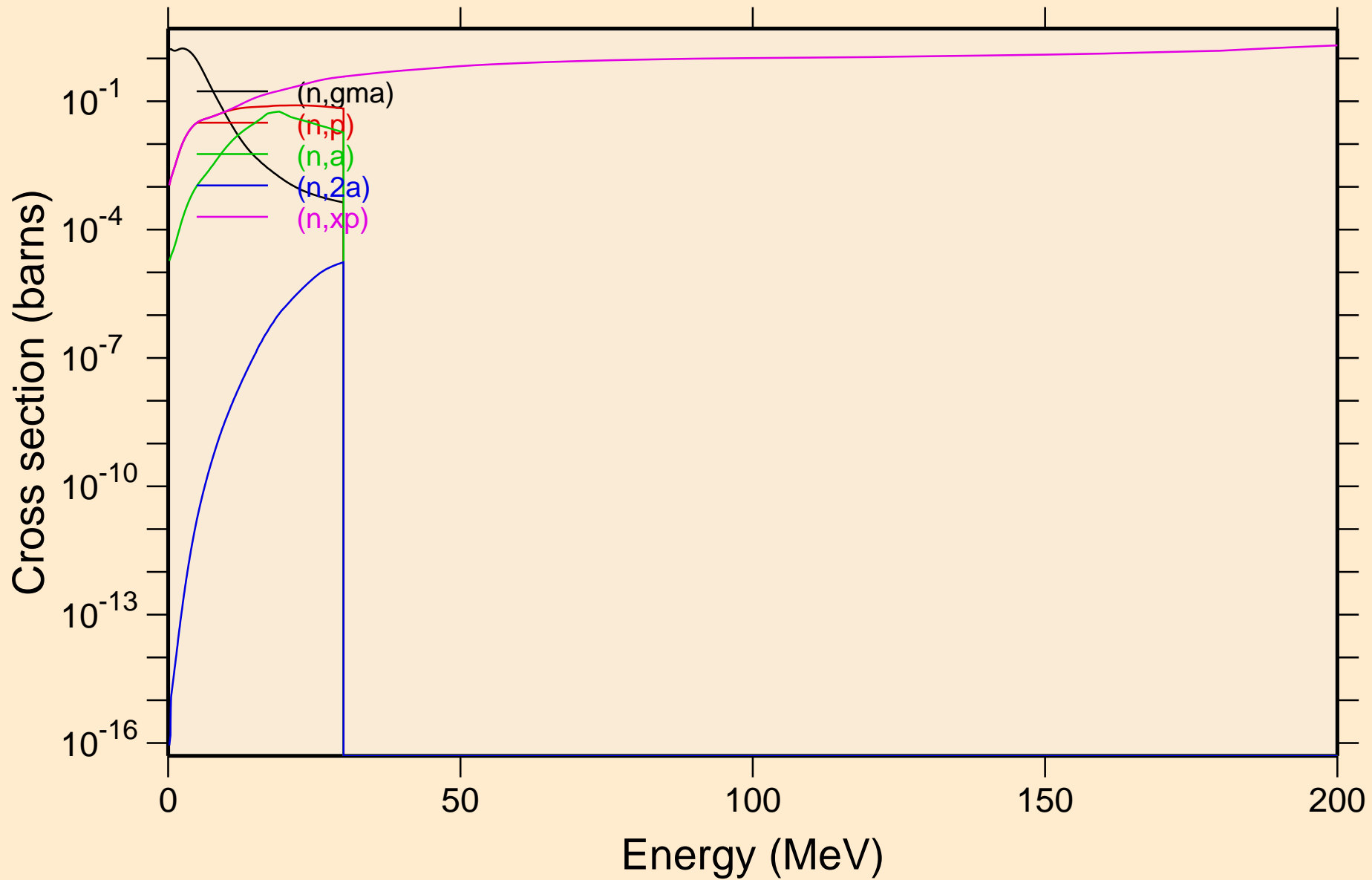

PB193M NEUTRON ACER TENDL-2021 LIBRARY; T=293.6K
Non-threshold reactions

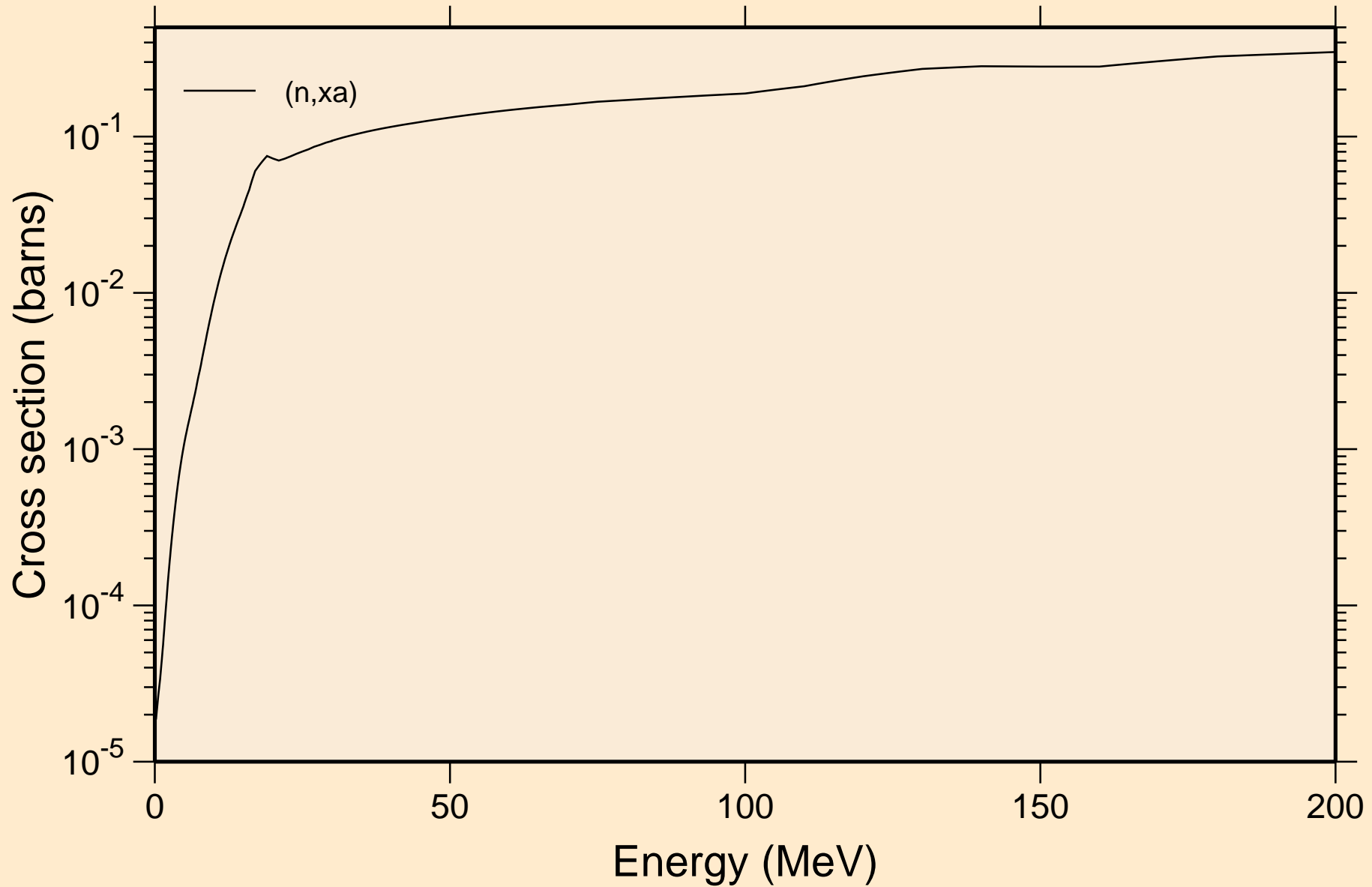

PB193M NEUTRON ACER TENDL-2021 LIBRARY; T=293.6K
Inelastic levels

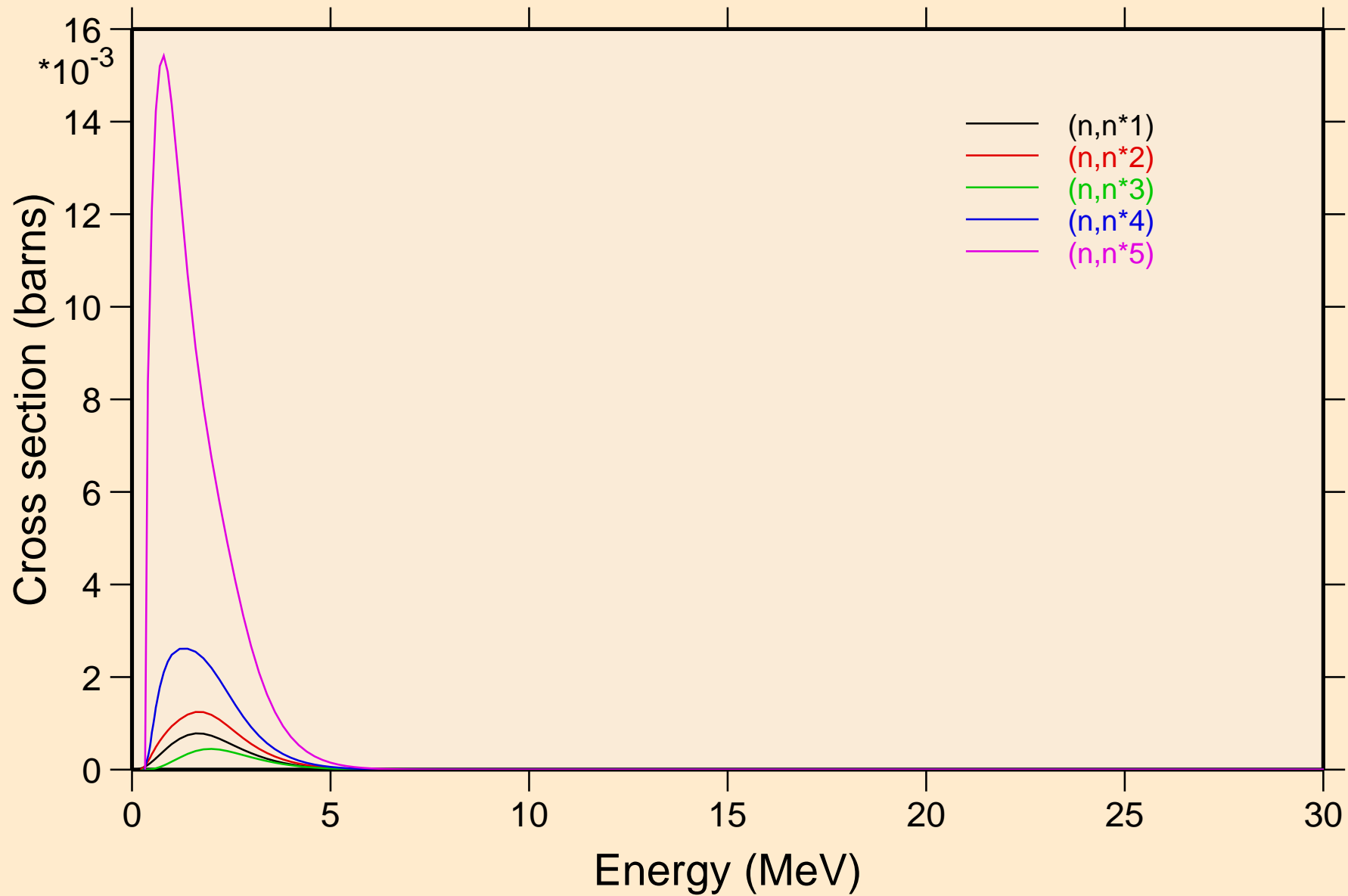

PB193M NEUTRON ACER TENDL-2021 LIBRARY; T=293.6K
Inelastic levels

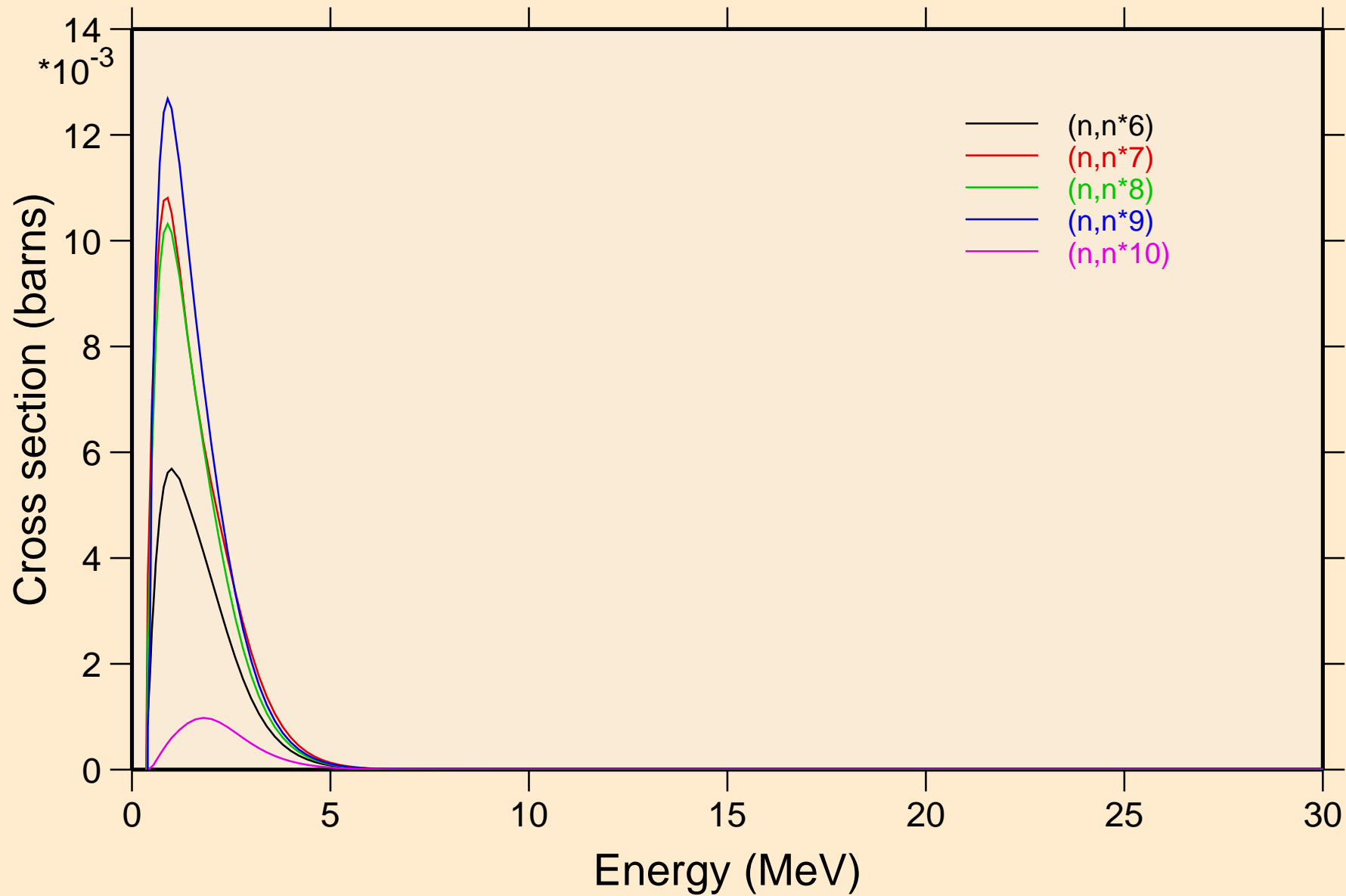

PB193M NEUTRON ACER TENDL-2021 LIBRARY; T=293.6K
Inelastic levels

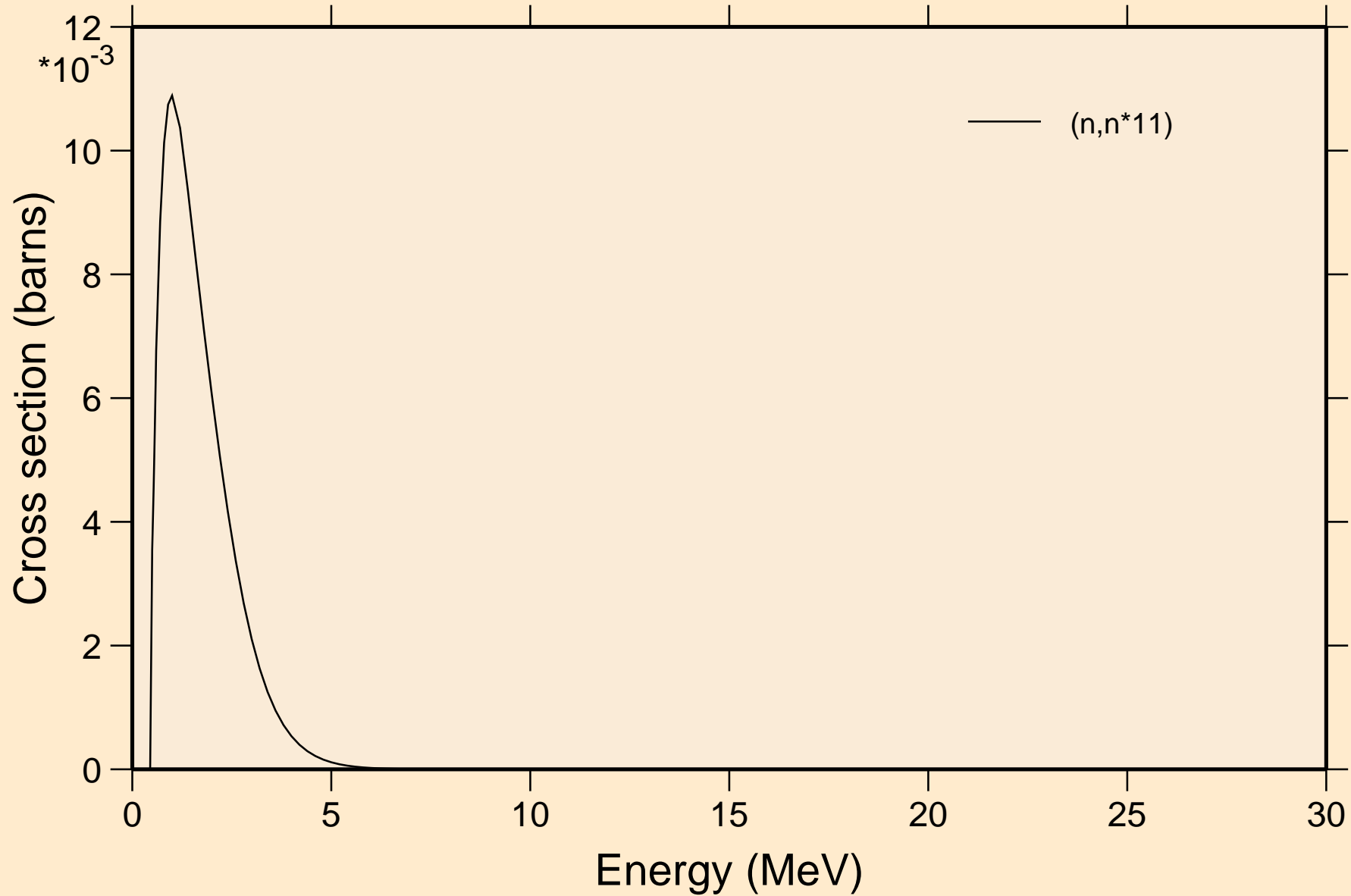

PB193M NEUTRON ACER TENDL-2021 LIBRARY; T=293.6K
Threshold reactions

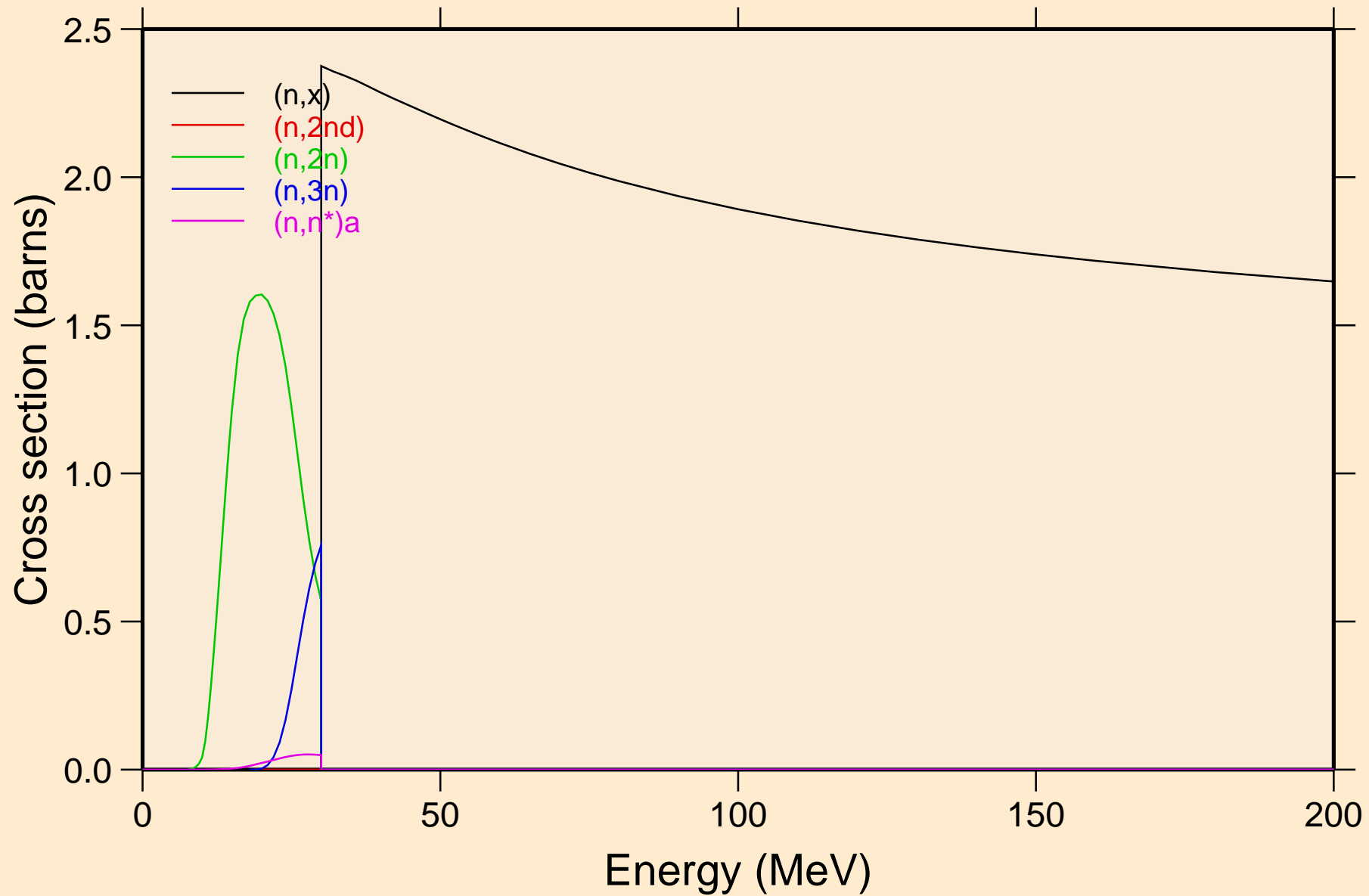

PB193M NEUTRON ACER TENDL-2021 LIBRARY; T=293.6K
Threshold reactions

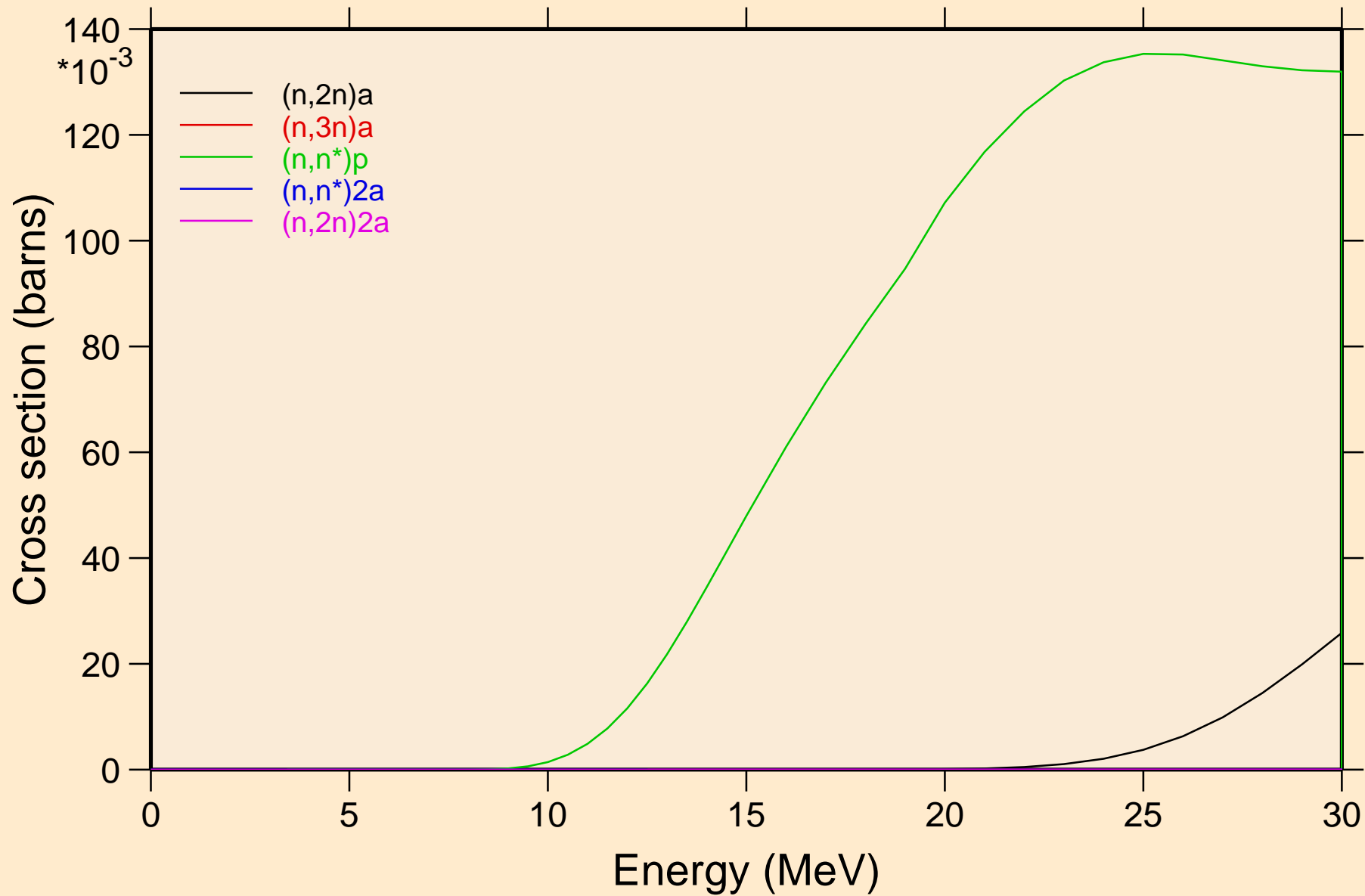

PB193M NEUTRON ACER TENDL-2021 LIBRARY; T=293.6K
Threshold reactions

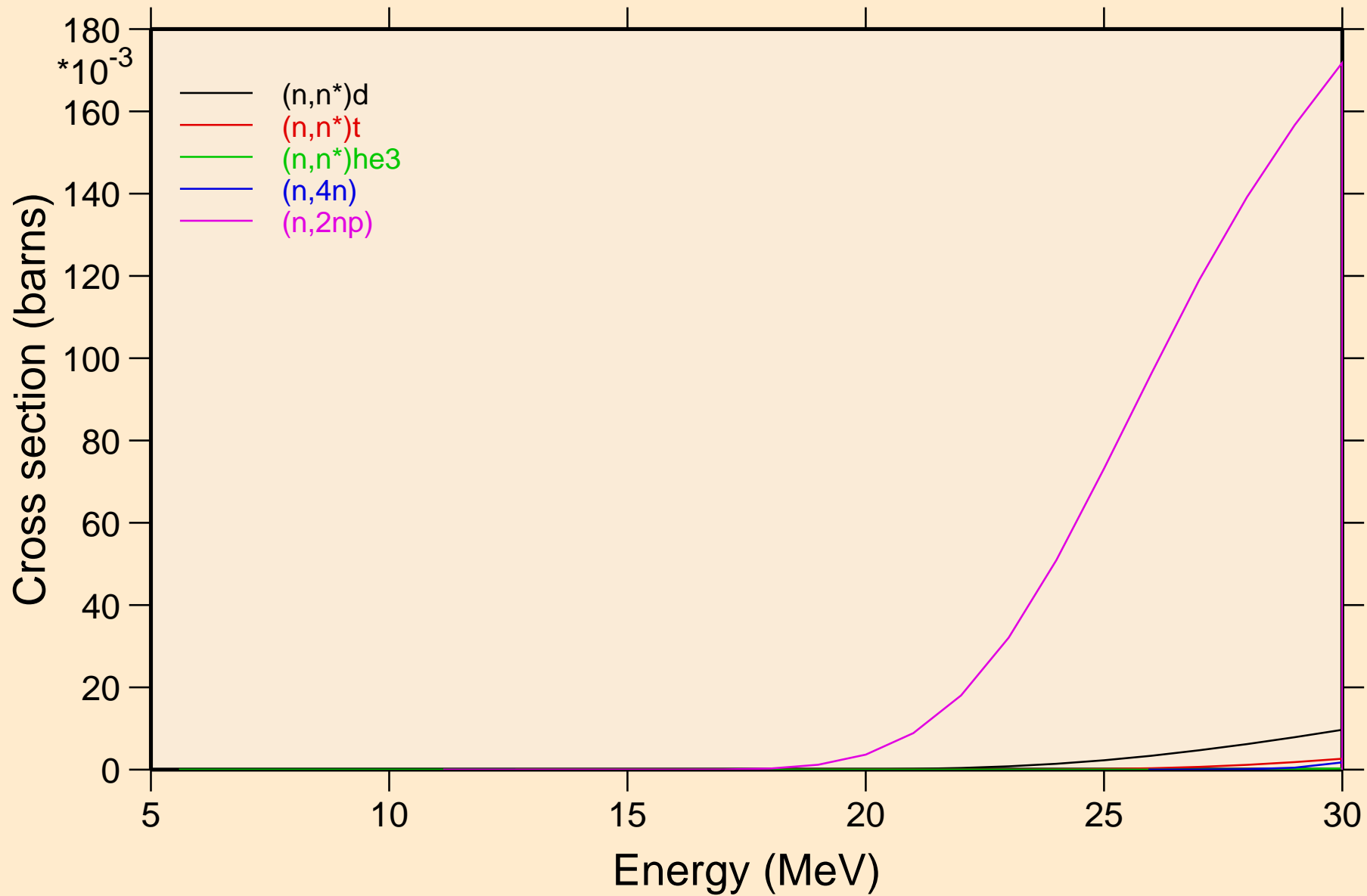

PB193M NEUTRON ACER TENDL-2021 LIBRARY; T=293.6K
Threshold reactions

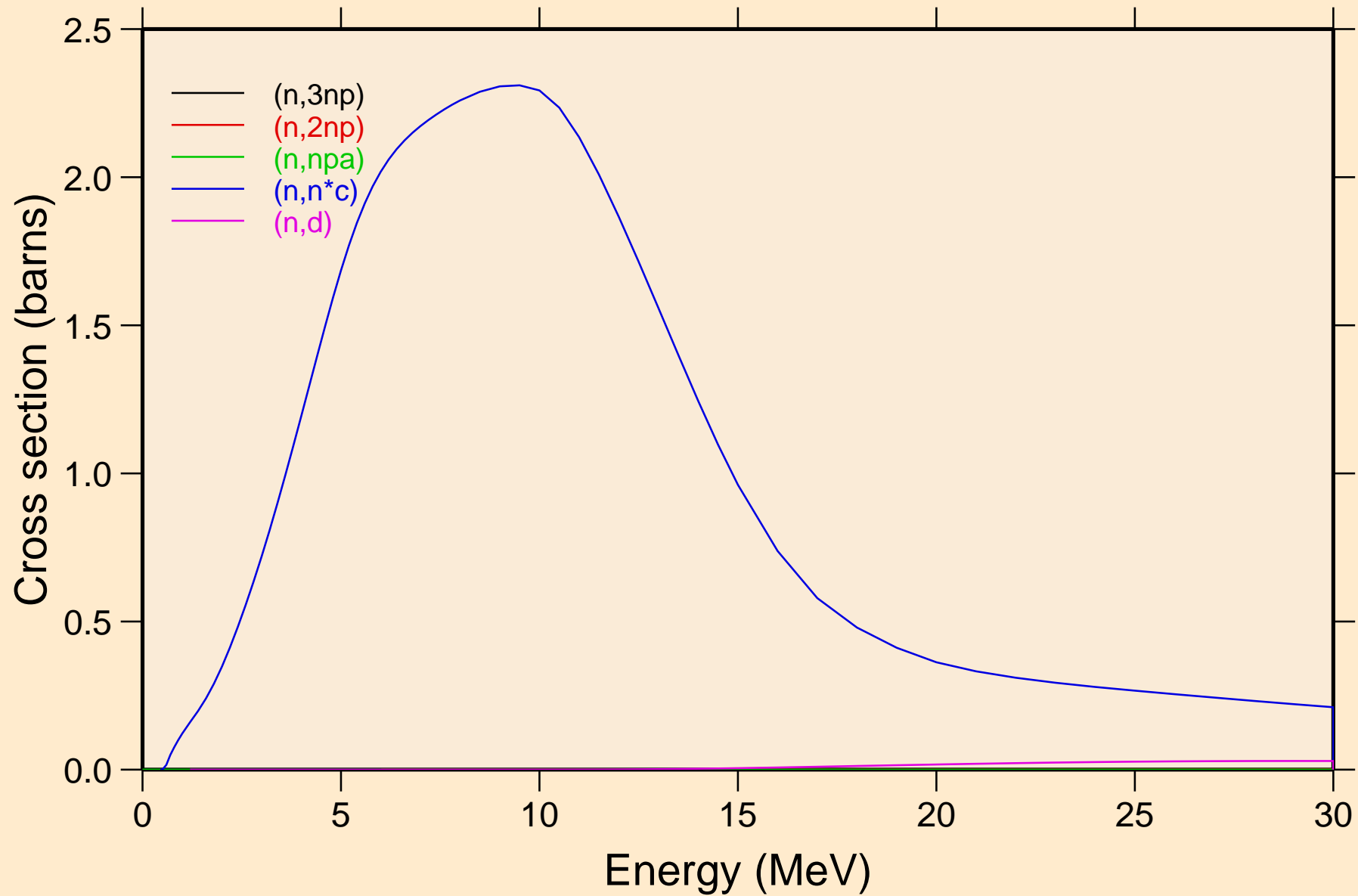

PB193M NEUTRON ACER TENDL-2021 LIBRARY; T=293.6K
Threshold reactions

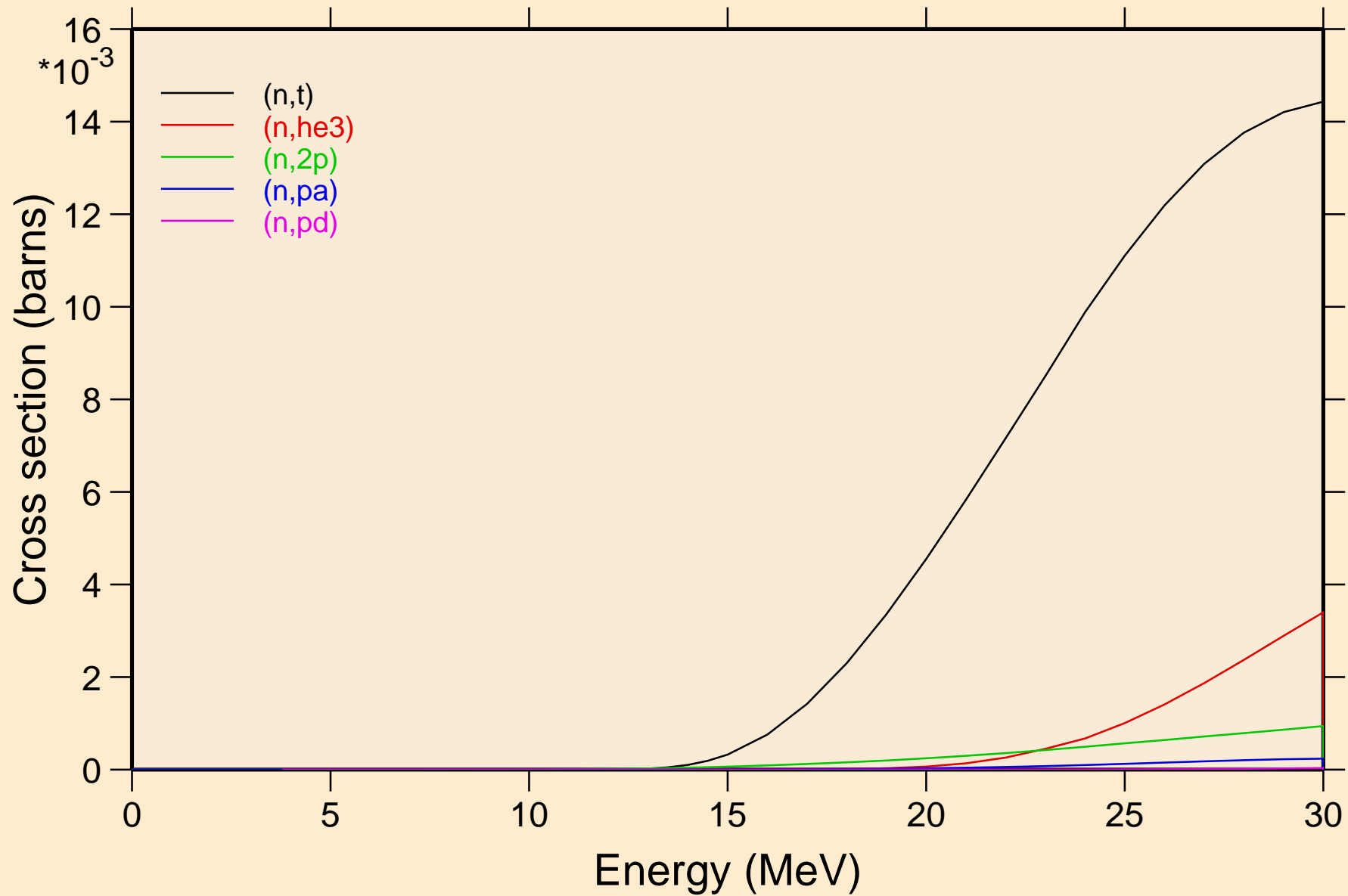

PB193M NEUTRON ACER TENDL-2021 LIBRARY; T=293.6K
Threshold reactions

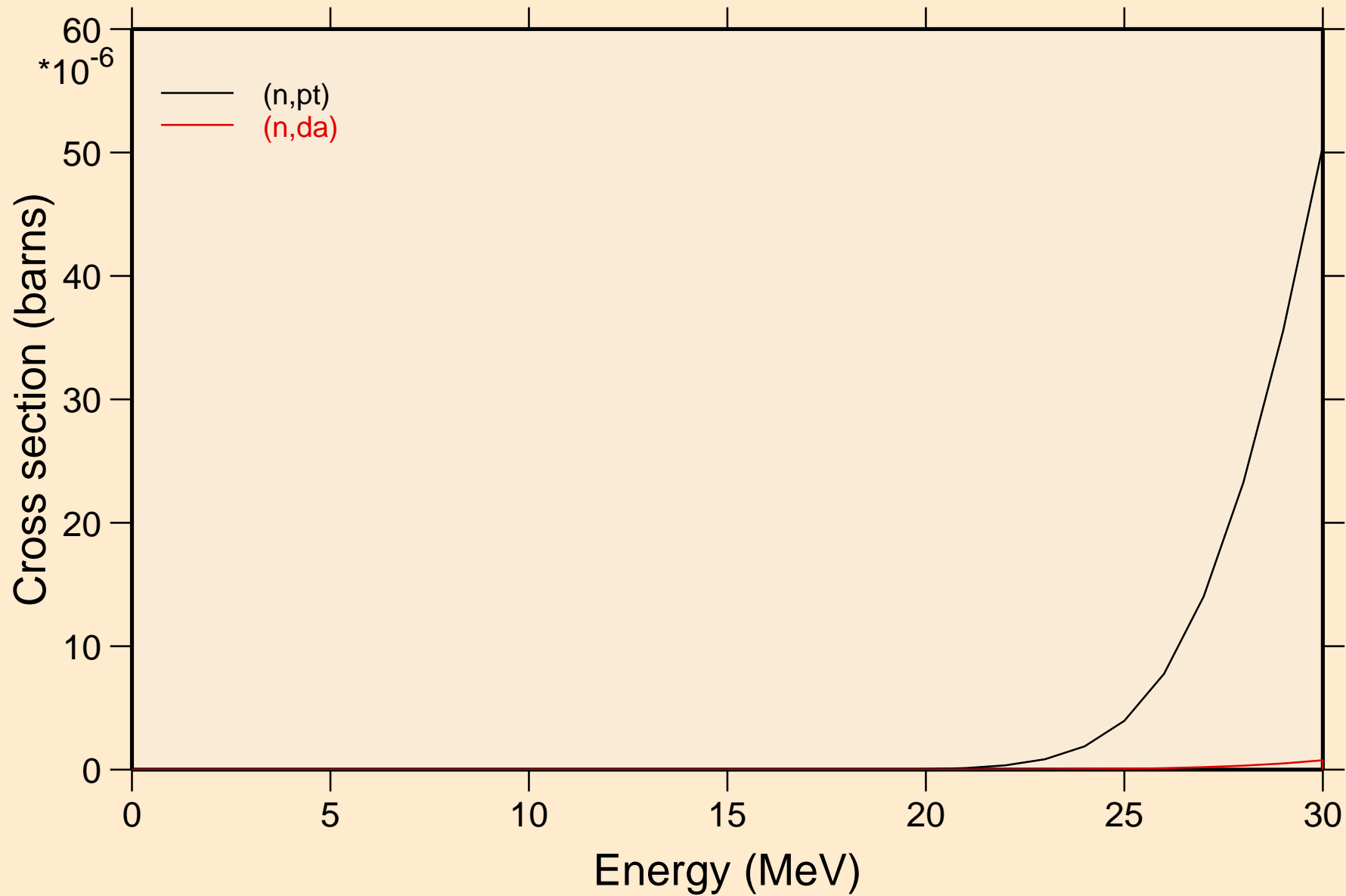

PB193M NEUTRON ACER TENDL-2021 LIBRARY; T=293.6K
Threshold reactions

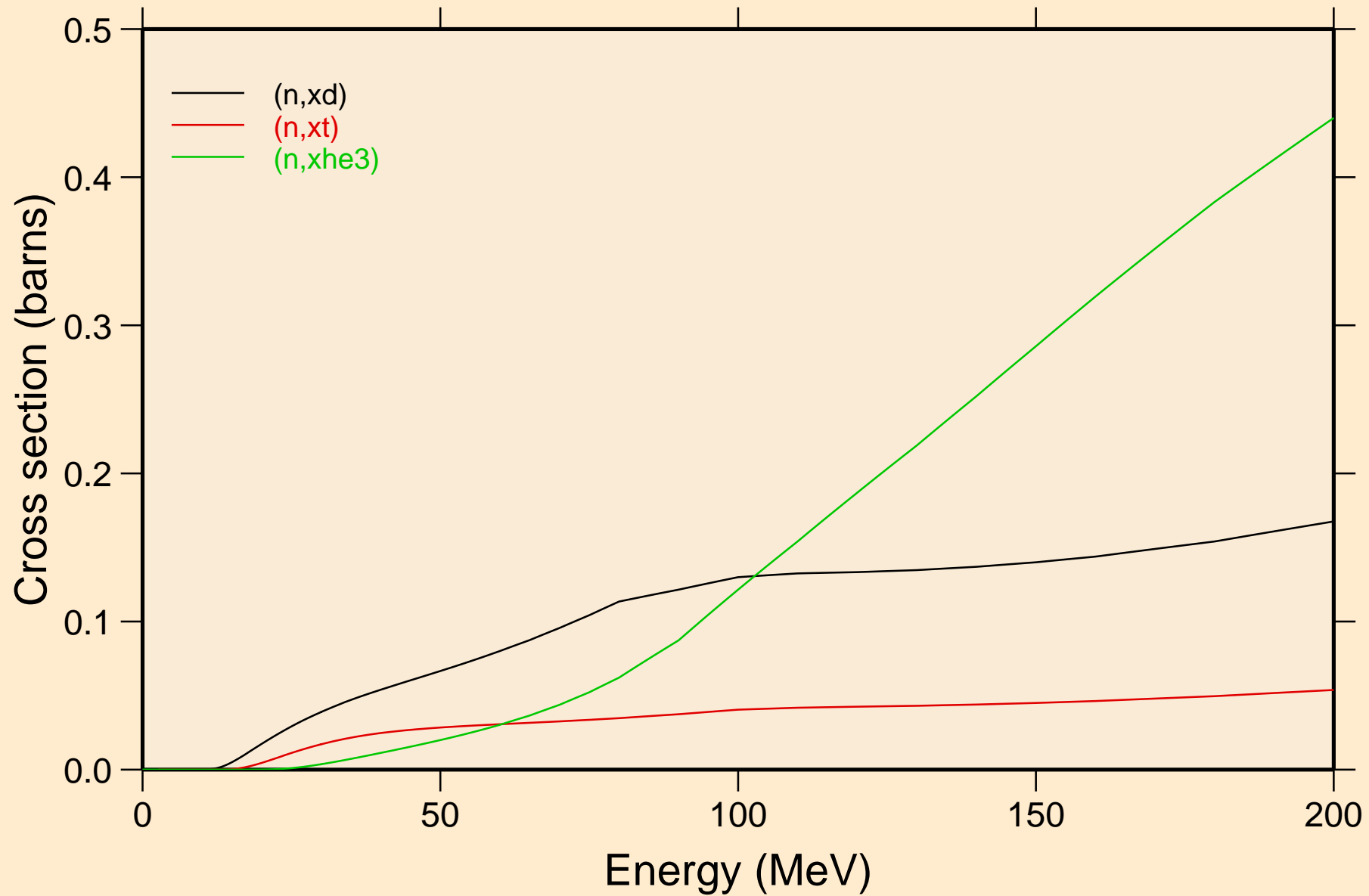

PB193M NEUTRON ACER TENDL-2021 LIBRARY; T=293.6K
angular distribution for elastic

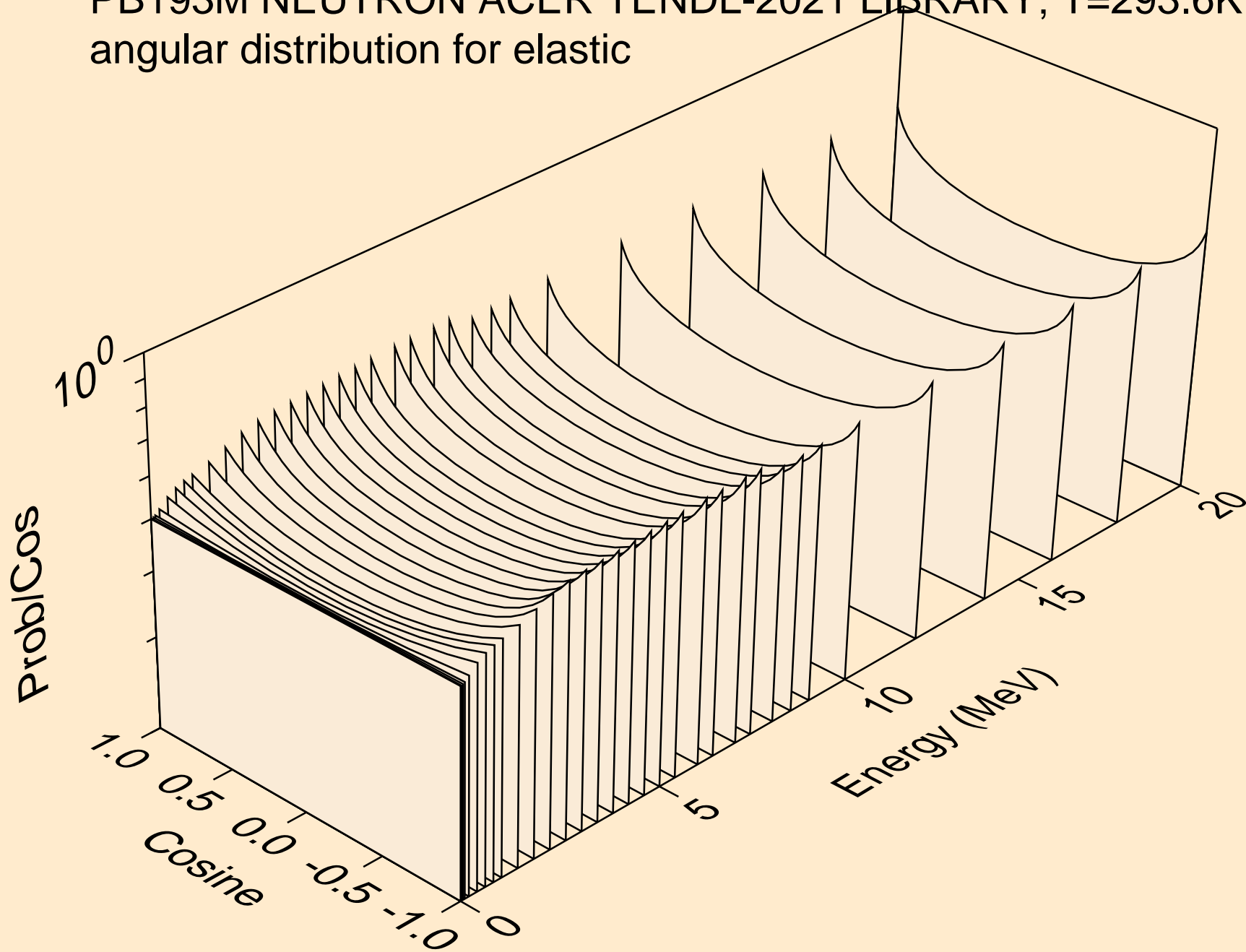

PB193M NEUTRON ACER TENDL-2021 LIBRARY; T=293.6K
angular distribution for elastic

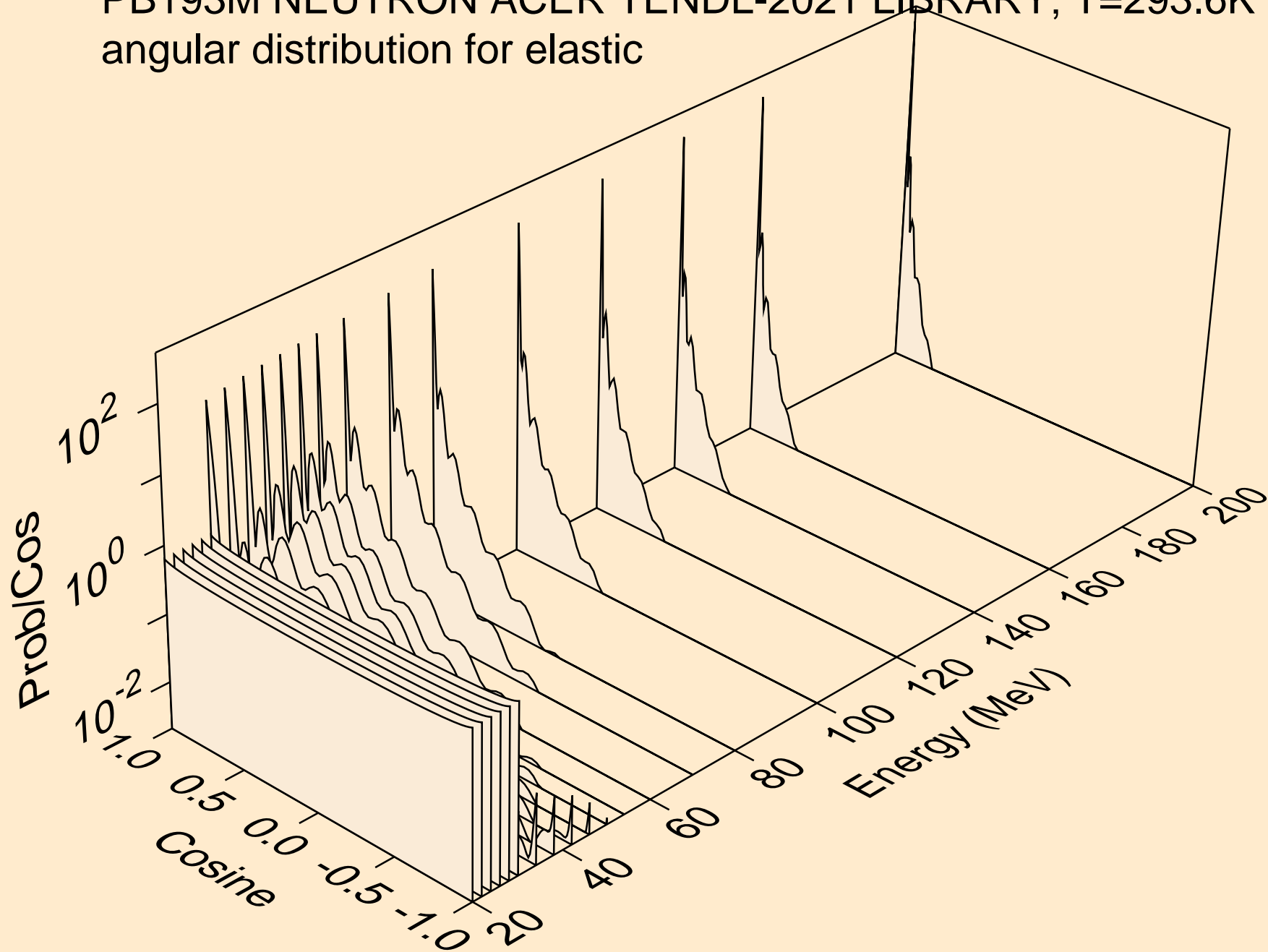

PB193M NEUTRON ACER TENDL-2021 LIBRARY; T=293.6K
angular distribution for (n,n*1)

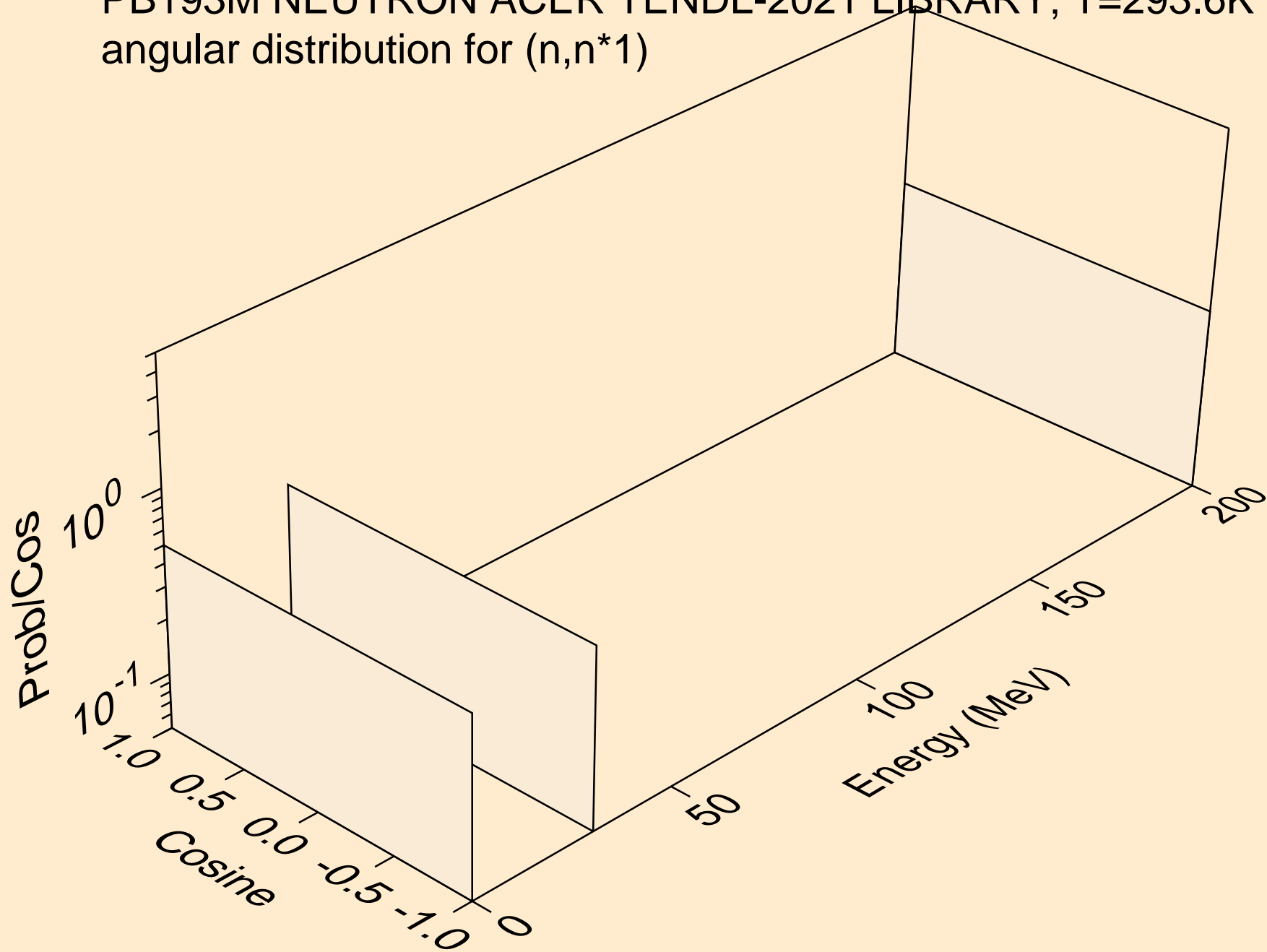

PB193M NEUTRON ACER TENDL-2021 LIBRARY; T=293.6K
angular distribution for (n,n*2)

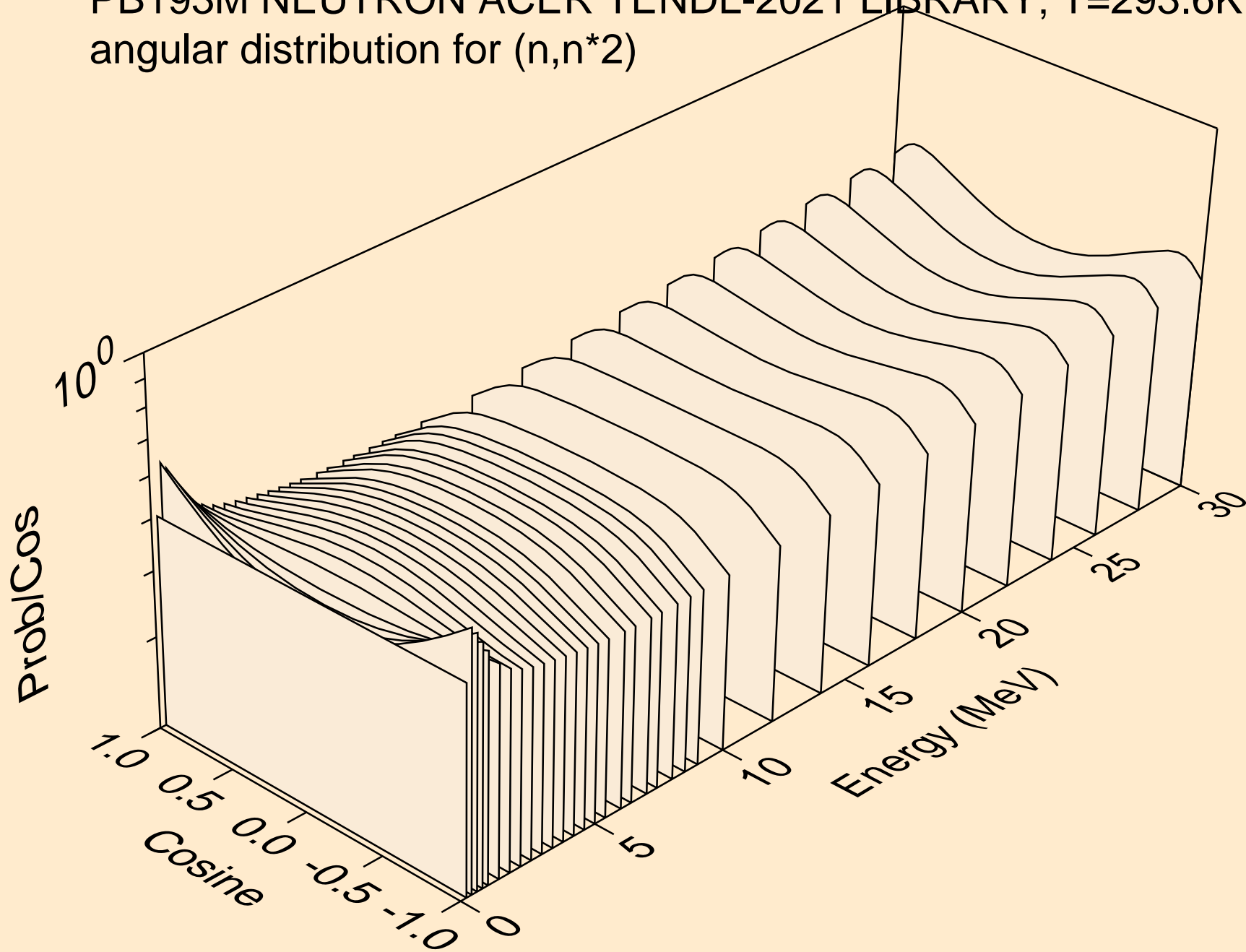

PB193M NEUTRON ACER TENDL-2021 LIBRARY; T=293.6K
angular distribution for (n,n*3)

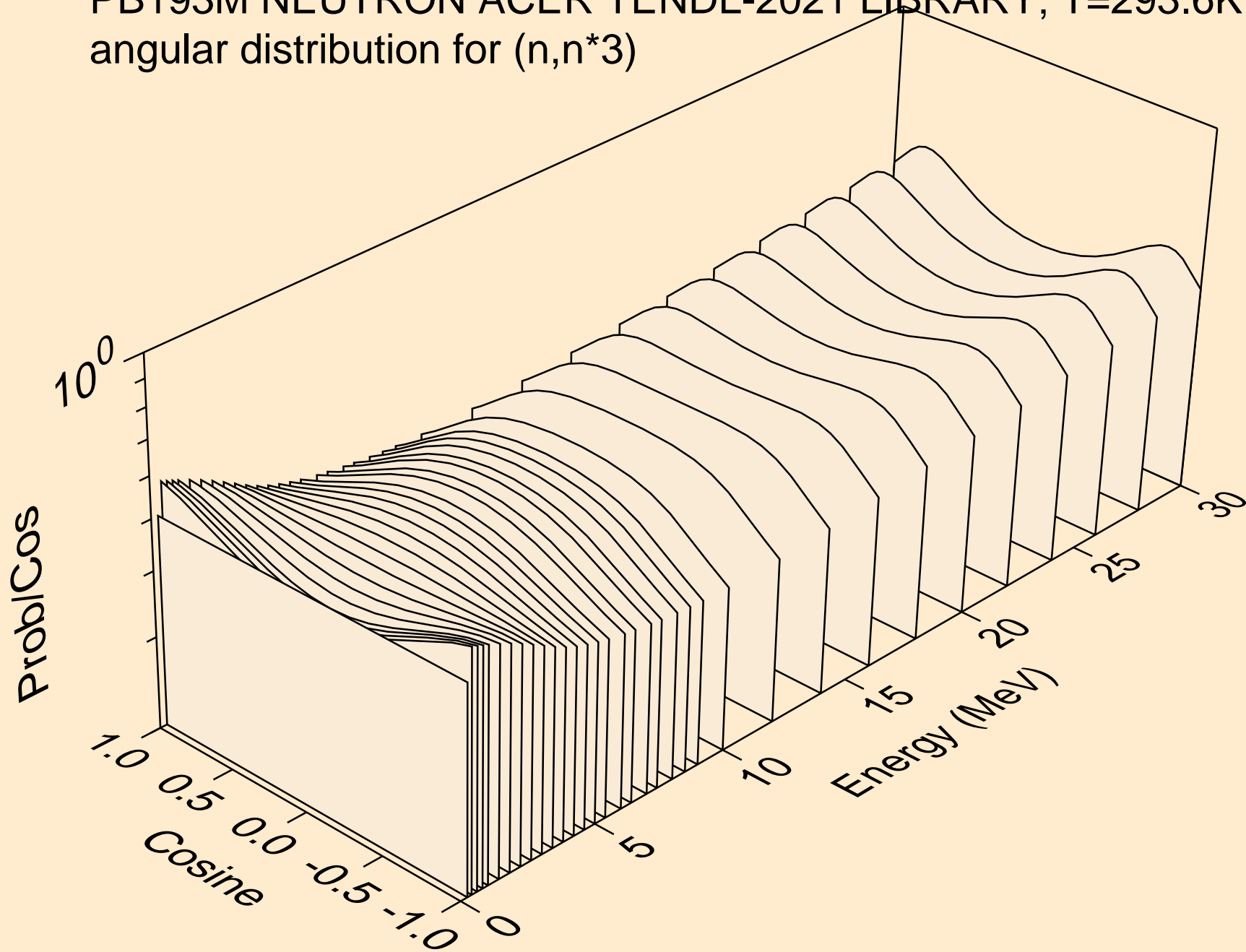

PB193M NEUTRON ACER TENDL-2021 LIBRARY; T=293.6K
angular distribution for (n,n*4)

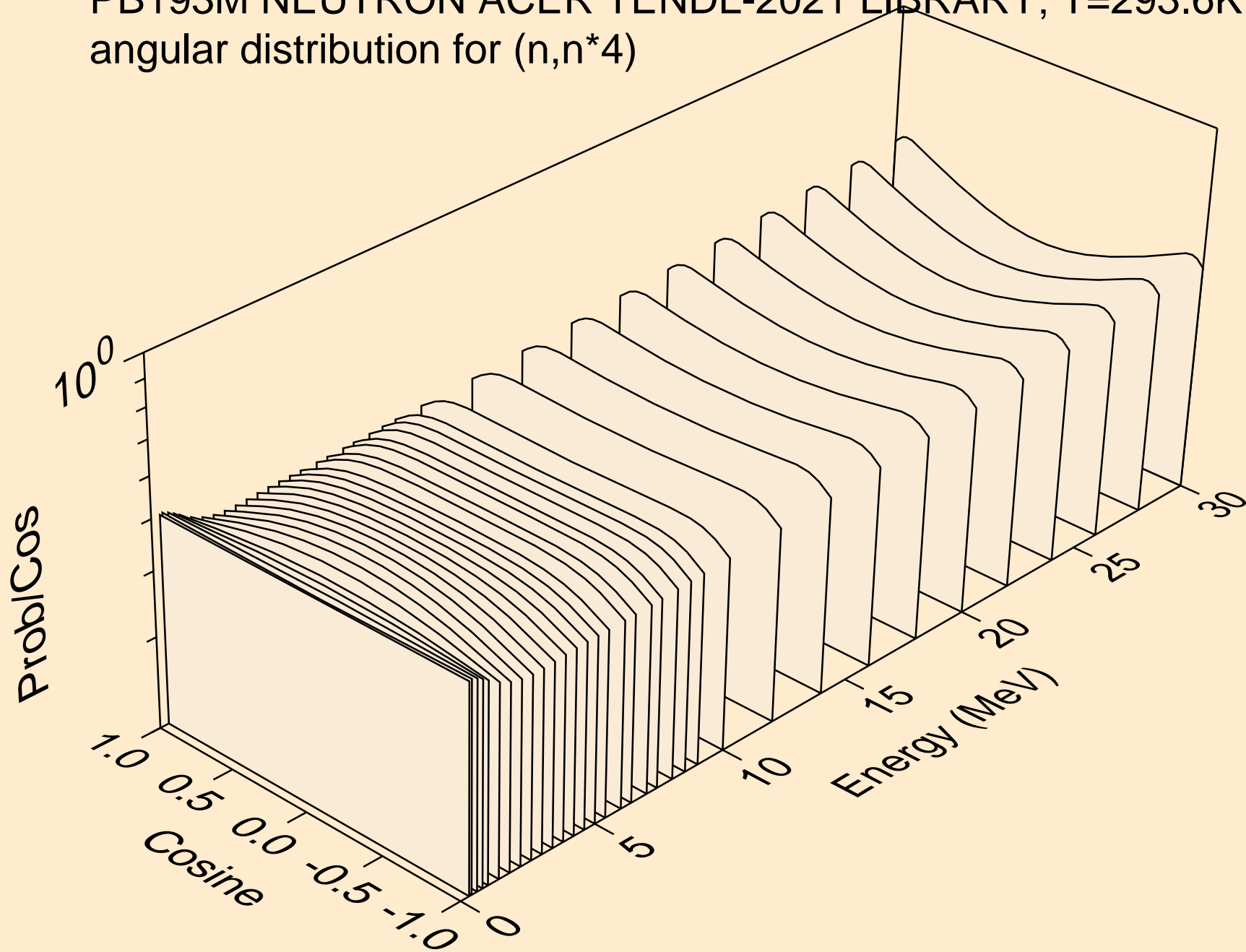

PB193M NEUTRON ACER TENDL-2021 LIBRARY; T=293.6K
angular distribution for (n,n*5)

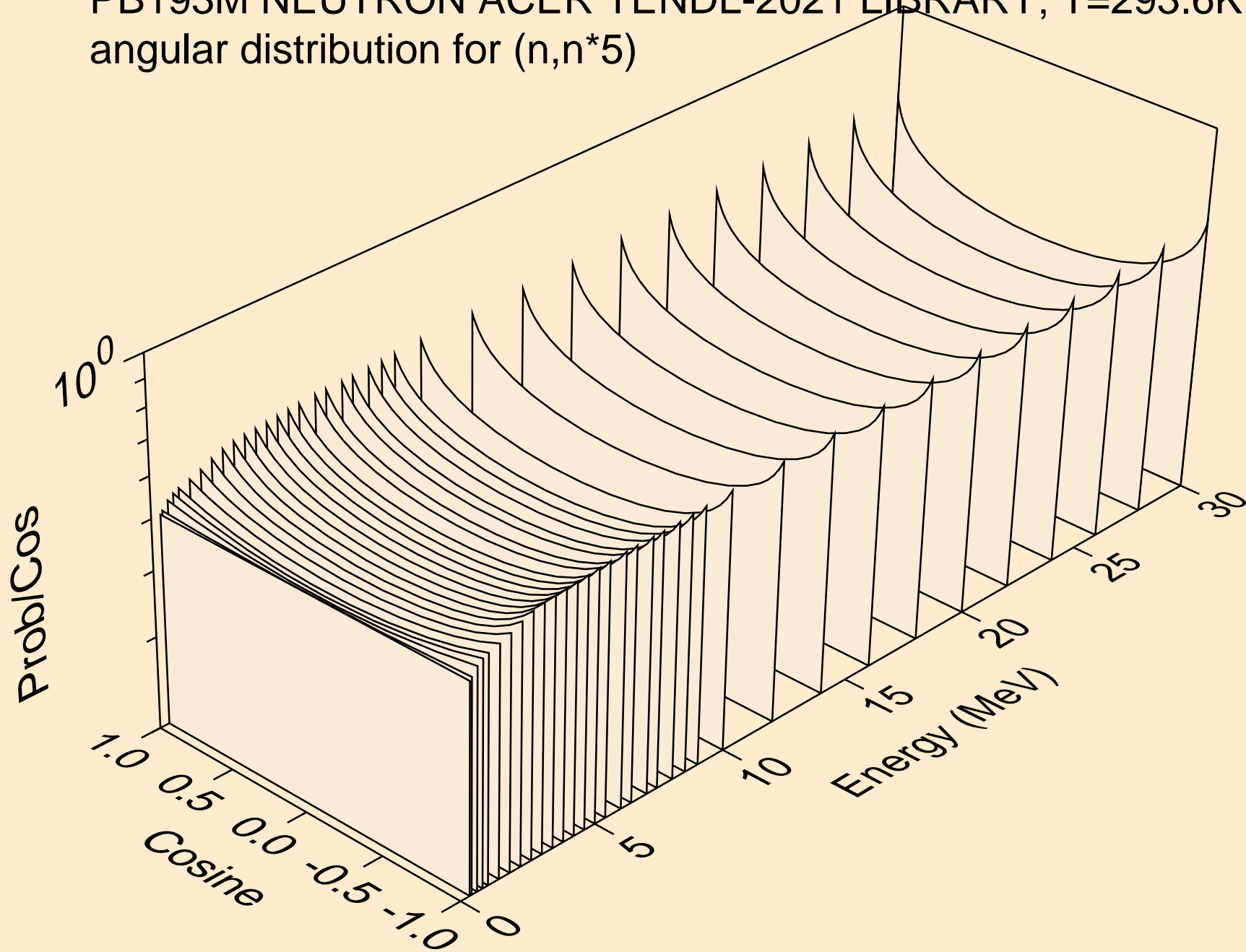

PB193M NEUTRON ACER TENDL-2021 LIBRARY; T=293.6K
angular distribution for (n,n*6)

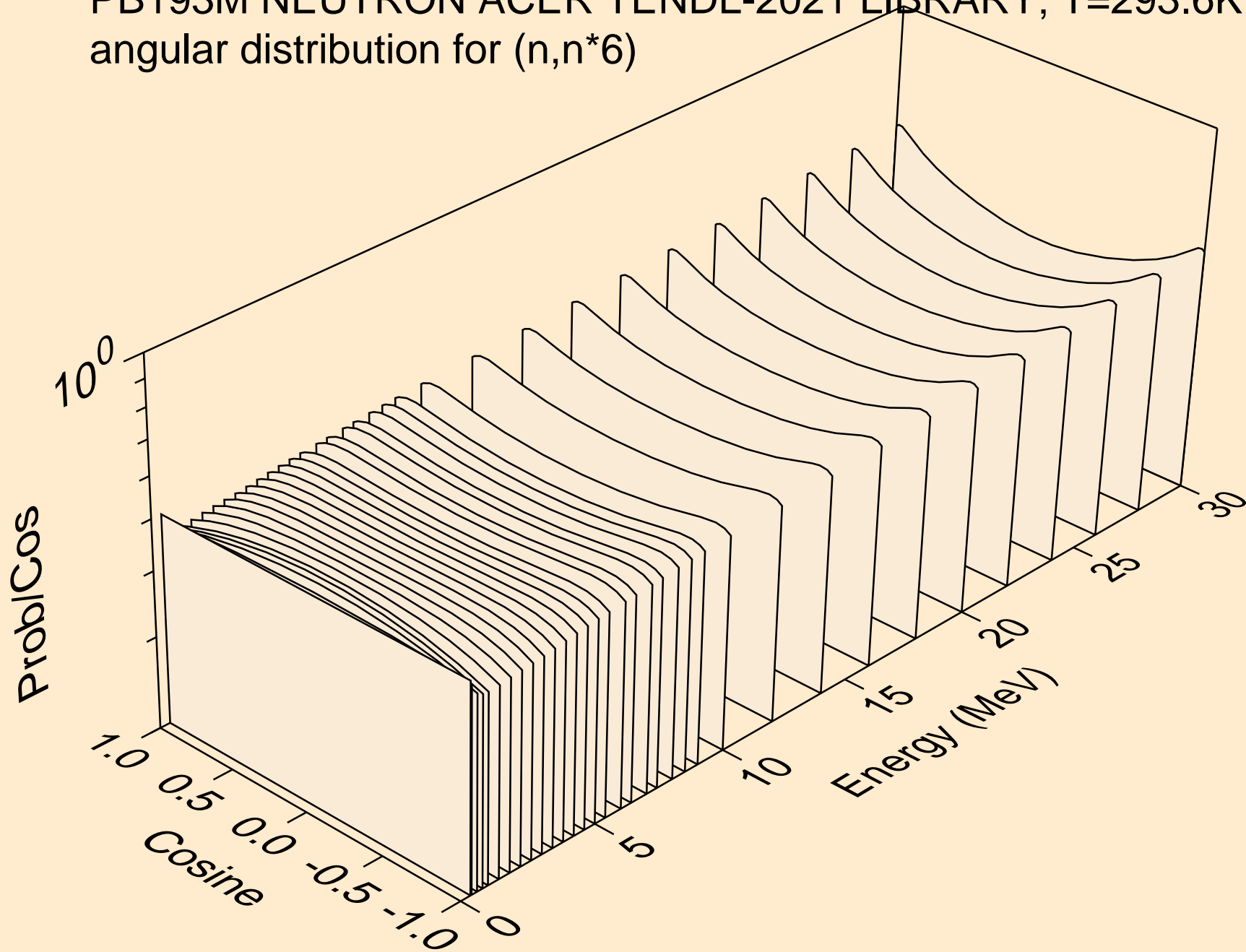

PB193M NEUTRON ACER TENDL-2021 LIBRARY; T=293.6K
angular distribution for (n,n*7)

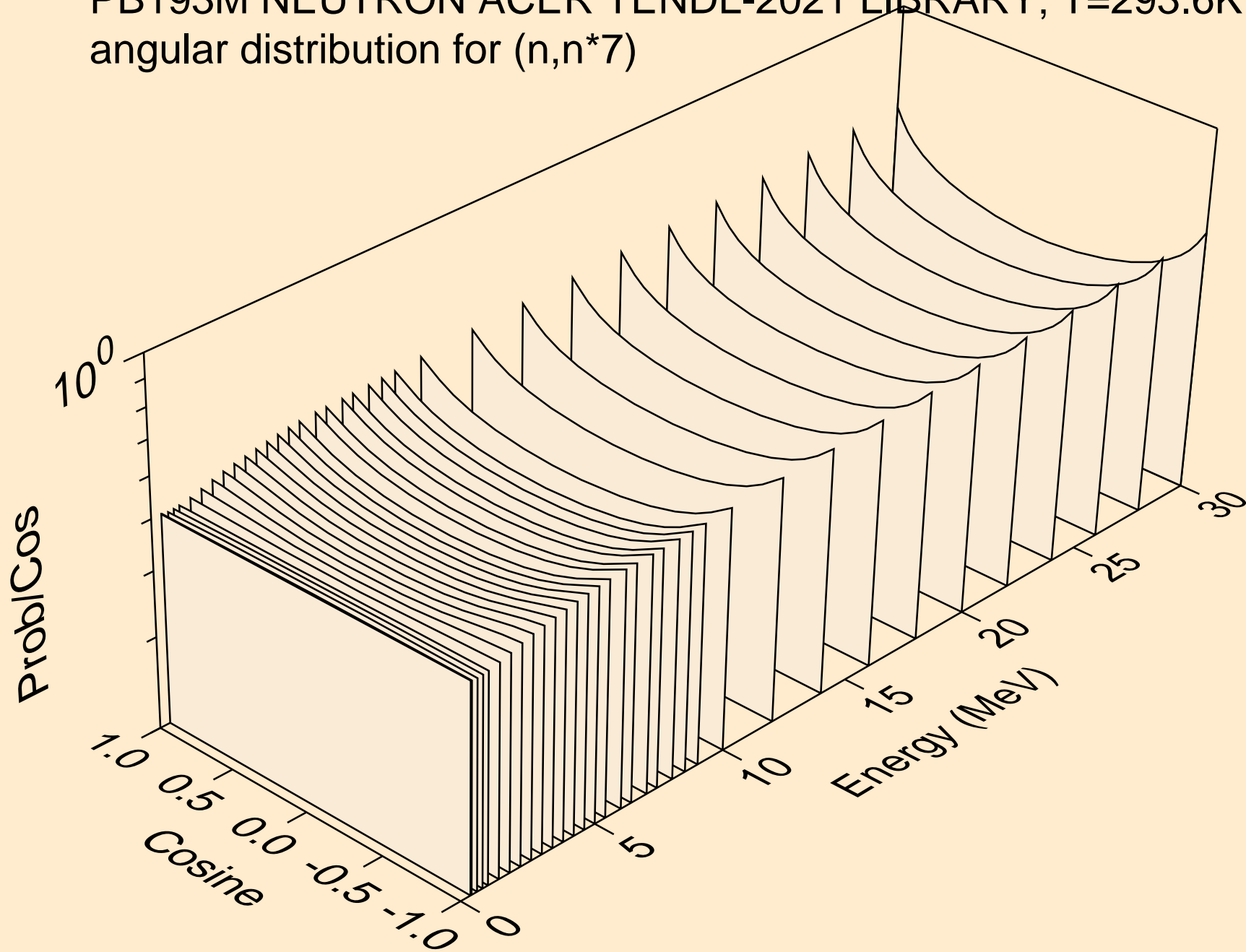

PB193M NEUTRON ACER TENDL-2021 LIBRARY; T=293.6K
angular distribution for (n,n*8)

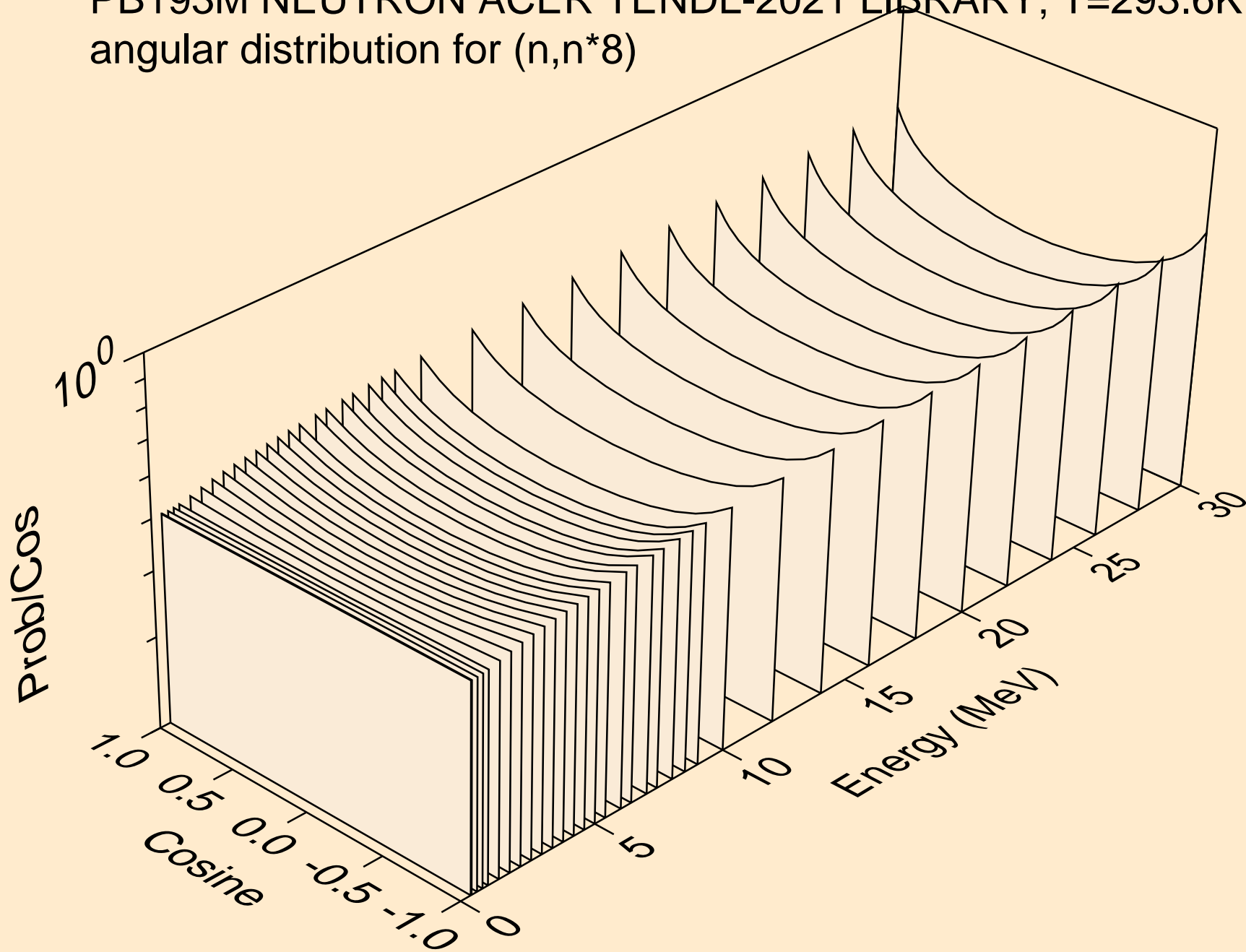

PB193M NEUTRON ACER TENDL-2021 LIBRARY; T=293.6K
angular distribution for (n,n*9)

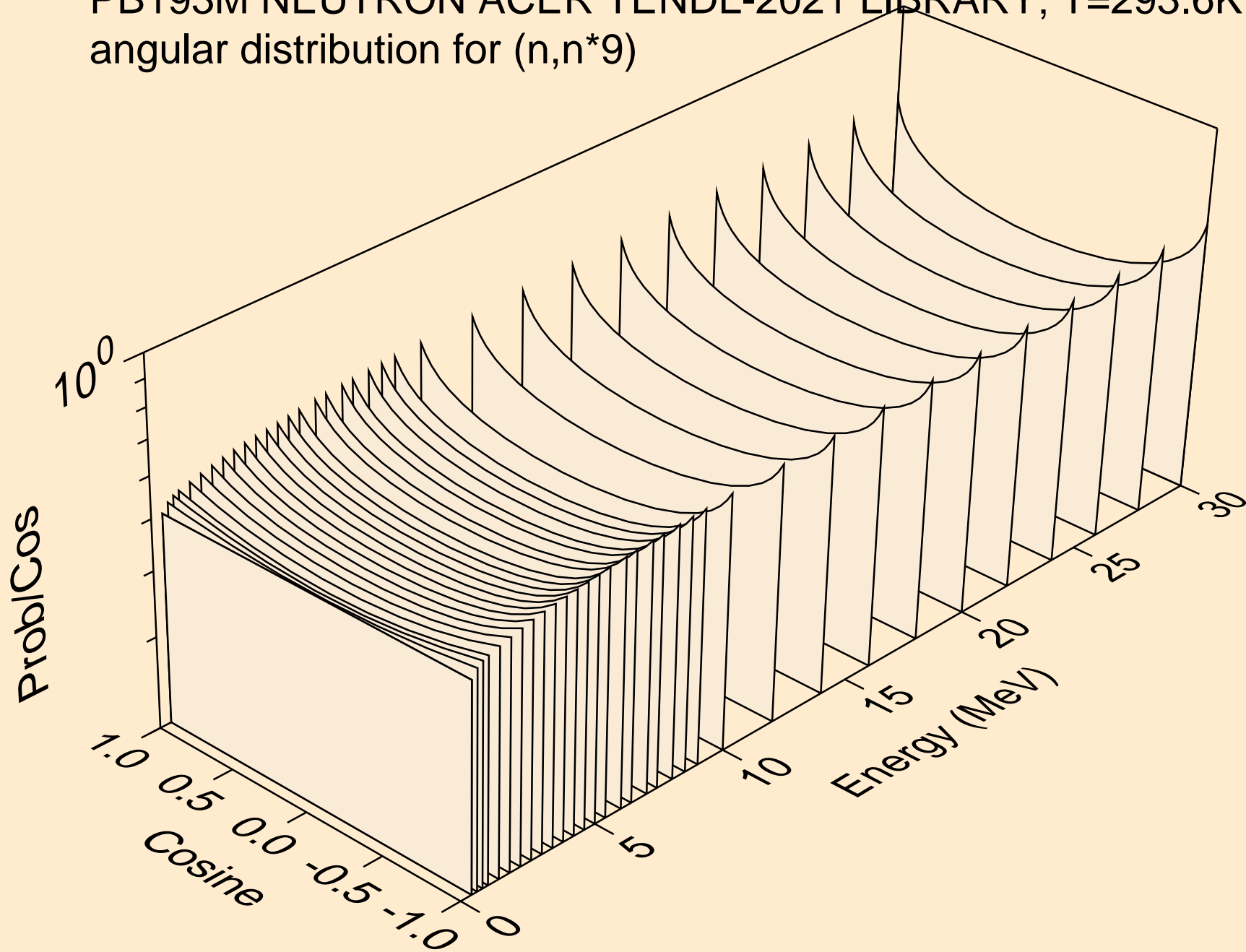

PB193M NEUTRON ACER TENDL-2021 LIBRARY; T=293.6K
angular distribution for (n,n*10)

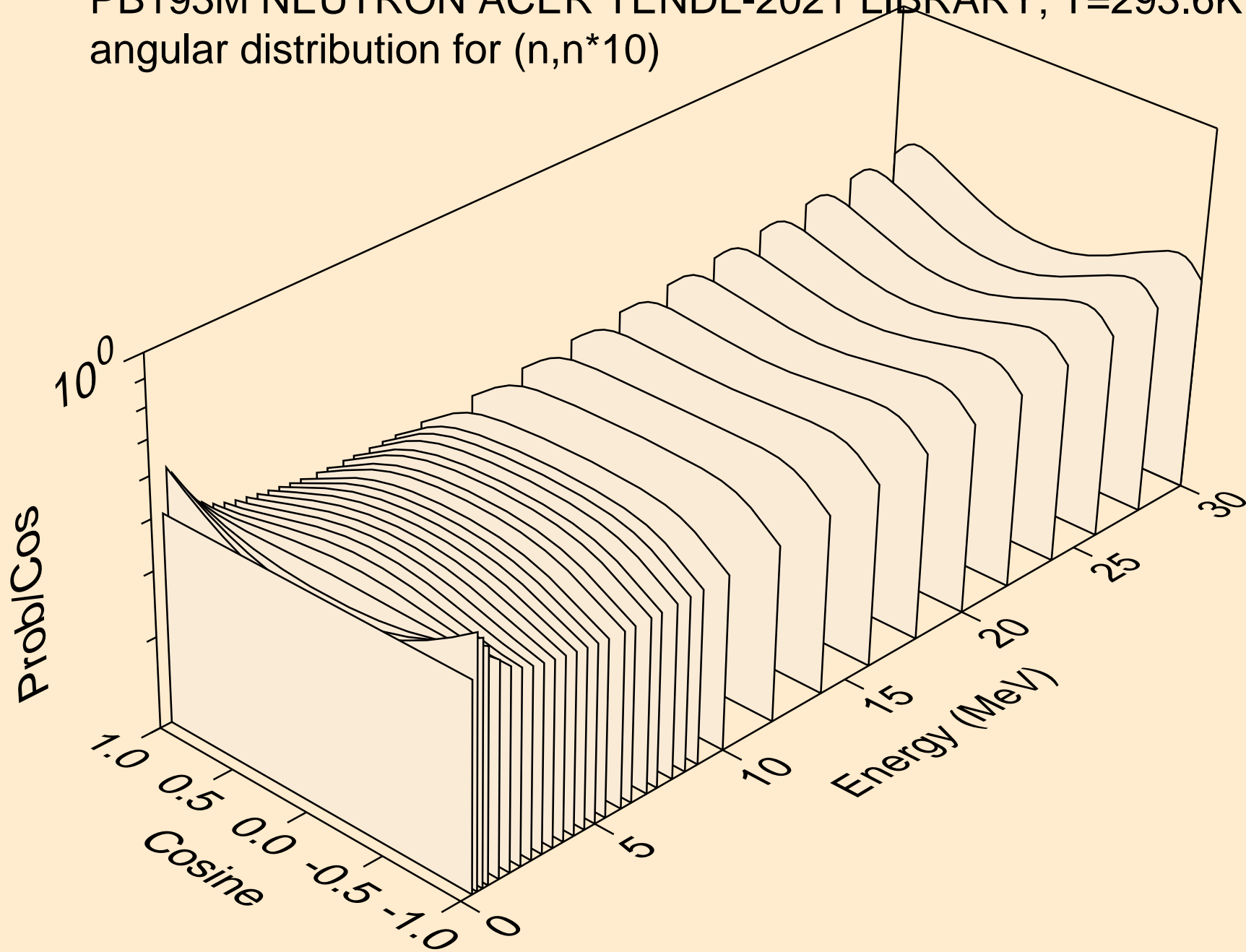

PB193M NEUTRON ACER TENDL-2021 LIBRARY; T=293.6K
angular distribution for (n,n*11)

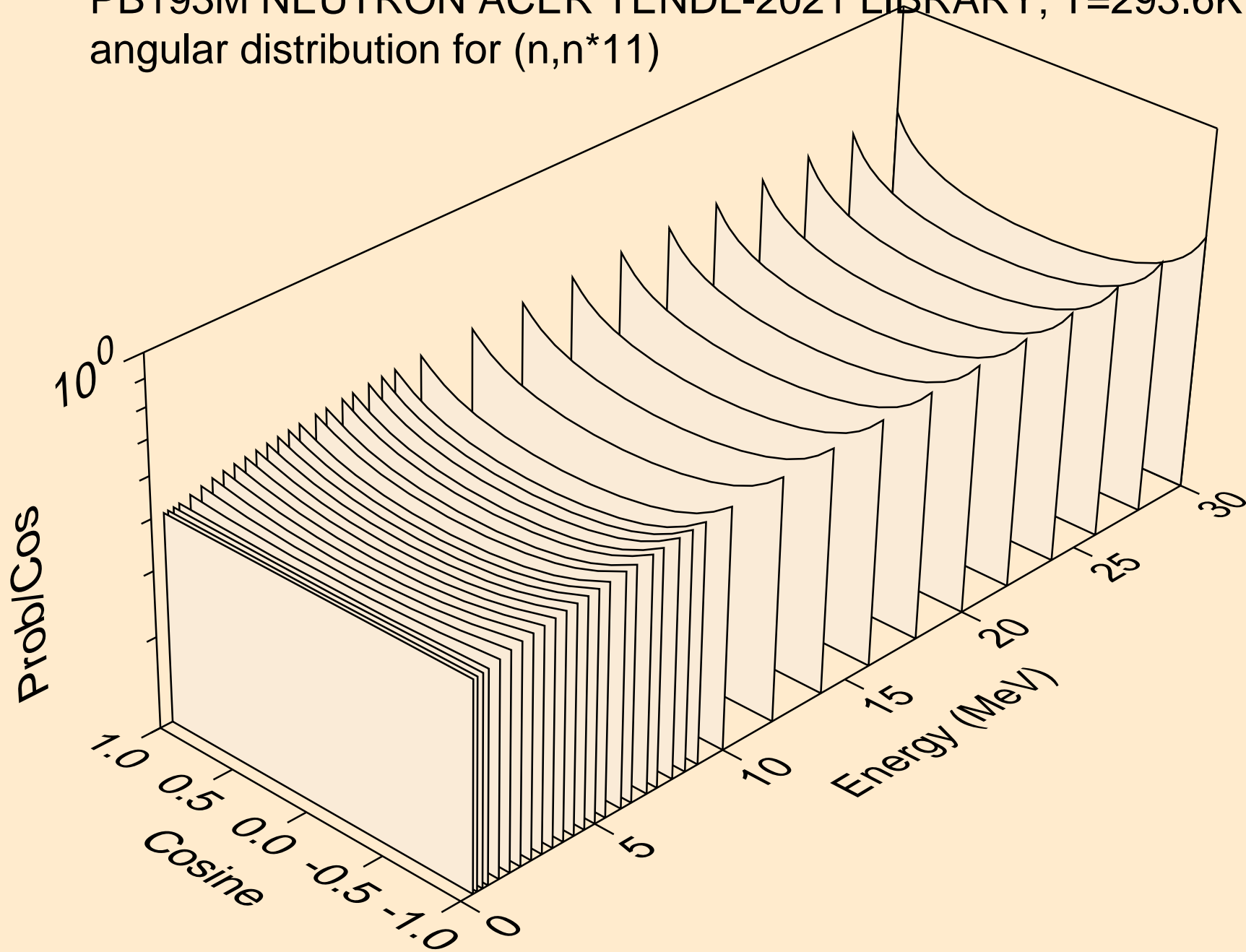

PB193M NEUTRON ACER TENDL-2021 LIBRARY; T=293.6K
Neutron emission for (n,x)

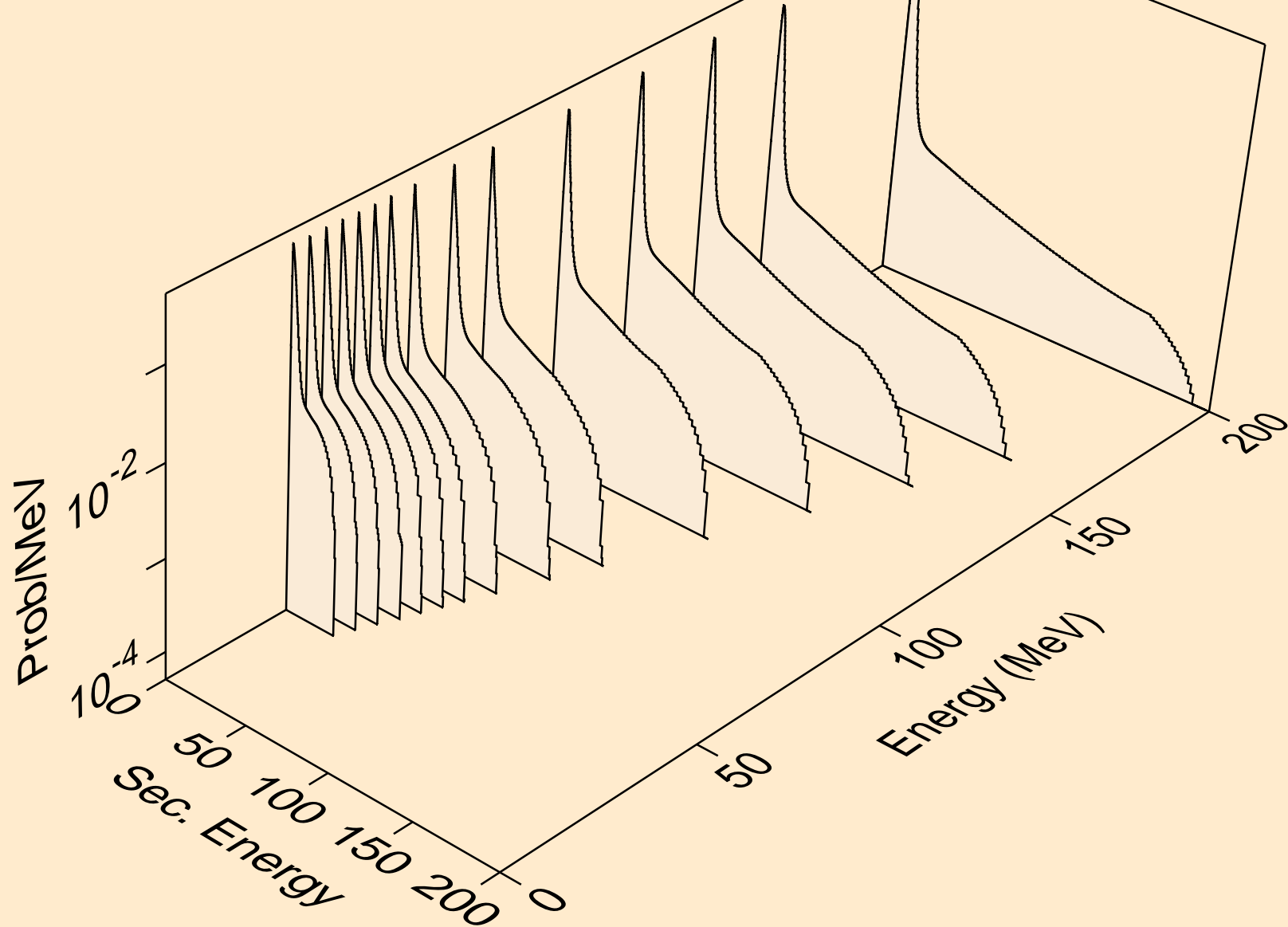

PB193M NEUTRON ACER TENDL-2021 LIBRARY; T=293.6K
Neutron emission for (n,2nd)

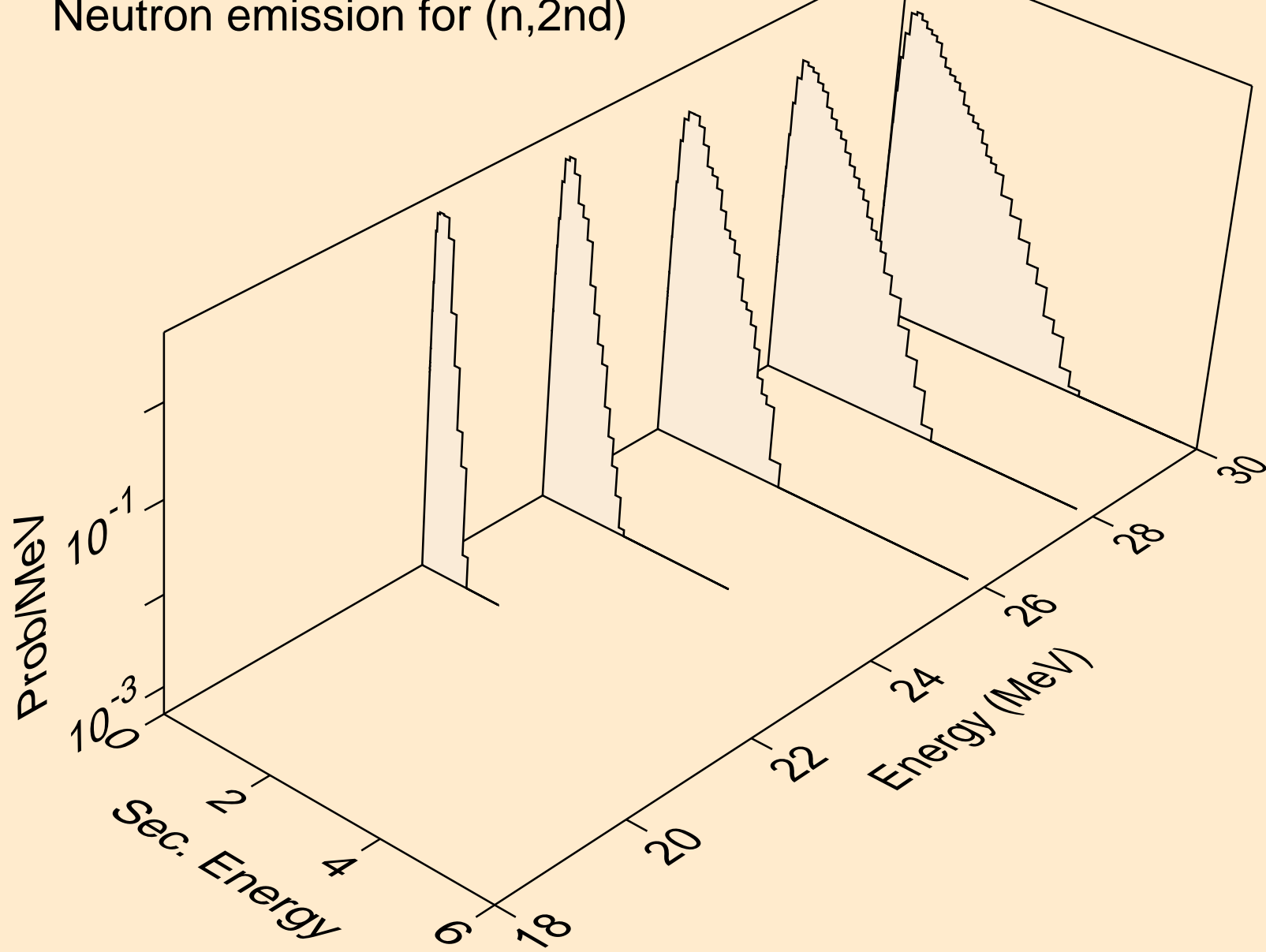

PB193M NEUTRON ACER TENDL-2021 LIBRARY; T=293.6K
Neutron emission for (n,2n)

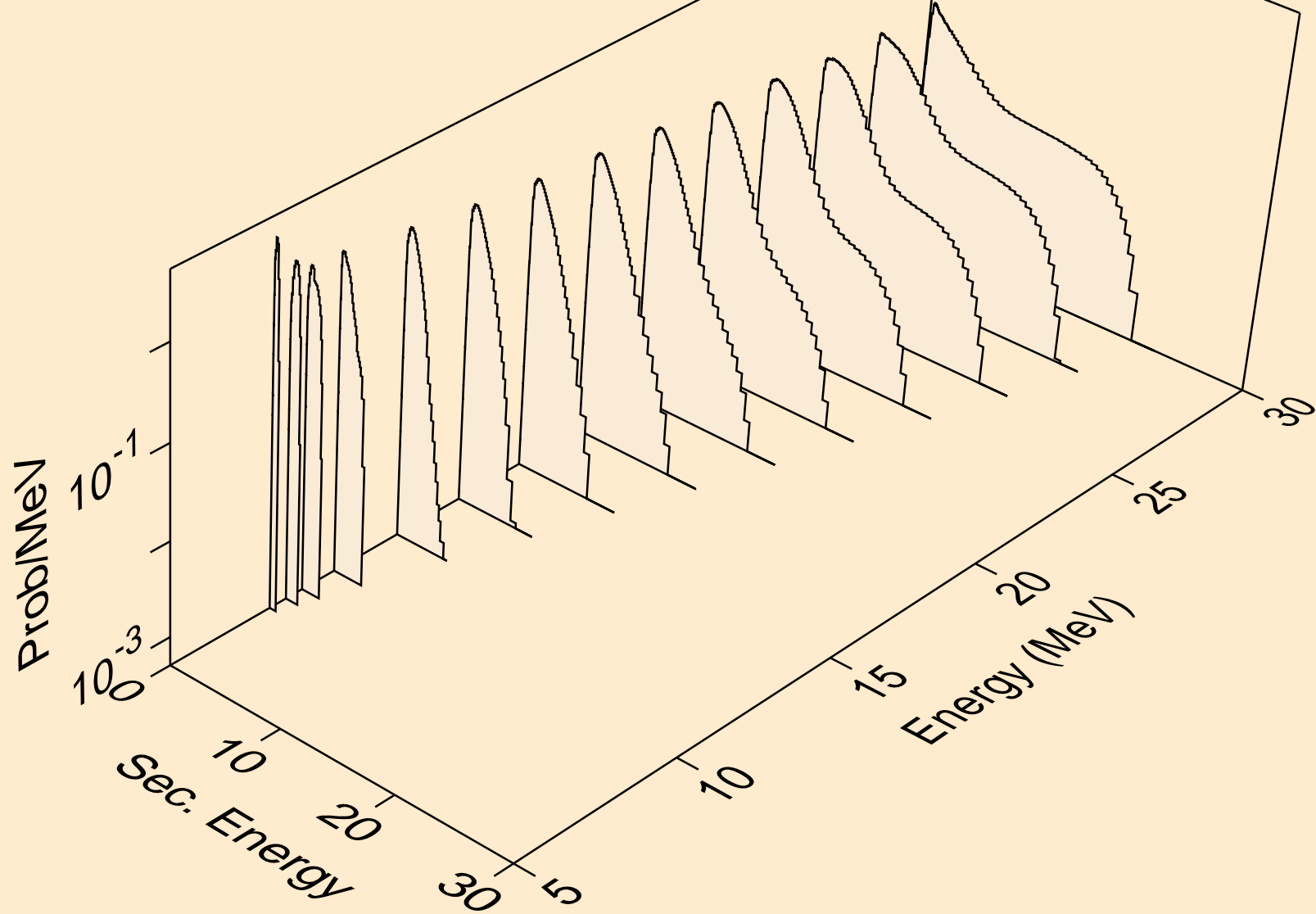

PB193M NEUTRON ACER TENDL-2021 LIBRARY; T=293.6K
Neutron emission for (n,3n)

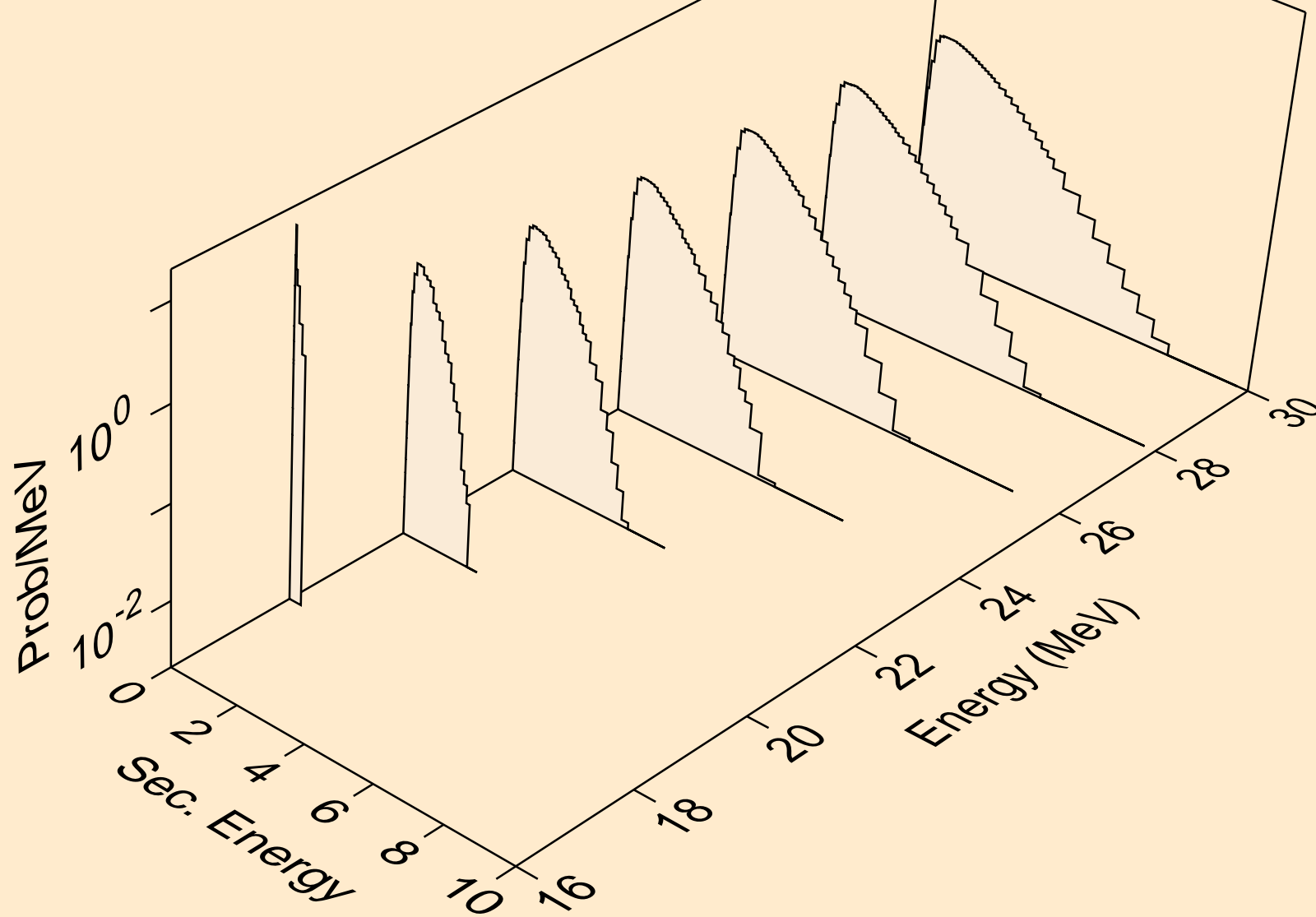

PB193M NEUTRON ACER TENDL-2021 LIBRARY; T=293.6K
Neutron emission for (n,n*)a

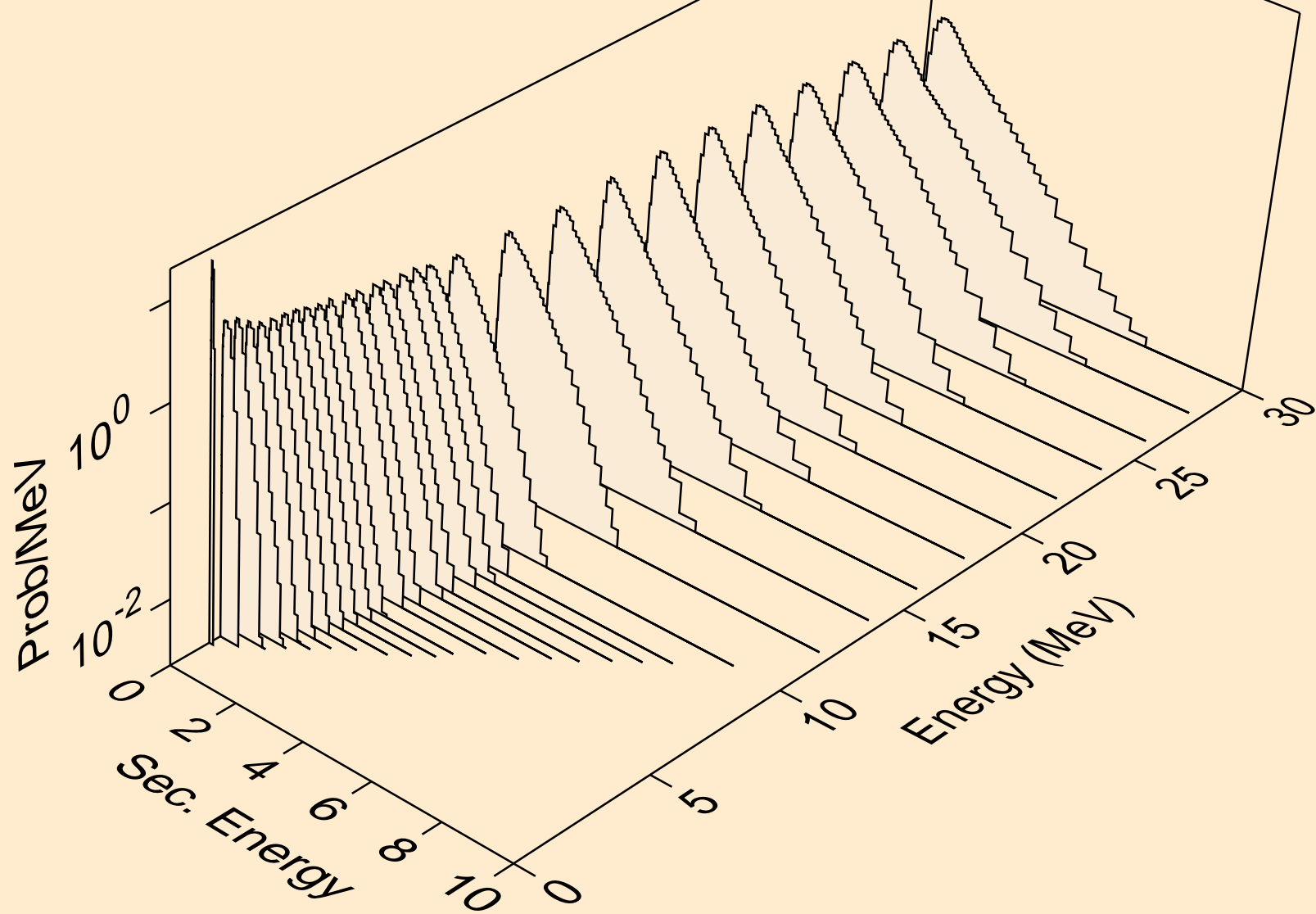

PB193M NEUTRON ACER TENDL-2021 LIBRARY; T=293.6K
Neutron emission for (n,2n)a

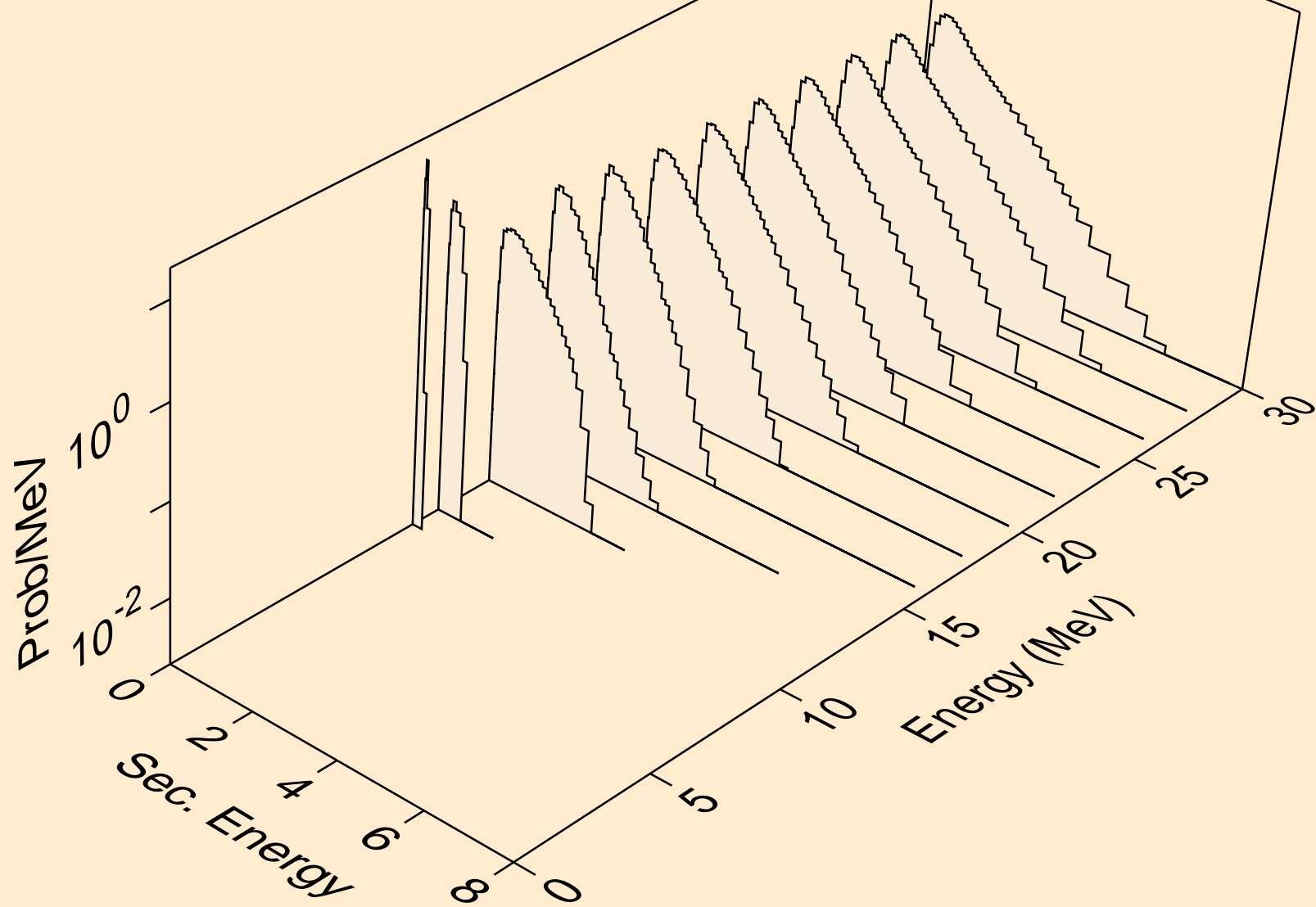

PB193M NEUTRON ACER TENDL-2021 LIBRARY; T=293.6K
Neutron emission for (n,3n)a

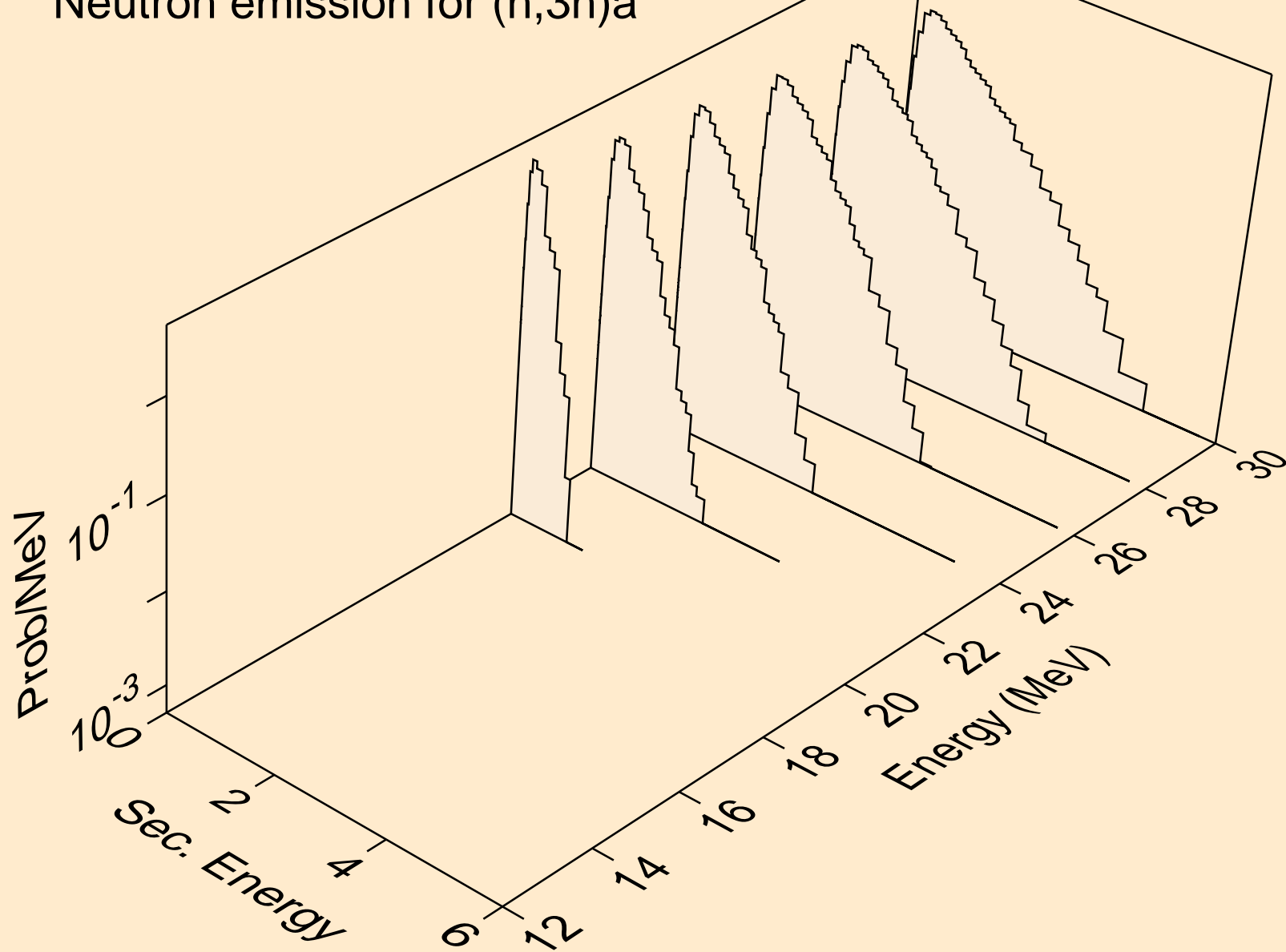

PB193M NEUTRON ACER TENDL-2021 LIBRARY; T=293.6K
Neutron emission for (n,n*)p

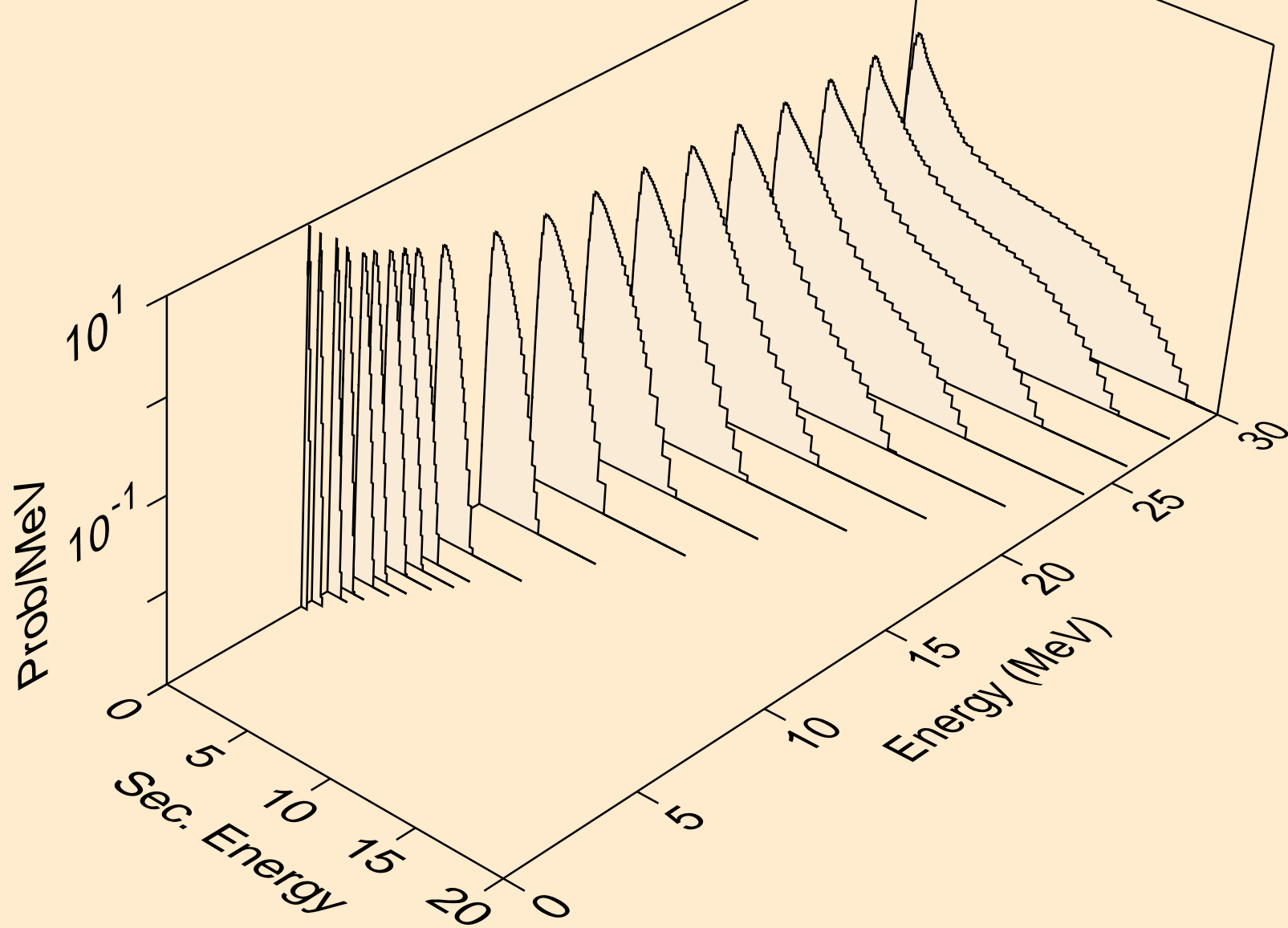

PB193M NEUTRON ACER TENDL-2021 LIBRARY; T=293.6K
Neutron emission for (n,n*)2a

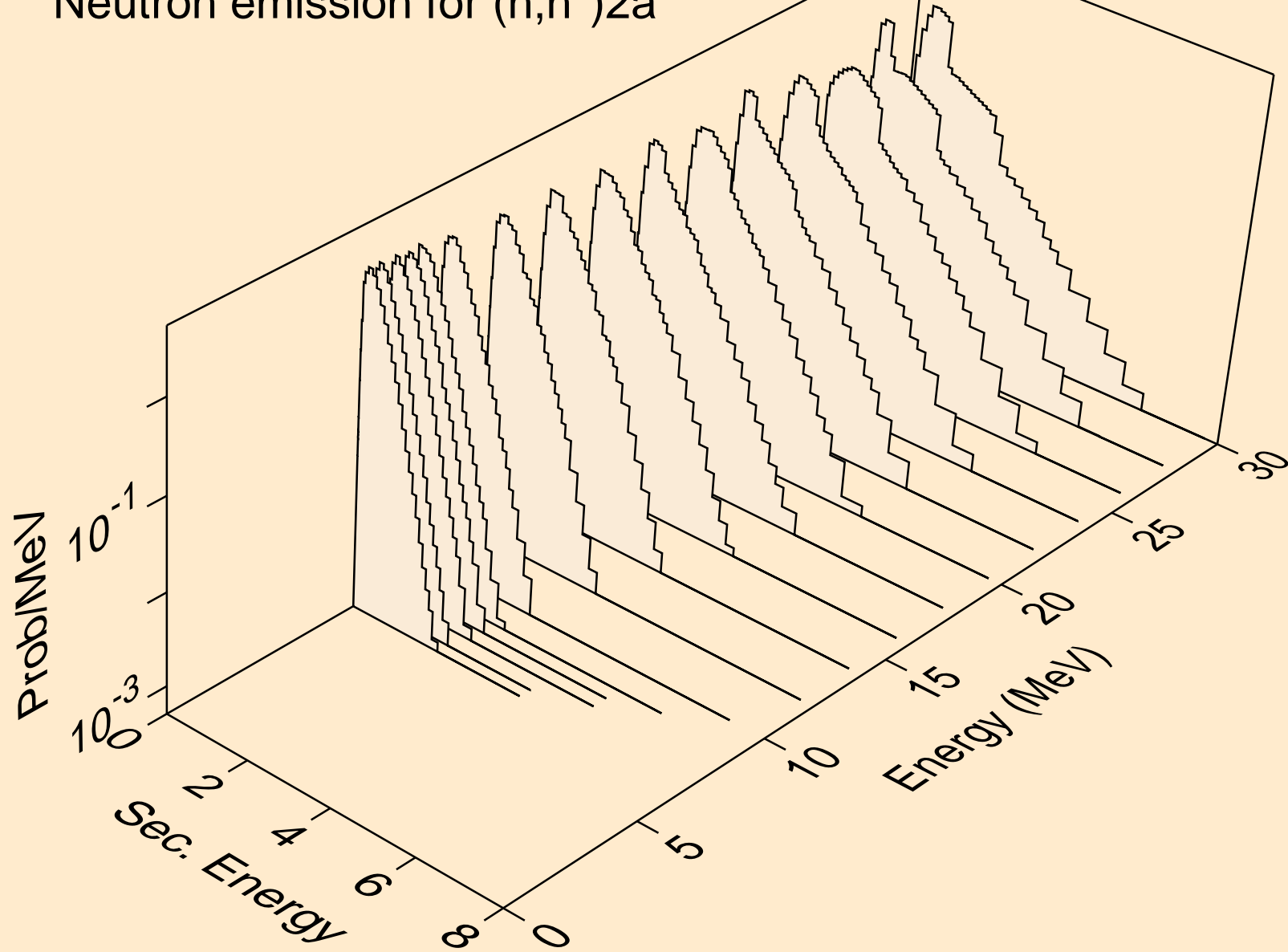

PB193M NEUTRON ACER TENDL-2021 LIBRARY; T=293.6K
Neutron emission for (n,2n)2a

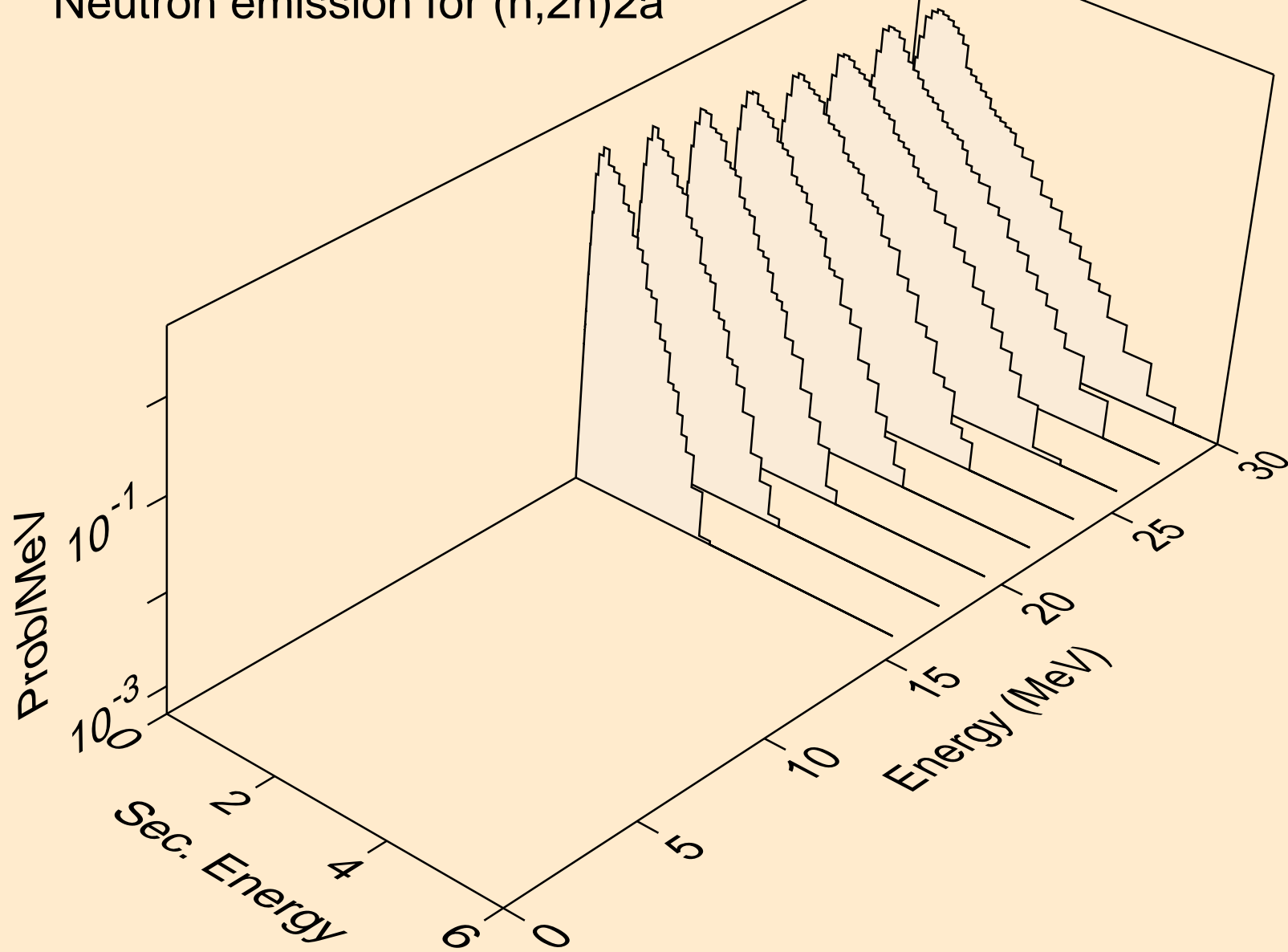

PB193M NEUTRON ACER TENDL-2021 LIBRARY; T=293.6K
Neutron emission for (n,n*)d

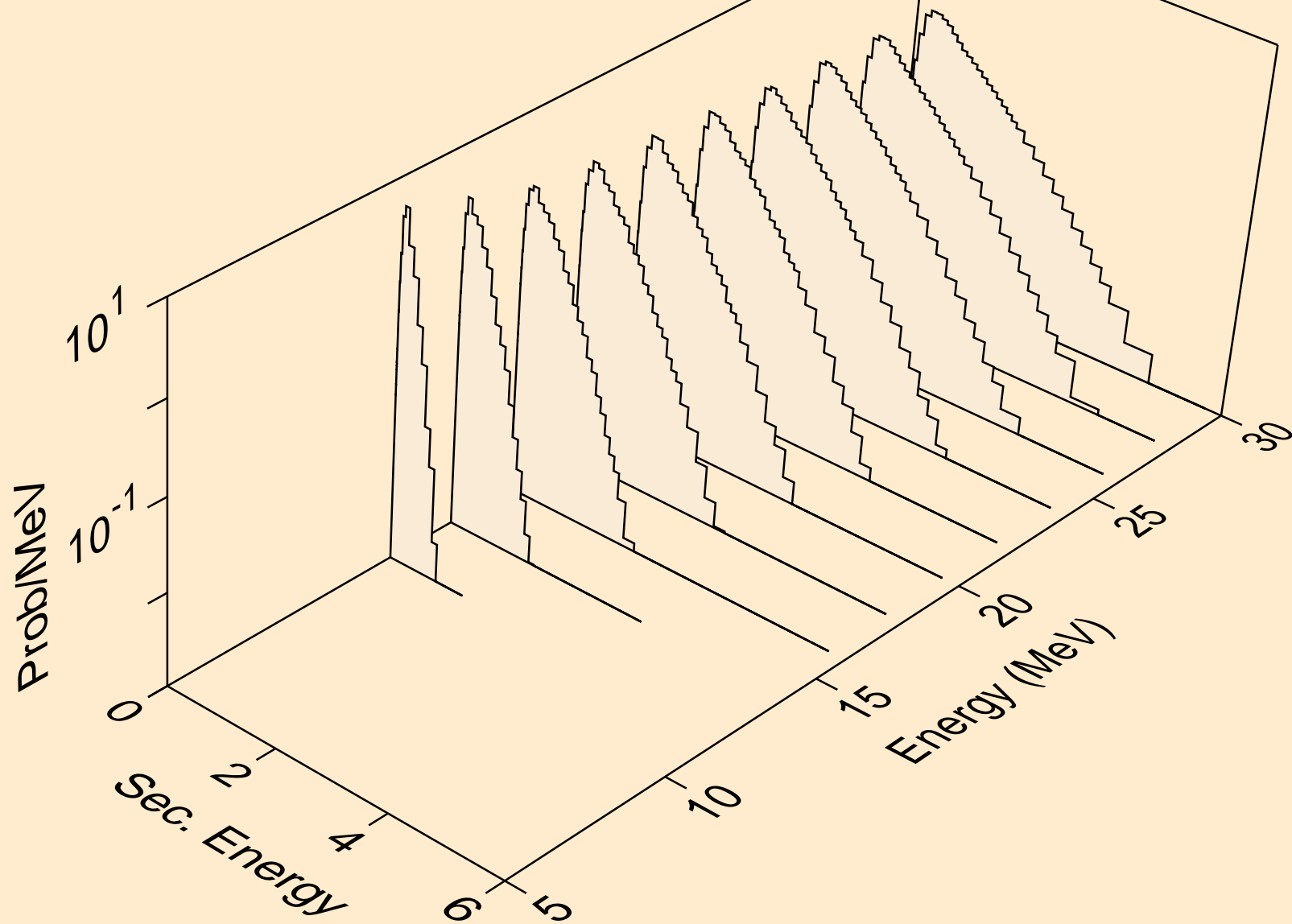

PB193M NEUTRON ACER TENDL-2021 LIBRARY; T=293.6K
Neutron emission for (n,n*)t

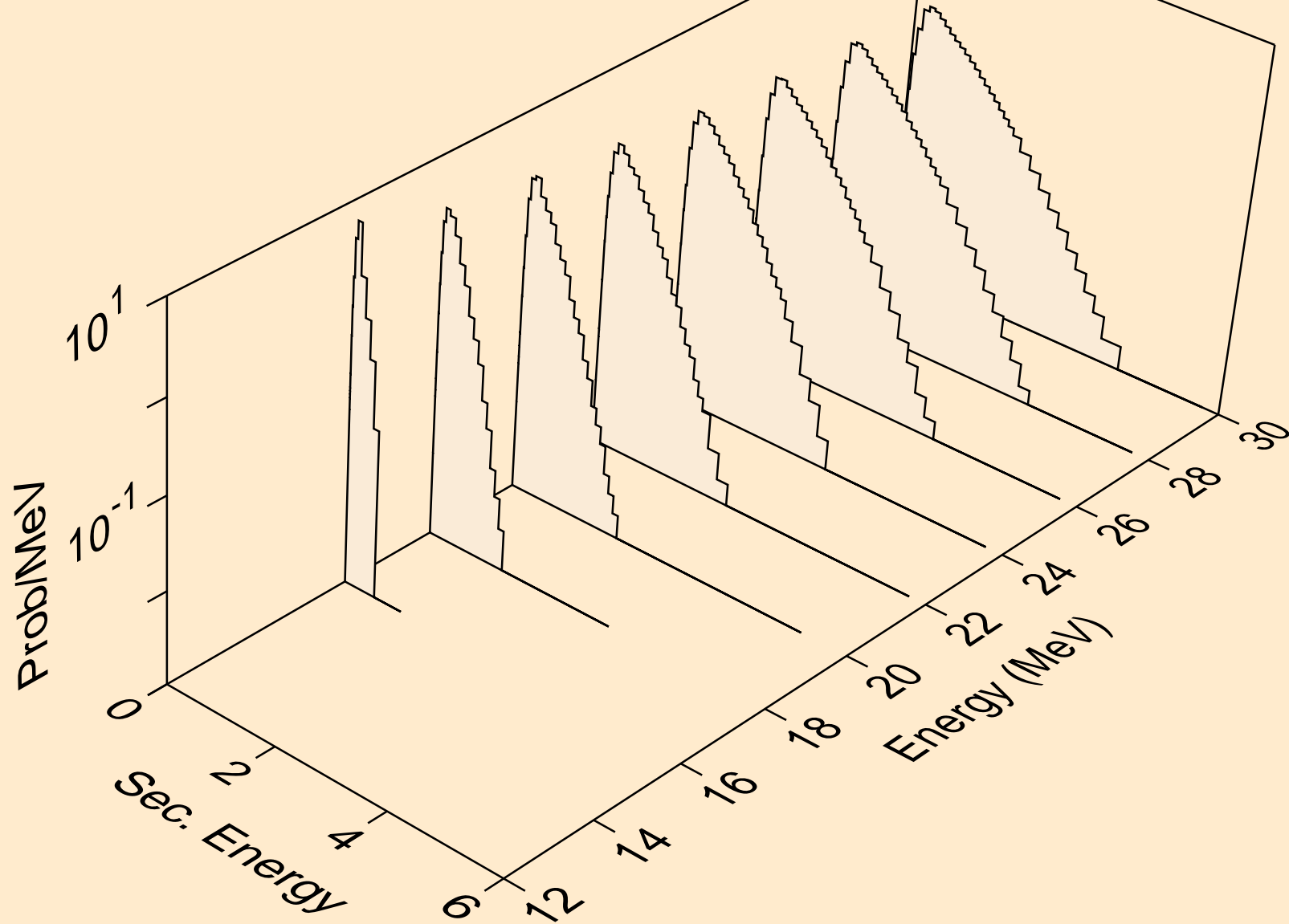

PB193M NEUTRON ACER TENDL-2021 LIBRARY; T=293.6K
Neutron emission for (n,n*)he3

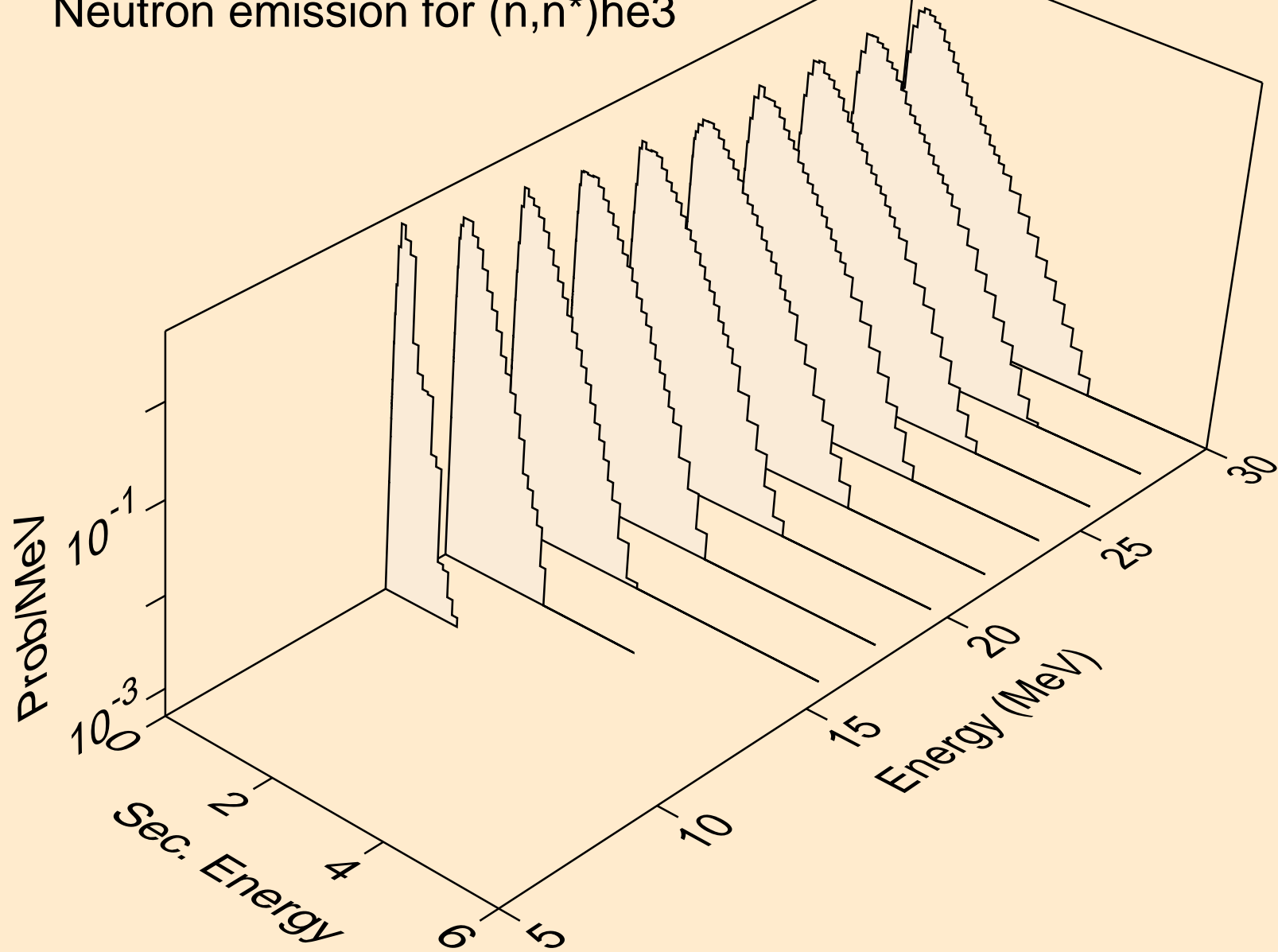

PB193M NEUTRON ACER TENDL-2021 LIBRARY; T=293.6K
Neutron emission for (n,4n)

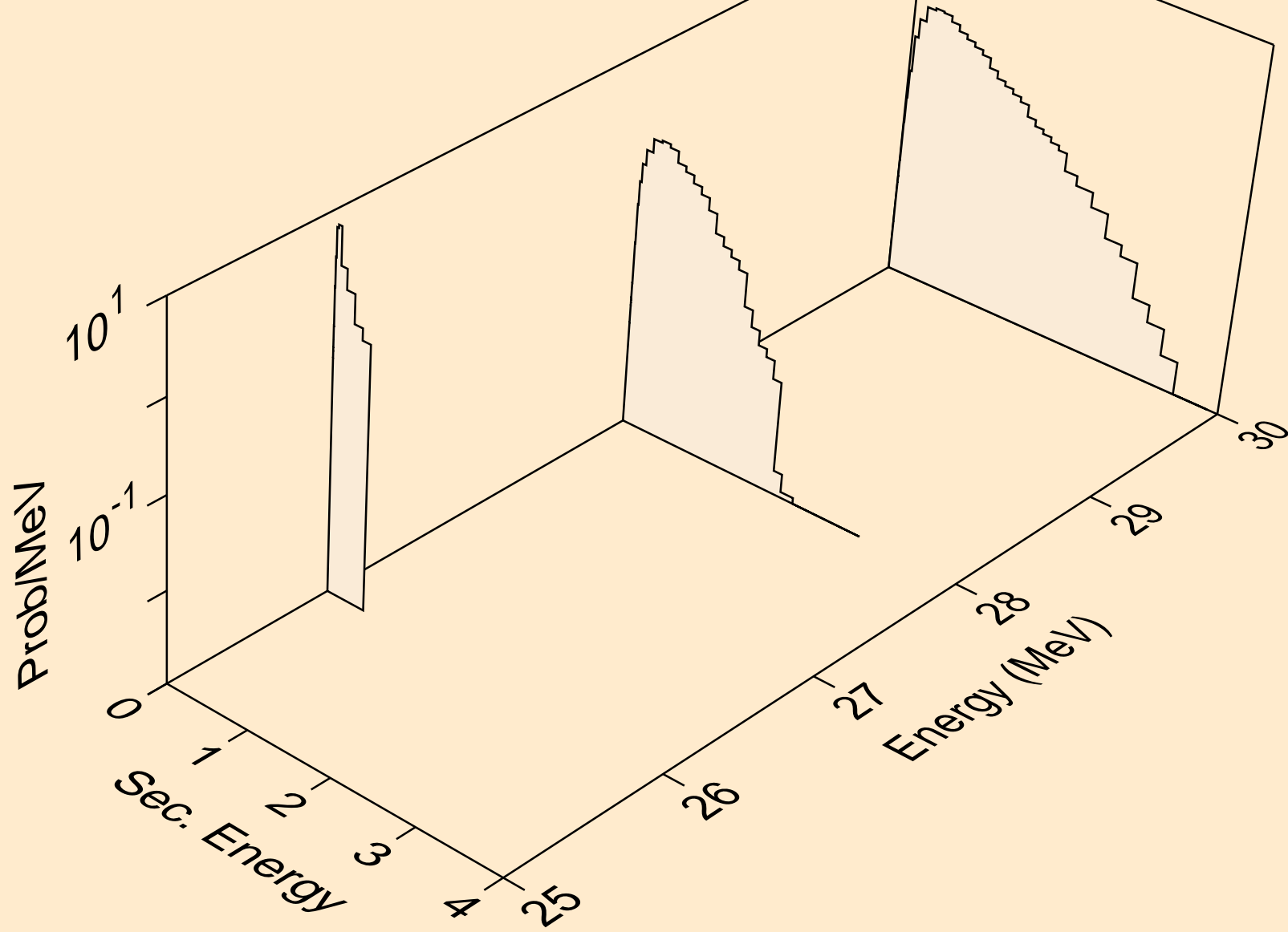

PB193M NEUTRON ACER TENDL-2021 LIBRARY; T=293.6K
Neutron emission for (n,2np)

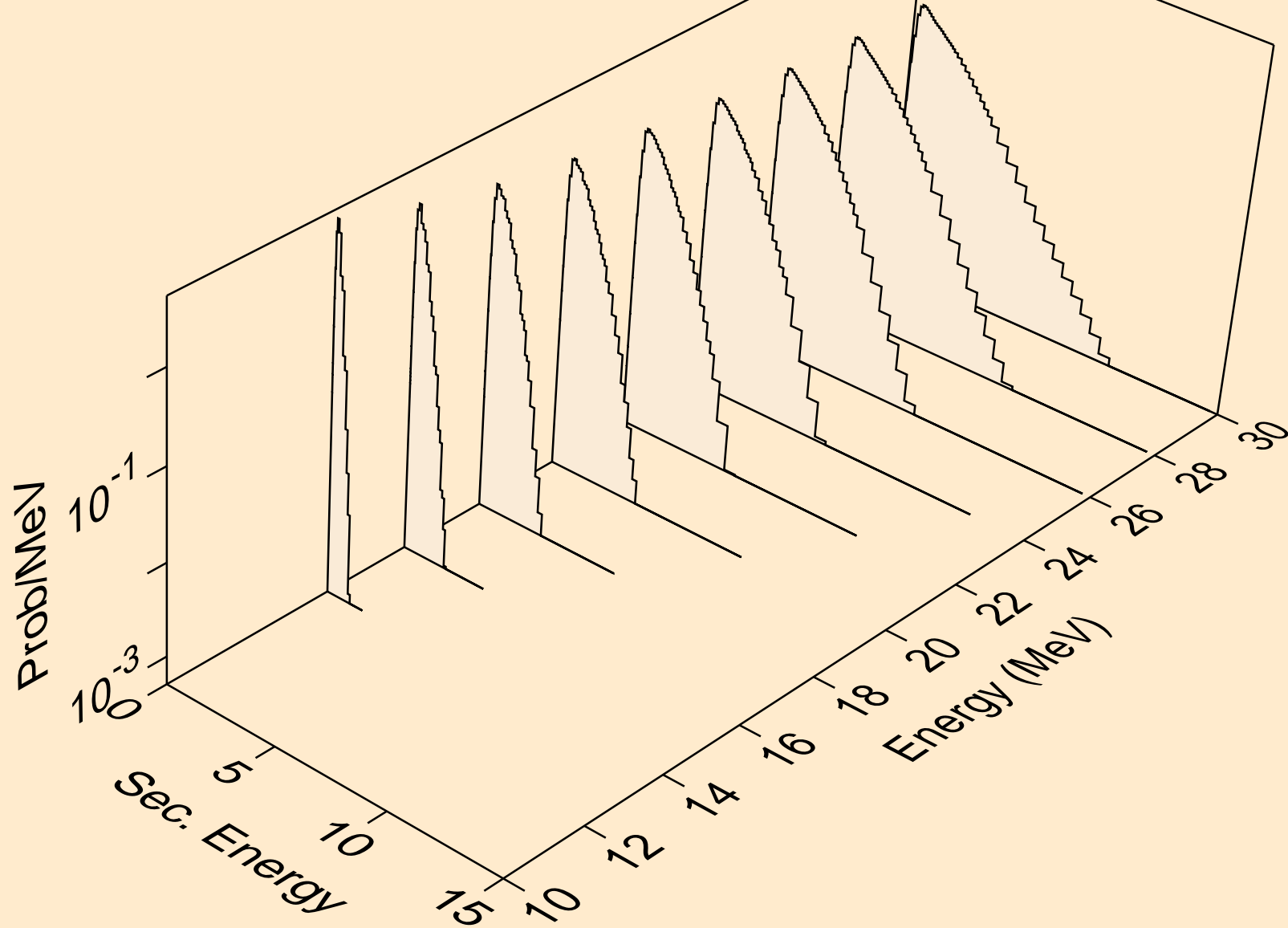

PB193M NEUTRON ACER TENDL-2021 LIBRARY; T=293.6K
Neutron emission for (n,3np)

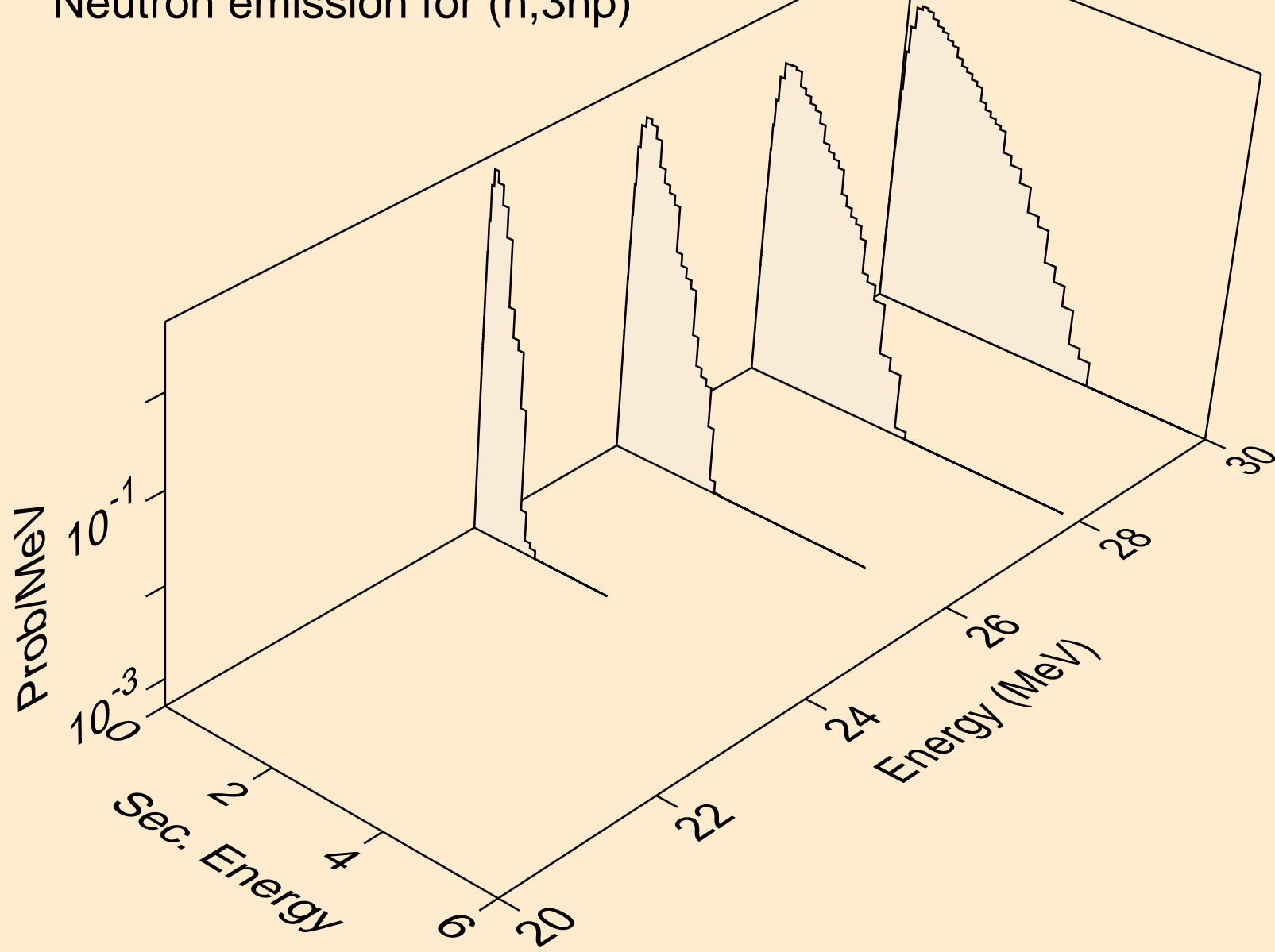

PB193M NEUTRON ACER TENDL-2021 LIBRARY; T=293.6K
Neutron emission for (n,2np)

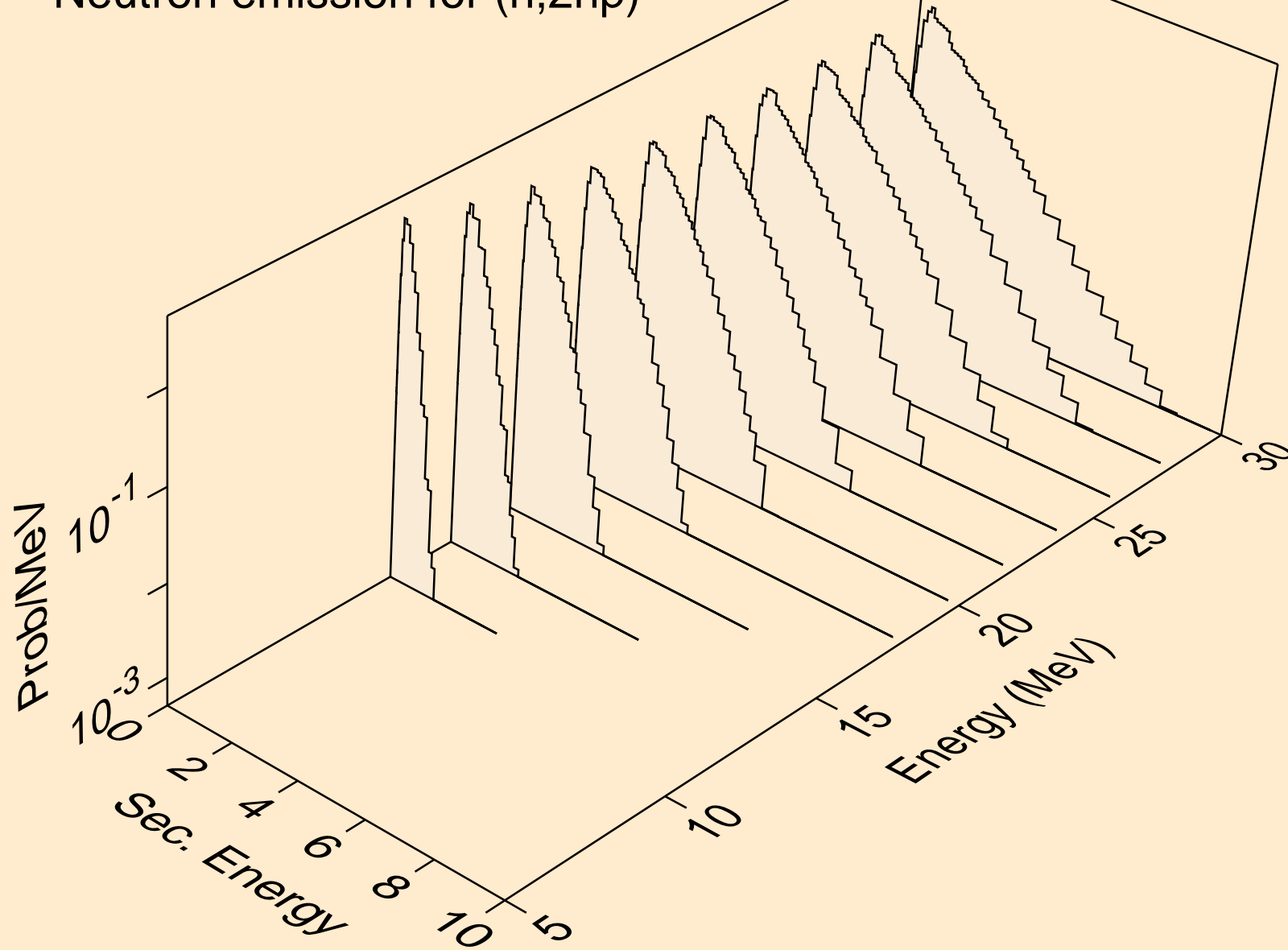

PB193M NEUTRON ACER TENDL-2021 LIBRARY; T=293.6K
Neutron emission for (n,npa)

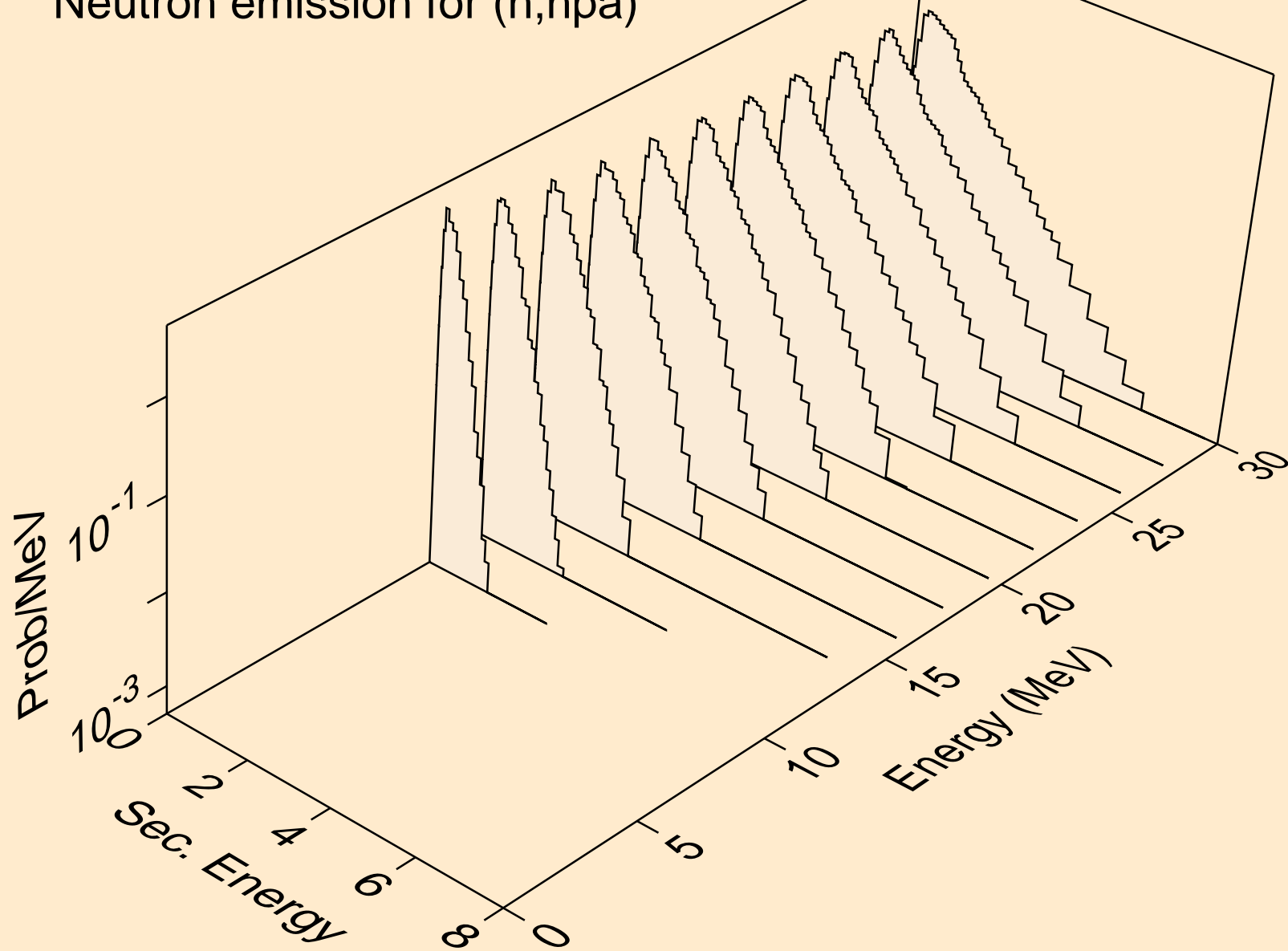

PB193M NEUTRON ACER TENDL-2021 LIBRARY; T=293.6K
Neutron emission for (n,n*c)

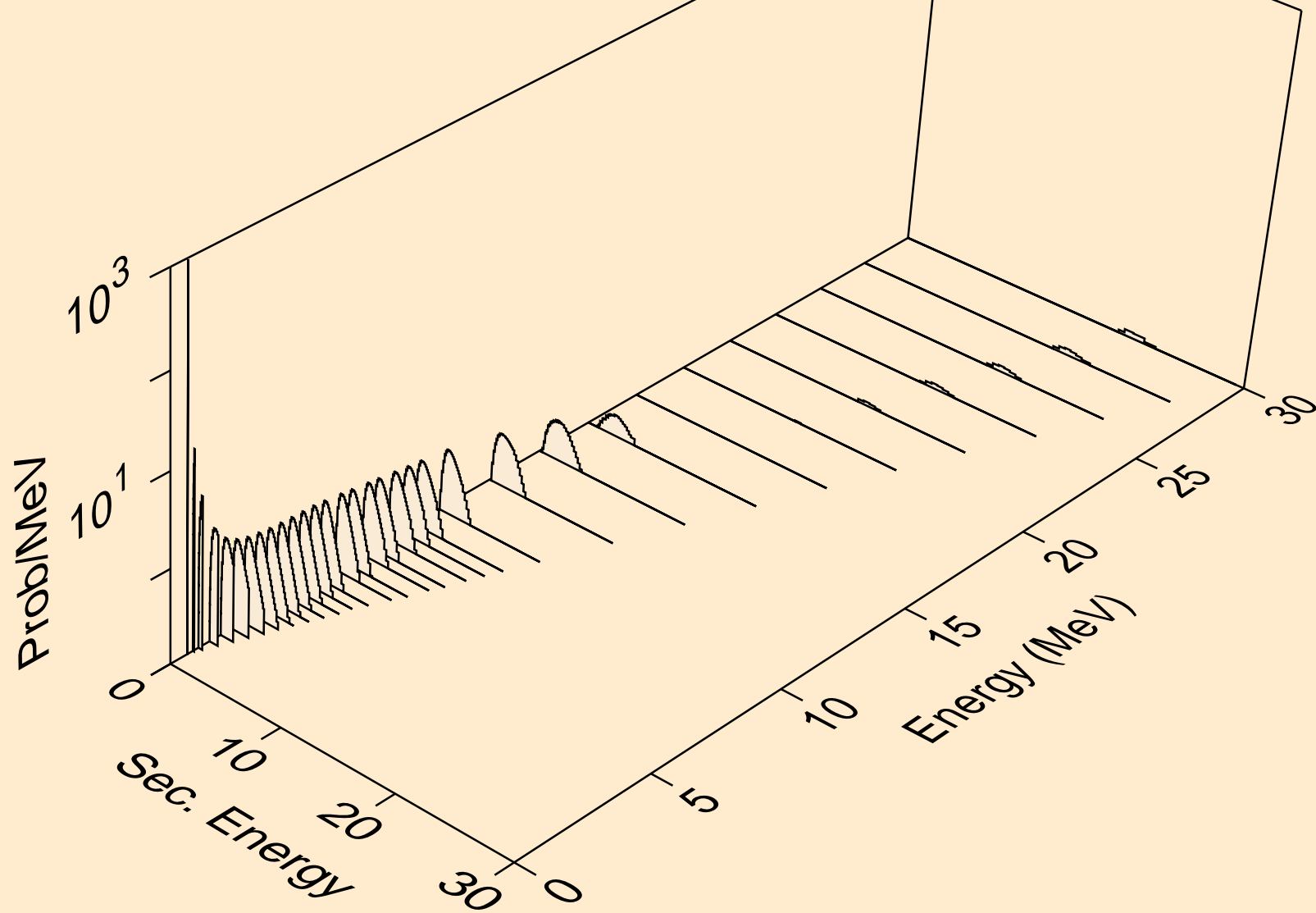

PB193M NEUTRON ACER TENDL-2021 LIBRARY; T=293.6K
Photon emission for (n,x)

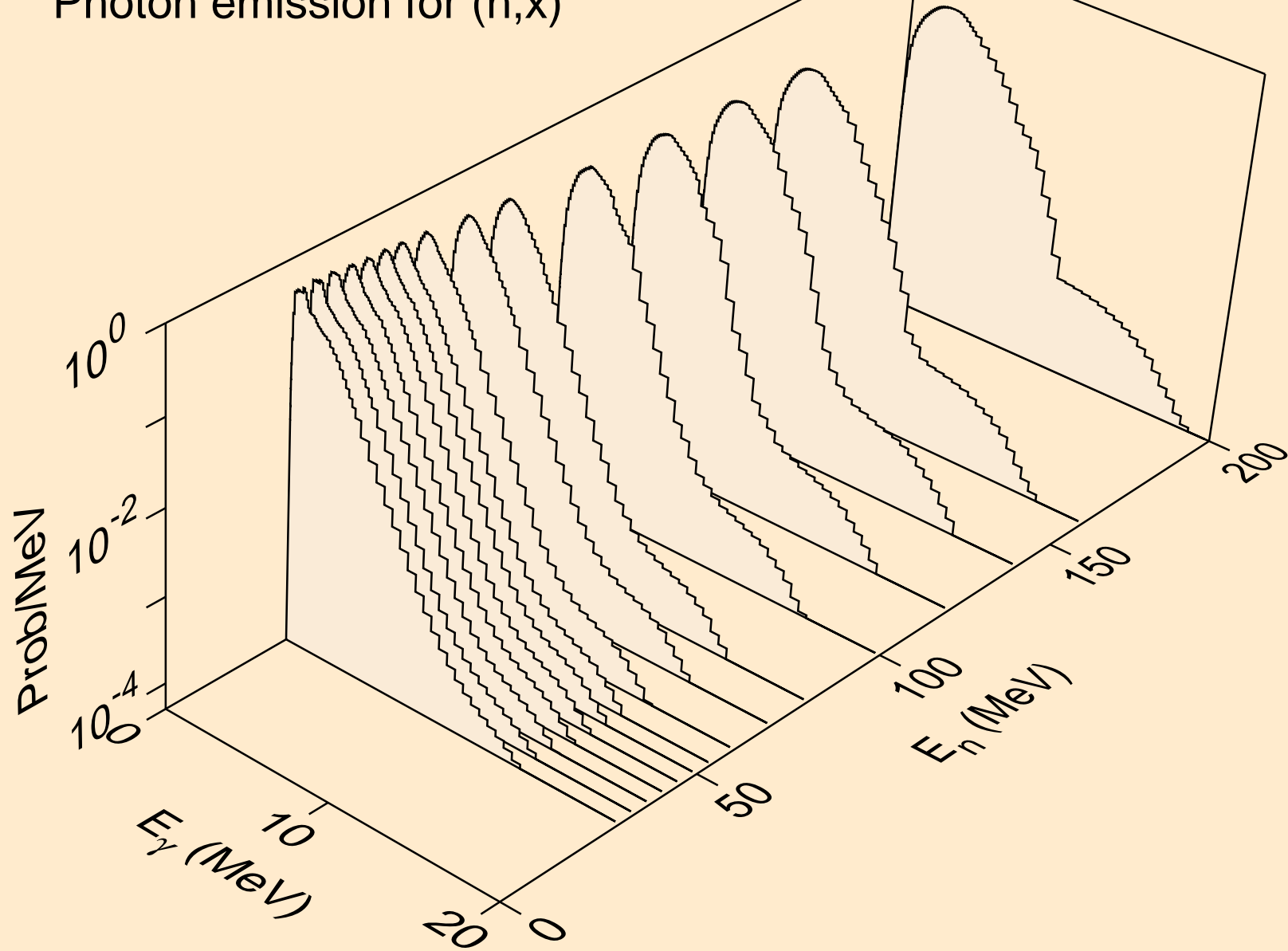

PB193M NEUTRON ACER TENDL-2021 LIBRARY; T=293.6K
Photon emission for (n,2nd)

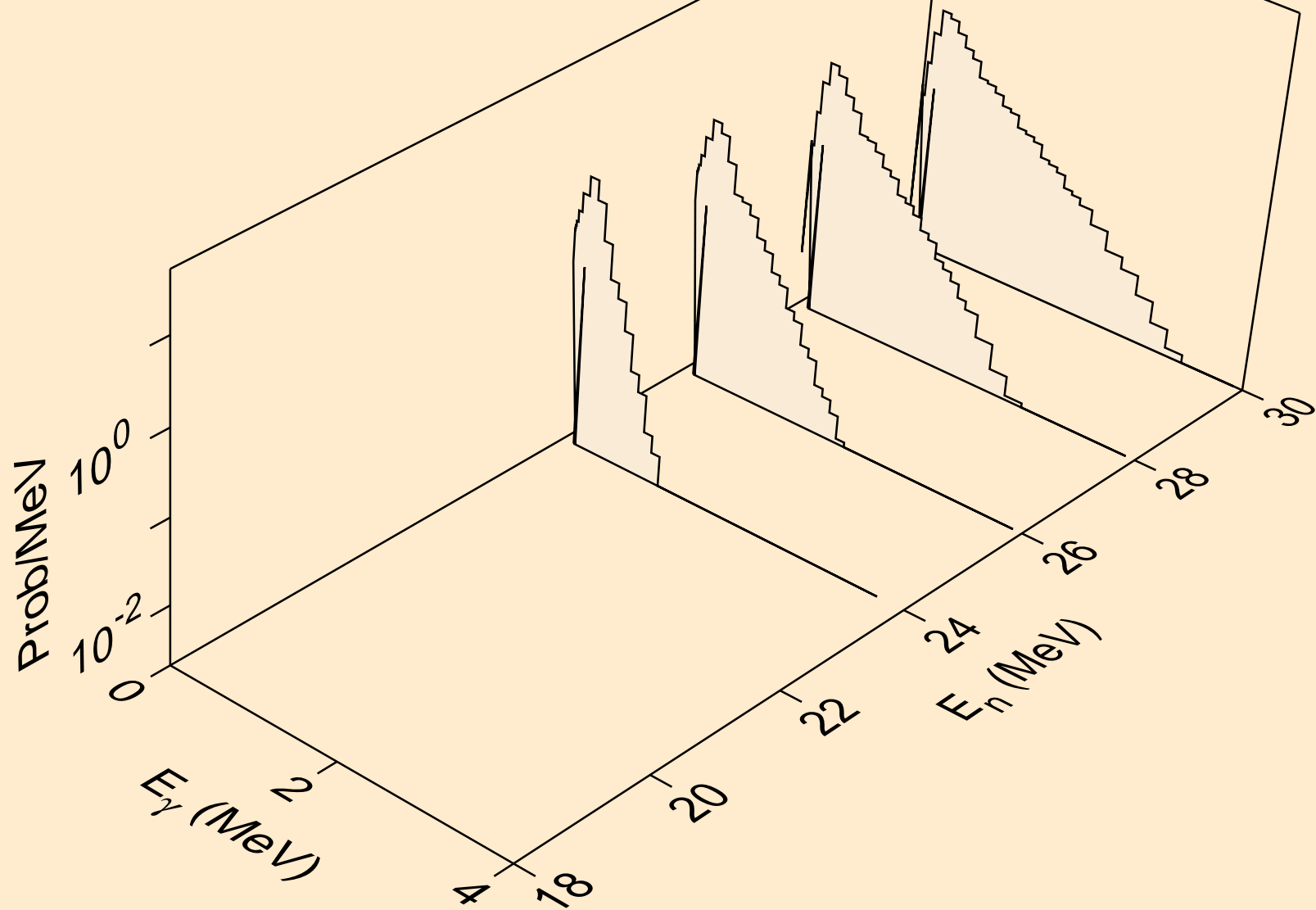

PB193M NEUTRON ACER TENDL-2021 LIBRARY; T=293.6K
Photon emission for (n,2n)

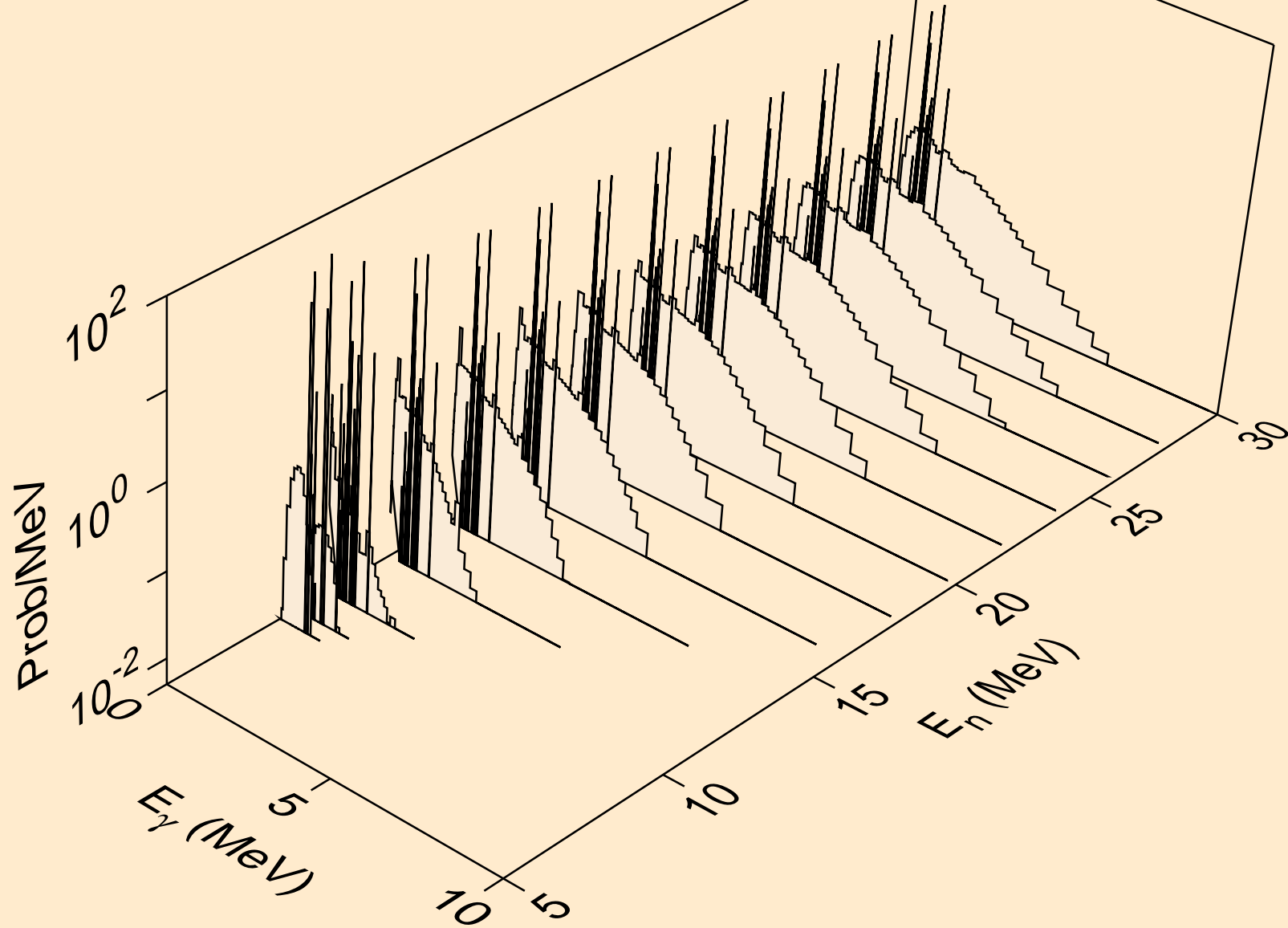

PB193M NEUTRON ACER TENDL-2021 LIBRARY; T=293.6K
Photon emission for (n,3n)

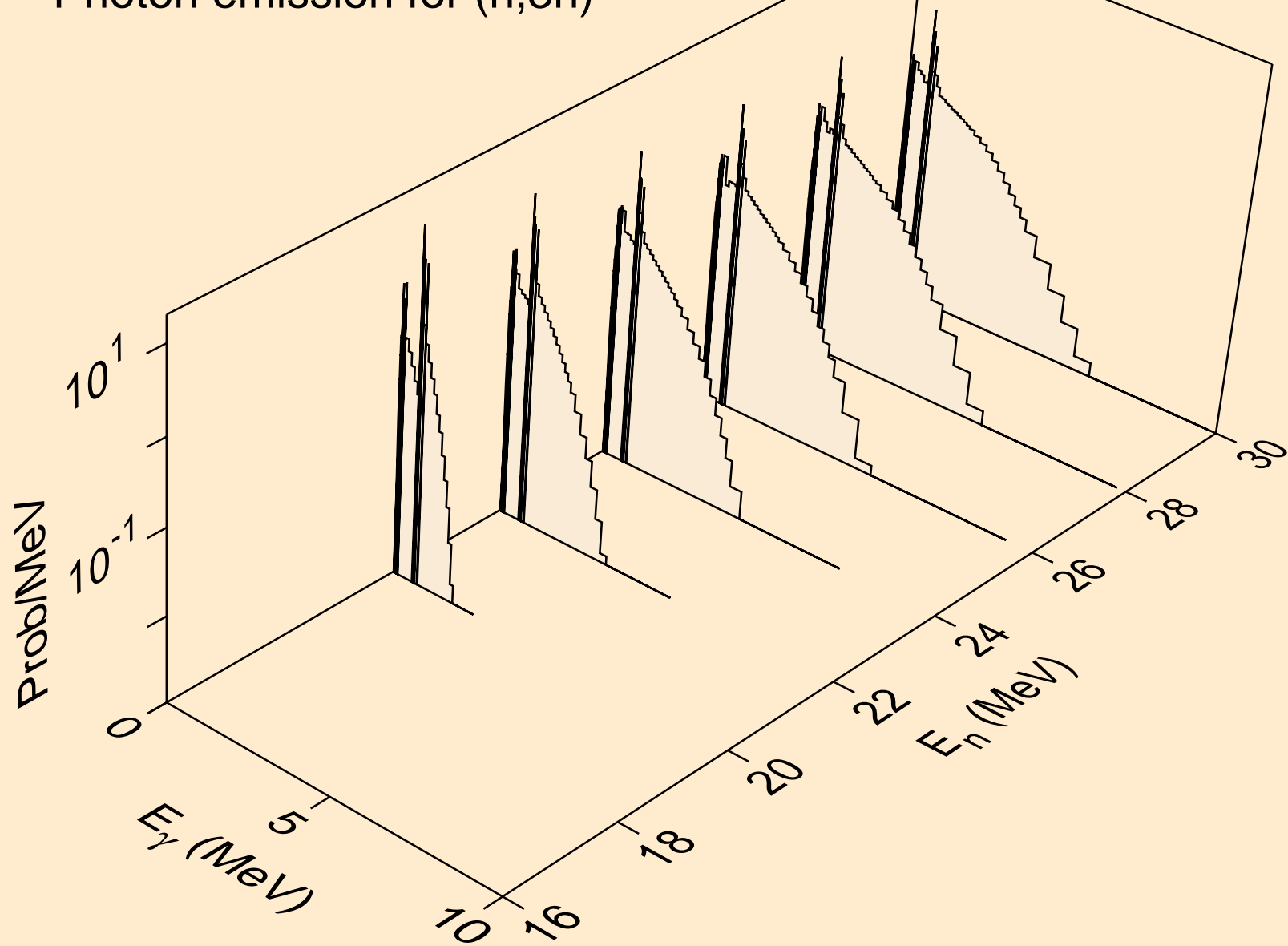

PB193M NEUTRON ACER TENDL-2021 LIBRARY; T=293.6K
Photon emission for (n,n*)a

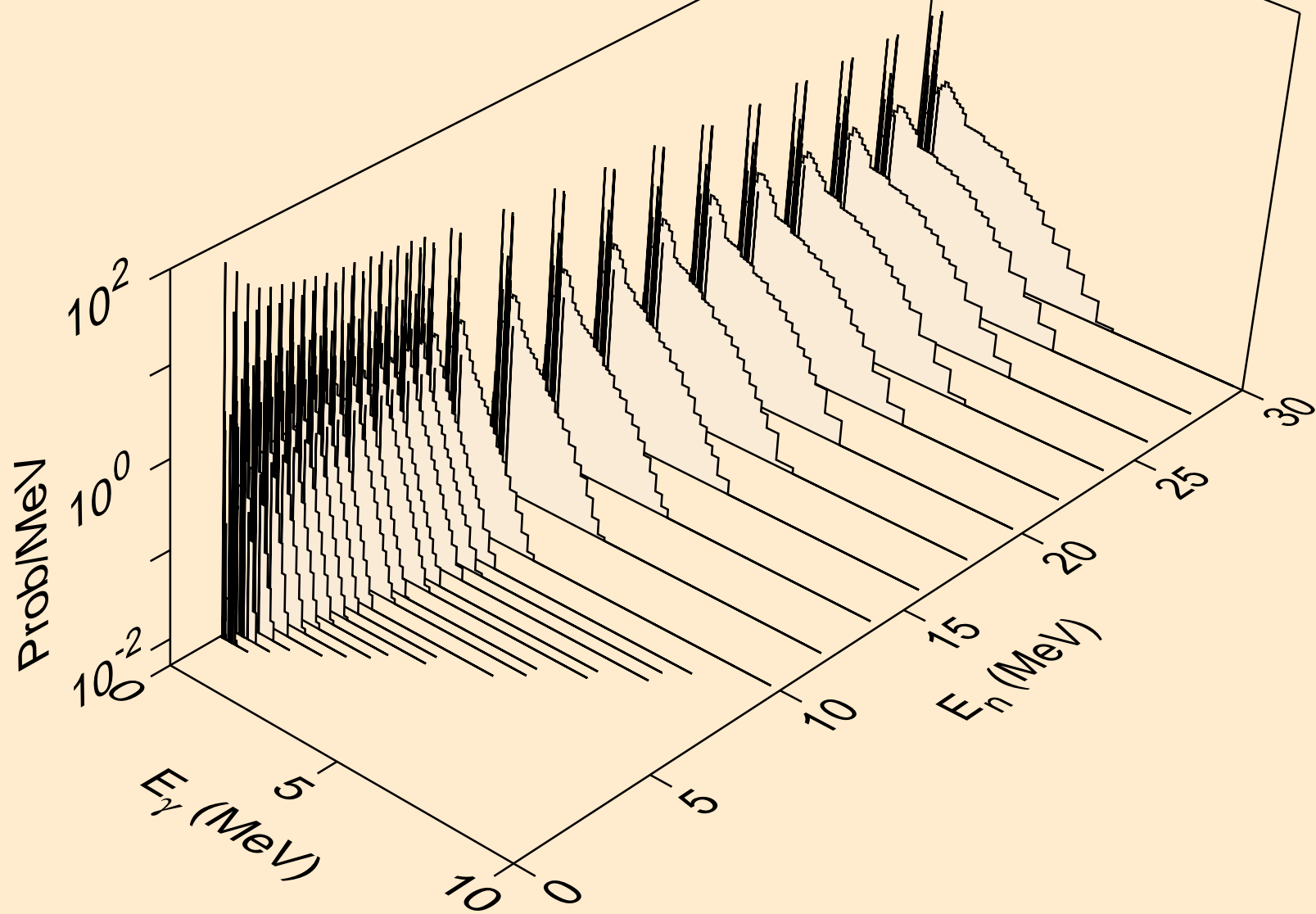

PB193M NEUTRON ACER TENDL-2021 LIBRARY; T=293.6K
Photon emission for (n,2n)a

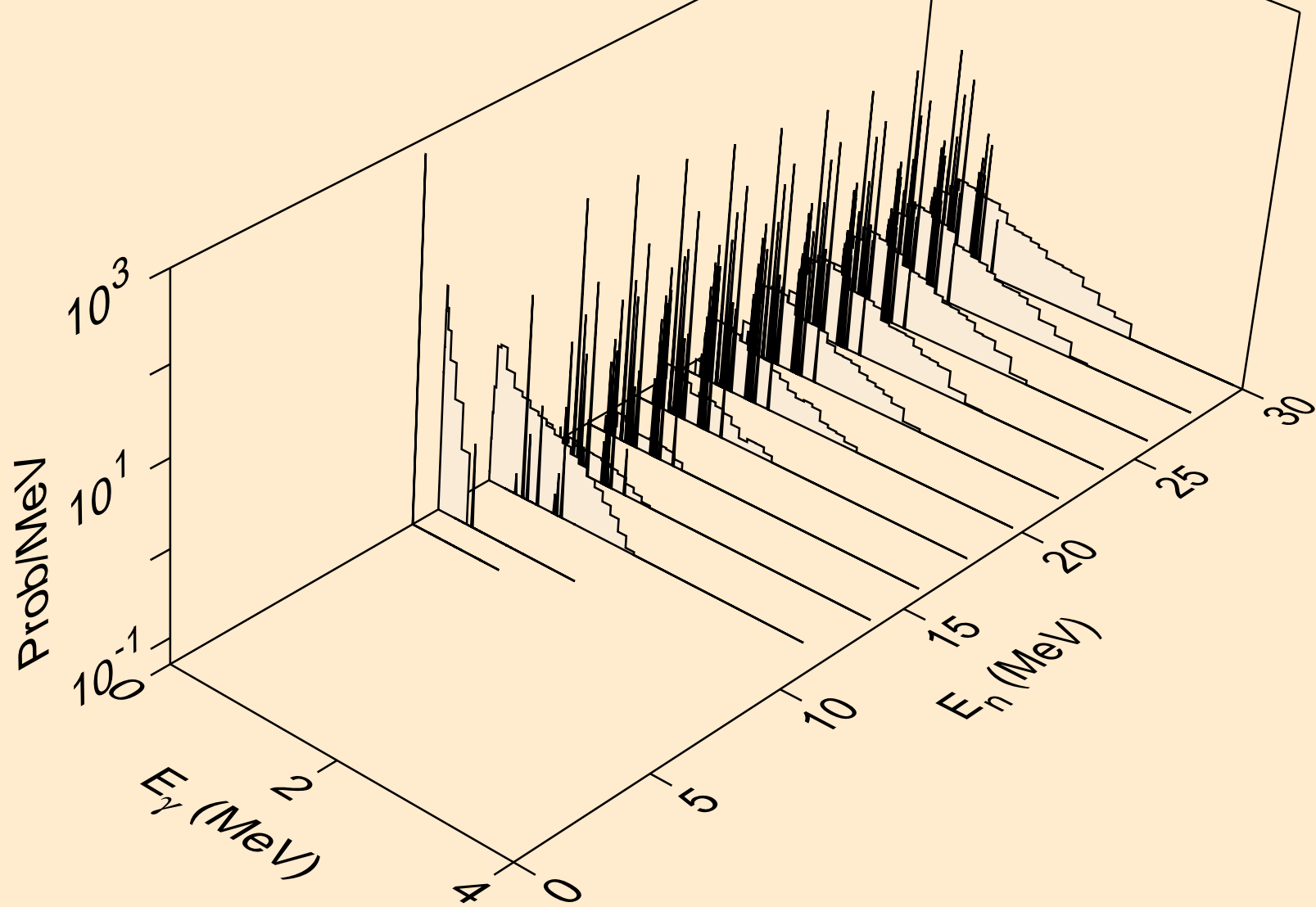

PB193M NEUTRON ACER TENDL-2021 LIBRARY; T=293.6K
Photon emission for (n,3n)a

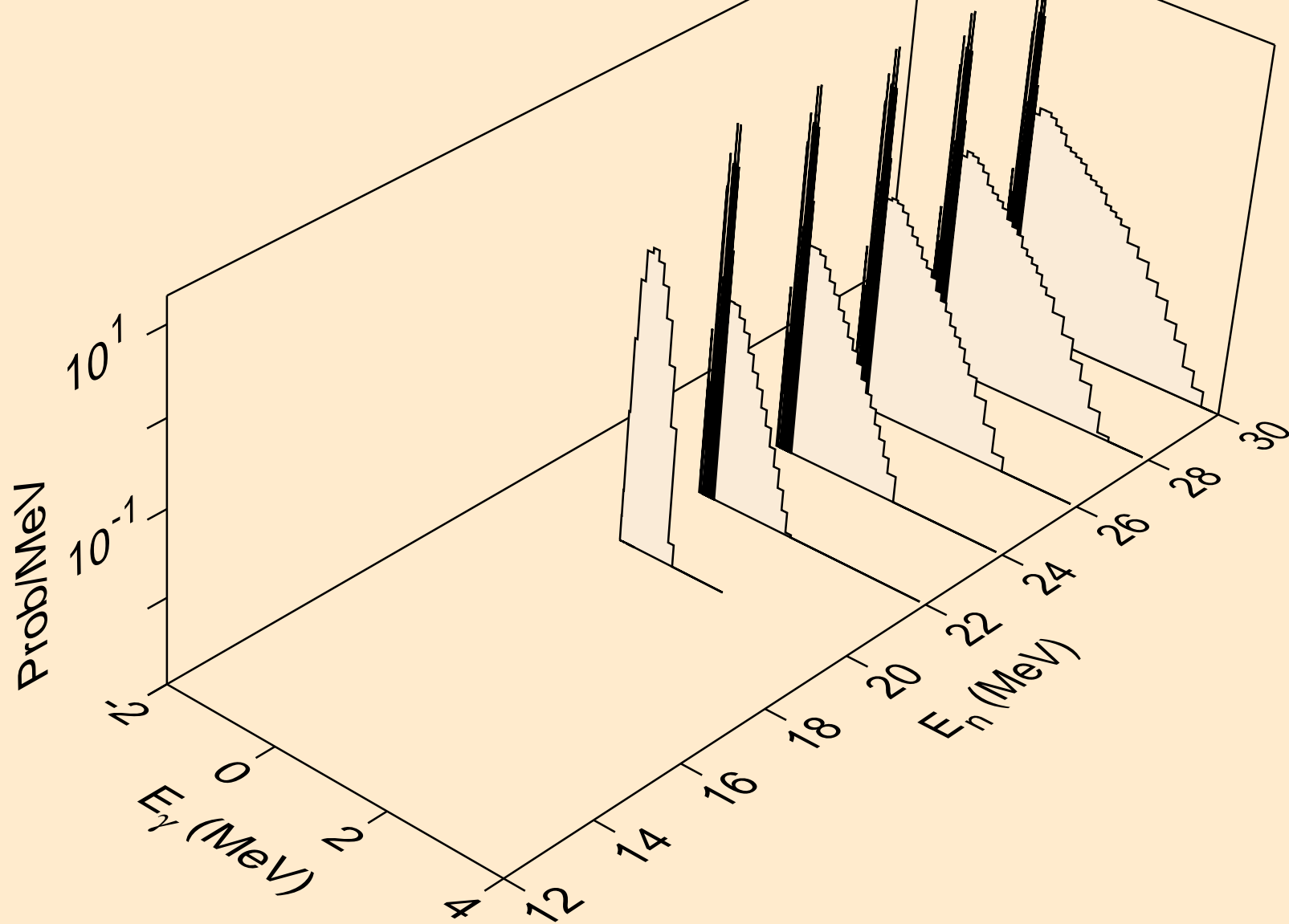

PB193M NEUTRON ACER TENDL-2021 LIBRARY; T=293.6K
Photon emission for (n,n*)p

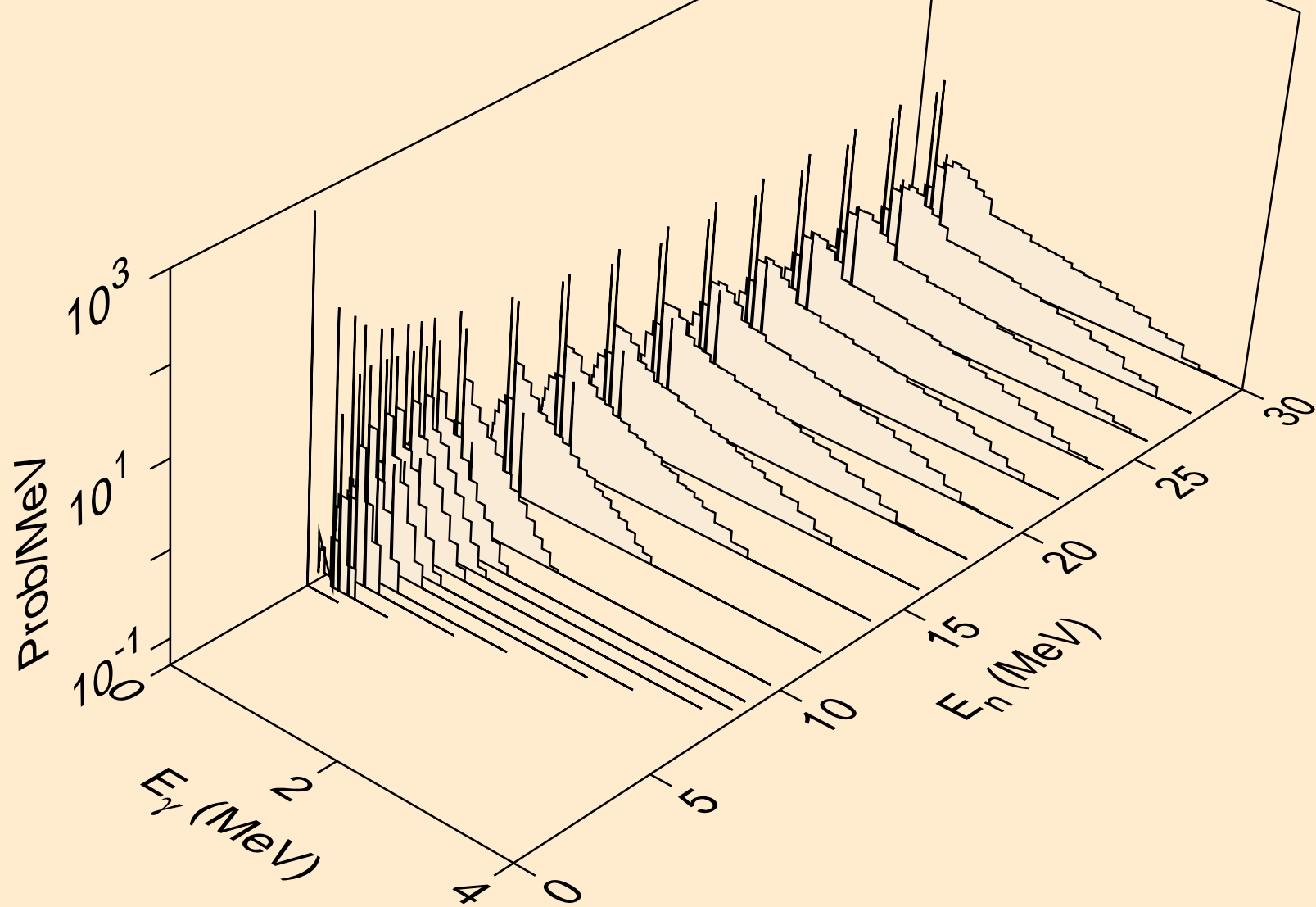

PB193M NEUTRON ACER TENDL-2021 LIBRARY; T=293.6K
Photon emission for (n,n*)2a

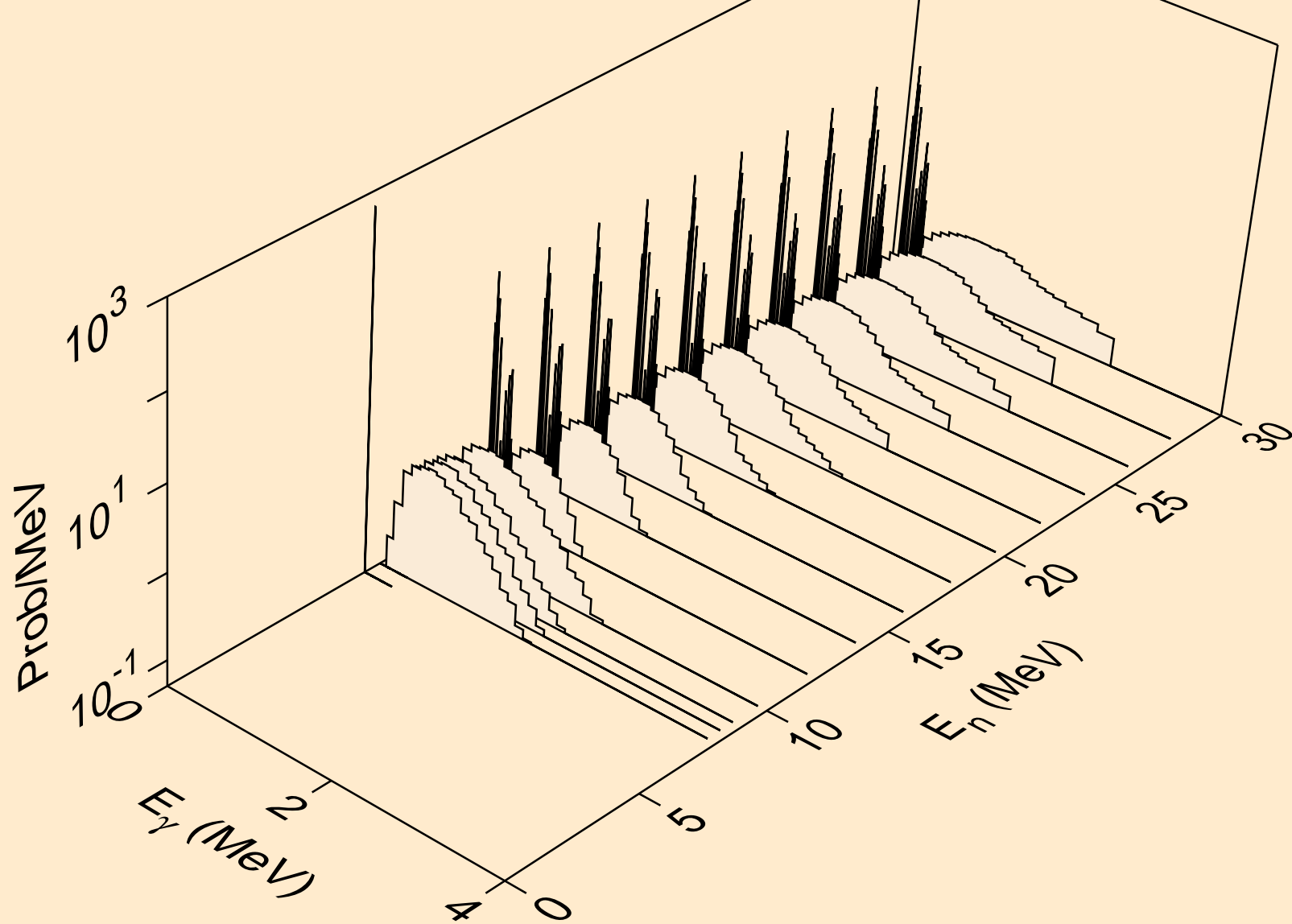

PB193M NEUTRON ACER TENDL-2021 LIBRARY; T=293.6K
Photon emission for (n,2n)2a

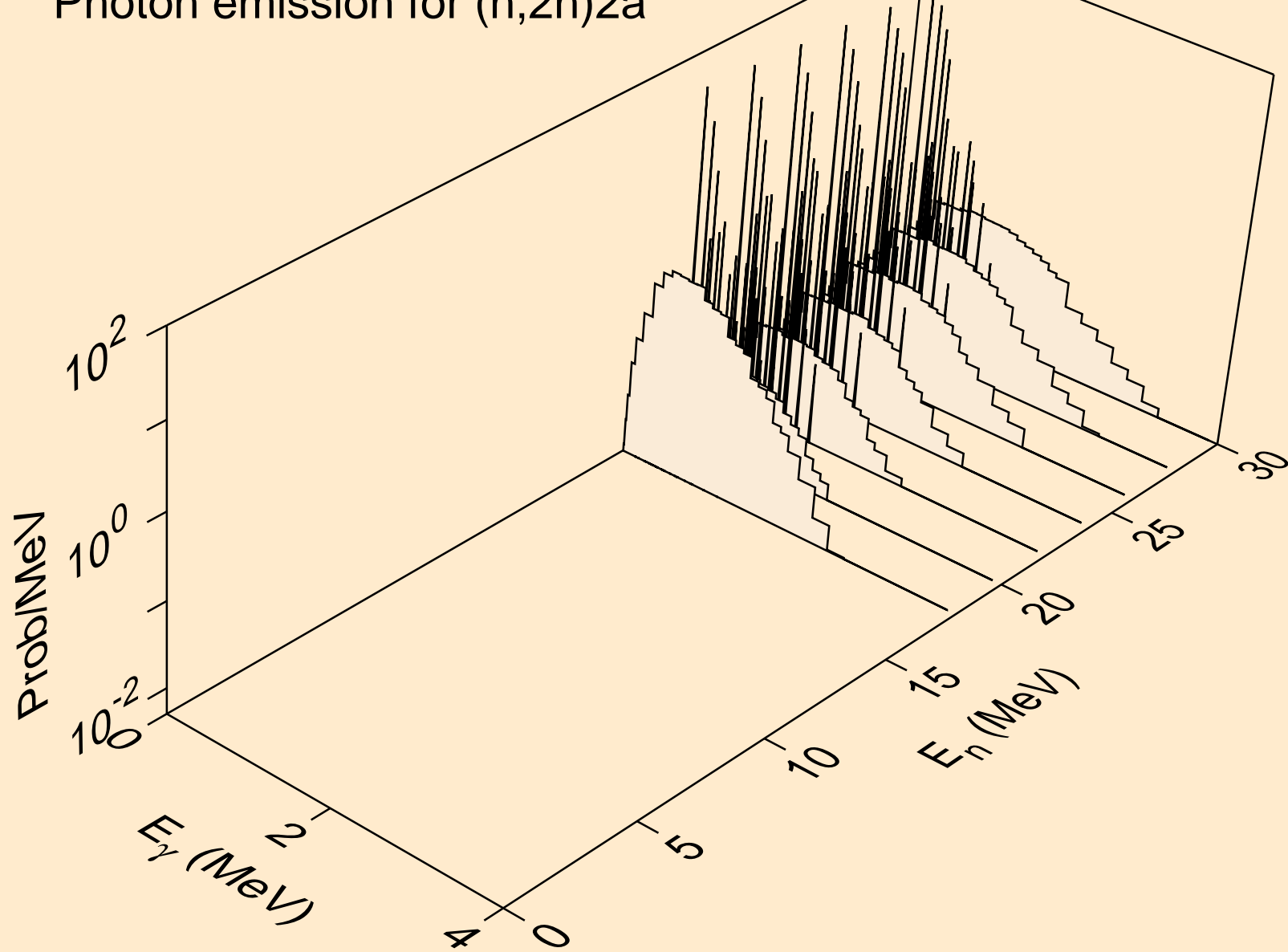

PB193M NEUTRON ACER TENDL-2021 LIBRARY; T=293.6K
Photon emission for (n,n*)d

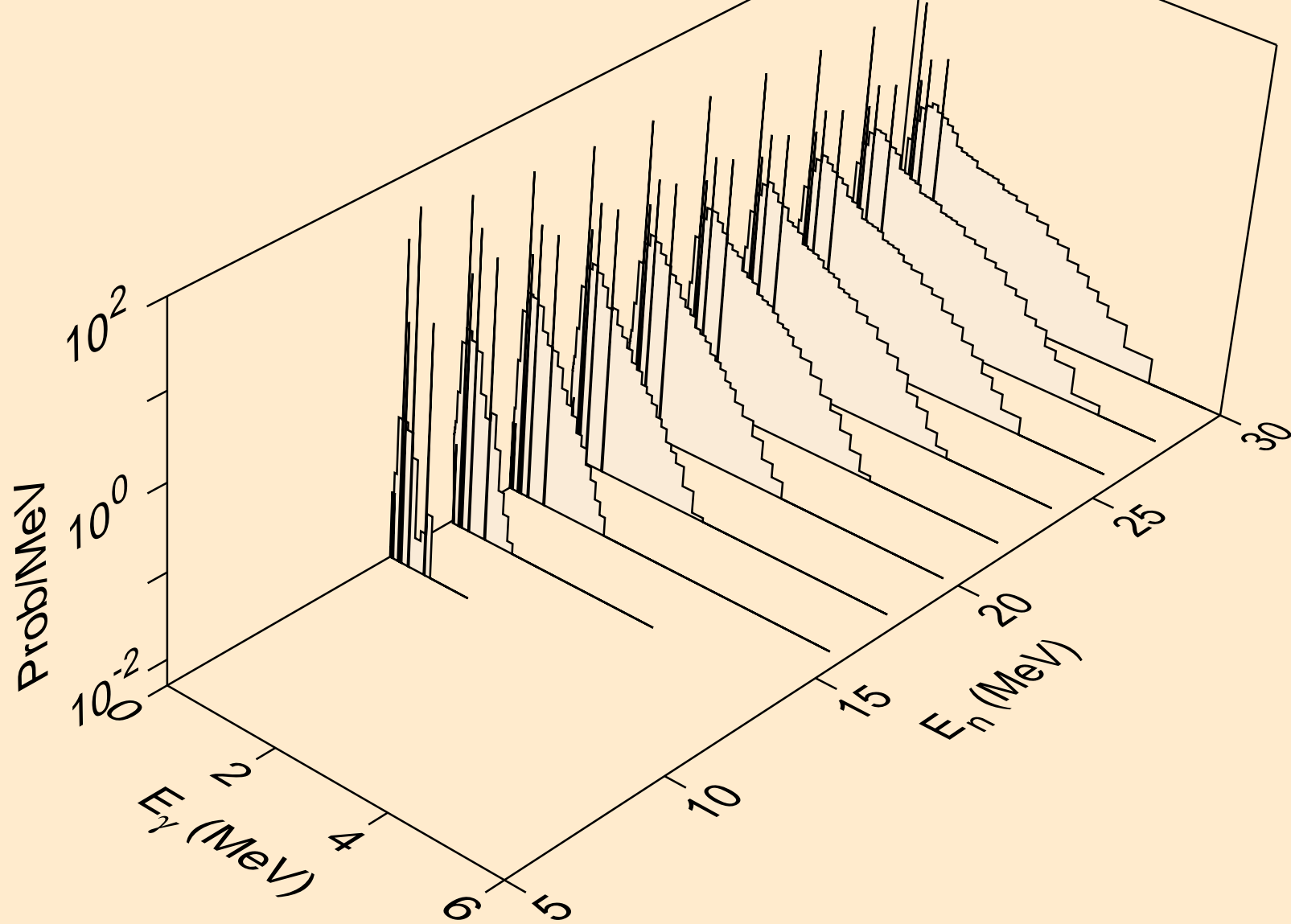

PB193M NEUTRON ACER TENDL-2021 LIBRARY; T=293.6K
Photon emission for (n,n*)t

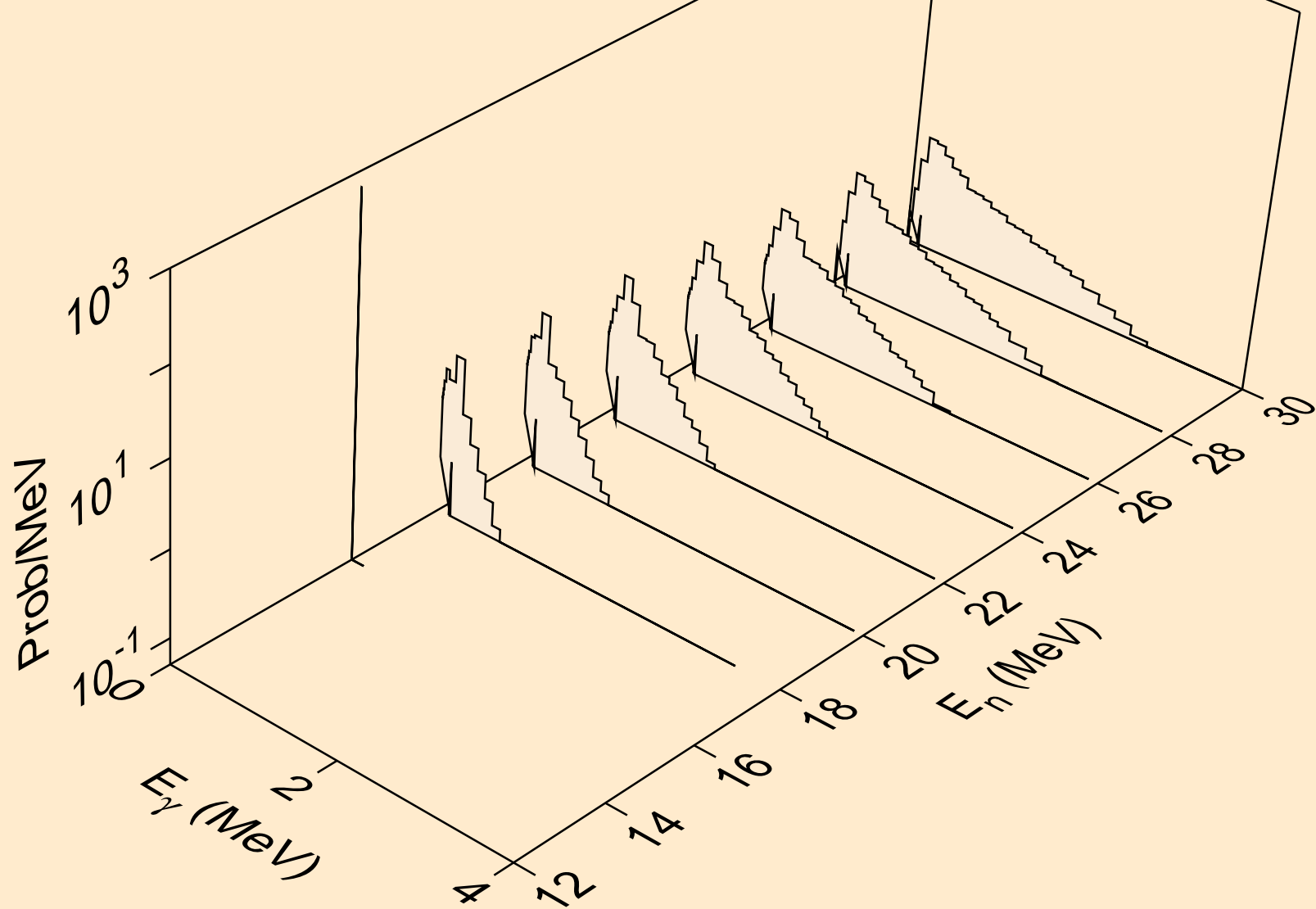

PB193M NEUTRON ACER TENDL-2021 LIBRARY; T=293.6K
Photon emission for (n,n*)he3

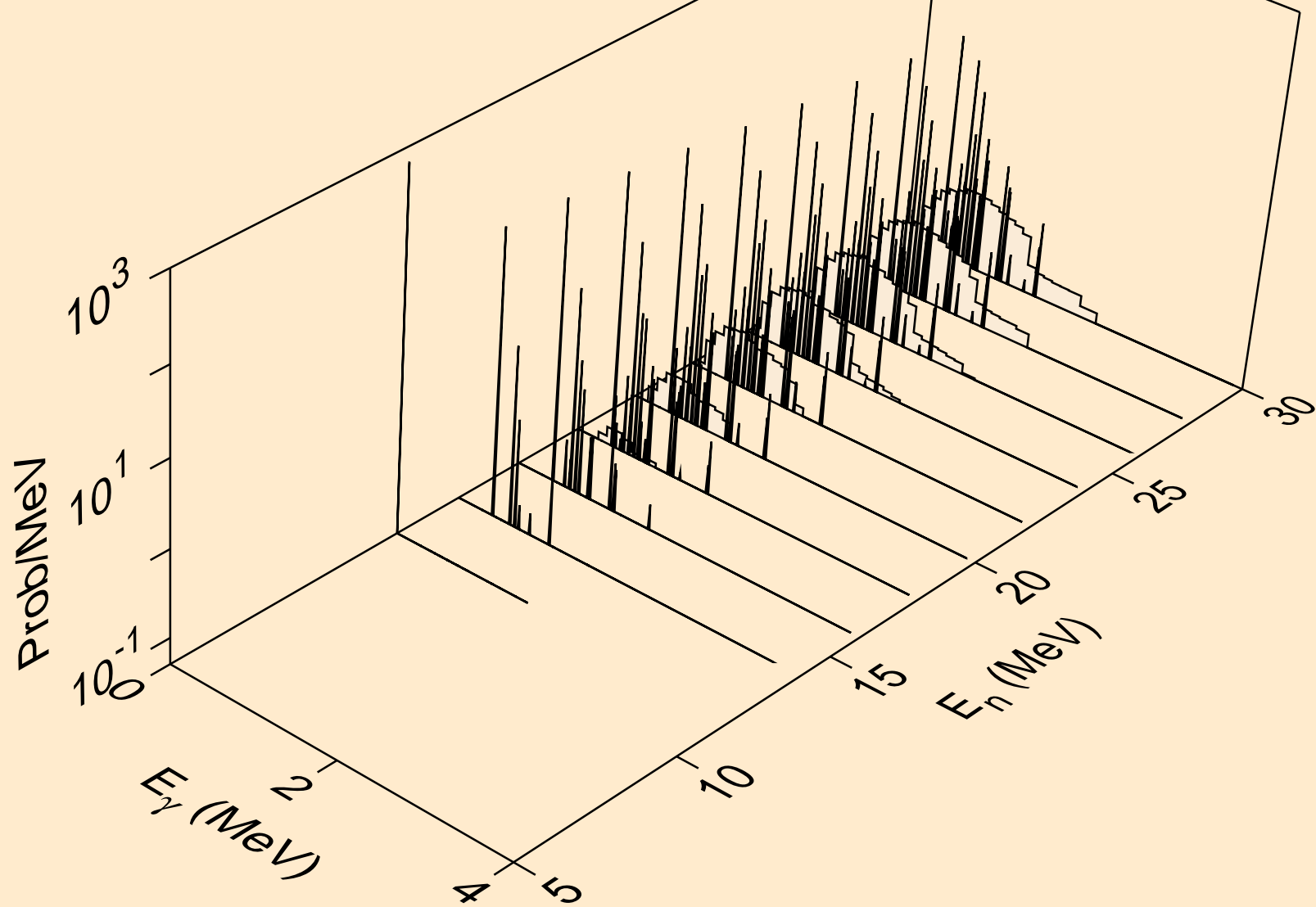

PB193M NEUTRON ACER TENDL-2021 LIBRARY; T=293.6K
Photon emission for (n,4n)

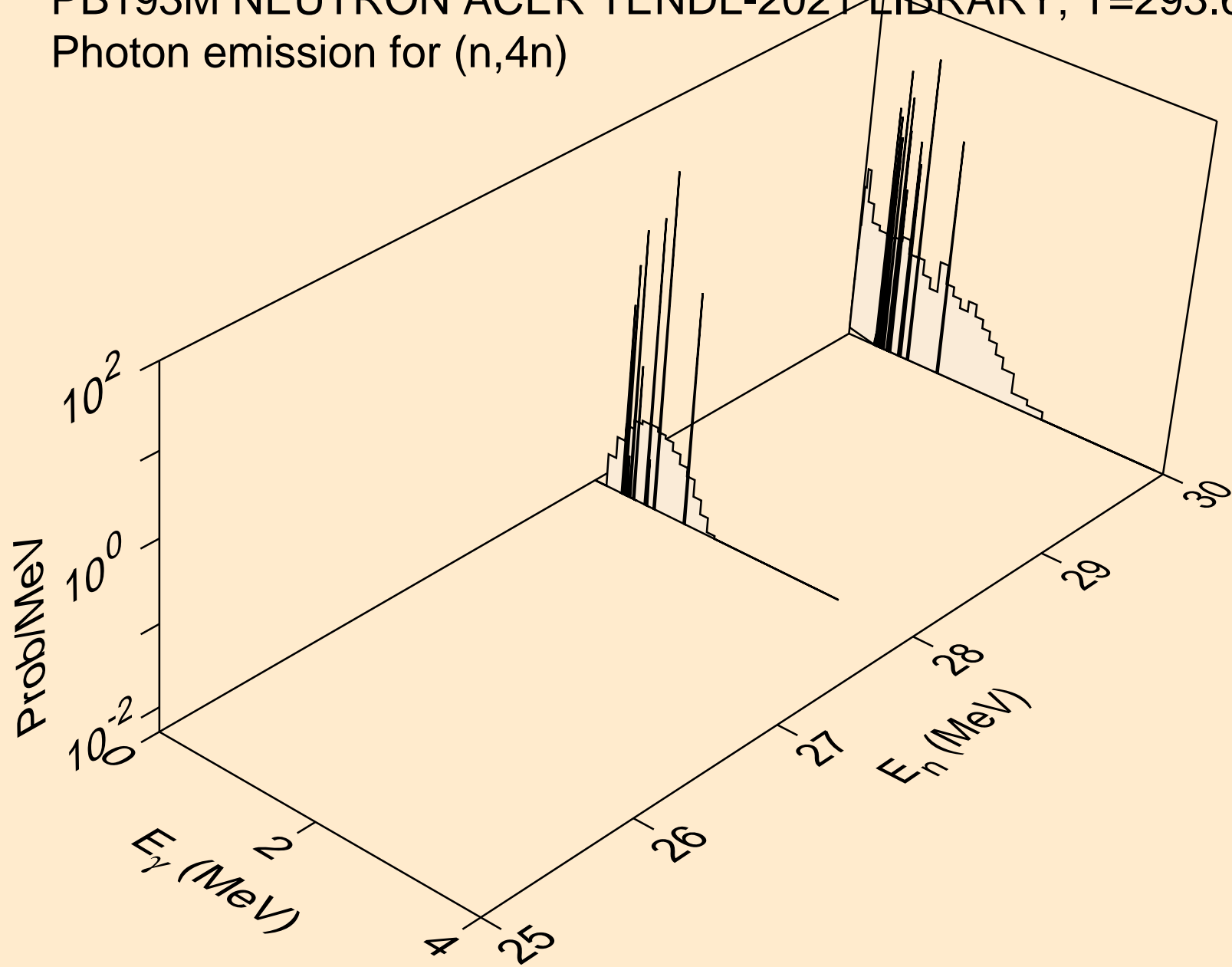

PB193M NEUTRON ACER TENDL-2021 LIBRARY; T=293.6K
Photon emission for (n,2np)

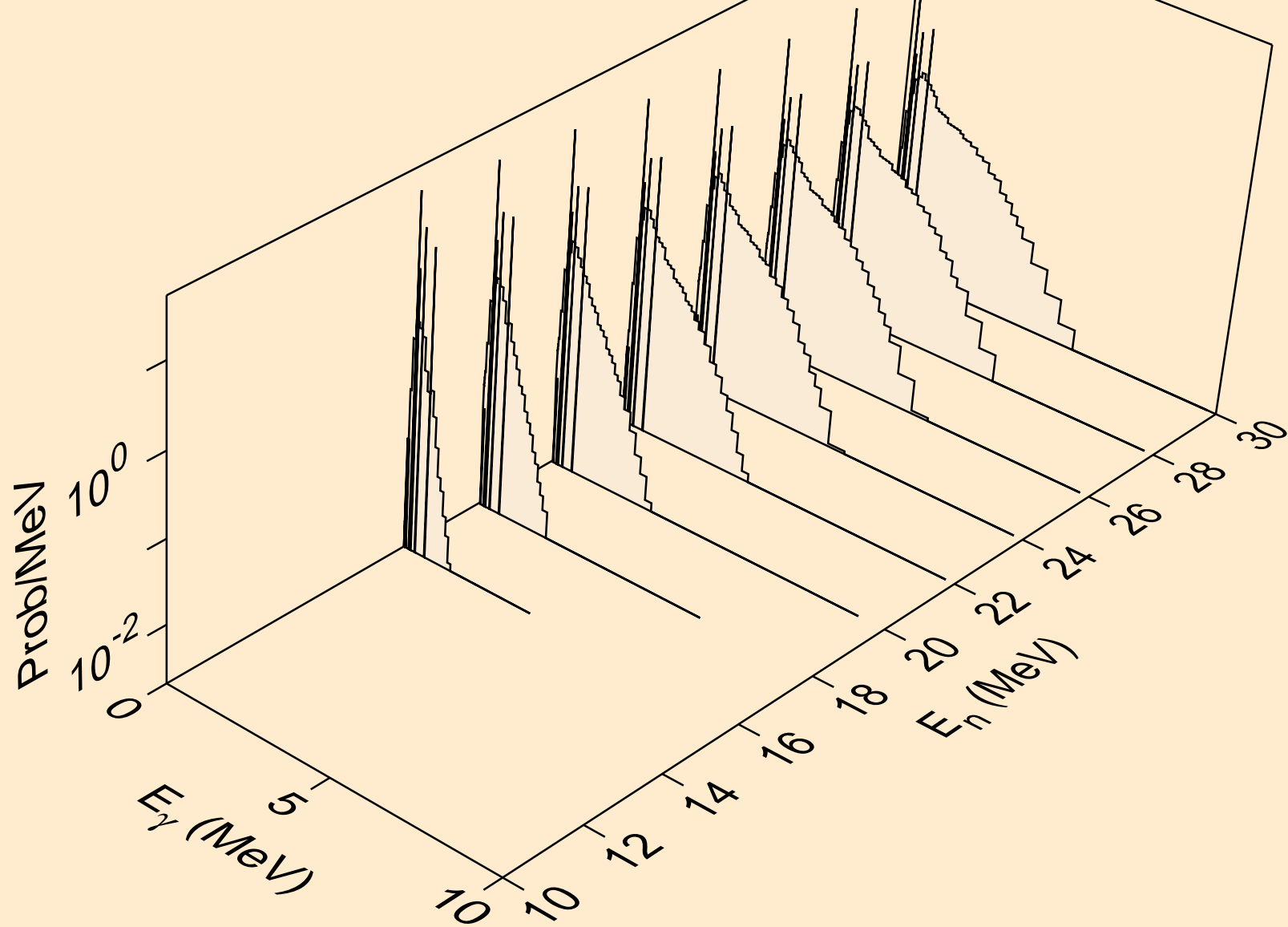

PB193M NEUTRON ACER TENDL-2021 LIBRARY; T=293.6K
Photon emission for (n,3np)

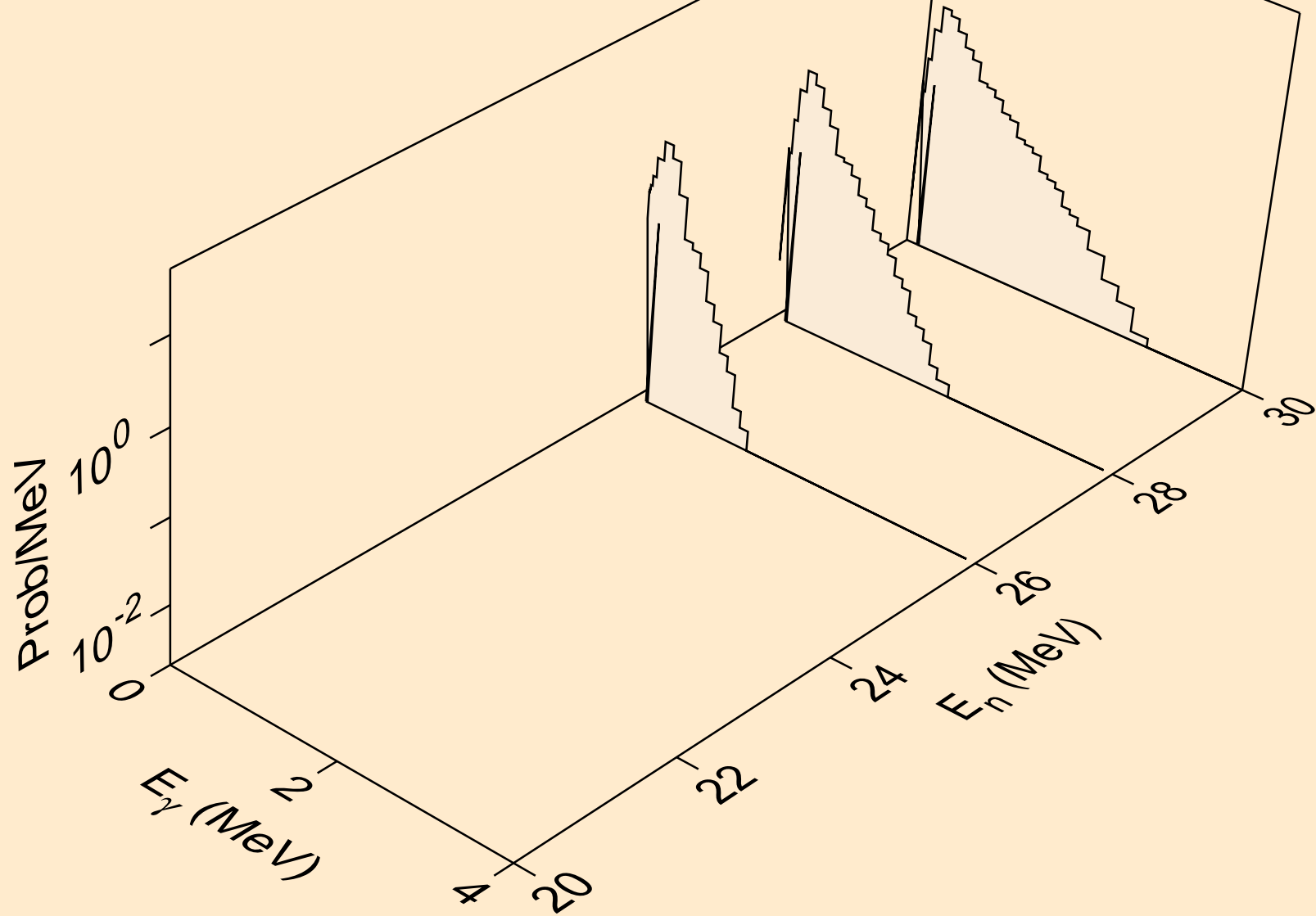

PB193M NEUTRON ACER TENDL-2021 LIBRARY; T=293.6K
Photon emission for (n,2np)

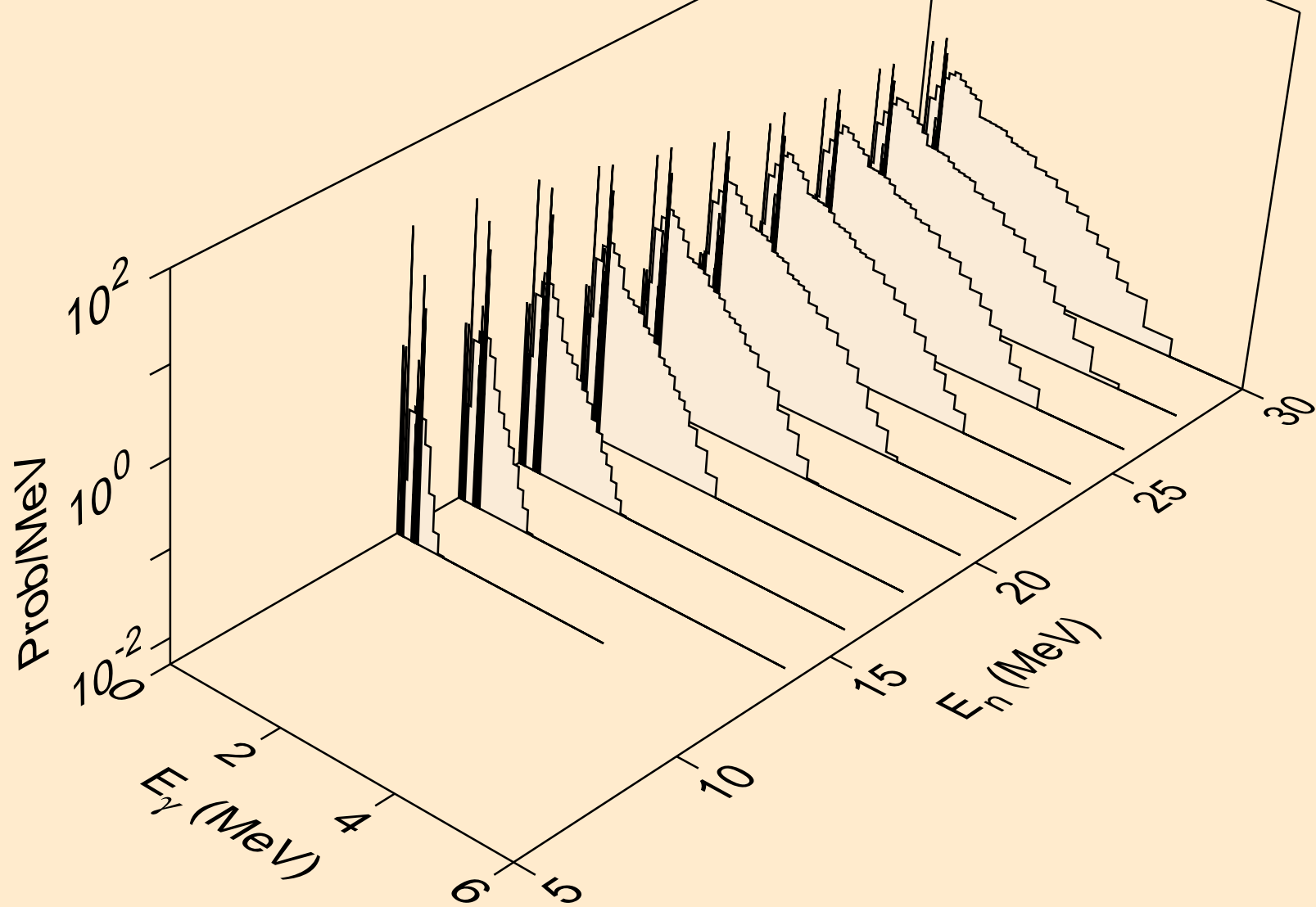

PB193M NEUTRON ACER TENDL-2021 LIBRARY; T=293.6K
Photon emission for (n,npa)

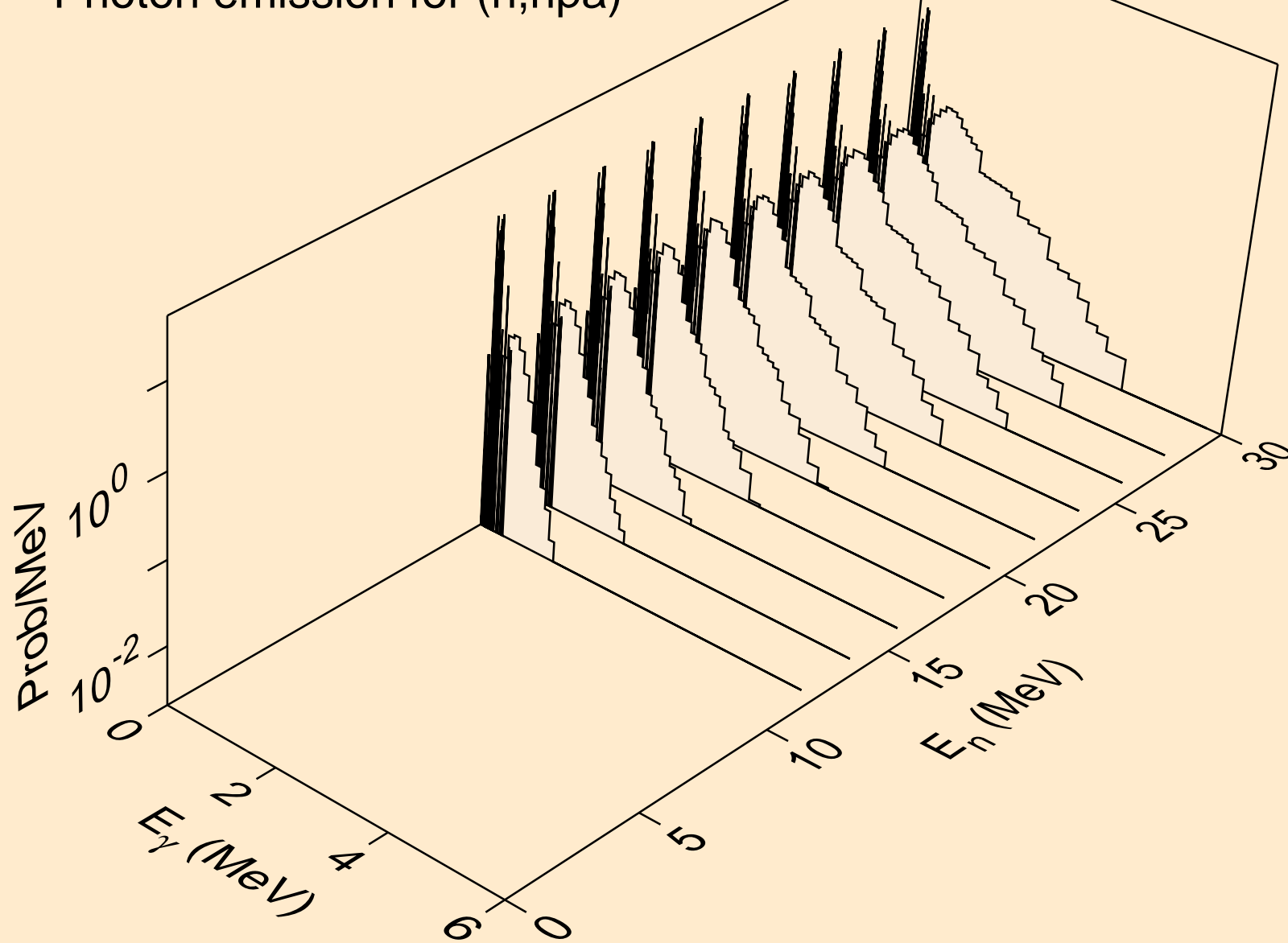

PB193M NEUTRON ACER TENDL-2021 LIBRARY; T=293.6K
Photon emission for (n,n*2)

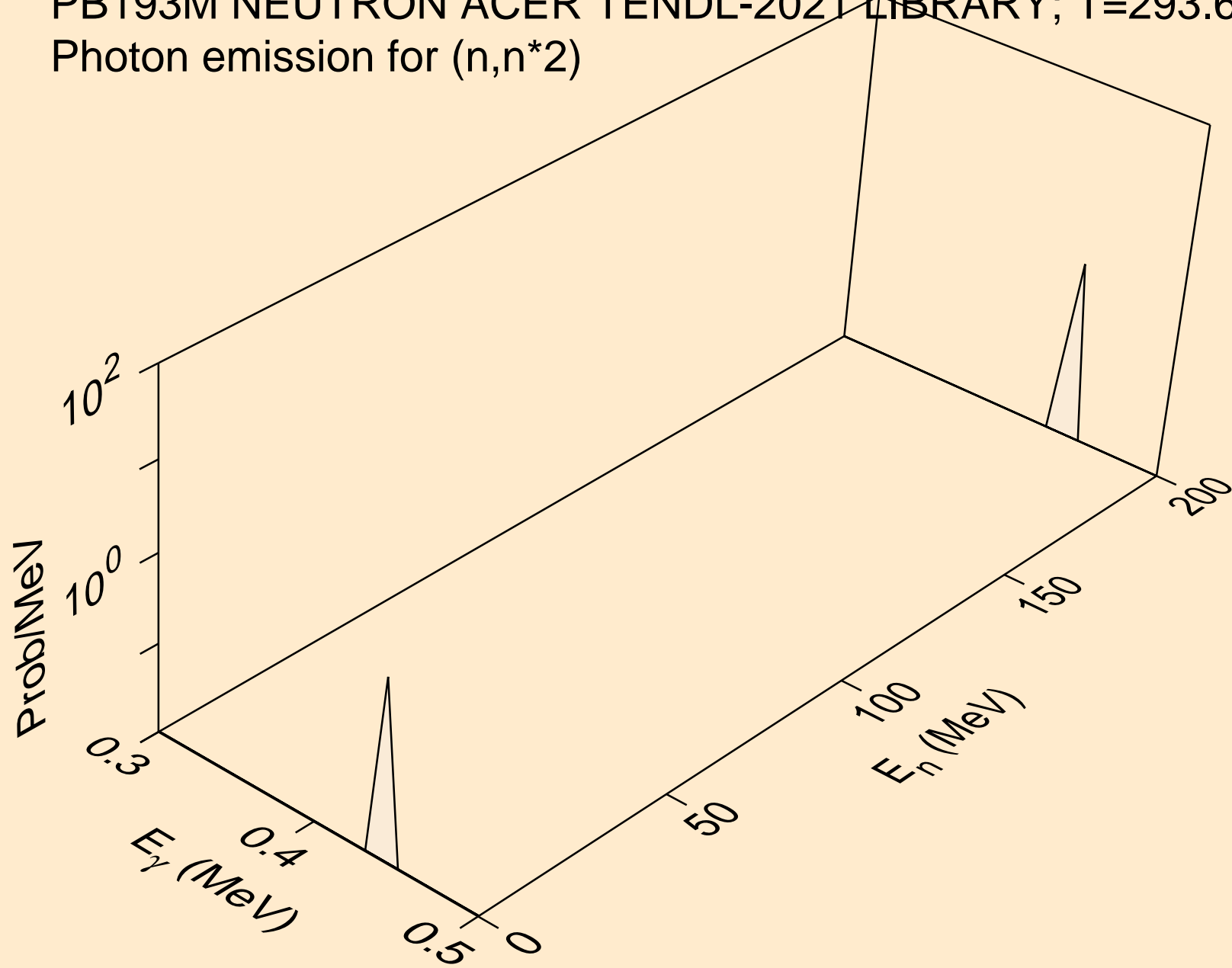

PB193M NEUTRON ACER TENDL-2021 LIBRARY; T=293.6K
Photon emission for (n,n*3)

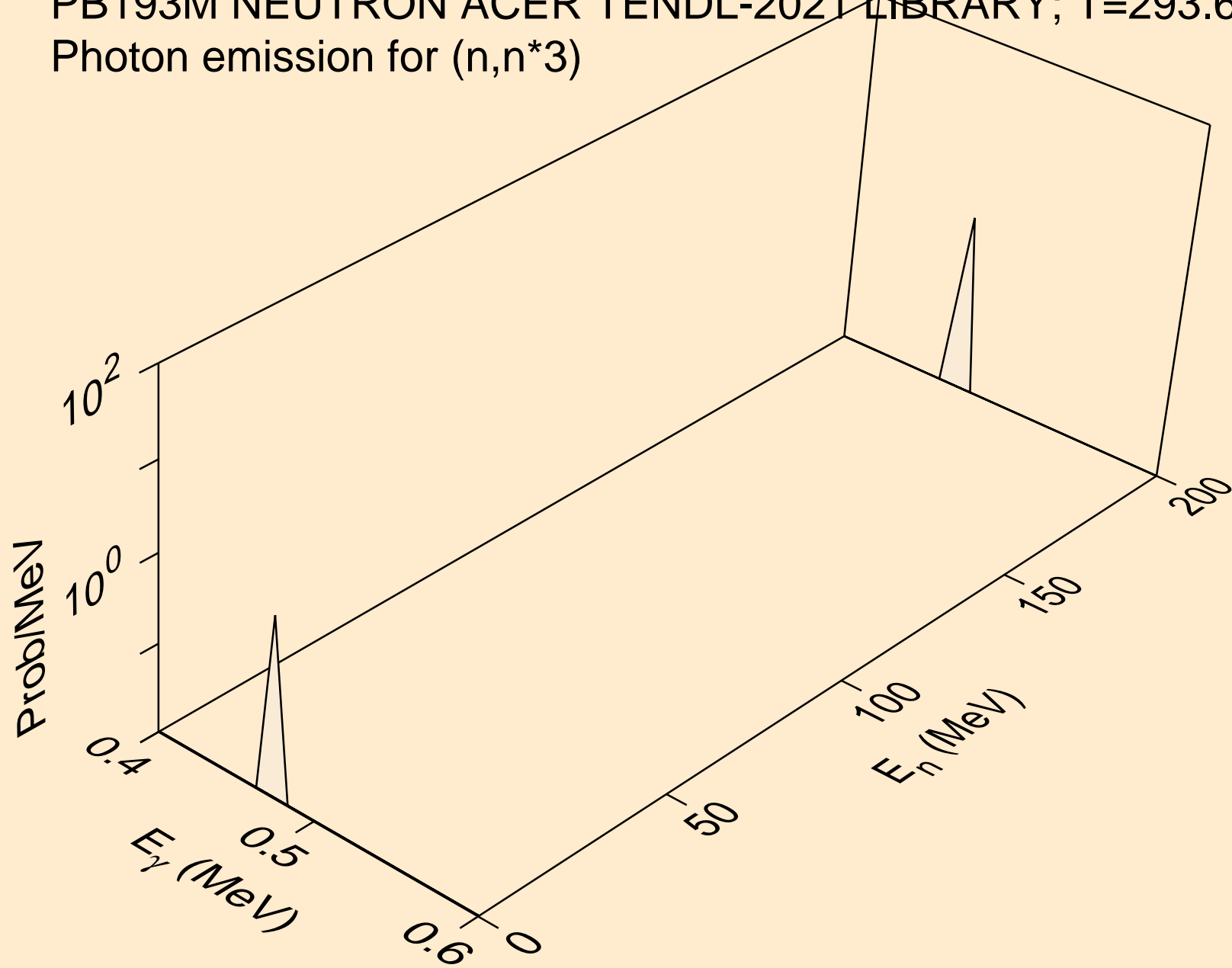

PB193M NEUTRON ACER TENDL-2021 LIBRARY; T=293.6K
Photon emission for (n,n*4)

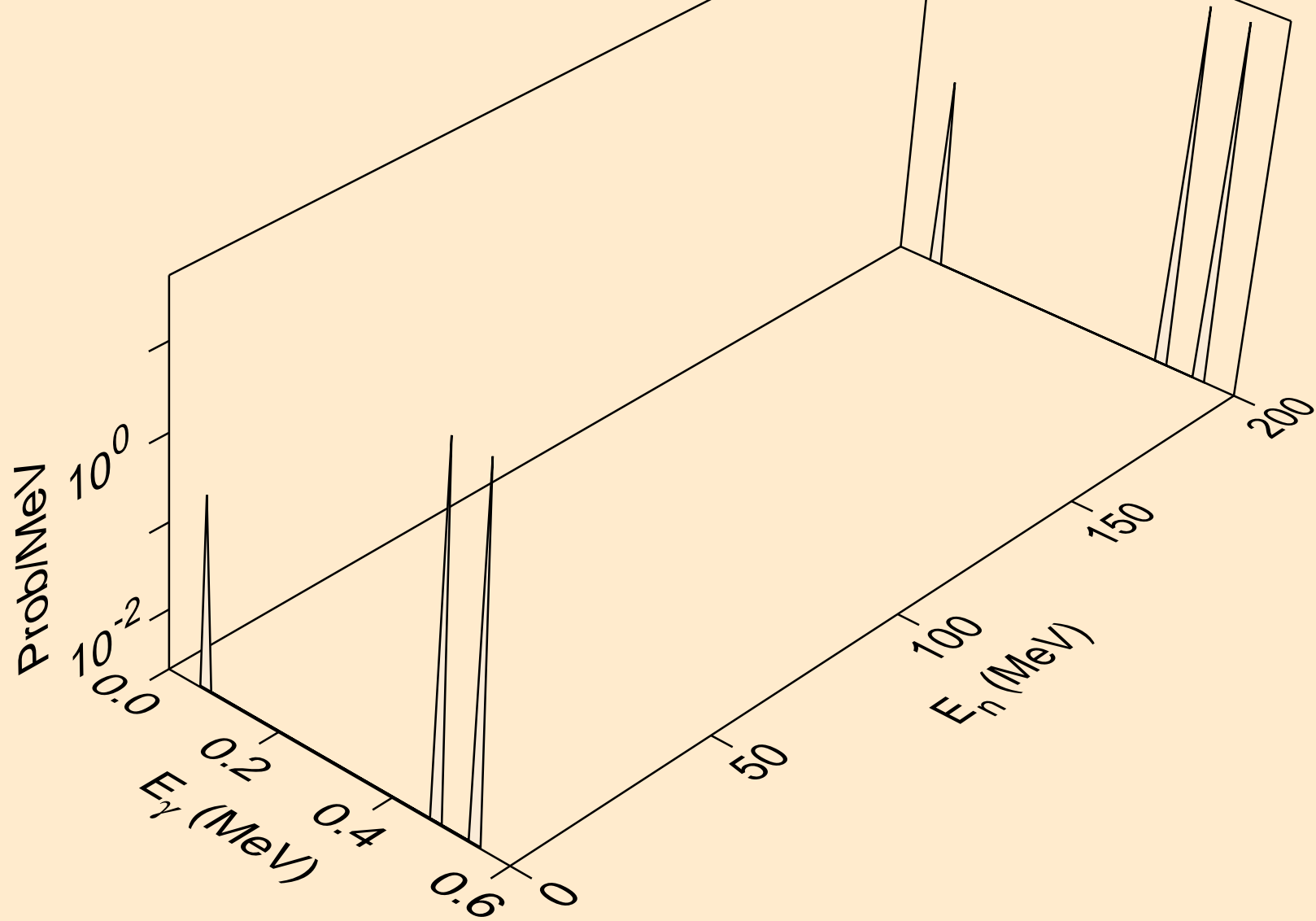

PB193M NEUTRON ACER TENDL-2021 LIBRARY; T=293.6K
Photon emission for (n,n*5)

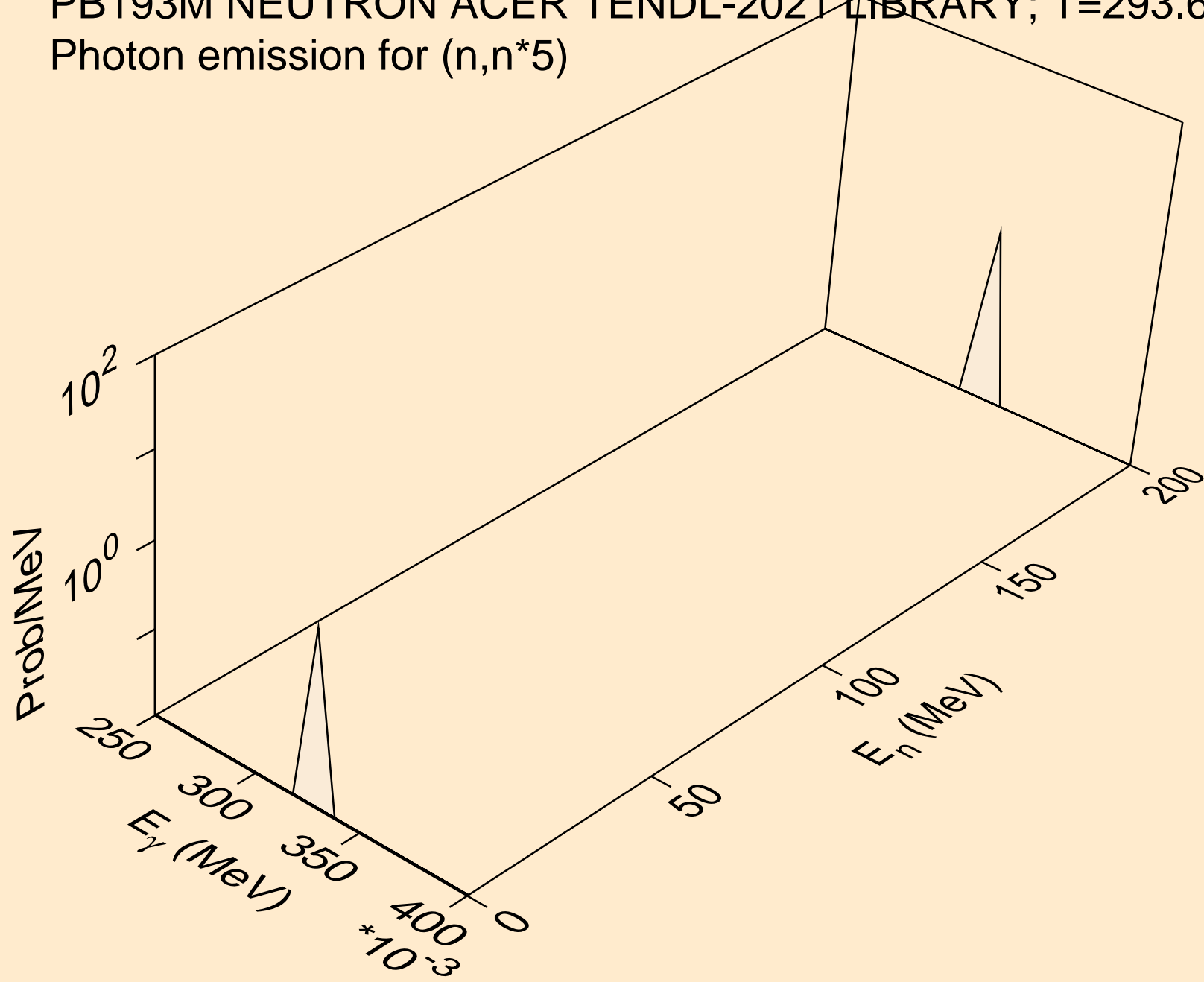

PB193M NEUTRON ACER TENDL-2021 LIBRARY; T=293.6K
Photon emission for (n,n*6)

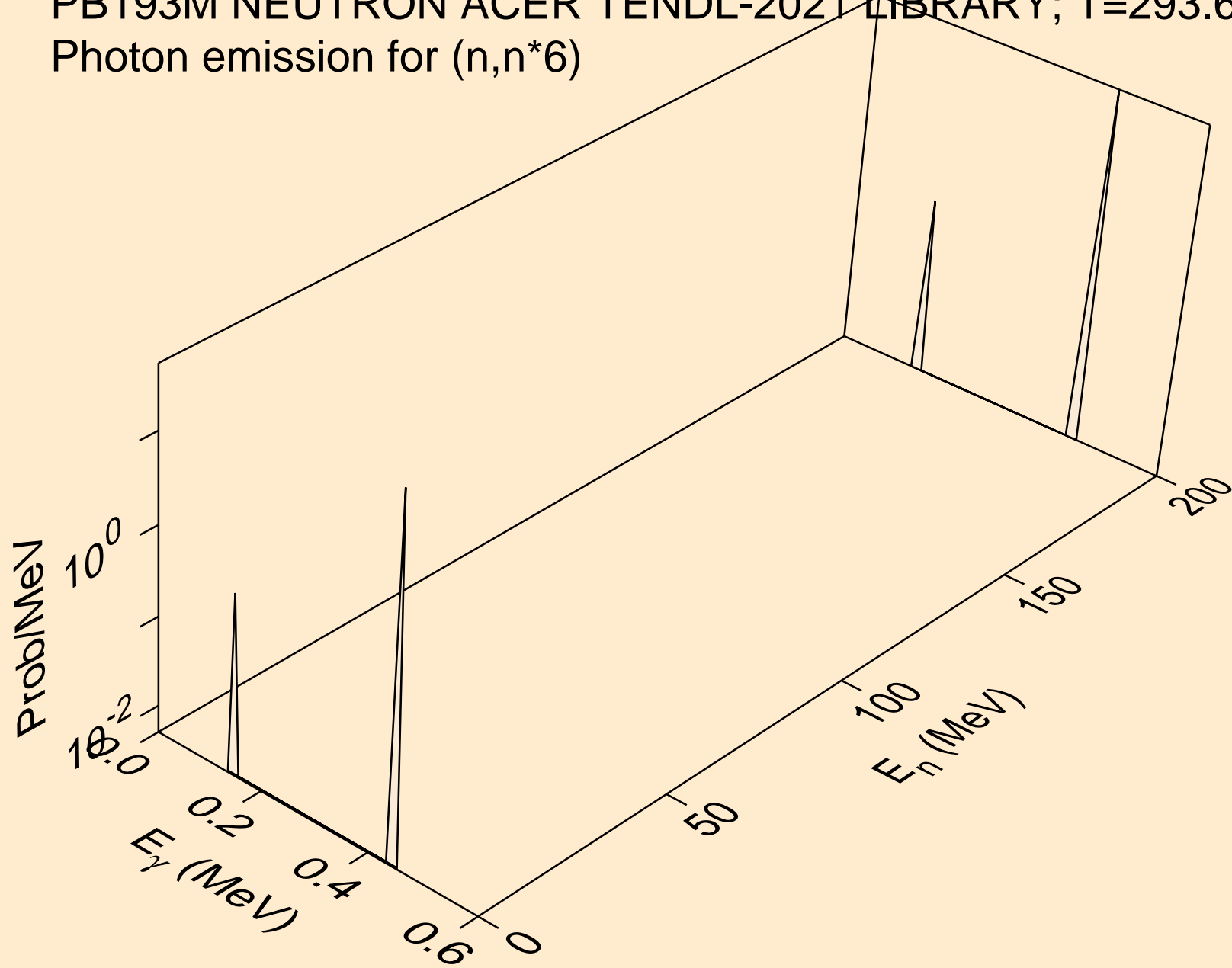

PB193M NEUTRON ACER TENDL-2021 LIBRARY; T=293.6K
Photon emission for (n,n*7)

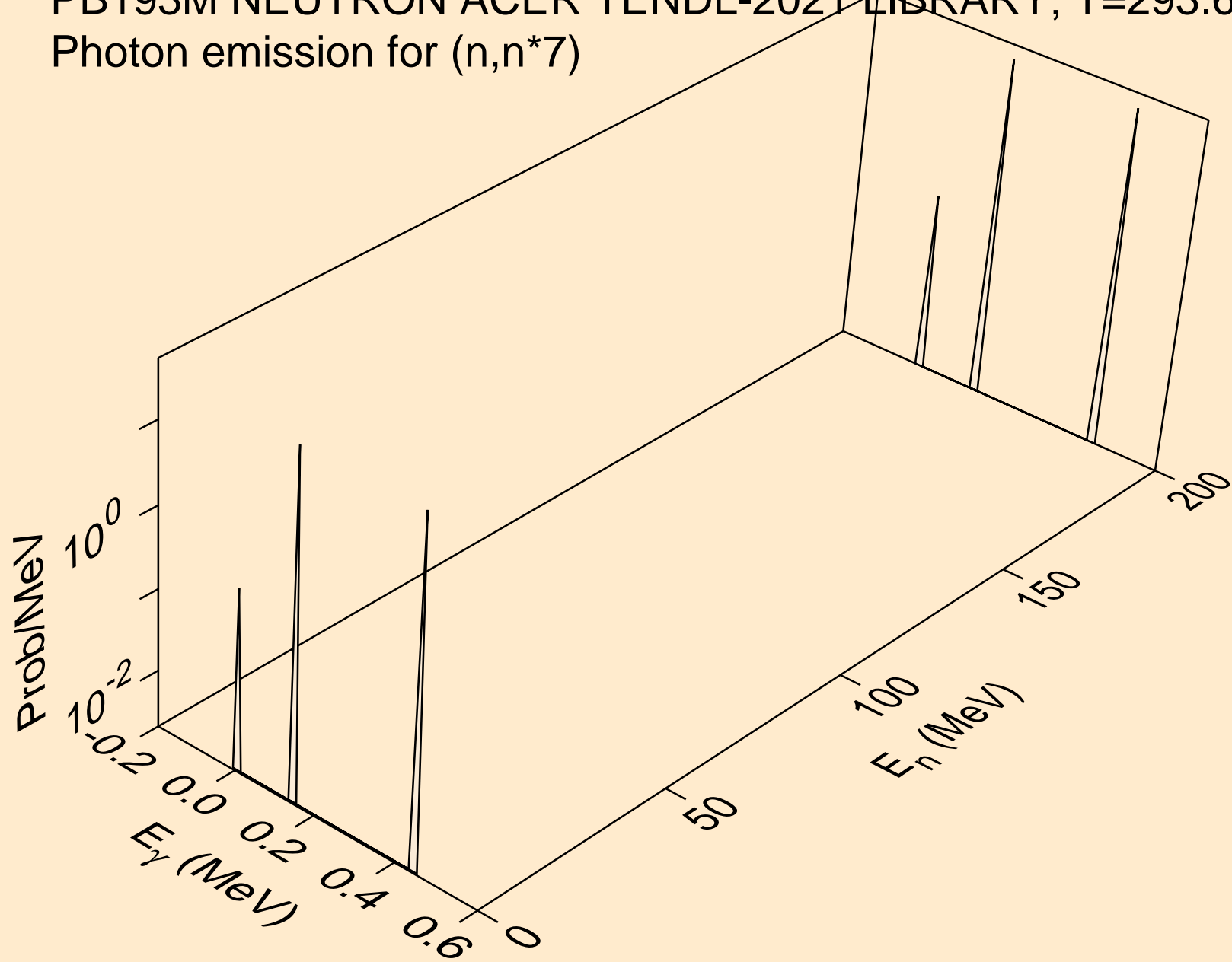

PB193M NEUTRON ACER TENDL-2021 LIBRARY; T=293.6K
Photon emission for (n,n*8)

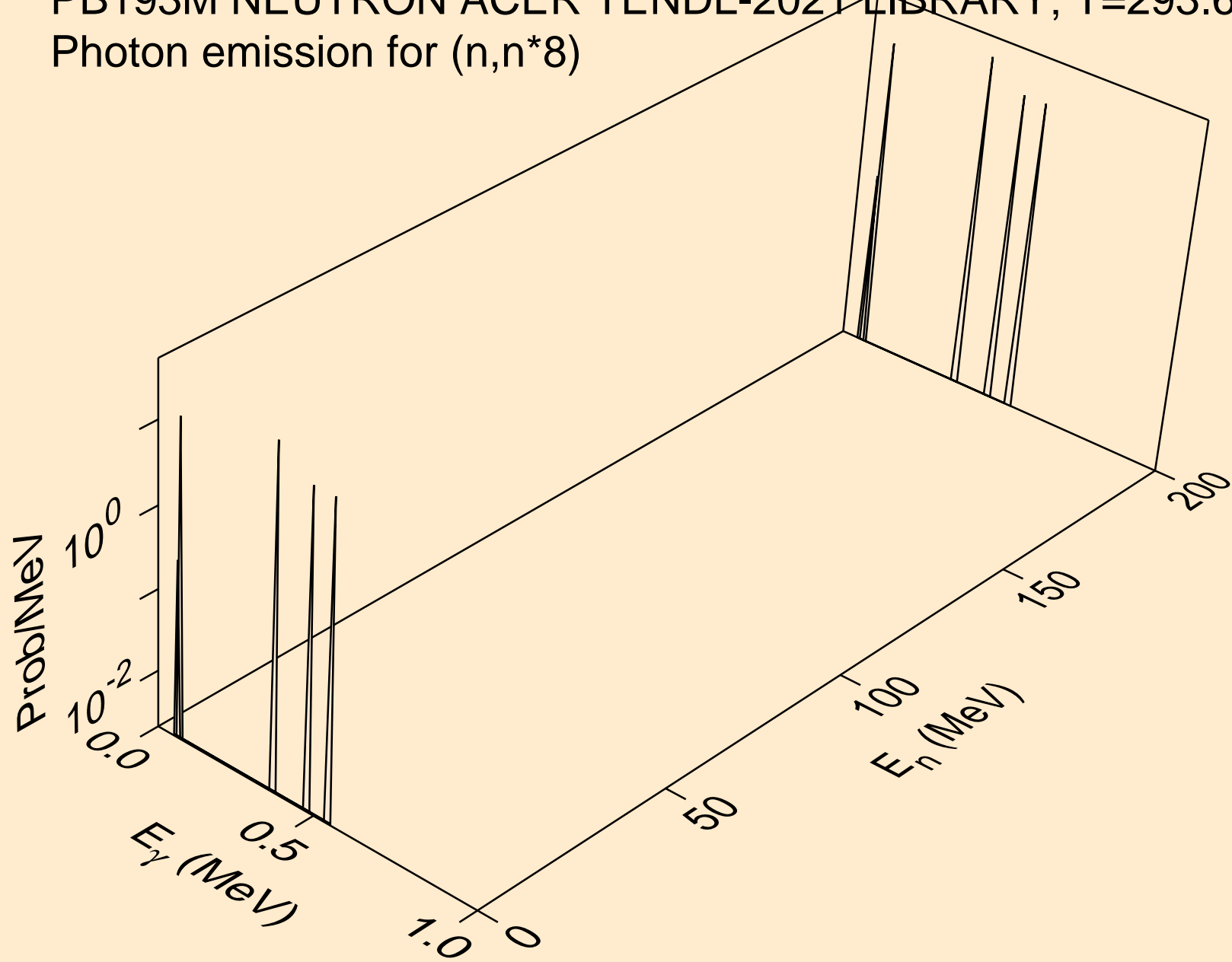

PB193M NEUTRON ACER TENDL-2021 LIBRARY; T=293.6K
Photon emission for (n,n*9)

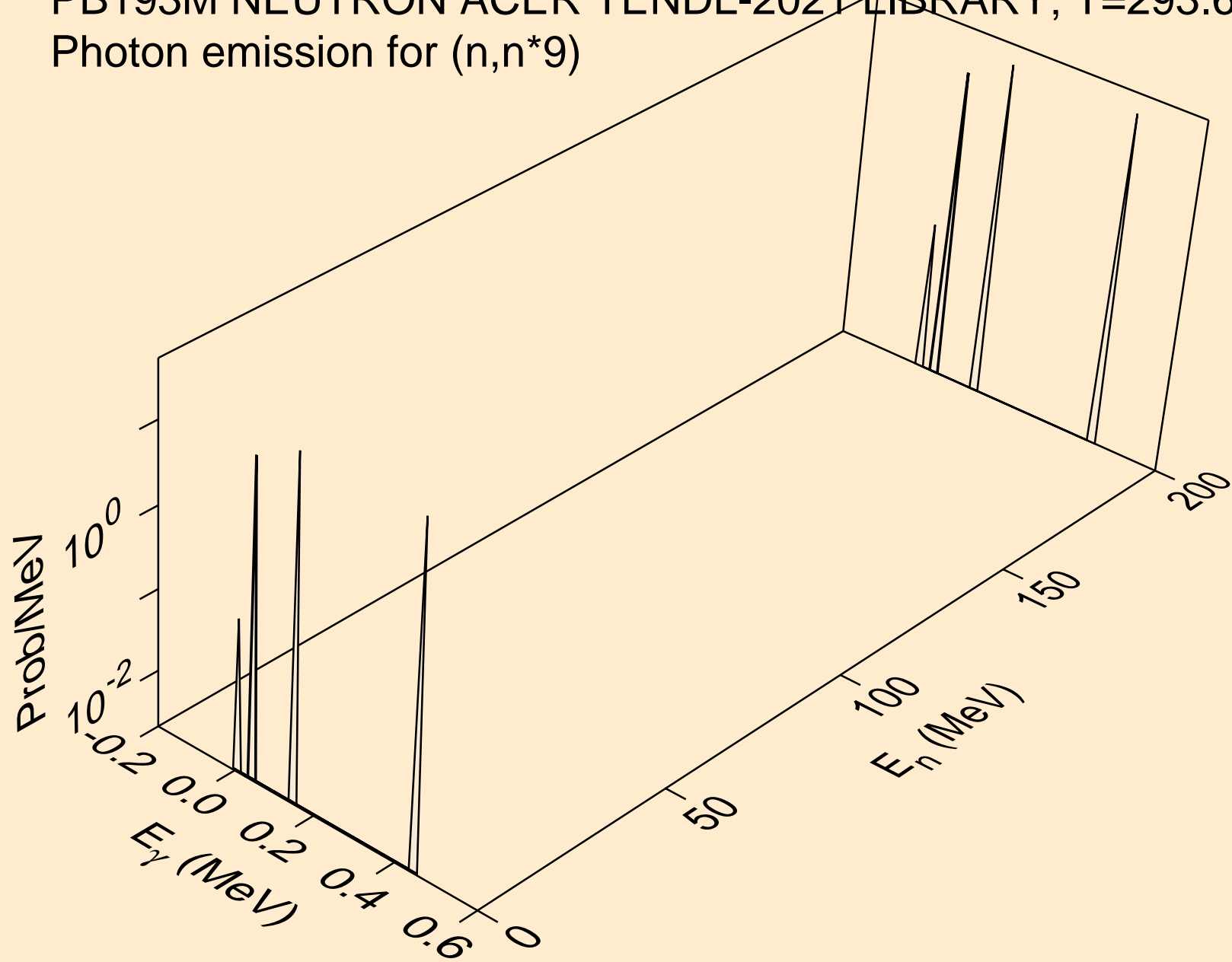

PB193M NEUTRON ACER TENDL-2021 LIBRARY; T=293.6K
Photon emission for (n,n*10)

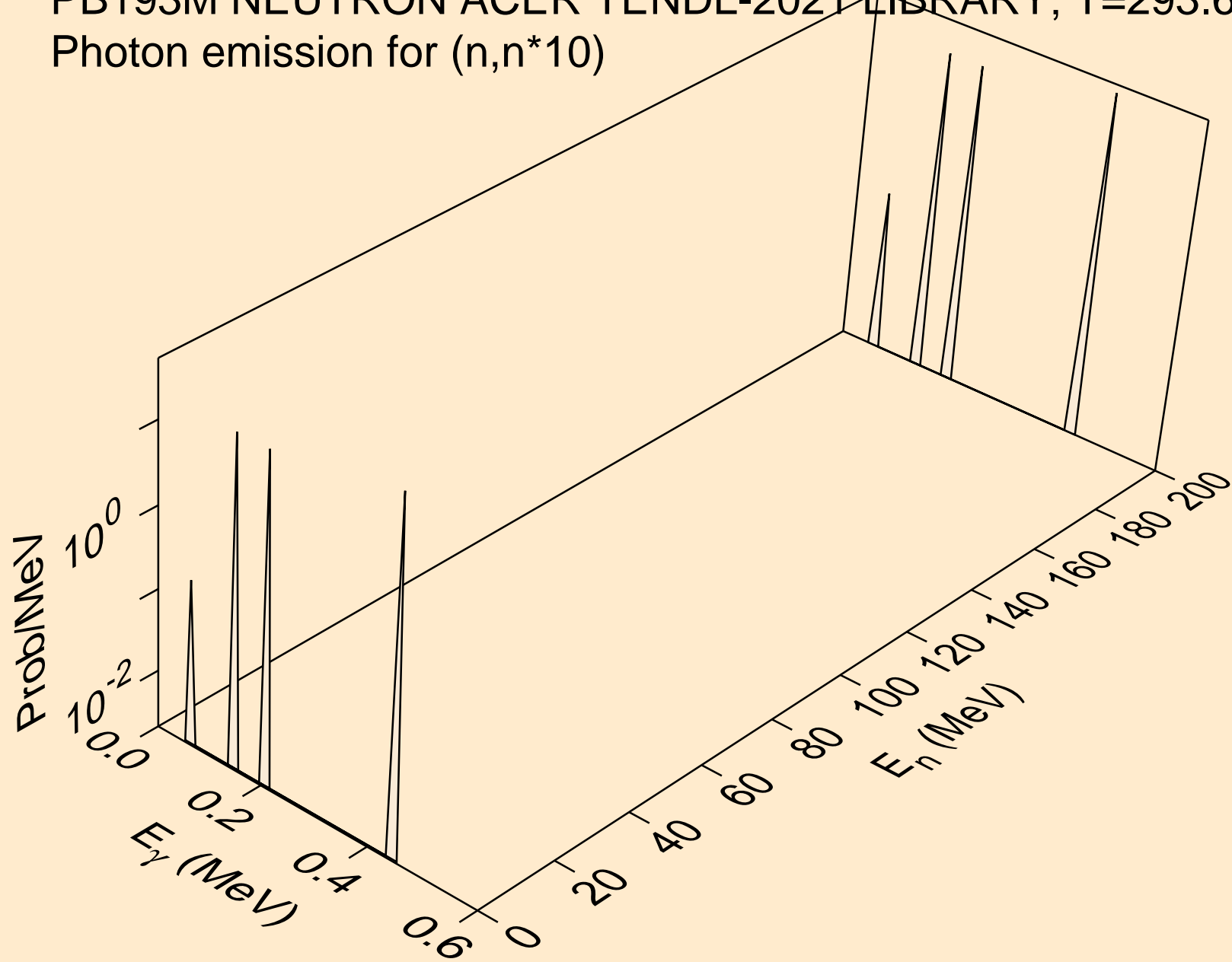

PB193M NEUTRON ACER TENDL-2021 LIBRARY; T=293.6K
Photon emission for (n,n*11)

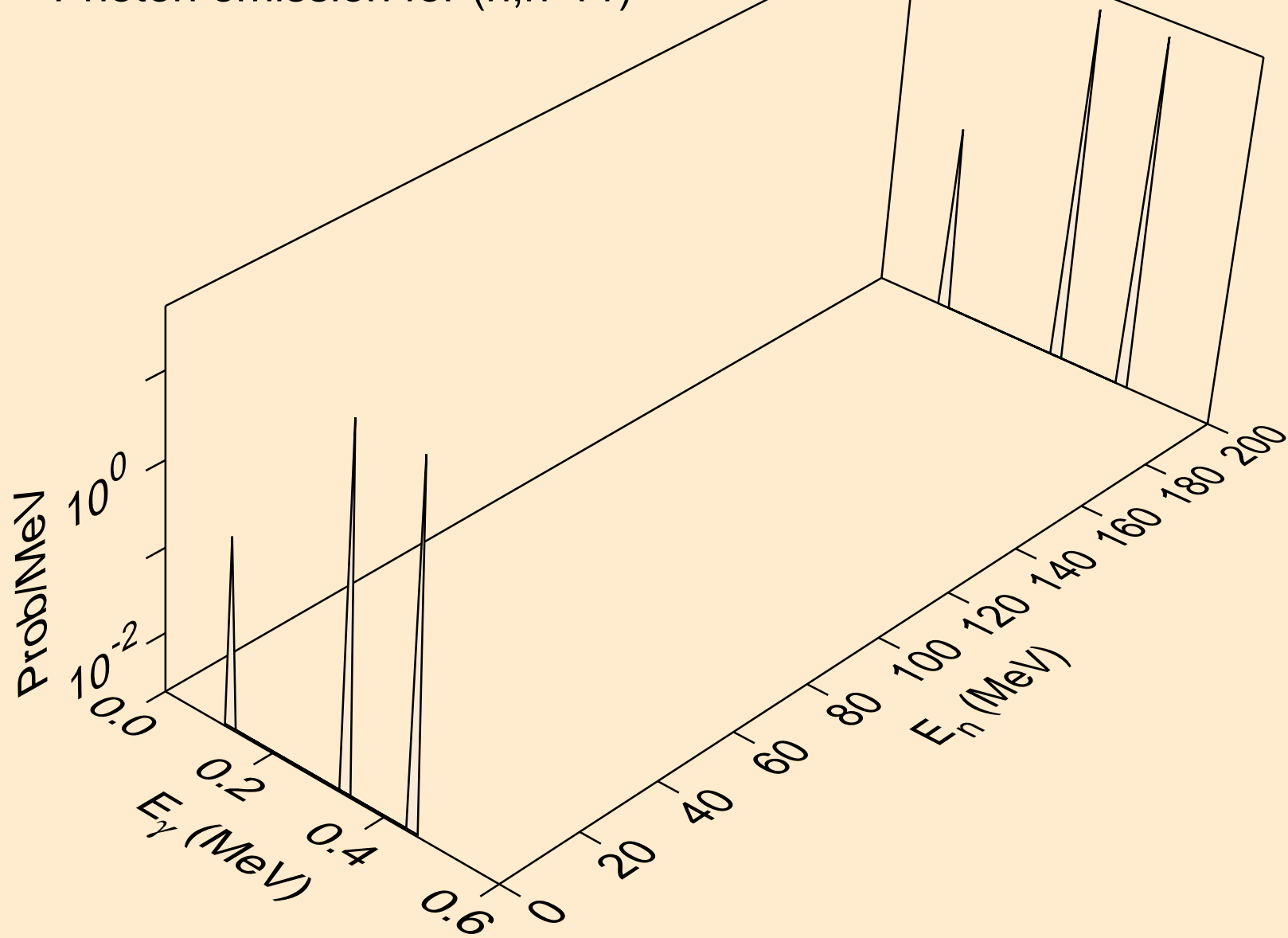

PB193M NEUTRON ACER TENDL-2021 LIBRARY; T=293.6K
Photon emission for (n,n*c)

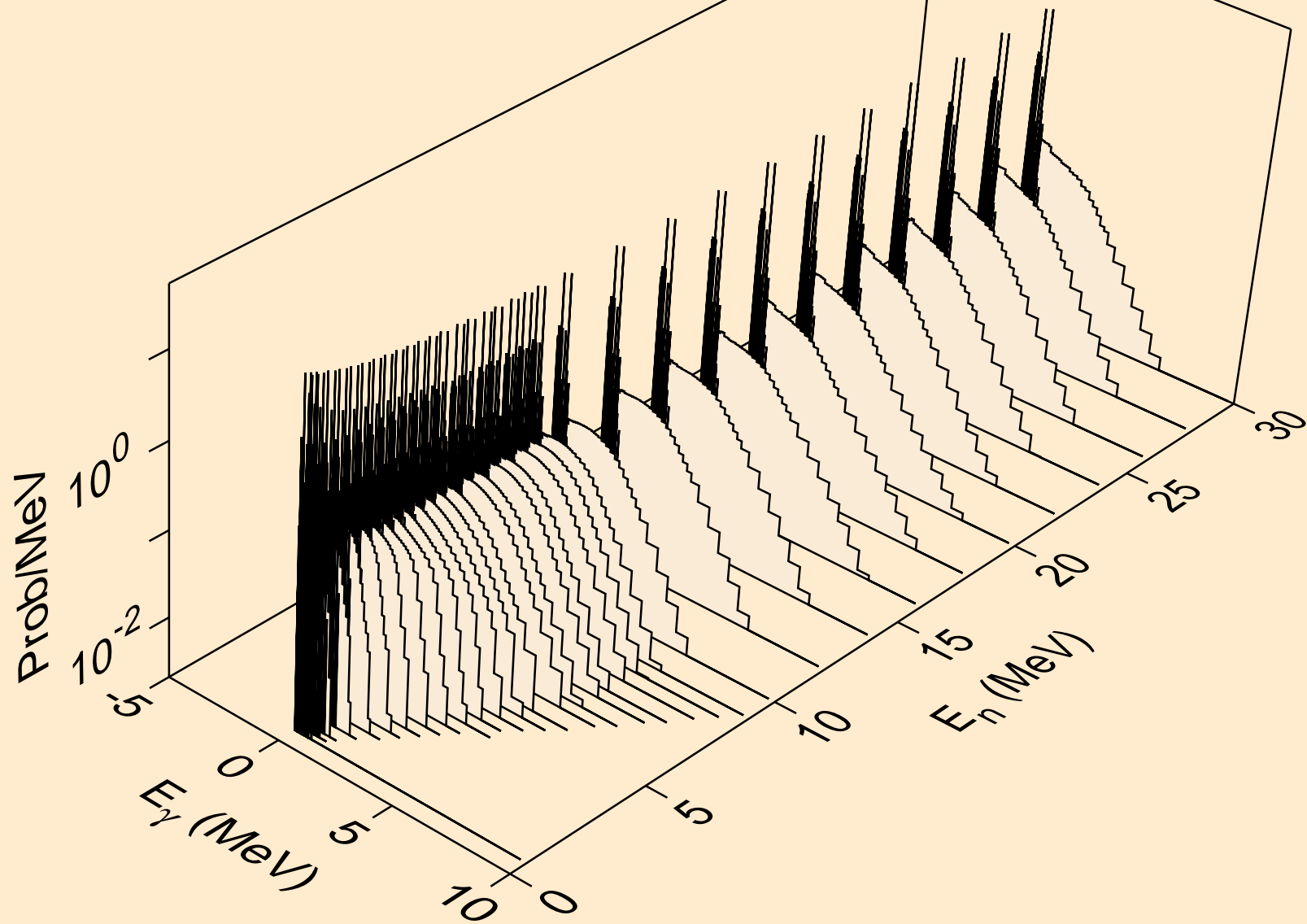

PB193M NEUTRON ACER TENDL-2021 LIBRARY; T=293.6K
Photon emission for (n,gma)

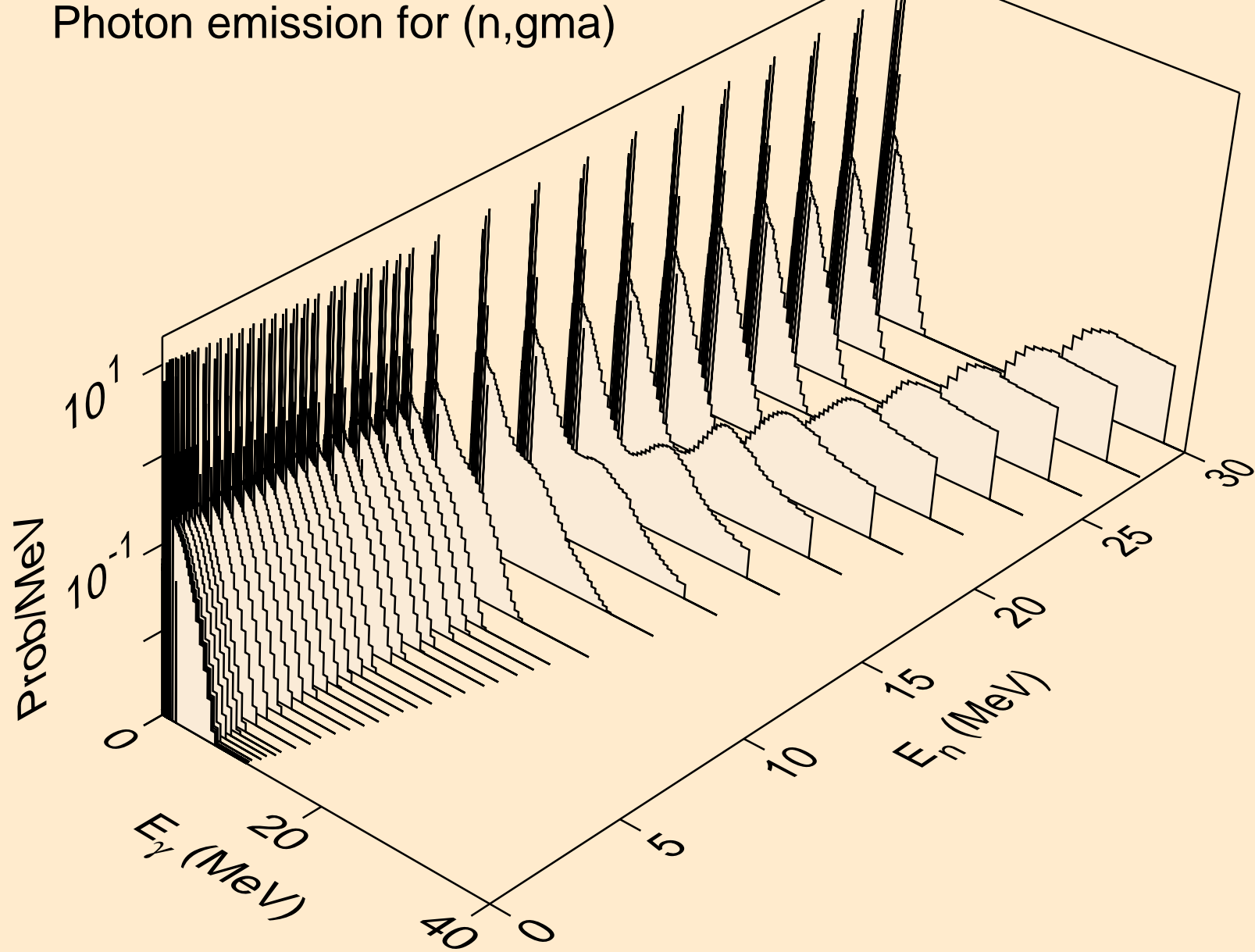

PB193M NEUTRON ACER TENDL-2021 LIBRARY; T=293.6K
Photon emission for (n,p)

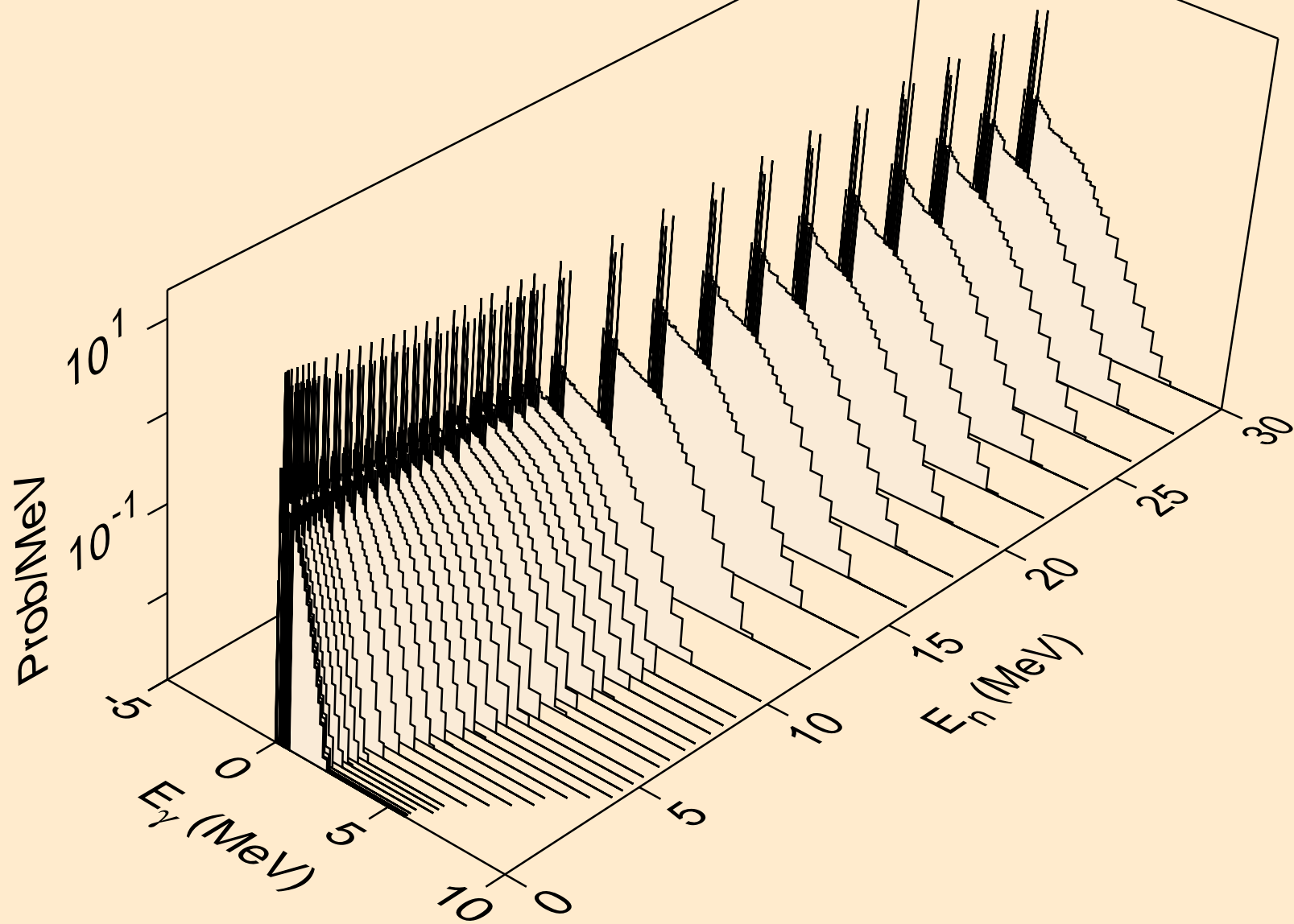

PB193M NEUTRON ACER TENDL-2021 LIBRARY; T=293.6K
Photon emission for (n,d)

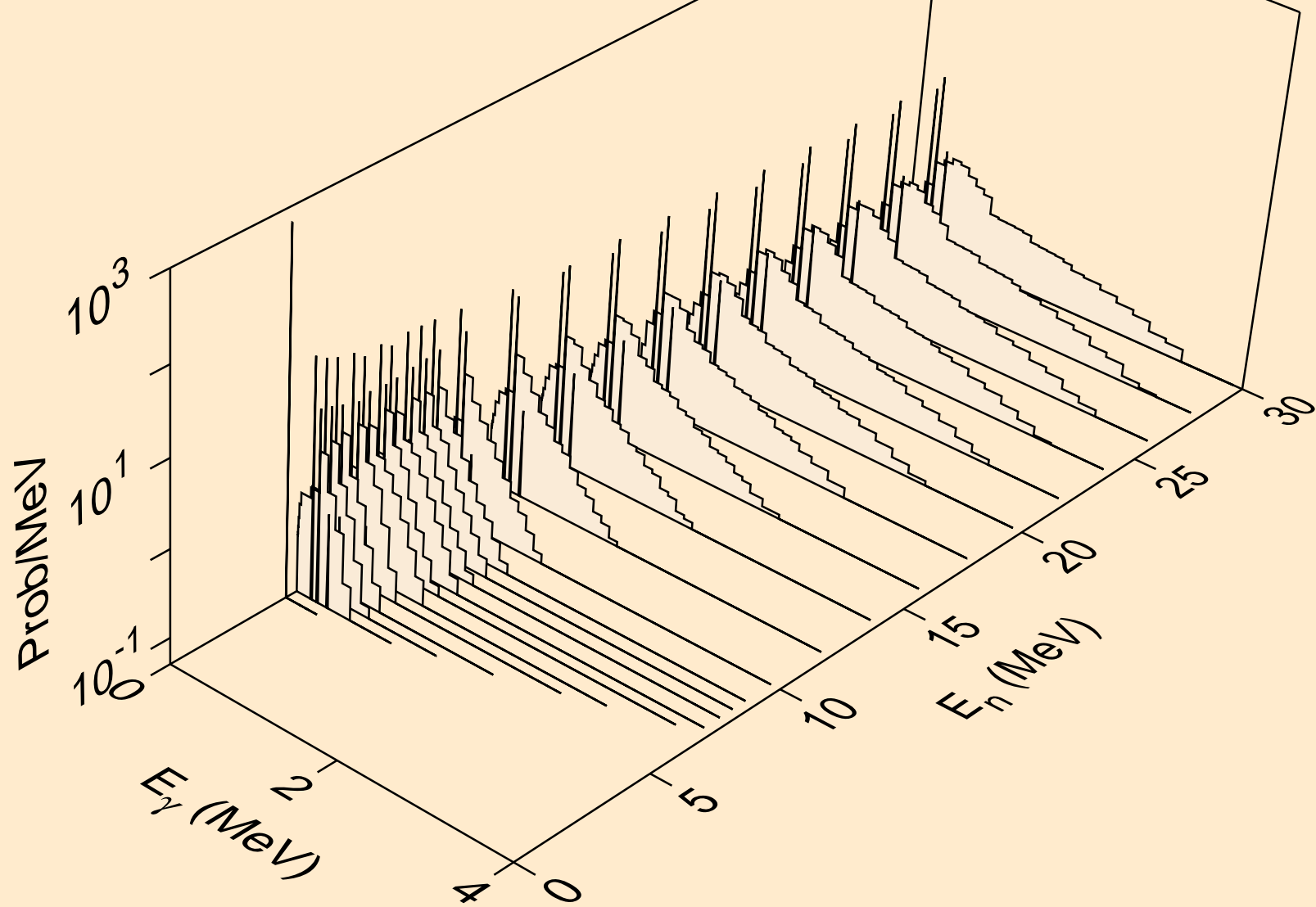

PB193M NEUTRON ACER TENDL-2021 LIBRARY; T=293.6K
Photon emission for (n,t)

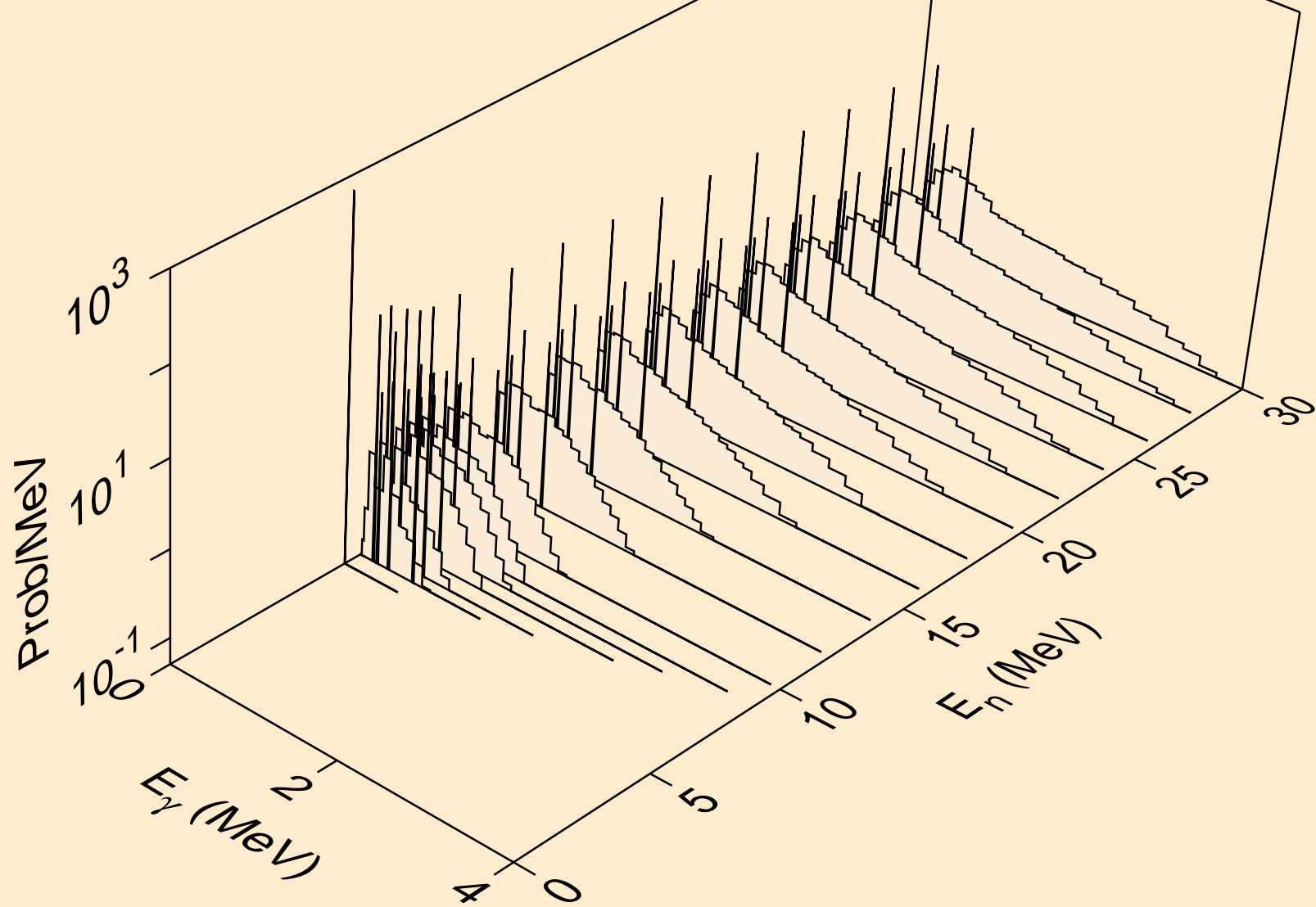

PB193M NEUTRON ACER TENDL-2021 LIBRARY; T=293.6K
Photon emission for (n,he3)

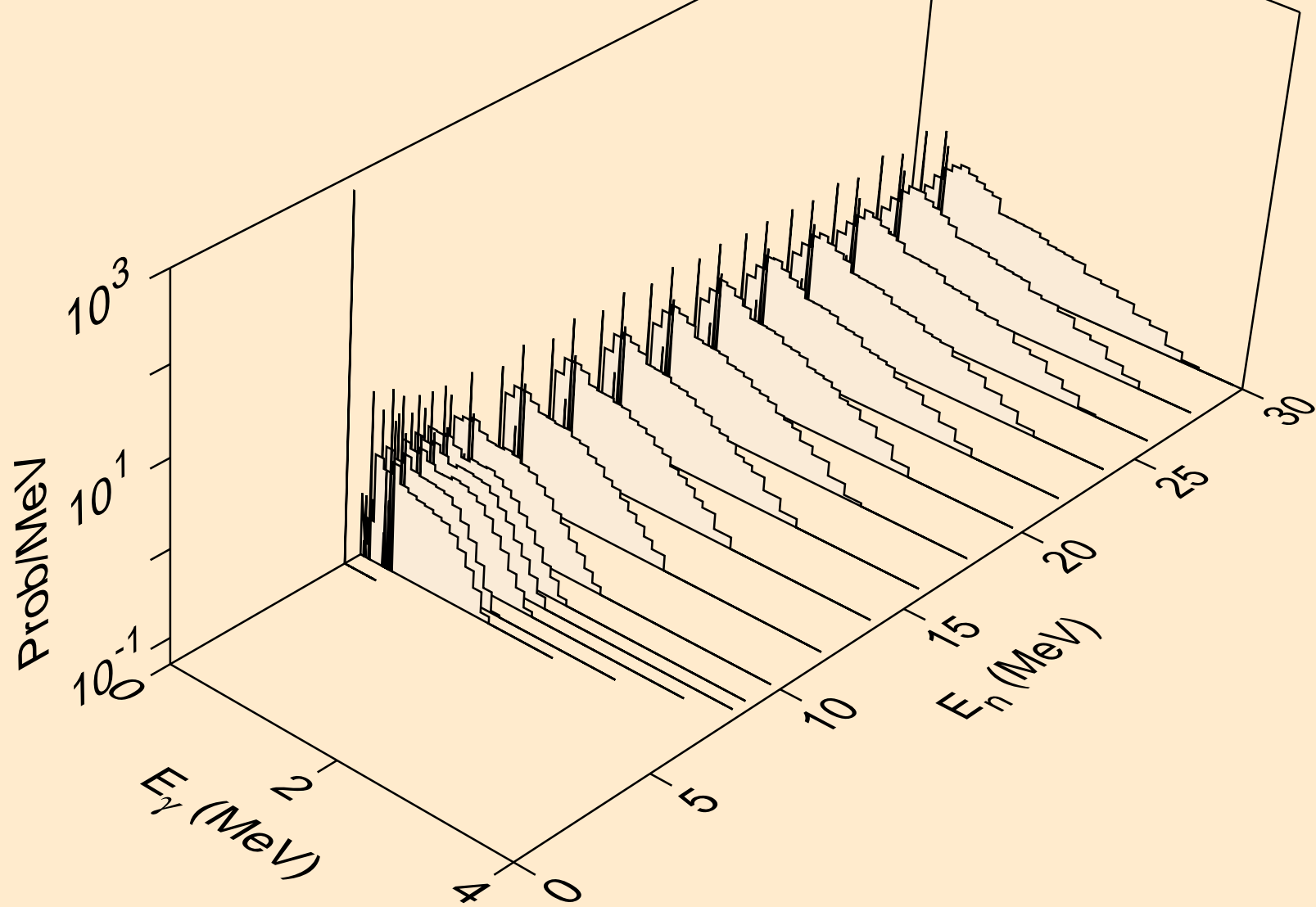

PB193M NEUTRON ACER TENDL-2021 LIBRARY; T=293.6K
Photon emission for (n,a)

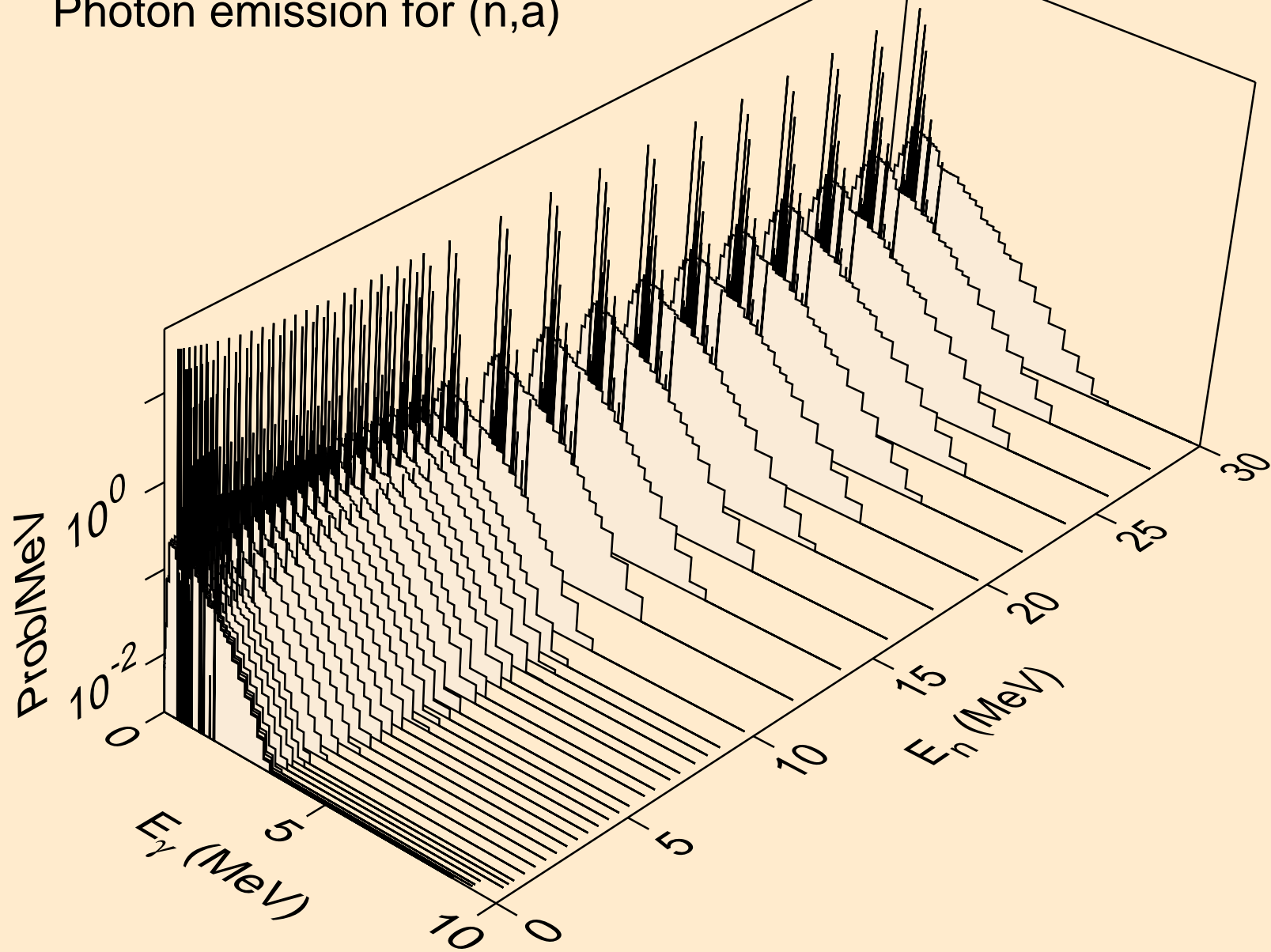

PB193M NEUTRON ACER TENDL-2021 LIBRARY; T=293.6K
Photon emission for (n,2a)

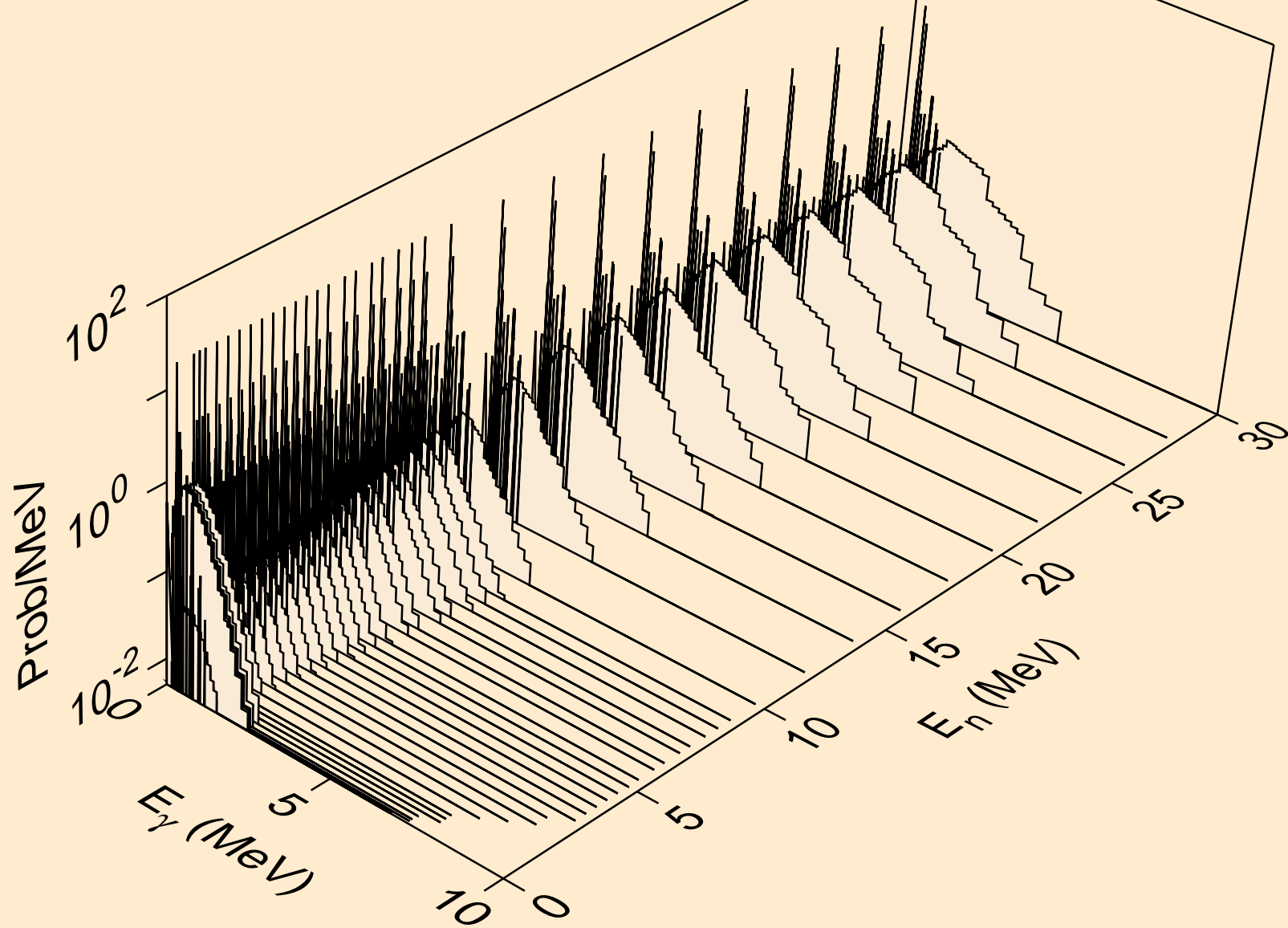

PB193M NEUTRON ACER TENDL-2021 LIBRARY; T=293.6K
Photon emission for (n,2p)

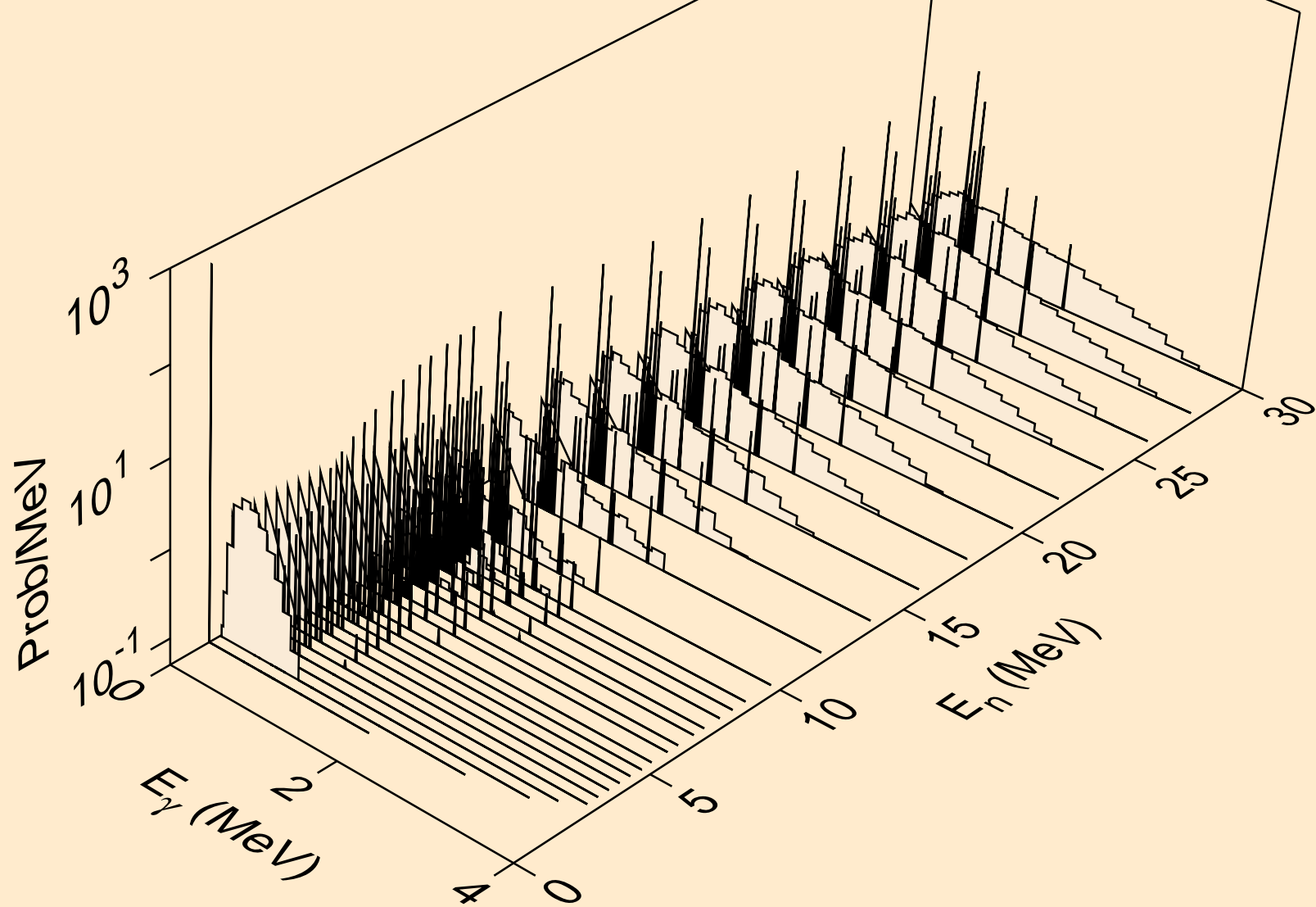

PB193M NEUTRON ACER TENDL-2021 LIBRARY; T=293.6K
Photon emission for (n,p α)

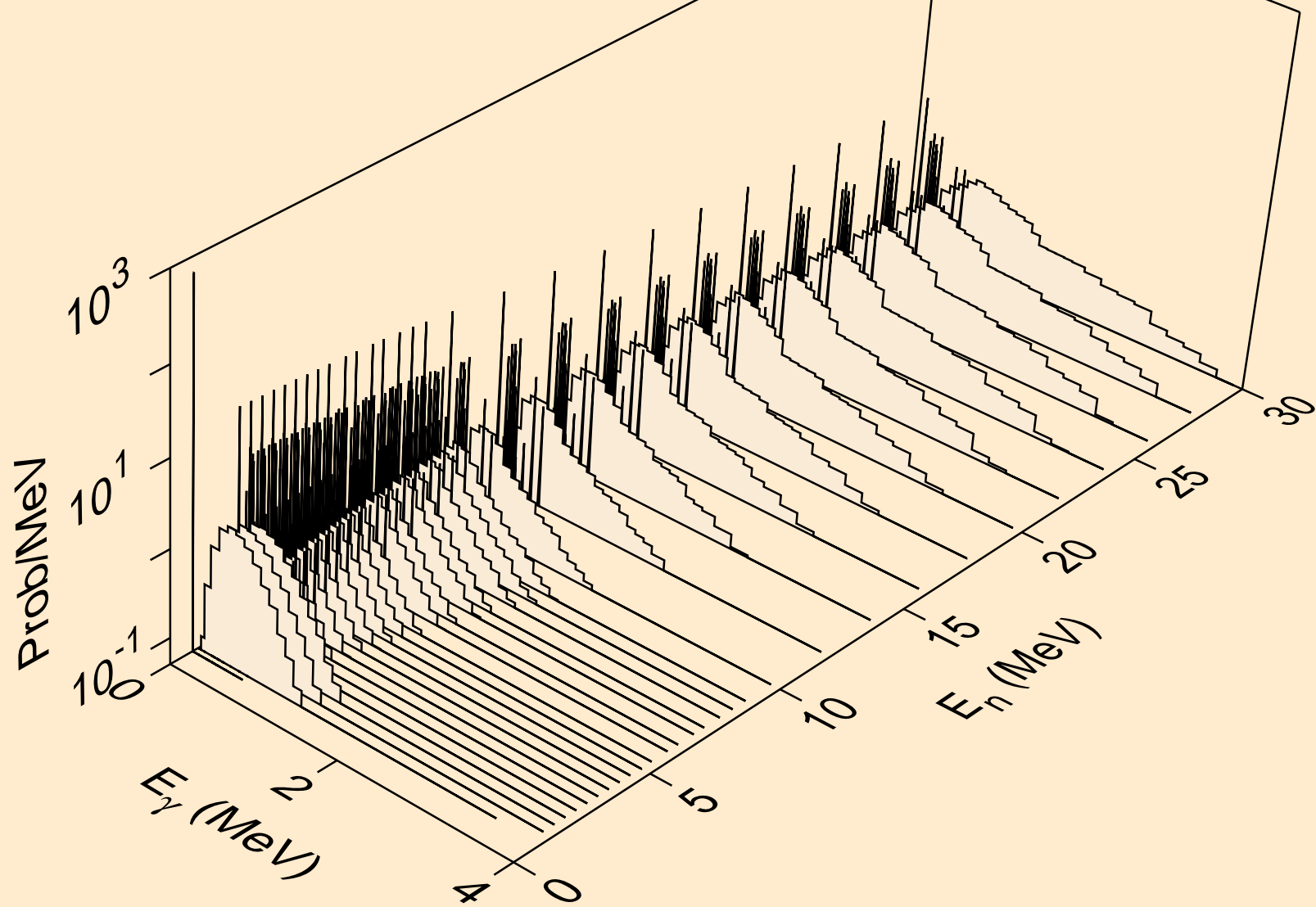

PB193M NEUTRON ACER TENDL-2021 LIBRARY; T=293.6K
Photon emission for (n,pd)

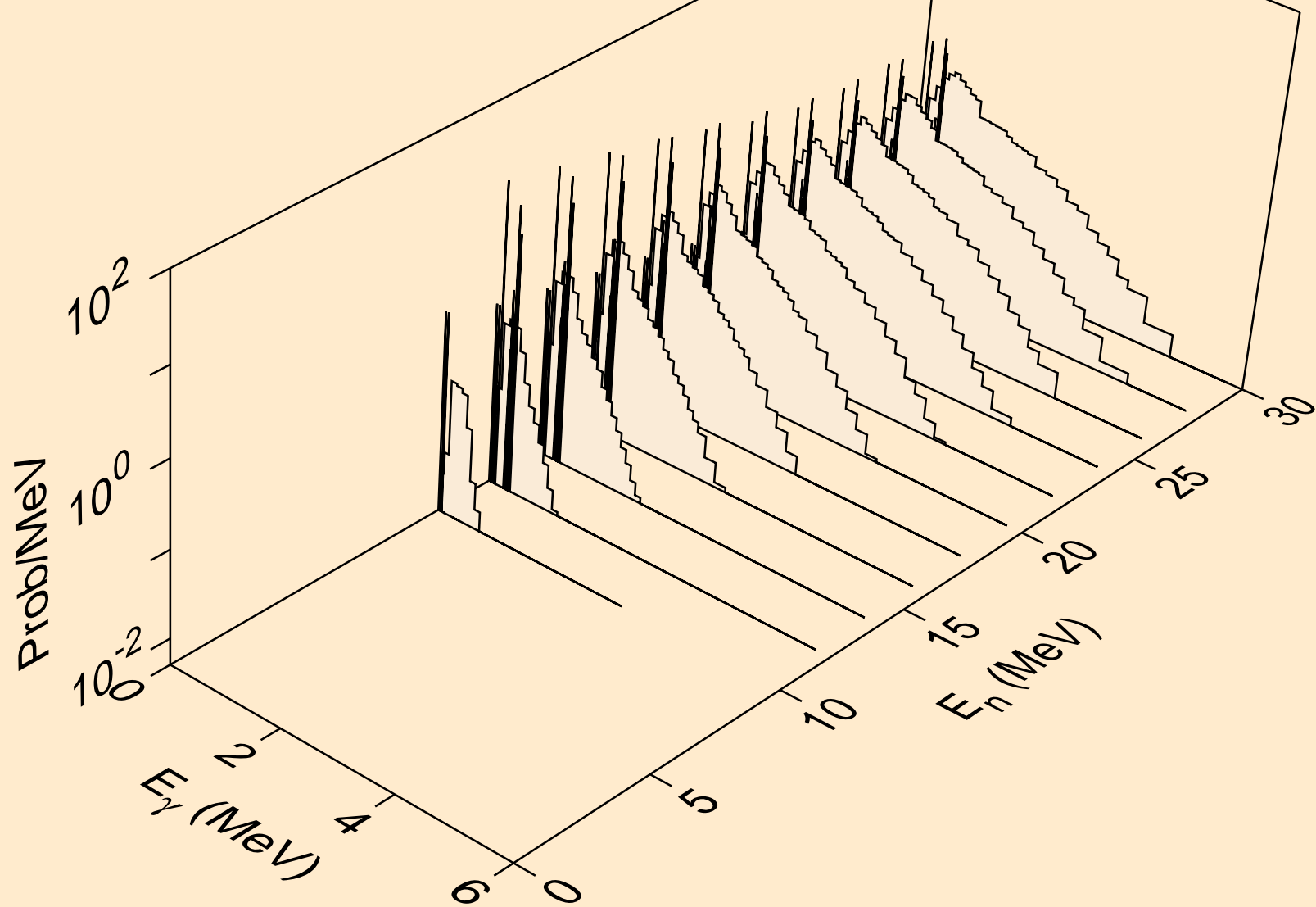

PB193M NEUTRON ACER TENDL-2021 LIBRARY; T=293.6K
Photon emission for (n,pt)

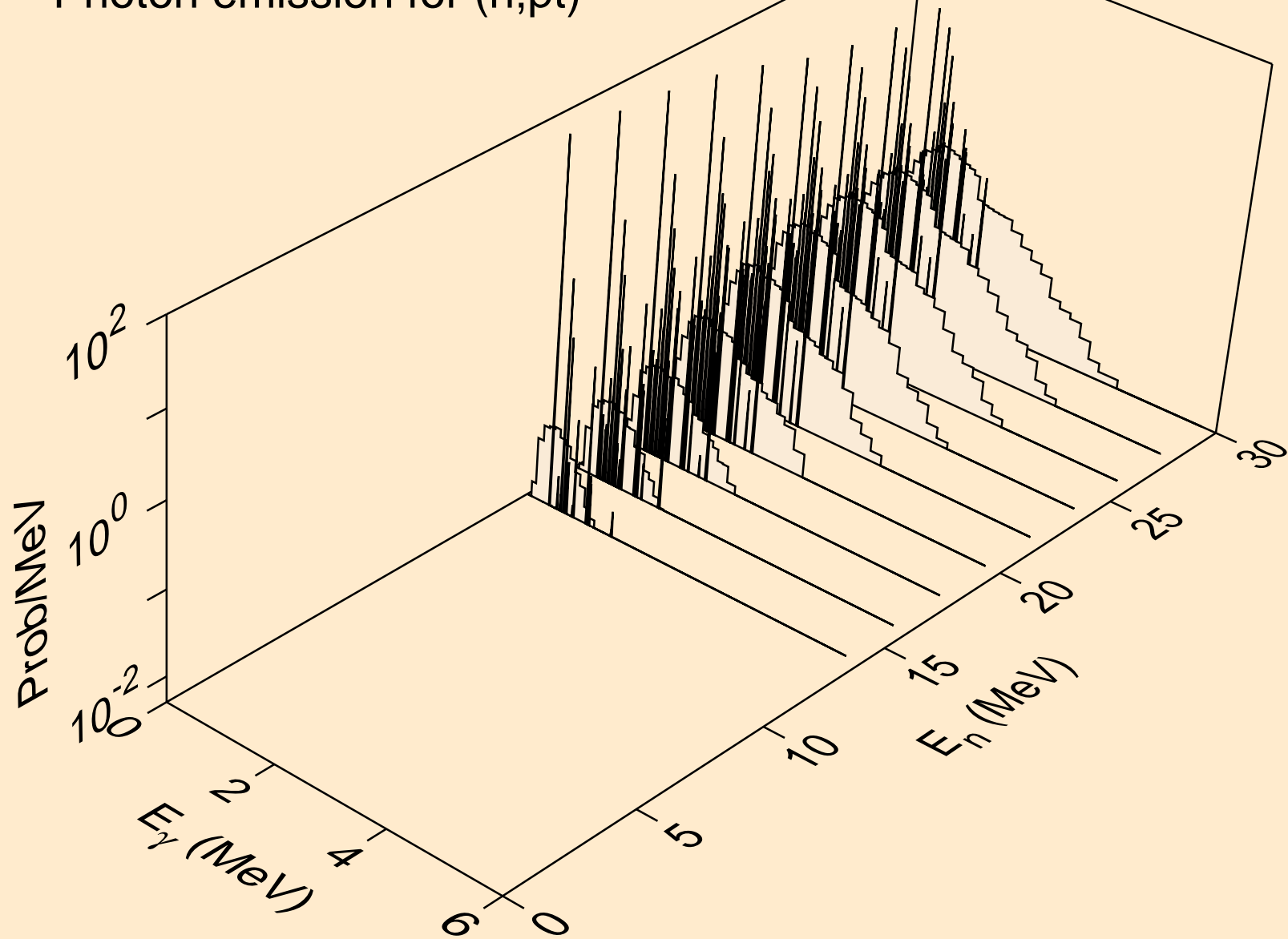

PB193M NEUTRON ACER TENDL-2021 LIBRARY; T=293.6K
Photon emission for (n,da)

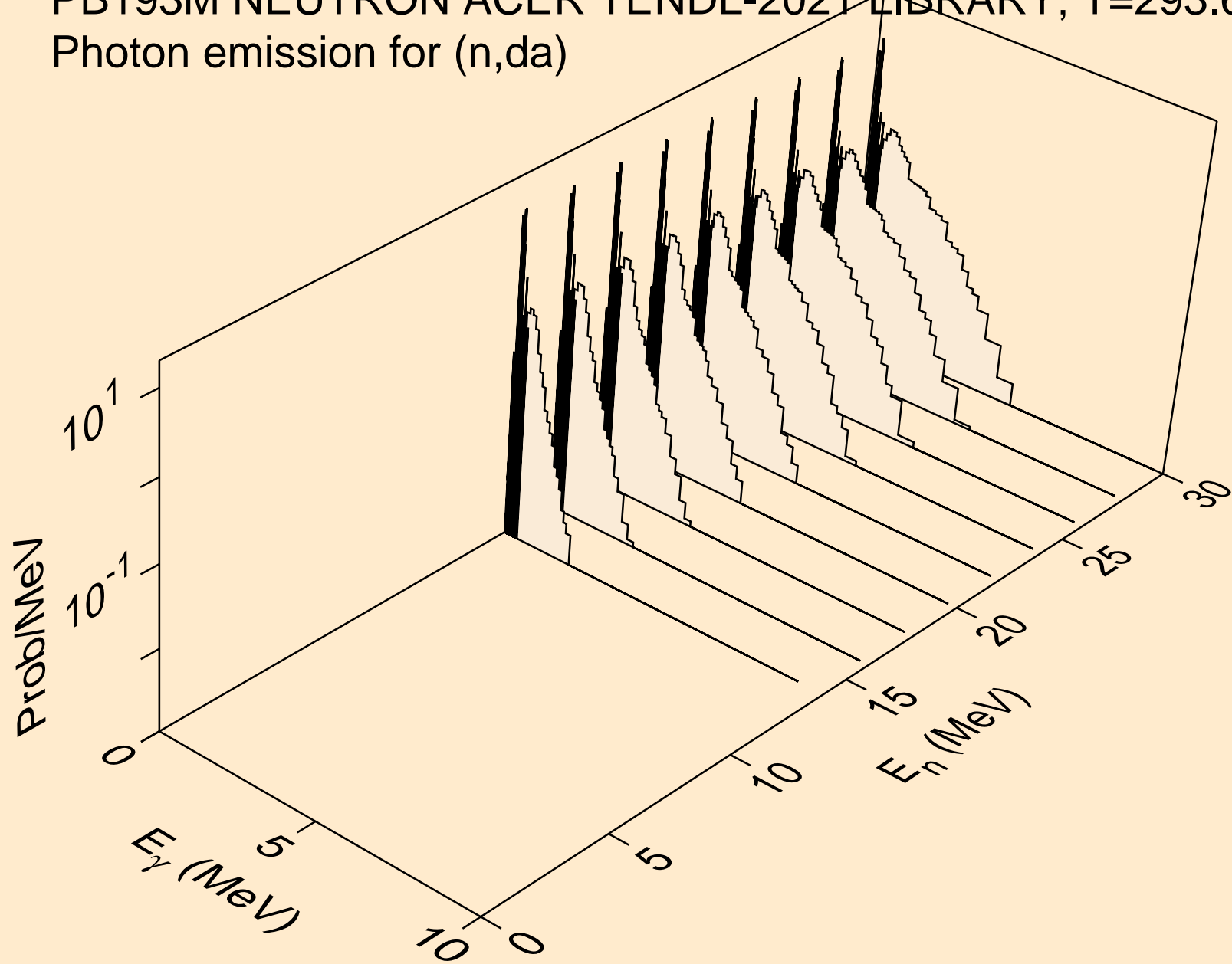

PB193M NEUTRON ACER TENDL-2021 LIBRARY; T=293.6K
thermal capture photon spectrum

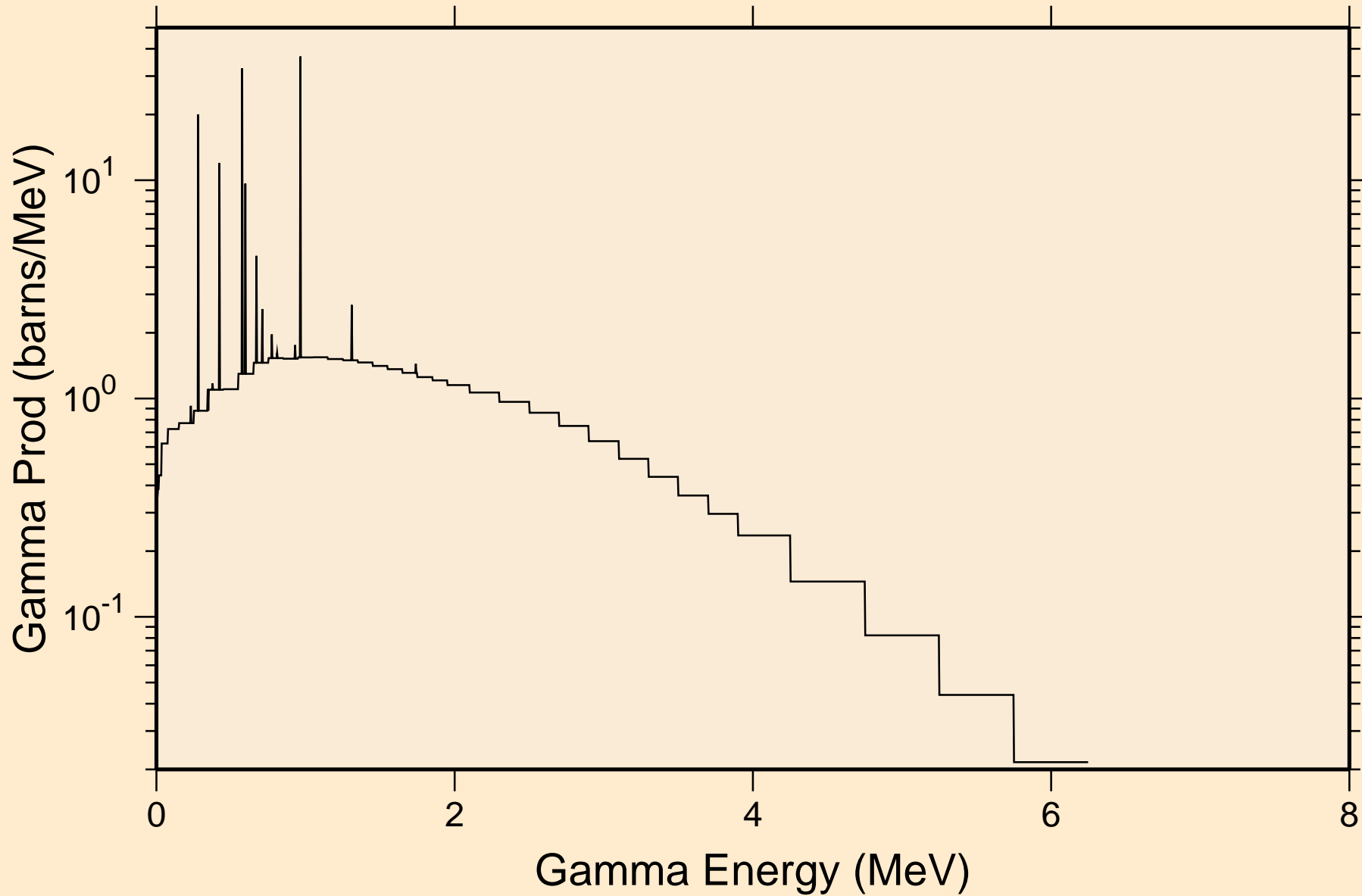

PB193M NEUTRON ACER TENDL-2021 LIBRARY; T=293.6K
14 MeV photon spectrum

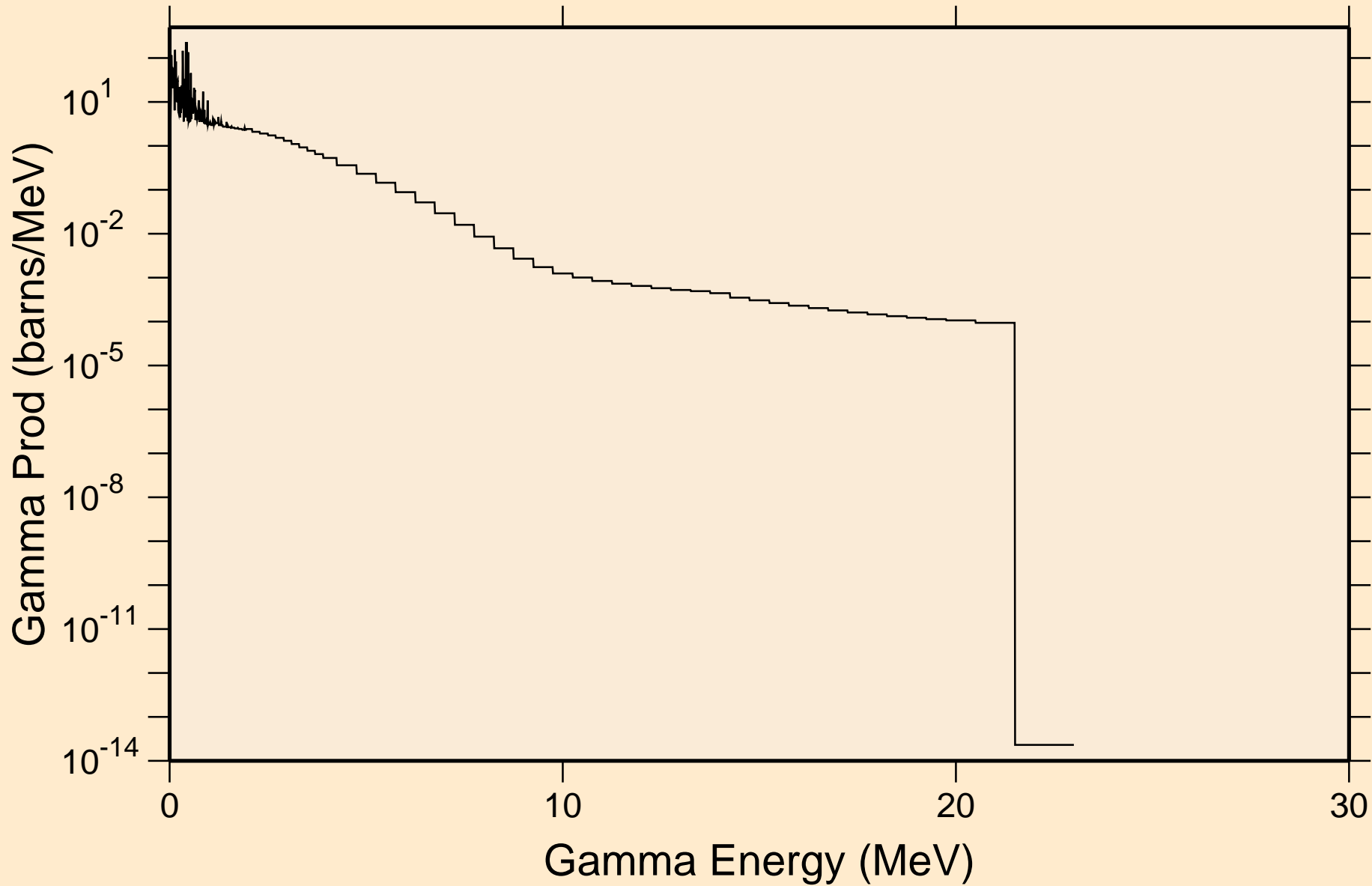

PB193M NEUTRON ACER TENDL-2021 LIBRARY; T=293.6K
Particle heating contributions

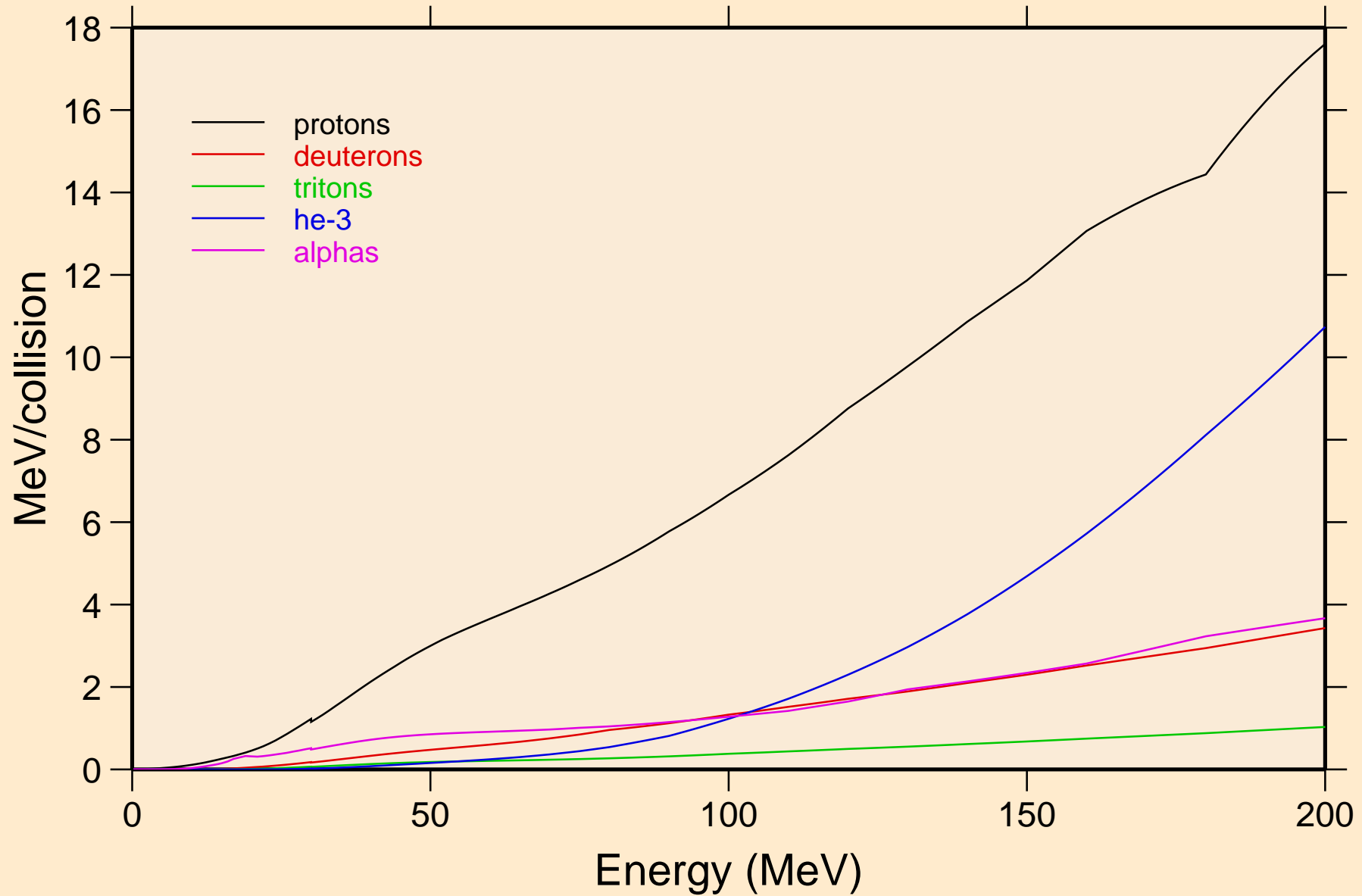

PB193M NEUTRON ACER TENDL-2021 LIBRARY; T=293.6K
Recoil Heating

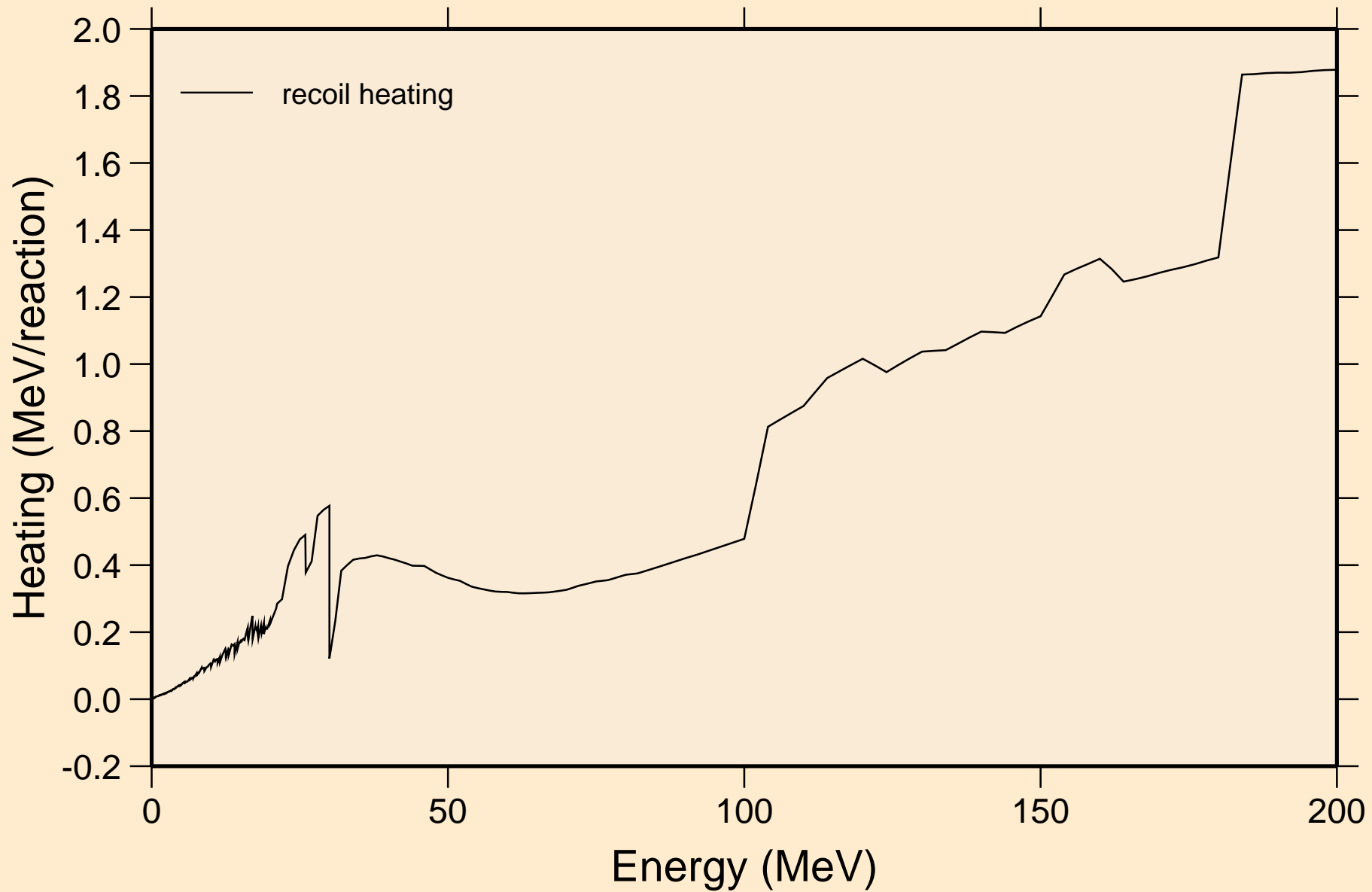

PB193M NEUTRON ACER TENDL-2021 LIBRARY; T=293.6K
Particle production cross sections

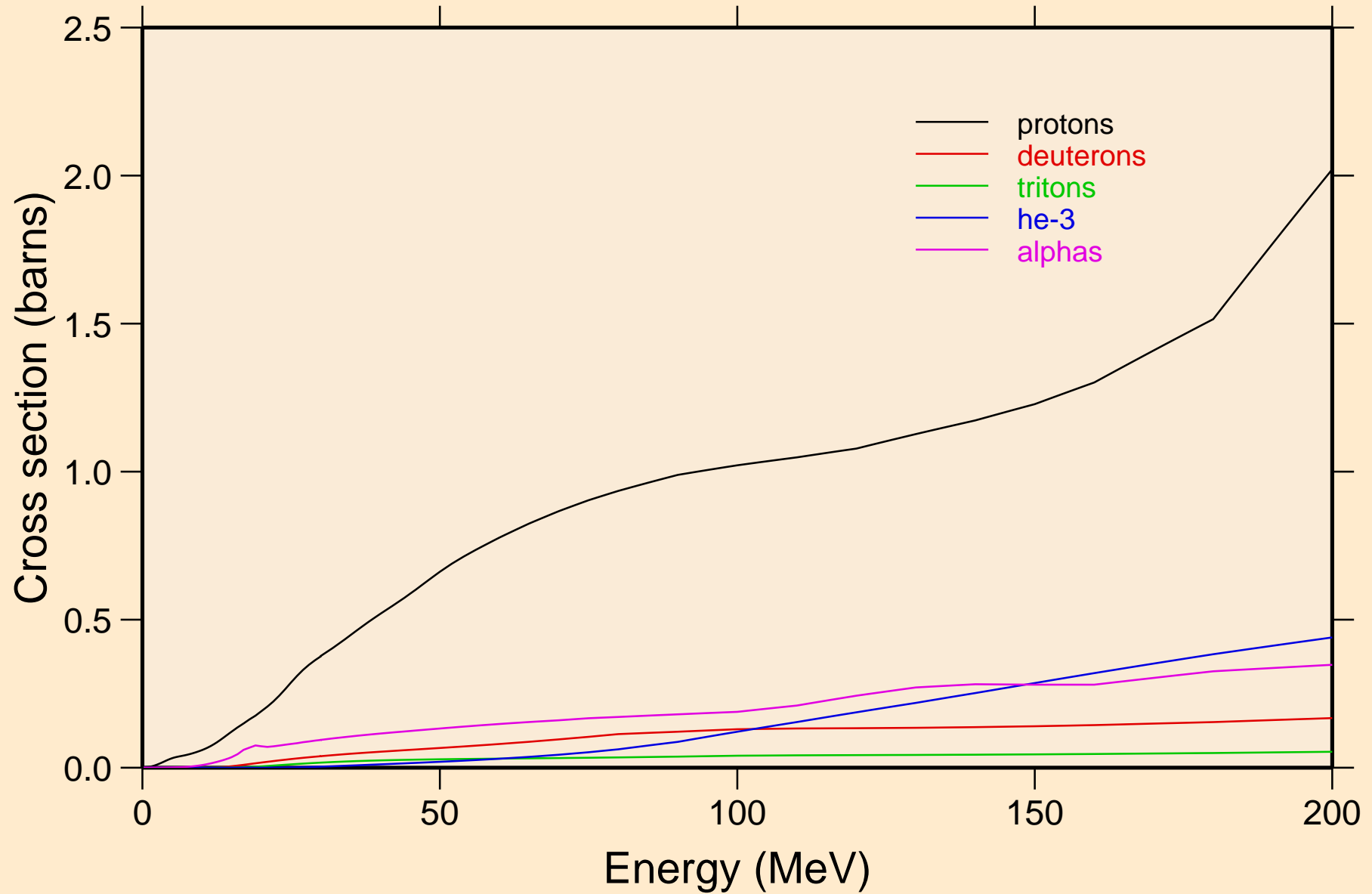

PB193M NEUTRON ACER TENDL-2021 LIBRARY; T=293.6K
protons from (n,x)

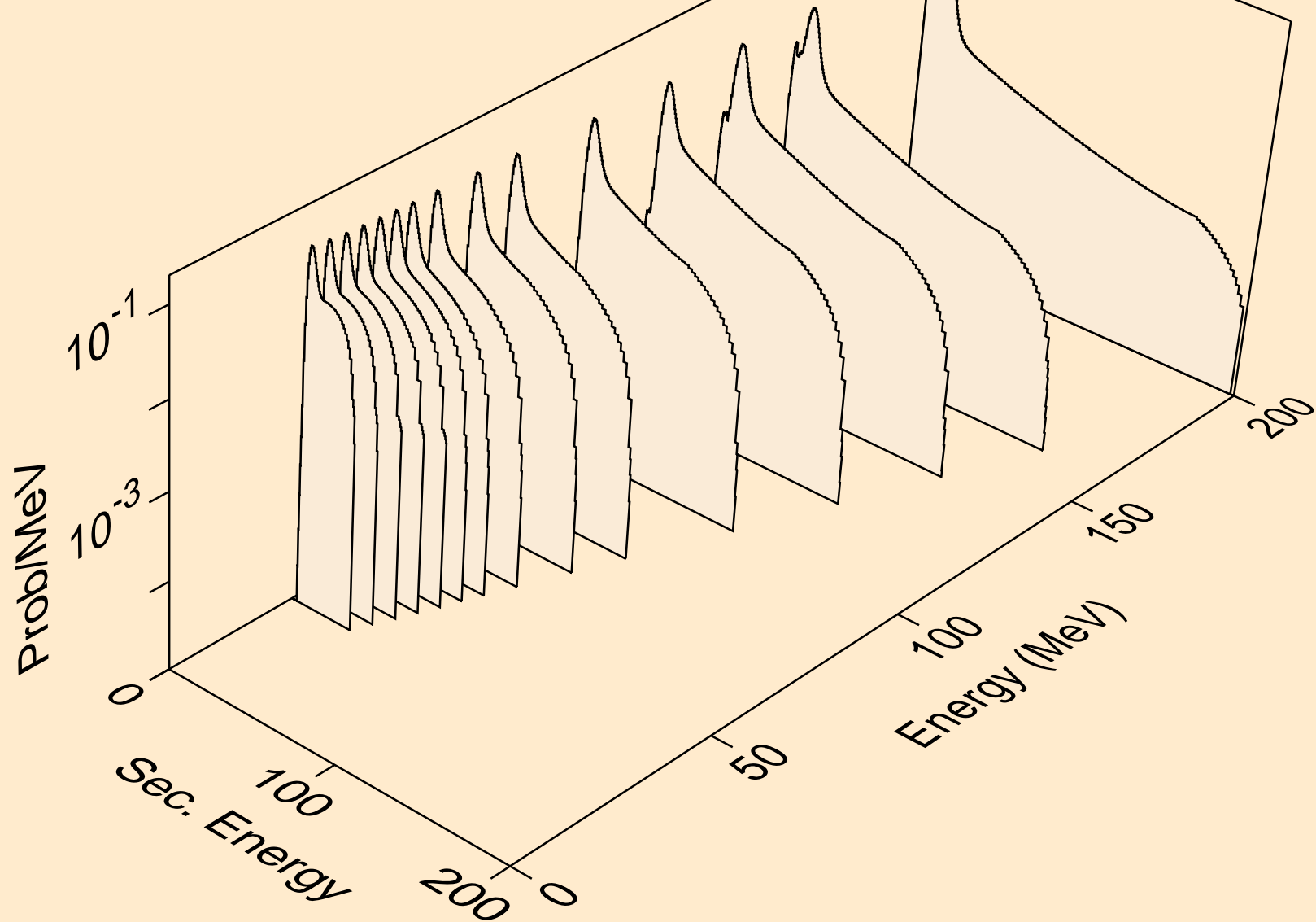

PB193M NEUTRON ACER TENDL-2021 LIBRARY; T=293.6K
protons from (n,n*)p

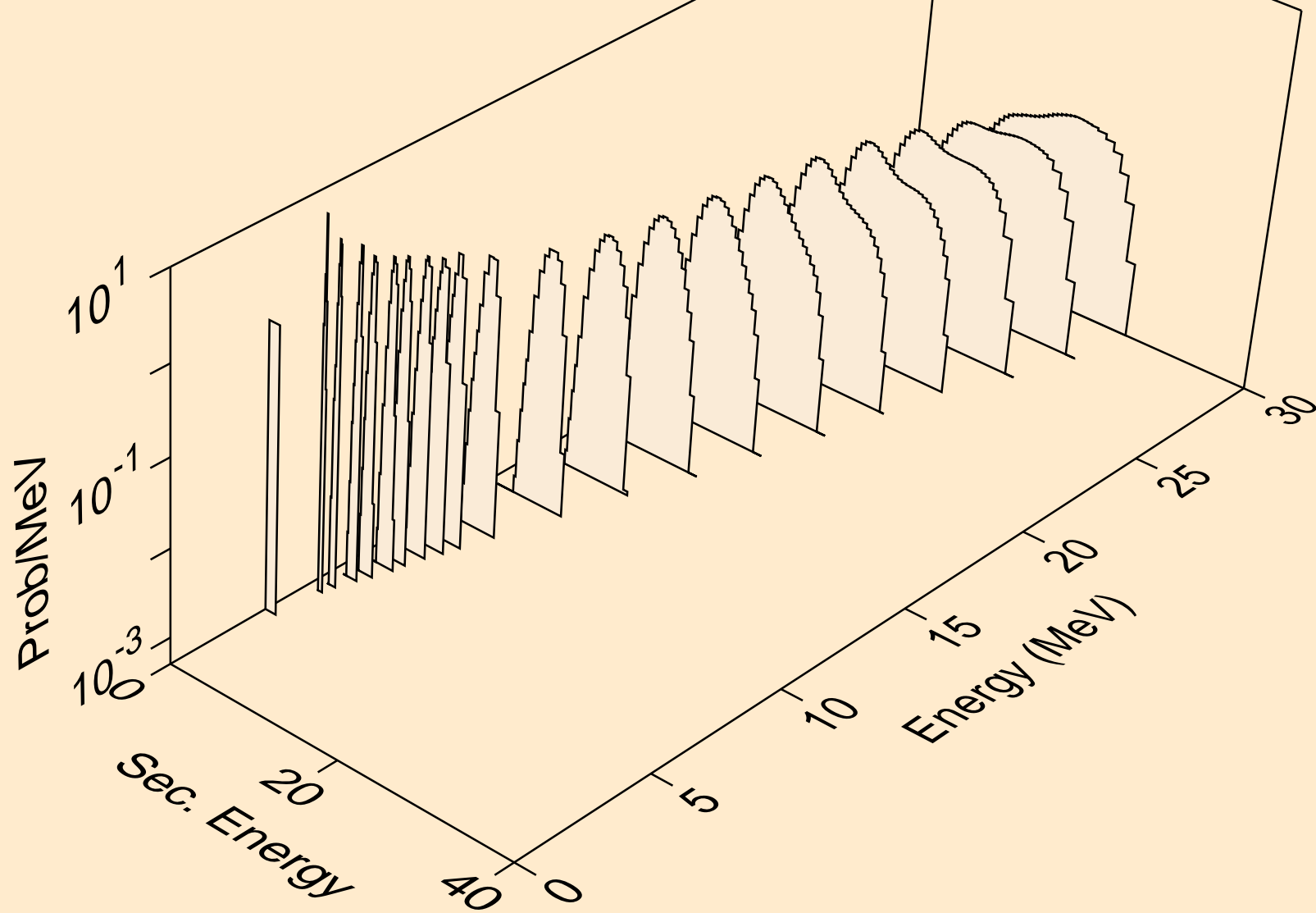

PB193M NEUTRON ACER TENDL-2021 LIBRARY; T=293.6K
protons from (n,2np)

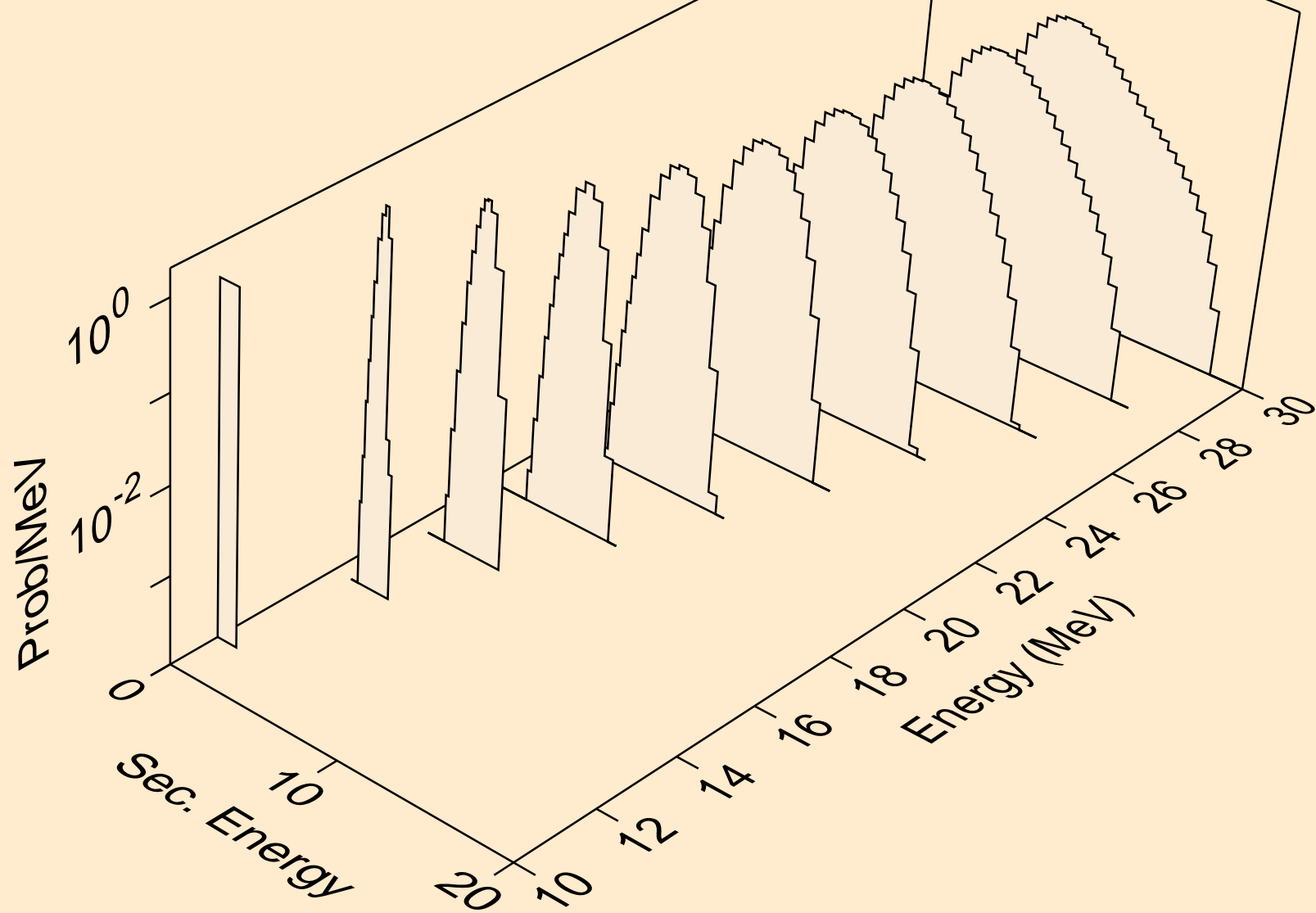

PB193M NEUTRON ACER TENDL-2021 LIBRARY; T=293.6K
protons from (n,3np)

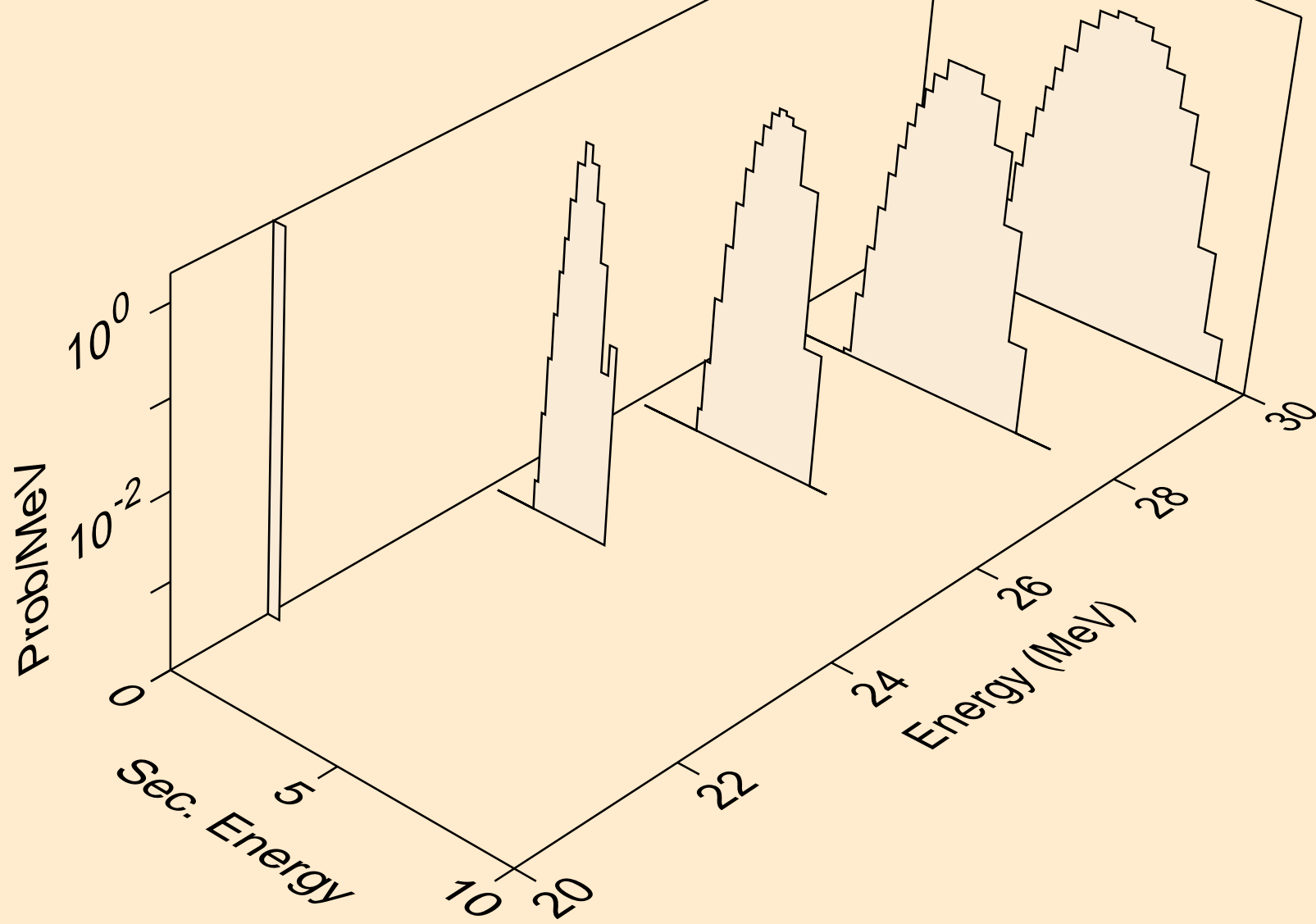

PB193M NEUTRON ACER TENDL-2021 LIBRARY; T=293.6K
protons from (n,2np)

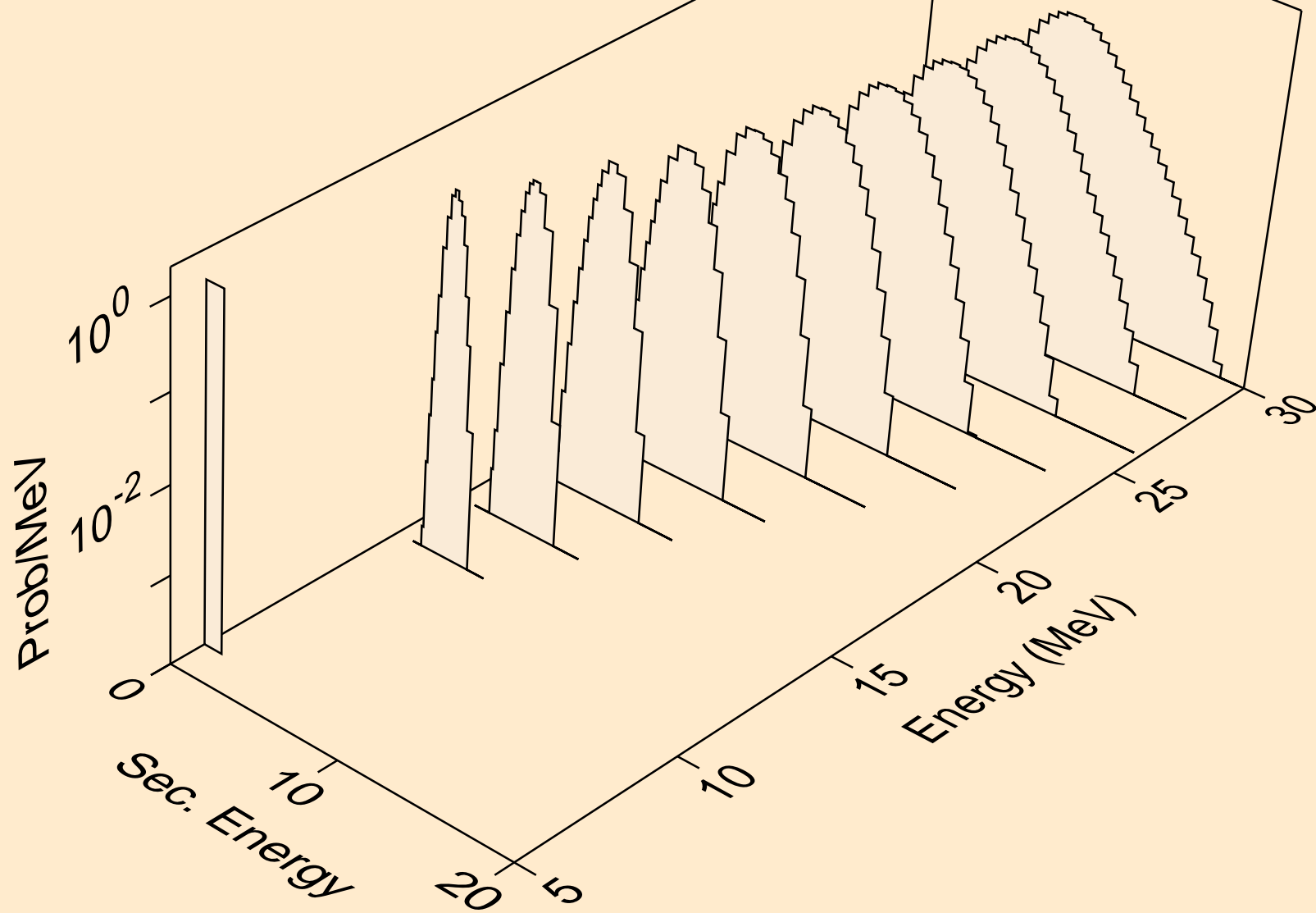

PB193M NEUTRON ACER TENDL-2021 LIBRARY; T=293.6K
protons from (n,npa)

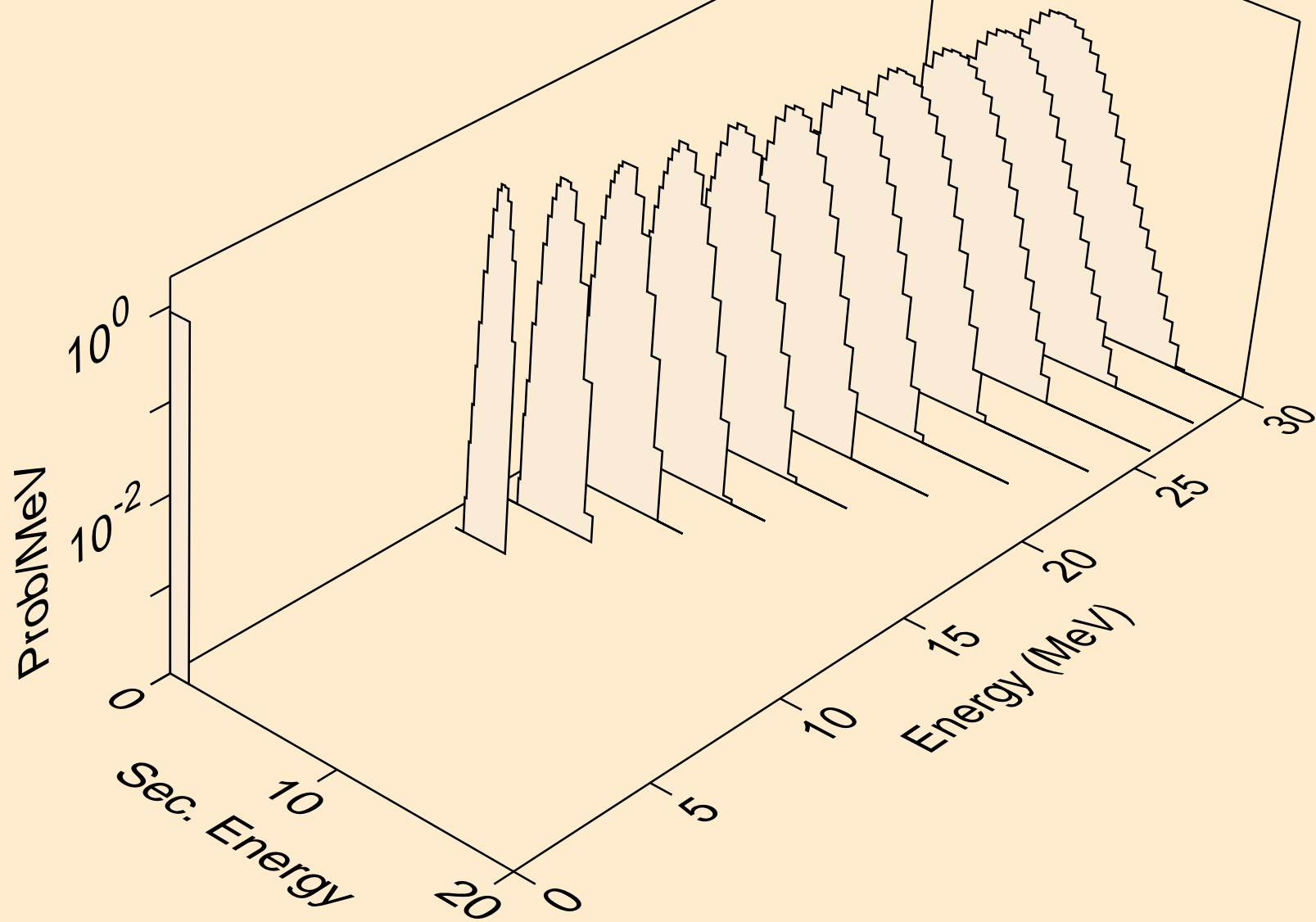

PB193M NEUTRON ACER TENDL-2021 LIBRARY; T=293.6K
protons from (n,p)

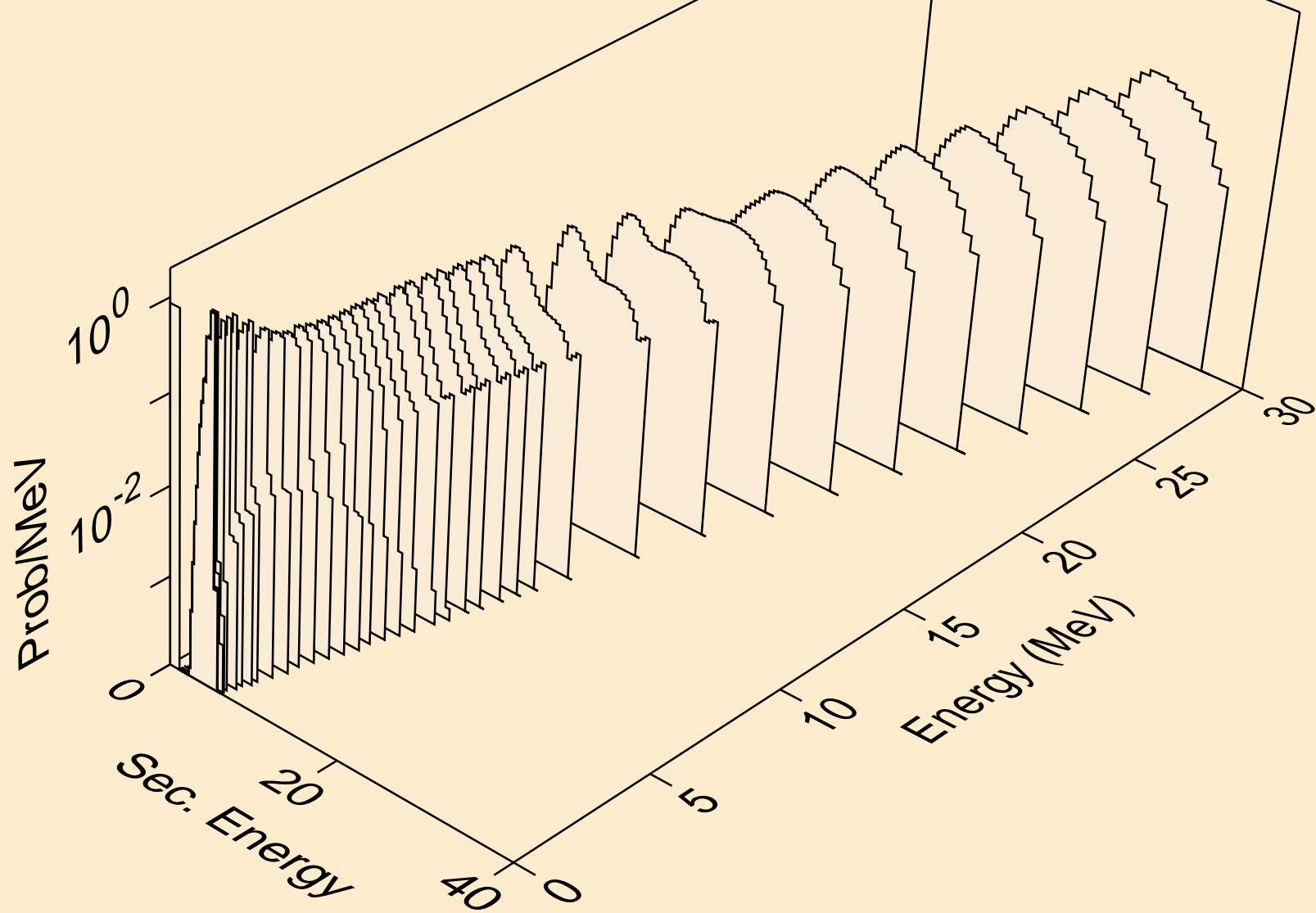

PB193M NEUTRON ACER TENDL-2021 LIBRARY; T=293.6K
protons from (n,2p)

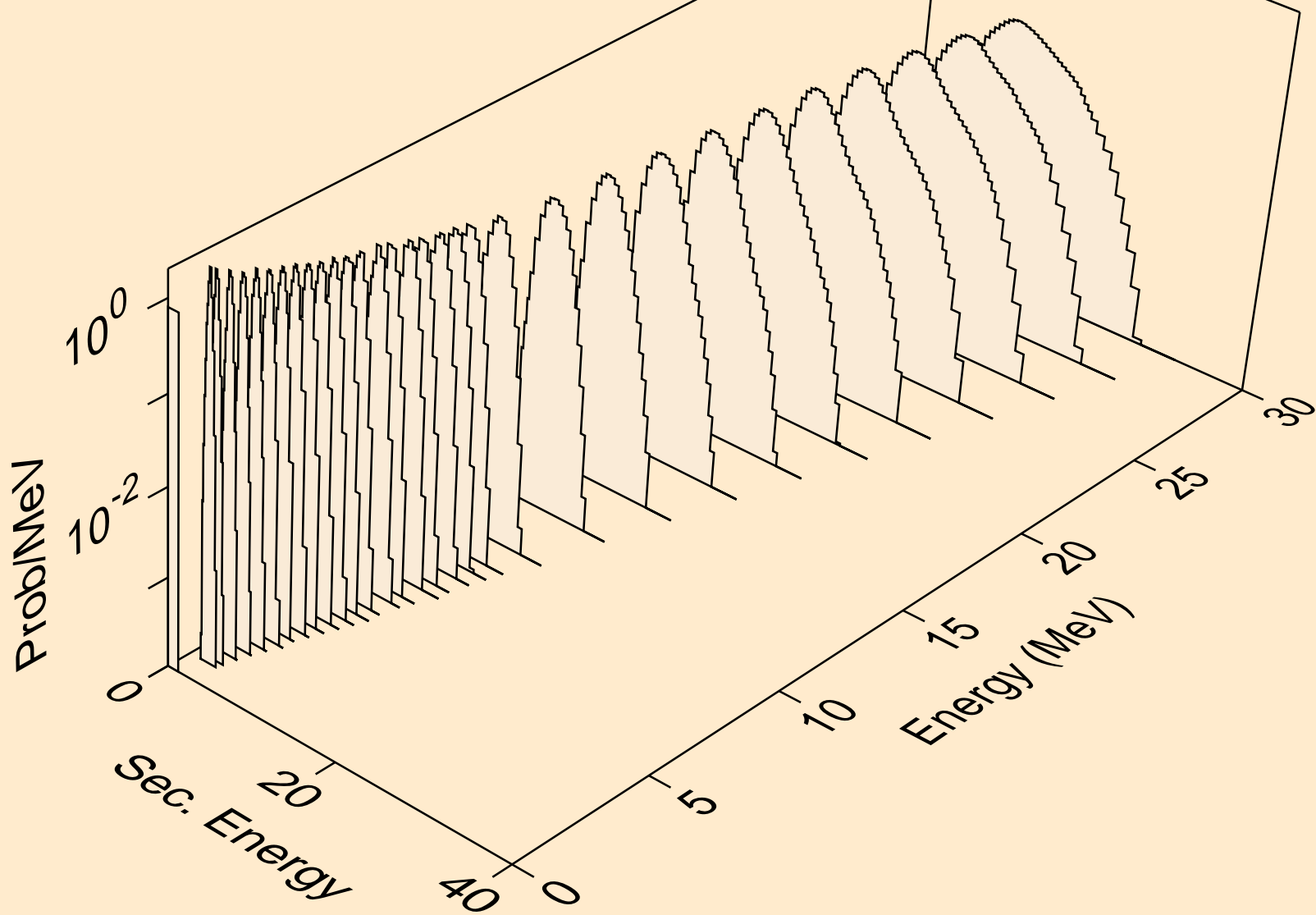

PB193M NEUTRON ACER TENDL-2021 LIBRARY; T=293.6K
protons from (n,p)

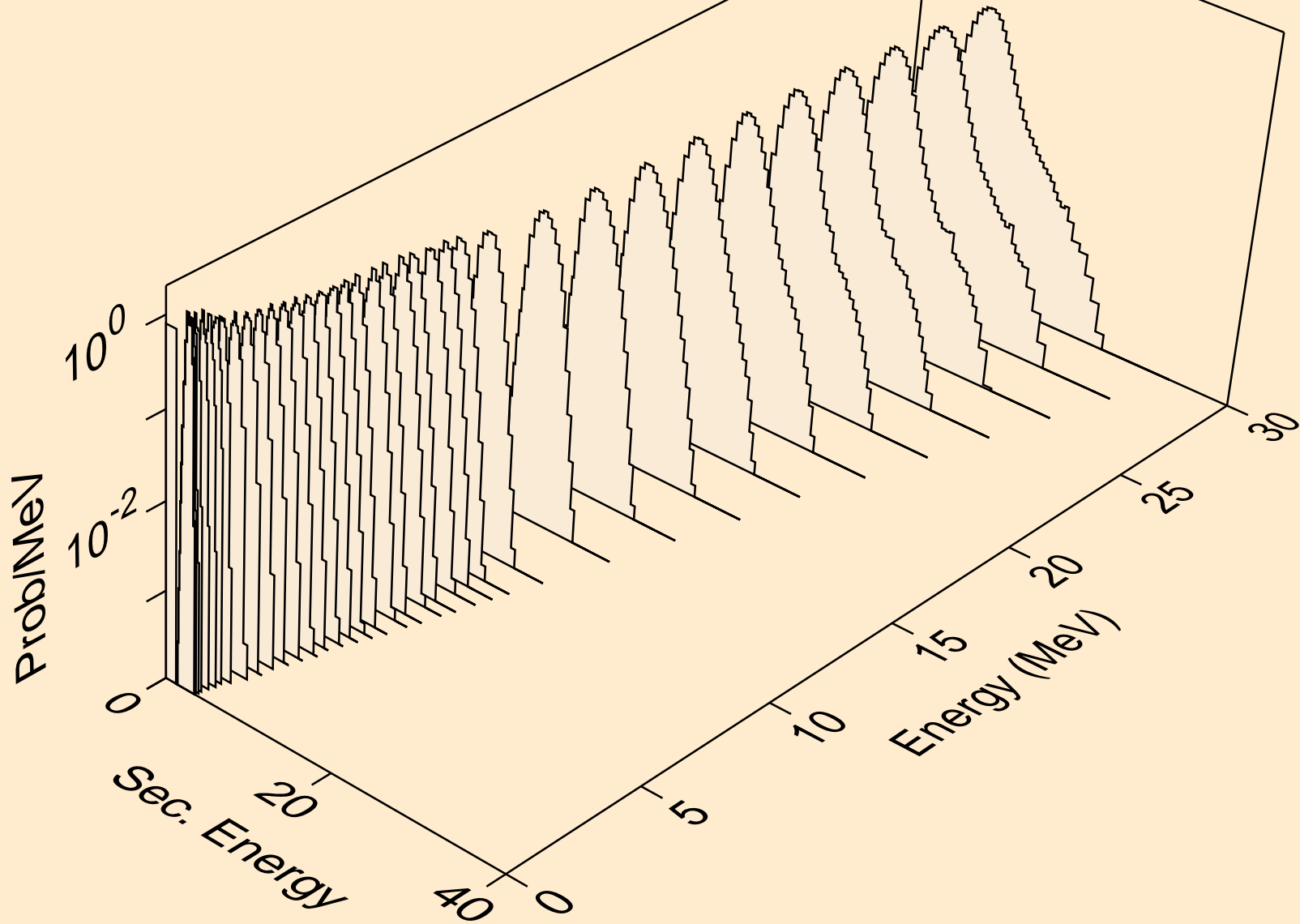

PB193M NEUTRON ACER TENDL-2021 LIBRARY; T=293.6K
protons from (n,pd)

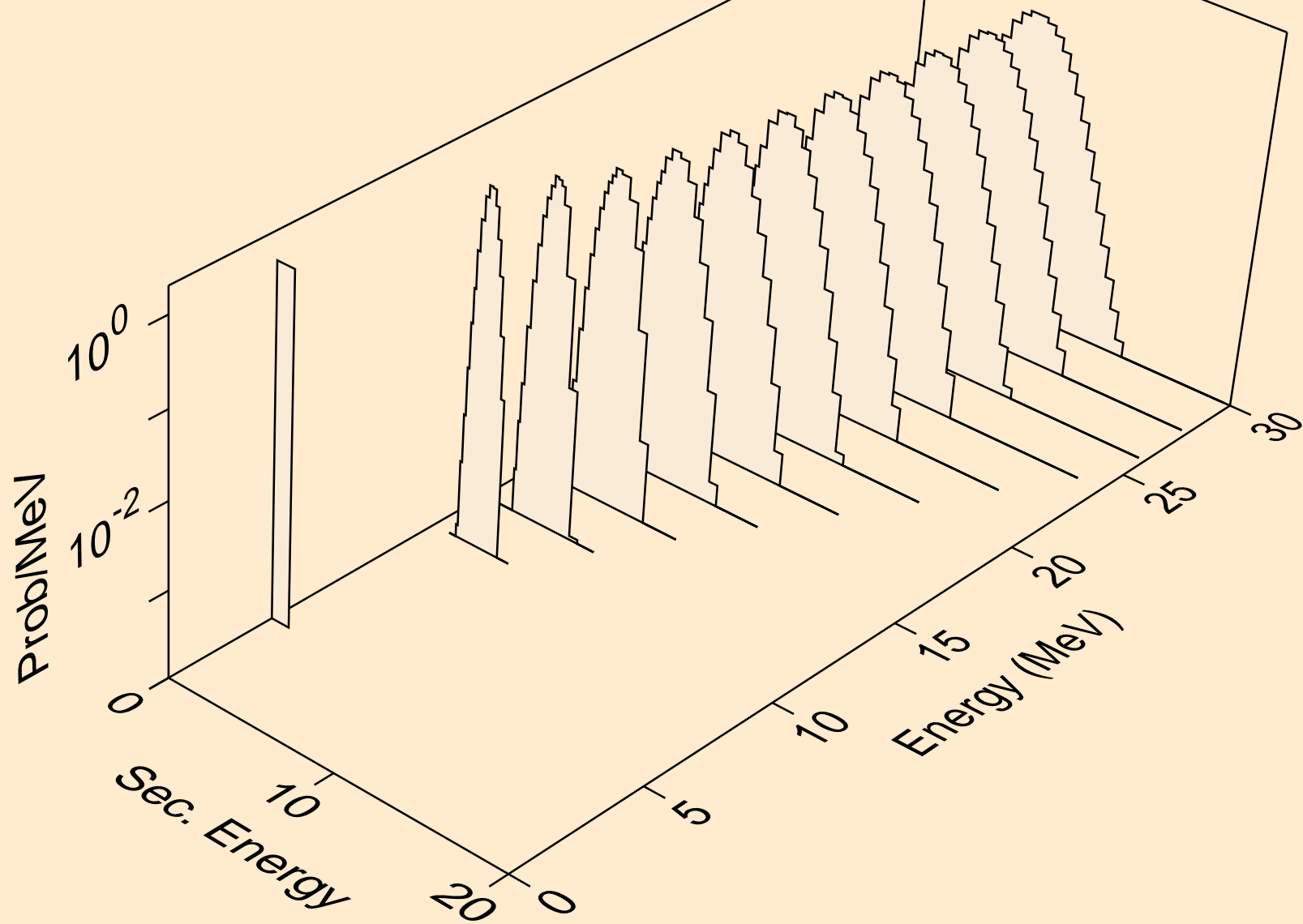

PB193M NEUTRON ACER TENDL-2021 LIBRARY; T=293.6K
protons from (n,pt)

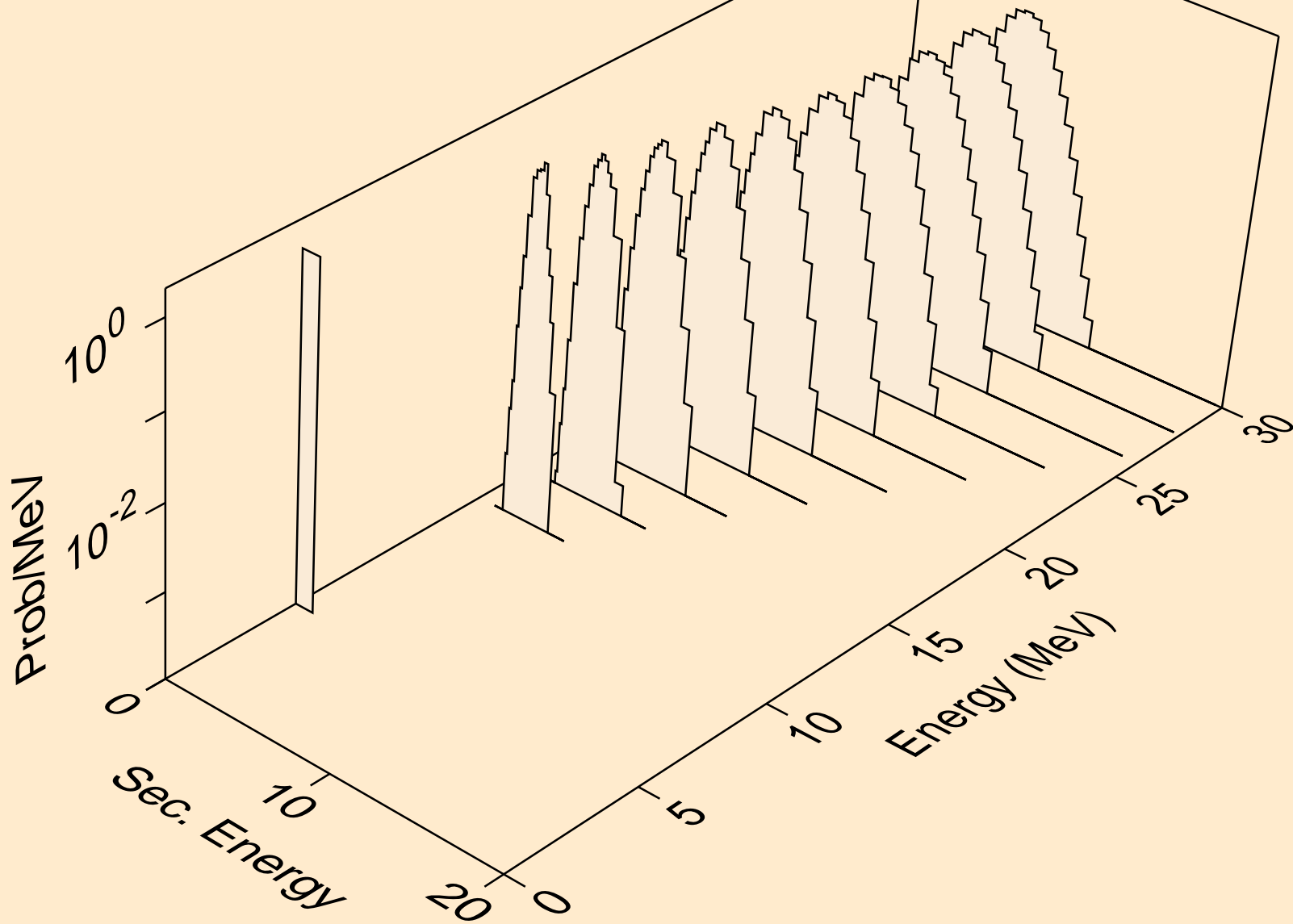

PB193M NEUTRON ACER TENDL-2021 LIBRARY; T=293.6K
deuterons from (n,x)

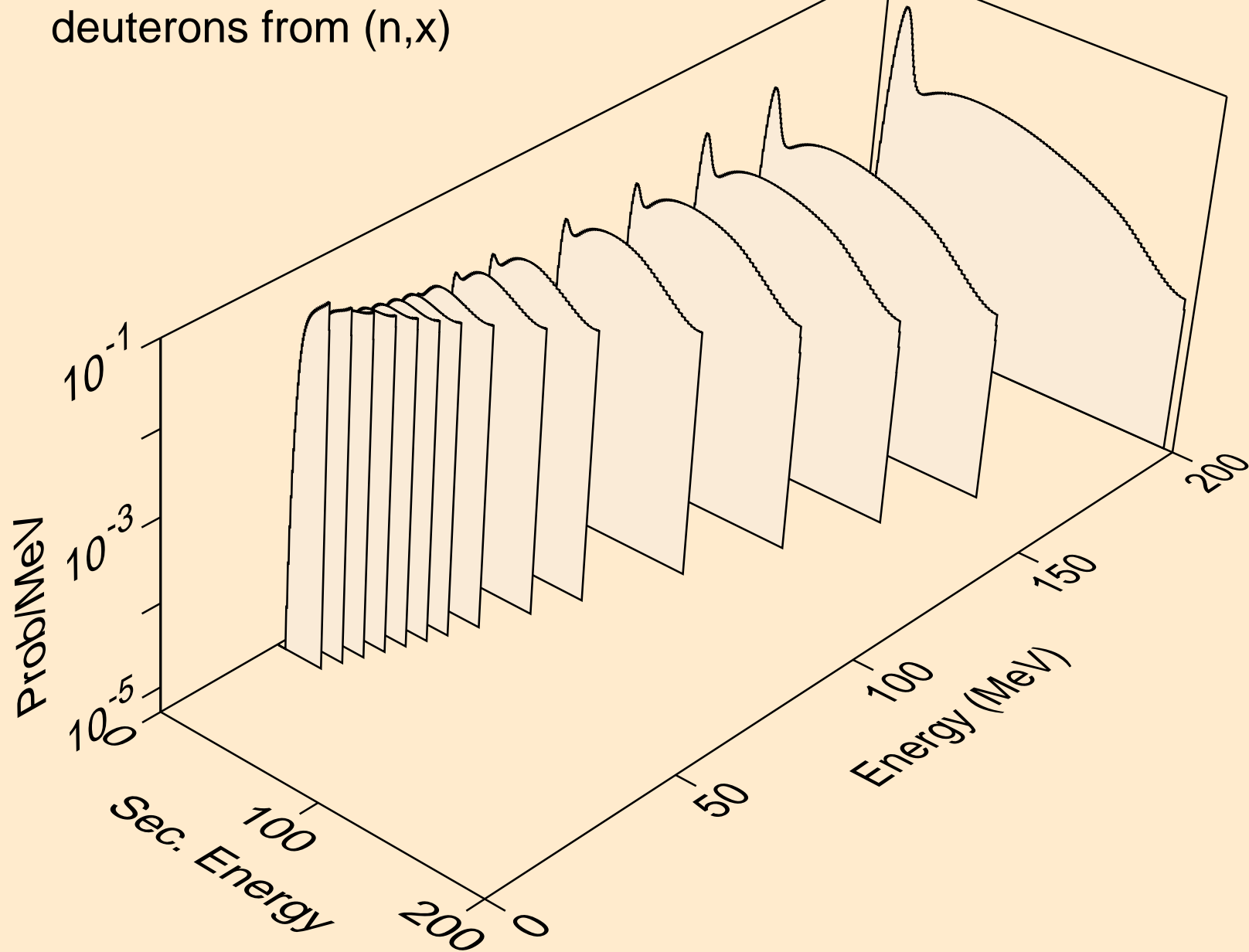

PB193M NEUTRON ACER TENDL-2021 LIBRARY; T=293.6K
deuterons from (n,2nd)

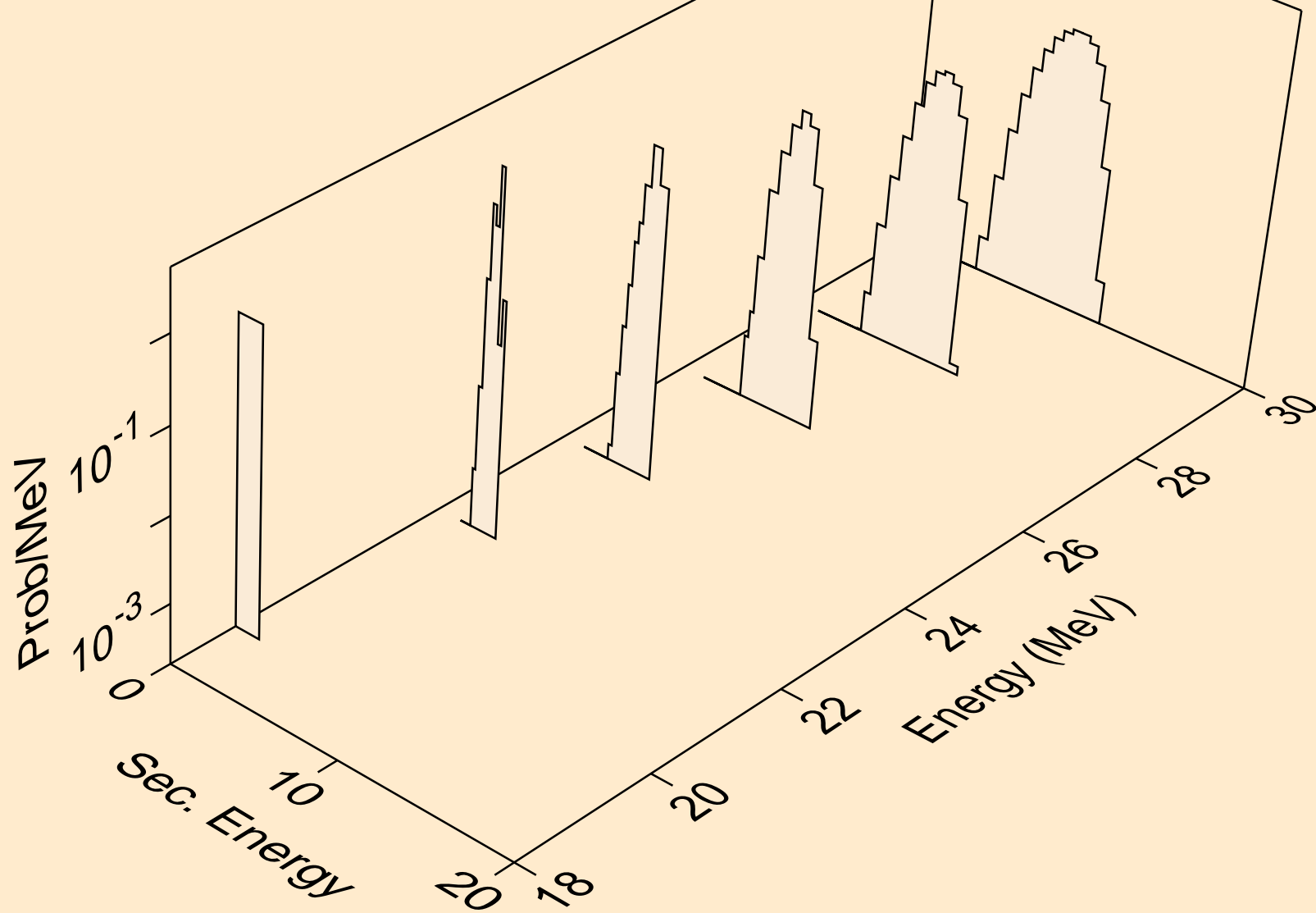

PB193M NEUTRON ACER TENDL-2021 LIBRARY; T=293.6K
deuterons from (n,n*)d

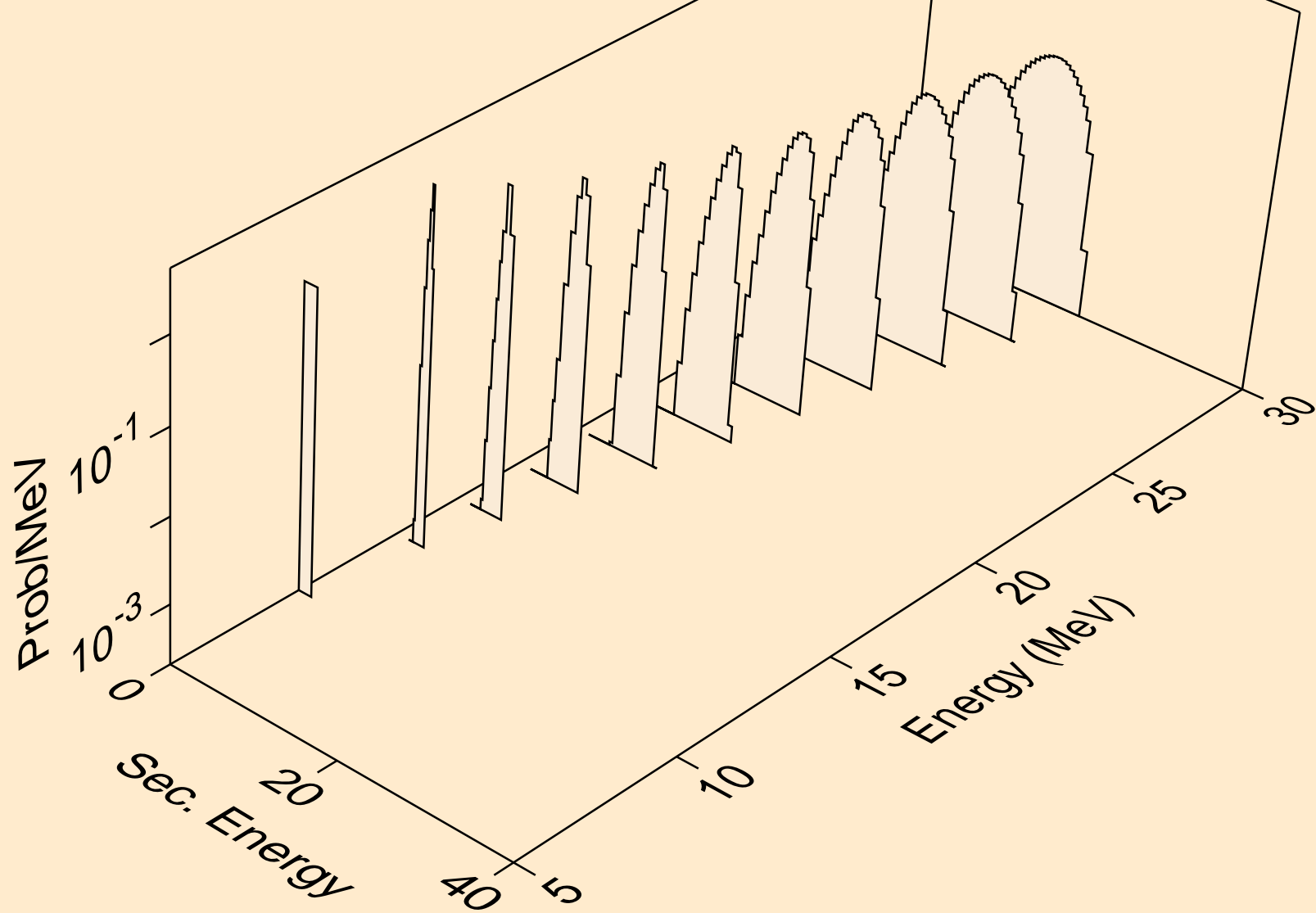

PB193M NEUTRON ACER TENDL-2021 LIBRARY; T=293.6K
deuterons from (n,d)

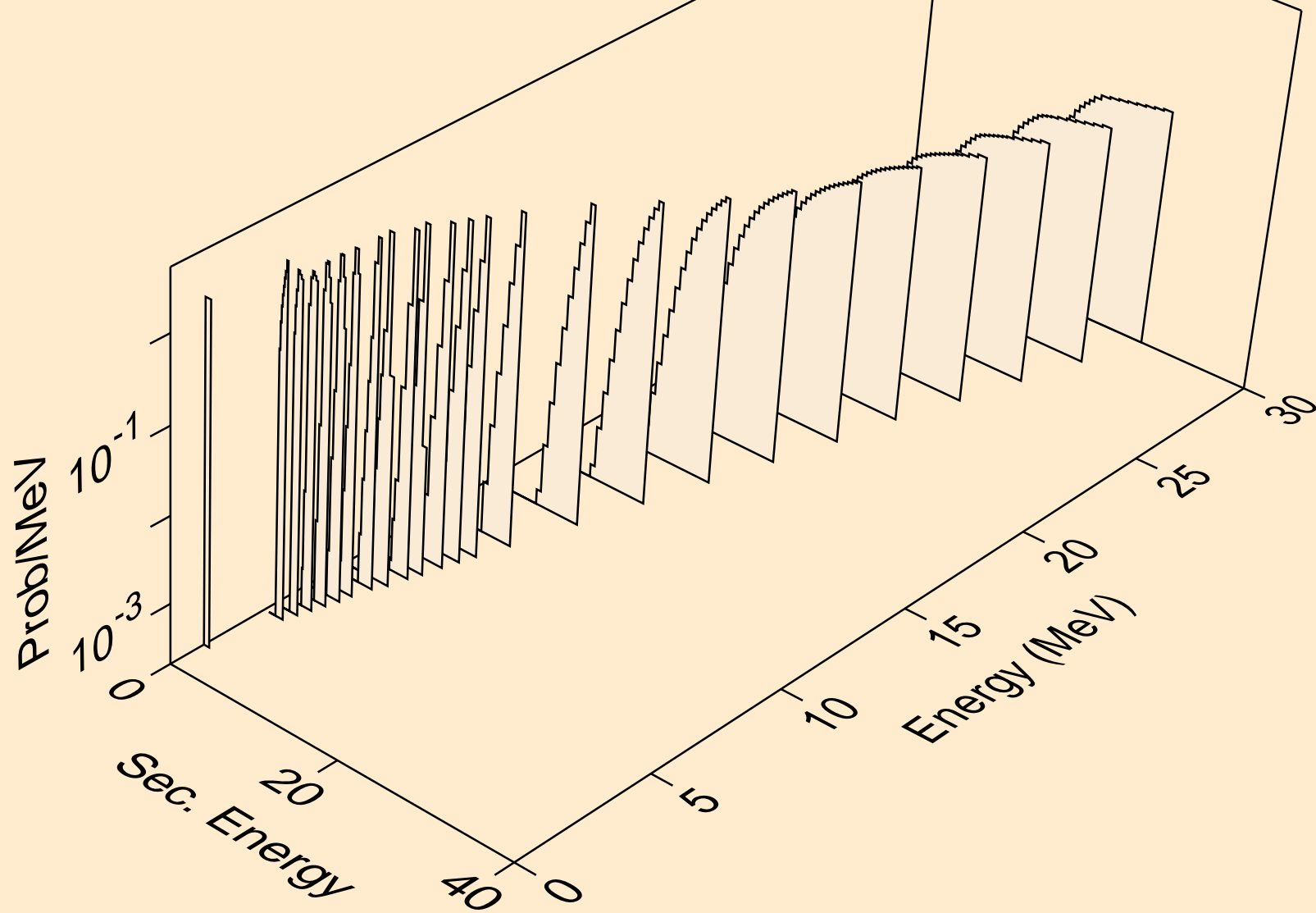

PB193M NEUTRON ACER TENDL-2021 LIBRARY; T=293.6K
deuterons from (n,pd)

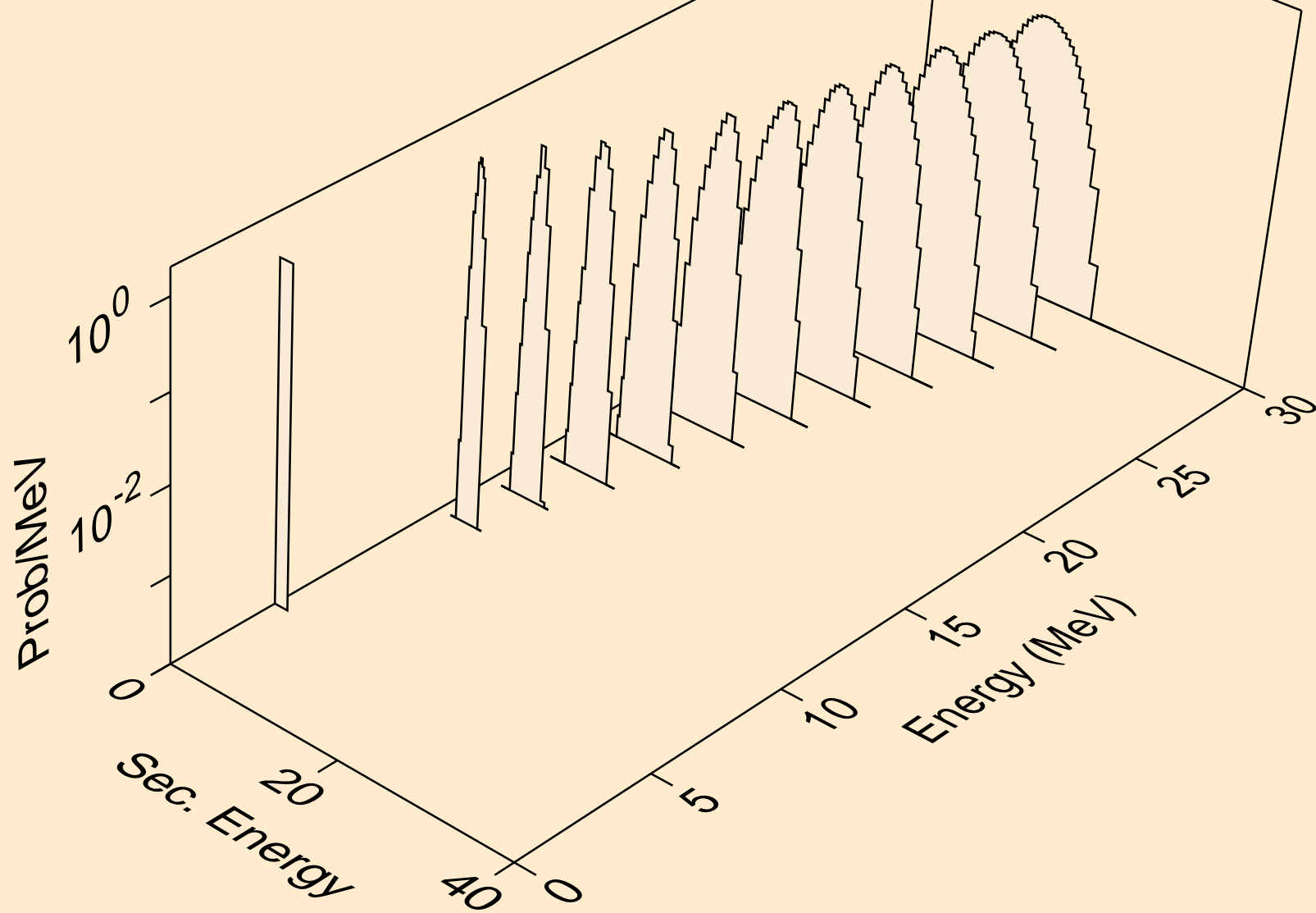

PB193M NEUTRON ACER TENDL-2021 LIBRARY; T=293.6K
deuterons from (n,da)

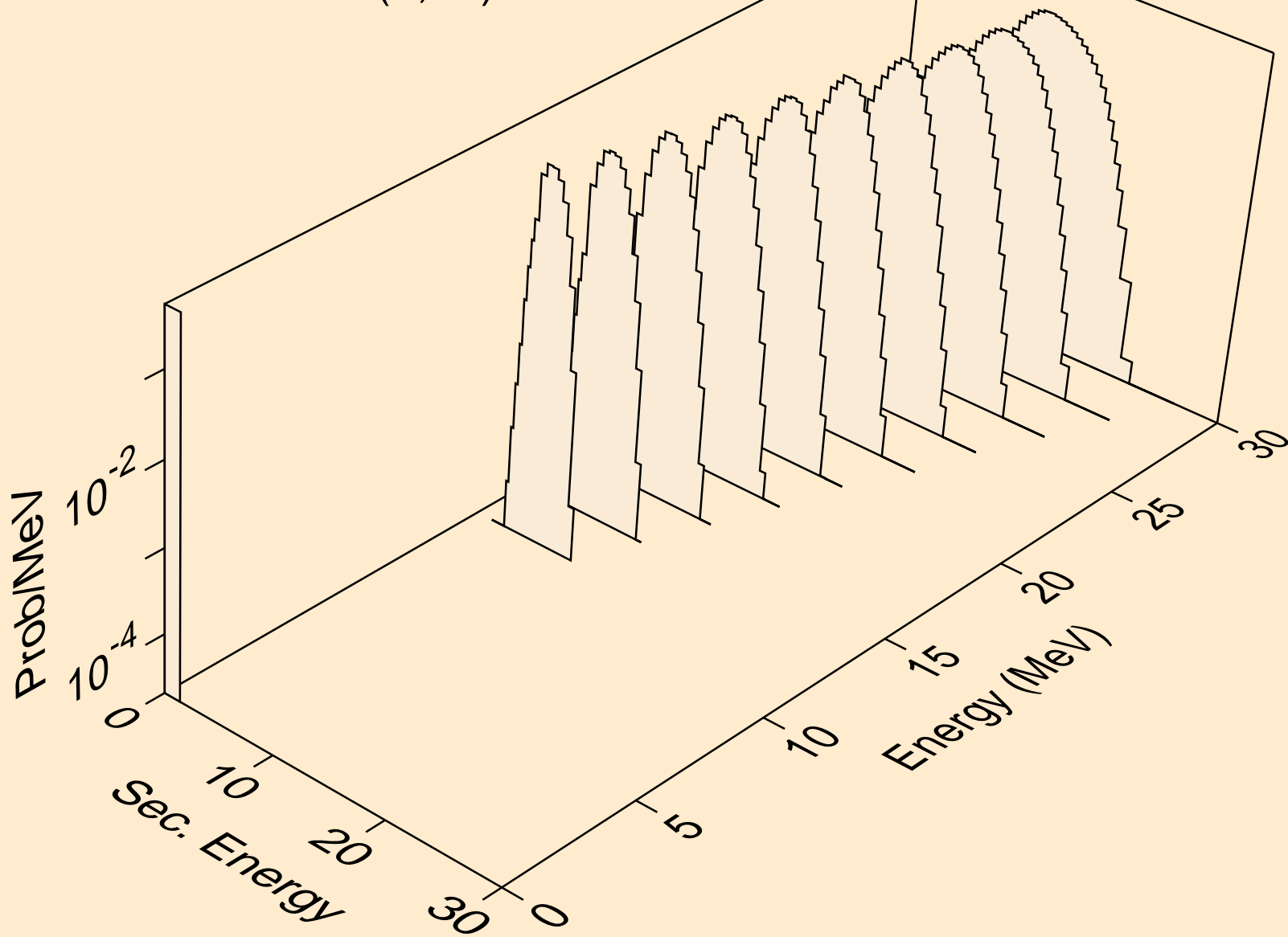

PB193M NEUTRON ACER TENDL-2021 LIBRARY; T=293.6K
tritons from (n,x)

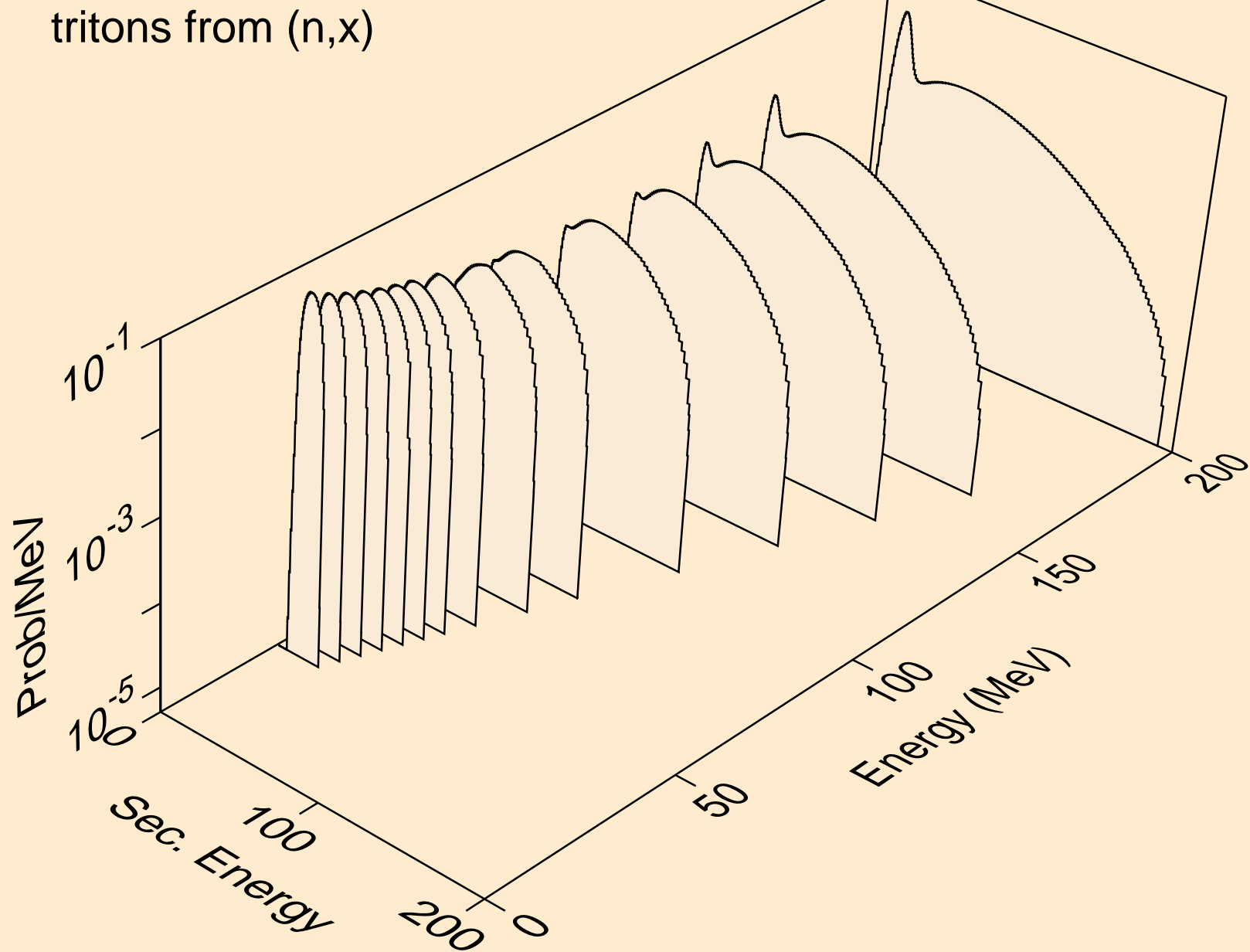

PB193M NEUTRON ACER TENDL-2021 LIBRARY; T=293.6K
tritons from (n,n*)t

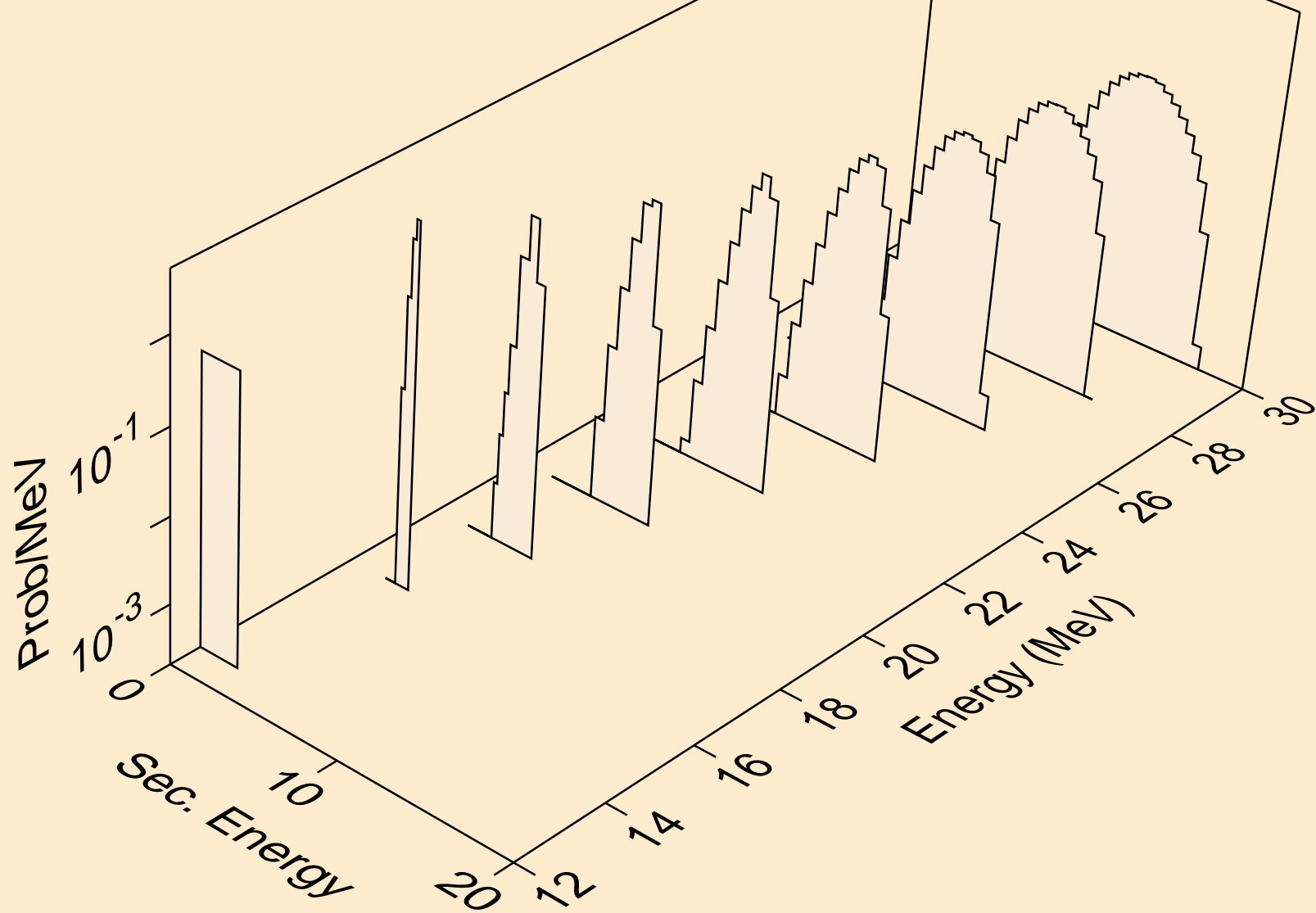

PB193M NEUTRON ACER TENDL-2021 LIBRARY; T=293.6K
tritons from (n,t)

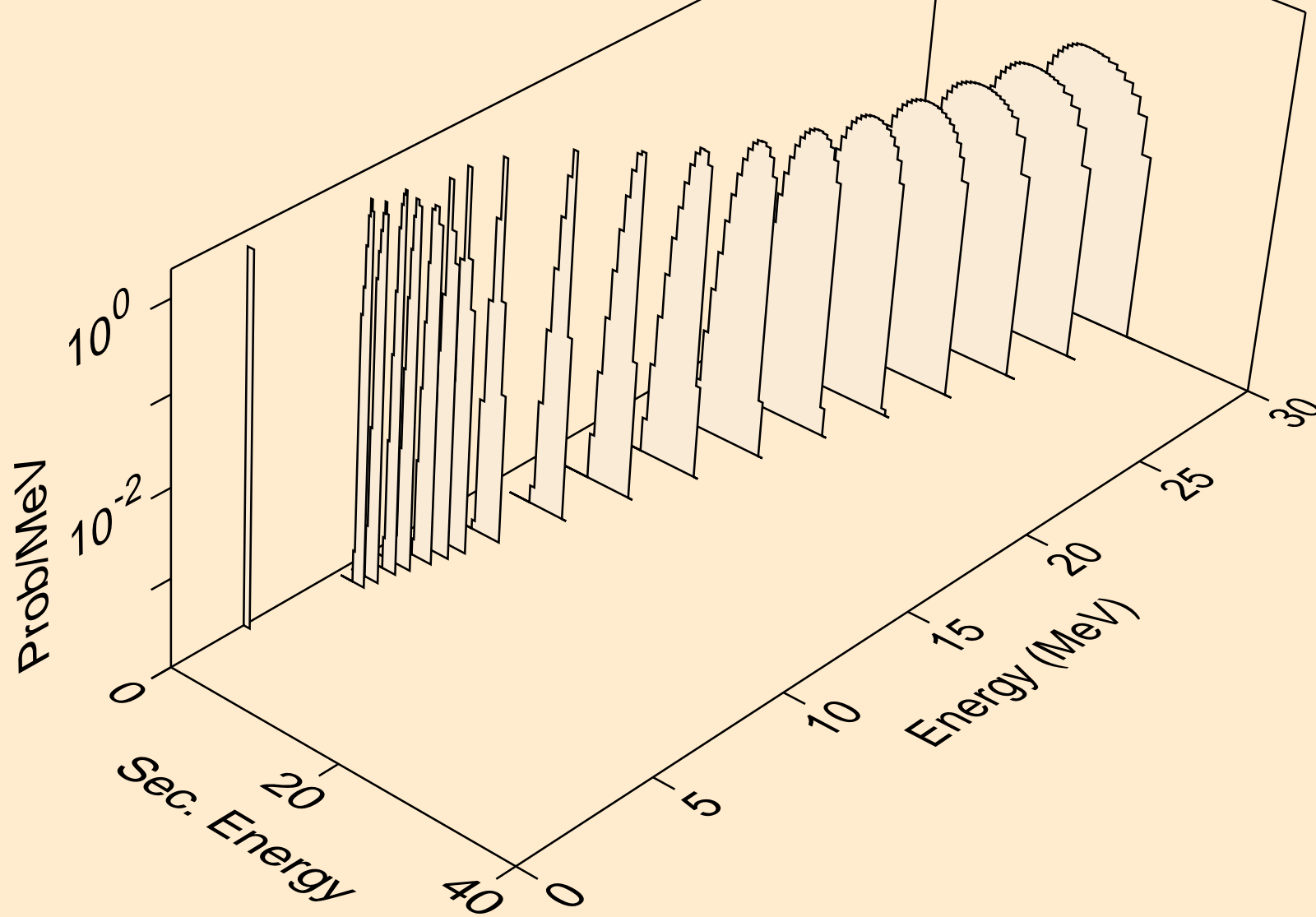

PB193M NEUTRON ACER TENDL-2021 LIBRARY; T=293.6K
tritons from (n,pt)

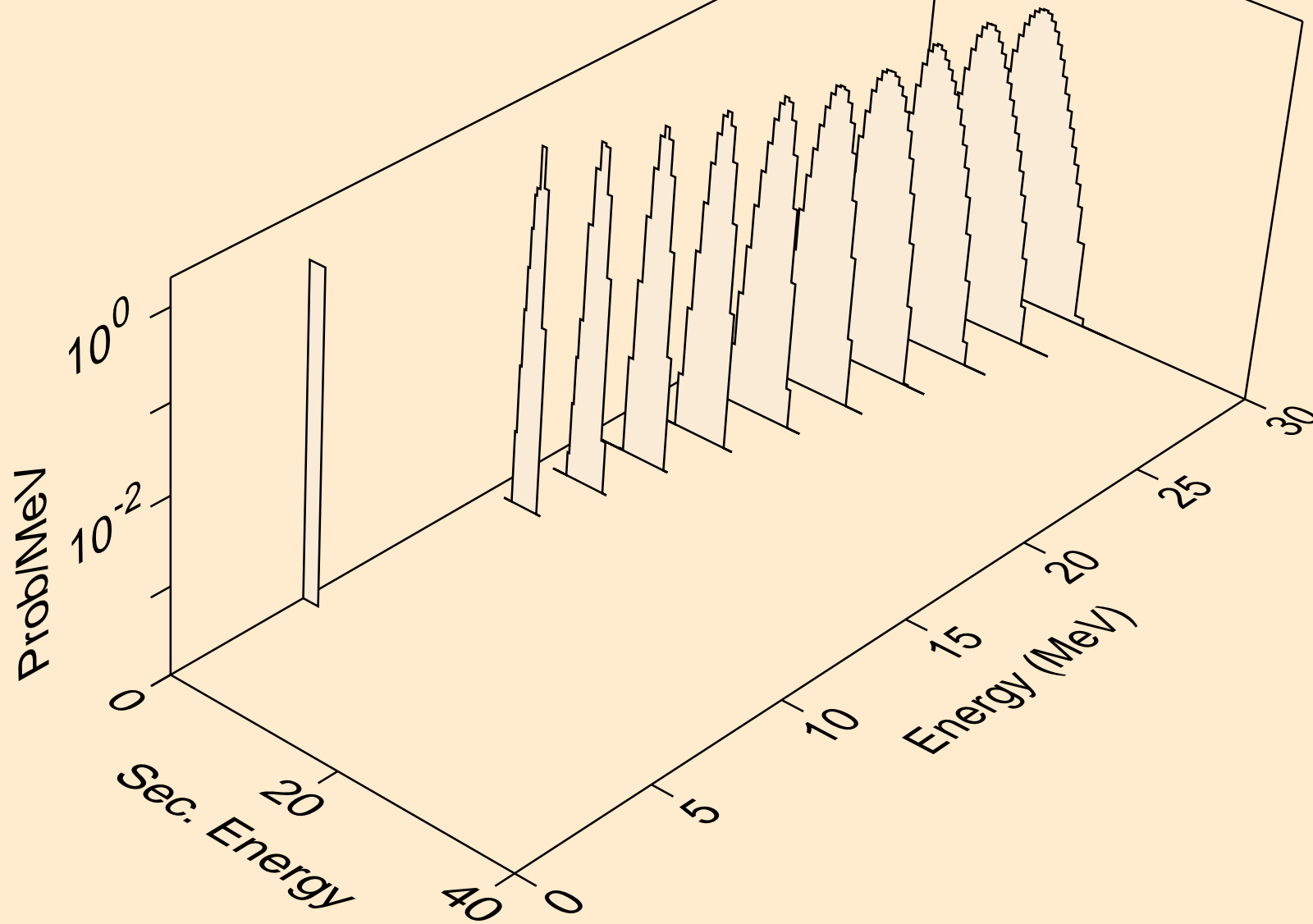

PB193M NEUTRON ACER TENDL-2021 LIBRARY; T=293.6K
he3s from (n,x)

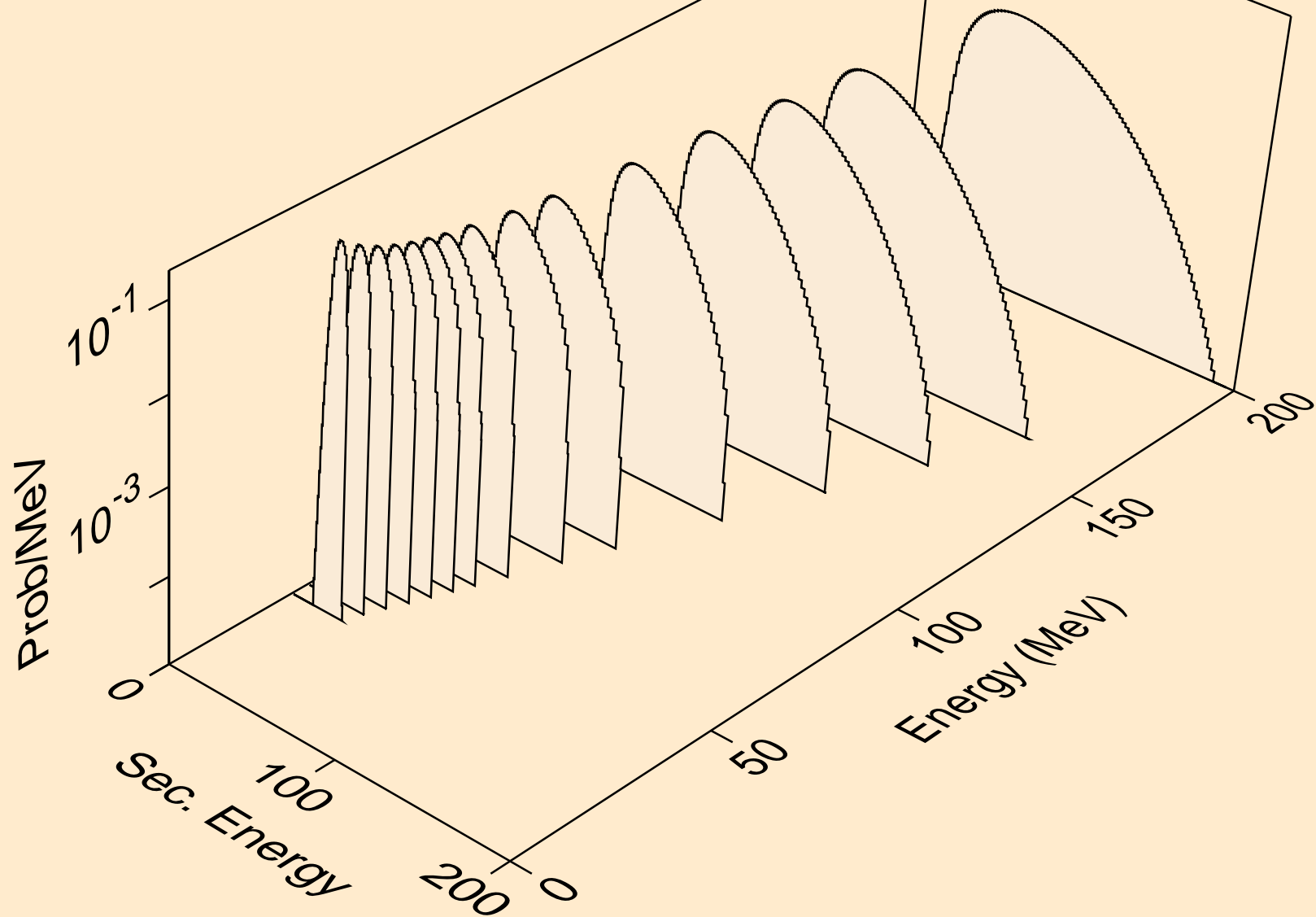

PB193M NEUTRON ACER TENDL-2021 LIBRARY; T=293.6K
he3s from (n,n*)he3

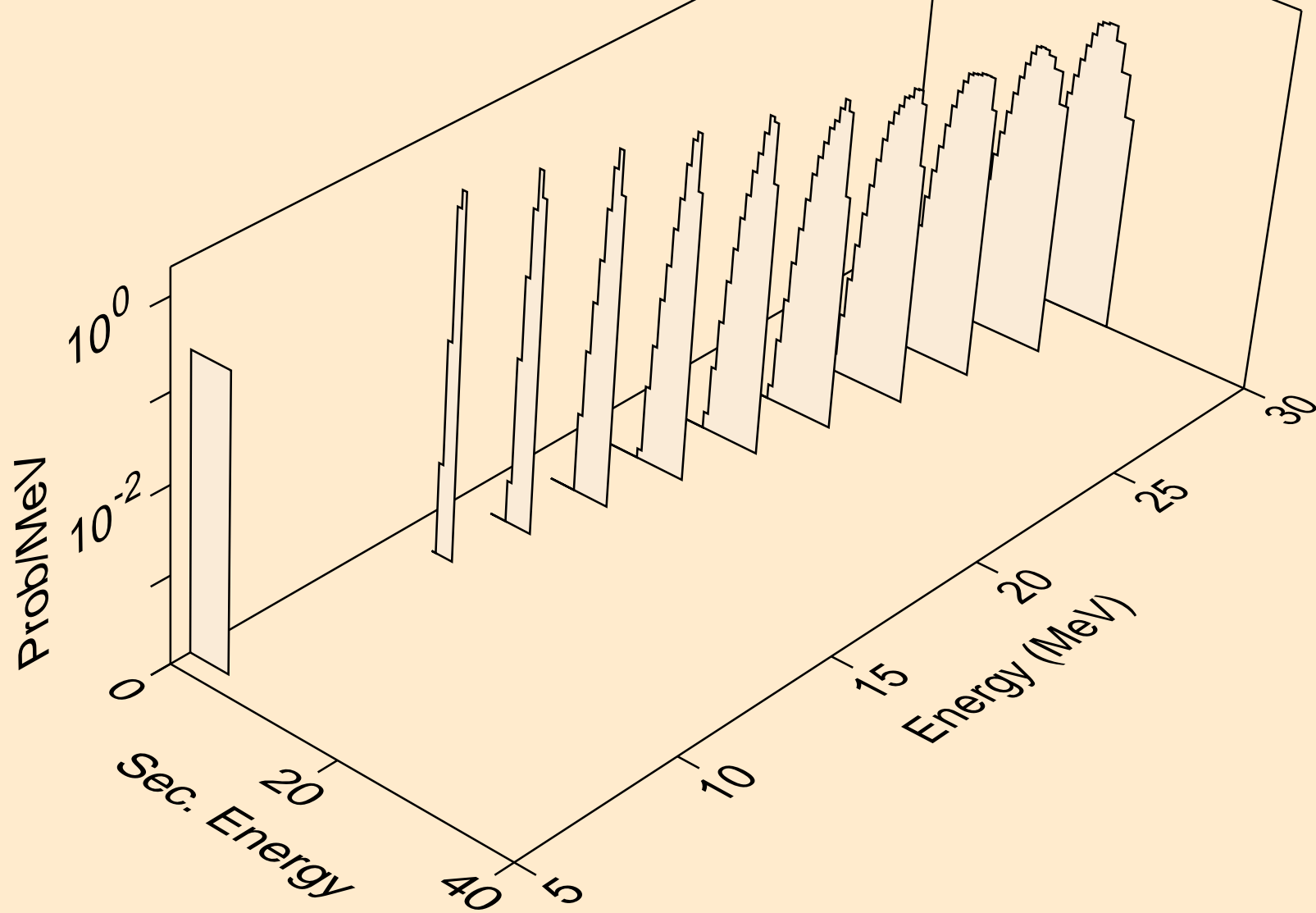

PB193M NEUTRON ACER TENDL-2021 LIBRARY; T=293.6K
he3s from (n,he3)

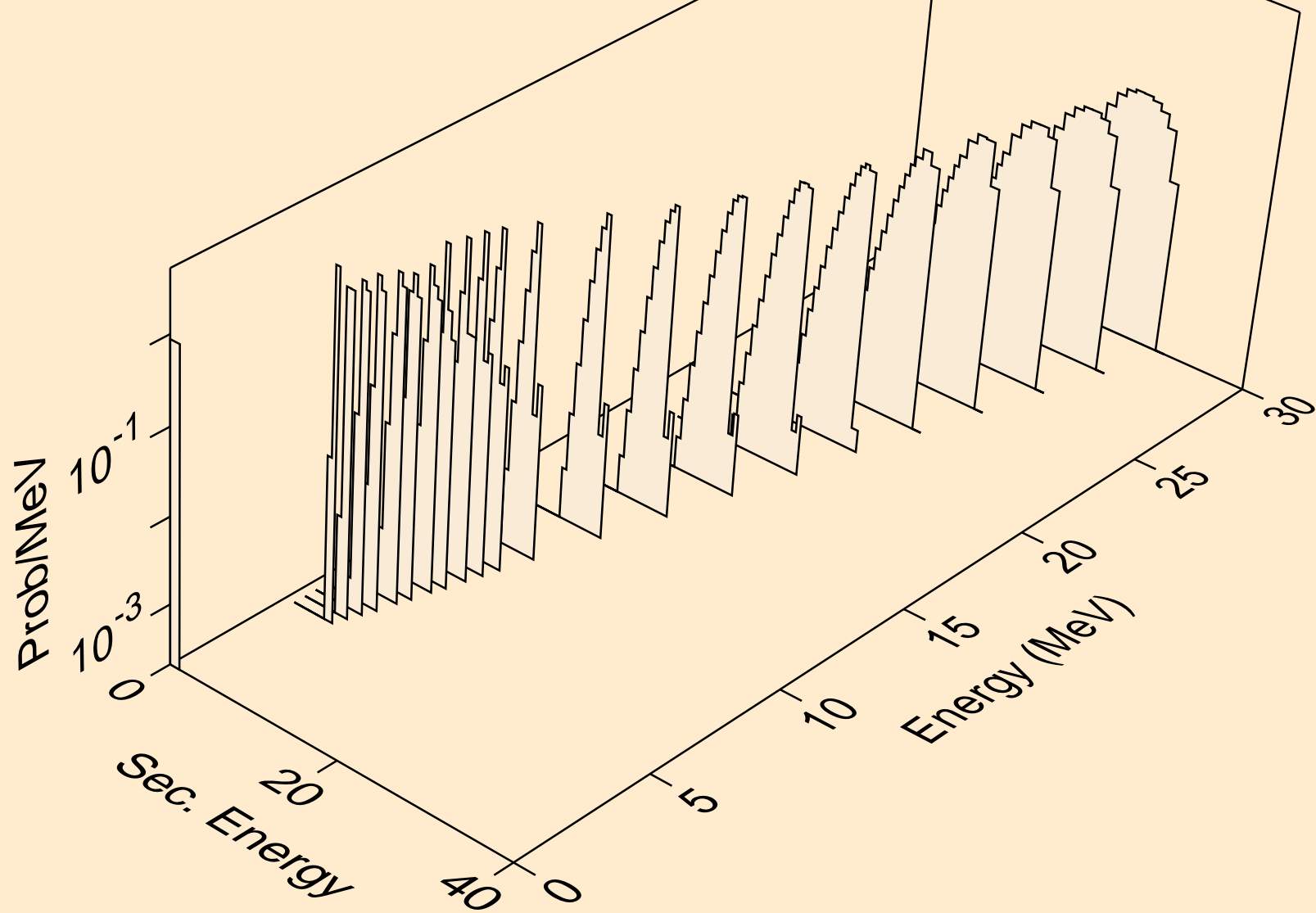

PB193M NEUTRON ACER TENDL-2021 LIBRARY; T=293.6K
alphas from (n,x)

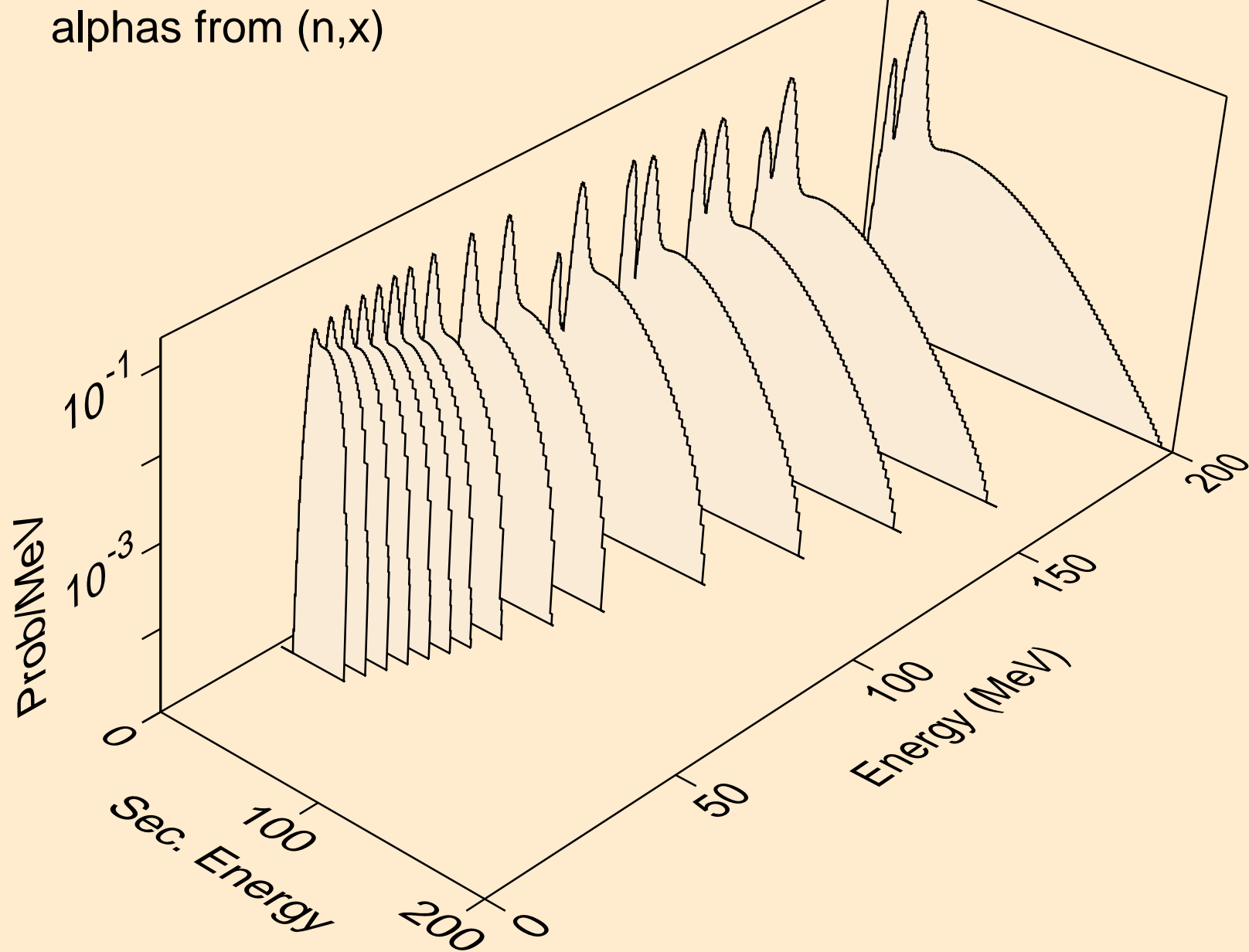

PB193M NEUTRON ACER TENDL-2021 LIBRARY; T=293.6K
alphas from (n,n*)a

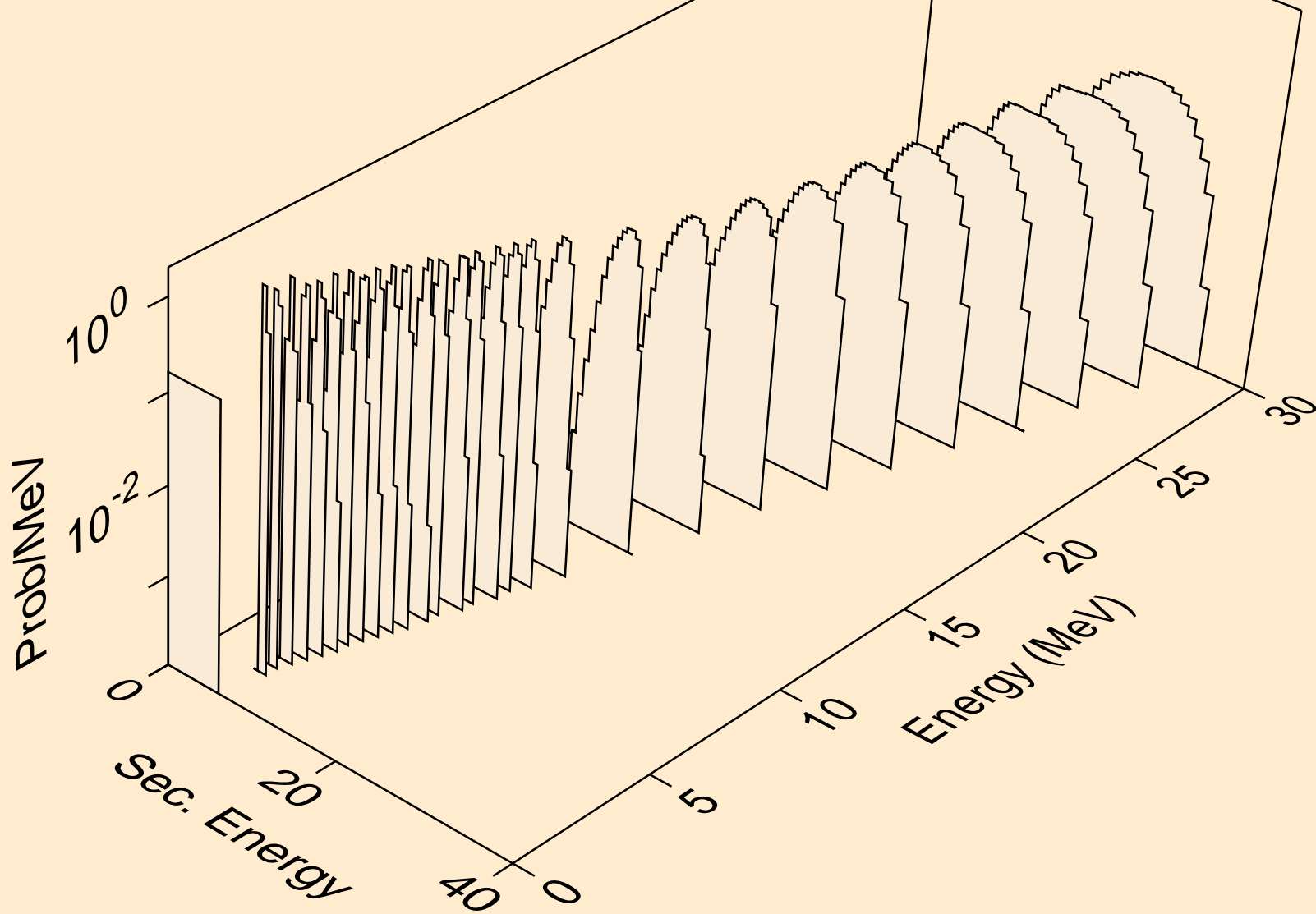

PB193M NEUTRON ACER TENDL-2021 LIBRARY; T=293.6K
alphas from (n,2n)a

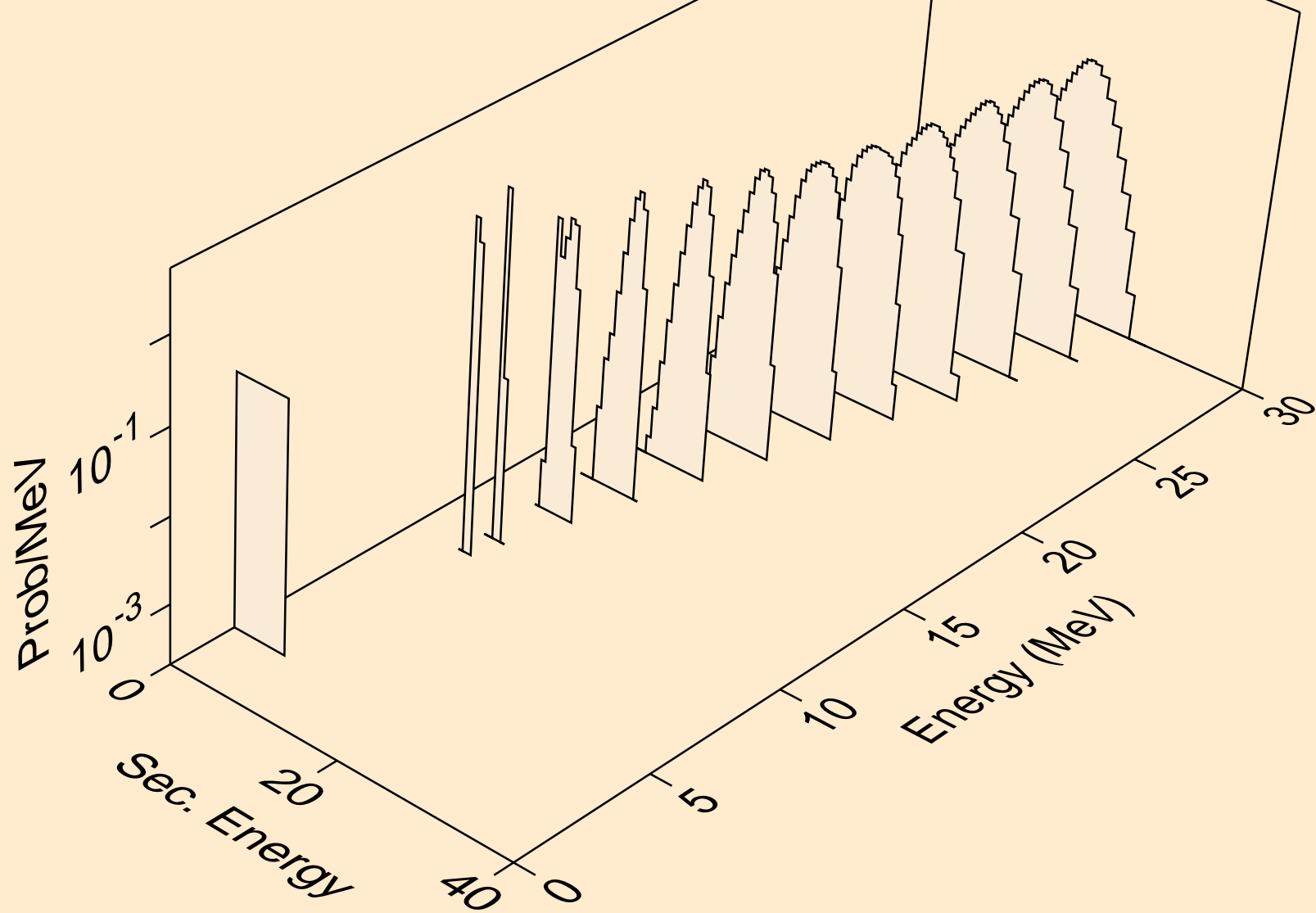

PB193M NEUTRON ACER TENDL-2021 LIBRARY; T=293.6K
alphas from (n,3n)a

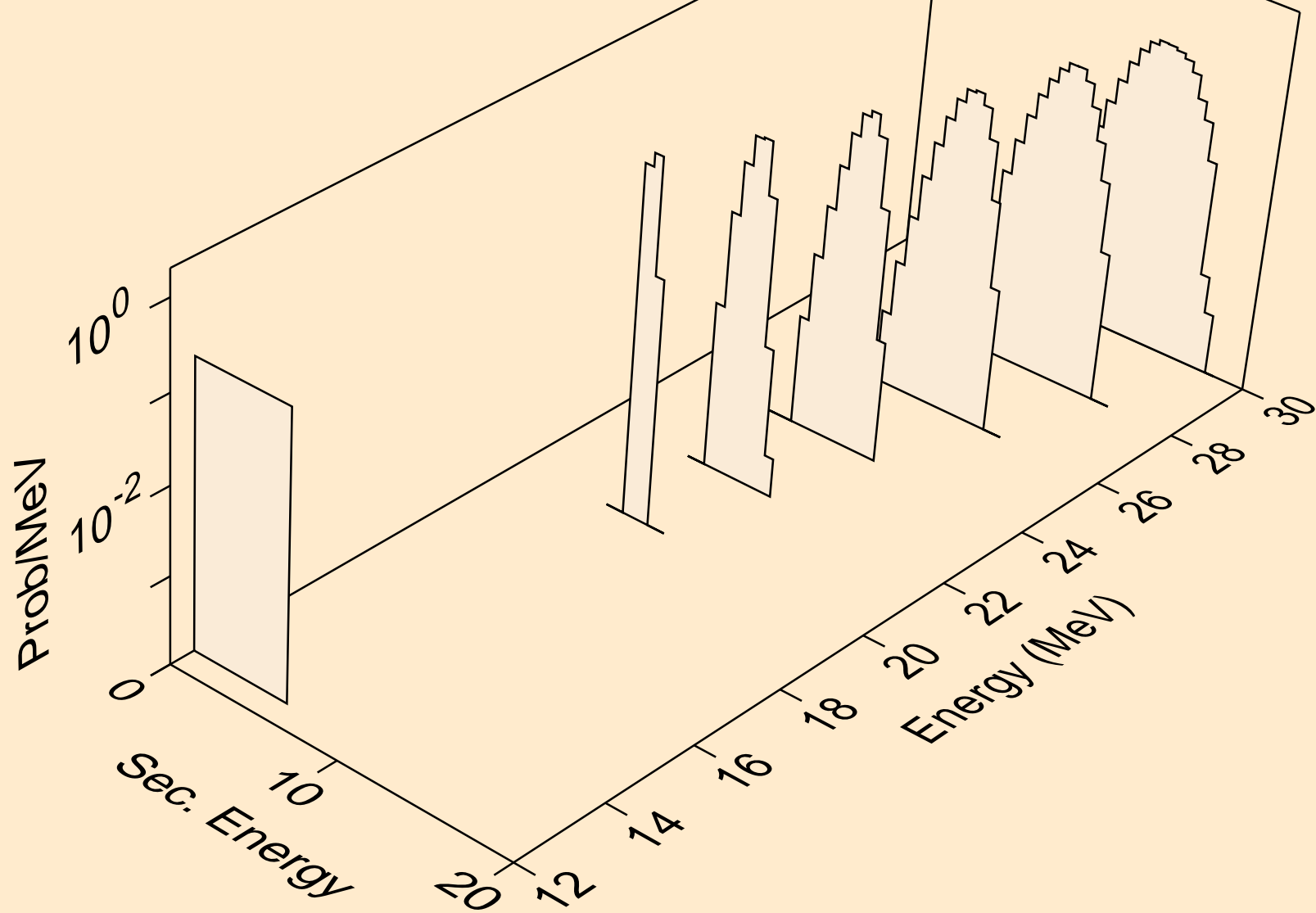

PB193M NEUTRON ACER TENDL-2021 LIBRARY; T=293.6K
alphas from (n,n*)2a

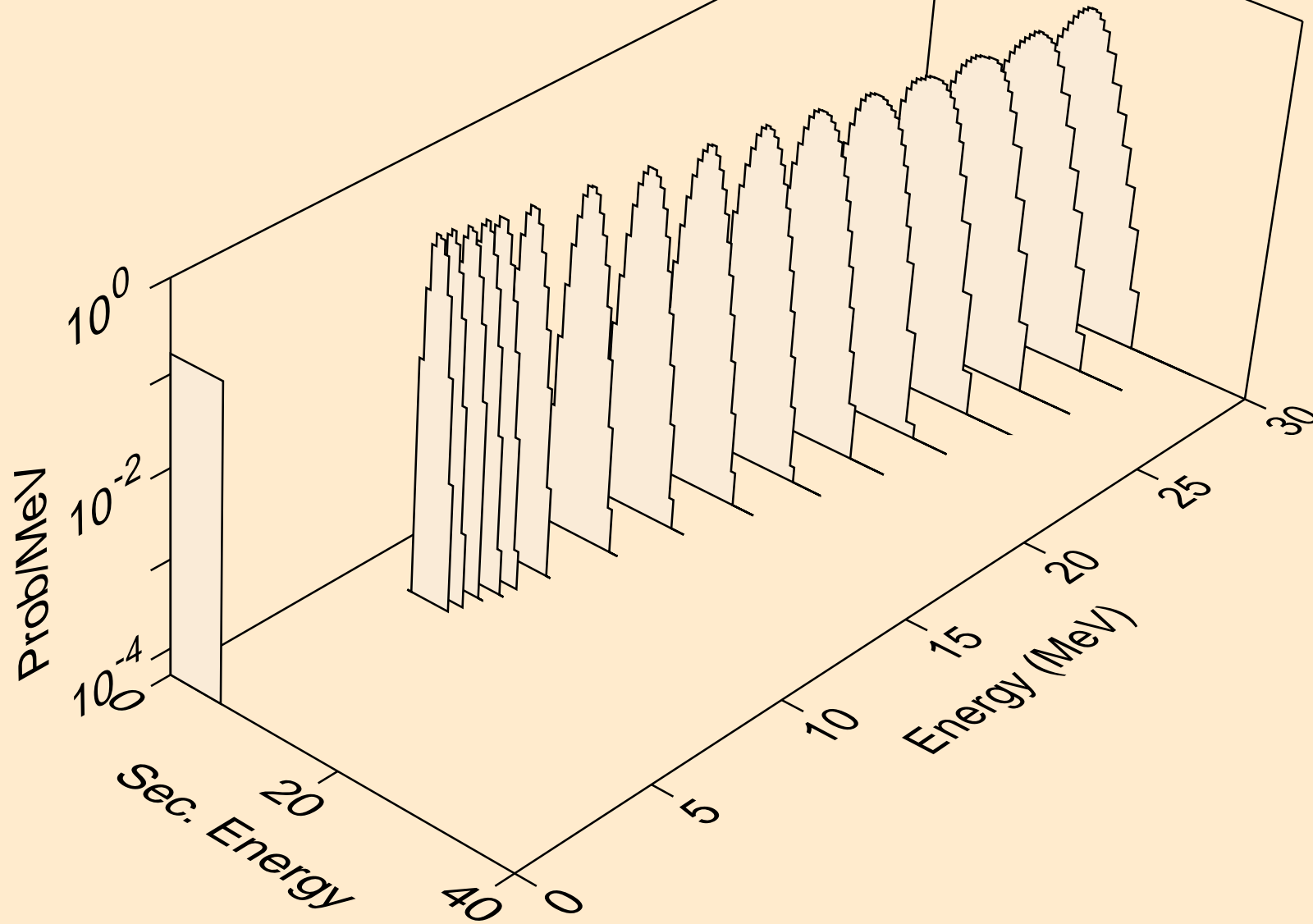

PB193M NEUTRON ACER TENDL-2021 LIBRARY; T=293.6K
alphas from (n,2n)2a

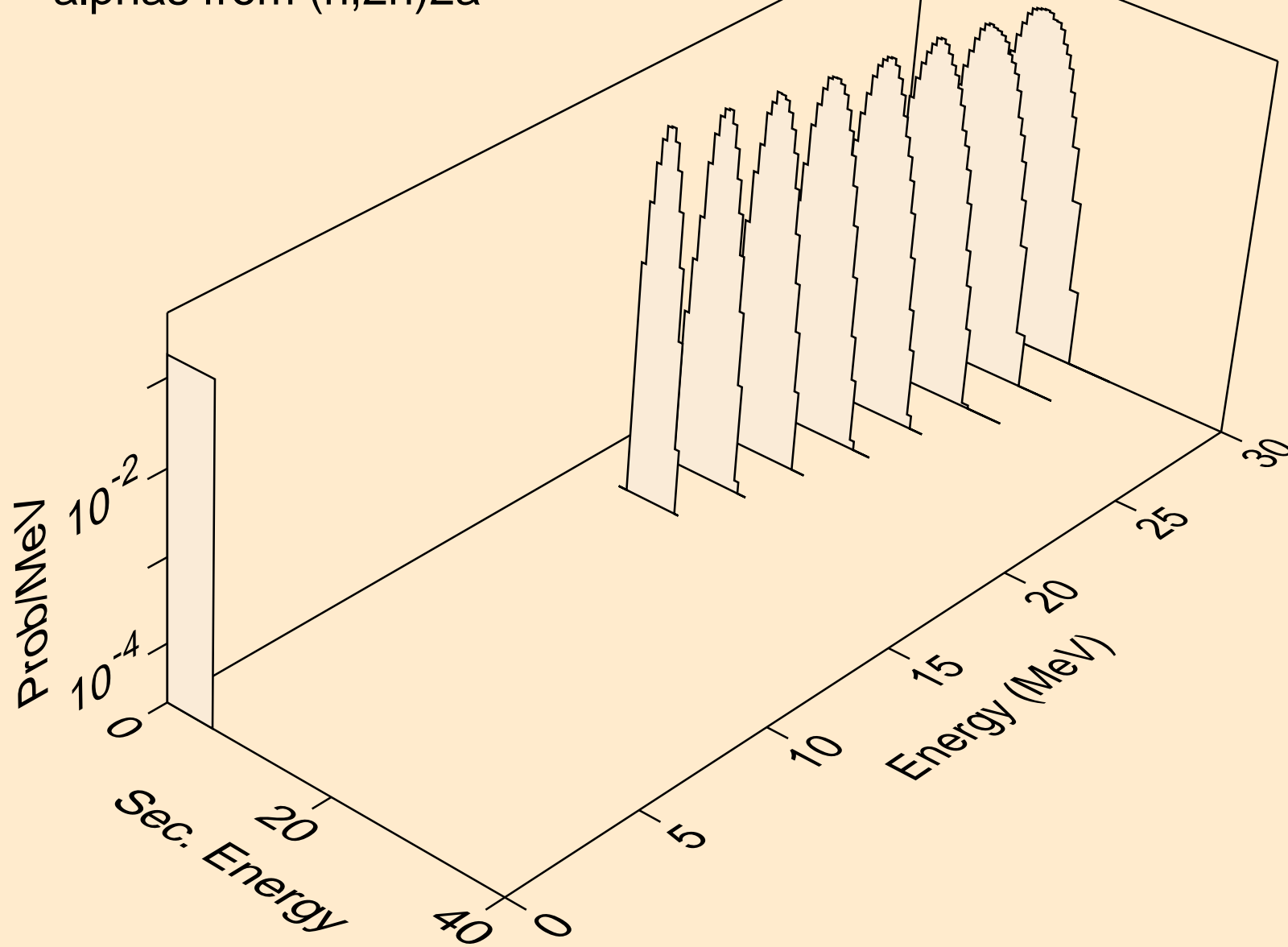

PB193M NEUTRON ACER TENDL-2021 LIBRARY; T=293.6K
alphas from (n,npa)

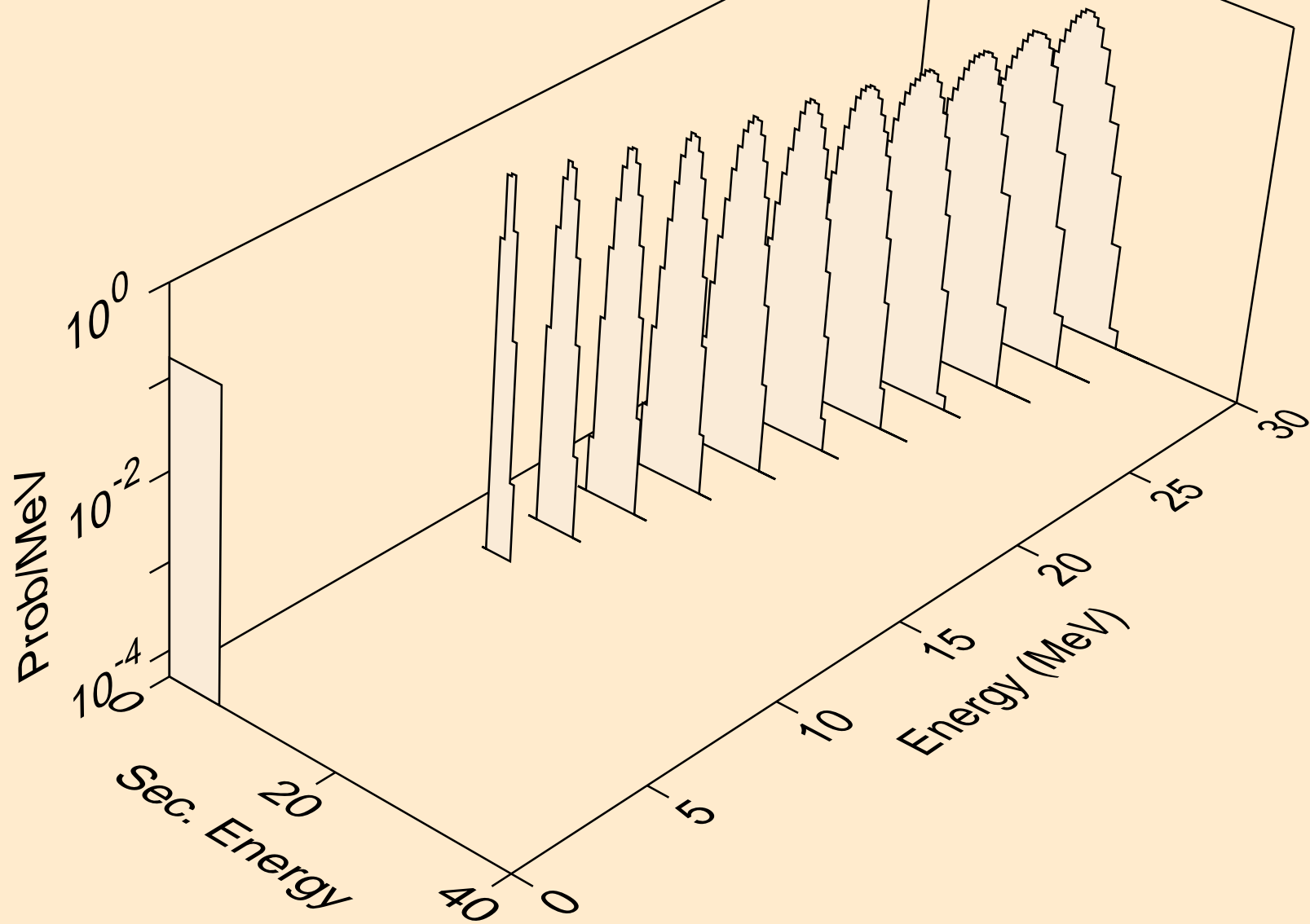

PB193M NEUTRON ACER TENDL-2021 LIBRARY; T=293.6K
alphas from (n,a)

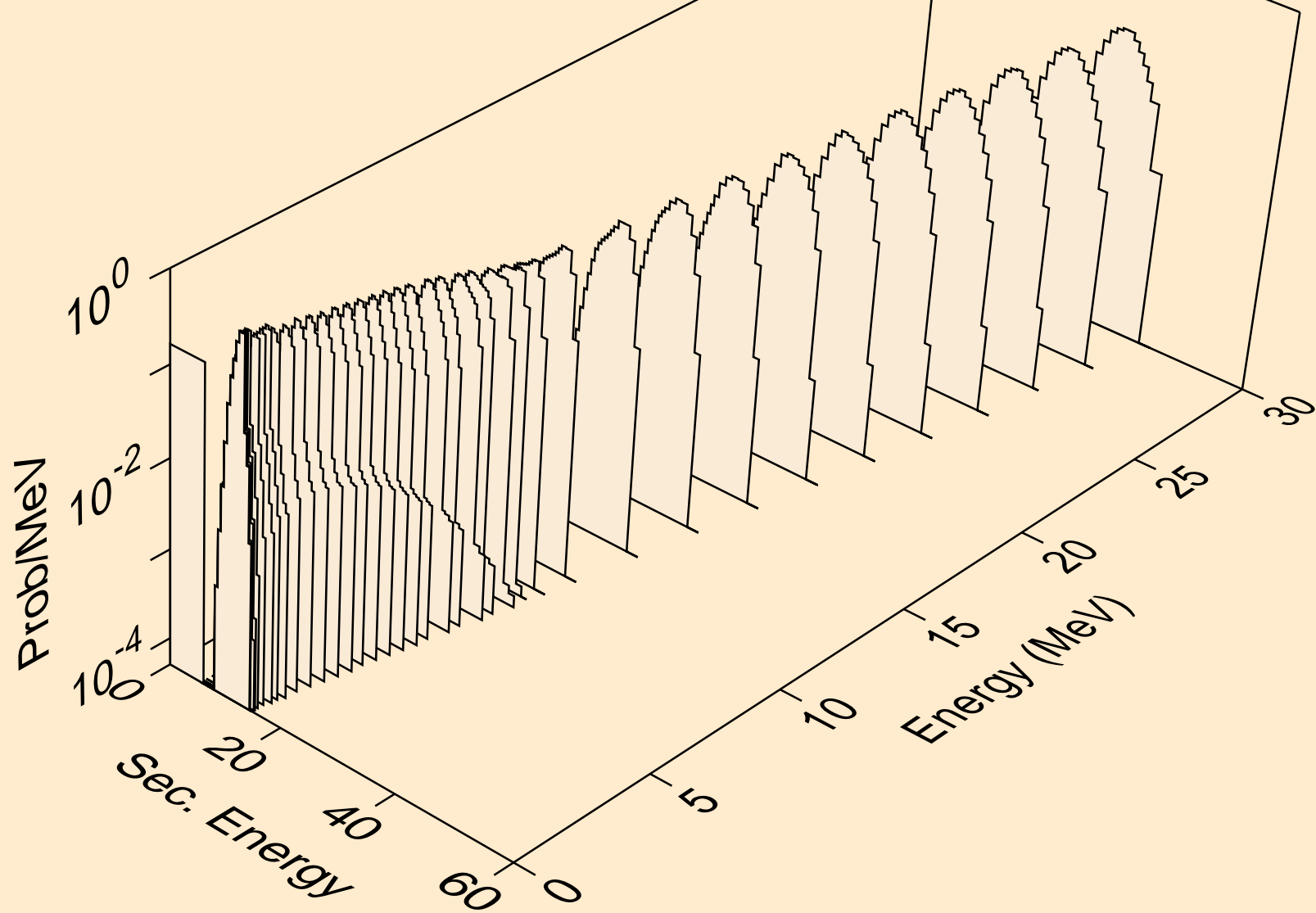

PB193M NEUTRON ACER TENDL-2021 LIBRARY; T=293.6K
alphas from (n,2a)

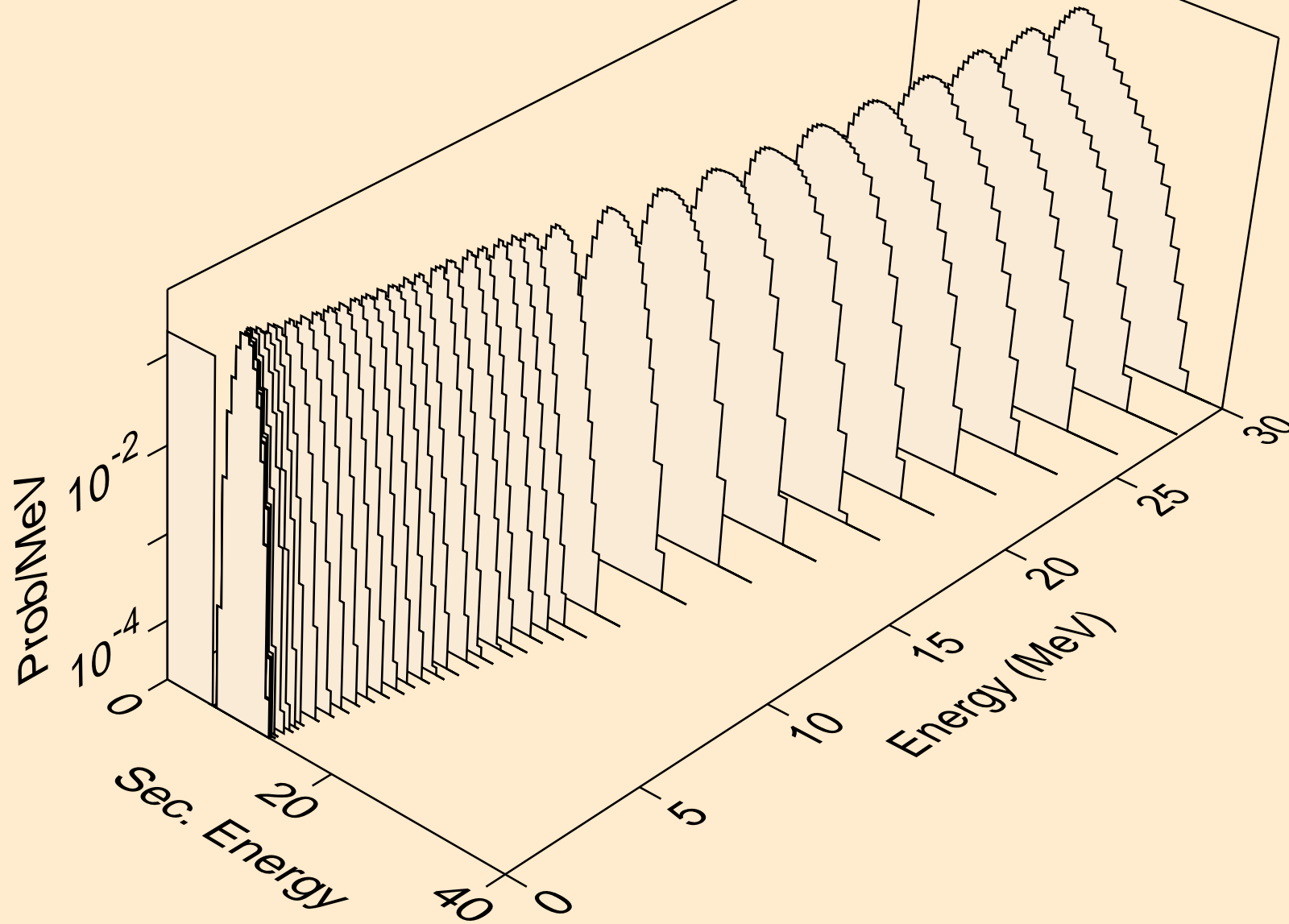

PB193M NEUTRON ACER TENDL-2021 LIBRARY; T=293.6K
alphas from (n,pa)

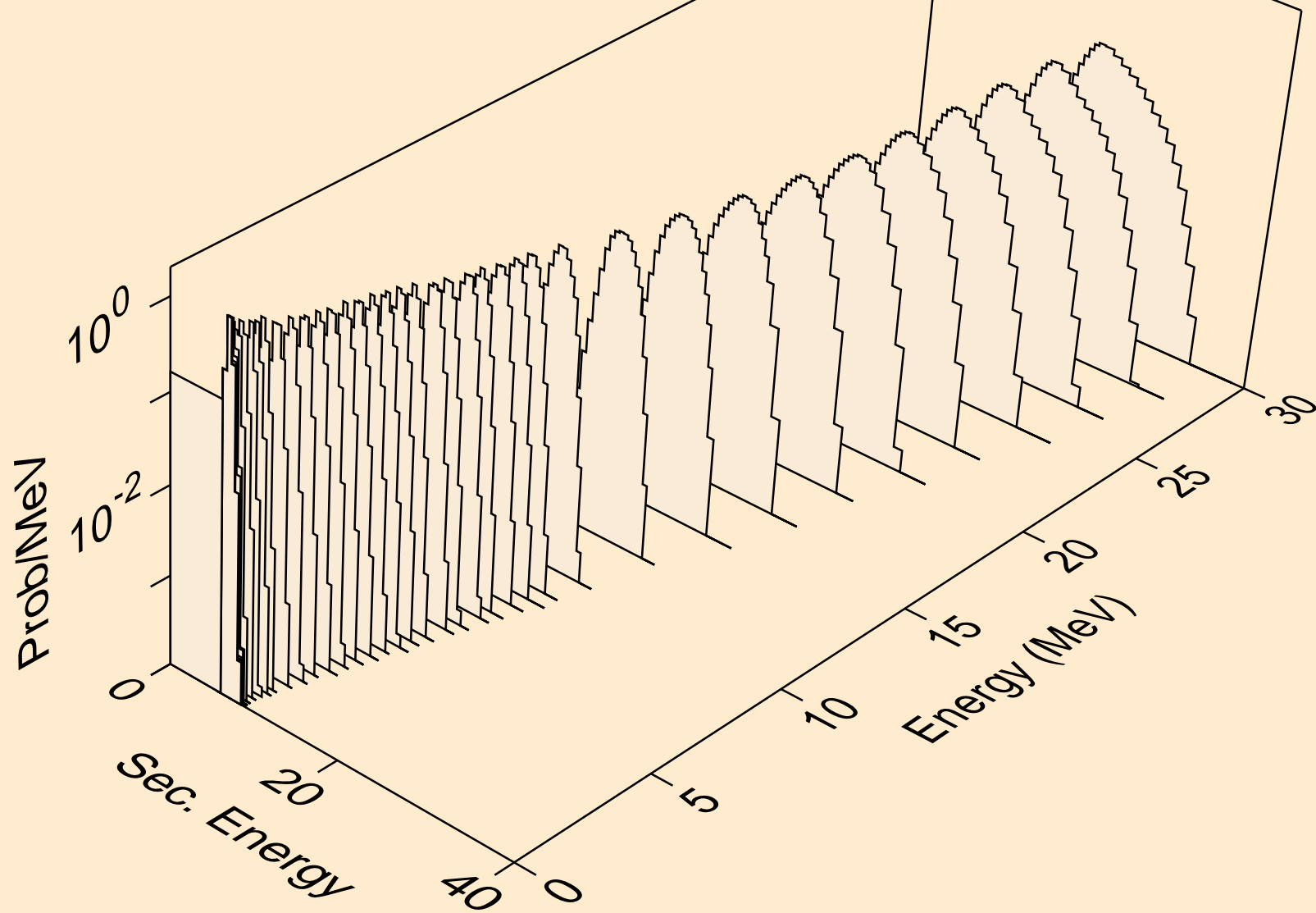

PB193M NEUTRON ACER TENDL-2021 LIBRARY; T=293.6K
alphas from (n,da)

