

PB204 NEUTRON ACER TENDL-2021 LIBRARY; T=293.6K
Principal cross sections

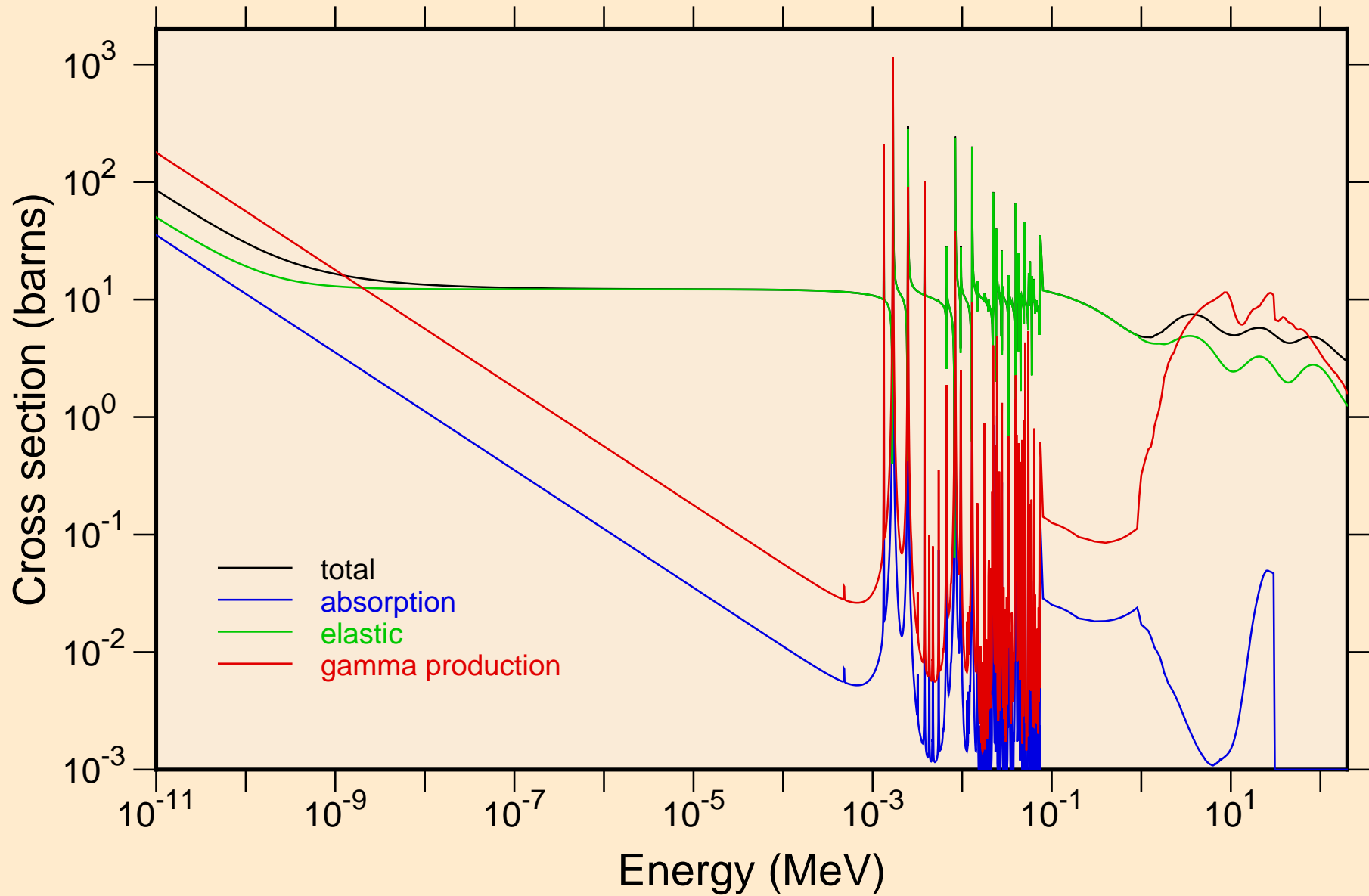

PB204 NEUTRON ACER TENDL-2021 LIBRARY; T=293.6K
resonance total cross section

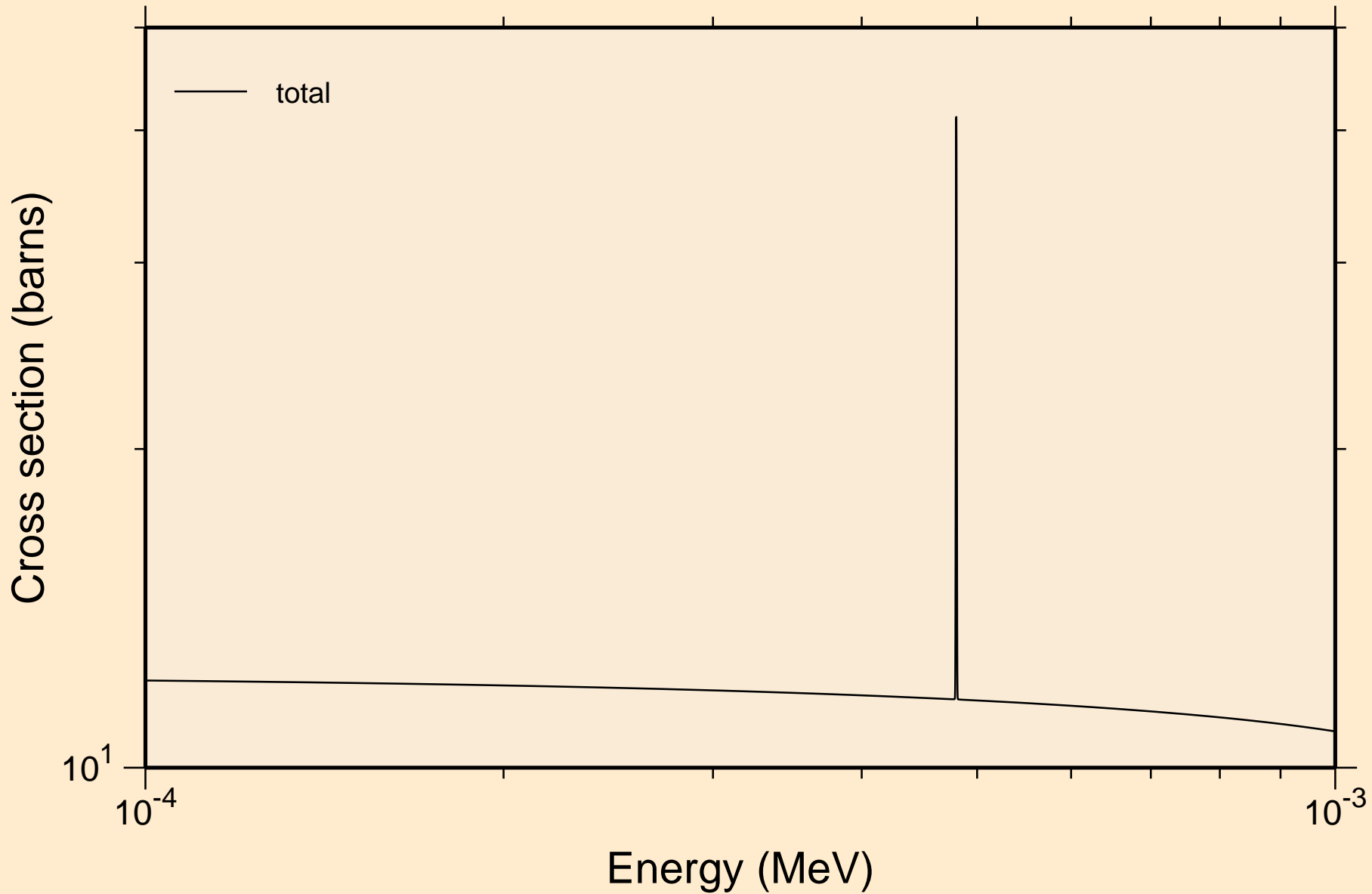

PB204 NEUTRON ACER TENDL-2021 LIBRARY; T=293.6K
resonance total cross section

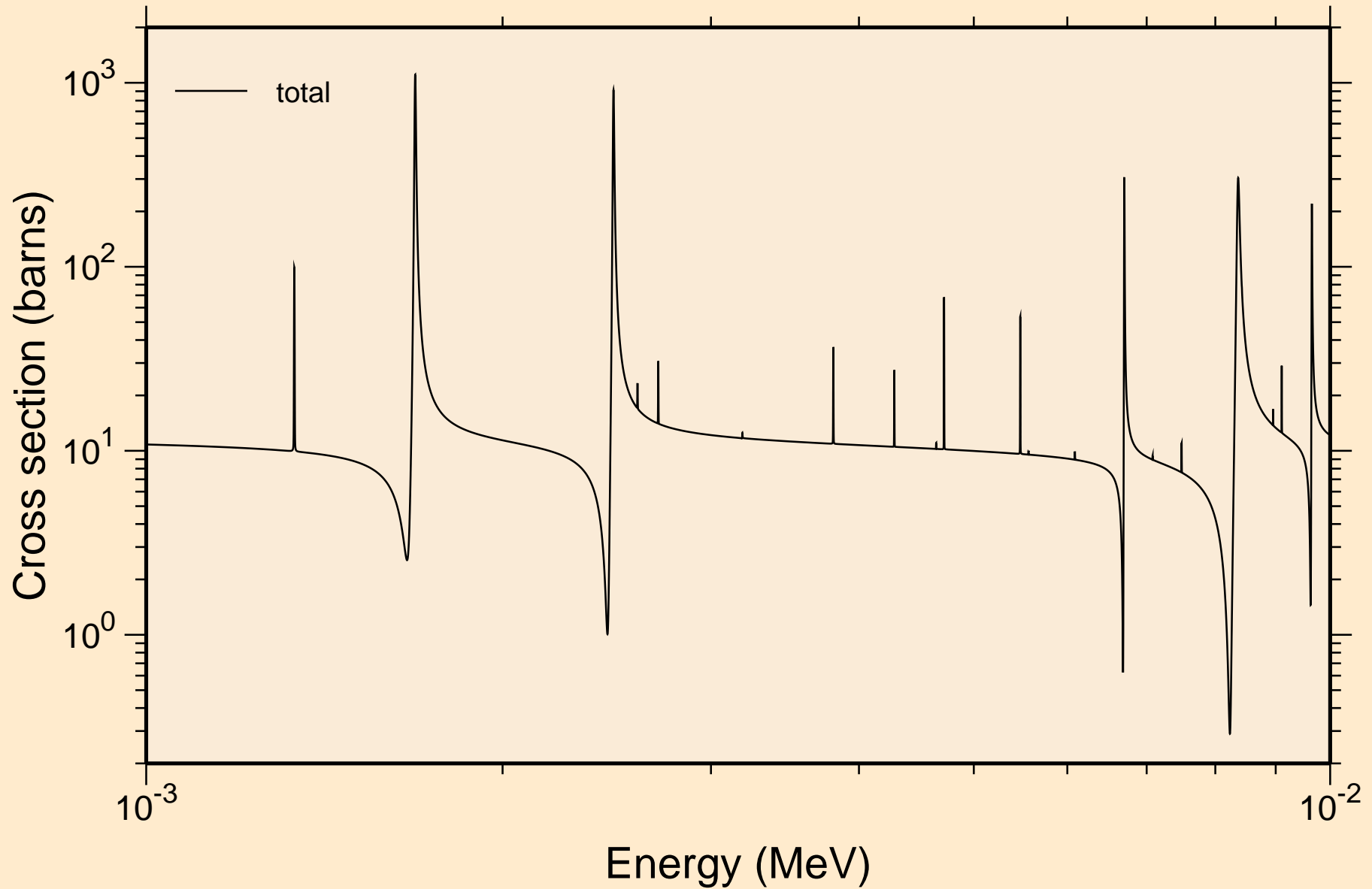

PB204 NEUTRON ACER TENDL-2021 LIBRARY; T=293.6K
resonance total cross section

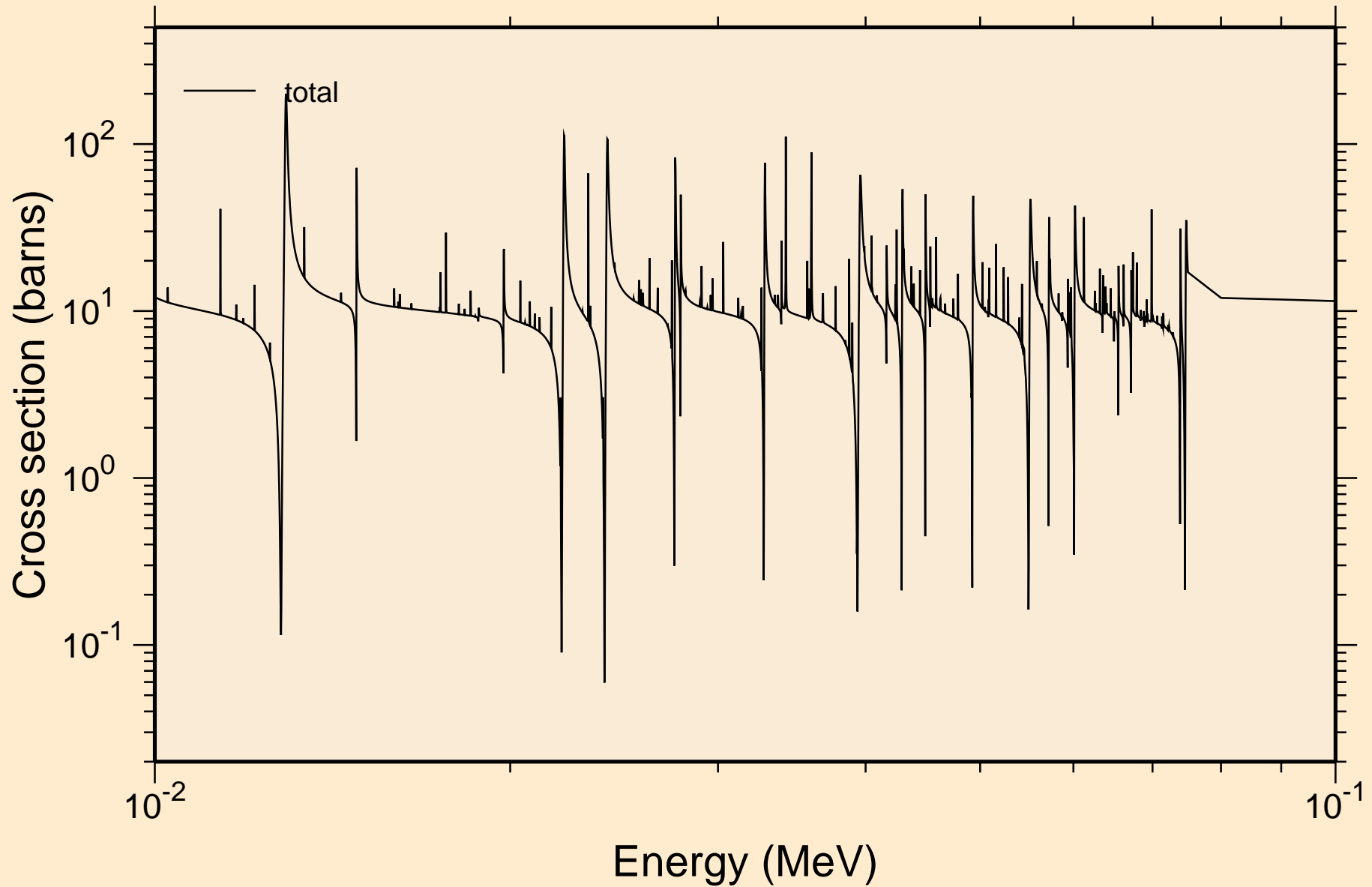

PB204 NEUTRON ACER TENDL-2021 LIBRARY; T=293.6K
resonance total cross section

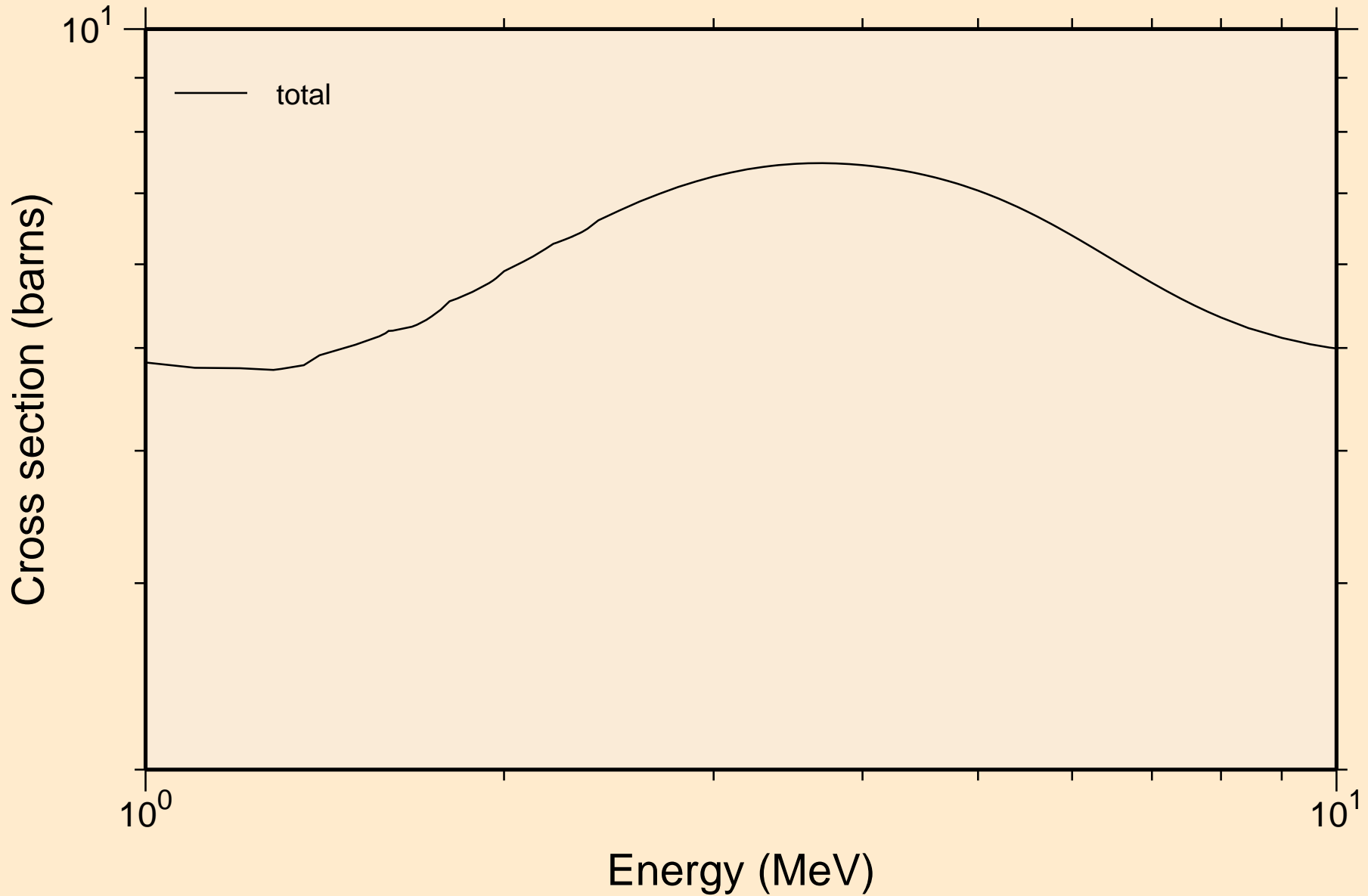

PB204 NEUTRON ACER TENDL-2021 LIBRARY; T=293.6K
resonance absorption cross sections

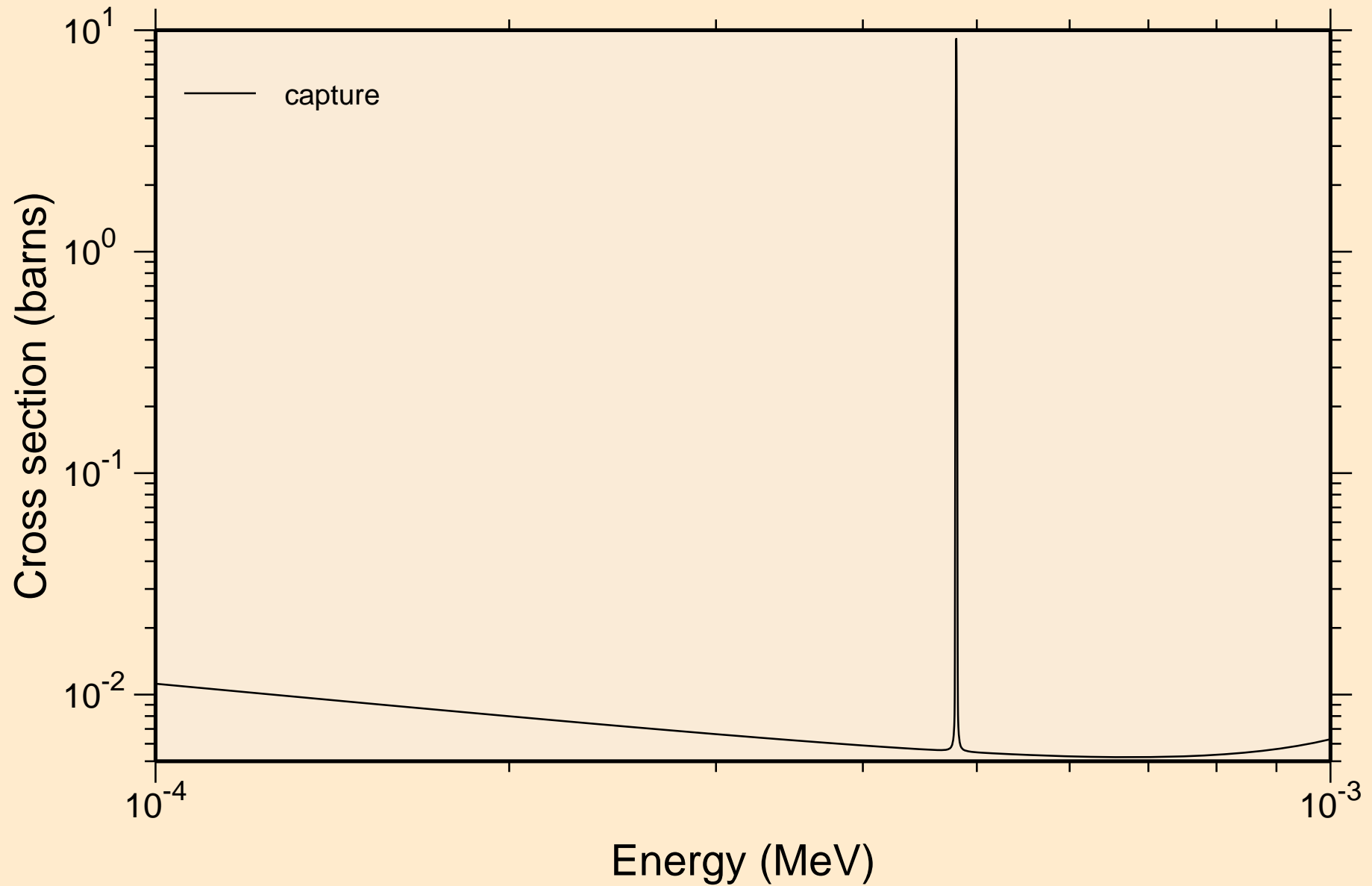

PB204 NEUTRON ACER TENDL-2021 LIBRARY; T=293.6K
resonance absorption cross sections

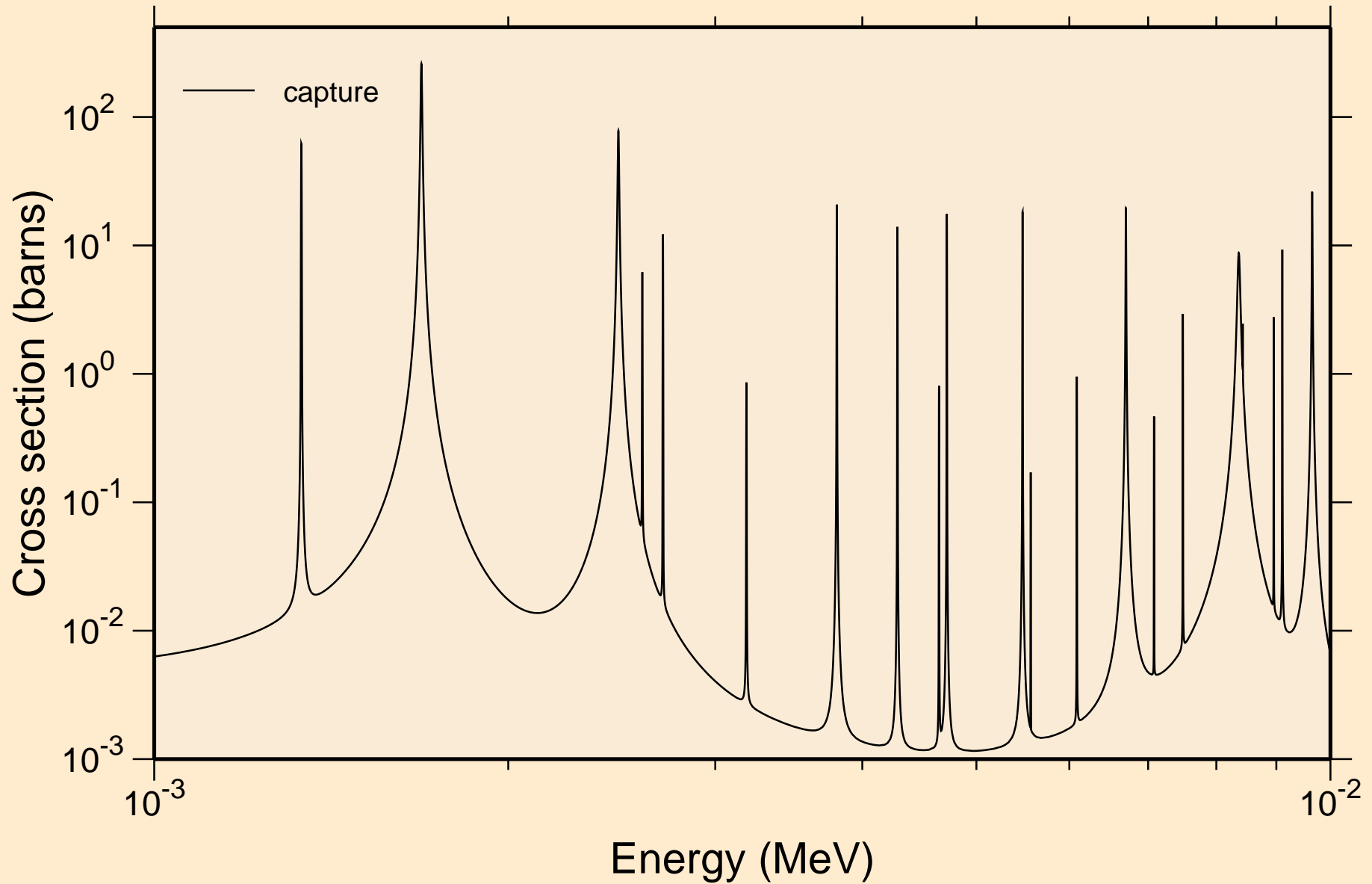

PB204 NEUTRON ACER TENDL-2021 LIBRARY; T=293.6K
resonance absorption cross sections

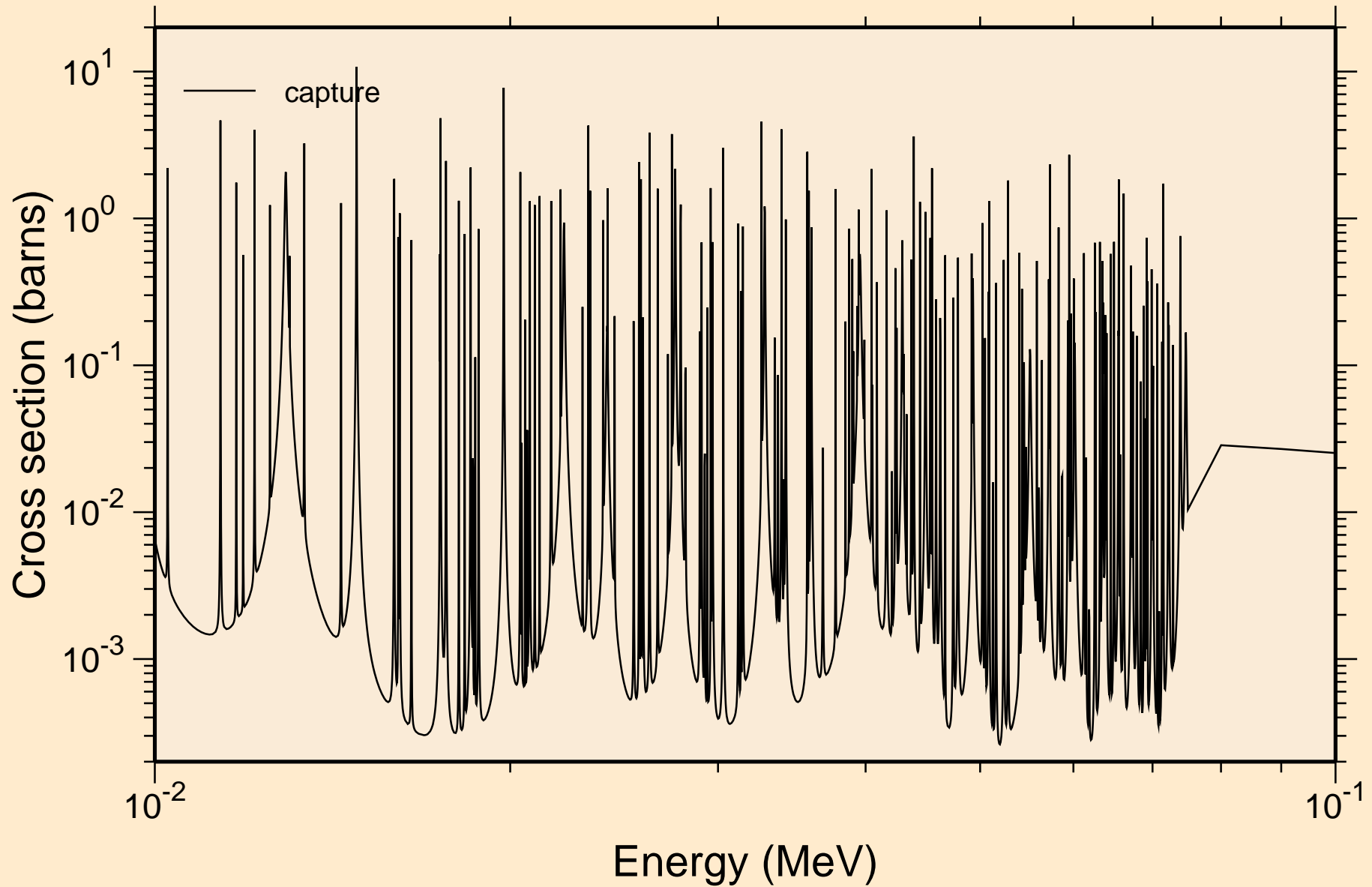

PB204 NEUTRON ACER TENDL-2021 LIBRARY; T=293.6K
resonance absorption cross sections

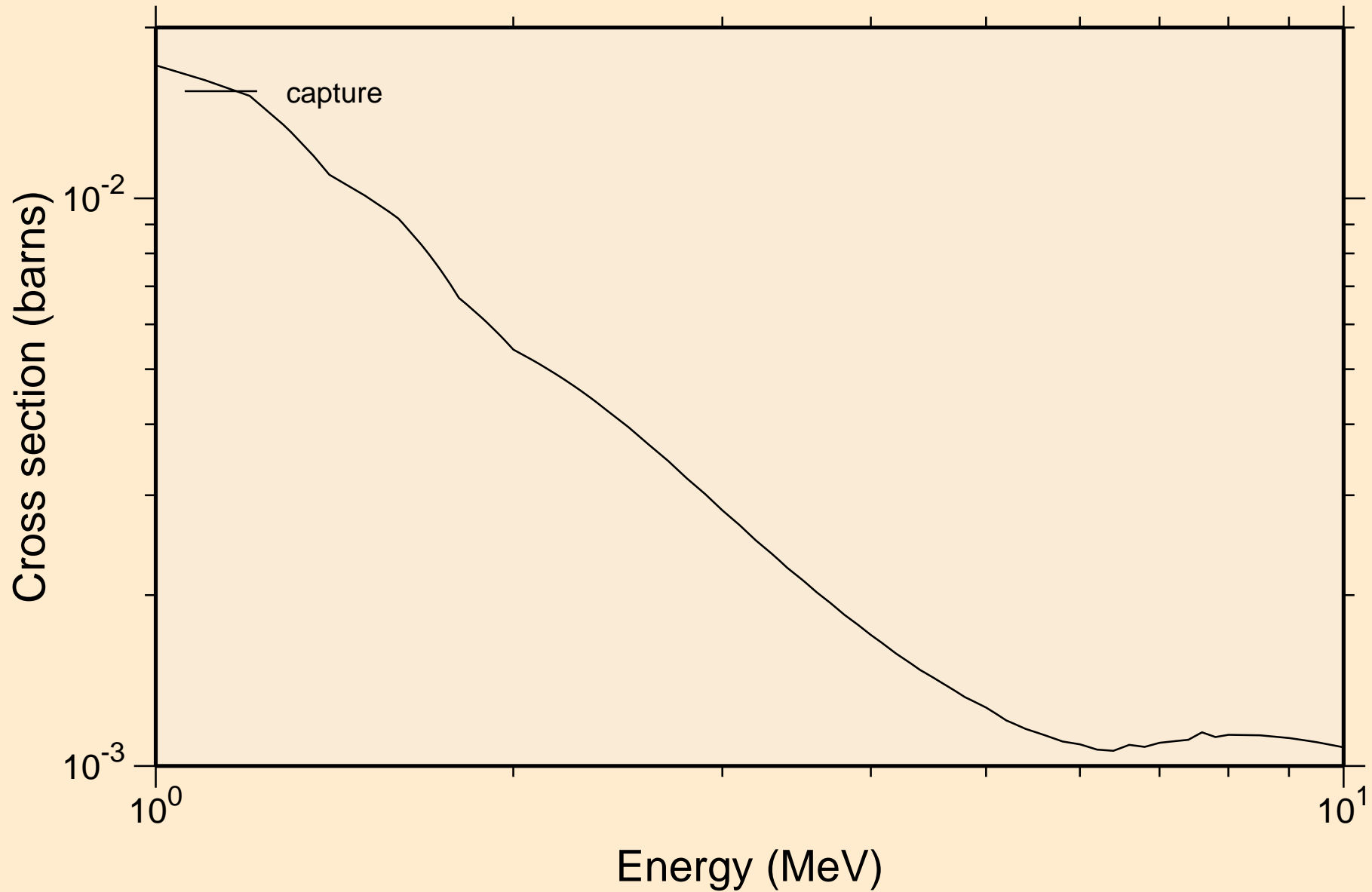

PB204 NEUTRON ACER TENDL-2021 LIBRARY; T=293.6K
Heating

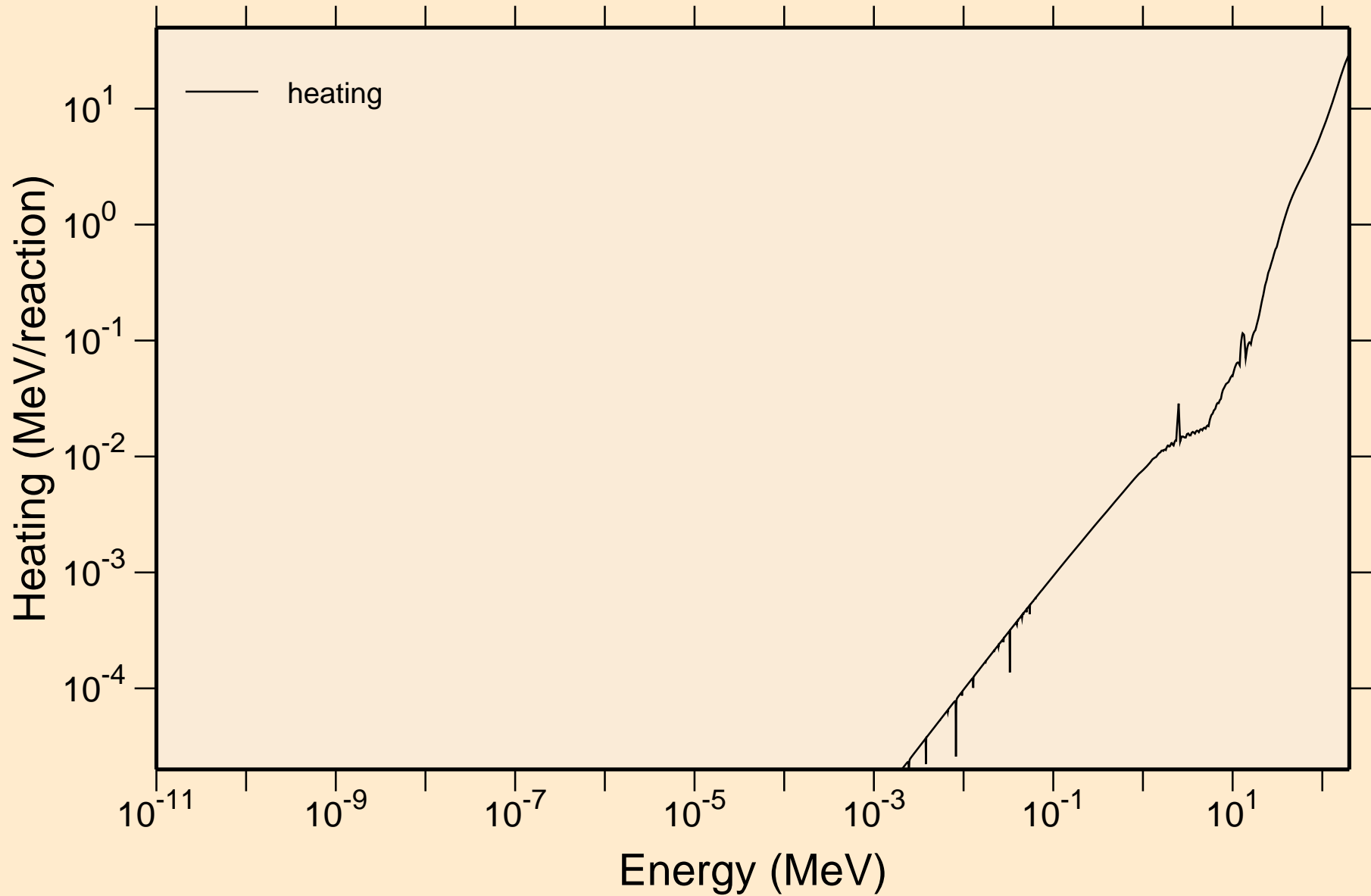

PB204 NEUTRON ACER TENDL-2021 LIBRARY; T=293.6K
Damage

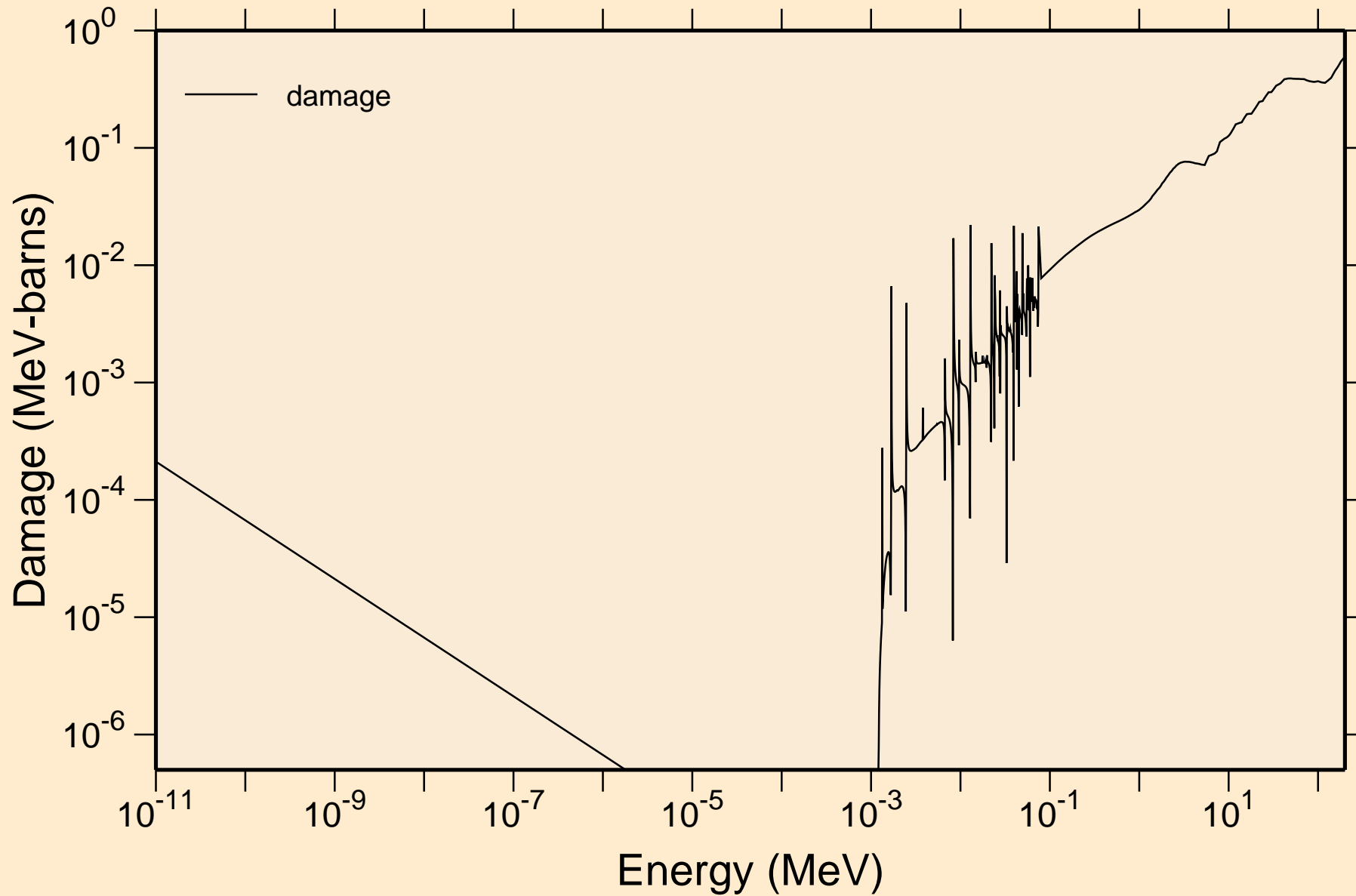

PB204 NEUTRON ACER TENDL-2021 LIBRARY; T=293.6K
Non-threshold reactions

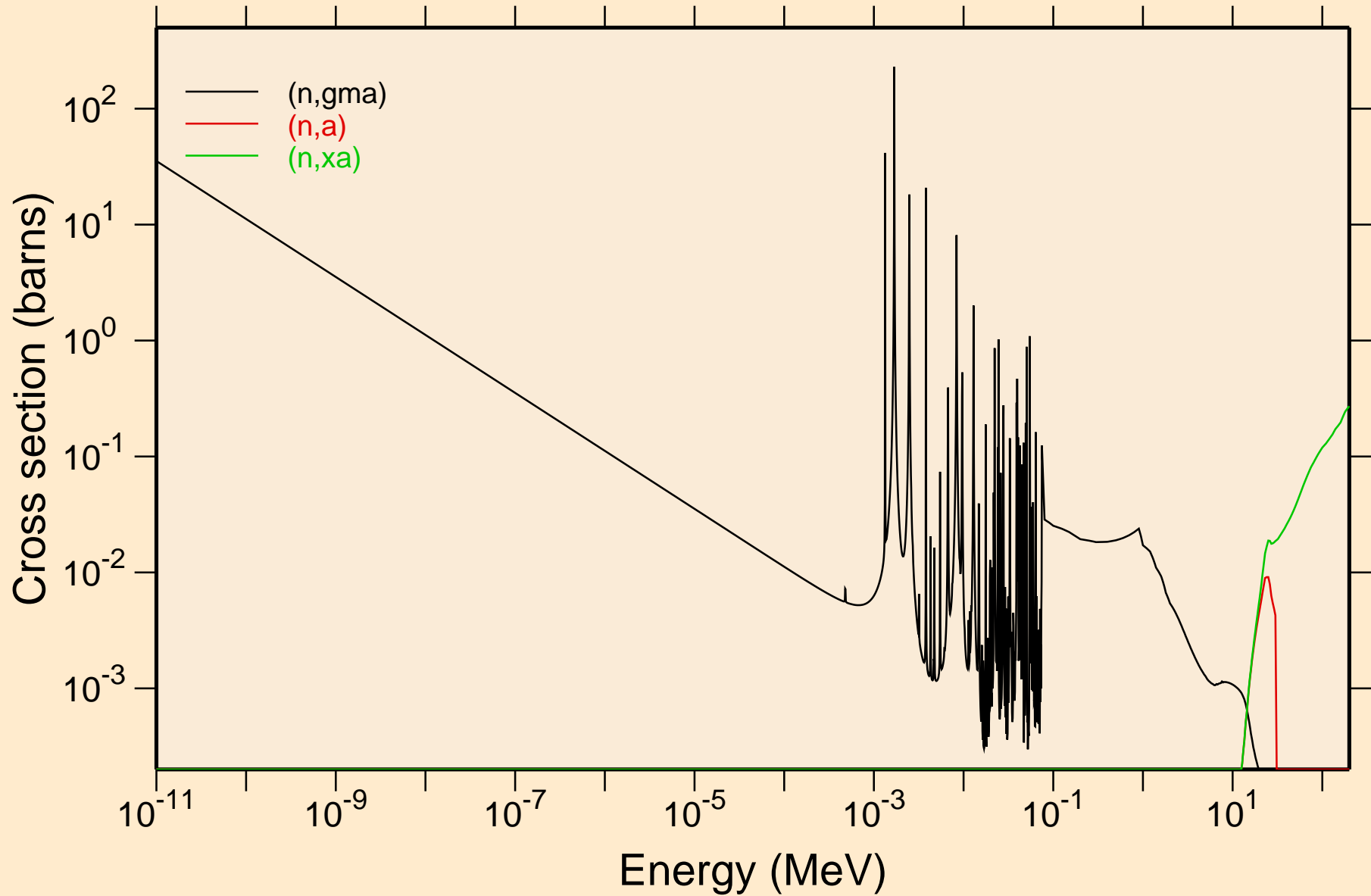

PB204 NEUTRON ACER TENDL-2021 LIBRARY; T=293.6K
Principal cross sections

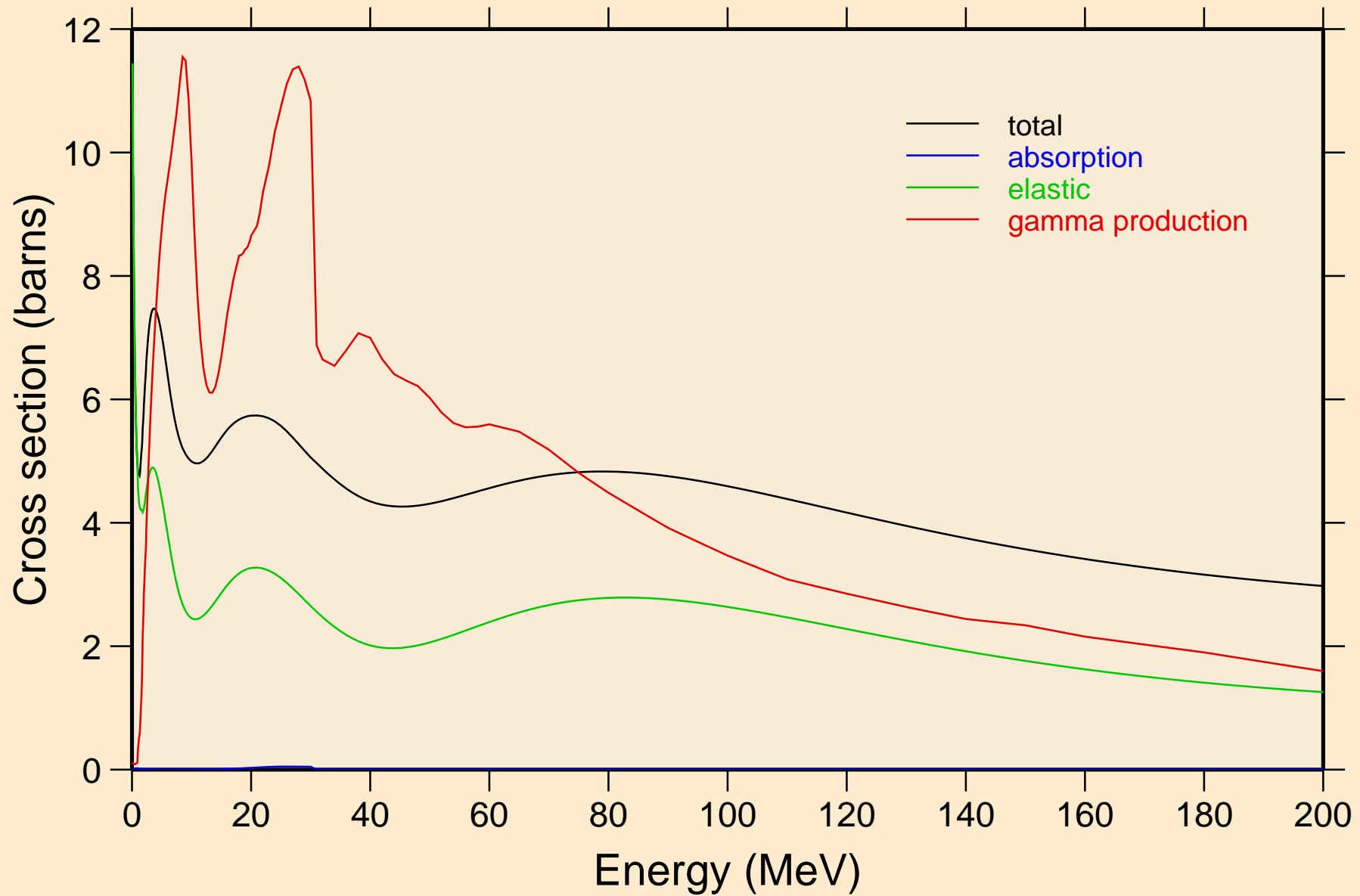

PB204 NEUTRON ACER TENDL-2021 LIBRARY; T=293.6K
Heating

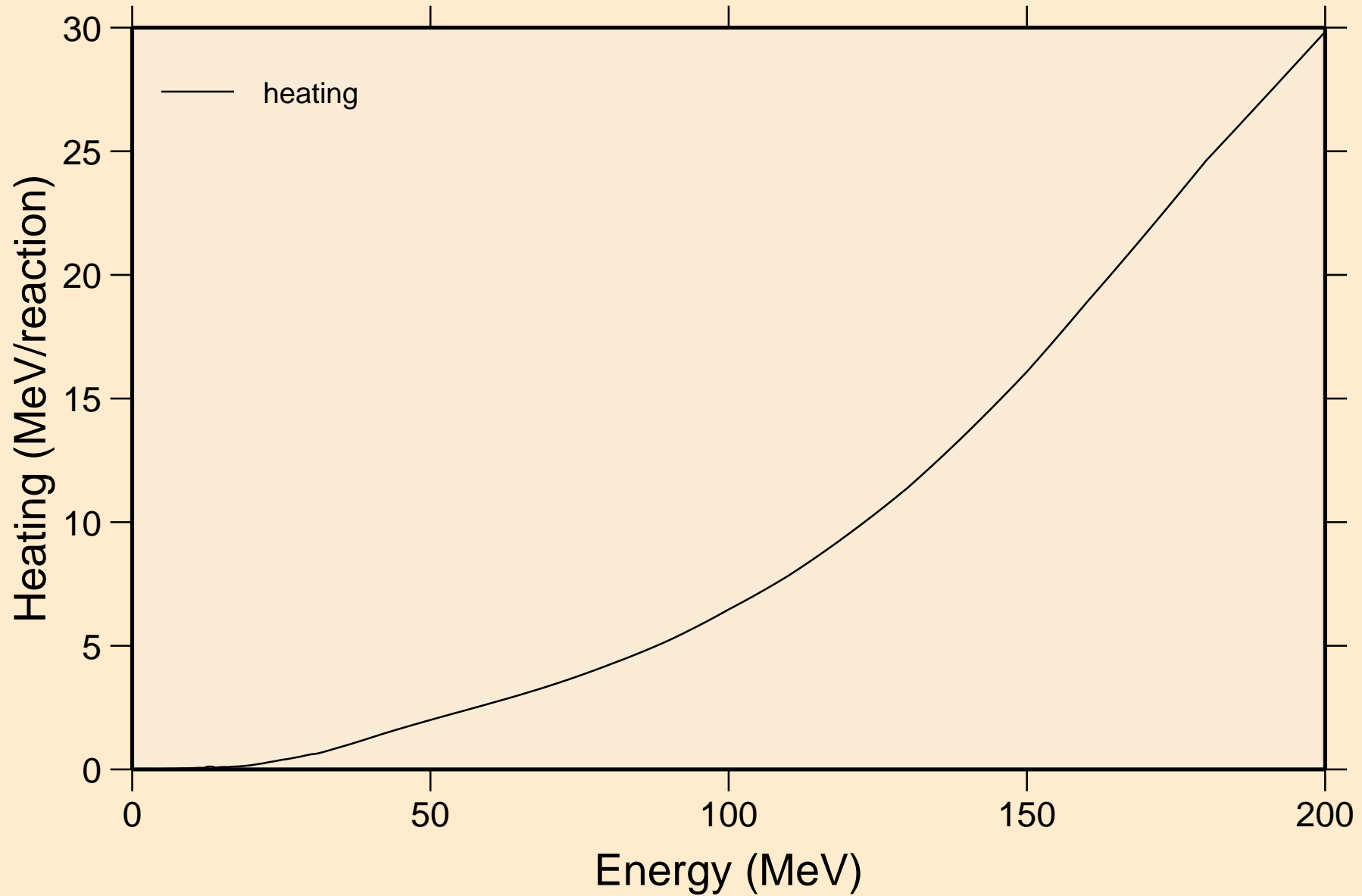

PB204 NEUTRON ACER TENDL-2021 LIBRARY; T=293.6K
Damage

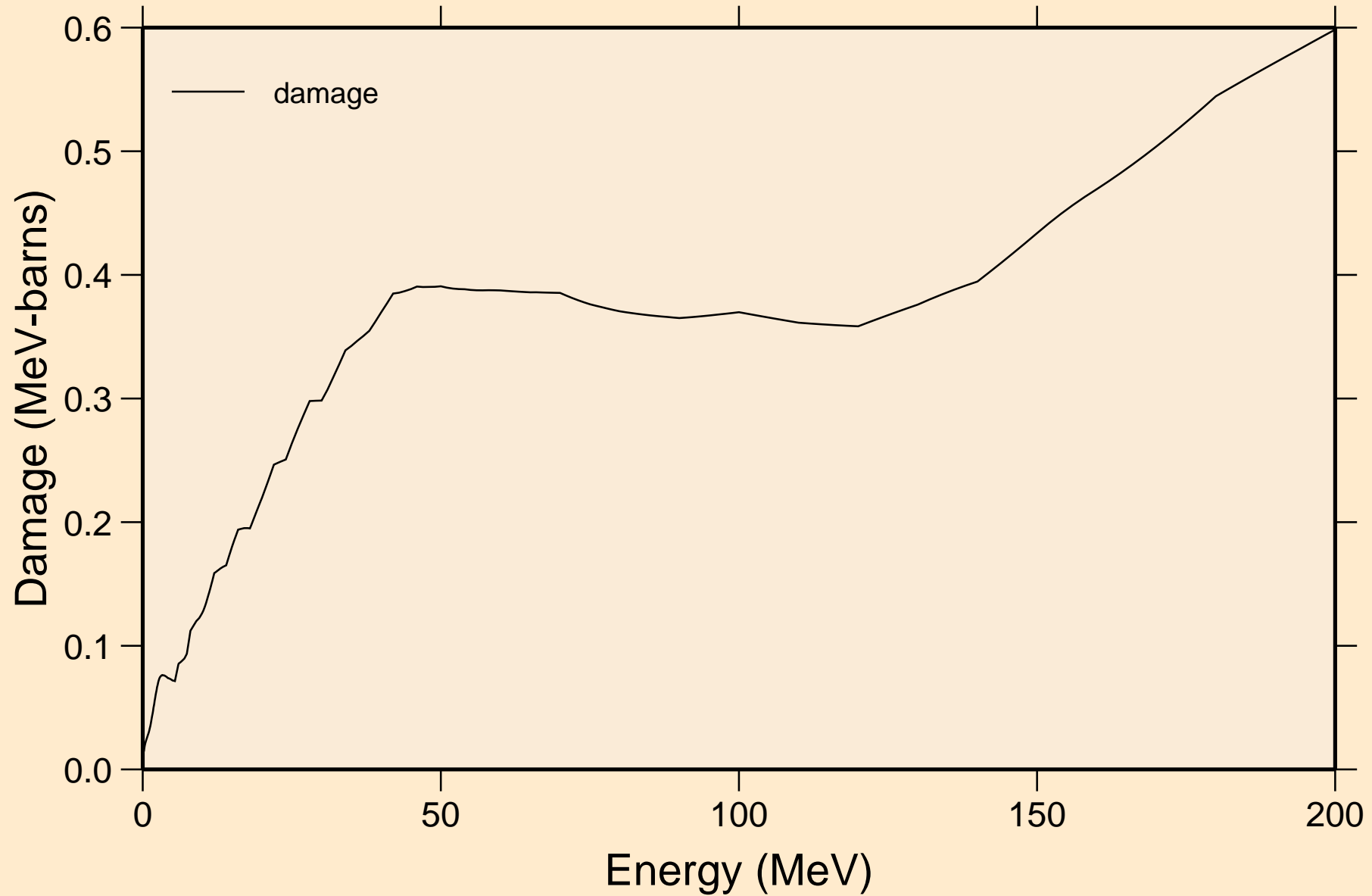

PB204 NEUTRON ACER TENDL-2021 LIBRARY; T=293.6K
Non-threshold reactions

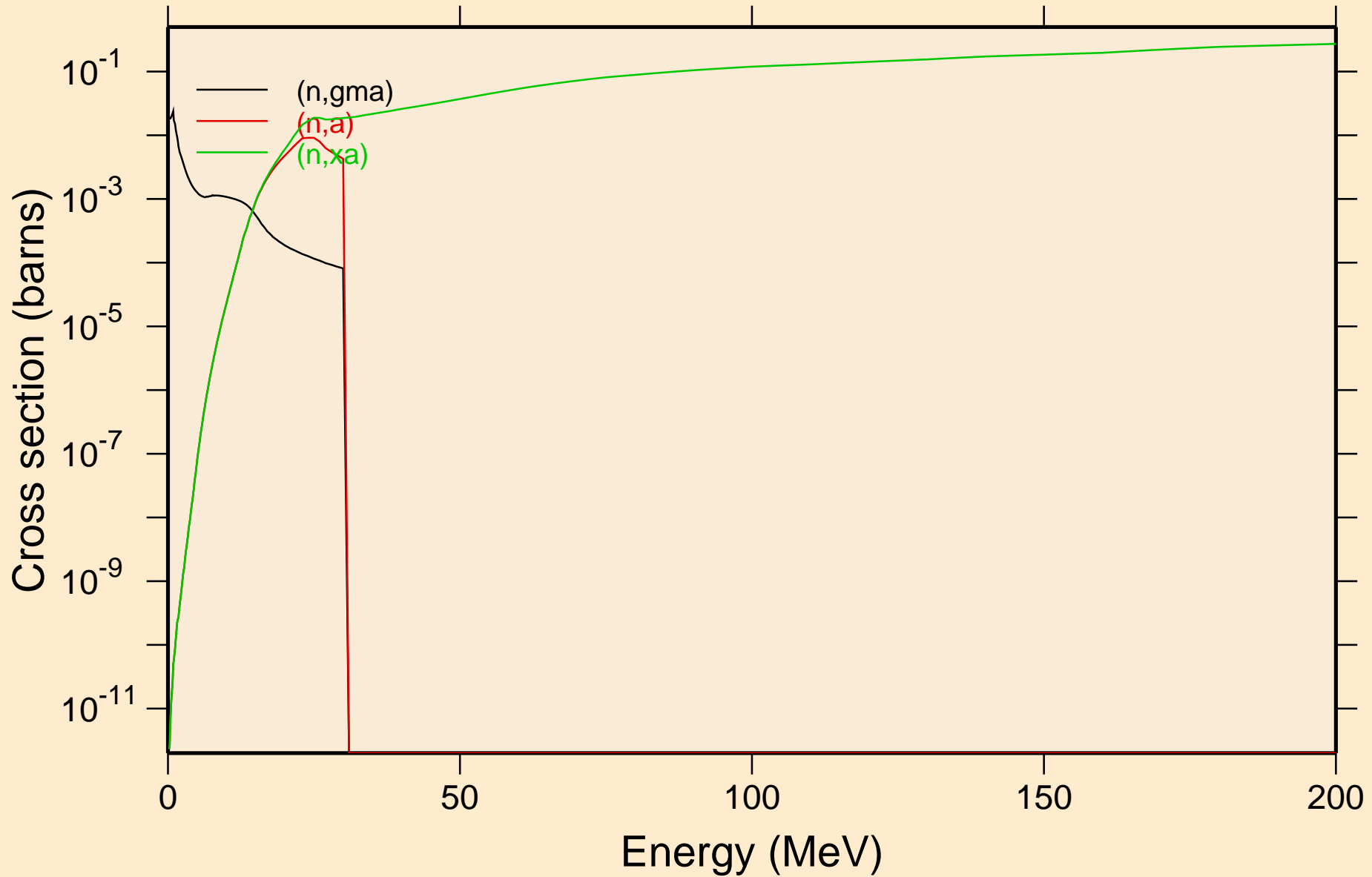

PB204 NEUTRON ACER TENDL-2021 LIBRARY; T=293.6K
Inelastic levels

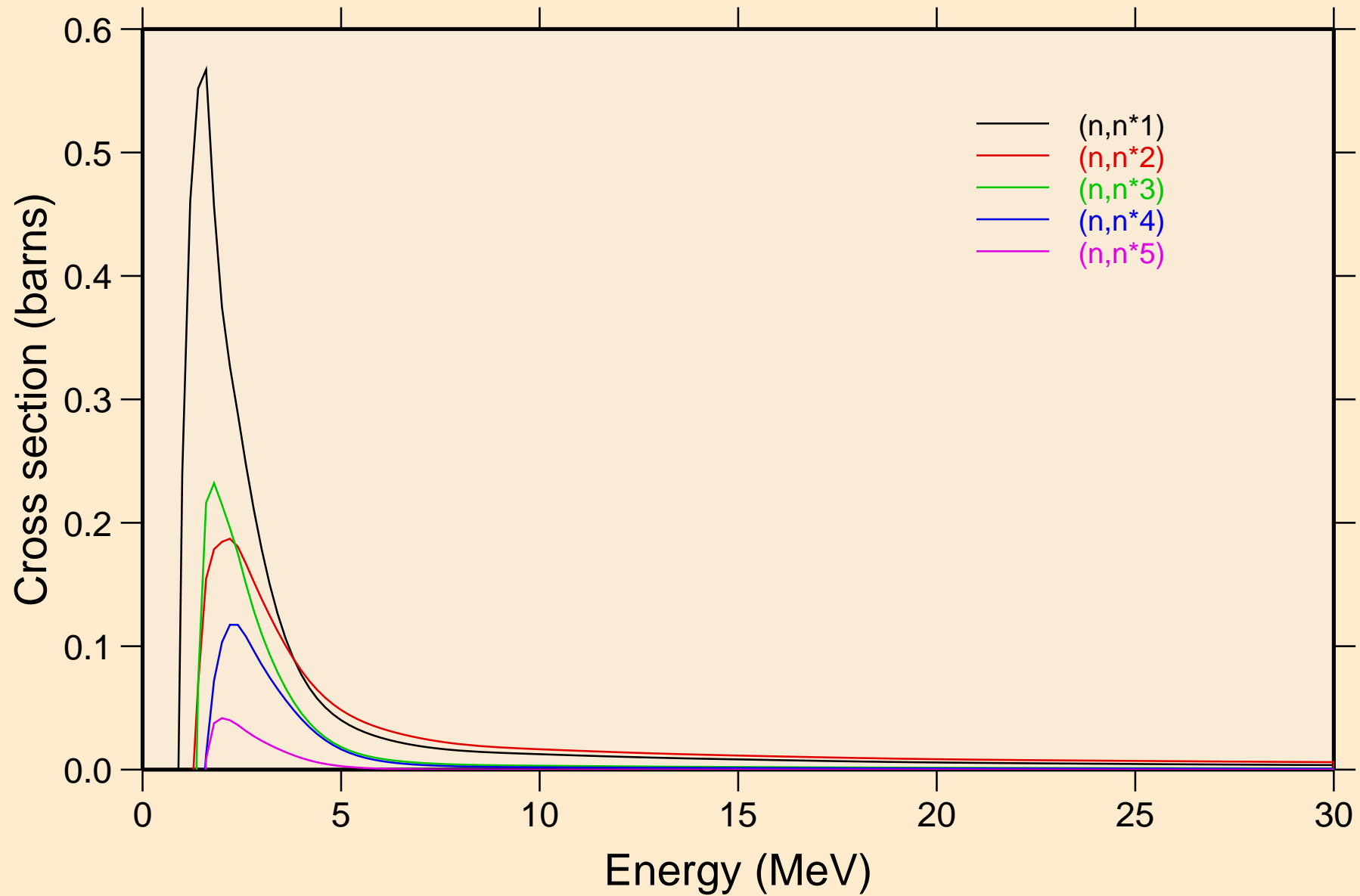

PB204 NEUTRON ACER TENDL-2021 LIBRARY; T=293.6K
Inelastic levels

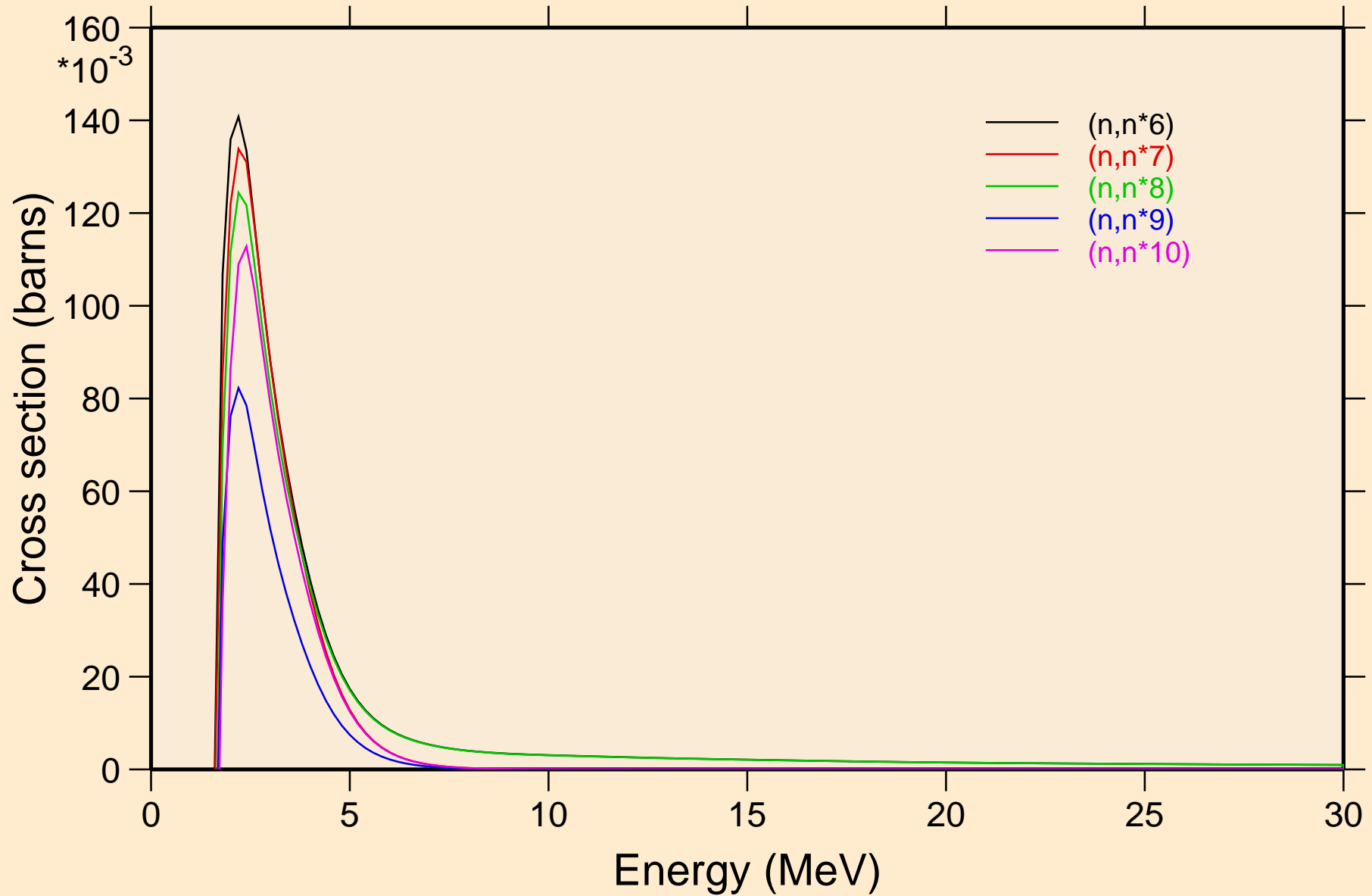

PB204 NEUTRON ACER TENDL-2021 LIBRARY; T=293.6K
Inelastic levels

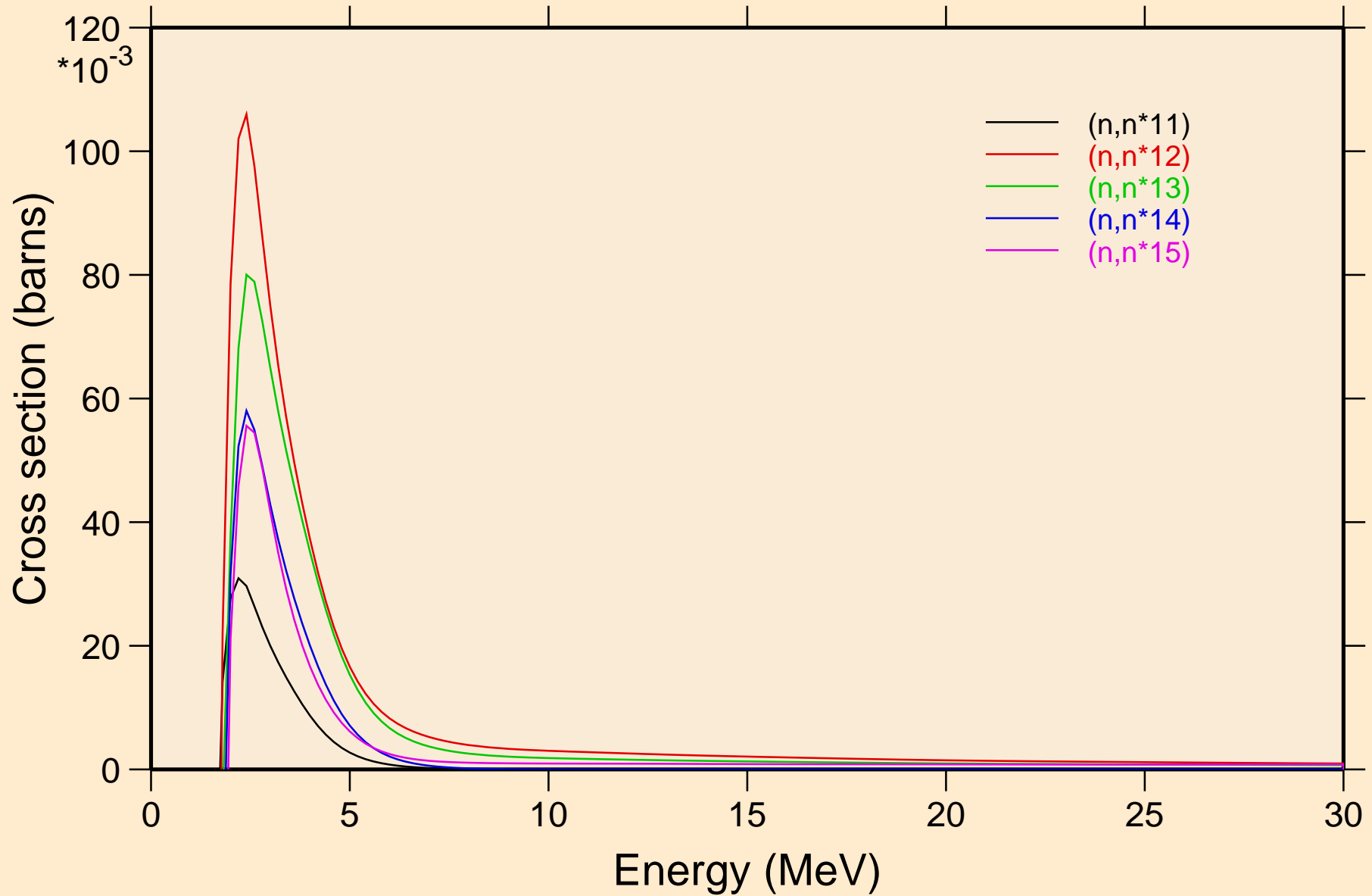

PB204 NEUTRON ACER TENDL-2021 LIBRARY; T=293.6K
Inelastic levels

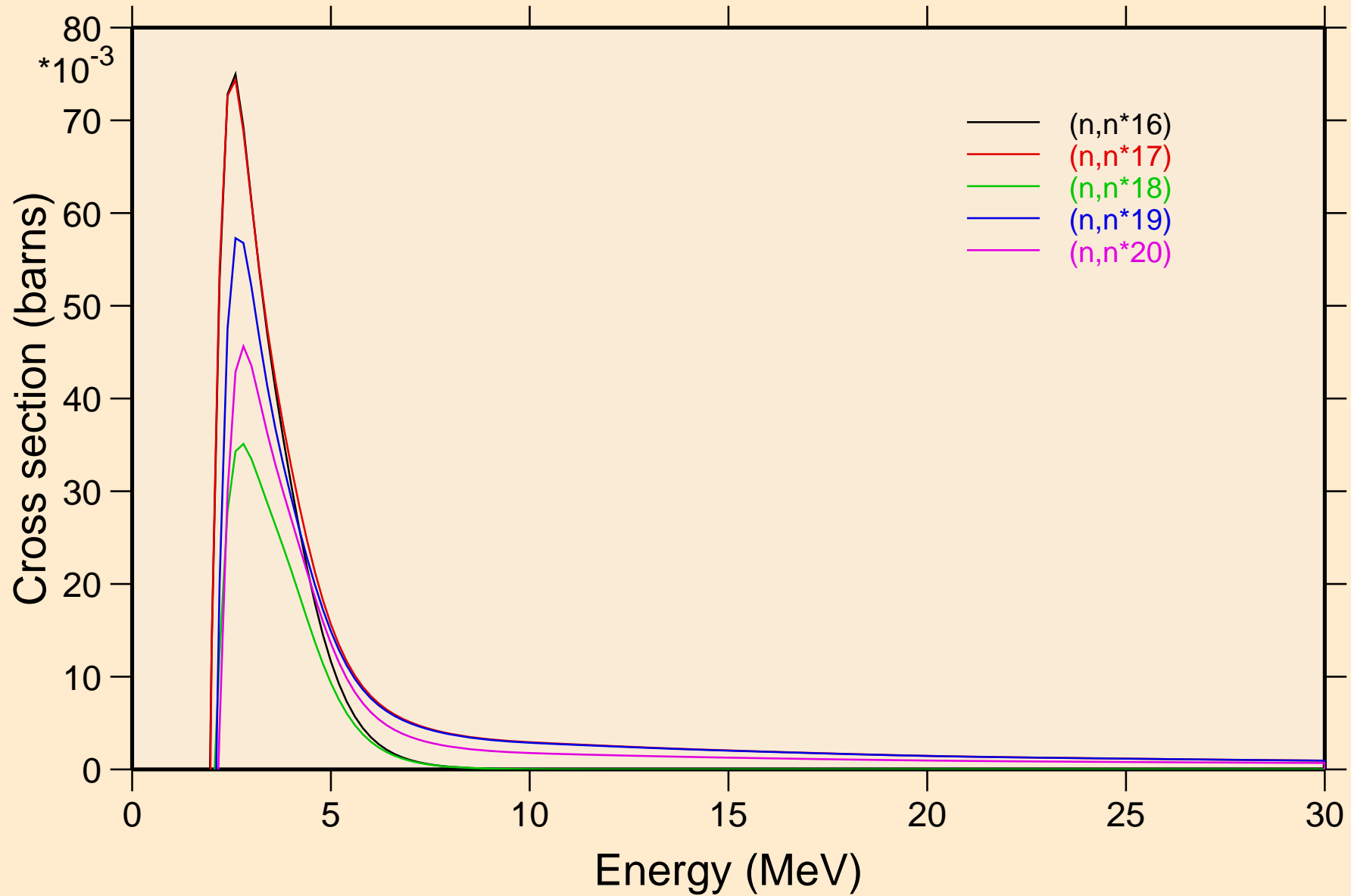

PB204 NEUTRON ACER TENDL-2021 LIBRARY; T=293.6K
Inelastic levels

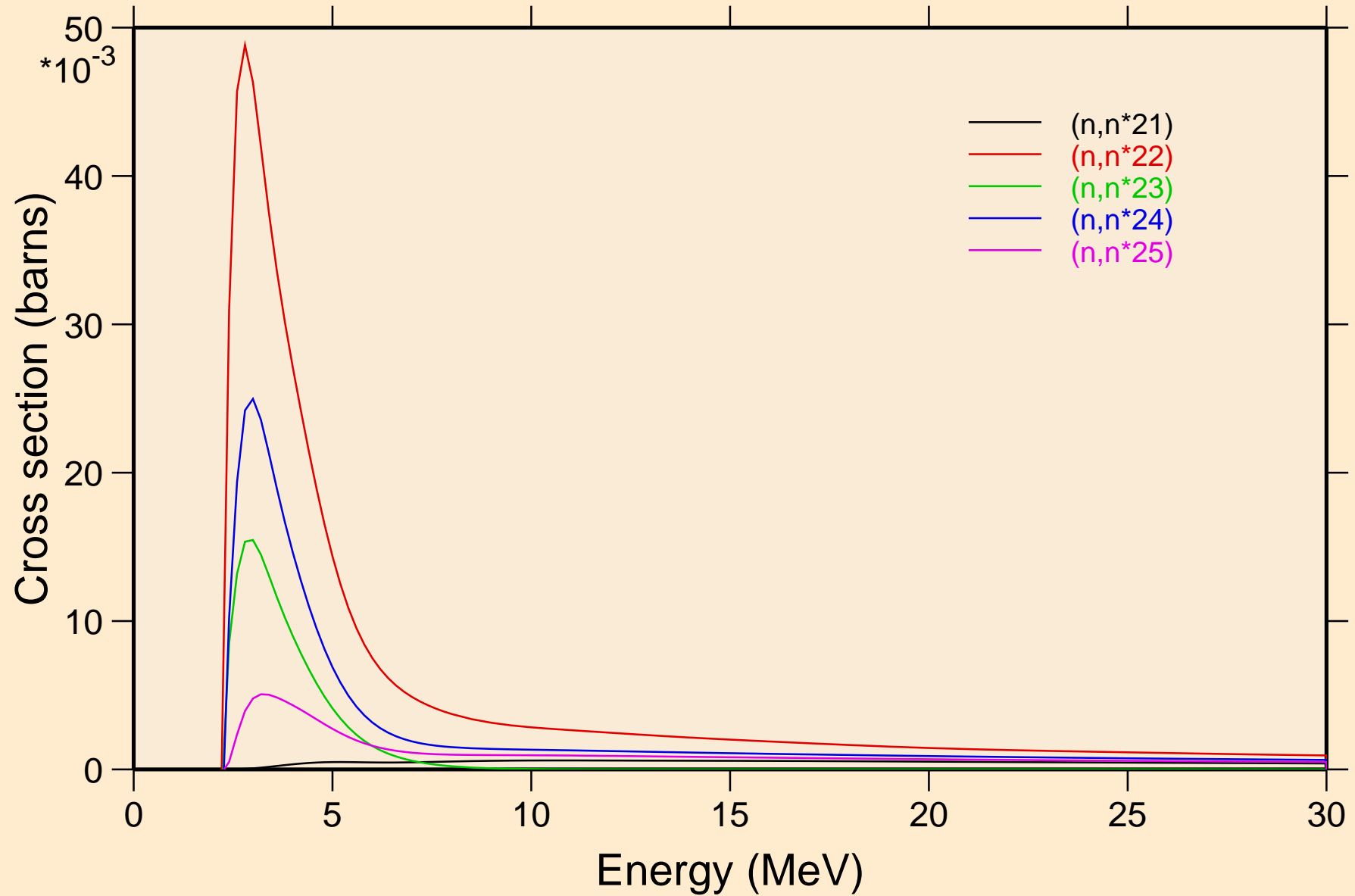

PB204 NEUTRON ACER TENDL-2021 LIBRARY; T=293.6K
Inelastic levels

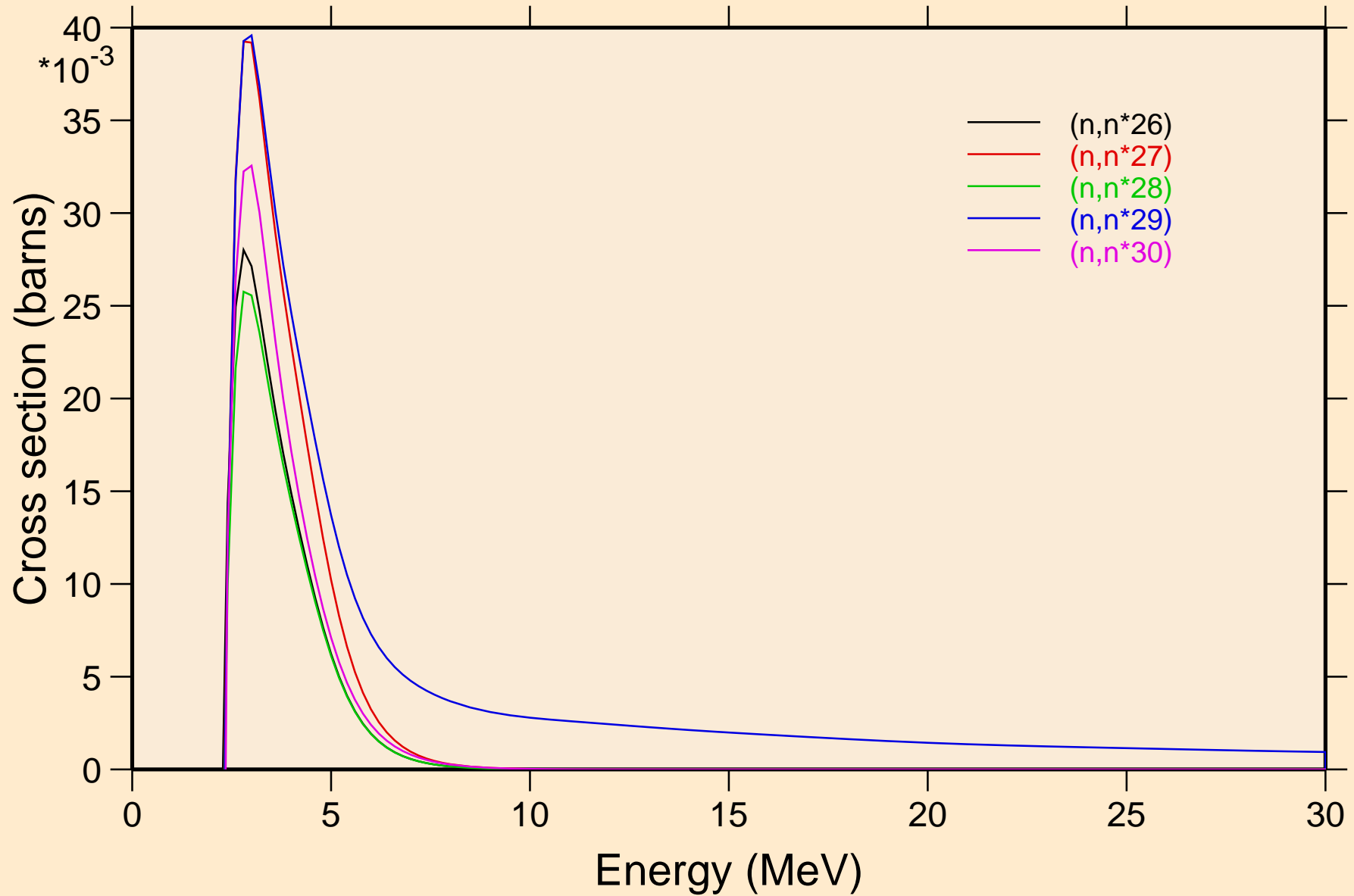

PB204 NEUTRON ACER TENDL-2021 LIBRARY; T=293.6K
Threshold reactions

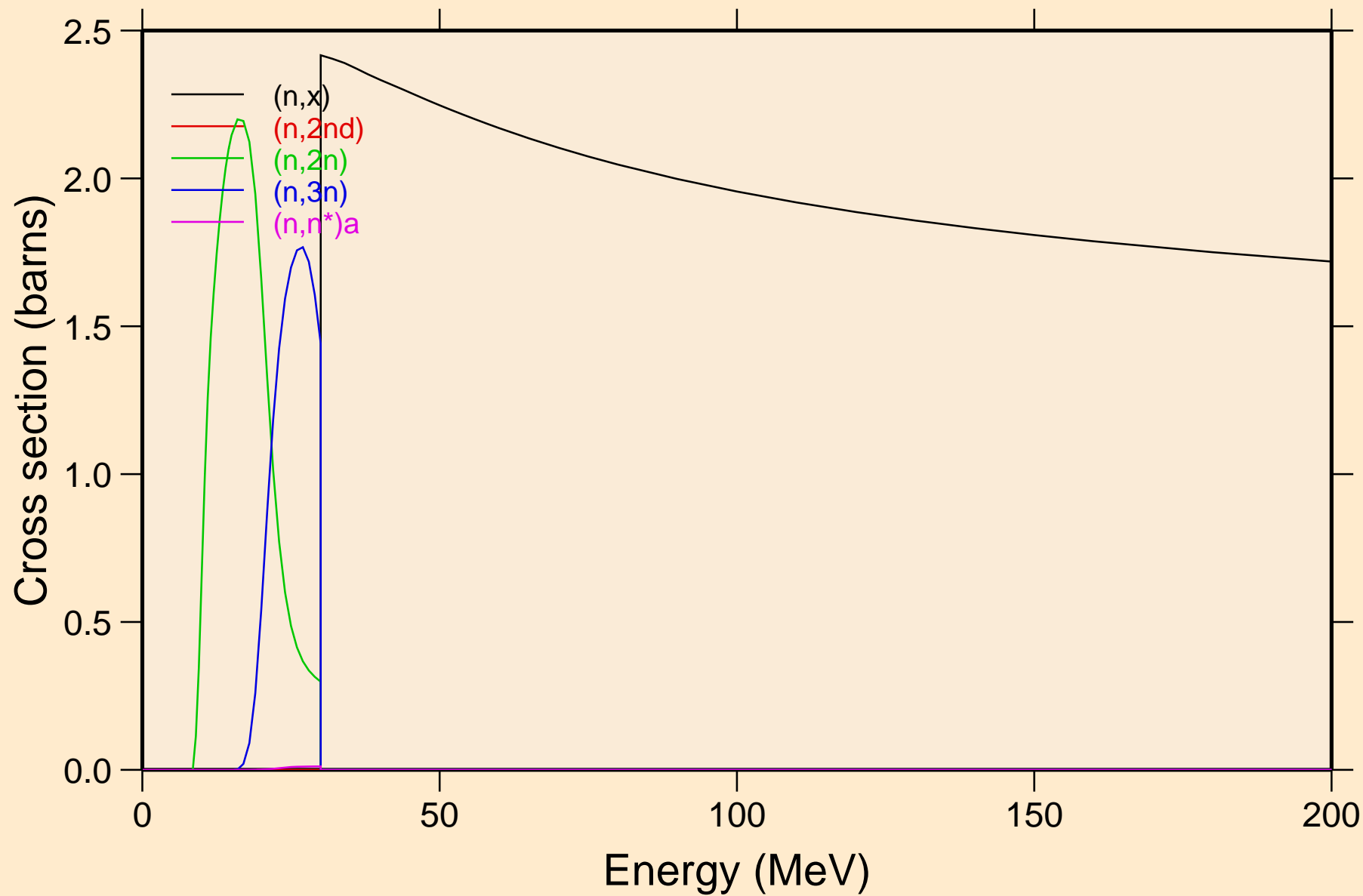

PB204 NEUTRON ACER TENDL-2021 LIBRARY; T=293.6K
Threshold reactions

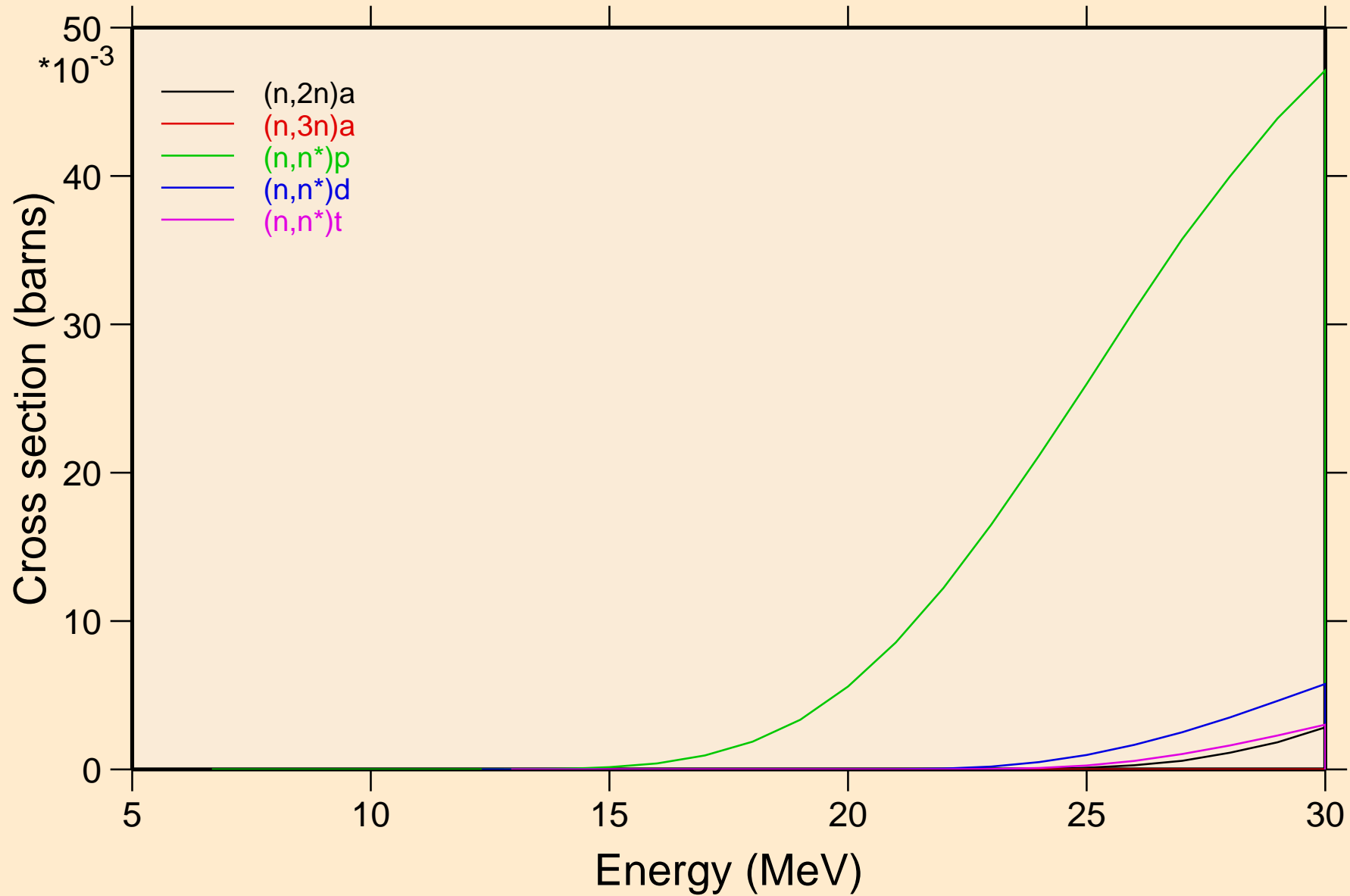

PB204 NEUTRON ACER TENDL-2021 LIBRARY; T=293.6K
Threshold reactions

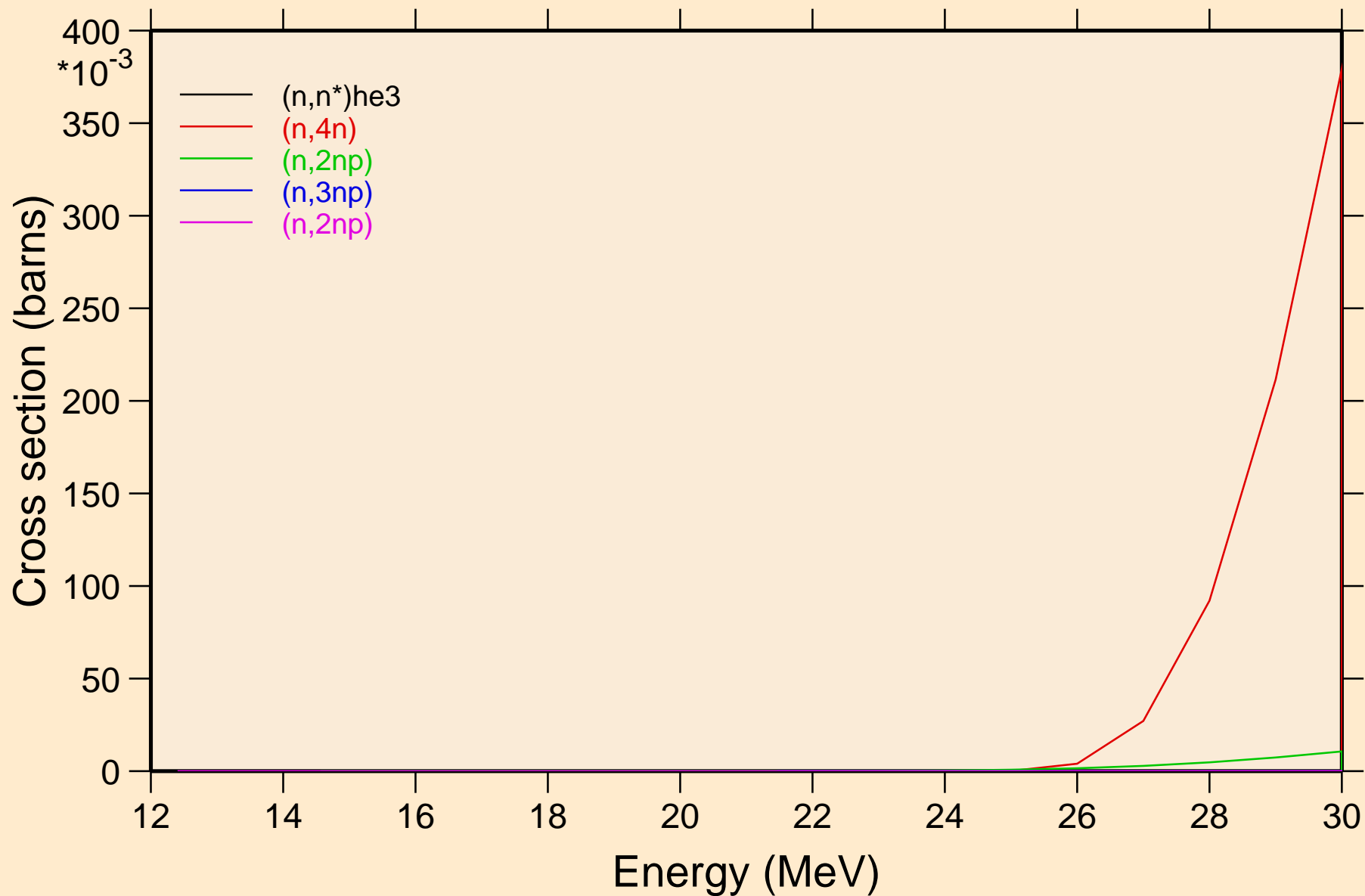

PB204 NEUTRON ACER TENDL-2021 LIBRARY; T=293.6K
Threshold reactions

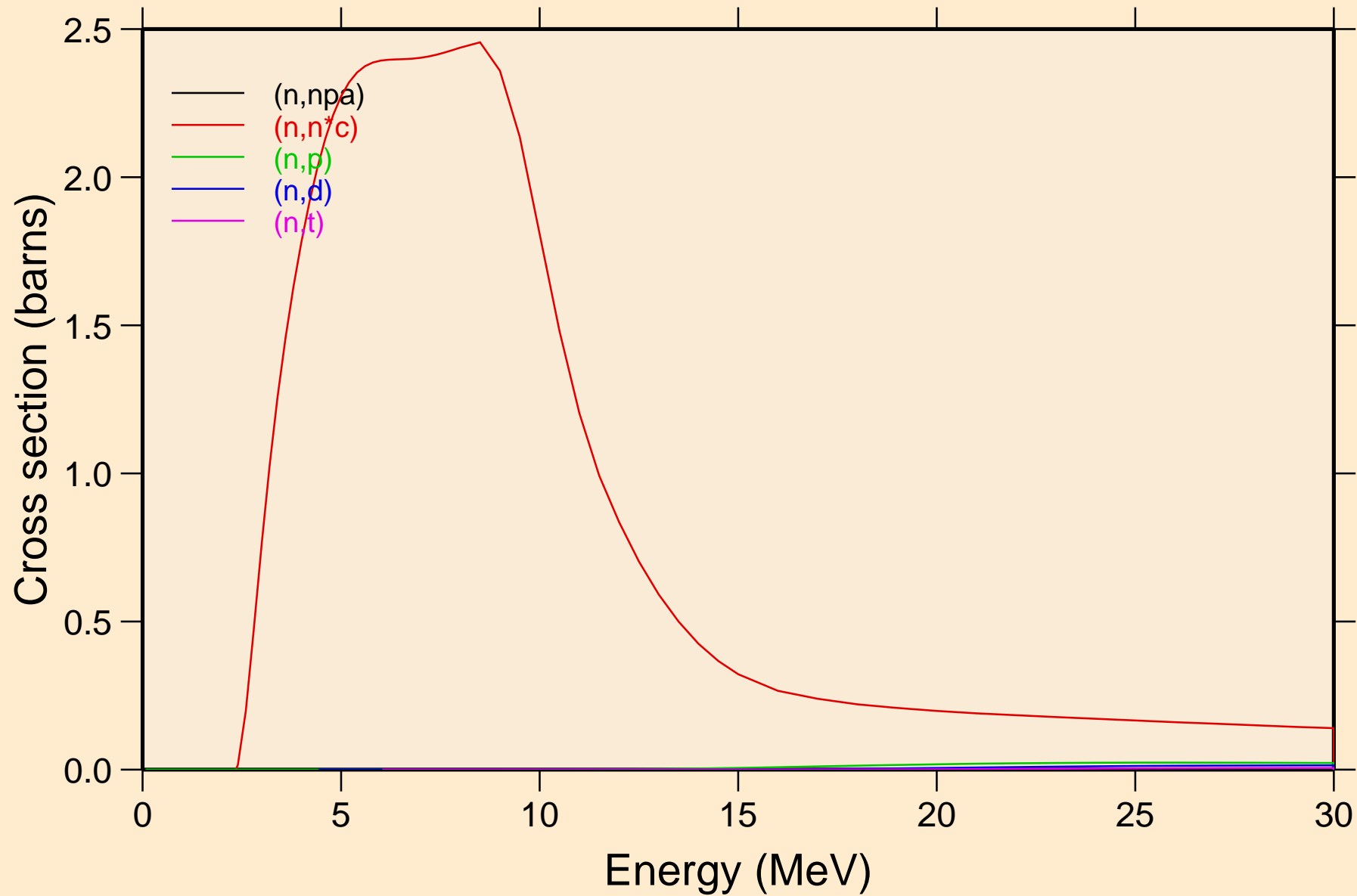

PB204 NEUTRON ACER TENDL-2021 LIBRARY; T=293.6K
Threshold reactions

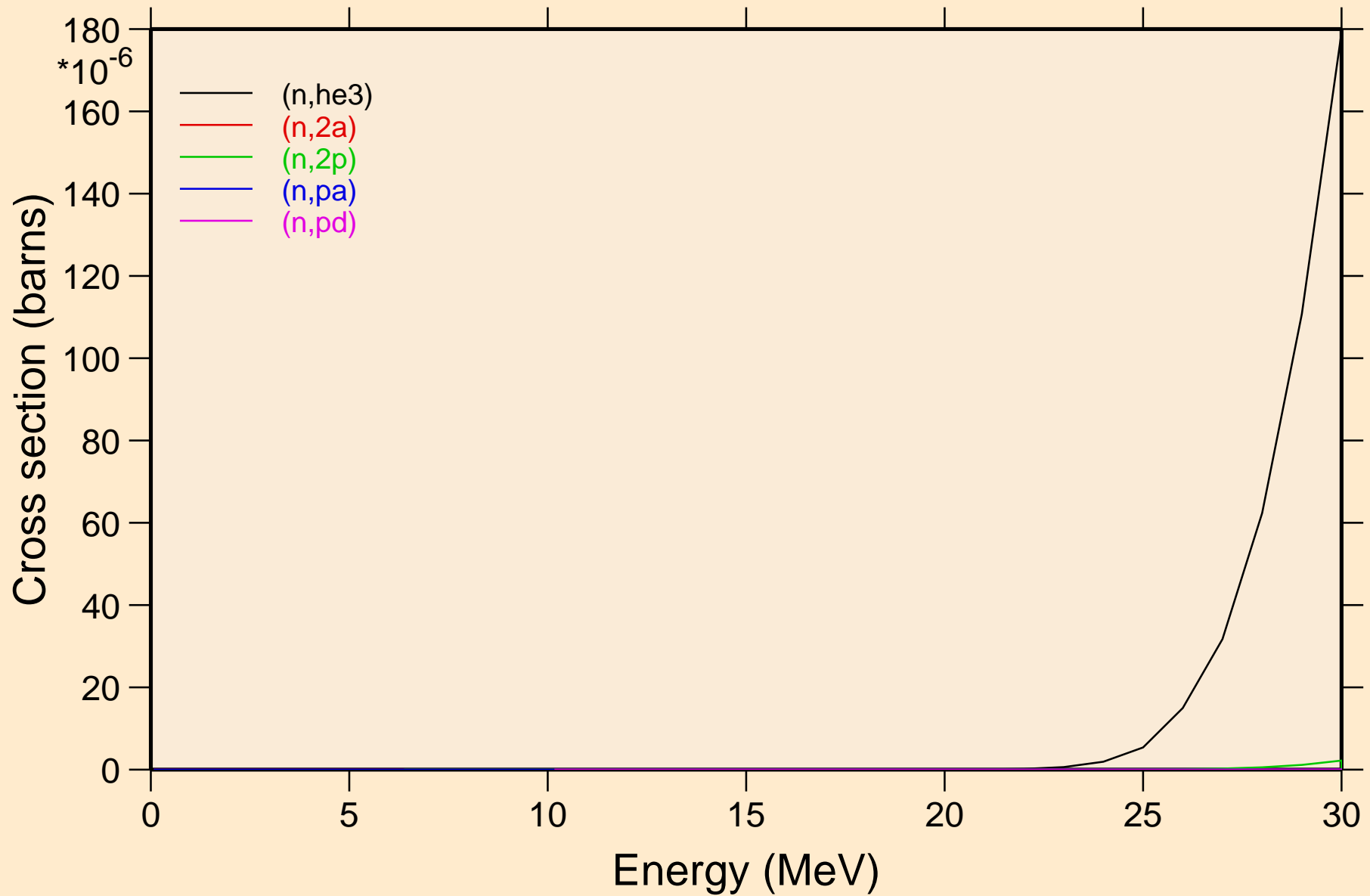

PB204 NEUTRON ACER TENDL-2021 LIBRARY; T=293.6K
Threshold reactions

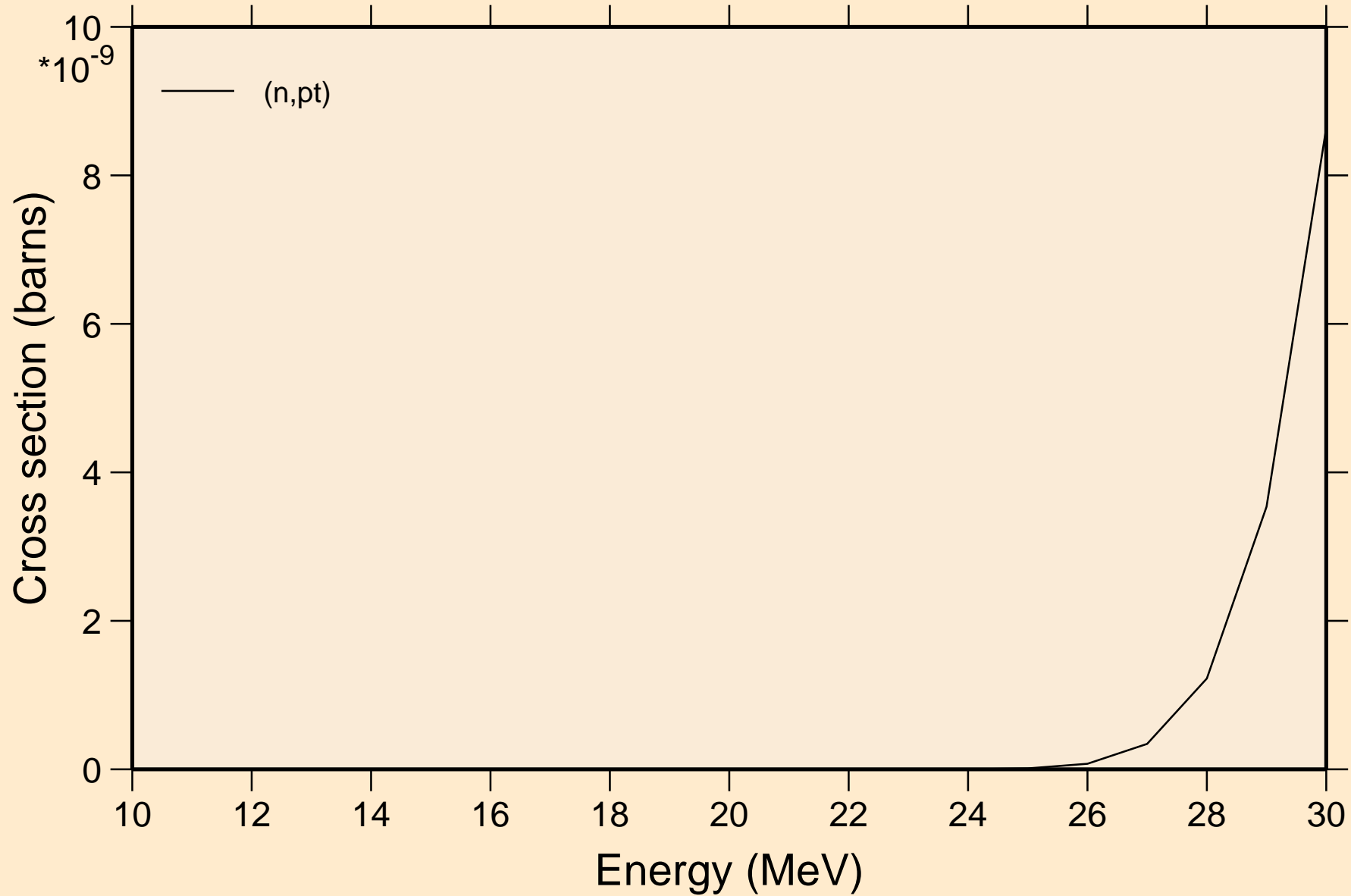

PB204 NEUTRON ACER TENDL-2021 LIBRARY; T=293.6K
Threshold reactions

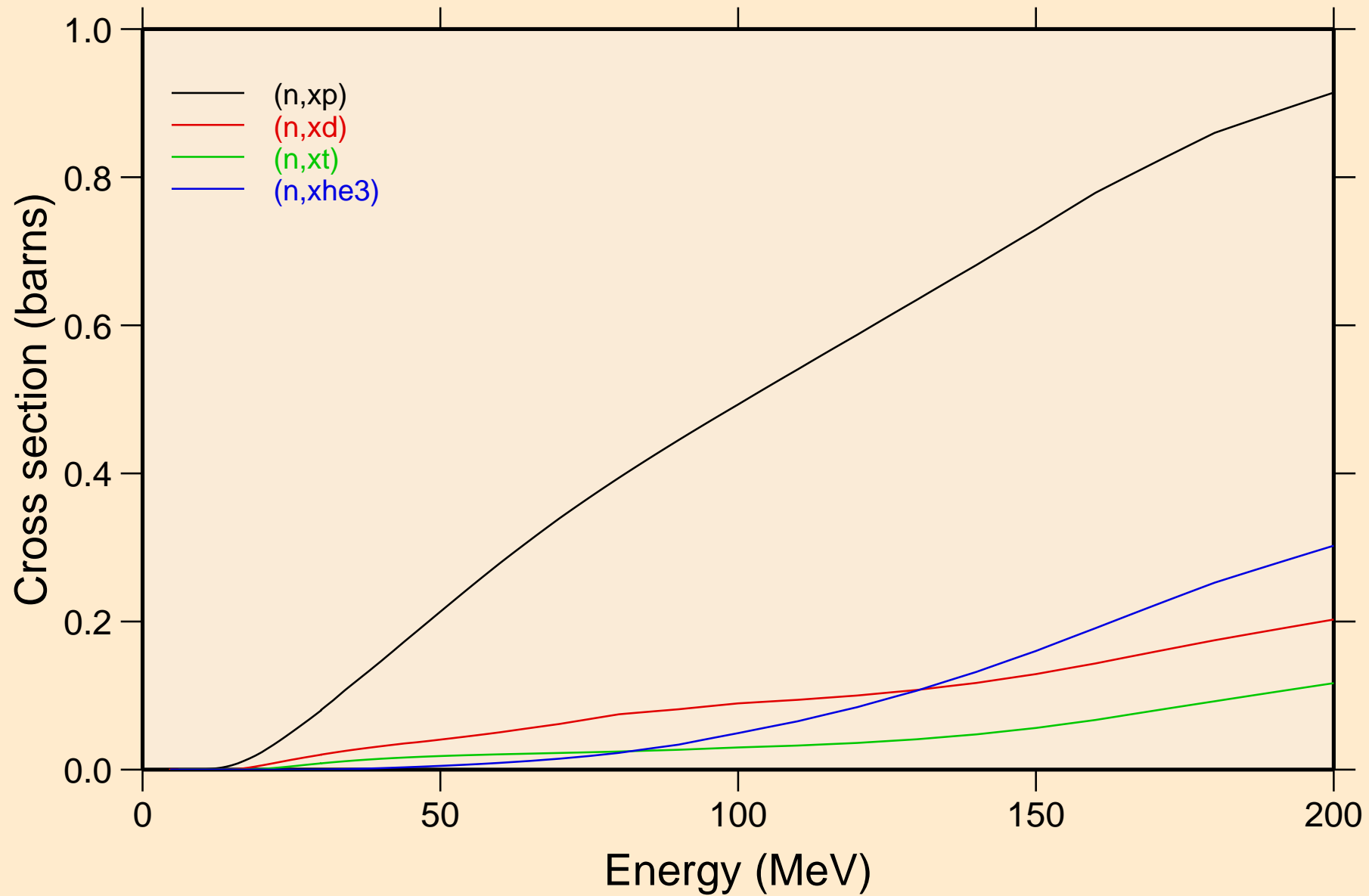

PB204 NEUTRON ACER TENDL-2021 LIBRARY; T=293.6K
angular distribution for elastic

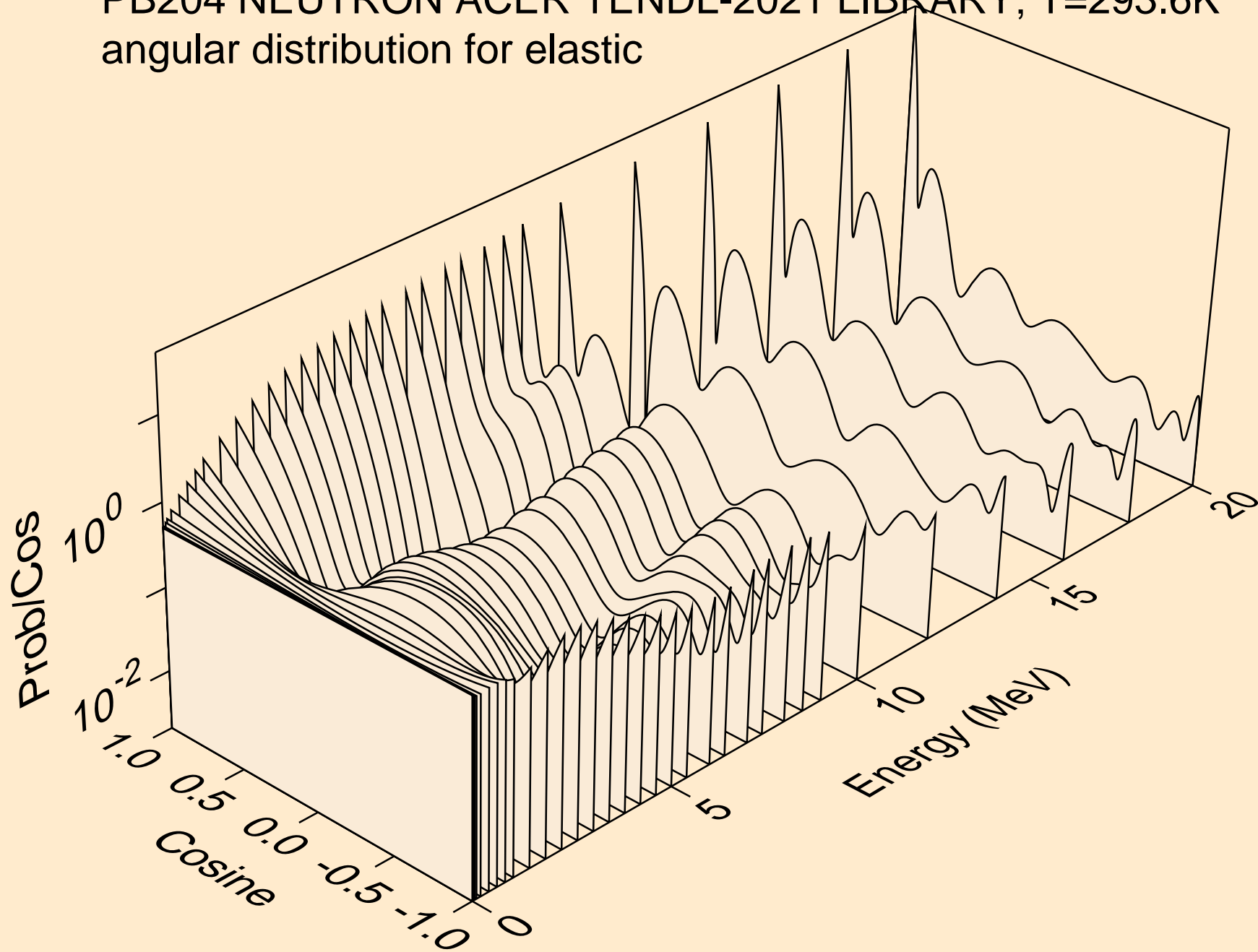

PB204 NEUTRON ACER TENDL-2021 LIBRARY; T=293.6K
angular distribution for elastic

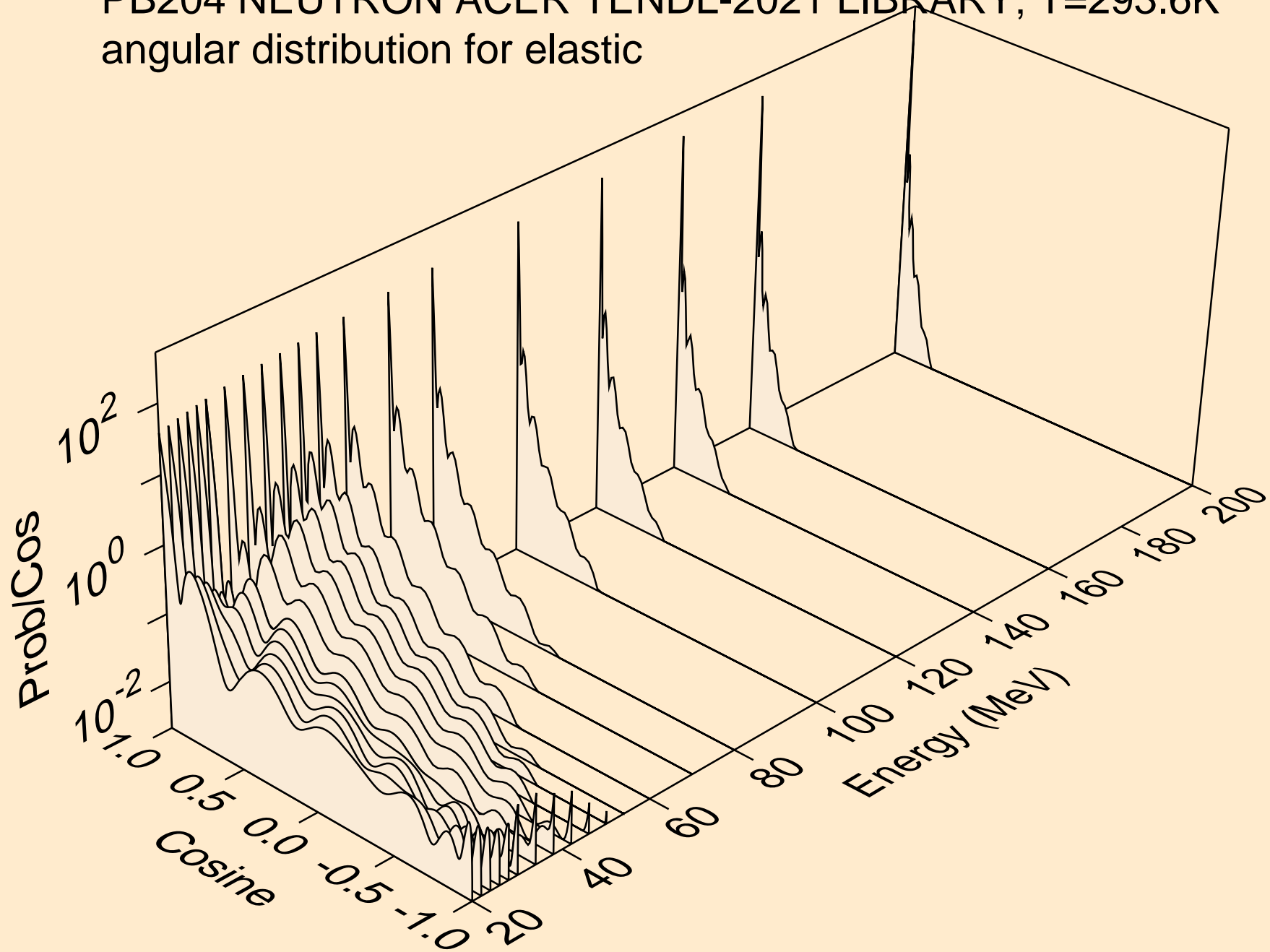

PB204 NEUTRON ACER TENDL-2021 LIBRARY; T=293.6K
angular distribution for (n,n*1)

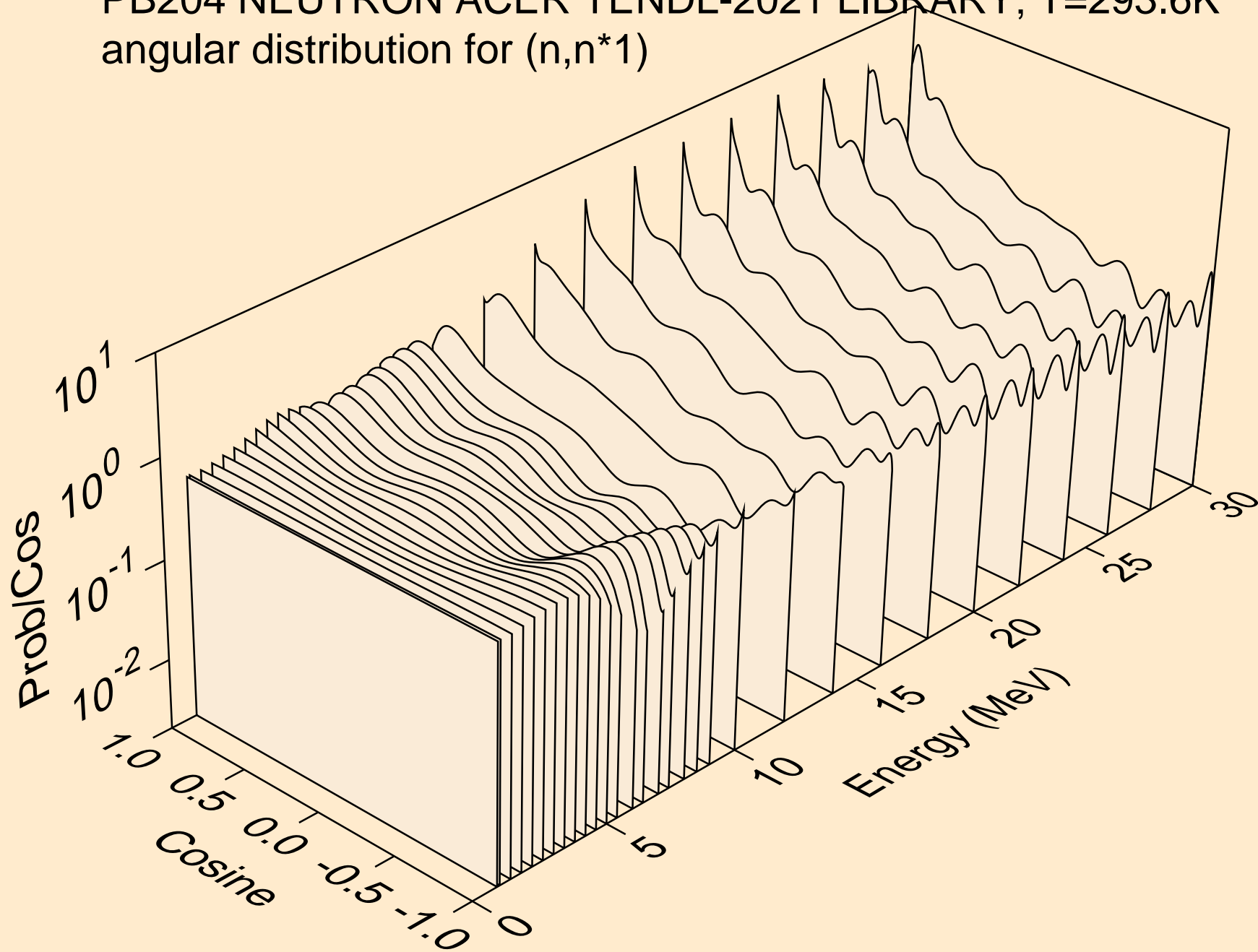

PB204 NEUTRON ACER TENDL-2021 LIBRARY; T=293.6K
angular distribution for (n,n*2)

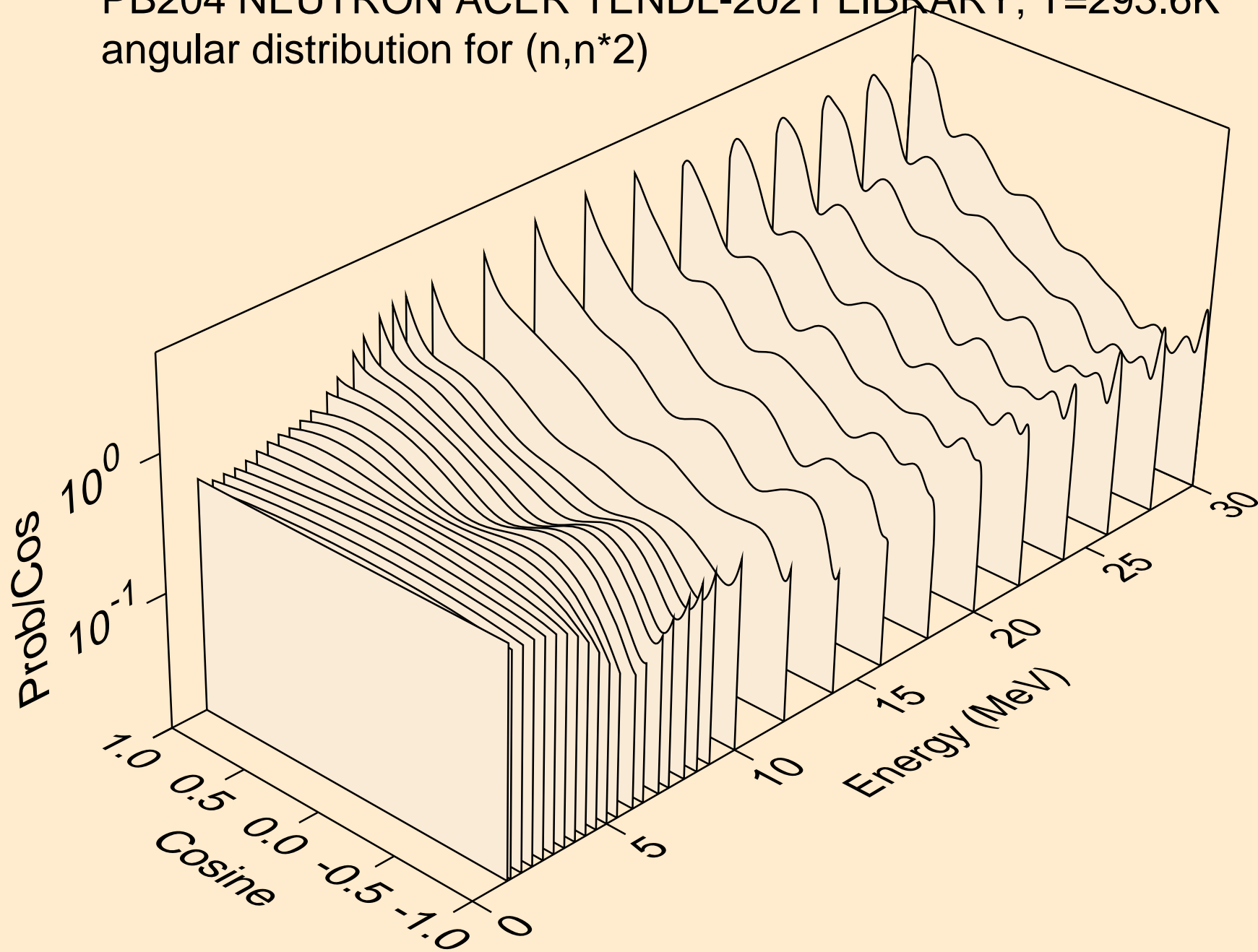

PB204 NEUTRON ACER TENDL-2021 LIBRARY; T=293.6K
angular distribution for (n,n*3)

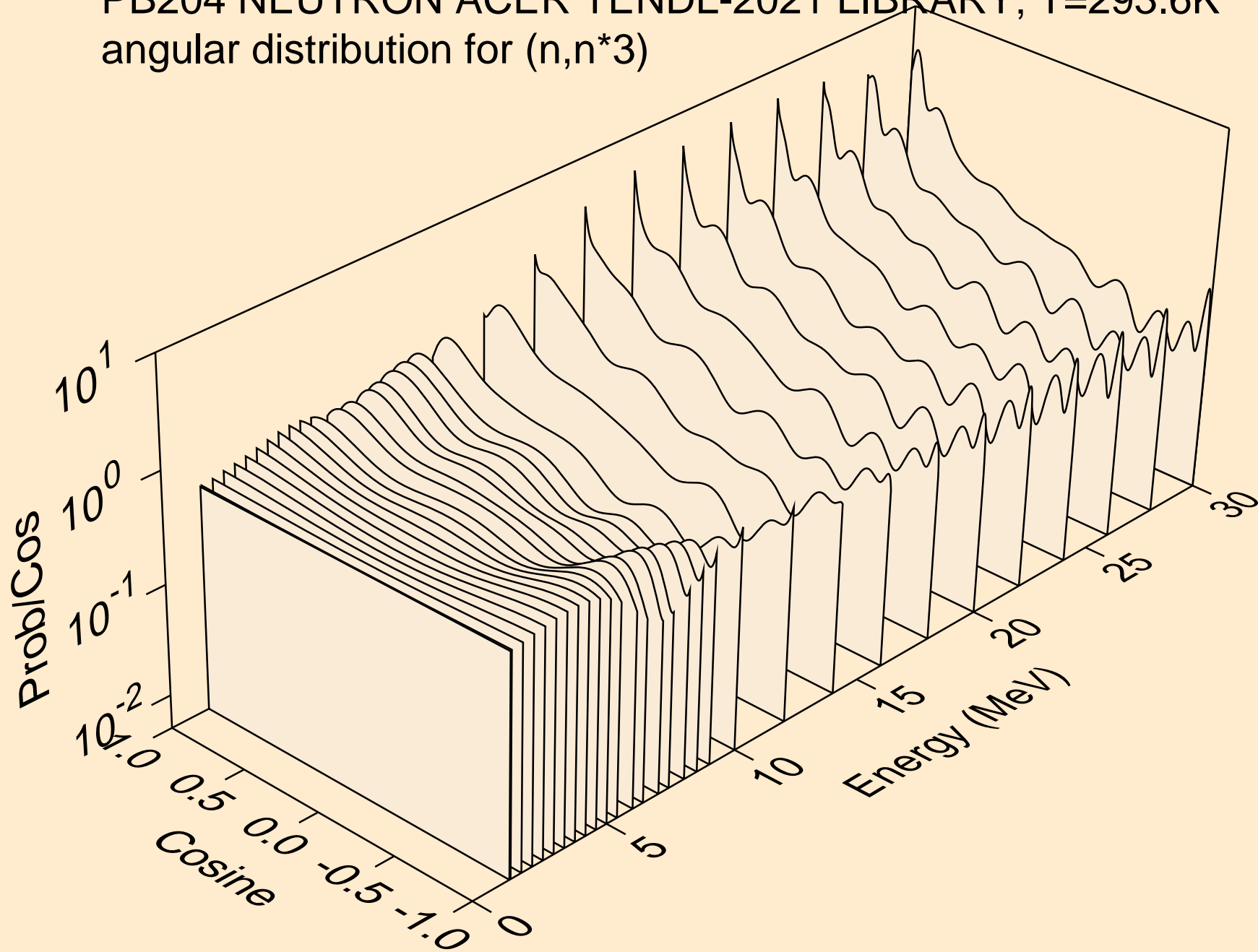

PB204 NEUTRON ACER TENDL-2021 LIBRARY; T=293.6K
angular distribution for (n,n*4)

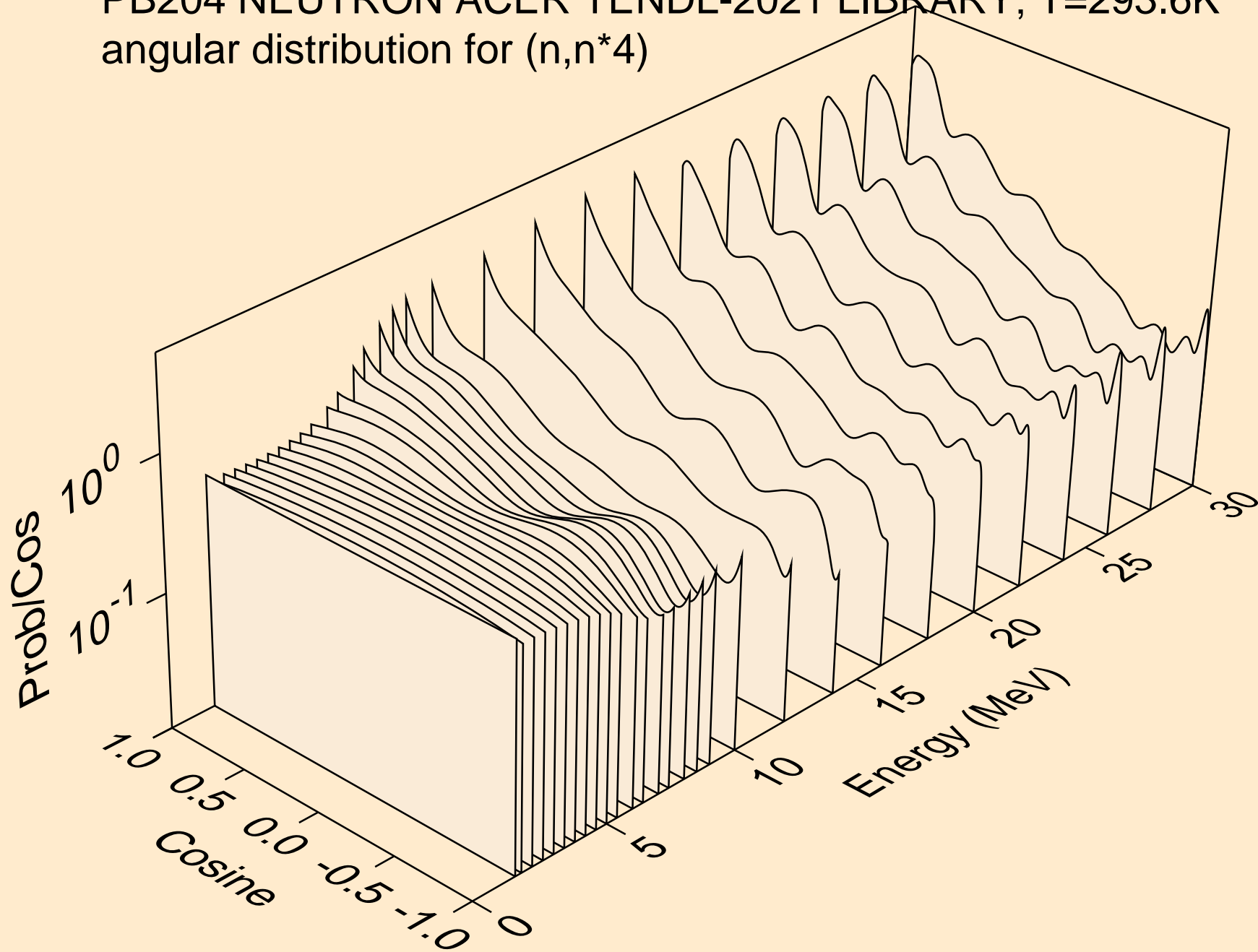

PB204 NEUTRON ACER TENDL-2021 LIBRARY; T=293.6K
angular distribution for (n,n*5)

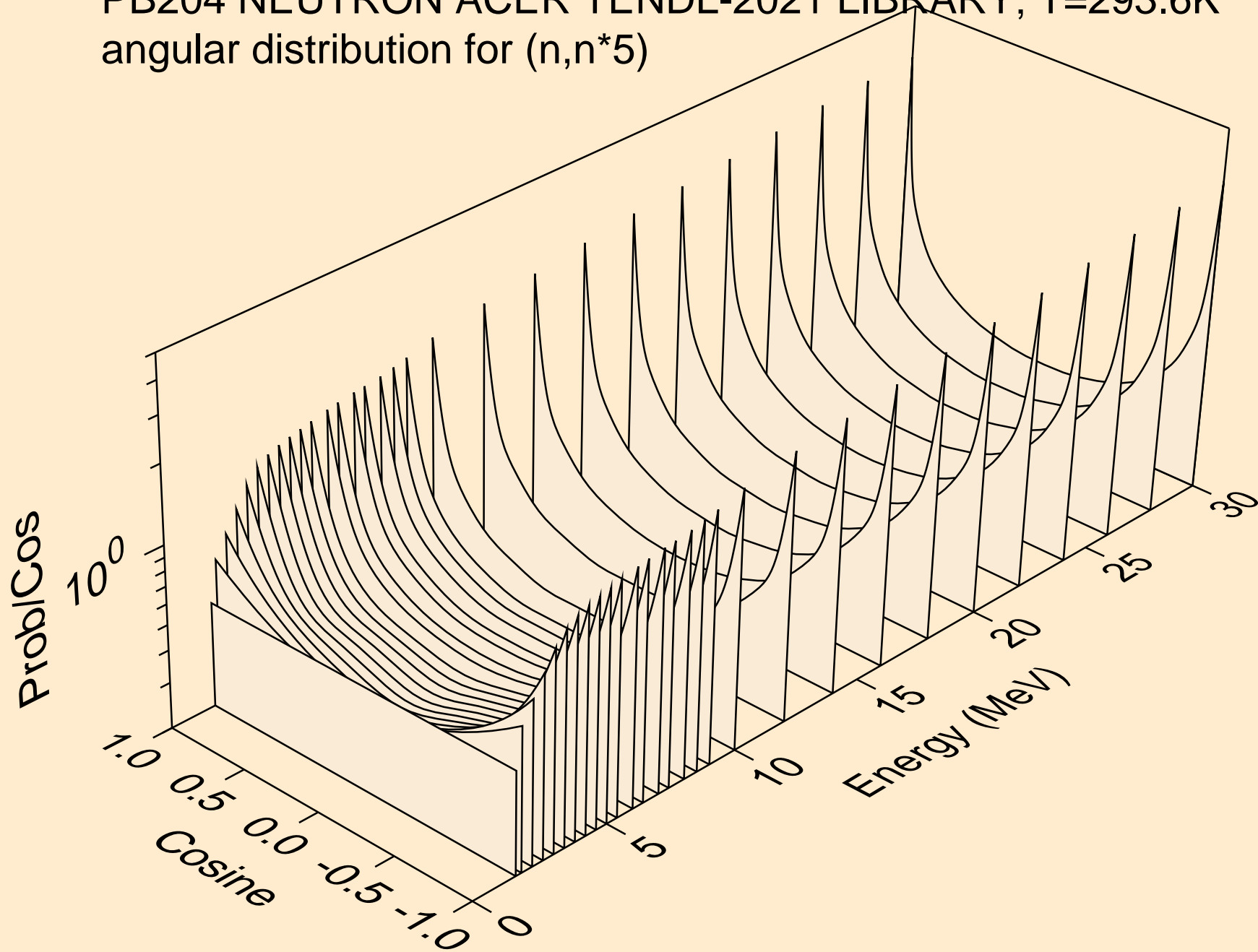

PB204 NEUTRON ACER TENDL-2021 LIBRARY; T=293.6K
angular distribution for (n,n*6)

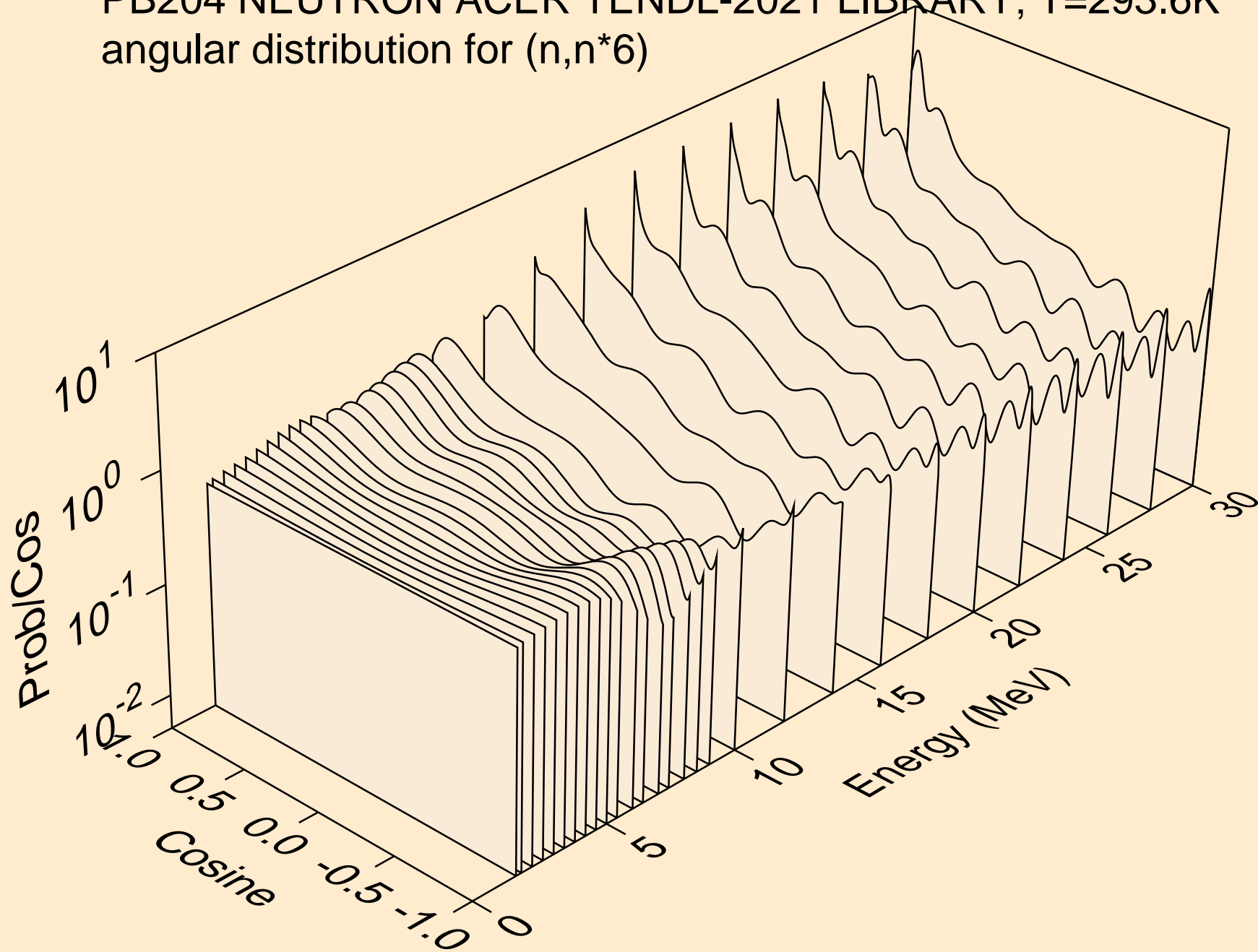

PB204 NEUTRON ACER TENDL-2021 LIBRARY; T=293.6K
angular distribution for (n,n*7)

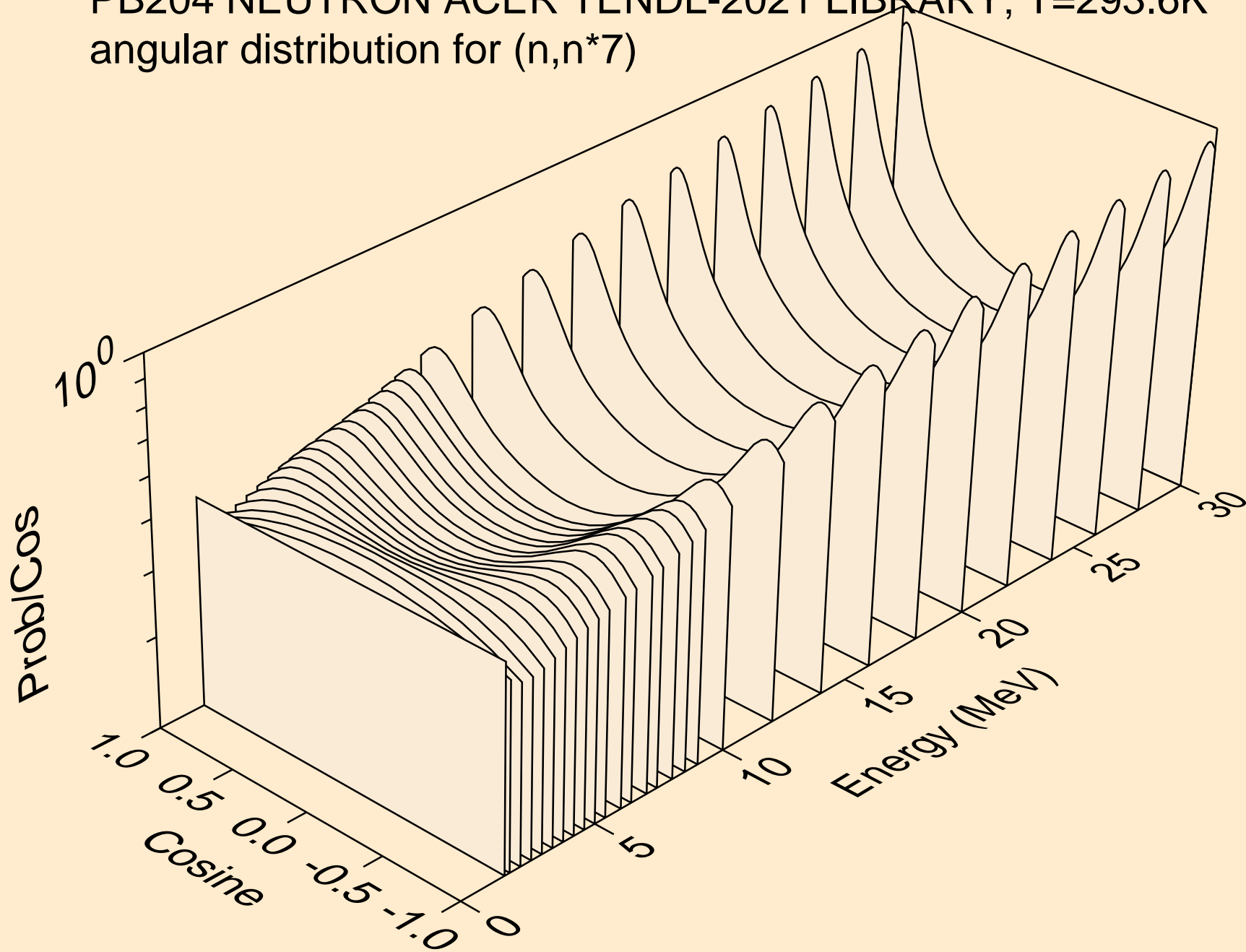

PB204 NEUTRON ACER TENDL-2021 LIBRARY; T=293.6K
angular distribution for (n,n*8)

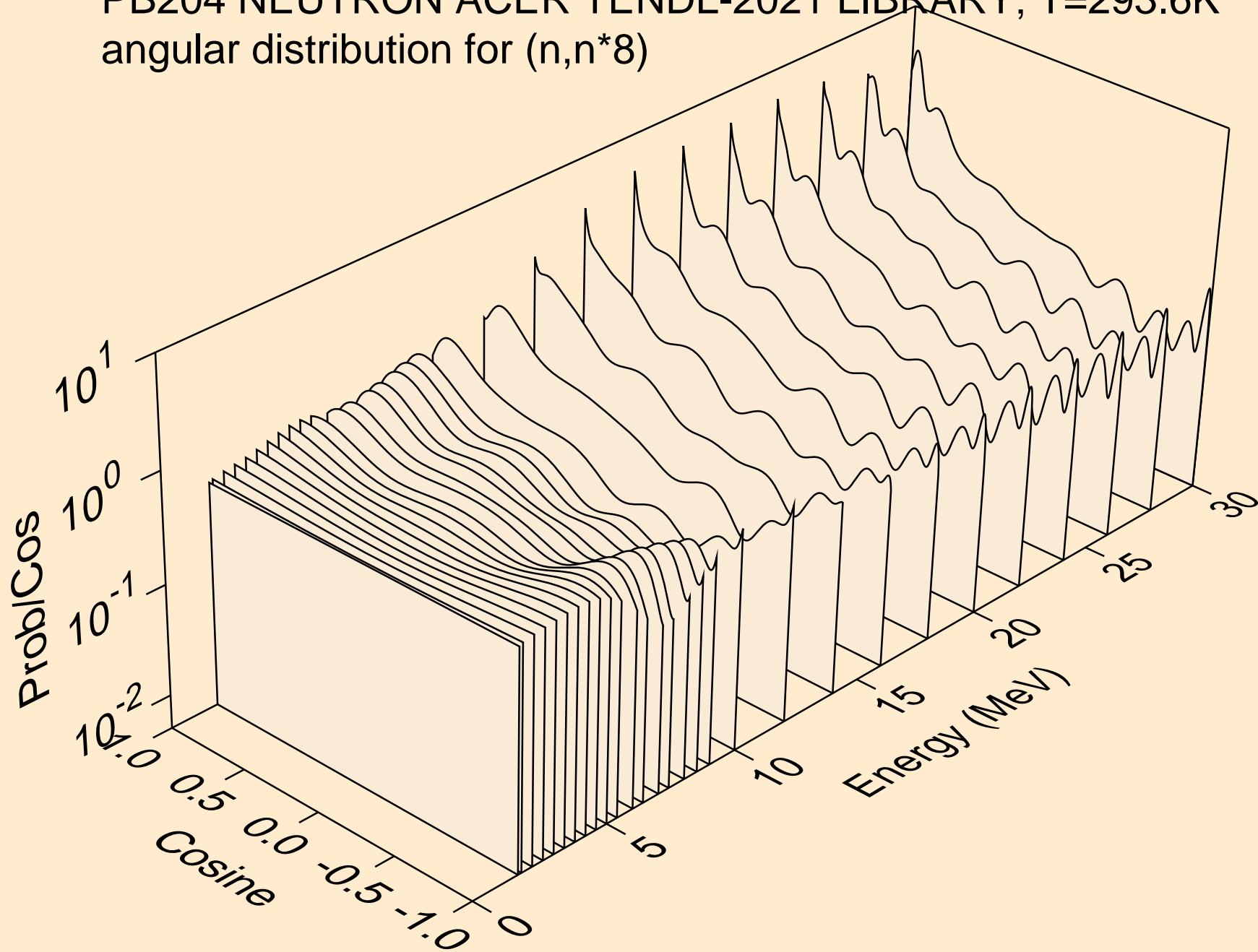

PB204 NEUTRON ACER TENDL-2021 LIBRARY; T=293.6K
angular distribution for (n,n*9)

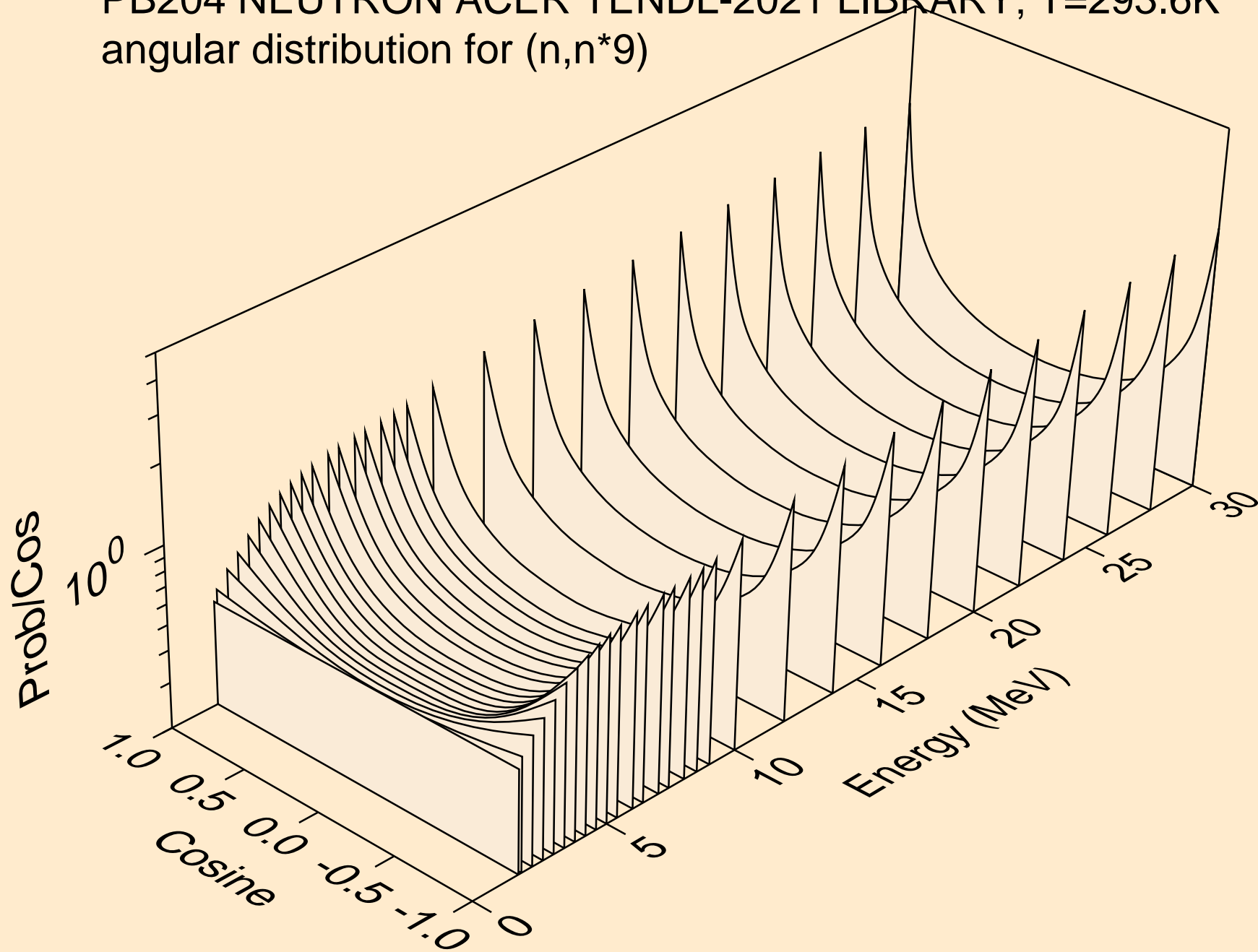

PB204 NEUTRON ACER TENDL-2021 LIBRARY; T=293.6K
angular distribution for (n,n*10)

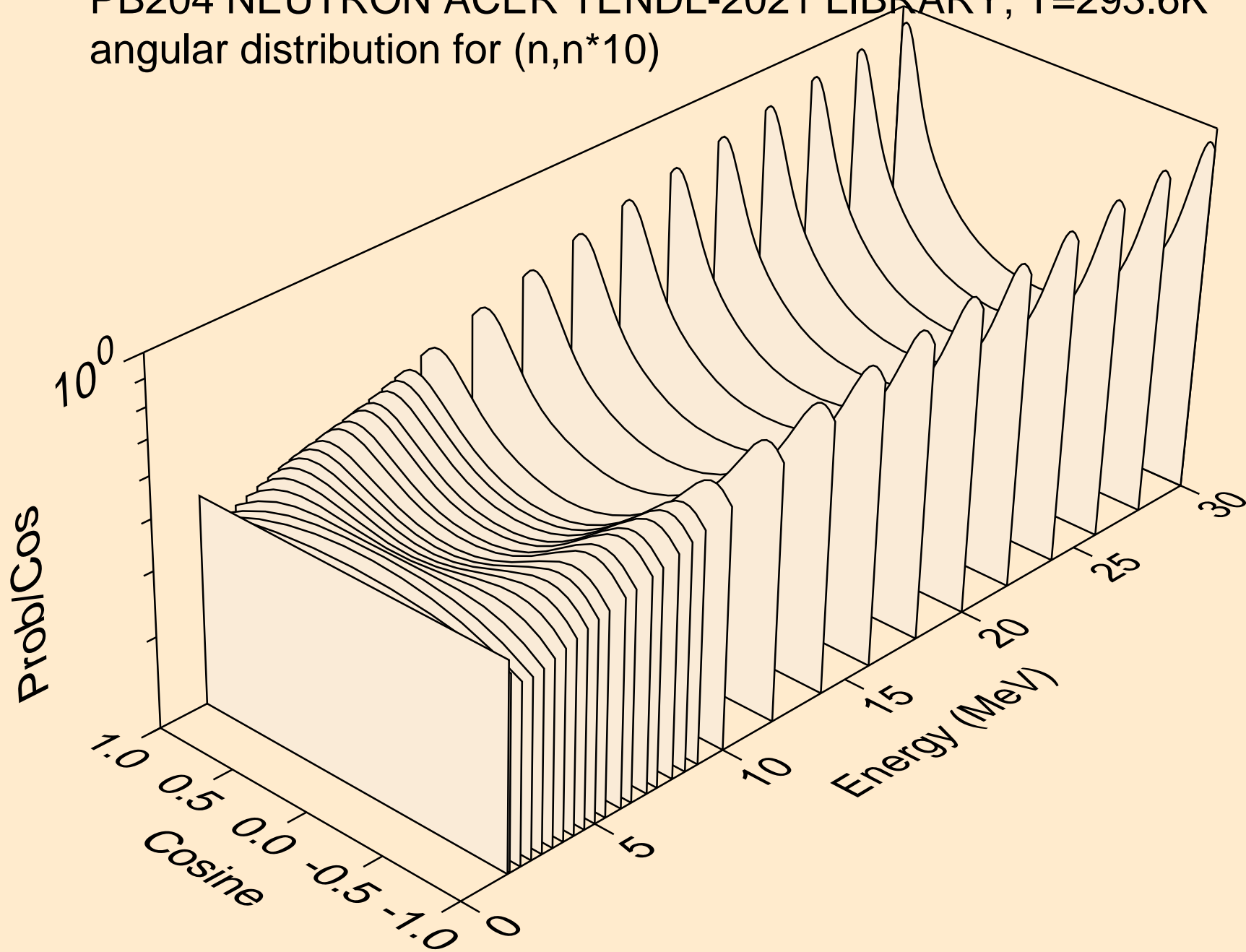

PB204 NEUTRON ACER TENDL-2021 LIBRARY; T=293.6K
angular distribution for (n,n*11)

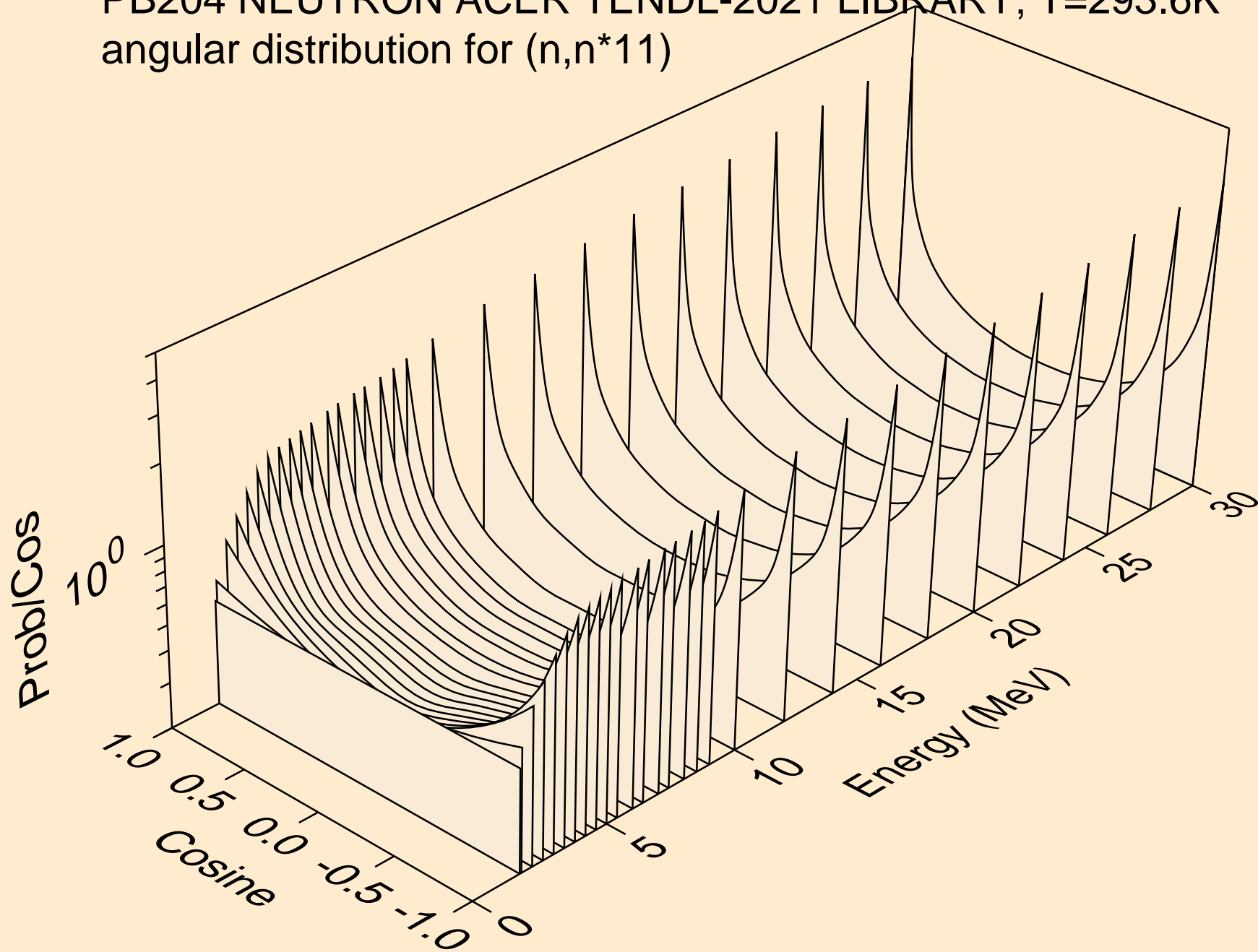

PB204 NEUTRON ACER TENDL-2021 LIBRARY; T=293.6K
angular distribution for (n,n*12)

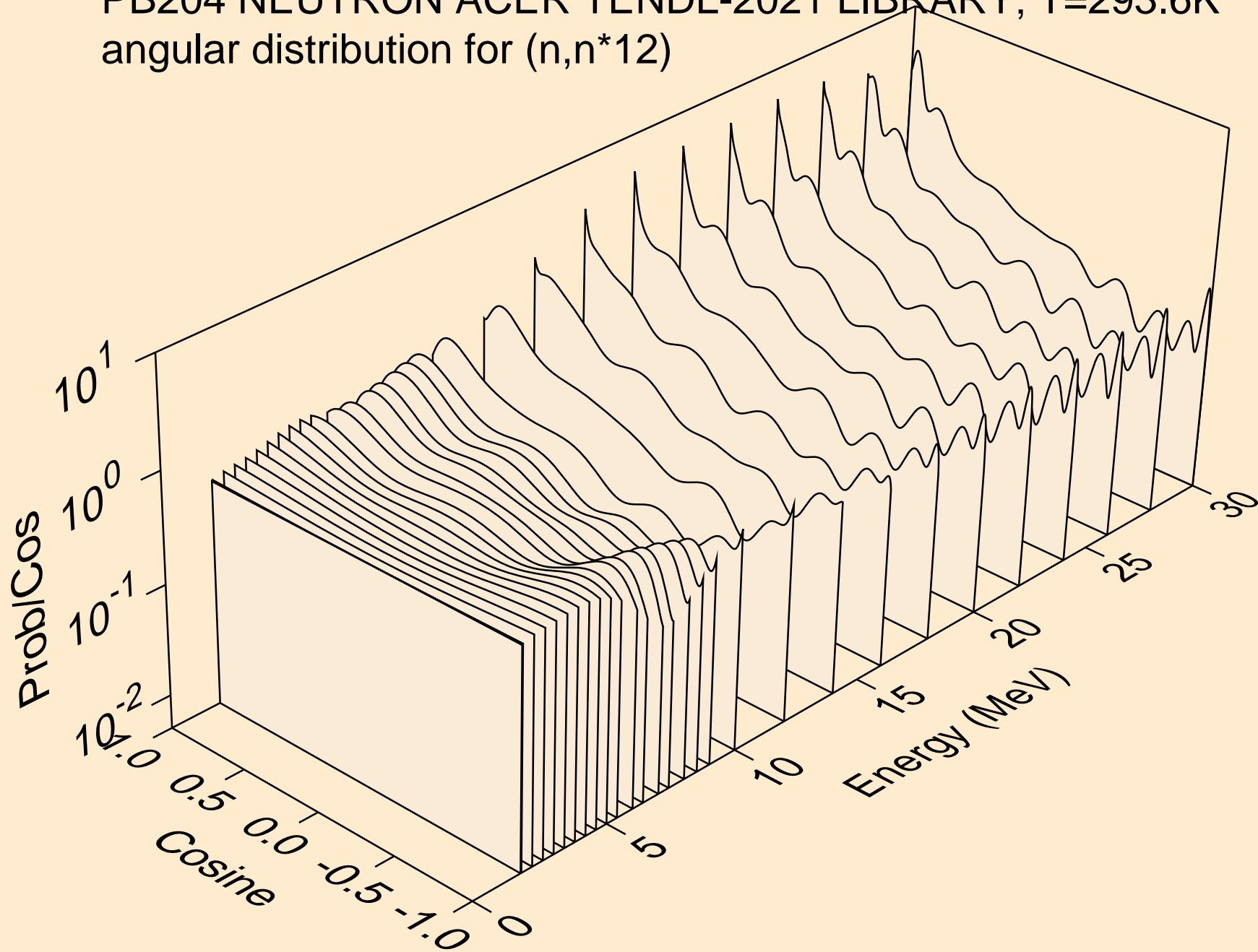

PB204 NEUTRON ACER TENDL-2021 LIBRARY; T=293.6K
angular distribution for (n,n*13)

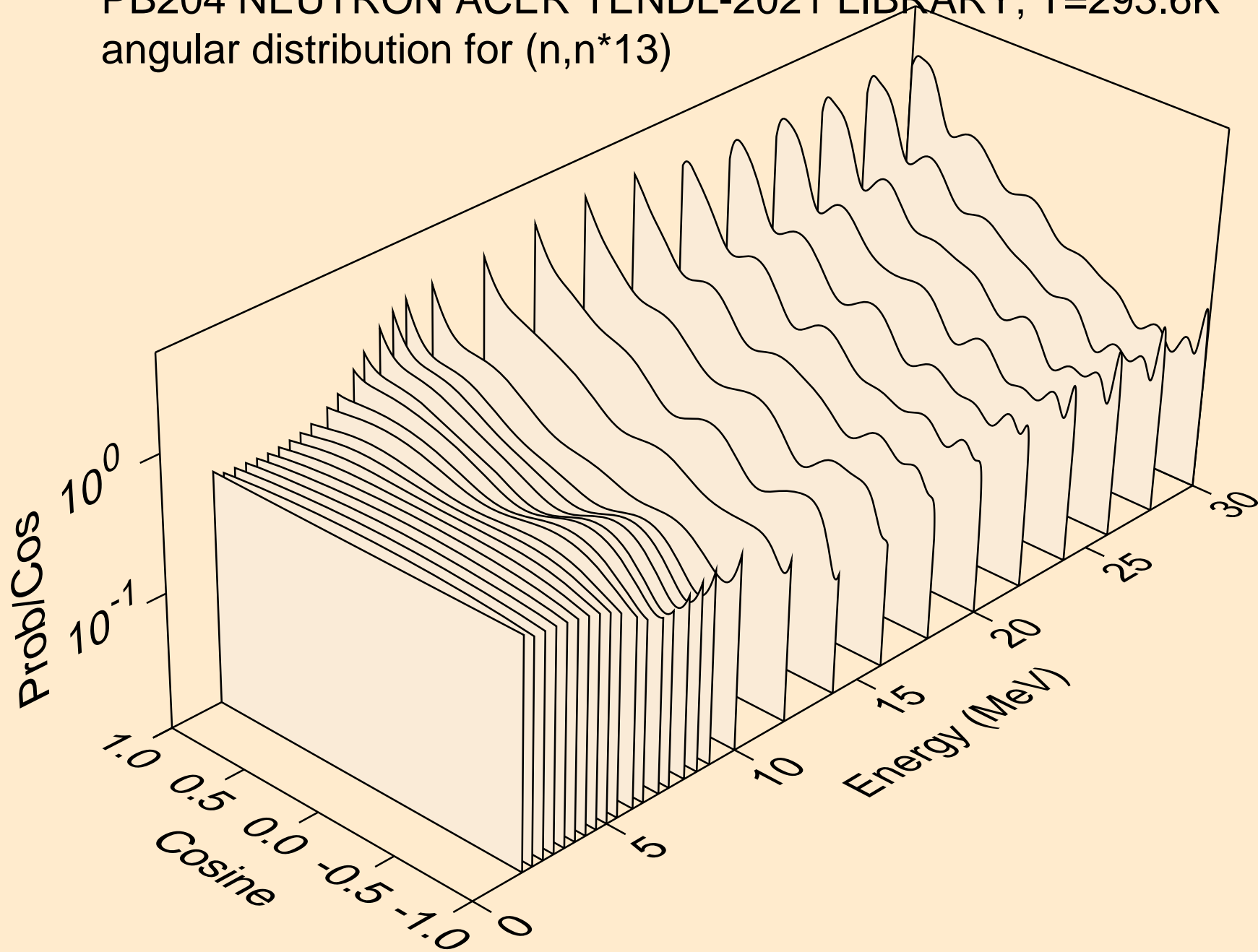

PB204 NEUTRON ACER TENDL-2021 LIBRARY; T=293.6K
angular distribution for (n,n*14)

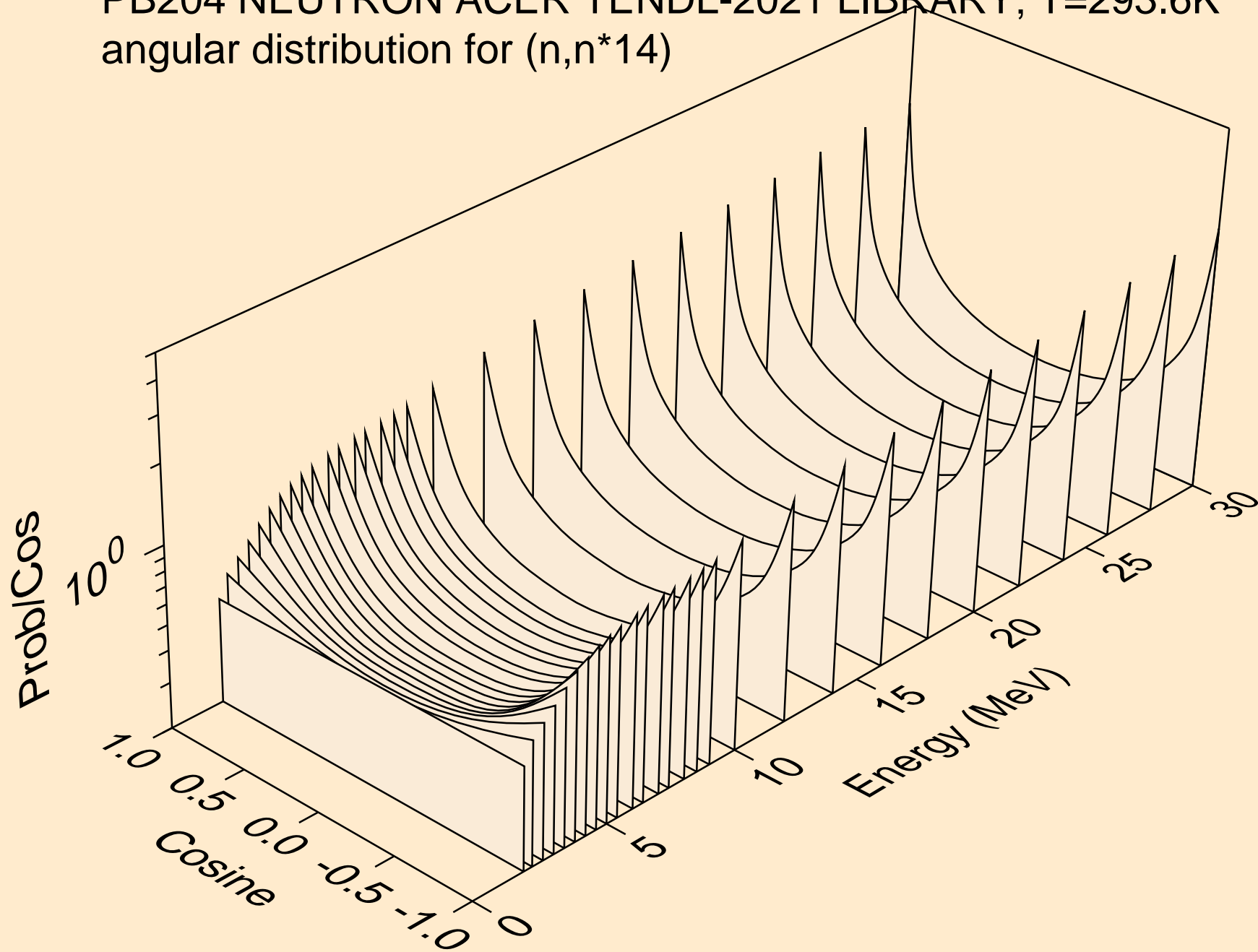

PB204 NEUTRON ACER TENDL-2021 LIBRARY; T=293.6K
angular distribution for (n,n*15)

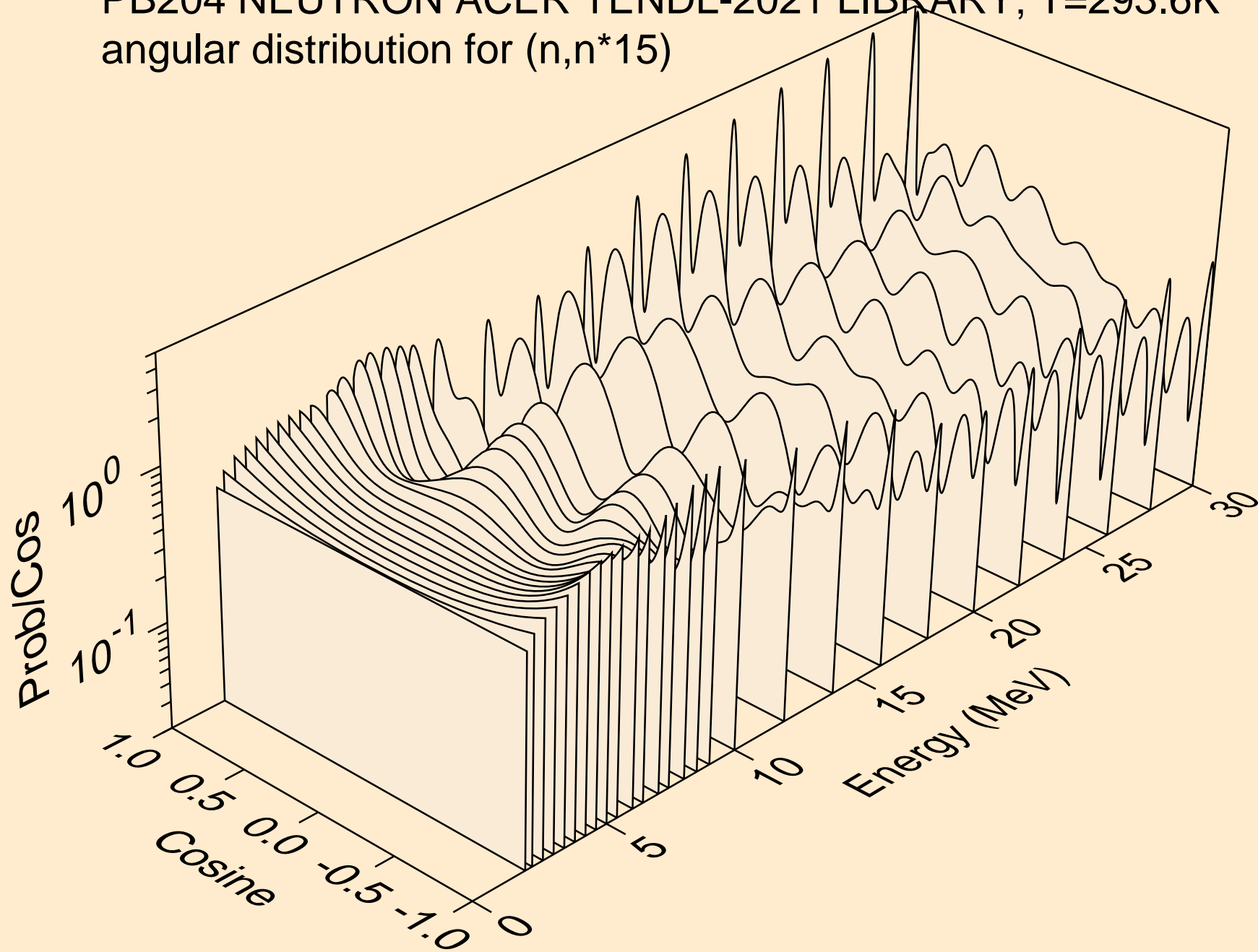

PB204 NEUTRON ACER TENDL-2021 LIBRARY; T=293.6K
angular distribution for (n,n*16)

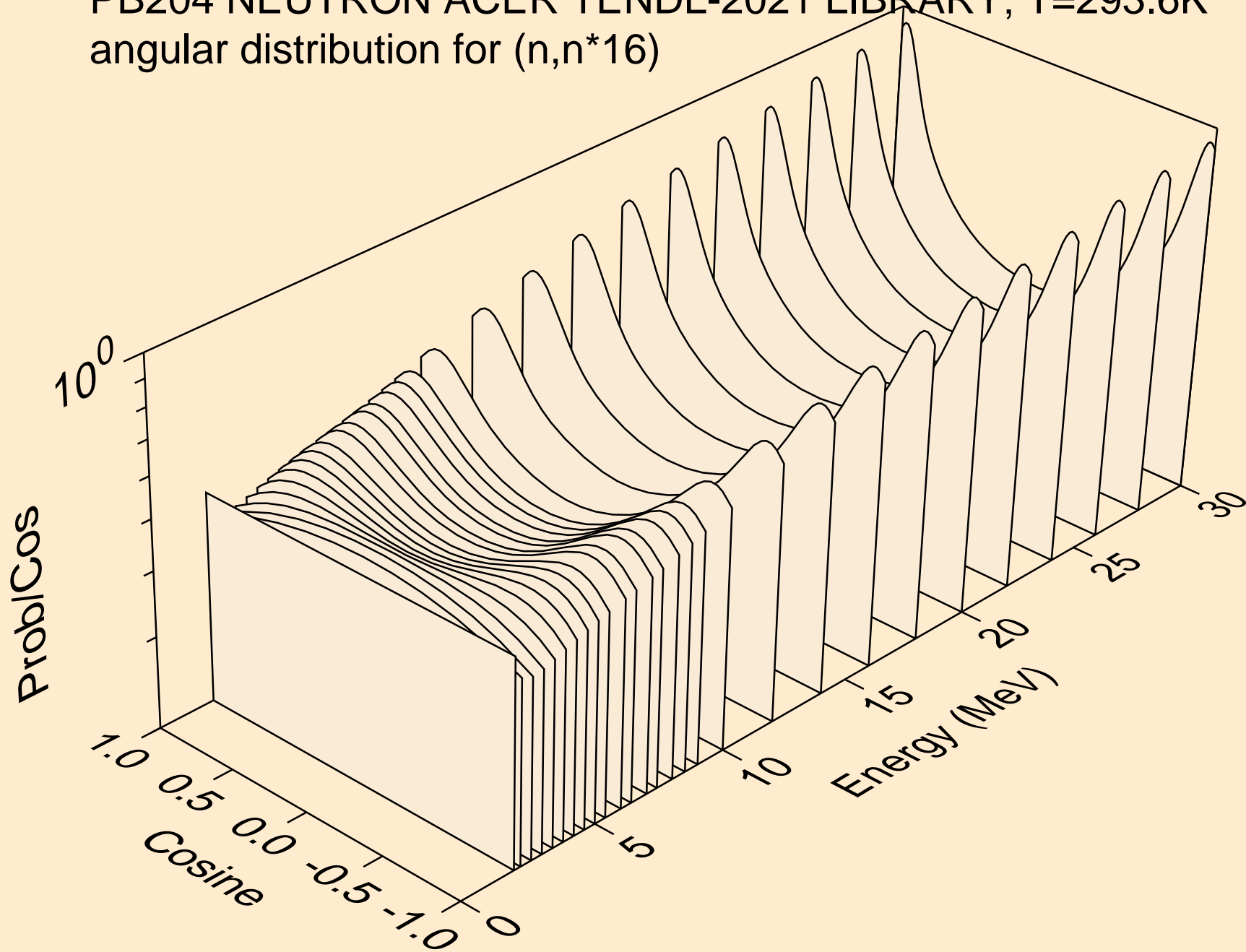

PB204 NEUTRON ACER TENDL-2021 LIBRARY; T=293.6K
angular distribution for (n,n*17)

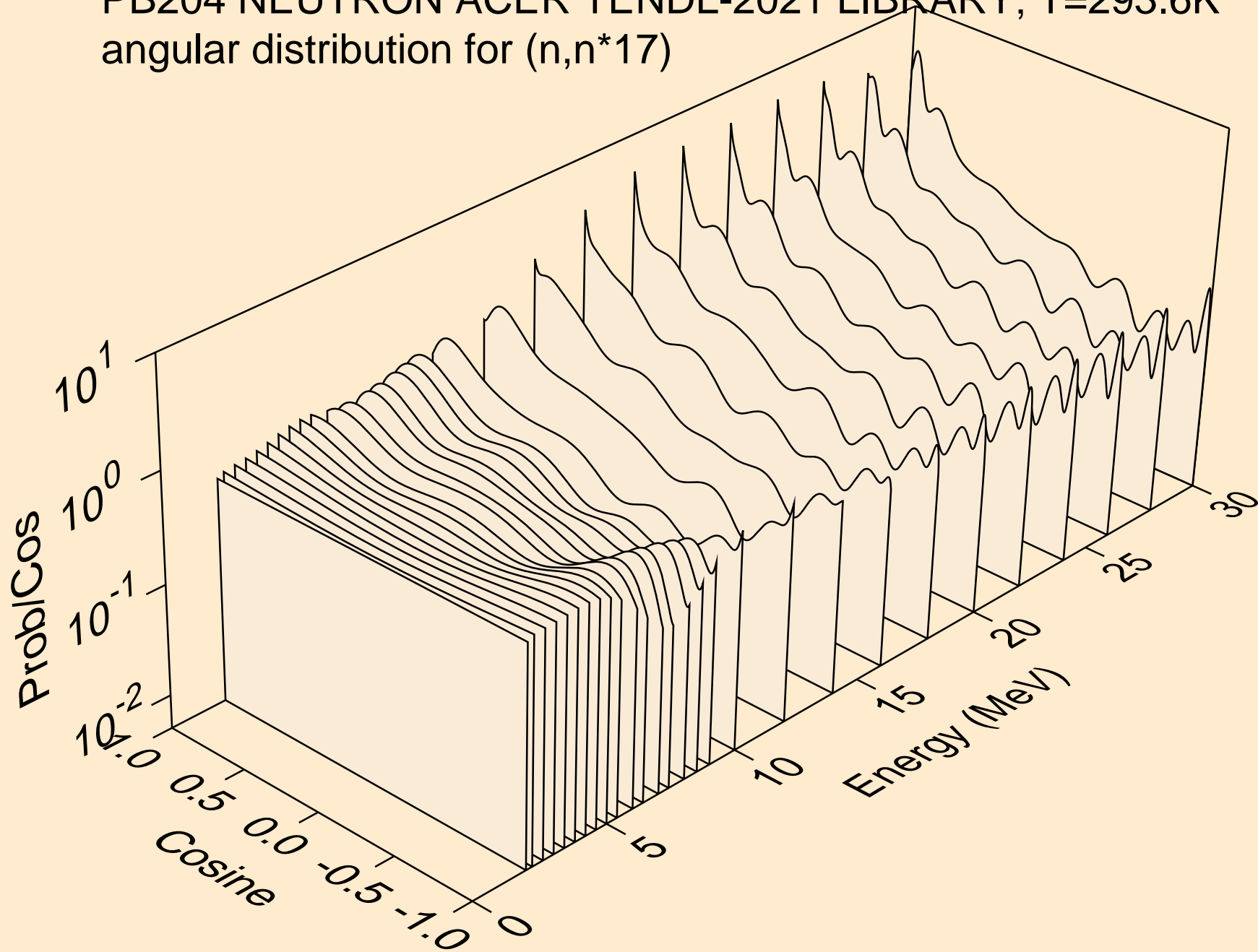

PB204 NEUTRON ACER TENDL-2021 LIBRARY; T=293.6K
angular distribution for (n,n*18)

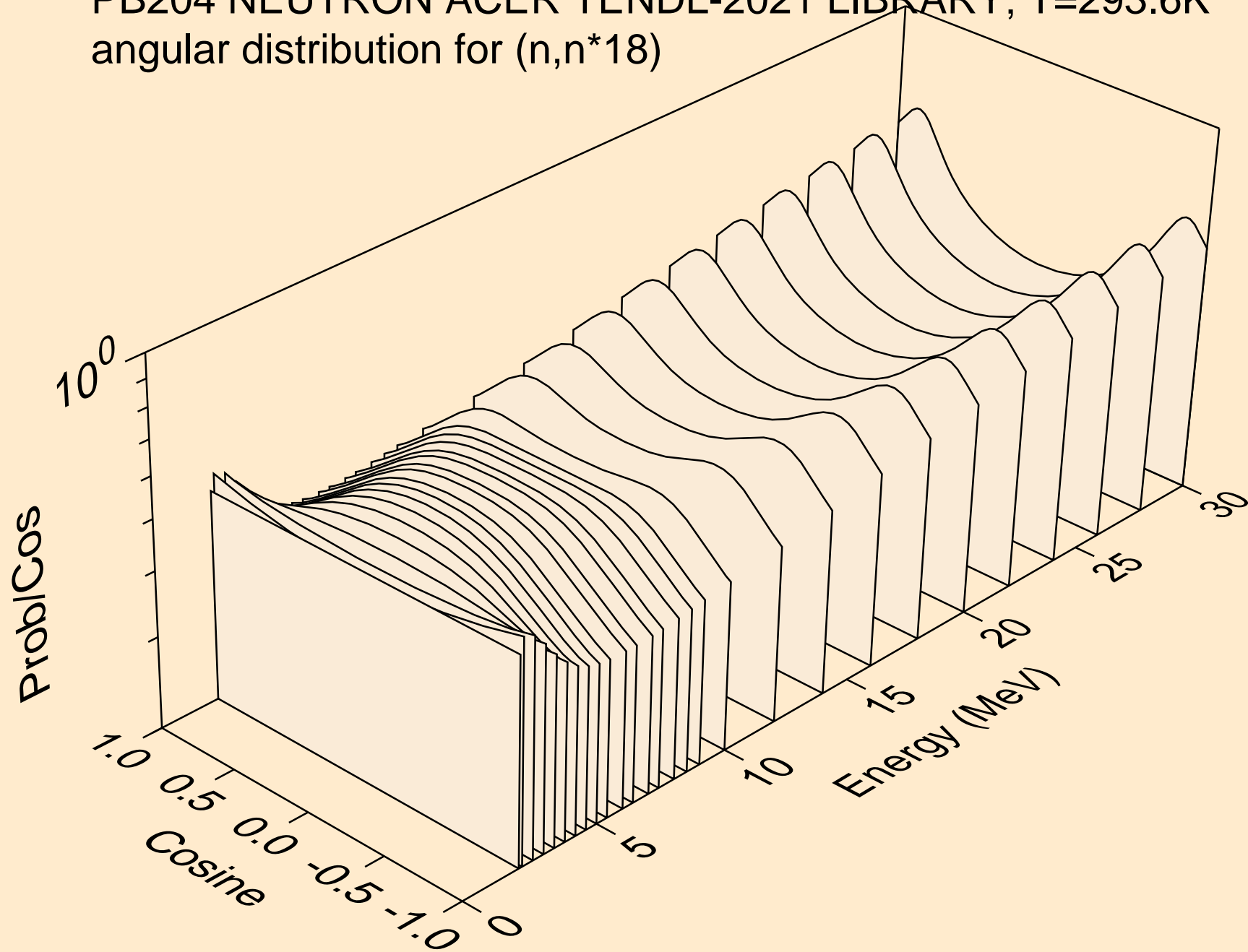

PB204 NEUTRON ACER TENDL-2021 LIBRARY; T=293.6K
angular distribution for (n,n*19)

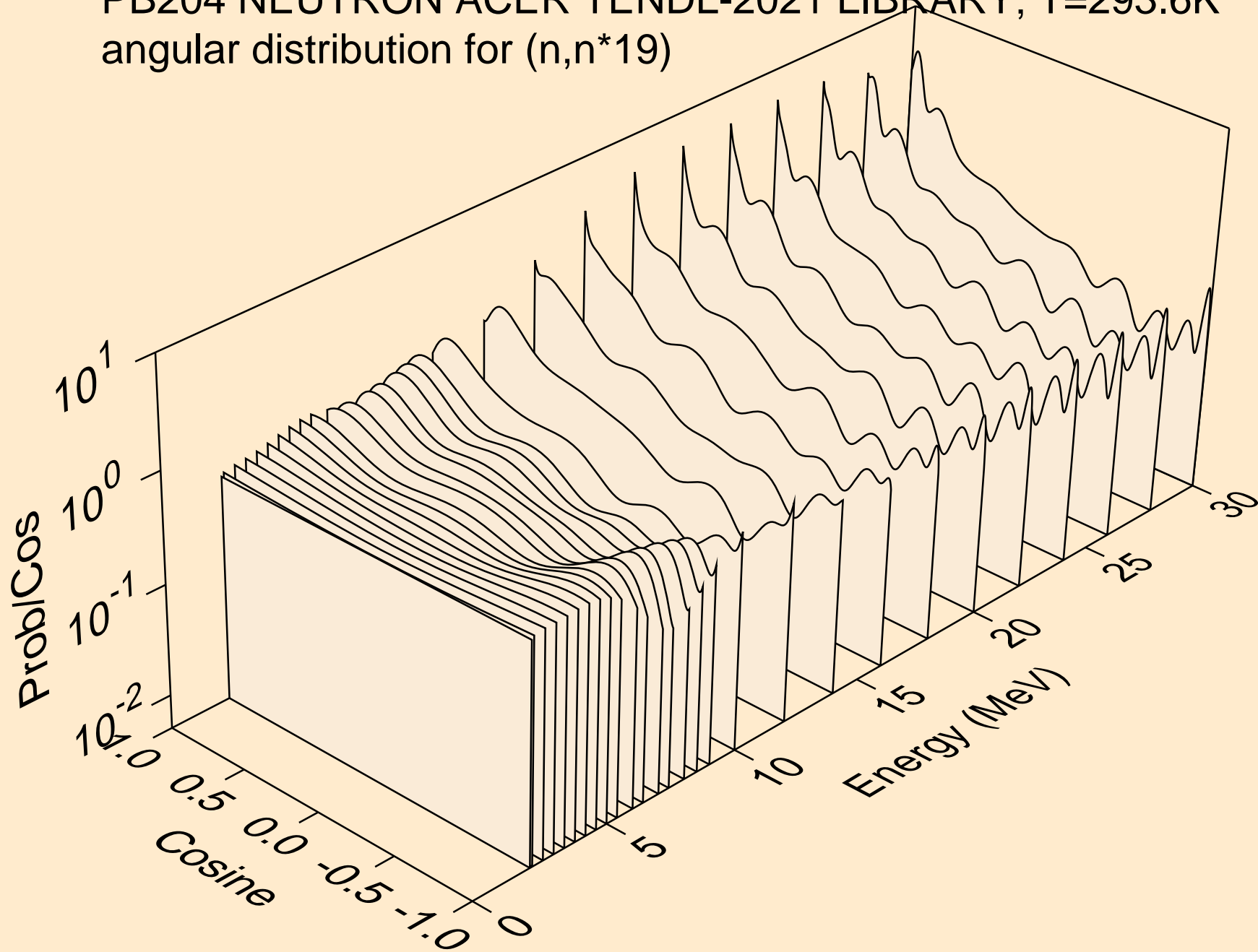

PB204 NEUTRON ACER TENDL-2021 LIBRARY; T=293.6K
angular distribution for (n,n*20)

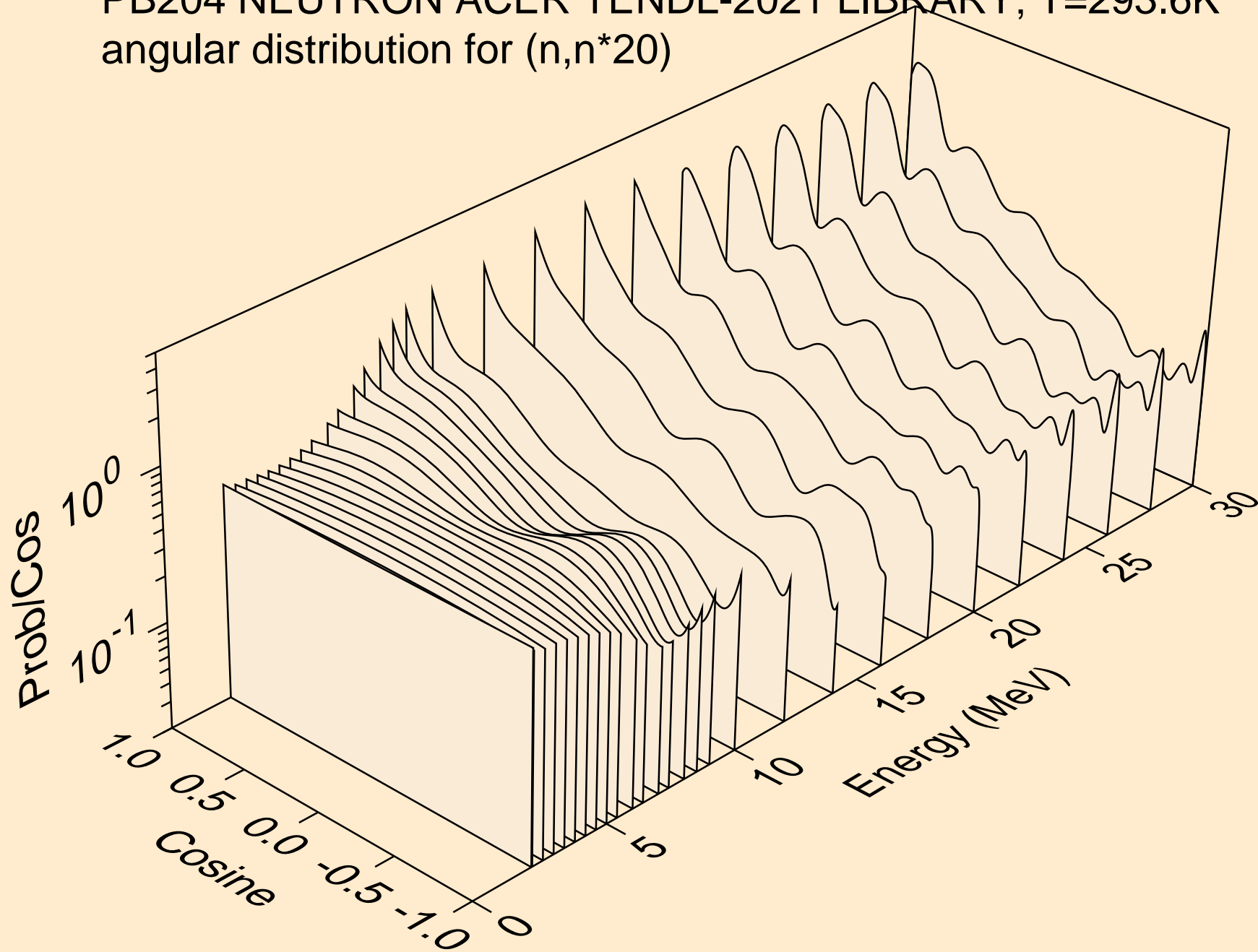

PB204 NEUTRON ACER TENDL-2021 LIBRARY; T=293.6K
angular distribution for (n,n*21)

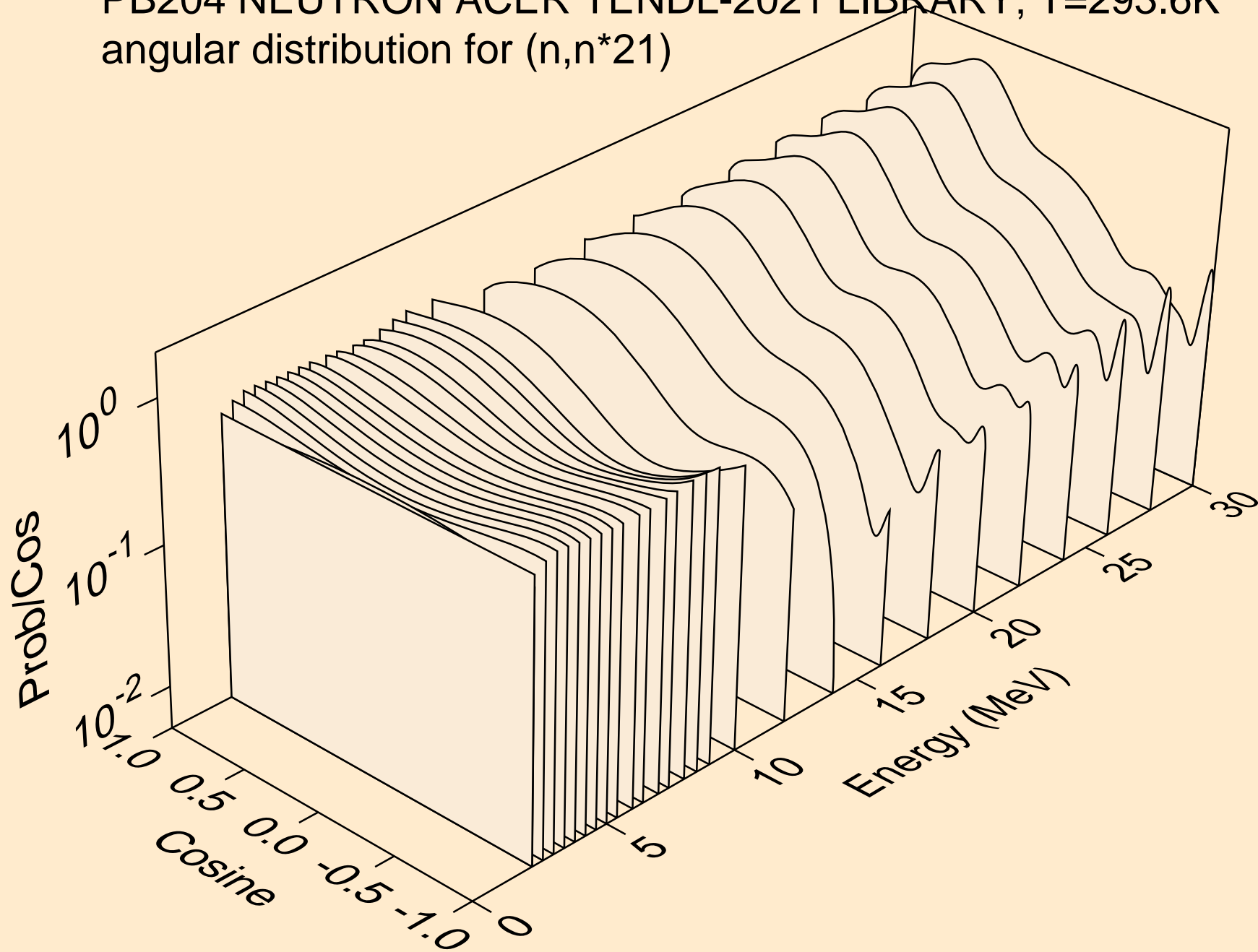

PB204 NEUTRON ACER TENDL-2021 LIBRARY; T=293.6K
angular distribution for (n,n*22)

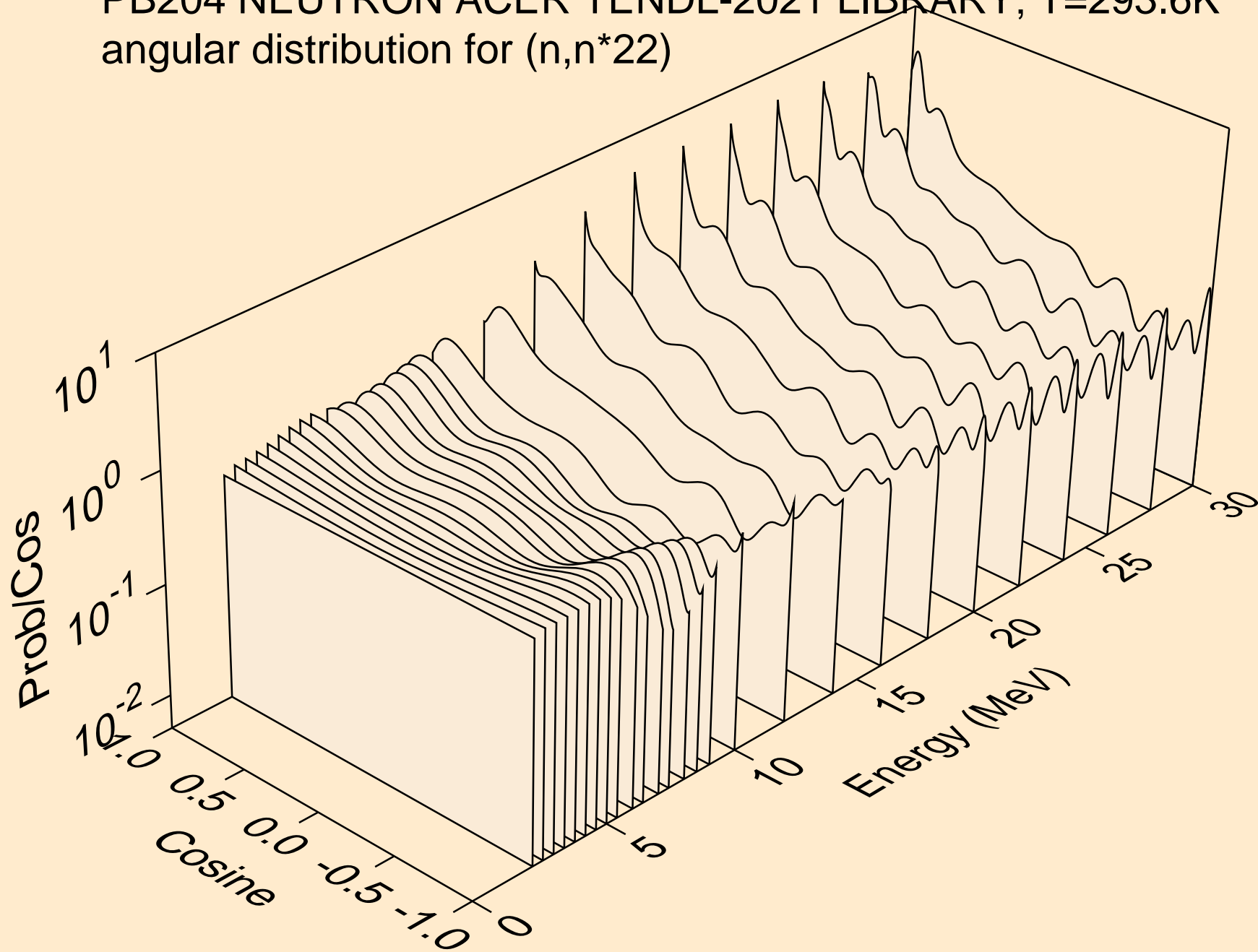

PB204 NEUTRON ACER TENDL-2021 LIBRARY; T=293.6K
angular distribution for (n,n*23)

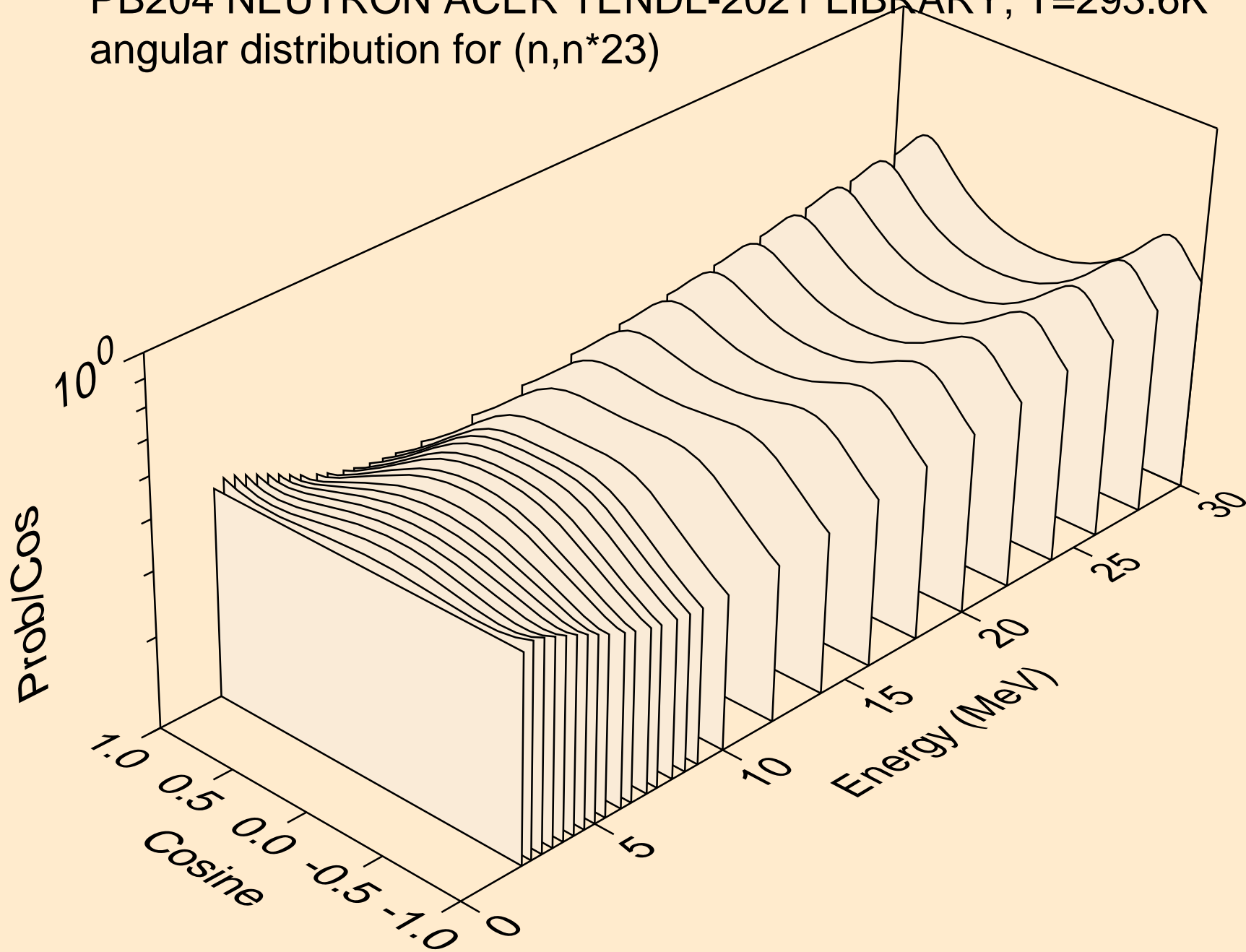

PB204 NEUTRON ACER TENDL-2021 LIBRARY; T=293.6K
angular distribution for (n,n*24)

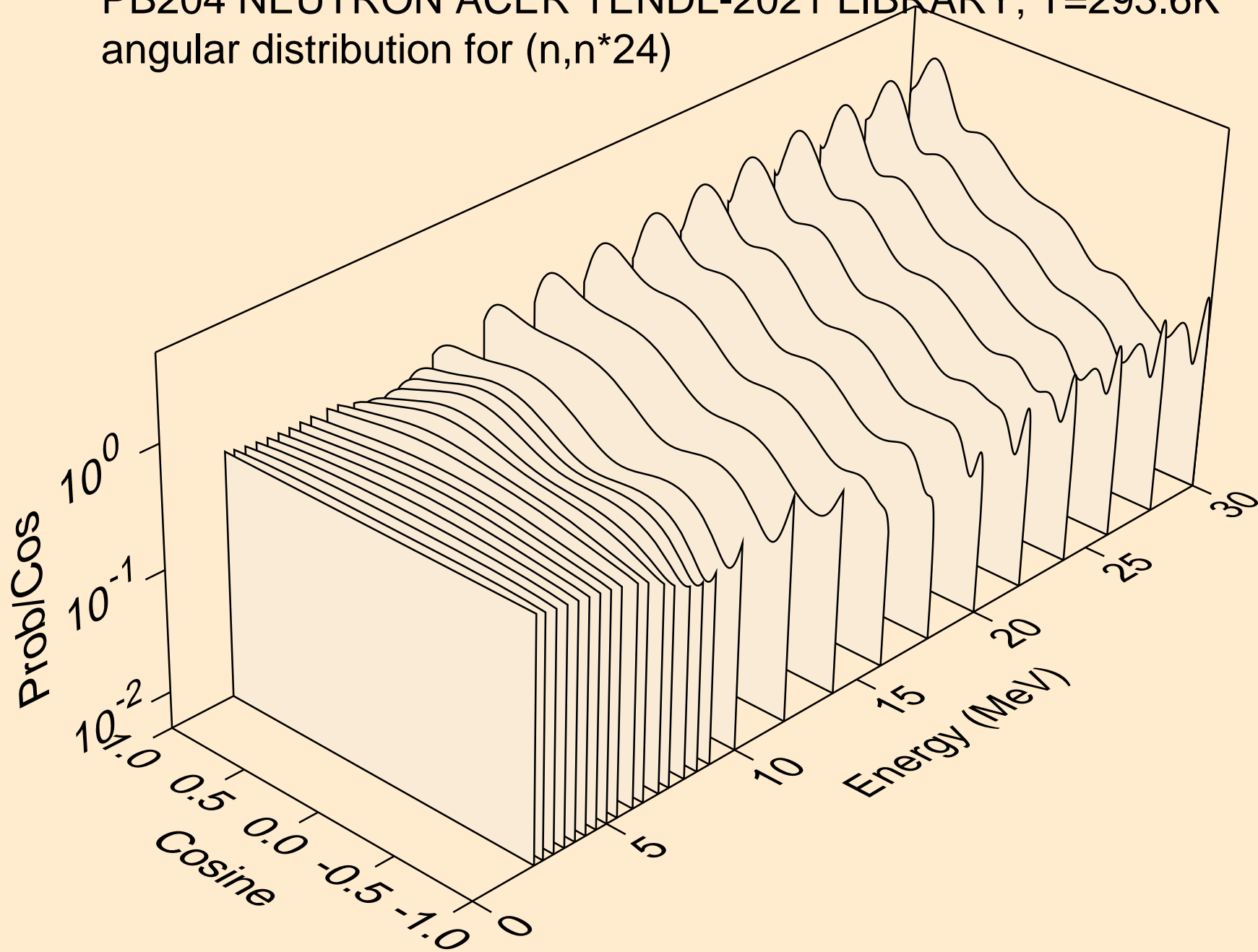

PB204 NEUTRON ACER TENDL-2021 LIBRARY; T=293.6K
angular distribution for (n,n*25)

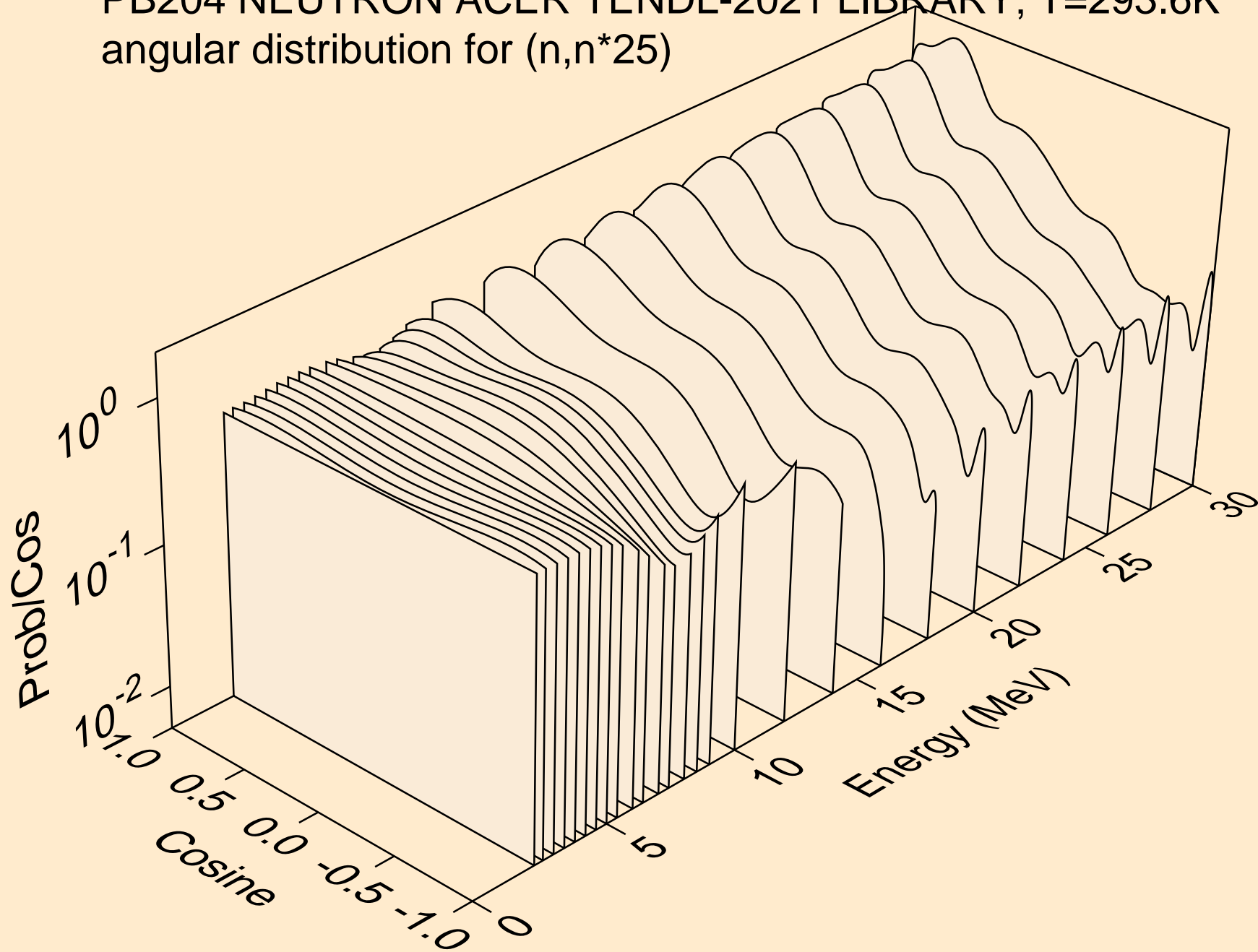

PB204 NEUTRON ACER TENDL-2021 LIBRARY; T=293.6K
angular distribution for (n,n*26)

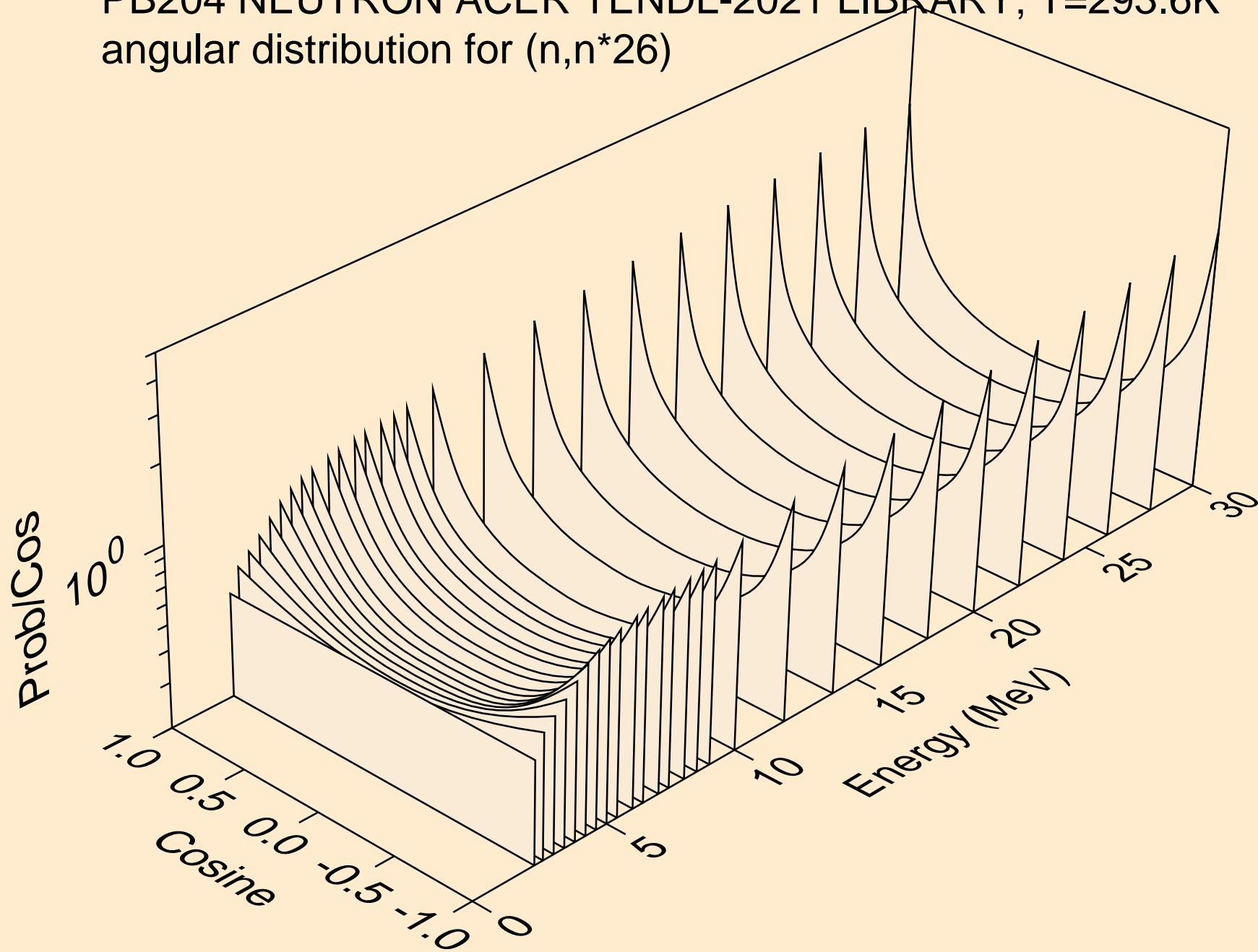

PB204 NEUTRON ACER TENDL-2021 LIBRARY; T=293.6K
angular distribution for (n,n*27)

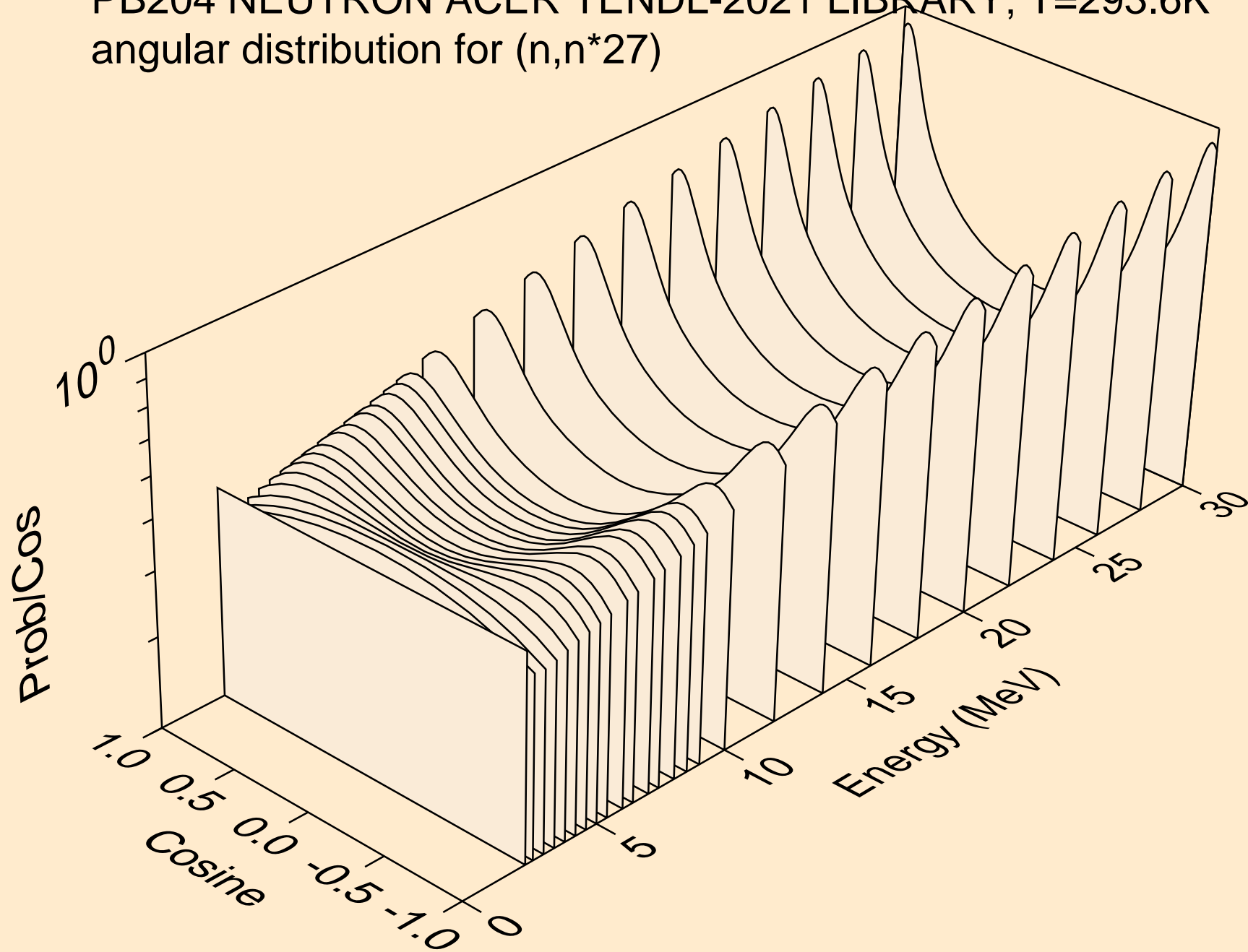

PB204 NEUTRON ACER TENDL-2021 LIBRARY; T=293.6K
angular distribution for (n,n*28)

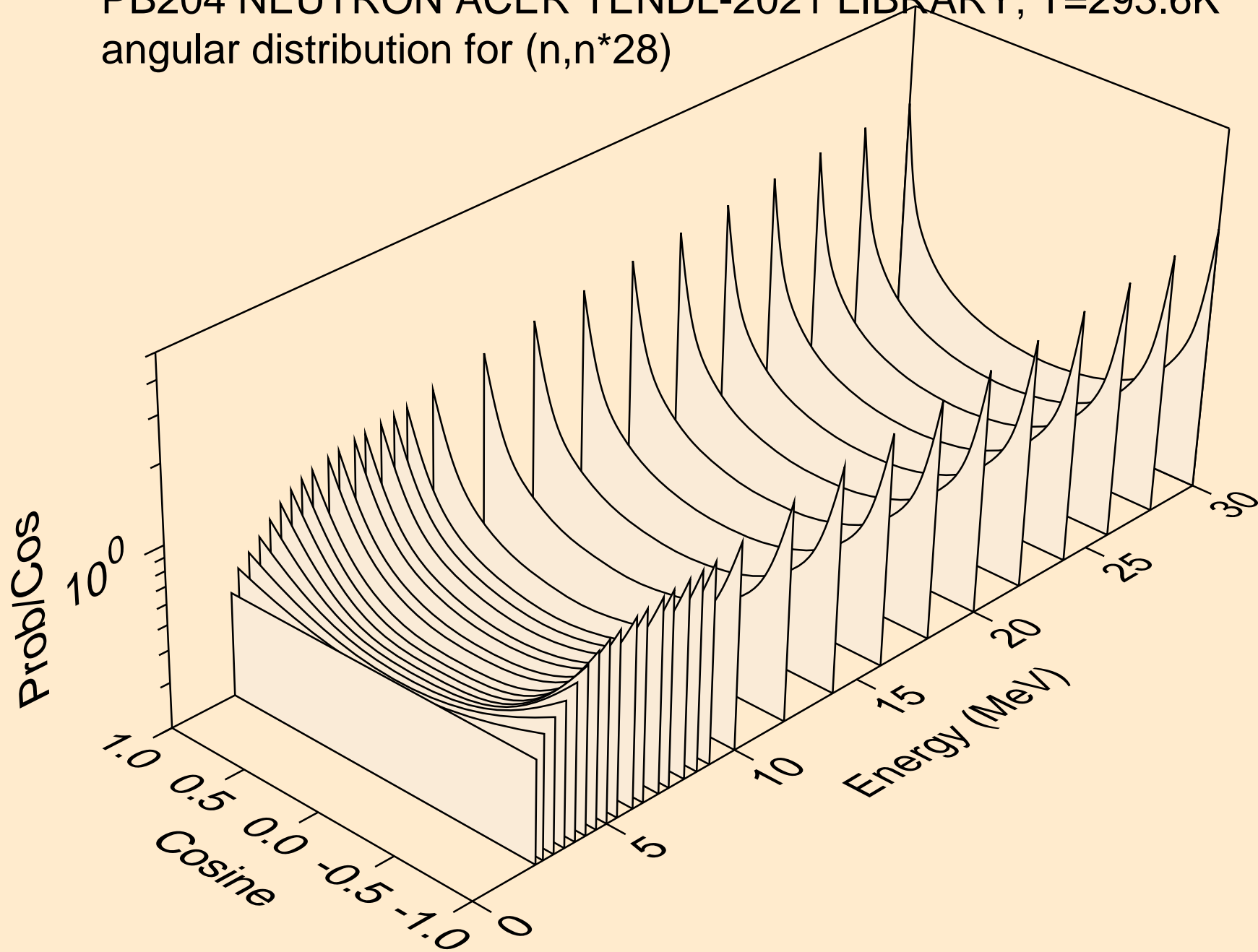

PB204 NEUTRON ACER TENDL-2021 LIBRARY; T=293.6K
angular distribution for (n,n*29)

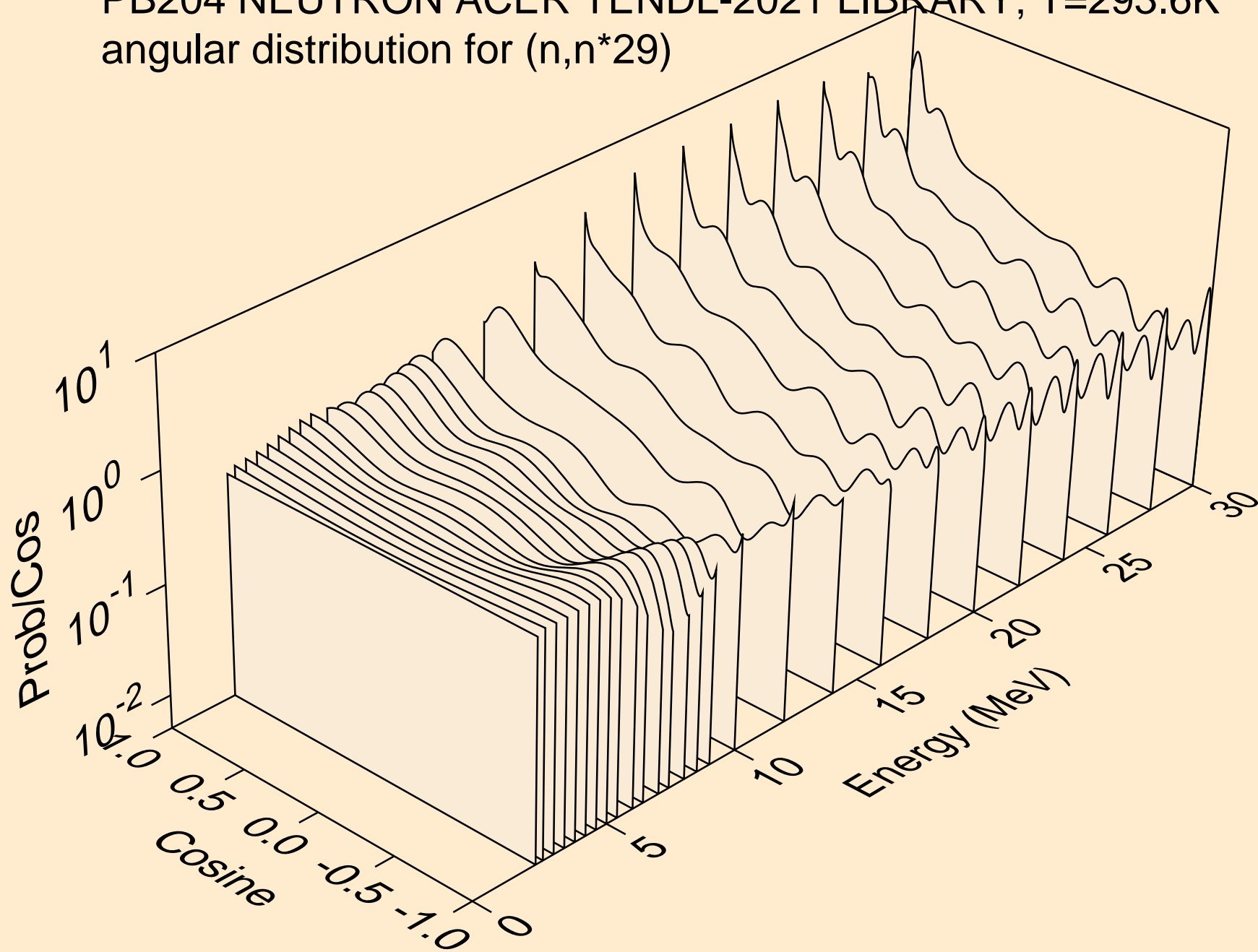

PB204 NEUTRON ACER TENDL-2021 LIBRARY; T=293.6K
angular distribution for (n,n*30)

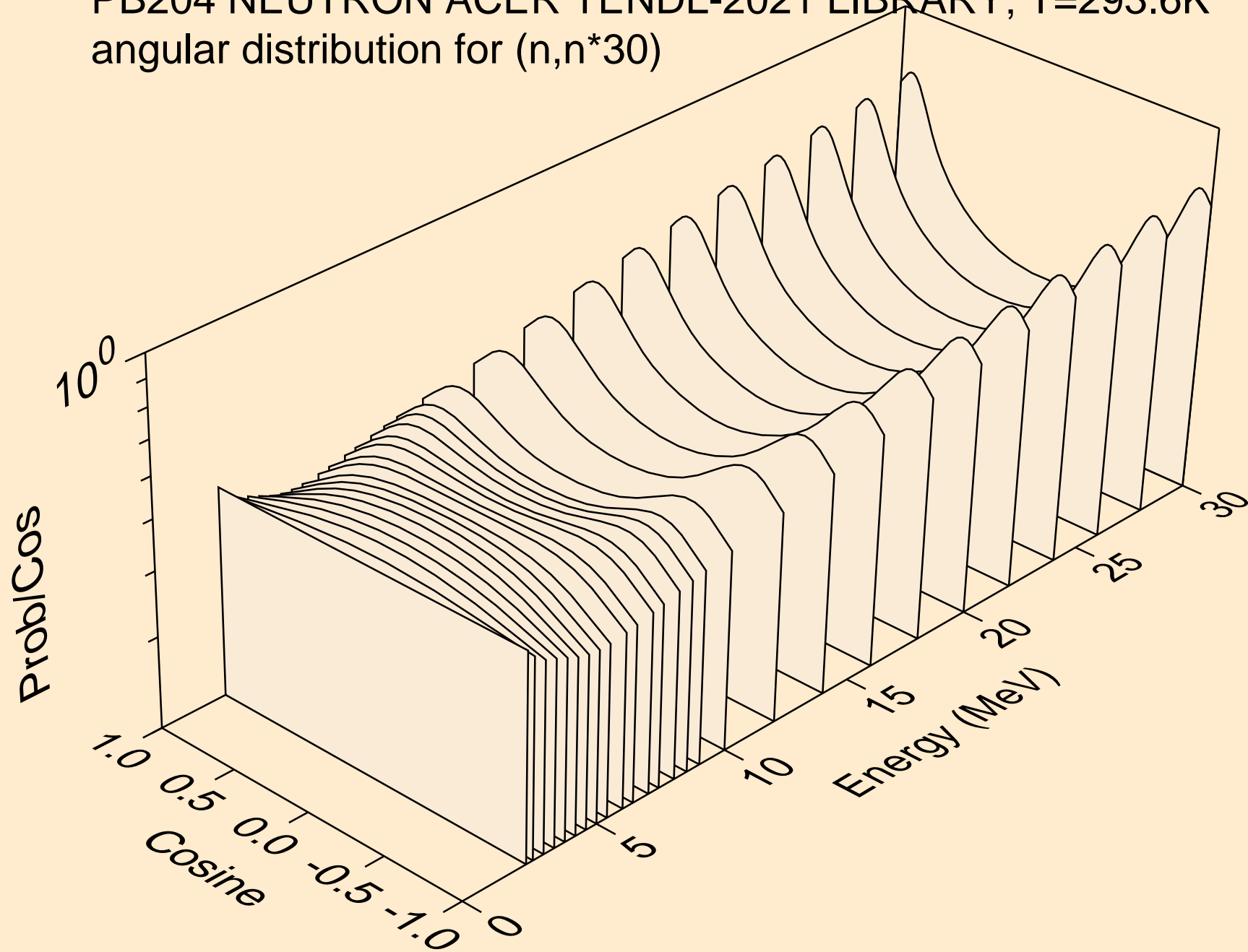

PB204 NEUTRON ACER TENDL-2021 LIBRARY; T=293.6K
Neutron emission for (n,x)

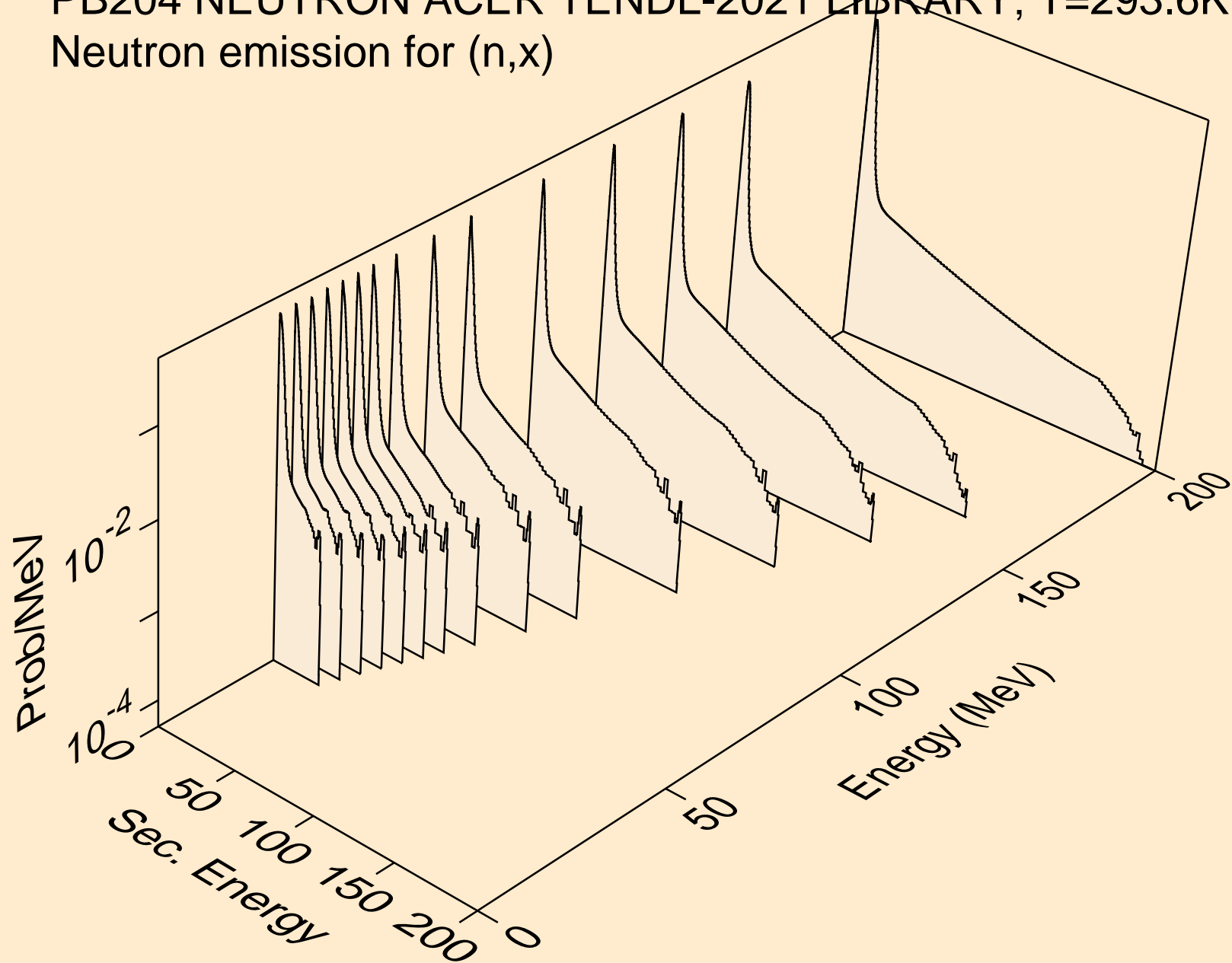

PB204 NEUTRON ACER TENDL-2021 LIBRARY; T=293.6K
Neutron emission for (n,2nd)

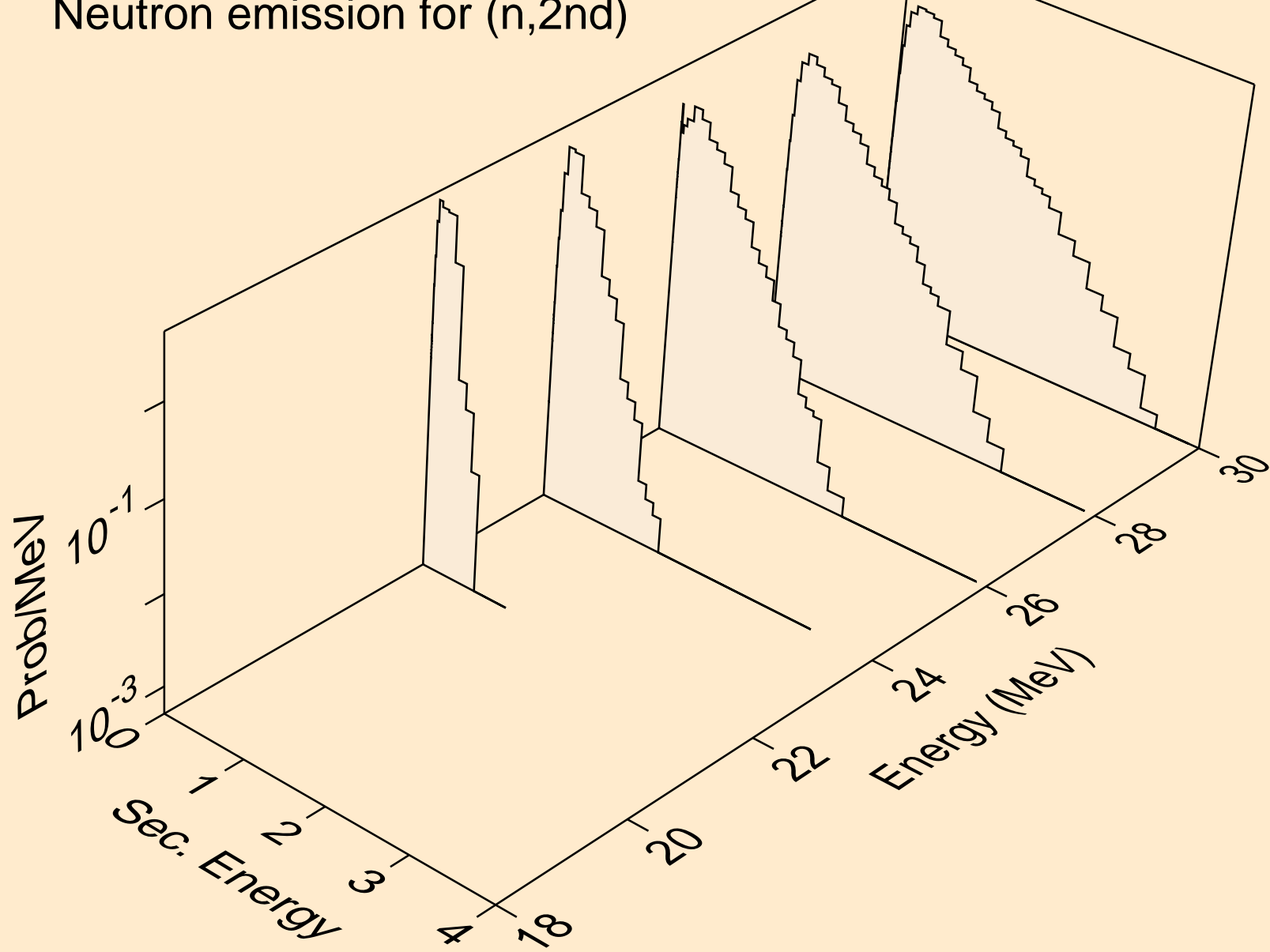

PB204 NEUTRON ACER TENDL-2021 LIBRARY; T=293.6K
Neutron emission for (n,2n)

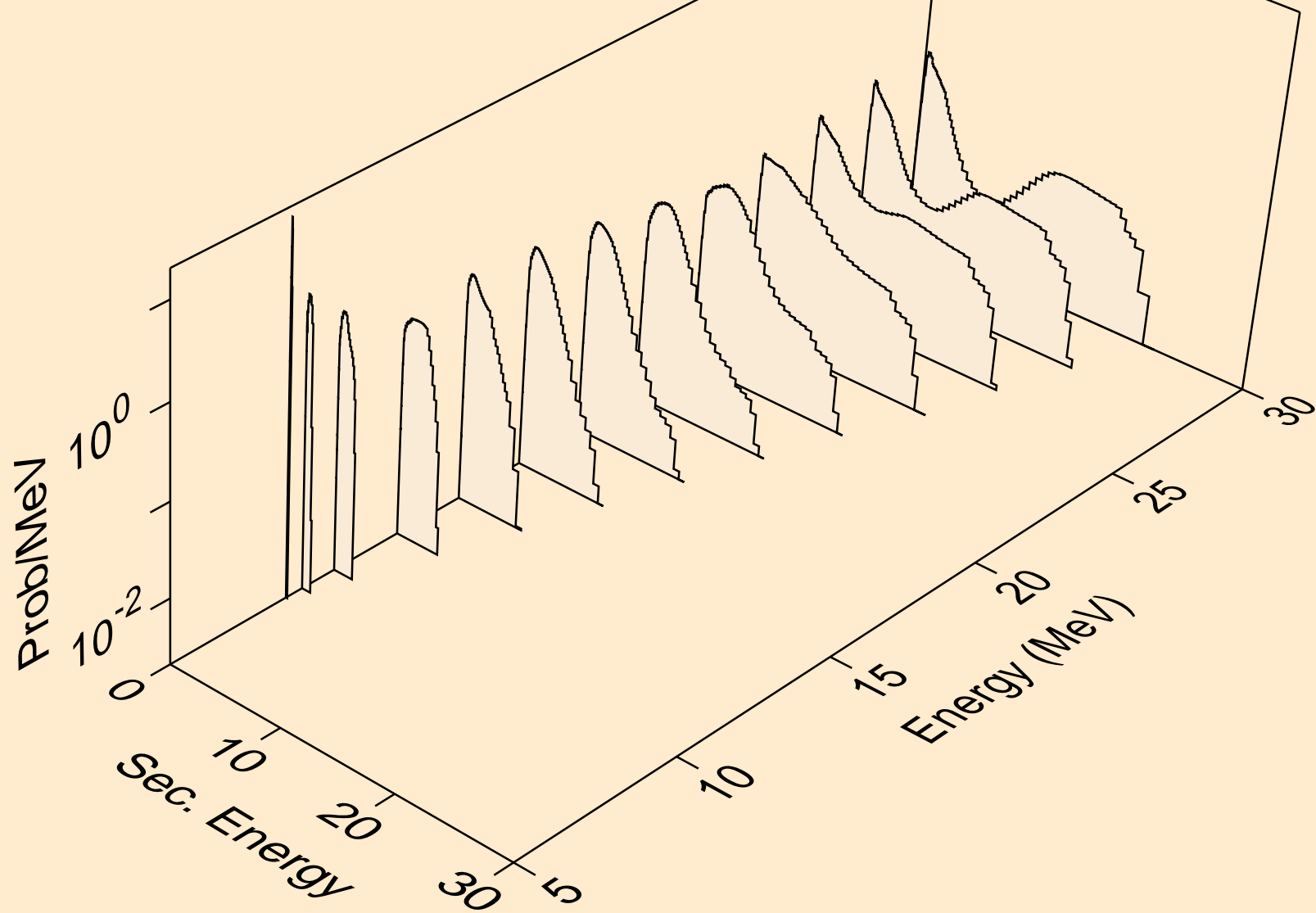

PB204 NEUTRON ACER TENDL-2021 LIBRARY; T=293.6K
Neutron emission for (n,3n)

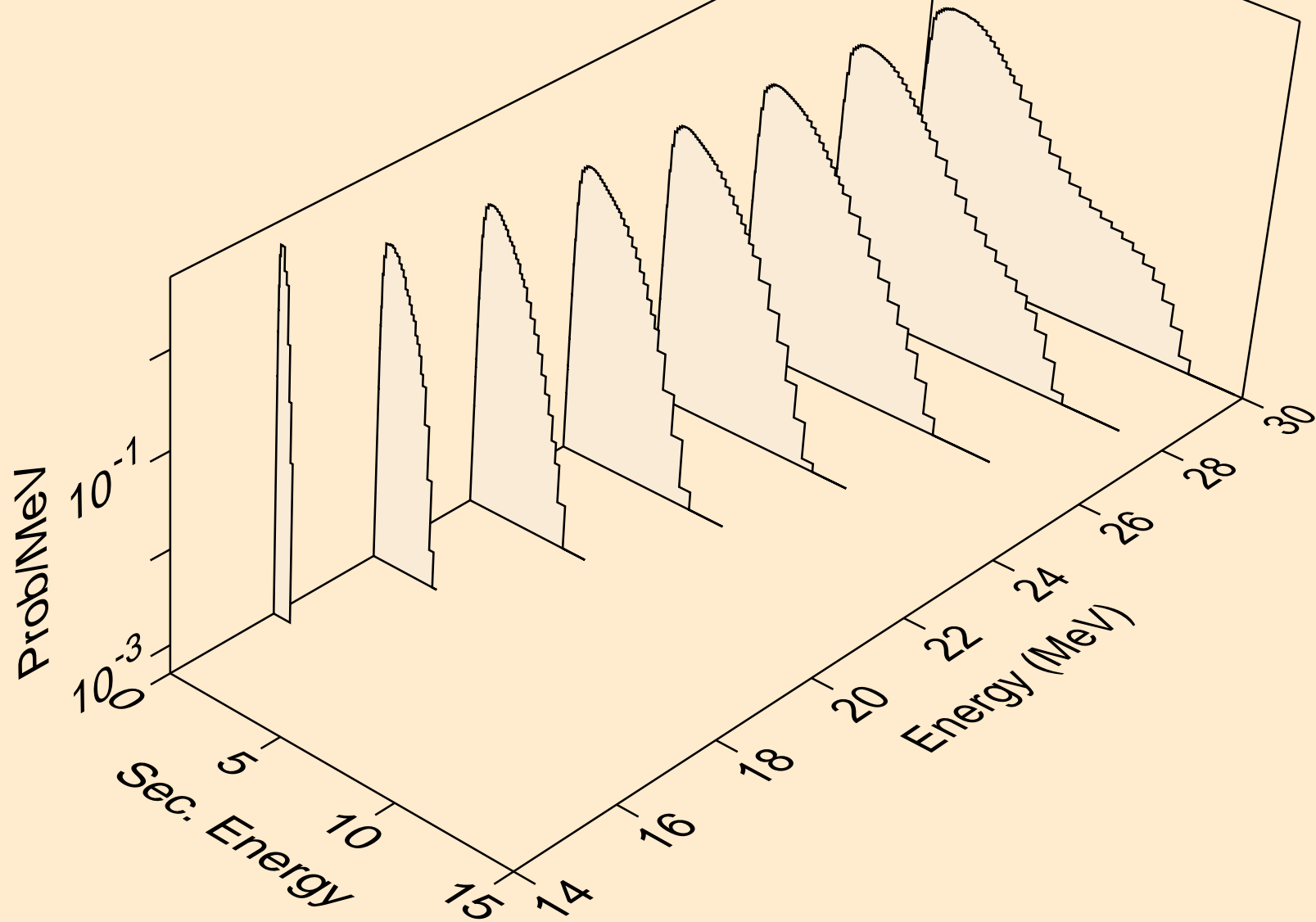

PB204 NEUTRON ACER TENDL-2021 LIBRARY; T=293.6K
Neutron emission for (n,n*)a

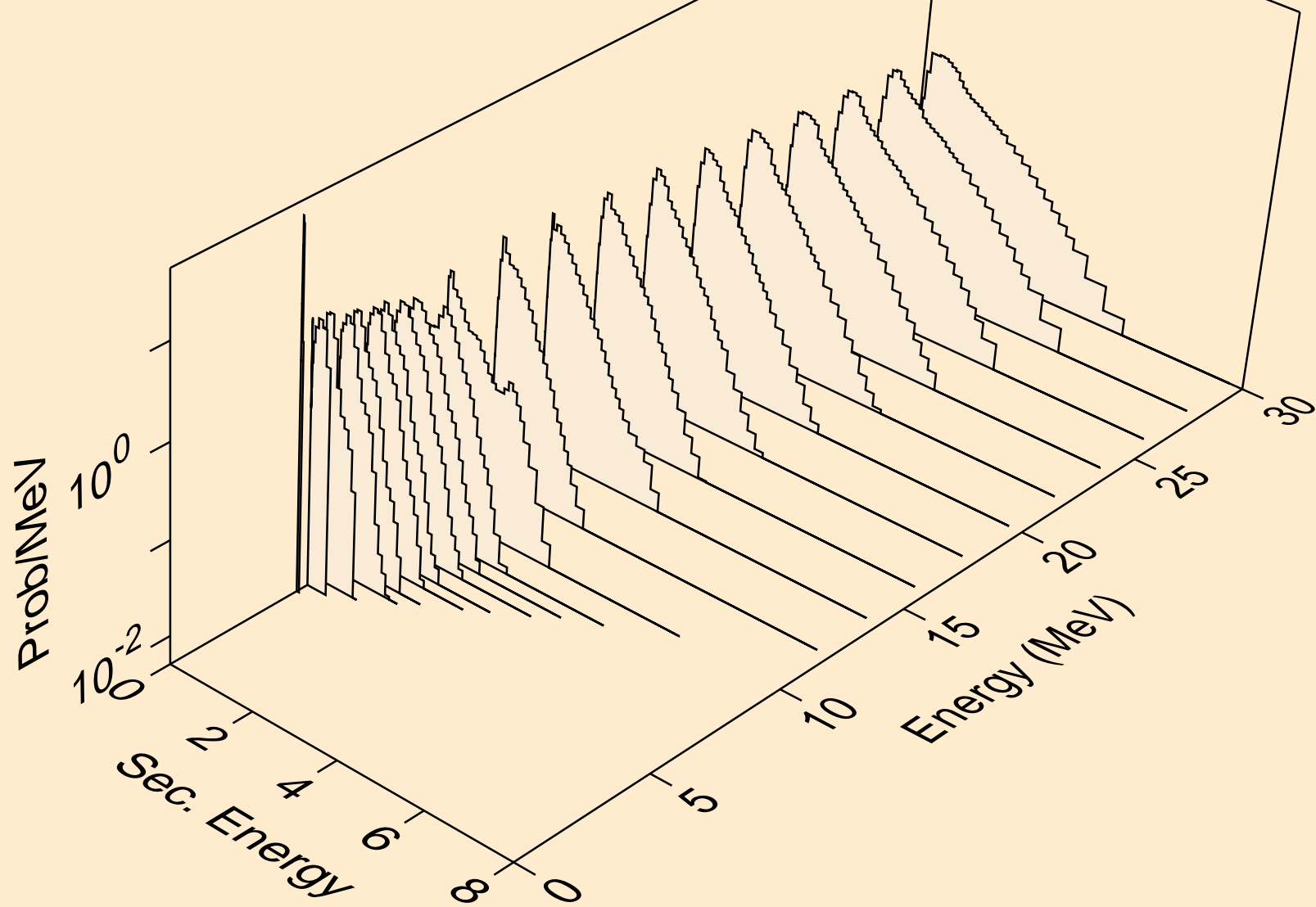

PB204 NEUTRON ACER TENDL-2021 LIBRARY; T=293.6K
Neutron emission for (n,2n)a

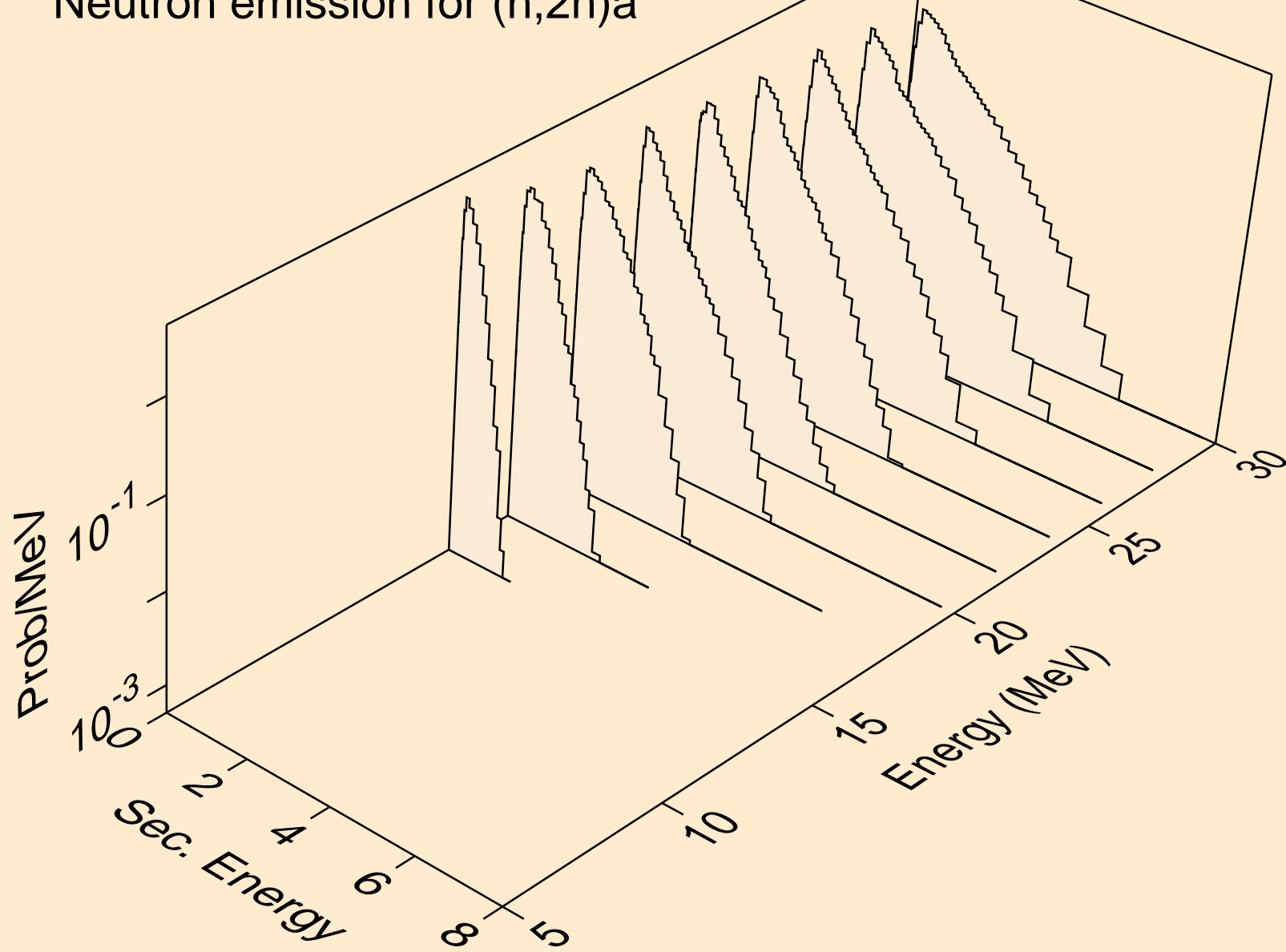

PB204 NEUTRON ACER TENDL-2021 LIBRARY; T=293.6K
Neutron emission for (n,3n)_a

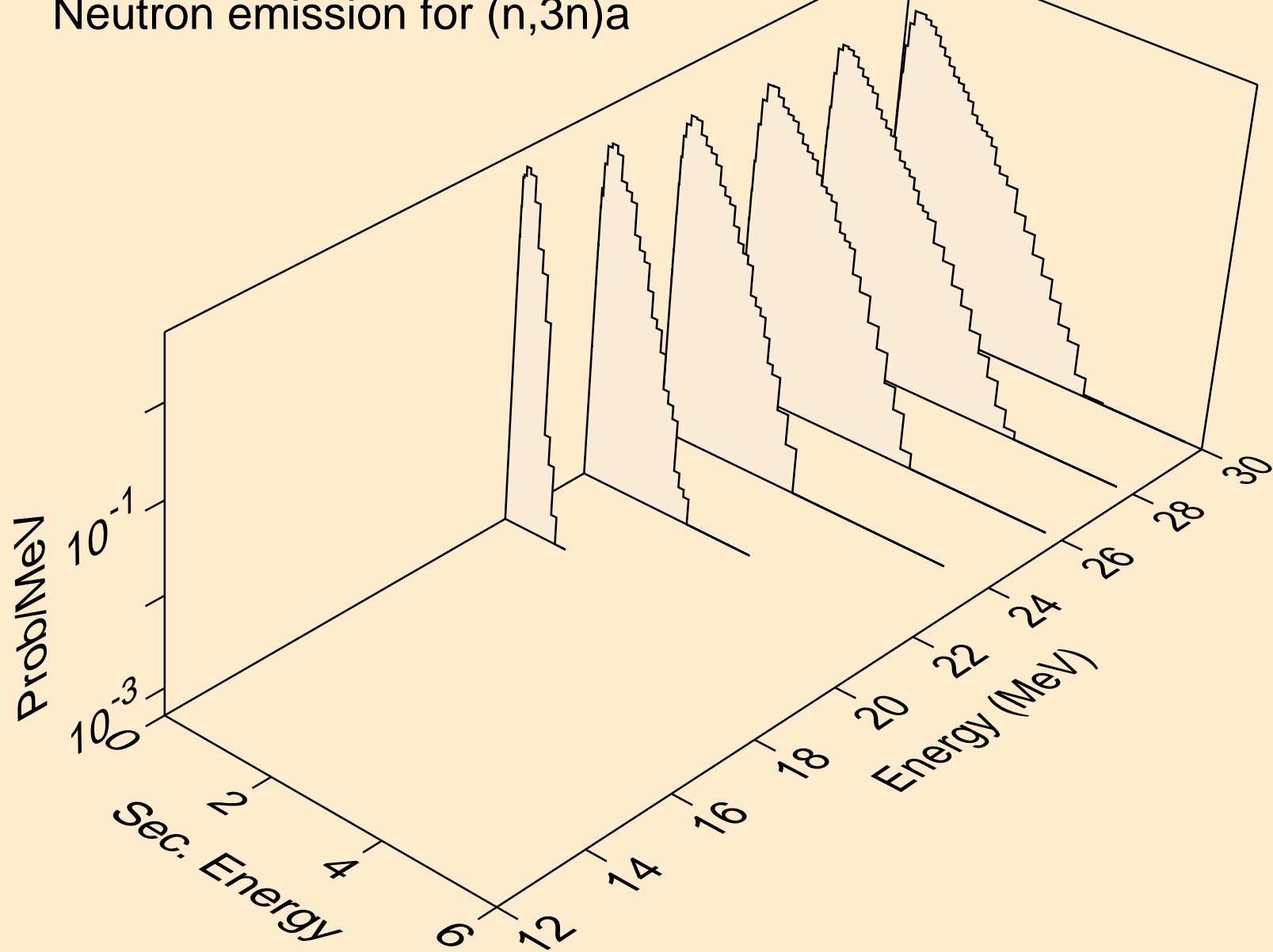

PB204 NEUTRON ACER TENDL-2021 LIBRARY; T=293.6K
Neutron emission for (n,n*)p

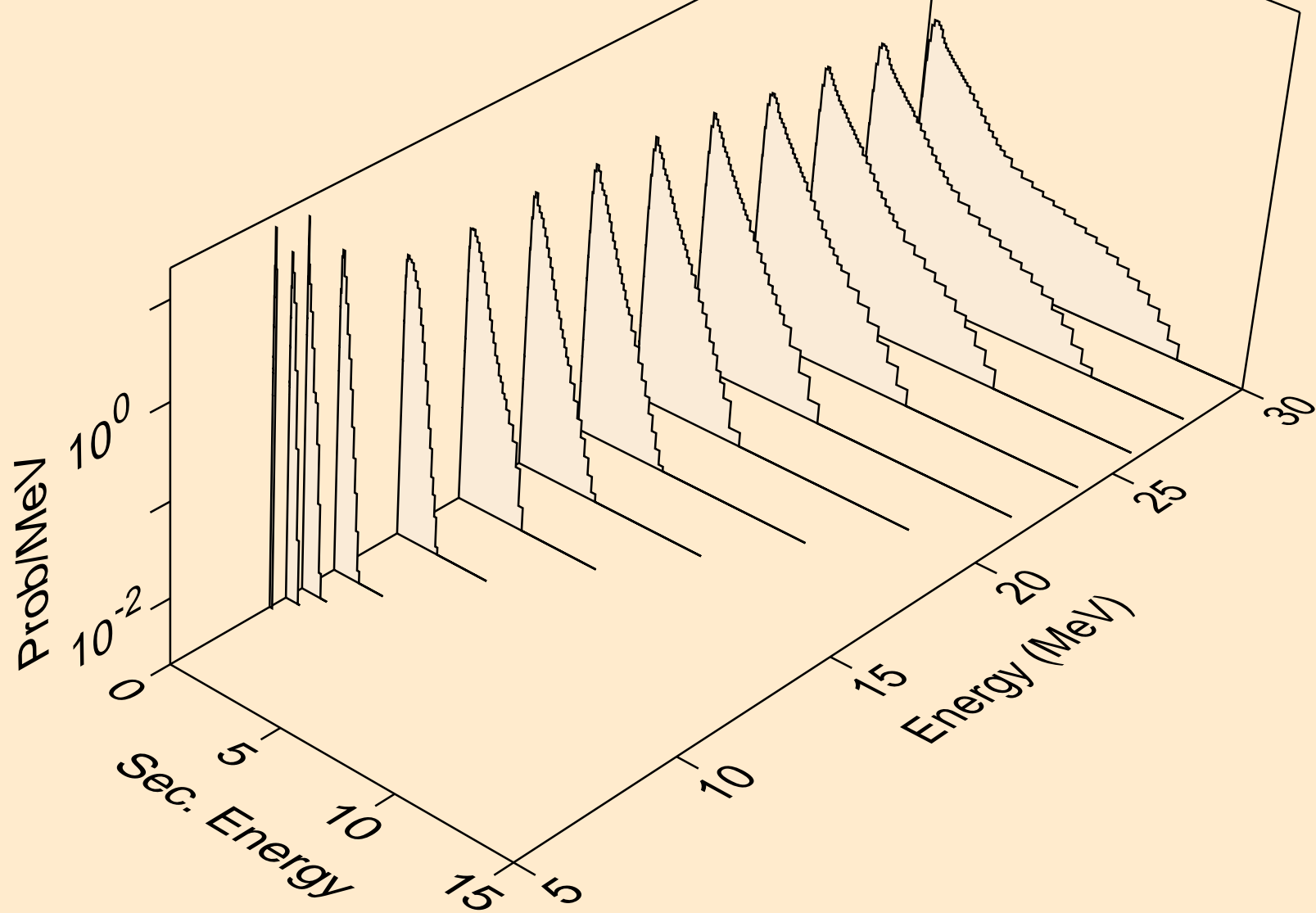

PB204 NEUTRON ACER TENDL-2021 LIBRARY; T=293.6K
Neutron emission for (n,n*)d

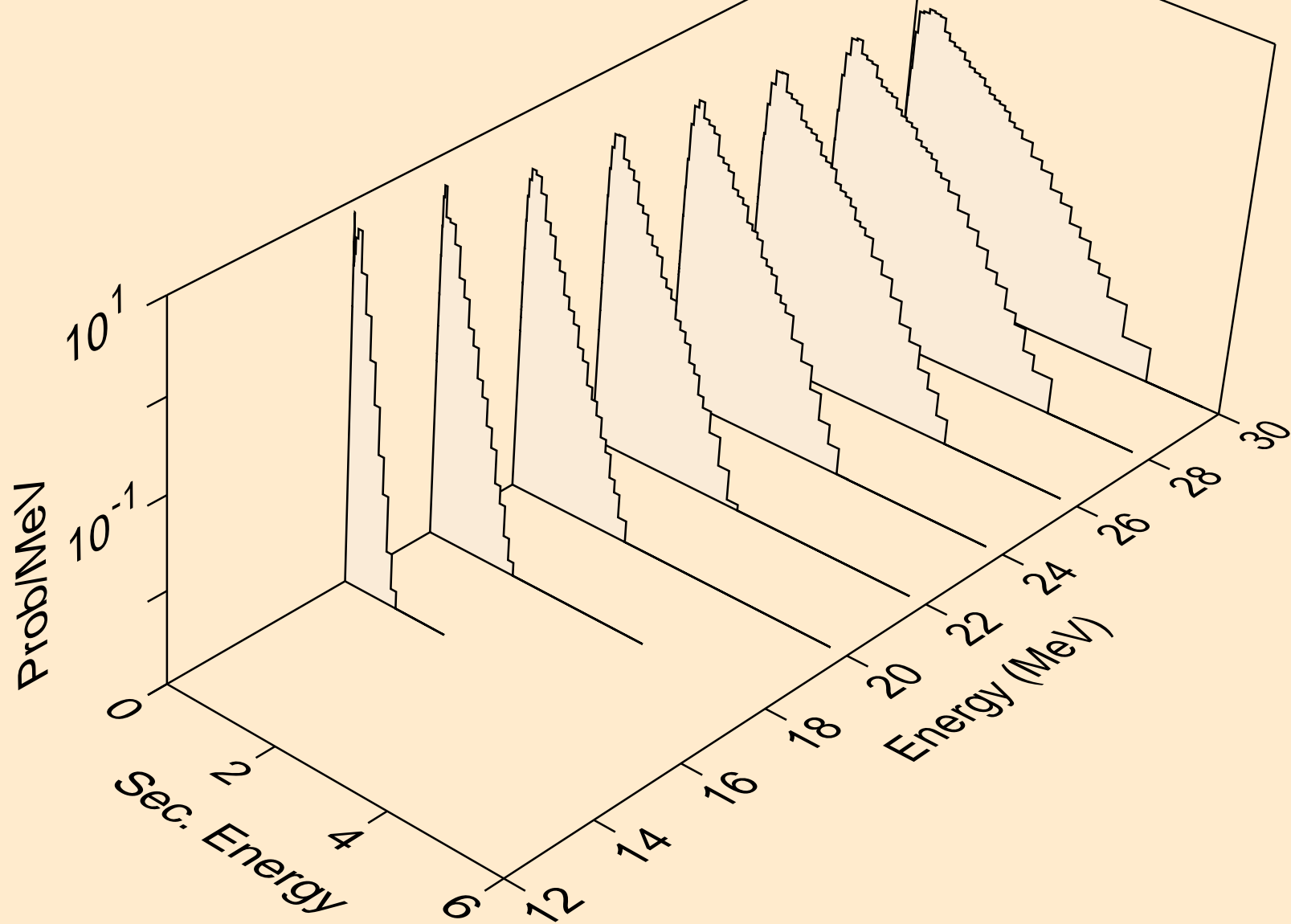

PB204 NEUTRON ACER TENDL-2021 LIBRARY; T=293.6K
Neutron emission for (n,n*)t

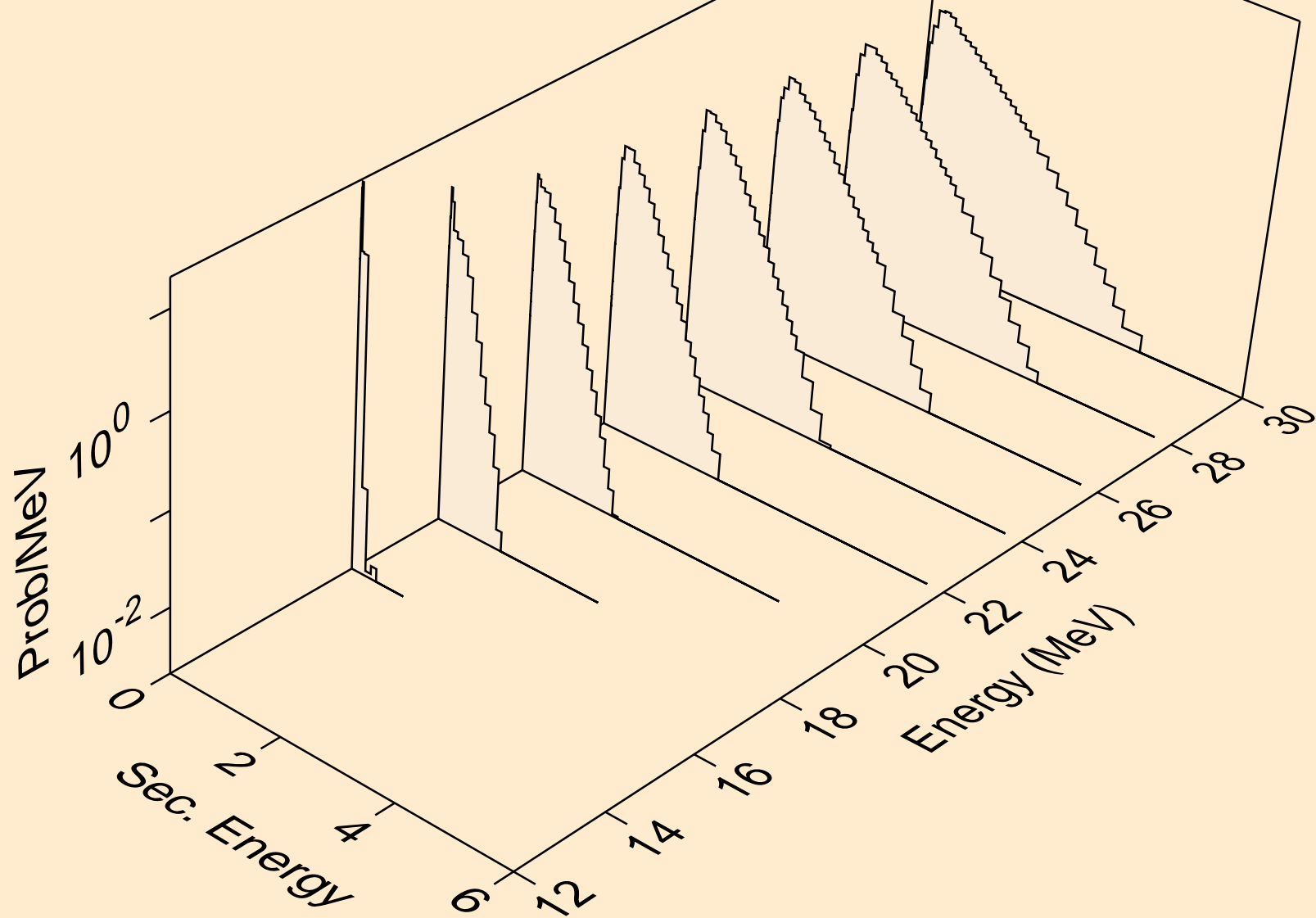

PB204 NEUTRON ACER TENDL-2021 LIBRARY; T=293.6K
Neutron emission for (n,n*)he3

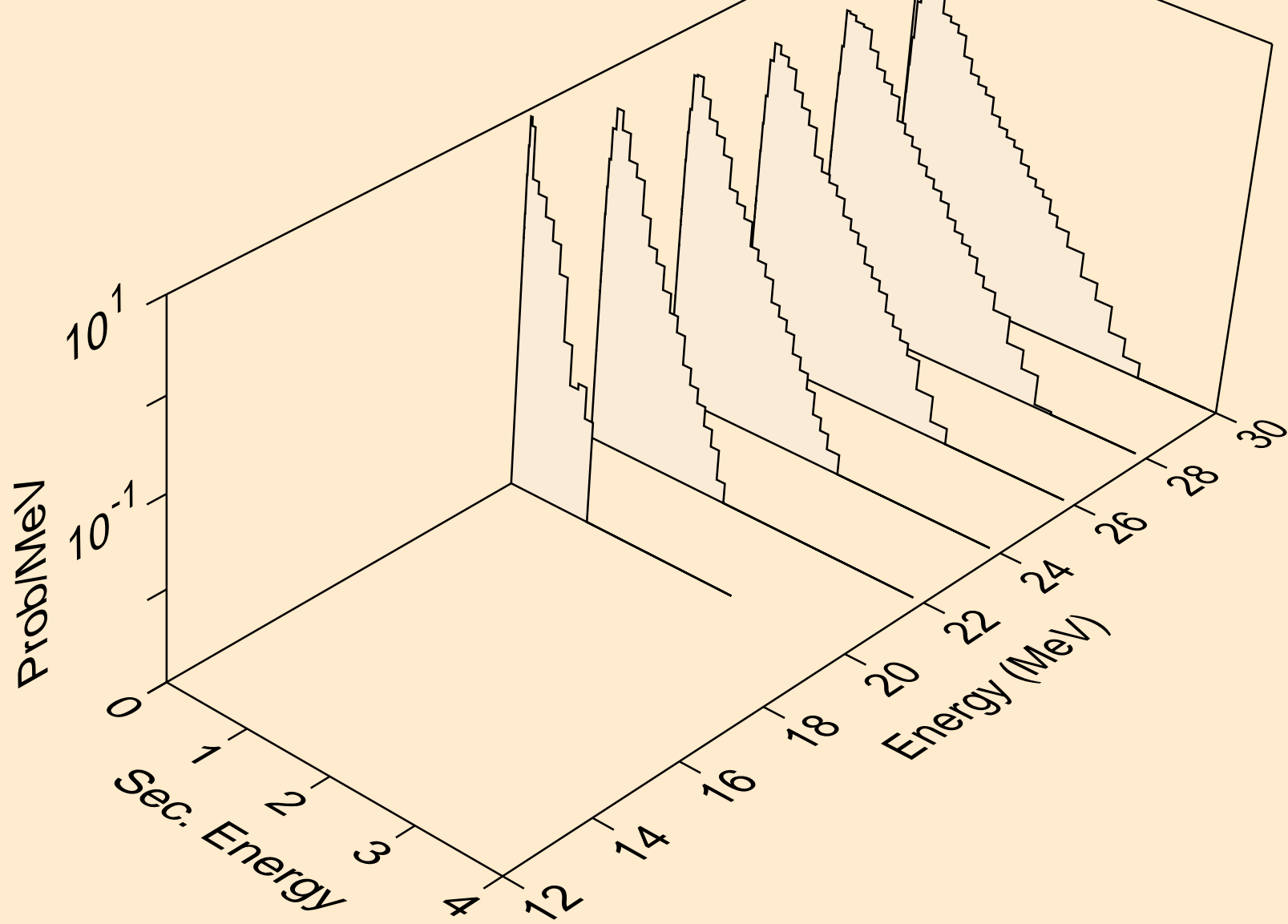

PB204 NEUTRON ACER TENDL-2021 LIBRARY; T=293.6K
Neutron emission for (n,4n)

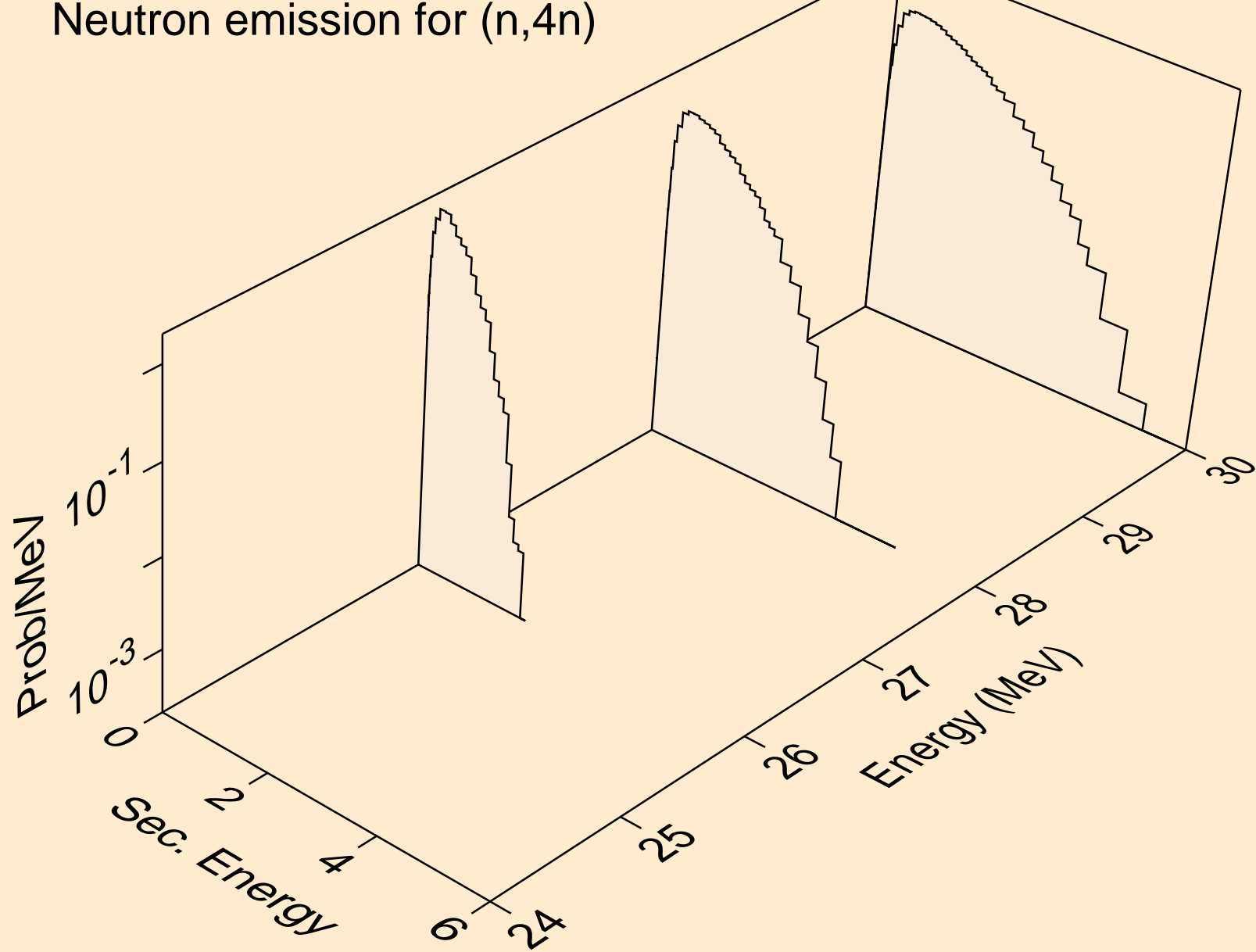

PB204 NEUTRON ACER TENDL-2021 LIBRARY; T=293.6K
Neutron emission for (n,2np)

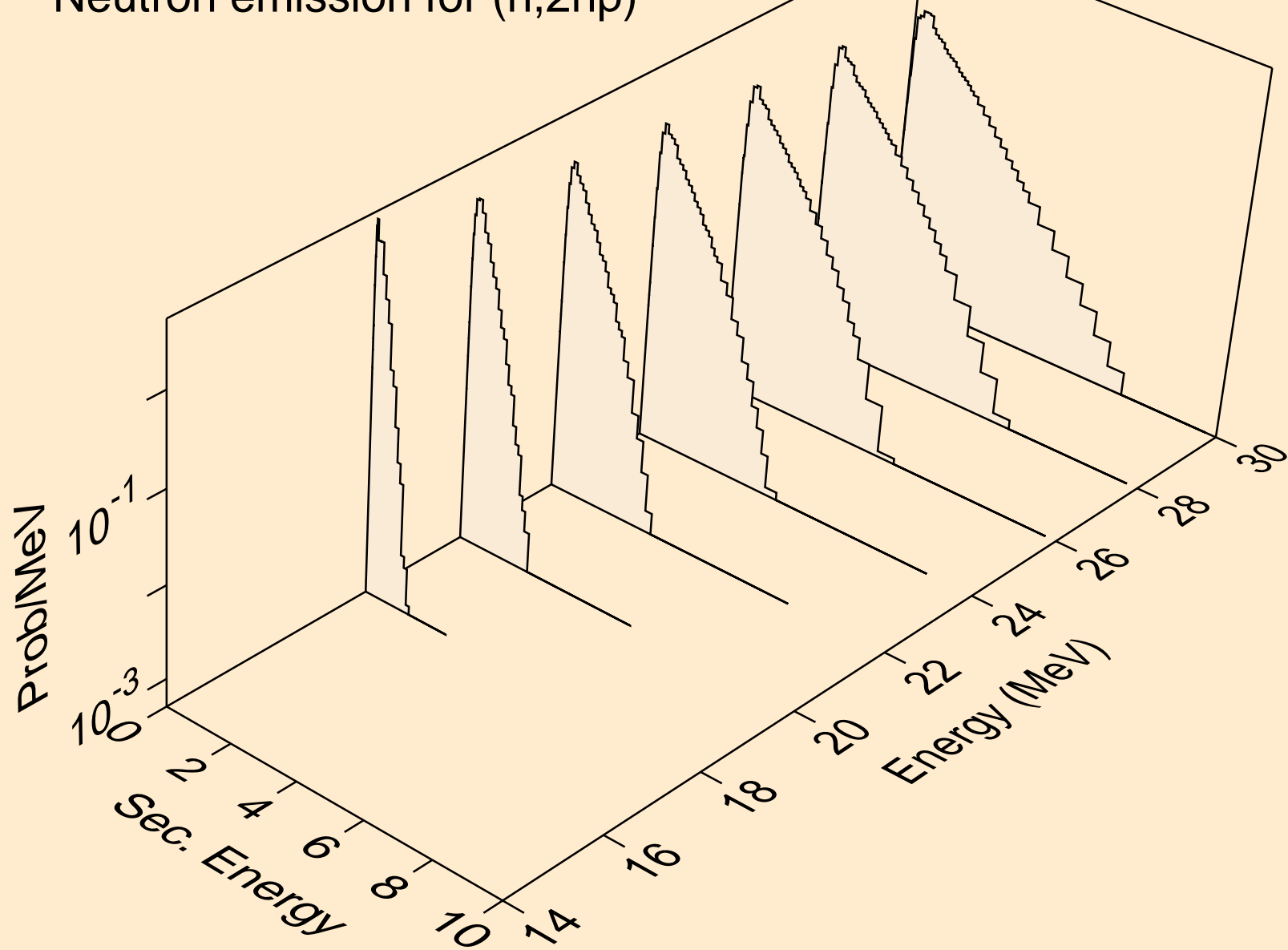

PB204 NEUTRON ACER TENDL-2021 LIBRARY; T=293.6K
Neutron emission for (n,3np)

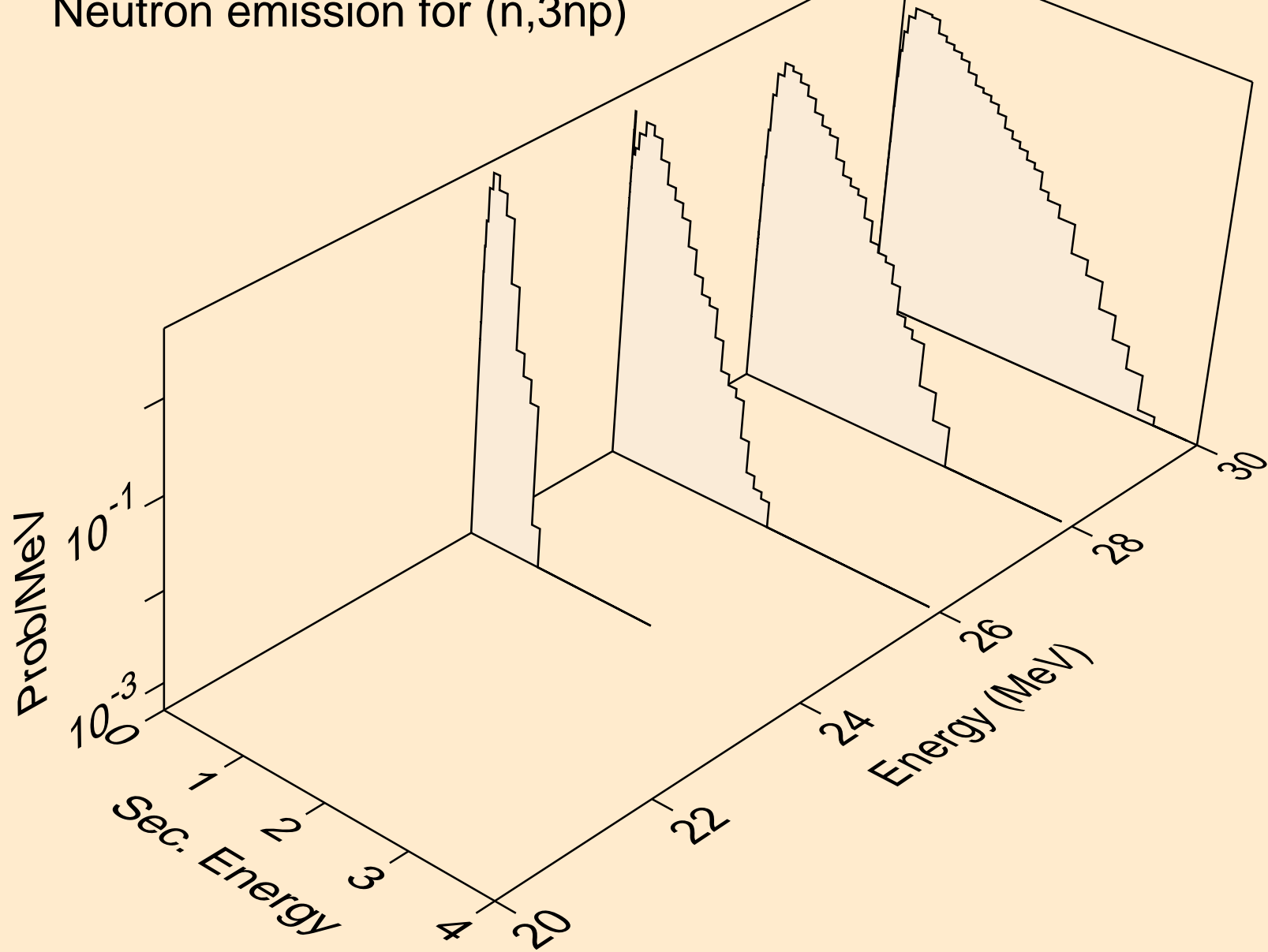

PB204 NEUTRON ACER TENDL-2021 LIBRARY; T=293.6K
Neutron emission for (n,2np)

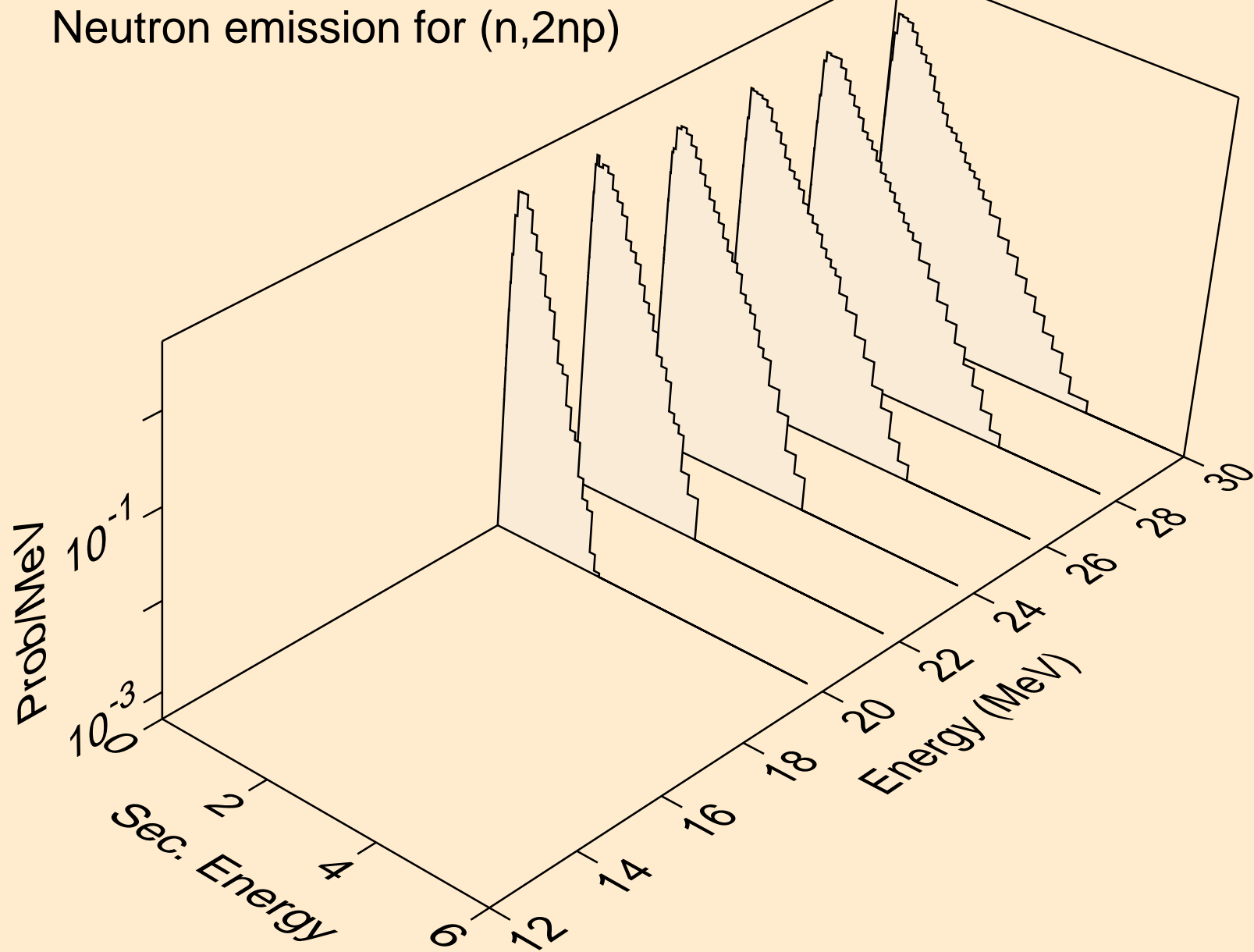

PB204 NEUTRON ACER TENDL-2021 LIBRARY; T=293.6K
Neutron emission for (n,npa)

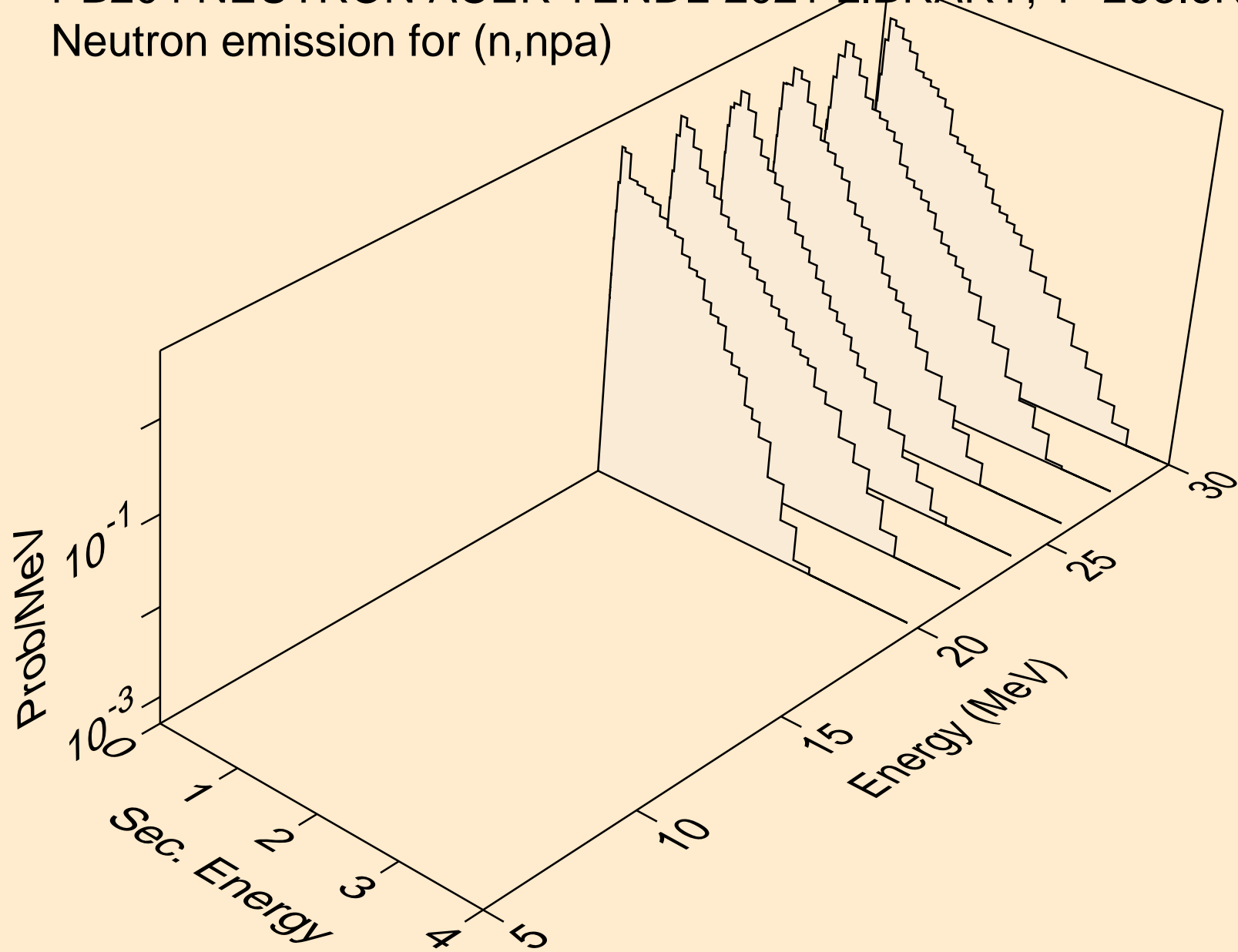

PB204 NEUTRON ACER TENDL-2021 LIBRARY; T=293.6K
Neutron emission for (n,n*c)

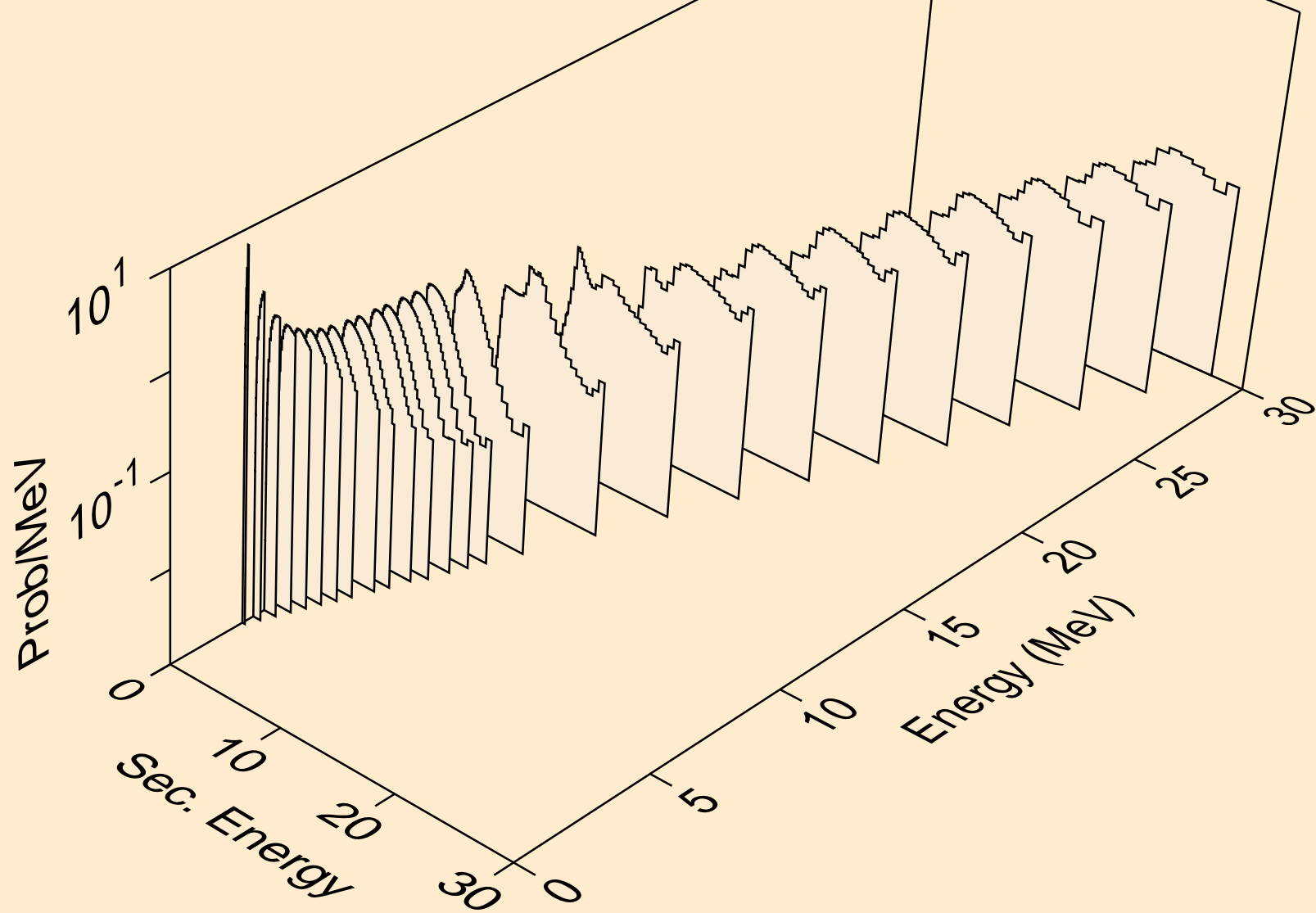

PB204 NEUTRON ACER TENDL-2021 LIBRARY; T=293.6K
Photon emission for (n,x)

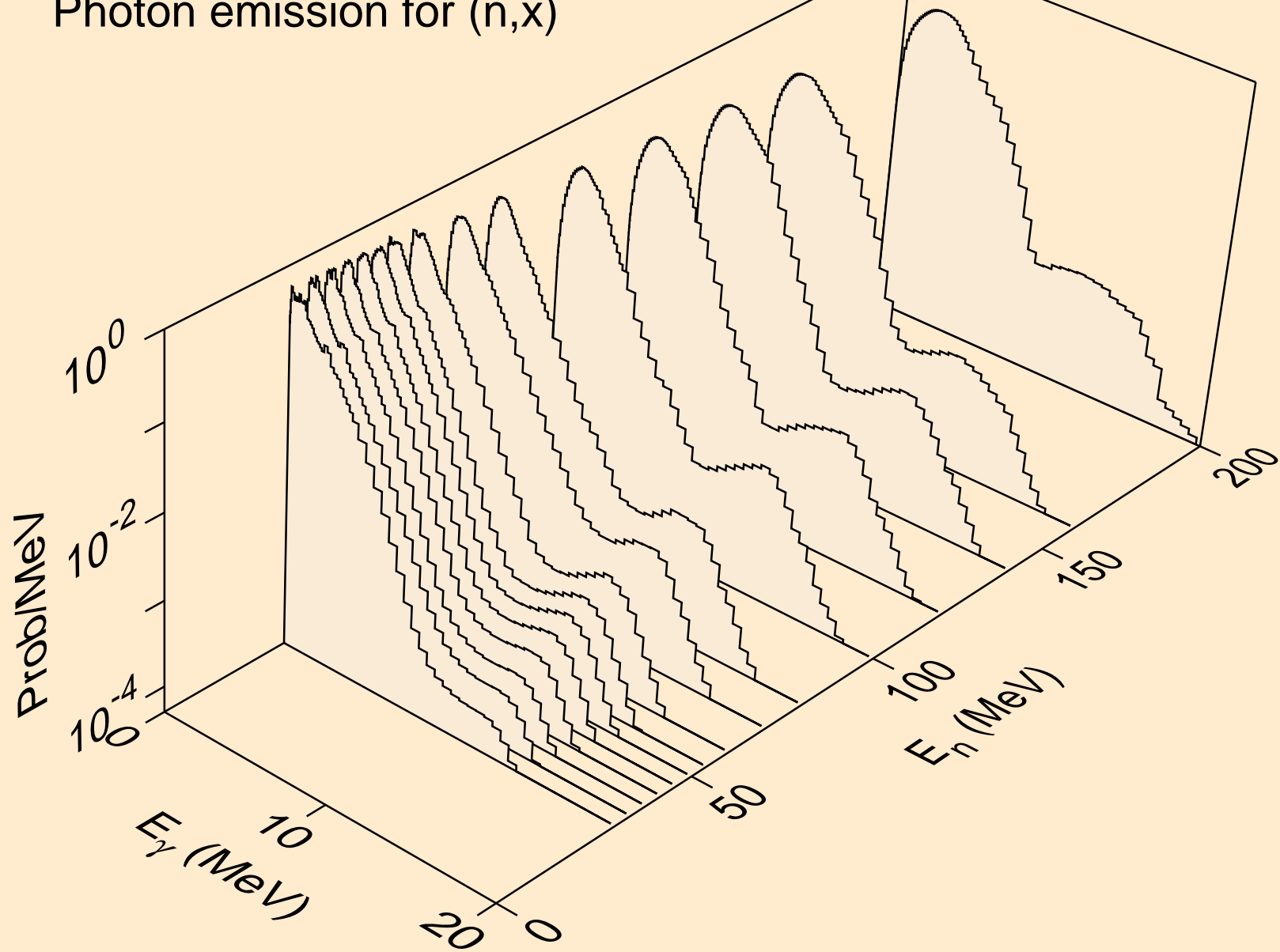

PB204 NEUTRON ACER TENDL-2021 LIBRARY; T=293.6K
Photon emission for (n,2nd)

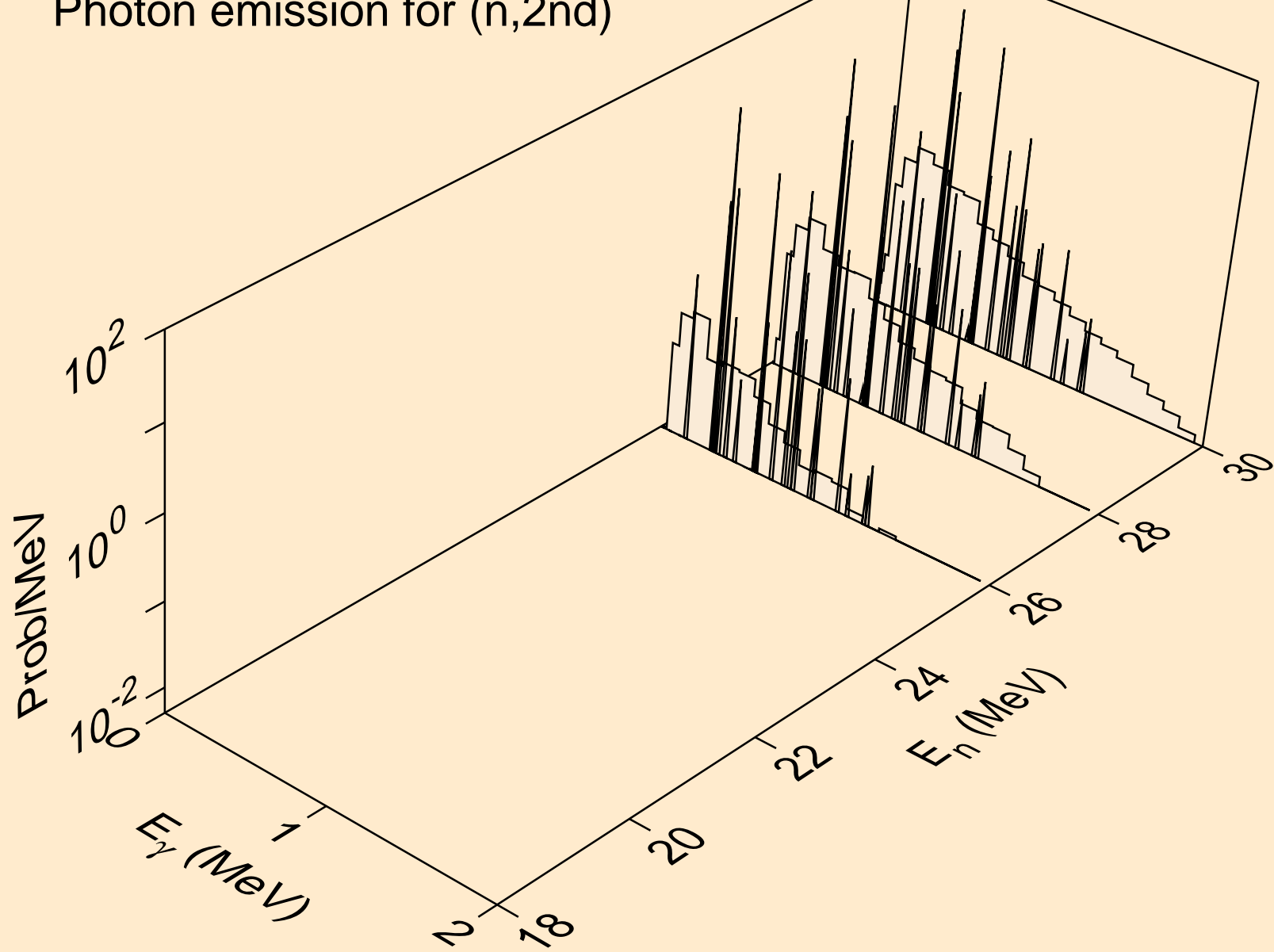

PB204 NEUTRON ACER TENDL-2021 LIBRARY; T=293.6K
Photon emission for (n,2n)

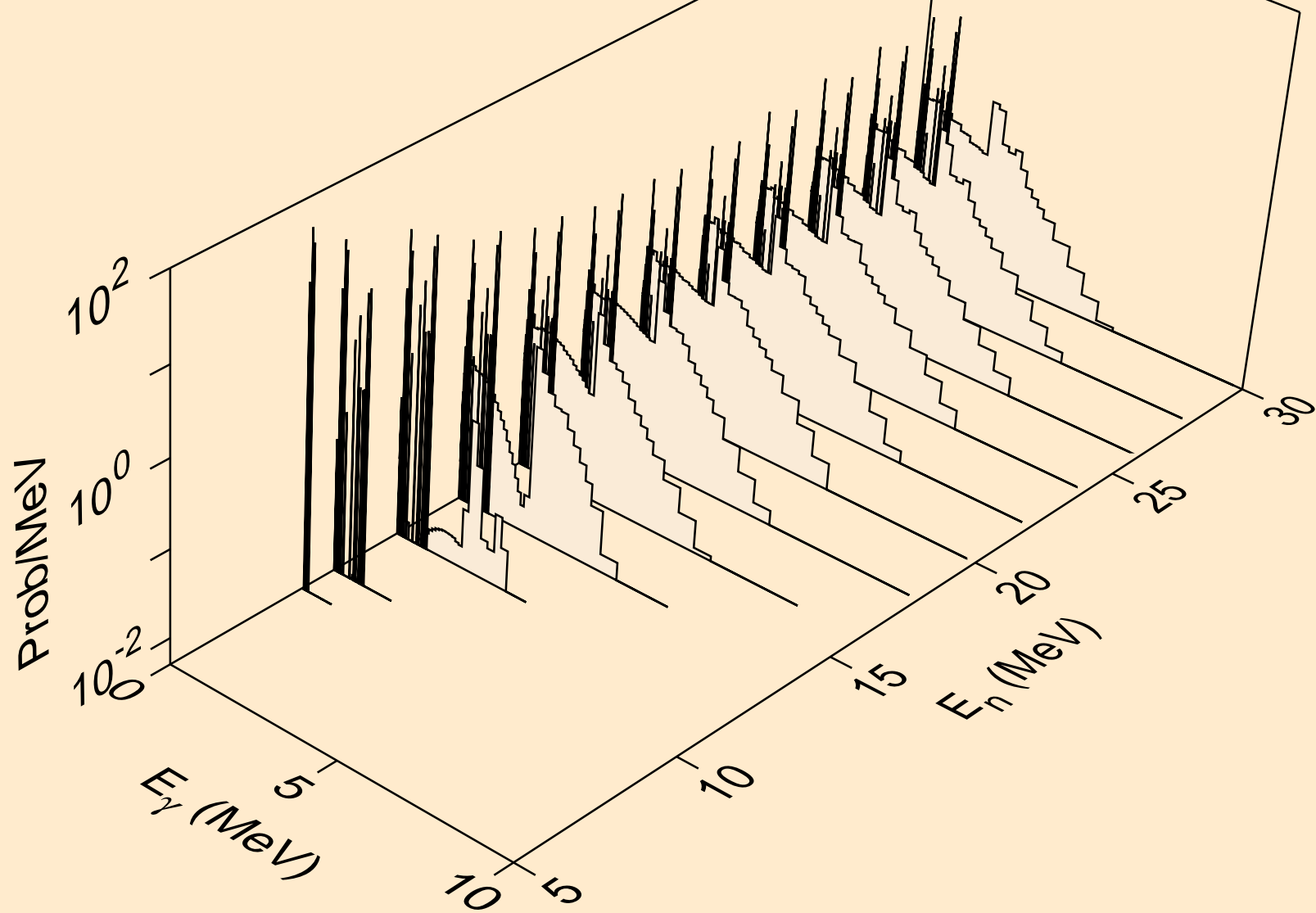

PB204 NEUTRON ACER TENDL-2021 LIBRARY; T=293.6K
Photon emission for (n,3n)

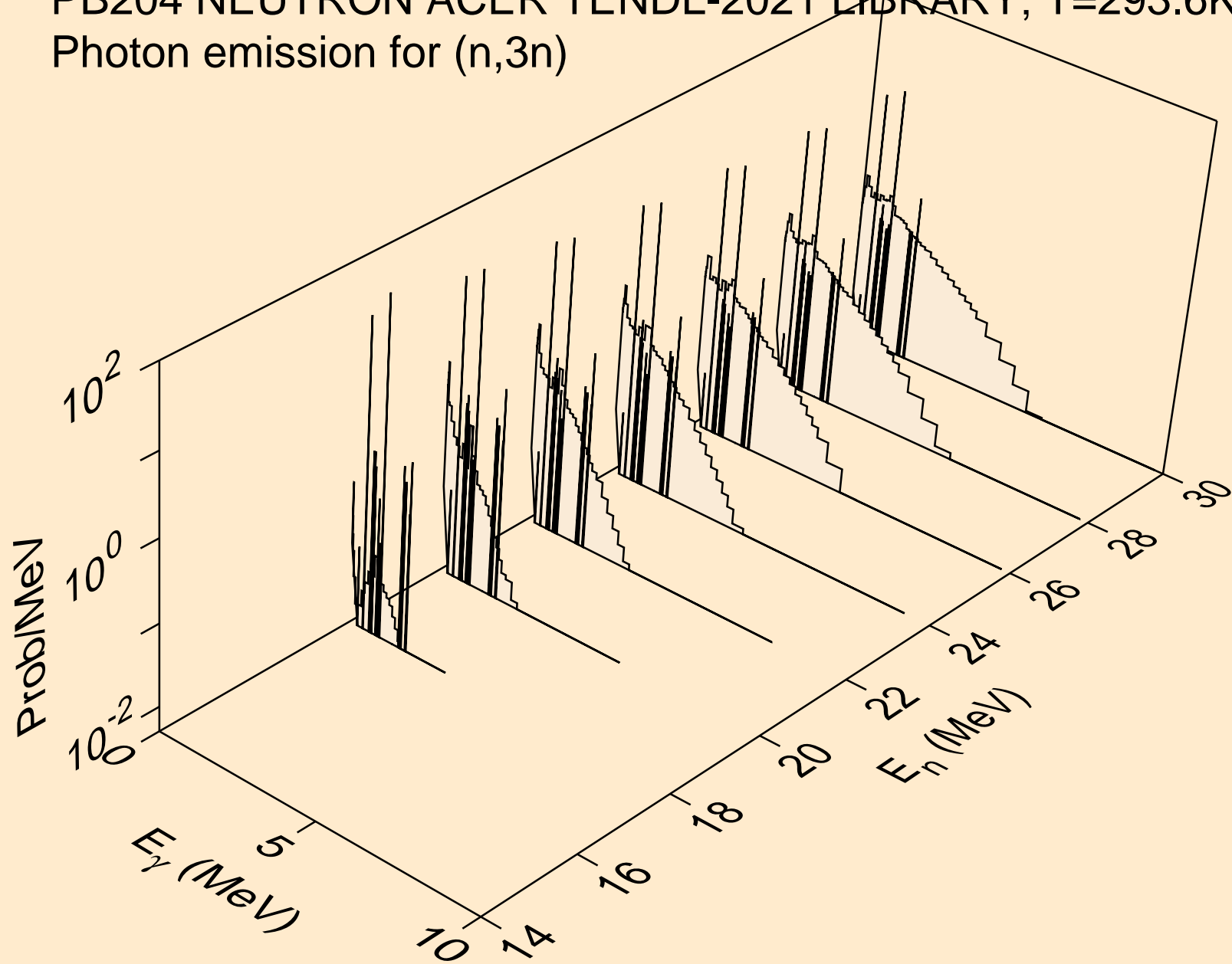

PB204 NEUTRON ACER TENDL-2021 LIBRARY; T=293.6K
Photon emission for (n,n*)a

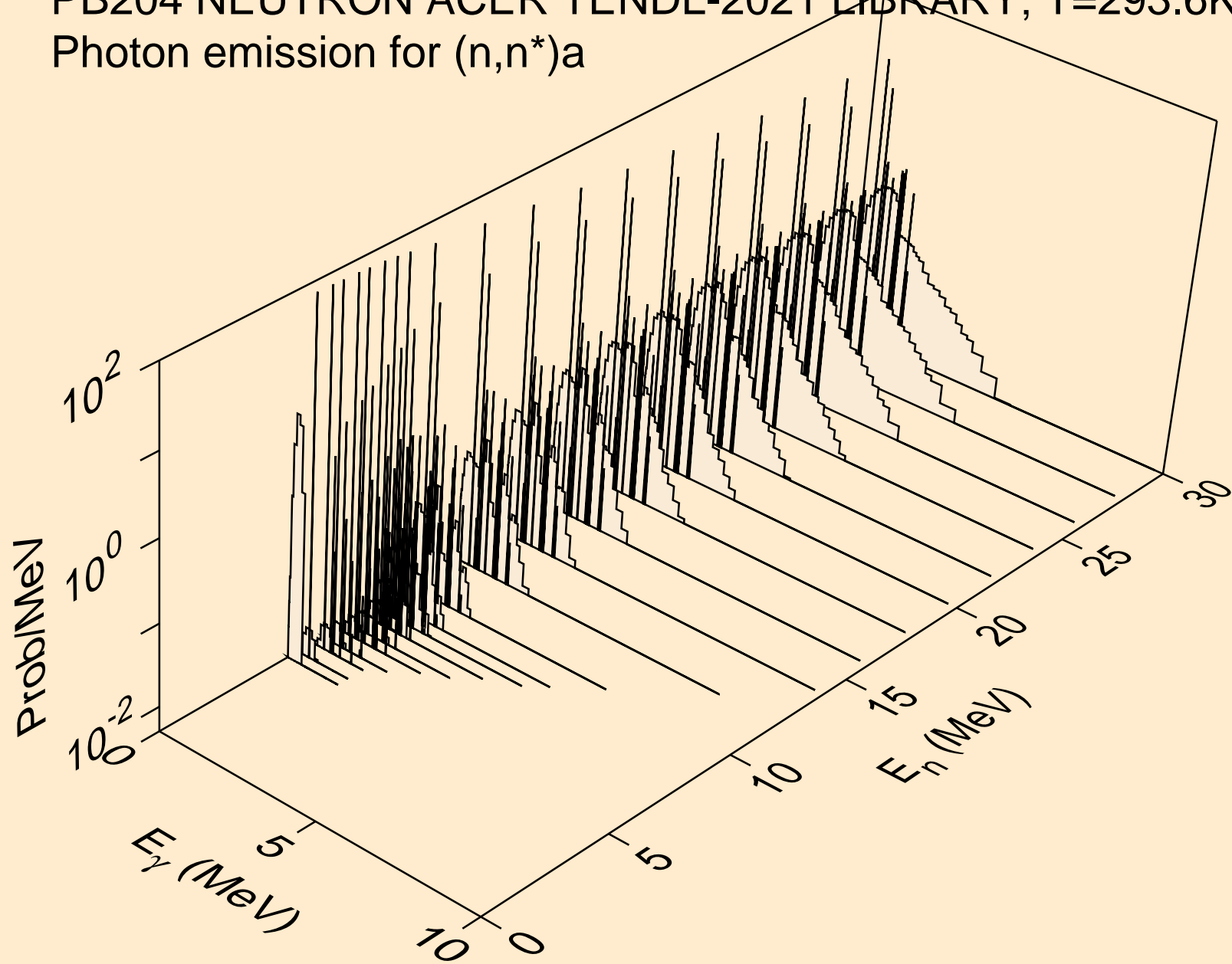

PB204 NEUTRON ACER TENDL-2021 LIBRARY; T=293.6K
Photon emission for (n,2n)a

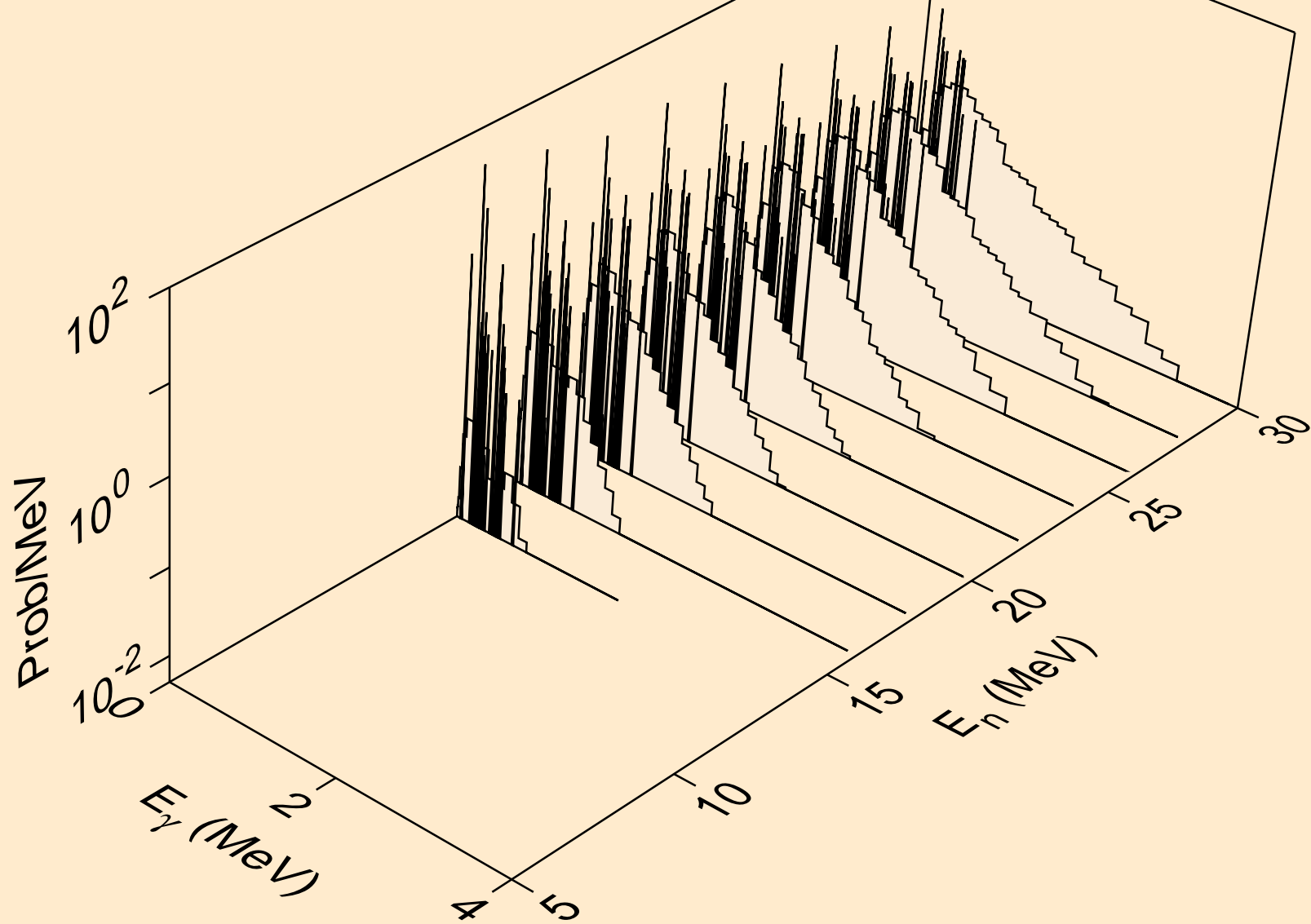

PB204 NEUTRON ACER TENDL-2021 LIBRARY; T=293.6K
Photon emission for (n,3n)a

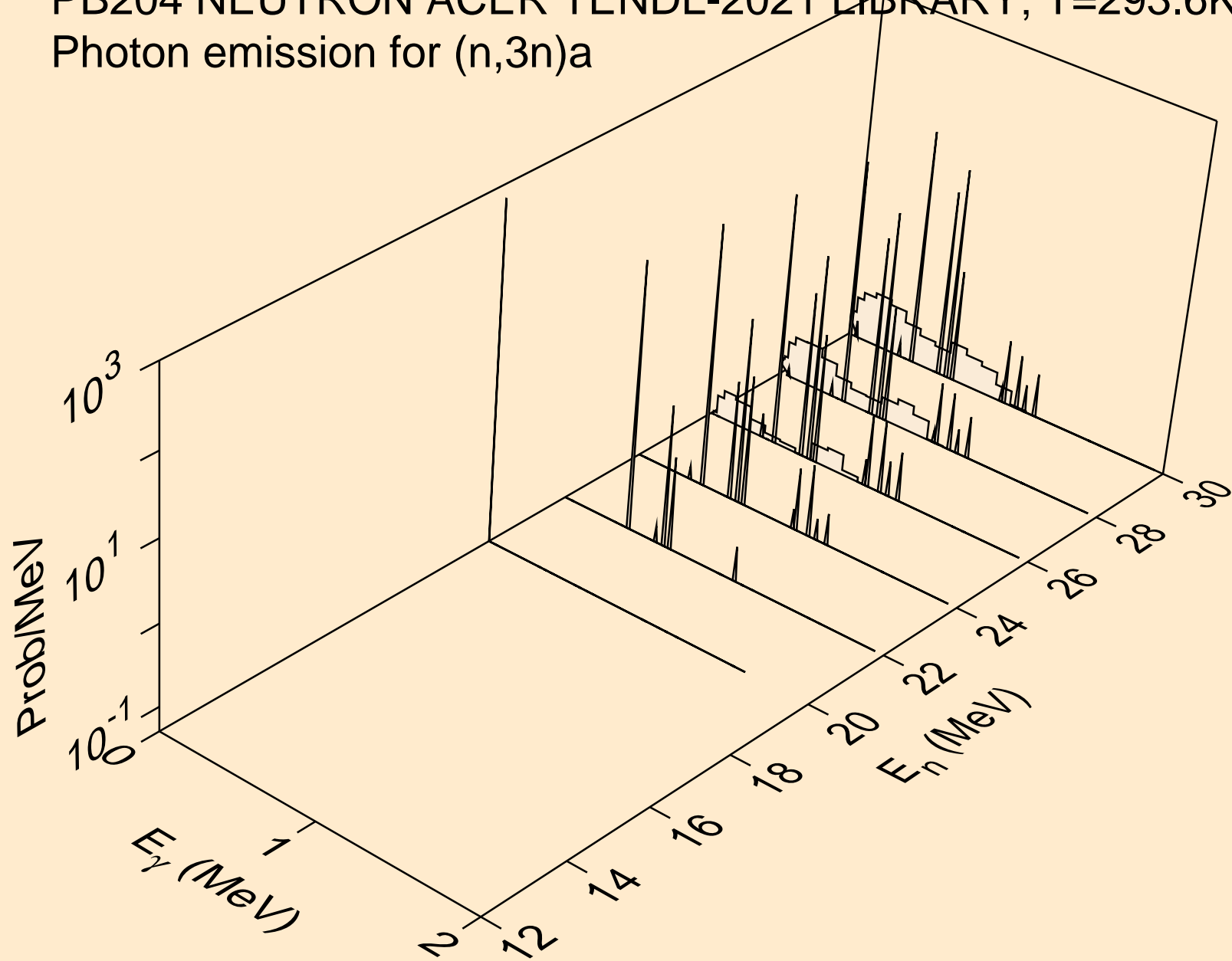

PB204 NEUTRON ACER TENDL-2021 LIBRARY; T=293.6K
Photon emission for (n,n*)p

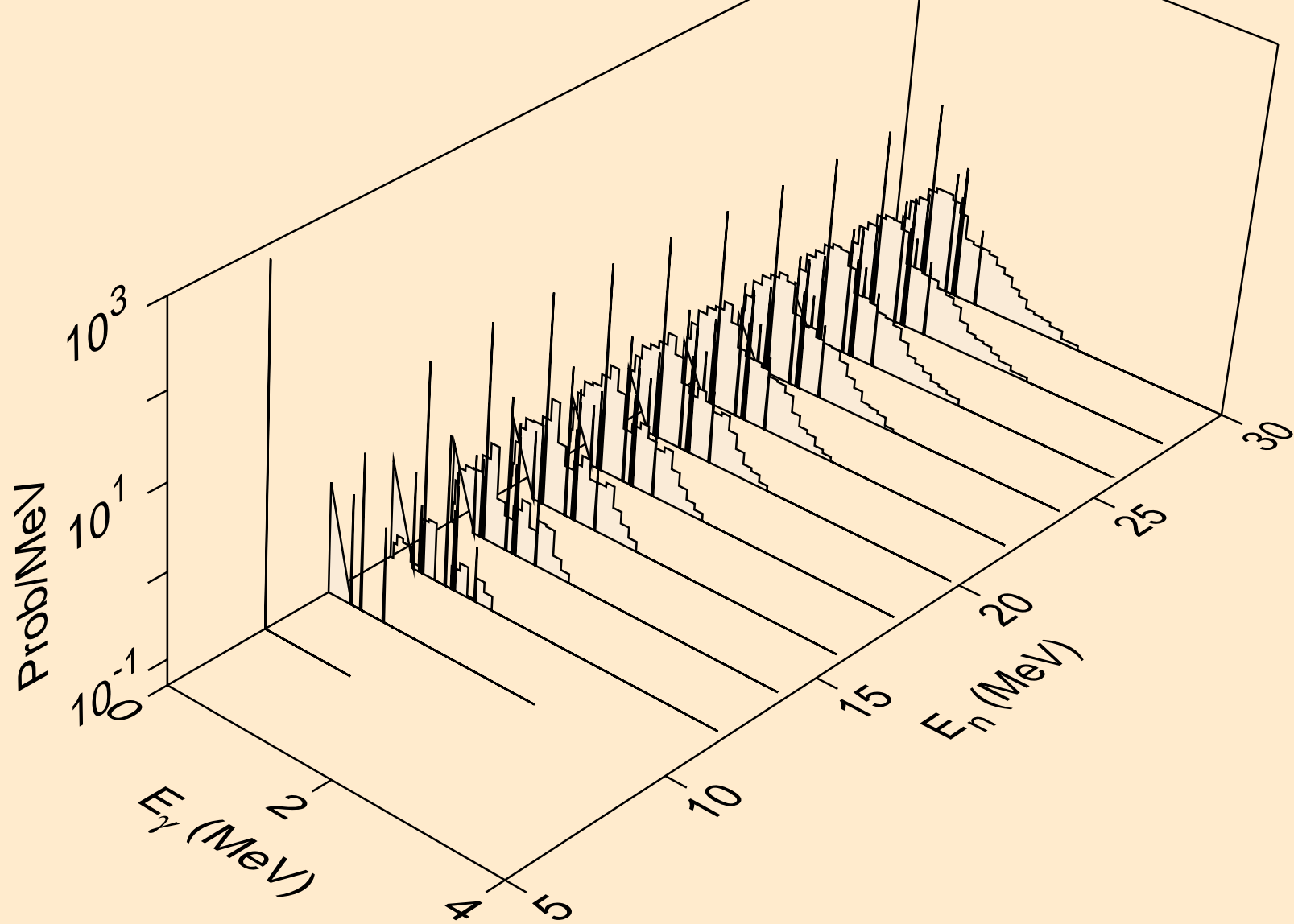

PB204 NEUTRON ACER TENDL-2021 LIBRARY; T=293.6K
Photon emission for (n,n*)d

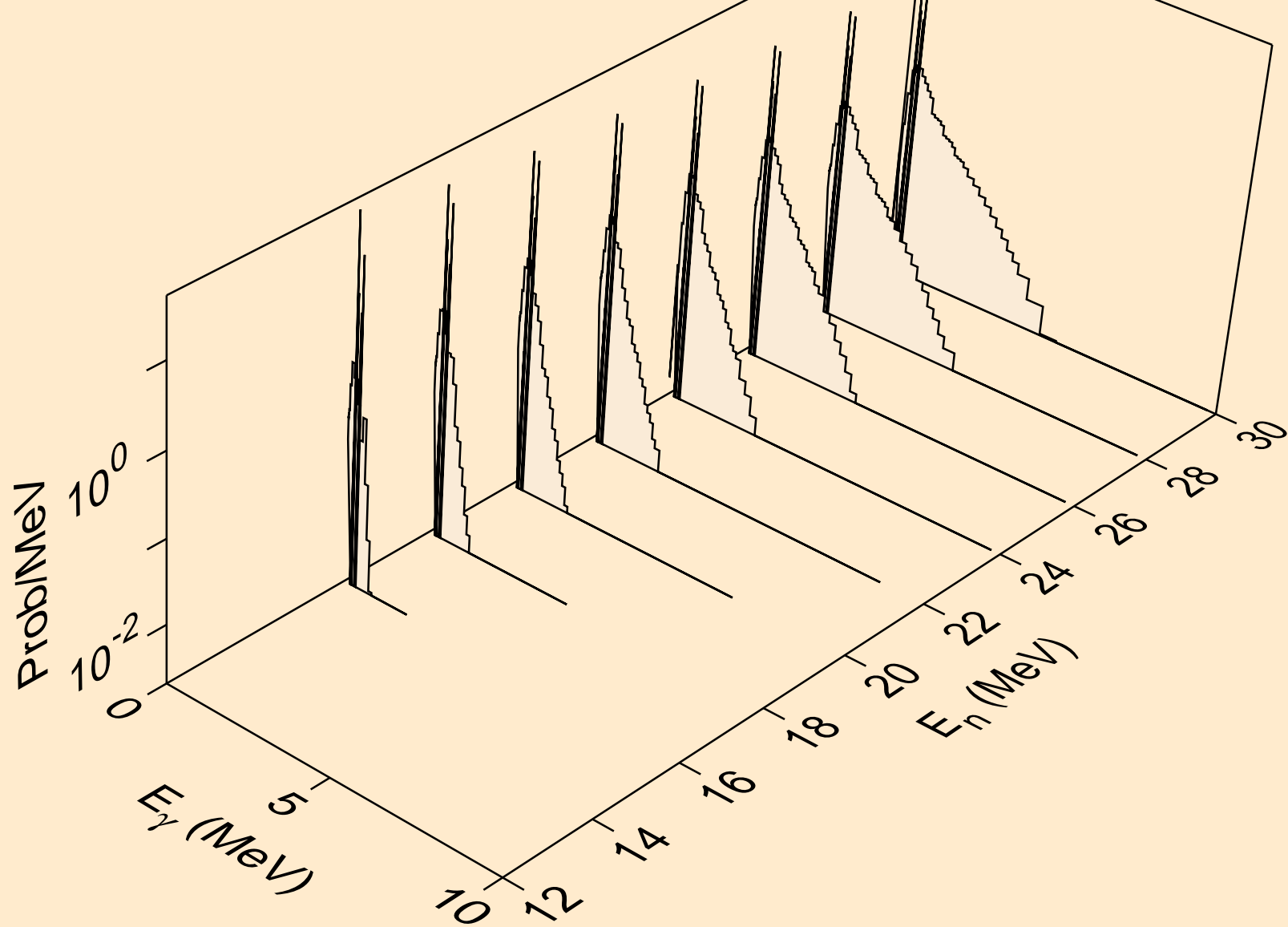

PB204 NEUTRON ACER TENDL-2021 LIBRARY; T=293.6K
Photon emission for (n,n*)t

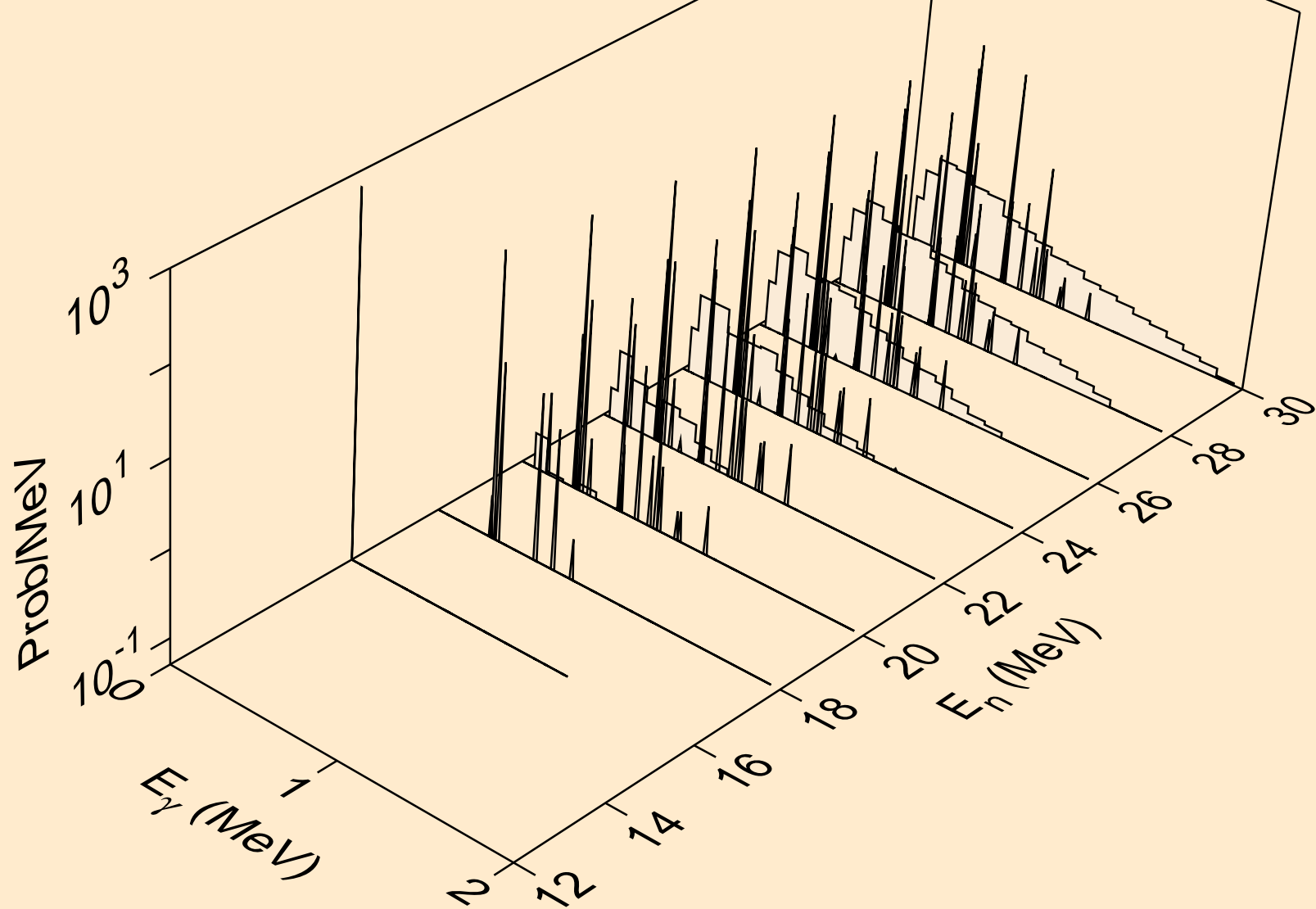

PB204 NEUTRON ACER TENDL-2021 LIBRARY; T=293.6K
Photon emission for (n,n*)he3

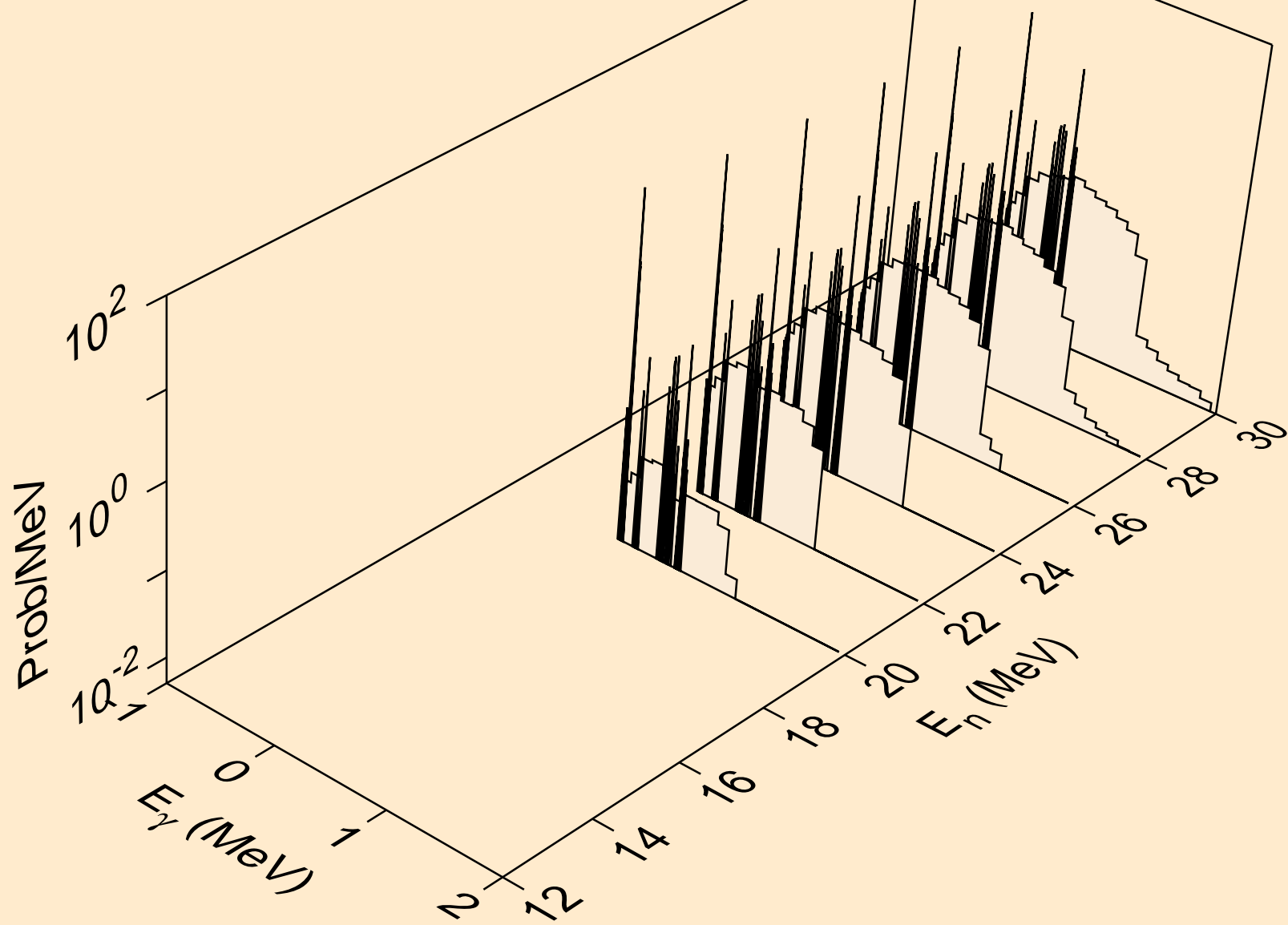

PB204 NEUTRON ACER TENDL-2021 LIBRARY; T=293.6K
Photon emission for (n,4n)

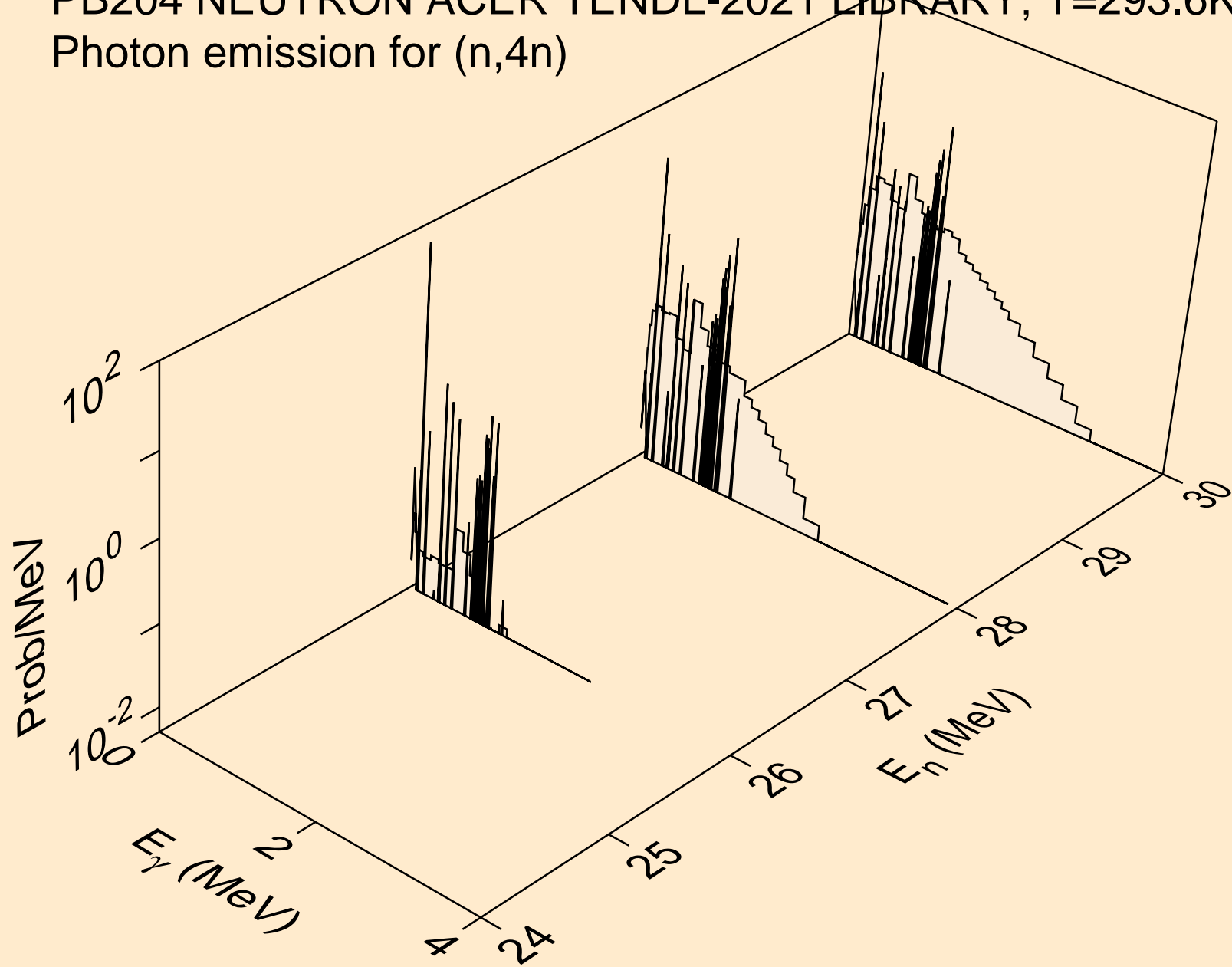

PB204 NEUTRON ACER TENDL-2021 LIBRARY; T=293.6K
Photon emission for (n,2np)

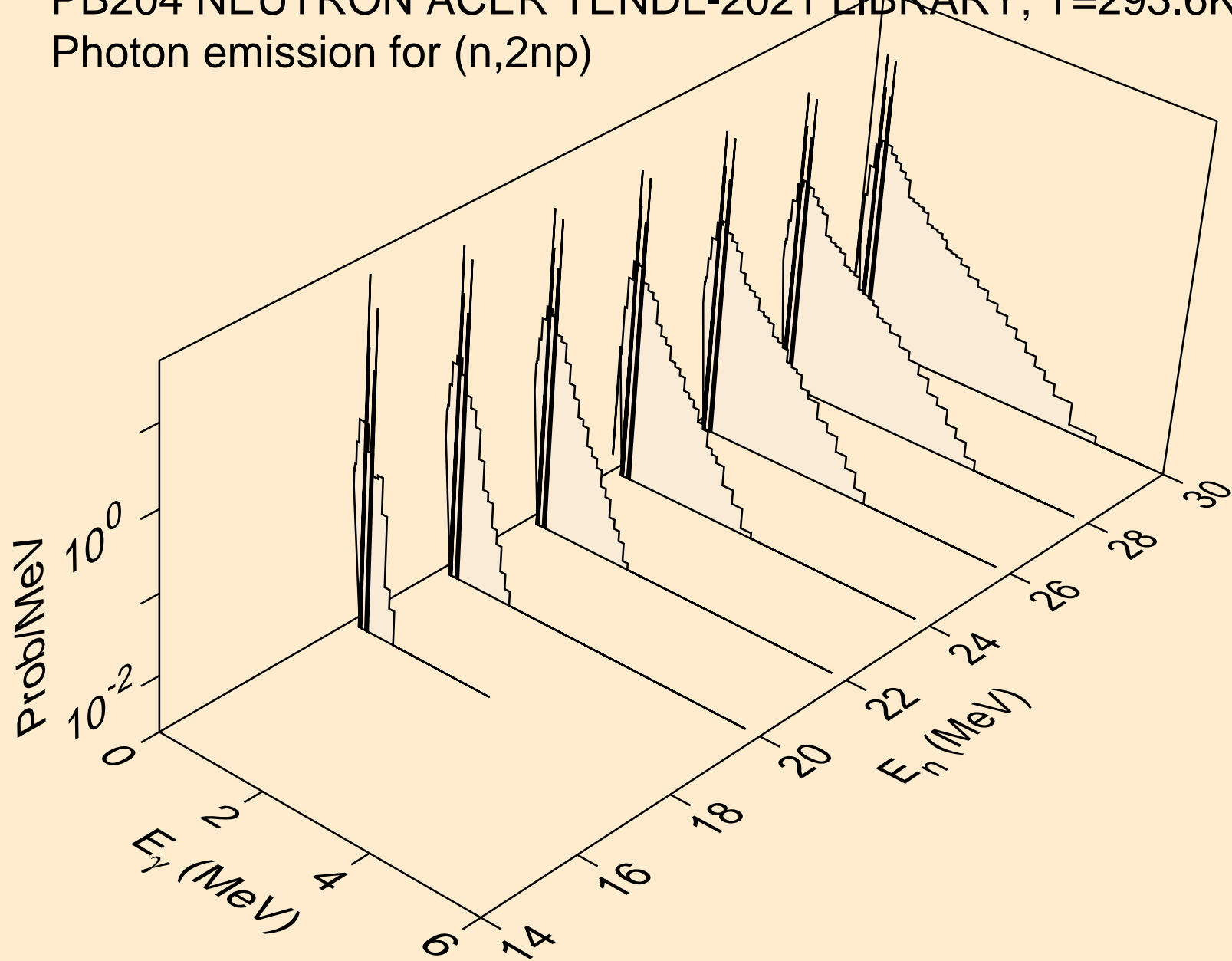

PB204 NEUTRON ACER TENDL-2021 LIBRARY; T=293.6K
Photon emission for (n,3np)

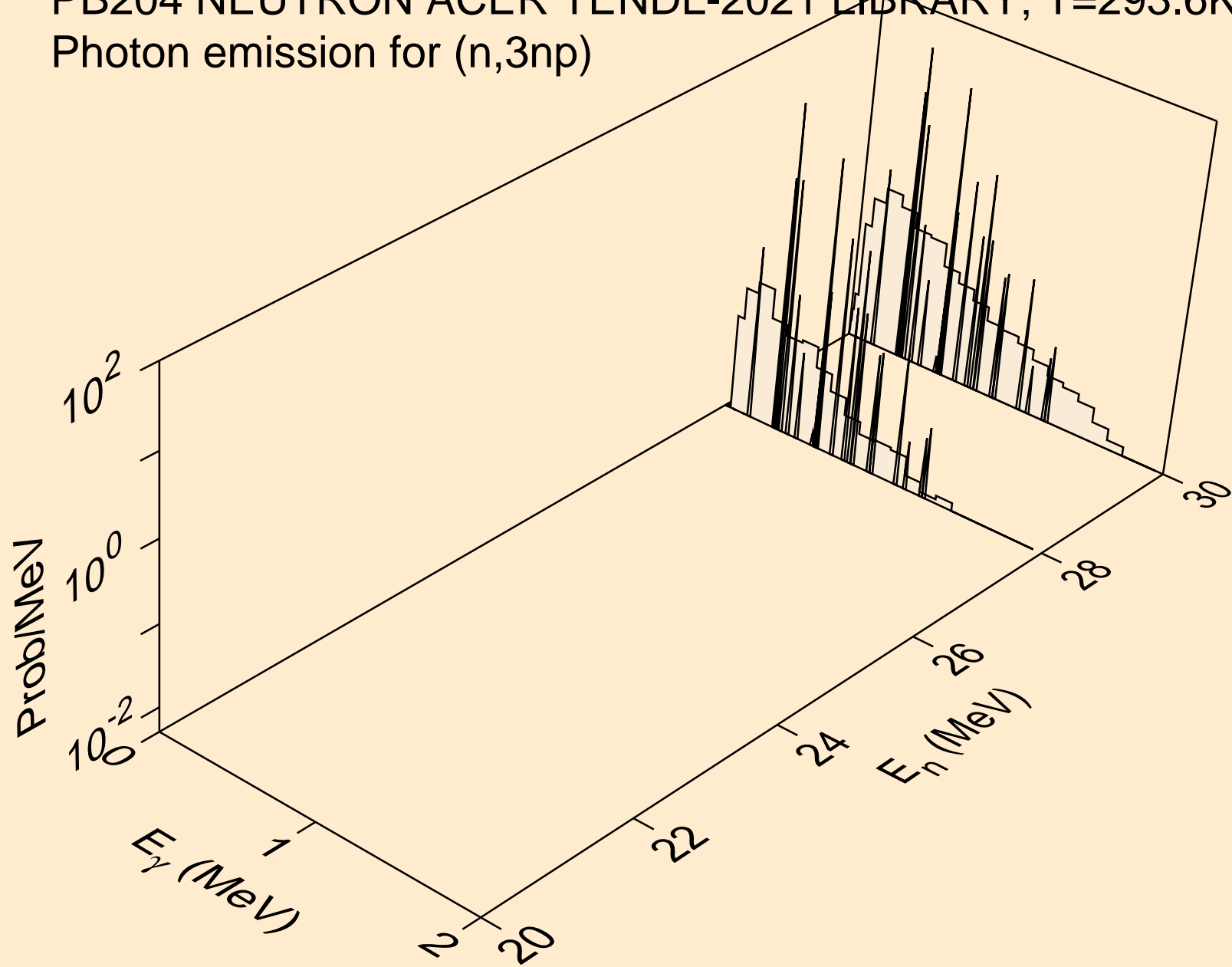

PB204 NEUTRON ACER TENDL-2021 LIBRARY; T=293.6K
Photon emission for (n,2np)

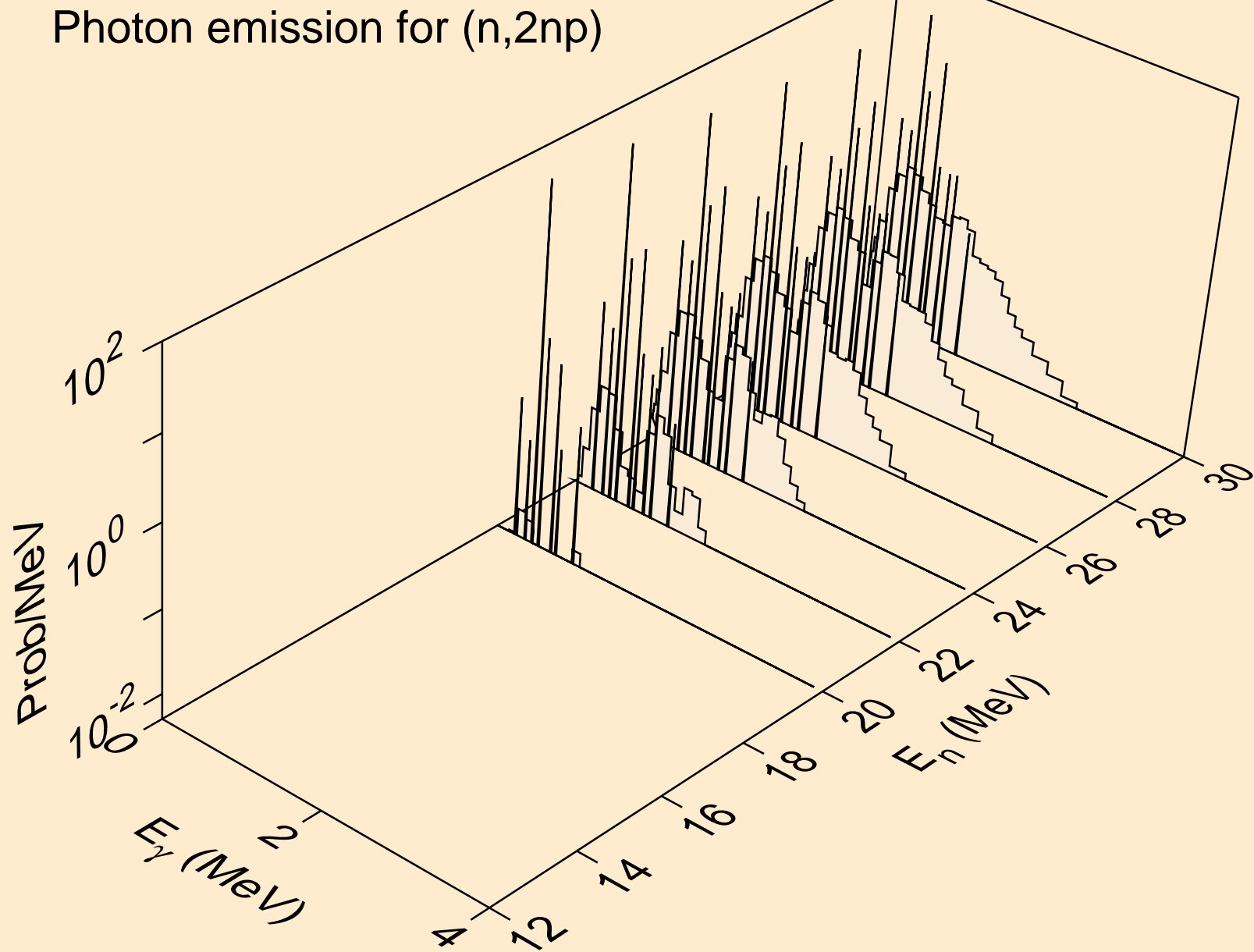

PB204 NEUTRON ACER TENDL-2021 LIBRARY; T=293.6K
Photon emission for (n,npa)

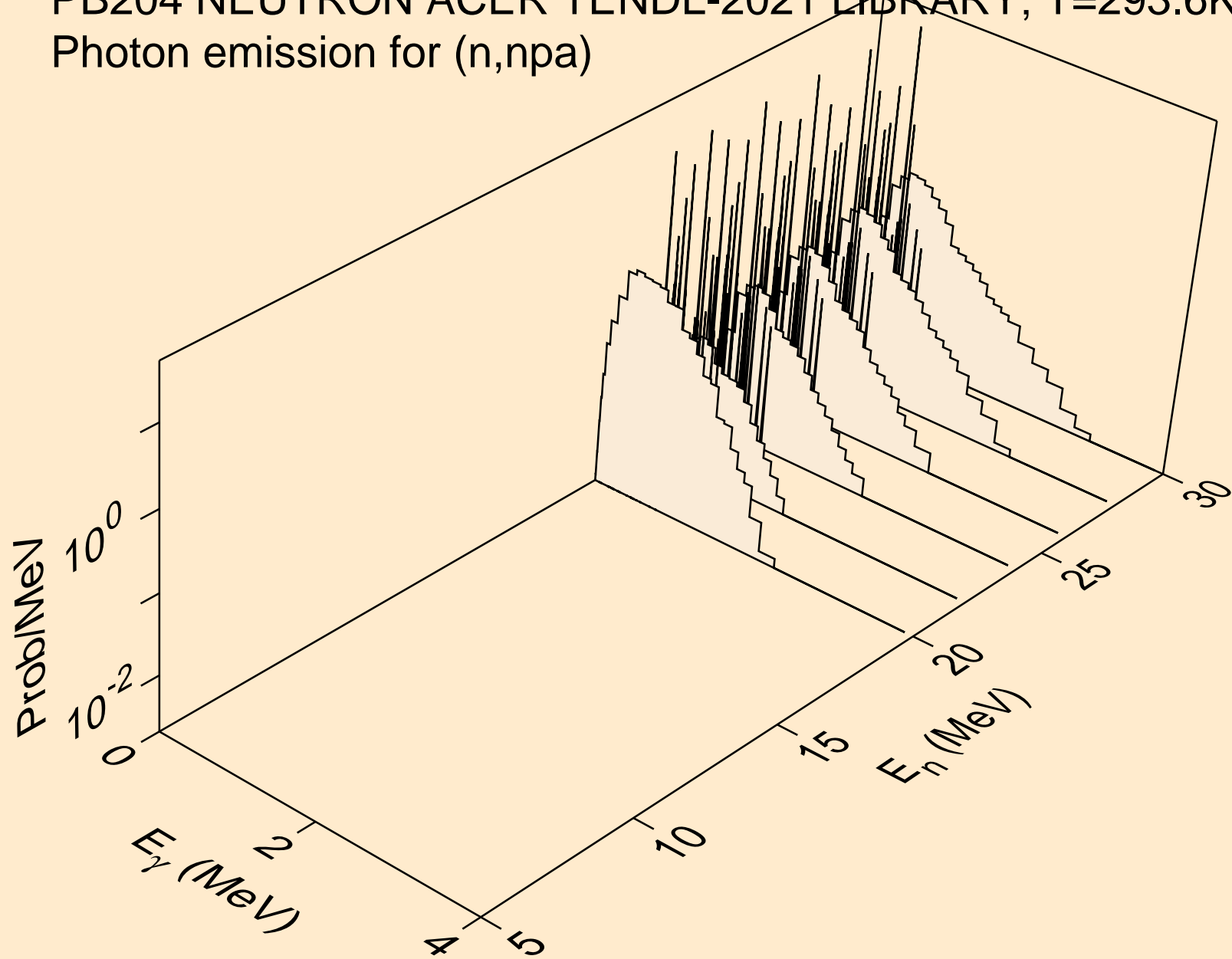

PB204 NEUTRON ACER TENDL-2021 LIBRARY; T=293.6K
Photon emission for (n,n*c)

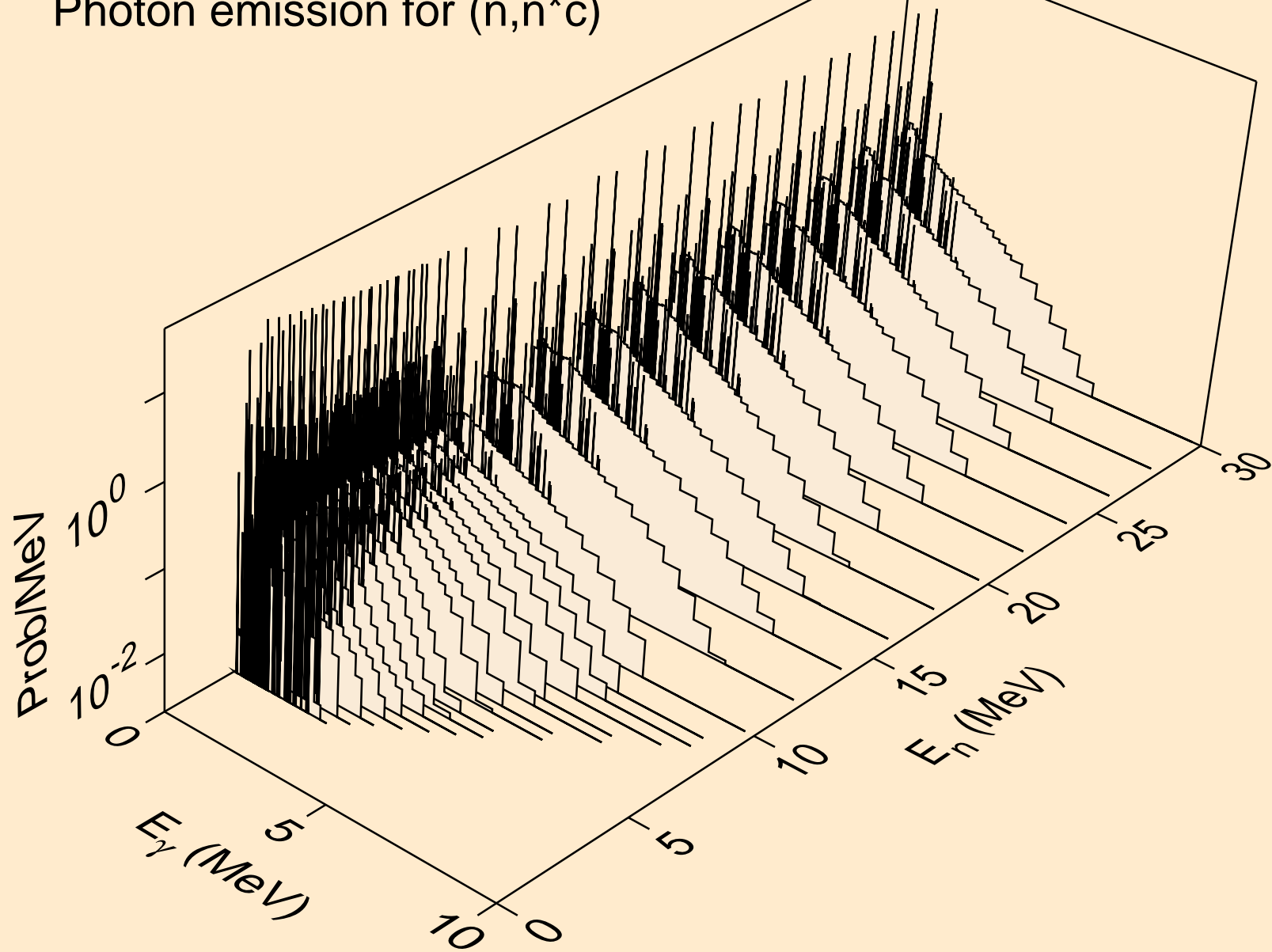

PB204 NEUTRON ACER TENDL-2021 LIBRARY; T=293.6K
Photon emission for (n,gma)

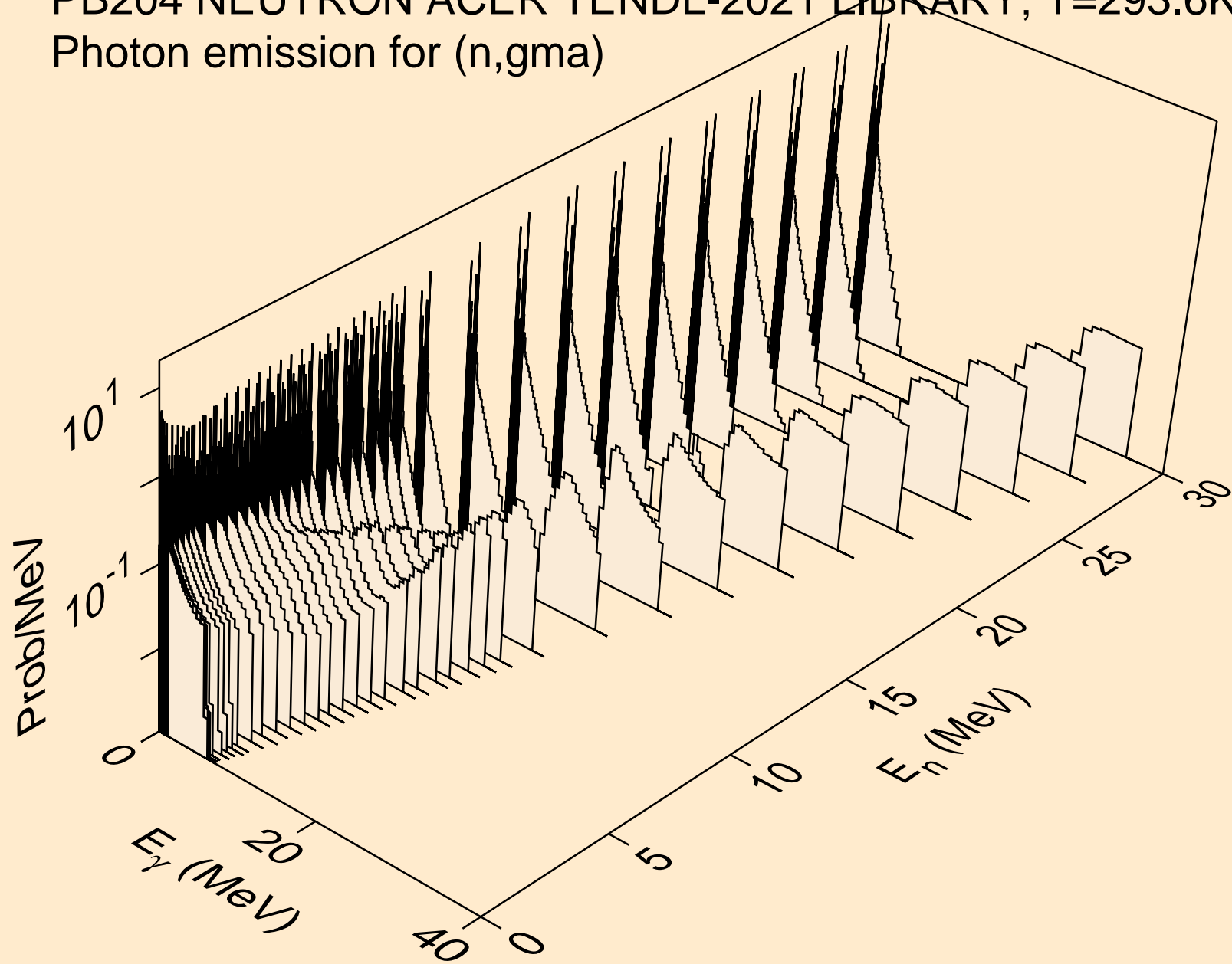

PB204 NEUTRON ACER TENDL-2021 LIBRARY; T=293.6K
Photon emission for (n,p)

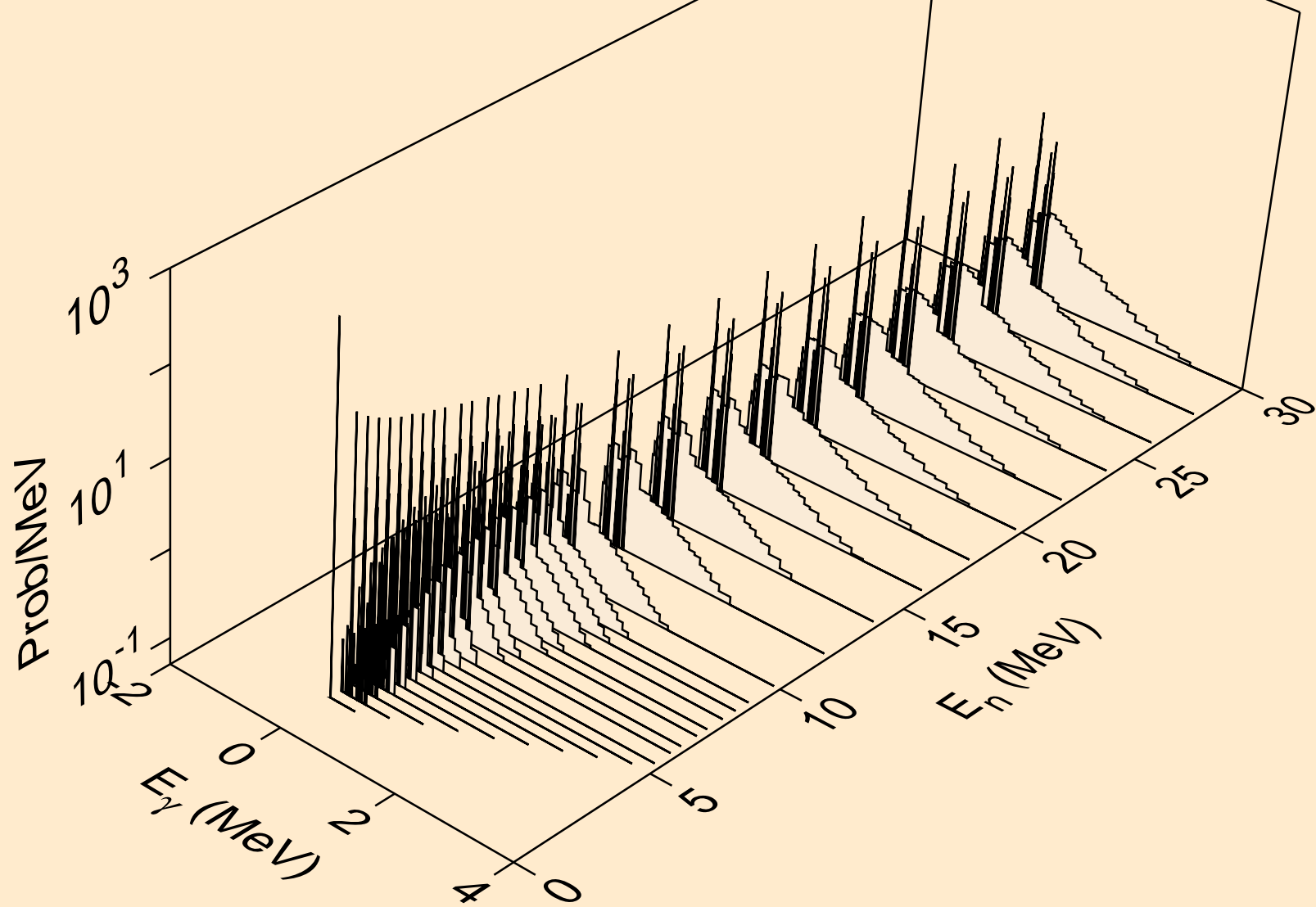

PB204 NEUTRON ACER TENDL-2021 LIBRARY; T=293.6K
Photon emission for (n,d)

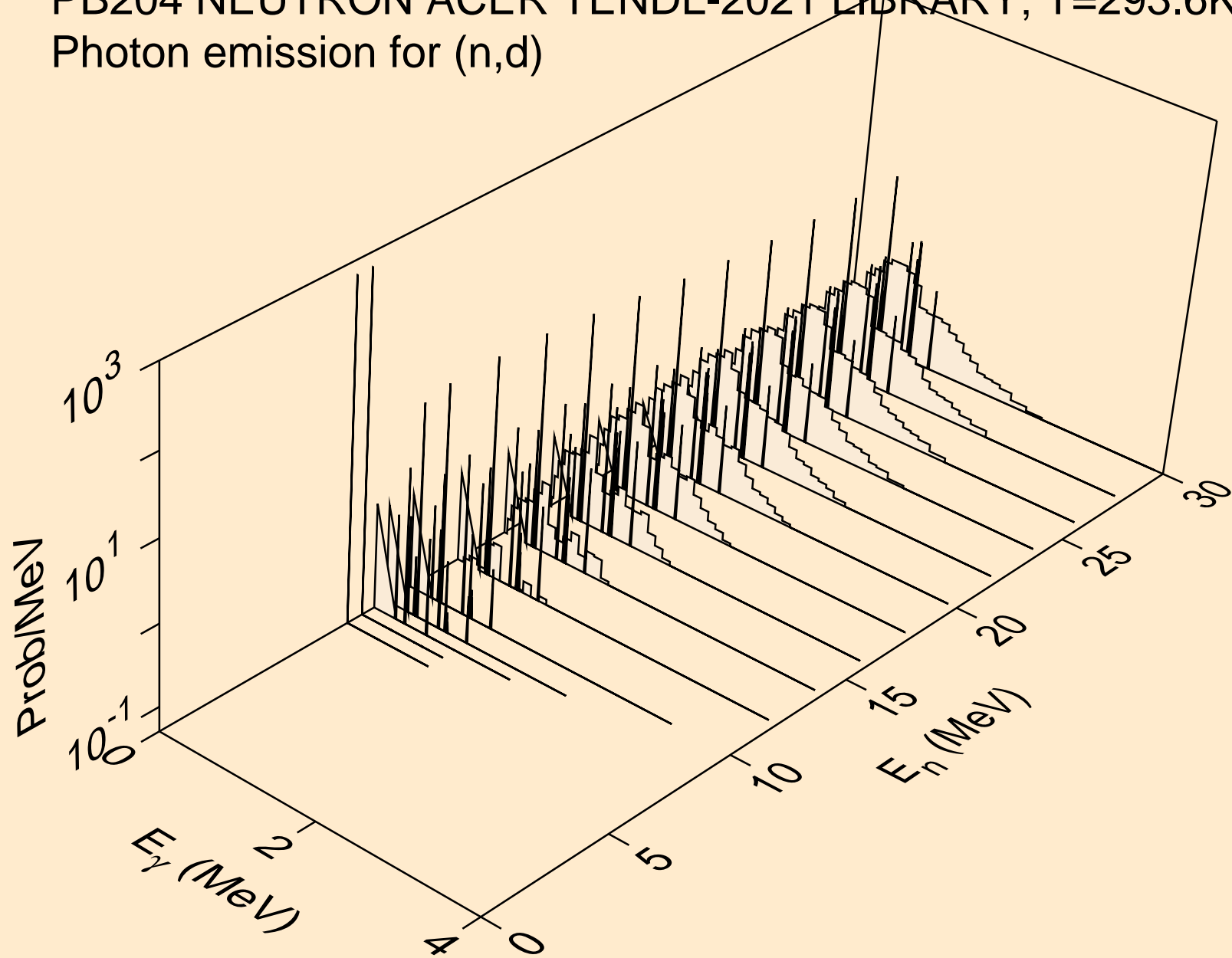

PB204 NEUTRON ACER TENDL-2021 LIBRARY; T=293.6K
Photon emission for (n,t)

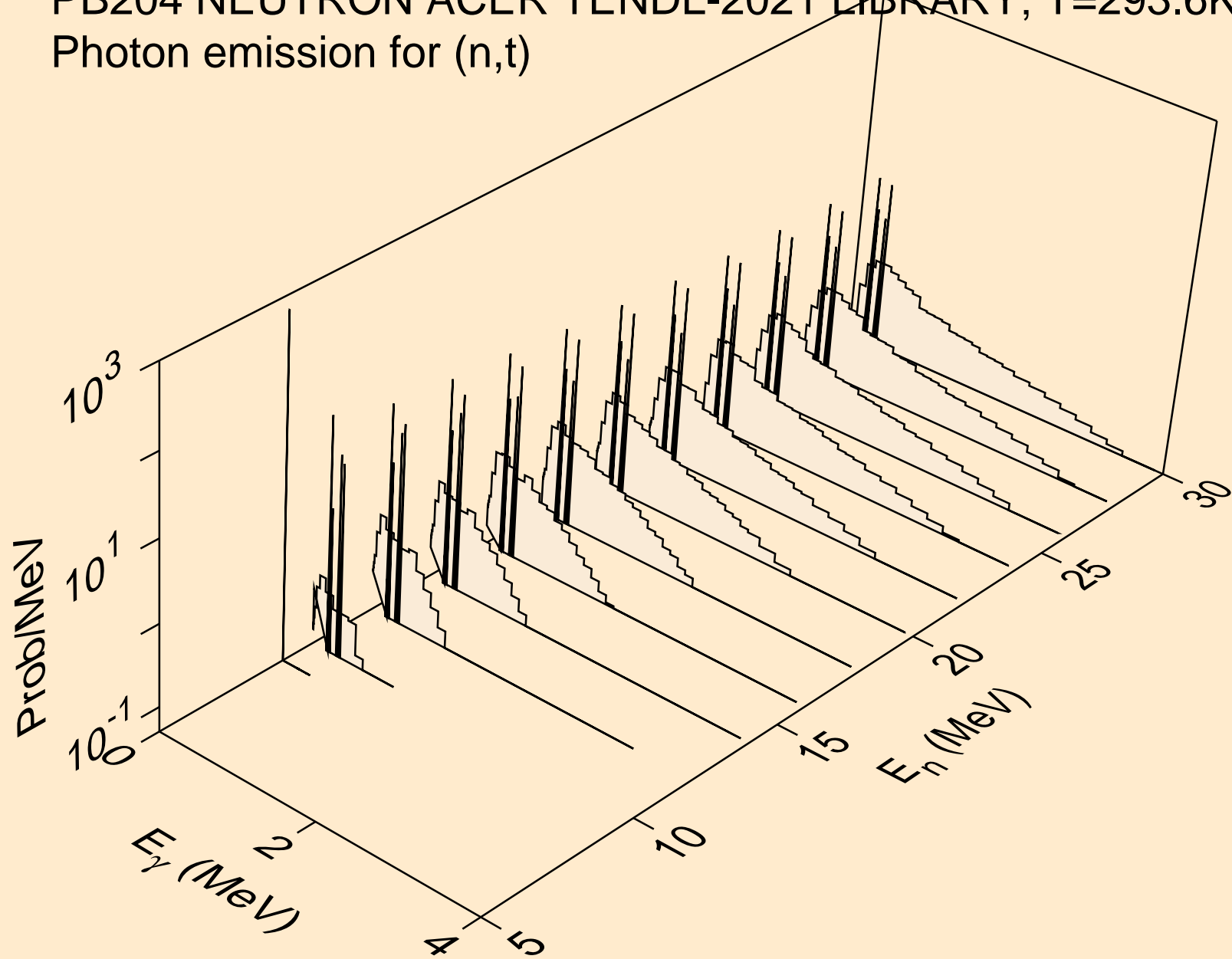

PB204 NEUTRON ACER TENDL-2021 LIBRARY; T=293.6K
Photon emission for (n,he3)

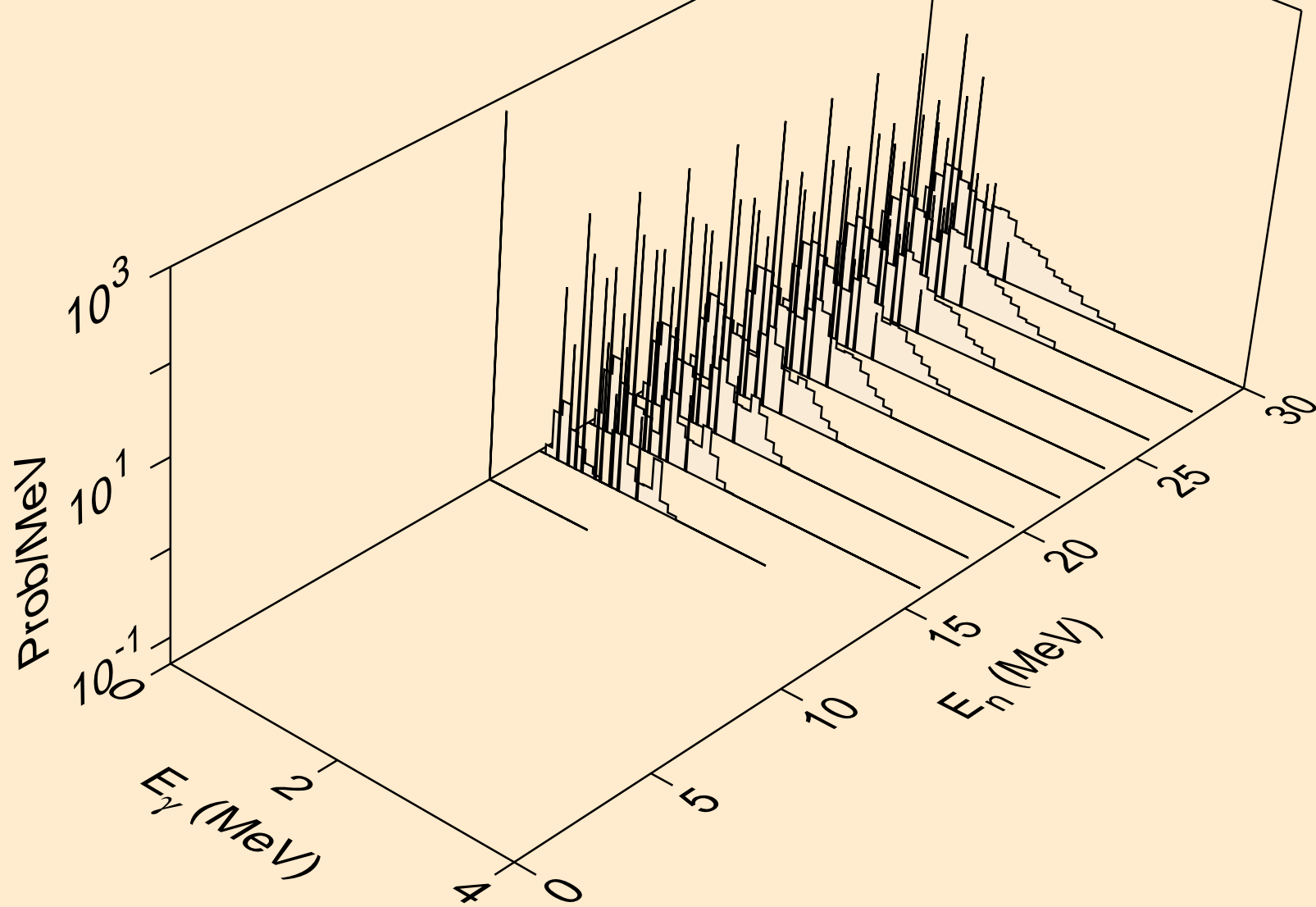

PB204 NEUTRON ACER TENDL-2021 LIBRARY; T=293.6K
Photon emission for (n,a)

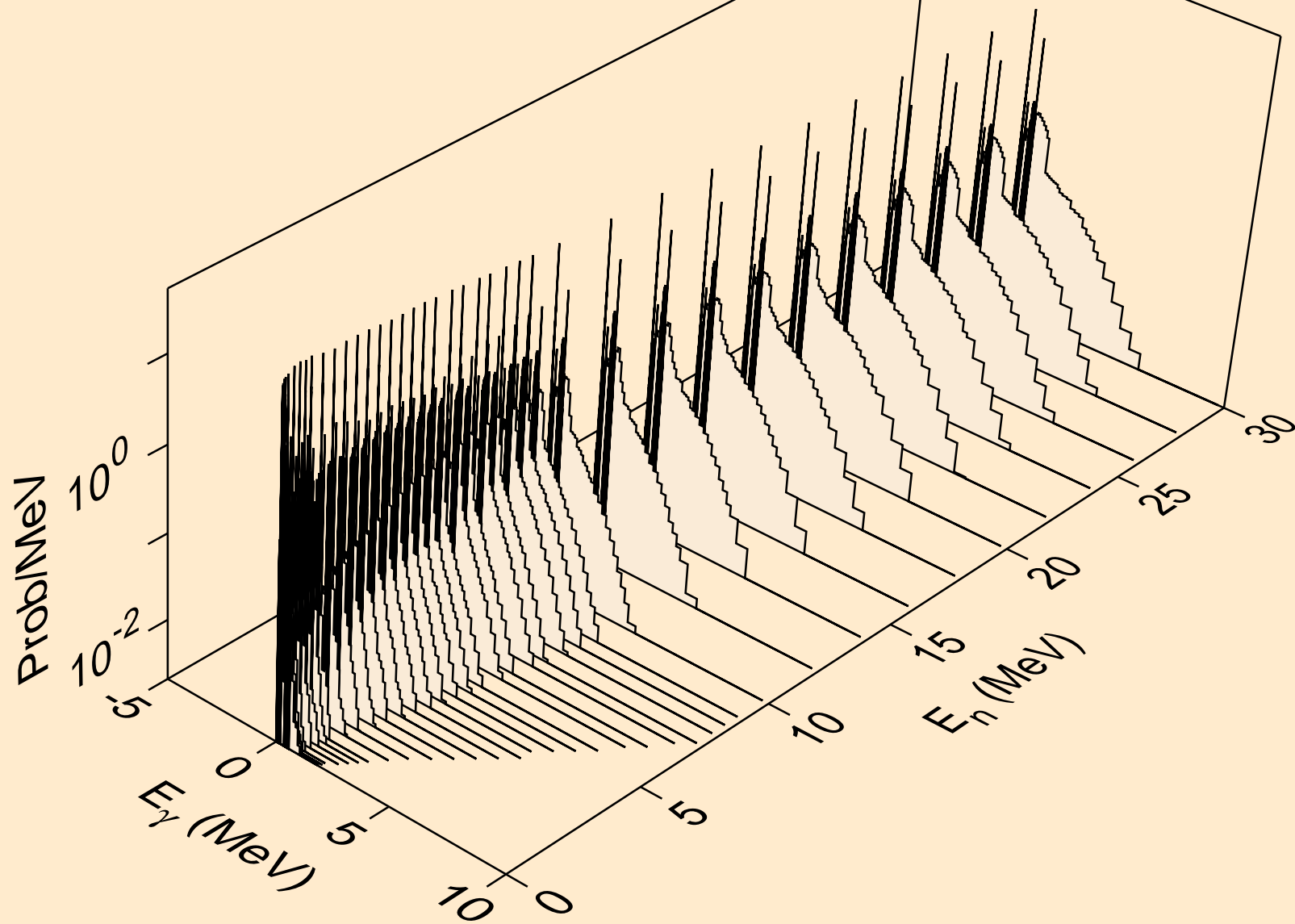

PB204 NEUTRON ACER TENDL-2021 LIBRARY; T=293.6K
Photon emission for (n,2a)

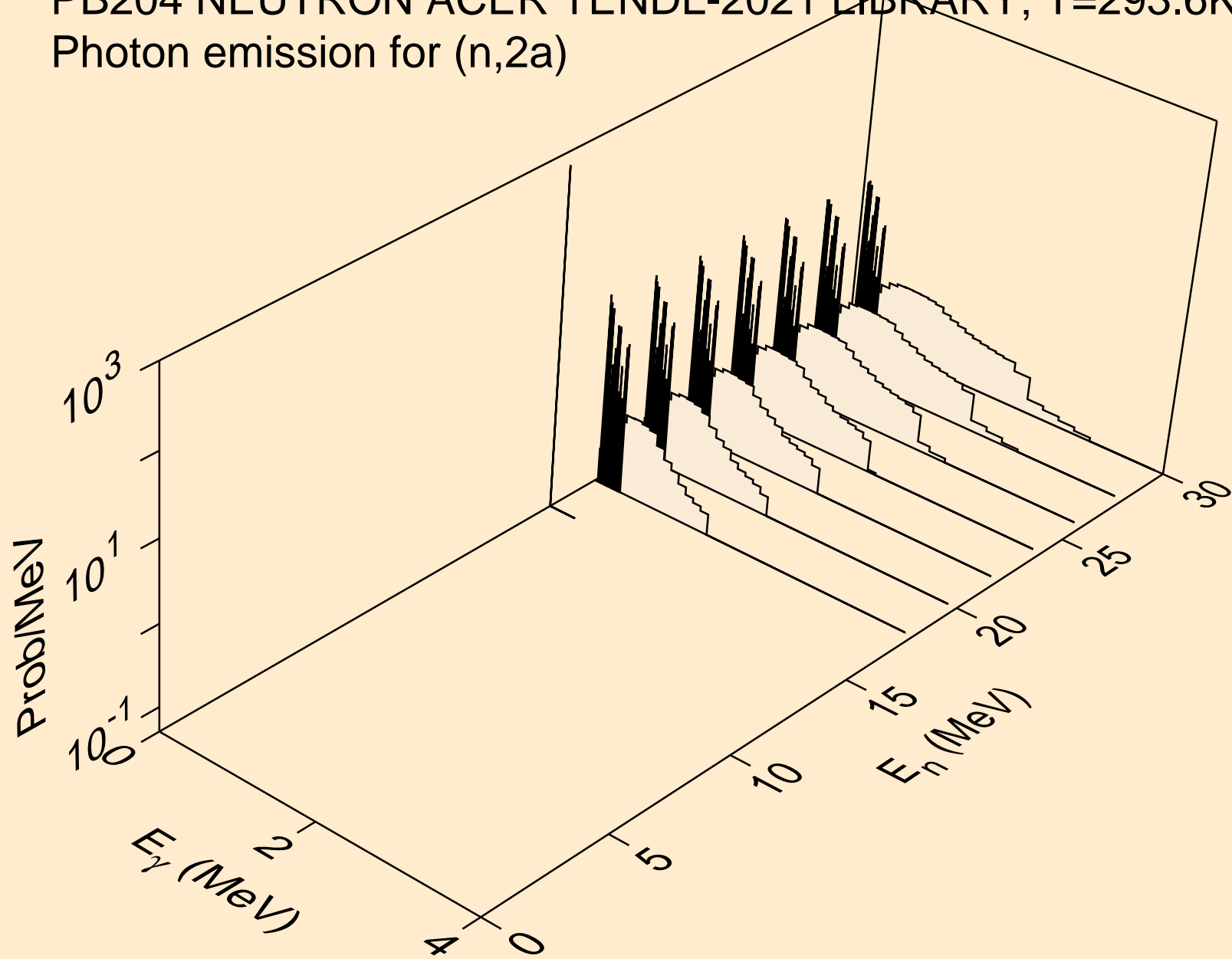

PB204 NEUTRON ACER TENDL-2021 LIBRARY; T=293.6K
Photon emission for (n,2p)

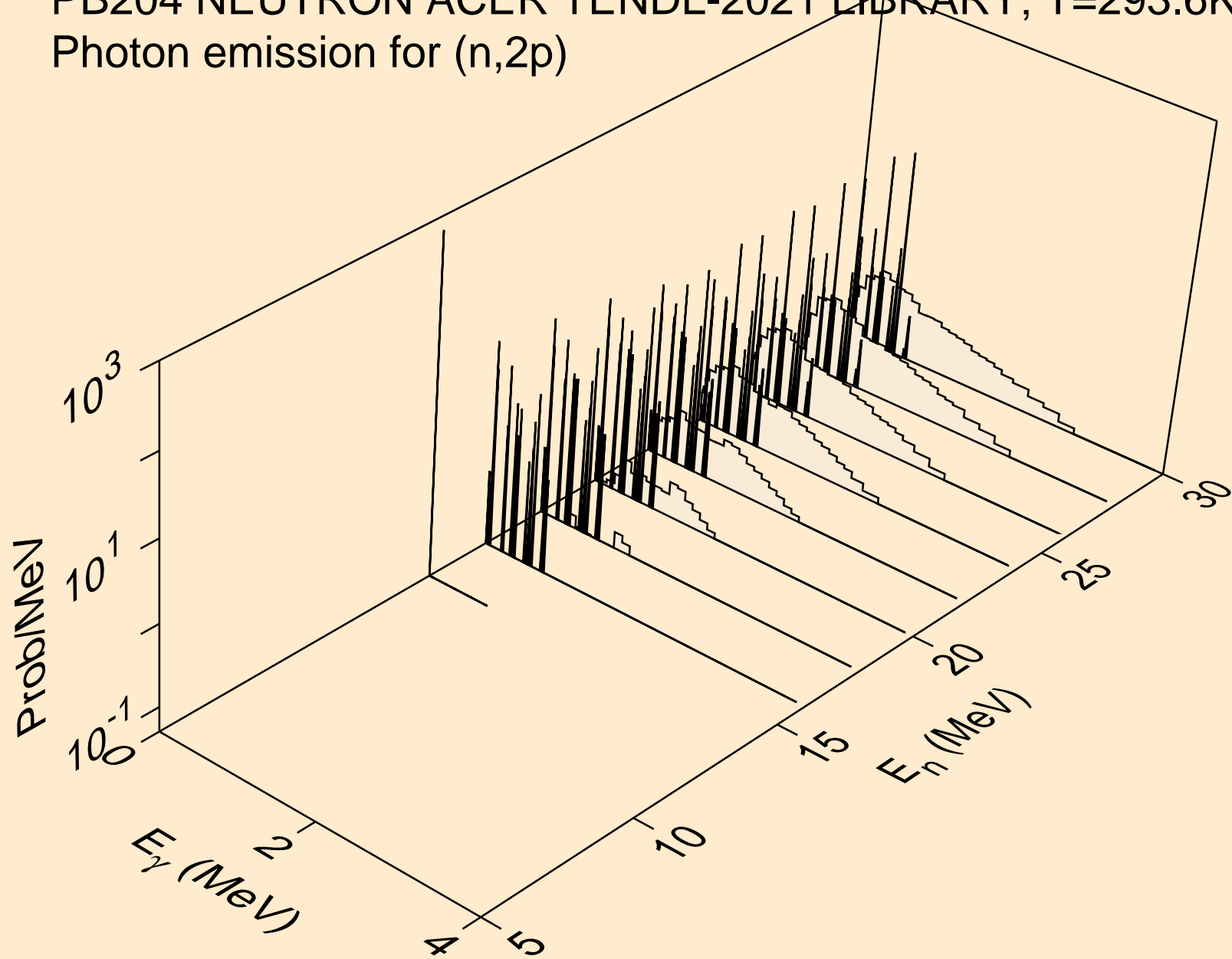

PB204 NEUTRON ACER TENDL-2021 LIBRARY; T=293.6K
Photon emission for (n,p)

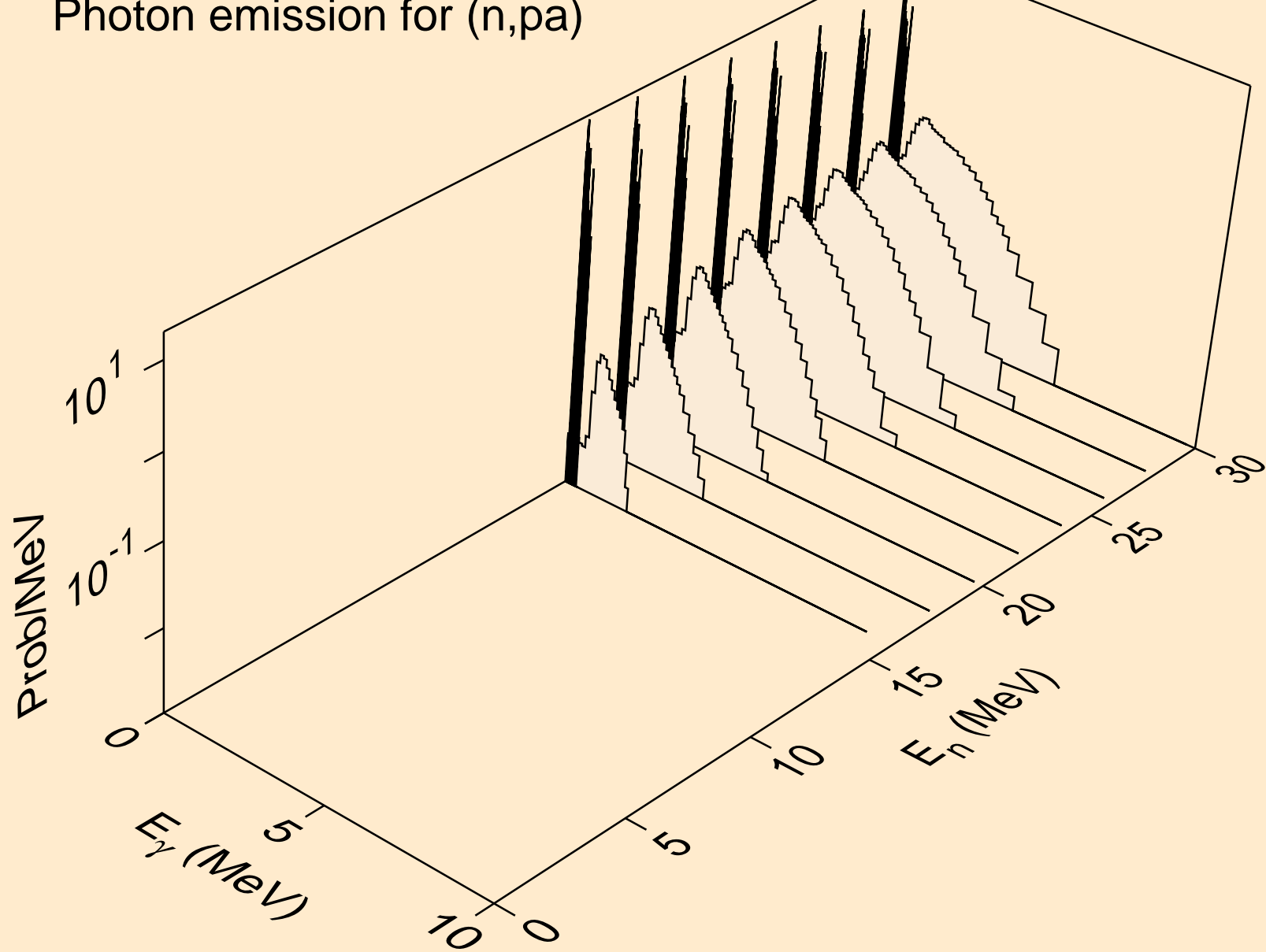

PB204 NEUTRON ACER TENDL-2021 LIBRARY; T=293.6K
Photon emission for (n,pd)

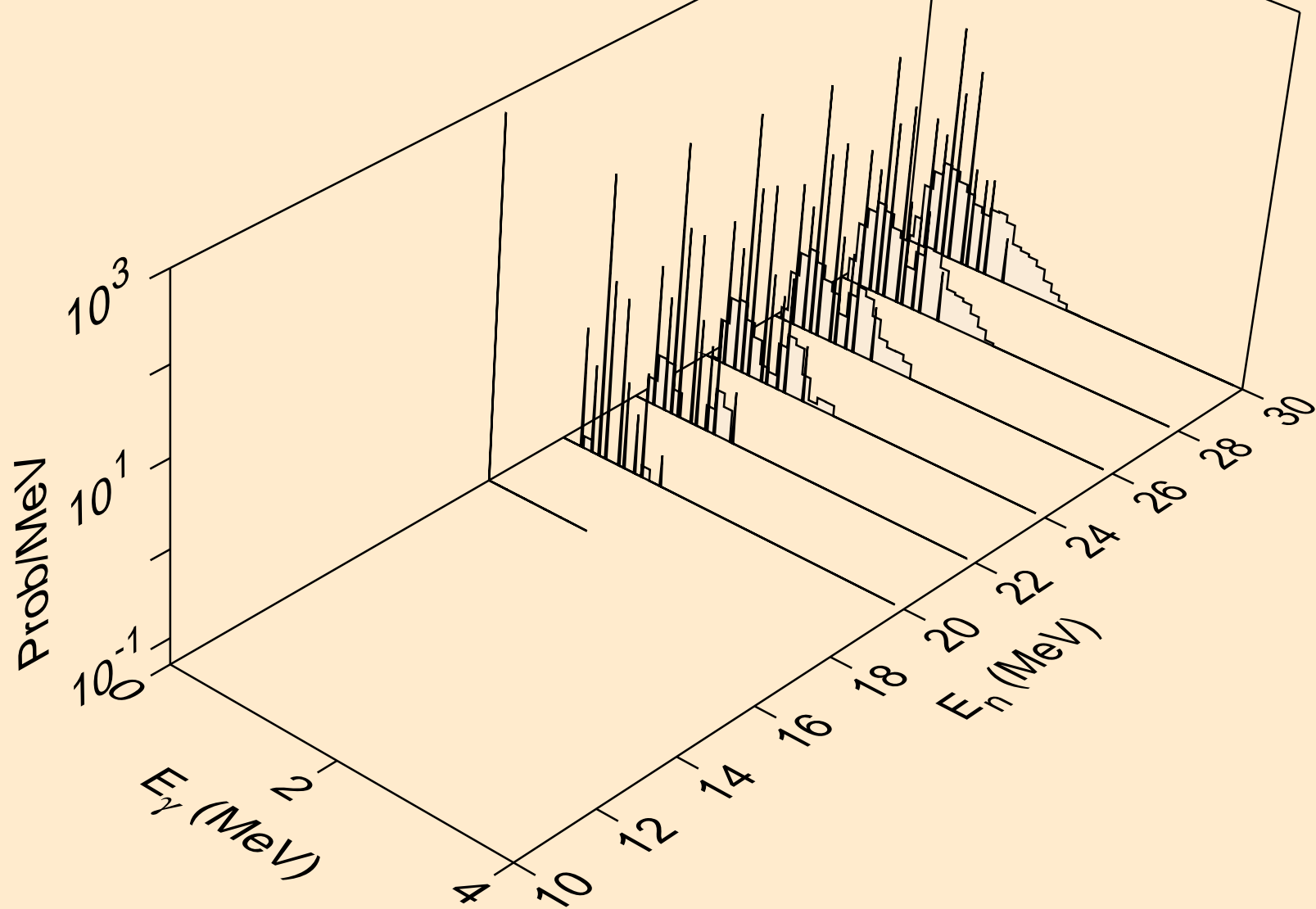

PB204 NEUTRON ACER TENDL-2021 LIBRARY; T=293.6K
Photon emission for (n,pt)

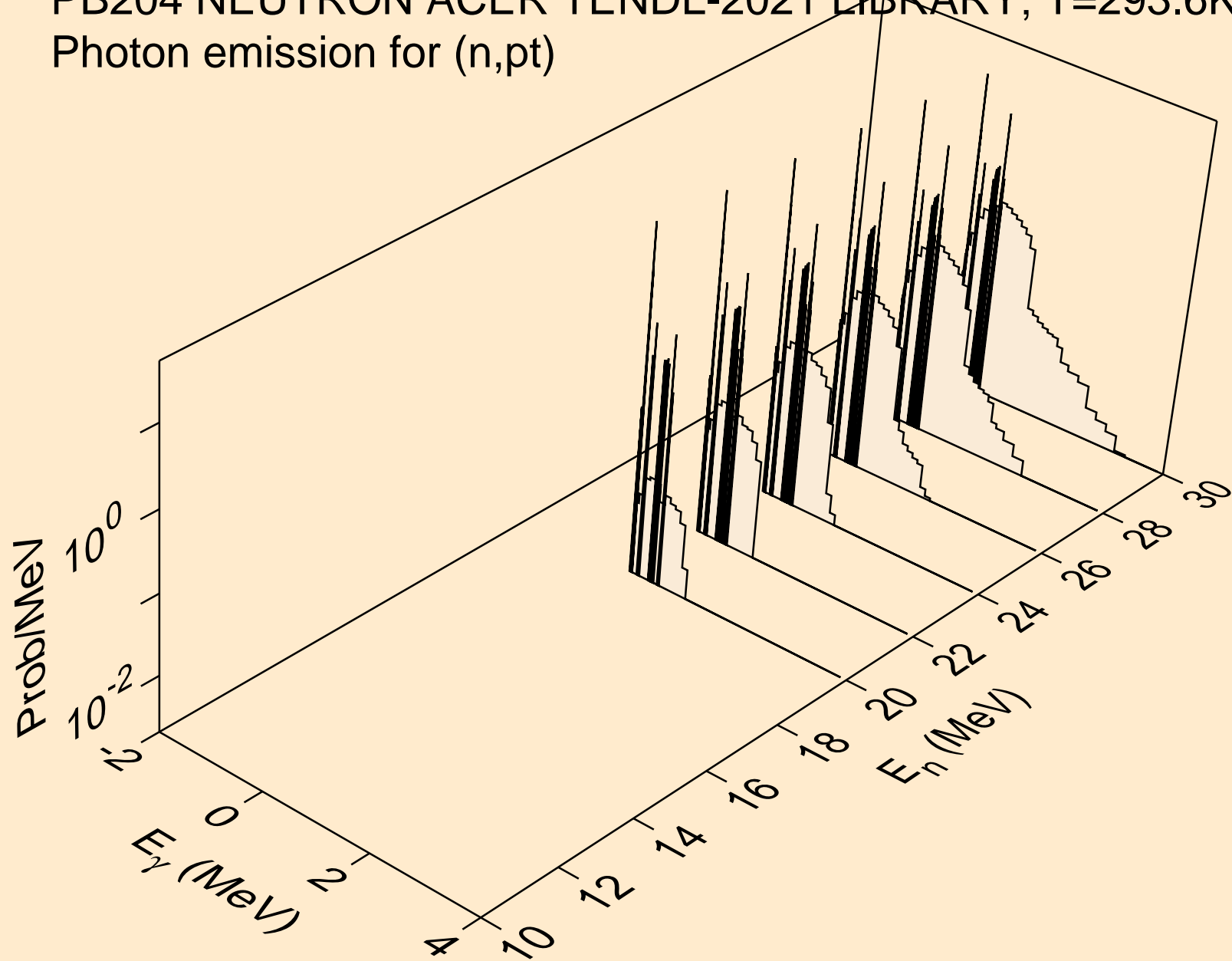

PB204 NEUTRON ACER TENDL-2021 LIBRARY; T=293.6K
thermal capture photon spectrum

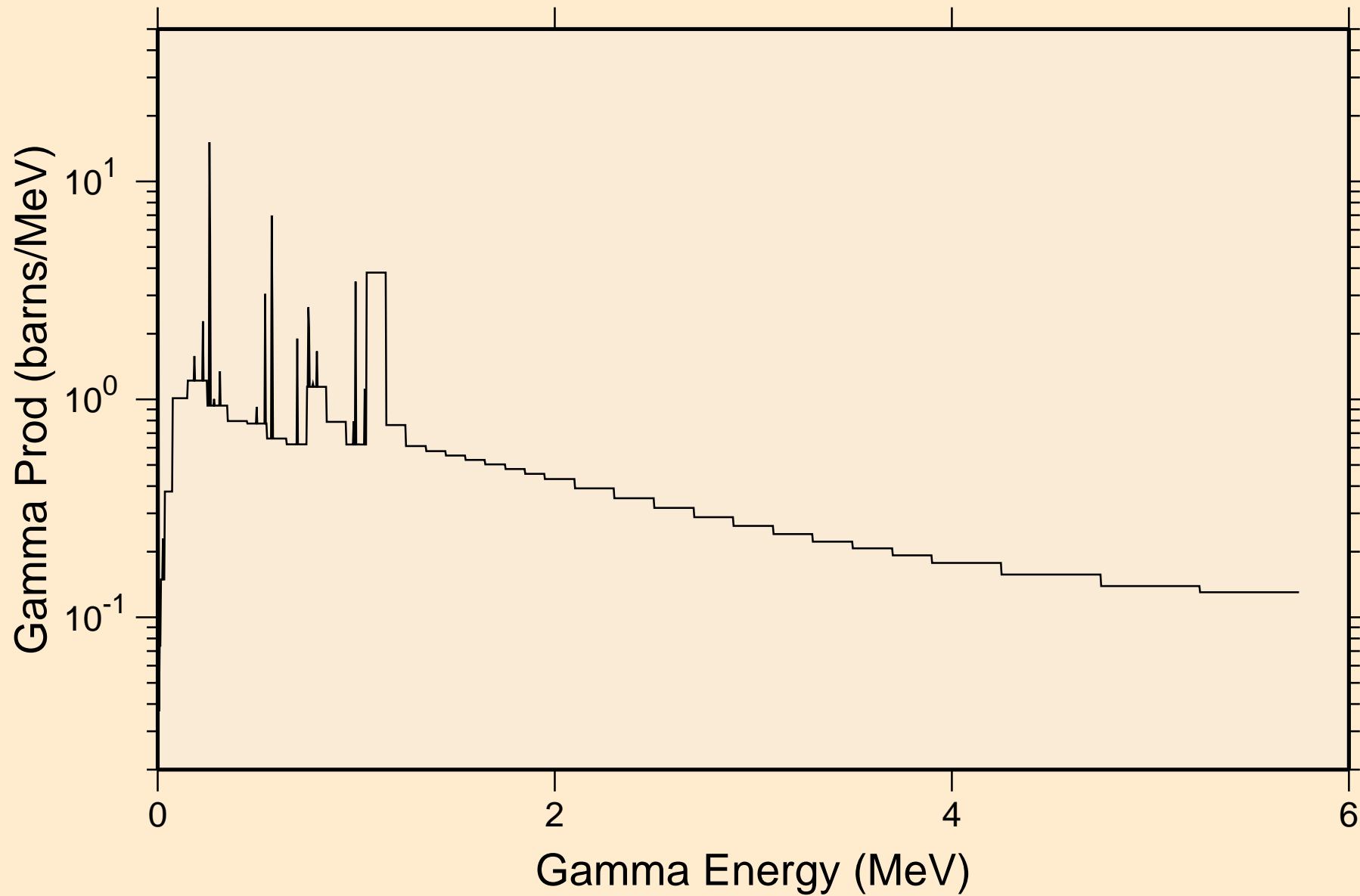

PB204 NEUTRON ACER TENDL-2021 LIBRARY; T=293.6K
14 MeV photon spectrum

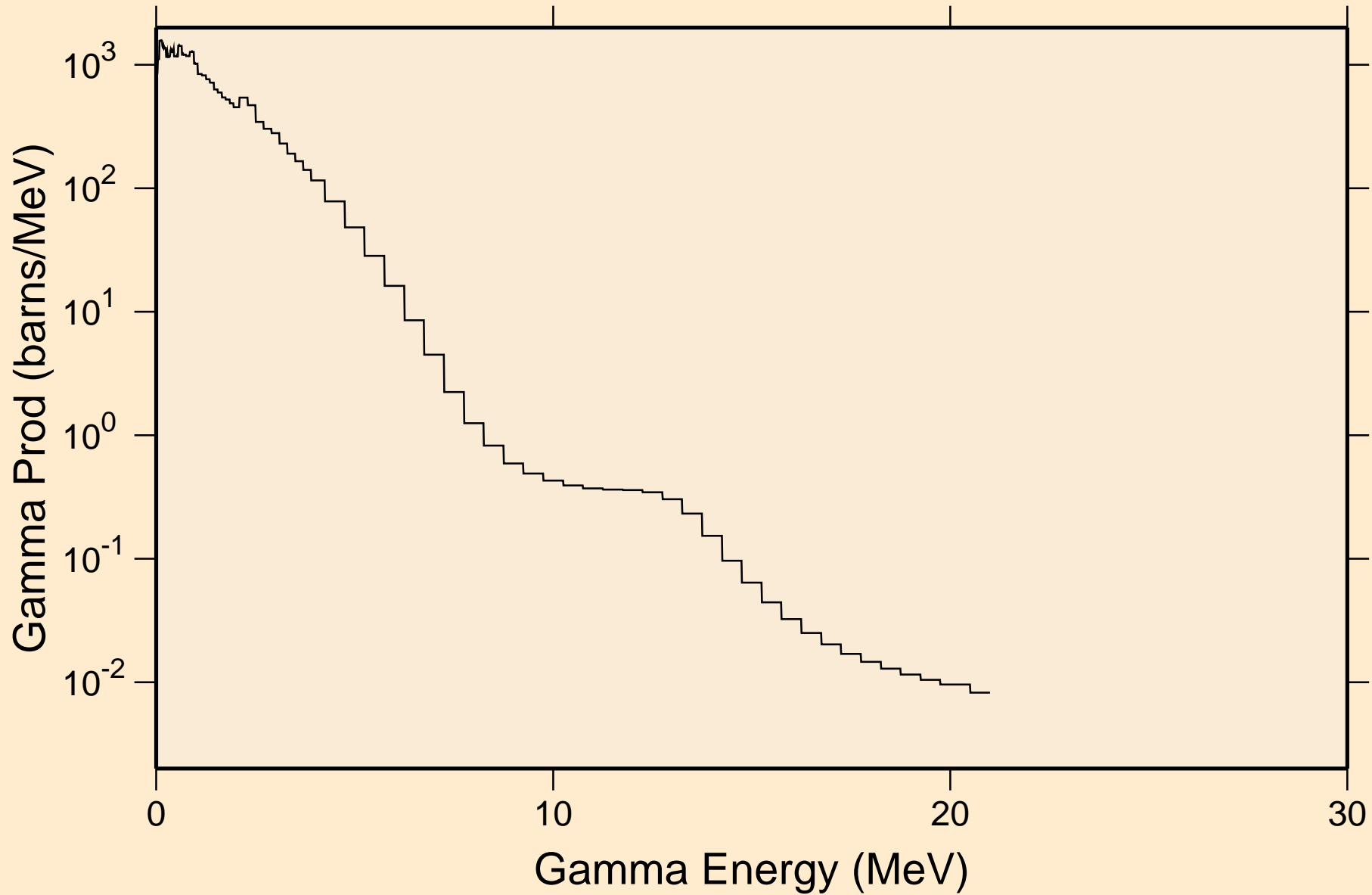

PB204 NEUTRON ACER TENDL-2021 LIBRARY; T=293.6K
Particle heating contributions

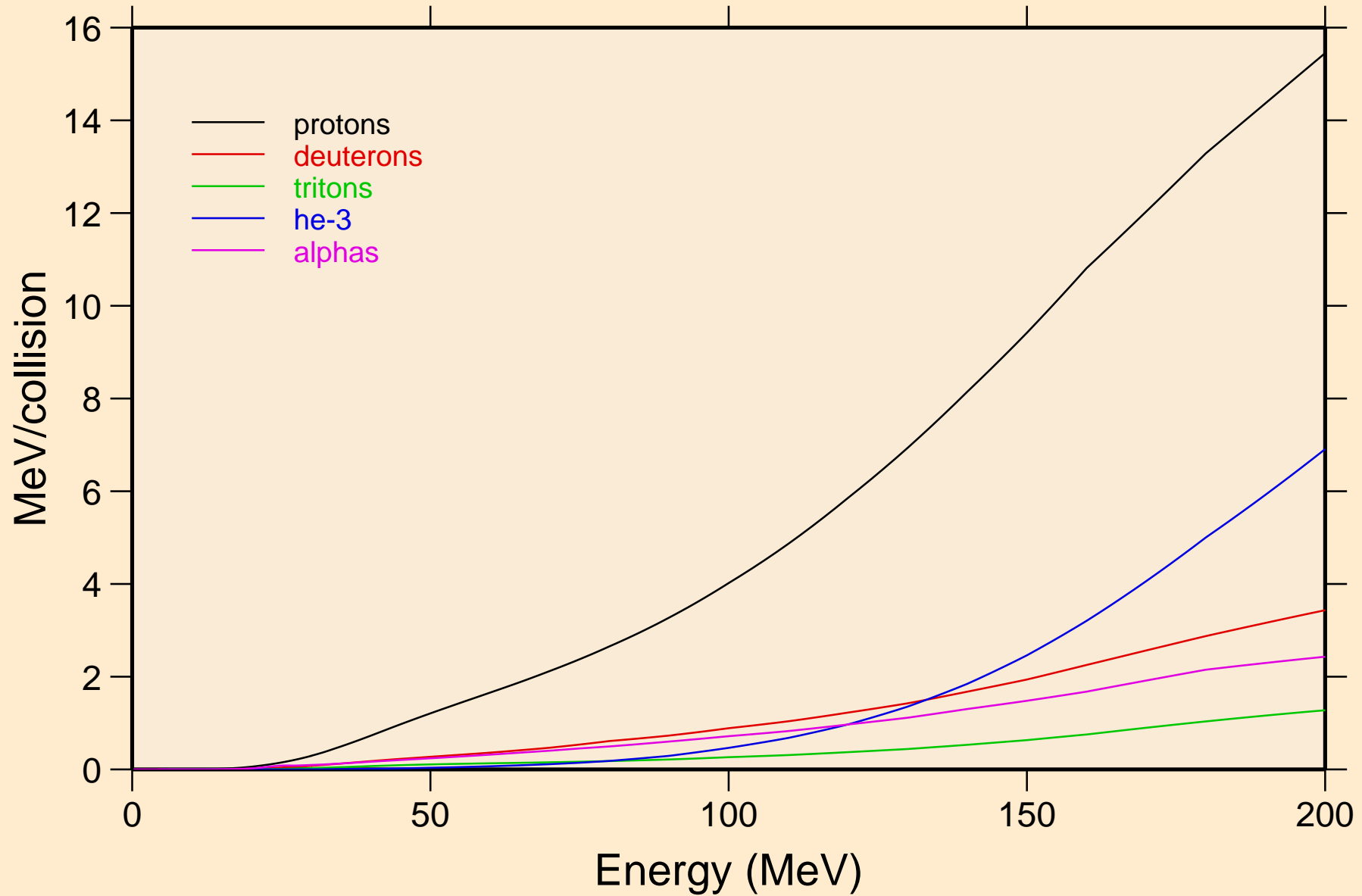

PB204 NEUTRON ACER TENDL-2021 LIBRARY; T=293.6K
Recoil Heating

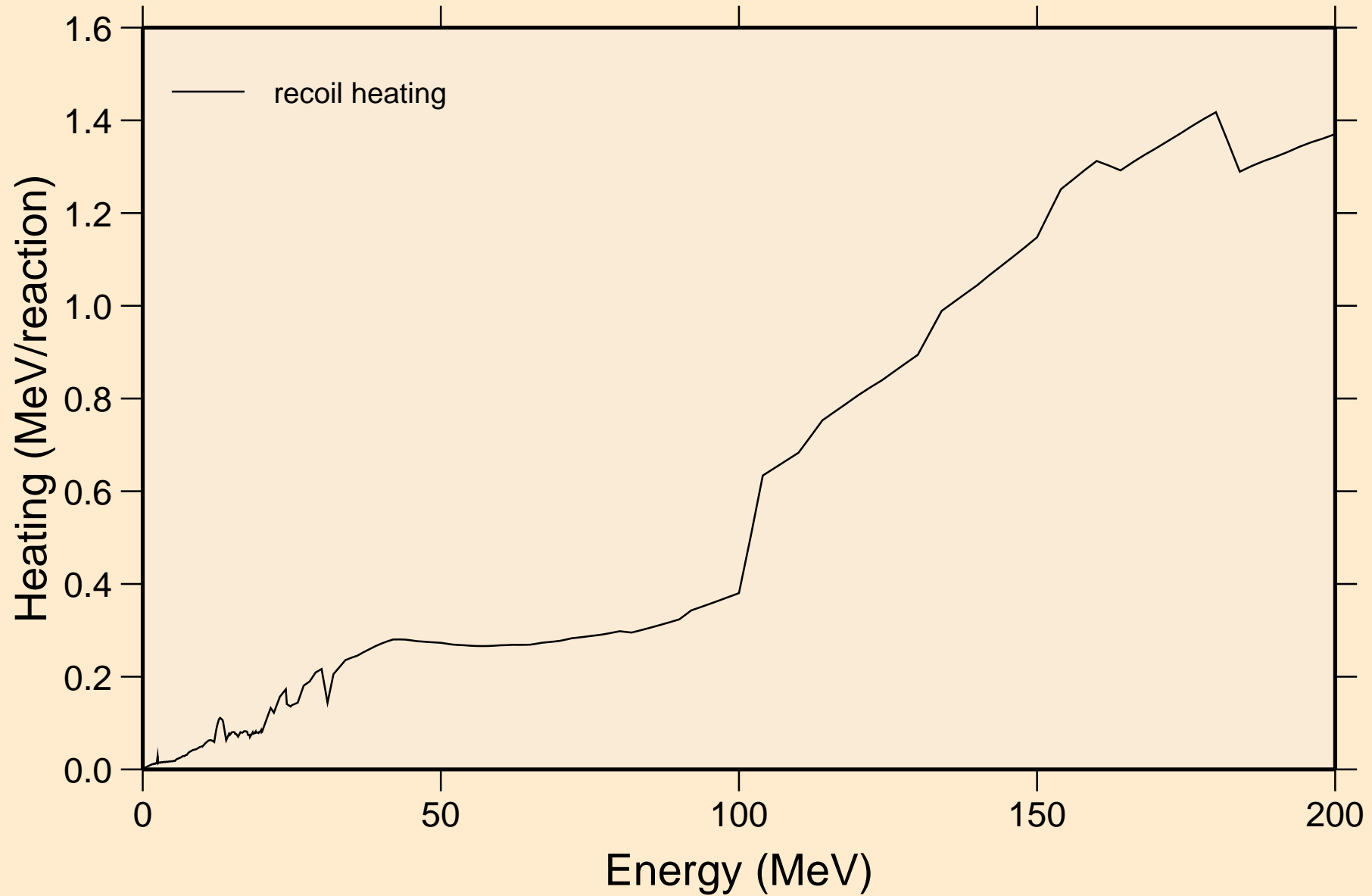

PB204 NEUTRON ACER TENDL-2021 LIBRARY; T=293.6K
Particle production cross sections

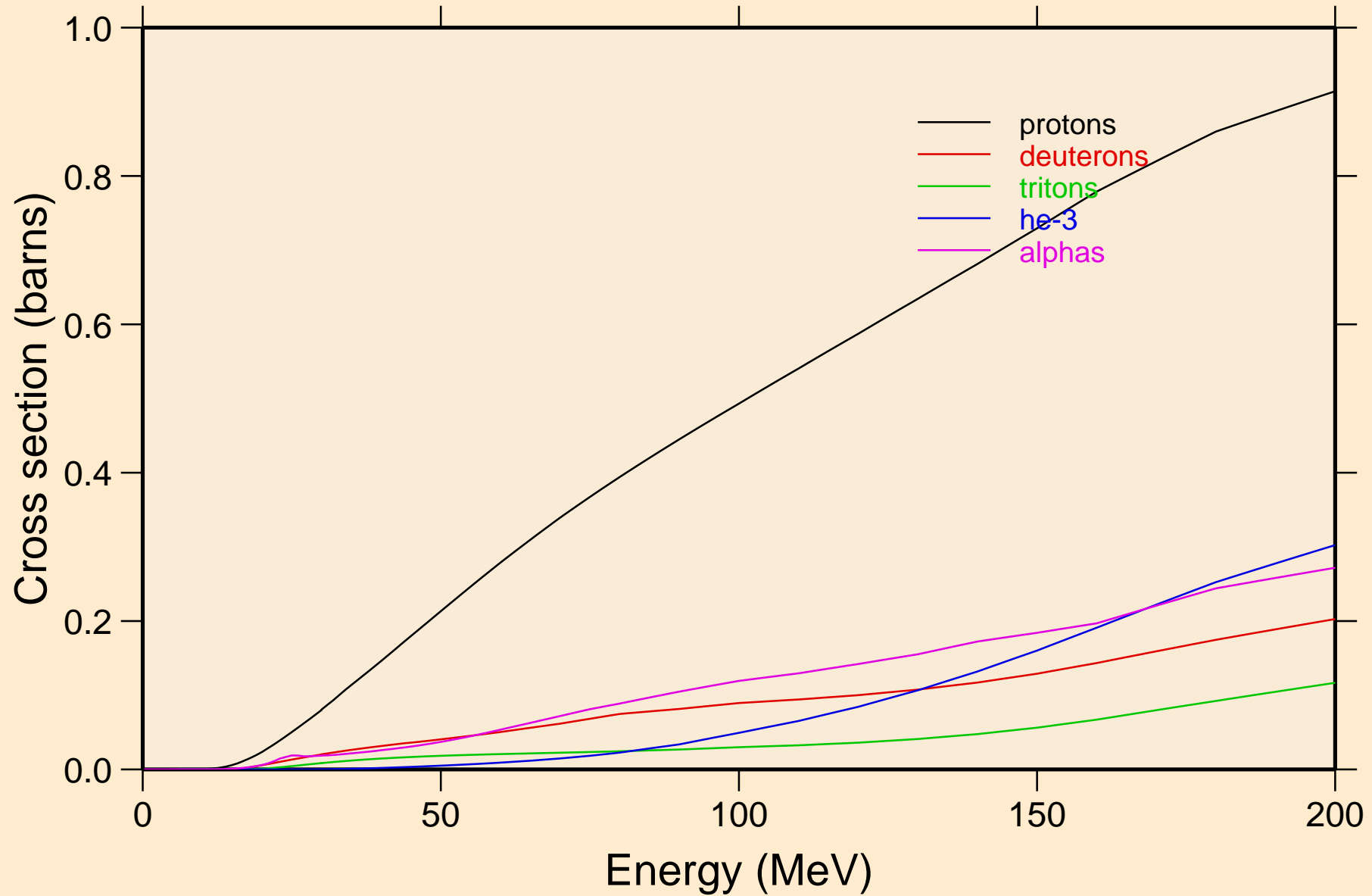

PB204 NEUTRON ACER TENDL-2021 LIBRARY; T=293.6K
protons from (n,x)

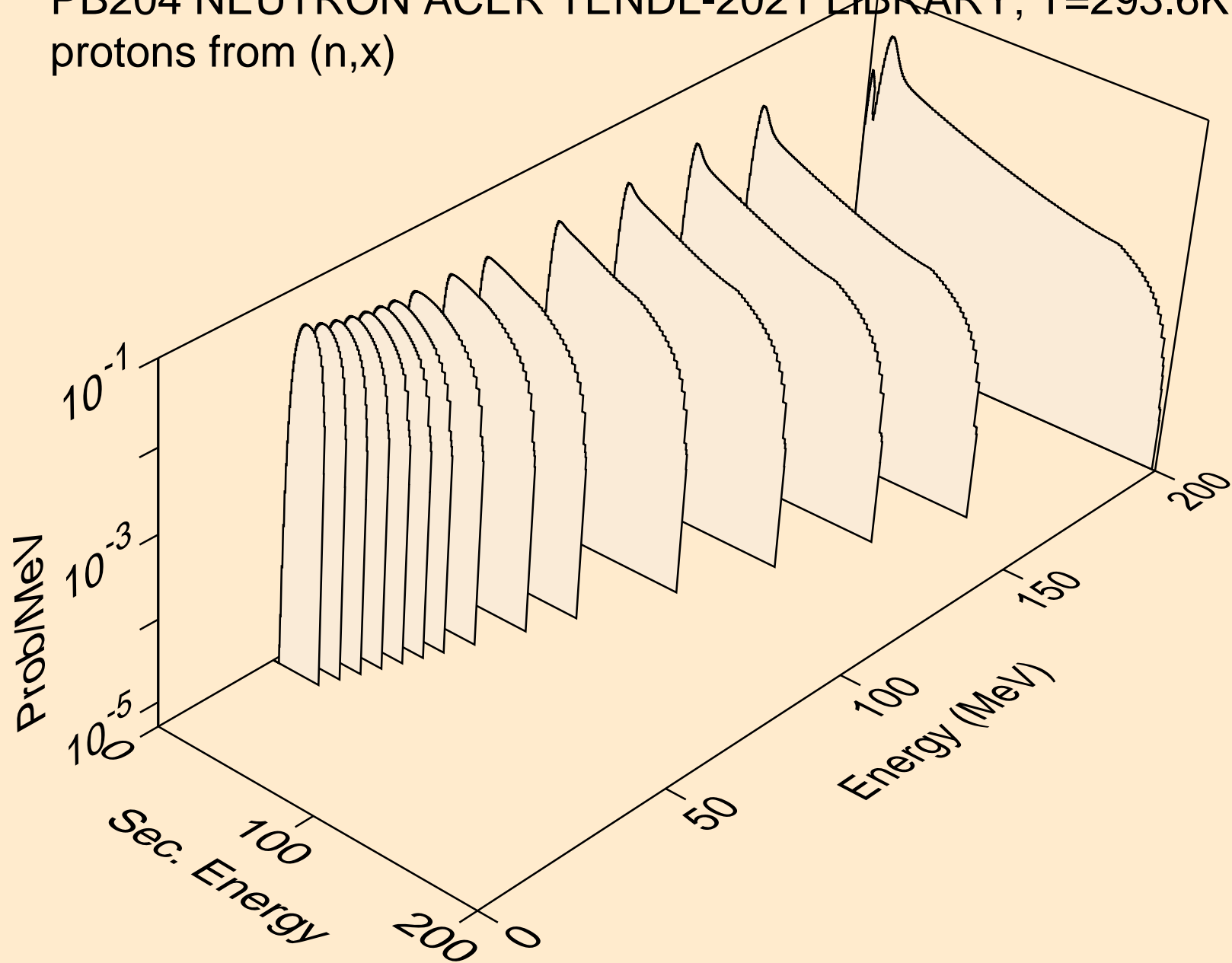

PB204 NEUTRON ACER TENDL-2021 LIBRARY; T=293.6K
protons from (n,n*)p

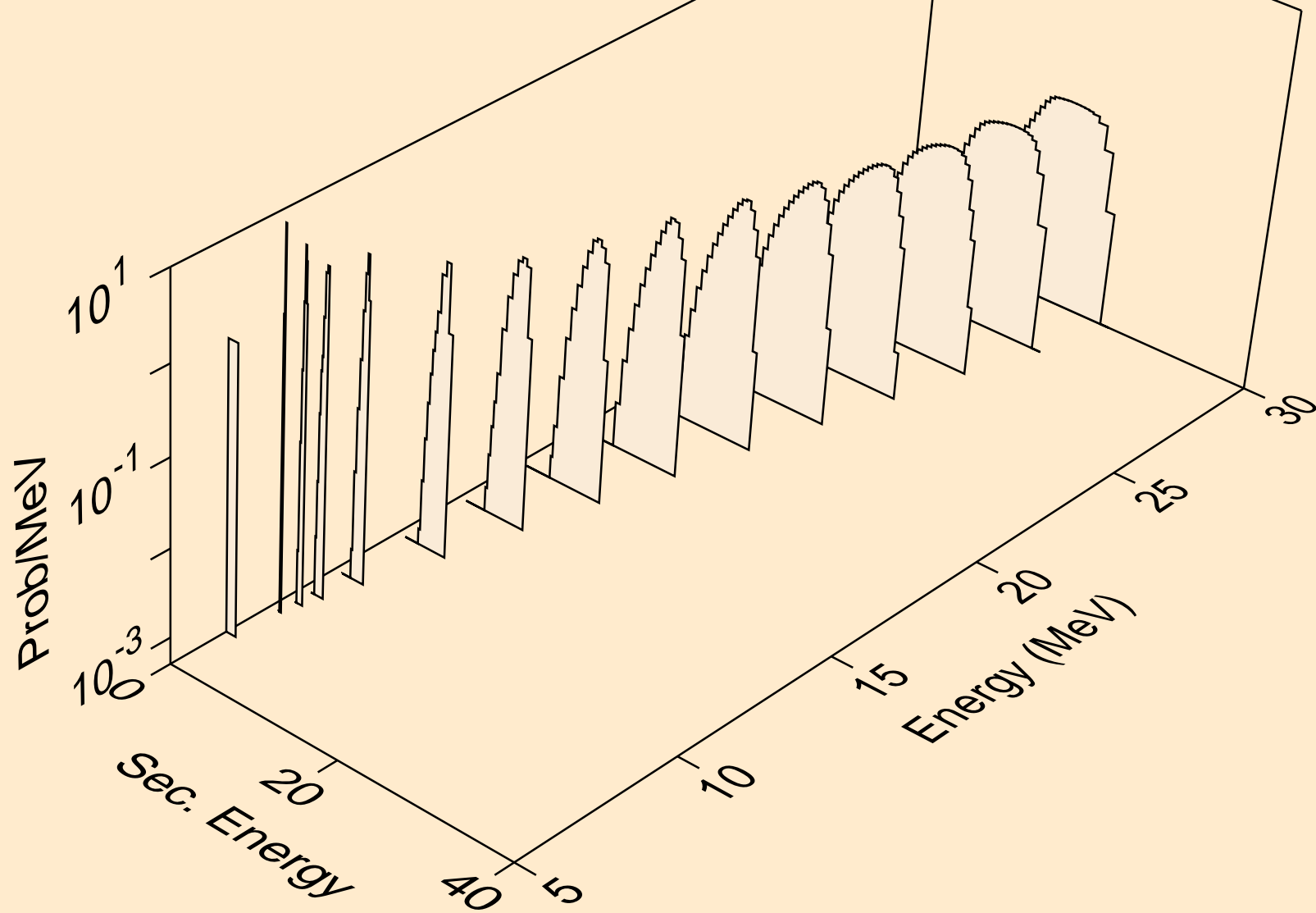

PB204 NEUTRON ACER TENDL-2021 LIBRARY; T=293.6K
protons from (n,2np)

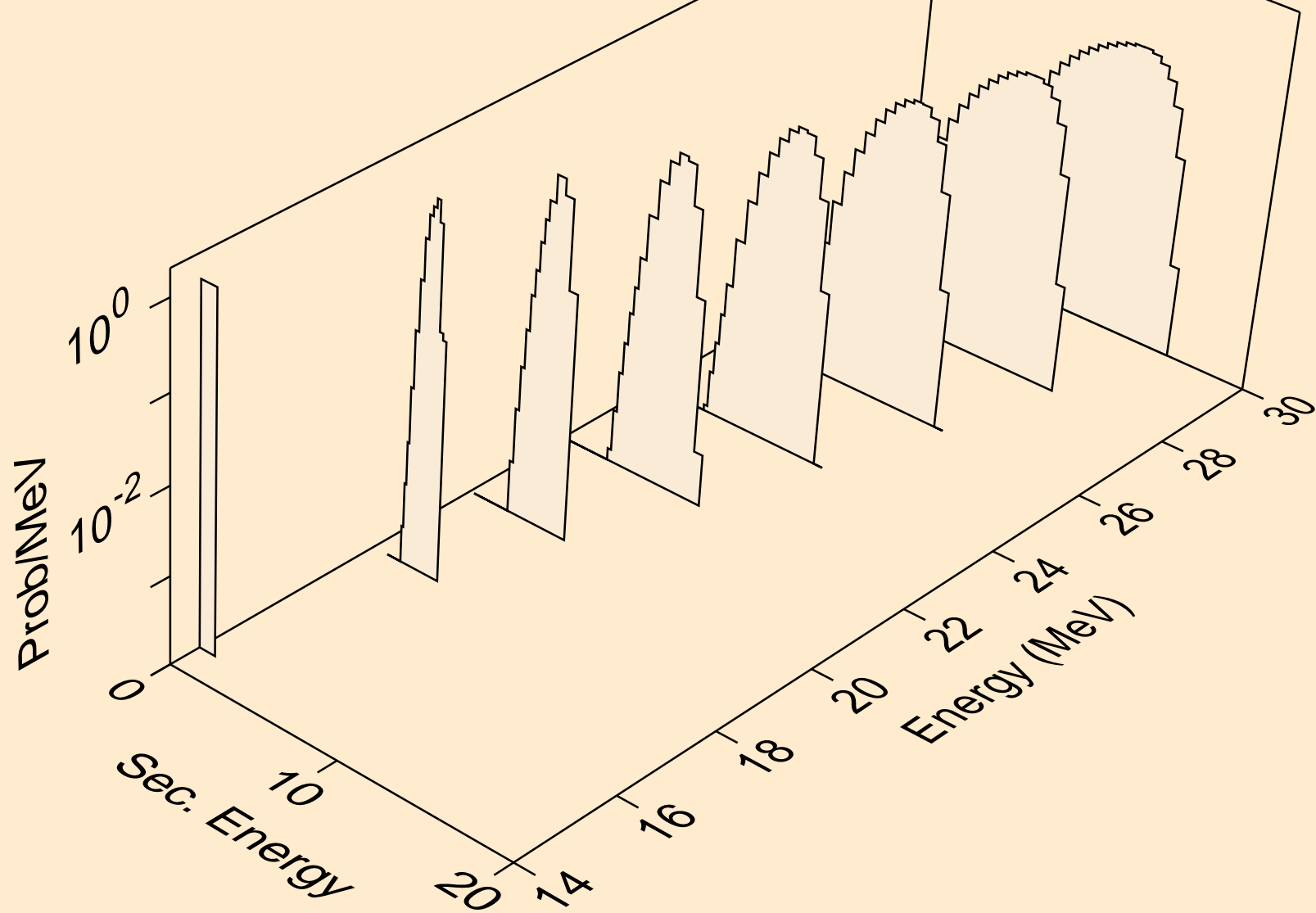

PB204 NEUTRON ACER TENDL-2021 LIBRARY; T=293.6K
protons from (n,3np)

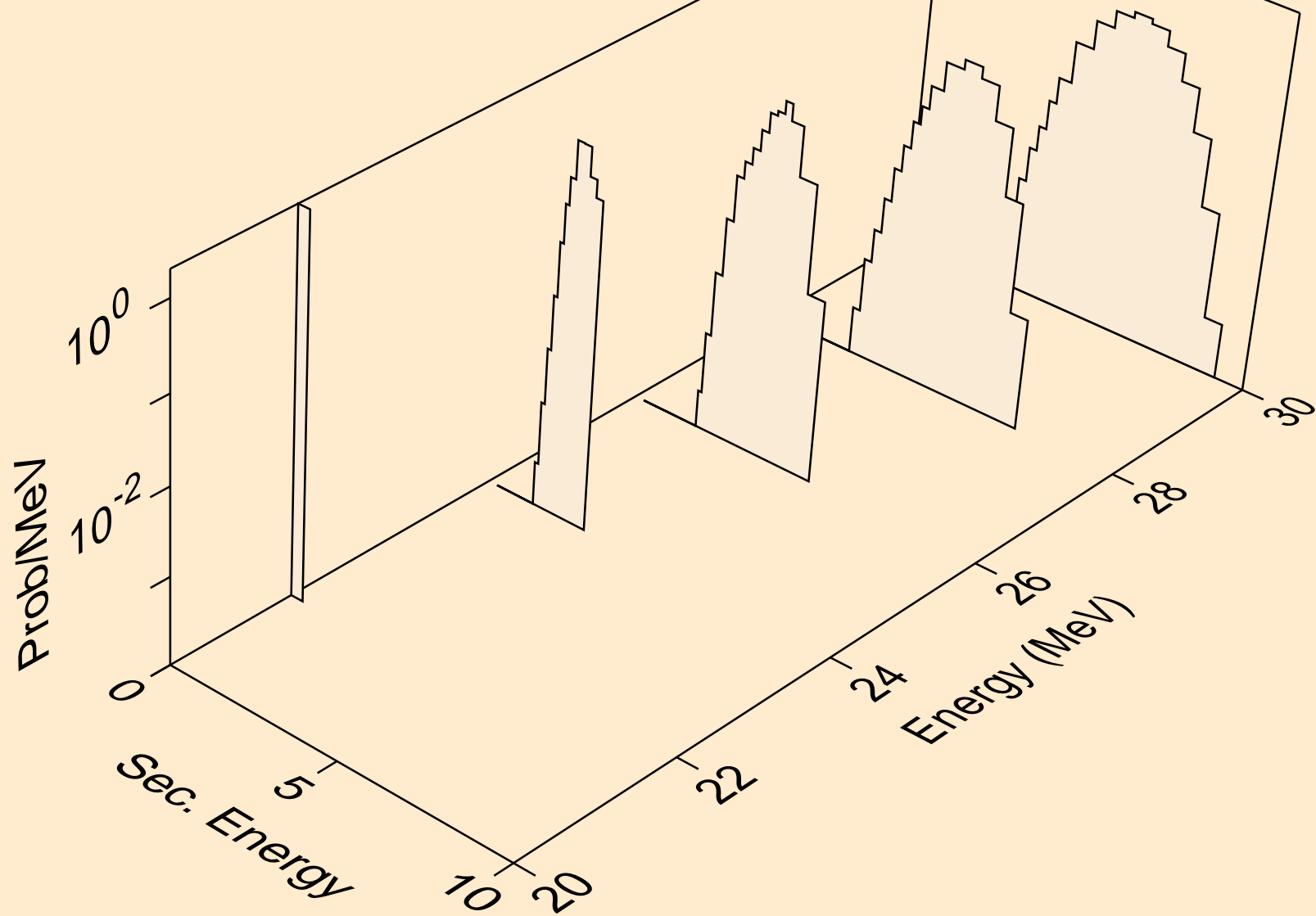

PB204 NEUTRON ACER TENDL-2021 LIBRARY; T=293.6K
protons from (n,2np)

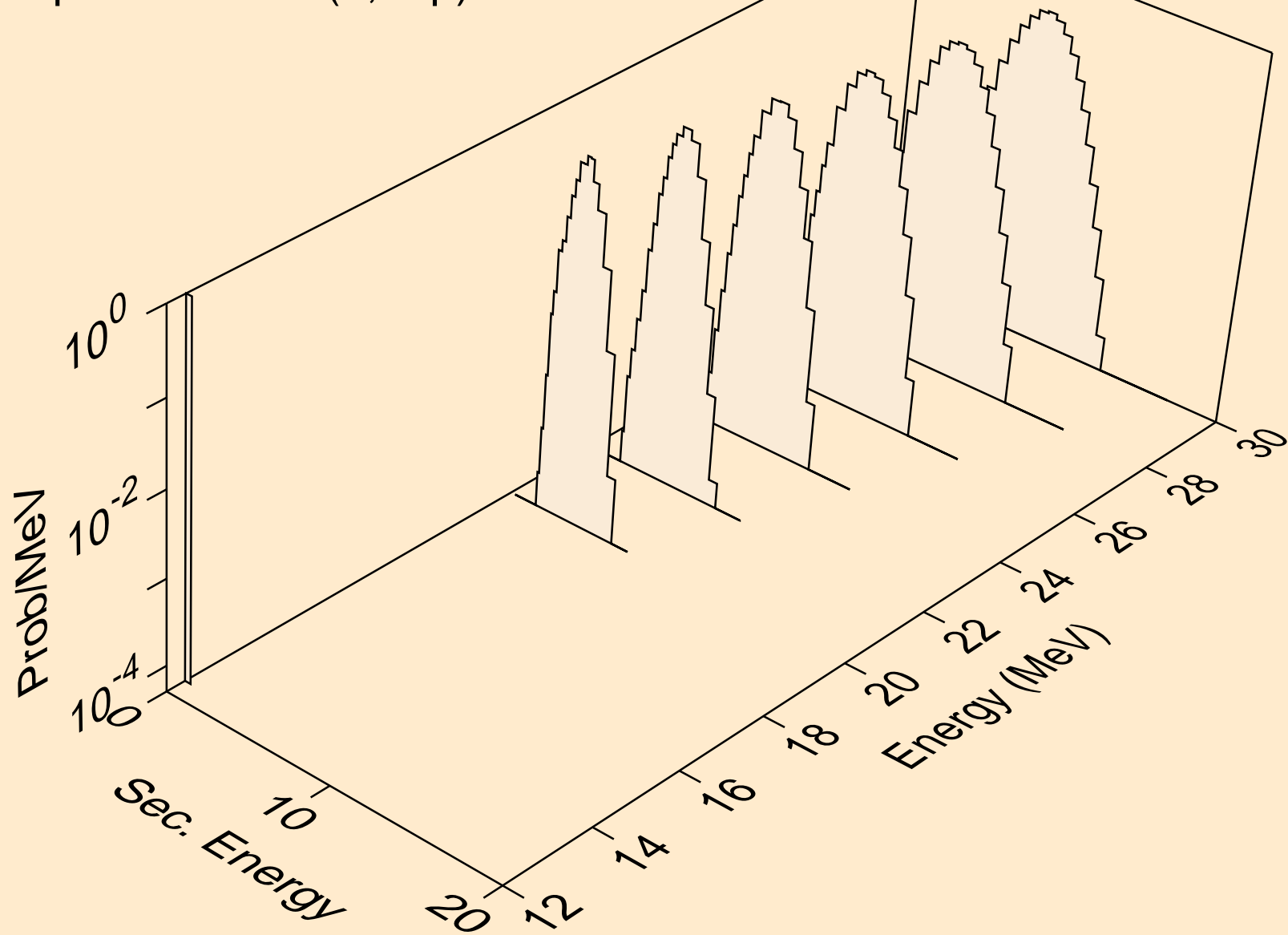

PB204 NEUTRON ACER TENDL-2021 LIBRARY; T=293.6K
protons from (n,npa)

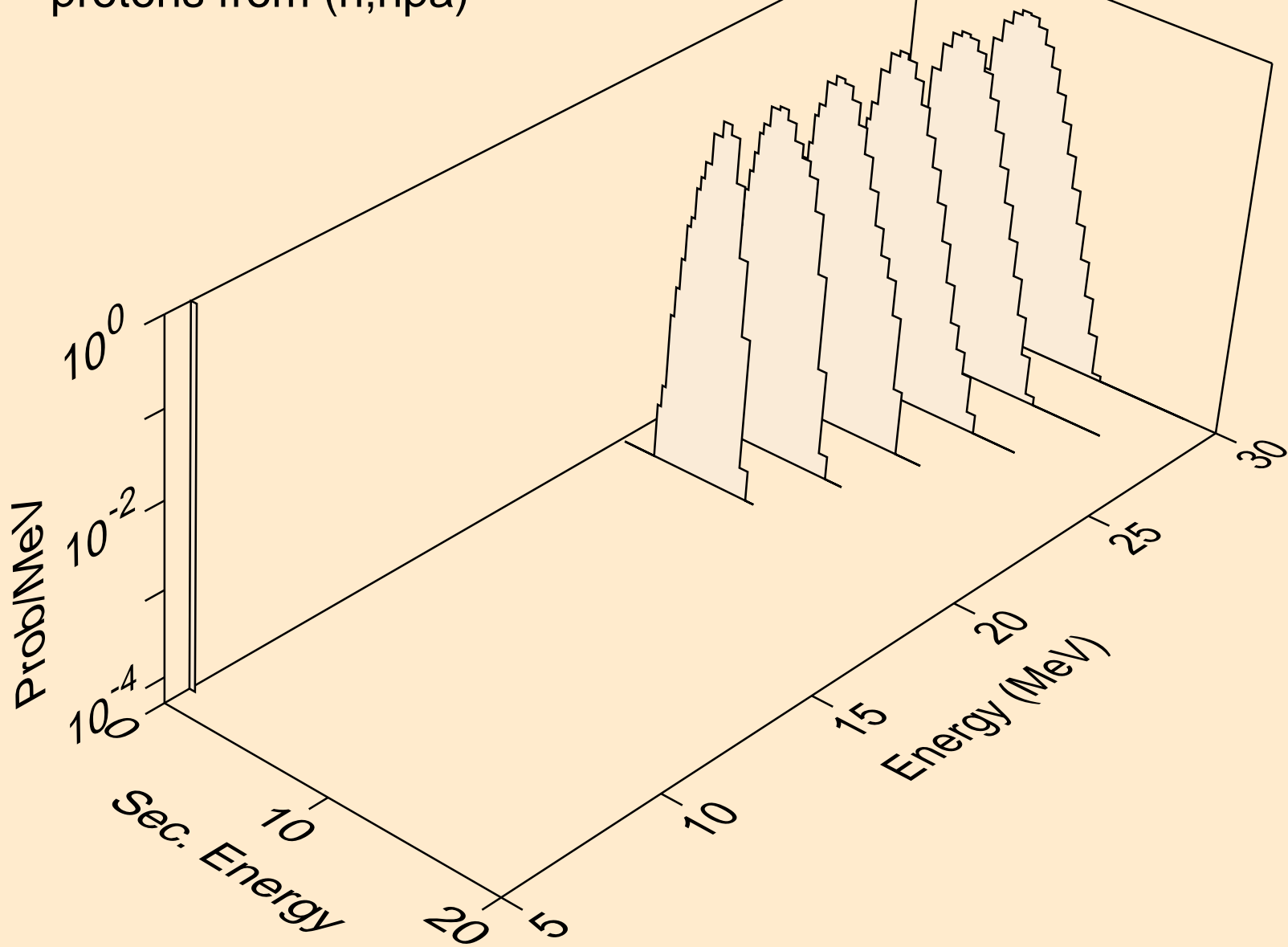

PB204 NEUTRON ACER TENDL-2021 LIBRARY; T=293.6K
protons from (n,p)

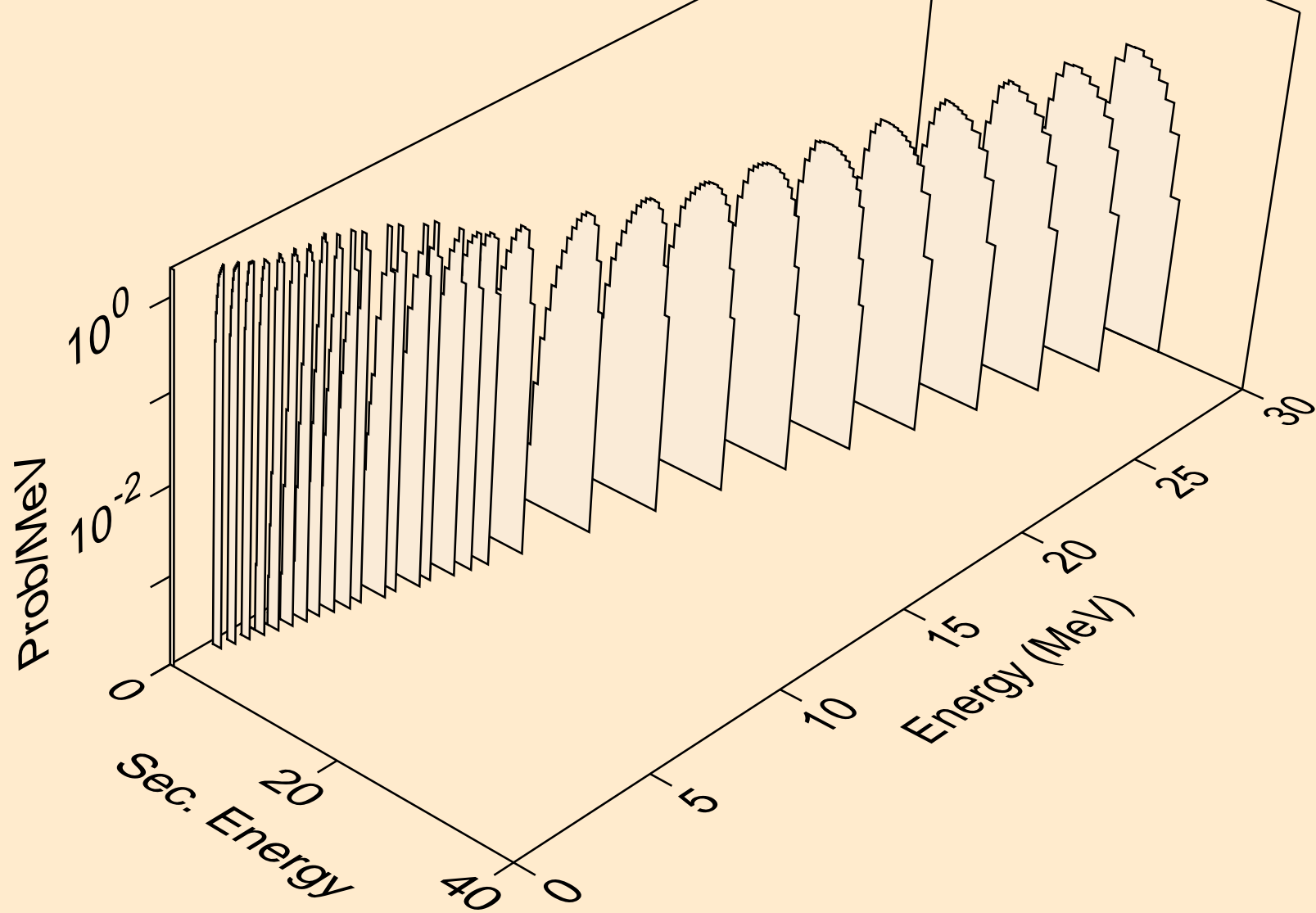

PB204 NEUTRON ACER TENDL-2021 LIBRARY; T=293.6K
protons from (n,2p)

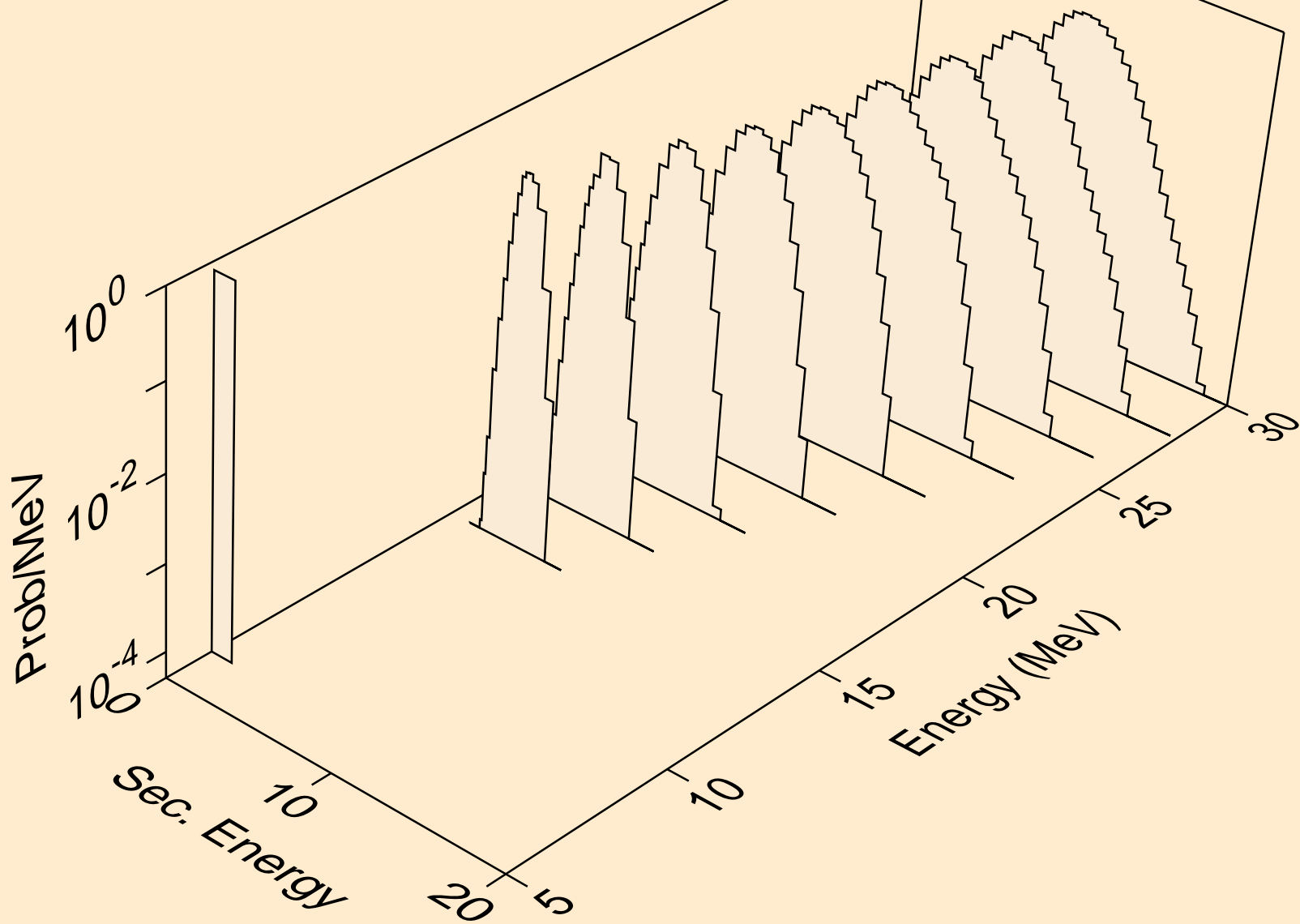

PB204 NEUTRON ACER TENDL-2021 LIBRARY; T=293.6K
protons from (n,p)

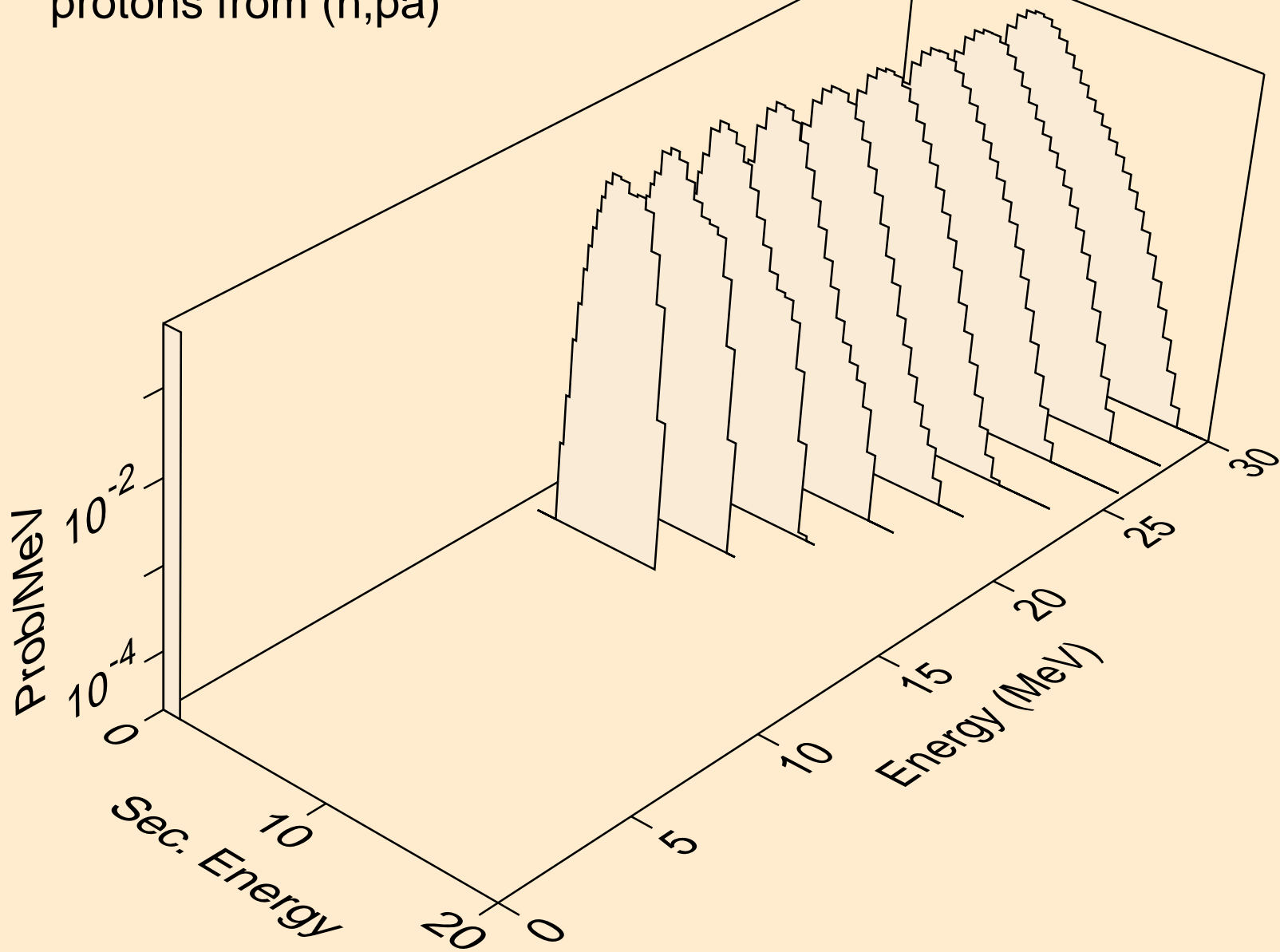

PB204 NEUTRON ACER TENDL-2021 LIBRARY; T=293.6K
protons from (n,pd)

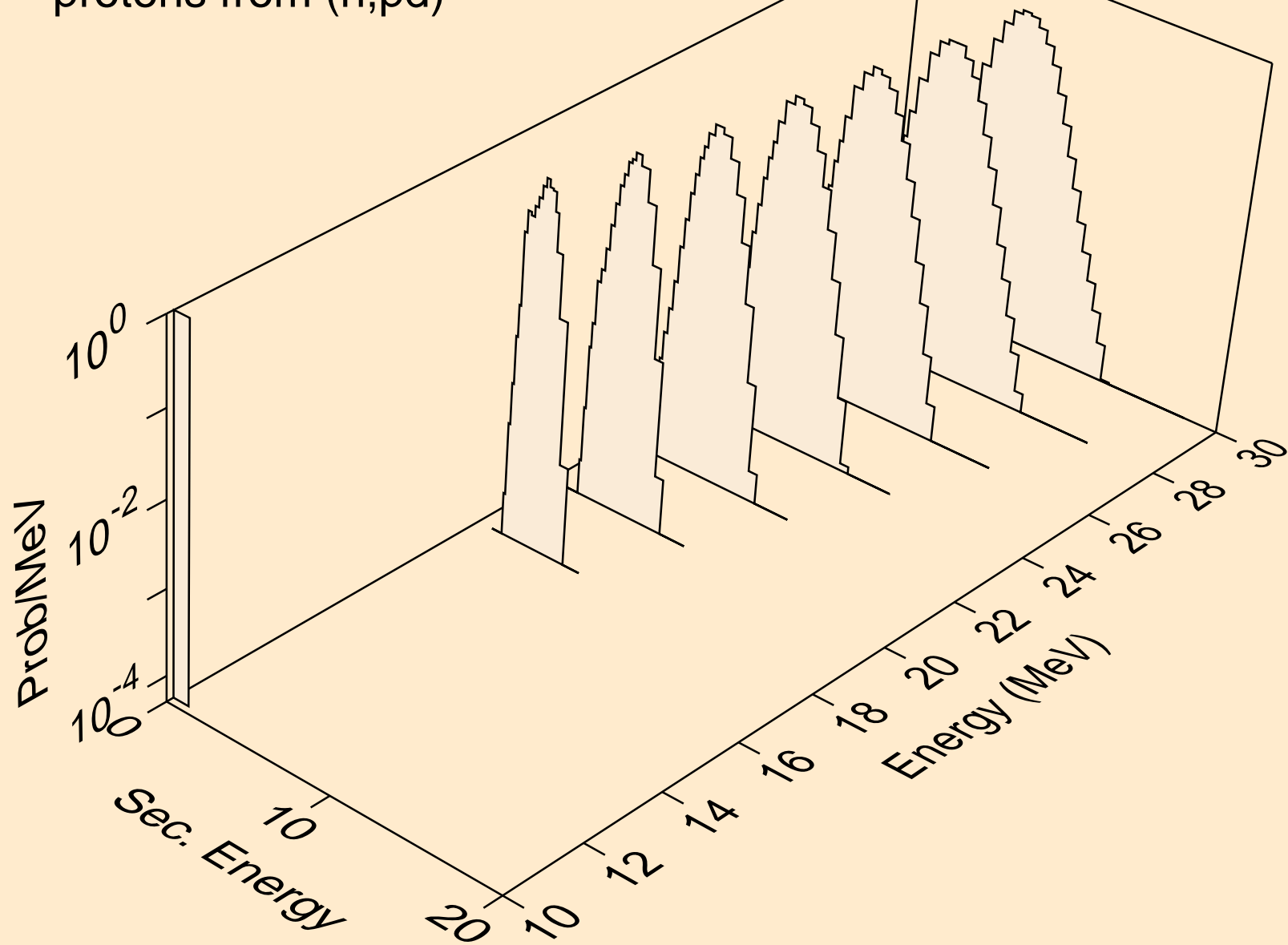

PB204 NEUTRON ACER TENDL-2021 LIBRARY; T=293.6K
protons from (n,pt)

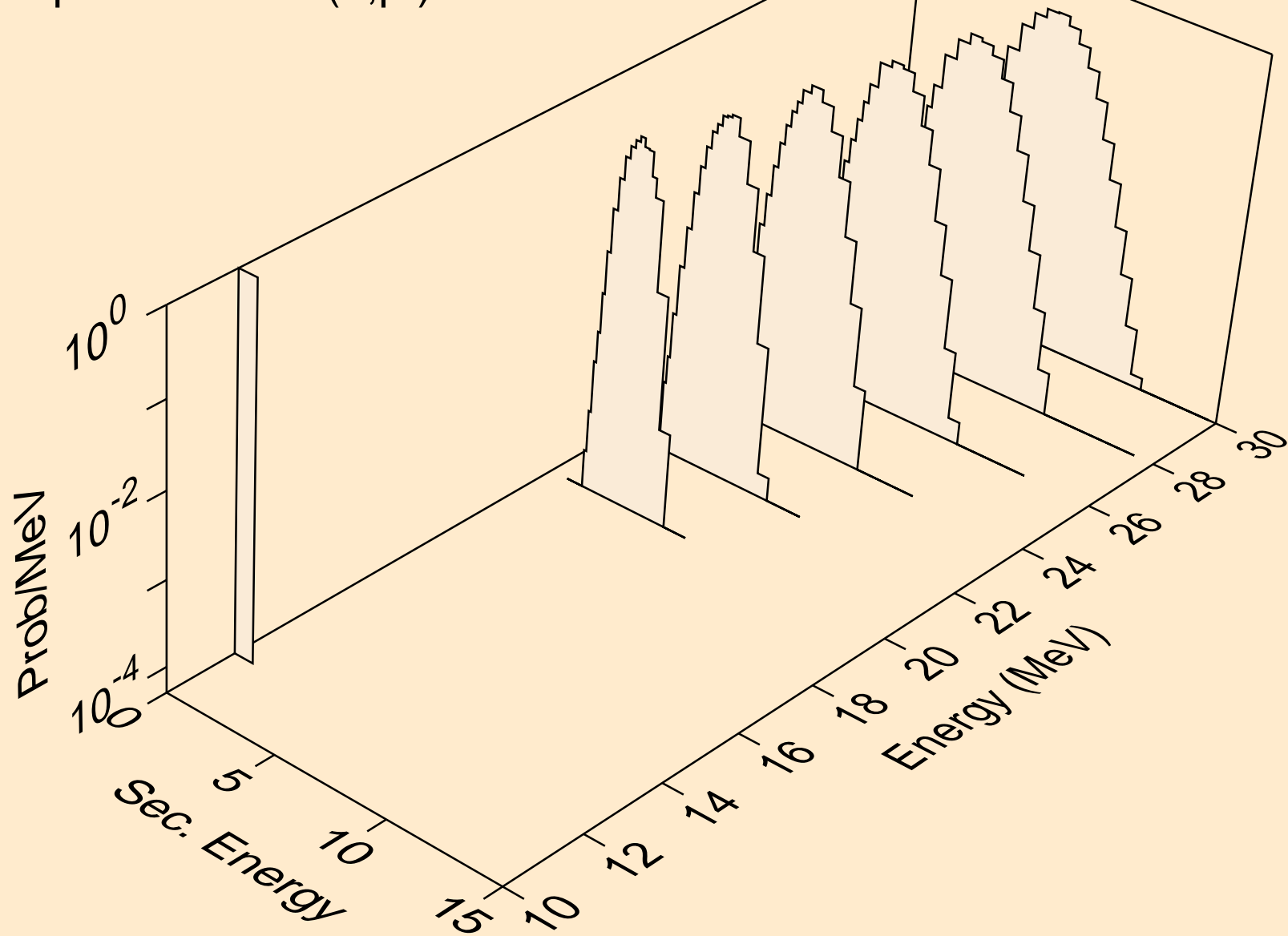

PB204 NEUTRON ACER TENDL-2021 LIBRARY; T=293.6K
deuterons from (n,x)

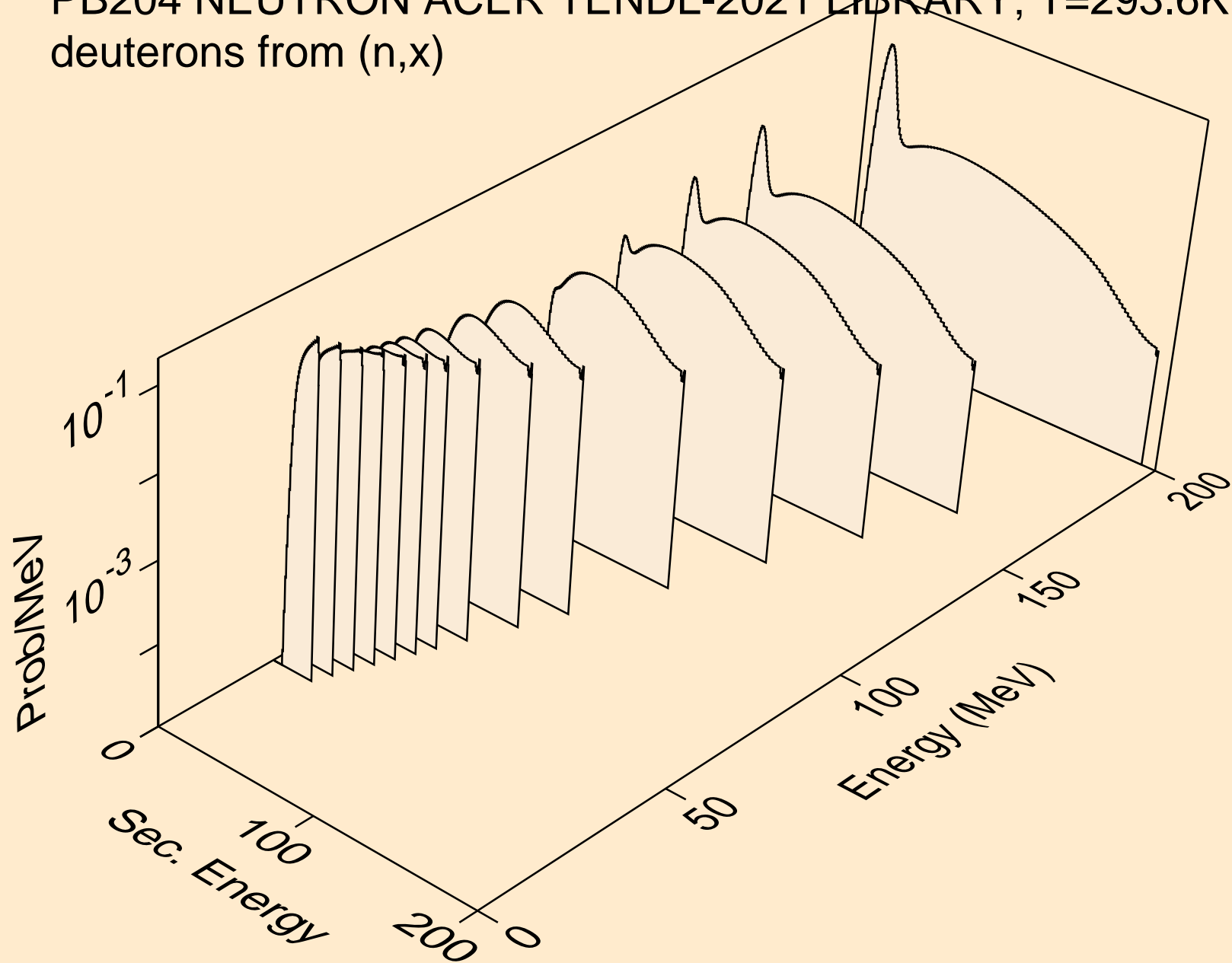

PB204 NEUTRON ACER TENDL-2021 LIBRARY; T=293.6K
deuterons from (n,2nd)

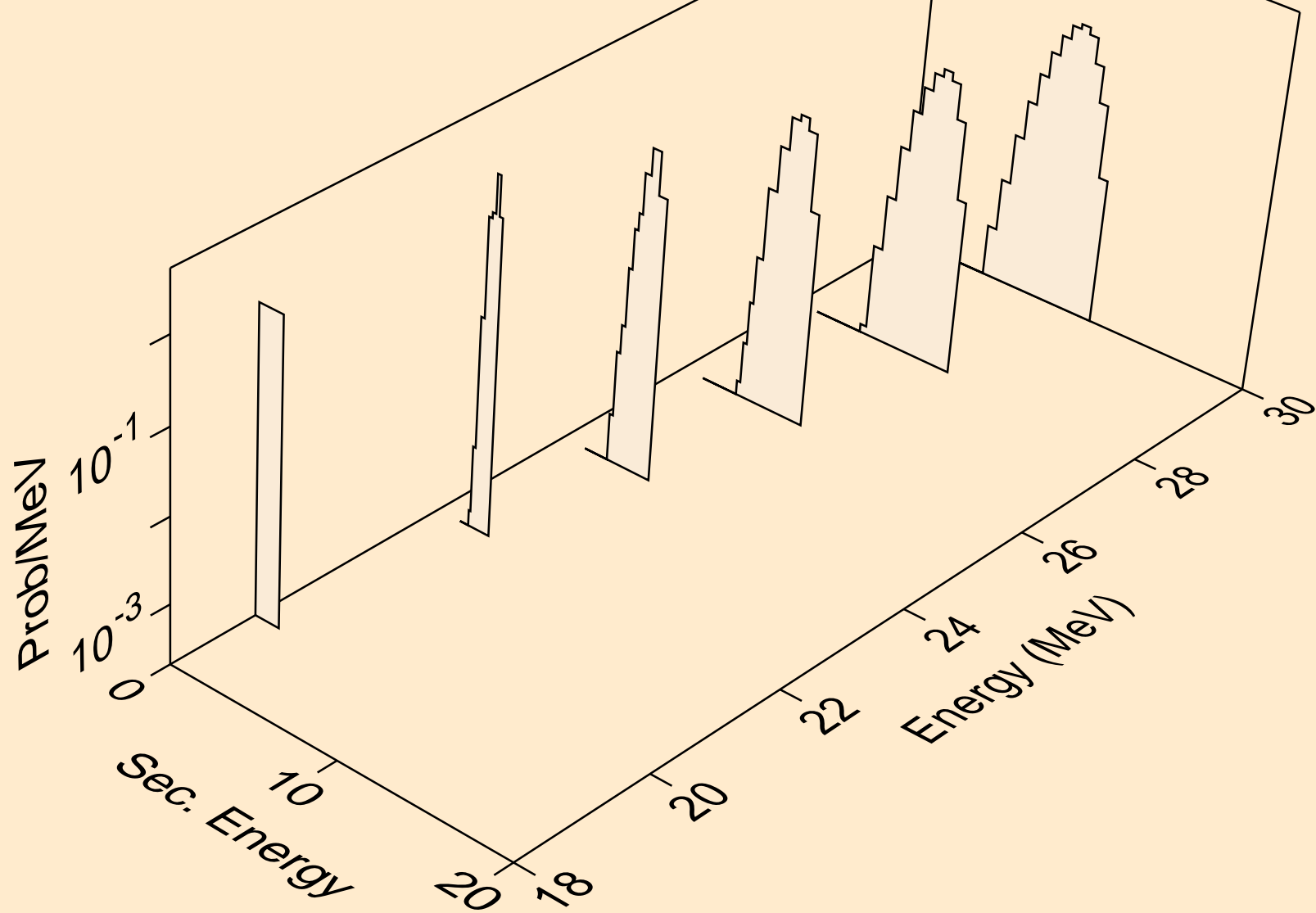

PB204 NEUTRON ACER TENDL-2021 LIBRARY; T=293.6K
deuterons from (n,n*)d

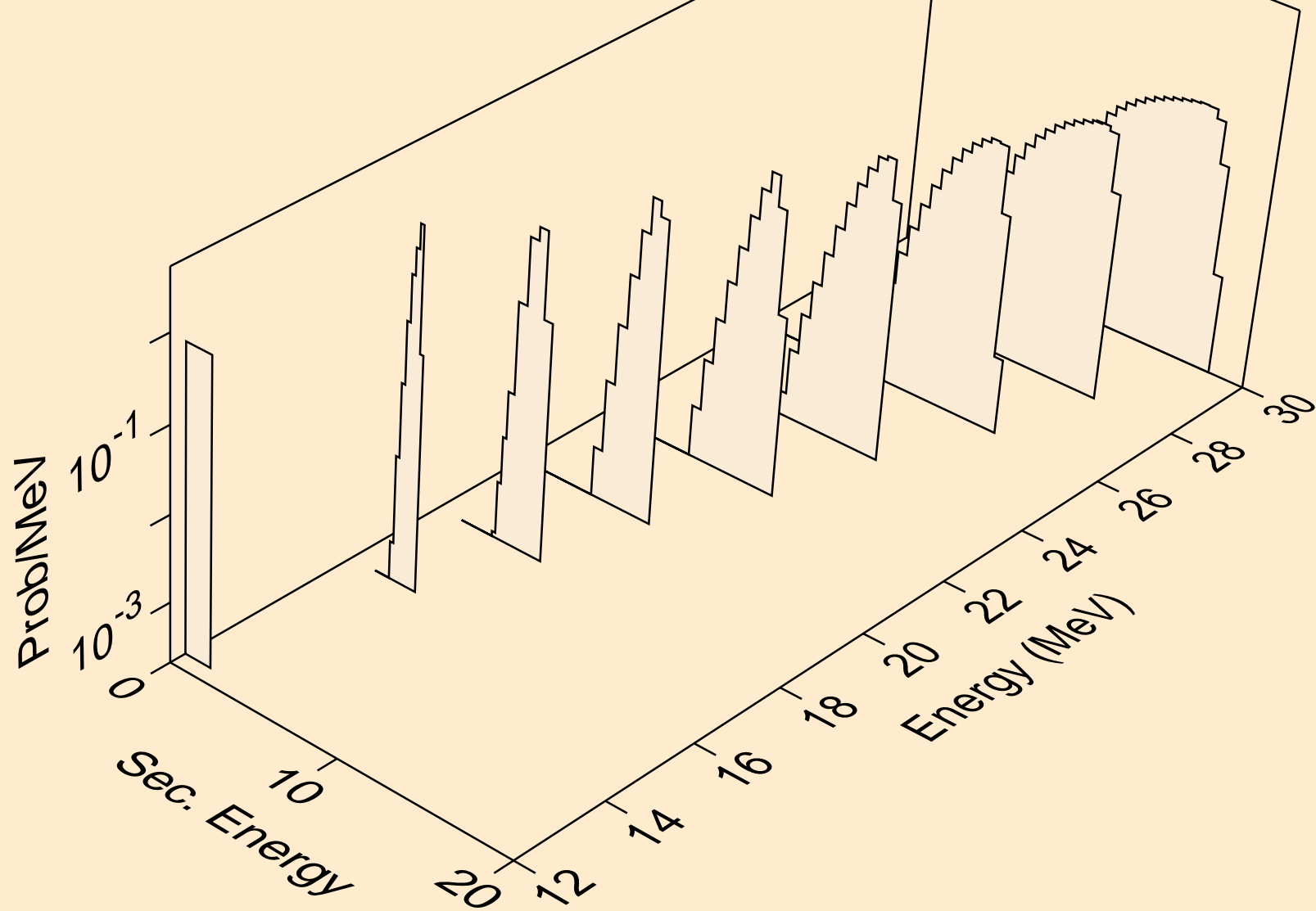

PB204 NEUTRON ACER TENDL-2021 LIBRARY; T=293.6K
deuterons from (n,d)

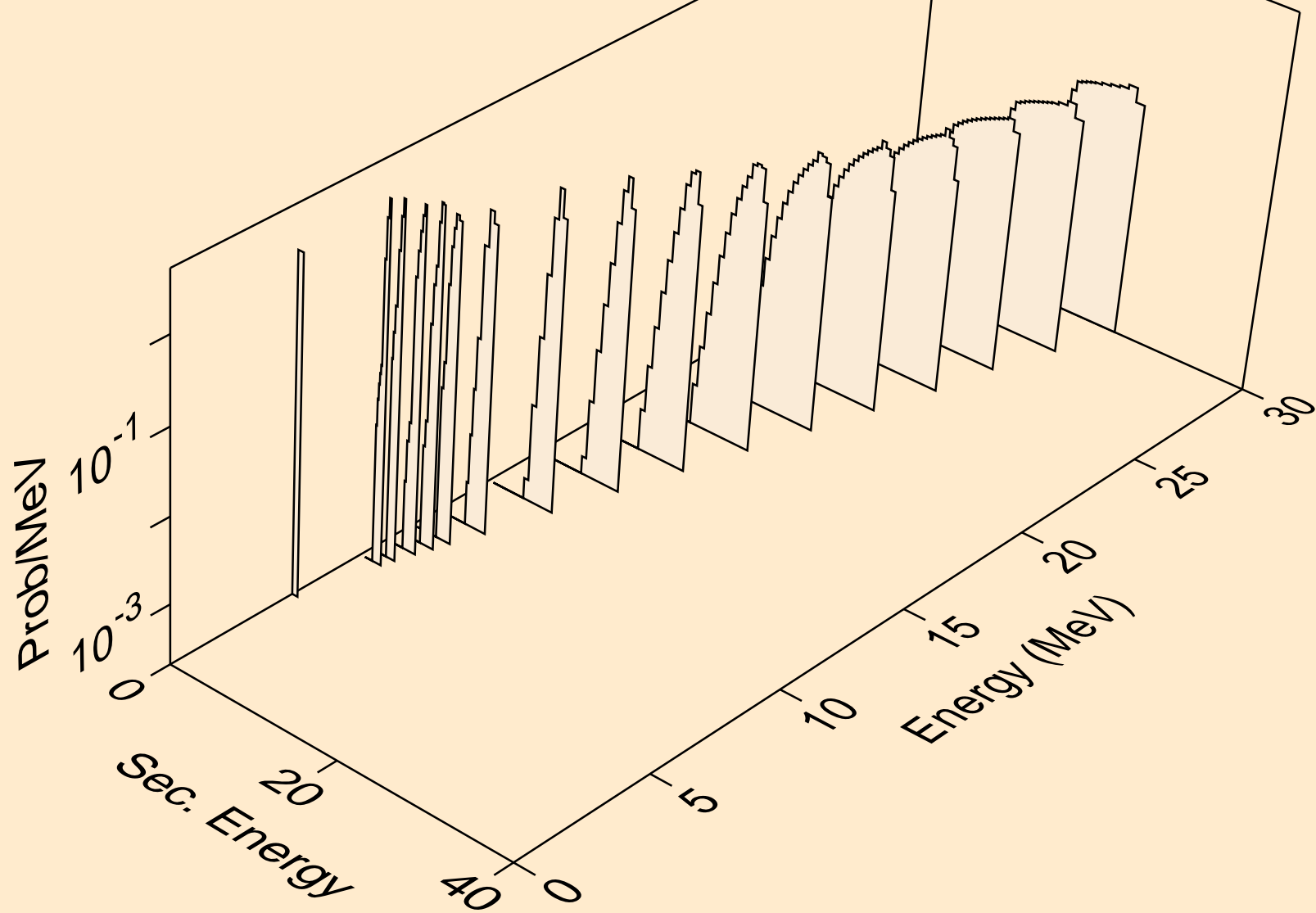

PB204 NEUTRON ACER TENDL-2021 LIBRARY; T=293.6K
deuterons from (n,pd)

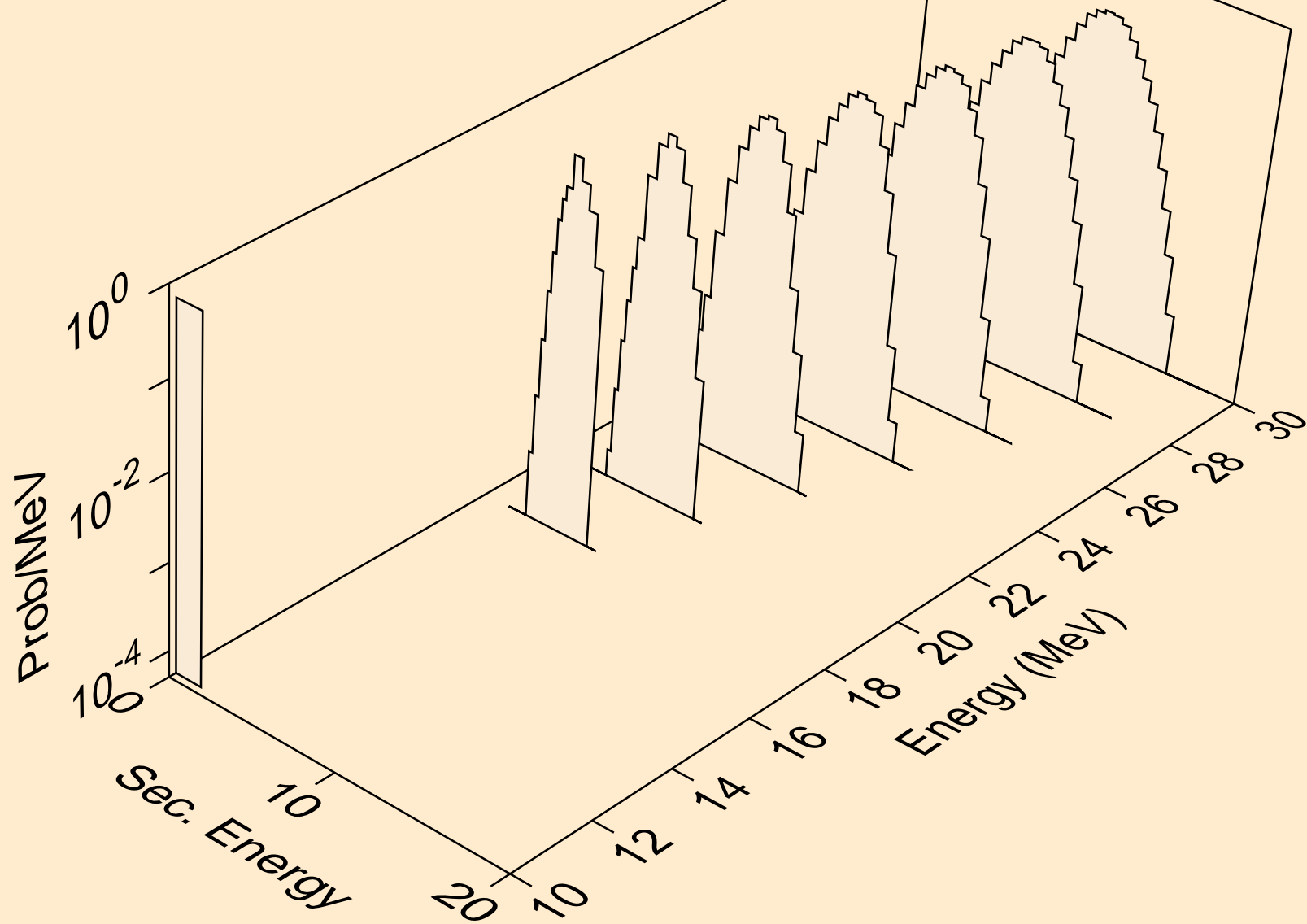

PB204 NEUTRON ACER TENDL-2021 LIBRARY; T=293.6K
tritons from (n,x)

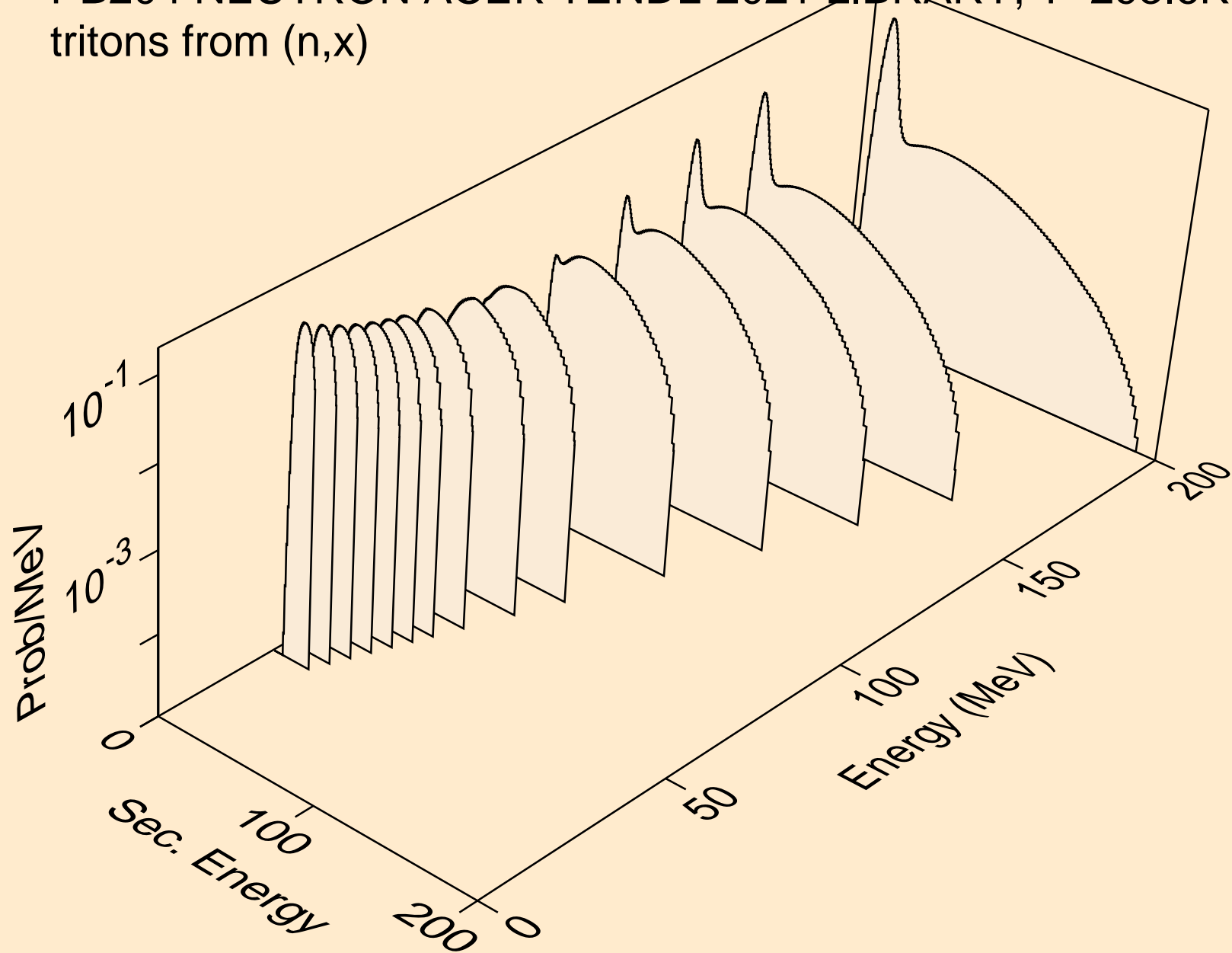

PB204 NEUTRON ACER TENDL-2021 LIBRARY; T=293.6K
tritons from (n,n*)t

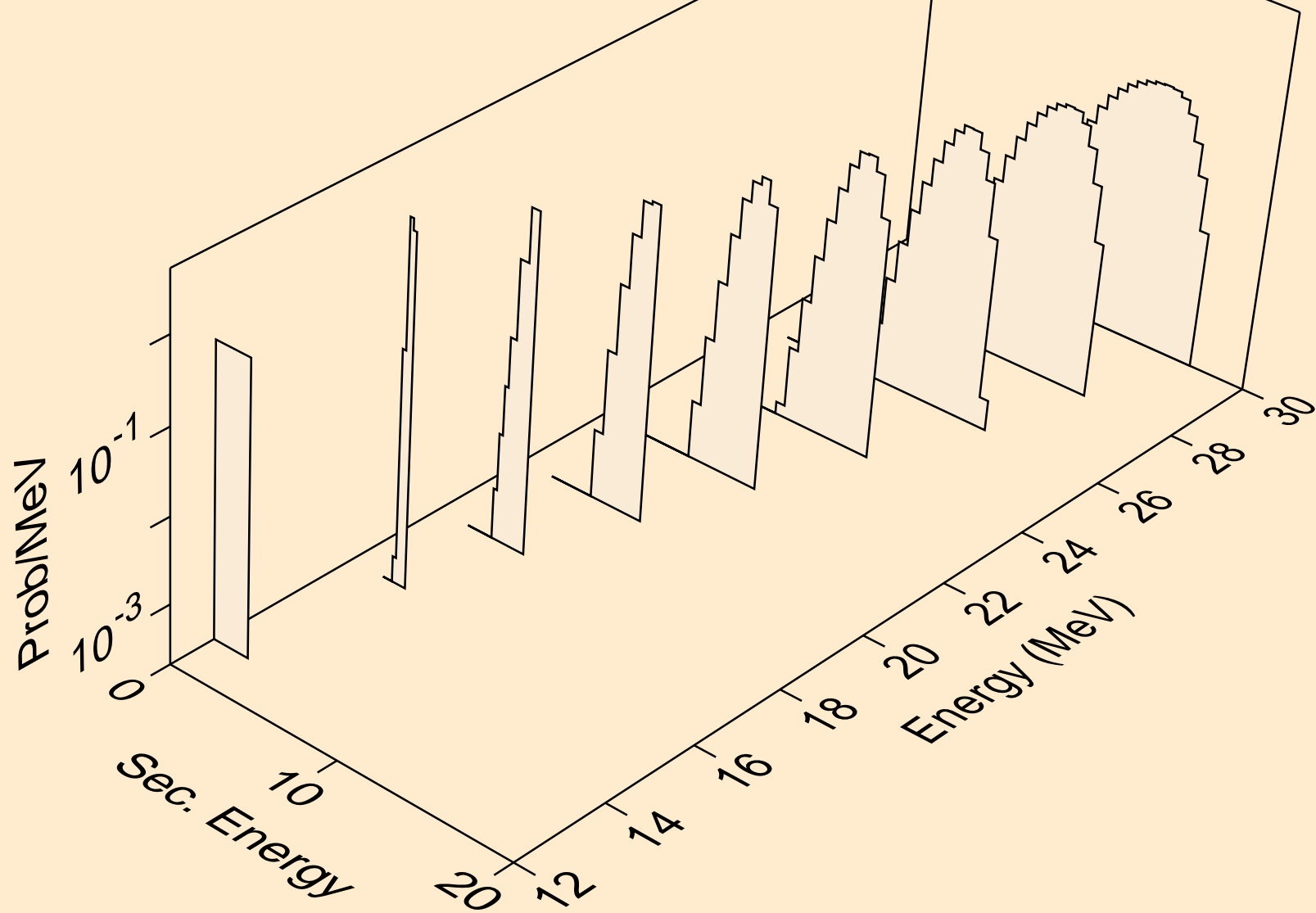

PB204 NEUTRON ACER TENDL-2021 LIBRARY; T=293.6K
tritons from (n,t)

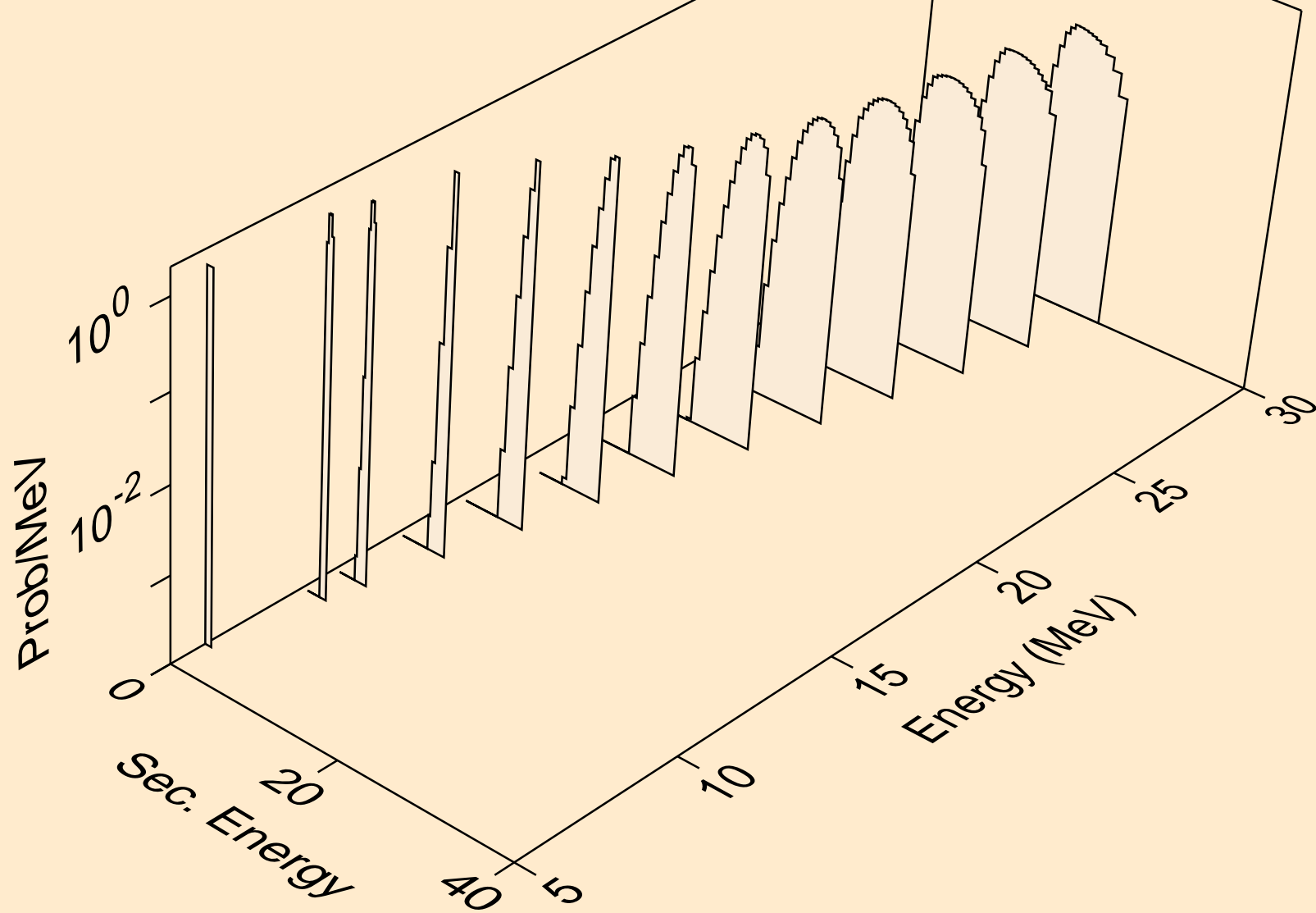

PB204 NEUTRON ACER TENDL-2021 LIBRARY; T=293.6K
tritons from (n,pt)

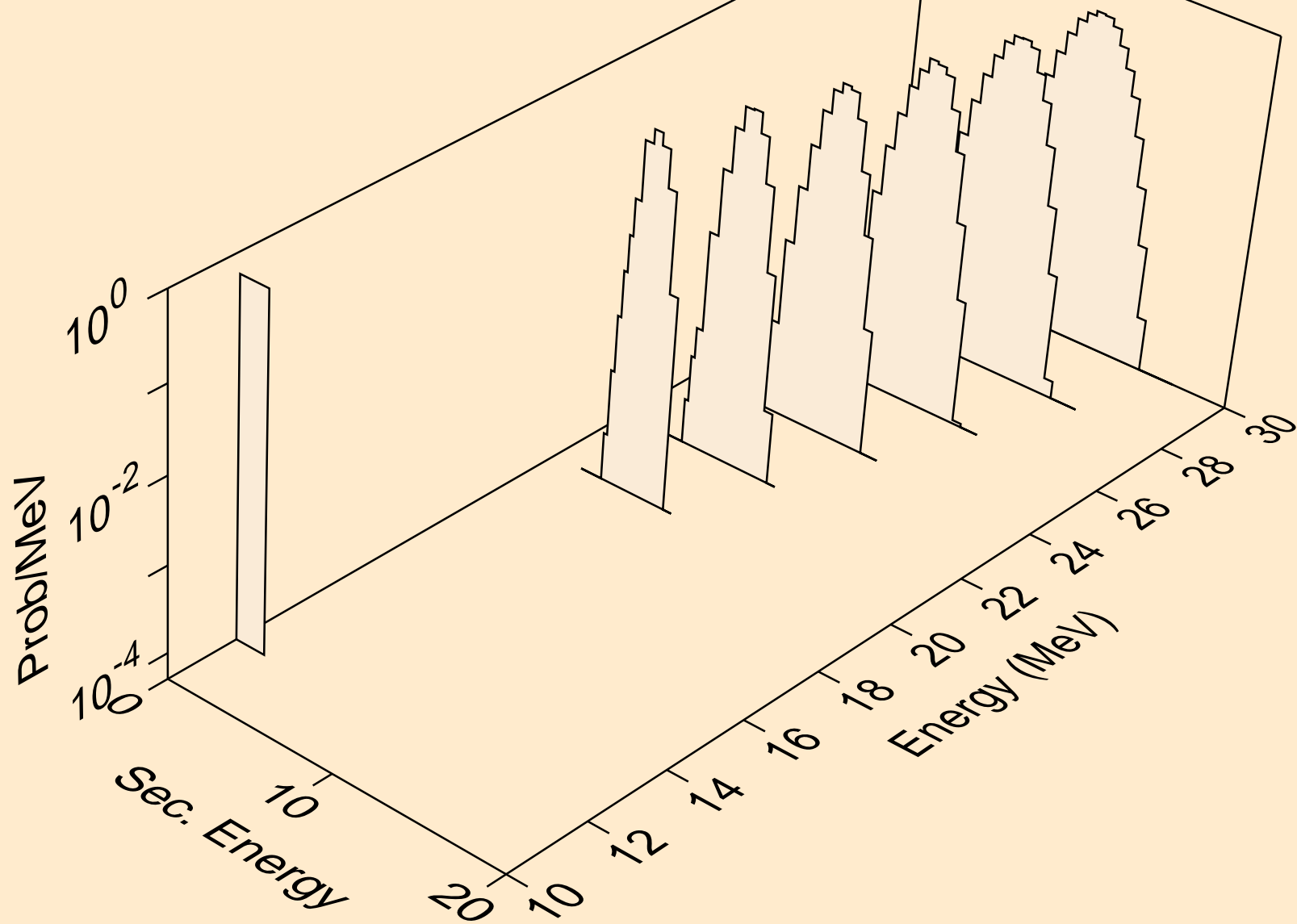

PB204 NEUTRON ACER TENDL-2021 LIBRARY; T=293.6K
he3s from (n,x)

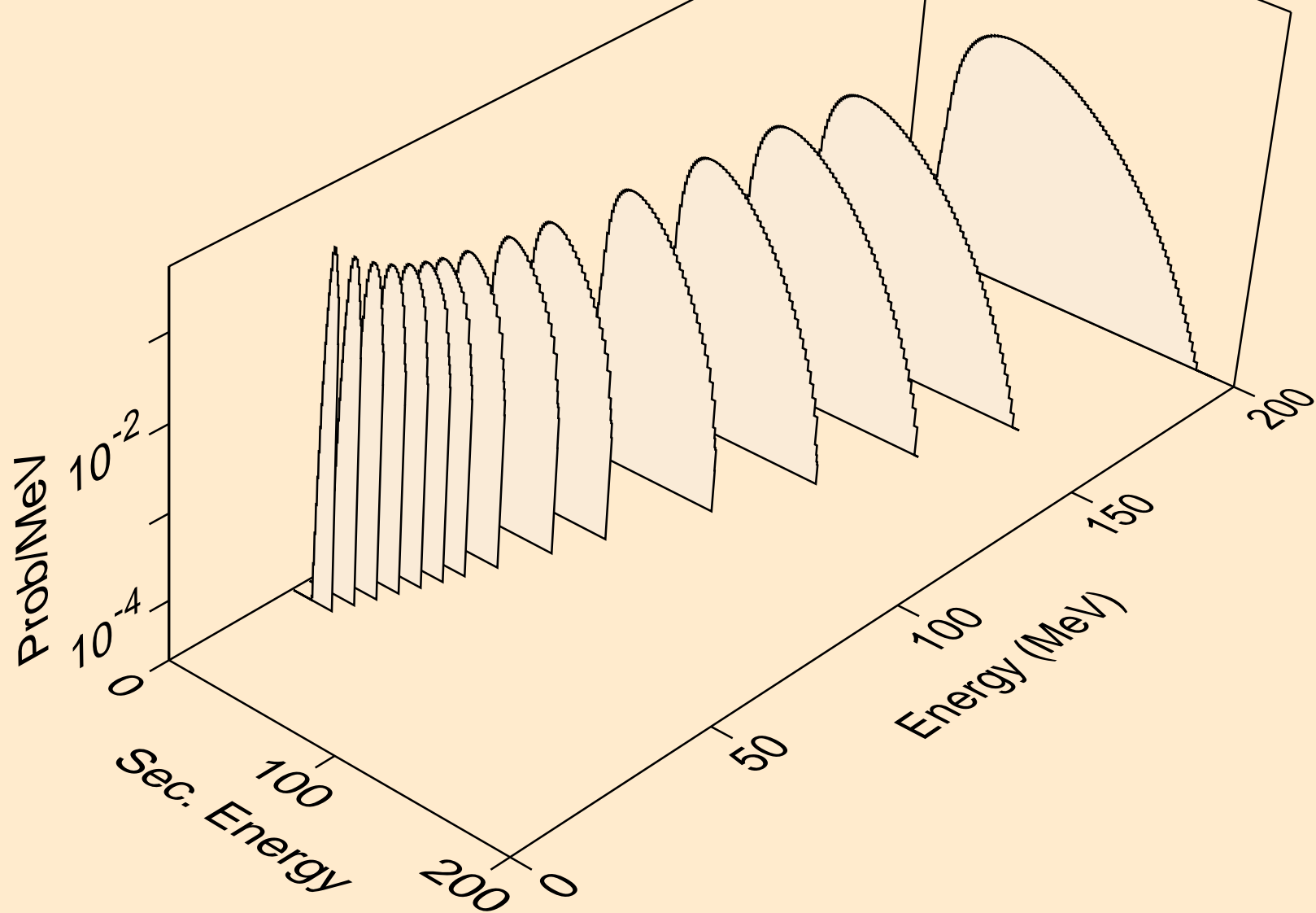

PB204 NEUTRON ACER TENDL-2021 LIBRARY; T=293.6K
he3s from (n,n*)he3

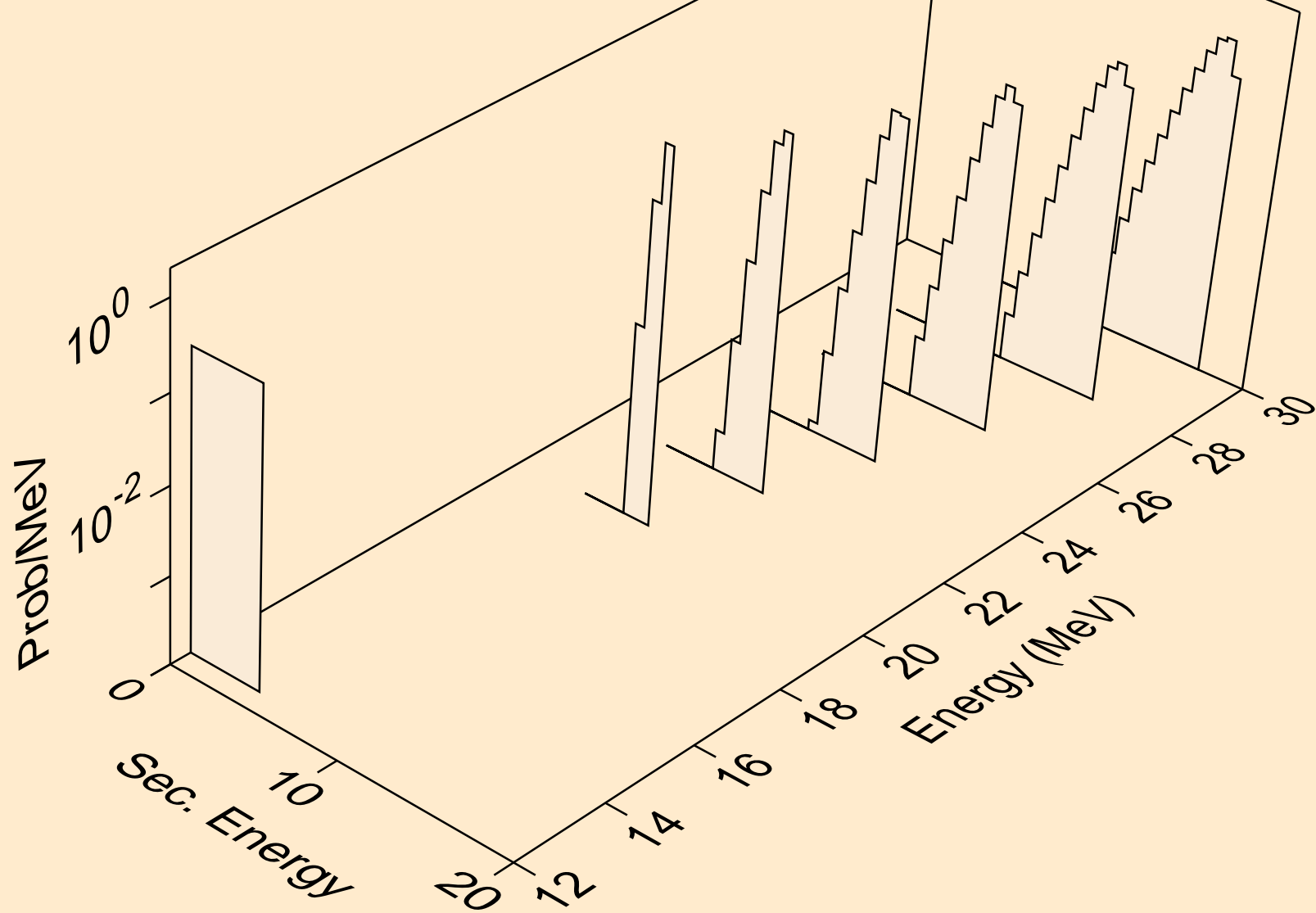

PB204 NEUTRON ACER TENDL-2021 LIBRARY; T=293.6K
he3s from (n,he3)

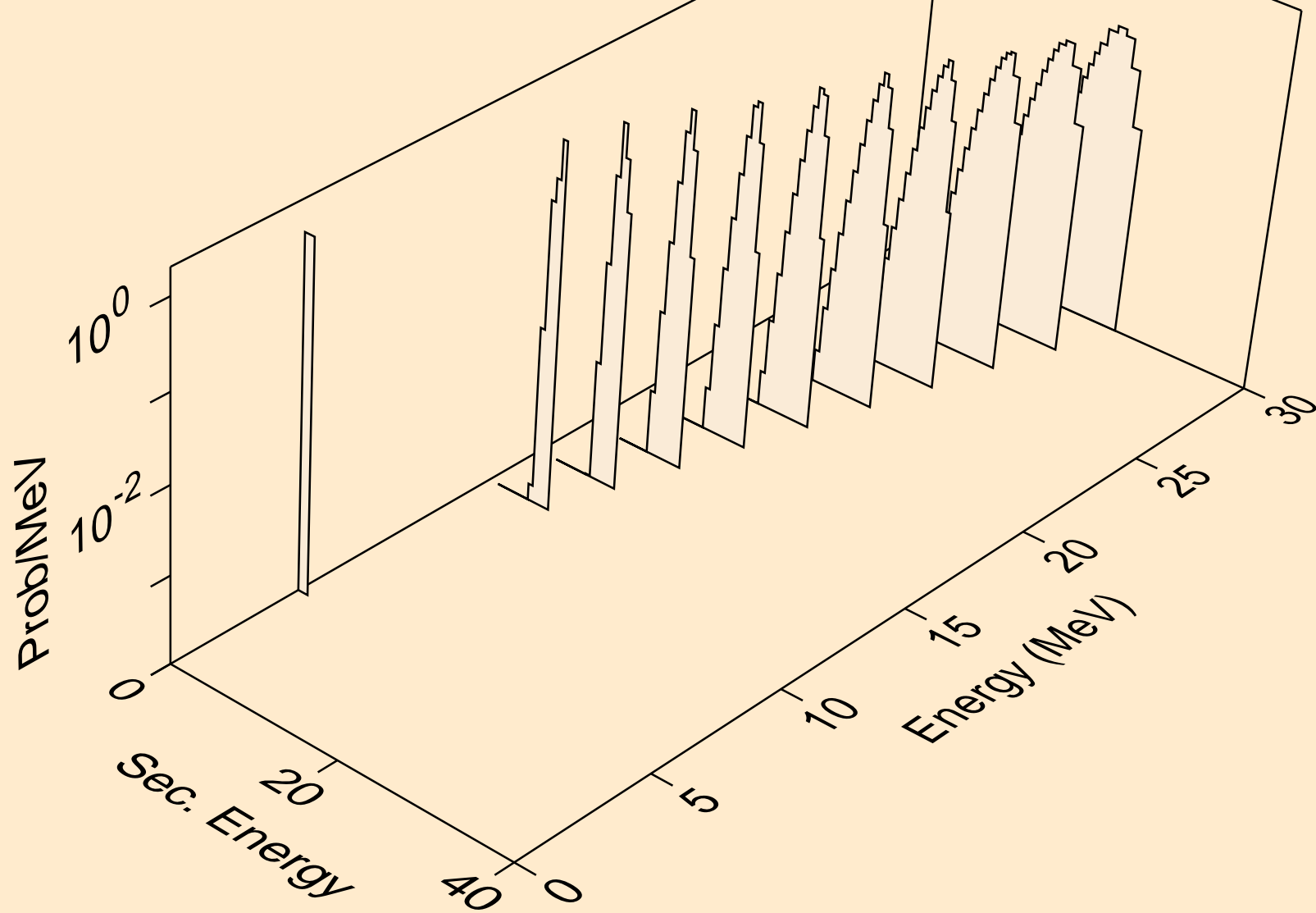

PB204 NEUTRON ACER TENDL-2021 LIBRARY; T=293.6K
alphas from (n,x)

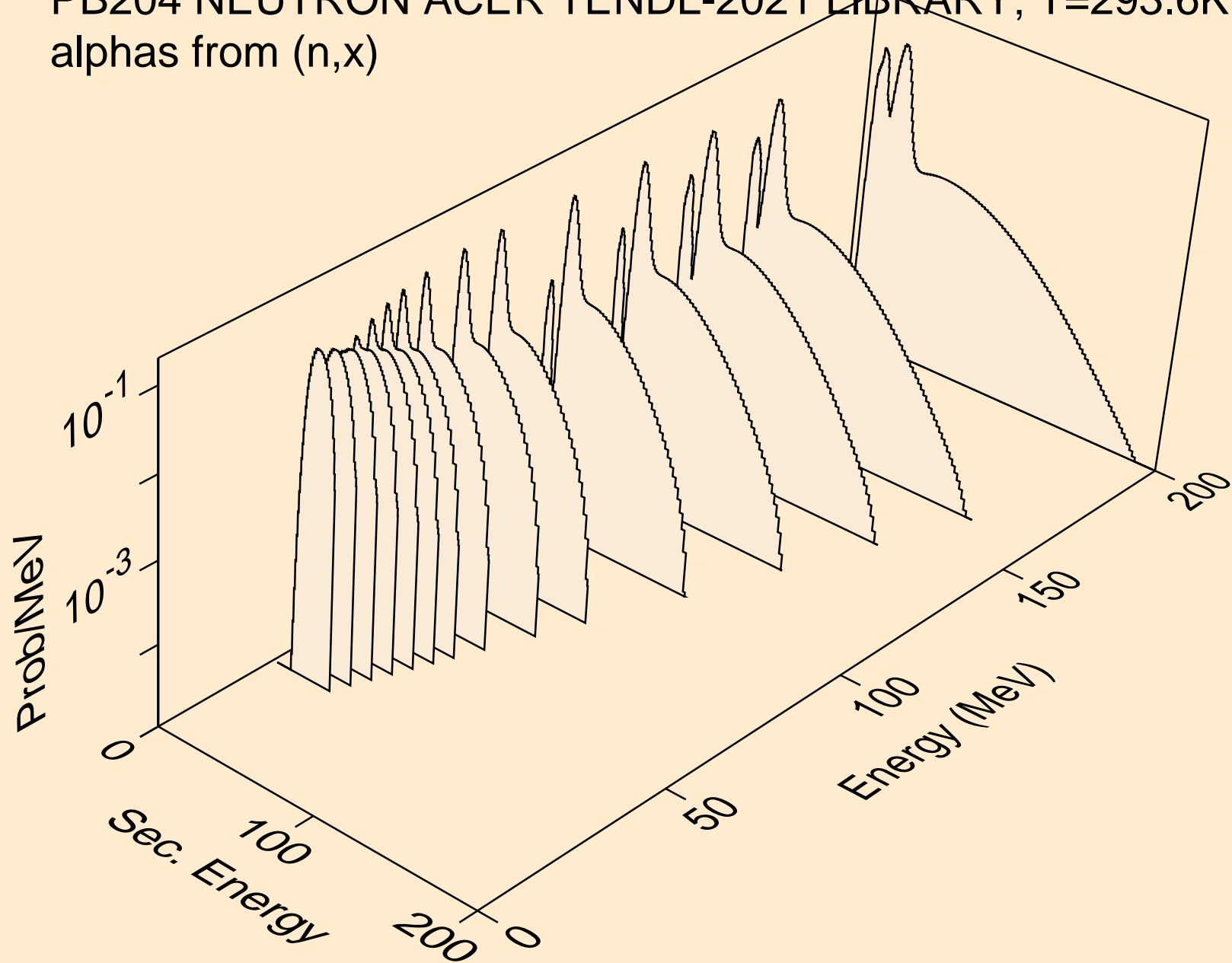

PB204 NEUTRON ACER TENDL-2021 LIBRARY; T=293.6K
alphas from (n,n*)a

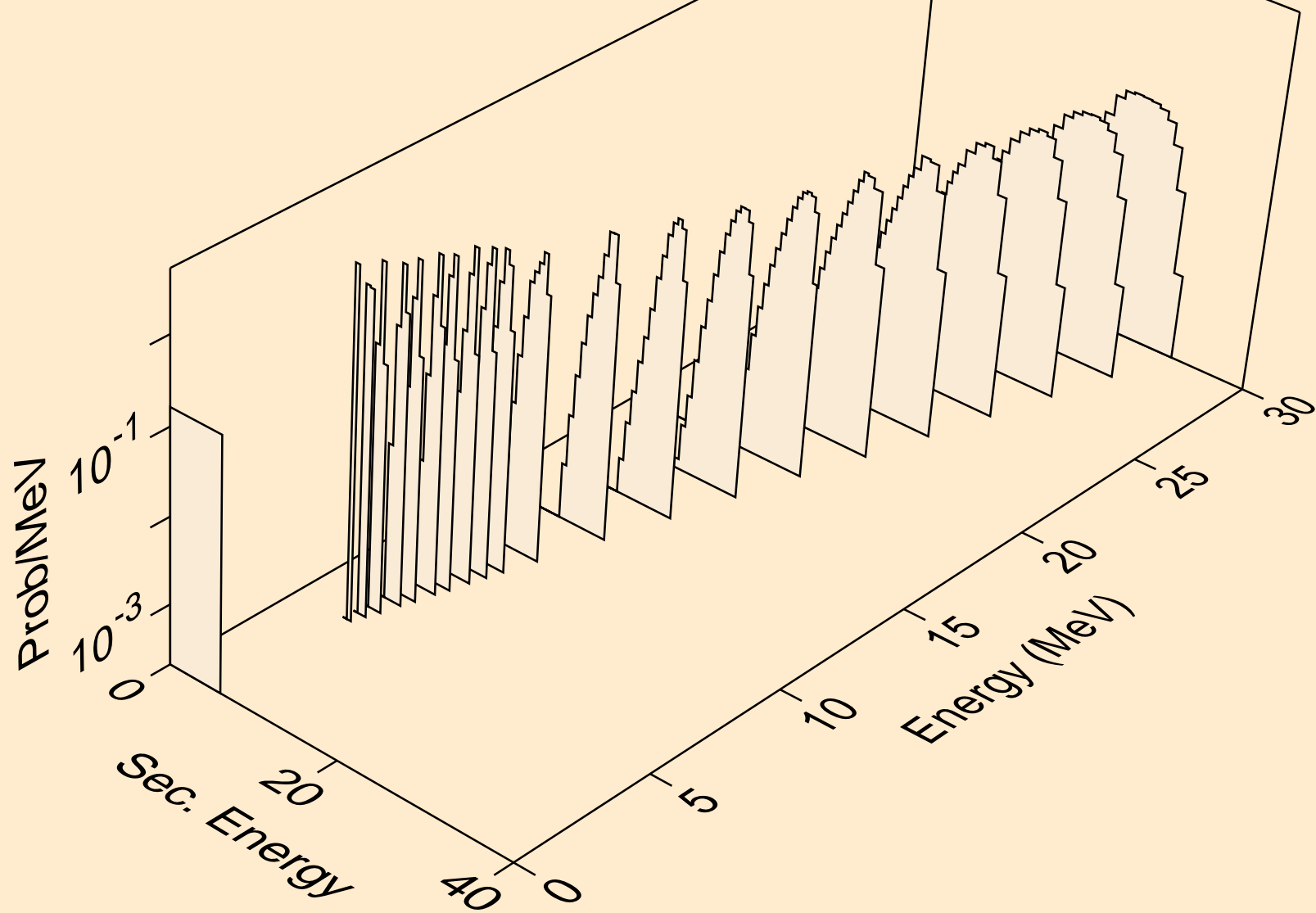

PB204 NEUTRON ACER TENDL-2021 LIBRARY; T=293.6K
alphas from (n,2n)a

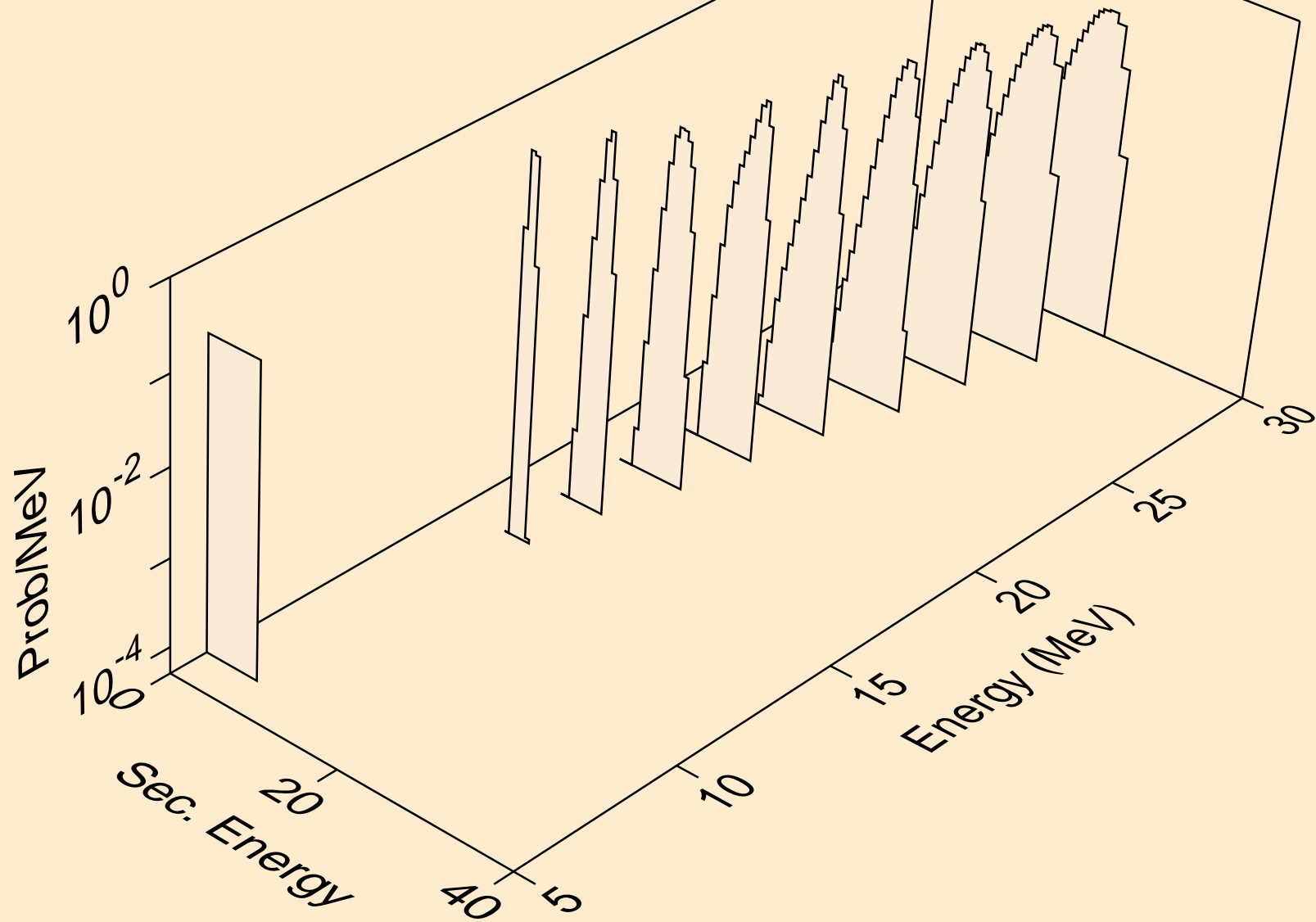

PB204 NEUTRON ACER TENDL-2021 LIBRARY; T=293.6K
alphas from (n,3n)a

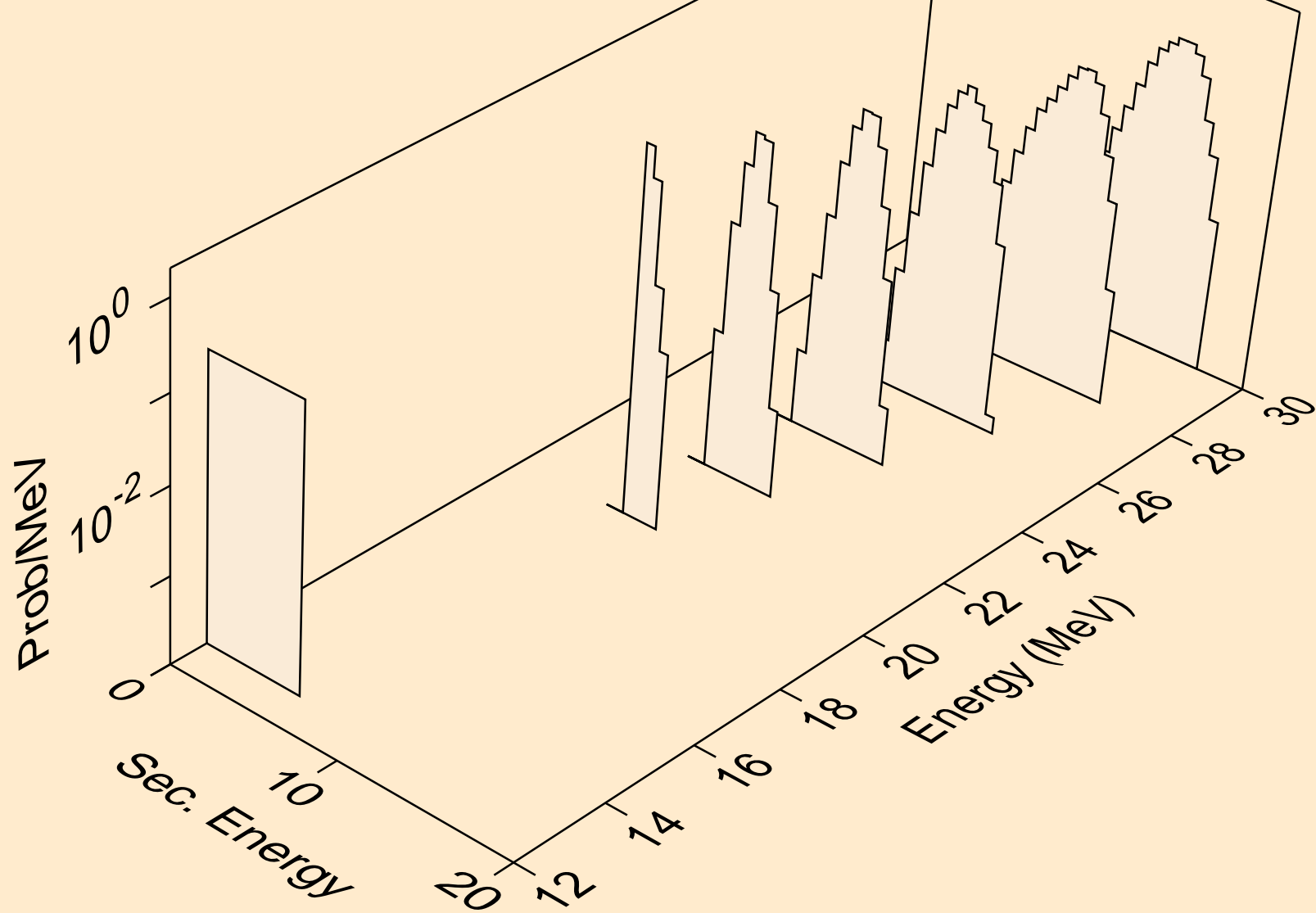

PB204 NEUTRON ACER TENDL-2021 LIBRARY; T=293.6K
alphas from (n,npa)

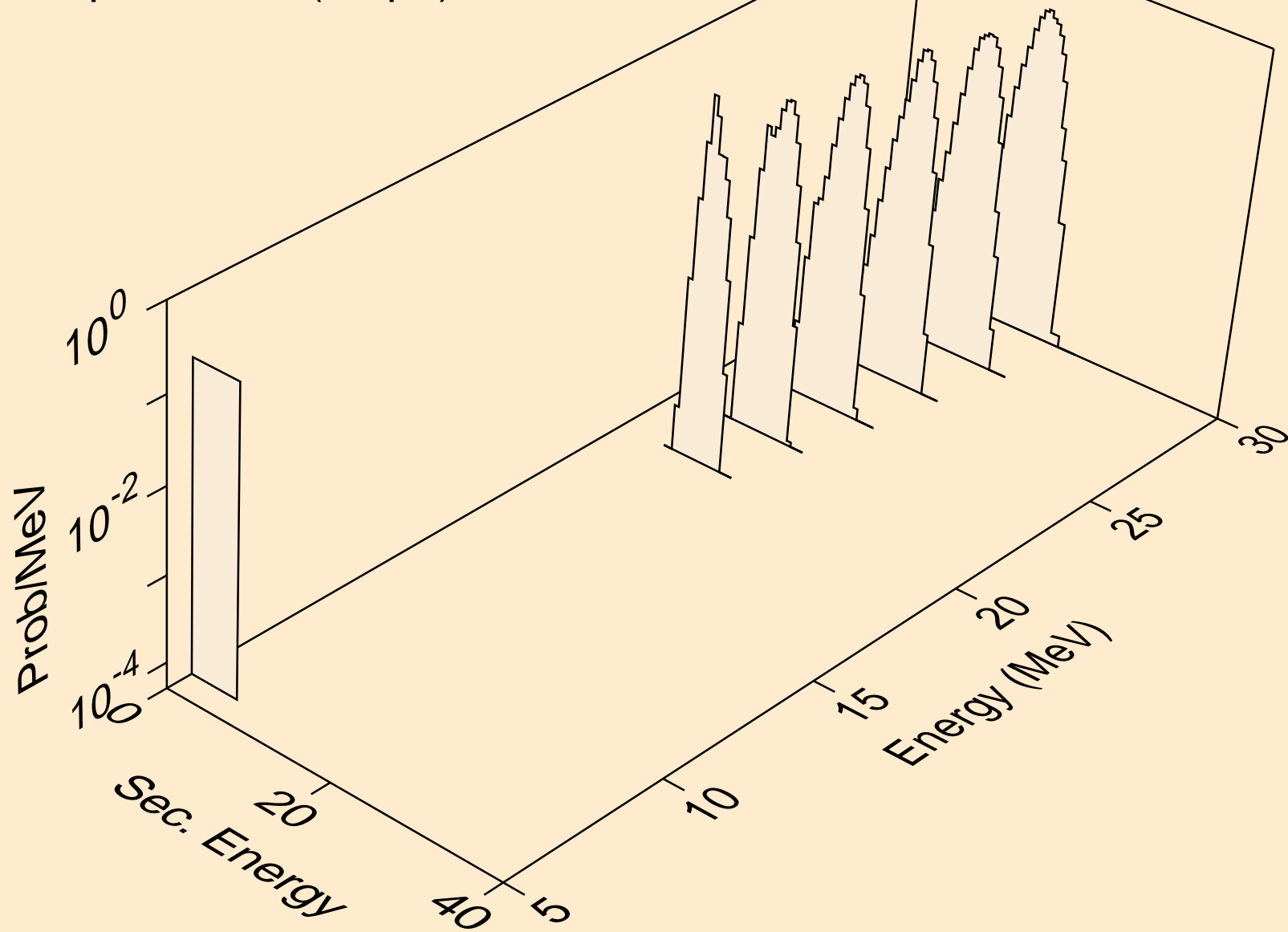

PB204 NEUTRON ACER TENDL-2021 LIBRARY; T=293.6K
alphas from (n,a)

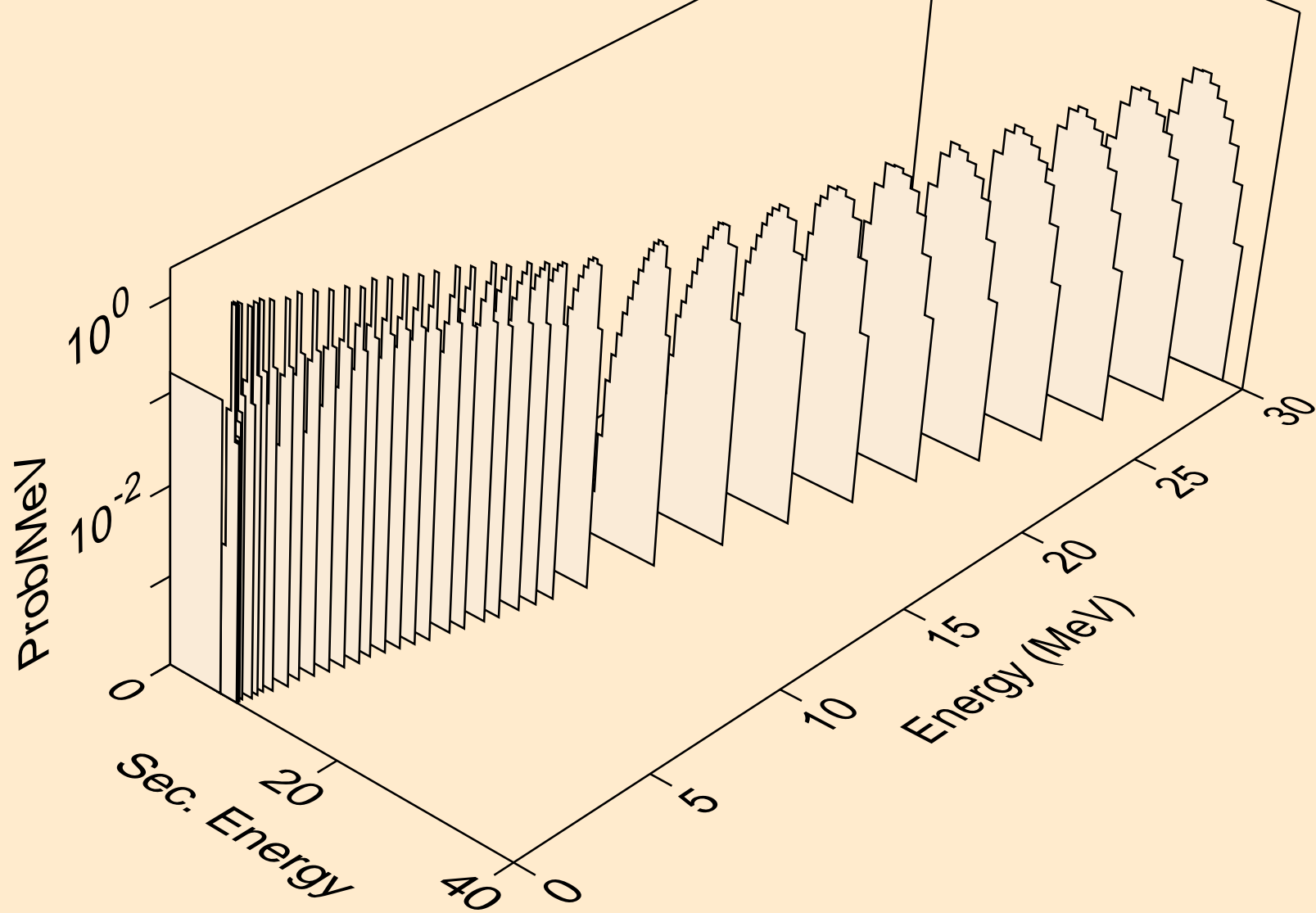

PB204 NEUTRON ACER TENDL-2021 LIBRARY; T=293.6K
alphas from (n,2a)

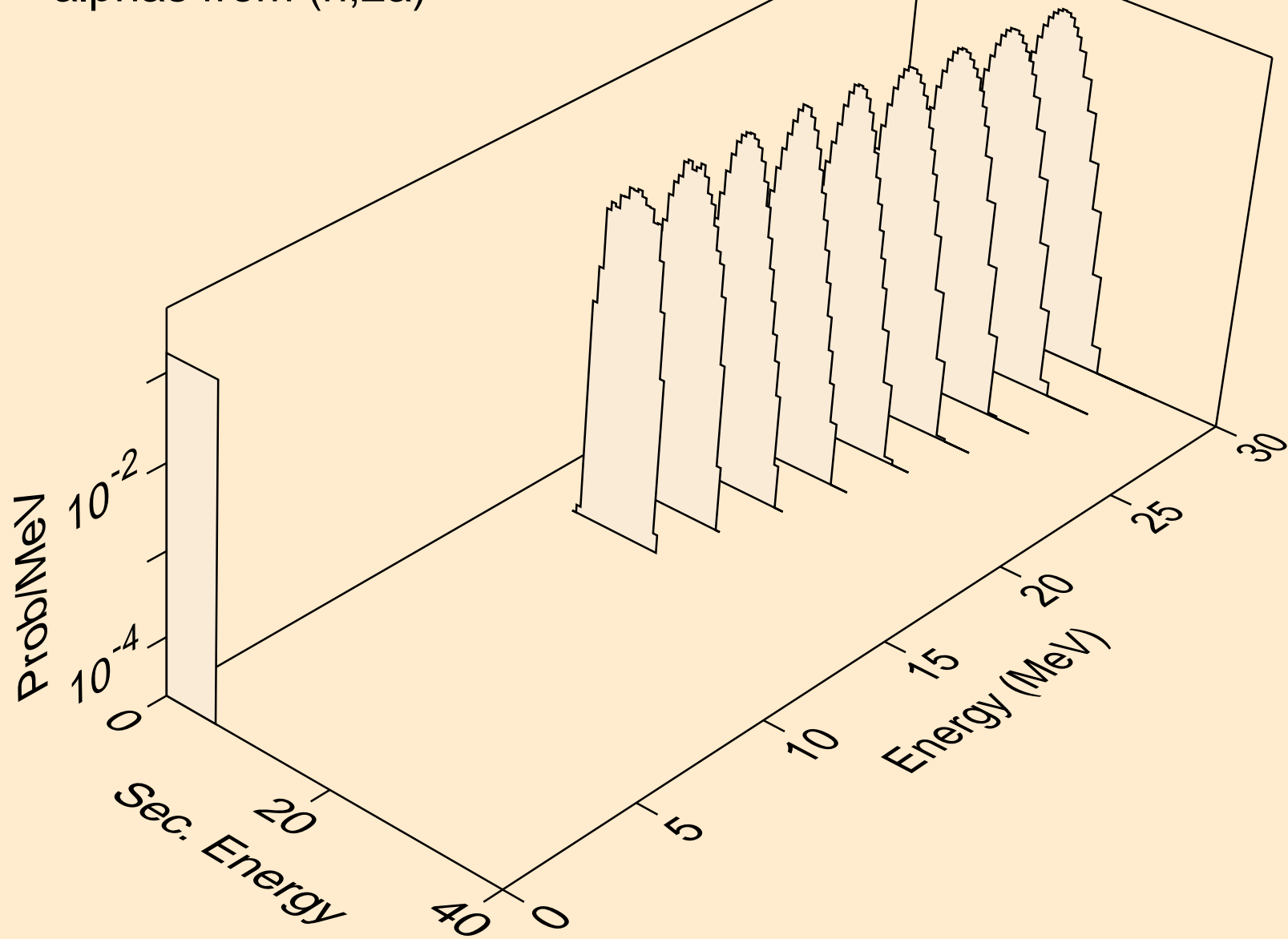

PB204 NEUTRON ACER TENDL-2021 LIBRARY; T=293.6K
alphas from (n,pa)

