

PB214 NEUTRON ACER TENDL-2021 LIBRARY; T=293.6K

Principal cross sections

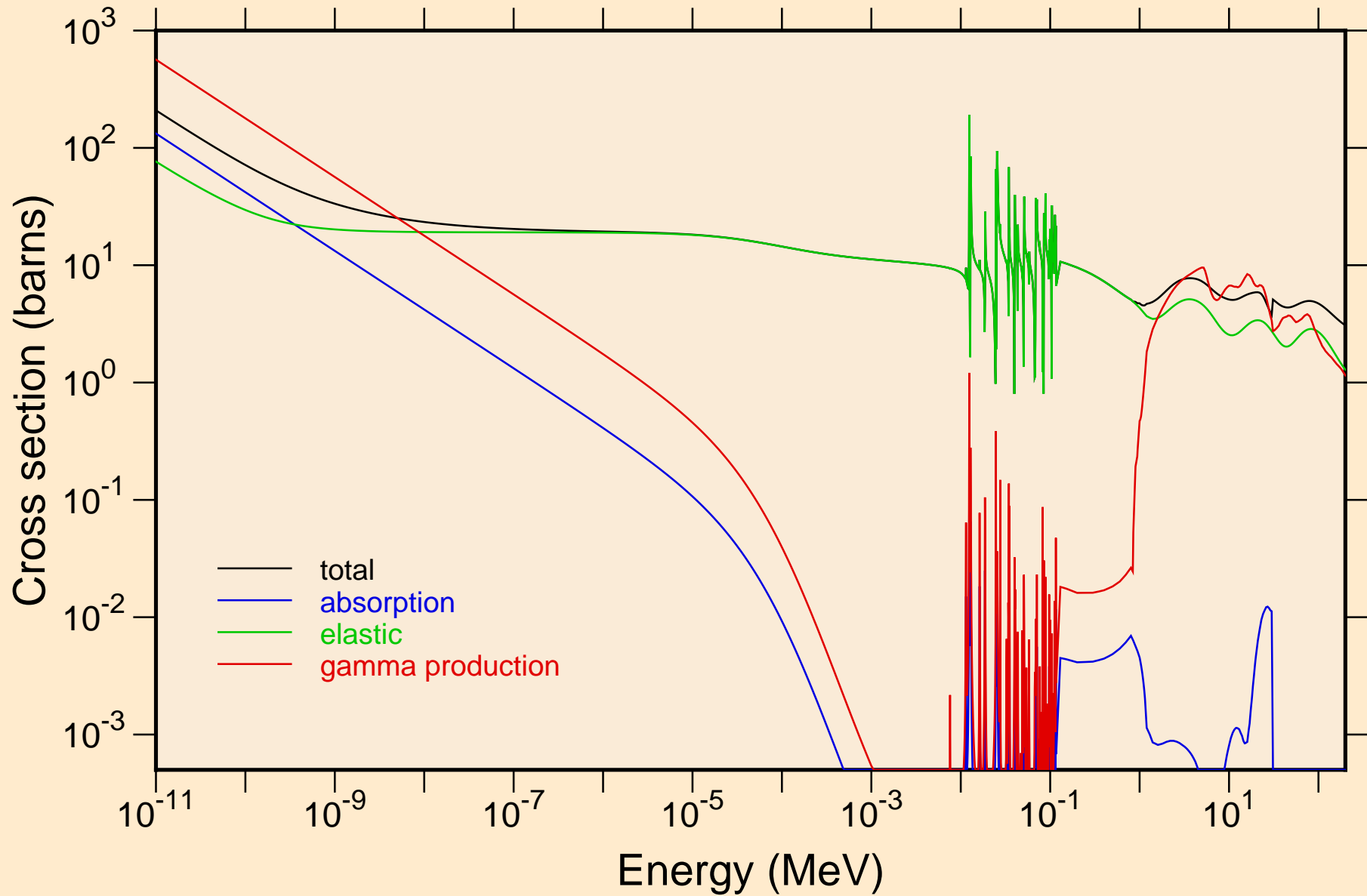

PB214 NEUTRON ACER TENDL-2021 LIBRARY; T=293.6K
resonance total cross section

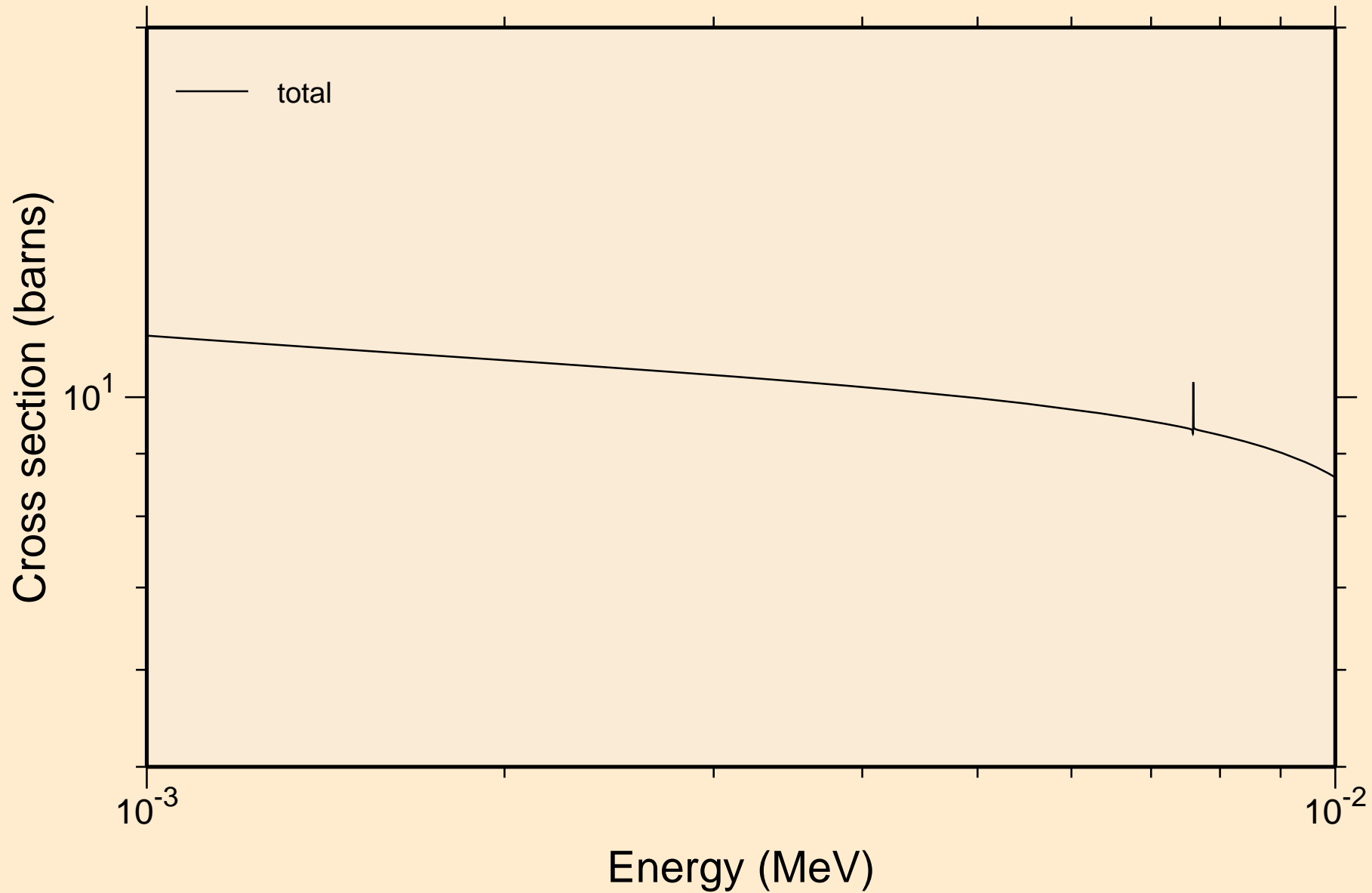

PB214 NEUTRON ACER TENDL-2021 LIBRARY; T=293.6K
resonance total cross section

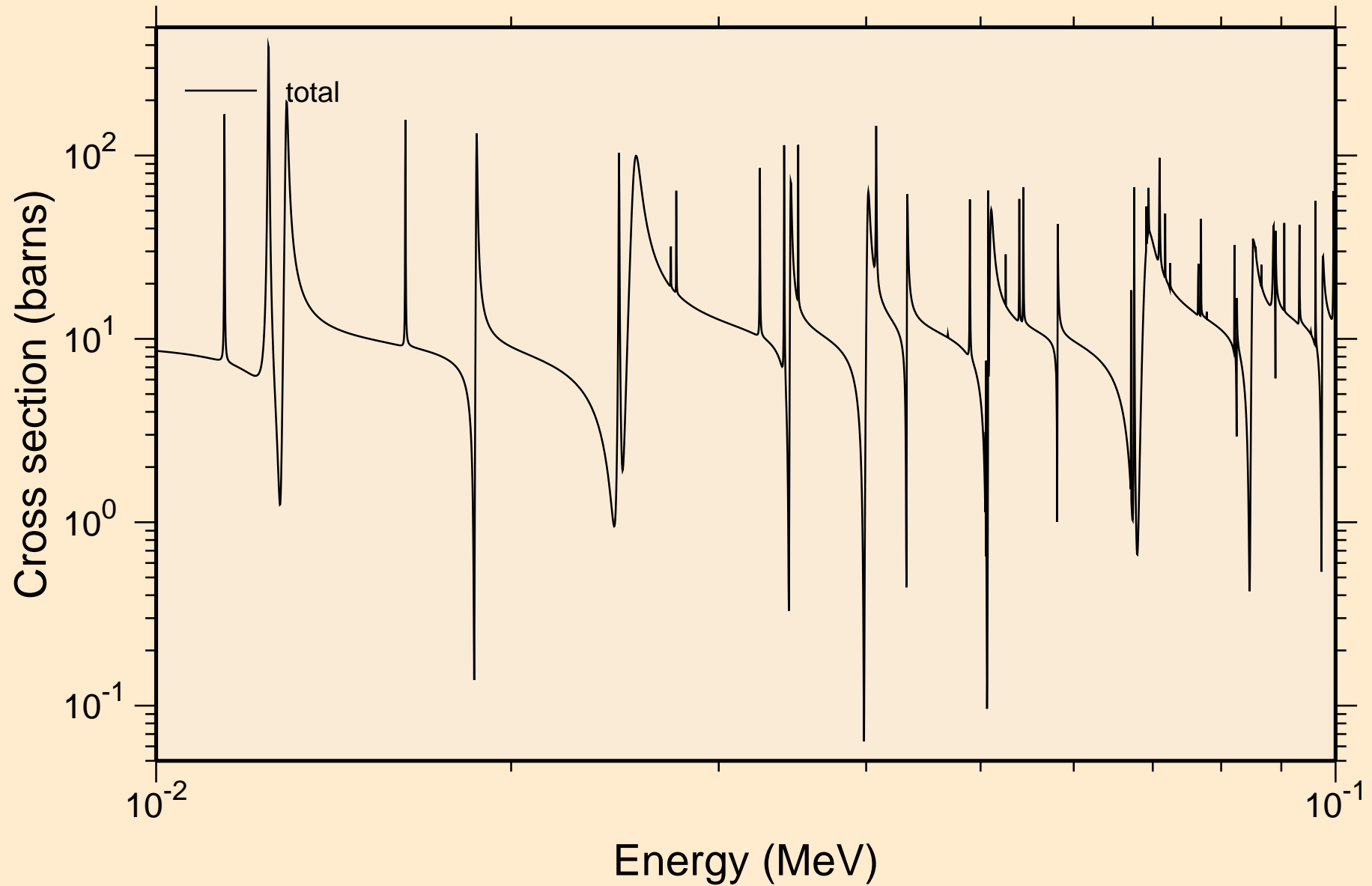

PB214 NEUTRON ACER TENDL-2021 LIBRARY; T=293.6K
resonance total cross section

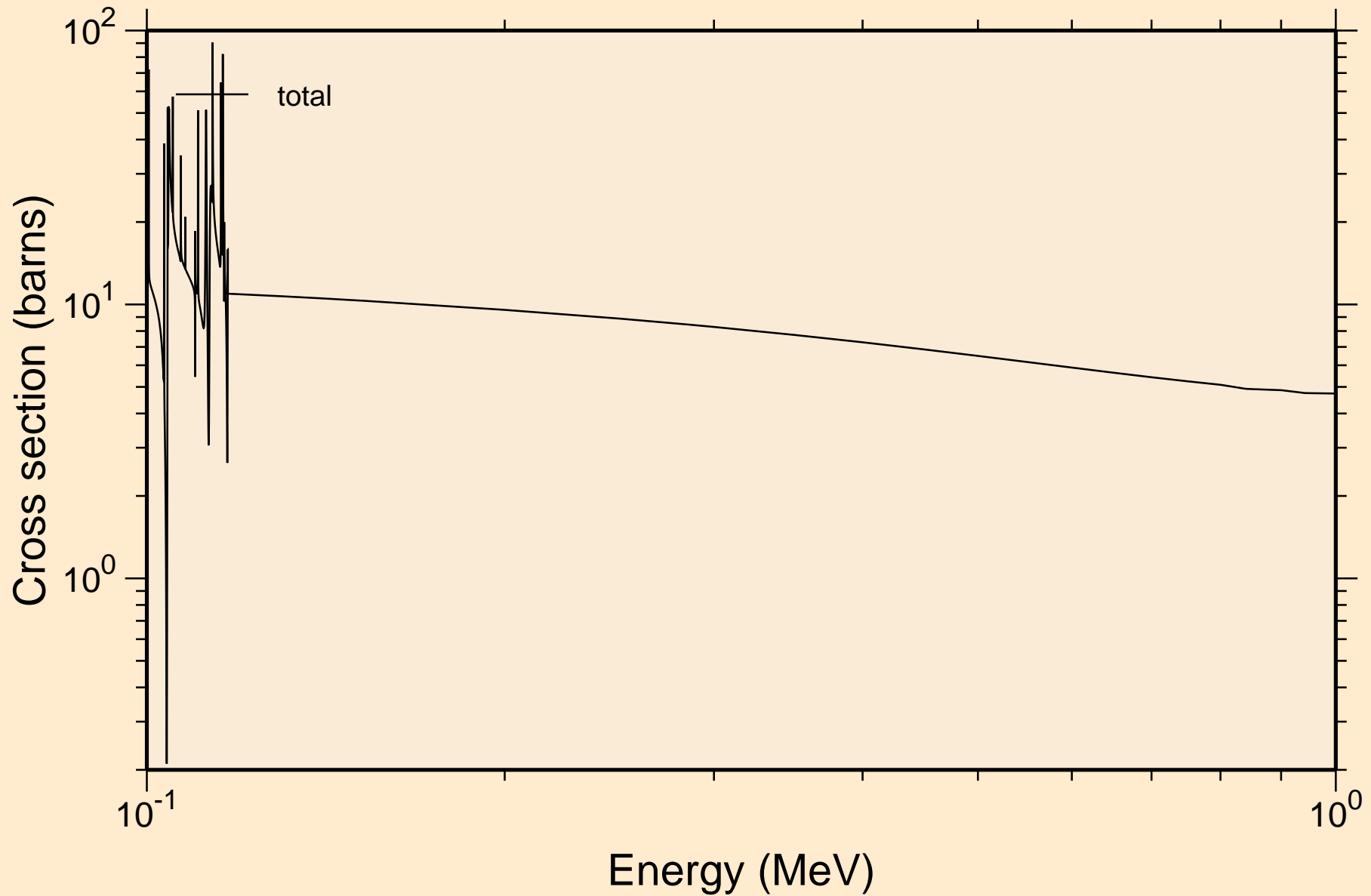

PB214 NEUTRON ACER TENDL-2021 LIBRARY; T=293.6K
resonance total cross section

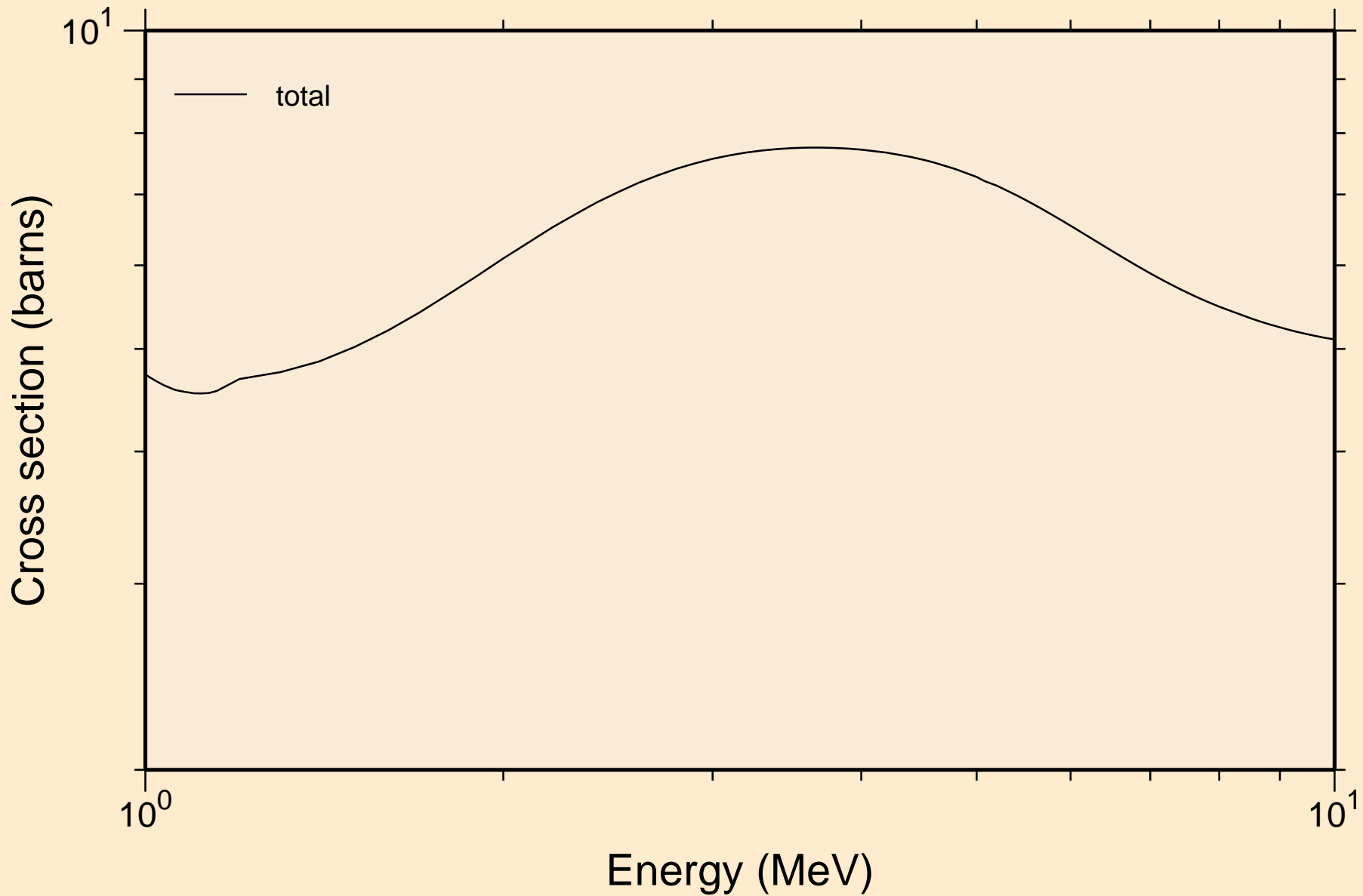

PB214 NEUTRON ACER TENDL-2021 LIBRARY; T=293.6K
resonance absorption cross sections

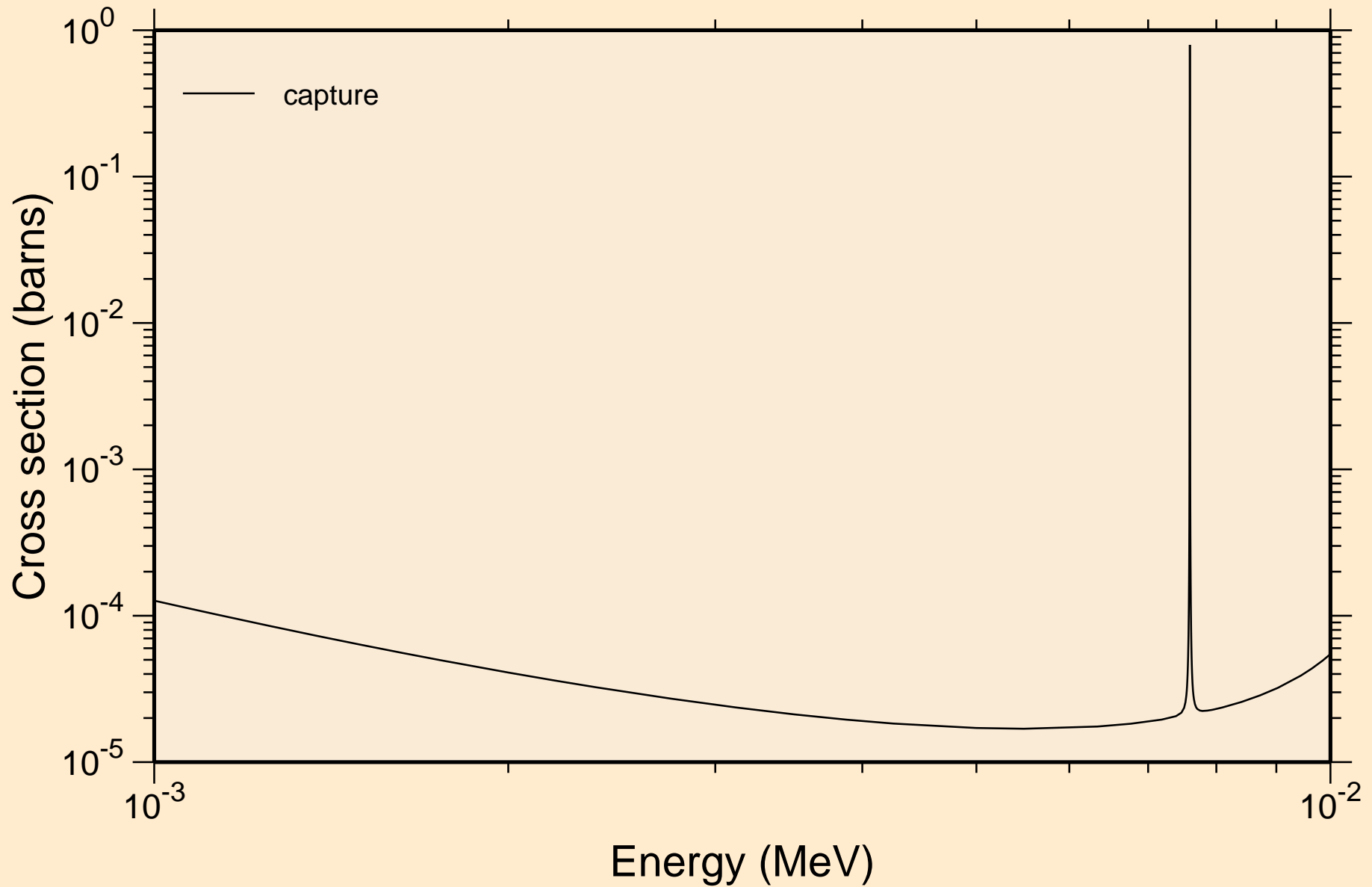

PB214 NEUTRON ACER TENDL-2021 LIBRARY; T=293.6K
resonance absorption cross sections

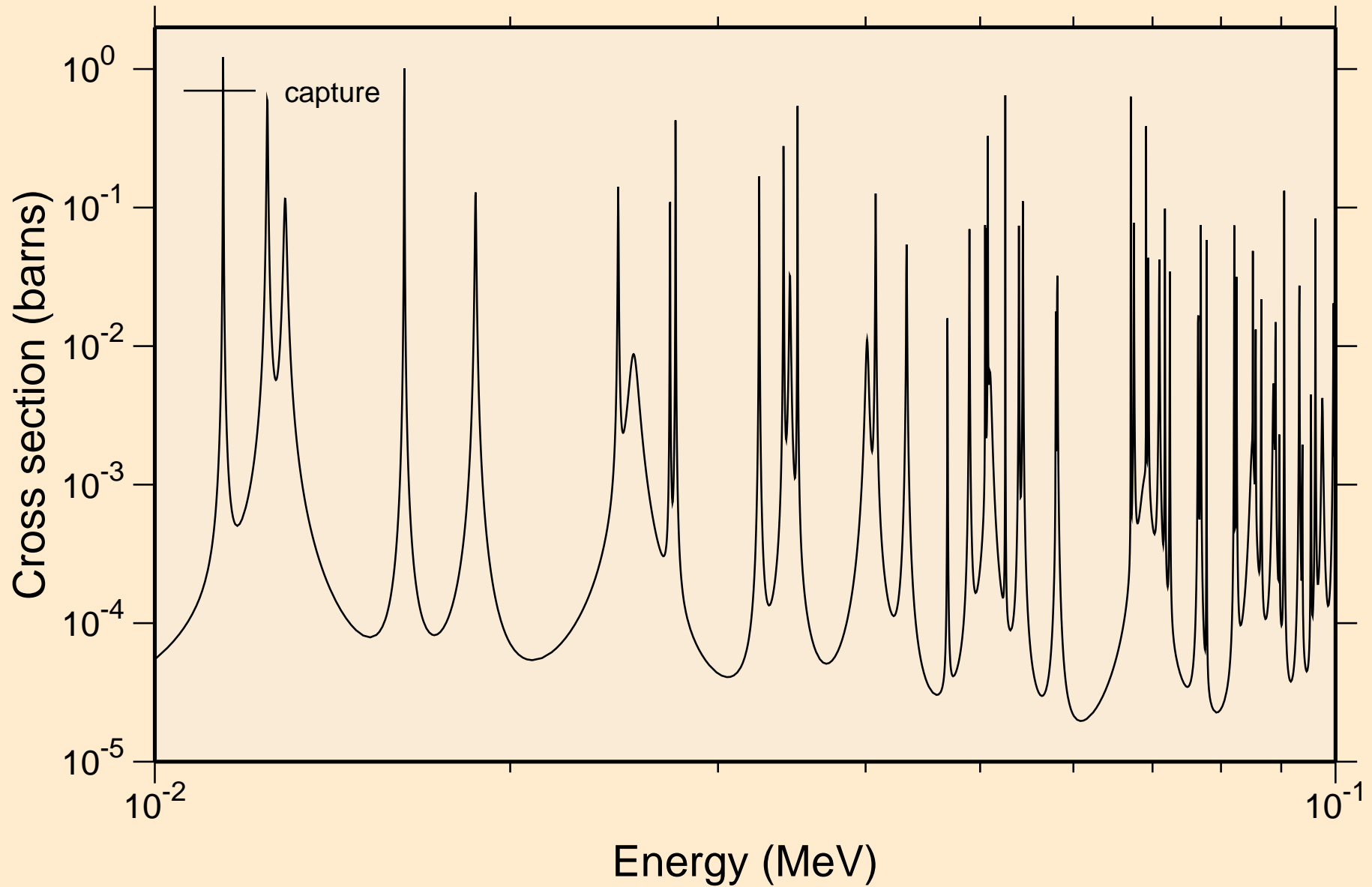

PB214 NEUTRON ACER TENDL-2021 LIBRARY; T=293.6K
resonance absorption cross sections

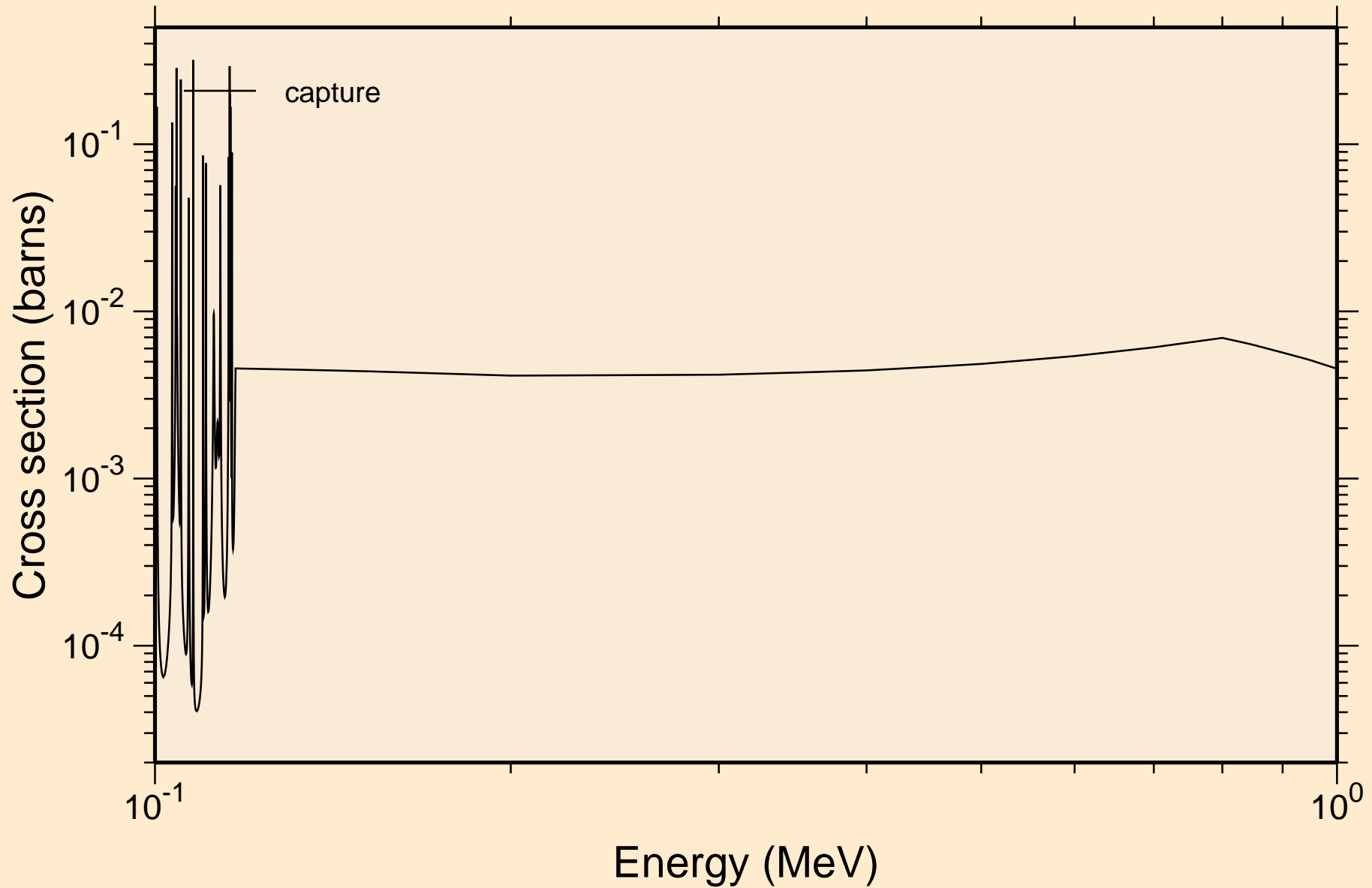

PB214 NEUTRON ACER TENDL-2021 LIBRARY; T=293.6K
resonance absorption cross sections

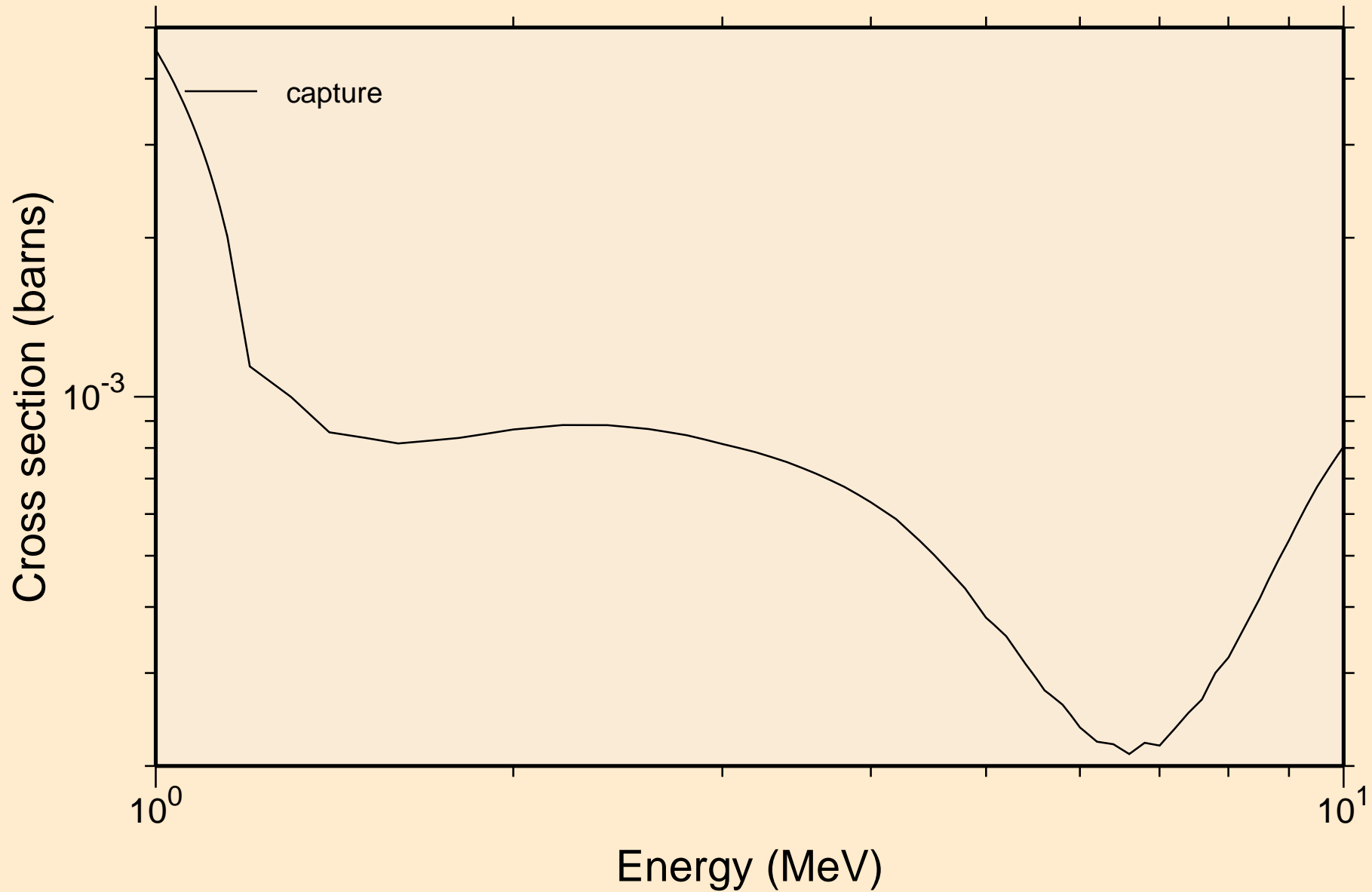

PB214 NEUTRON ACER TENDL-2021 LIBRARY; T=293.6K
Heating

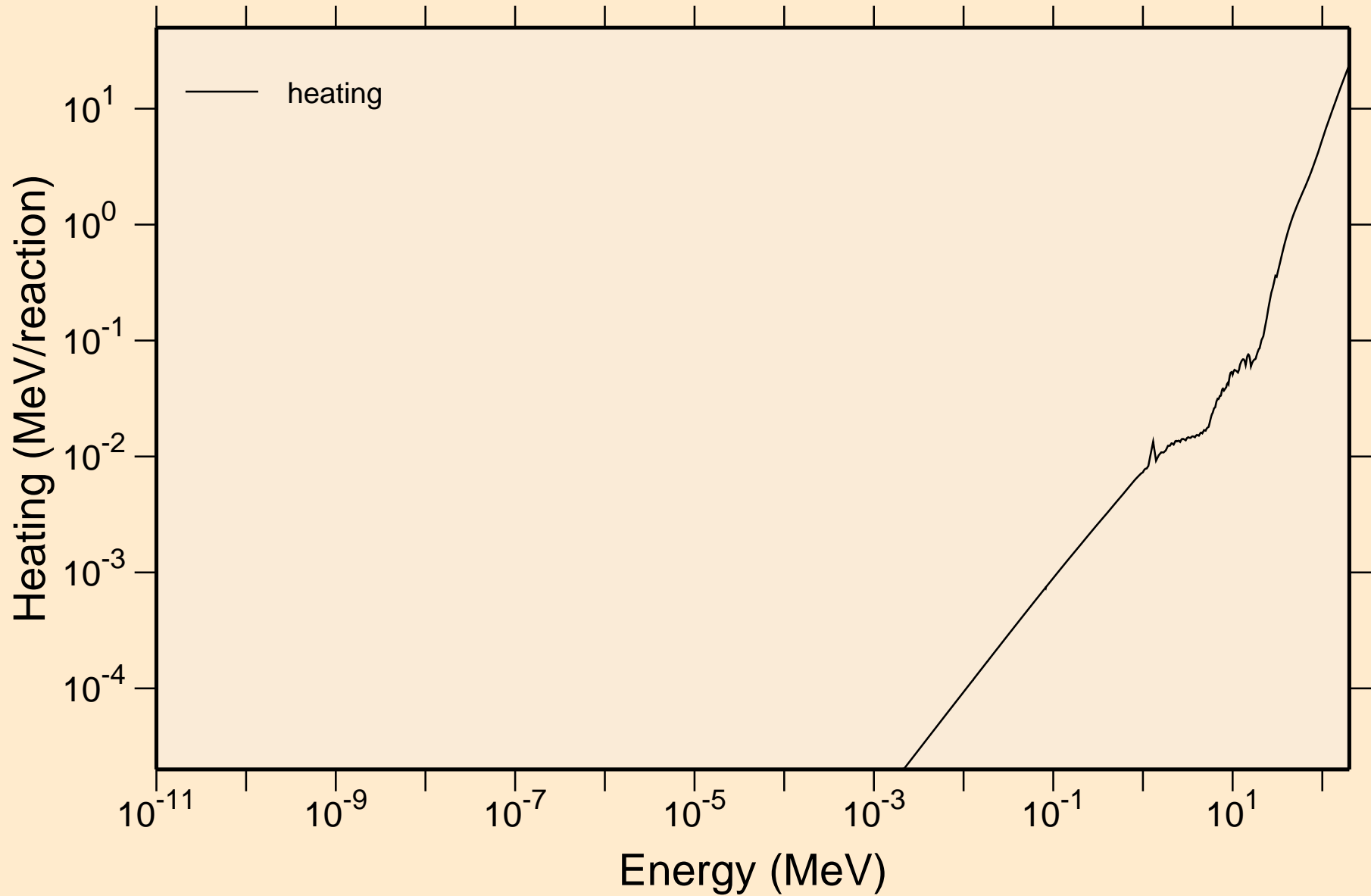

PB214 NEUTRON ACER TENDL-2021 LIBRARY; T=293.6K
Damage

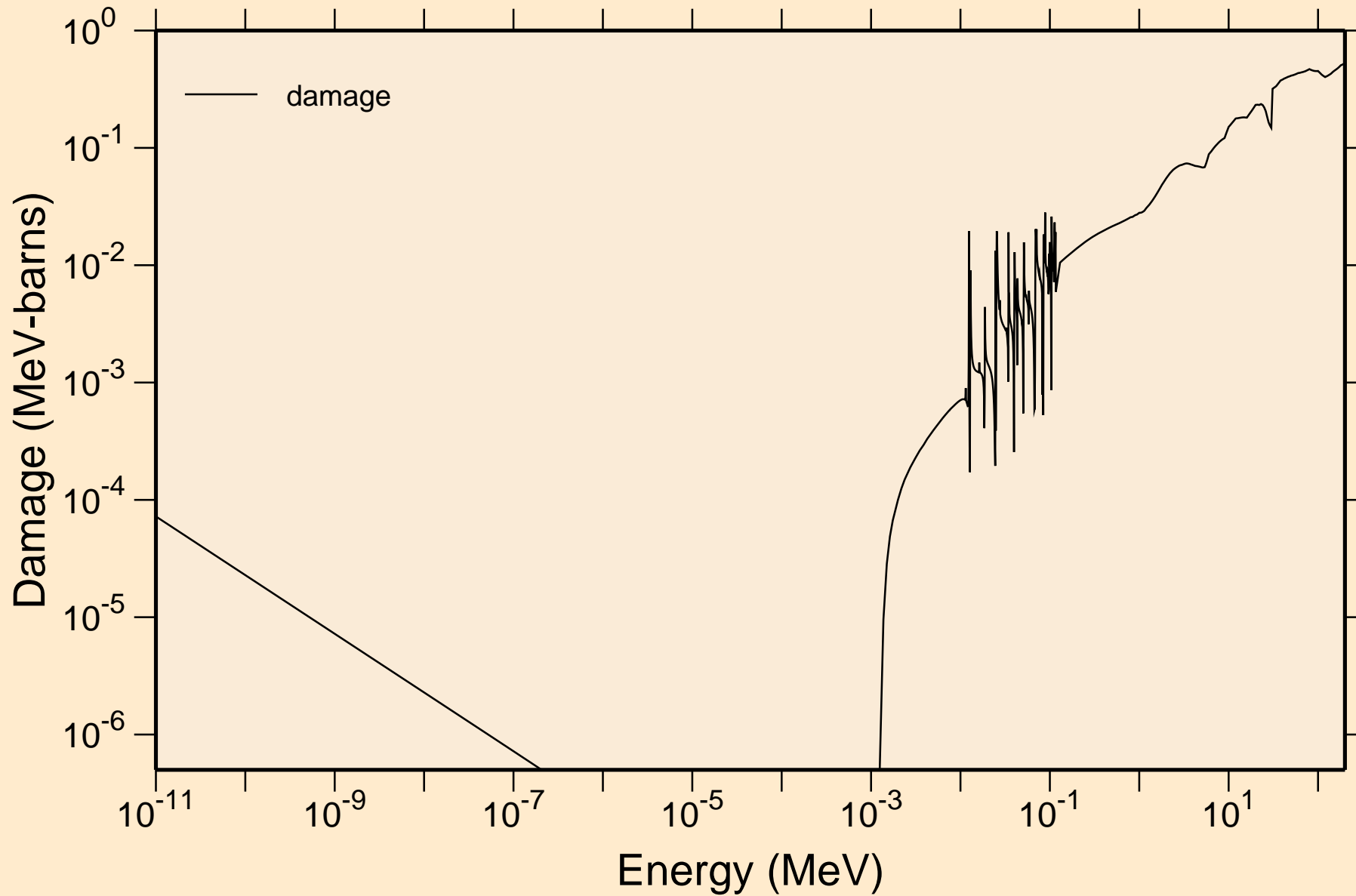

PB214 NEUTRON ACER TENDL-2021 LIBRARY; T=293.6K
Non-threshold reactions

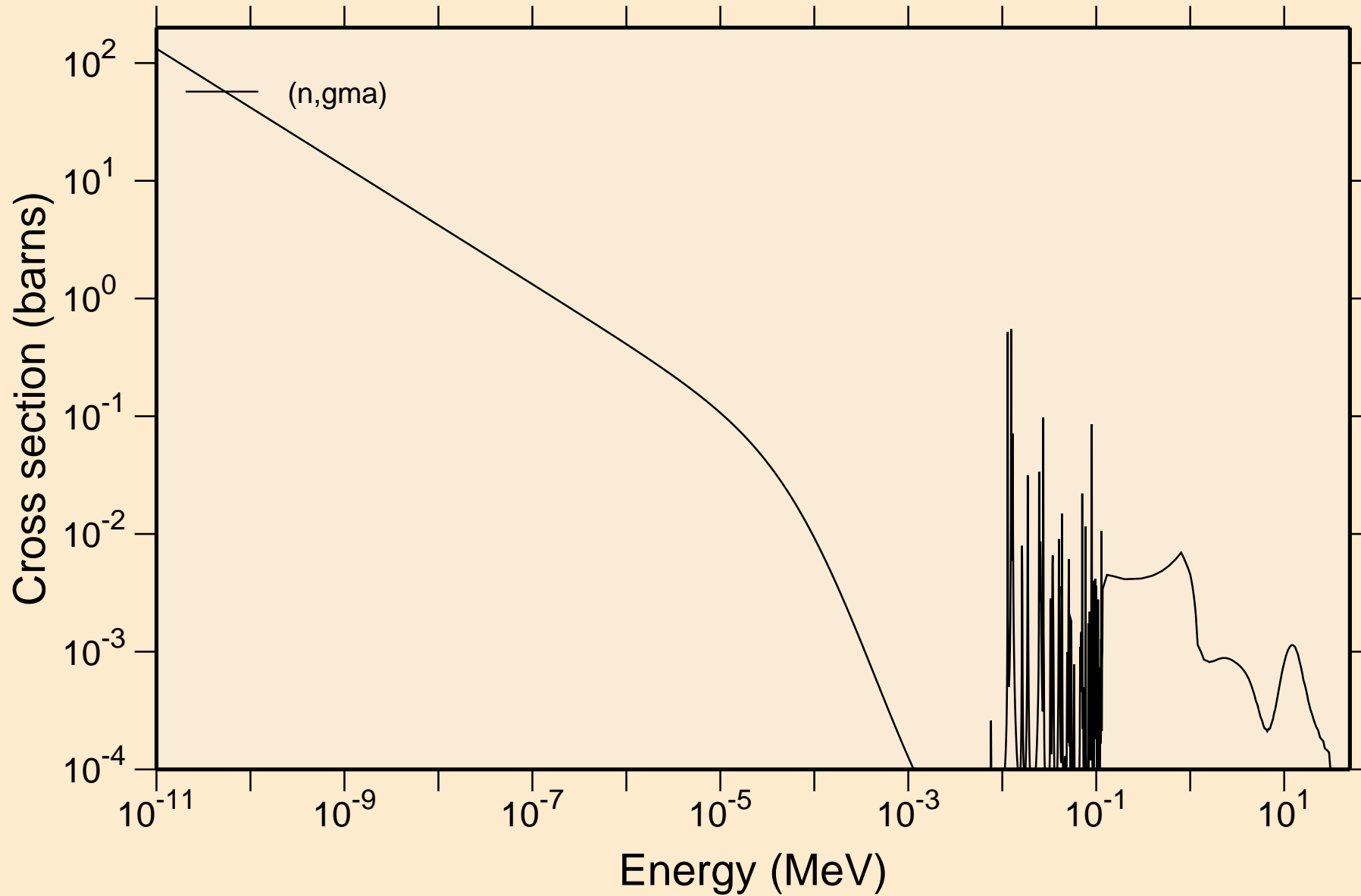

PB214 NEUTRON ACER TENDL-2021 LIBRARY; T=293.6K
Principal cross sections

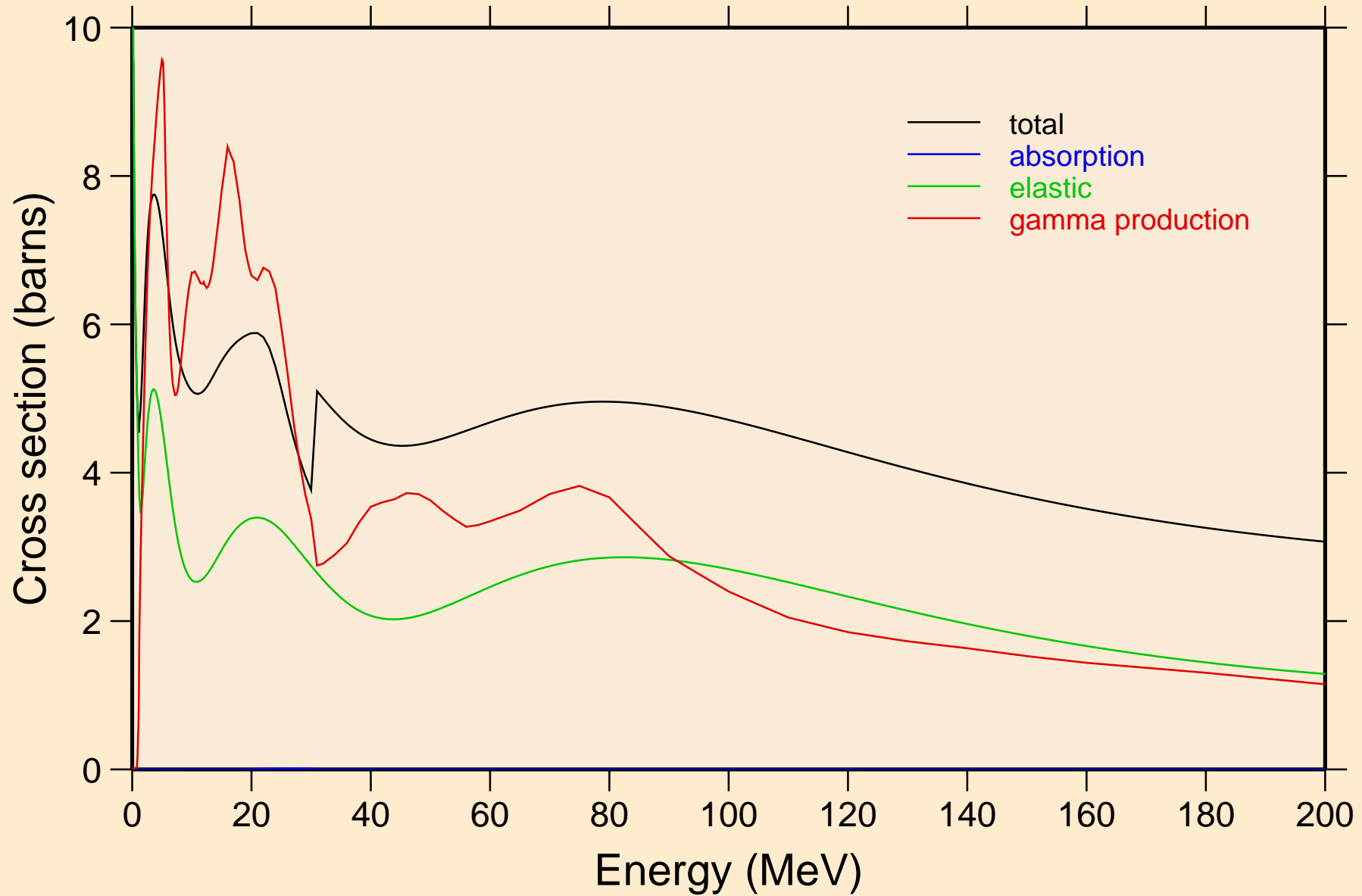

PB214 NEUTRON ACER TENDL-2021 LIBRARY; T=293.6K
Heating

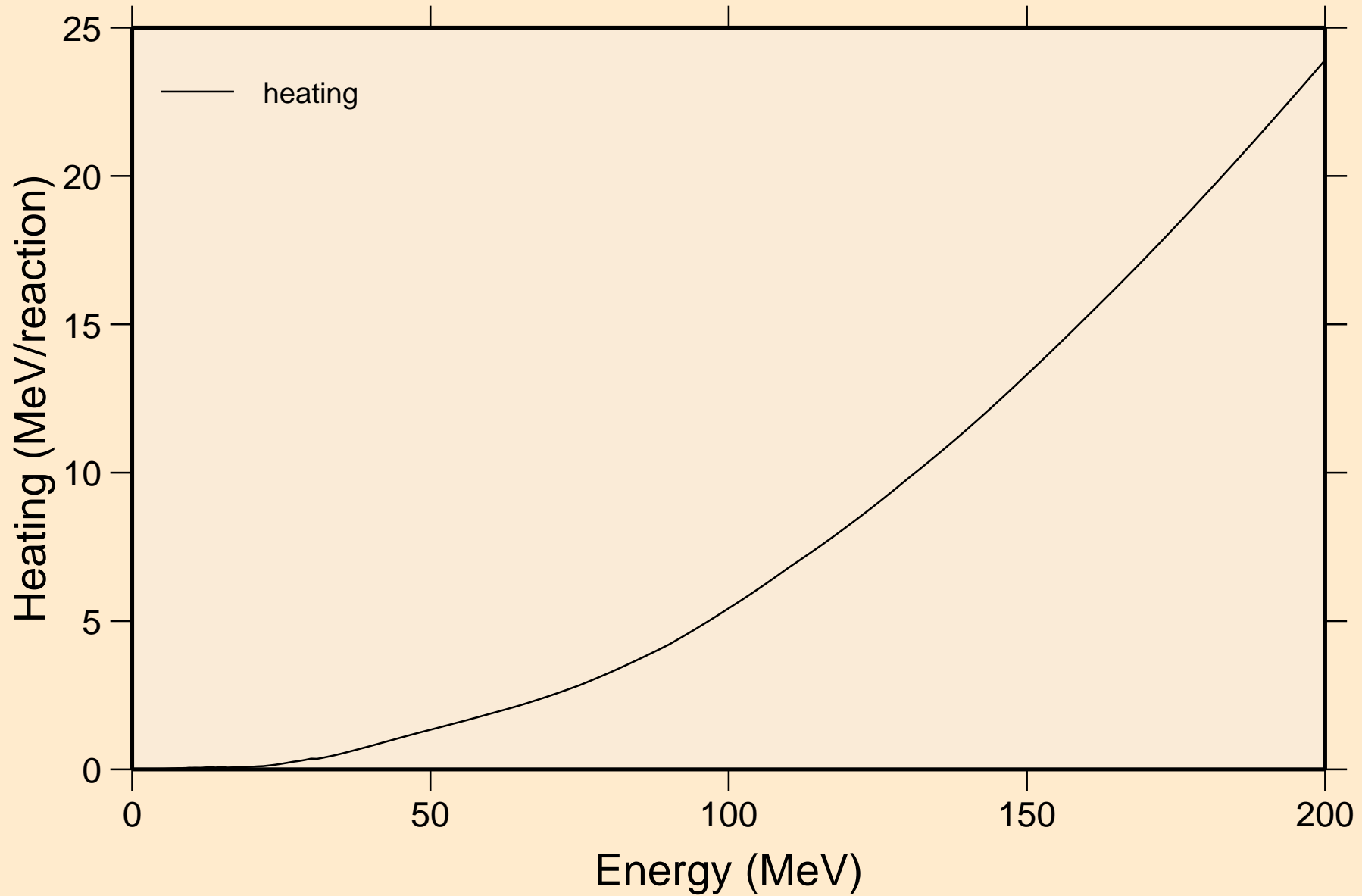

PB214 NEUTRON ACER TENDL-2021 LIBRARY; T=293.6K
Damage

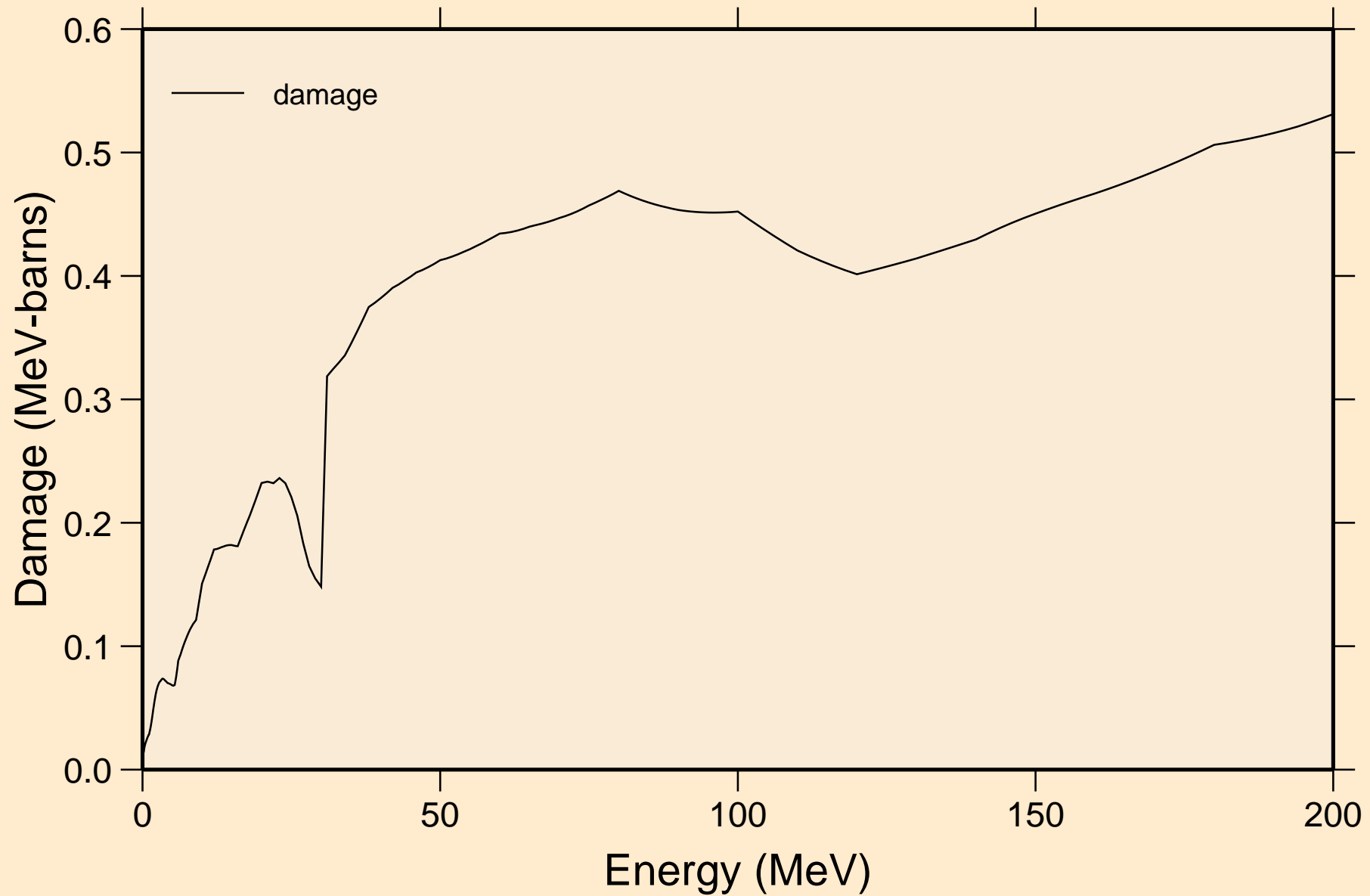

PB214 NEUTRON ACER TENDL-2021 LIBRARY; T=293.6K
Non-threshold reactions

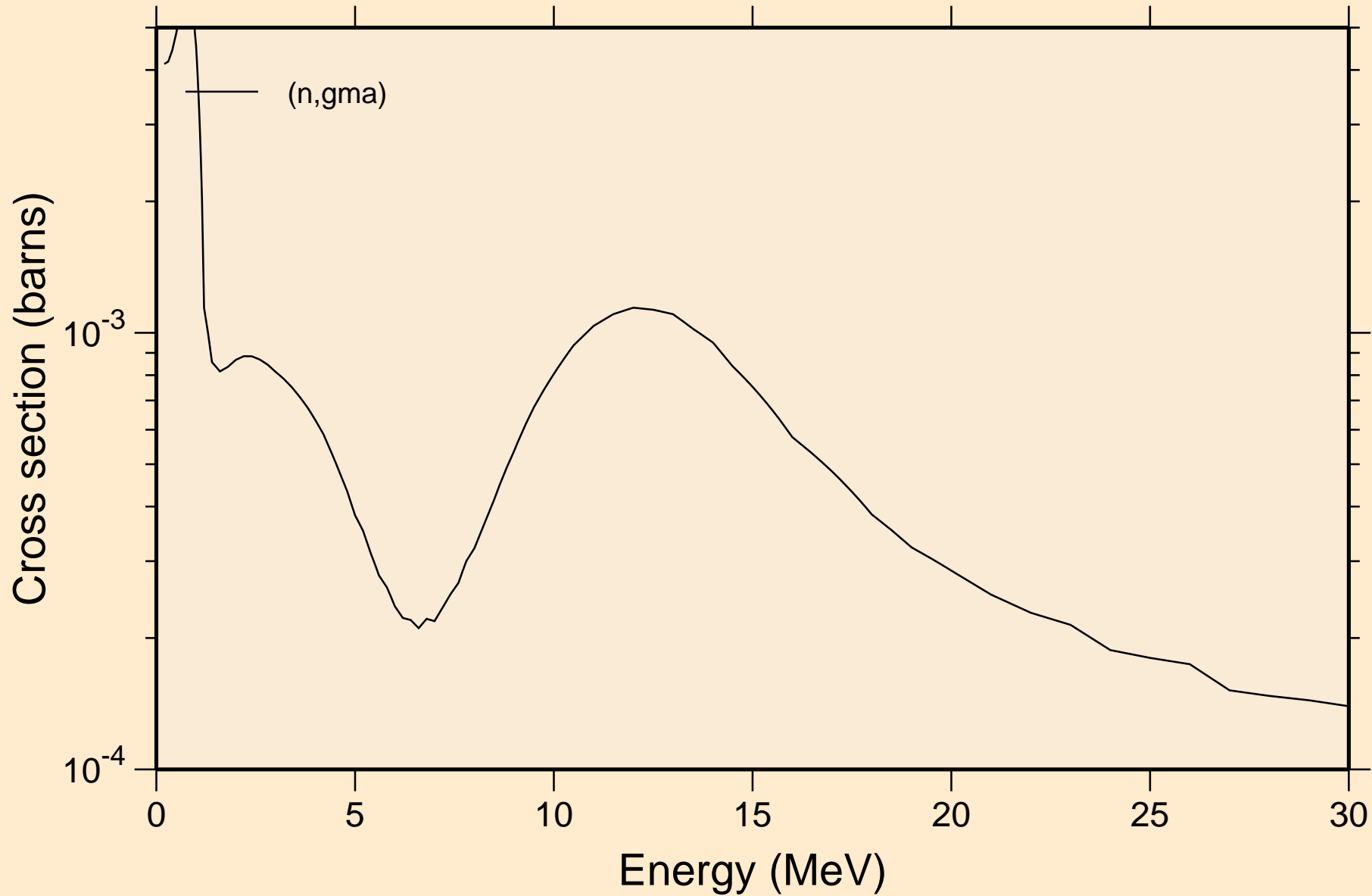

PB214 NEUTRON ACER TENDL-2021 LIBRARY; T=293.6K
Inelastic levels

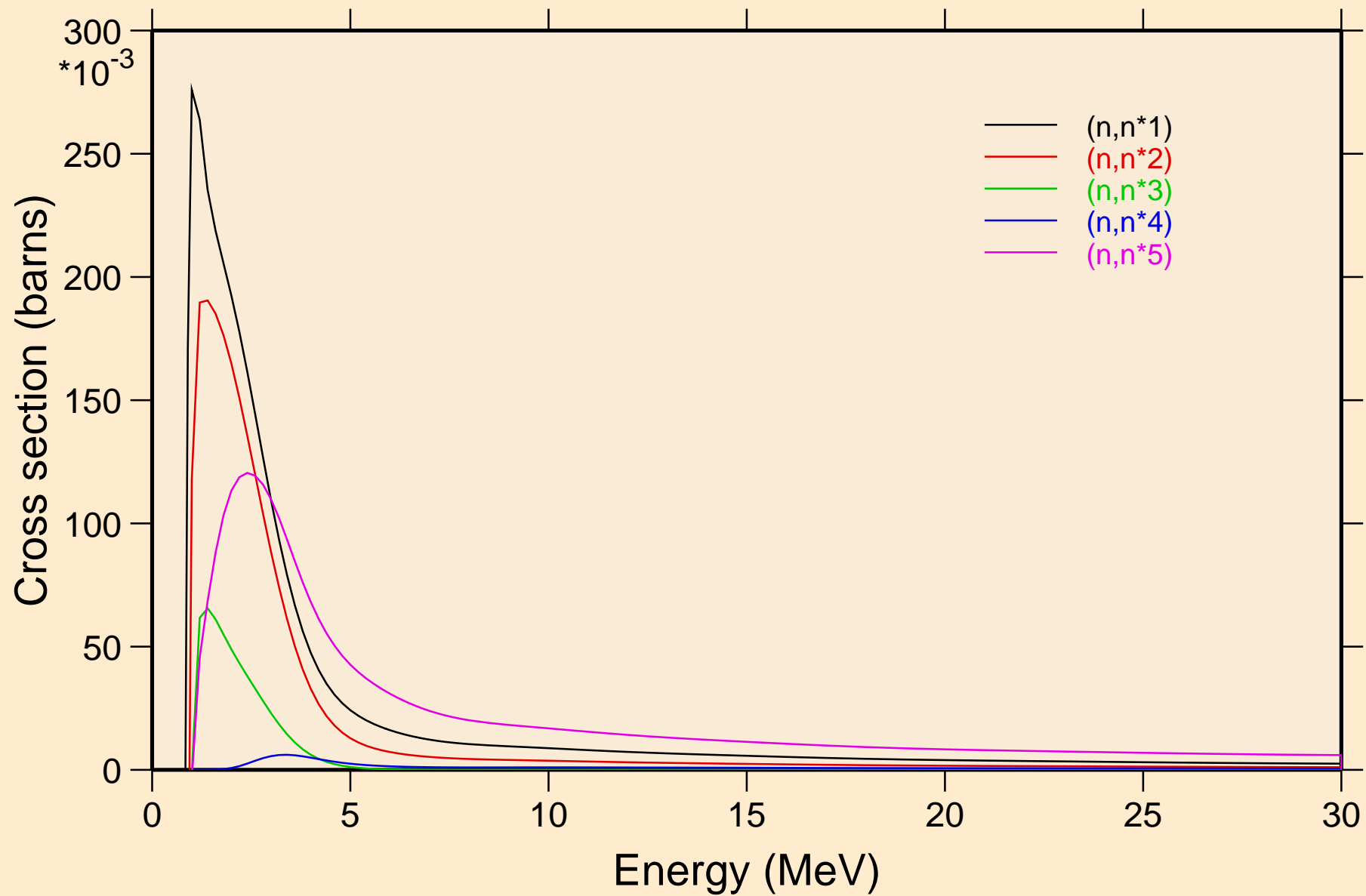

PB214 NEUTRON ACER TENDL-2021 LIBRARY; T=293.6K
Inelastic levels

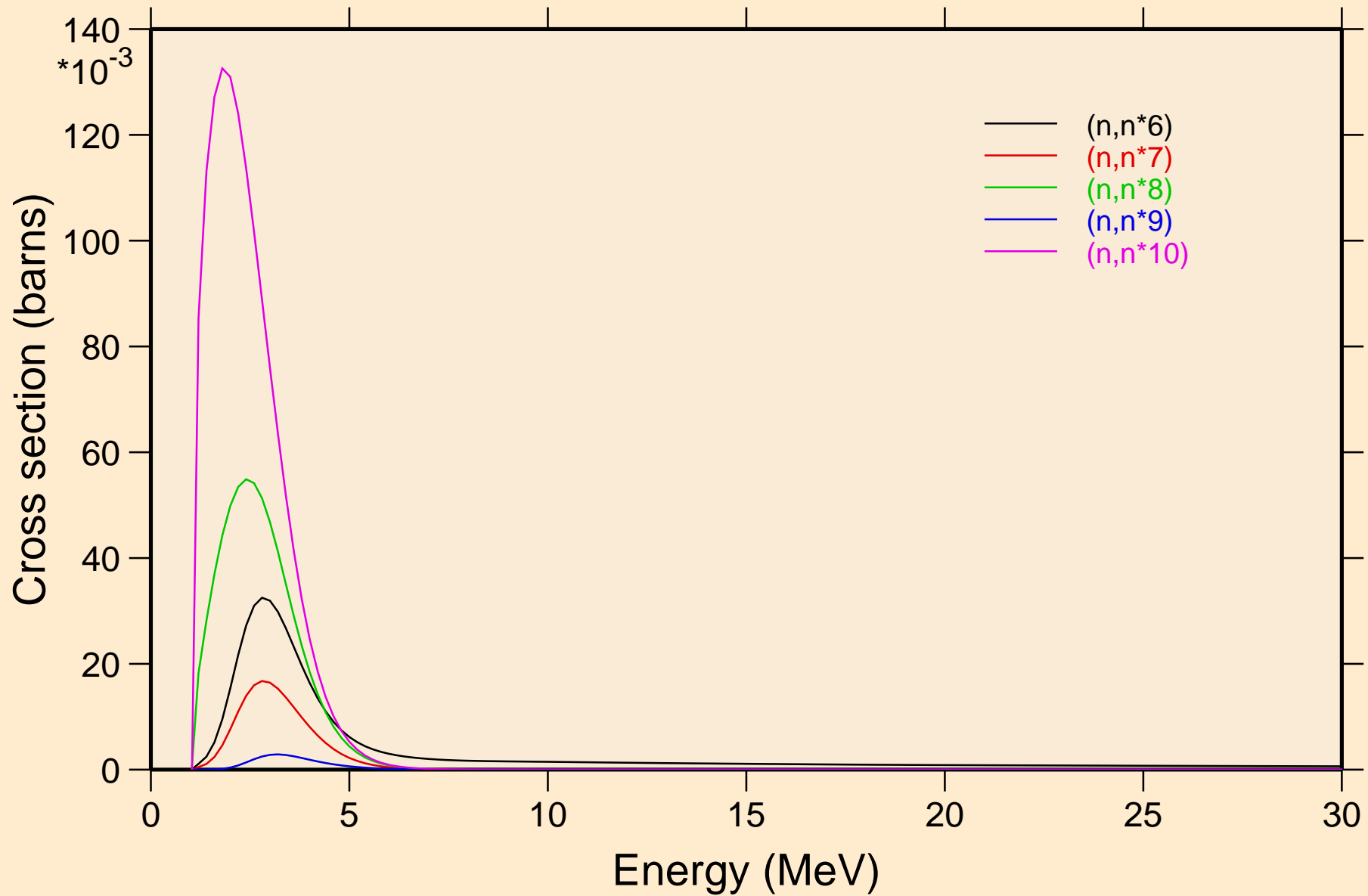

PB214 NEUTRON ACER TENDL-2021 LIBRARY; T=293.6K
Inelastic levels

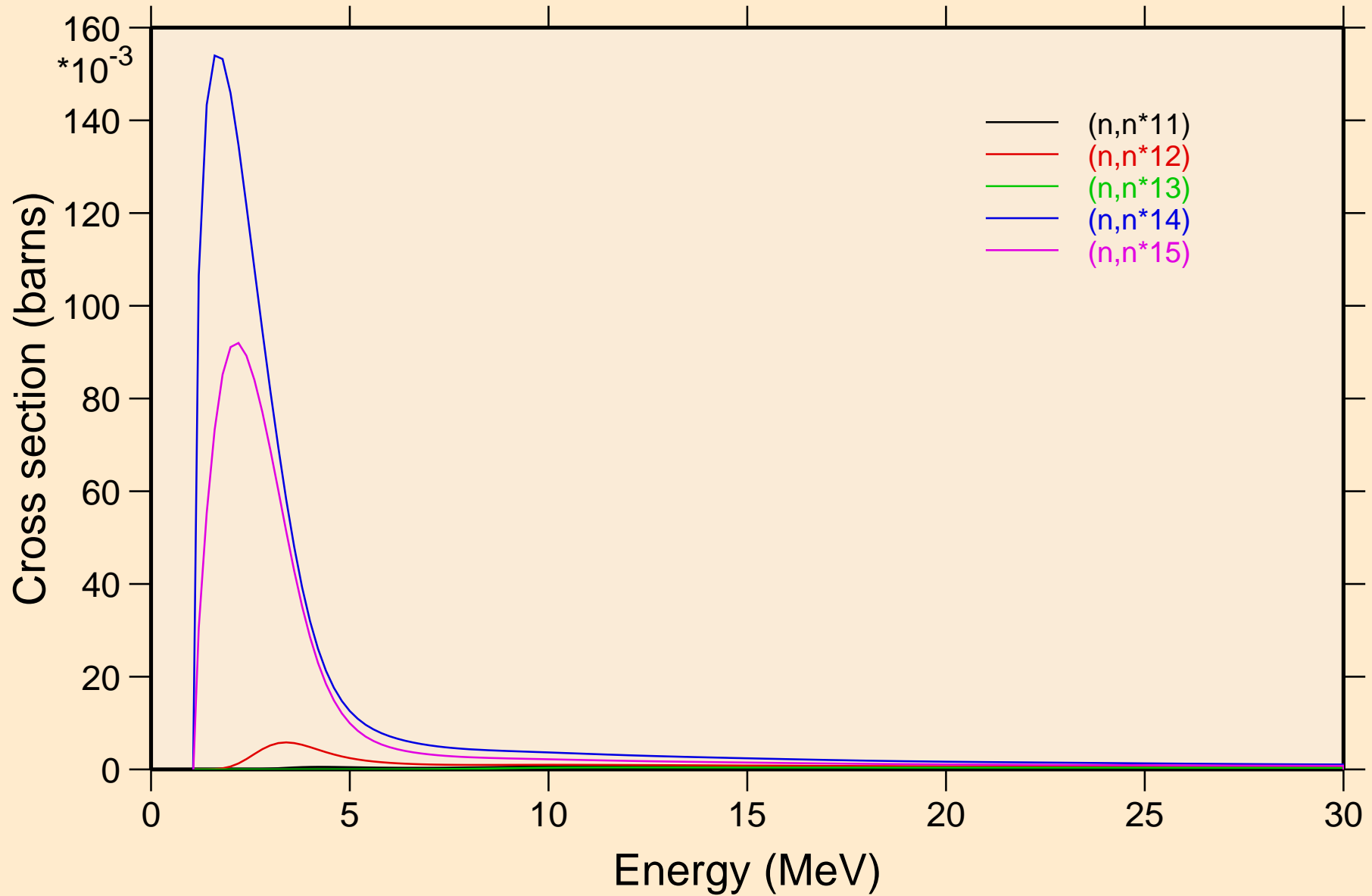

PB214 NEUTRON ACER TENDL-2021 LIBRARY; T=293.6K
Inelastic levels

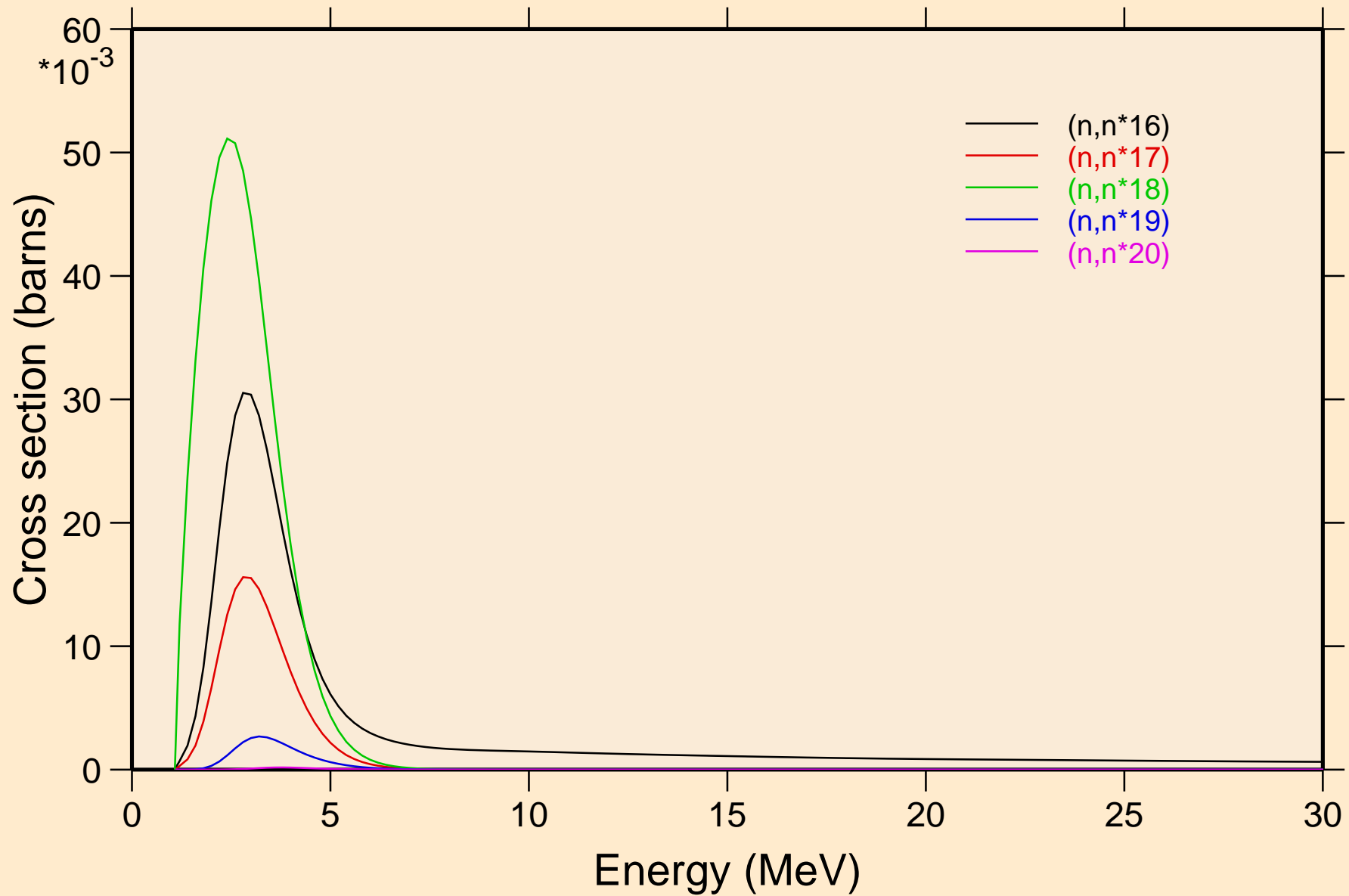

PB214 NEUTRON ACER TENDL-2021 LIBRARY; T=293.6K
Inelastic levels

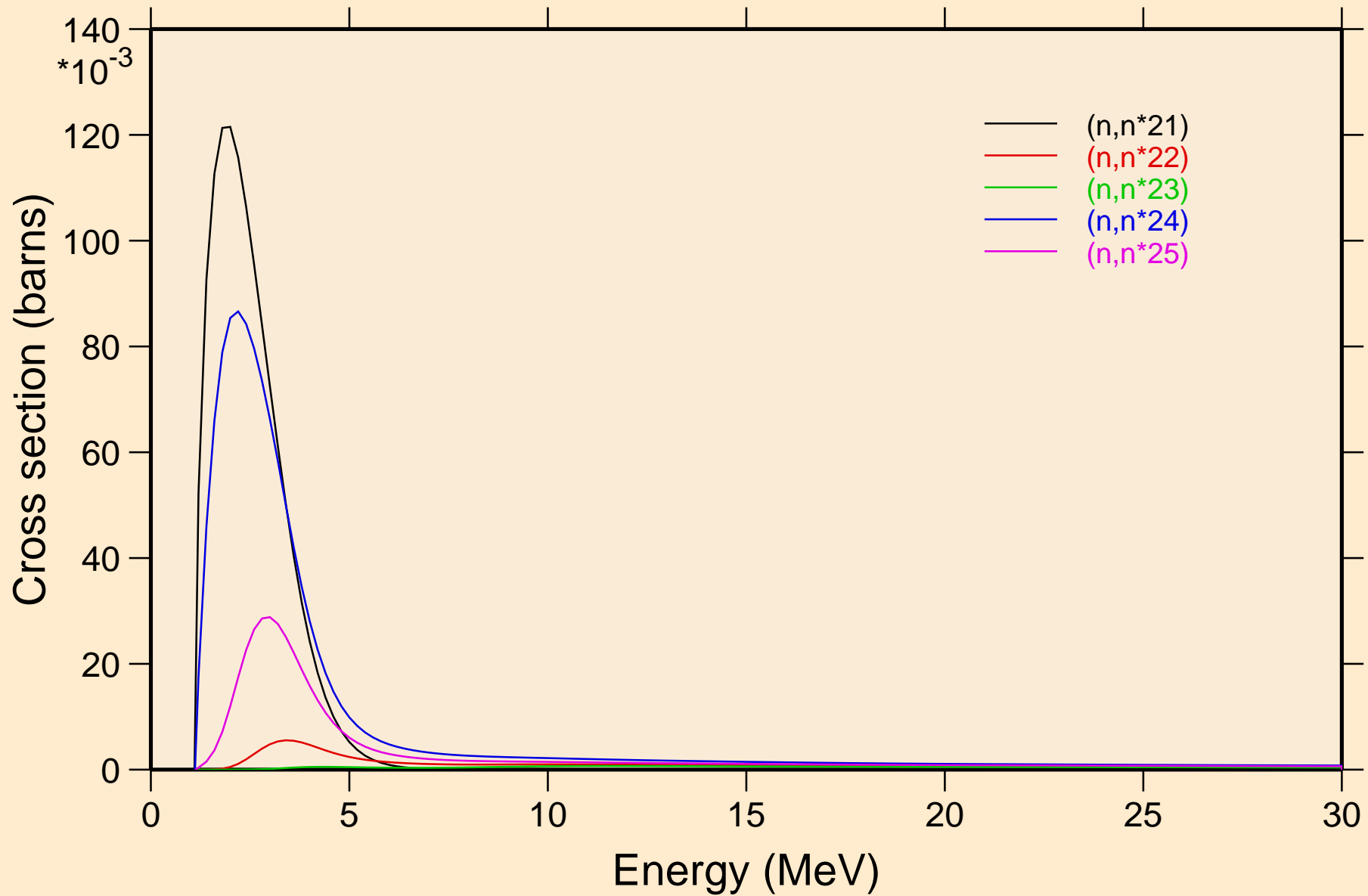

PB214 NEUTRON ACER TENDL-2021 LIBRARY; T=293.6K
Inelastic levels

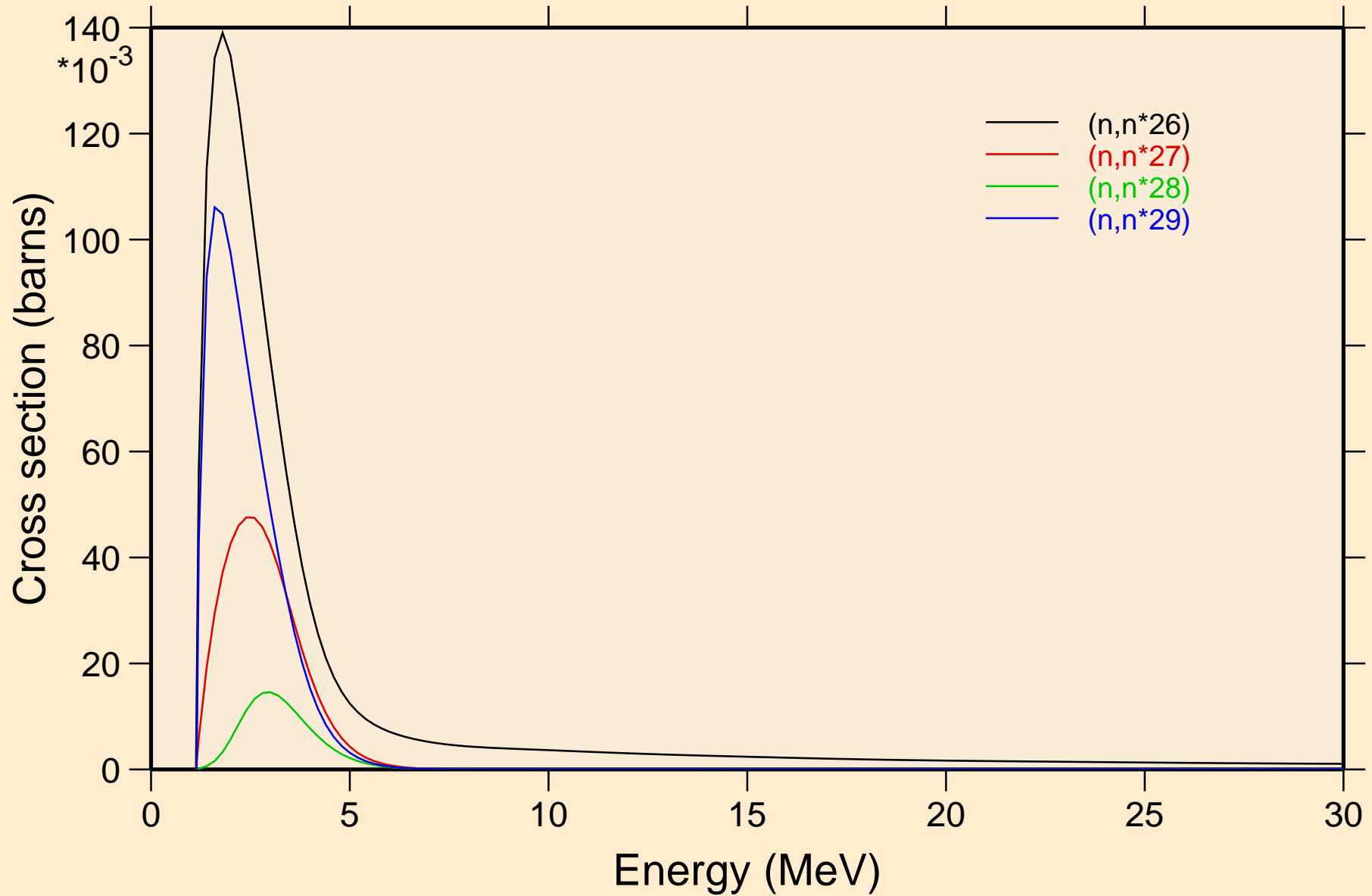

PB214 NEUTRON ACER TENDL-2021 LIBRARY; T=293.6K
Threshold reactions

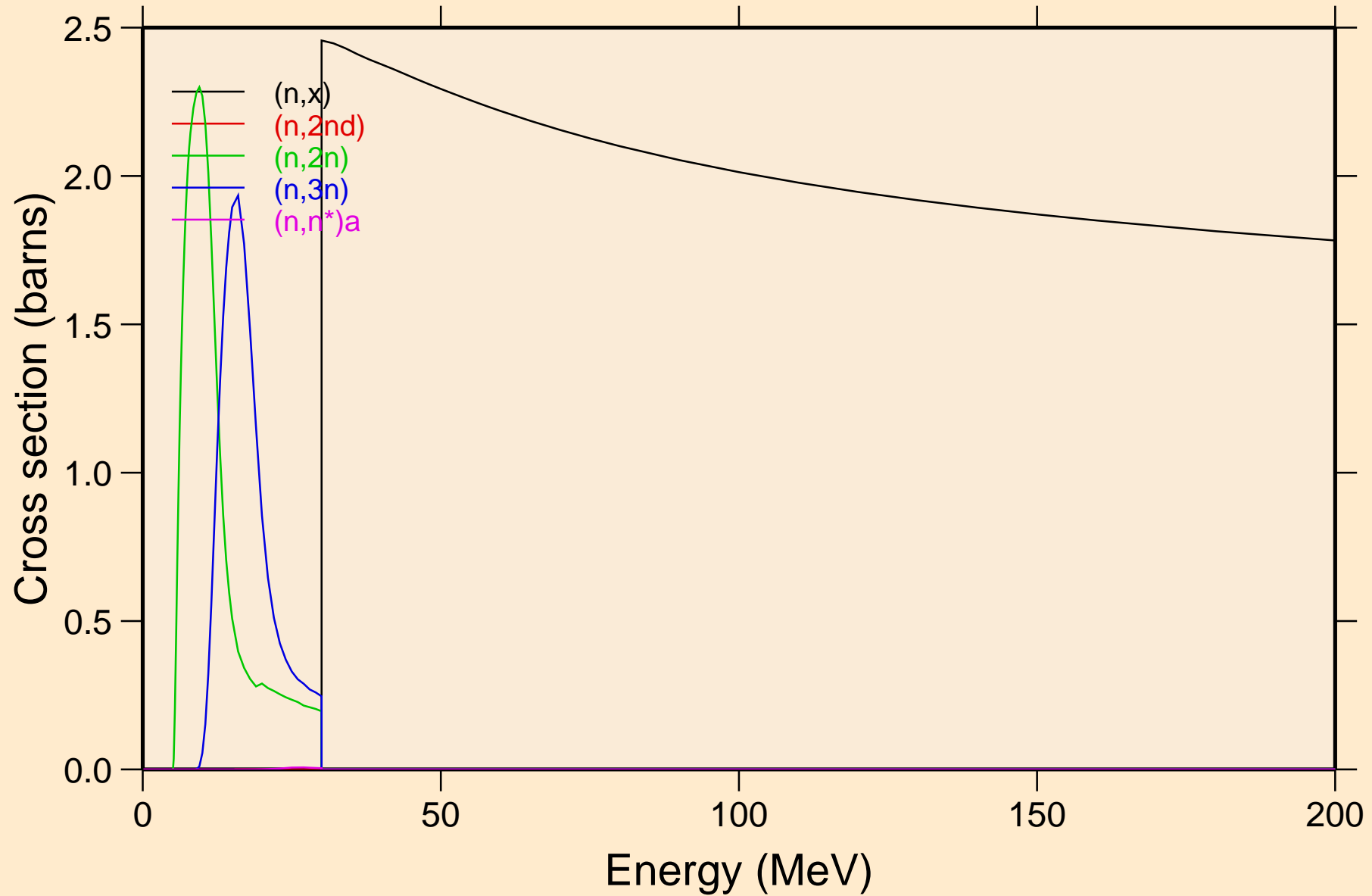

PB214 NEUTRON ACER TENDL-2021 LIBRARY; T=293.6K
Threshold reactions

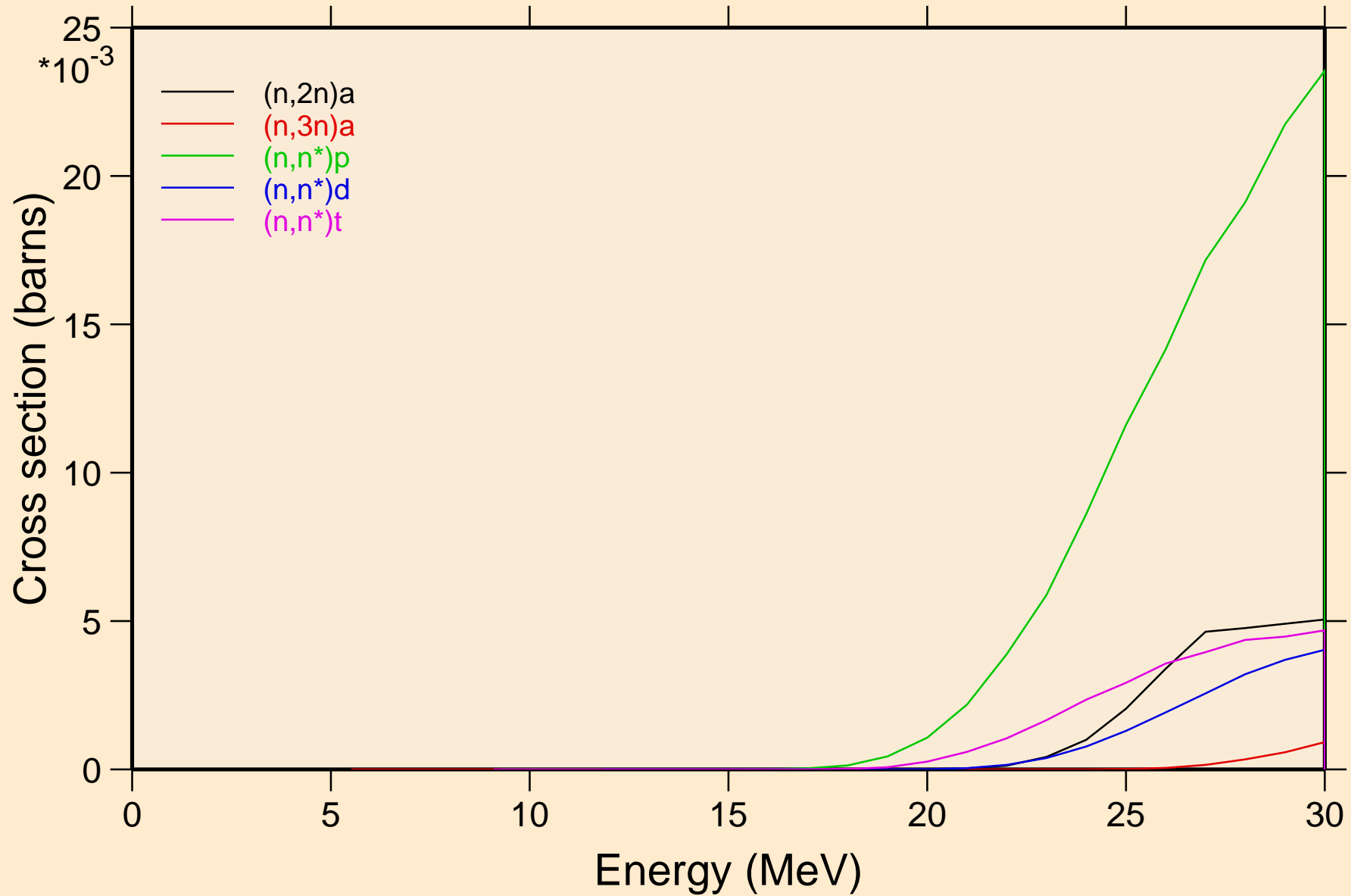

PB214 NEUTRON ACER TENDL-2021 LIBRARY; T=293.6K
Threshold reactions

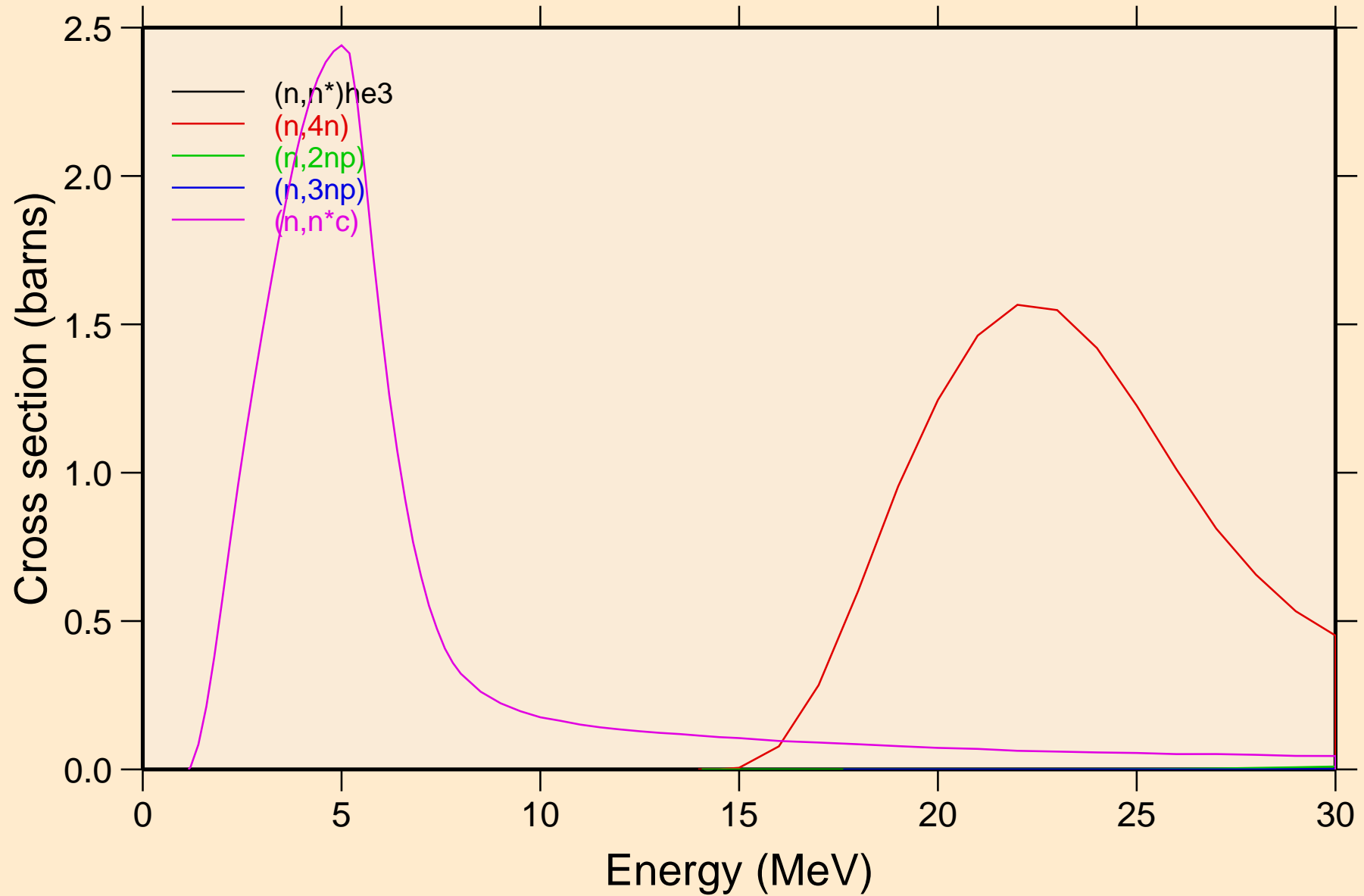

PB214 NEUTRON ACER TENDL-2021 LIBRARY; T=293.6K
Threshold reactions

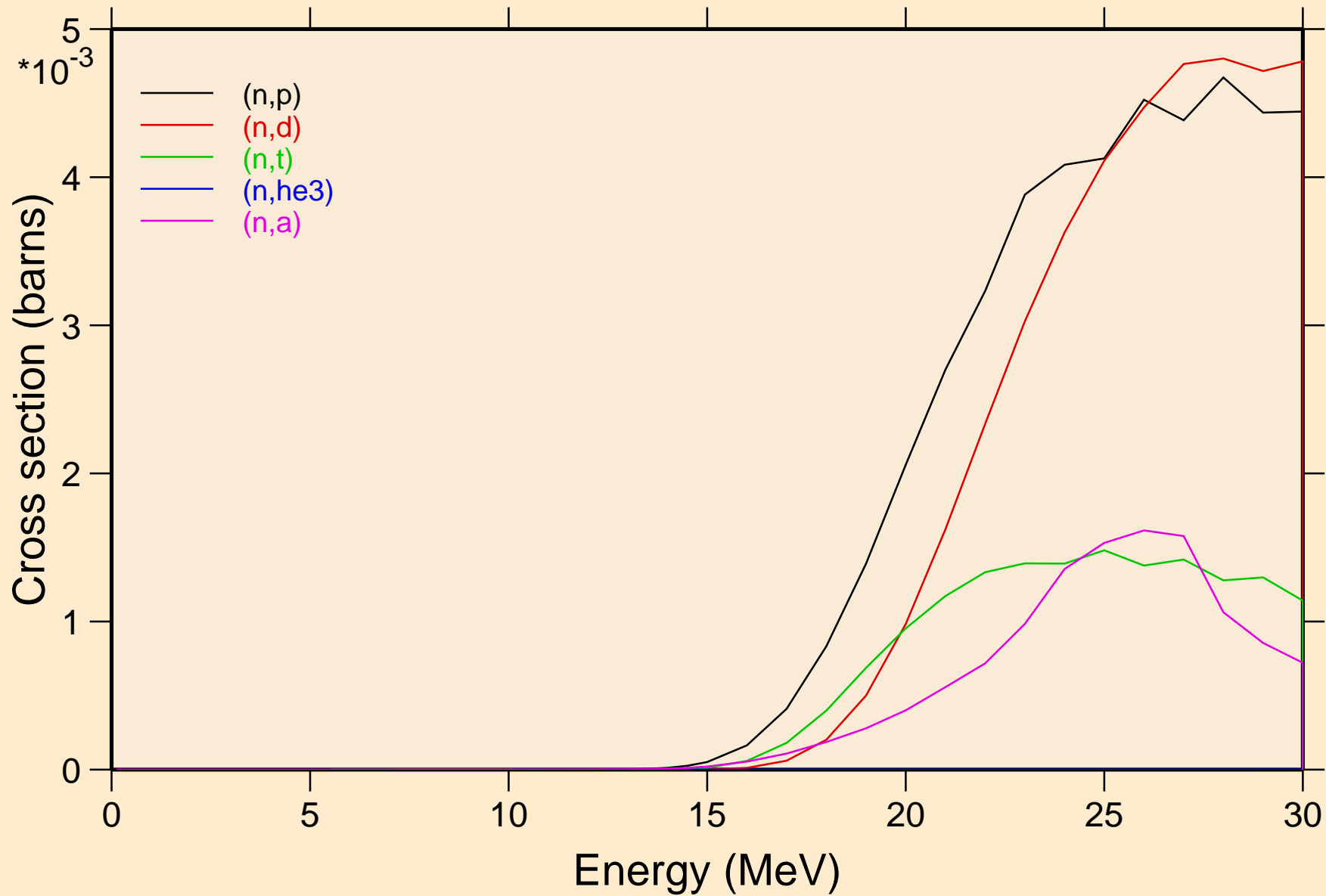

PB214 NEUTRON ACER TENDL-2021 LIBRARY; T=293.6K
Threshold reactions

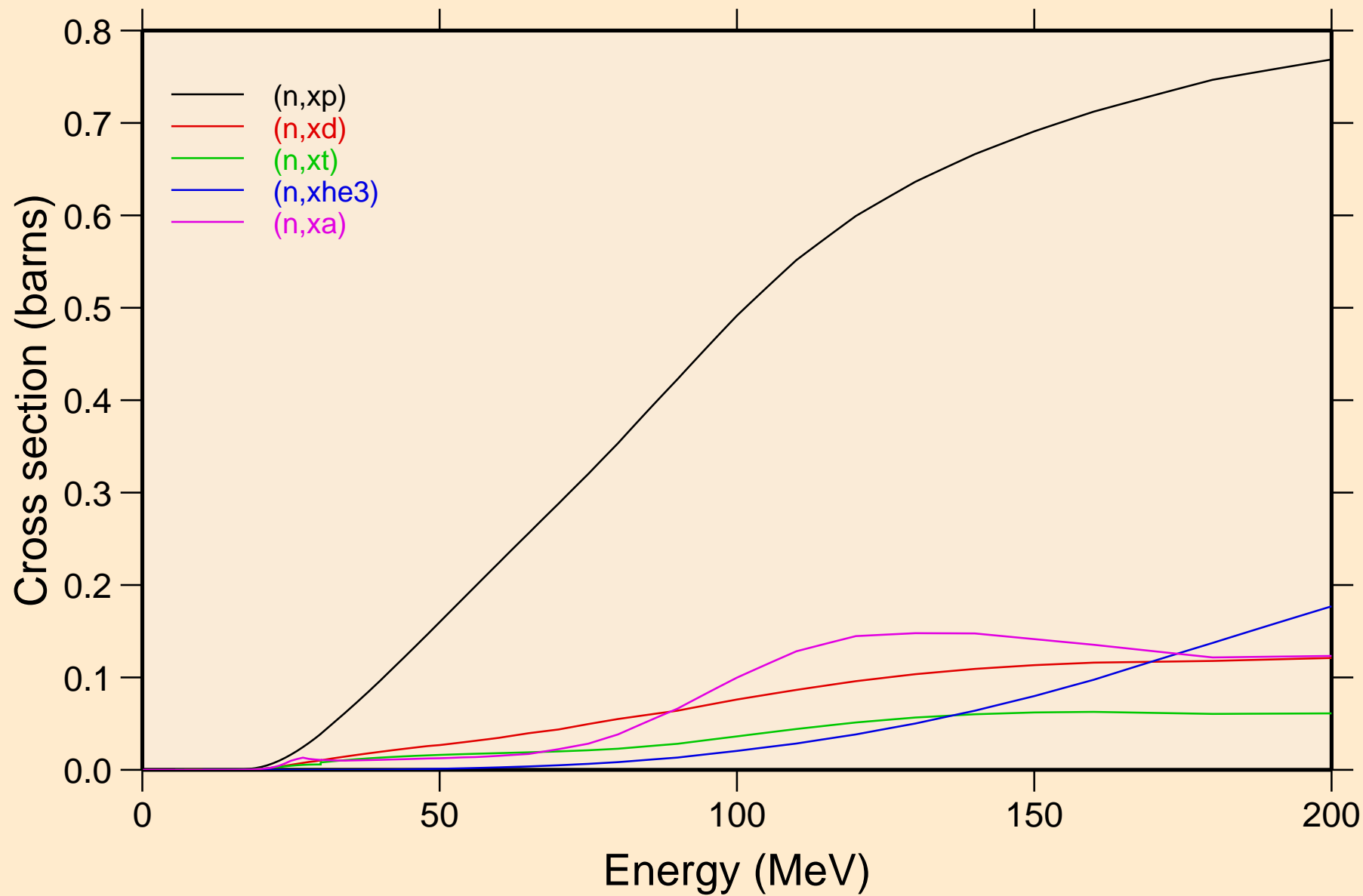

PB214 NEUTRON ACER TENDL-2021 LIBRARY; T=293.6K
angular distribution for elastic

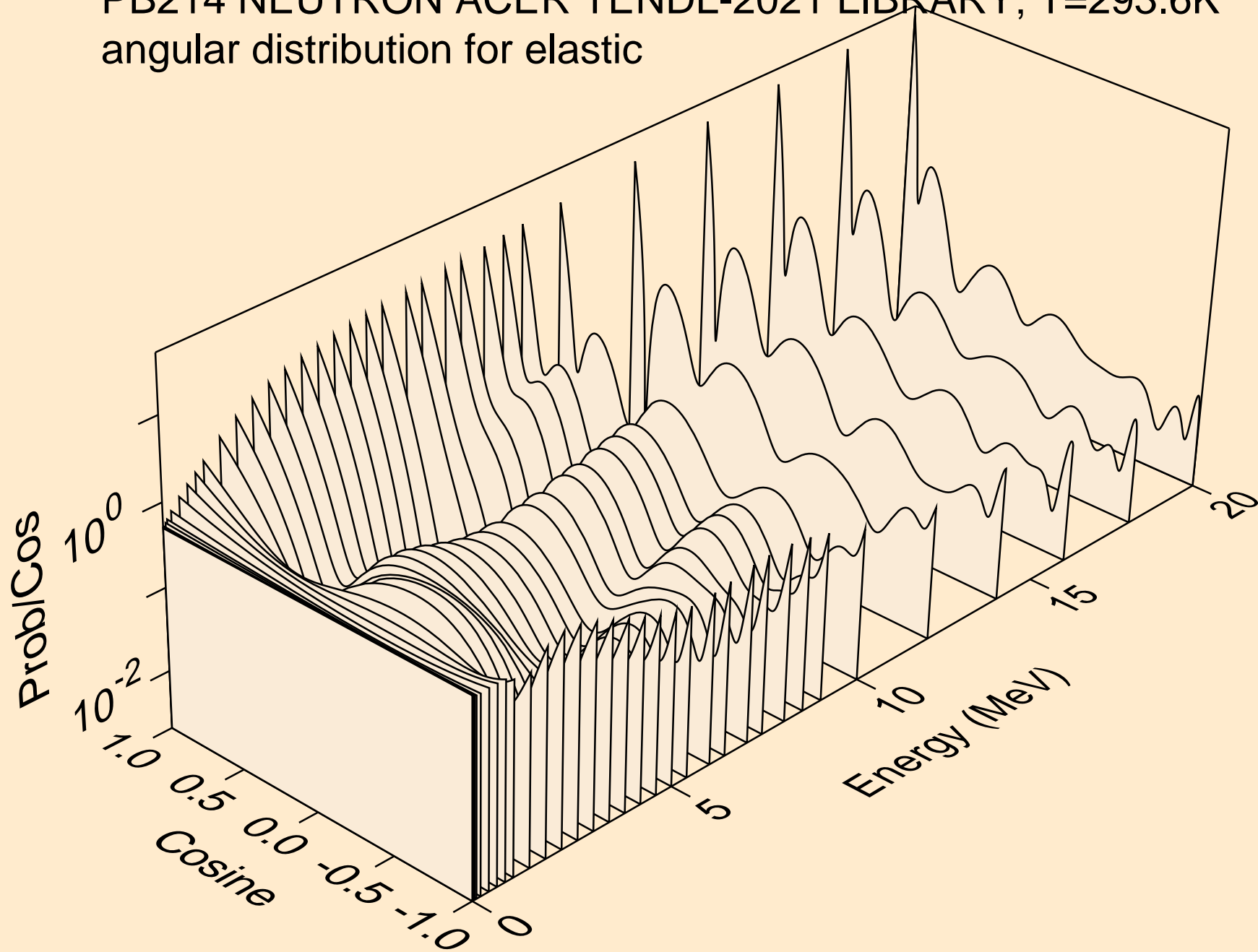

PB214 NEUTRON ACER TENDL-2021 LIBRARY; T=293.6K
angular distribution for elastic

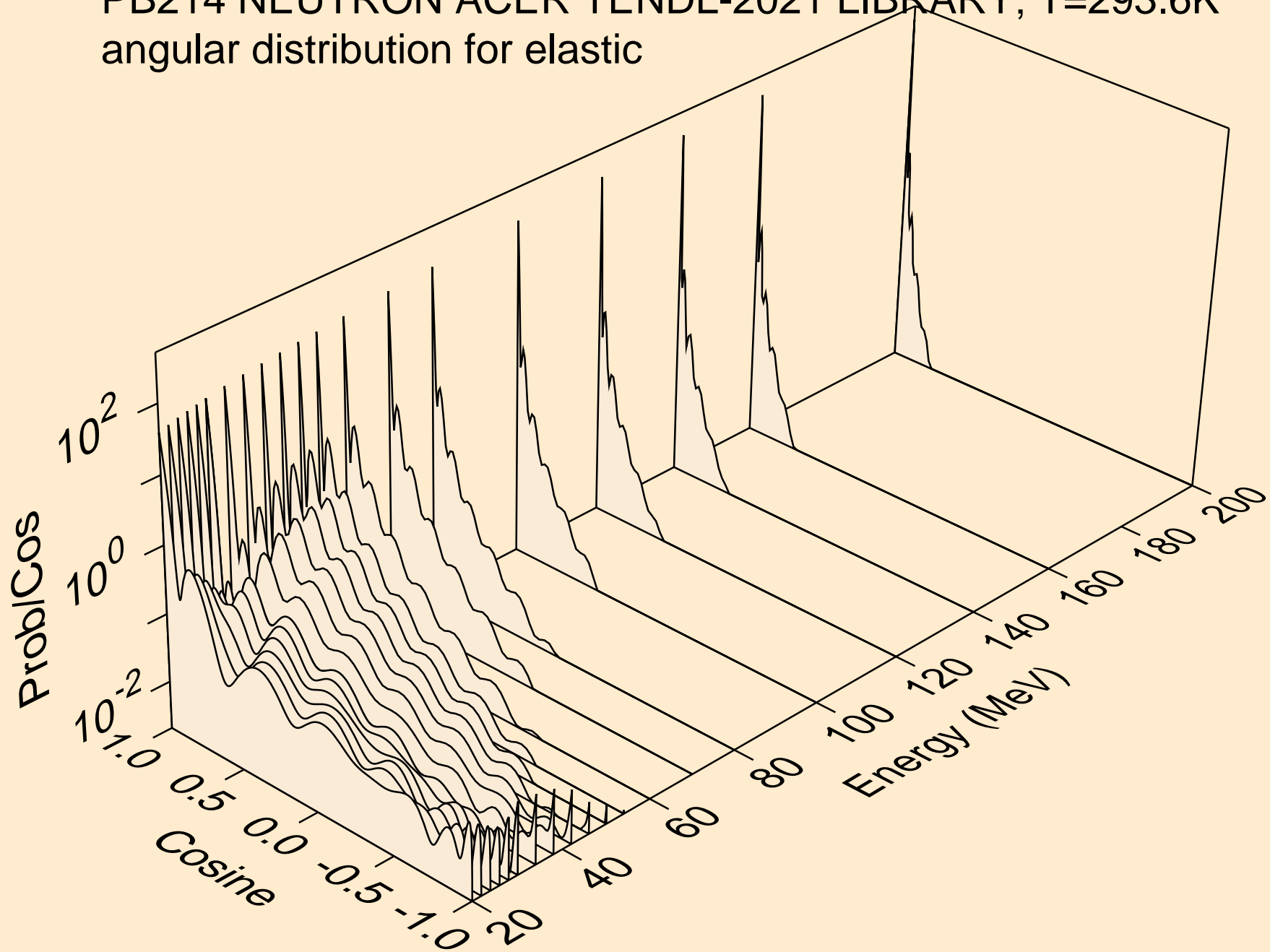

PB214 NEUTRON ACER TENDL-2021 LIBRARY; T=293.6K
angular distribution for (n,n*1)

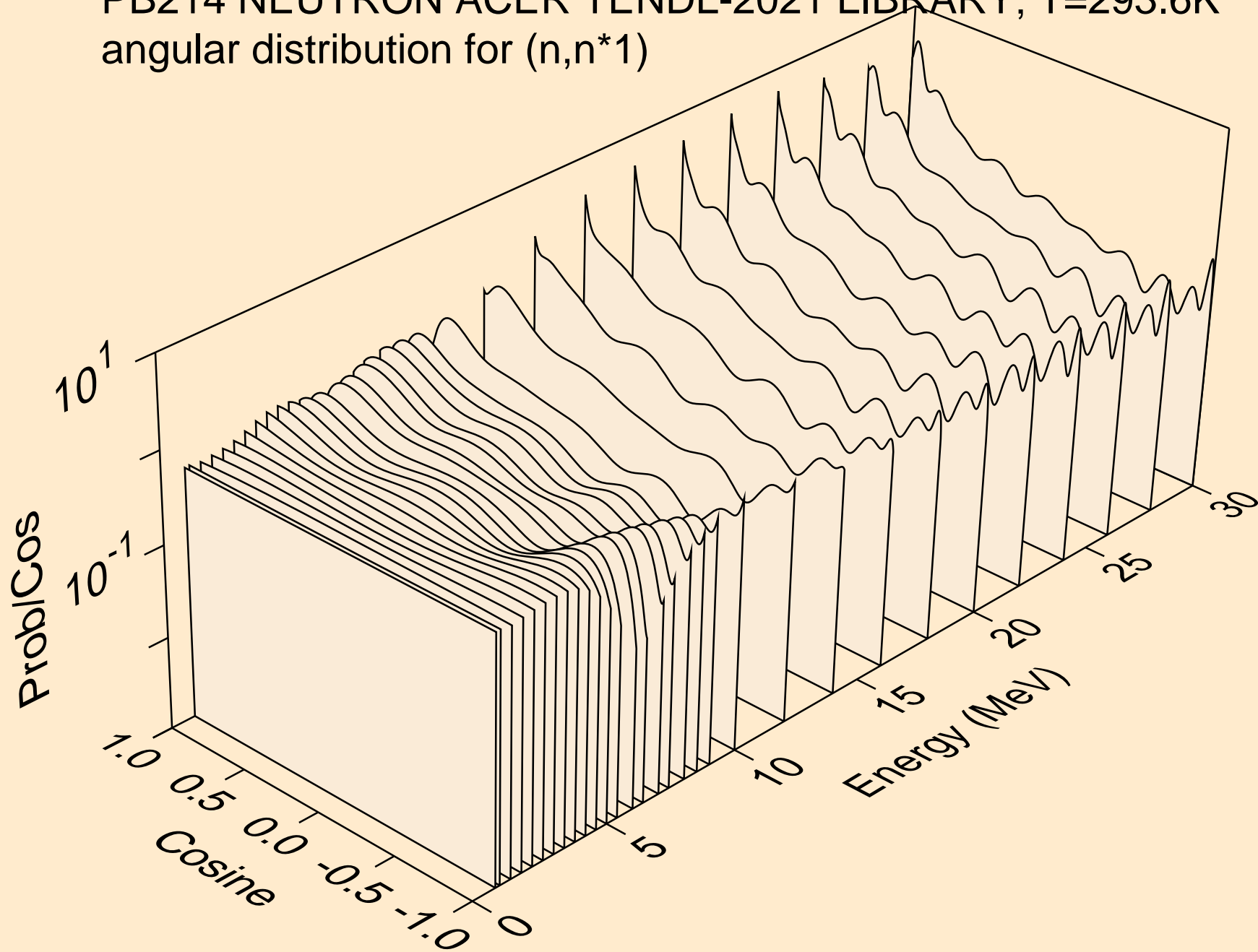

PB214 NEUTRON ACER TENDL-2021 LIBRARY; T=293.6K
angular distribution for (n,n*2)

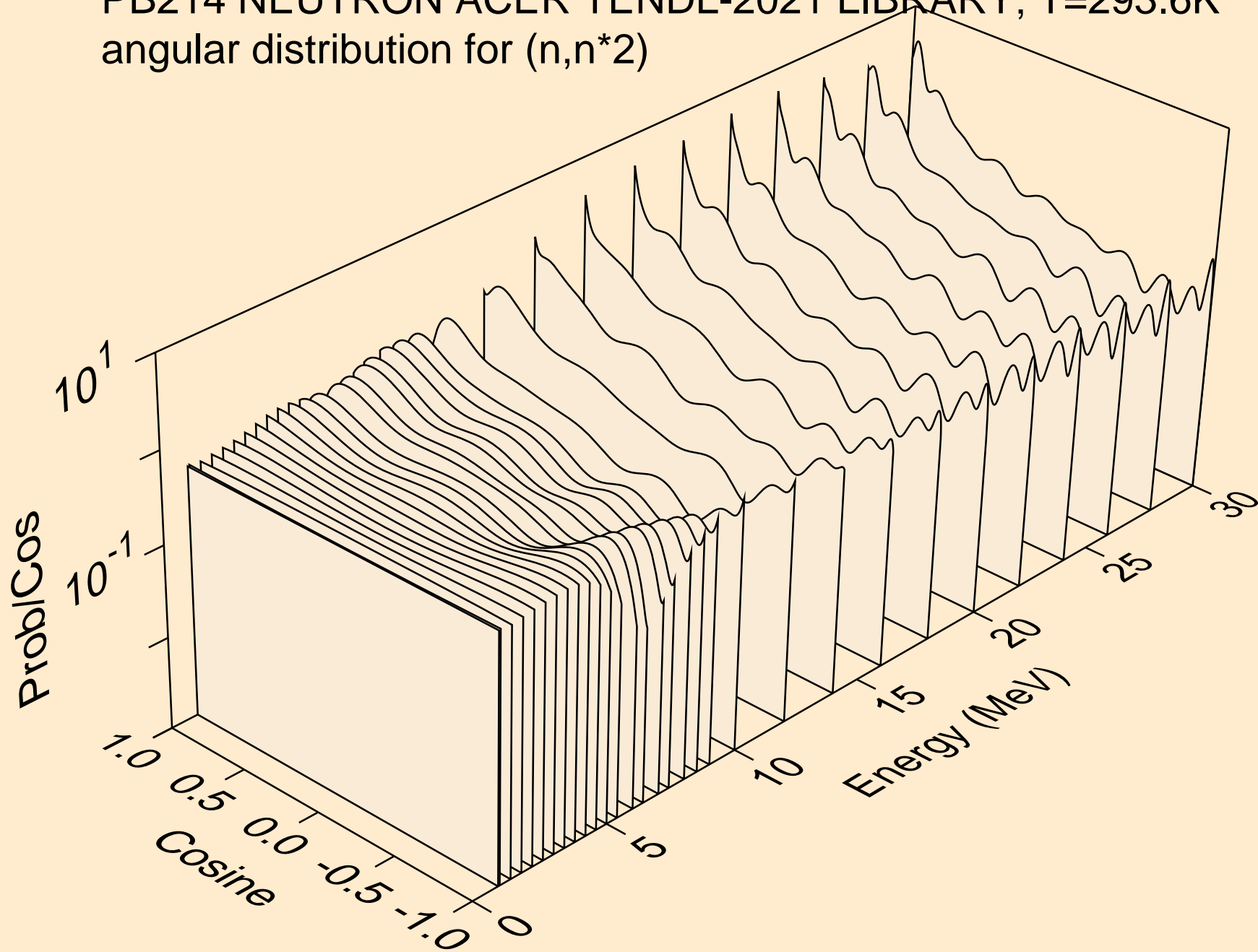

PB214 NEUTRON ACER TENDL-2021 LIBRARY; T=293.6K
angular distribution for (n,n*3)

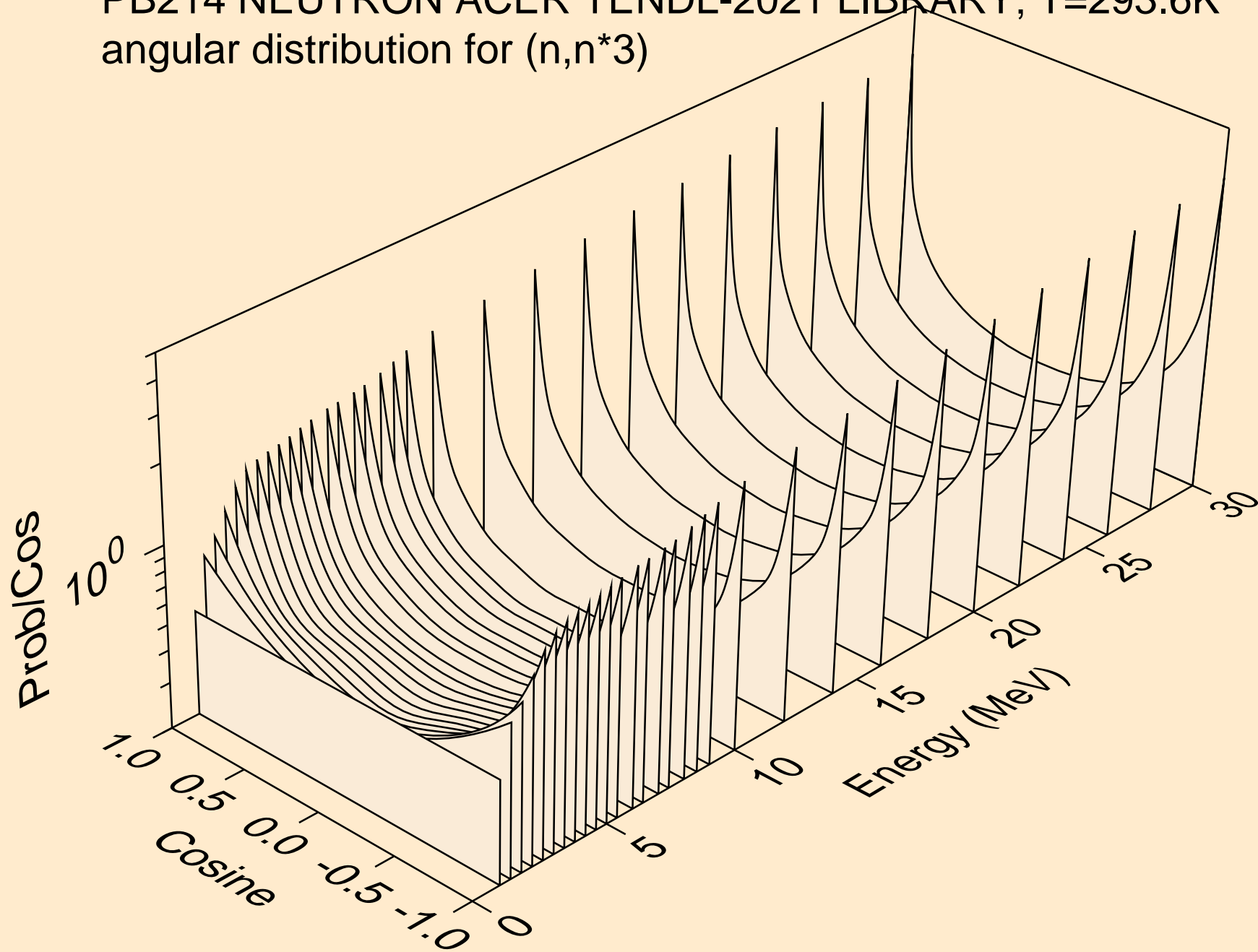

PB214 NEUTRON ACER TENDL-2021 LIBRARY; T=293.6K
angular distribution for (n,n*4)

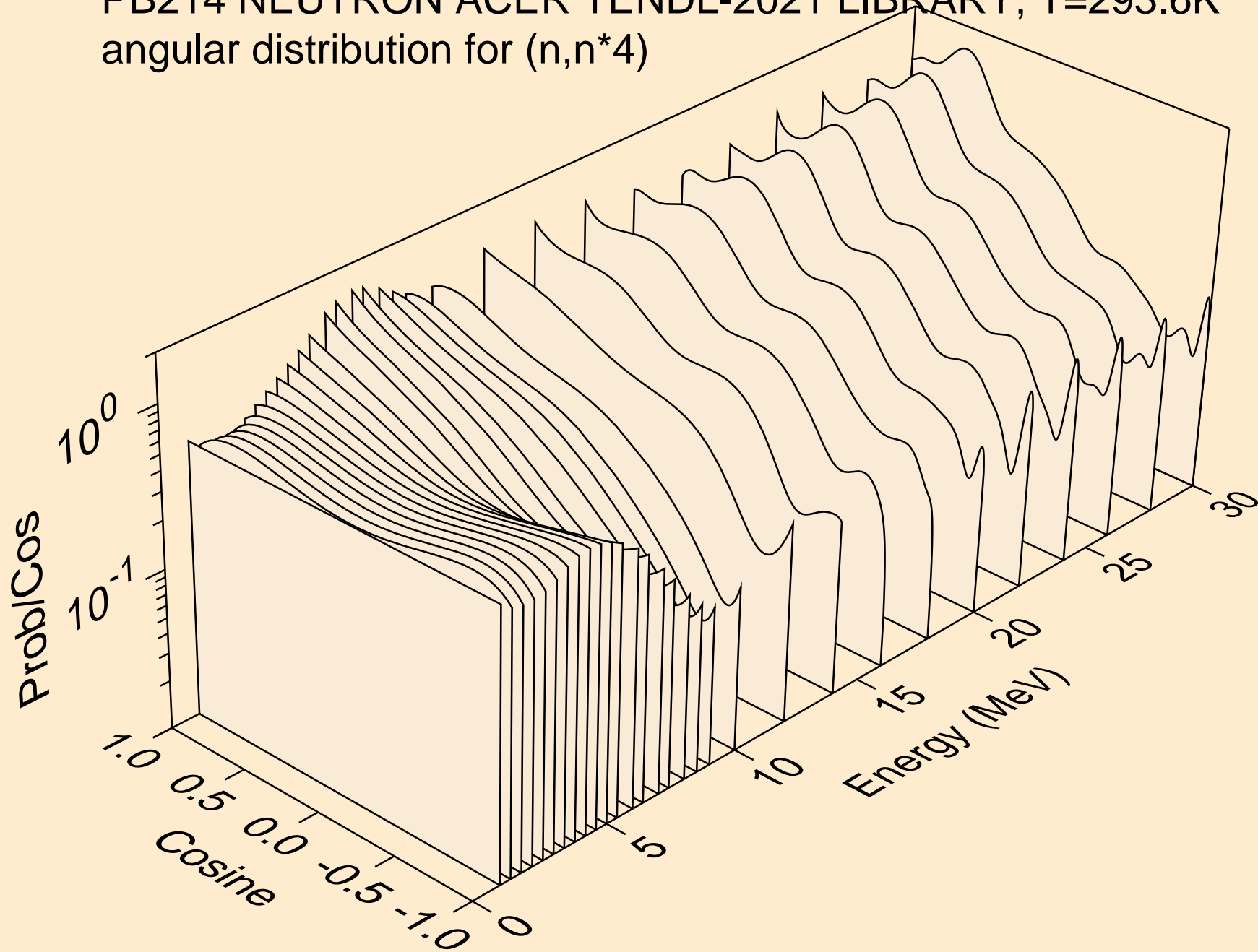

PB214 NEUTRON ACER TENDL-2021 LIBRARY; T=293.6K
angular distribution for (n,n*5)

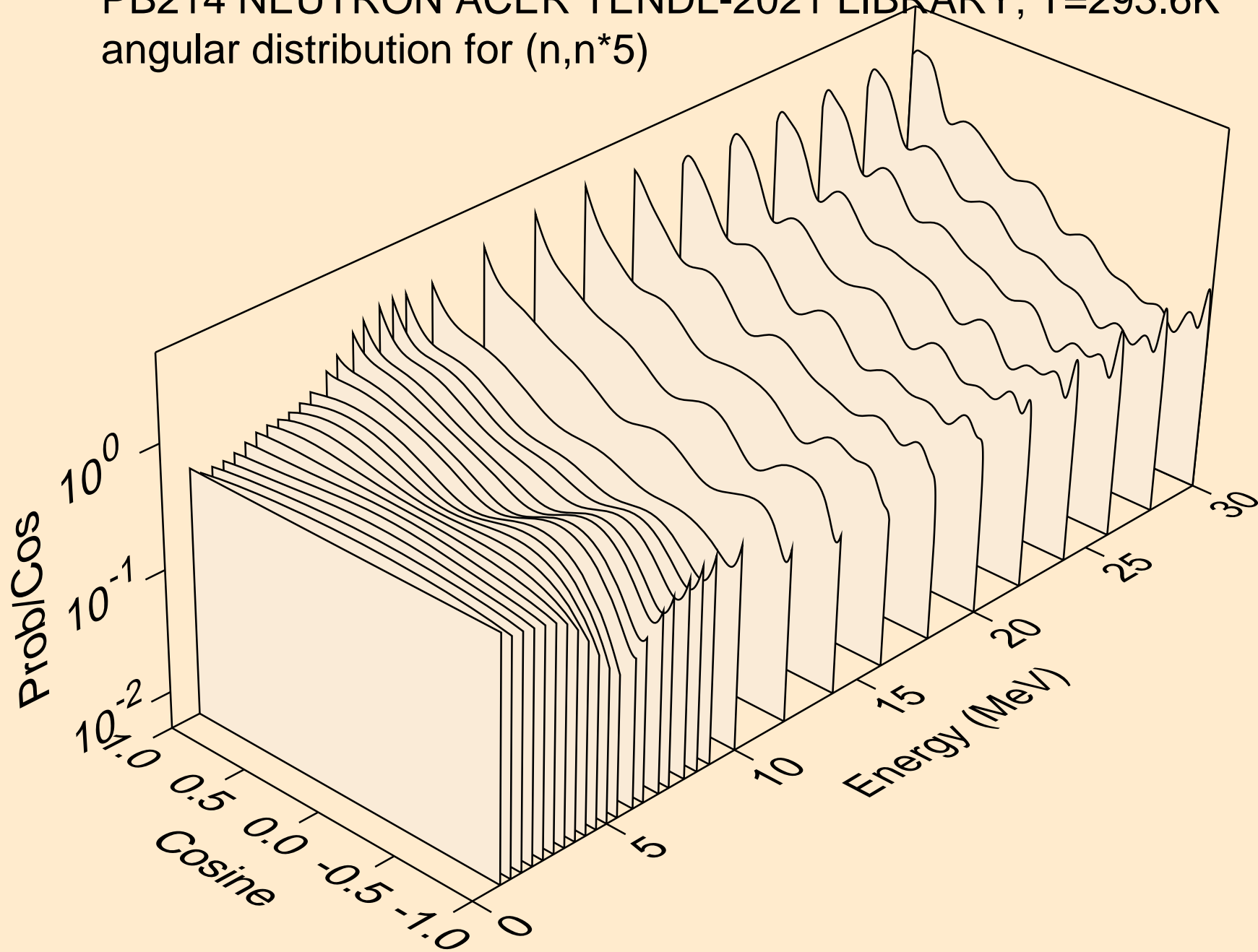

PB214 NEUTRON ACER TENDL-2021 LIBRARY; T=293.6K
angular distribution for (n,n*6)

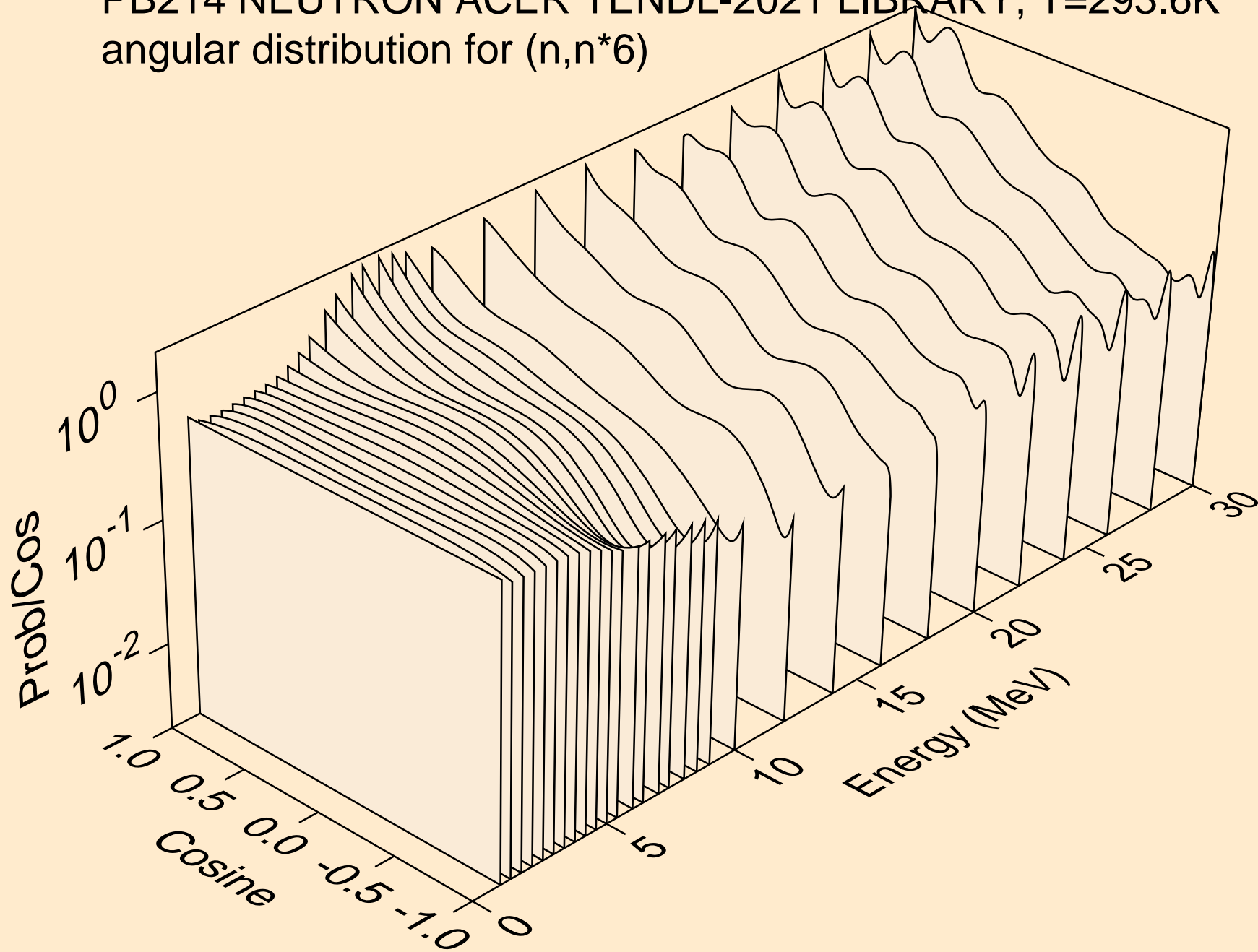

PB214 NEUTRON ACER TENDL-2021 LIBRARY; T=293.6K
angular distribution for (n,n*7)

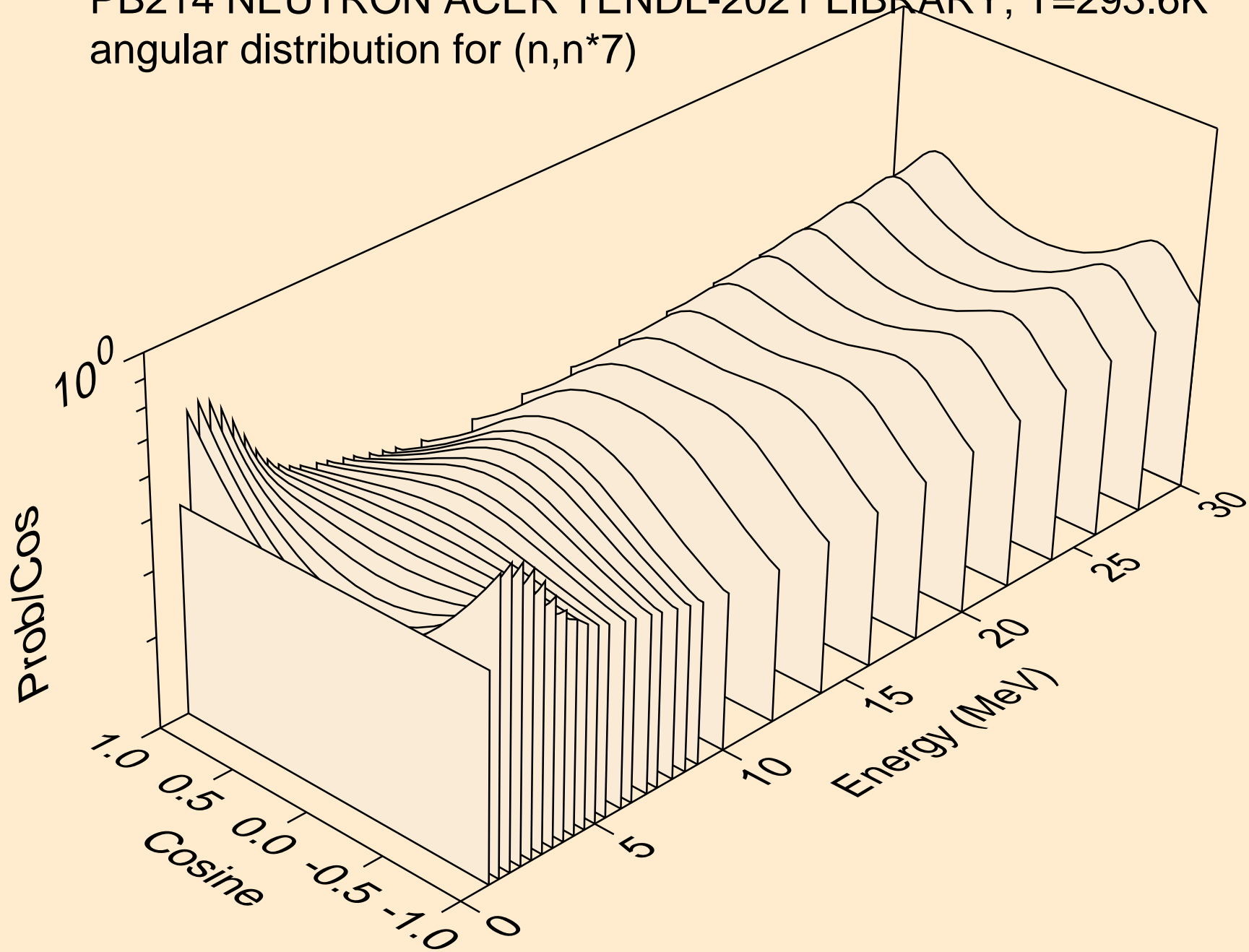

PB214 NEUTRON ACER TENDL-2021 LIBRARY; T=293.6K
angular distribution for (n,n*8)

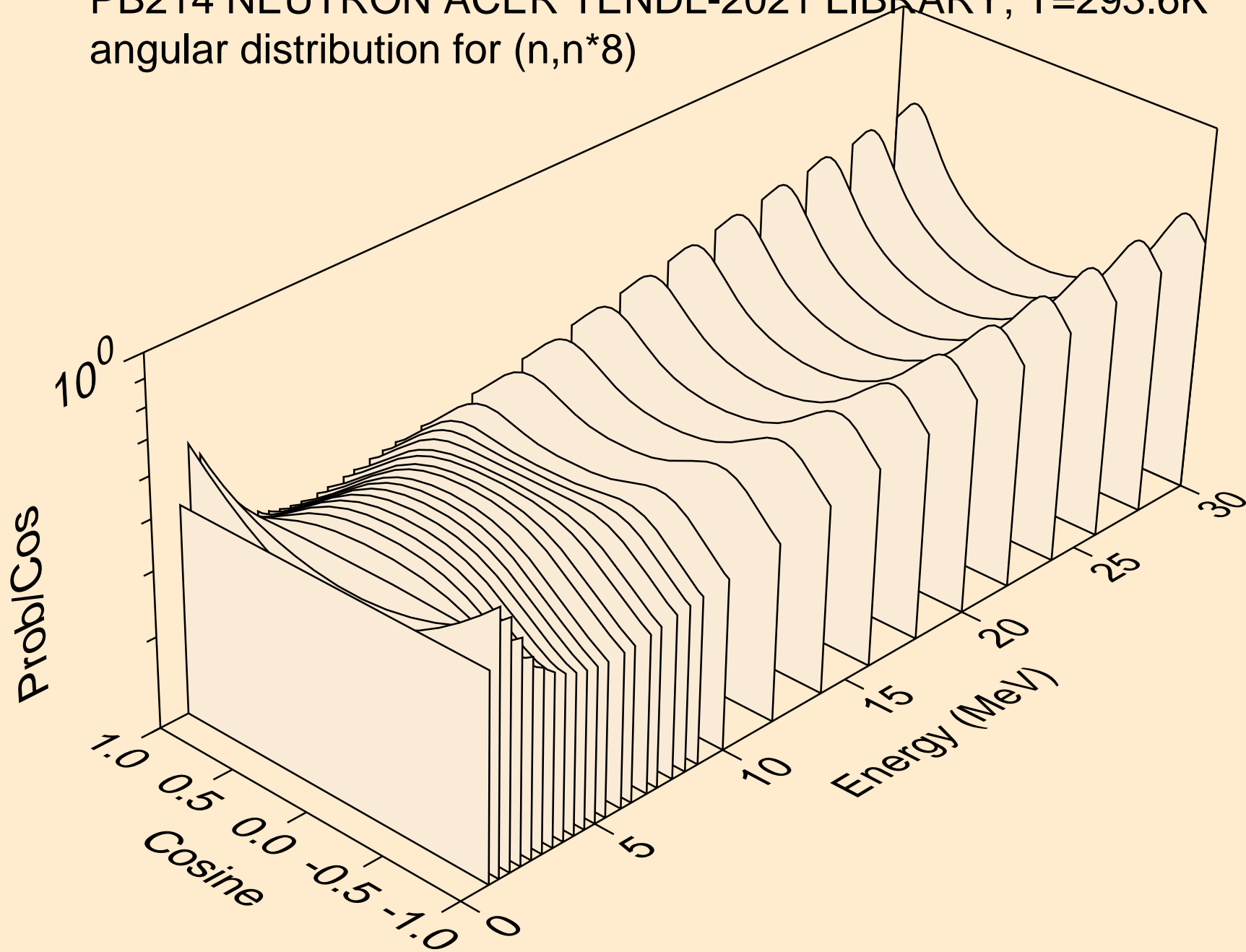

PB214 NEUTRON ACER TENDL-2021 LIBRARY; T=293.6K
angular distribution for (n,n*9)

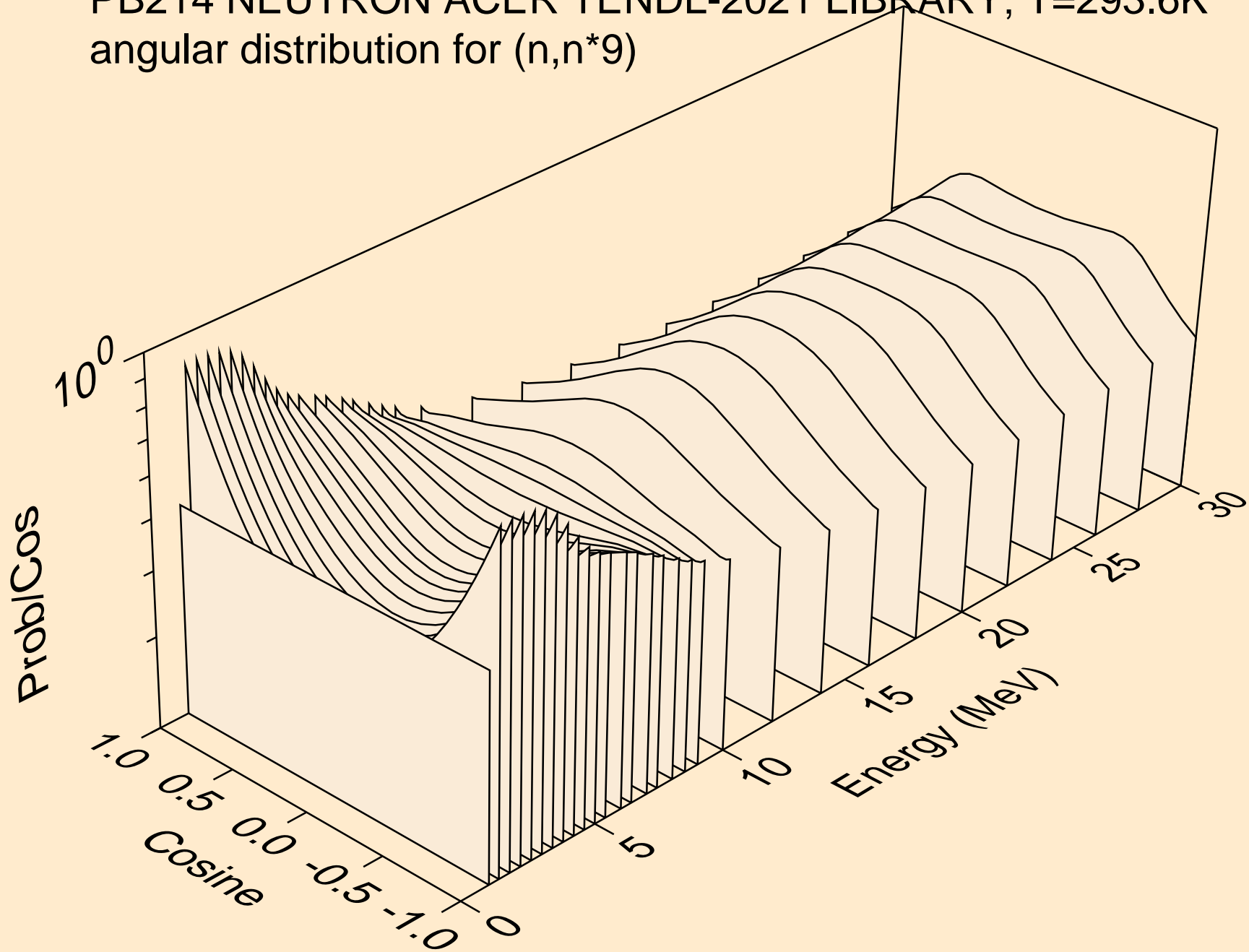

PB214 NEUTRON ACER TENDL-2021 LIBRARY; T=293.6K
angular distribution for (n,n*10)

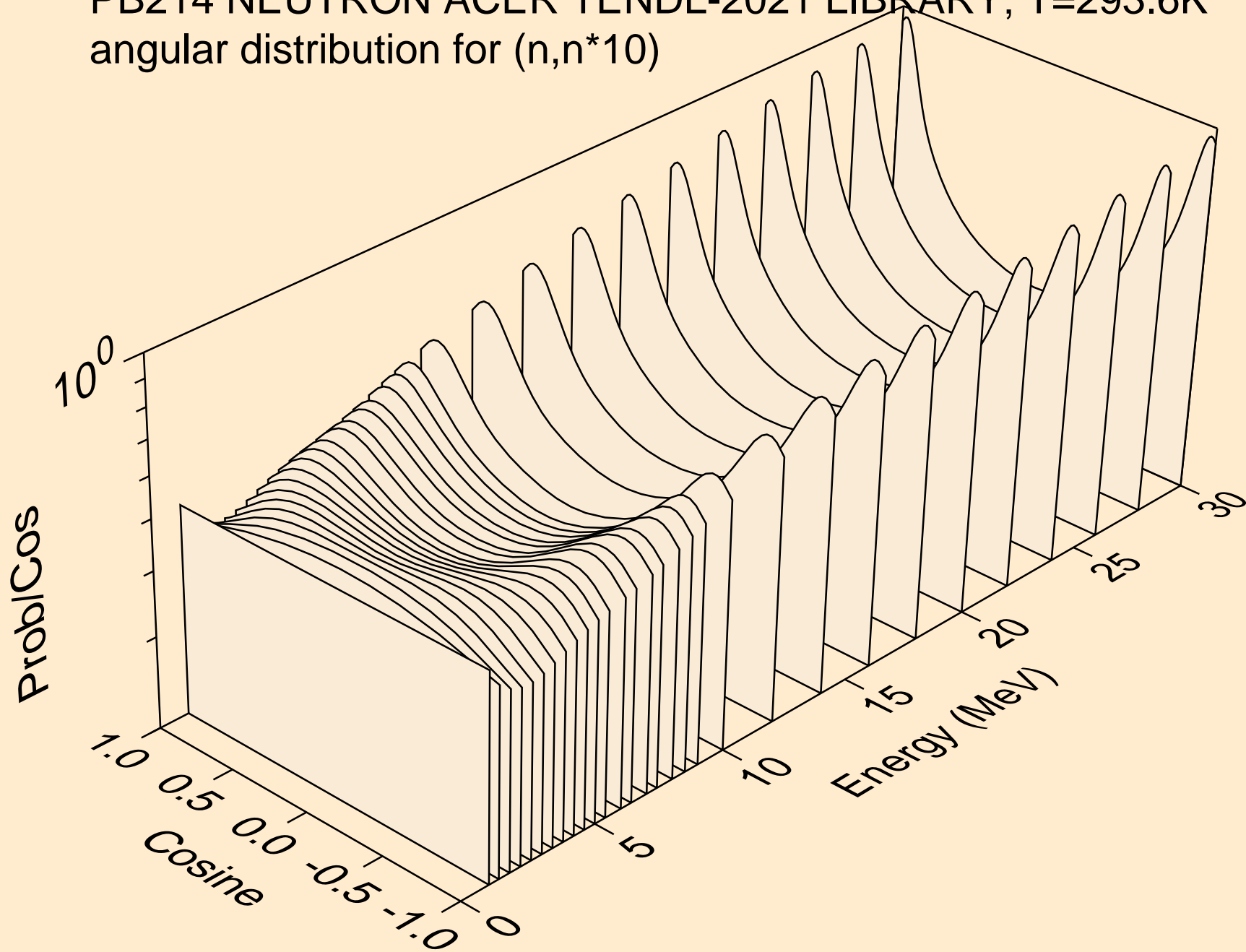

PB214 NEUTRON ACER TENDL-2021 LIBRARY; T=293.6K
angular distribution for (n,n*11)

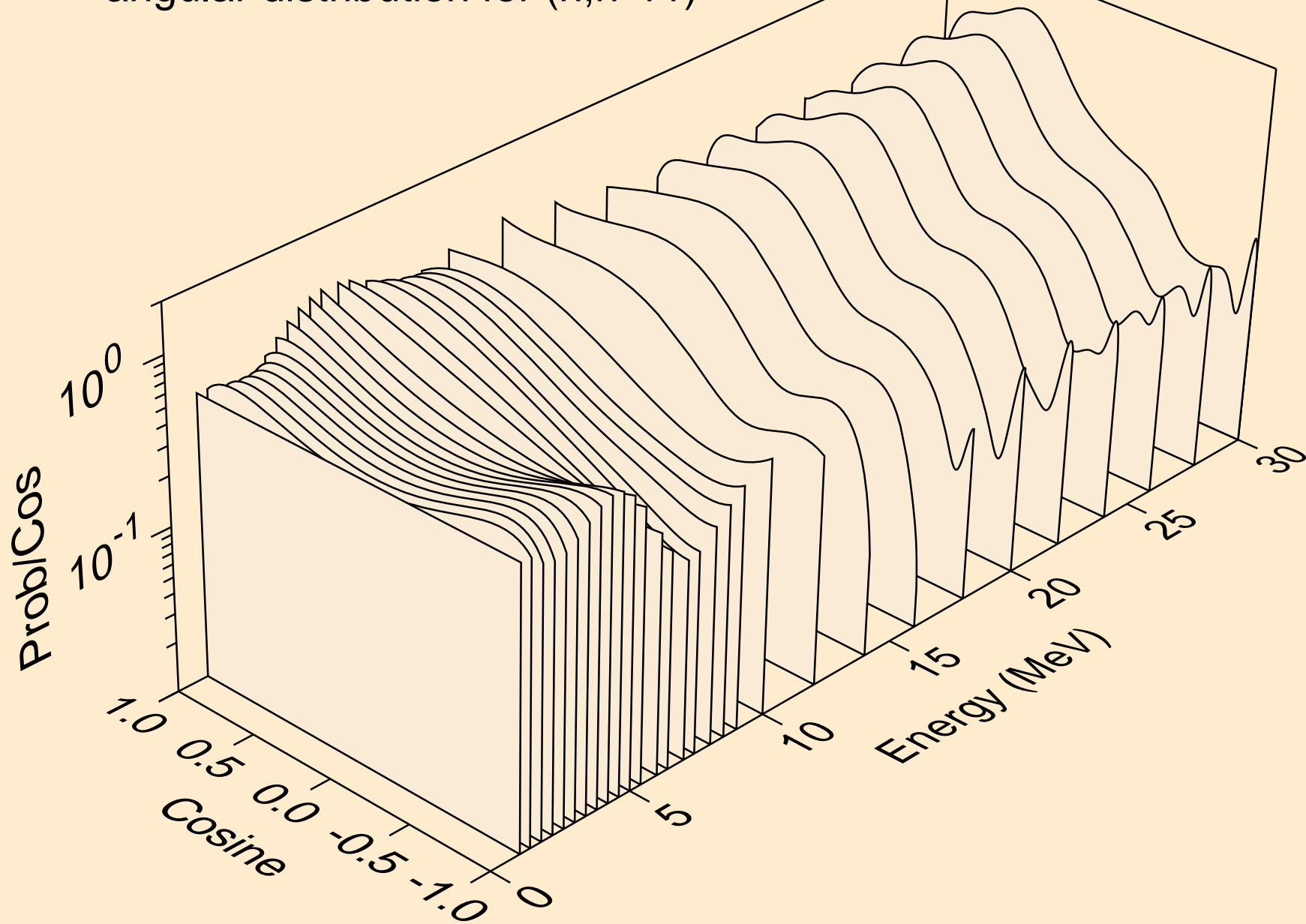

PB214 NEUTRON ACER TENDL-2021 LIBRARY; T=293.6K
angular distribution for (n,n*12)

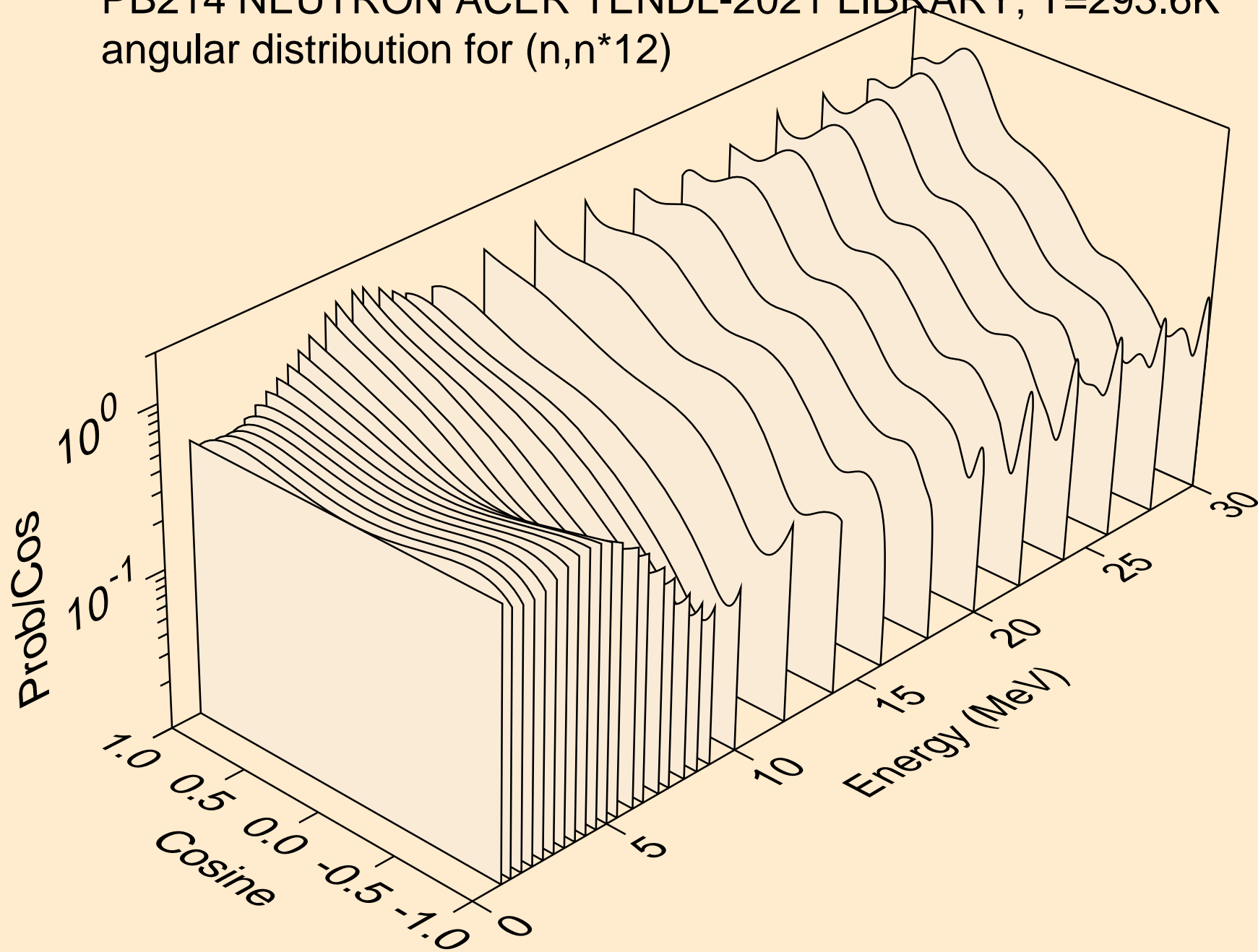

PB214 NEUTRON ACER TENDL-2021 LIBRARY; T=293.6K
angular distribution for (n,n*13)

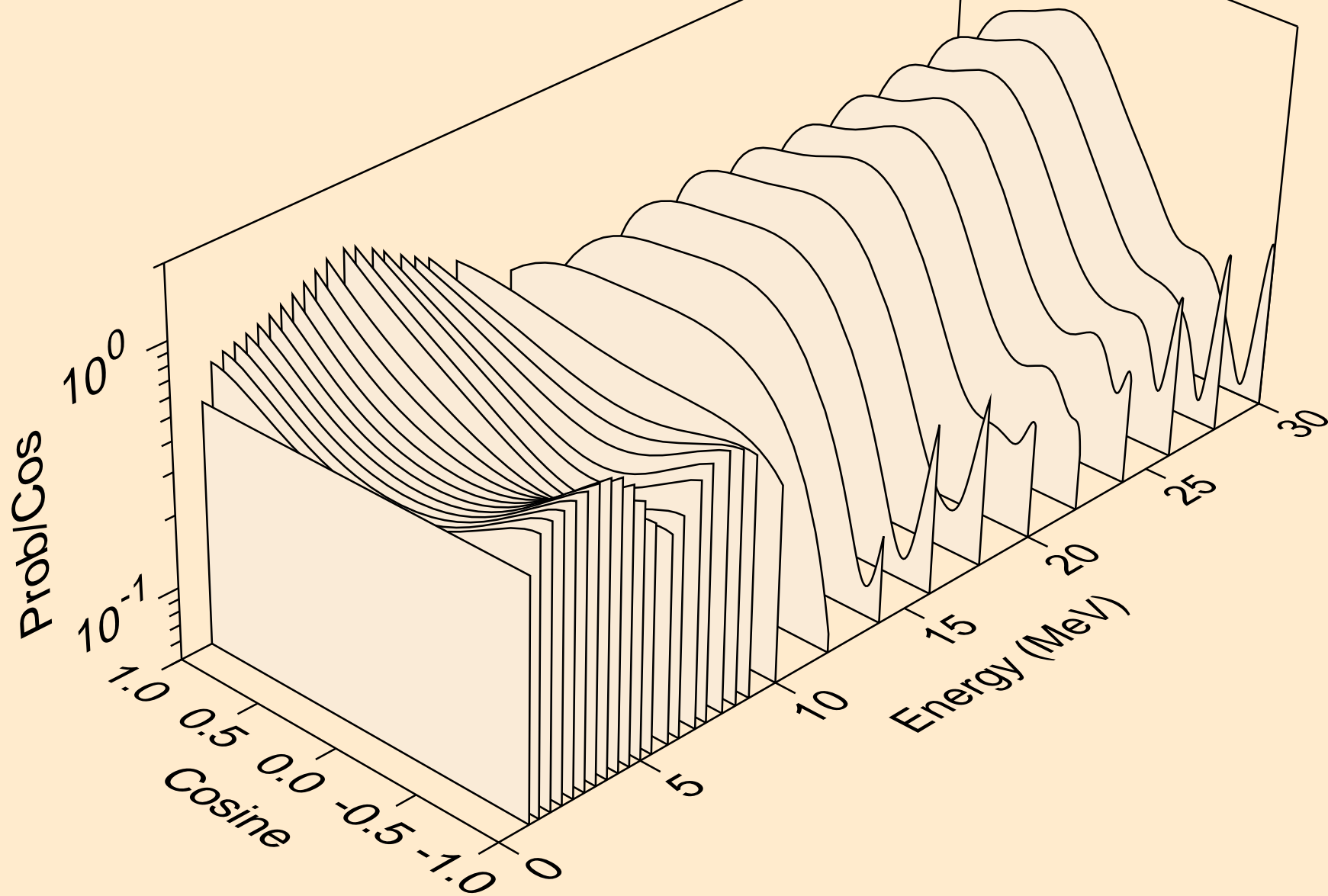

PB214 NEUTRON ACER TENDL-2021 LIBRARY; T=293.6K
angular distribution for (n,n*14)

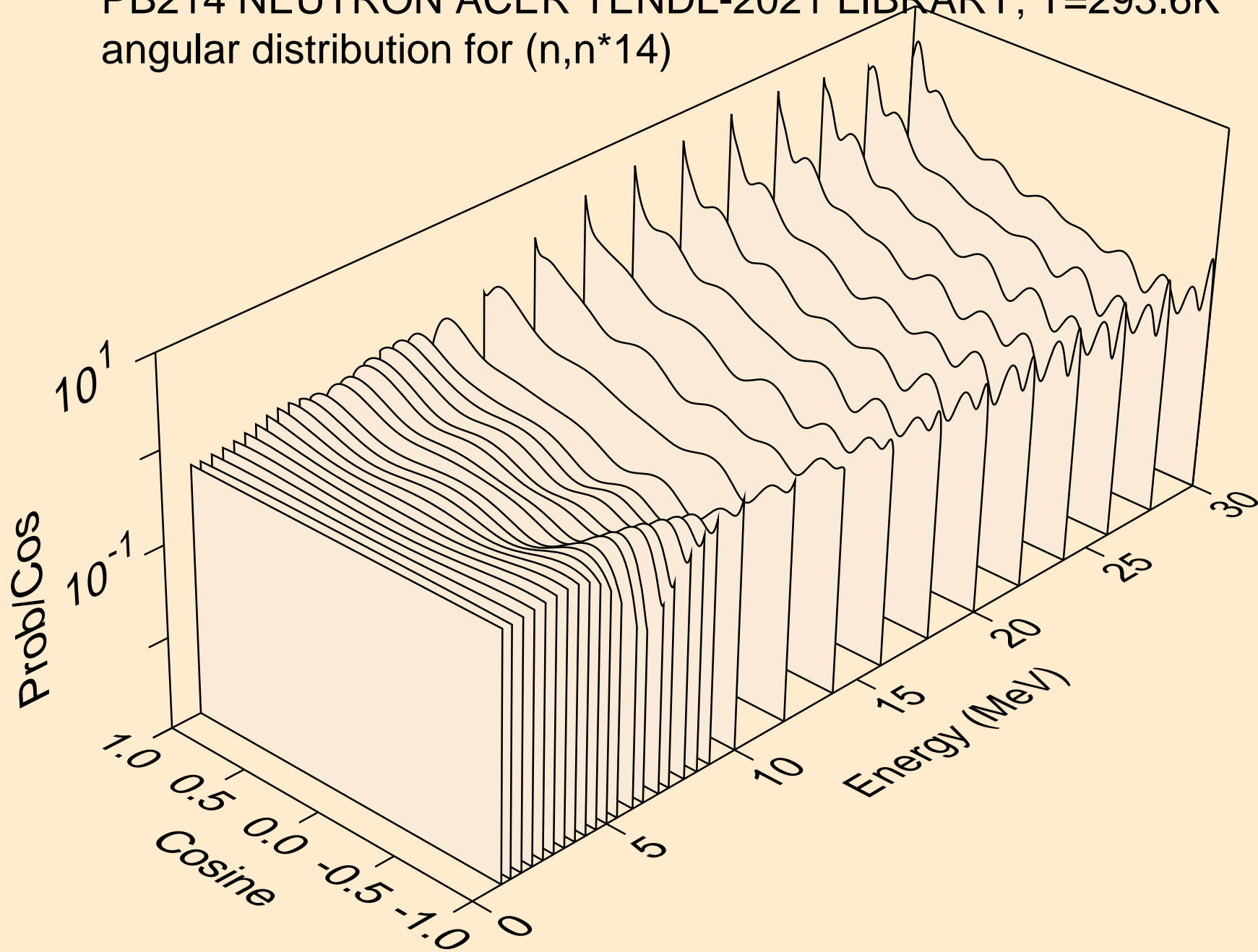

PB214 NEUTRON ACER TENDL-2021 LIBRARY; T=293.6K
angular distribution for (n,n*15)

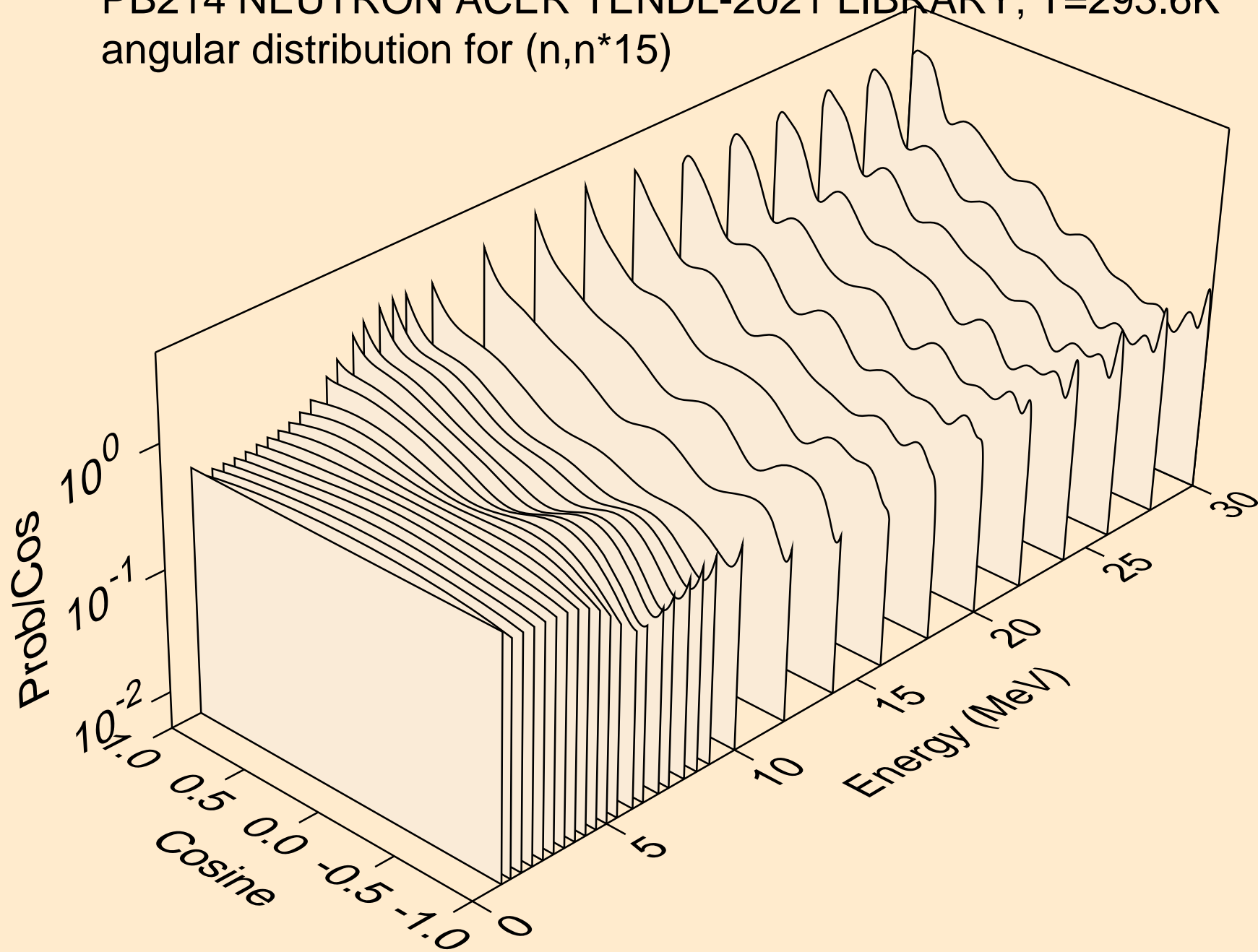

PB214 NEUTRON ACER TENDL-2021 LIBRARY; T=293.6K
angular distribution for (n,n*16)

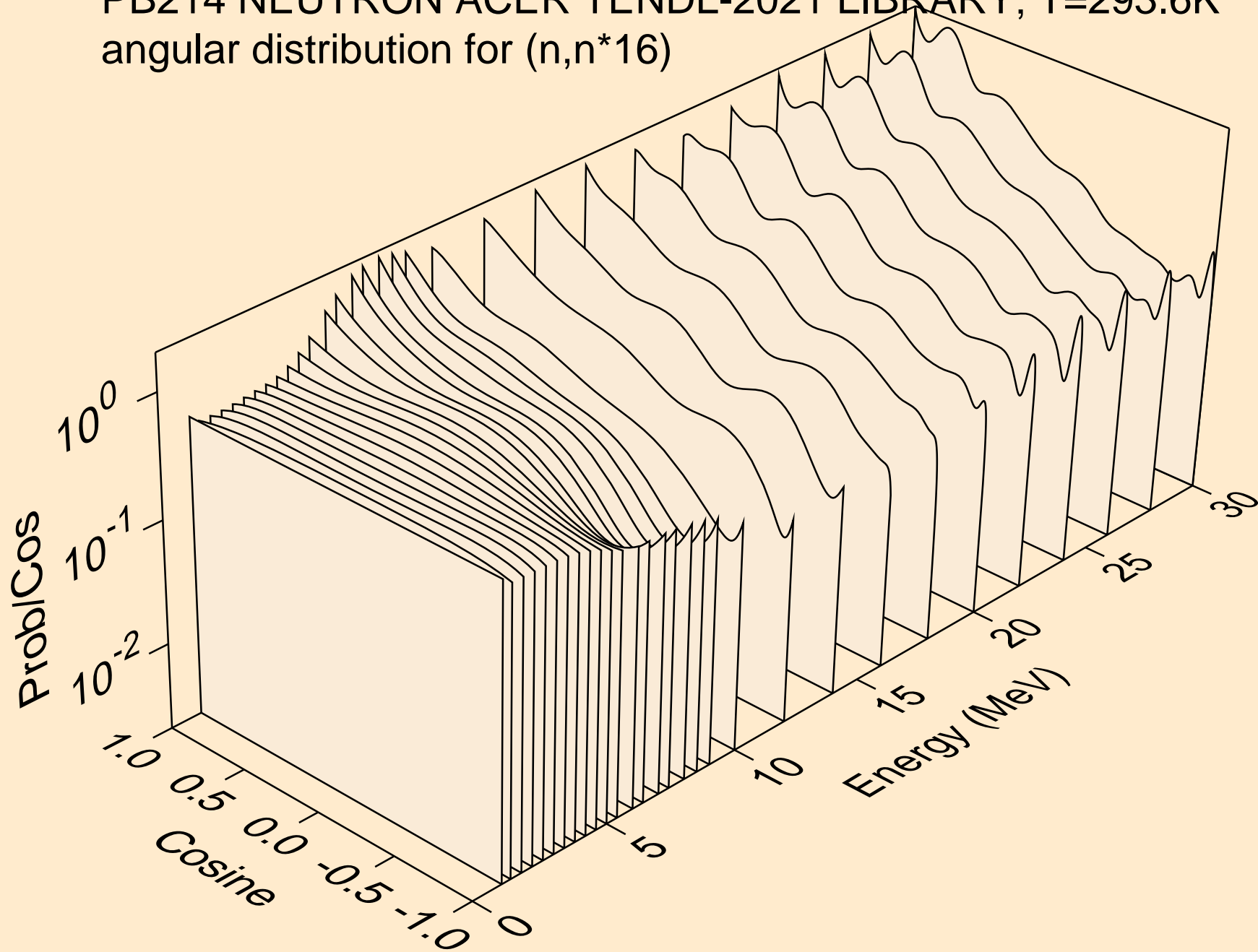

PB214 NEUTRON ACER TENDL-2021 LIBRARY; T=293.6K
angular distribution for (n,n*17)

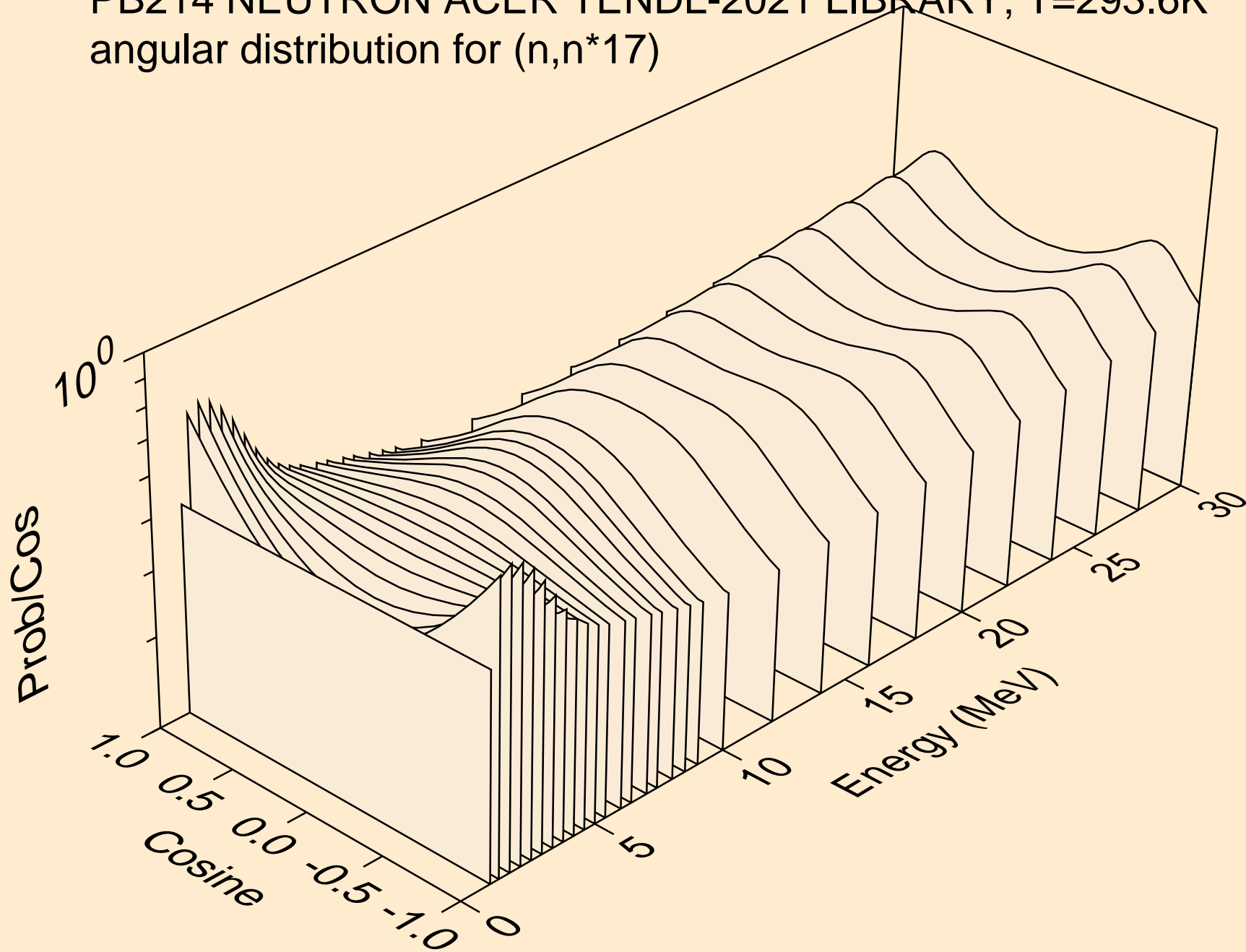

PB214 NEUTRON ACER TENDL-2021 LIBRARY; T=293.6K
angular distribution for (n,n*18)

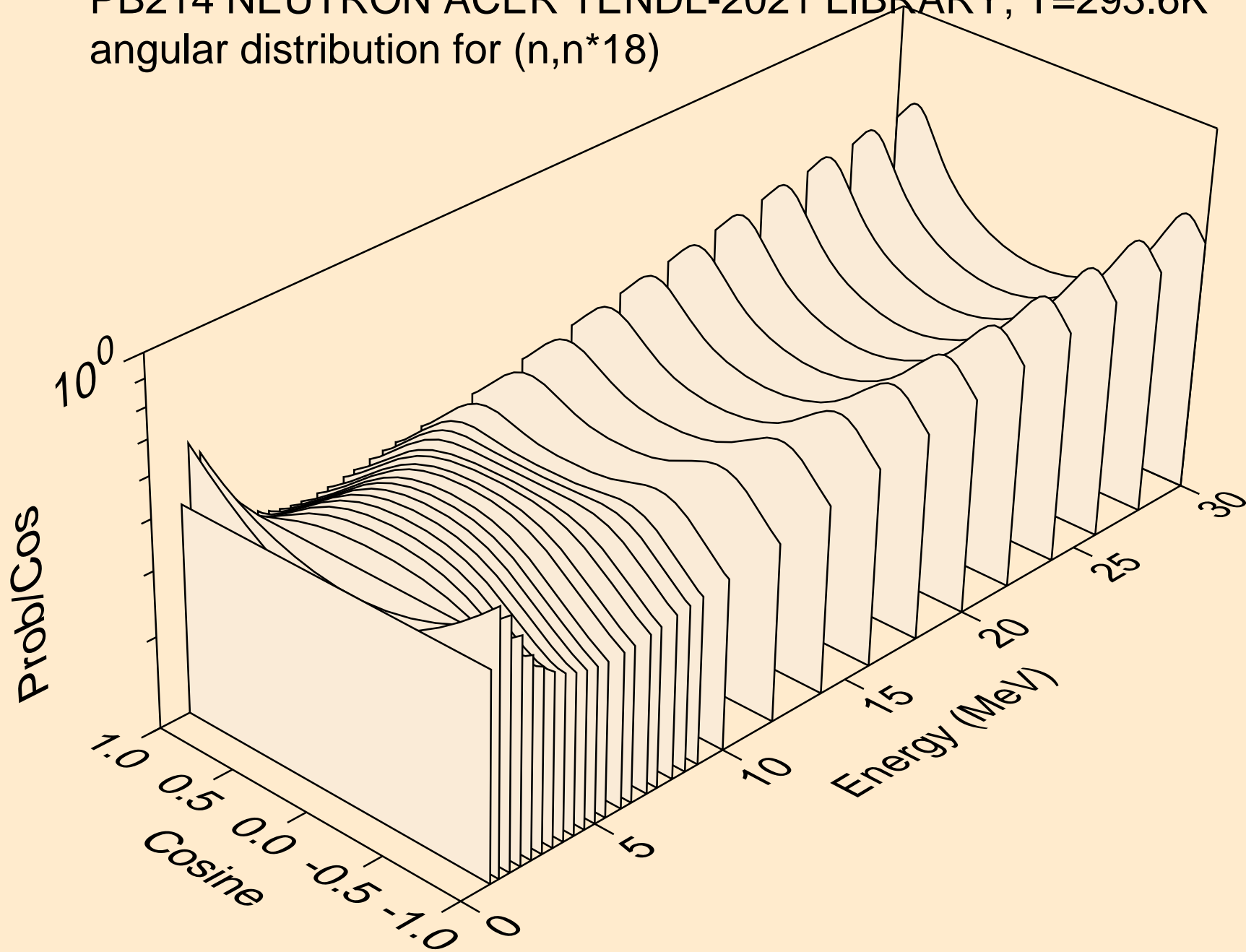

PB214 NEUTRON ACER TENDL-2021 LIBRARY; T=293.6K
angular distribution for (n,n*19)

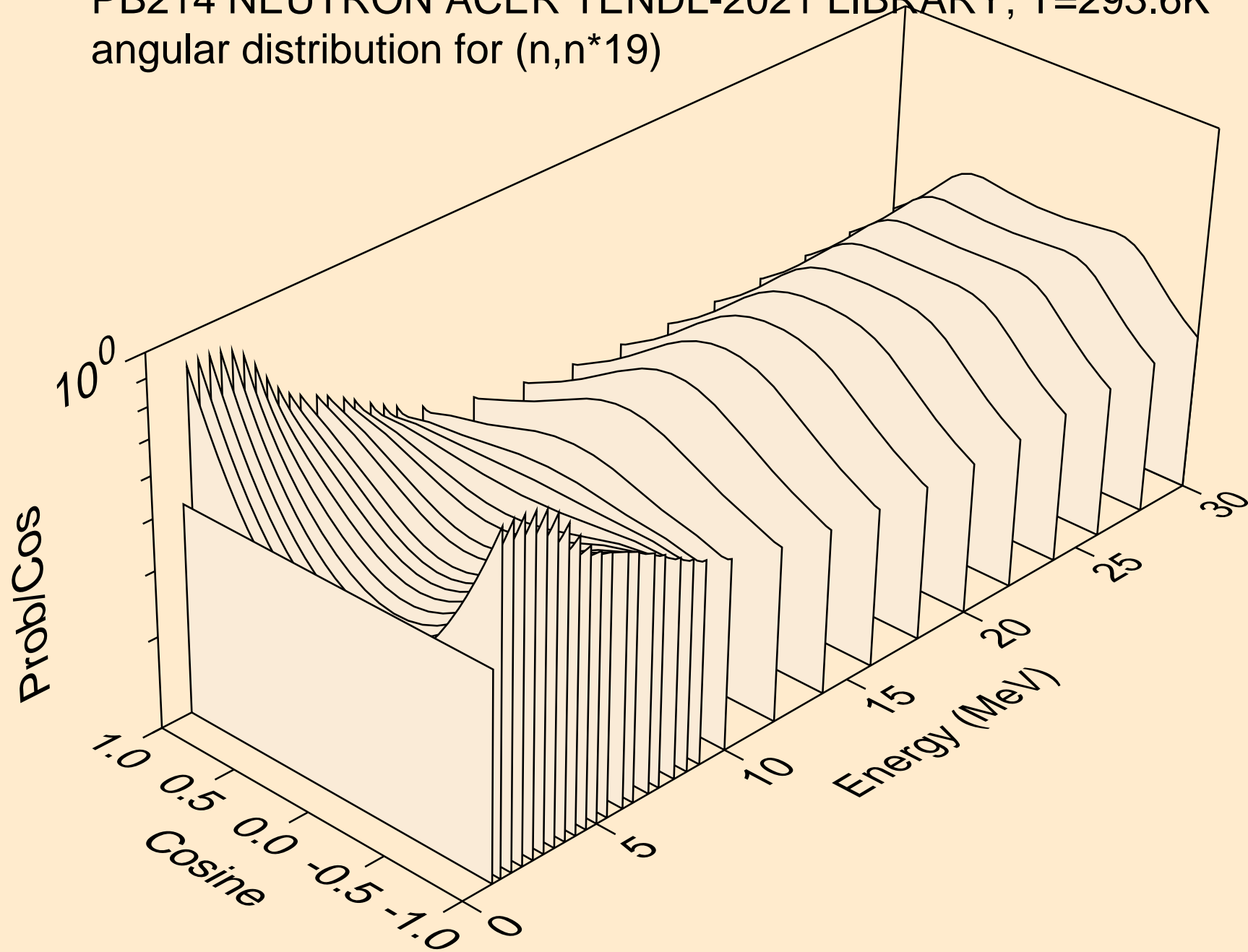

PB214 NEUTRON ACER TENDL-2021 LIBRARY; T=293.6K
angular distribution for (n,n*20)

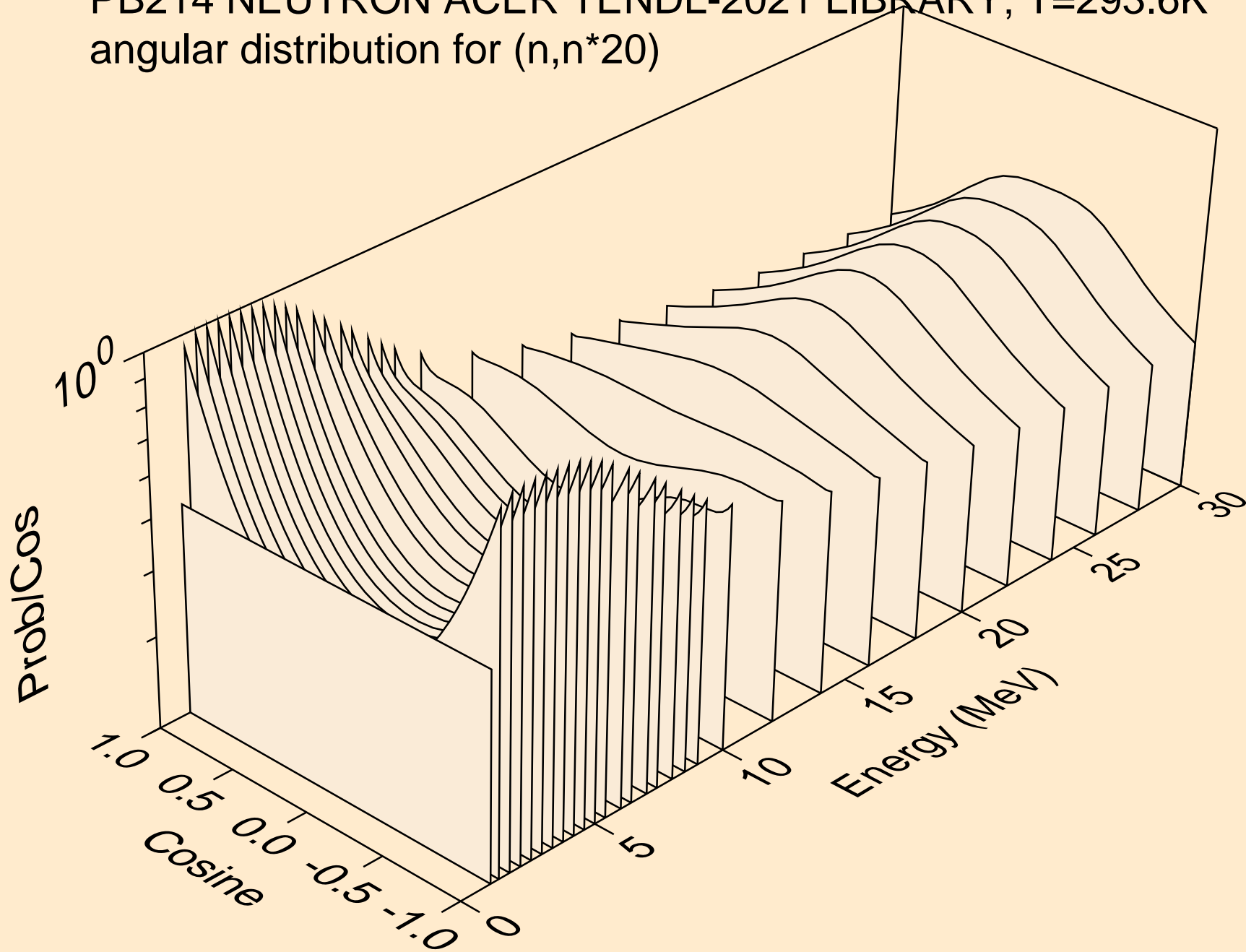

PB214 NEUTRON ACER TENDL-2021 LIBRARY; T=293.6K
angular distribution for (n,n*21)

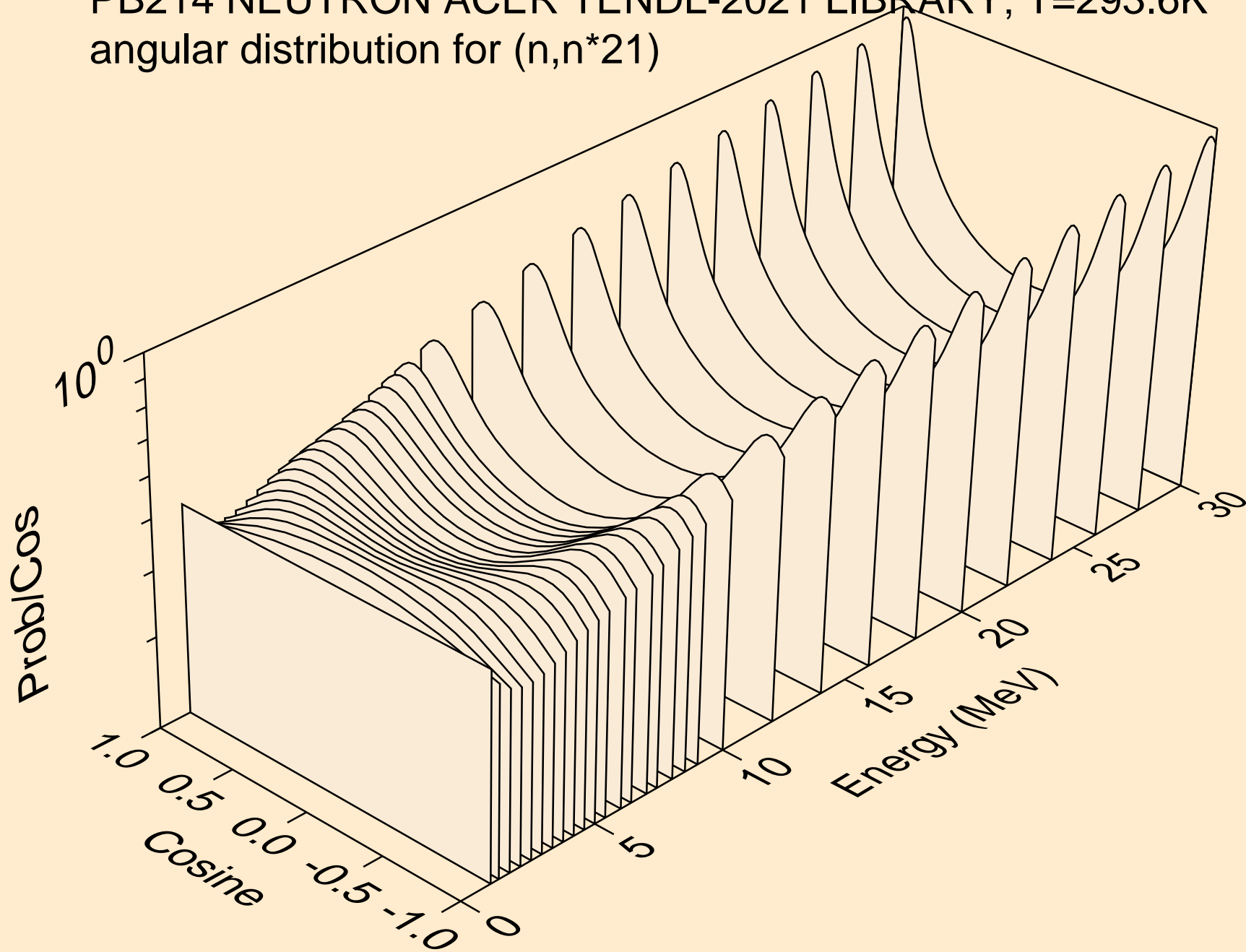

PB214 NEUTRON ACER TENDL-2021 LIBRARY; T=293.6K
angular distribution for (n,n*22)

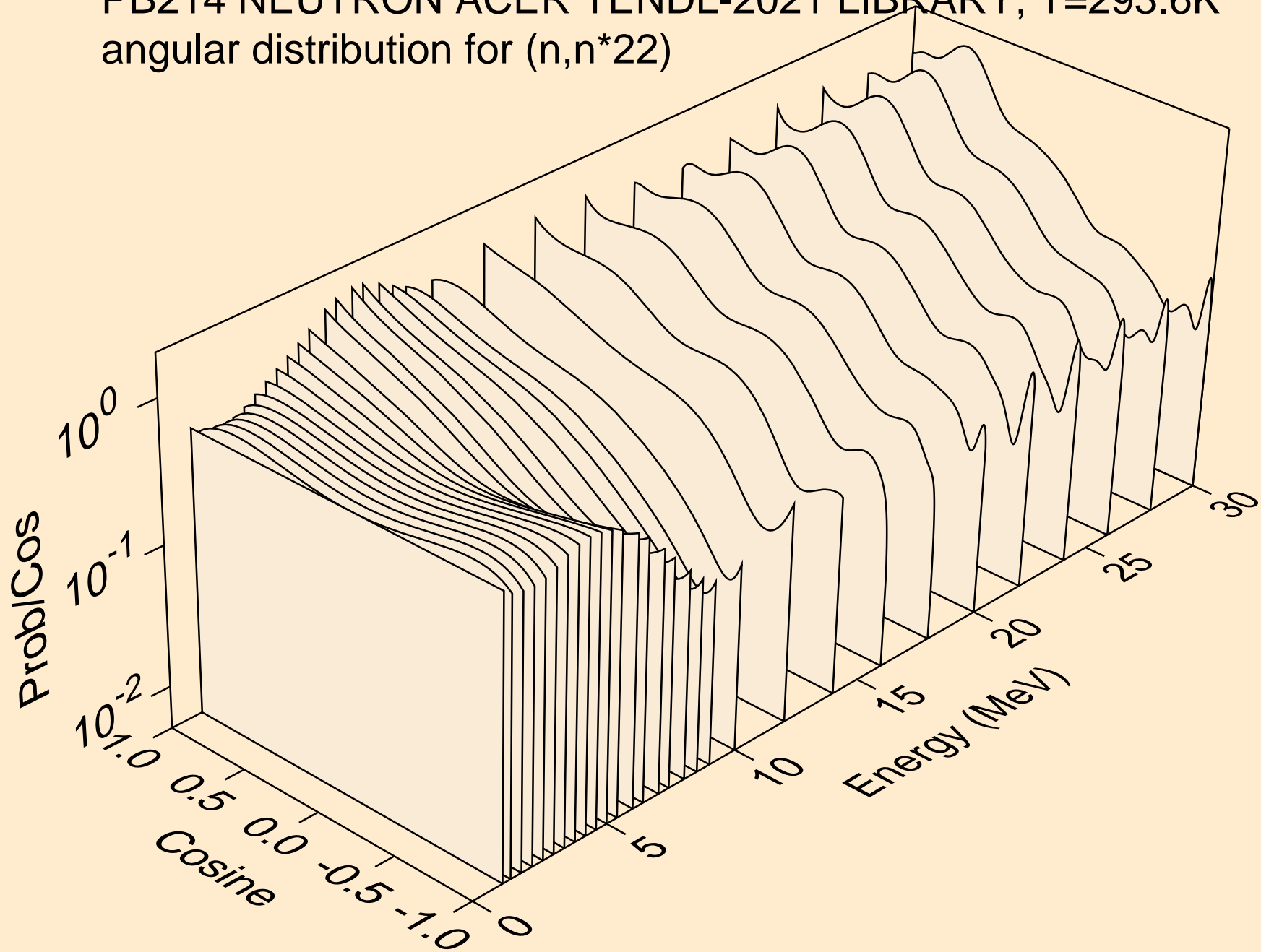

PB214 NEUTRON ACER TENDL-2021 LIBRARY; T=293.6K
angular distribution for (n,n*23)

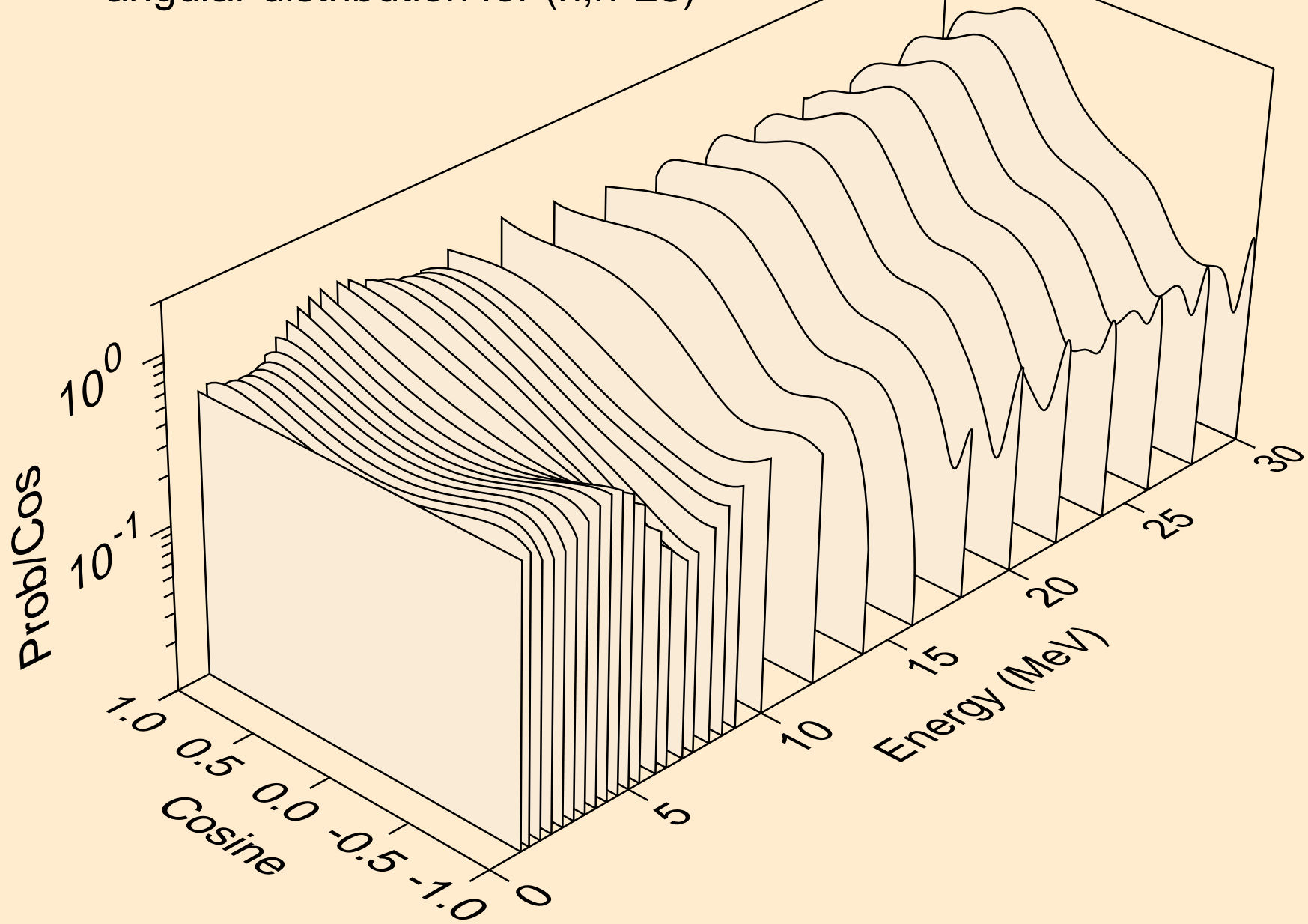

PB214 NEUTRON ACER TENDL-2021 LIBRARY; T=293.6K
angular distribution for (n,n*24)

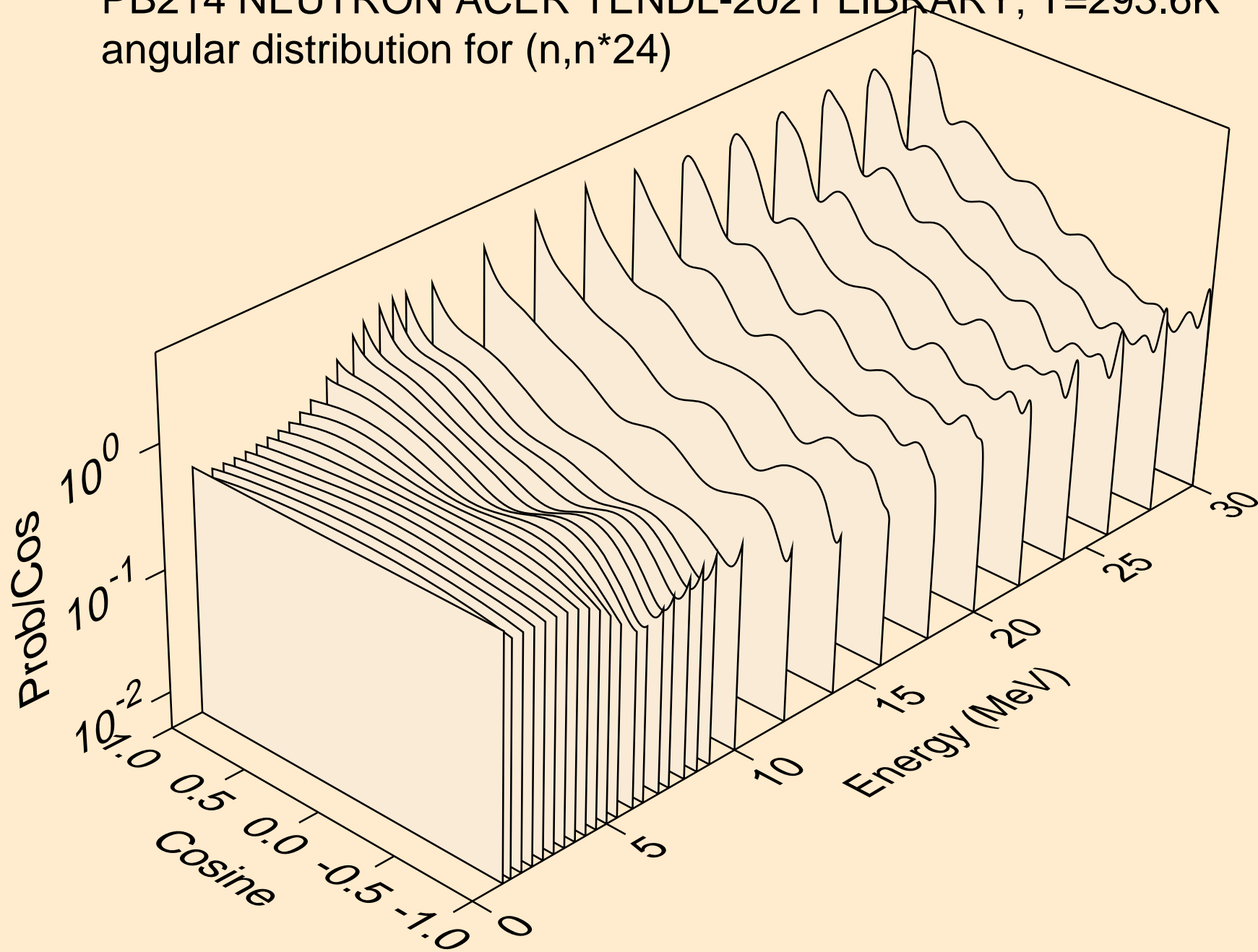

PB214 NEUTRON ACER TENDL-2021 LIBRARY; T=293.6K
angular distribution for (n,n*25)

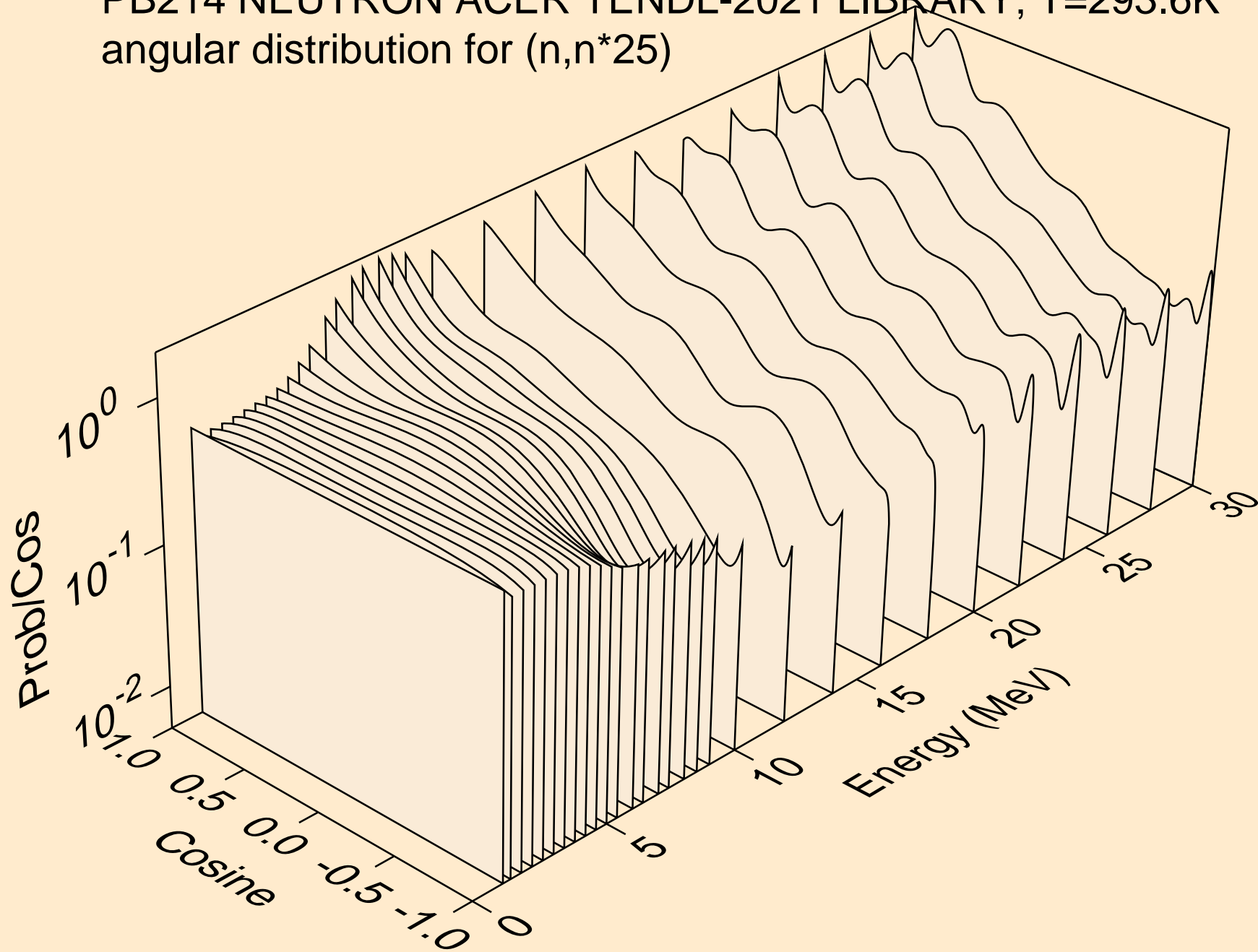

PB214 NEUTRON ACER TENDL-2021 LIBRARY; T=293.6K
angular distribution for (n,n*26)

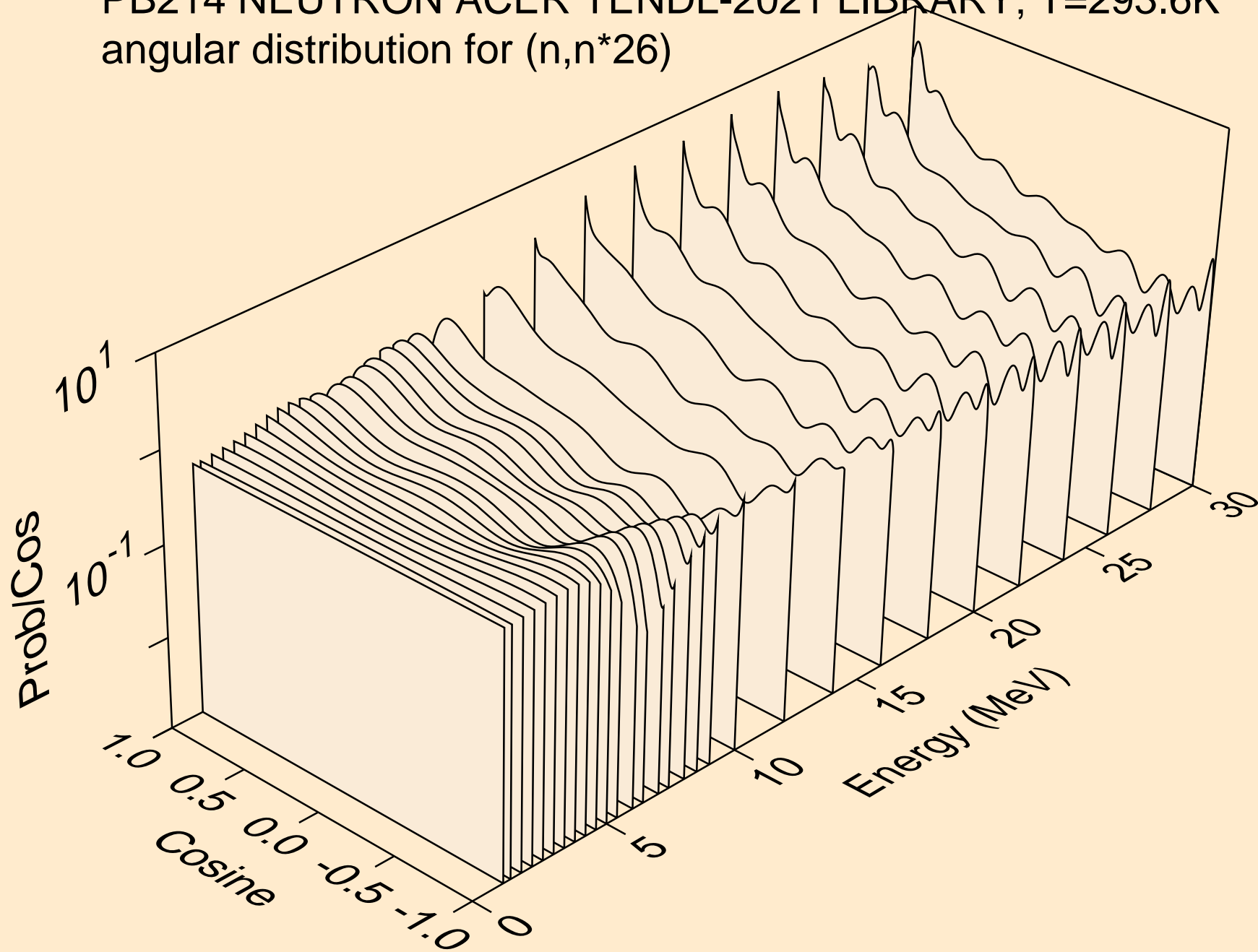

PB214 NEUTRON ACER TENDL-2021 LIBRARY; T=293.6K
angular distribution for (n,n*27)

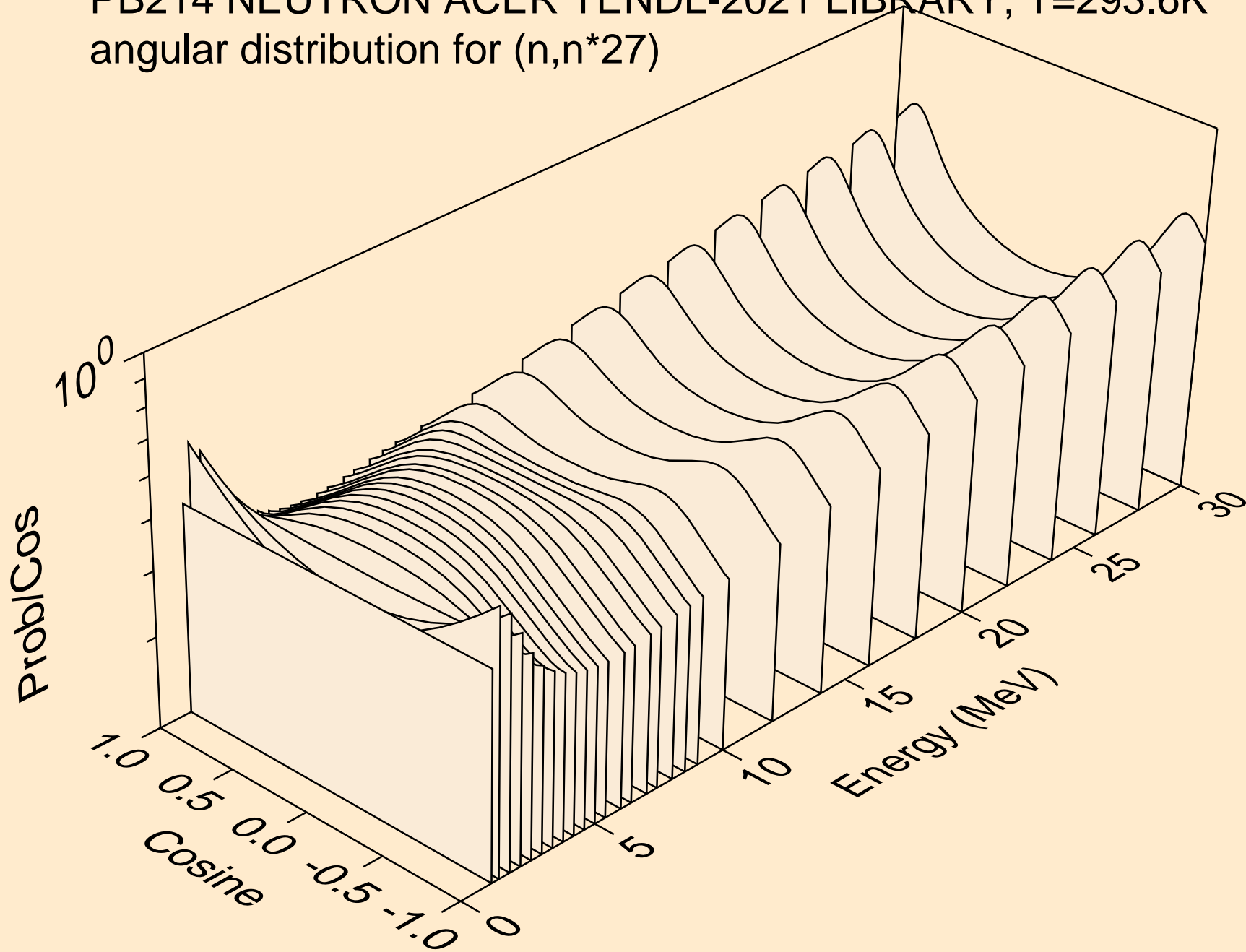

PB214 NEUTRON ACER TENDL-2021 LIBRARY; T=293.6K
angular distribution for (n,n*28)

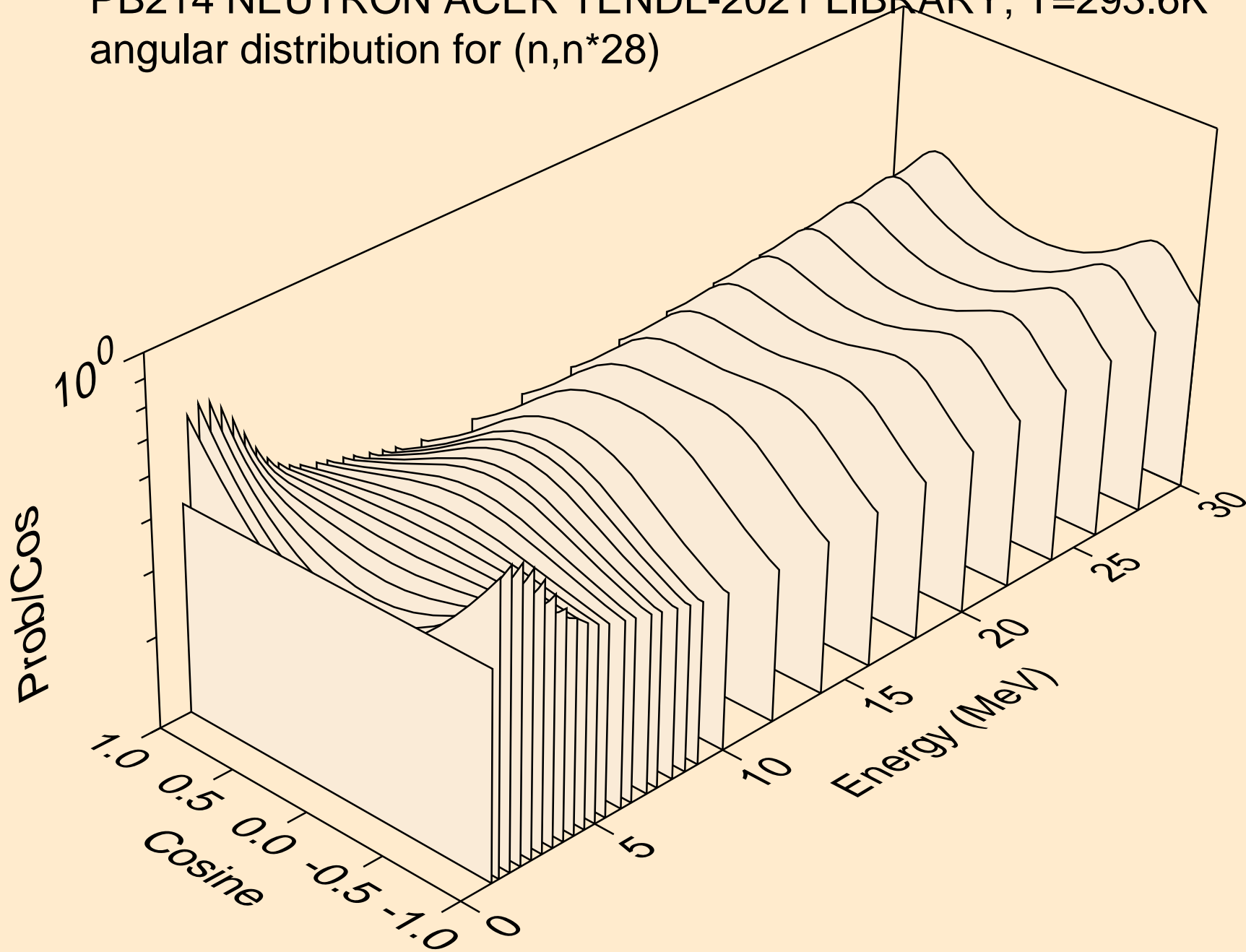

PB214 NEUTRON ACER TENDL-2021 LIBRARY; T=293.6K
angular distribution for (n,n*29)

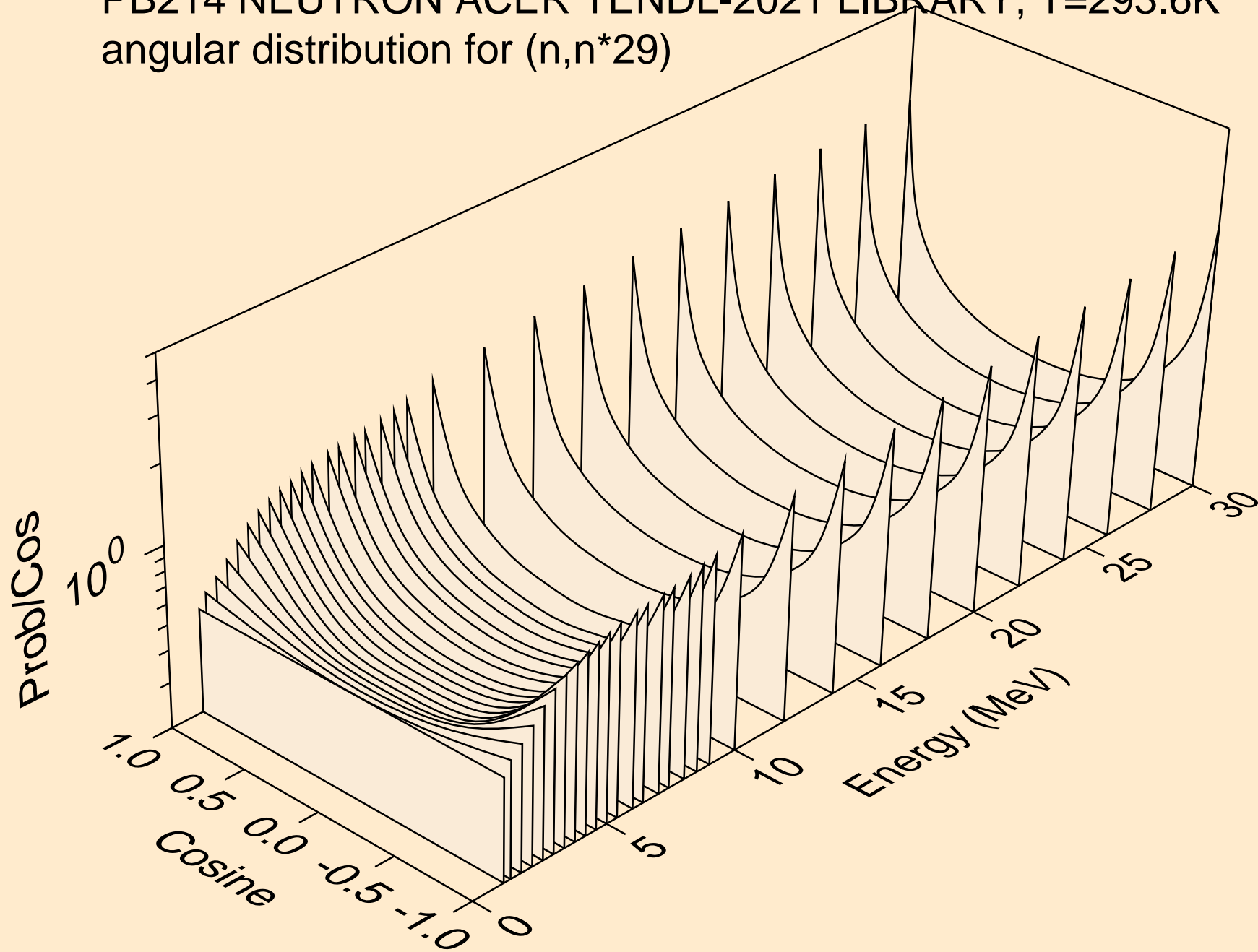

PB214 NEUTRON ACER TENDL-2021 LIBRARY; T=293.6K
Neutron emission for (n,x)

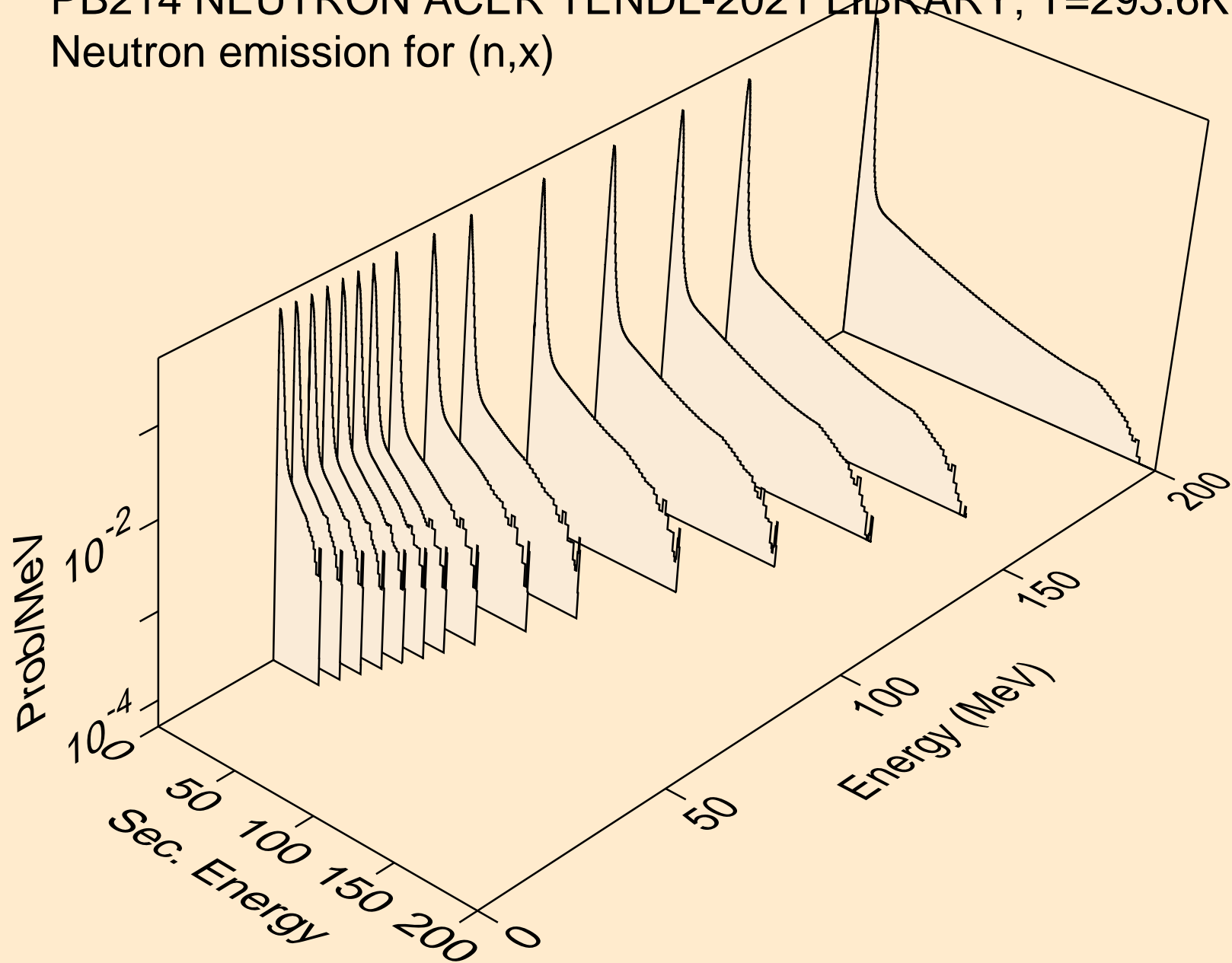

PB214 NEUTRON ACER TENDL-2021 LIBRARY; T=293.6K
Neutron emission for (n,2nd)

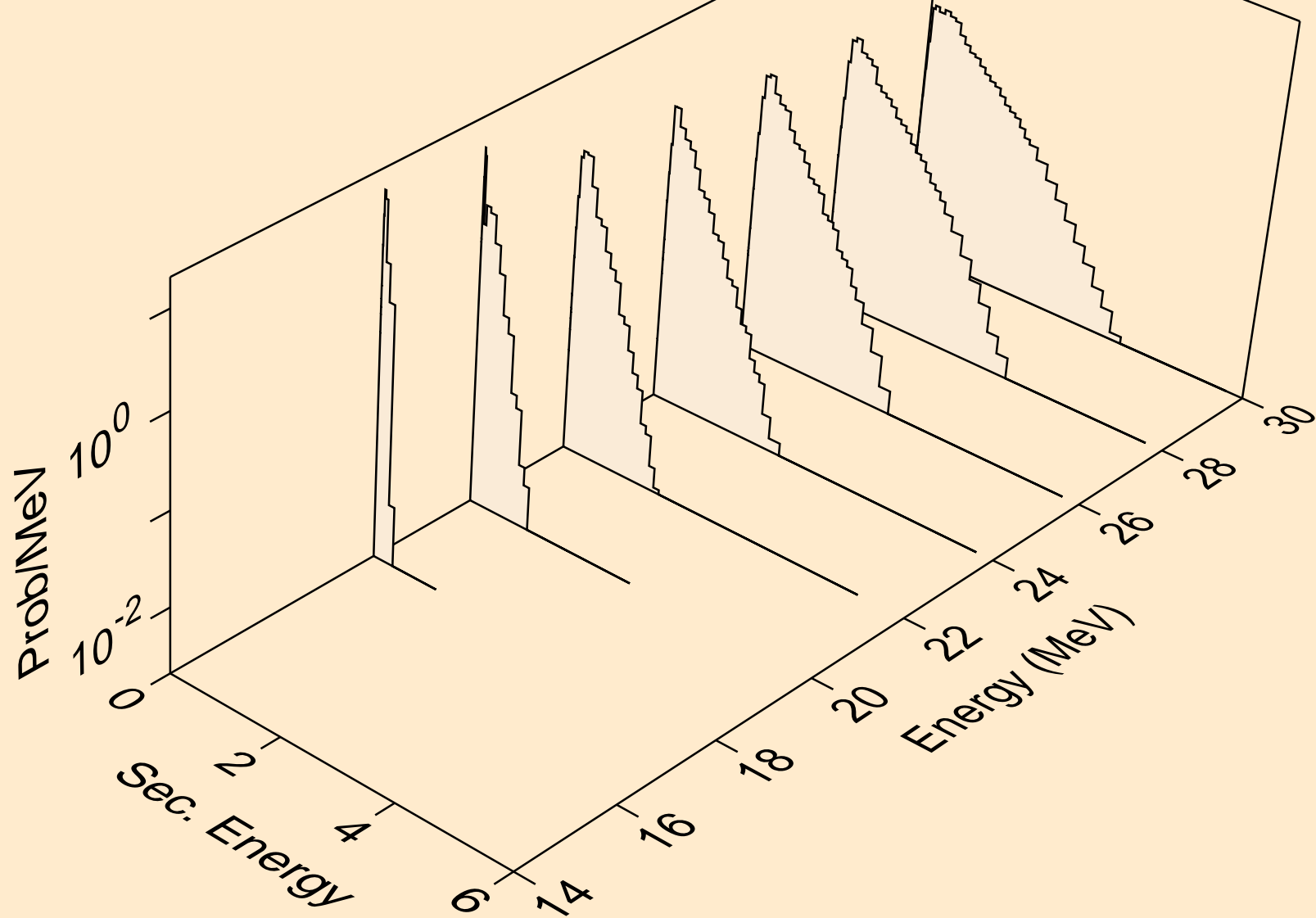

PB214 NEUTRON ACER TENDL-2021 LIBRARY; T=293.6K
Neutron emission for (n,2n)

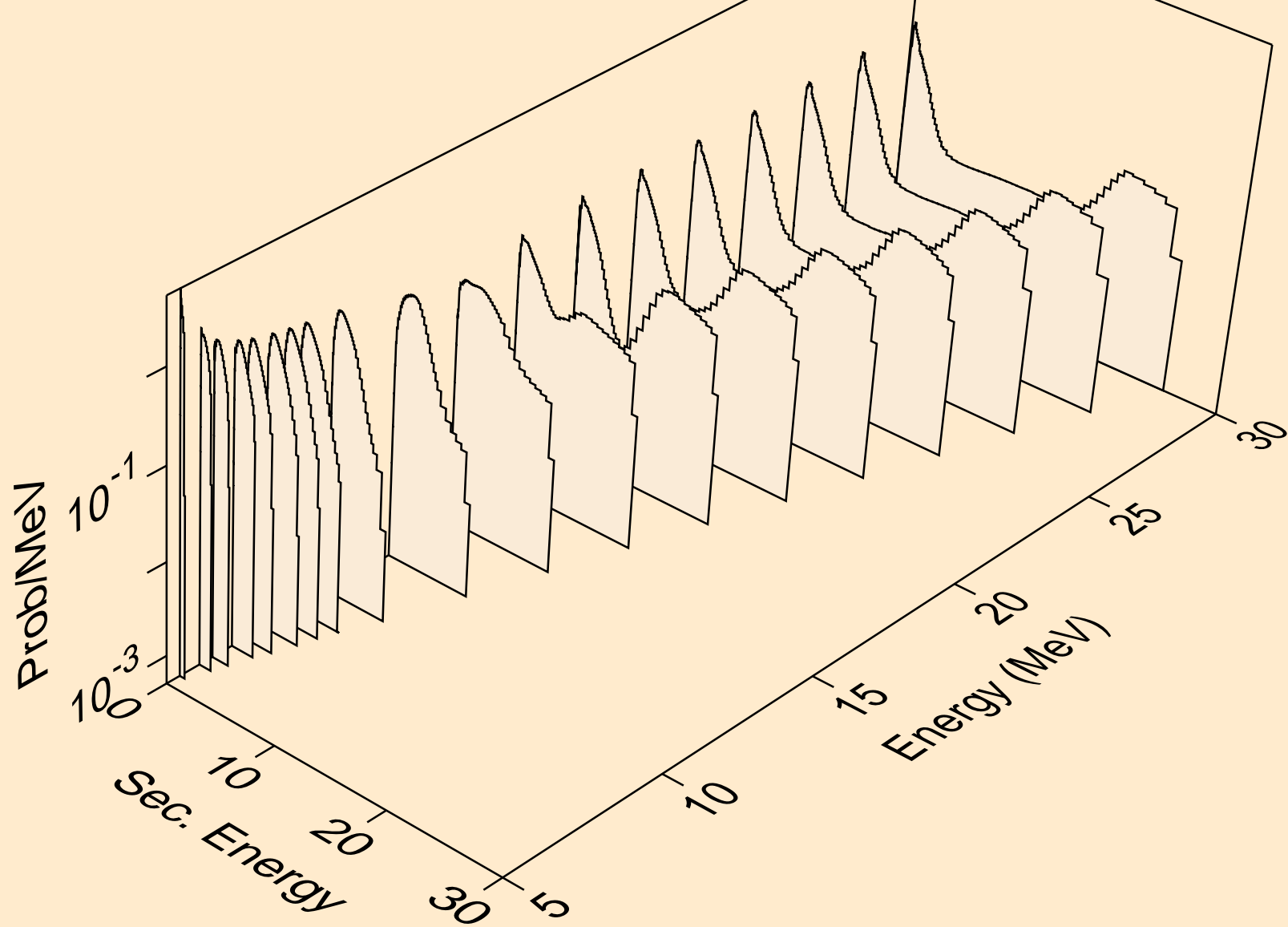

PB214 NEUTRON ACER TENDL-2021 LIBRARY; T=293.6K
Neutron emission for (n,3n)

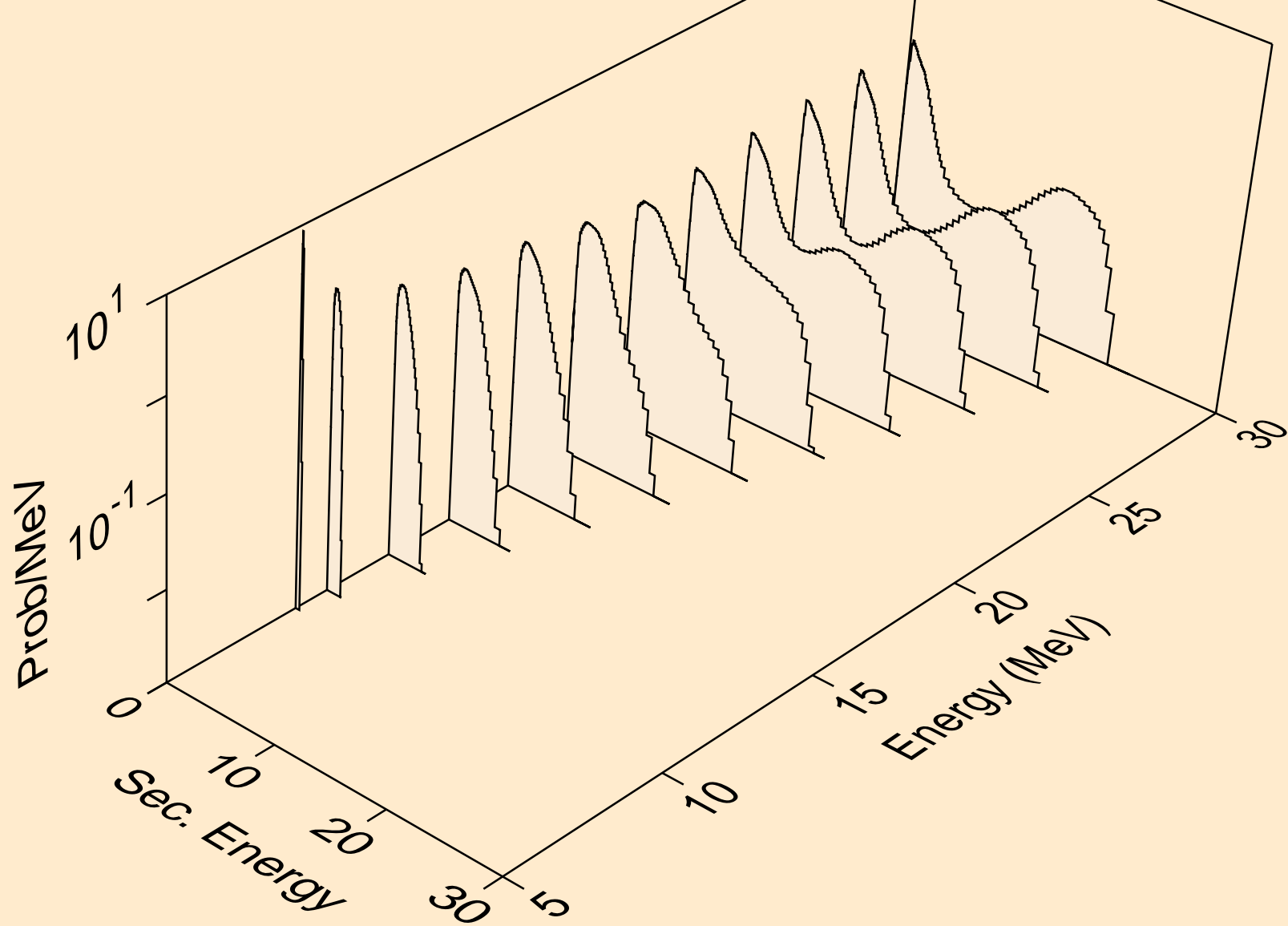

PB214 NEUTRON ACER TENDL-2021 LIBRARY; T=293.6K
Neutron emission for (n,n*)a

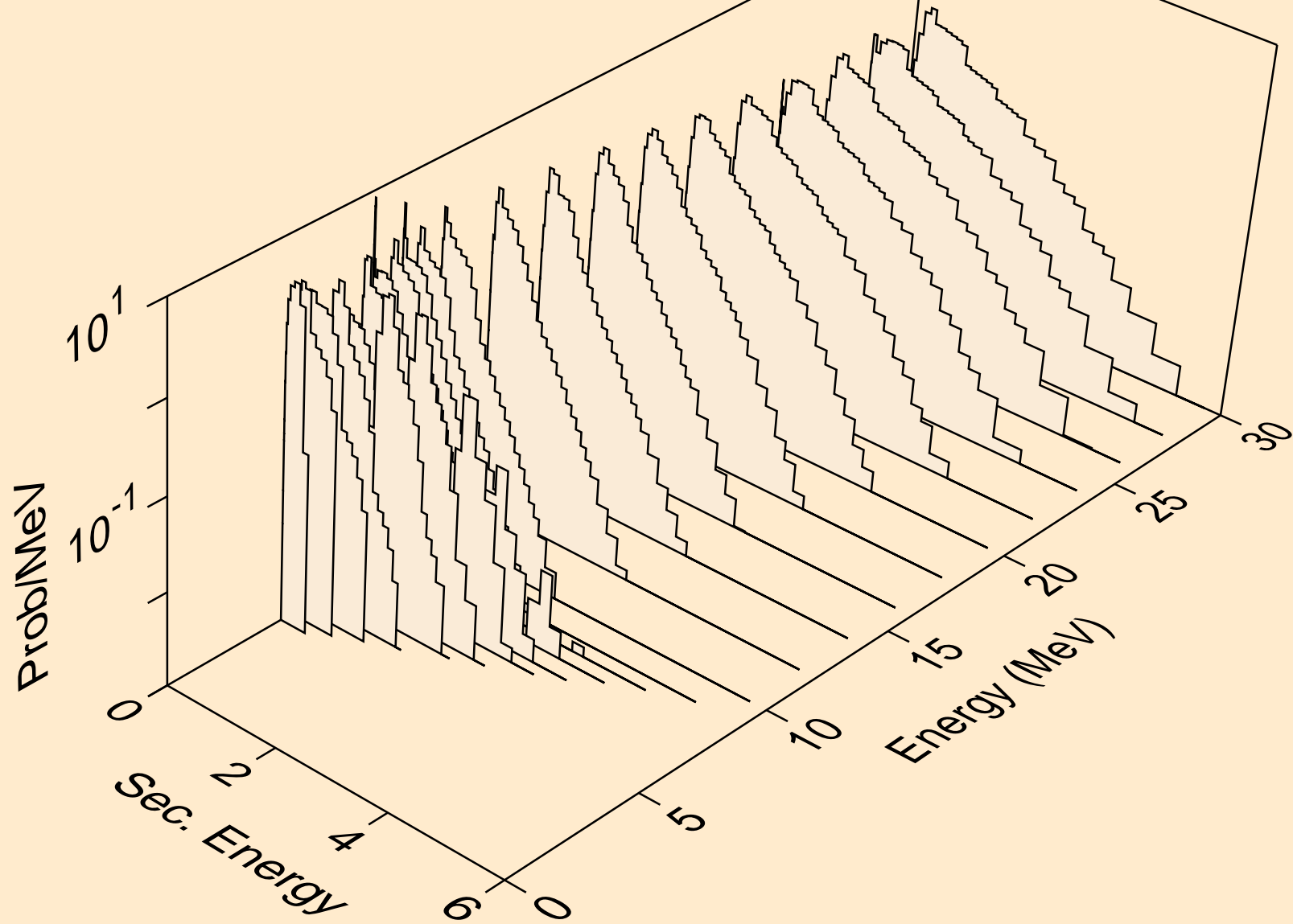

PB214 NEUTRON ACER TENDL-2021 LIBRARY; T=293.6K
Neutron emission for (n,2n)_a

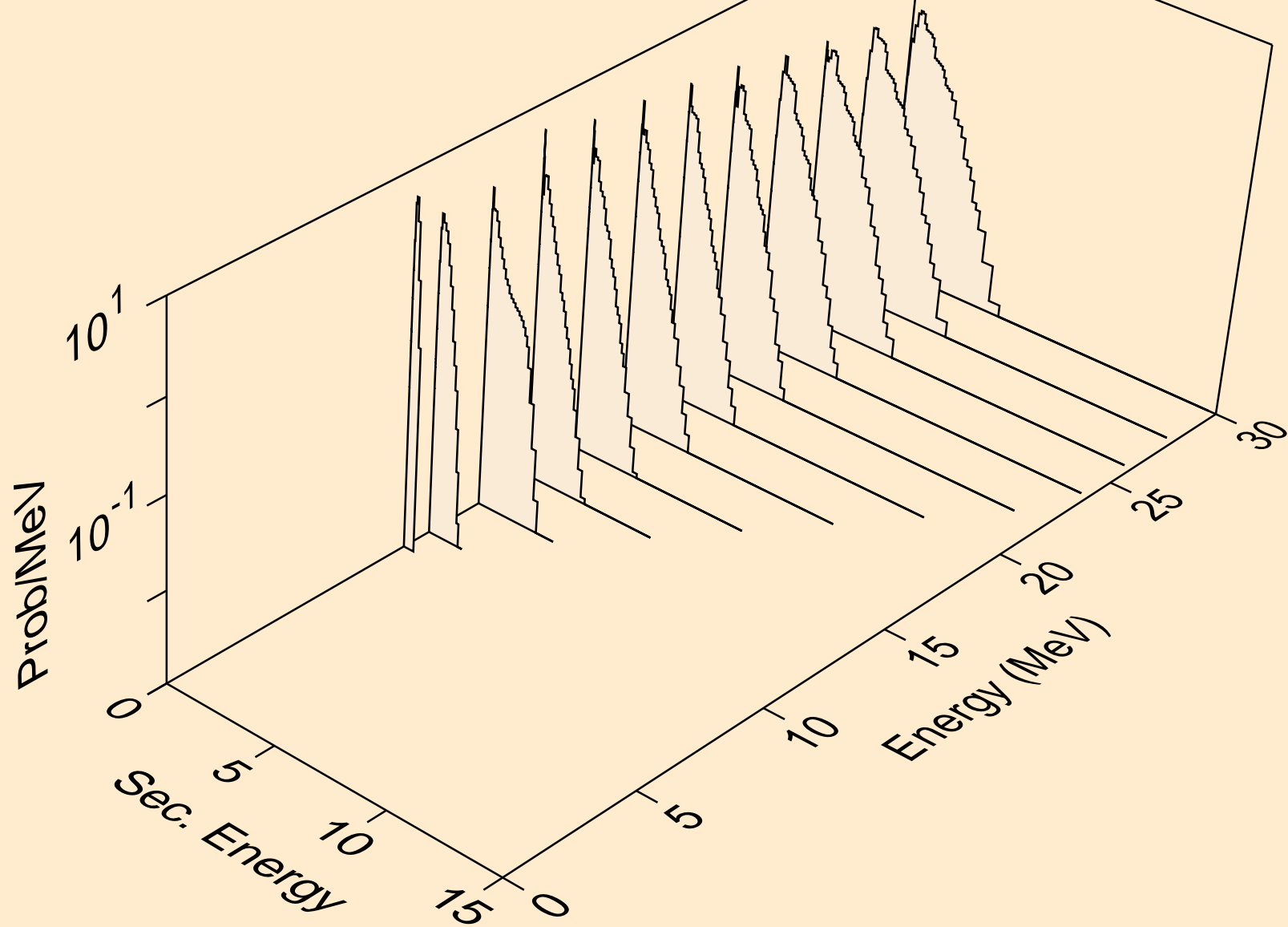

PB214 NEUTRON ACER TENDL-2021 LIBRARY; T=293.6K
Neutron emission for (n,3n)_a

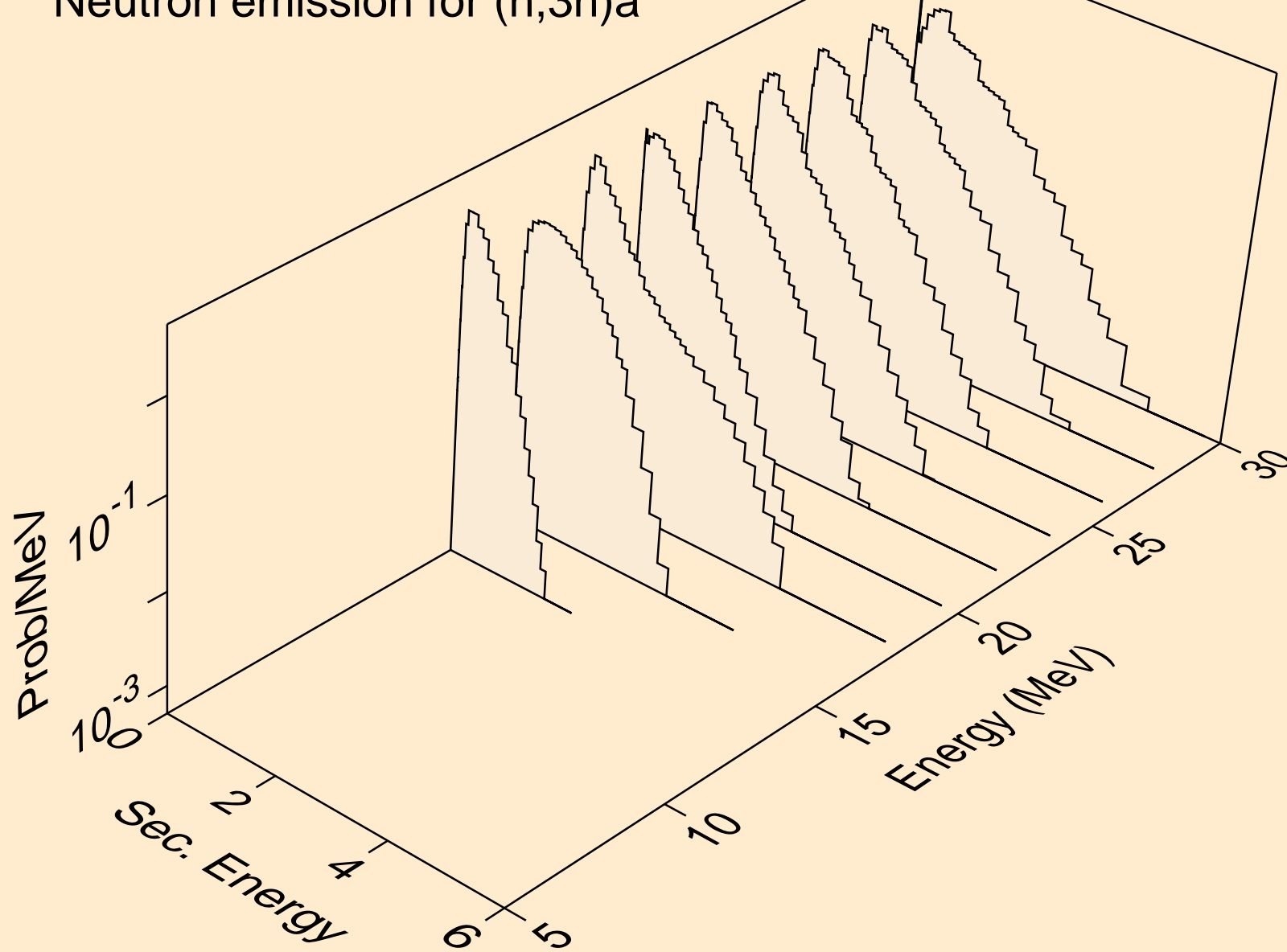

PB214 NEUTRON ACER TENDL-2021 LIBRARY; T=293.6K
Neutron emission for (n,n*)p

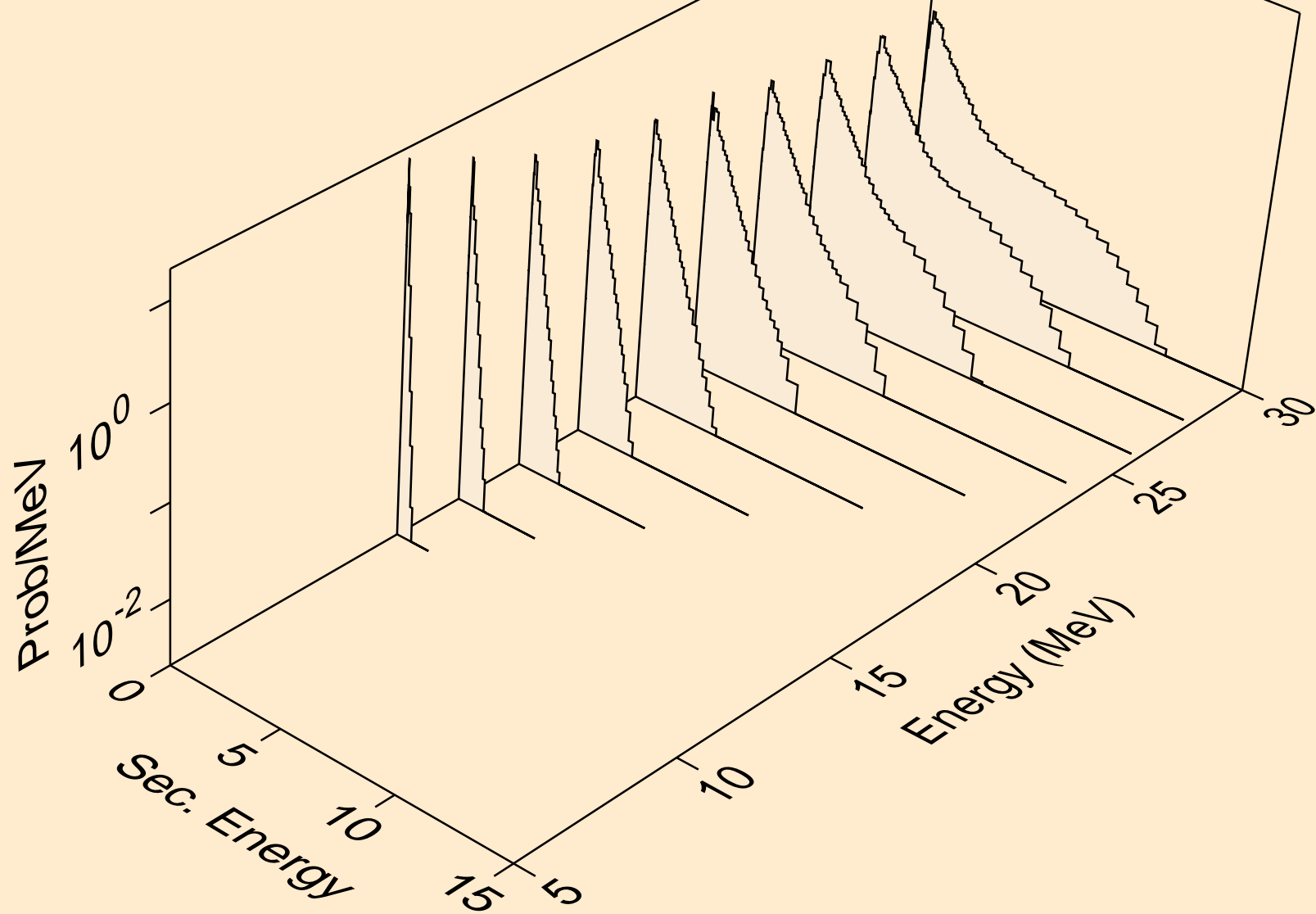

PB214 NEUTRON ACER TENDL-2021 LIBRARY; T=293.6K
Neutron emission for (n,n*)d

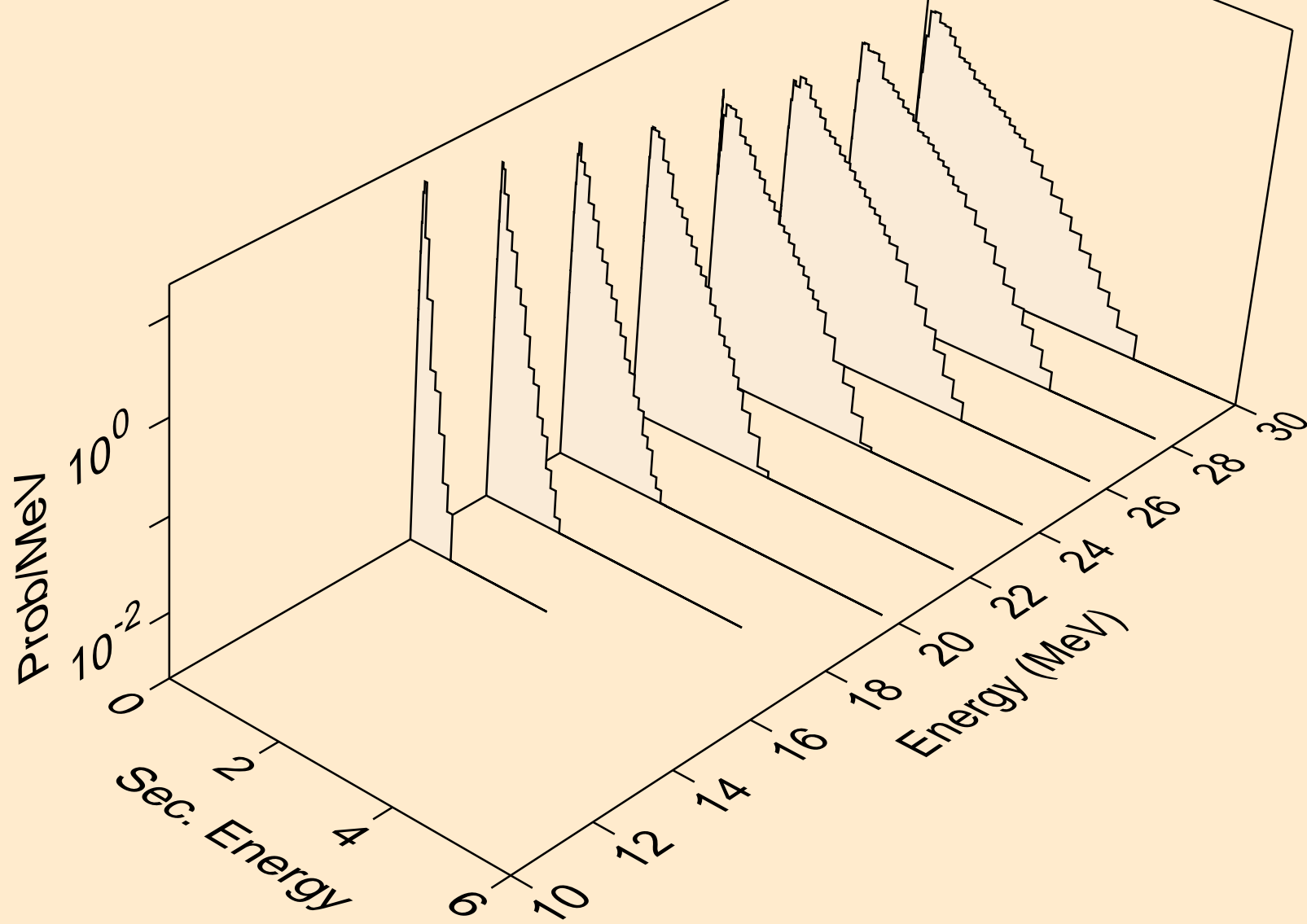

PB214 NEUTRON ACER TENDL-2021 LIBRARY; T=293.6K
Neutron emission for (n,n*)t

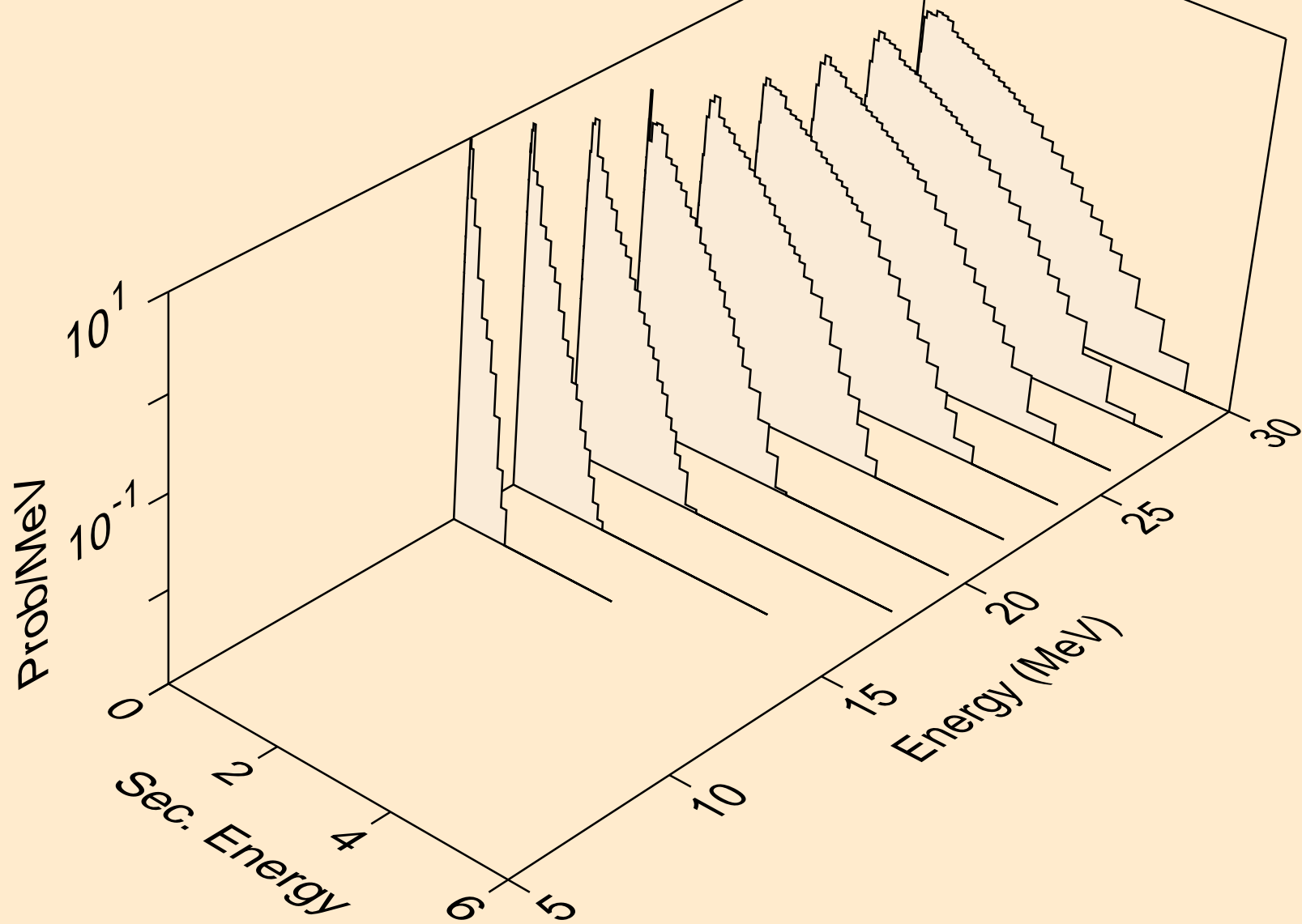

PB214 NEUTRON ACER TENDL-2021 LIBRARY; T=293.6K
Neutron emission for (n,n*)he3

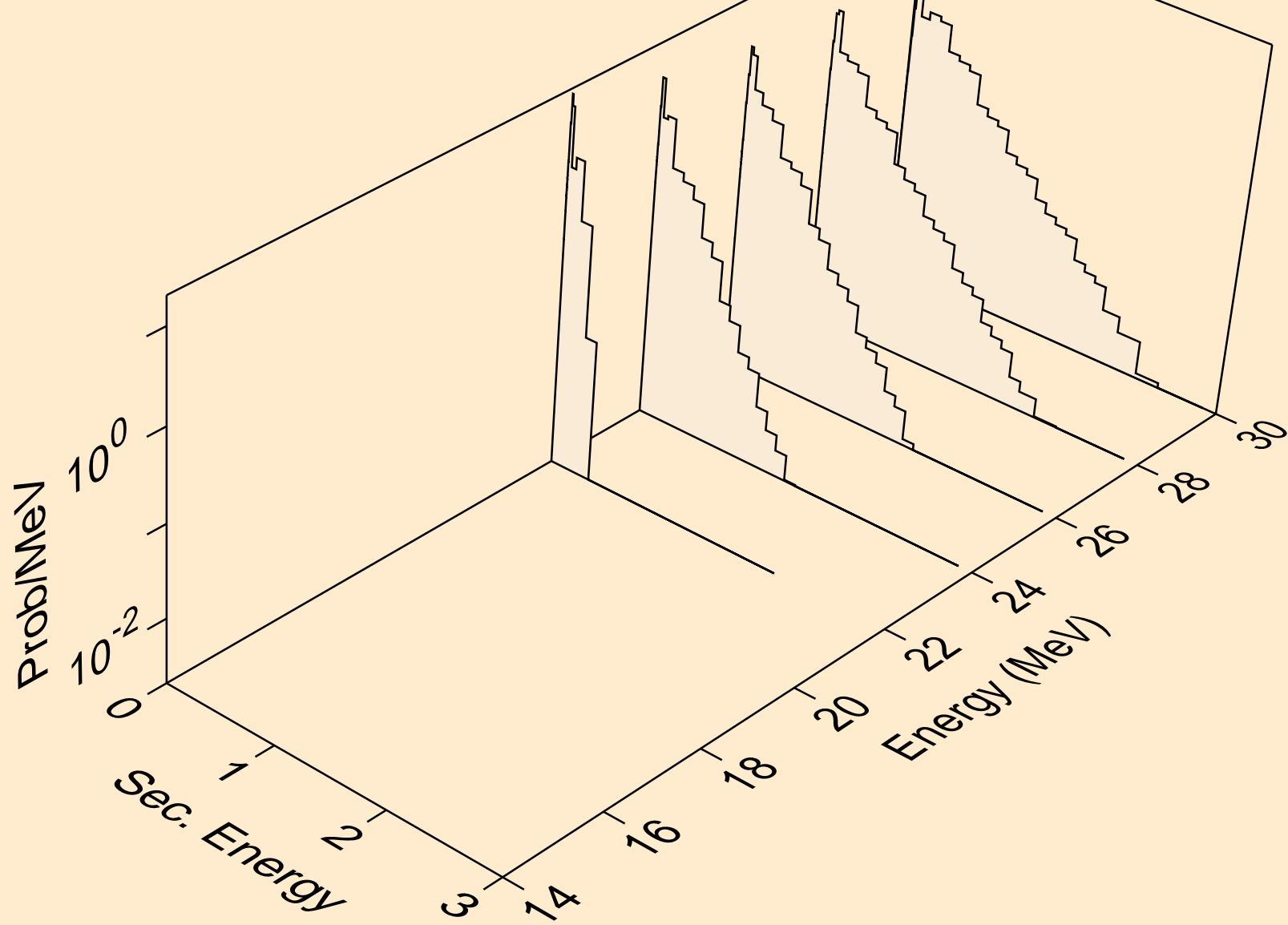

PB214 NEUTRON ACER TENDL-2021 LIBRARY; T=293.6K
Neutron emission for (n,4n)

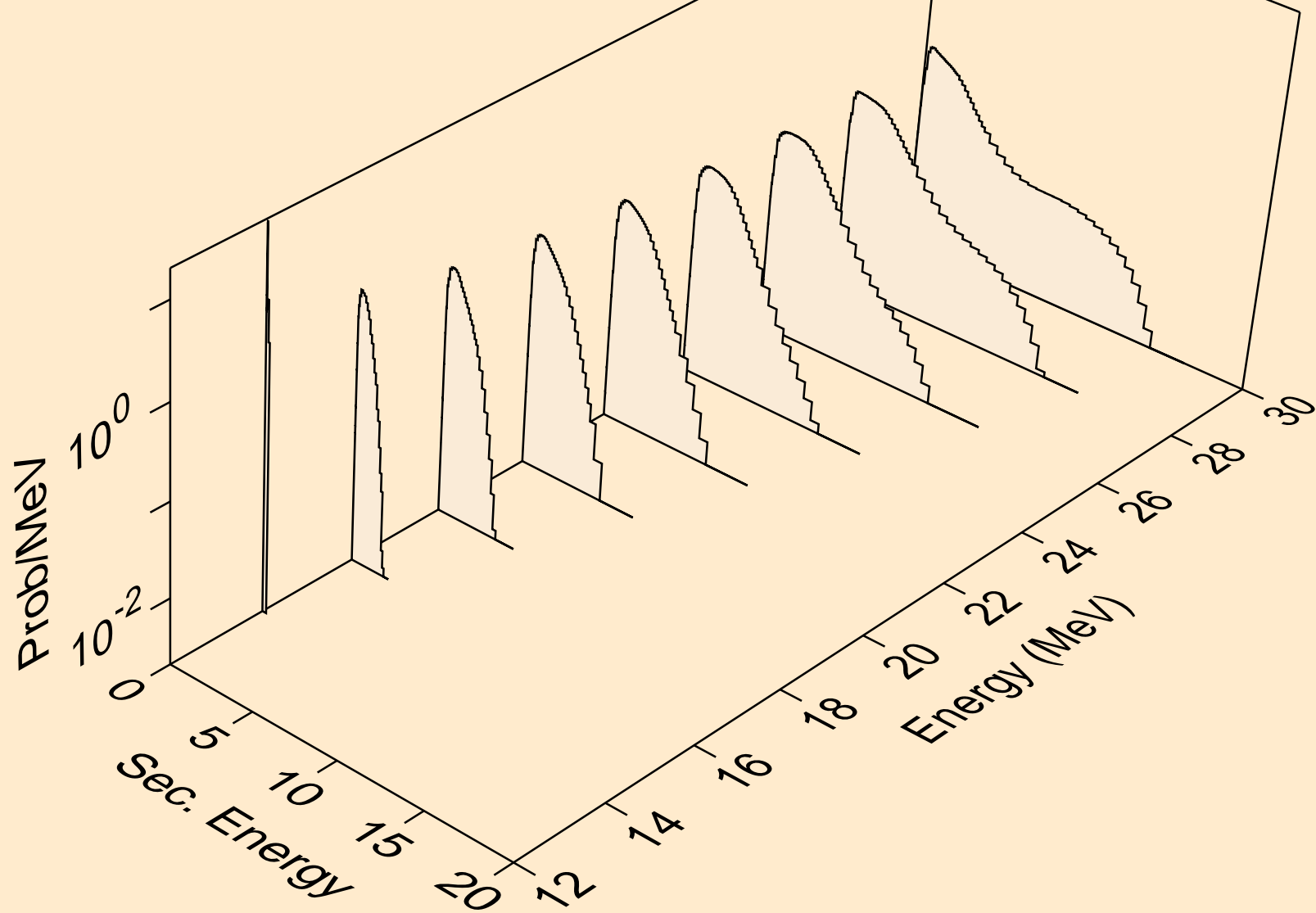

PB214 NEUTRON ACER TENDL-2021 LIBRARY; T=293.6K
Neutron emission for (n,2np)

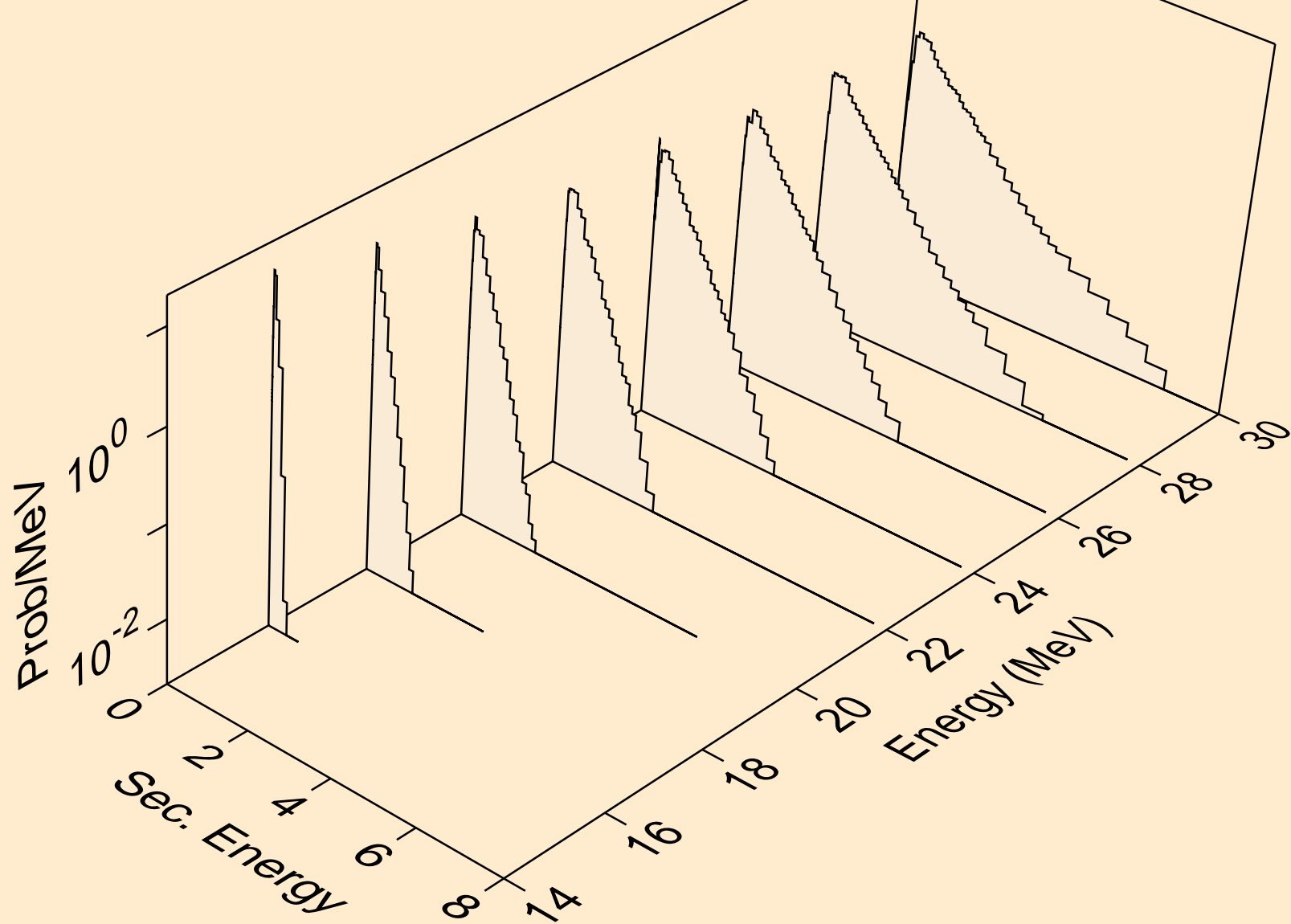

PB214 NEUTRON ACER TENDL-2021 LIBRARY; T=293.6K
Neutron emission for (n,3np)

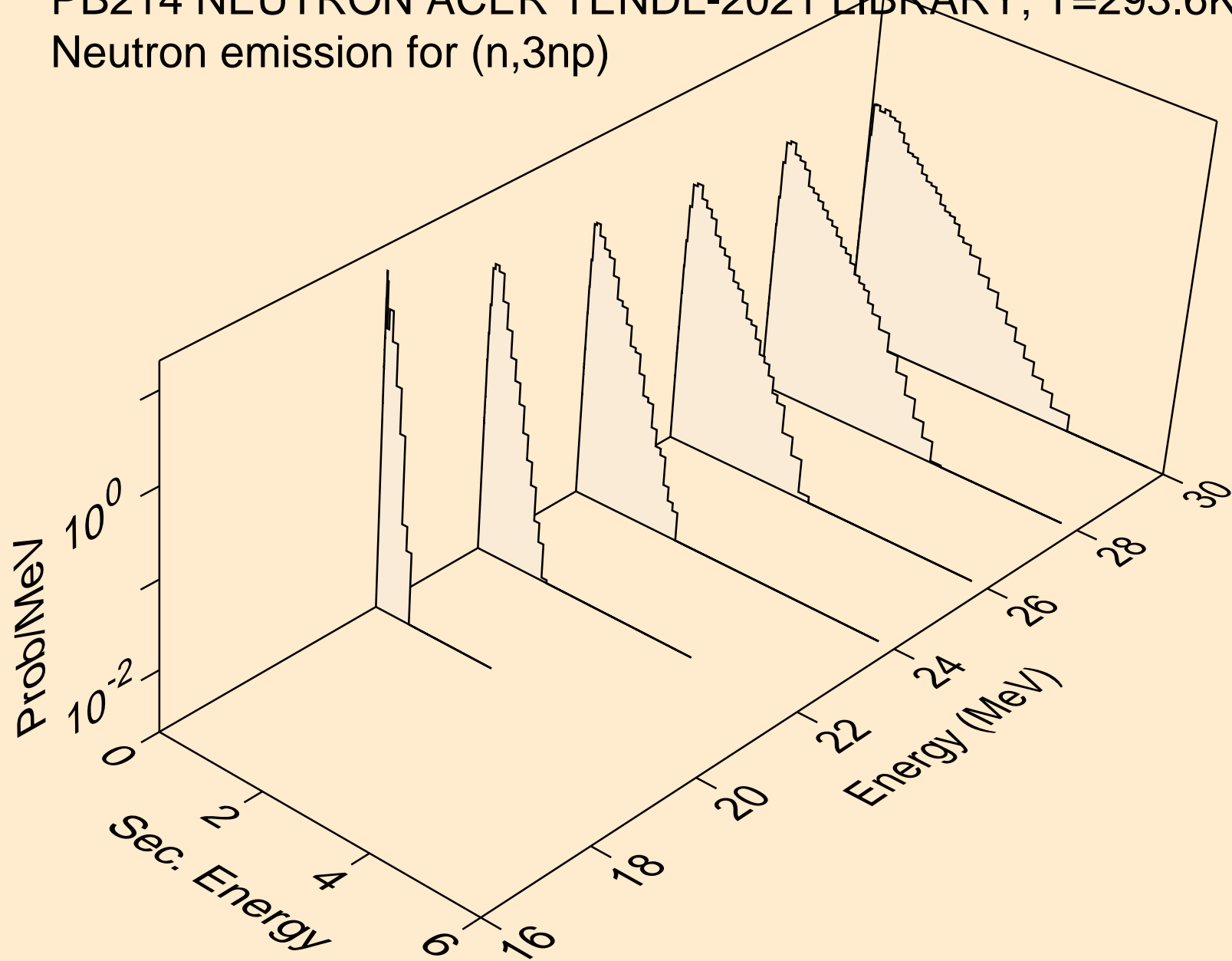

PB214 NEUTRON ACER TENDL-2021 LIBRARY; T=293.6K
Neutron emission for (n,n*c)

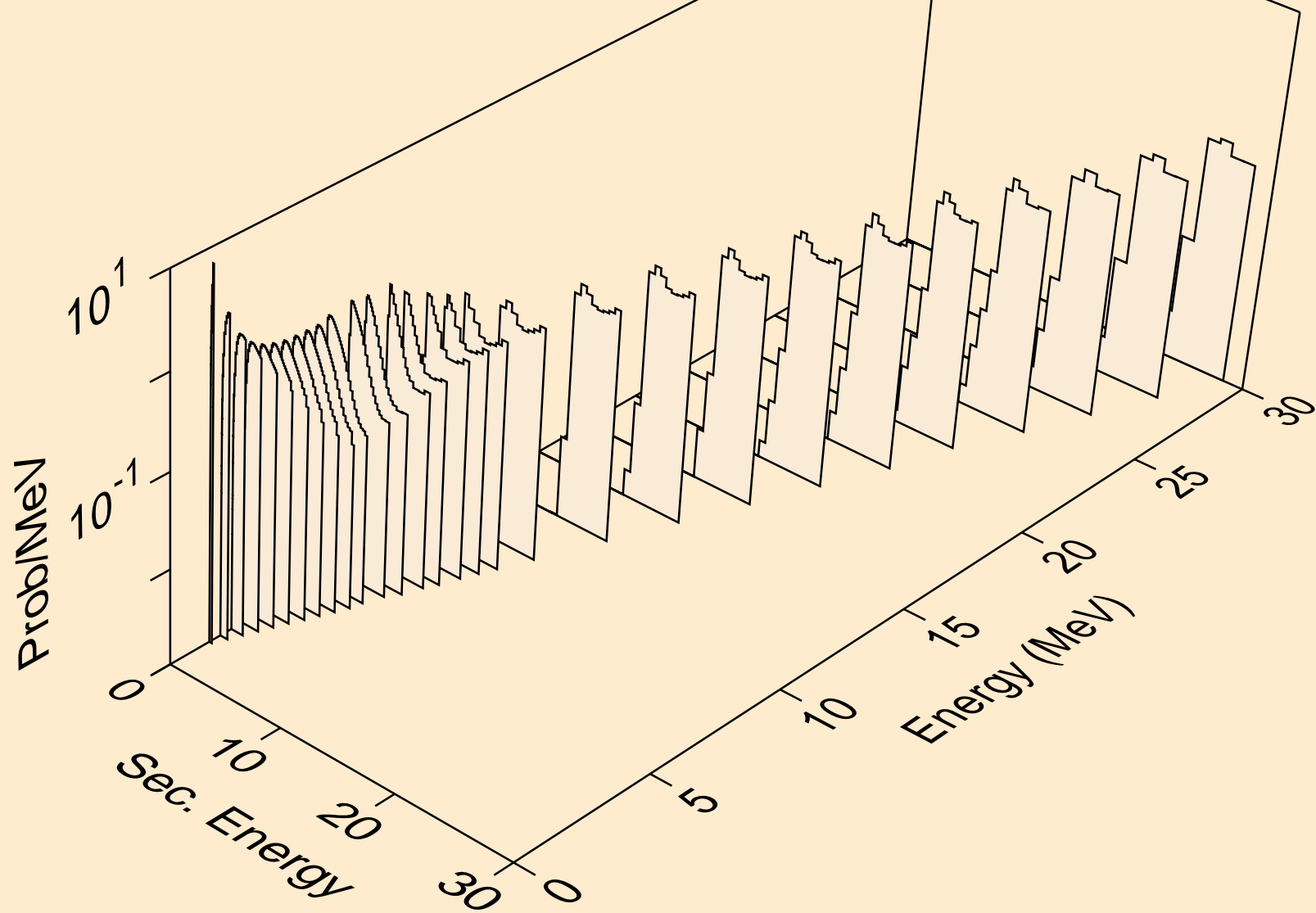

PB214 NEUTRON ACER TENDL-2021 LIBRARY; T=293.6K
Photon emission for (n,x)

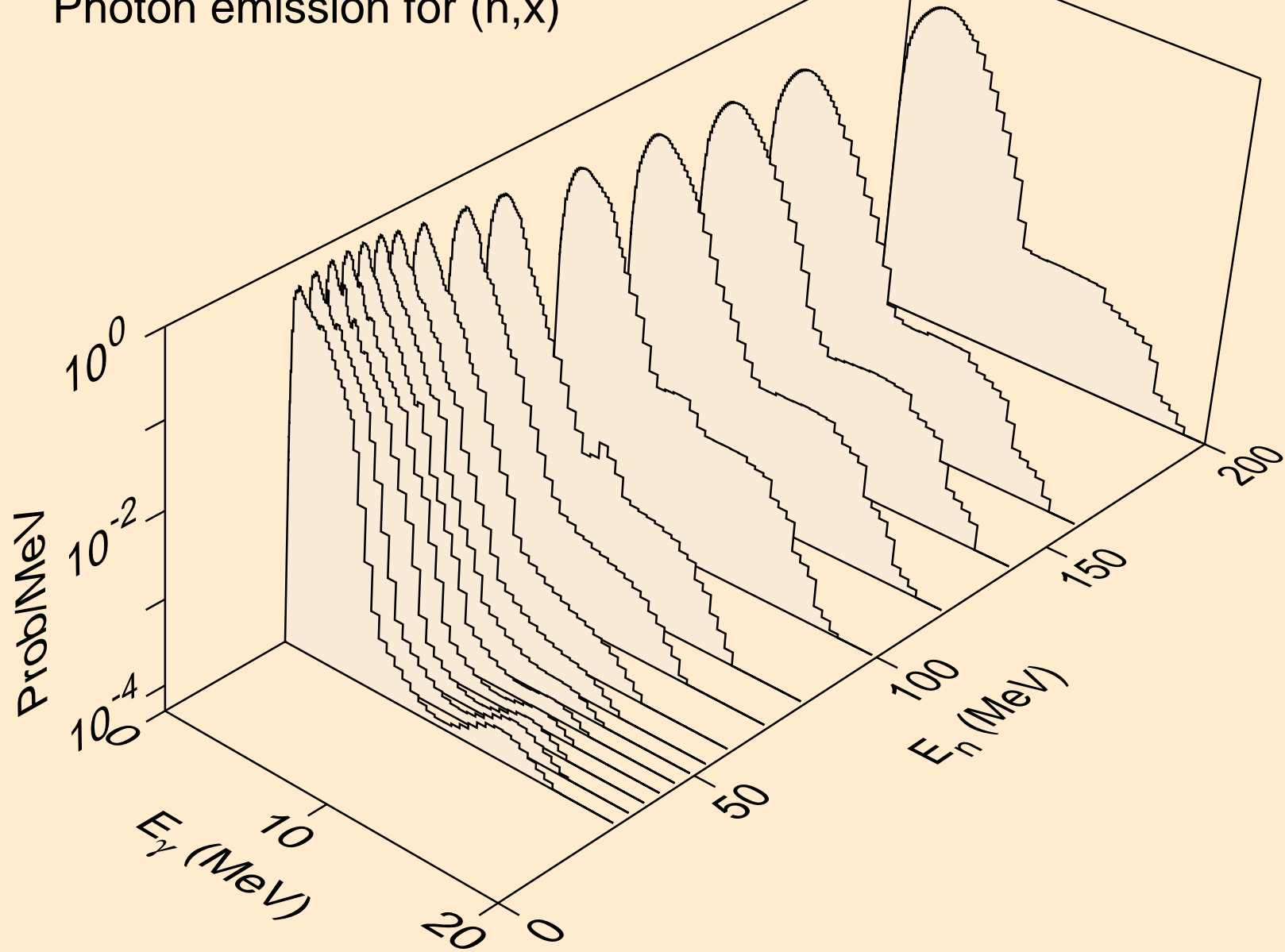

PB214 NEUTRON ACER TENDL-2021 LIBRARY; T=293.6K
Photon emission for (n,2nd)

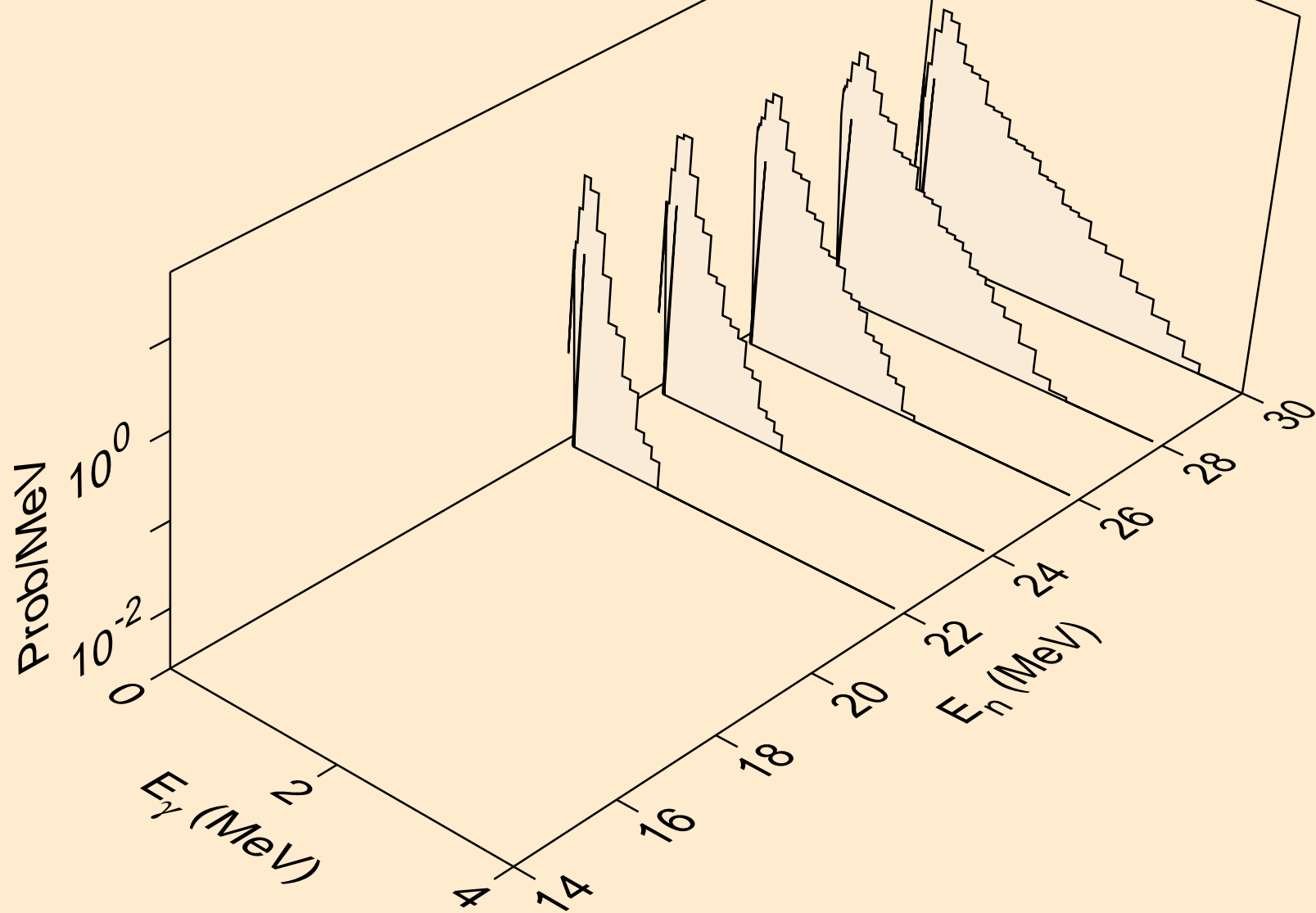

PB214 NEUTRON ACER TENDL-2021 LIBRARY; T=293.6K
Photon emission for (n,2n)

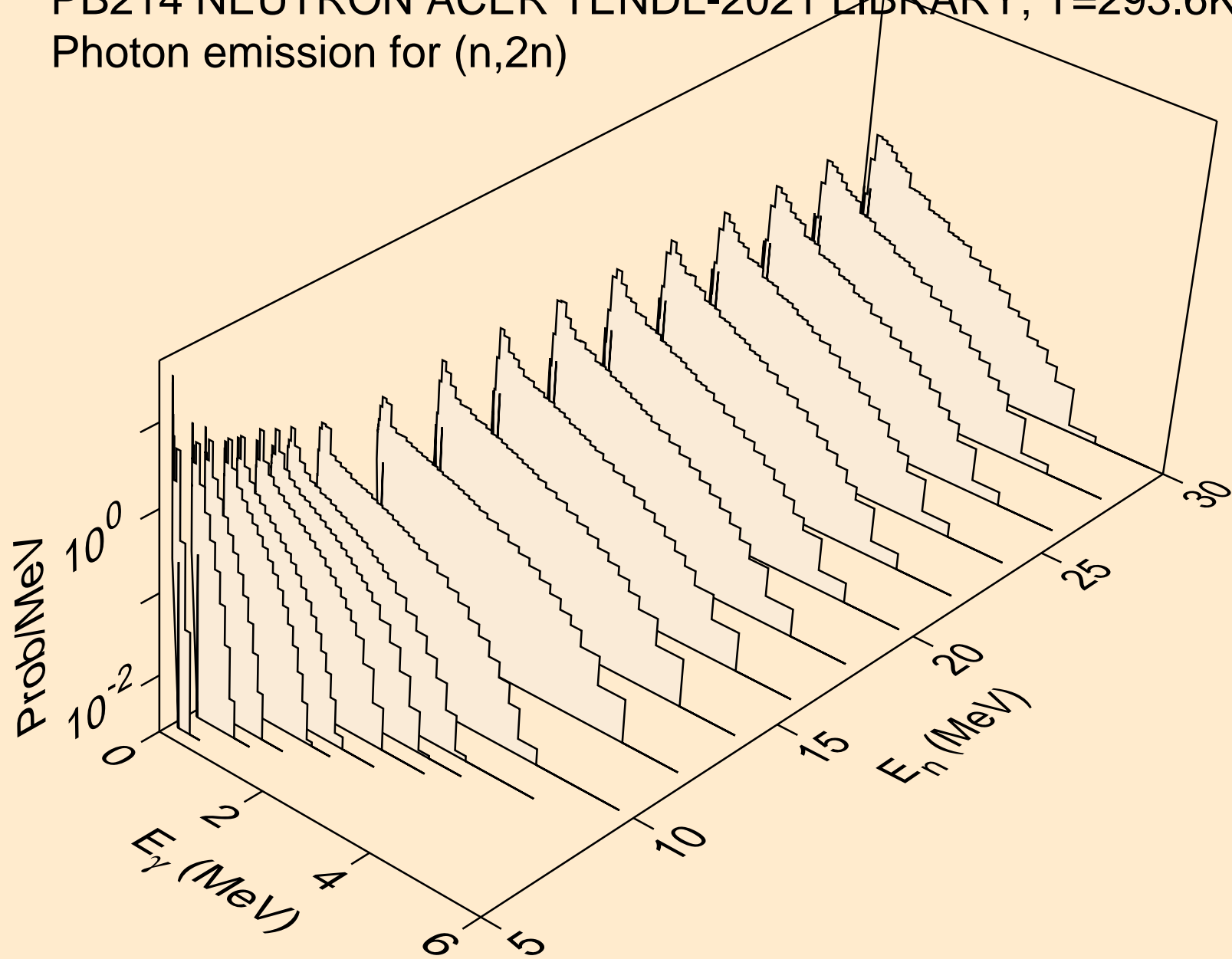

PB214 NEUTRON ACER TENDL-2021 LIBRARY; T=293.6K
Photon emission for (n,3n)

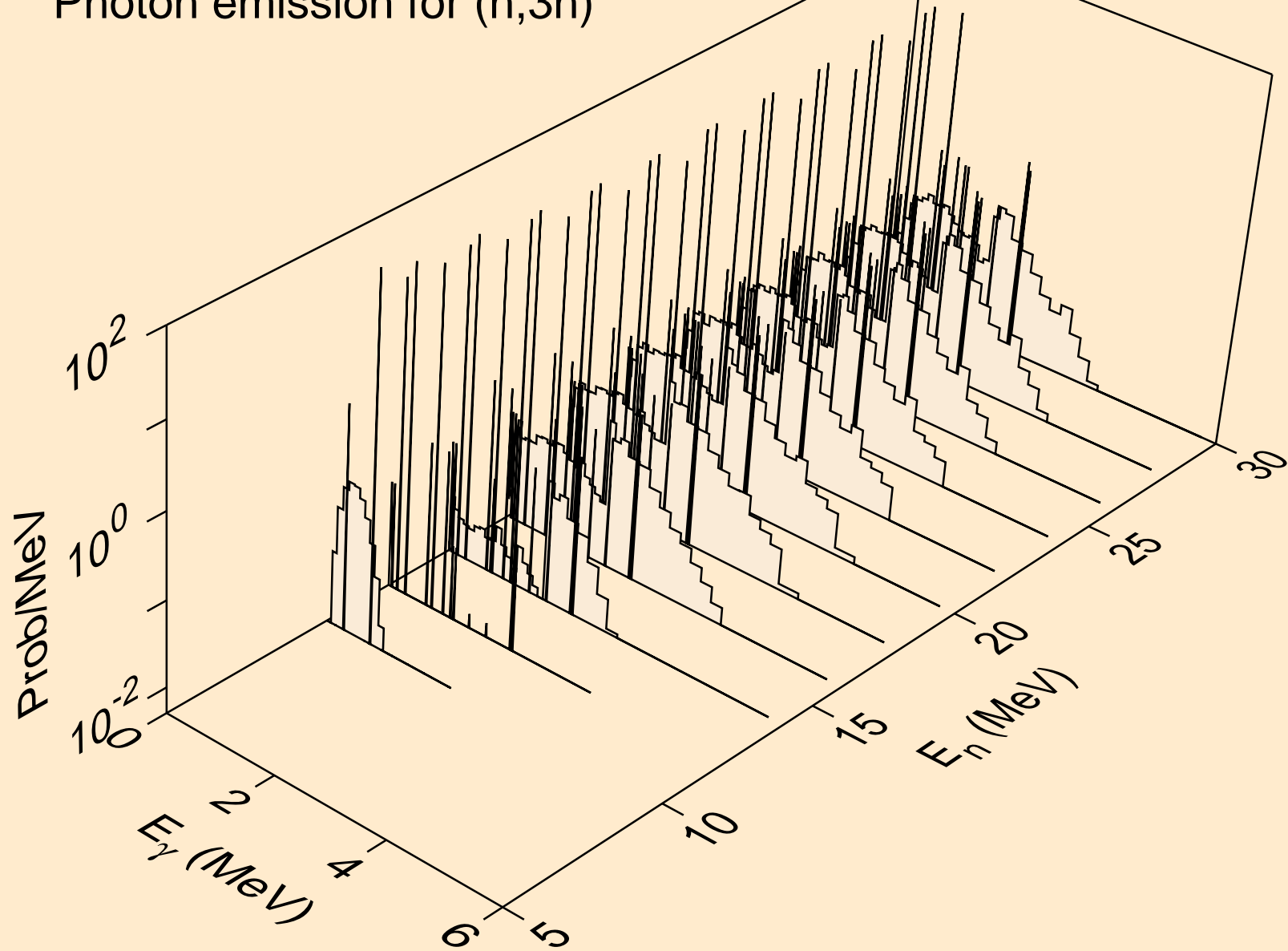

PB214 NEUTRON ACER TENDL-2021 LIBRARY; T=293.6K
Photon emission for (n,n*)a

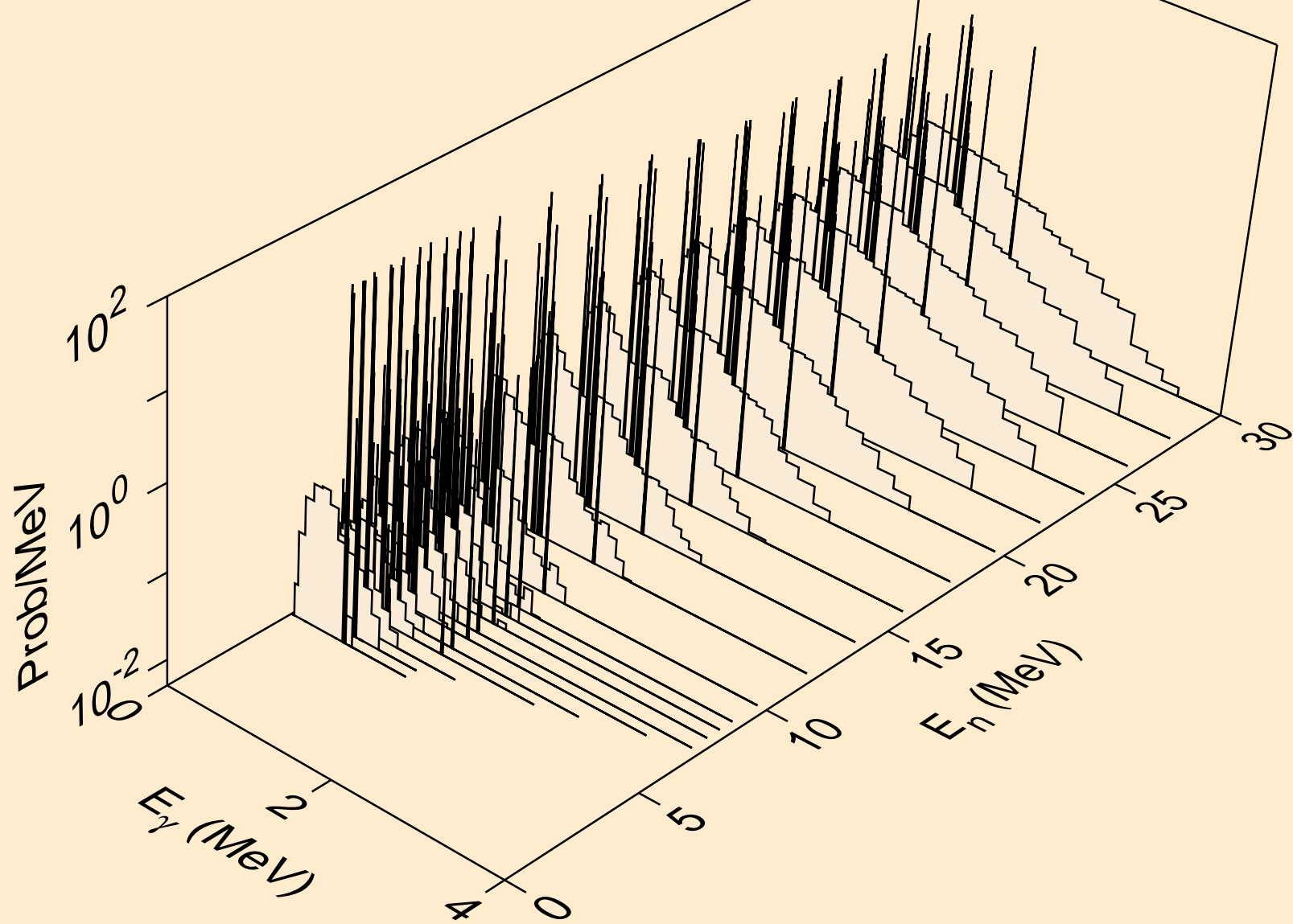

PB214 NEUTRON ACER TENDL-2021 LIBRARY; T=293.6K
Photon emission for (n,2n) α

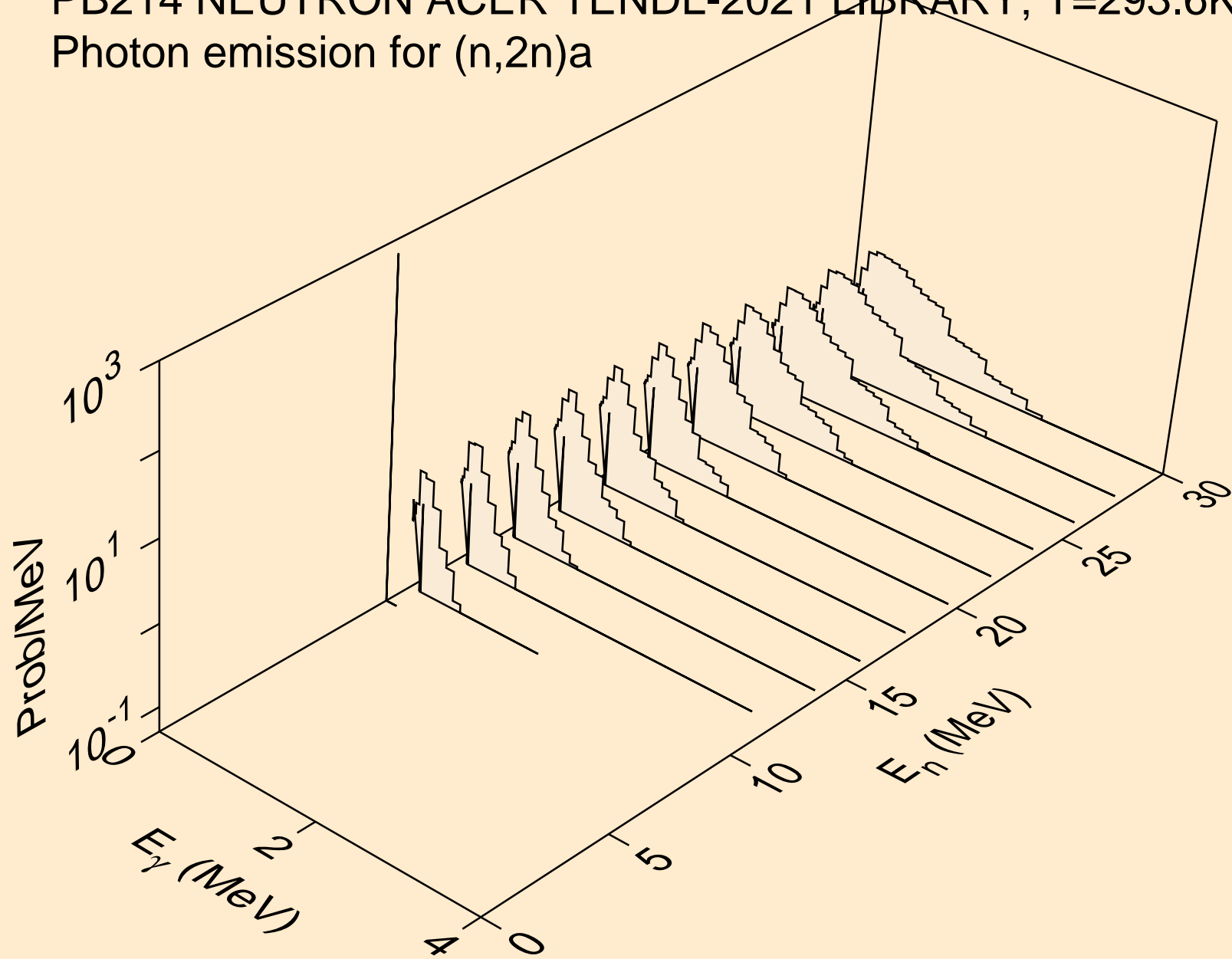

PB214 NEUTRON ACER TENDL-2021 LIBRARY; T=293.6K
Photon emission for (n,3n)a

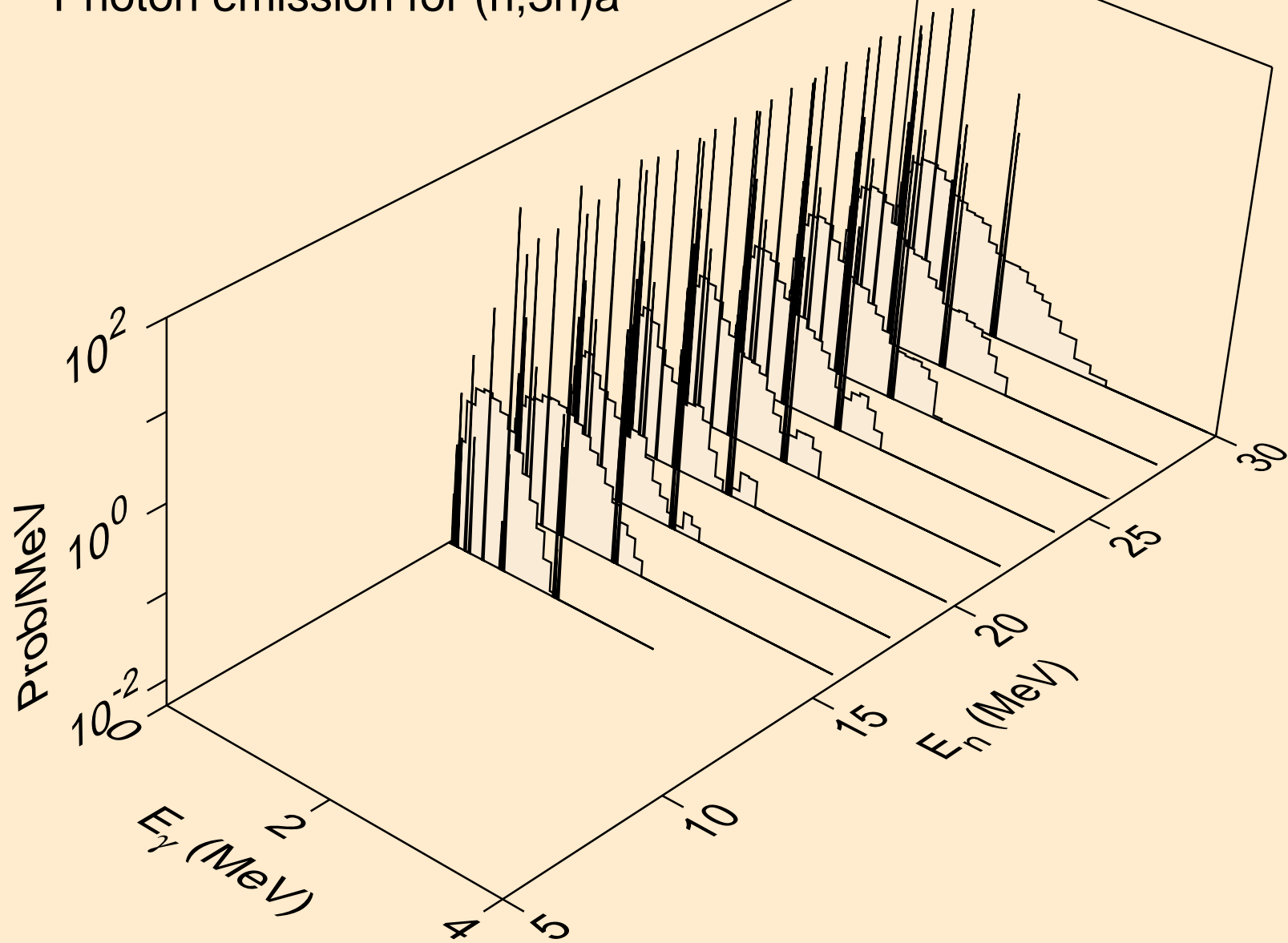

PB214 NEUTRON ACER TENDL-2021 LIBRARY; T=293.6K
Photon emission for (n,n*)p

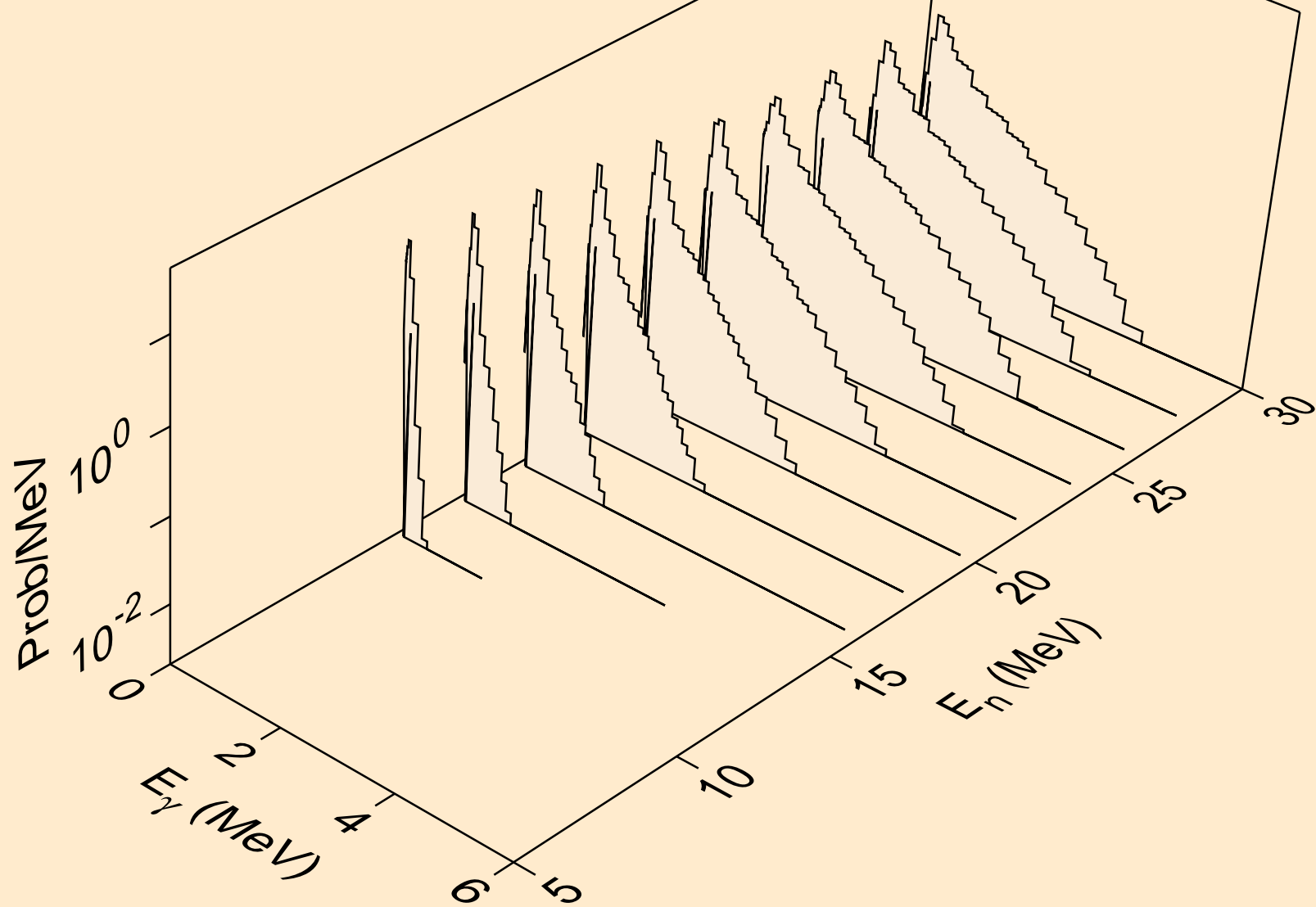

PB214 NEUTRON ACER TENDL-2021 LIBRARY; T=293.6K
Photon emission for (n,n*)d

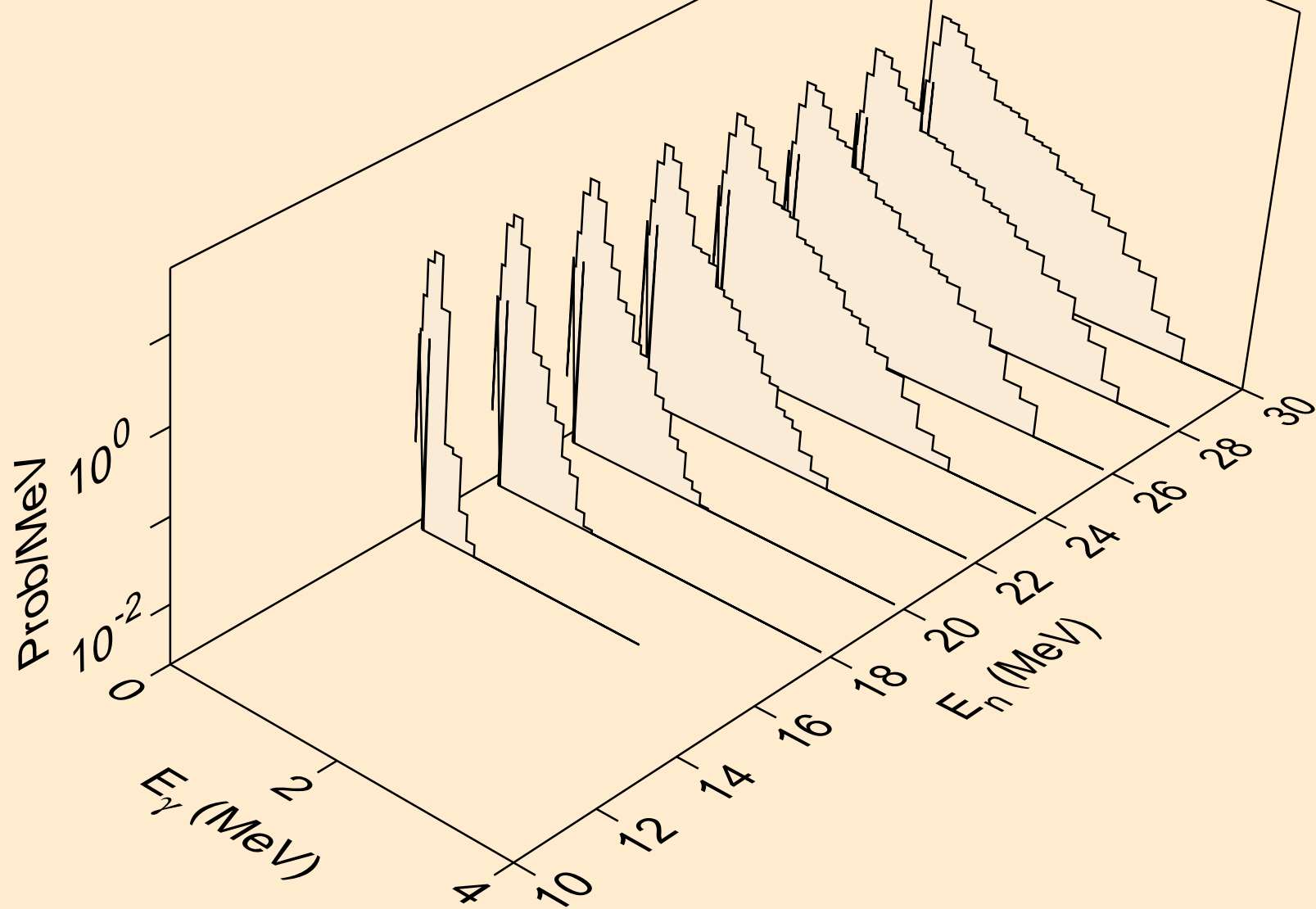

PB214 NEUTRON ACER TENDL-2021 LIBRARY; T=293.6K
Photon emission for (n,n*)t

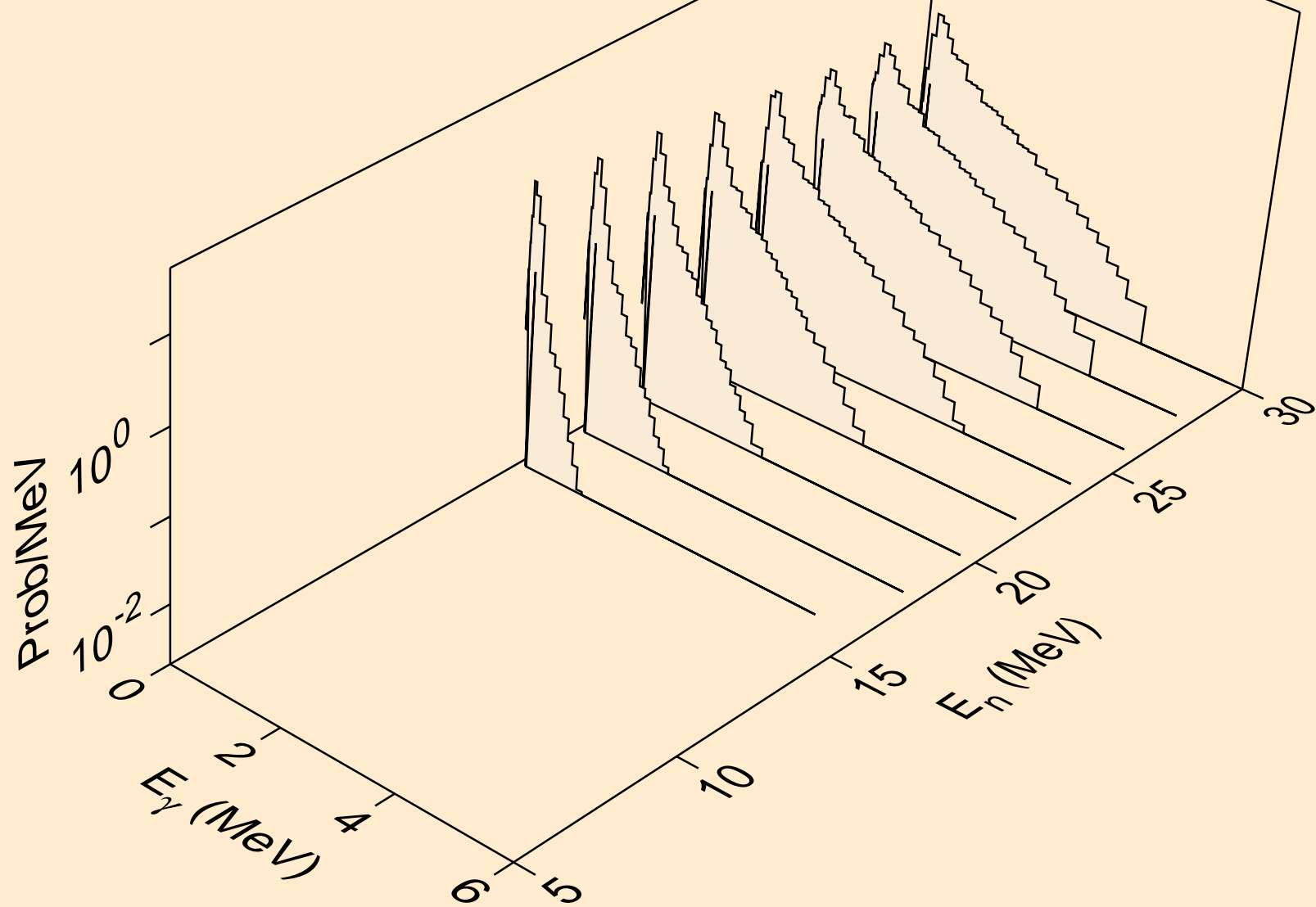

PB214 NEUTRON ACER TENDL-2021 LIBRARY; T=293.6K
Photon emission for (n,n*)he3

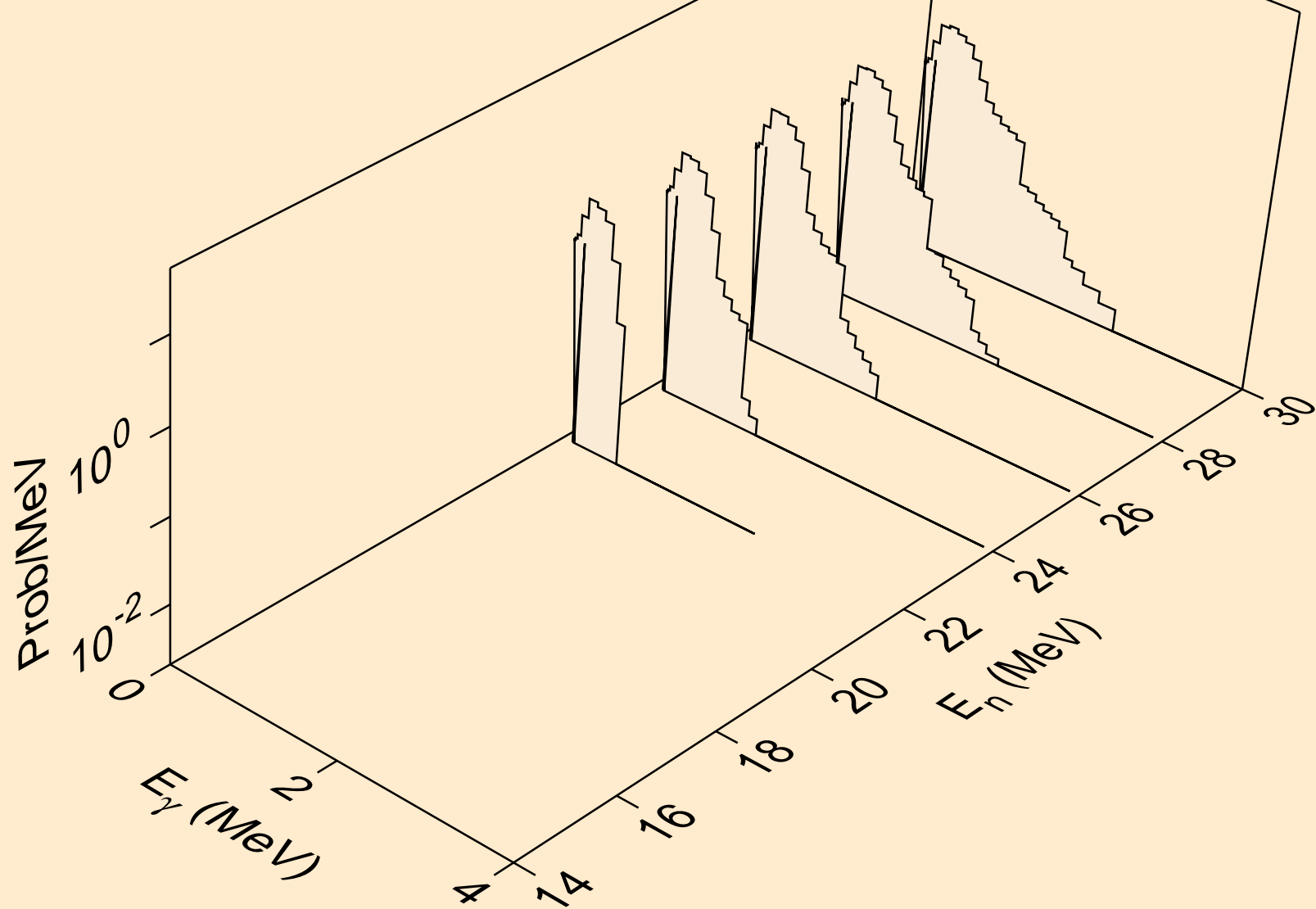

PB214 NEUTRON ACER TENDL-2021 LIBRARY; T=293.6K
Photon emission for (n,4n)

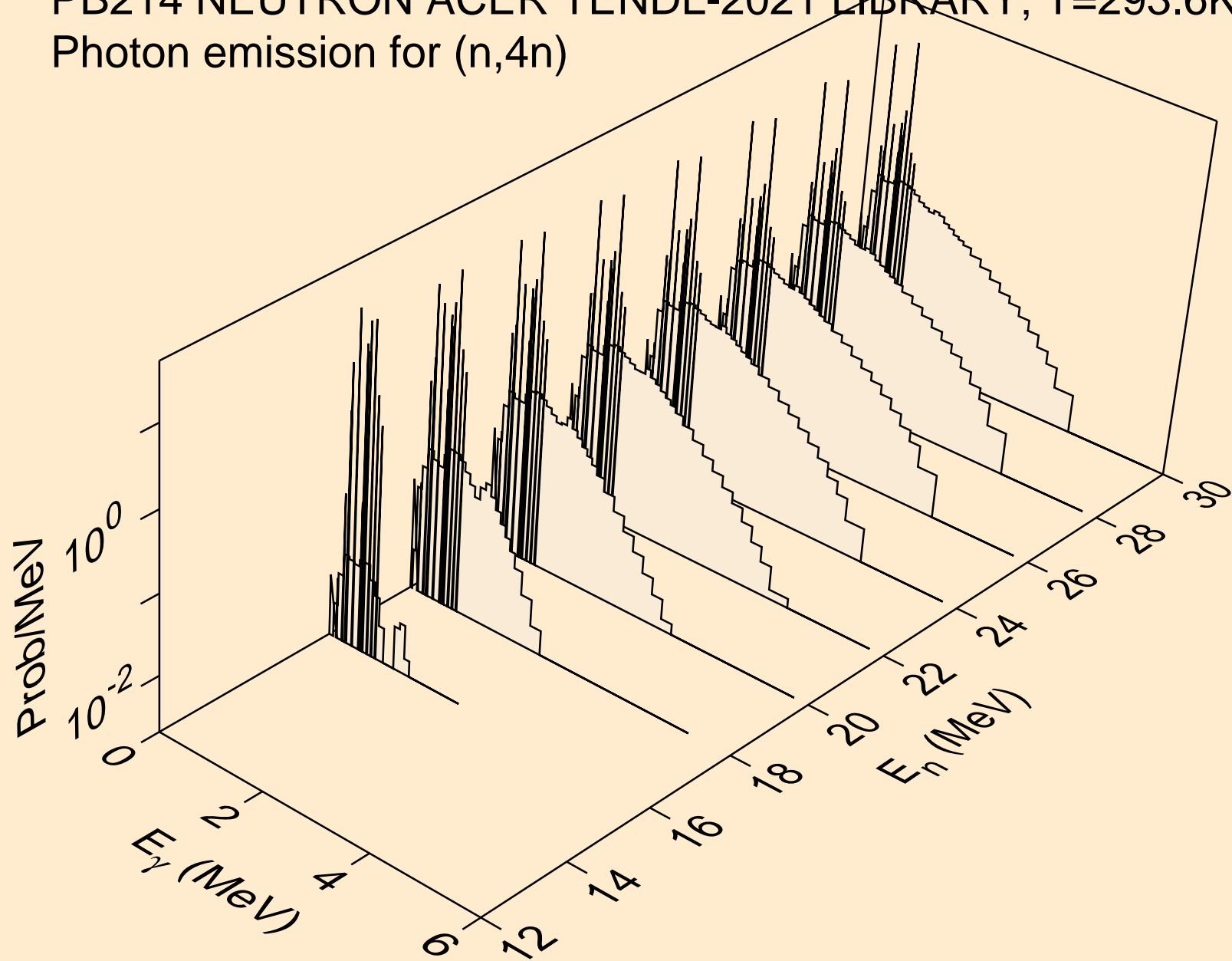

PB214 NEUTRON ACER TENDL-2021 LIBRARY; T=293.6K
Photon emission for (n,2np)

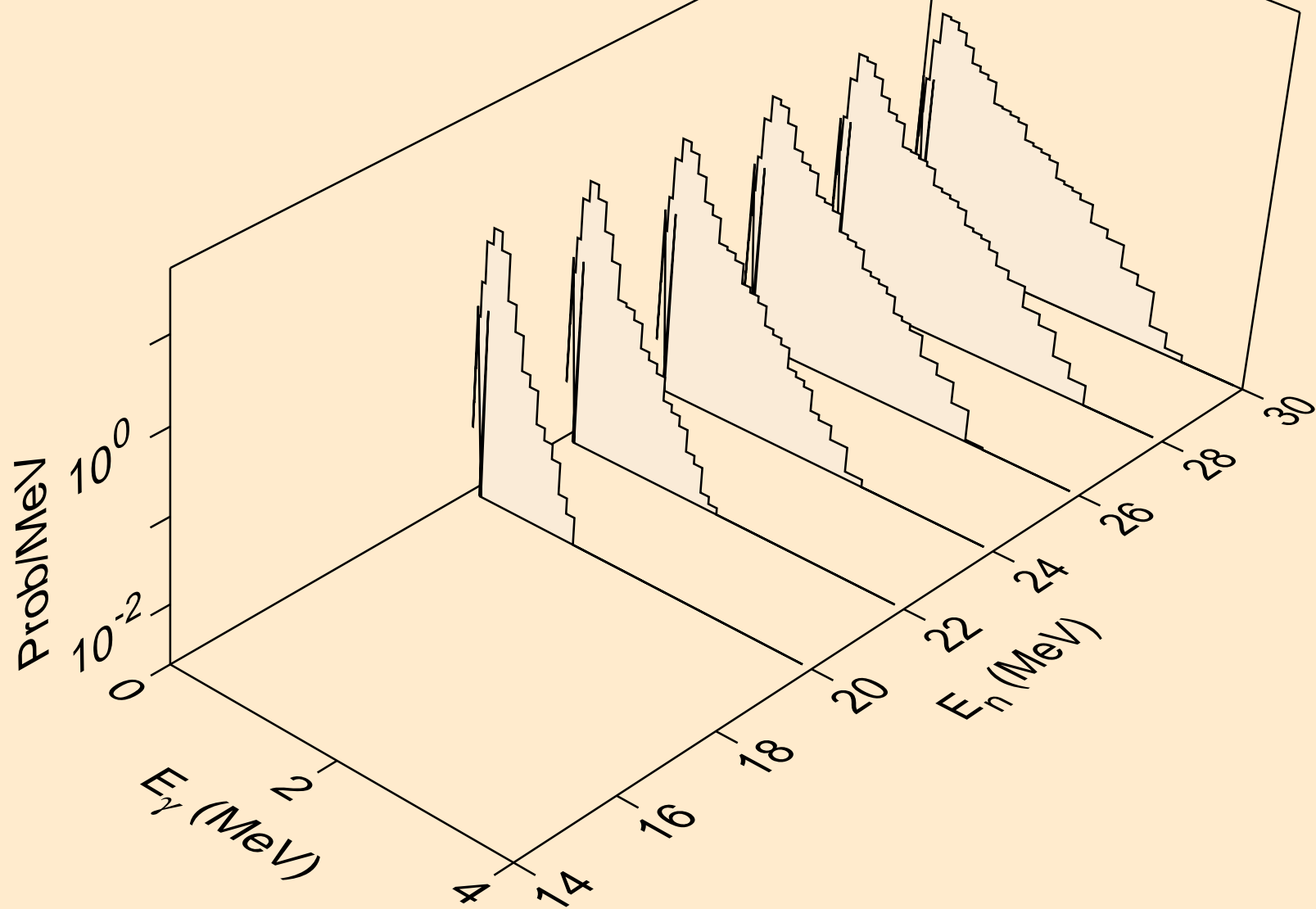

PB214 NEUTRON ACER TENDL-2021 LIBRARY; T=293.6K
Photon emission for (n,3np)

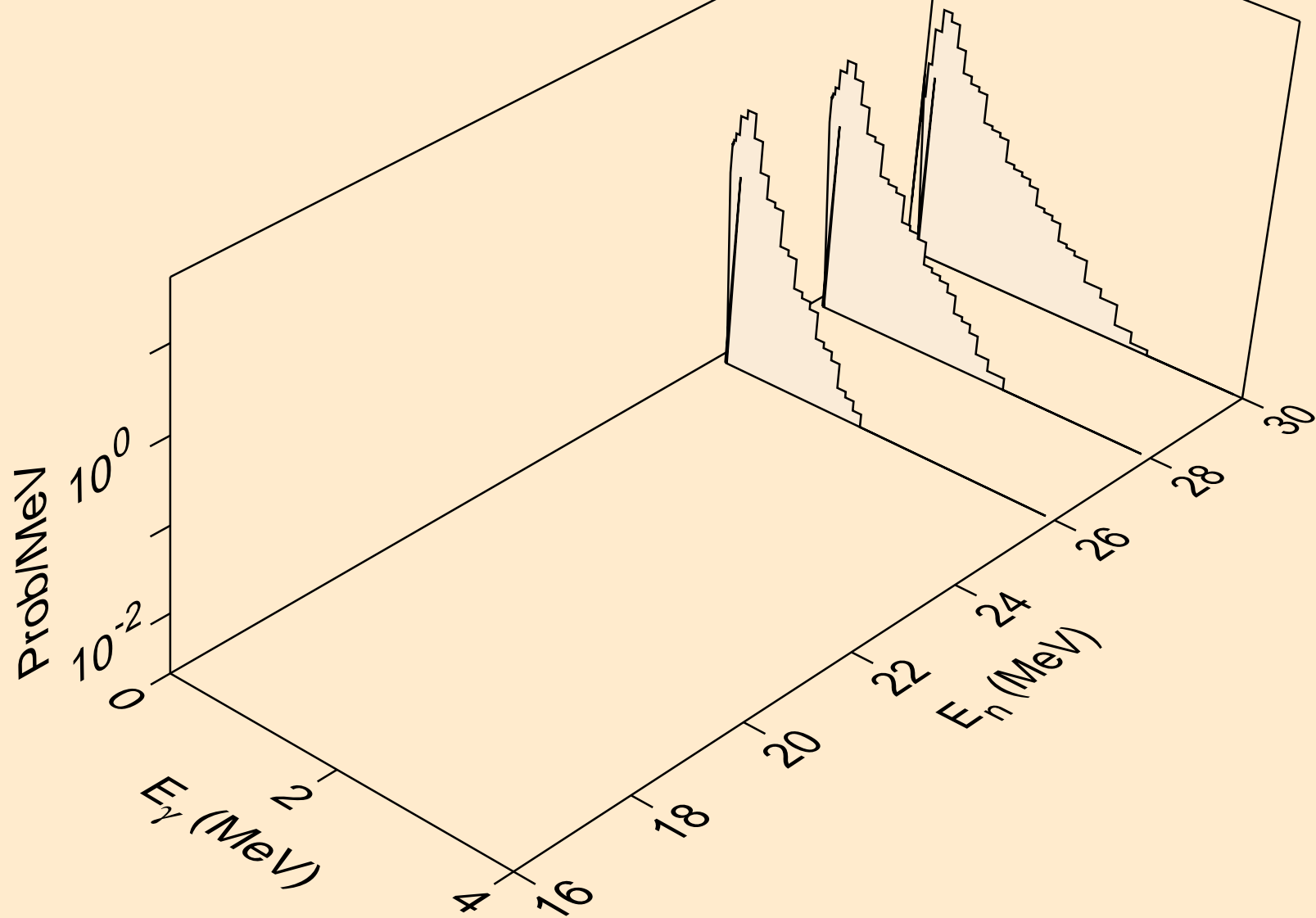

PB214 NEUTRON ACER TENDL-2021 LIBRARY; T=293.6K
Photon emission for (n,n*c)

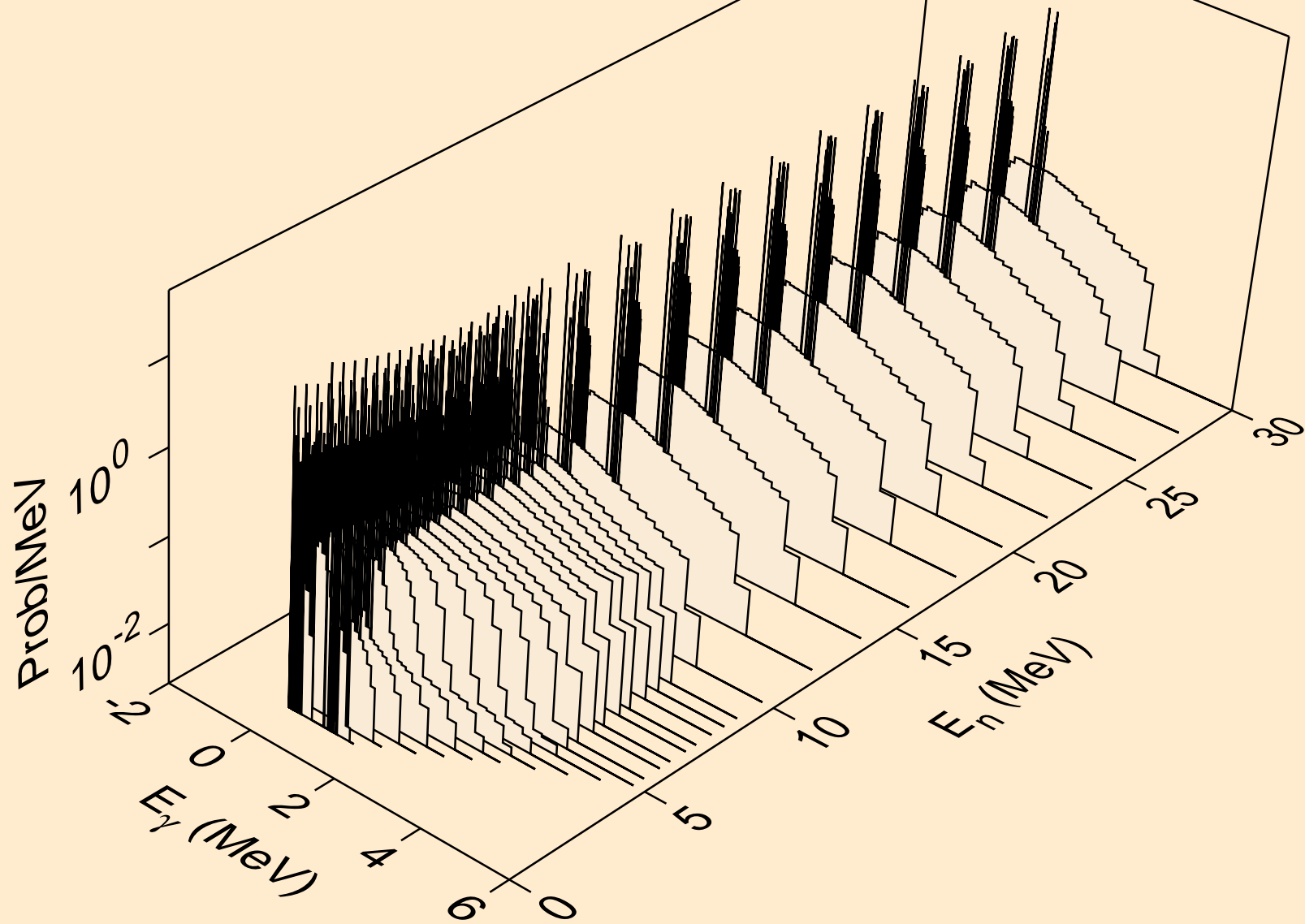

PB214 NEUTRON ACER TENDL-2021 LIBRARY; T=293.6K
Photon emission for (n,gma)

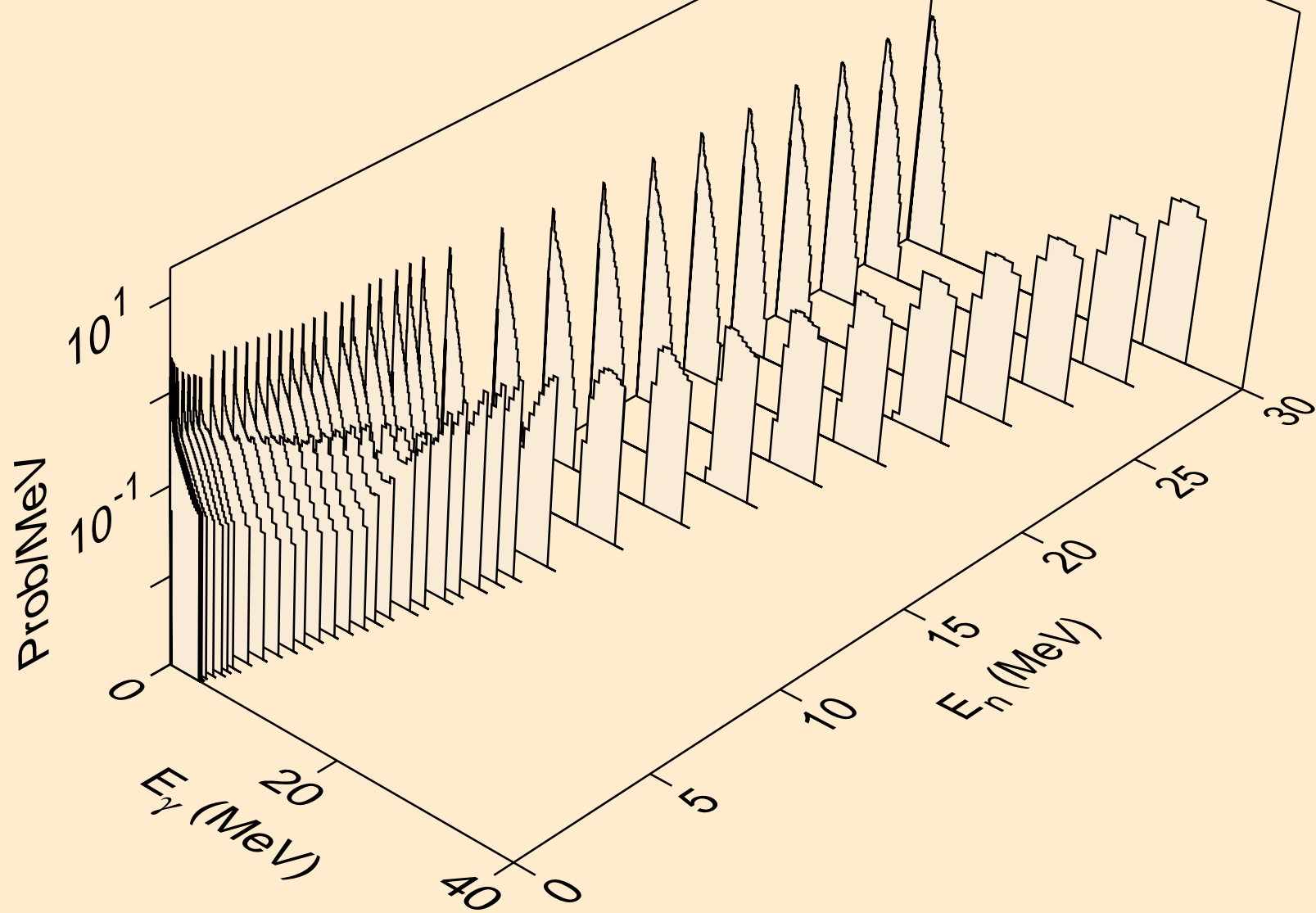

PB214 NEUTRON ACER TENDL-2021 LIBRARY; T=293.6K
Photon emission for (n,p)

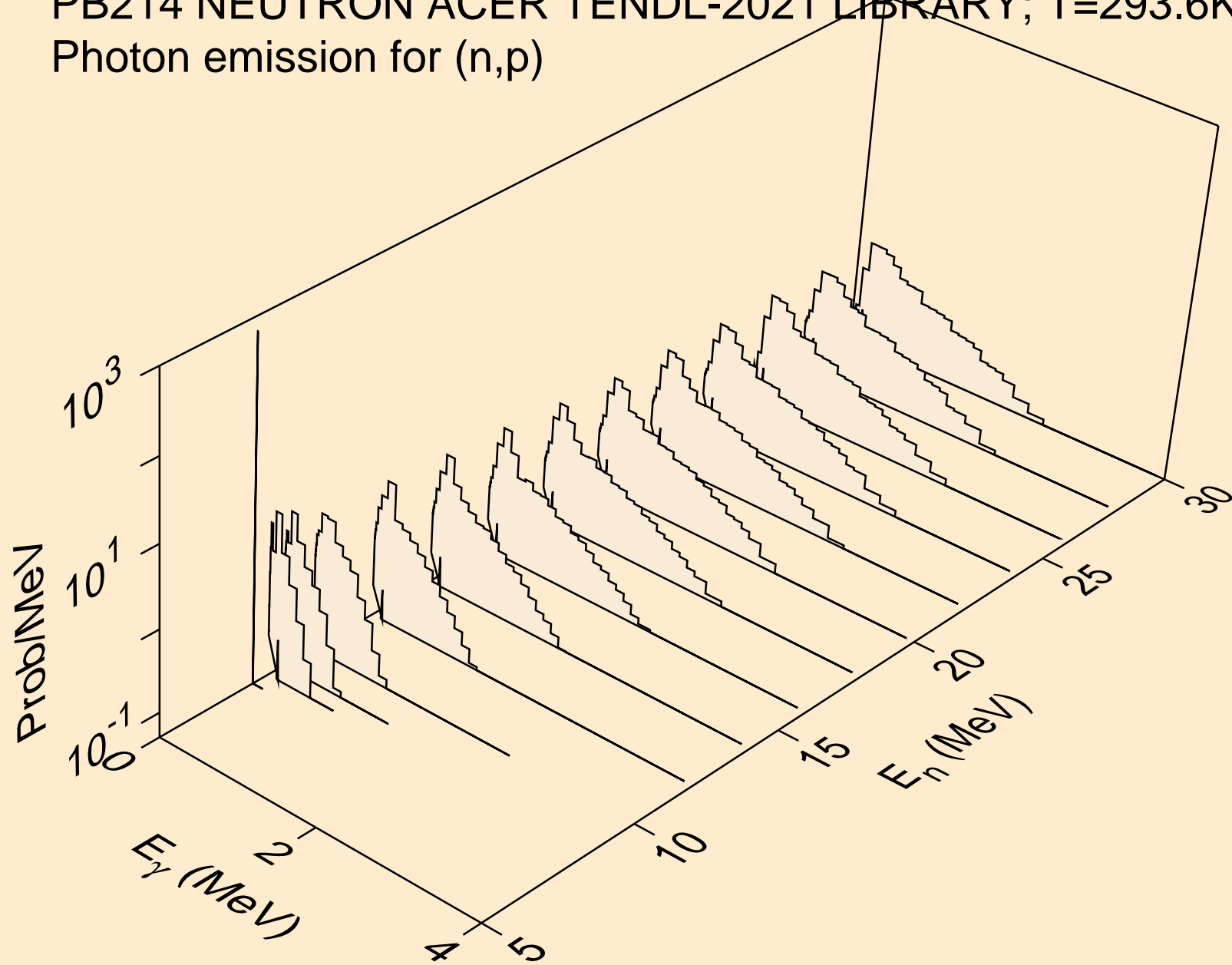

PB214 NEUTRON ACER TENDL-2021 LIBRARY; T=293.6K
Photon emission for (n,d)

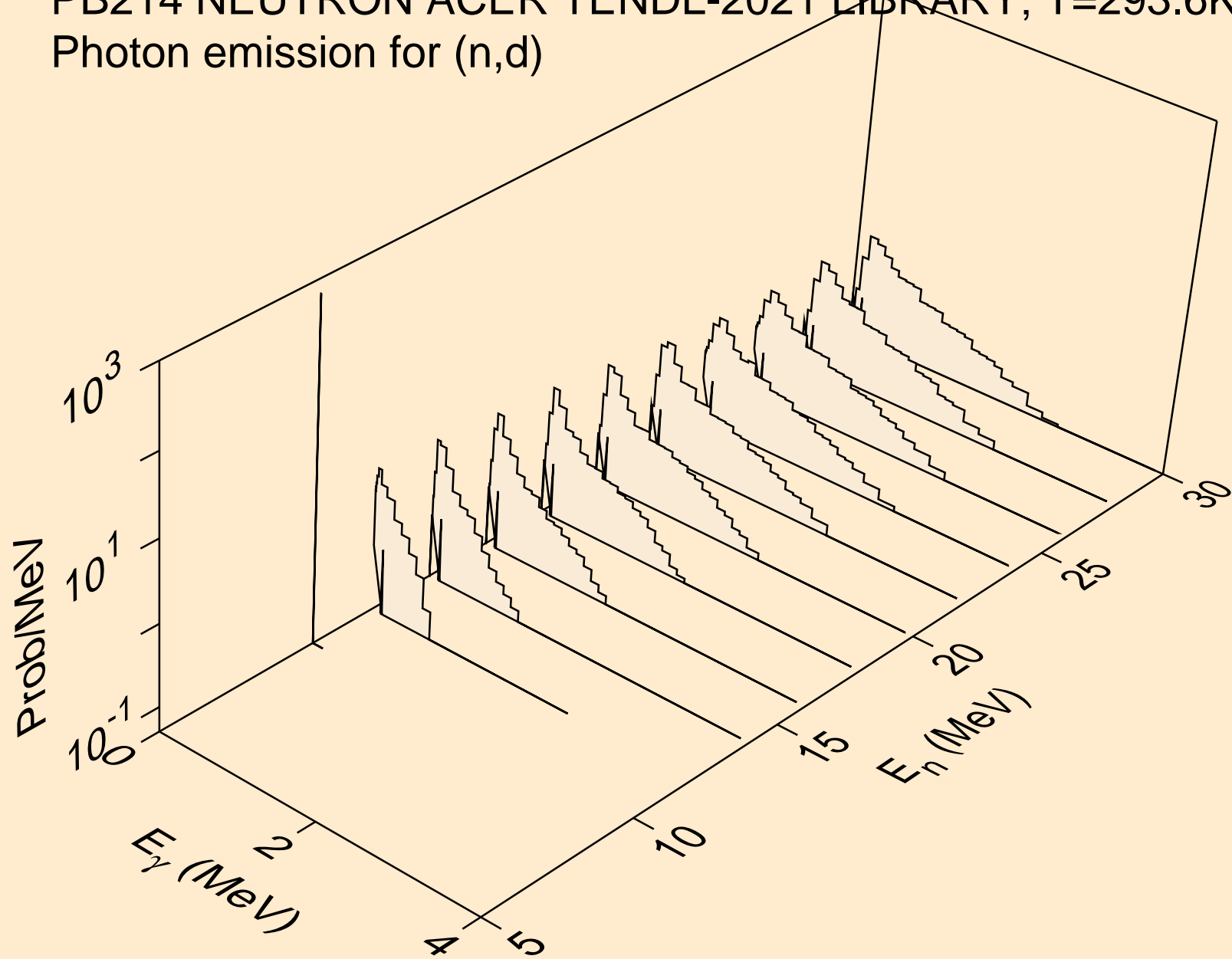

PB214 NEUTRON ACER TENDL-2021 LIBRARY; T=293.6K
Photon emission for (n,t)

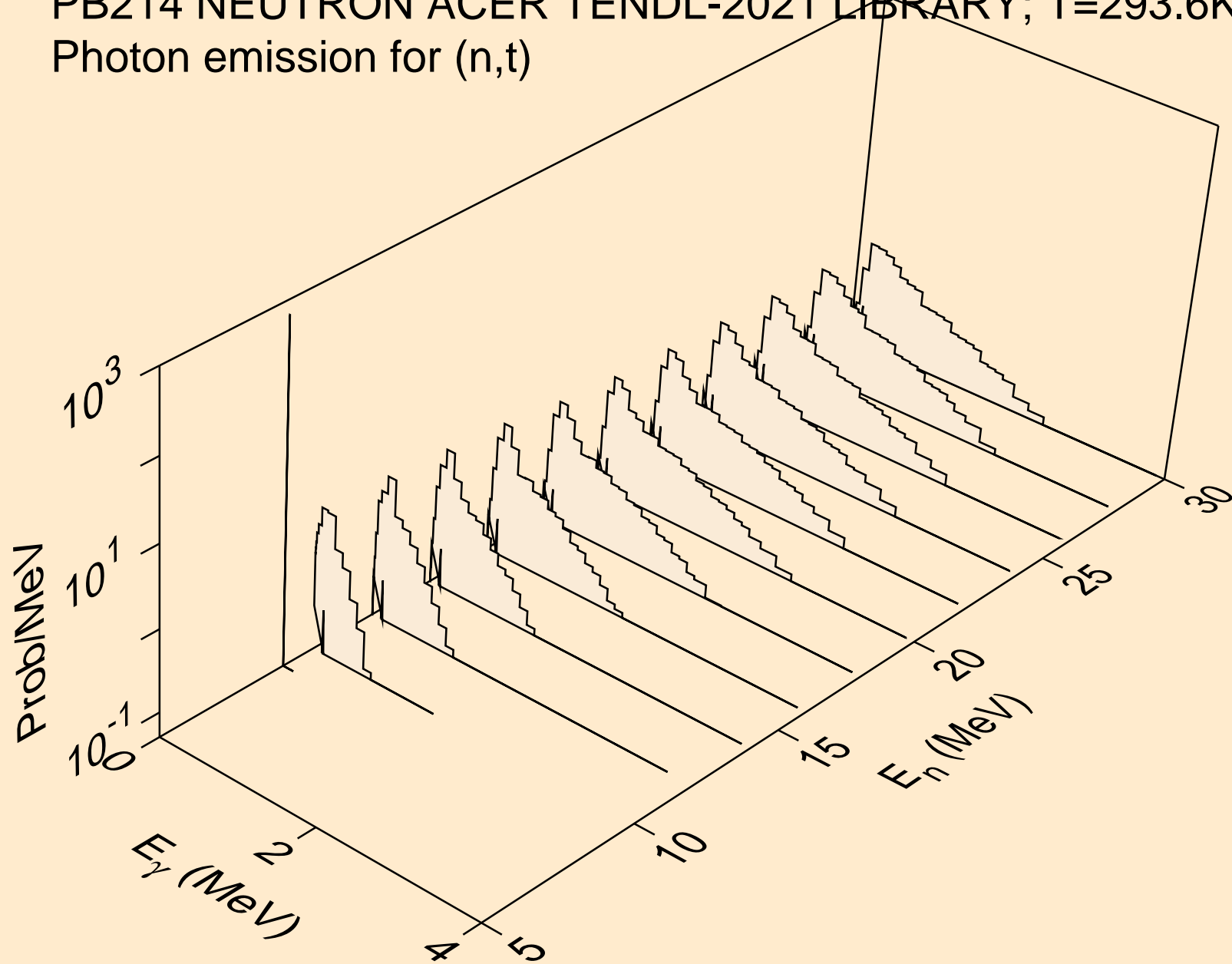

PB214 NEUTRON ACER TENDL-2021 LIBRARY; T=293.6K
Photon emission for (n,he3)

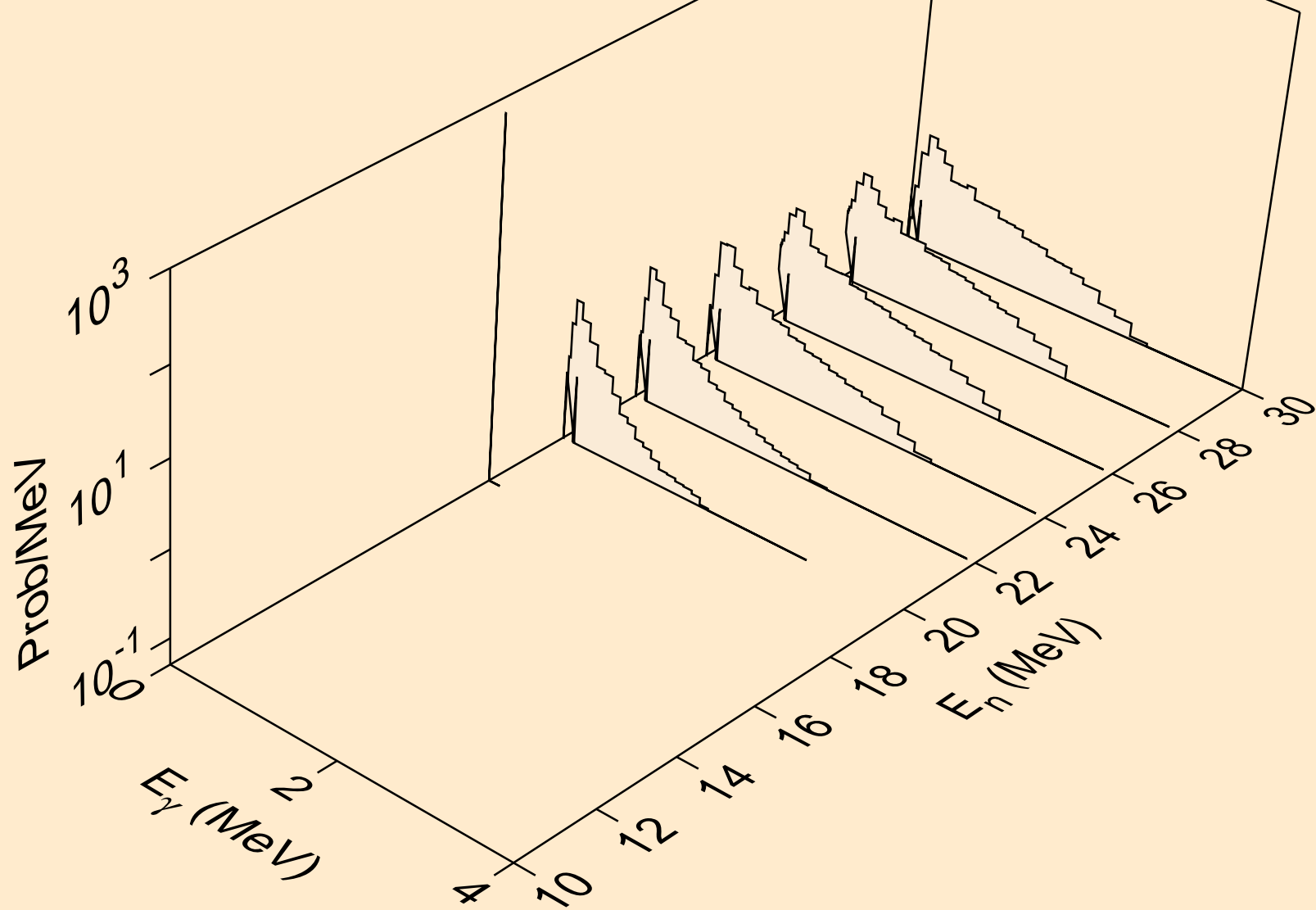

PB214 NEUTRON ACER TENDL-2021 LIBRARY; T=293.6K
Photon emission for (n,a)

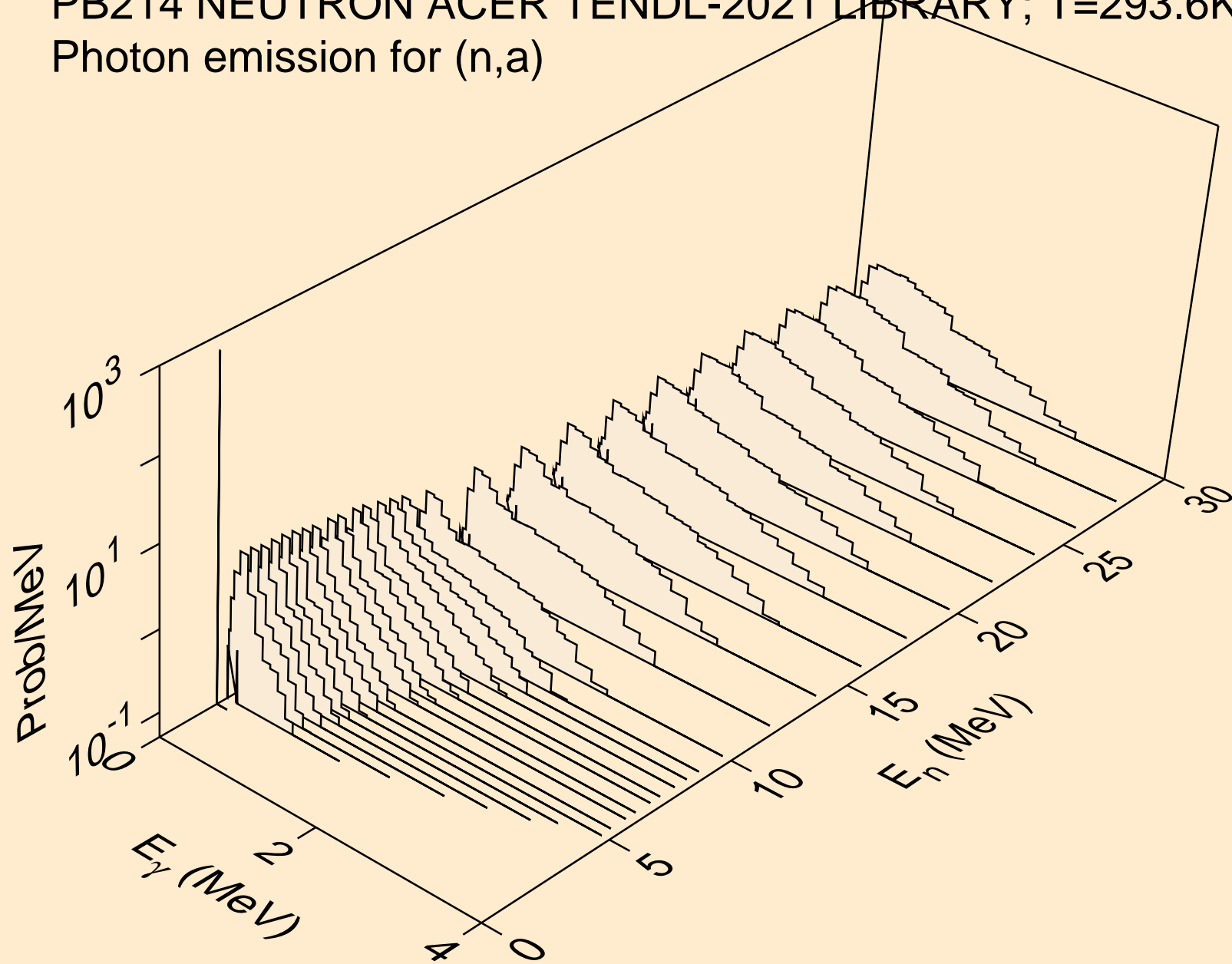

PB214 NEUTRON ACER TENDL-2021 LIBRARY; T=293.6K
thermal capture photon spectrum

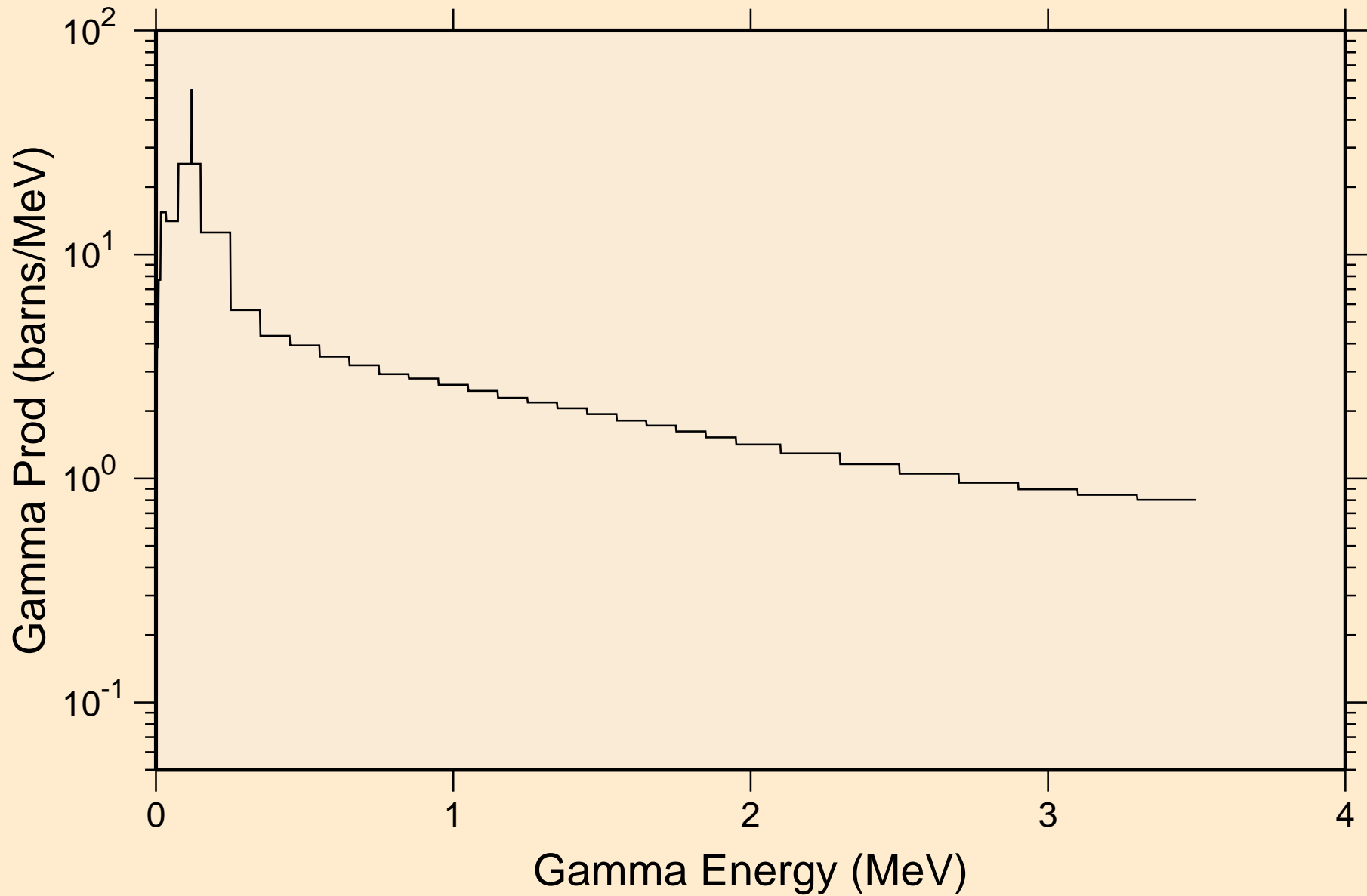

PB214 NEUTRON ACER TENDL-2021 LIBRARY; T=293.6K
14 MeV photon spectrum

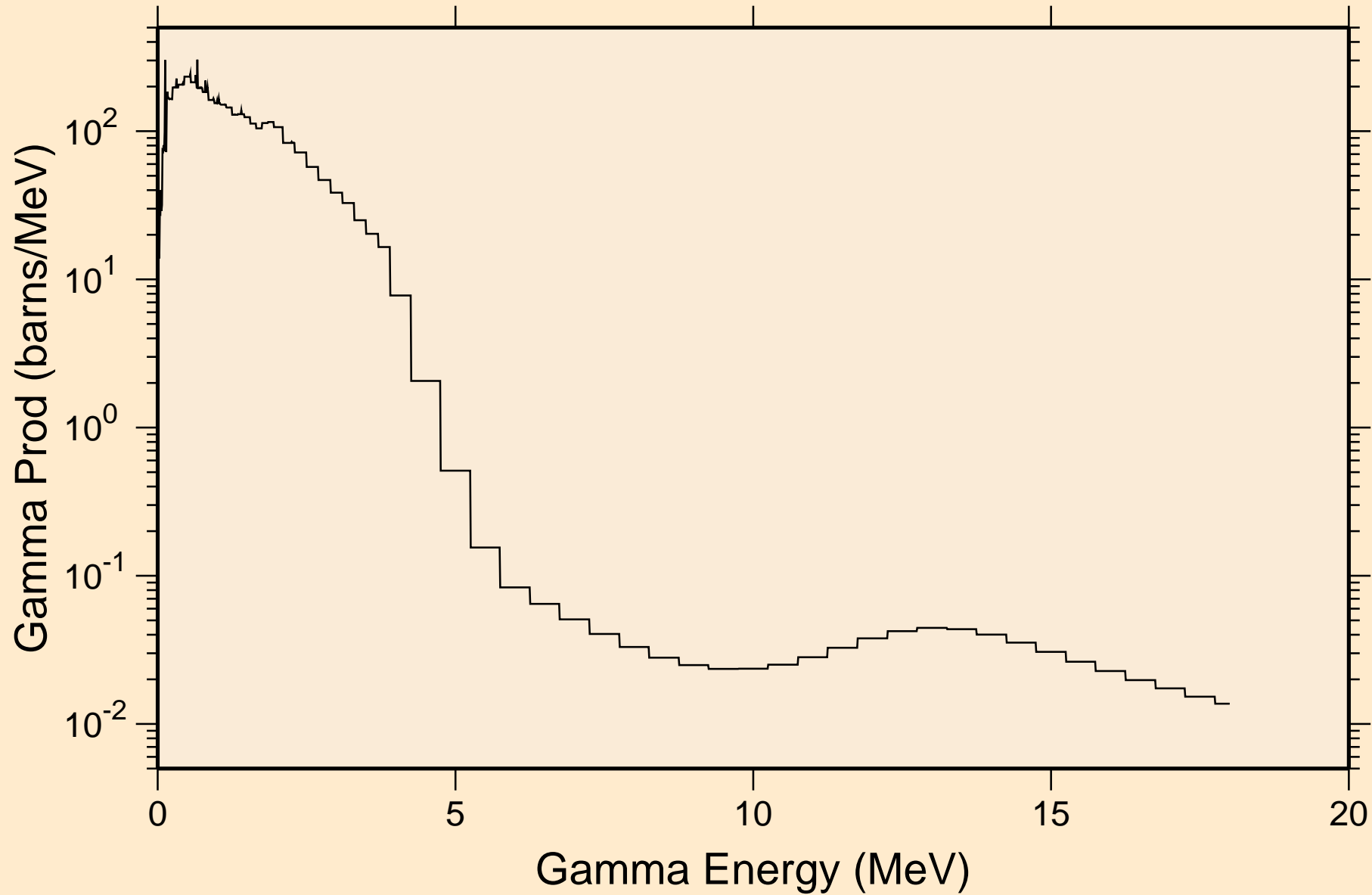

PB214 NEUTRON ACER TENDL-2021 LIBRARY; T=293.6K
Particle heating contributions

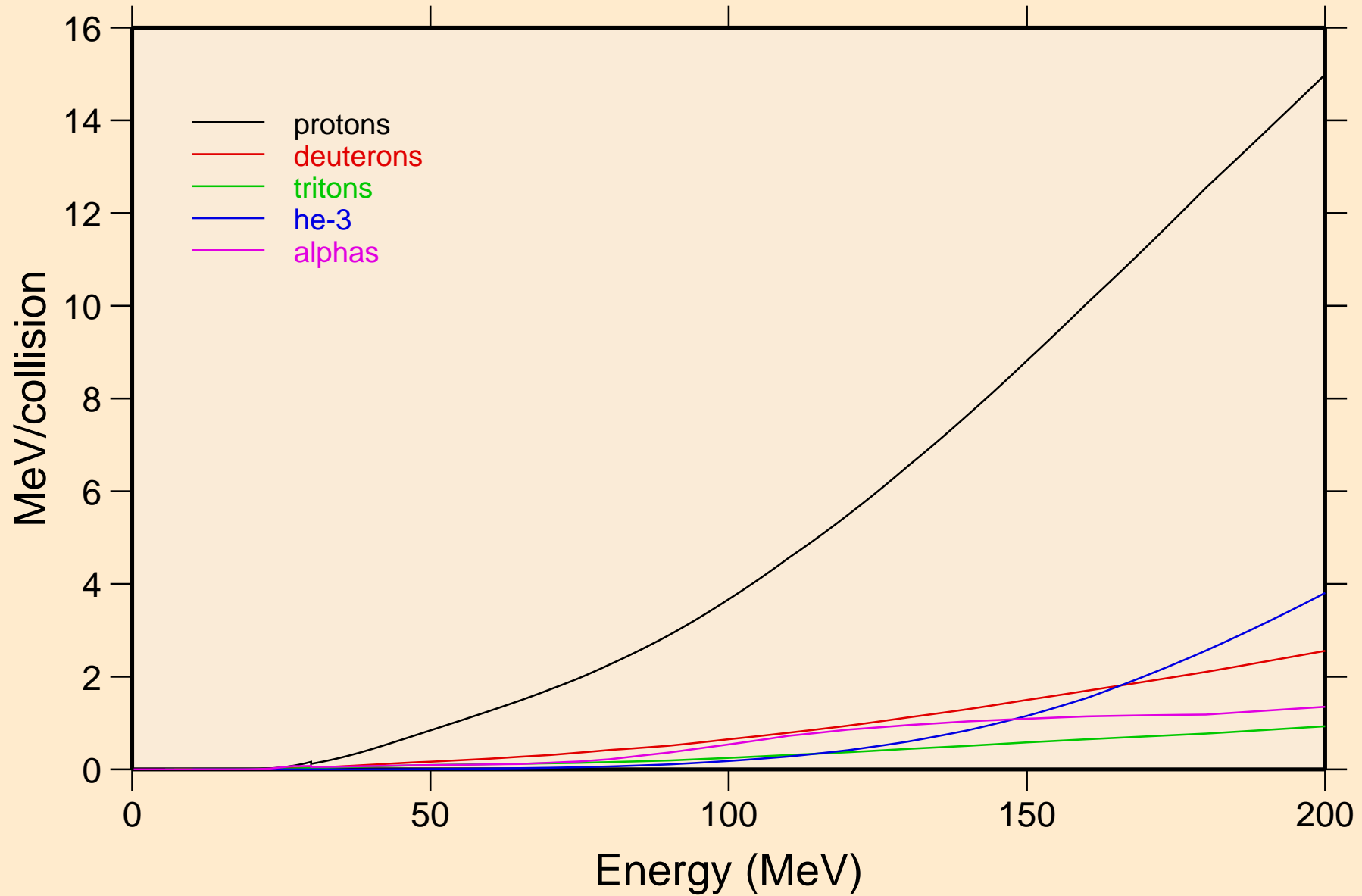

PB214 NEUTRON ACER TENDL-2021 LIBRARY; T=293.6K
Recoil Heating

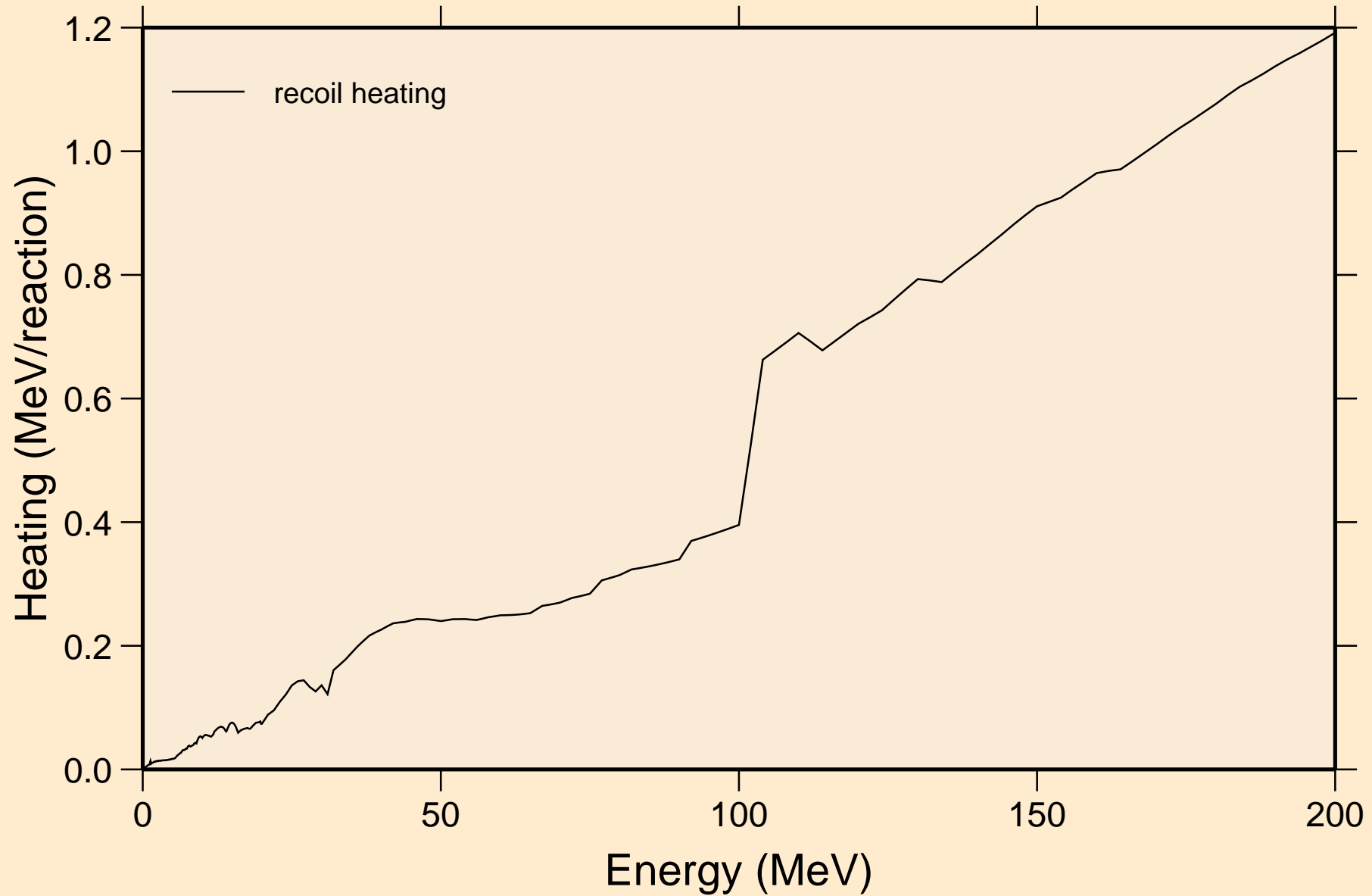

PB214 NEUTRON ACER TENDL-2021 LIBRARY; T=293.6K
Particle production cross sections

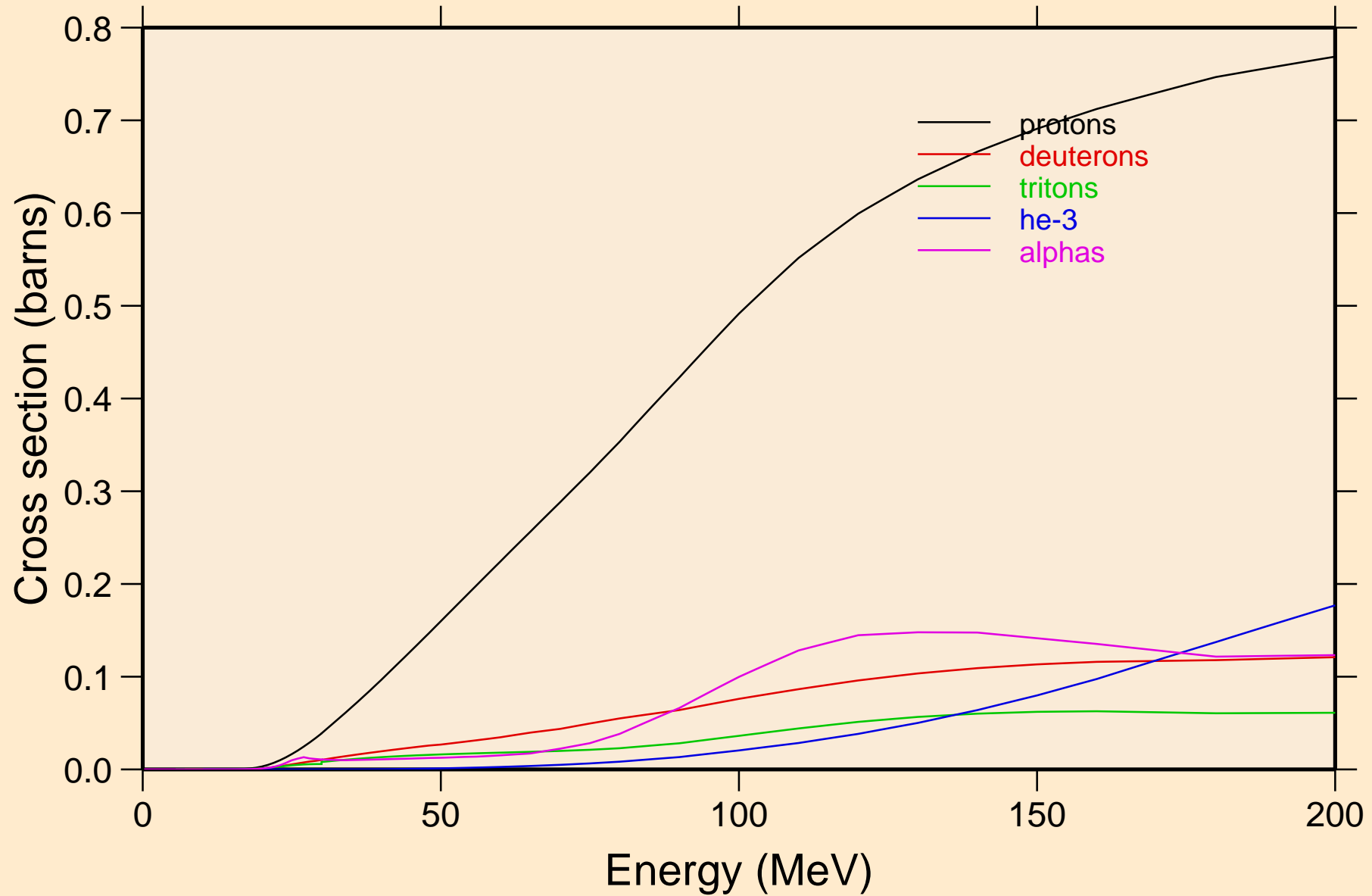

PB214 NEUTRON ACER TENDL-2021 LIBRARY; T=293.6K
protons from (n,x)

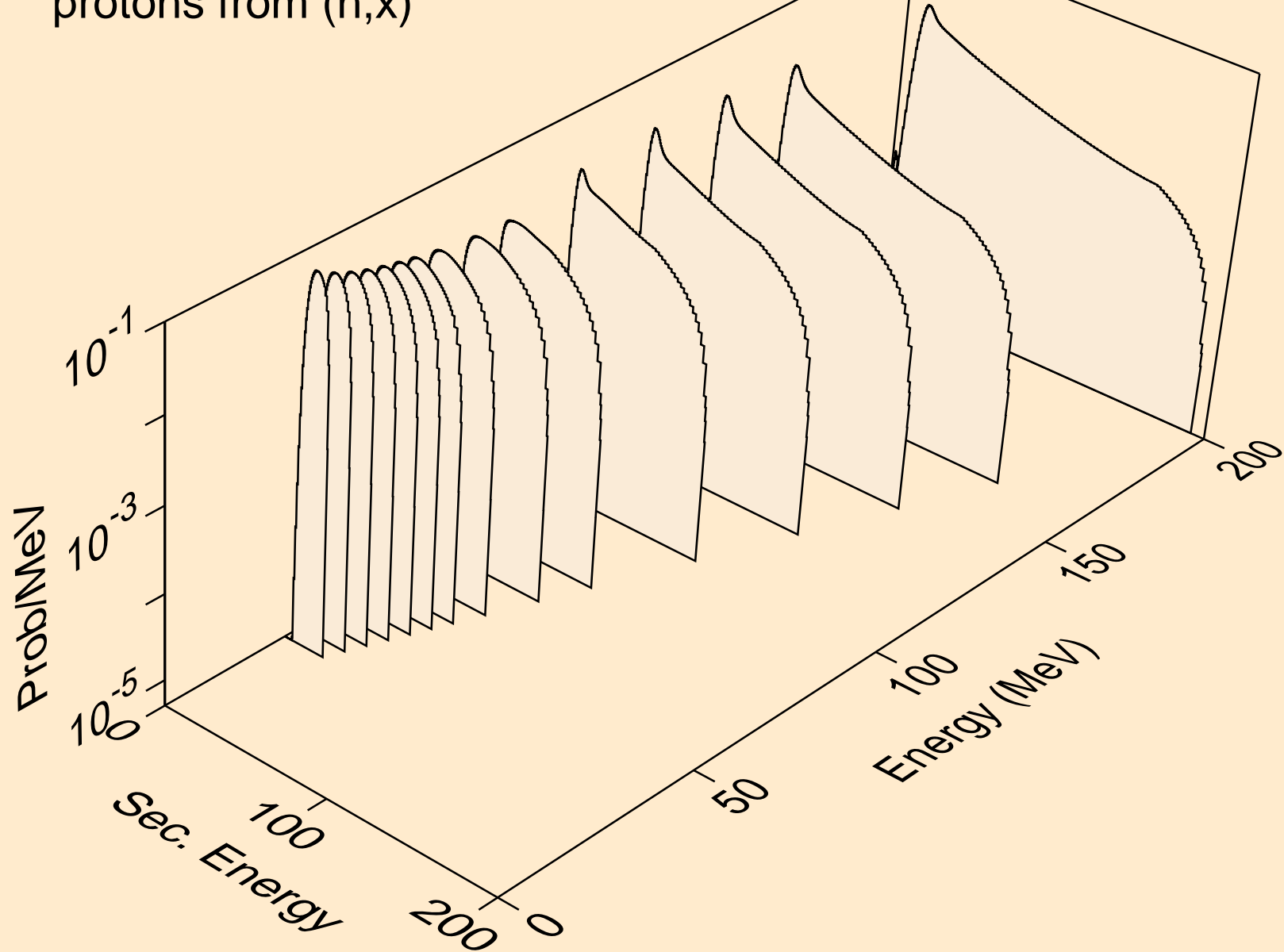

PB214 NEUTRON ACER TENDL-2021 LIBRARY; T=293.6K
protons from (n,n*)p

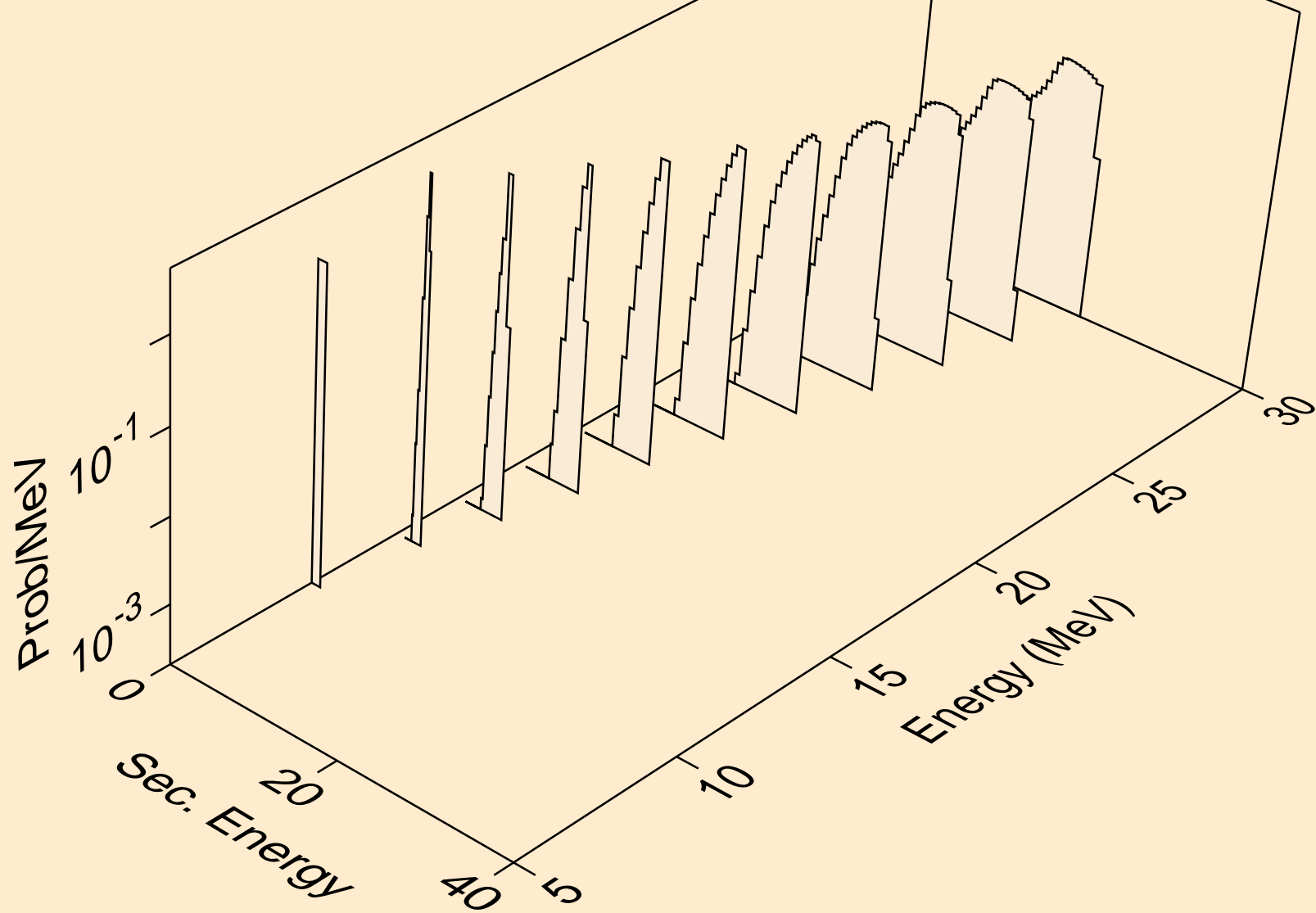

PB214 NEUTRON ACER TENDL-2021 LIBRARY; T=293.6K
protons from (n,2np)

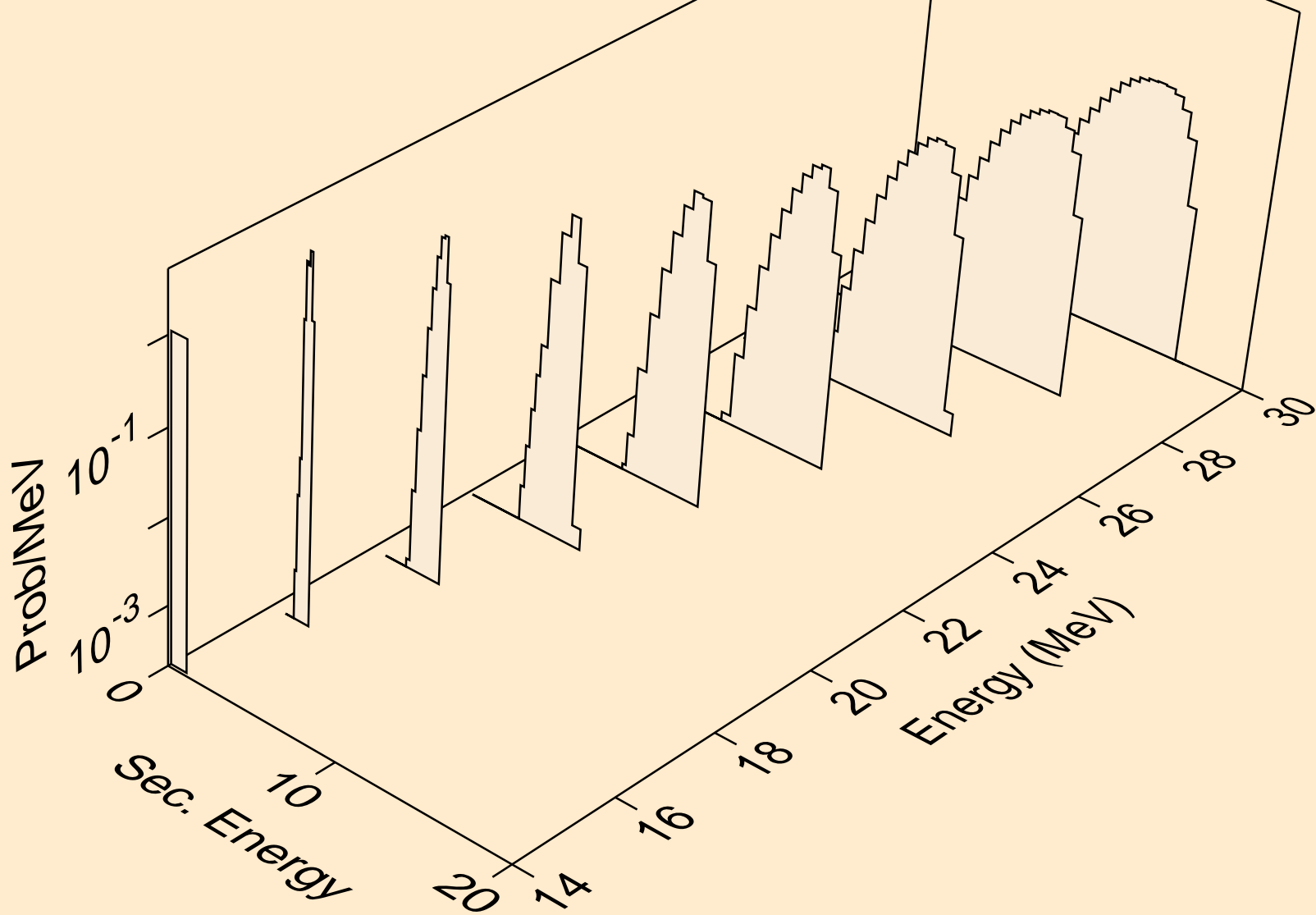

PB214 NEUTRON ACER TENDL-2021 LIBRARY; T=293.6K
protons from (n,3np)

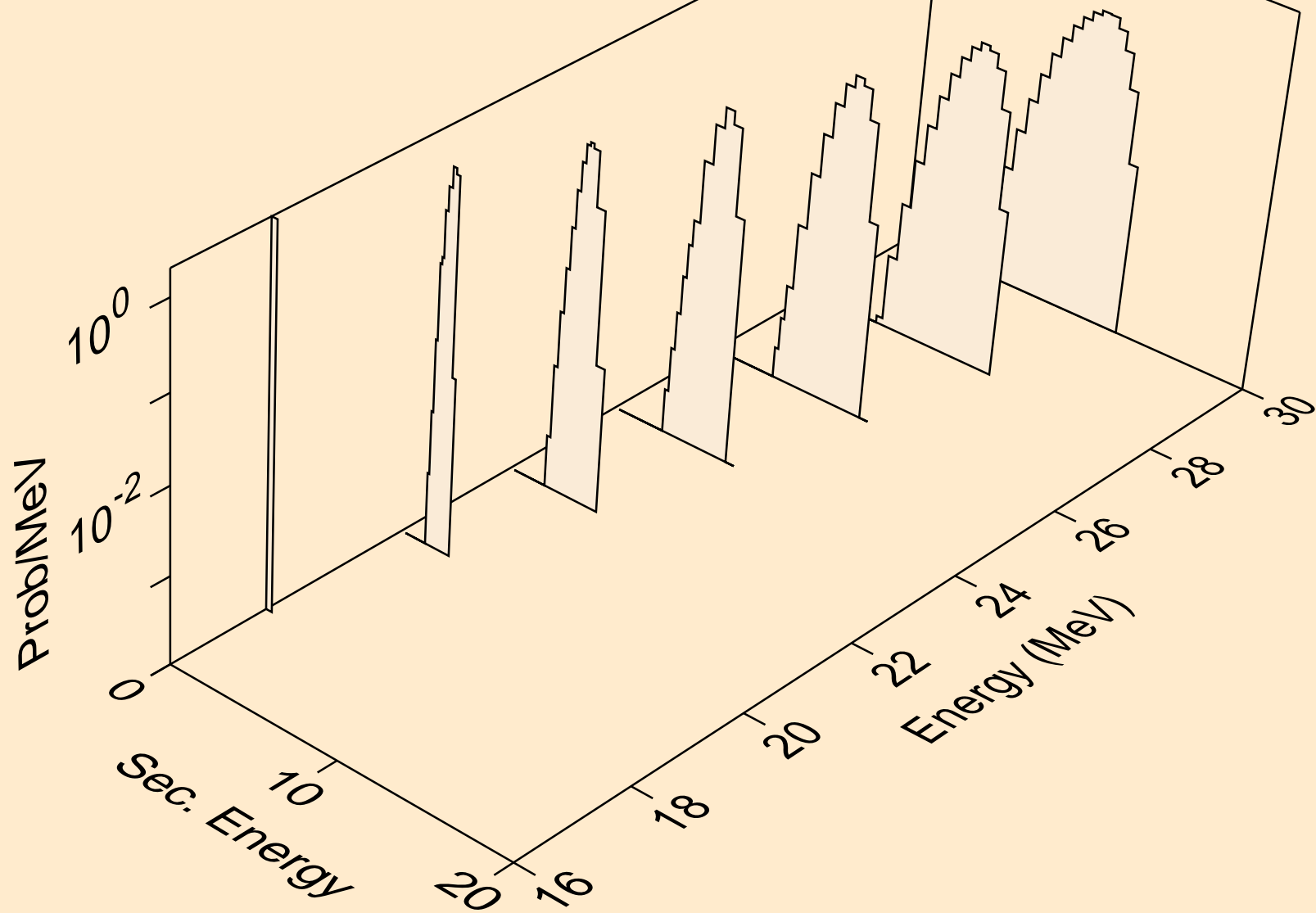

PB214 NEUTRON ACER TENDL-2021 LIBRARY; T=293.6K
protons from (n,p)

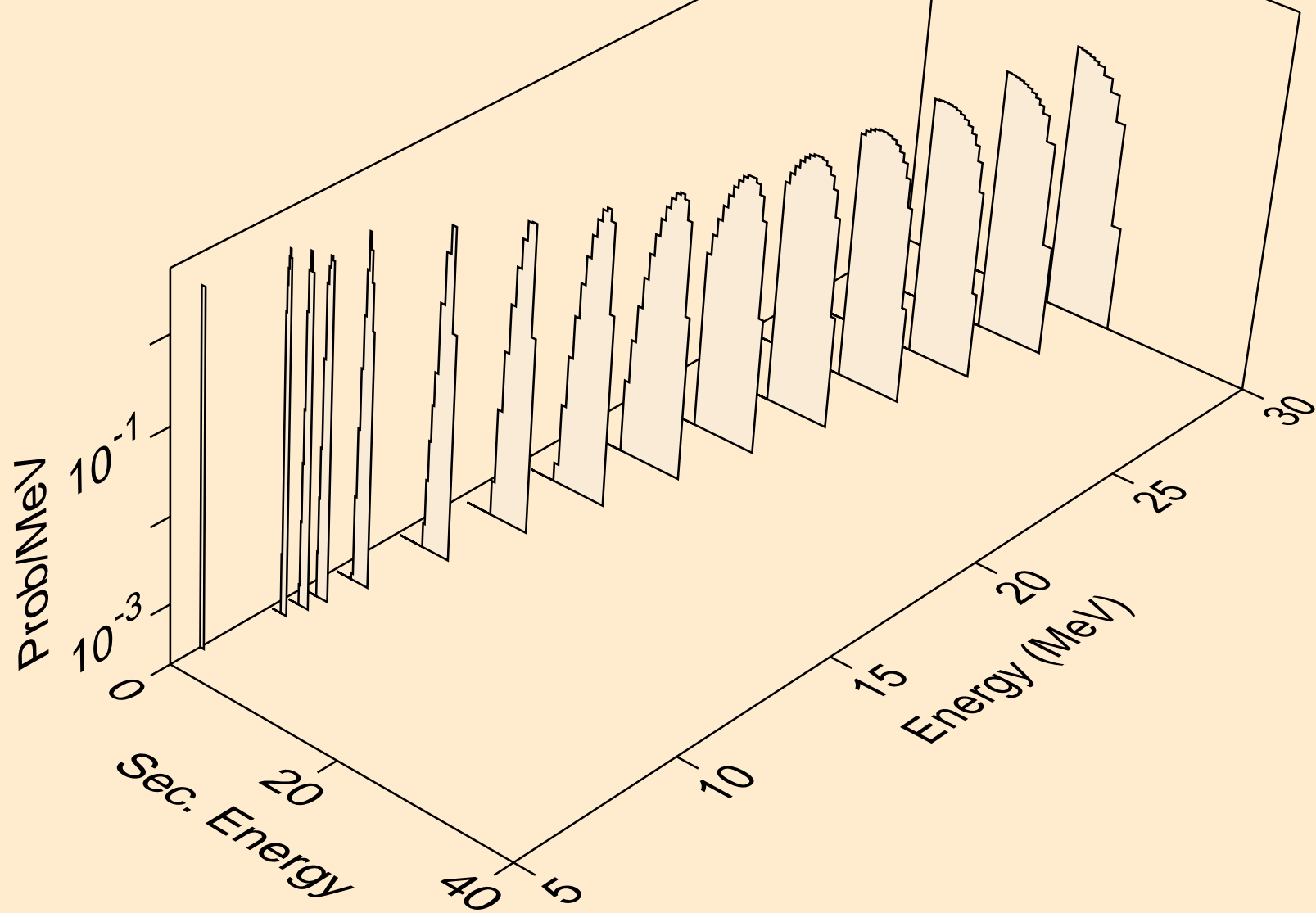

PB214 NEUTRON ACER TENDL-2021 LIBRARY; T=293.6K
deuterons from (n,x)

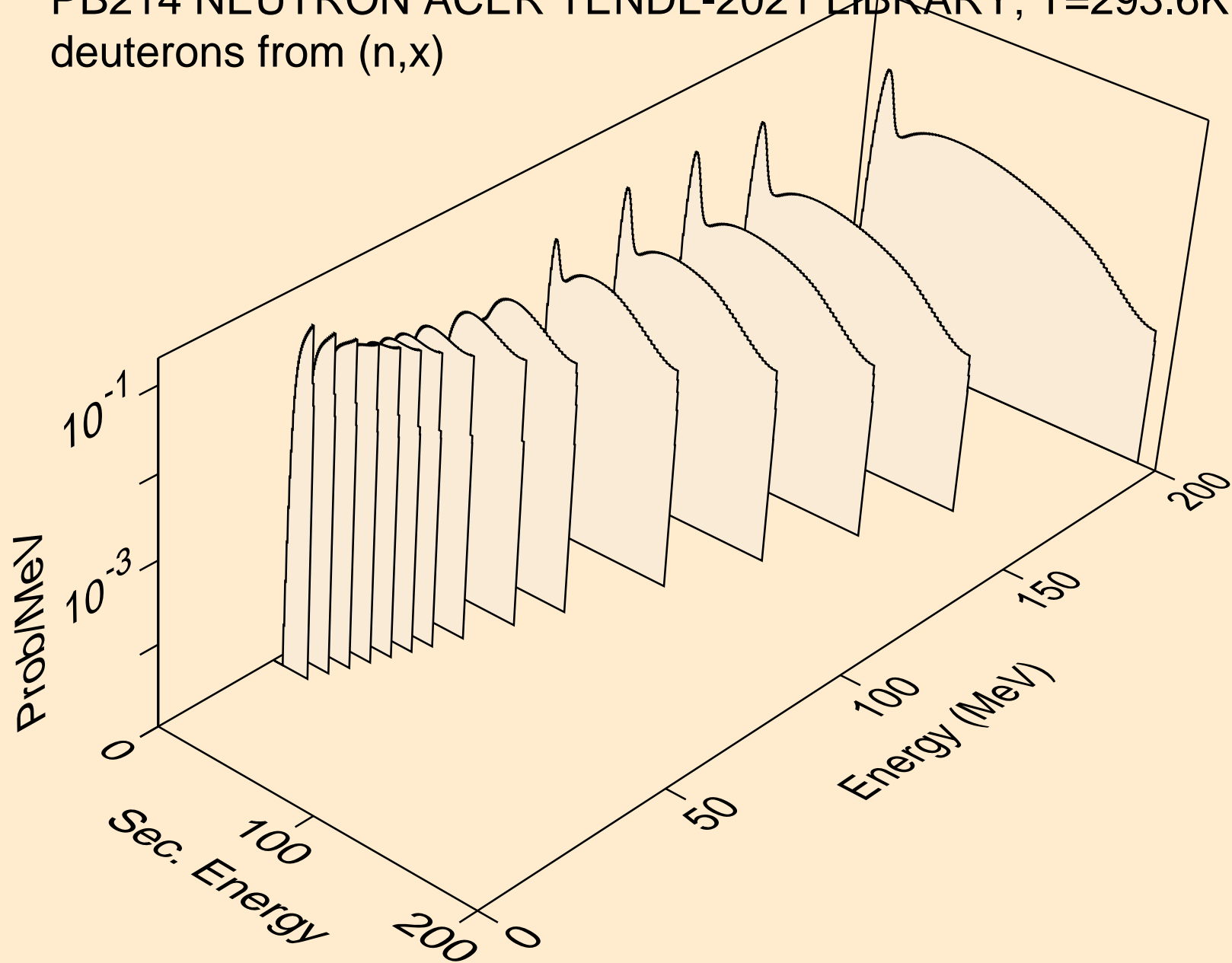

PB214 NEUTRON ACER TENDL-2021 LIBRARY; T=293.6K
deuterons from (n,2nd)

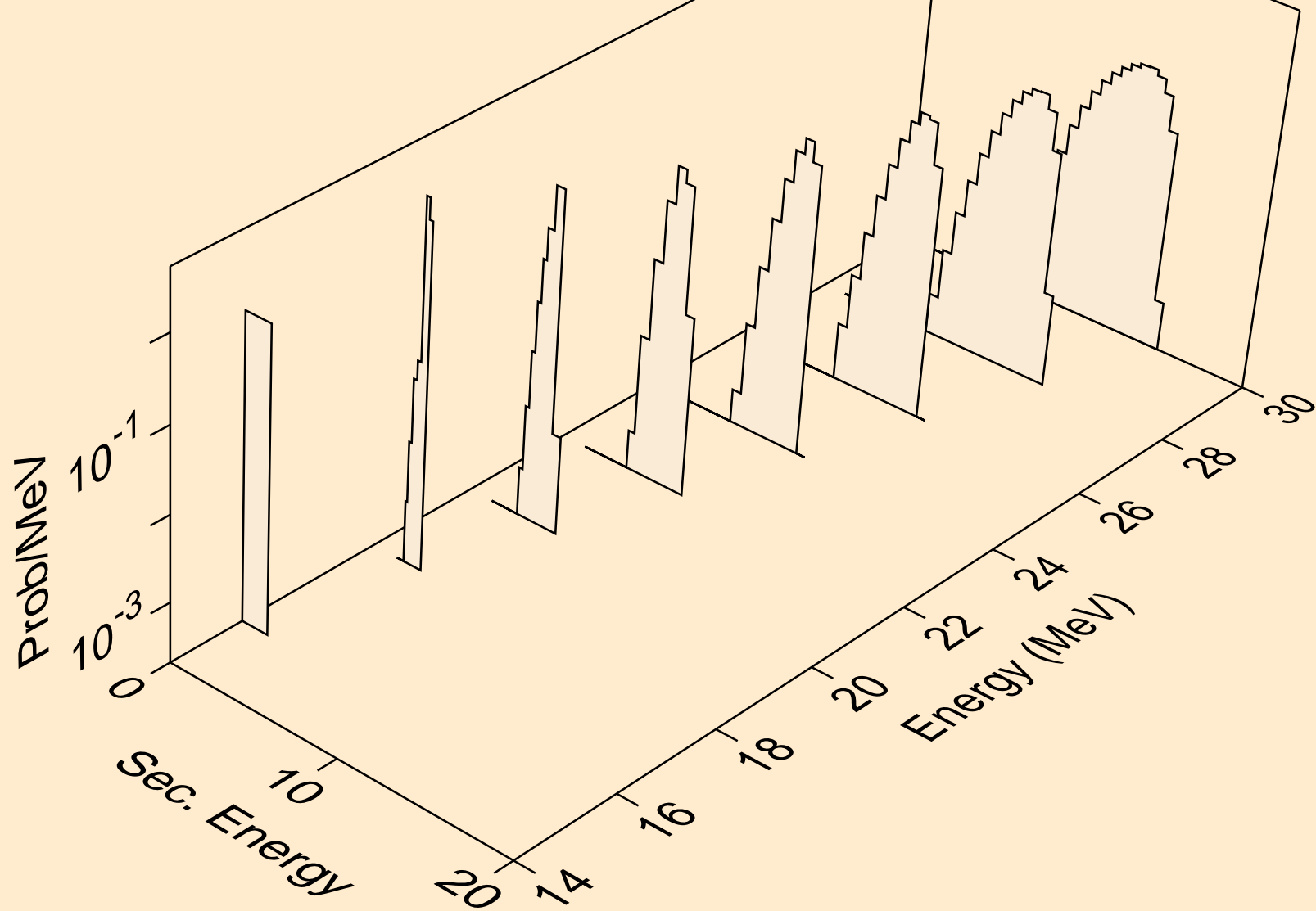

PB214 NEUTRON ACER TENDL-2021 LIBRARY; T=293.6K
deuterons from (n,n*)d

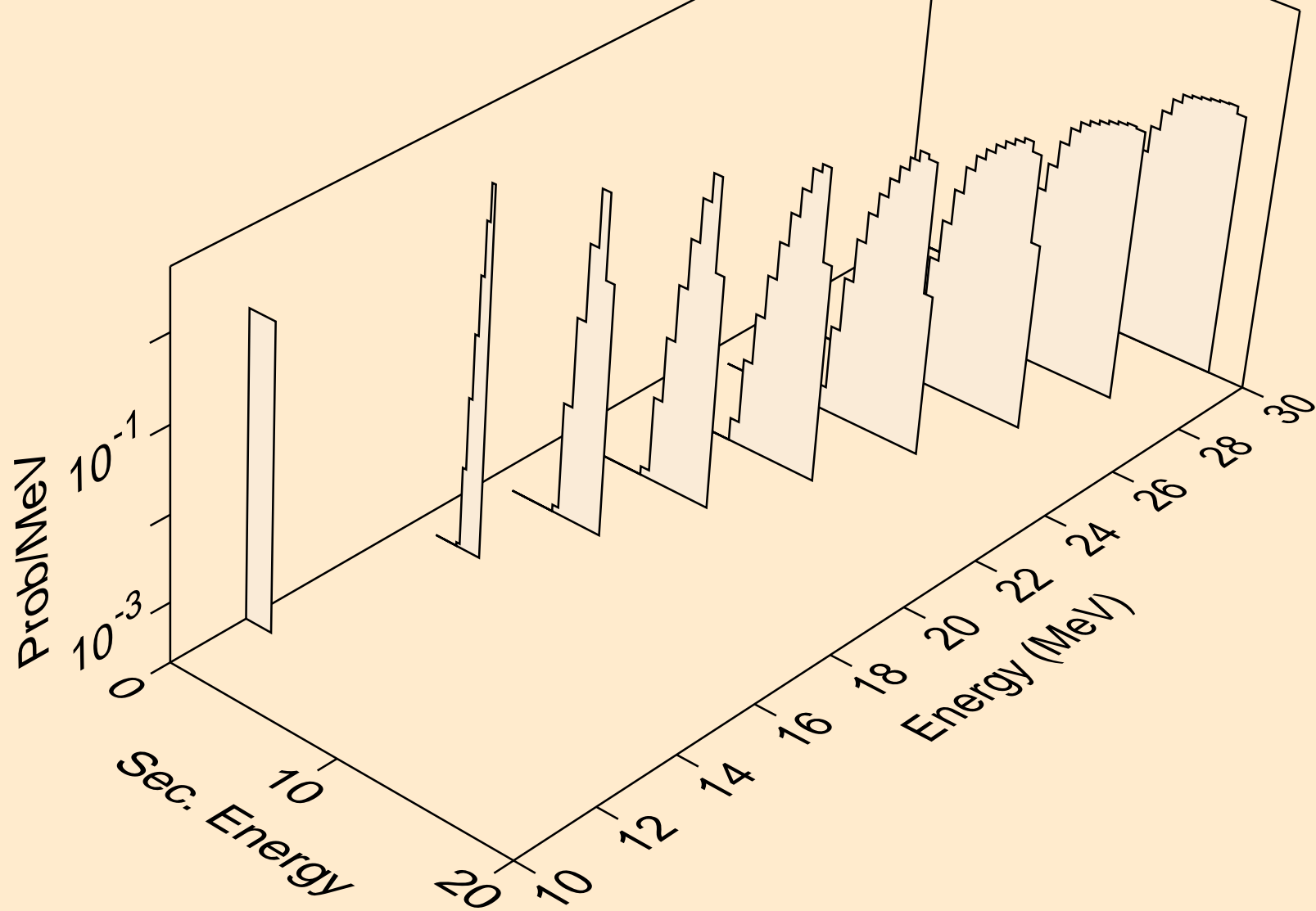

PB214 NEUTRON ACER TENDL-2021 LIBRARY; T=293.6K
deuterons from (n,d)

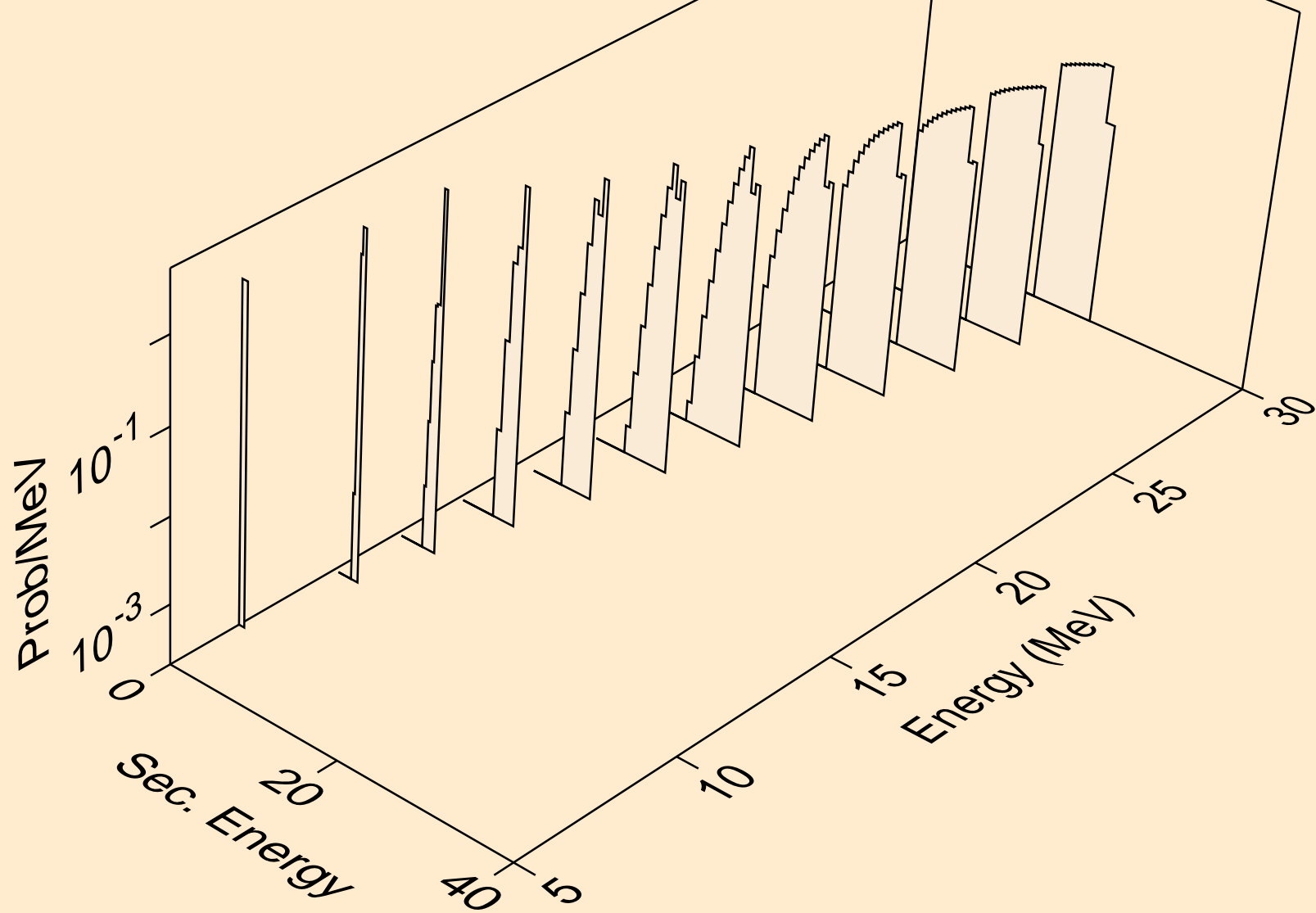

PB214 NEUTRON ACER TENDL-2021 LIBRARY; T=293.6K
tritons from (n,x)

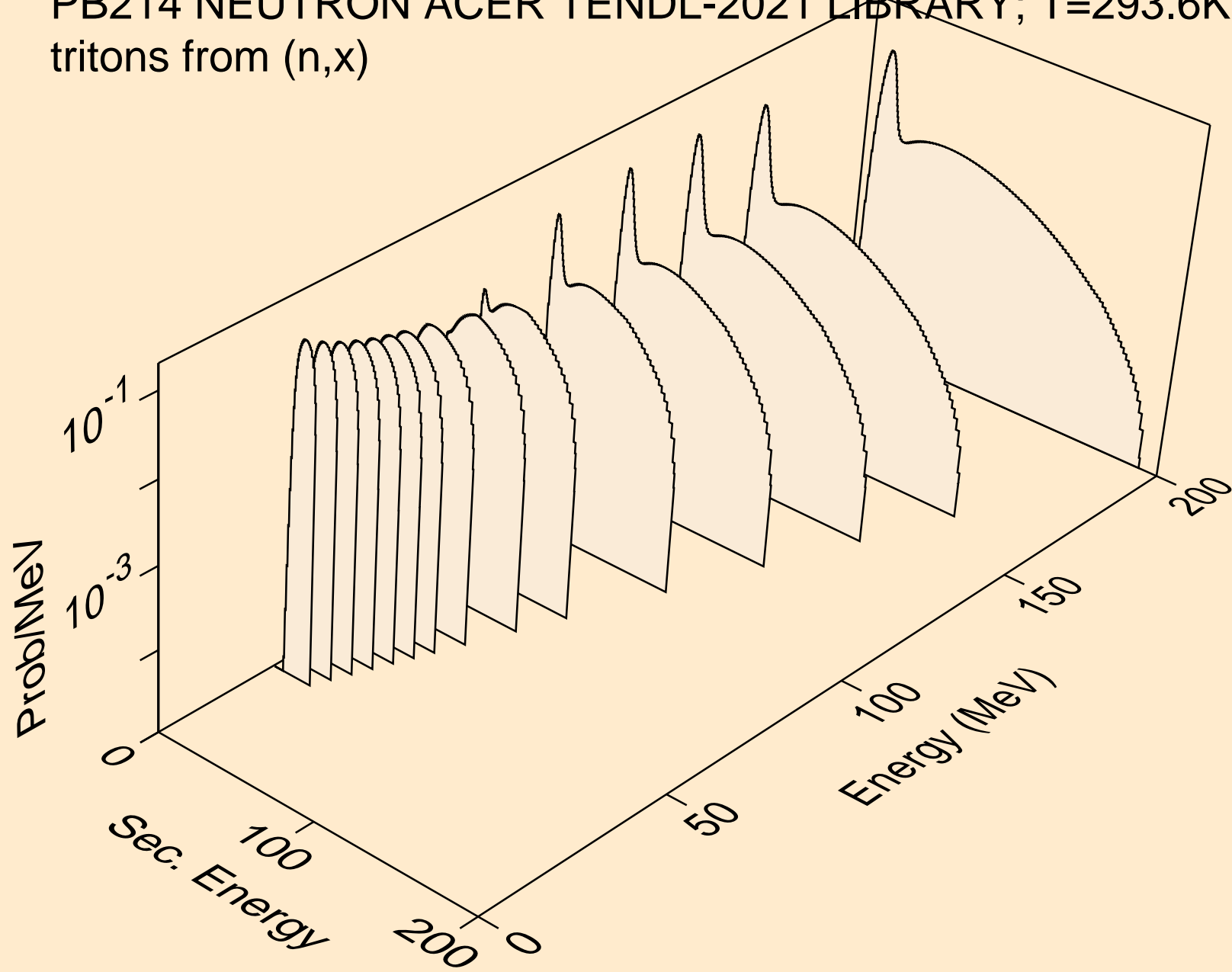

PB214 NEUTRON ACER TENDL-2021 LIBRARY; T=293.6K
tritons from (n,n*)t

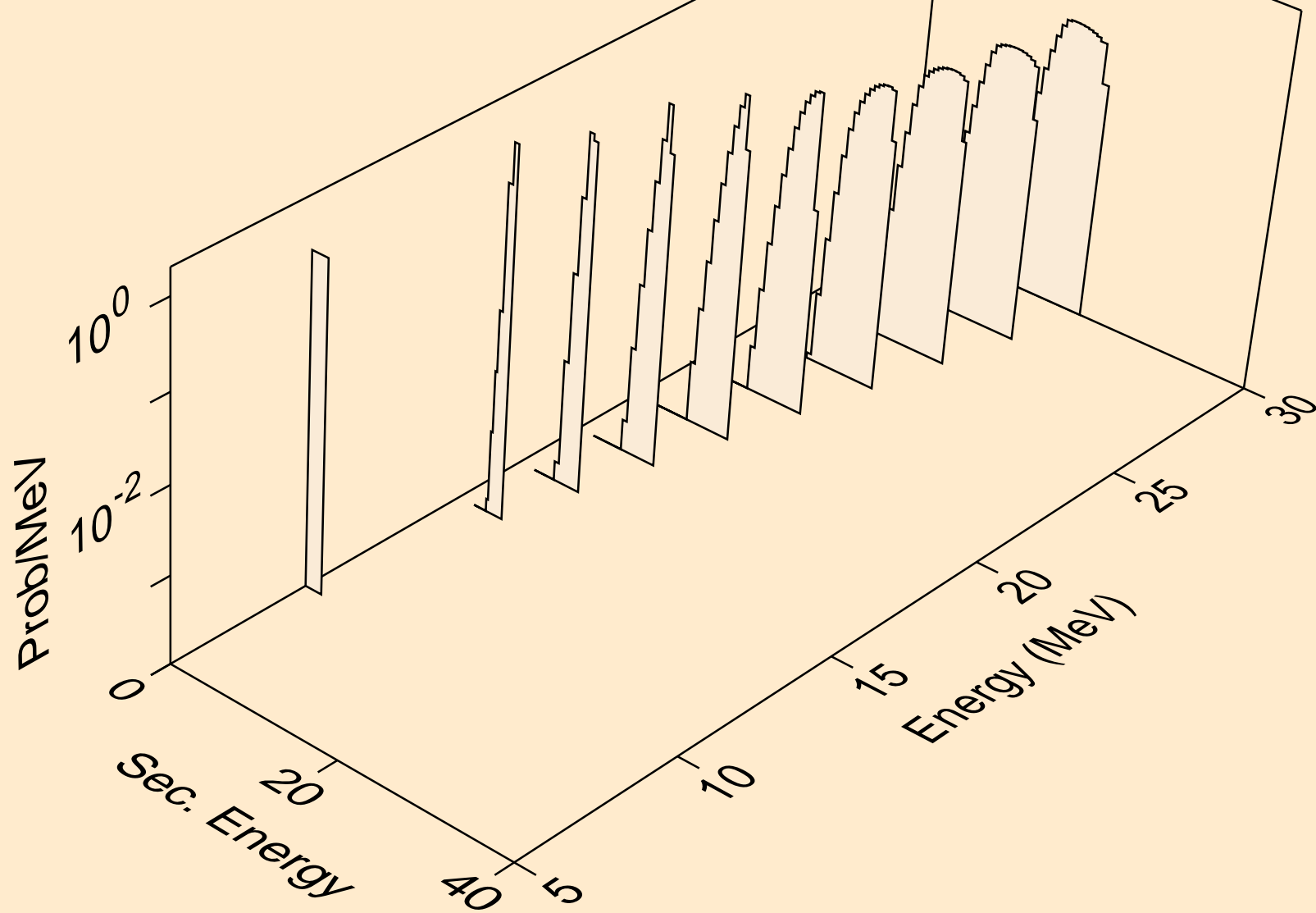

PB214 NEUTRON ACER TENDL-2021 LIBRARY; T=293.6K
tritons from (n,t)

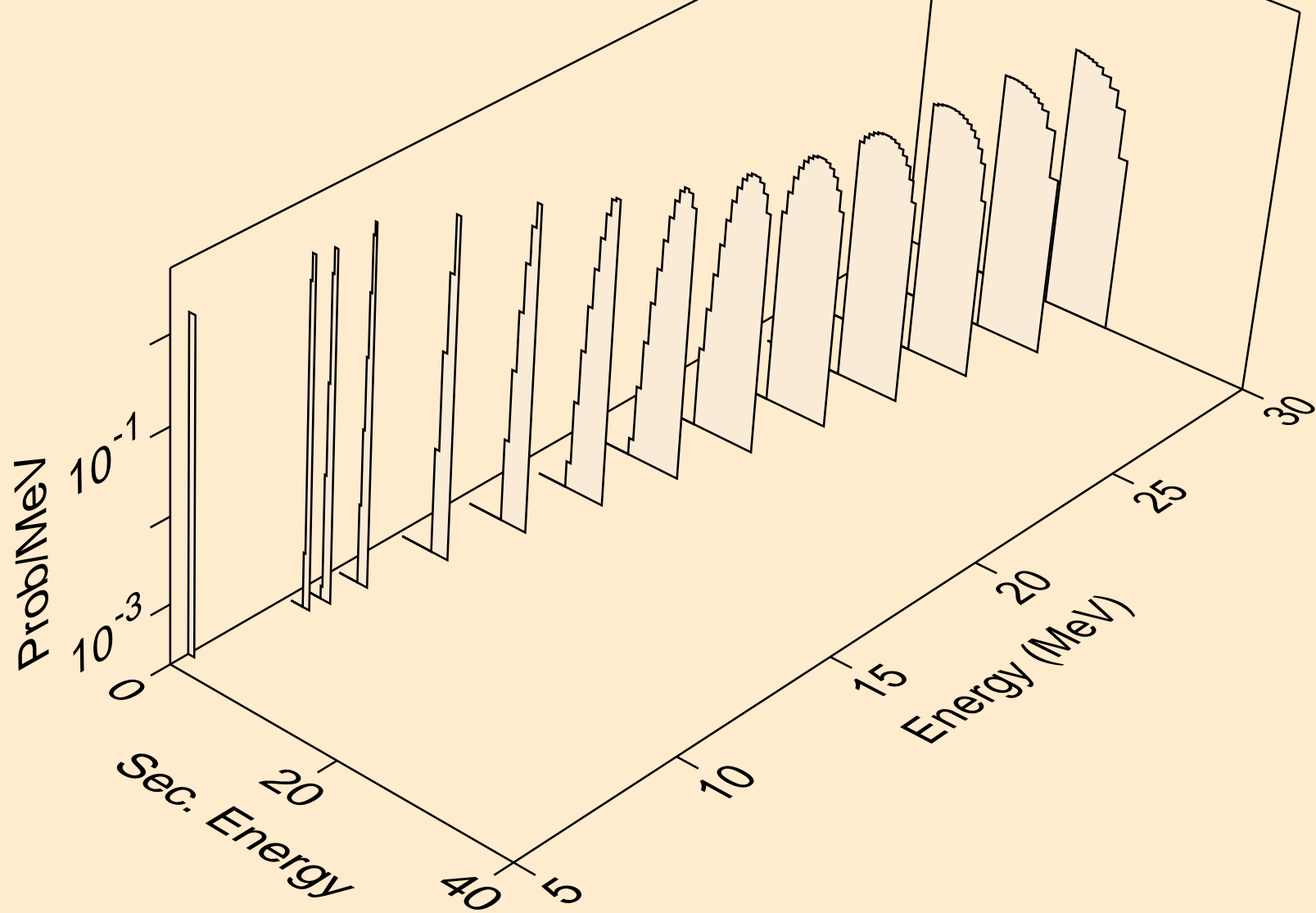

PB214 NEUTRON ACER TENDL-2021 LIBRARY; T=293.6K
he3s from (n,x)

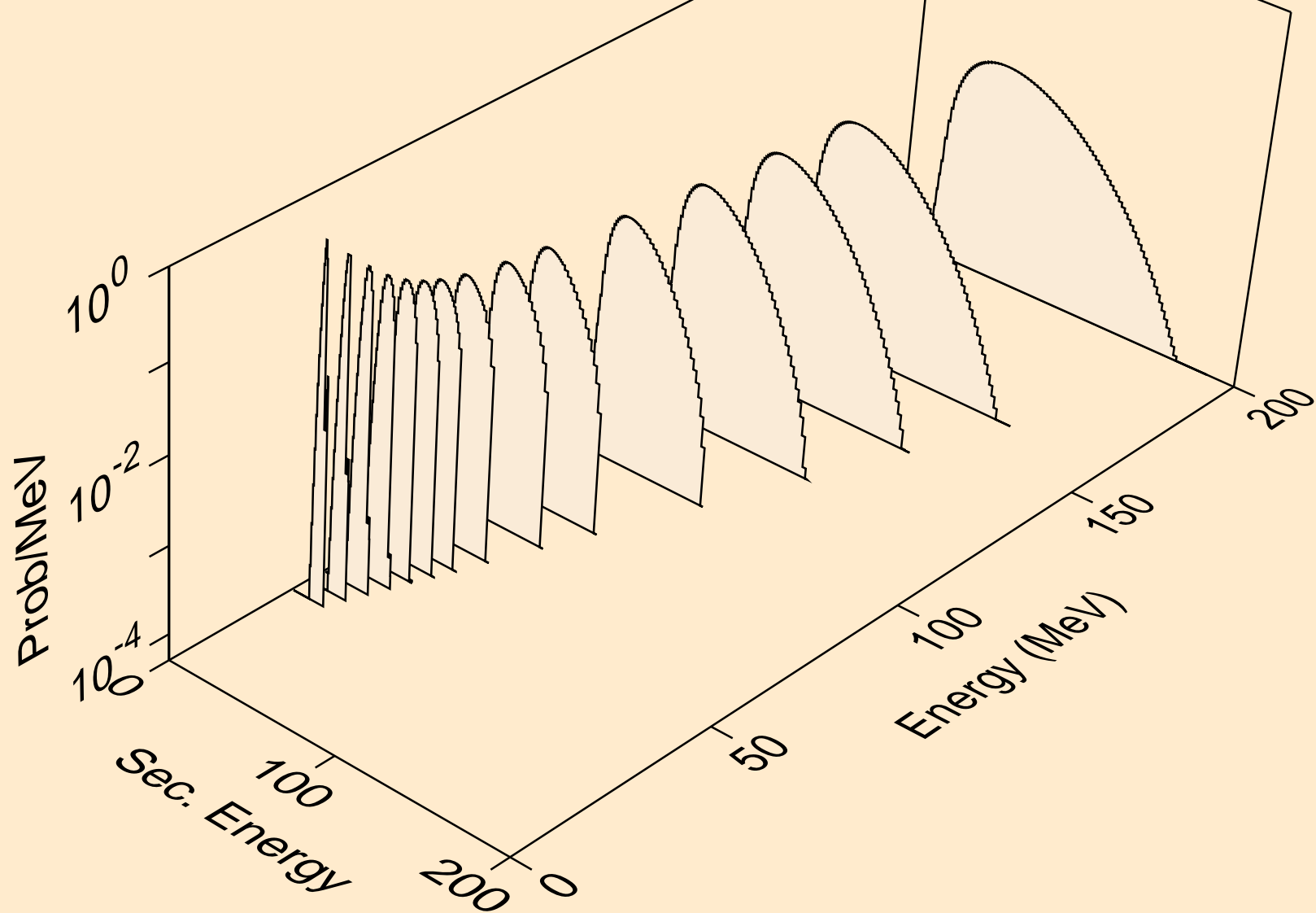

PB214 NEUTRON ACER TENDL-2021 LIBRARY; T=293.6K
he3s from (n,n*)he3

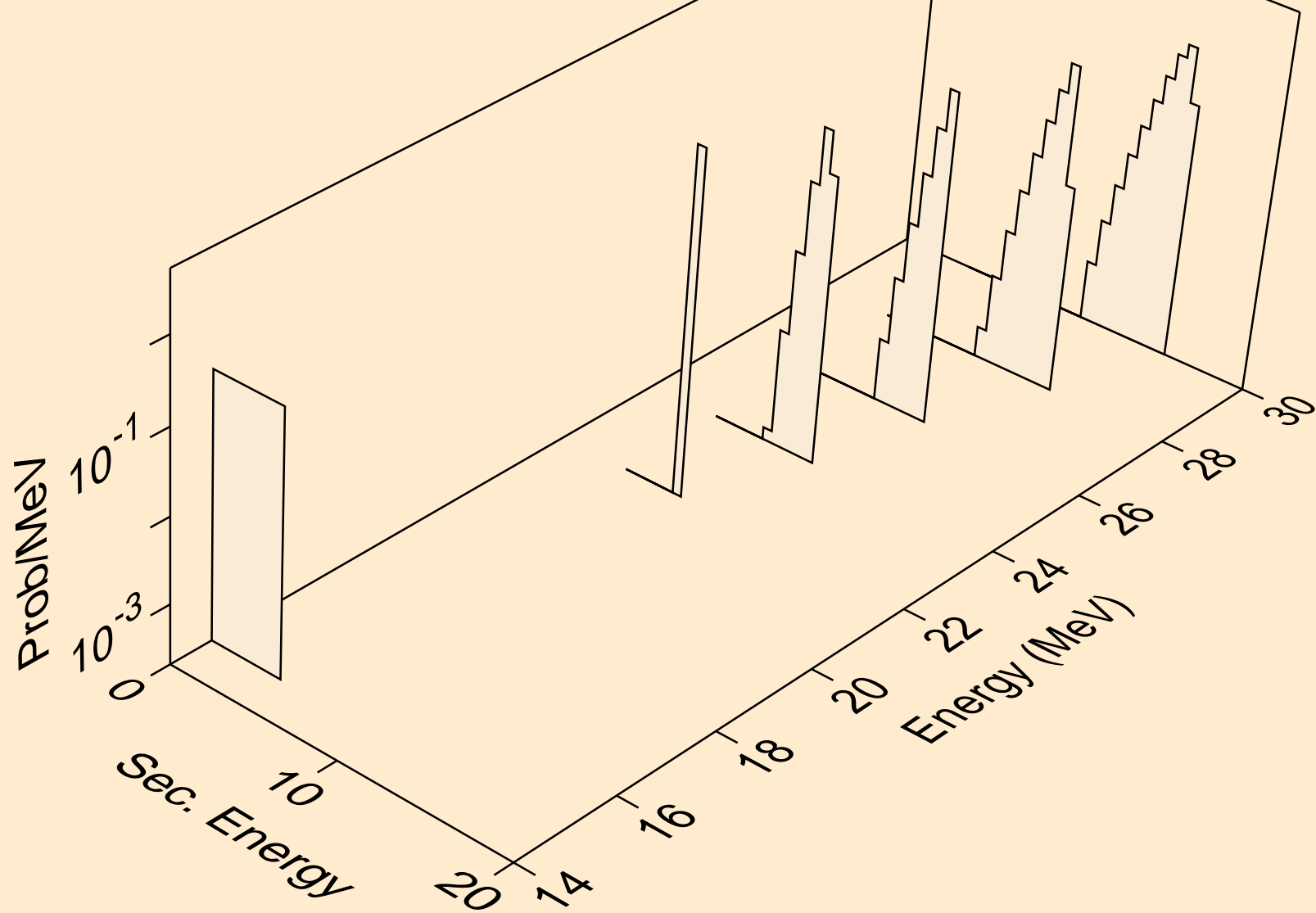

PB214 NEUTRON ACER TENDL-2021 LIBRARY; T=293.6K
he3s from (n,he3)

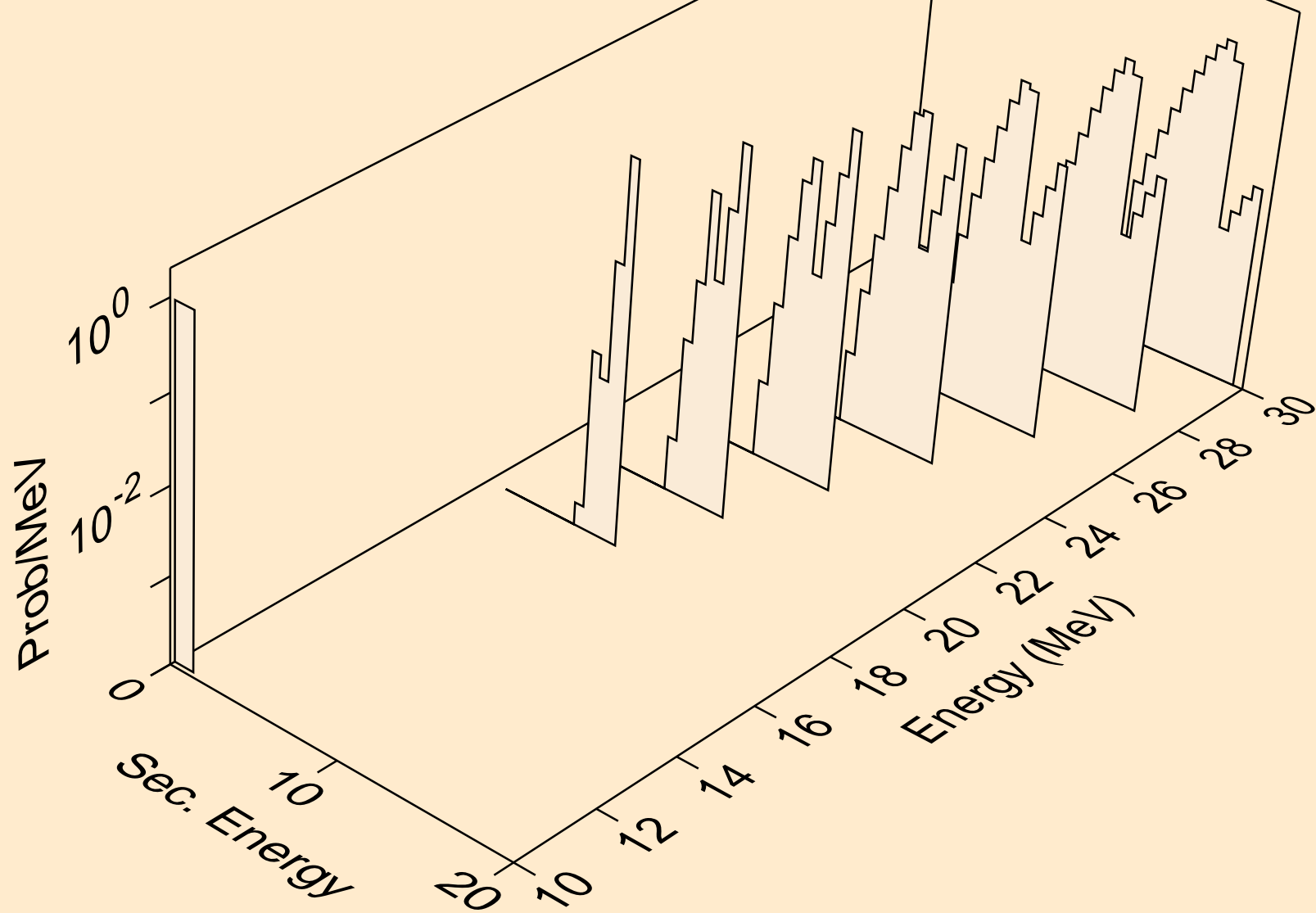

PB214 NEUTRON ACER TENDL-2021 LIBRARY; T=293.6K
alphas from (n,x)

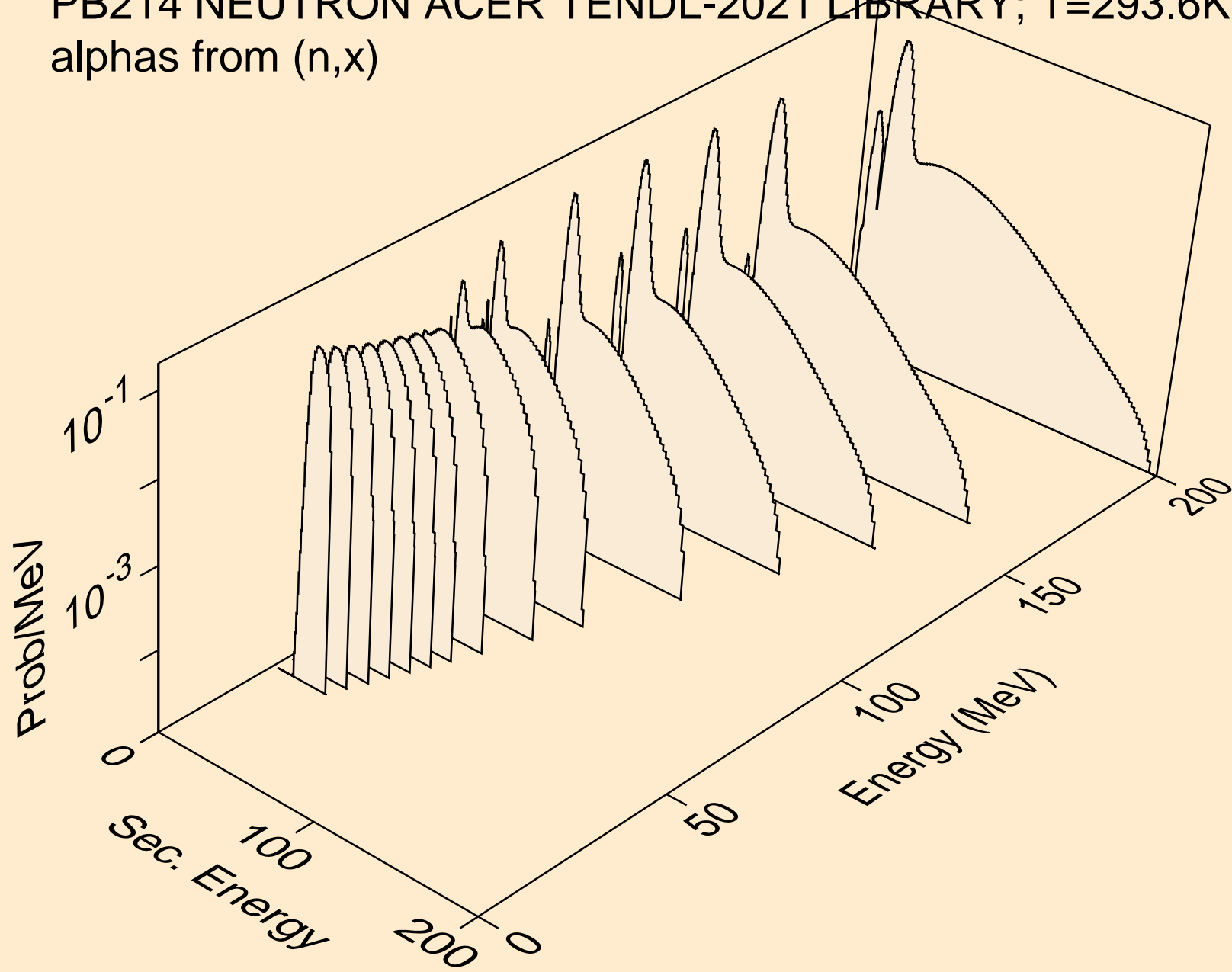

PB214 NEUTRON ACER TENDL-2021 LIBRARY; T=293.6K
alphas from (n,n*)a

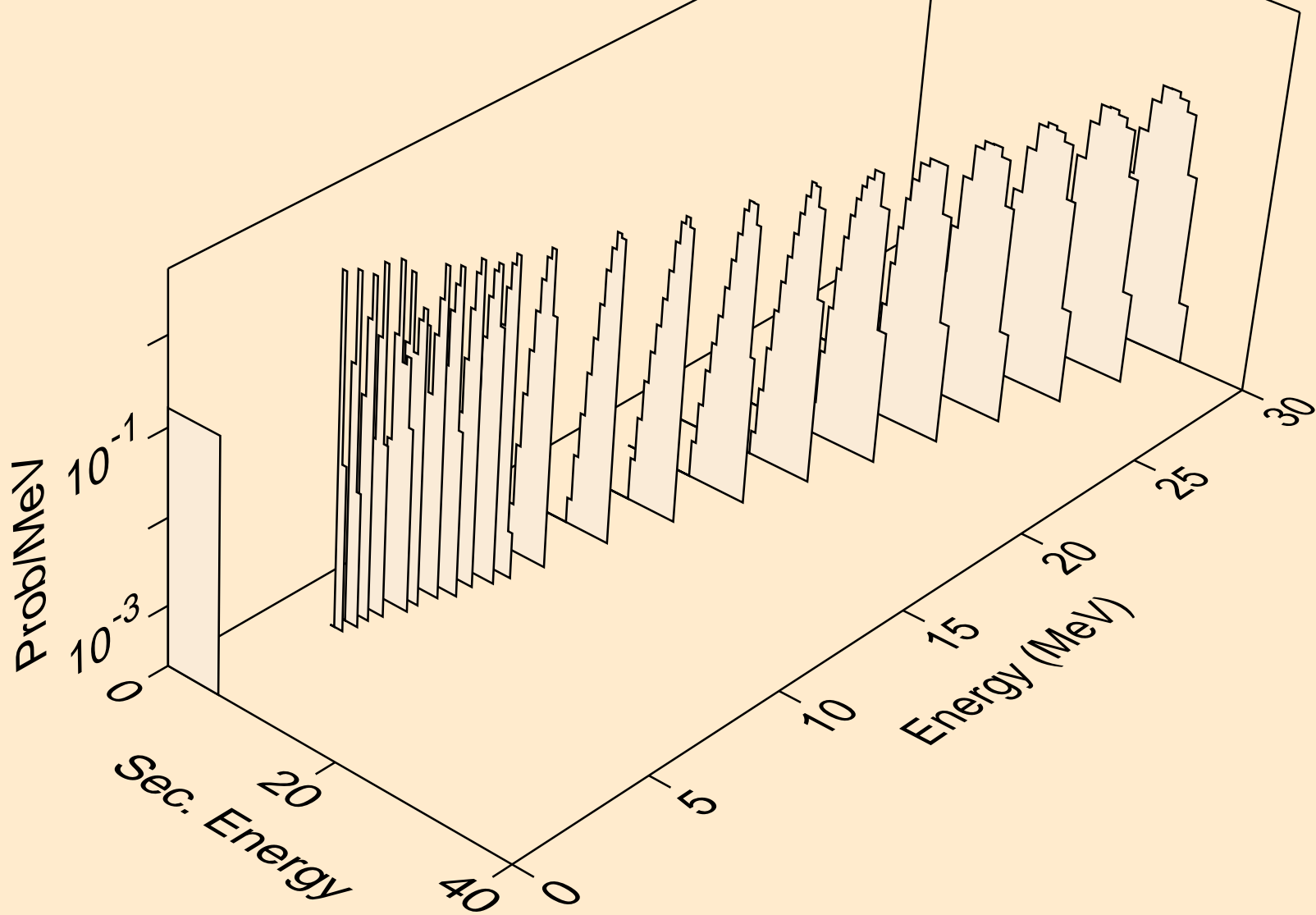

PB214 NEUTRON ACER TENDL-2021 LIBRARY; T=293.6K
alphas from (n,2n)a

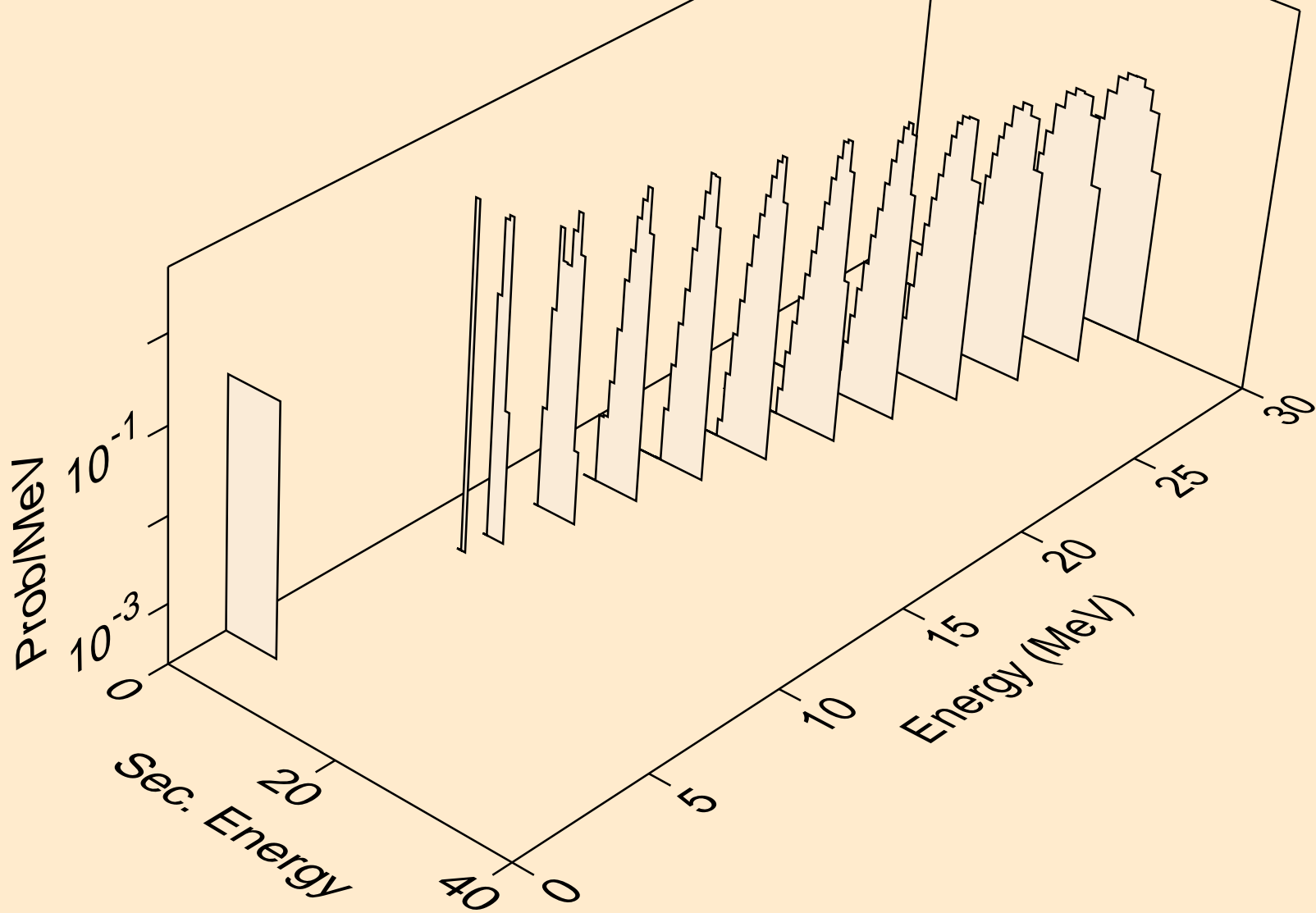

PB214 NEUTRON ACER TENDL-2021 LIBRARY; T=293.6K
alphas from (n,3n)a

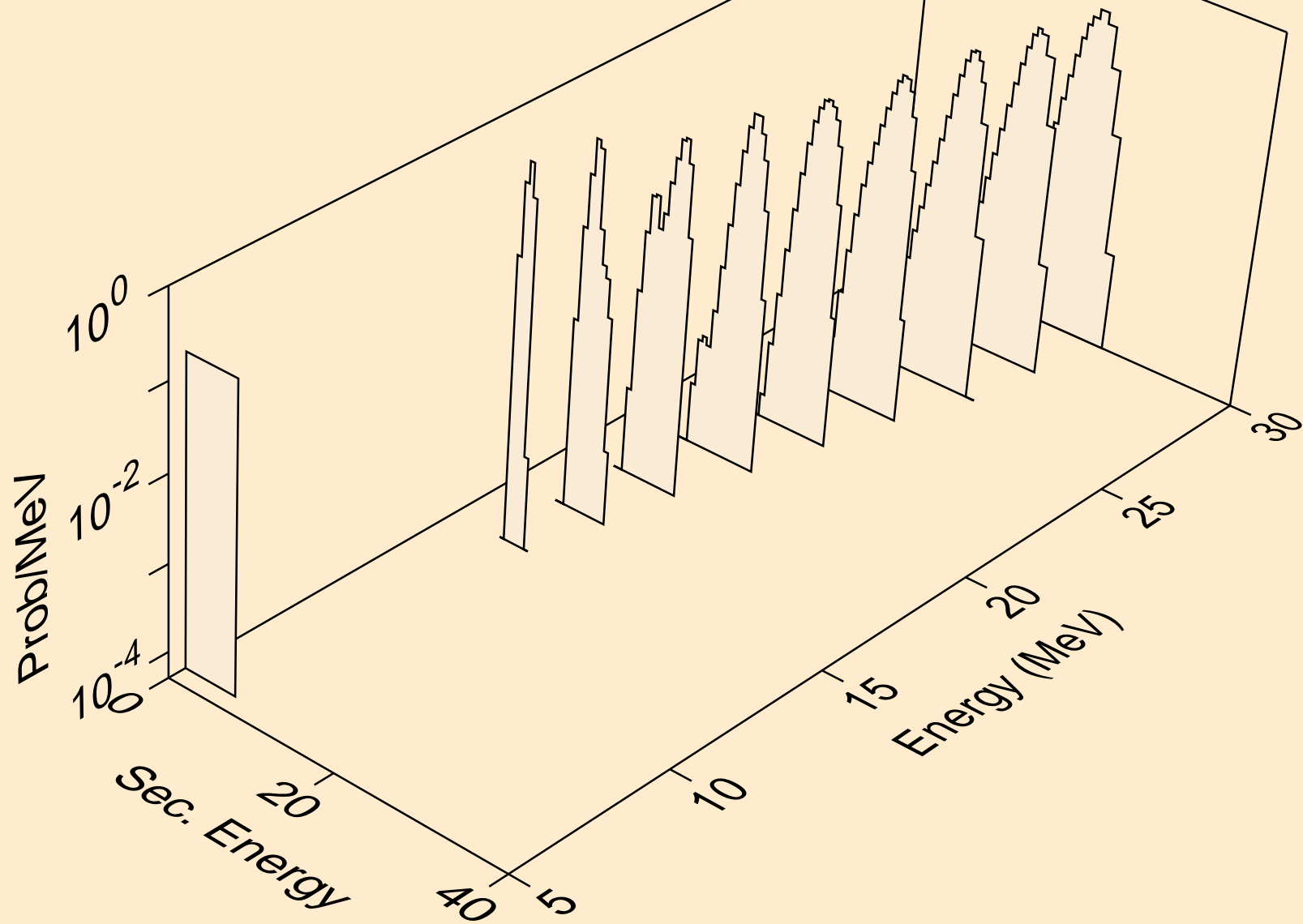

PB214 NEUTRON ACER TENDL-2021 LIBRARY; T=293.6K
alphas from (n,a)

