

PB217 NEUTRON ACER TENDL-2021 LIBRARY; T=293.6K
Principal cross sections

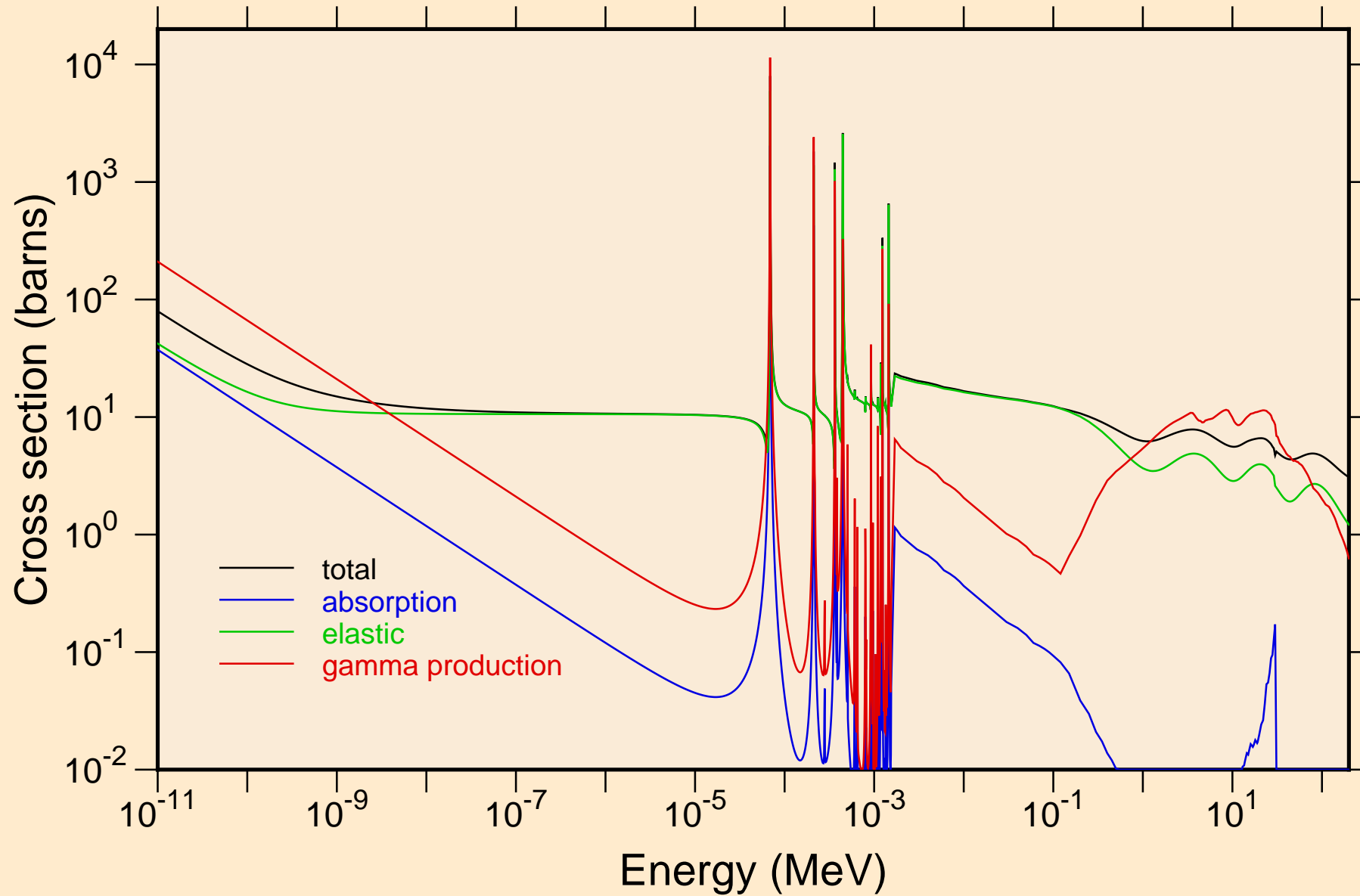

PB217 NEUTRON ACER TENDL-2021 LIBRARY; T=293.6K
resonance total cross section

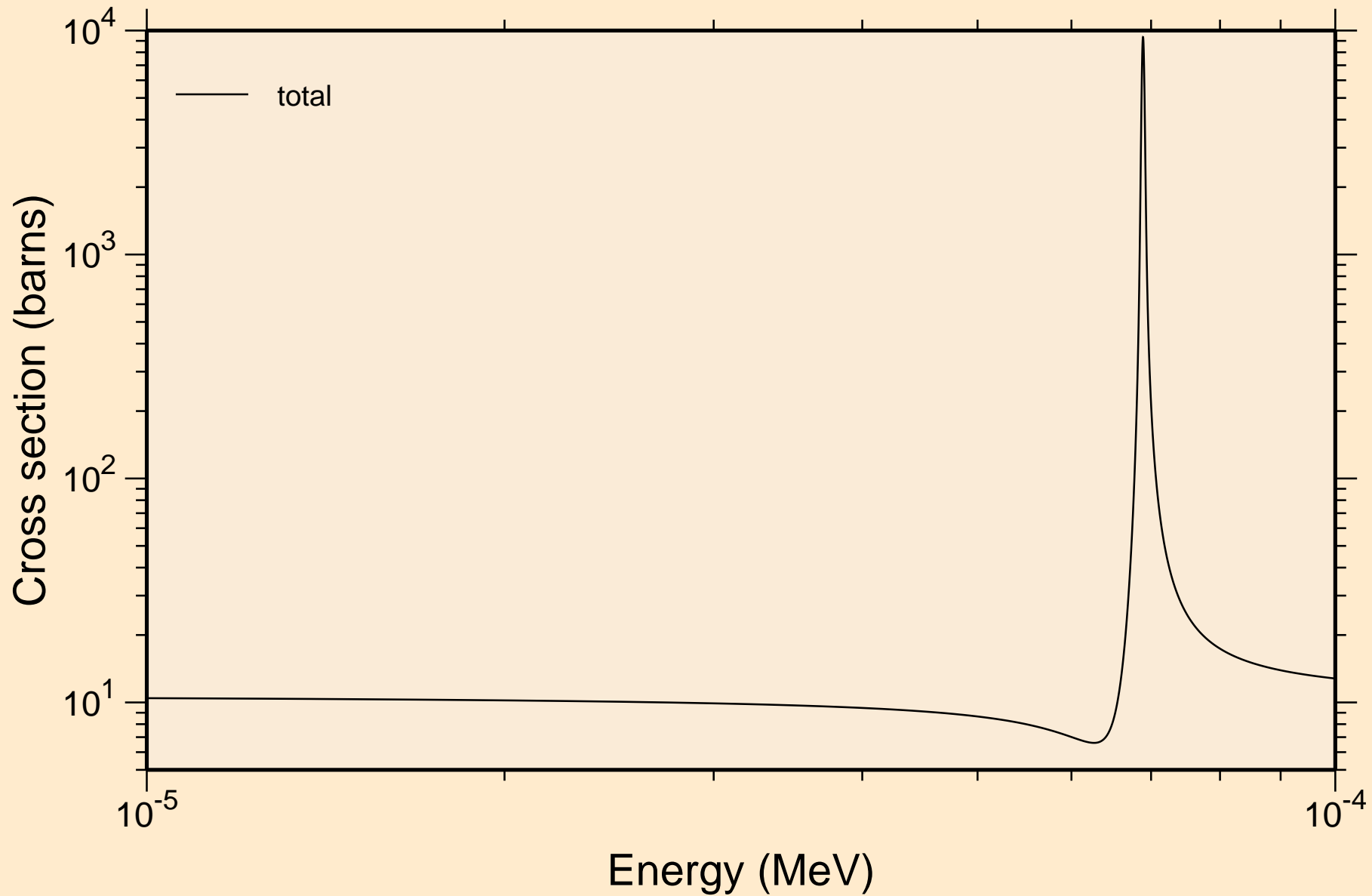

PB217 NEUTRON ACER TENDL-2021 LIBRARY; T=293.6K
resonance total cross section

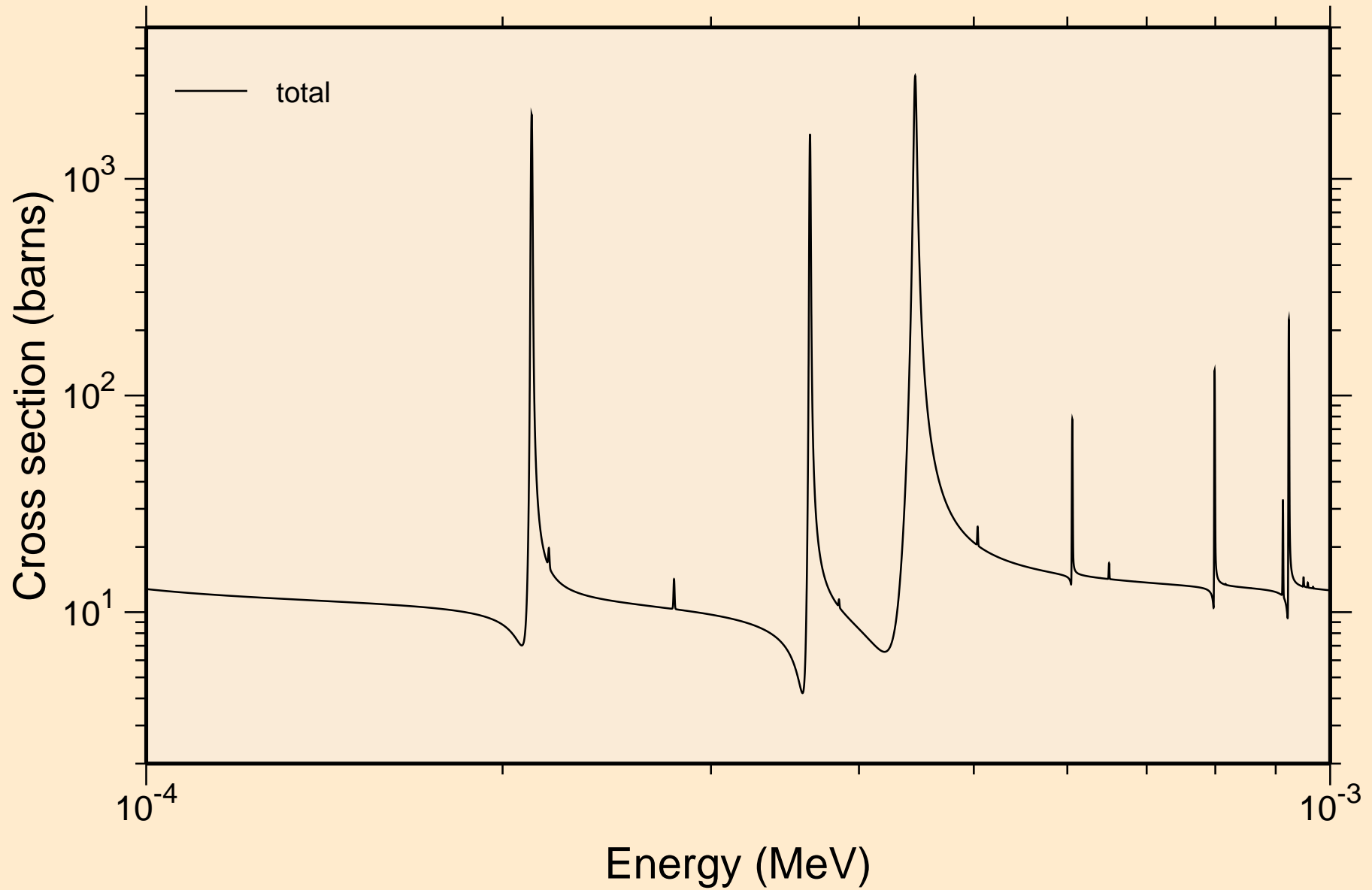

PB217 NEUTRON ACER TENDL-2021 LIBRARY; T=293.6K
resonance total cross section

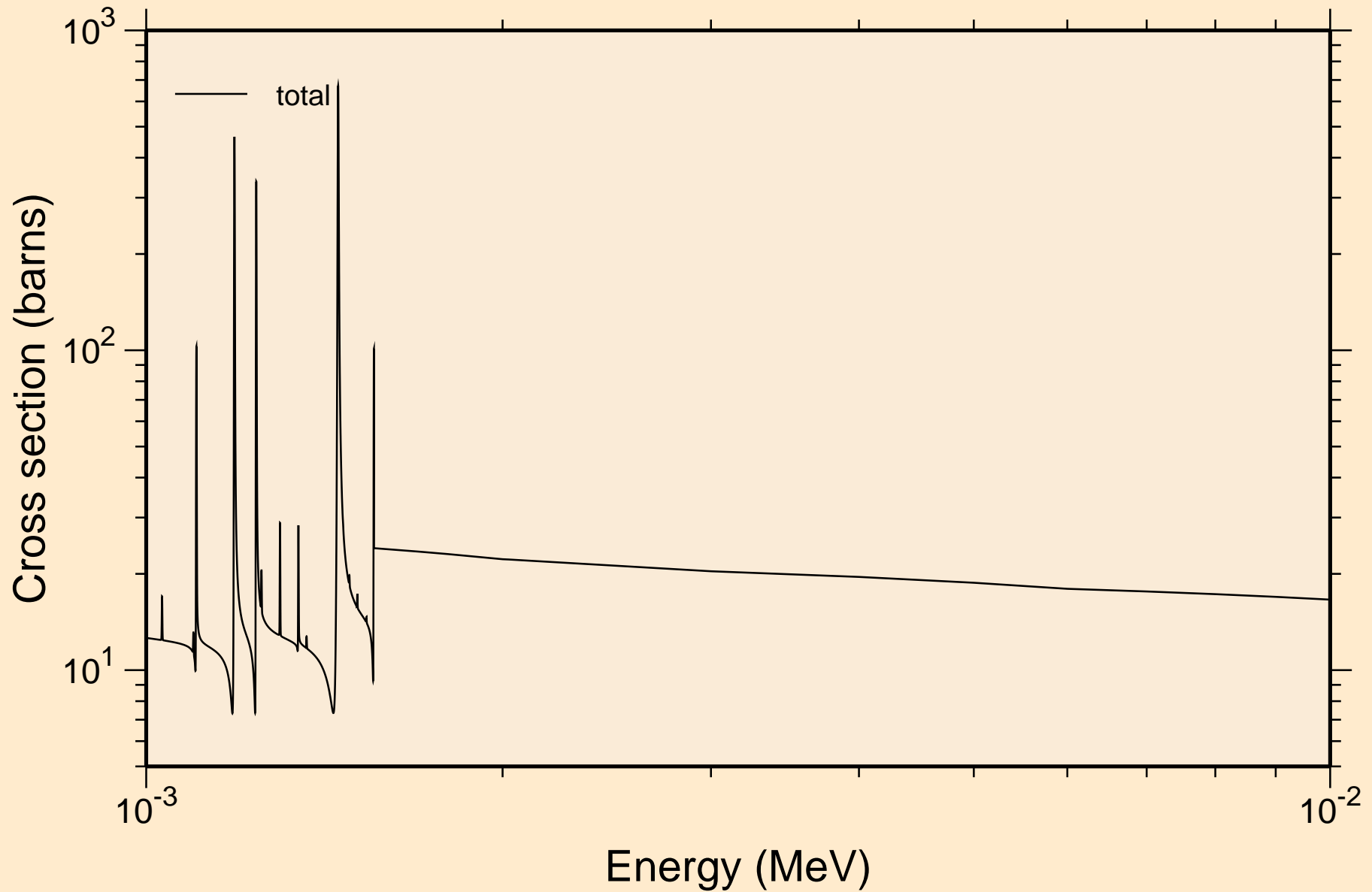

PB217 NEUTRON ACER TENDL-2021 LIBRARY; T=293.6K
resonance total cross section

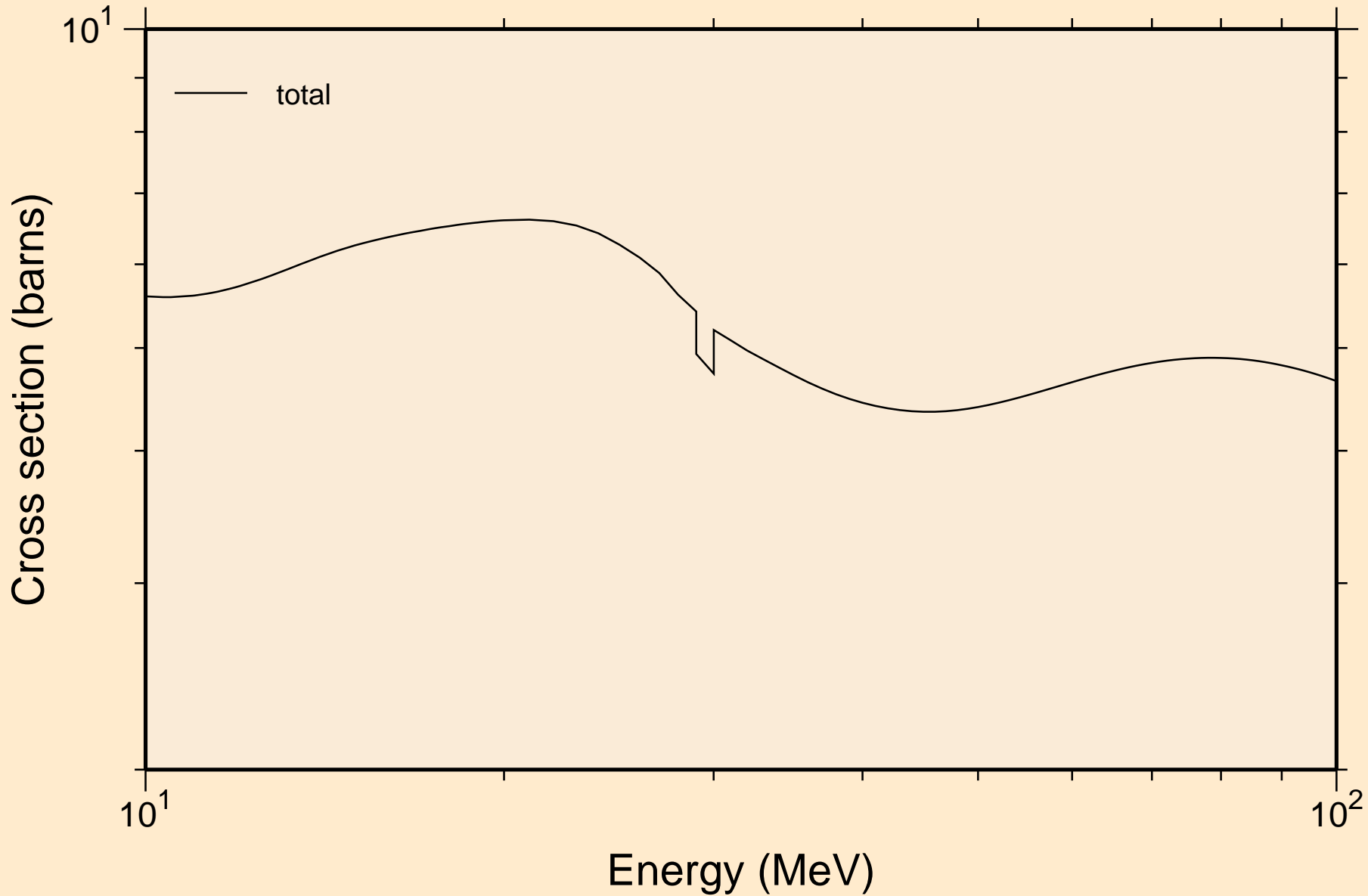

PB217 NEUTRON ACER TENDL-2021 LIBRARY; T=293.6K
resonance absorption cross sections

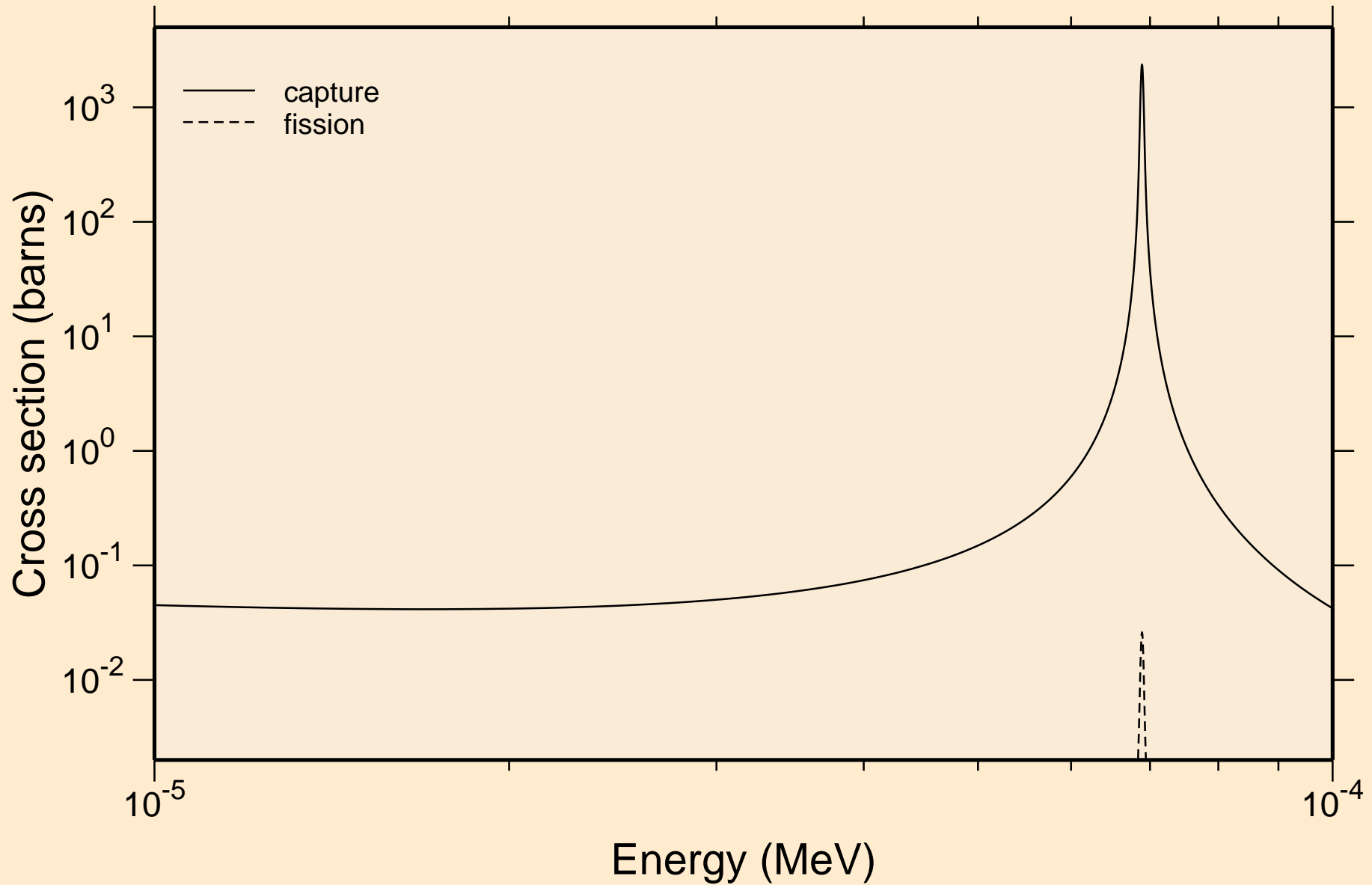

PB217 NEUTRON ACER TENDL-2021 LIBRARY; T=293.6K
resonance absorption cross sections

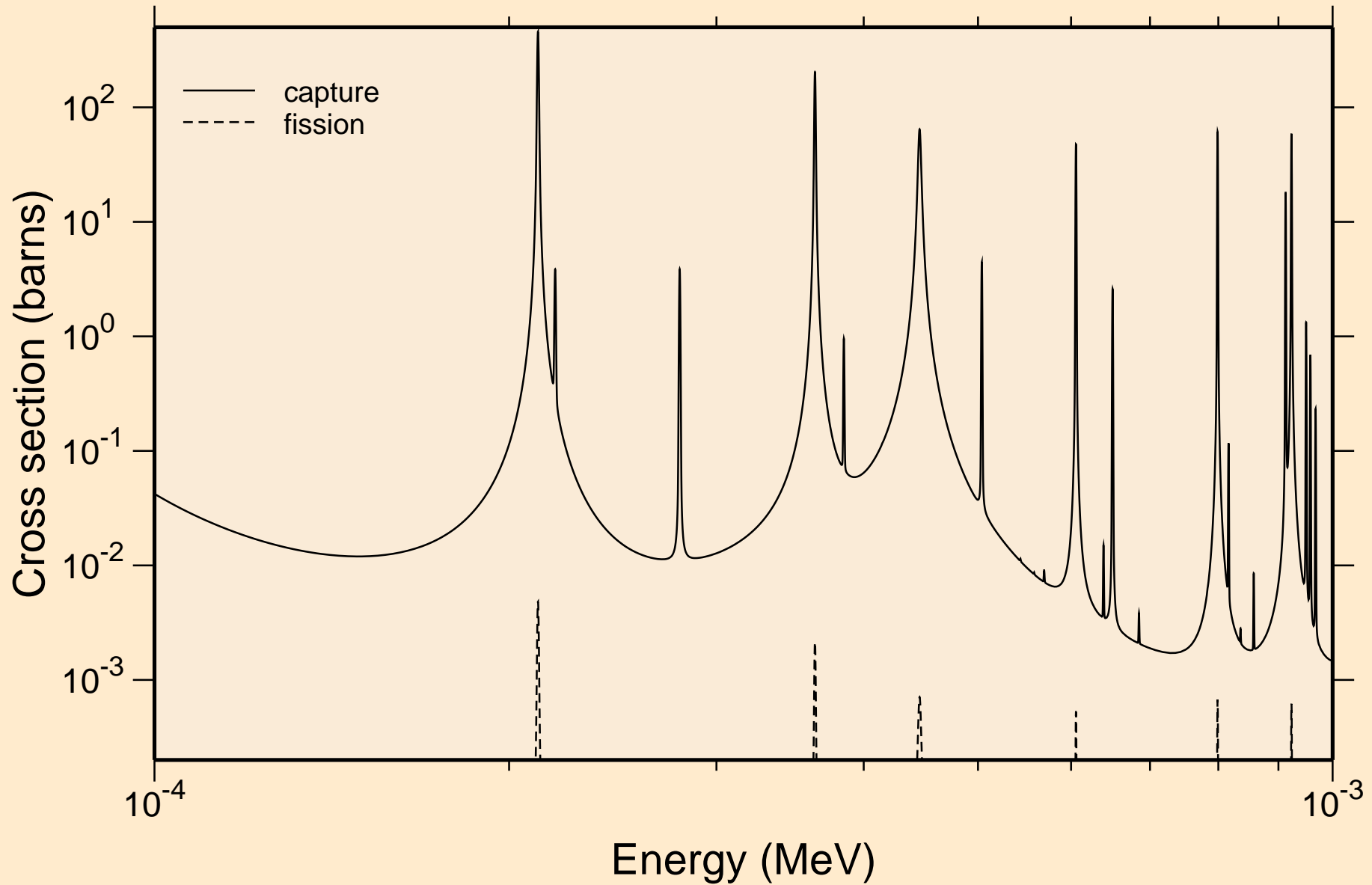

PB217 NEUTRON ACER TENDL-2021 LIBRARY; T=293.6K
resonance absorption cross sections

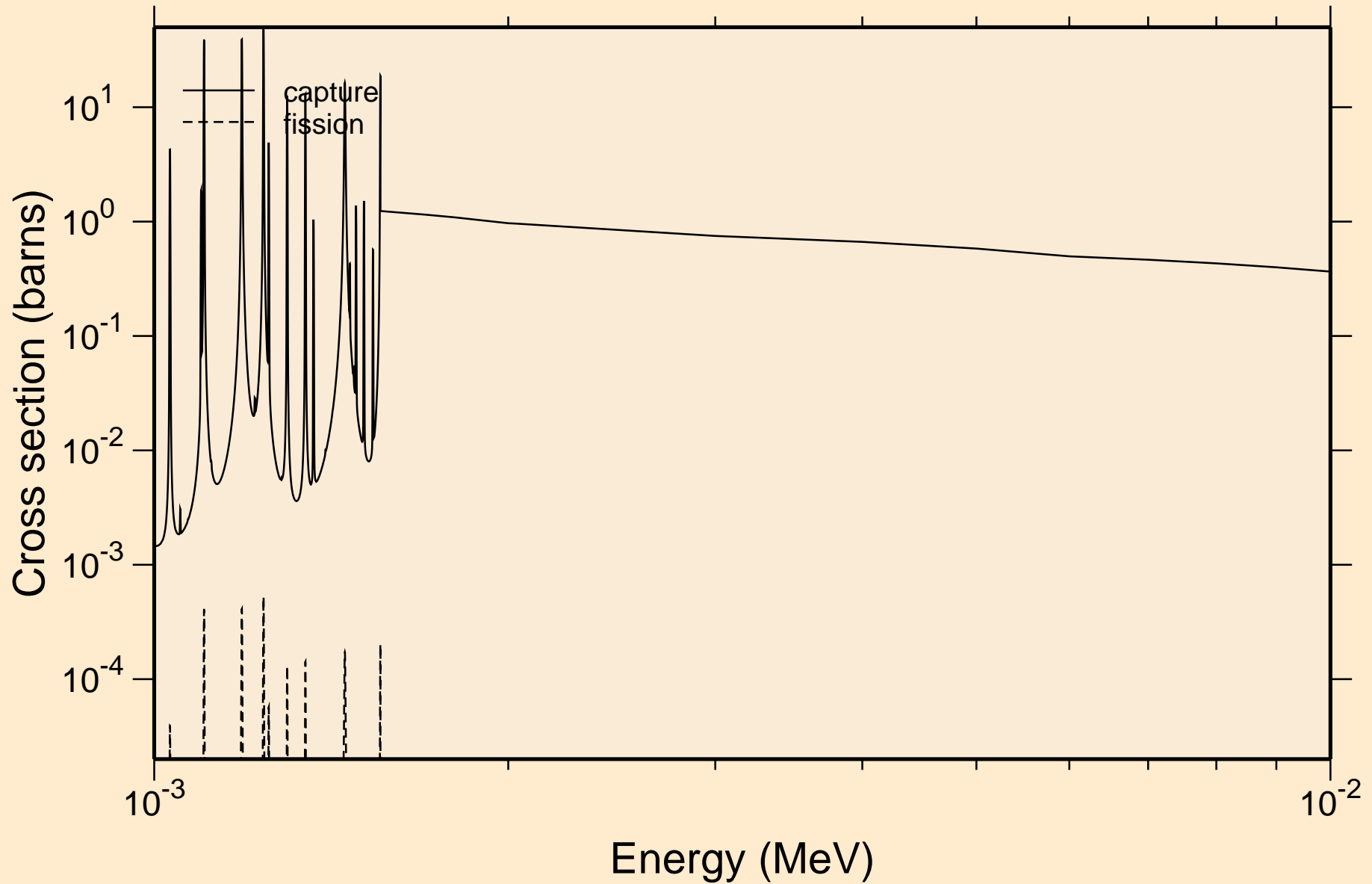

PB217 NEUTRON ACER TENDL-2021 LIBRARY; T=293.6K
resonance absorption cross sections

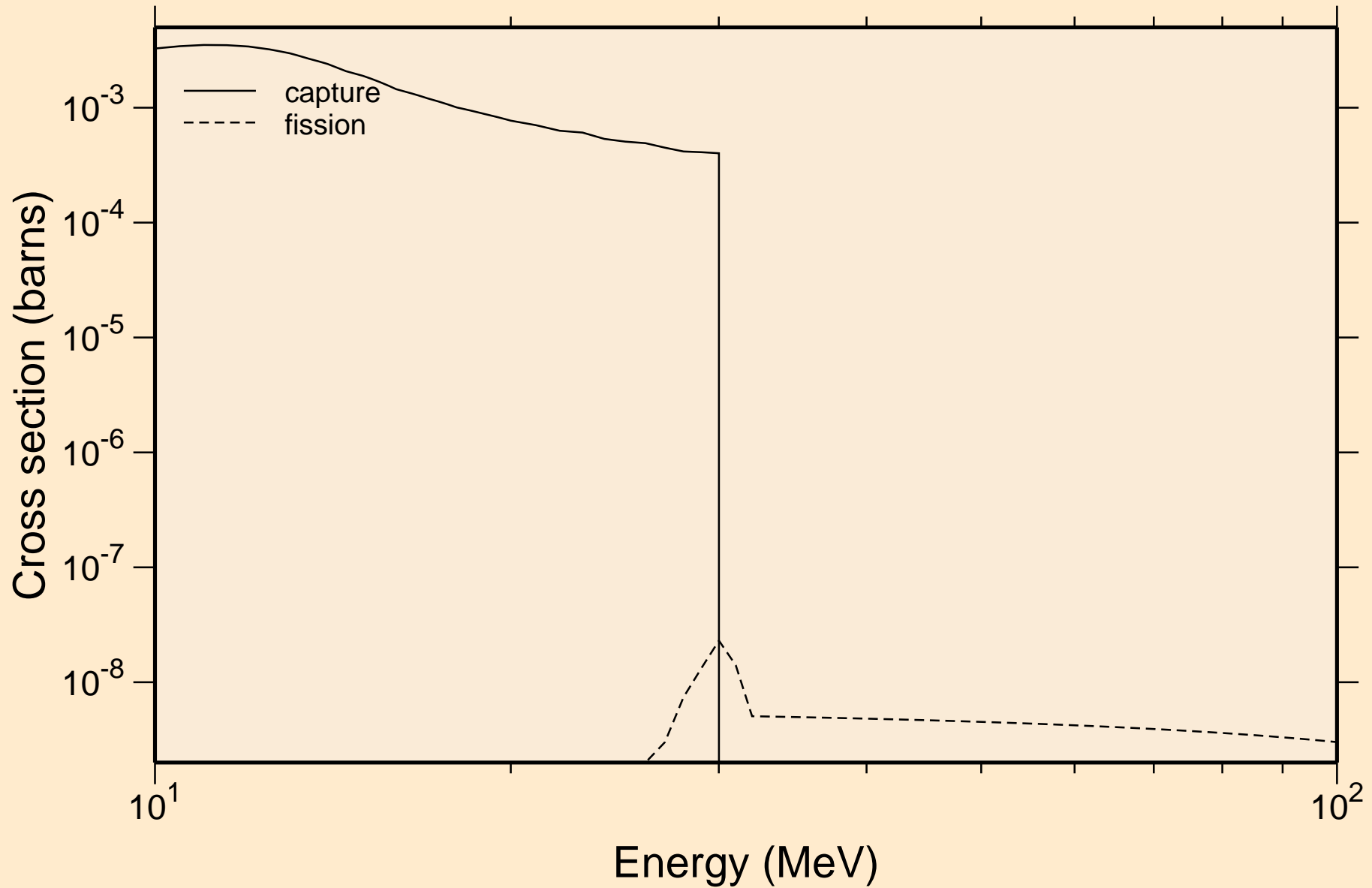

PB217 NEUTRON ACER TENDL-2021 LIBRARY; T=293.6K
Heating

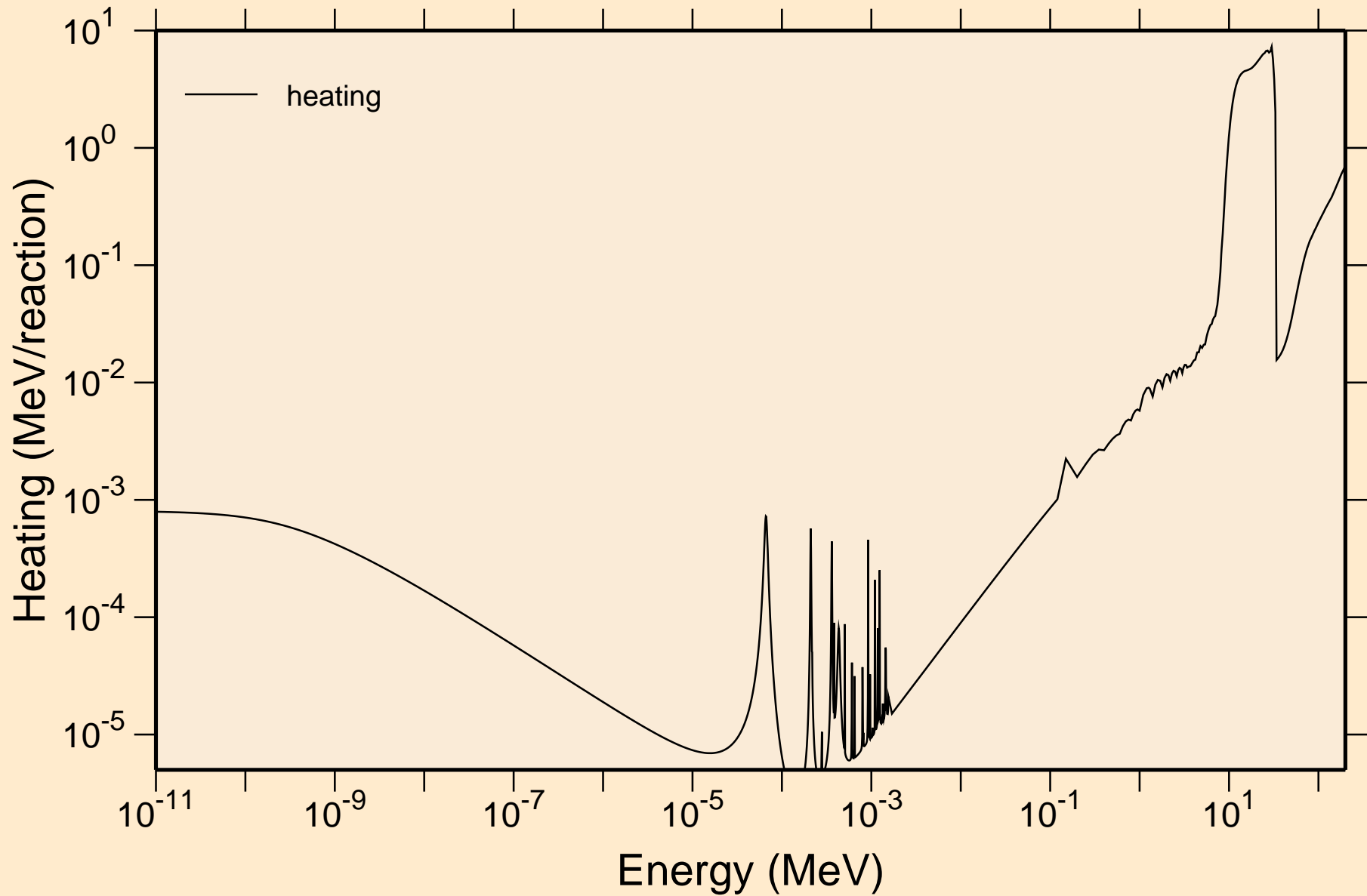

PB217 NEUTRON ACER TENDL-2021 LIBRARY; T=293.6K
Damage

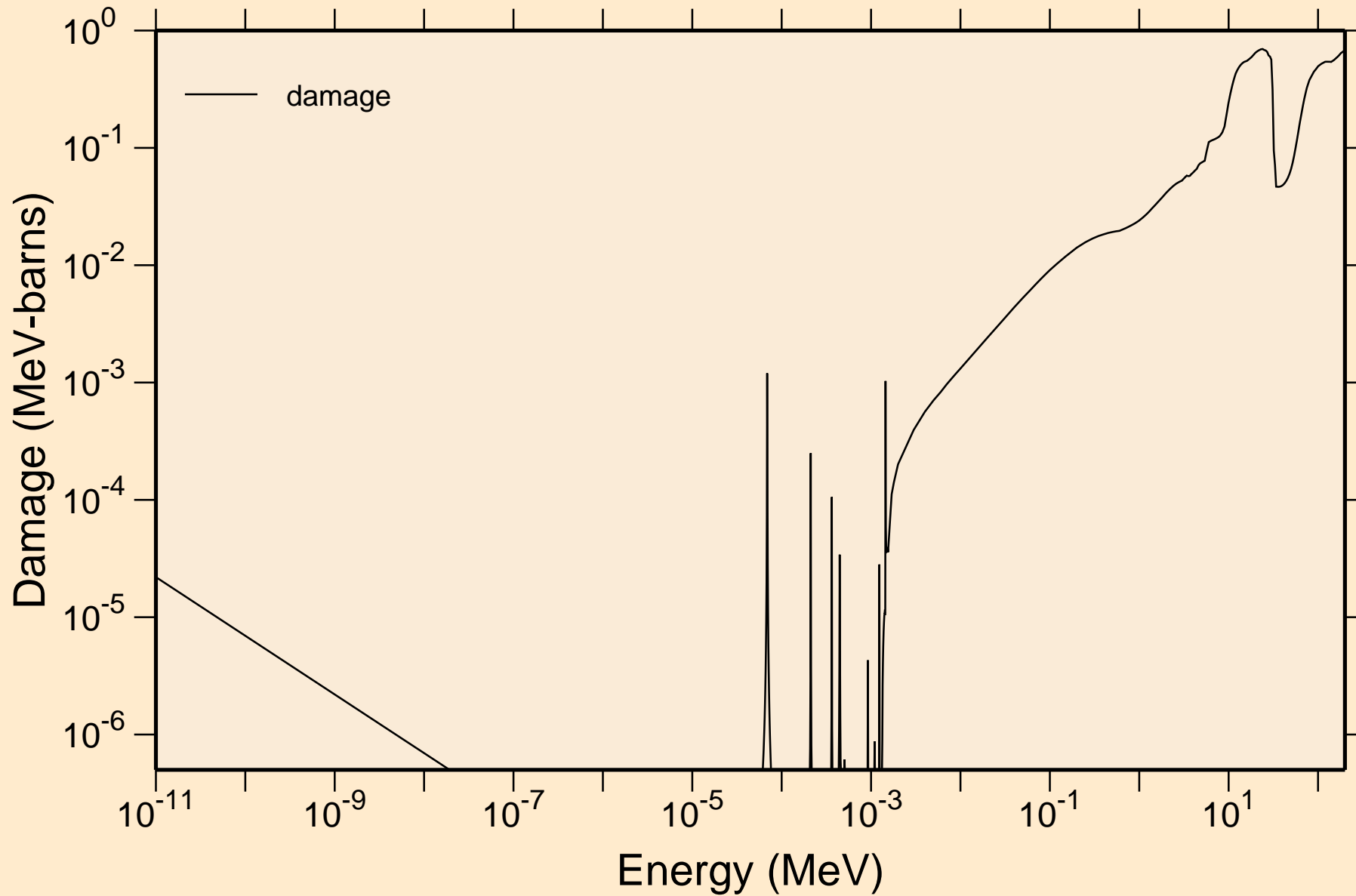

PB217 NEUTRON ACER TENDL-2021 LIBRARY; T=293.6K
Non-threshold reactions

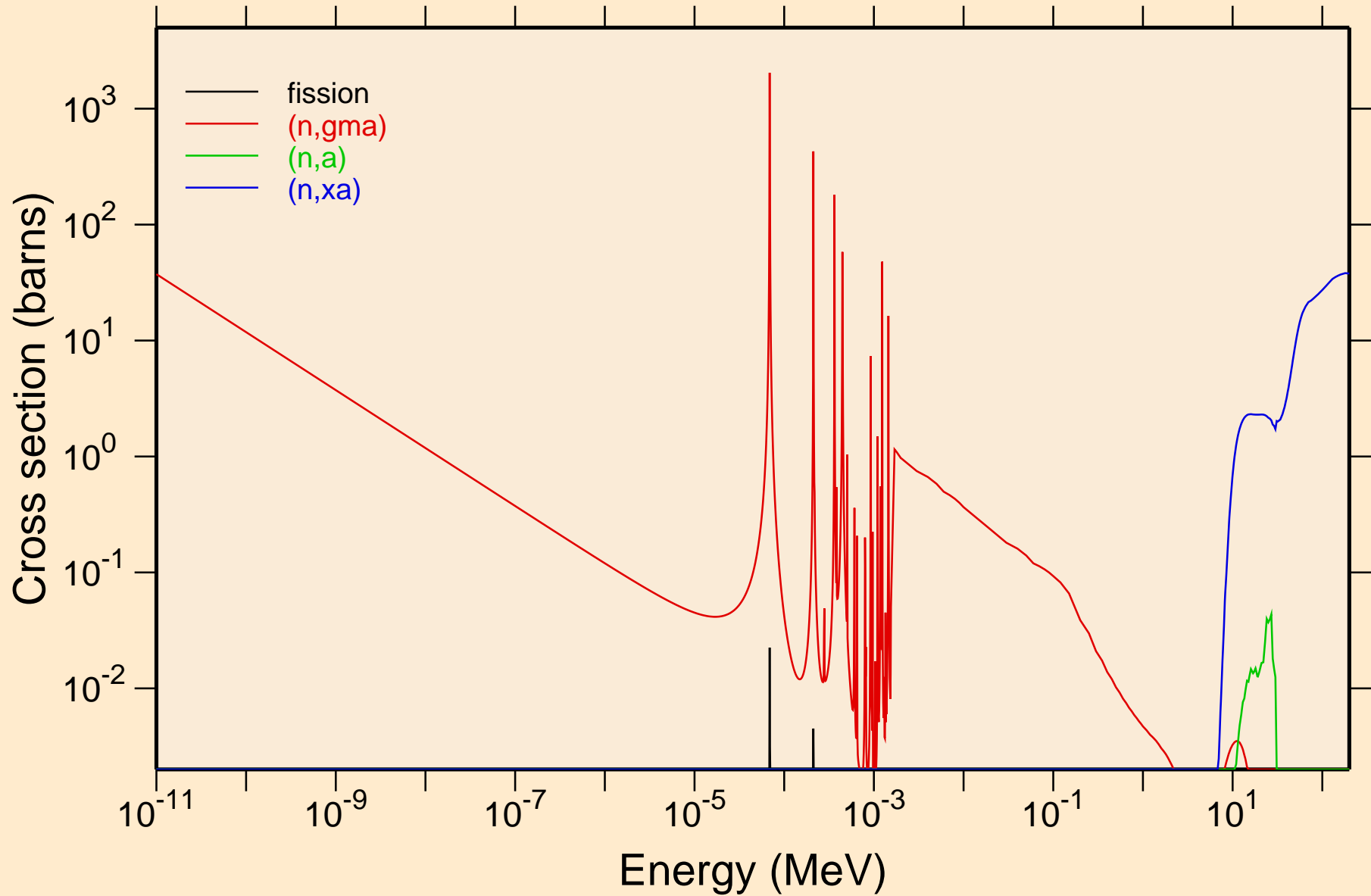

PB217 NEUTRON ACER TENDL-2021 LIBRARY; T=293.6K
Principal cross sections

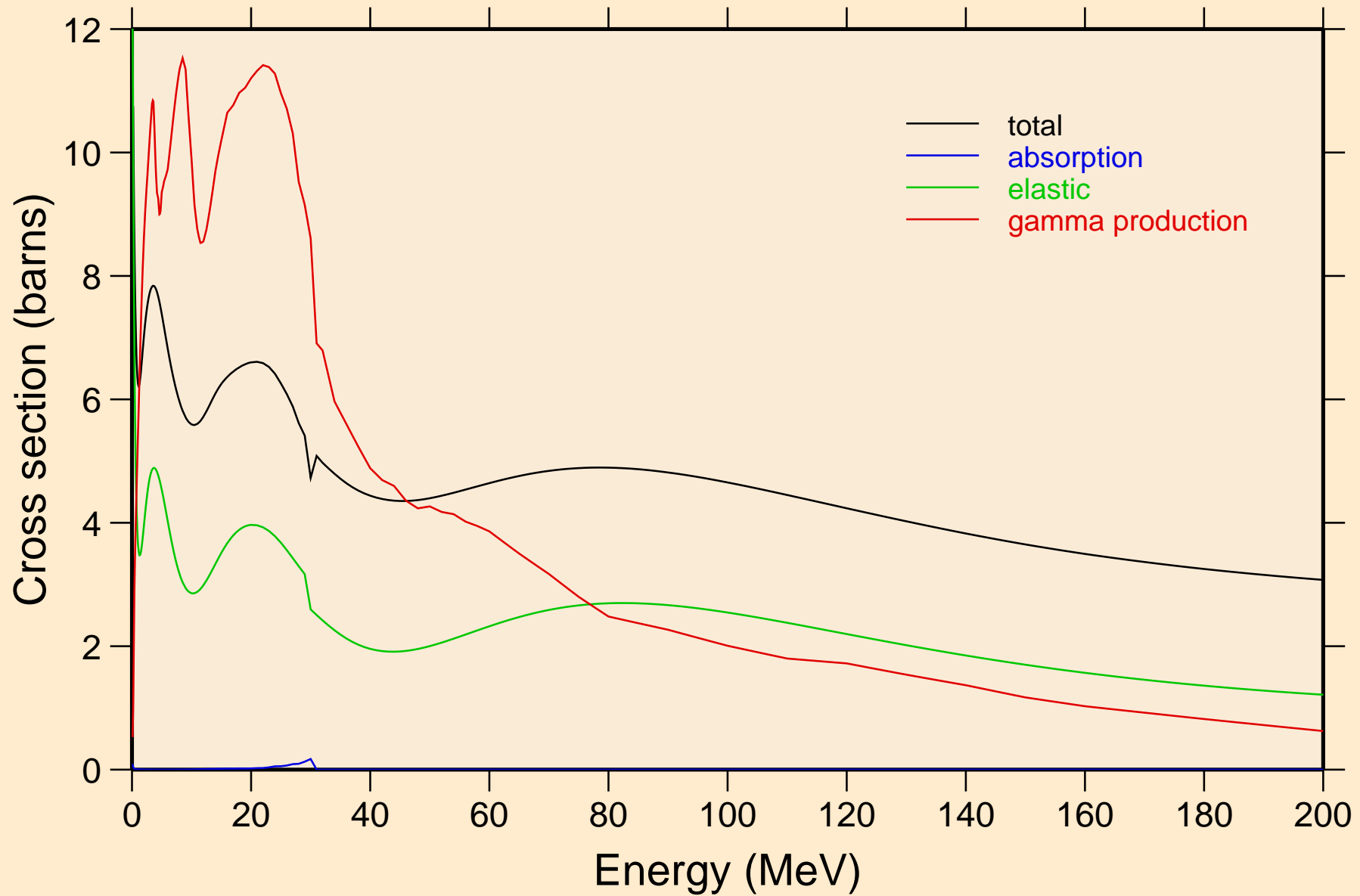

PB217 NEUTRON ACER TENDL-2021 LIBRARY; T=293.6K
Heating

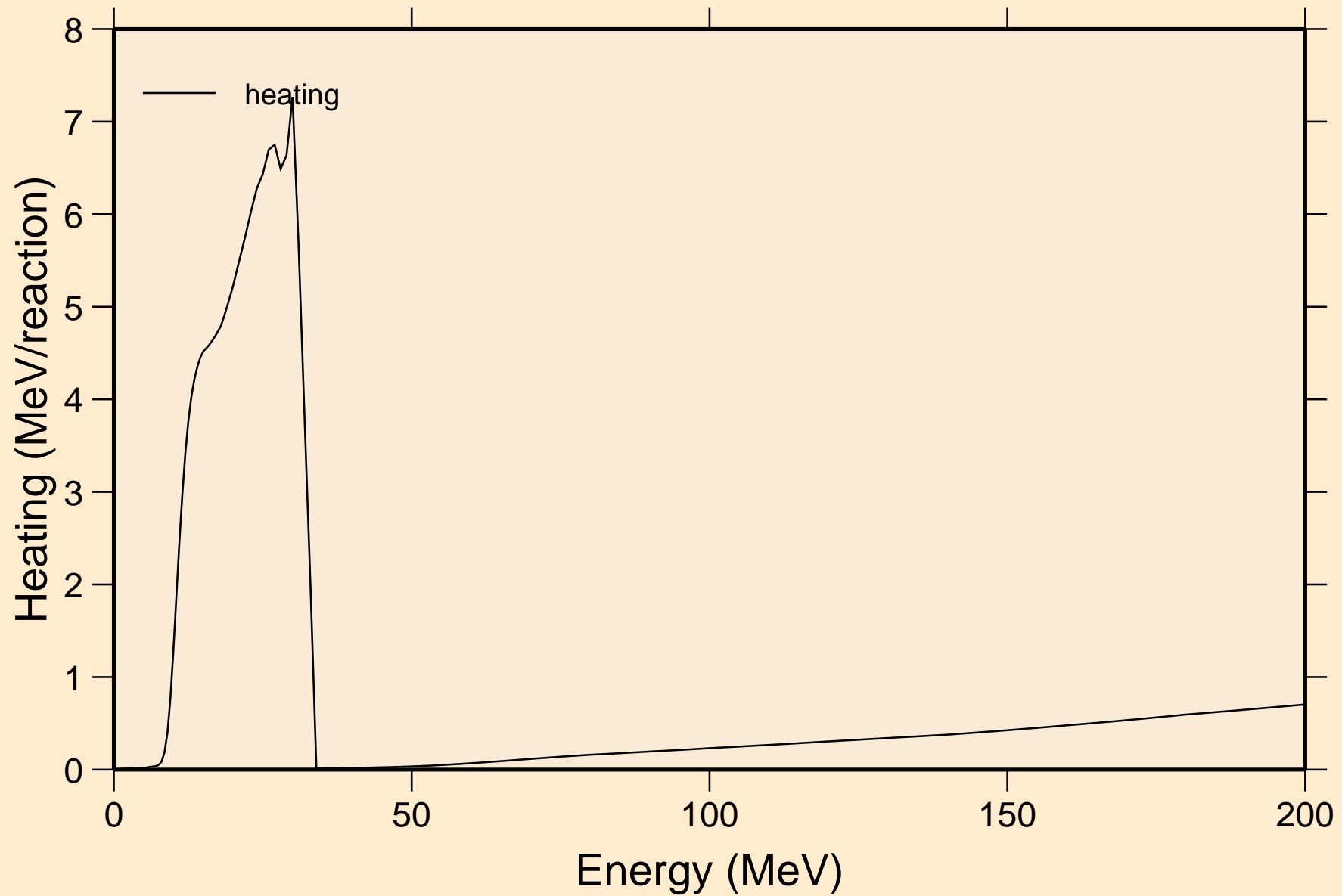

PB217 NEUTRON ACER TENDL-2021 LIBRARY; T=293.6K
Damage

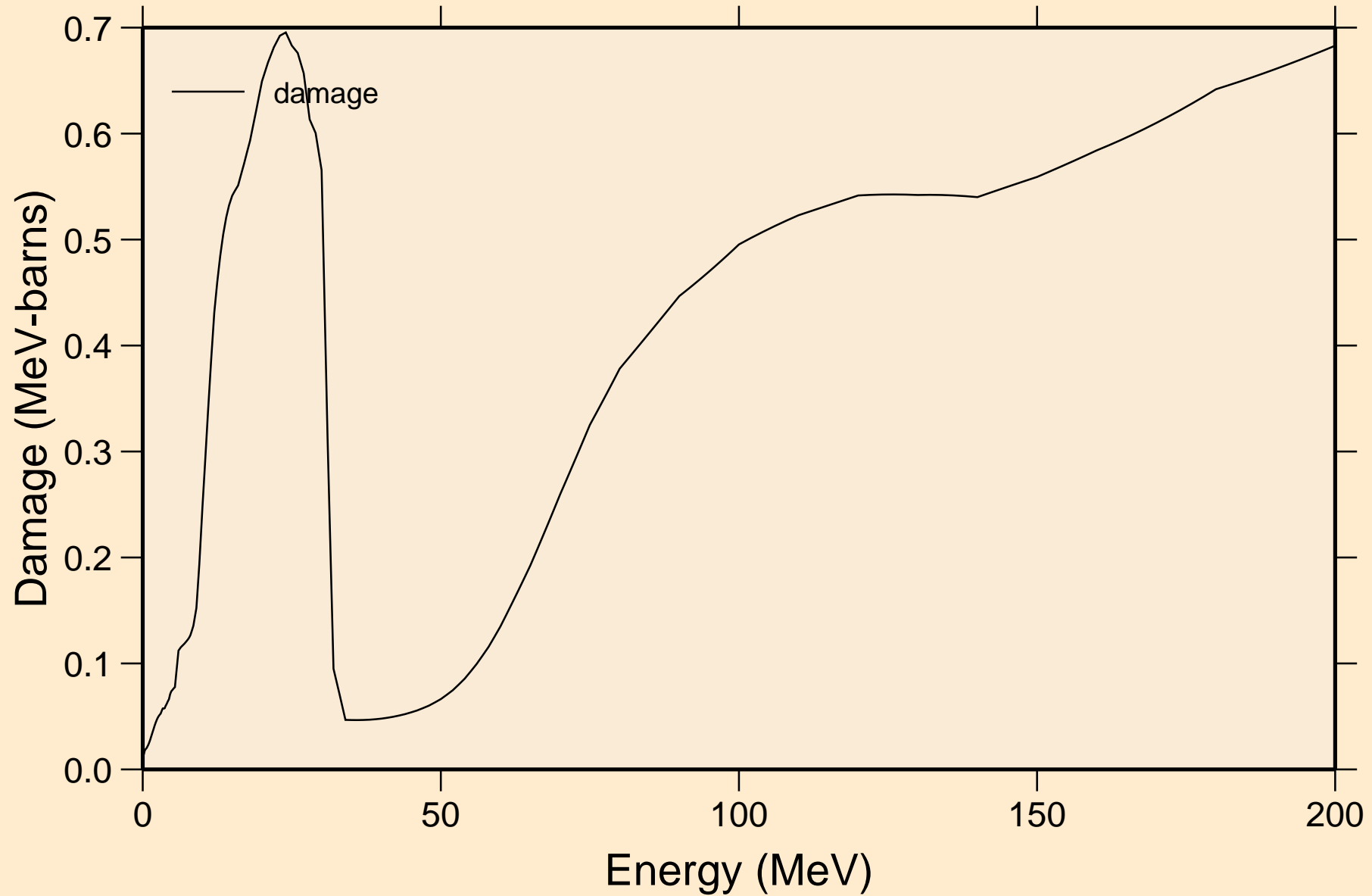

PB217 NEUTRON ACER TENDL-2021 LIBRARY; T=293.6K

Non-threshold reactions

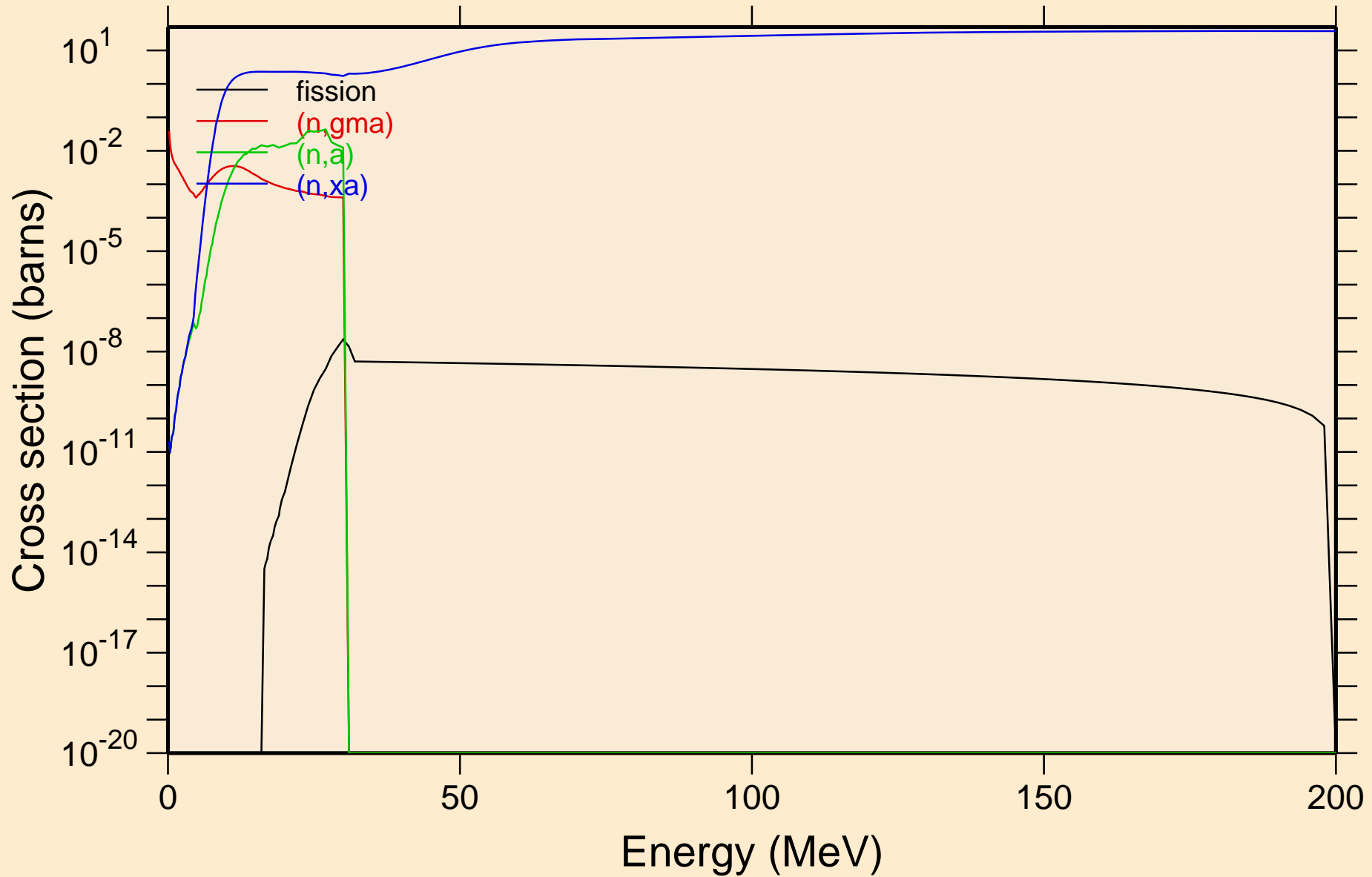

PB217 NEUTRON ACER TENDL-2021 LIBRARY; T=293.6K
Inelastic levels

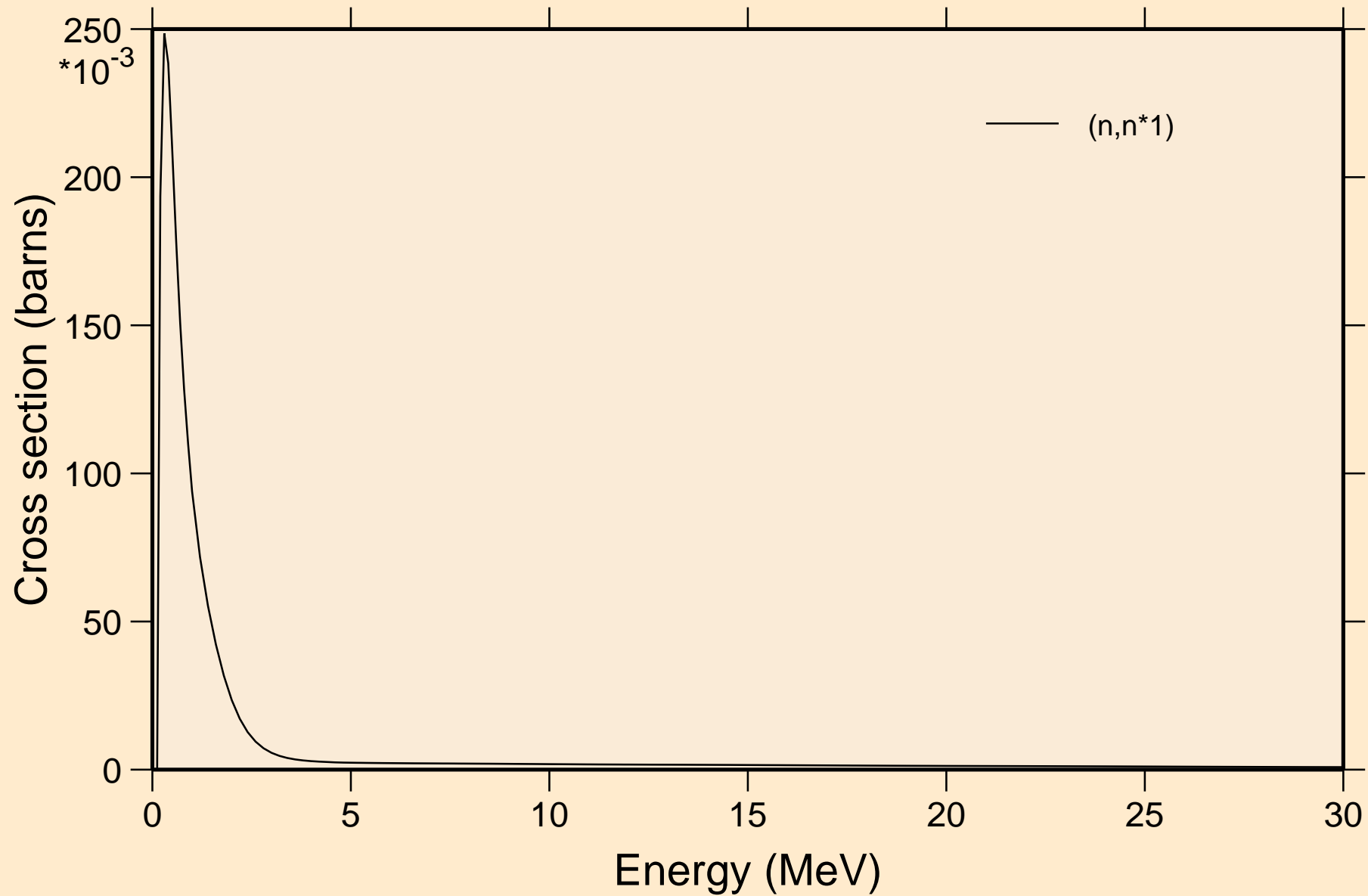

PB217 NEUTRON ACER TENDL-2021 LIBRARY; T=293.6K
Threshold reactions

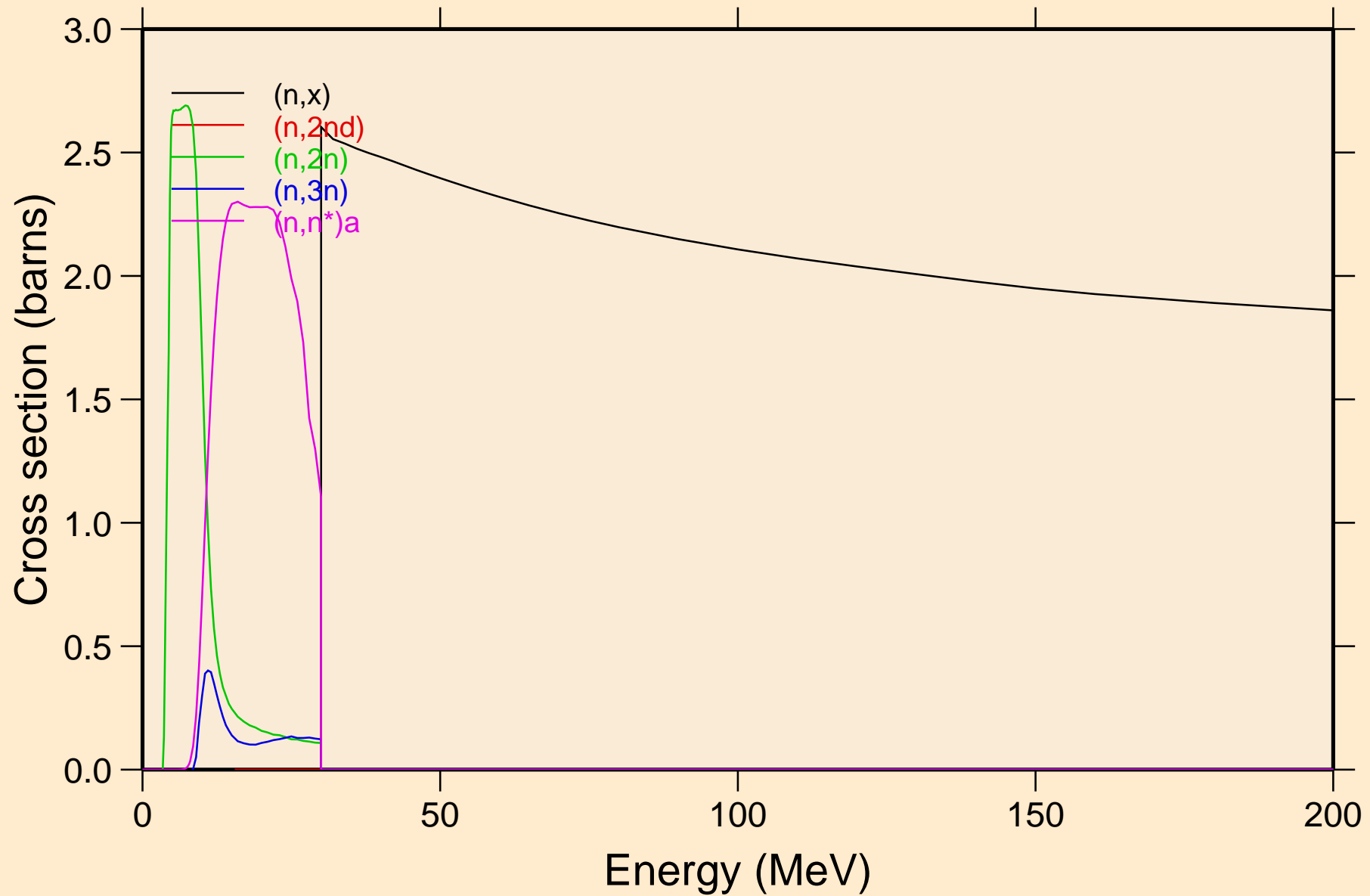

PB217 NEUTRON ACER TENDL-2021 LIBRARY; T=293.6K
Threshold reactions

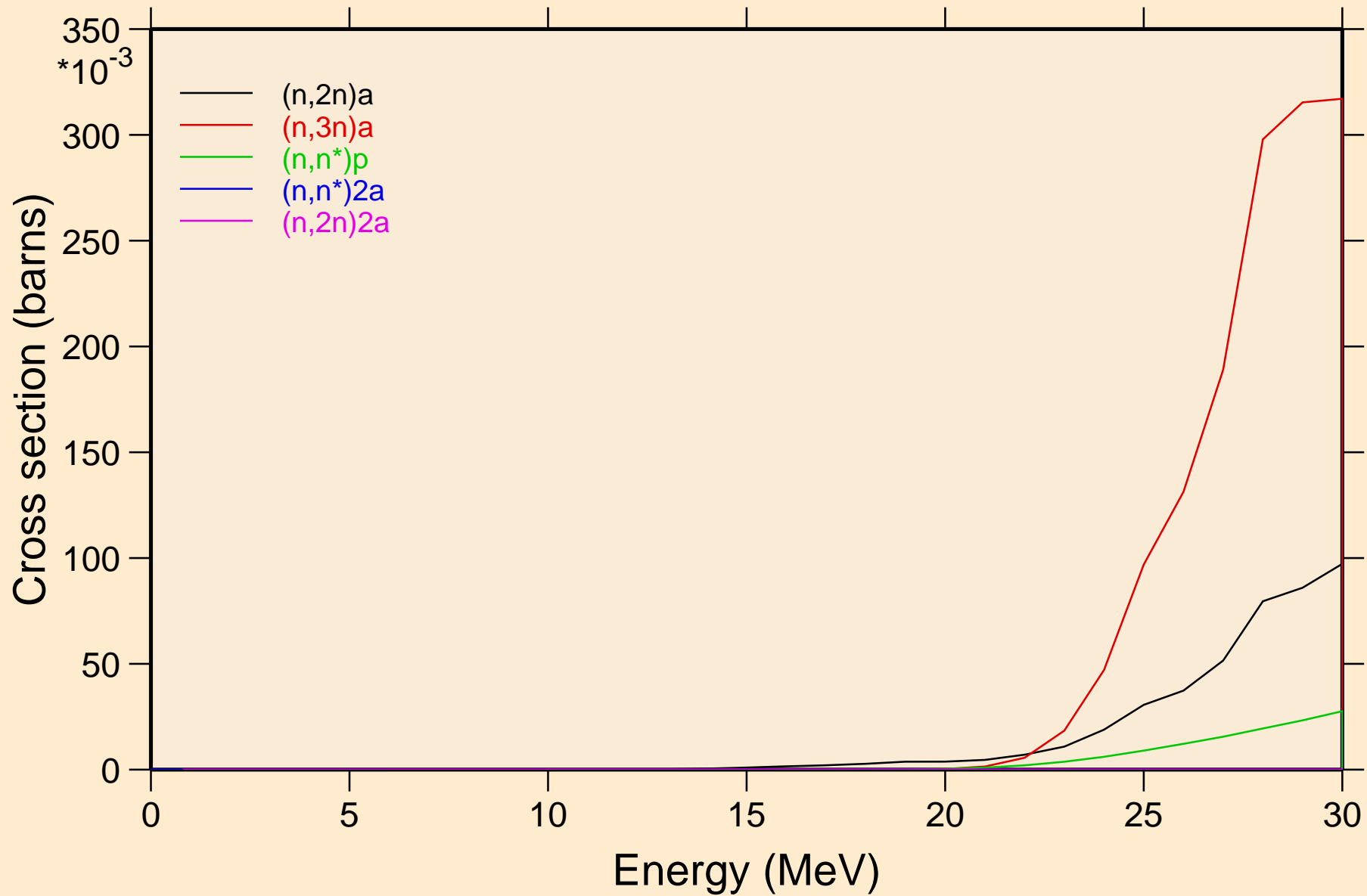

PB217 NEUTRON ACER TENDL-2021 LIBRARY; T=293.6K
Threshold reactions

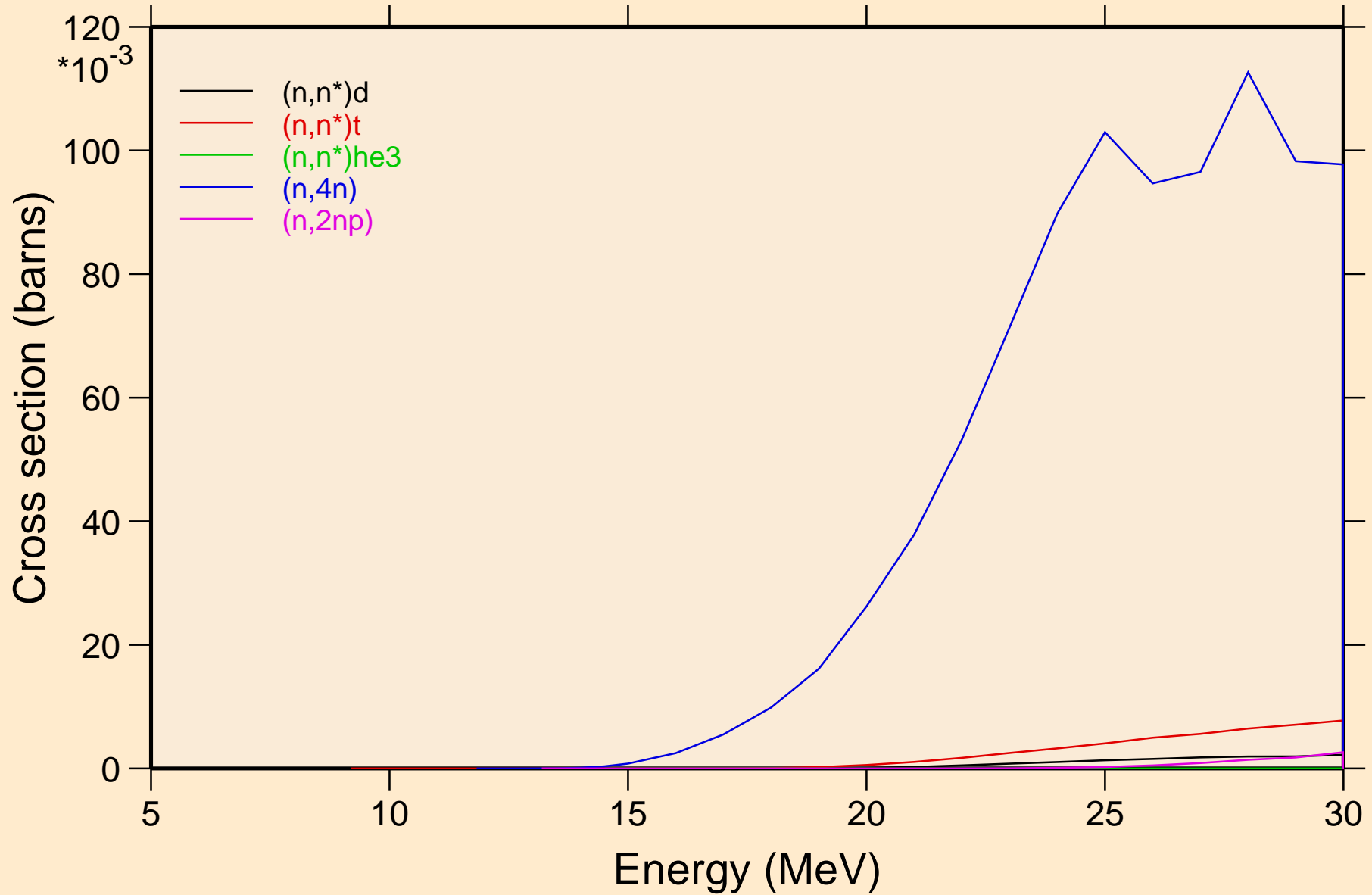

PB217 NEUTRON ACER TENDL-2021 LIBRARY; T=293.6K
Threshold reactions

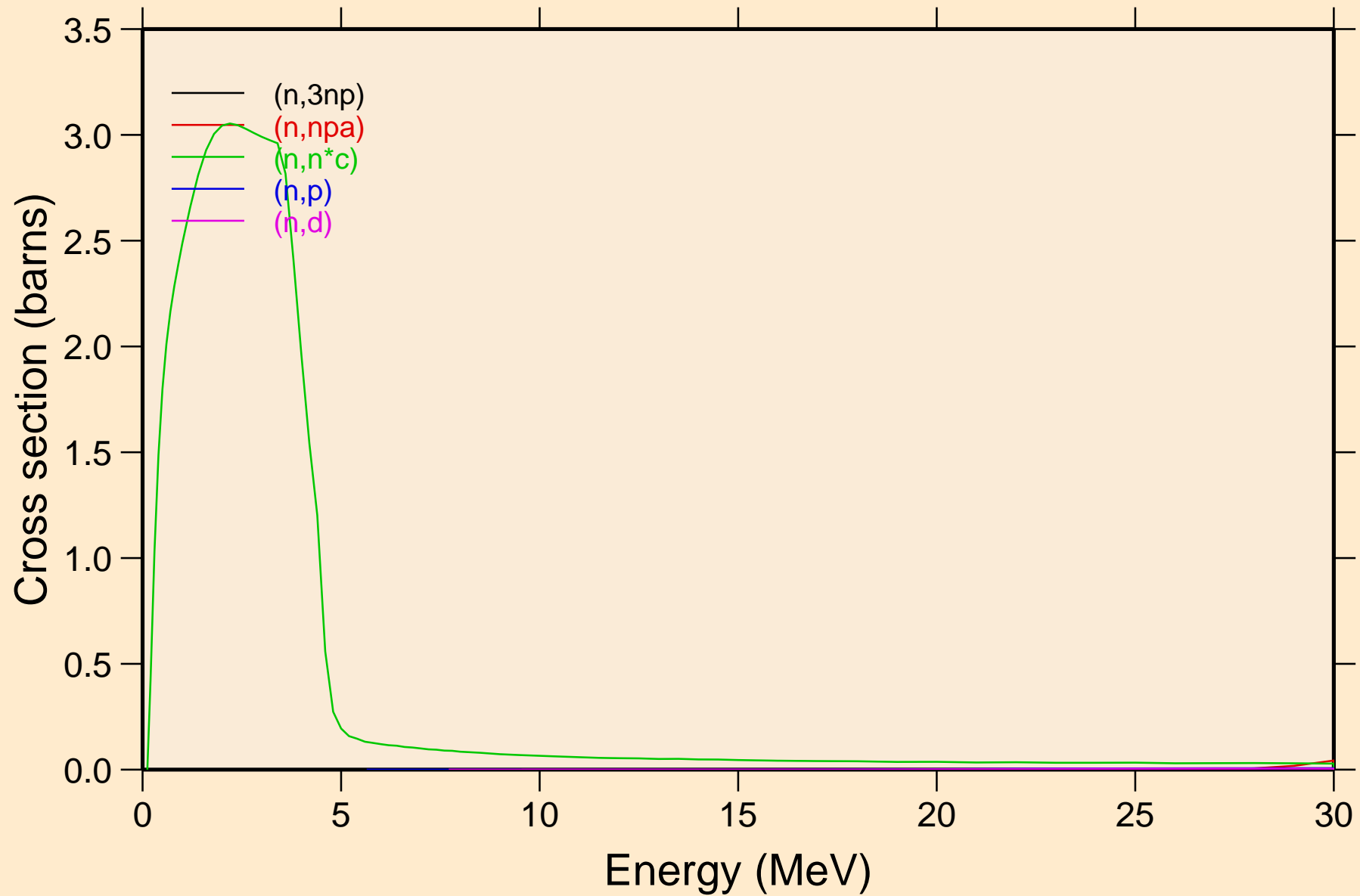

PB217 NEUTRON ACER TENDL-2021 LIBRARY; T=293.6K
Threshold reactions

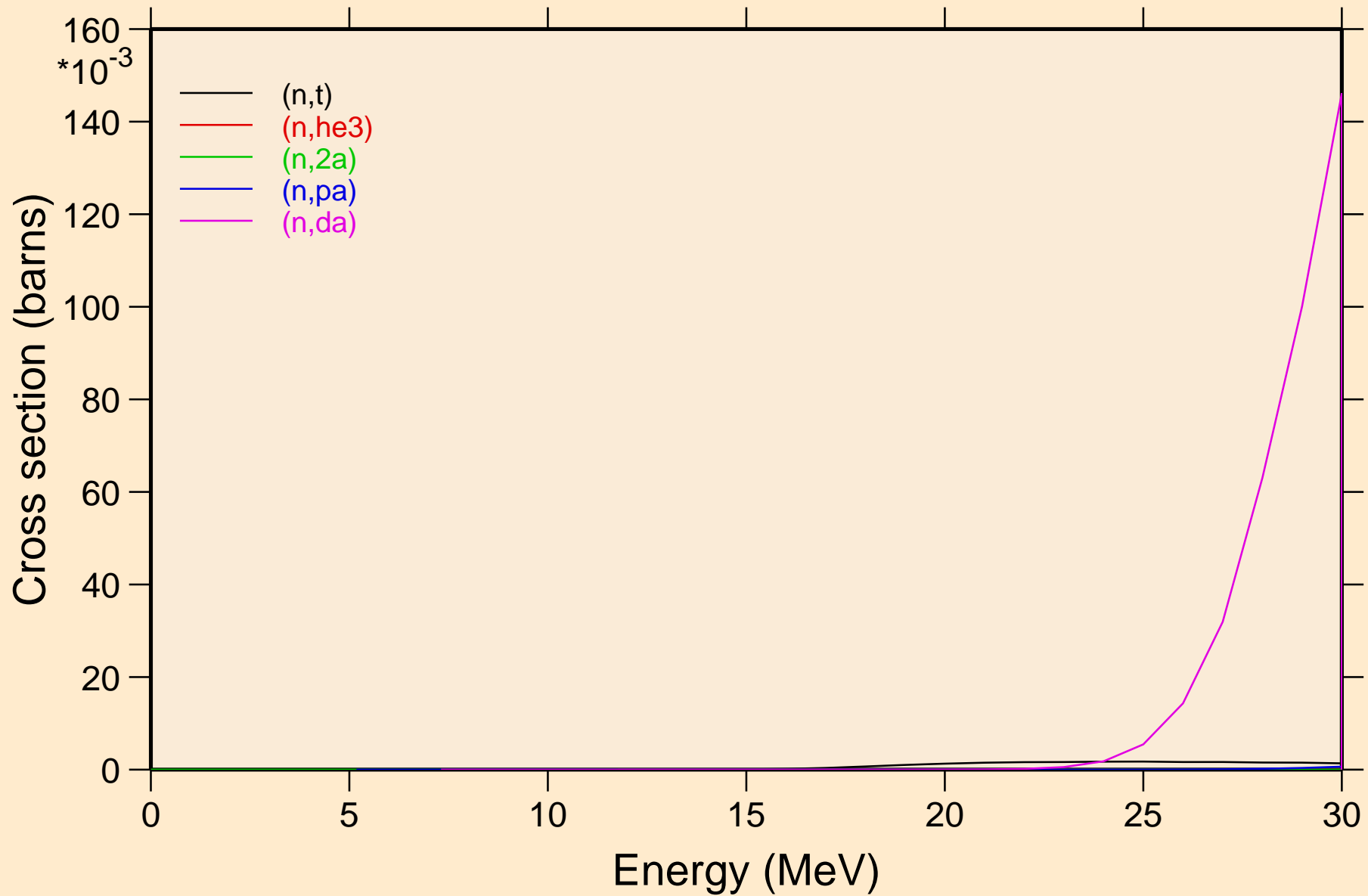

PB217 NEUTRON ACER TENDL-2021 LIBRARY; T=293.6K
Threshold reactions

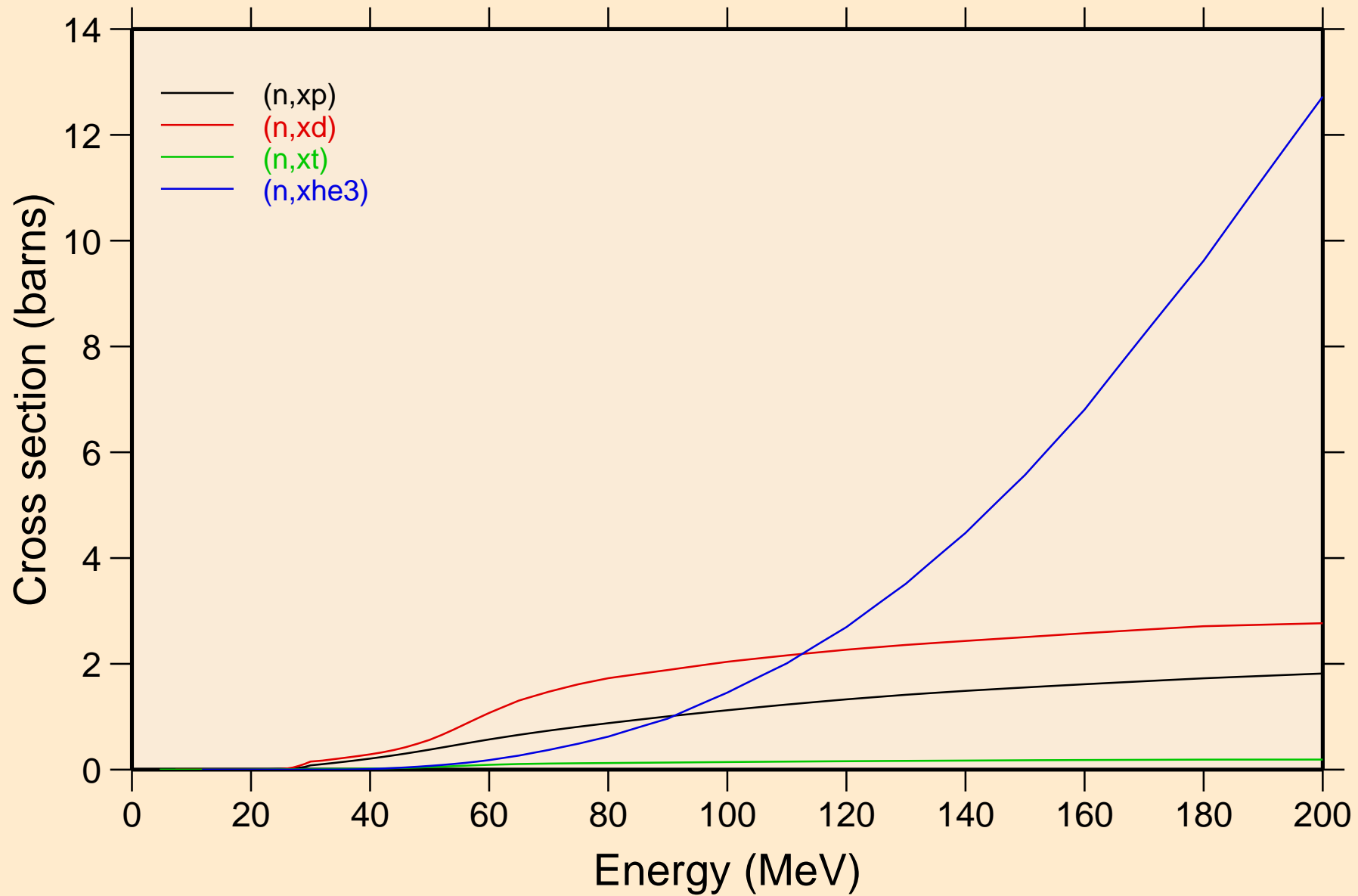

PB217 NEUTRON ACER TENDL-2021 LIBRARY; T=293.6K
angular distribution for elastic

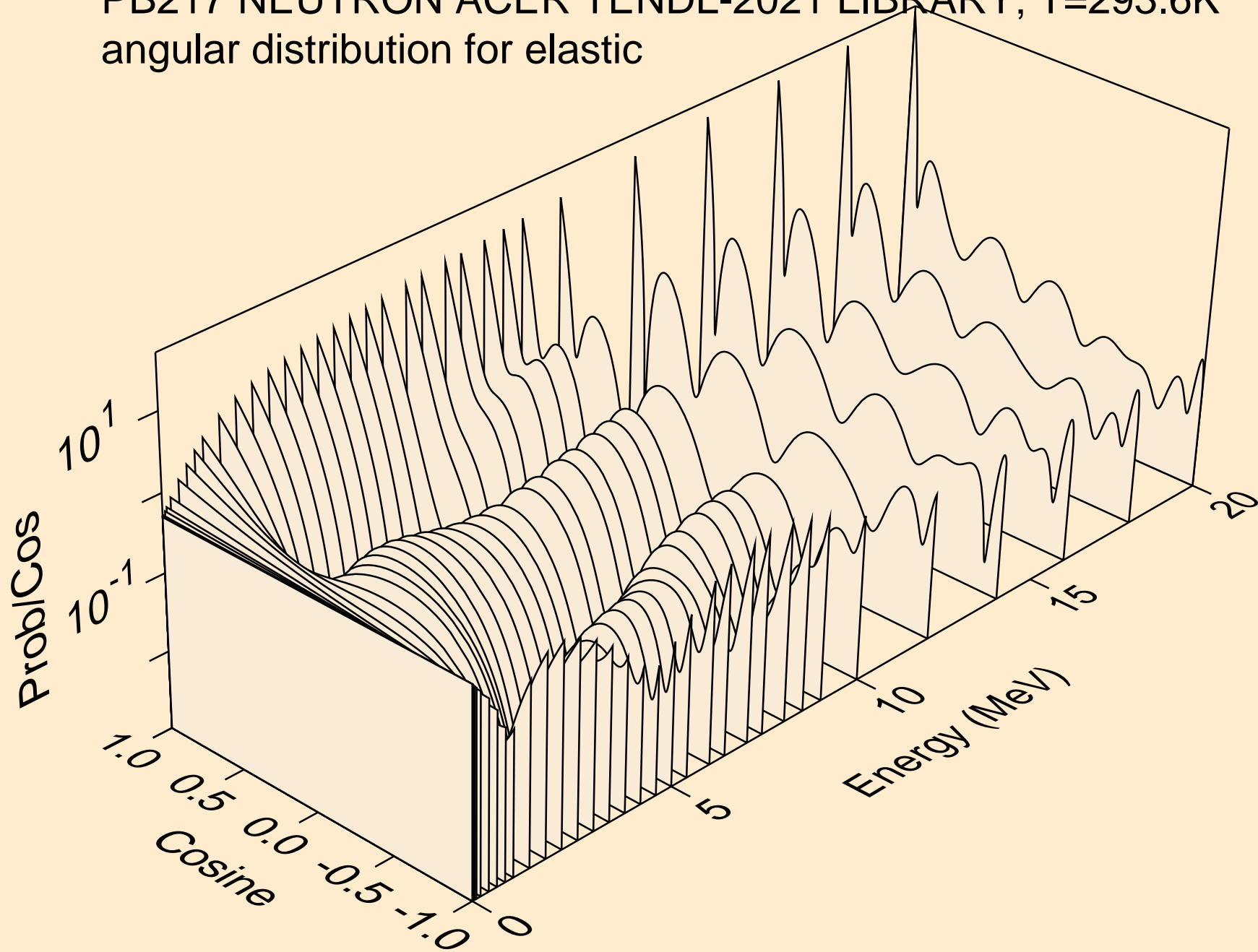

PB217 NEUTRON ACER TENDL-2021 LIBRARY; T=293.6K
angular distribution for elastic

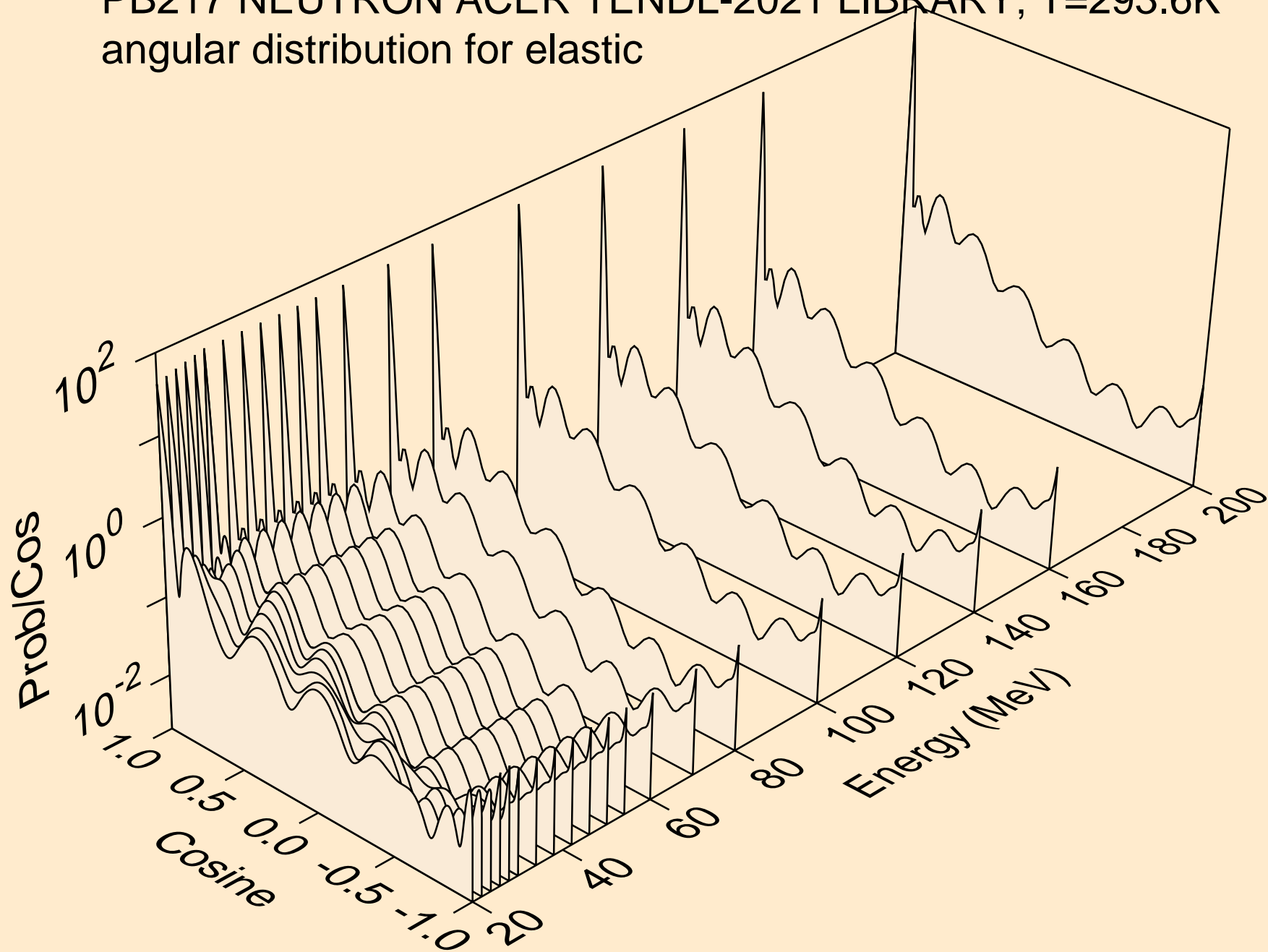

PB217 NEUTRON ACER TENDL-2021 LIBRARY; T=293.6K
angular distribution for (n,n*1)

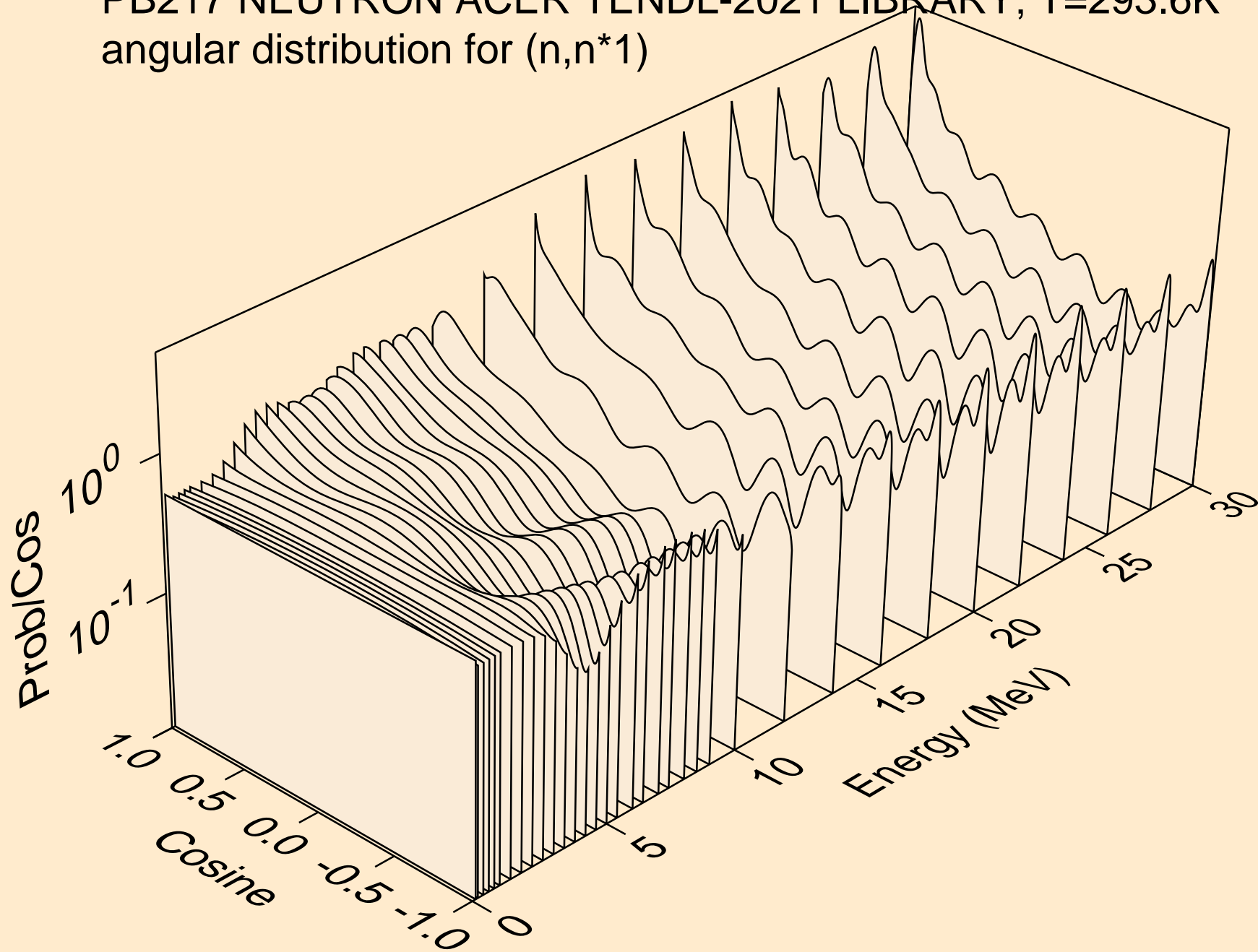

PB217 NEUTRON ACER TENDL-2021 LIBRARY; T=293.6K
Total fission nubar

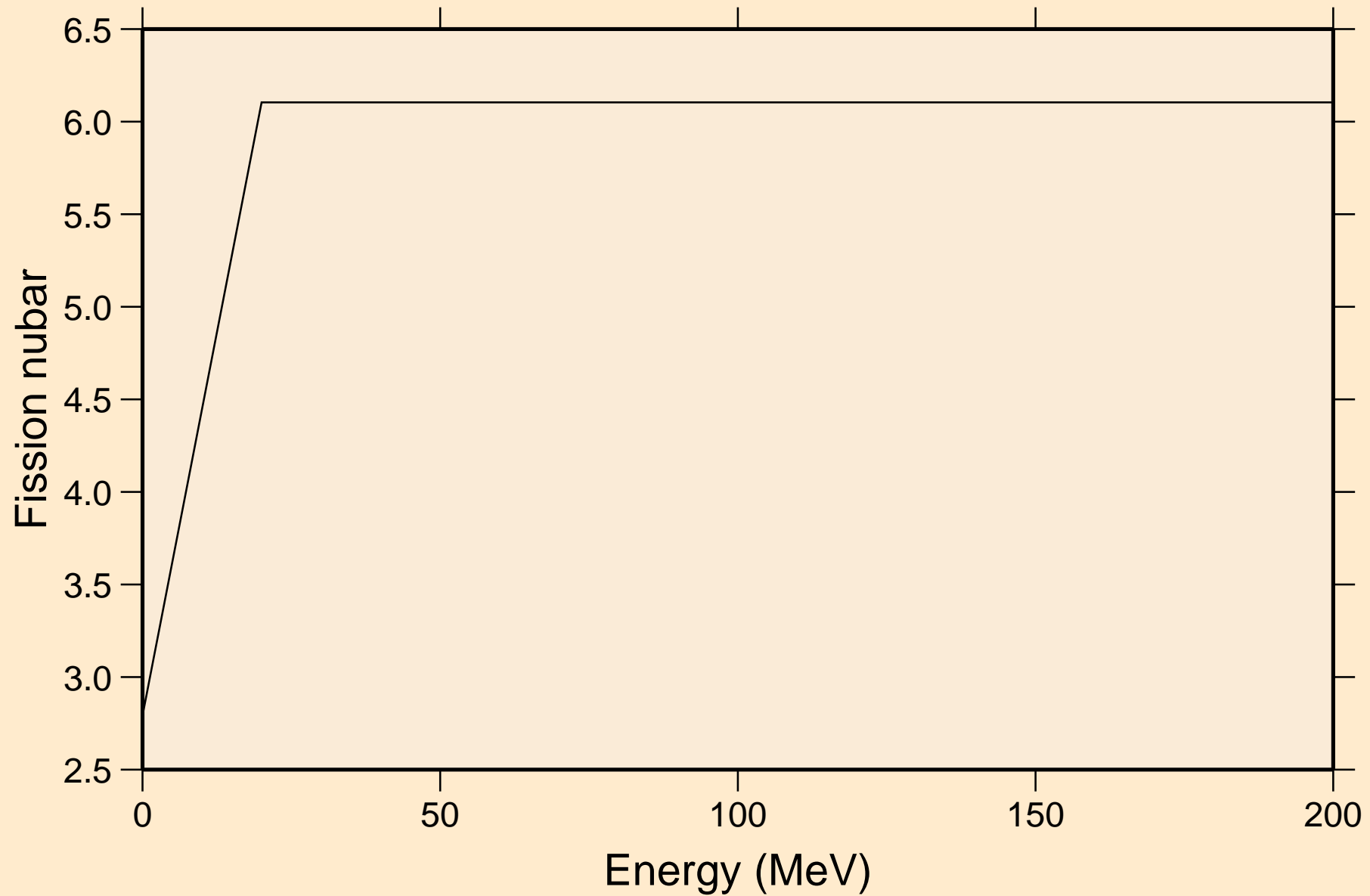

PB217 NEUTRON ACER TENDL-2021 LIBRARY; T=293.6K
Neutron emission for (n,x)

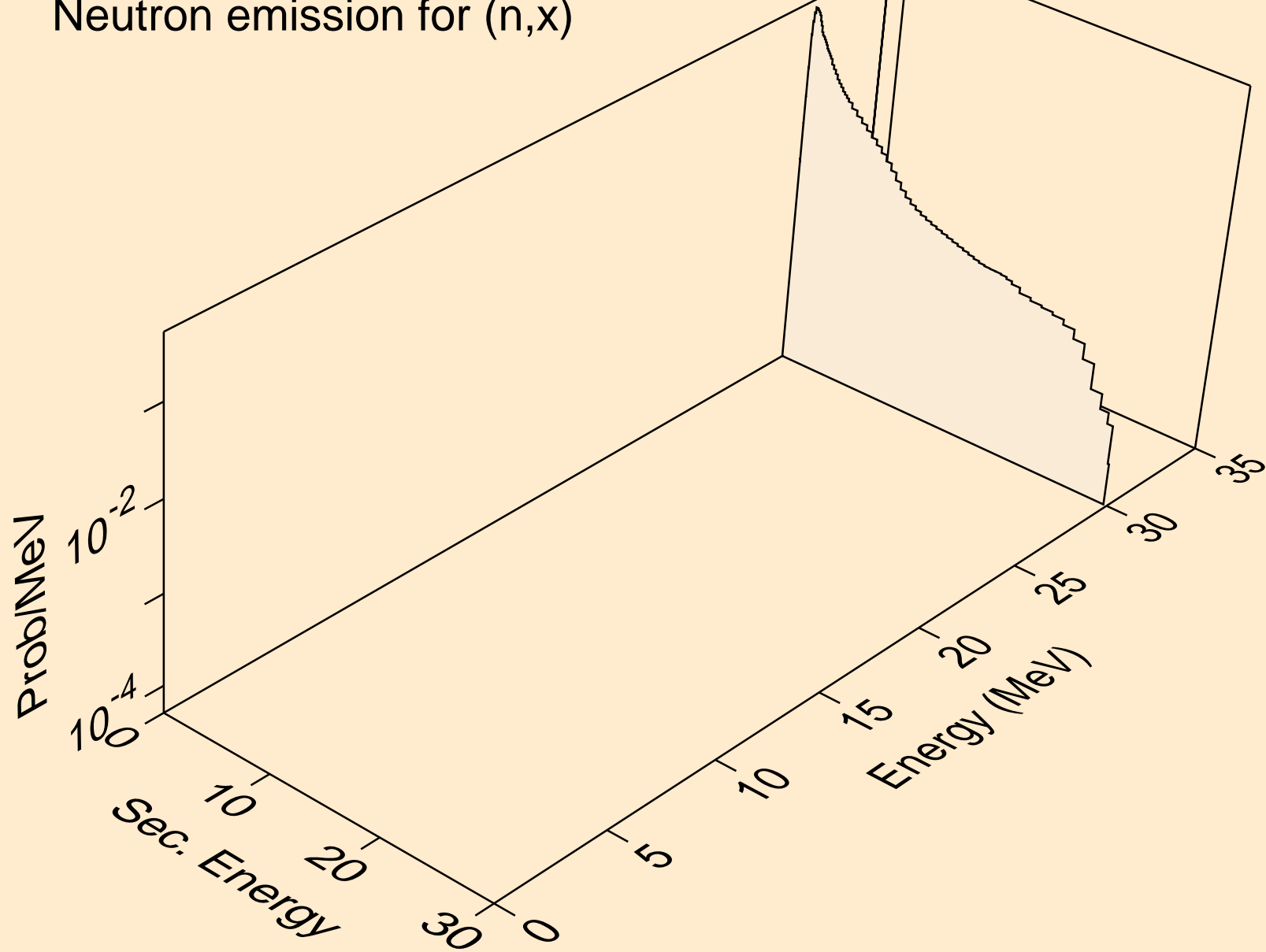

PB217 NEUTRON ACER TENDL-2021 LIBRARY; T=293.6K
Neutron emission for (n,2nd)

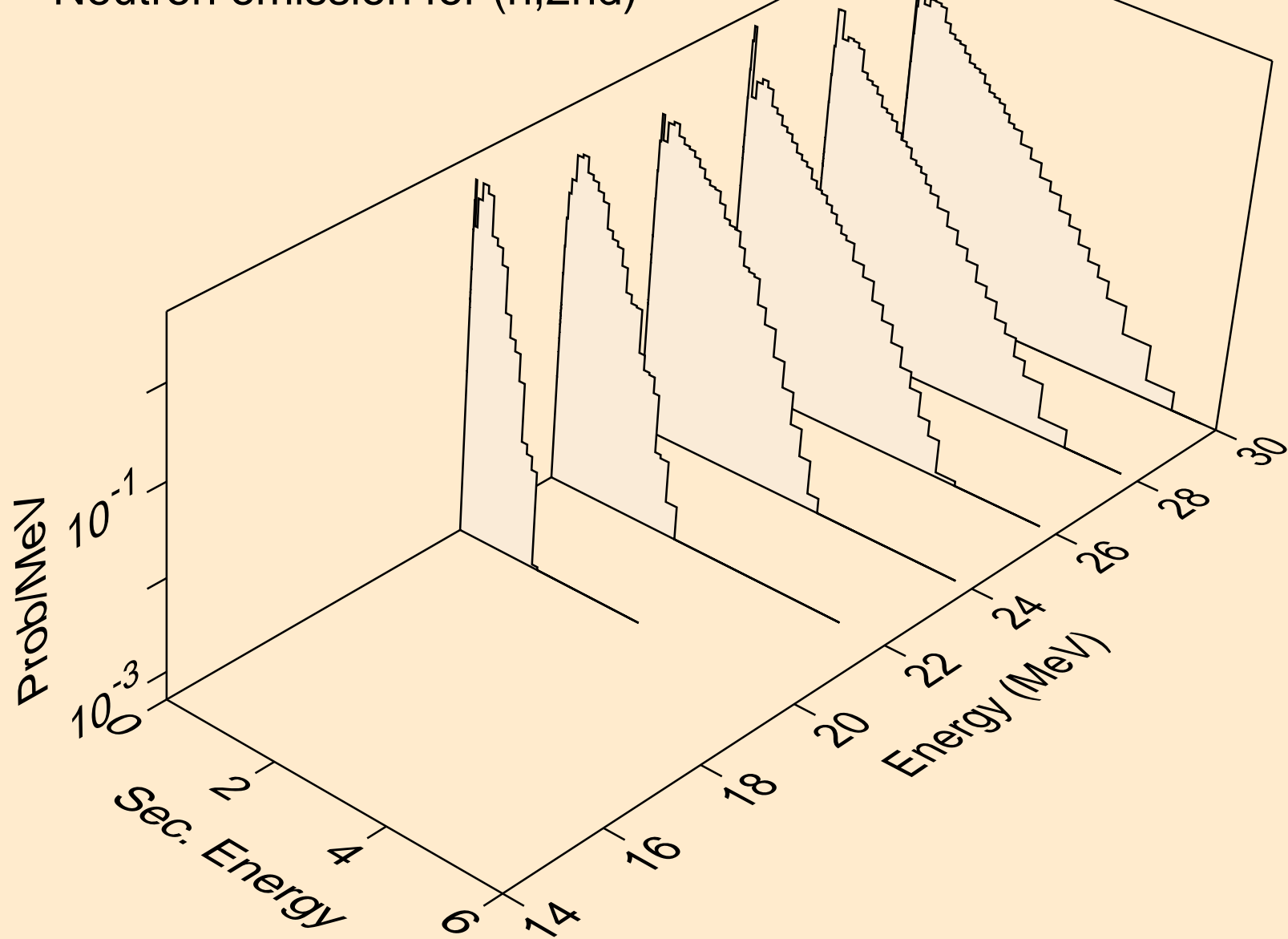

PB217 NEUTRON ACER TENDL-2021 LIBRARY; T=293.6K
Neutron emission for (n,2n)

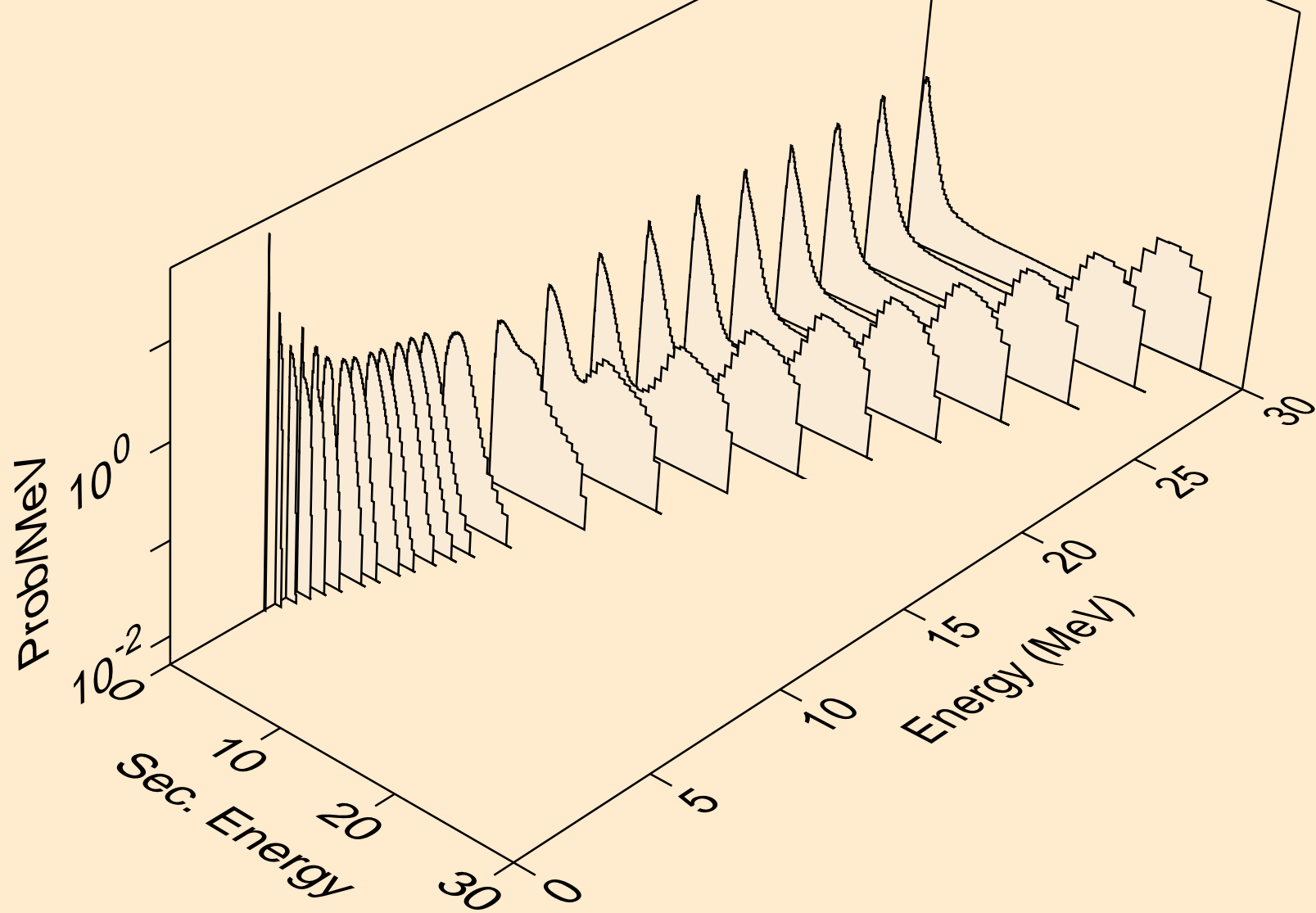

PB217 NEUTRON ACER TENDL-2021 LIBRARY; T=293.6K
Neutron emission for (n,3n)

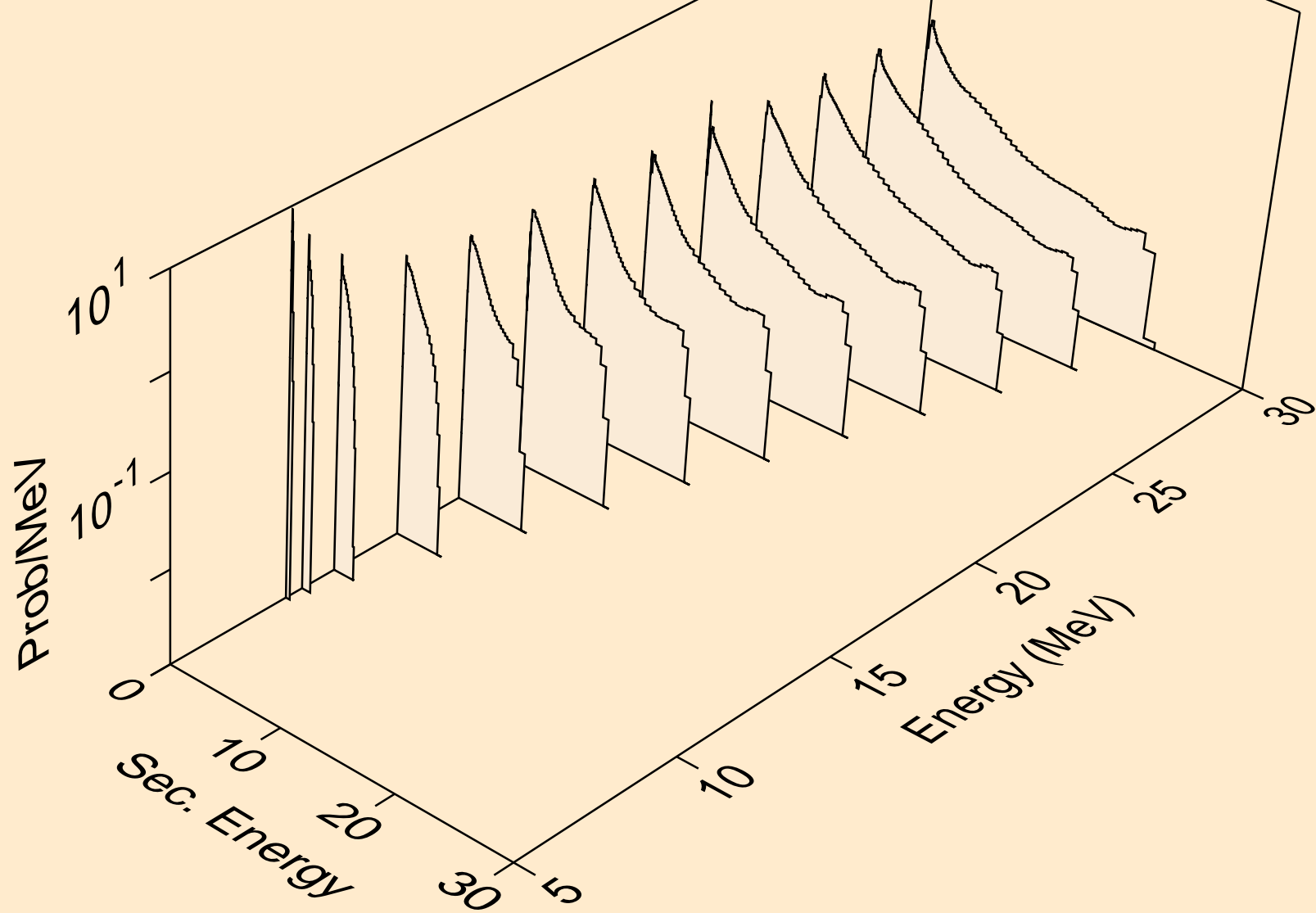

PB217 NEUTRON ACER TENDL-2021 LIBRARY; T=293.6K
Neutron emission for fission

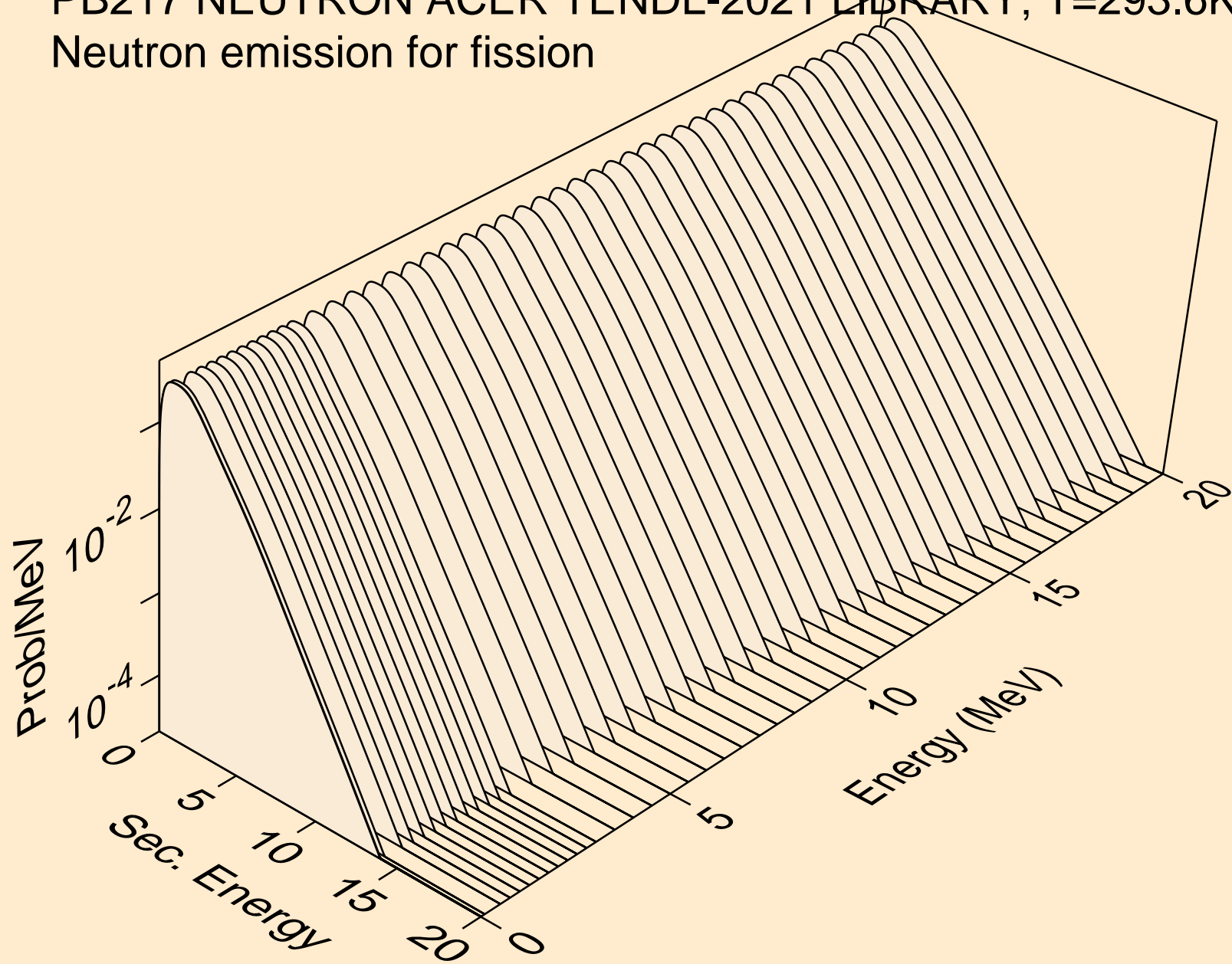

PB217 NEUTRON ACER TENDL-2021 LIBRARY; T=293.6K
Neutron emission for (n,n*)a

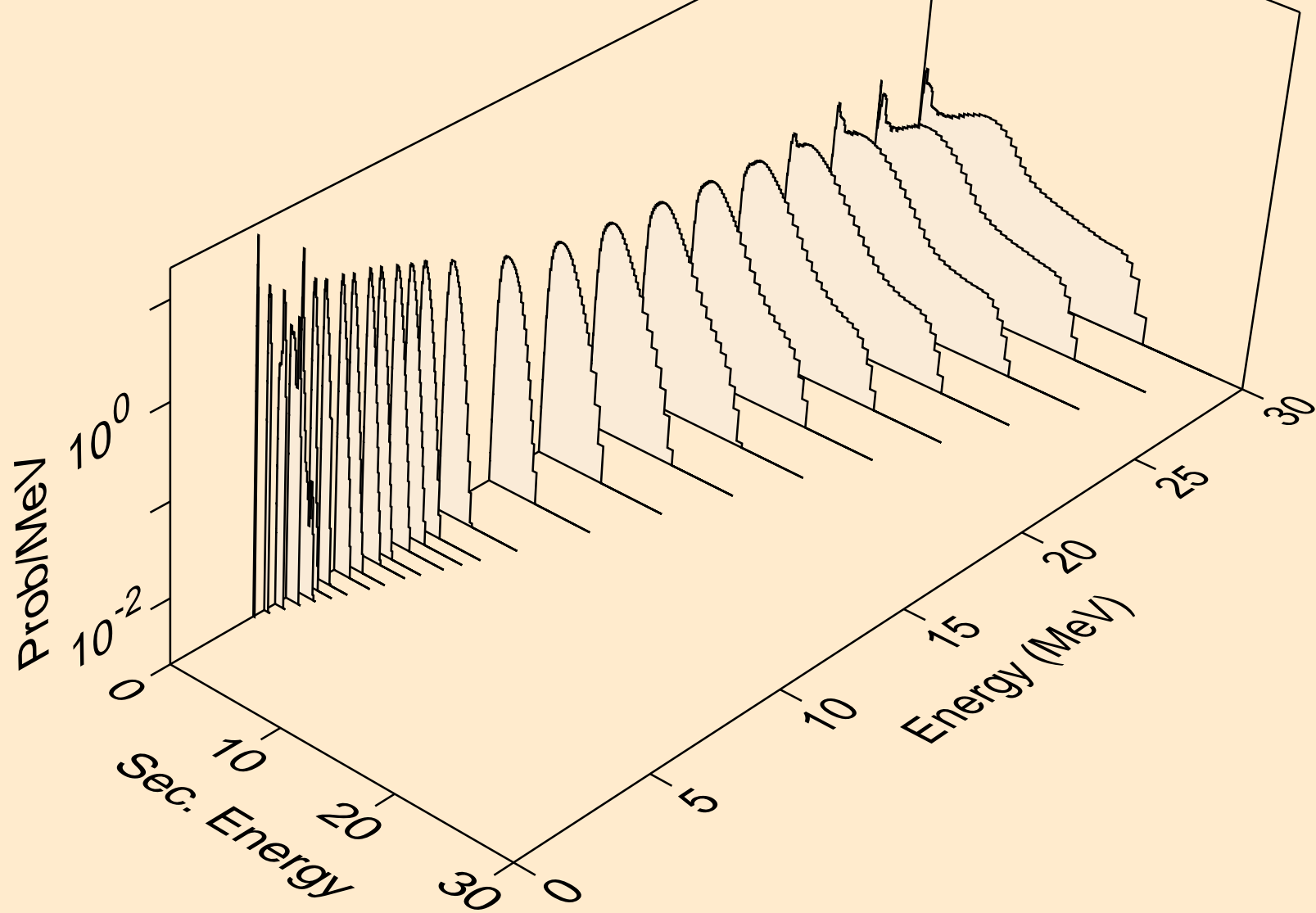

PB217 NEUTRON ACER TENDL-2021 LIBRARY; T=293.6K
Neutron emission for (n,2n)a

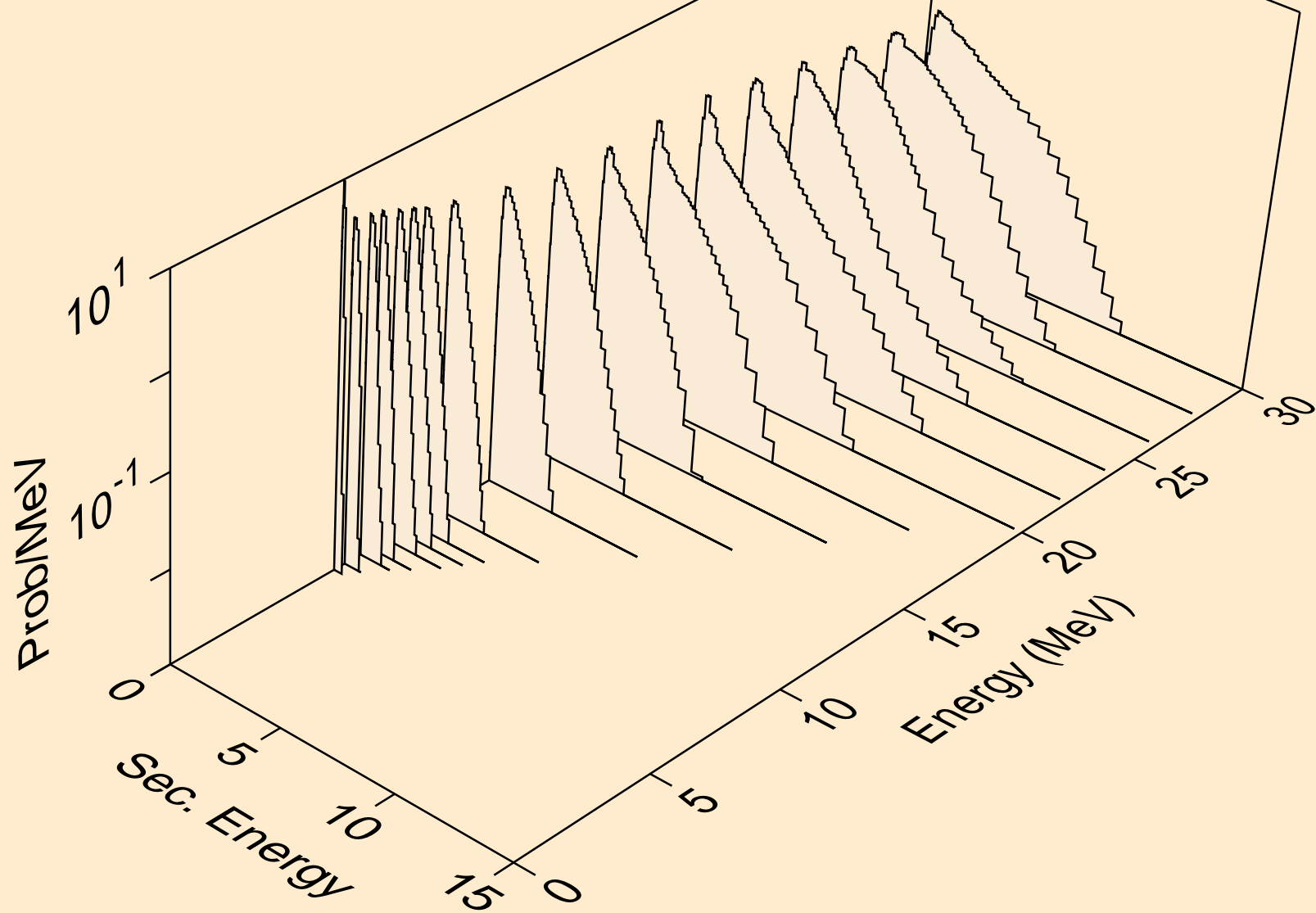

PB217 NEUTRON ACER TENDL-2021 LIBRARY; T=293.6K
Neutron emission for (n,3n)_a

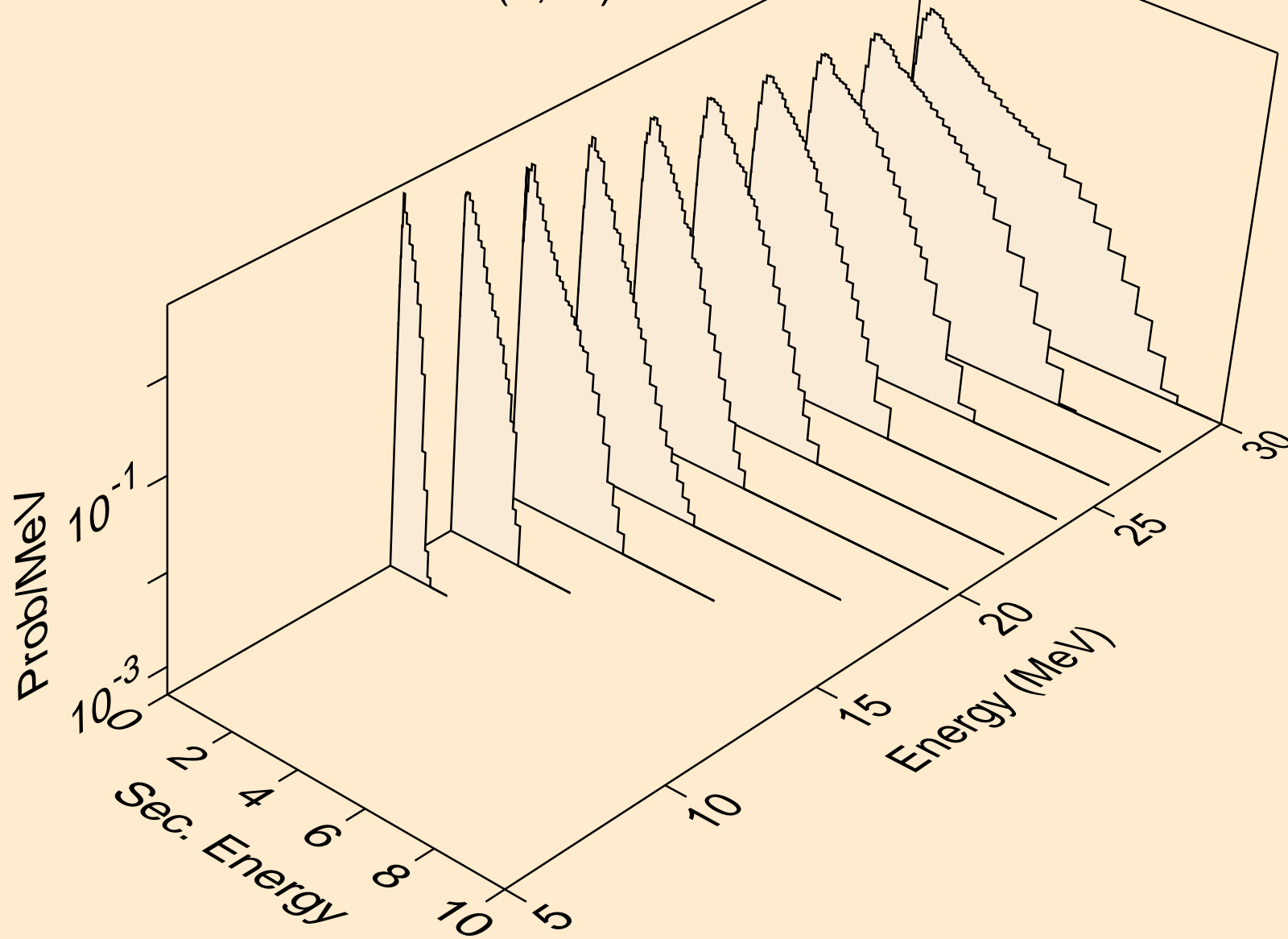

PB217 NEUTRON ACER TENDL-2021 LIBRARY; T=293.6K
Neutron emission for (n,n*)p

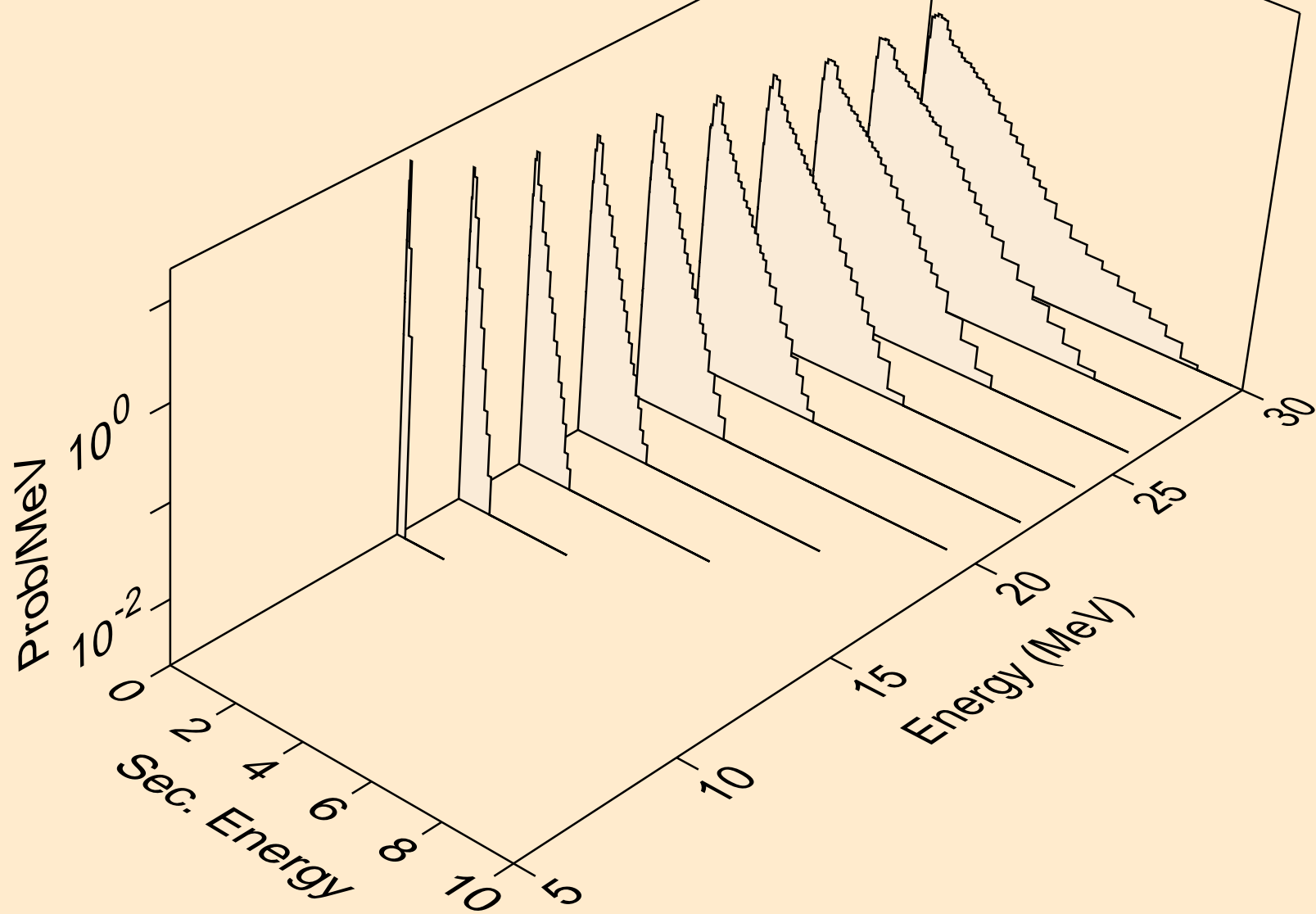

PB217 NEUTRON ACER TENDL-2021 LIBRARY; T=293.6K
Neutron emission for (n,n*)2a

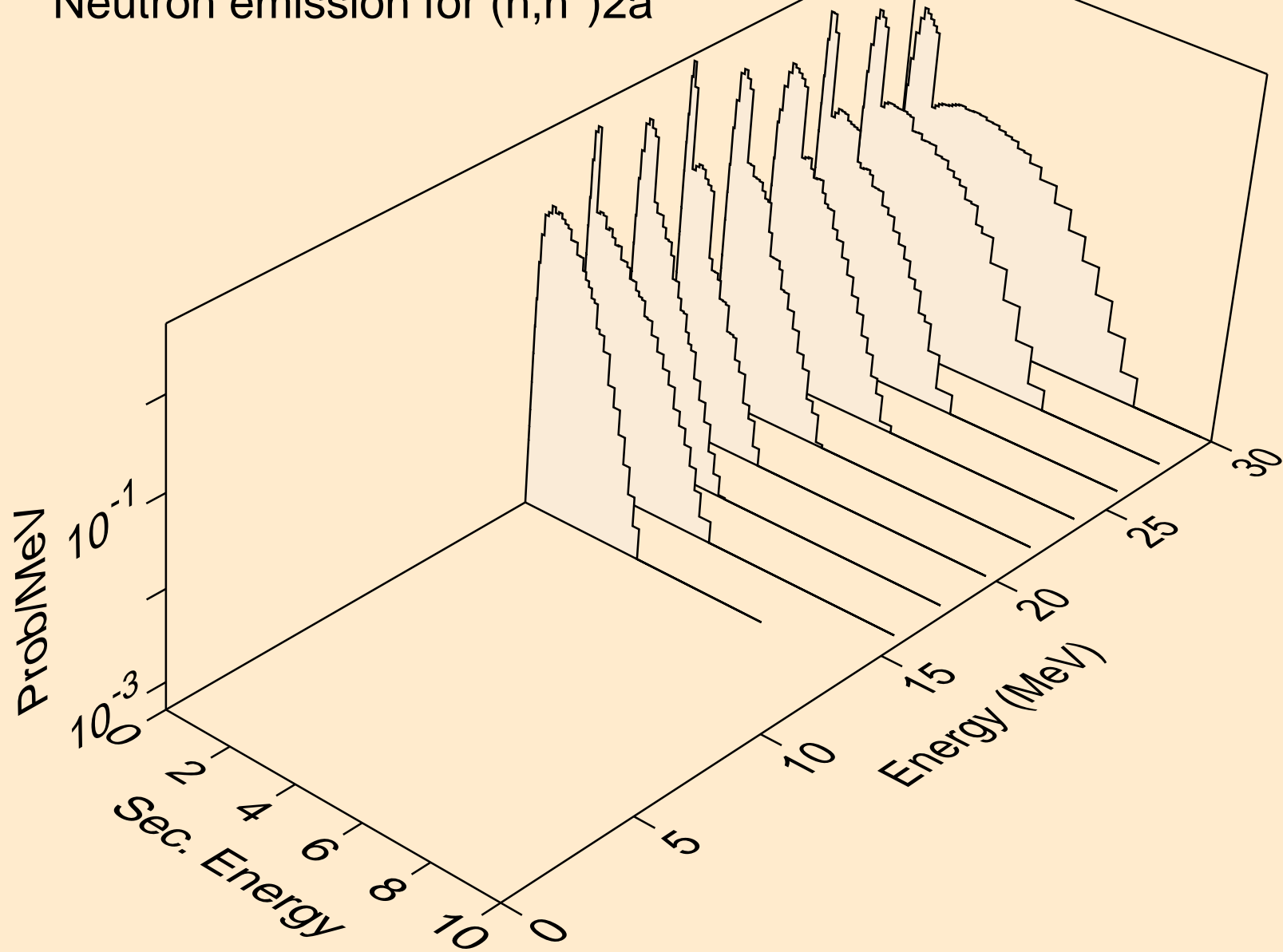

PB217 NEUTRON ACER TENDL-2021 LIBRARY; T=293.6K
Neutron emission for (n,2n)2a

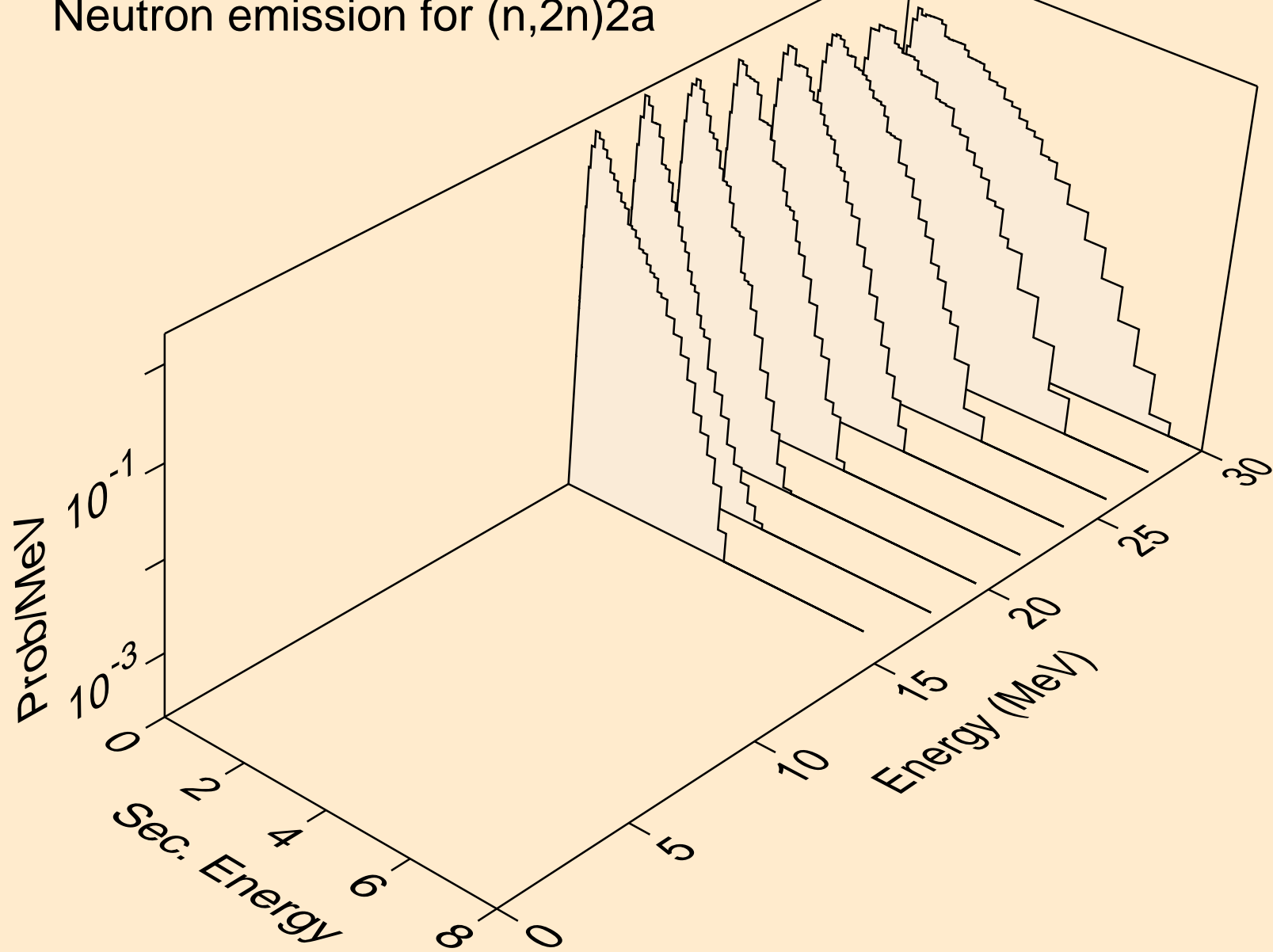

PB217 NEUTRON ACER TENDL-2021 LIBRARY; T=293.6K
Neutron emission for (n,n*)d

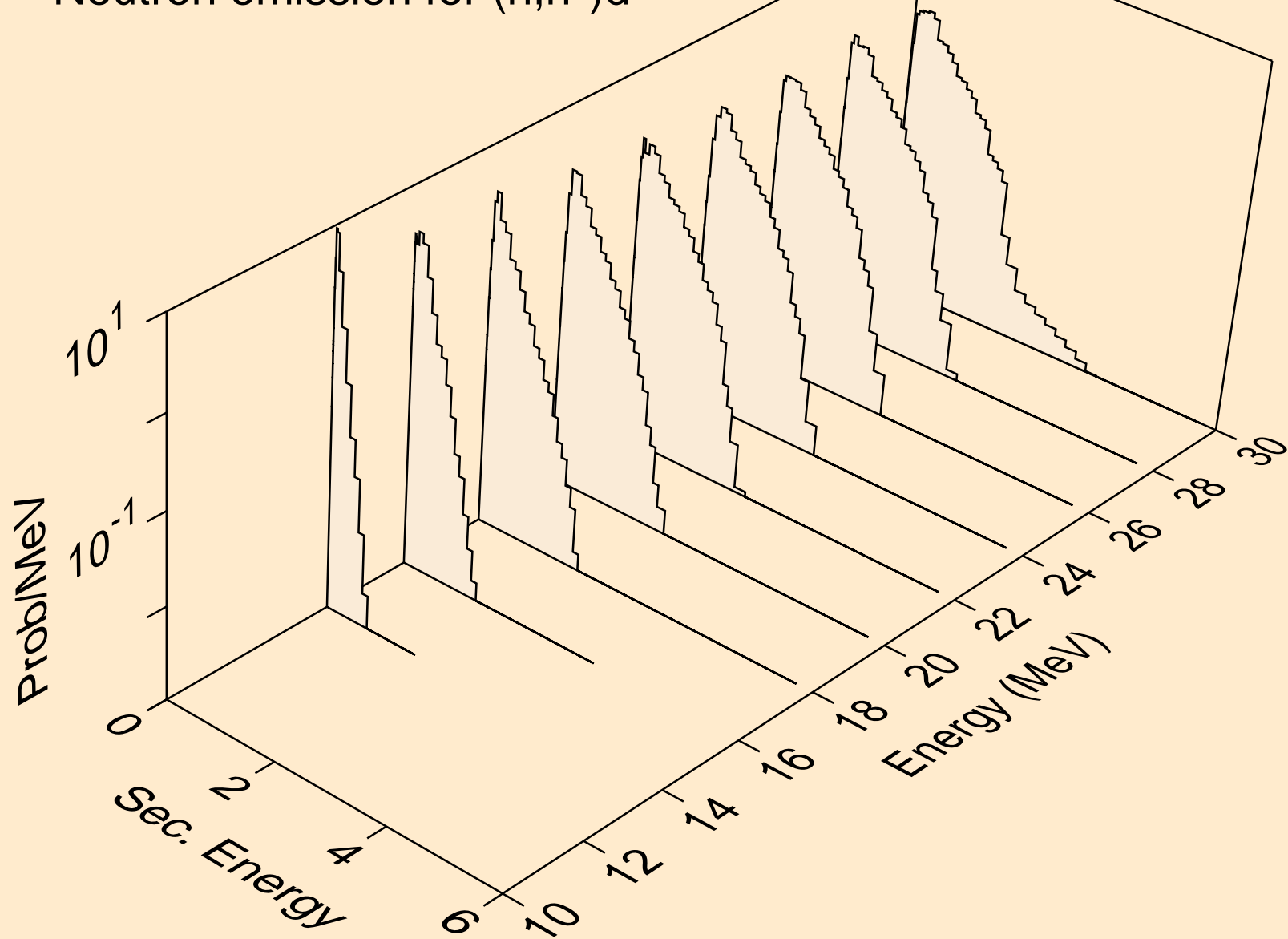

PB217 NEUTRON ACER TENDL-2021 LIBRARY; T=293.6K
Neutron emission for (n,n*)t

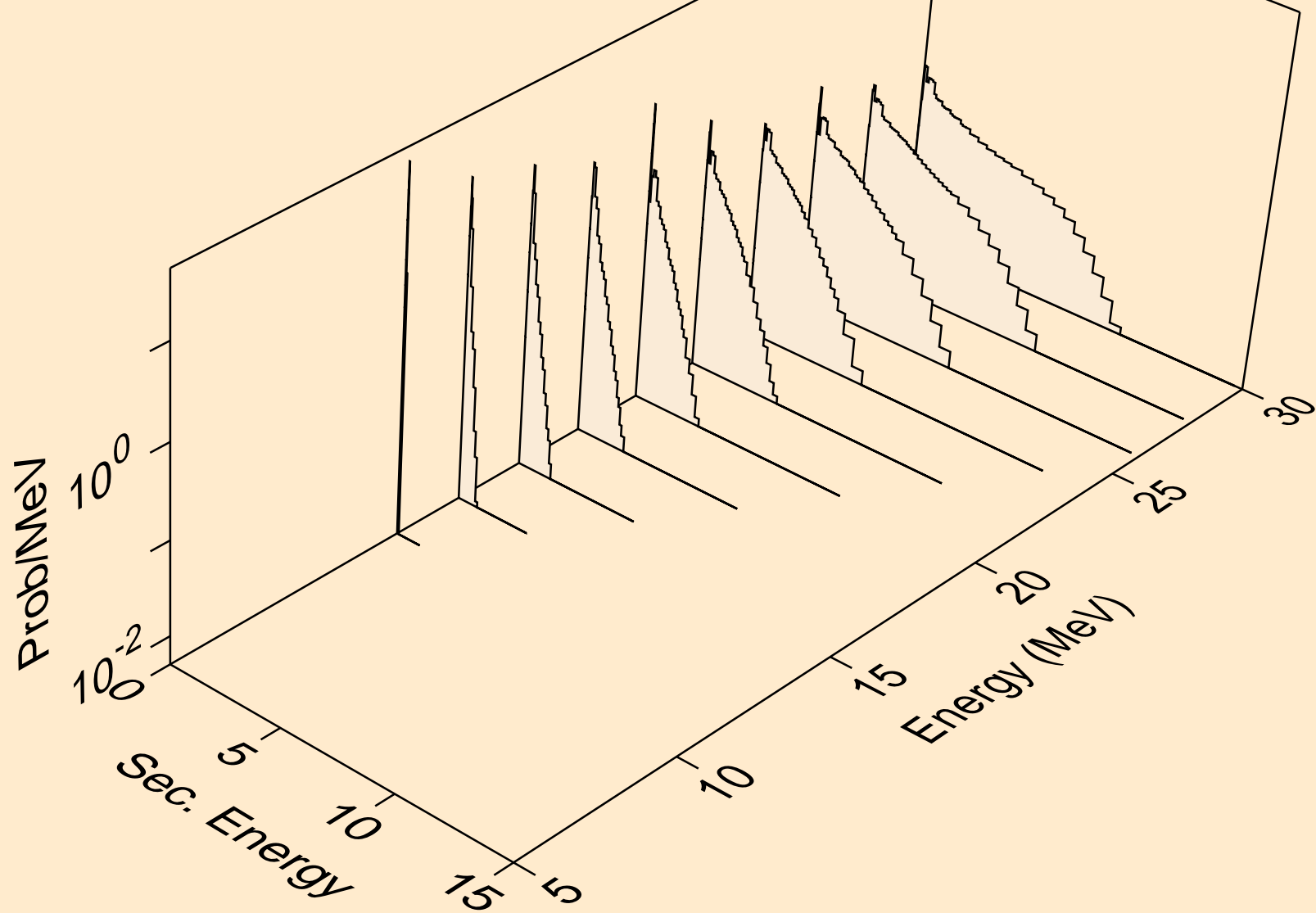

PB217 NEUTRON ACER TENDL-2021 LIBRARY; T=293.6K
Neutron emission for (n,n*)he3

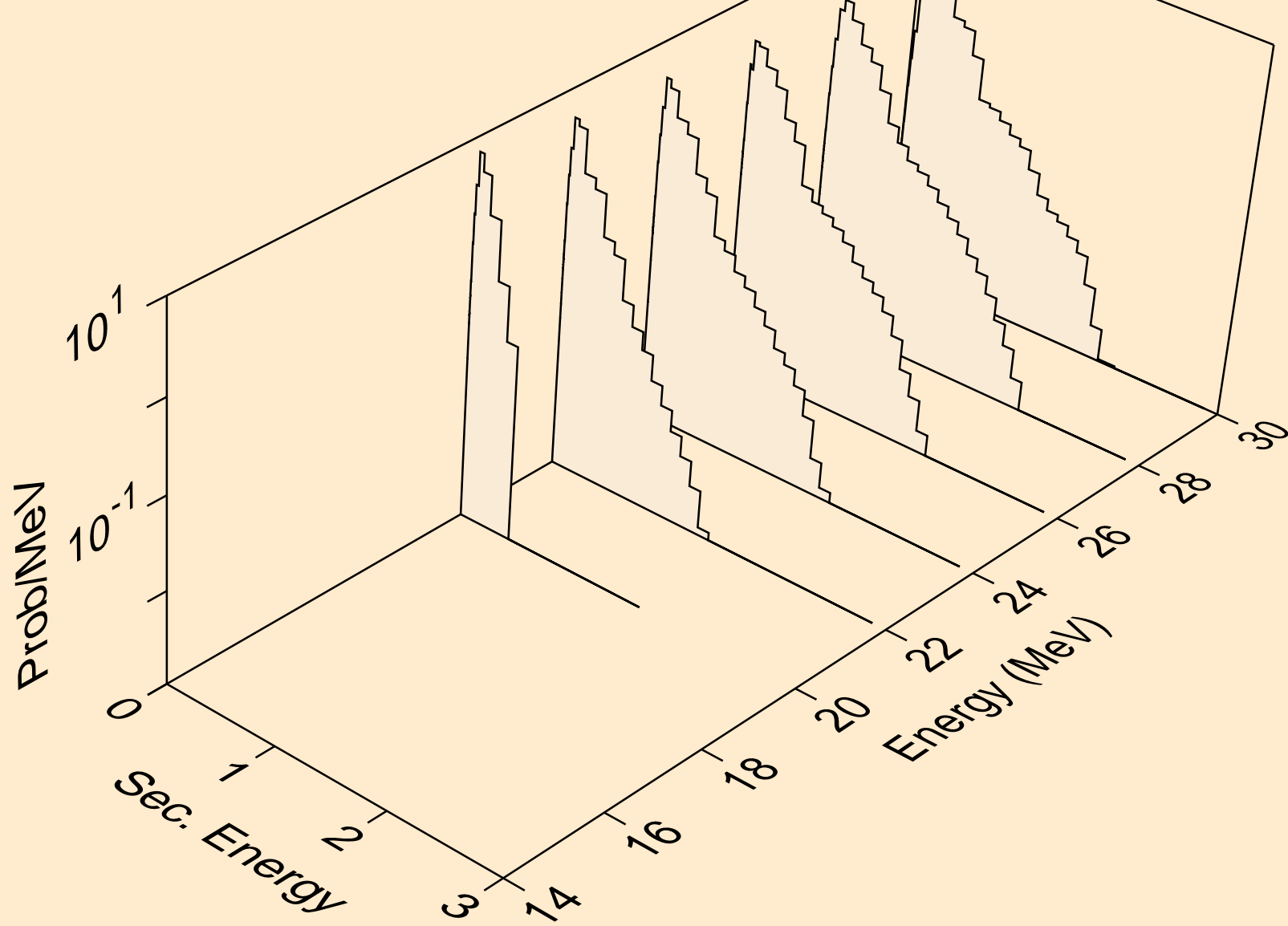

PB217 NEUTRON ACER TENDL-2021 LIBRARY; T=293.6K
Neutron emission for (n,4n)

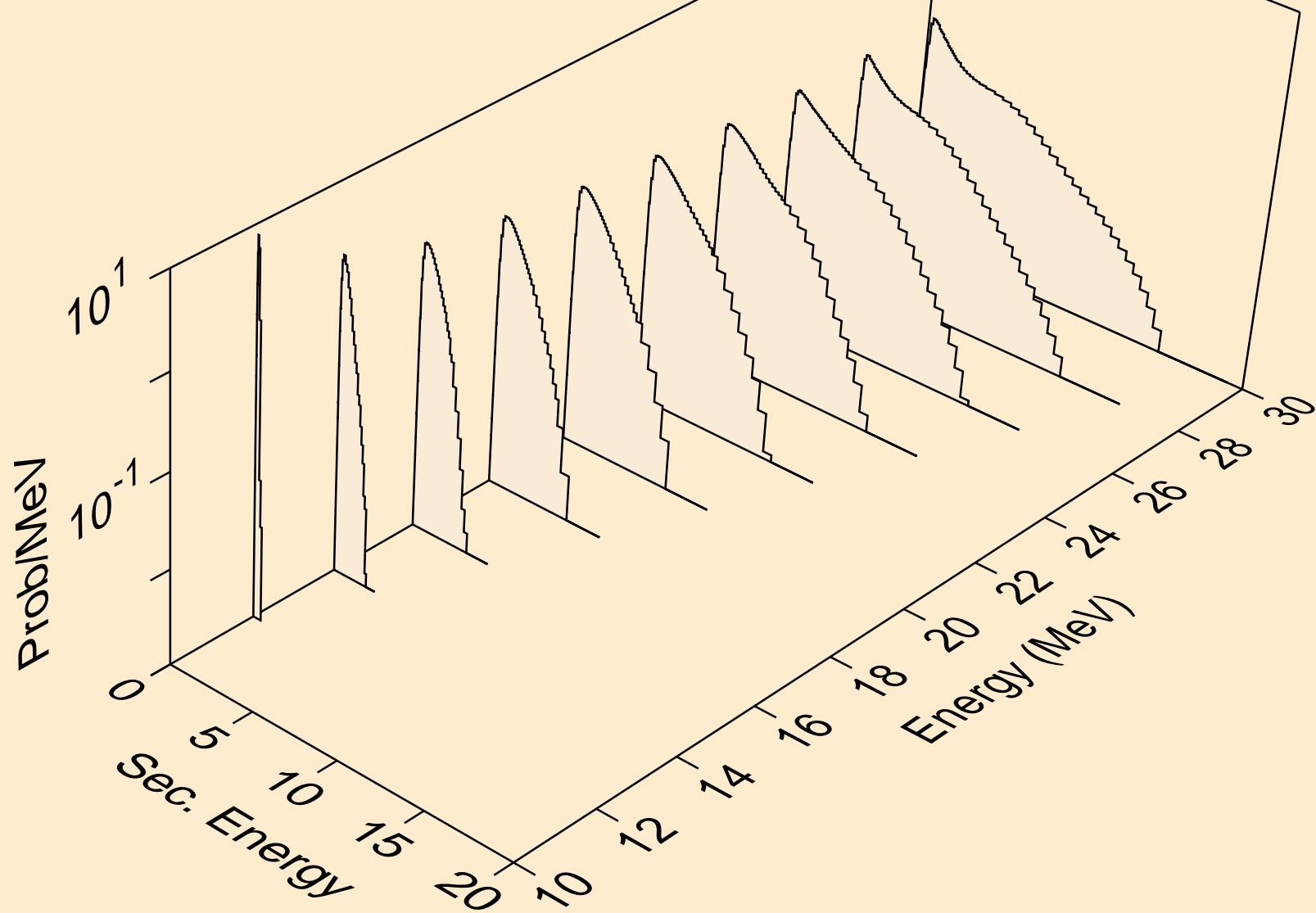

PB217 NEUTRON ACER TENDL-2021 LIBRARY; T=293.6K
Neutron emission for (n,2np)

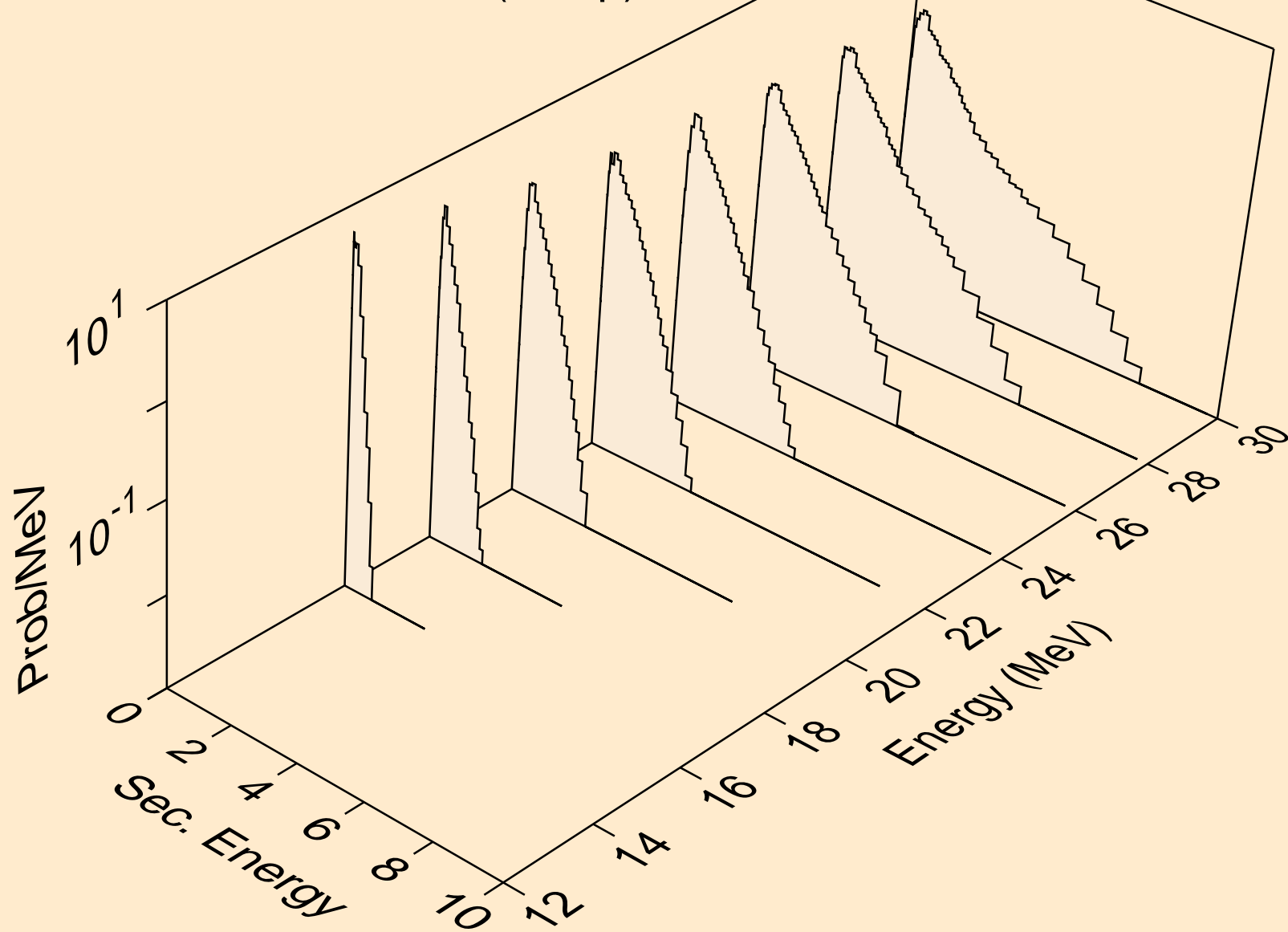

PB217 NEUTRON ACER TENDL-2021 LIBRARY; T=293.6K
Neutron emission for (n,3np)

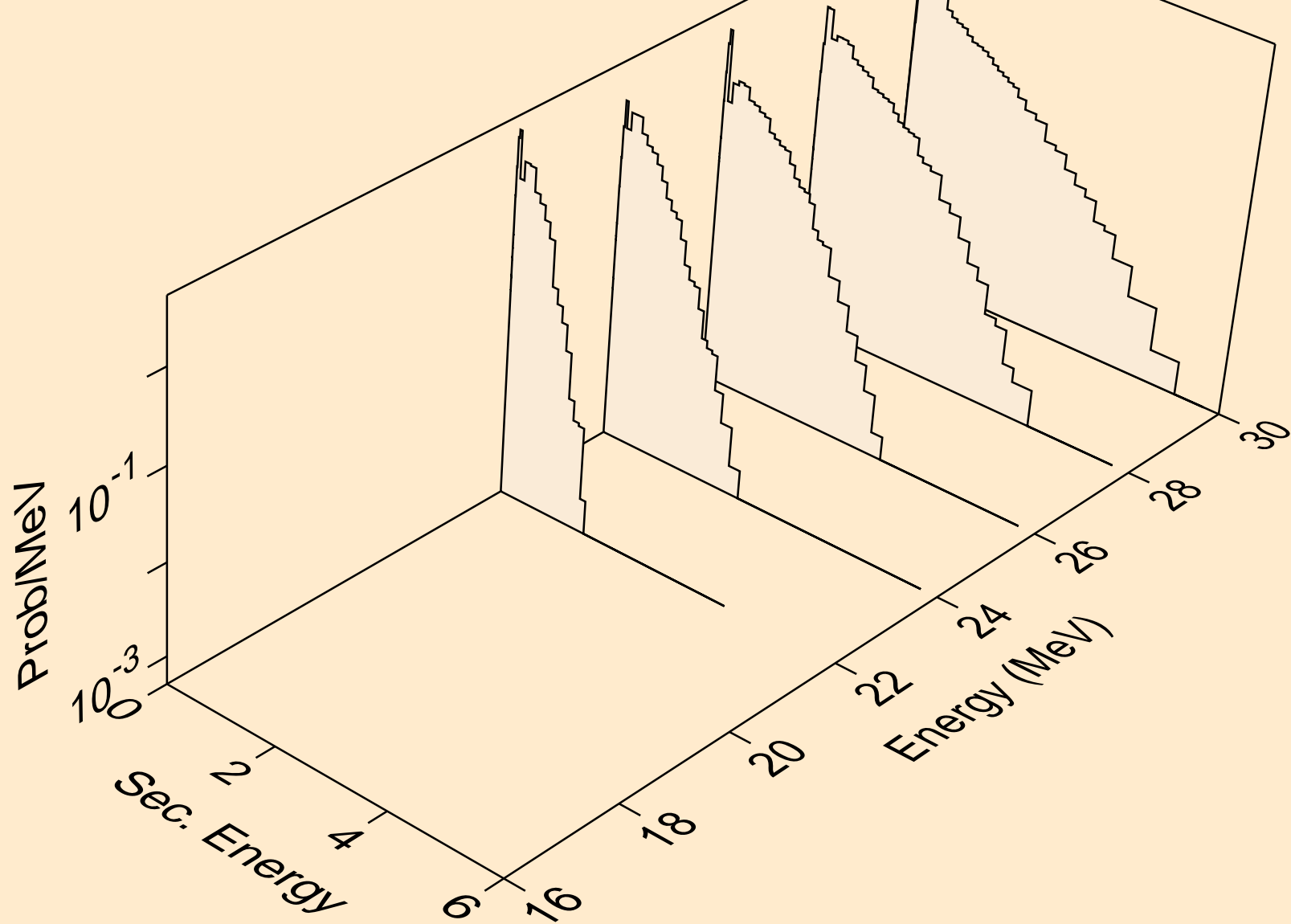

PB217 NEUTRON ACER TENDL-2021 LIBRARY; T=293.6K
Neutron emission for (n,npa)

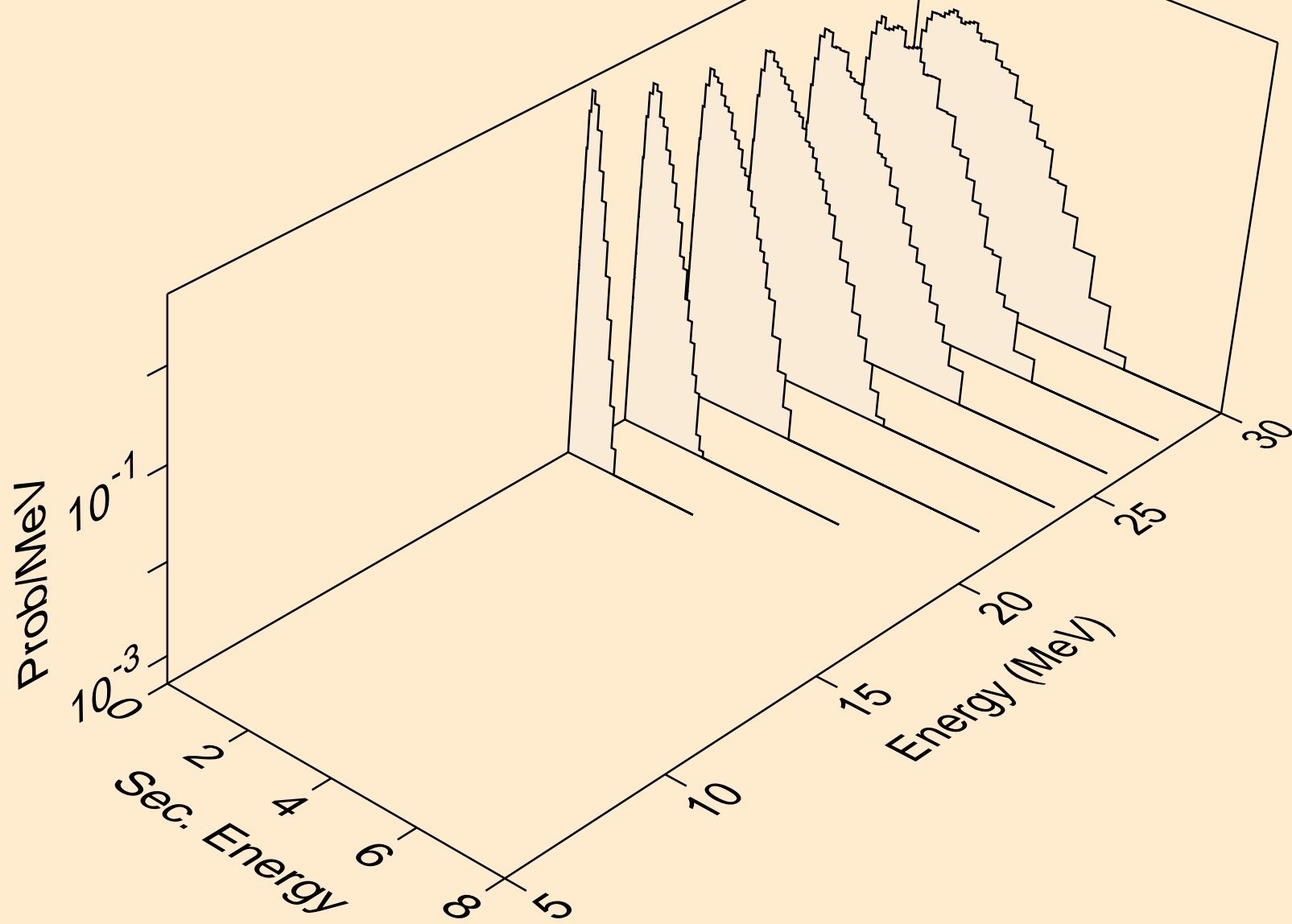

PB217 NEUTRON ACER TENDL-2021 LIBRARY; T=293.6K
Neutron emission for (n,n*c)

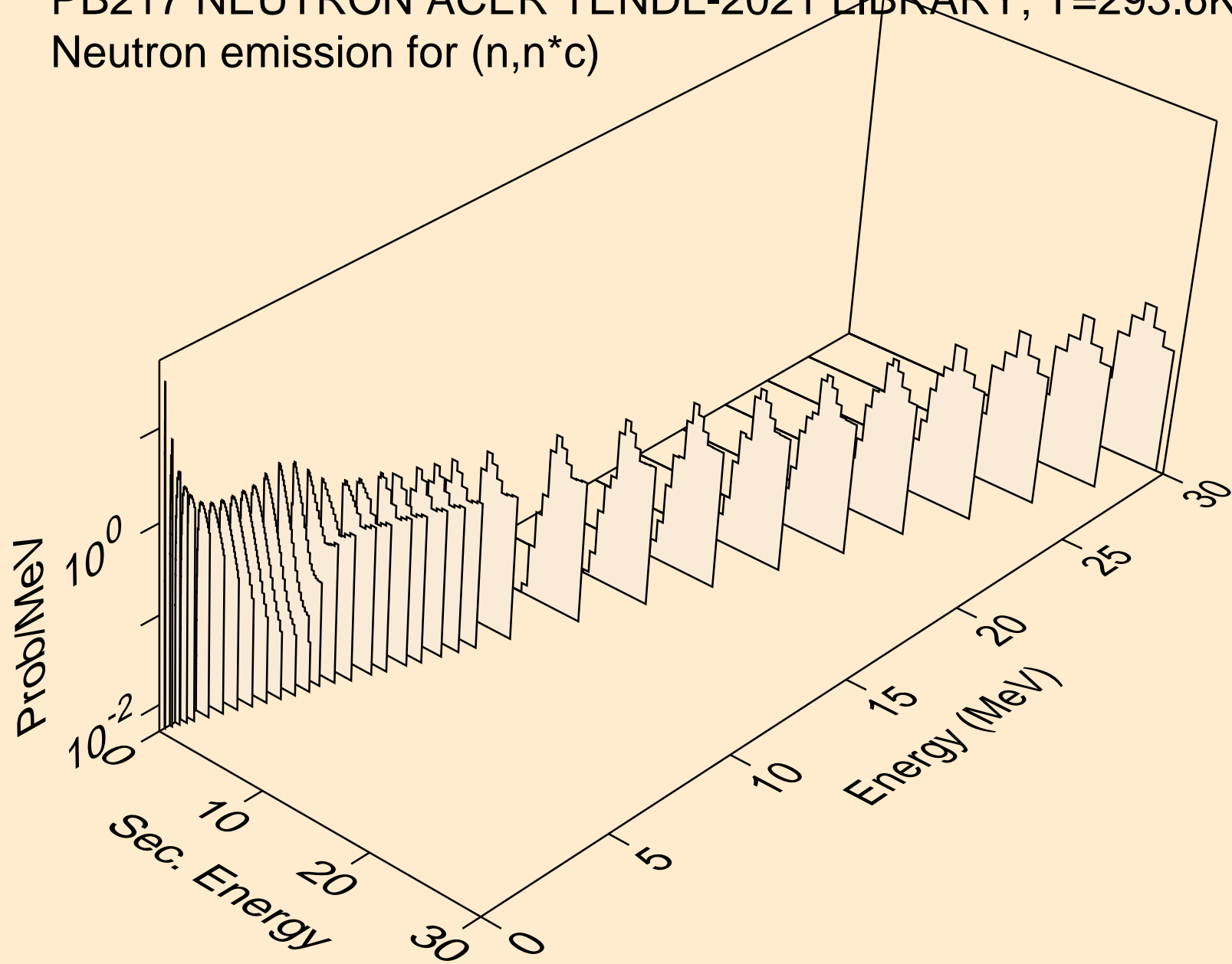

PB217 NEUTRON ACER TENDL-2021 LIBRARY; T=293.6K
Delayed nubar

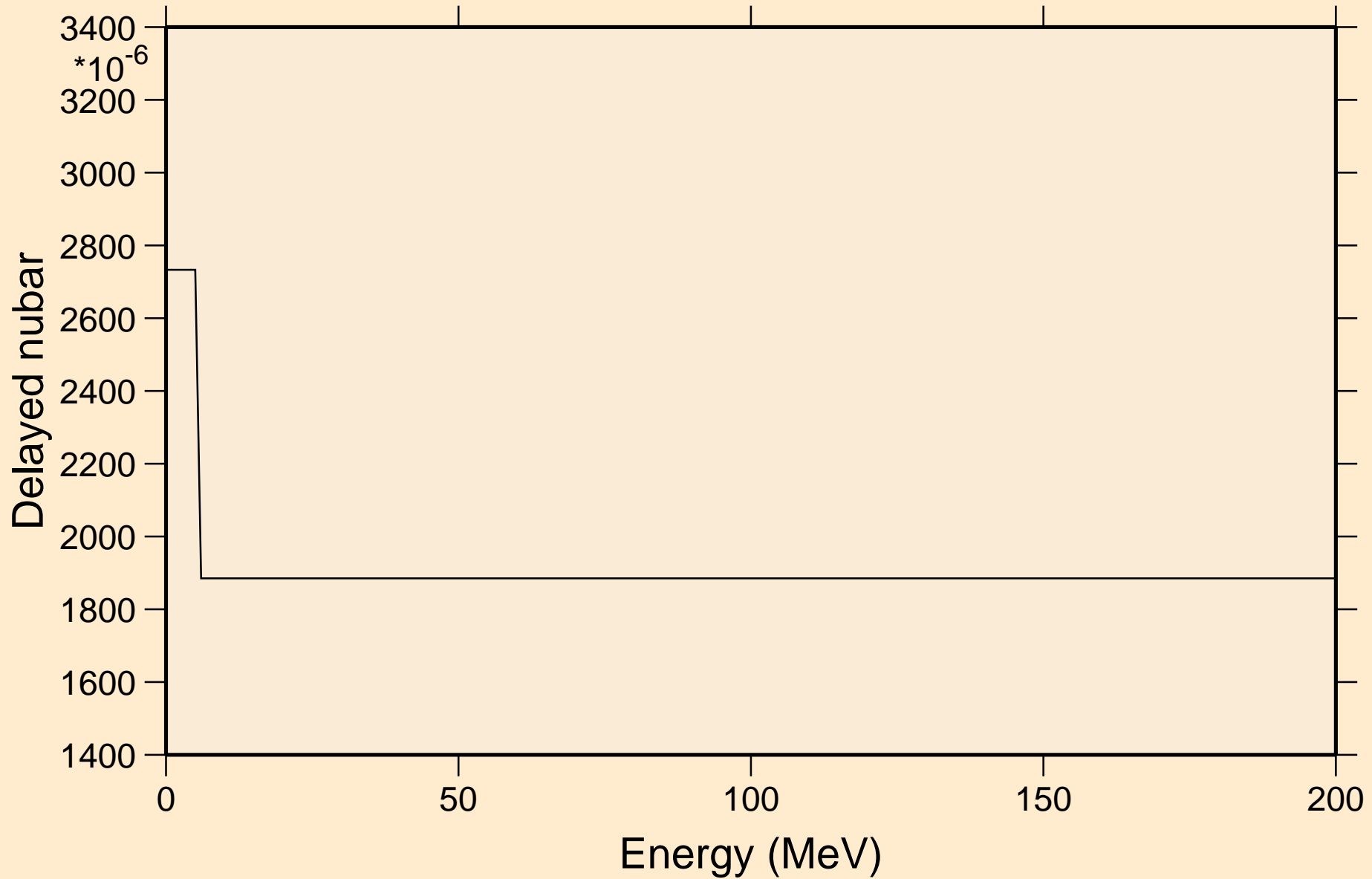

PB217 NEUTRON ACER TENDL-2021 LIBRARY; T=293.6K

Delayed neutron spectra

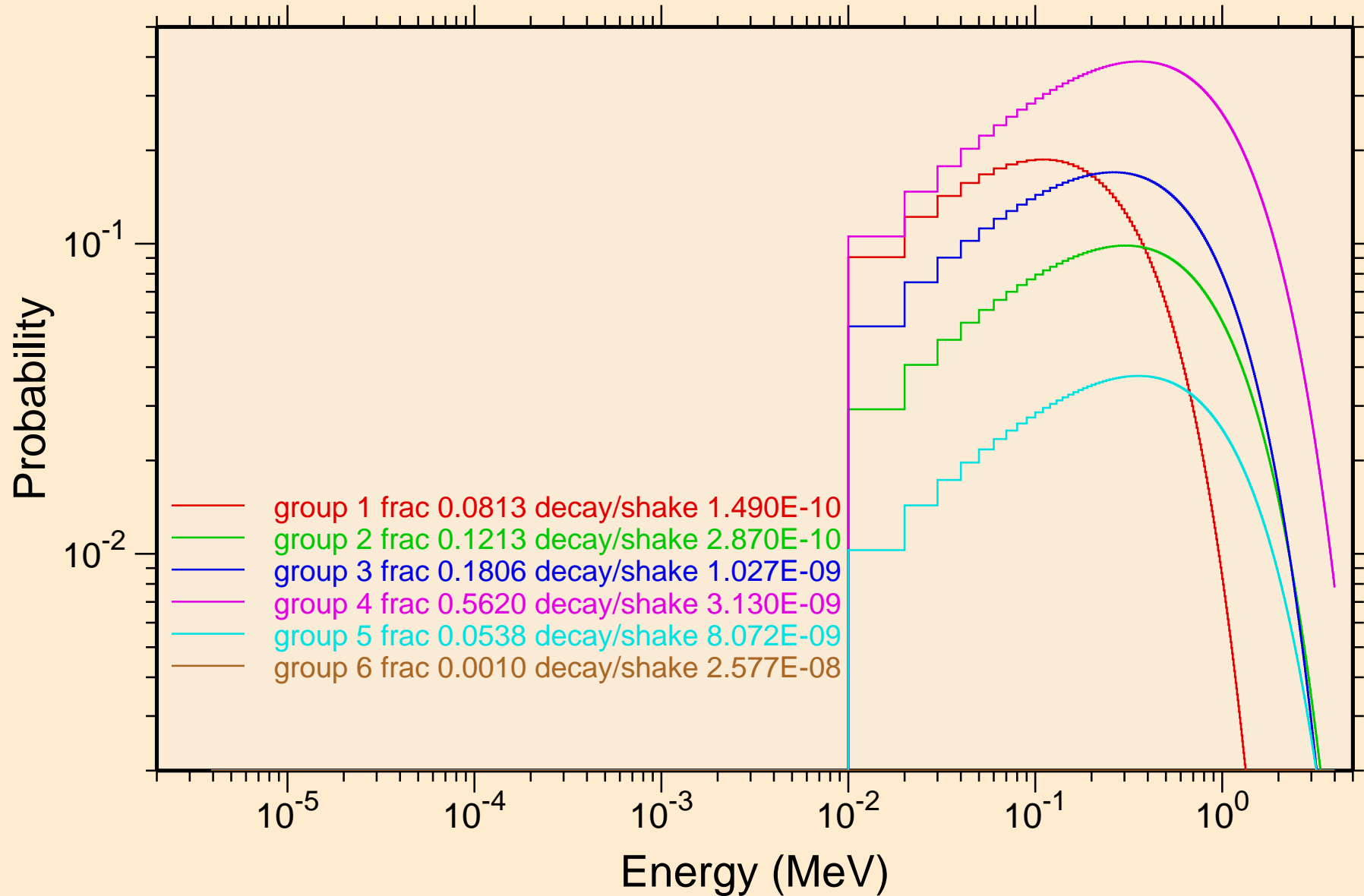

PB217 NEUTRON ACER TENDL-2021 LIBRARY; T=293.6K
Photon emission for (n,x)

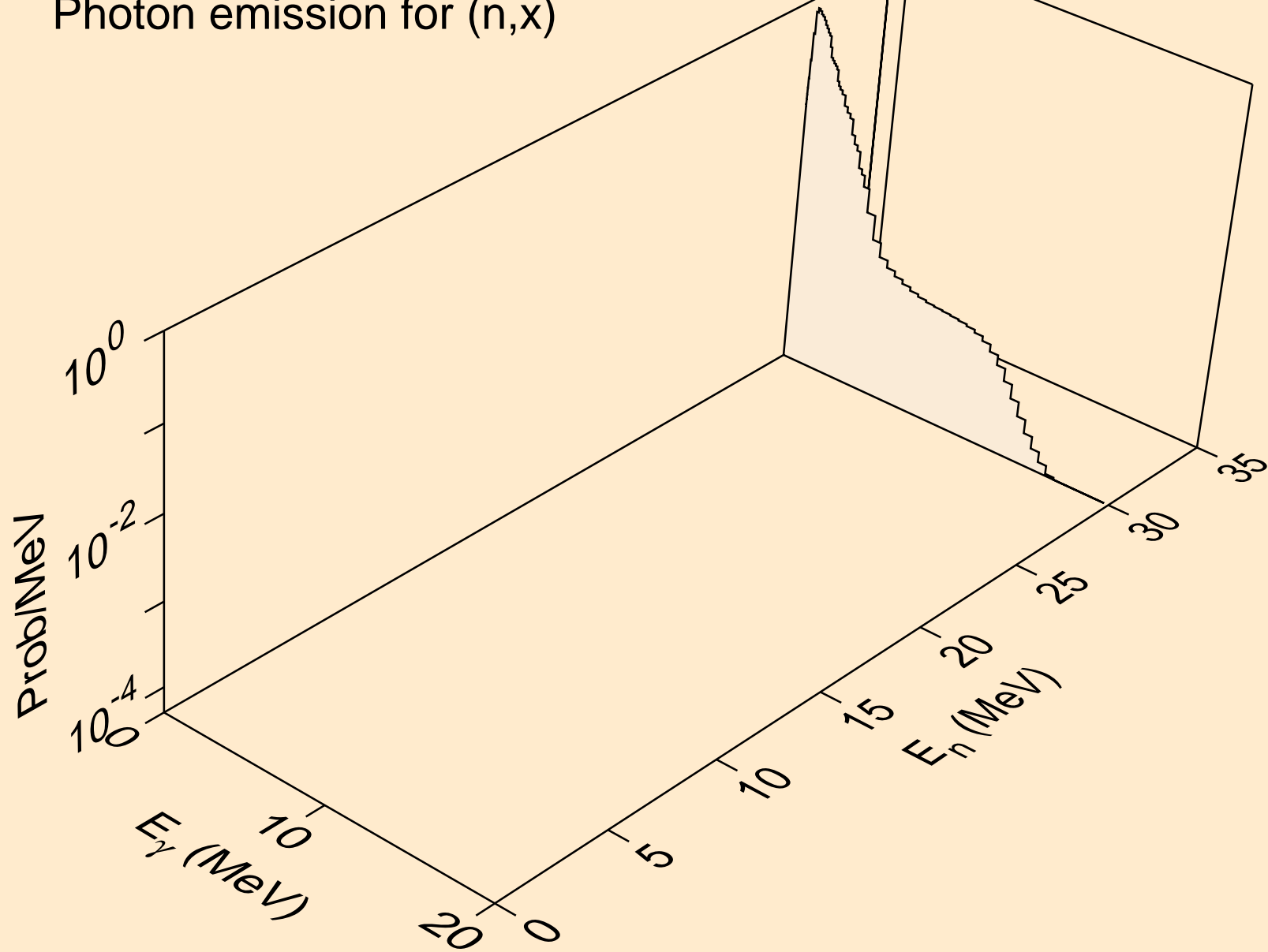

PB217 NEUTRON ACER TENDL-2021 LIBRARY; T=293.6K
Photon emission for (n,2nd)

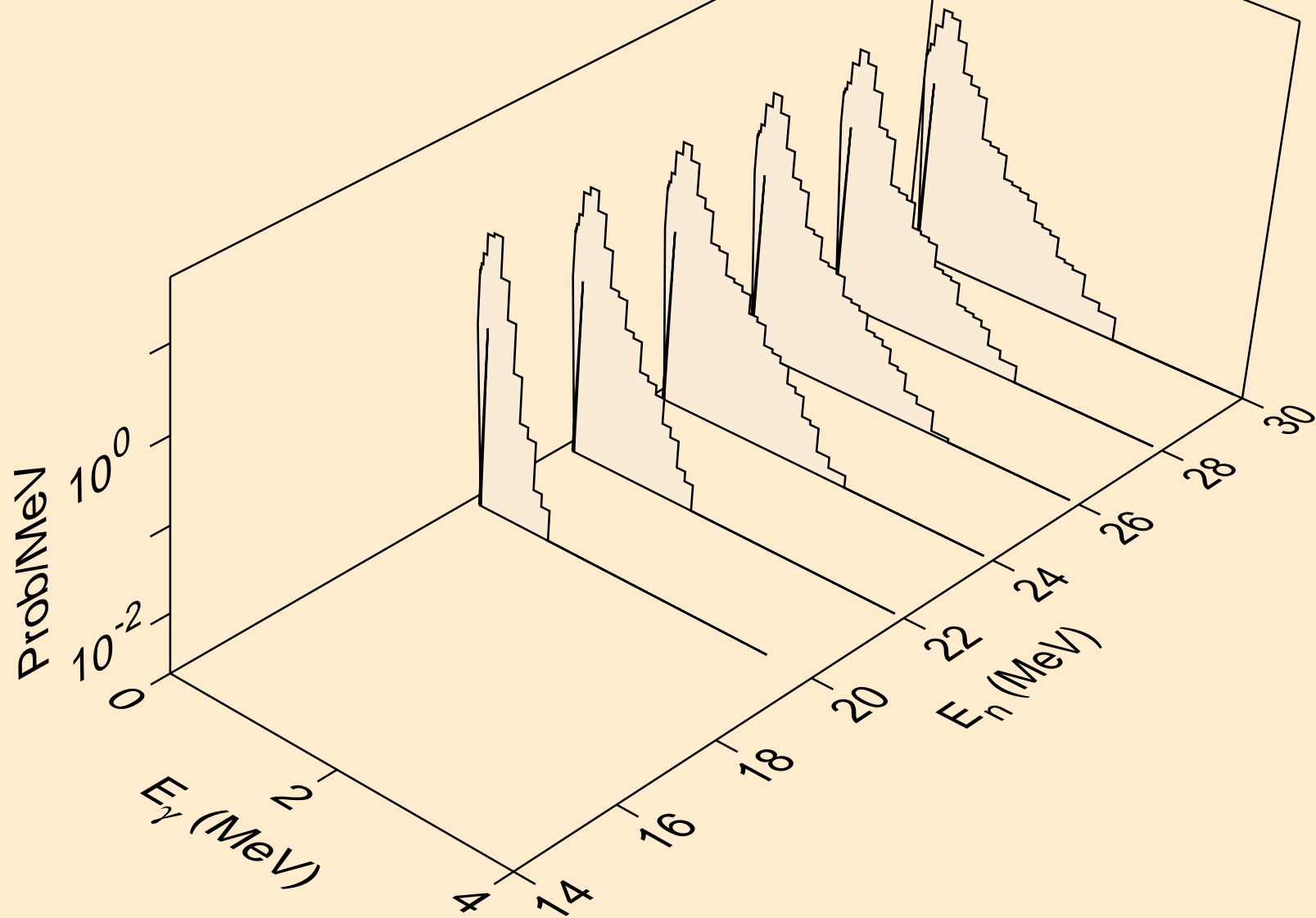

PB217 NEUTRON ACER TENDL-2021 LIBRARY; T=293.6K
Photon emission for (n,2n)

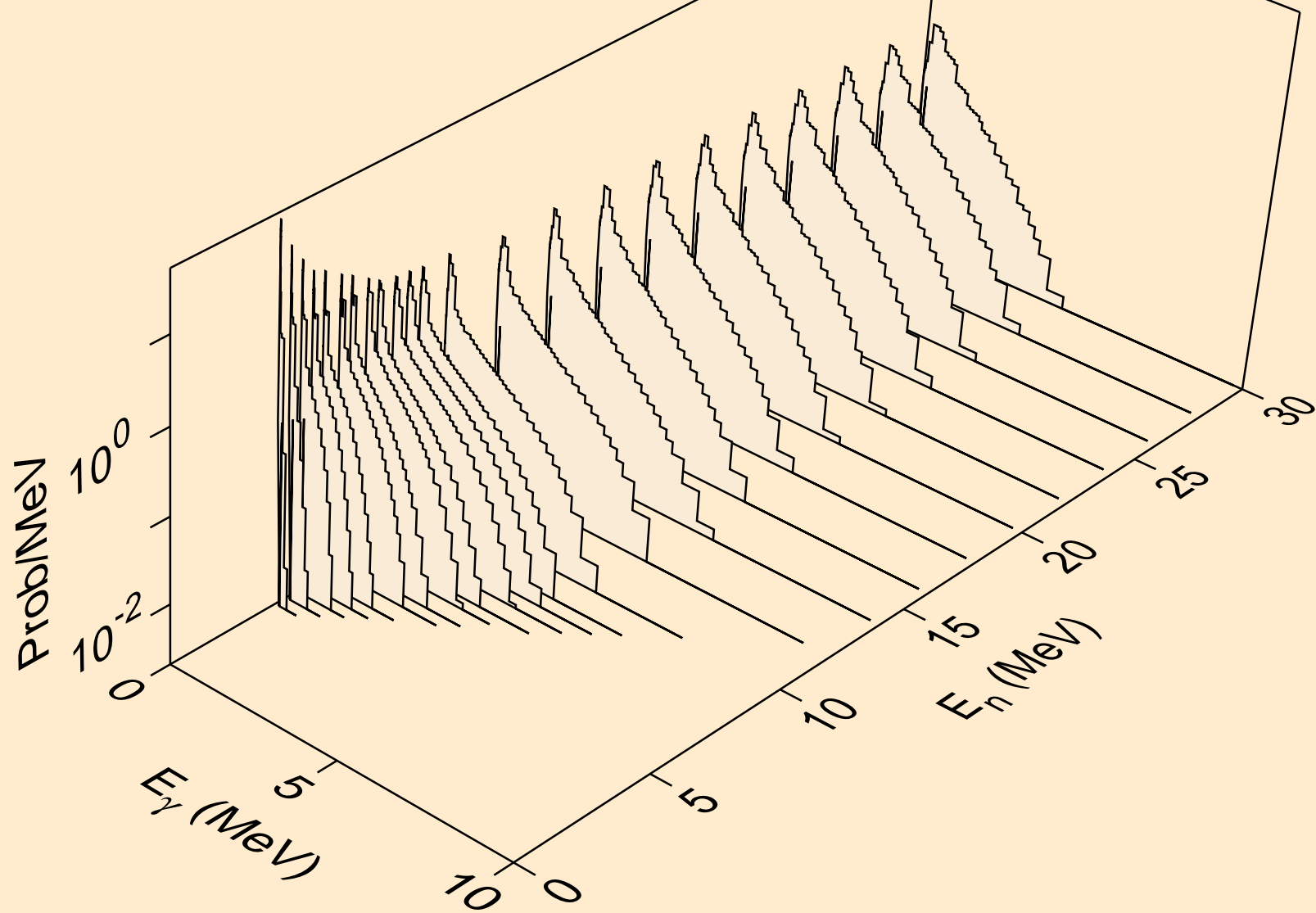

PB217 NEUTRON ACER TENDL-2021 LIBRARY; T=293.6K
Photon emission for (n,3n)

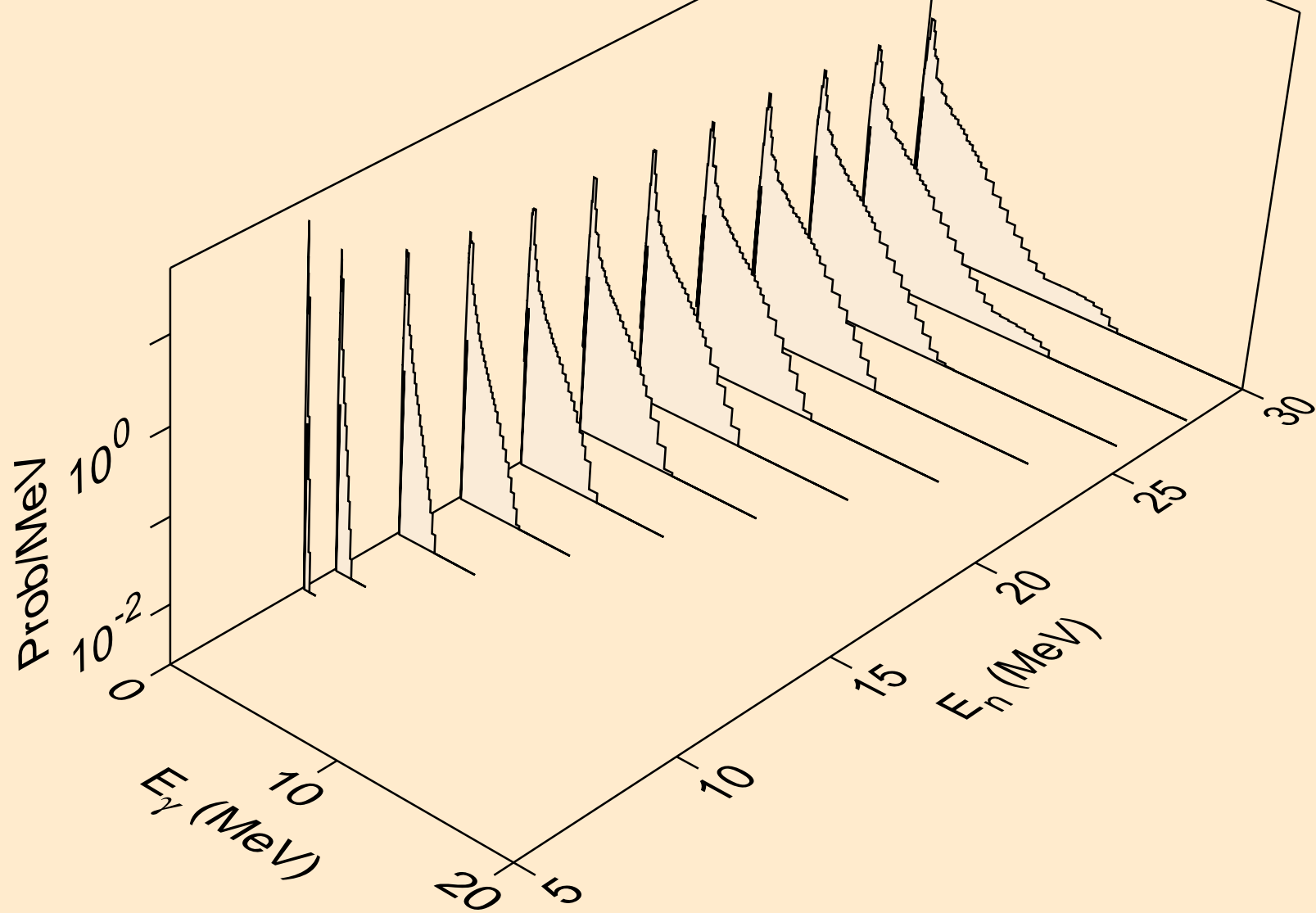

PB217 NEUTRON ACER TENDL-2021 LIBRARY; T=293.6K
Photon emission for (n,n*)a

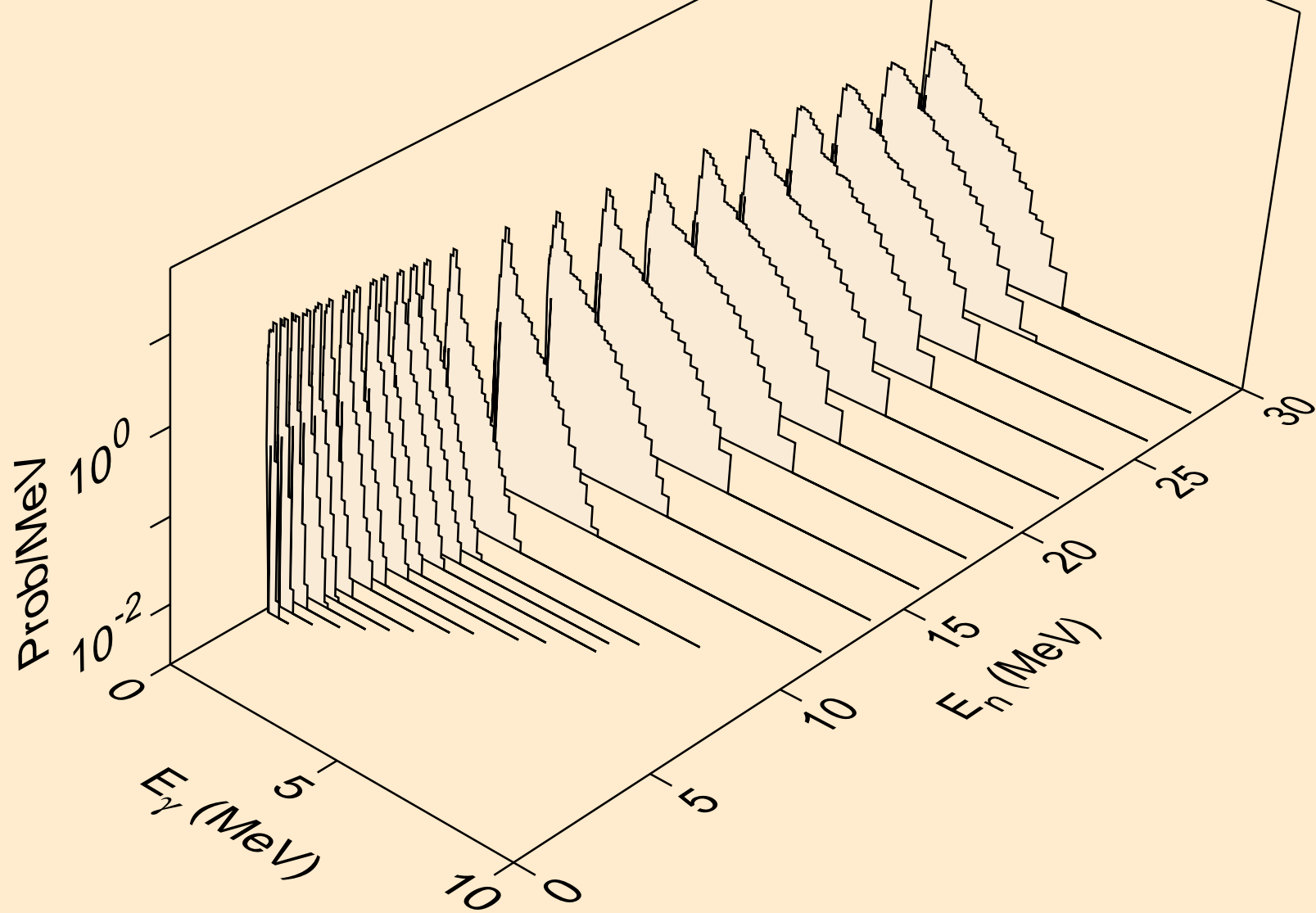

PB217 NEUTRON ACER TENDL-2021 LIBRARY; T=293.6K
Photon emission for (n,2n)a

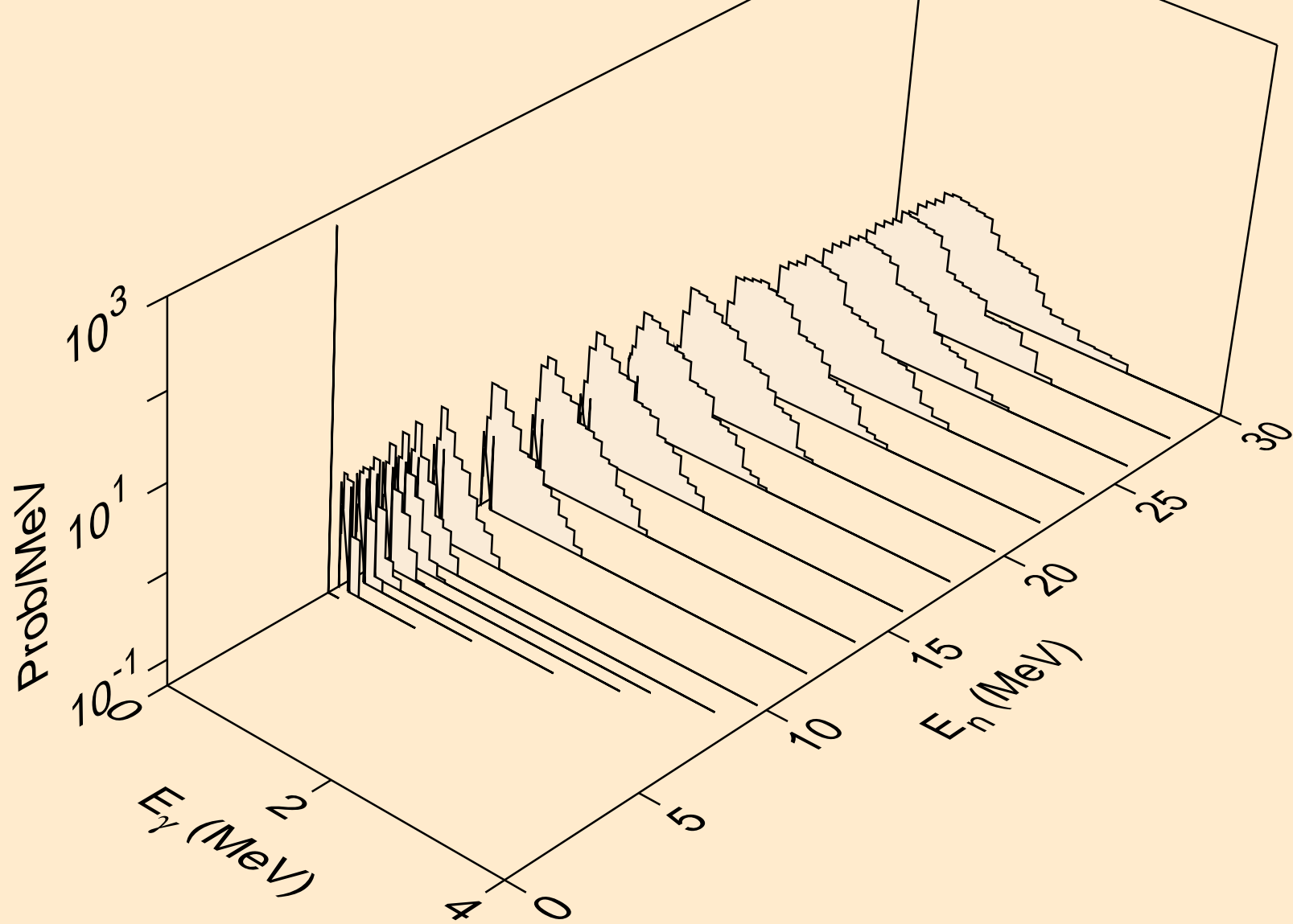

PB217 NEUTRON ACER TENDL-2021 LIBRARY; T=293.6K
Photon emission for (n,3n)a

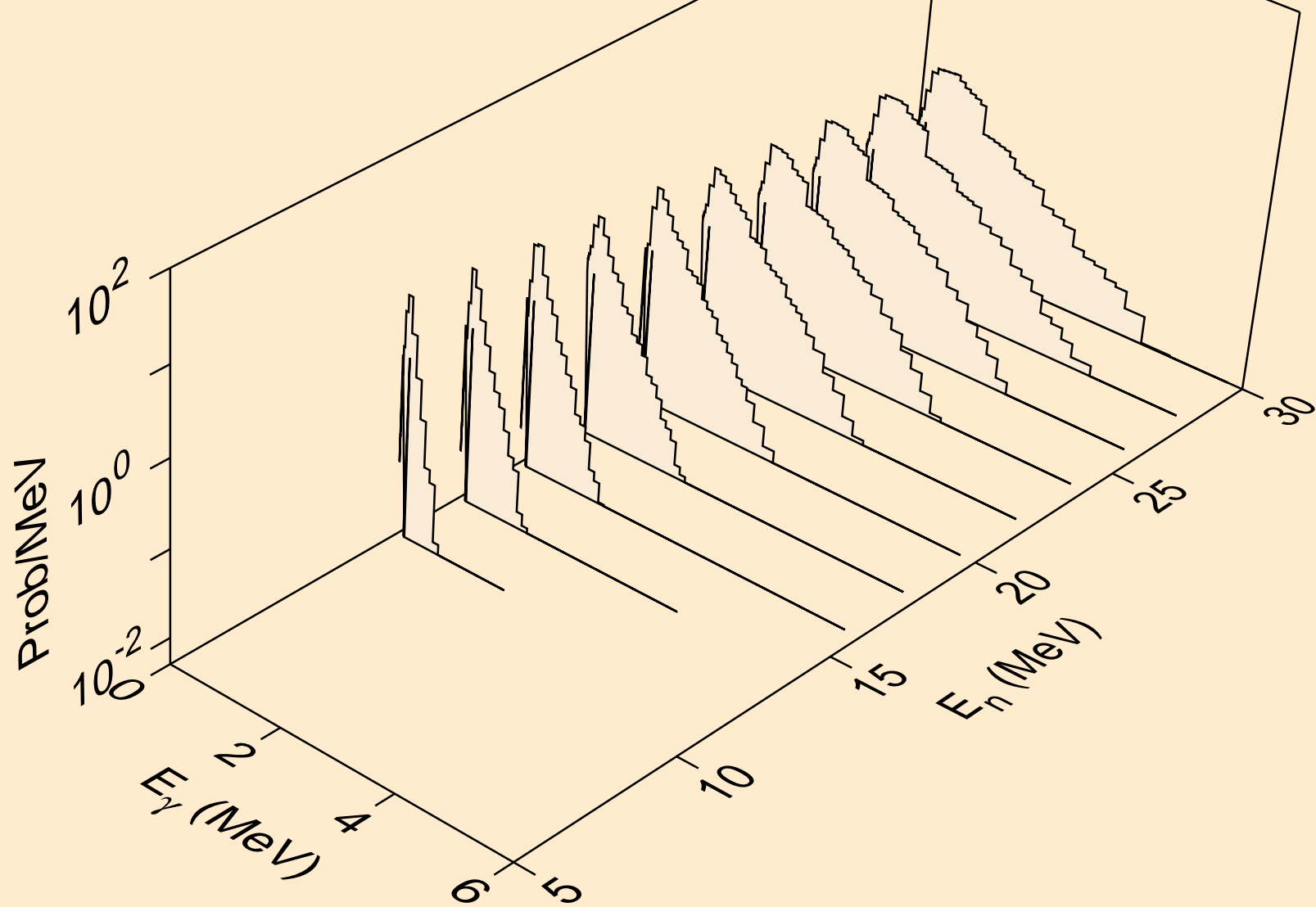

PB217 NEUTRON ACER TENDL-2021 LIBRARY; T=293.6K
Photon emission for (n,n*)p

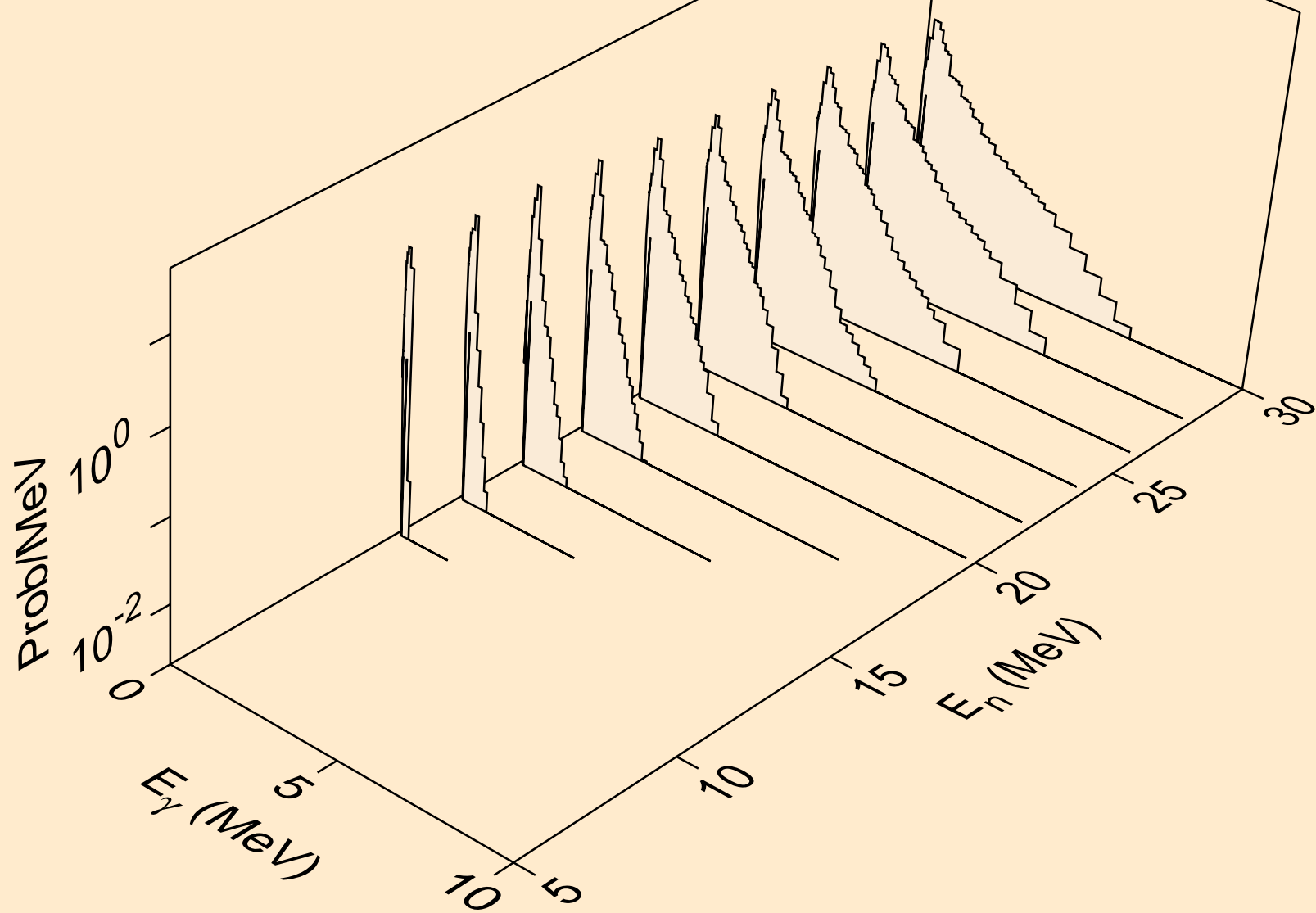

PB217 NEUTRON ACER TENDL-2021 LIBRARY; T=293.6K
Photon emission for (n,n*)2a

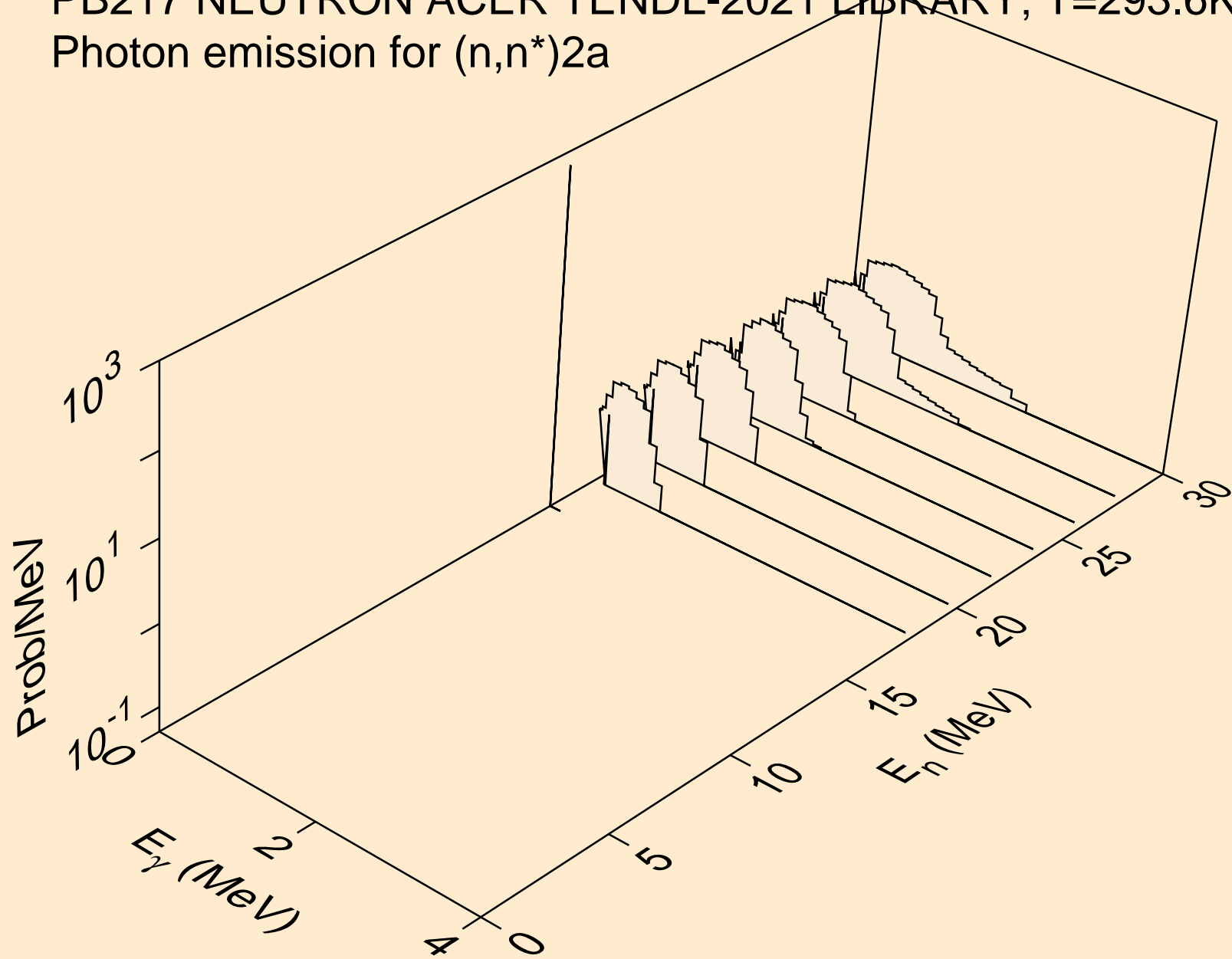

PB217 NEUTRON ACER TENDL-2021 LIBRARY; T=293.6K
Photon emission for (n,2n)2a

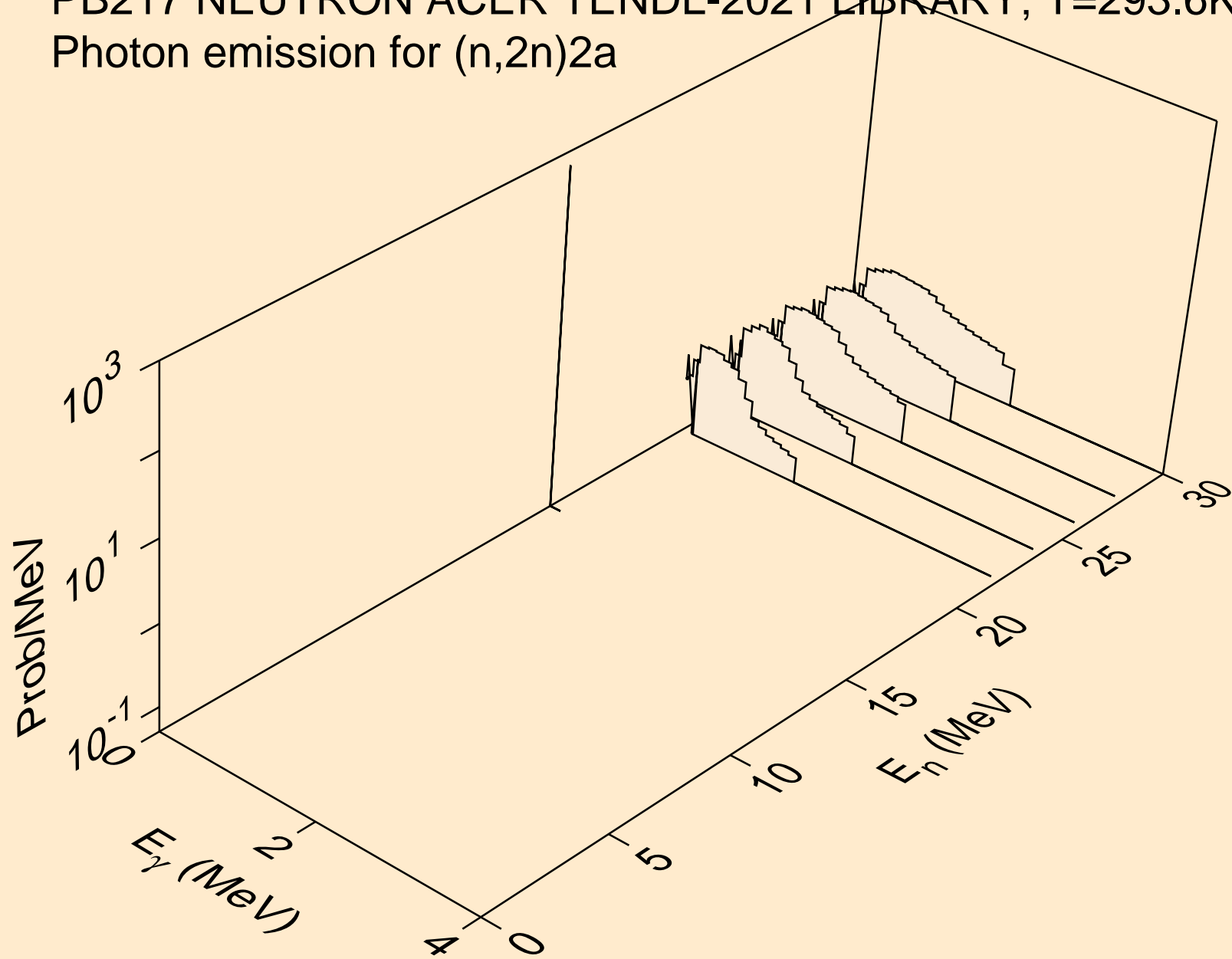

PB217 NEUTRON ACER TENDL-2021 LIBRARY; T=293.6K
Photon emission for (n,n*)d

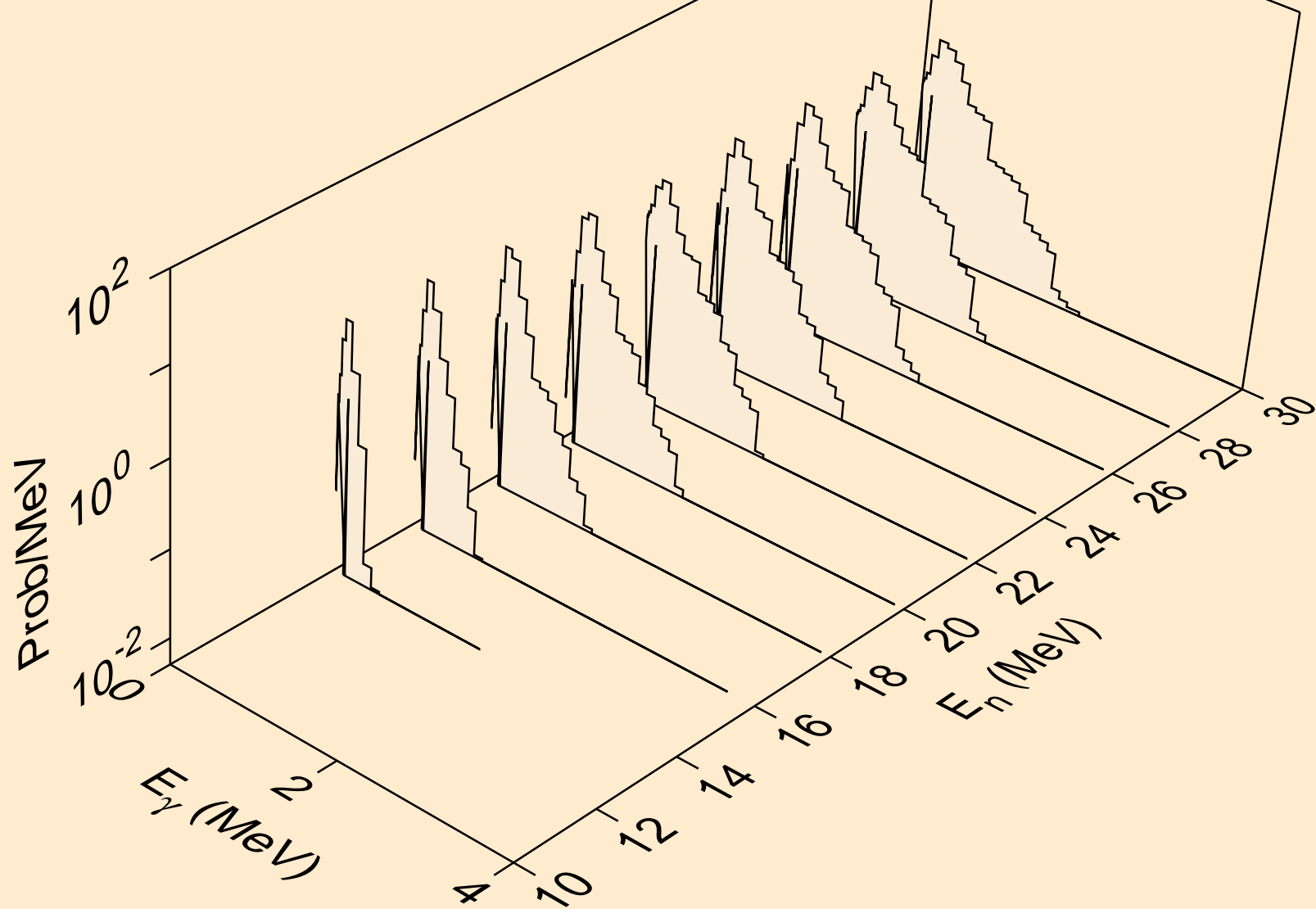

PB217 NEUTRON ACER TENDL-2021 LIBRARY; T=293.6K
Photon emission for (n,n*)t

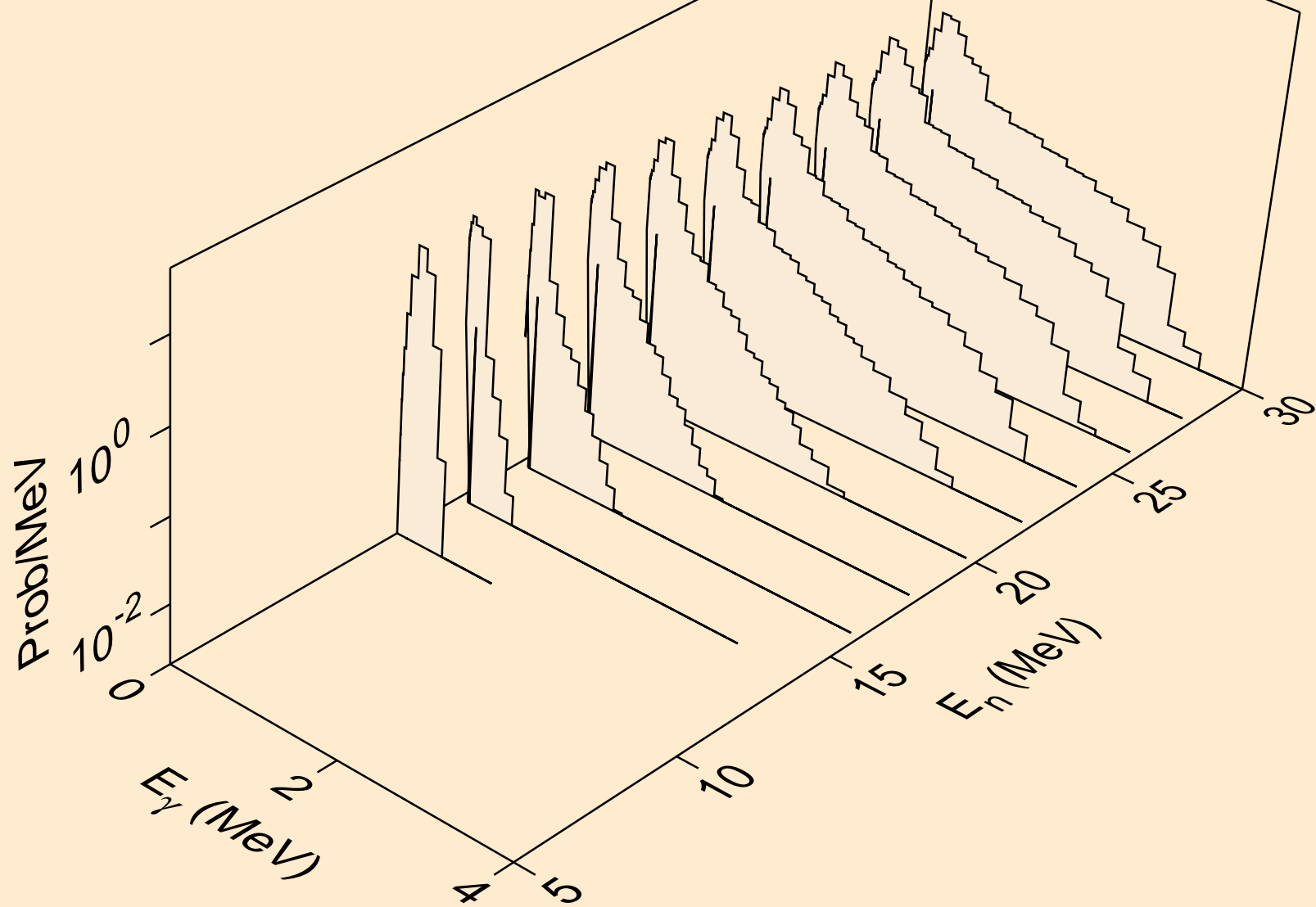

PB217 NEUTRON ACER TENDL-2021 LIBRARY; T=293.6K
Photon emission for (n,n*)he3

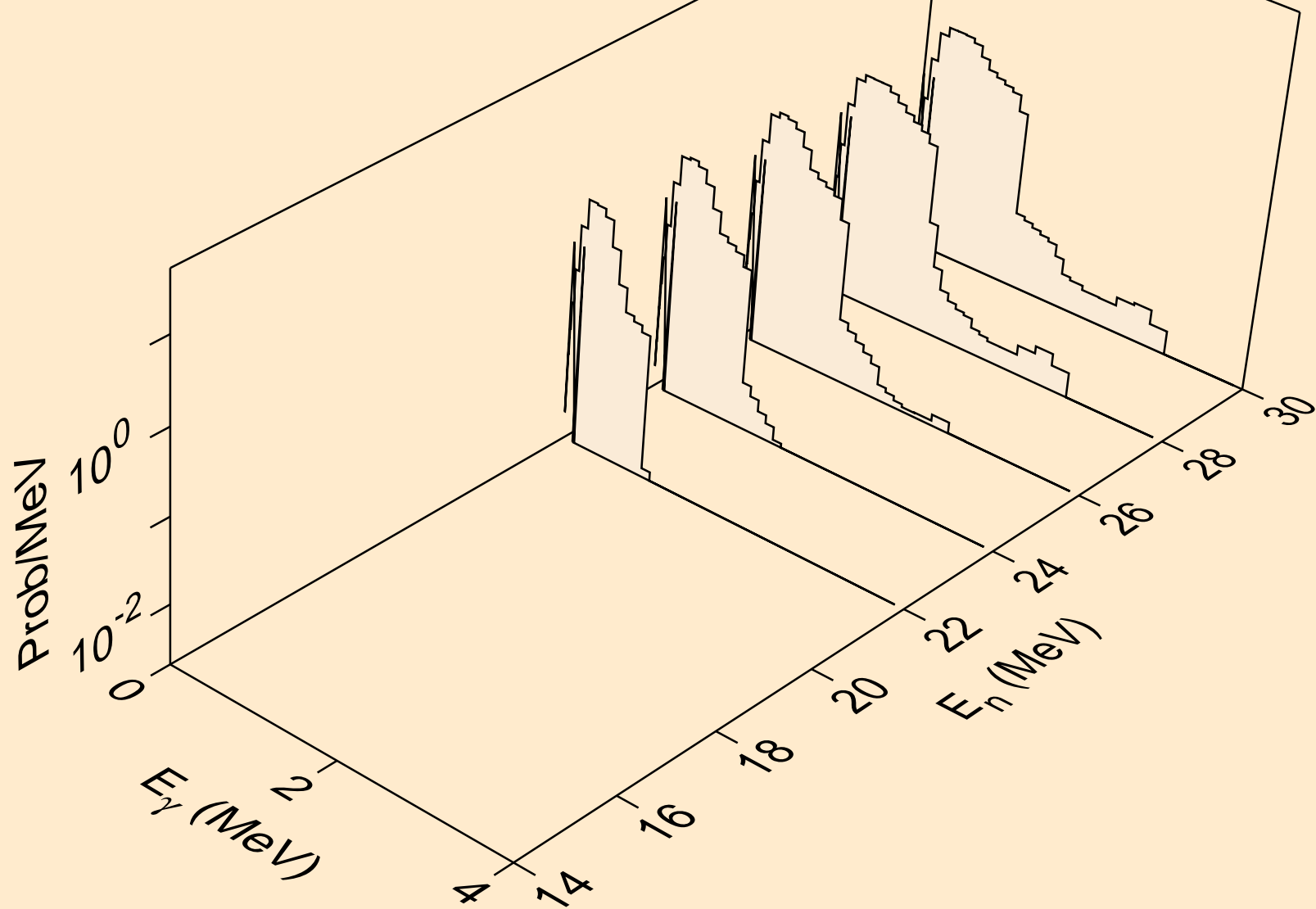

PB217 NEUTRON ACER TENDL-2021 LIBRARY; T=293.6K
Photon emission for (n,4n)

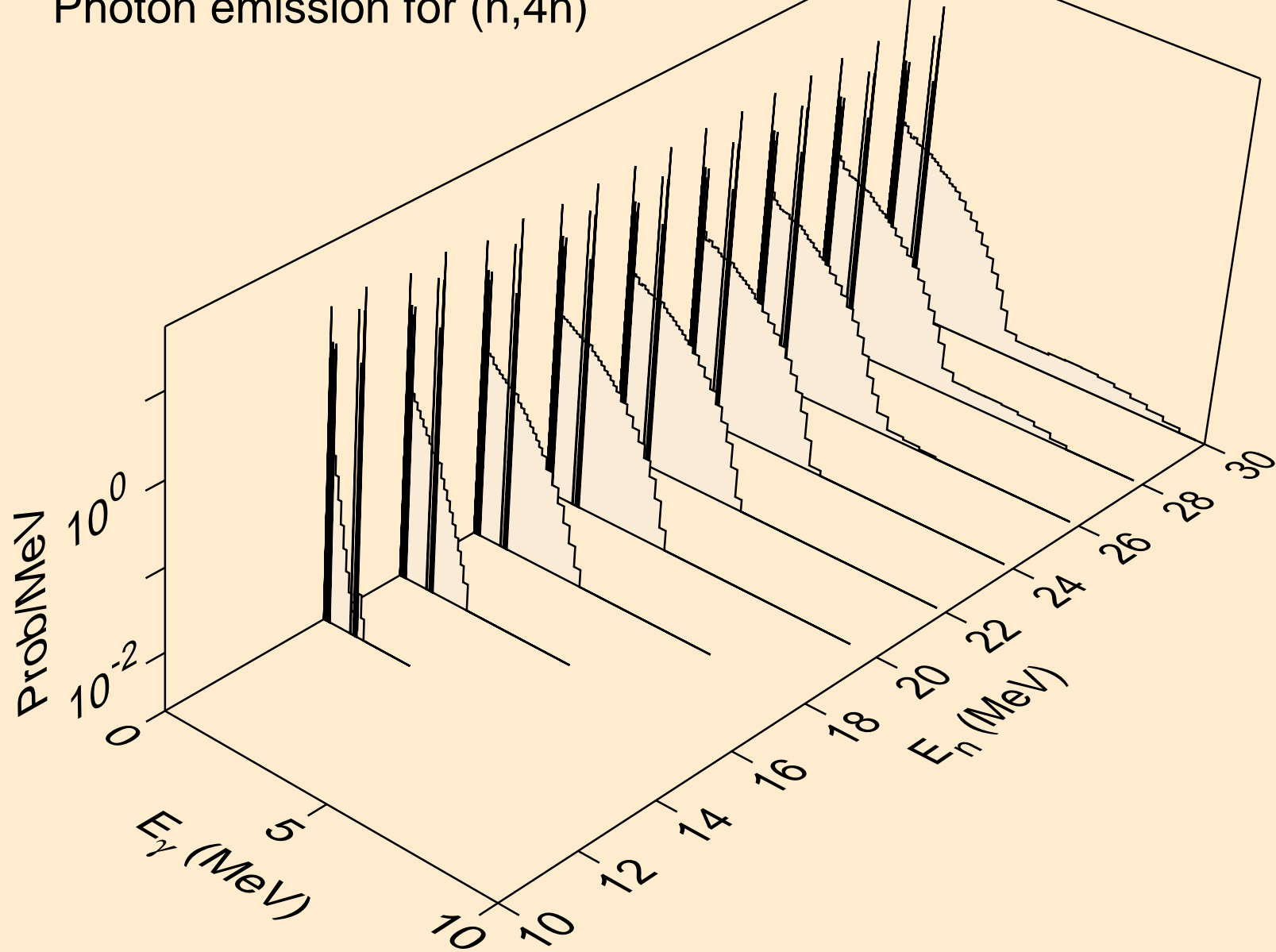

PB217 NEUTRON ACER TENDL-2021 LIBRARY; T=293.6K
Photon emission for (n,2np)

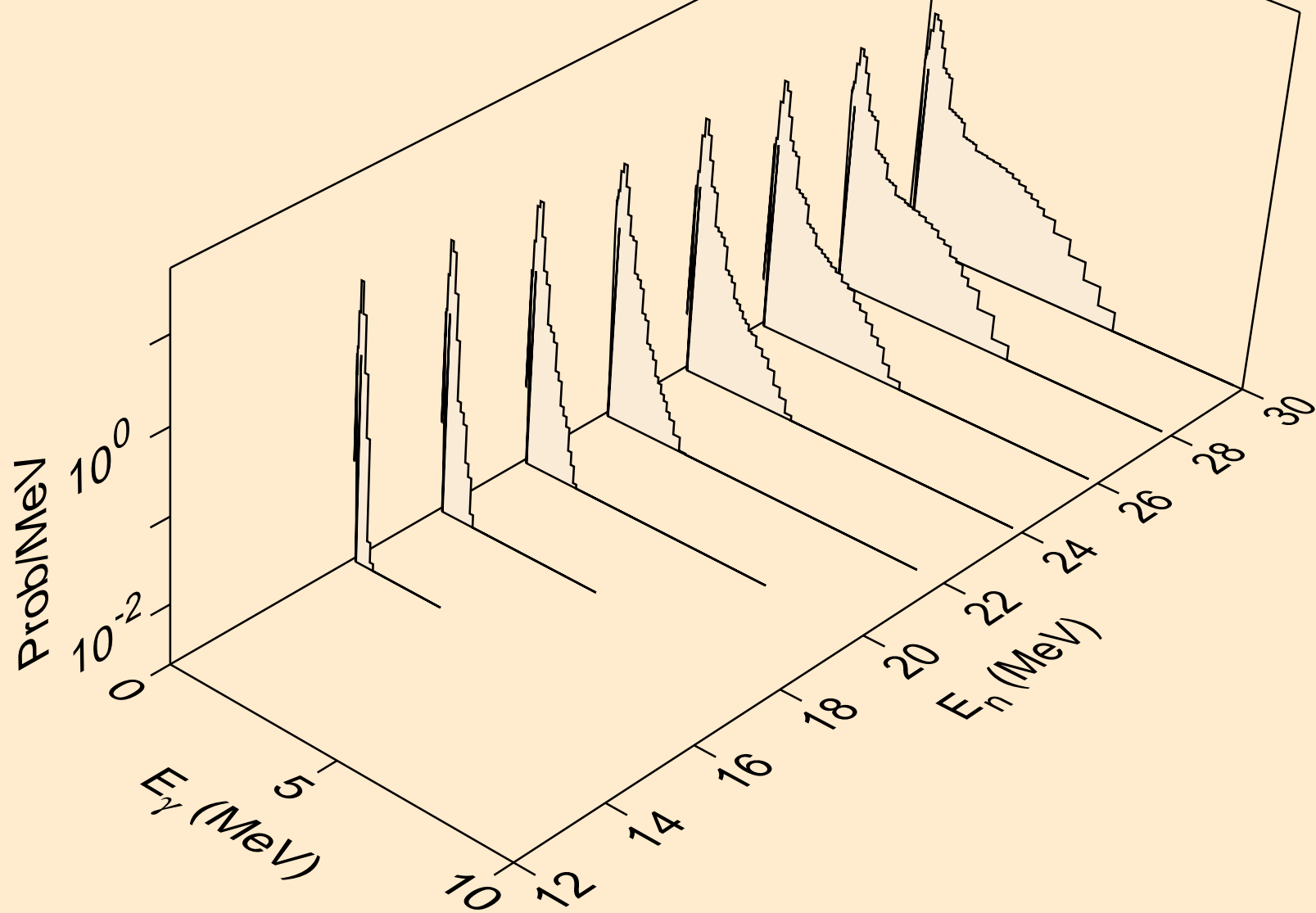

PB217 NEUTRON ACER TENDL-2021 LIBRARY; T=293.6K
Photon emission for (n,3np)

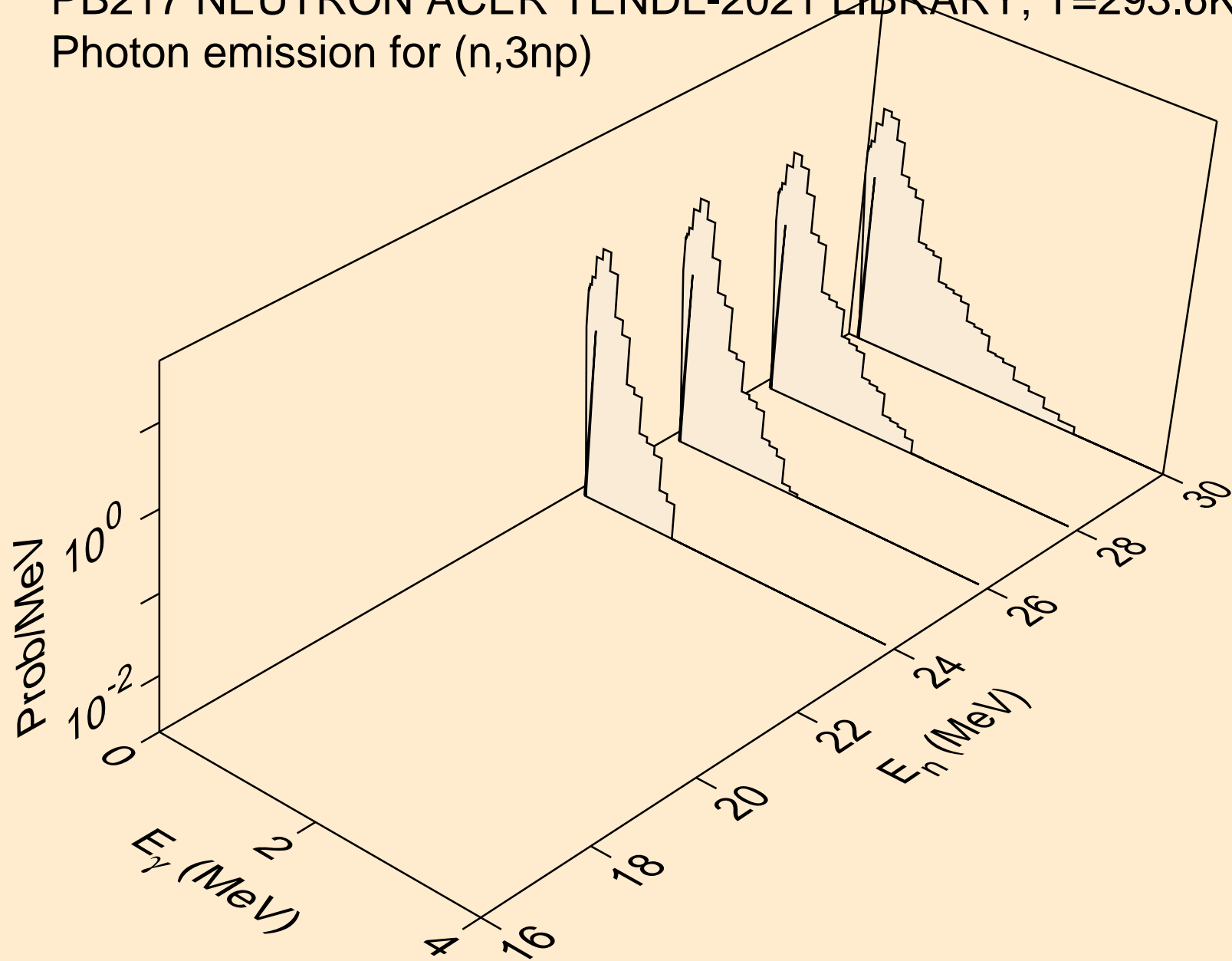

PB217 NEUTRON ACER TENDL-2021 LIBRARY; T=293.6K
Photon emission for (n,npa)

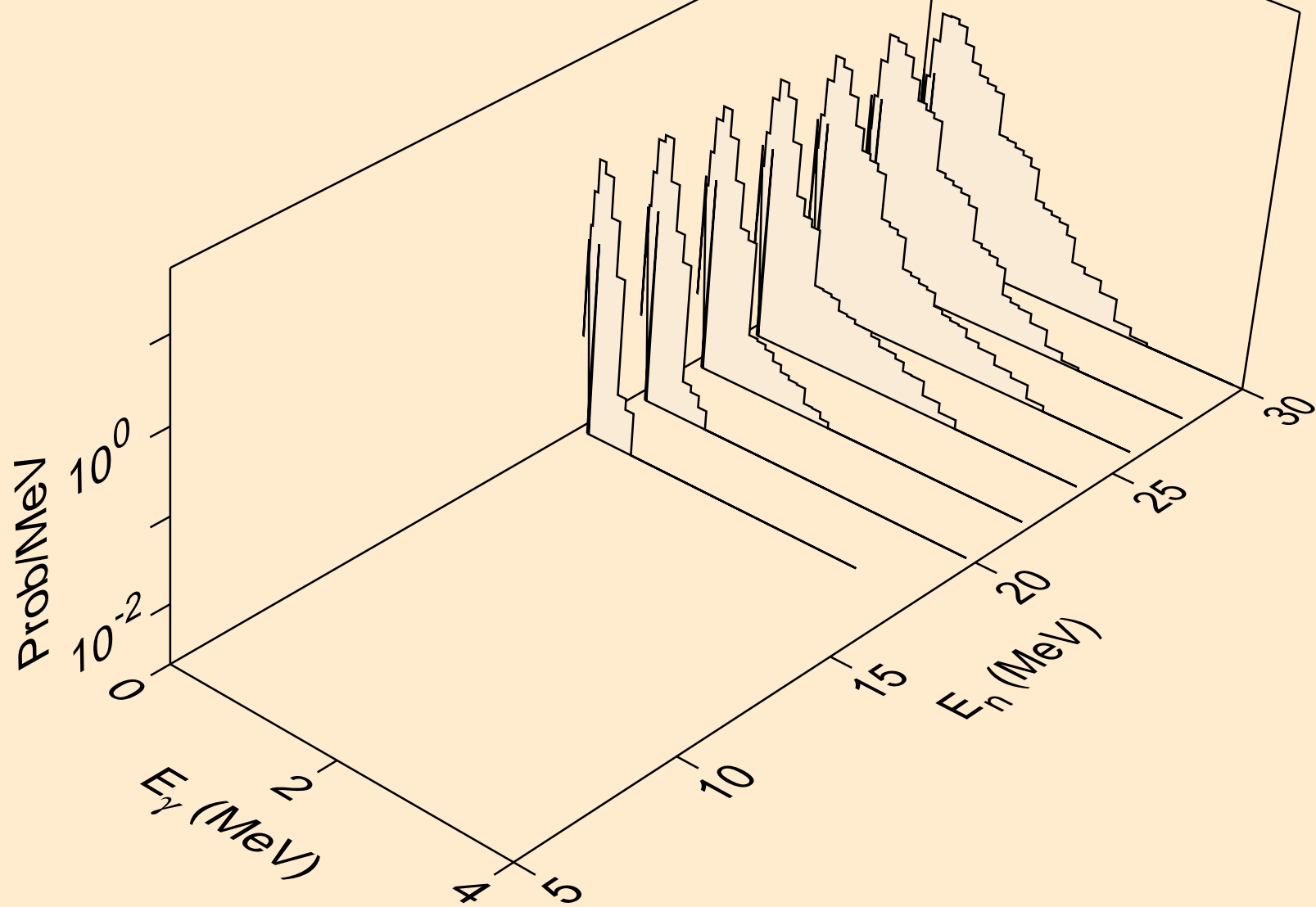

PB217 NEUTRON ACER TENDL-2021 LIBRARY; T=293.6K
Photon emission for (n,n*c)

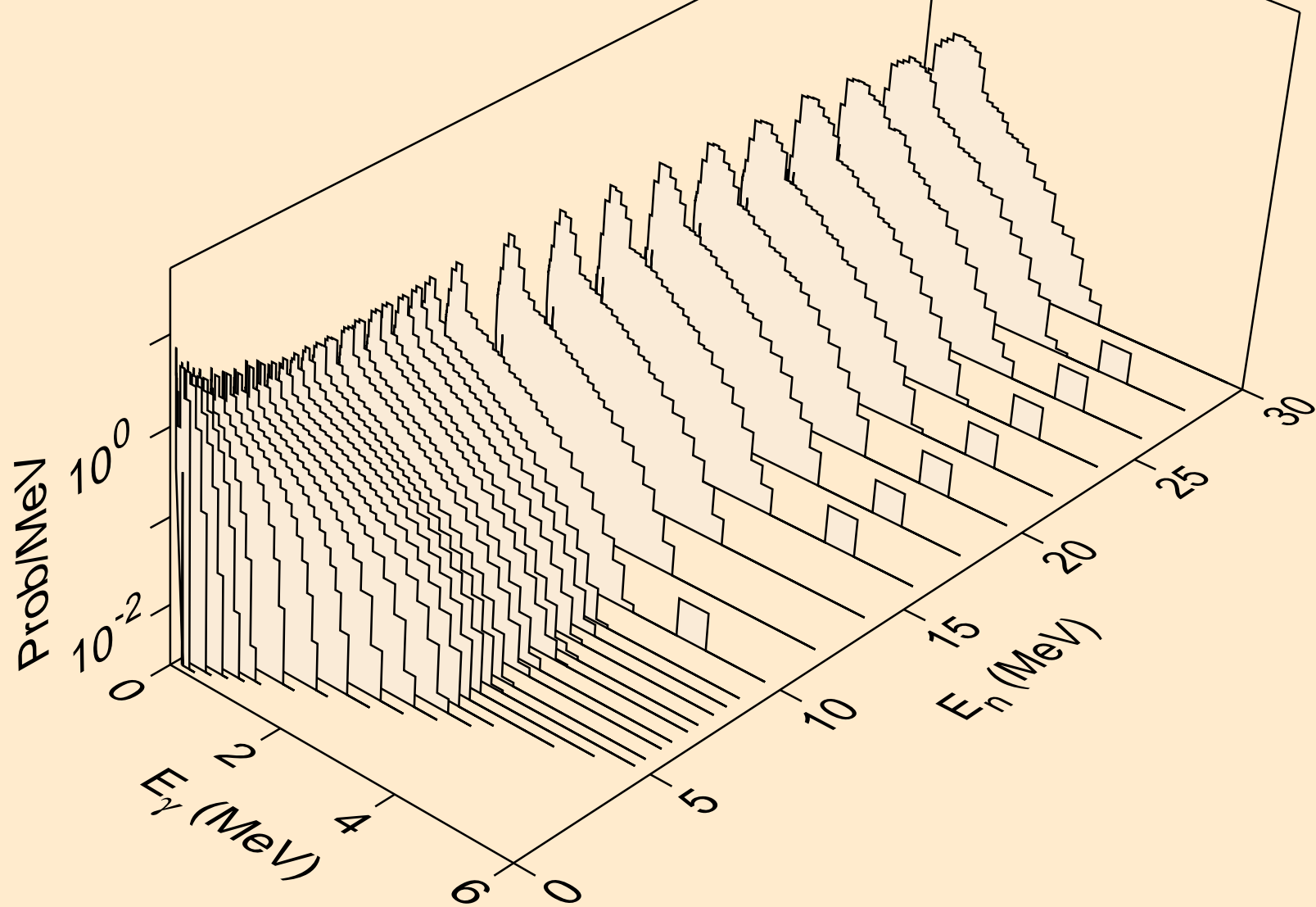

PB217 NEUTRON ACER TENDL-2021 LIBRARY; T=293.6K
Photon emission for (n,gma)

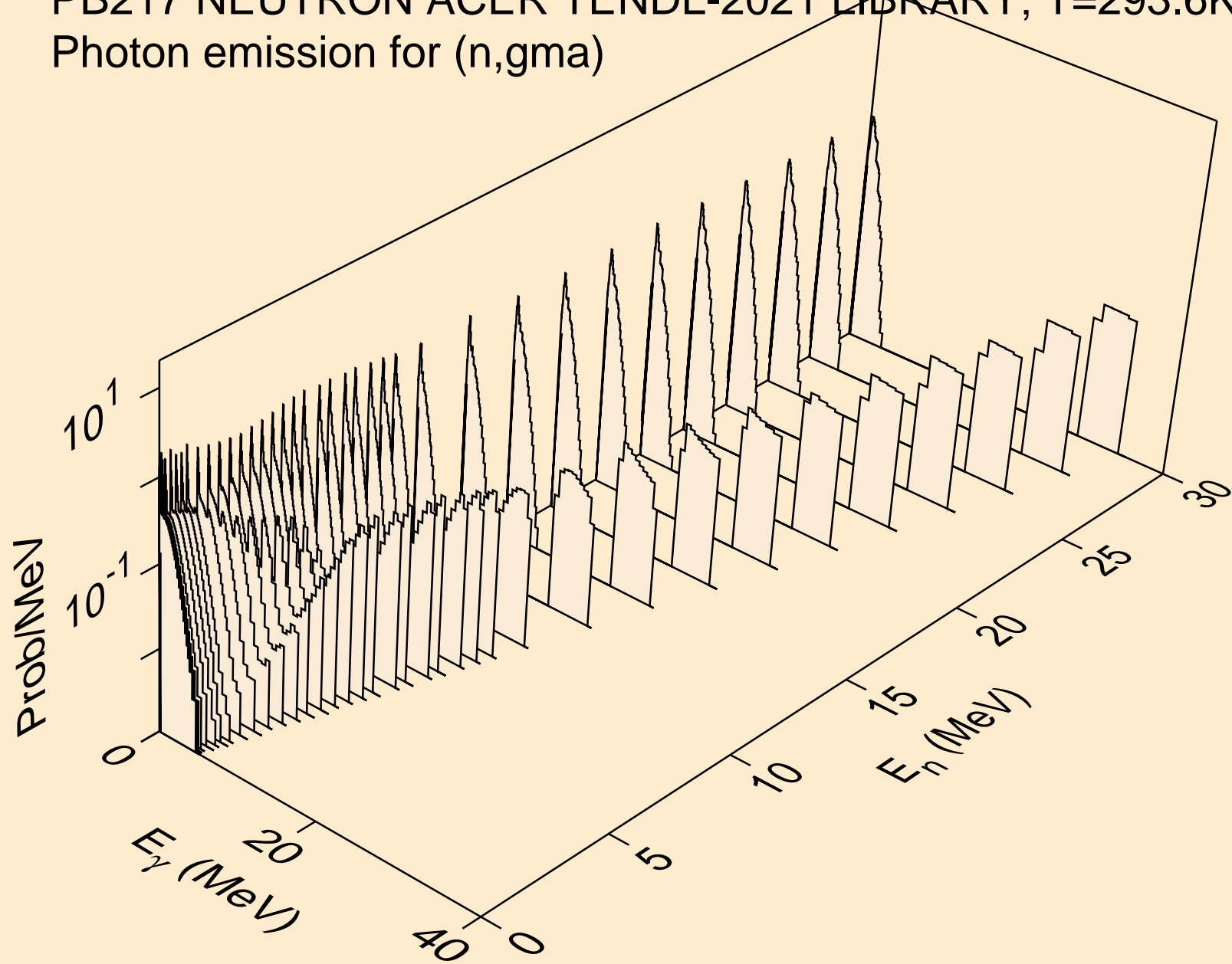

PB217 NEUTRON ACER TENDL-2021 LIBRARY; T=293.6K
Photon emission for (n,p)

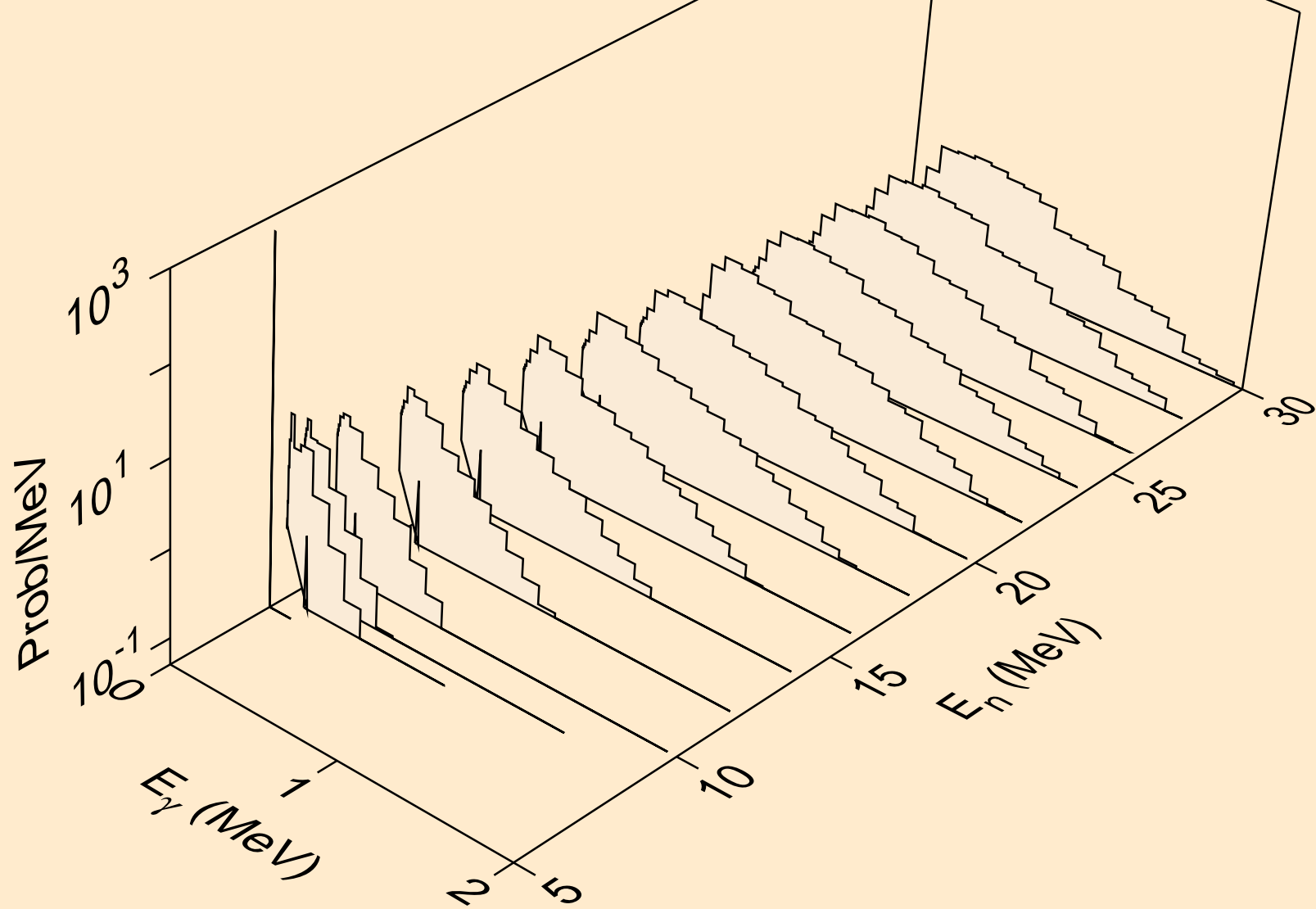

PB217 NEUTRON ACER TENDL-2021 LIBRARY; T=293.6K
Photon emission for (n,d)

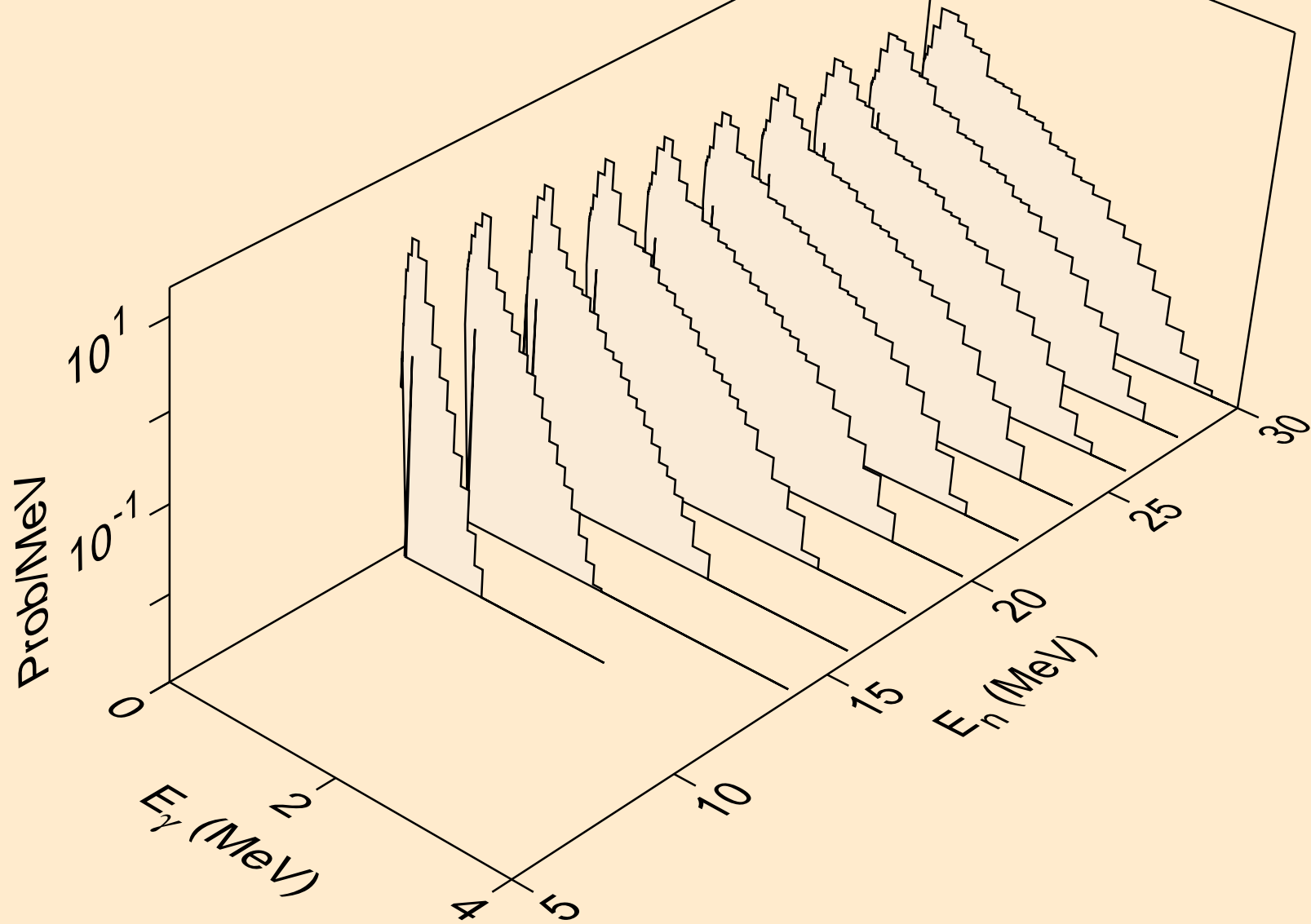

PB217 NEUTRON ACER TENDL-2021 LIBRARY; T=293.6K
Photon emission for (n,t)

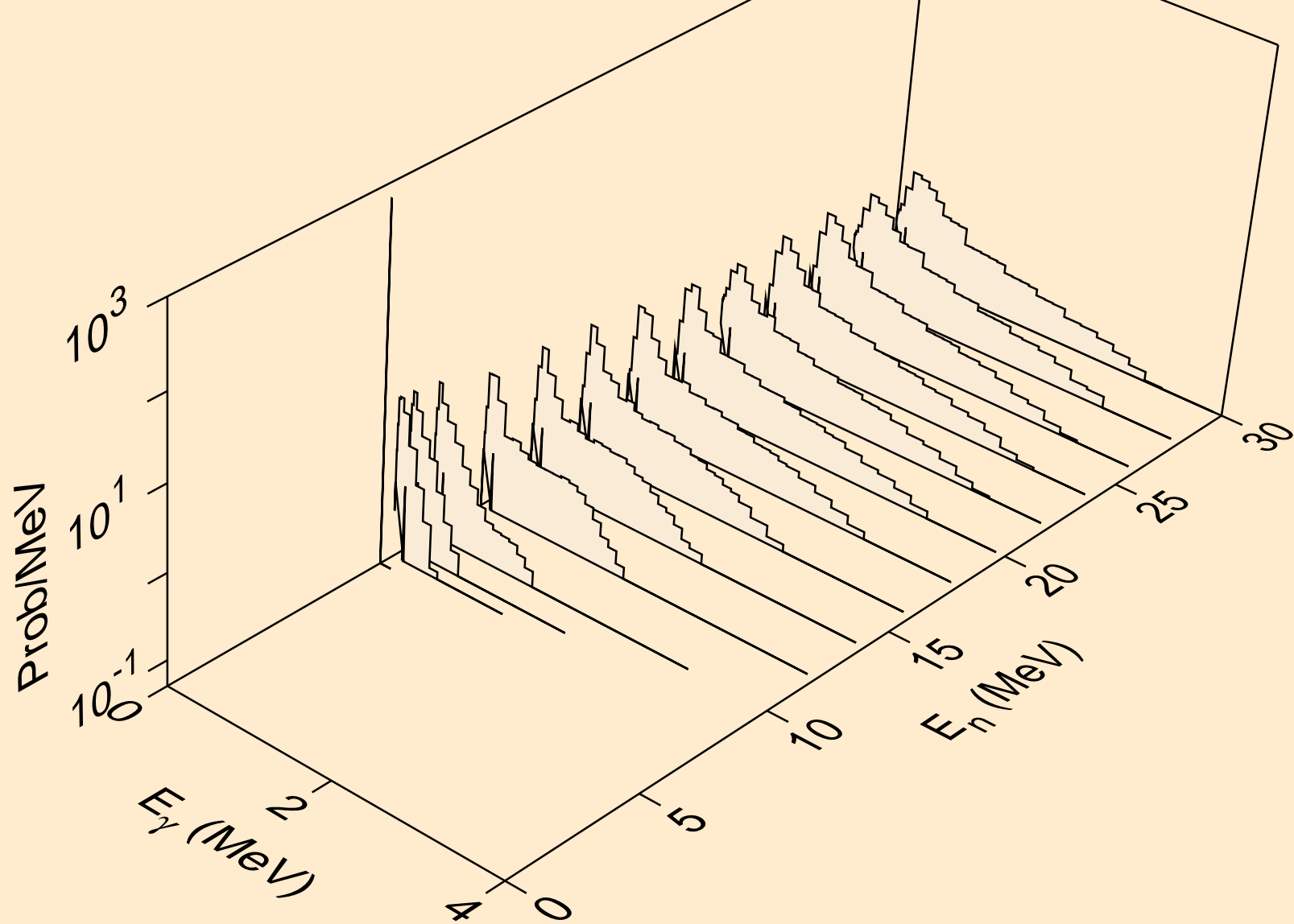

PB217 NEUTRON ACER TENDL-2021 LIBRARY; T=293.6K
Photon emission for (n,he3)

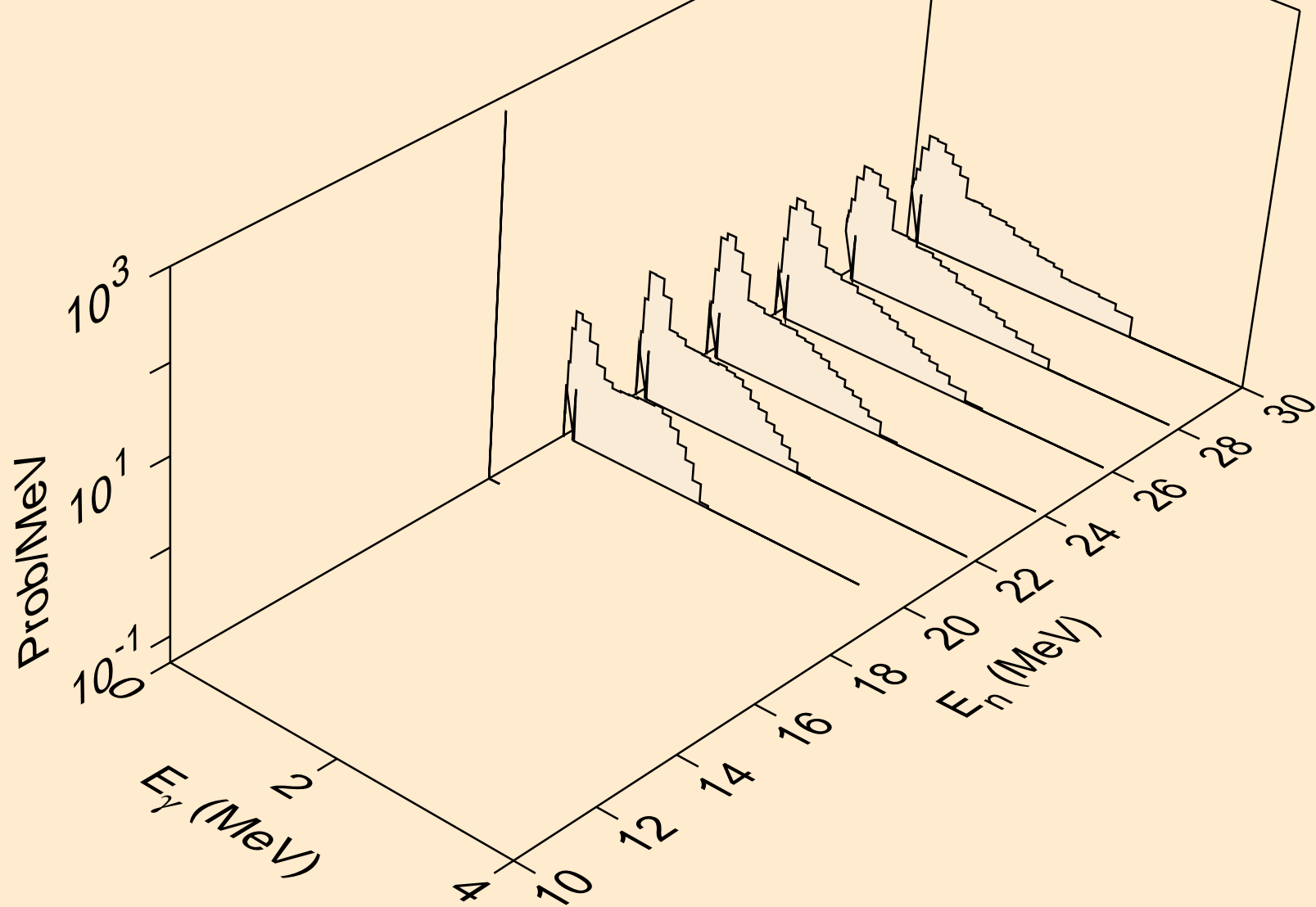

PB217 NEUTRON ACER TENDL-2021 LIBRARY; T=293.6K
Photon emission for (n,a)

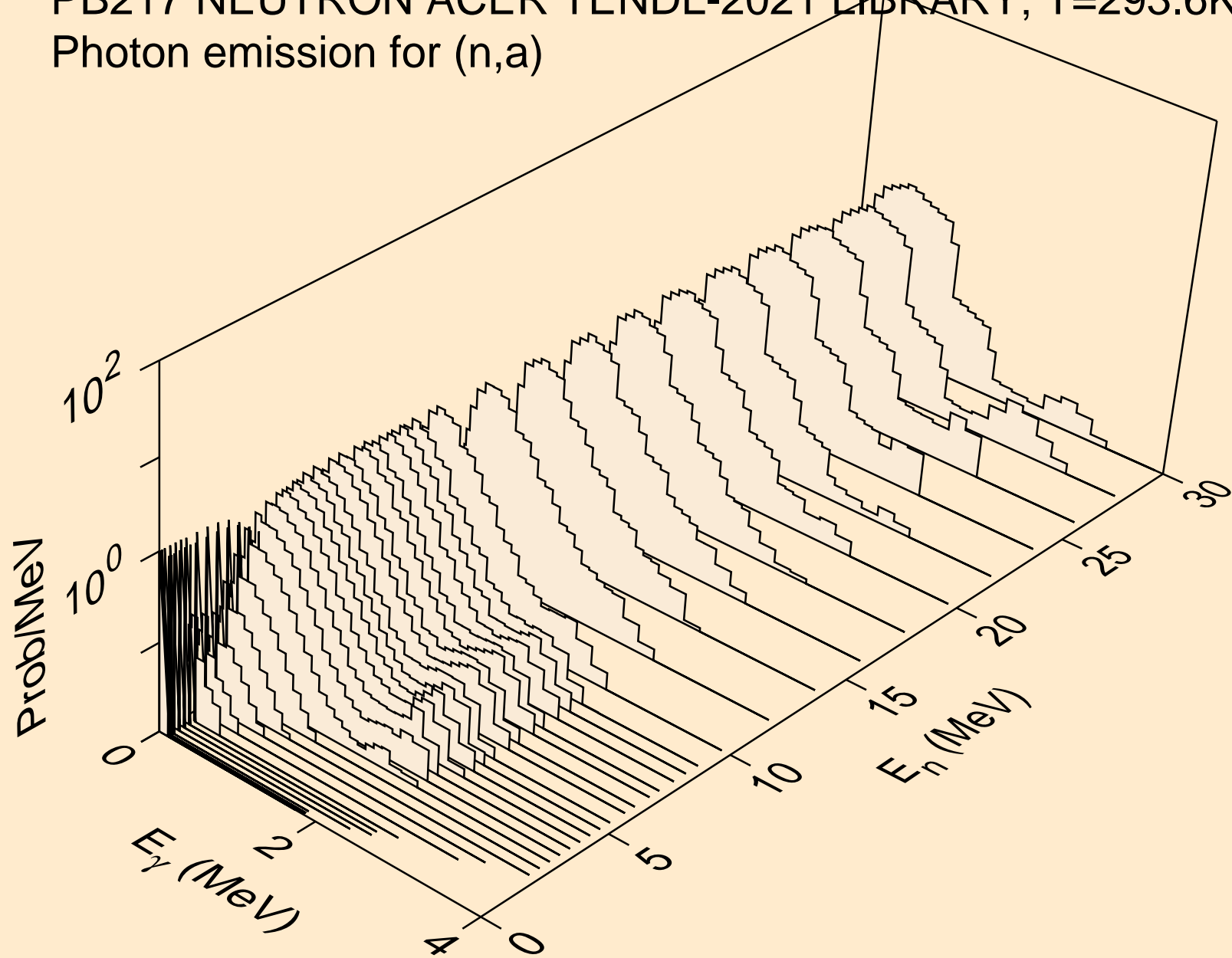

PB217 NEUTRON ACER TENDL-2021 LIBRARY; T=293.6K
Photon emission for (n,2a)

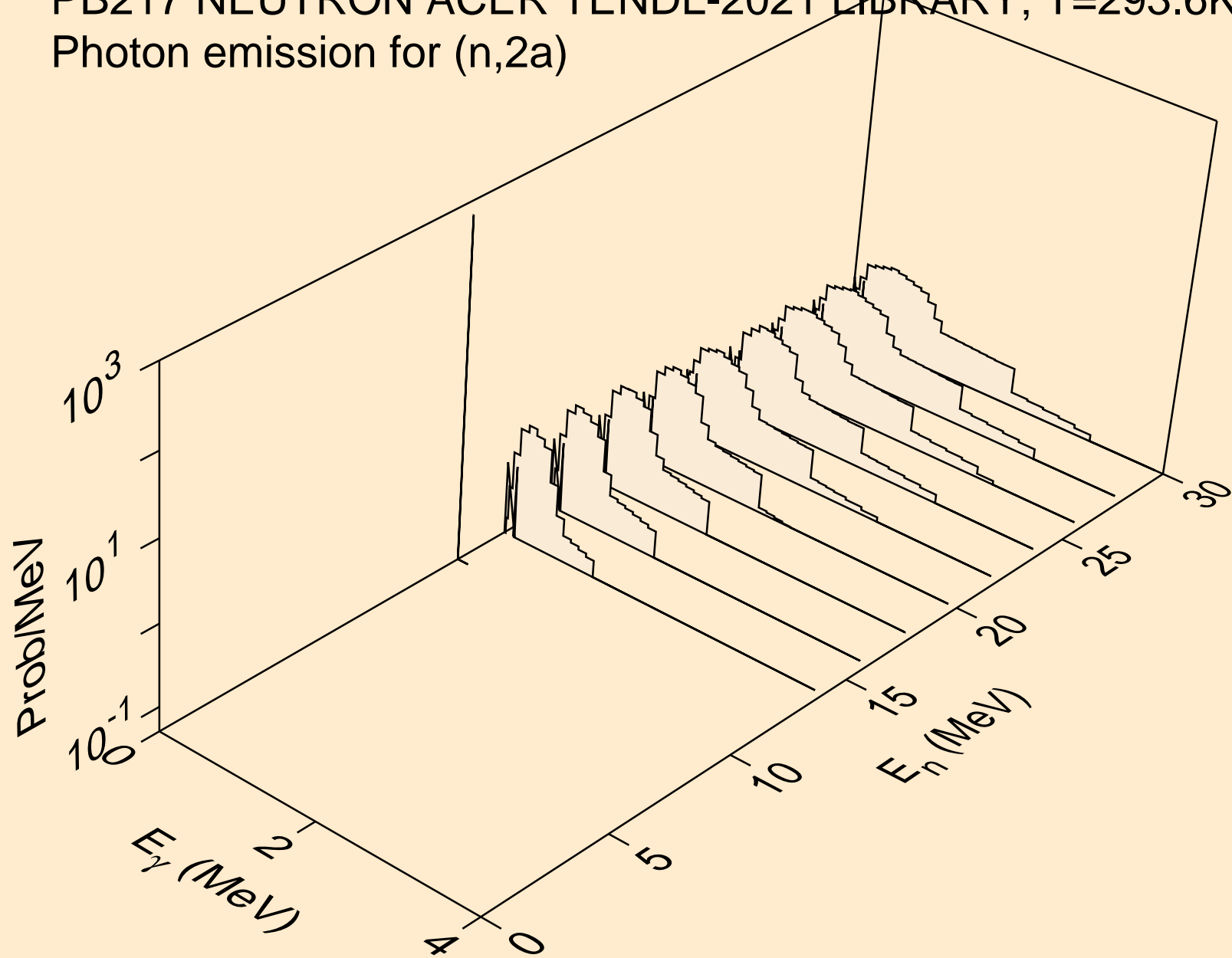

PB217 NEUTRON ACER TENDL-2021 LIBRARY; T=293.6K
Photon emission for (n,p α)

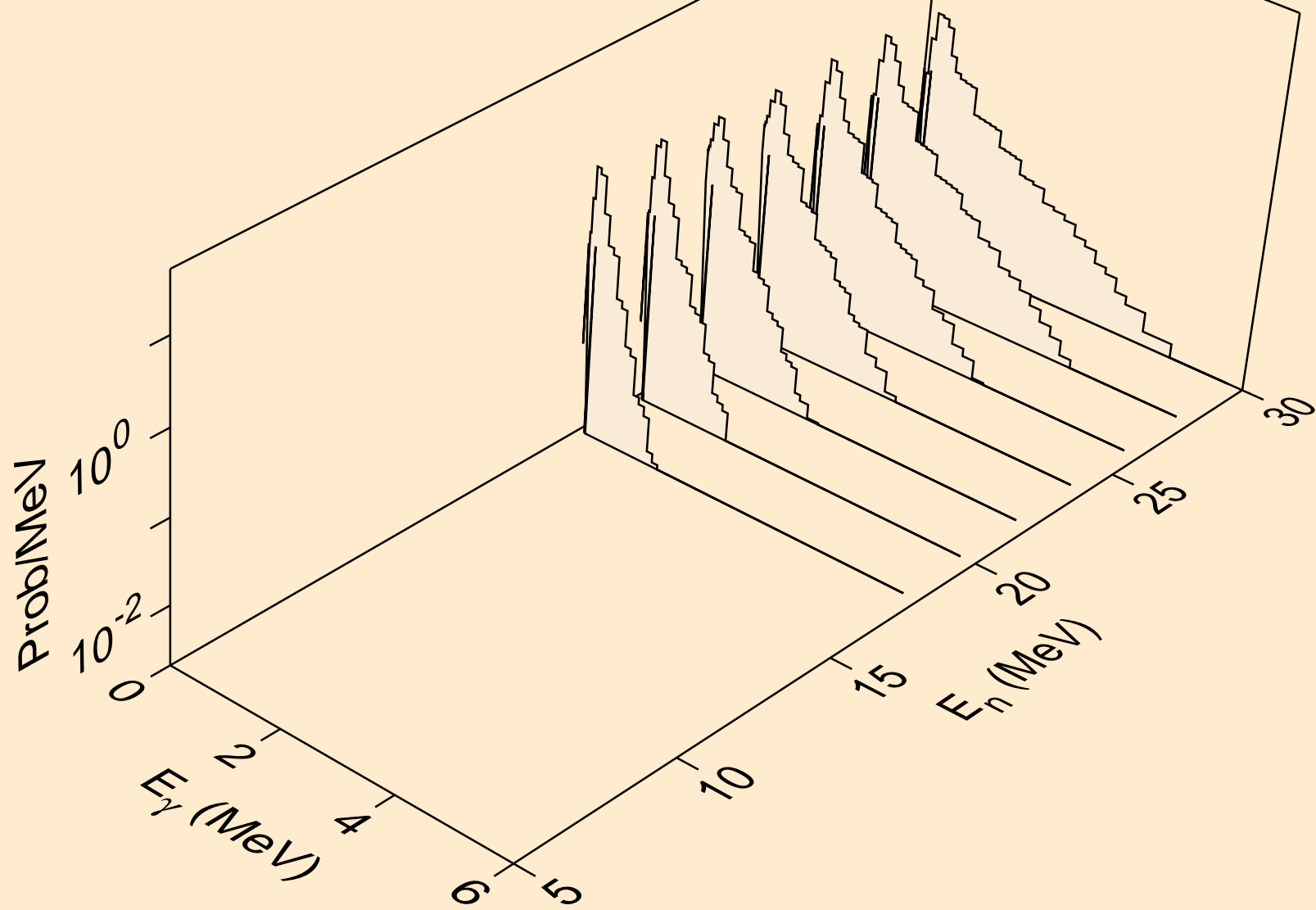

PB217 NEUTRON ACER TENDL-2021 LIBRARY; T=293.6K
Photon emission for (n,da)

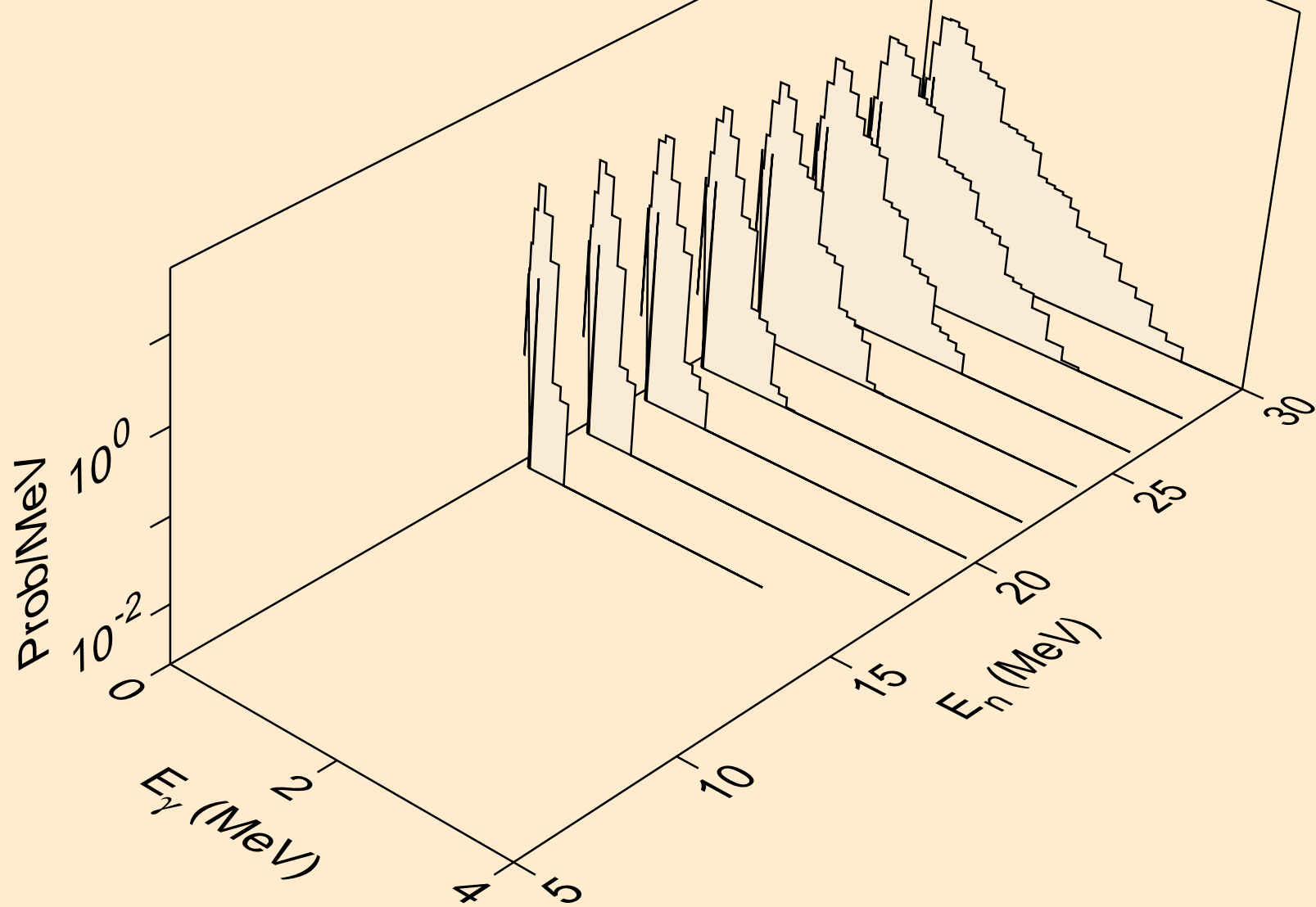

PB217 NEUTRON ACER TENDL-2021 LIBRARY; T=293.6K
thermal capture photon spectrum

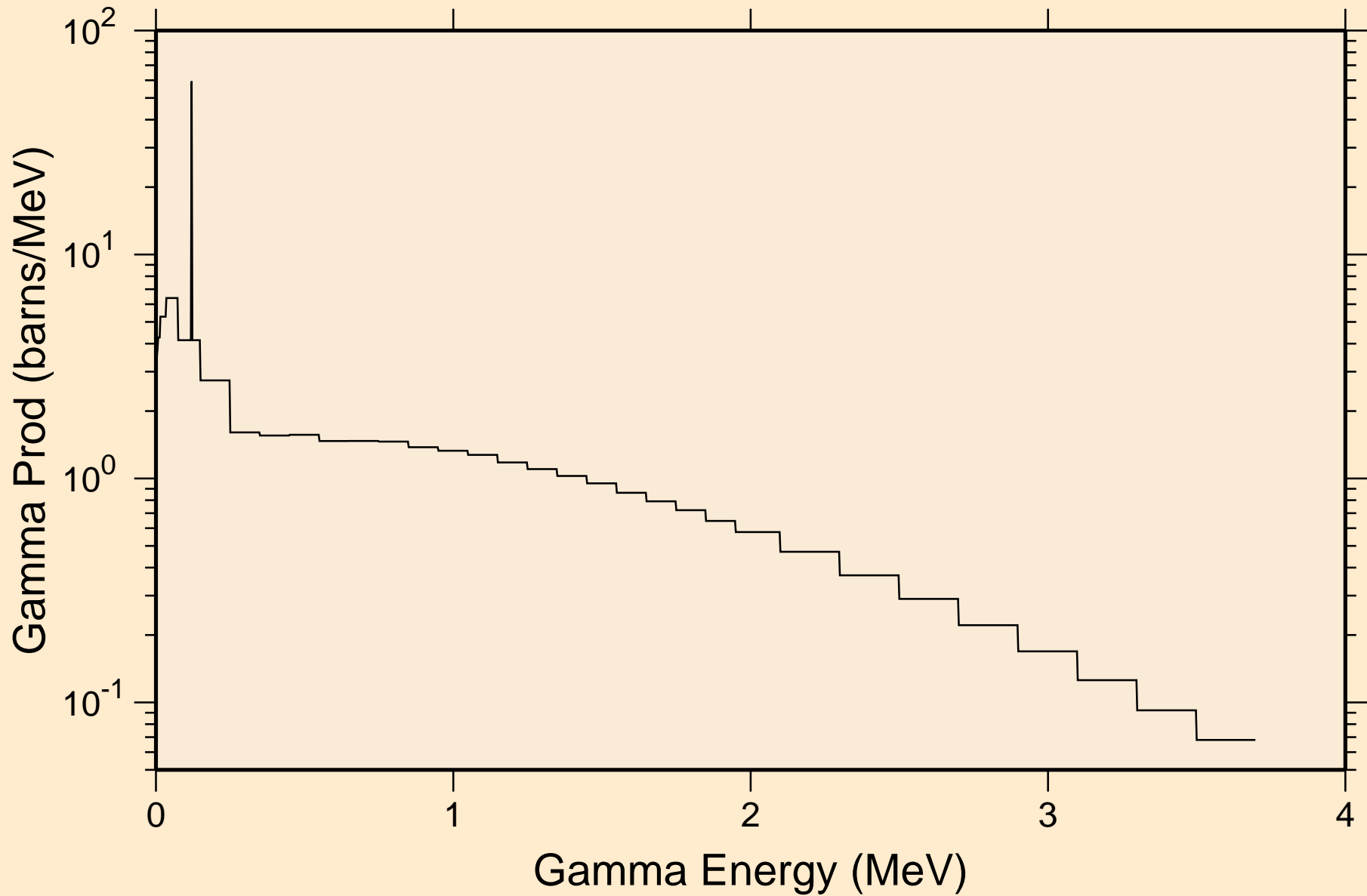

PB217 NEUTRON ACER TENDL-2021 LIBRARY; T=293.6K
14 MeV photon spectrum

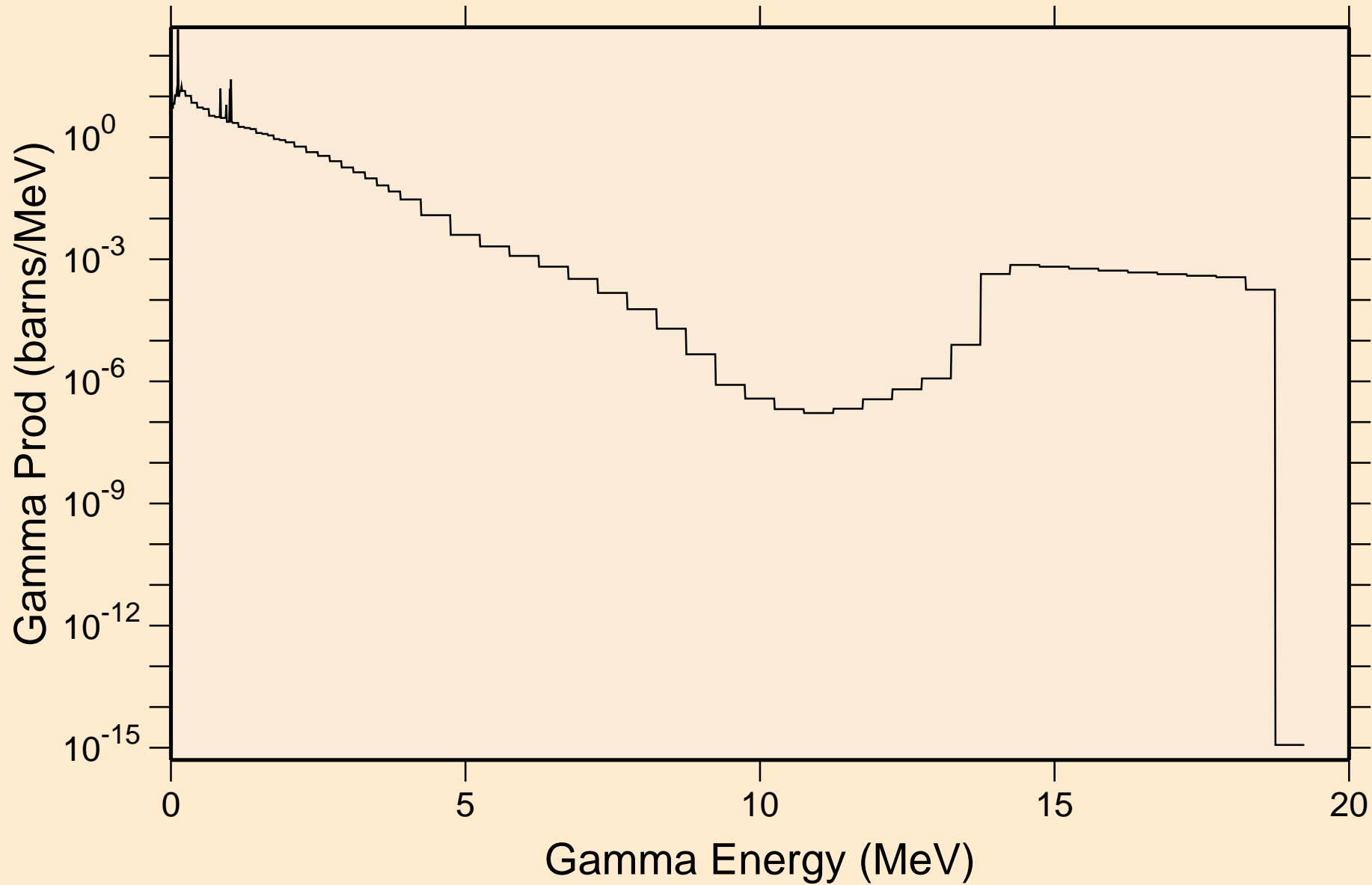

PB217 NEUTRON ACER TENDL-2021 LIBRARY; T=293.6K
Particle heating contributions

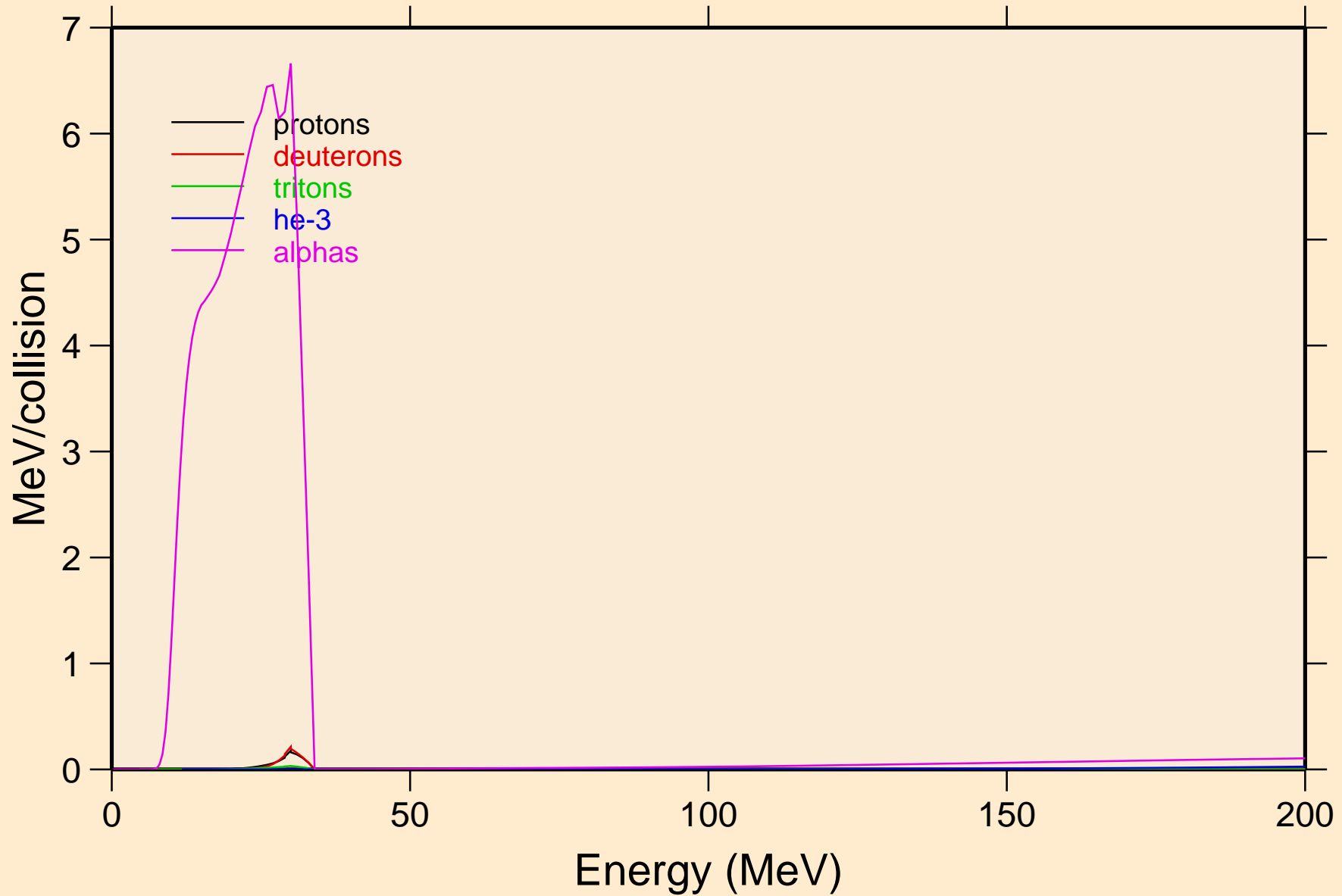

PB217 NEUTRON ACER TENDL-2021 LIBRARY; T=293.6K
Recoil Heating

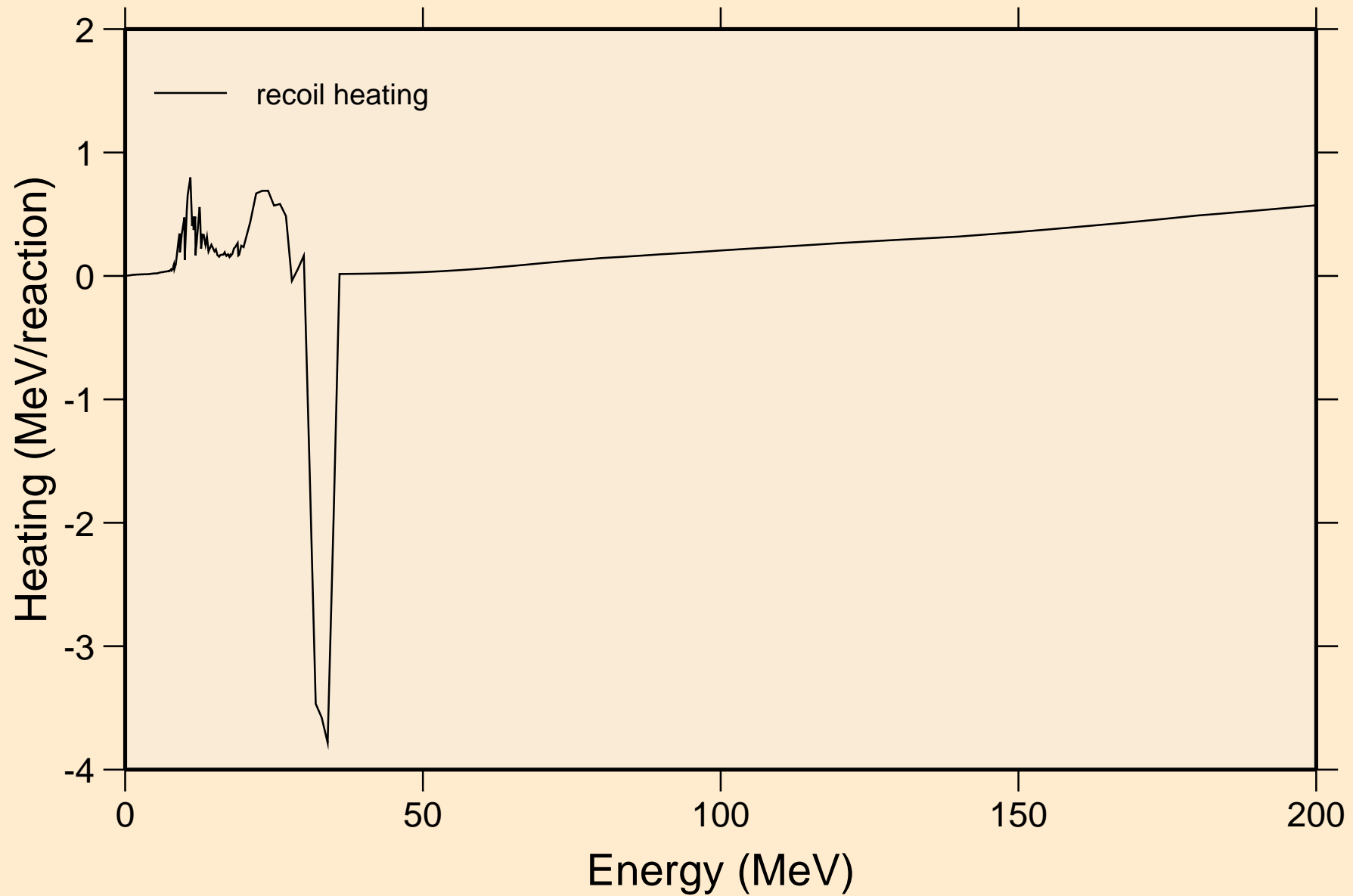

PB217 NEUTRON ACER TENDL-2021 LIBRARY; T=293.6K

Particle production cross sections

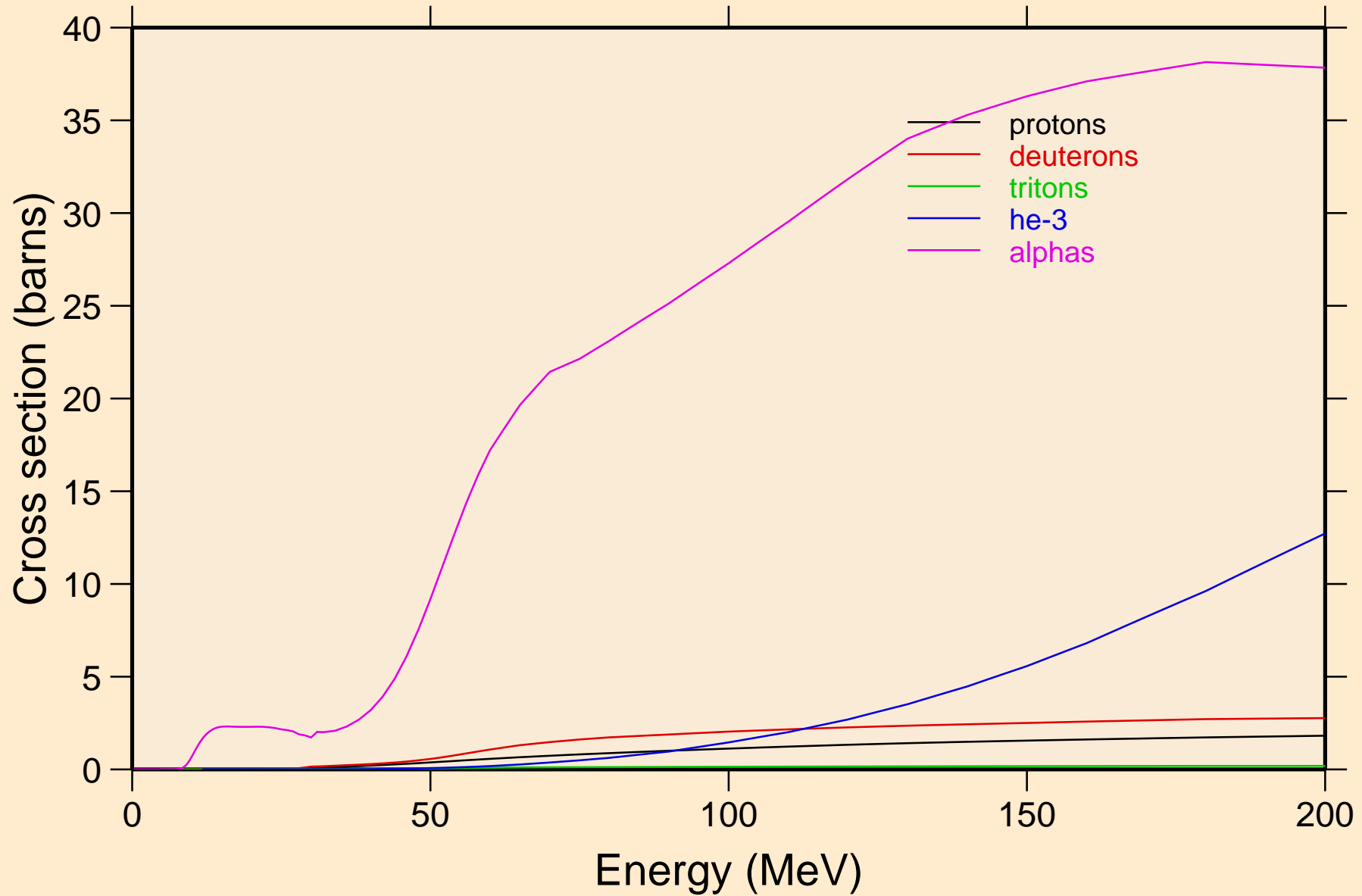

PB217 NEUTRON ACER TENDL-2021 LIBRARY; T=293.6K
protons from (n,x)

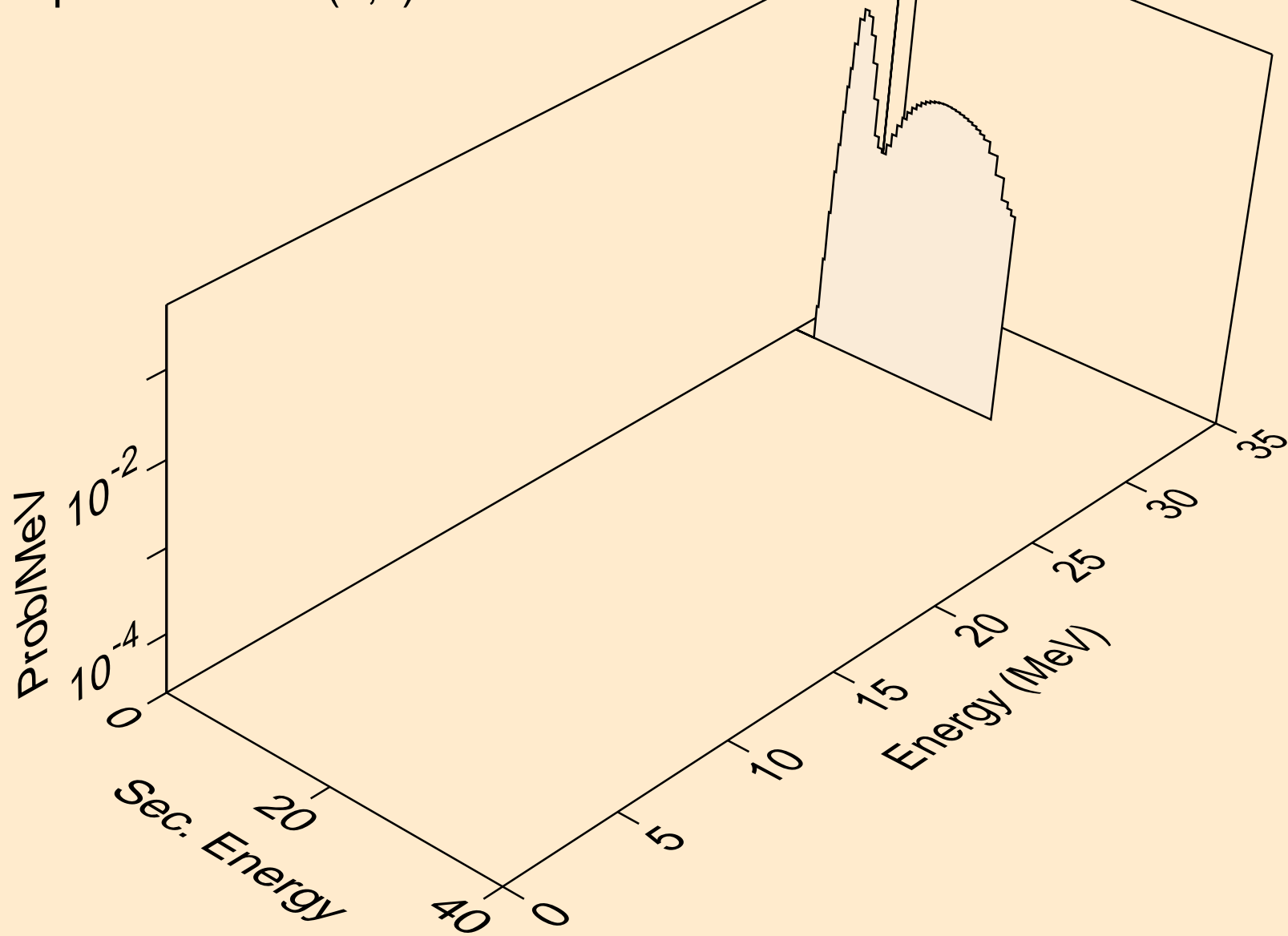

PB217 NEUTRON ACER TENDL-2021 LIBRARY; T=293.6K
protons from (n,n*)p

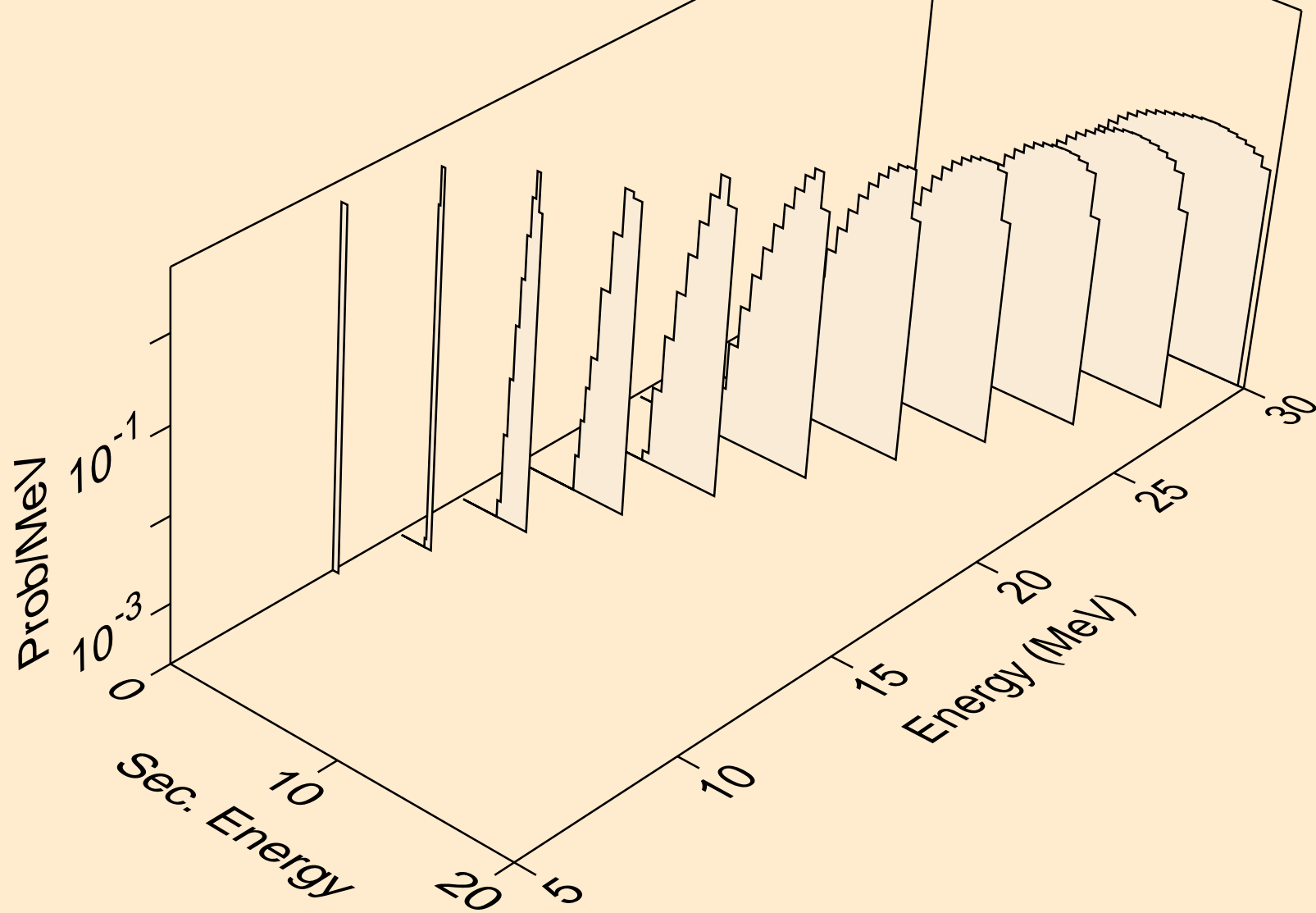

PB217 NEUTRON ACER TENDL-2021 LIBRARY; T=293.6K
protons from (n,2np)

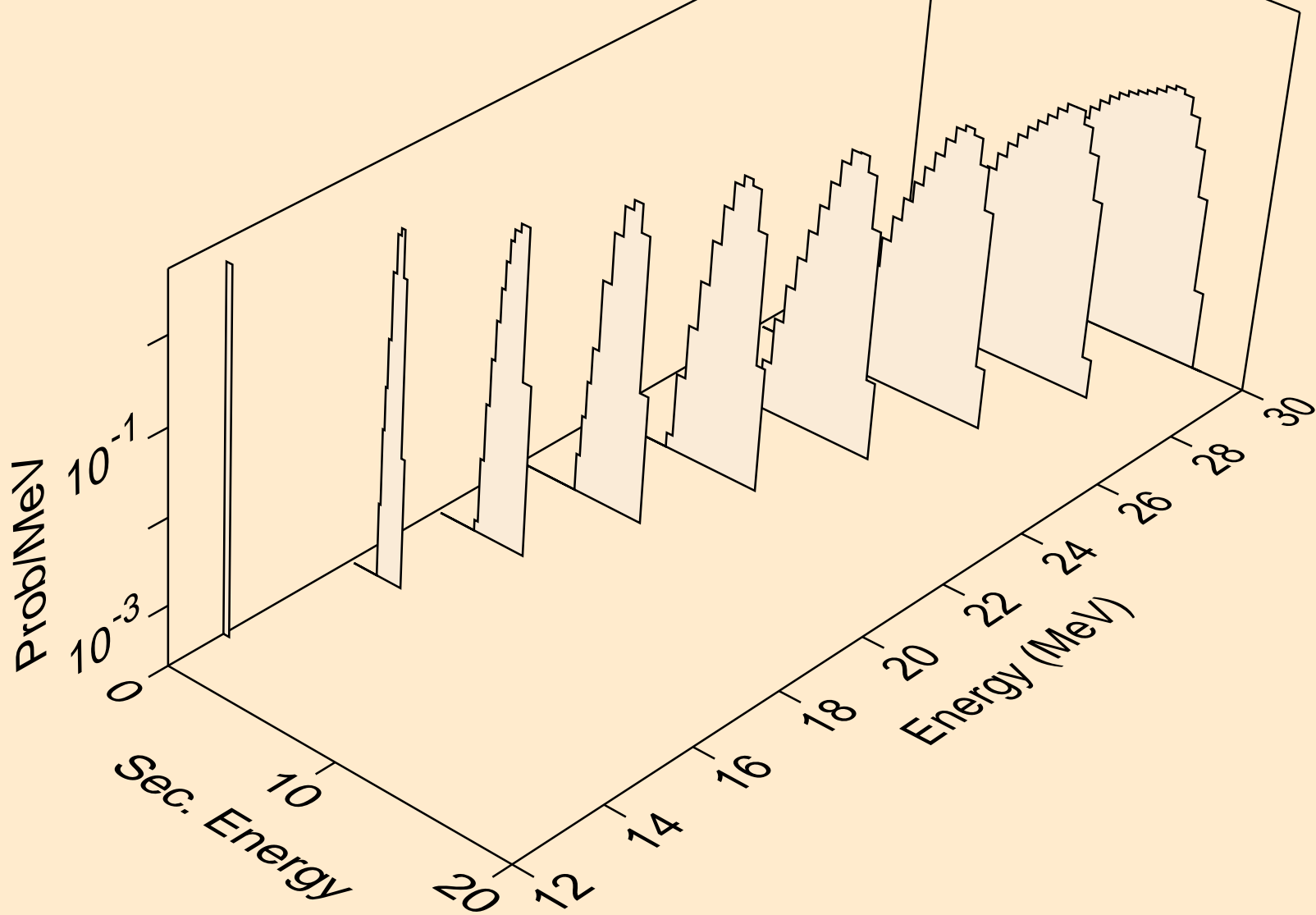

PB217 NEUTRON ACER TENDL-2021 LIBRARY; T=293.6K
protons from (n,3np)

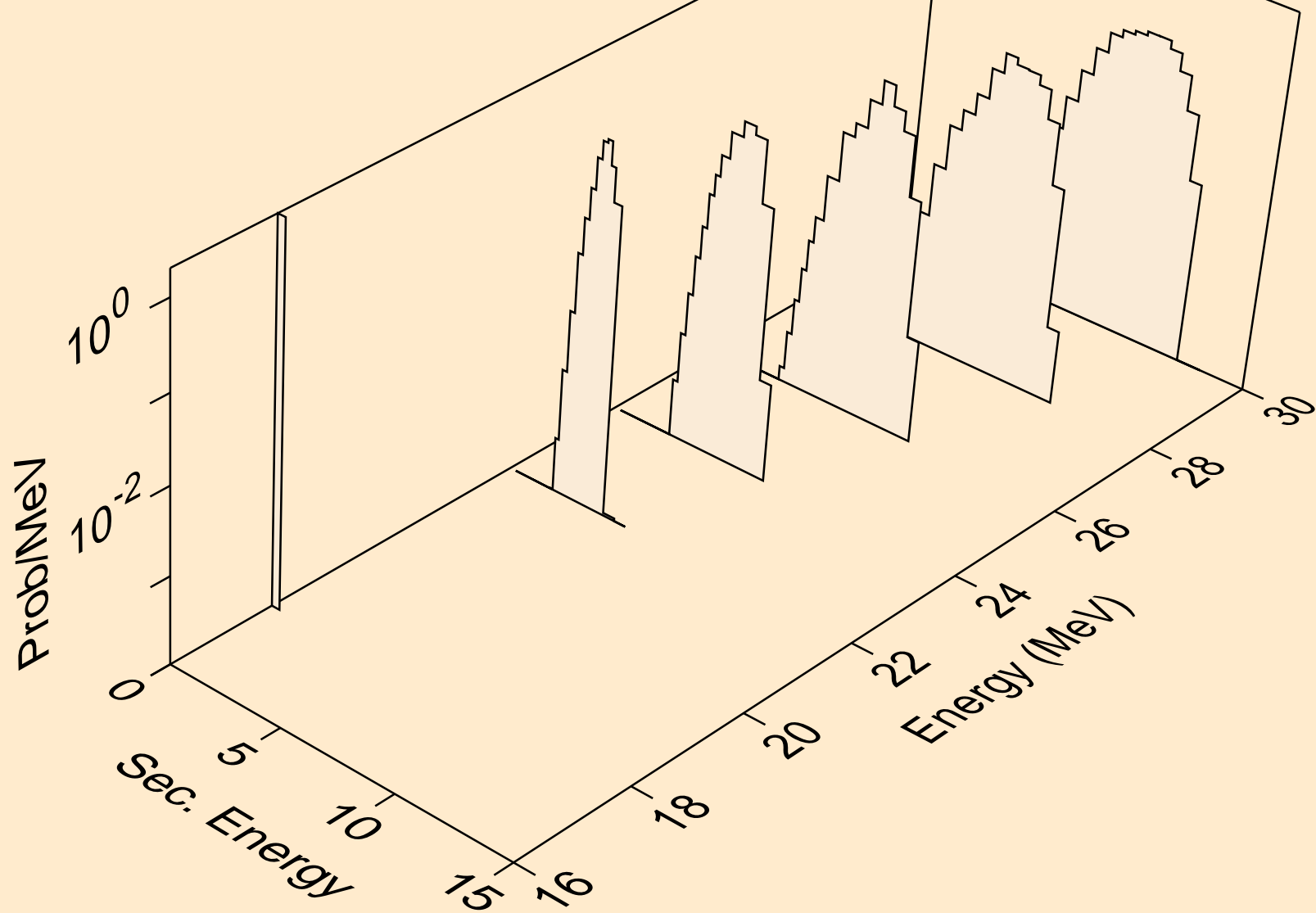

PB217 NEUTRON ACER TENDL-2021 LIBRARY; T=293.6K
protons from (n,npa)

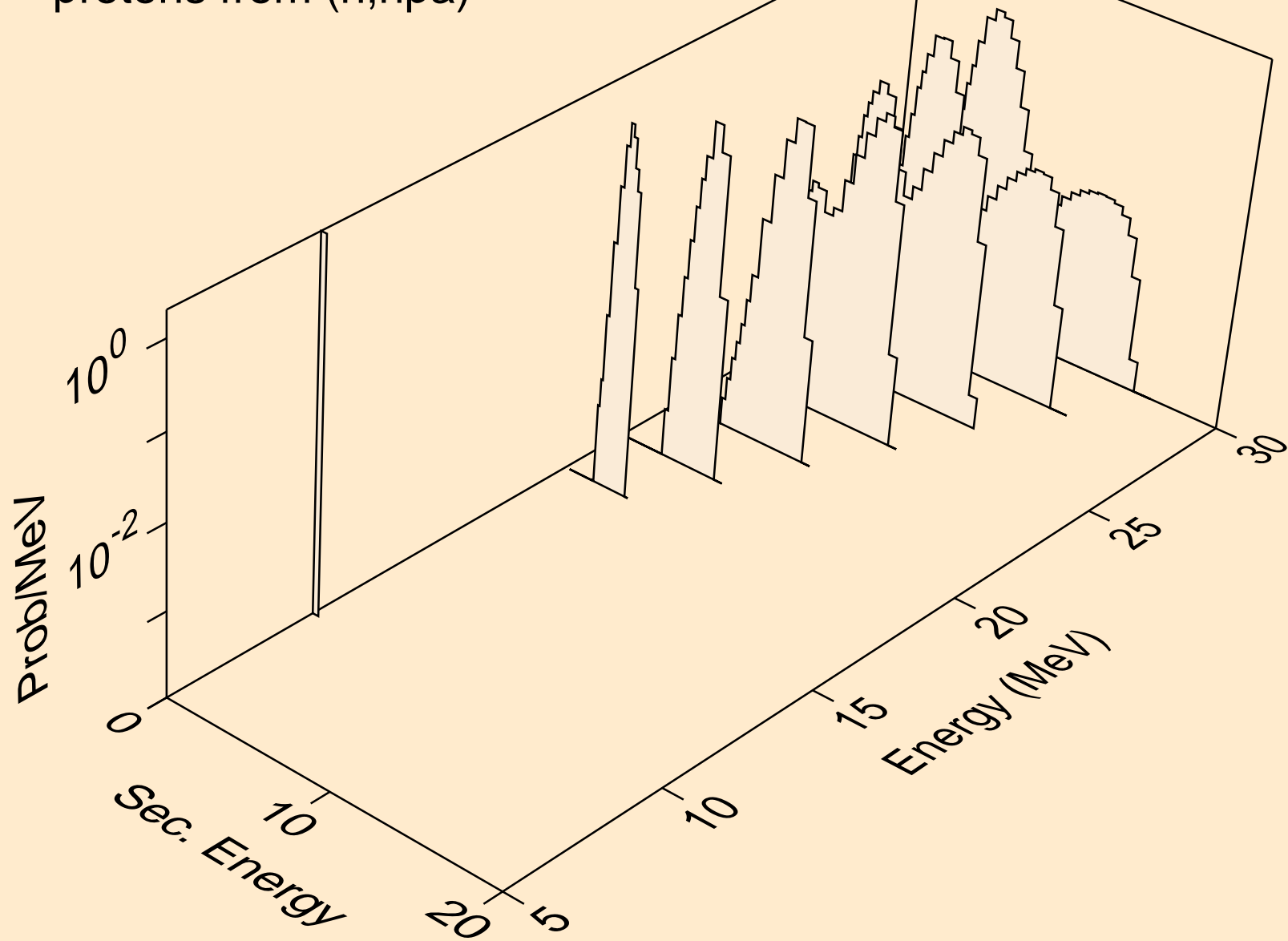

PB217 NEUTRON ACER TENDL-2021 LIBRARY; T=293.6K
protons from (n,p)

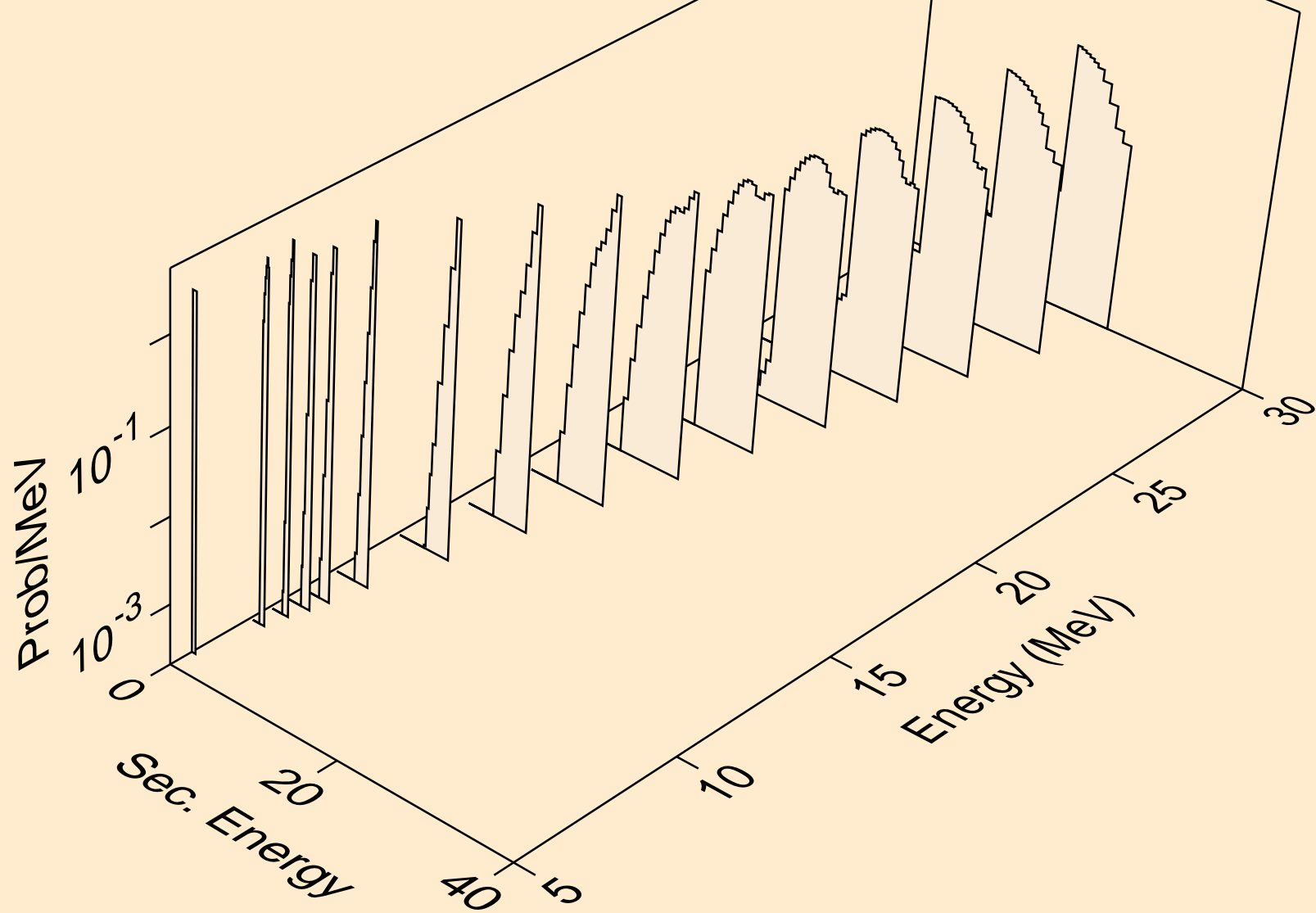

PB217 NEUTRON ACER TENDL-2021 LIBRARY; T=293.6K
protons from (n,p)

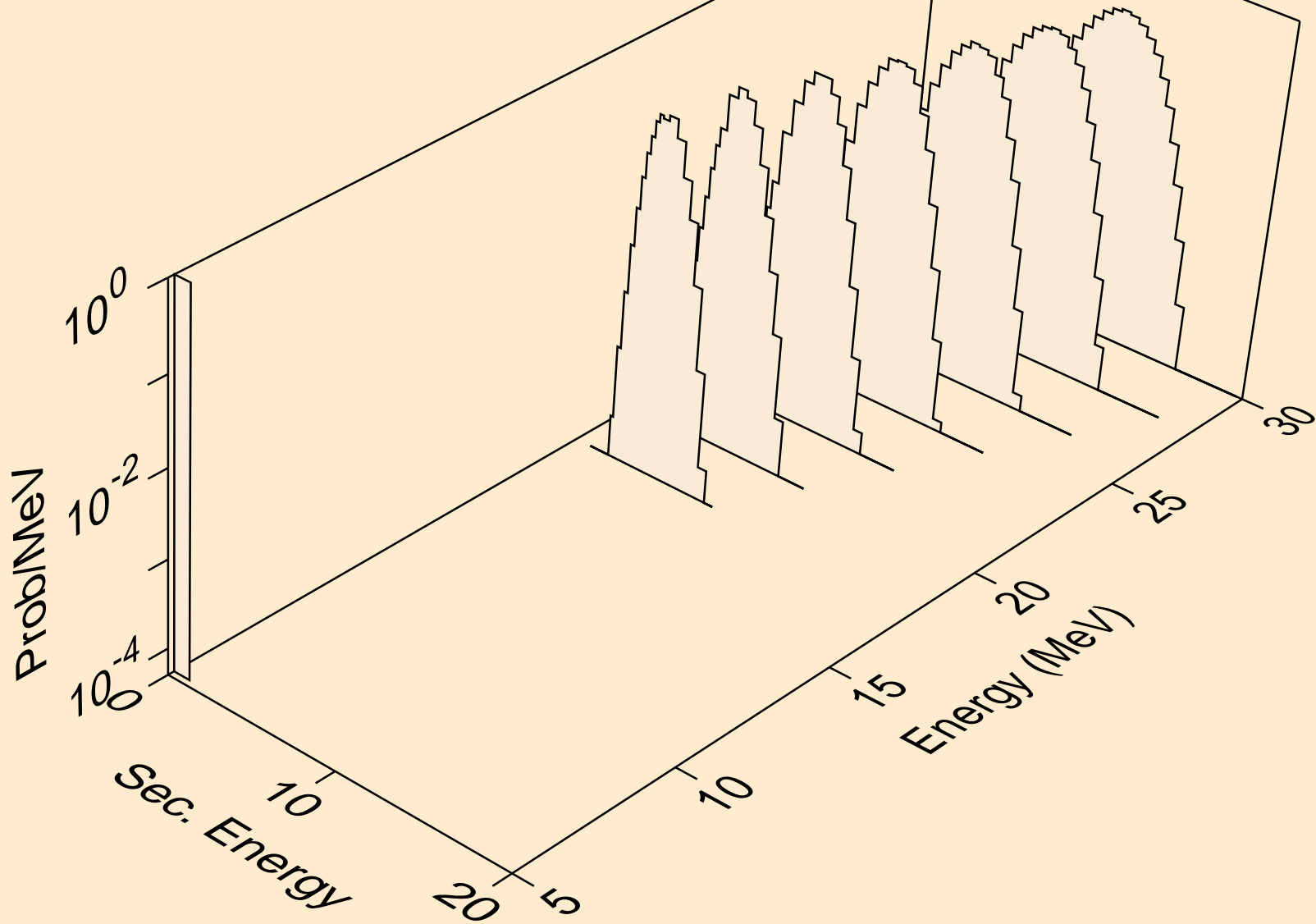

PB217 NEUTRON ACER TENDL-2021 LIBRARY; T=293.6K
deuterons from (n,x)

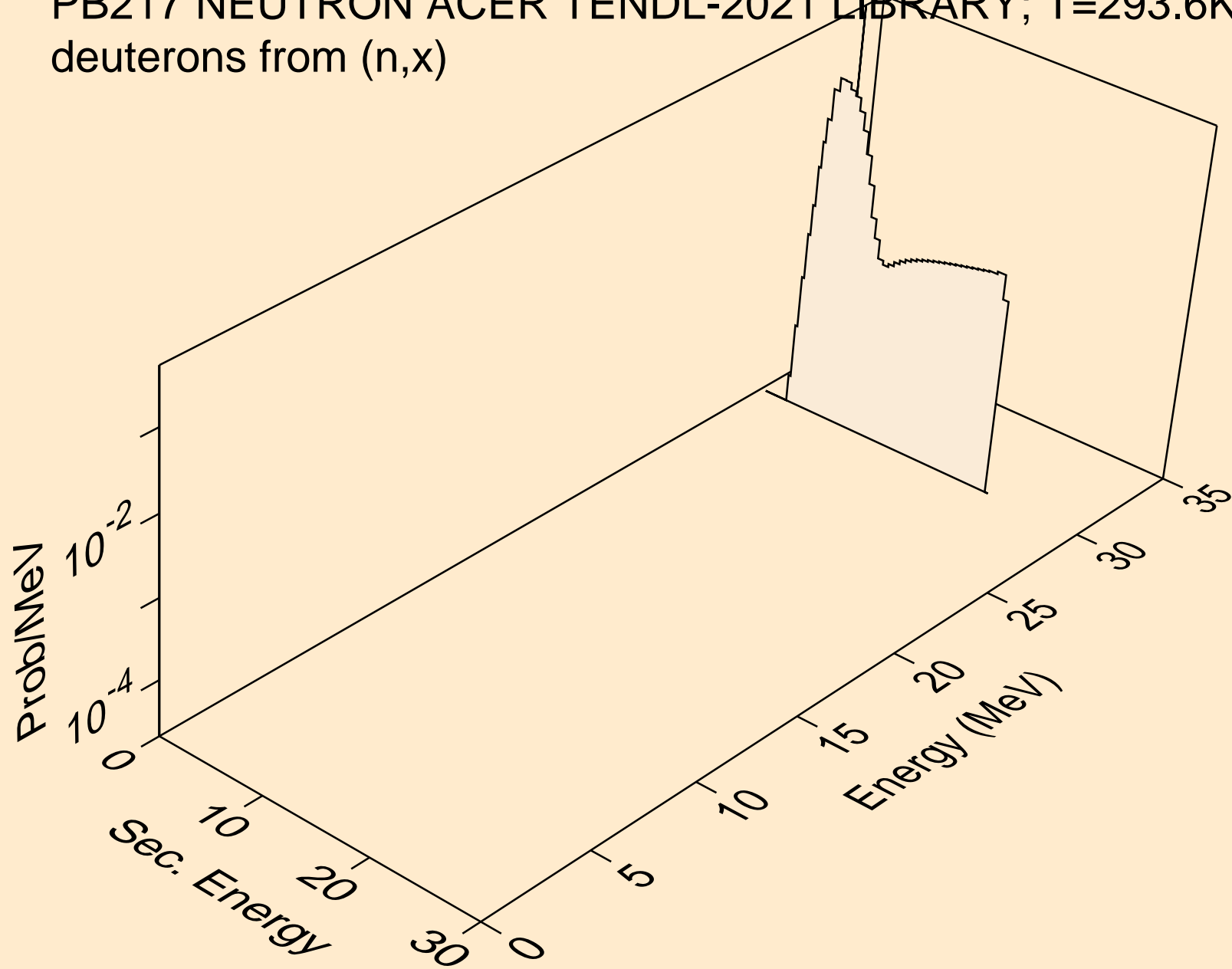

PB217 NEUTRON ACER TENDL-2021 LIBRARY; T=293.6K
deuterons from (n,2nd)

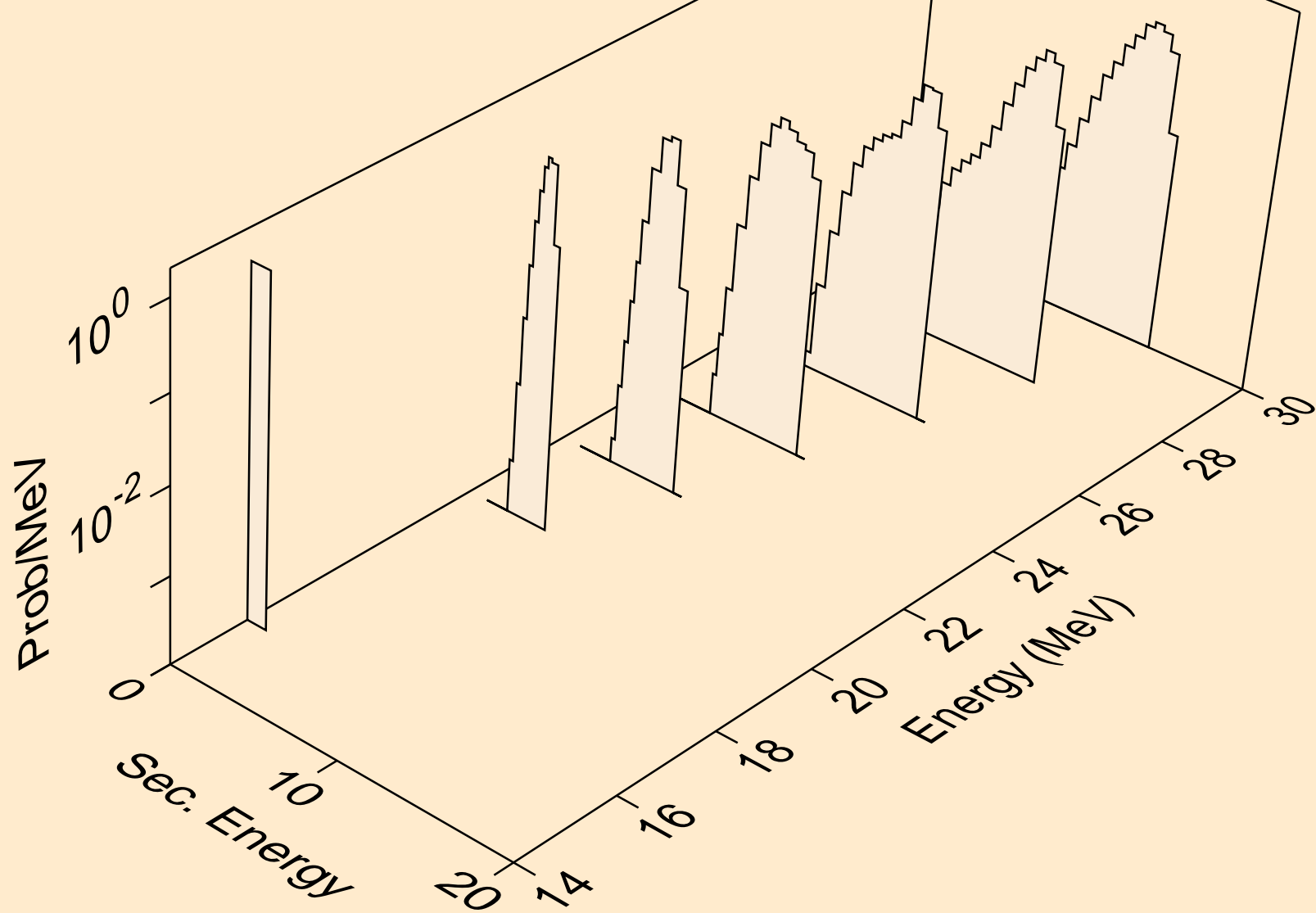

PB217 NEUTRON ACER TENDL-2021 LIBRARY; T=293.6K
deuterons from (n,n*)d

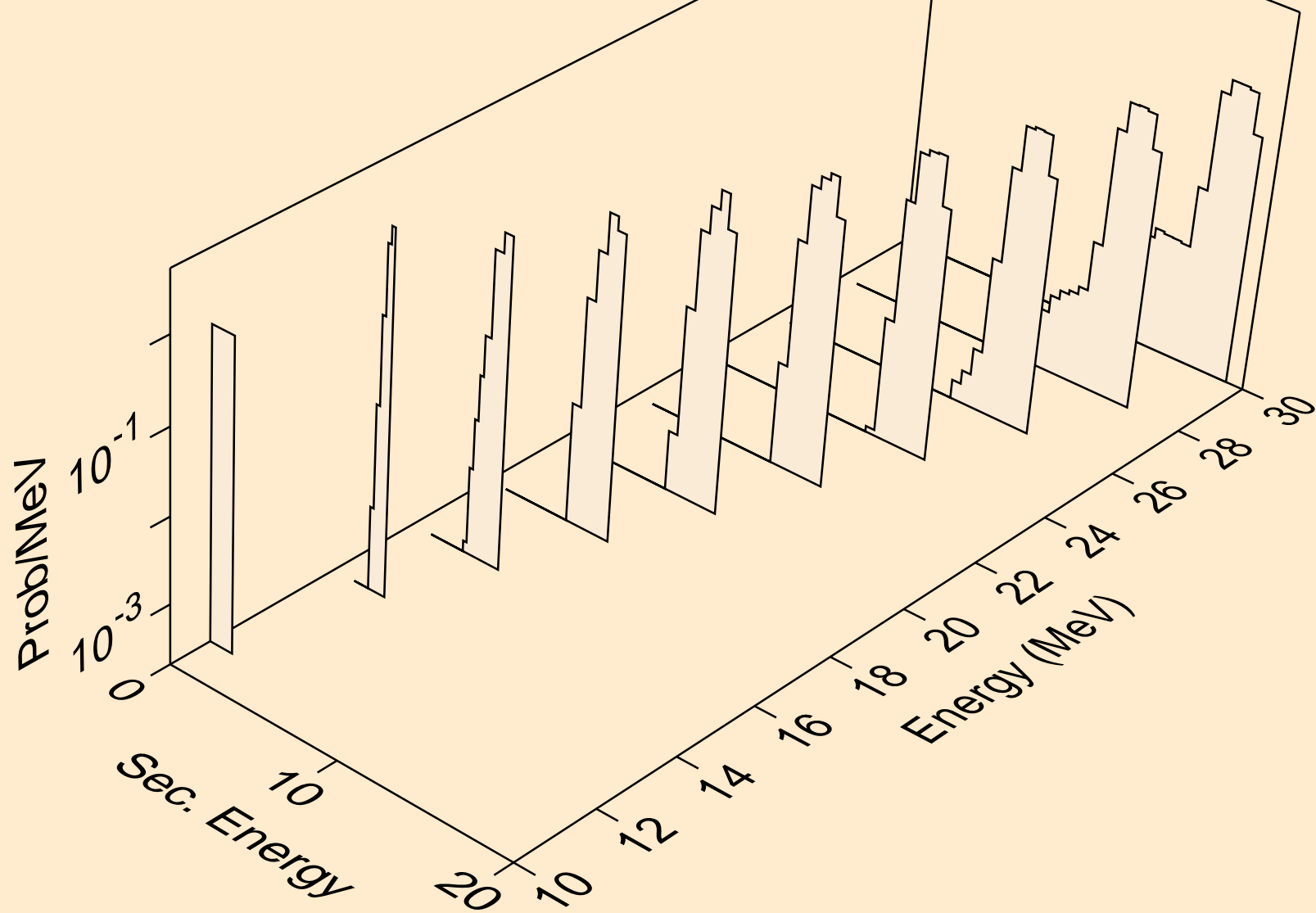

PB217 NEUTRON ACER TENDL-2021 LIBRARY; T=293.6K
deuterons from (n,d)

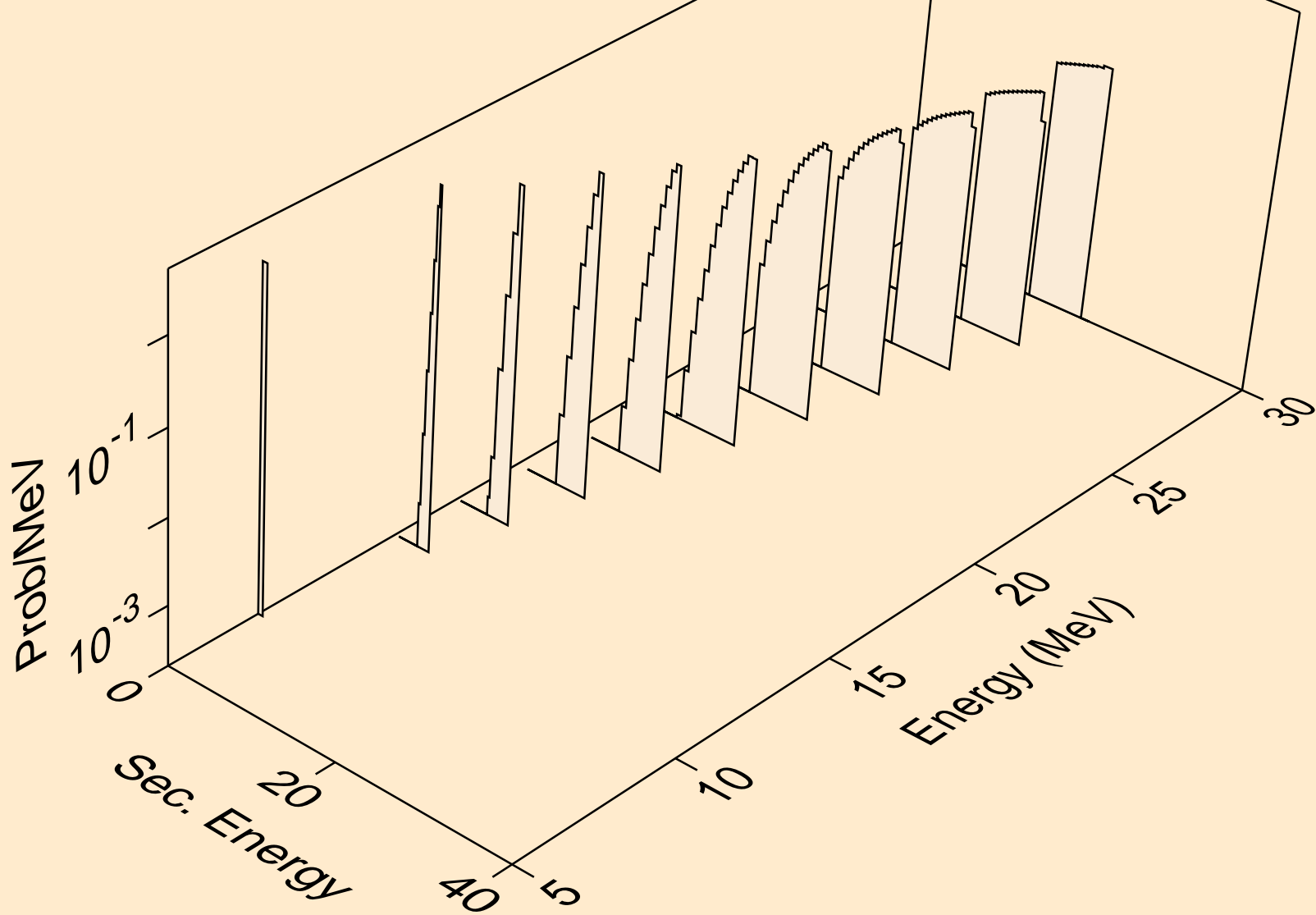

PB217 NEUTRON ACER TENDL-2021 LIBRARY; T=293.6K
deuterons from (n,da)

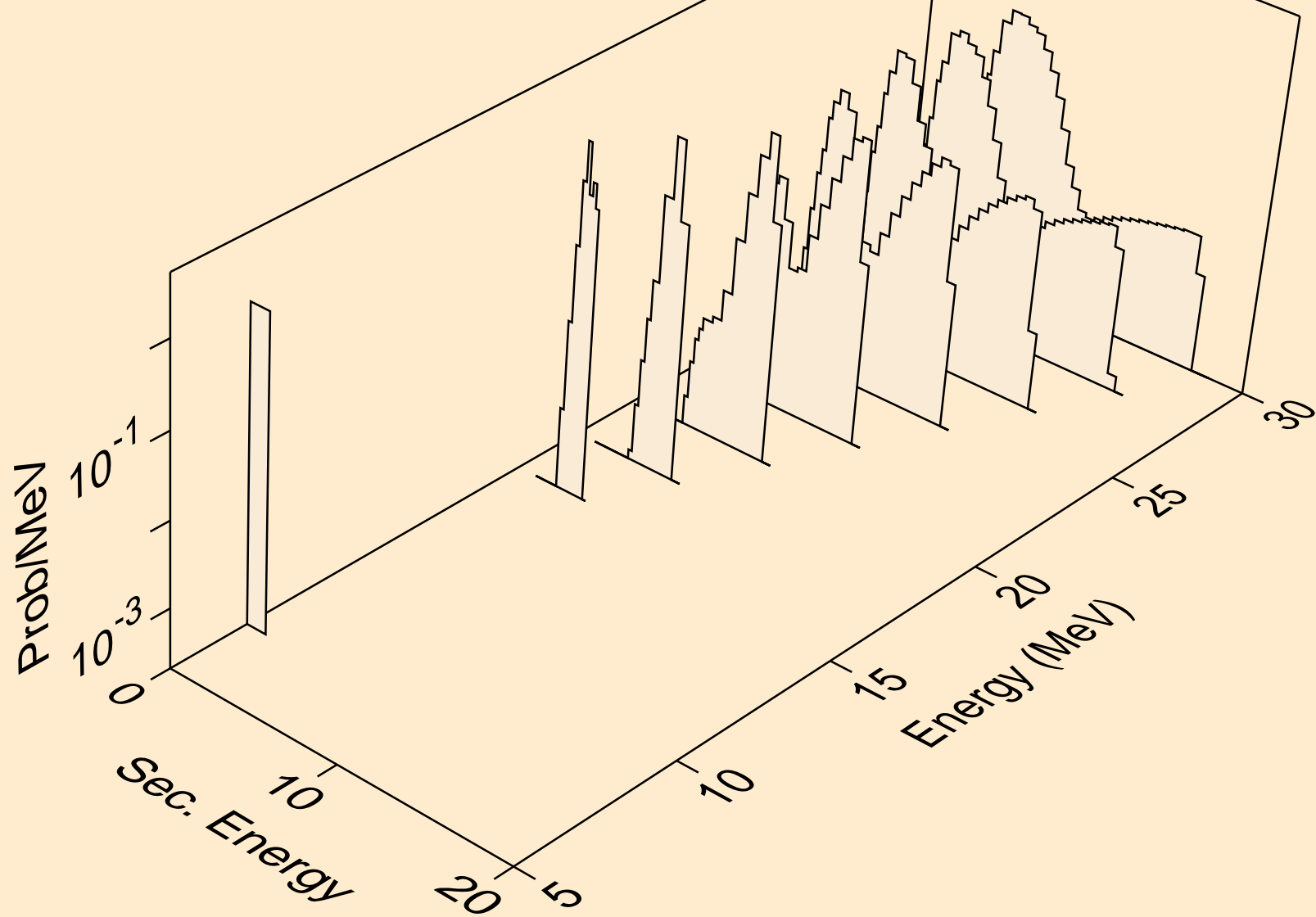

PB217 NEUTRON ACER TENDL-2021 LIBRARY; T=293.6K
tritons from (n,x)

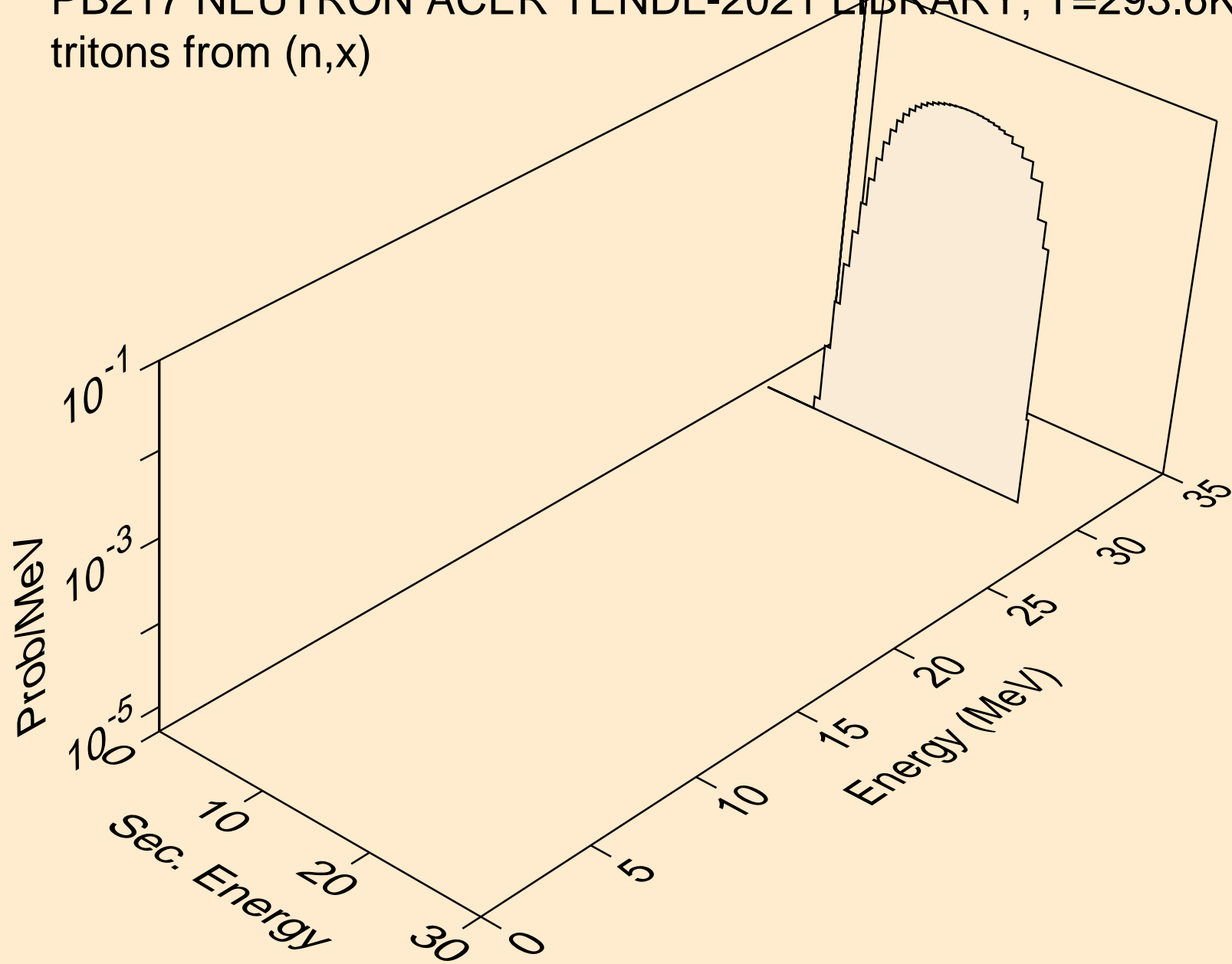

PB217 NEUTRON ACER TENDL-2021 LIBRARY; T=293.6K
tritons from (n,n*)t

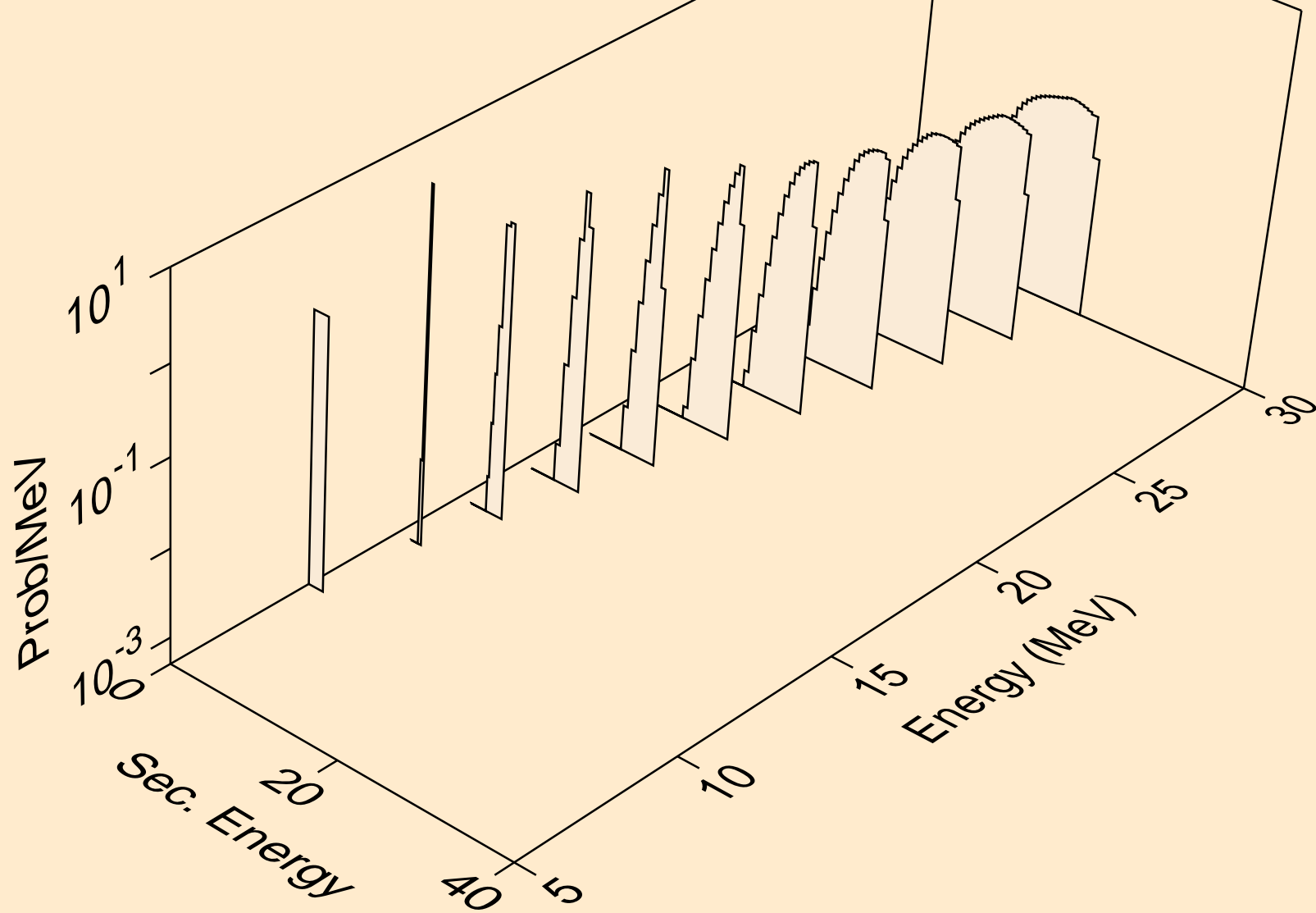

PB217 NEUTRON ACER TENDL-2021 LIBRARY; T=293.6K
tritons from (n,t)

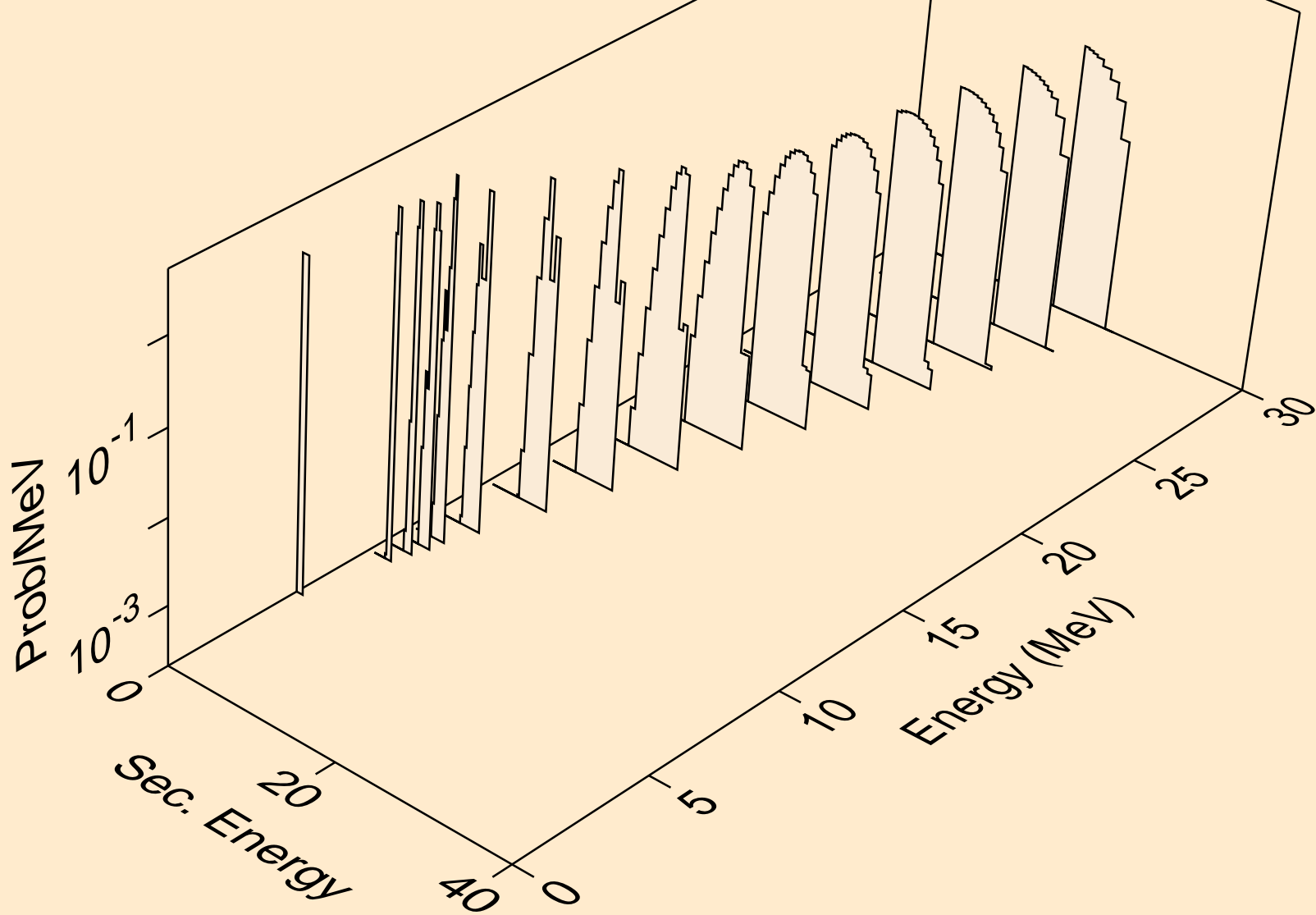

PB217 NEUTRON ACER TENDL-2021 LIBRARY; T=293.6K
he3s from (n,x)

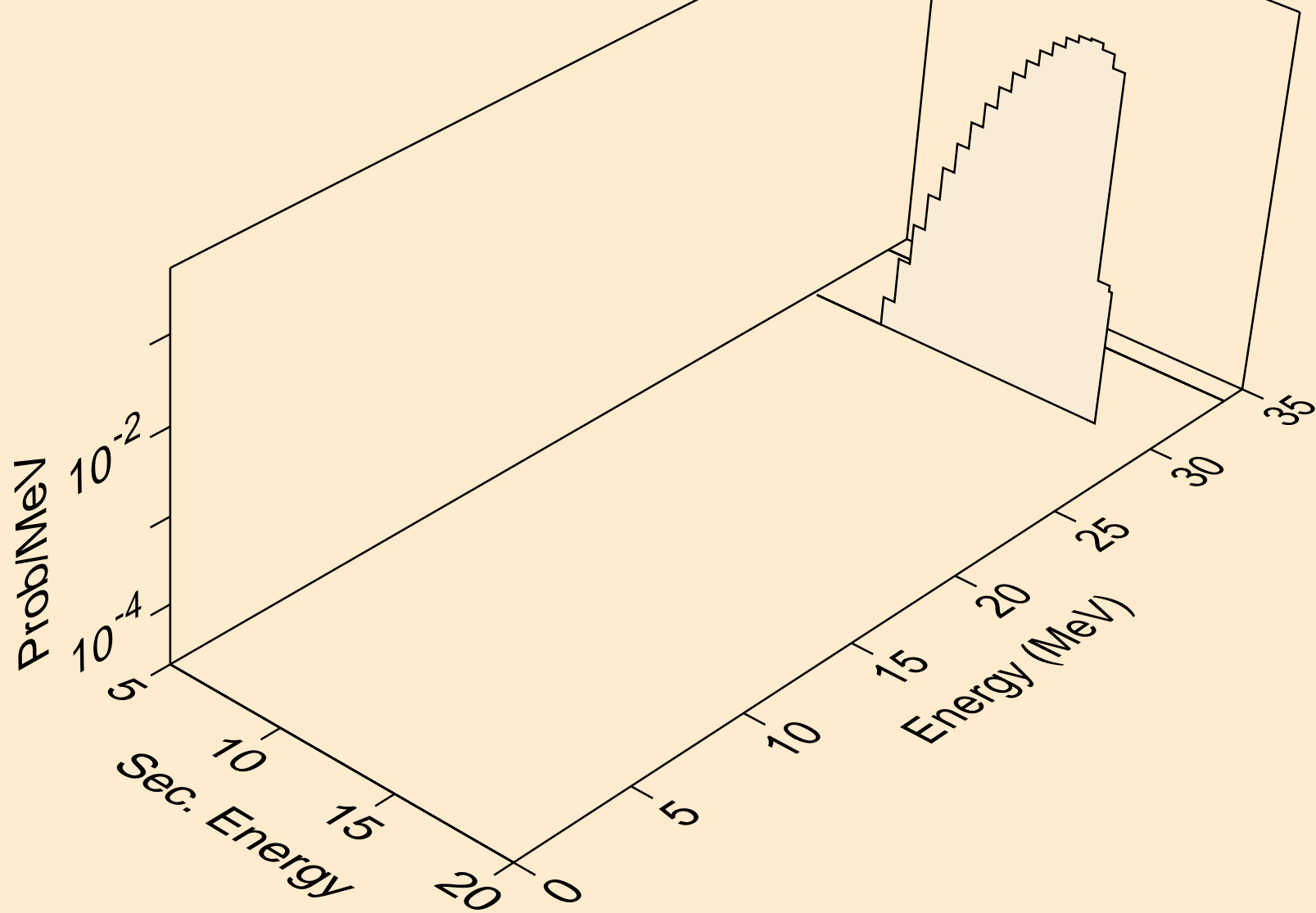

PB217 NEUTRON ACER TENDL-2021 LIBRARY; T=293.6K
he3s from (n,n*)he3

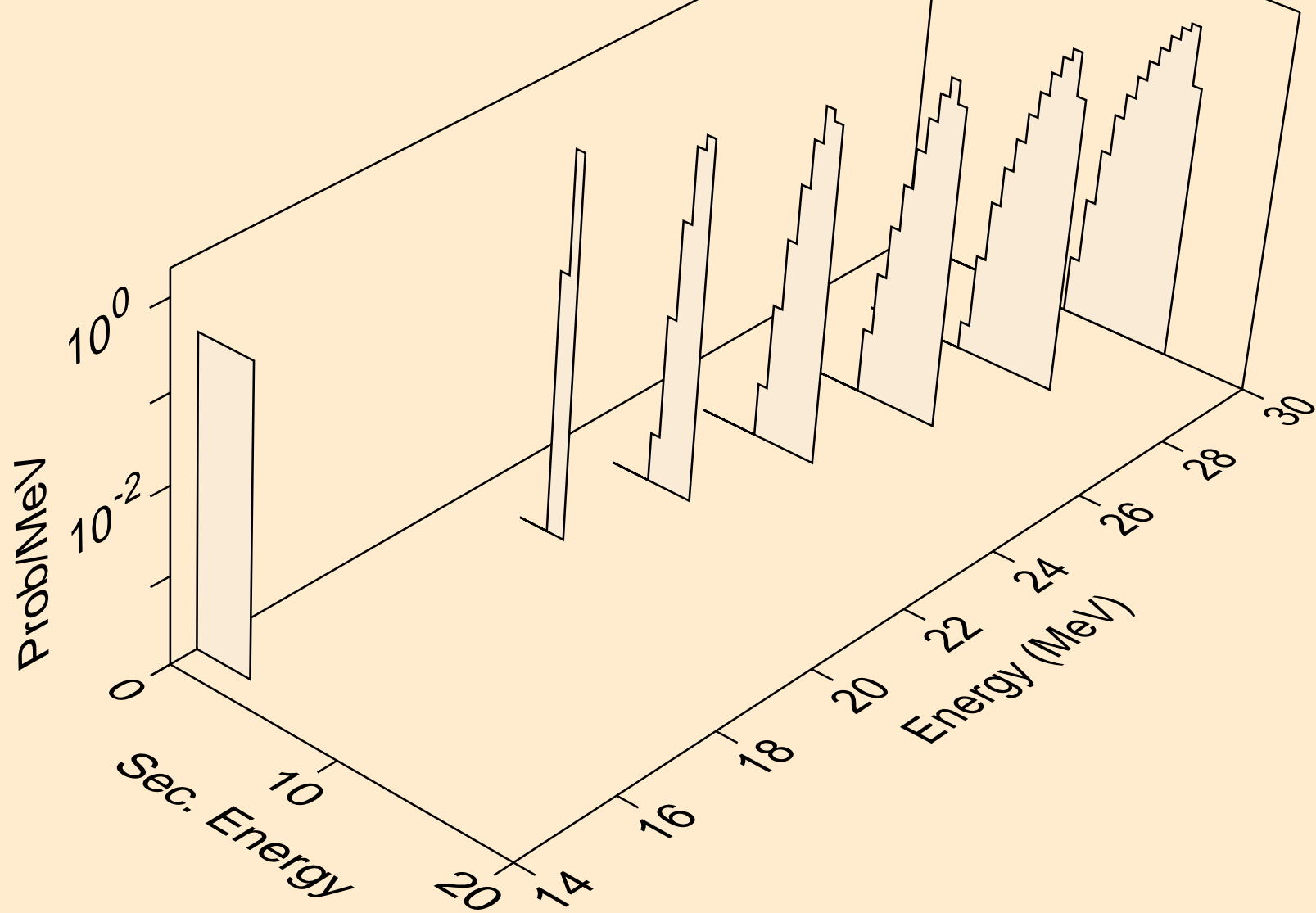

PB217 NEUTRON ACER TENDL-2021 LIBRARY; T=293.6K
he3s from (n,he3)

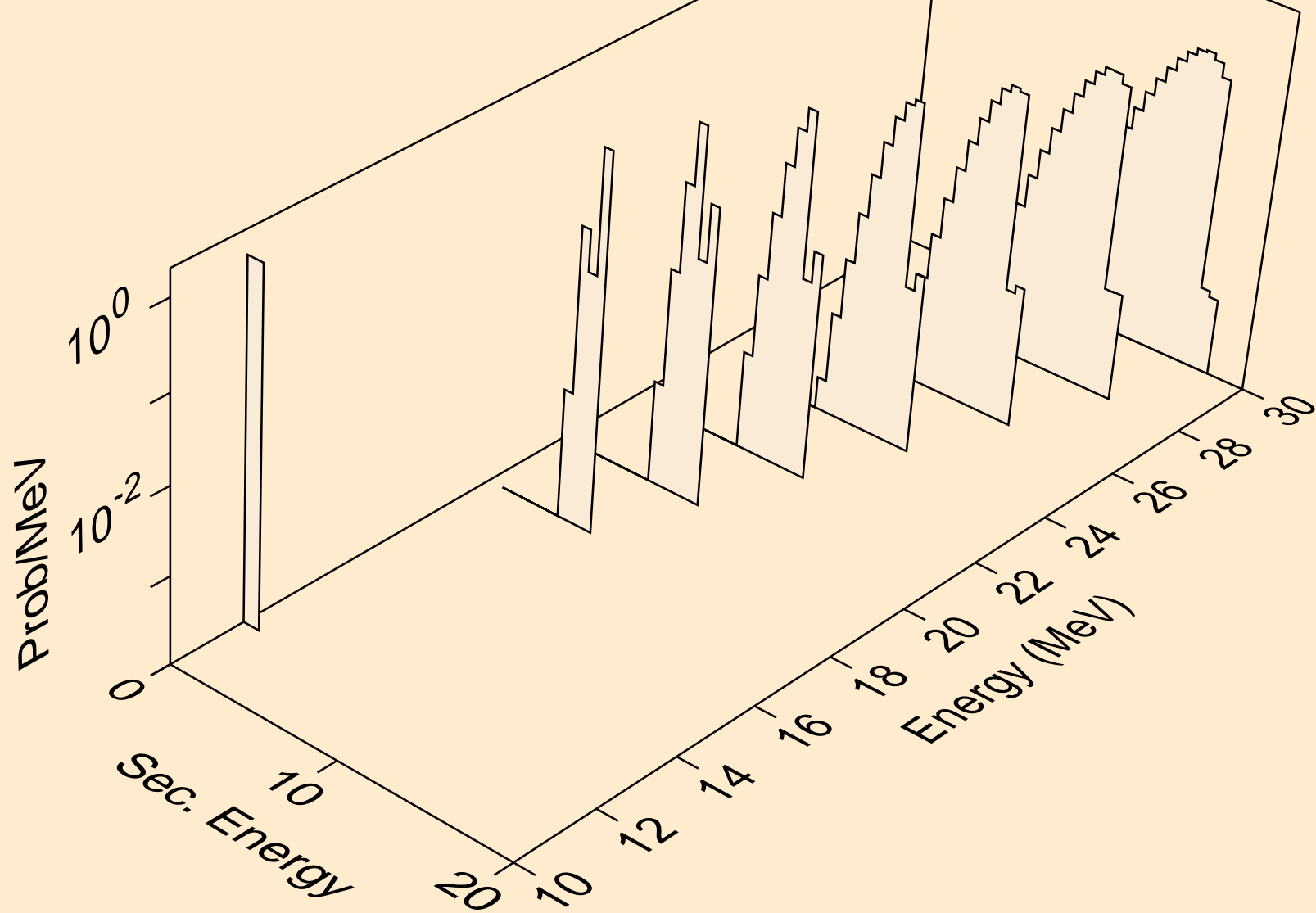

PB217 NEUTRON ACER TENDL-2021 LIBRARY; T=293.6K
alphas from (n,x)

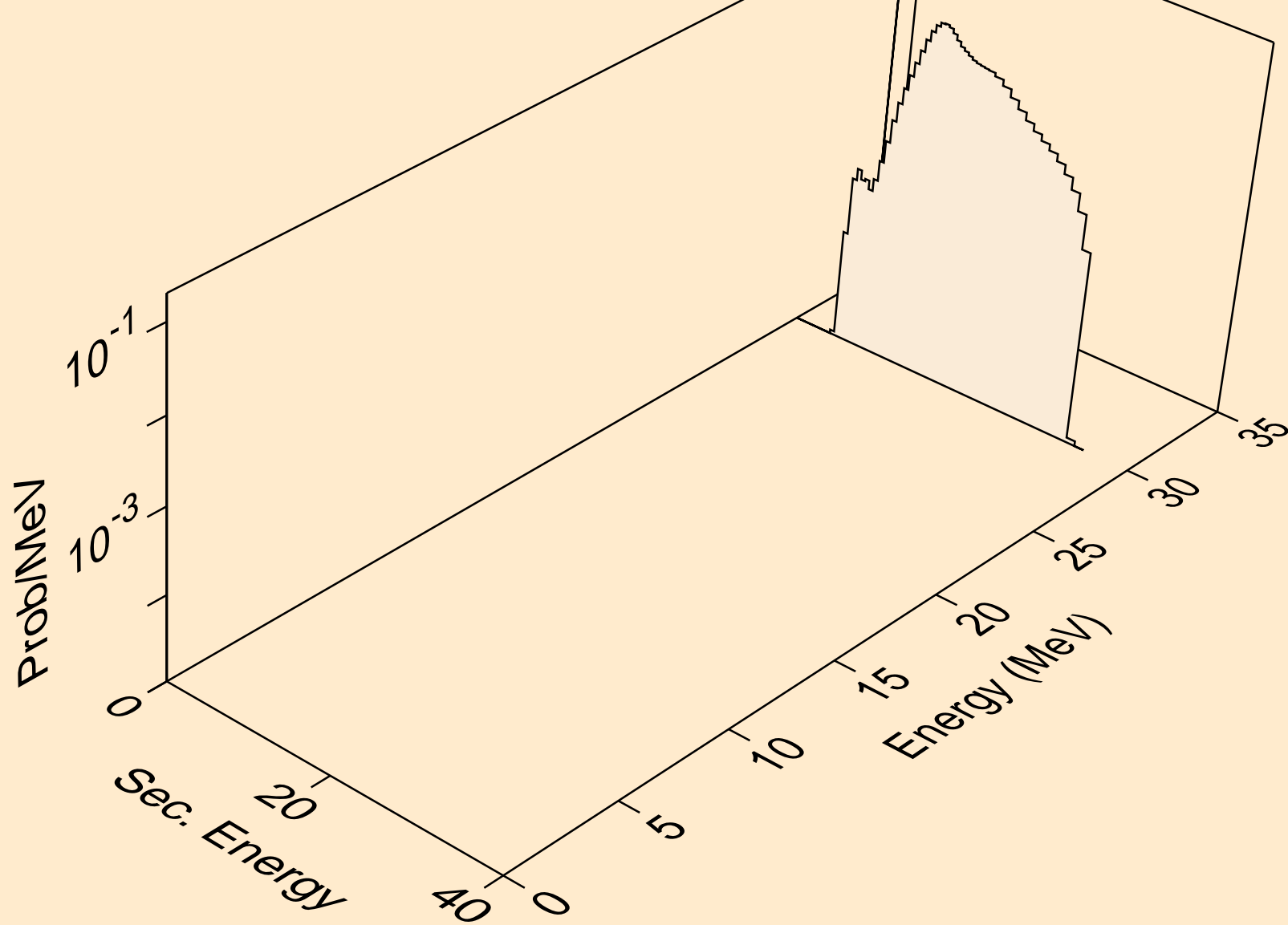

PB217 NEUTRON ACER TENDL-2021 LIBRARY; T=293.6K
alphas from (n,n*)a

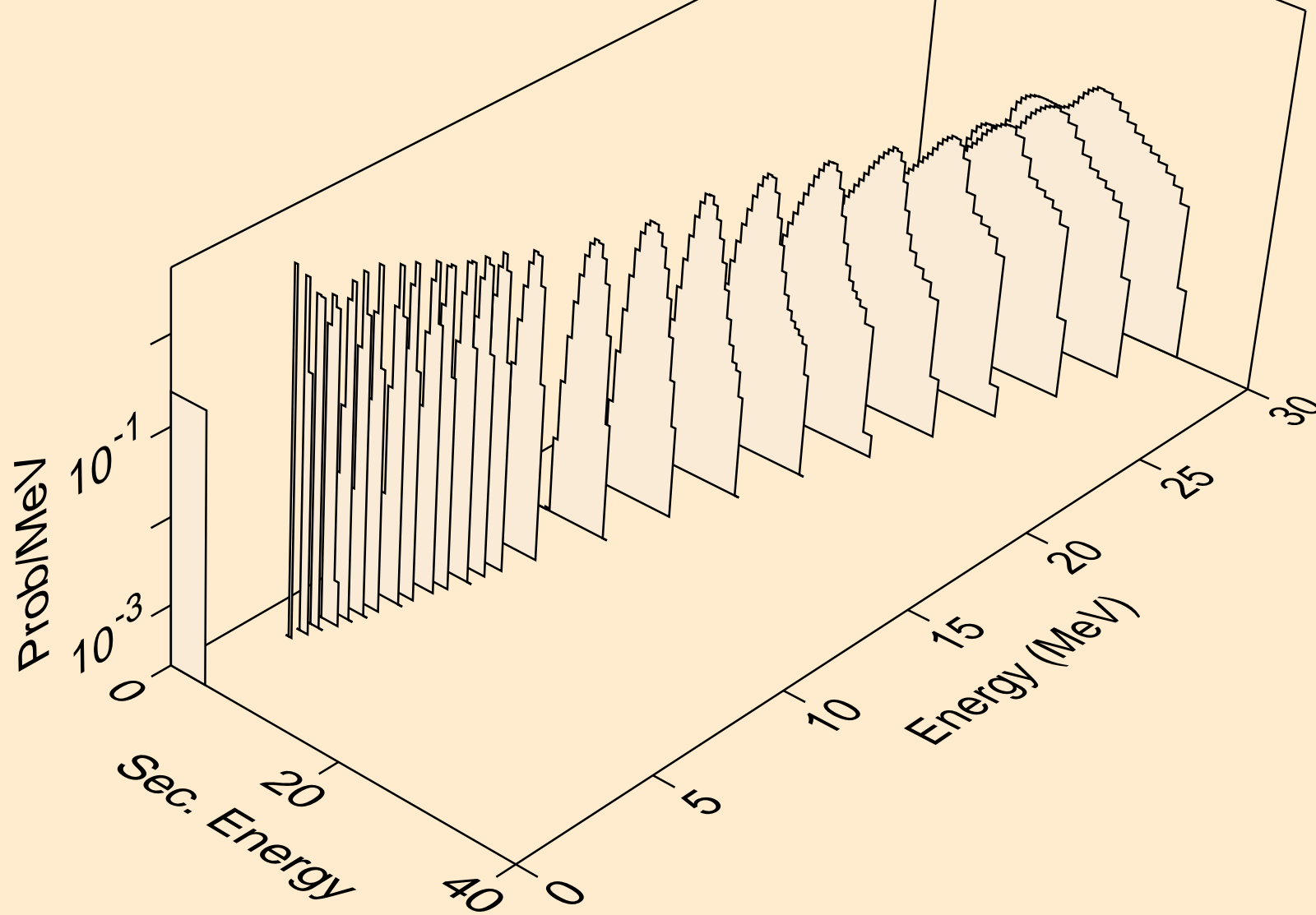

PB217 NEUTRON ACER TENDL-2021 LIBRARY; T=293.6K
alphas from (n,2n)a

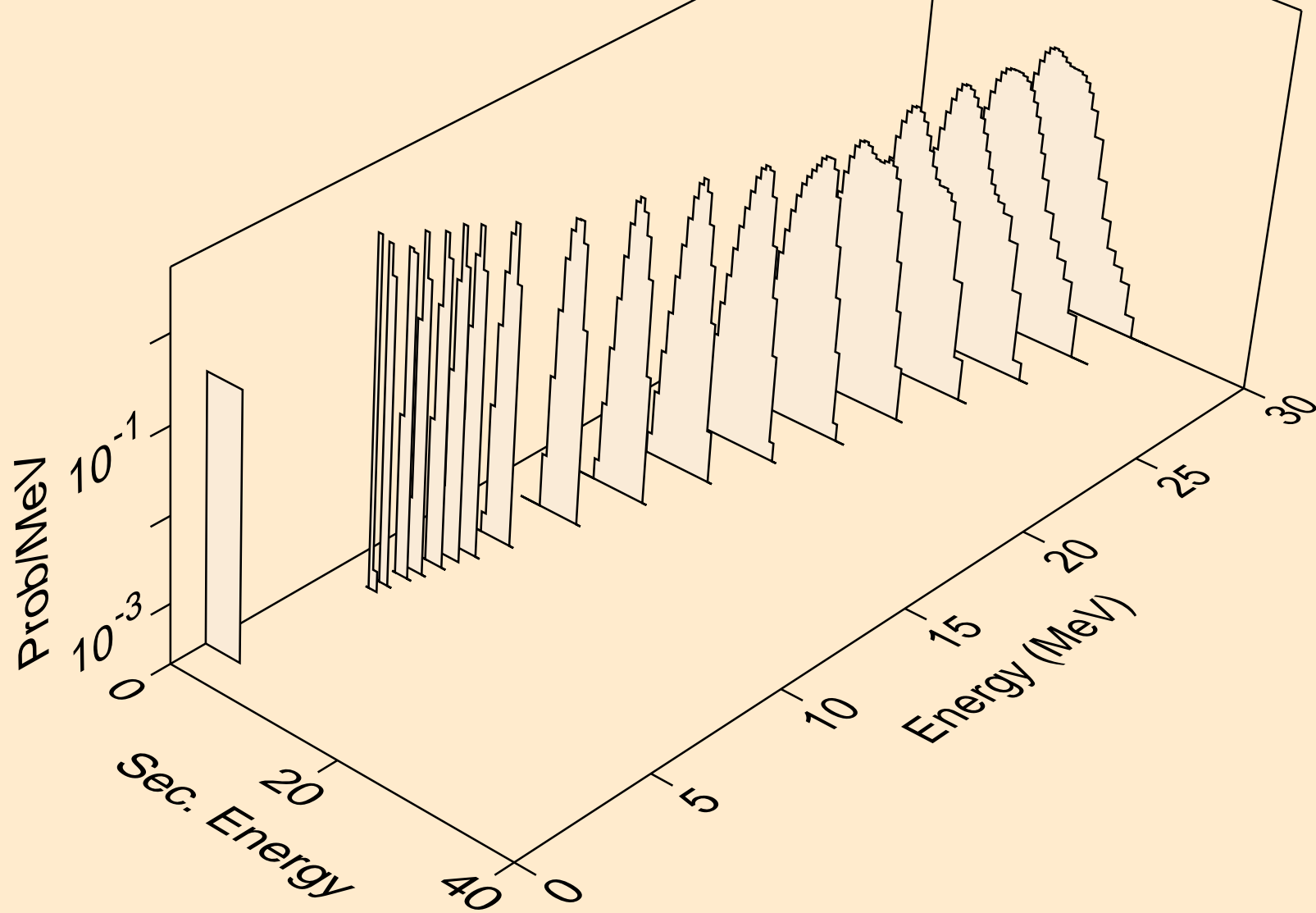

PB217 NEUTRON ACER TENDL-2021 LIBRARY; T=293.6K
alphas from (n,3n)a

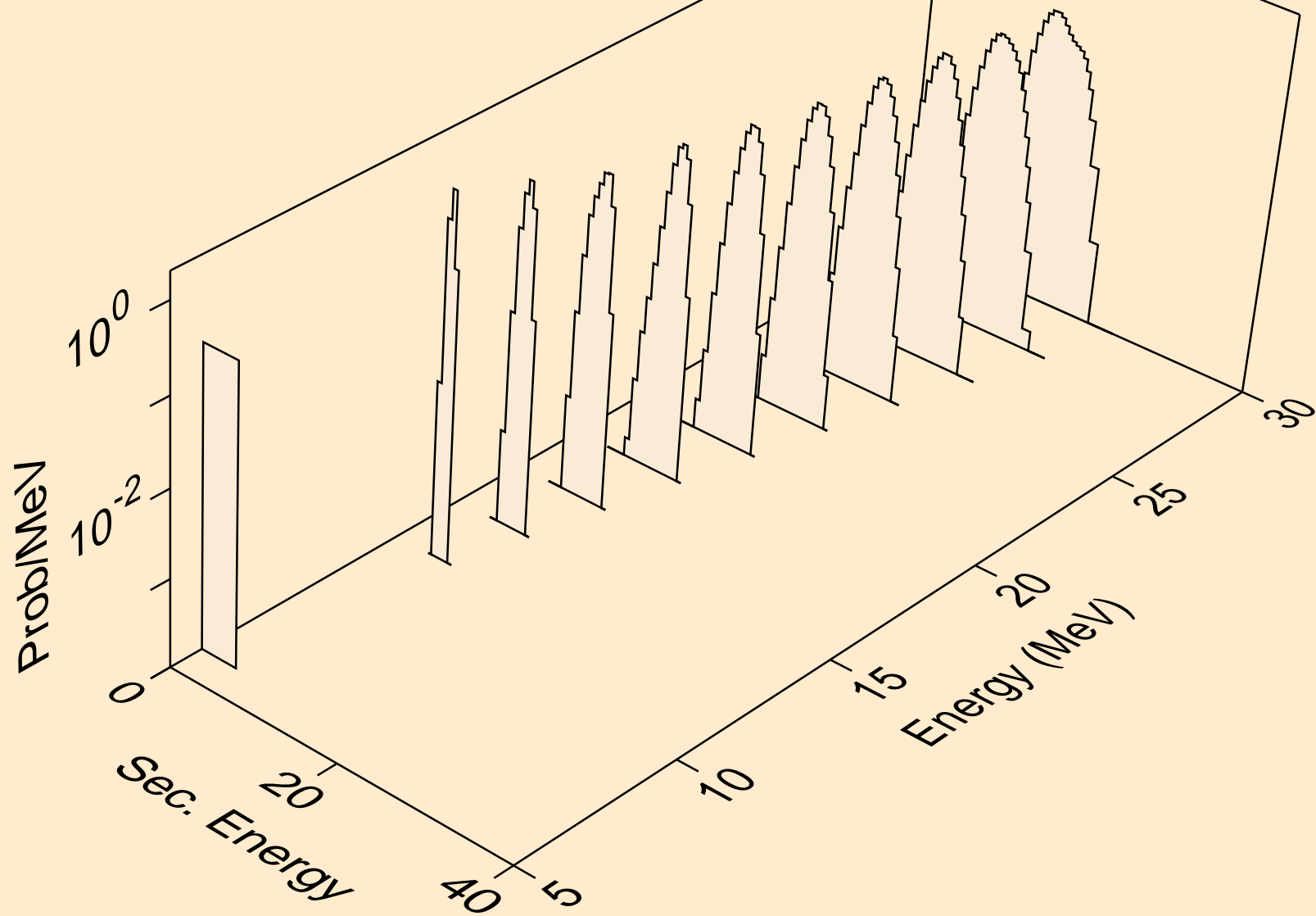

PB217 NEUTRON ACER TENDL-2021 LIBRARY; T=293.6K
alphas from (n,n*)2a

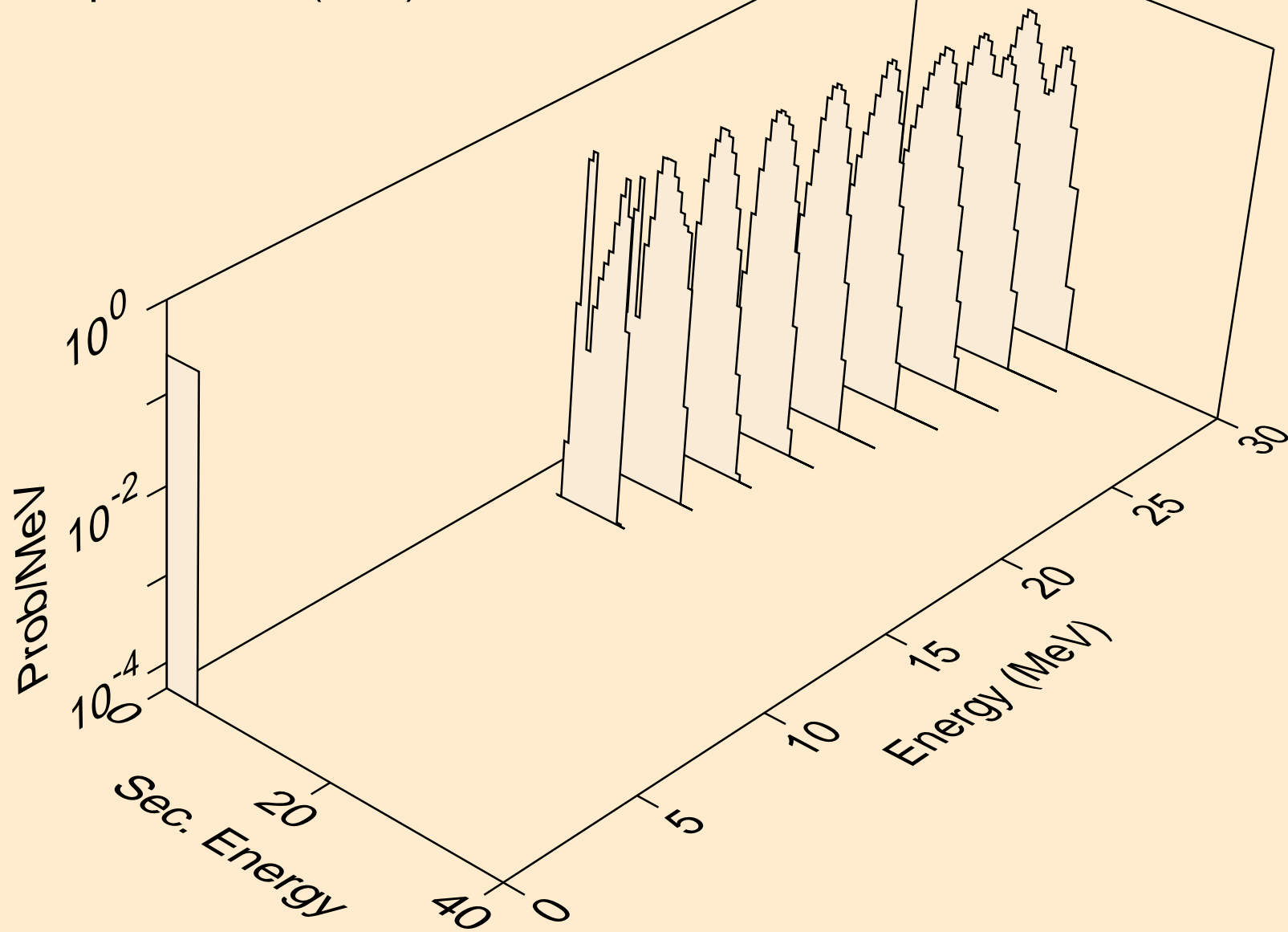

PB217 NEUTRON ACER TENDL-2021 LIBRARY; T=293.6K
alphas from (n,2n)2a

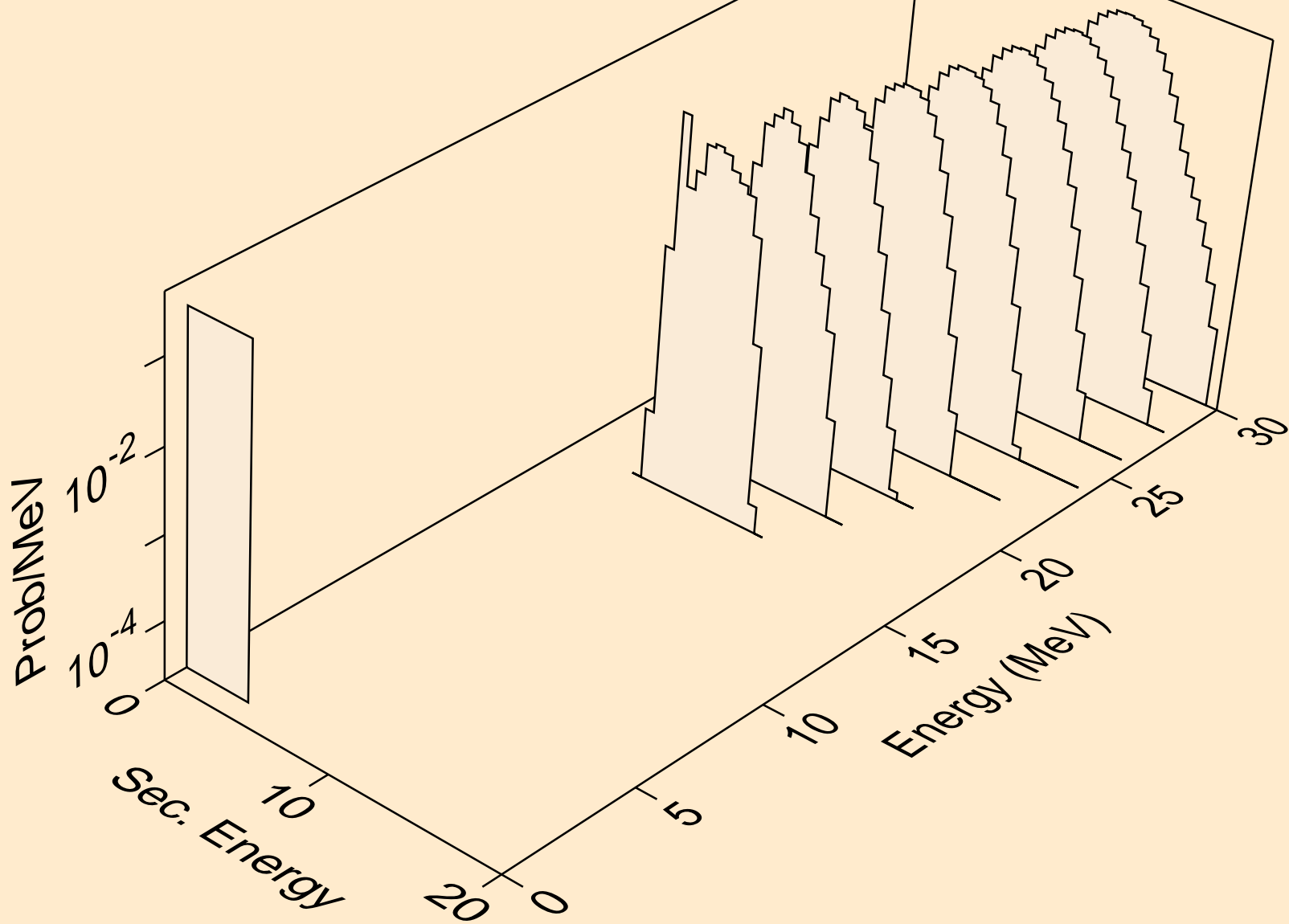

PB217 NEUTRON ACER TENDL-2021 LIBRARY; T=293.6K
alphas from (n,npa)

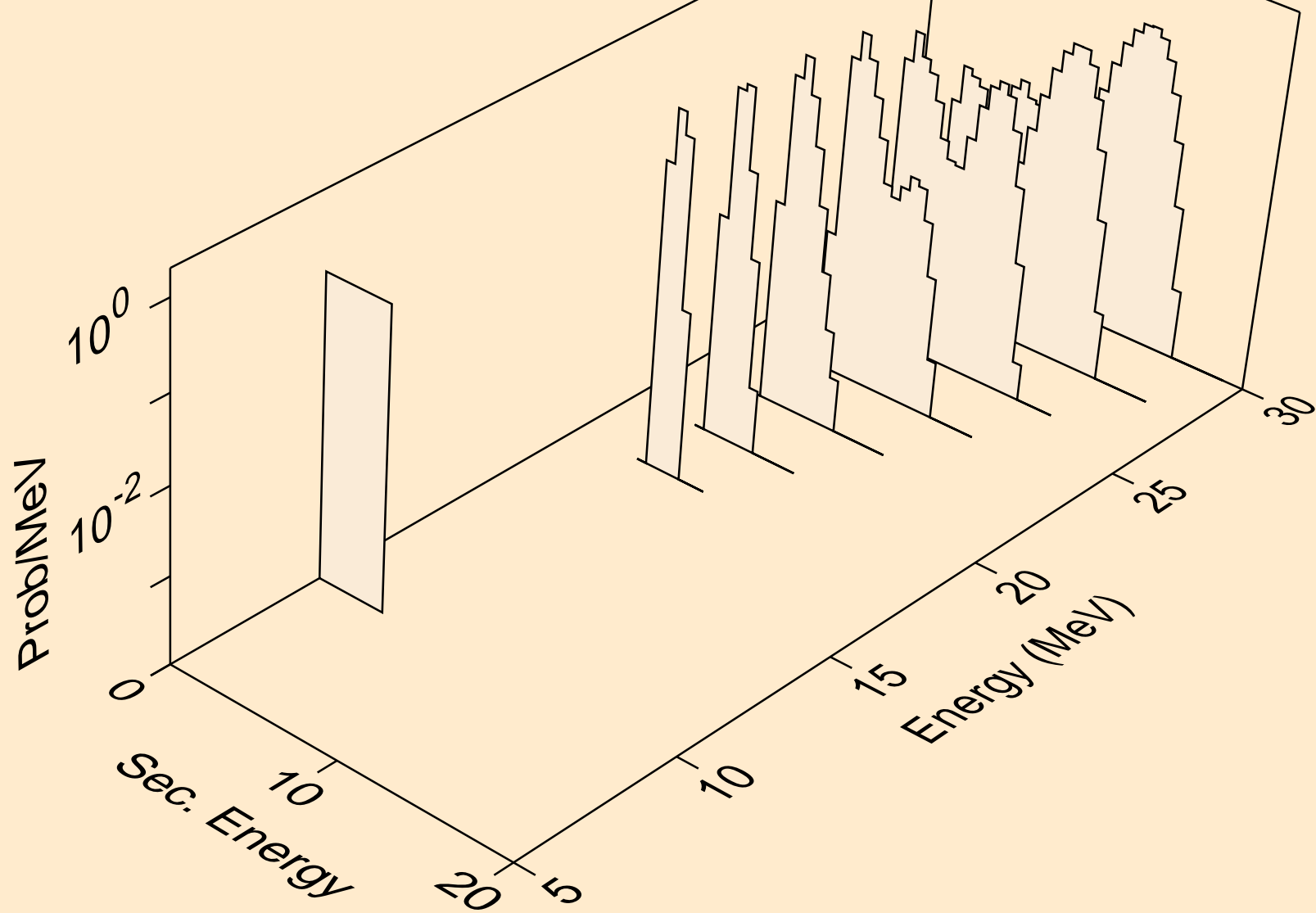

PB217 NEUTRON ACER TENDL-2021 LIBRARY; T=293.6K
alphas from (n,a)

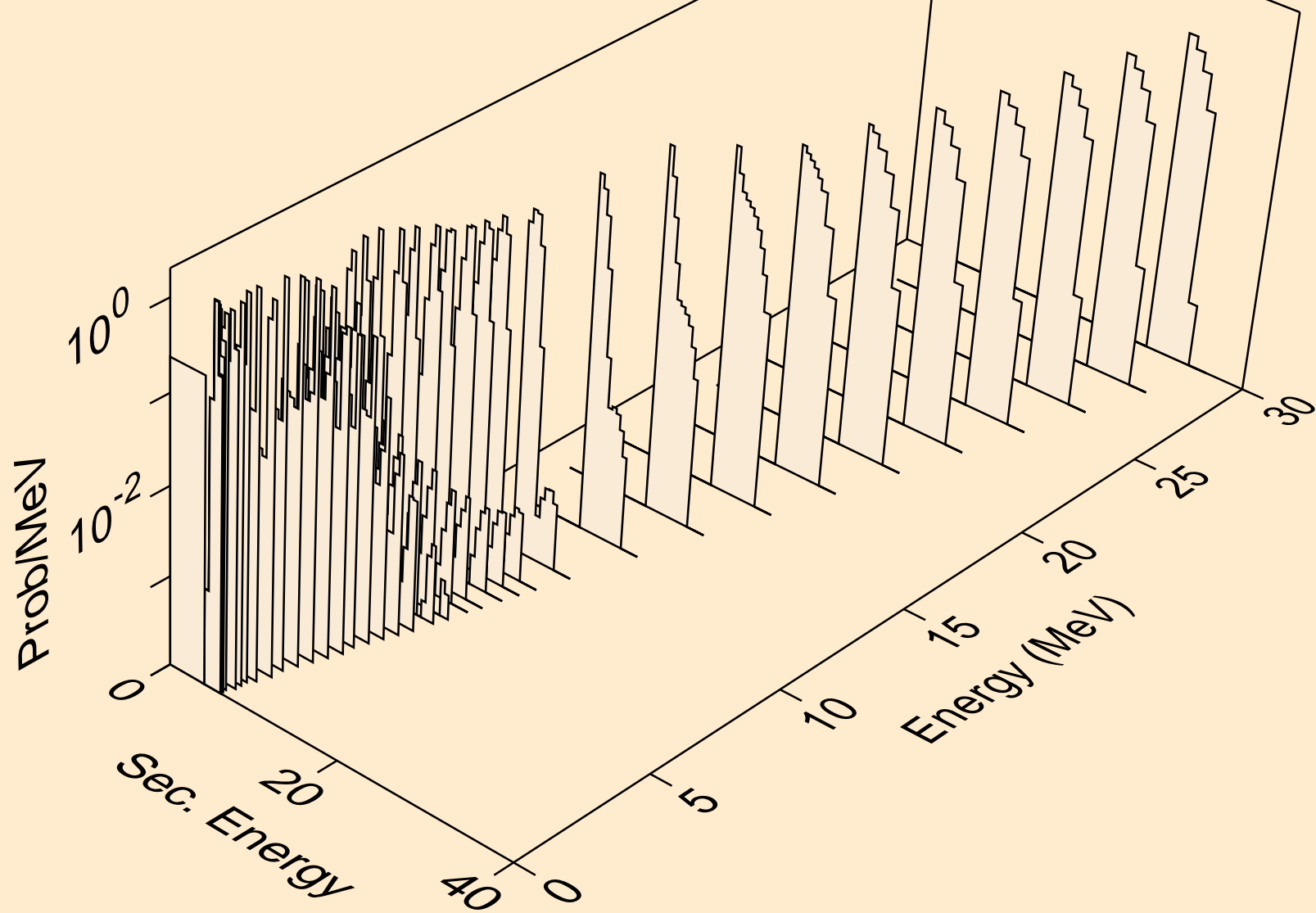

PB217 NEUTRON ACER TENDL-2021 LIBRARY; T=293.6K
alphas from (n,2a)

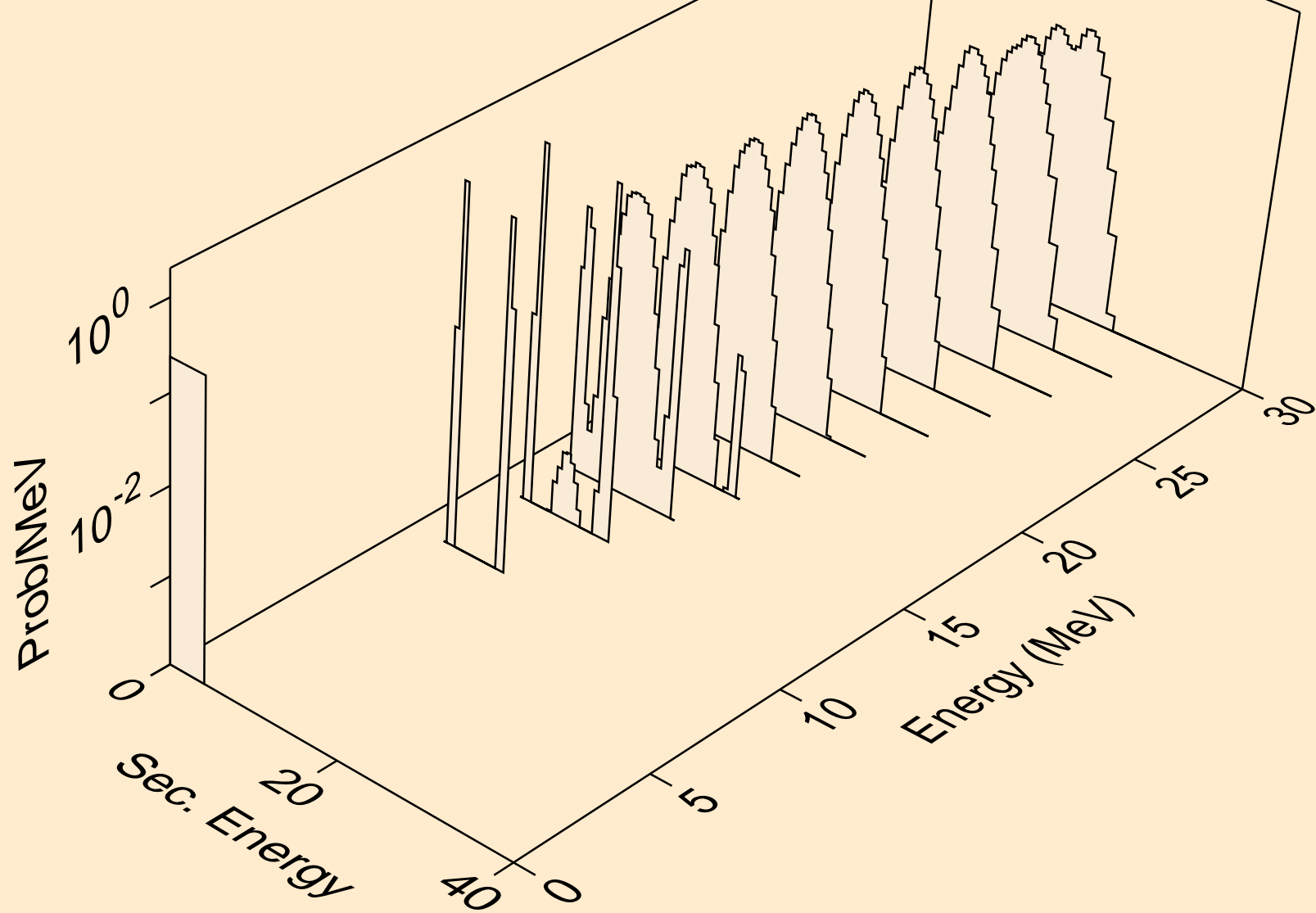

PB217 NEUTRON ACER TENDL-2021 LIBRARY; T=293.6K
alphas from (n,pa)

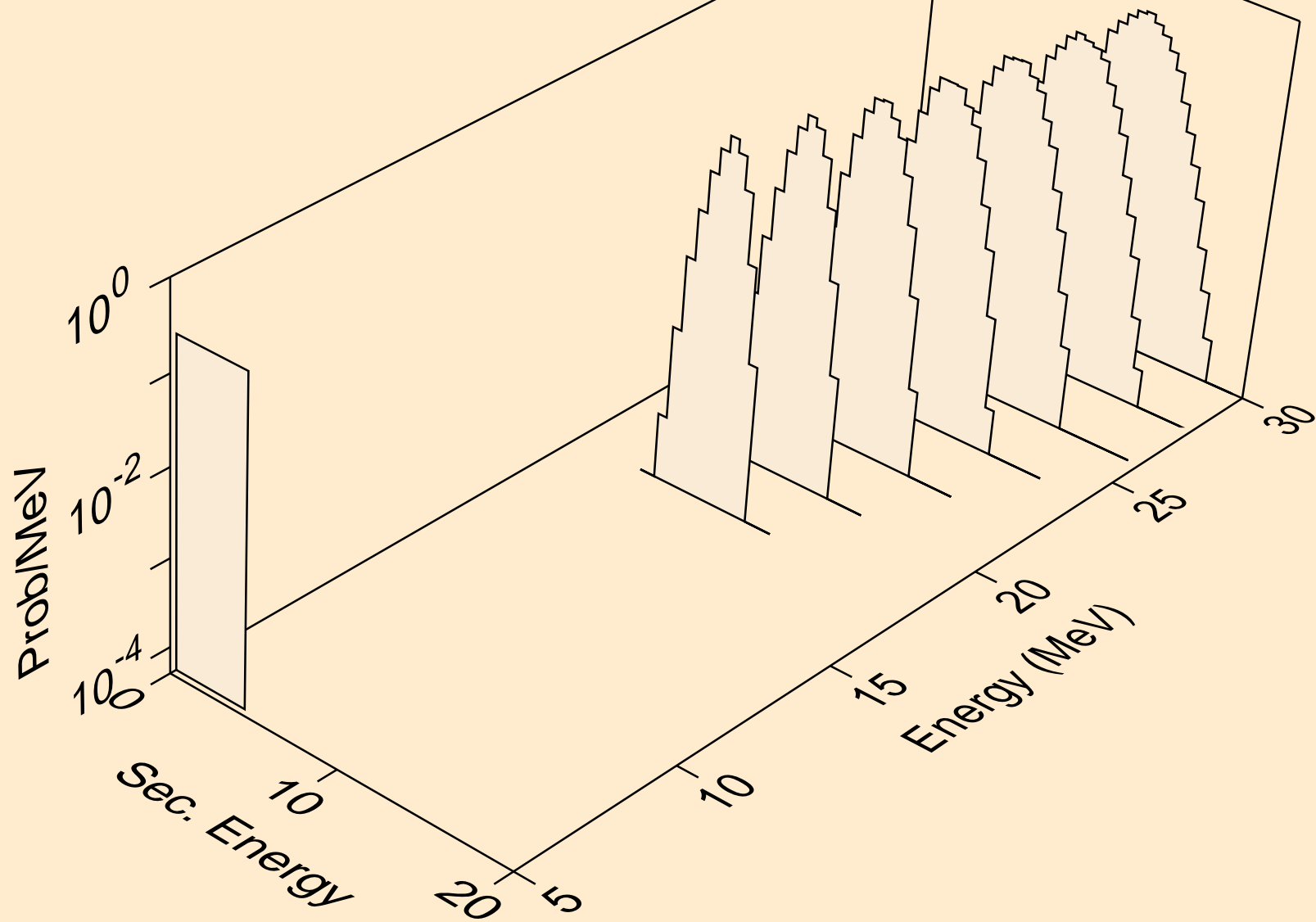

PB217 NEUTRON ACER TENDL-2021 LIBRARY; T=293.6K
alphas from (n,da)

