

PD094 NEUTRON ACER TENDL-2021 LIBRARY; T=293.6K
Principal cross sections

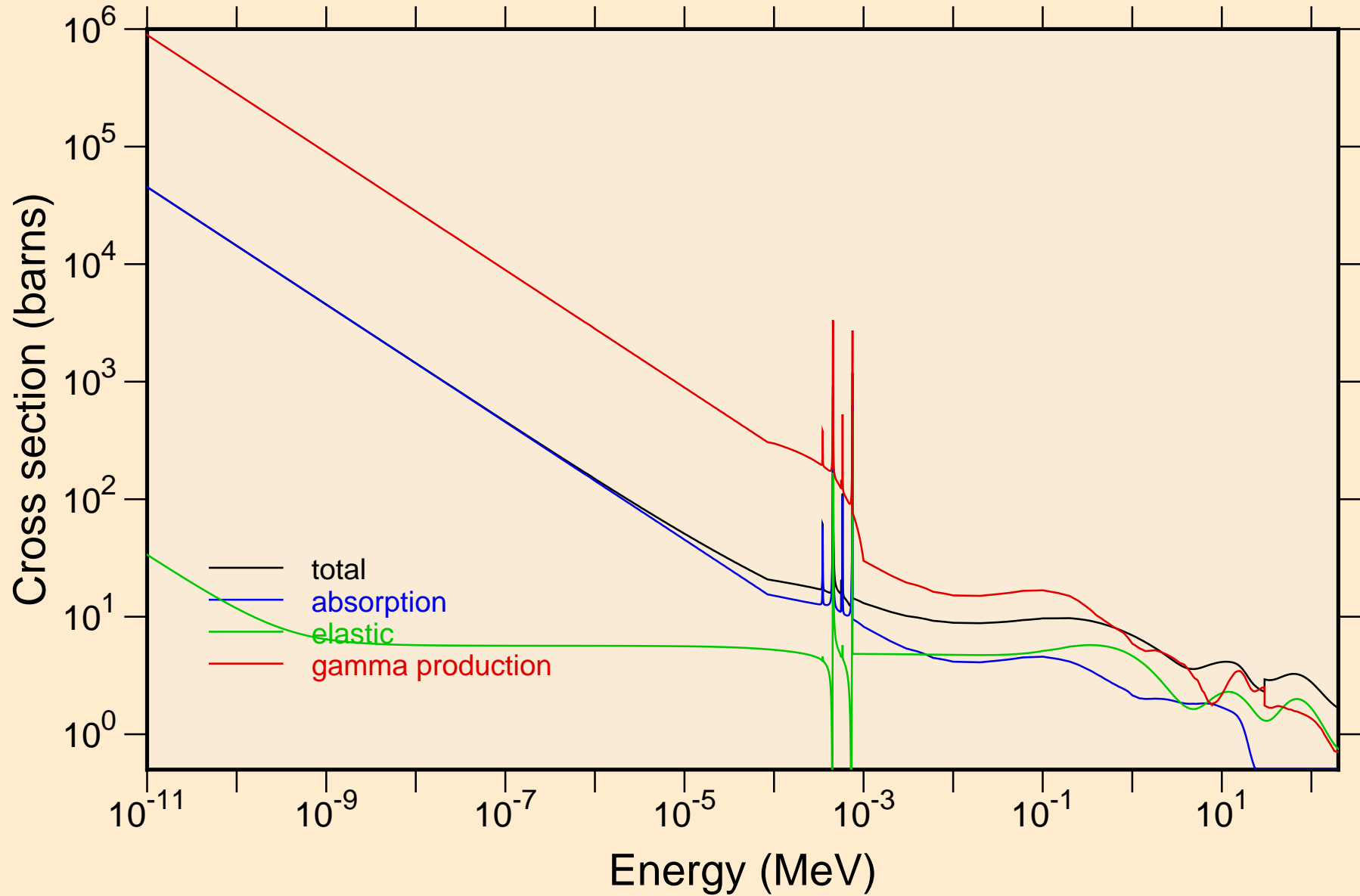

PD094 NEUTRON ACER TENDL-2021 LIBRARY; T=293.6K
resonance total cross section

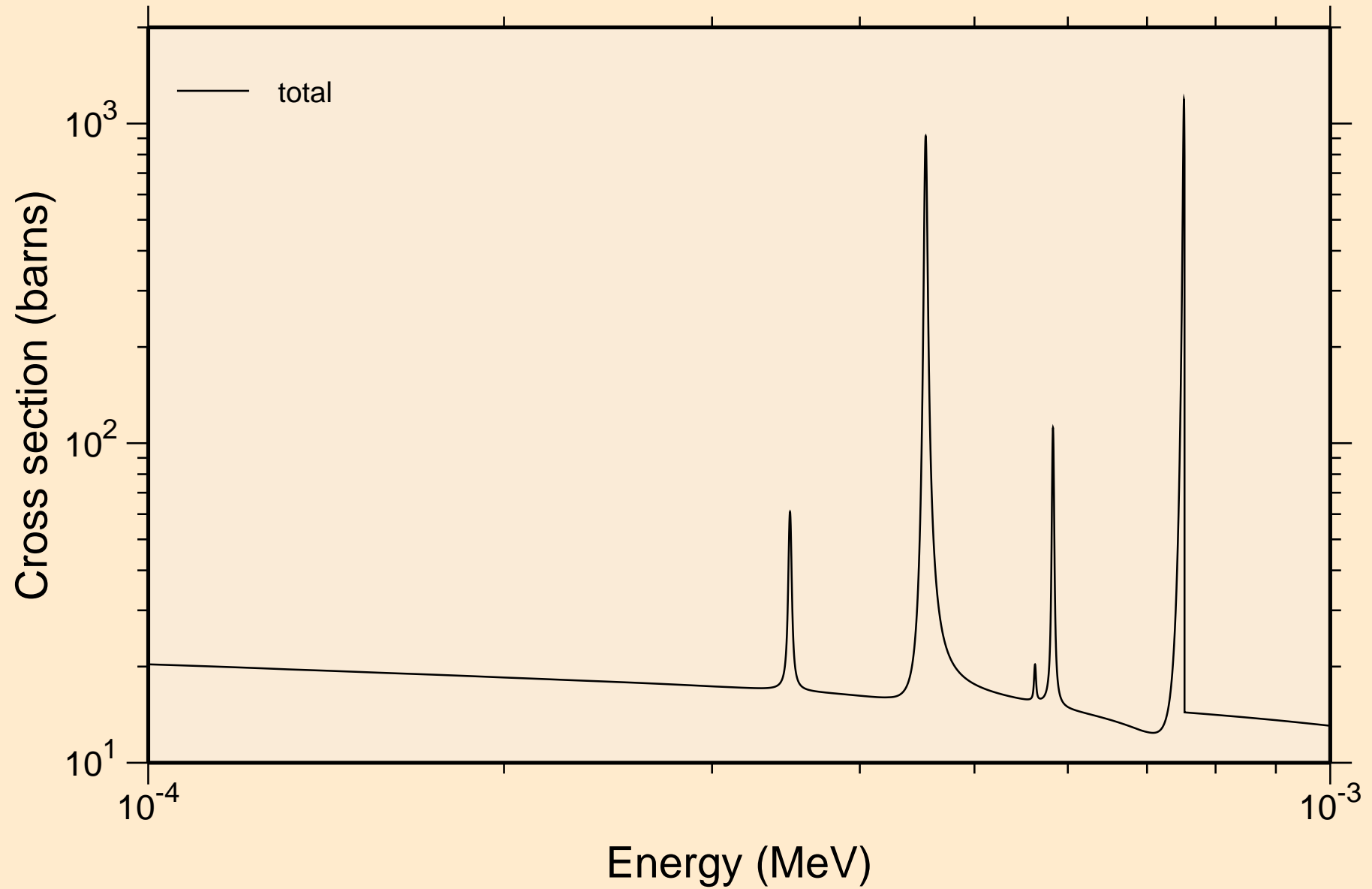

PD094 NEUTRON ACER TENDL-2021 LIBRARY; T=293.6K
resonance total cross section

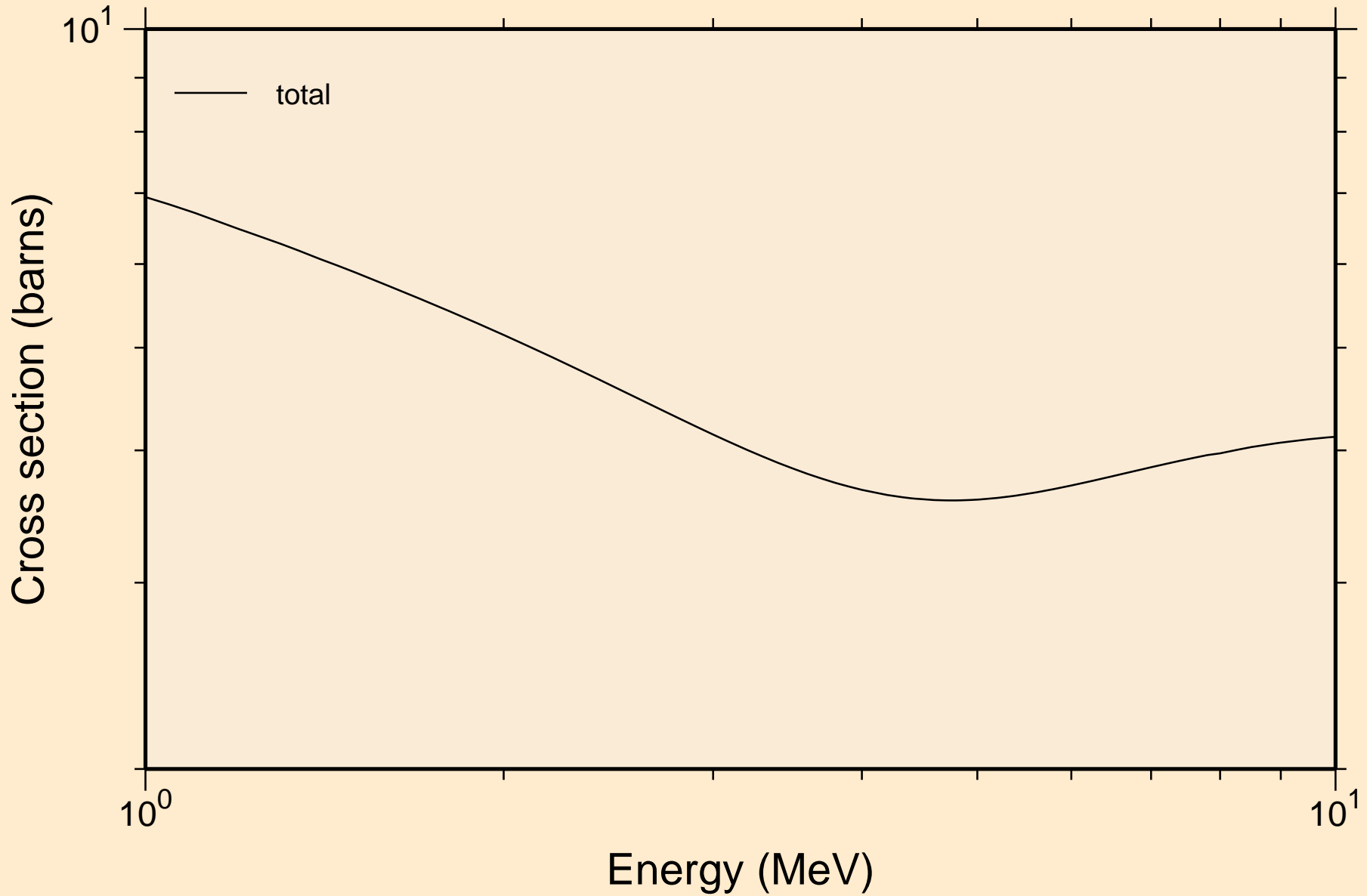

PD094 NEUTRON ACER TENDL-2021 LIBRARY; T=293.6K
resonance absorption cross sections

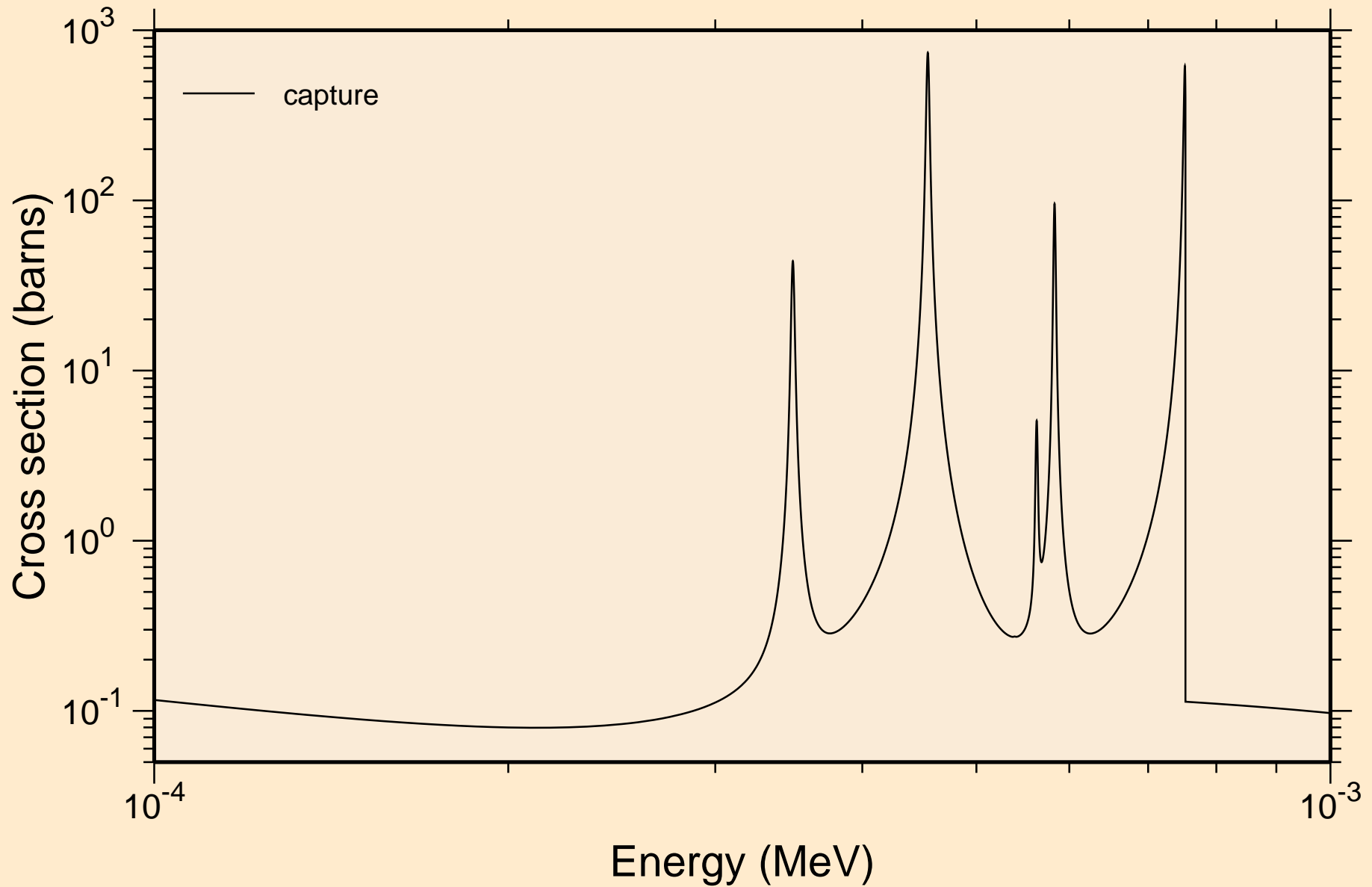

PD094 NEUTRON ACER TENDL-2021 LIBRARY; T=293.6K
resonance absorption cross sections

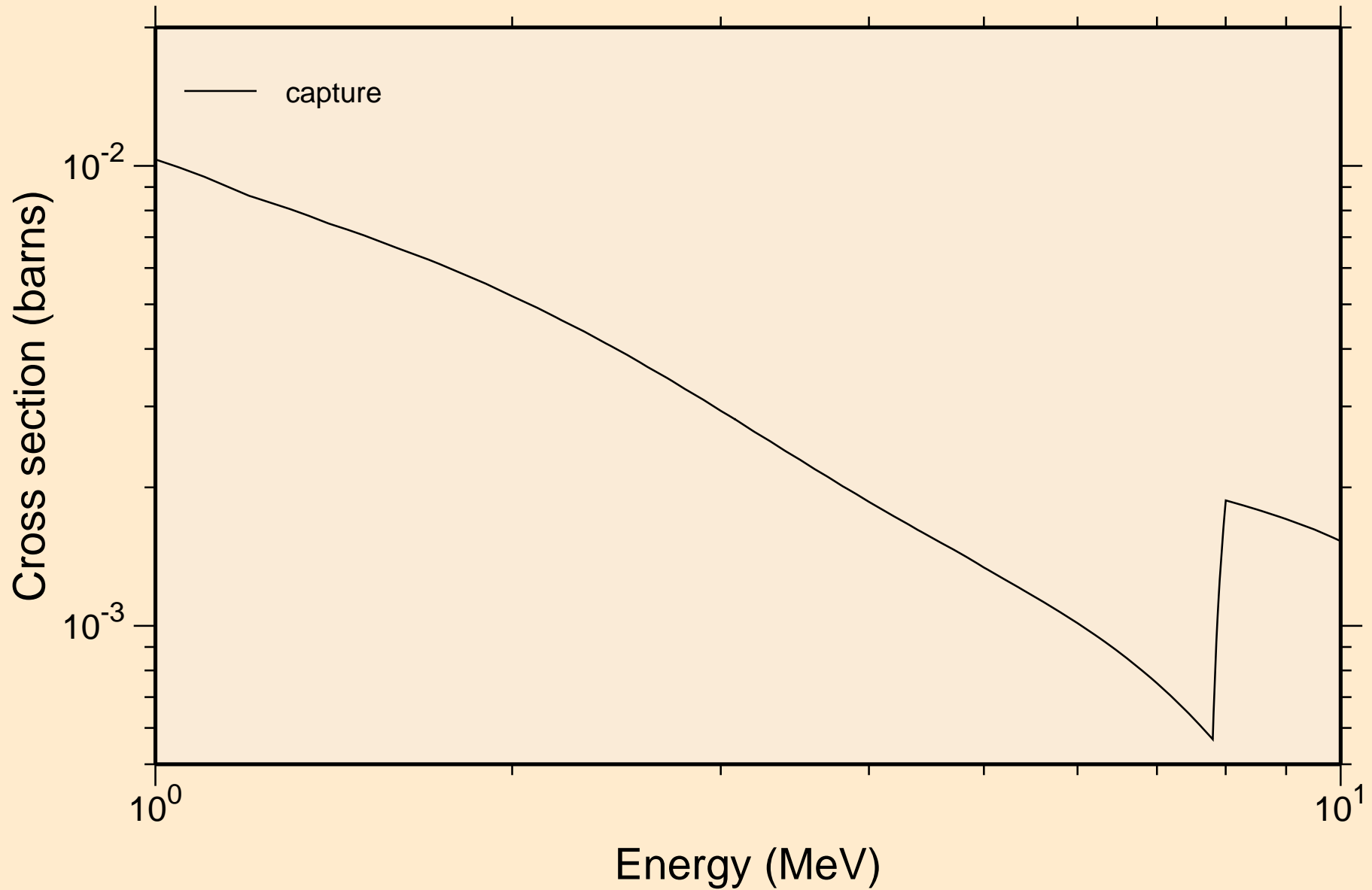

PD094 NEUTRON ACER TENDL-2021 LIBRARY; T=293.6K
Heating

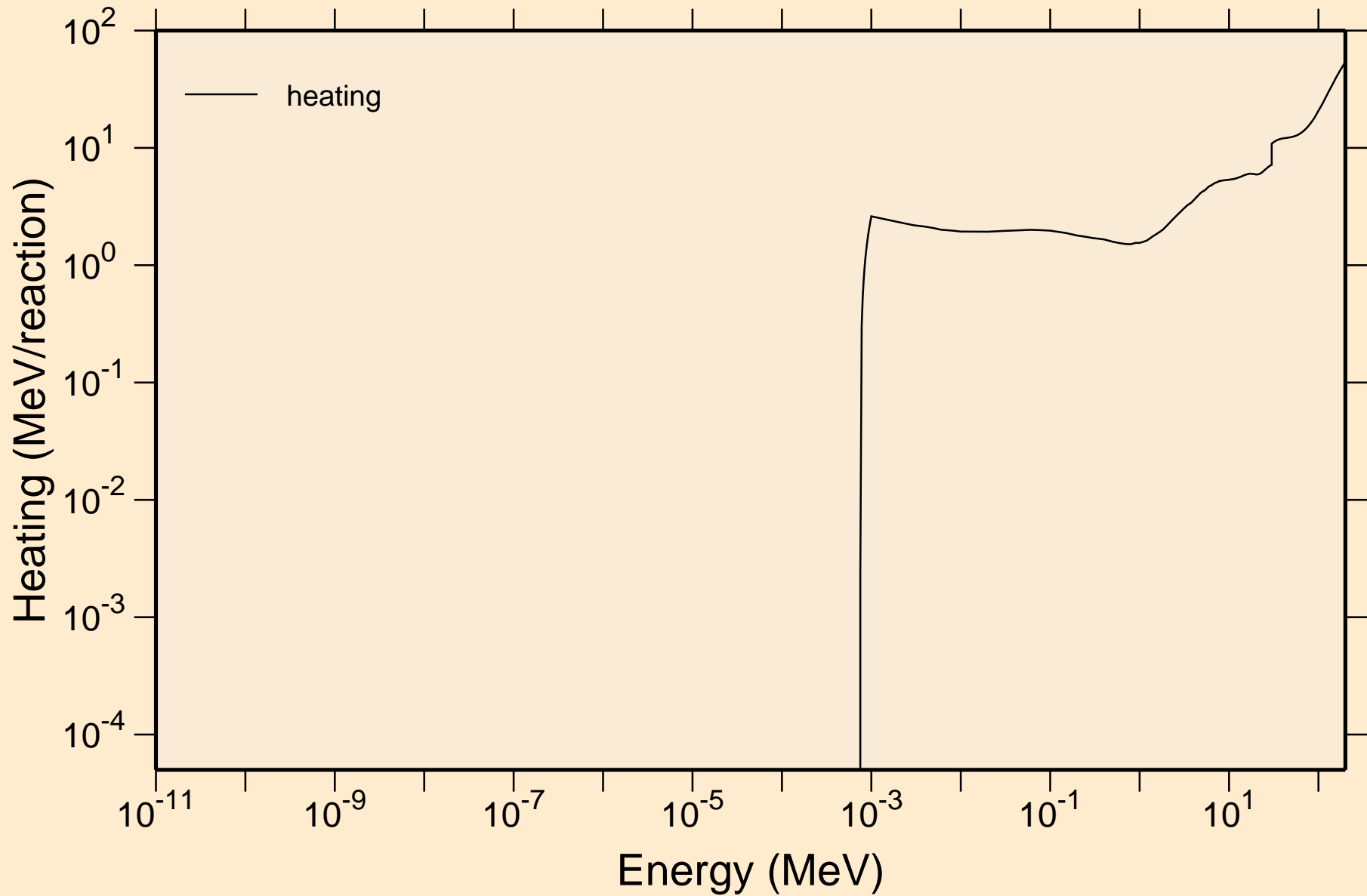

PD094 NEUTRON ACER TENDL-2021 LIBRARY; T=293.6K
Damage

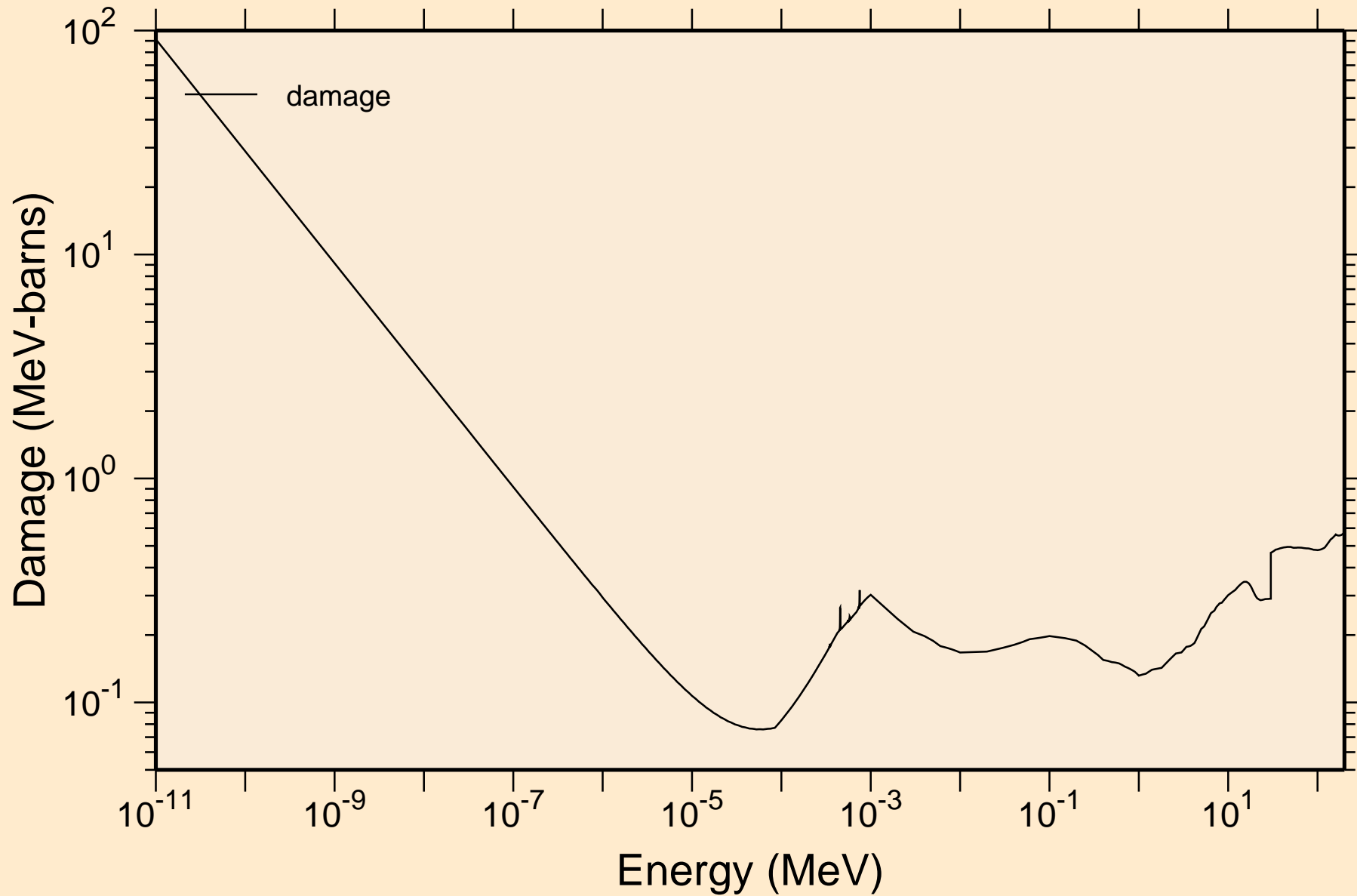

PD094 NEUTRON ACER TENDL-2021 LIBRARY; T=293.6K
Non-threshold reactions

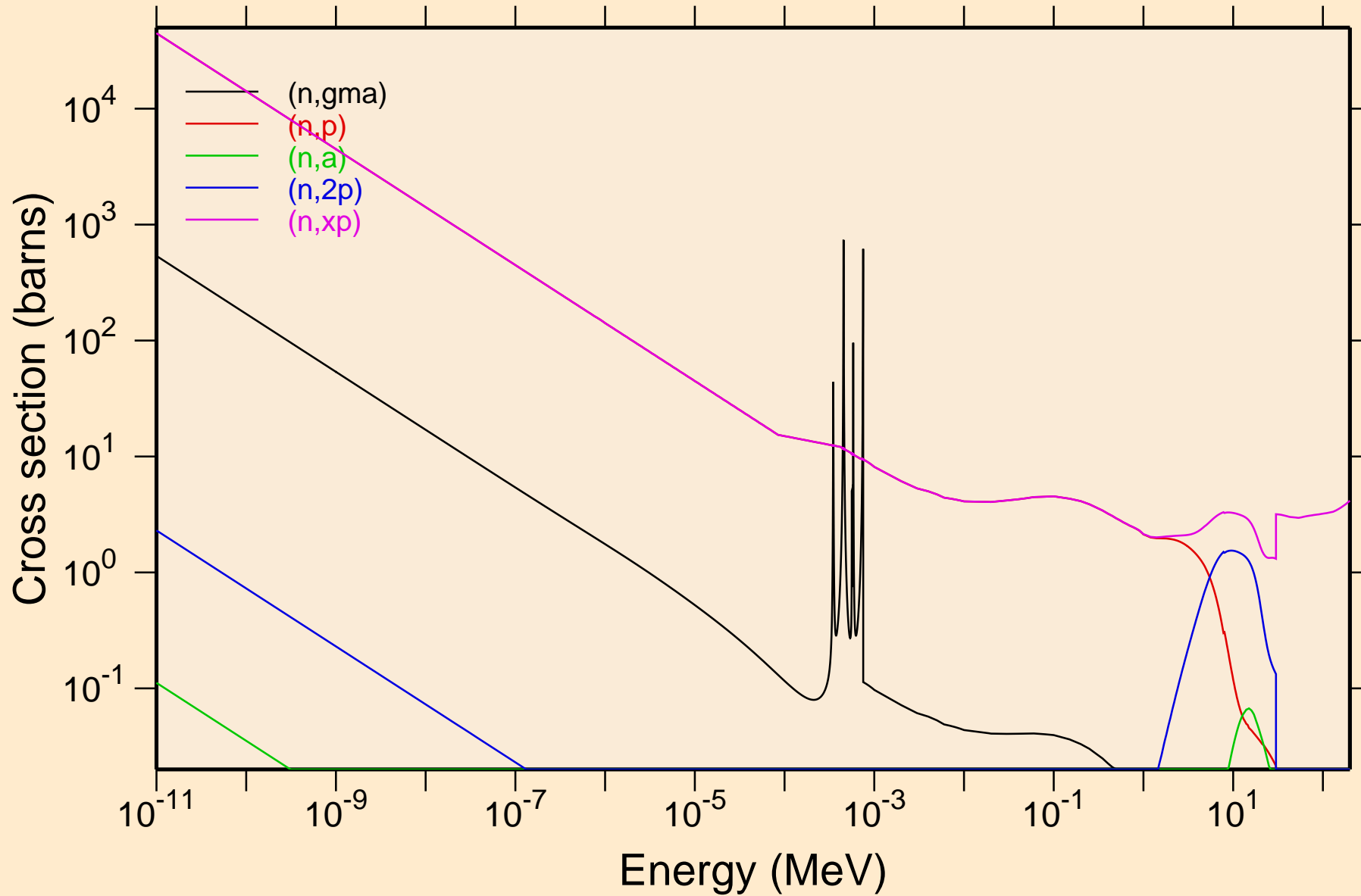

PD094 NEUTRON ACER TENDL-2021 LIBRARY; T=293.6K
Non-threshold reactions

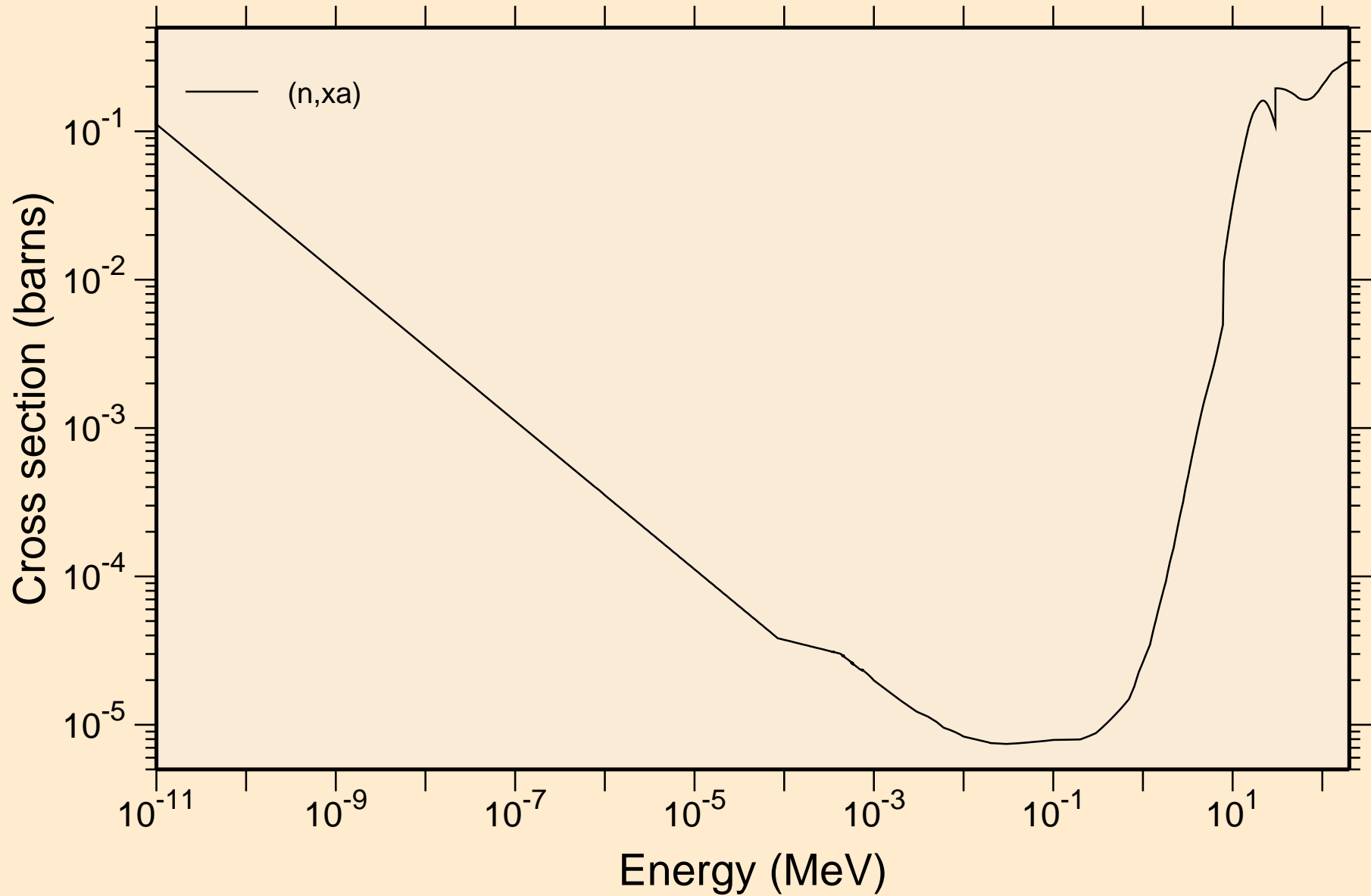

PD094 NEUTRON ACER TENDL-2021 LIBRARY; T=293.6K
Principal cross sections

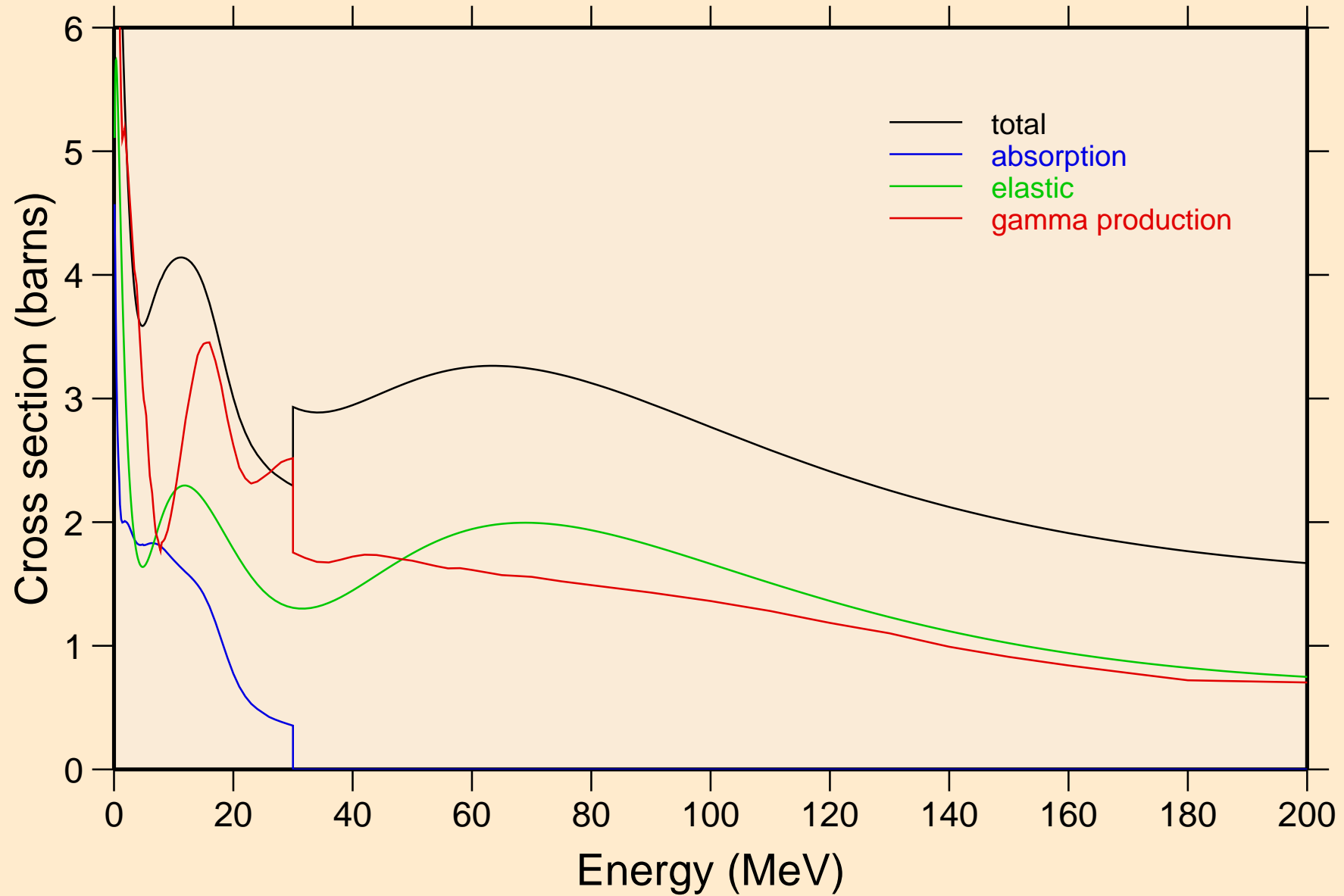

PD094 NEUTRON ACER TENDL-2021 LIBRARY; T=293.6K
Heating

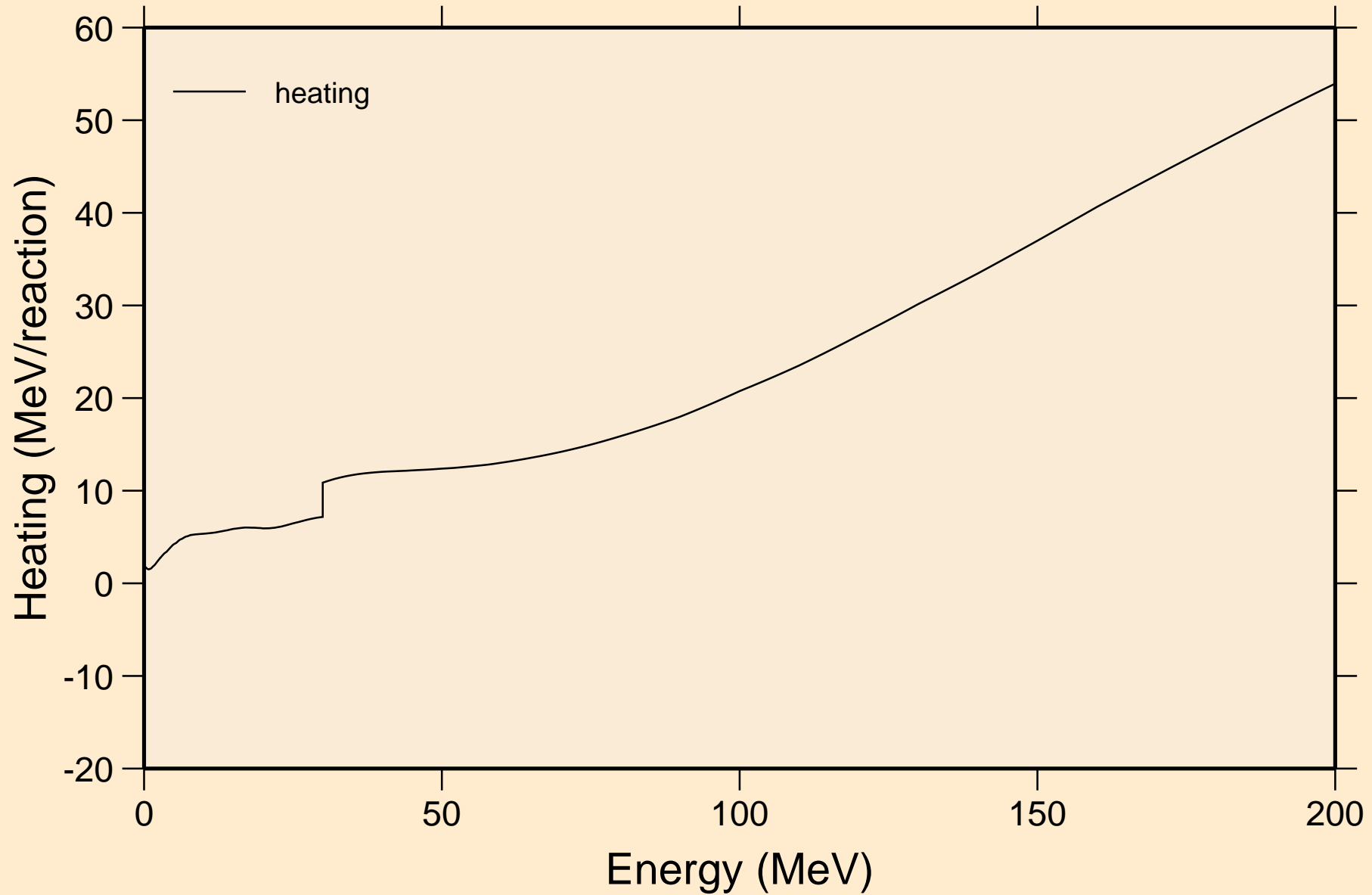

PD094 NEUTRON ACER TENDL-2021 LIBRARY; T=293.6K
Damage

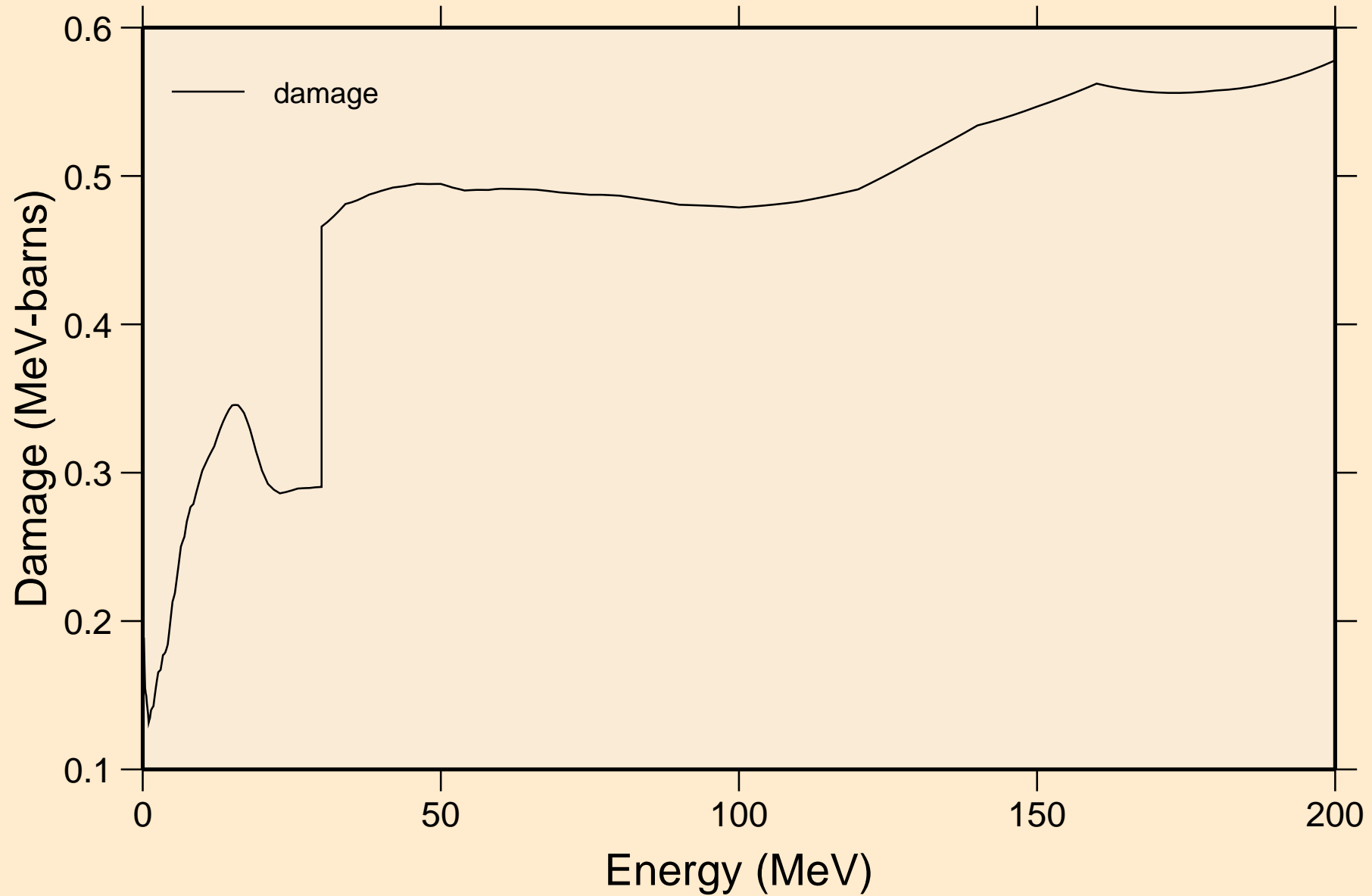

PD094 NEUTRON ACER TENDL-2021 LIBRARY; T=293.6K
Non-threshold reactions

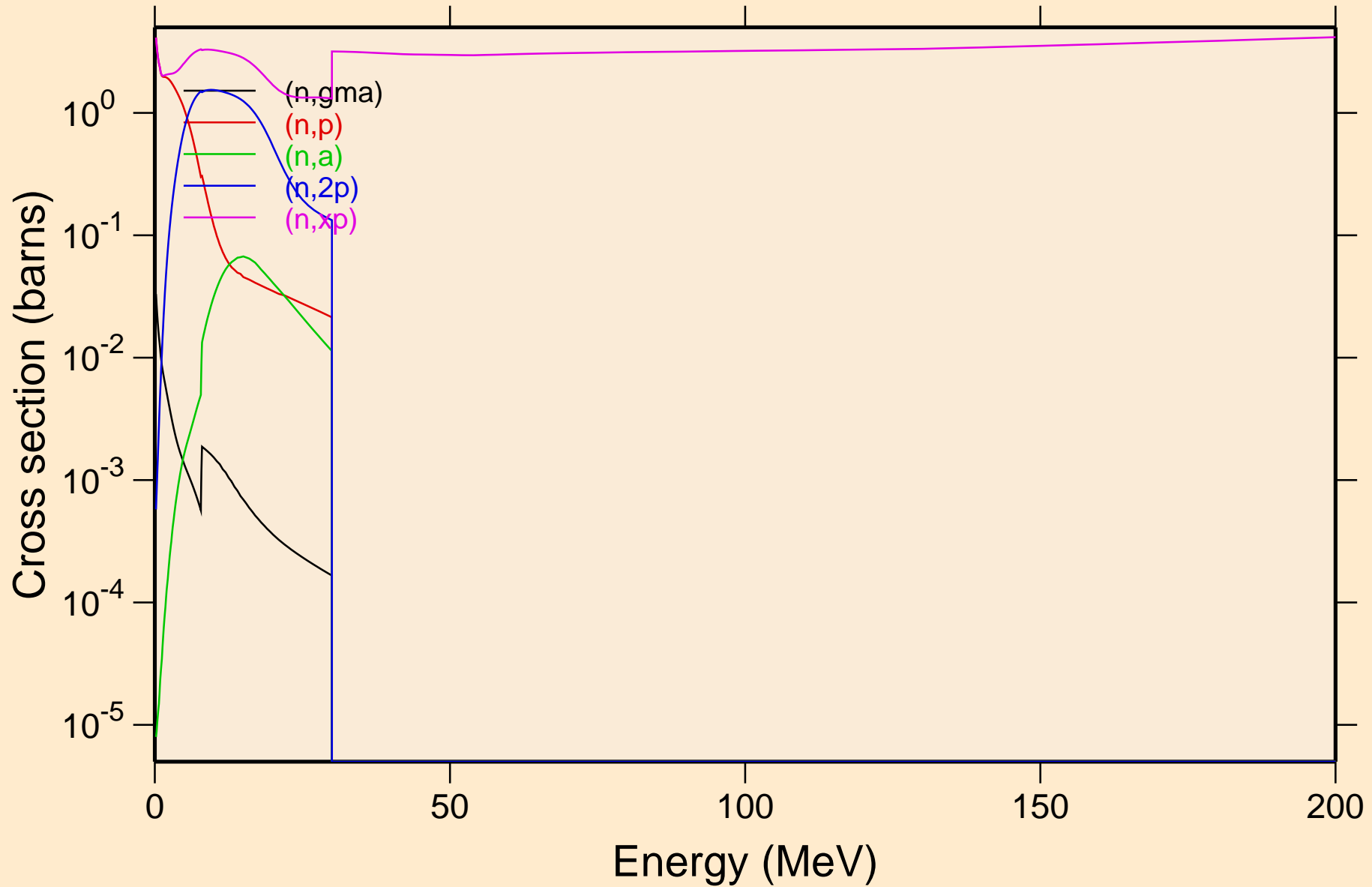

PD094 NEUTRON ACER TENDL-2021 LIBRARY; T=293.6K
Non-threshold reactions

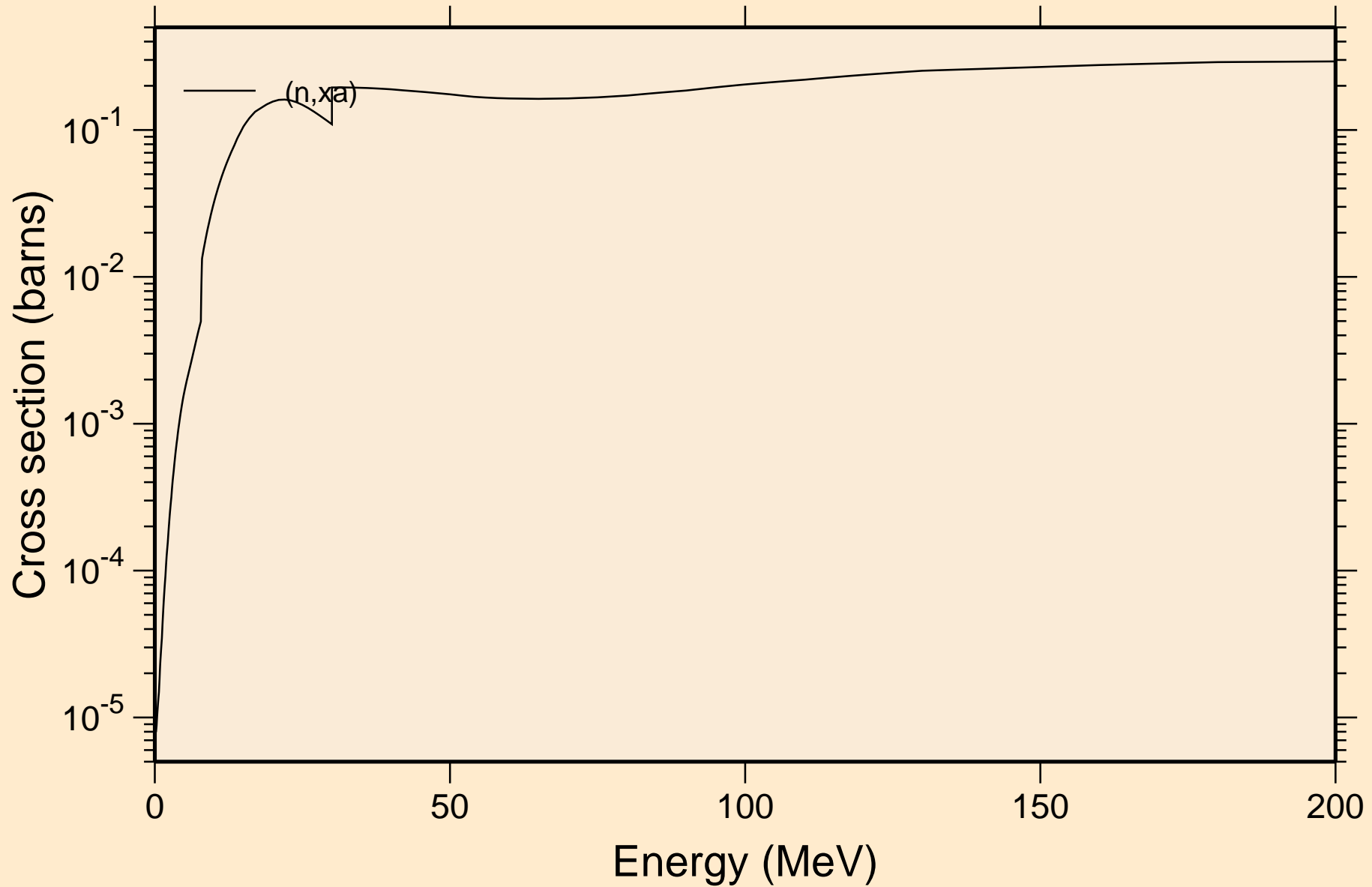

PD094 NEUTRON ACER TENDL-2021 LIBRARY; T=293.6K
Inelastic levels

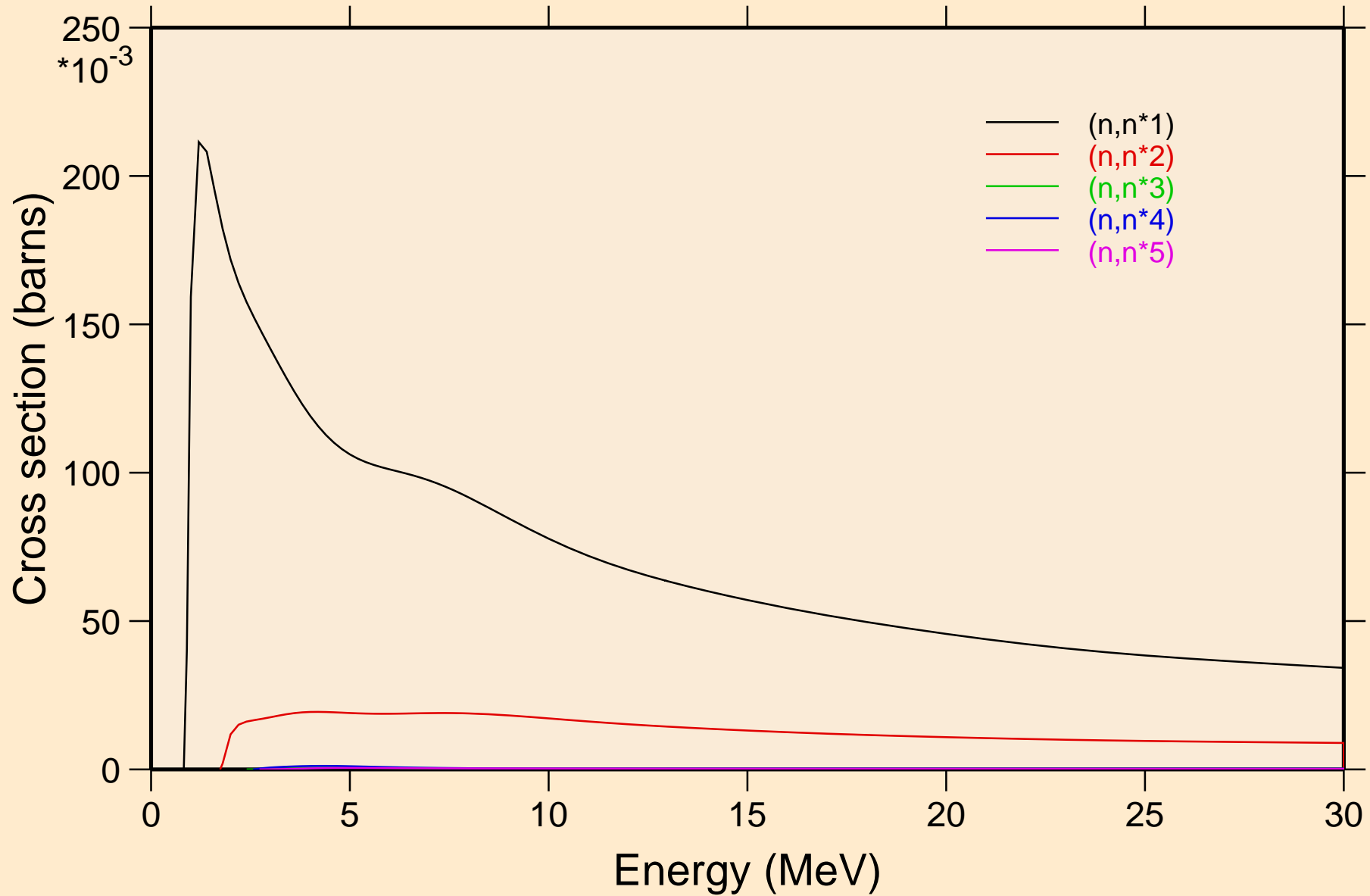

PD094 NEUTRON ACER TENDL-2021 LIBRARY; T=293.6K
Inelastic levels

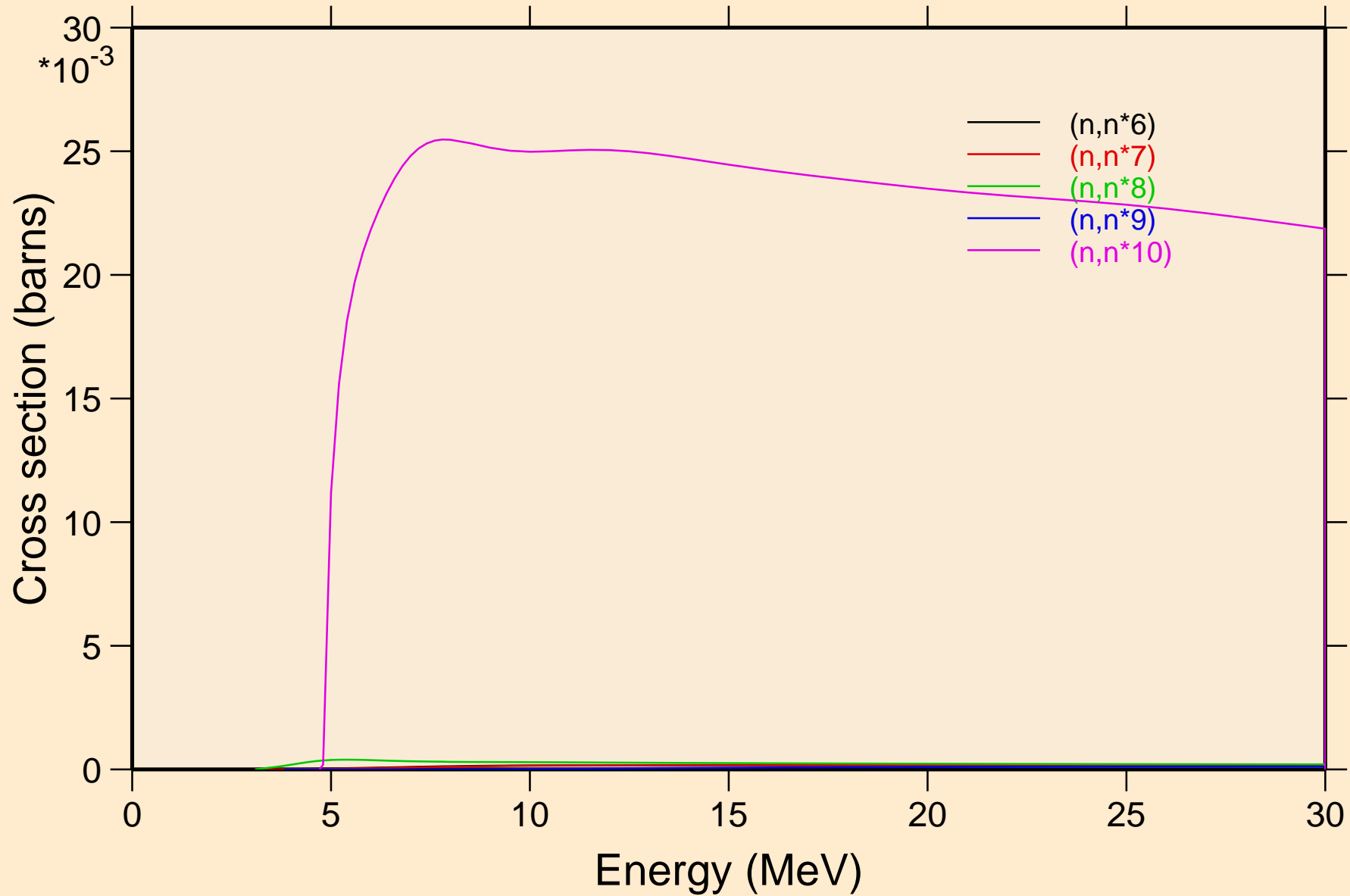

PD094 NEUTRON ACER TENDL-2021 LIBRARY; T=293.6K
Threshold reactions

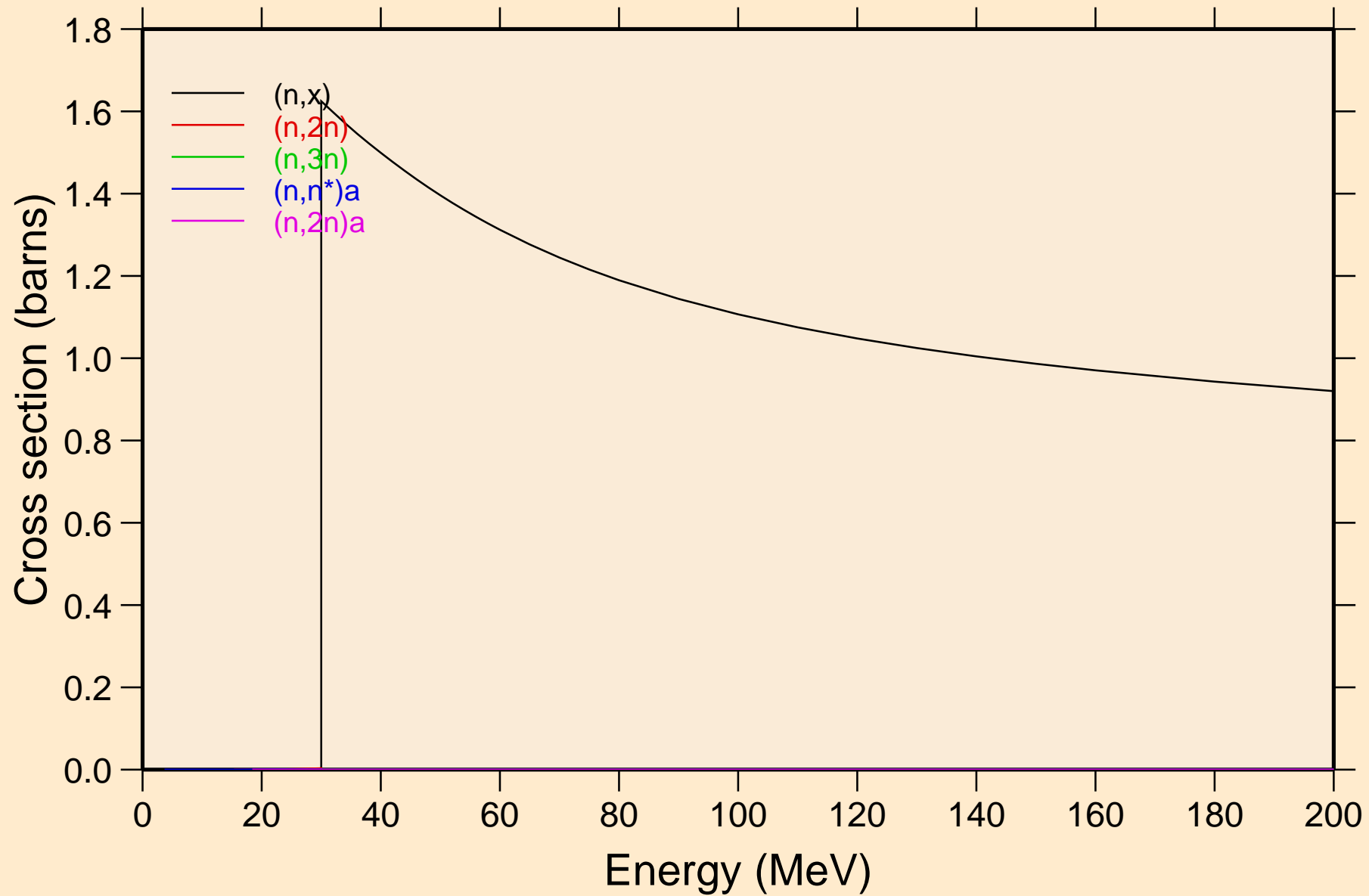

PD094 NEUTRON ACER TENDL-2021 LIBRARY; T=293.6K
Threshold reactions

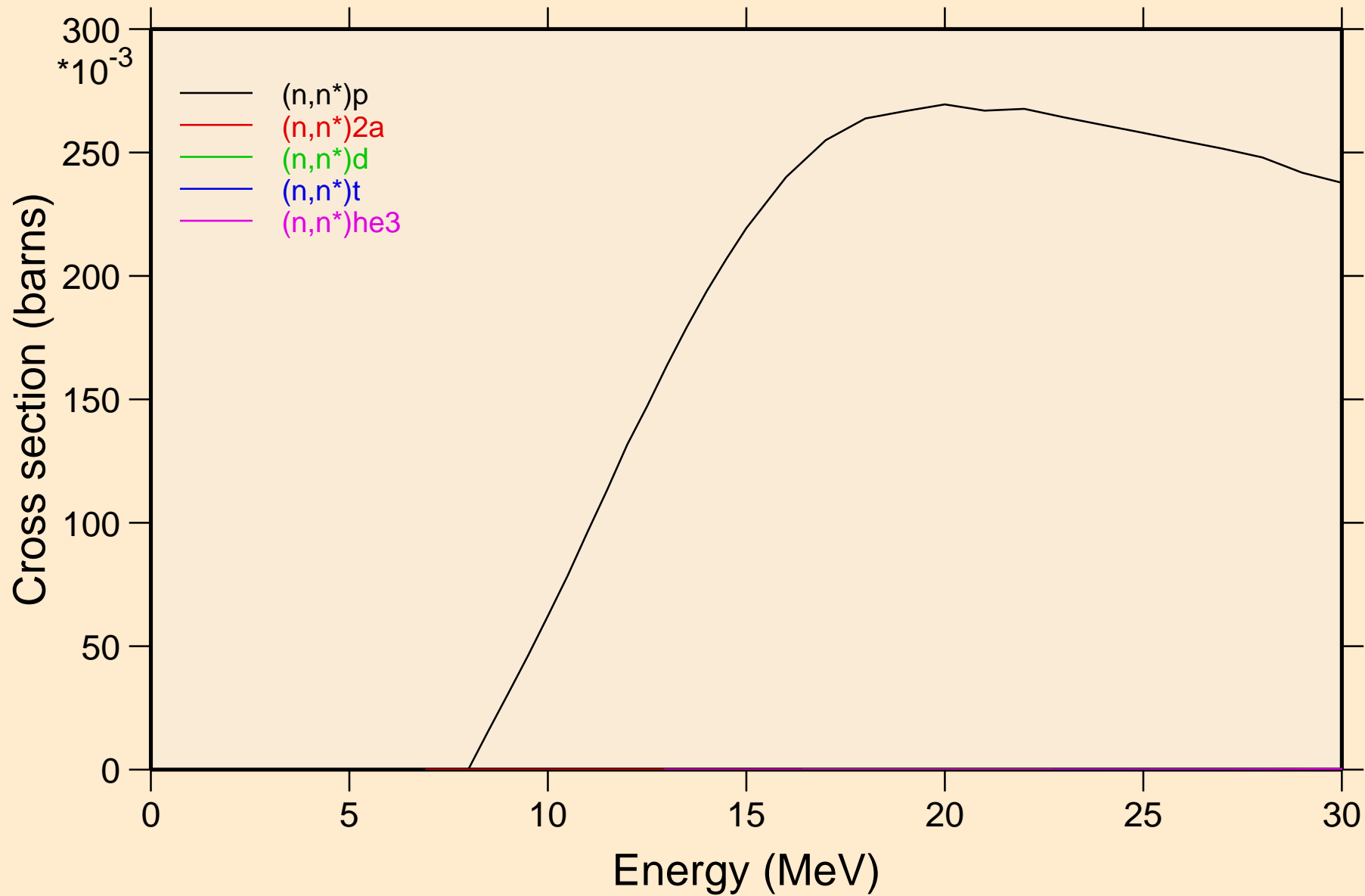

PD094 NEUTRON ACER TENDL-2021 LIBRARY; T=293.6K
Threshold reactions

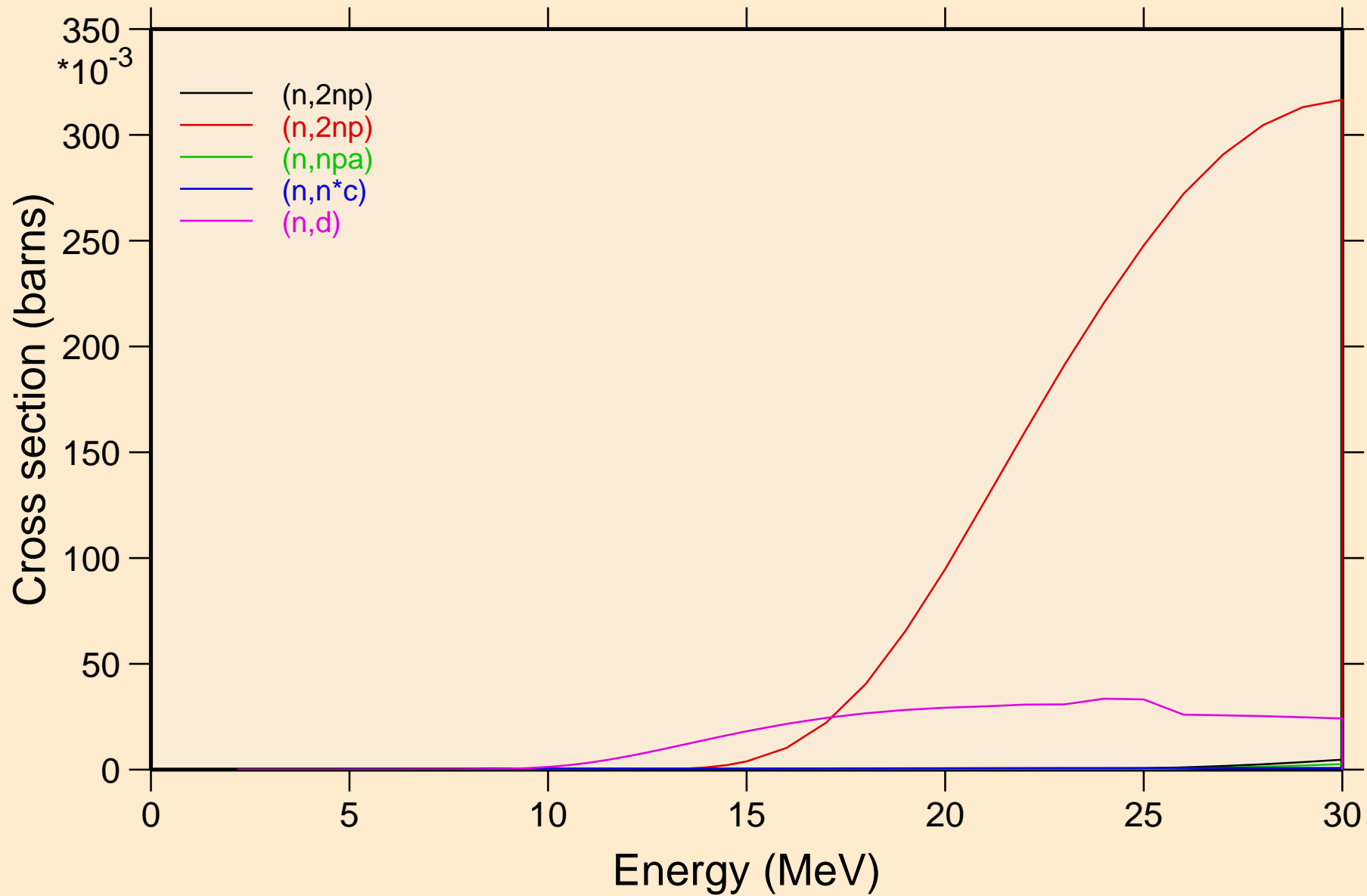

PD094 NEUTRON ACER TENDL-2021 LIBRARY; T=293.6K
Threshold reactions

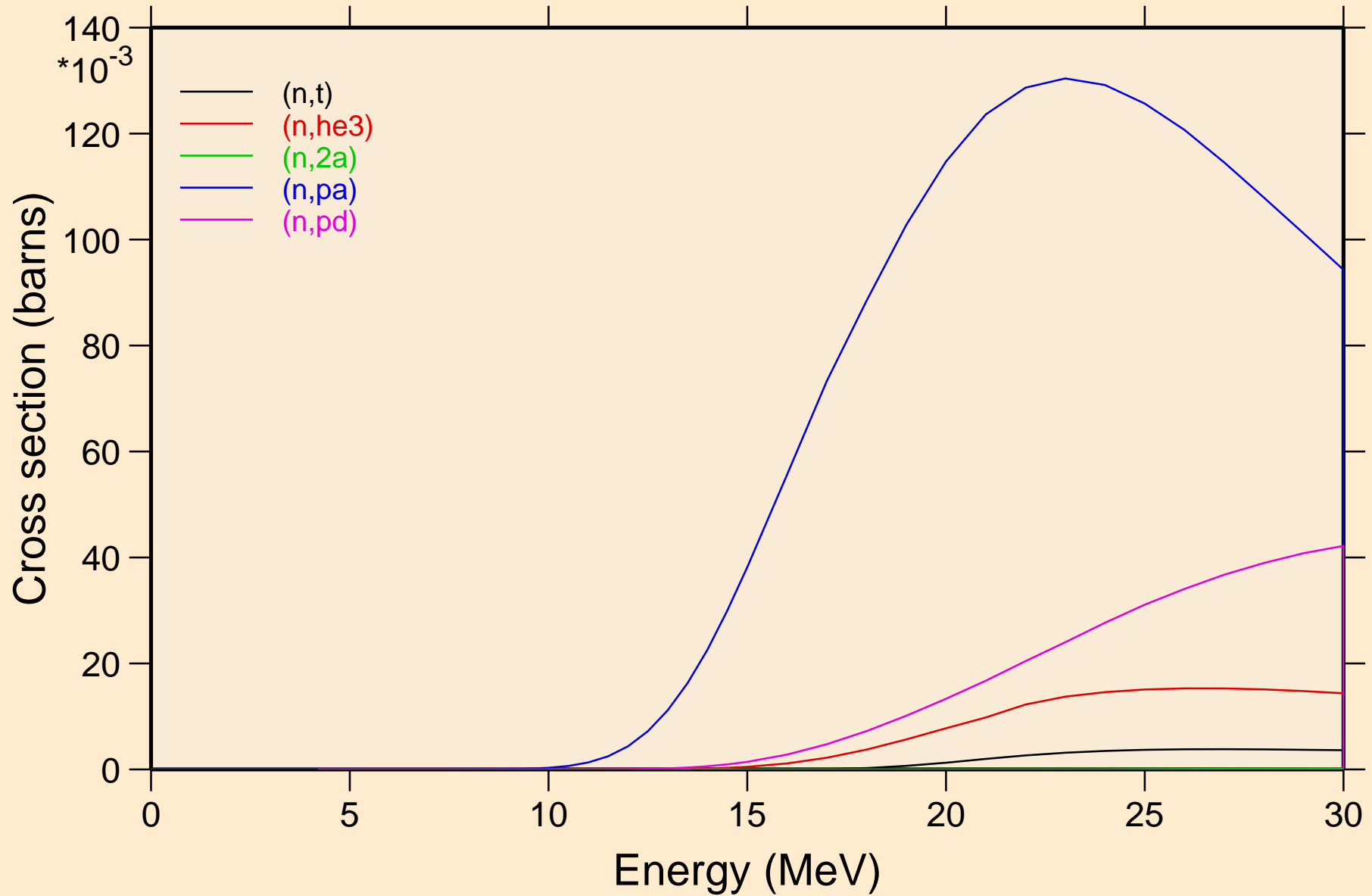

PD094 NEUTRON ACER TENDL-2021 LIBRARY; T=293.6K
Threshold reactions

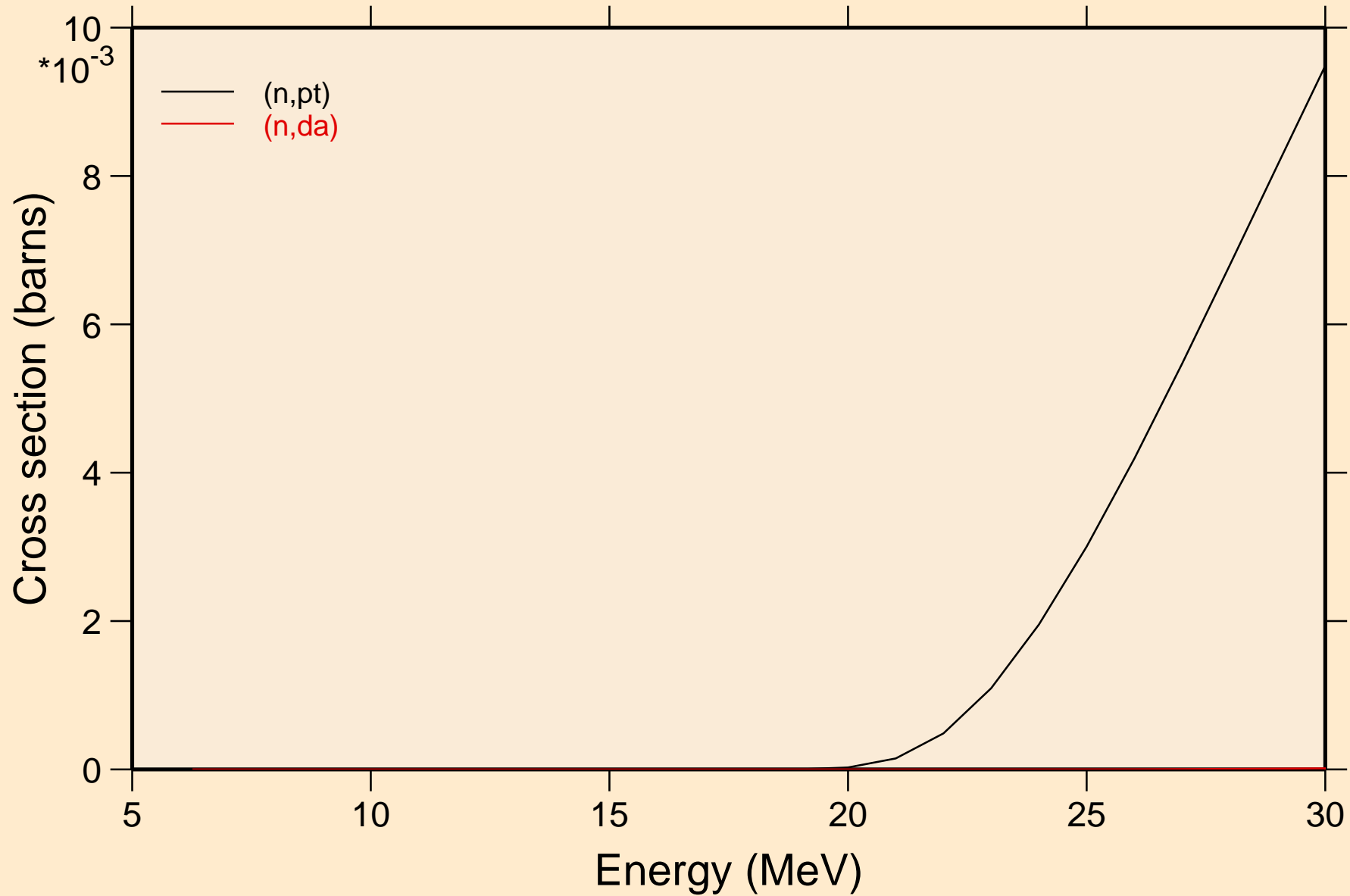

PD094 NEUTRON ACER TENDL-2021 LIBRARY; T=293.6K
Threshold reactions

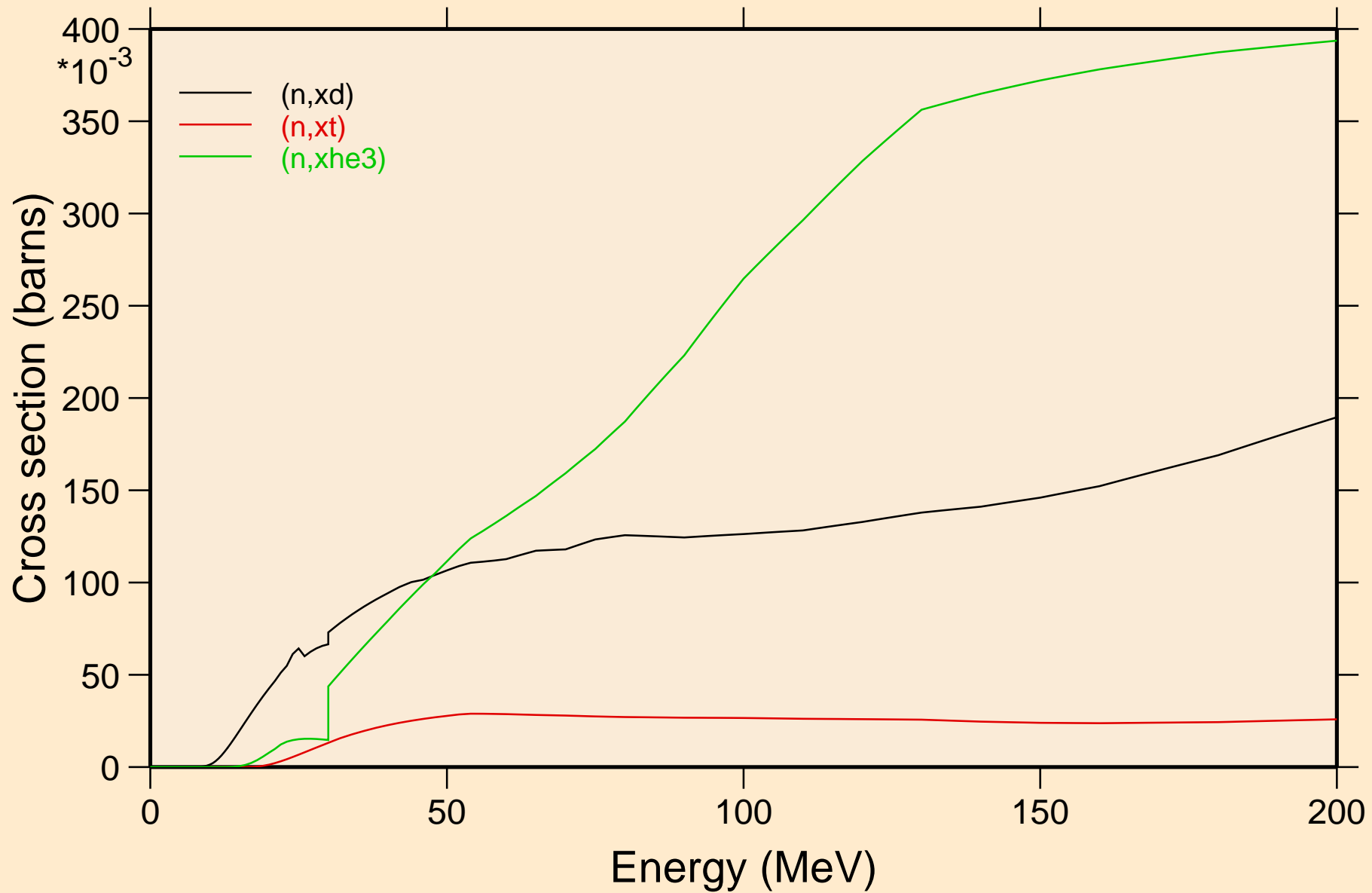

PD094 NEUTRON ACER TENDL-2021 LIBRARY; T=293.6K
angular distribution for elastic

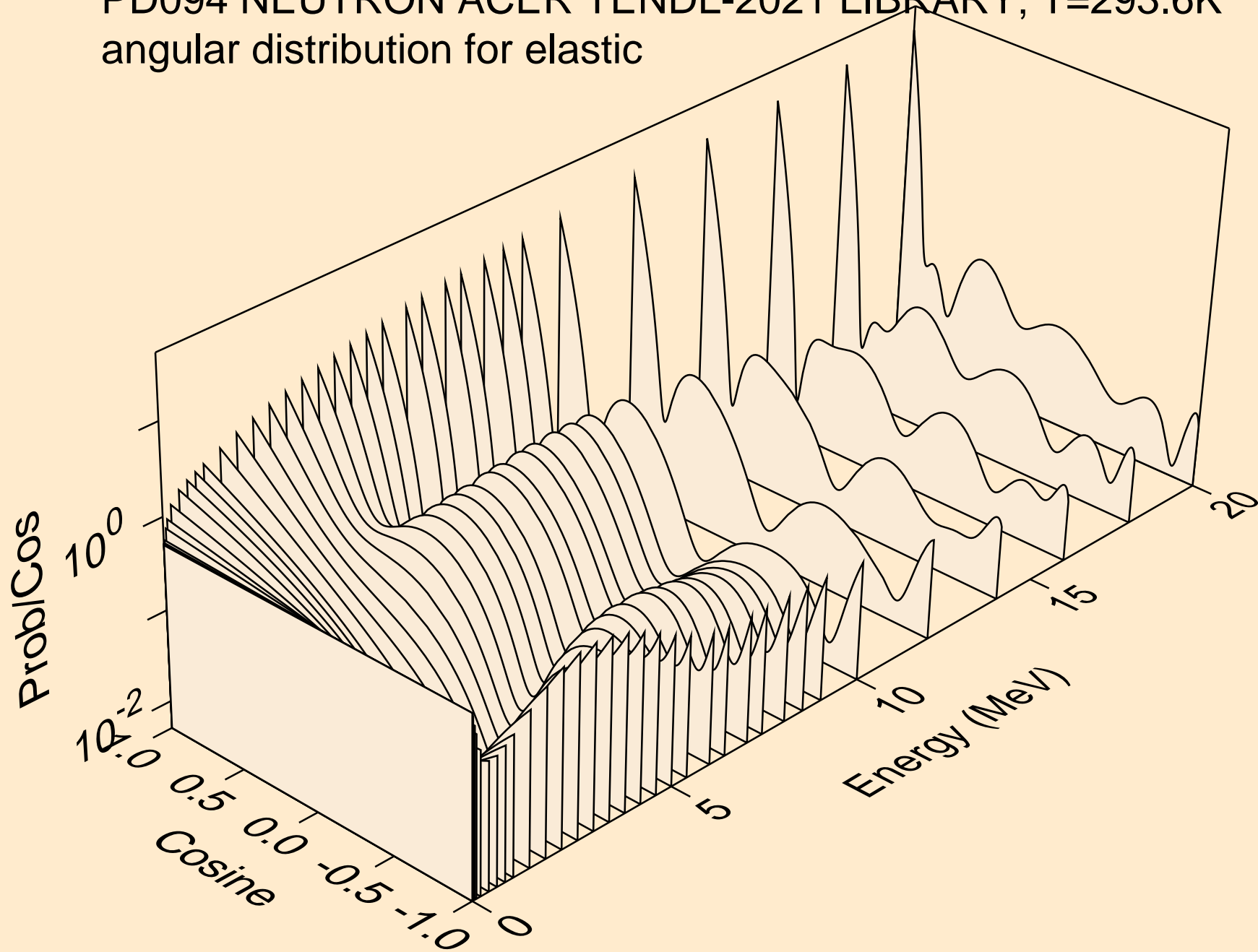

PD094 NEUTRON ACER TENDL-2021 LIBRARY; T=293.6K
angular distribution for elastic

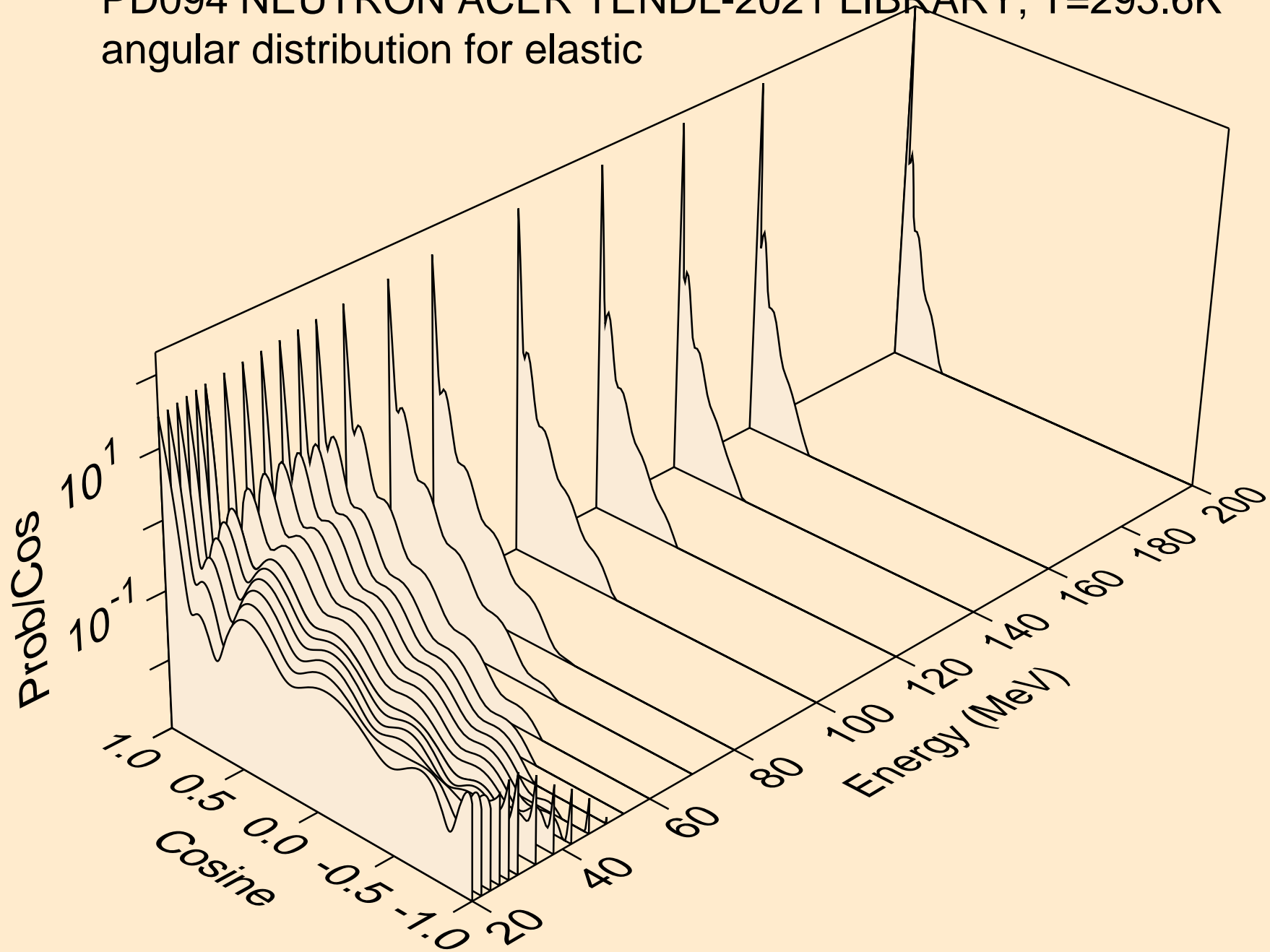

PD094 NEUTRON ACER TENDL-2021 LIBRARY; T=293.6K
angular distribution for (n,n*1)

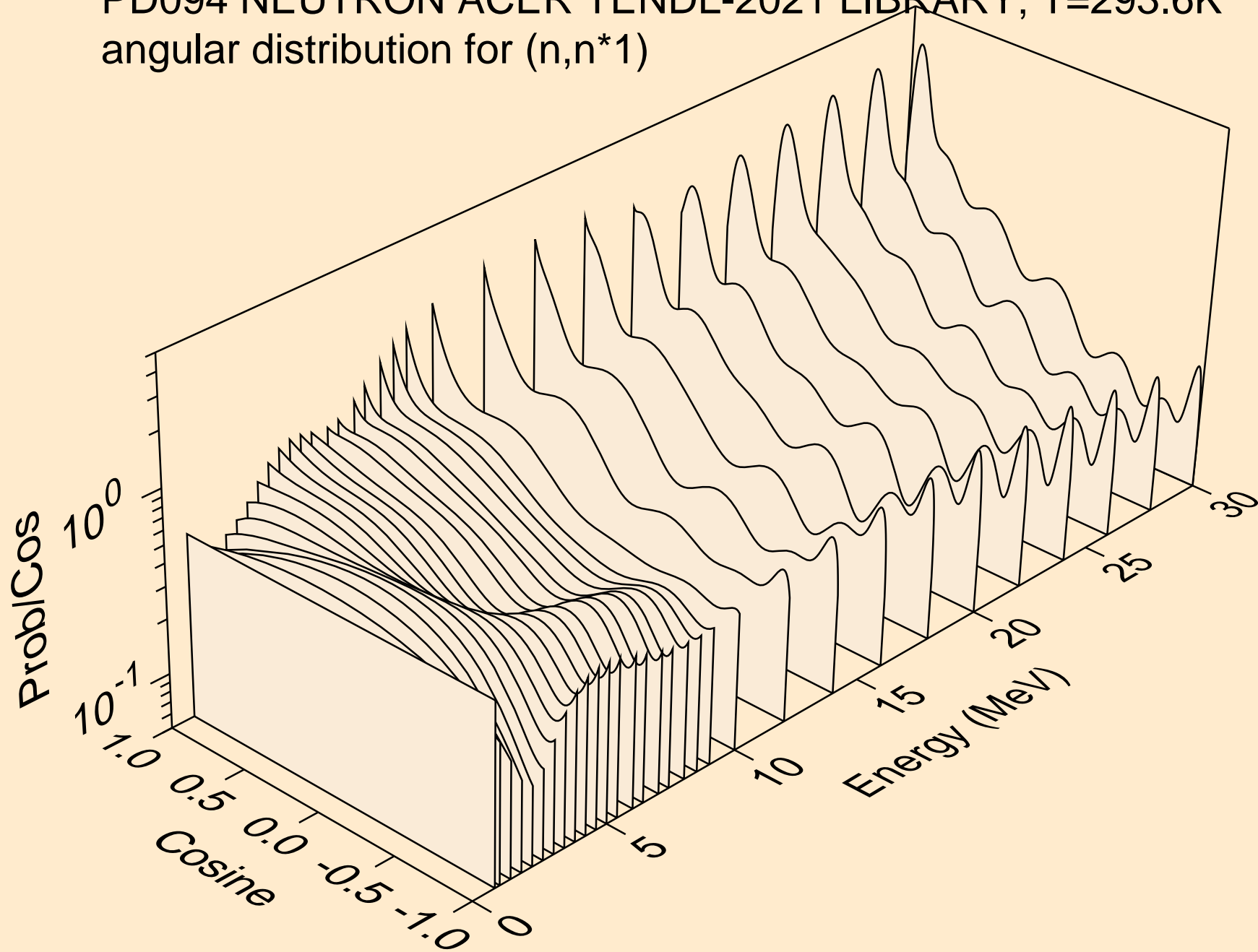

PD094 NEUTRON ACER TENDL-2021 LIBRARY; T=293.6K
angular distribution for (n,n*2)

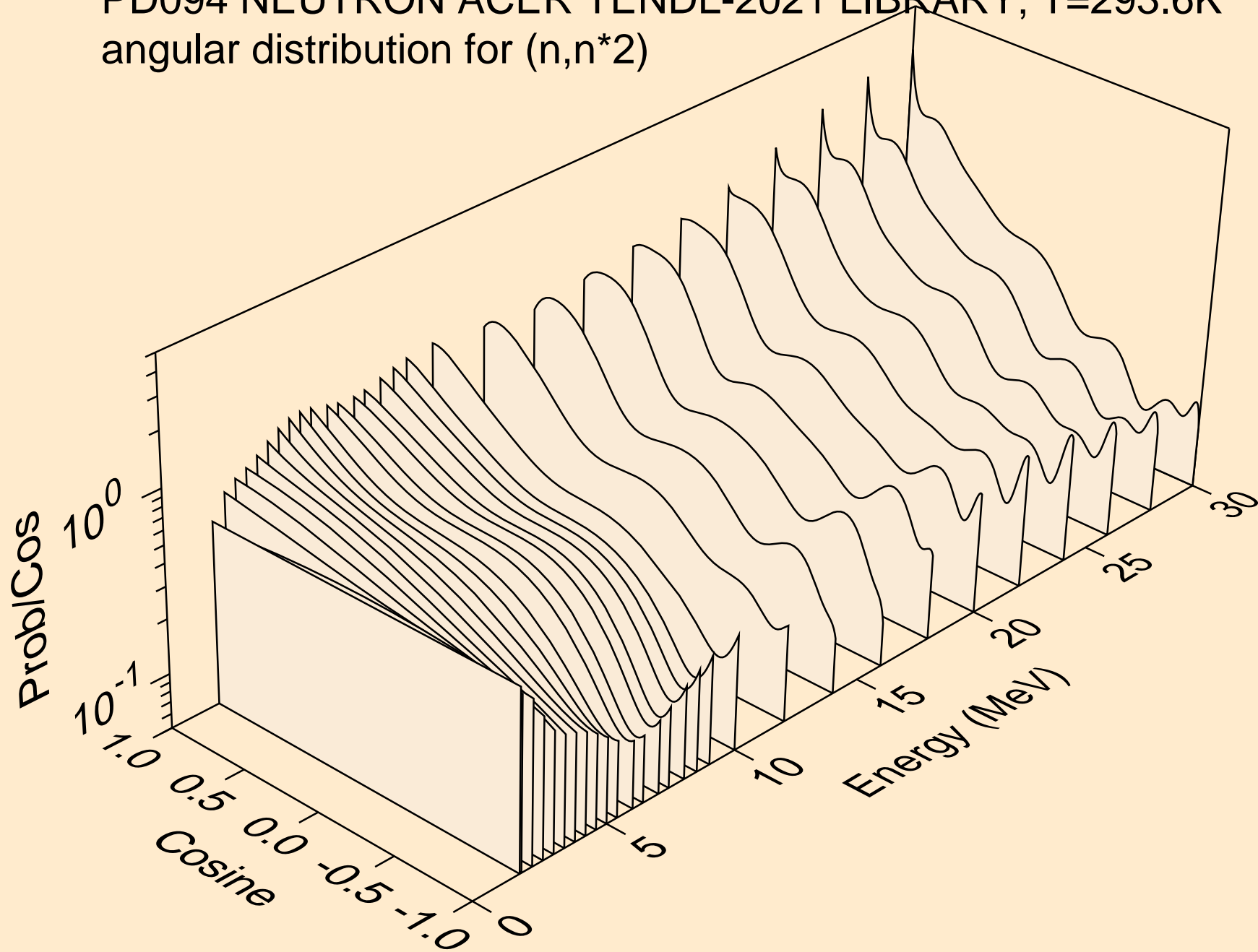

PD094 NEUTRON ACER TENDL-2021 LIBRARY; T=293.6K
angular distribution for (n,n*3)

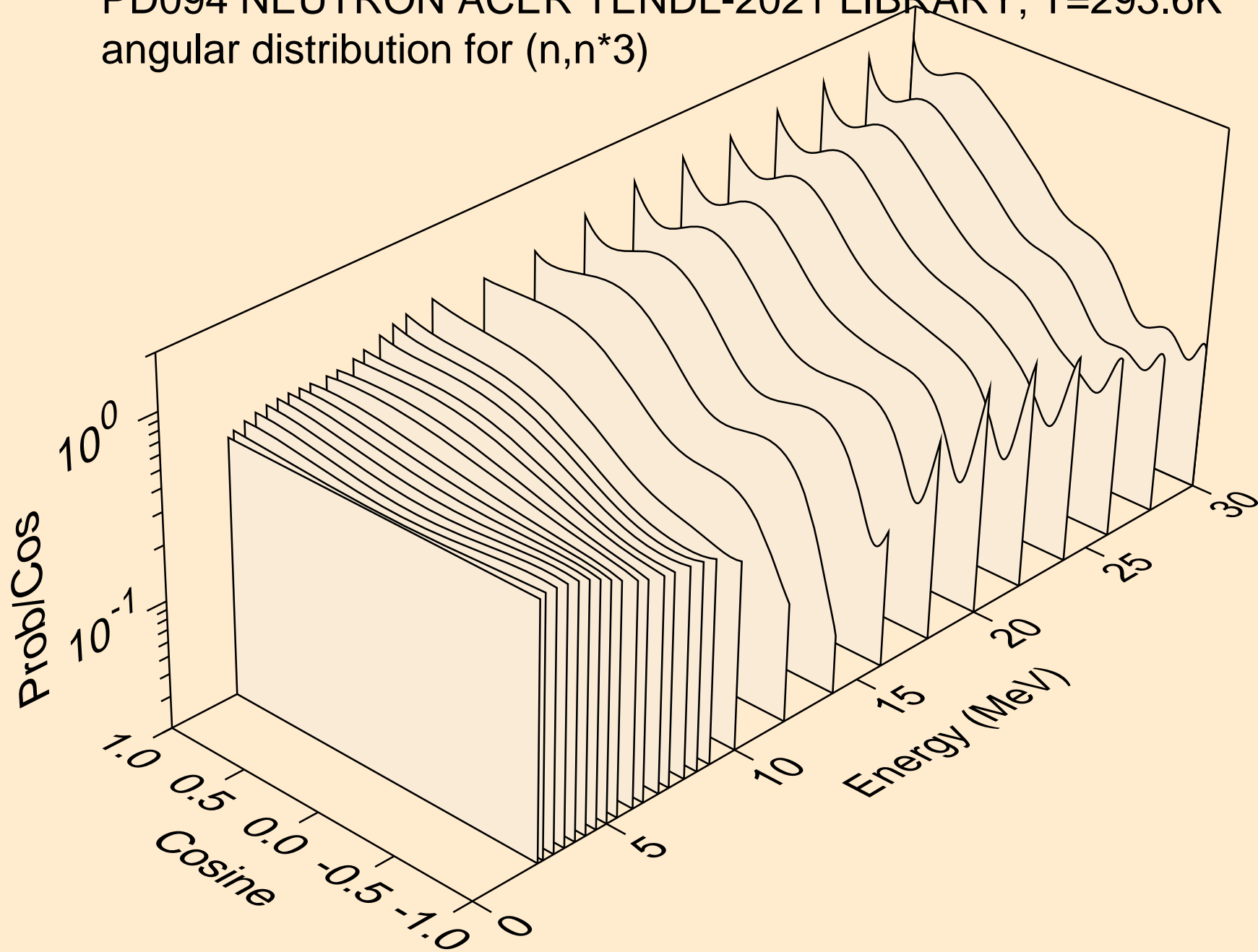

PD094 NEUTRON ACER TENDL-2021 LIBRARY; T=293.6K
angular distribution for (n,n*4)

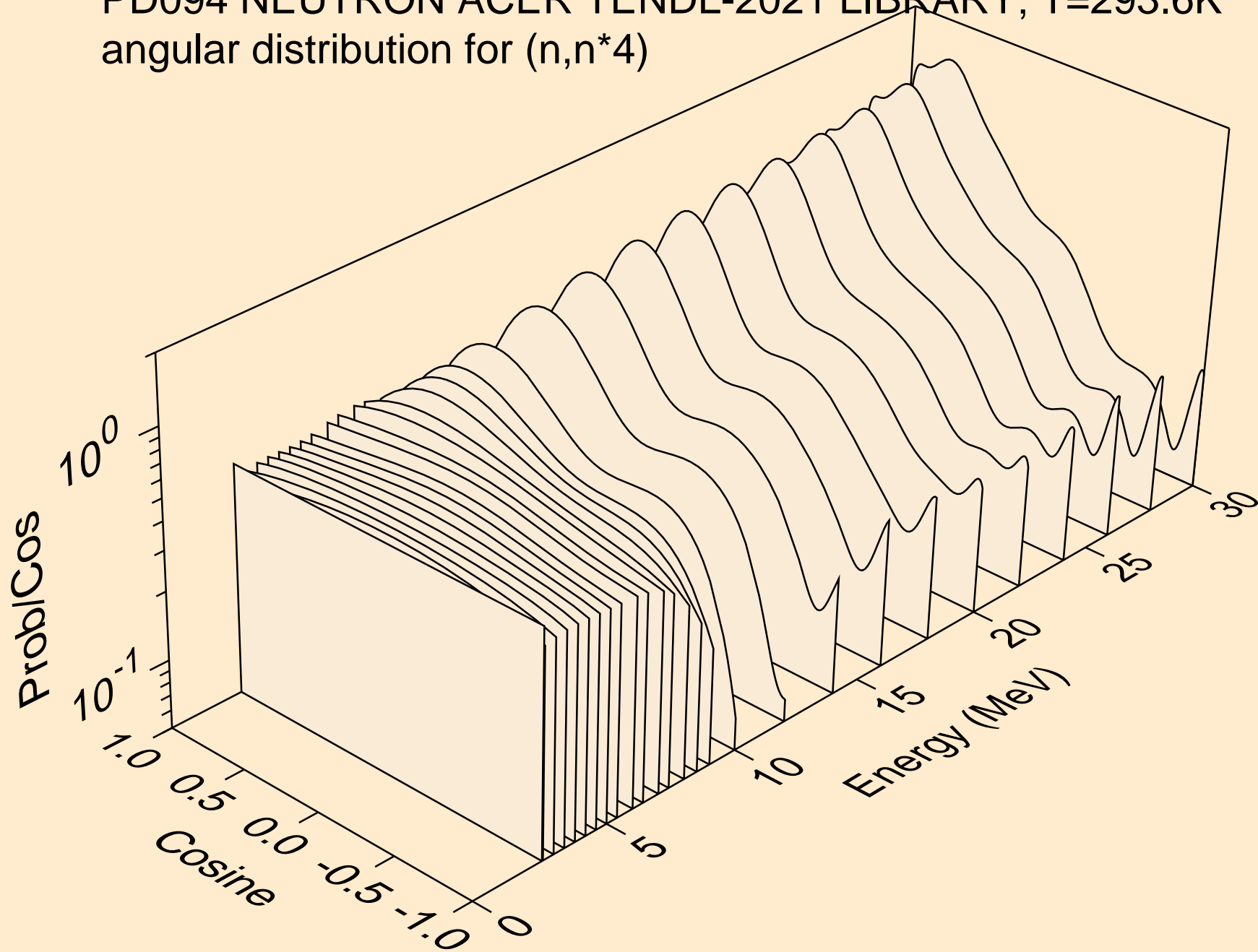

PD094 NEUTRON ACER TENDL-2021 LIBRARY; T=293.6K
angular distribution for (n,n*5)

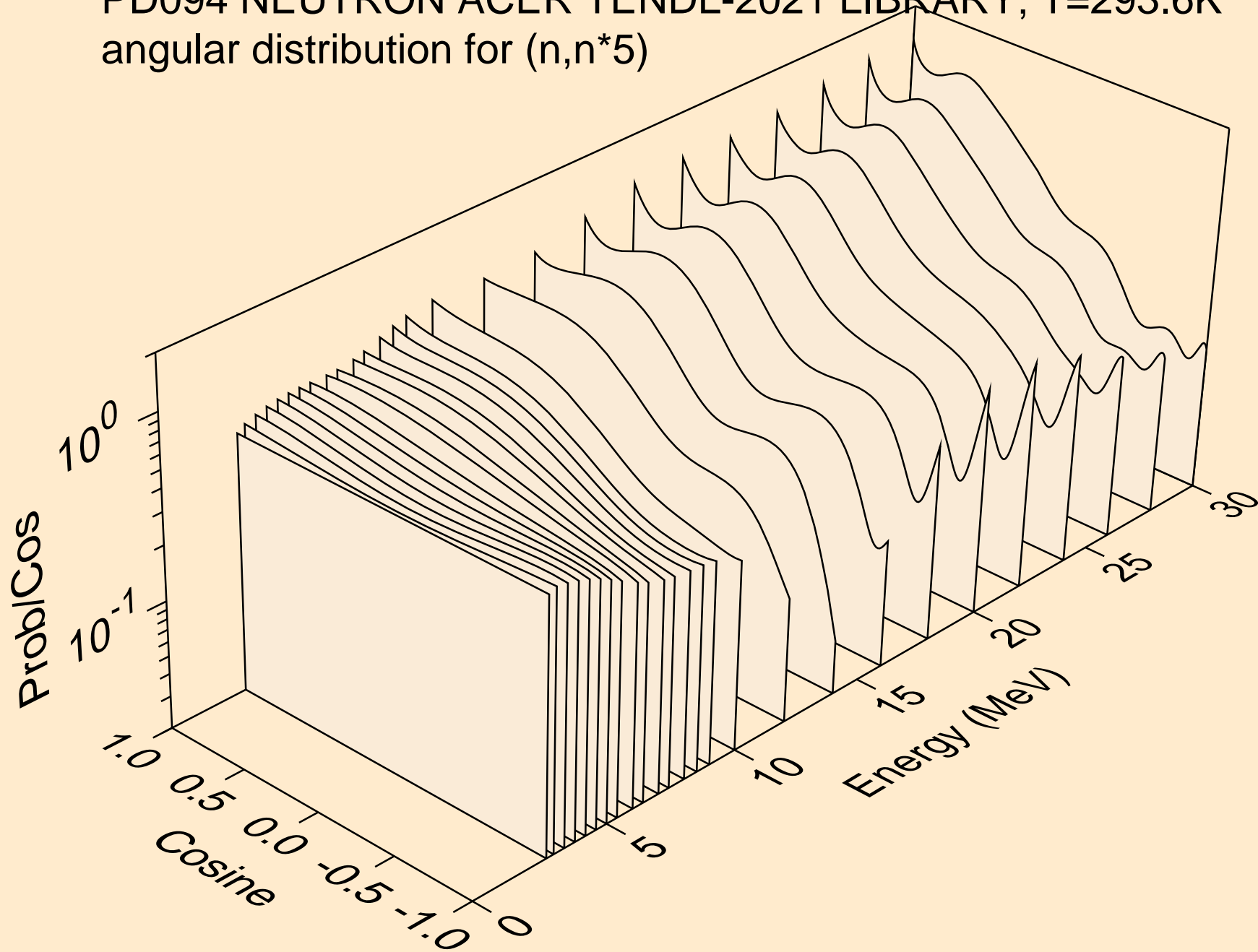

PD094 NEUTRON ACER TENDL-2021 LIBRARY; T=293.6K
angular distribution for (n,n*6)

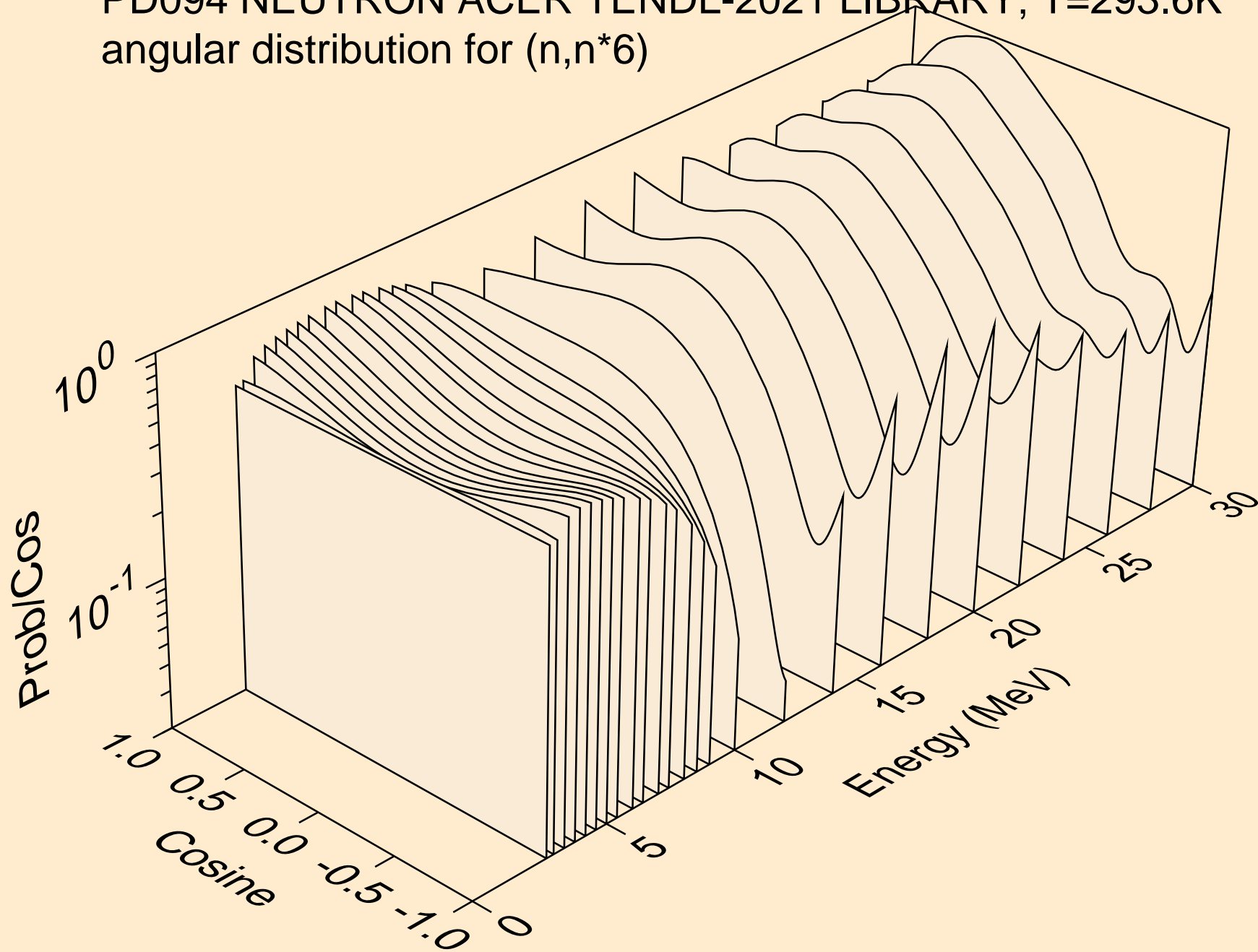

PD094 NEUTRON ACER TENDL-2021 LIBRARY; T=293.6K
angular distribution for (n,n*7)

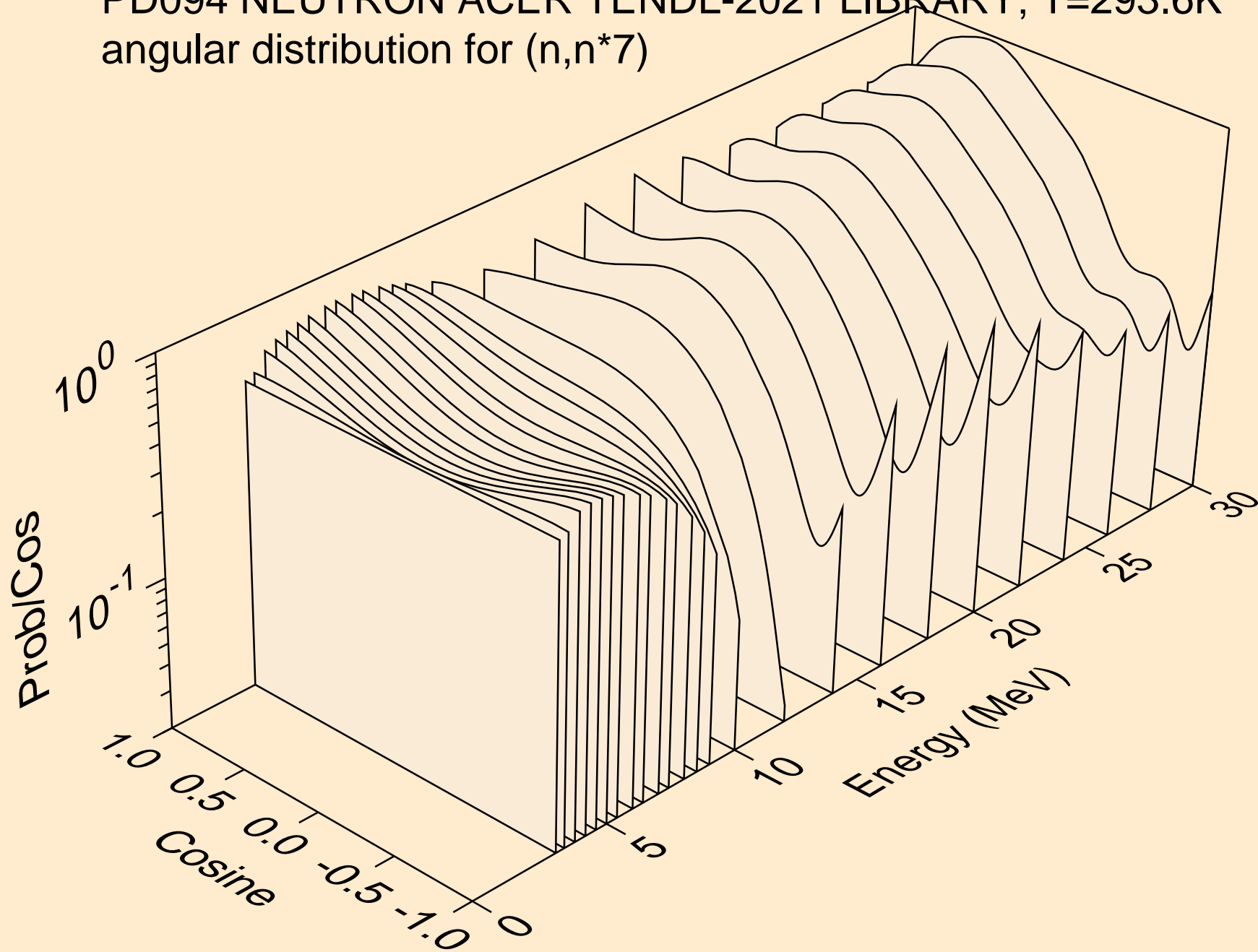

PD094 NEUTRON ACER TENDL-2021 LIBRARY; T=293.6K
angular distribution for (n,n*8)

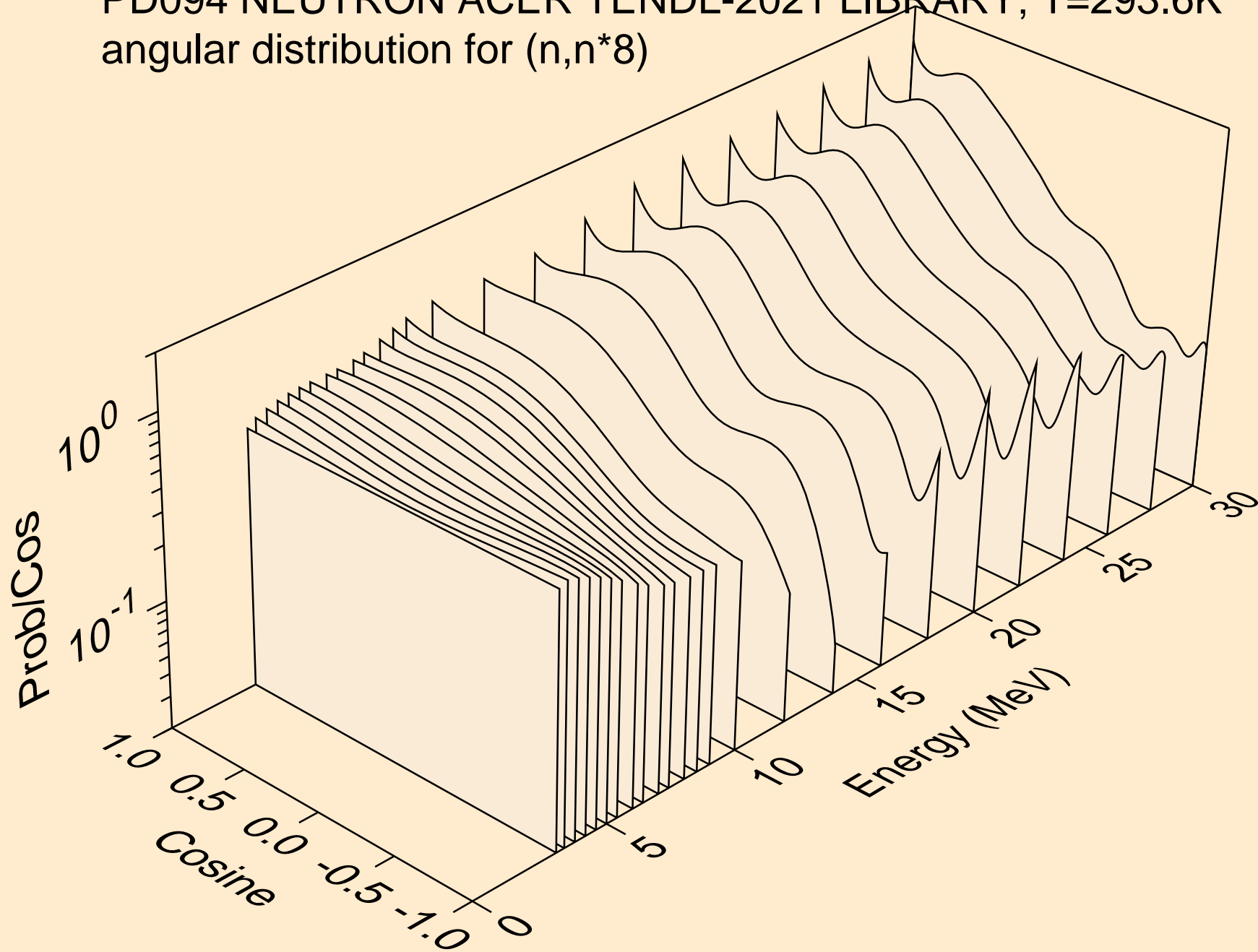

PD094 NEUTRON ACER TENDL-2021 LIBRARY; T=293.6K
angular distribution for (n,n*9)

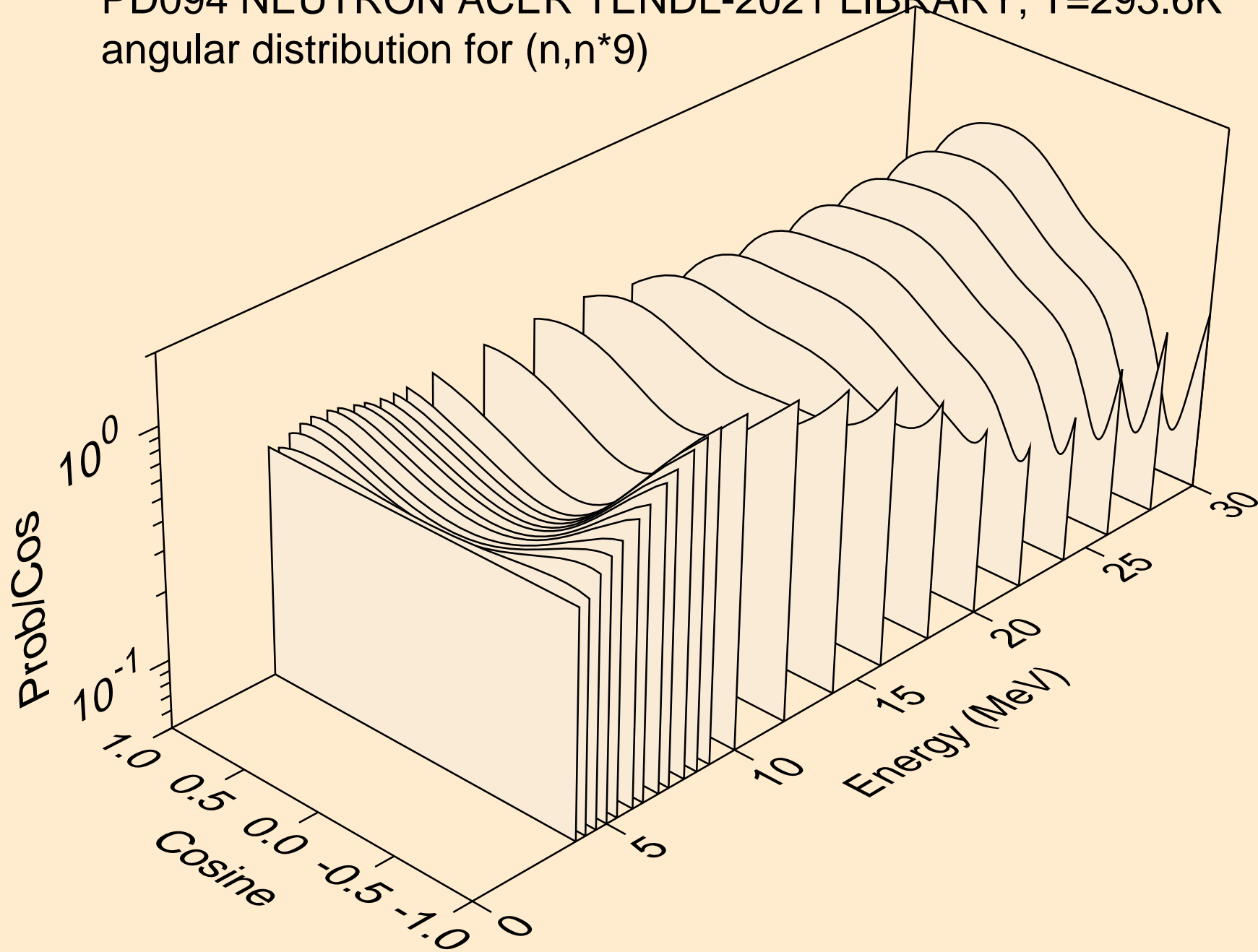

PD094 NEUTRON ACER TENDL-2021 LIBRARY; T=293.6K
angular distribution for (n,n*10)

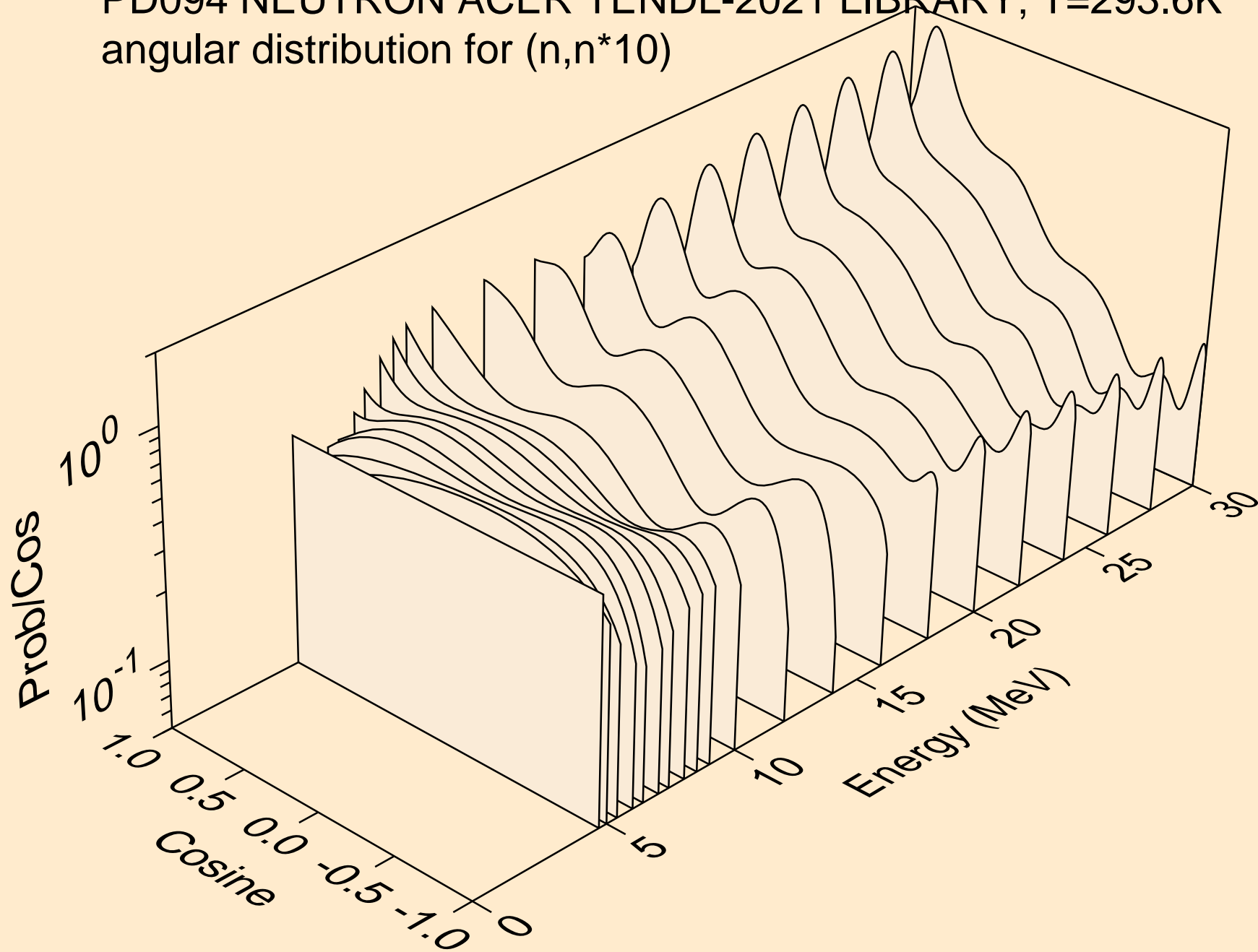

PD094 NEUTRON ACER TENDL-2021 LIBRARY; T=293.6K
Neutron emission for (n,x)

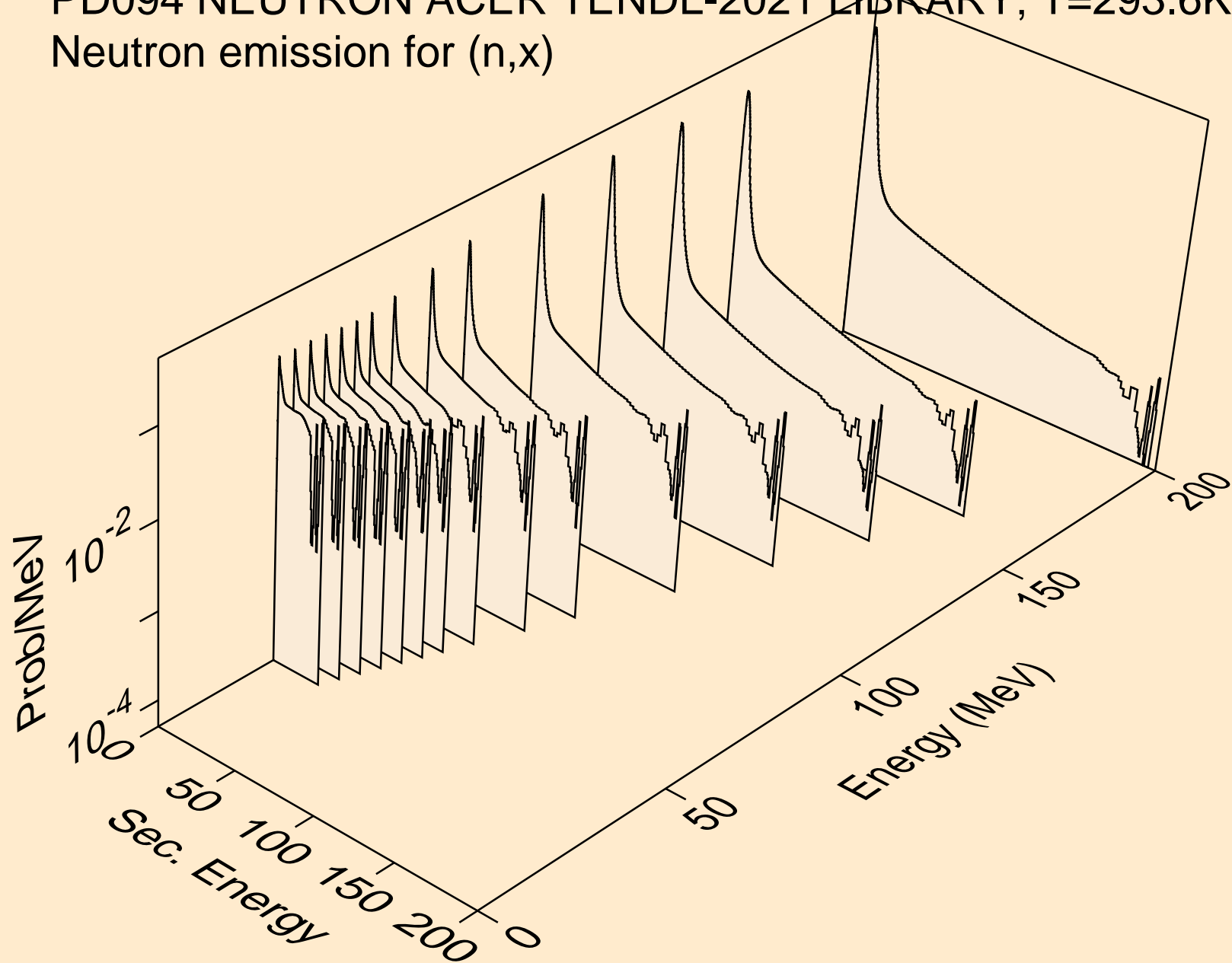

PD094 NEUTRON ACER TENDL-2021 LIBRARY; T=293.6K
Neutron emission for (n,2n)

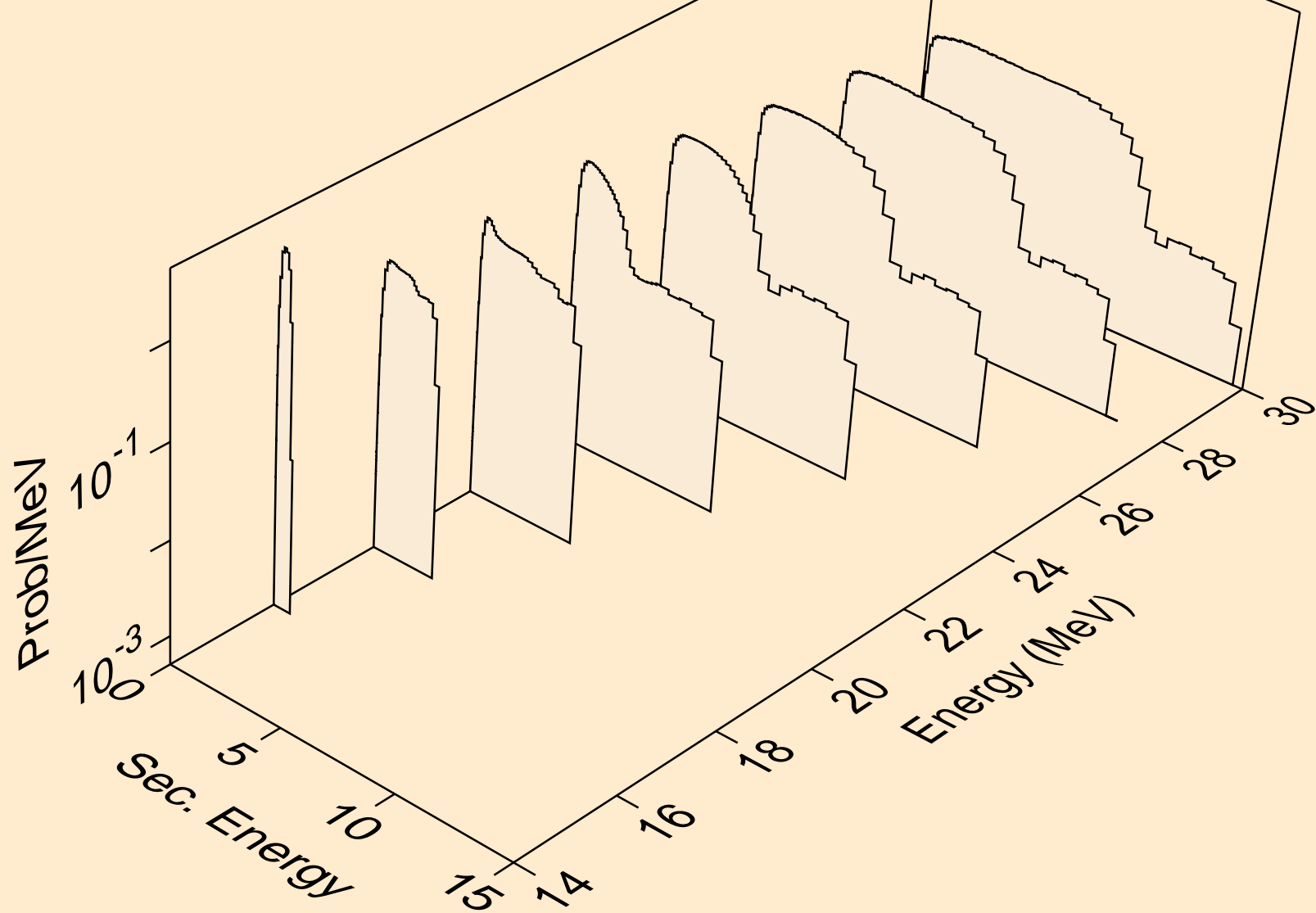

PD094 NEUTRON ACER TENDL-2021 LIBRARY; T=293.6K
Neutron emission for (n,3n)

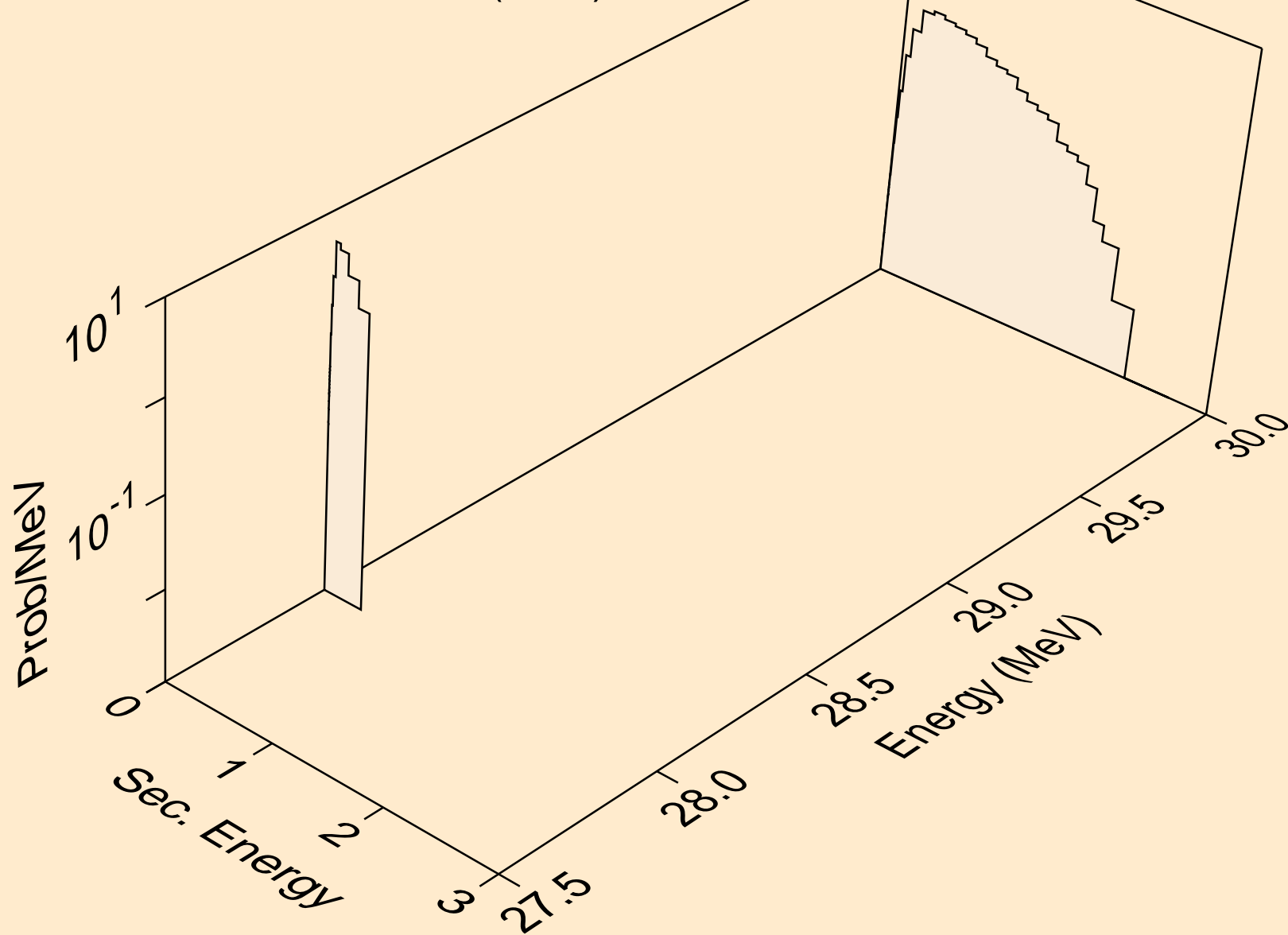

PD094 NEUTRON ACER TENDL-2021 LIBRARY; T=293.6K
Neutron emission for (n,n*)a

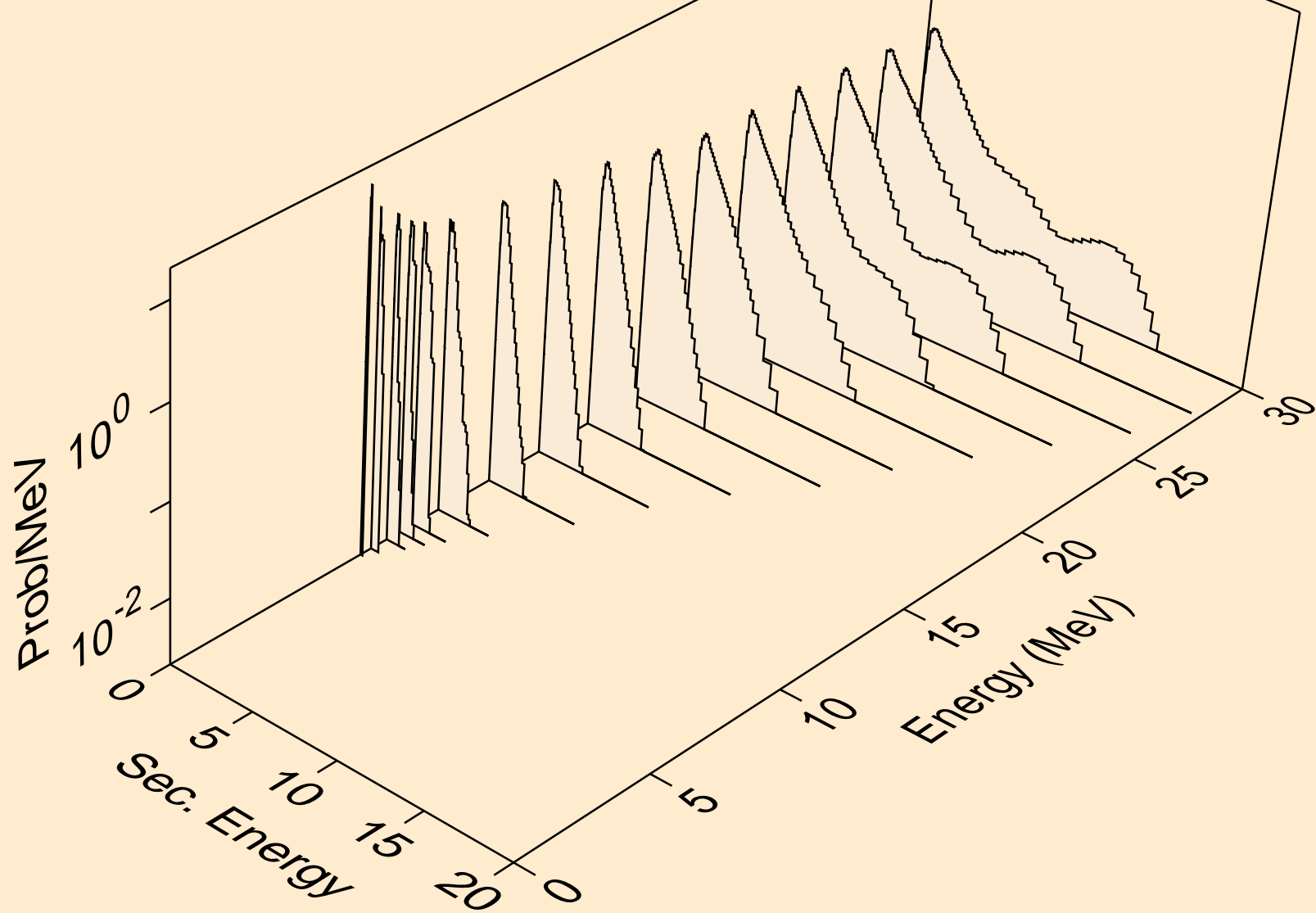

PD094 NEUTRON ACER TENDL-2021 LIBRARY; T=293.6K
Neutron emission for (n,2n)a

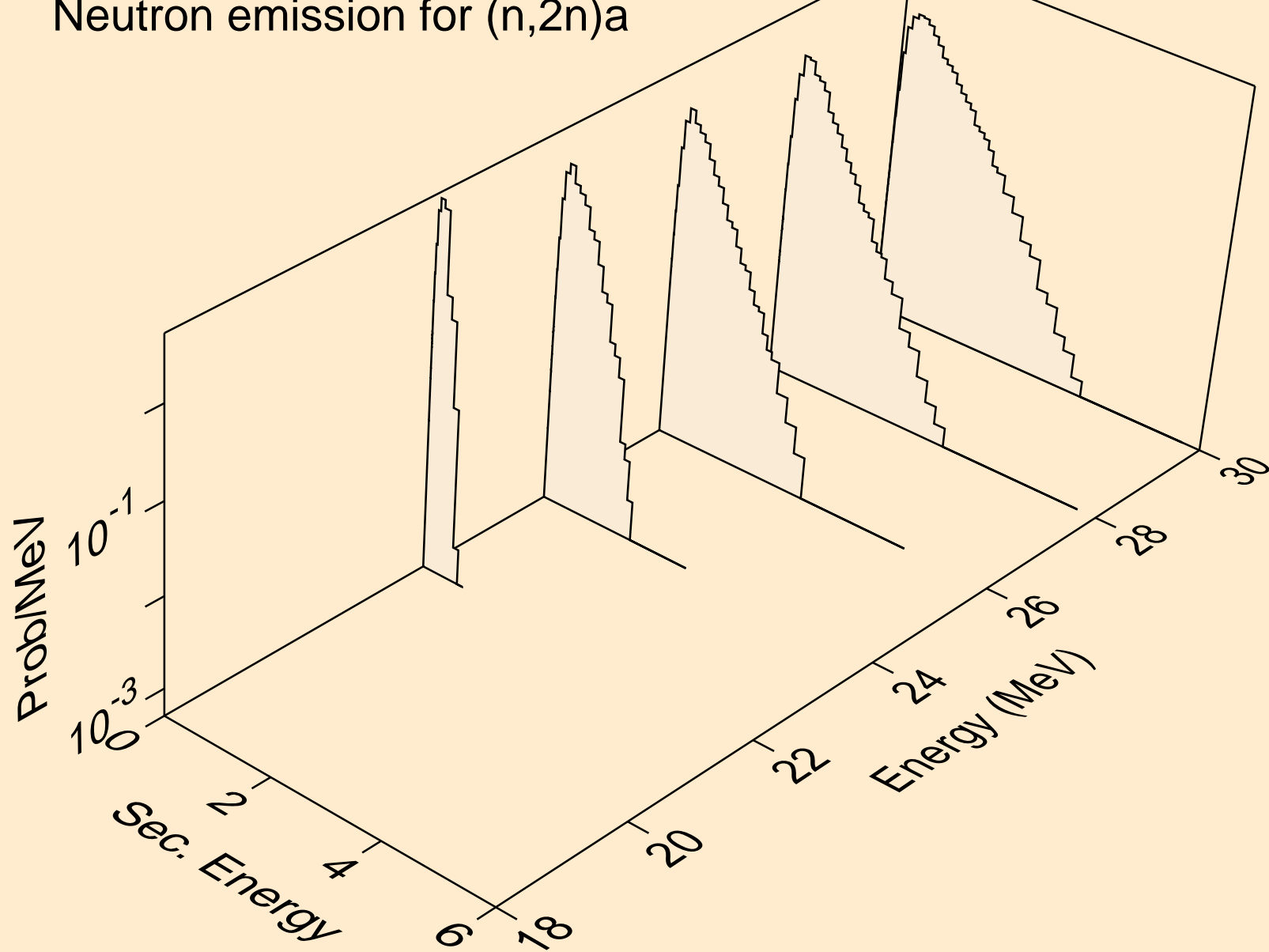

PD094 NEUTRON ACER TENDL-2021 LIBRARY; T=293.6K
Neutron emission for (n,n*)p

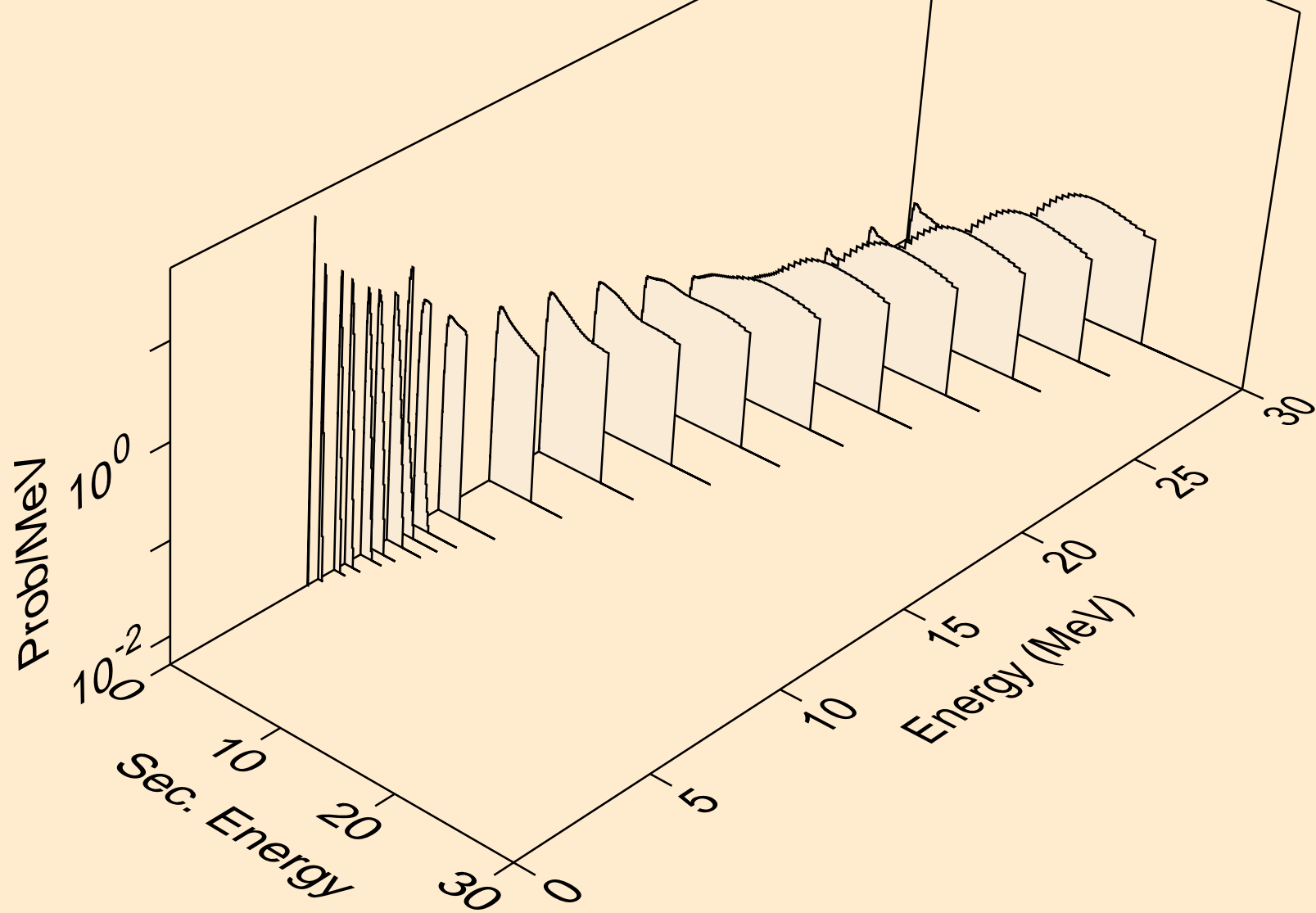

PD094 NEUTRON ACER TENDL-2021 LIBRARY; T=293.6K
Neutron emission for (n,n*)2a

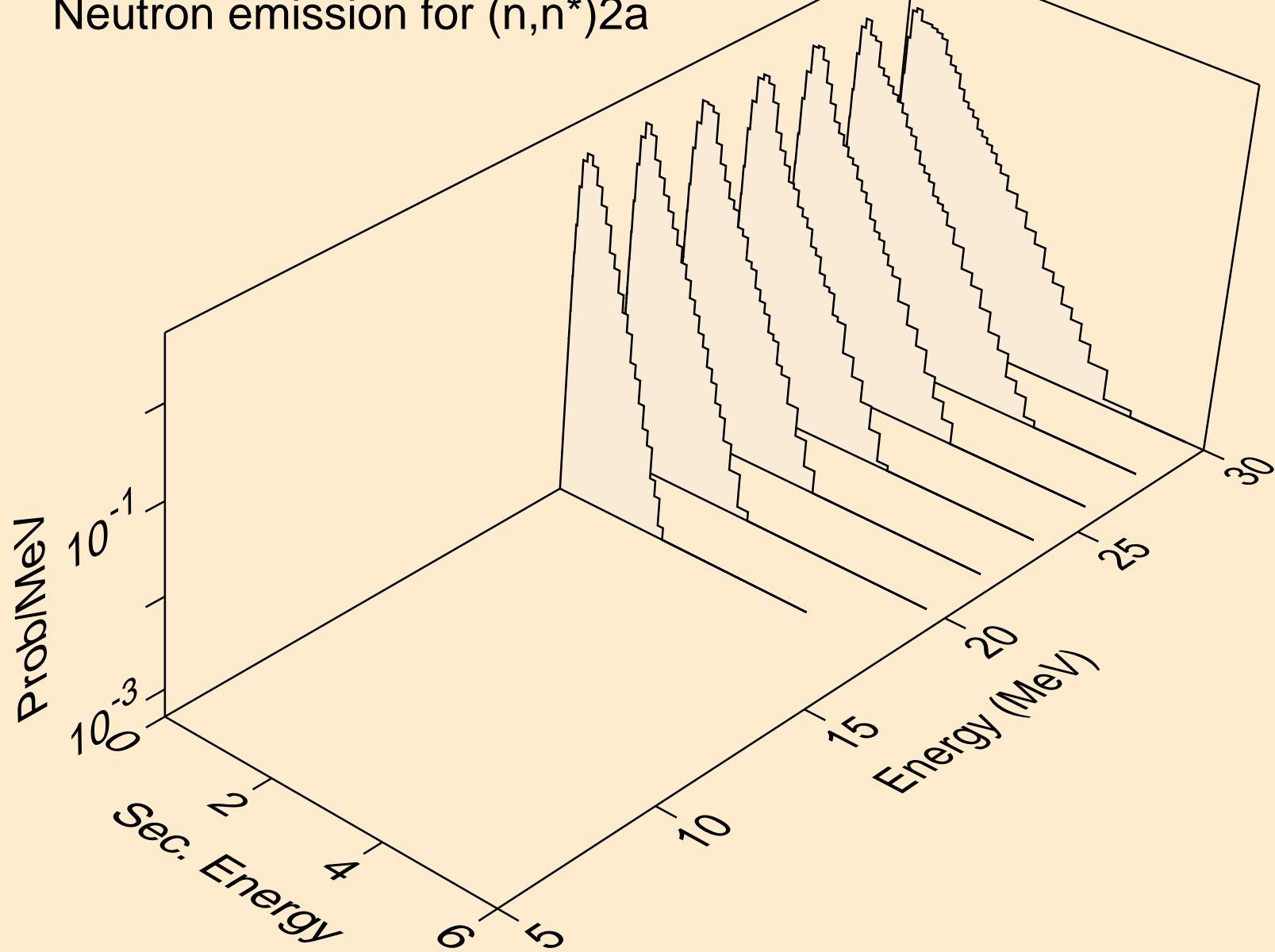

PD094 NEUTRON ACER TENDL-2021 LIBRARY; T=293.6K
Neutron emission for (n,n*)d

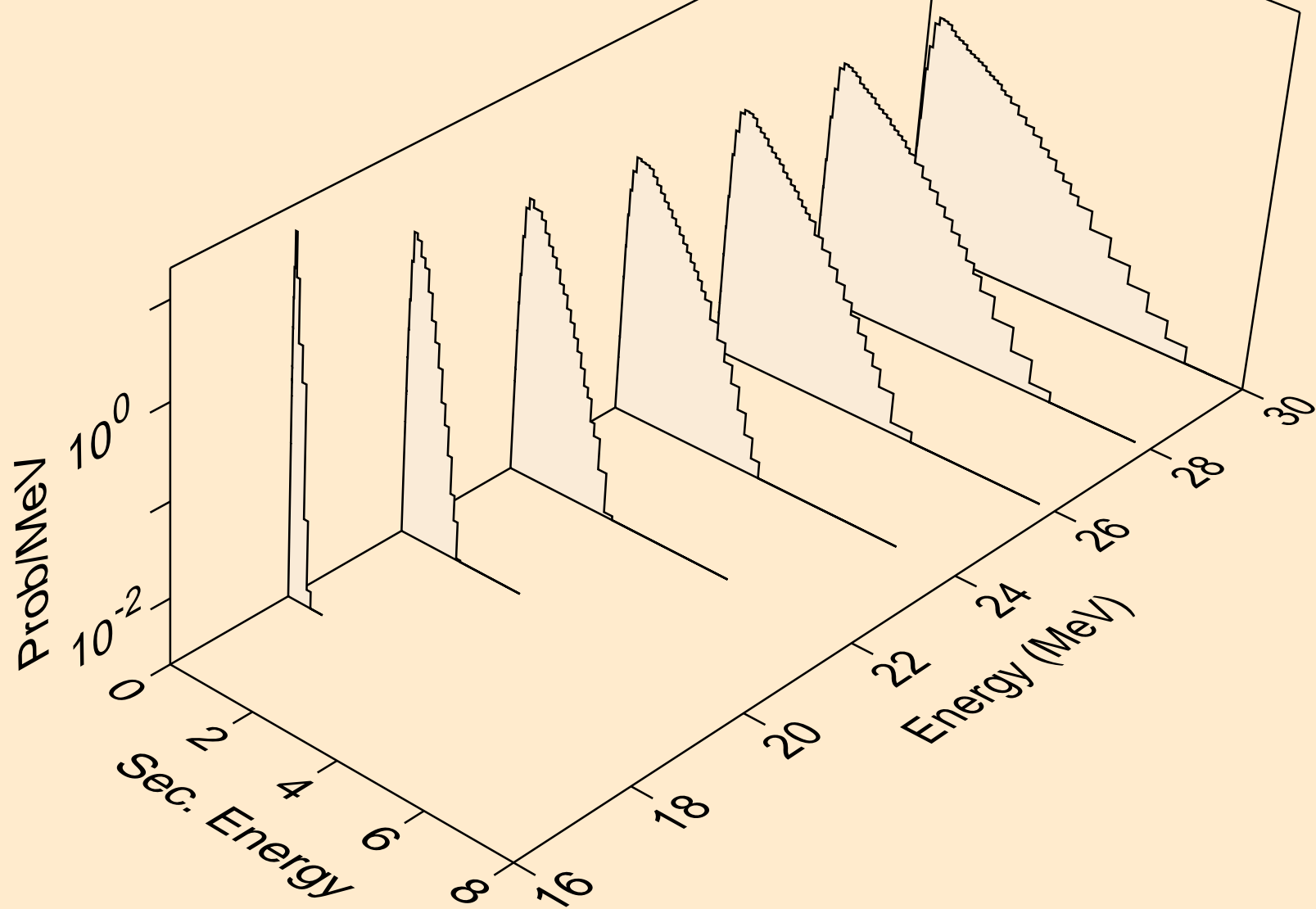

PD094 NEUTRON ACER TENDL-2021 LIBRARY; T=293.6K
Neutron emission for (n,n*)t

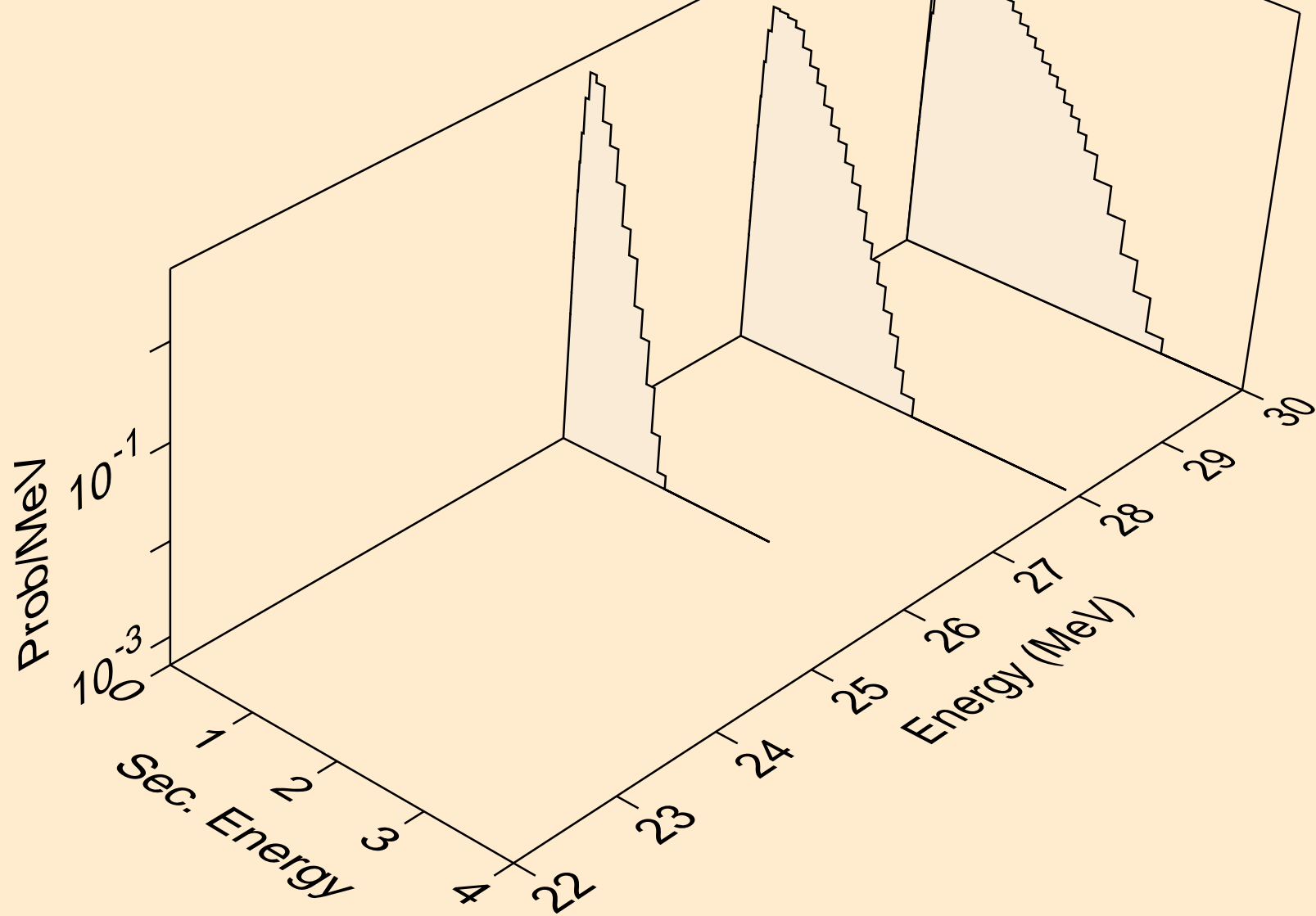

PD094 NEUTRON ACER TENDL-2021 LIBRARY; T=293.6K
Neutron emission for (n,n*)he3

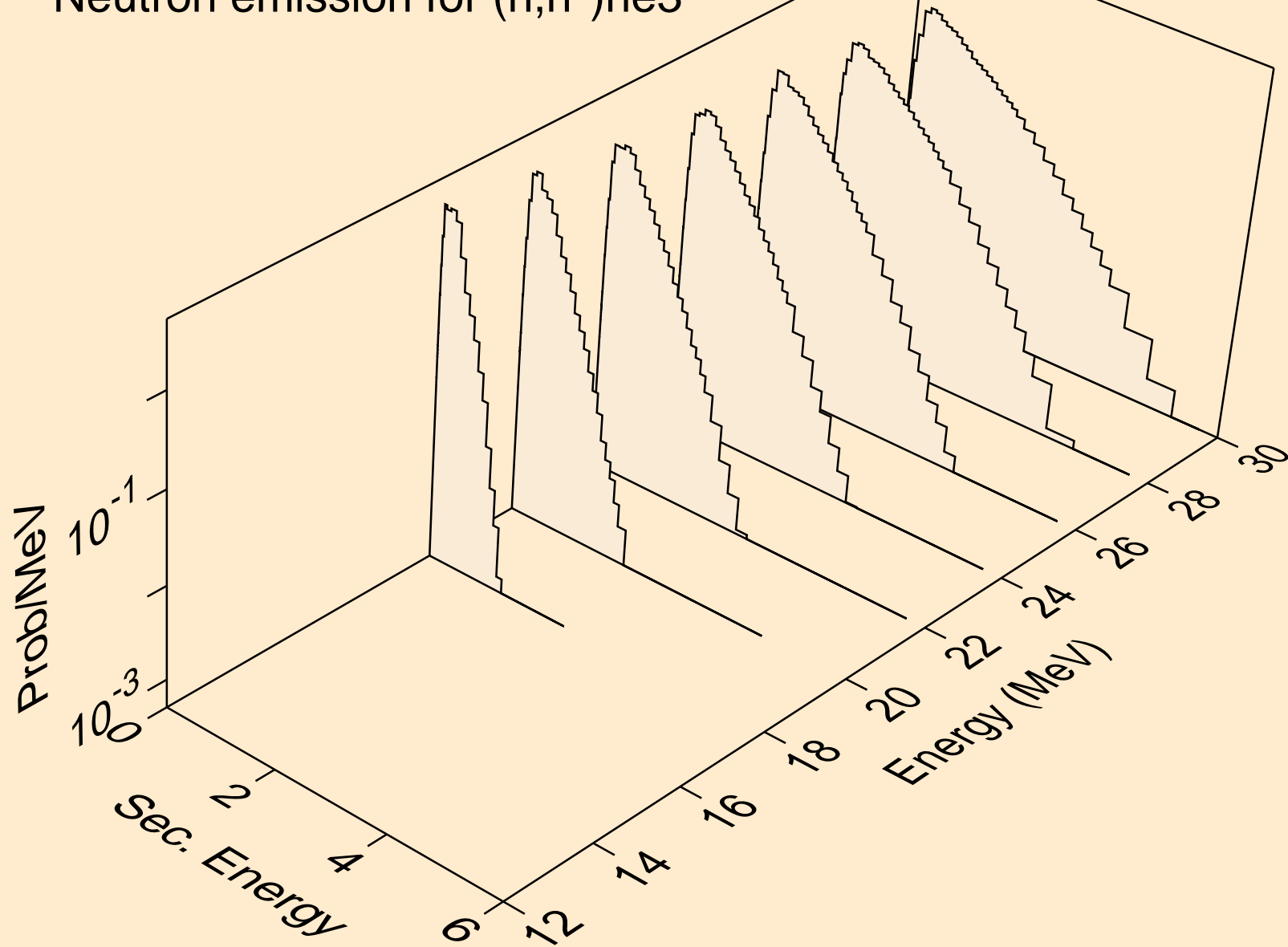

PD094 NEUTRON ACER TENDL-2021 LIBRARY; T=293.6K
Neutron emission for (n,2np)

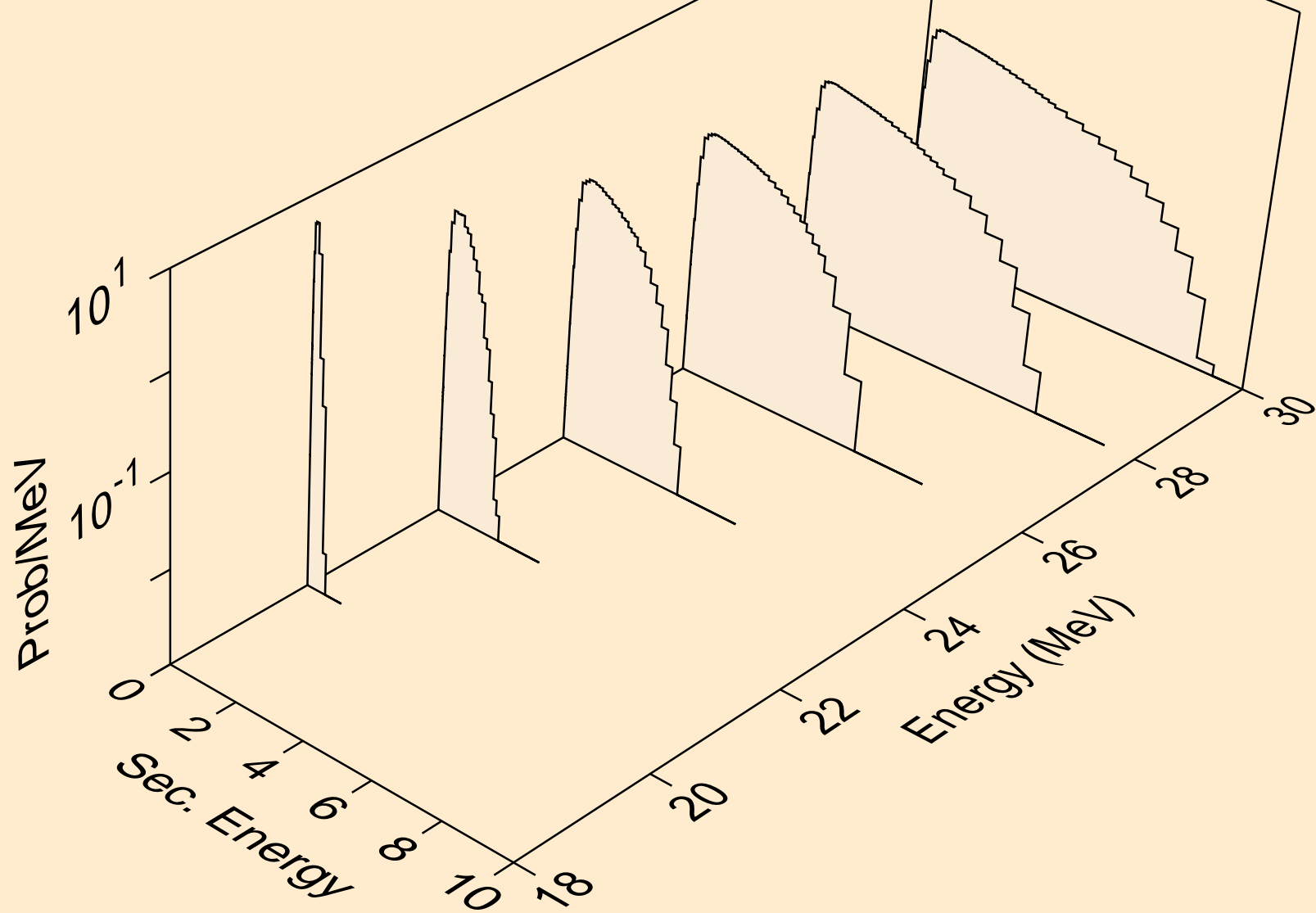

PD094 NEUTRON ACER TENDL-2021 LIBRARY; T=293.6K
Neutron emission for (n,2np)

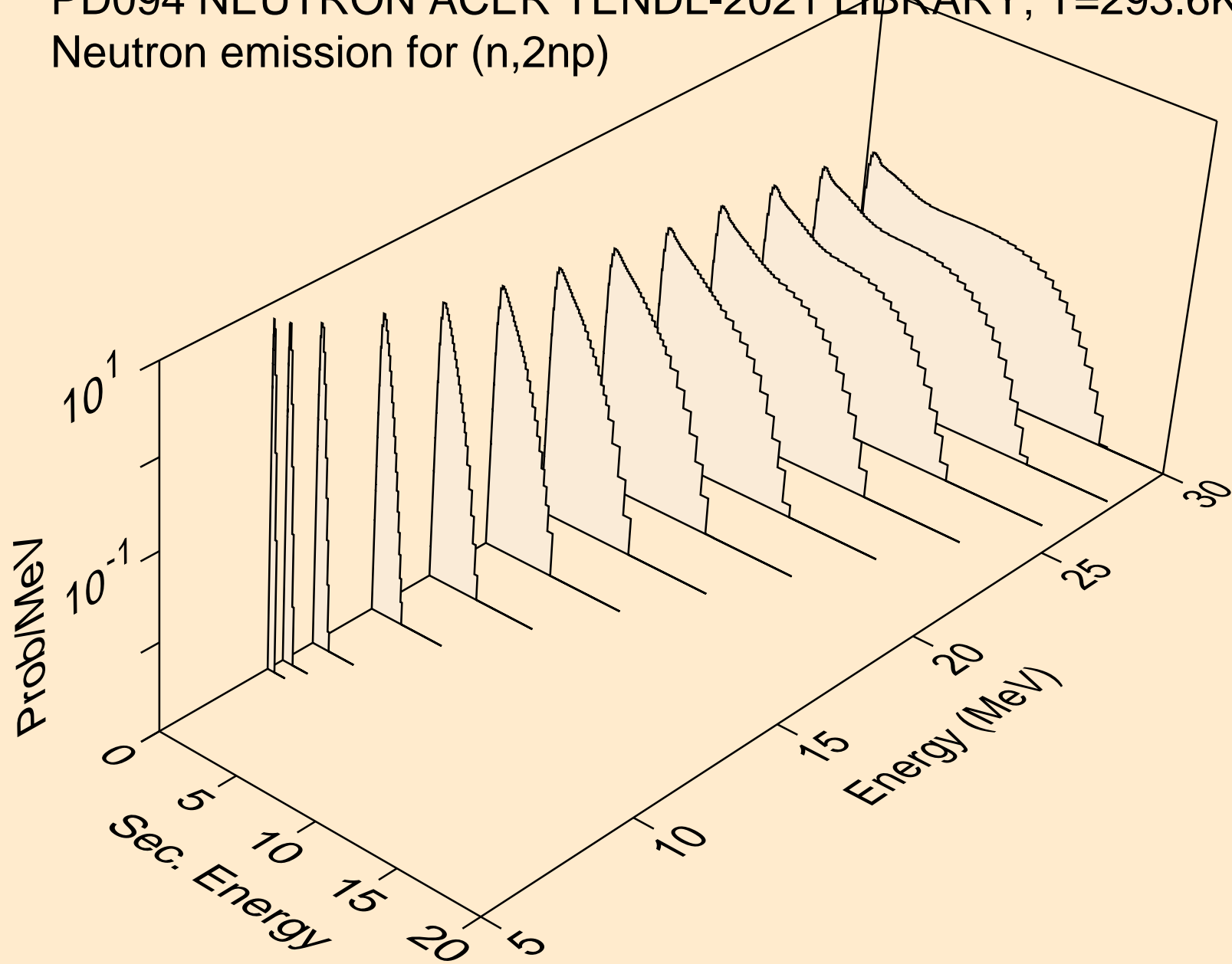

PD094 NEUTRON ACER TENDL-2021 LIBRARY; T=293.6K
Neutron emission for (n,npa)

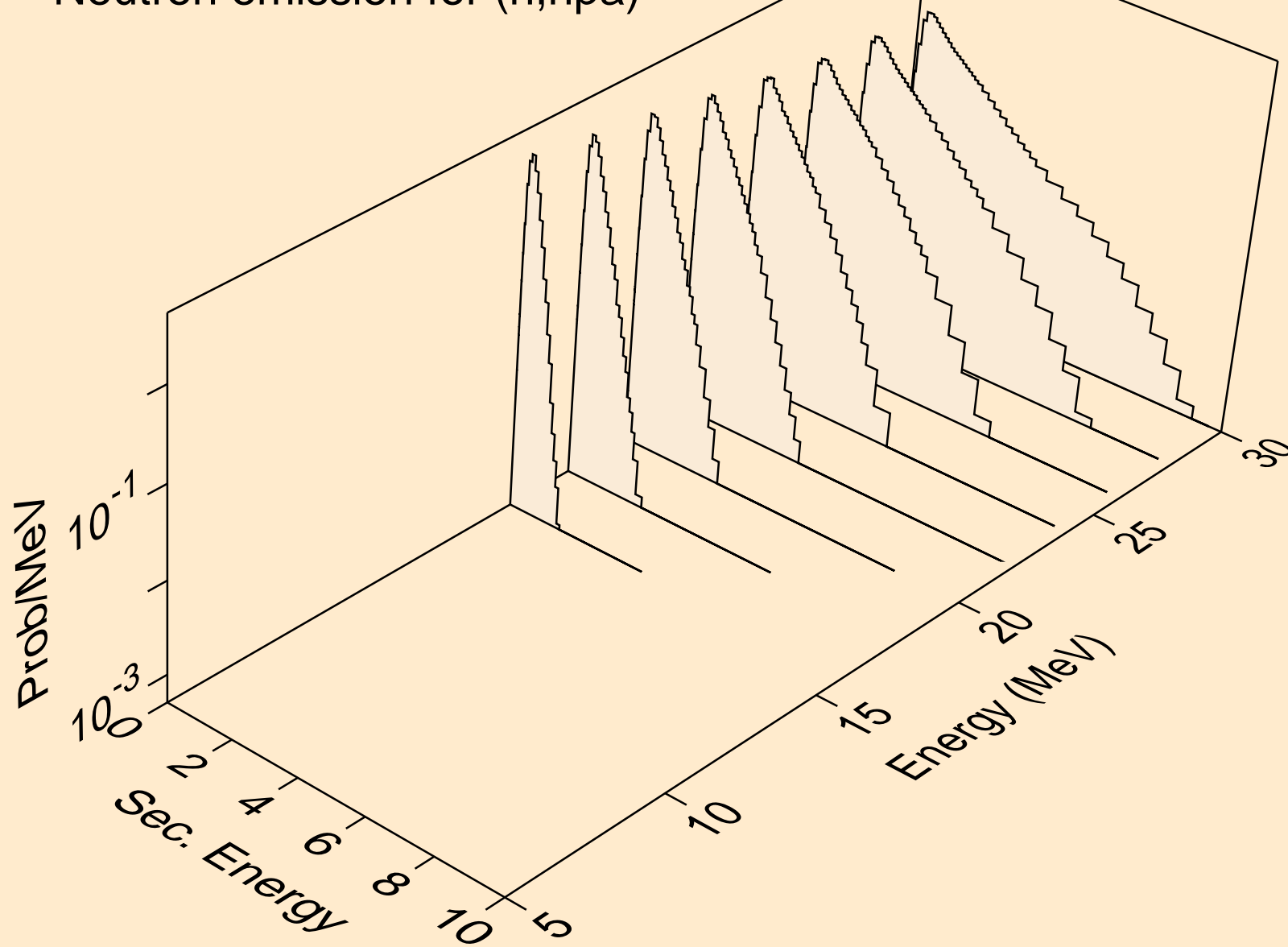

PD094 NEUTRON ACER TENDL-2021 LIBRARY; T=293.6K
Neutron emission for (n,n*c)

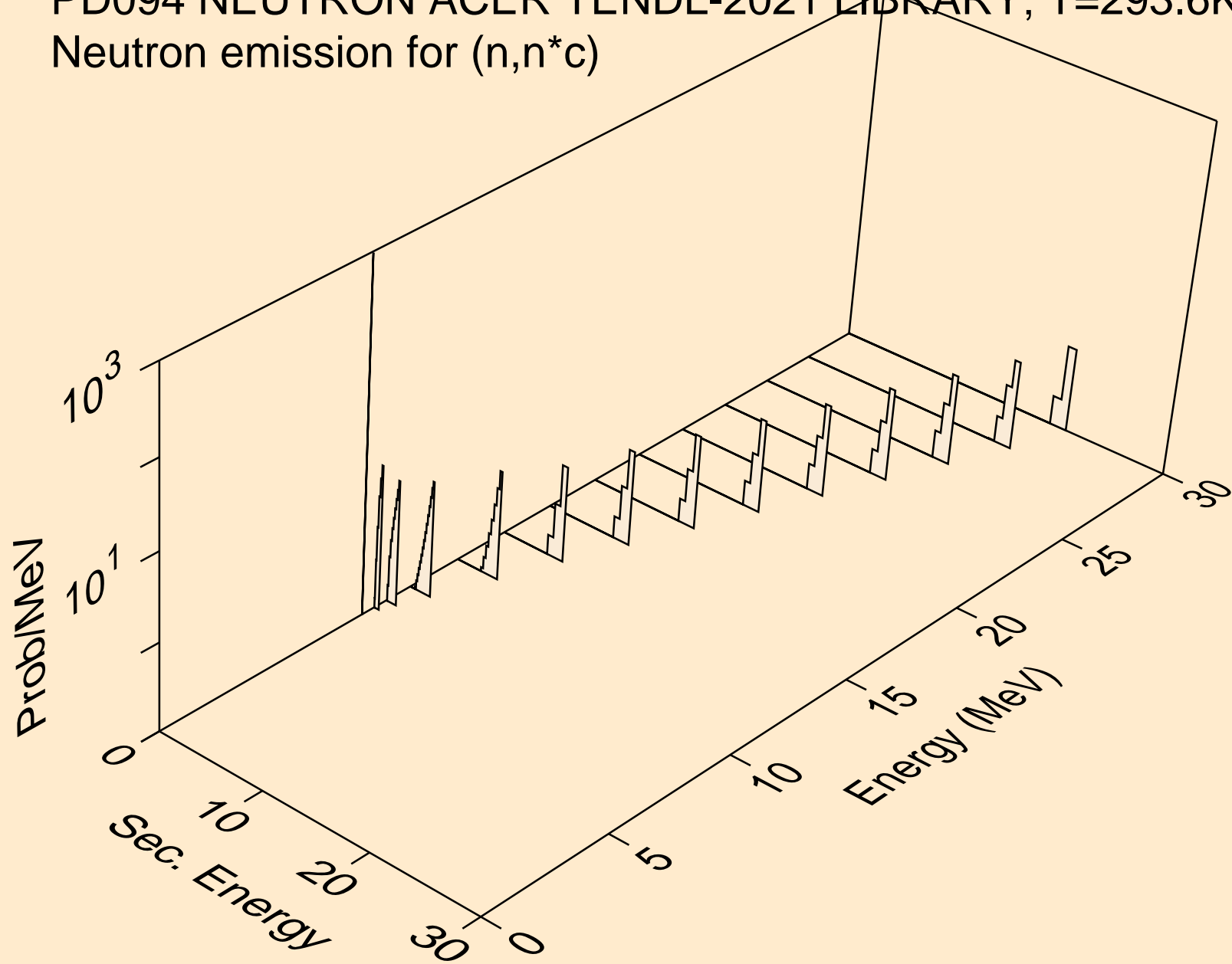

PD094 NEUTRON ACER TENDL-2021 LIBRARY; T=293.6K
Photon emission for (n,x)

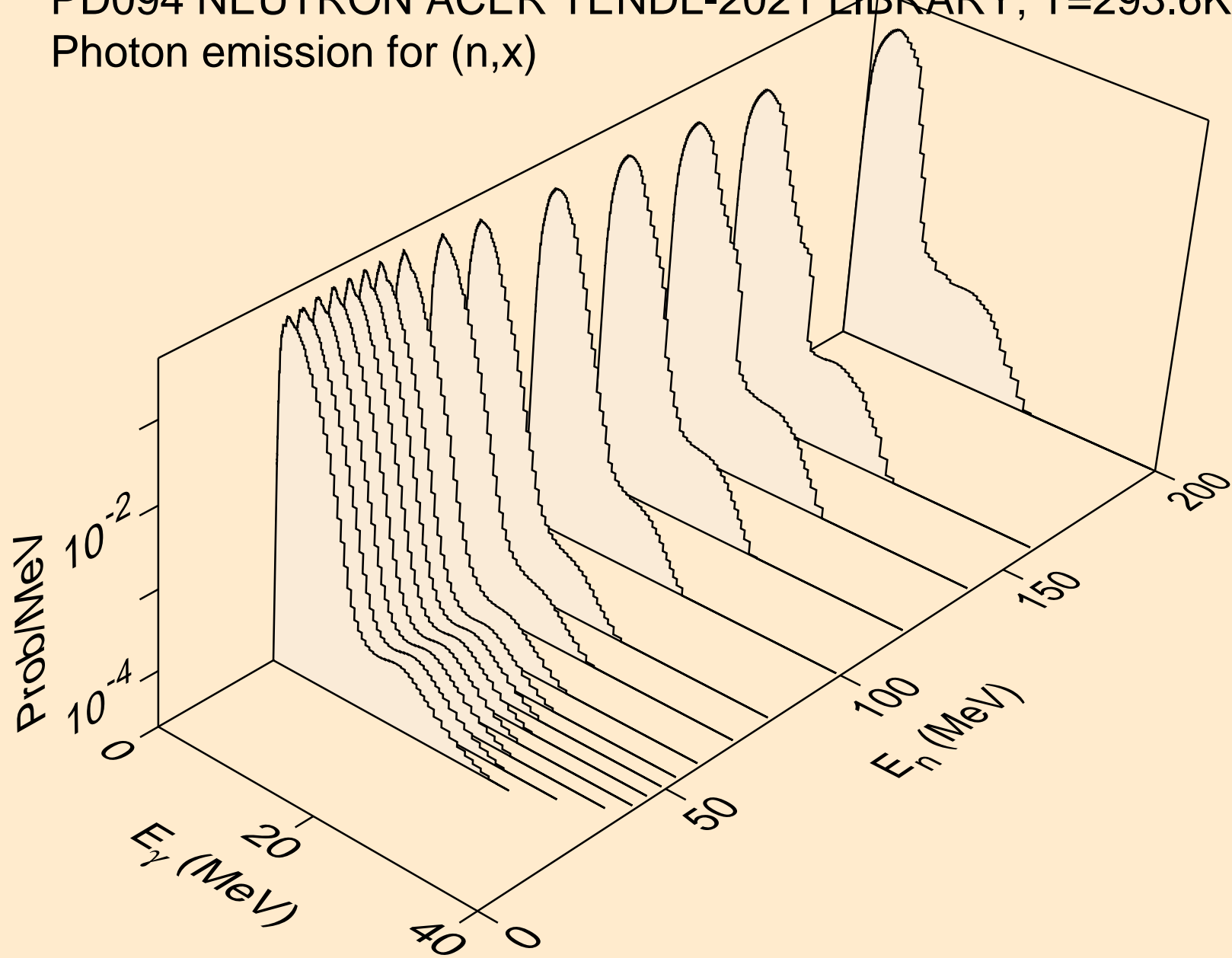

PD094 NEUTRON ACER TENDL-2021 LIBRARY; T=293.6K
Photon emission for (n,2n)

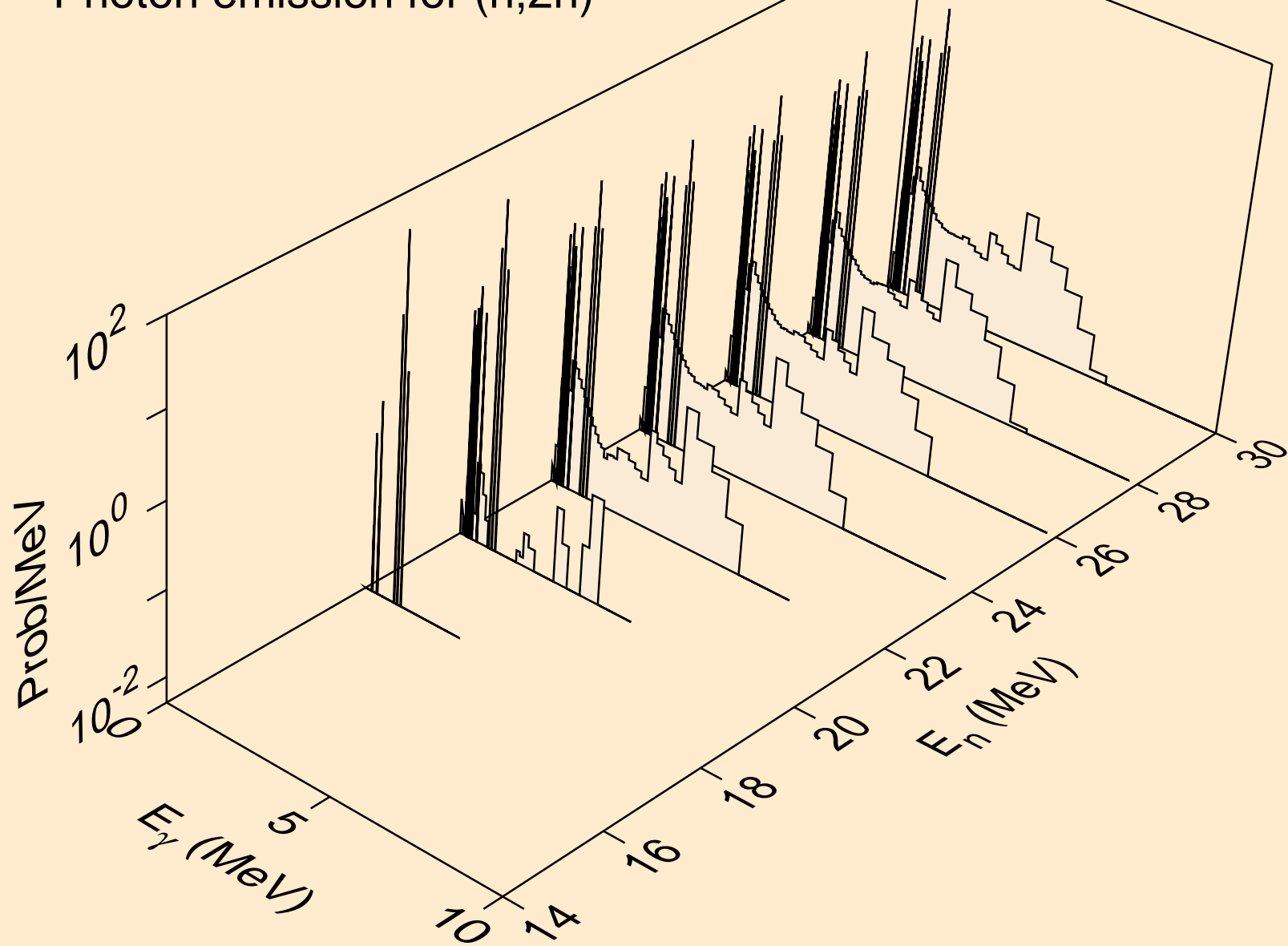

PD094 NEUTRON ACER TENDL-2021 LIBRARY; T=293.6K
Photon emission for (n,3n)

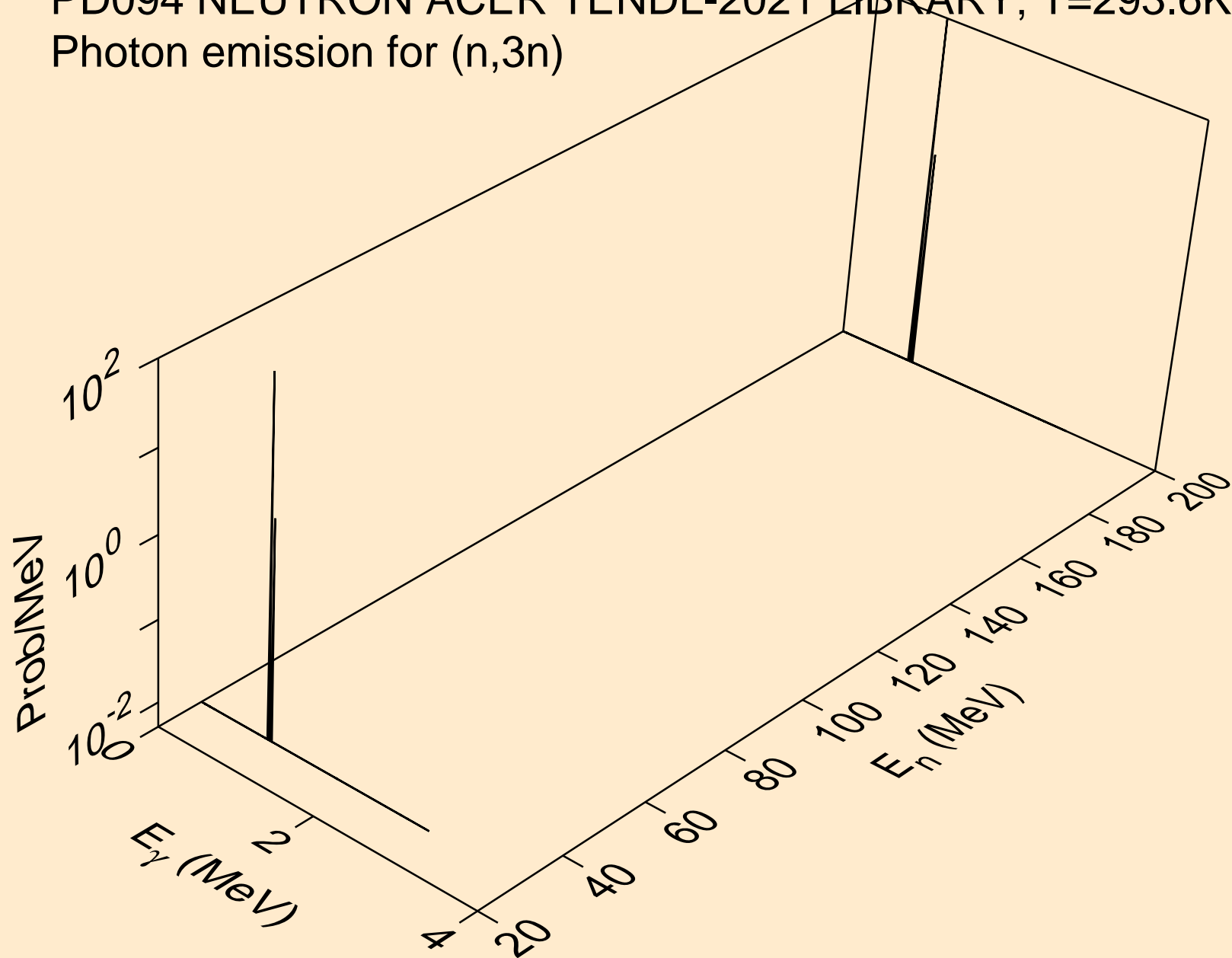

PD094 NEUTRON ACER TENDL-2021 LIBRARY; T=293.6K
Photon emission for (n,n*)a

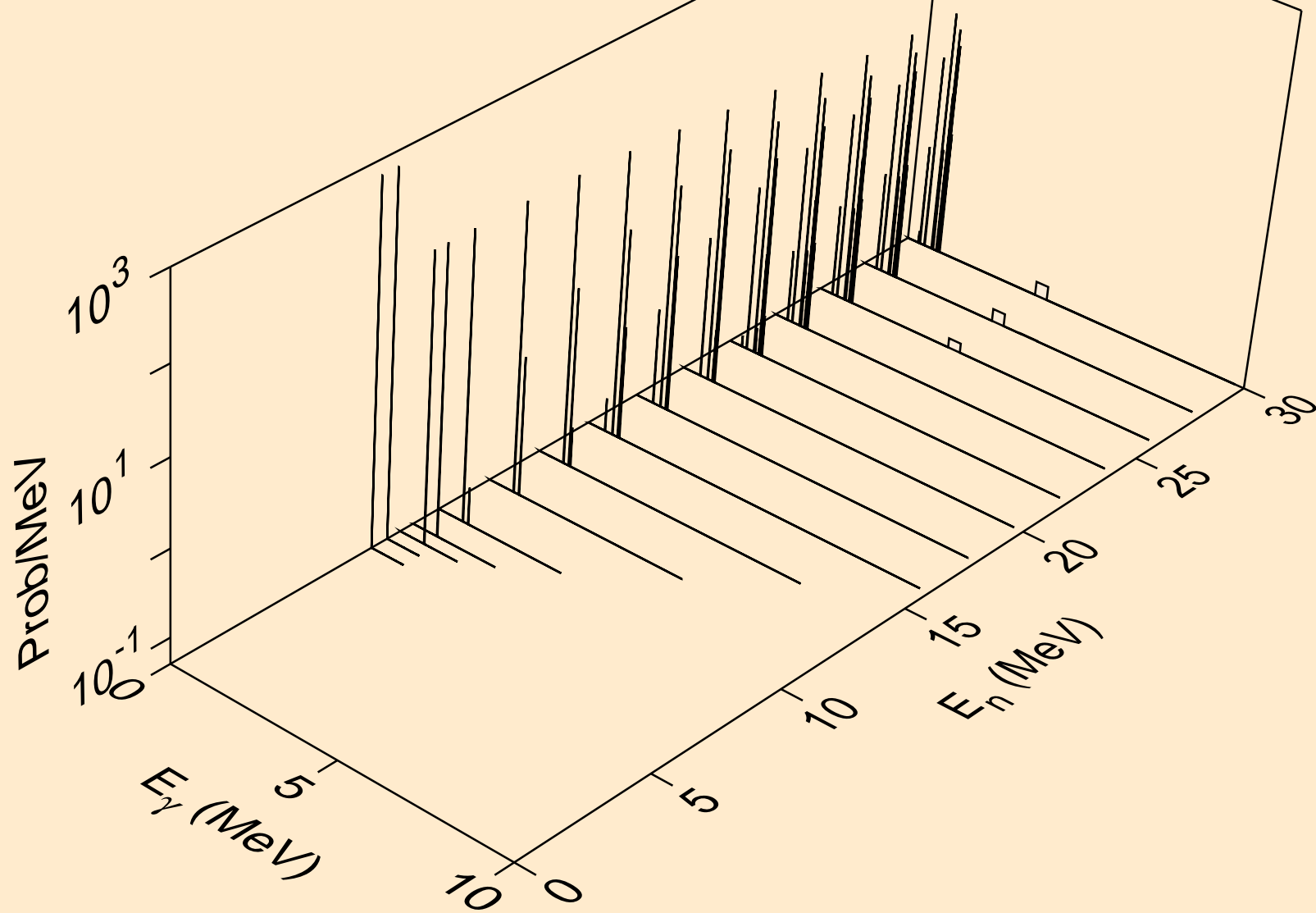

PD094 NEUTRON ACER TENDL-2021 LIBRARY; T=293.6K
Photon emission for (n,2n)a

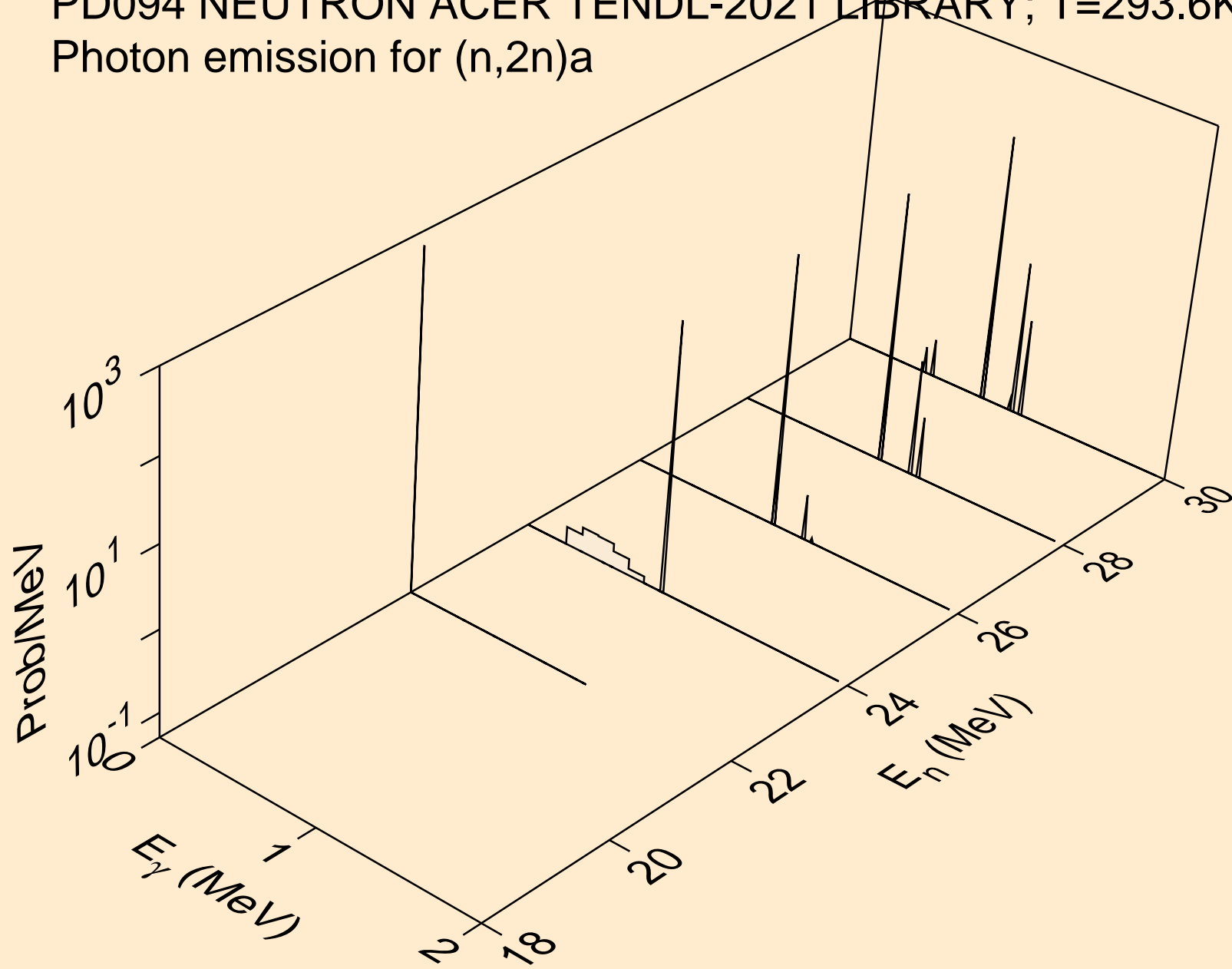

PD094 NEUTRON ACER TENDL-2021 LIBRARY; T=293.6K
Photon emission for (n,n*)p

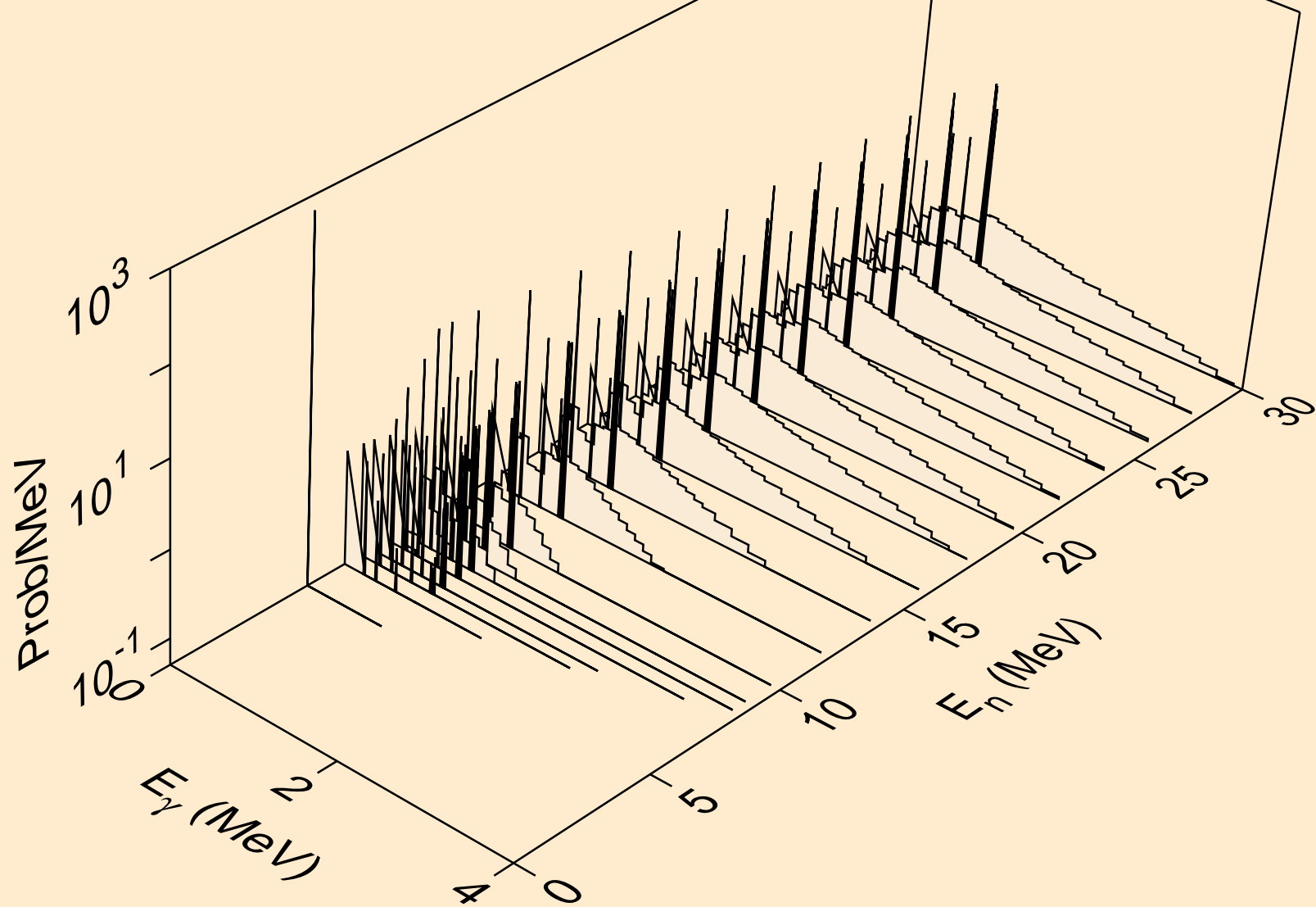

PD094 NEUTRON ACER TENDL-2021 LIBRARY; T=293.6K
Photon emission for (n,n*)2a

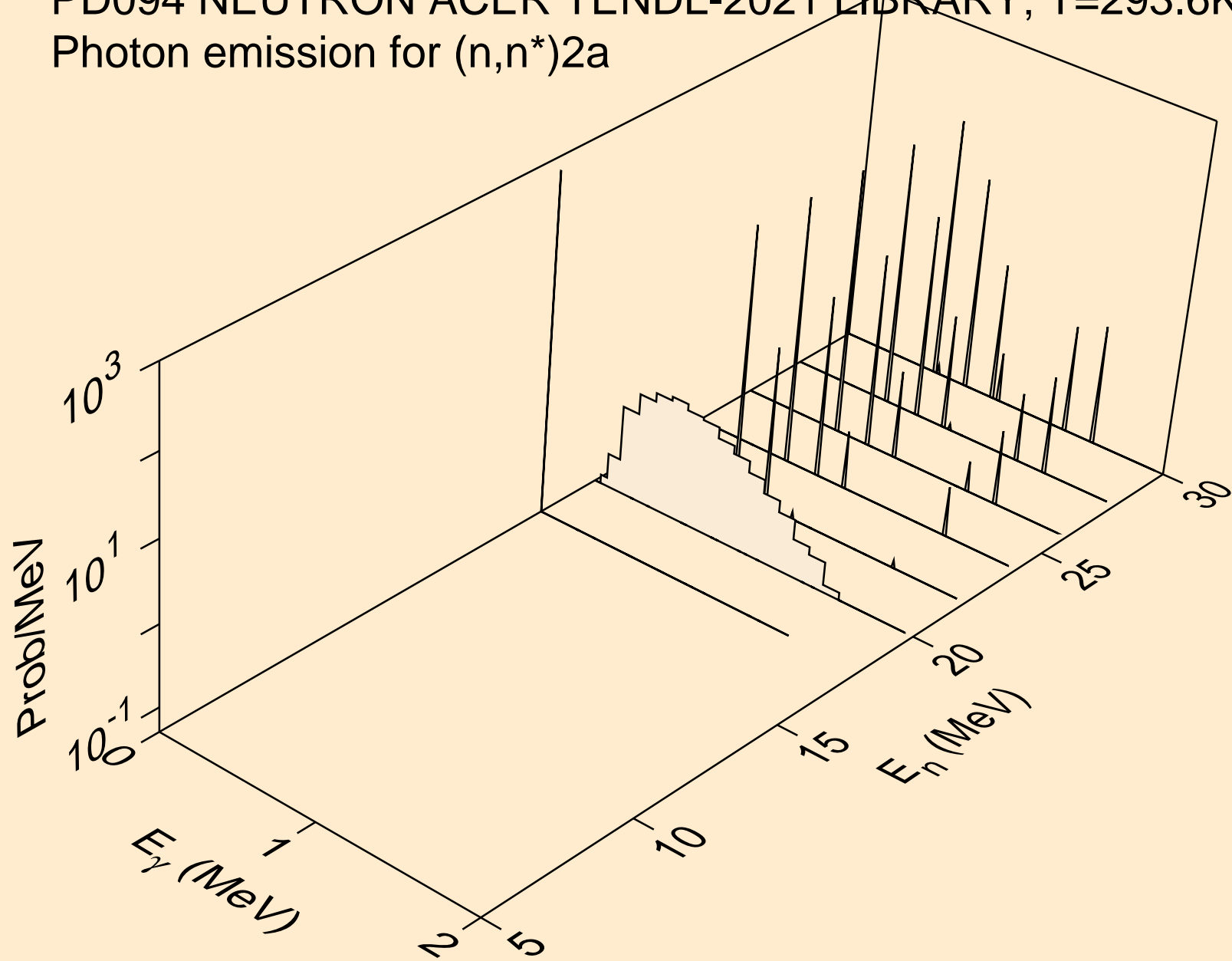

PD094 NEUTRON ACER TENDL-2021 LIBRARY; T=293.6K
Photon emission for (n,n*)d

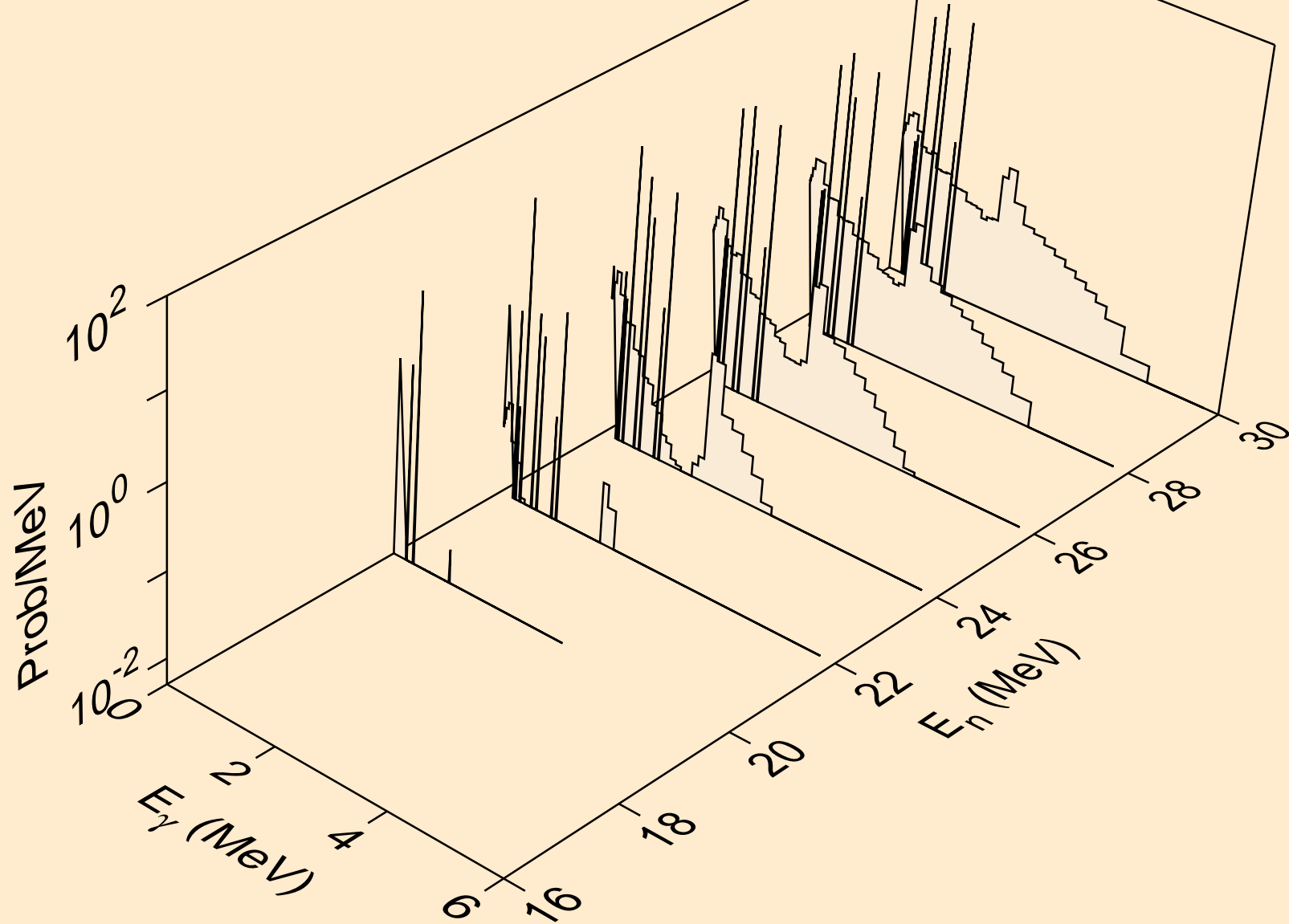

PD094 NEUTRON ACER TENDL-2021 LIBRARY; T=293.6K
Photon emission for (n,n*)t

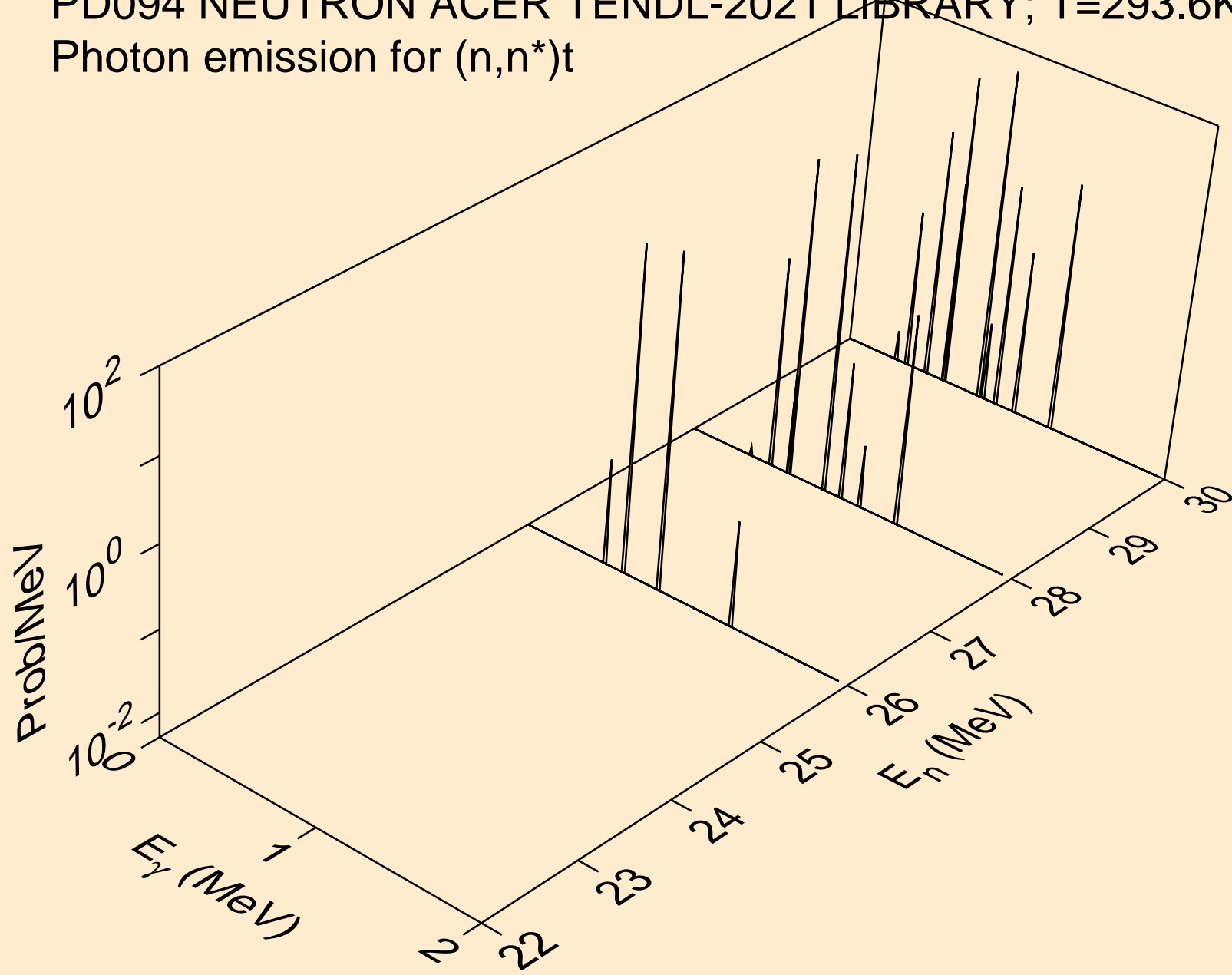

PD094 NEUTRON ACER TENDL-2021 LIBRARY; T=293.6K
Photon emission for (n,n*)he3

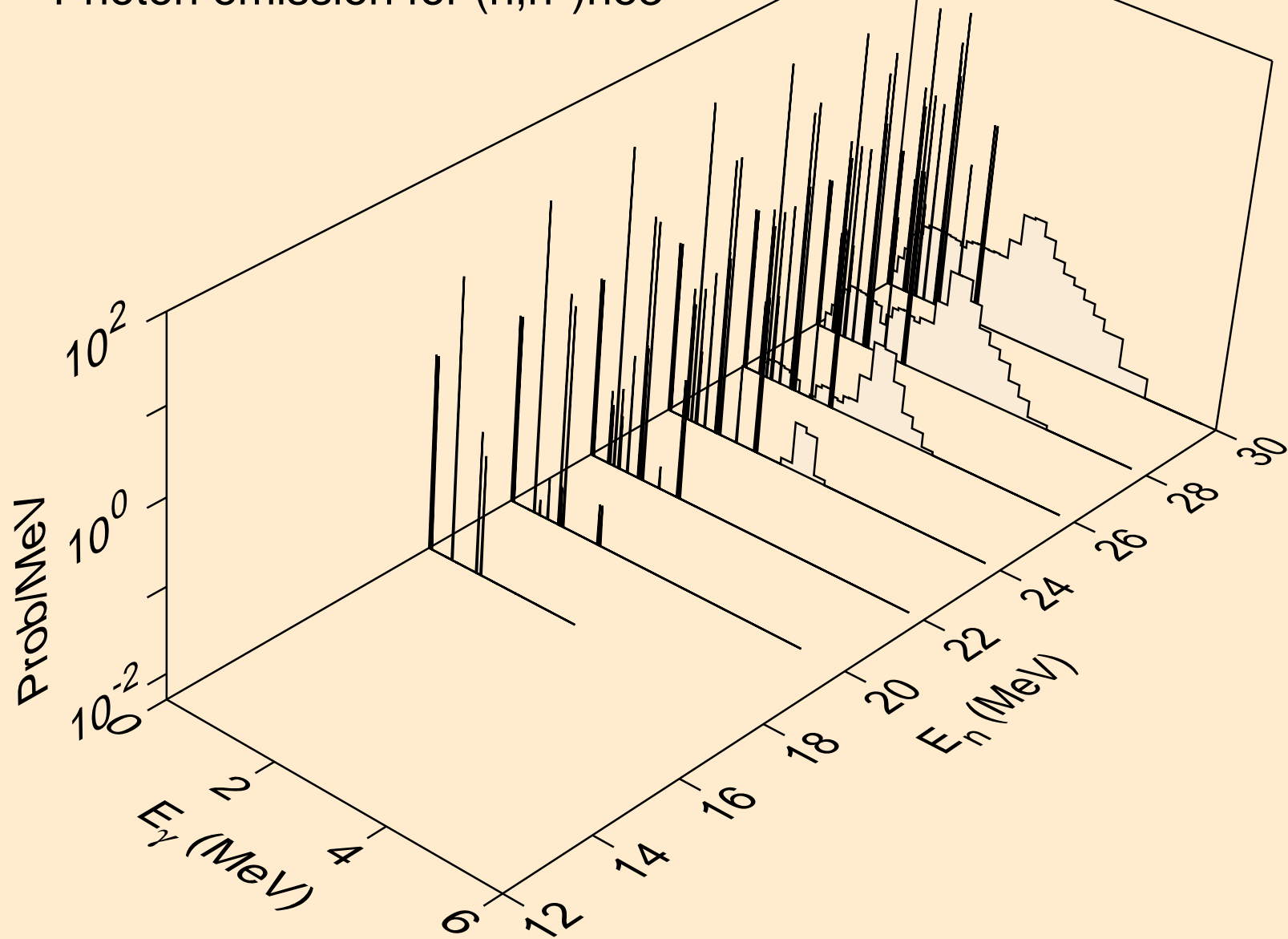

PD094 NEUTRON ACER TENDL-2021 LIBRARY; T=293.6K
Photon emission for (n,2np)

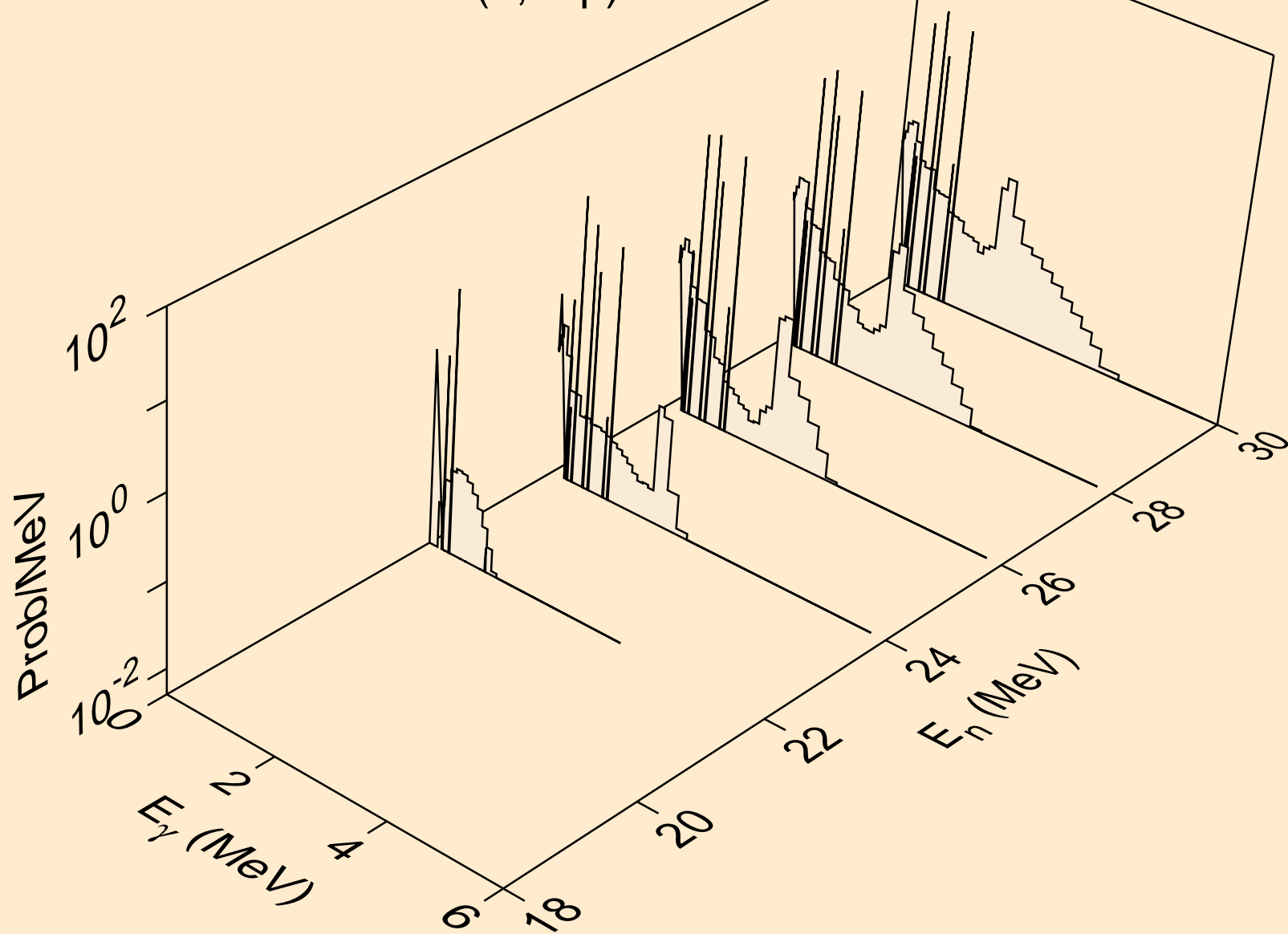

PD094 NEUTRON ACER TENDL-2021 LIBRARY; T=293.6K
Photon emission for (n,2np)

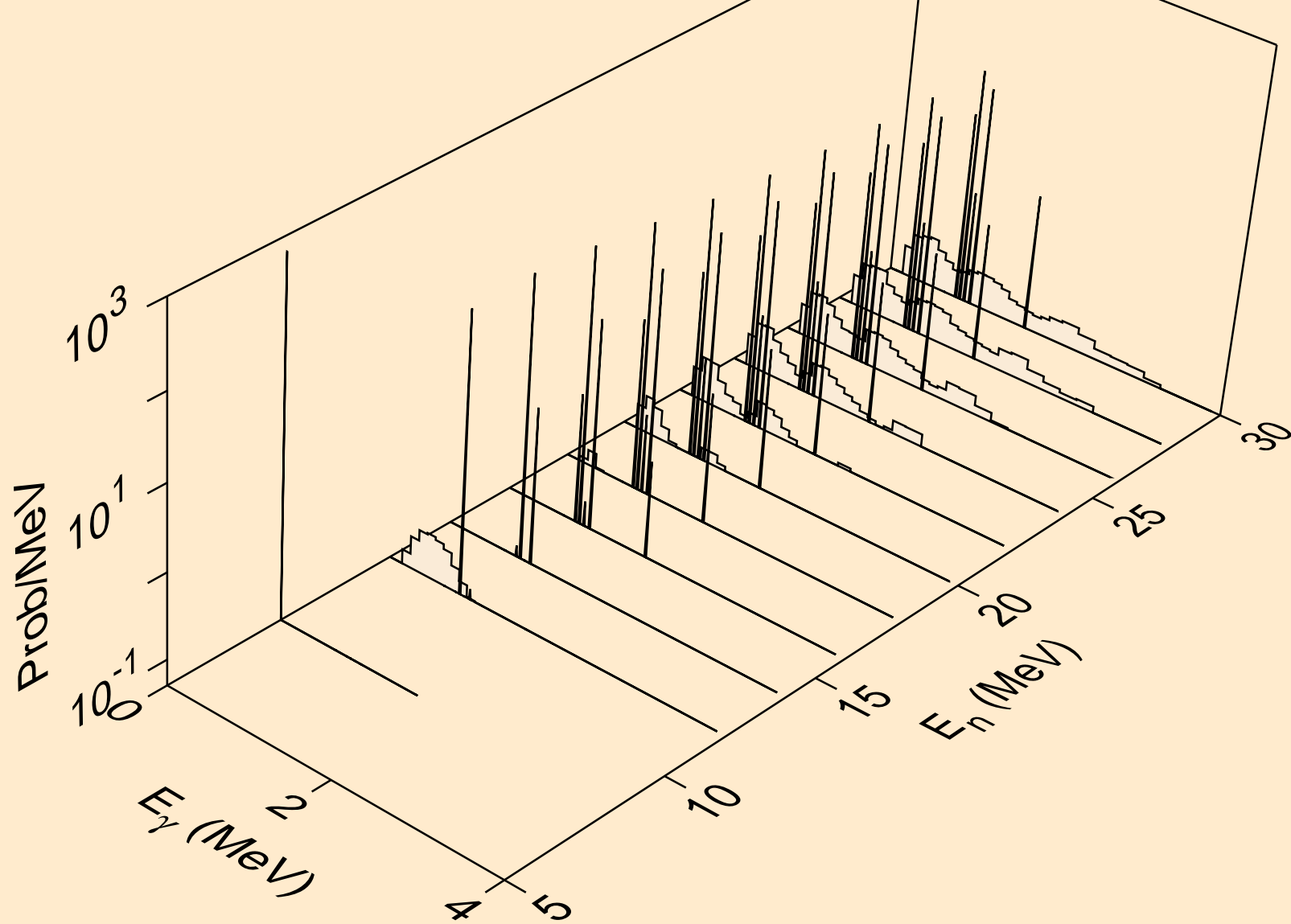

PD094 NEUTRON ACER TENDL-2021 LIBRARY; T=293.6K
Photon emission for (n,npa)

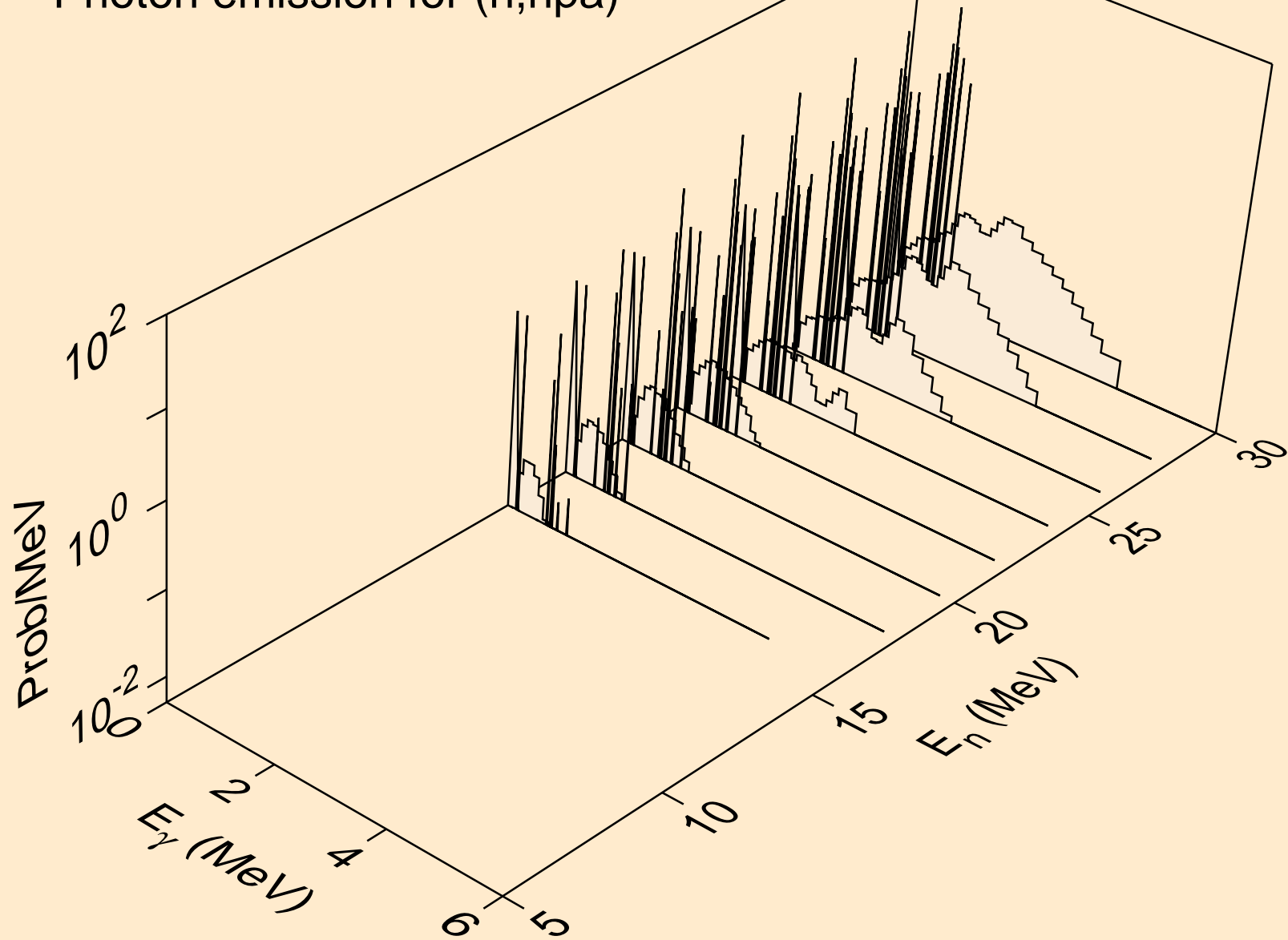

PD094 NEUTRON ACER TENDL-2021 LIBRARY; T=293.6K
Photon emission for (n,n*c)

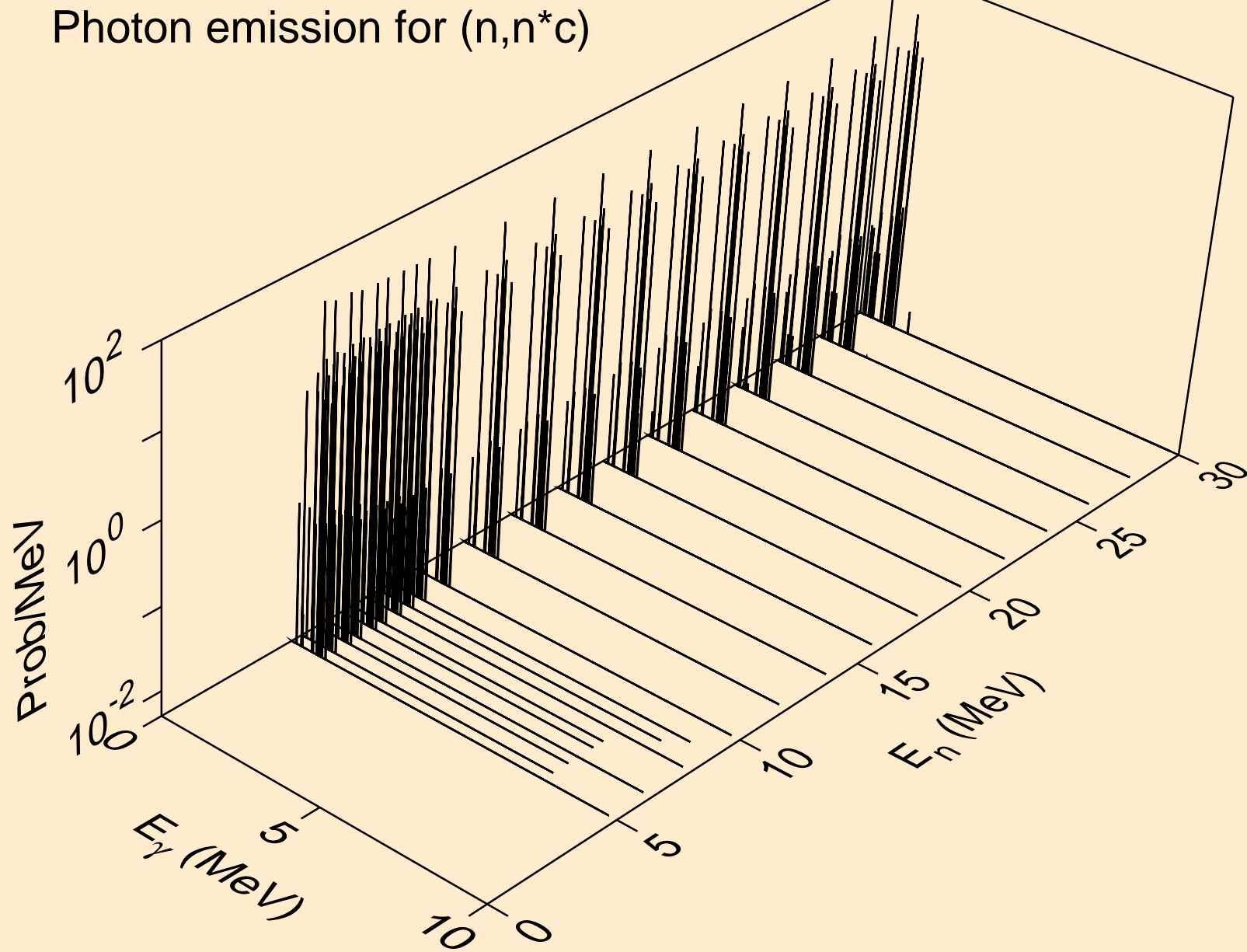

PD094 NEUTRON ACER TENDL-2021 LIBRARY; T=293.6K
Photon emission for (n,gma)

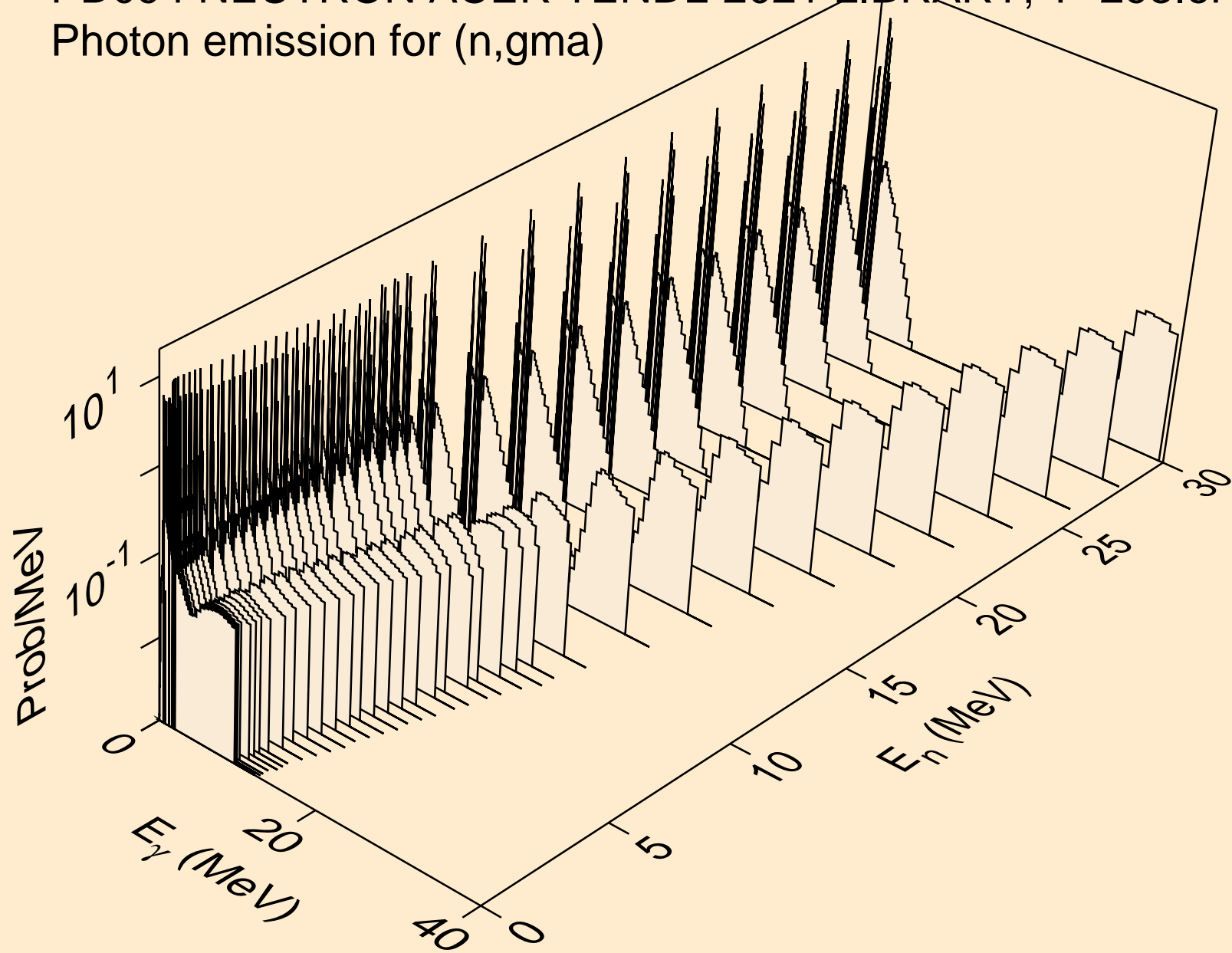

PD094 NEUTRON ACER TENDL-2021 LIBRARY; T=293.6K
Photon emission for (n,p)

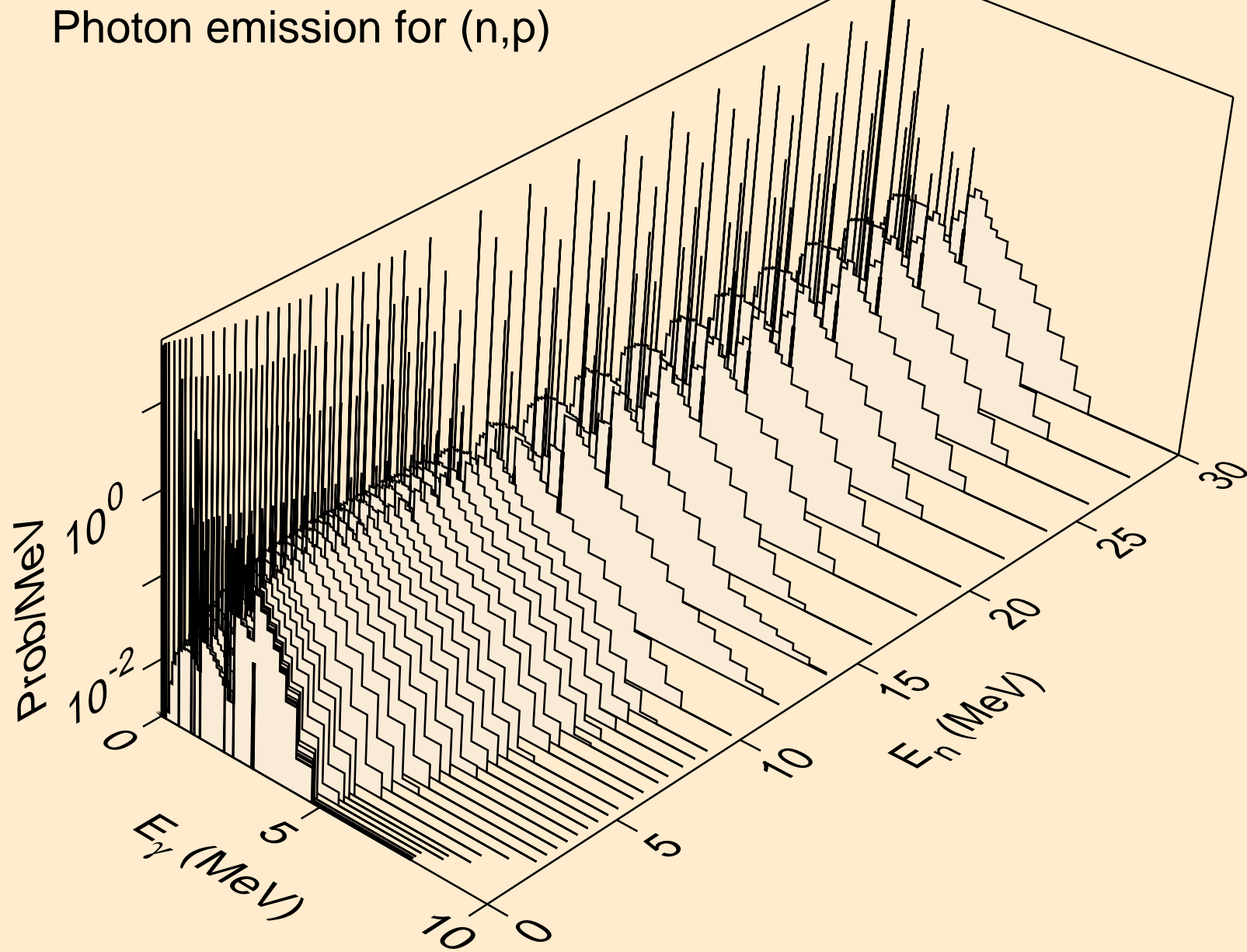

PD094 NEUTRON ACER TENDL-2021 LIBRARY; T=293.6K
Photon emission for (n,d)

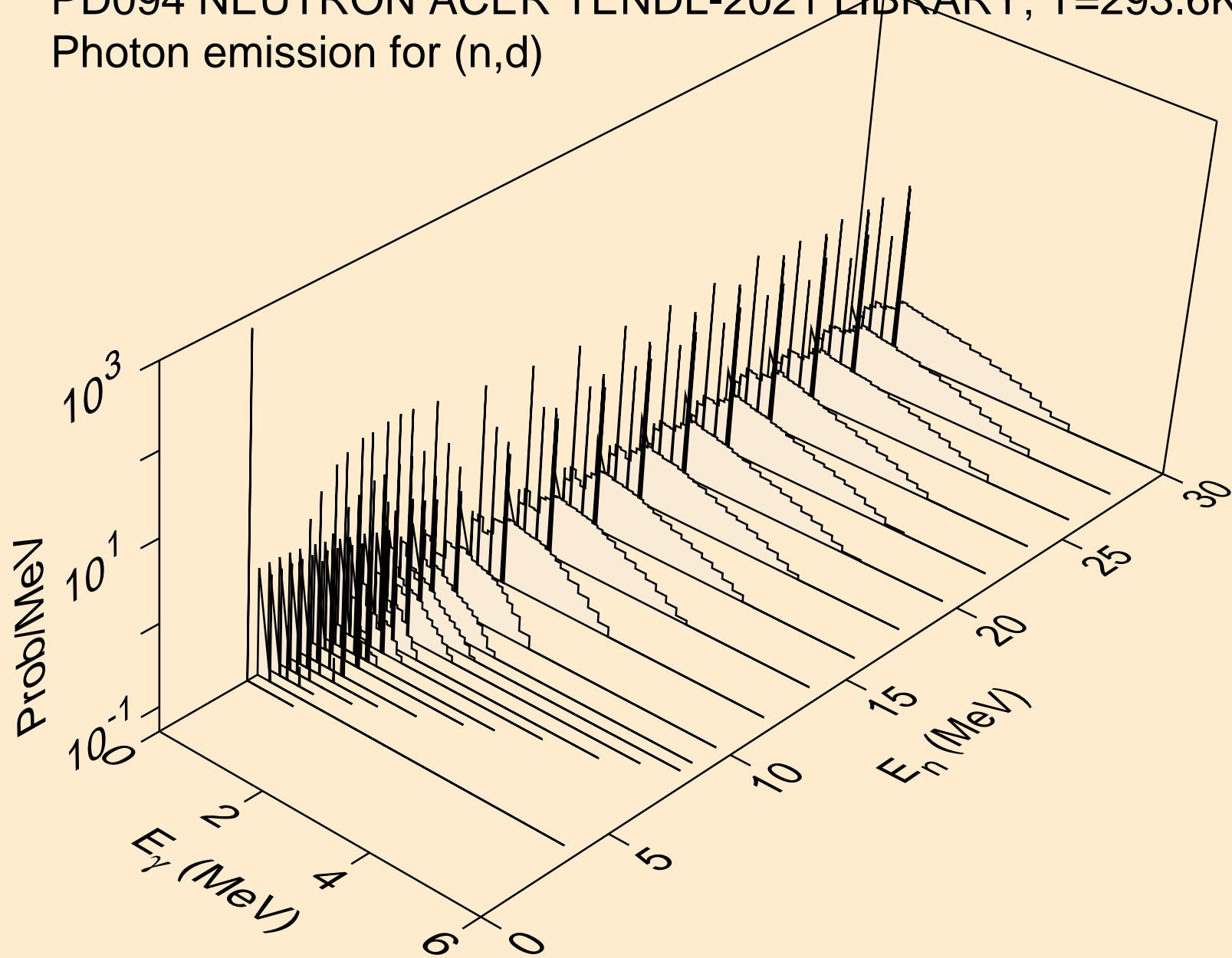

PD094 NEUTRON ACER TENDL-2021 LIBRARY; T=293.6K
Photon emission for (n,t)

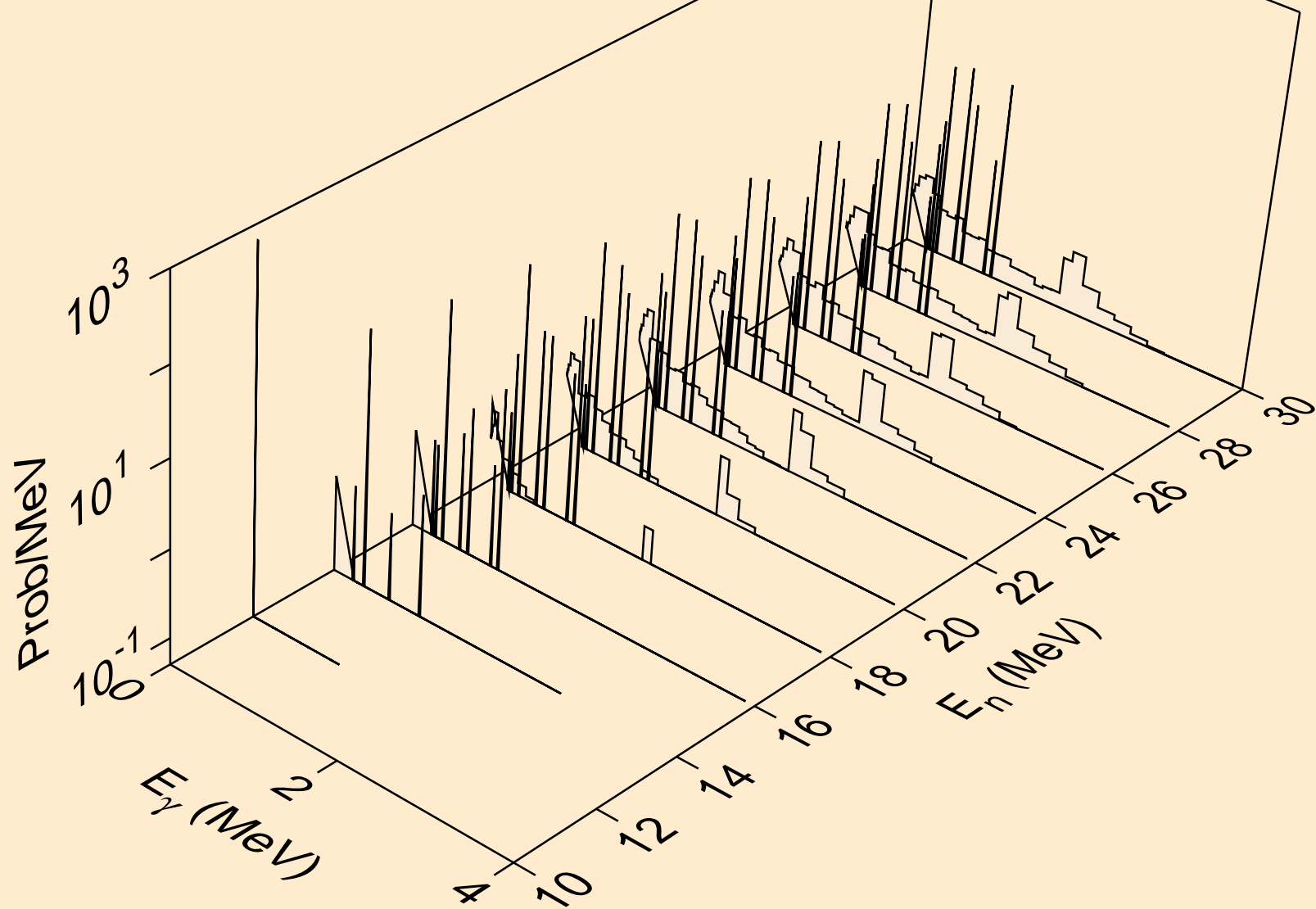

PD094 NEUTRON ACER TENDL-2021 LIBRARY; T=293.6K
Photon emission for (n,he3)

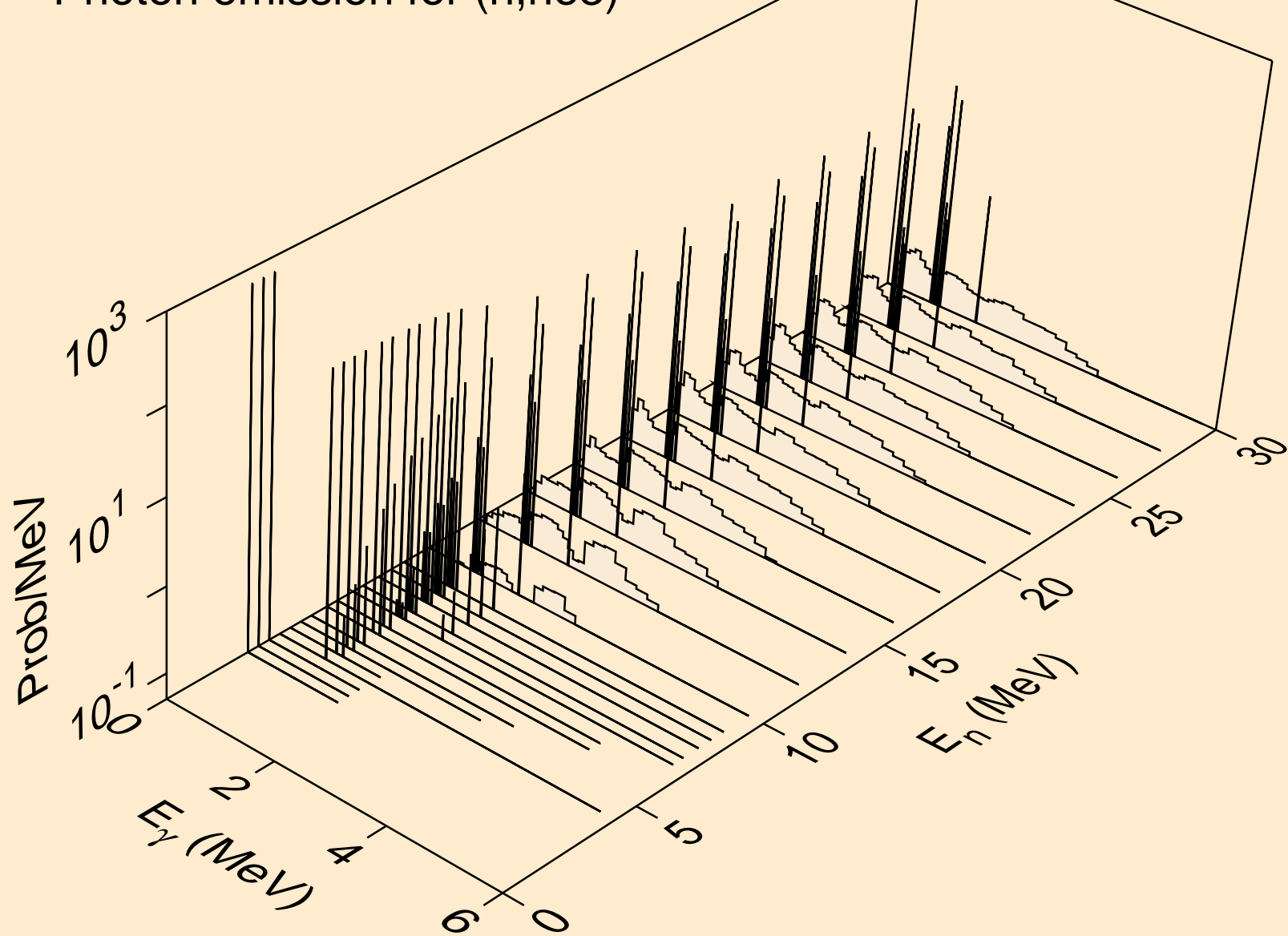

PD094 NEUTRON ACER TENDL-2021 LIBRARY; T=293.6K
Photon emission for (n,a)

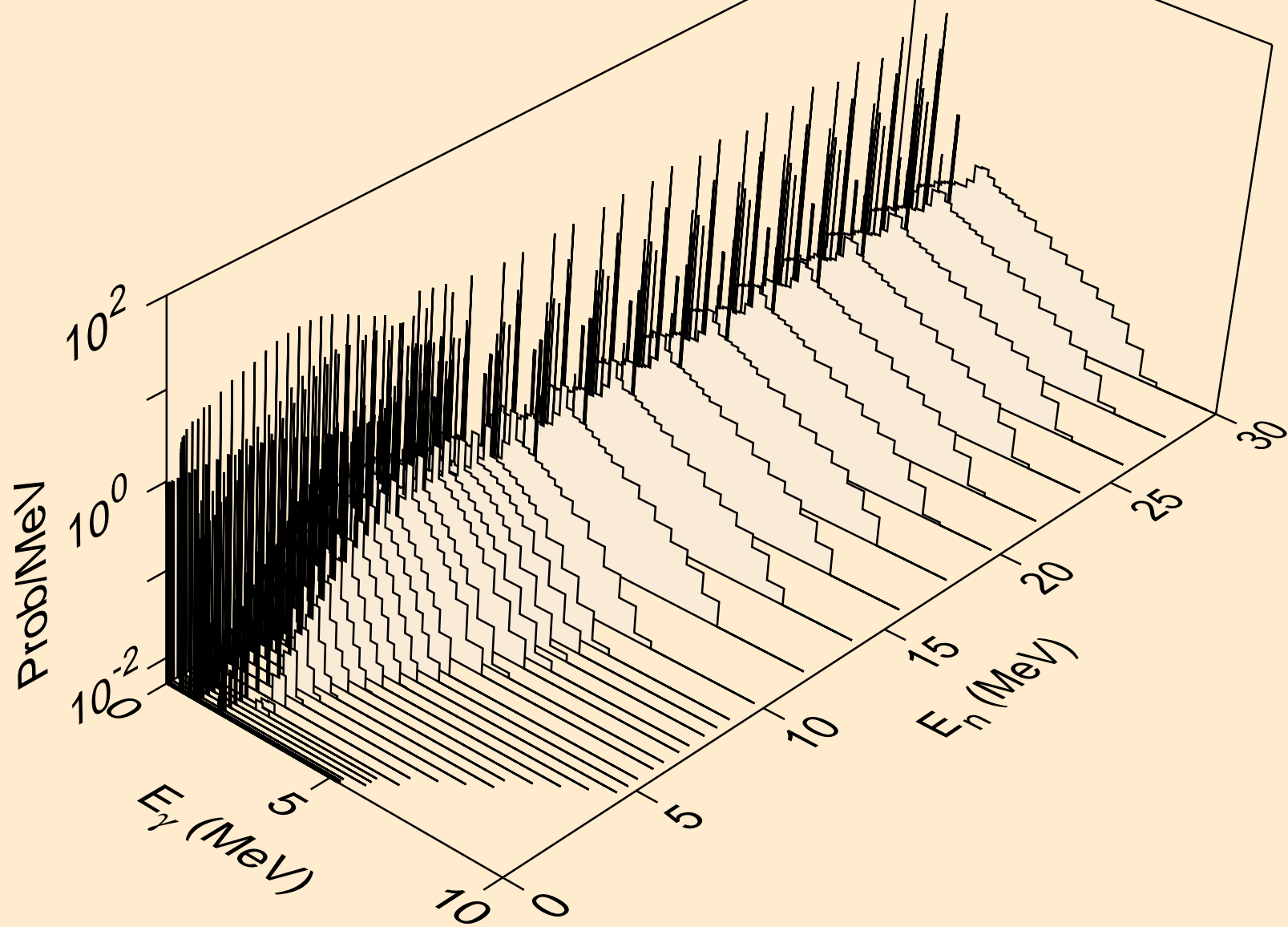

PD094 NEUTRON ACER TENDL-2021 LIBRARY; T=293.6K
Photon emission for (n,2a)

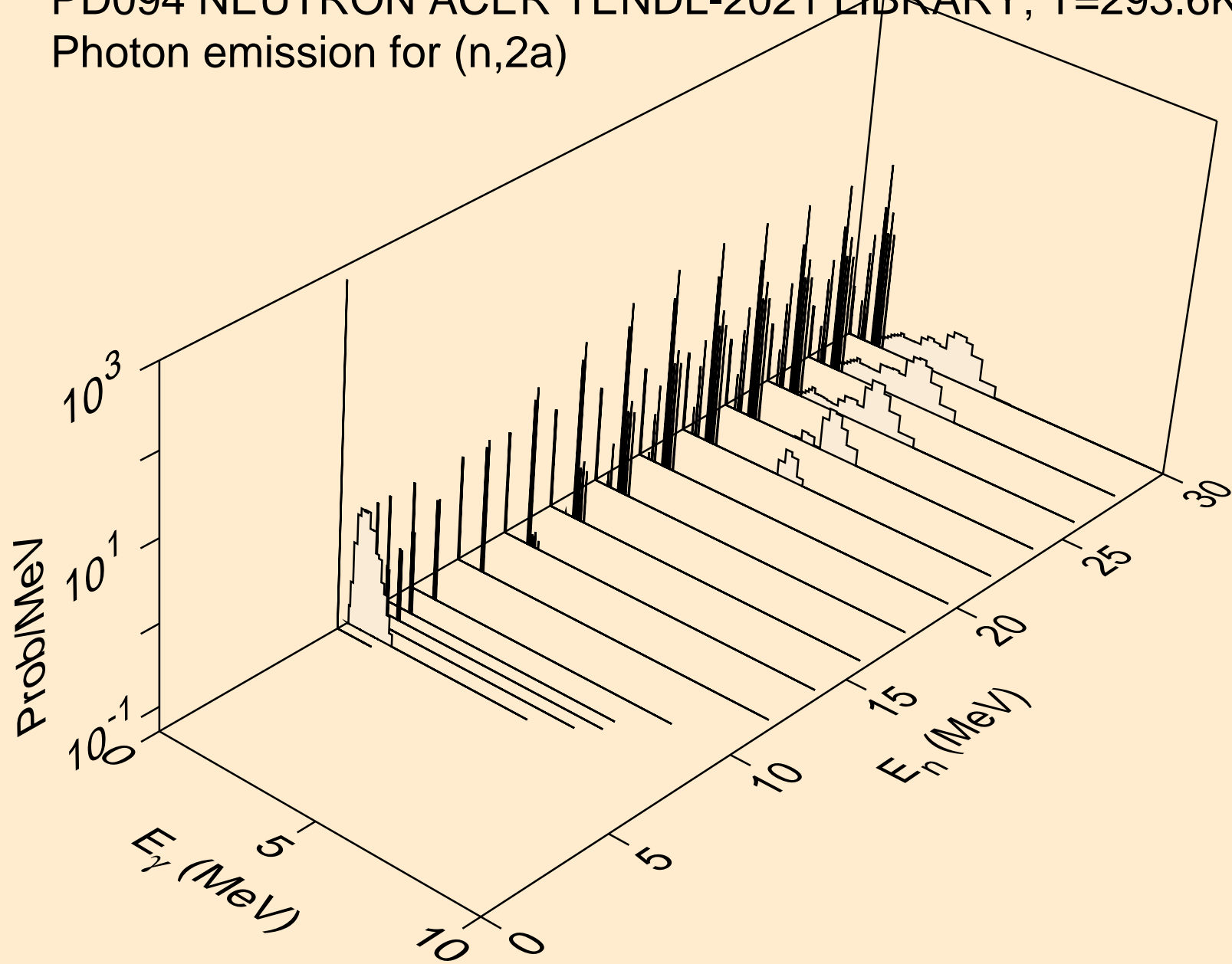

PD094 NEUTRON ACER TENDL-2021 LIBRARY; T=293.6K
Photon emission for (n,2p)

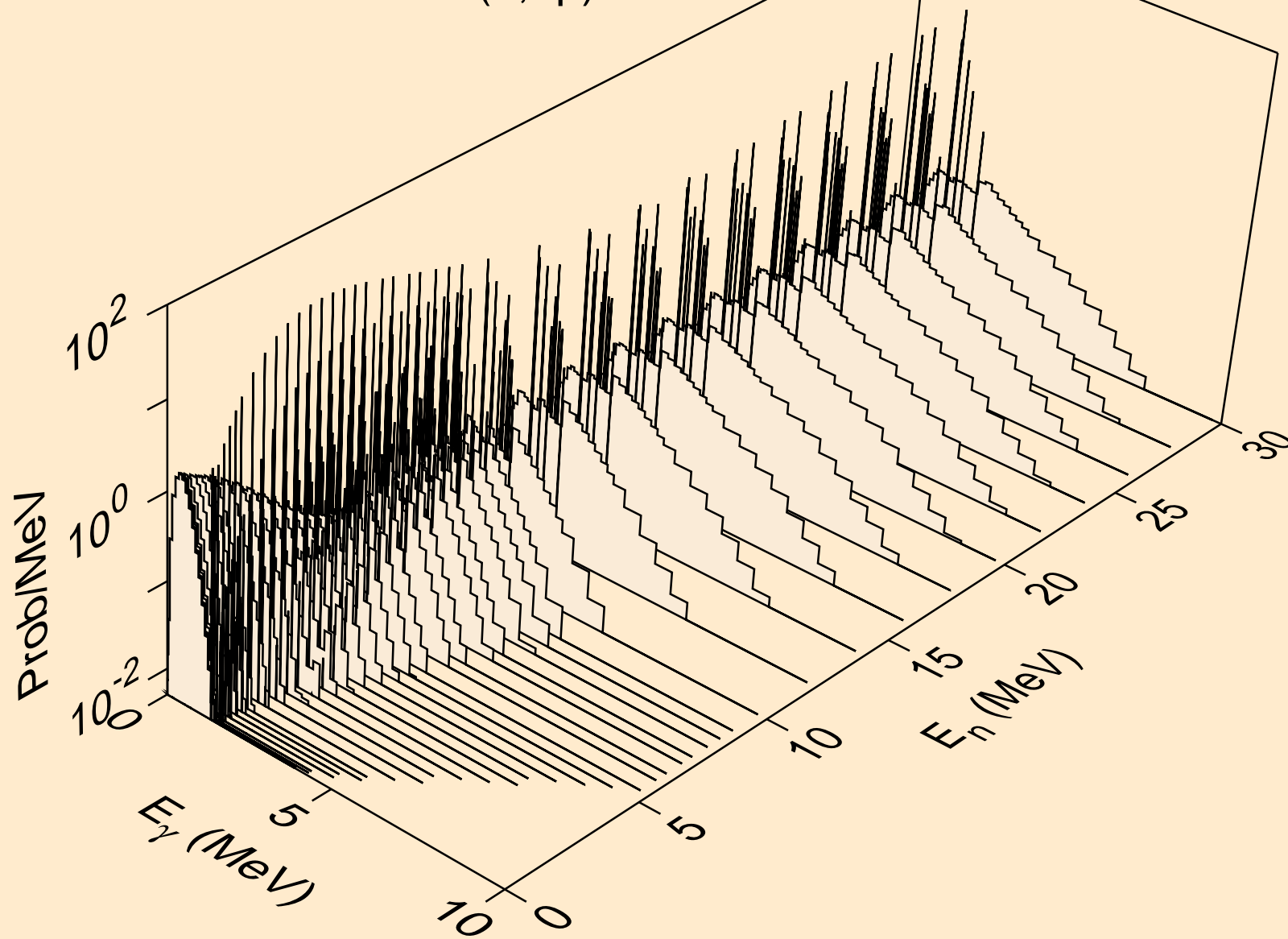

PD094 NEUTRON ACER TENDL-2021 LIBRARY; T=293.6K
Photon emission for (n,p)

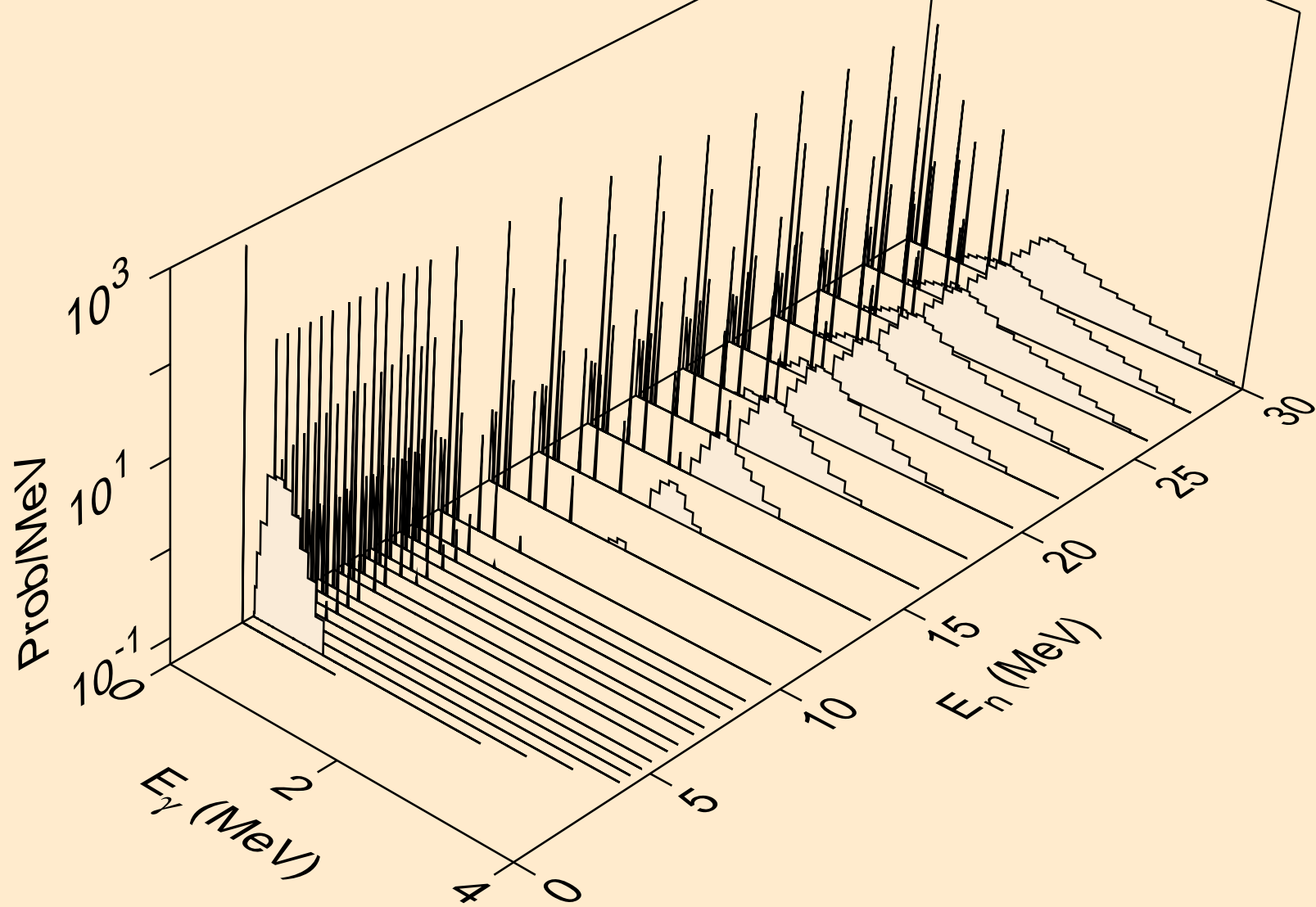

PD094 NEUTRON ACER TENDL-2021 LIBRARY; T=293.6K
Photon emission for (n,pd)

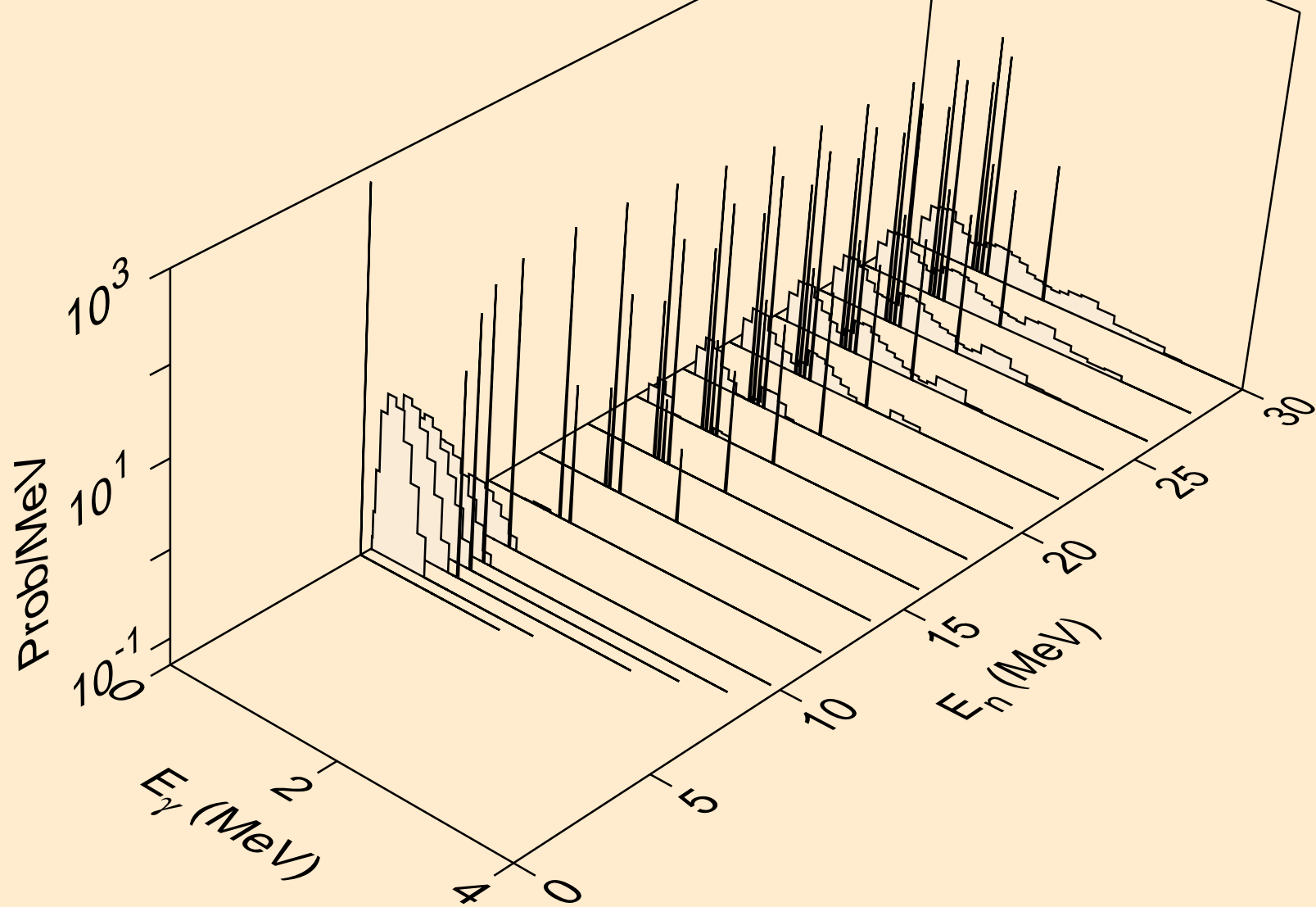

PD094 NEUTRON ACER TENDL-2021 LIBRARY; T=293.6K
Photon emission for (n,pt)

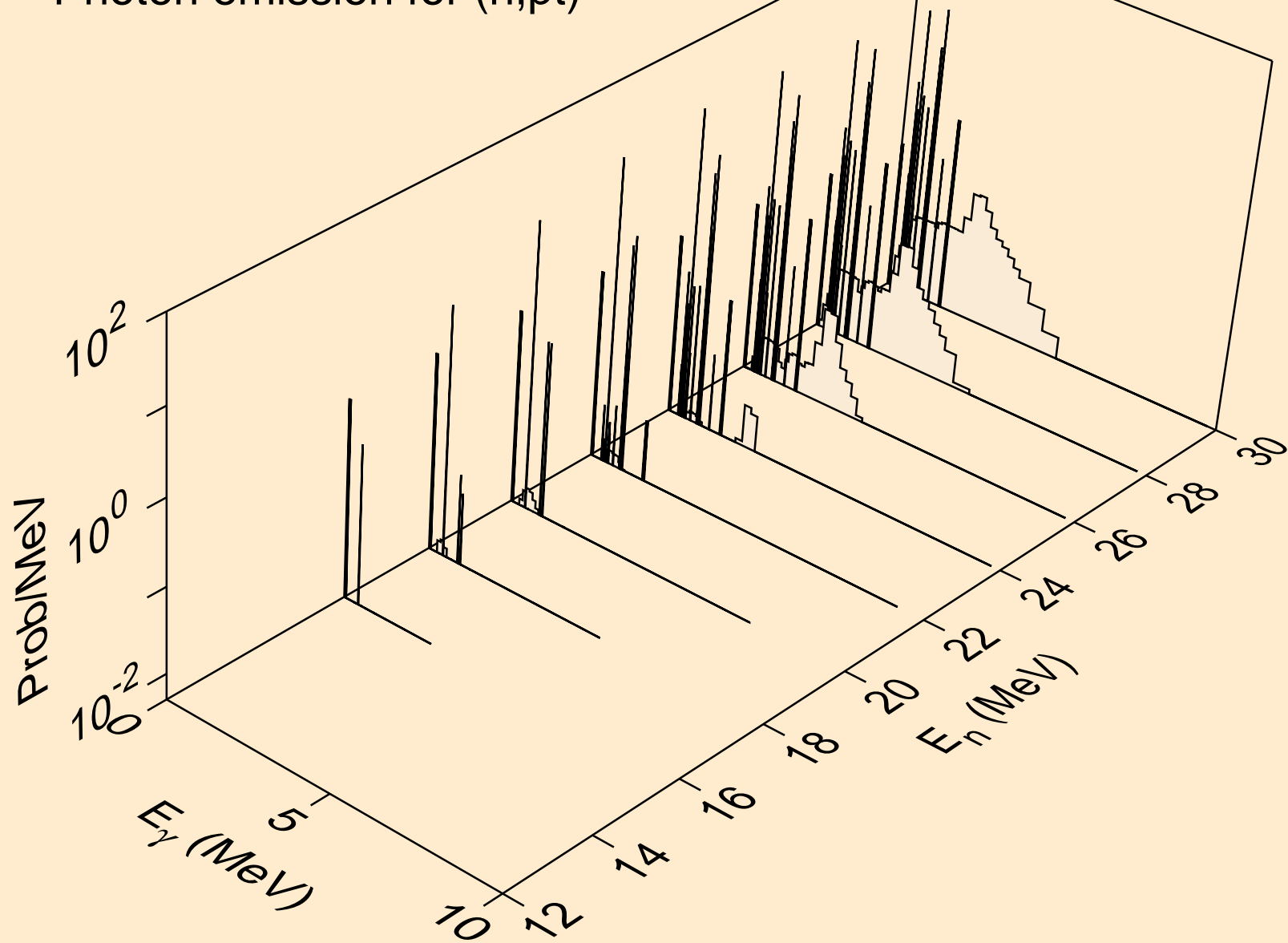

PD094 NEUTRON ACER TENDL-2021 LIBRARY; T=293.6K
Photon emission for (n,da)

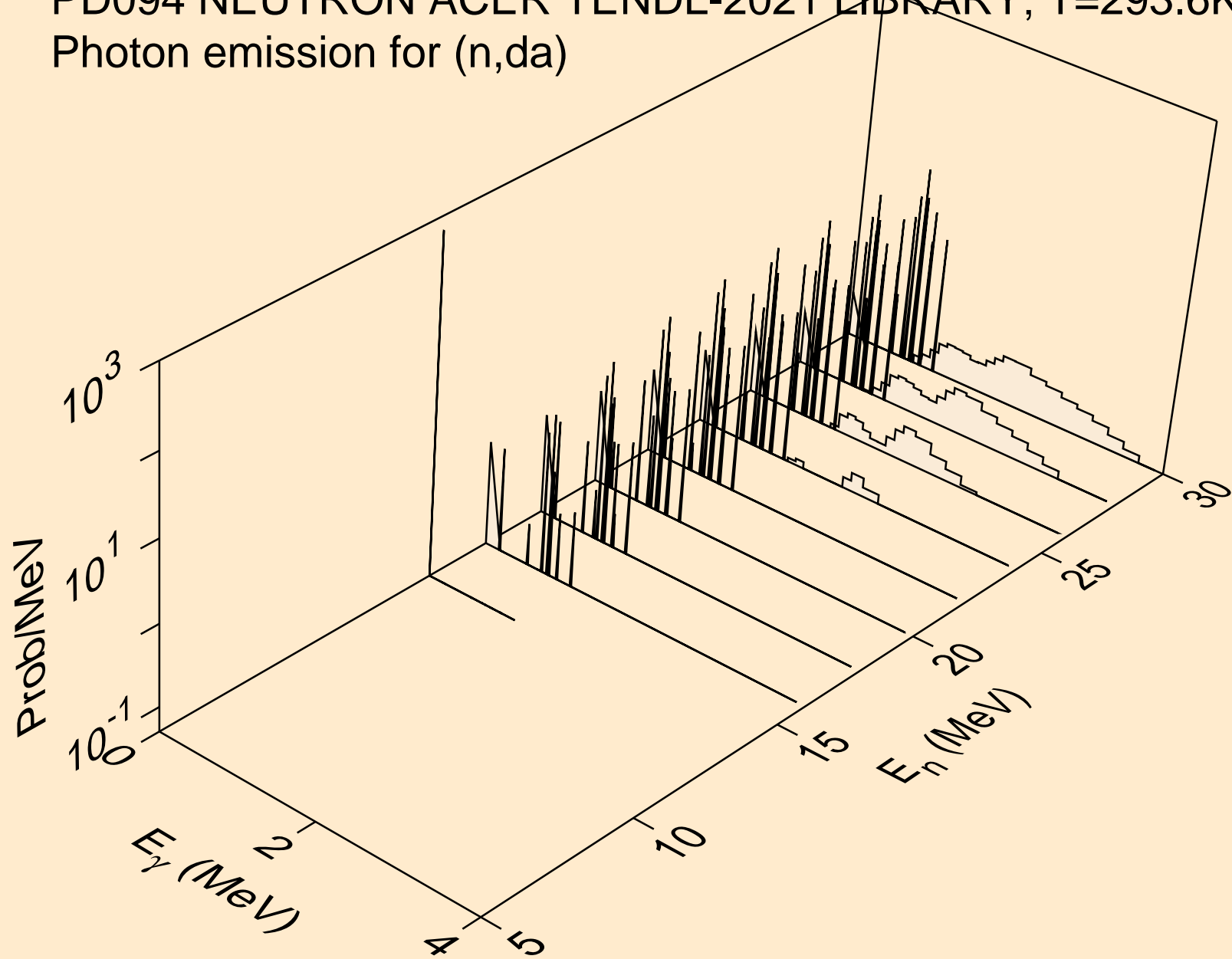

PD094 NEUTRON ACER TENDL-2021 LIBRARY; T=293.6K
thermal capture photon spectrum

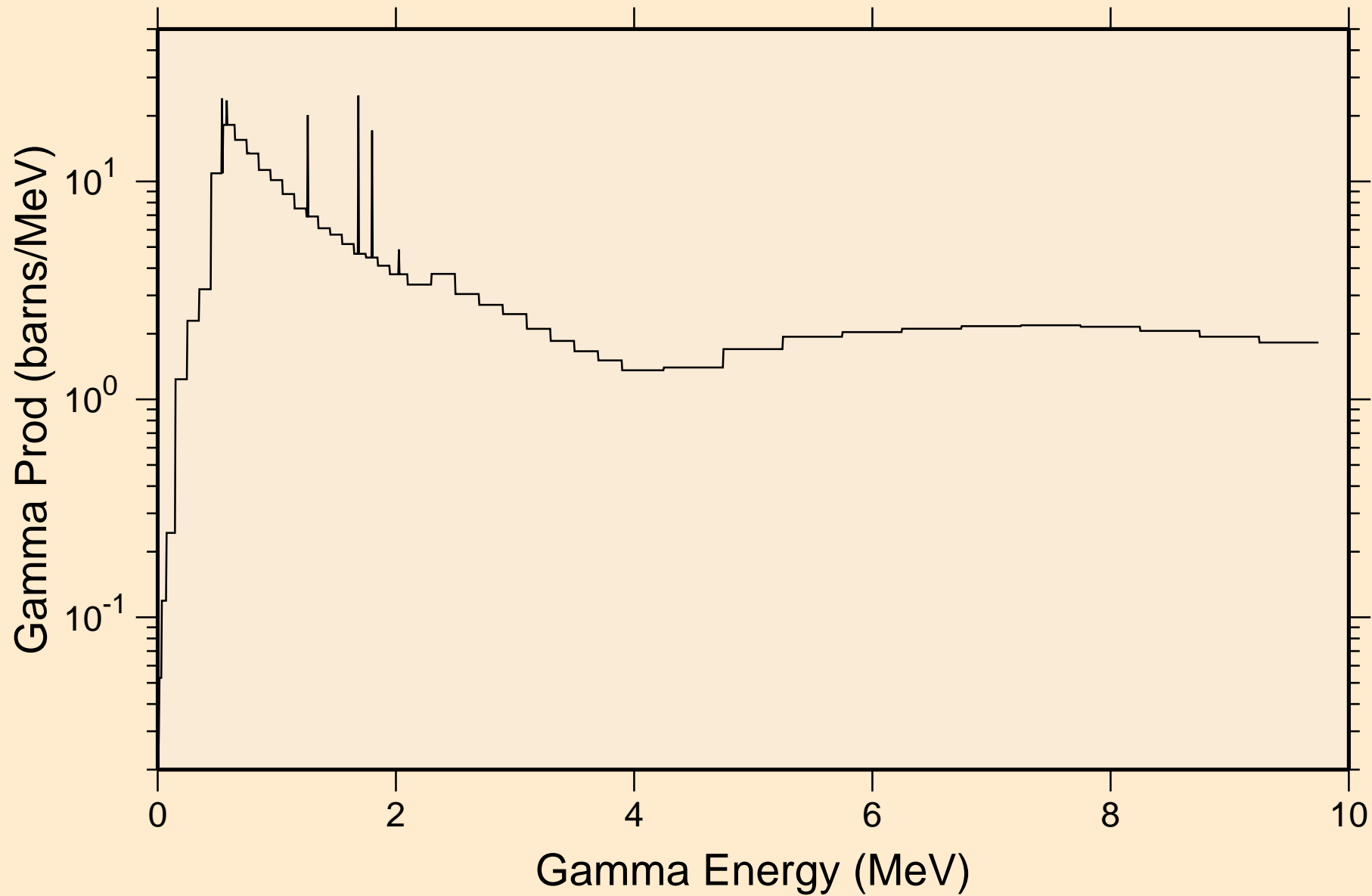

PD094 NEUTRON ACER TENDL-2021 LIBRARY; T=293.6K
14 MeV photon spectrum

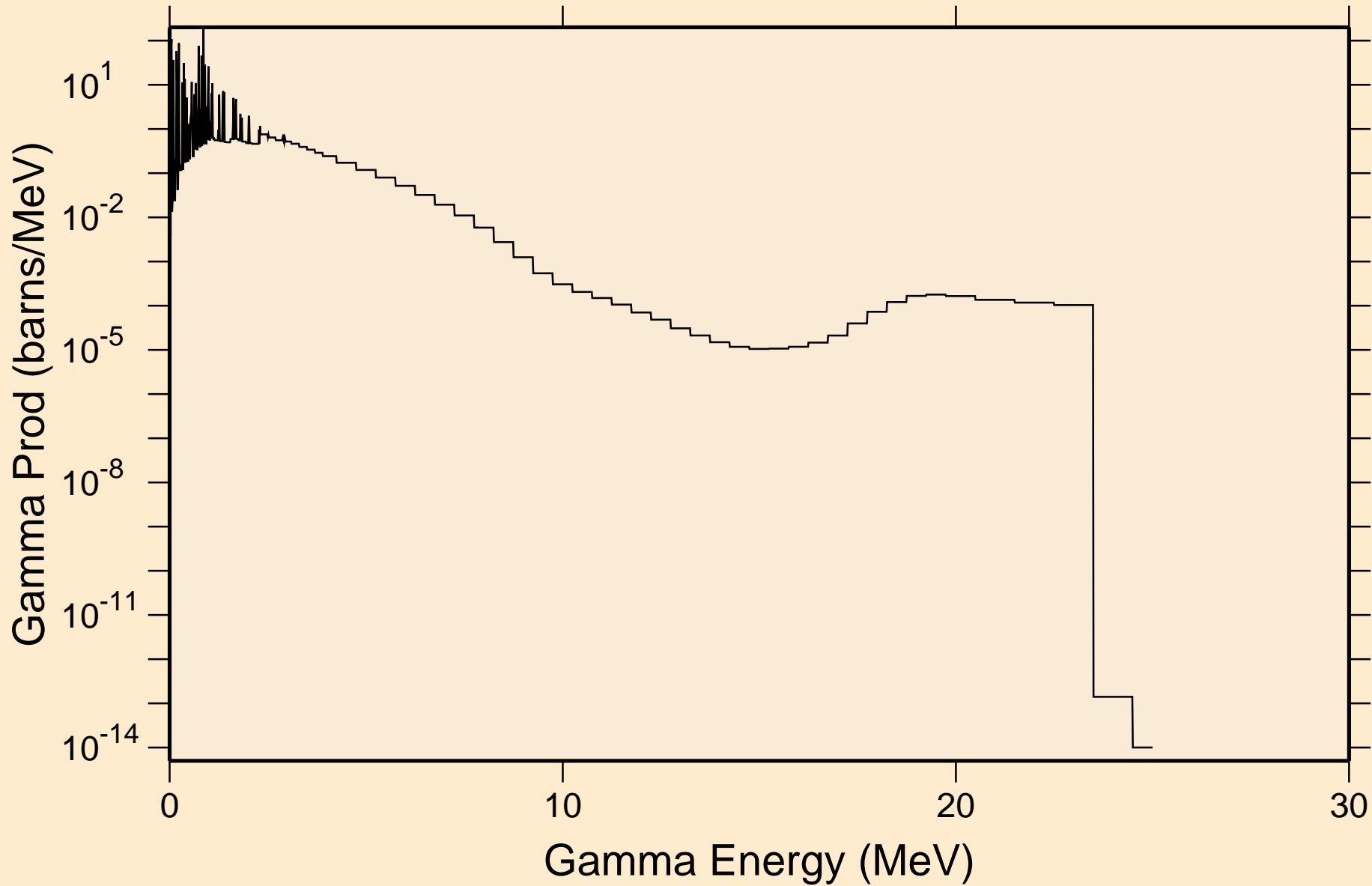

PD094 NEUTRON ACER TENDL-2021 LIBRARY; T=293.6K
Particle heating contributions

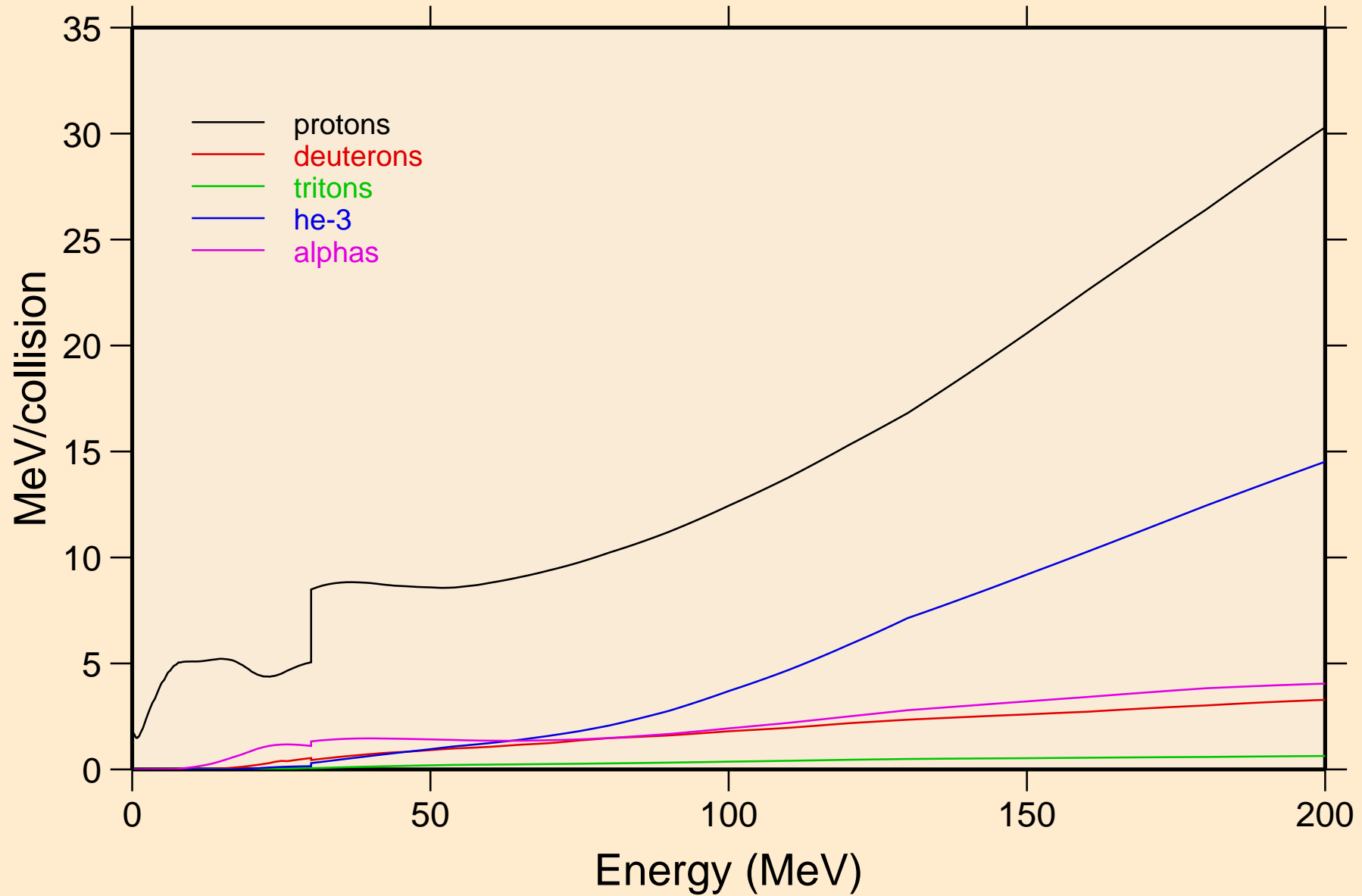

PD094 NEUTRON ACER TENDL-2021 LIBRARY; T=293.6K
Recoil Heating

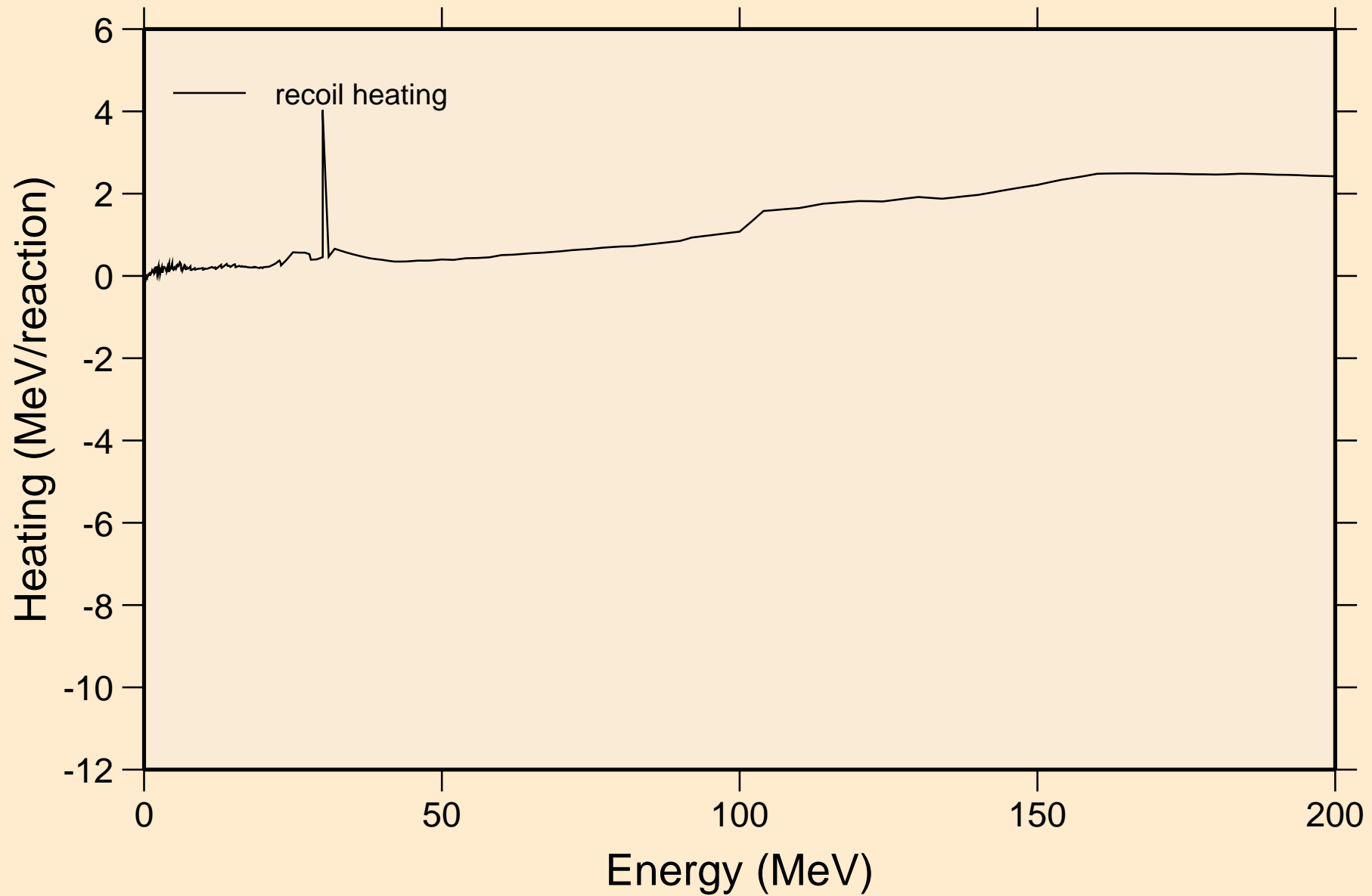

PD094 NEUTRON ACER TENDL-2021 LIBRARY; T=293.6K
Particle production cross sections

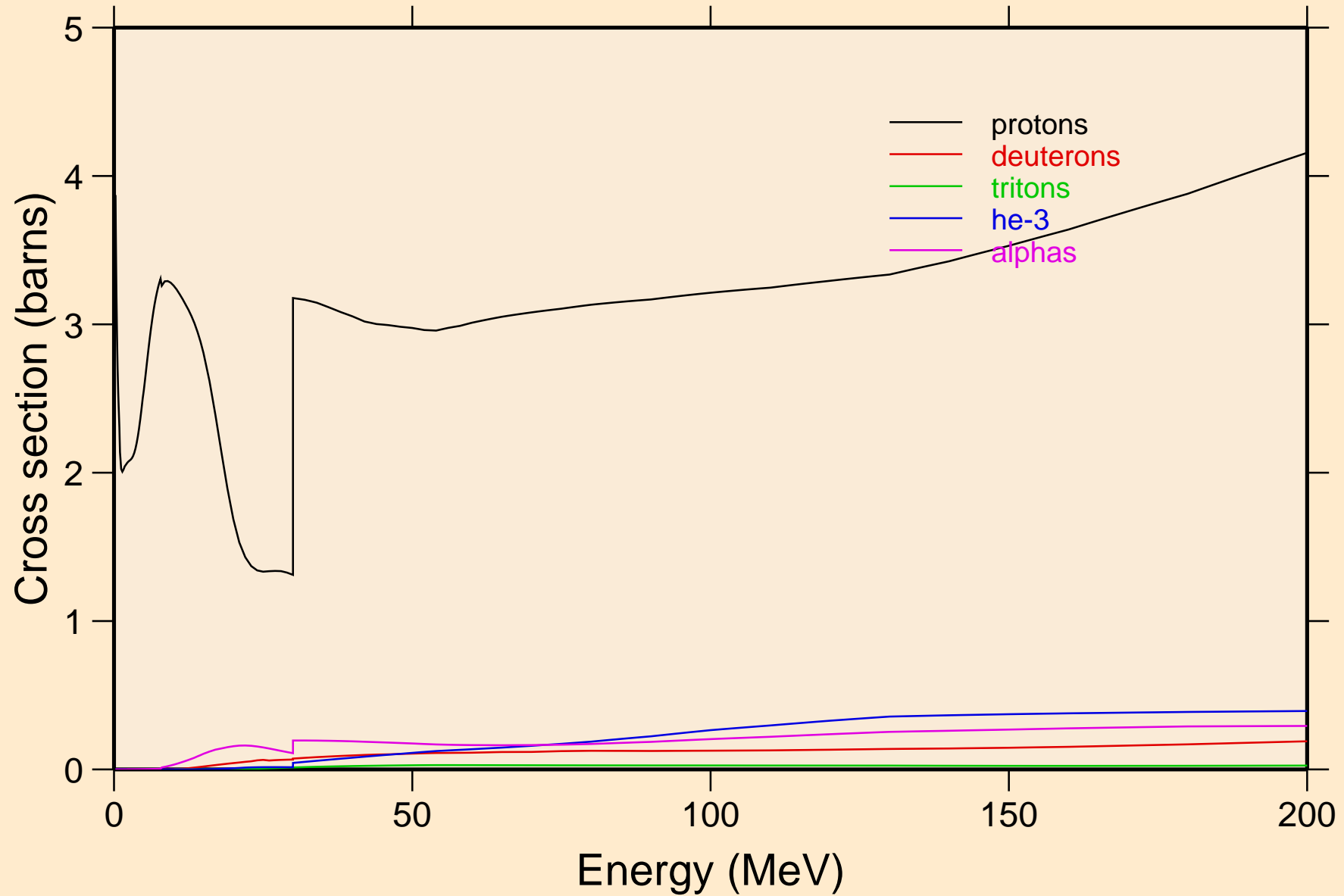

PD094 NEUTRON ACER TENDL-2021 LIBRARY; T=293.6K
protons from (n,x)

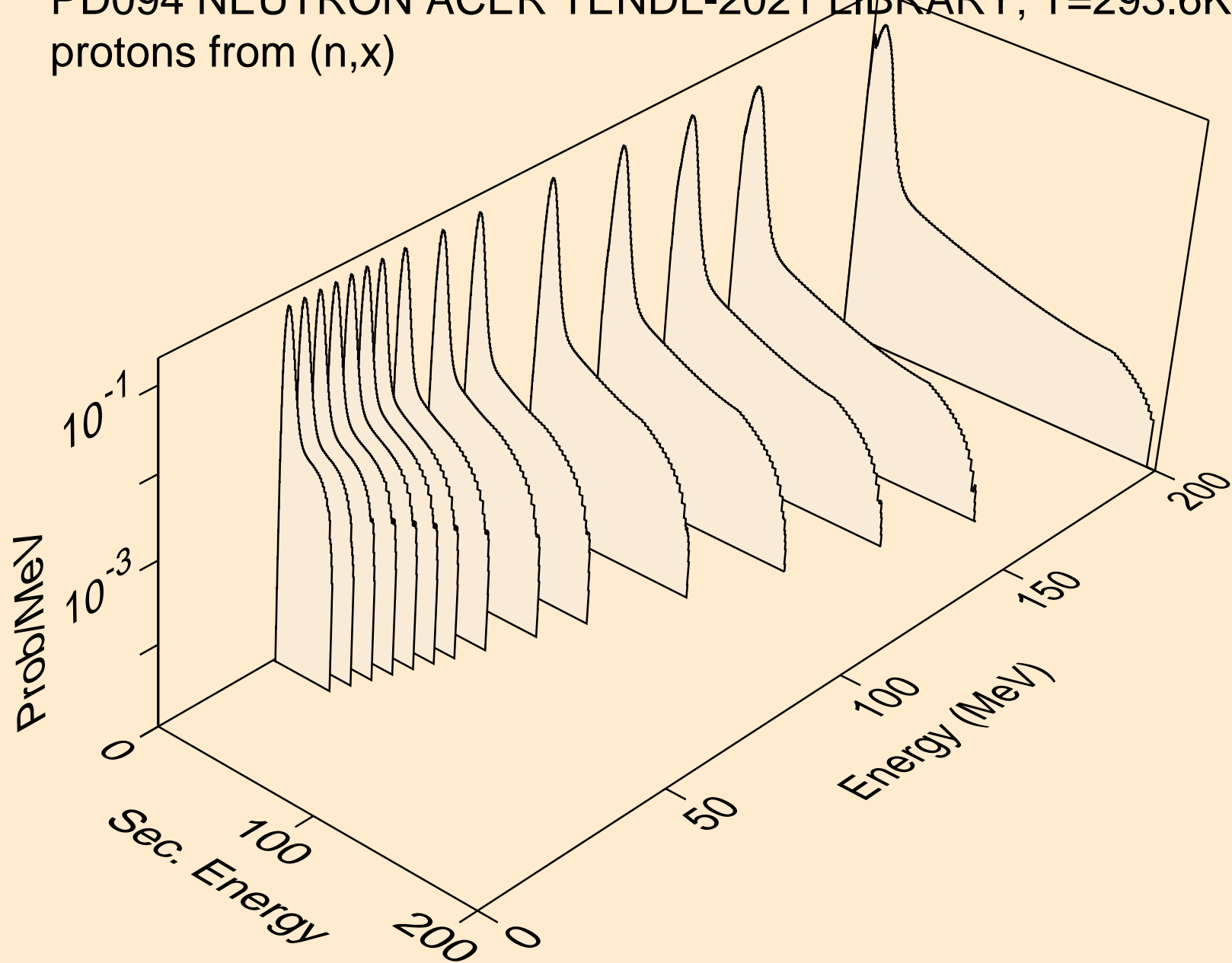

PD094 NEUTRON ACER TENDL-2021 LIBRARY; T=293.6K
protons from (n,n*)p

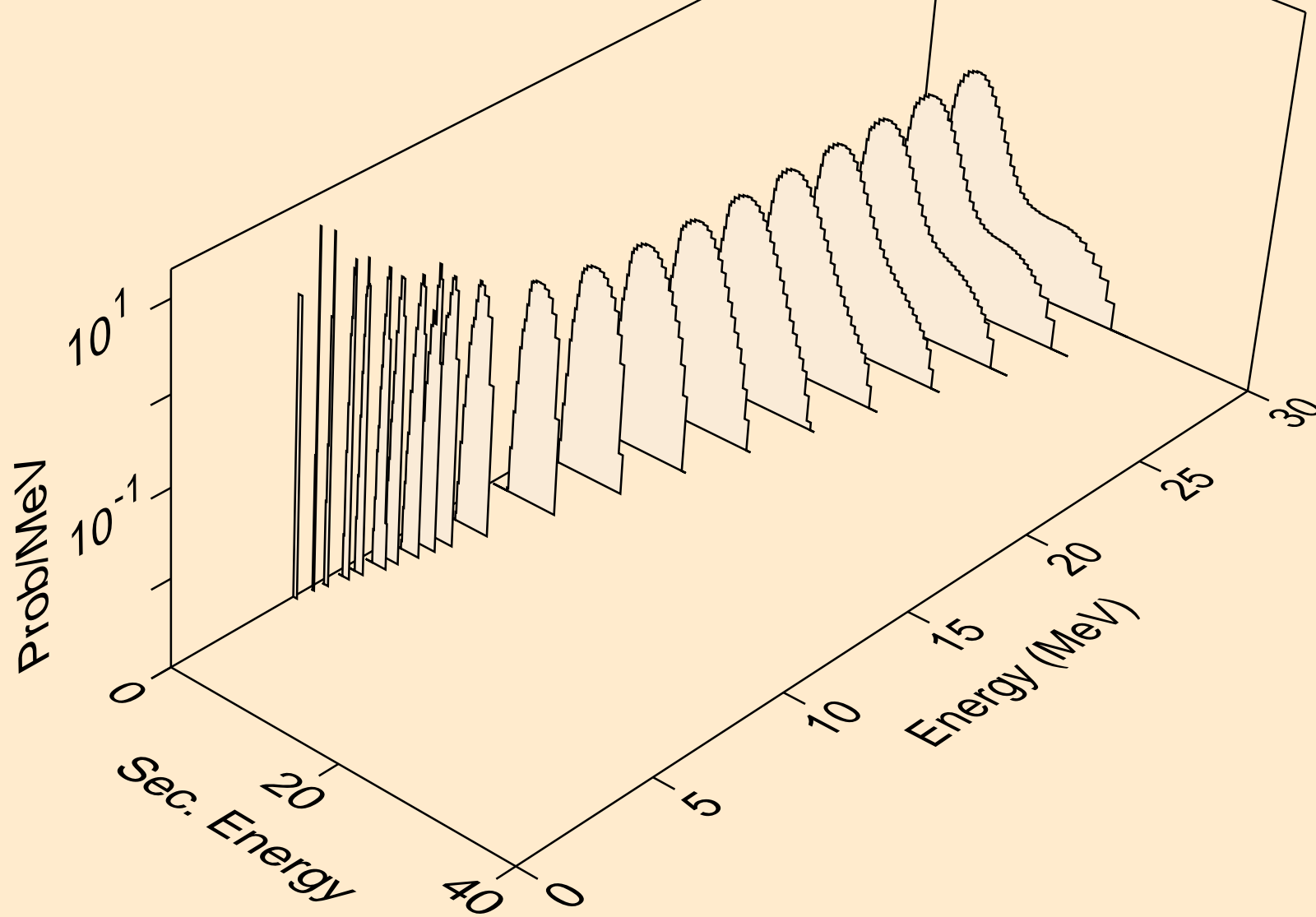

PD094 NEUTRON ACER TENDL-2021 LIBRARY; T=293.6K
protons from (n,2np)

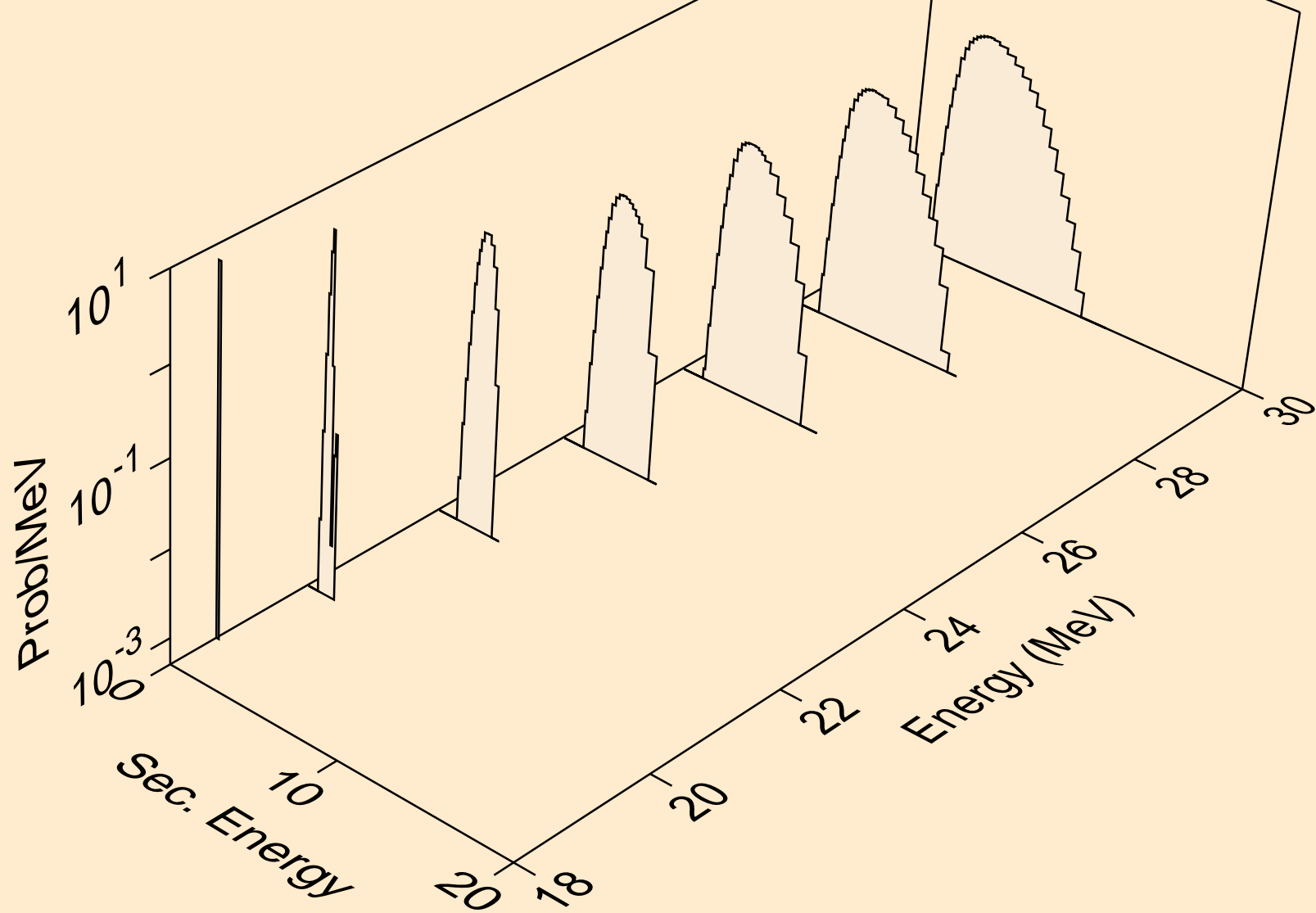

PD094 NEUTRON ACER TENDL-2021 LIBRARY; T=293.6K
protons from (n,2np)

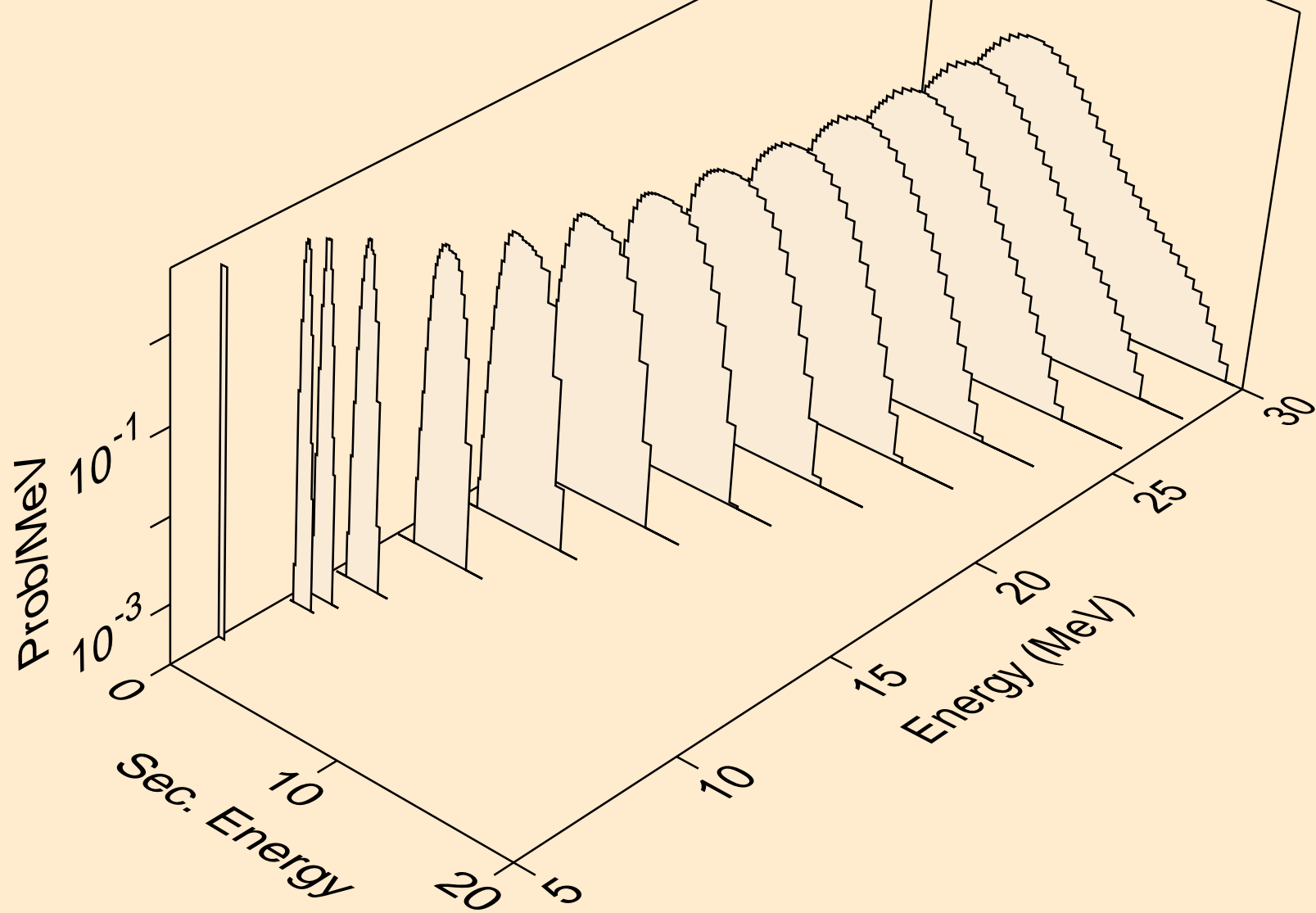

PD094 NEUTRON ACER TENDL-2021 LIBRARY; T=293.6K
protons from (n,npa)

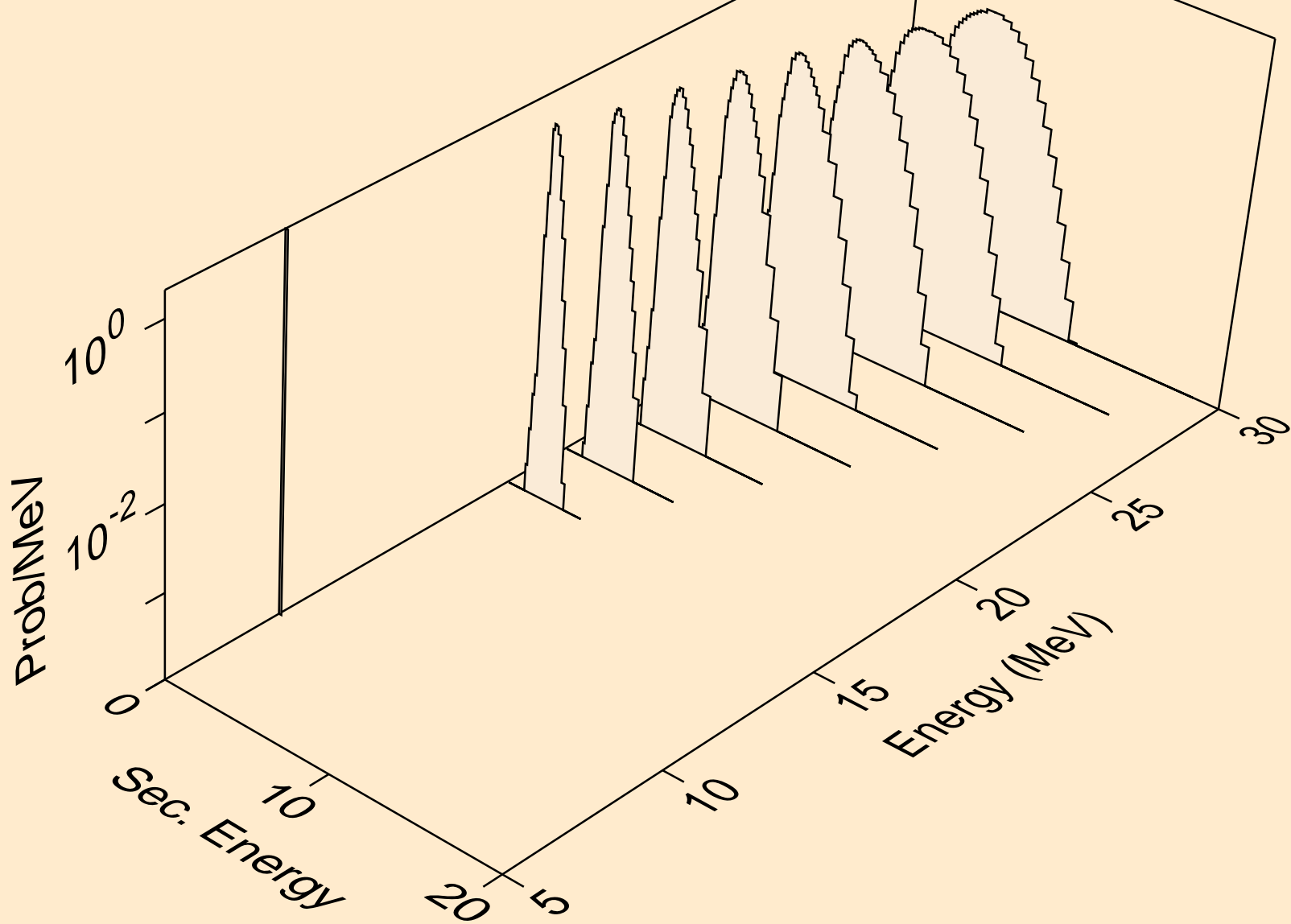

PD094 NEUTRON ACER TENDL-2021 LIBRARY; T=293.6K
protons from (n,p)

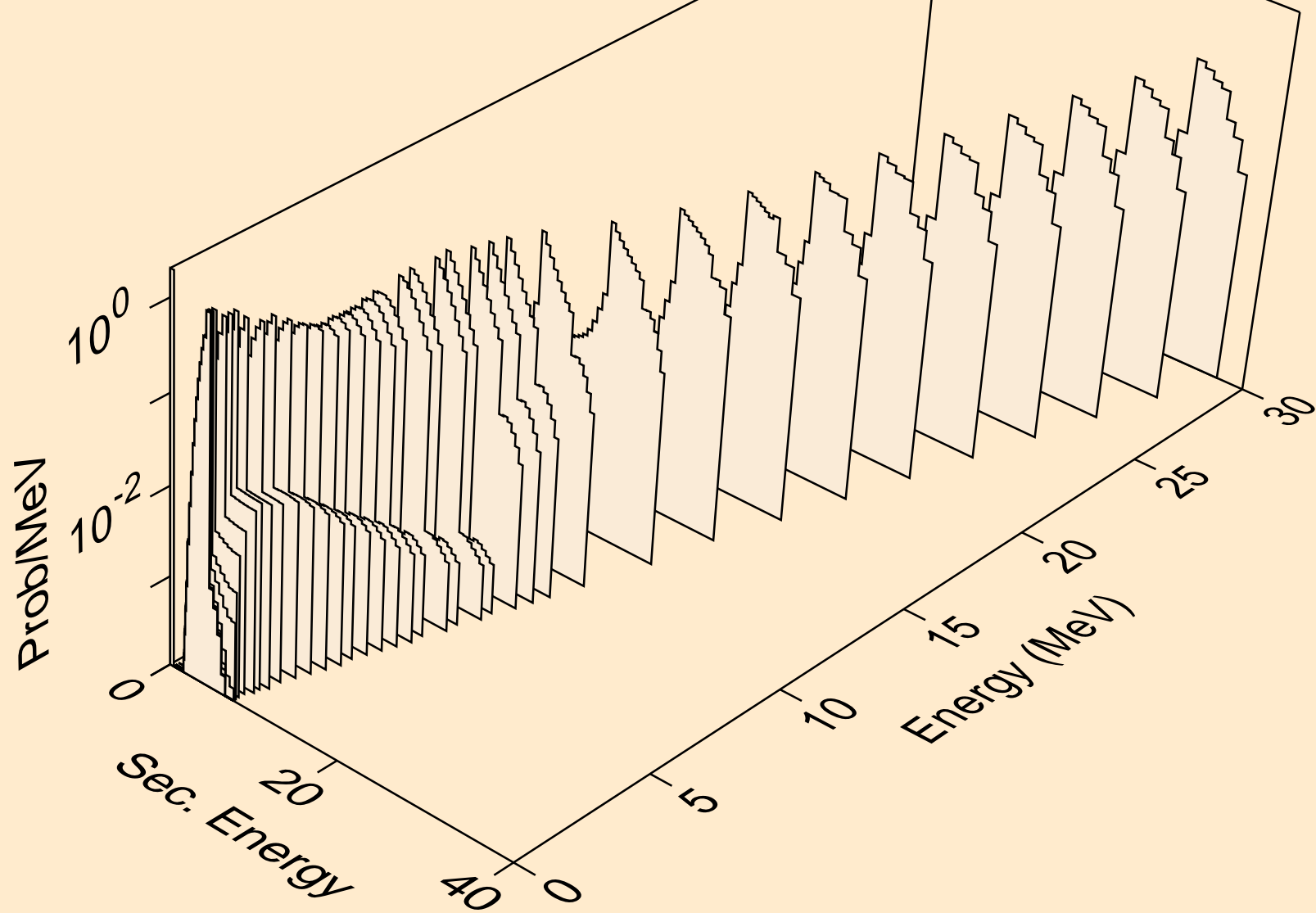

PD094 NEUTRON ACER TENDL-2021 LIBRARY; T=293.6K
protons from (n,2p)

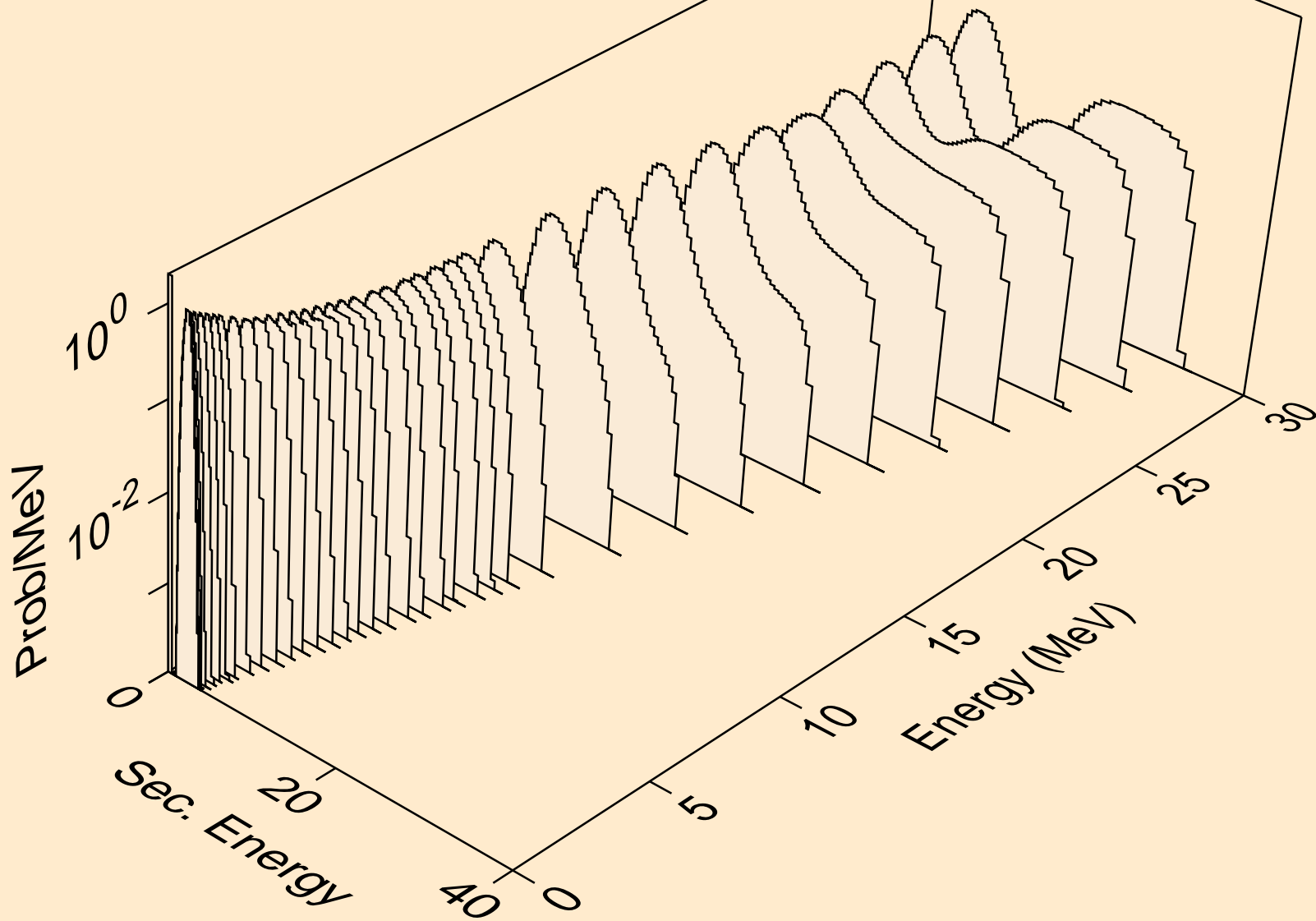

PD094 NEUTRON ACER TENDL-2021 LIBRARY; T=293.6K
protons from (n,p)

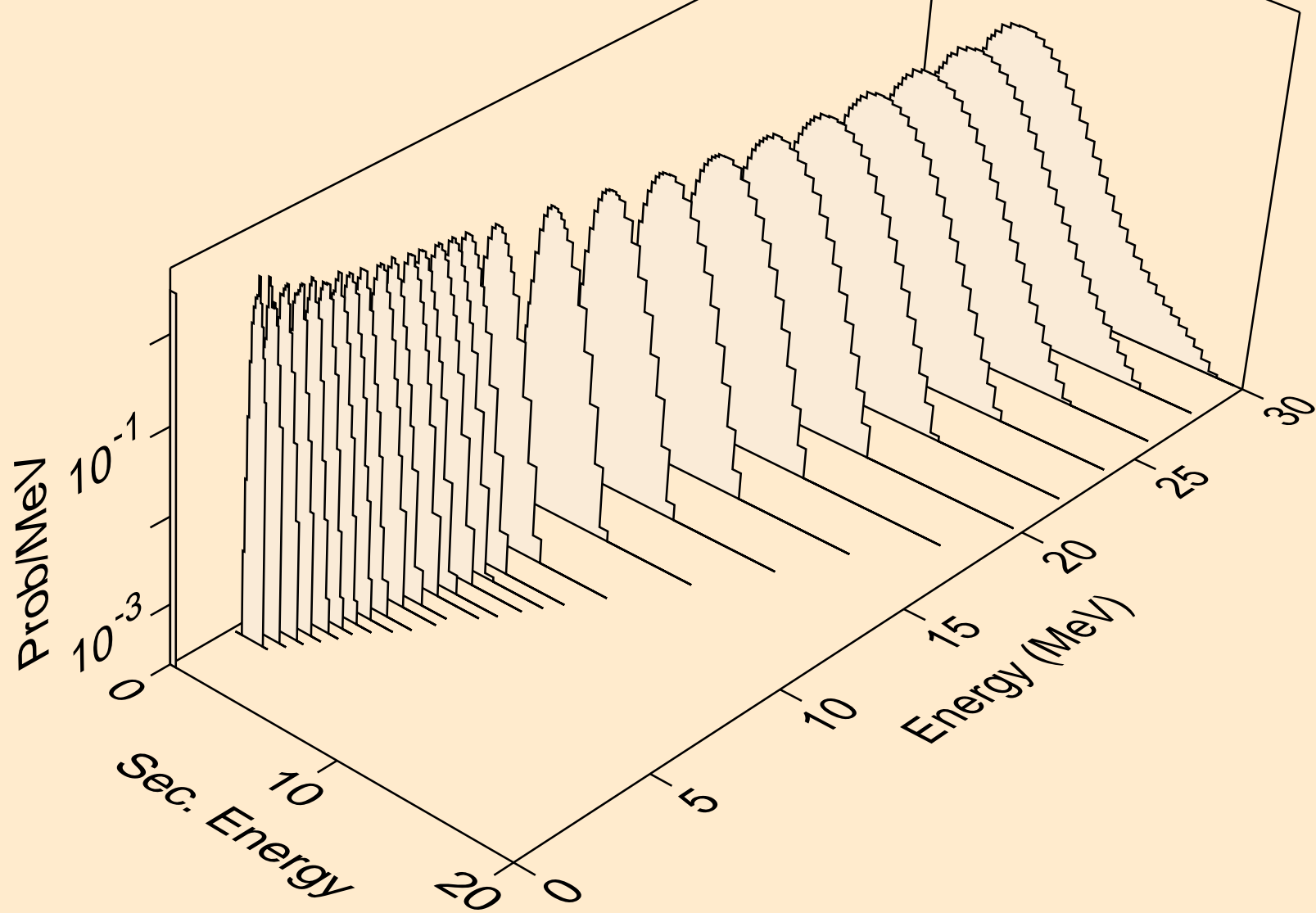

PD094 NEUTRON ACER TENDL-2021 LIBRARY; T=293.6K
protons from (n,pd)

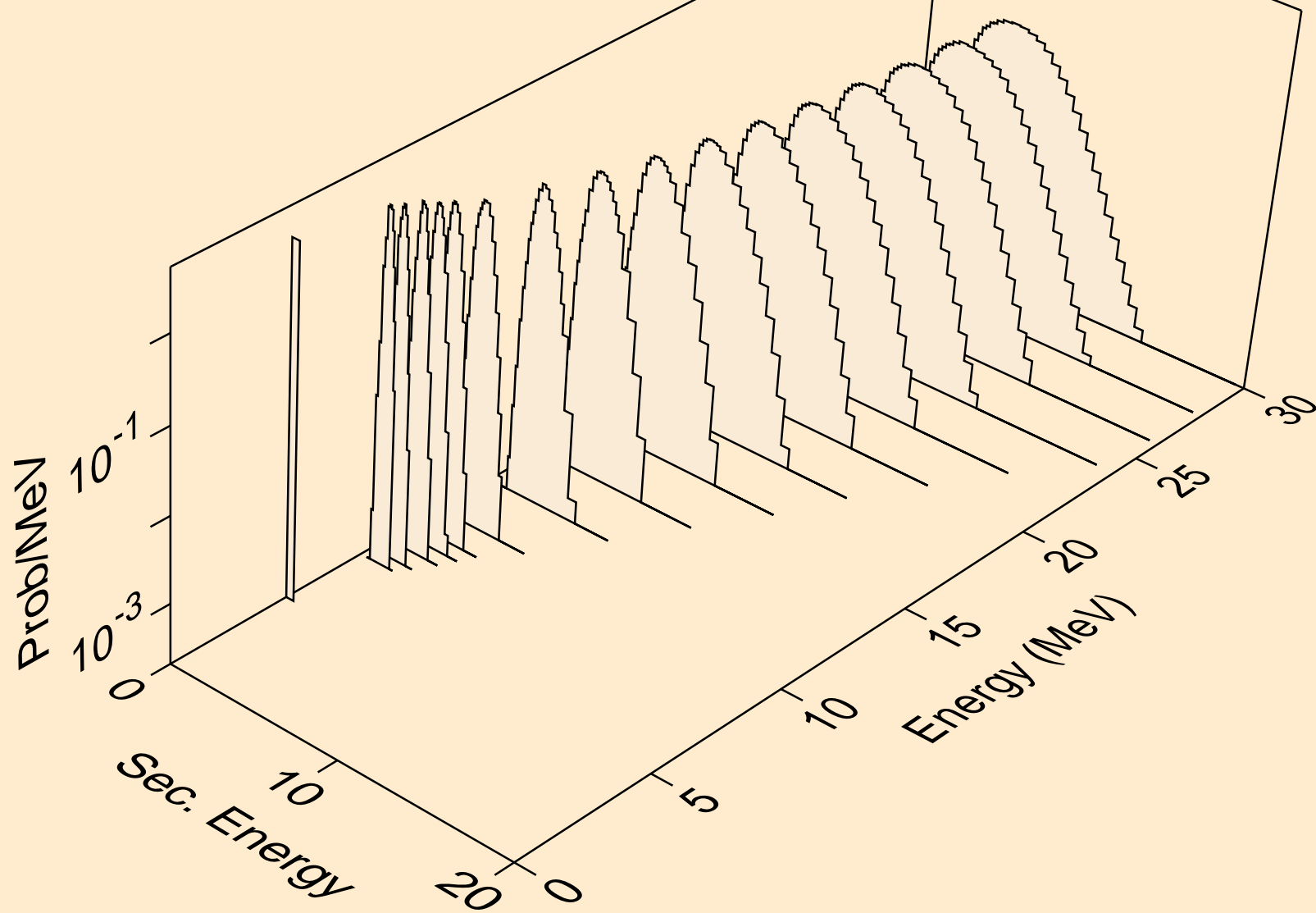

PD094 NEUTRON ACER TENDL-2021 LIBRARY; T=293.6K
protons from (n,pt)

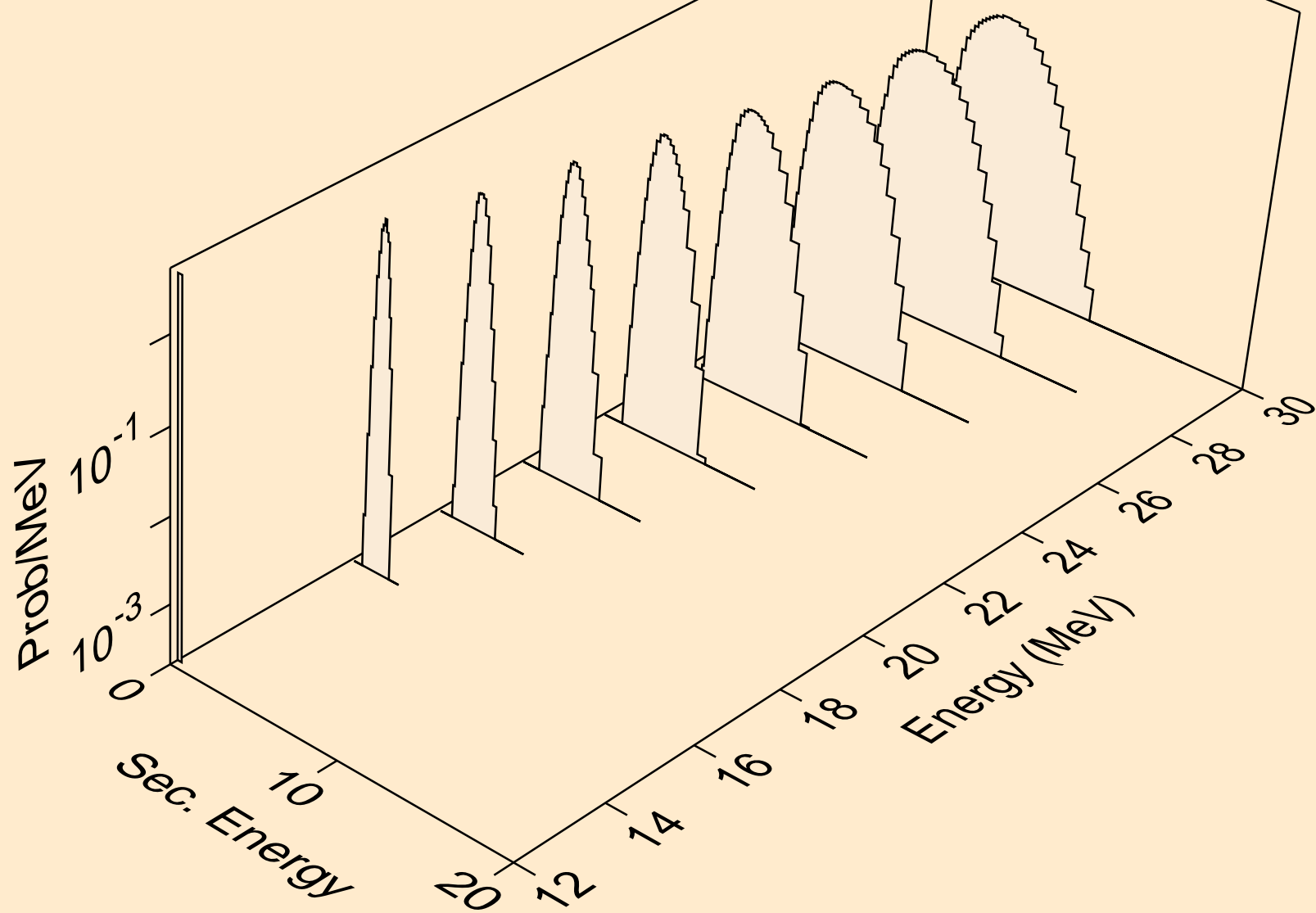

PD094 NEUTRON ACER TENDL-2021 LIBRARY; T=293.6K
deuterons from (n,x)

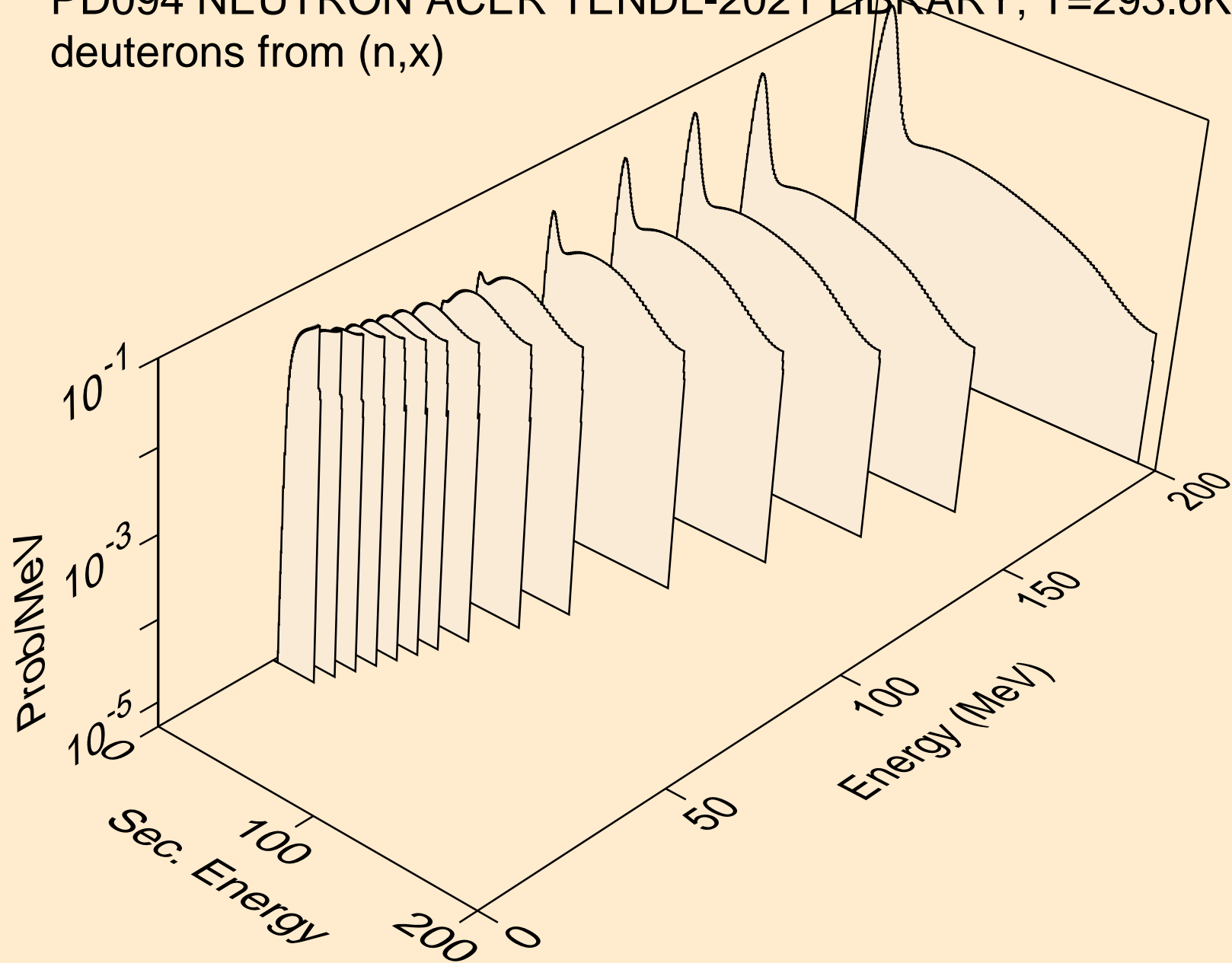

PD094 NEUTRON ACER TENDL-2021 LIBRARY; T=293.6K
deuterons from (n,n*)d

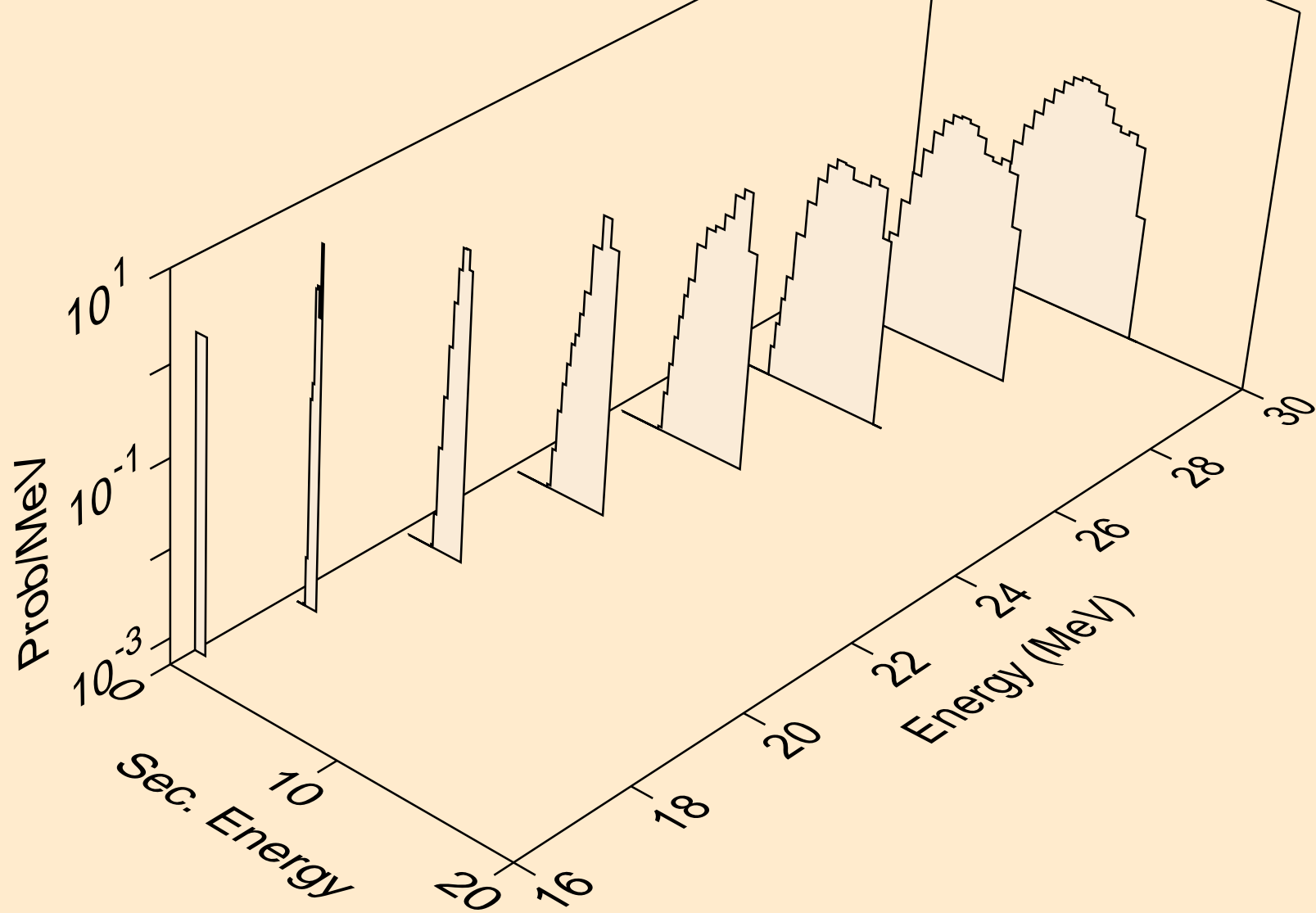

PD094 NEUTRON ACER TENDL-2021 LIBRARY; T=293.6K
deuterons from (n,d)

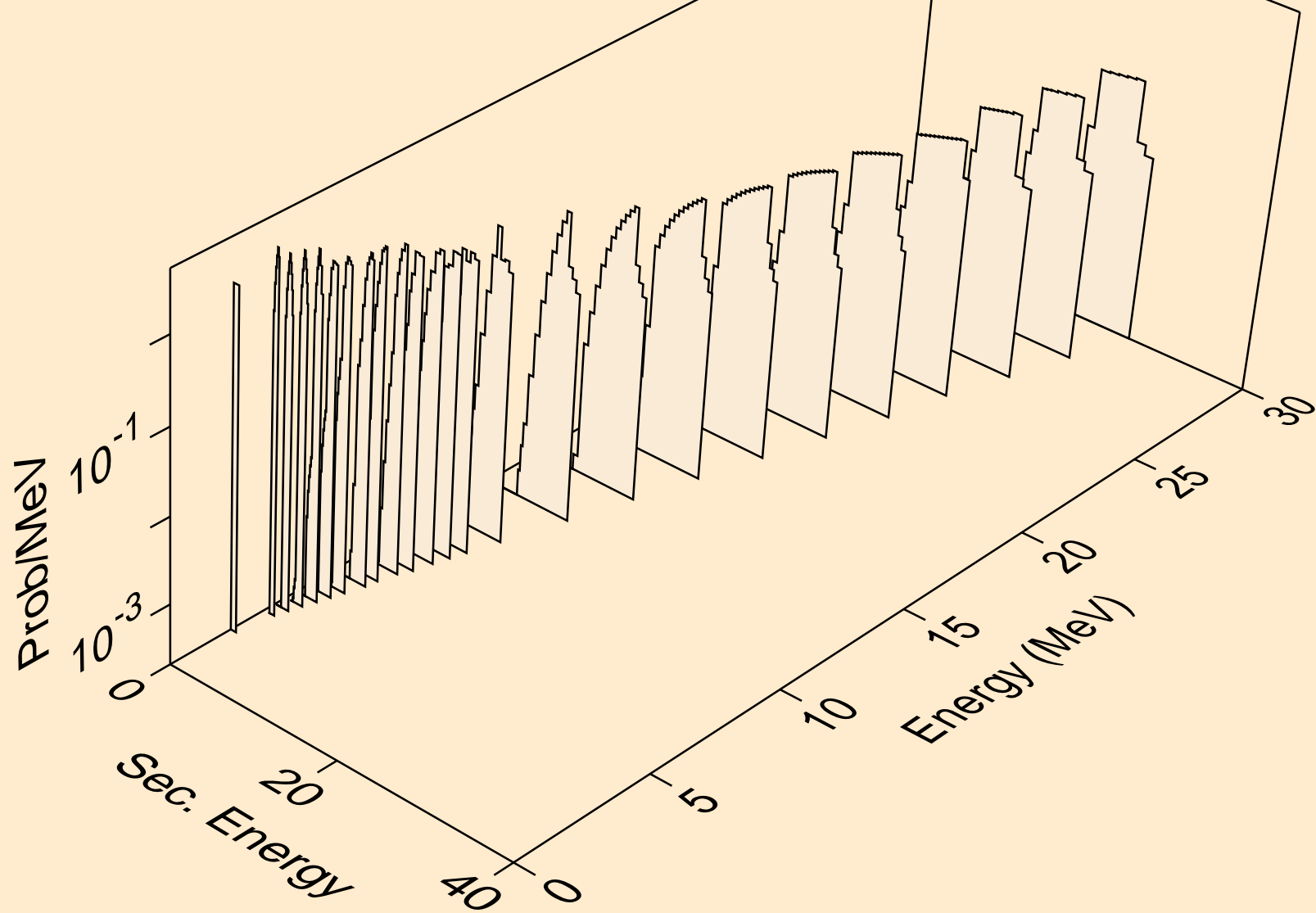

PD094 NEUTRON ACER TENDL-2021 LIBRARY; T=293.6K
deuterons from (n,pd)

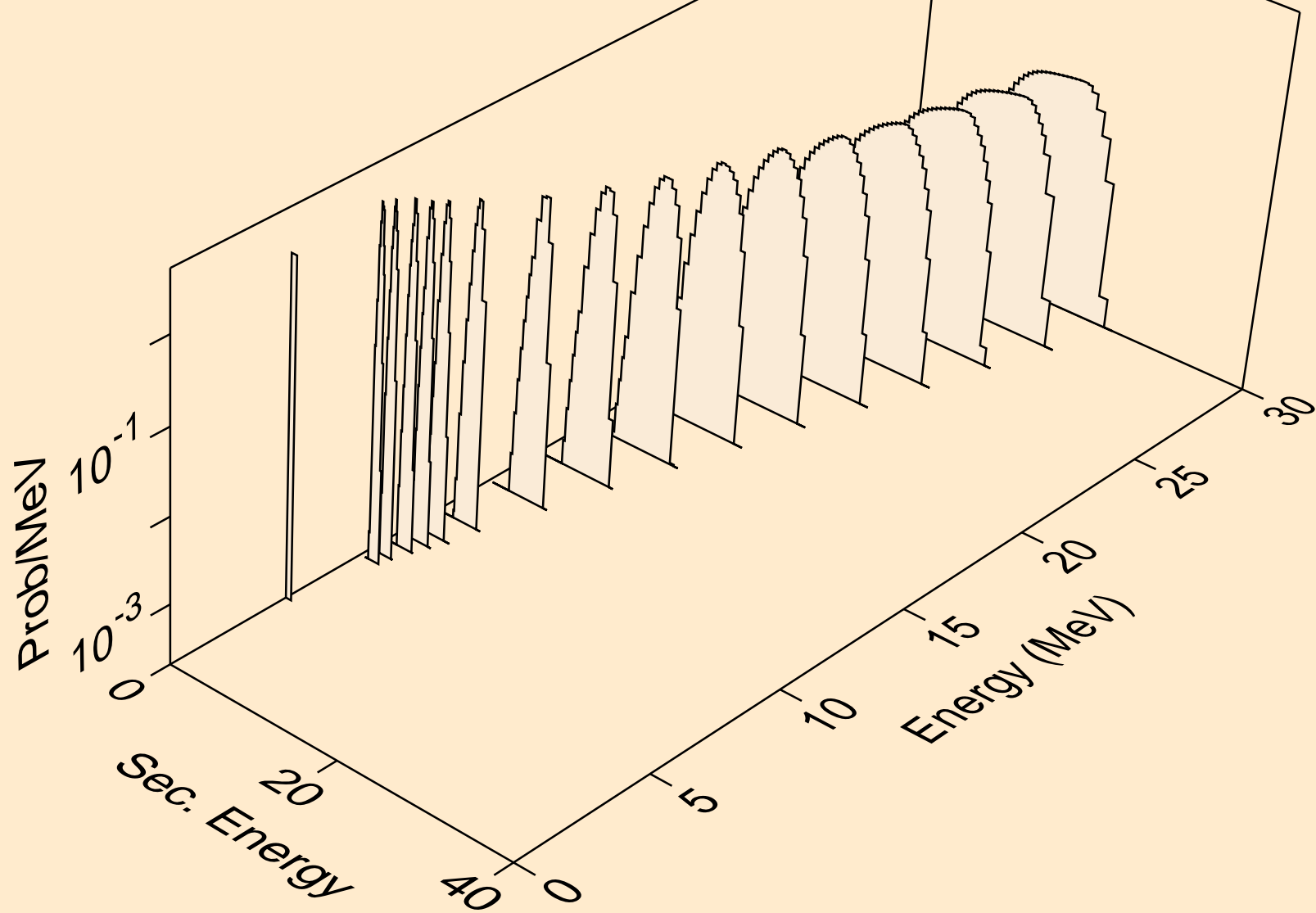

PD094 NEUTRON ACER TENDL-2021 LIBRARY; T=293.6K
deuterons from (n,da)

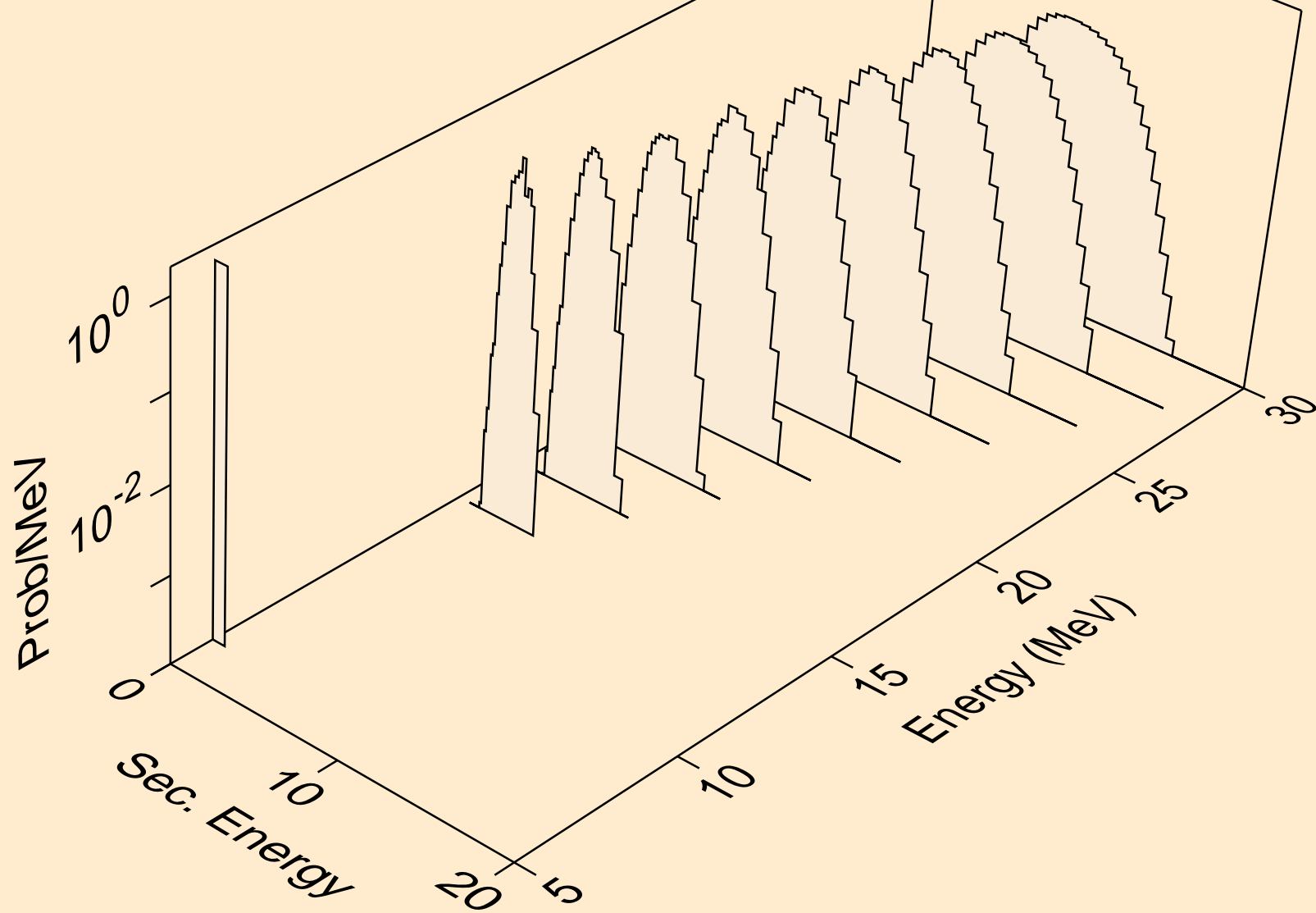

PD094 NEUTRON ACER TENDL-2021 LIBRARY; T=293.6K
tritons from (n,x)

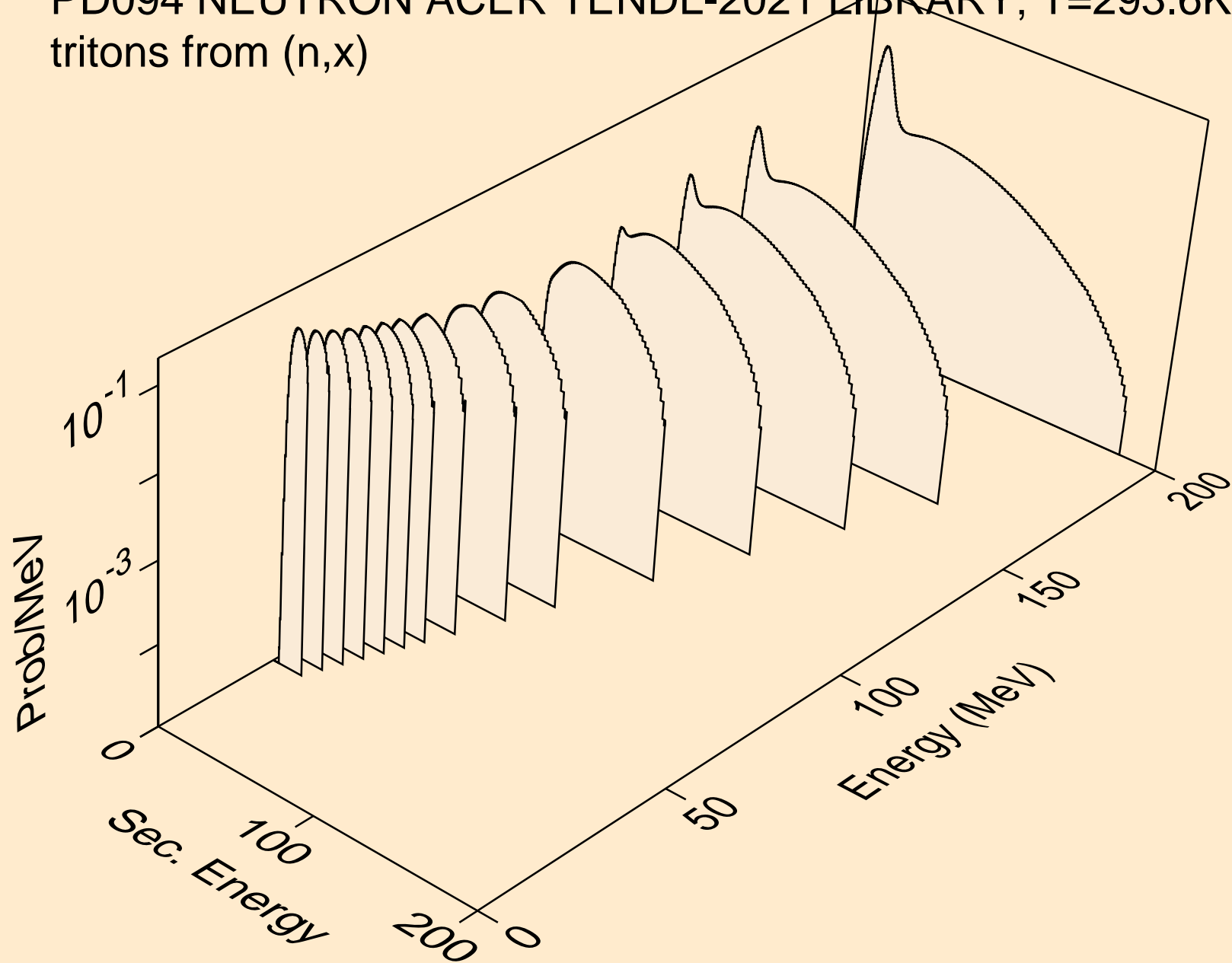

PD094 NEUTRON ACER TENDL-2021 LIBRARY; T=293.6K
tritons from (n,n*)t

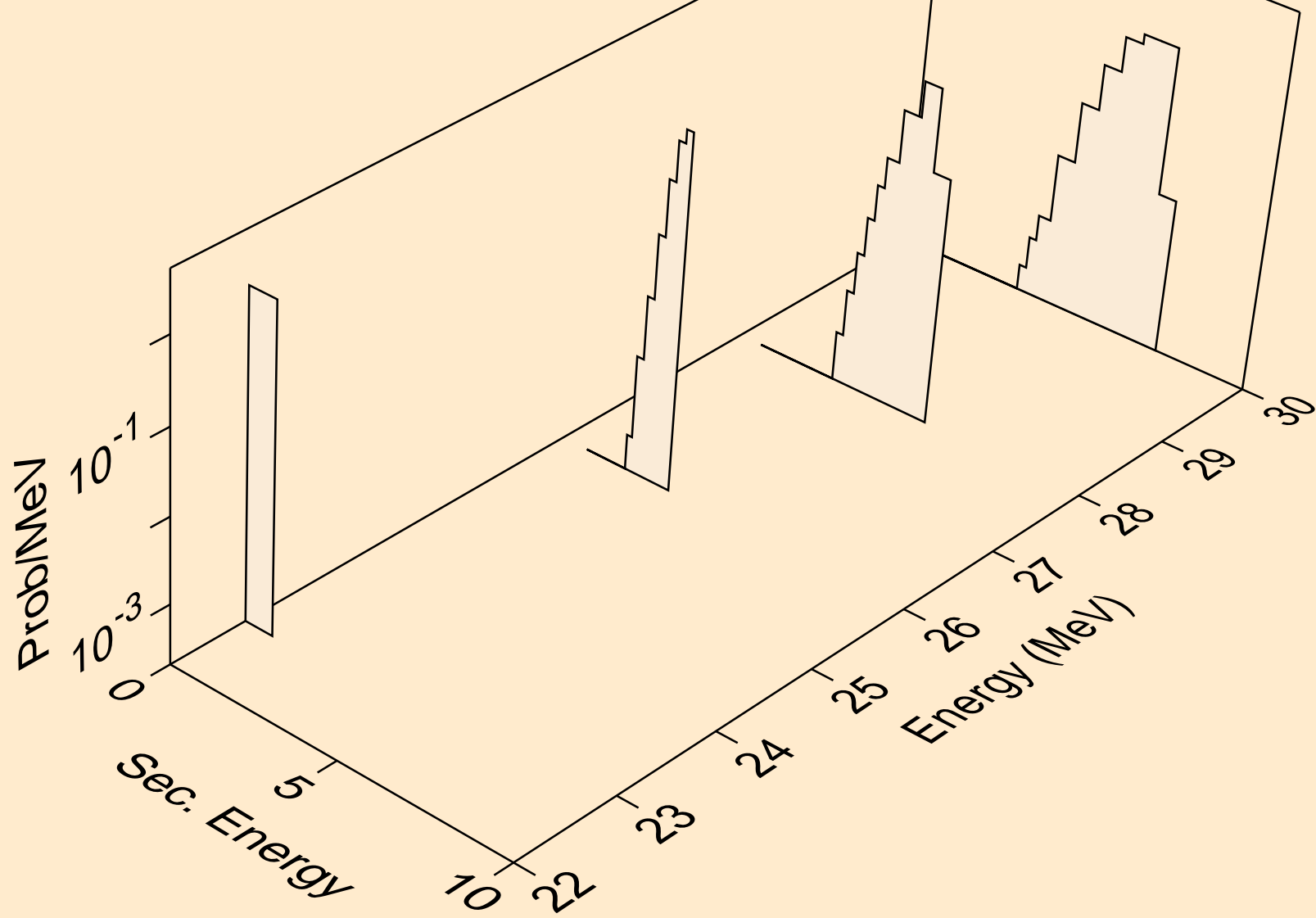

PD094 NEUTRON ACER TENDL-2021 LIBRARY; T=293.6K
tritons from (n,t)

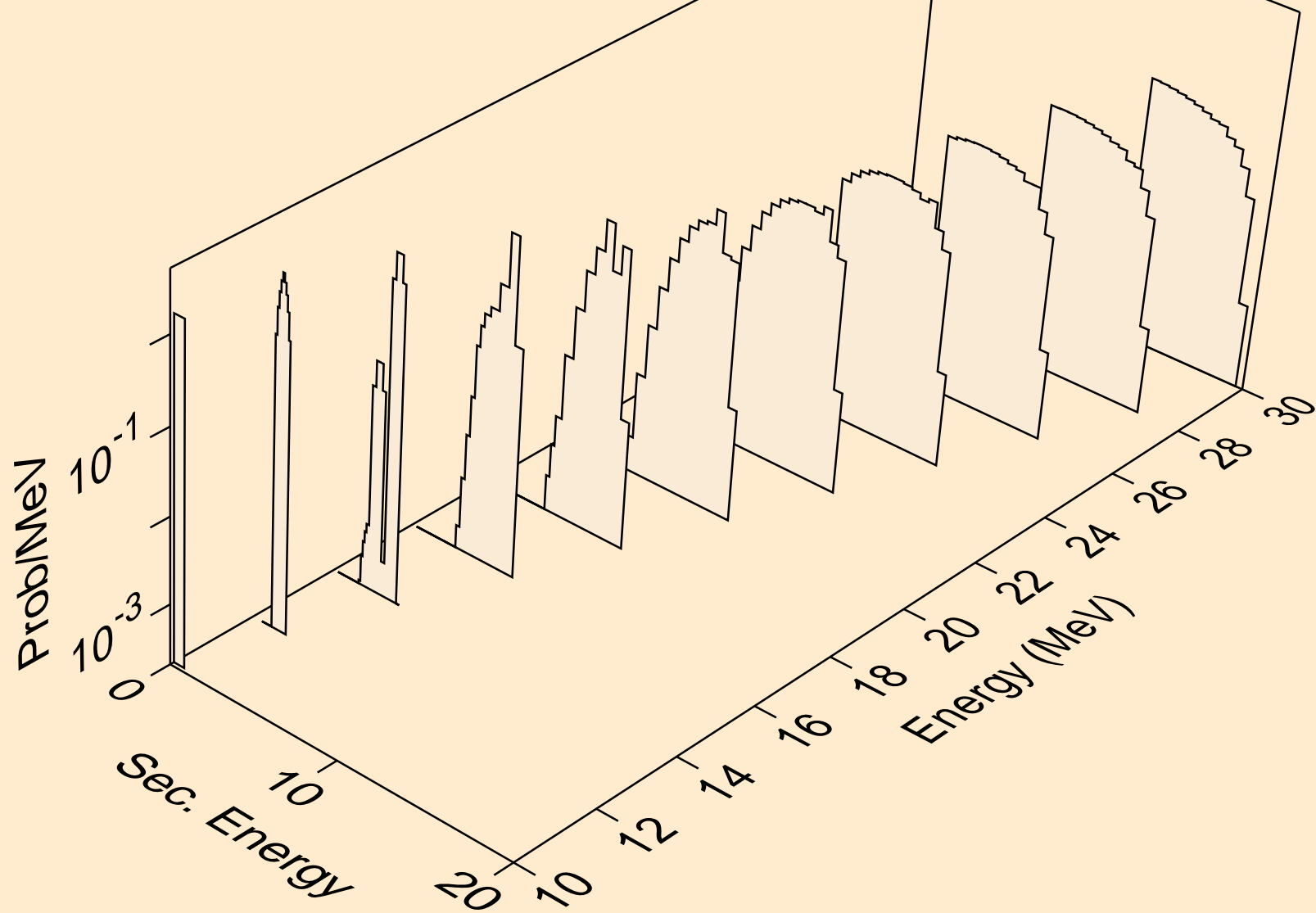

PD094 NEUTRON ACER TENDL-2021 LIBRARY; T=293.6K
tritons from (n,pt)

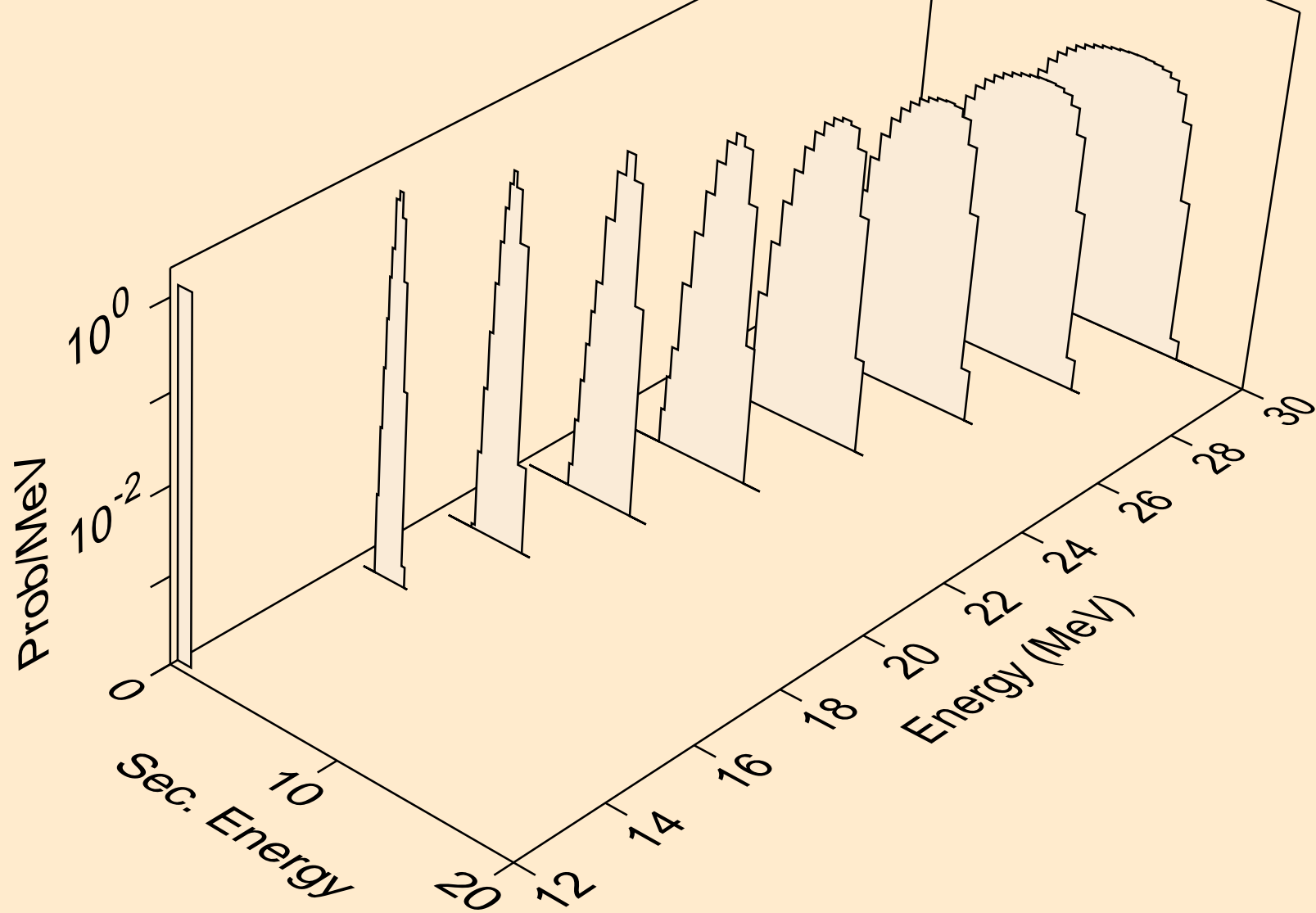

PD094 NEUTRON ACER TENDL-2021 LIBRARY; T=293.6K
he3s from (n,x)

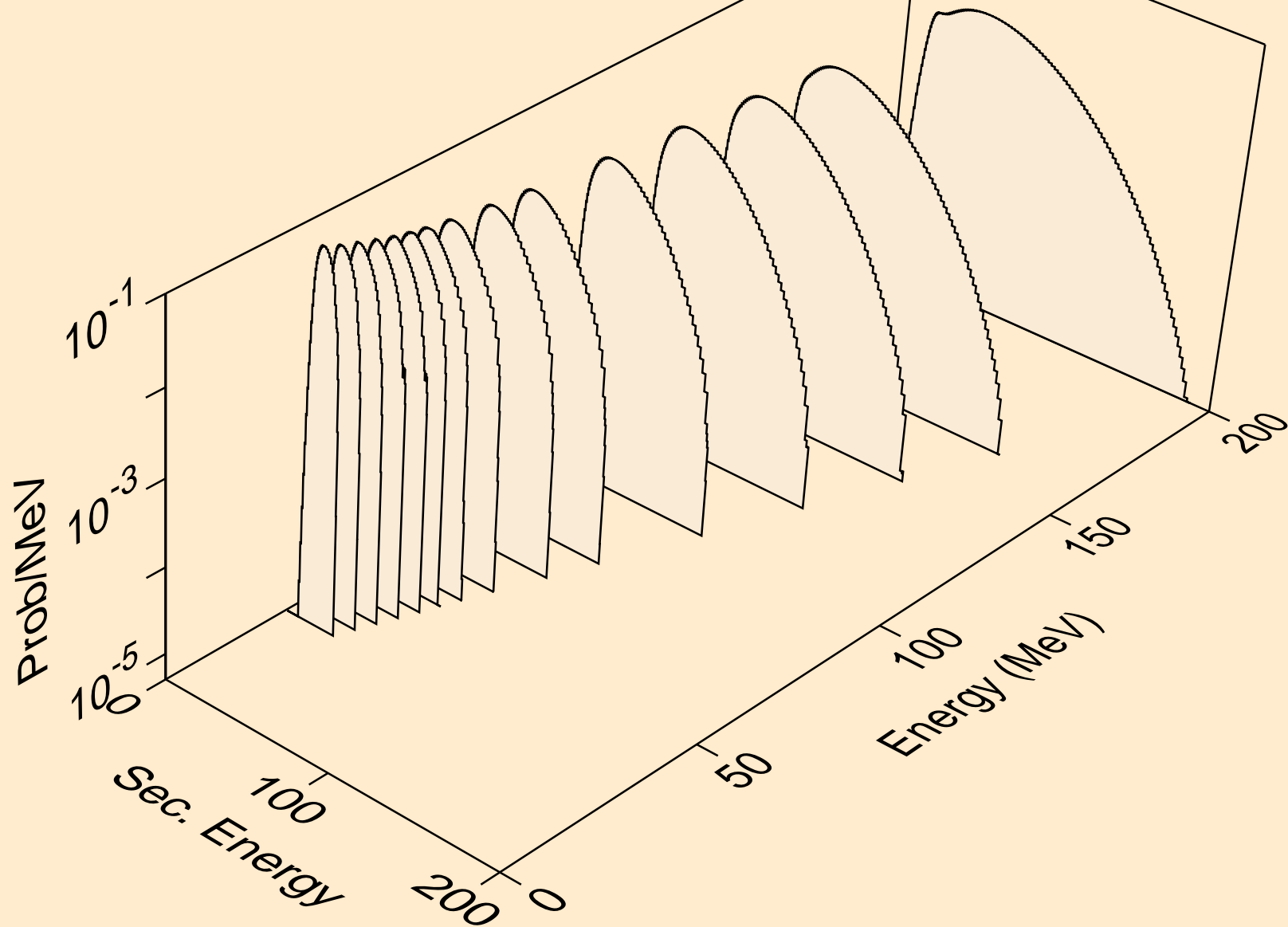

PD094 NEUTRON ACER TENDL-2021 LIBRARY; T=293.6K
he3s from (n,n*)he3

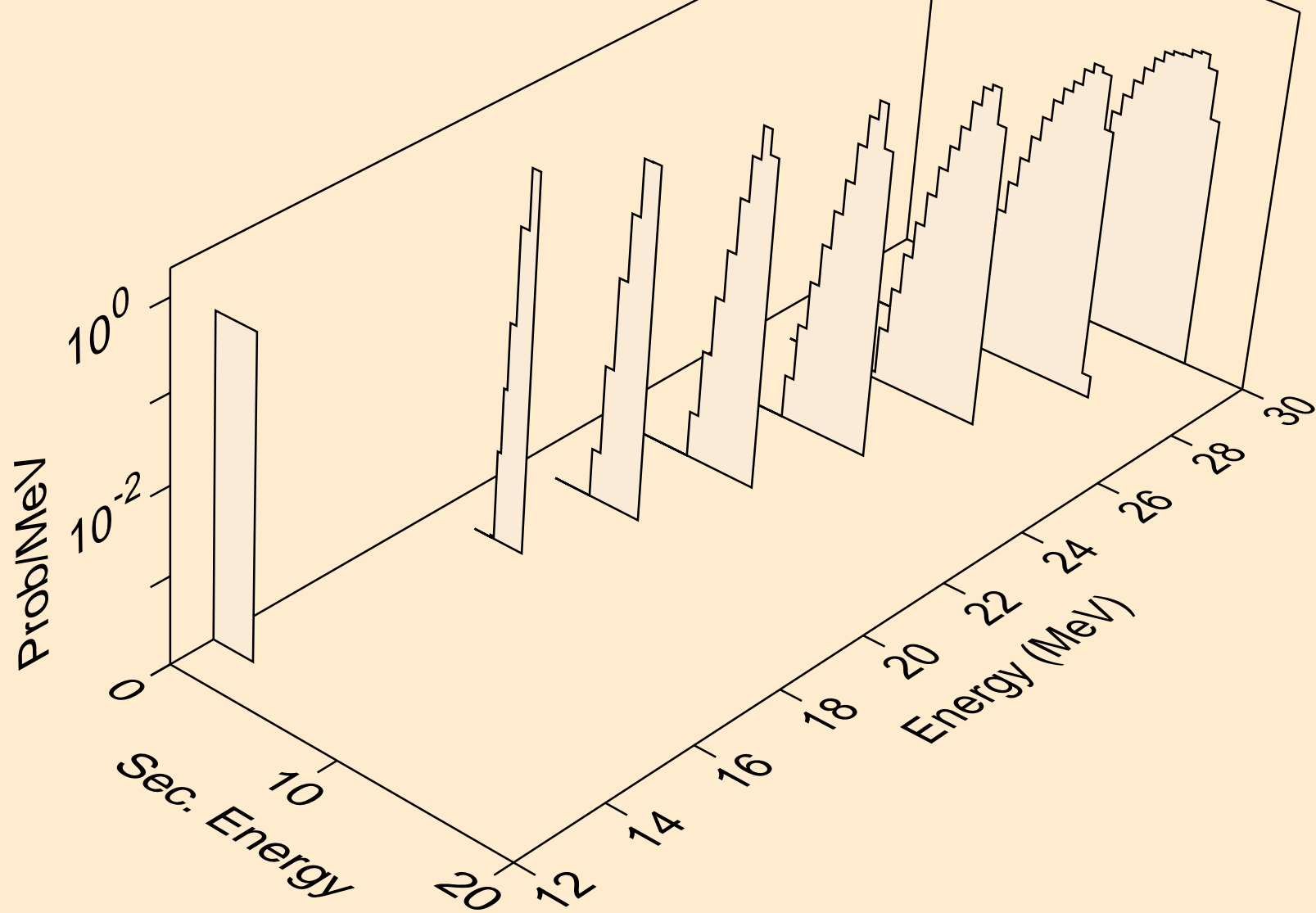

PD094 NEUTRON ACER TENDL-2021 LIBRARY; T=293.6K
he3s from (n,he3)

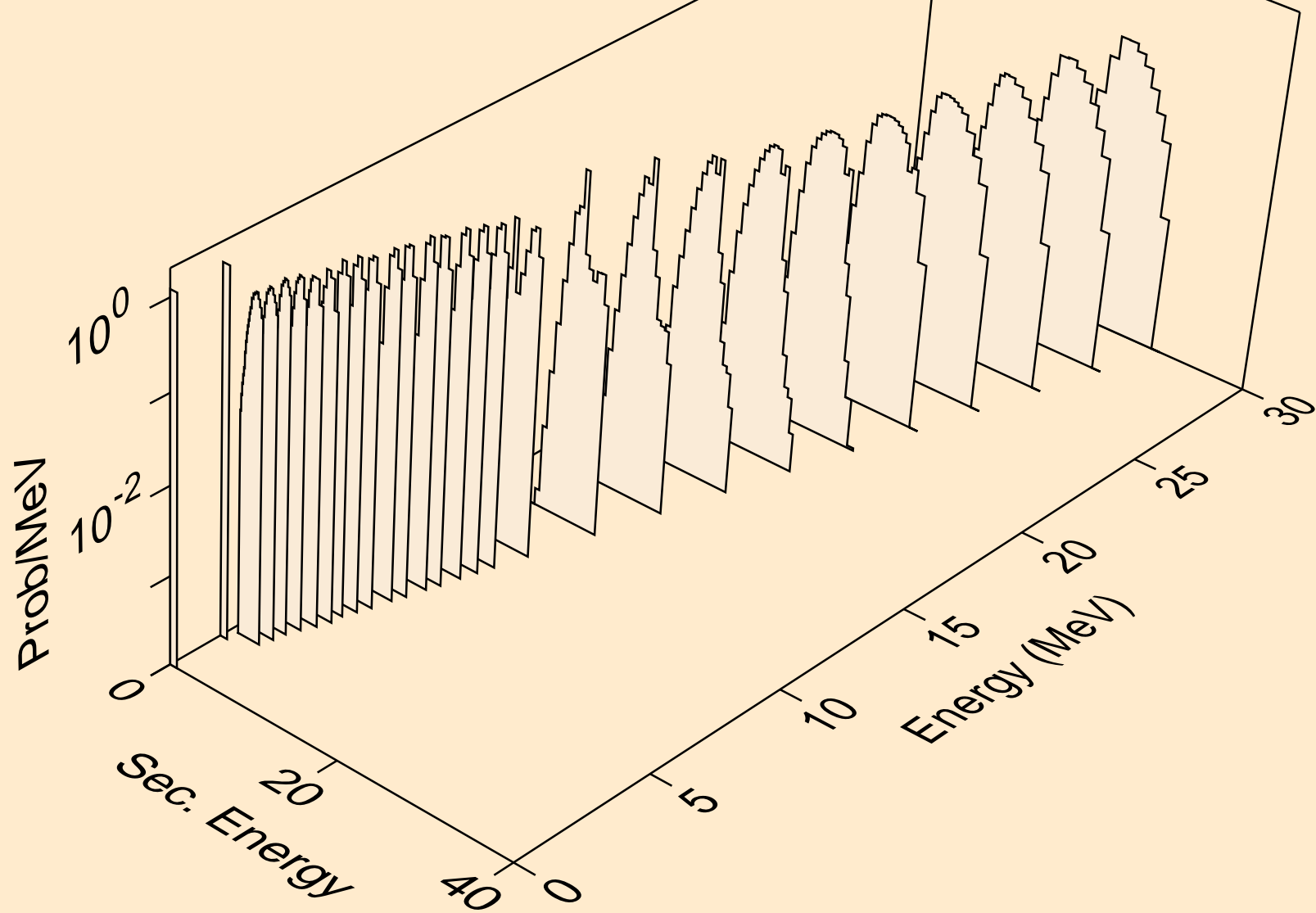

PD094 NEUTRON ACER TENDL-2021 LIBRARY; T=293.6K
alphas from (n,x)

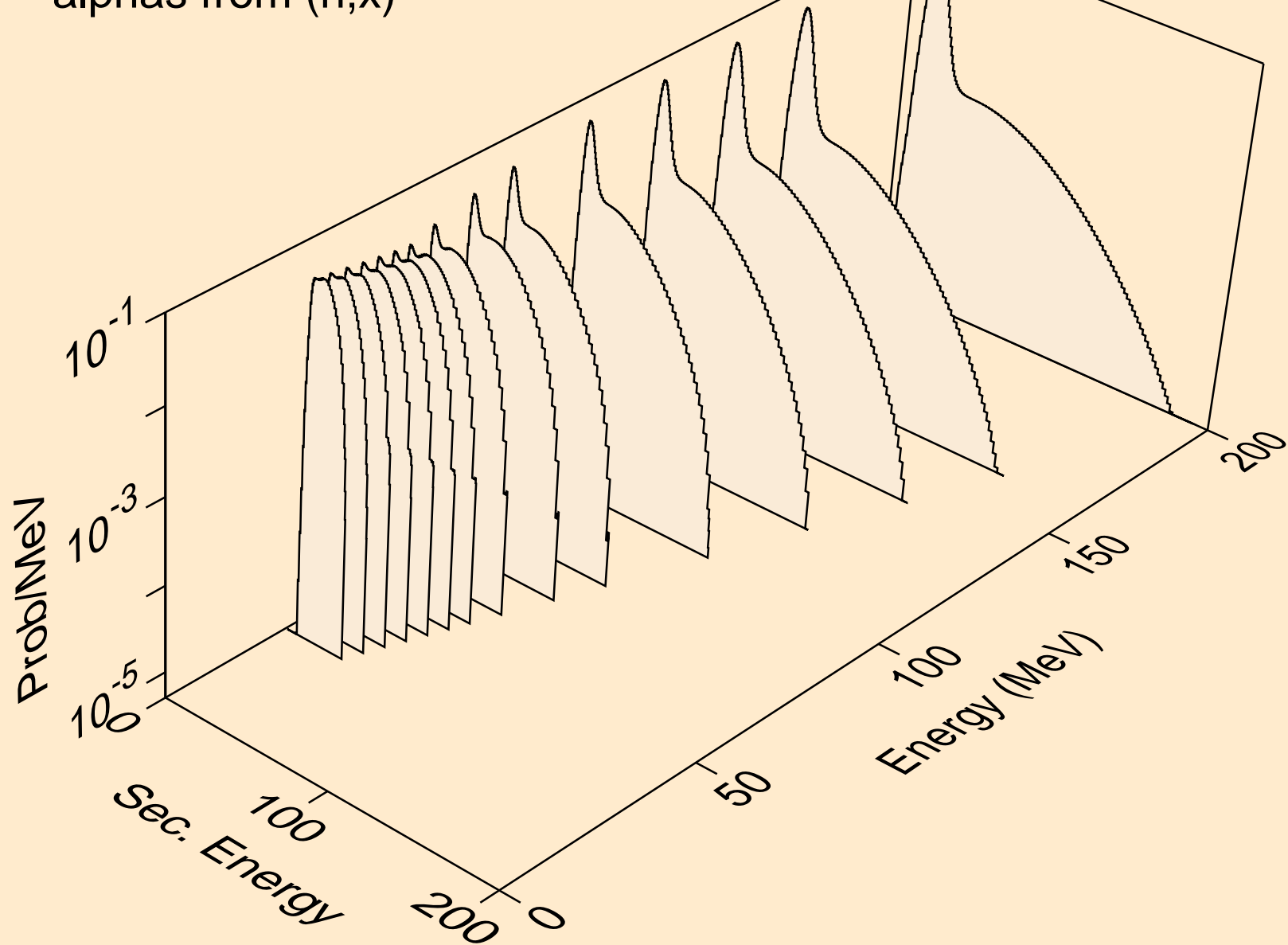

PD094 NEUTRON ACER TENDL-2021 LIBRARY; T=293.6K
alphas from (n,n*)a

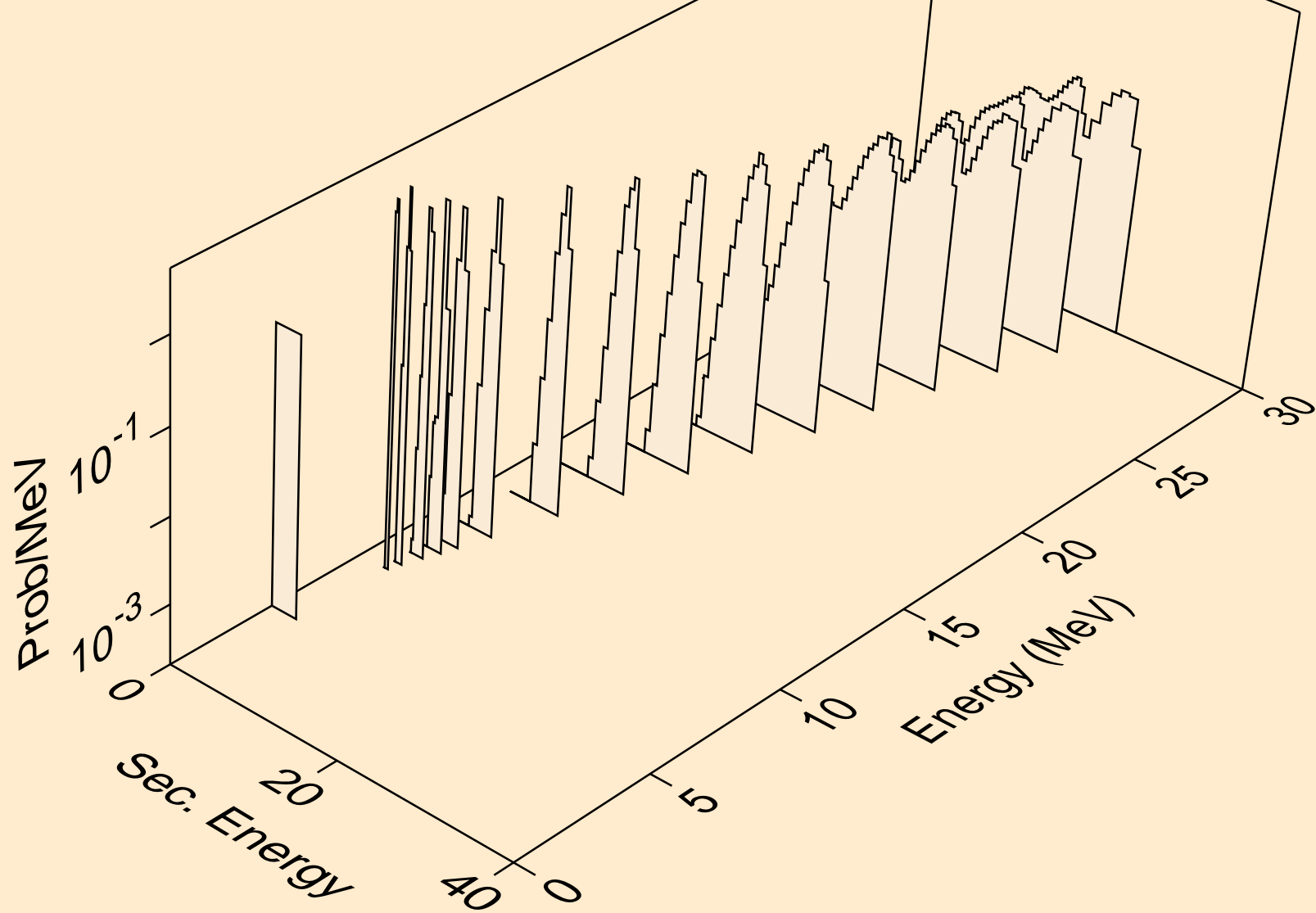

PD094 NEUTRON ACER TENDL-2021 LIBRARY; T=293.6K
alphas from (n,2n)a

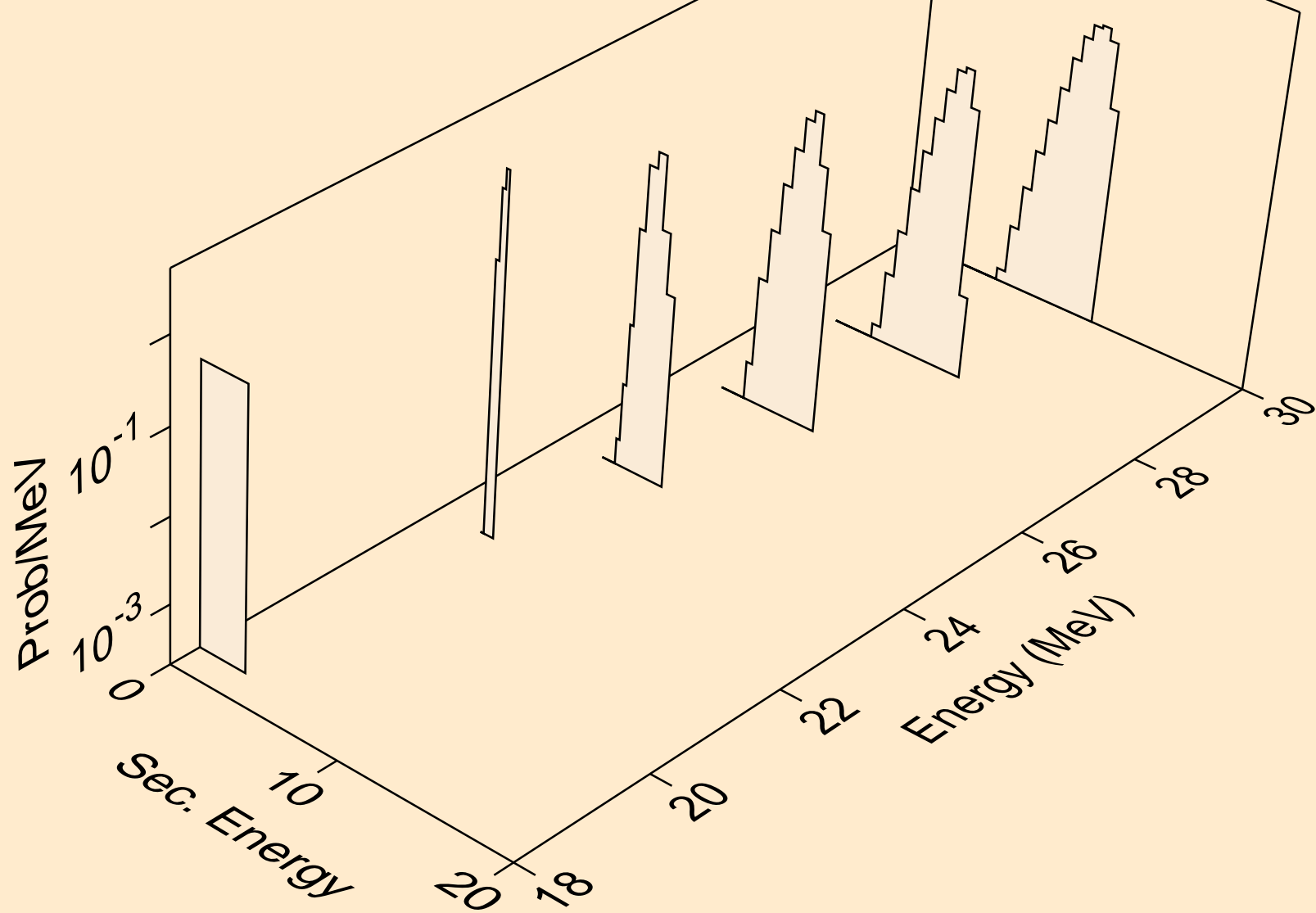

PD094 NEUTRON ACER TENDL-2021 LIBRARY; T=293.6K
alphas from (n,n*)2a

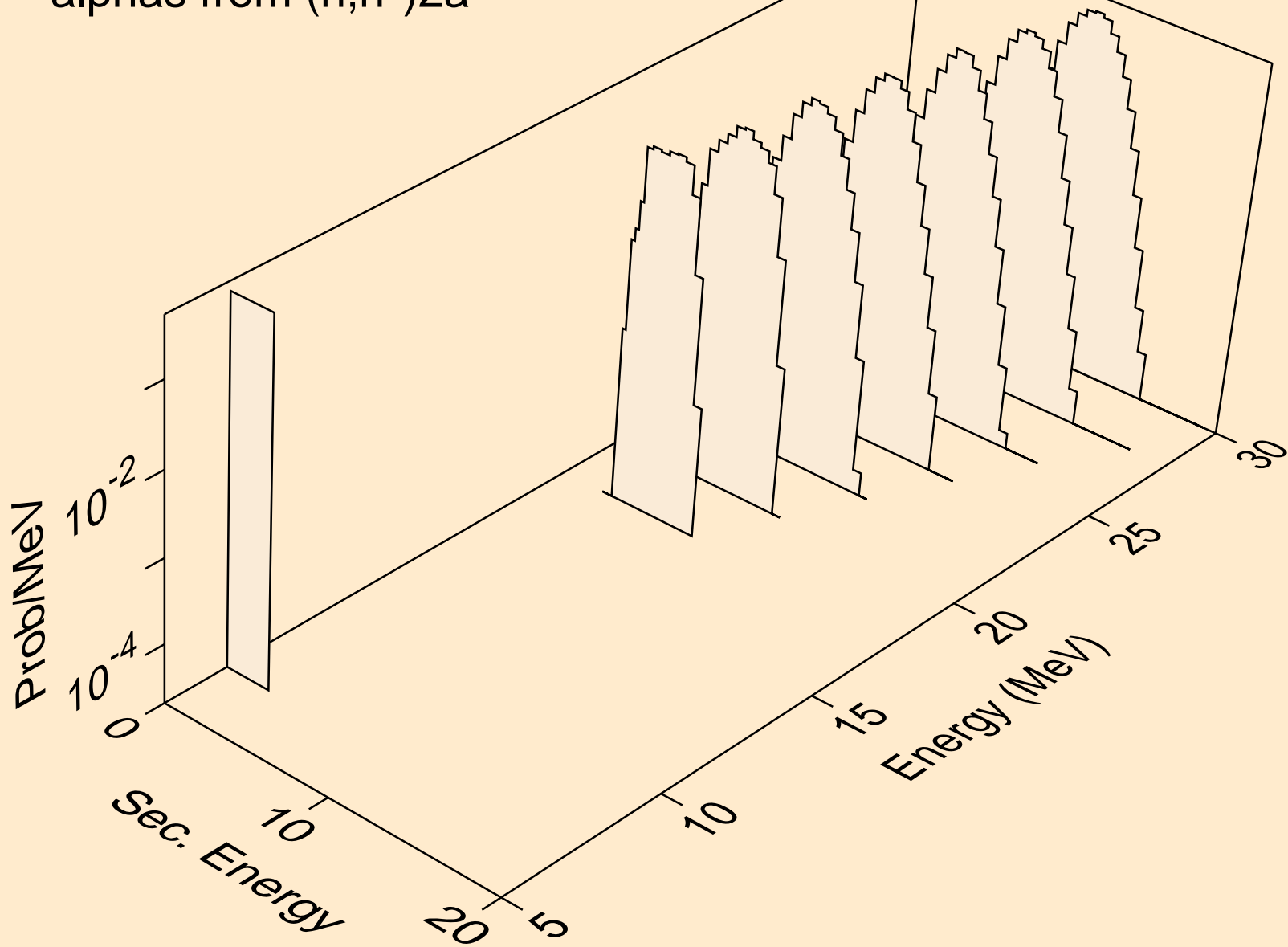

PD094 NEUTRON ACER TENDL-2021 LIBRARY; T=293.6K
alphas from (n,npa)

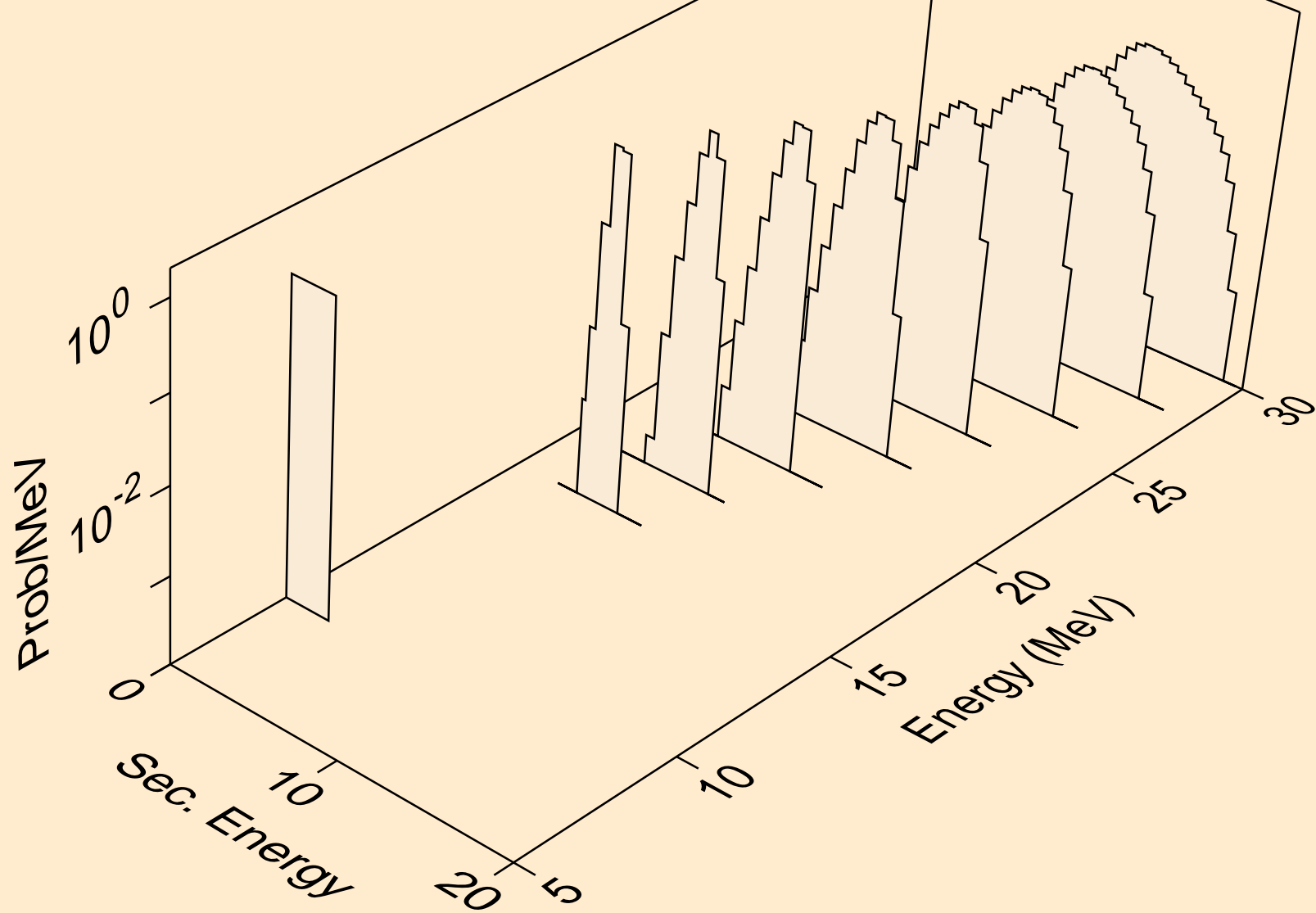

PD094 NEUTRON ACER TENDL-2021 LIBRARY; T=293.6K
alphas from (n,a)

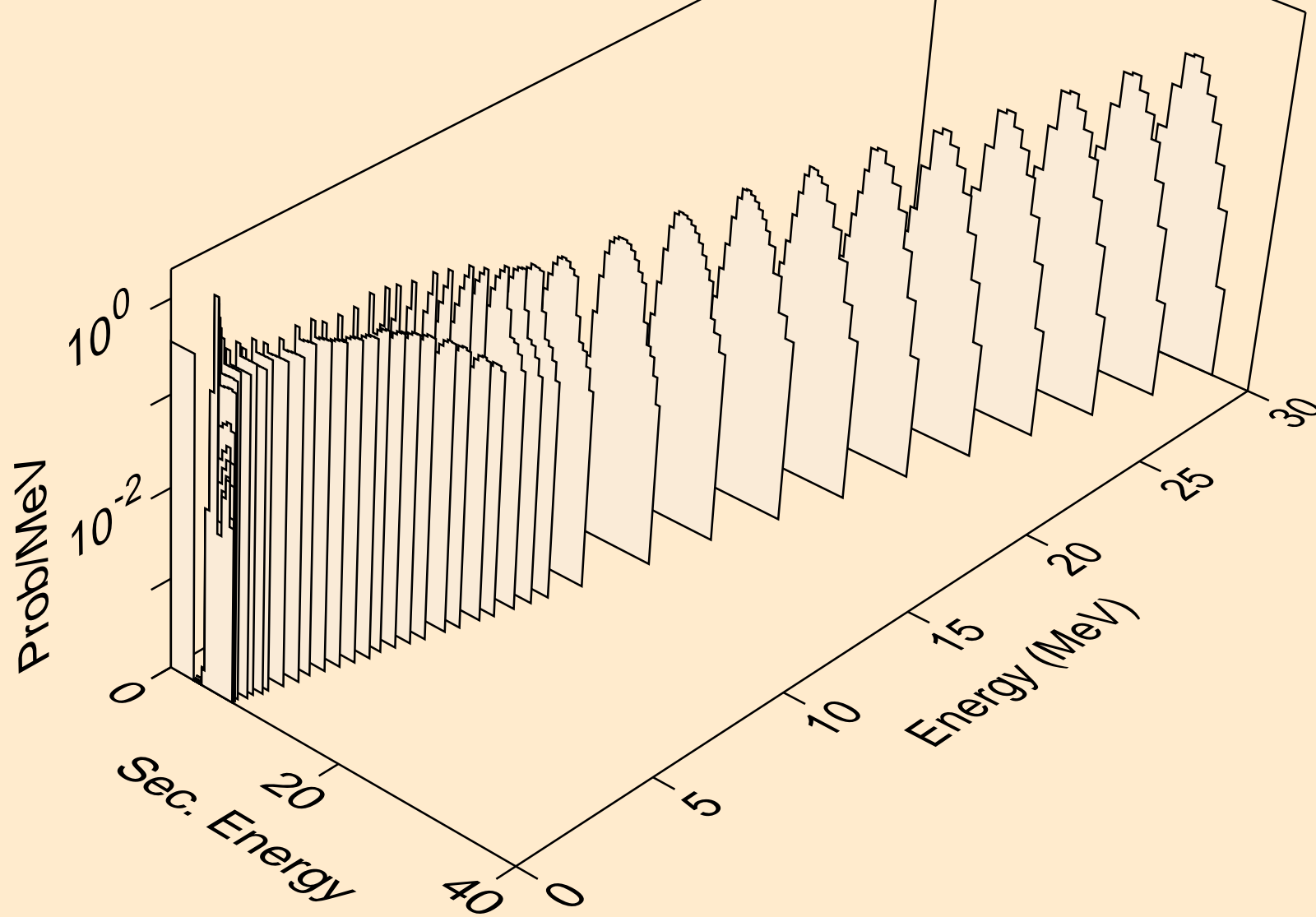

PD094 NEUTRON ACER TENDL-2021 LIBRARY; T=293.6K
alphas from (n,2a)

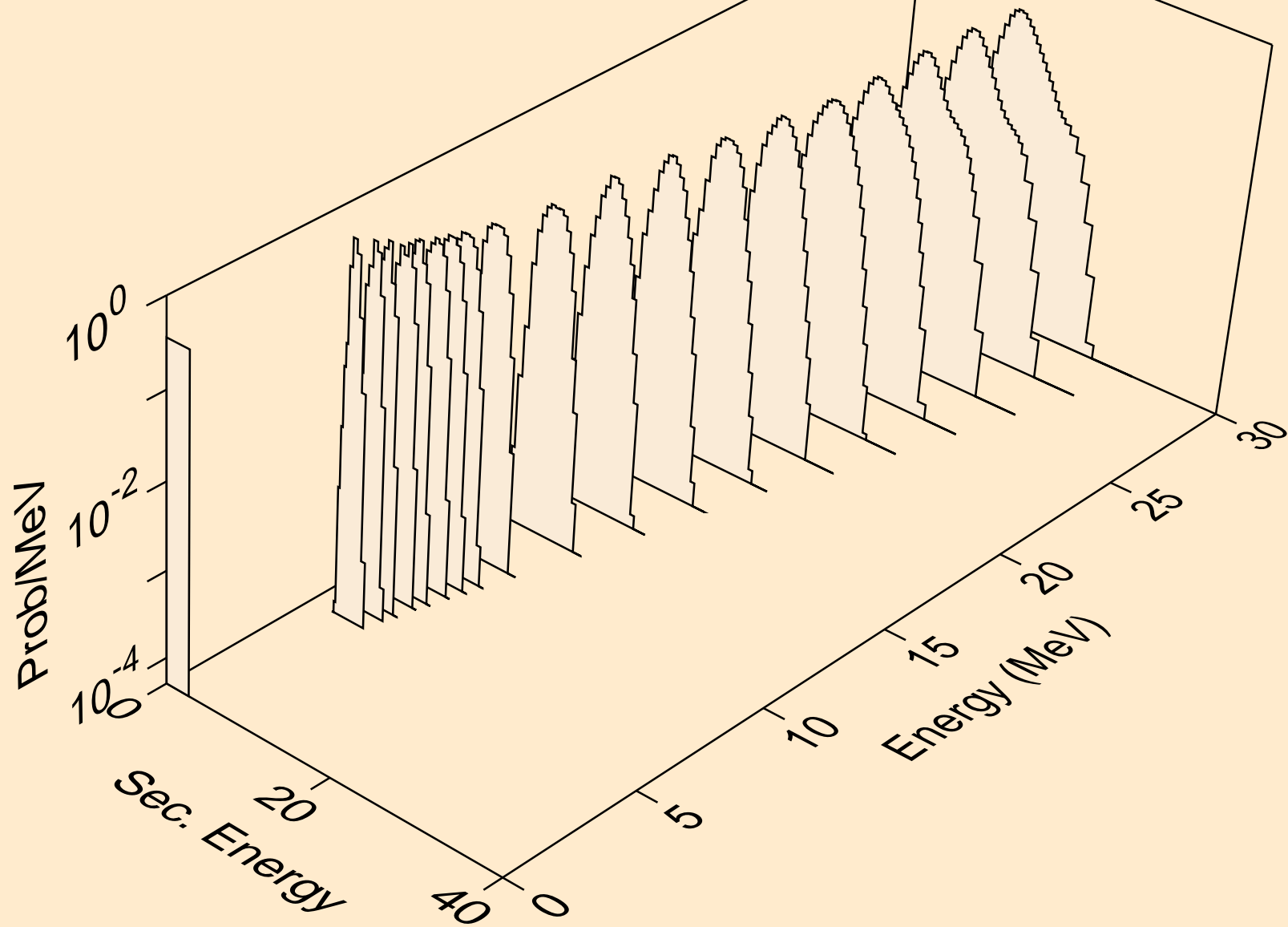

PD094 NEUTRON ACER TENDL-2021 LIBRARY; T=293.6K
alphas from (n,pa)

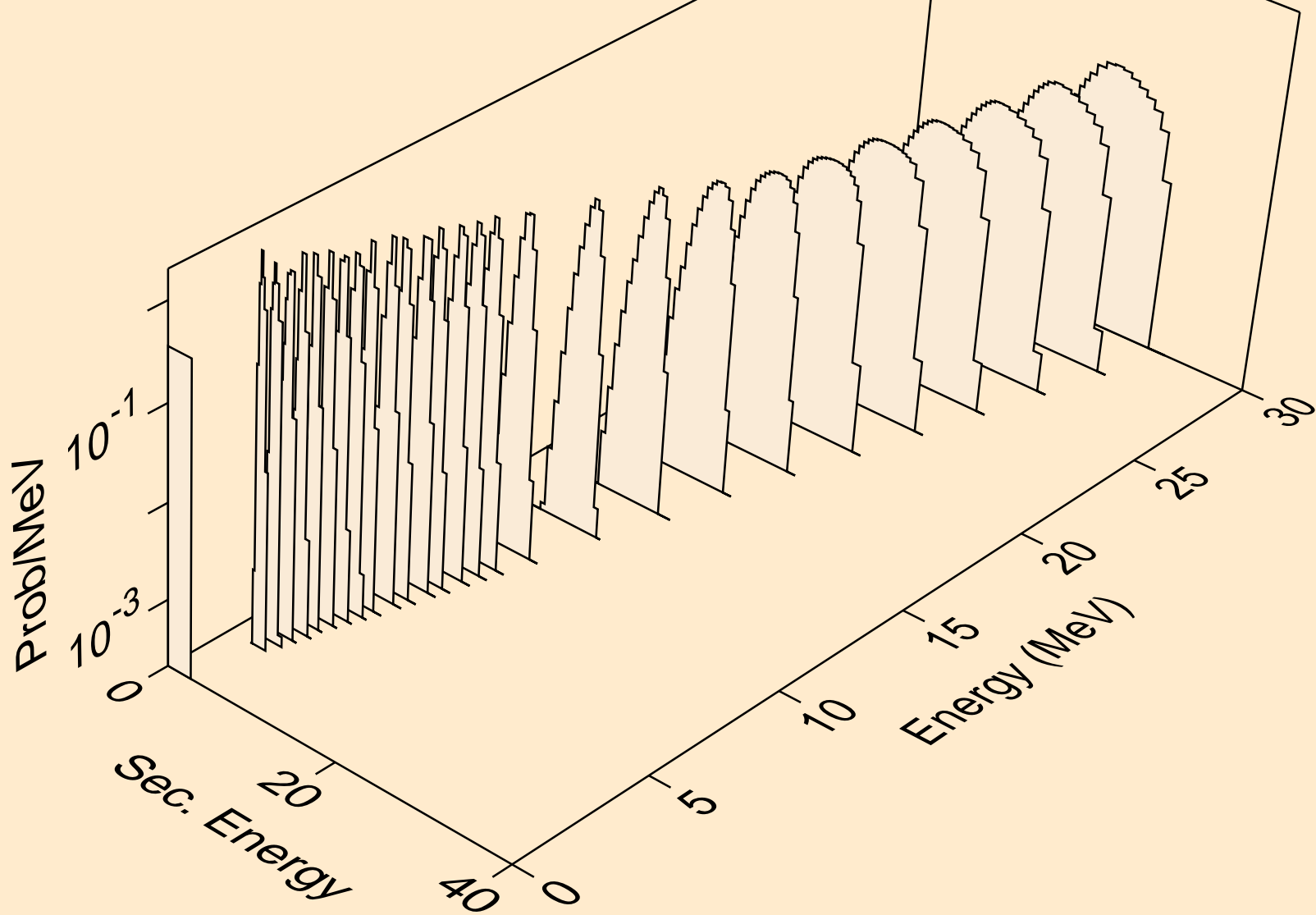

PD094 NEUTRON ACER TENDL-2021 LIBRARY; T=293.6K
alphas from (n,da)

