

PD095M NEUTRON ACER TENDL-2021 LIBRARY; T=293.6K  
Principal cross sections

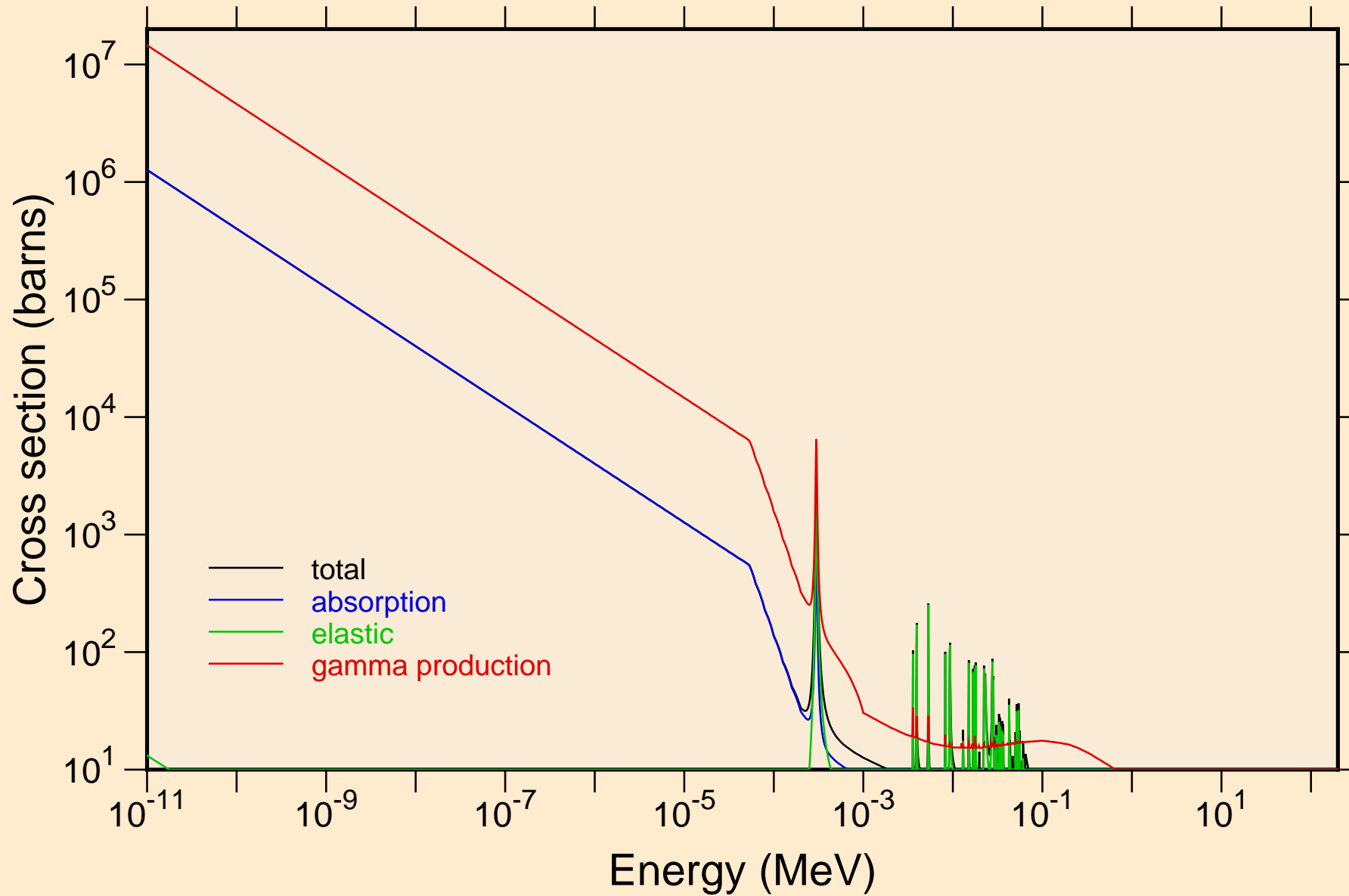

PD095M NEUTRON ACER TENDL-2021 LIBRARY; T=293.6K  
resonance total cross section

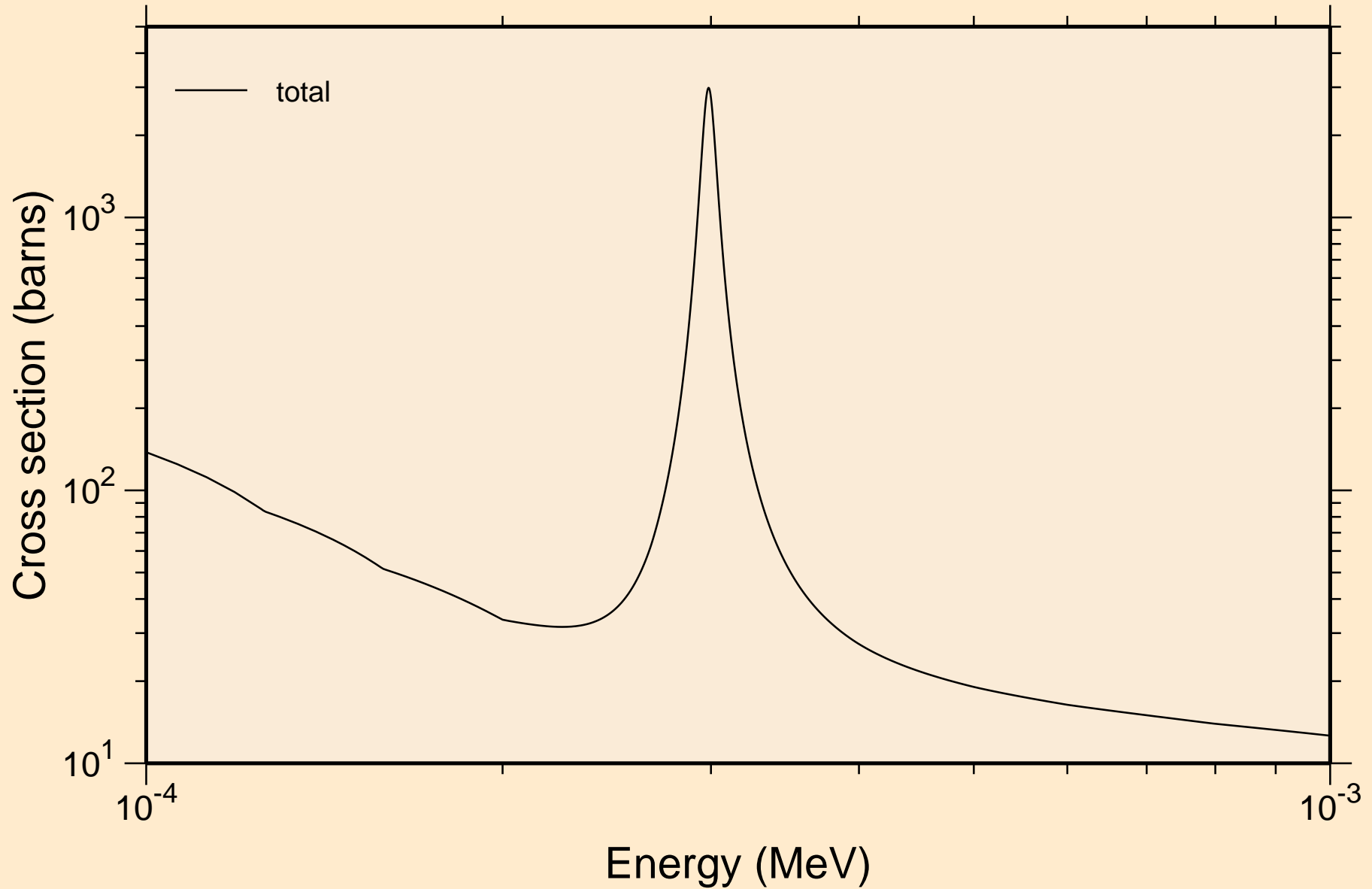

PD095M NEUTRON ACER TENDL-2021 LIBRARY; T=293.6K  
resonance total cross section

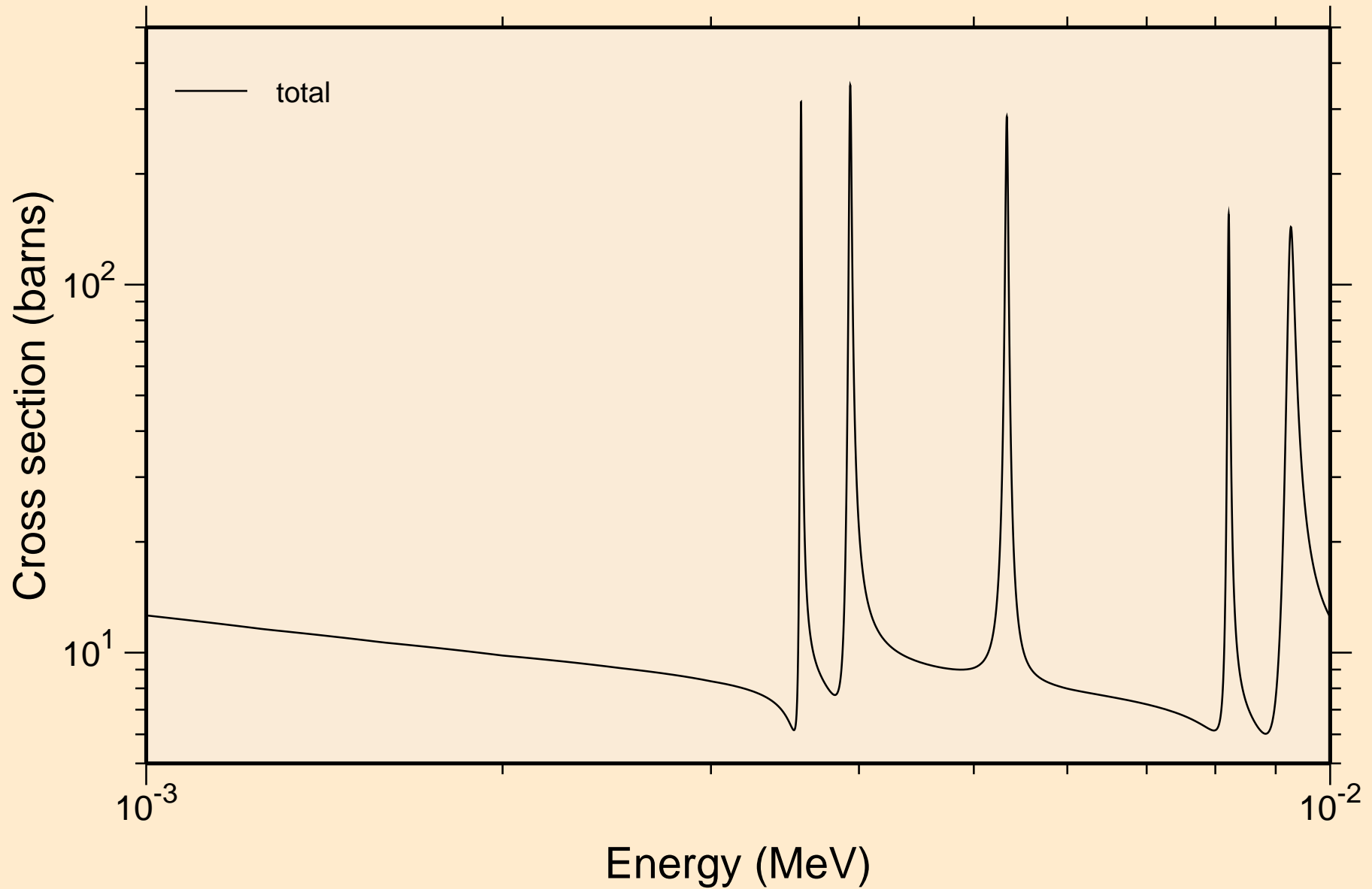

PD095M NEUTRON ACER TENDL-2021 LIBRARY; T=293.6K  
resonance total cross section

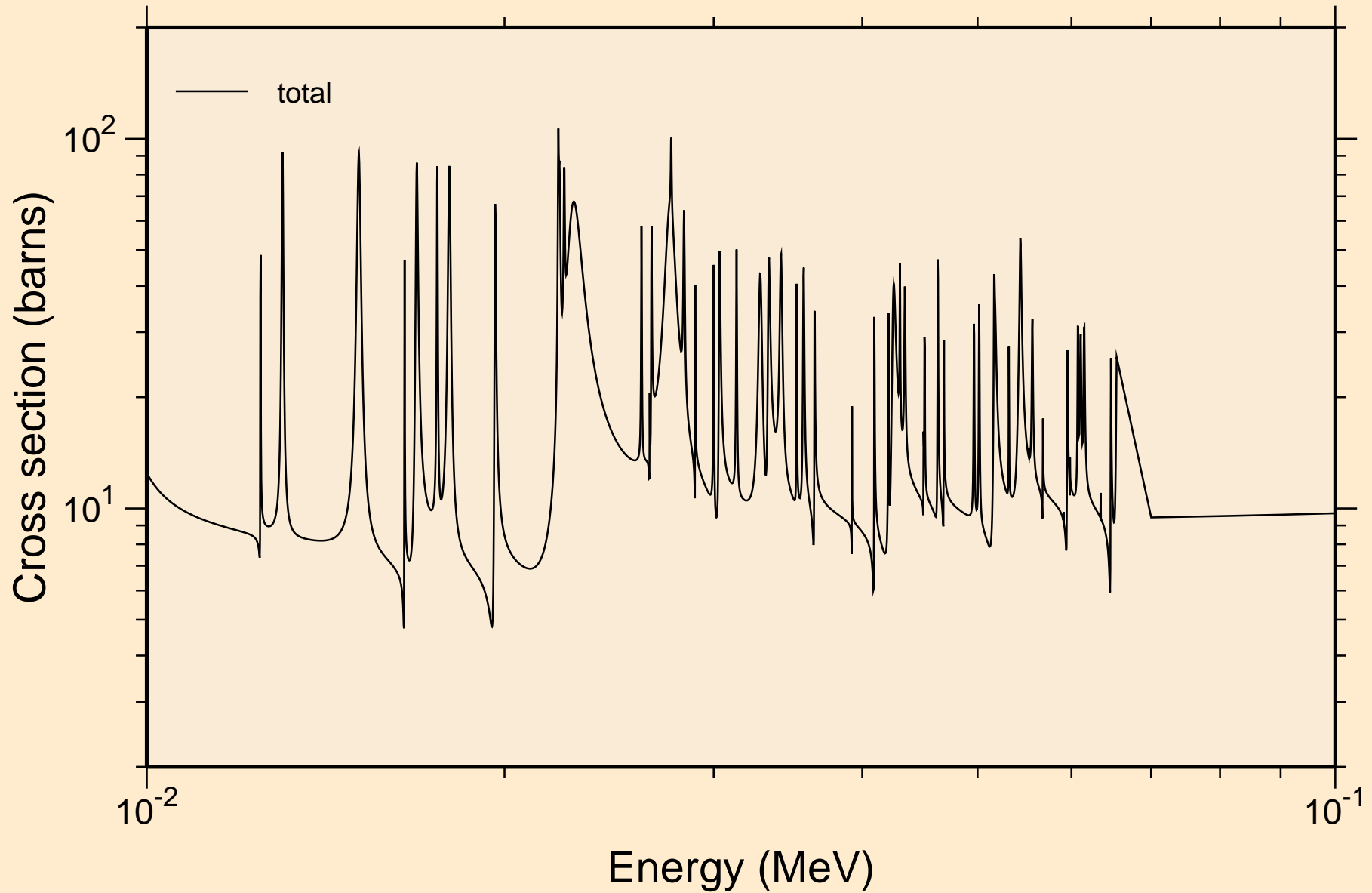

P̄095M NEUTRON ACER TENDL-2021 LIBRARY; T=293.6K  
resonance total cross section

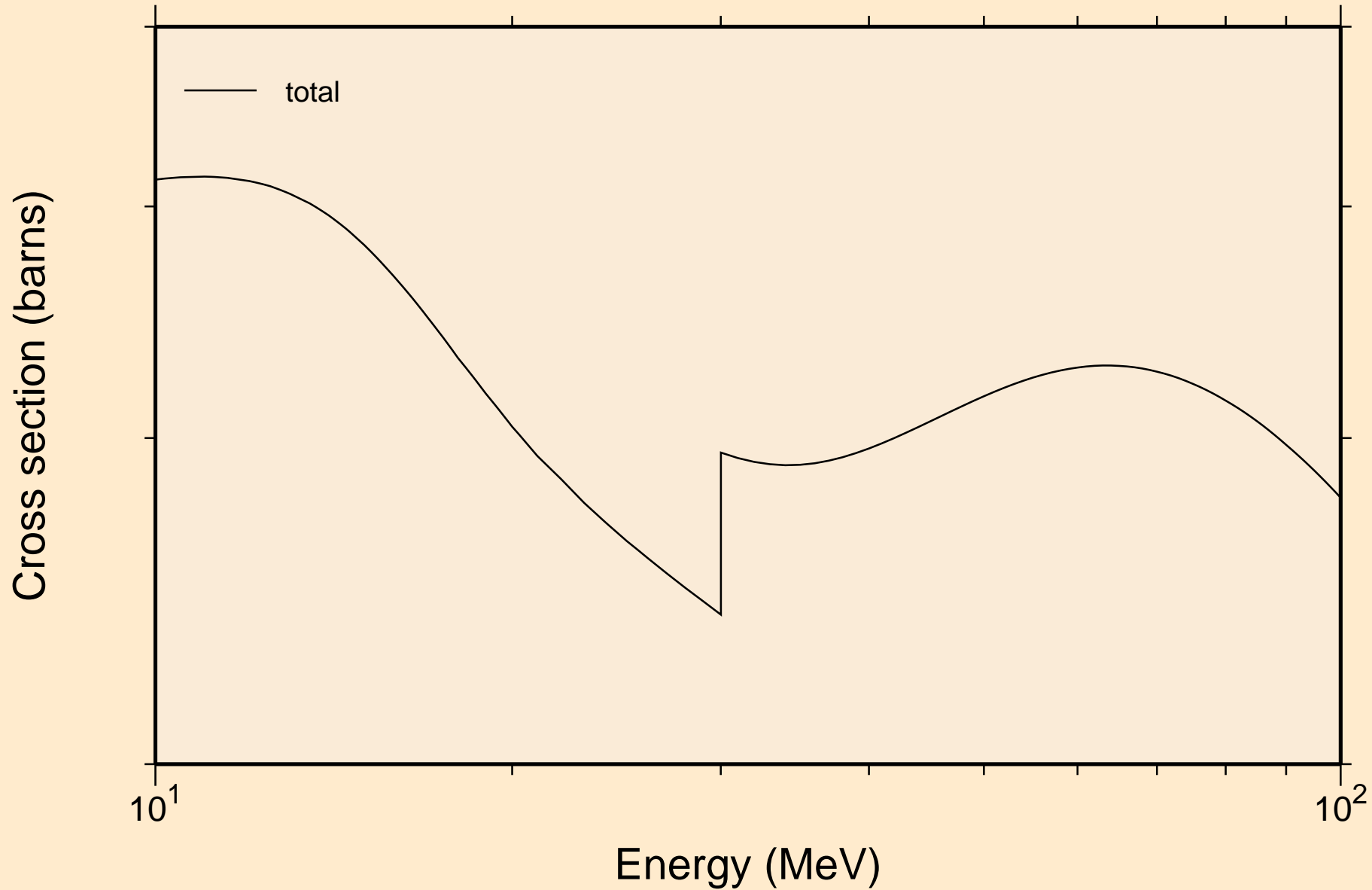

PD095M NEUTRON ACER TENDL-2021 LIBRARY; T=293.6K  
resonance absorption cross sections

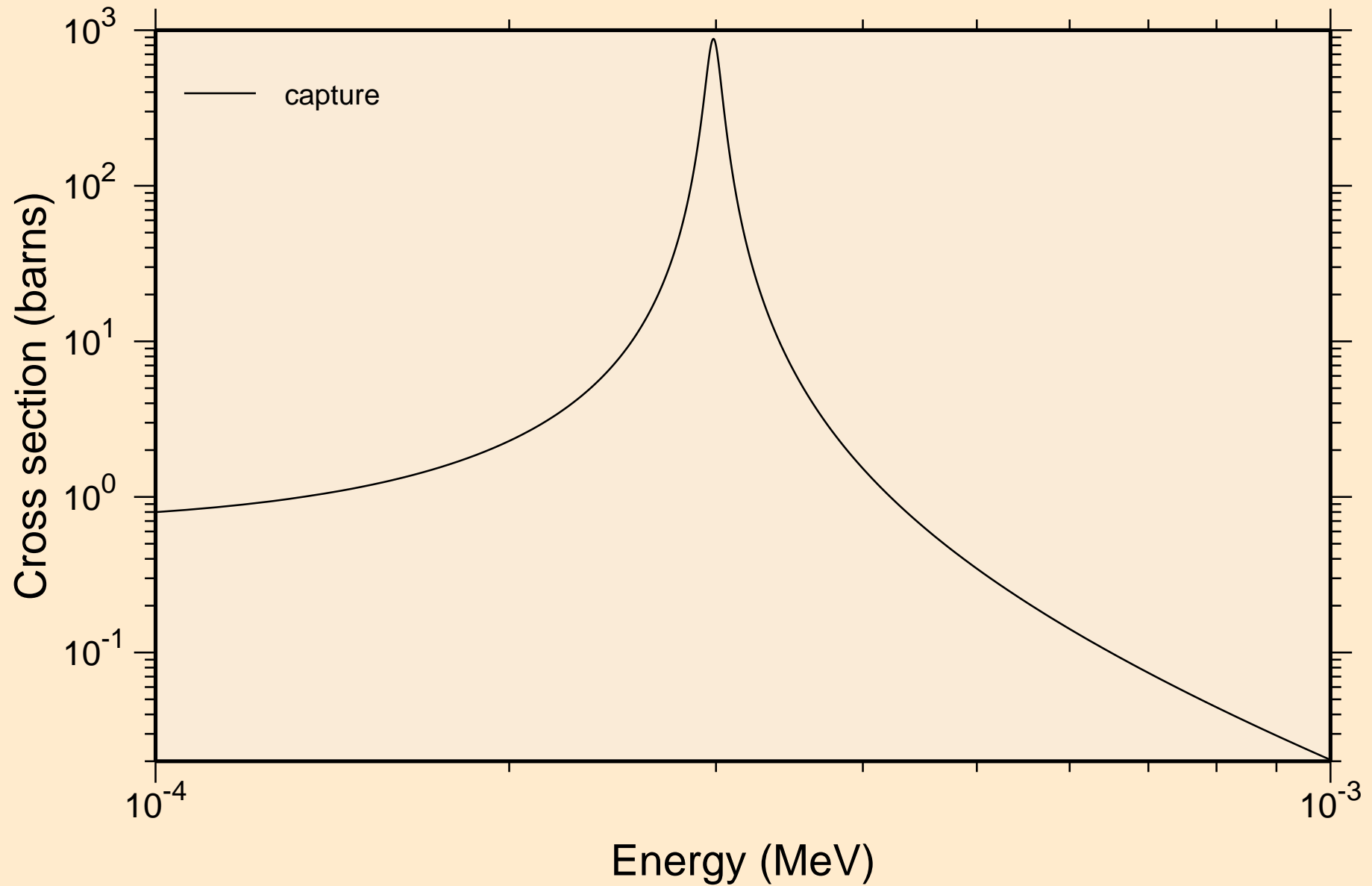

PD095M NEUTRON ACER TENDL-2021 LIBRARY; T=293.6K  
resonance absorption cross sections

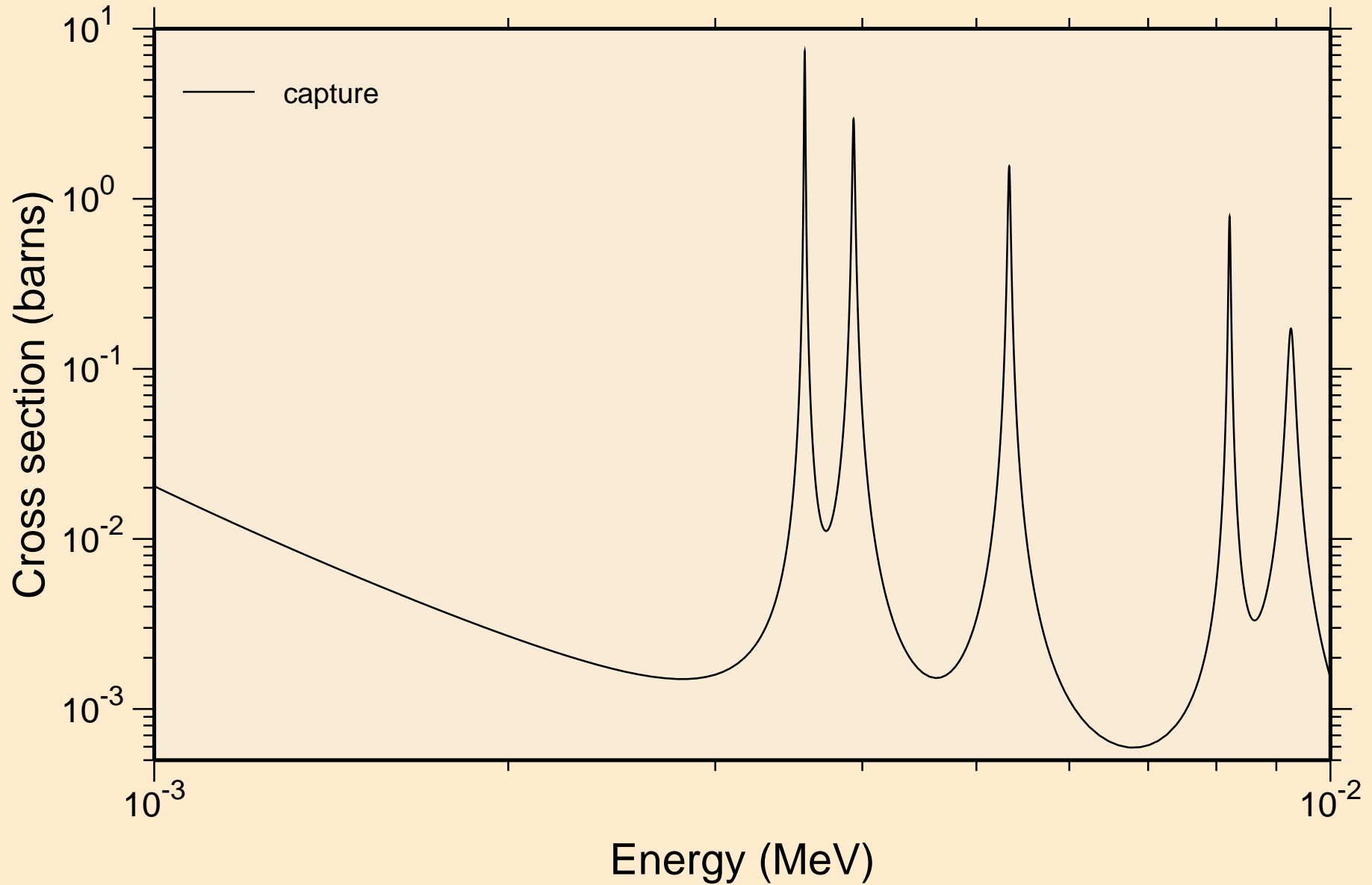

PD095M NEUTRON ACER TENDL-2021 LIBRARY; T=293.6K  
resonance absorption cross sections

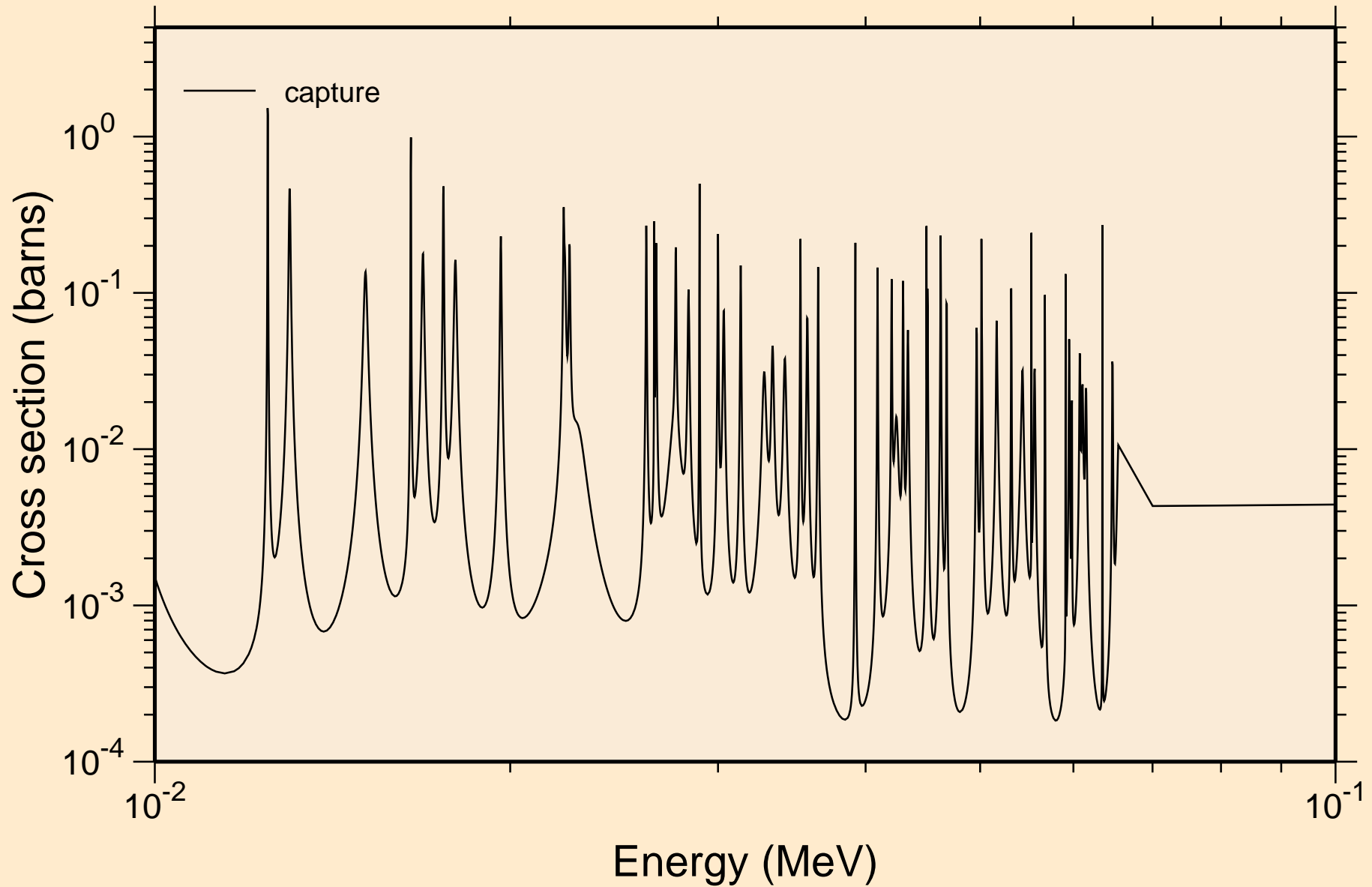



PD095M NEUTRON ACER TENDL-2021 LIBRARY; T=293.6K  
resonance absorption cross sections

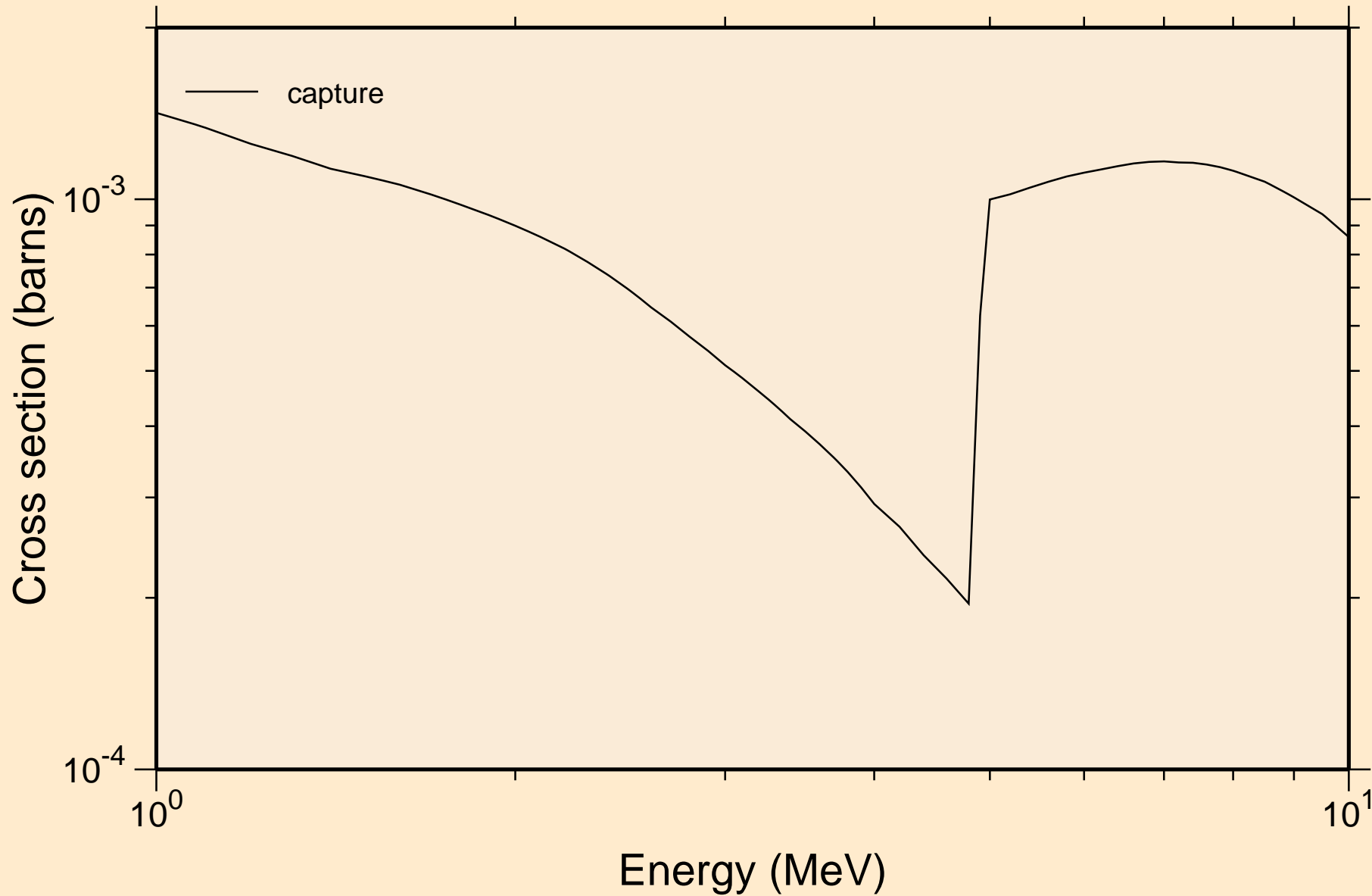

PD095M NEUTRON ACER TENDL-2021 LIBRARY; T=293.6K  
Heating

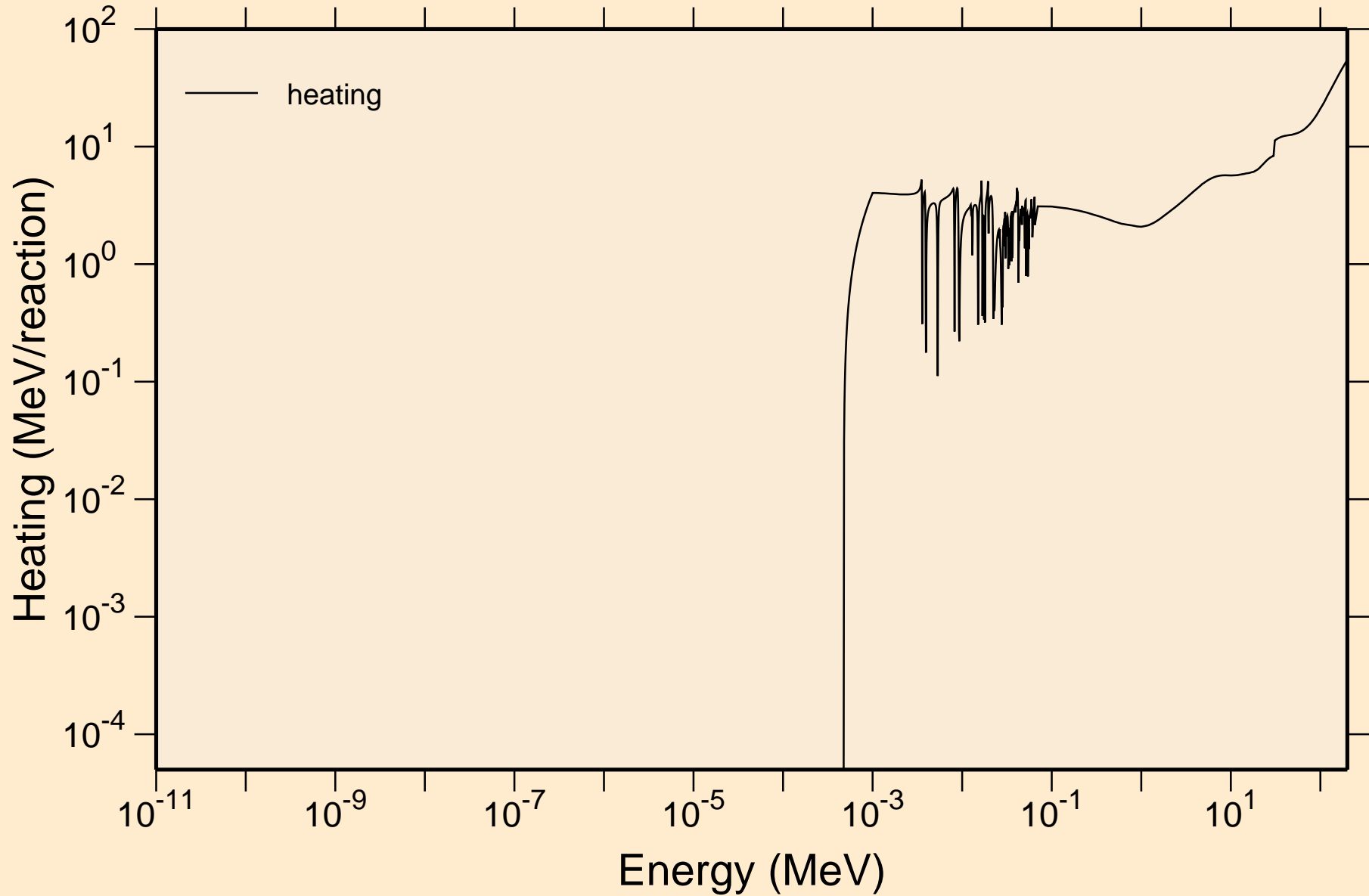

PD095M NEUTRON ACER TENDL-2021 LIBRARY; T=293.6K  
Damage

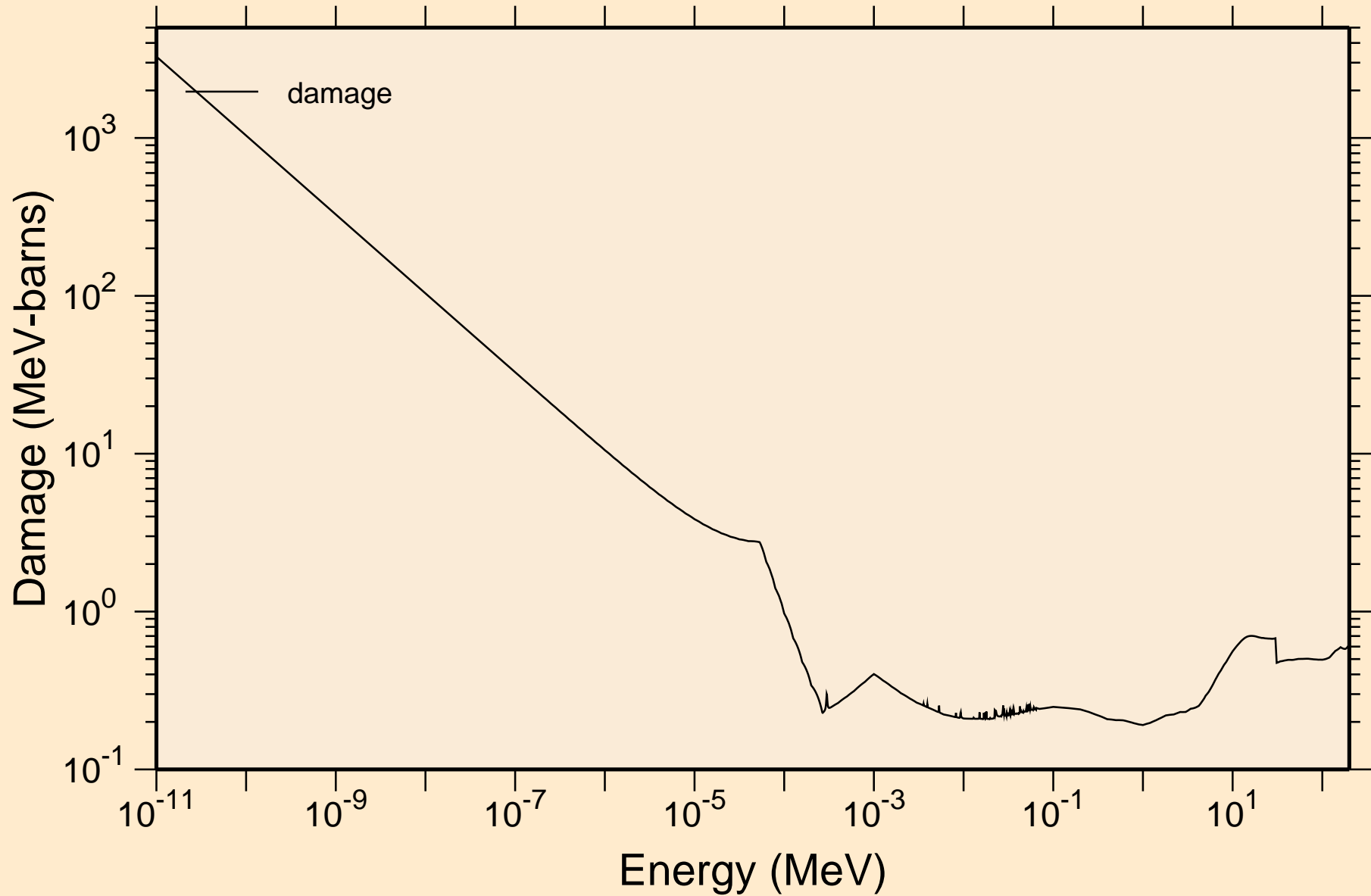

PD095M NEUTRON ACER TENDL-2021 LIBRARY; T=293.6K  
Non-threshold reactions

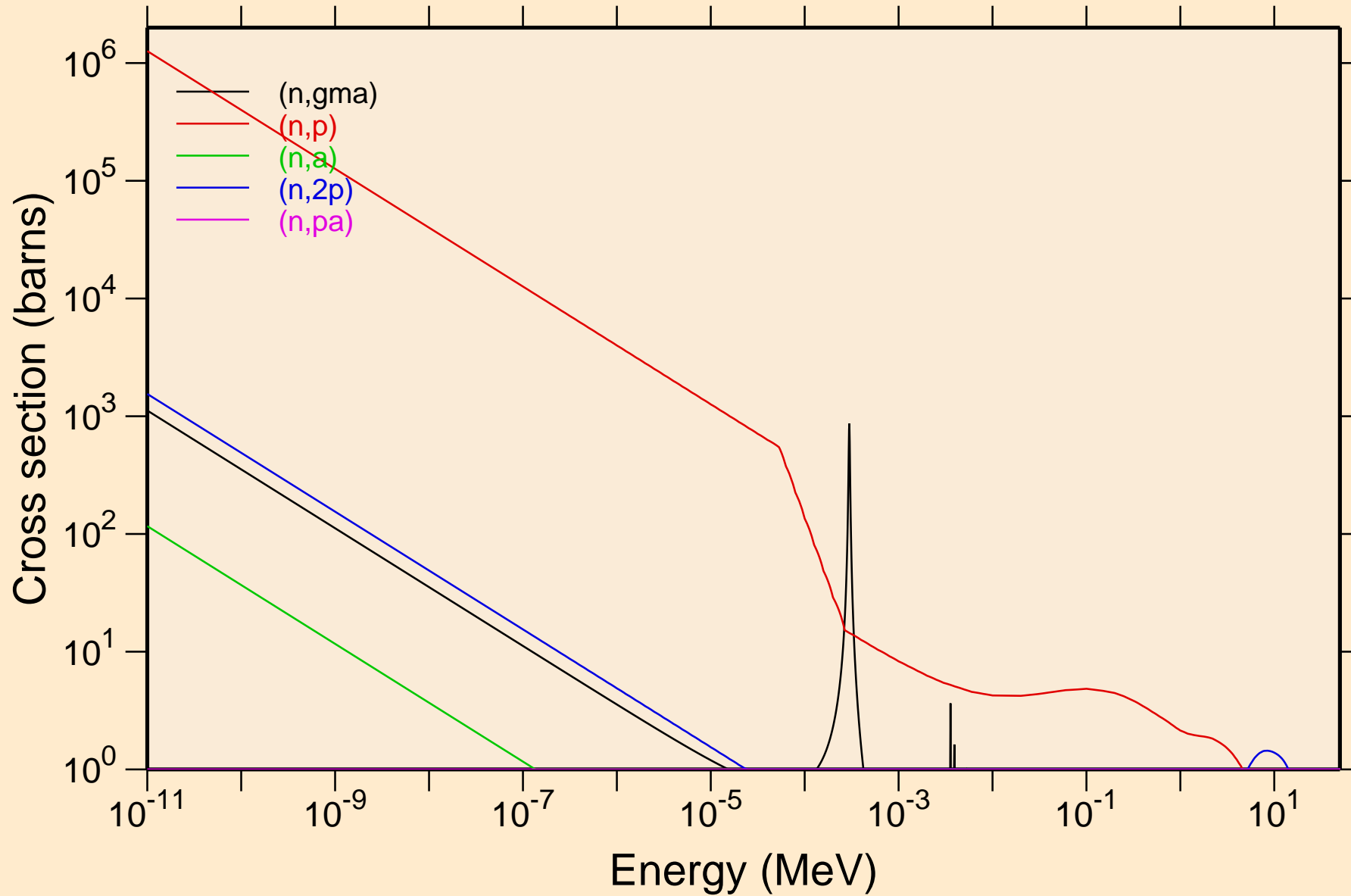

PD095M NEUTRON ACER TENDL-2021 LIBRARY; T=293.6K  
Non-threshold reactions

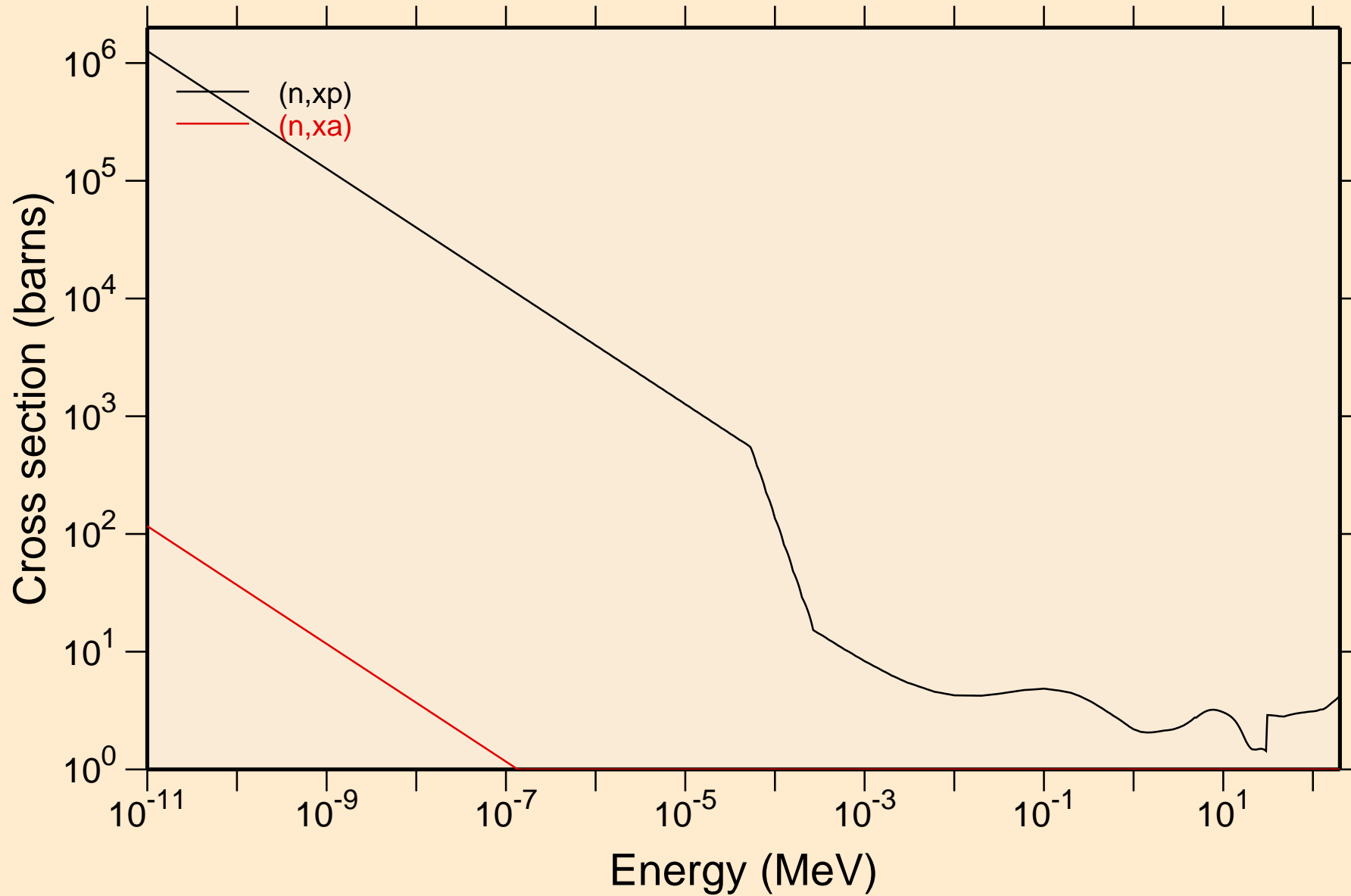

PD095M NEUTRON ACER TENDL-2021 LIBRARY; T=293.6K  
Principal cross sections

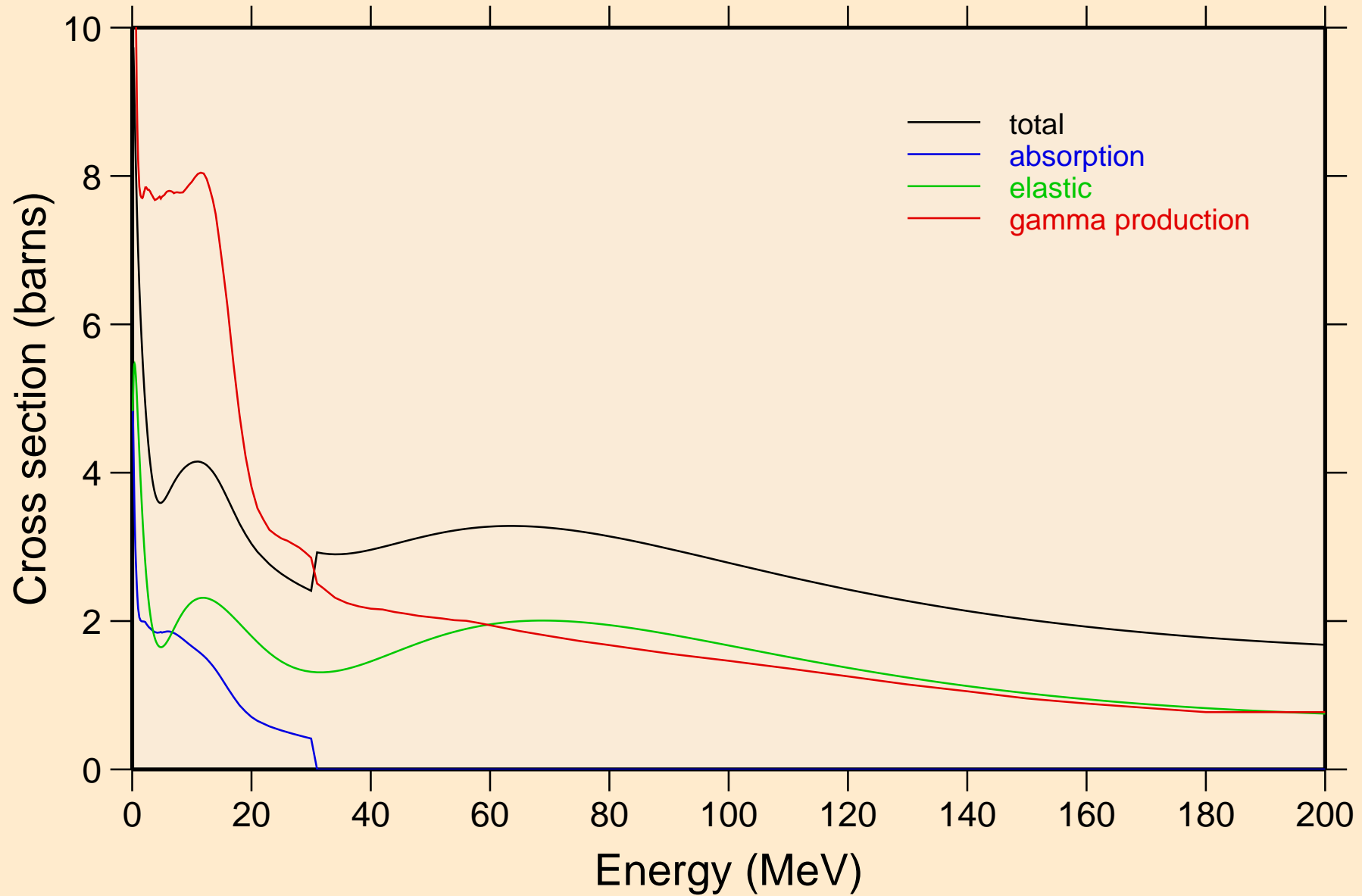

PD095M NEUTRON ACER TENDL-2021 LIBRARY; T=293.6K  
Heating

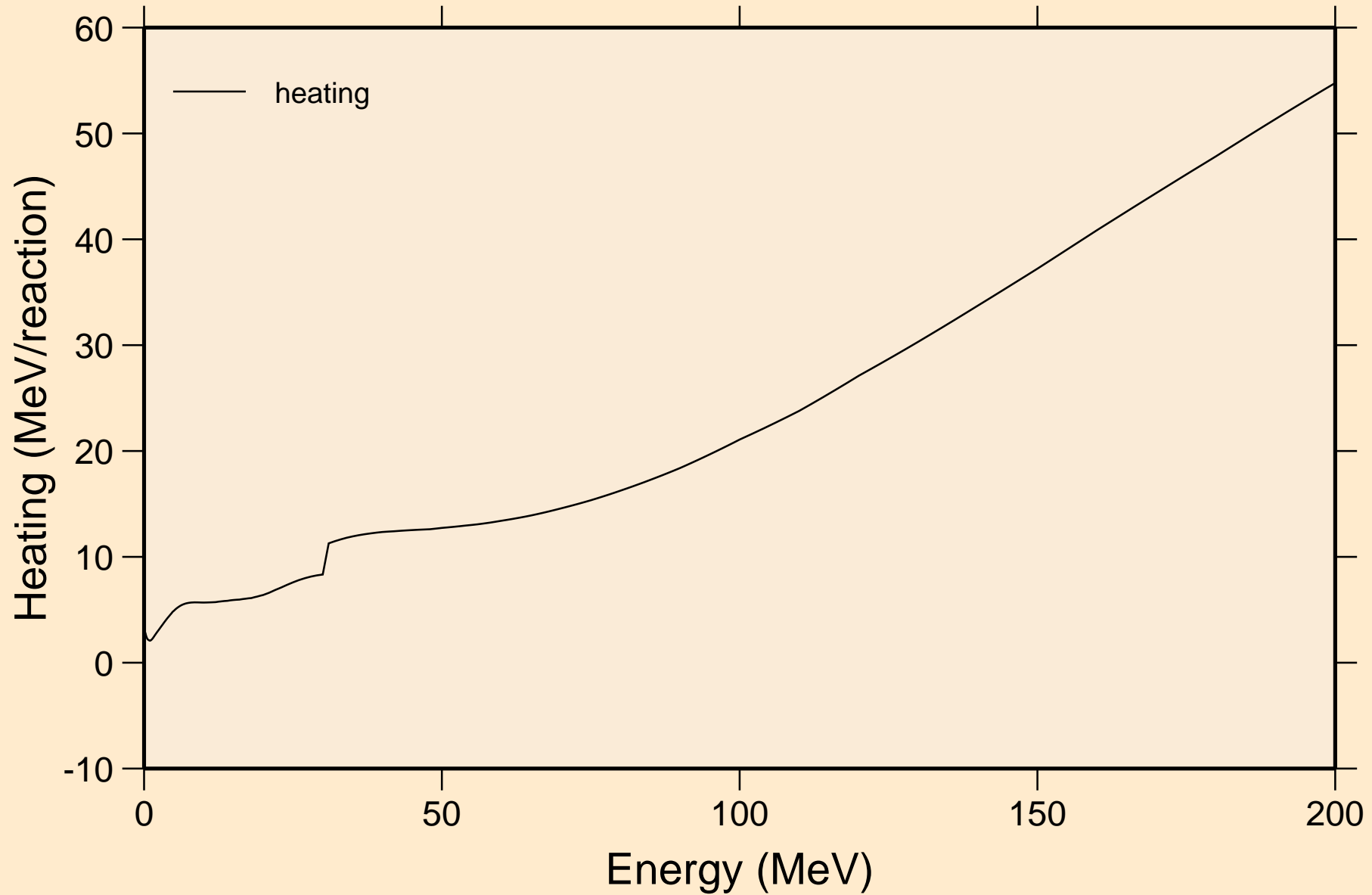

PD095M NEUTRON ACER TENDL-2021 LIBRARY; T=293.6K  
Damage

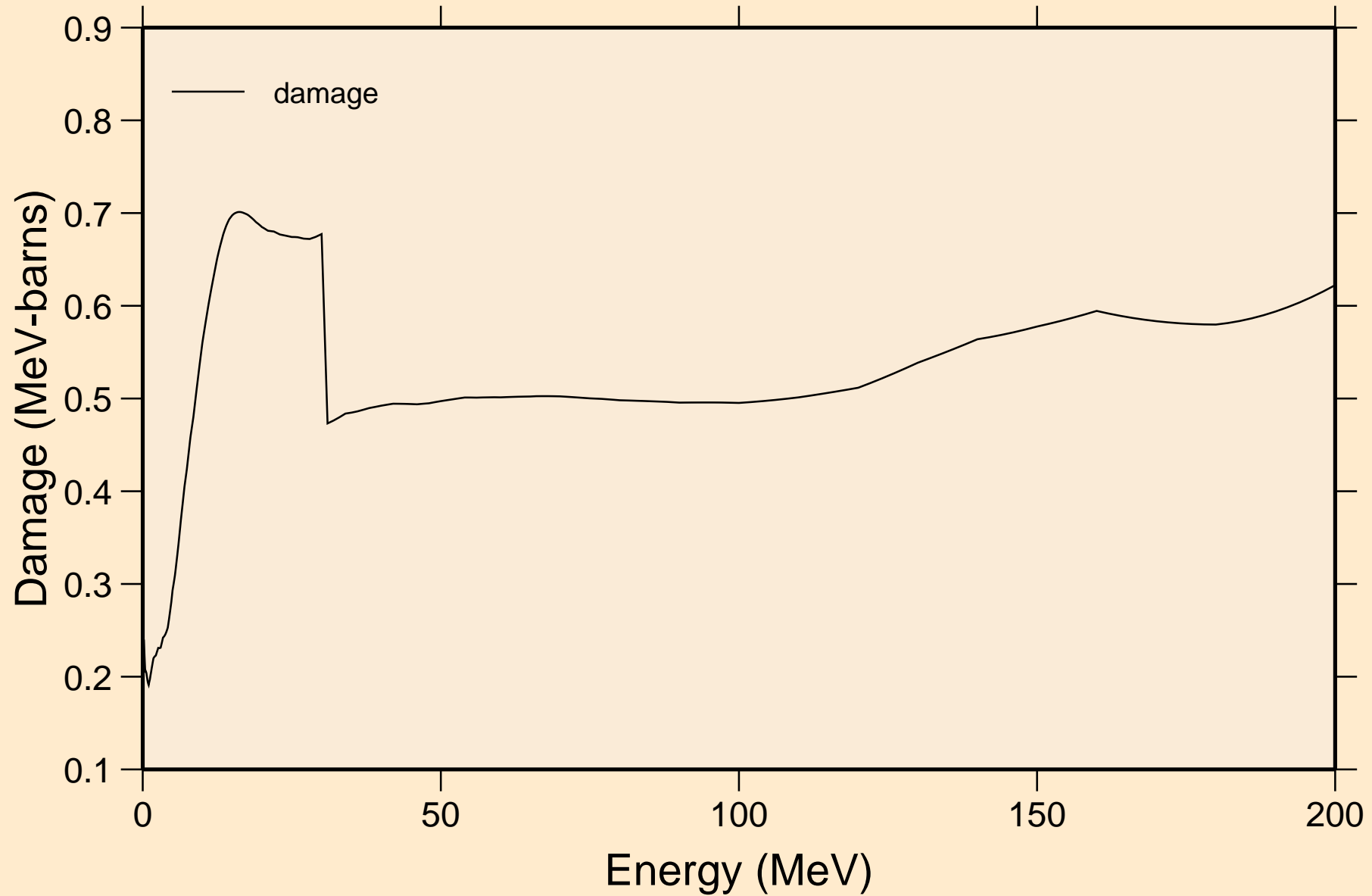



PD095M NEUTRON ACER TENDL-2021 LIBRARY; T=293.6K  
Non-threshold reactions

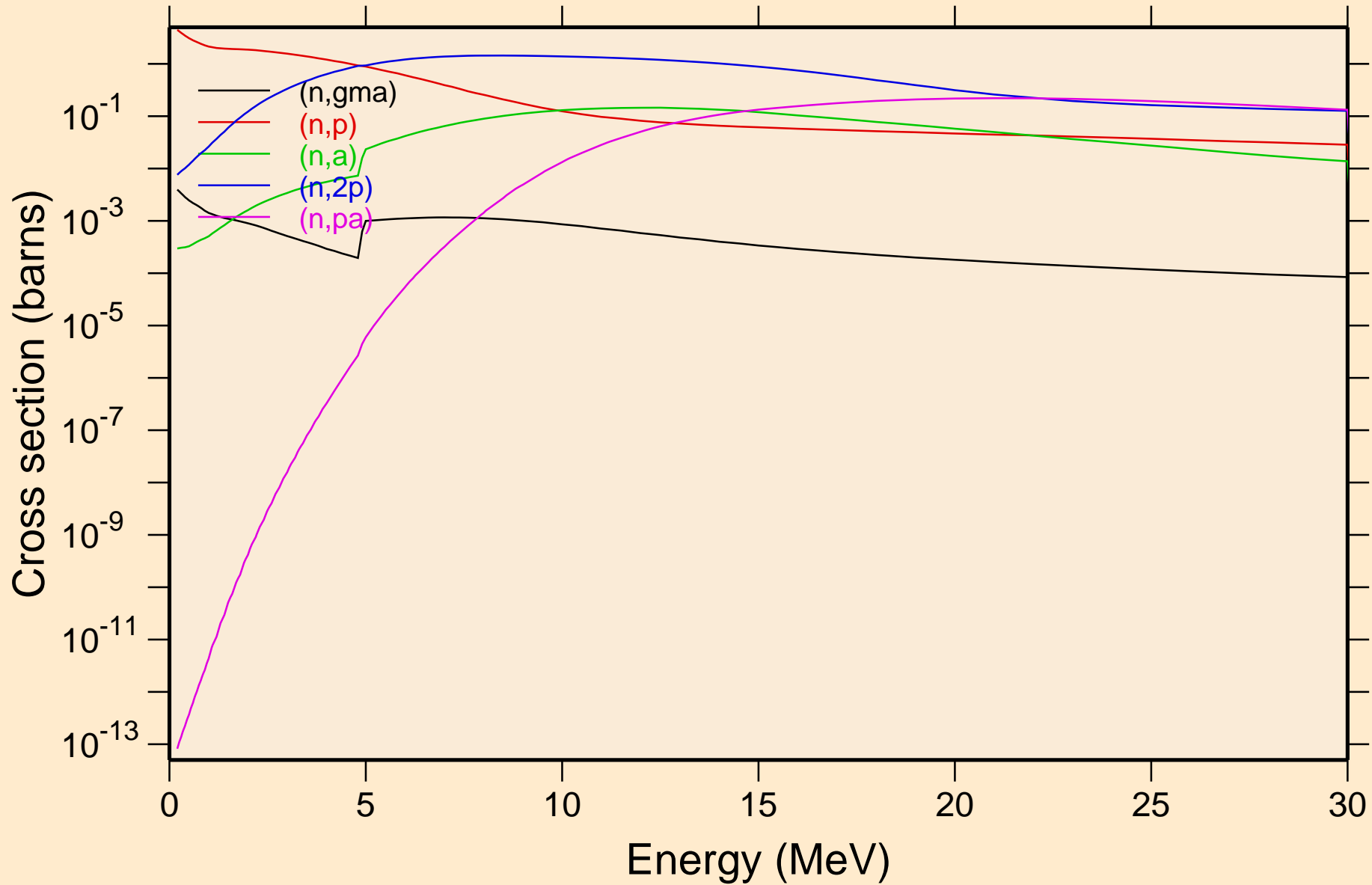

PD095M NEUTRON ACER TENDL-2021 LIBRARY; T=293.6K  
Non-threshold reactions

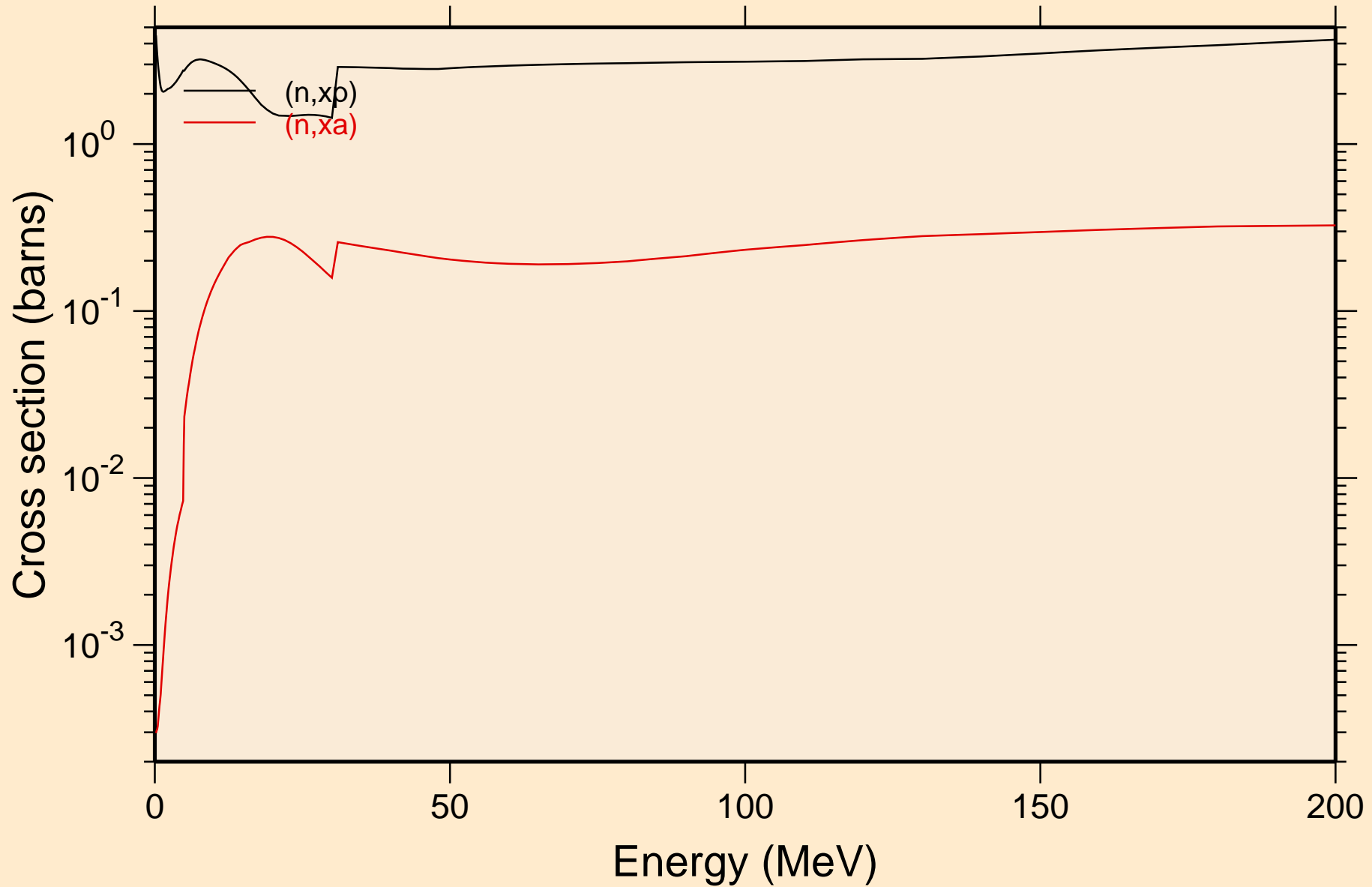

PD095M NEUTRON ACER TENDL-2021 LIBRARY; T=293.6K  
Inelastic levels

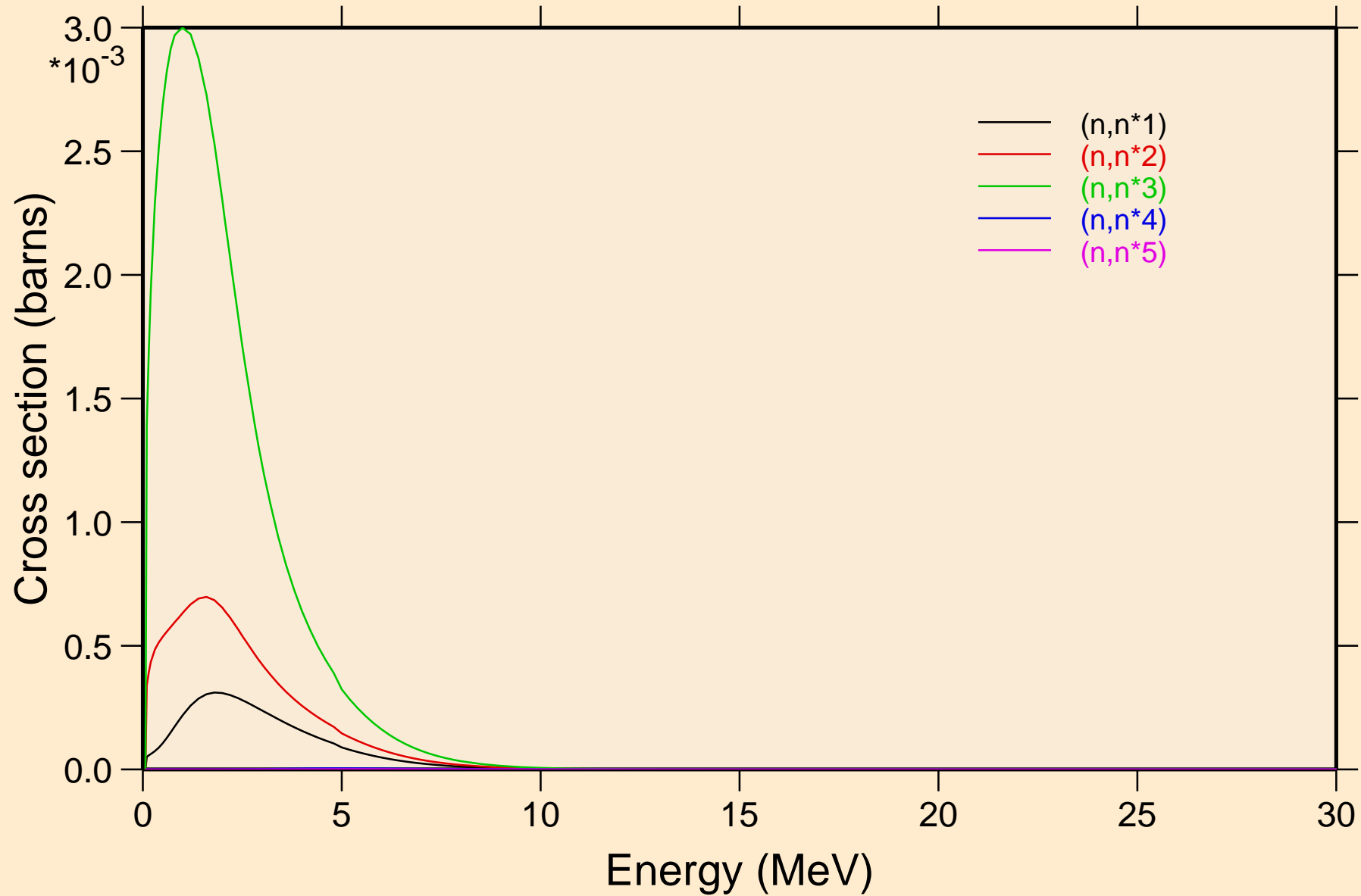

PD095M NEUTRON ACER TENDL-2021 LIBRARY; T=293.6K  
Inelastic levels

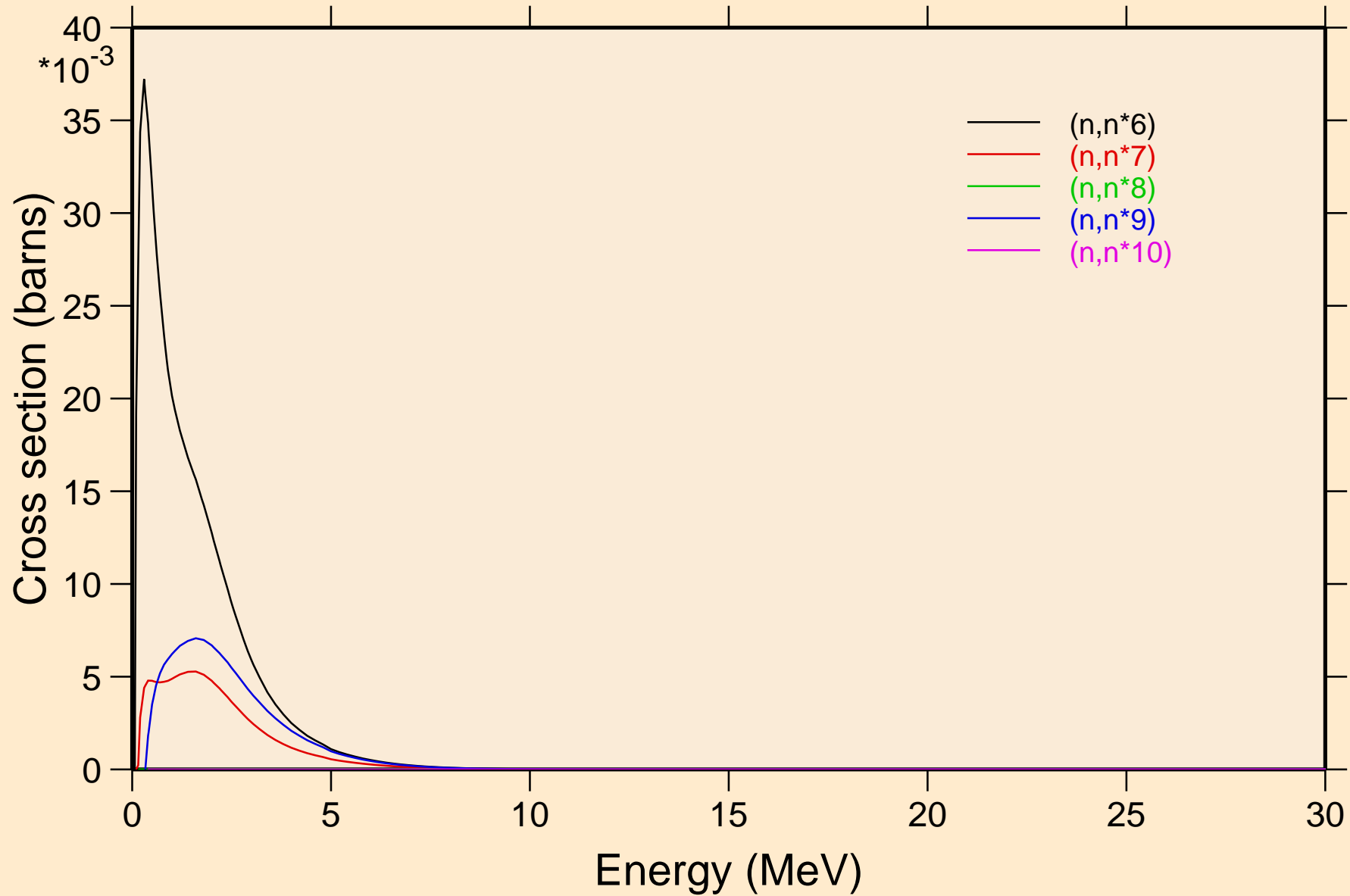

PD095M NEUTRON ACER TENDL-2021 LIBRARY; T=293.6K  
Inelastic levels

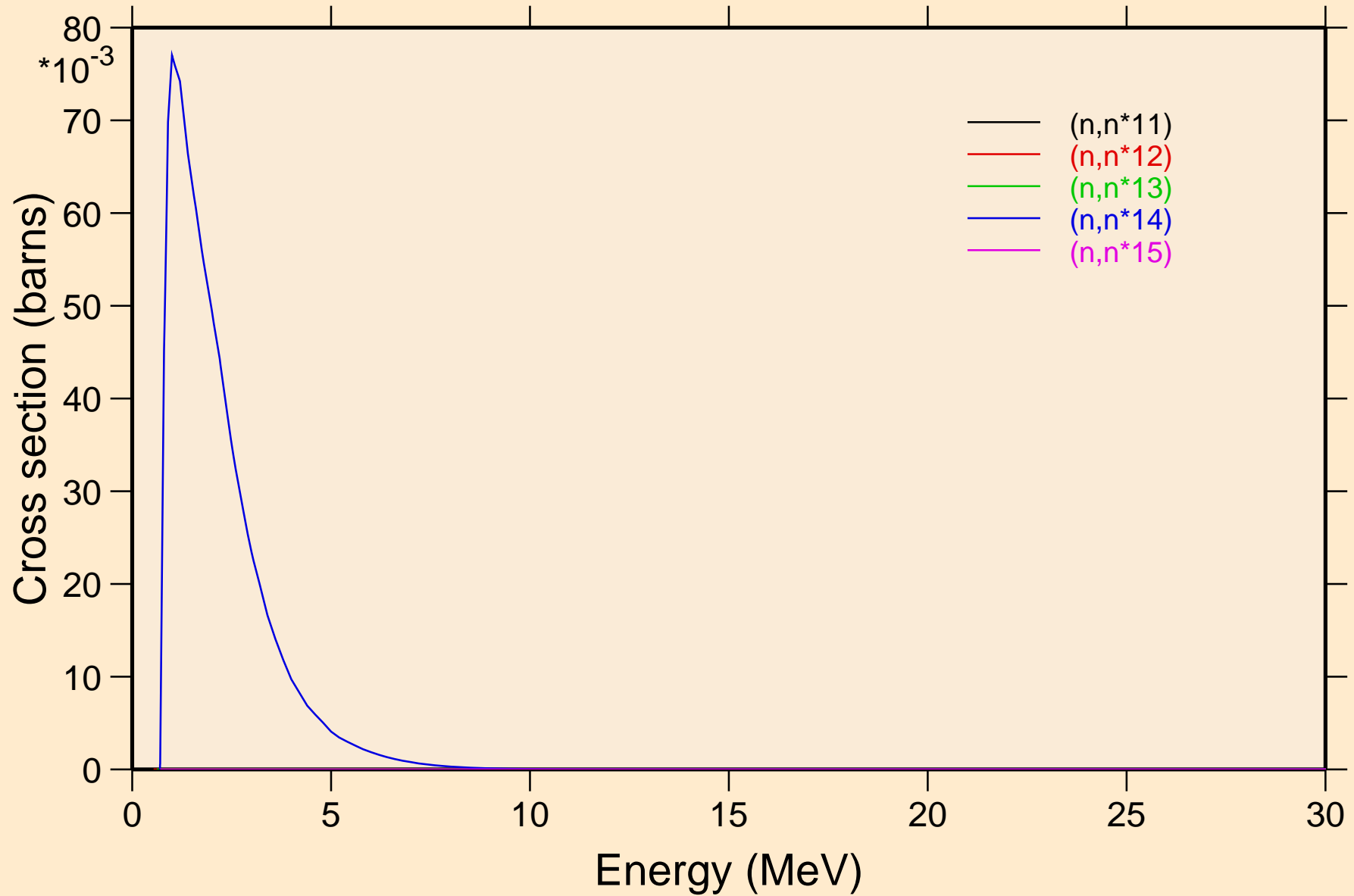

PD095M NEUTRON ACER TENDL-2021 LIBRARY; T=293.6K  
Inelastic levels

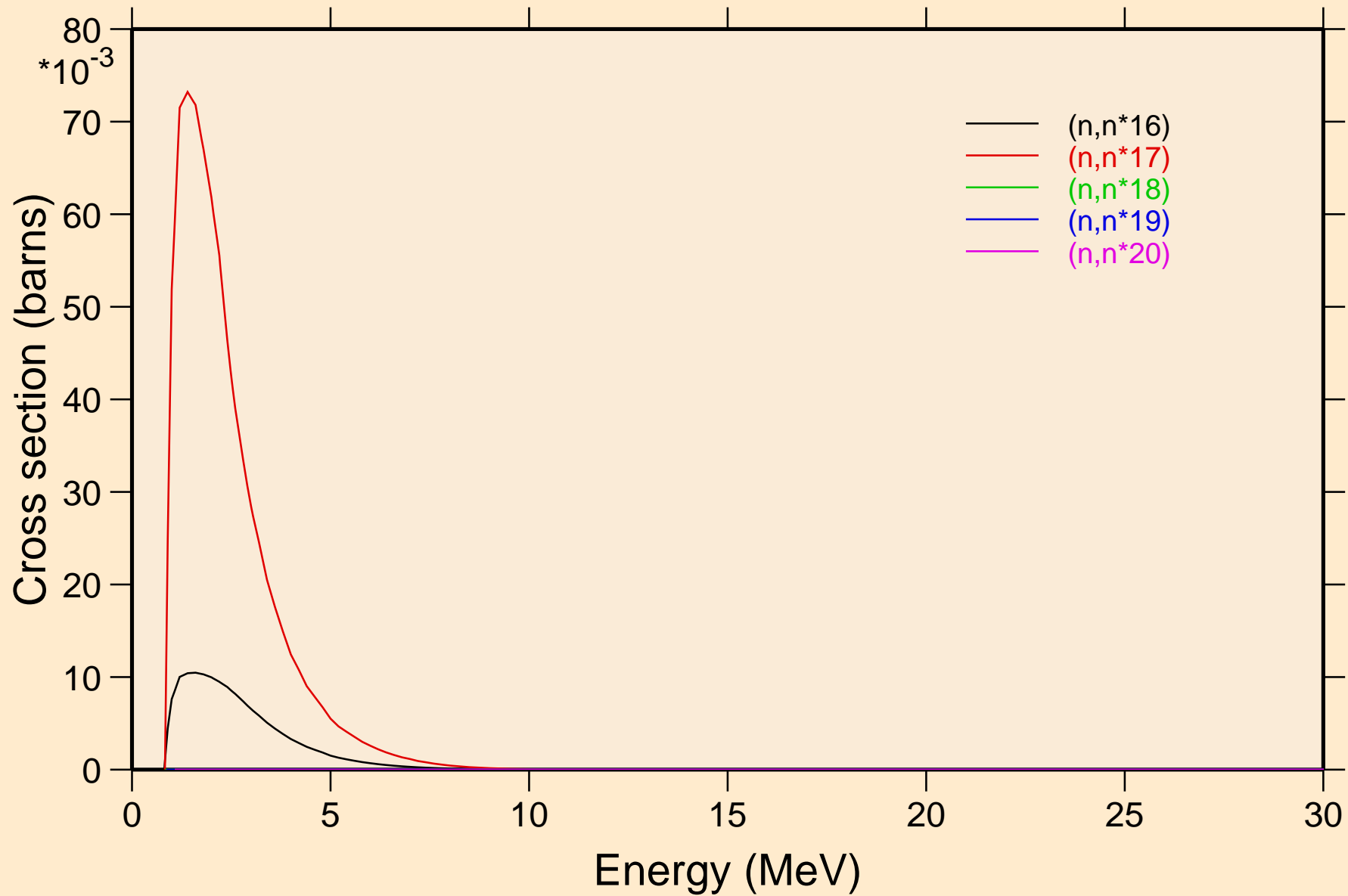

PD095M NEUTRON ACER TENDL-2021 LIBRARY; T=293.6K  
Inelastic levels

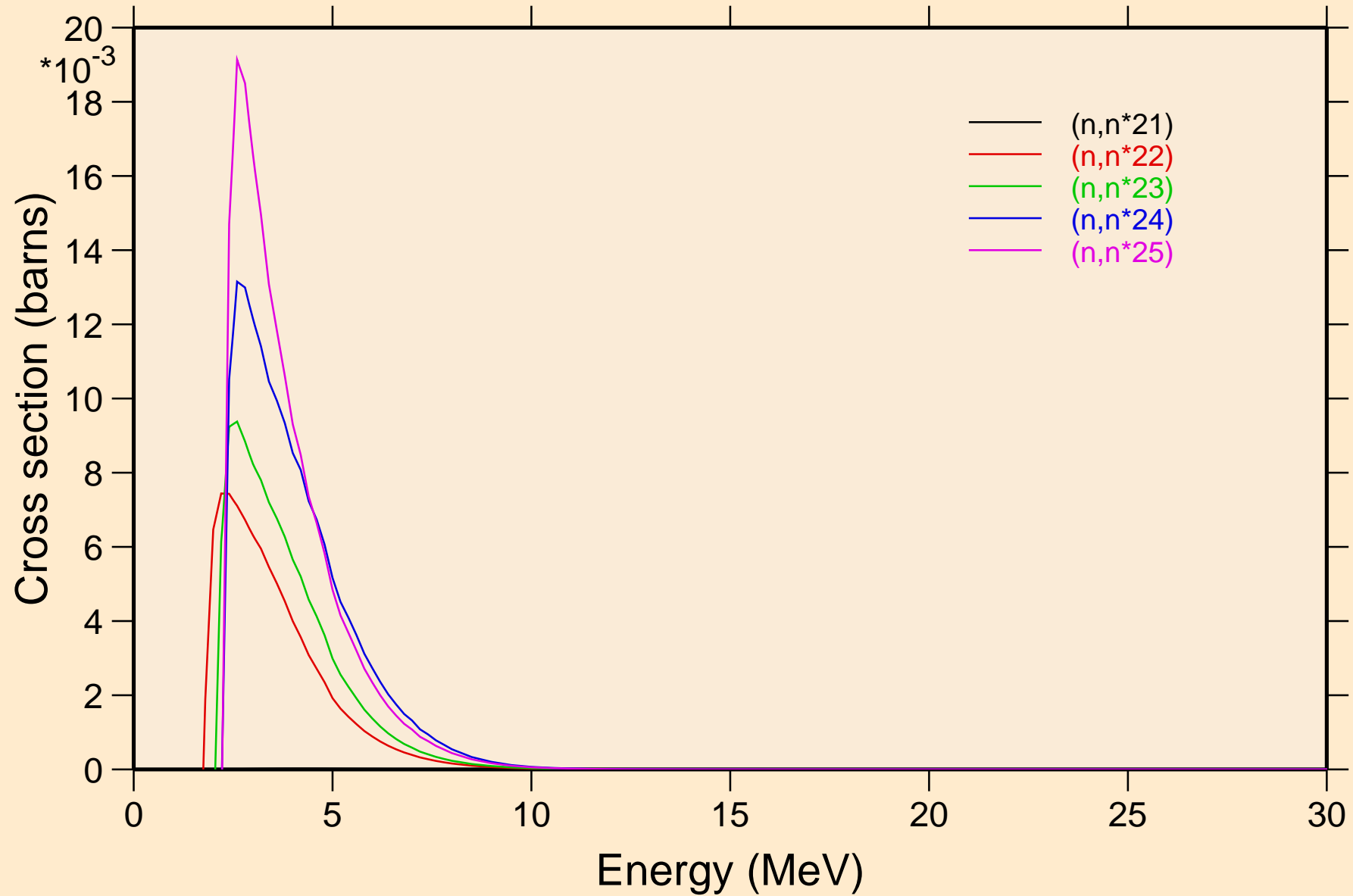

PD095M NEUTRON ACER TENDL-2021 LIBRARY; T=293.6K  
Threshold reactions

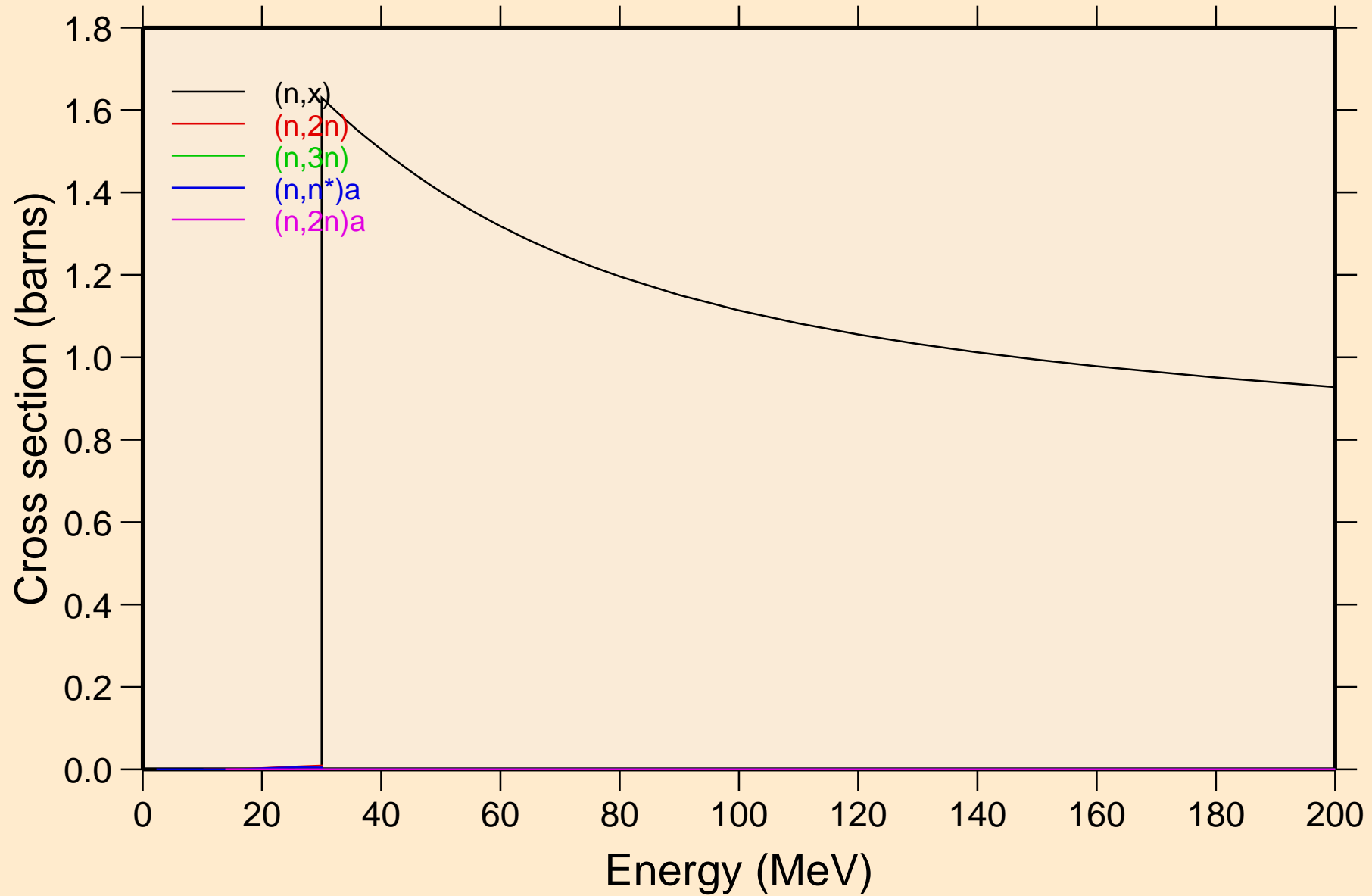



PD095M NEUTRON ACER TENDL-2021 LIBRARY; T=293.6K  
Threshold reactions

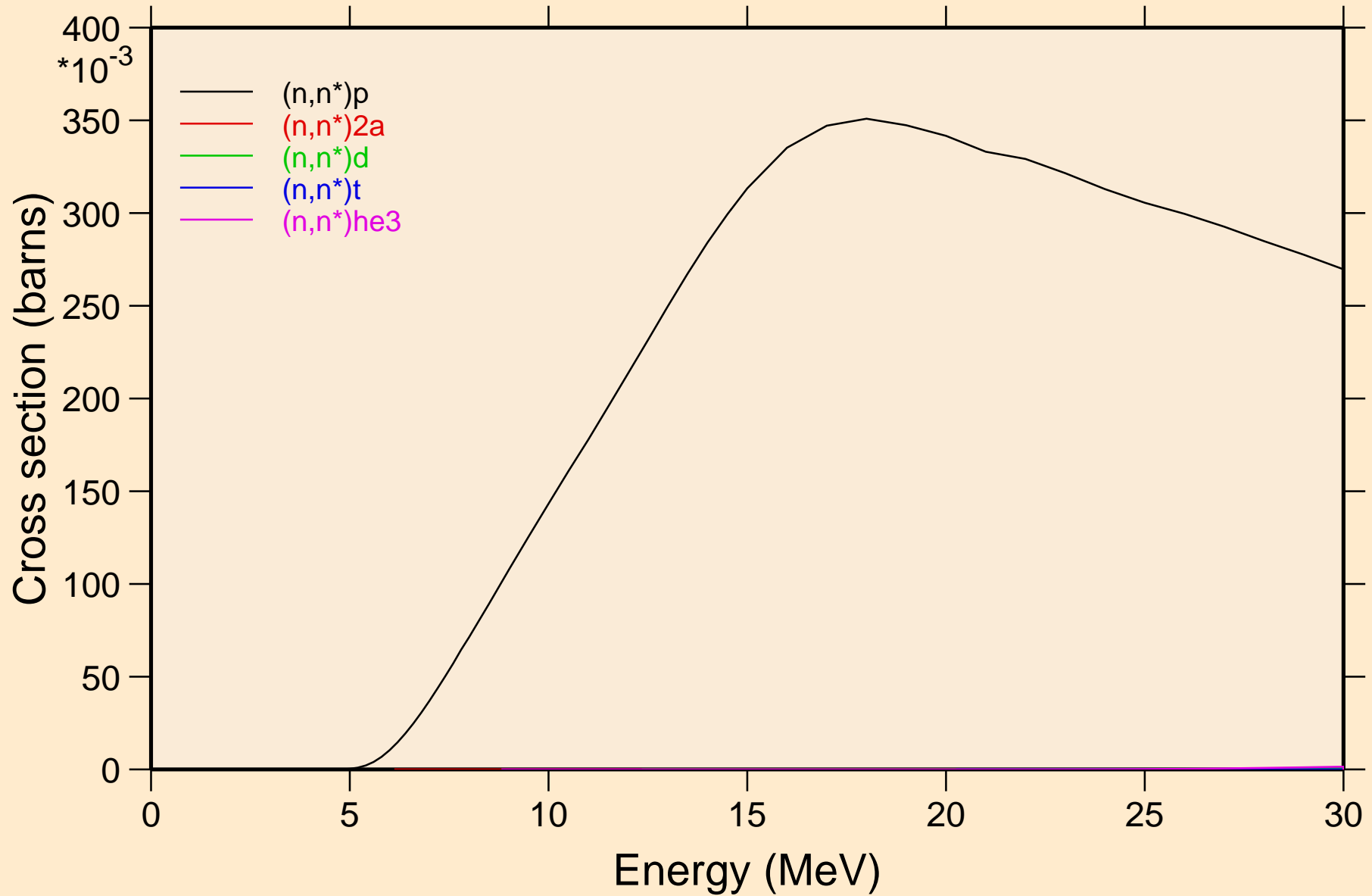

PD095M NEUTRON ACER TENDL-2021 LIBRARY; T=293.6K  
Threshold reactions

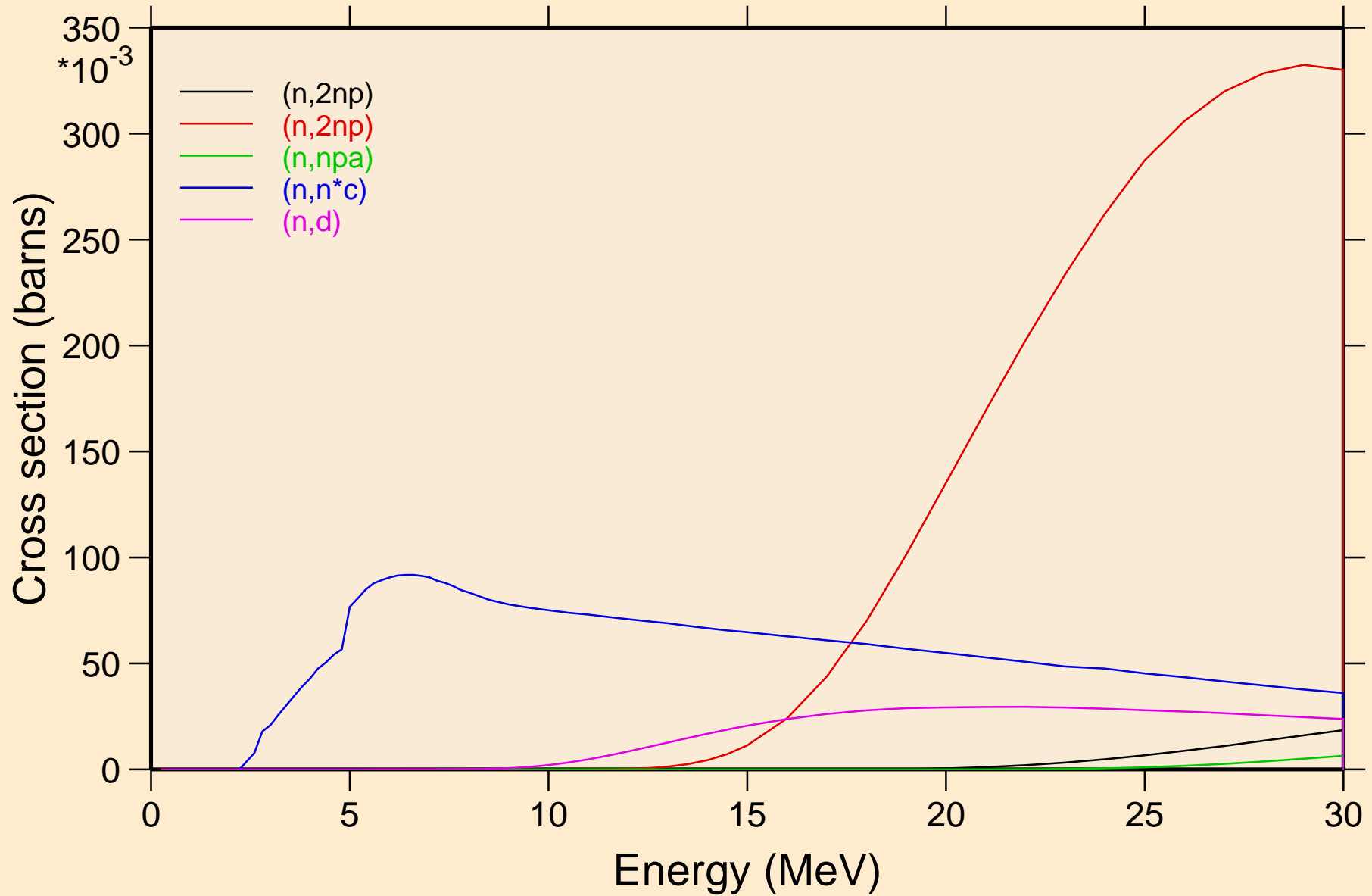

PD095M NEUTRON ACER TENDL-2021 LIBRARY; T=293.6K  
Threshold reactions

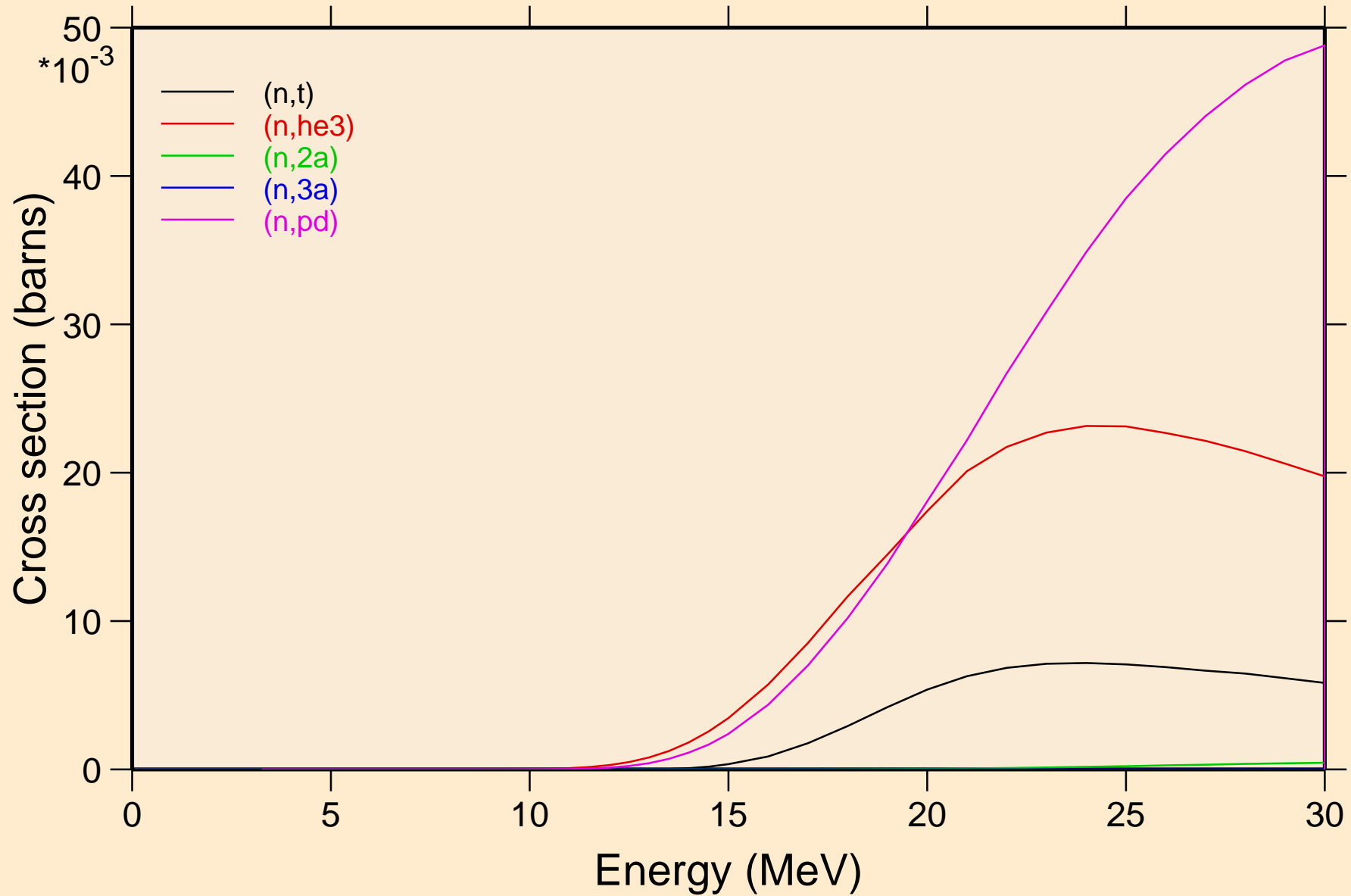

PD095M NEUTRON ACER TENDL-2021 LIBRARY; T=293.6K  
Threshold reactions

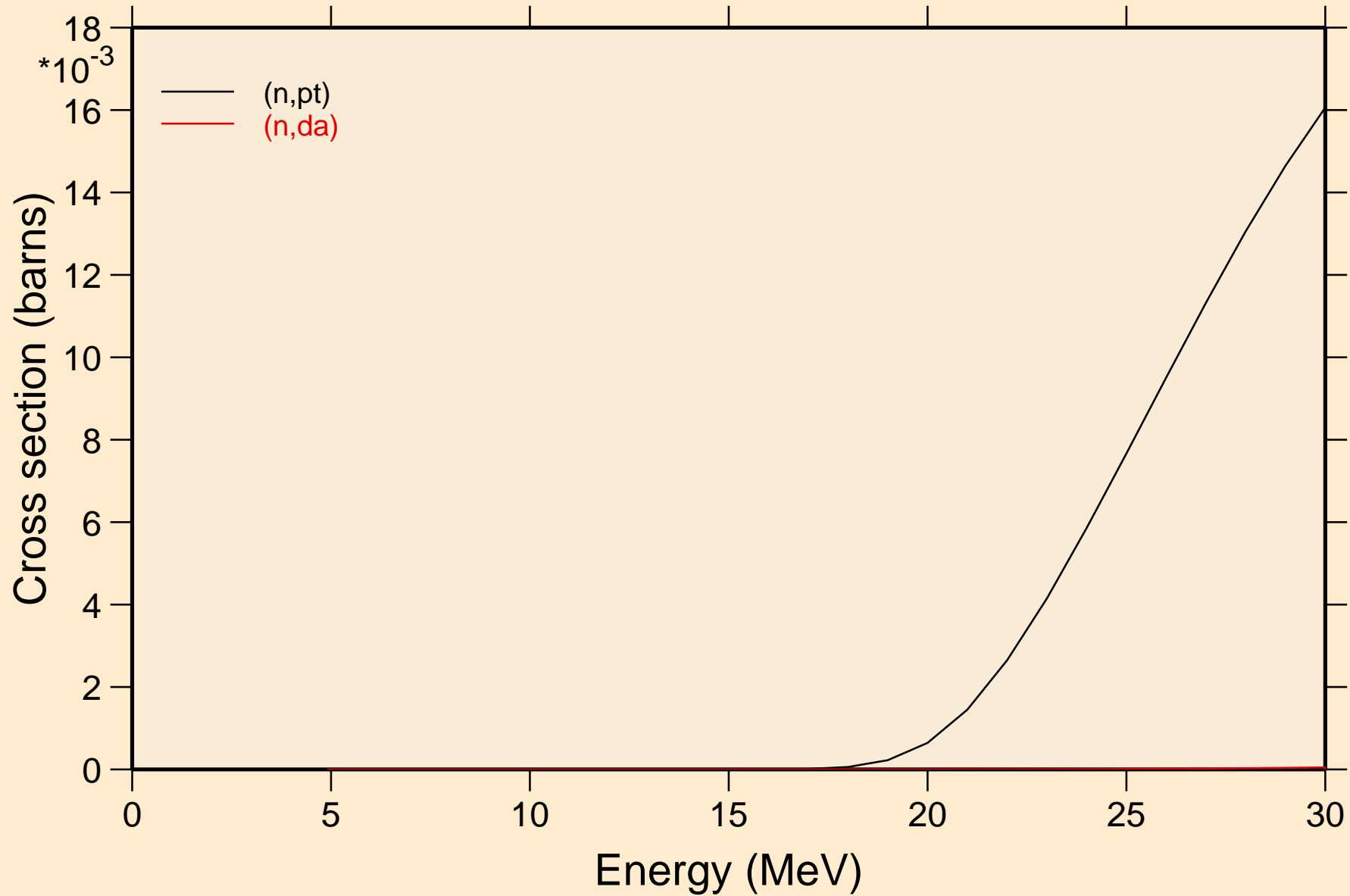

PD095M NEUTRON ACER TENDL-2021 LIBRARY; T=293.6K  
Threshold reactions

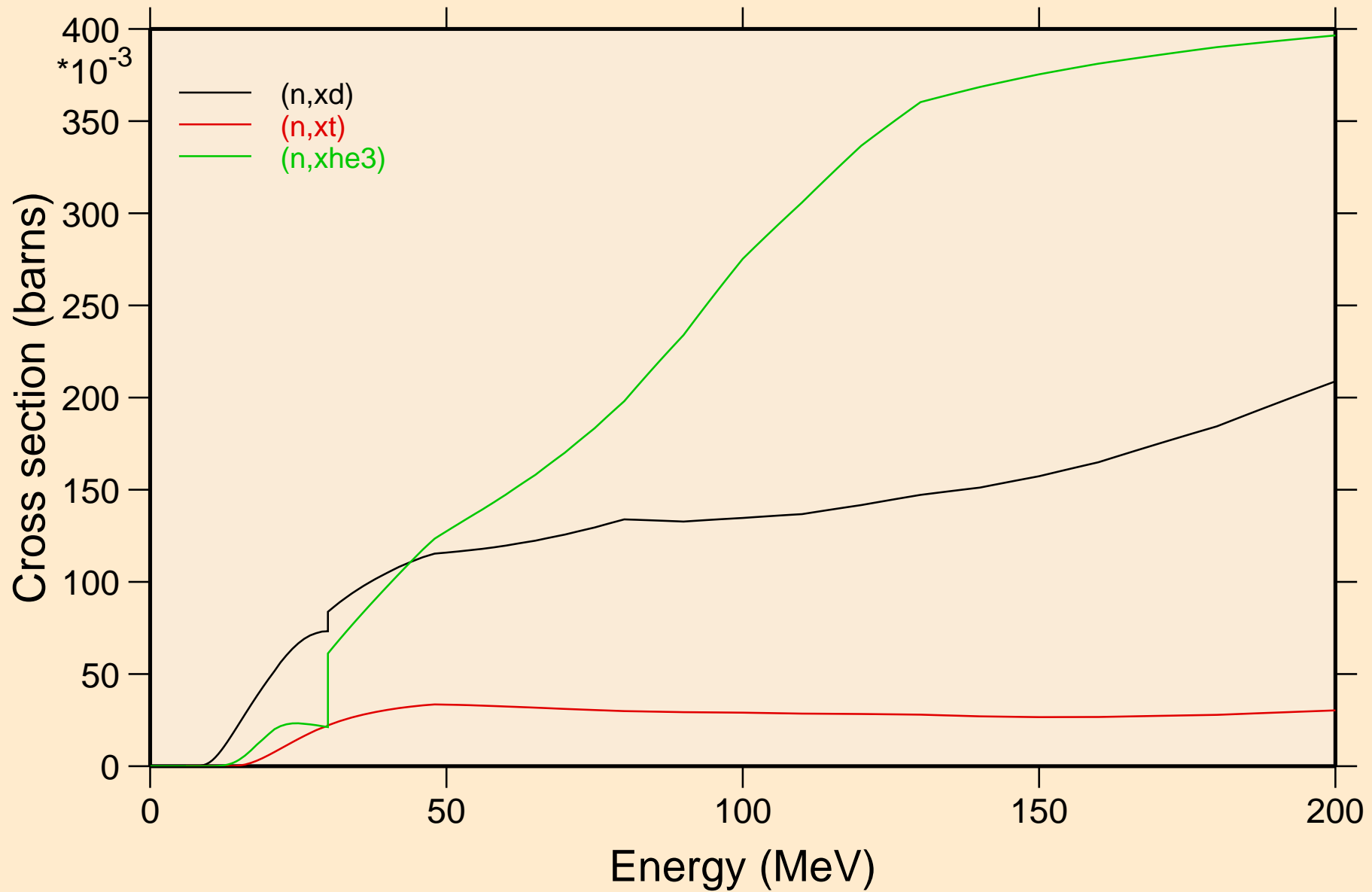

PD095M NEUTRON ACER TENDL-2021 LIBRARY; T=293.6K  
angular distribution for elastic

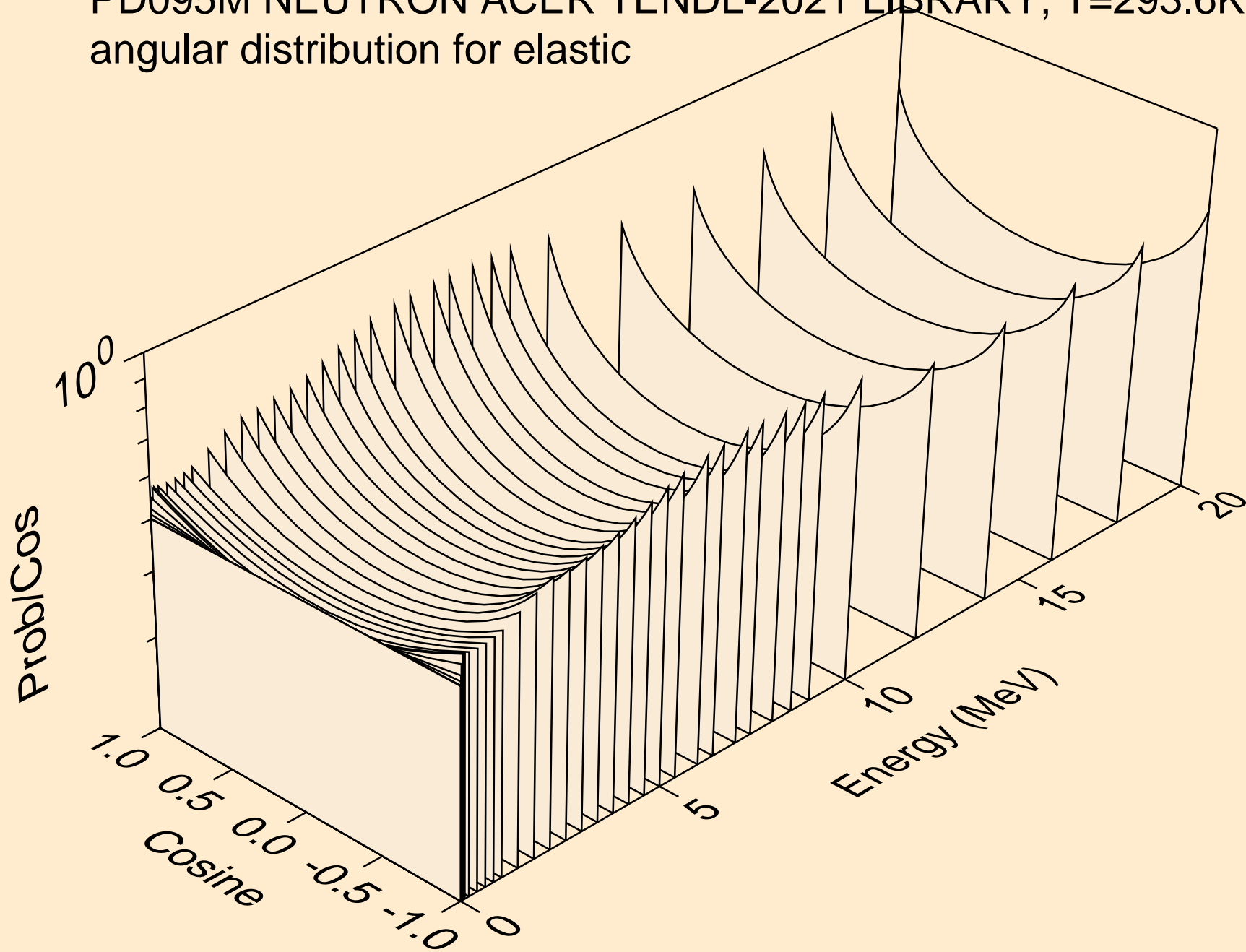

PD095M NEUTRON ACER TENDL-2021 LIBRARY; T=293.6K  
angular distribution for elastic

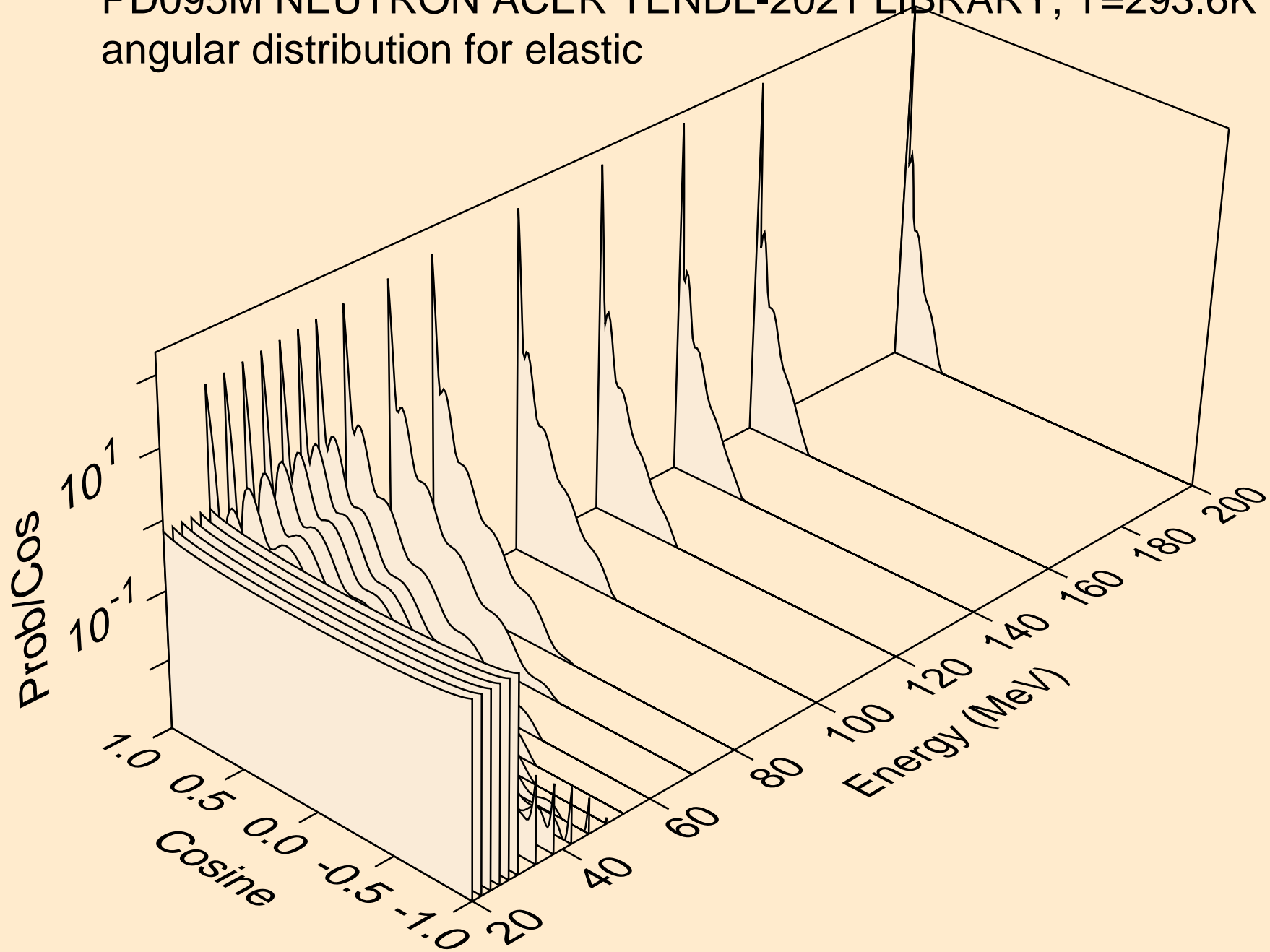

PD095M NEUTRON ACER TENDL-2021 LIBRARY; T=293.6K  
angular distribution for (n,n\*1)

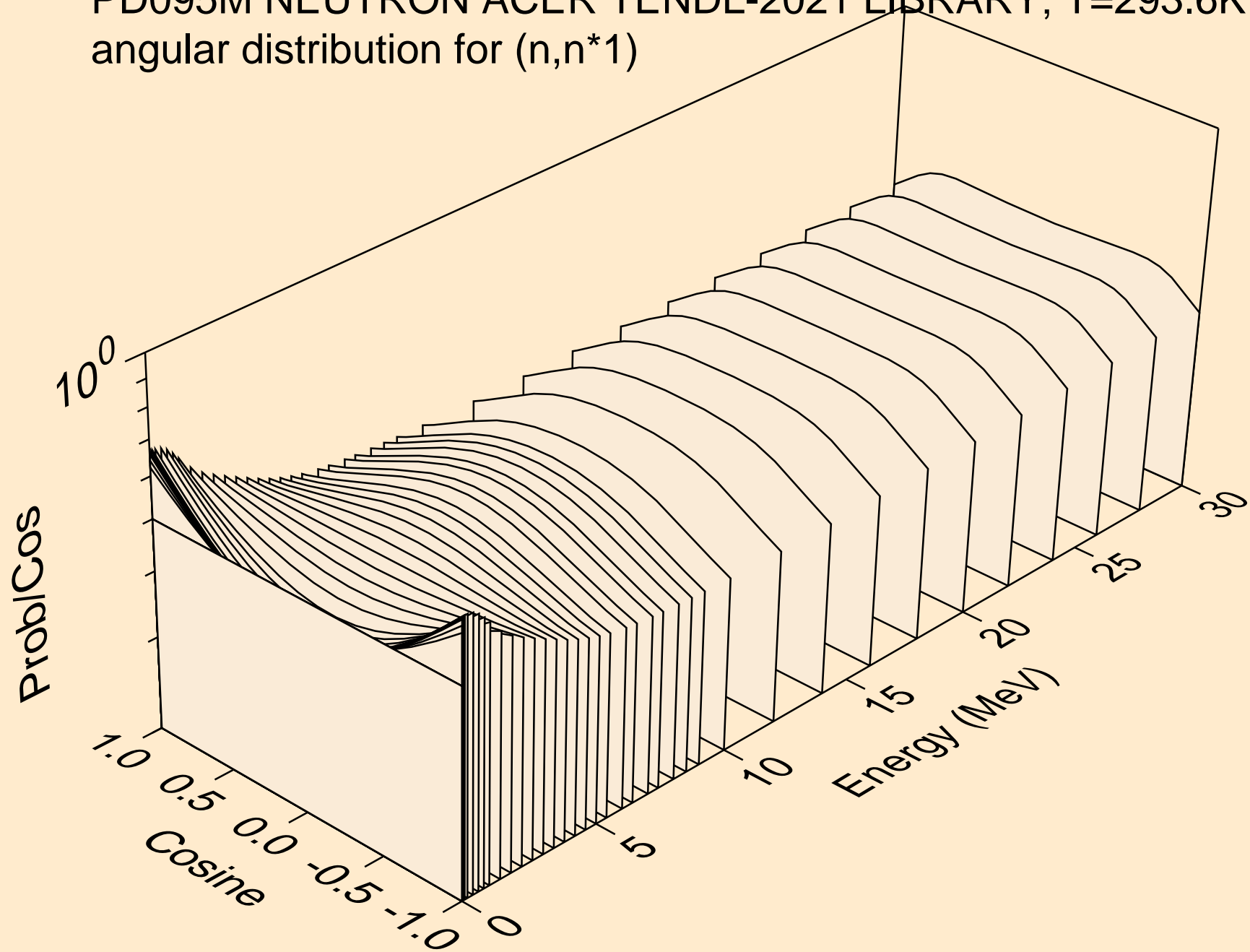



PD095M NEUTRON ACER TENDL-2021 LIBRARY; T=293.6K  
angular distribution for (n,n\*2)

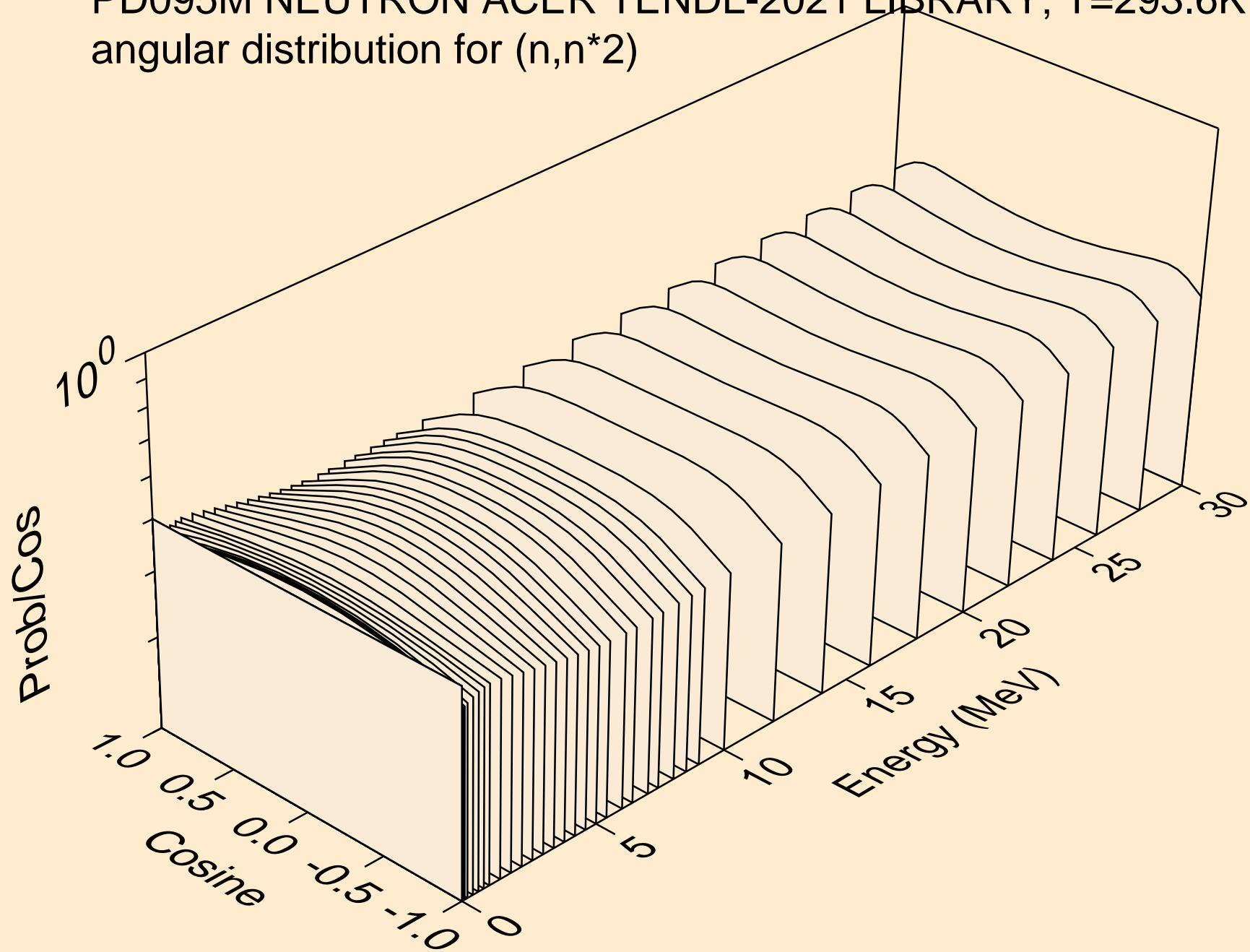

PD095M NEUTRON ACER TENDL-2021 LIBRARY; T=293.6K  
angular distribution for (n,n\*3)

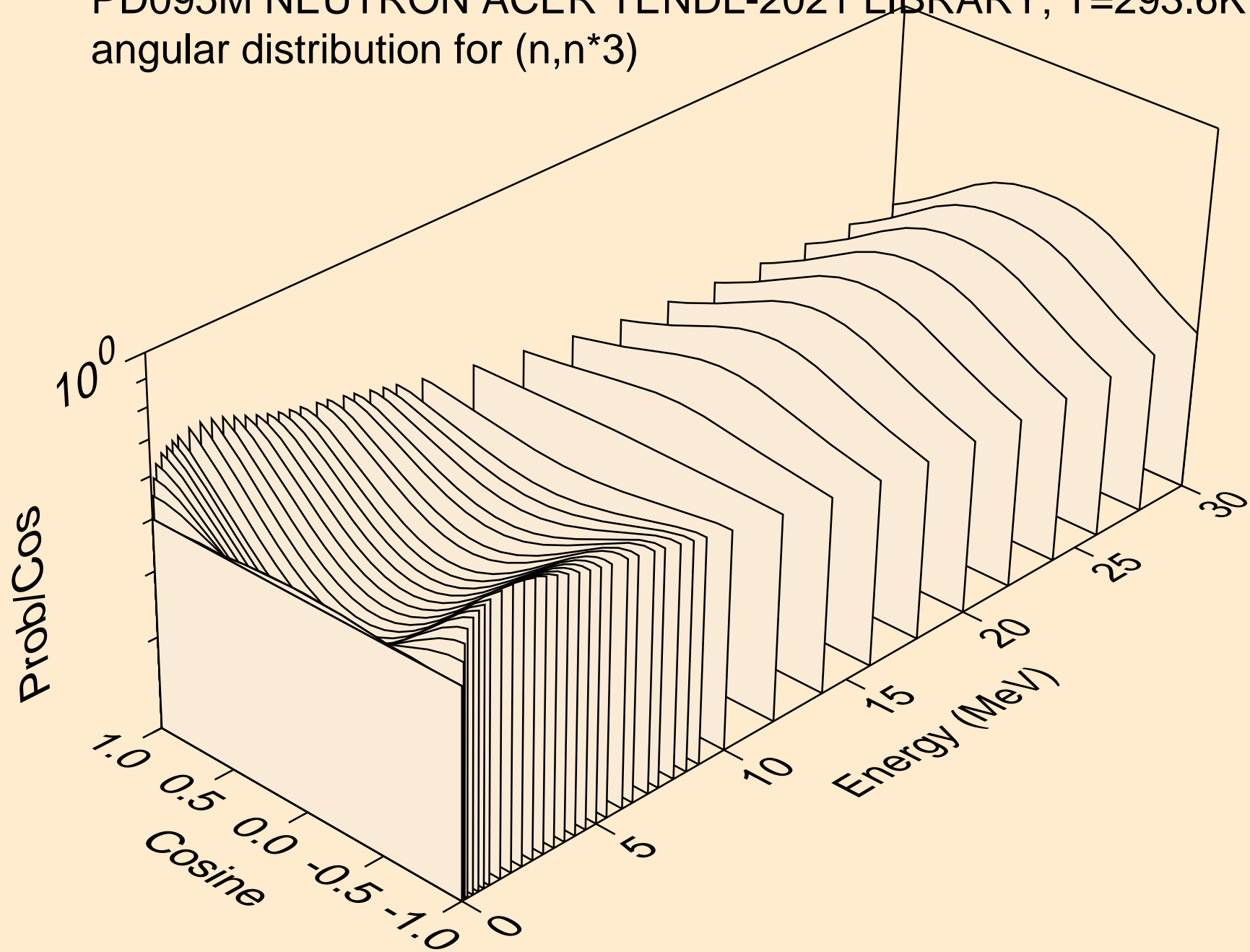

PD095M NEUTRON ACER TENDL-2021 LIBRARY; T=293.6K  
angular distribution for (n,n\*4)

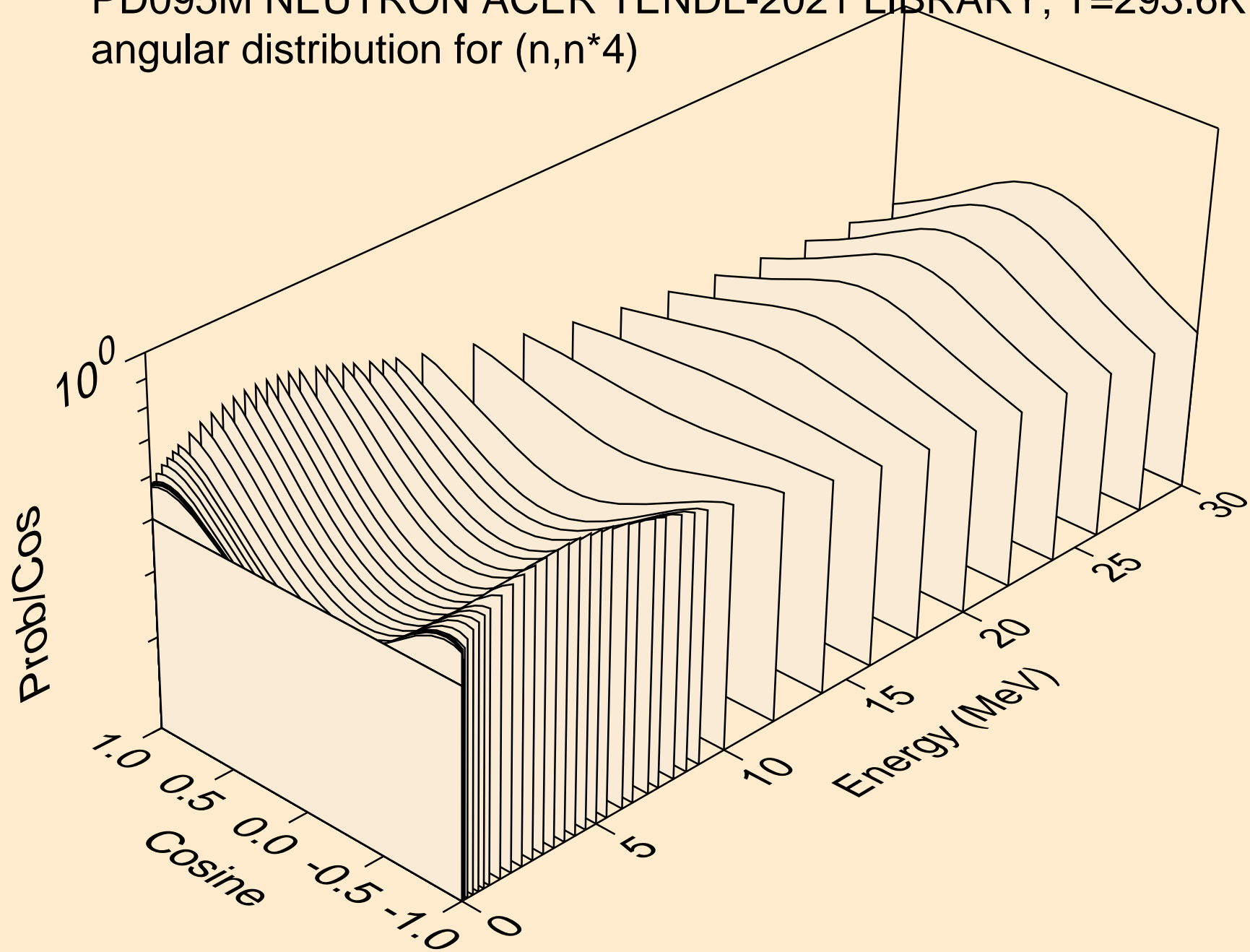

PD095M NEUTRON ACER TENDL-2021 LIBRARY; T=293.6K  
angular distribution for (n,n\*5)

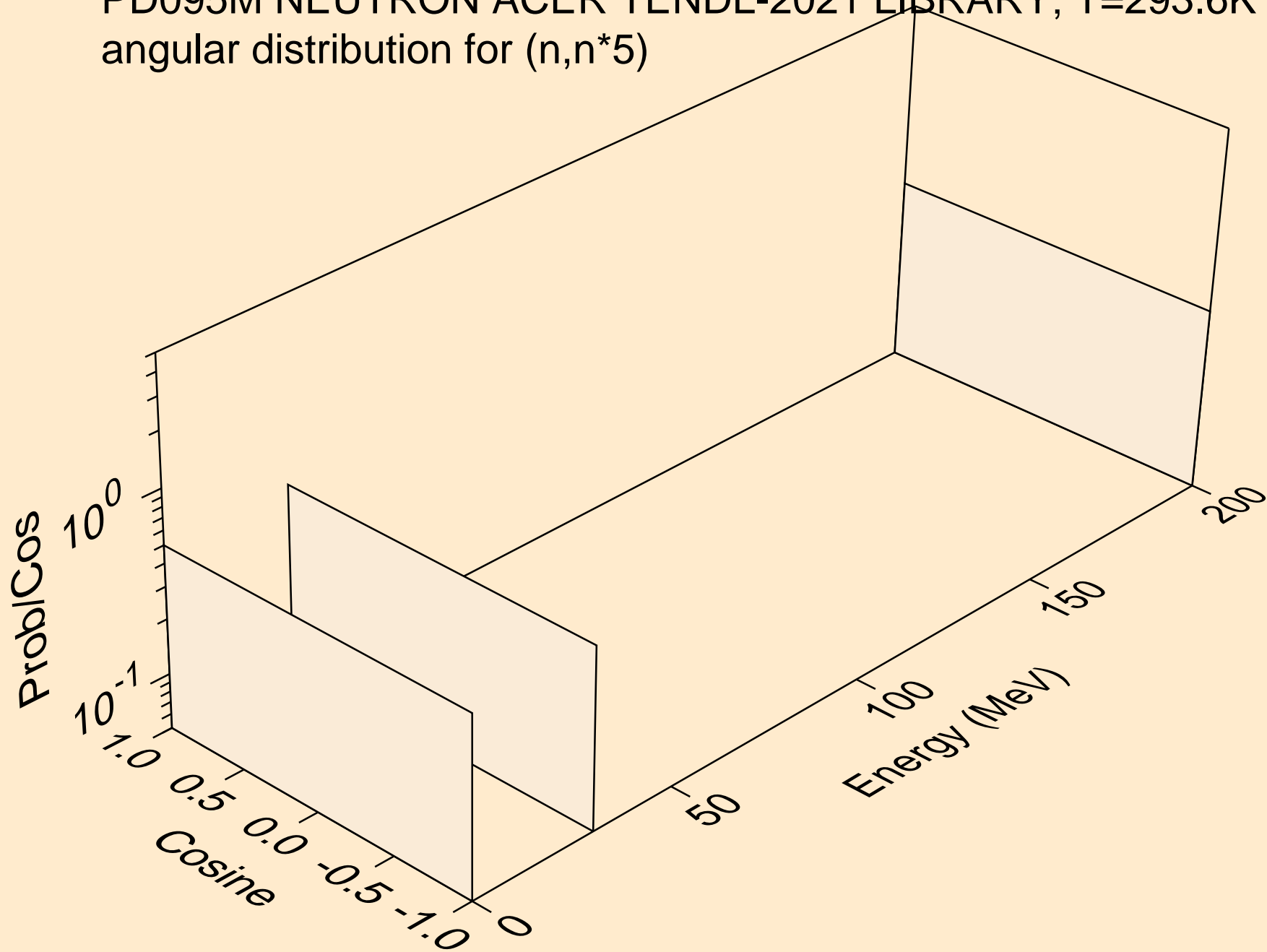

PD095M NEUTRON ACER TENDL-2021 LIBRARY; T=293.6K  
angular distribution for (n,n\*6)

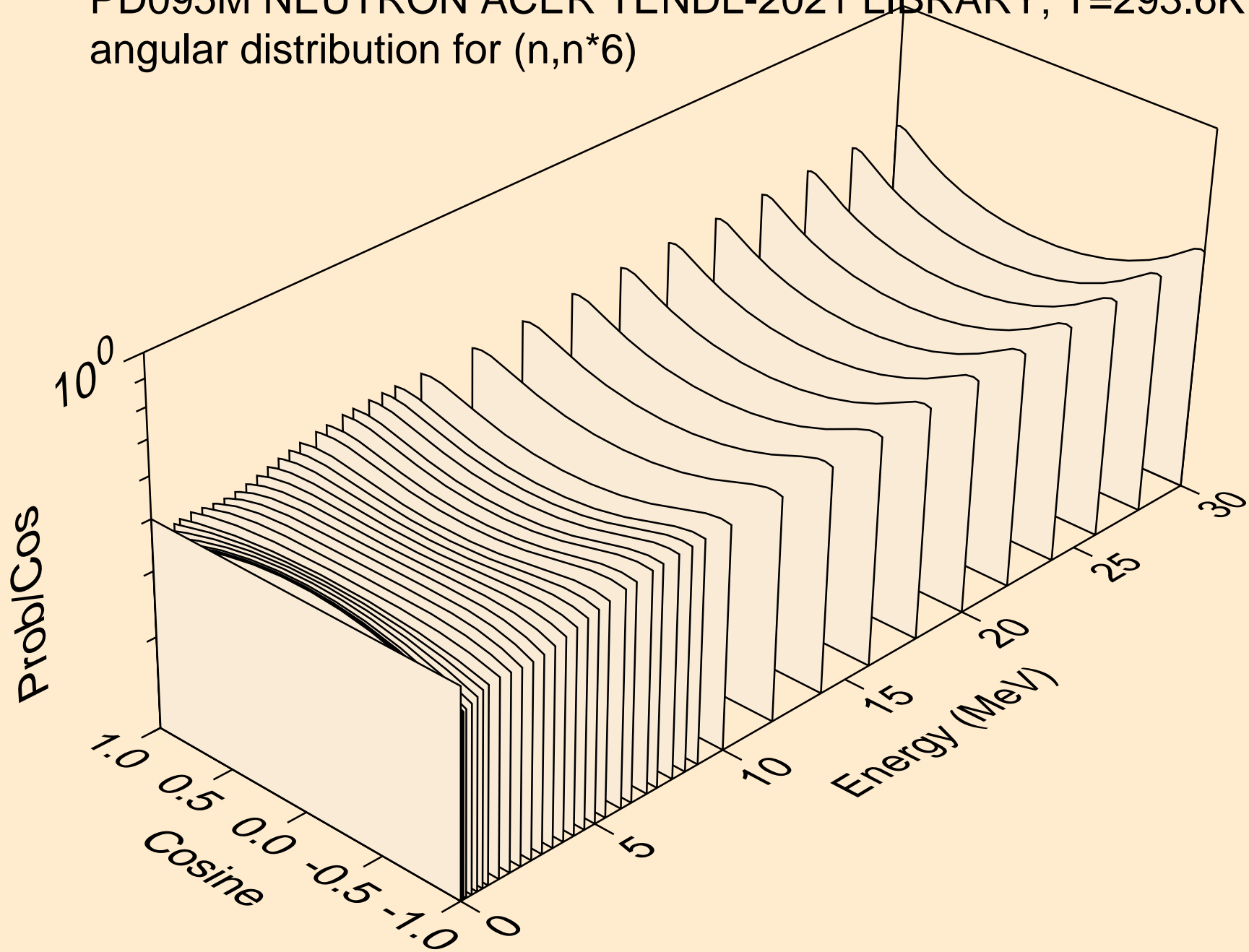

PD095M NEUTRON ACER TENDL-2021 LIBRARY; T=293.6K  
angular distribution for (n,n\*7)

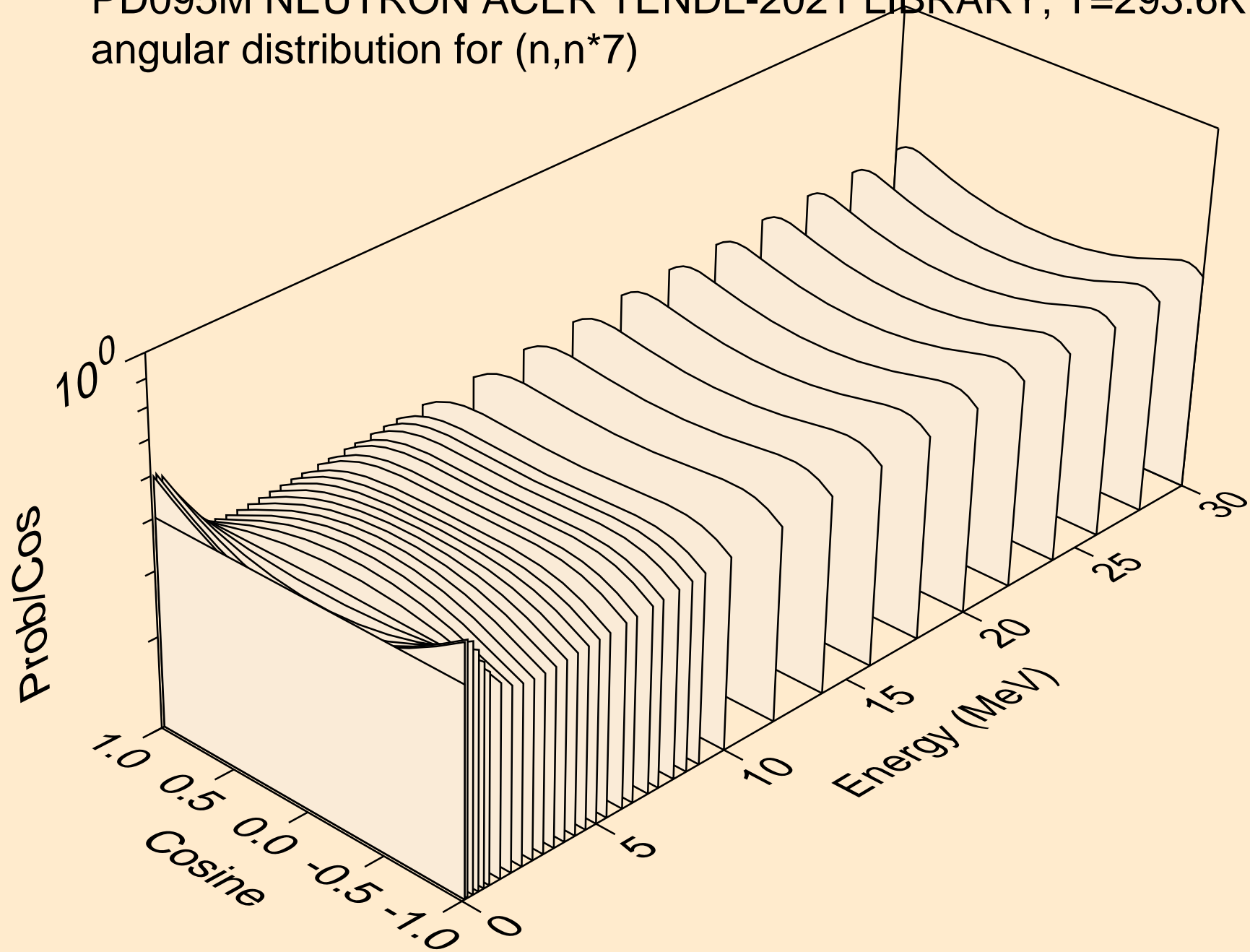

PD095M NEUTRON ACER TENDL-2021 LIBRARY; T=293.6K  
angular distribution for (n,n\*8)

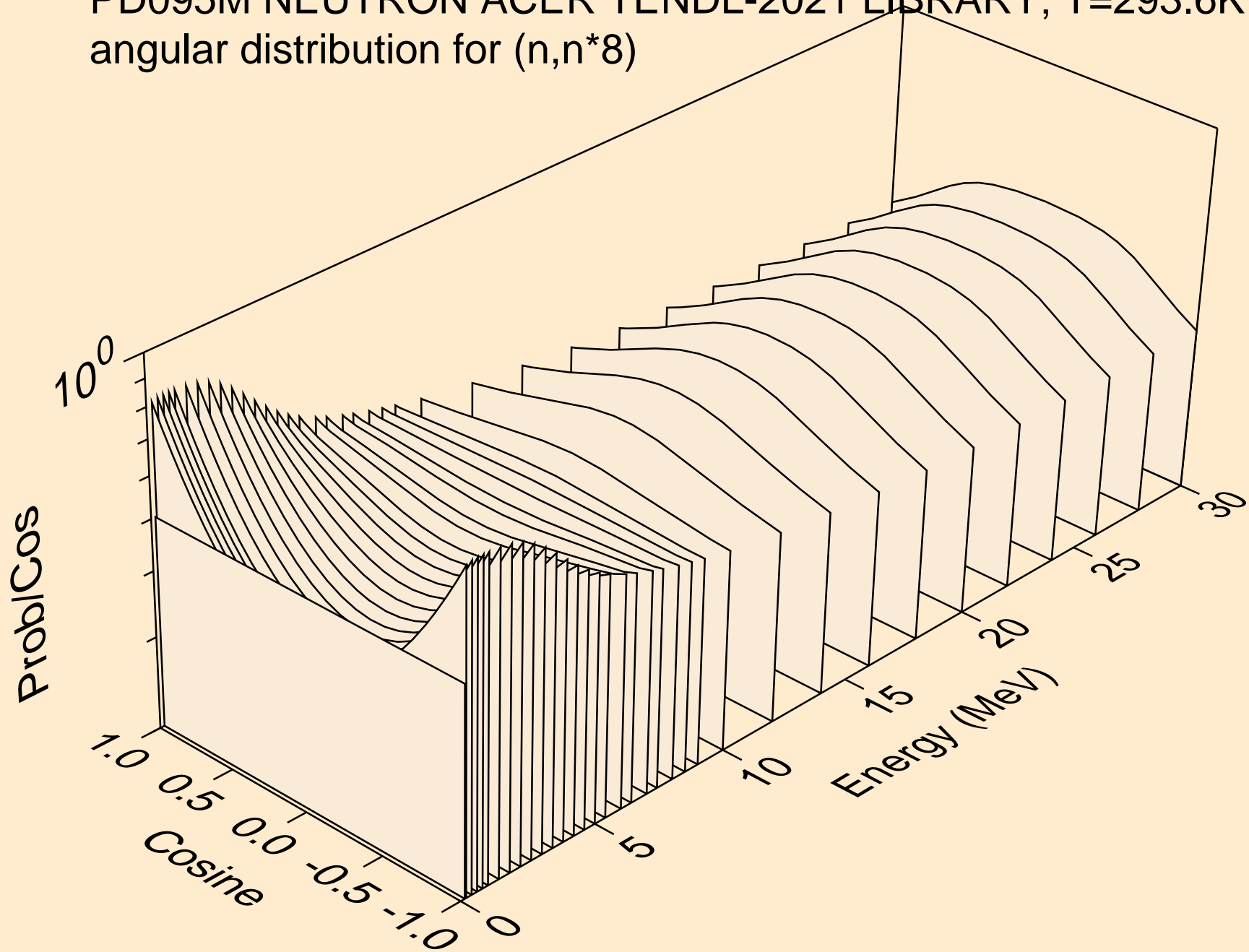

PD095M NEUTRON ACER TENDL-2021 LIBRARY; T=293.6K  
angular distribution for (n,n\*9)

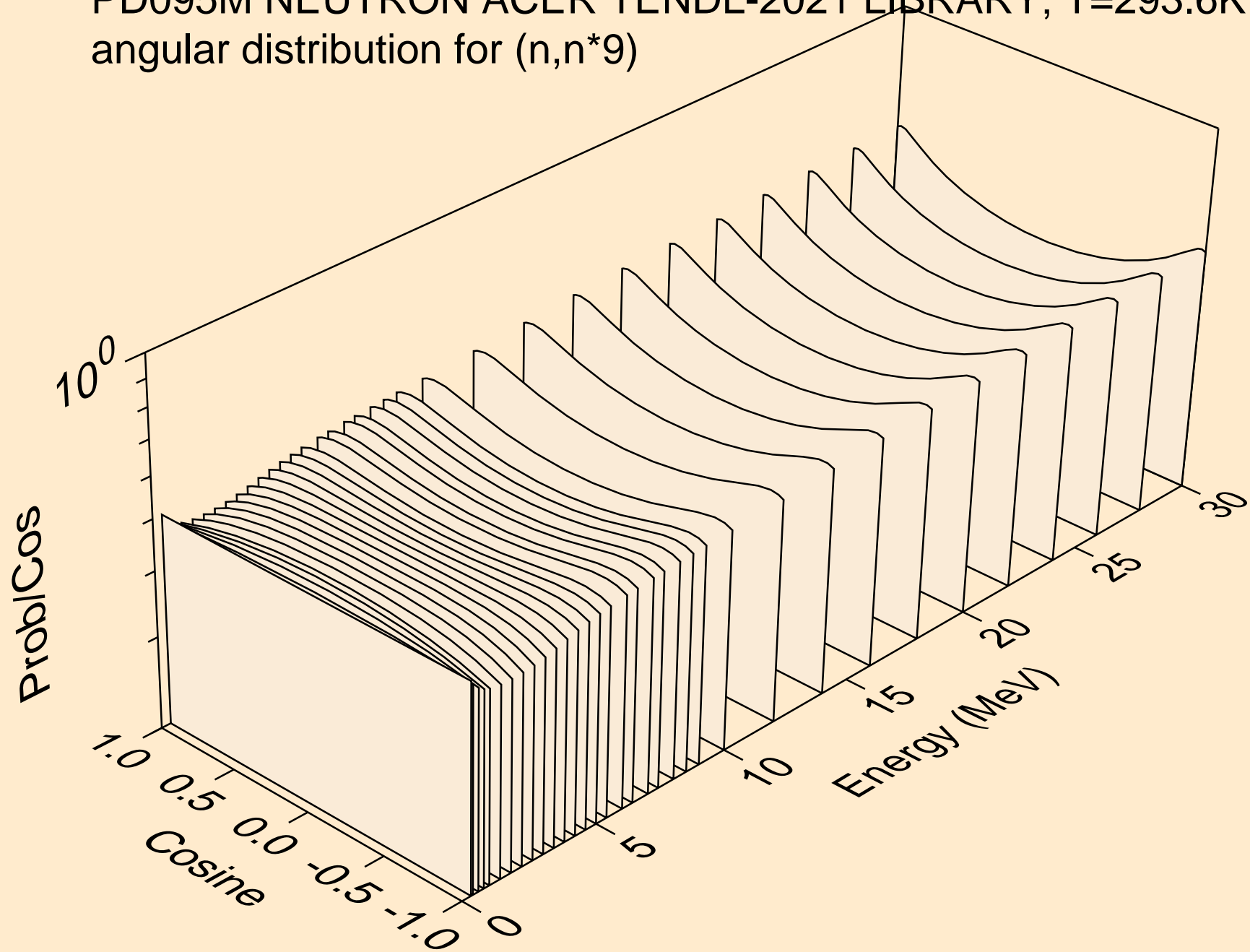



PD095M NEUTRON ACER TENDL-2021 LIBRARY; T=293.6K  
angular distribution for (n,n\*10)

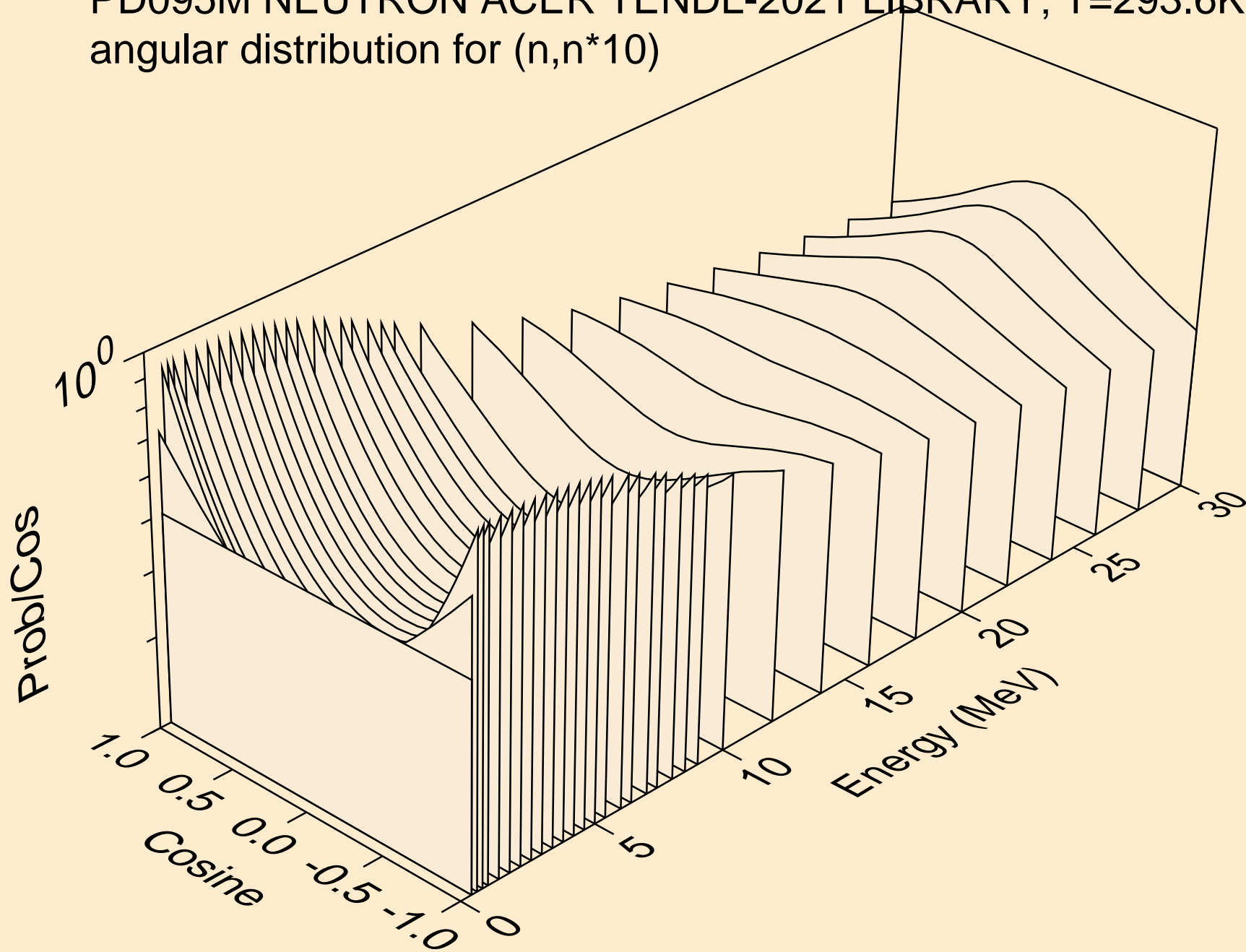

PD095M NEUTRON ACER TENDL-2021 LIBRARY; T=293.6K  
angular distribution for (n,n\*11)

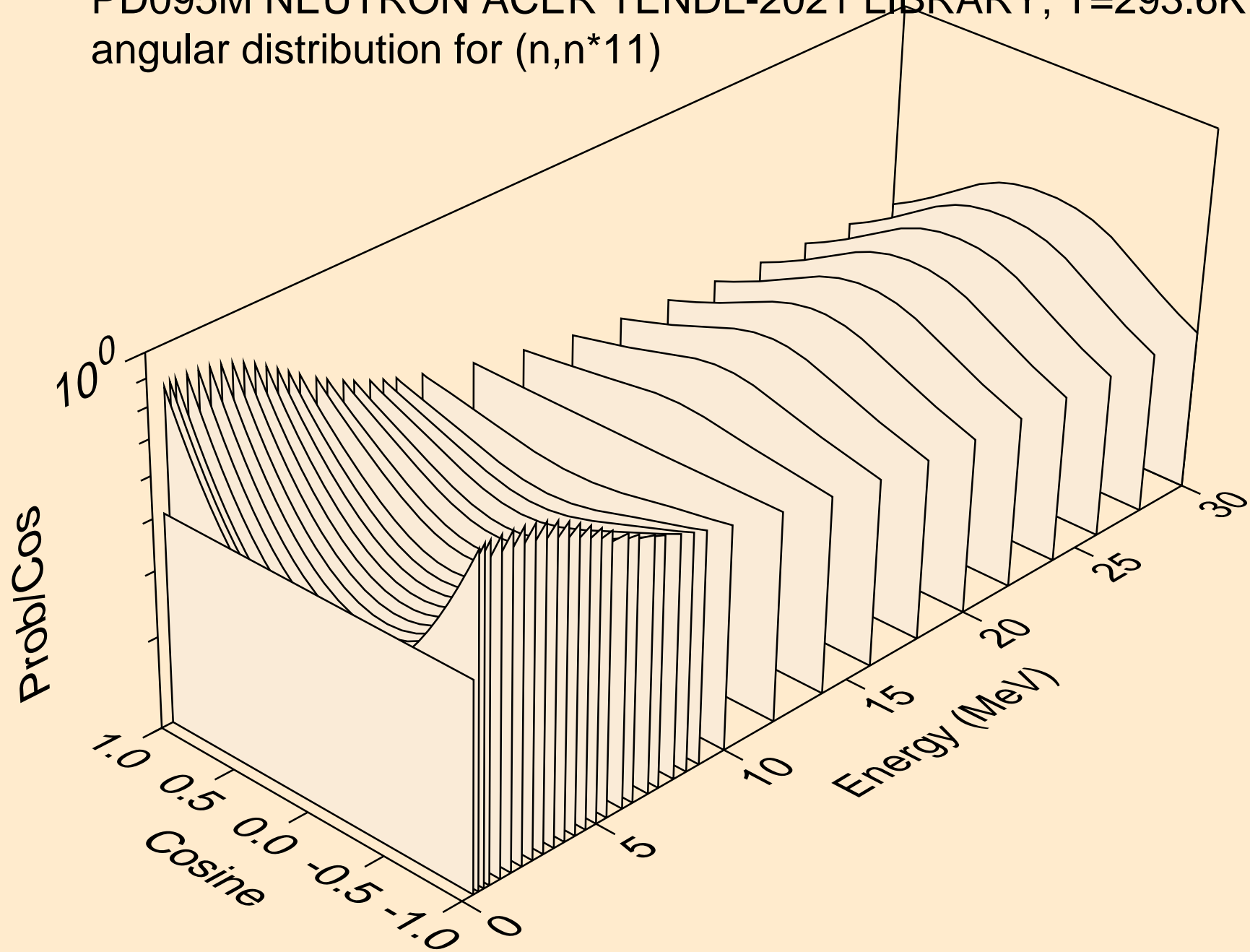

PD095M NEUTRON ACER TENDL-2021 LIBRARY; T=293.6K  
angular distribution for (n,n\*12)

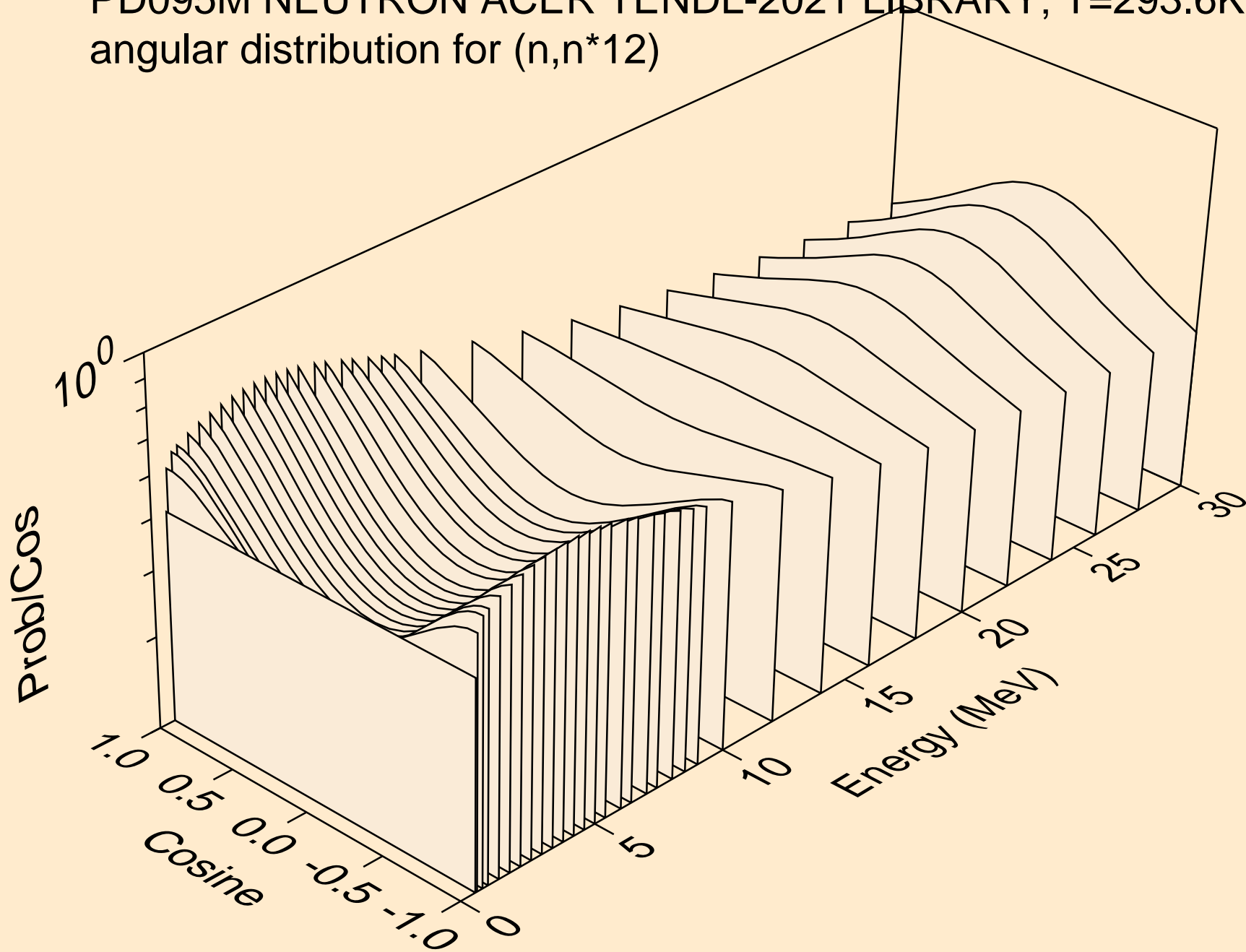

PD095M NEUTRON ACER TENDL-2021 LIBRARY; T=293.6K  
angular distribution for (n,n\*13)

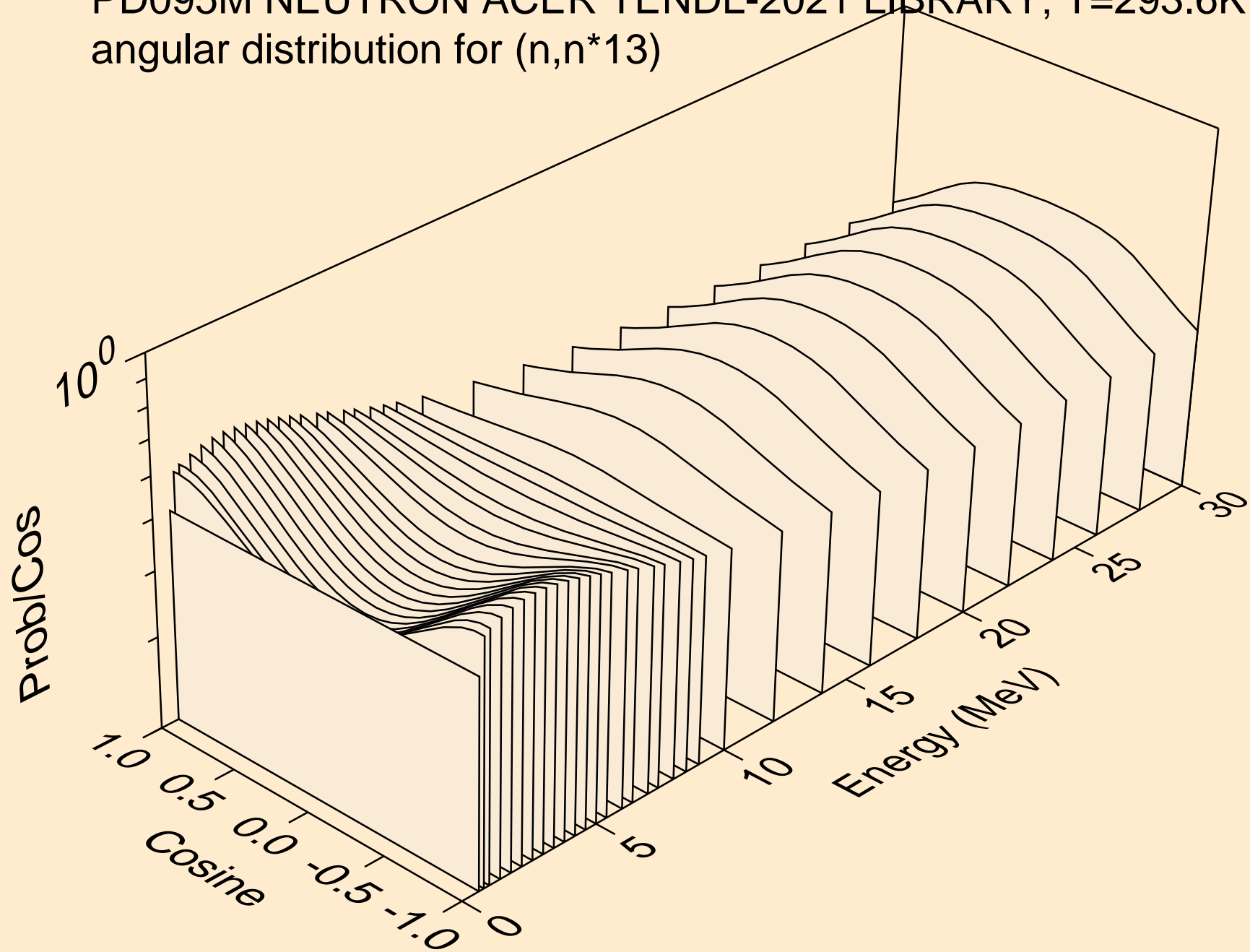

PD095M NEUTRON ACER TENDL-2021 LIBRARY; T=293.6K  
angular distribution for (n,n\*14)

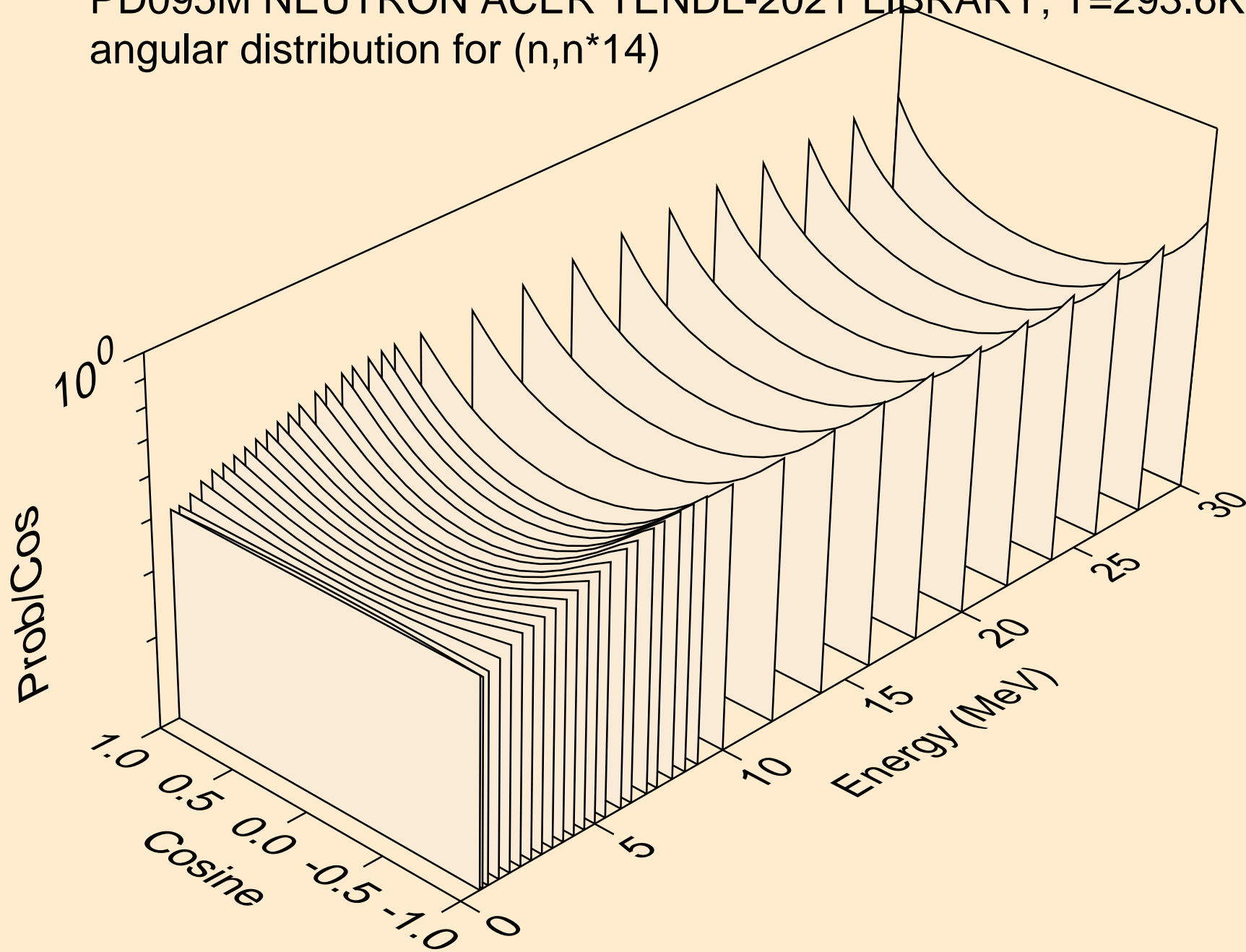

PD095M NEUTRON ACER TENDL-2021 LIBRARY; T=293.6K  
angular distribution for (n,n\*15)

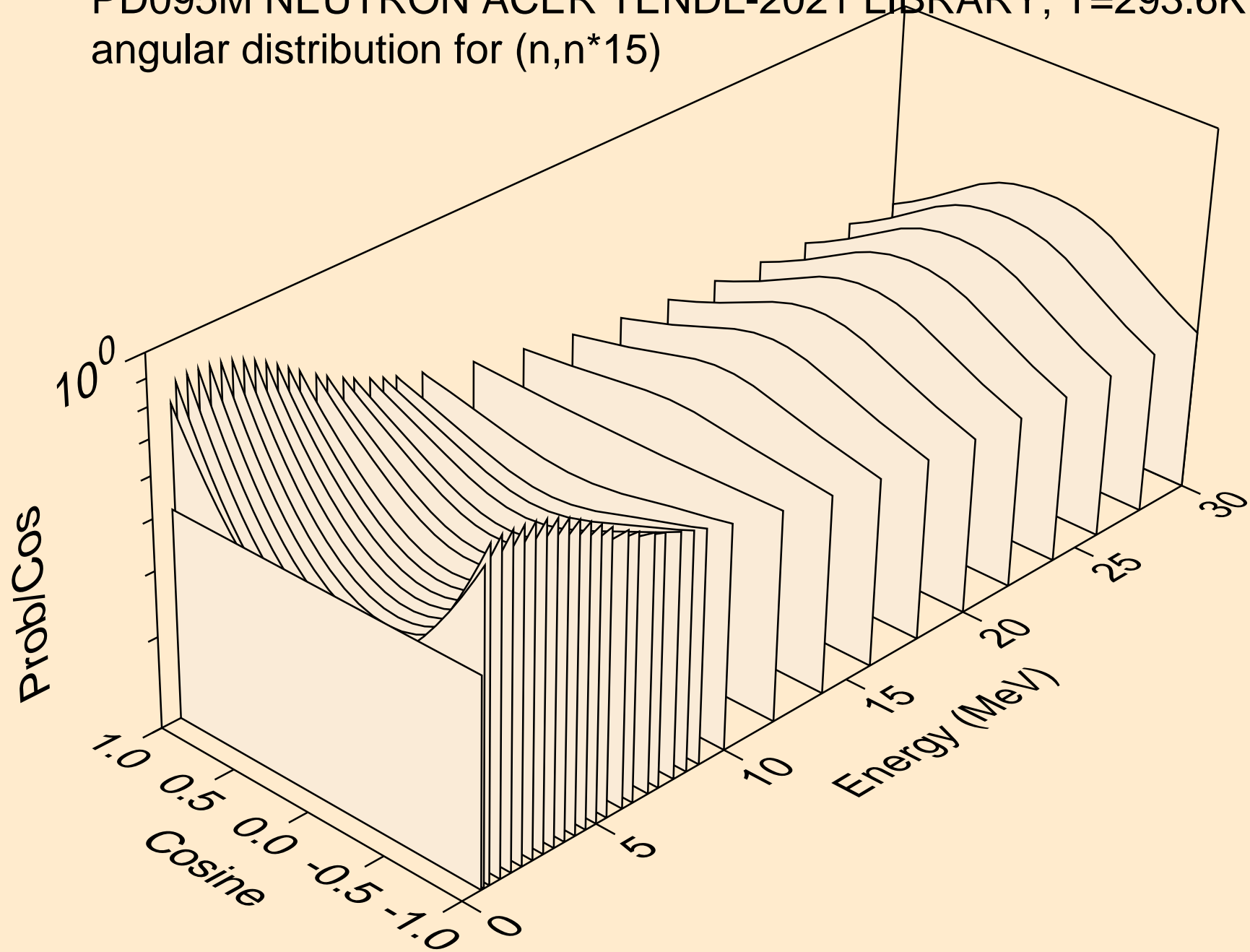

PD095M NEUTRON ACER TENDL-2021 LIBRARY; T=293.6K  
angular distribution for (n,n\*16)

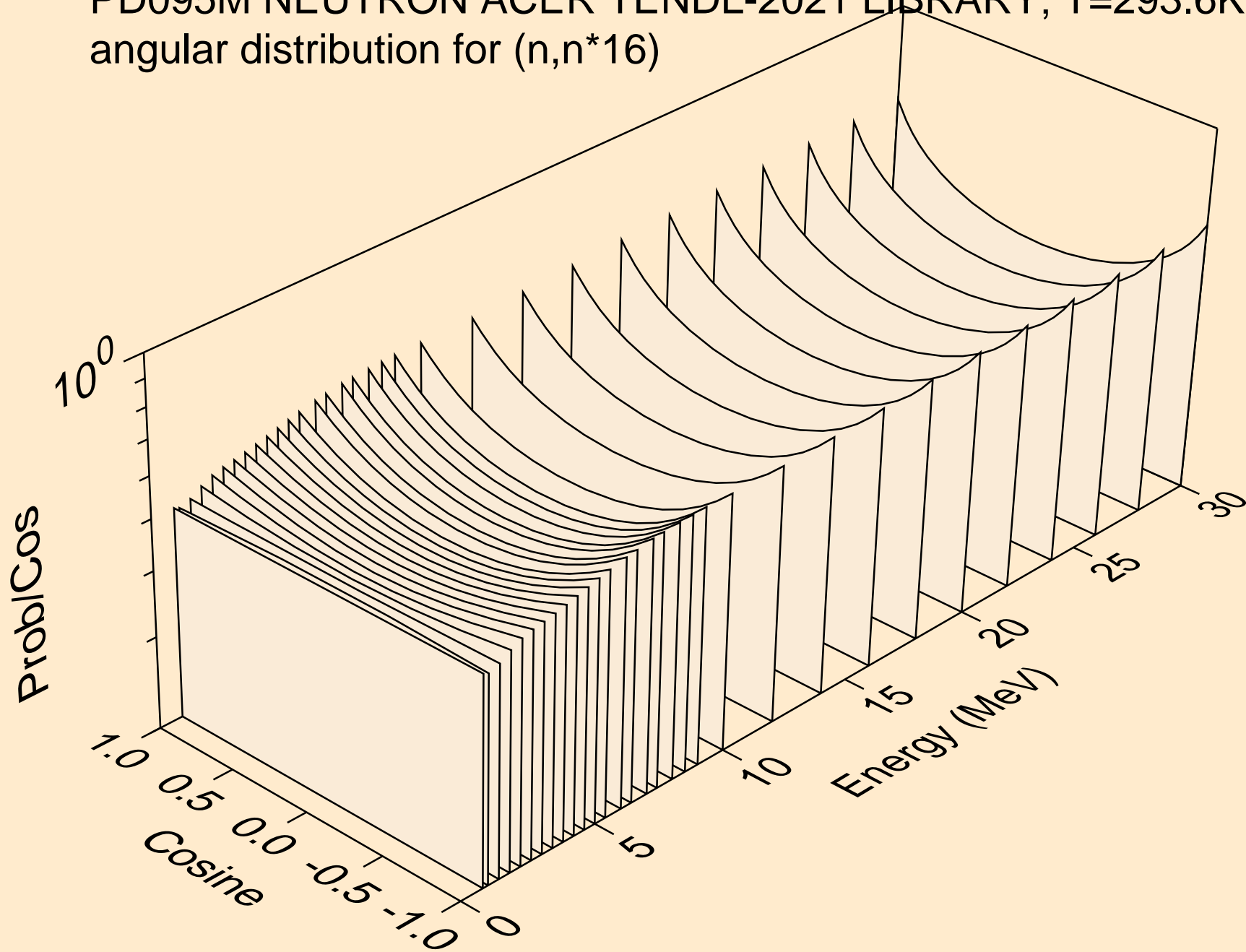

PD095M NEUTRON ACER TENDL-2021 LIBRARY; T=293.6K  
angular distribution for (n,n\*17)

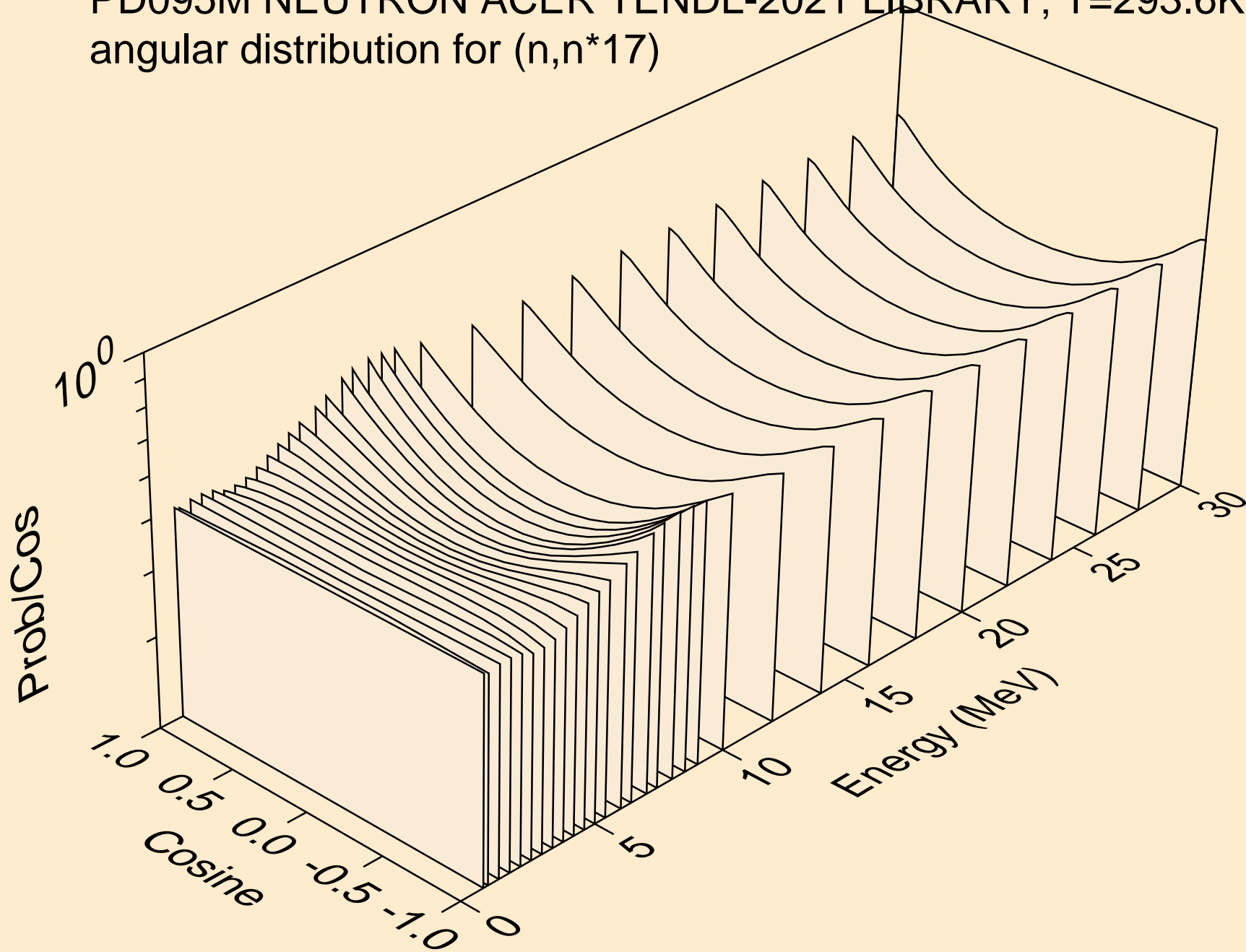



PD095M NEUTRON ACER TENDL-2021 LIBRARY; T=293.6K  
angular distribution for (n,n\*18)

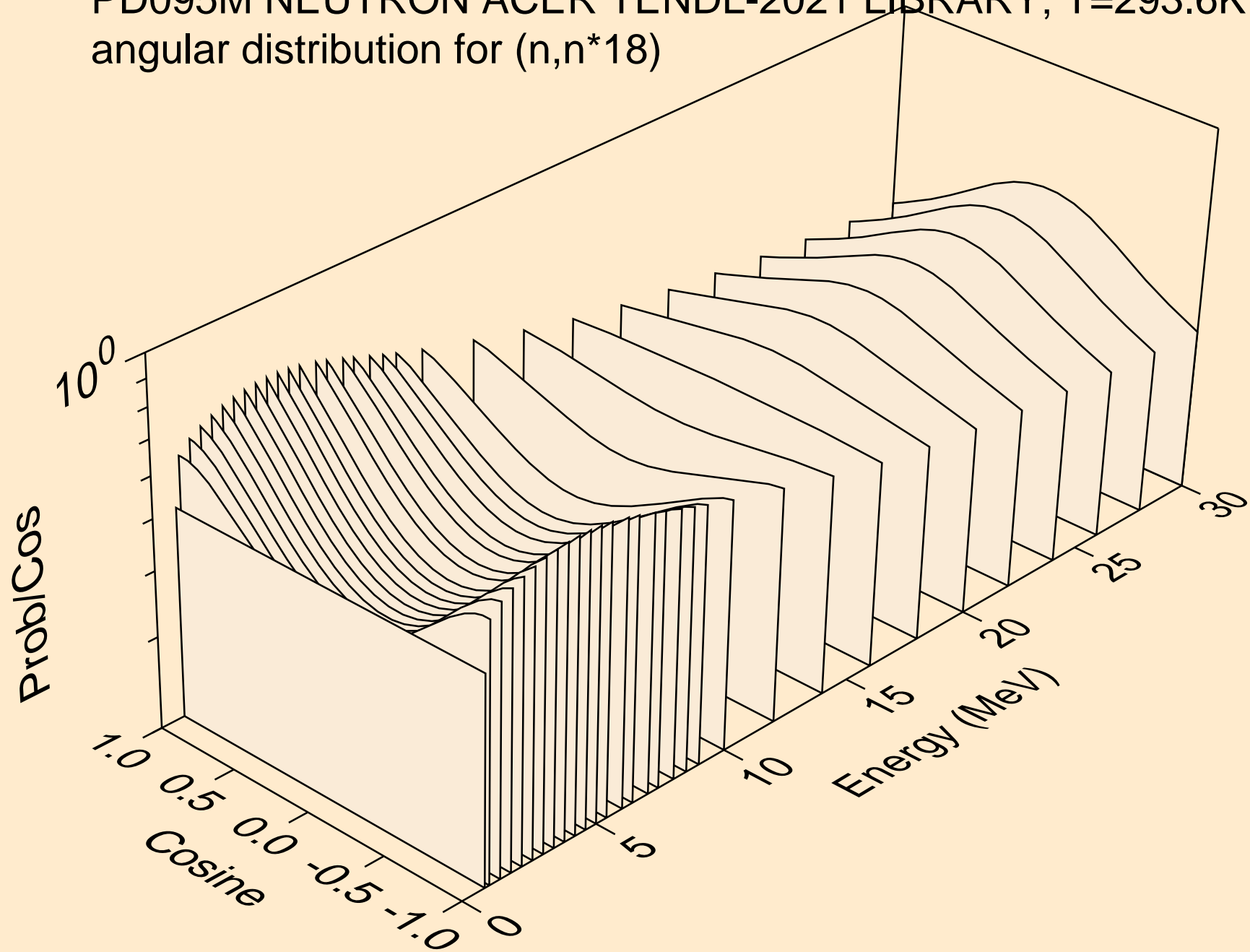

PD095M NEUTRON ACER TENDL-2021 LIBRARY; T=293.6K  
angular distribution for (n,n\*19)

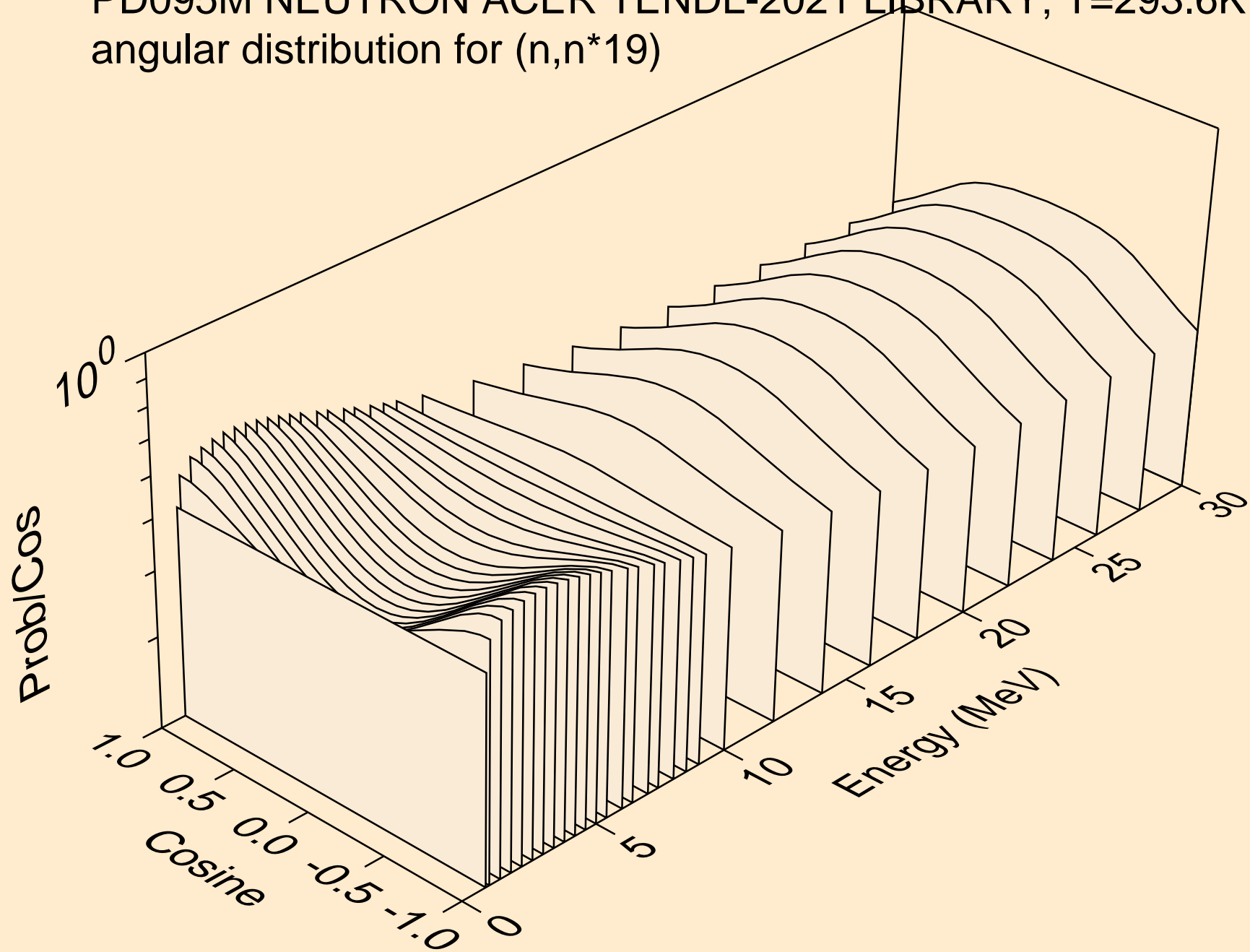

PD095M NEUTRON ACER TENDL-2021 LIBRARY; T=293.6K  
angular distribution for (n,n\*20)

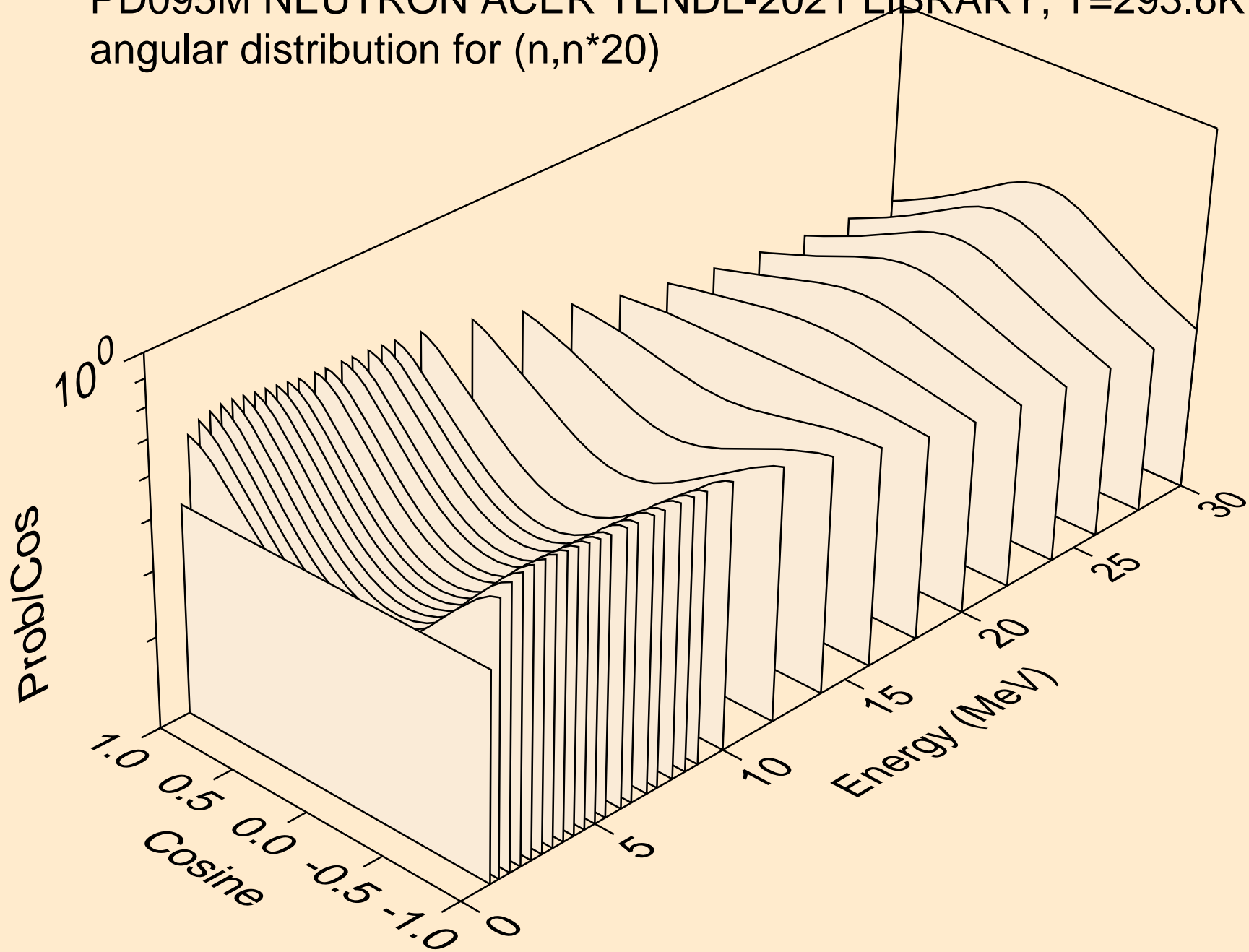

PD095M NEUTRON ACER TENDL-2021 LIBRARY; T=293.6K  
angular distribution for (n,n\*21)

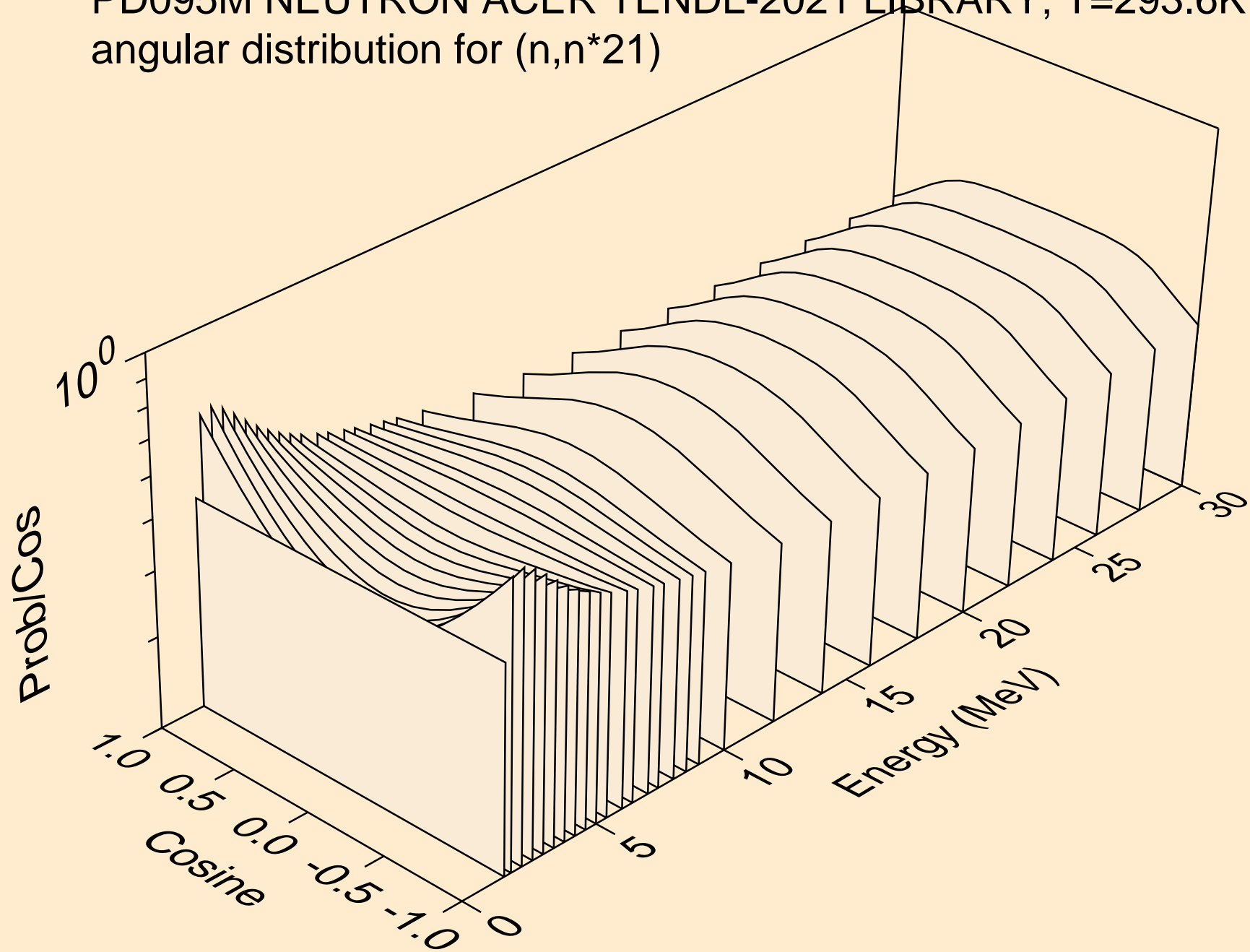

PD095M NEUTRON ACER TENDL-2021 LIBRARY; T=293.6K  
angular distribution for (n,n\*22)

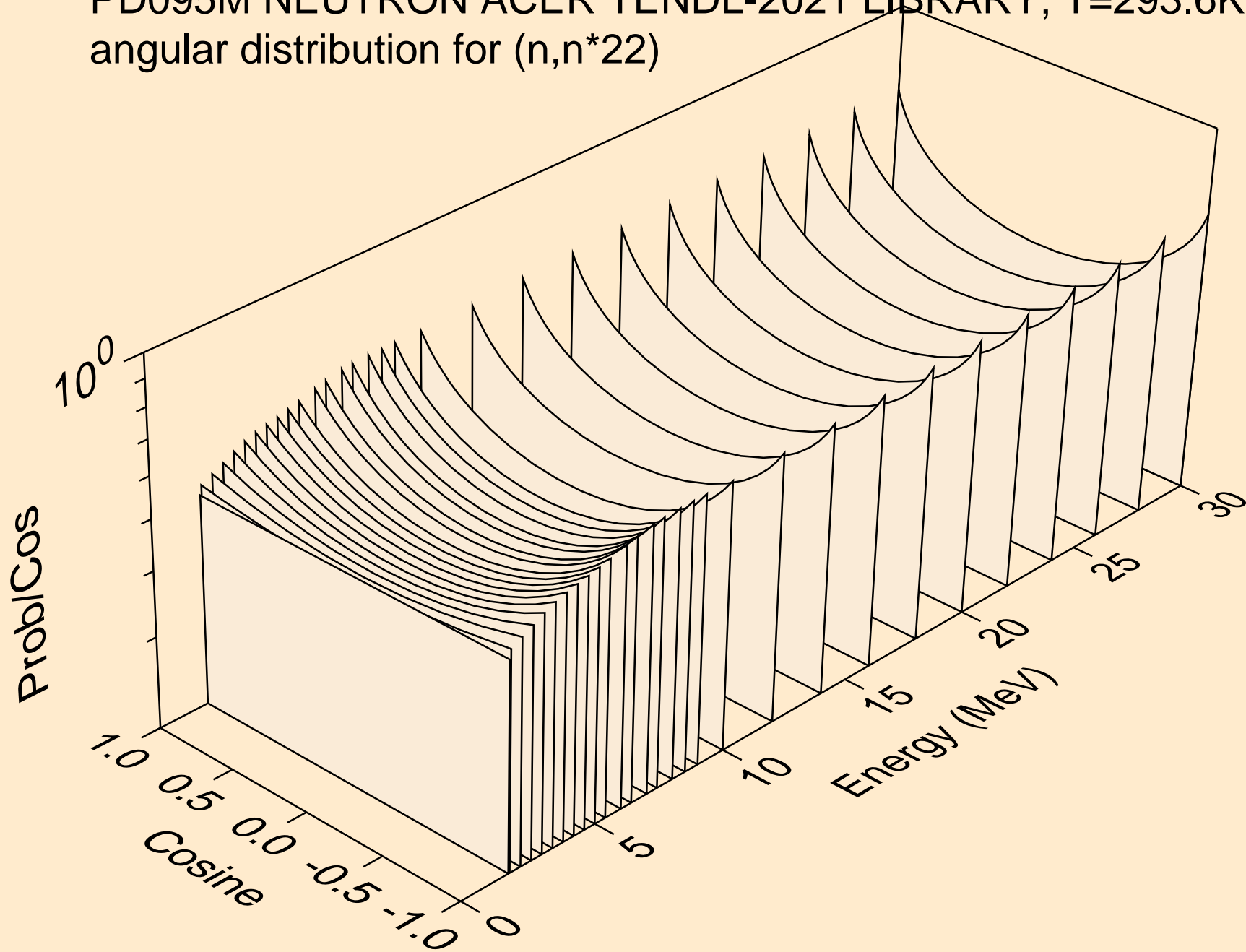

PD095M NEUTRON ACER TENDL-2021 LIBRARY; T=293.6K  
angular distribution for (n,n\*23)

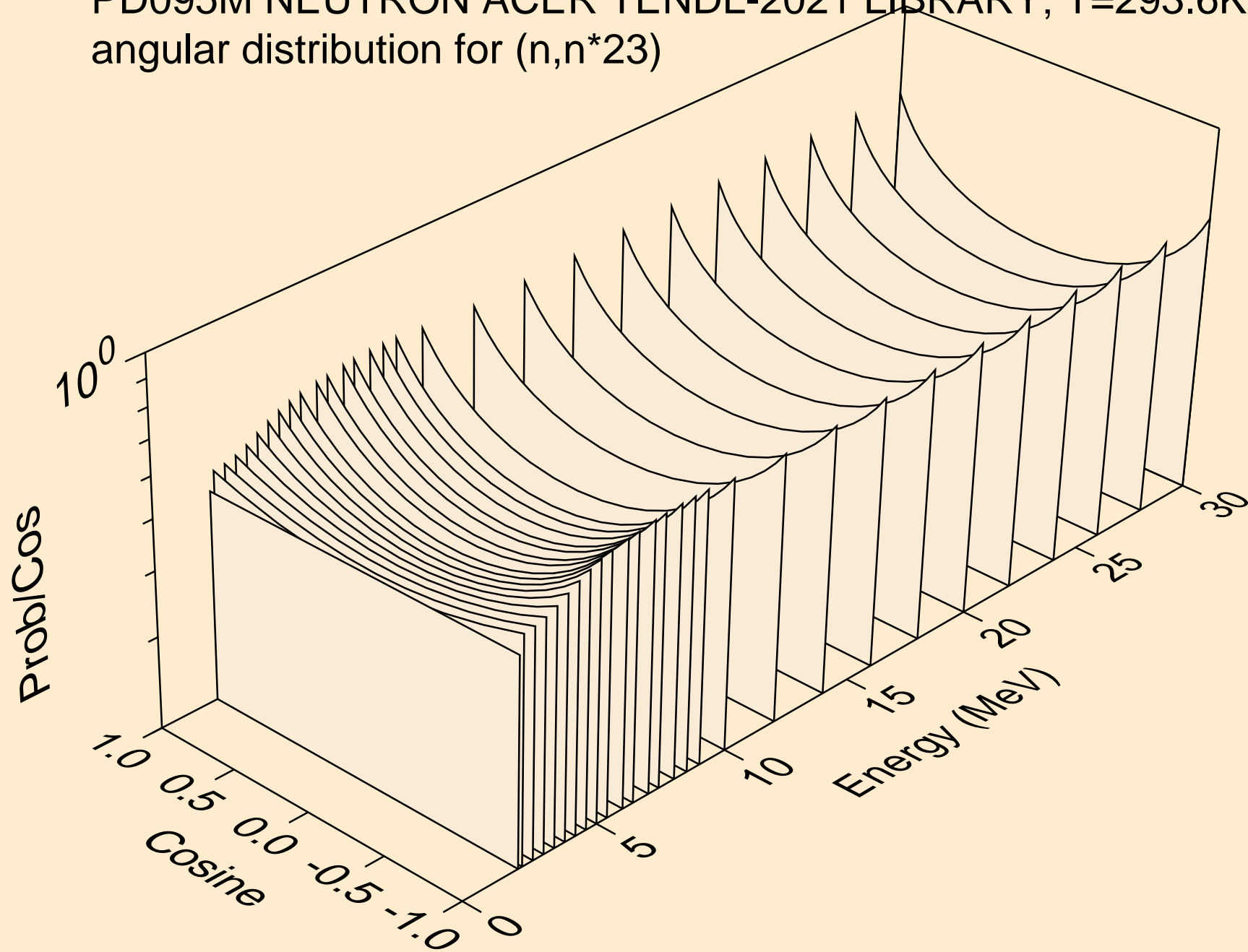

PD095M NEUTRON ACER TENDL-2021 LIBRARY; T=293.6K  
angular distribution for (n,n\*24)

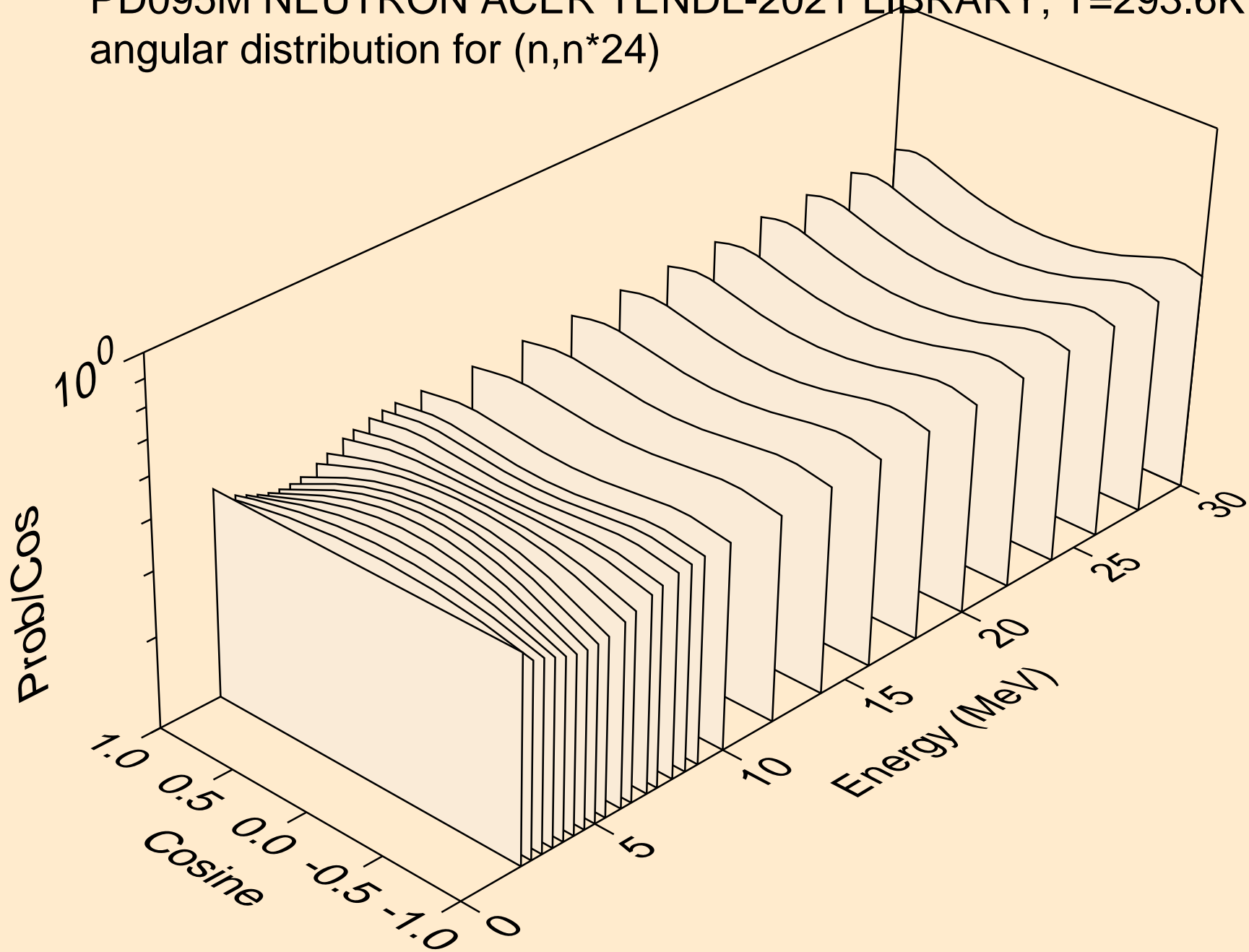

PD095M NEUTRON ACER TENDL-2021 LIBRARY; T=293.6K  
angular distribution for (n,n\*25)

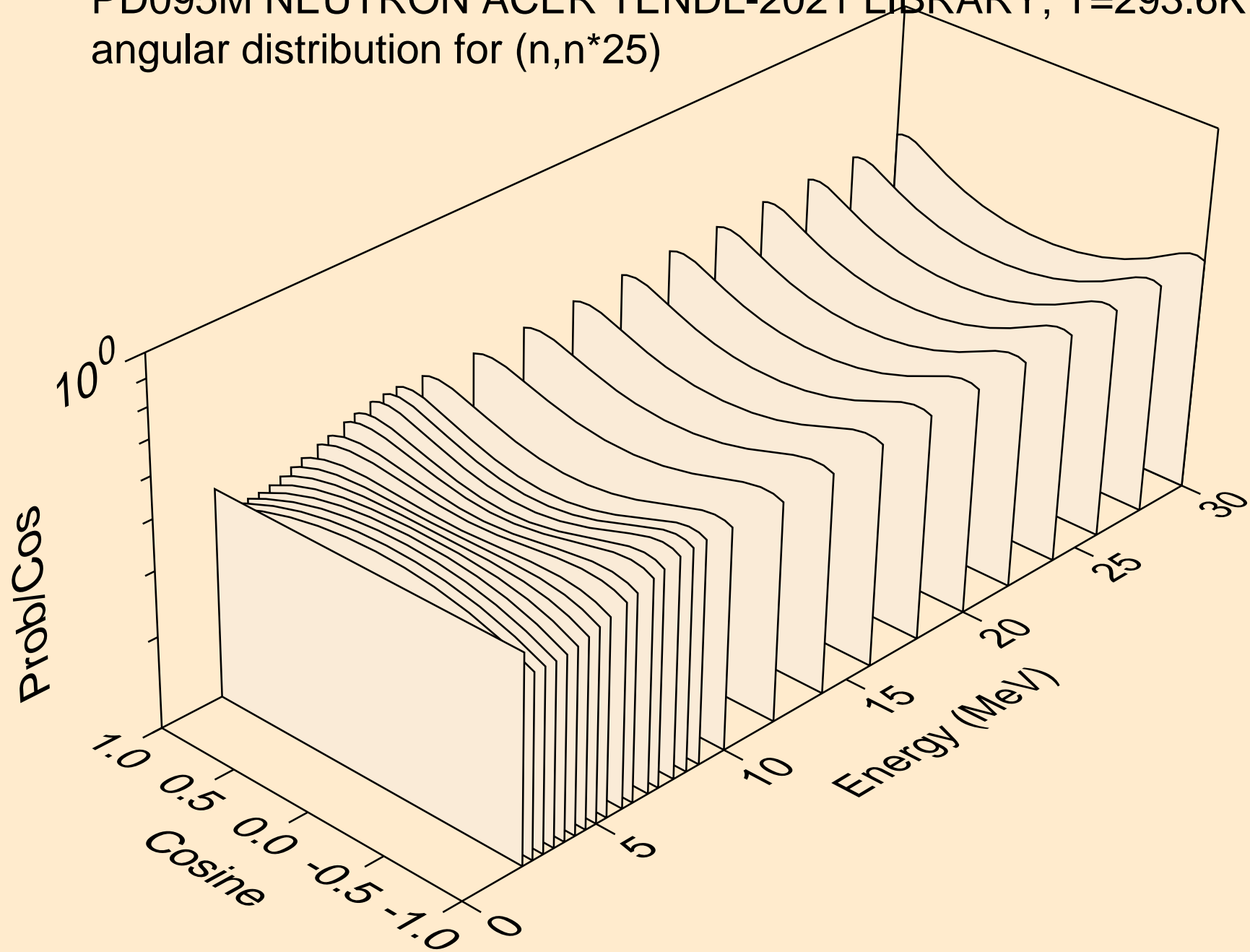



PD095M NEUTRON ACER TENDL-2021 LIBRARY; T=293.6K  
Neutron emission for (n,x)

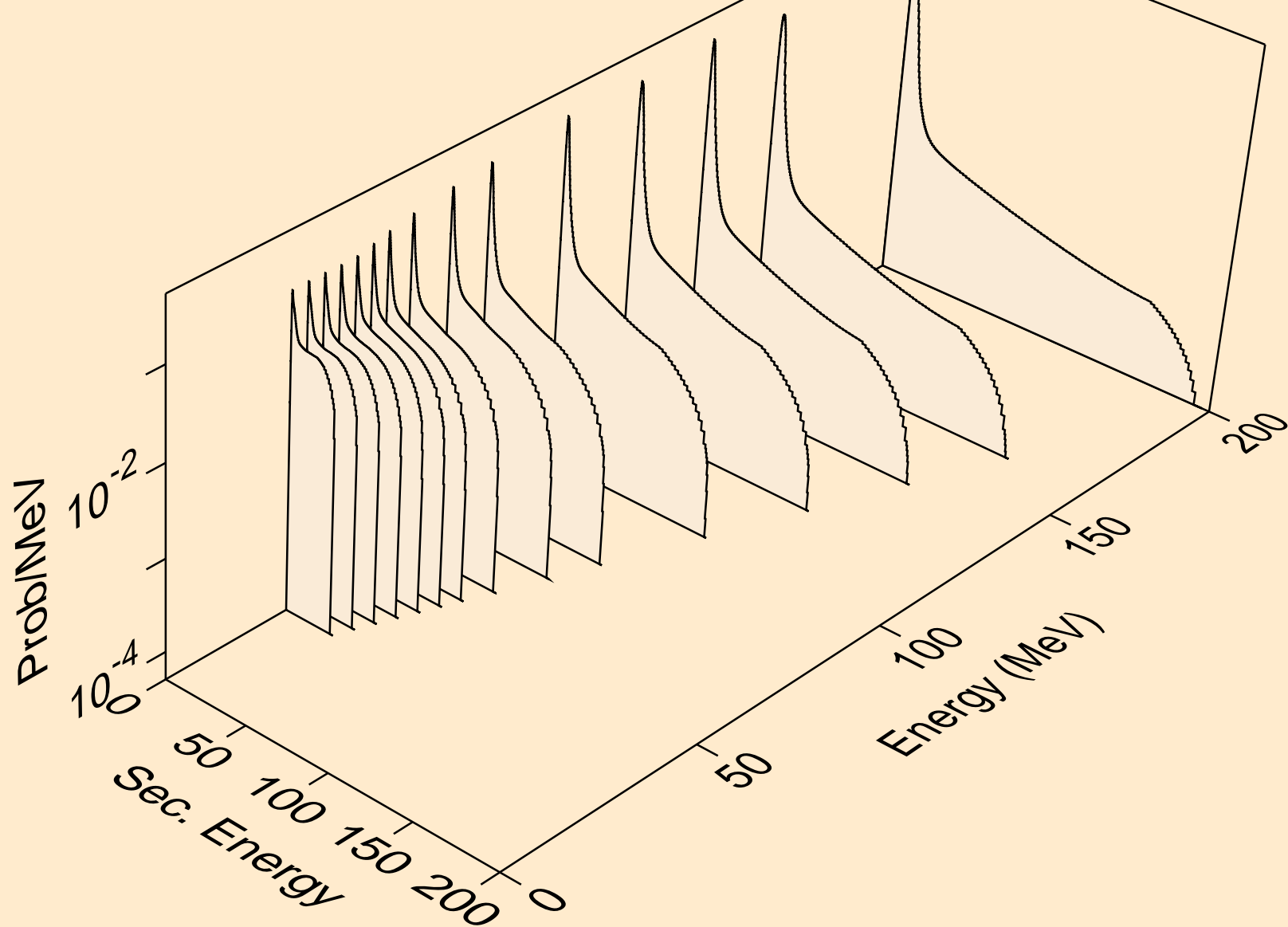

PD095M NEUTRON ACER TENDL-2021 LIBRARY; T=293.6K  
Neutron emission for (n,2n)

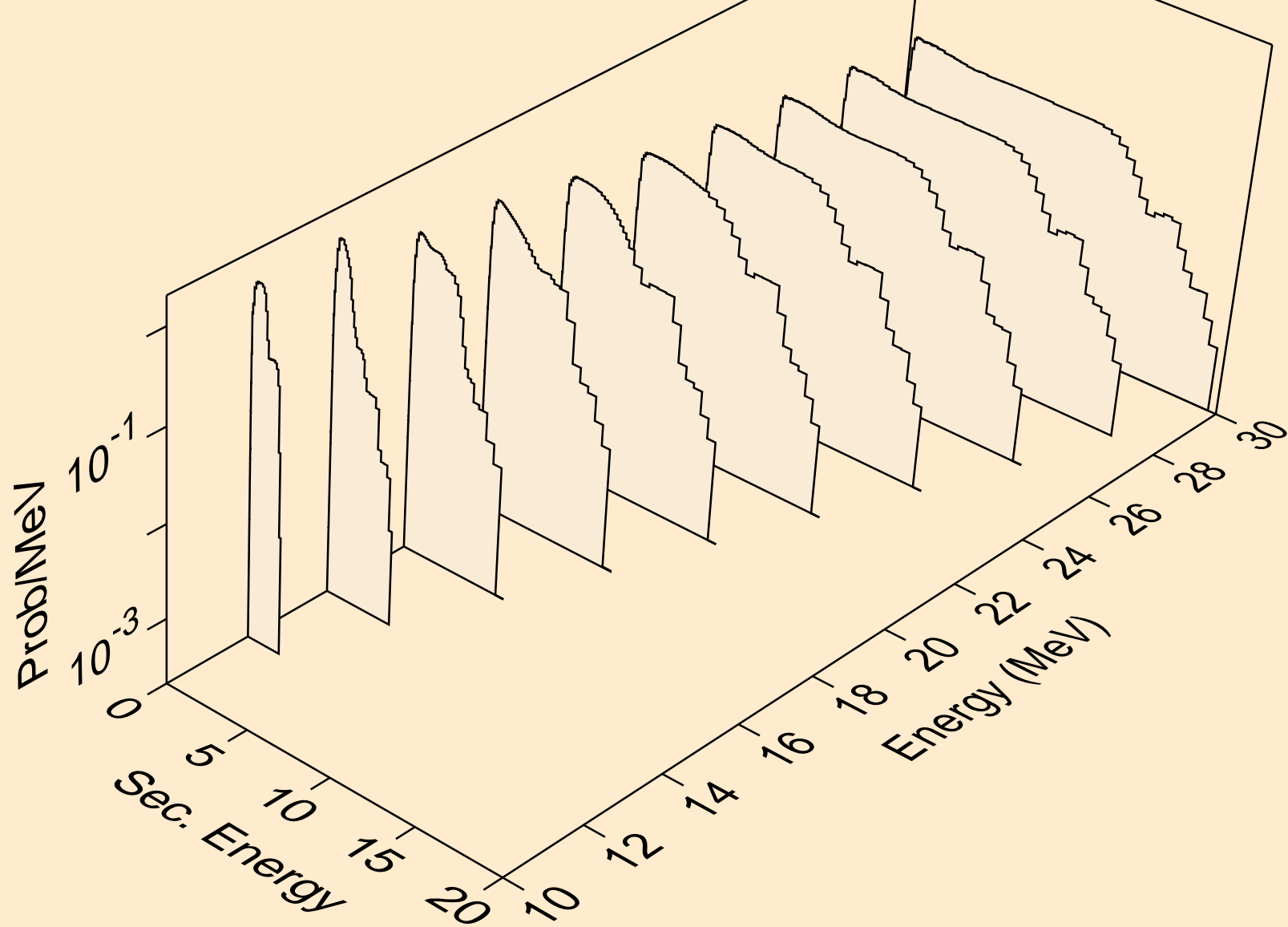

PD095M NEUTRON ACER TENDL-2021 LIBRARY; T=293.6K  
Neutron emission for (n,3n)

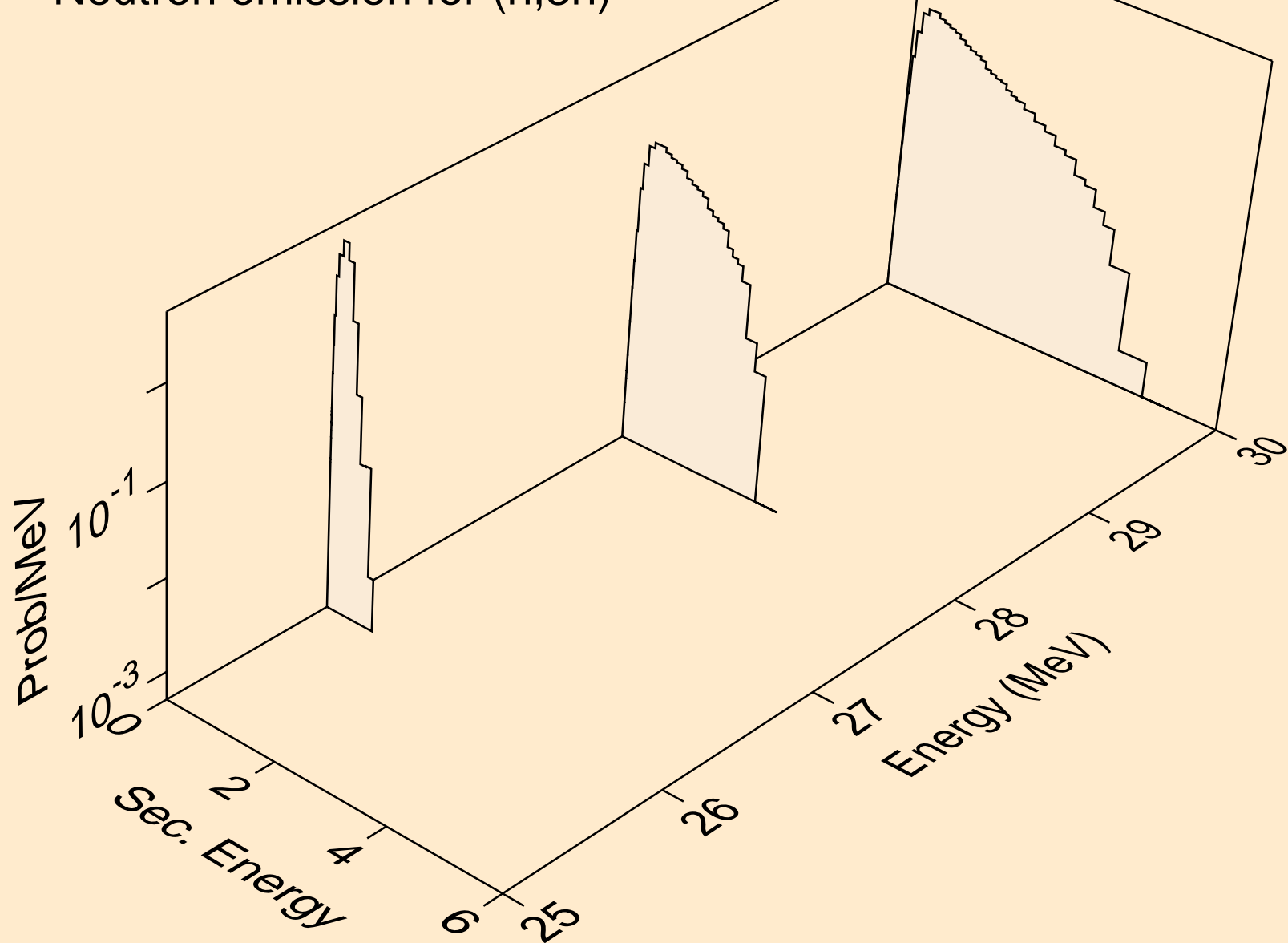

PD095M NEUTRON ACER TENDL-2021 LIBRARY; T=293.6K  
Neutron emission for (n,n\*)a

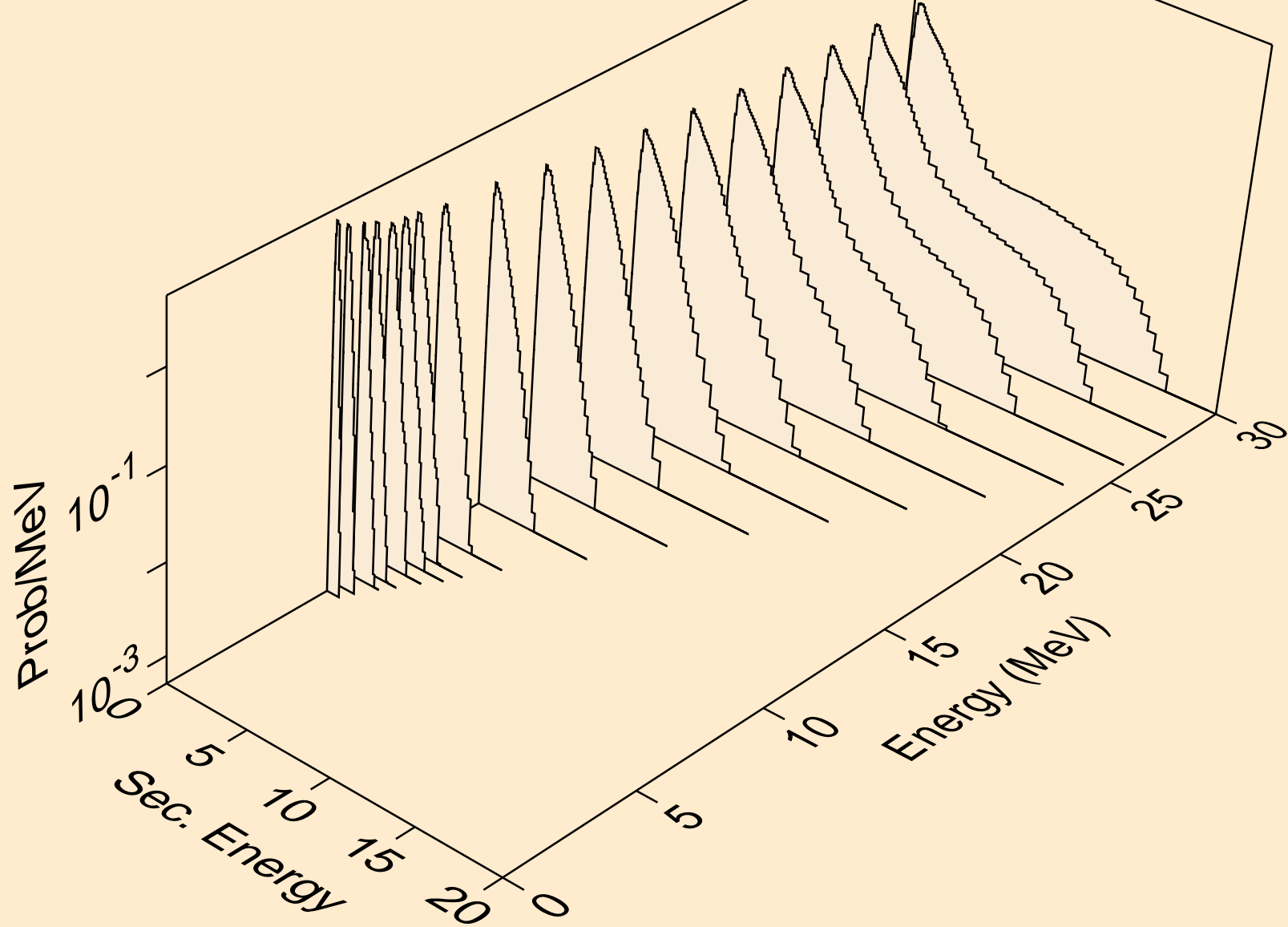

PD095M NEUTRON ACER TENDL-2021 LIBRARY; T=293.6K  
Neutron emission for (n,2n)<sub>a</sub>

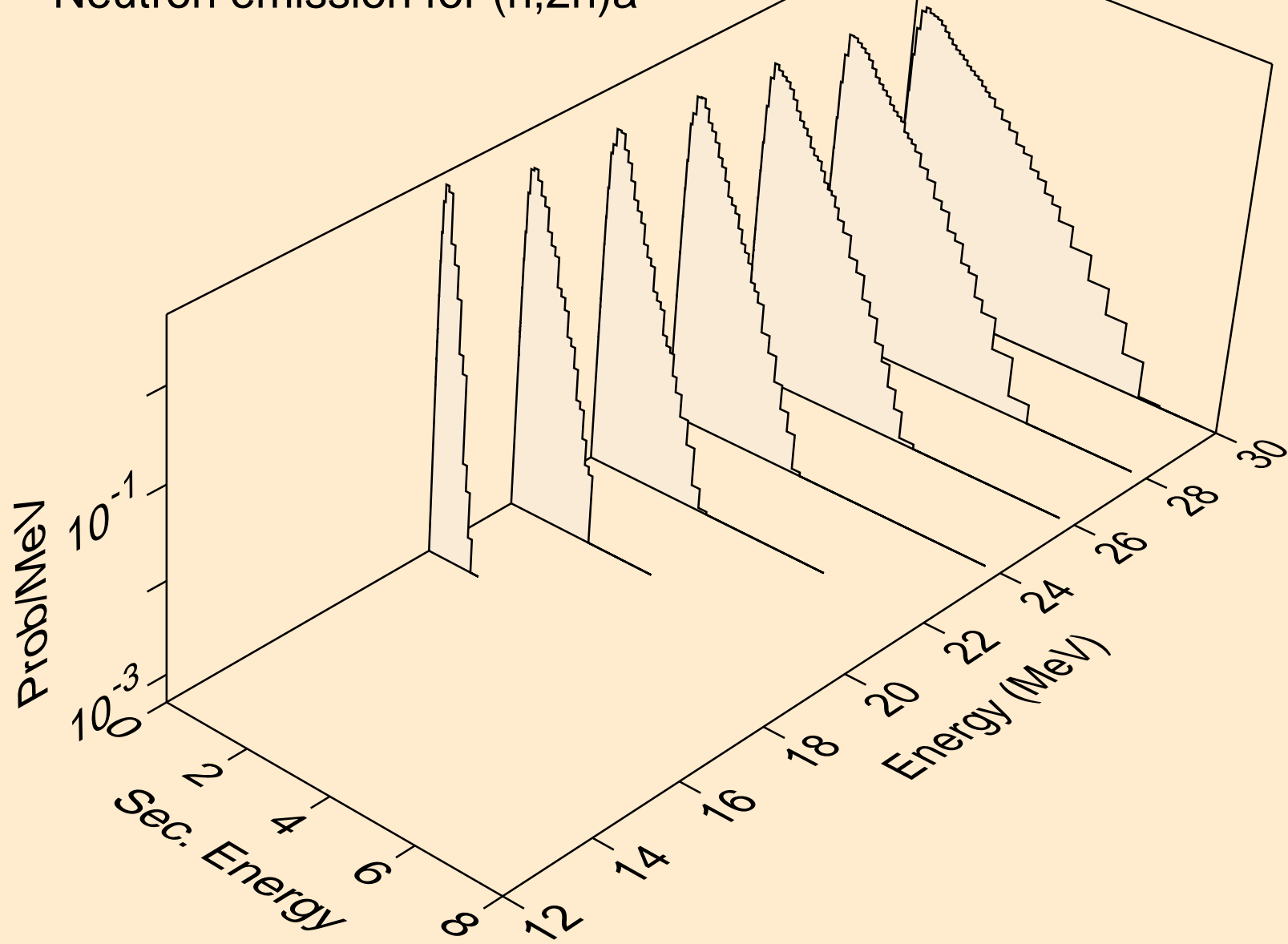

PD095M NEUTRON ACER TENDL-2021 LIBRARY; T=293.6K  
Neutron emission for (n,n\*)p

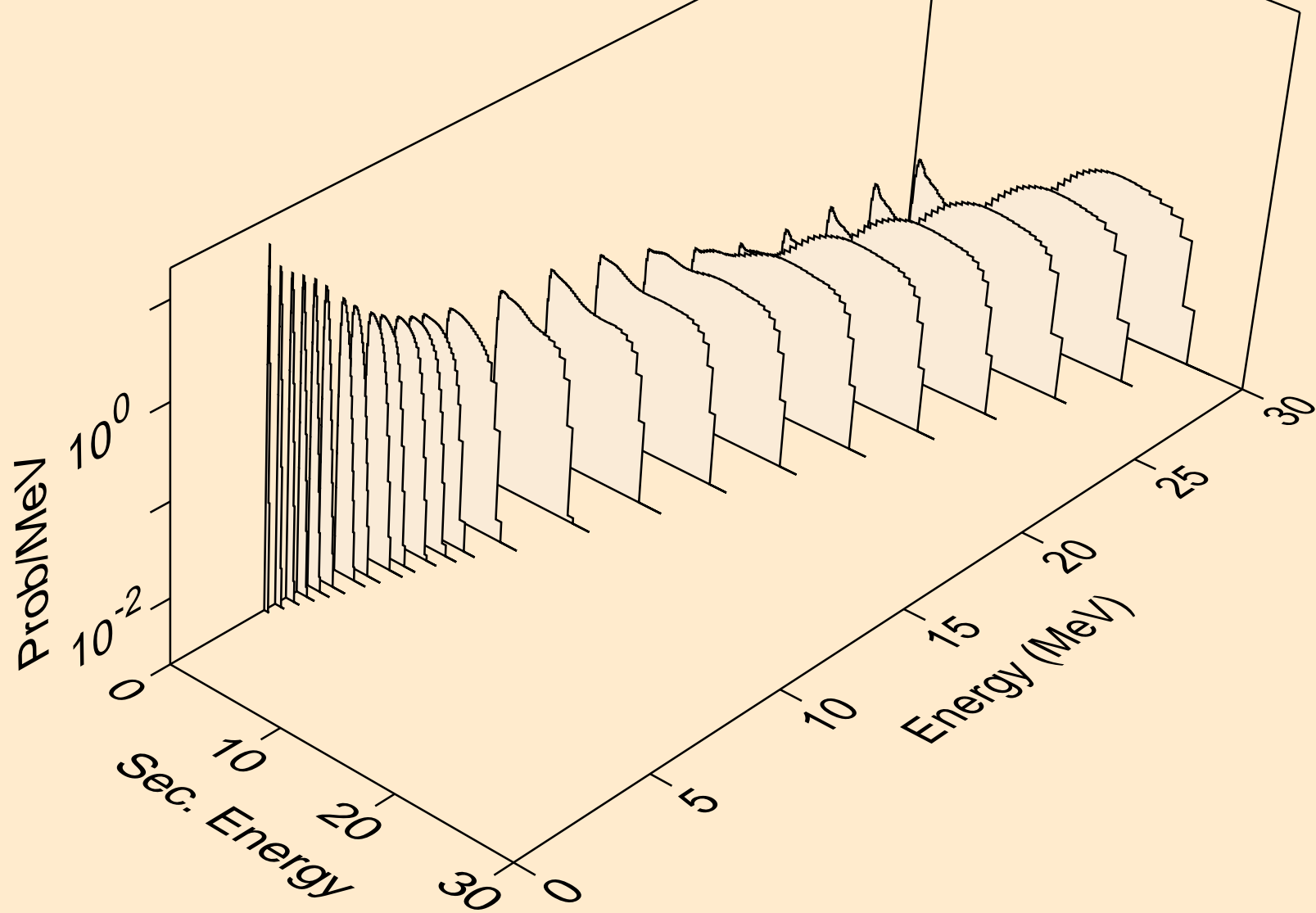

PD095M NEUTRON ACER TENDL-2021 LIBRARY; T=293.6K  
Neutron emission for (n,n\*)2a

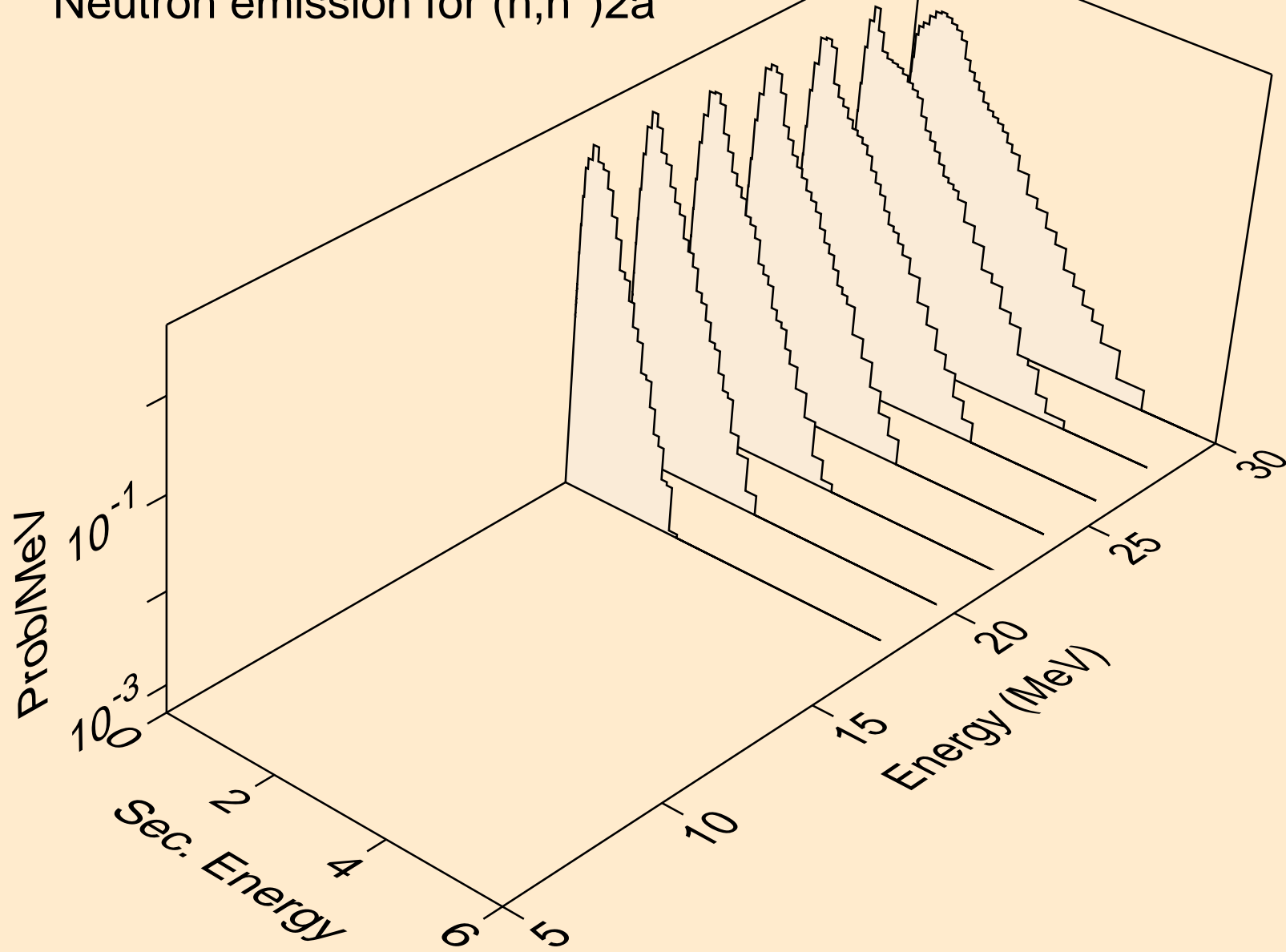

PD095M NEUTRON ACER TENDL-2021 LIBRARY; T=293.6K  
Neutron emission for (n,n\*)d

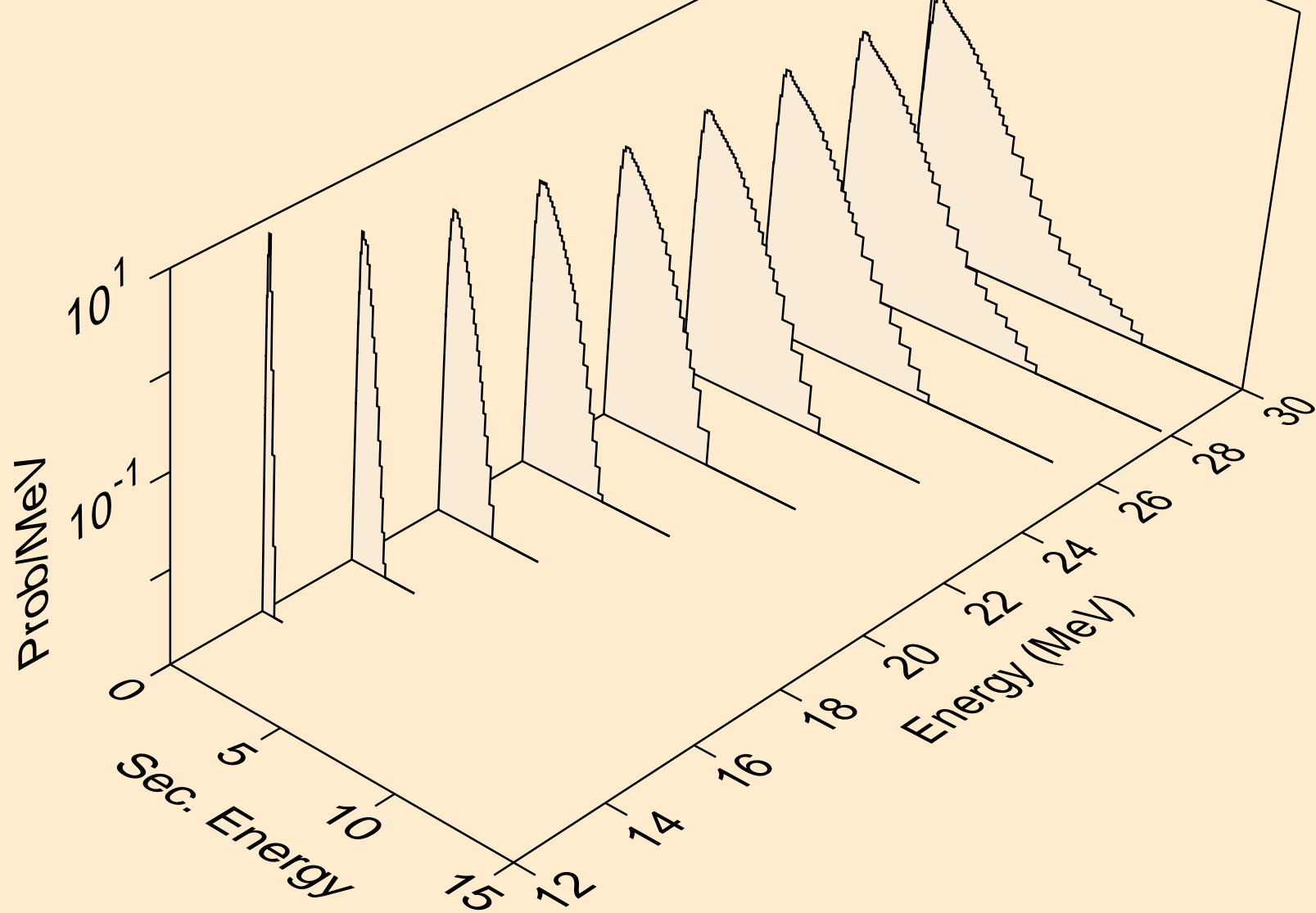



PD095M NEUTRON ACER TENDL-2021 LIBRARY; T=293.6K  
Neutron emission for (n,n\*)t

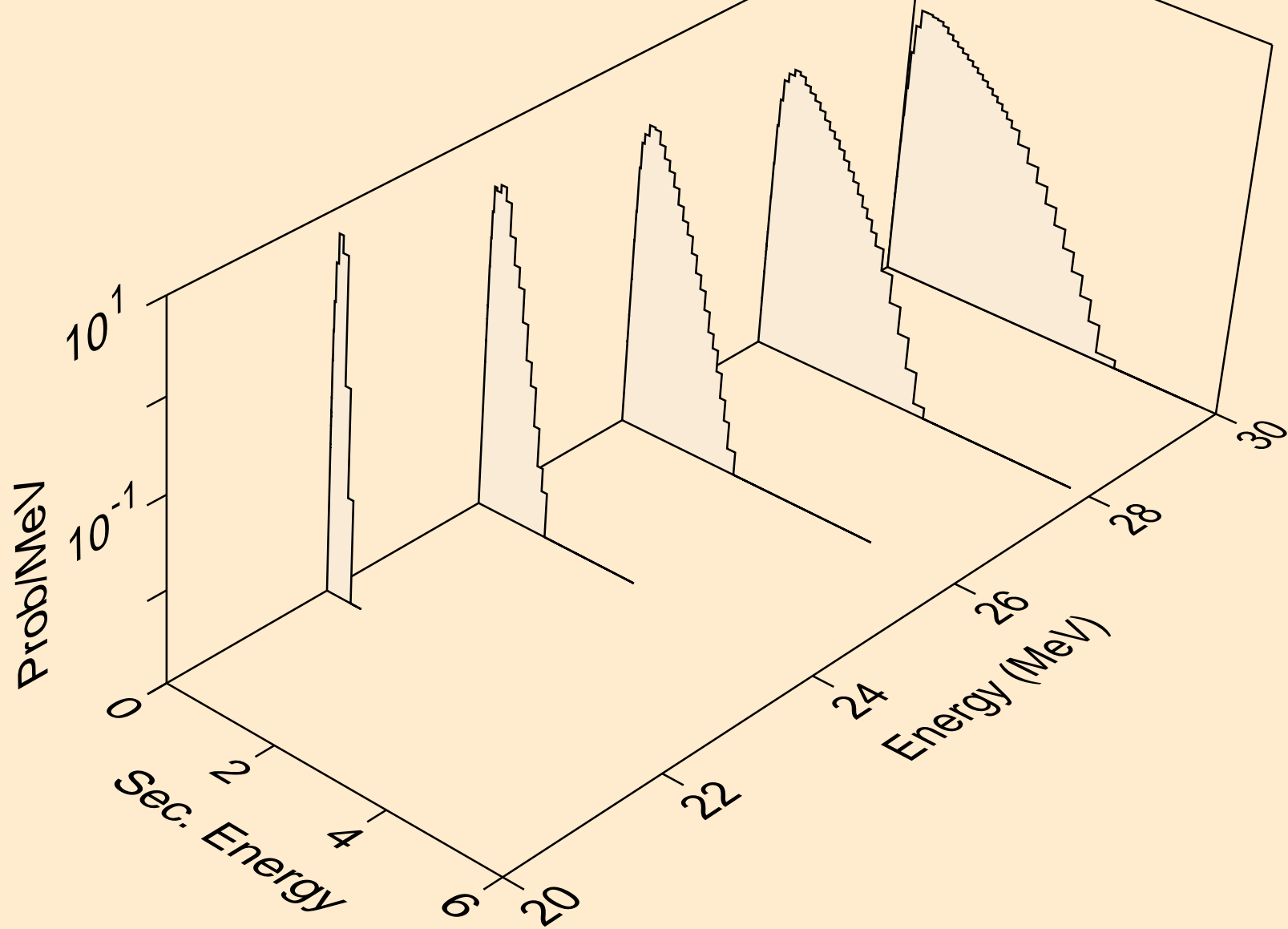

PD095M NEUTRON ACER TENDL-2021 LIBRARY; T=293.6K  
Neutron emission for (n,n\*)he3

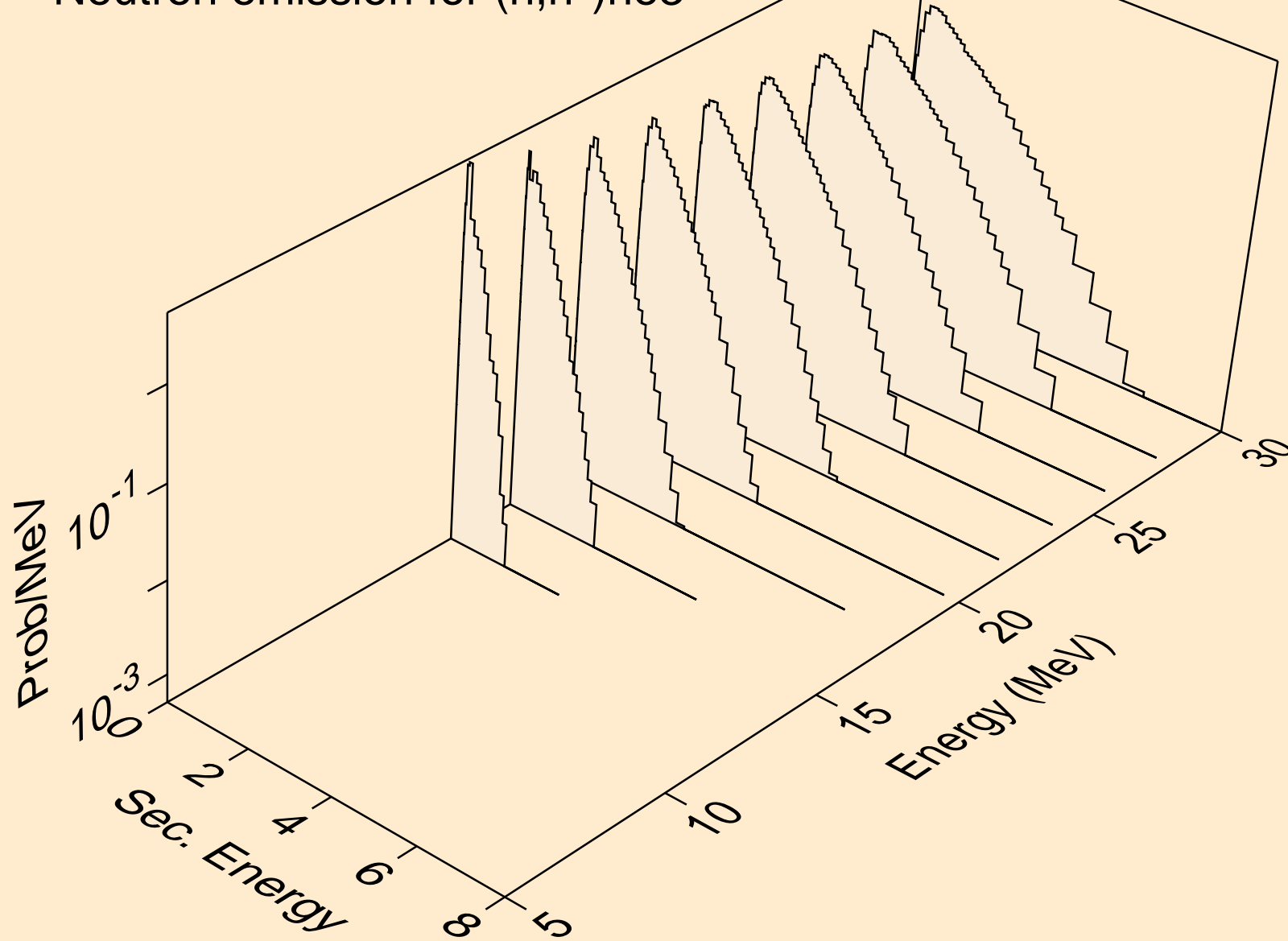

PD095M NEUTRON ACER TENDL-2021 LIBRARY; T=293.6K  
Neutron emission for (n,2np)

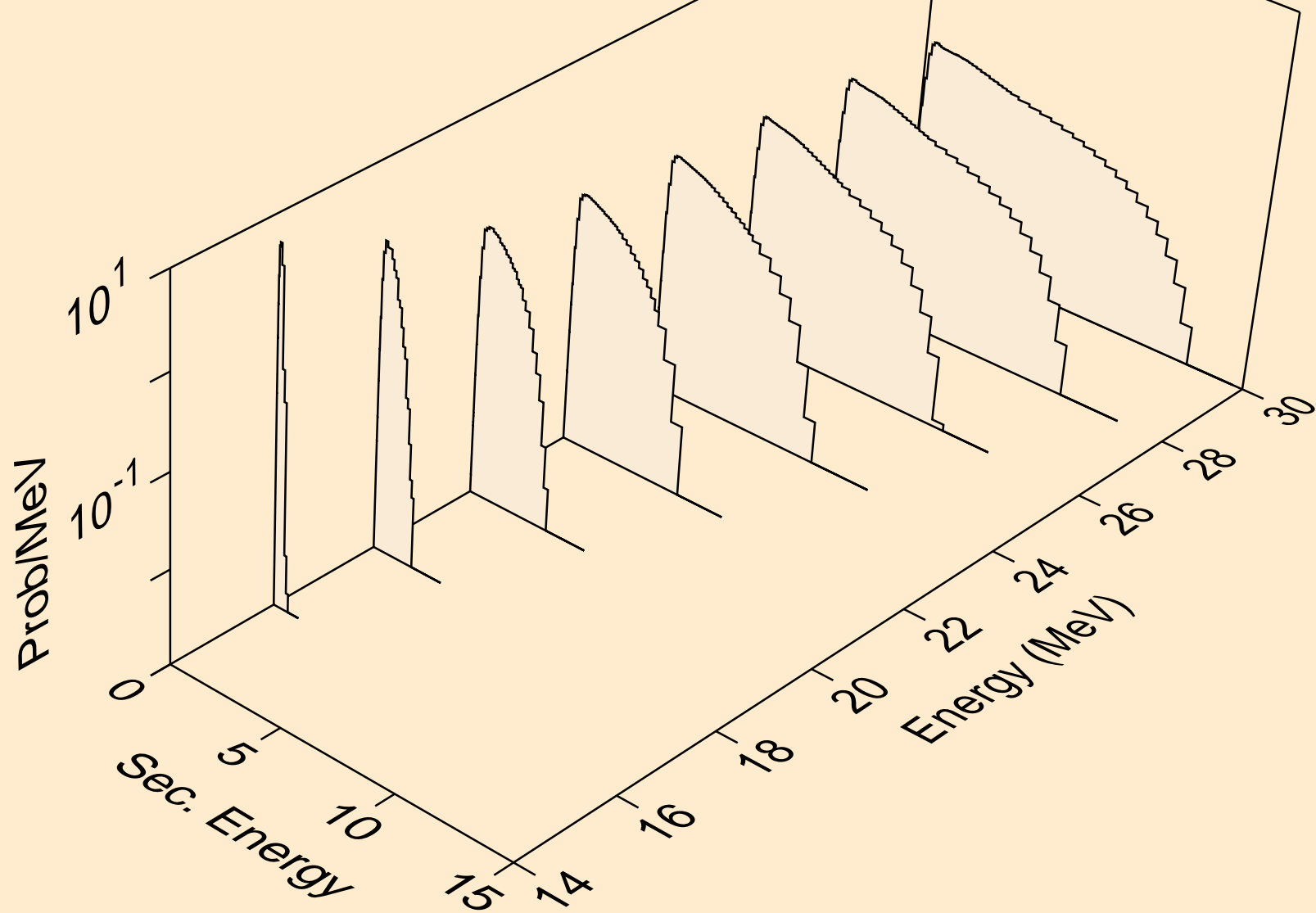

PD095M NEUTRON ACER TENDL-2021 LIBRARY; T=293.6K  
Neutron emission for (n,2np)

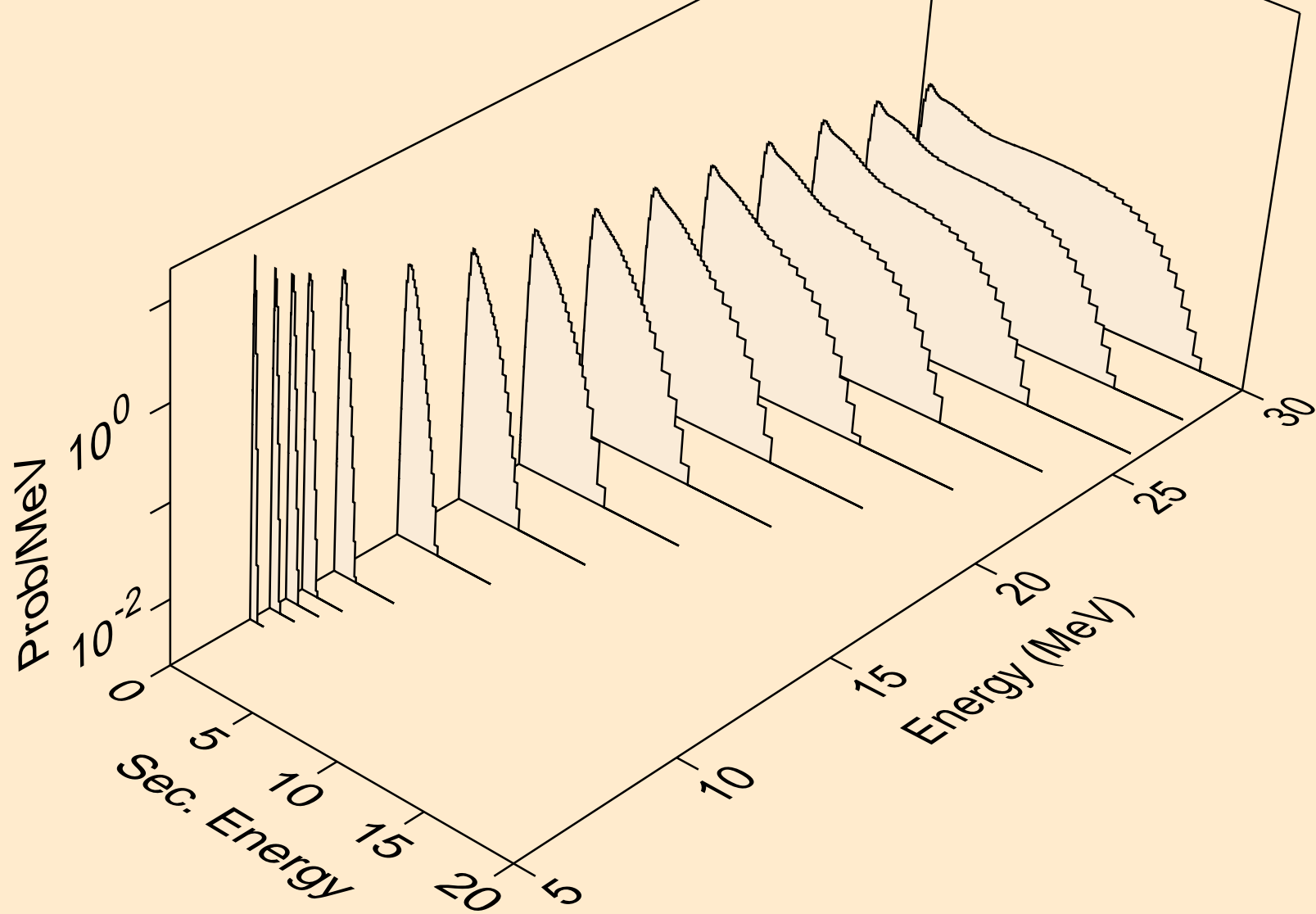

PD095M NEUTRON ACER TENDL-2021 LIBRARY; T=293.6K  
Neutron emission for (n,npa)

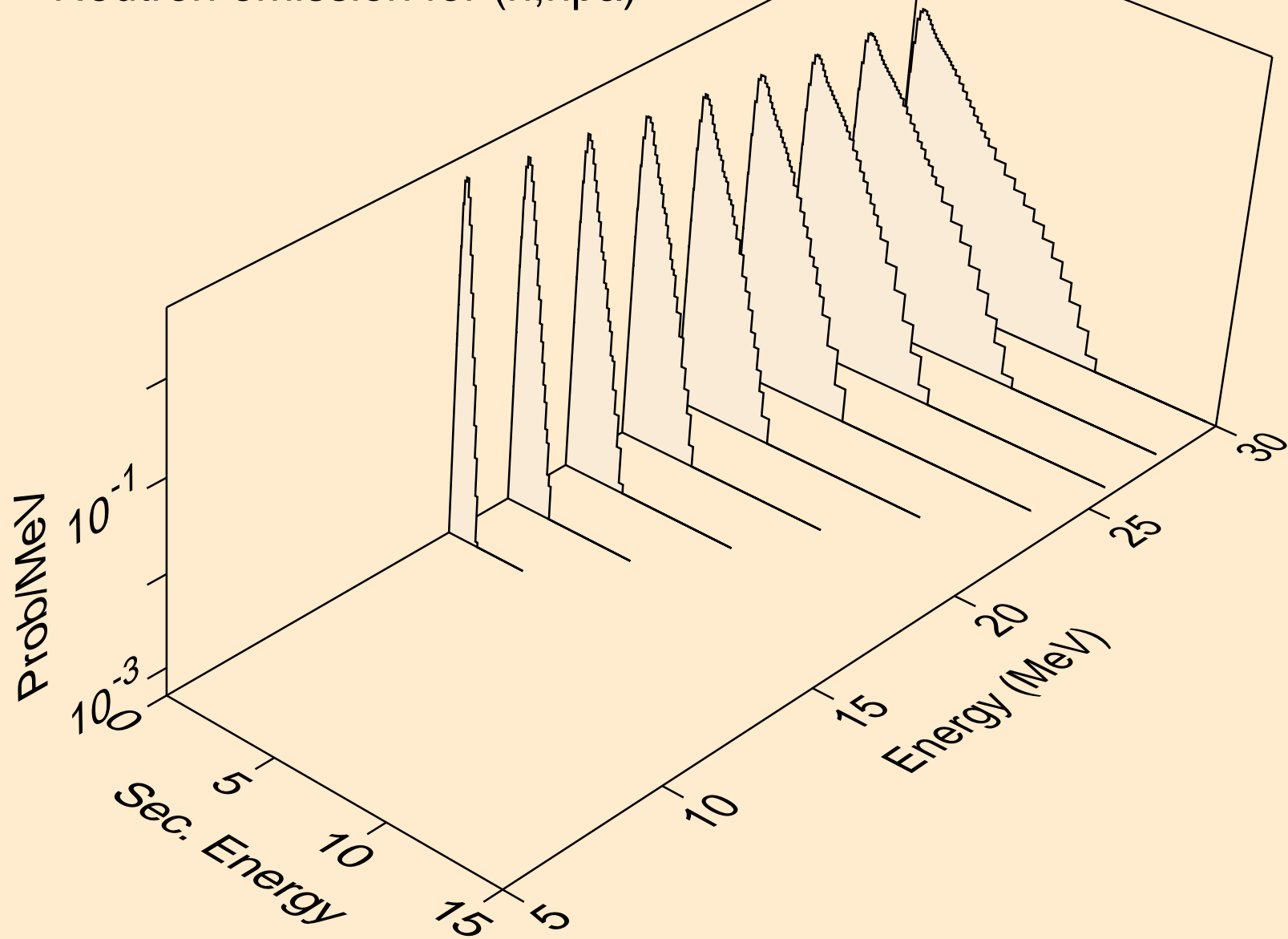

PD095M NEUTRON ACER TENDL-2021 LIBRARY; T=293.6K  
Neutron emission for (n,n\*c)

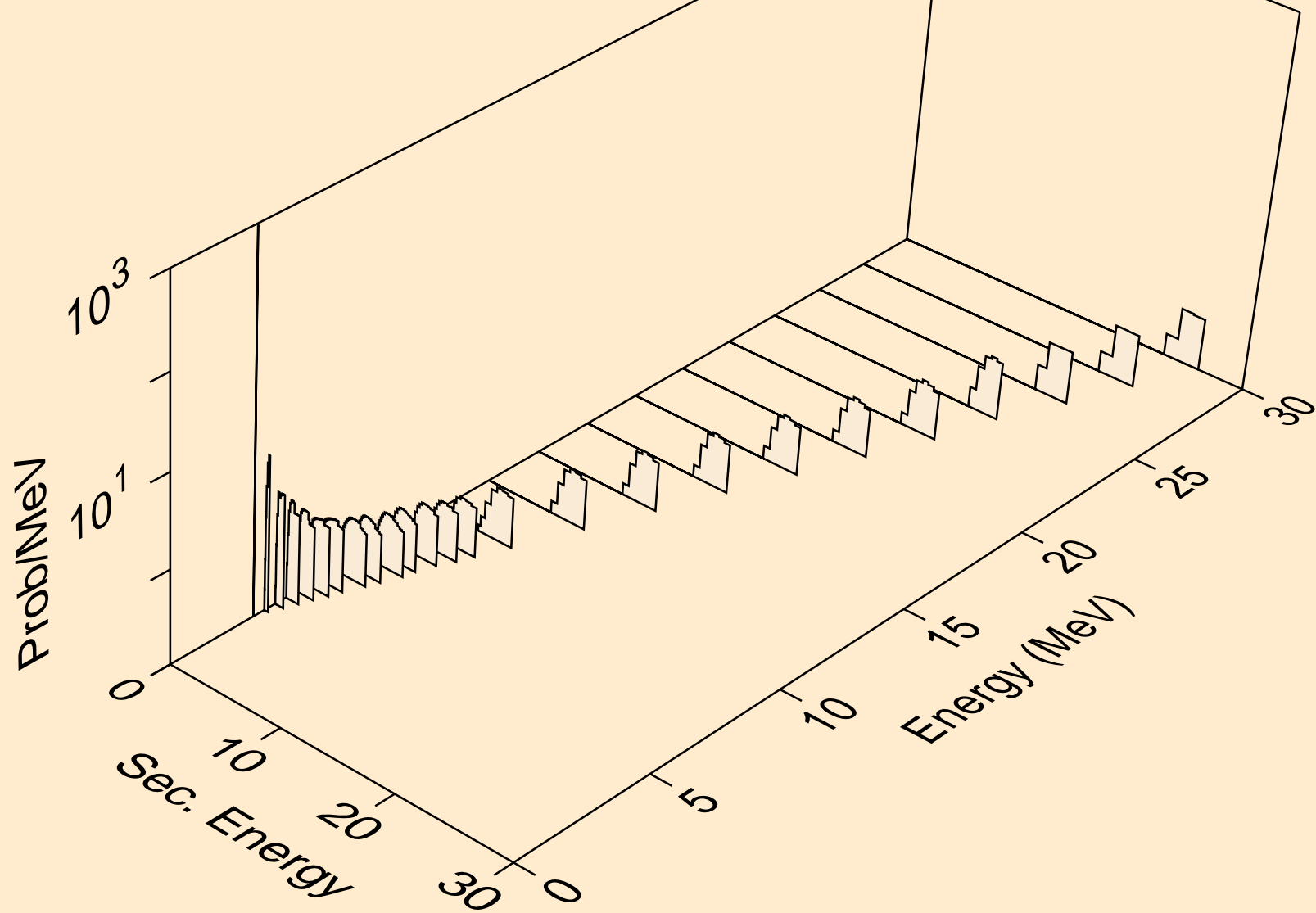

PD095M NEUTRON ACER TENDL-2021 LIBRARY; T=293.6K  
Photon emission for (n,x)

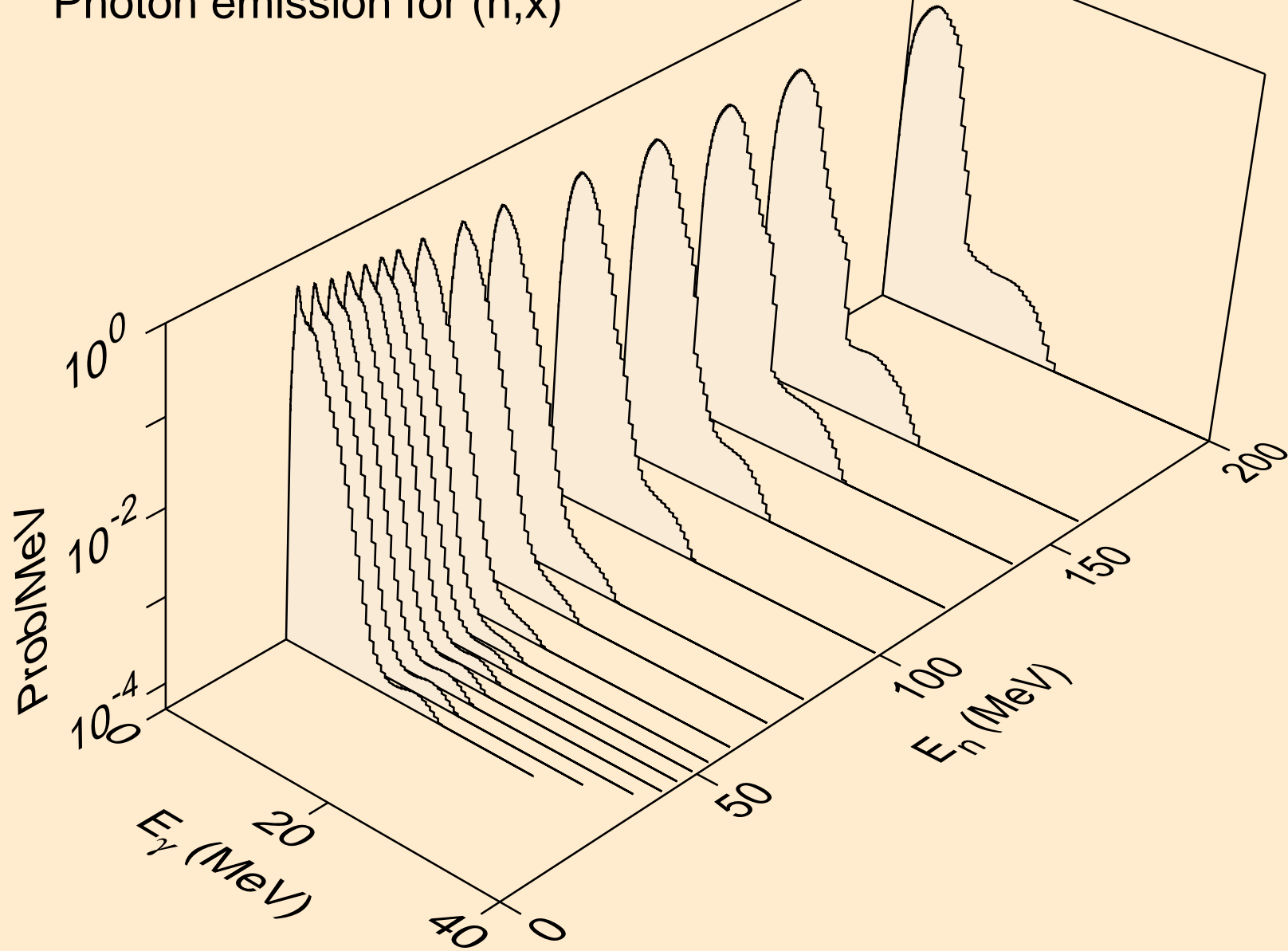

PD095M NEUTRON ACER TENDL-2021 LIBRARY; T=293.6K  
Photon emission for (n,2n)

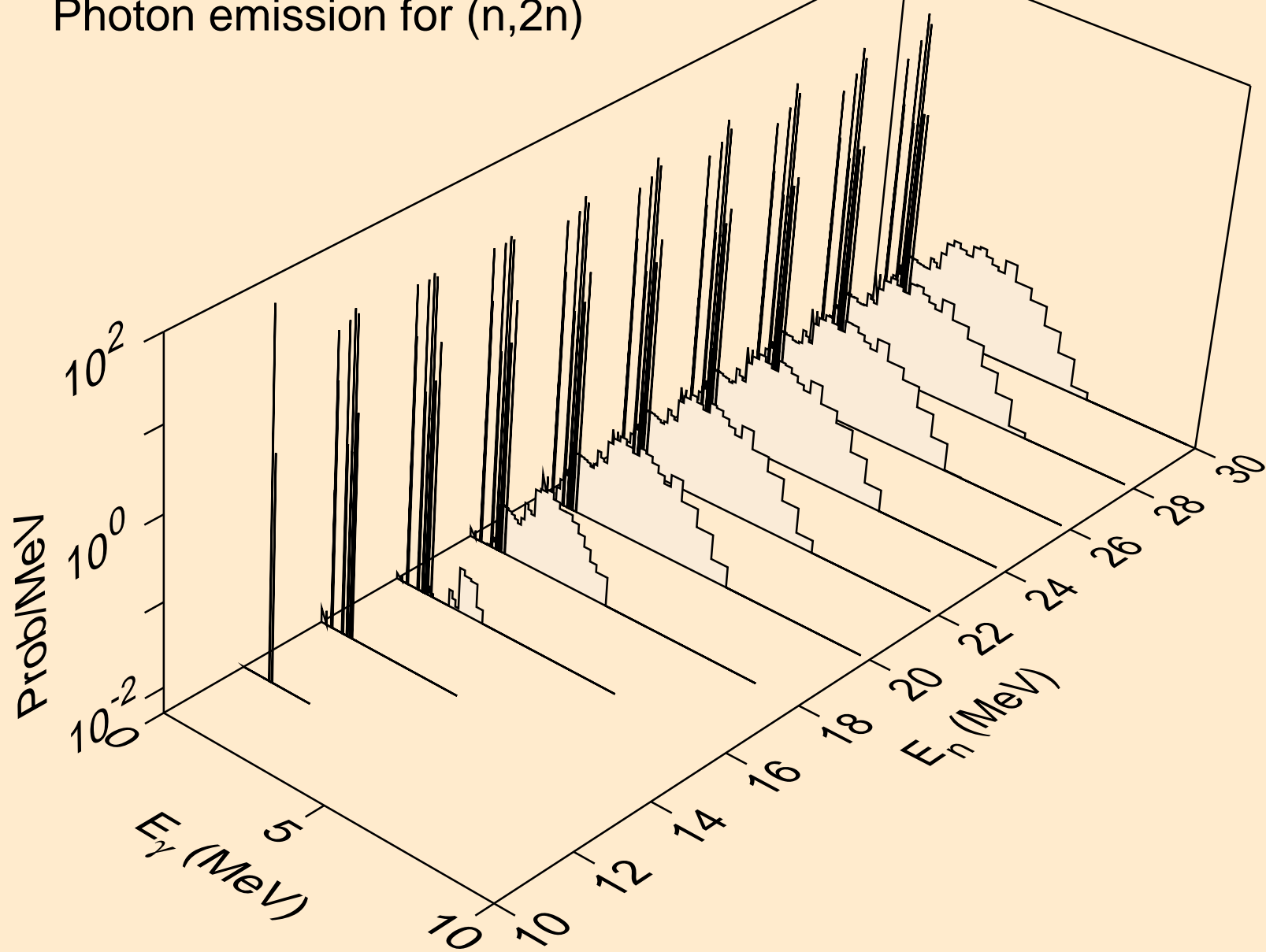



PD095M NEUTRON ACER TENDL-2021 LIBRARY; T=293.6K  
Photon emission for (n,3n)

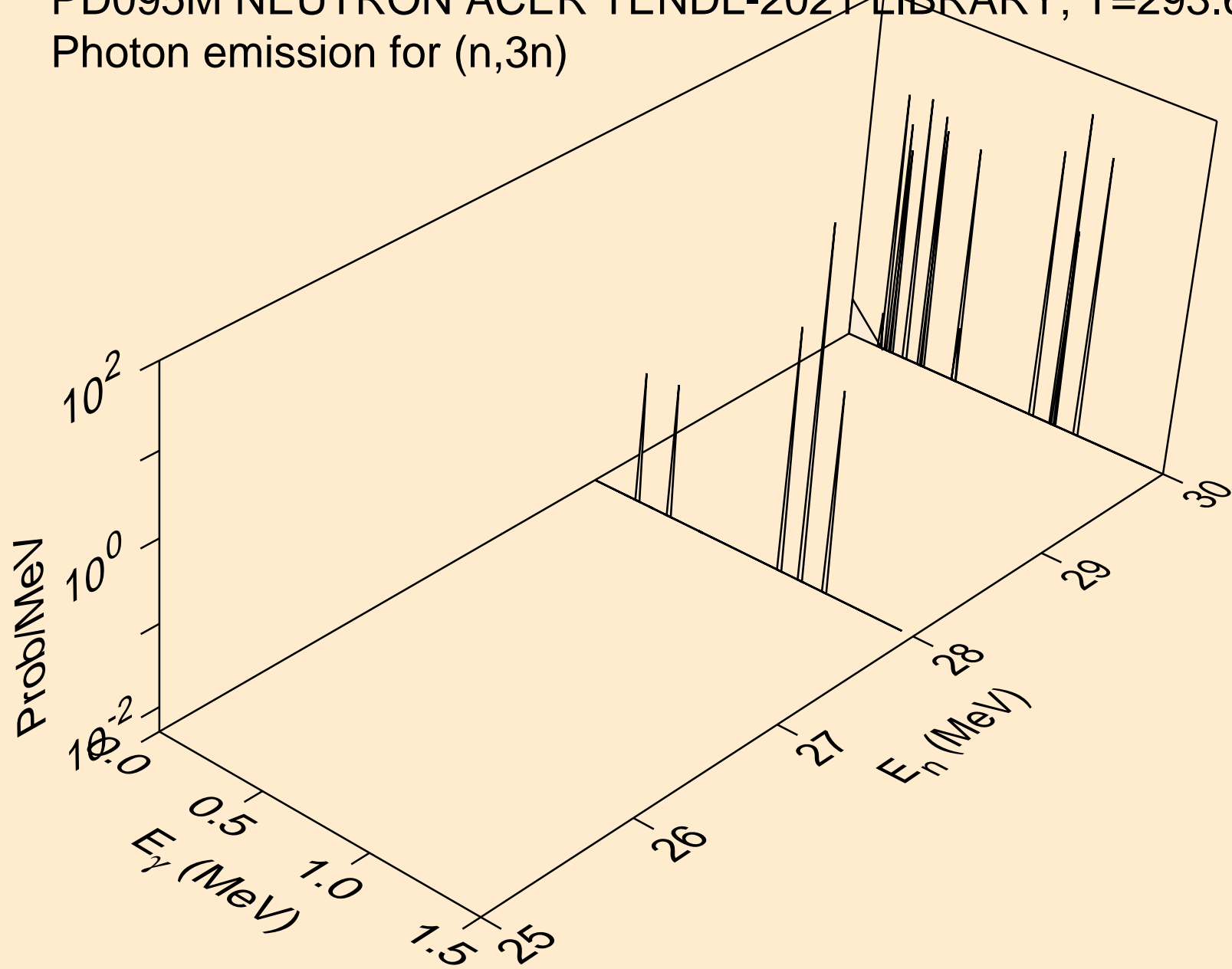

PD095M NEUTRON ACER TENDL-2021 LIBRARY; T=293.6K  
Photon emission for (n,n\*)a

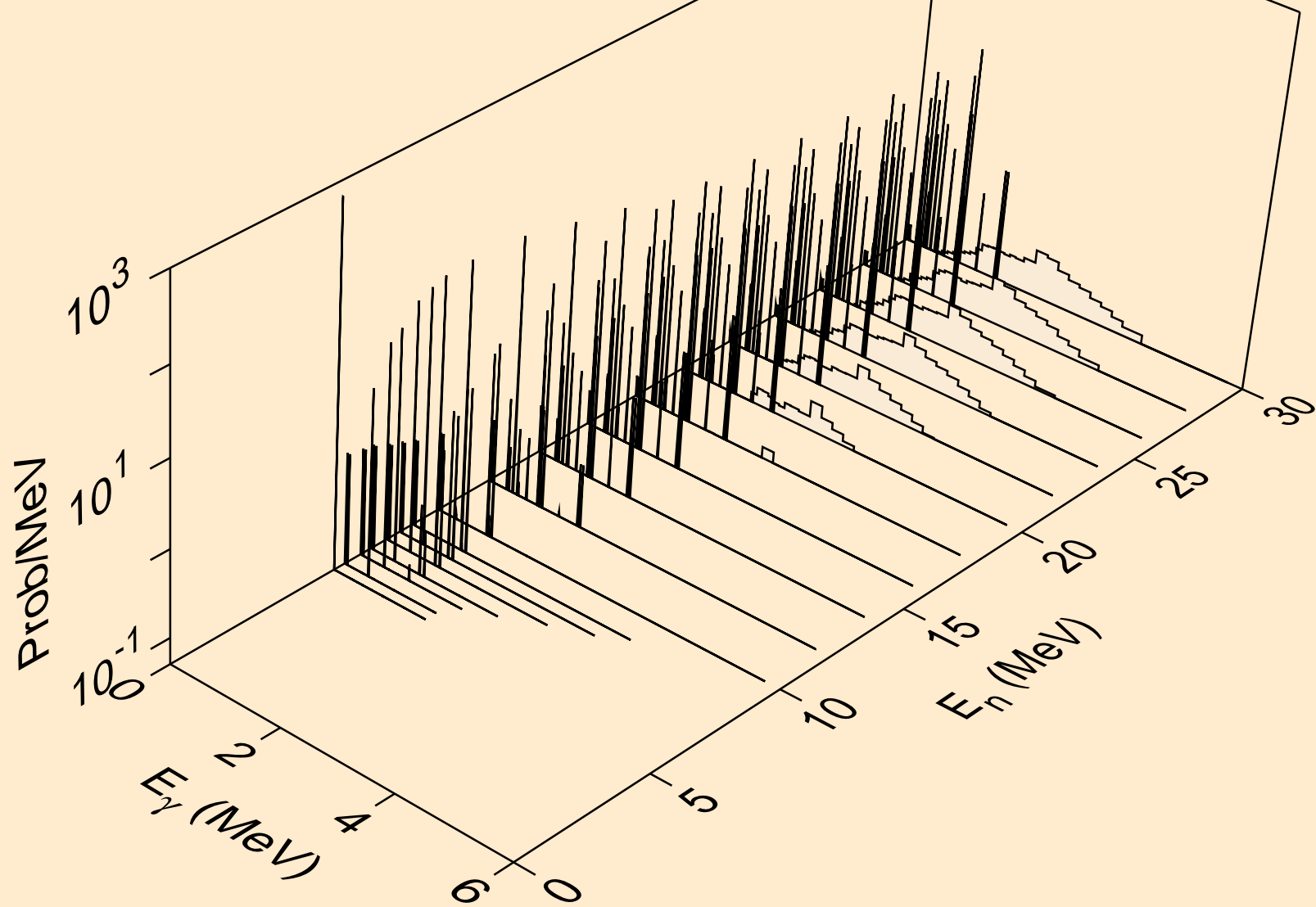

PD095M NEUTRON ACER TENDL-2021 LIBRARY; T=293.6K  
Photon emission for (n,2n)a

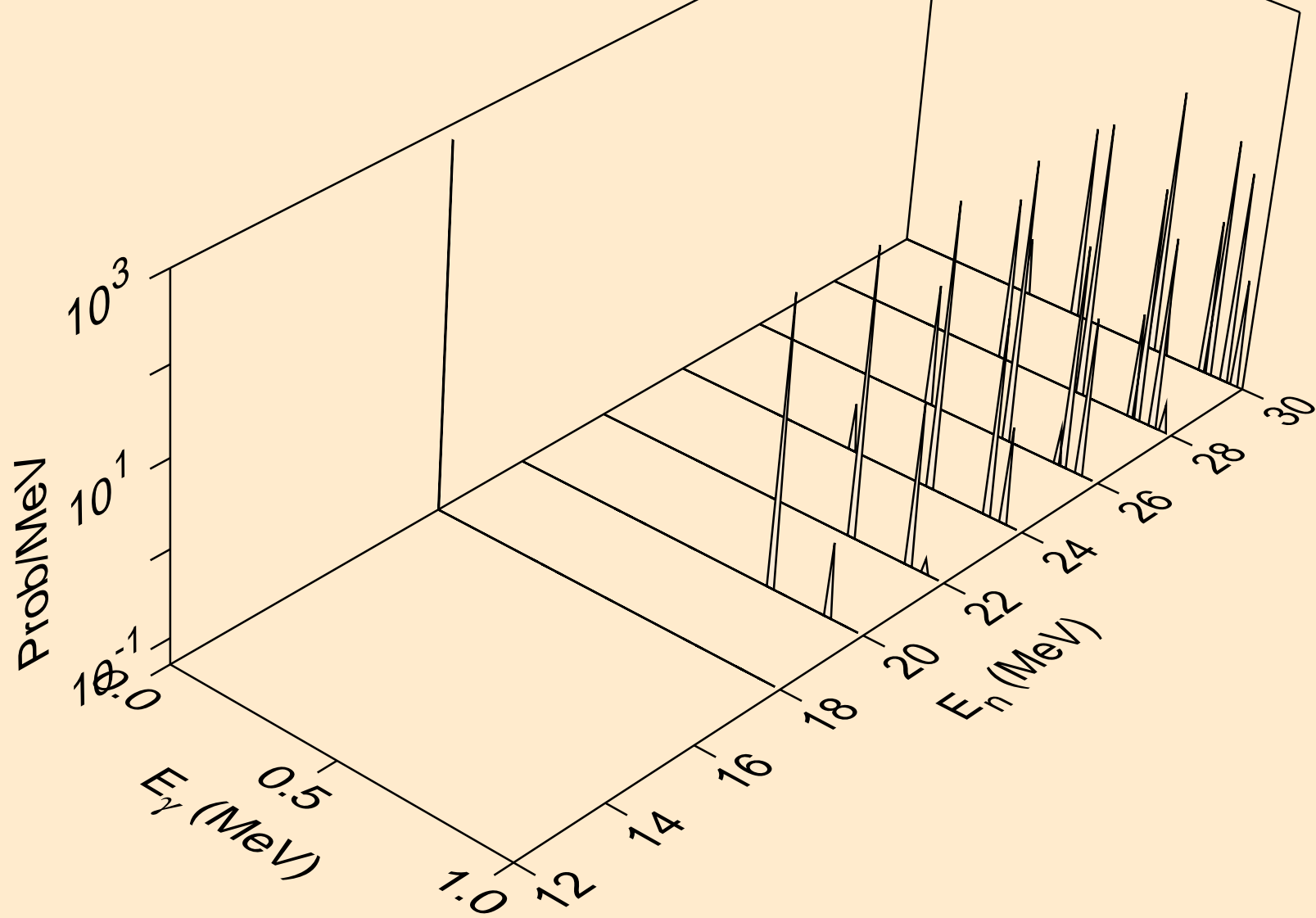

PD095M NEUTRON ACER TENDL-2021 LIBRARY; T=293.6K  
Photon emission for (n,n\*)p

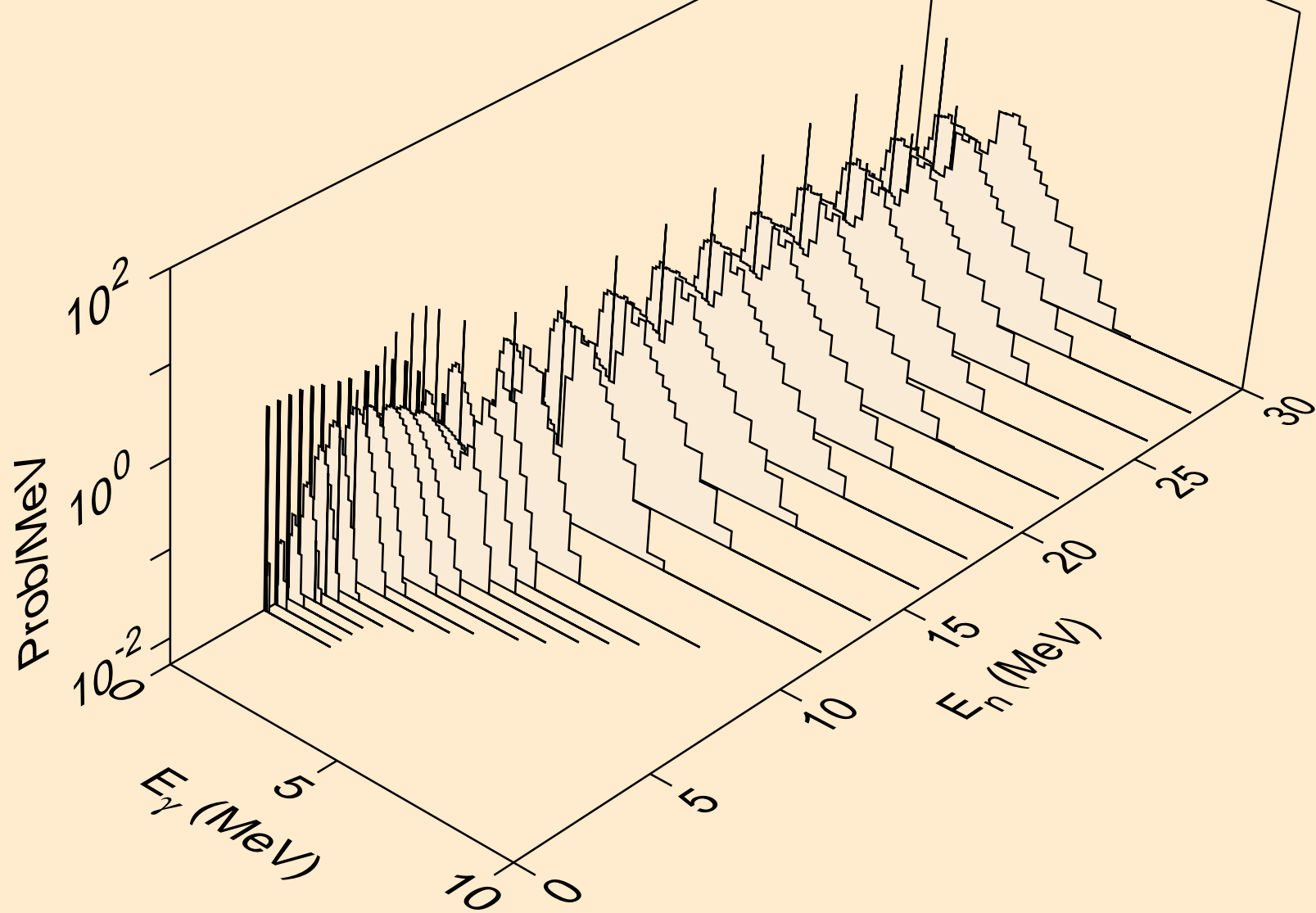

PD095M NEUTRON ACER TENDL-2021 LIBRARY; T=293.6K  
Photon emission for (n,n\*)2a

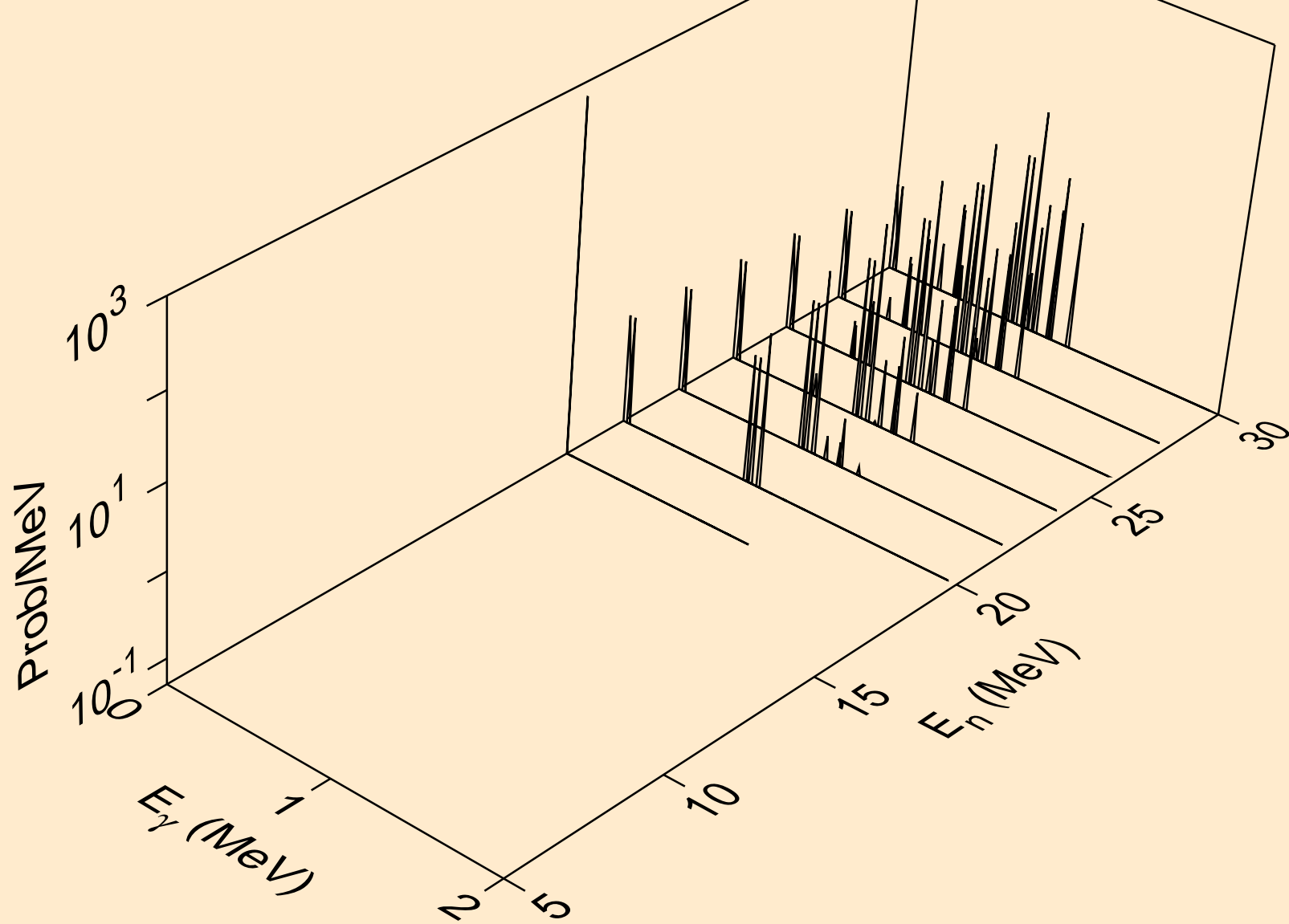

PD095M NEUTRON ACER TENDL-2021 LIBRARY; T=293.6K  
Photon emission for (n,n\*)d

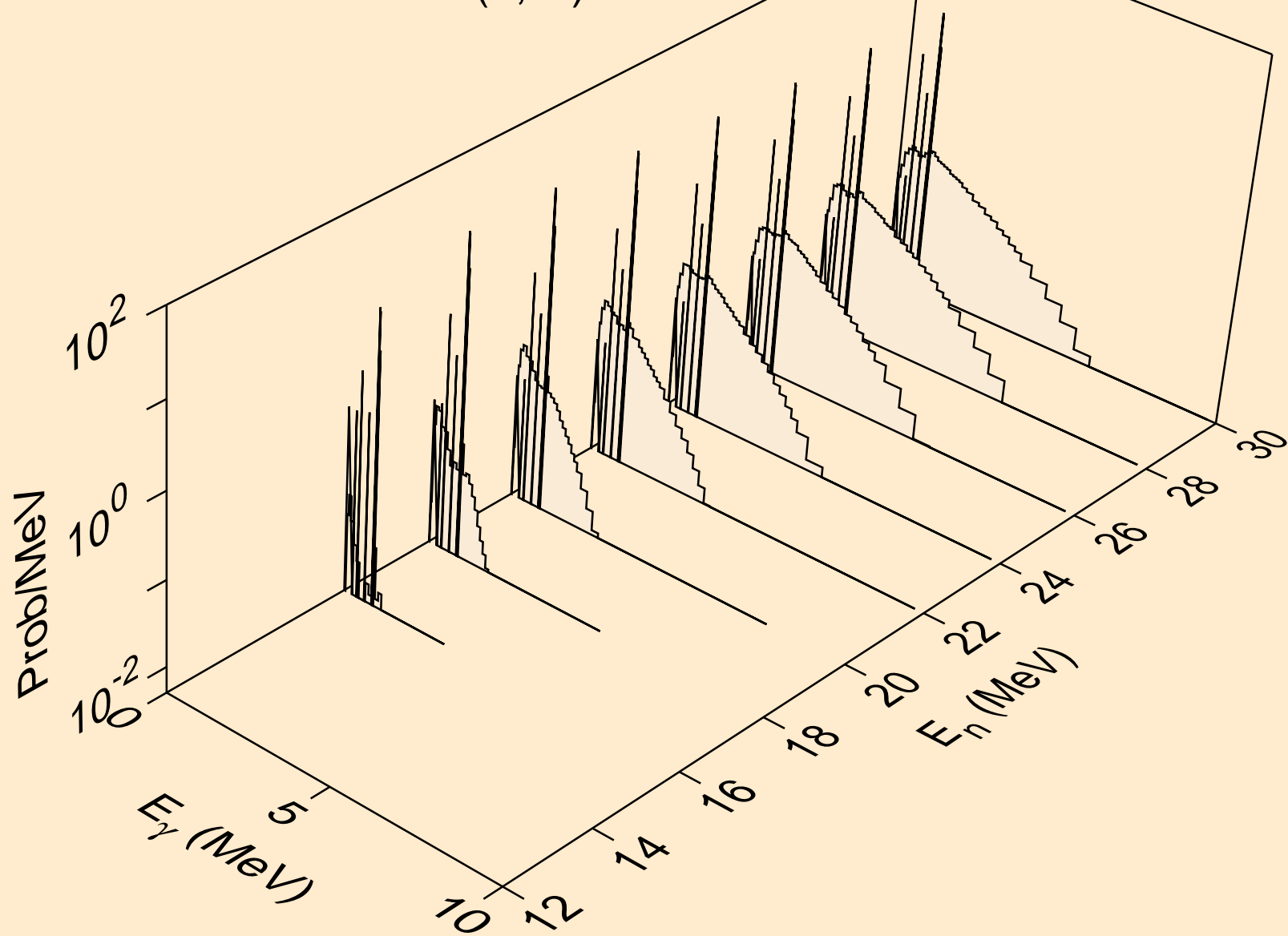

PD095M NEUTRON ACER TENDL-2021 LIBRARY; T=293.6K  
Photon emission for (n,n\*)t

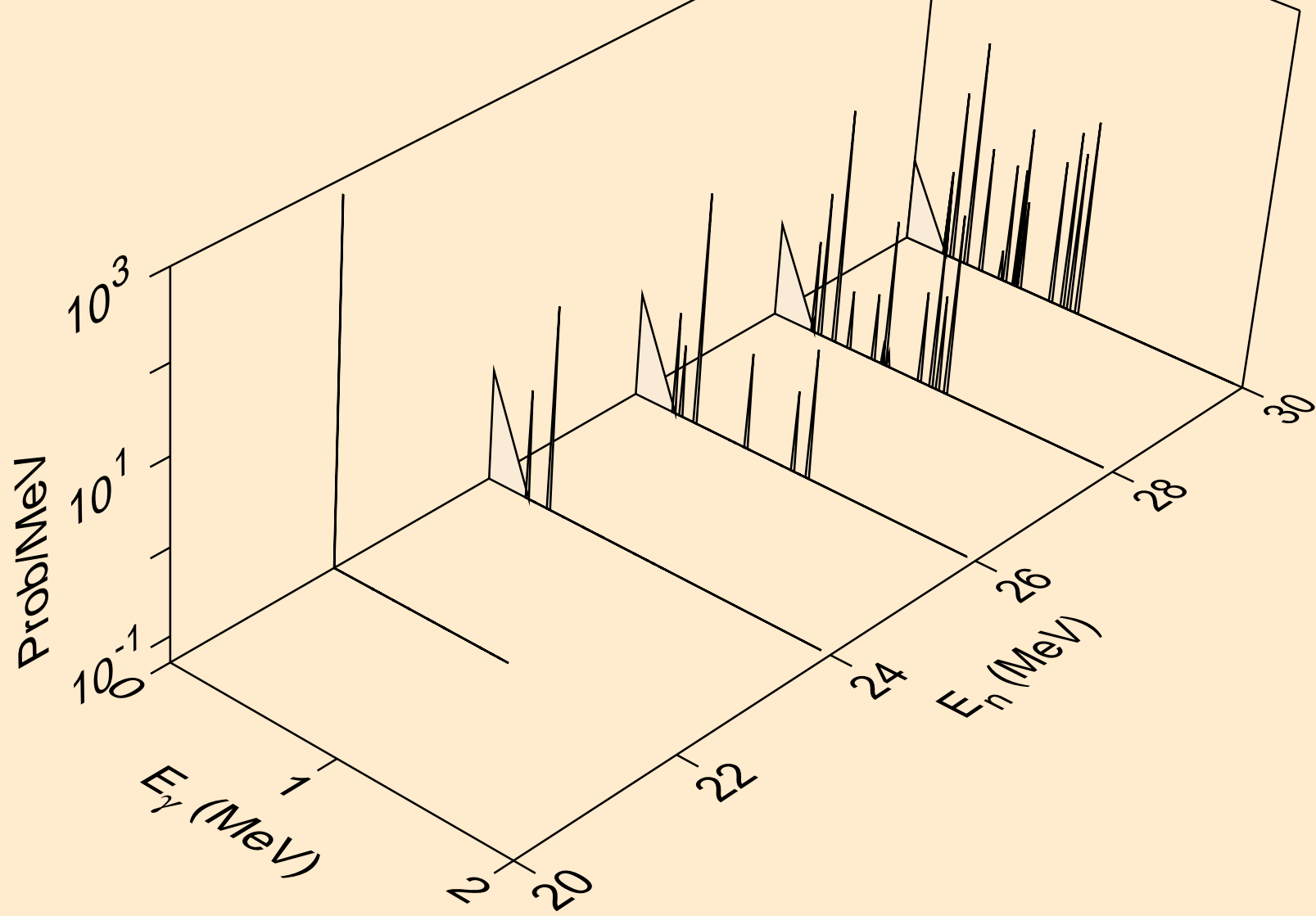

PD095M NEUTRON ACER TENDL-2021 LIBRARY; T=293.6K  
Photon emission for (n,n\*)he3

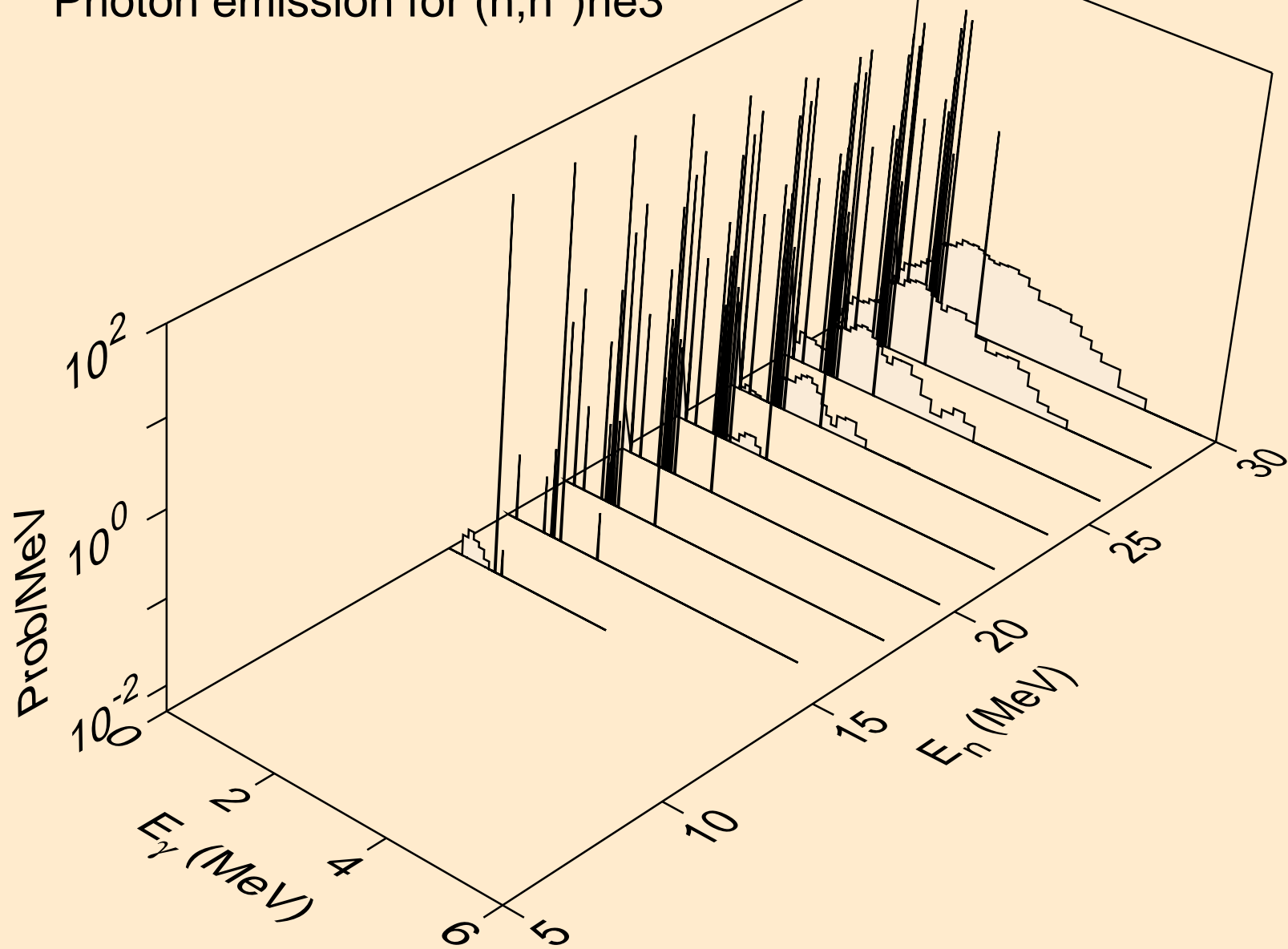



PD095M NEUTRON ACER TENDL-2021 LIBRARY; T=293.6K  
Photon emission for (n,2np)

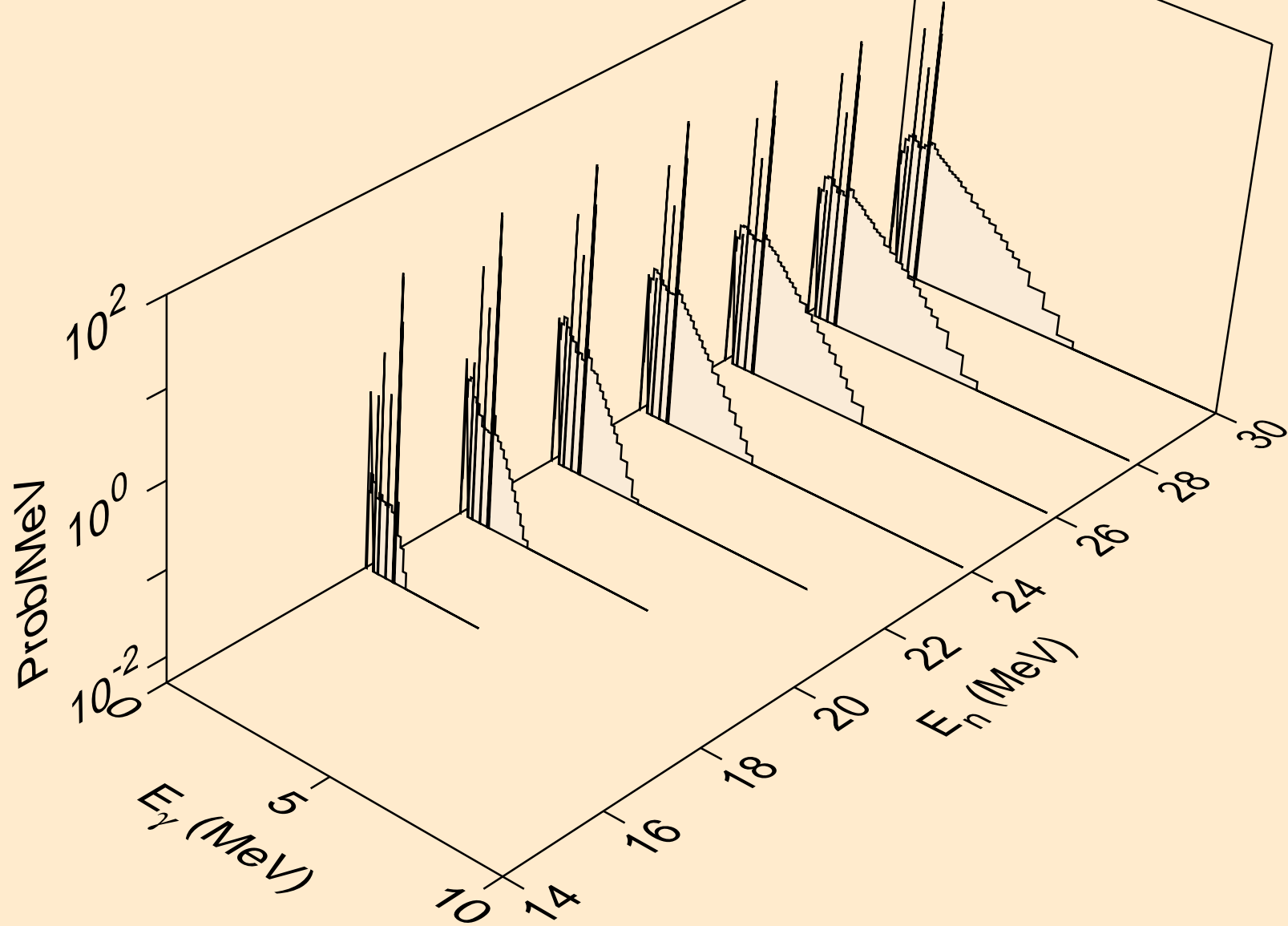

PD095M NEUTRON ACER TENDL-2021 LIBRARY; T=293.6K  
Photon emission for (n,2np)

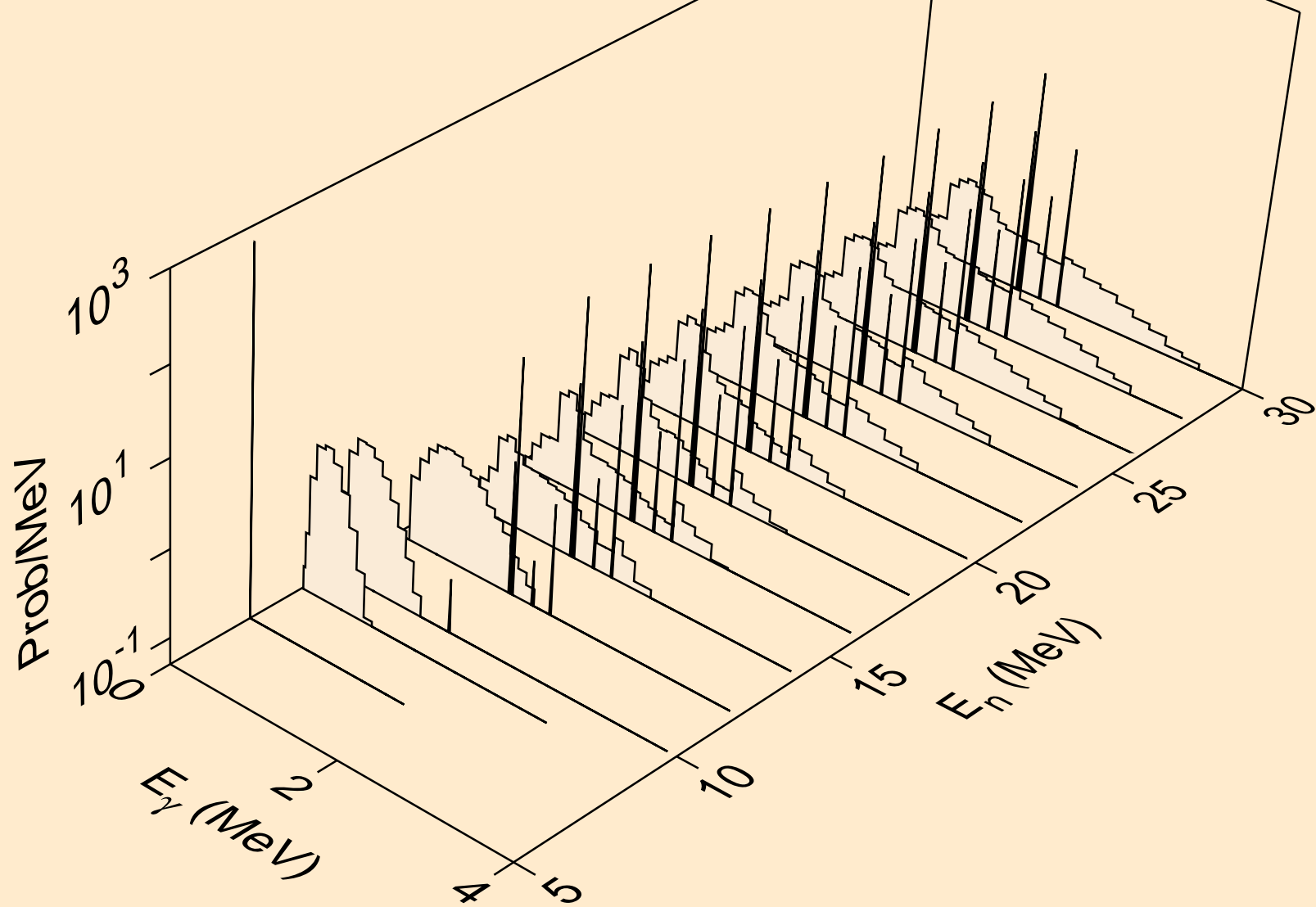

PD095M NEUTRON ACER TENDL-2021 LIBRARY; T=293.6K  
Photon emission for (n,npa)

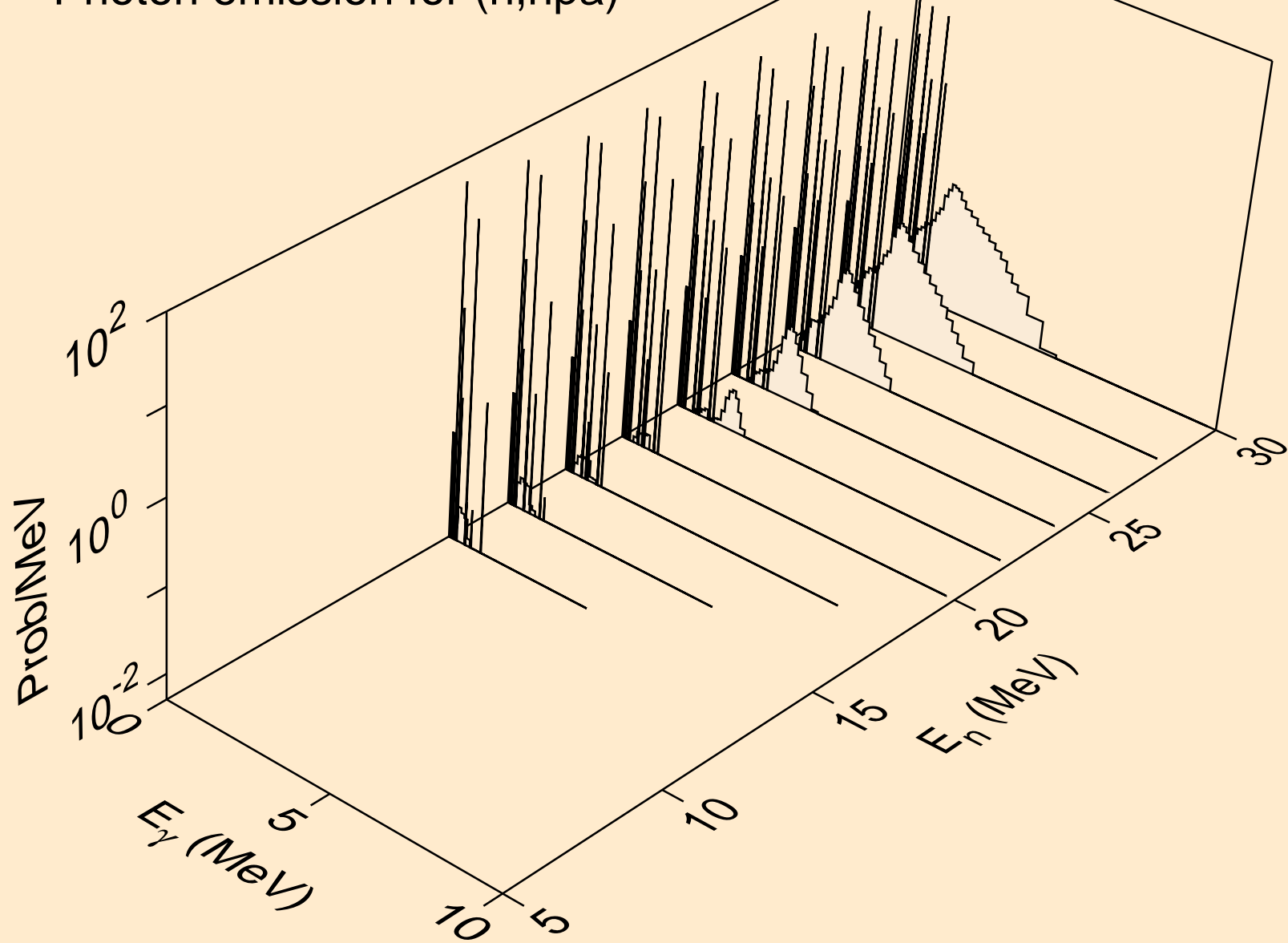

PD095M NEUTRON ACER TENDL-2021 LIBRARY; T=293.6K  
Photon emission for (n,n\*1)

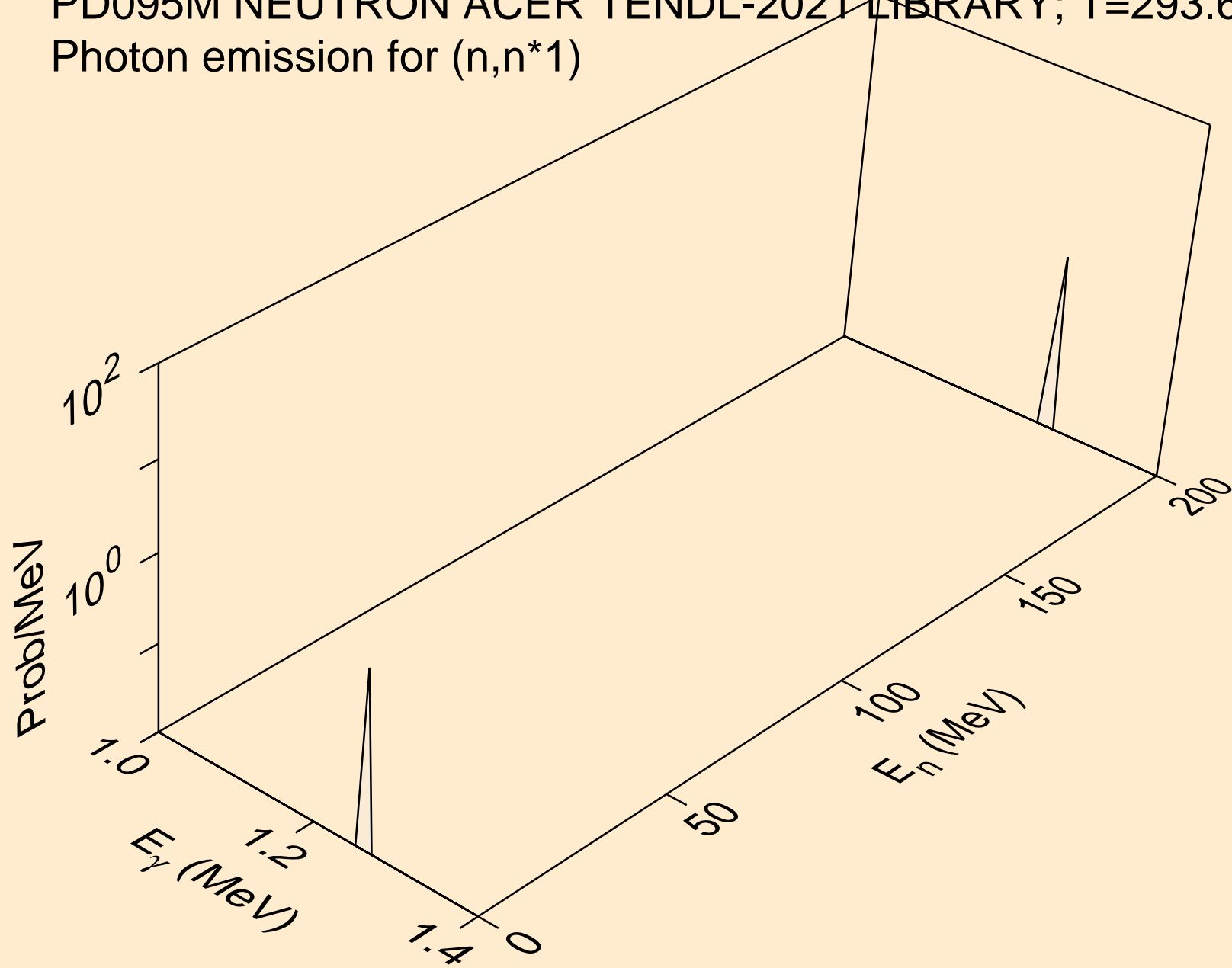

PD095M NEUTRON ACER TENDL-2021 LIBRARY; T=293.6K  
Photon emission for (n,n\*2)

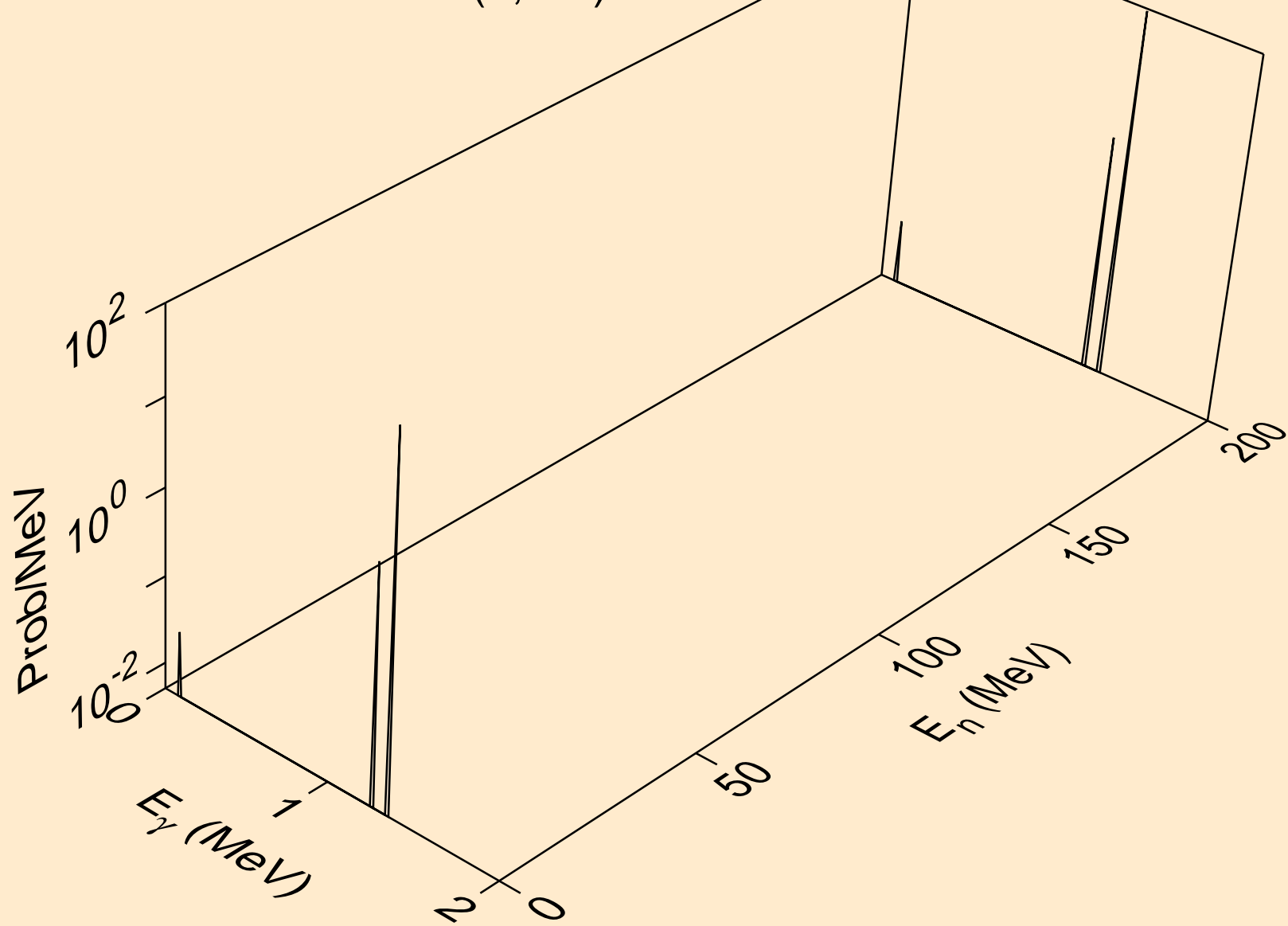

PD095M NEUTRON ACER TENDL-2021 LIBRARY; T=293.6K  
Photon emission for (n,n\*3)

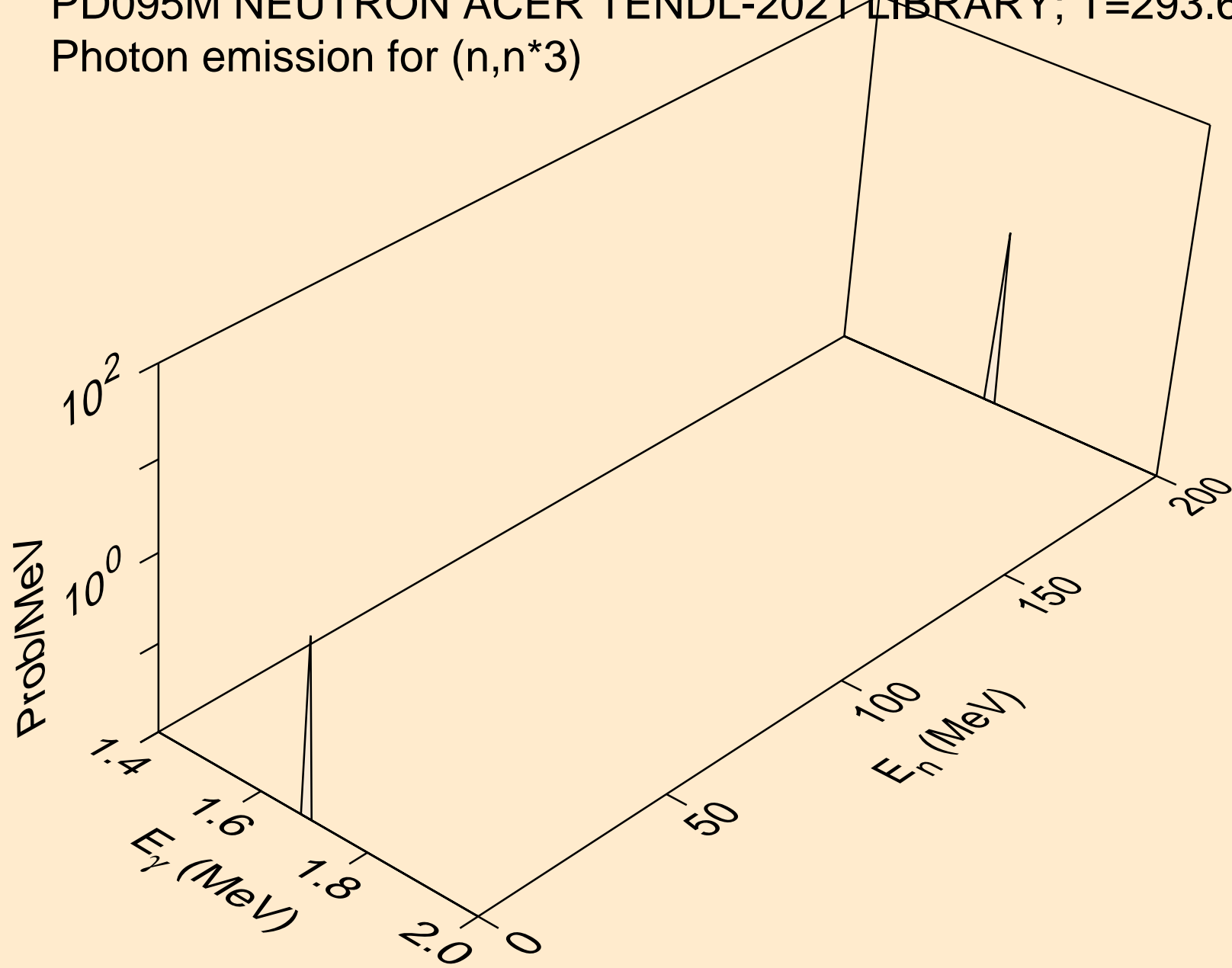

PD095M NEUTRON ACER TENDL-2021 LIBRARY; T=293.6K  
Photon emission for (n,n\*4)

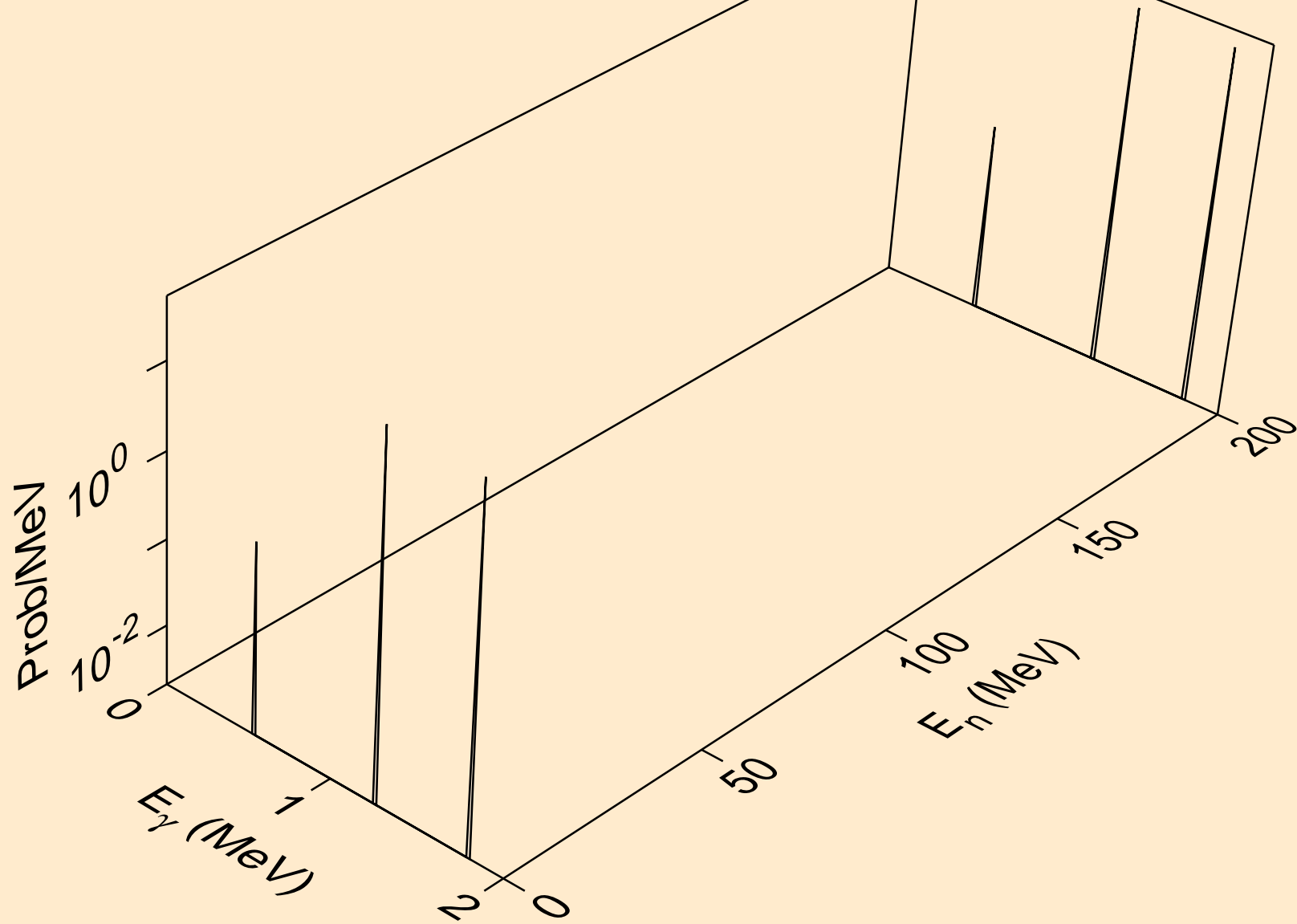

PD095M NEUTRON ACER TENDL-2021 LIBRARY; T=293.6K  
Photon emission for (n,n\*6)

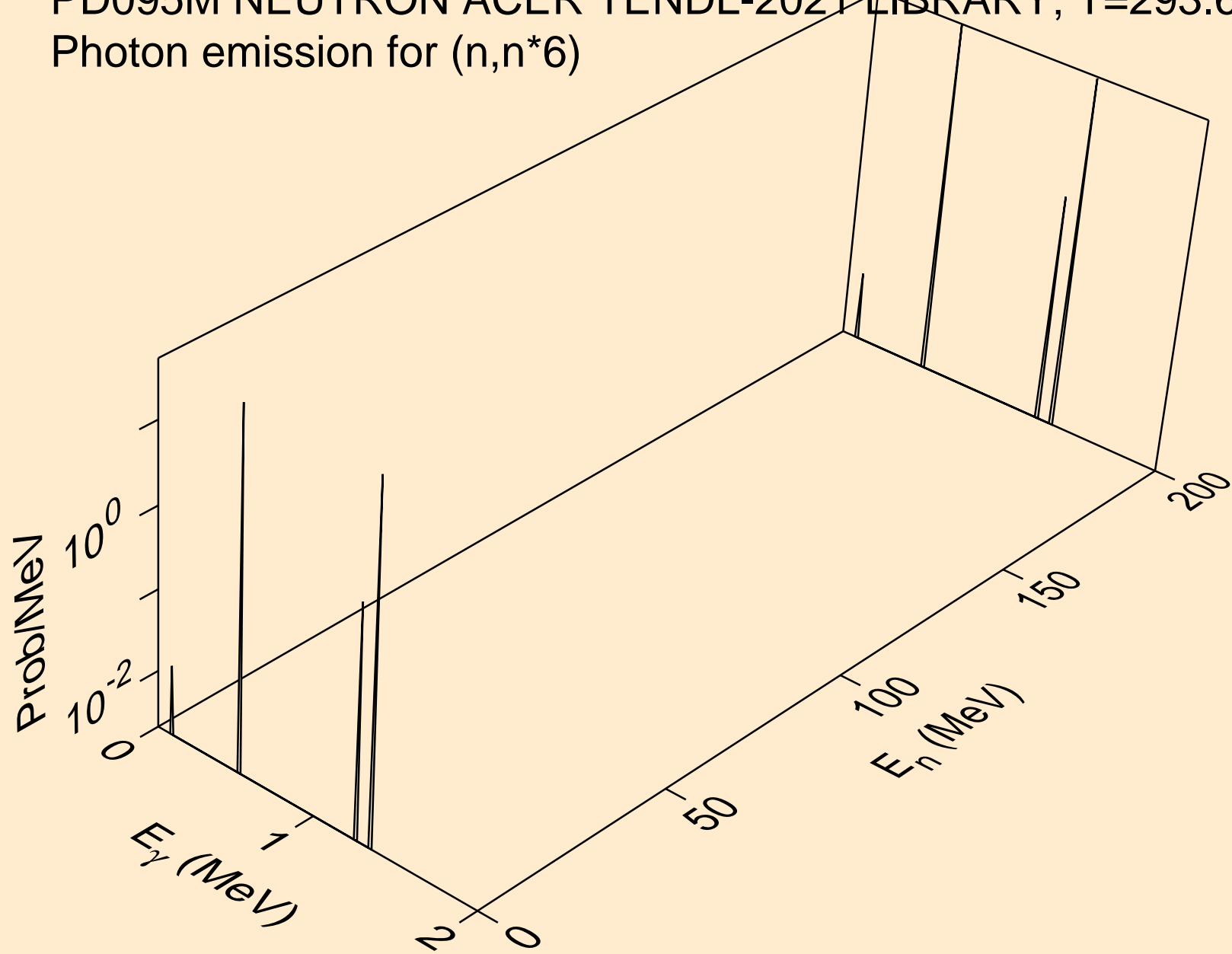



PD095M NEUTRON ACER TENDL-2021 LIBRARY; T=293.6K  
Photon emission for (n,n\*7)

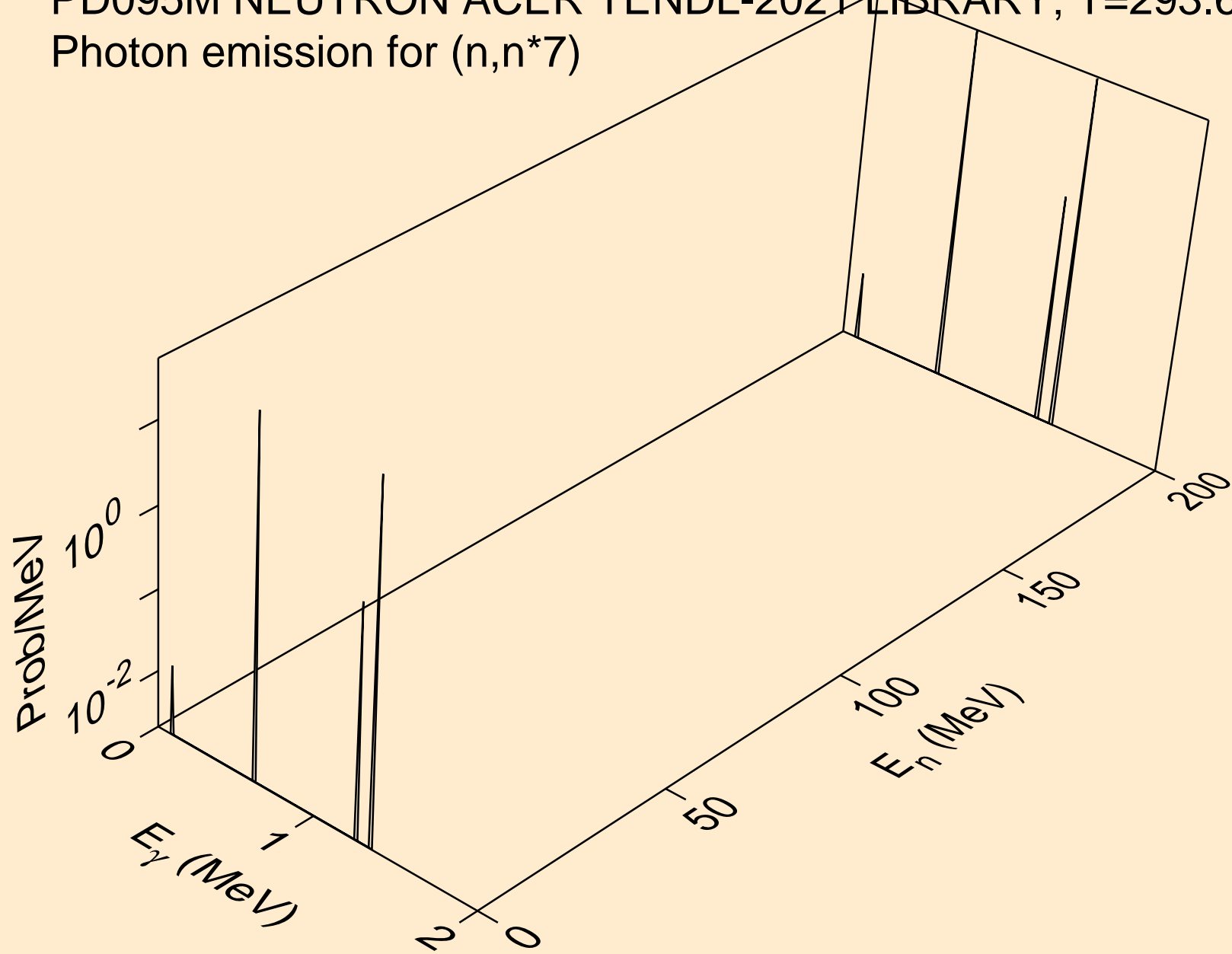

PD095M NEUTRON ACER TENDL-2021 LIBRARY; T=293.6K  
Photon emission for (n,n\*8)

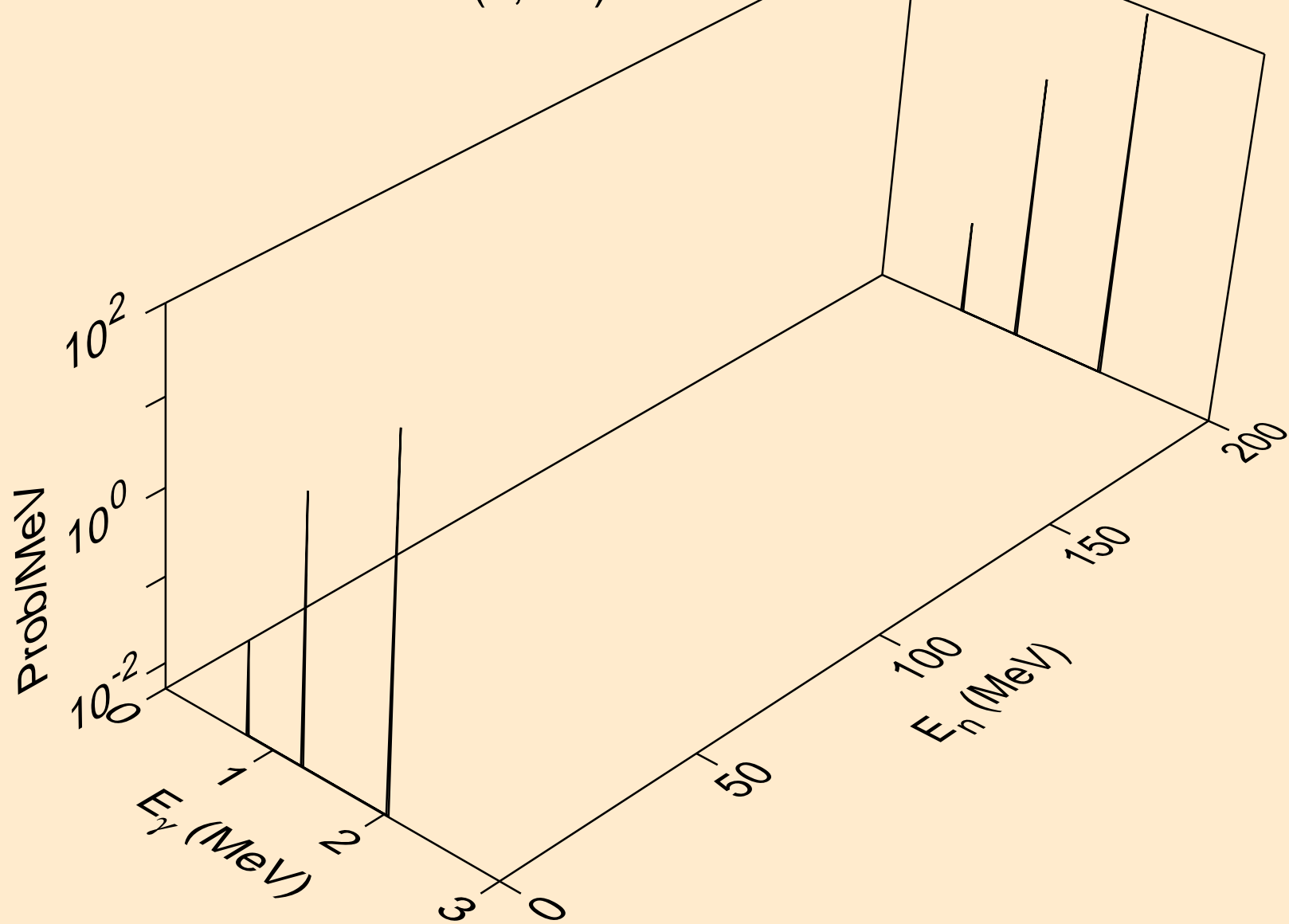

PD095M NEUTRON ACER TENDL-2021 LIBRARY; T=293.6K  
Photon emission for (n,n\*9)

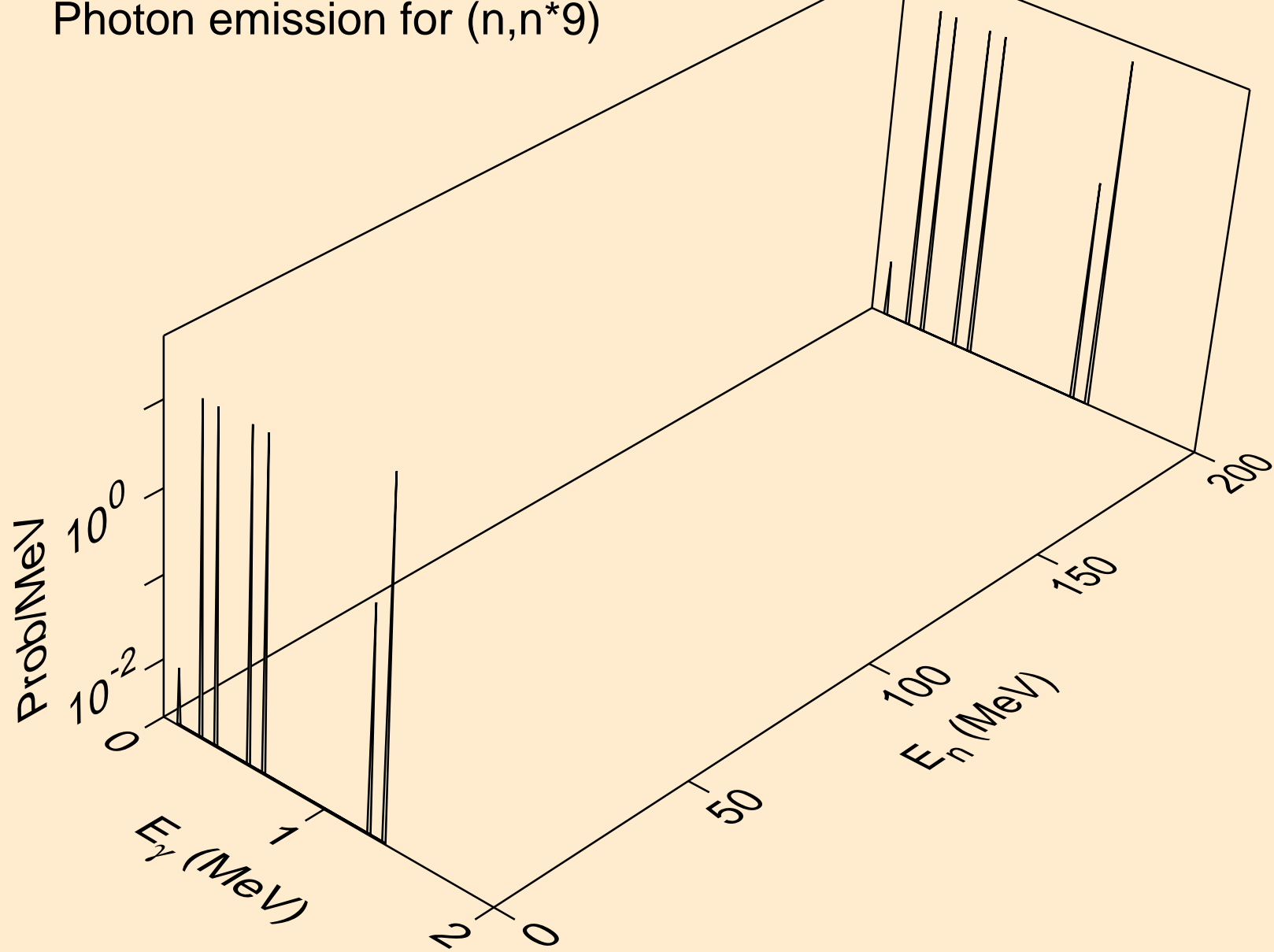

PD095M NEUTRON ACER TENDL-2021 LIBRARY; T=293.6K  
Photon emission for (n,n\*10)

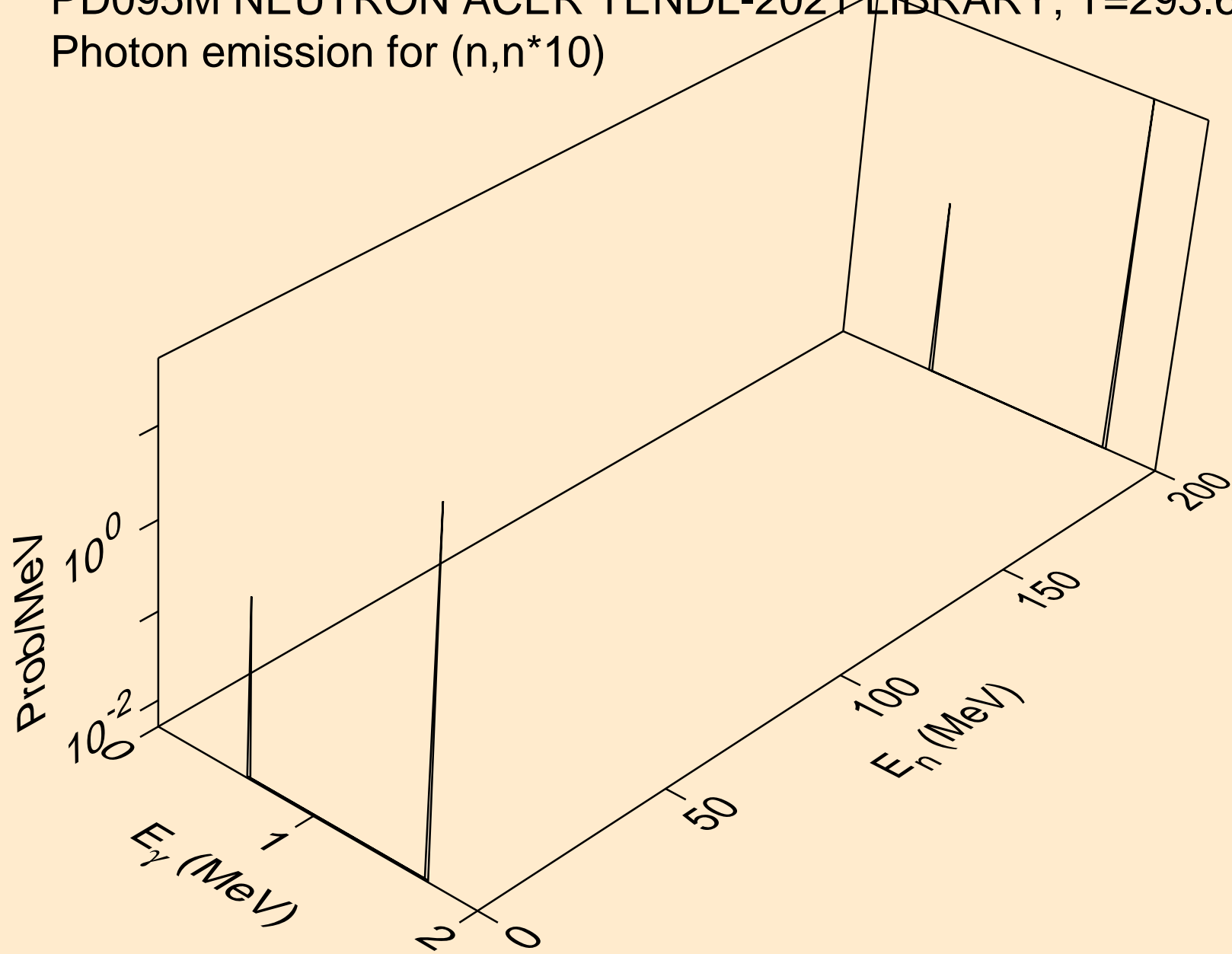

PD095M NEUTRON ACER TENDL-2021 LIBRARY; T=293.6K  
Photon emission for (n,n\*11)

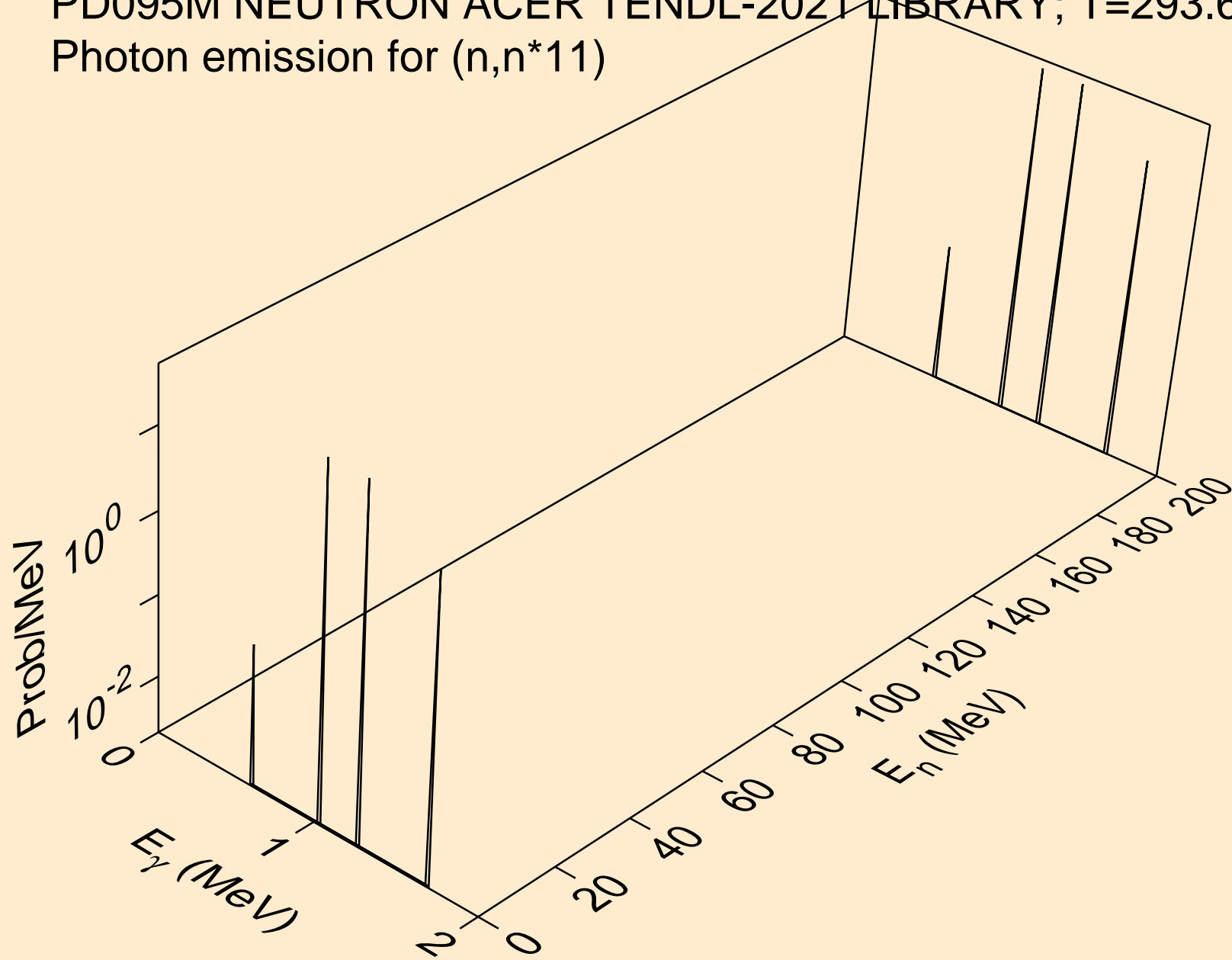

PD095M NEUTRON ACER TENDL-2021 LIBRARY; T=293.6K  
Photon emission for (n,n\*12)

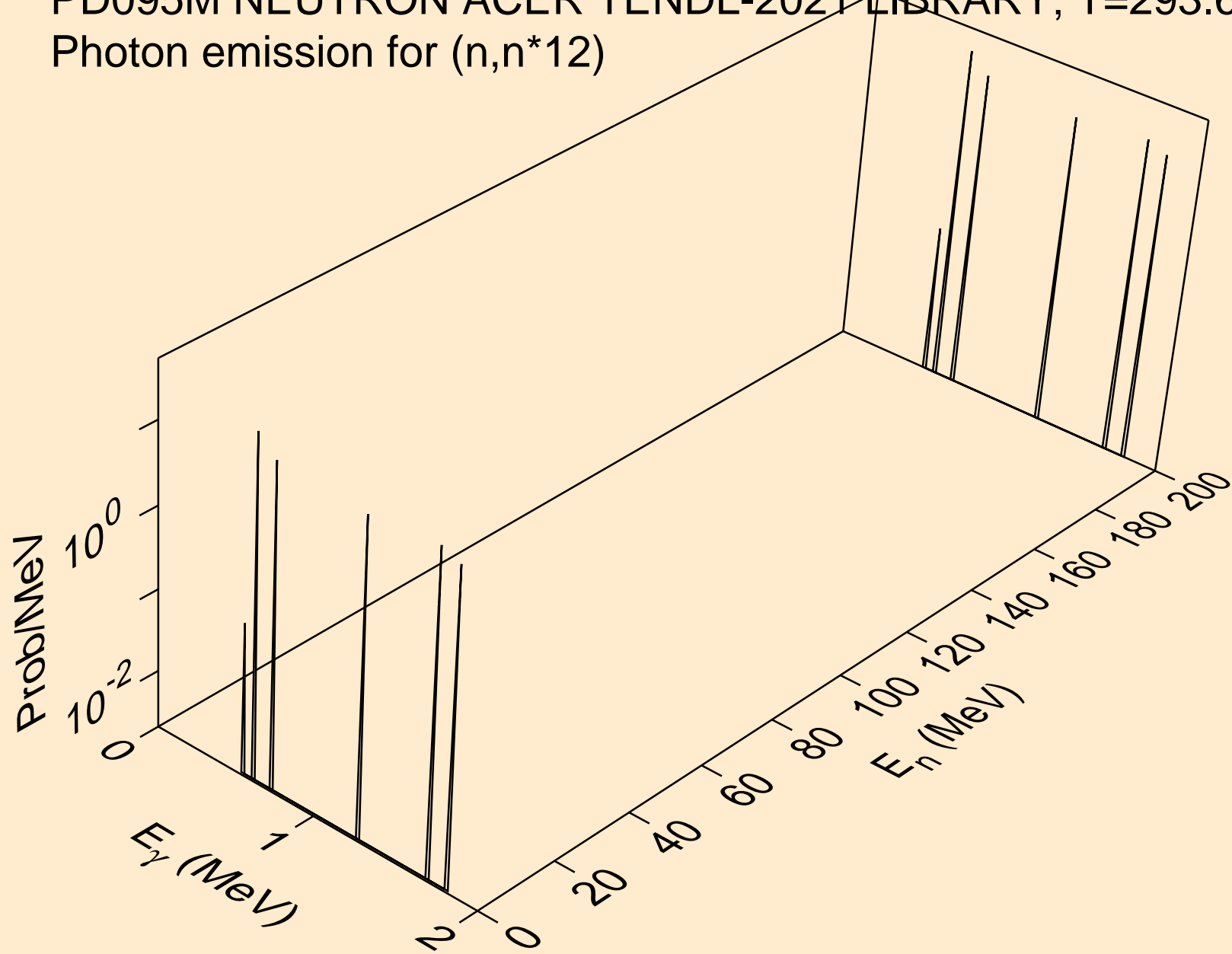

PD095M NEUTRON ACER TENDL-2021 LIBRARY; T=293.6K  
Photon emission for (n,n\*13)

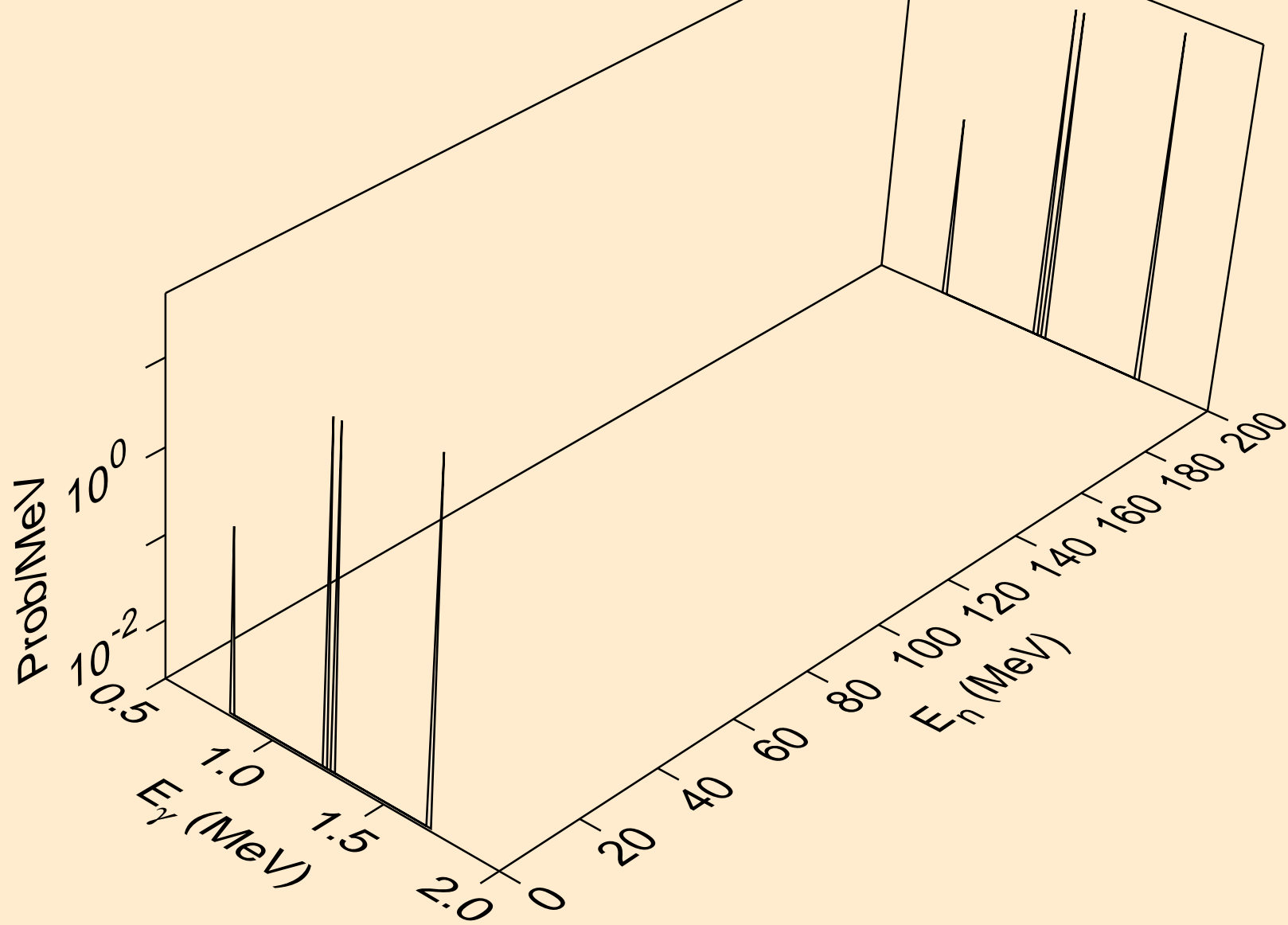

PD095M NEUTRON ACER TENDL-2021 LIBRARY; T=293.6K  
Photon emission for (n,n\*14)

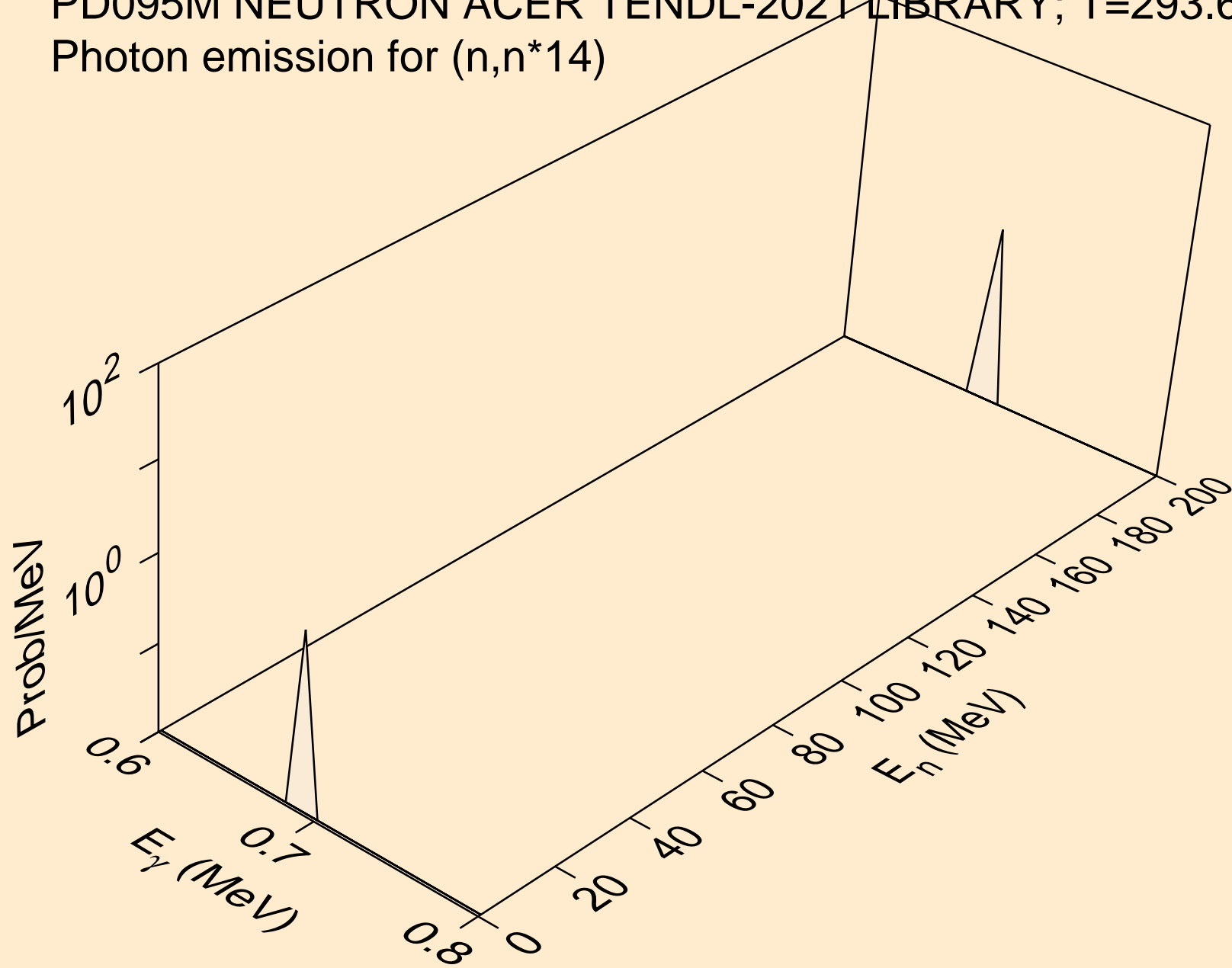



PD095M NEUTRON ACER TENDL-2021 LIBRARY; T=293.6K  
Photon emission for (n,n\*15)

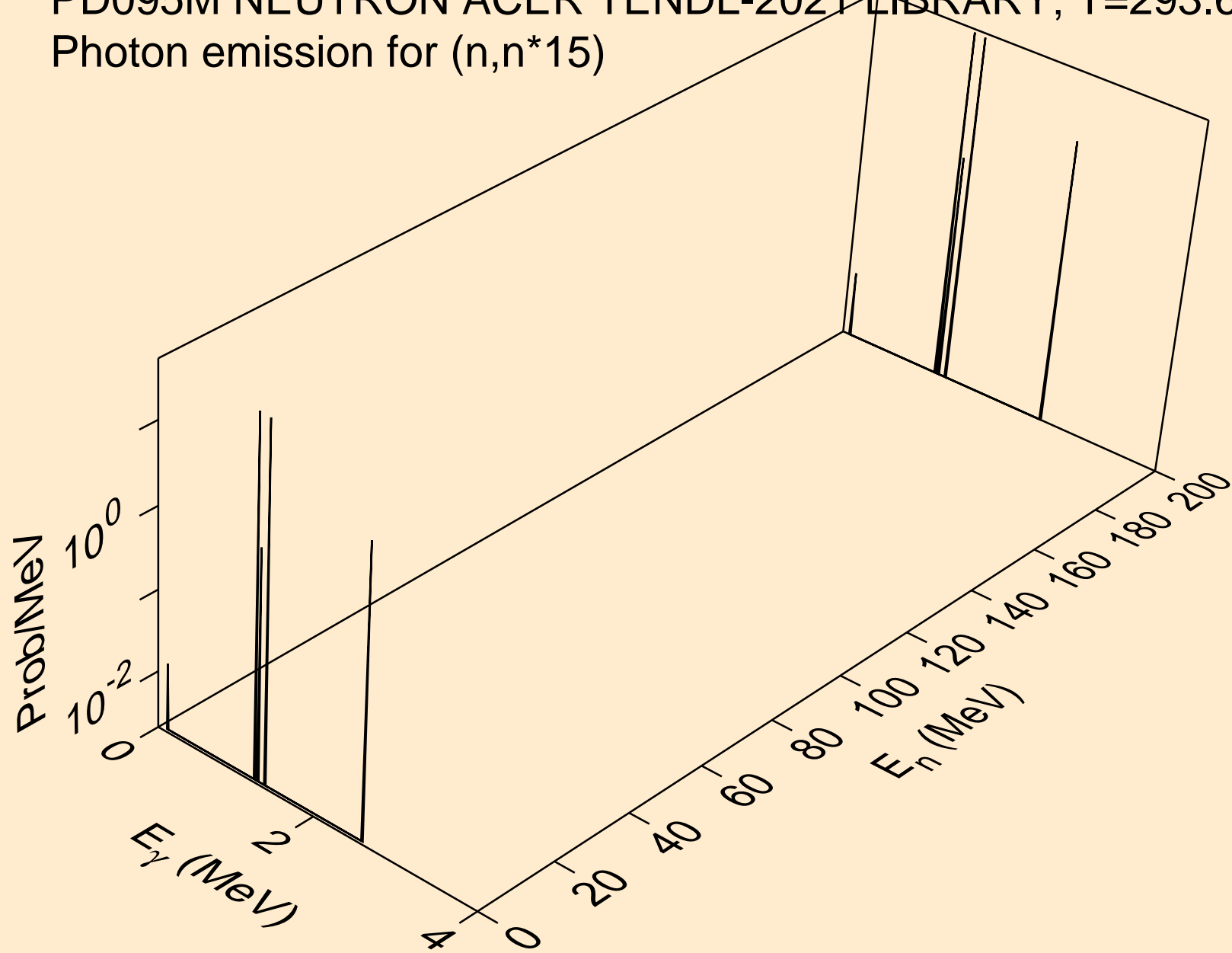

PD095M NEUTRON ACER TENDL-2021 LIBRARY; T=293.6K  
Photon emission for (n,n\*16)

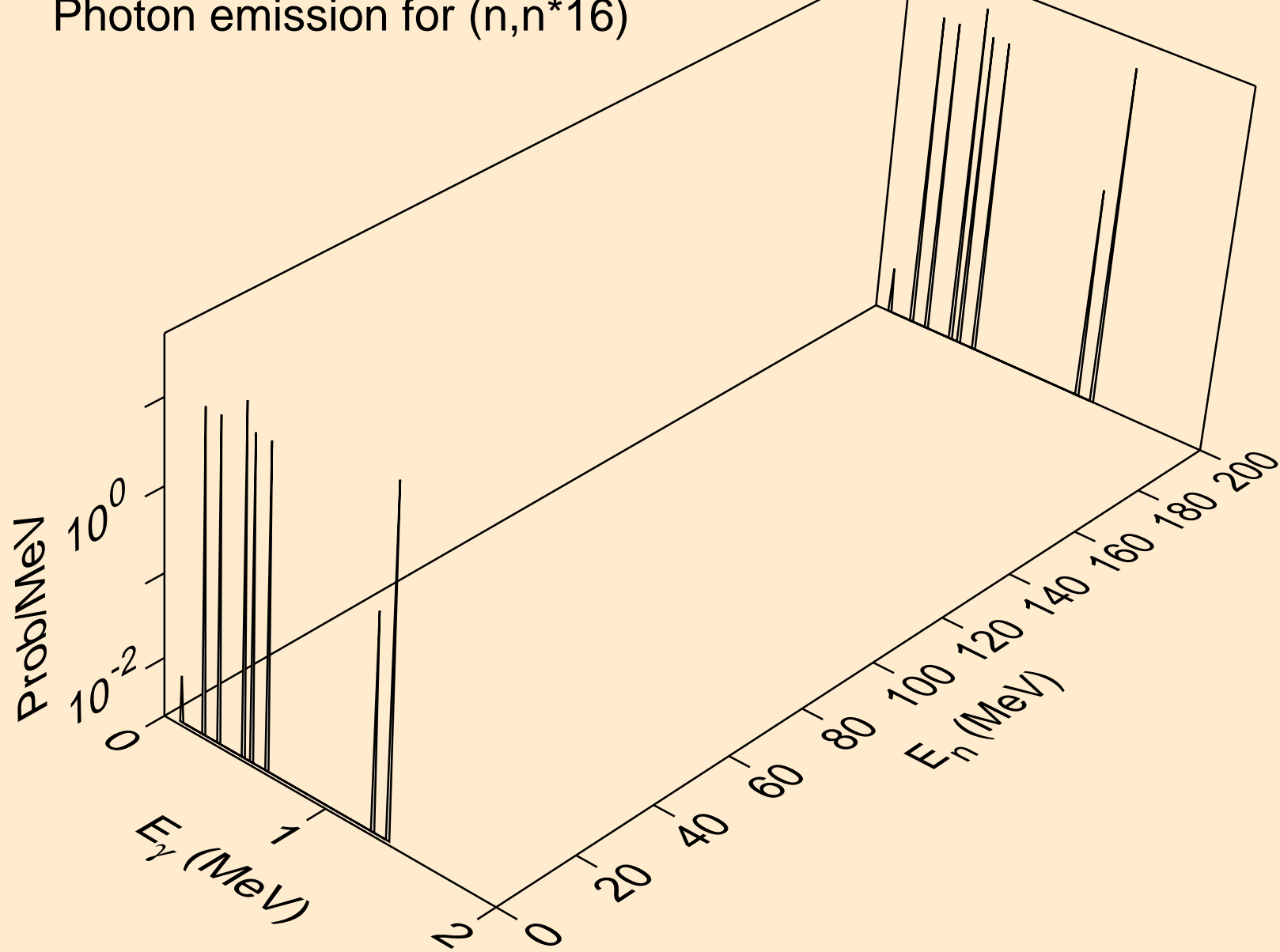

PD095M NEUTRON ACER TENDL-2021 LIBRARY; T=293.6K  
Photon emission for (n,n\*17)

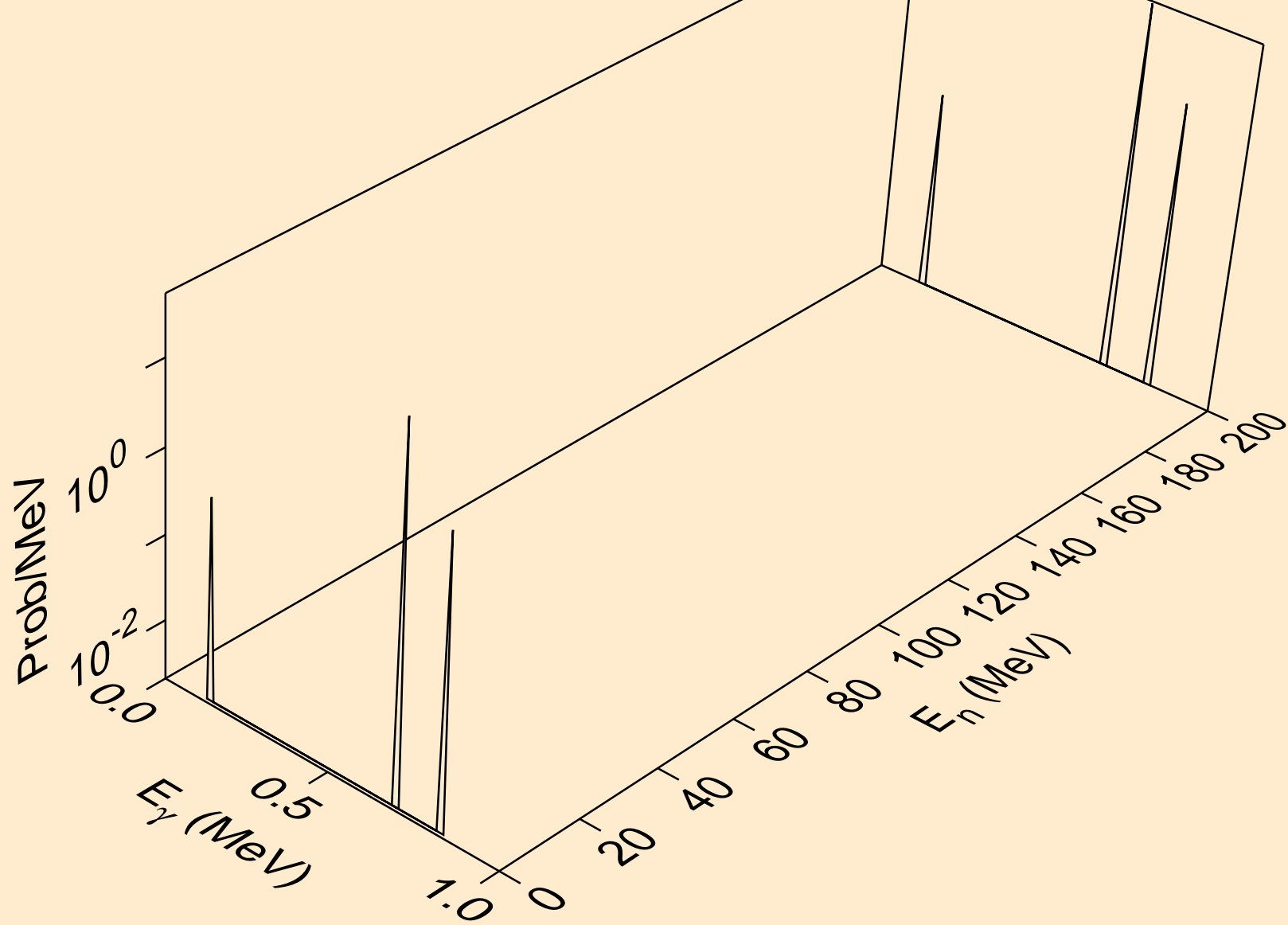

PD095M NEUTRON ACER TENDL-2021 LIBRARY; T=293.6K  
Photon emission for (n,n\*18)

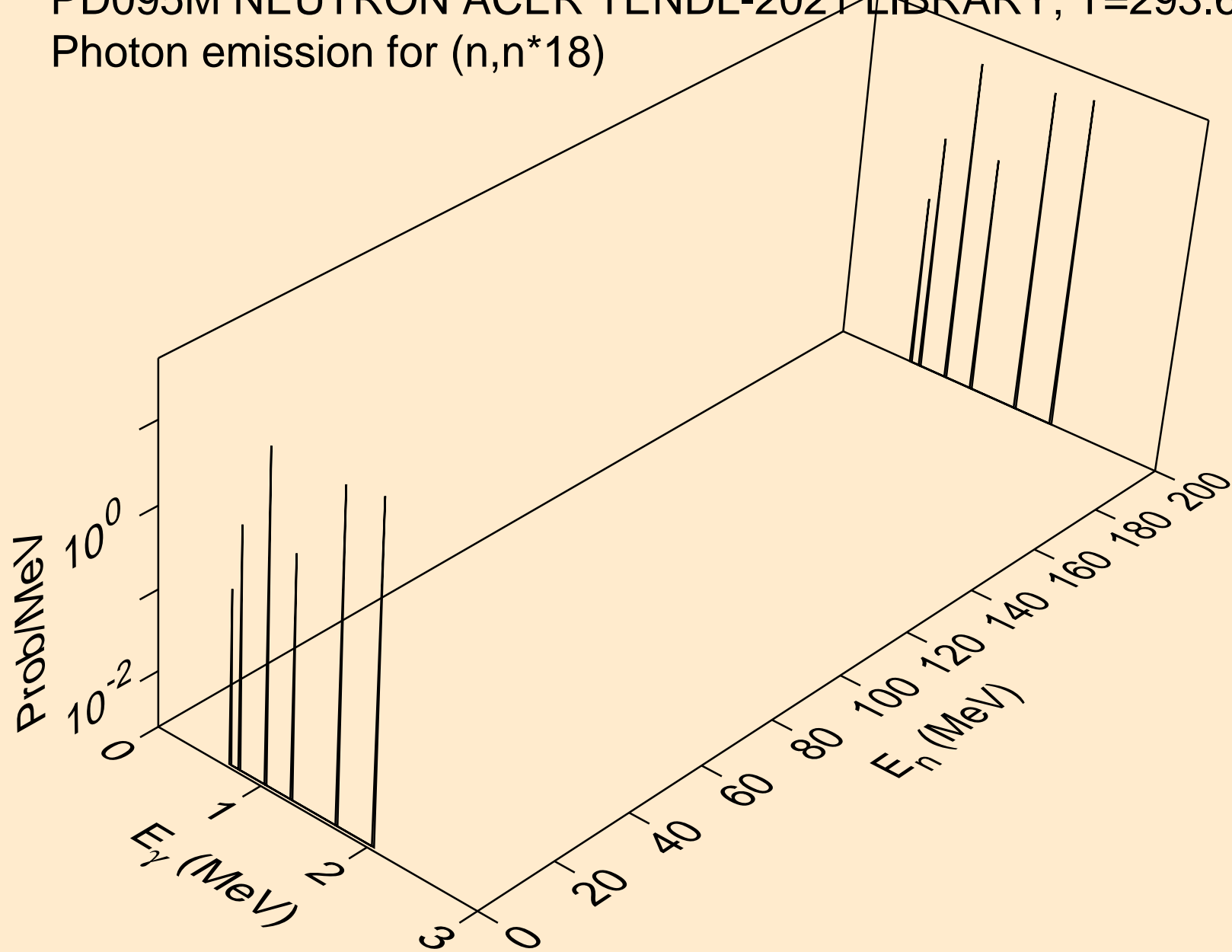

PD095M NEUTRON ACER TENDL-2021 LIBRARY; T=293.6K  
Photon emission for (n,n\*19)

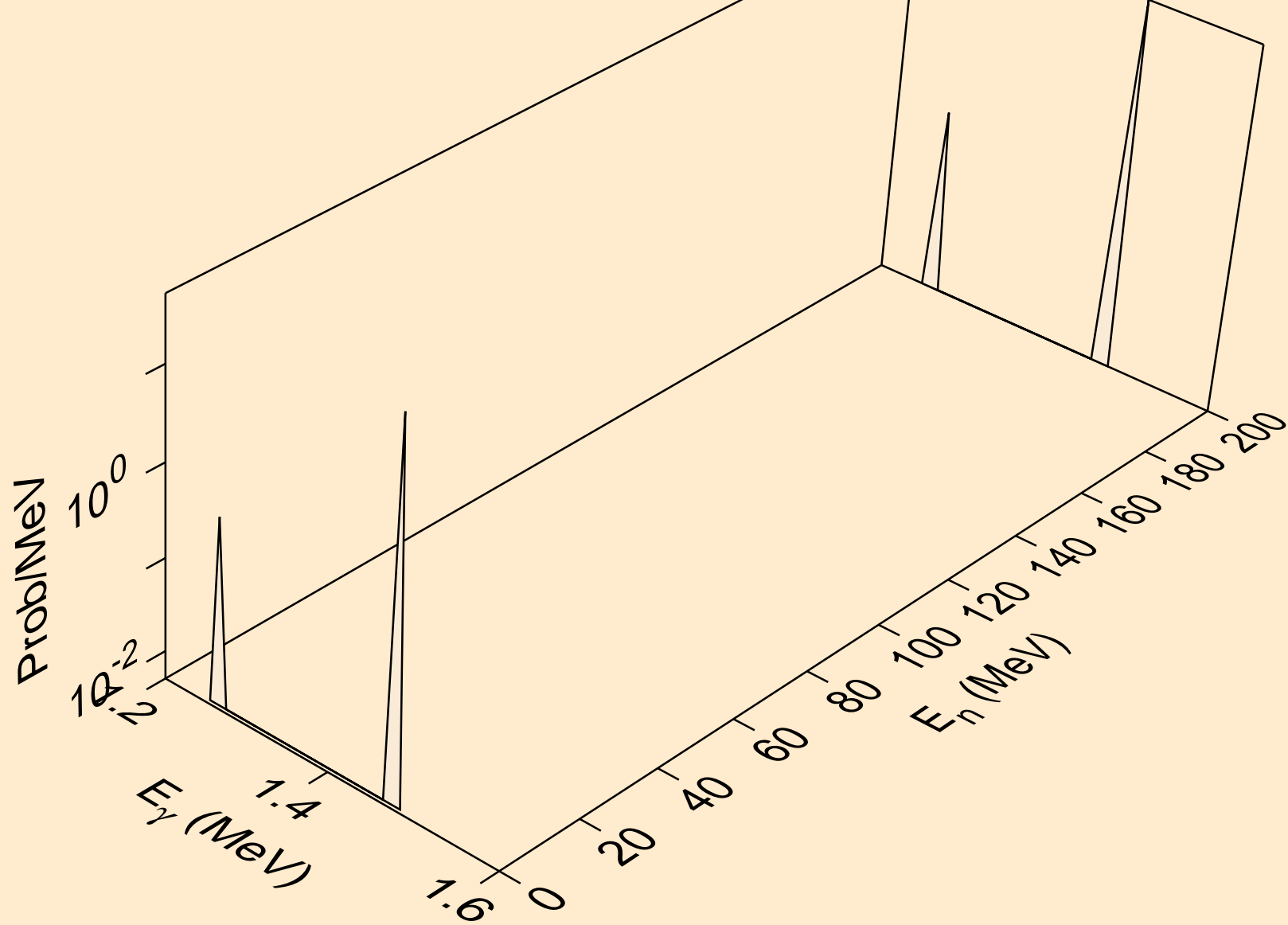

PD095M NEUTRON ACER TENDL-2021 LIBRARY; T=293.6K  
Photon emission for (n,n\*20)

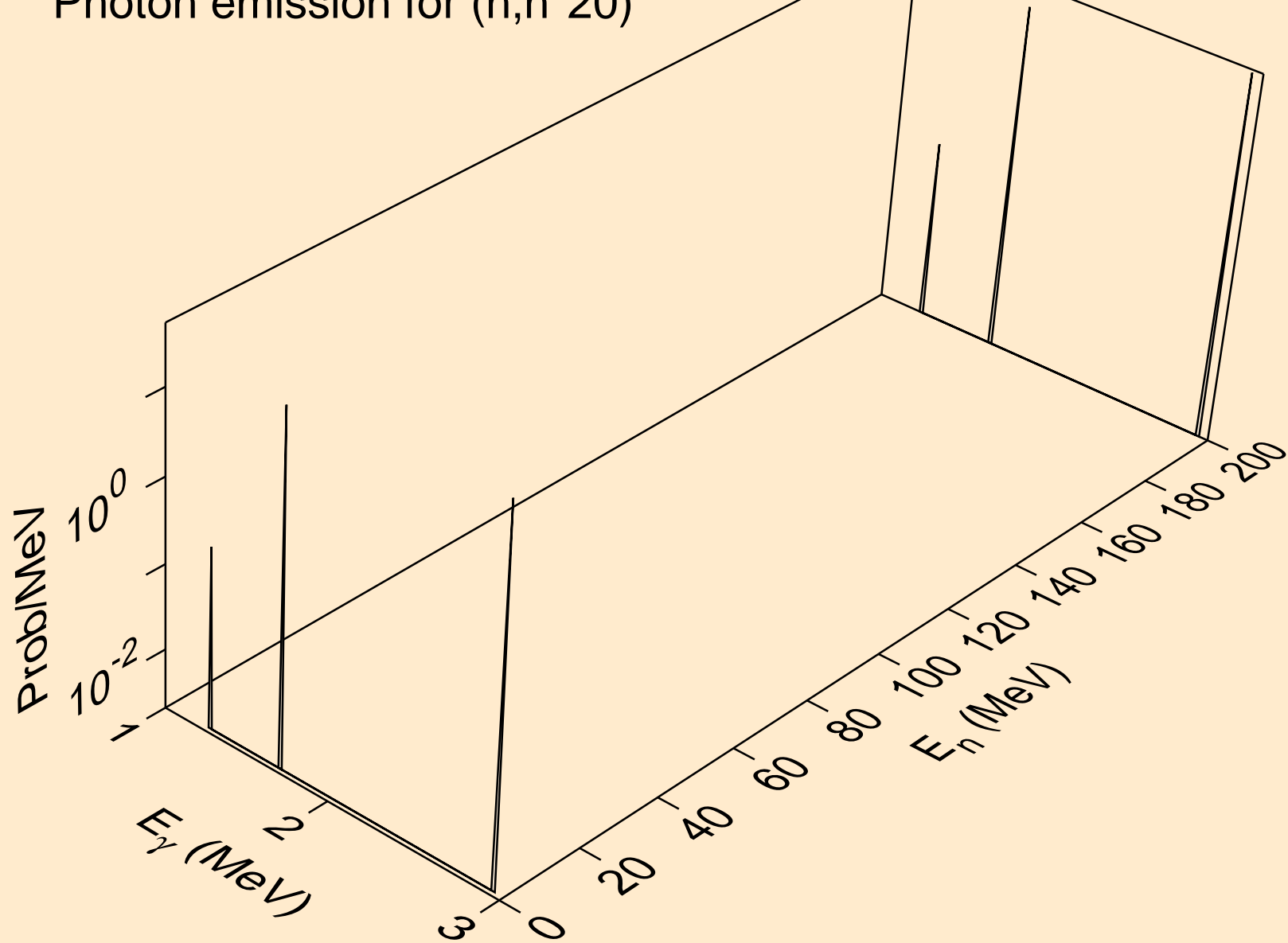

PD095M NEUTRON ACER TENDL-2021 LIBRARY; T=293.6K  
Photon emission for (n,n\*21)

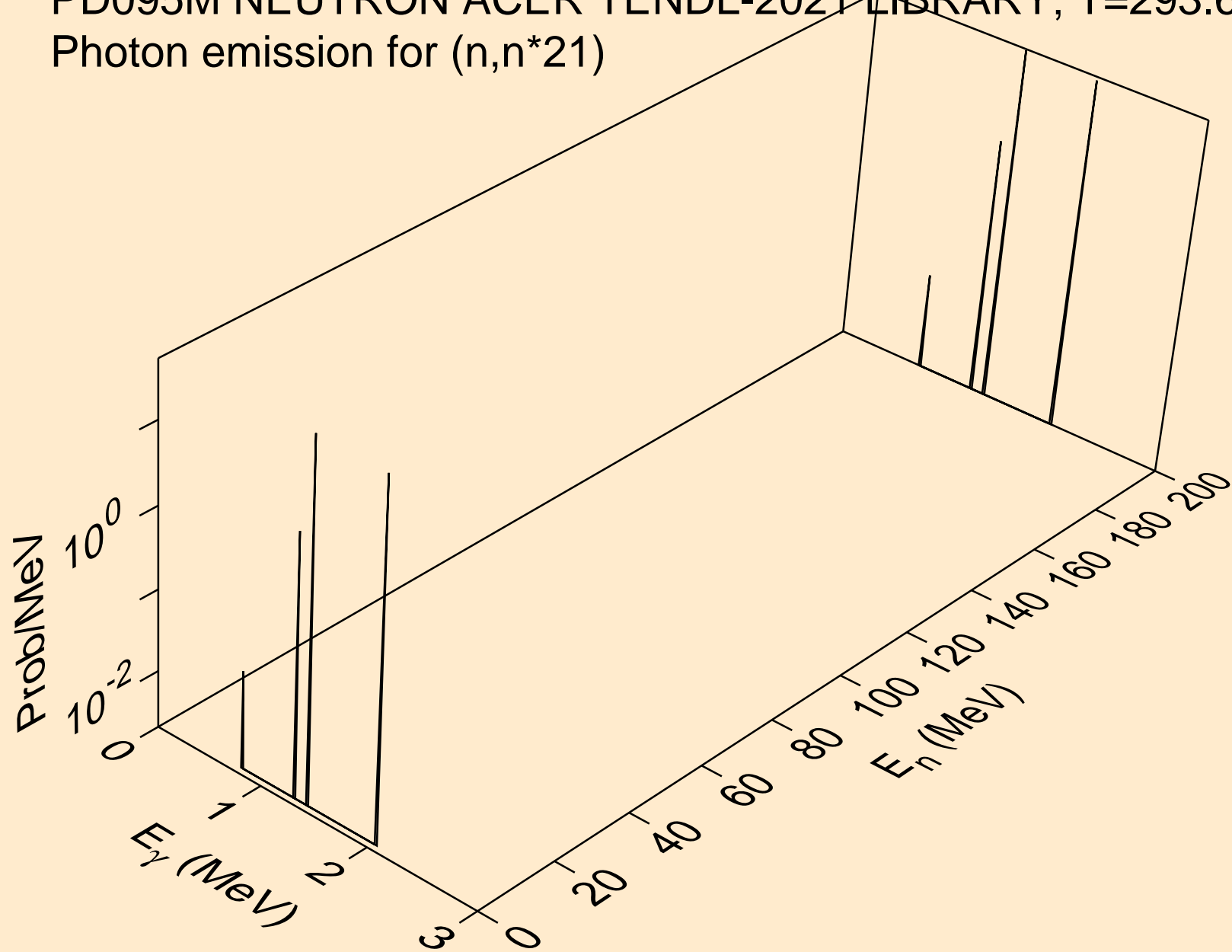

PD095M NEUTRON ACER TENDL-2021 LIBRARY; T=293.6K  
Photon emission for (n,n\*22)

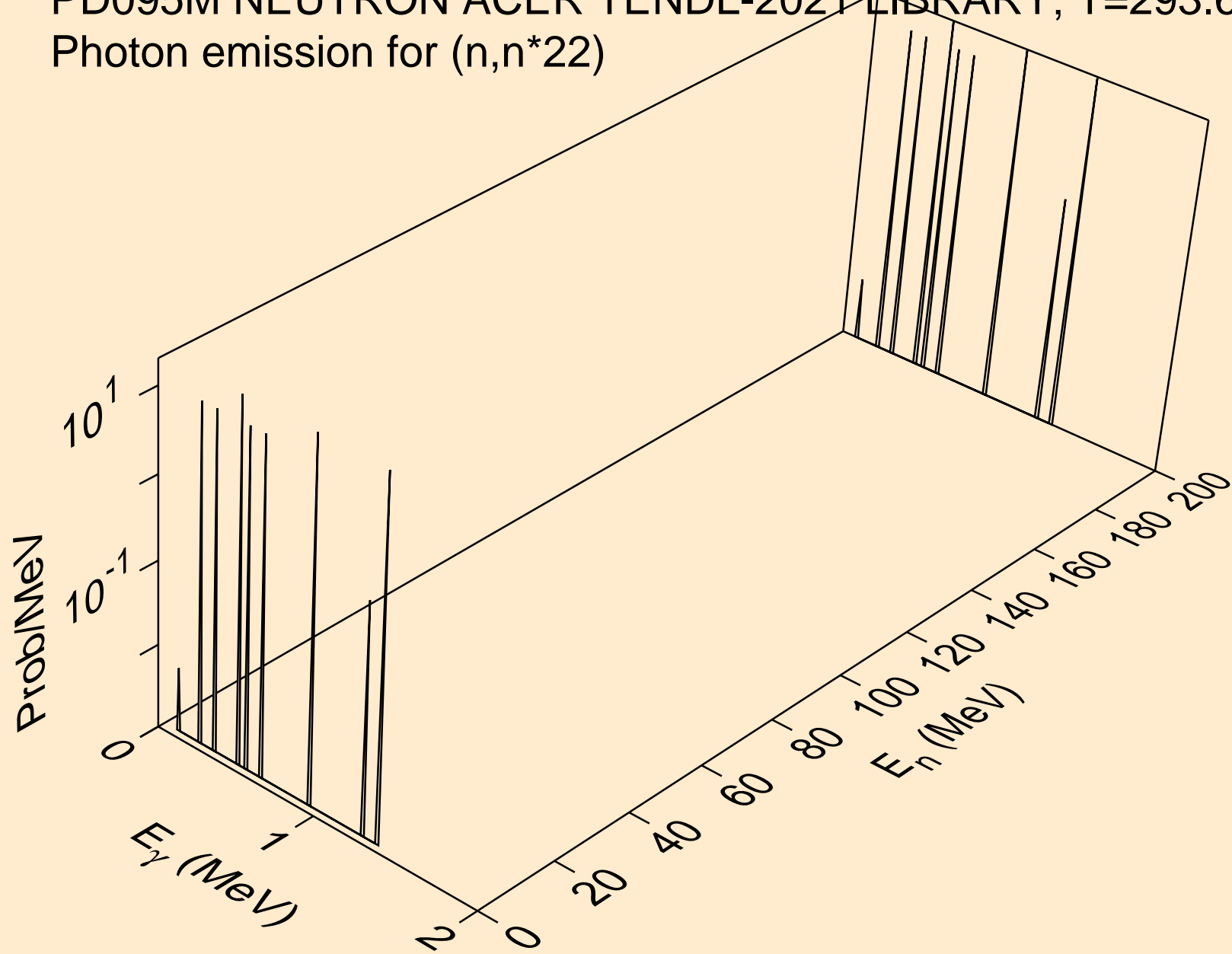



PD095M NEUTRON ACER TENDL-2021 LIBRARY; T=293.6K  
Photon emission for (n,n\*23)

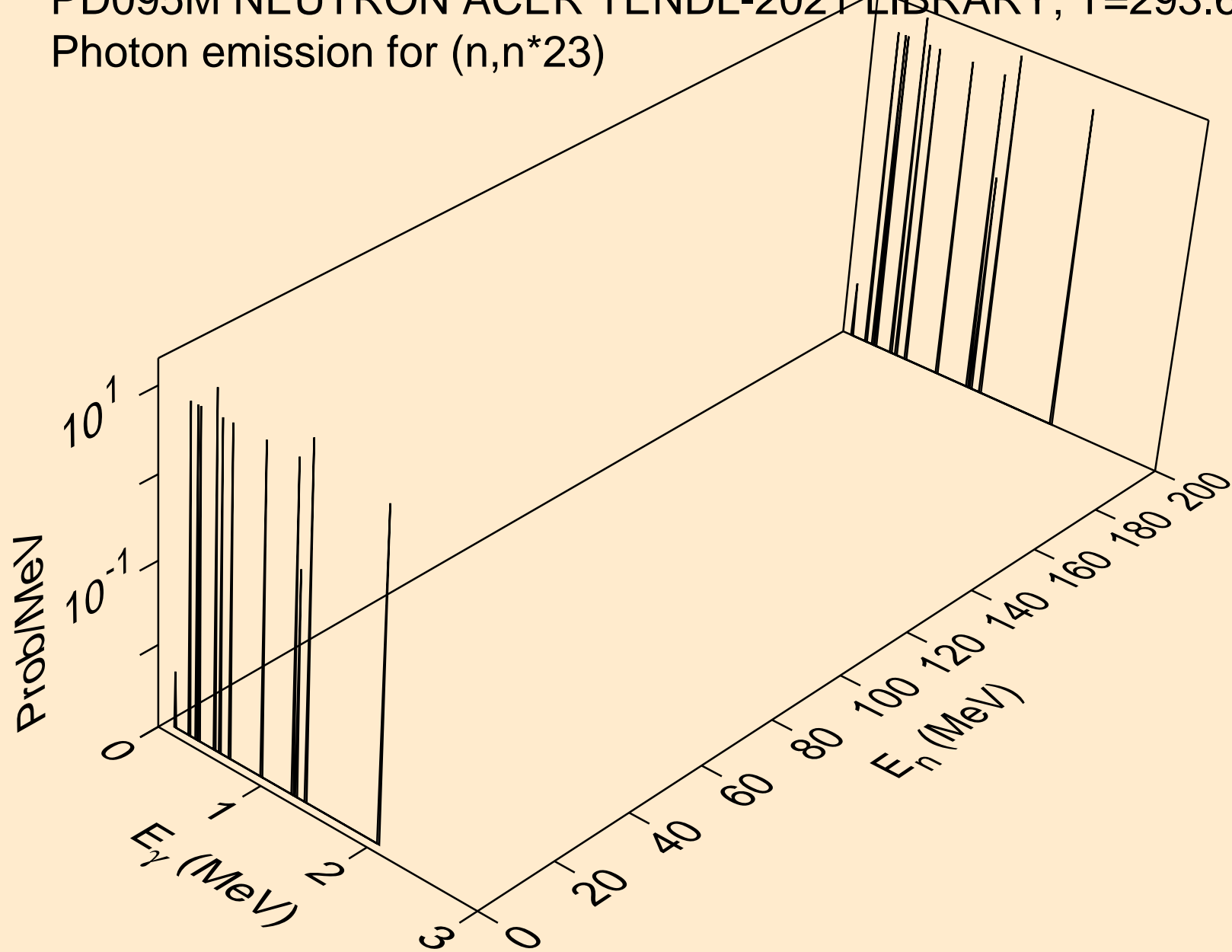

PD095M NEUTRON ACER TENDL-2021 LIBRARY; T=293.6K  
Photon emission for (n,n\*24)

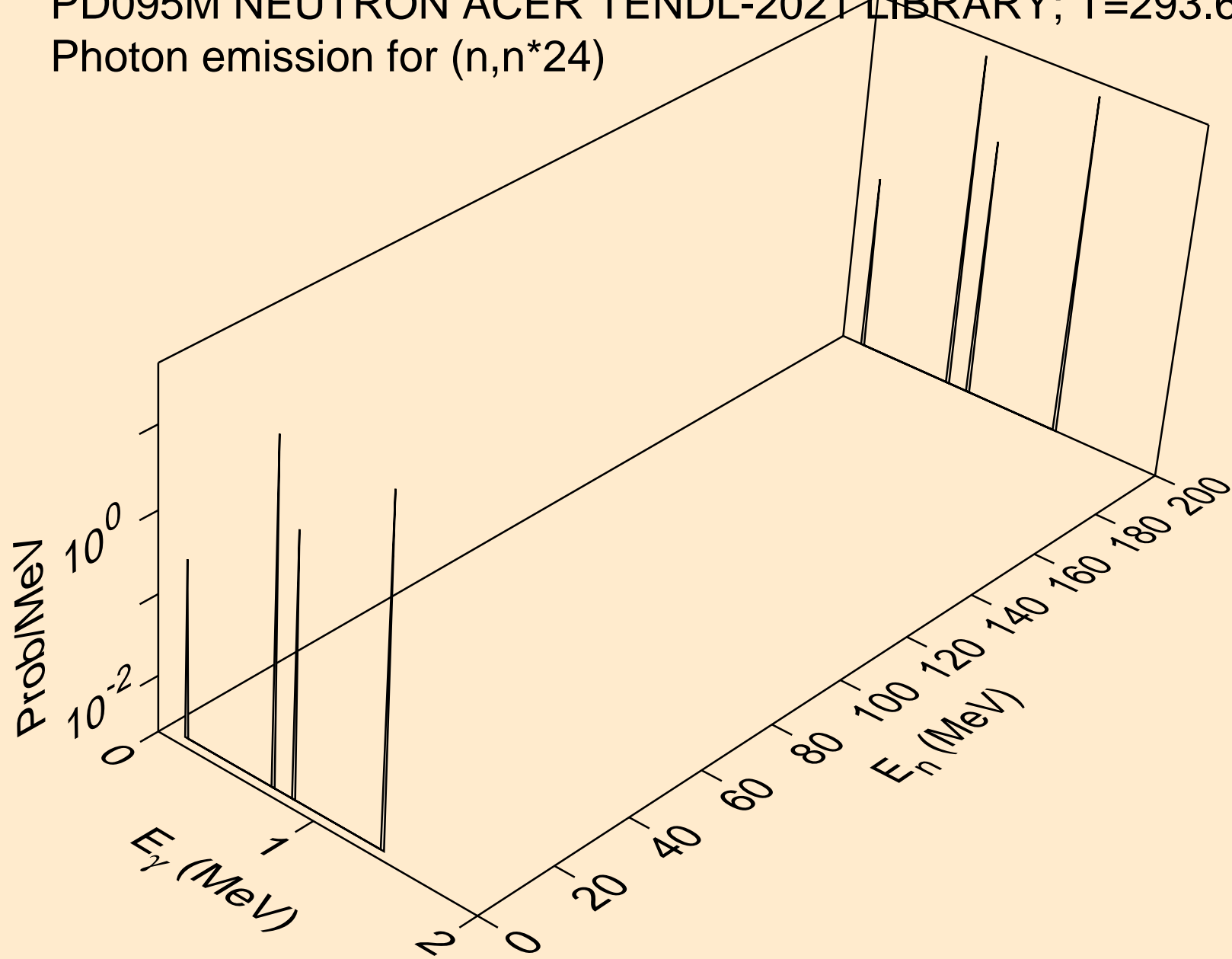

PD095M NEUTRON ACER TENDL-2021 LIBRARY; T=293.6K  
Photon emission for (n,n\*25)

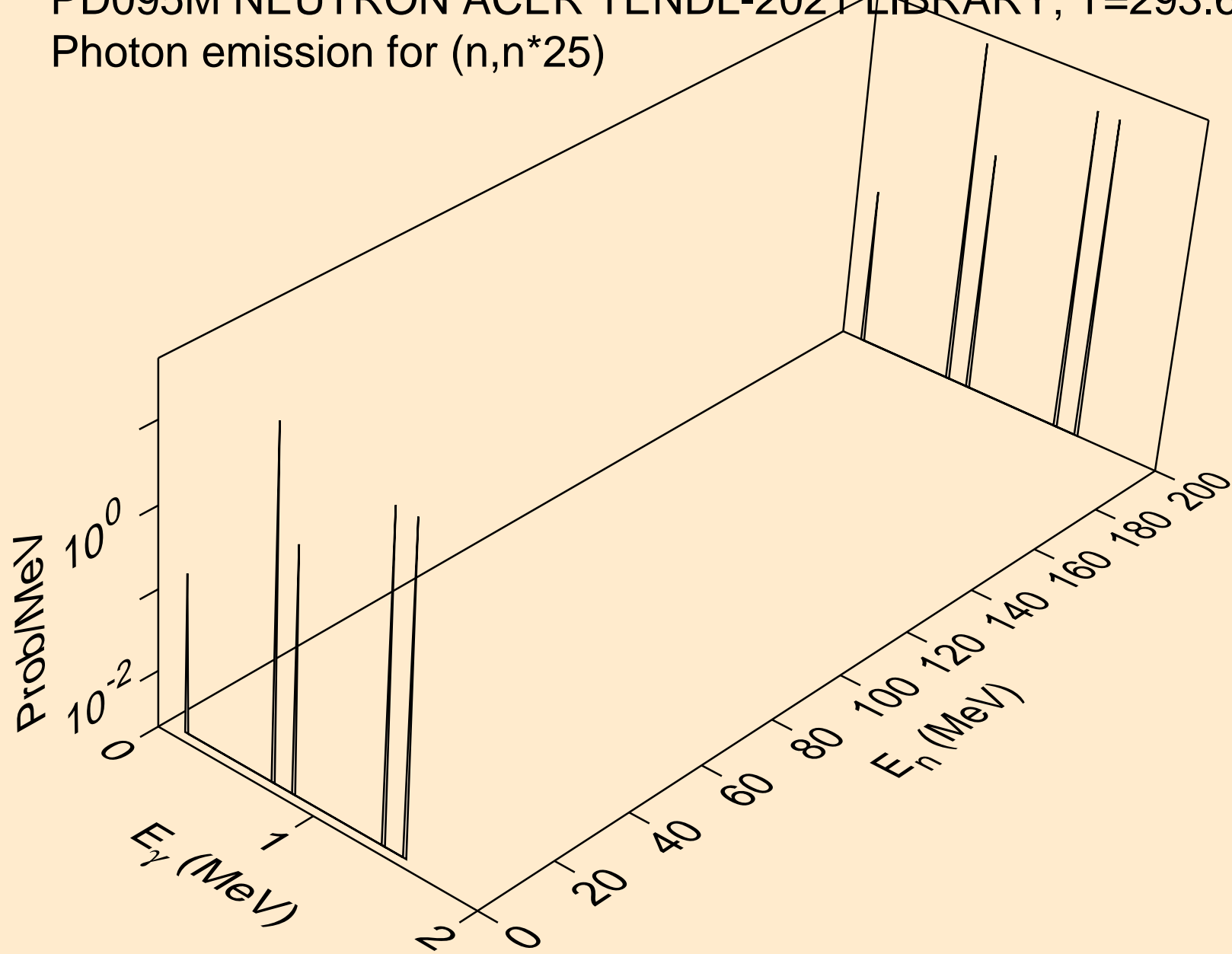

PD095M NEUTRON ACER TENDL-2021 LIBRARY; T=293.6K  
Photon emission for (n,n\*c)

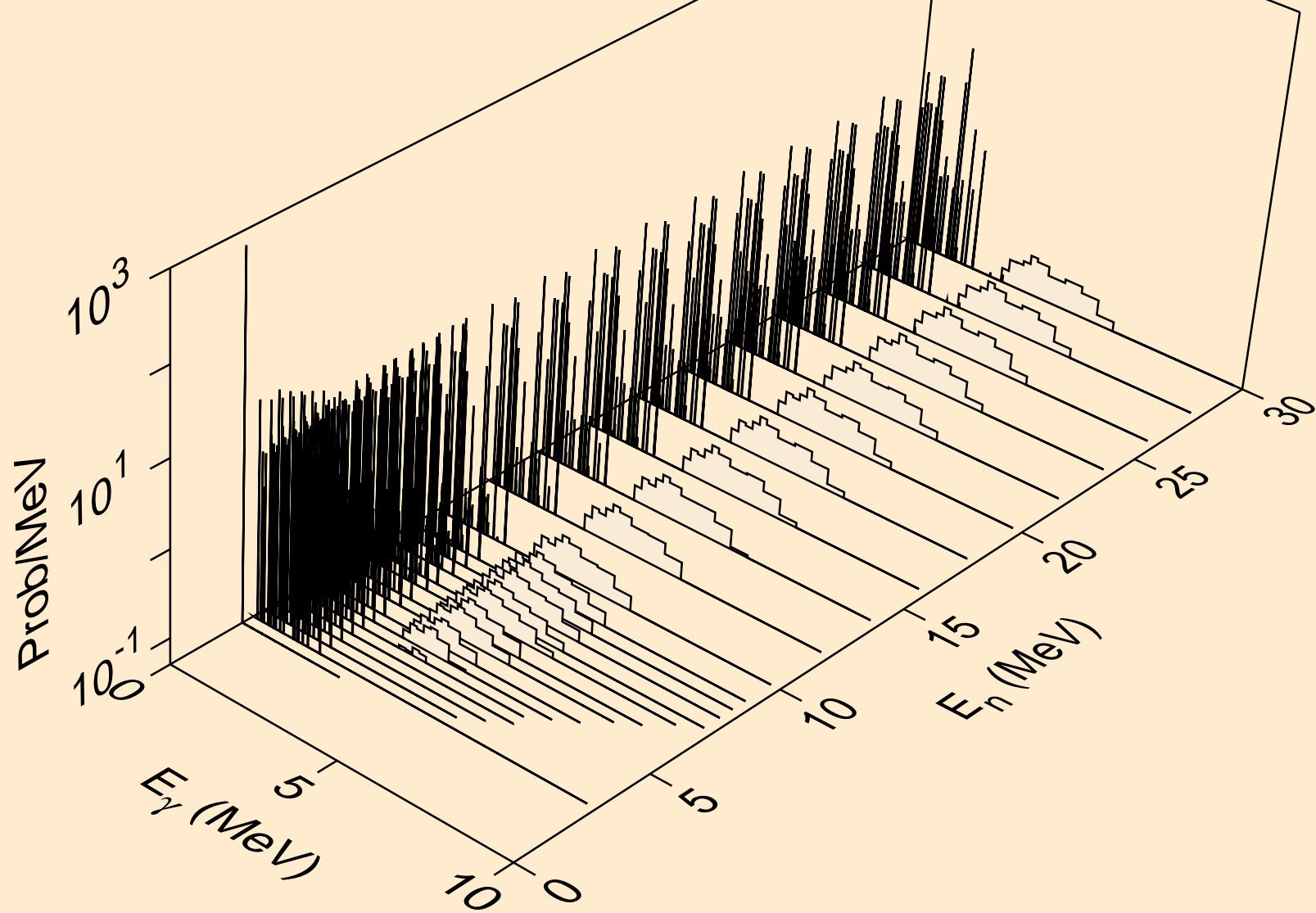

PD095M NEUTRON ACER TENDL-2021 LIBRARY; T=293.6K  
Photon emission for (n,gma)

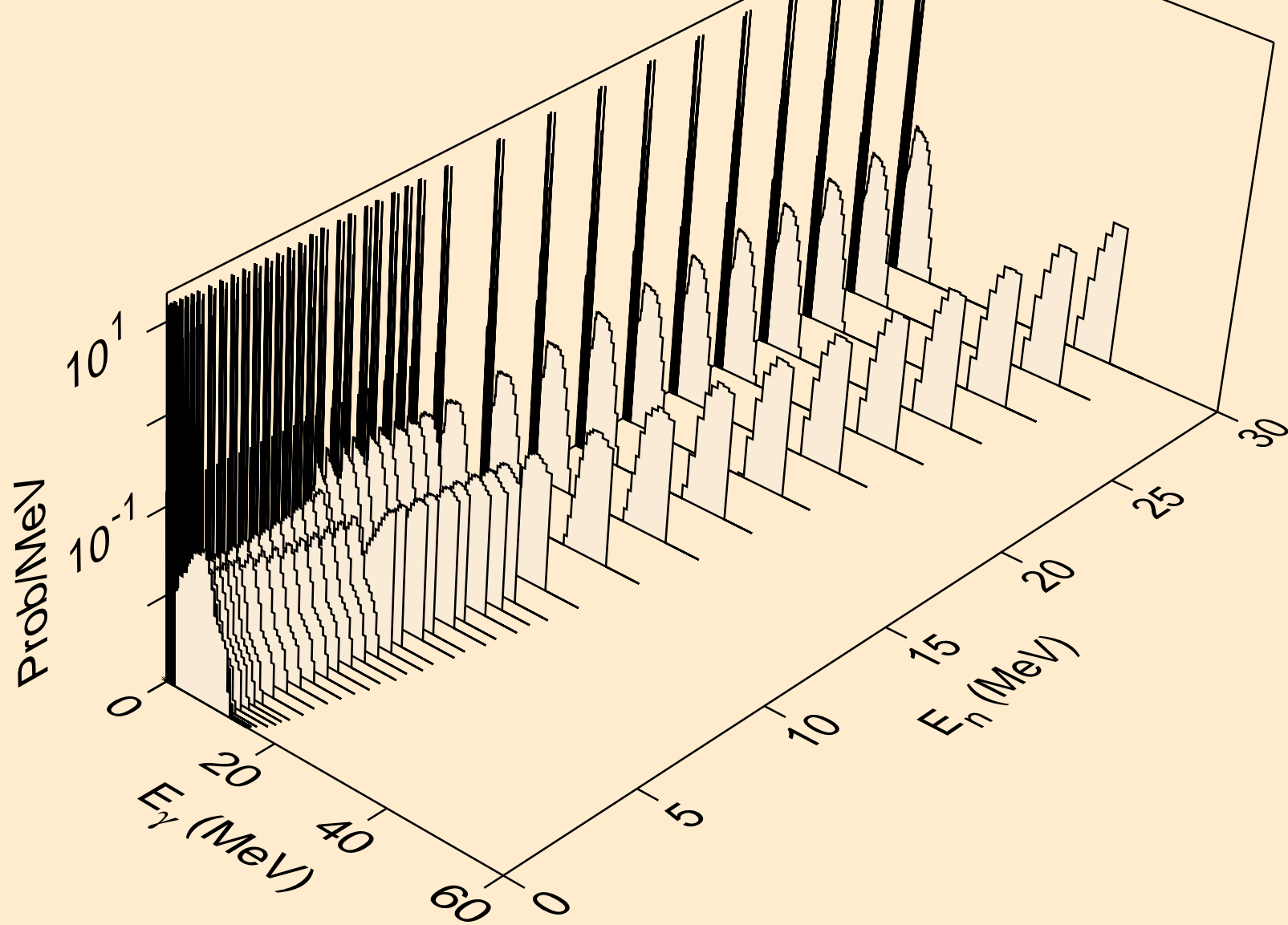

PD095M NEUTRON ACER TENDL-2021 LIBRARY; T=293.6K  
Photon emission for (n,p)

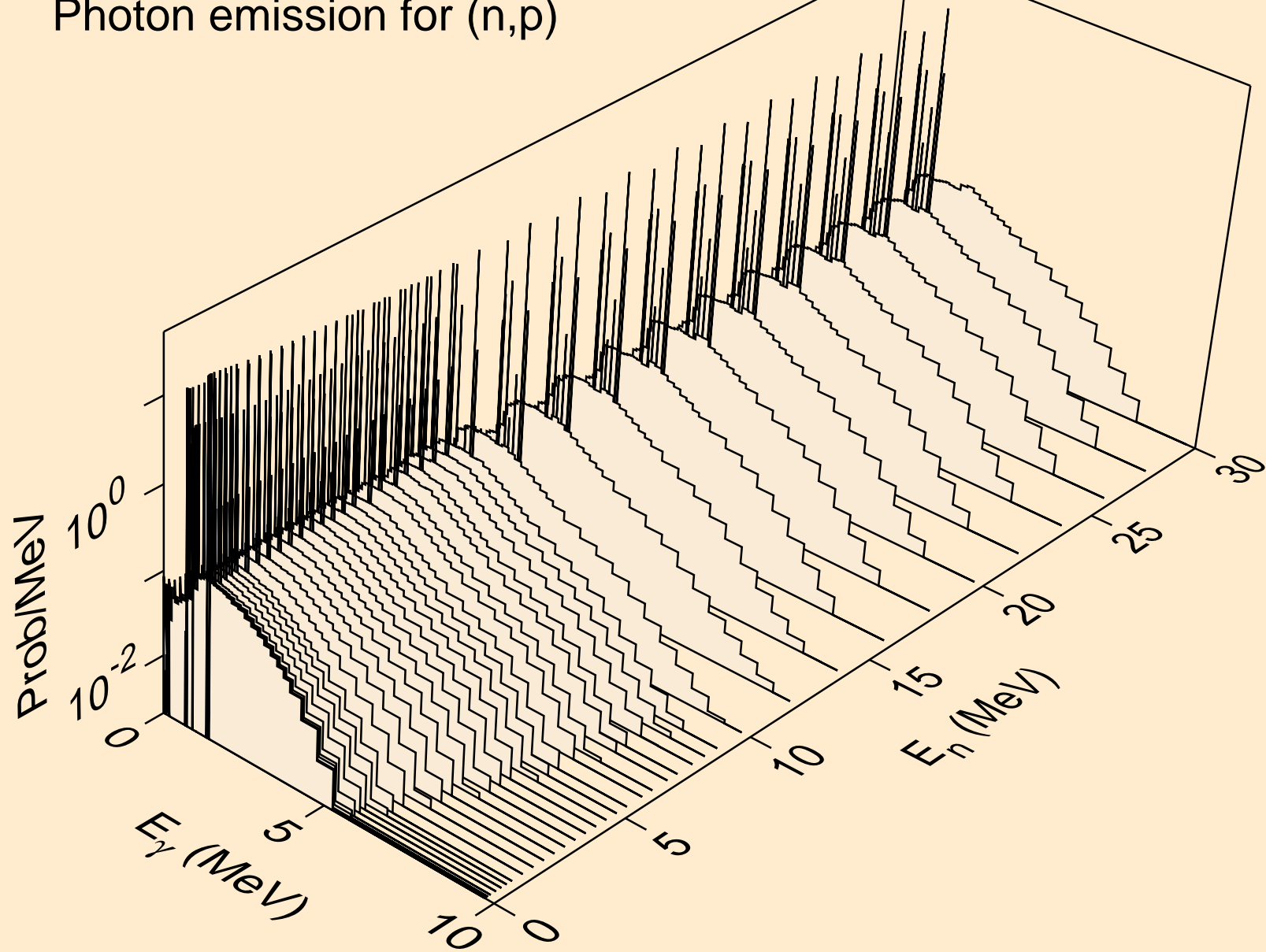

PD095M NEUTRON ACER TENDL-2021 LIBRARY; T=293.6K  
Photon emission for (n,d)

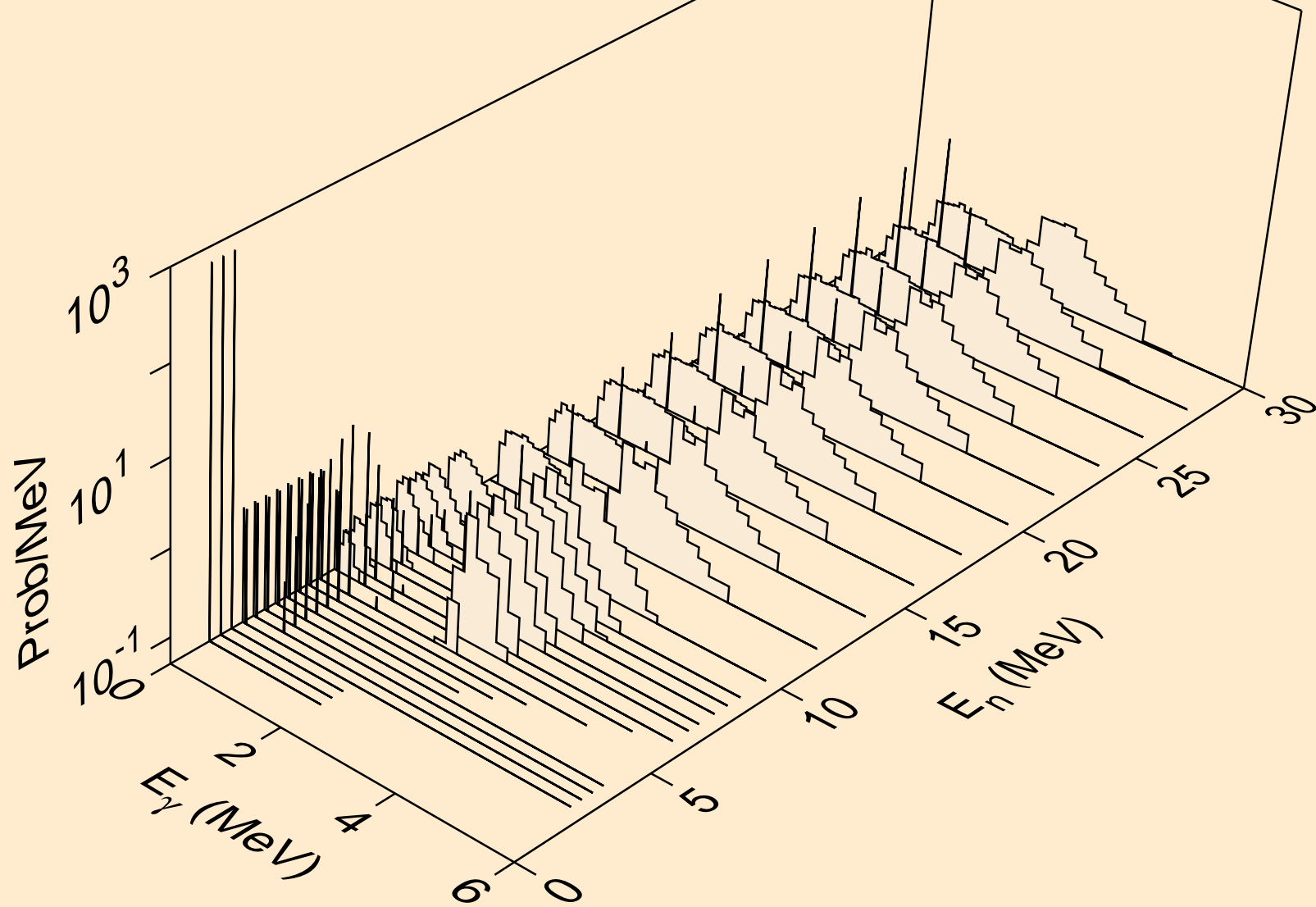

PD095M NEUTRON ACER TENDL-2021 LIBRARY; T=293.6K  
Photon emission for (n,t)

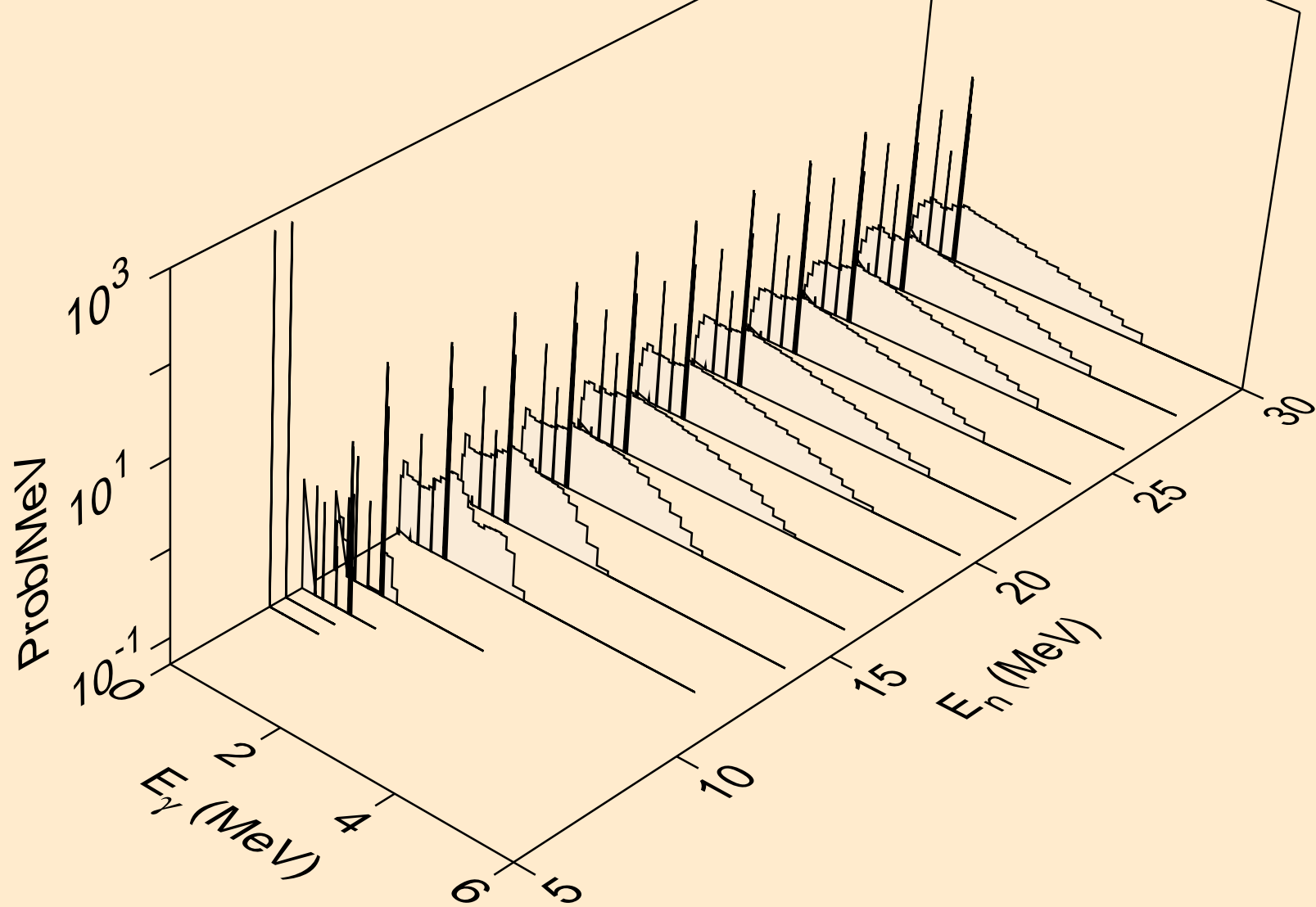



PD095M NEUTRON ACER TENDL-2021 LIBRARY; T=293.6K  
Photon emission for (n,he3)

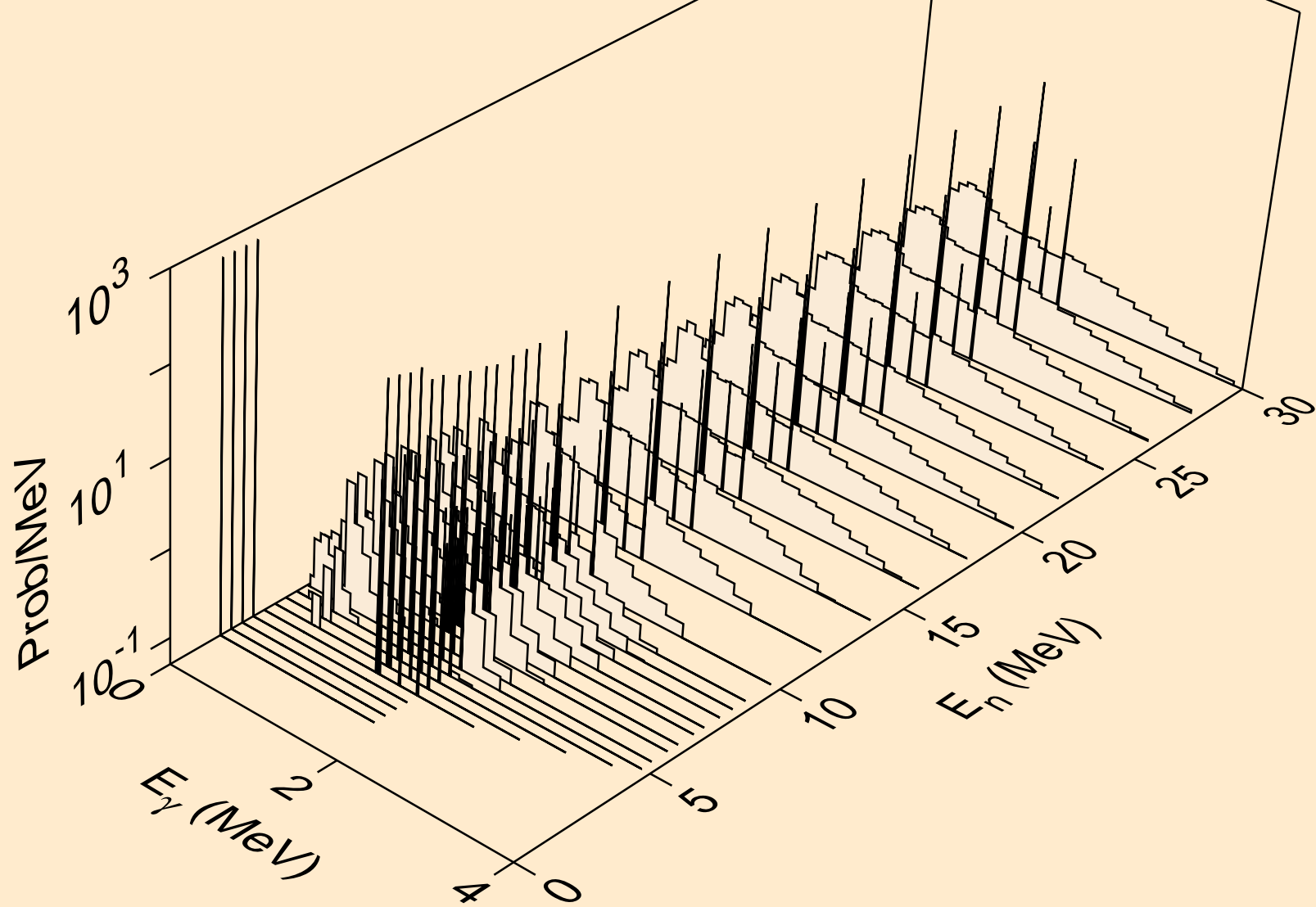

PD095M NEUTRON ACER TENDL-2021 LIBRARY; T=293.6K  
Photon emission for (n,a)

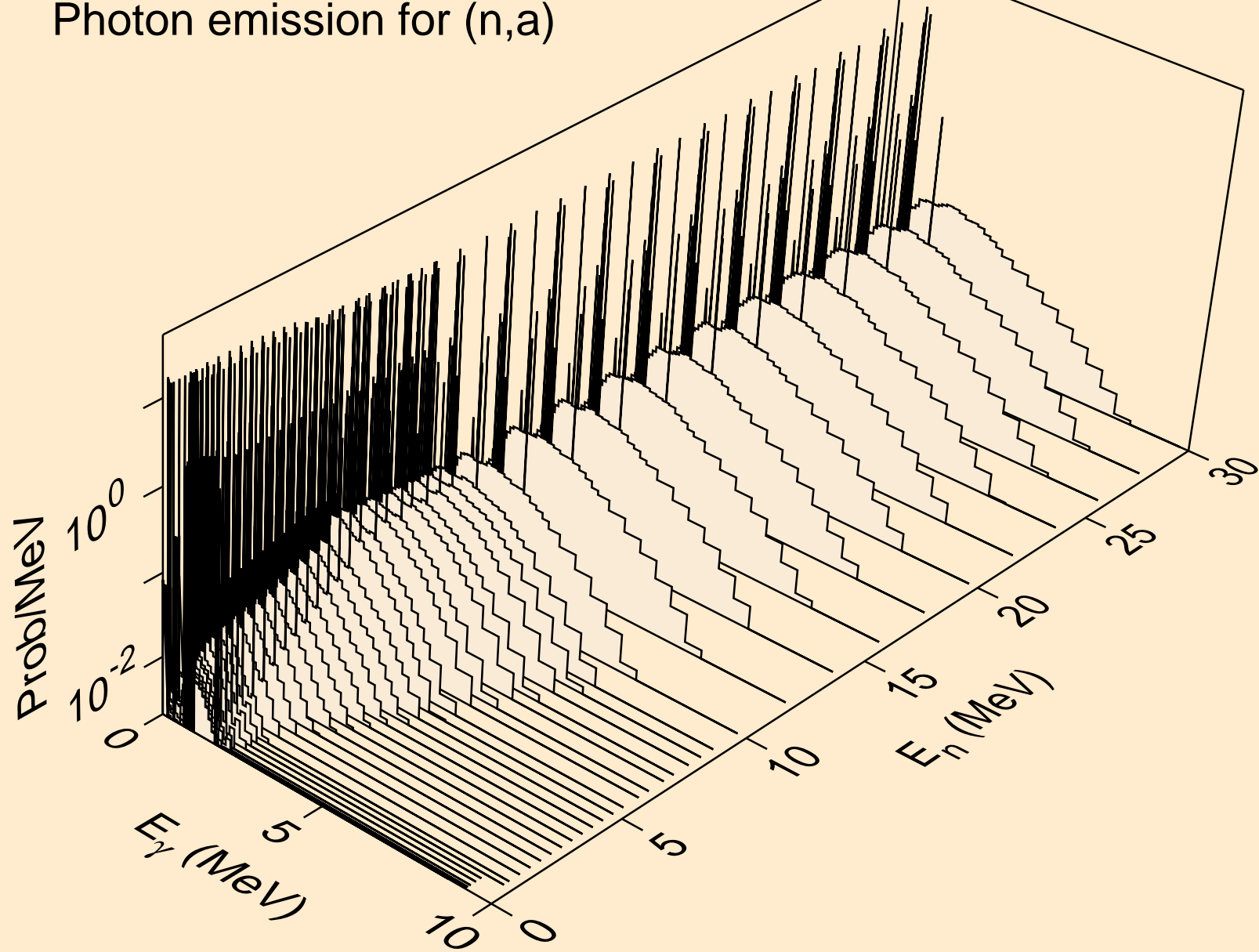

PD095M NEUTRON ACER TENDL-2021 LIBRARY; T=293.6K  
Photon emission for (n,2a)

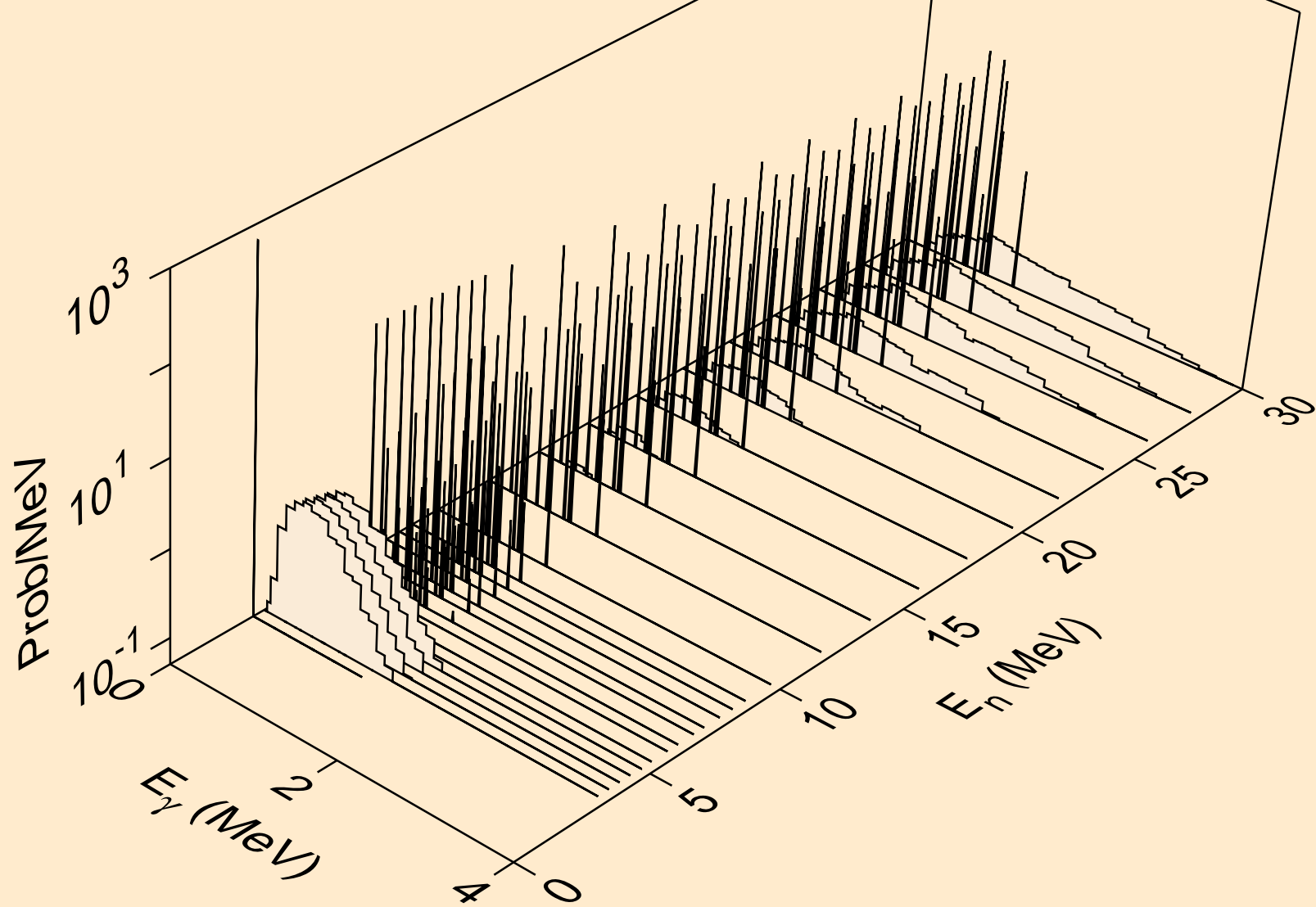

PD095M NEUTRON ACER TENDL-2021 LIBRARY; T=293.6K  
Photon emission for (n,3a)

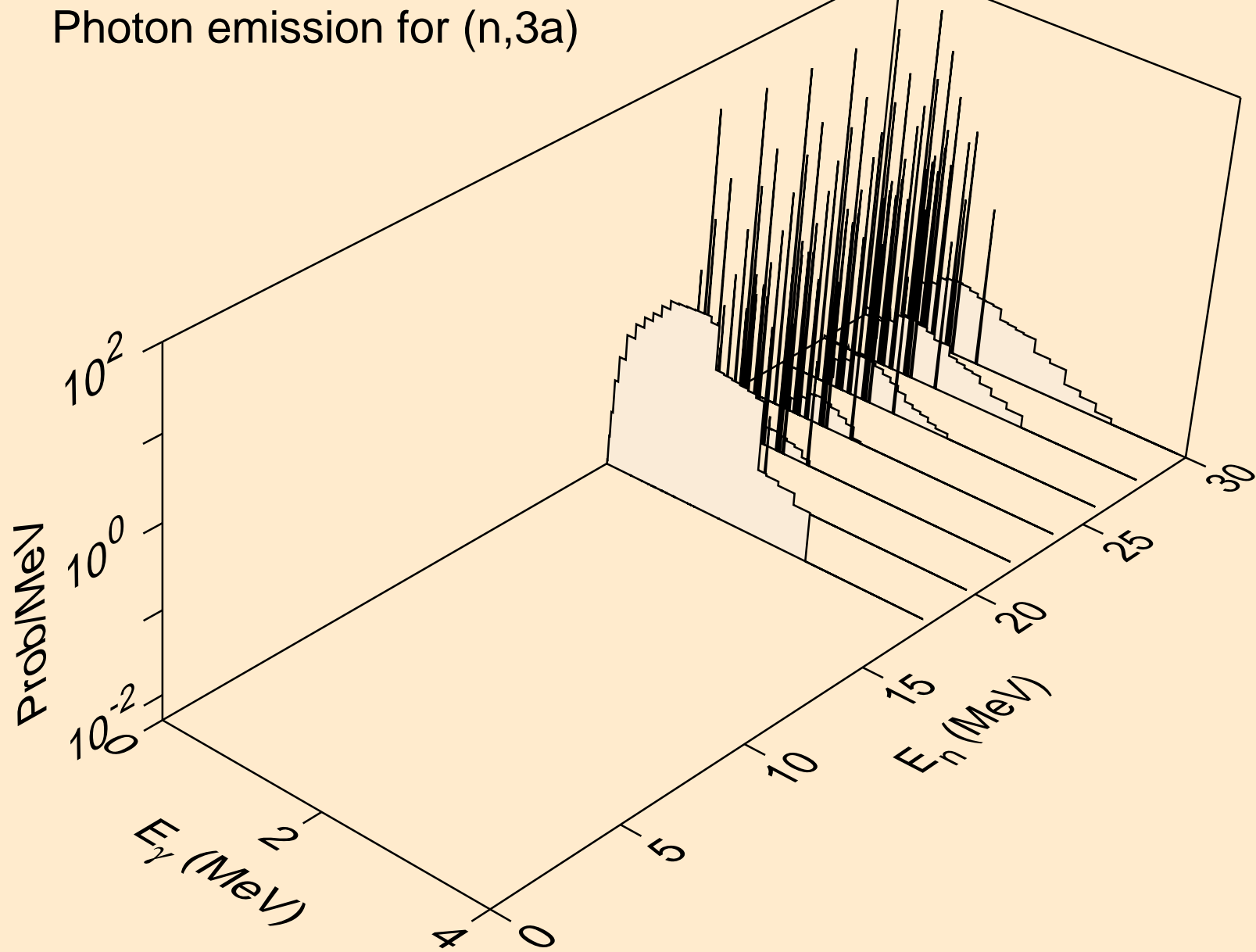

PD095M NEUTRON ACER TENDL-2021 LIBRARY; T=293.6K  
Photon emission for (n,2p)

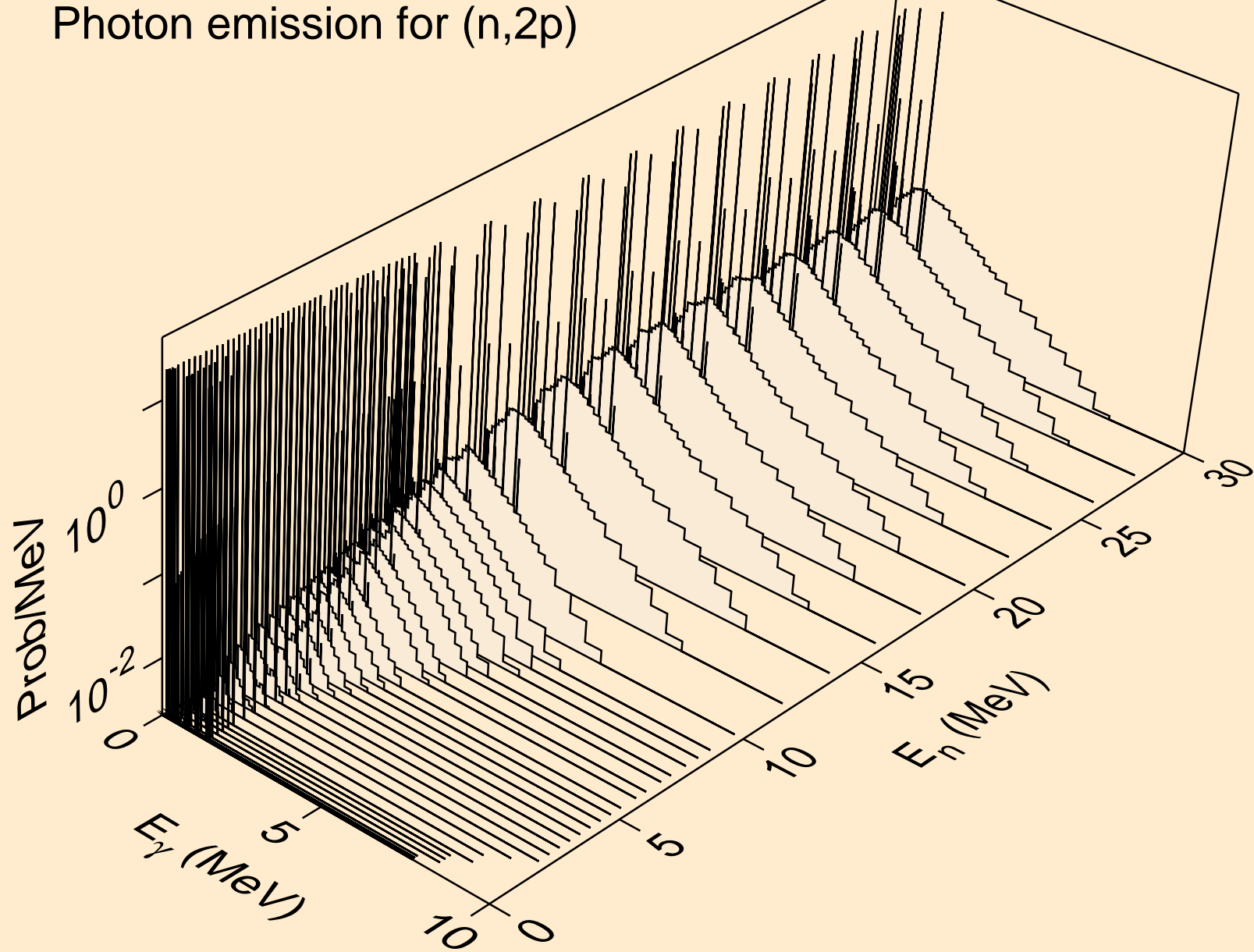

PD095M NEUTRON ACER TENDL-2021 LIBRARY; T=293.6K  
Photon emission for (n,p)

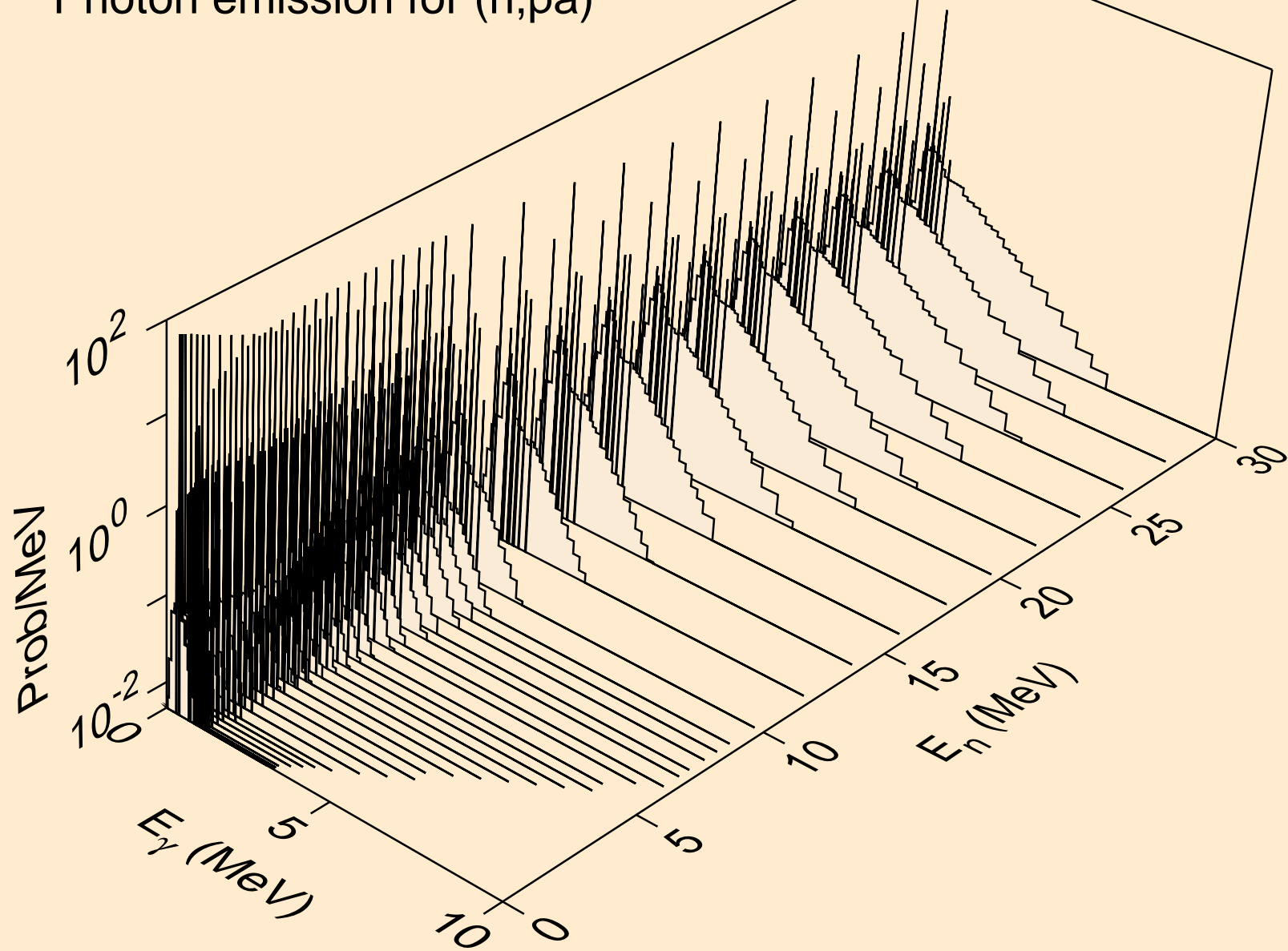

PD095M NEUTRON ACER TENDL-2021 LIBRARY; T=293.6K  
Photon emission for (n,pd)

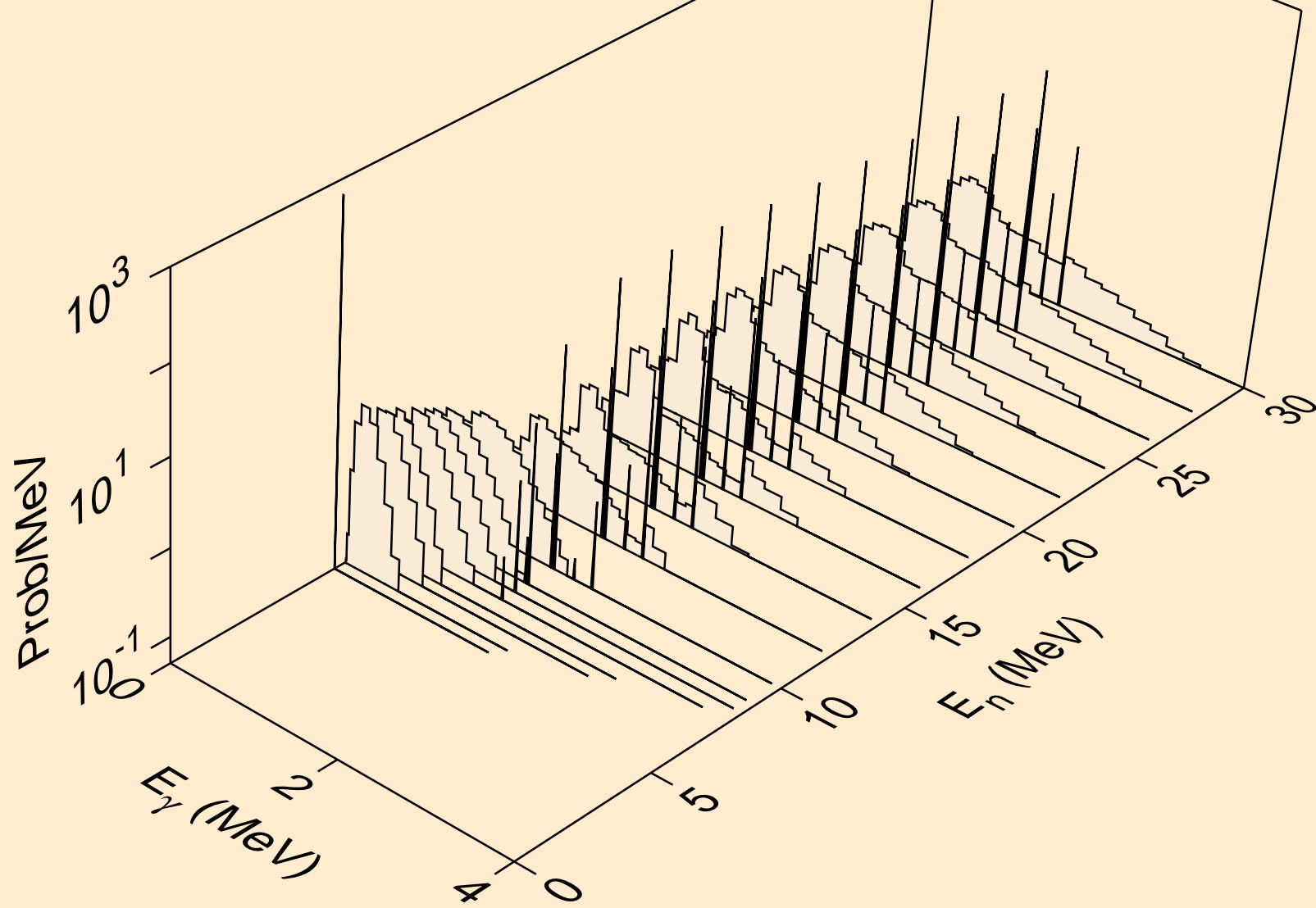

PD095M NEUTRON ACER TENDL-2021 LIBRARY; T=293.6K  
Photon emission for (n,pt)

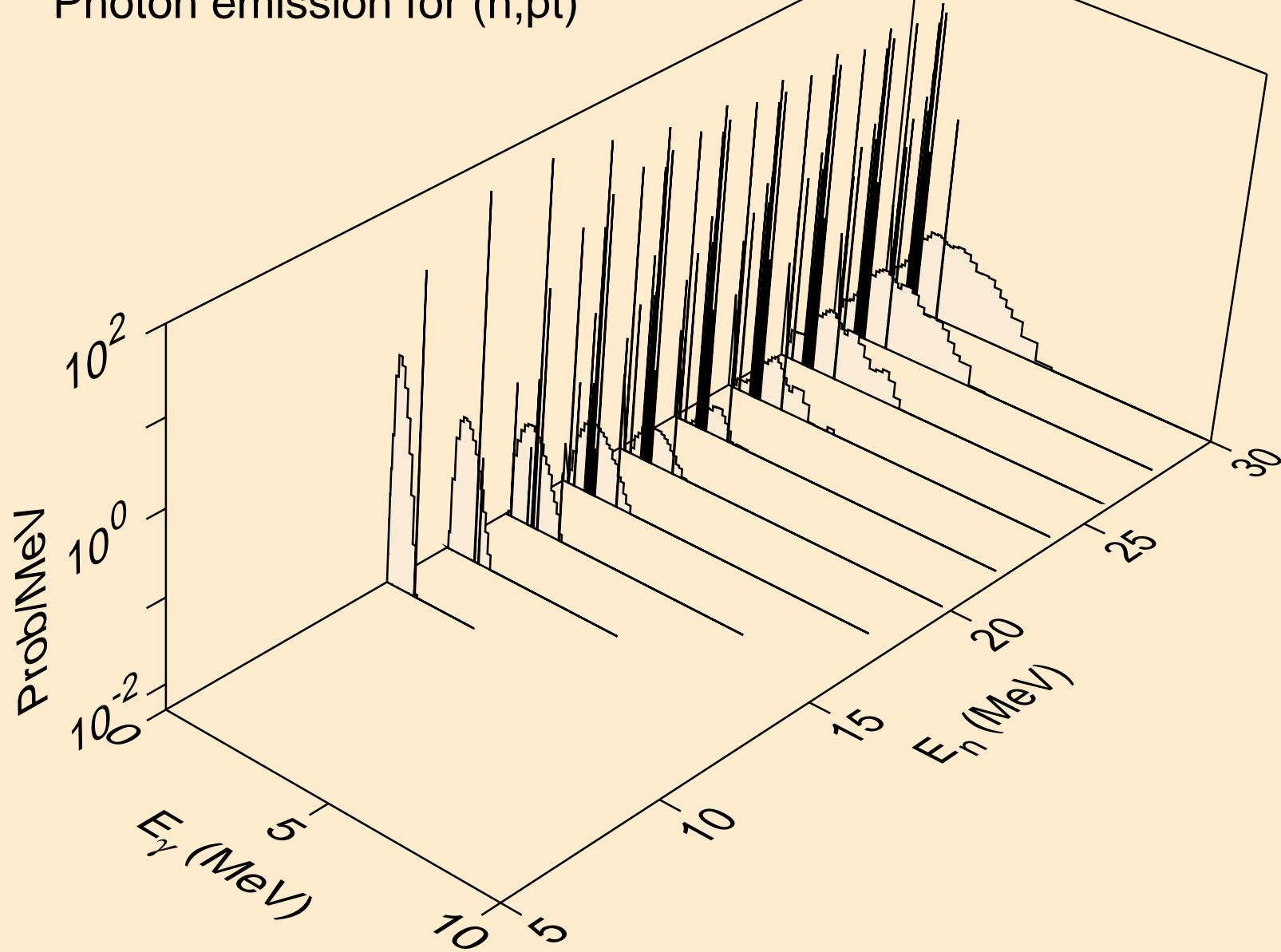



PD095M NEUTRON ACER TENDL-2021 LIBRARY; T=293.6K  
Photon emission for (n,da)

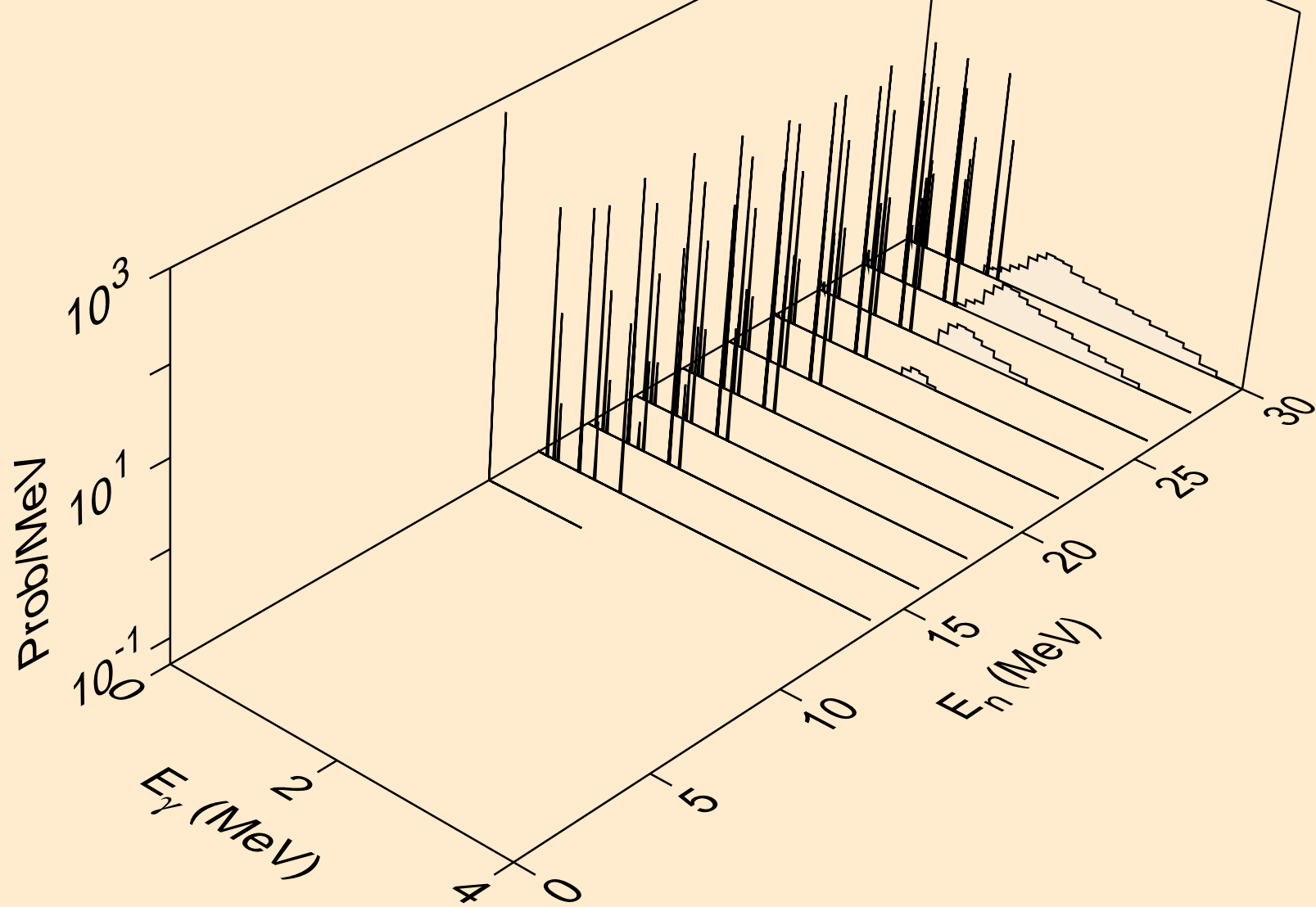

PD095M NEUTRON ACER TENDL-2021 LIBRARY; T=293.6K  
thermal capture photon spectrum

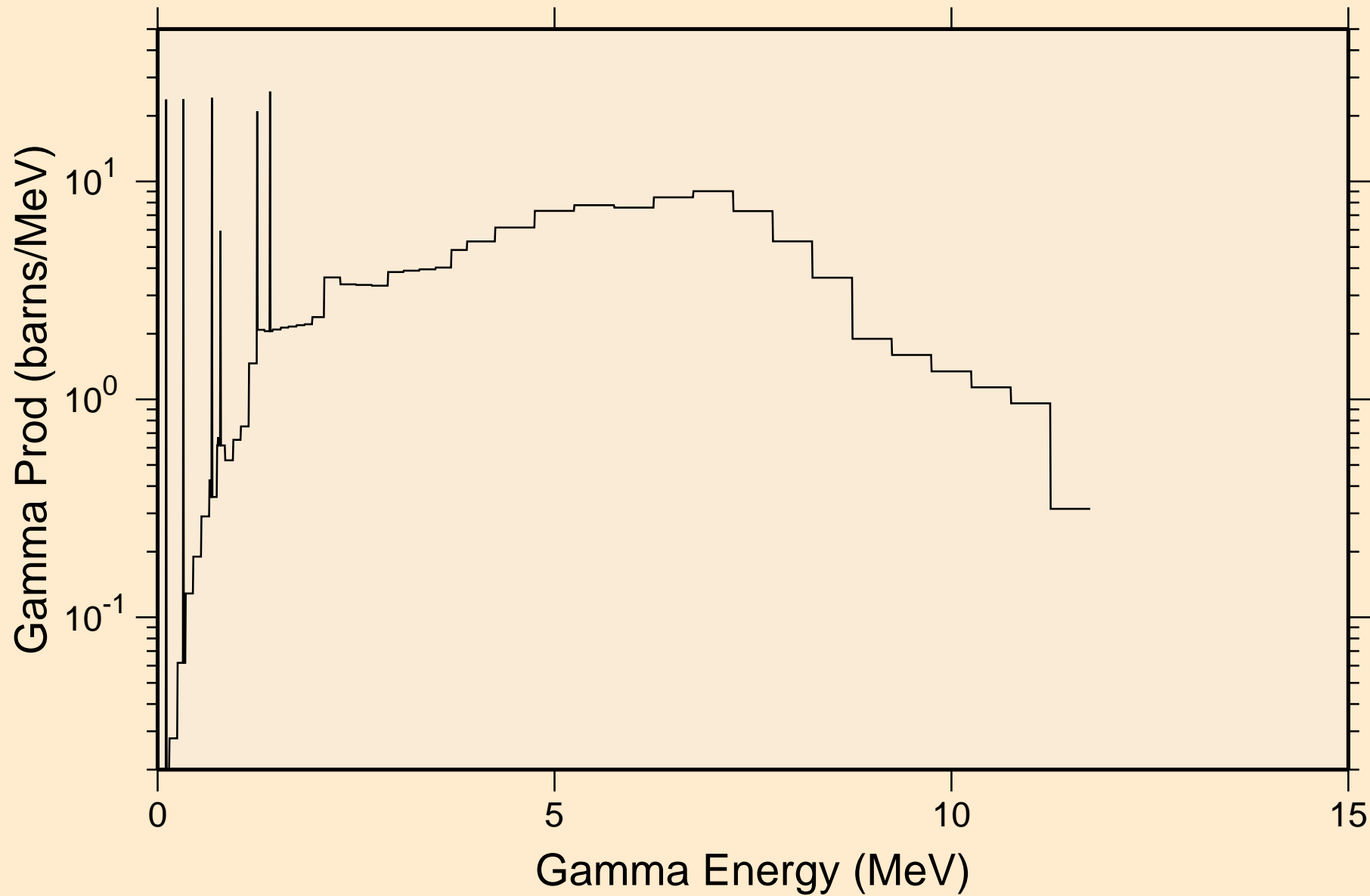

PD095M NEUTRON ACER TENDL-2021 LIBRARY; T=293.6K  
14 MeV photon spectrum

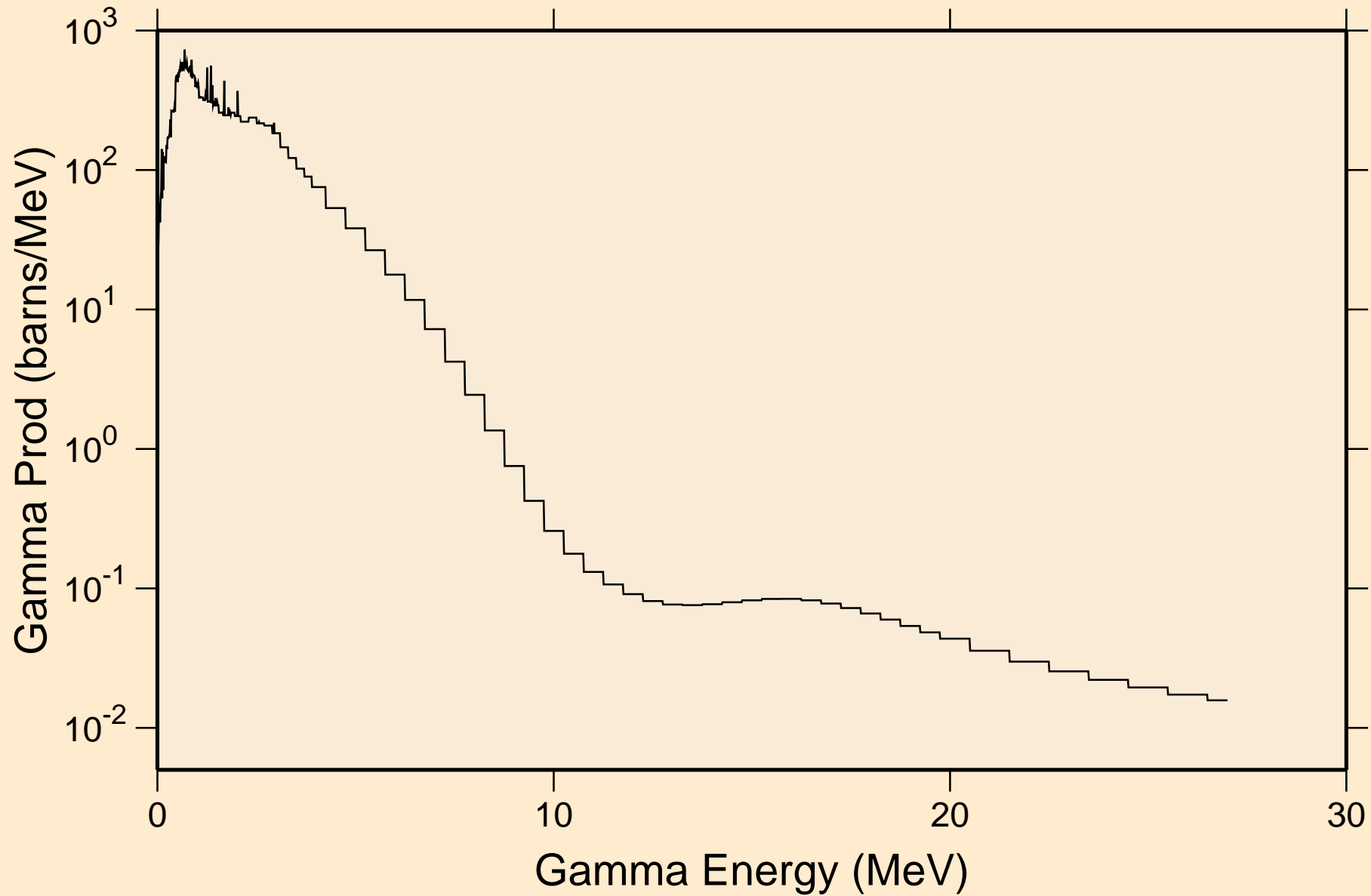

PD095M NEUTRON ACER TENDL-2021 LIBRARY; T=293.6K  
Particle heating contributions

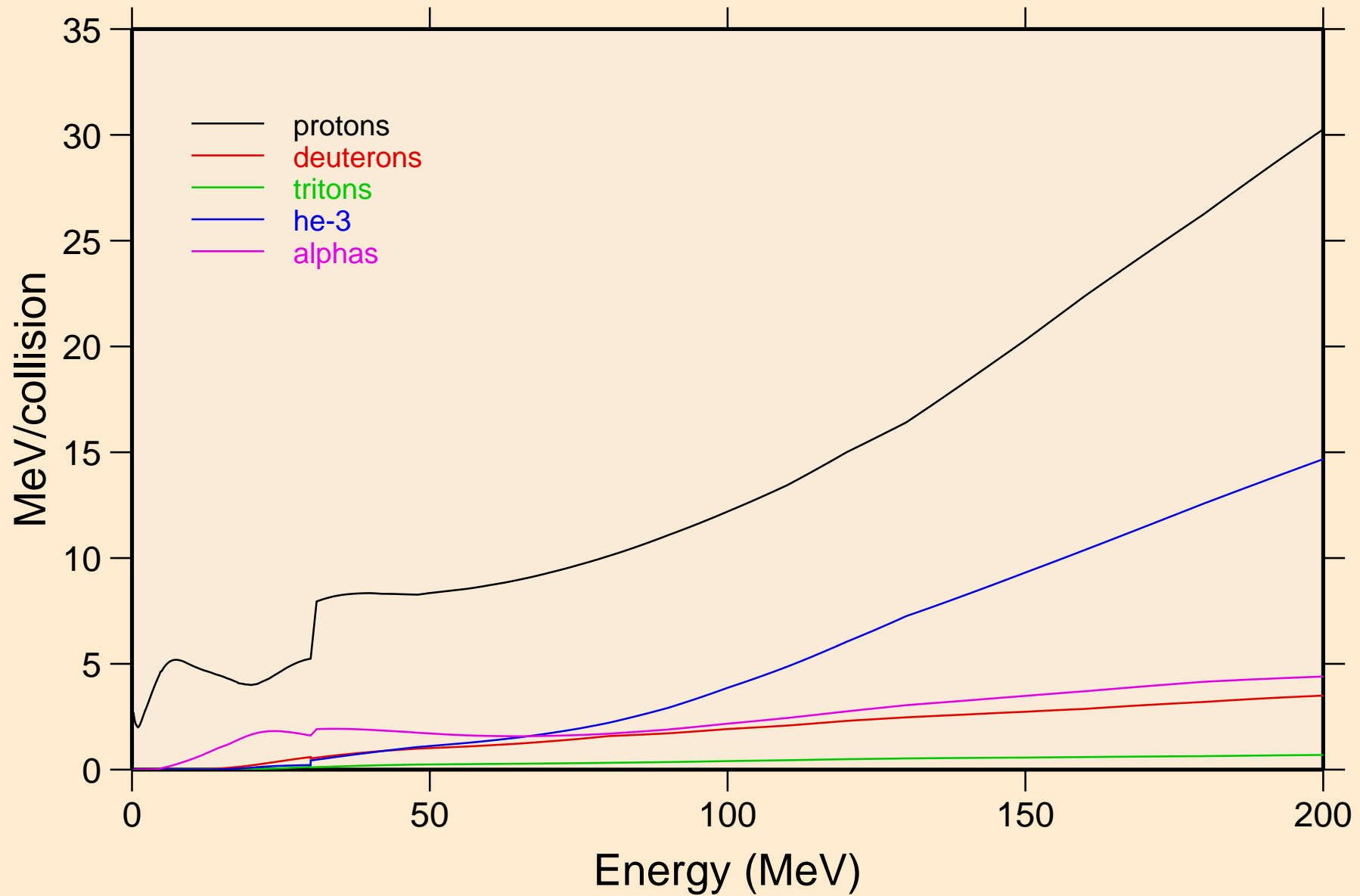

PD095M NEUTRON ACER TENDL-2021 LIBRARY; T=293.6K  
Recoil Heating

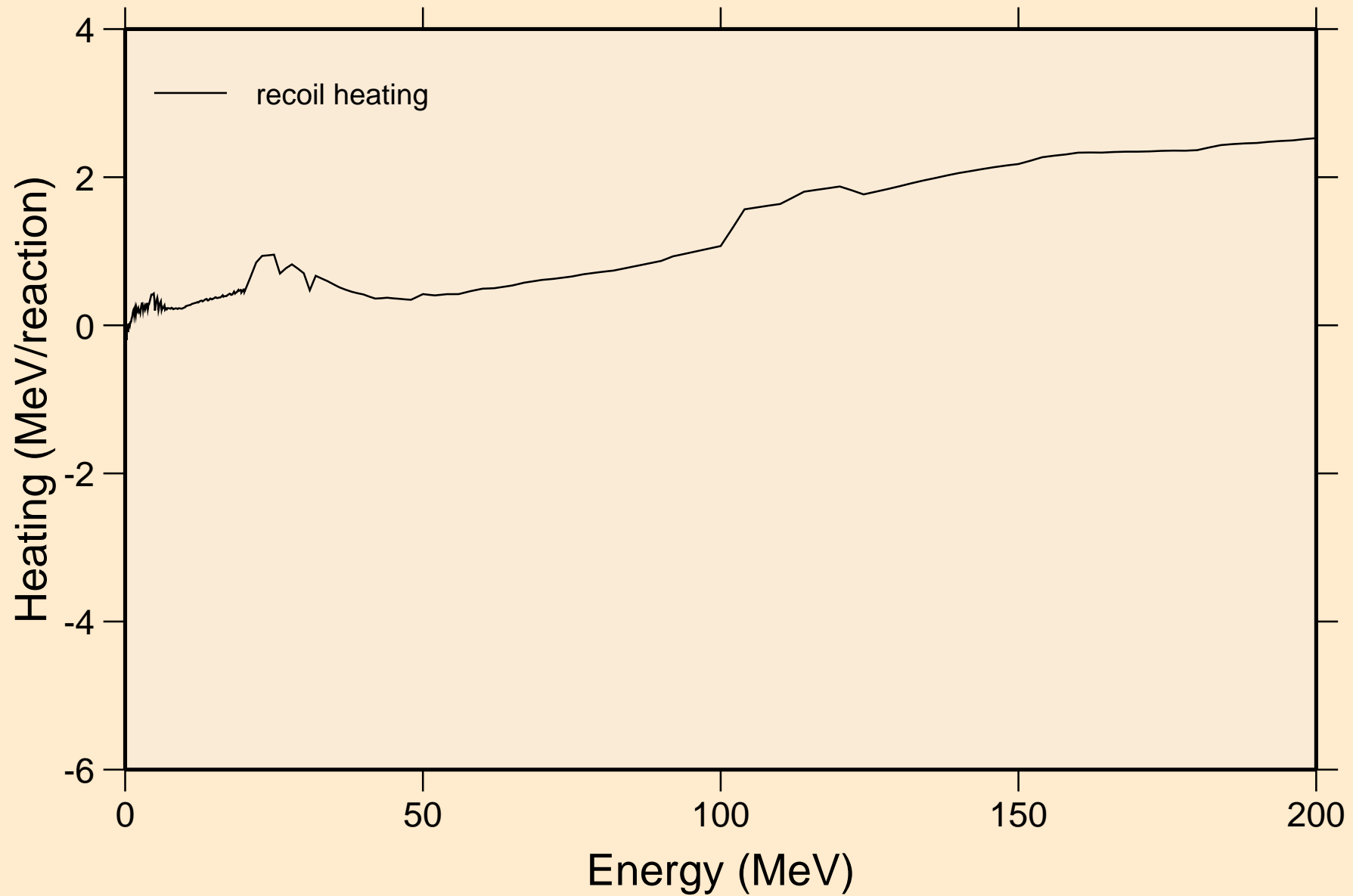

PD095M NEUTRON ACER TENDL-2021 LIBRARY; T=293.6K  
Particle production cross sections

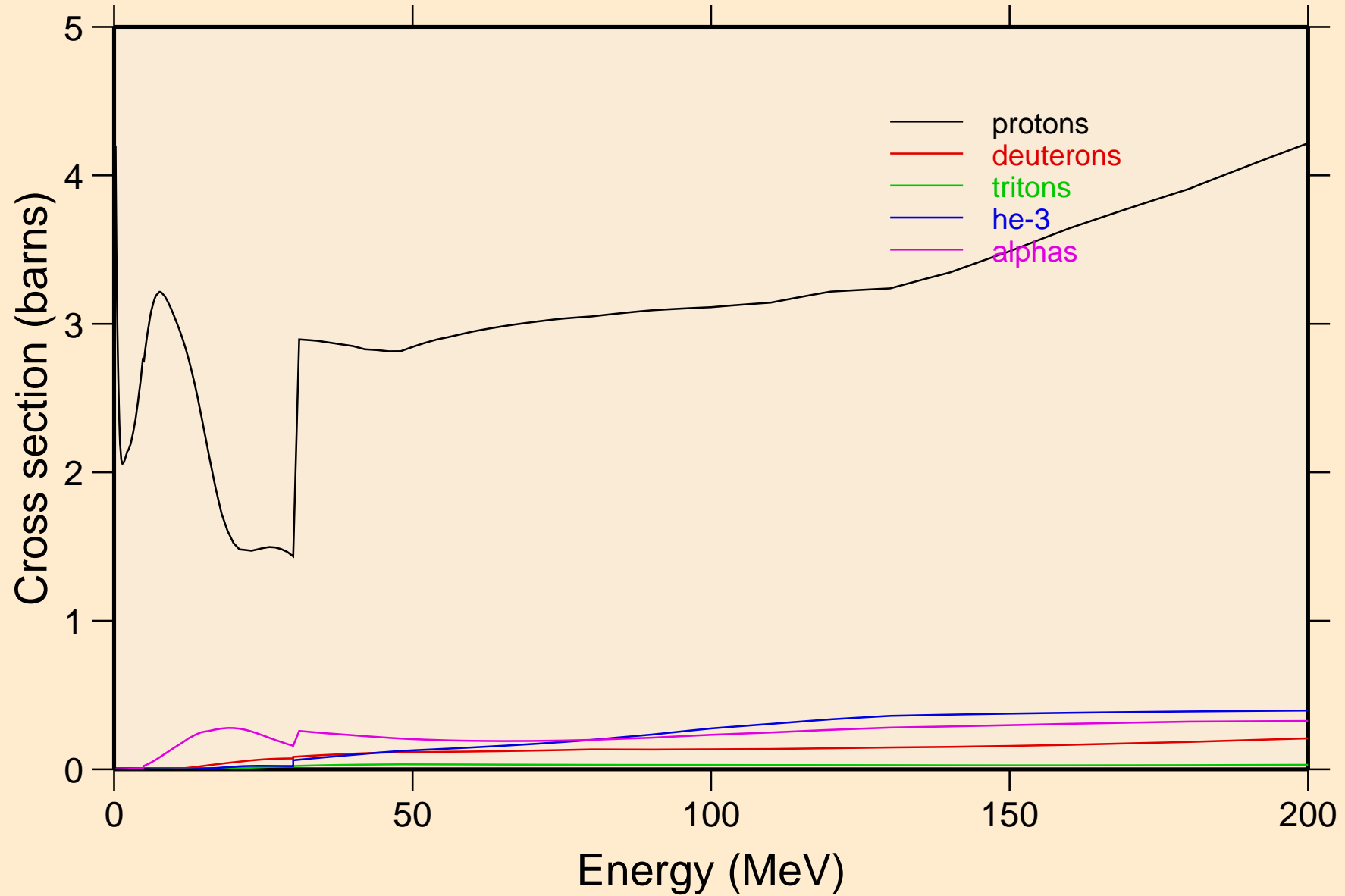

PD095M NEUTRON ACER TENDL-2021 LIBRARY; T=293.6K  
protons from (n,x)

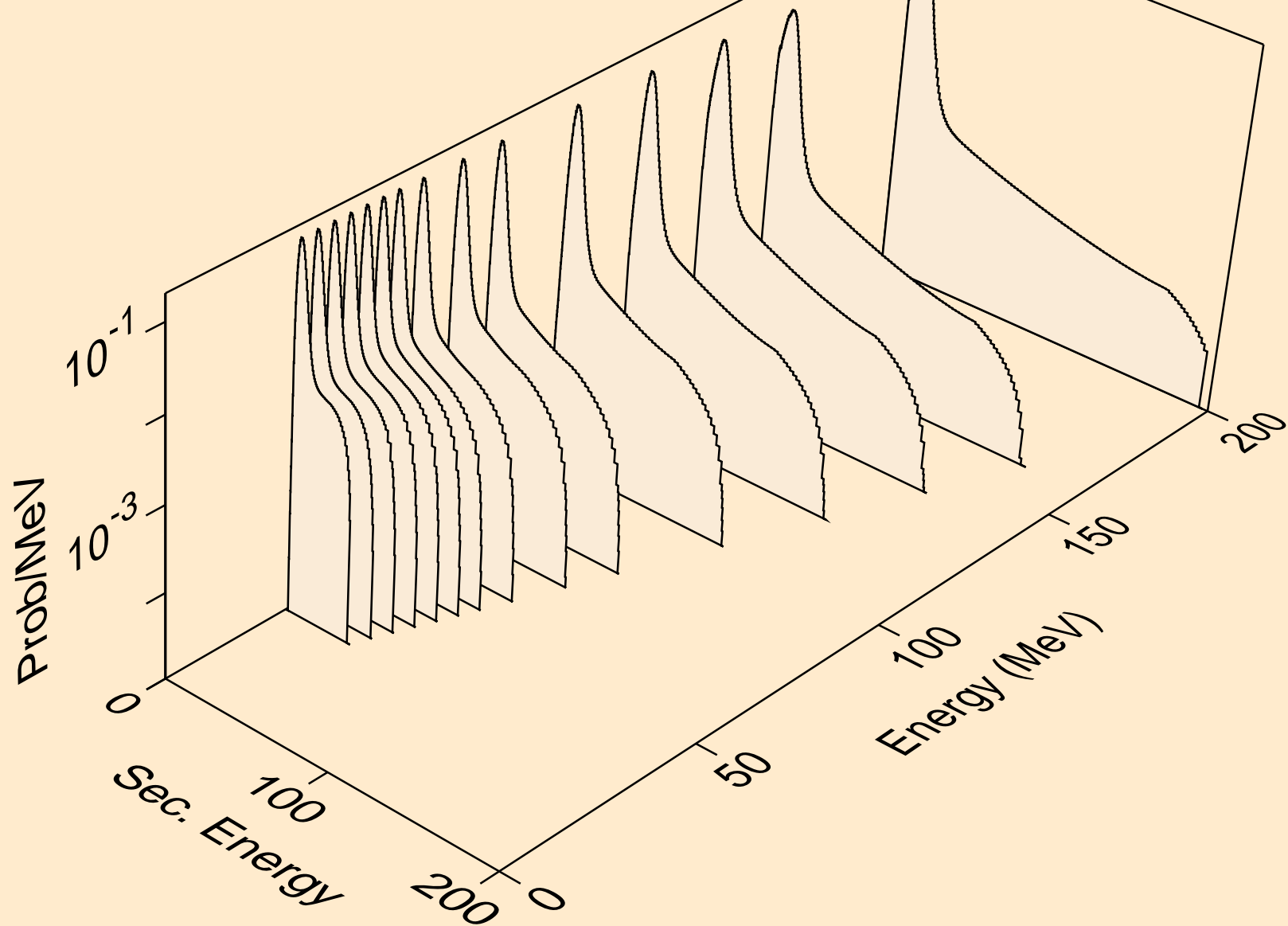

PD095M NEUTRON ACER TENDL-2021 LIBRARY; T=293.6K  
protons from (n,n\*)p

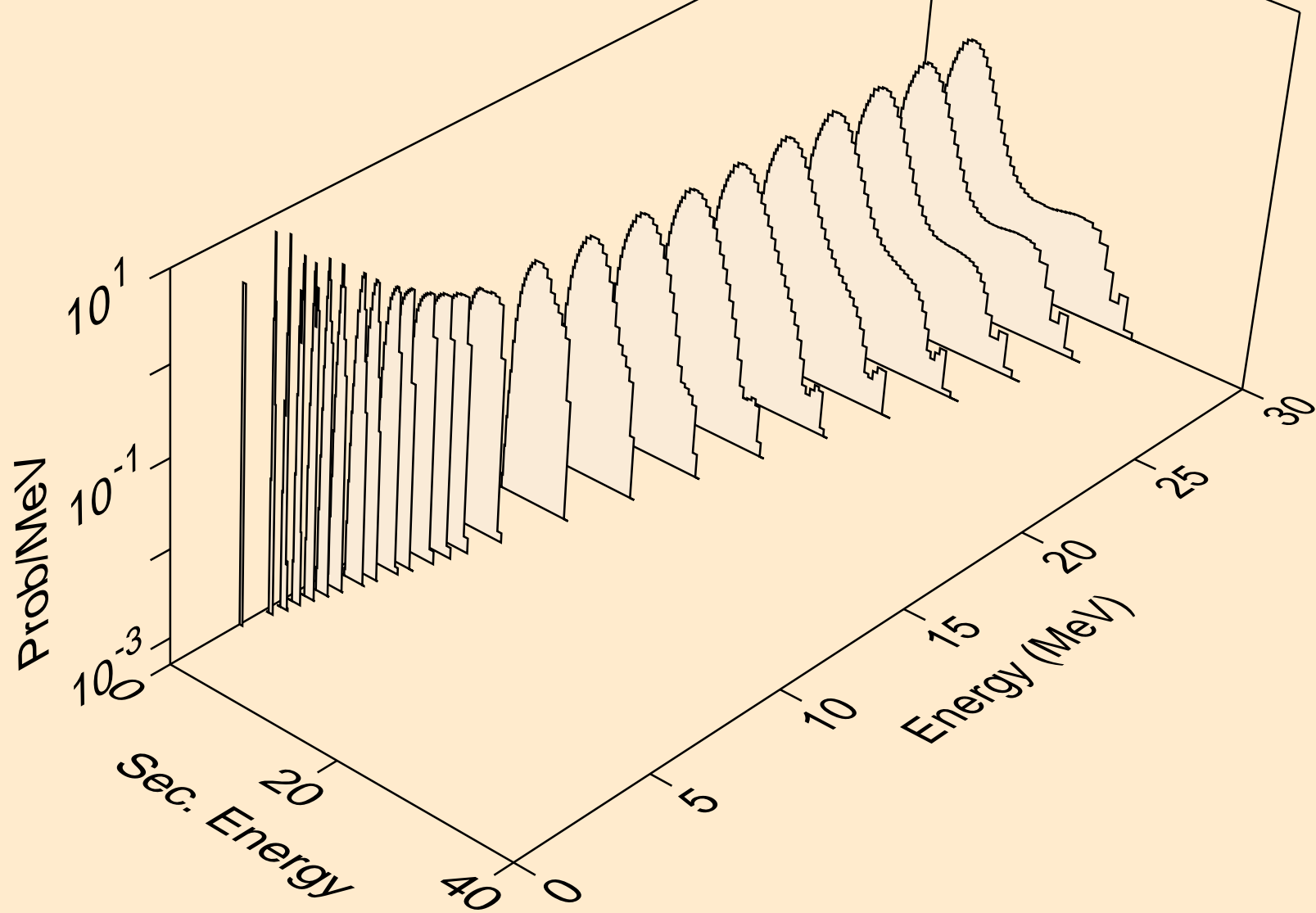



PD095M NEUTRON ACER TENDL-2021 LIBRARY; T=293.6K  
protons from (n,2np)

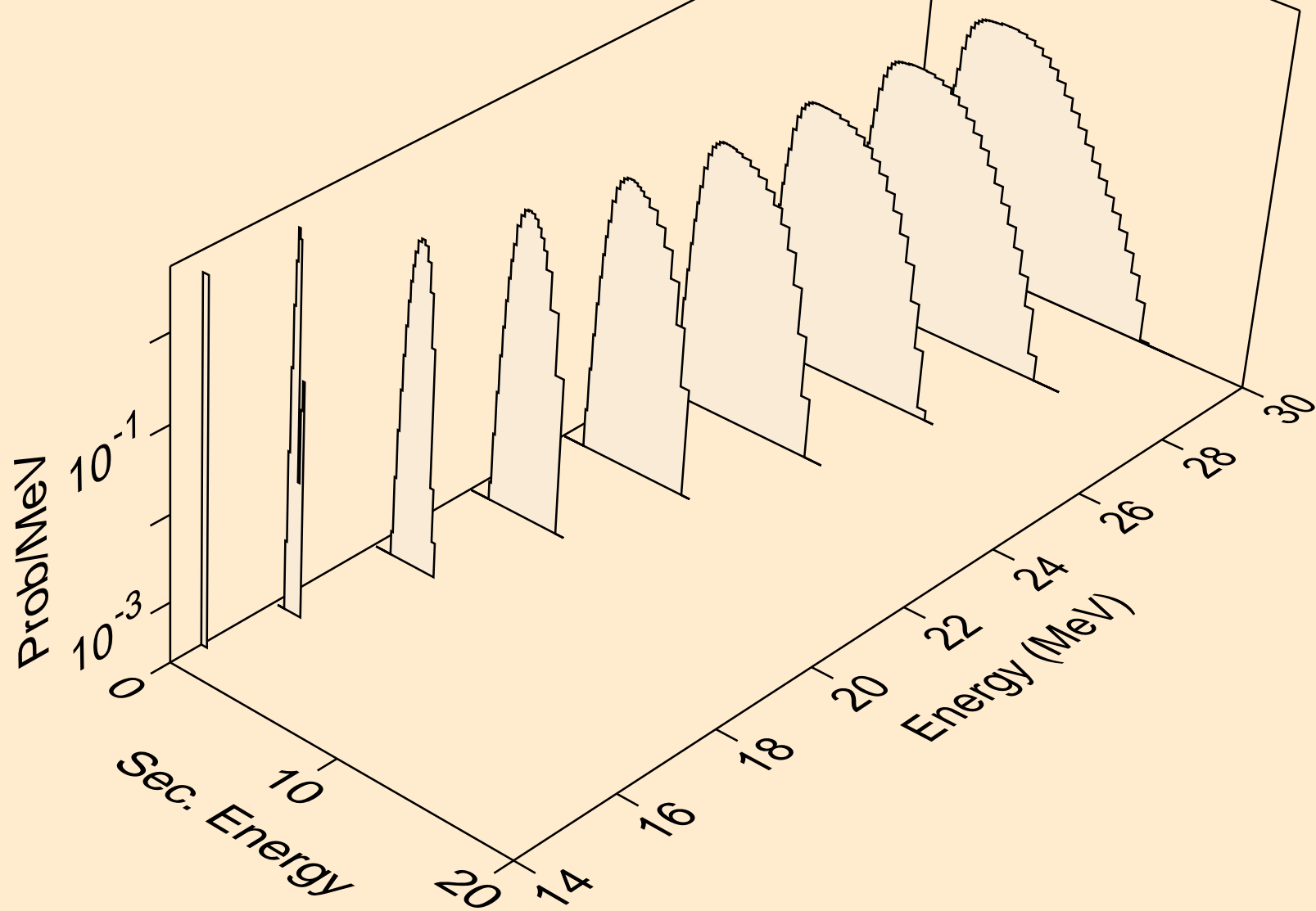

PD095M NEUTRON ACER TENDL-2021 LIBRARY; T=293.6K  
protons from (n,2np)

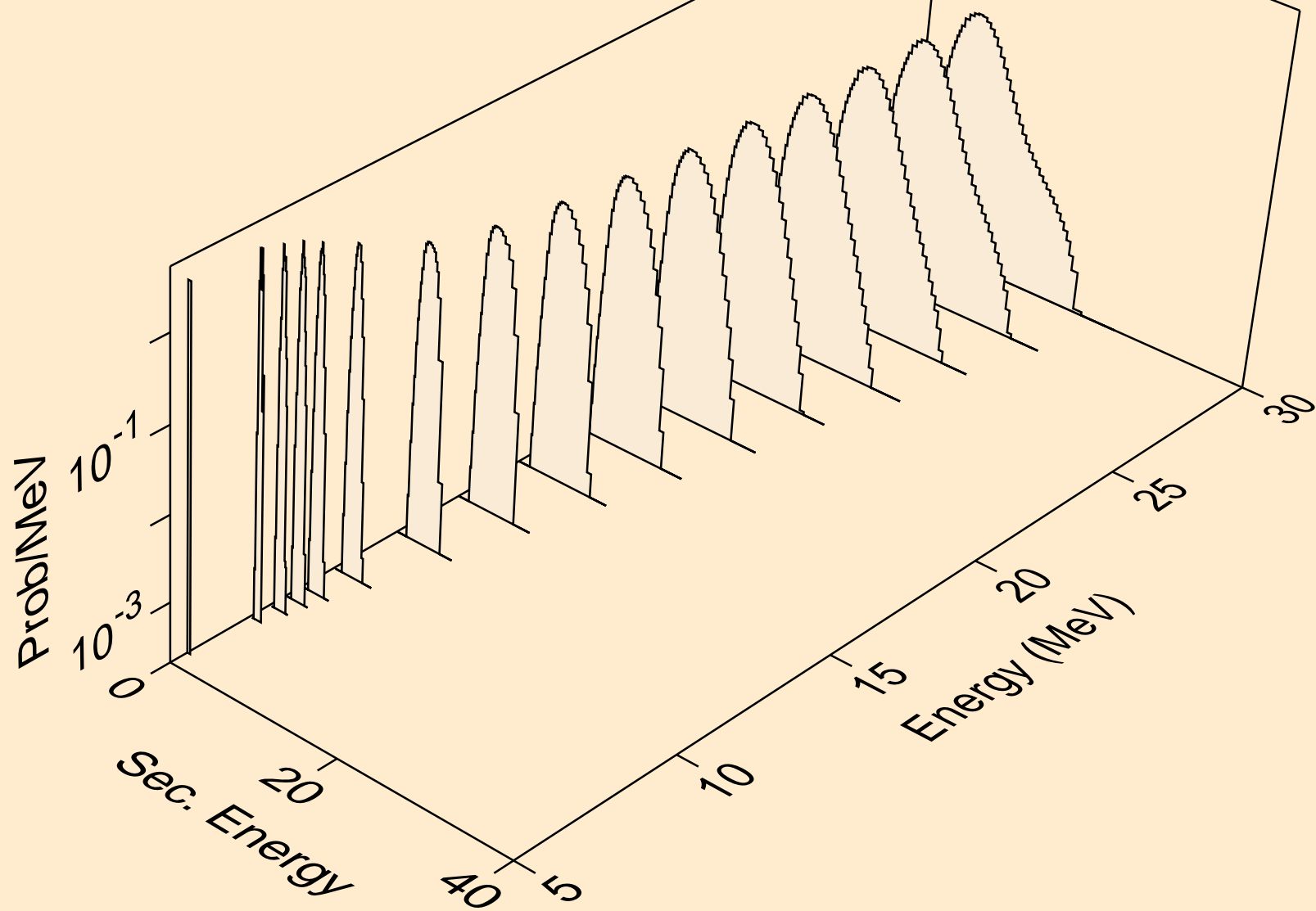

PD095M NEUTRON ACER TENDL-2021 LIBRARY; T=293.6K  
protons from (n,npa)

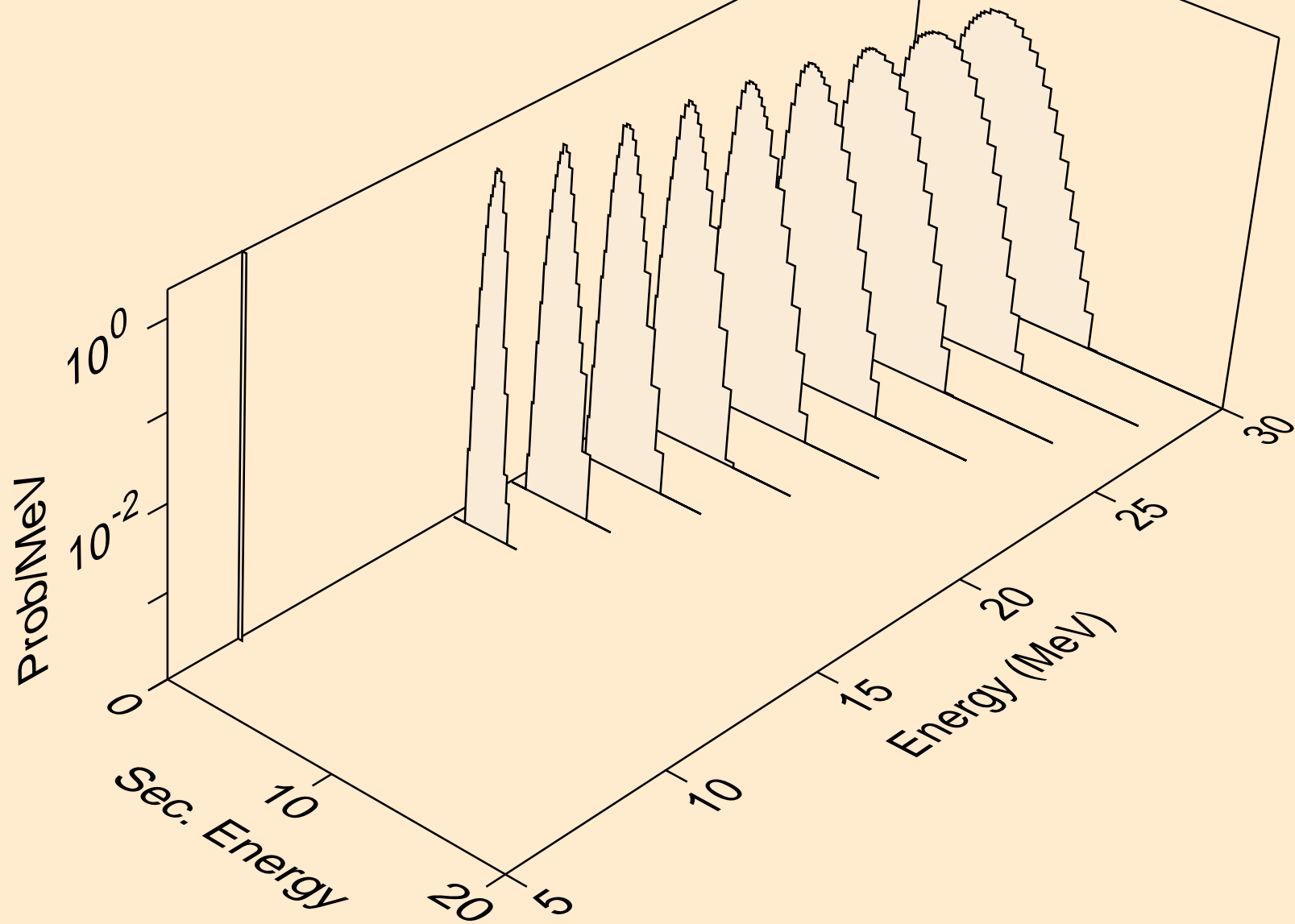

PD095M NEUTRON ACER TENDL-2021 LIBRARY; T=293.6K  
protons from (n,p)

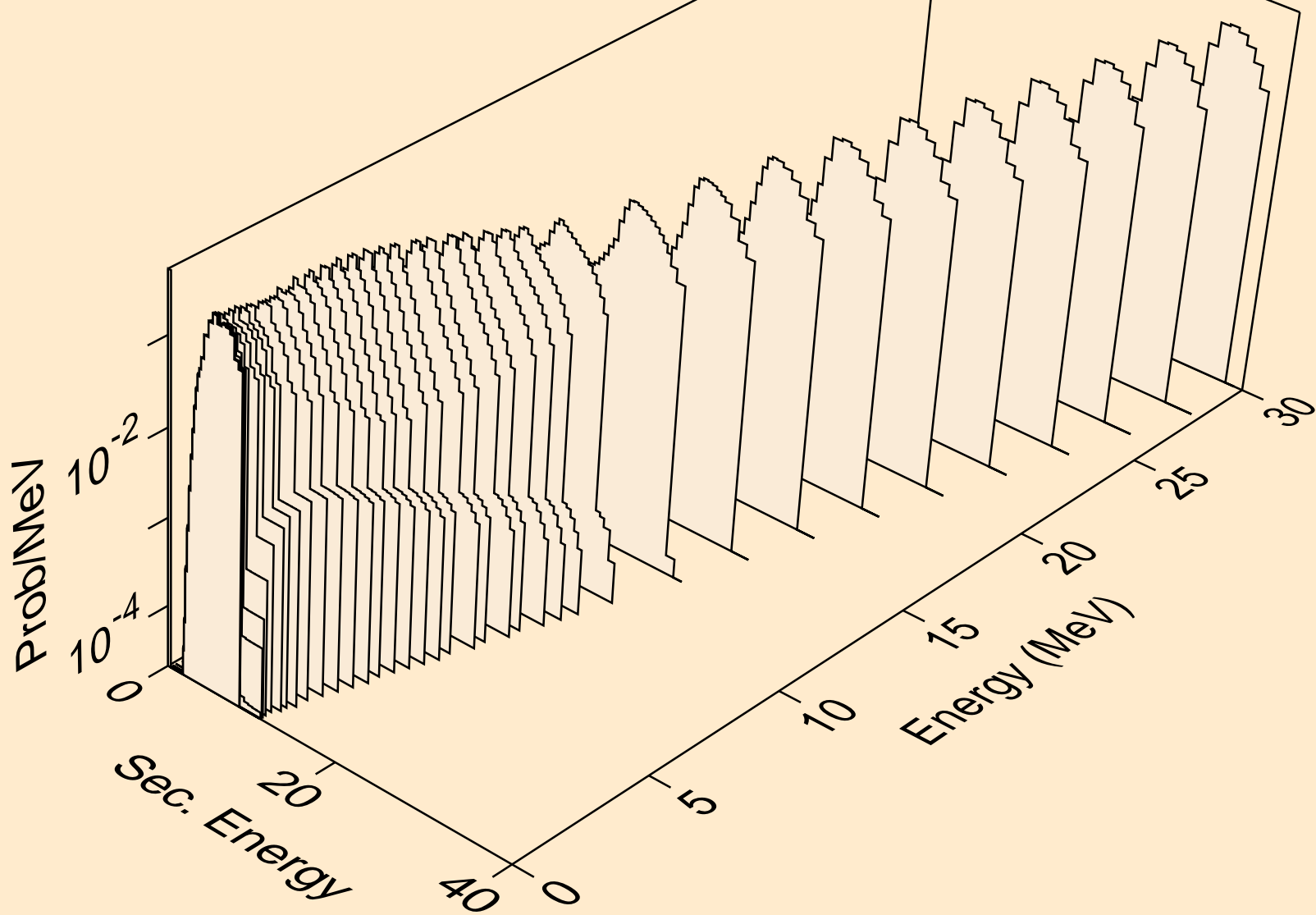

PD095M NEUTRON ACER TENDL-2021 LIBRARY; T=293.6K  
protons from (n,2p)

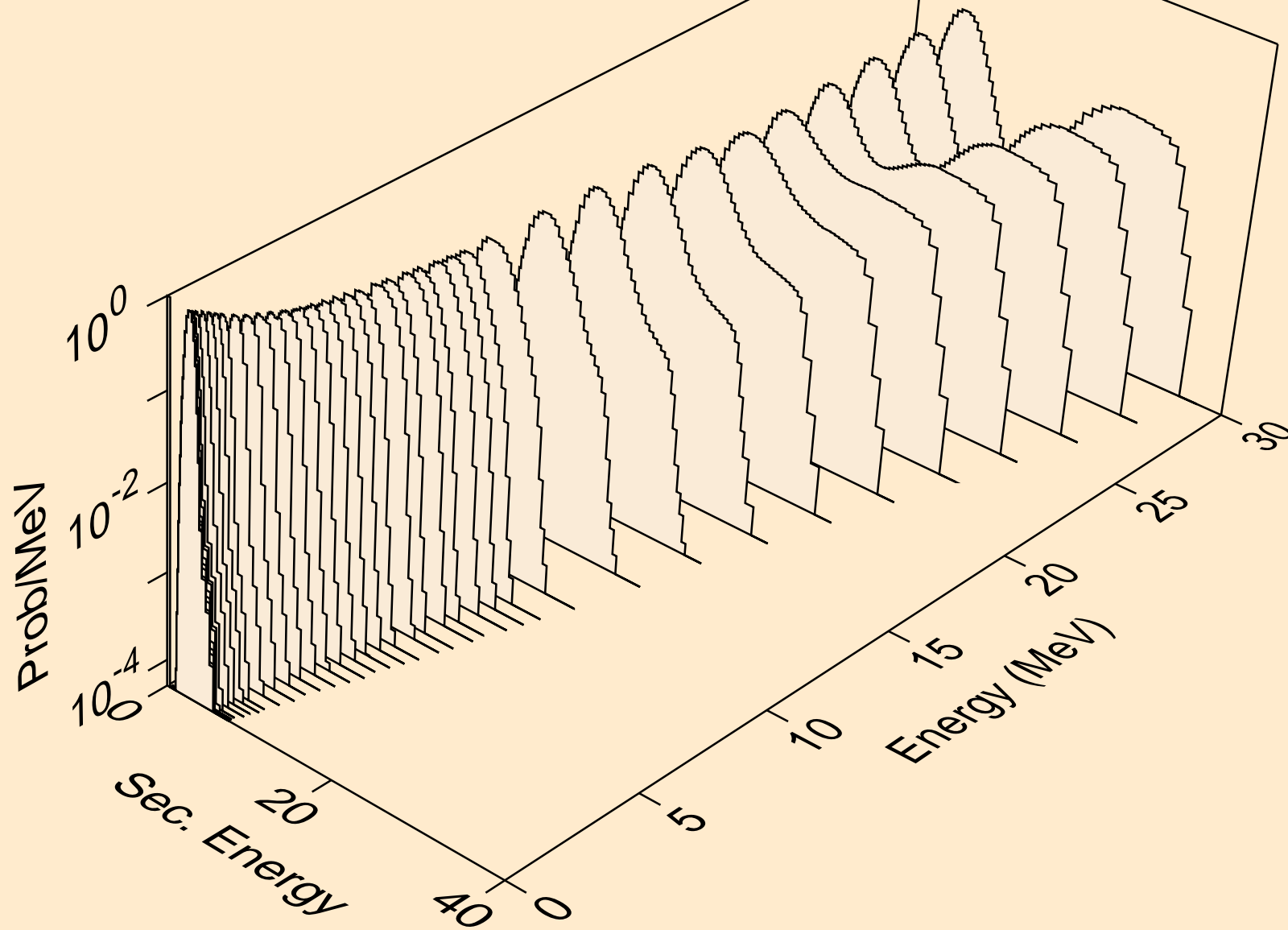

PD095M NEUTRON ACER TENDL-2021 LIBRARY; T=293.6K  
protons from (n,p)

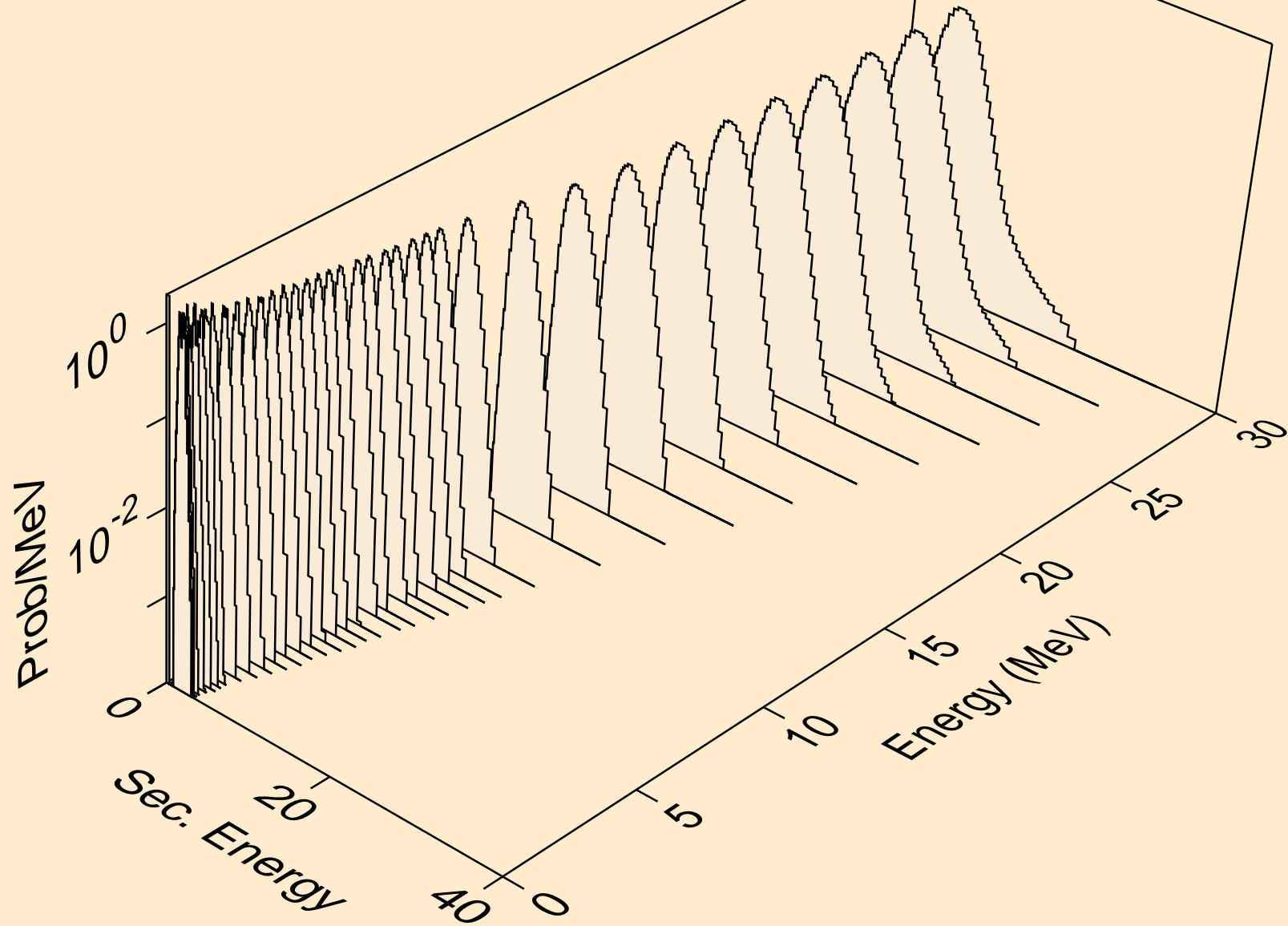

PD095M NEUTRON ACER TENDL-2021 LIBRARY; T=293.6K  
protons from (n,pd)

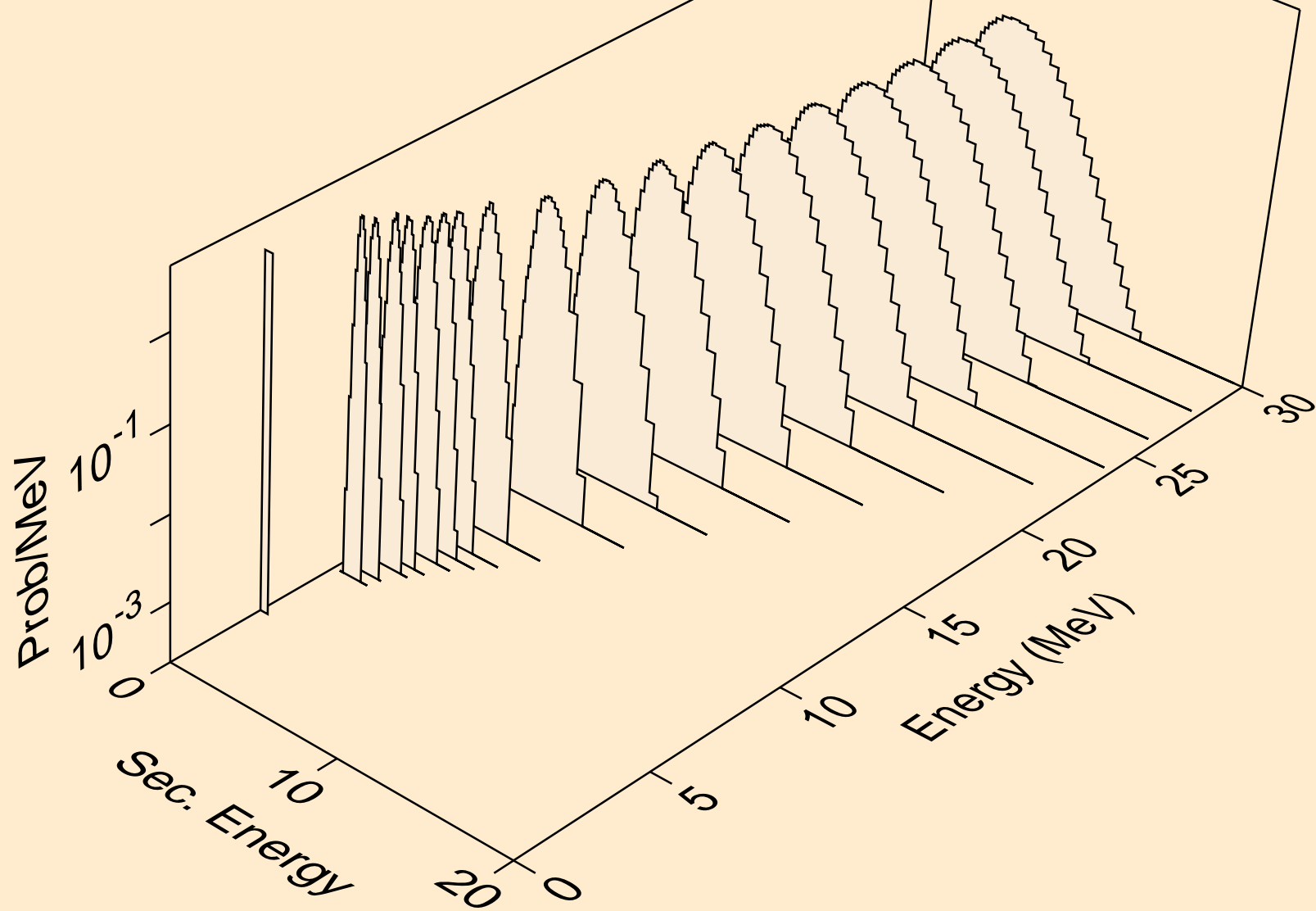

PD095M NEUTRON ACER TENDL-2021 LIBRARY; T=293.6K  
protons from (n,pt)

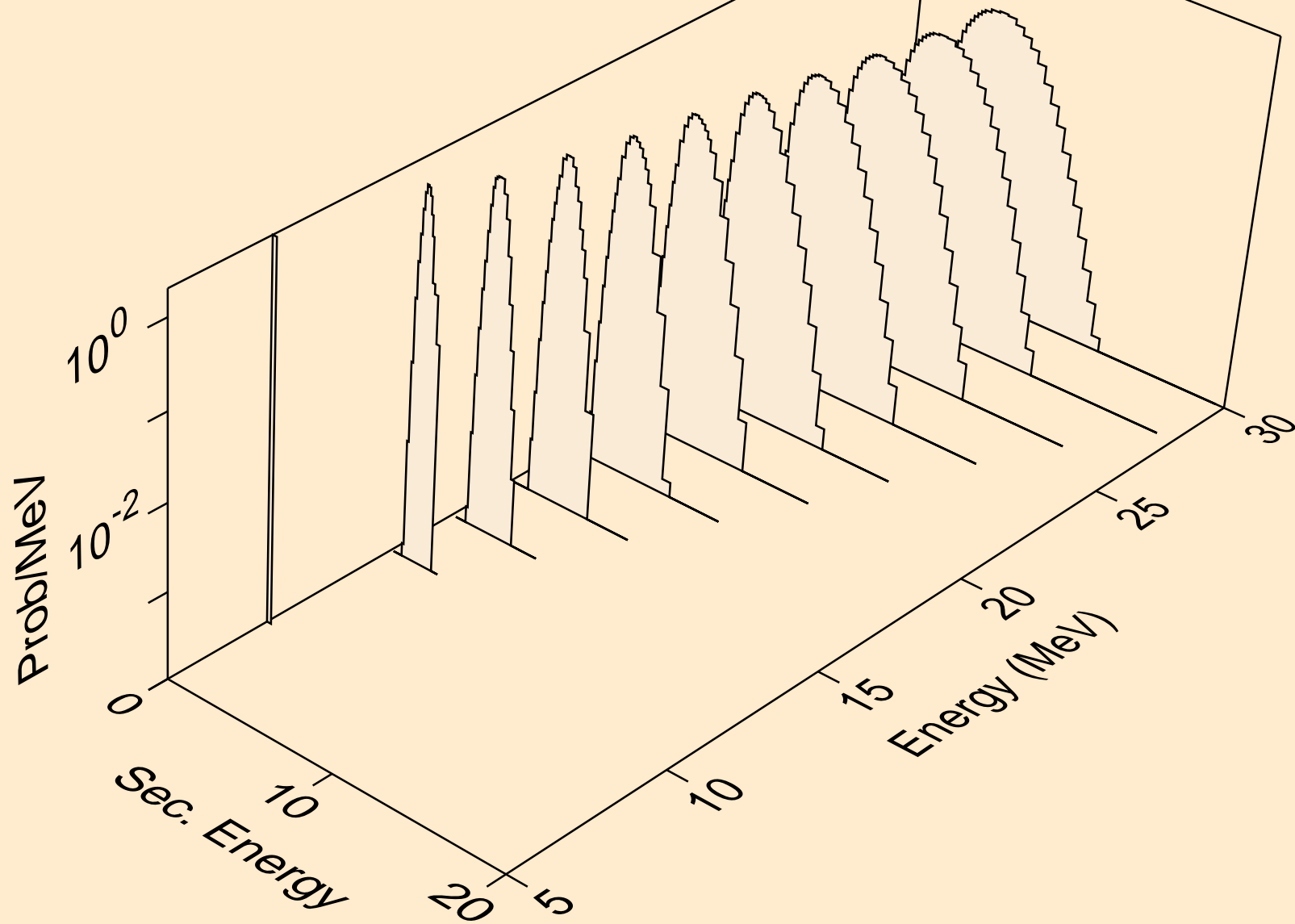



PD095M NEUTRON ACER TENDL-2021 LIBRARY; T=293.6K  
deuterons from (n,x)

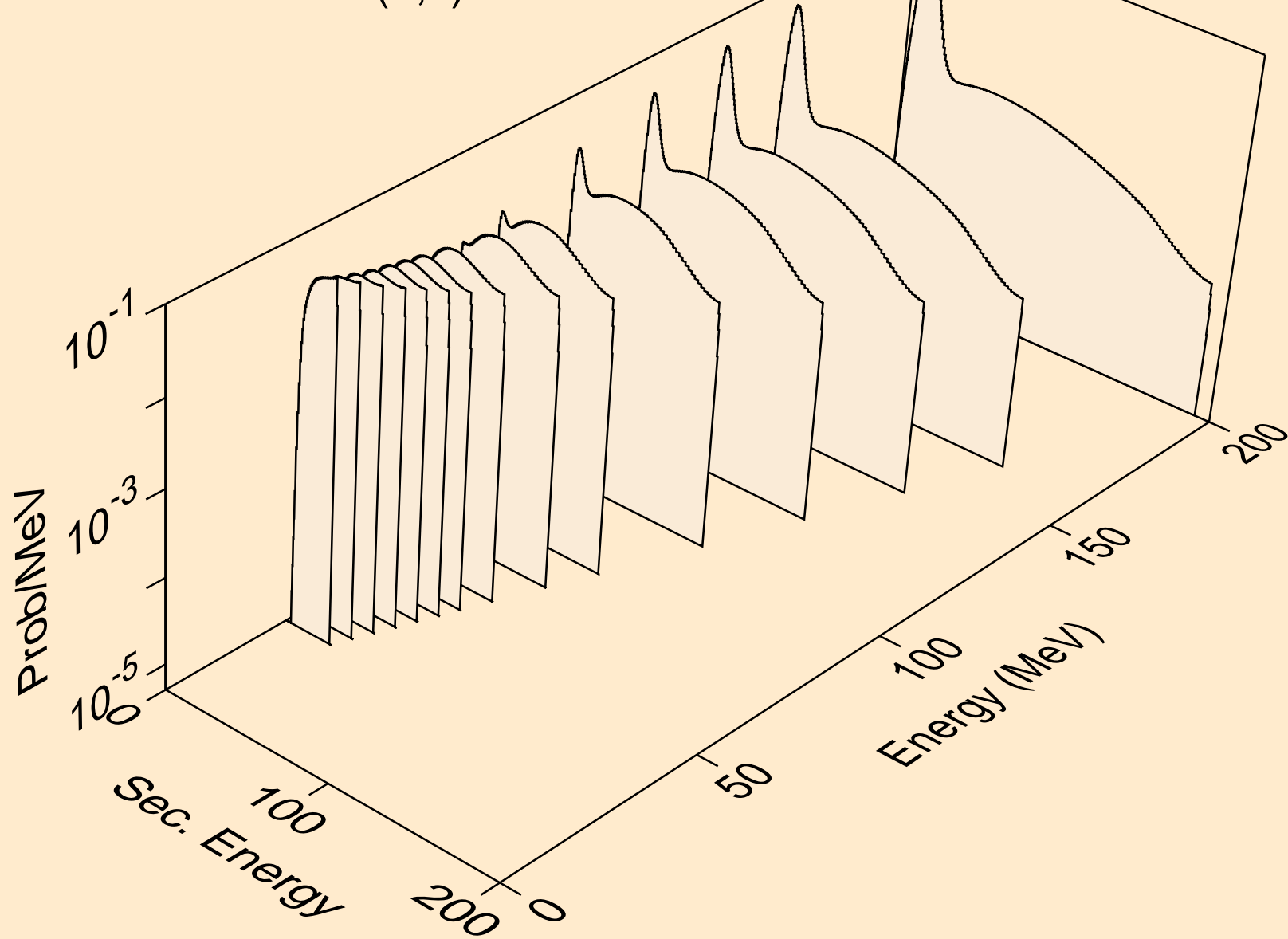

PD095M NEUTRON ACER TENDL-2021 LIBRARY; T=293.6K  
deuterons from (n,n\*)d

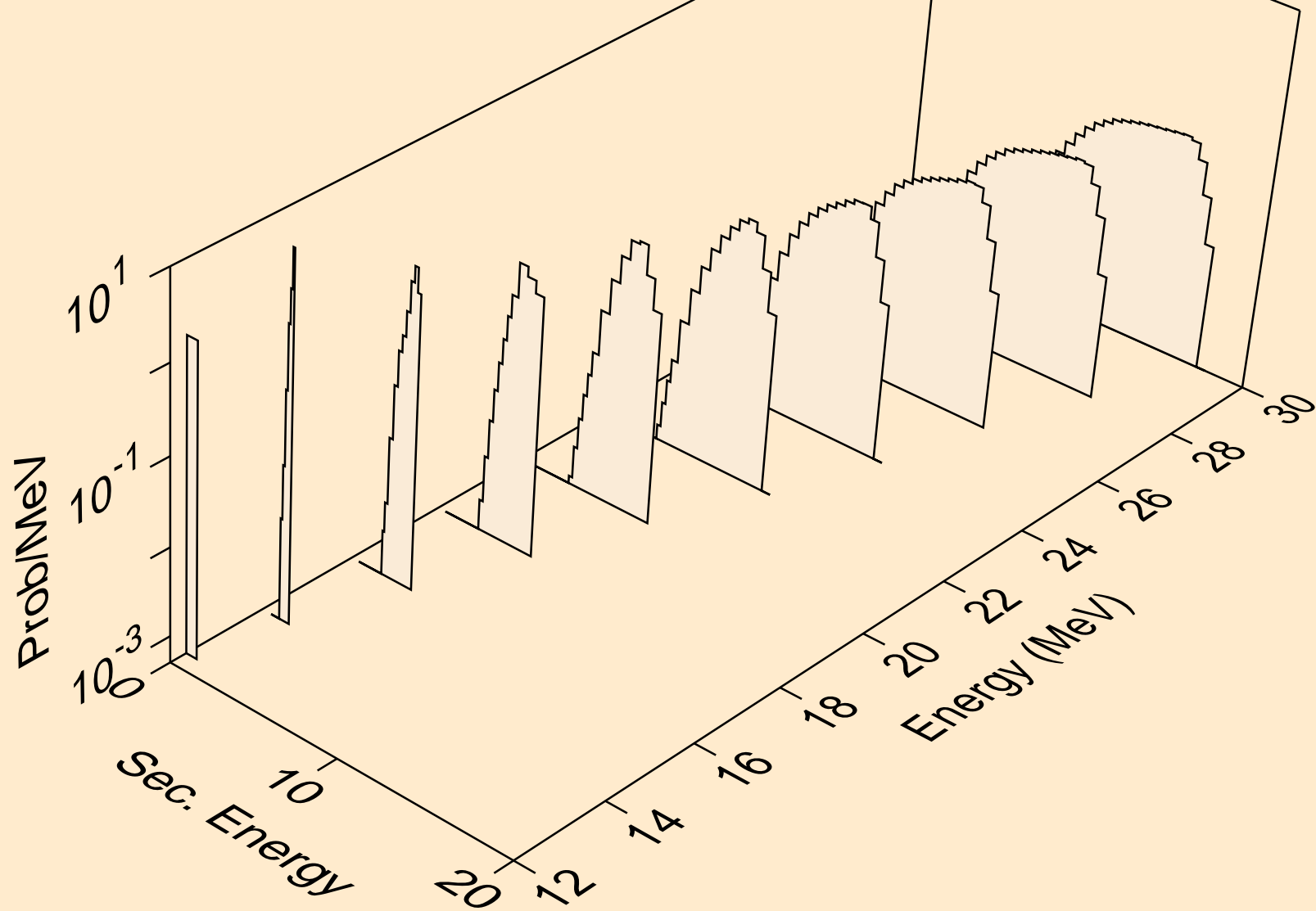

PD095M NEUTRON ACER TENDL-2021 LIBRARY; T=293.6K  
deuterons from (n,d)

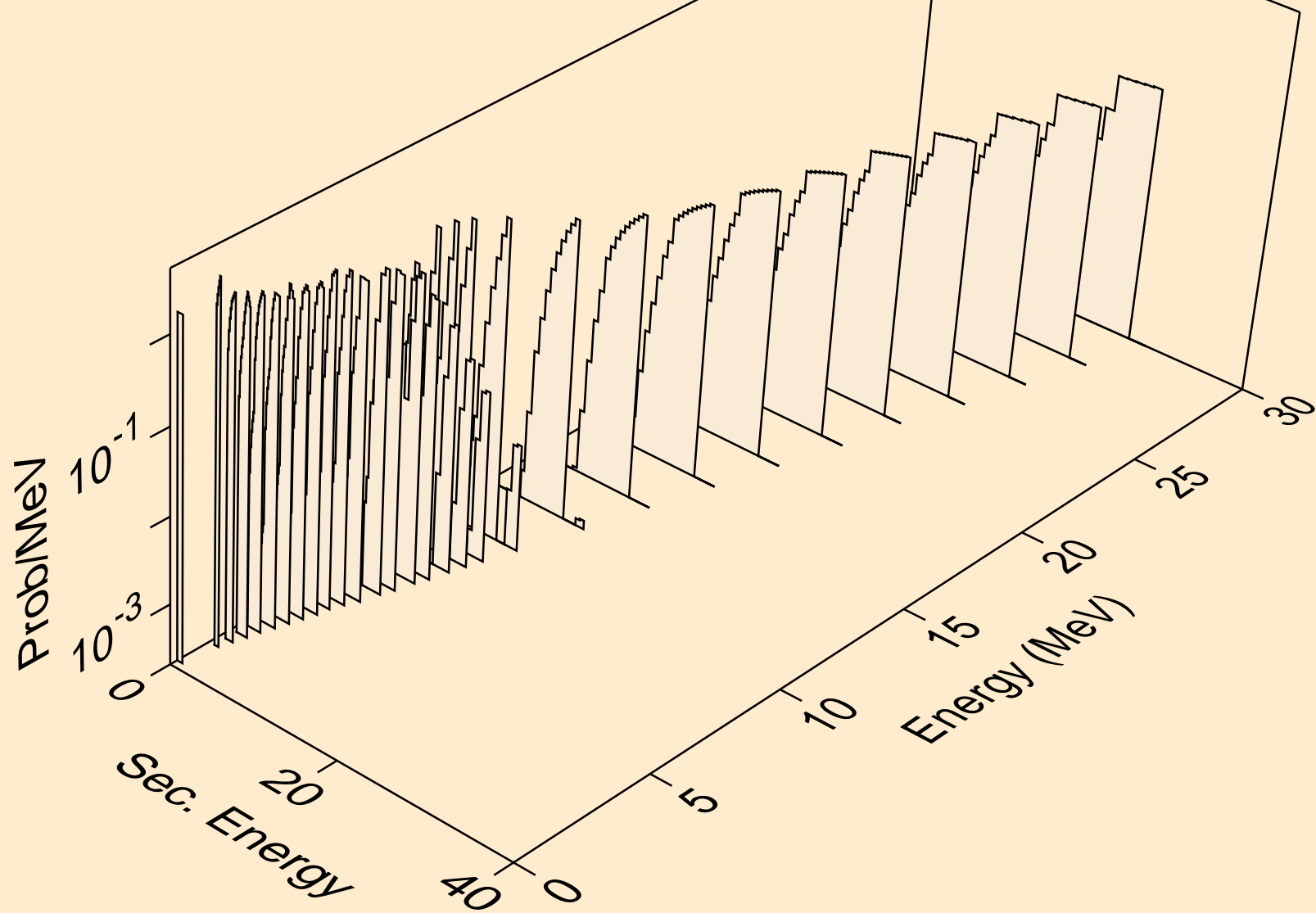

PD095M NEUTRON ACER TENDL-2021 LIBRARY; T=293.6K  
deuterons from (n,pd)

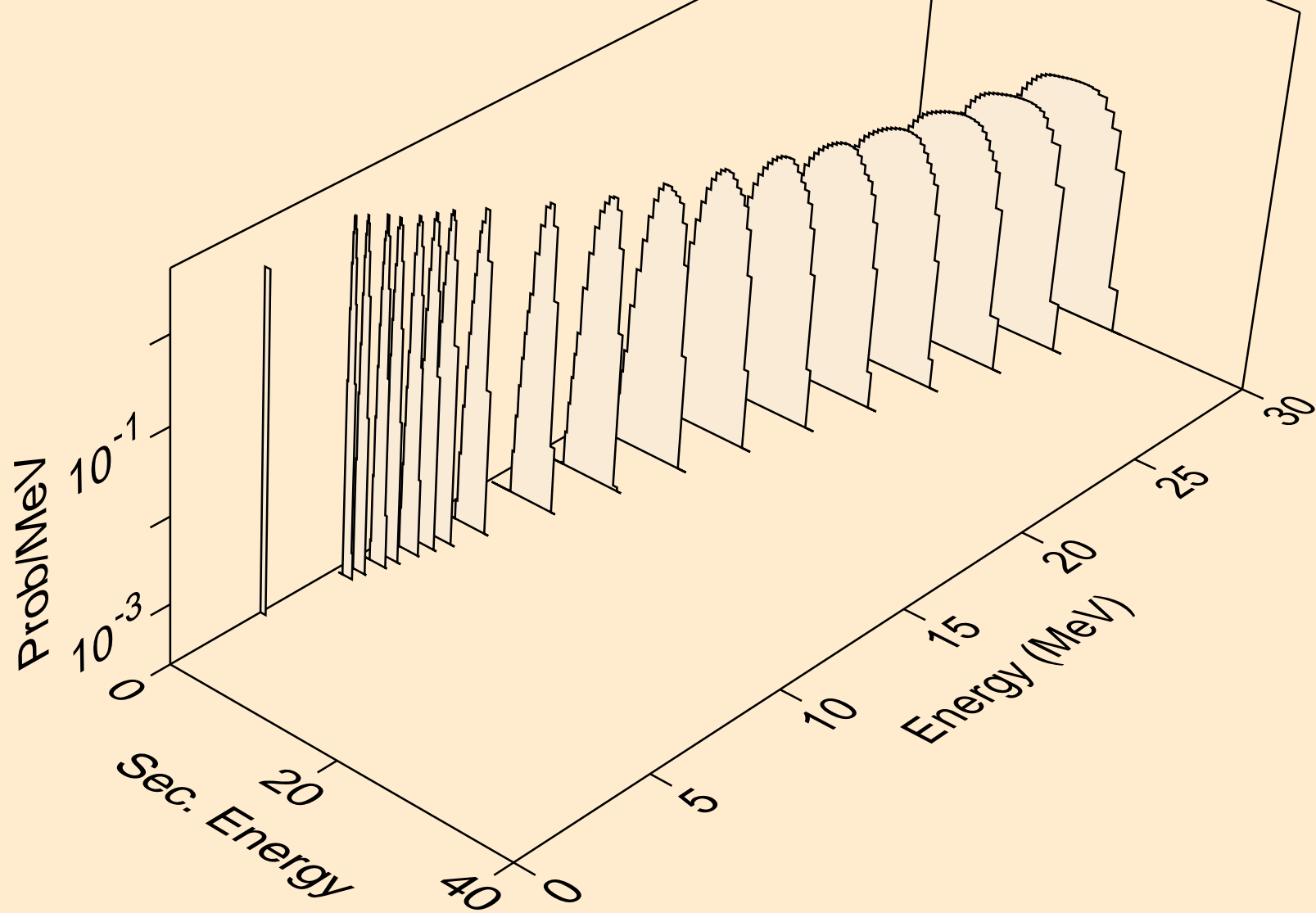

PD095M NEUTRON ACER TENDL-2021 LIBRARY; T=293.6K  
deuterons from (n,da)

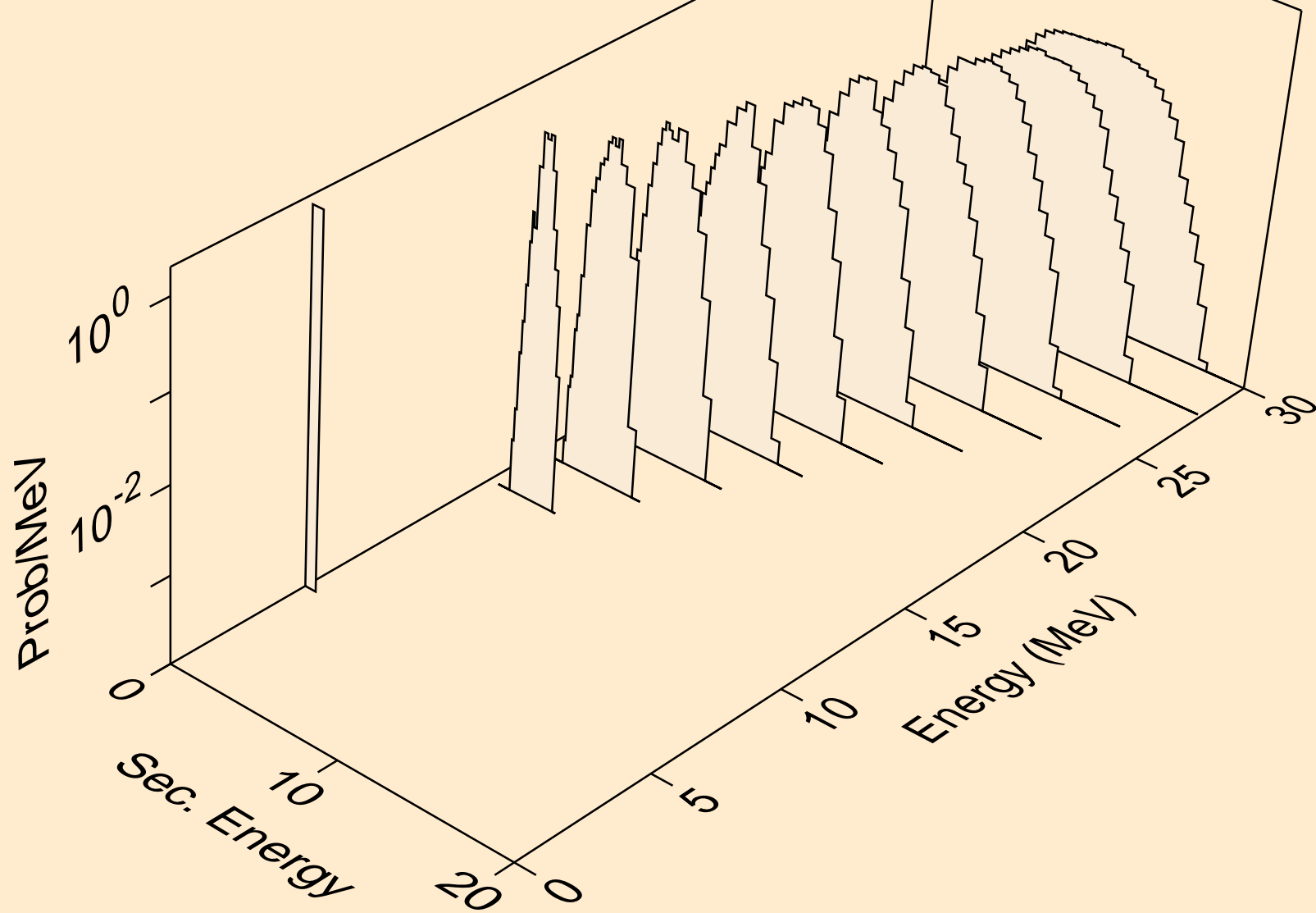

PD095M NEUTRON ACER TENDL-2021 LIBRARY; T=293.6K  
tritons from (n,x)

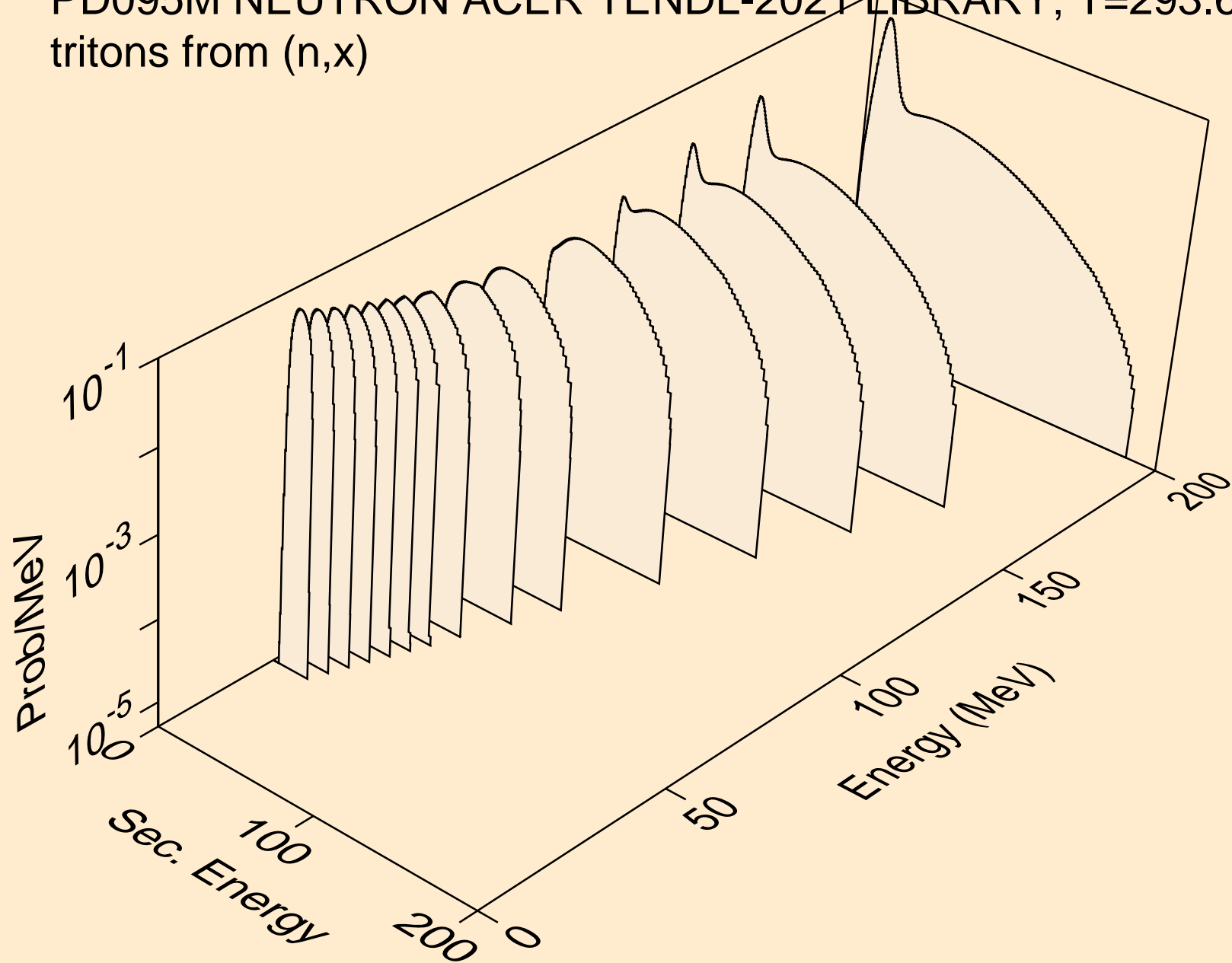

PD095M NEUTRON ACER TENDL-2021 LIBRARY; T=293.6K  
tritons from (n,n\*)t

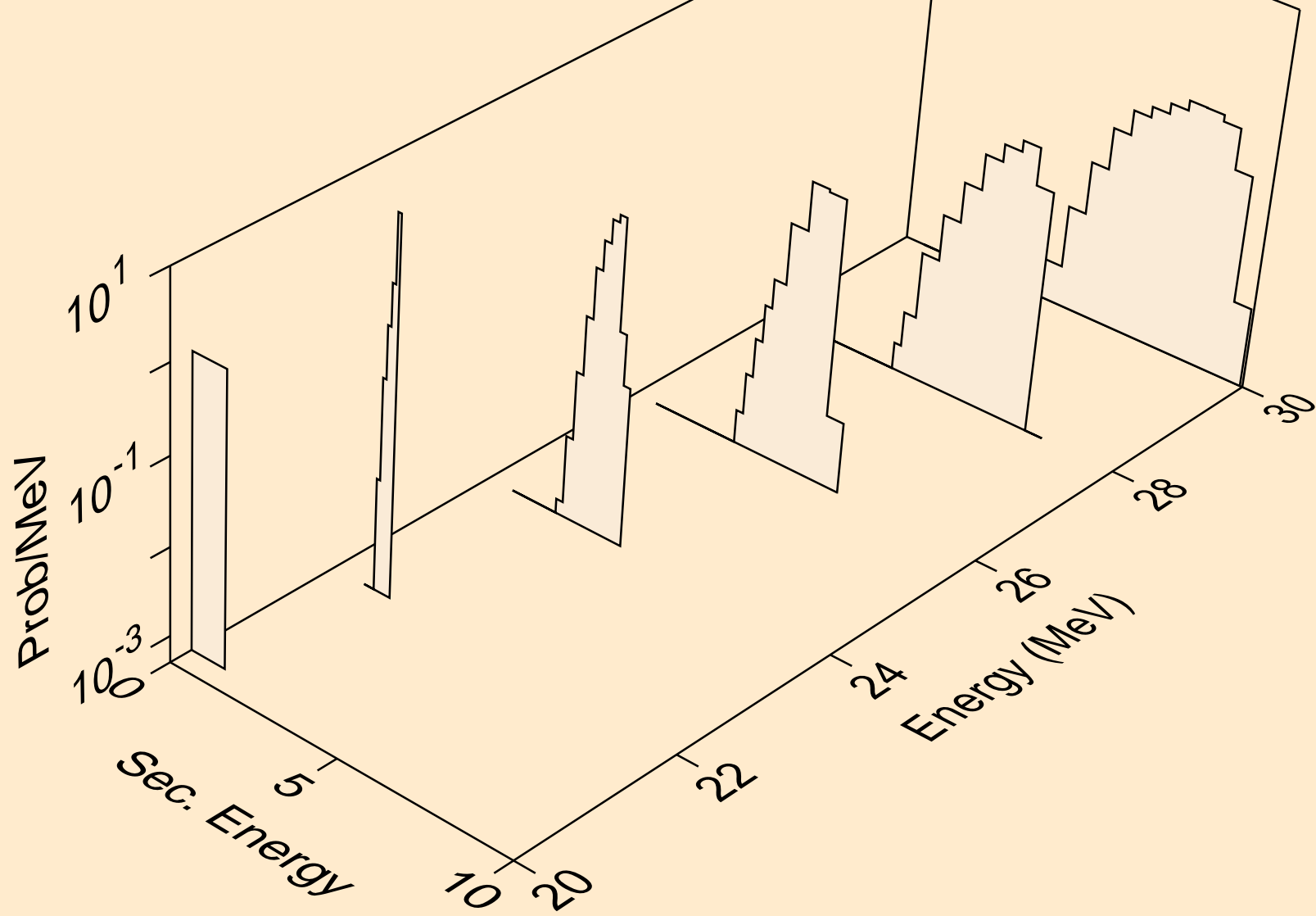

PD095M NEUTRON ACER TENDL-2021 LIBRARY; T=293.6K  
tritons from (n,t)

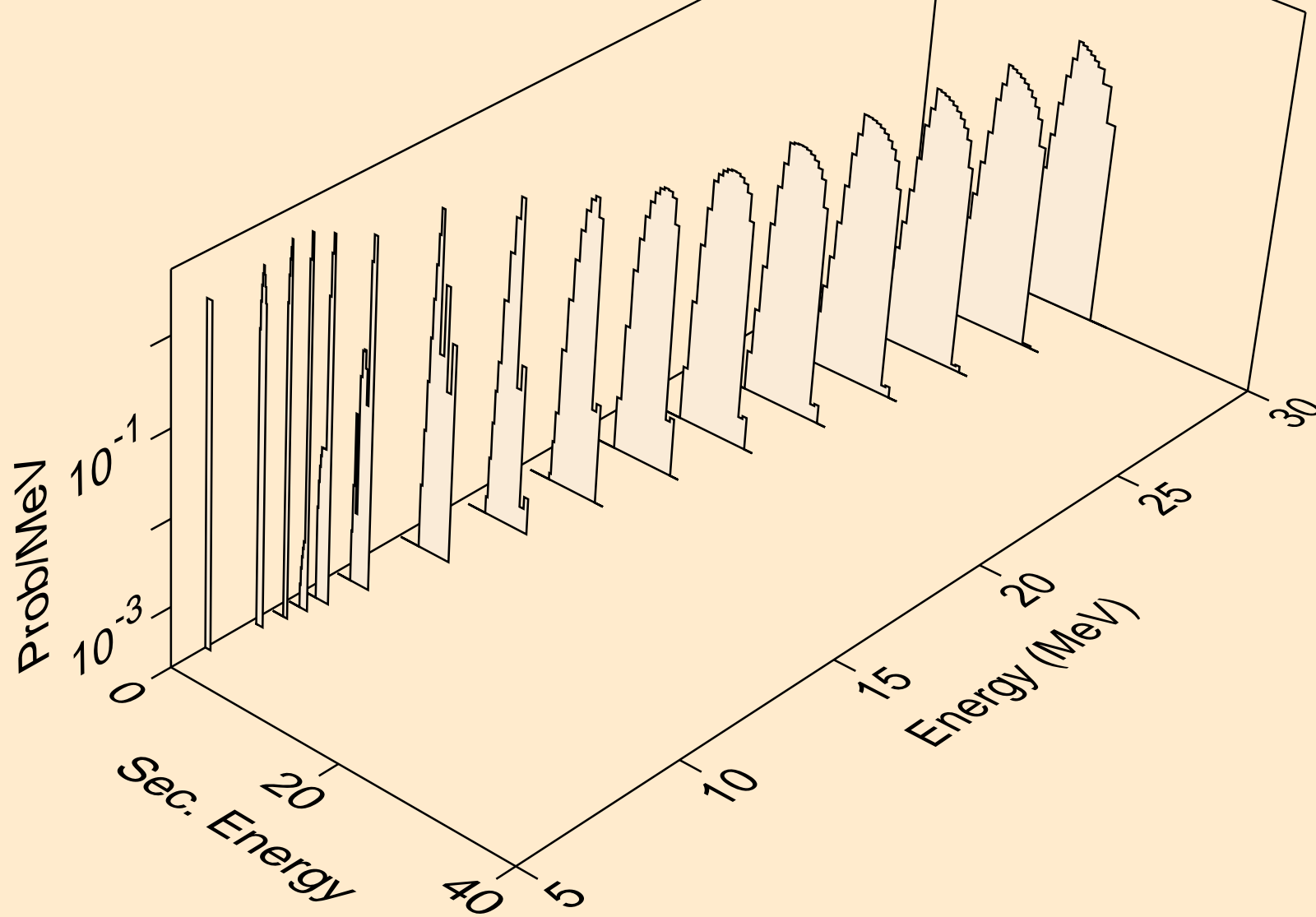



PD095M NEUTRON ACER TENDL-2021 LIBRARY; T=293.6K  
tritons from (n,pt)

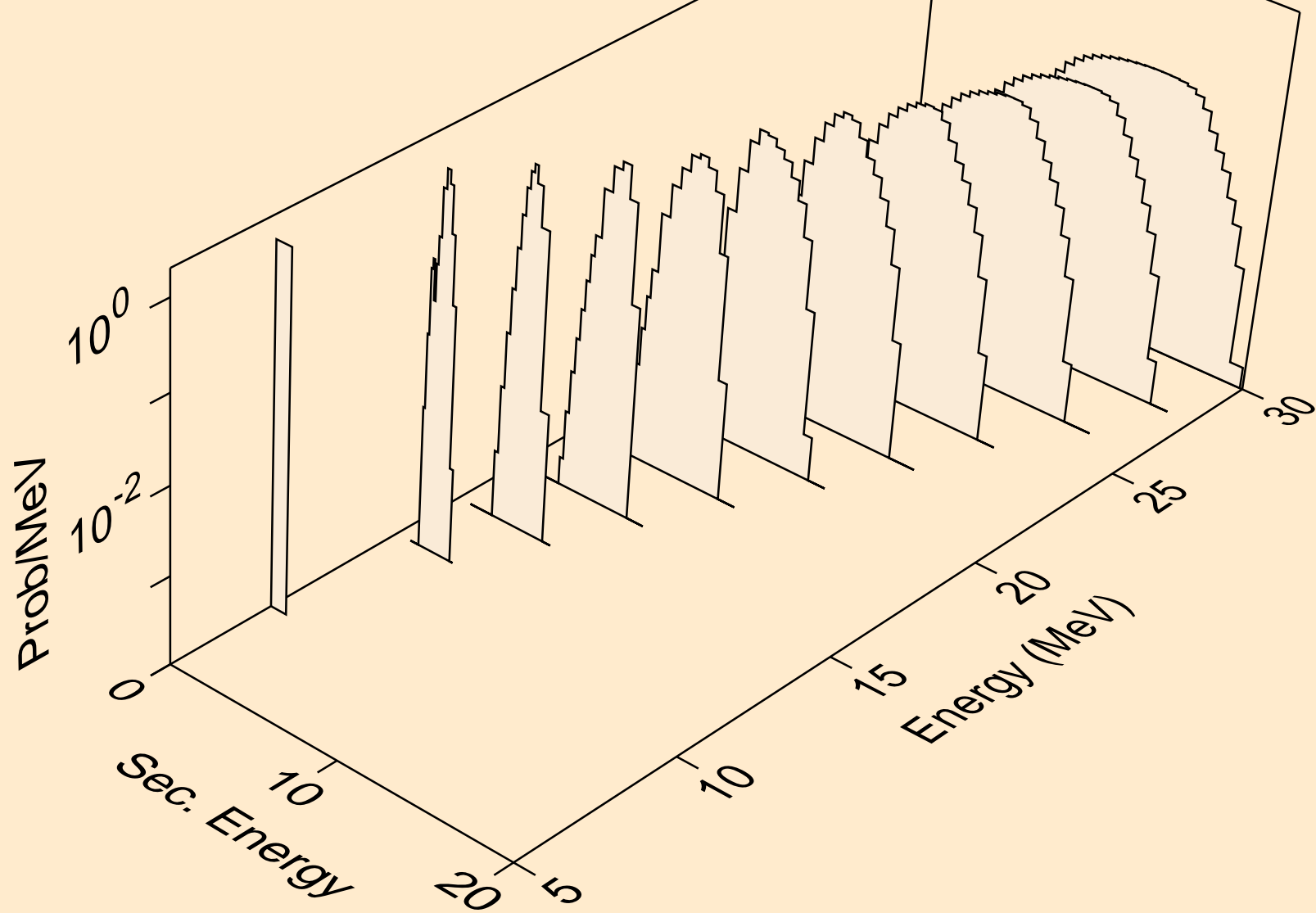

PD095M NEUTRON ACER TENDL-2021 LIBRARY; T=293.6K  
he3s from (n,x)

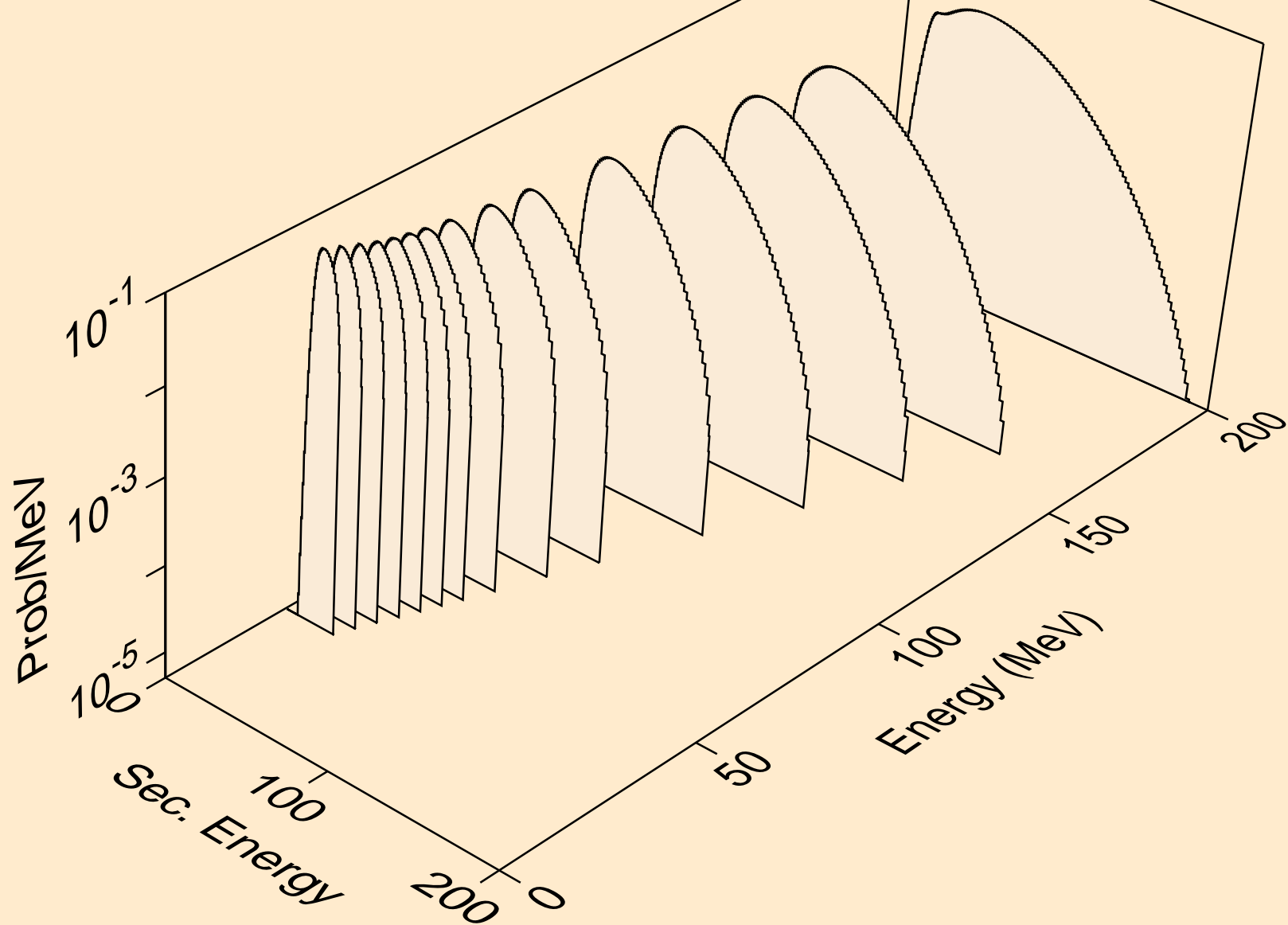

PD095M NEUTRON ACER TENDL-2021 LIBRARY; T=293.6K  
he3s from (n,n\*)he3

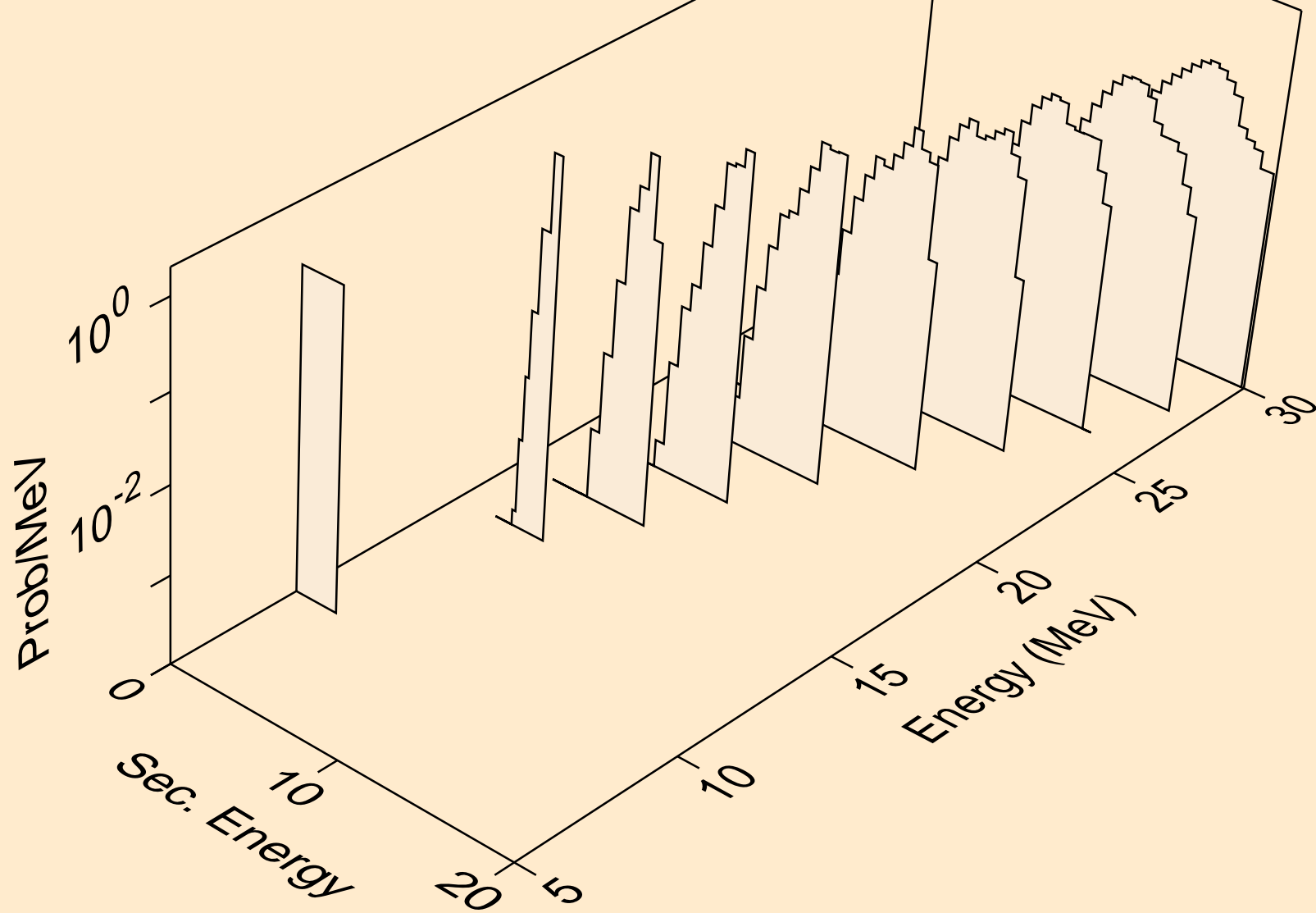

PD095M NEUTRON ACER TENDL-2021 LIBRARY; T=293.6K  
he3s from (n,he3)

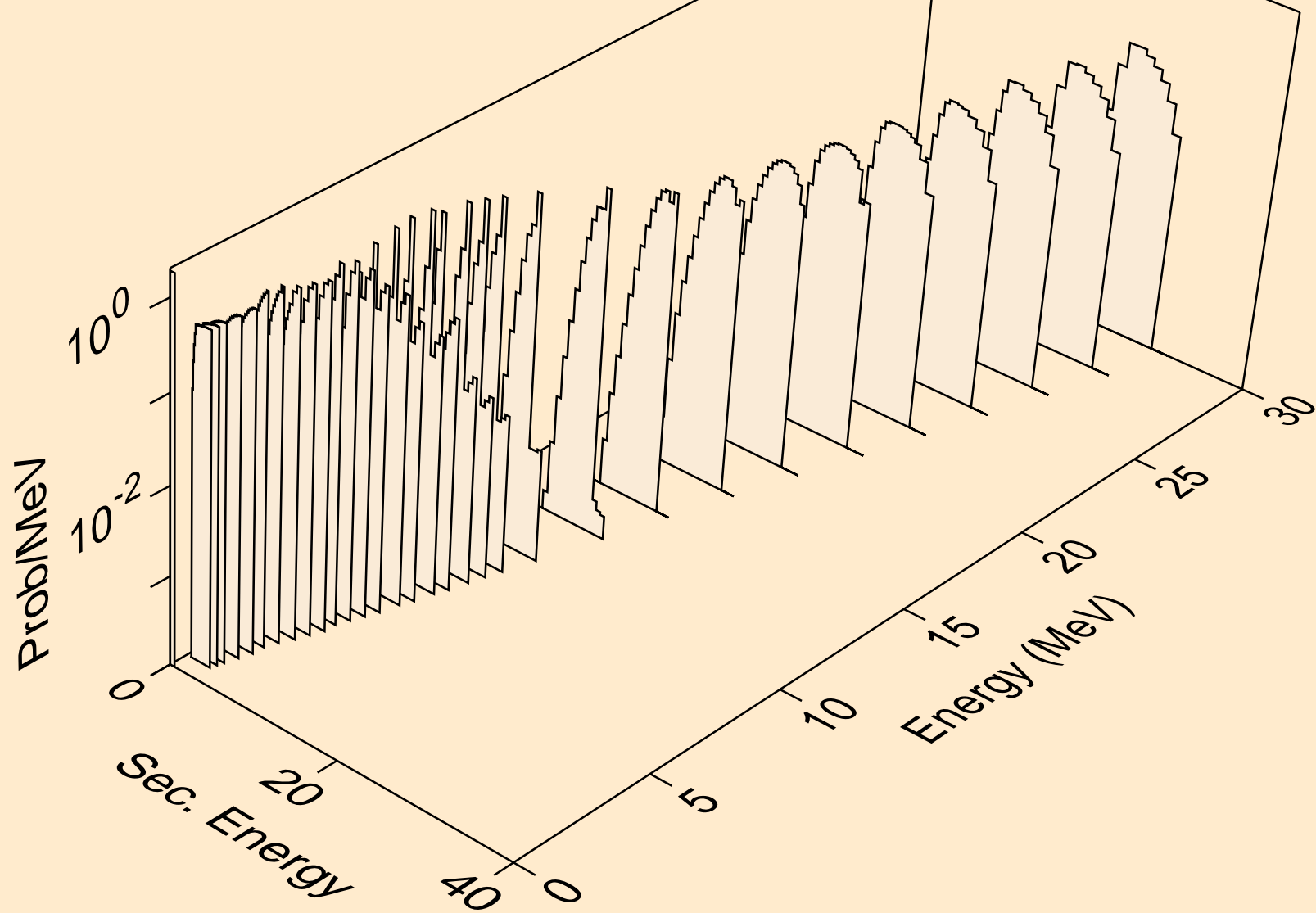

PD095M NEUTRON ACER TENDL-2021 LIBRARY; T=293.6K  
alphas from (n,x)

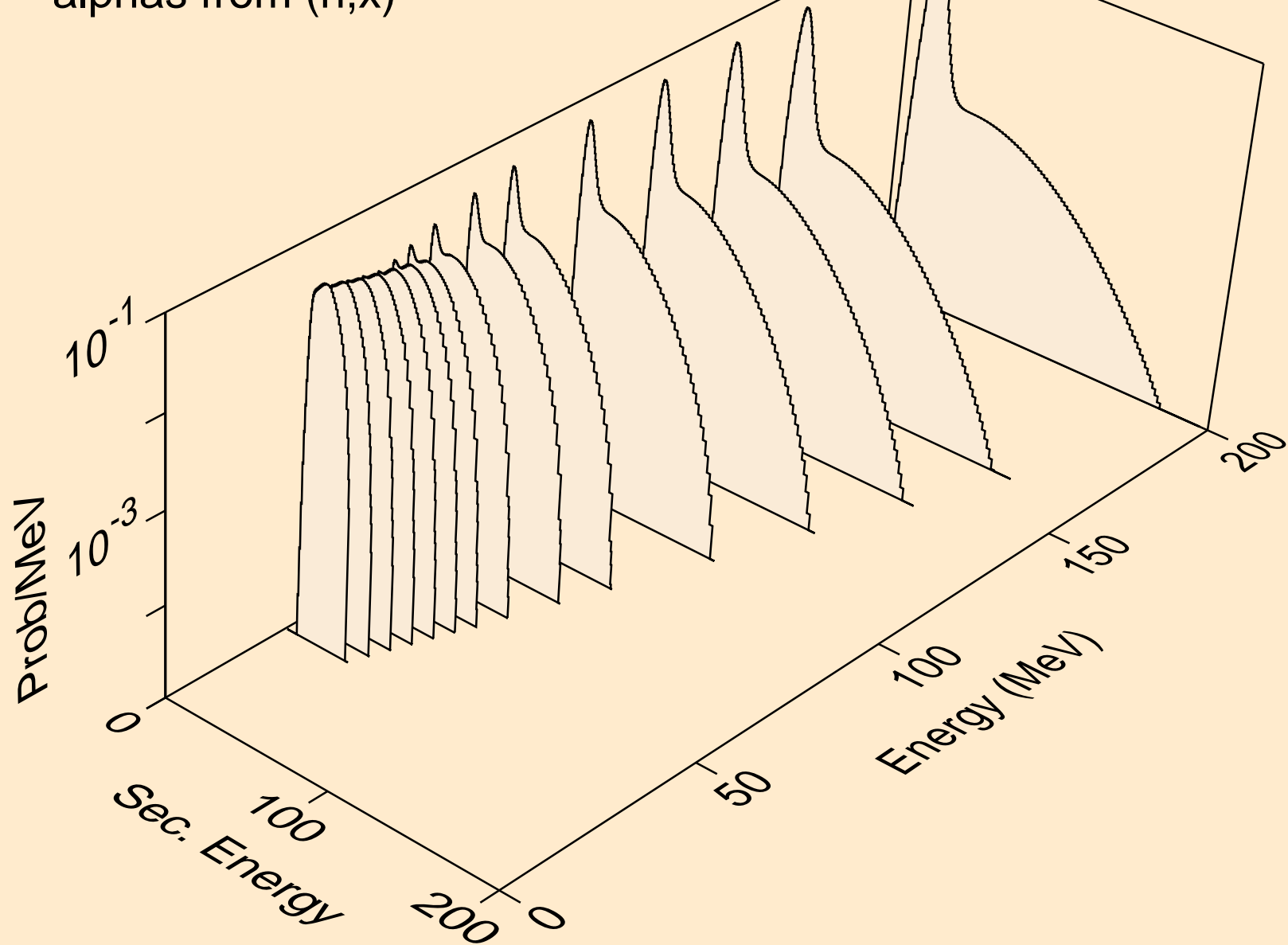

PD095M NEUTRON ACER TENDL-2021 LIBRARY; T=293.6K  
alphas from (n,n\*)a

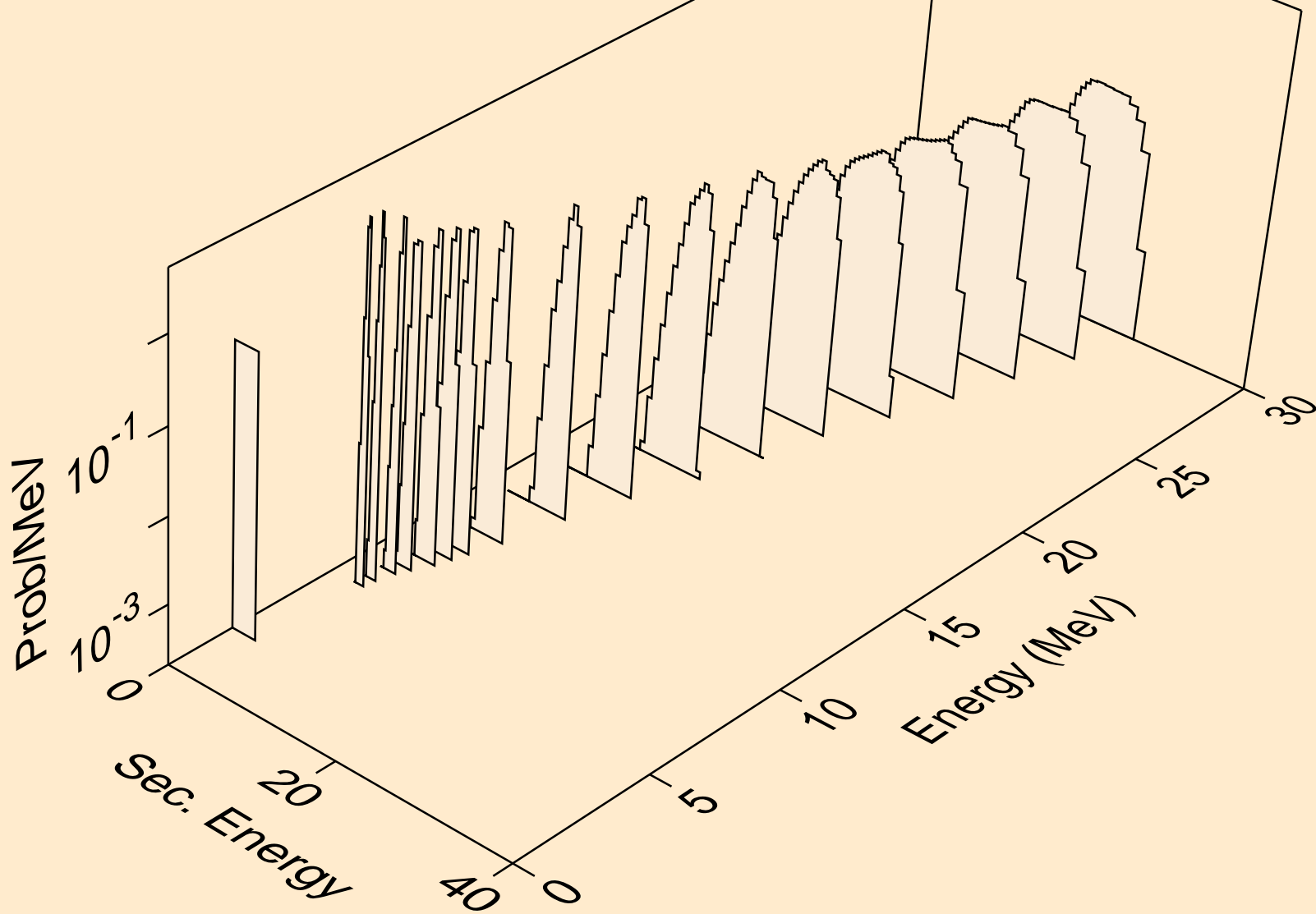

PD095M NEUTRON ACER TENDL-2021 LIBRARY; T=293.6K  
alphas from (n,2n)a

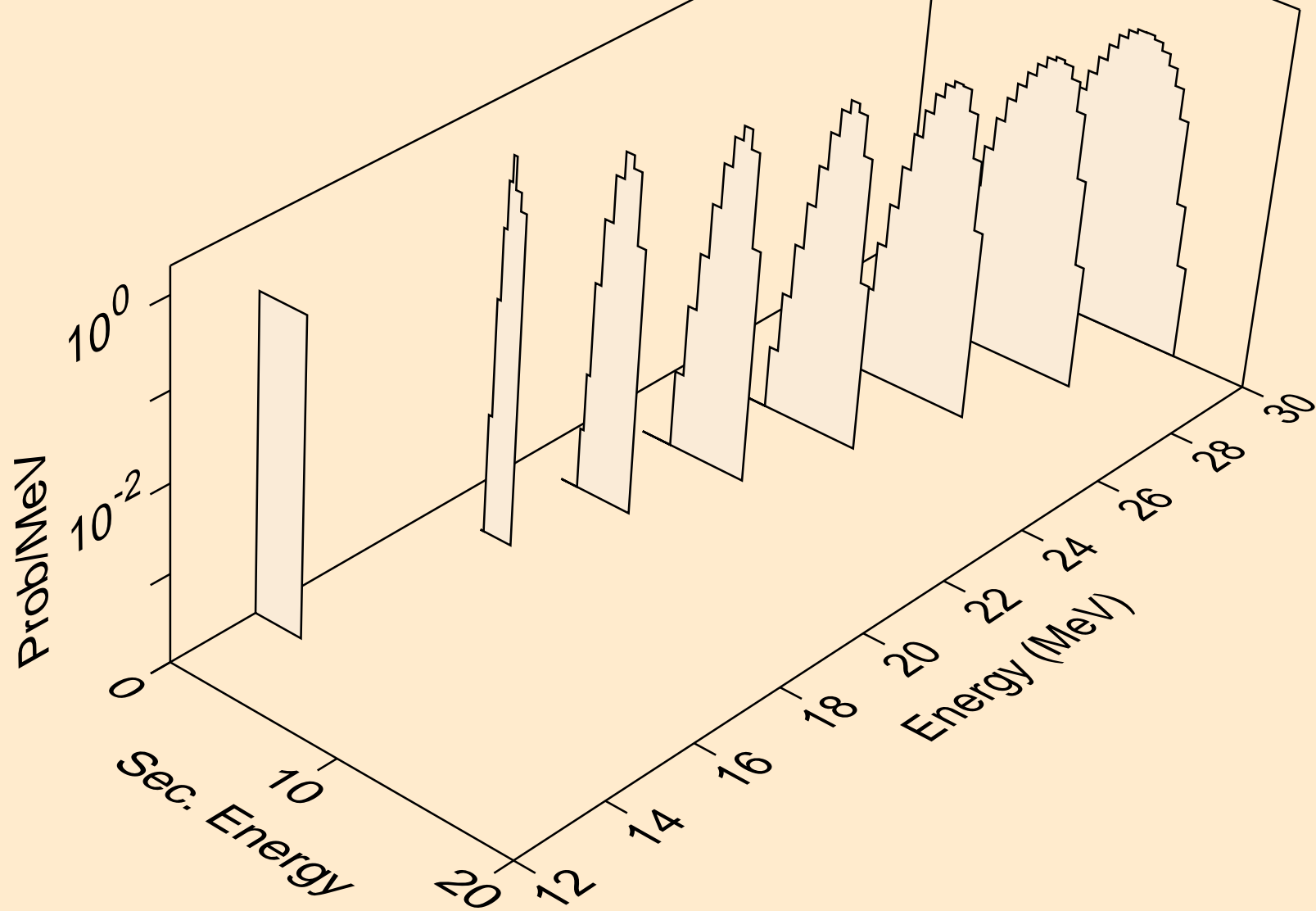

PD095M NEUTRON ACER TENDL-2021 LIBRARY; T=293.6K  
alphas from (n,n\*)2a

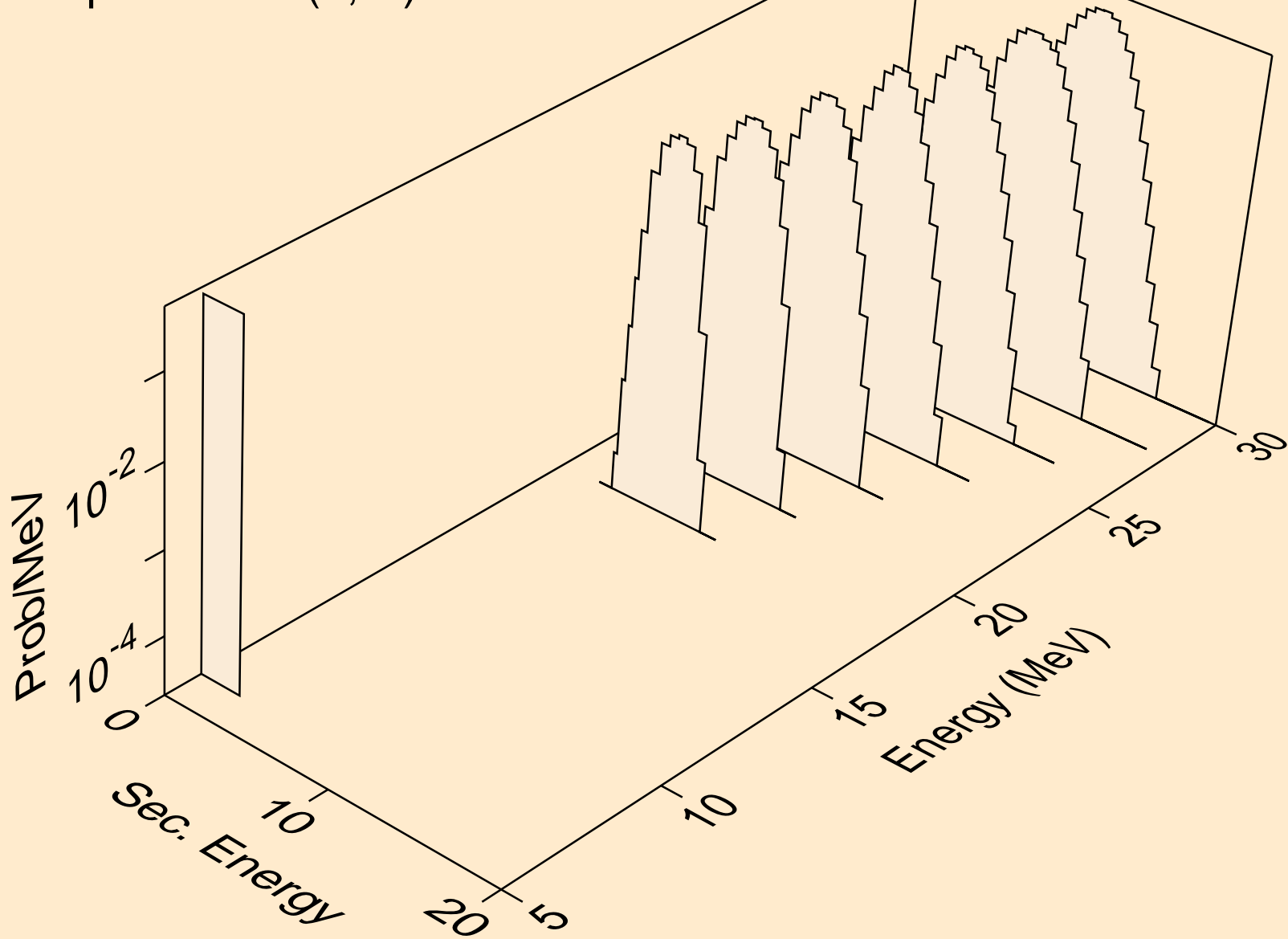



PD095M NEUTRON ACER TENDL-2021 LIBRARY; T=293.6K  
alphas from (n,npa)

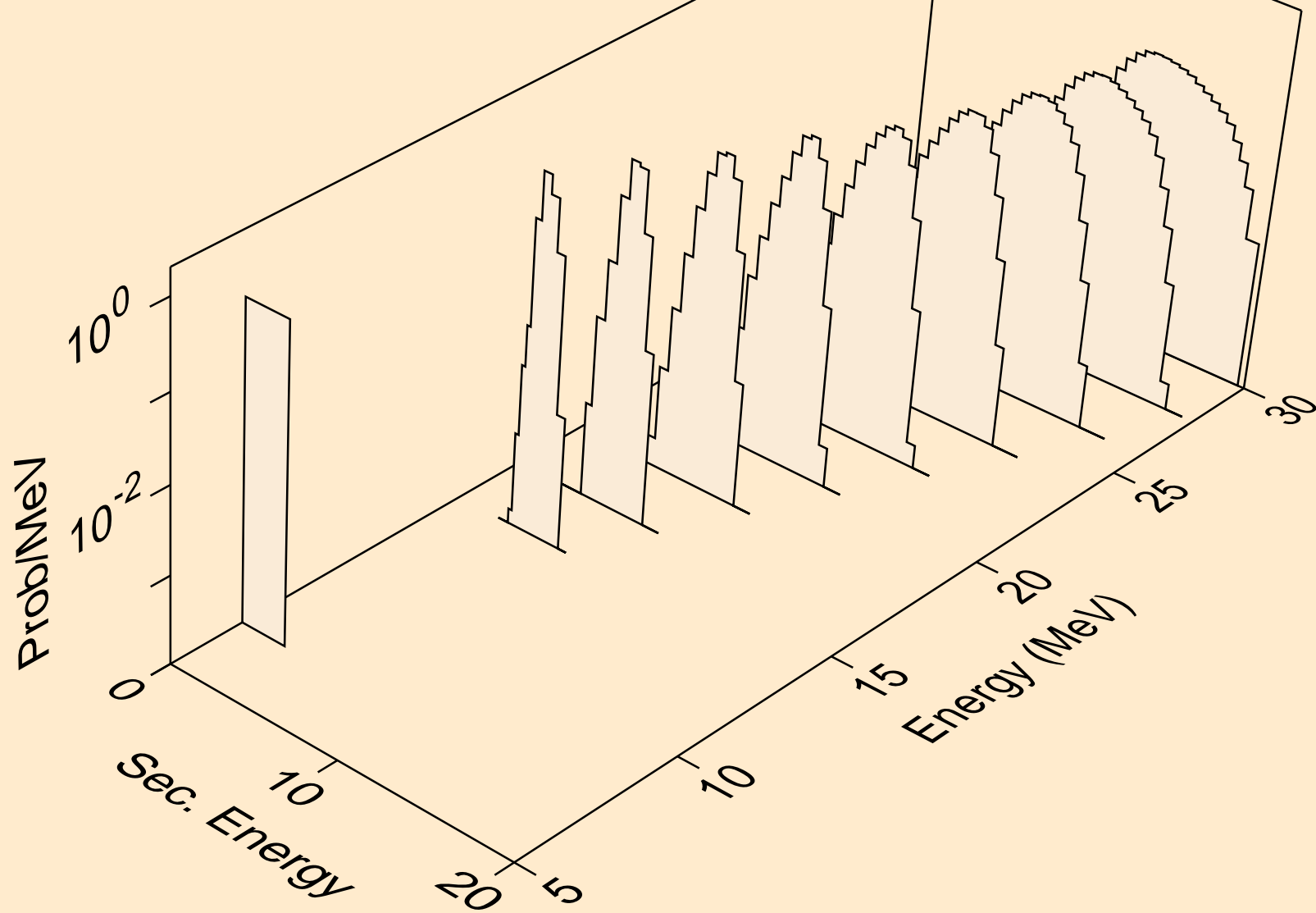

PD095M NEUTRON ACER TENDL-2021 LIBRARY; T=293.6K  
alphas from (n,a)

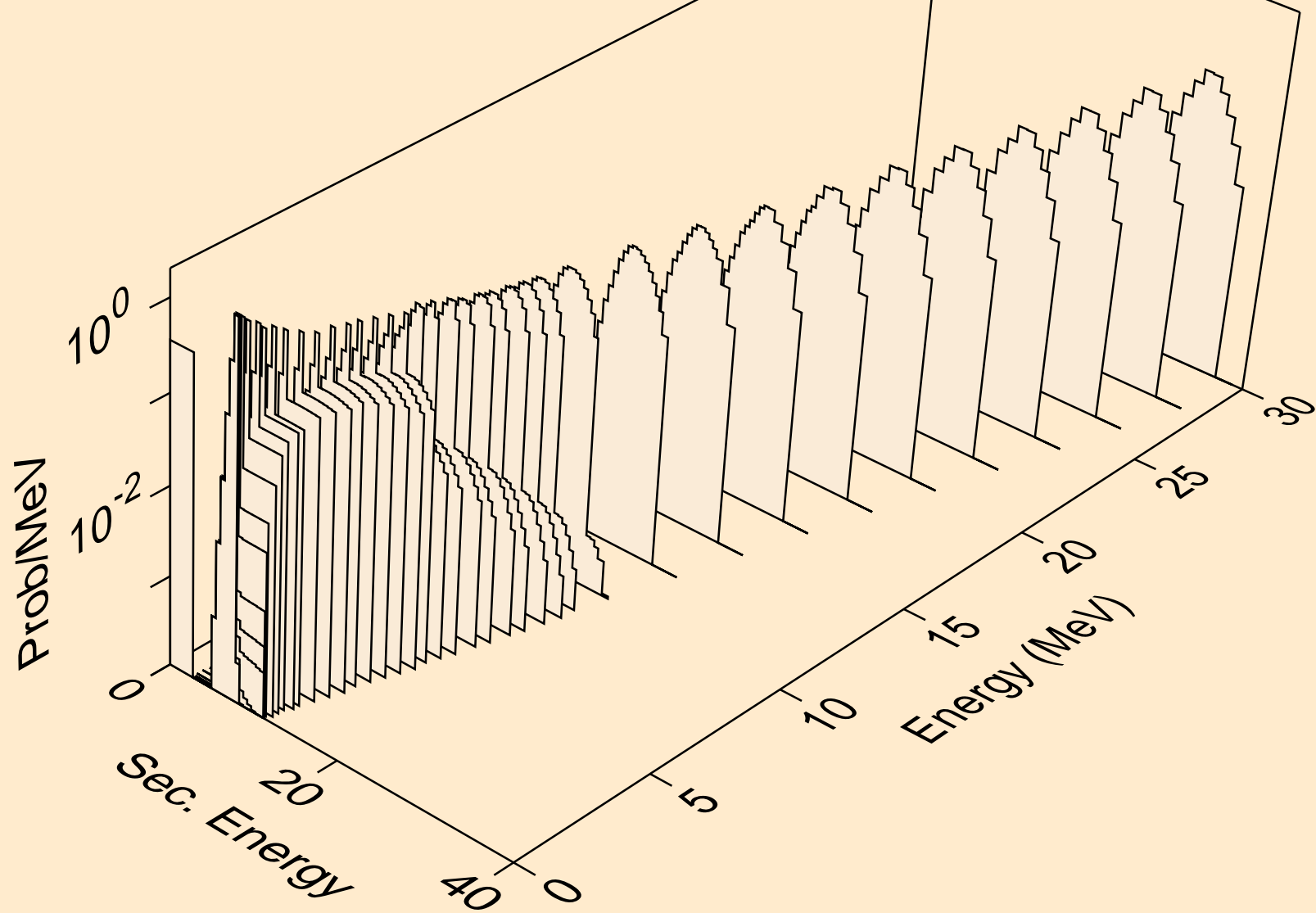

PD095M NEUTRON ACER TENDL-2021 LIBRARY; T=293.6K  
alphas from (n,2a)

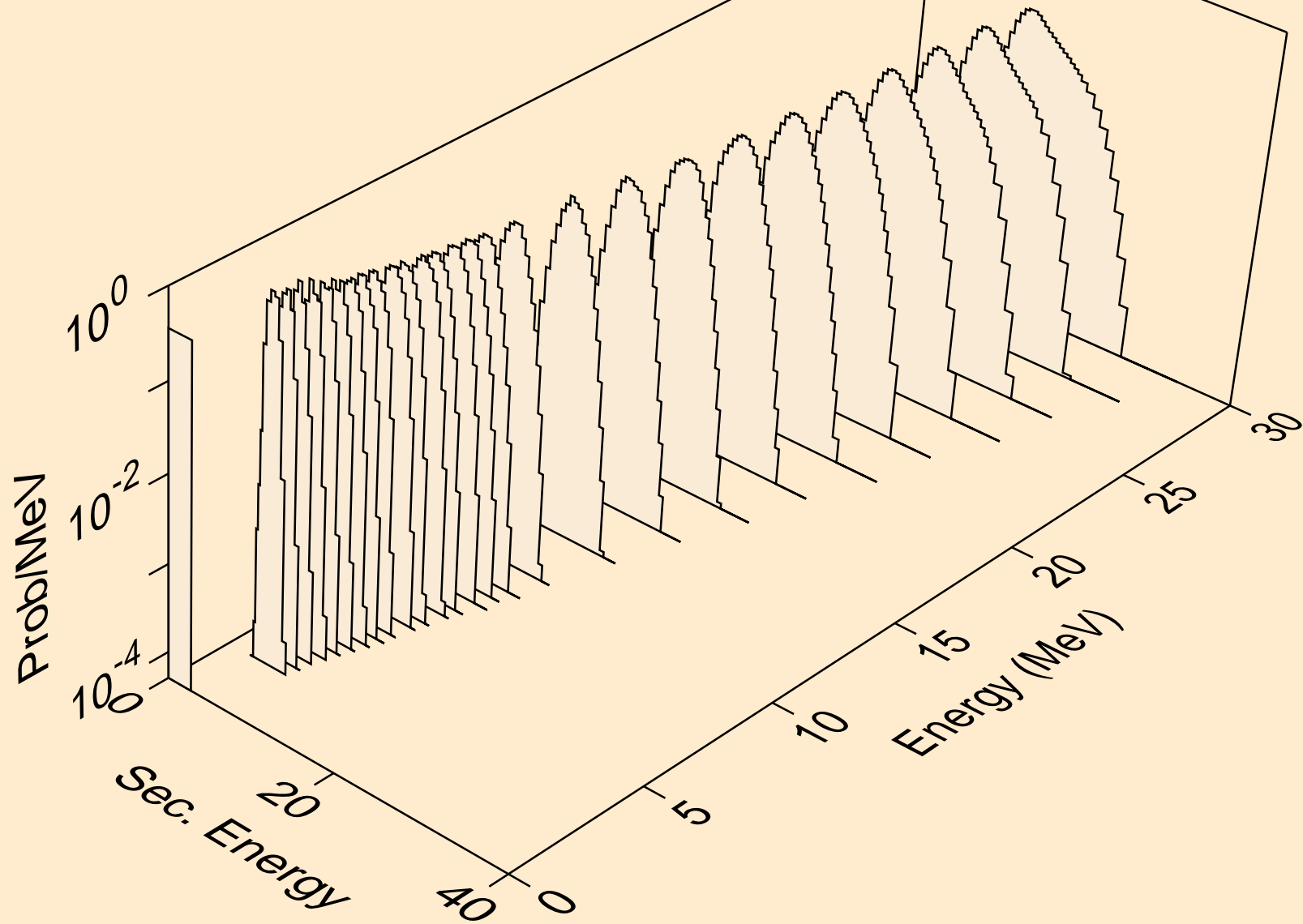

PD095M NEUTRON ACER TENDL-2021 LIBRARY; T=293.6K  
alphas from (n,3a)

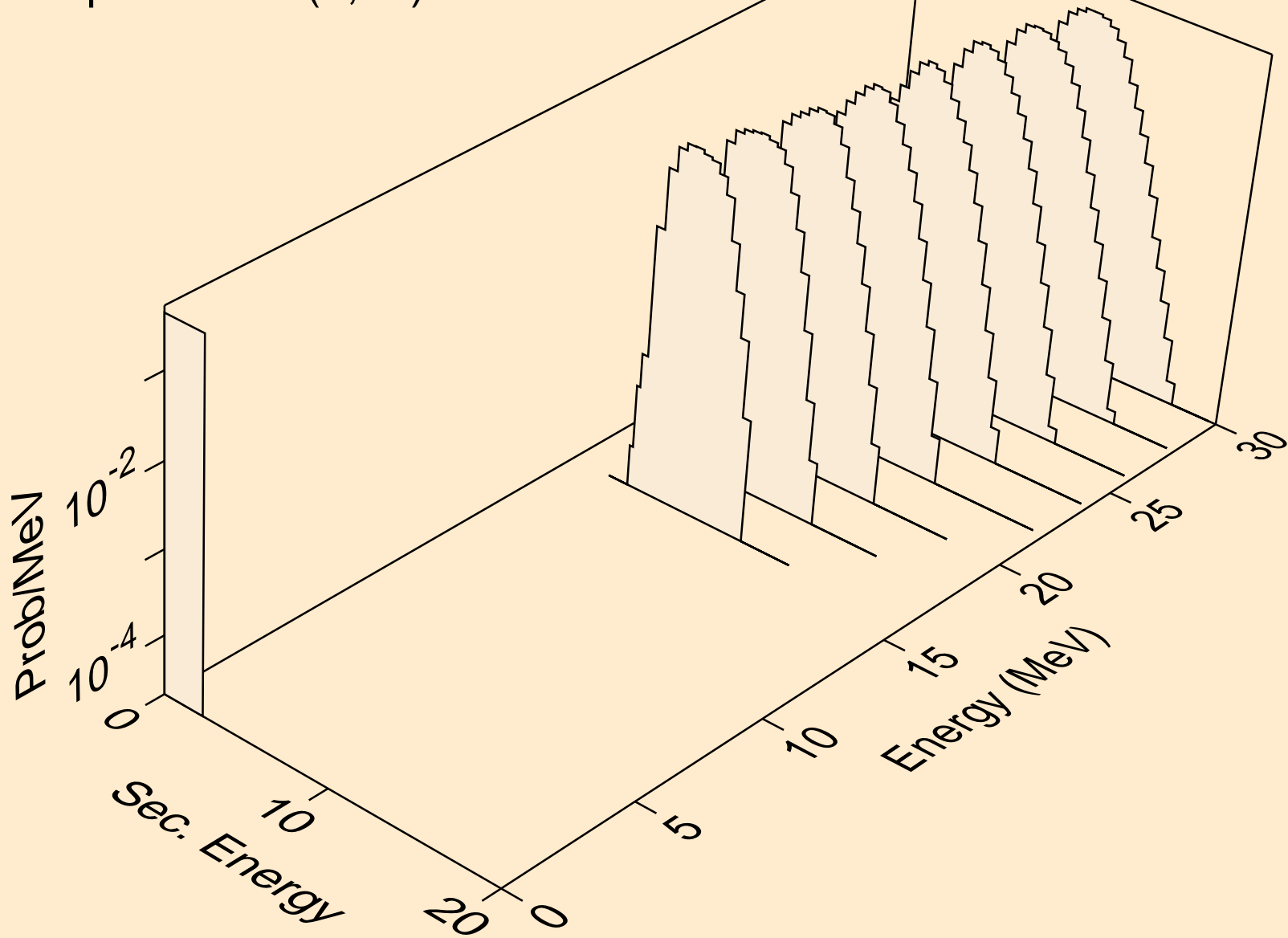

PD095M NEUTRON ACER TENDL-2021 LIBRARY; T=293.6K  
alphas from (n,pa)

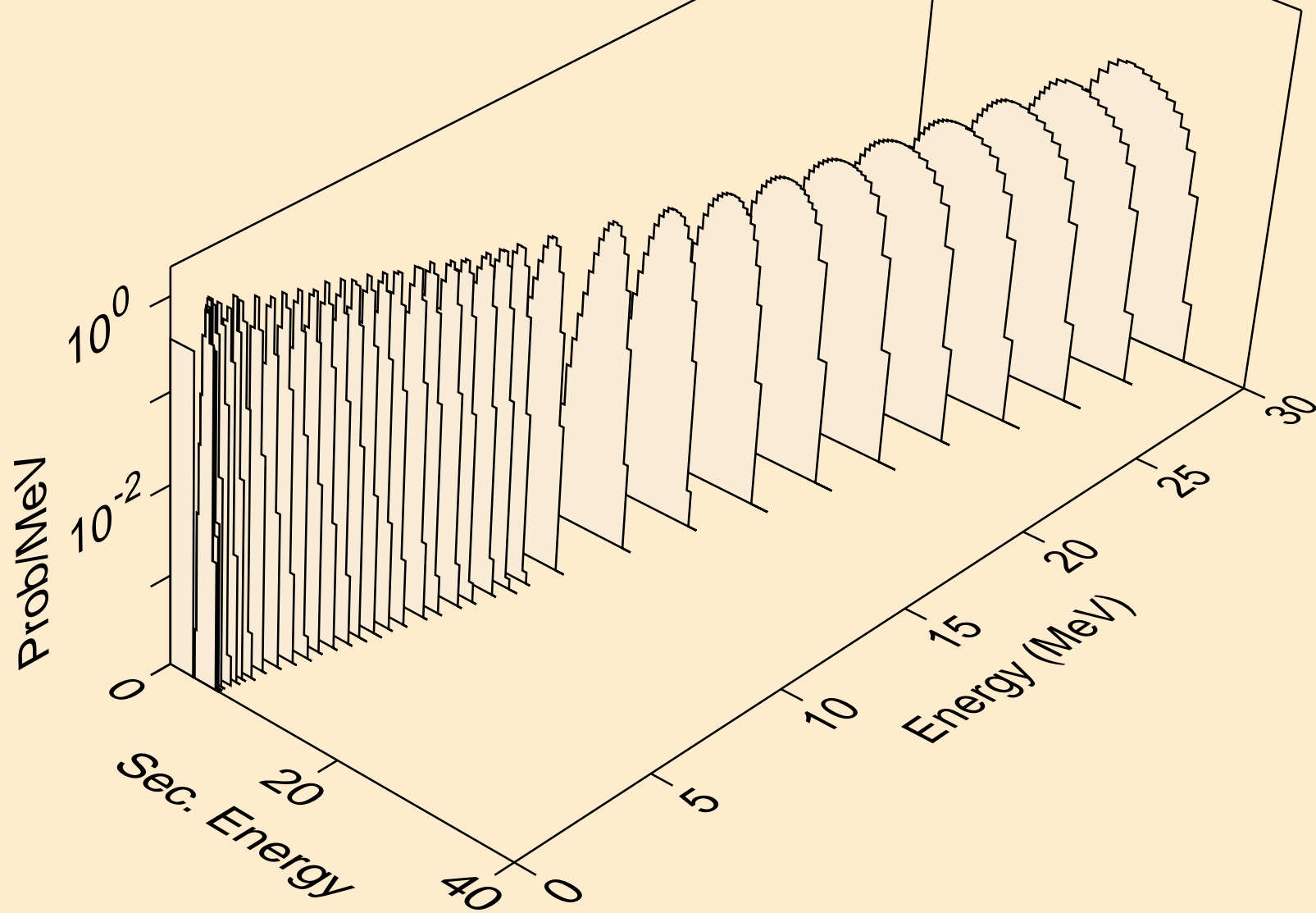

PD095M NEUTRON ACER TENDL-2021 LIBRARY; T=293.6K  
alphas from (n,da)

