

PM129 NEUTRON ACER TENDL-2021 LIBRARY; T=293.6K  
Principal cross sections

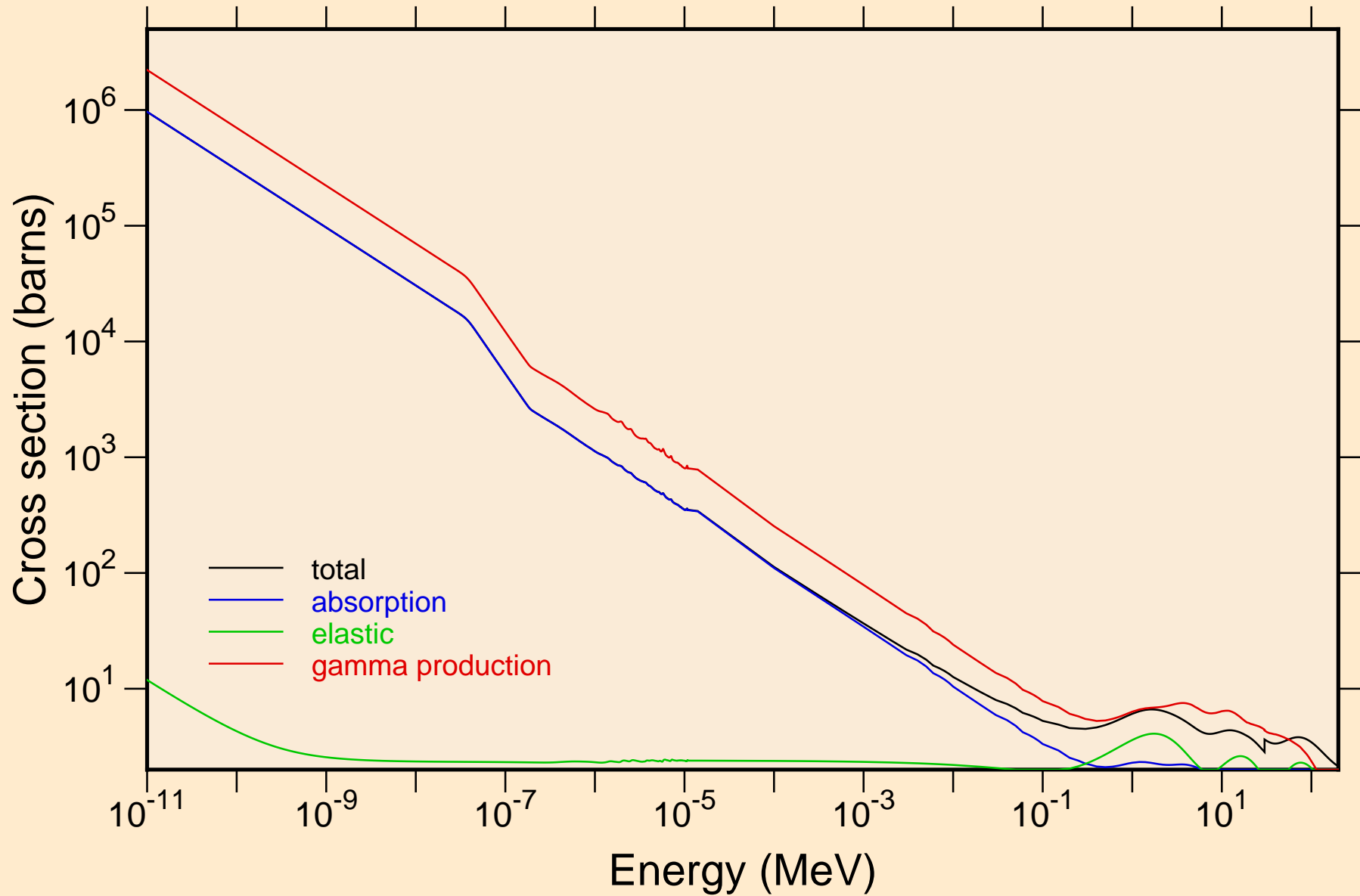

PM129 NEUTRON ACER TENDL-2021 LIBRARY; T=293.6K  
Heating

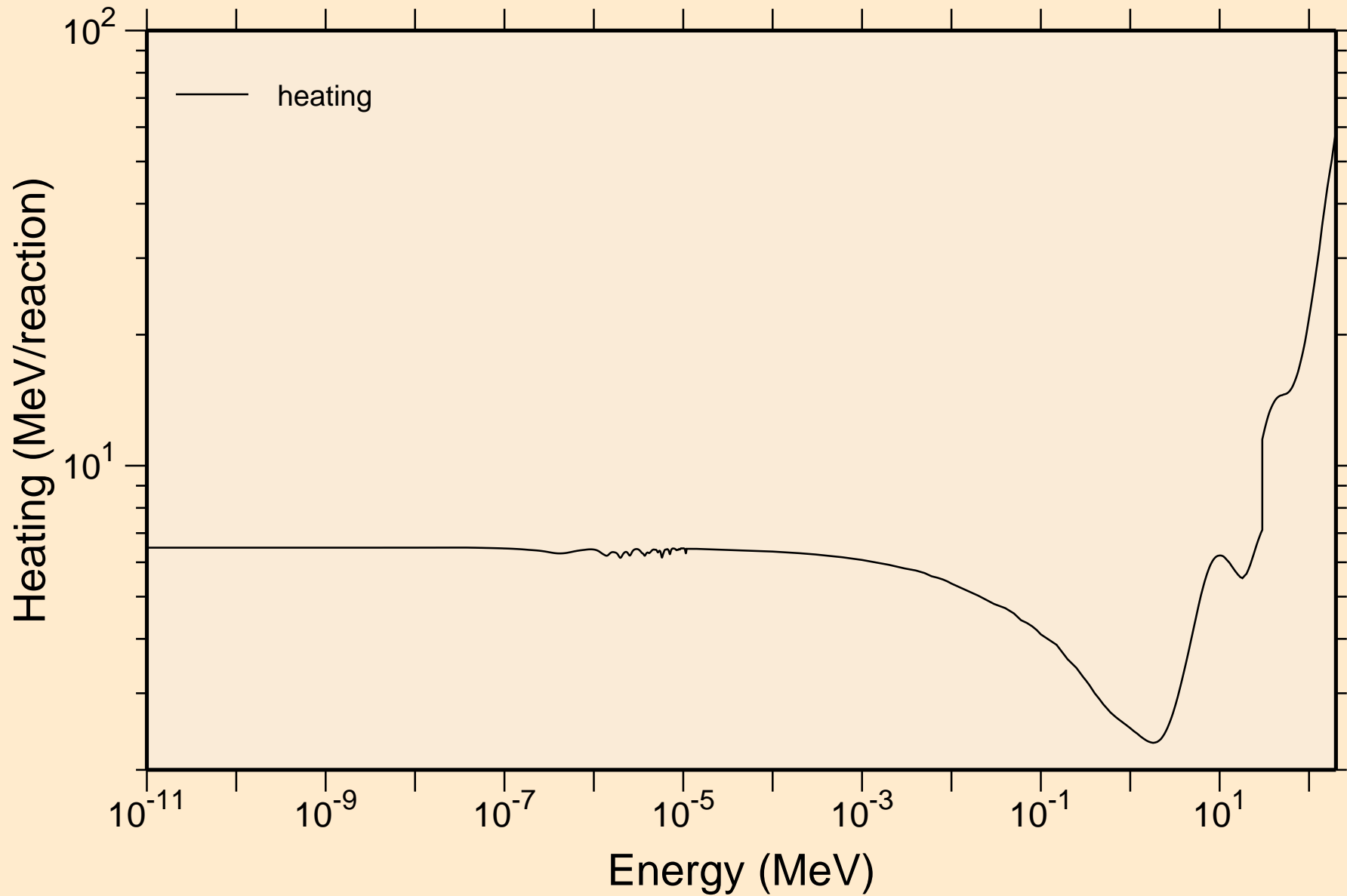

PM129 NEUTRON ACER TENDL-2021 LIBRARY; T=293.6K  
Damage

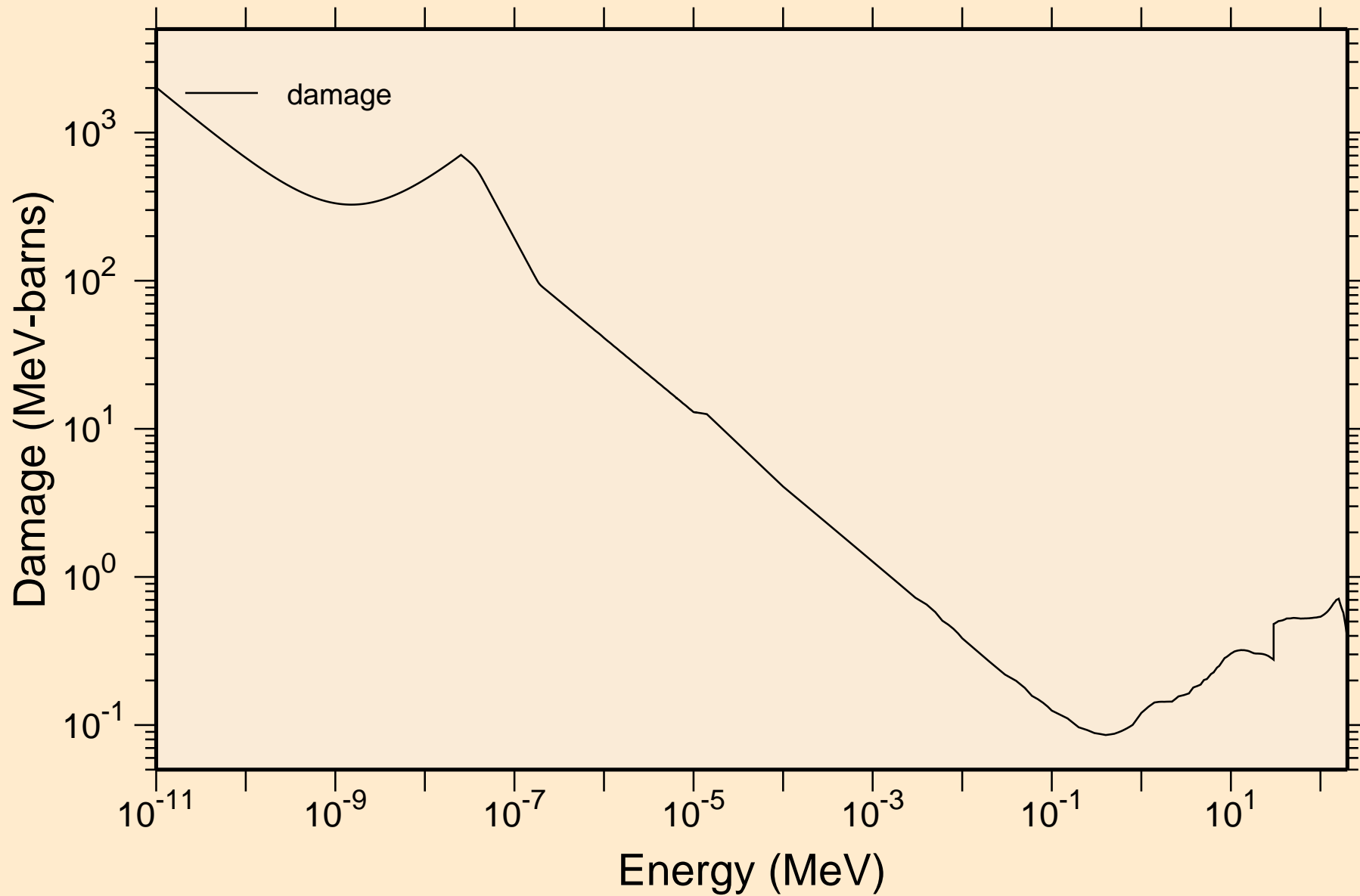

PM129 NEUTRON ACER TENDL-2021 LIBRARY; T=293.6K  
Non-threshold reactions

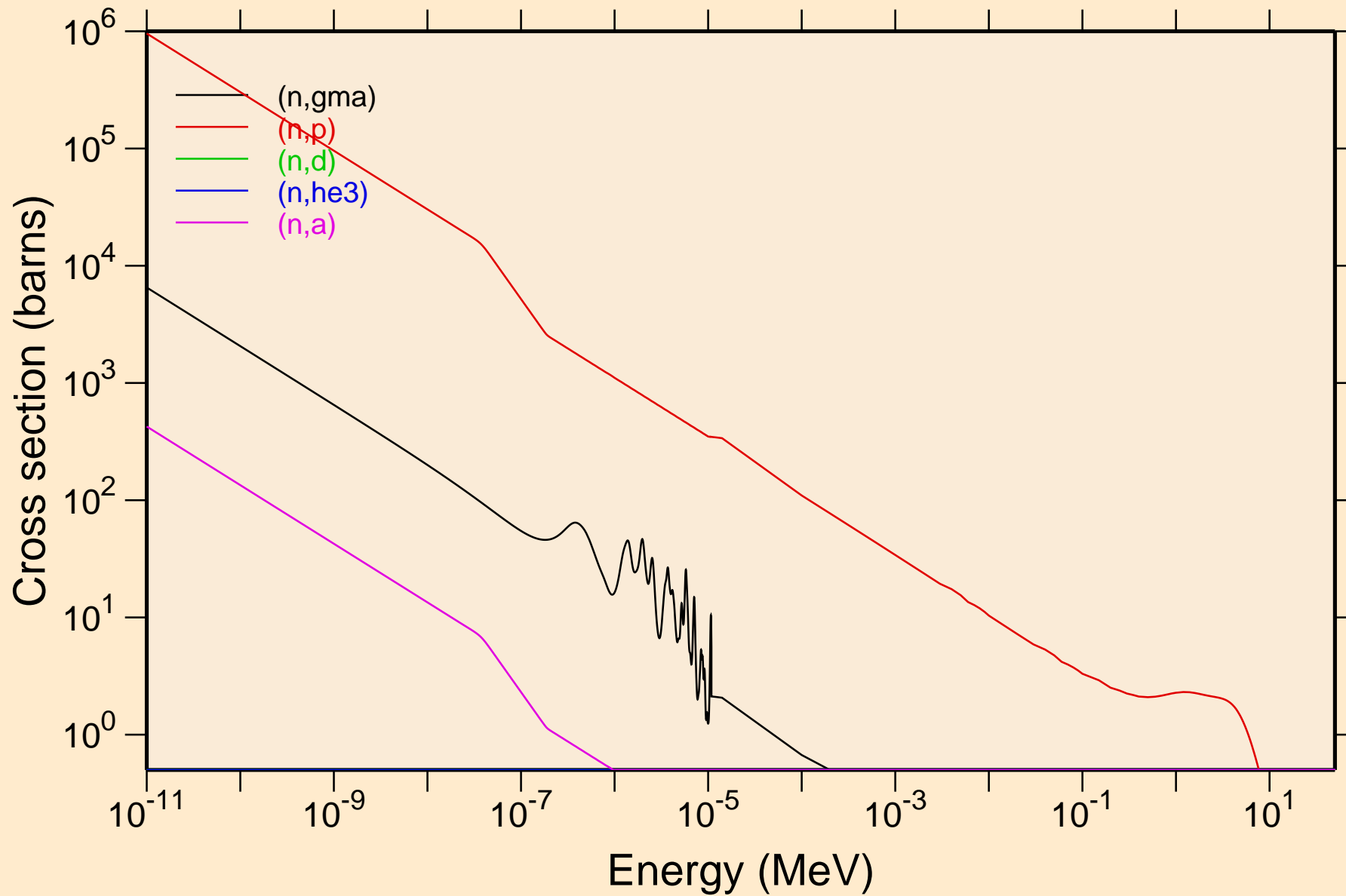

PM129 NEUTRON ACER TENDL-2021 LIBRARY; T=293.6K  
Non-threshold reactions

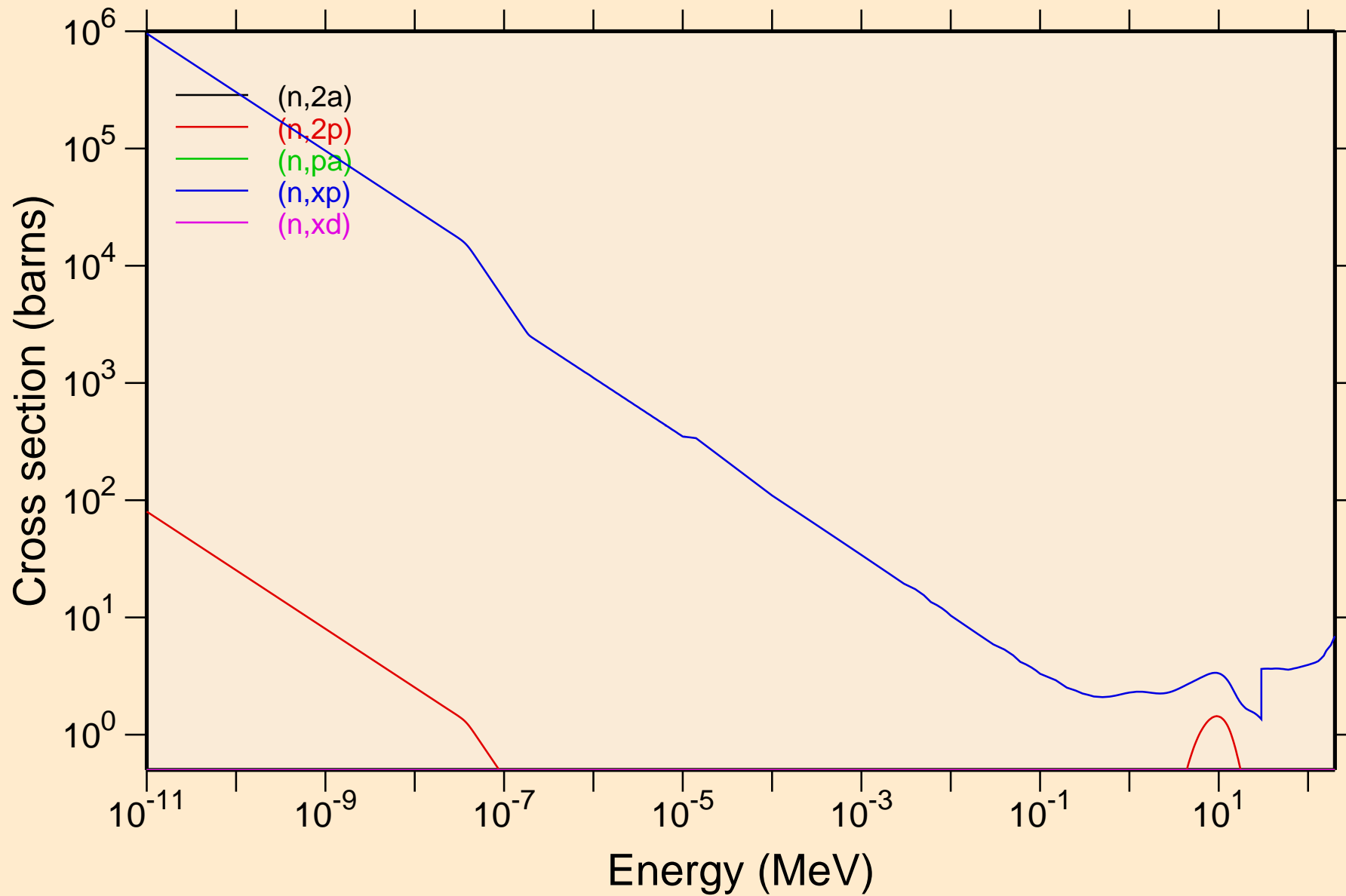

PM129 NEUTRON ACER TENDL-2021 LIBRARY; T=293.6K  
Non-threshold reactions

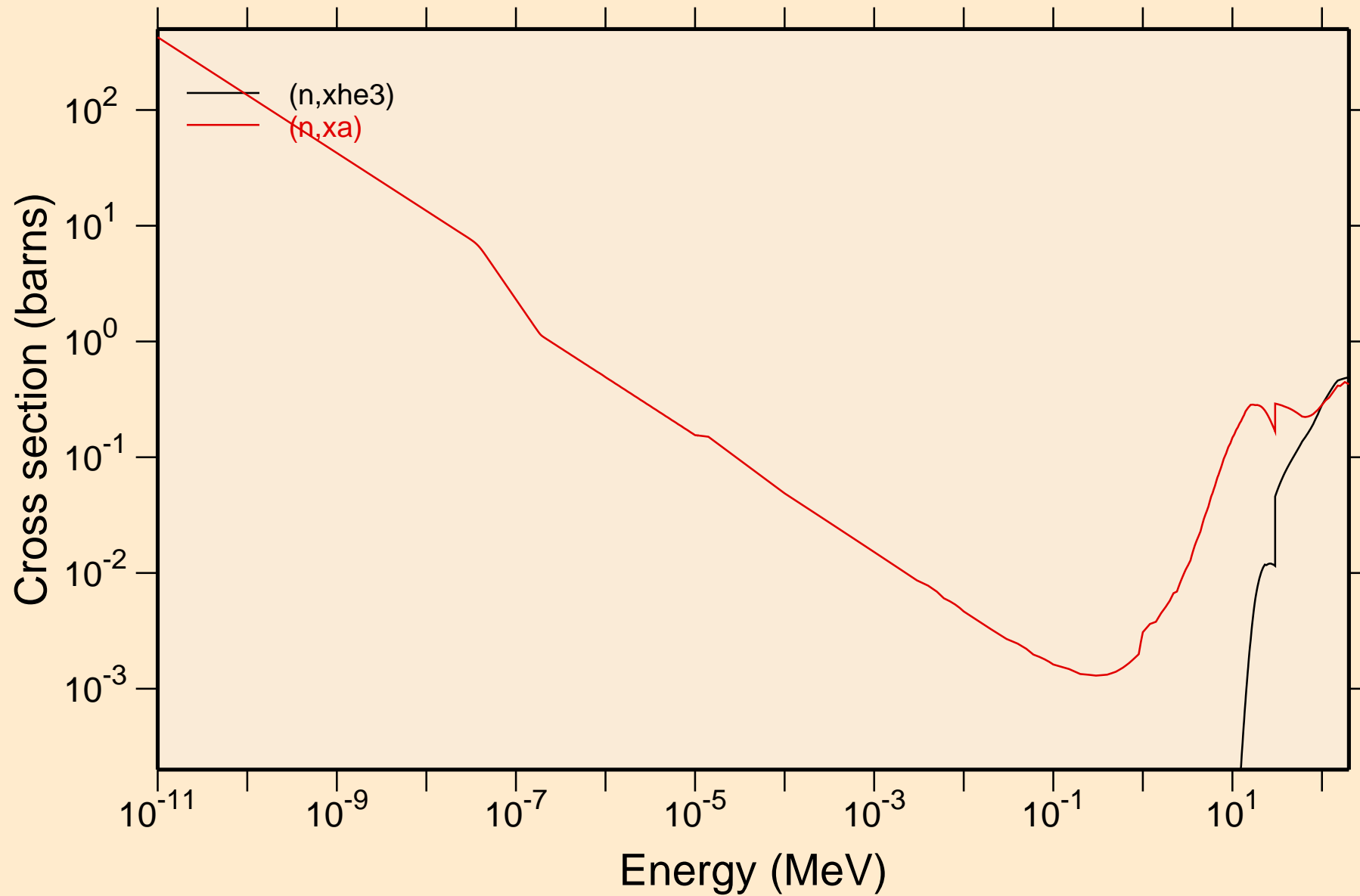

PM129 NEUTRON ACER TENDL-2021 LIBRARY; T=293.6K  
Principal cross sections

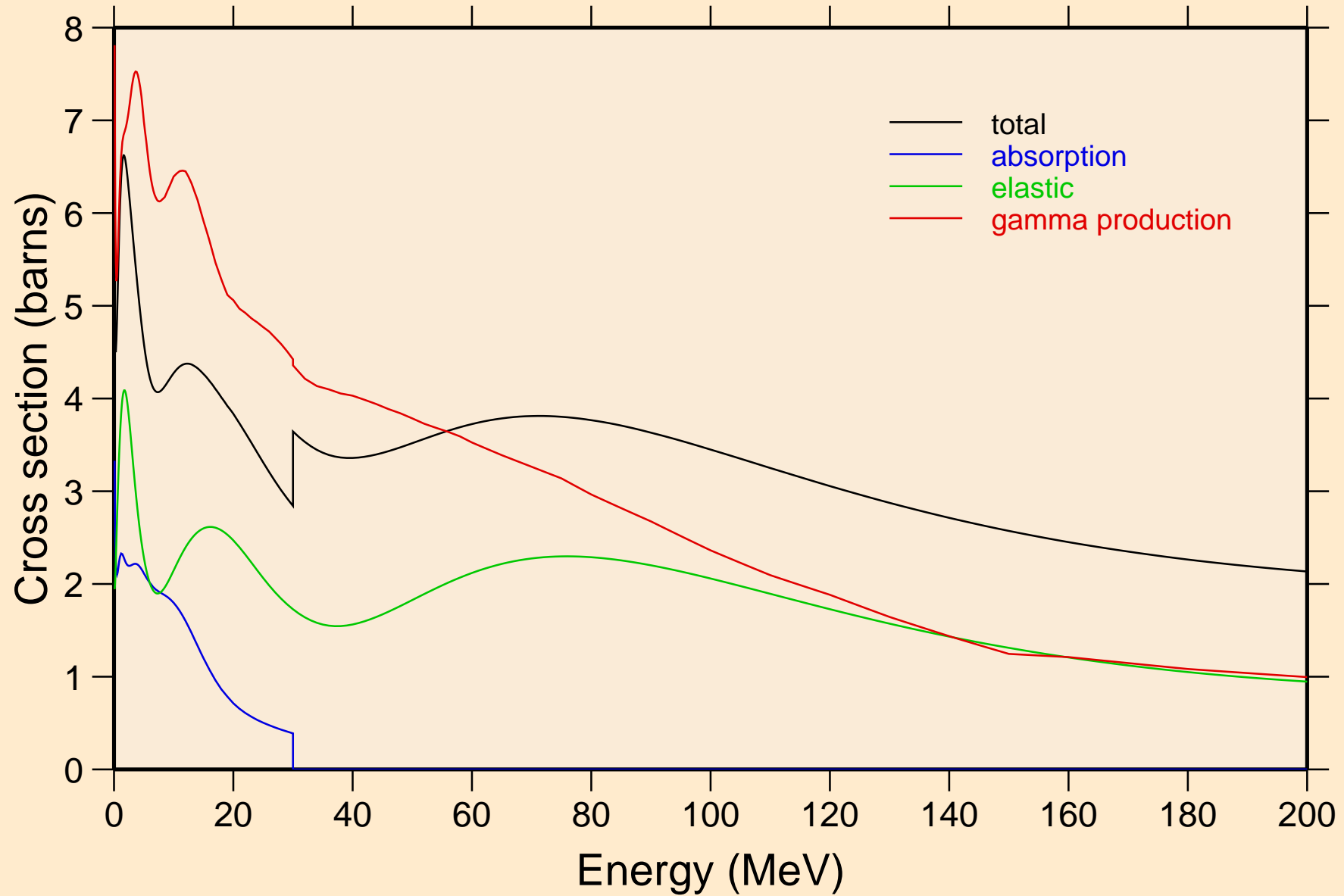

PM129 NEUTRON ACER TENDL-2021 LIBRARY; T=293.6K  
Heating

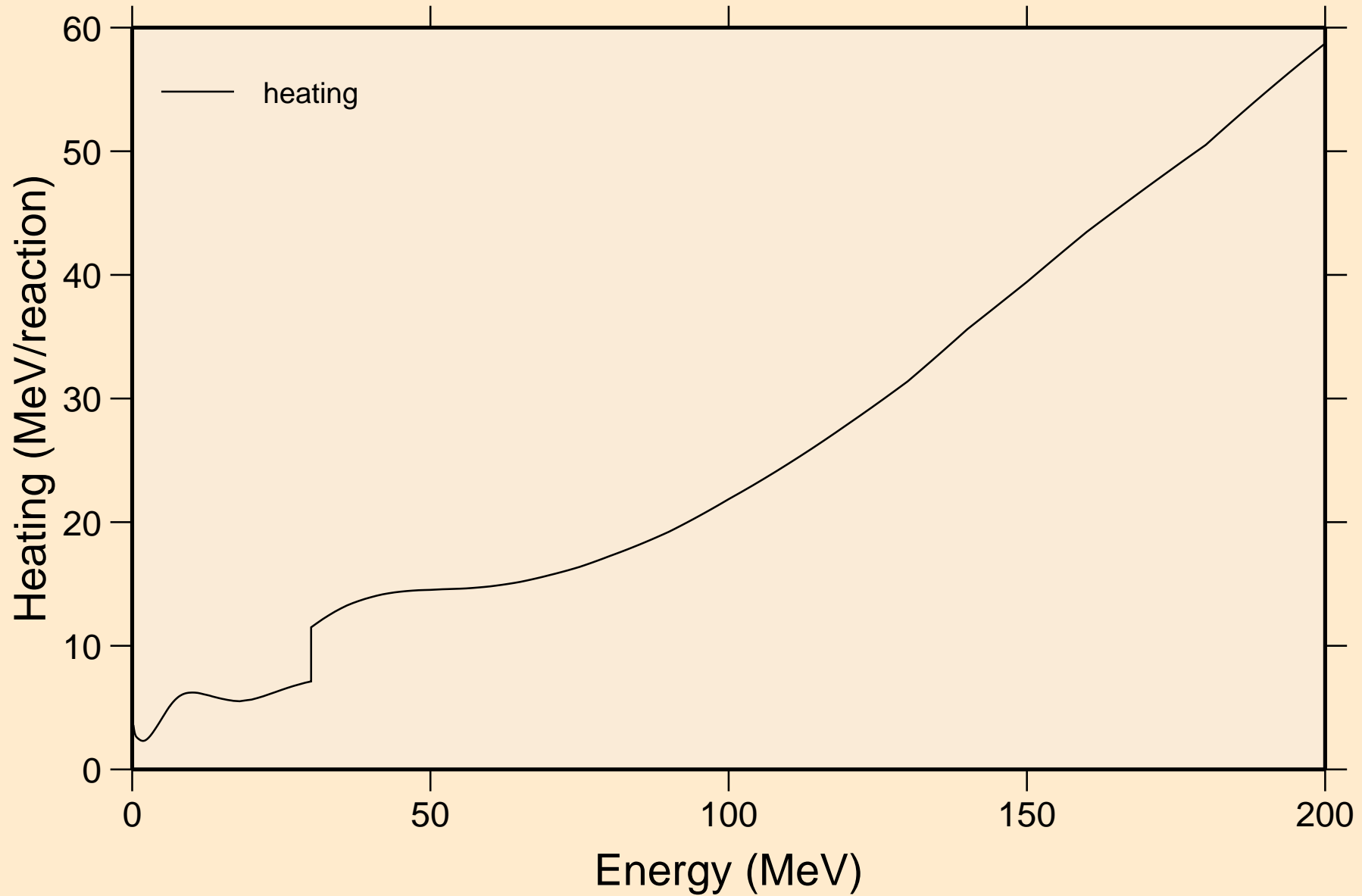



PM129 NEUTRON ACER TENDL-2021 LIBRARY; T=293.6K  
Damage

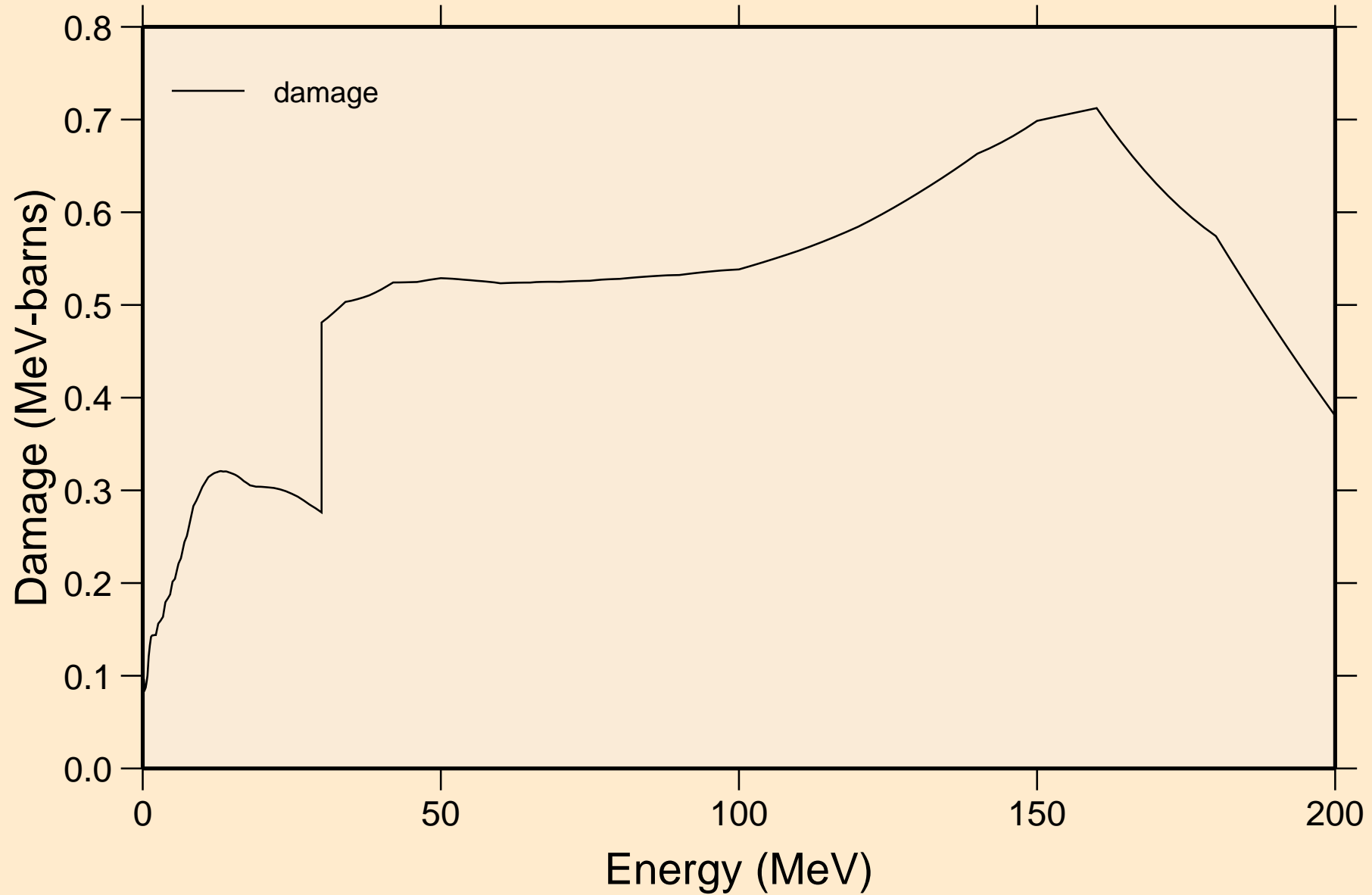

PM129 NEUTRON ACER TENDL-2021 LIBRARY; T=293.6K  
Non-threshold reactions

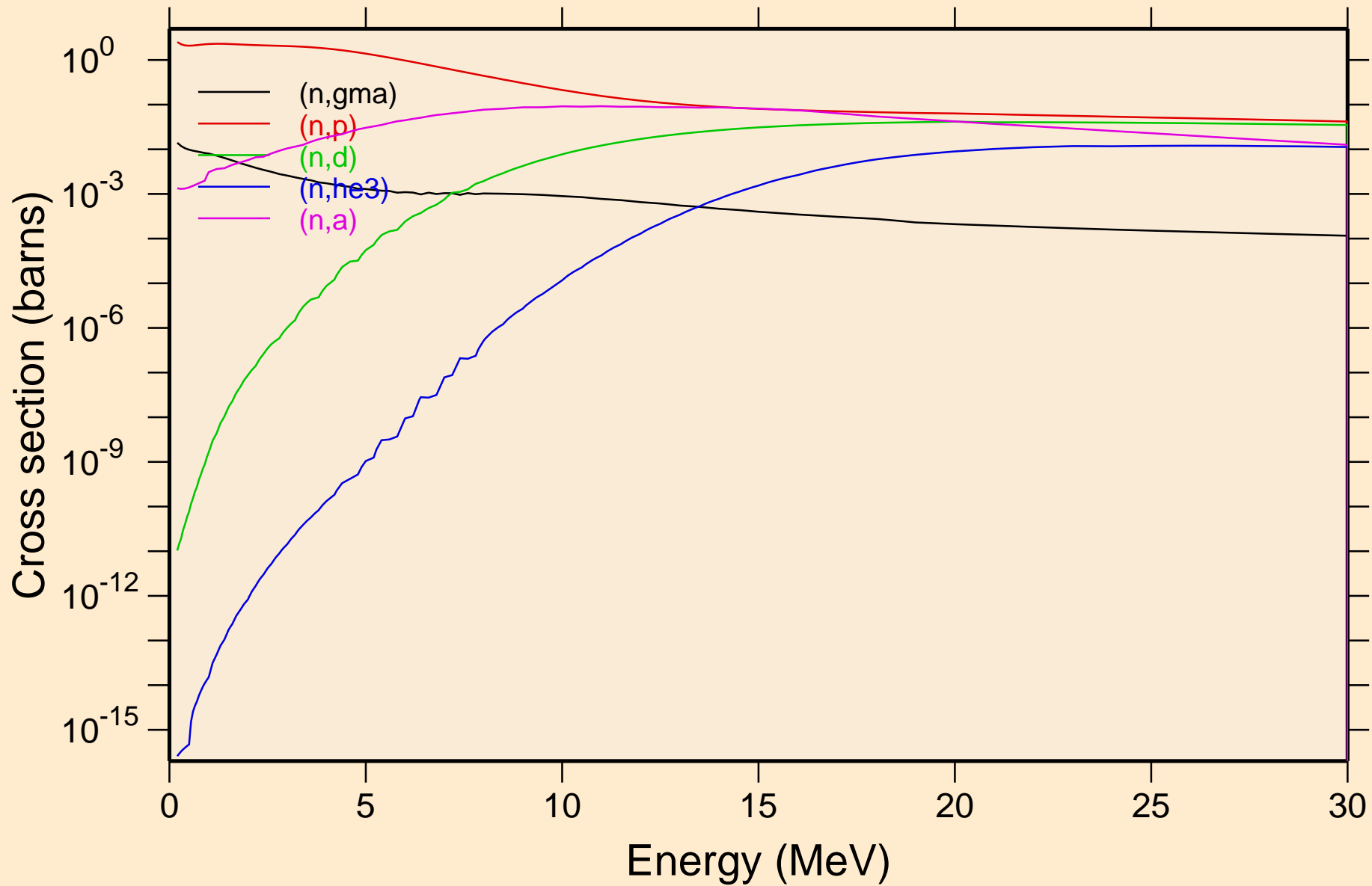

PM129 NEUTRON ACER TENDL-2021 LIBRARY; T=293.6K  
Non-threshold reactions

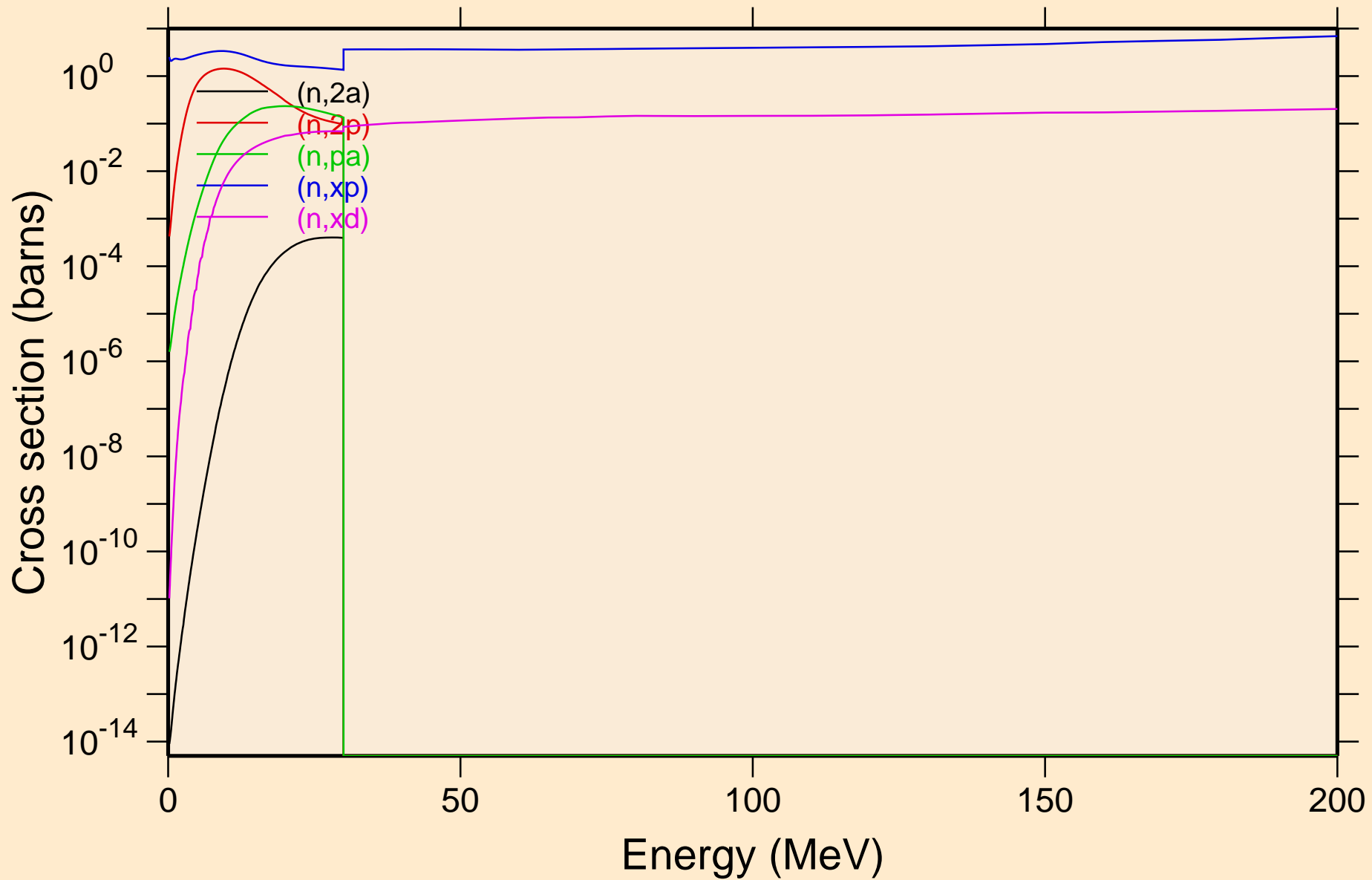

PM129 NEUTRON ACER TENDL-2021 LIBRARY; T=293.6K  
Non-threshold reactions

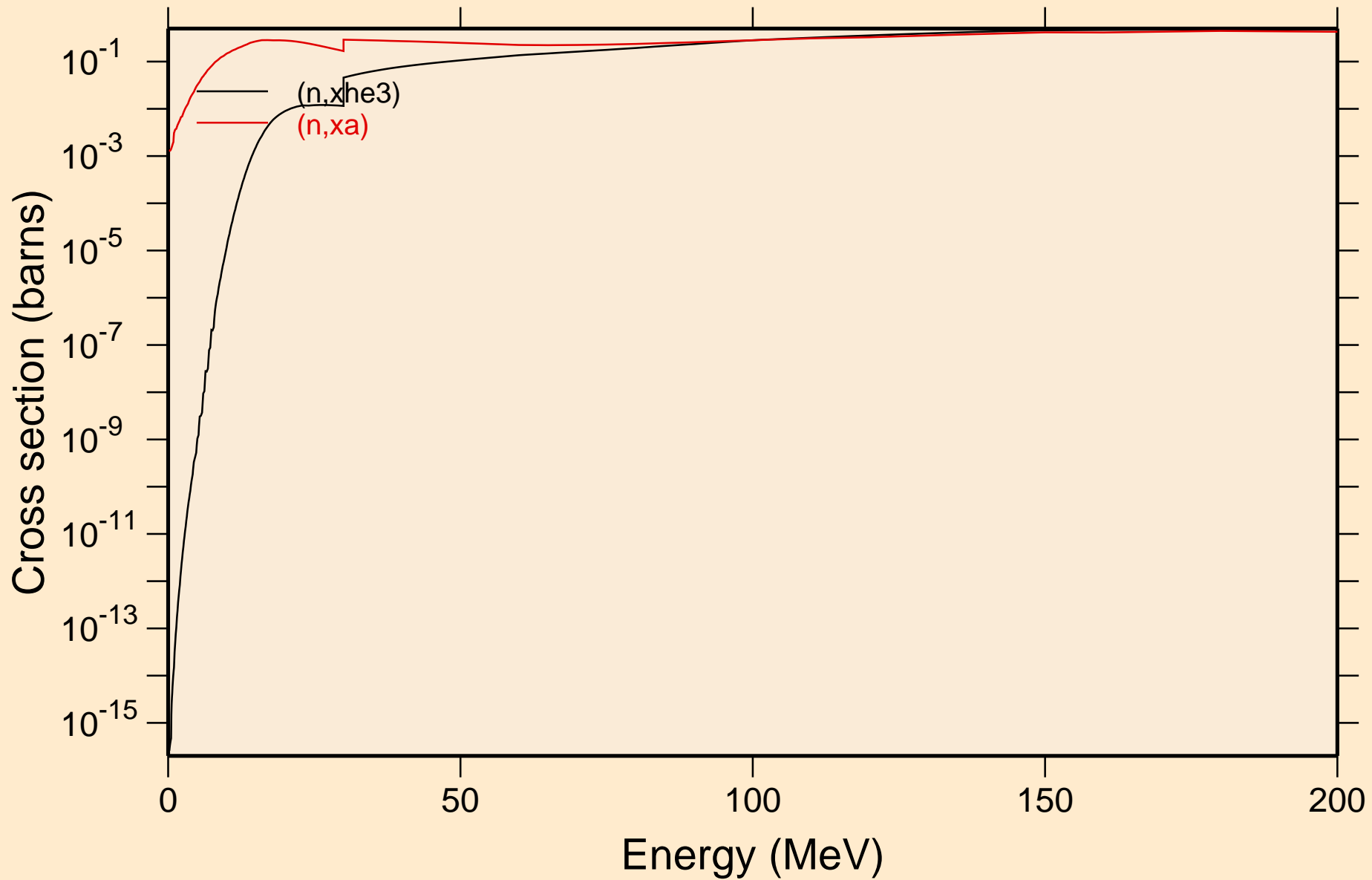

PM129 NEUTRON ACER TENDL-2021 LIBRARY; T=293.6K  
Inelastic levels

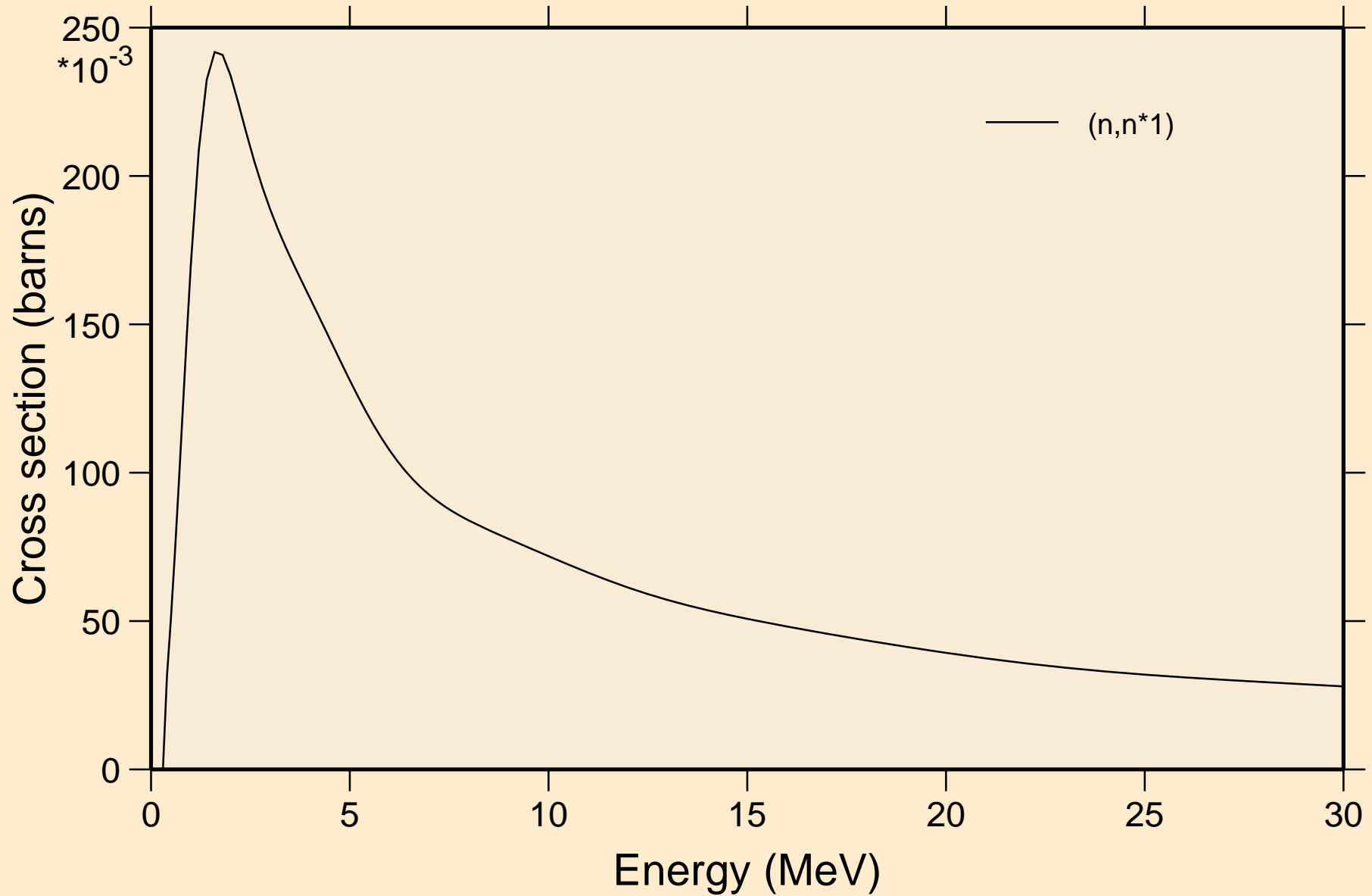

PM129 NEUTRON ACER TENDL-2021 LIBRARY; T=293.6K  
Threshold reactions

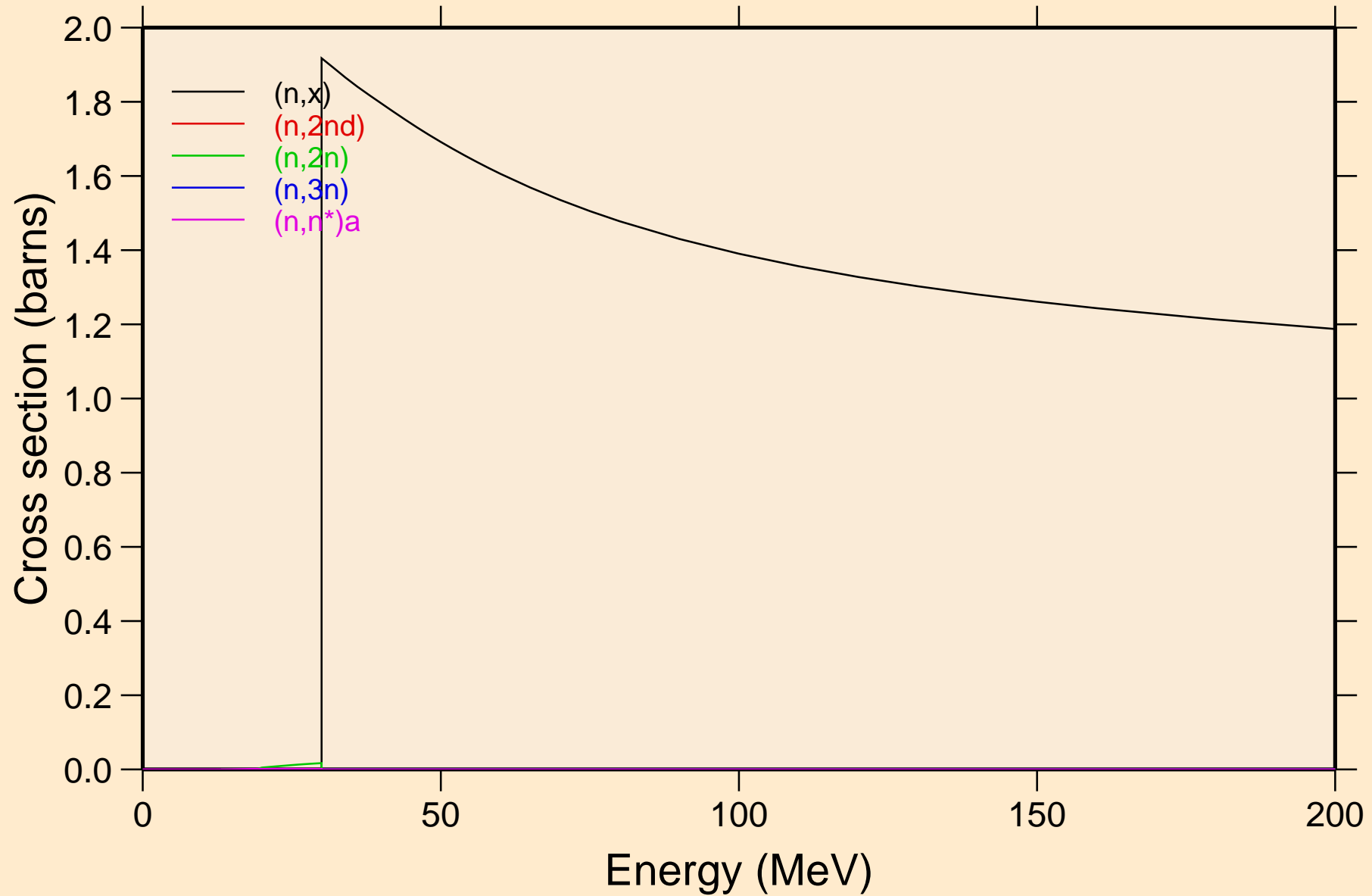

PM129 NEUTRON ACER TENDL-2021 LIBRARY; T=293.6K  
Threshold reactions

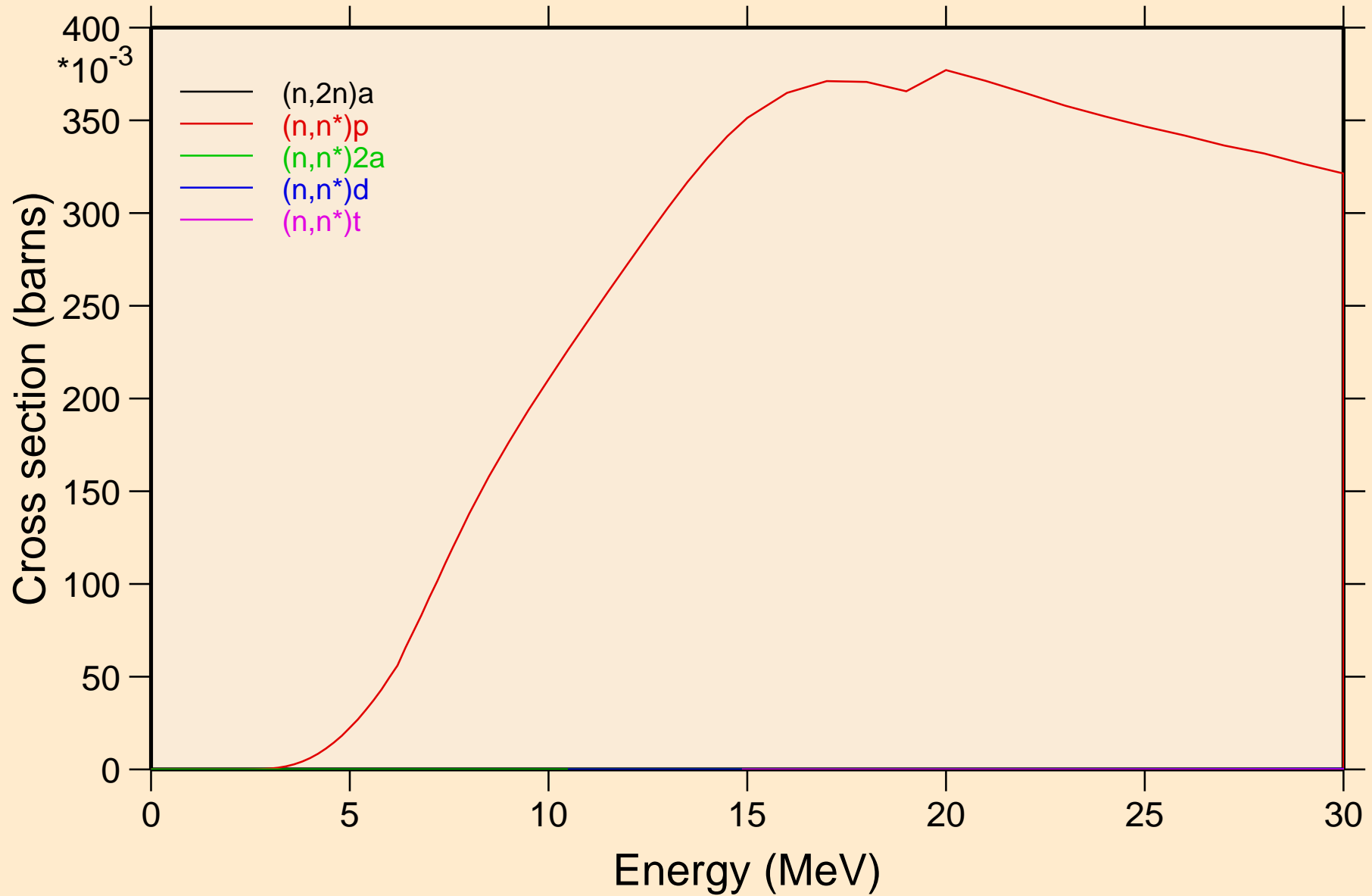

PM129 NEUTRON ACER TENDL-2021 LIBRARY; T=293.6K  
Threshold reactions

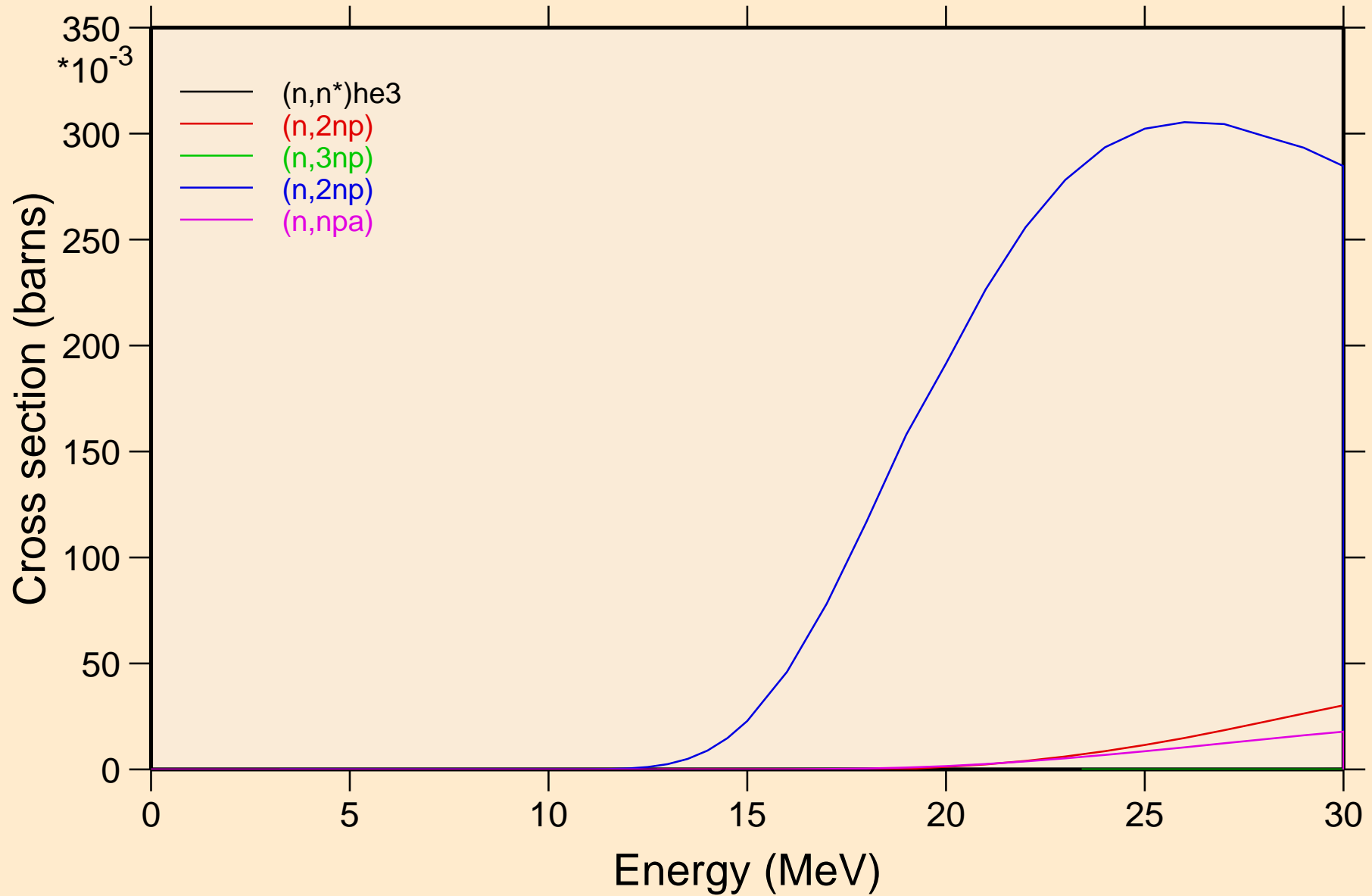



PM129 NEUTRON ACER TENDL-2021 LIBRARY; T=293.6K  
Threshold reactions

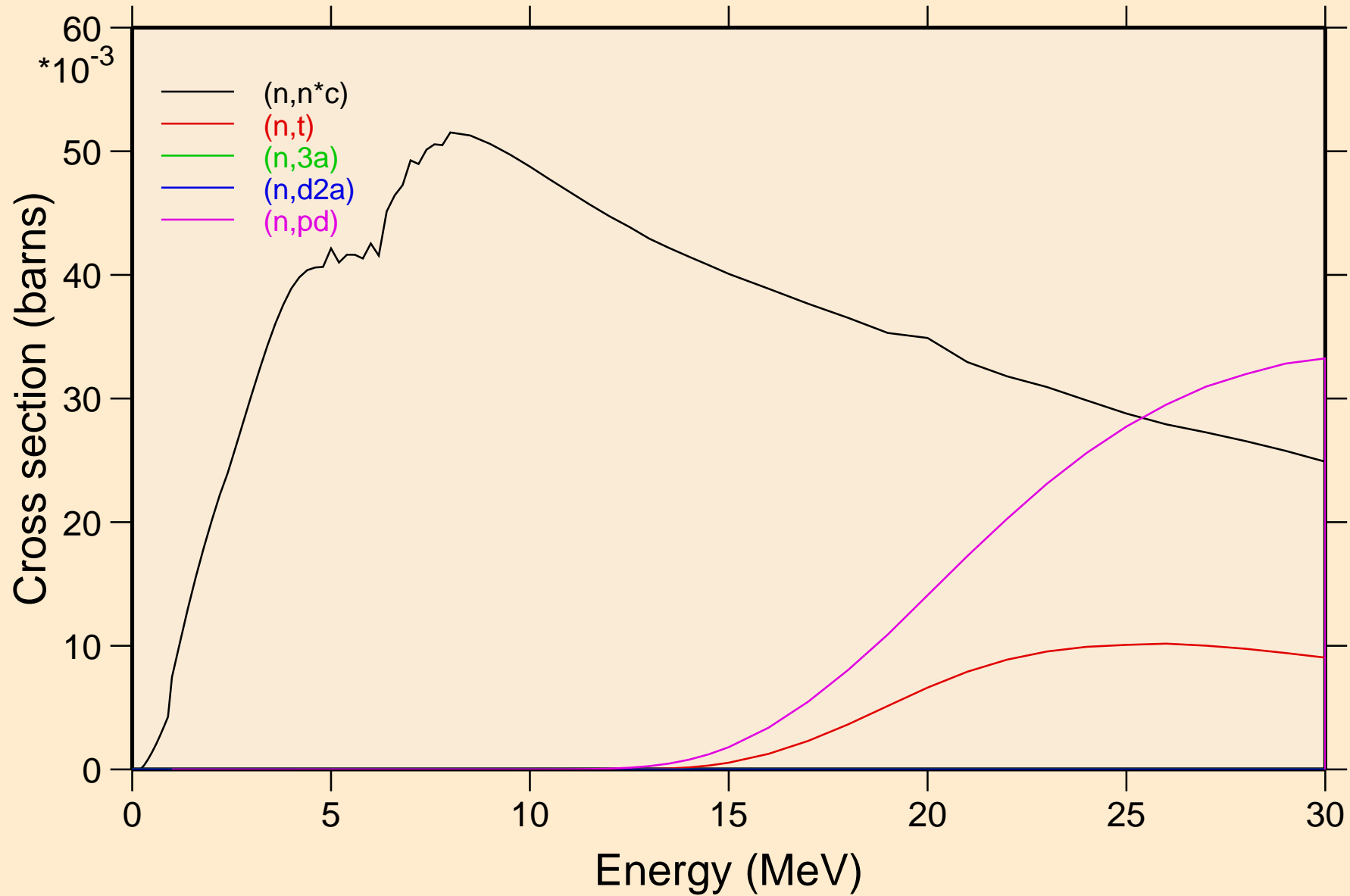

PM129 NEUTRON ACER TENDL-2021 LIBRARY; T=293.6K  
Threshold reactions

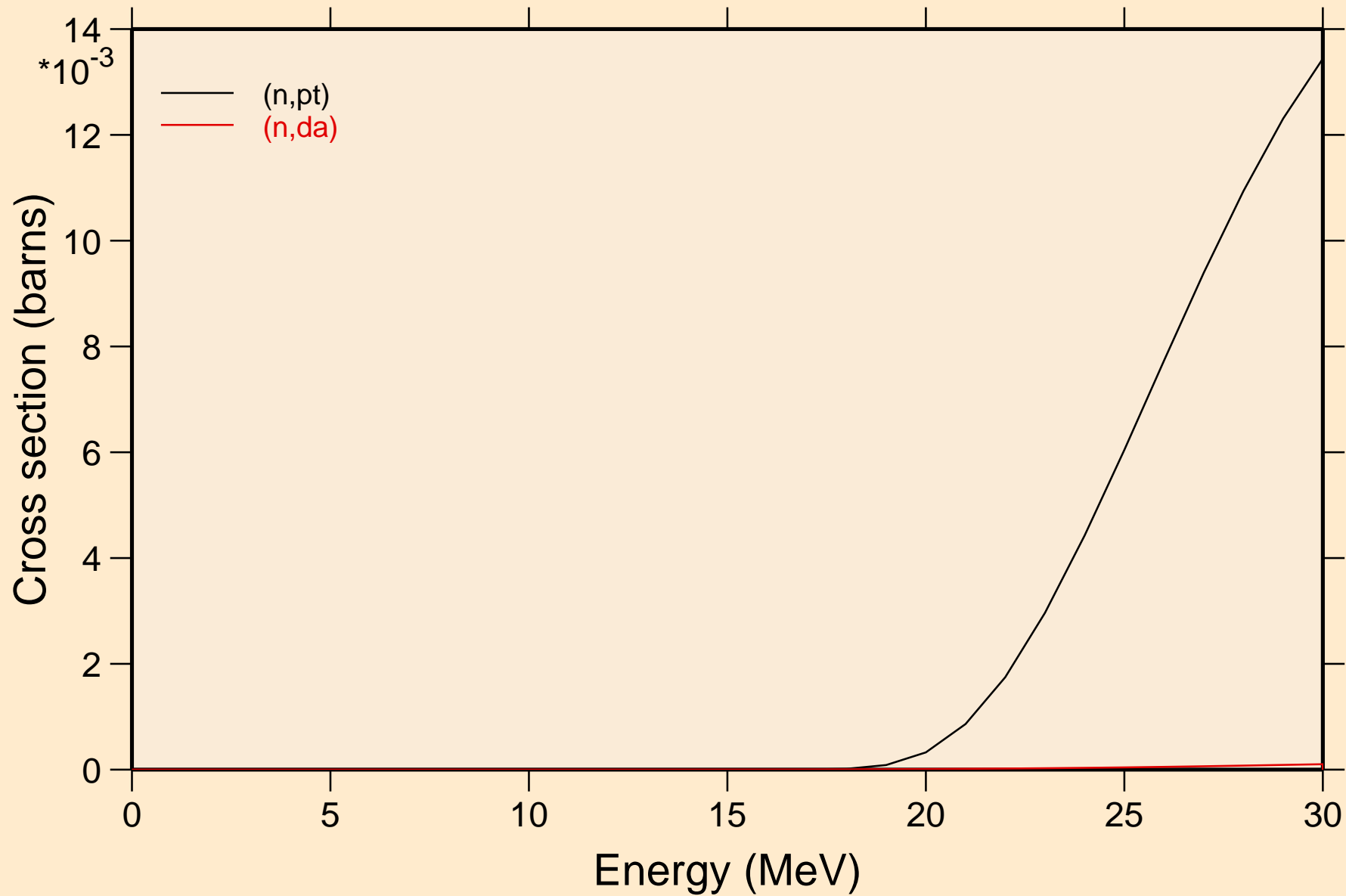

PM129 NEUTRON ACER TENDL-2021 LIBRARY; T=293.6K  
Threshold reactions

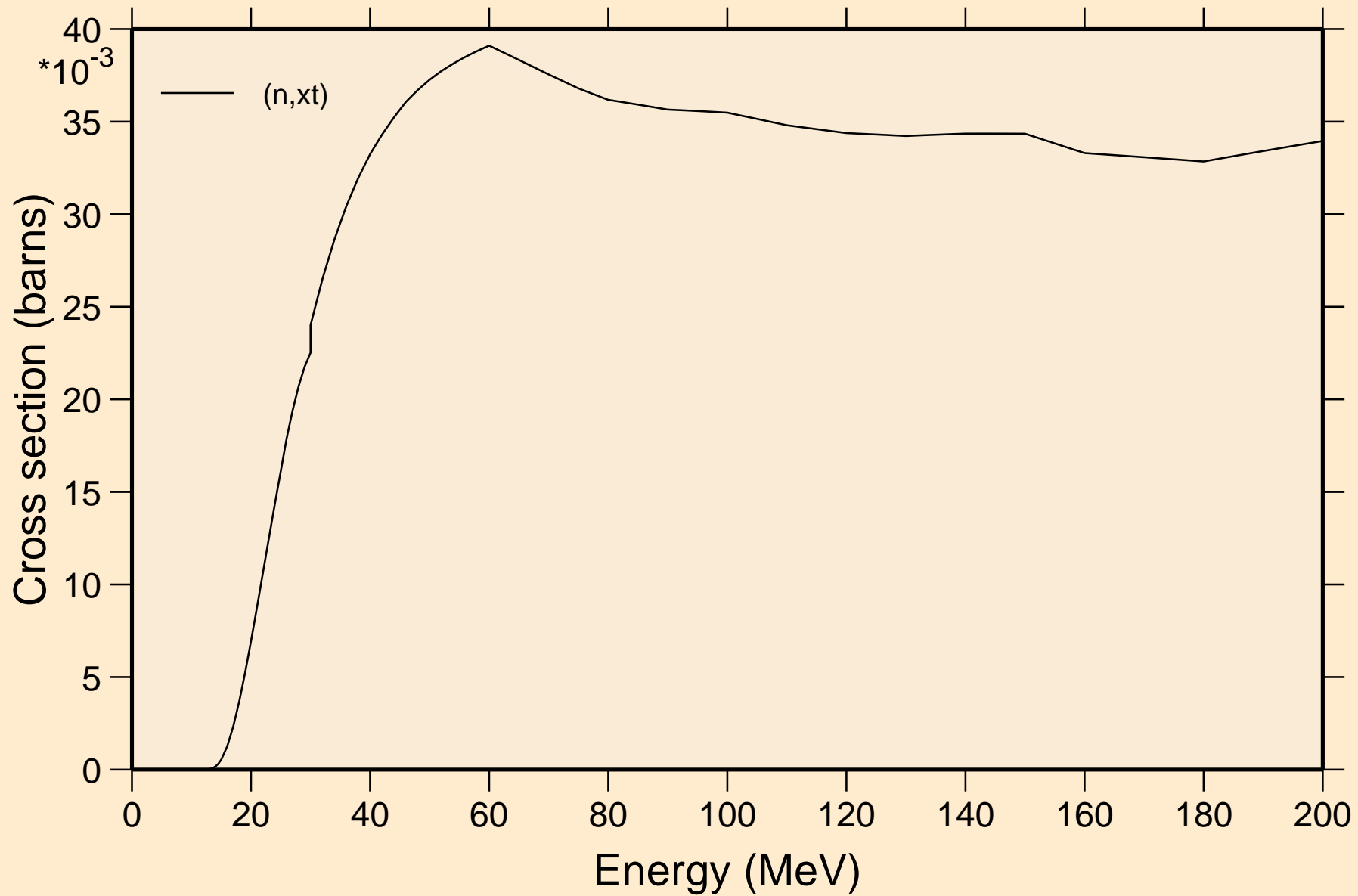

PM129 NEUTRON ACER TENDL-2021 LIBRARY; T=293.6K  
angular distribution for elastic

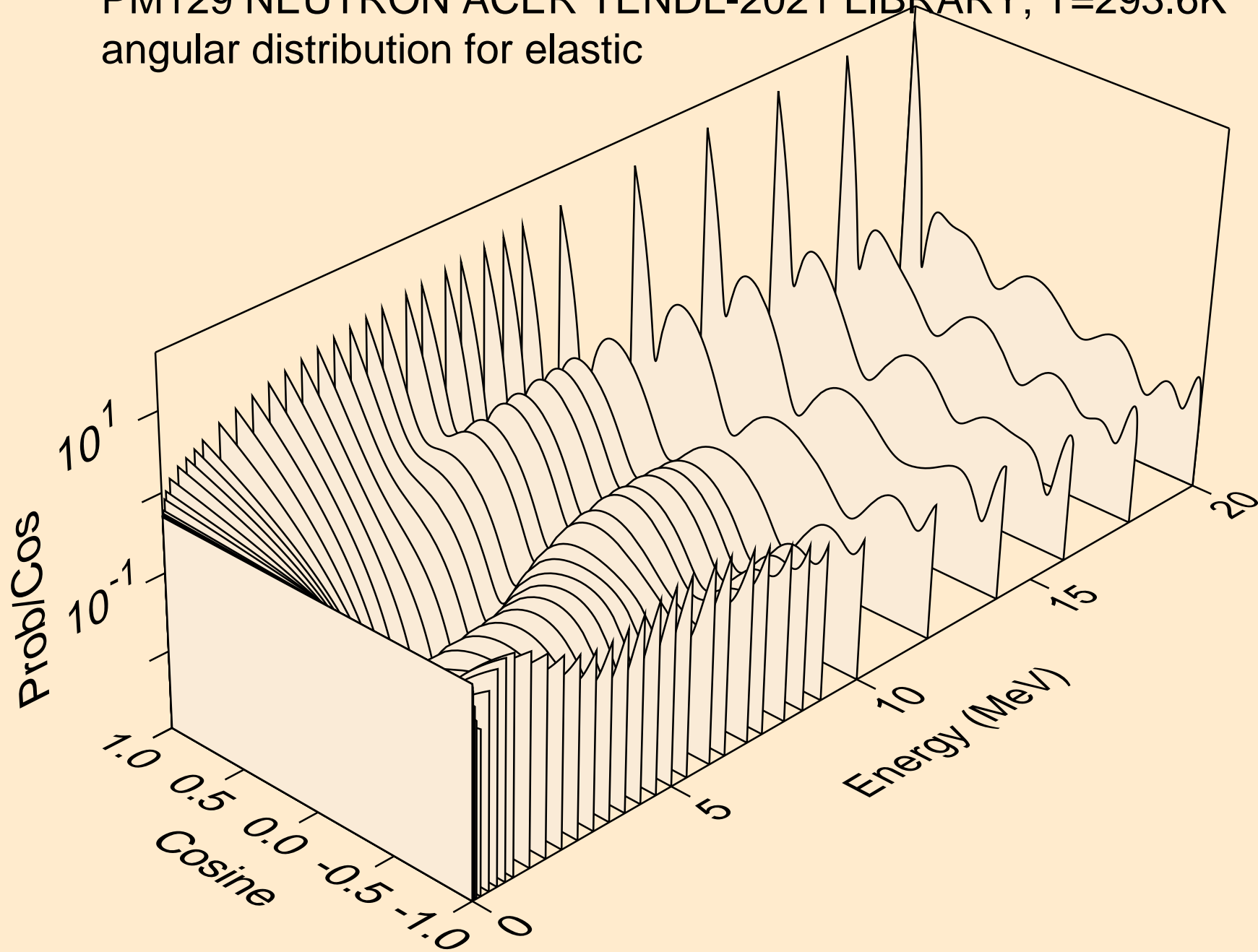

PM129 NEUTRON ACER TENDL-2021 LIBRARY; T=293.6K  
angular distribution for elastic

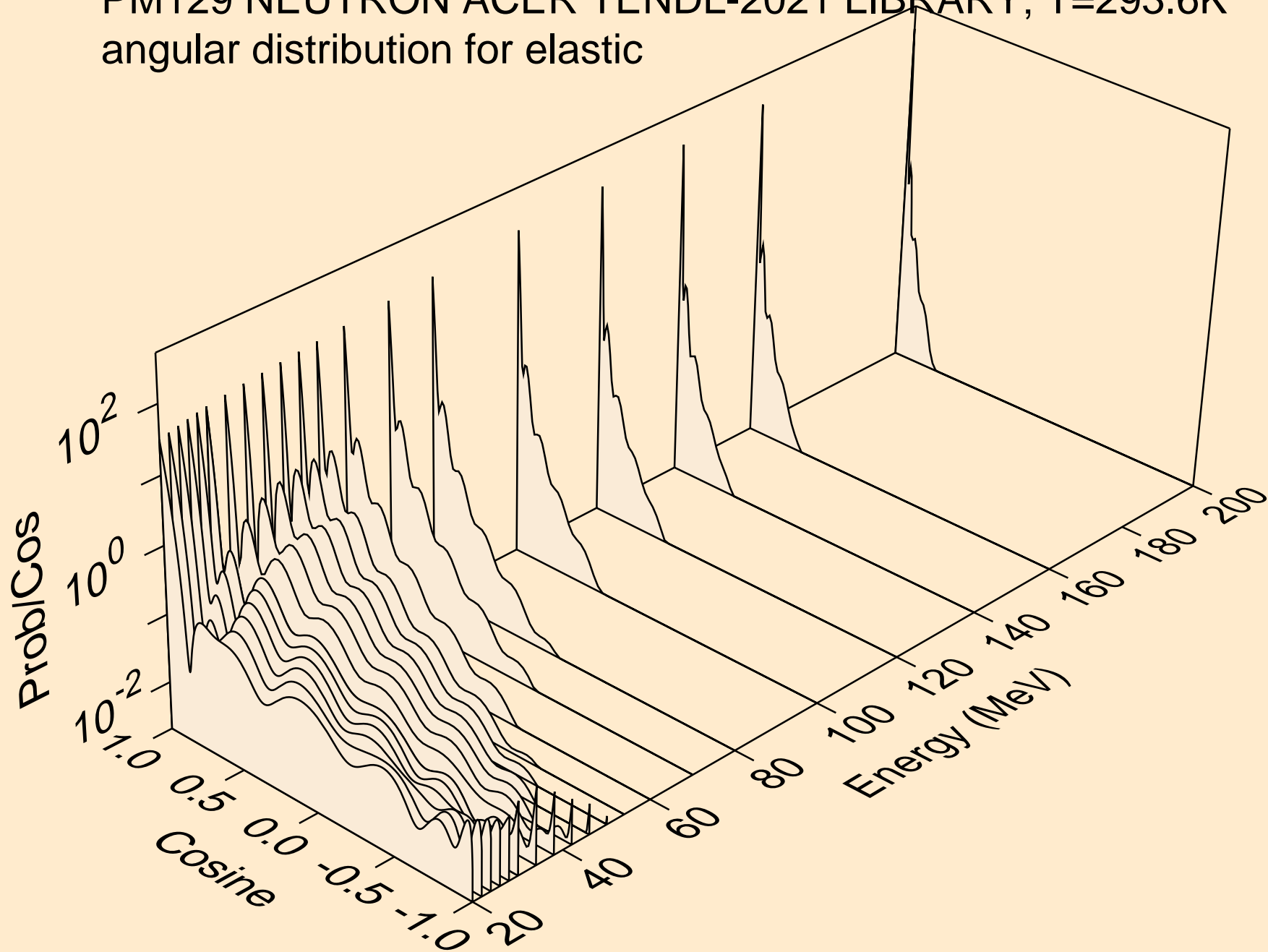

PM129 NEUTRON ACER TENDL-2021 LIBRARY; T=293.6K  
angular distribution for (n,n\*1)

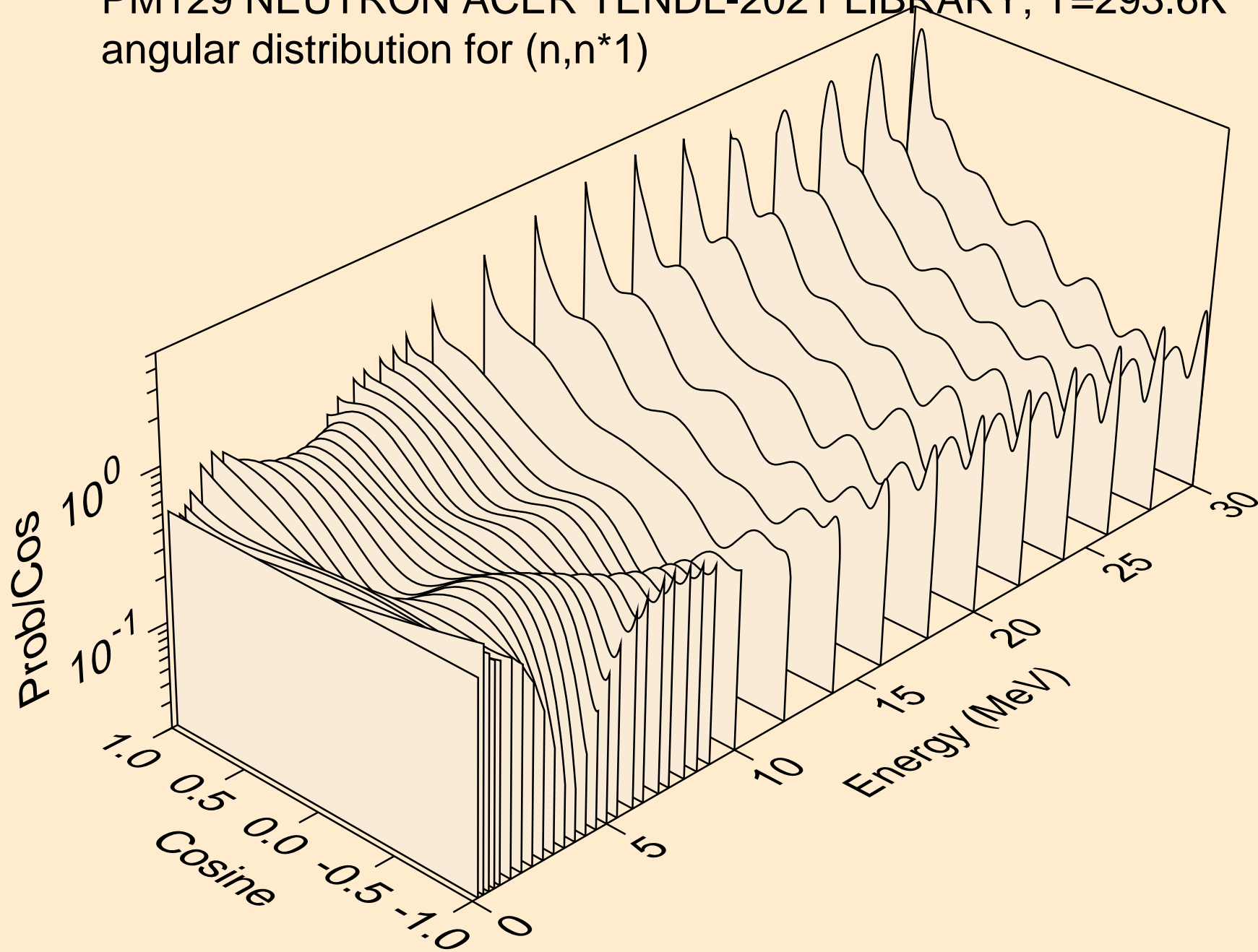

PM129 NEUTRON ACER TENDL-2021 LIBRARY; T=293.6K  
Neutron emission for (n,x)

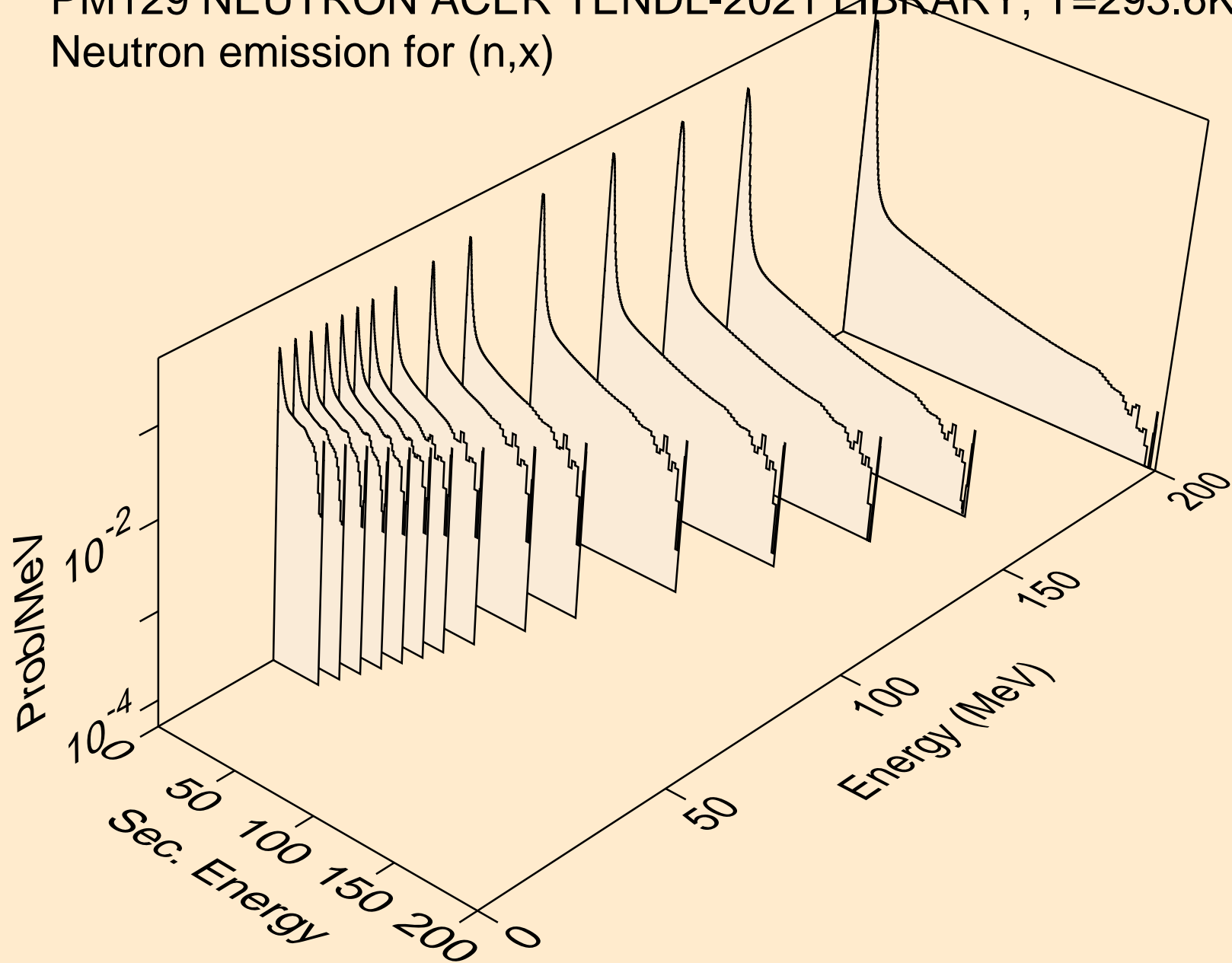

PM129 NEUTRON ACER TENDL-2021 LIBRARY; T=293.6K  
Neutron emission for (n,2nd)

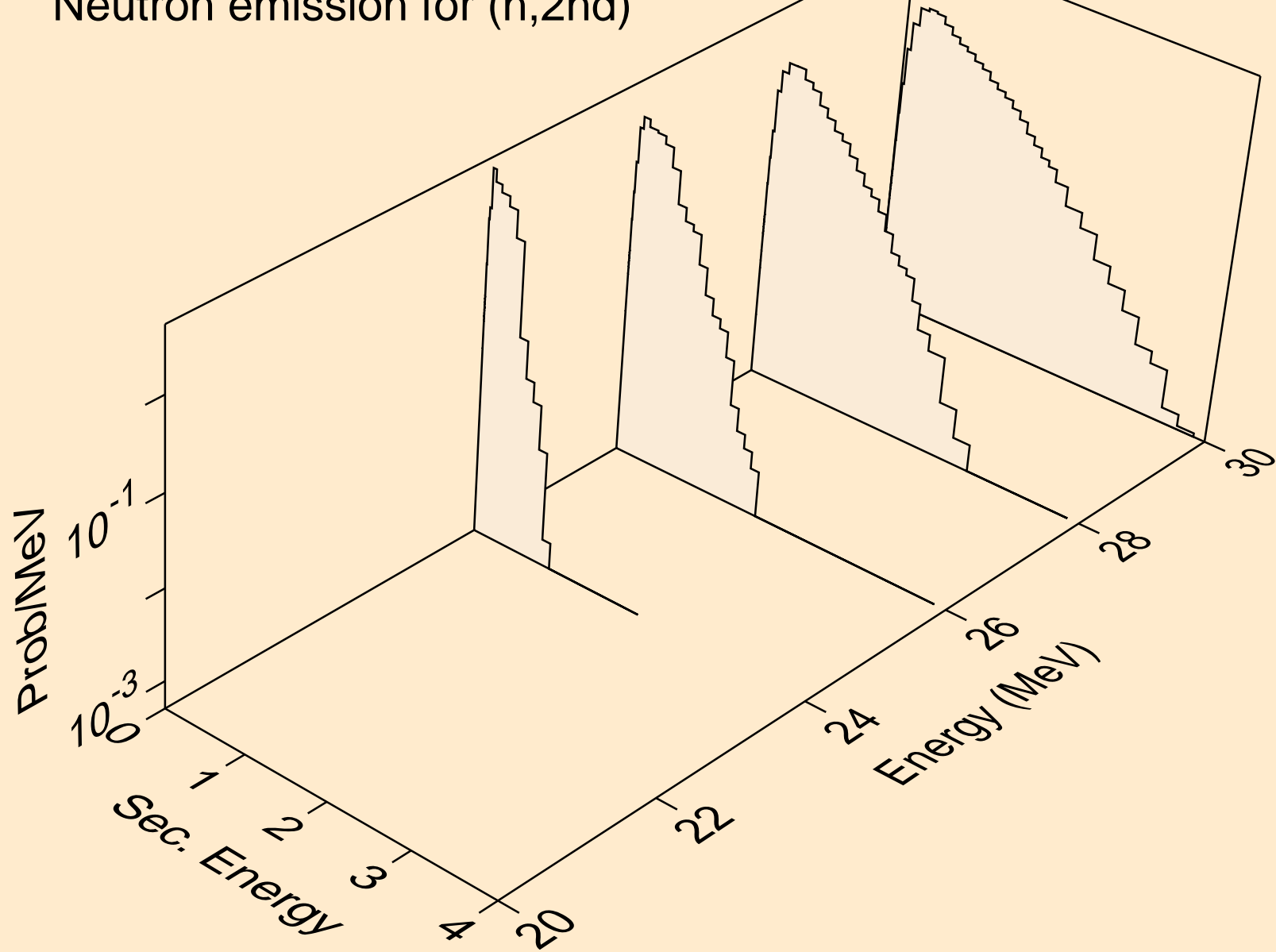



PM129 NEUTRON ACER TENDL-2021 LIBRARY; T=293.6K  
Neutron emission for (n,2n)

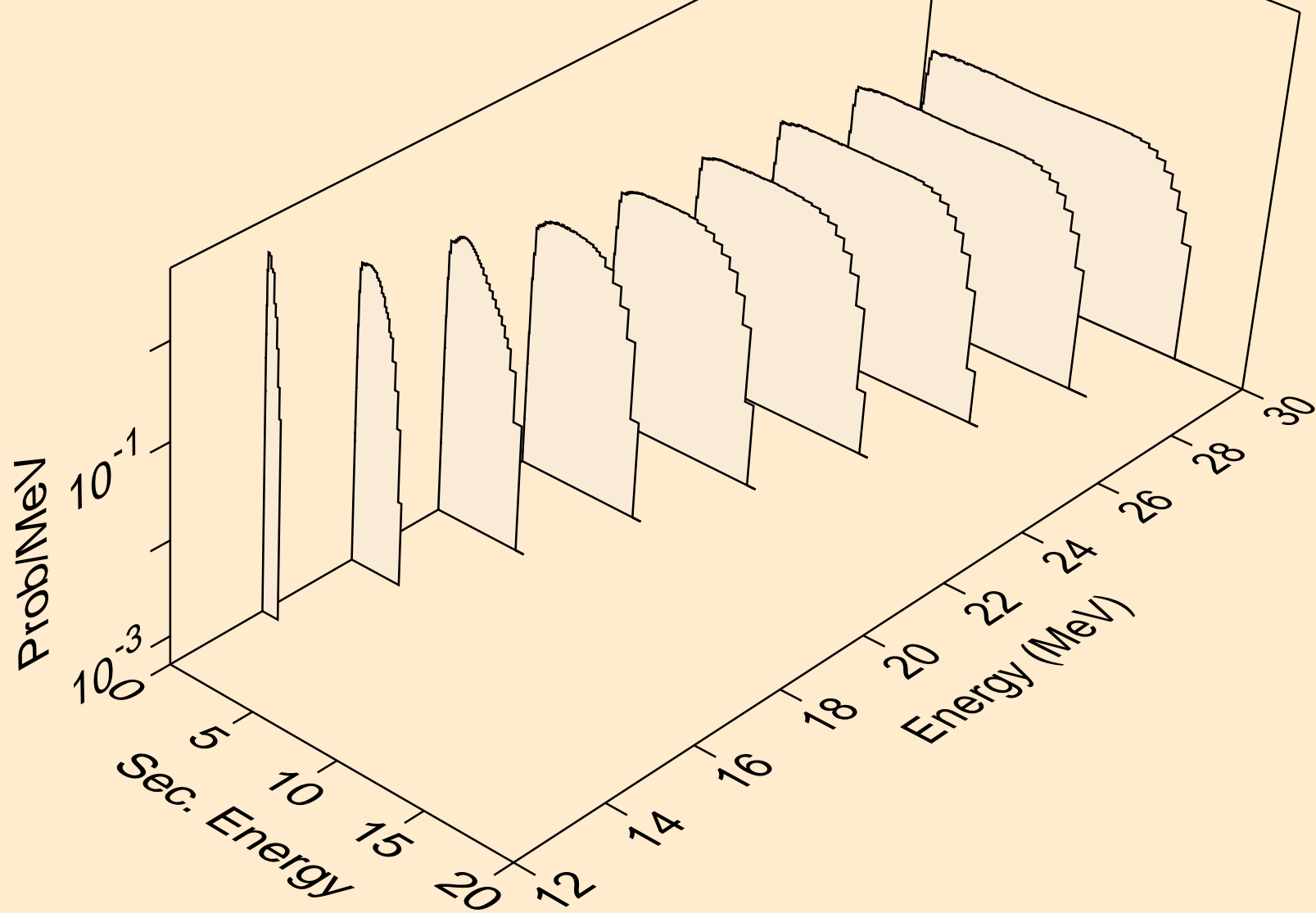

PM129 NEUTRON ACER TENDL-2021 LIBRARY; T=293.6K  
Neutron emission for (n,3n)

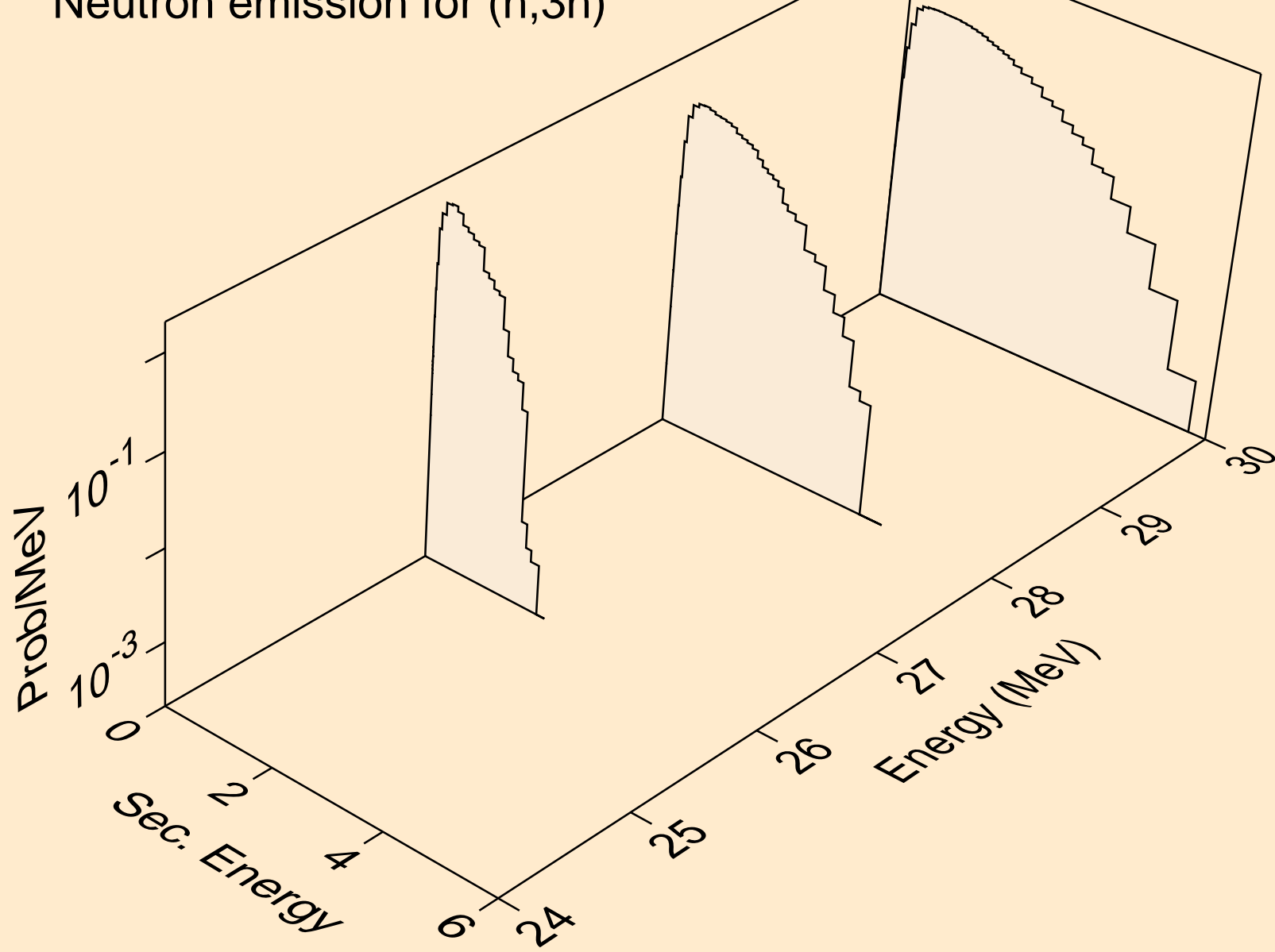

PM129 NEUTRON ACER TENDL-2021 LIBRARY; T=293.6K  
Neutron emission for (n,n\*)a

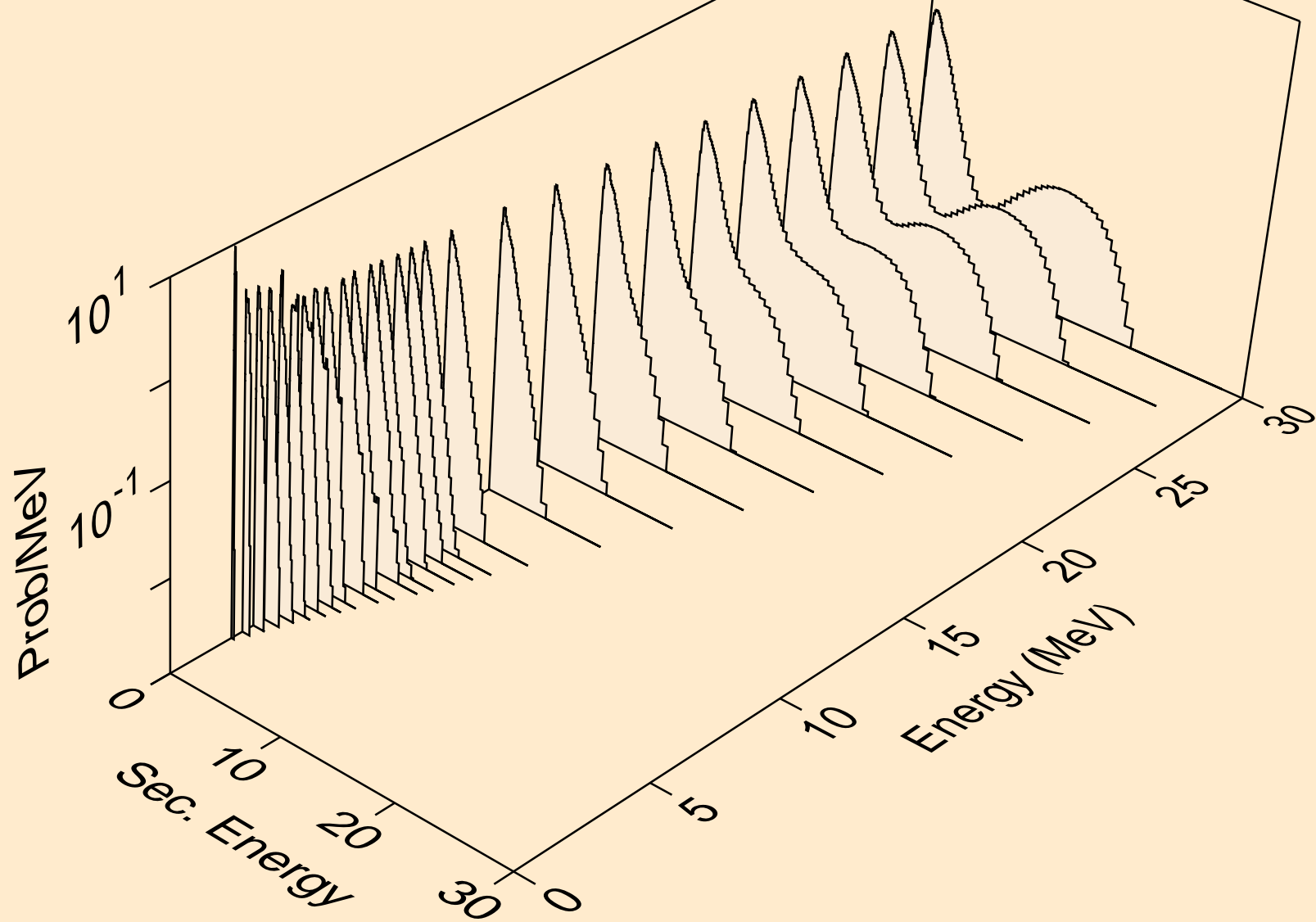

PM129 NEUTRON ACER TENDL-2021 LIBRARY; T=293.6K  
Neutron emission for (n,2n)a

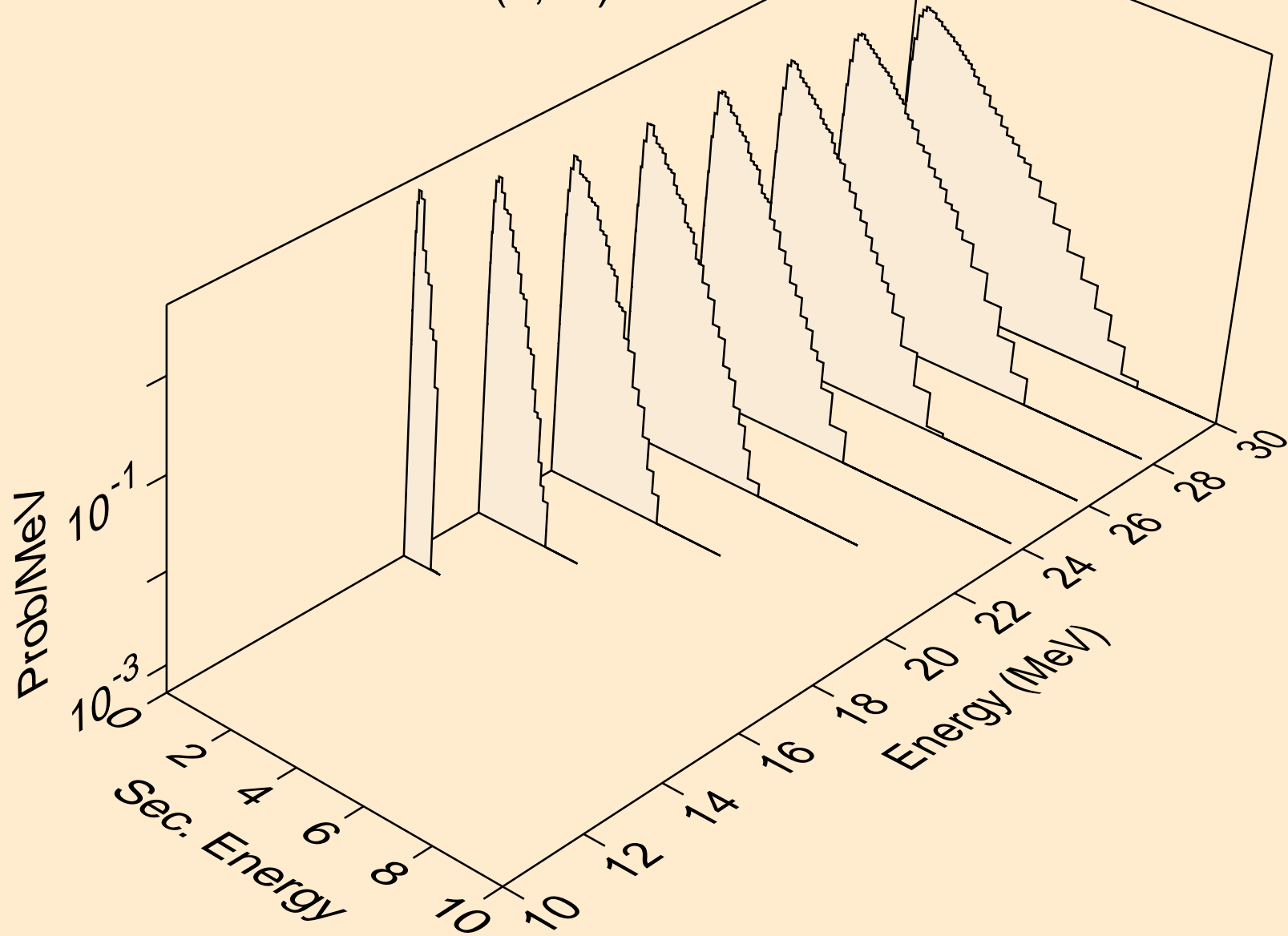

PM129 NEUTRON ACER TENDL-2021 LIBRARY; T=293.6K  
Neutron emission for (n,n\*)p

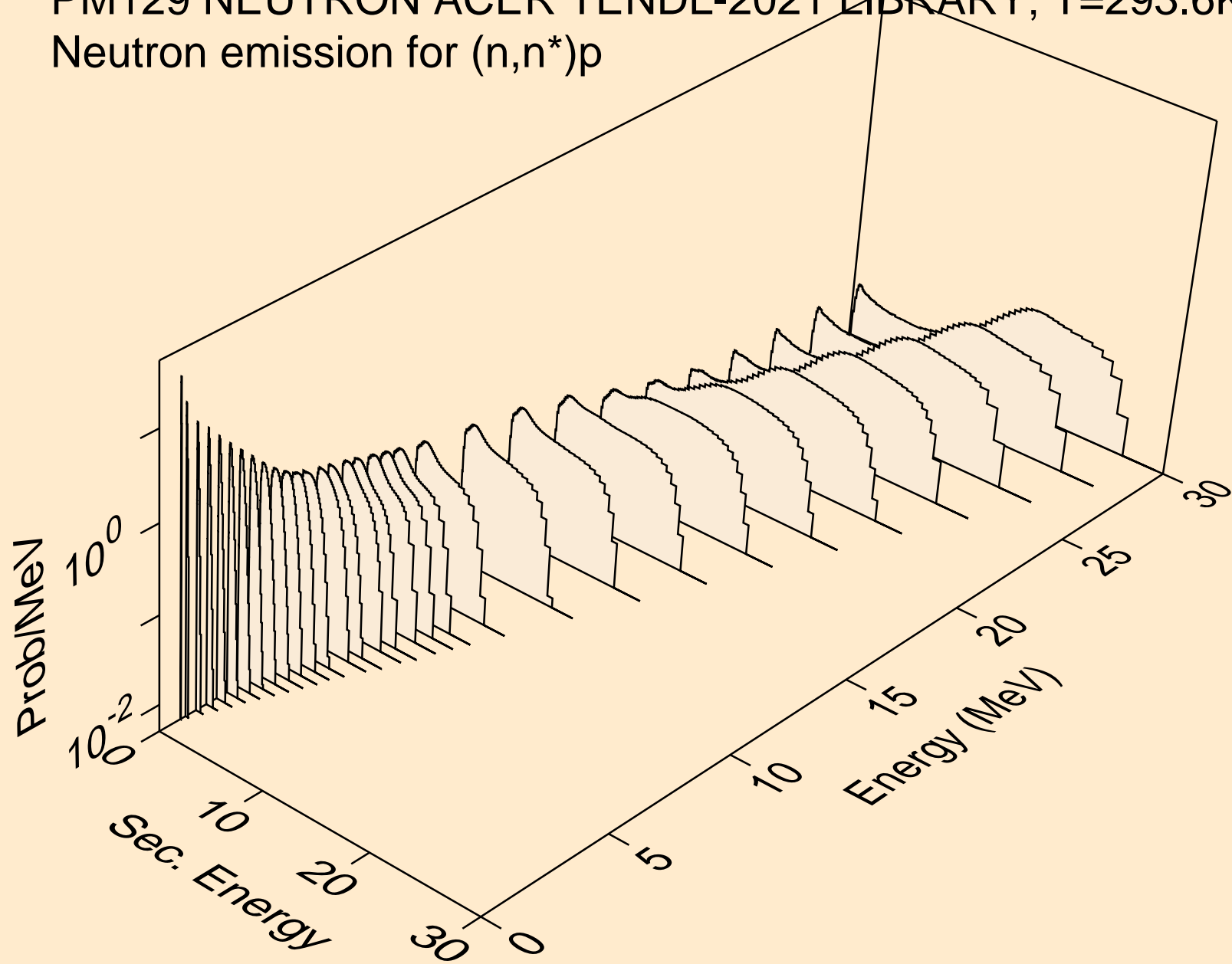

PM129 NEUTRON ACER TENDL-2021 LIBRARY; T=293.6K  
Neutron emission for (n,n\*)2a

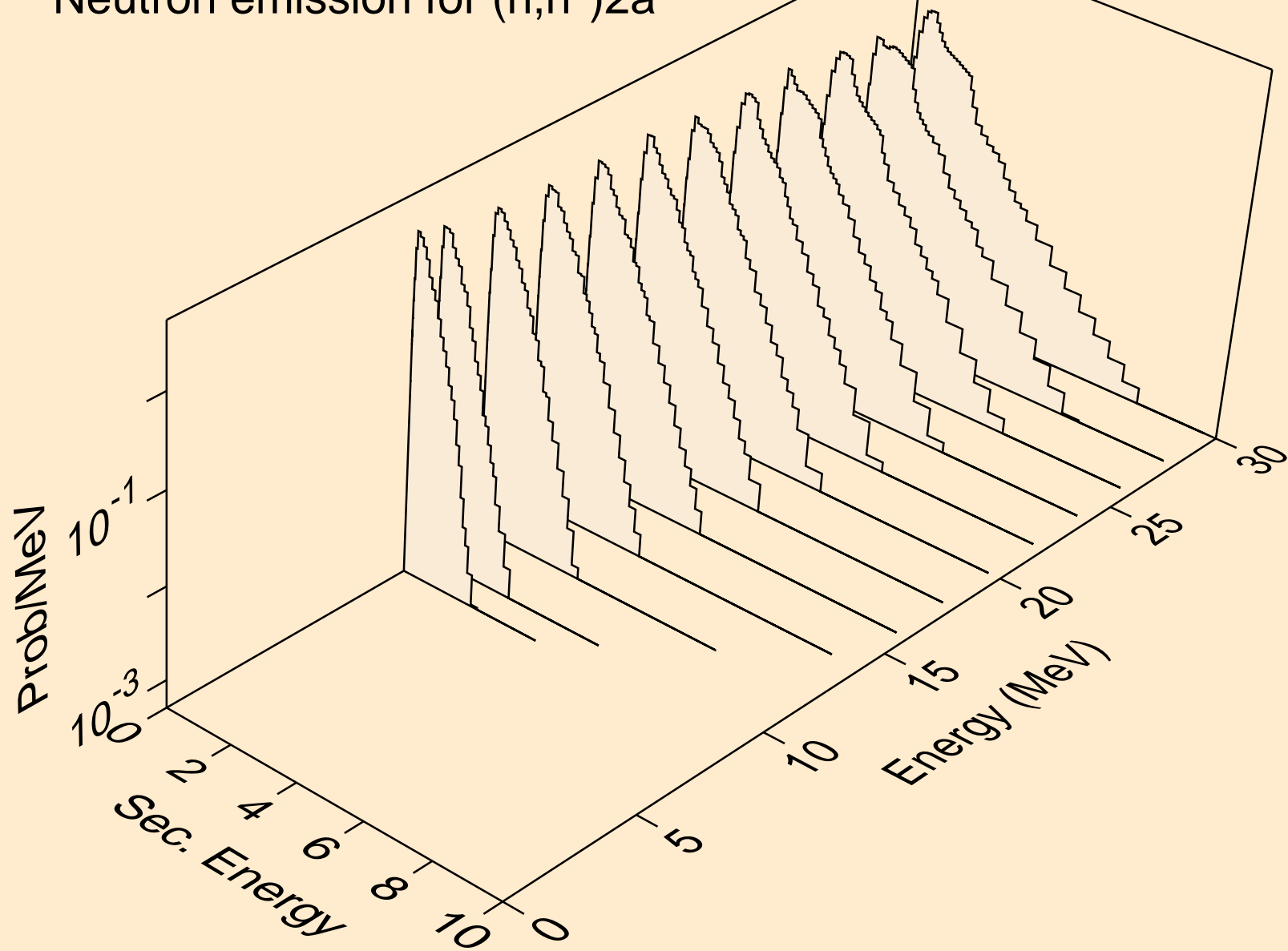

PM129 NEUTRON ACER TENDL-2021 LIBRARY; T=293.6K  
Neutron emission for (n,n\*)d

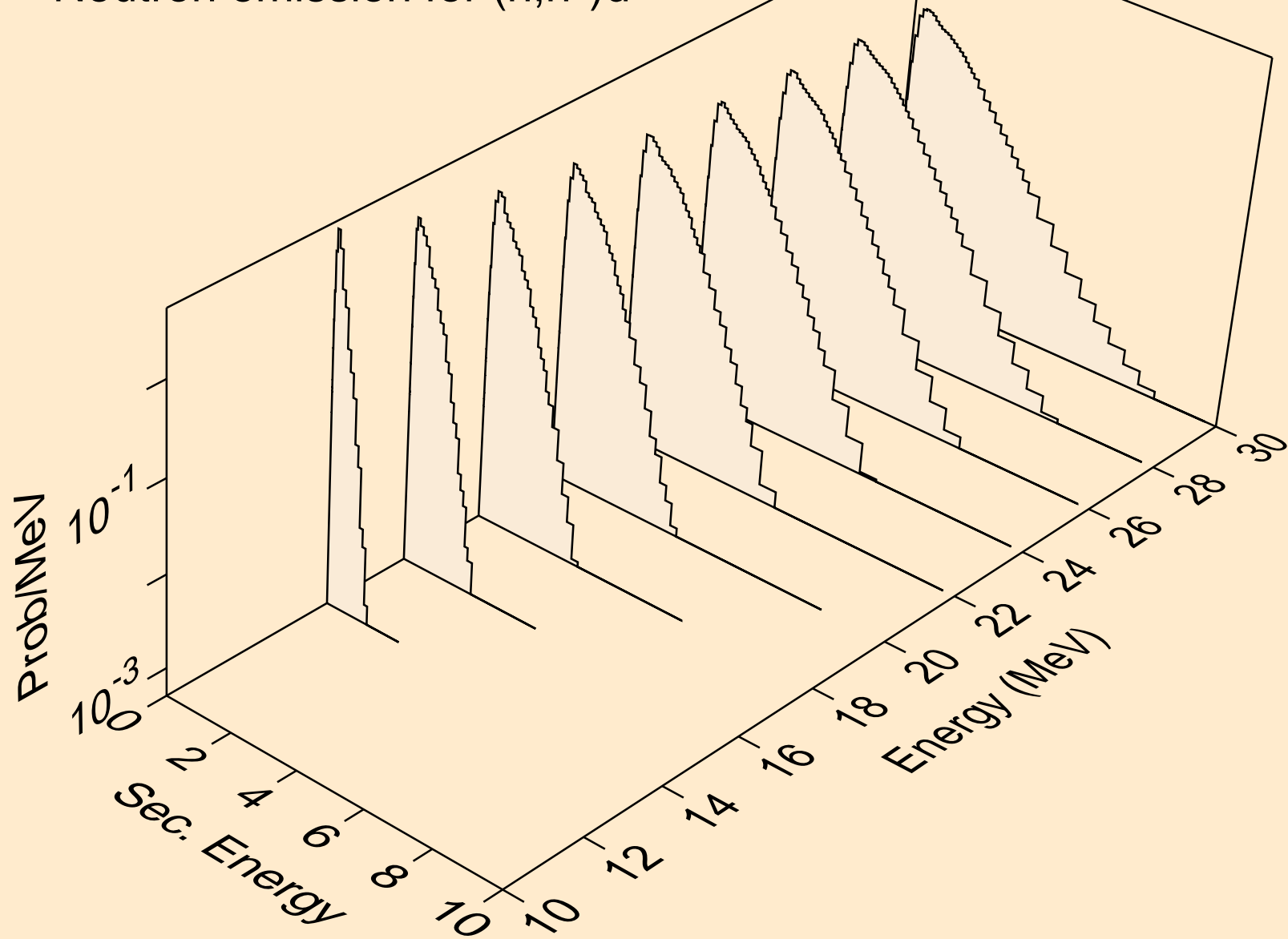

PM129 NEUTRON ACER TENDL-2021 LIBRARY; T=293.6K  
Neutron emission for (n,n\*)t

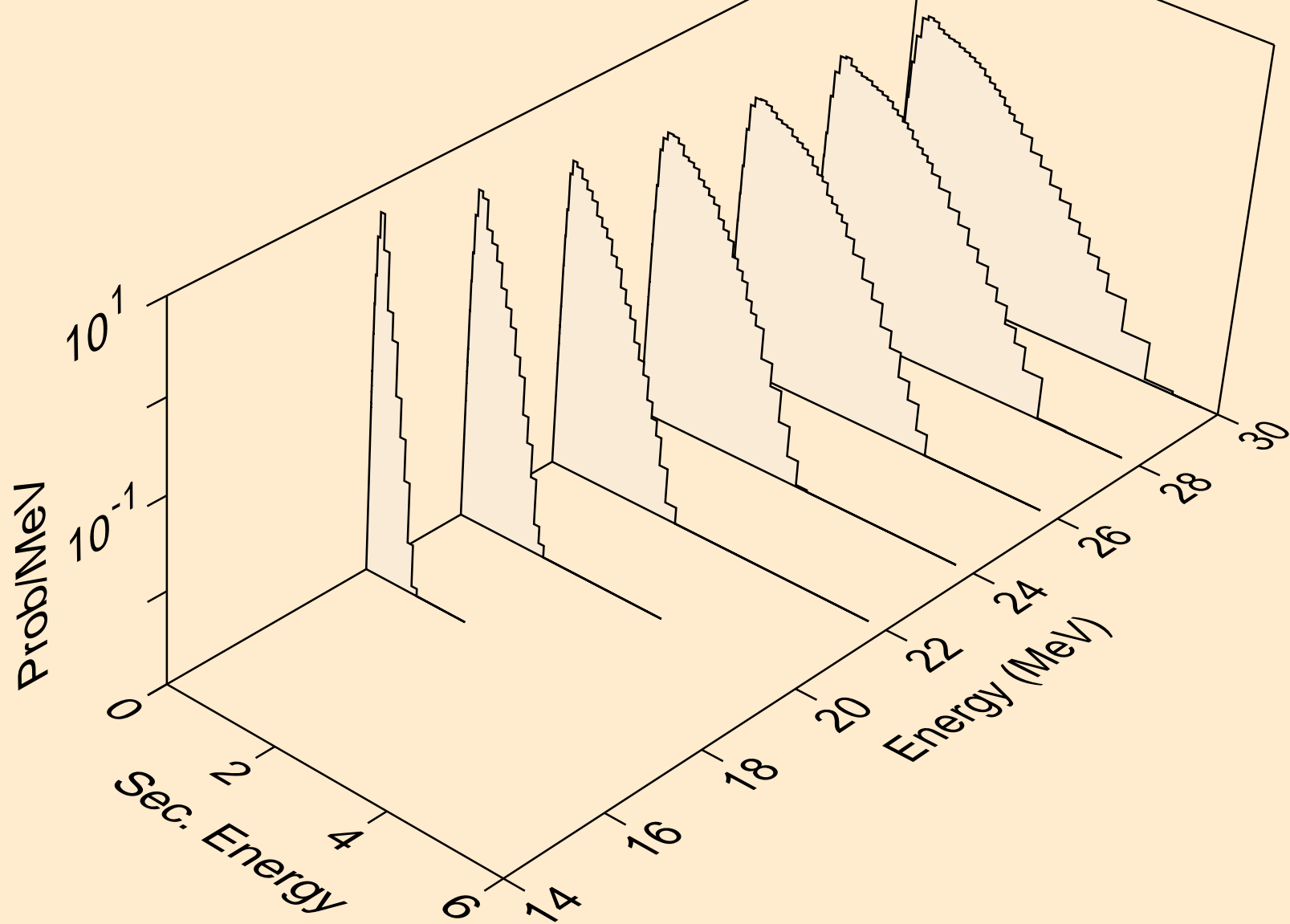



PM129 NEUTRON ACER TENDL-2021 LIBRARY; T=293.6K  
Neutron emission for (n,n\*)he3

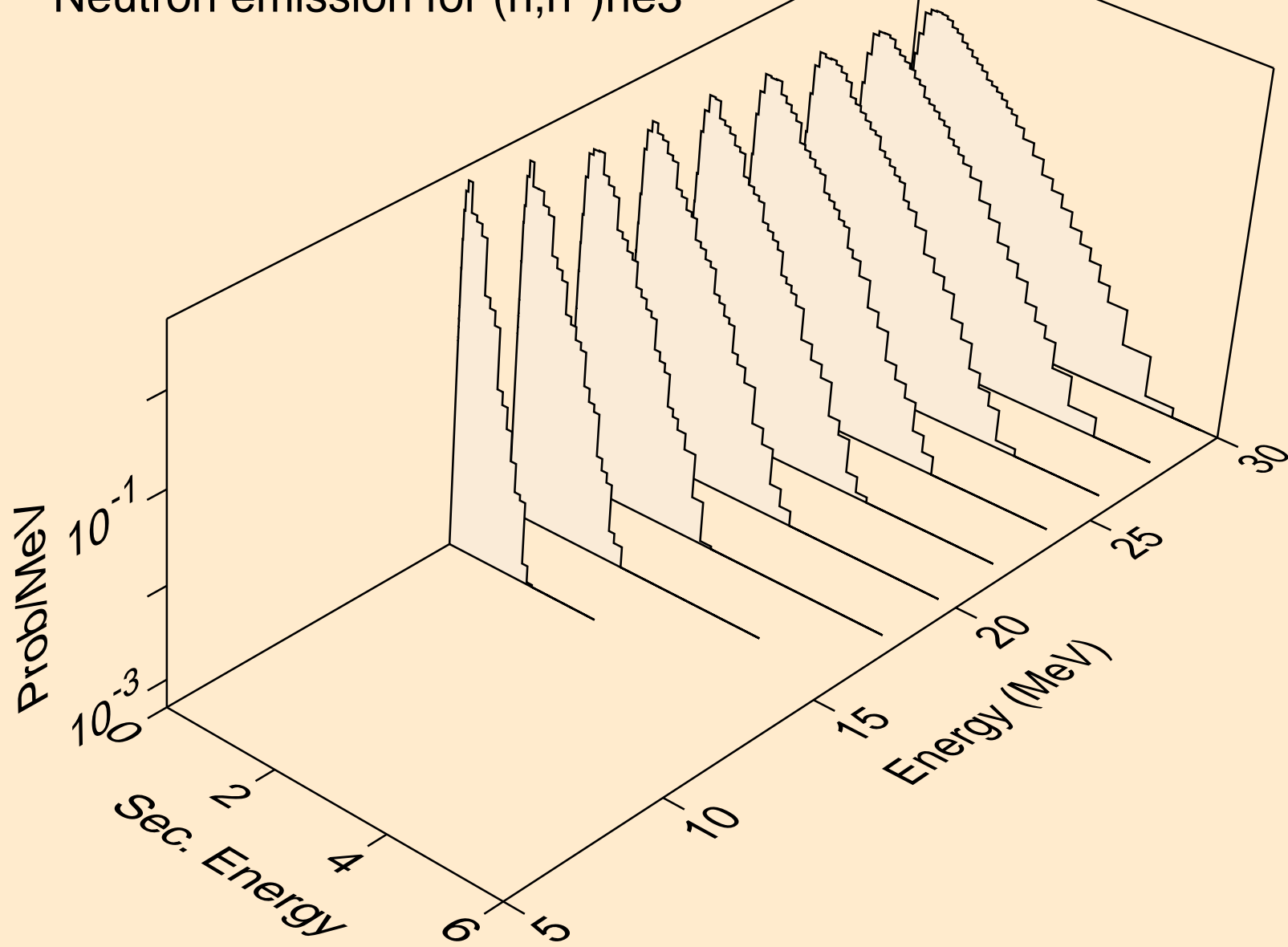

PM129 NEUTRON ACER TENDL-2021 LIBRARY; T=293.6K  
Neutron emission for (n,2np)

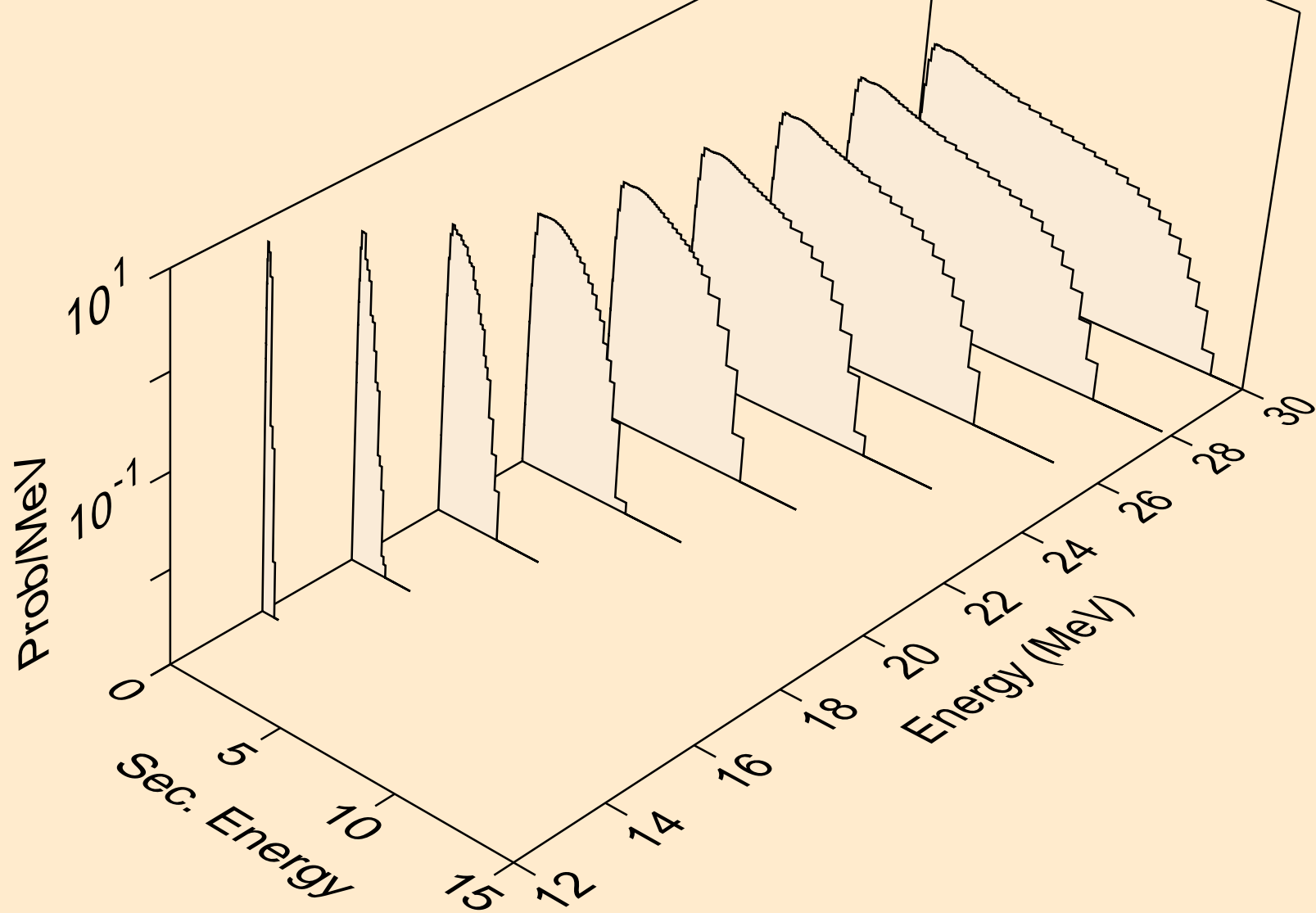

PM129 NEUTRON ACER TENDL-2021 LIBRARY; T=293.6K  
Neutron emission for (n,3np)

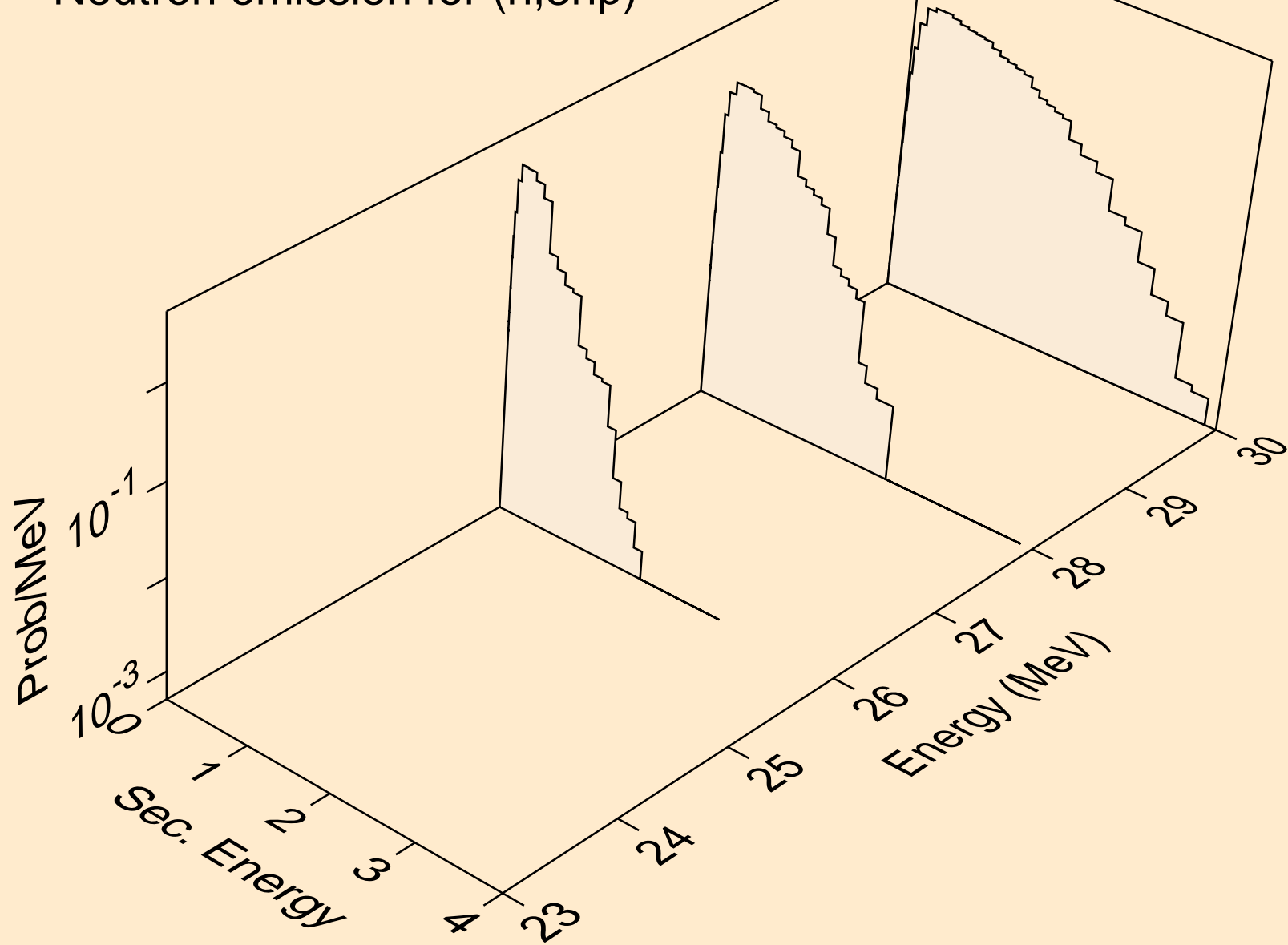

PM129 NEUTRON ACER TENDL-2021 LIBRARY; T=293.6K  
Neutron emission for (n,2np)

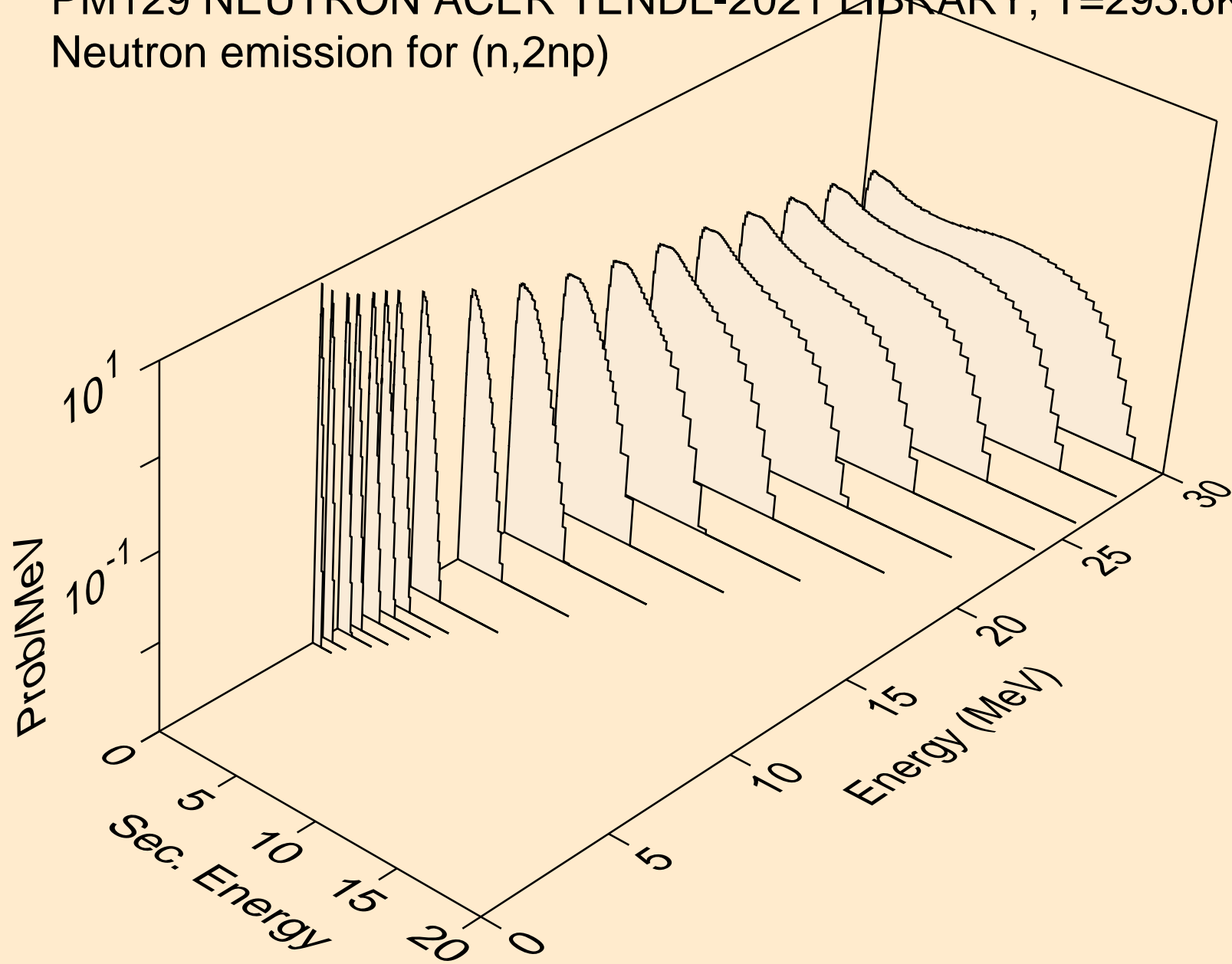

PM129 NEUTRON ACER TENDL-2021 LIBRARY; T=293.6K  
Neutron emission for (n,npa)

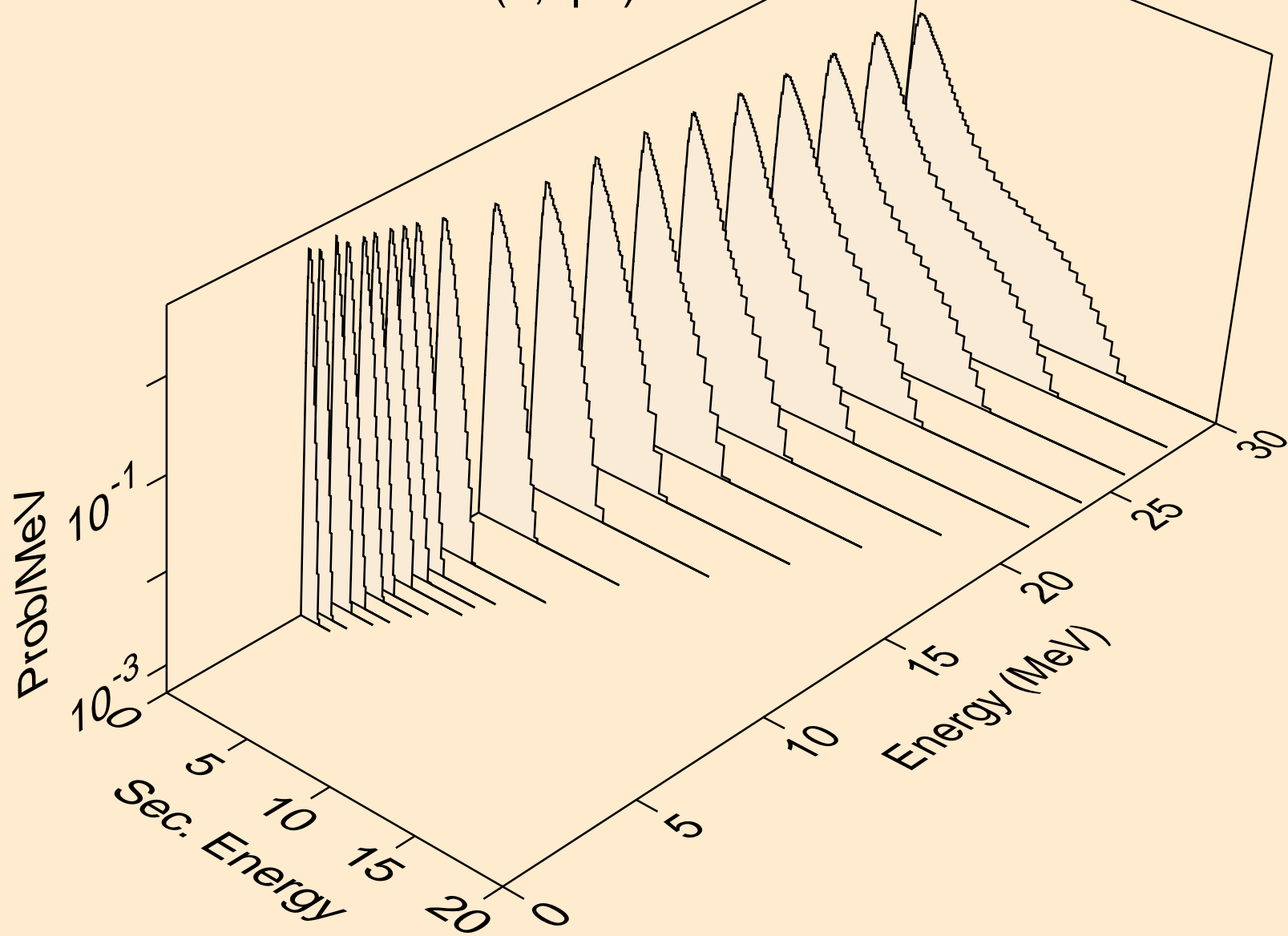

PM129 NEUTRON ACER TENDL-2021 LIBRARY; T=293.6K  
Neutron emission for (n,n\*c)

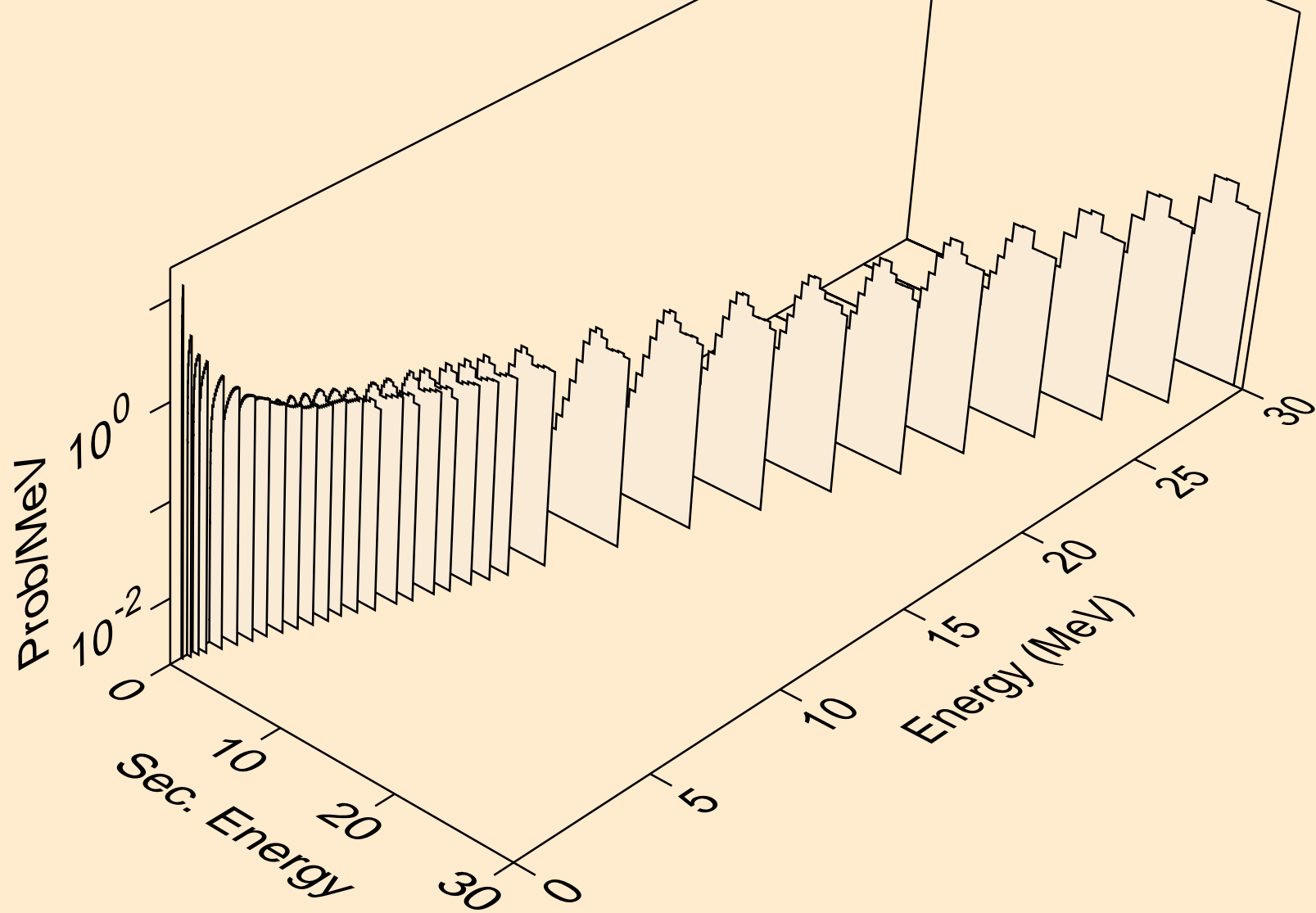

PM129 NEUTRON ACER TENDL-2021 LIBRARY; T=293.6K  
Photon emission for (n,x)

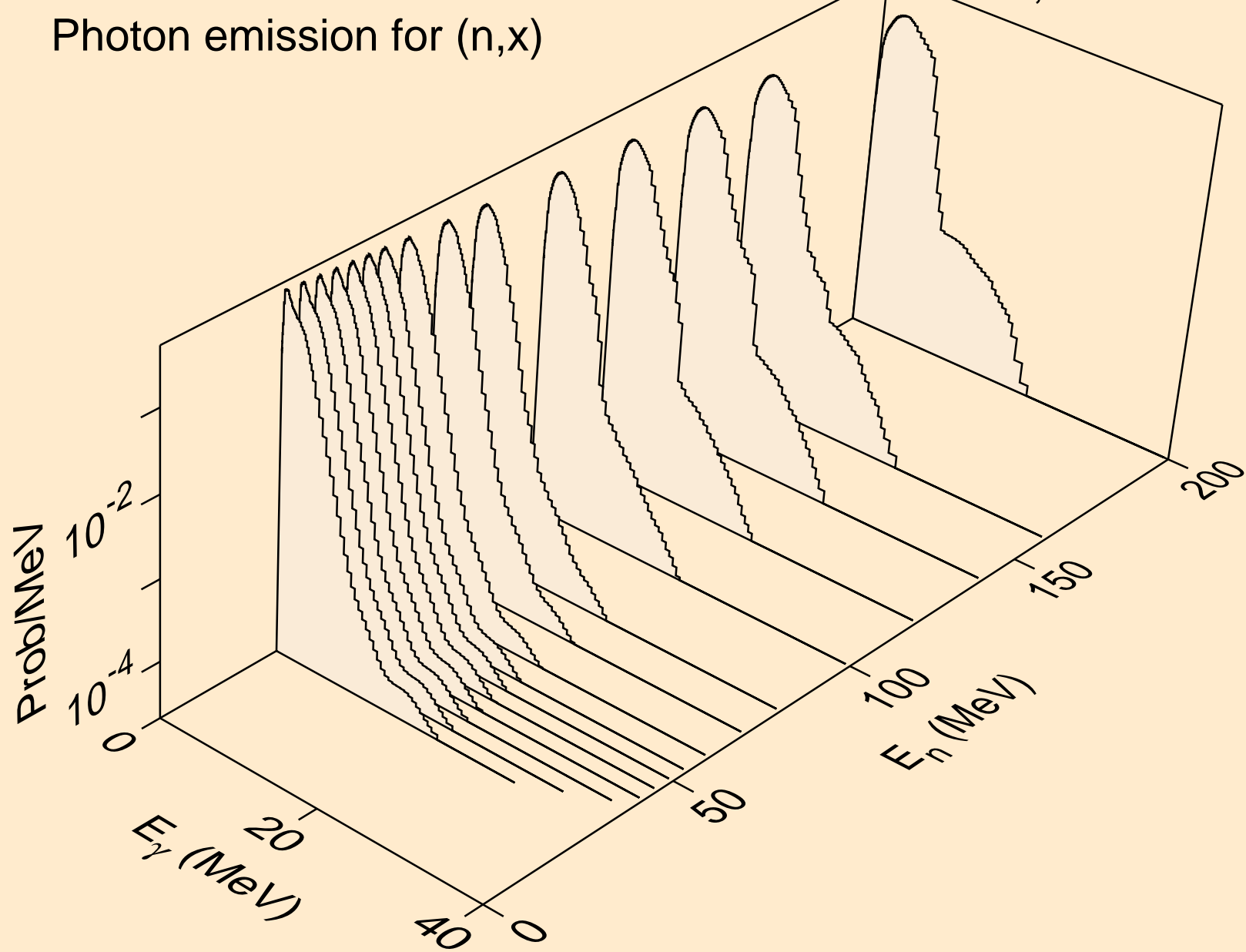

PM129 NEUTRON ACER TENDL-2021 LIBRARY; T=293.6K  
Photon emission for (n,2nd)

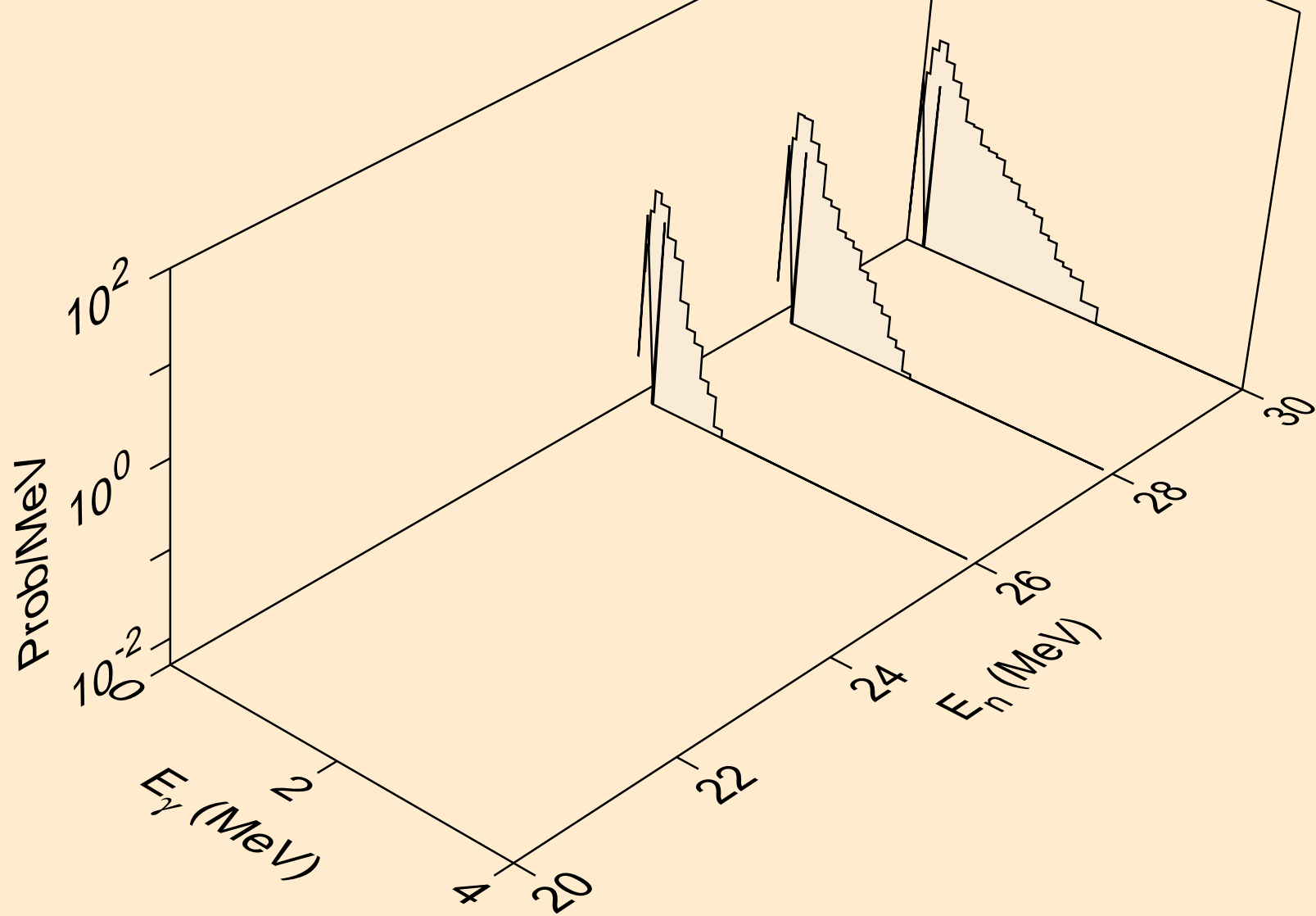



PM129 NEUTRON ACER TENDL-2021 LIBRARY; T=293.6K  
Photon emission for (n,2n)

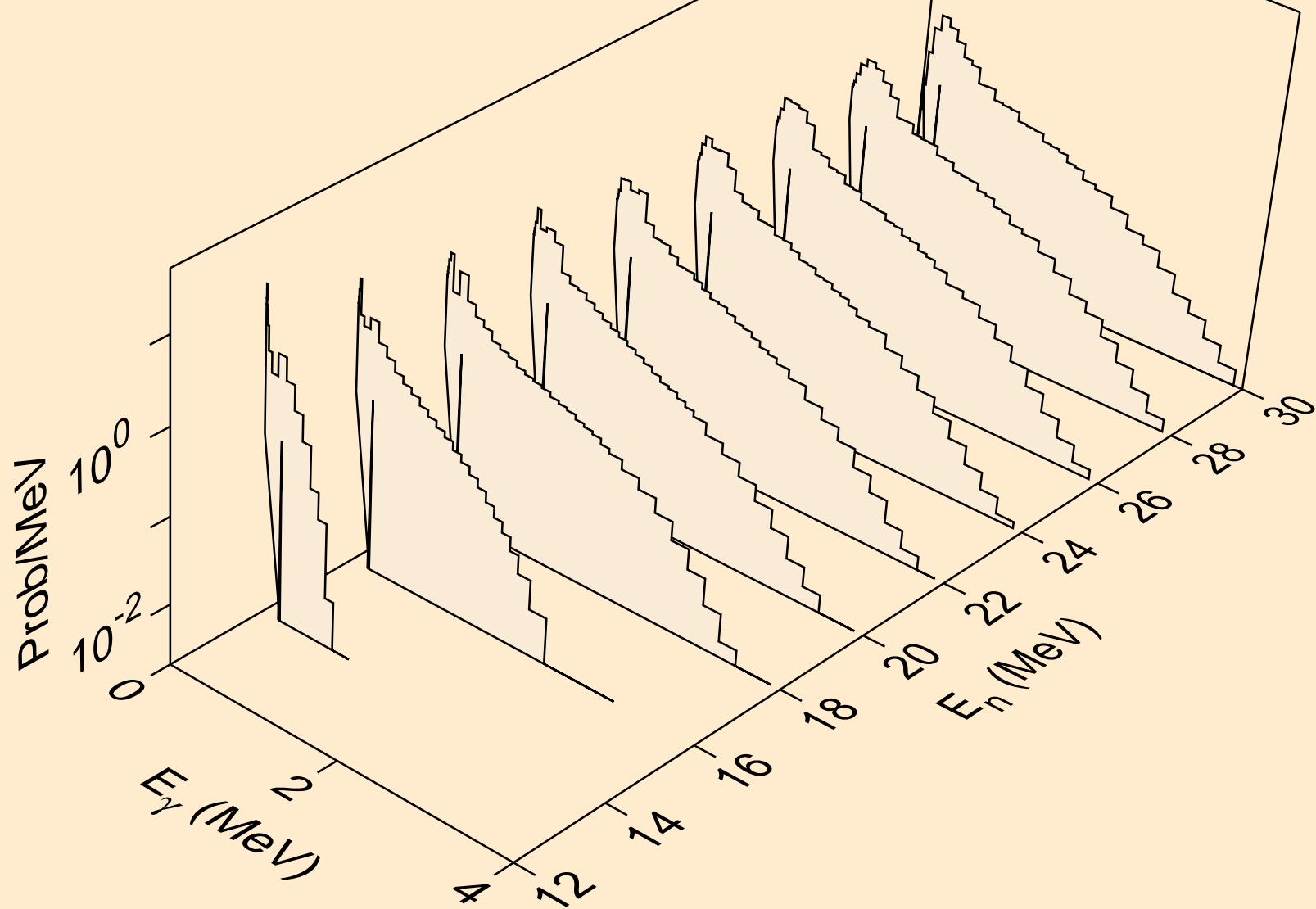

PM129 NEUTRON ACER TENDL-2021 LIBRARY; T=293.6K  
Photon emission for (n,3n)

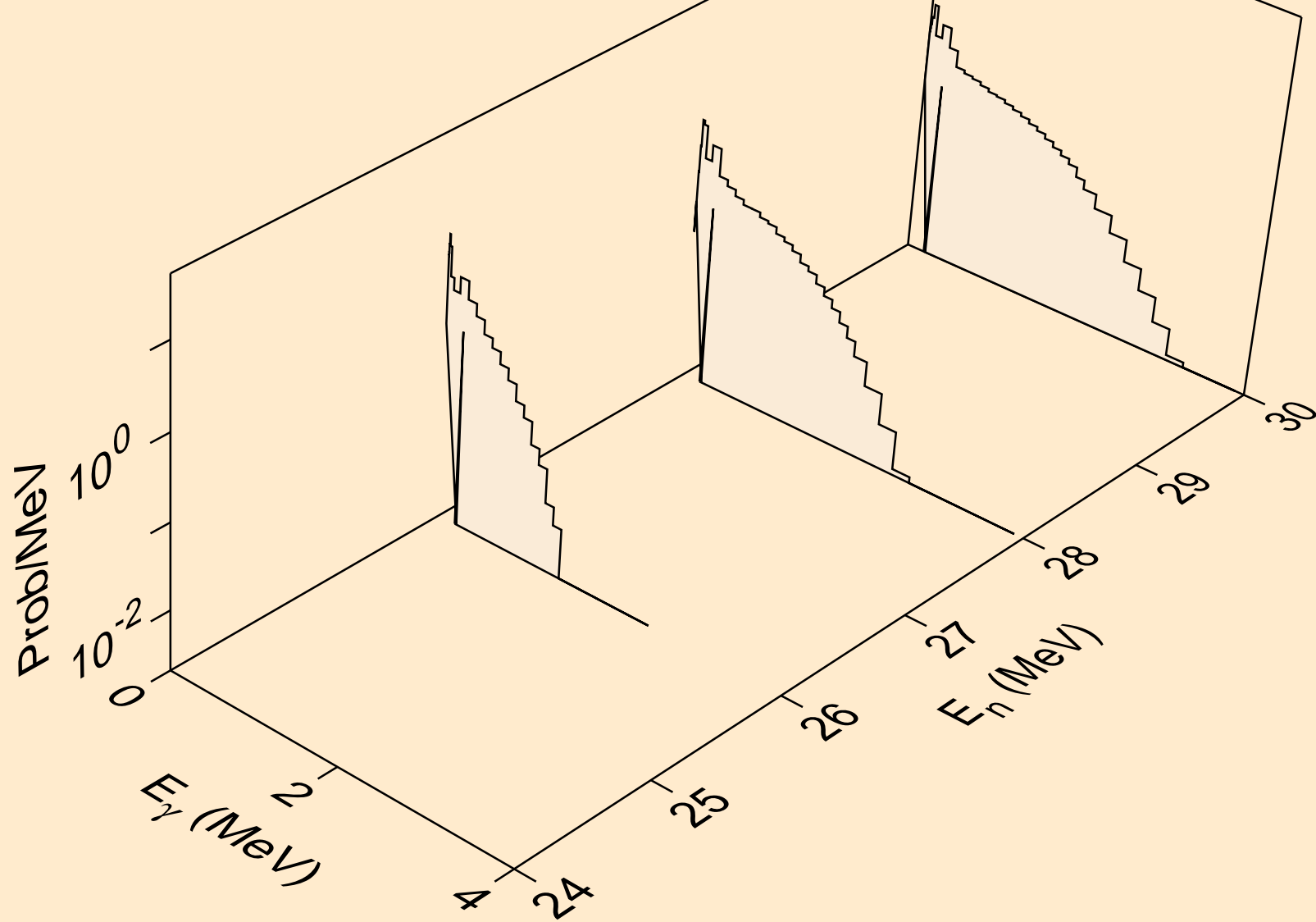

PM129 NEUTRON ACER TENDL-2021 LIBRARY; T=293.6K  
Photon emission for (n,n\*)a

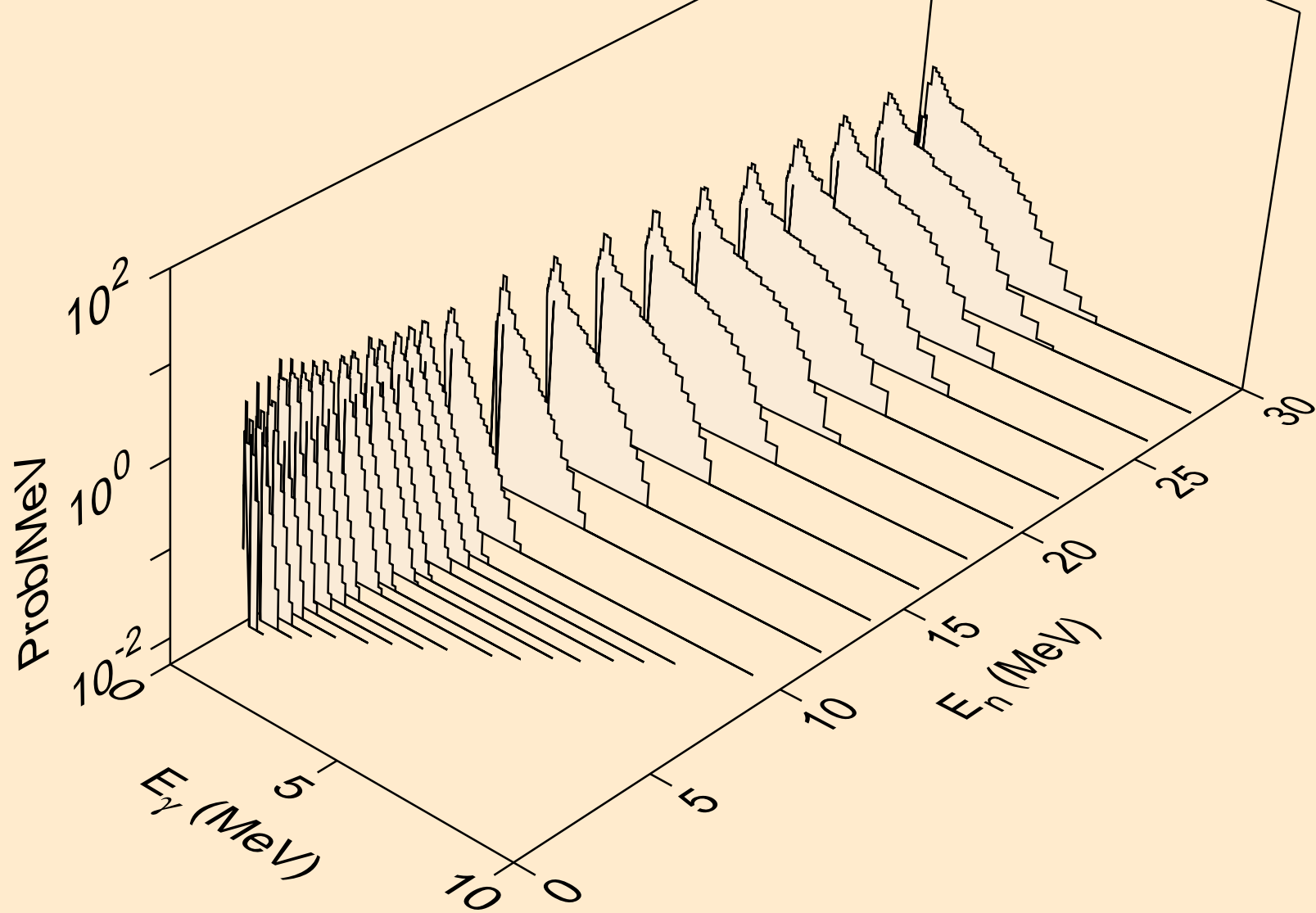

PM129 NEUTRON ACER TENDL-2021 LIBRARY; T=293.6K  
Photon emission for (n,2n)a

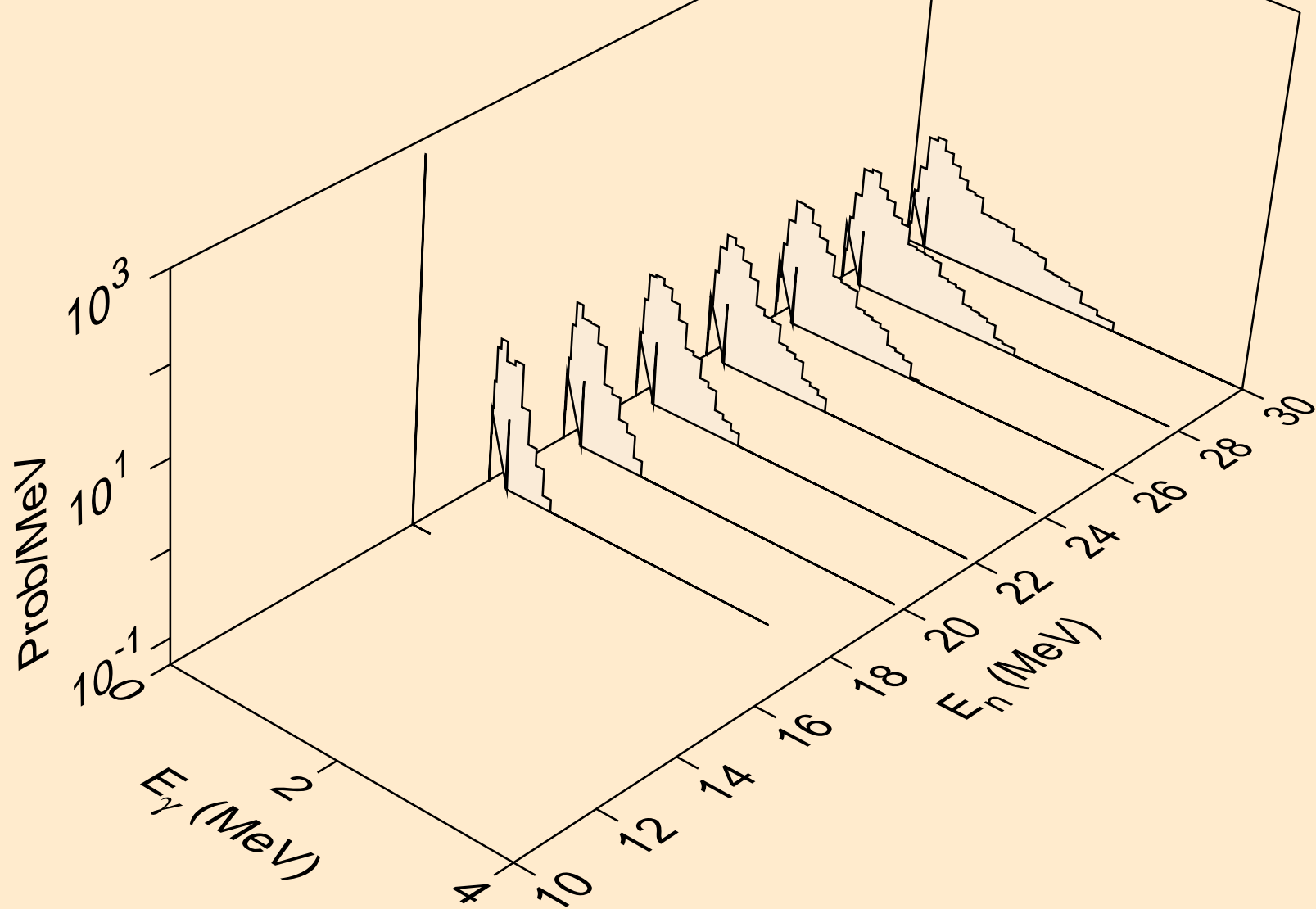

PM129 NEUTRON ACER TENDL-2021 LIBRARY; T=293.6K  
Photon emission for (n,n\*)p

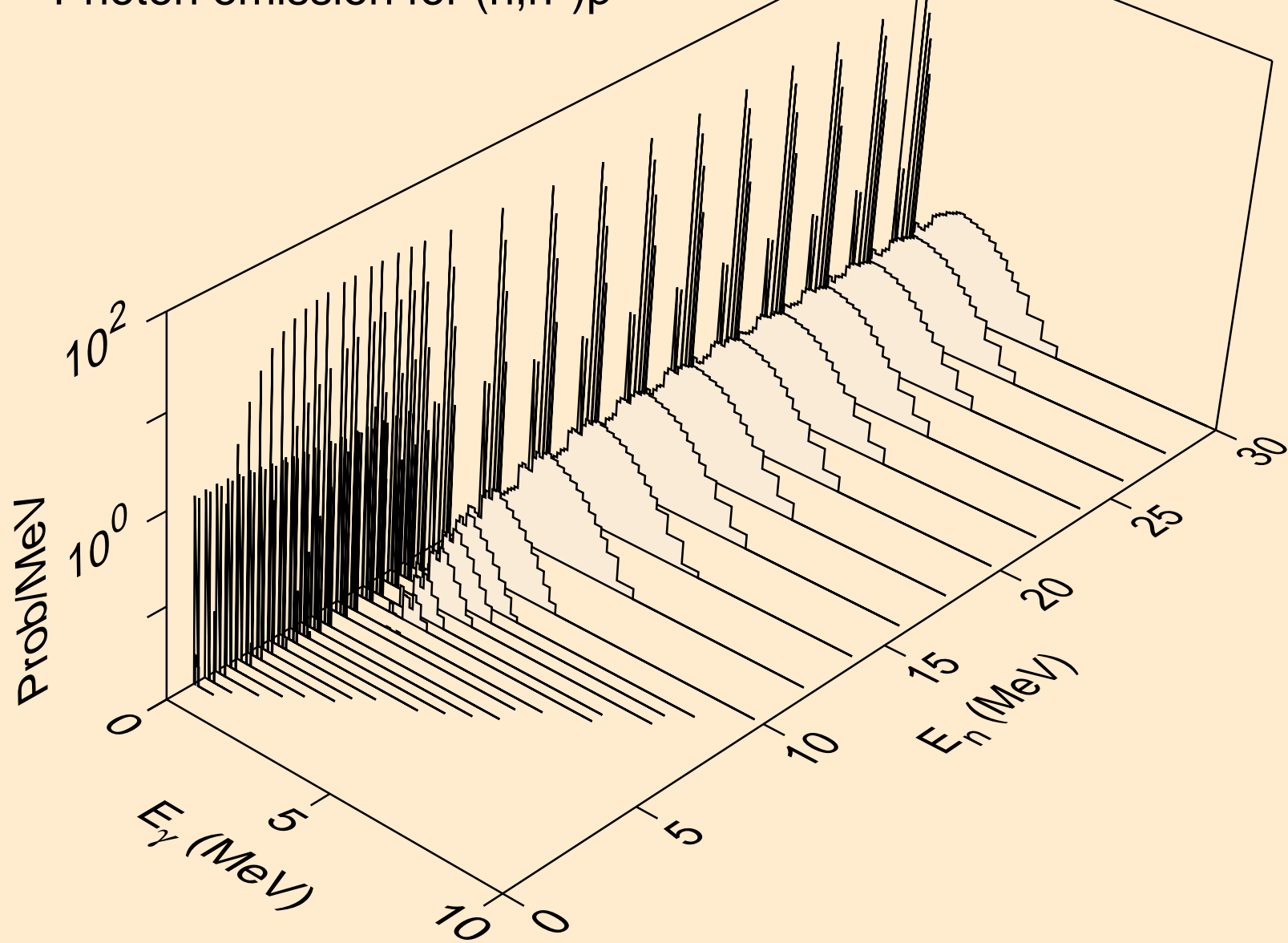

PM129 NEUTRON ACER TENDL-2021 LIBRARY; T=293.6K  
Photon emission for (n,n\*)2a

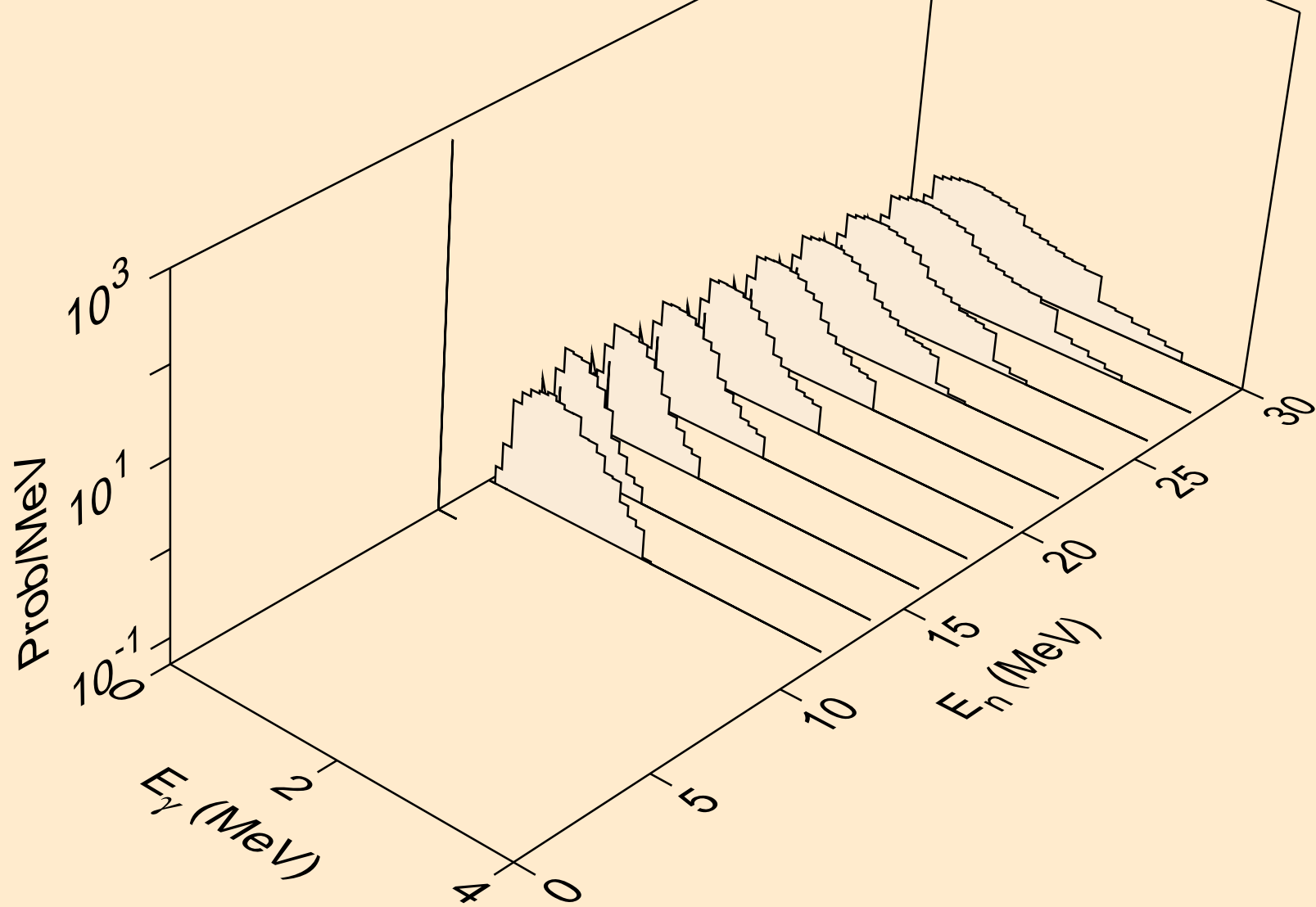

PM129 NEUTRON ACER TENDL-2021 LIBRARY; T=293.6K  
Photon emission for (n,n\*)d

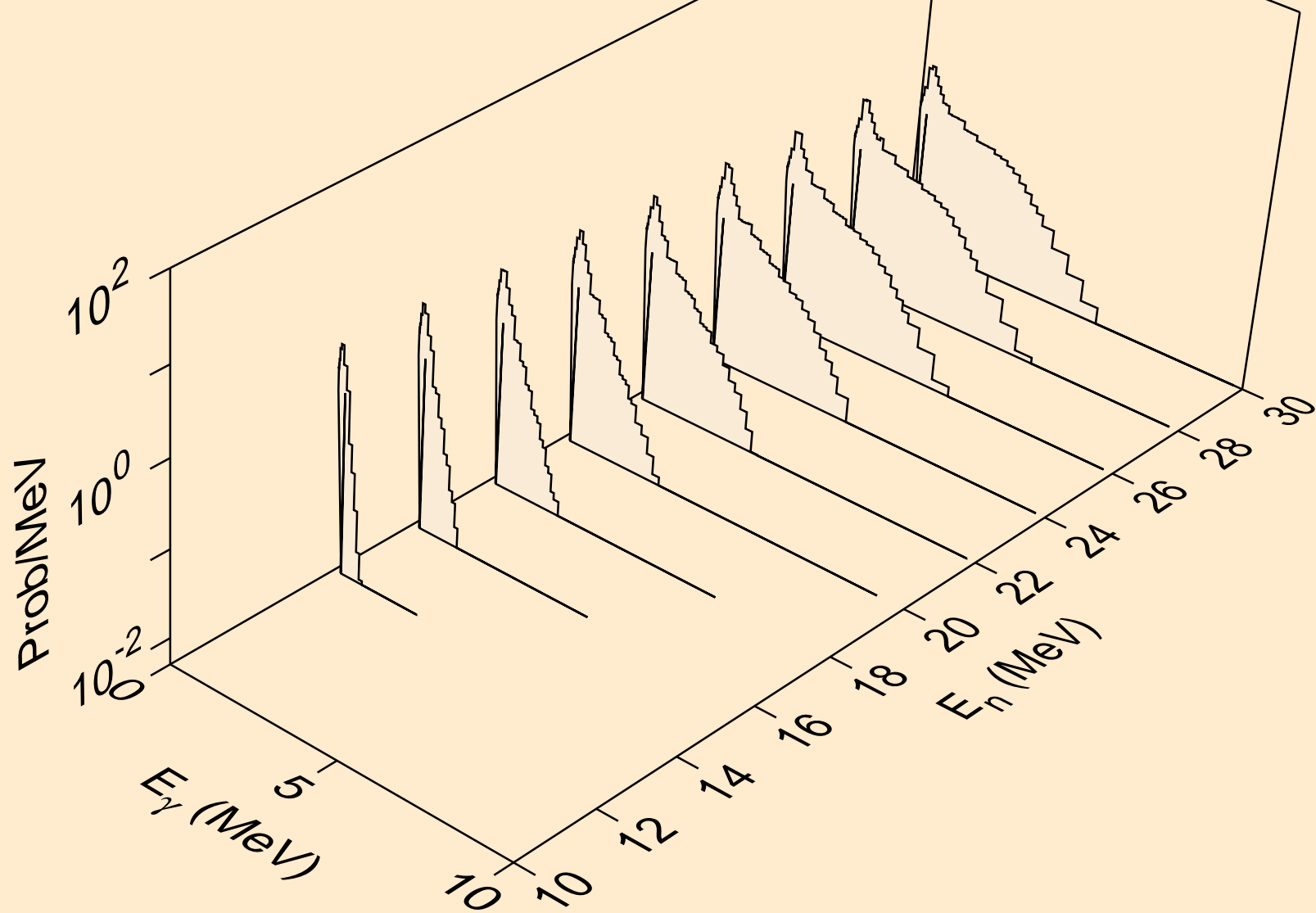

PM129 NEUTRON ACER TENDL-2021 LIBRARY; T=293.6K  
Photon emission for (n,n\*)t

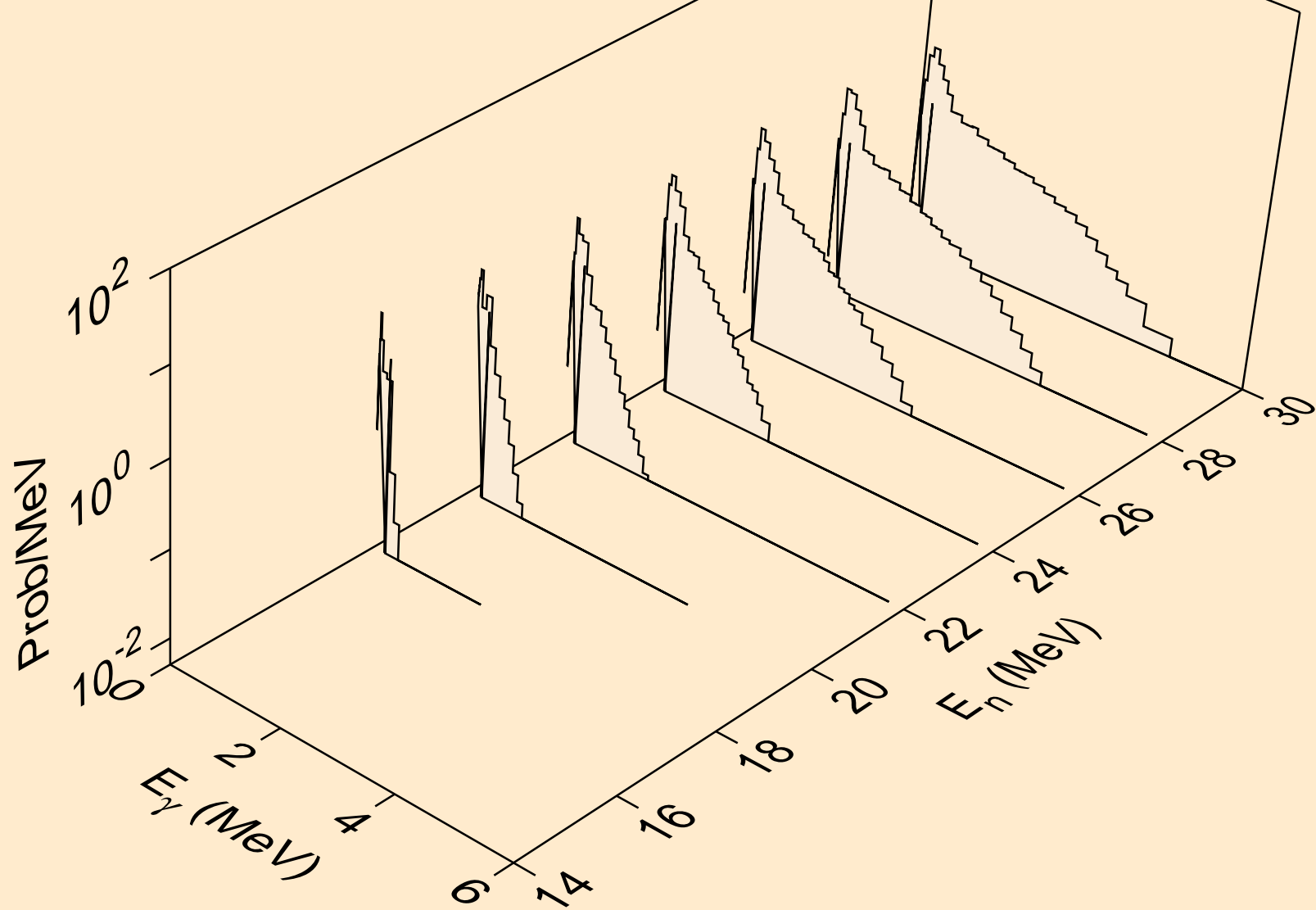



PM129 NEUTRON ACER TENDL-2021 LIBRARY; T=293.6K  
Photon emission for (n,n\*)he3

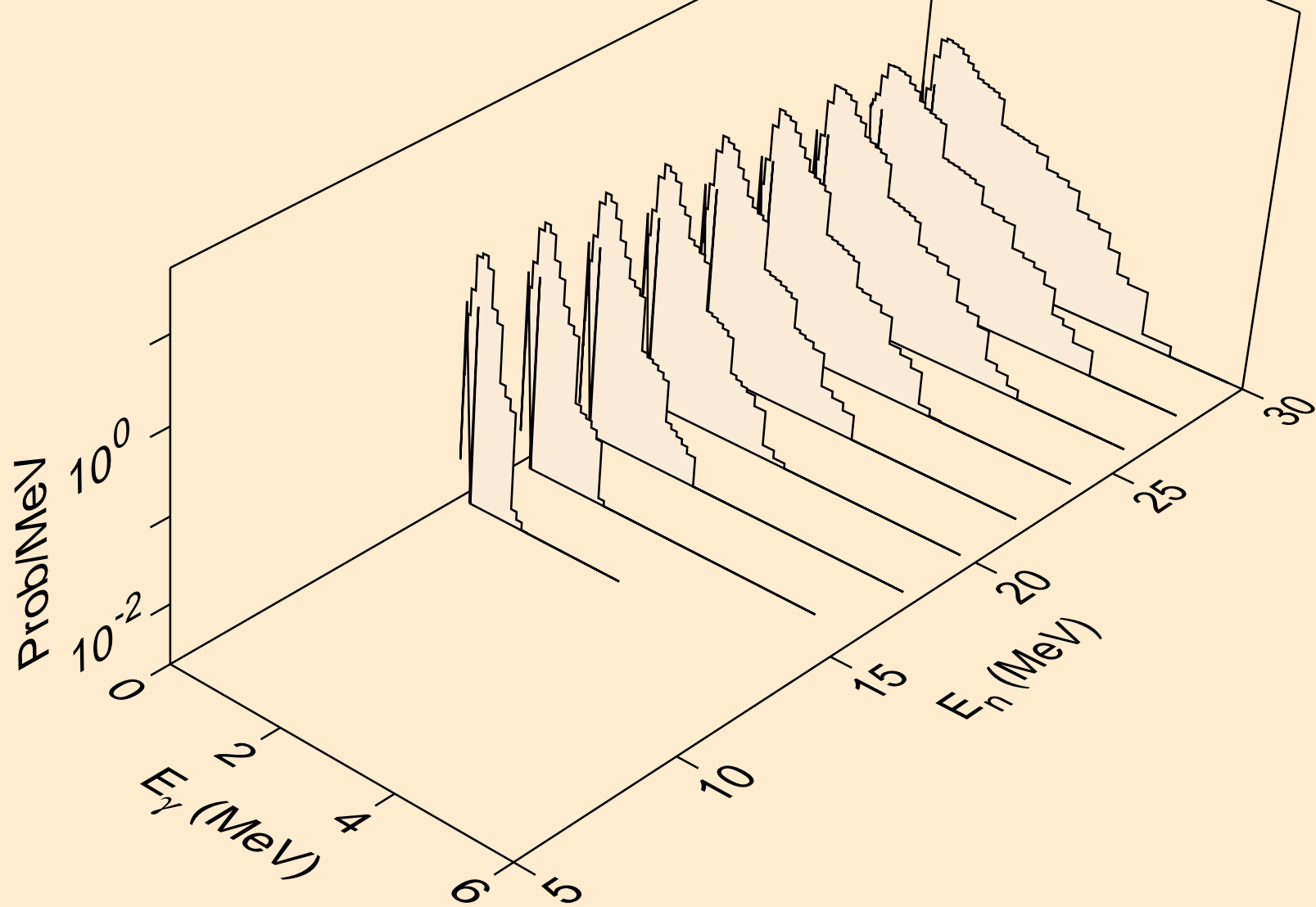

PM129 NEUTRON ACER TENDL-2021 LIBRARY; T=293.6K  
Photon emission for (n,2np)

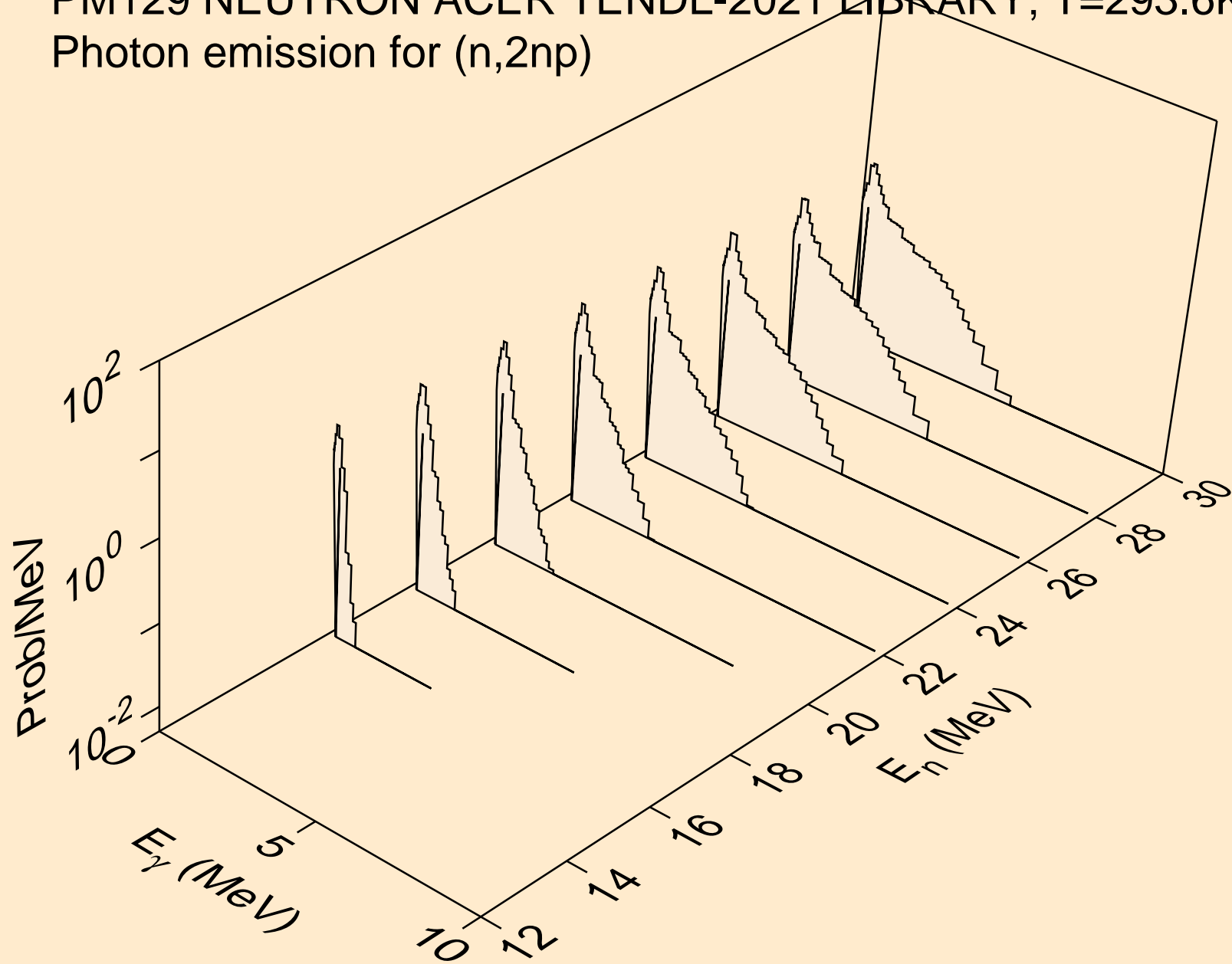

PM129 NEUTRON ACER TENDL-2021 LIBRARY; T=293.6K  
Photon emission for (n,3np)

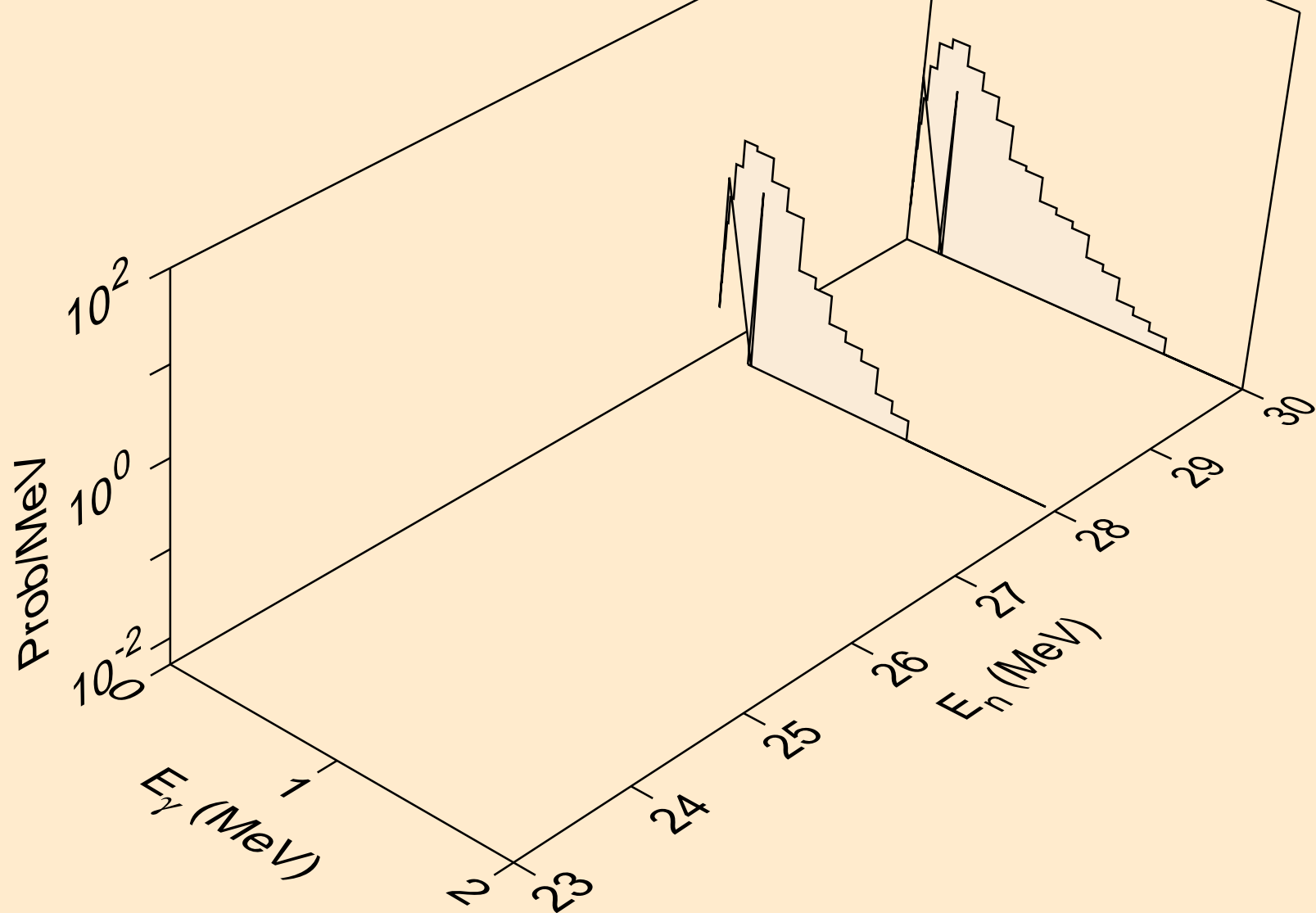

PM129 NEUTRON ACER TENDL-2021 LIBRARY; T=293.6K  
Photon emission for (n,2np)

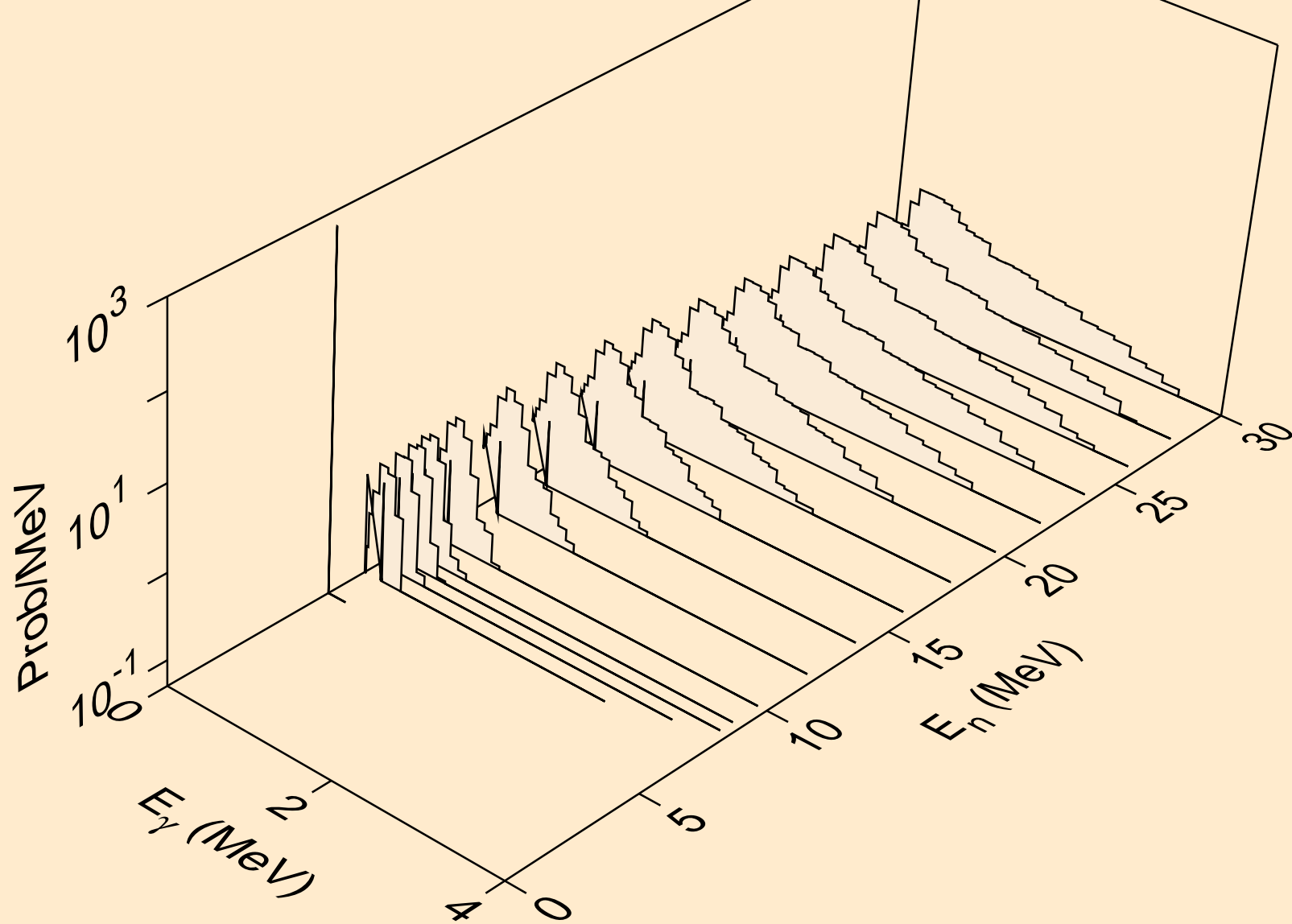

PM129 NEUTRON ACER TENDL-2021 LIBRARY; T=293.6K  
Photon emission for (n,npa)

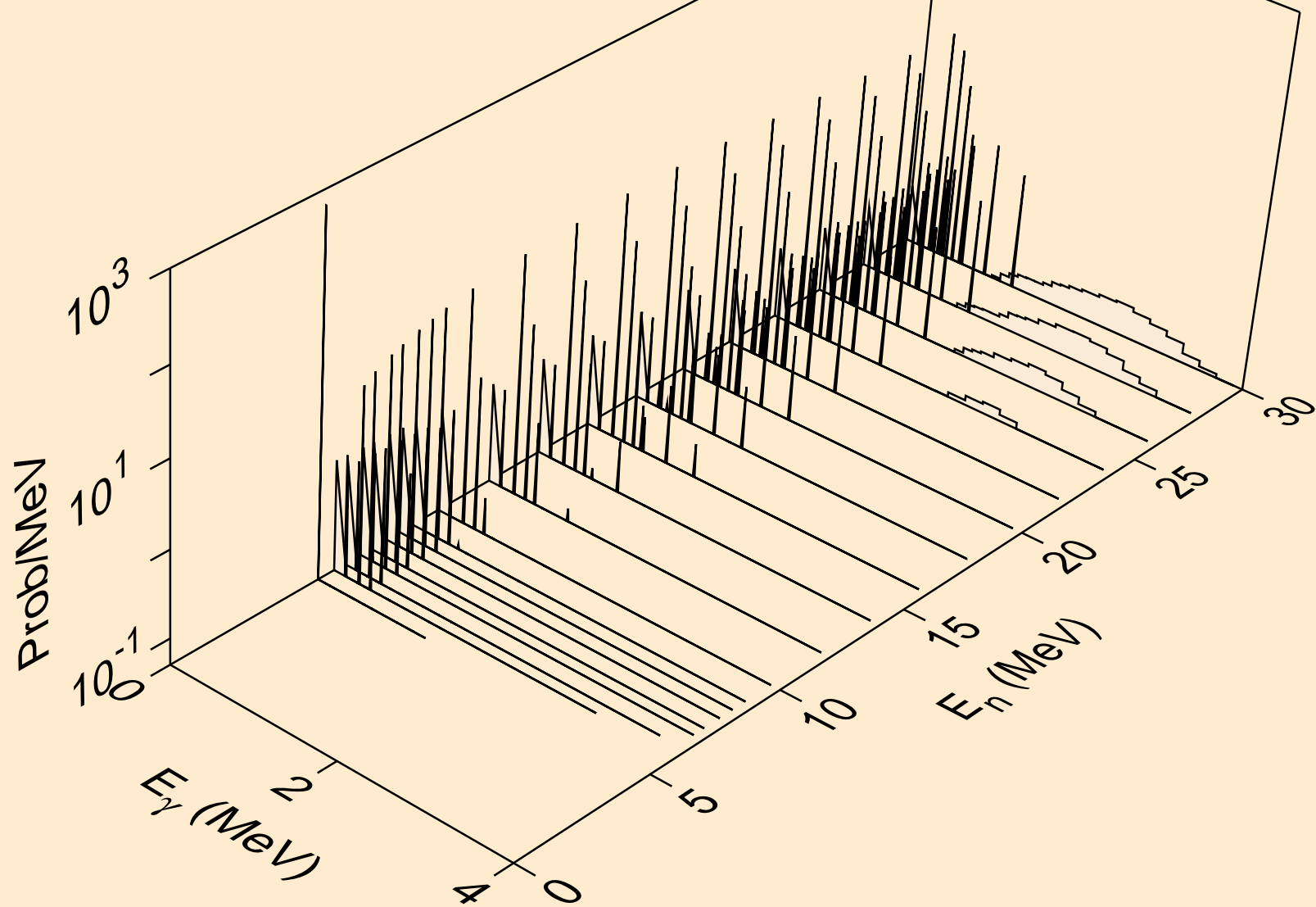

PM129 NEUTRON ACER TENDL-2021 LIBRARY; T=293.6K  
Photon emission for (n,n\*c)

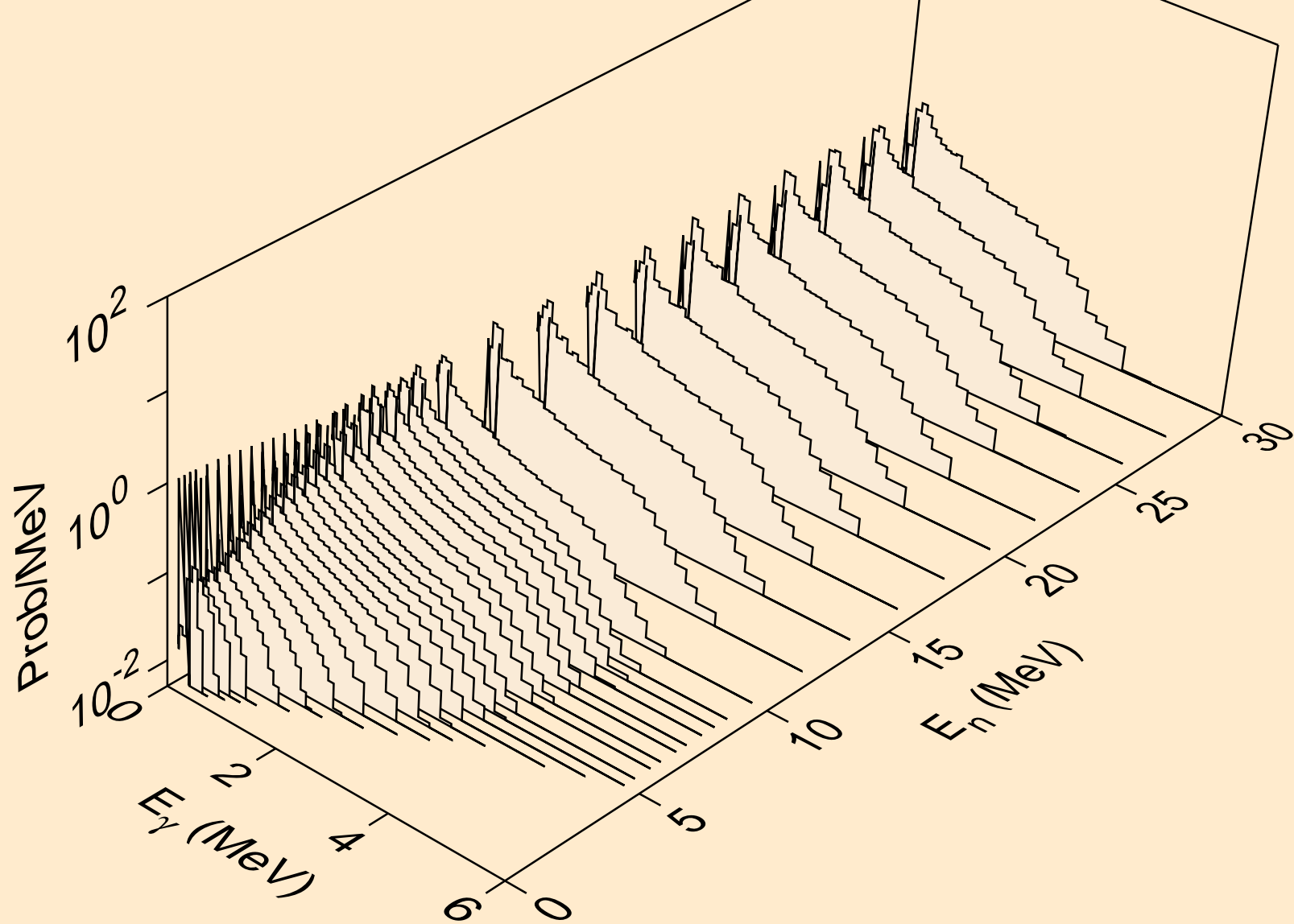

PM129 NEUTRON ACER TENDL-2021 LIBRARY; T=293.6K  
Photon emission for (n,gma)

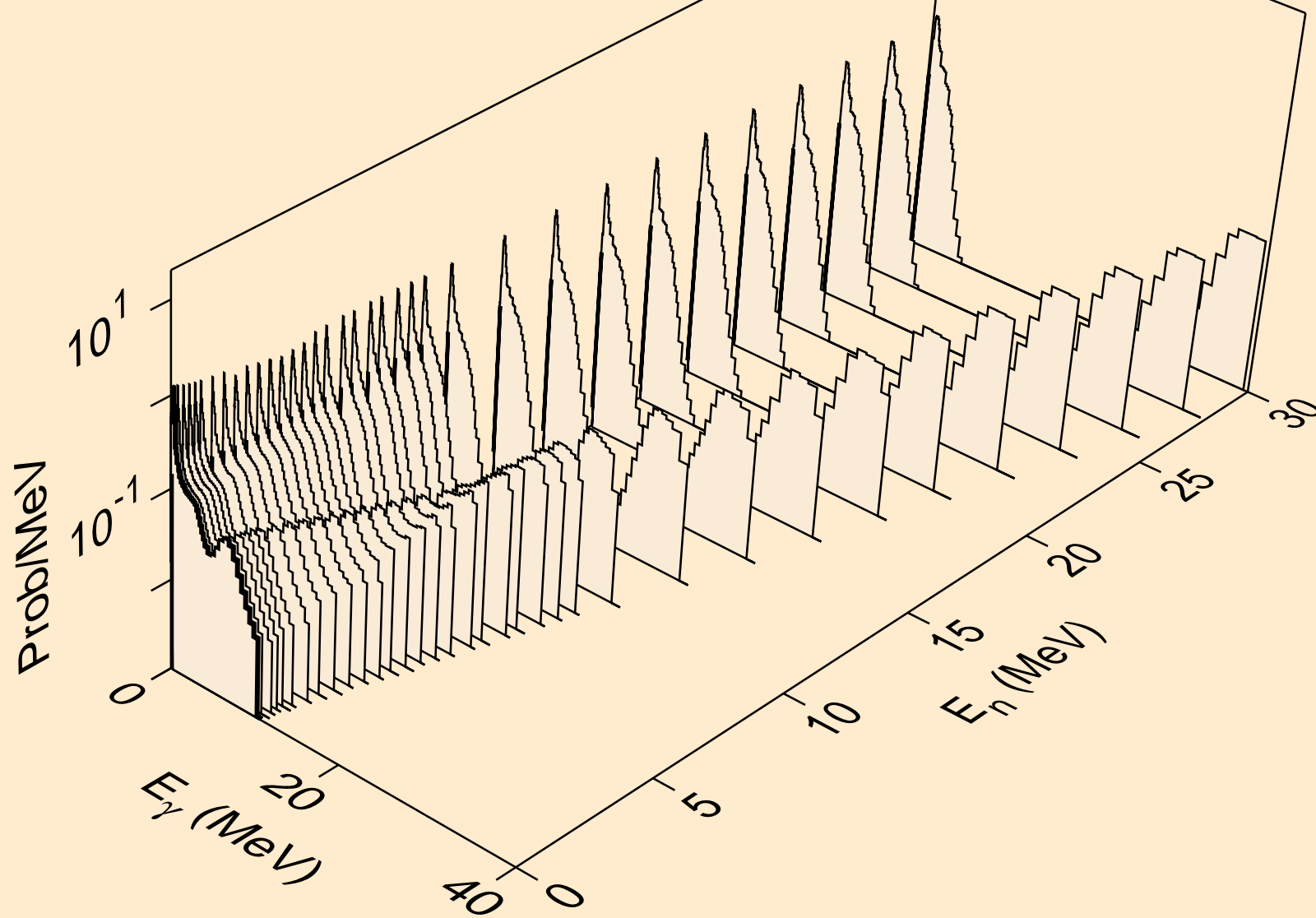

PM129 NEUTRON ACER TENDL-2021 LIBRARY; T=293.6K  
Photon emission for (n,p)

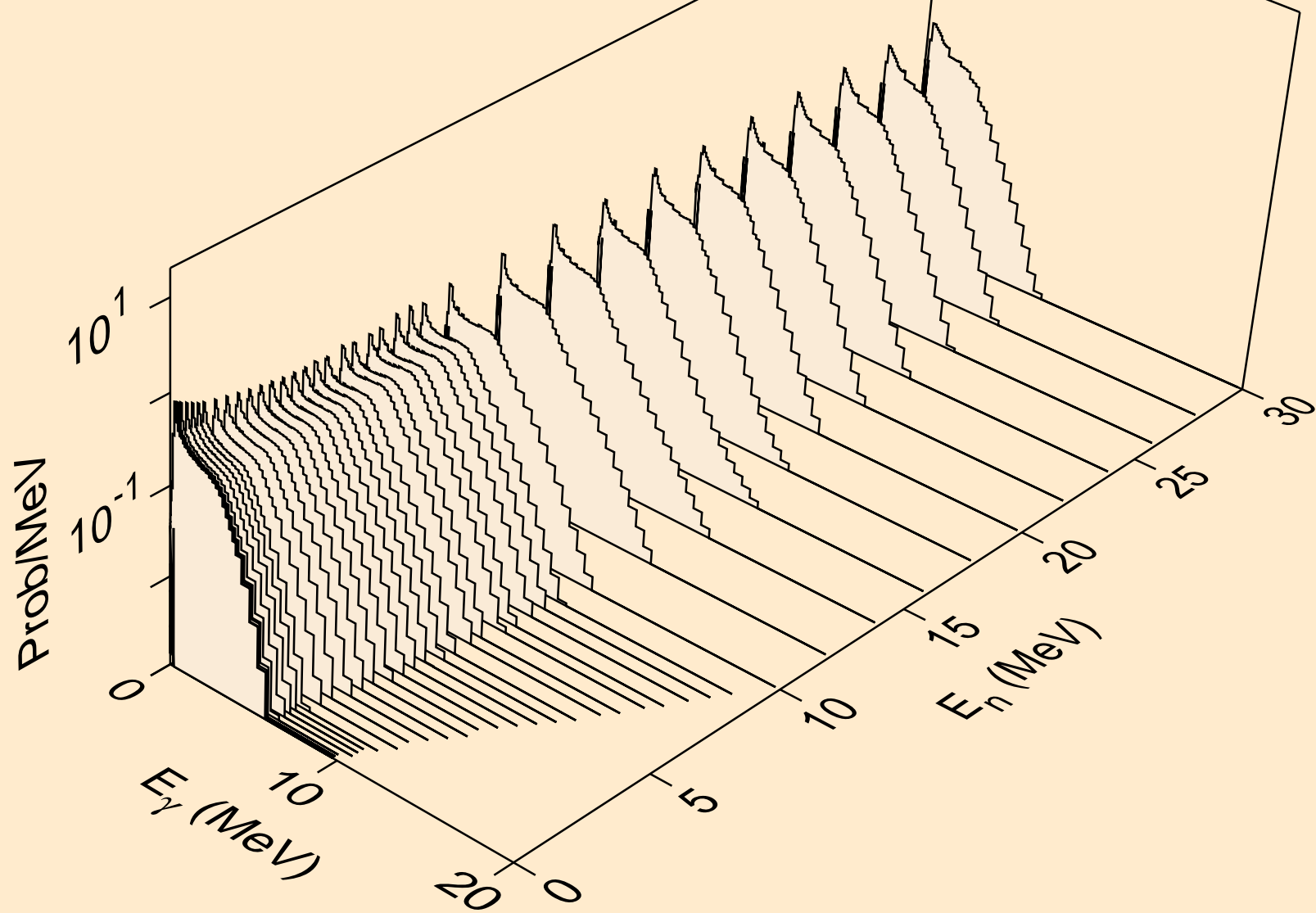



PM129 NEUTRON ACER TENDL-2021 LIBRARY; T=293.6K  
Photon emission for (n,d)

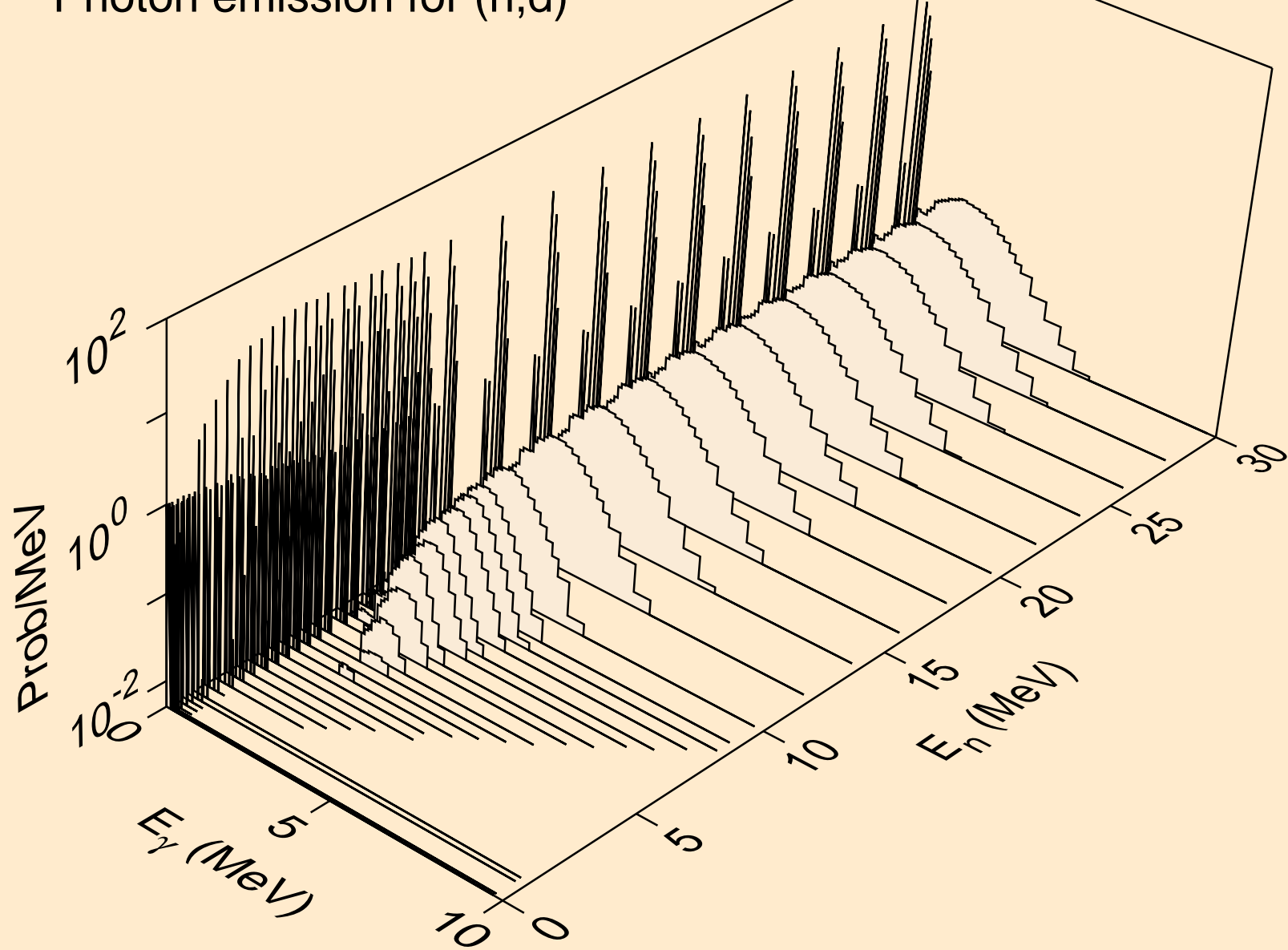

PM129 NEUTRON ACER TENDL-2021 LIBRARY; T=293.6K  
Photon emission for (n,t)

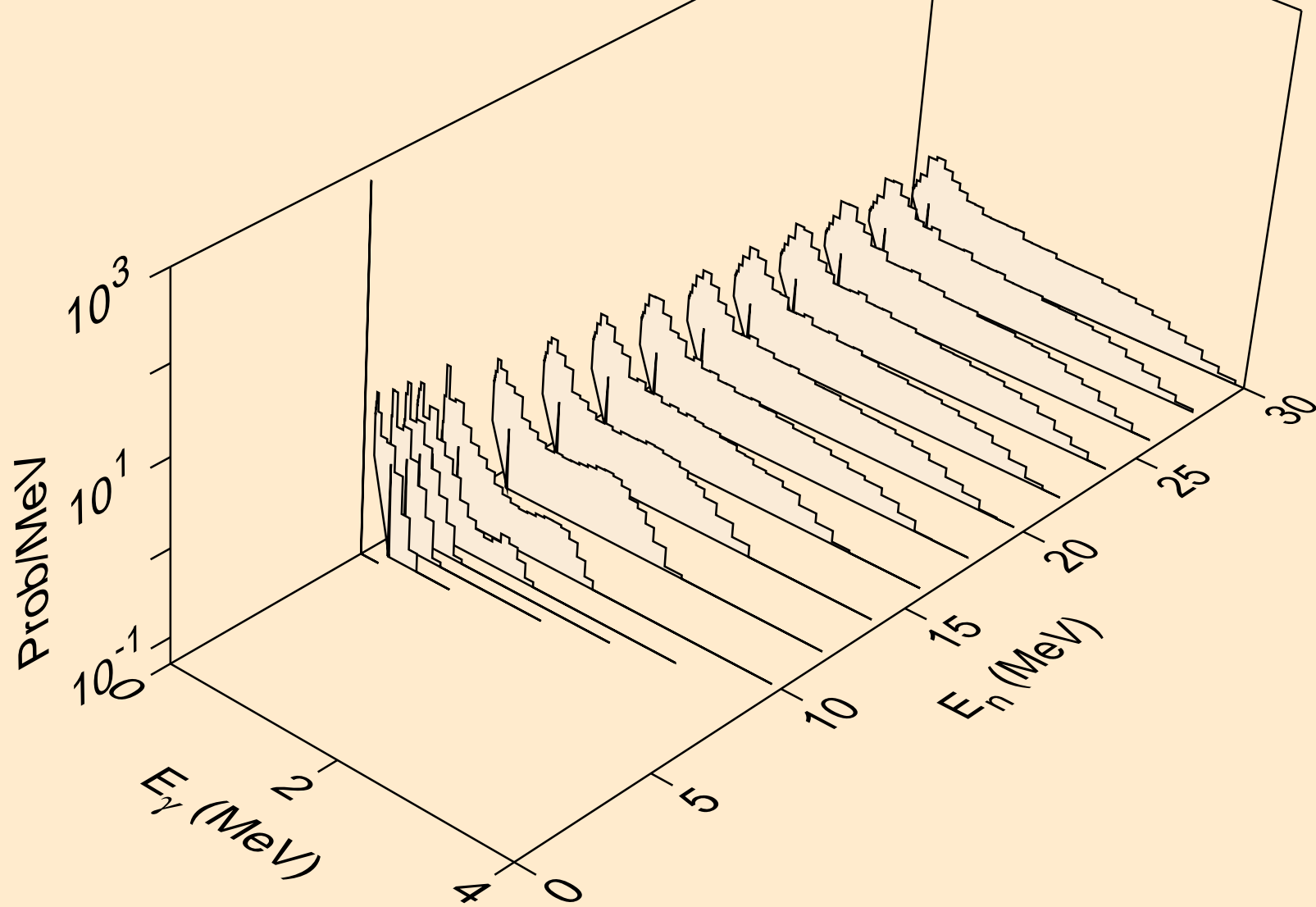

PM129 NEUTRON ACER TENDL-2021 LIBRARY; T=293.6K  
Photon emission for (n,he3)

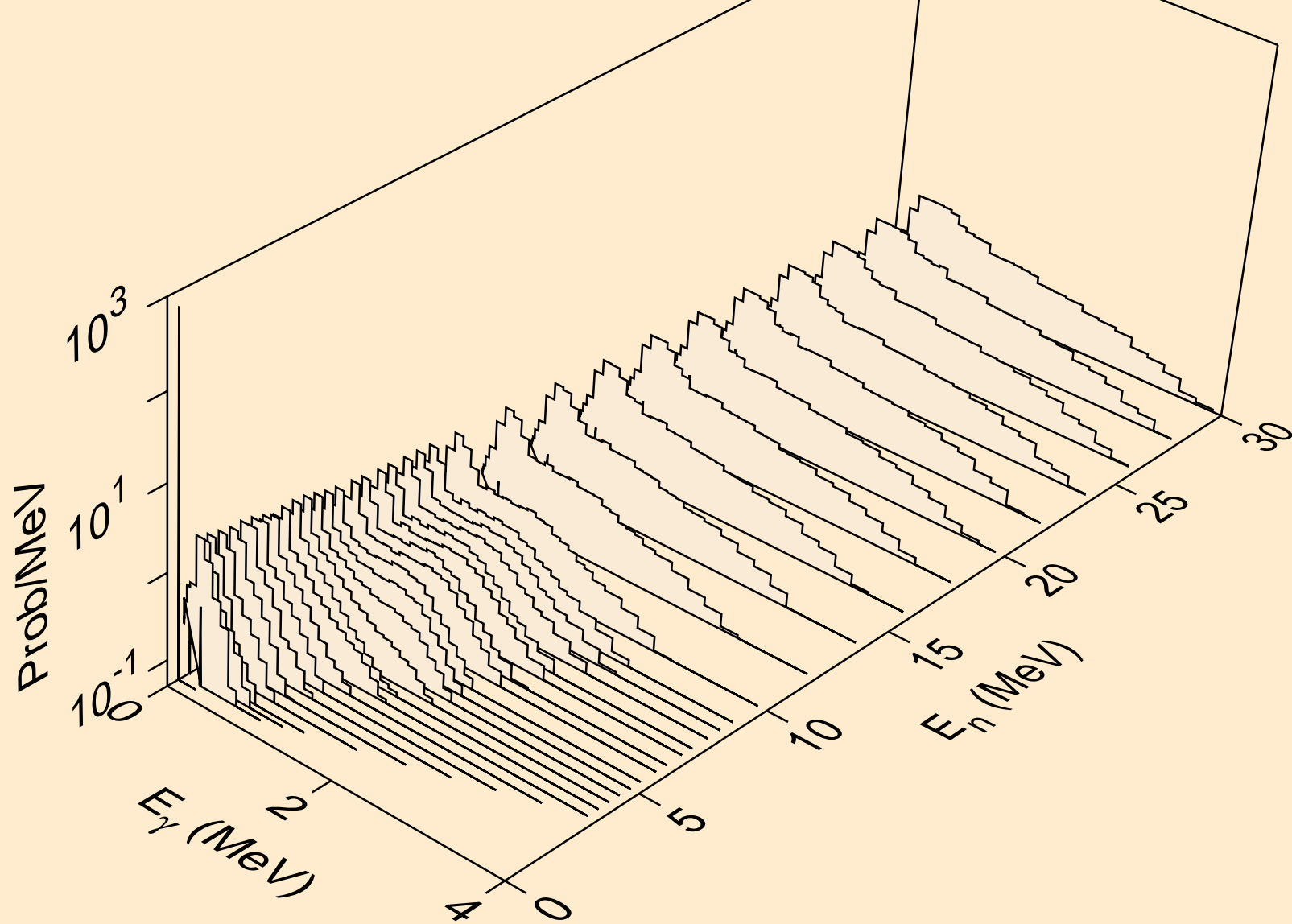

PM129 NEUTRON ACER TENDL-2021 LIBRARY; T=293.6K  
Photon emission for (n,a)

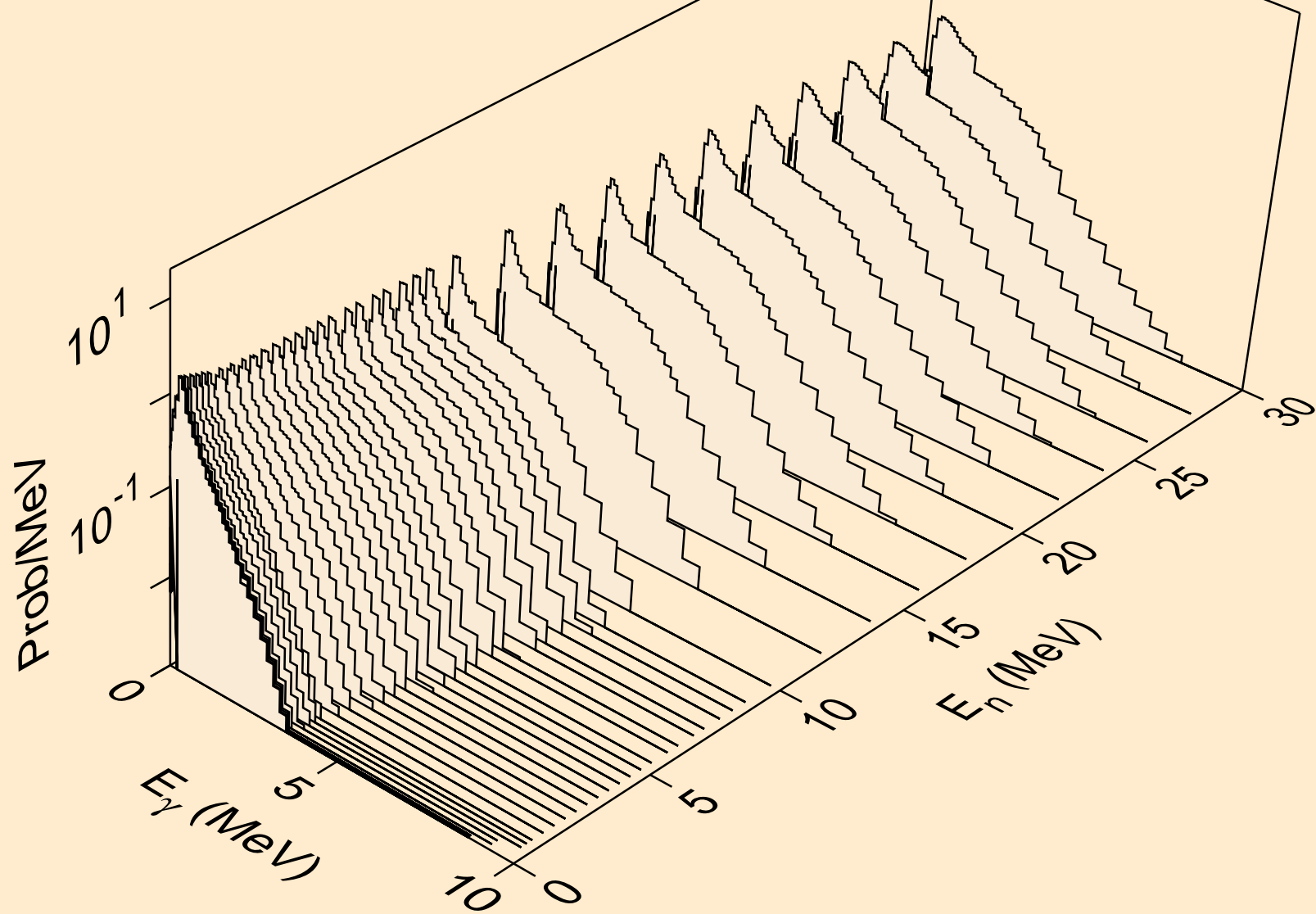

PM129 NEUTRON ACER TENDL-2021 LIBRARY; T=293.6K  
Photon emission for (n,2a)

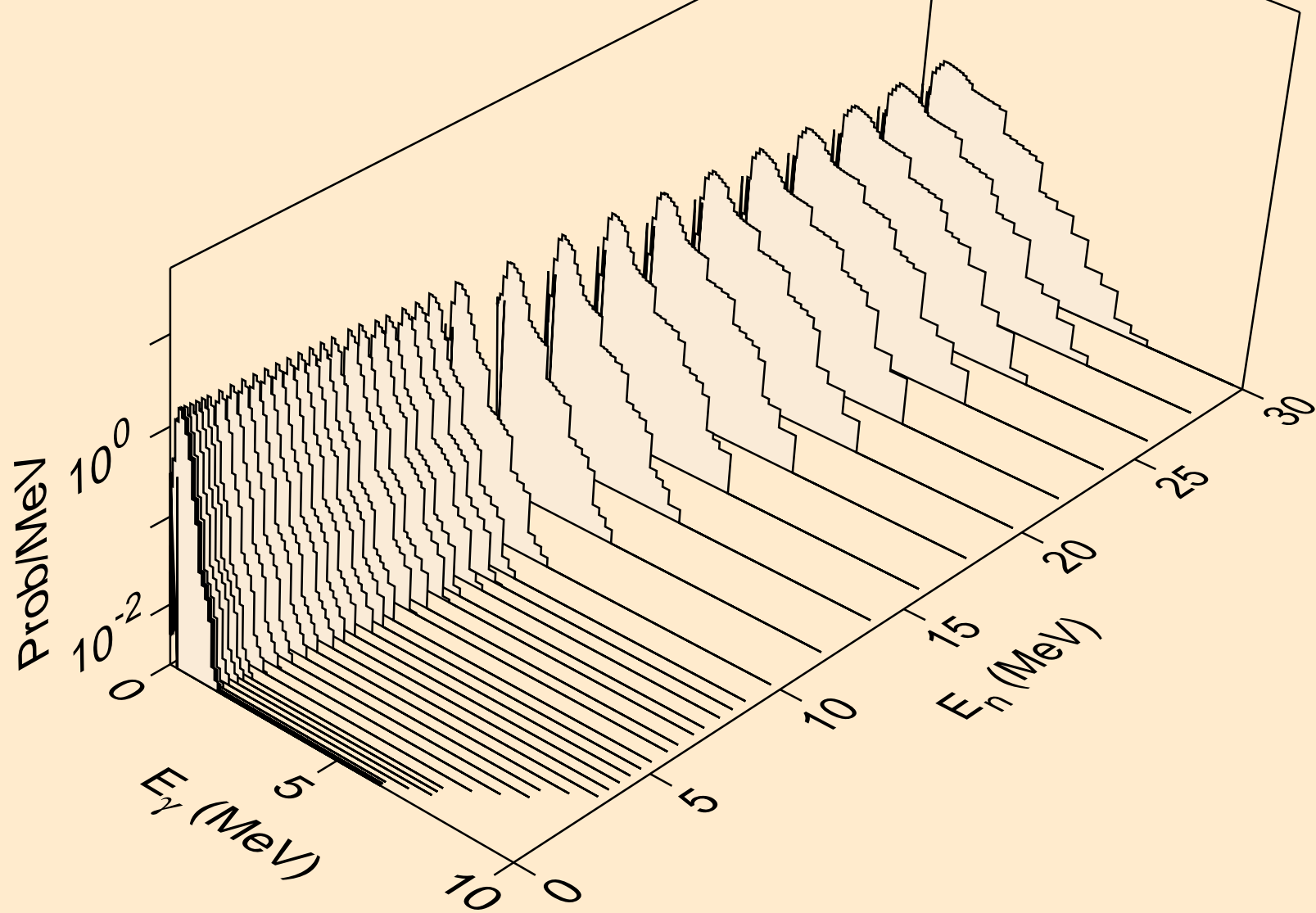

PM129 NEUTRON ACER TENDL-2021 LIBRARY; T=293.6K  
Photon emission for (n,3a)

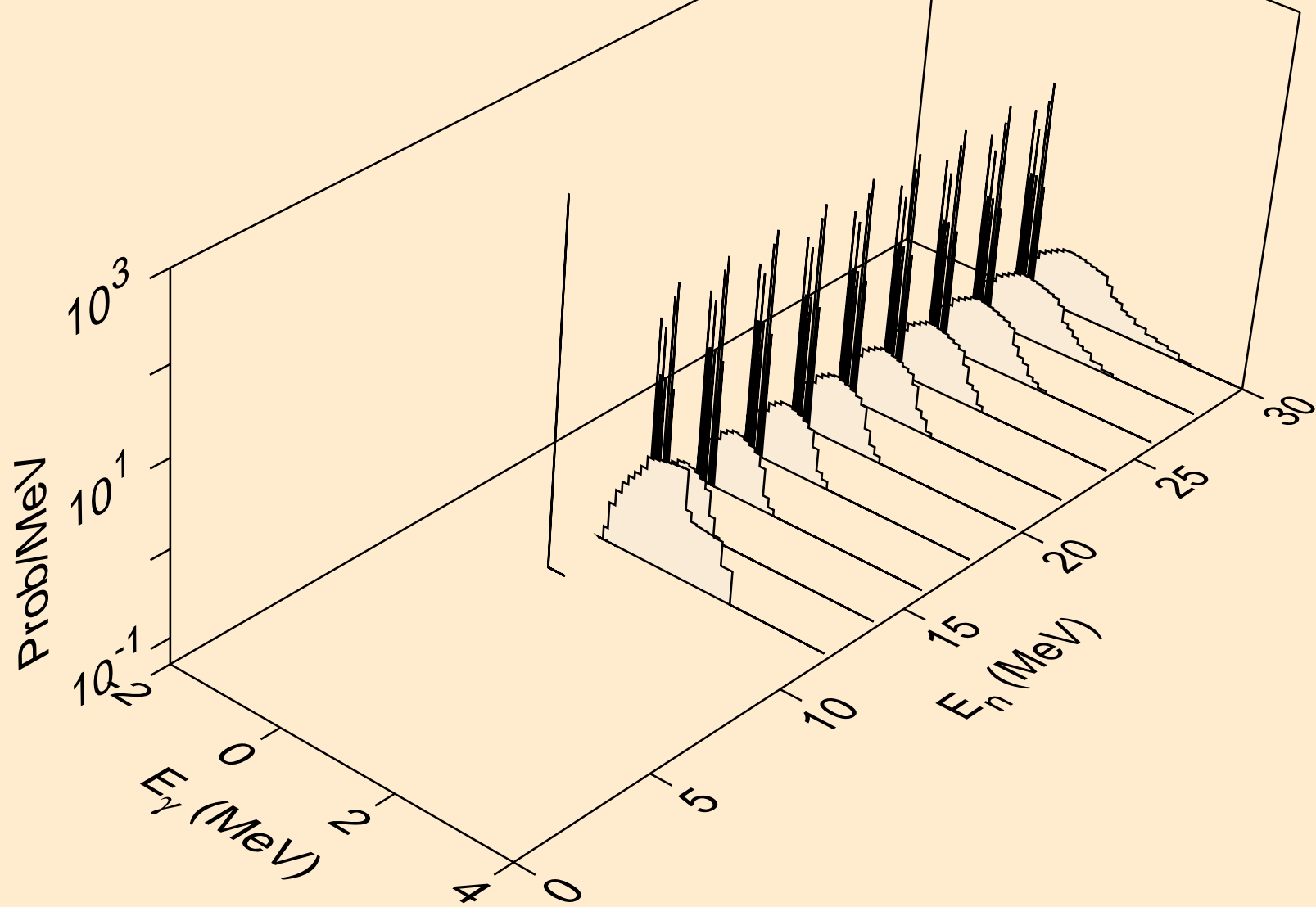

PM129 NEUTRON ACER TENDL-2021 LIBRARY; T=293.6K  
Photon emission for (n,2p)

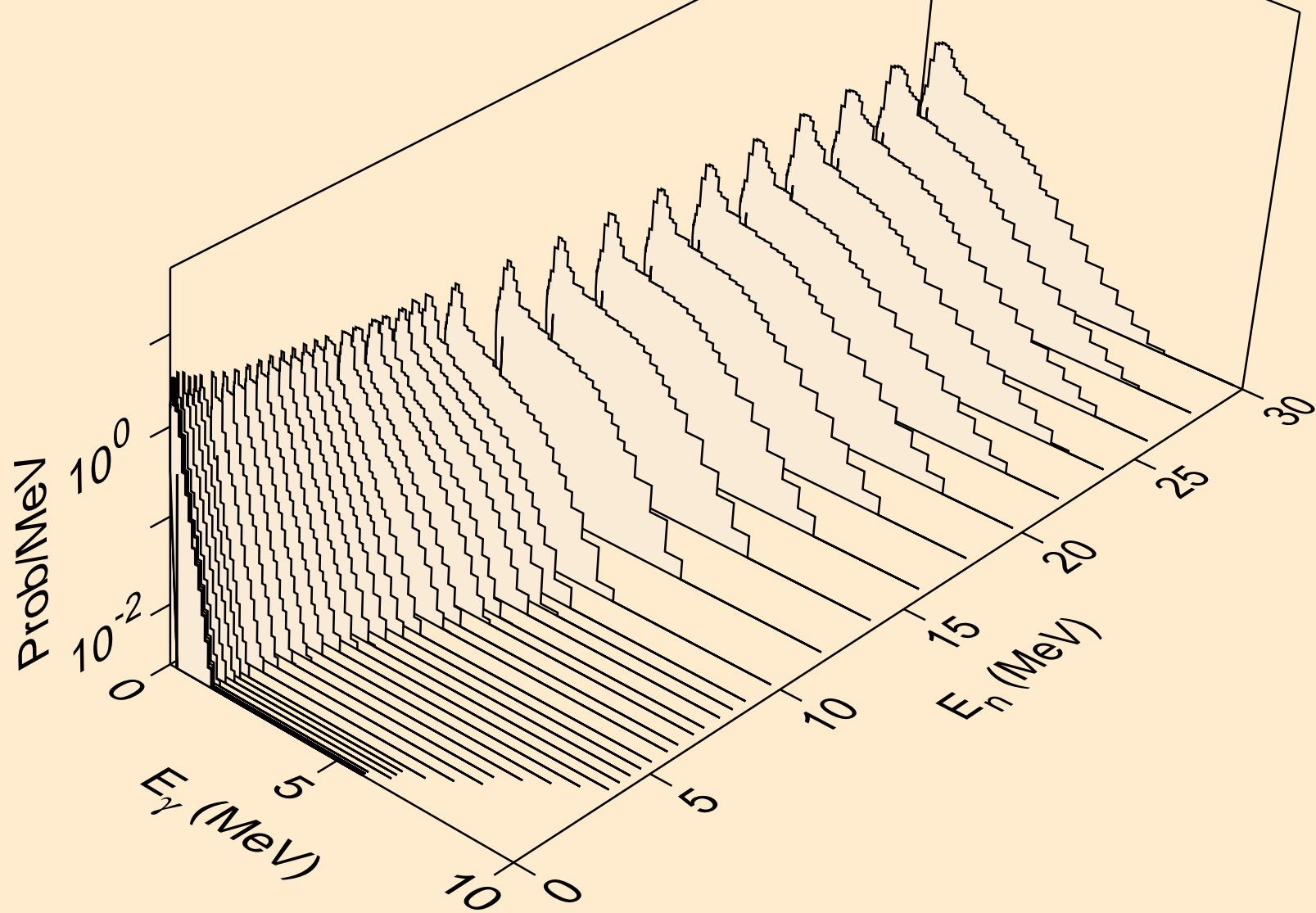

PM129 NEUTRON ACER TENDL-2021 LIBRARY; T=293.6K  
Photon emission for (n,p)

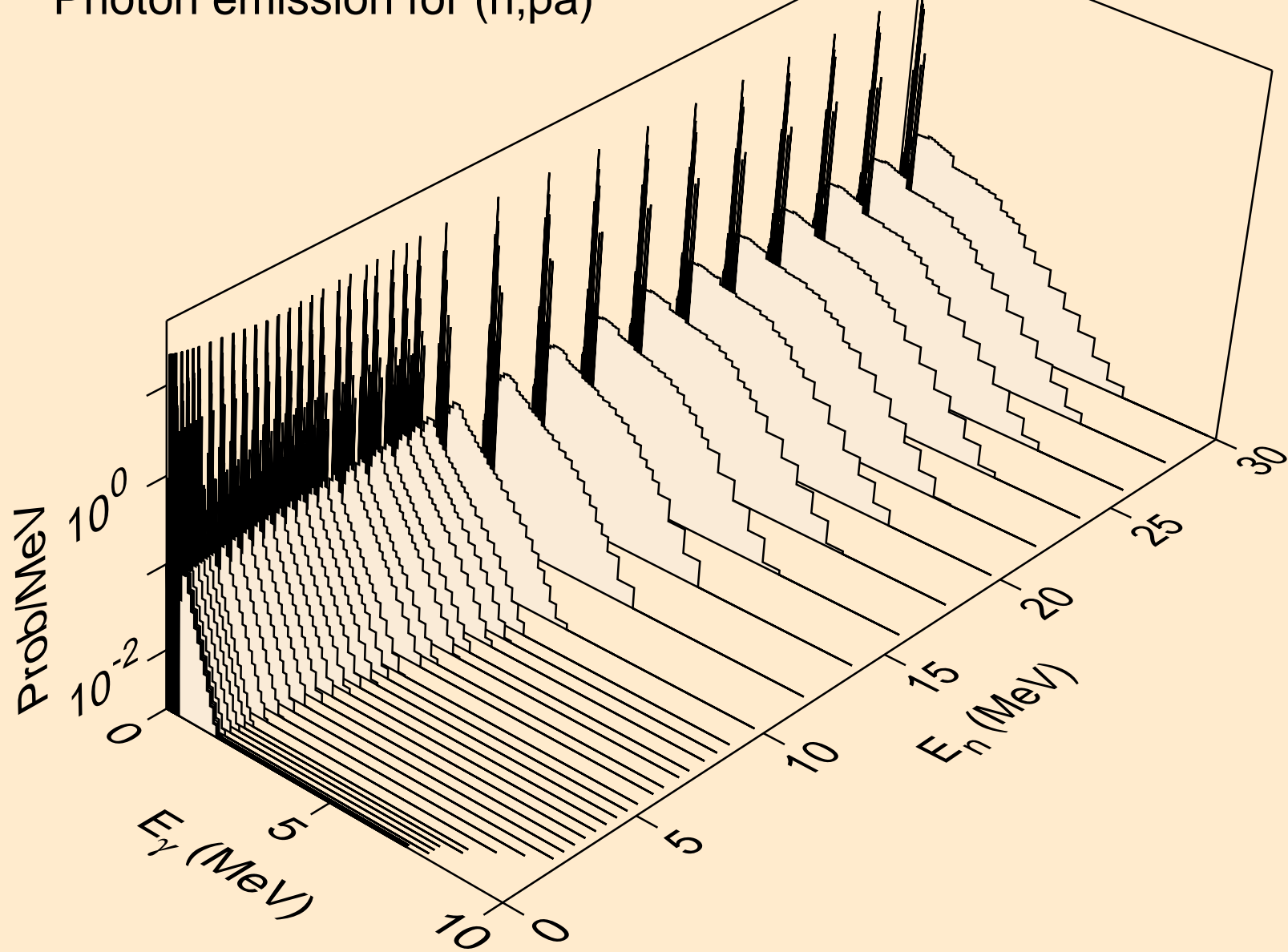



PM129 NEUTRON ACER TENDL-2021 LIBRARY; T=293.6K  
Photon emission for (n,d2a)

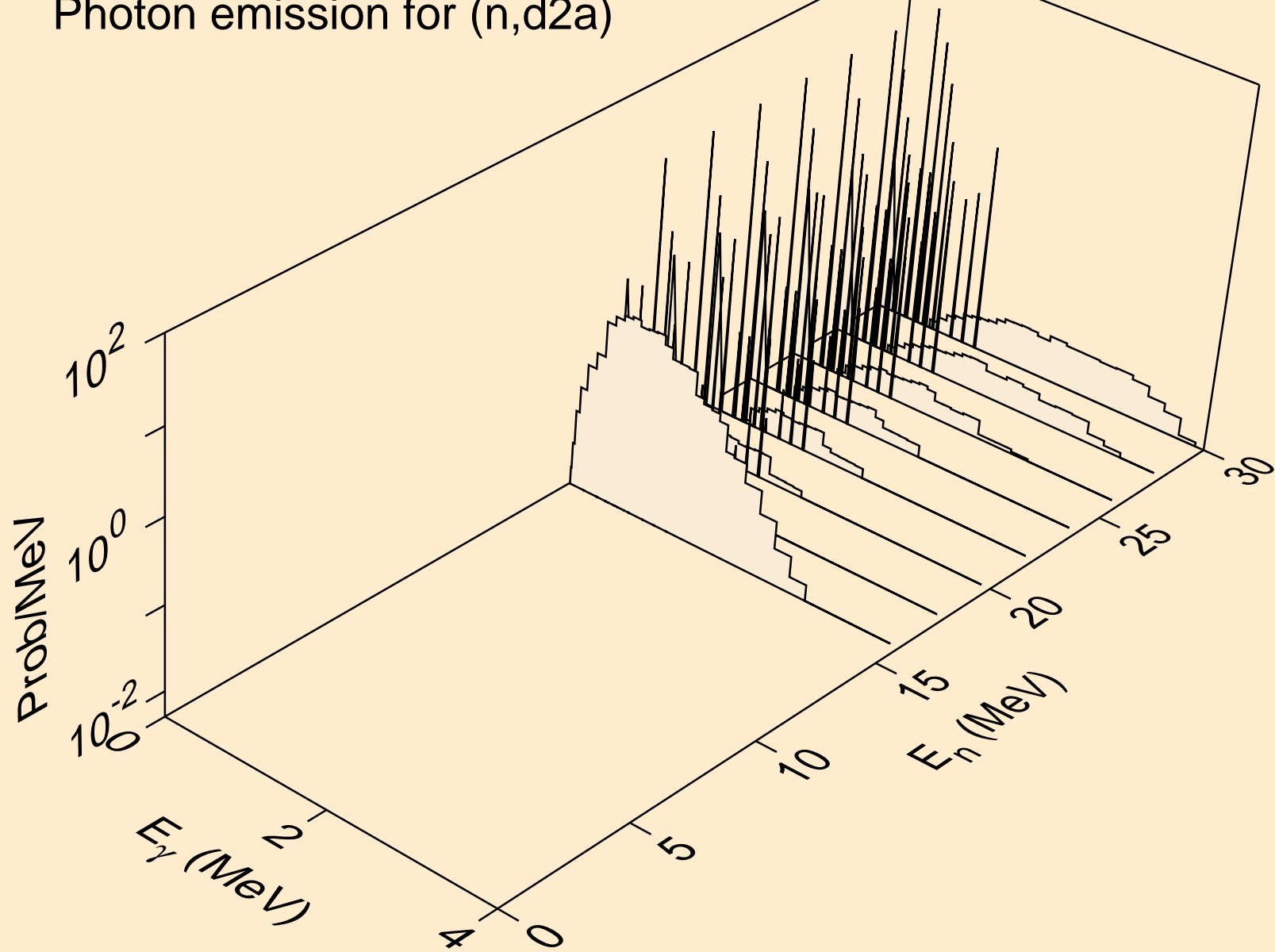

PM129 NEUTRON ACER TENDL-2021 LIBRARY; T=293.6K  
Photon emission for (n,pd)

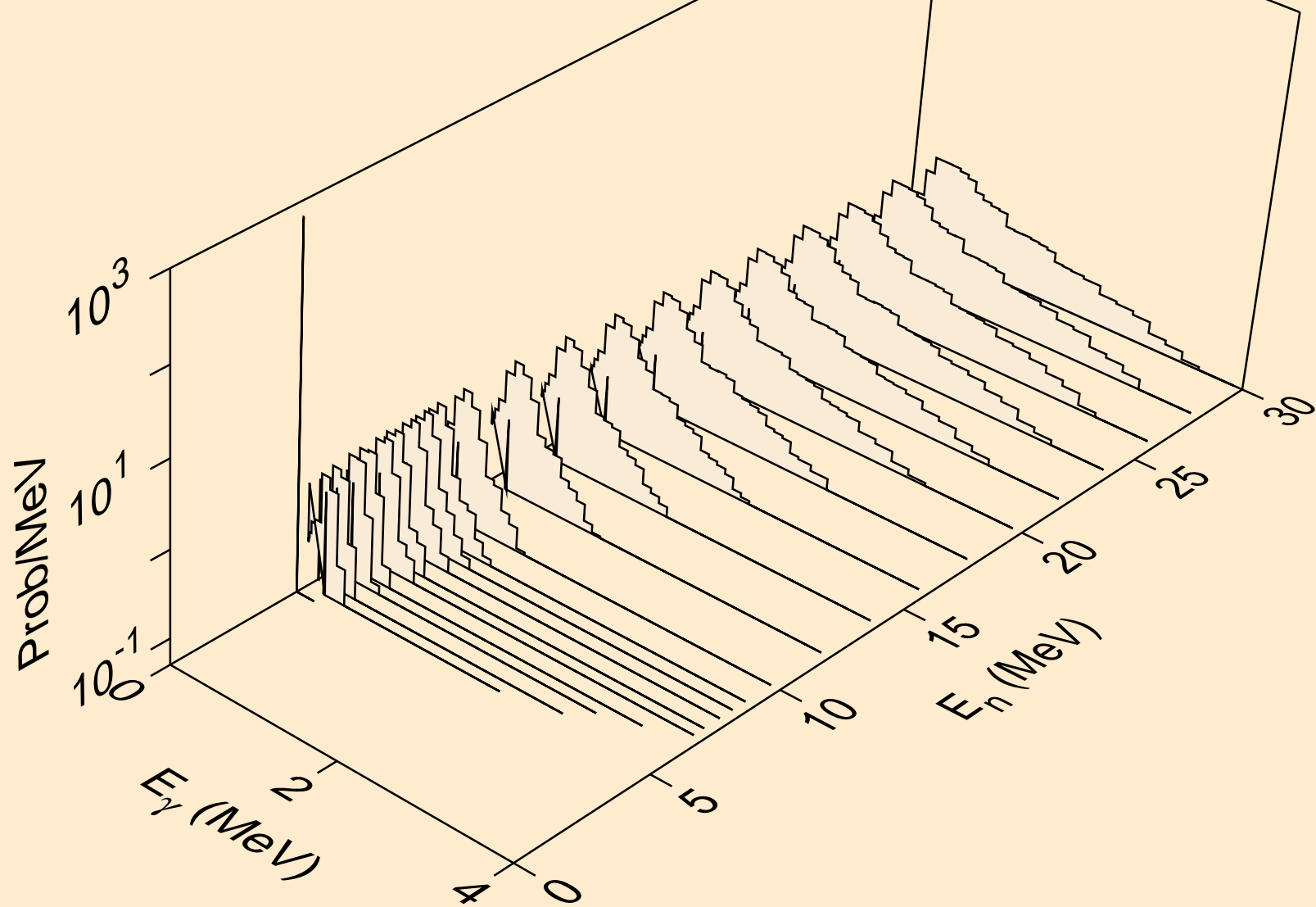

PM129 NEUTRON ACER TENDL-2021 LIBRARY; T=293.6K  
Photon emission for (n,pt)

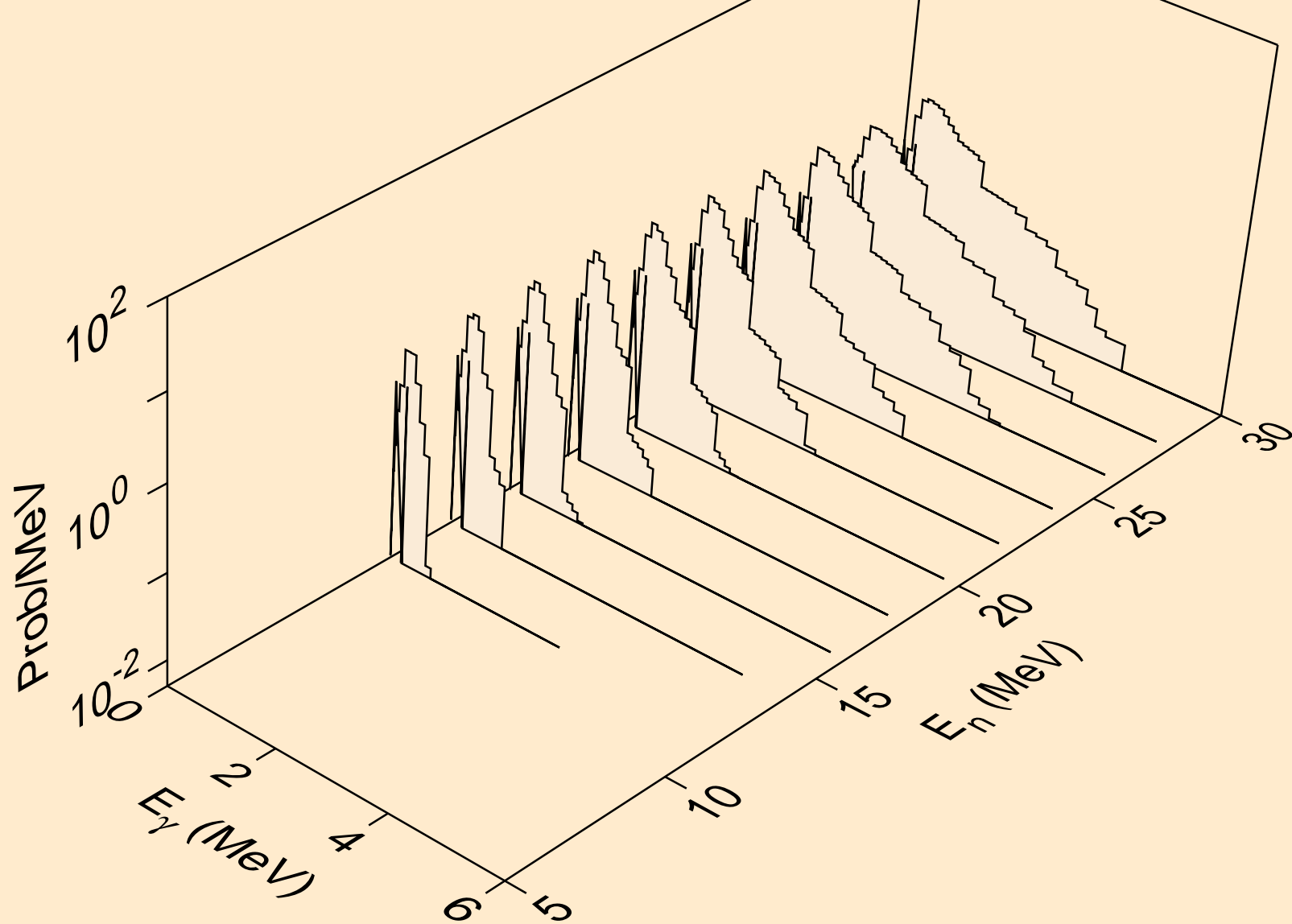

PM129 NEUTRON ACER TENDL-2021 LIBRARY; T=293.6K  
Photon emission for (n,da)

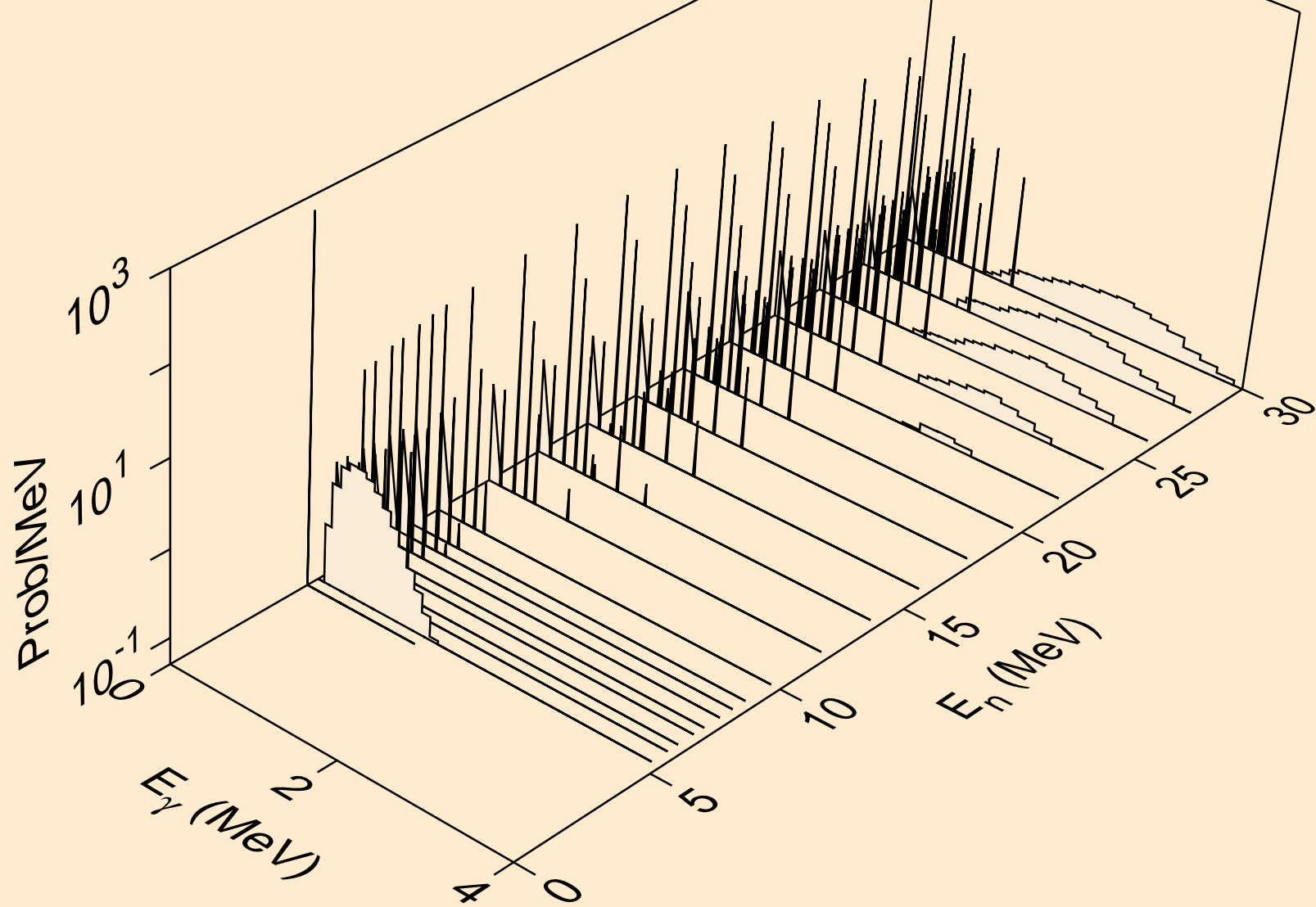

PM129 NEUTRON ACER TENDL-2021 LIBRARY; T=293.6K  
thermal capture photon spectrum

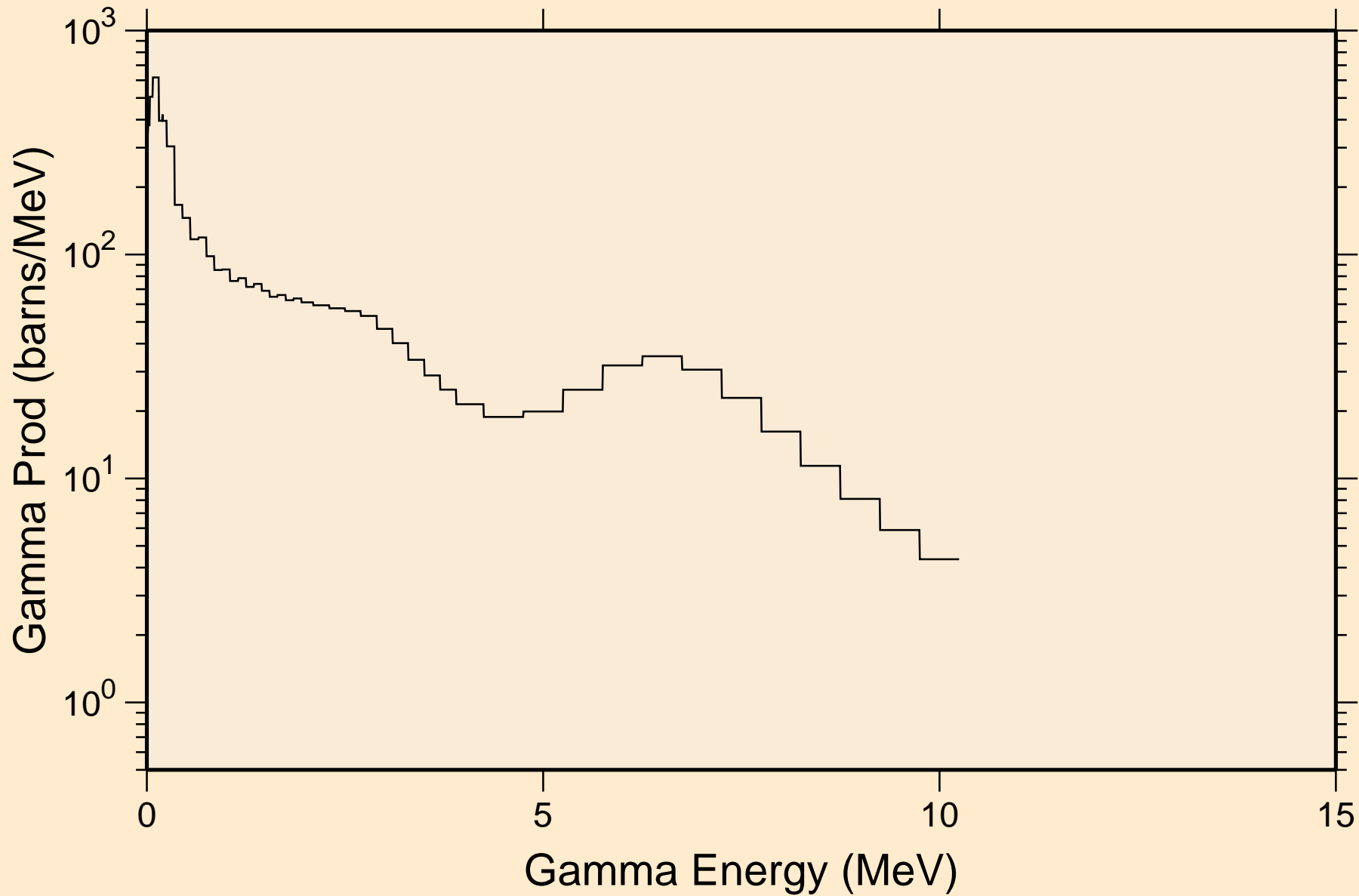

PM129 NEUTRON ACER TENDL-2021 LIBRARY; T=293.6K  
14 MeV photon spectrum

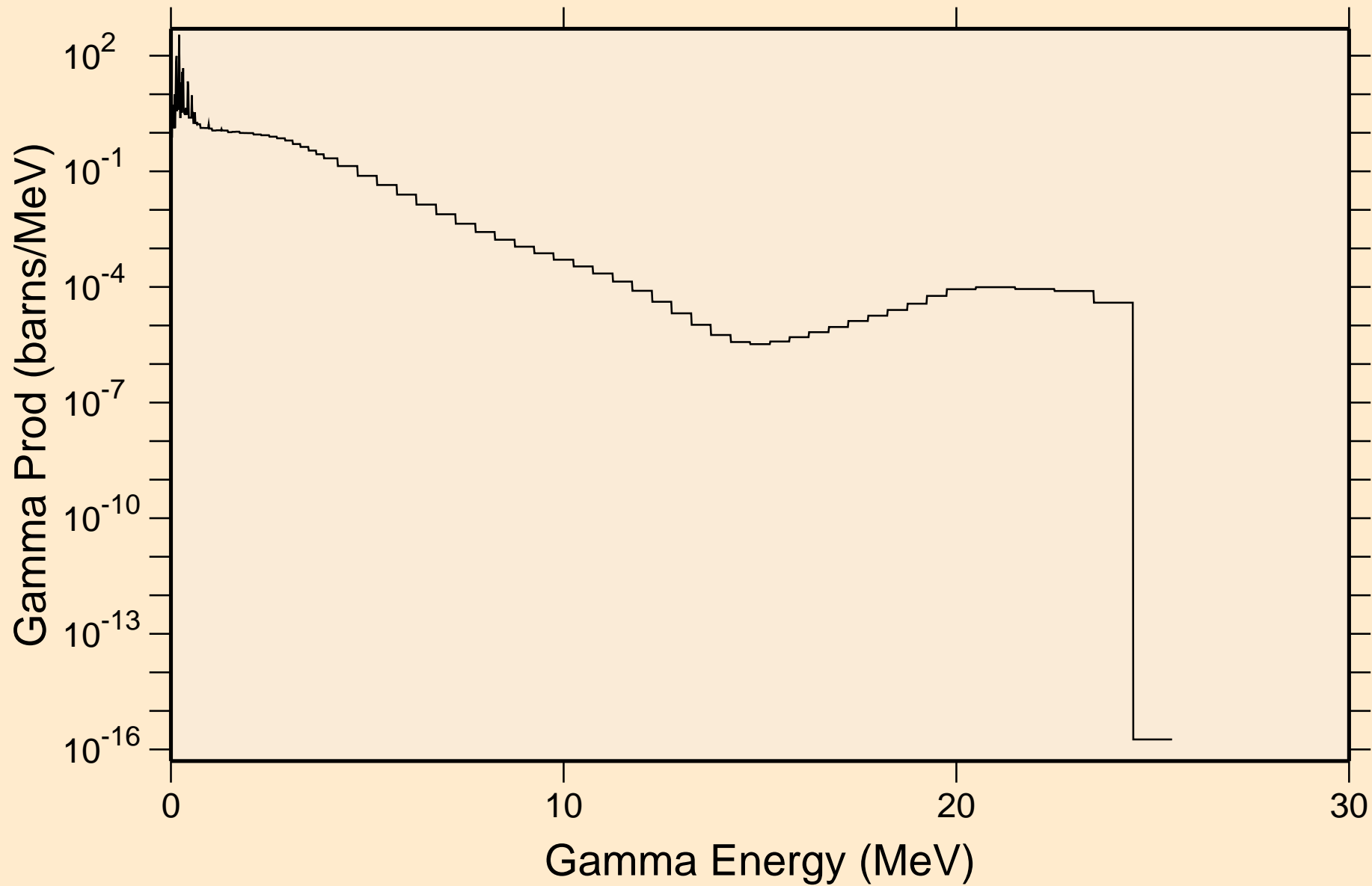

PM129 NEUTRON ACER TENDL-2021 LIBRARY; T=293.6K  
Particle heating contributions

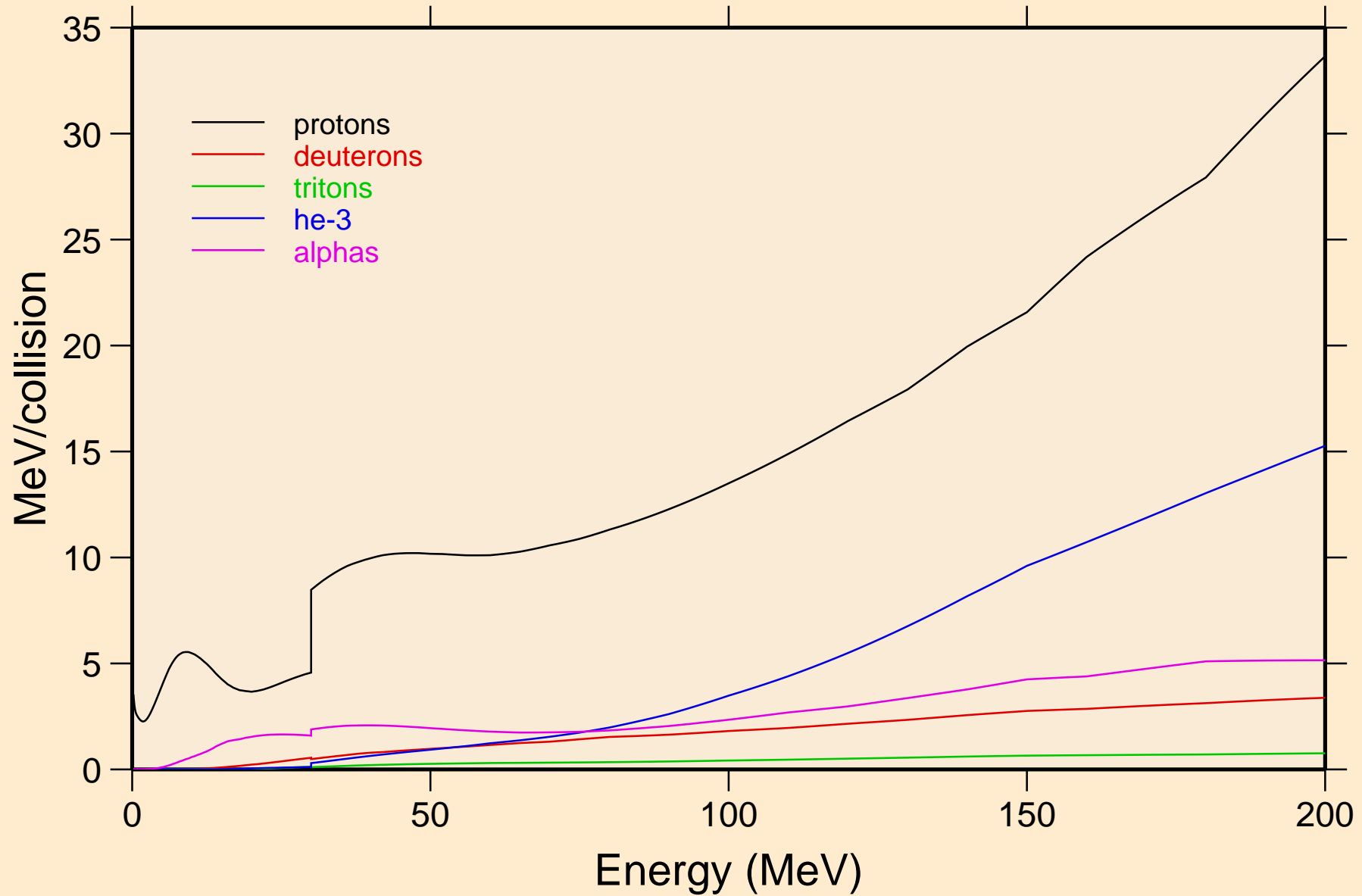

PM129 NEUTRON ACER TENDL-2021 LIBRARY; T=293.6K  
Recoil Heating

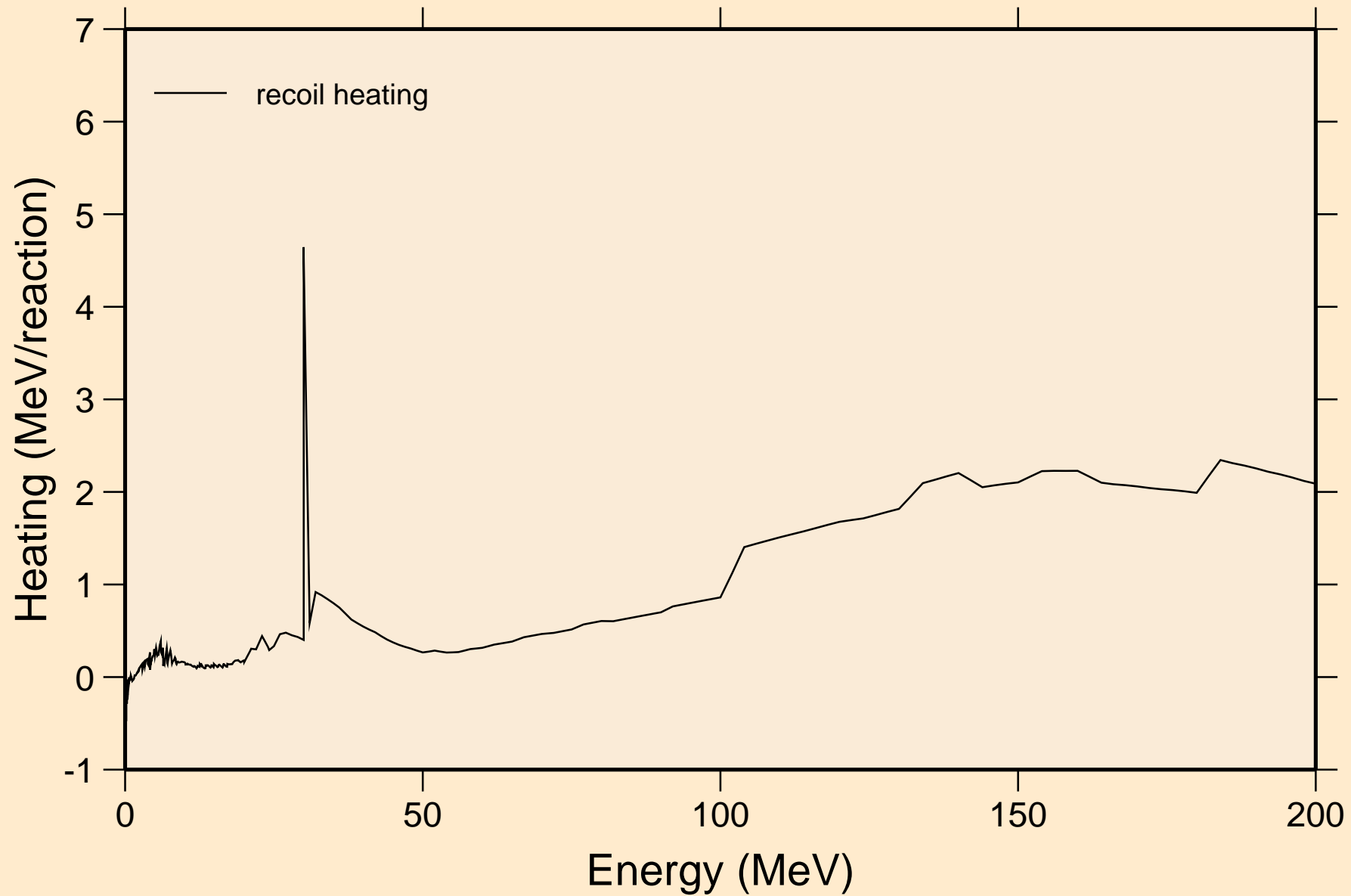



PM129 NEUTRON ACER TENDL-2021 LIBRARY; T=293.6K  
Particle production cross sections

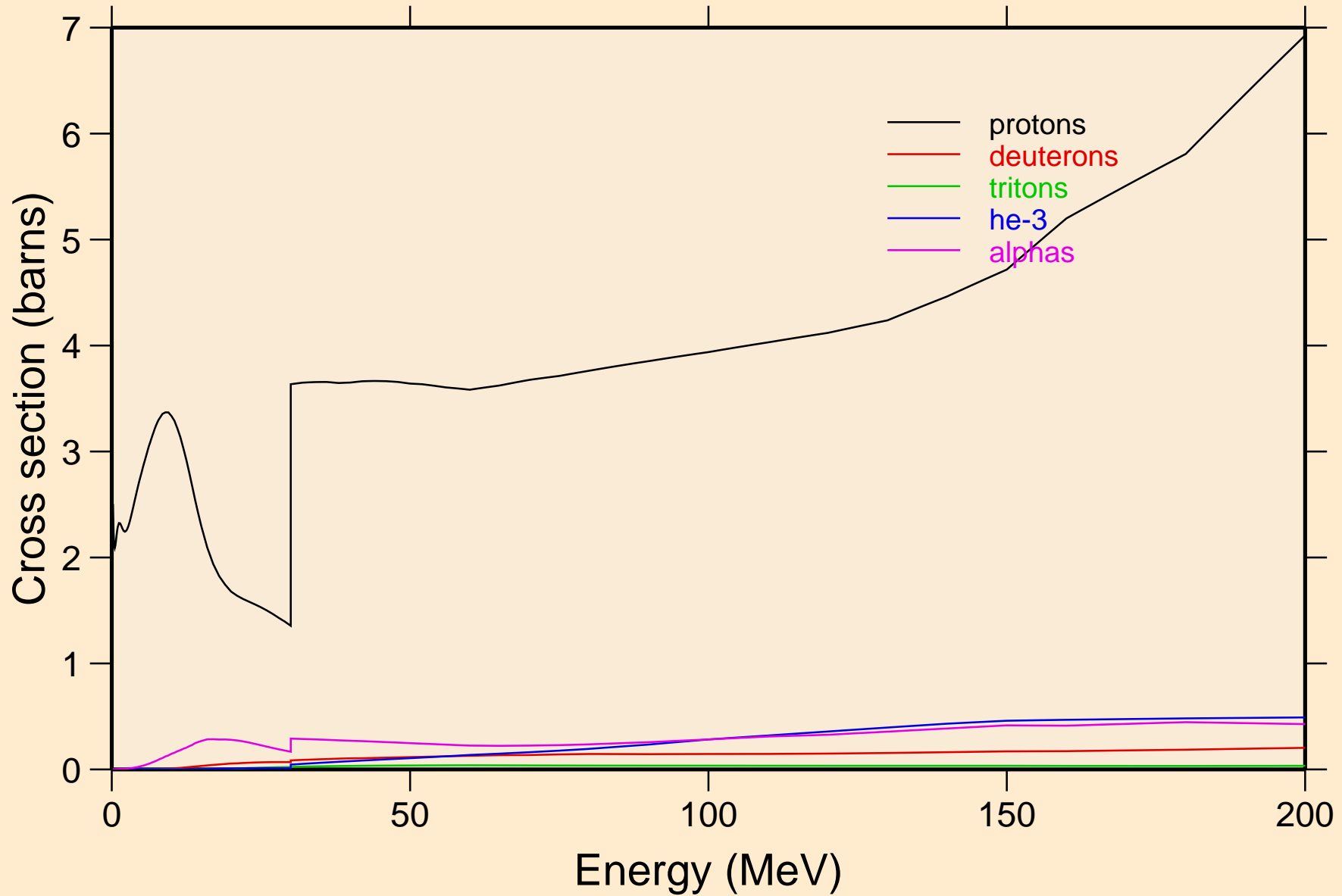

PM129 NEUTRON ACER TENDL-2021 LIBRARY; T=293.6K  
protons from (n,x)

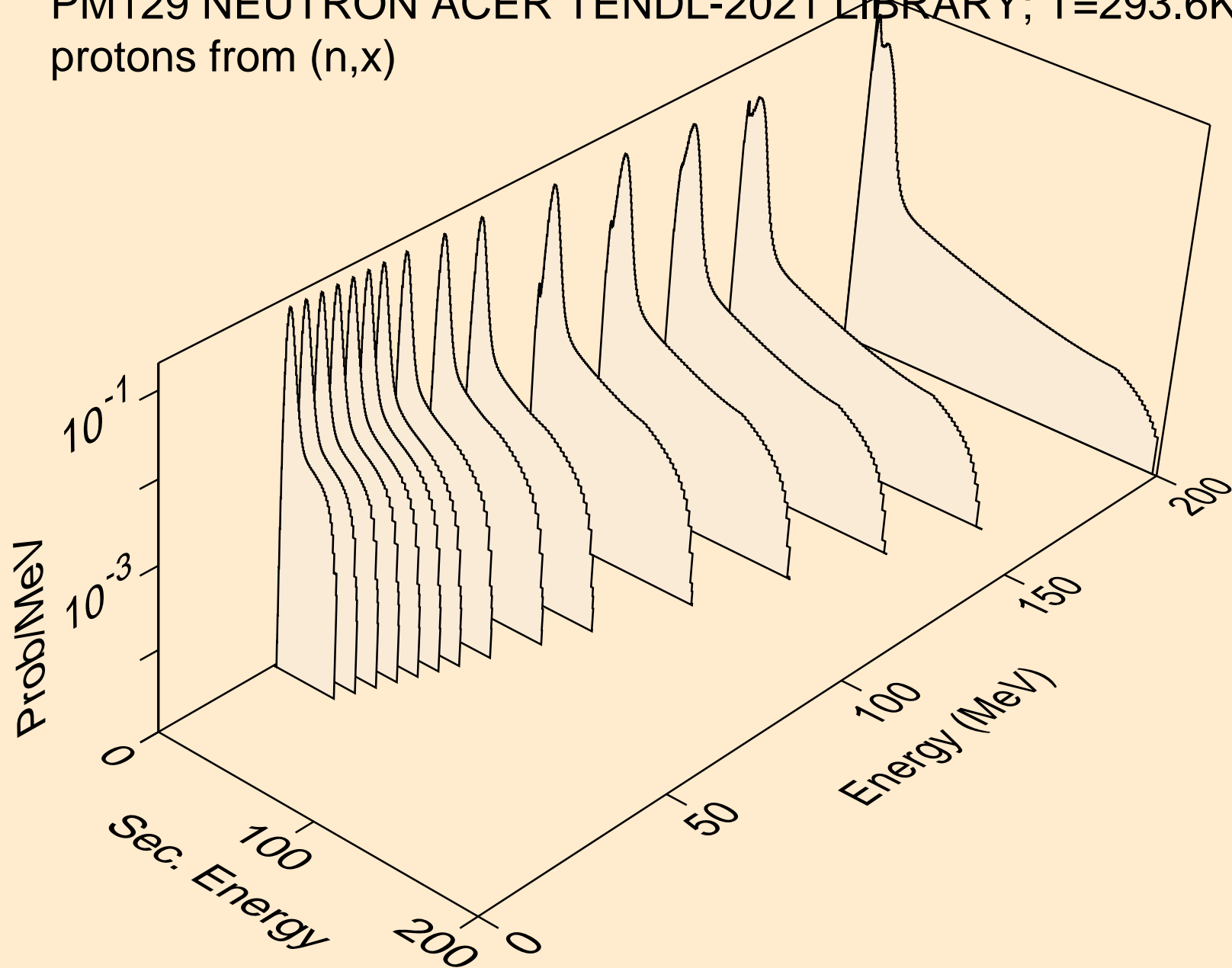

PM129 NEUTRON ACER TENDL-2021 LIBRARY; T=293.6K  
protons from (n,n\*)p

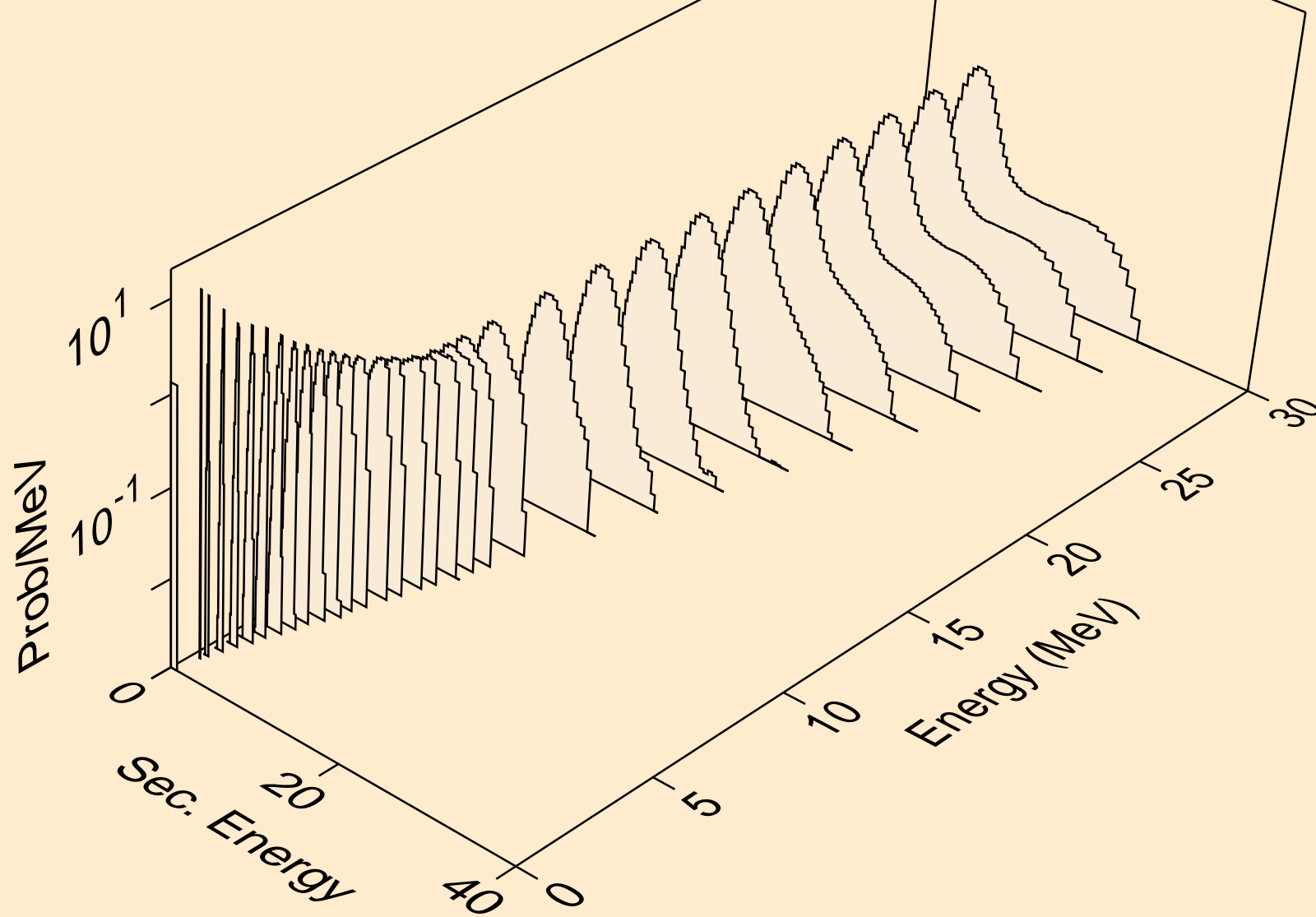

PM129 NEUTRON ACER TENDL-2021 LIBRARY; T=293.6K  
protons from (n,2np)

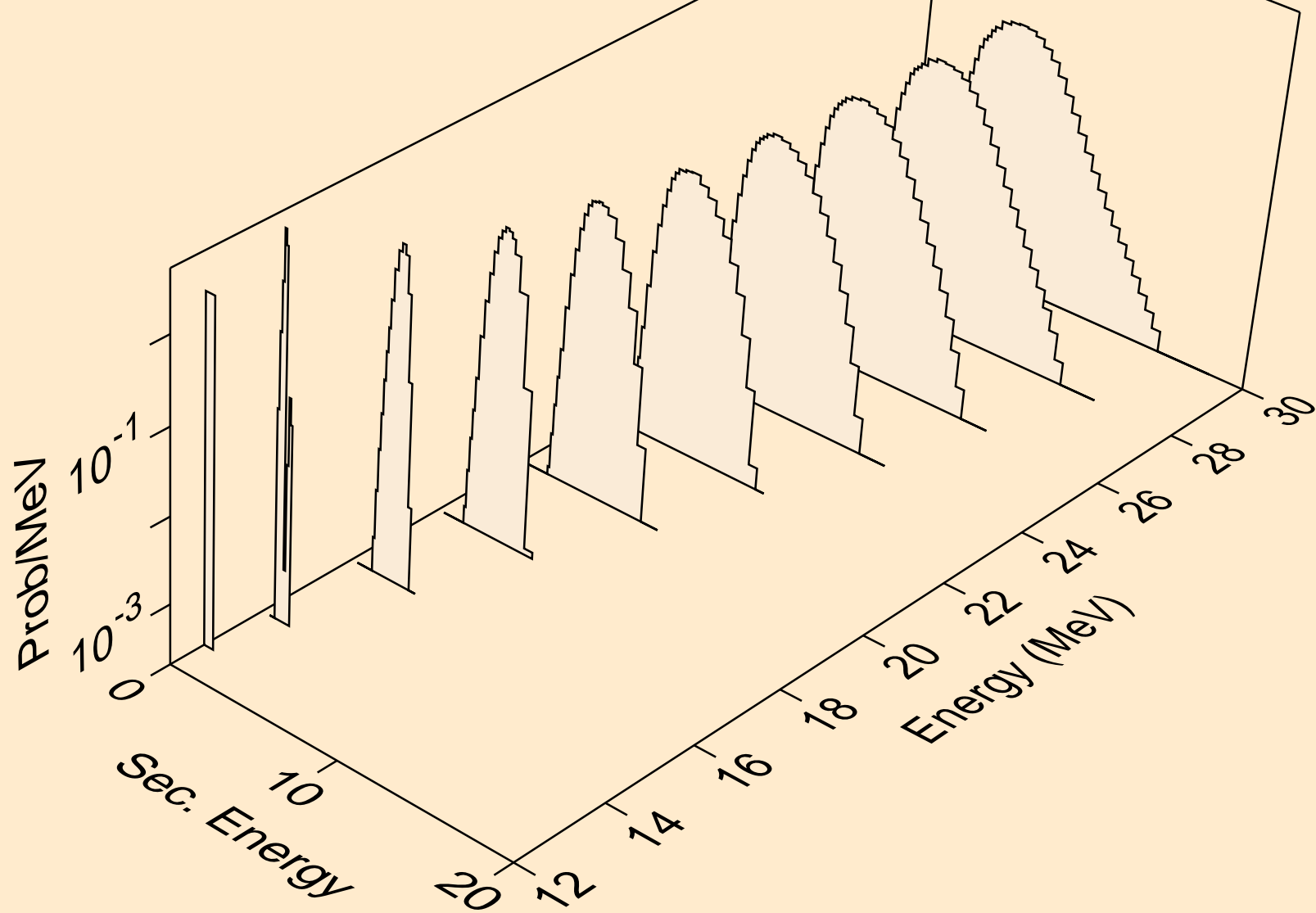

PM129 NEUTRON ACER TENDL-2021 LIBRARY; T=293.6K  
protons from (n,3np)

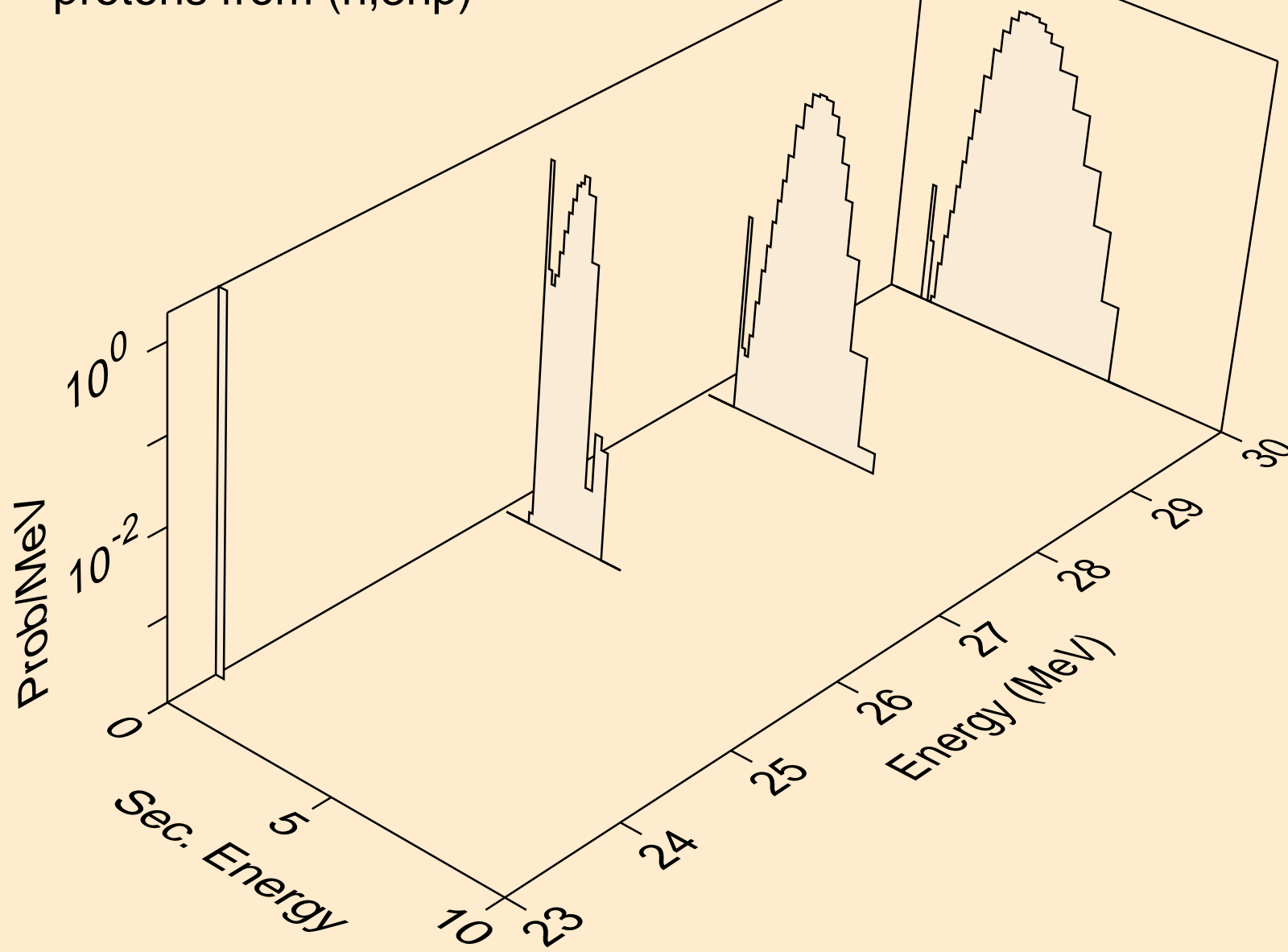

PM129 NEUTRON ACER TENDL-2021 LIBRARY; T=293.6K  
protons from (n,2np)

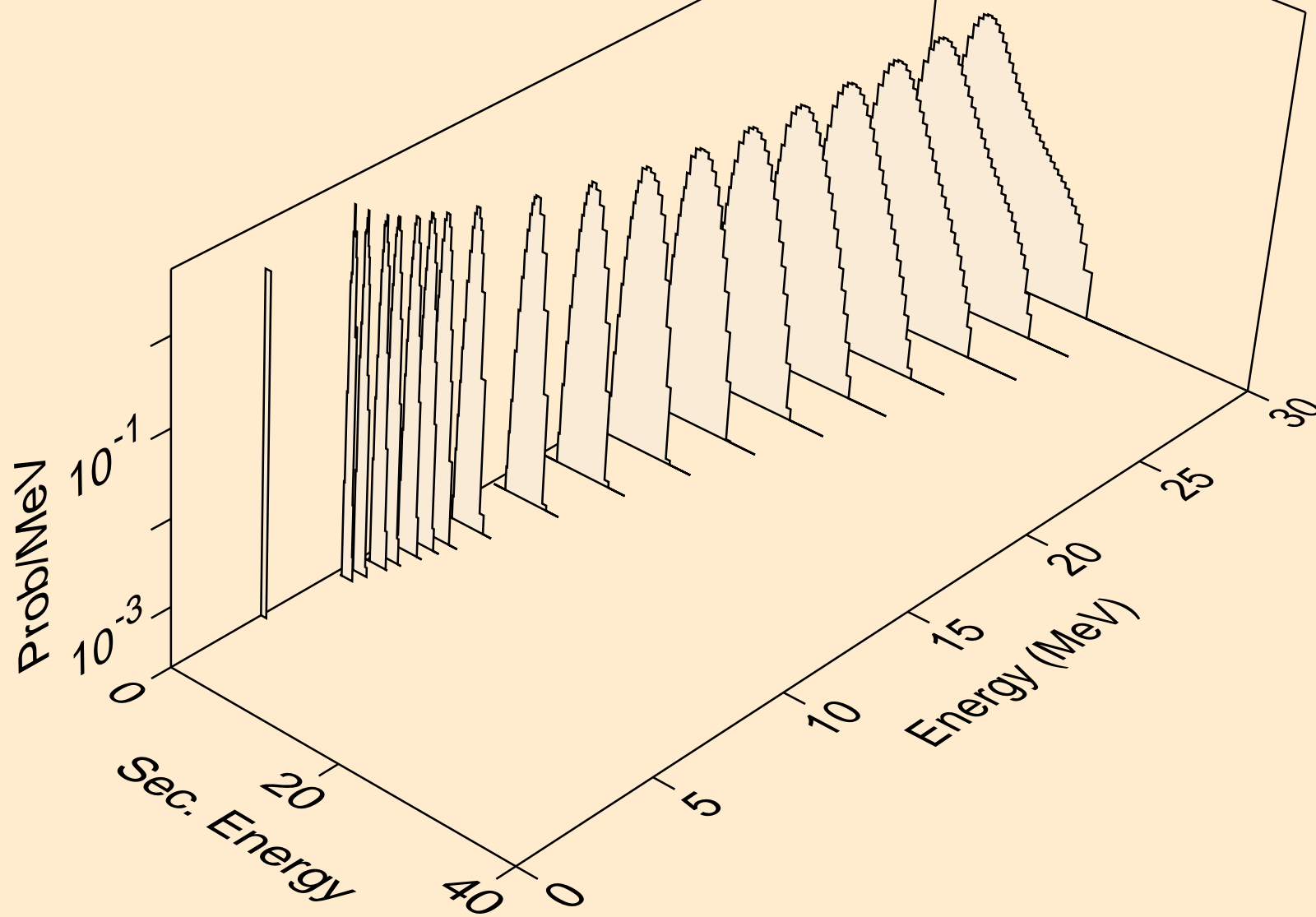

PM129 NEUTRON ACER TENDL-2021 LIBRARY; T=293.6K  
protons from (n,npa)

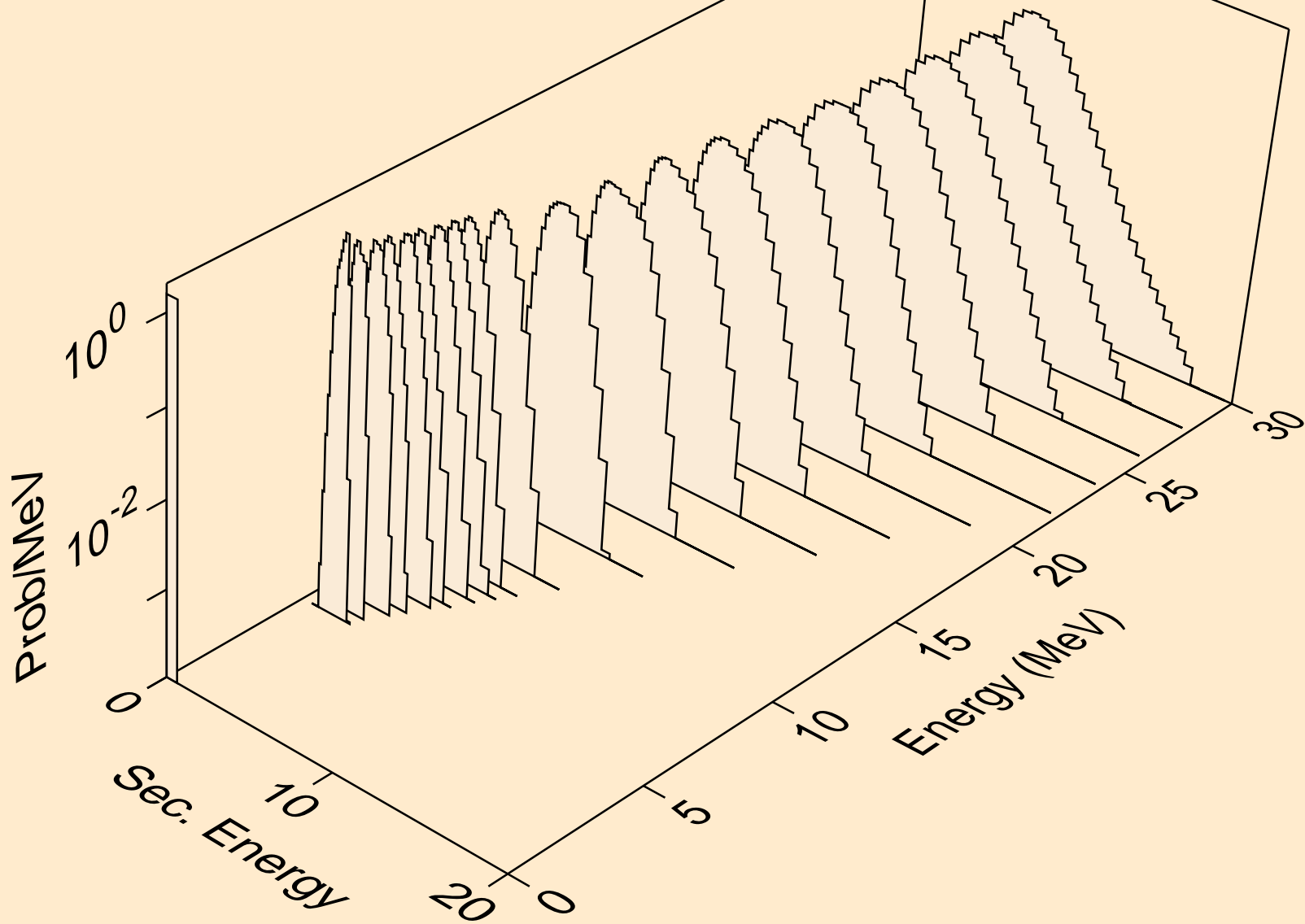

PM129 NEUTRON ACER TENDL-2021 LIBRARY; T=293.6K  
protons from (n,p)

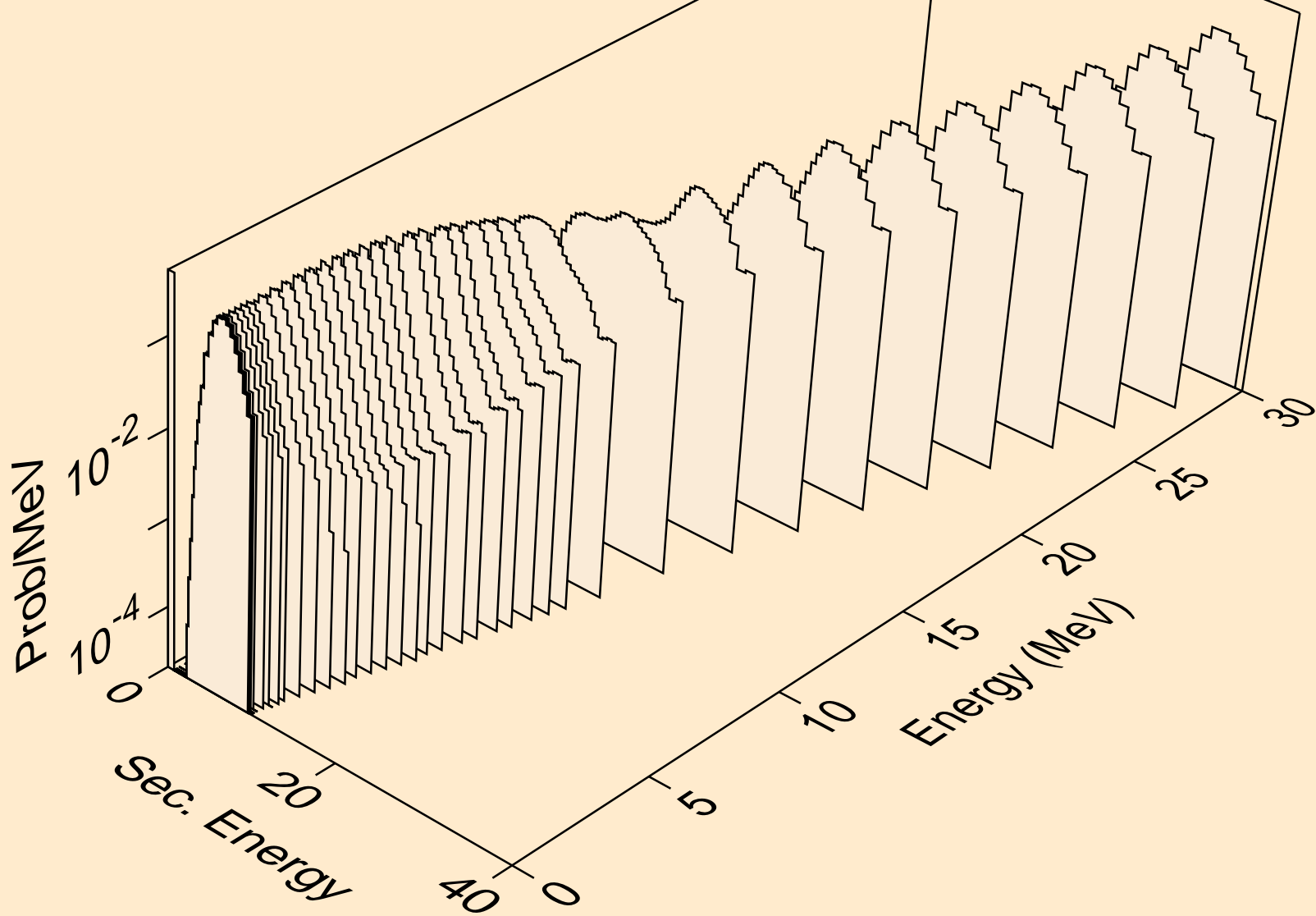



PM129 NEUTRON ACER TENDL-2021 LIBRARY; T=293.6K  
protons from (n,2p)

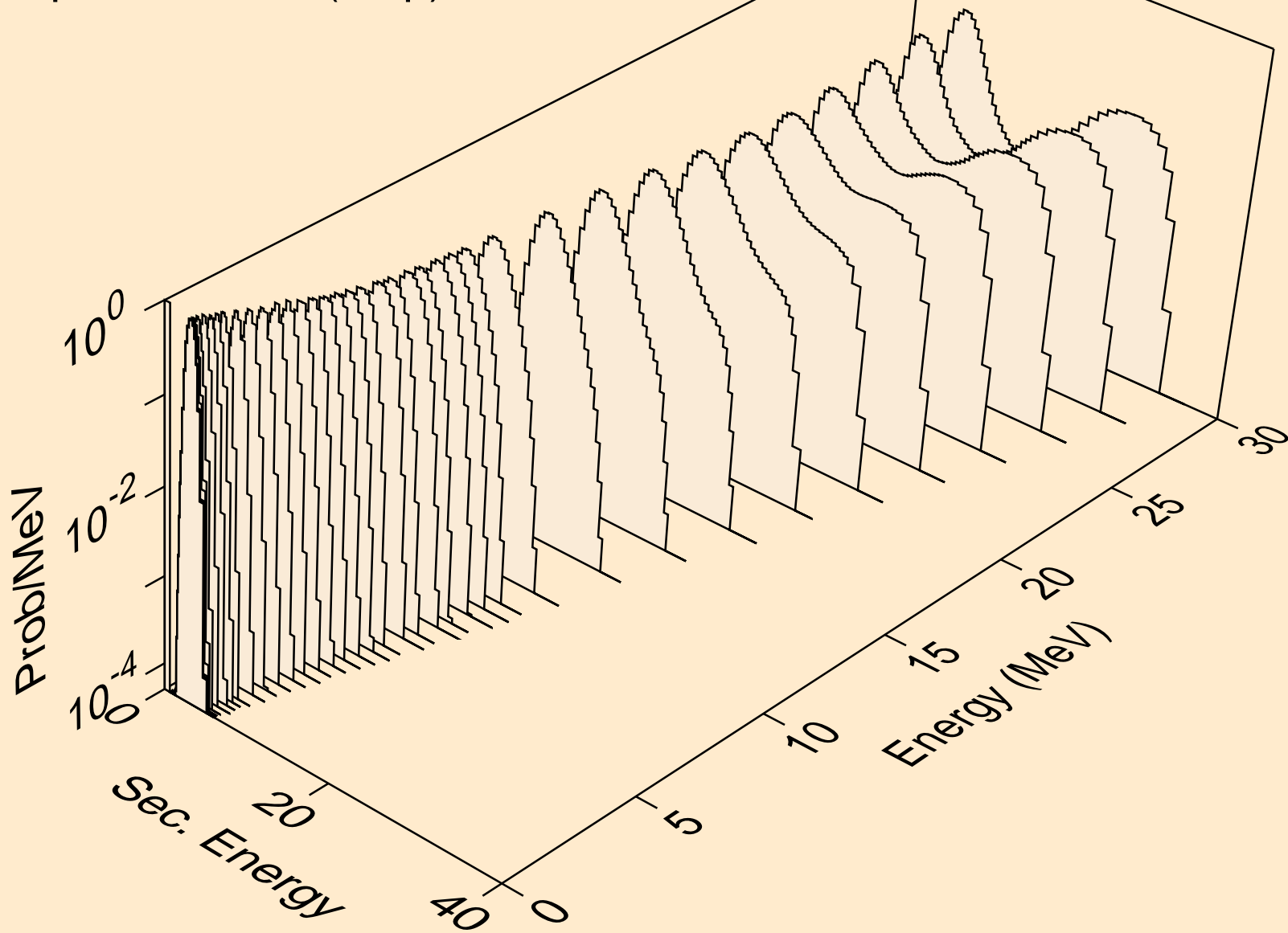

PM129 NEUTRON ACER TENDL-2021 LIBRARY; T=293.6K  
protons from (n,p)

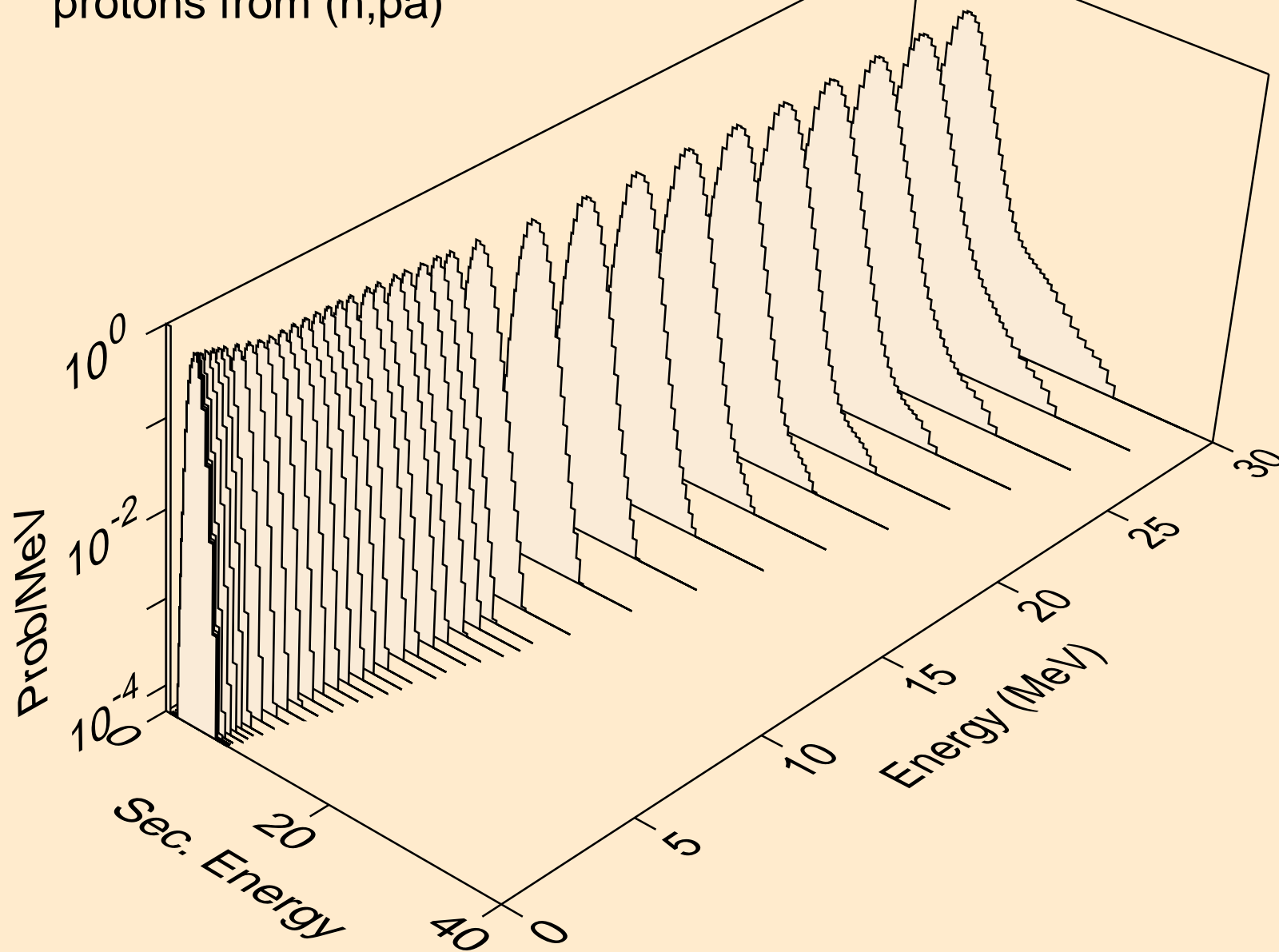

PM129 NEUTRON ACER TENDL-2021 LIBRARY; T=293.6K  
protons from (n,pd)

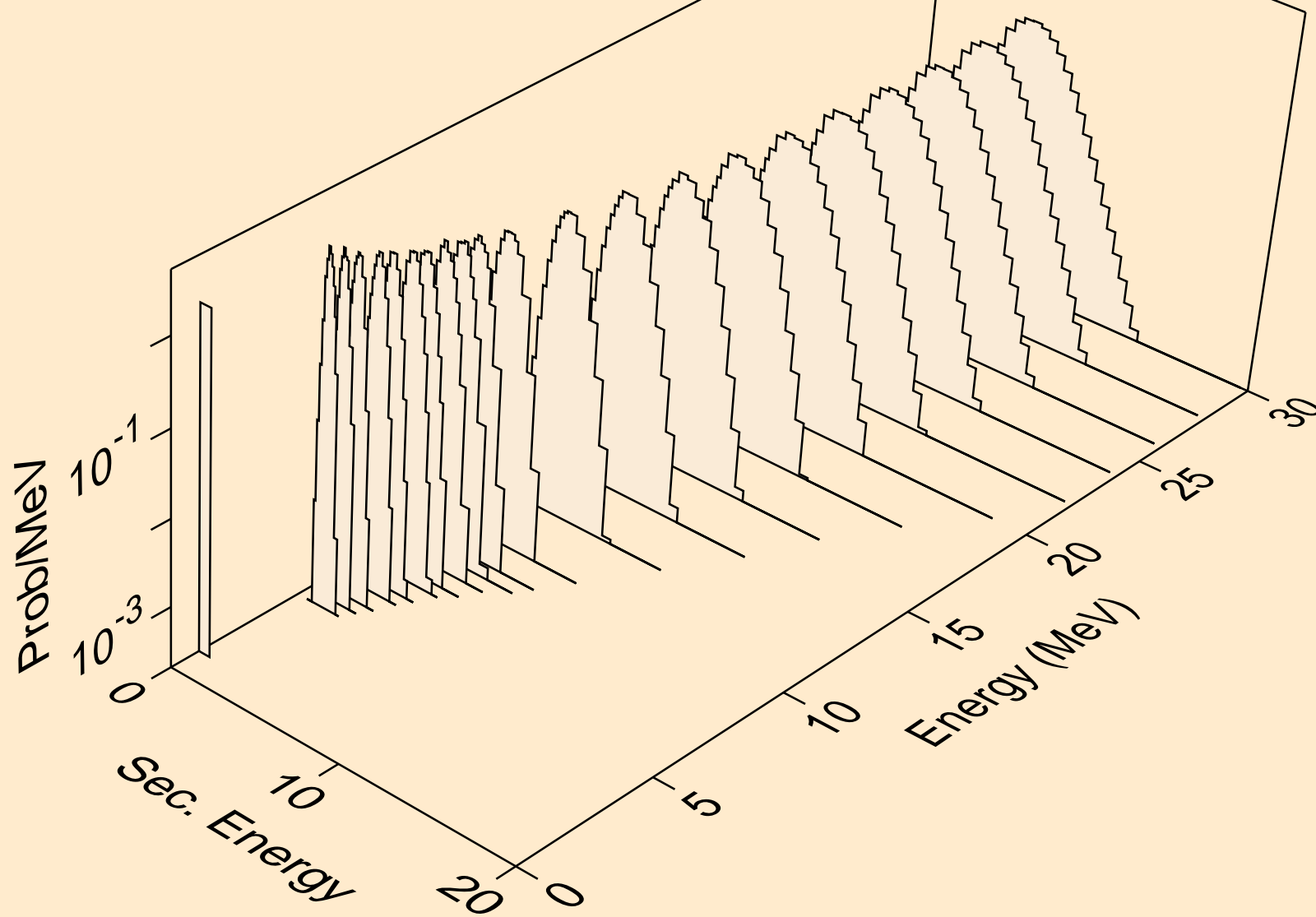

PM129 NEUTRON ACER TENDL-2021 LIBRARY; T=293.6K  
protons from (n,pt)

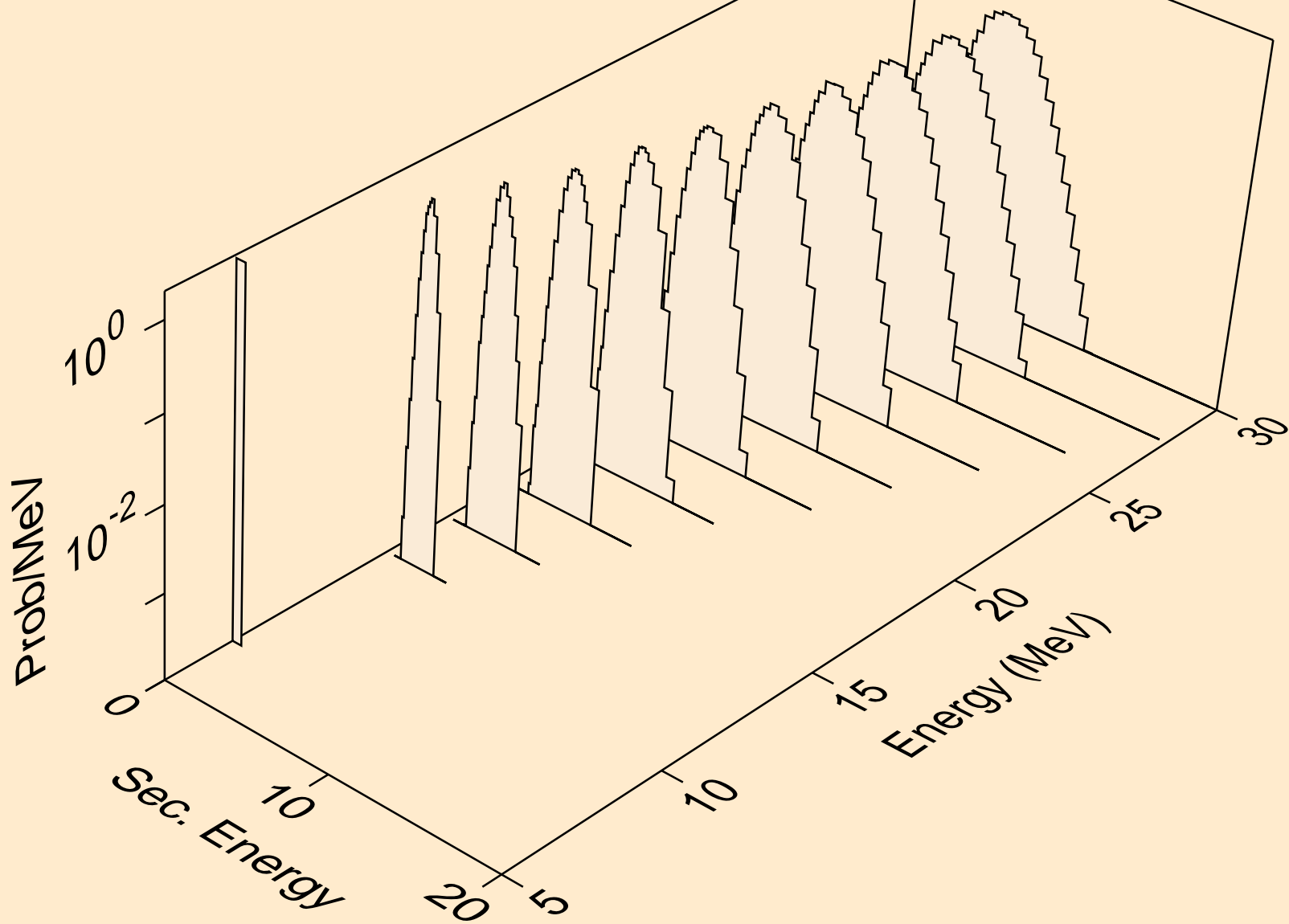

PM129 NEUTRON ACER TENDL-2021 LIBRARY; T=293.6K  
deuterons from (n,x)

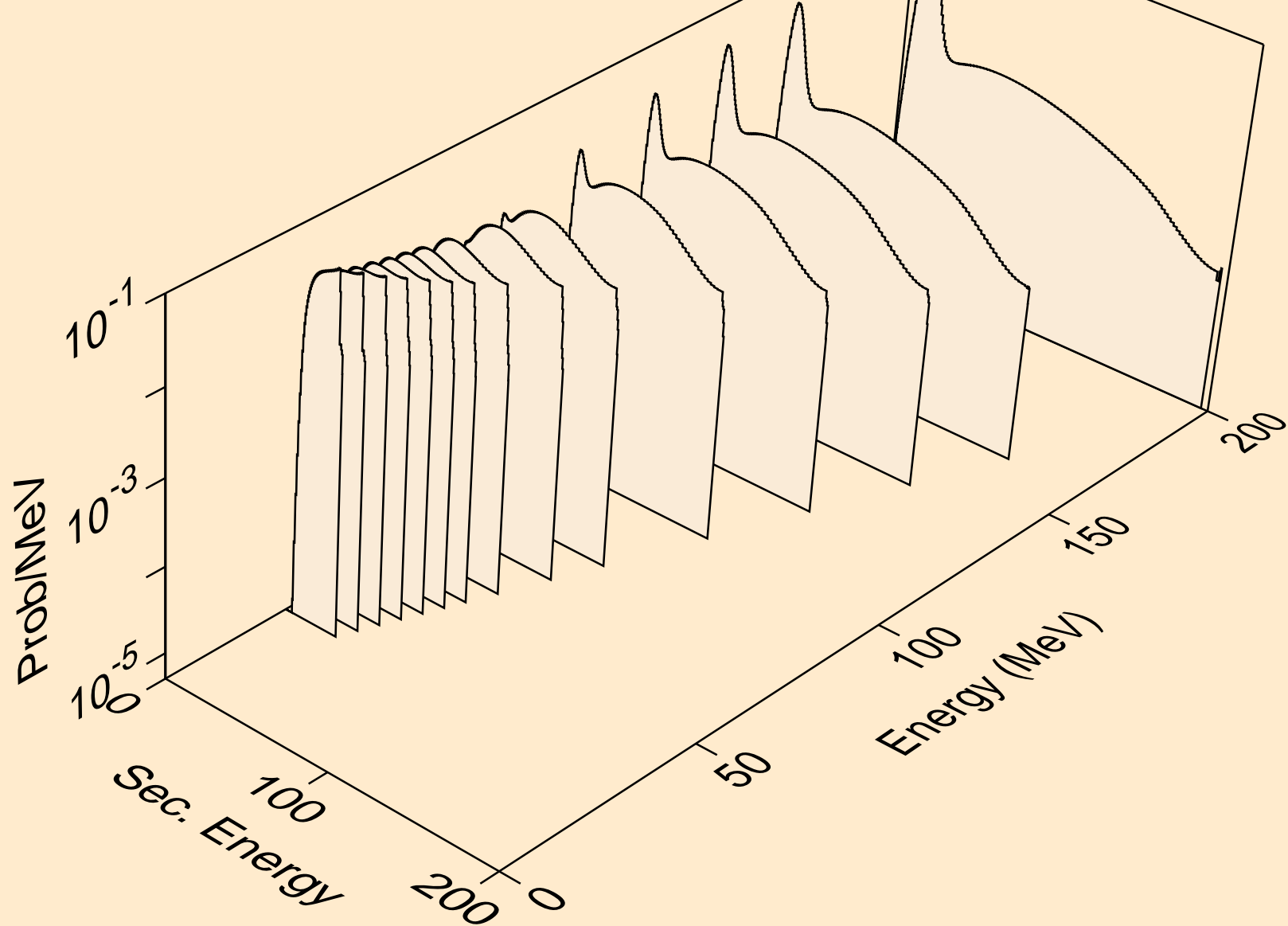

PM129 NEUTRON ACER TENDL-2021 LIBRARY; T=293.6K  
deuterons from (n,2nd)

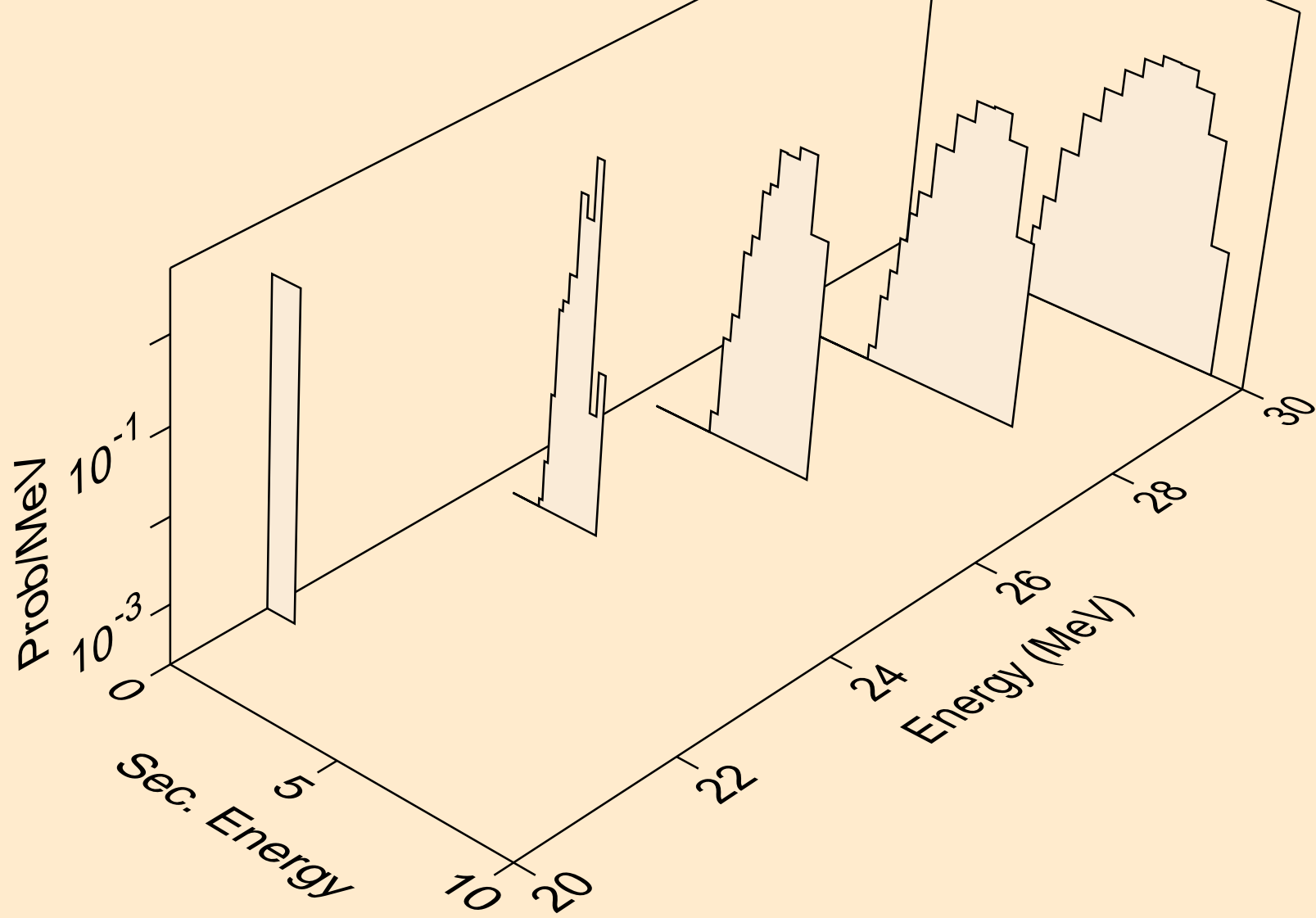

PM129 NEUTRON ACER TENDL-2021 LIBRARY; T=293.6K  
deuterons from (n,n\*)d

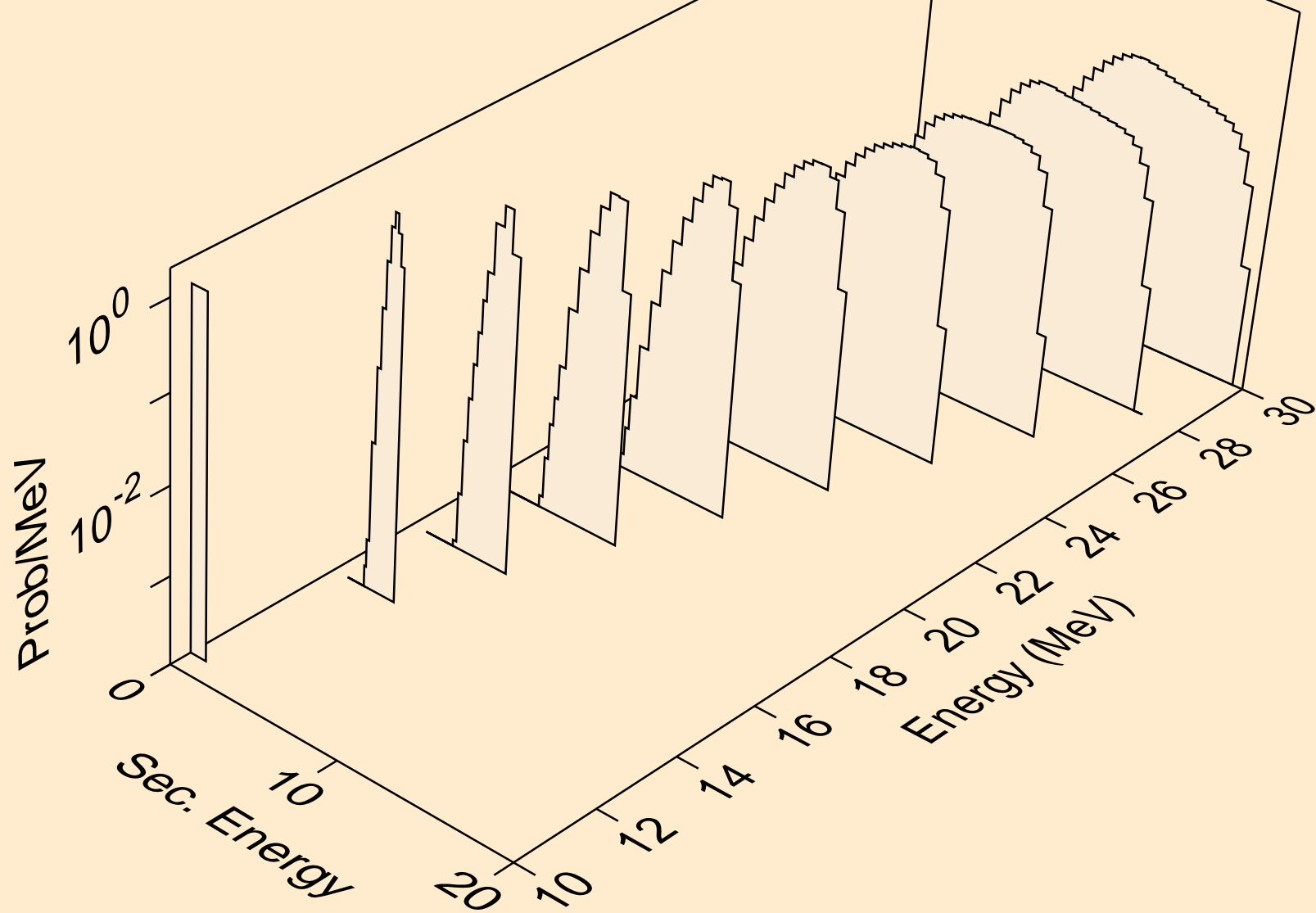

PM129 NEUTRON ACER TENDL-2021 LIBRARY; T=293.6K  
deuterons from (n,d)

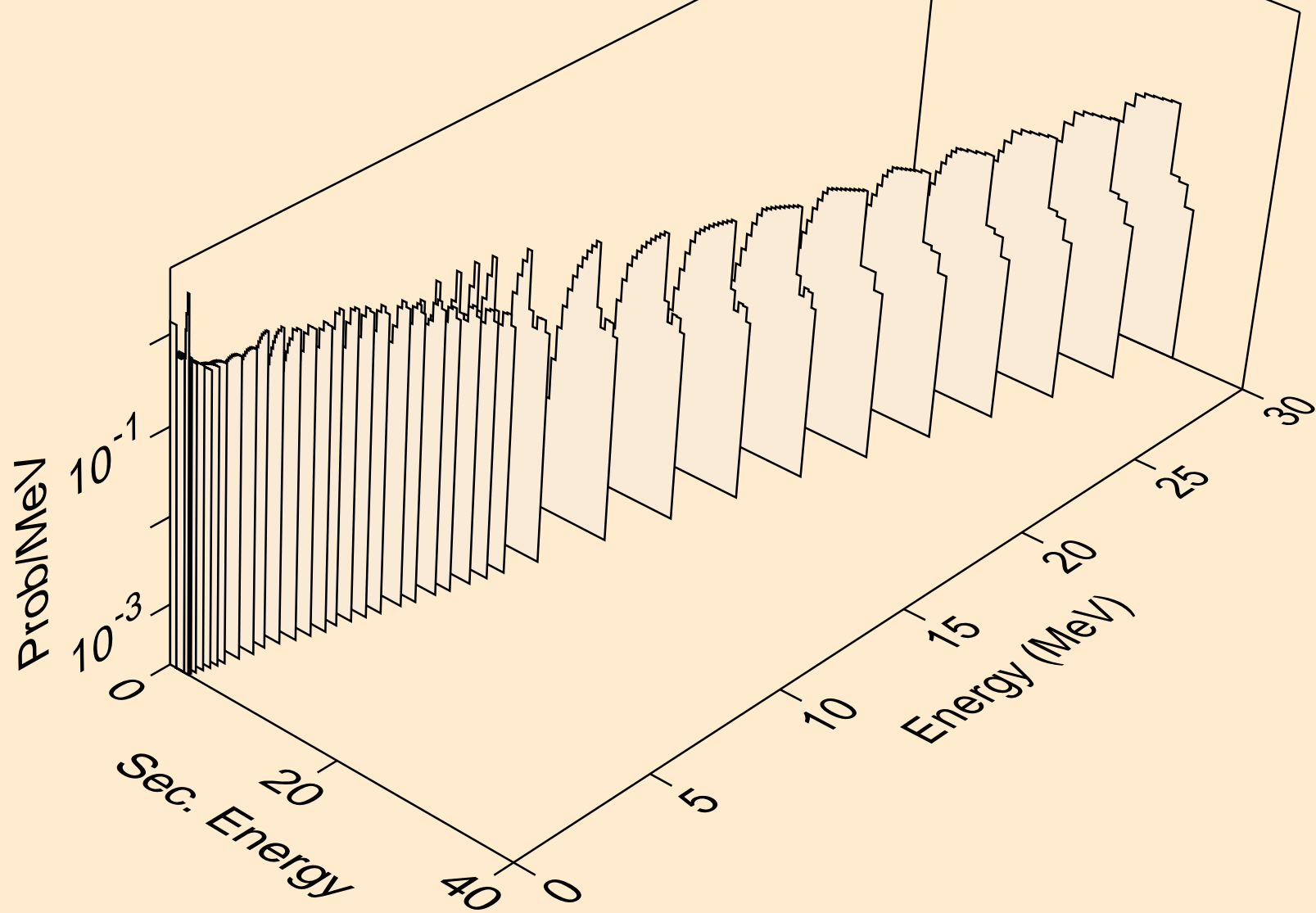



PM129 NEUTRON ACER TENDL-2021 LIBRARY; T=293.6K  
deuterons from (n,d2a)

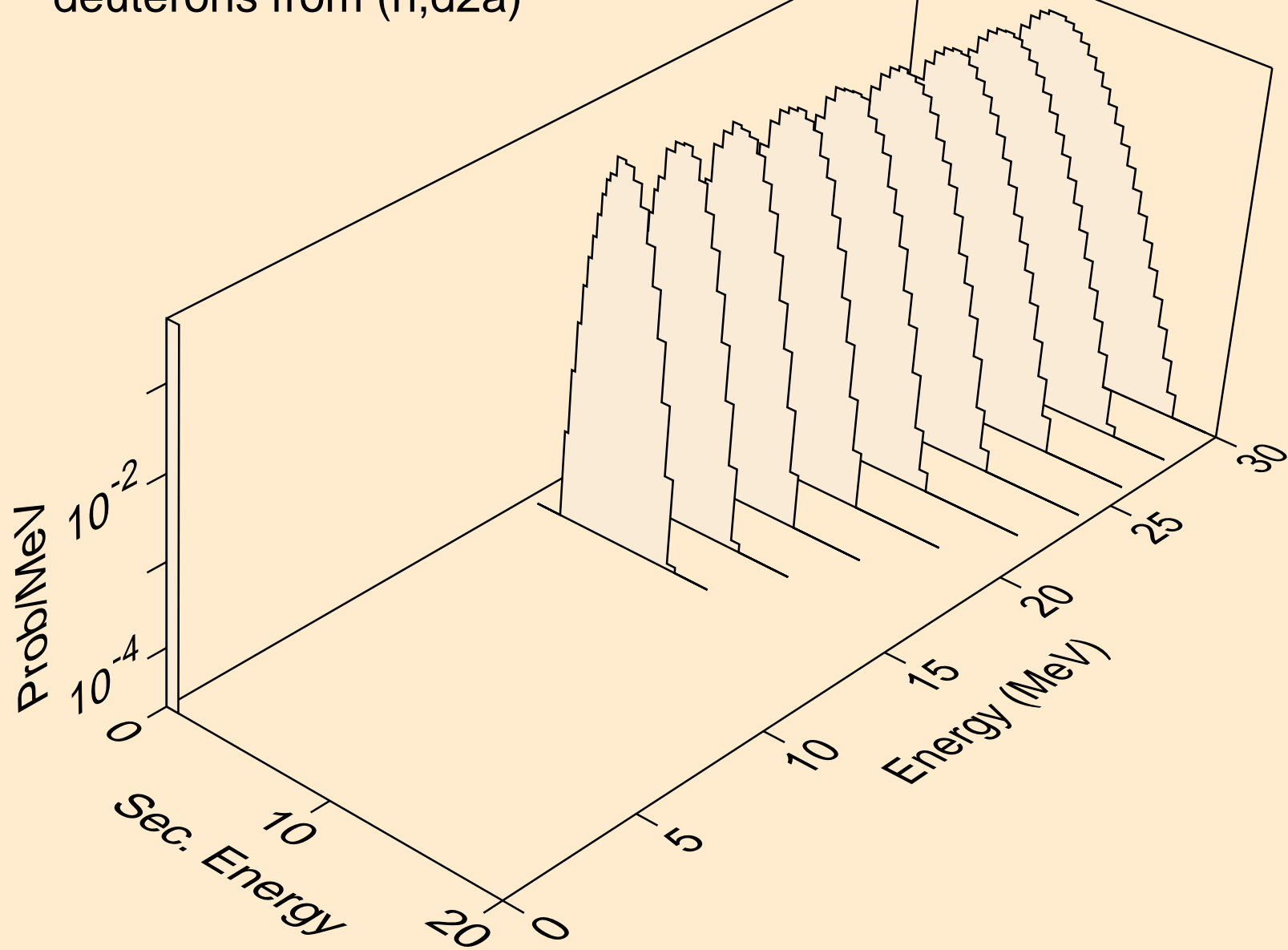

PM129 NEUTRON ACER TENDL-2021 LIBRARY; T=293.6K  
deuterons from (n,pd)

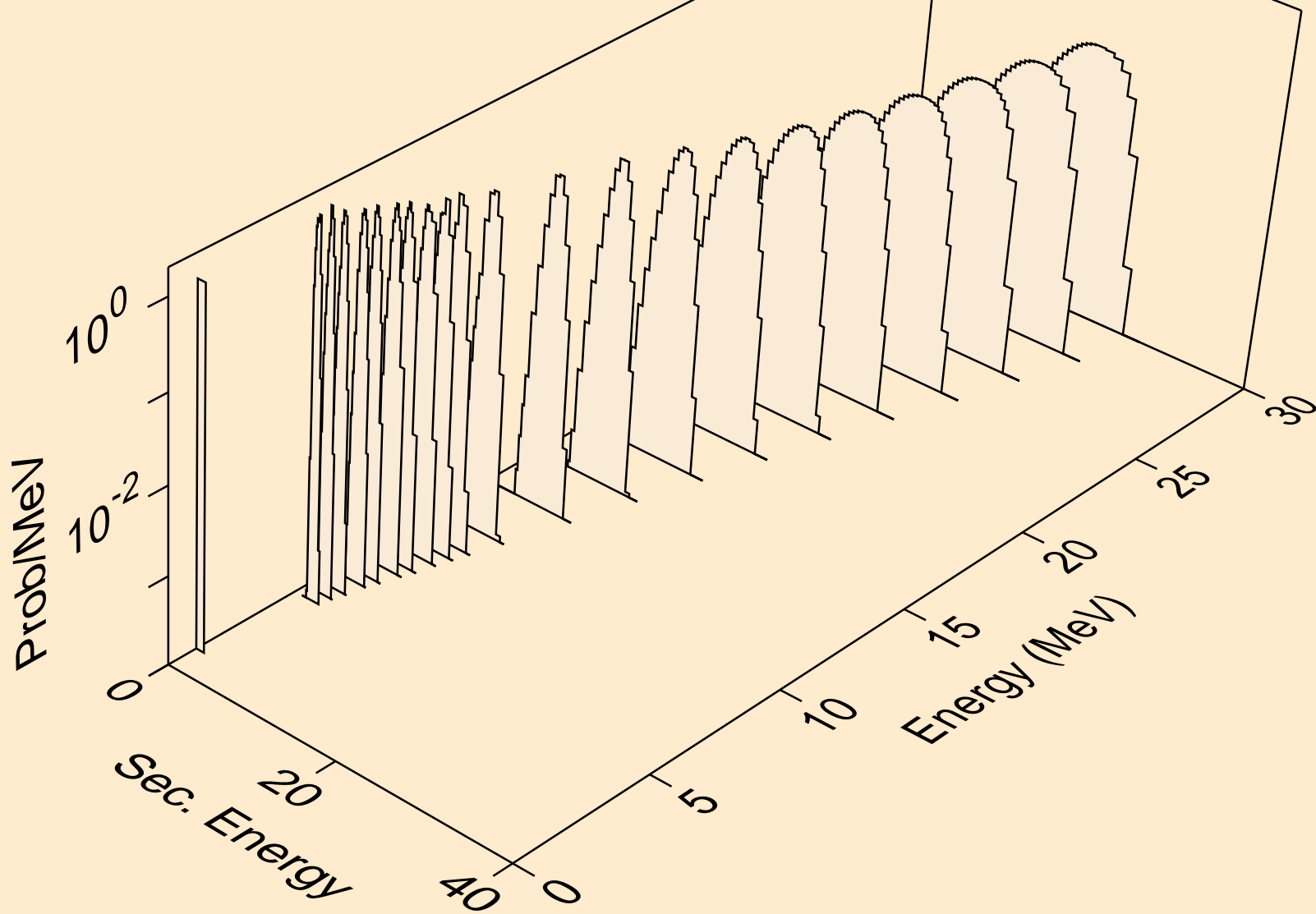

PM129 NEUTRON ACER TENDL-2021 LIBRARY; T=293.6K  
deuterons from (n,da)

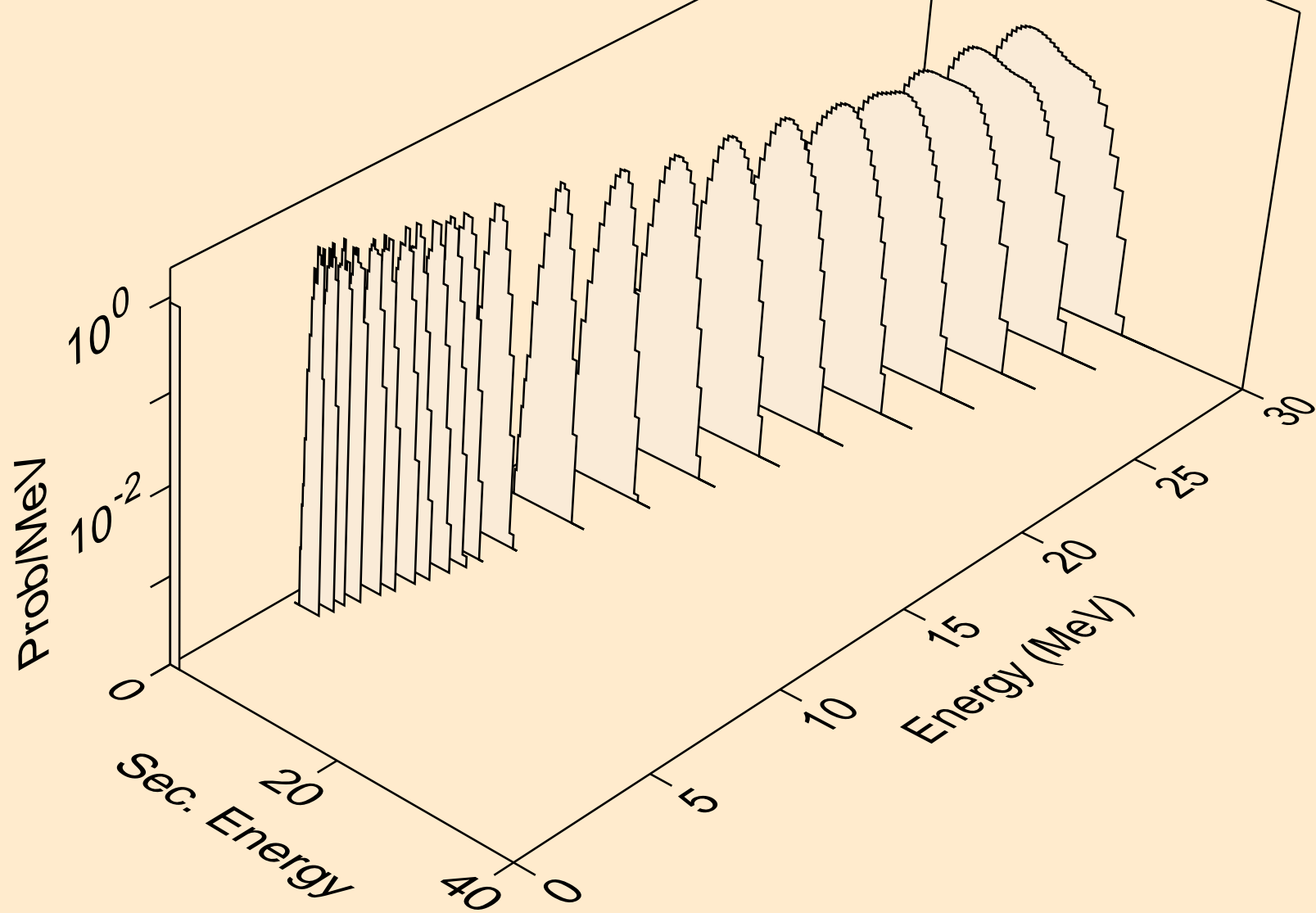

PM129 NEUTRON ACER TENDL-2021 LIBRARY; T=293.6K  
tritons from (n,x)

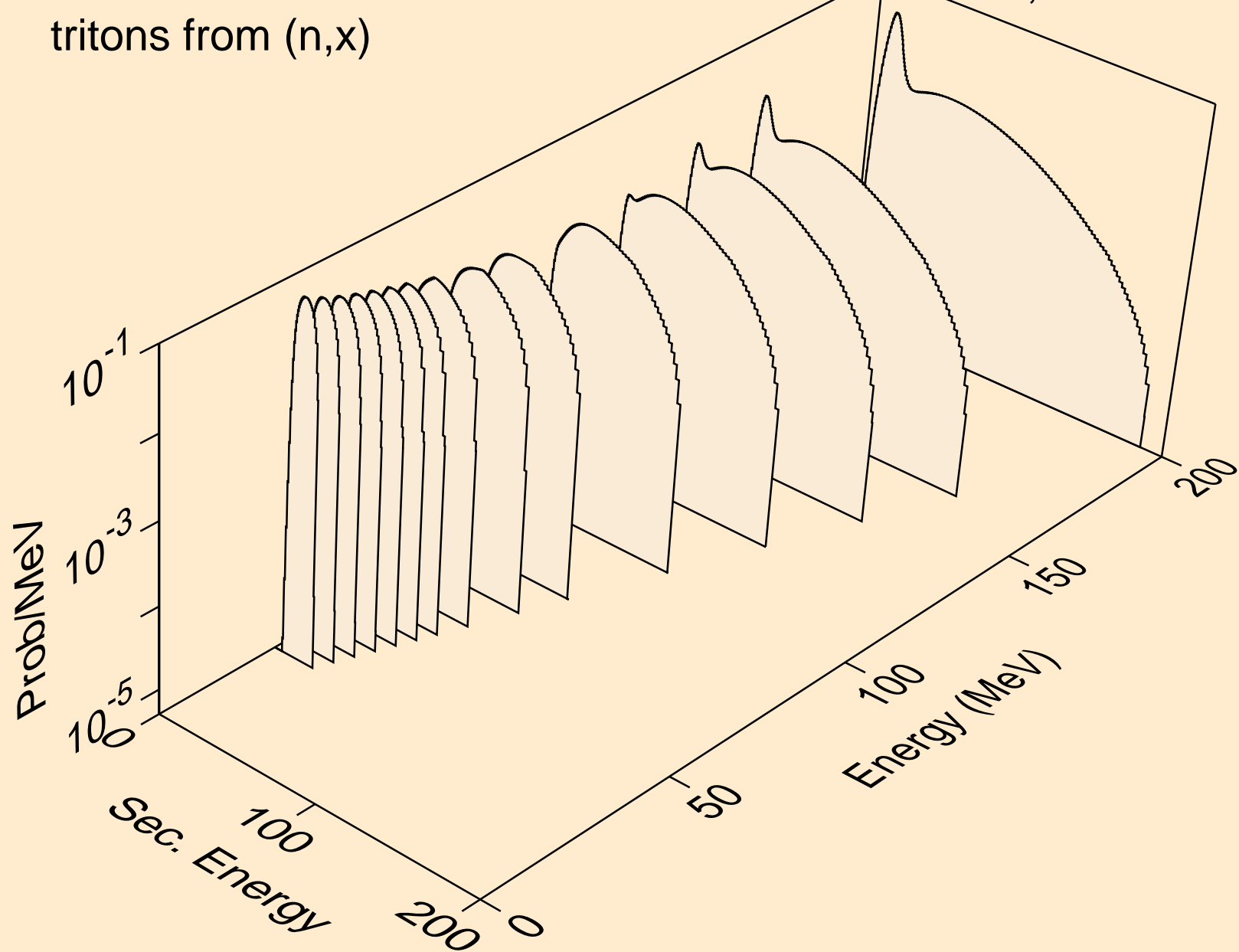

PM129 NEUTRON ACER TENDL-2021 LIBRARY; T=293.6K  
tritons from (n,n\*)t

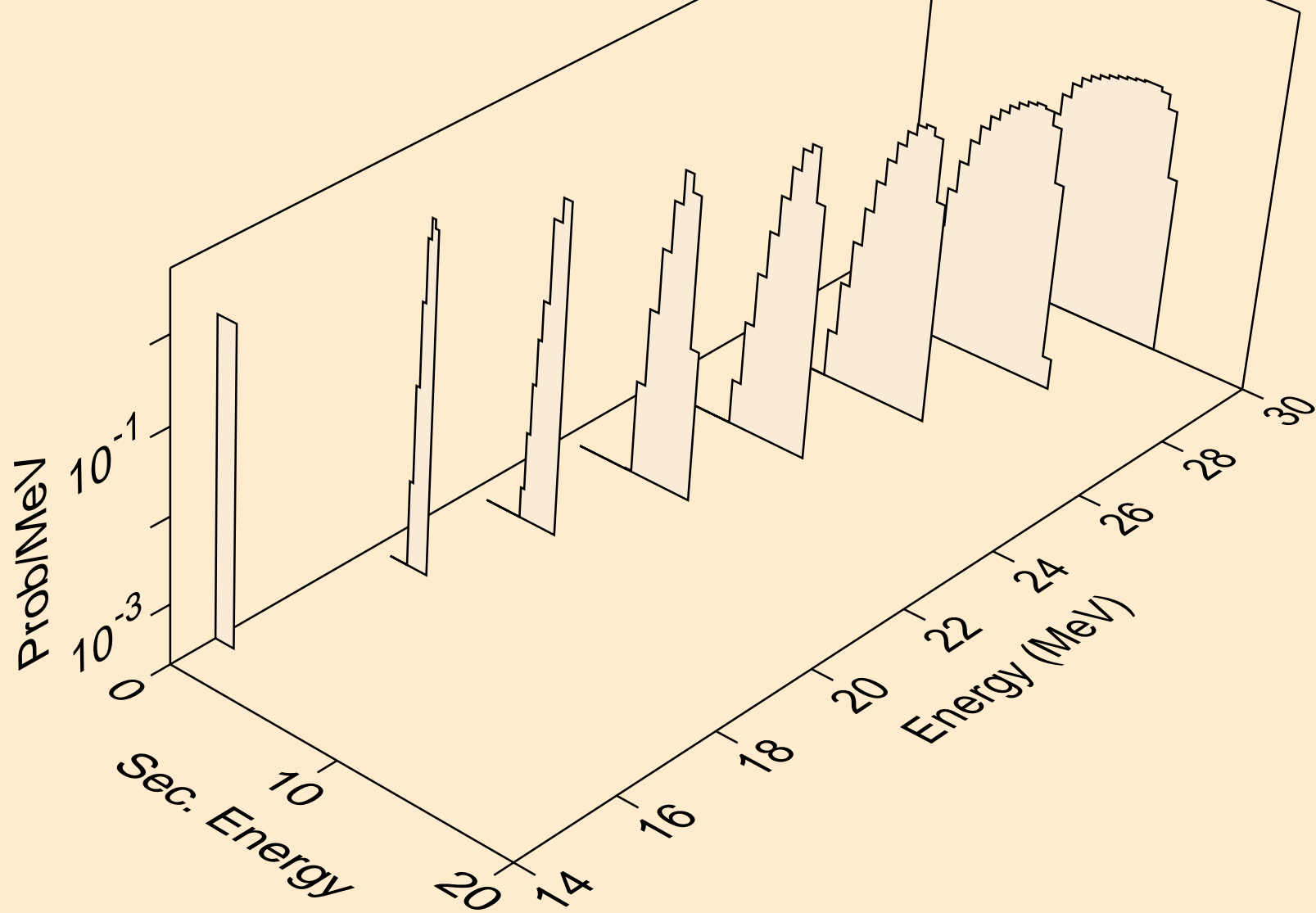

PM129 NEUTRON ACER TENDL-2021 LIBRARY; T=293.6K  
tritons from (n,t)

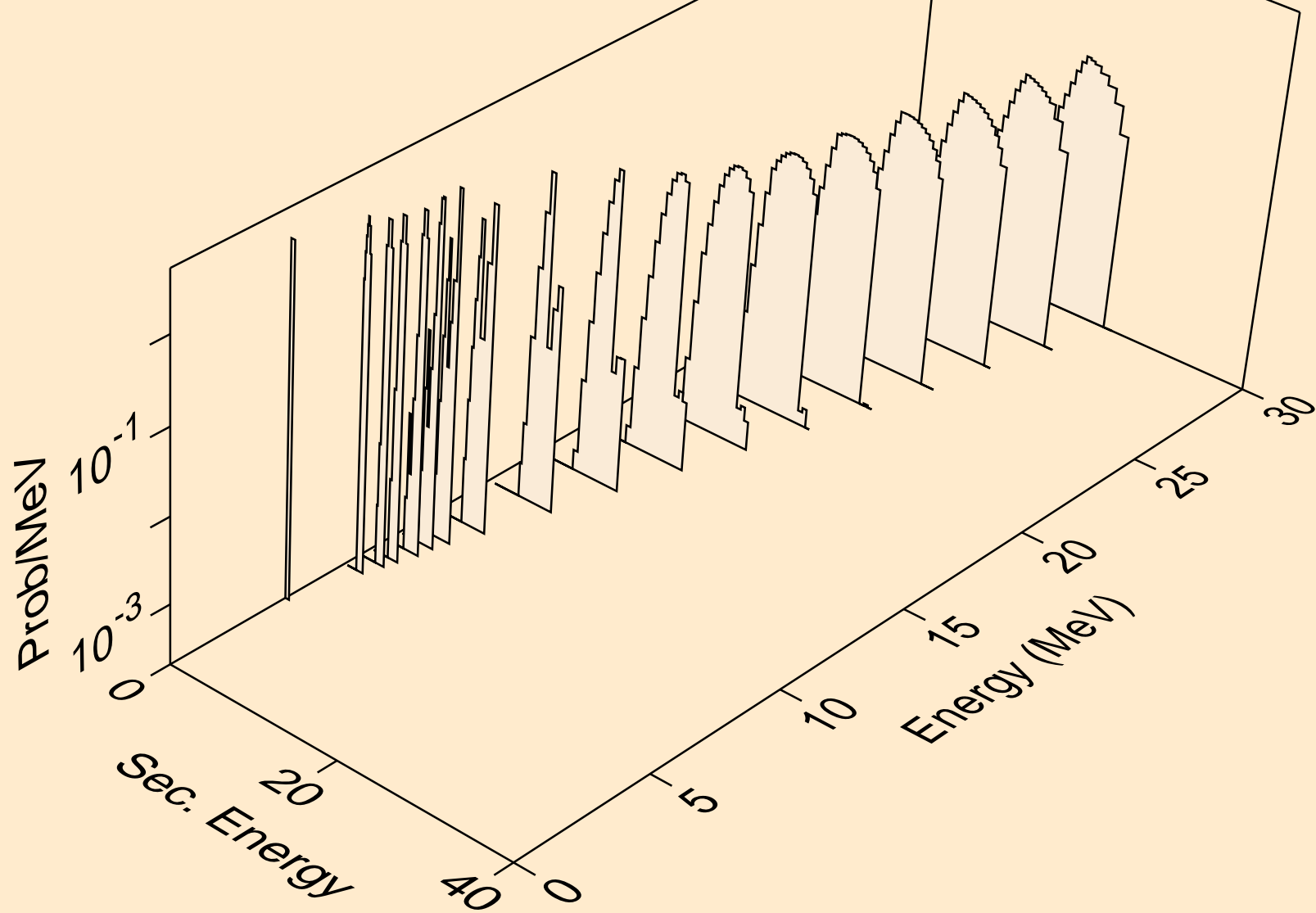

PM129 NEUTRON ACER TENDL-2021 LIBRARY; T=293.6K  
tritons from (n,pt)

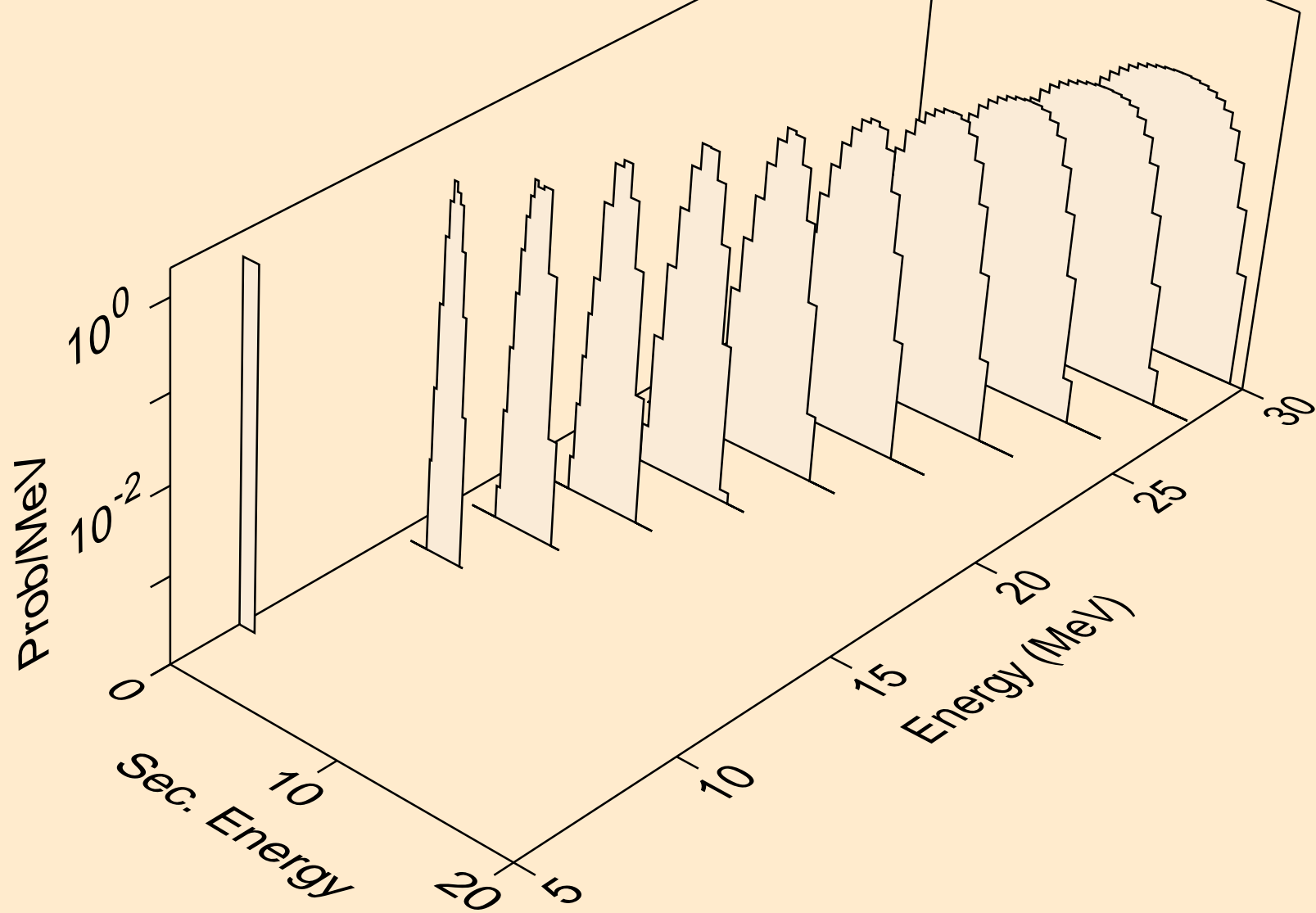

PM129 NEUTRON ACER TENDL-2021 LIBRARY; T=293.6K  
he3s from (n,x)

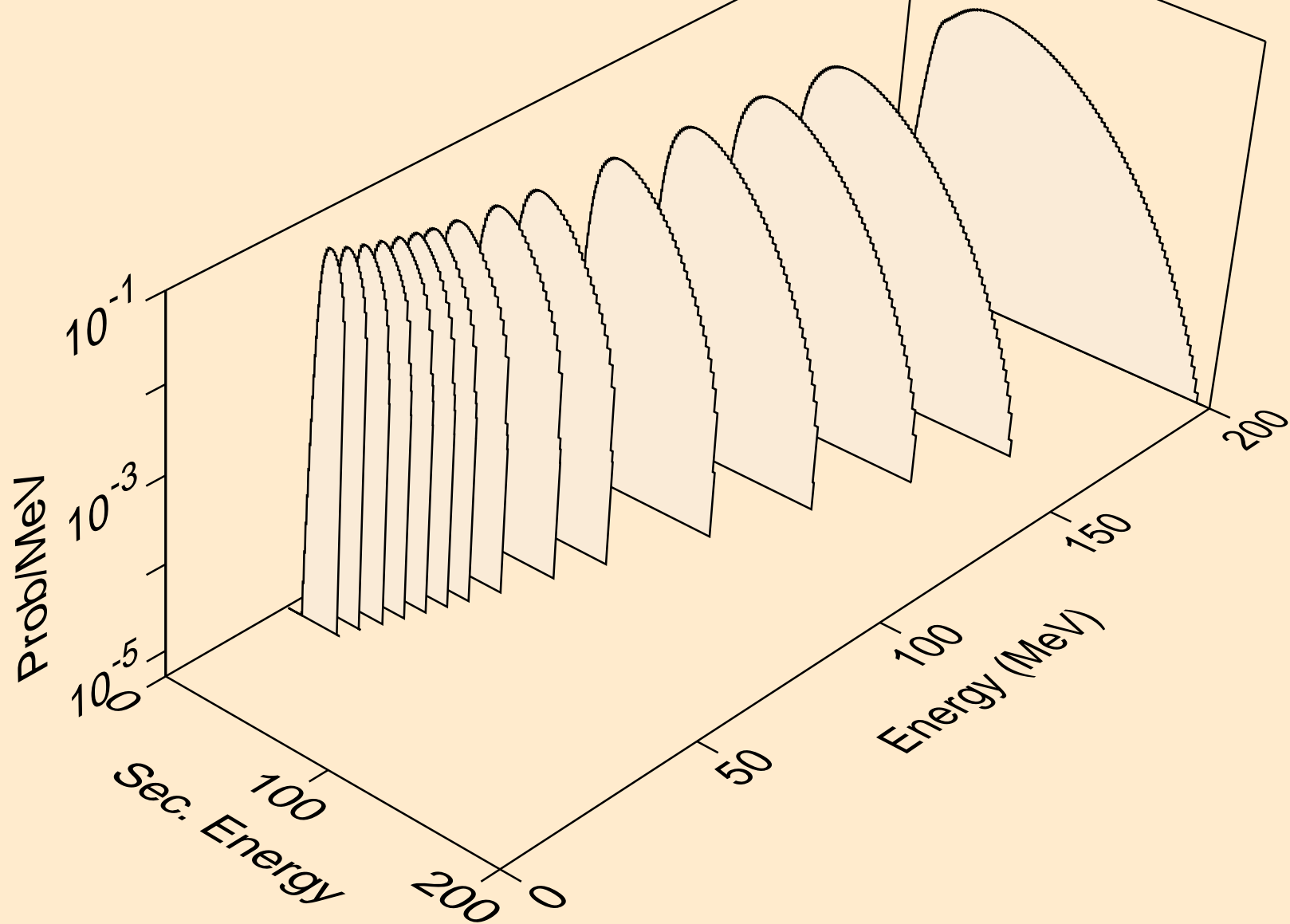



PM129 NEUTRON ACER TENDL-2021 LIBRARY; T=293.6K  
he3s from (n,n\*)he3

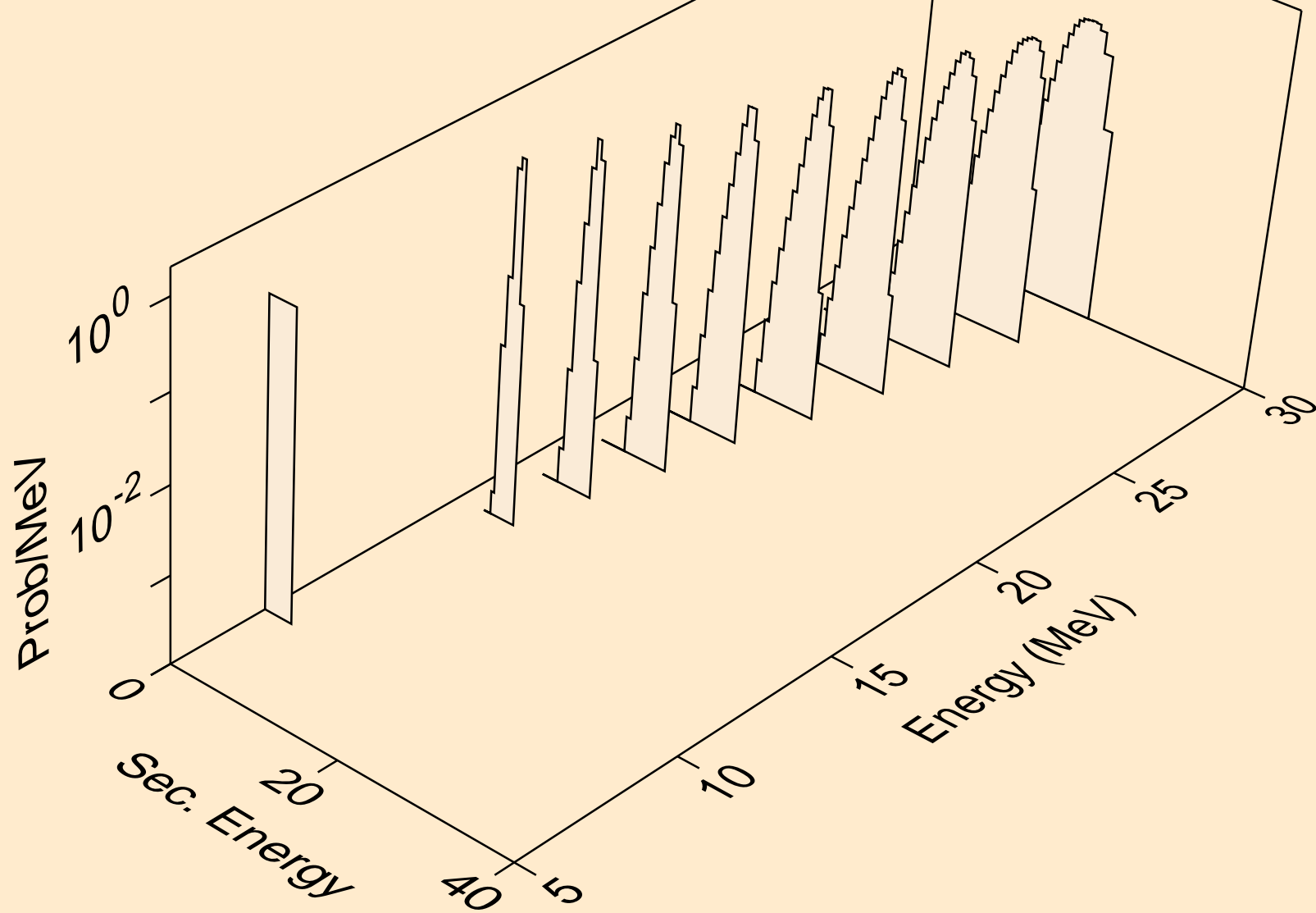

PM129 NEUTRON ACER TENDL-2021 LIBRARY; T=293.6K  
he3s from (n,he3)

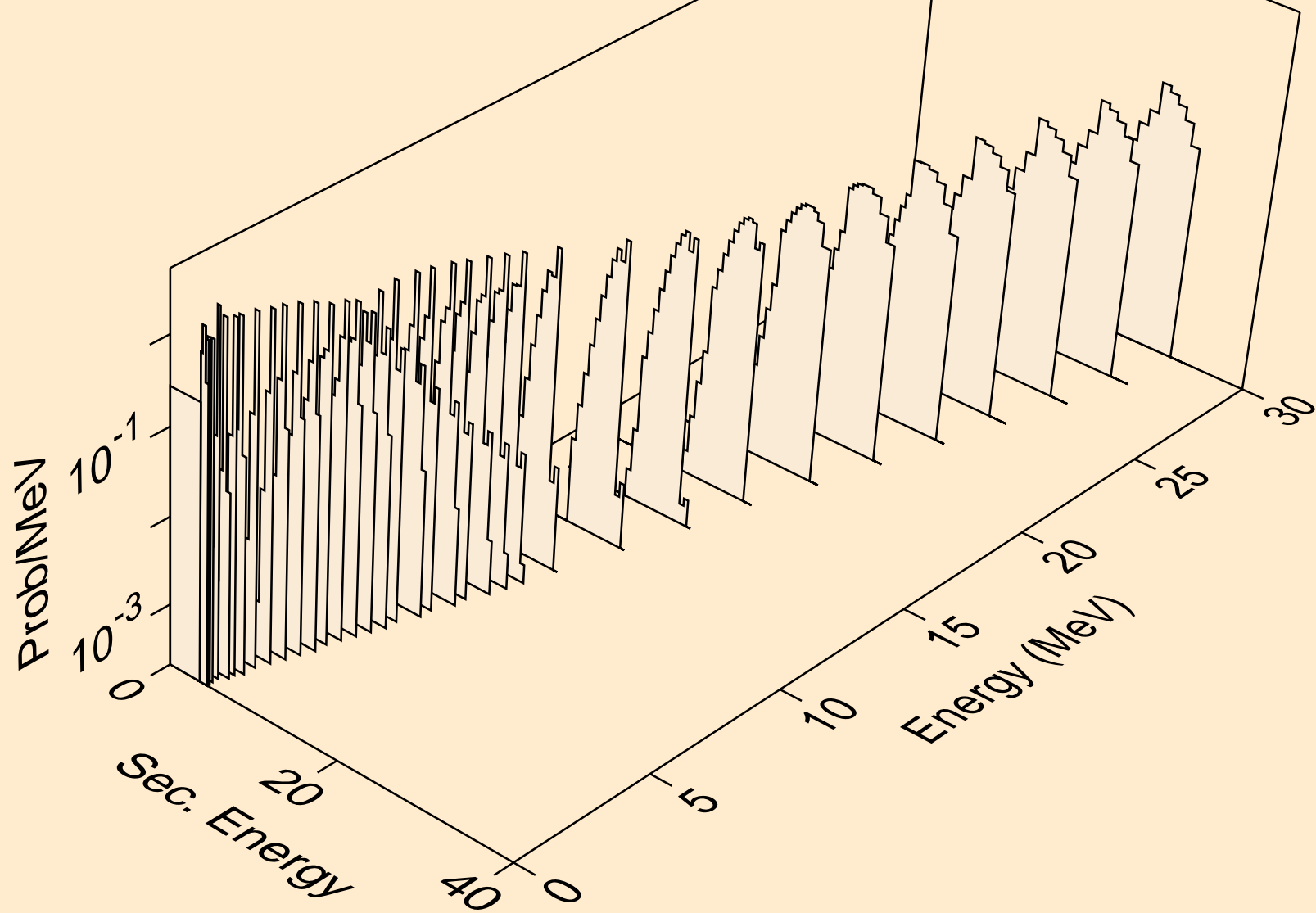

PM129 NEUTRON ACER TENDL-2021 LIBRARY; T=293.6K  
alphas from (n,x)

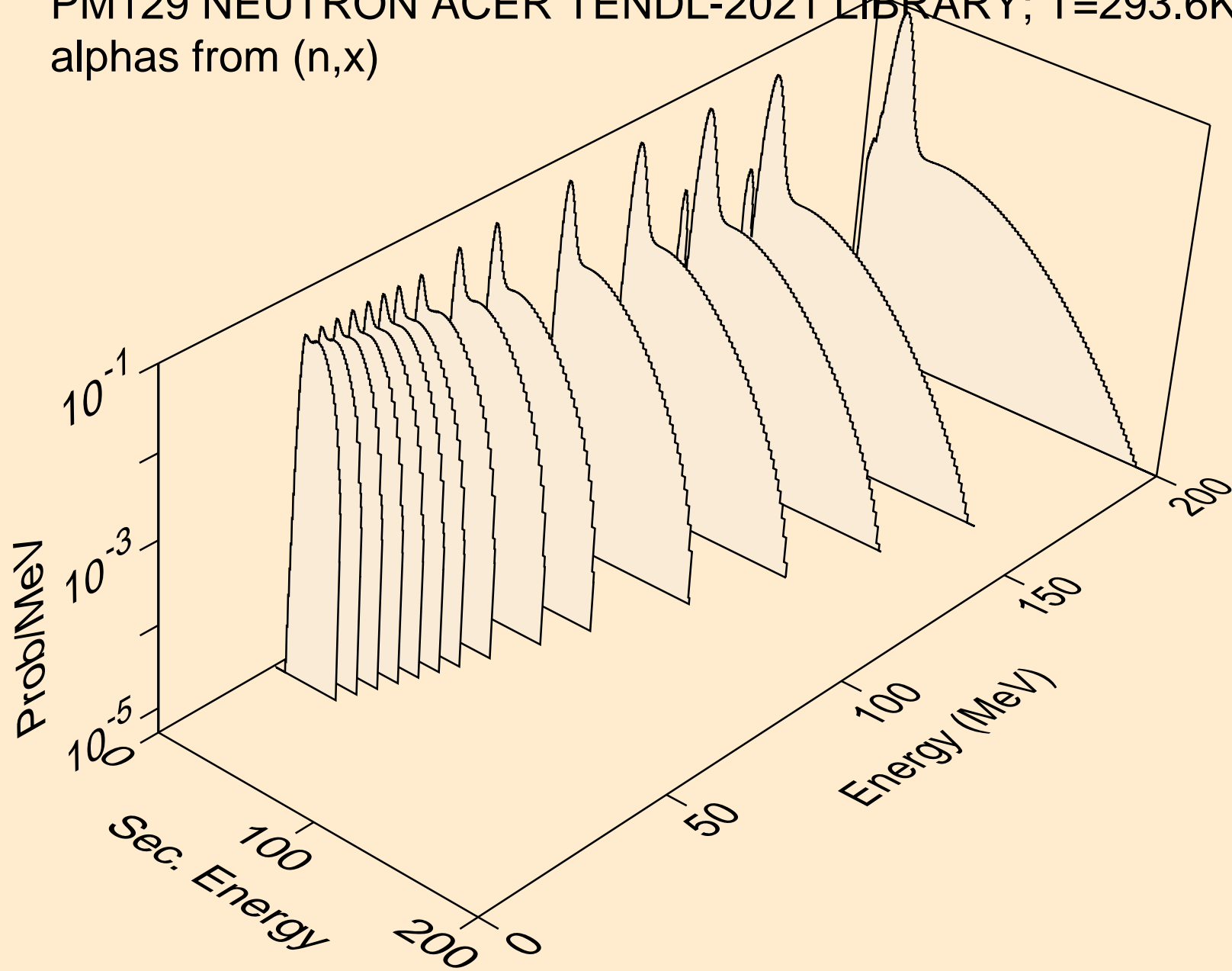

PM129 NEUTRON ACER TENDL-2021 LIBRARY; T=293.6K  
alphas from (n,n\*)a

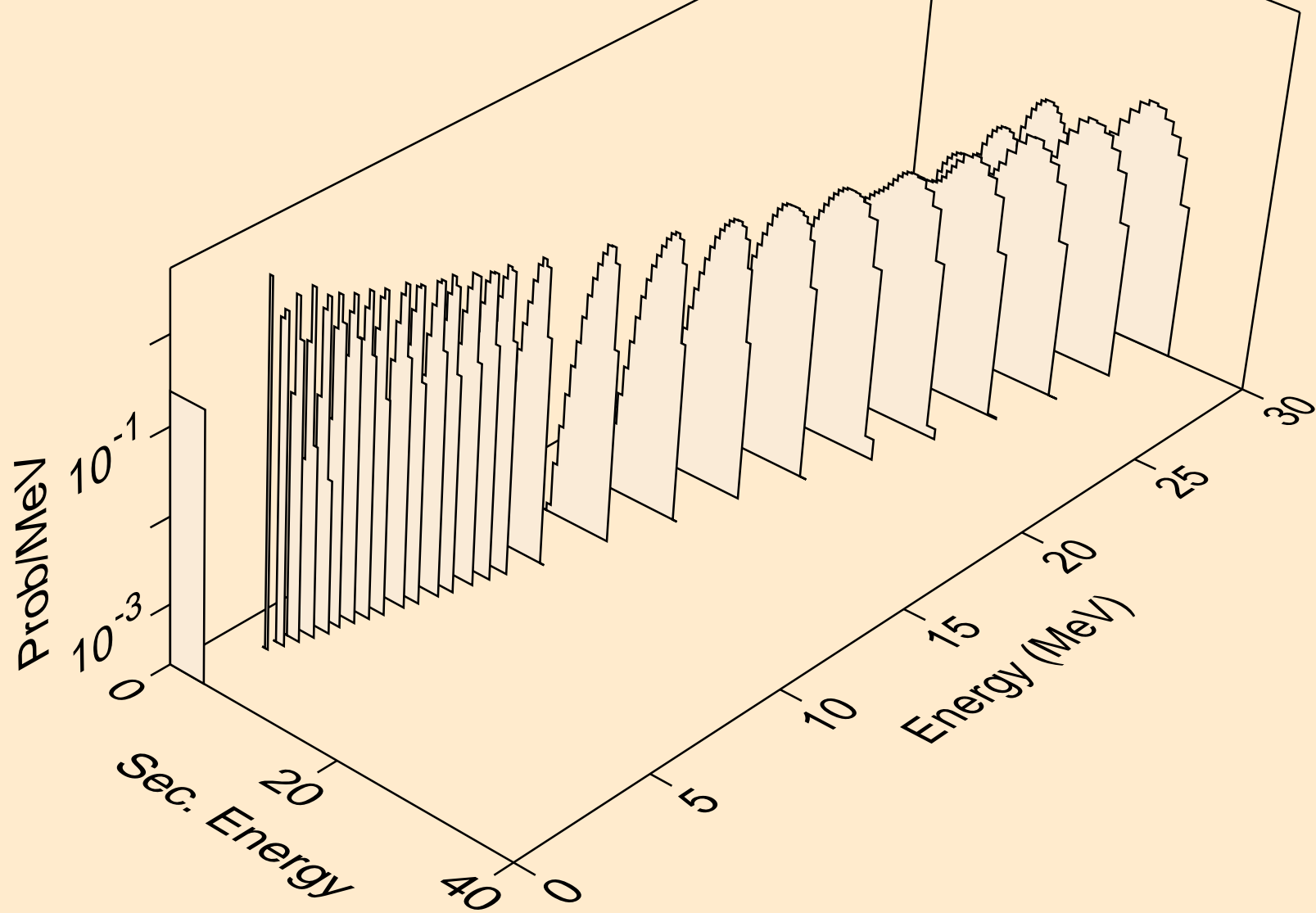

PM129 NEUTRON ACER TENDL-2021 LIBRARY; T=293.6K  
alphas from (n,2n)a

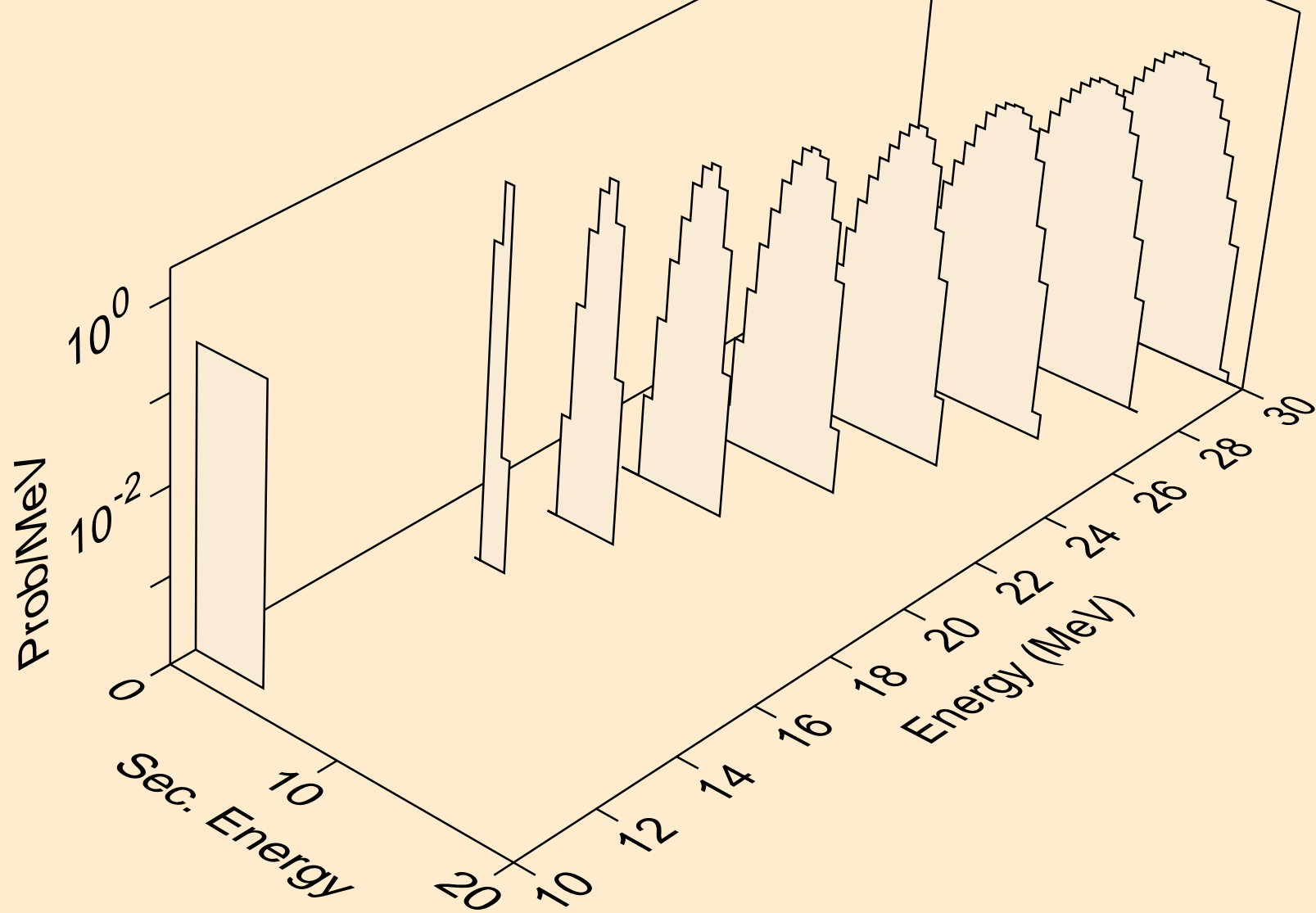

PM129 NEUTRON ACER TENDL-2021 LIBRARY; T=293.6K  
alphas from (n,n\*)2a

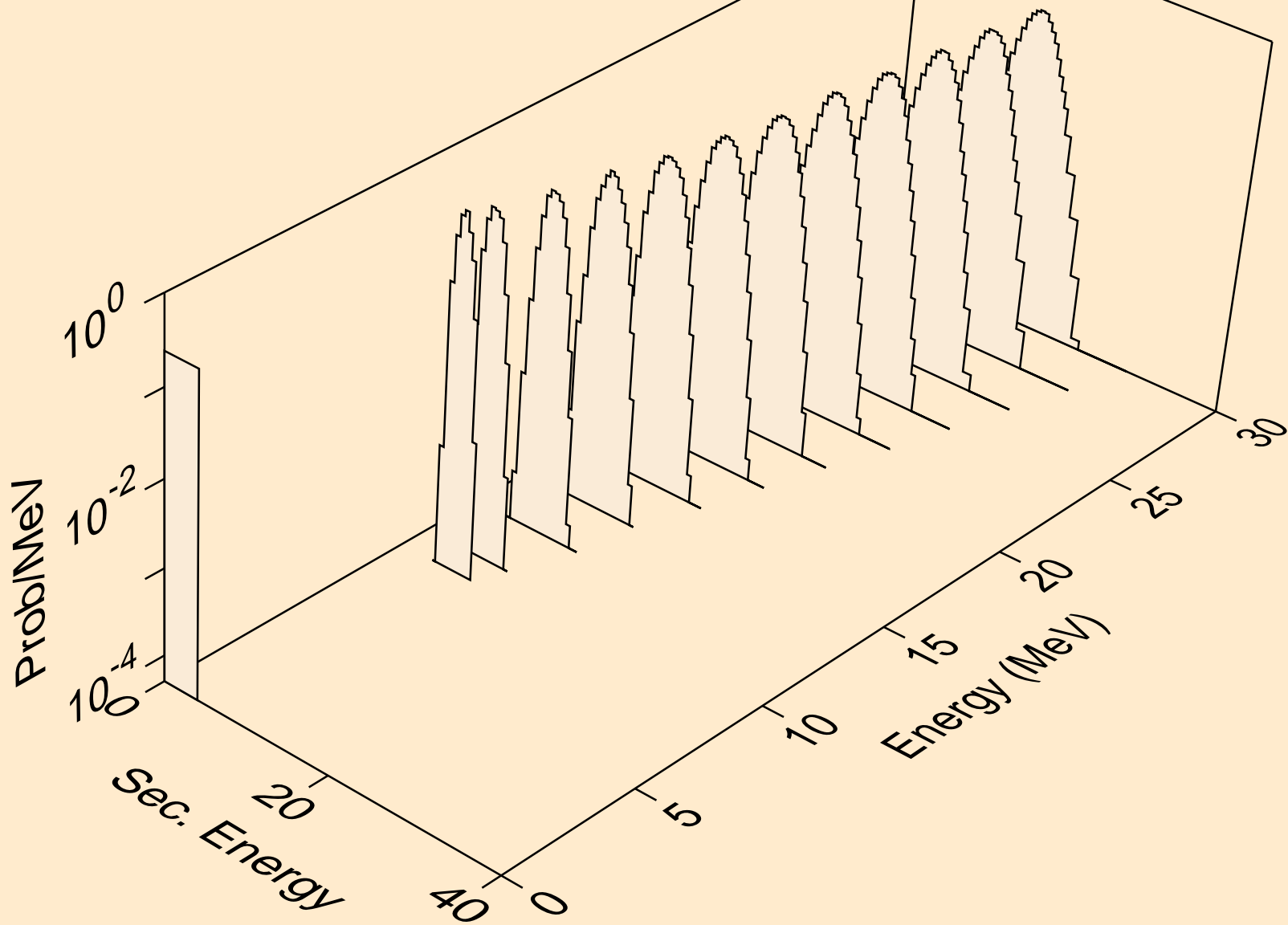

PM129 NEUTRON ACER TENDL-2021 LIBRARY; T=293.6K  
alphas from (n,npa)

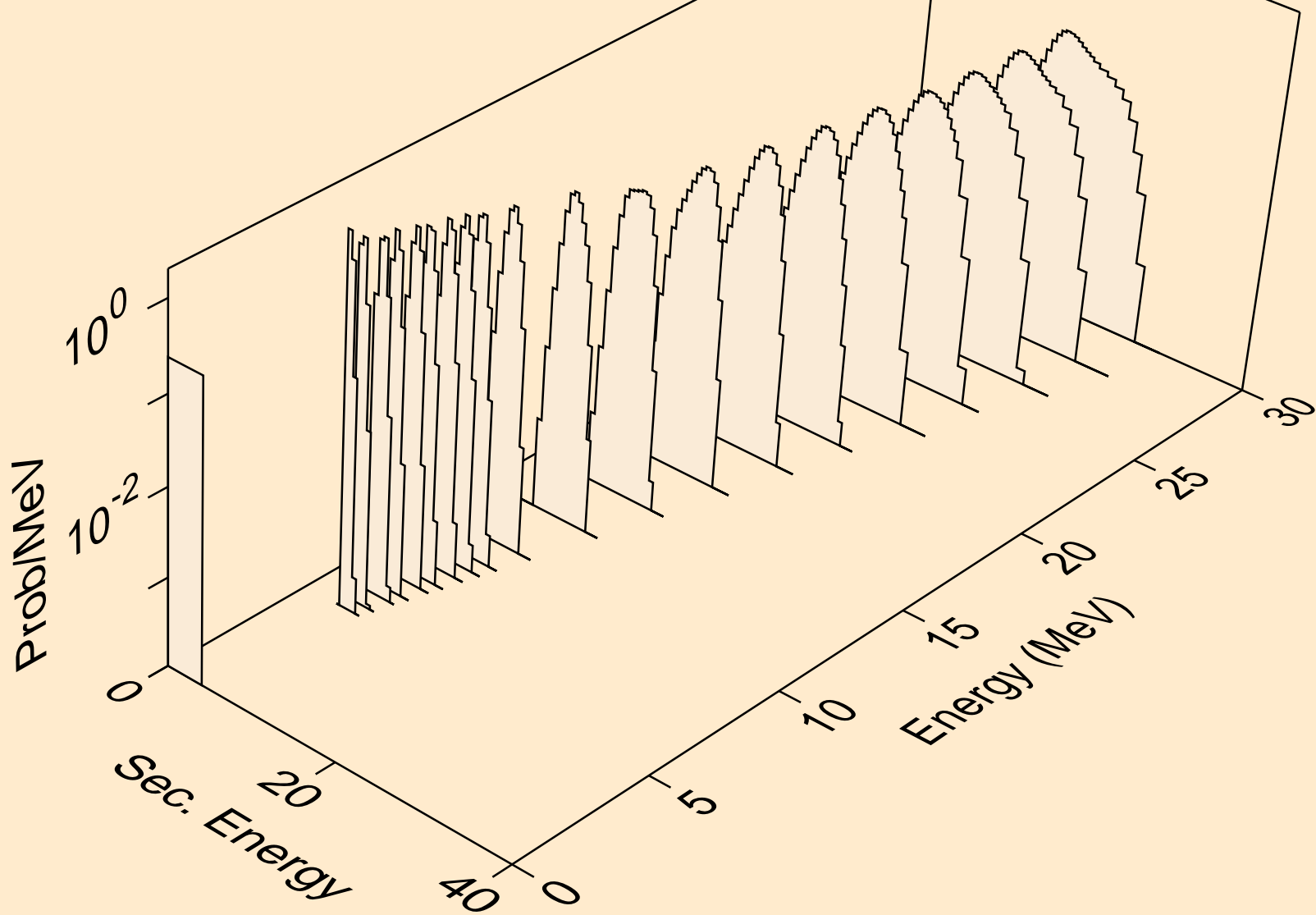

PM129 NEUTRON ACER TENDL-2021 LIBRARY; T=293.6K  
alphas from (n,a)

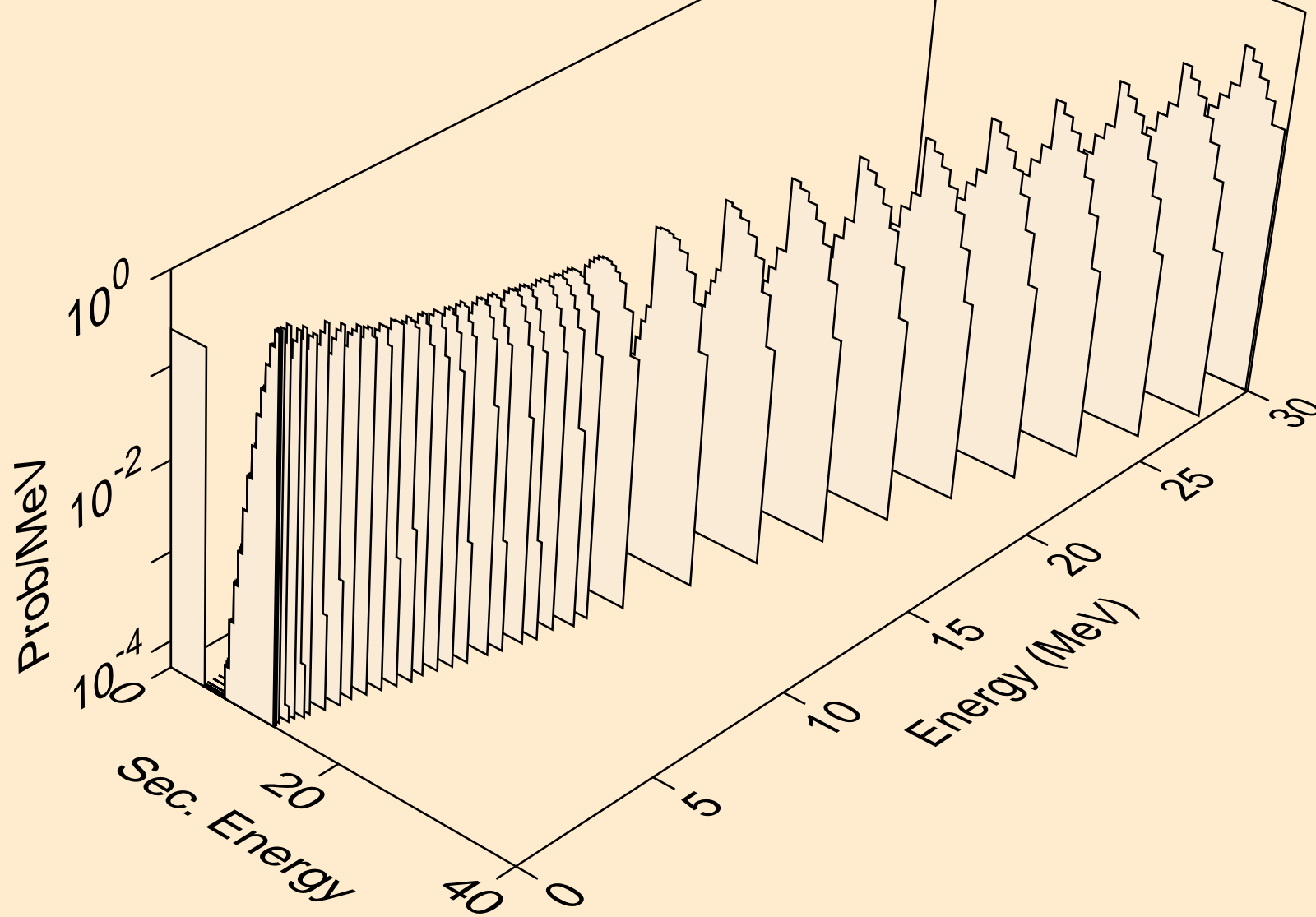



PM129 NEUTRON ACER TENDL-2021 LIBRARY; T=293.6K  
alphas from (n,2a)

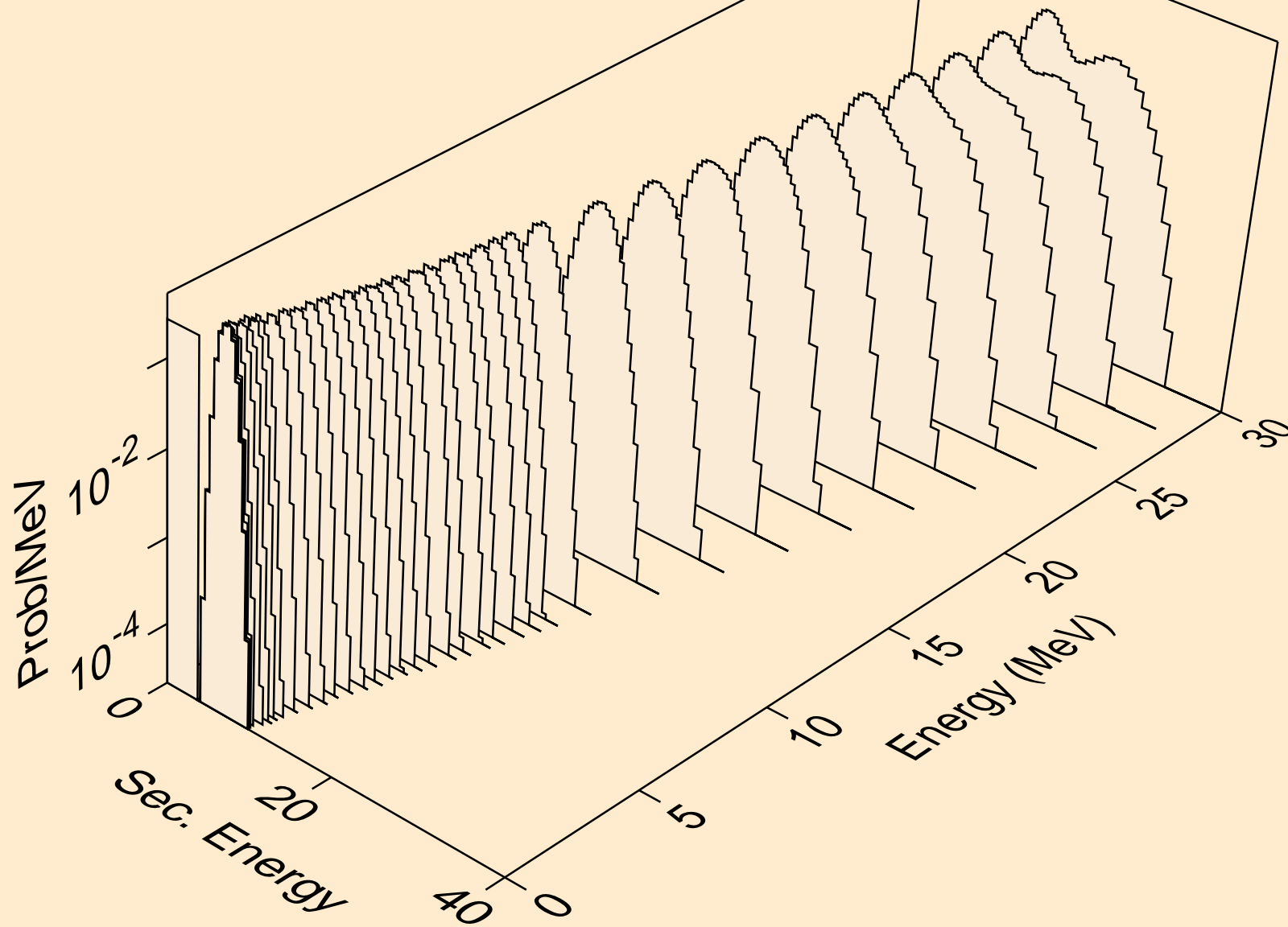

PM129 NEUTRON ACER TENDL-2021 LIBRARY; T=293.6K  
alphas from (n,3a)

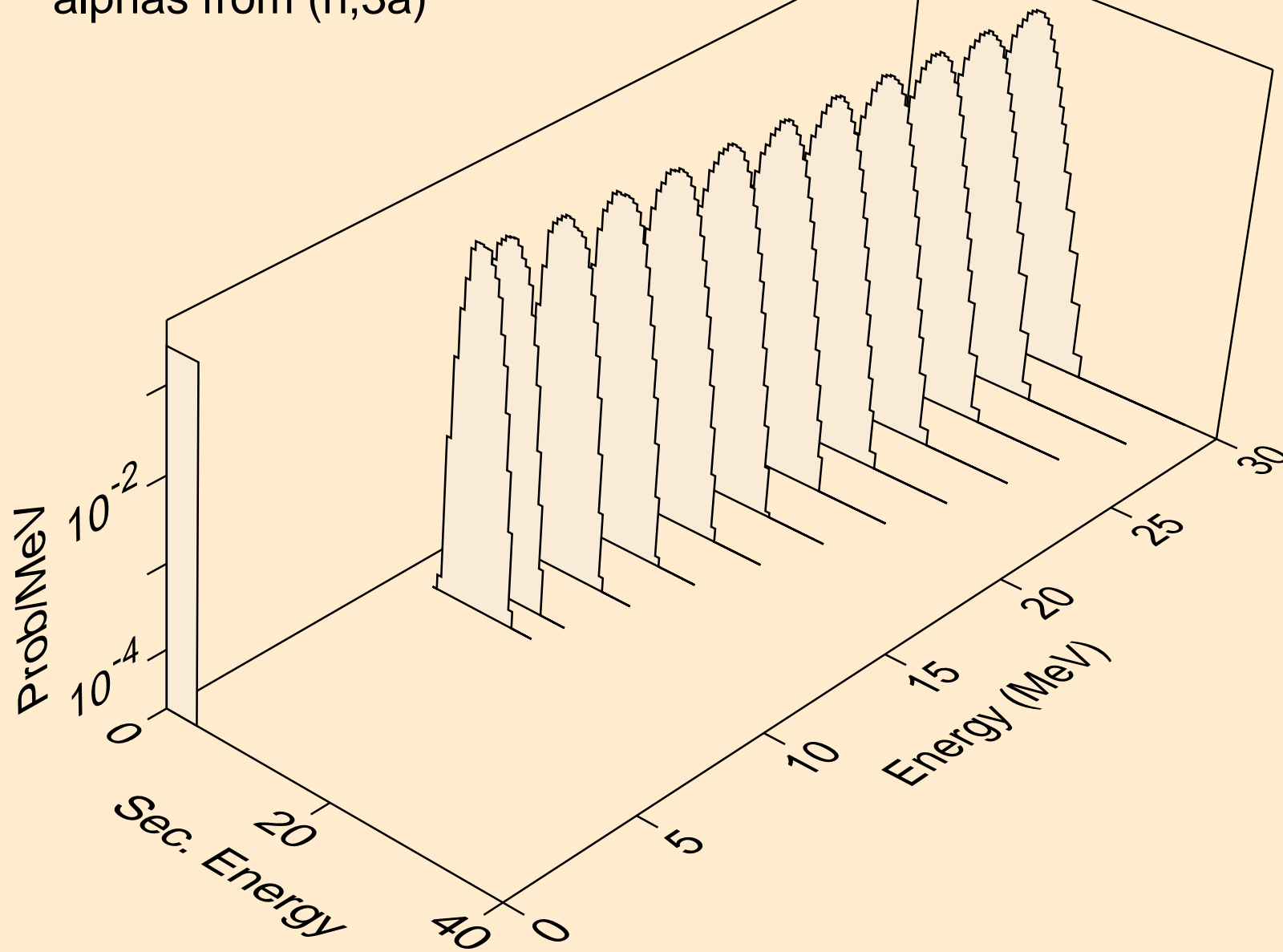

PM129 NEUTRON ACER TENDL-2021 LIBRARY; T=293.6K  
alphas from (n,pa)

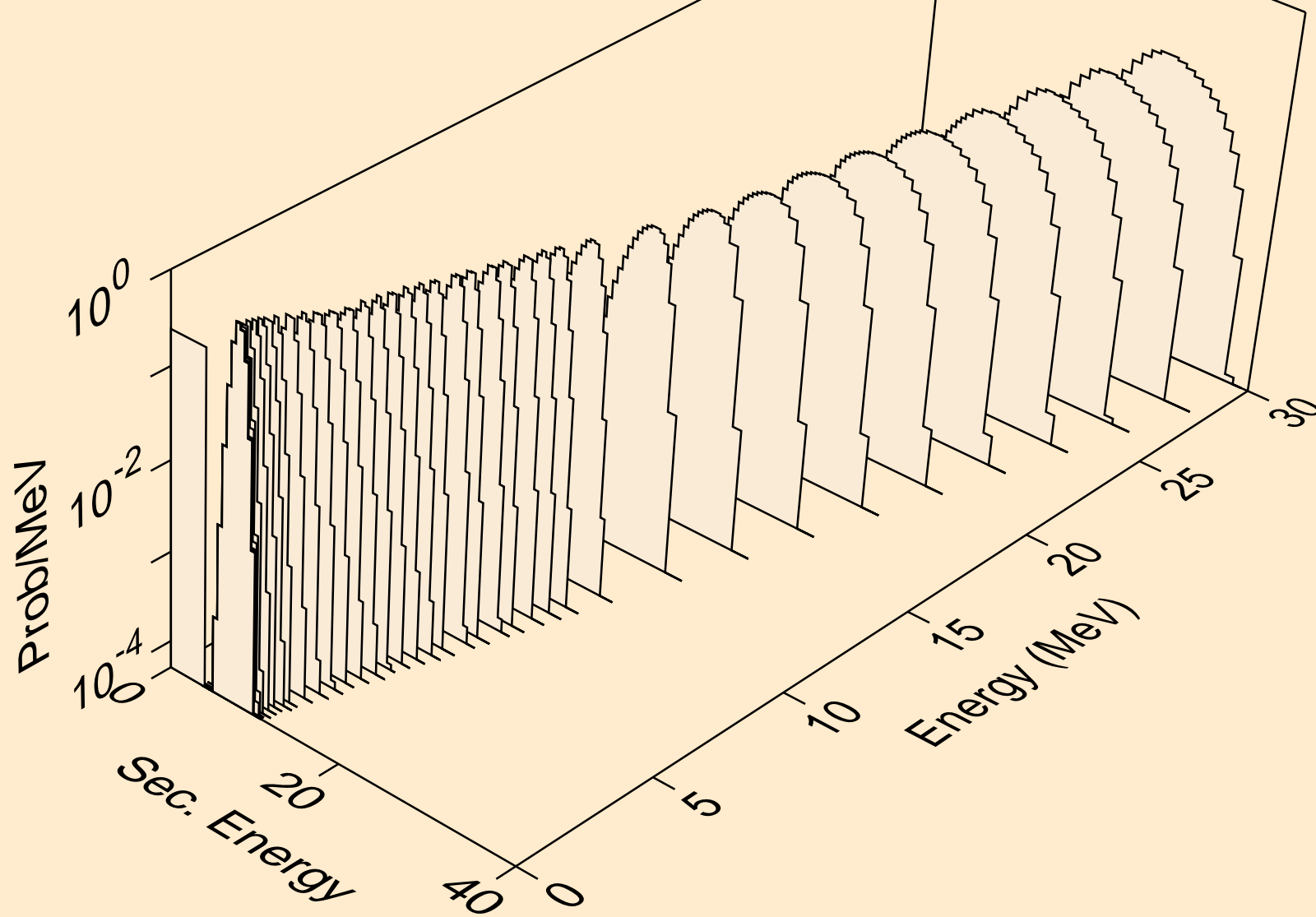

PM129 NEUTRON ACER TENDL-2021 LIBRARY; T=293.6K  
alphas from (n,d2a)

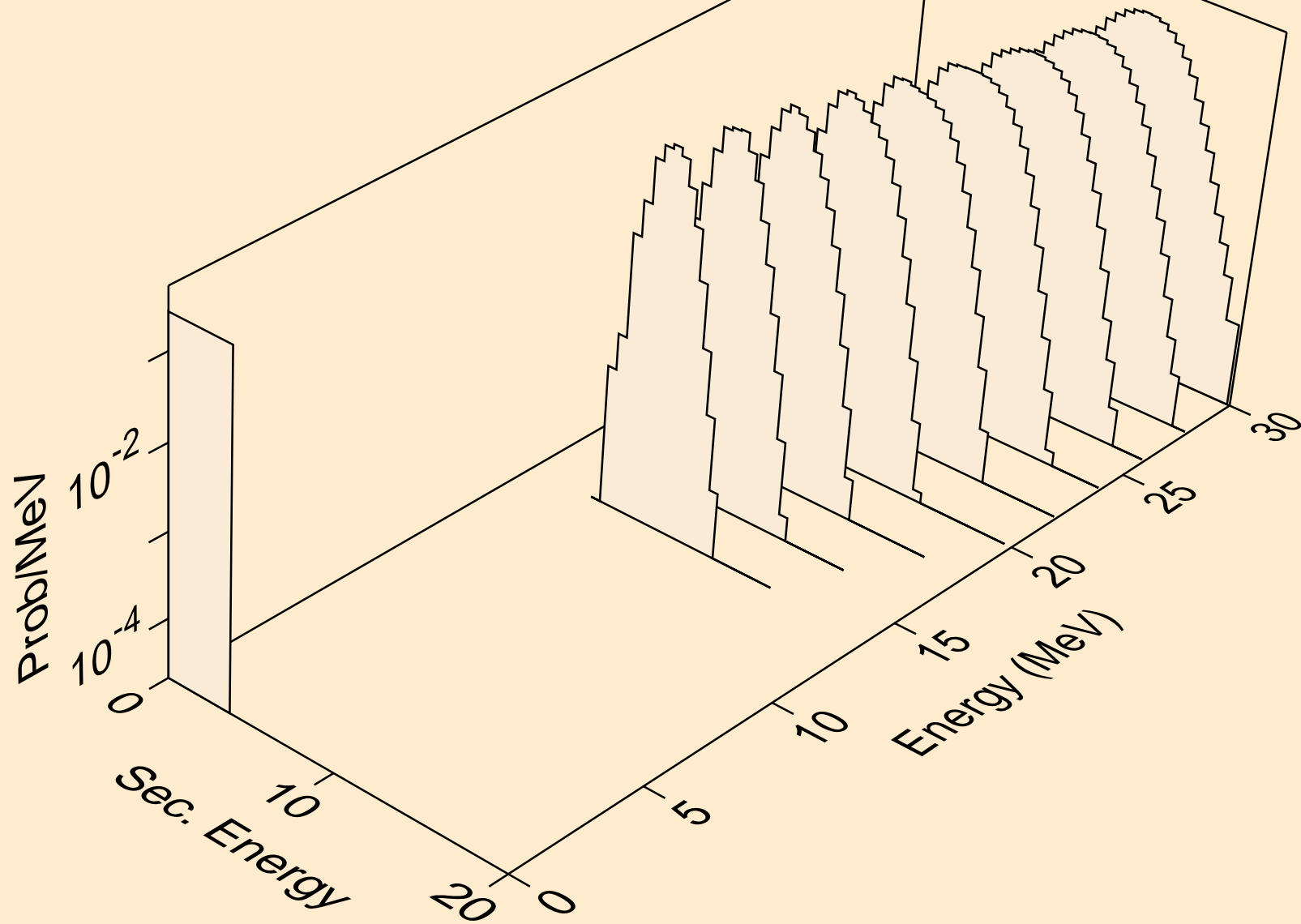

PM129 NEUTRON ACER TENDL-2021 LIBRARY; T=293.6K  
alphas from (n,da)

