

PM136M NEUTRON ACER TENDL-2021 LIBRARY; T=293.6K  
Principal cross sections

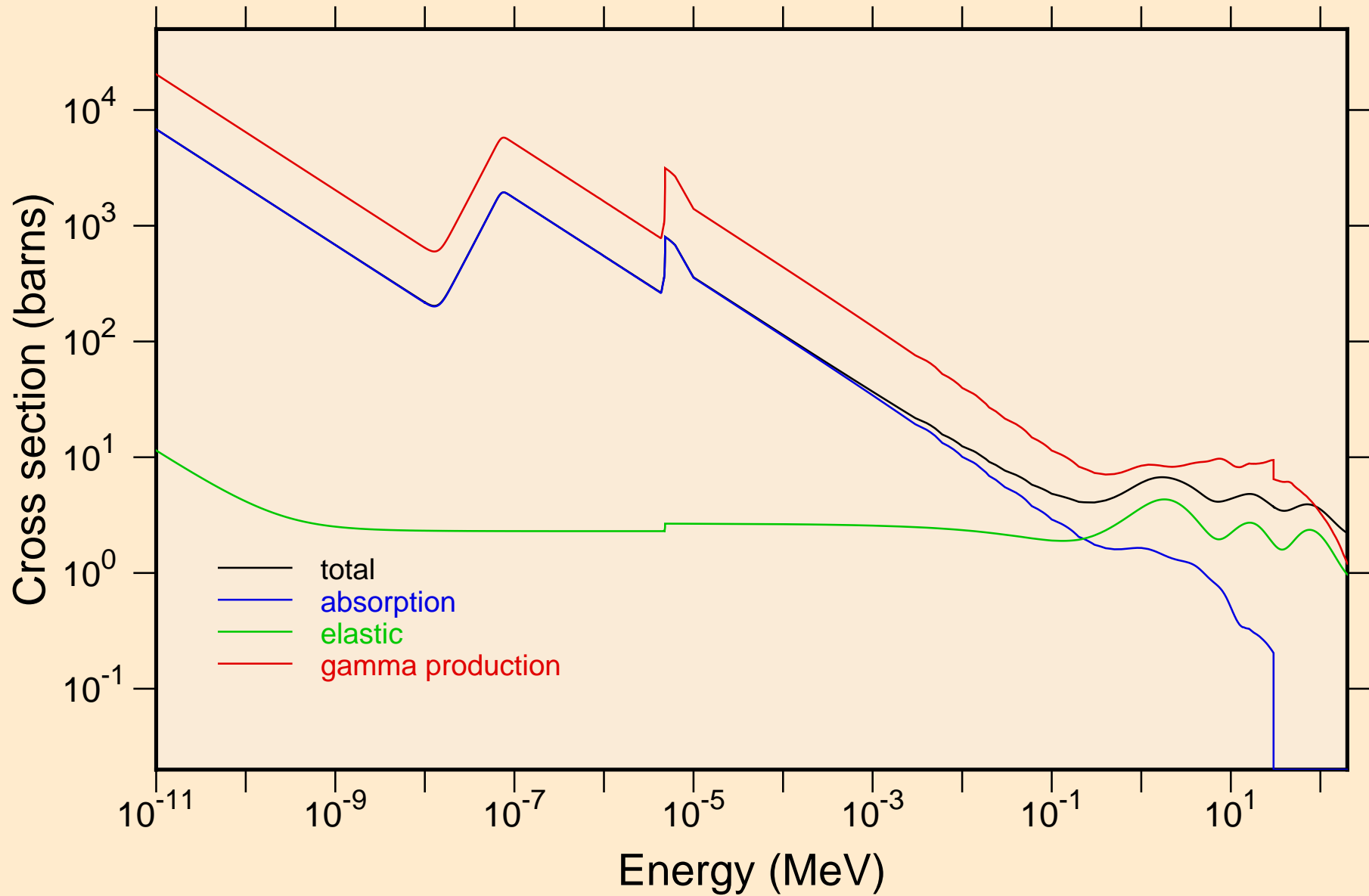

PM136M NEUTRON ACER TENDL-2021 LIBRARY; T=293.6K  
Heating

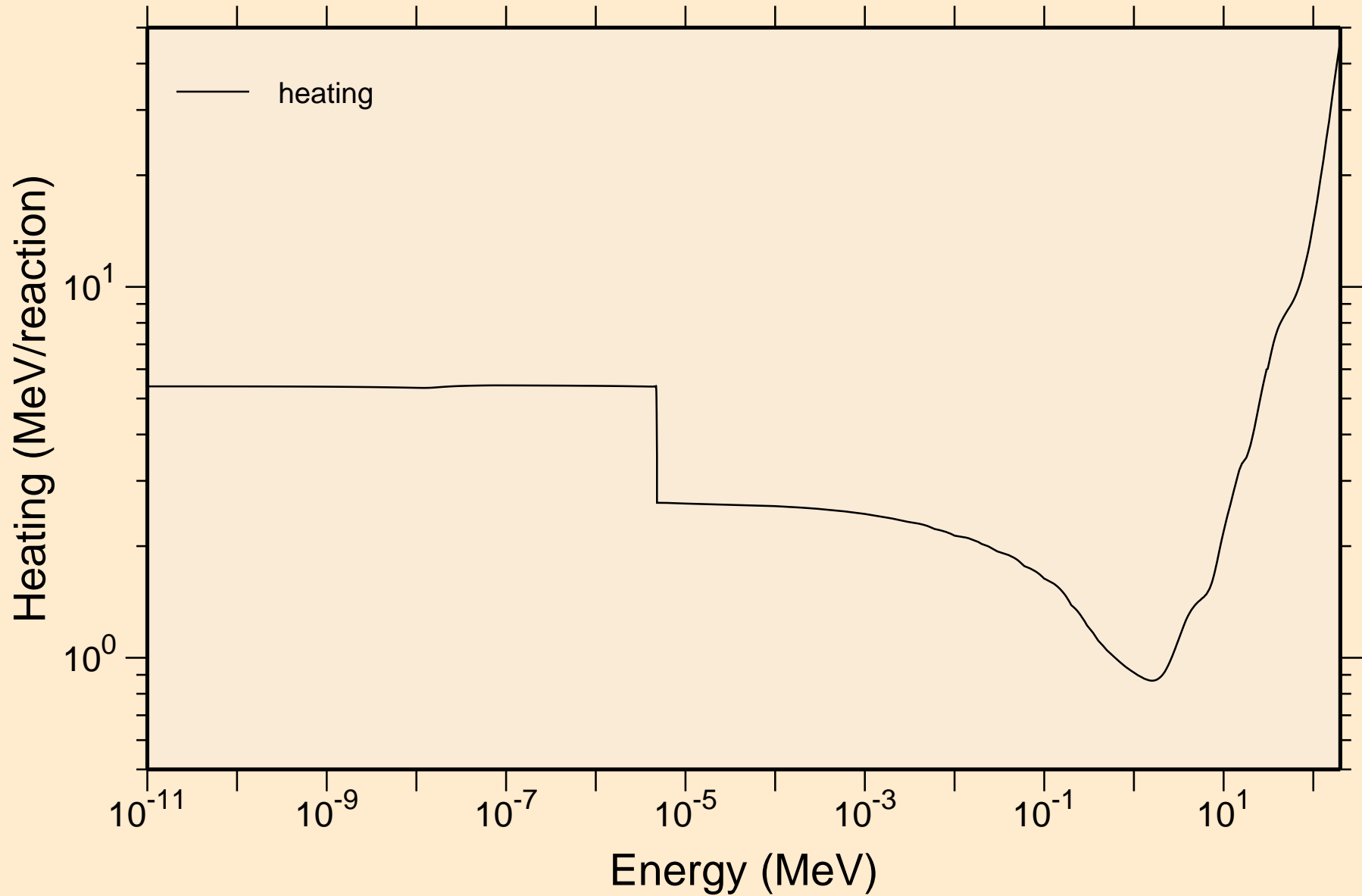

PM136M NEUTRON ACER TENDL-2021 LIBRARY; T=293.6K  
Damage

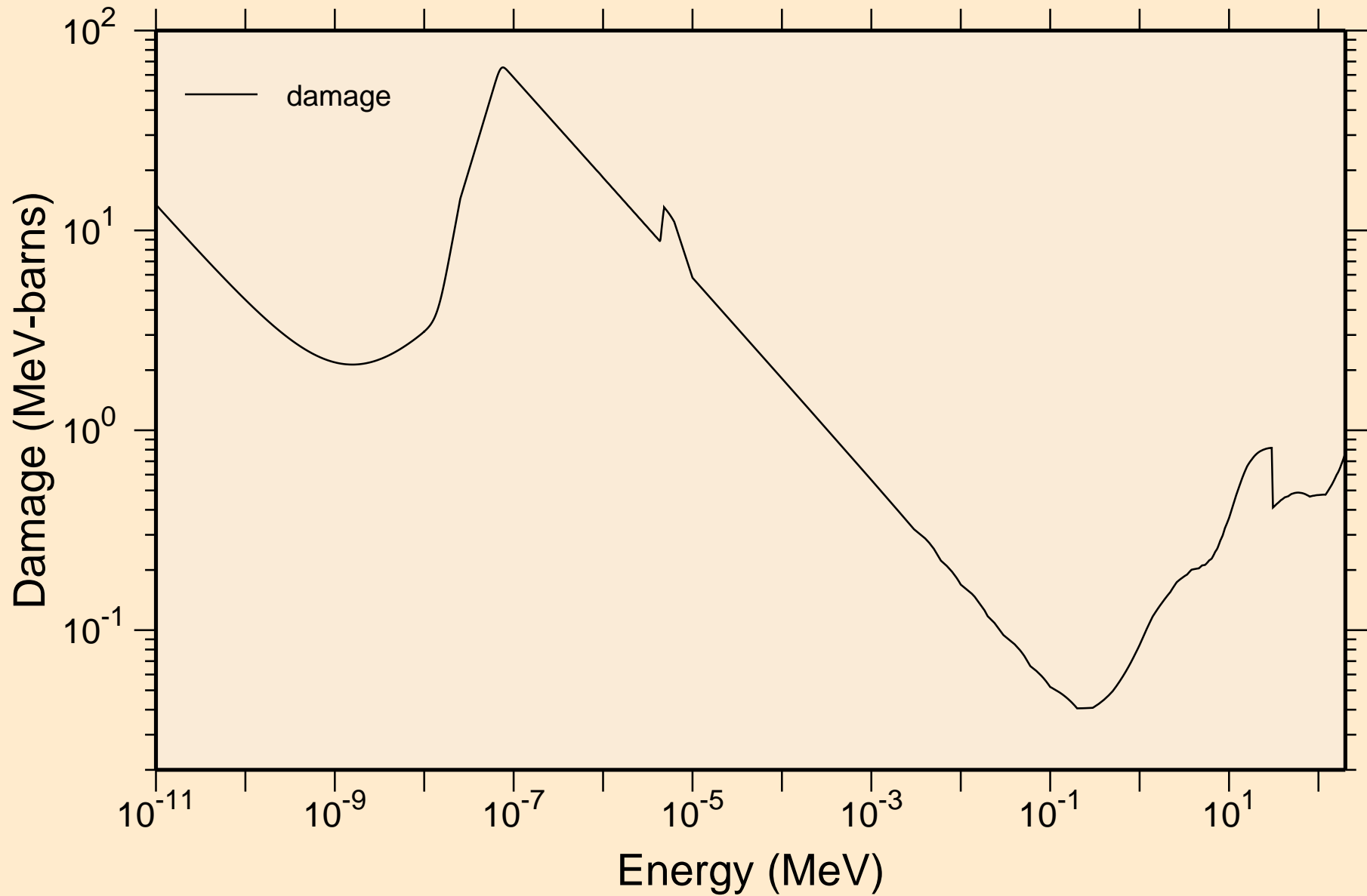

PM136M NEUTRON ACER TENDL-2021 LIBRARY; T=293.6K  
Non-threshold reactions

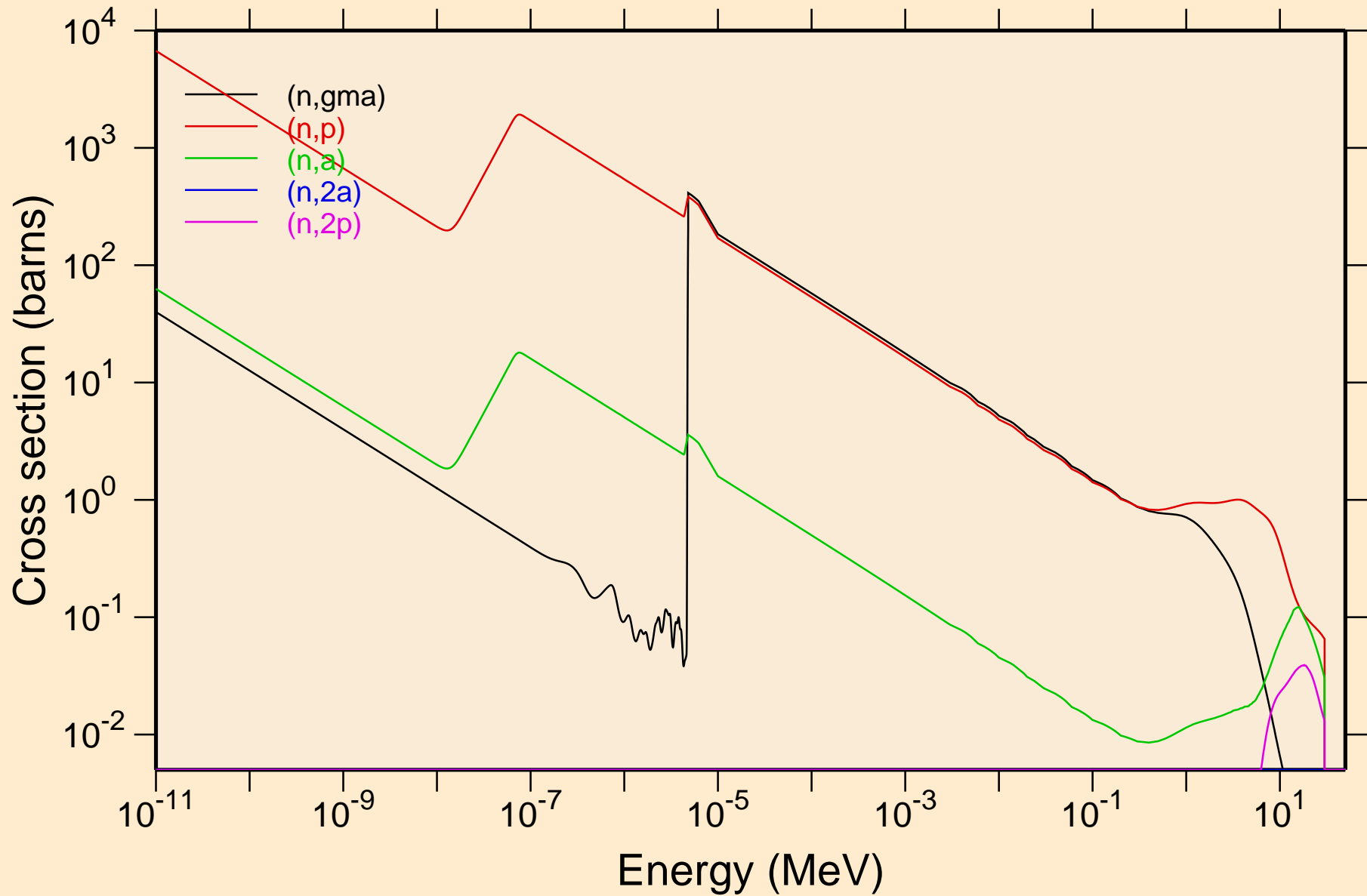

PM136M NEUTRON ACER TENDL-2021 LIBRARY; T=293.6K  
Non-threshold reactions

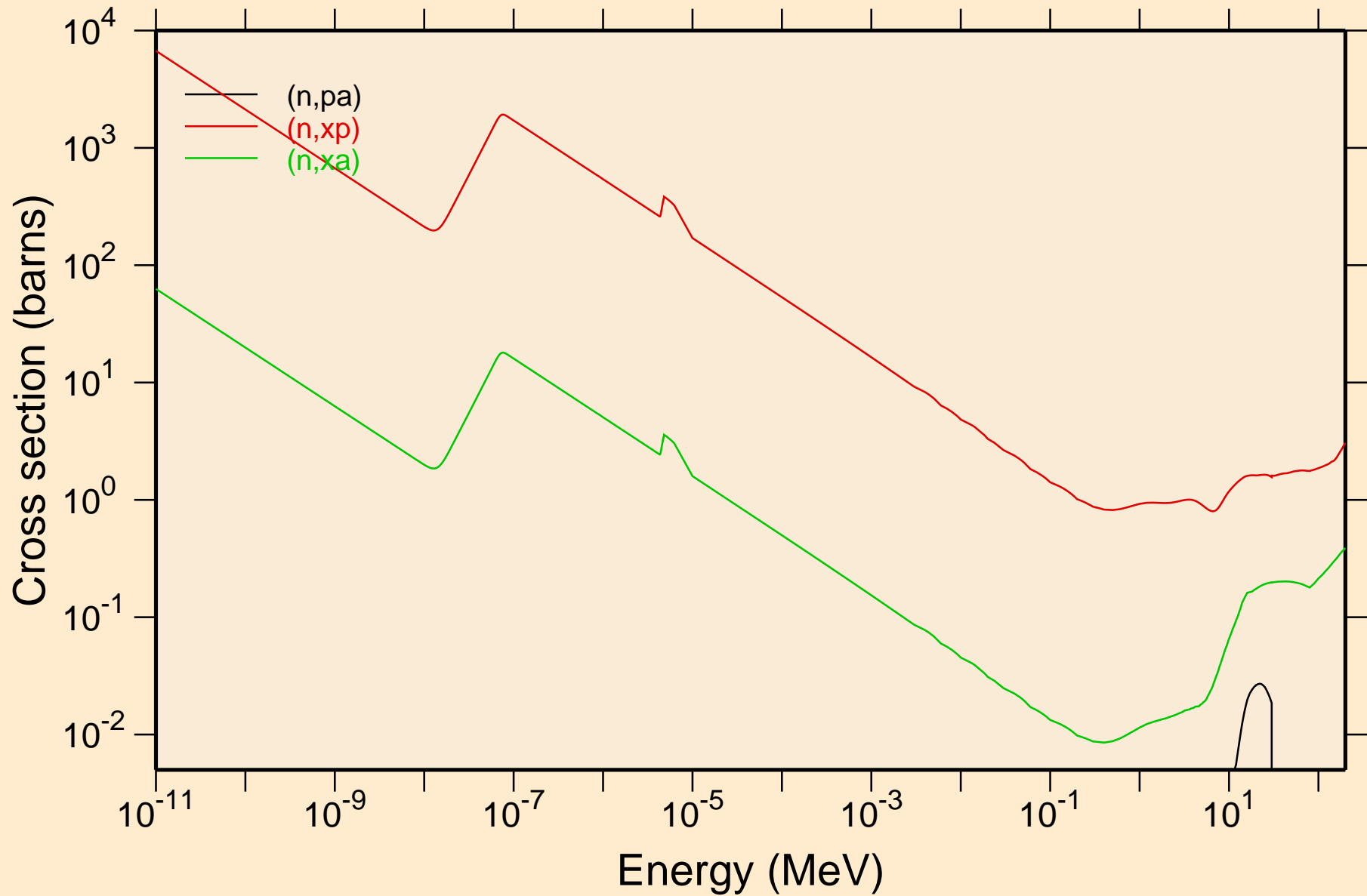

PM136M NEUTRON ACER TENDL-2021 LIBRARY; T=293.6K  
Principal cross sections

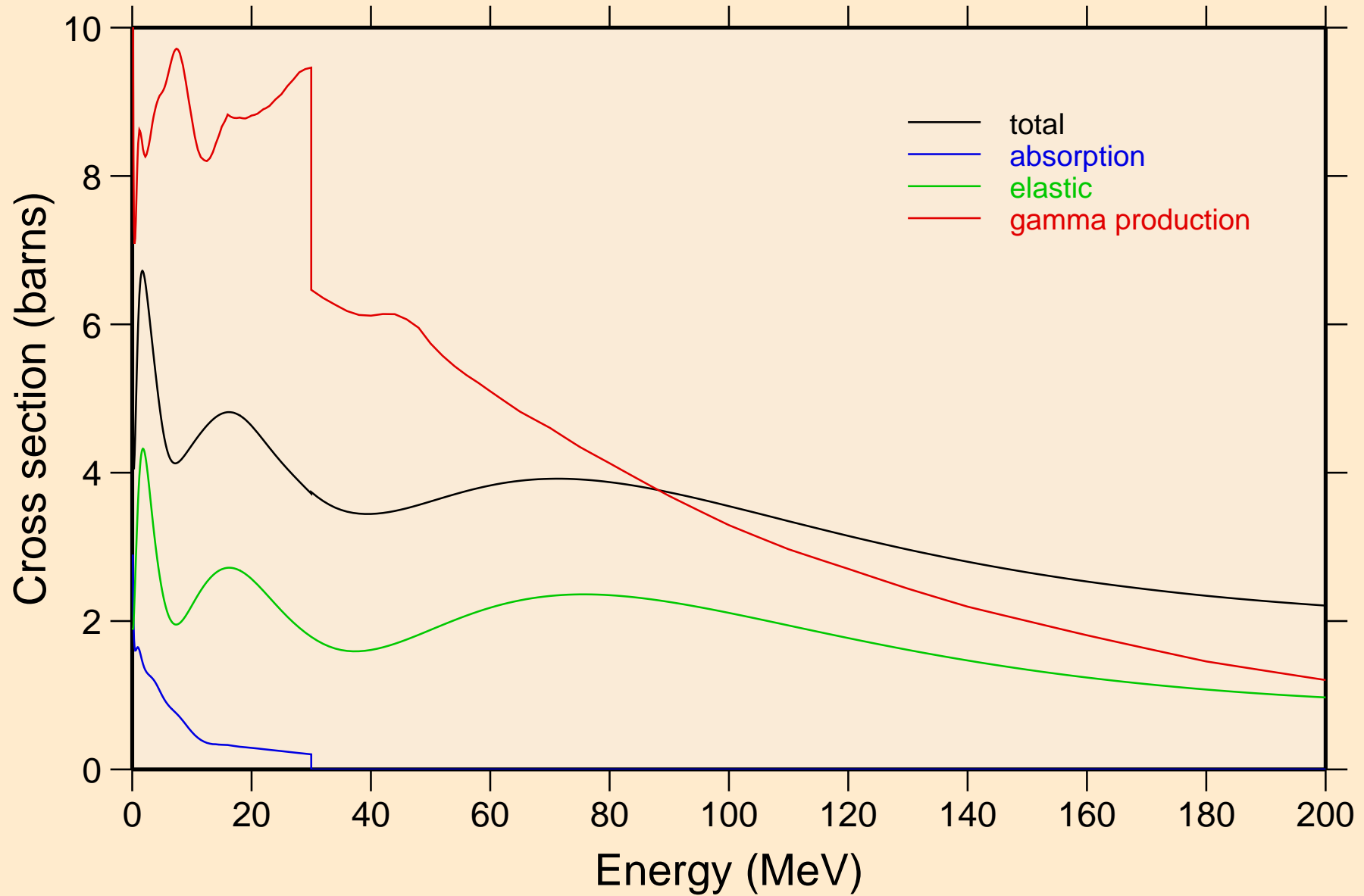

PM136M NEUTRON ACER TENDL-2021 LIBRARY; T=293.6K  
Heating

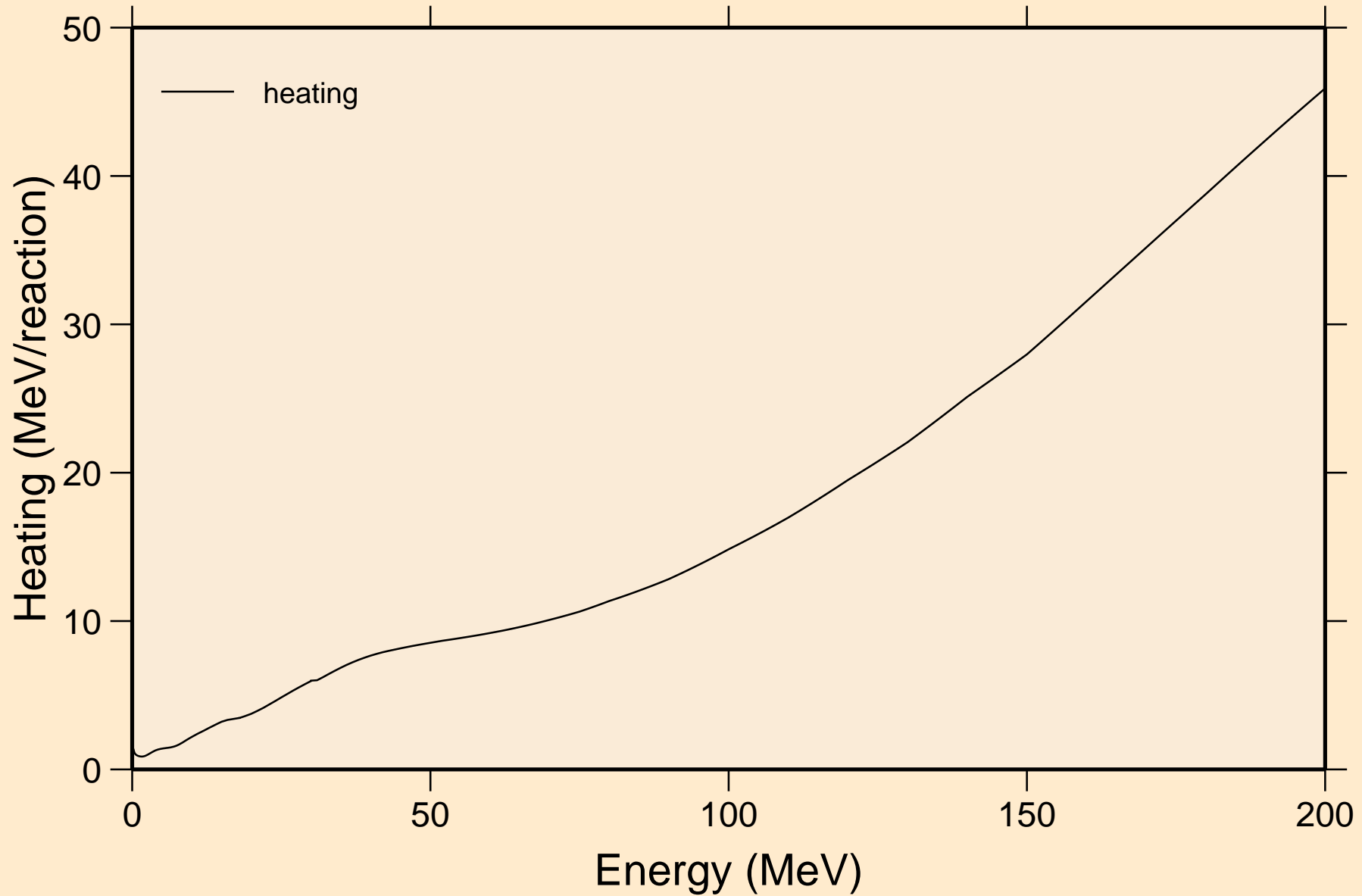

PM136M NEUTRON ACER TENDL-2021 LIBRARY; T=293.6K  
Damage

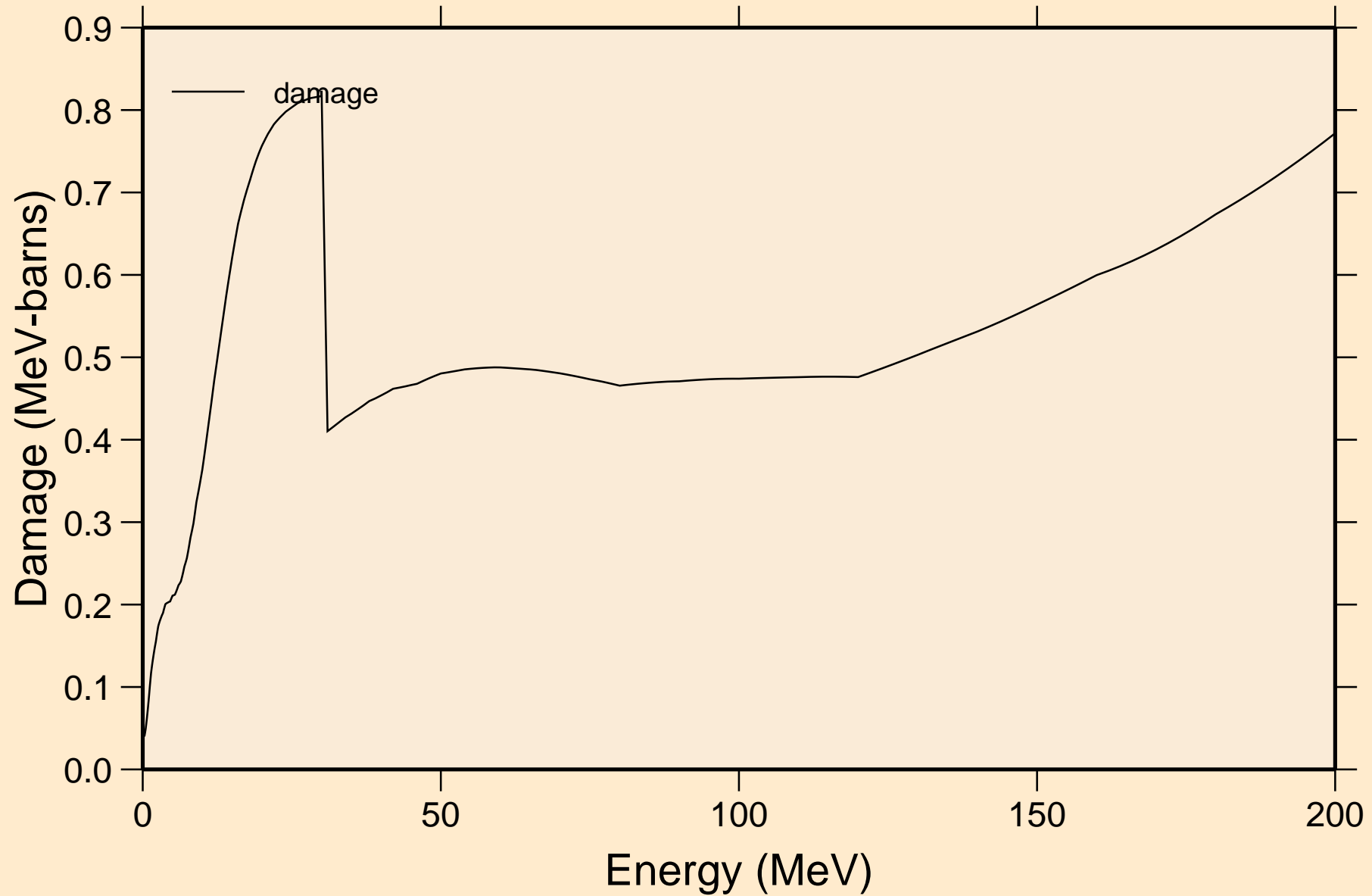



PM136M NEUTRON ACER TENDL-2021 LIBRARY; T=293.6K  
Non-threshold reactions

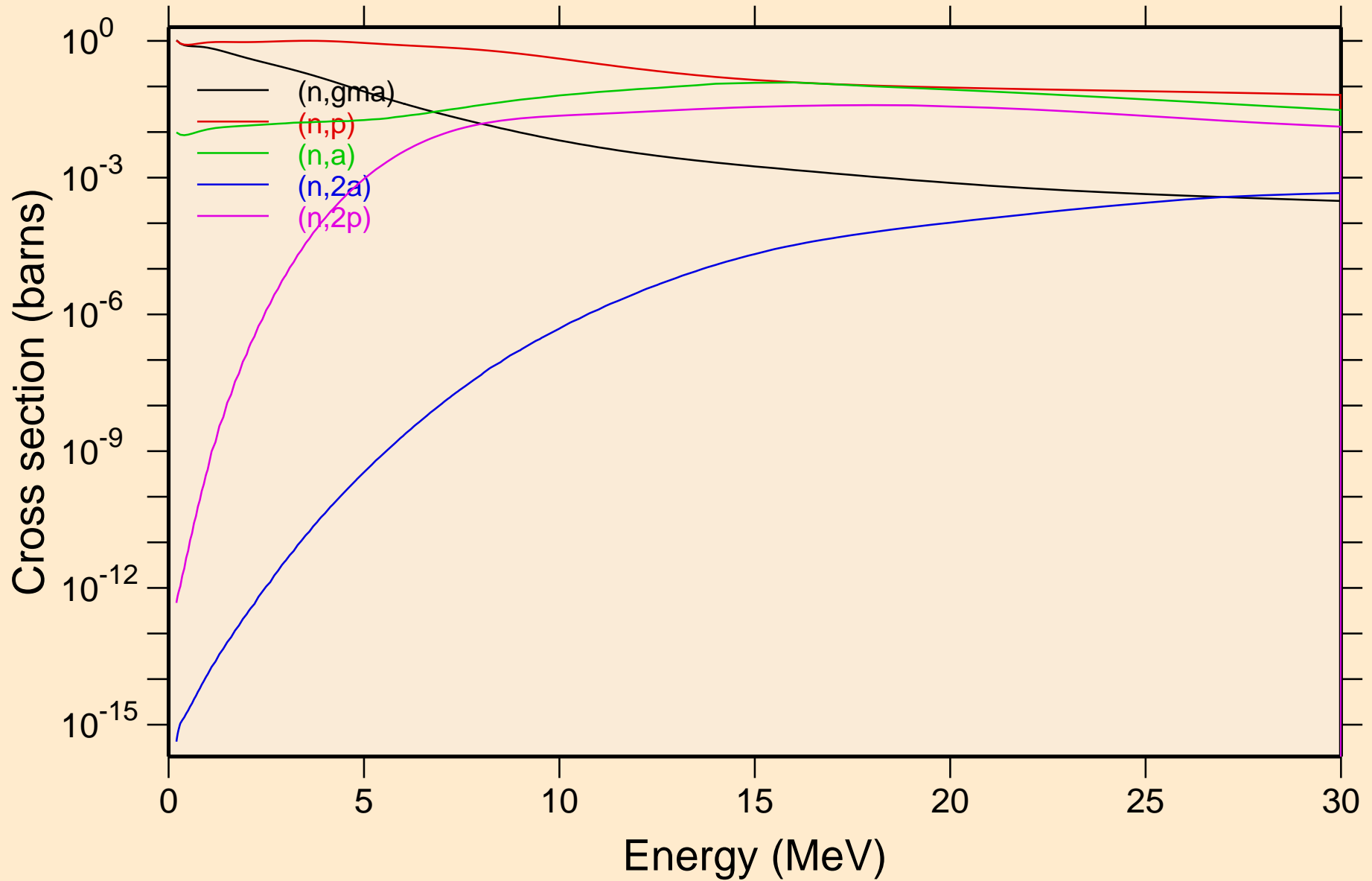

PM136M NEUTRON ACER TENDL-2021 LIBRARY; T=293.6K  
Non-threshold reactions

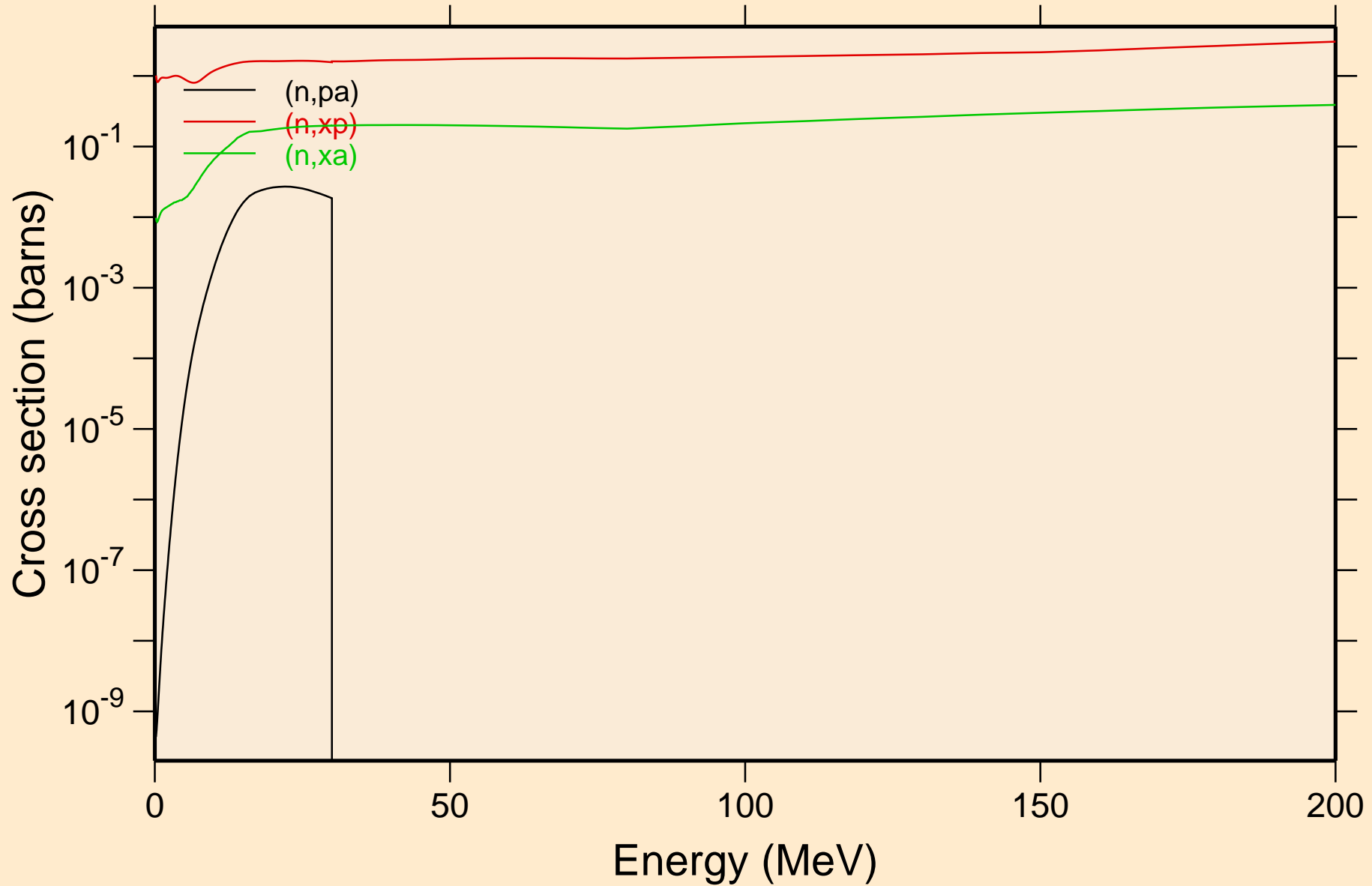

PM136M NEUTRON ACER TENDL-2021 LIBRARY; T=293.6K  
Inelastic levels

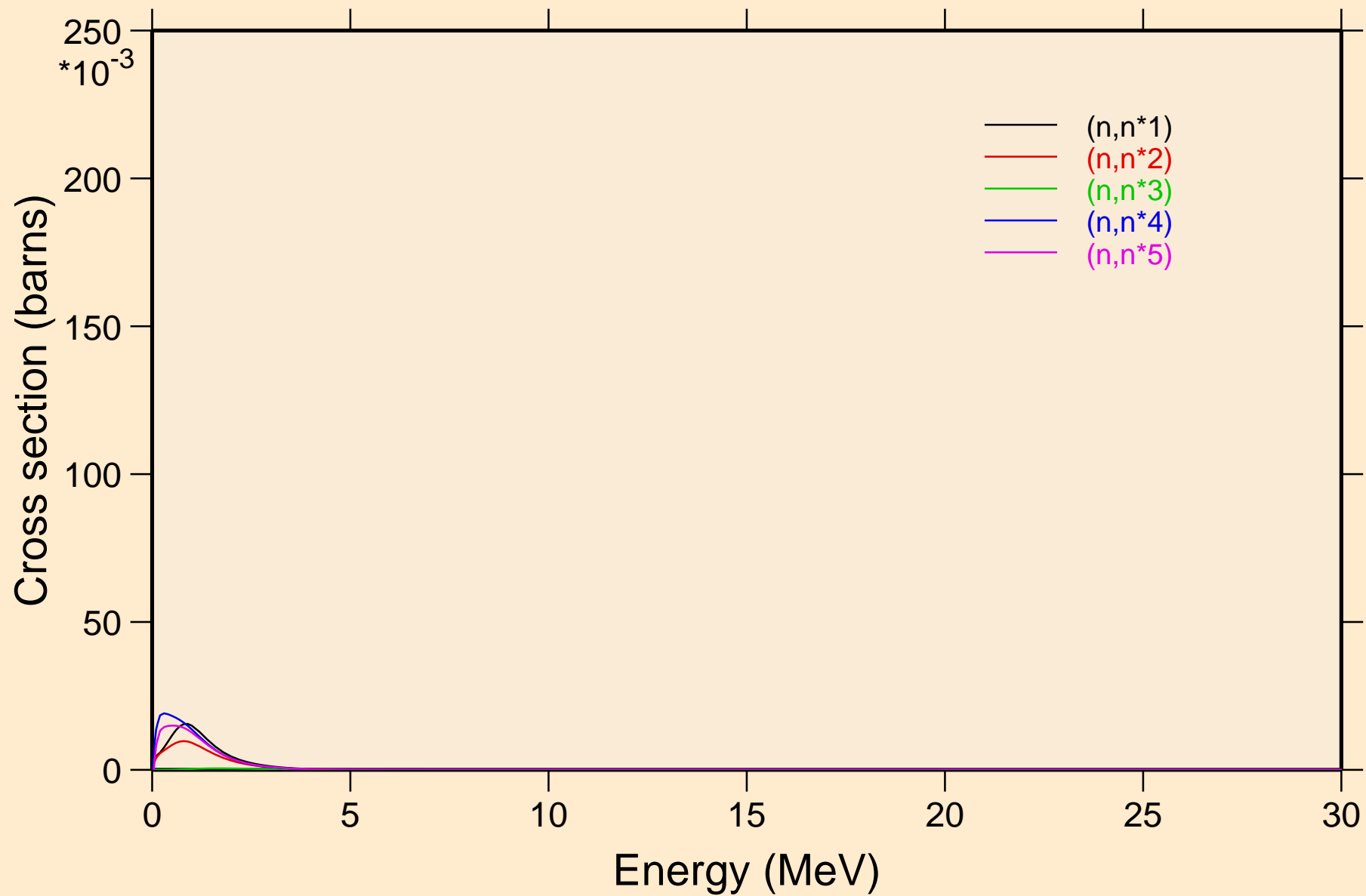

PM136M NEUTRON ACER TENDL-2021 LIBRARY; T=293.6K  
Inelastic levels

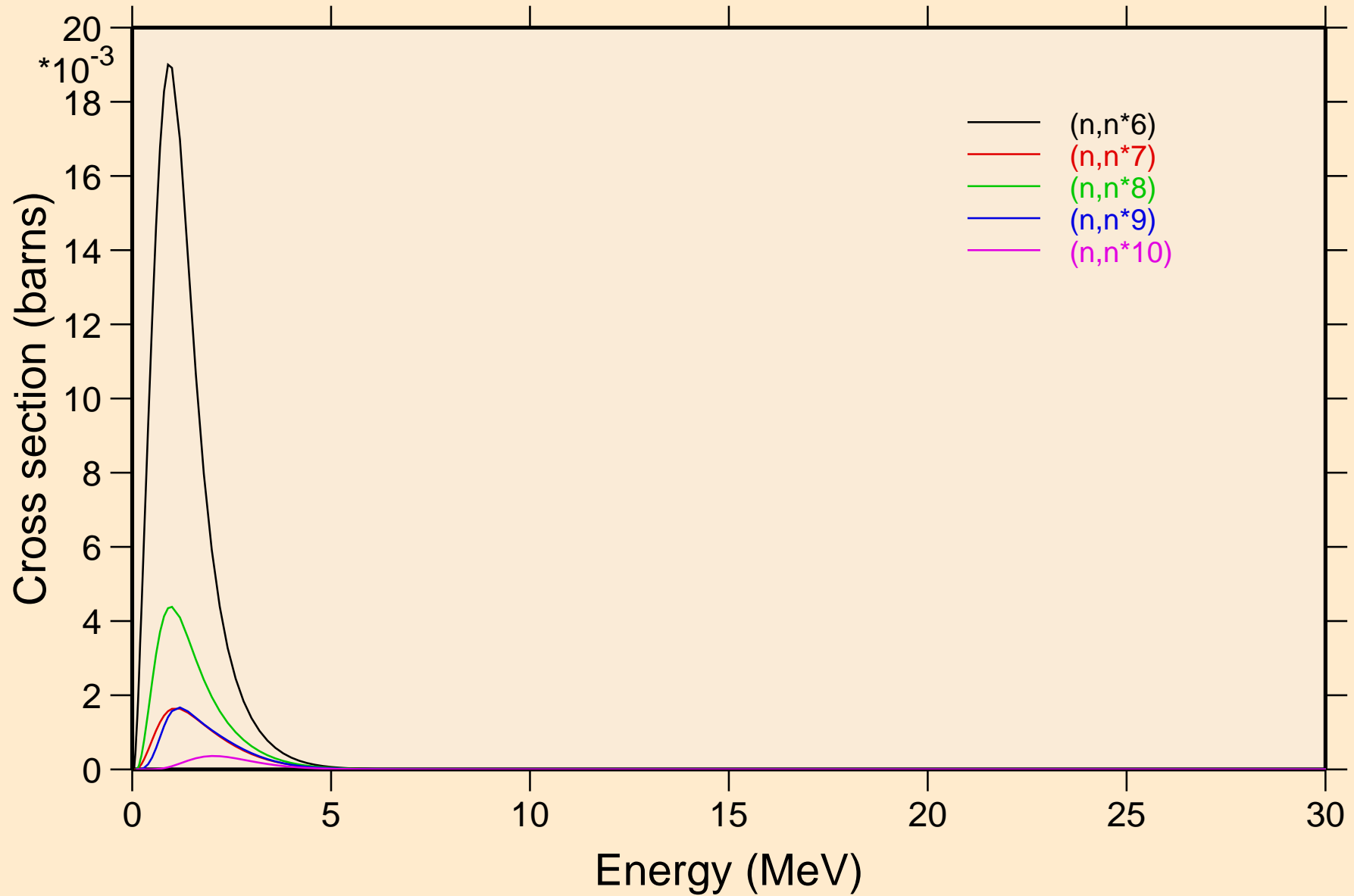

PM136M NEUTRON ACER TENDL-2021 LIBRARY; T=293.6K  
Inelastic levels

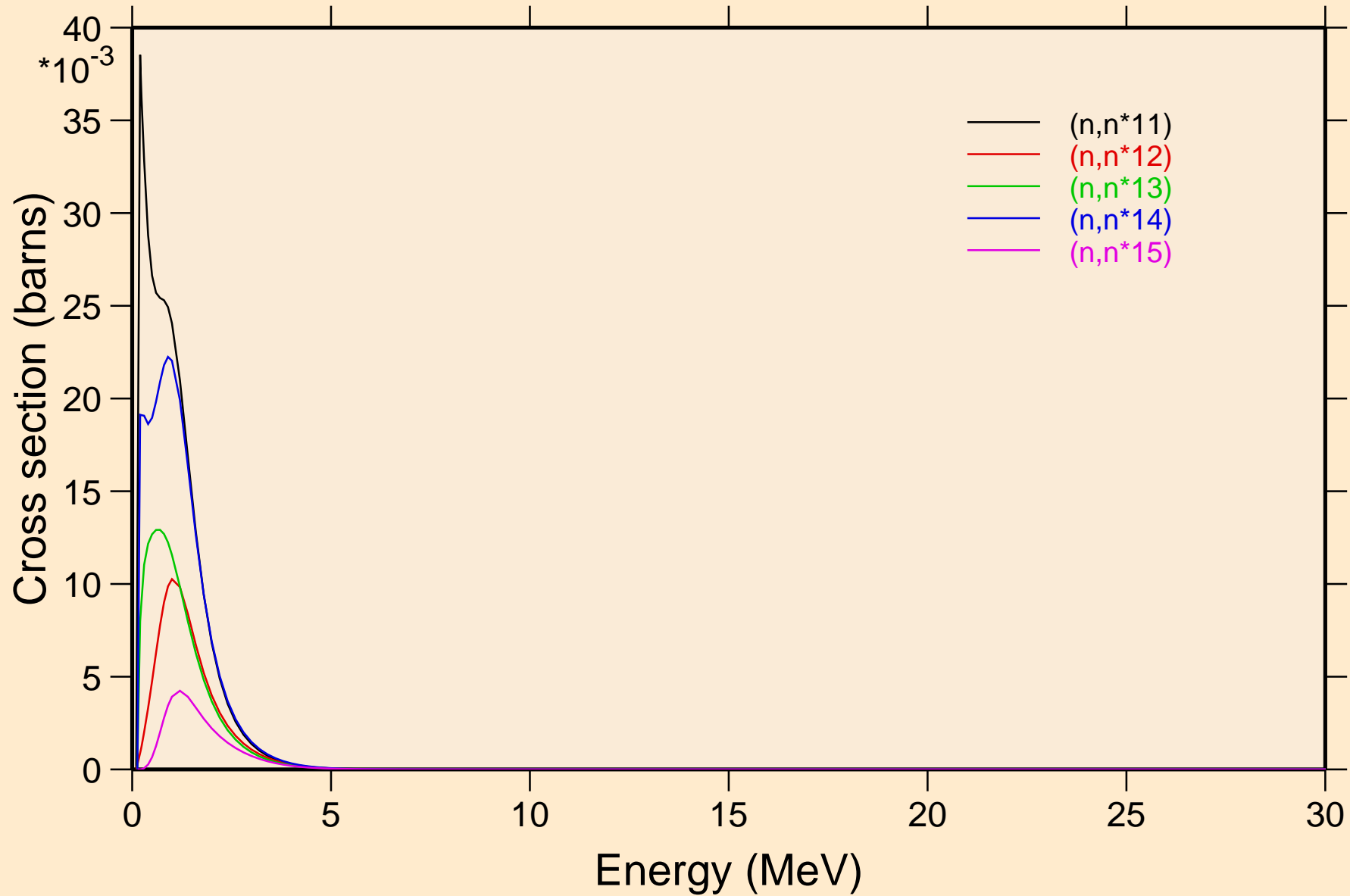

PM136M NEUTRON ACER TENDL-2021 LIBRARY; T=293.6K  
Inelastic levels

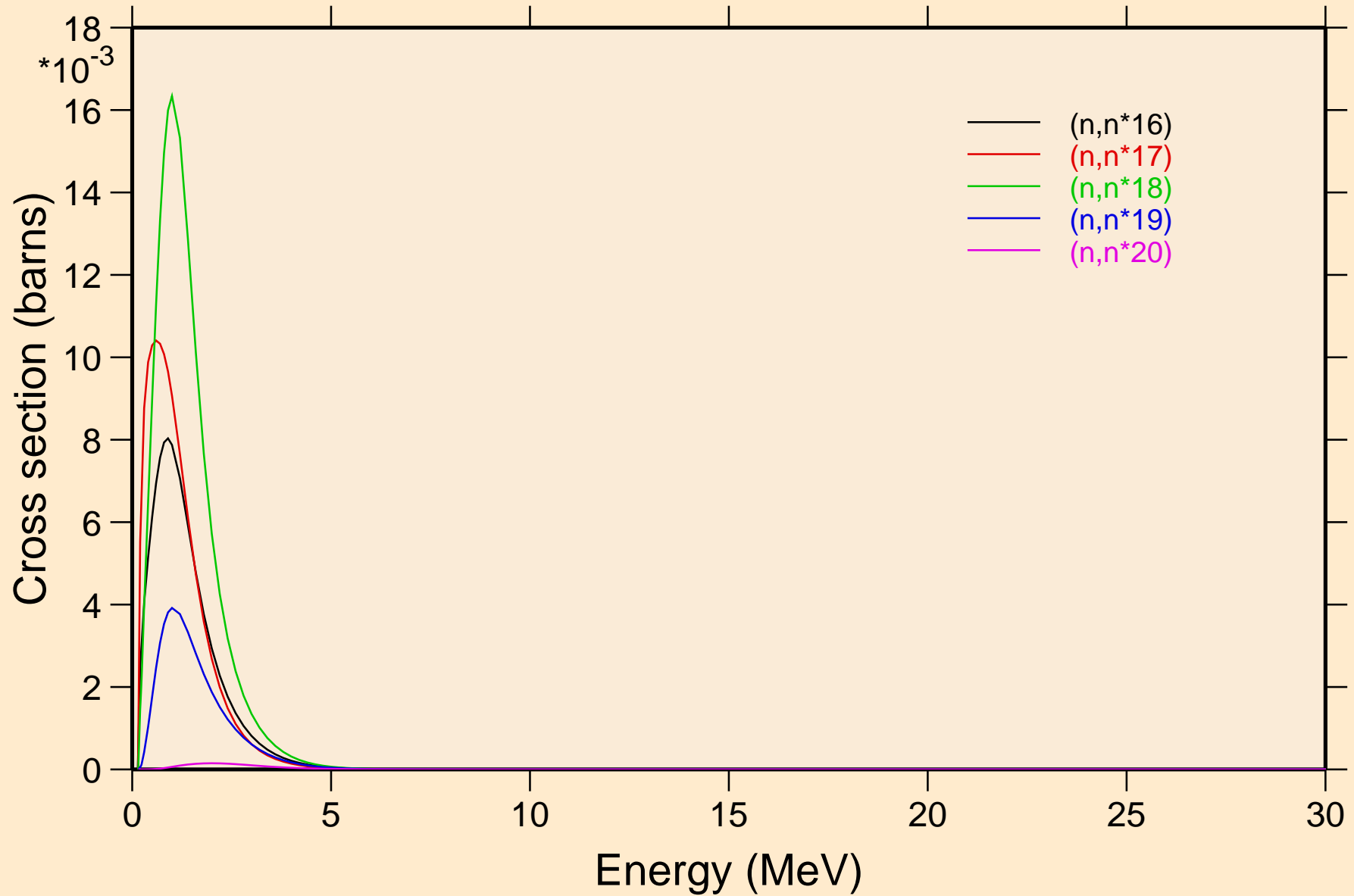

PM136M NEUTRON ACER TENDL-2021 LIBRARY; T=293.6K  
Inelastic levels

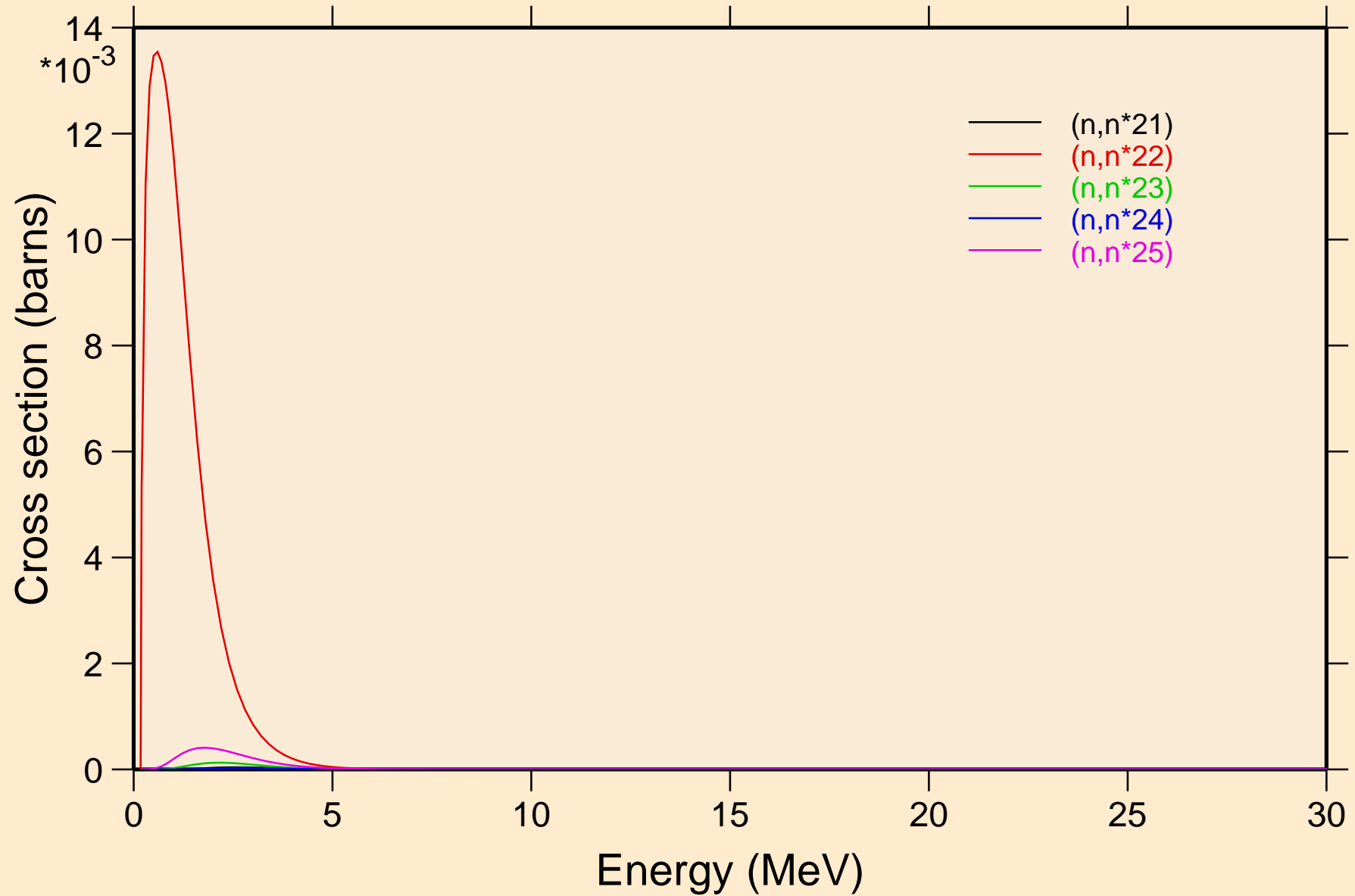

PM136M NEUTRON ACER TENDL-2021 LIBRARY; T=293.6K  
Inelastic levels

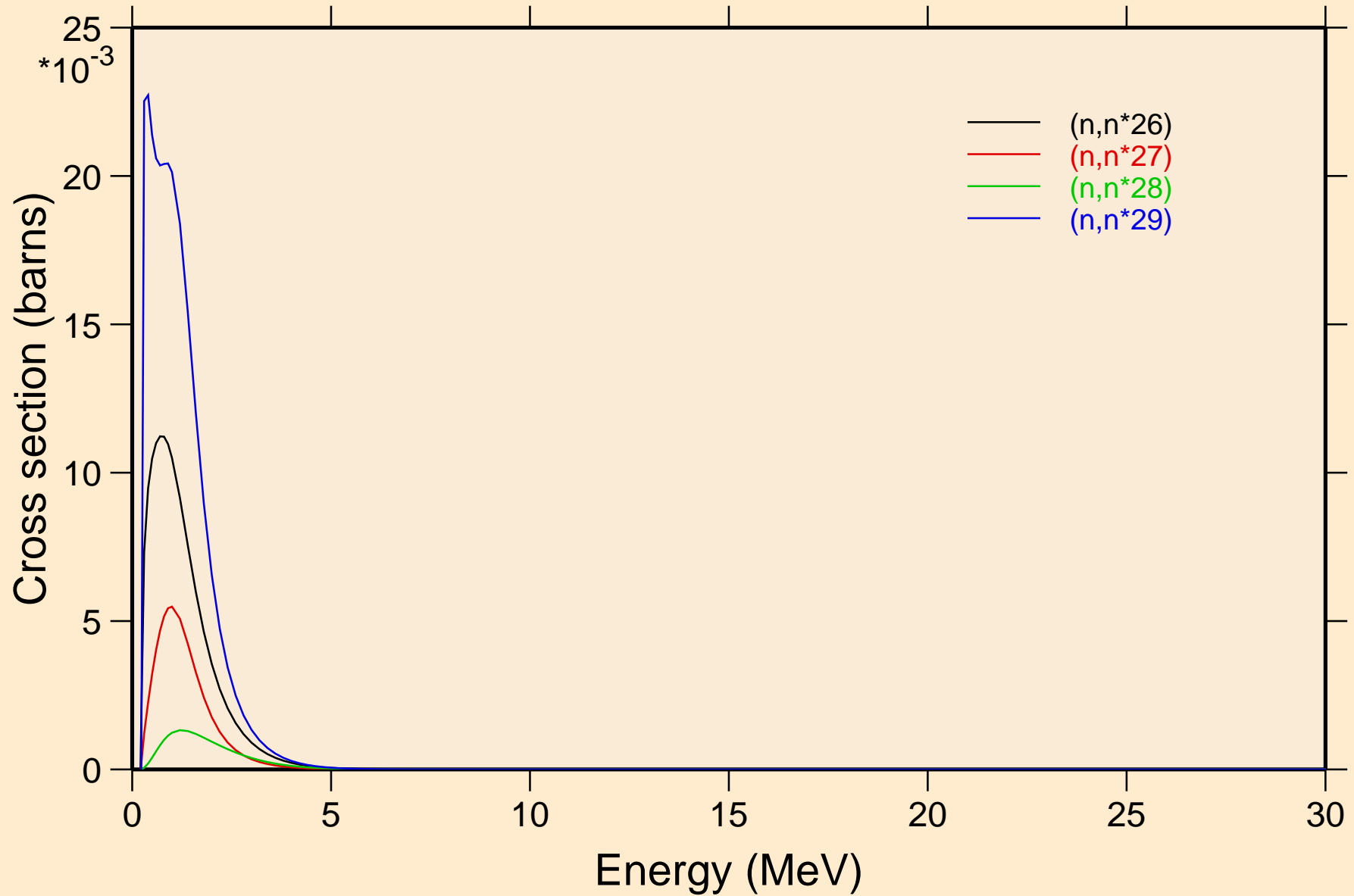



PM136M NEUTRON ACER TENDL-2021 LIBRARY; T=293.6K  
Threshold reactions

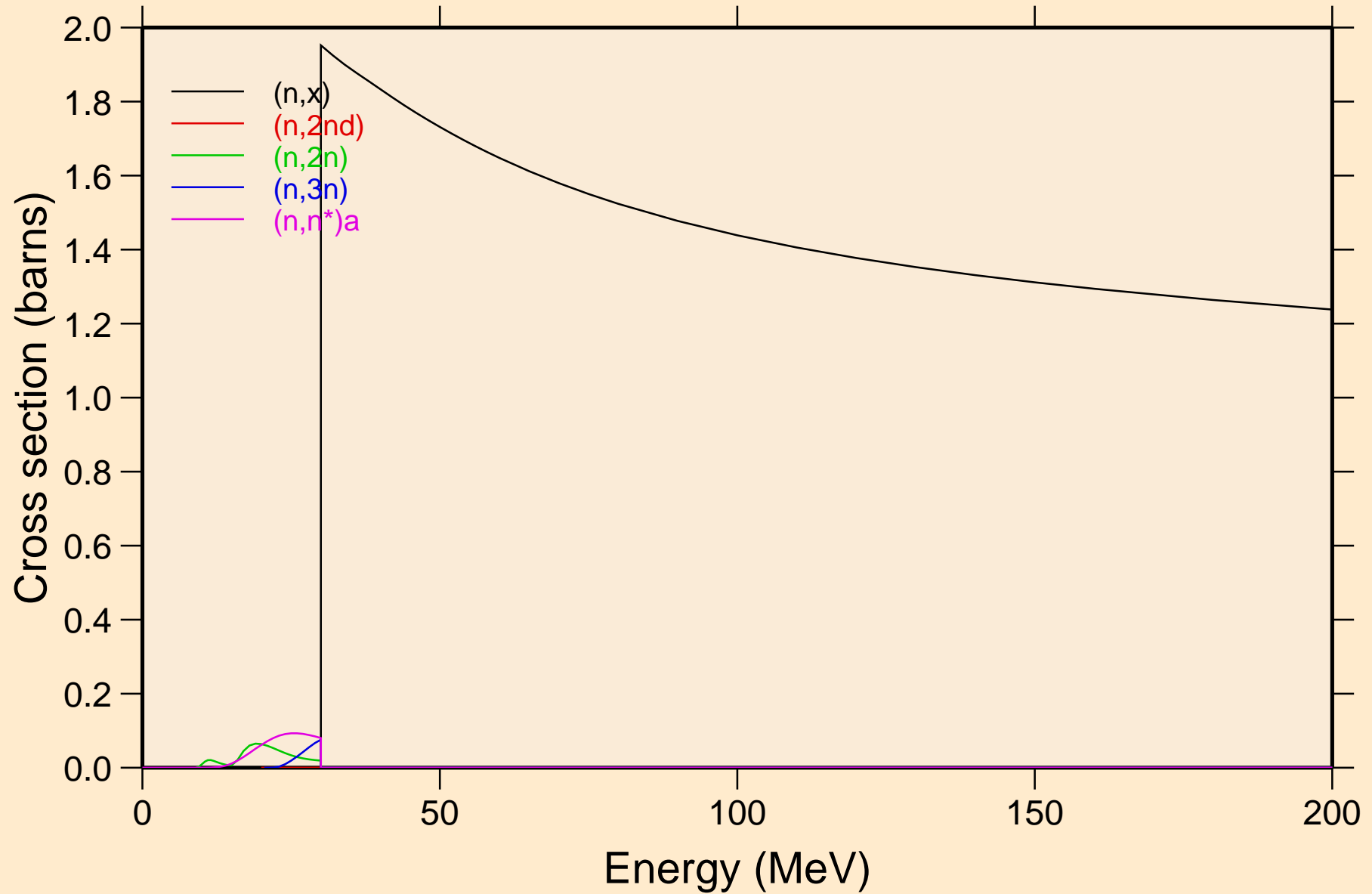

PM136M NEUTRON ACER TENDL-2021 LIBRARY; T=293.6K  
Threshold reactions

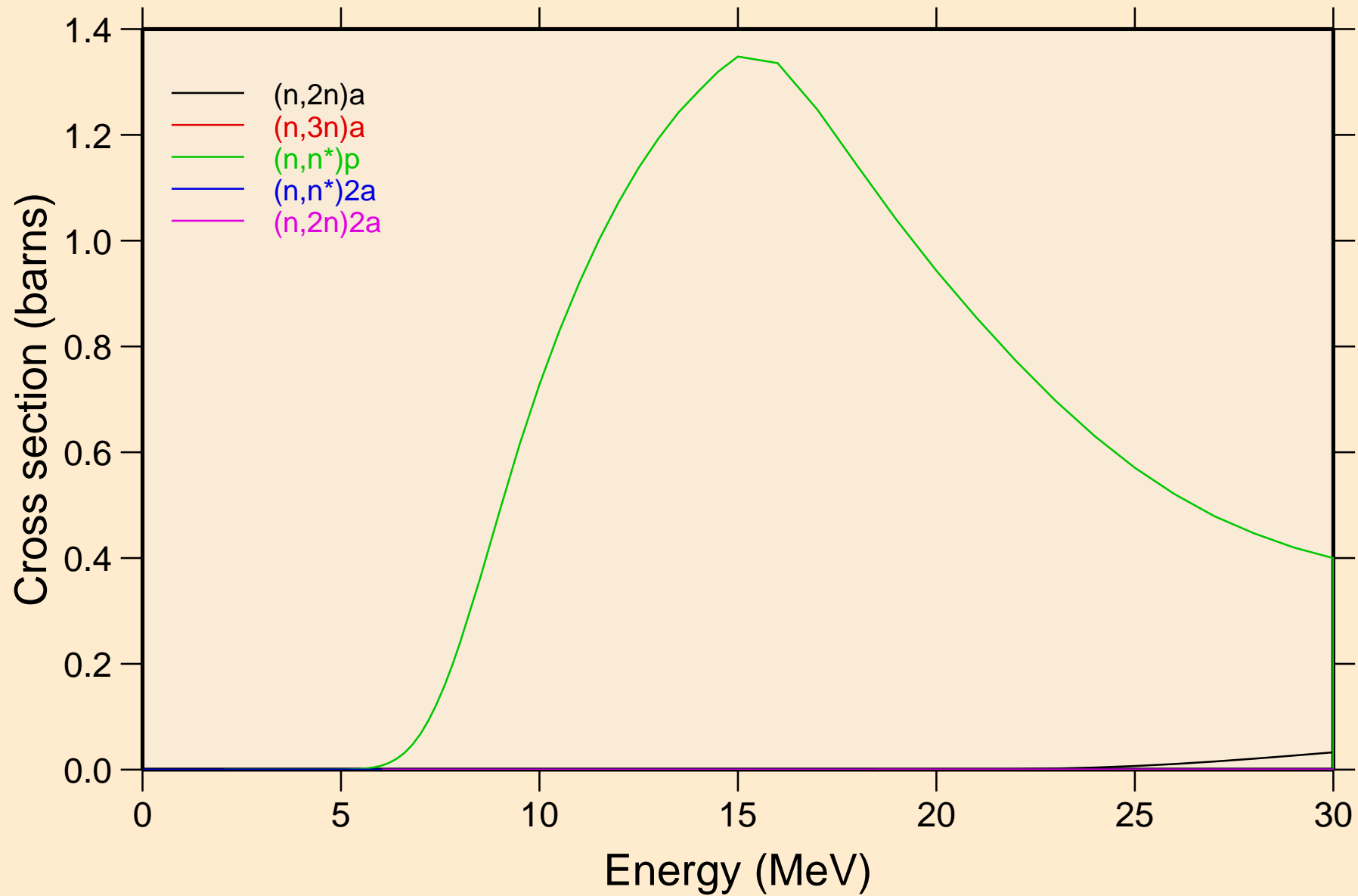

PM136M NEUTRON ACER TENDL-2021 LIBRARY; T=293.6K  
Threshold reactions

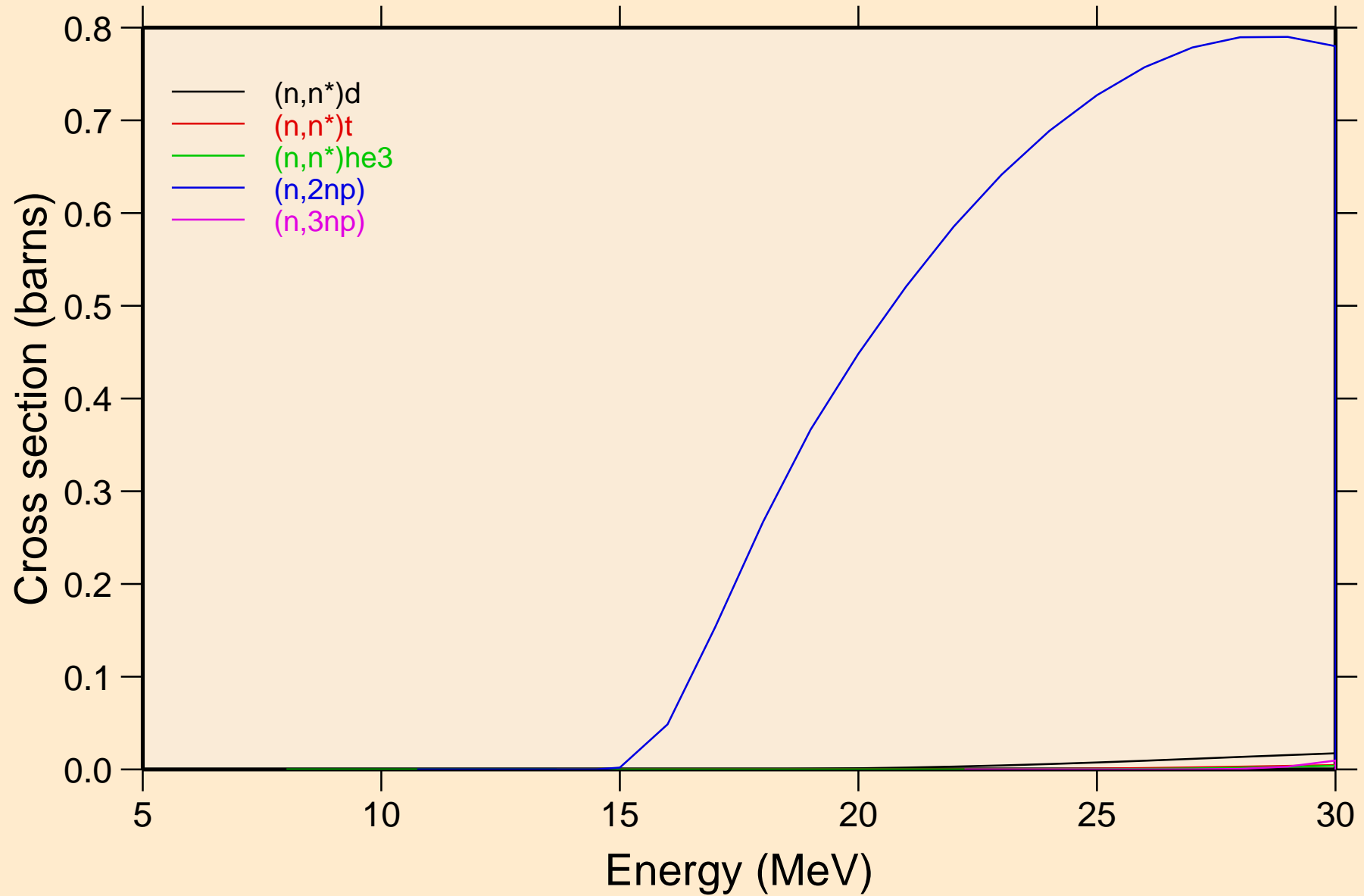

PM136M NEUTRON ACER TENDL-2021 LIBRARY; T=293.6K  
Threshold reactions

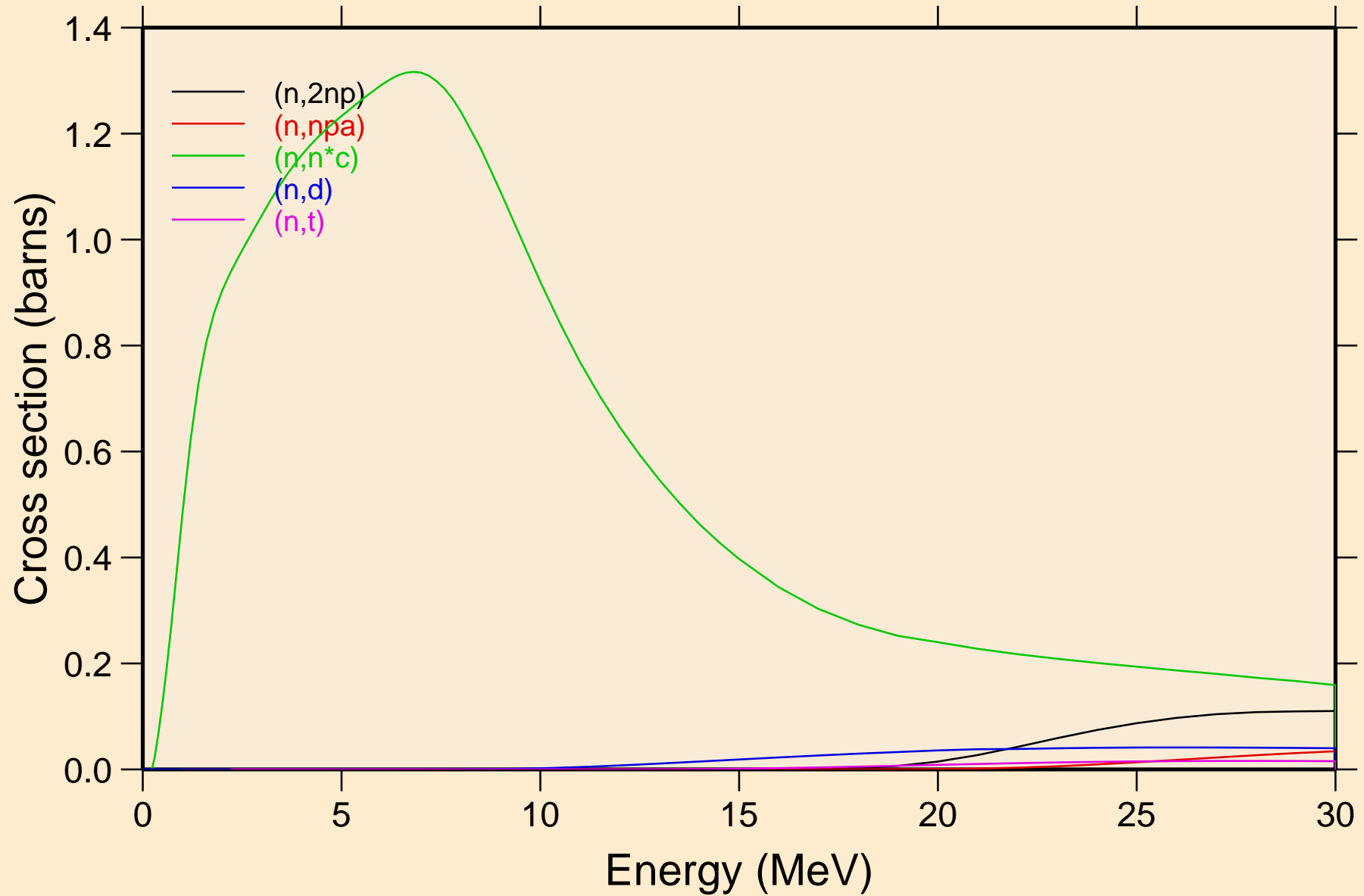

PM136M NEUTRON ACER TENDL-2021 LIBRARY; T=293.6K  
Threshold reactions

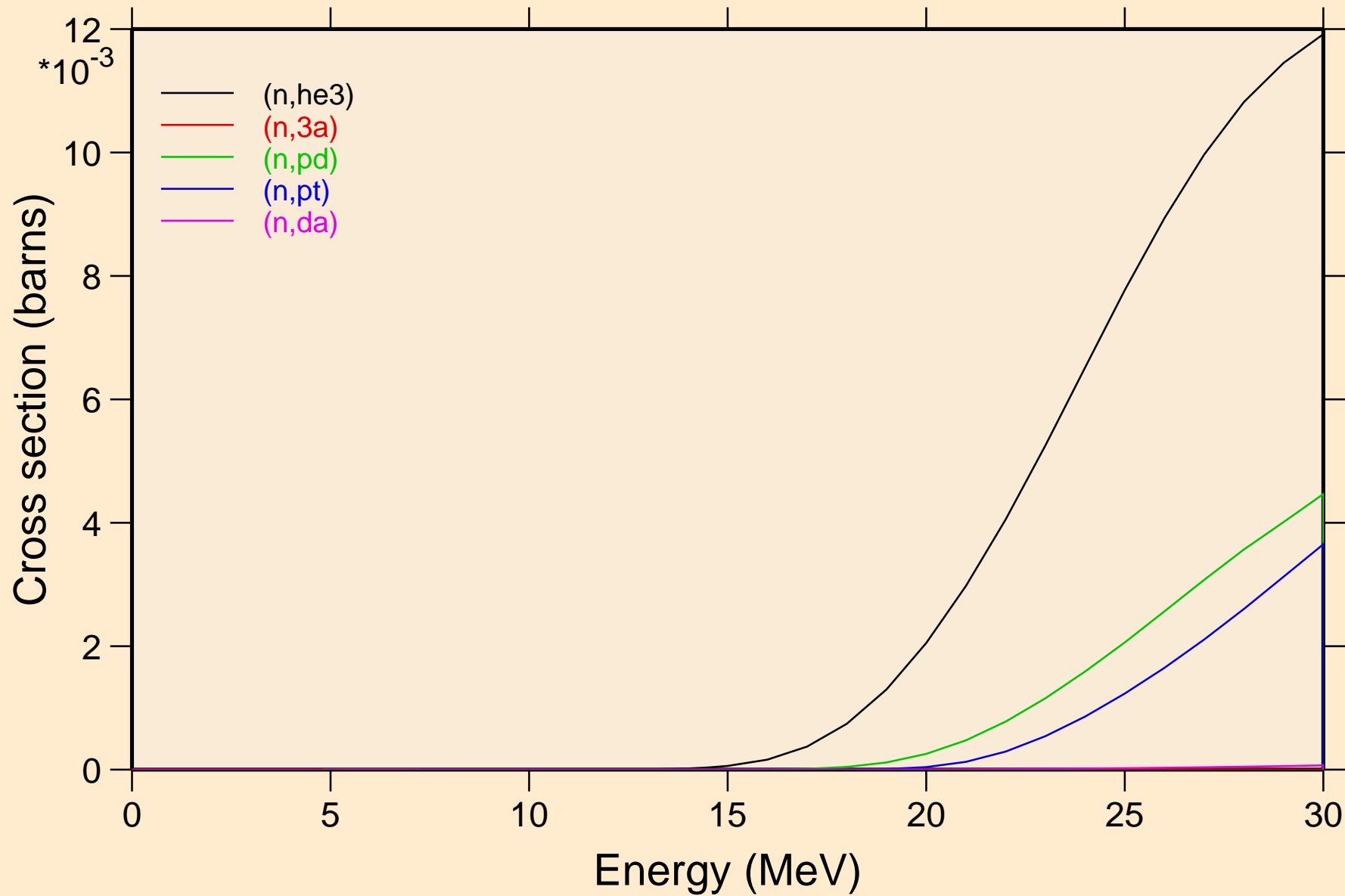

PM136M NEUTRON ACER TENDL-2021 LIBRARY; T=293.6K  
Threshold reactions

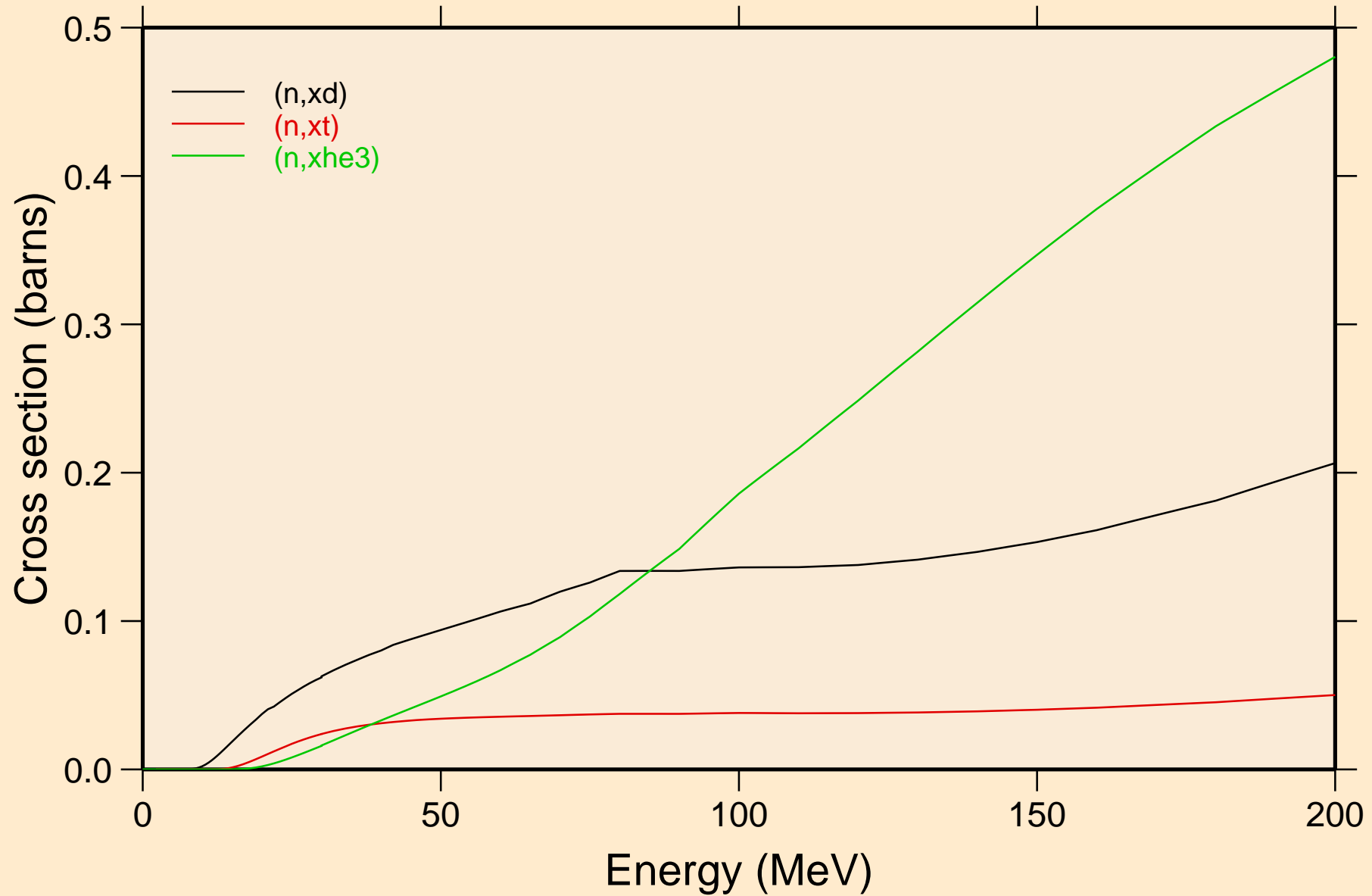

PM136M NEUTRON ACER TENDL-2021 LIBRARY; T=293.6K  
angular distribution for elastic

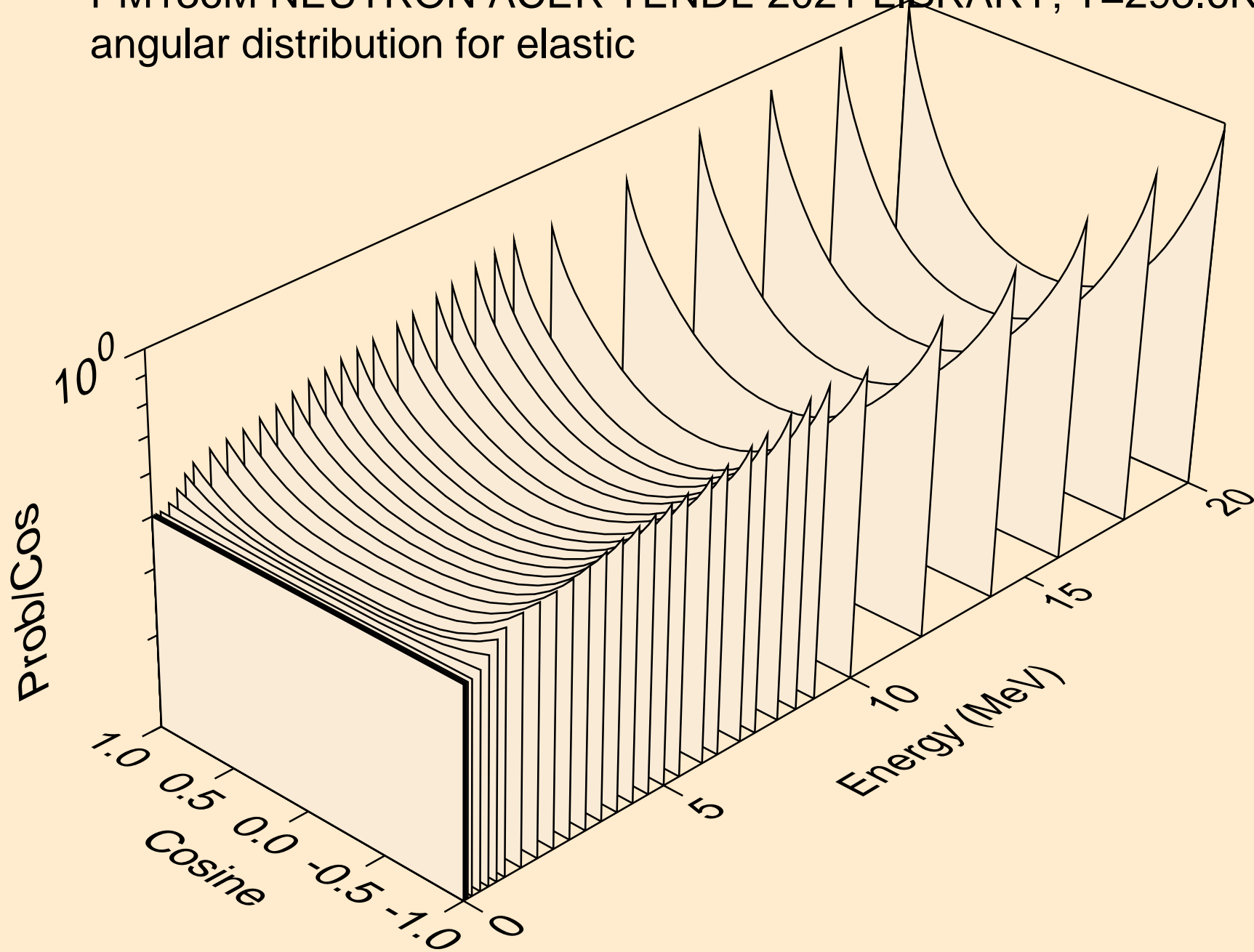

PM136M NEUTRON ACER TENDL-2021 LIBRARY; T=293.6K  
angular distribution for elastic

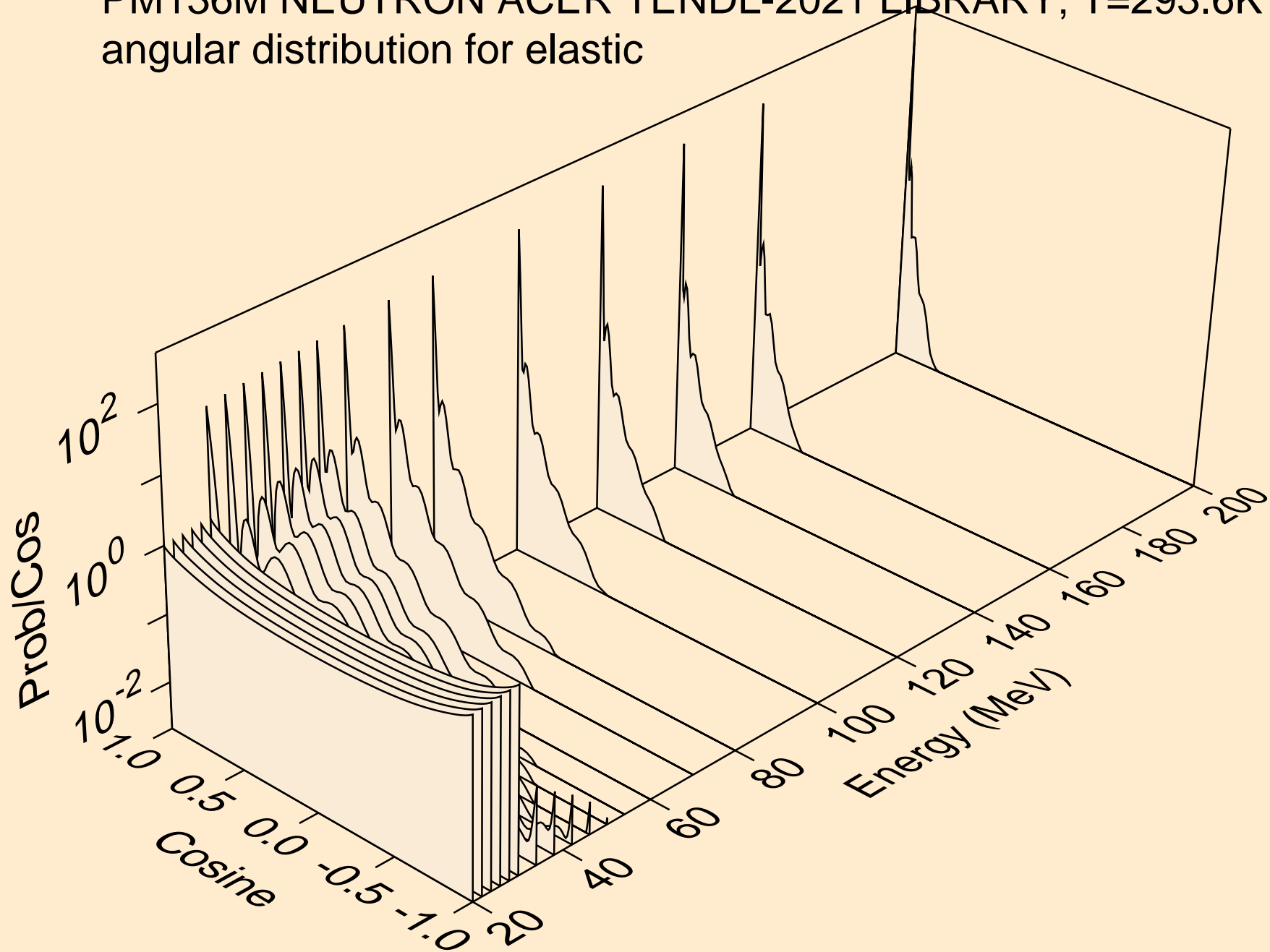



PM136M NEUTRON ACER TENDL-2021 LIBRARY; T=293.6K  
angular distribution for (n,n\*1)

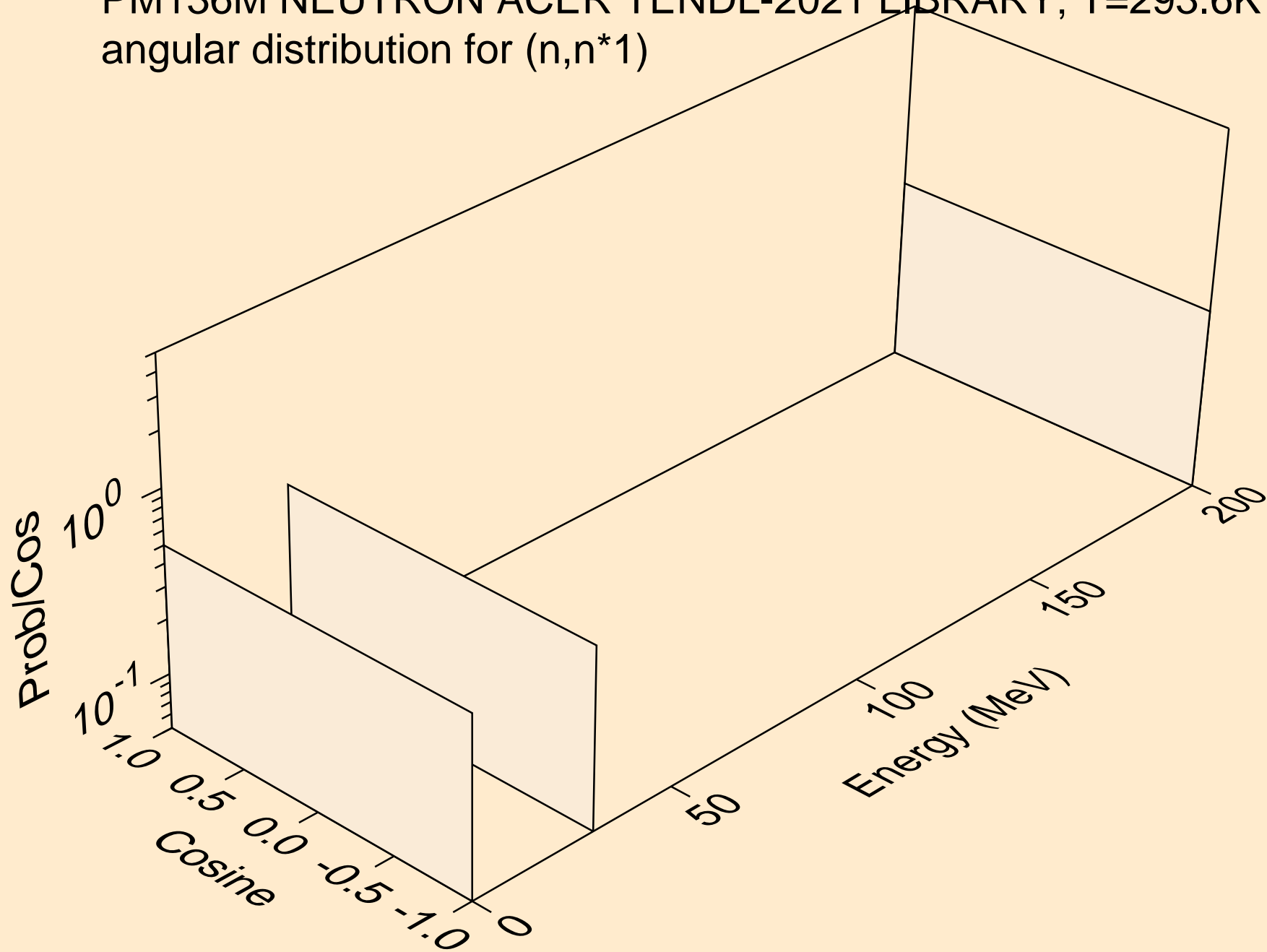

PM136M NEUTRON ACER TENDL-2021 LIBRARY; T=293.6K  
angular distribution for (n,n\*2)

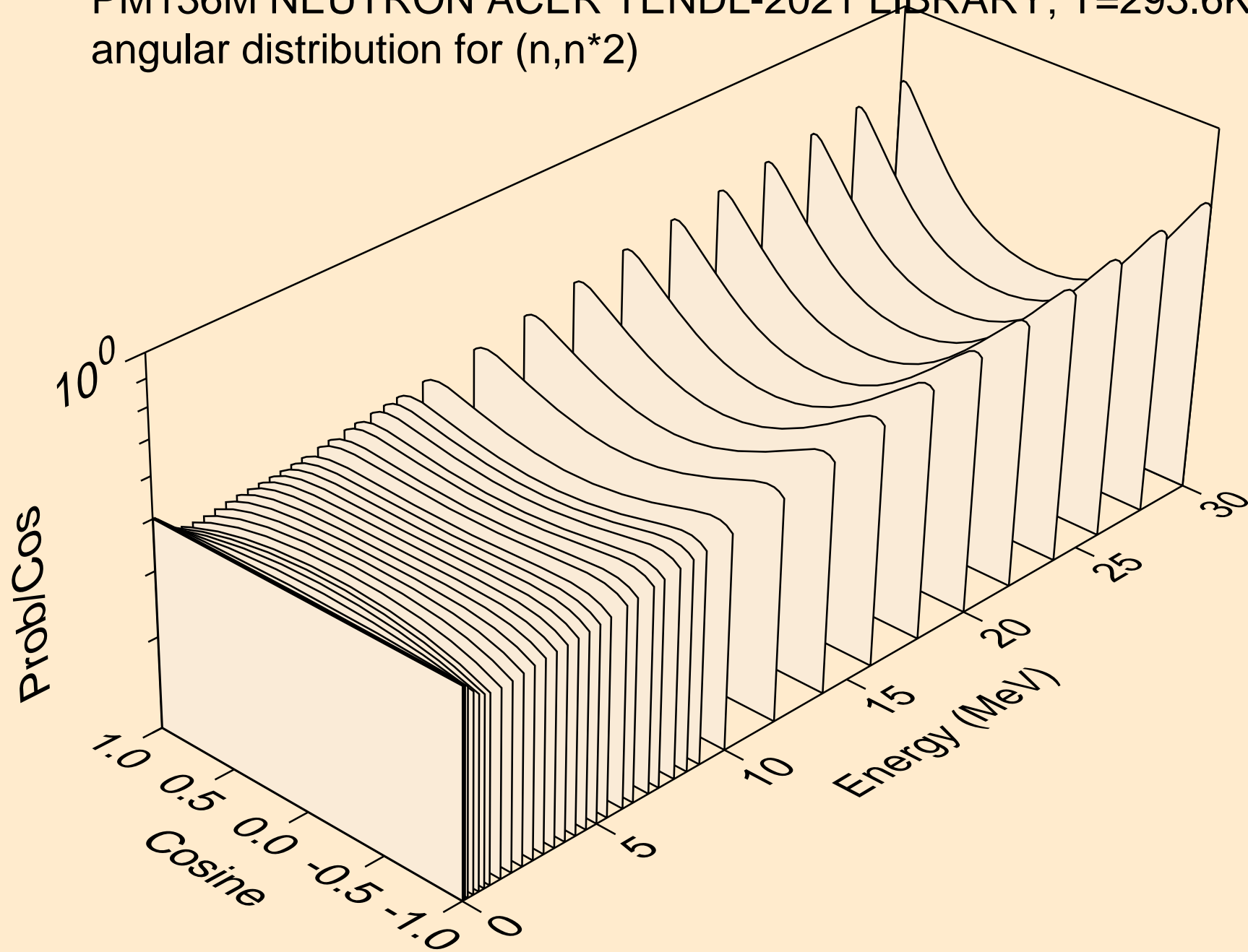

PM136M NEUTRON ACER TENDL-2021 LIBRARY; T=293.6K  
angular distribution for (n,n\*3)

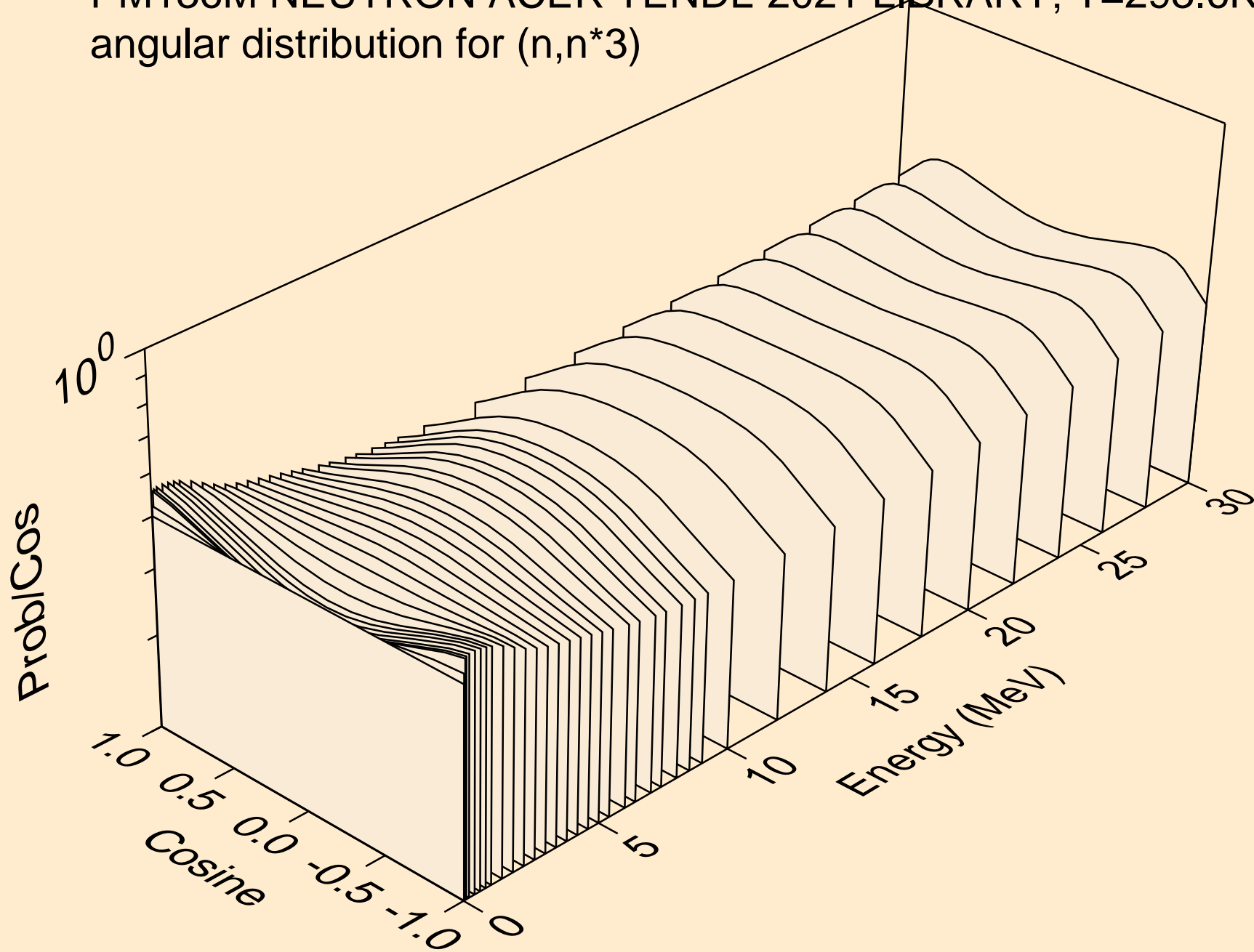

PM136M NEUTRON ACER TENDL-2021 LIBRARY; T=293.6K  
angular distribution for (n,n\*4)

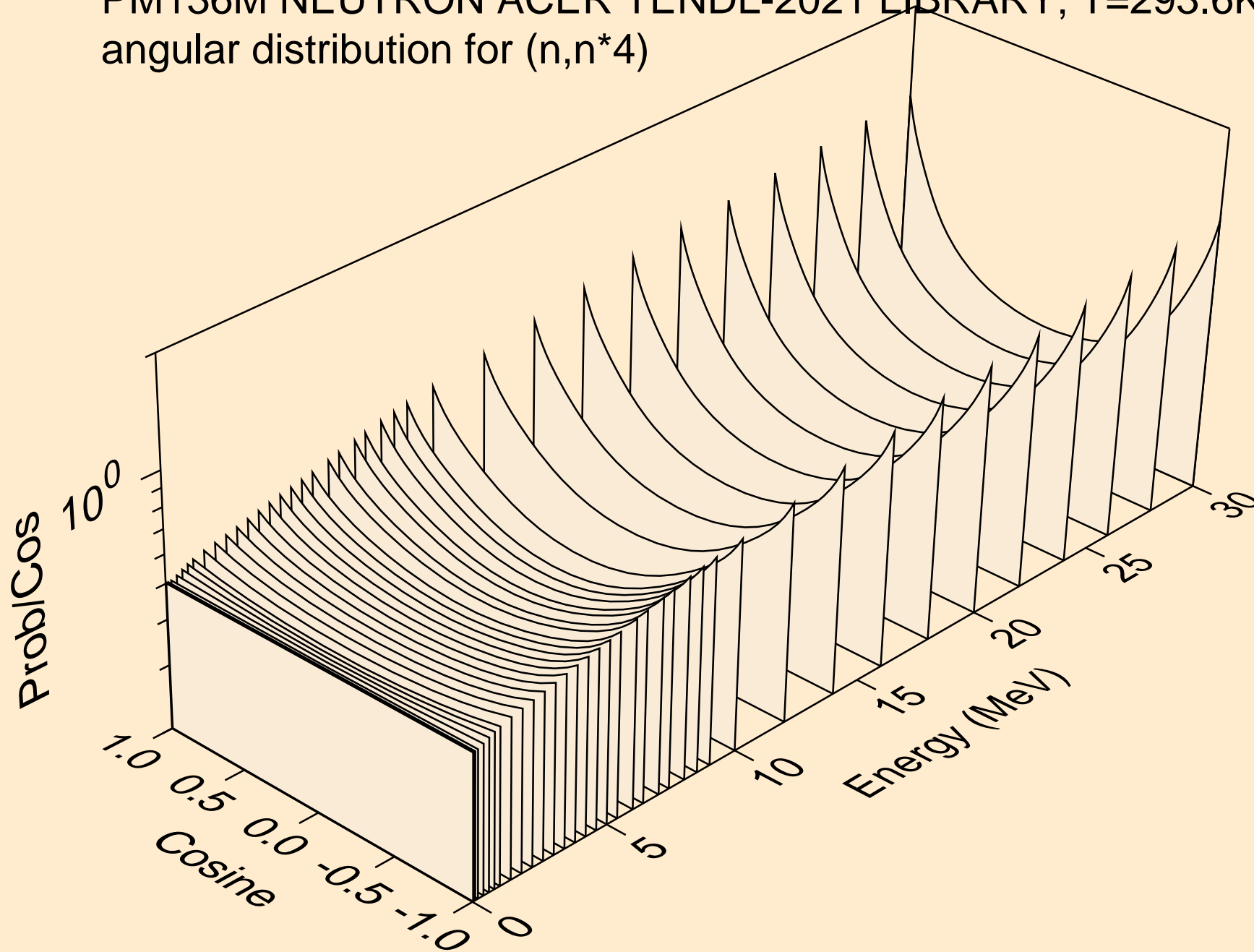

PM136M NEUTRON ACER TENDL-2021 LIBRARY; T=293.6K  
angular distribution for (n,n\*5)

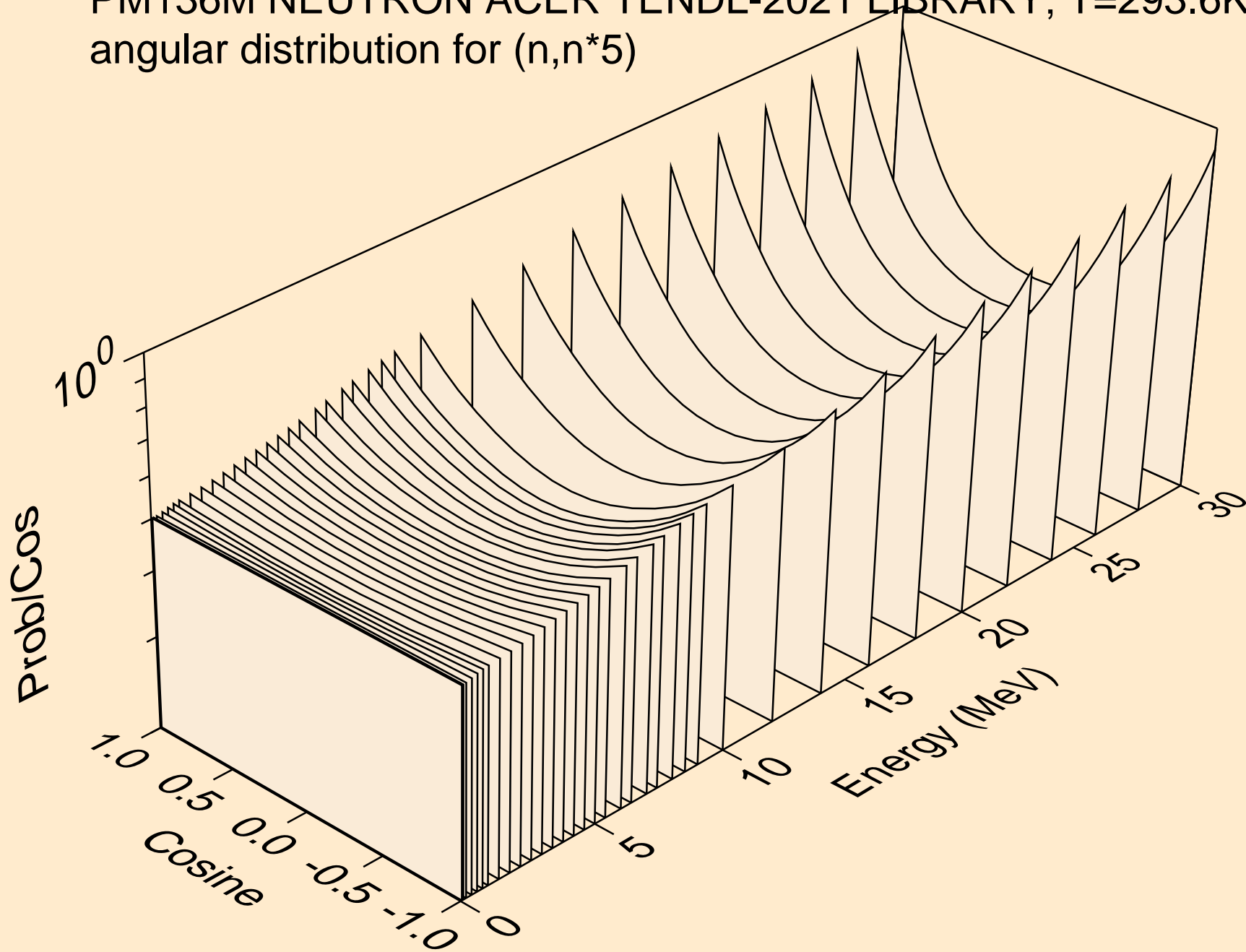

PM136M NEUTRON ACER TENDL-2021 LIBRARY; T=293.6K  
angular distribution for (n,n\*6)

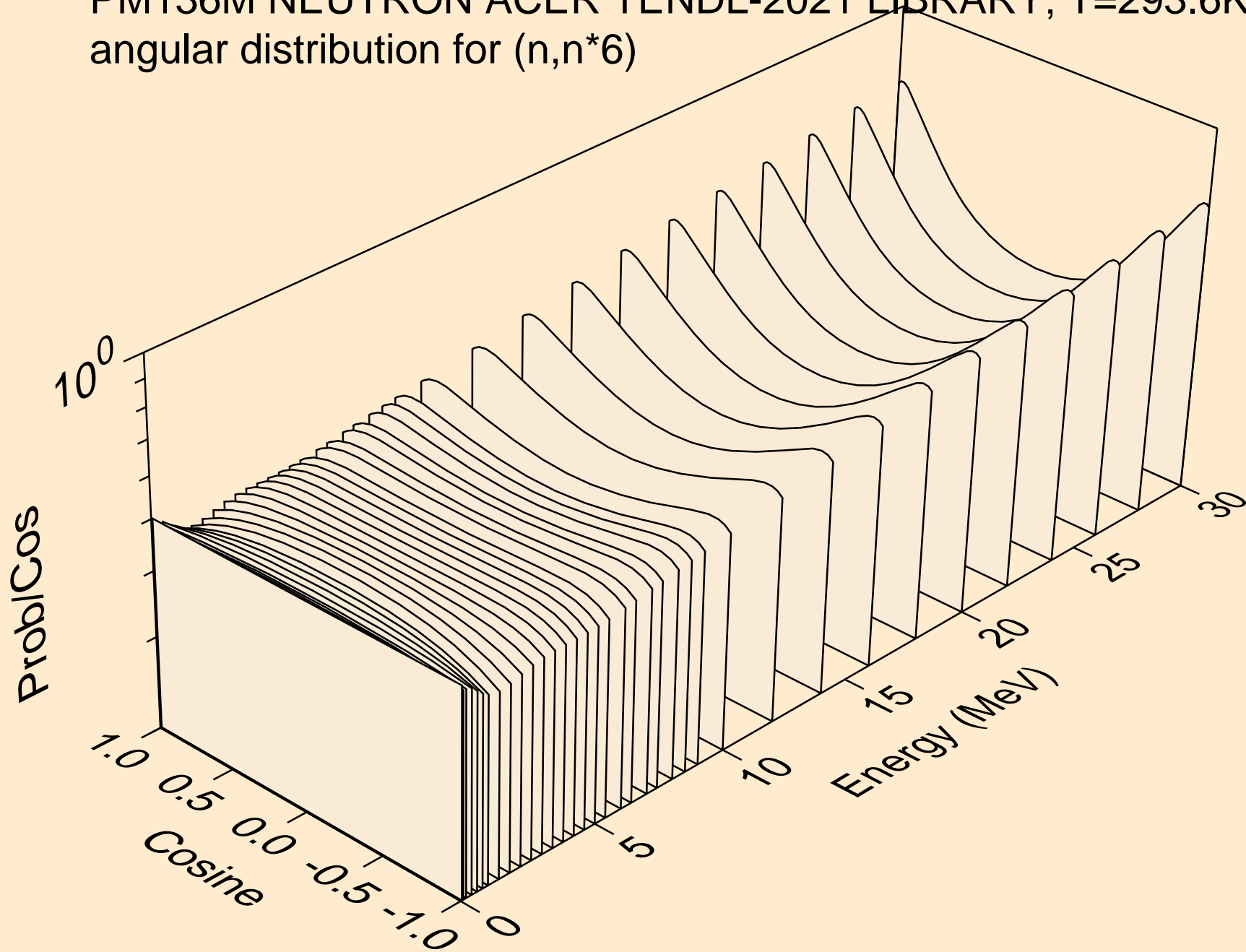

PM136M NEUTRON ACER TENDL-2021 LIBRARY; T=293.6K  
angular distribution for (n,n\*7)

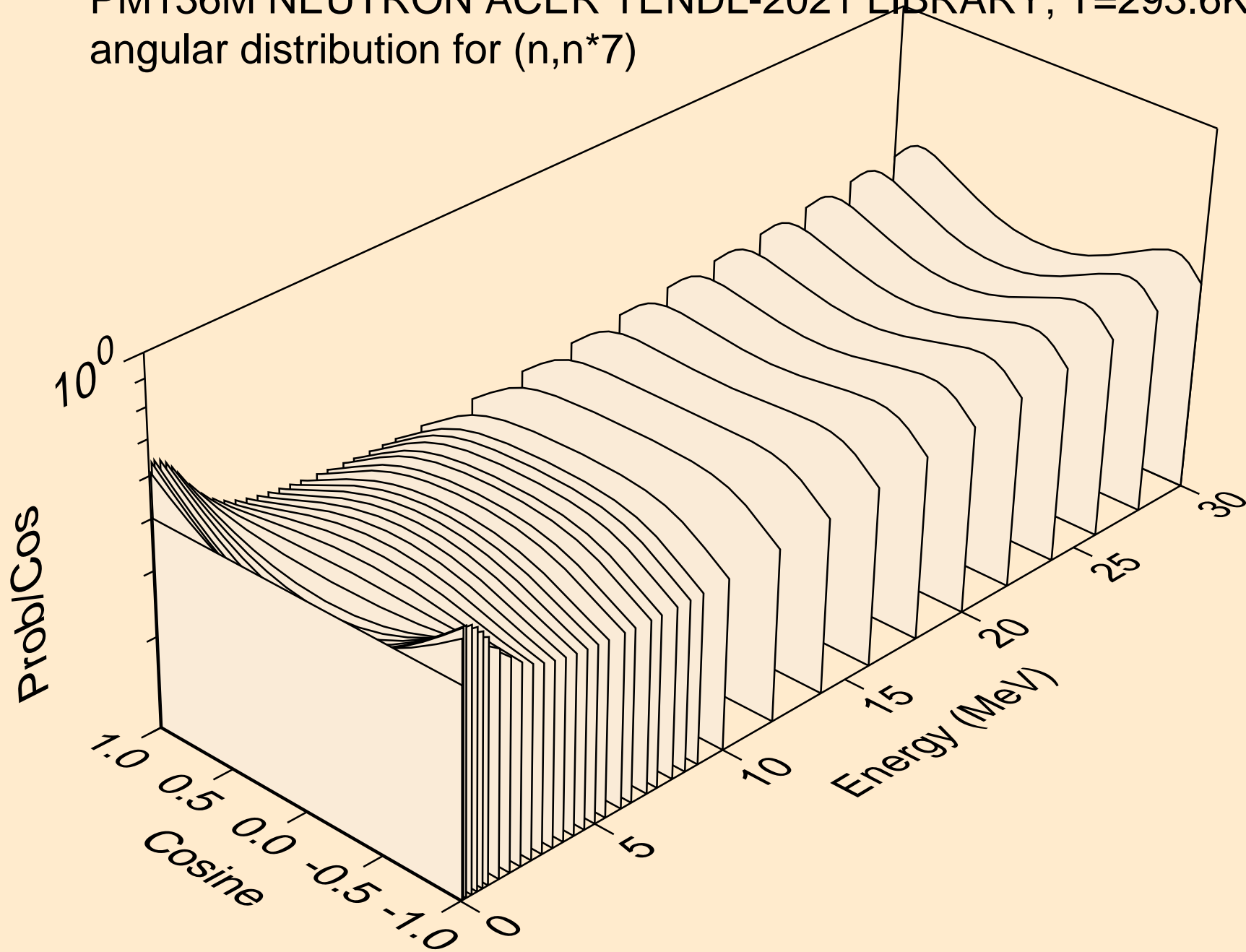

PM136M NEUTRON ACER TENDL-2021 LIBRARY; T=293.6K  
angular distribution for (n,n\*8)

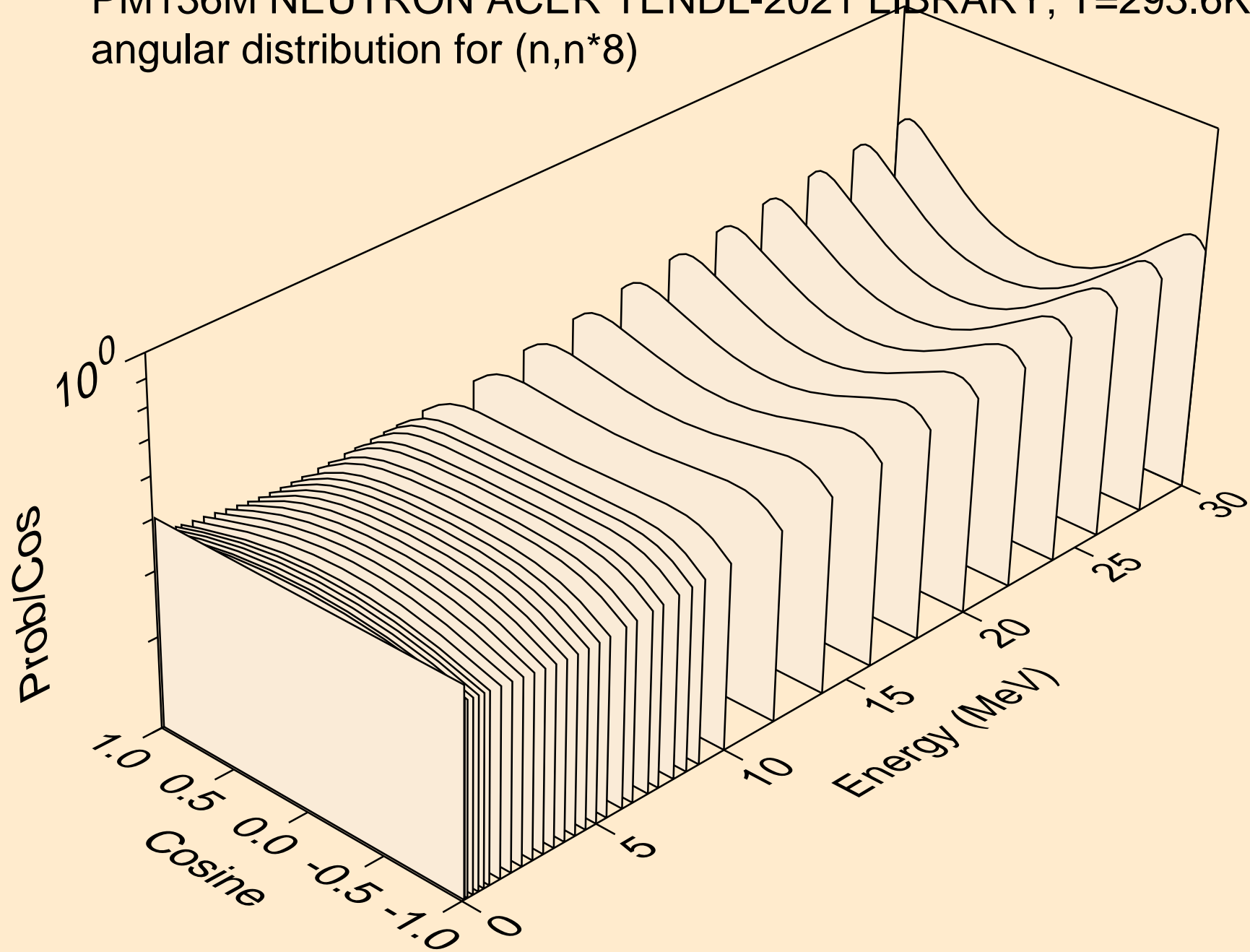



PM136M NEUTRON ACER TENDL-2021 LIBRARY; T=293.6K  
angular distribution for (n,n\*9)

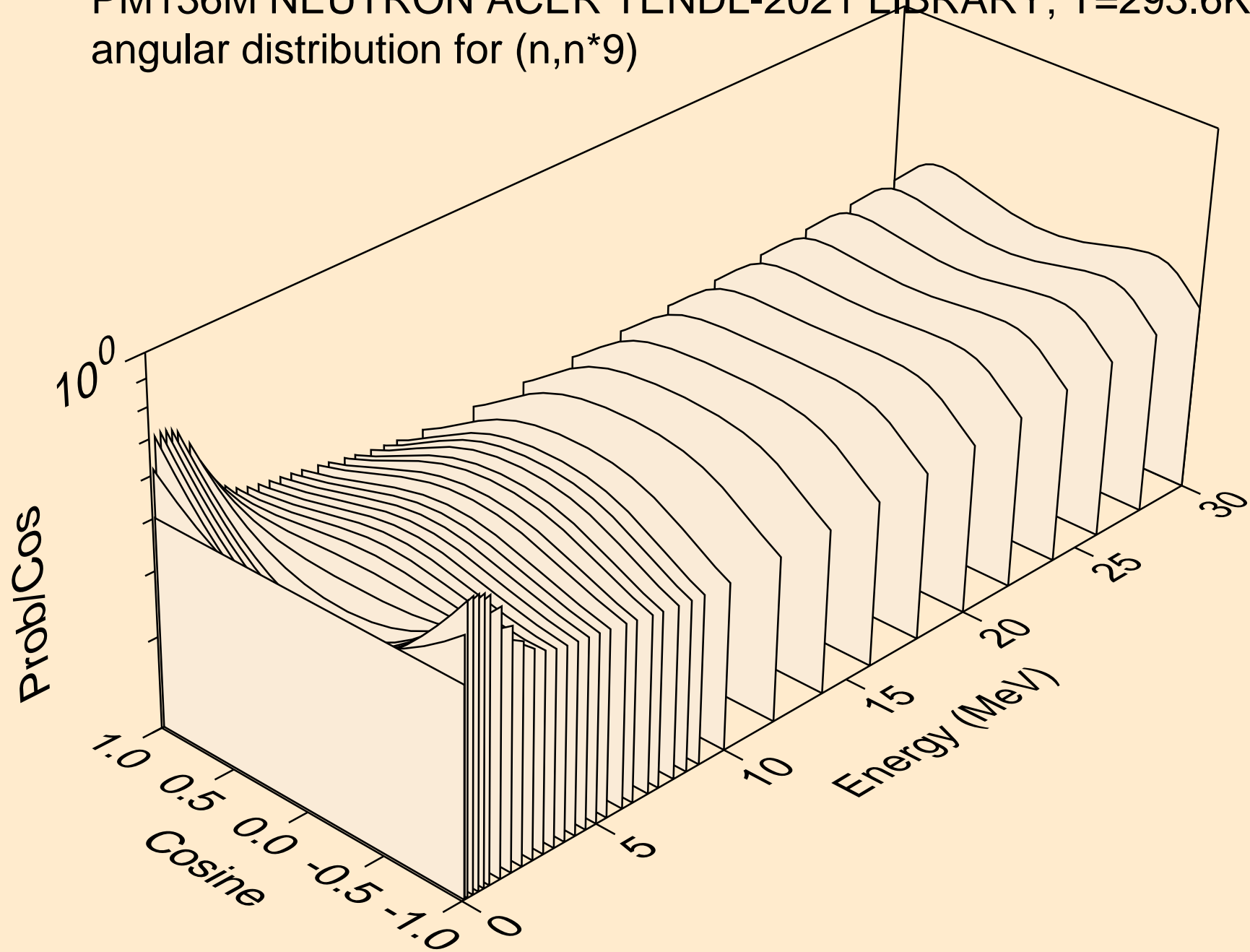

PM136M NEUTRON ACER TENDL-2021 LIBRARY; T=293.6K  
angular distribution for (n,n\*10)

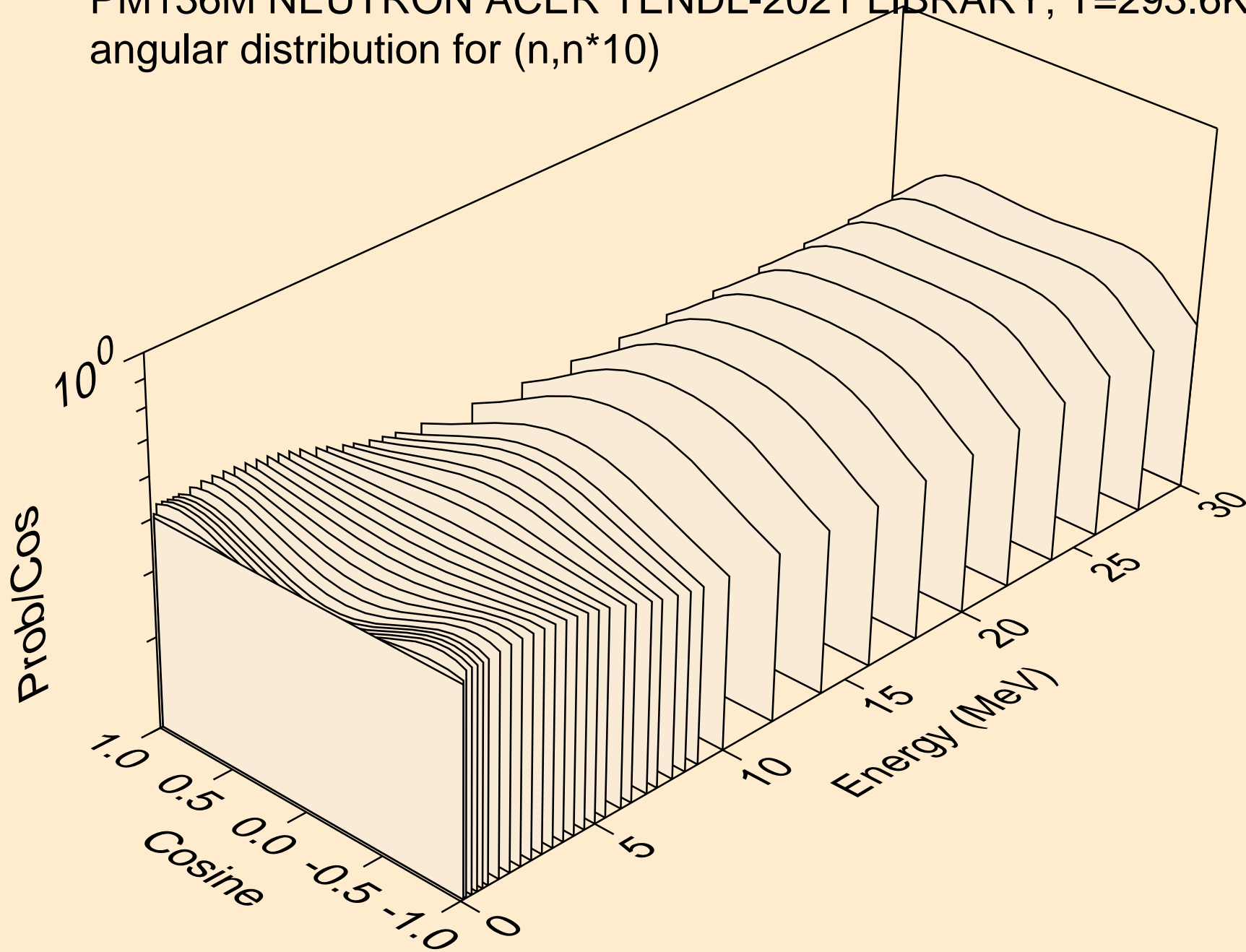

PM136M NEUTRON ACER TENDL-2021 LIBRARY; T=293.6K  
angular distribution for (n,n\*11)

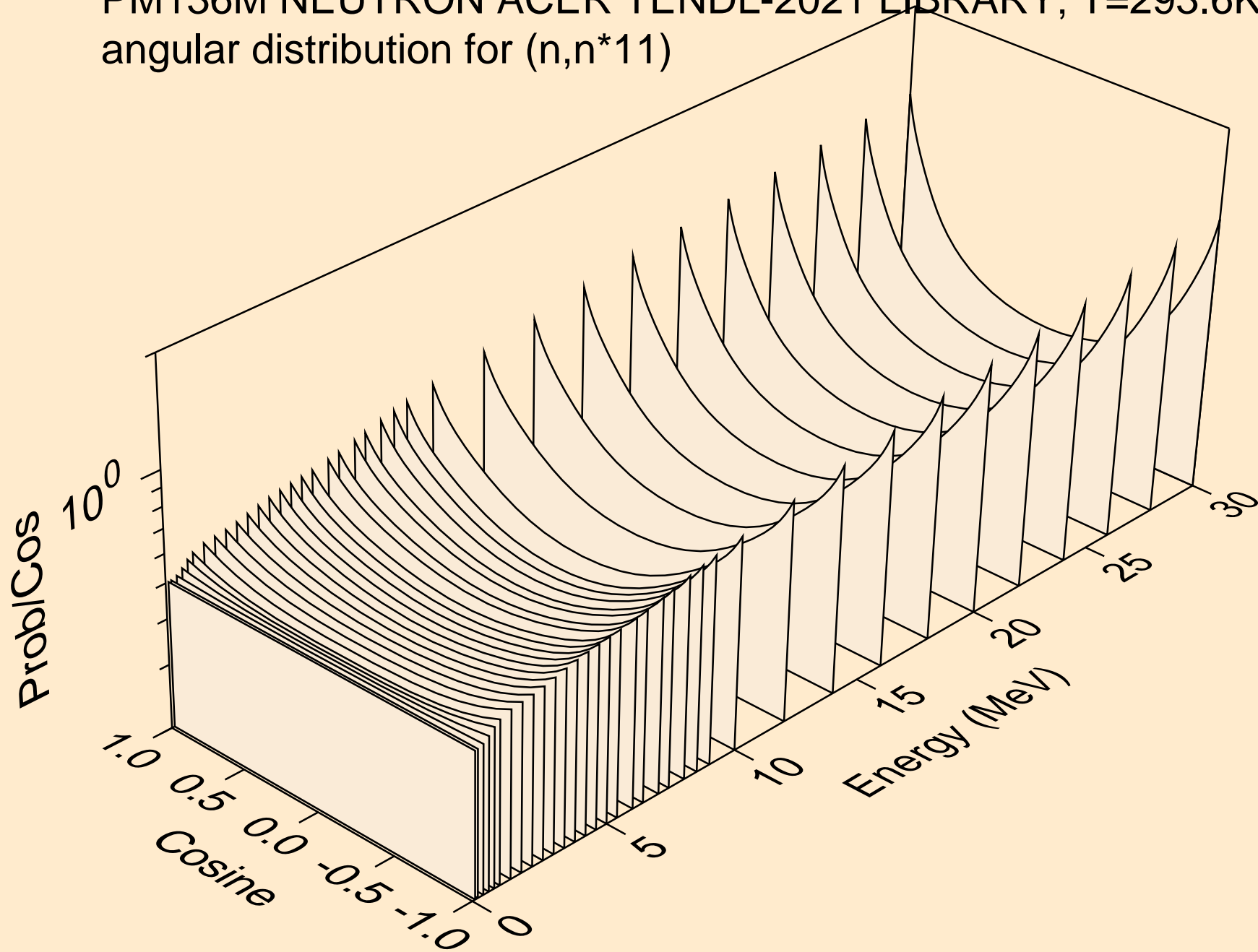

PM136M NEUTRON ACER TENDL-2021 LIBRARY; T=293.6K  
angular distribution for (n,n\*12)

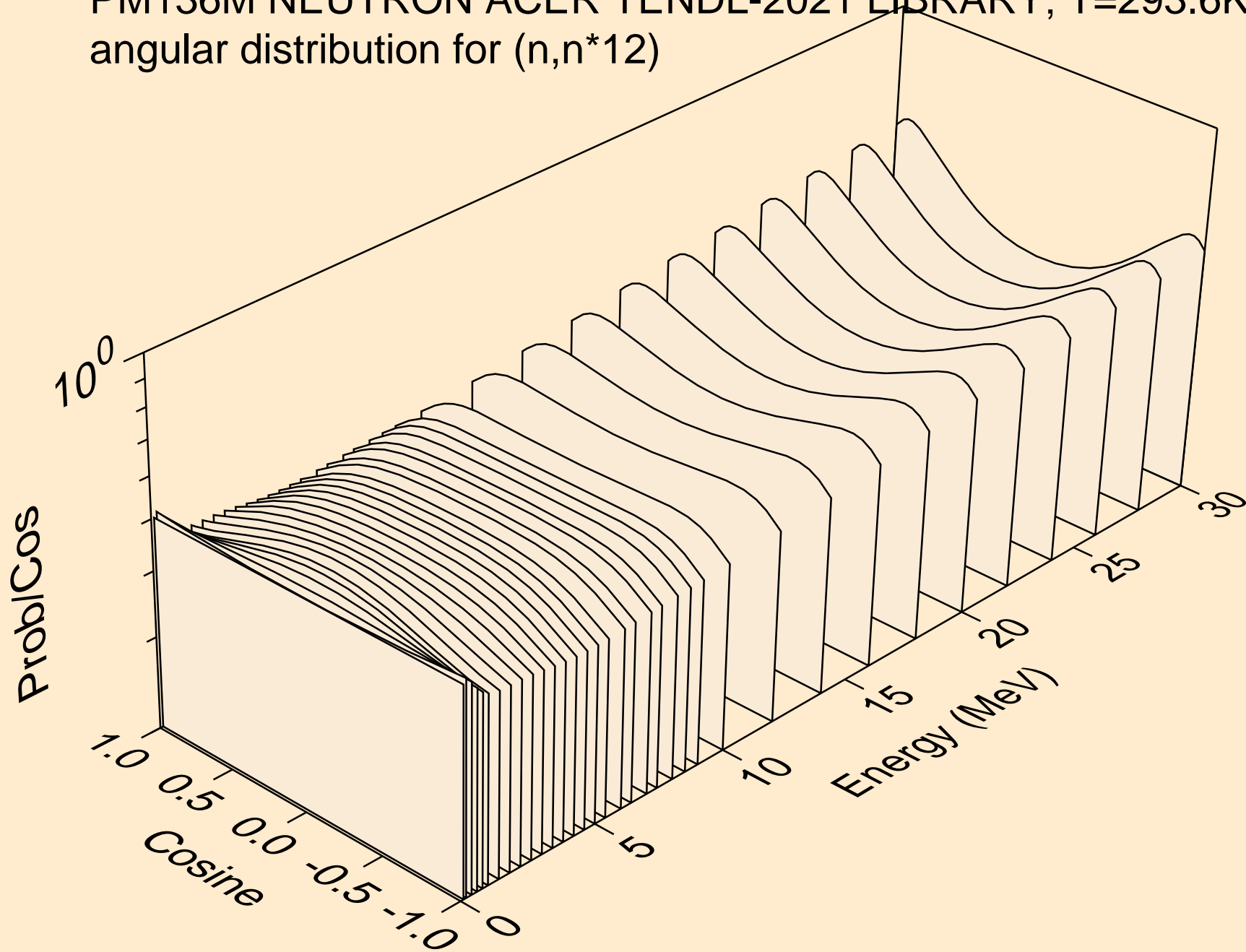

PM136M NEUTRON ACER TENDL-2021 LIBRARY; T=293.6K  
angular distribution for (n,n\*13)

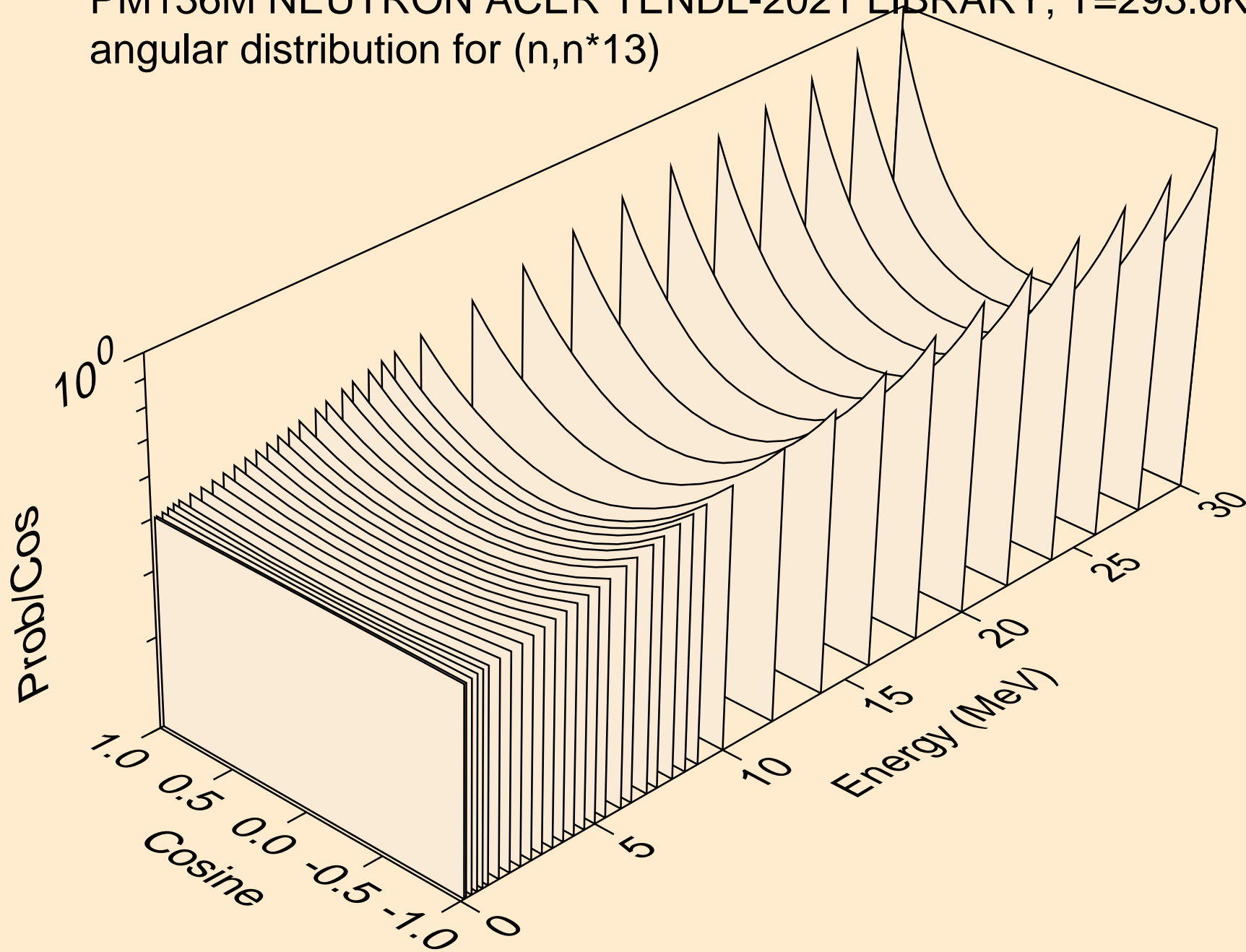

PM136M NEUTRON ACER TENDL-2021 LIBRARY; T=293.6K  
angular distribution for (n,n\*14)

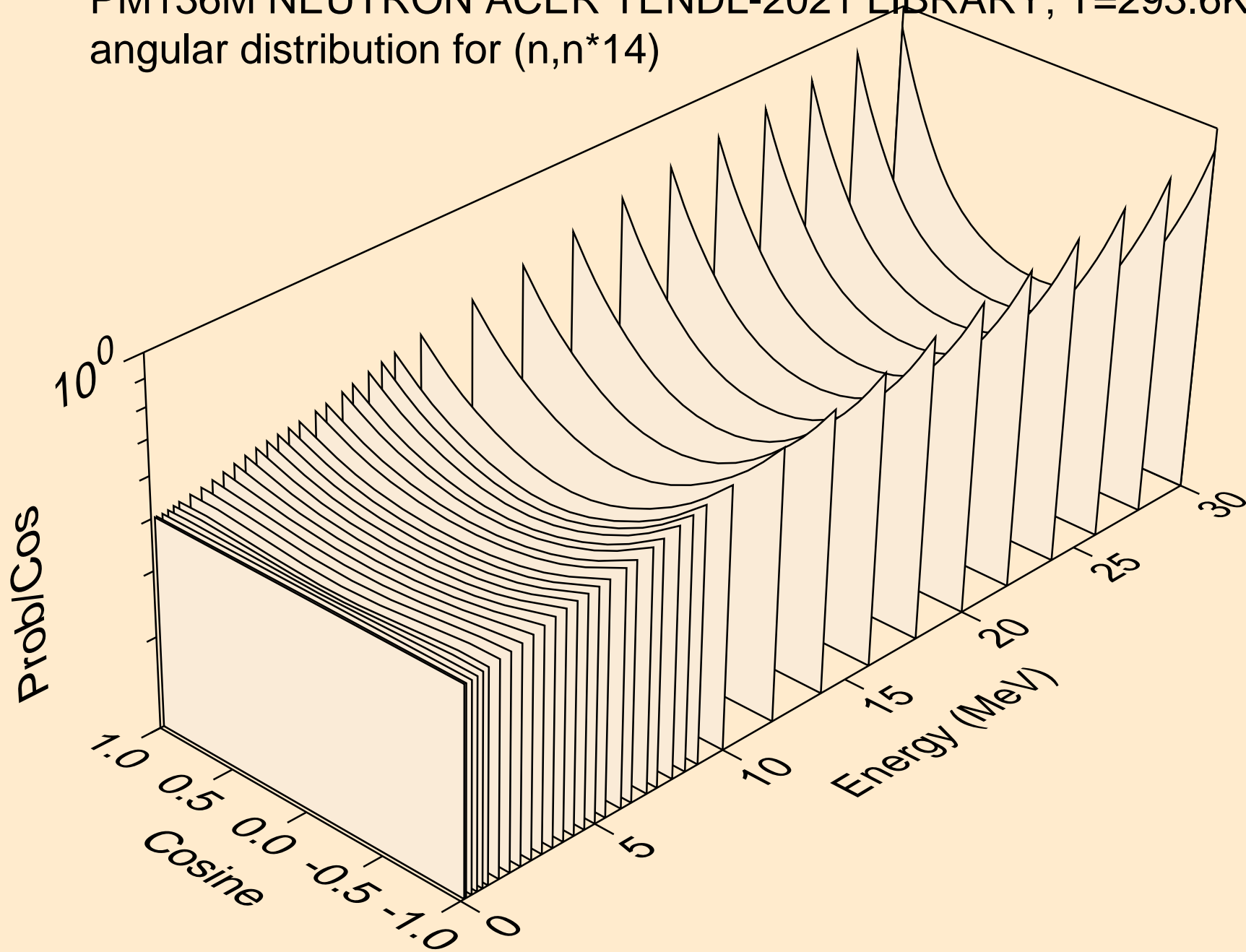

PM136M NEUTRON ACER TENDL-2021 LIBRARY; T=293.6K  
angular distribution for (n,n\*15)

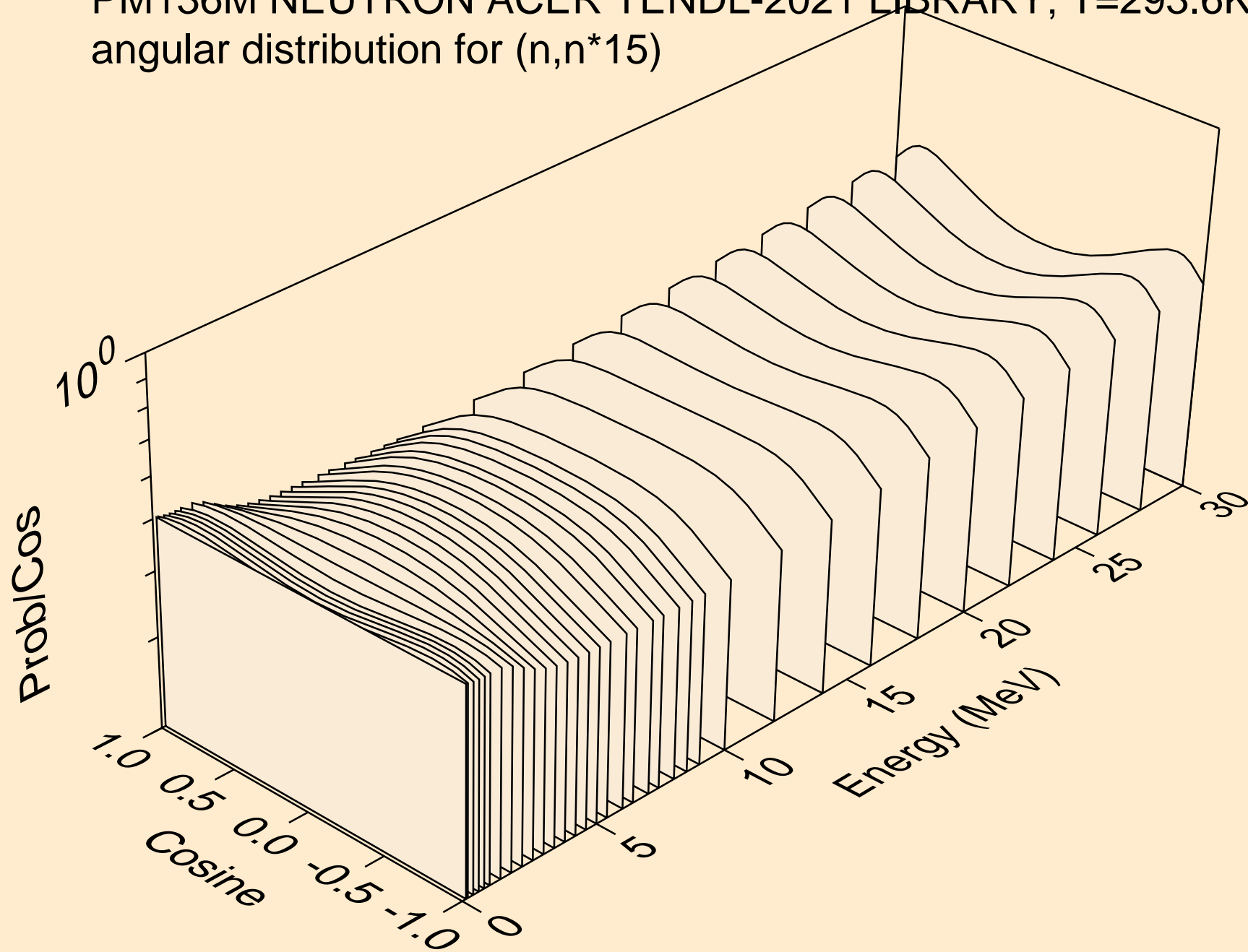

PM136M NEUTRON ACER TENDL-2021 LIBRARY; T=293.6K  
angular distribution for (n,n\*16)

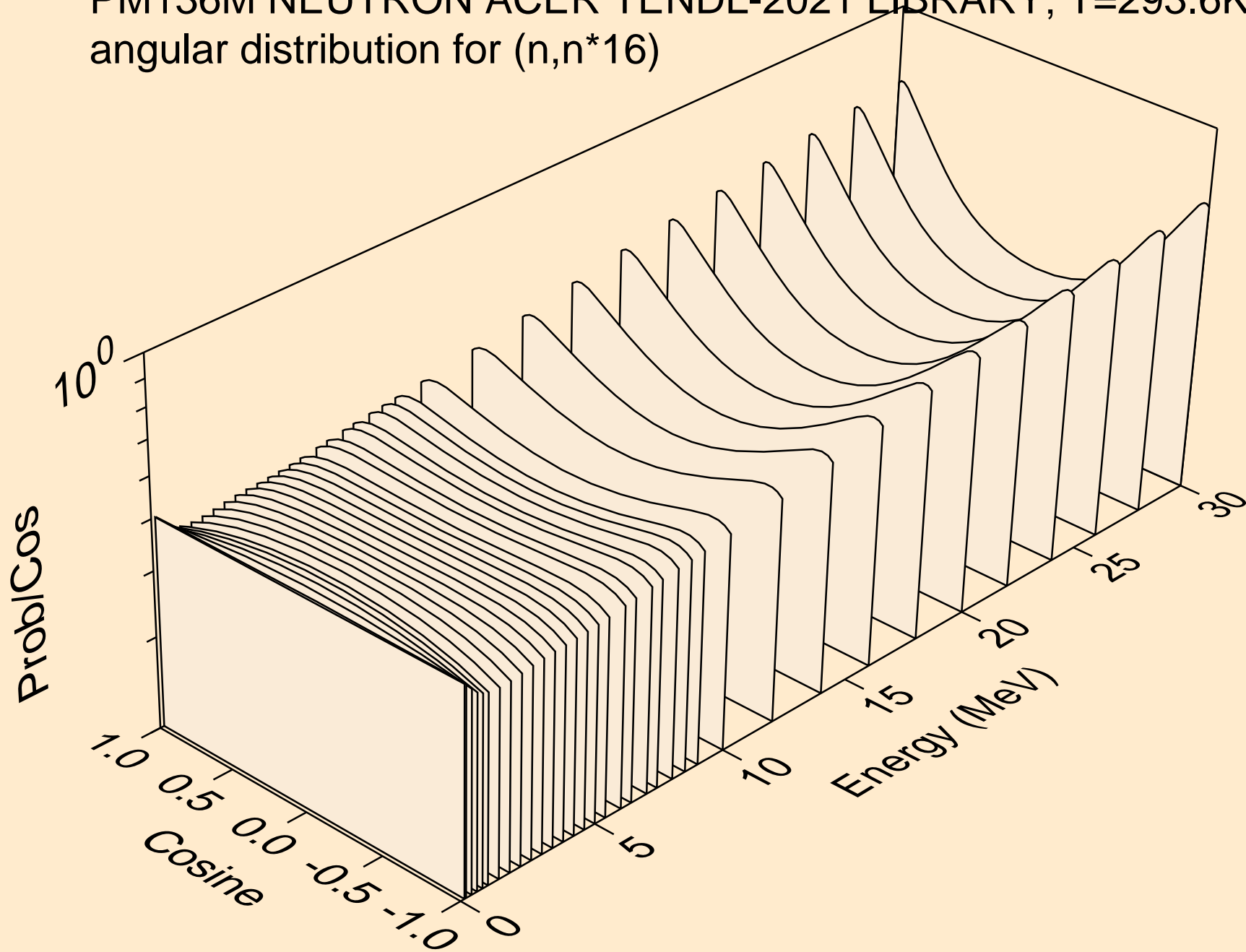



PM136M NEUTRON ACER TENDL-2021 LIBRARY; T=293.6K  
angular distribution for (n,n\*17)

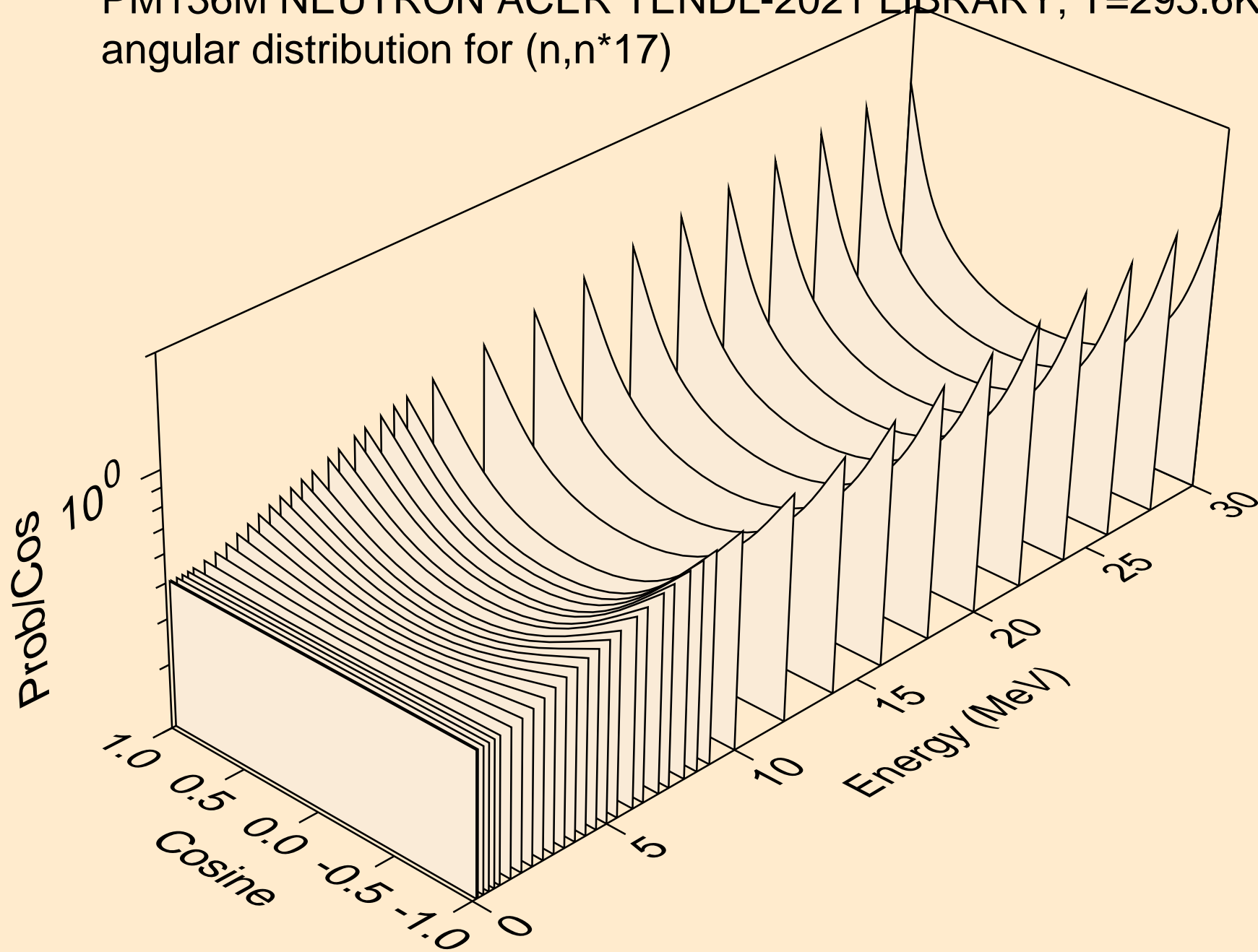

PM136M NEUTRON ACER TENDL-2021 LIBRARY; T=293.6K  
angular distribution for (n,n\*18)

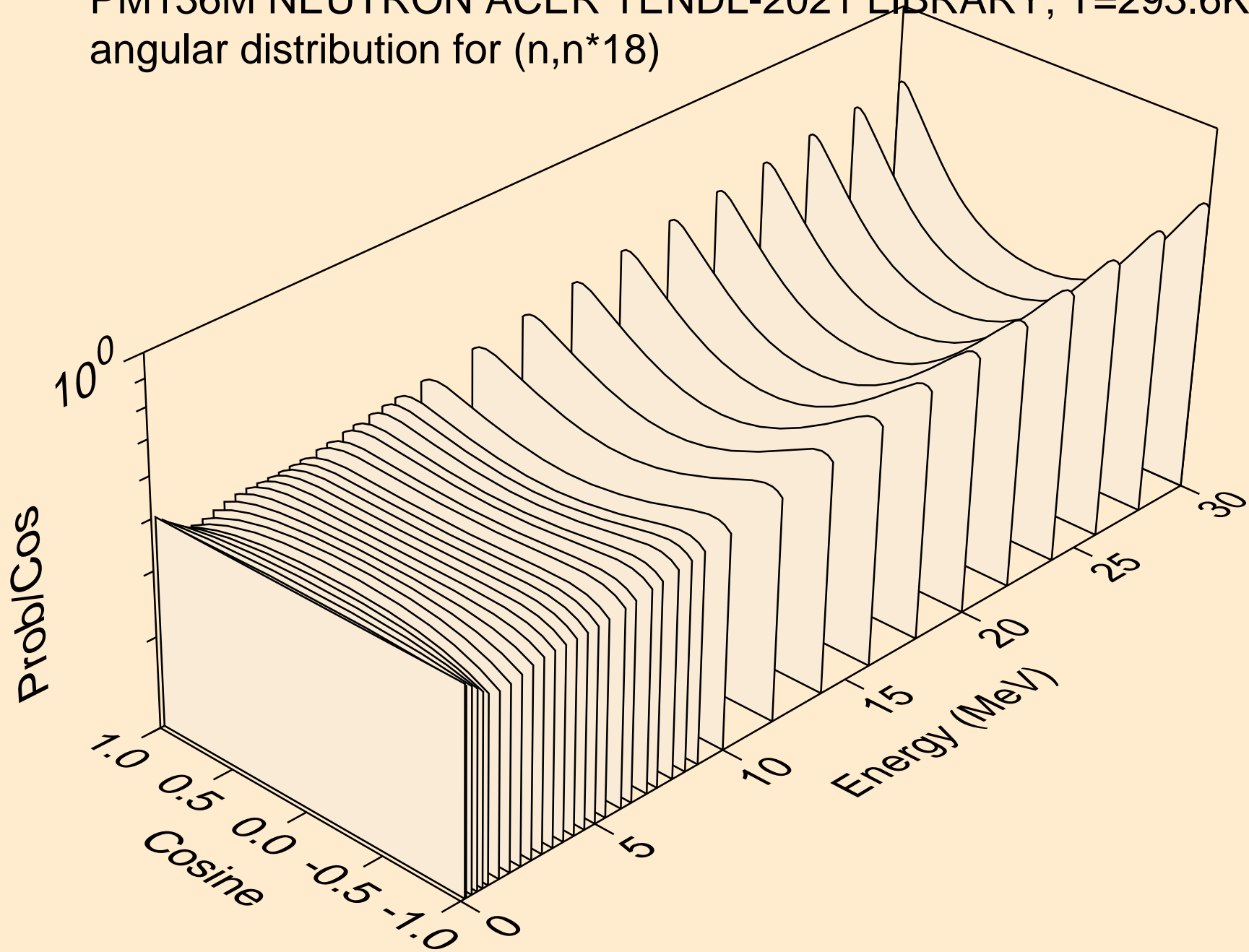

PM136M NEUTRON ACER TENDL-2021 LIBRARY; T=293.6K  
angular distribution for (n,n\*19)

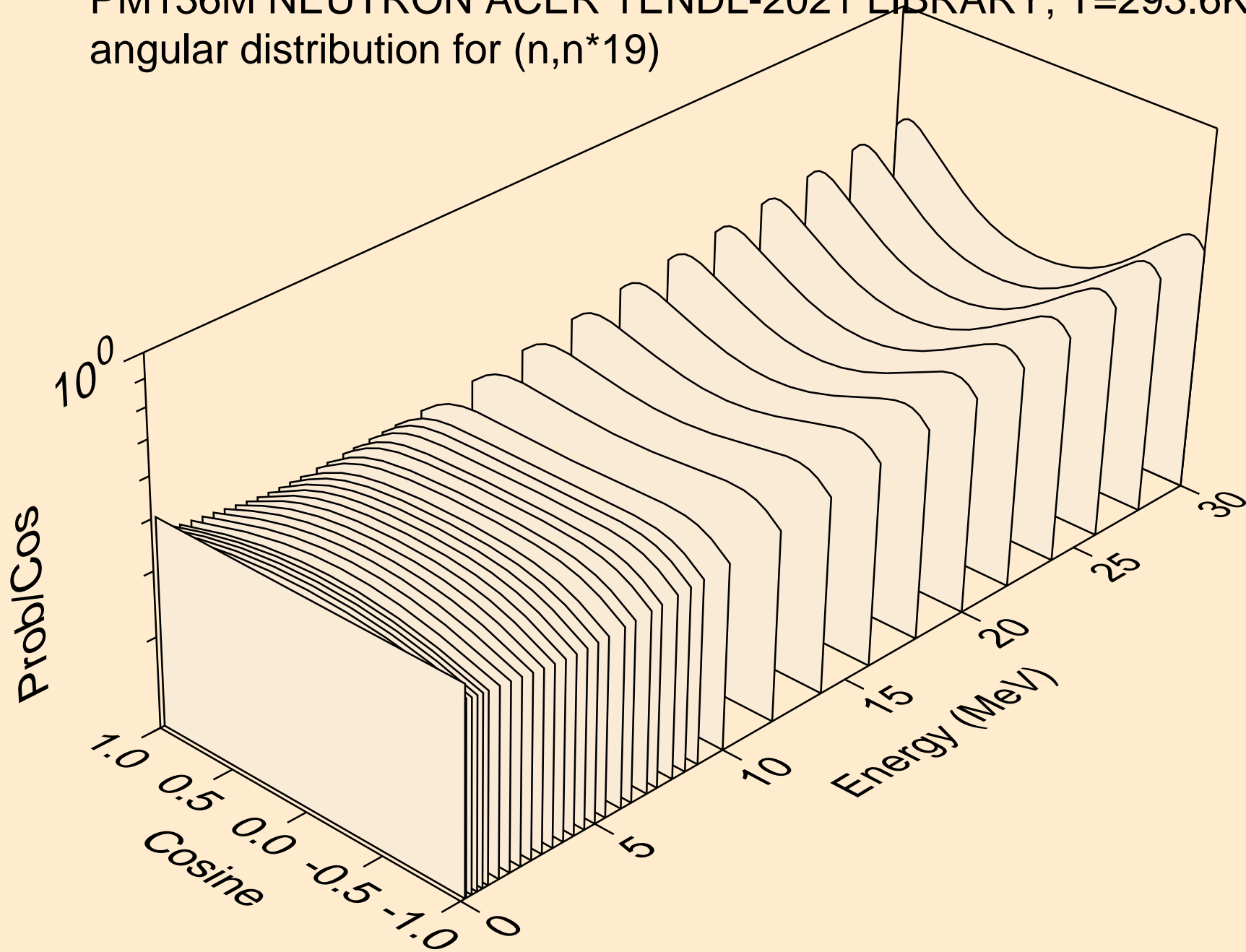

PM136M NEUTRON ACER TENDL-2021 LIBRARY; T=293.6K  
angular distribution for (n,n\*20)

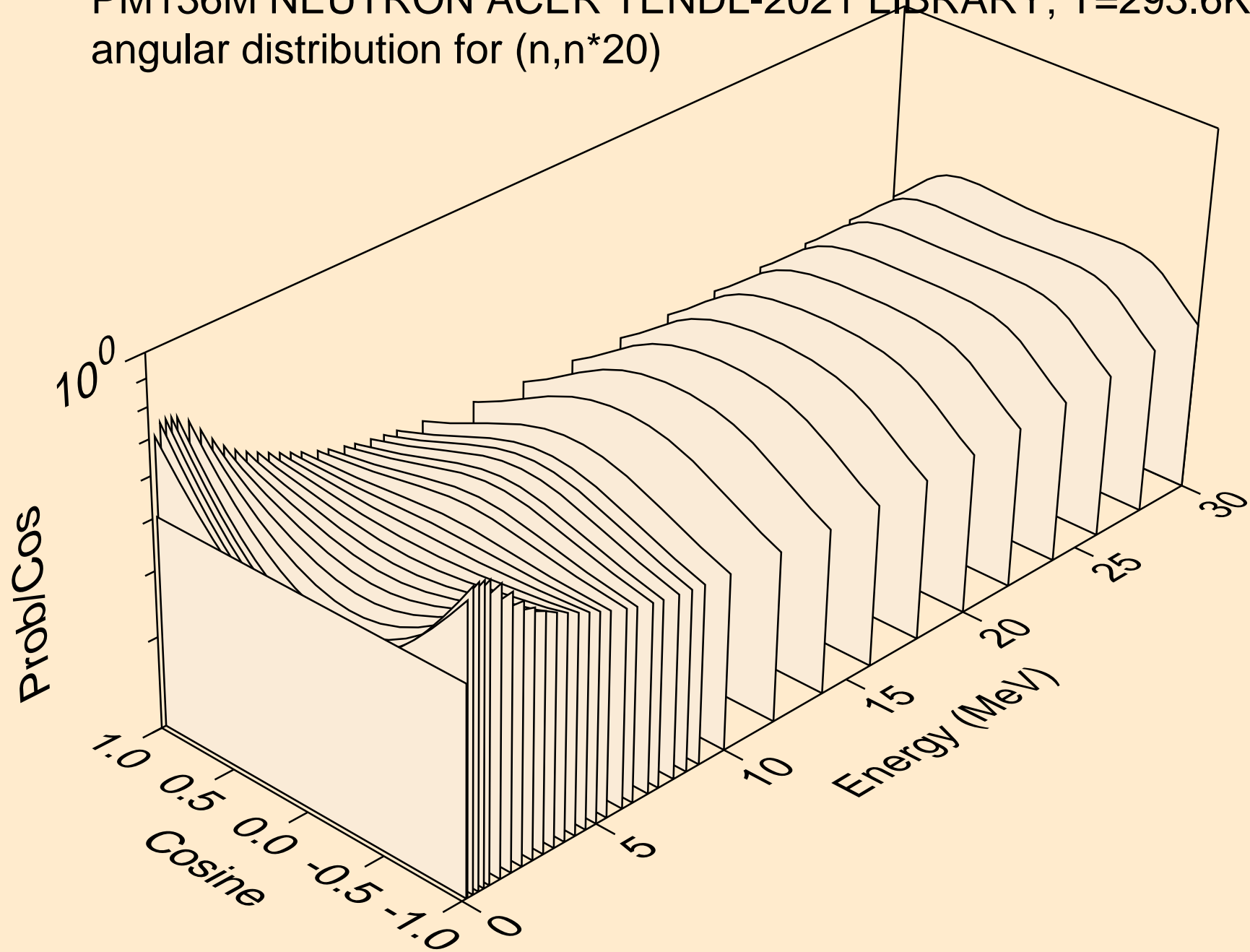

PM136M NEUTRON ACER TENDL-2021 LIBRARY; T=293.6K  
angular distribution for (n,n\*21)

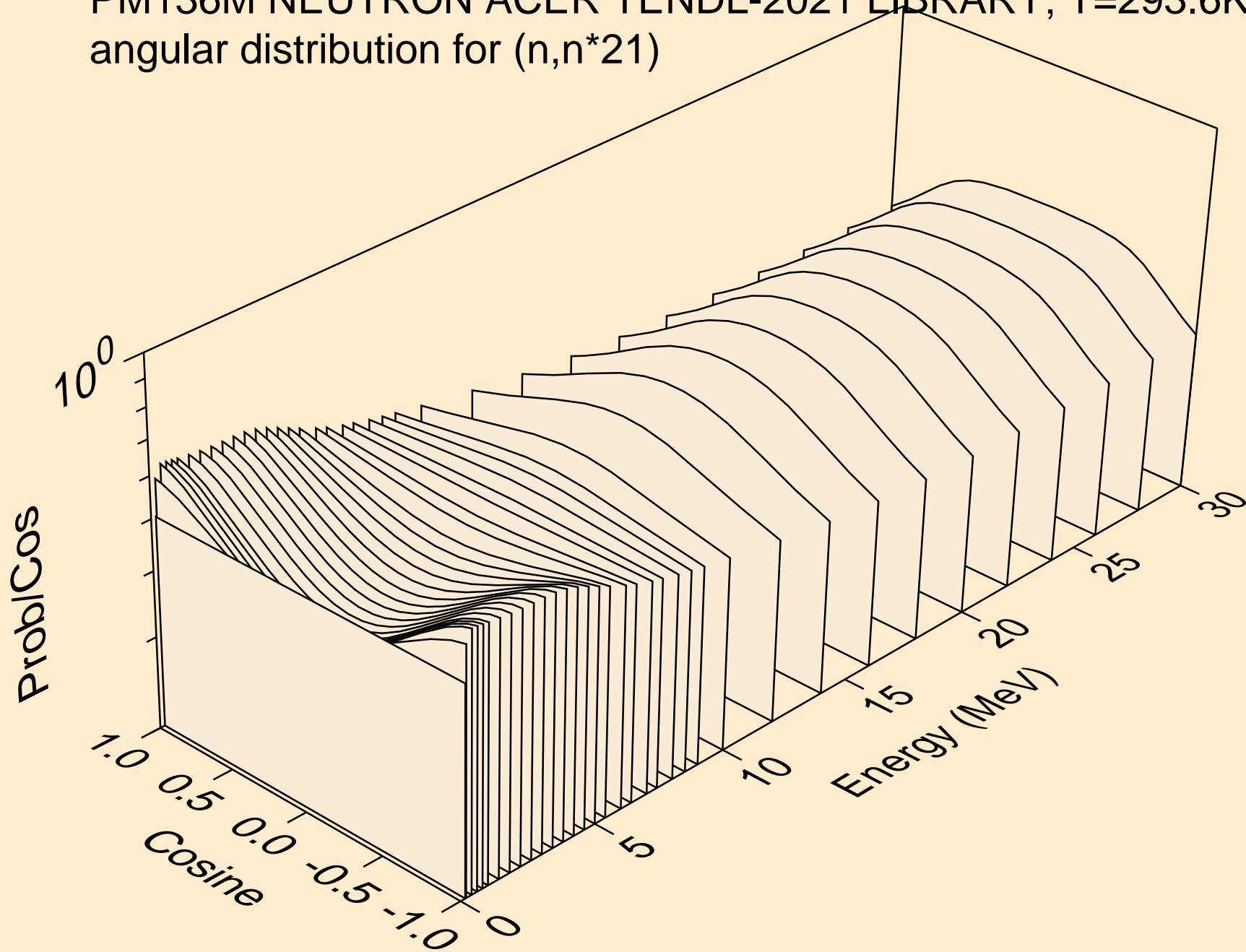

PM136M NEUTRON ACER TENDL-2021 LIBRARY; T=293.6K  
angular distribution for (n,n\*22)

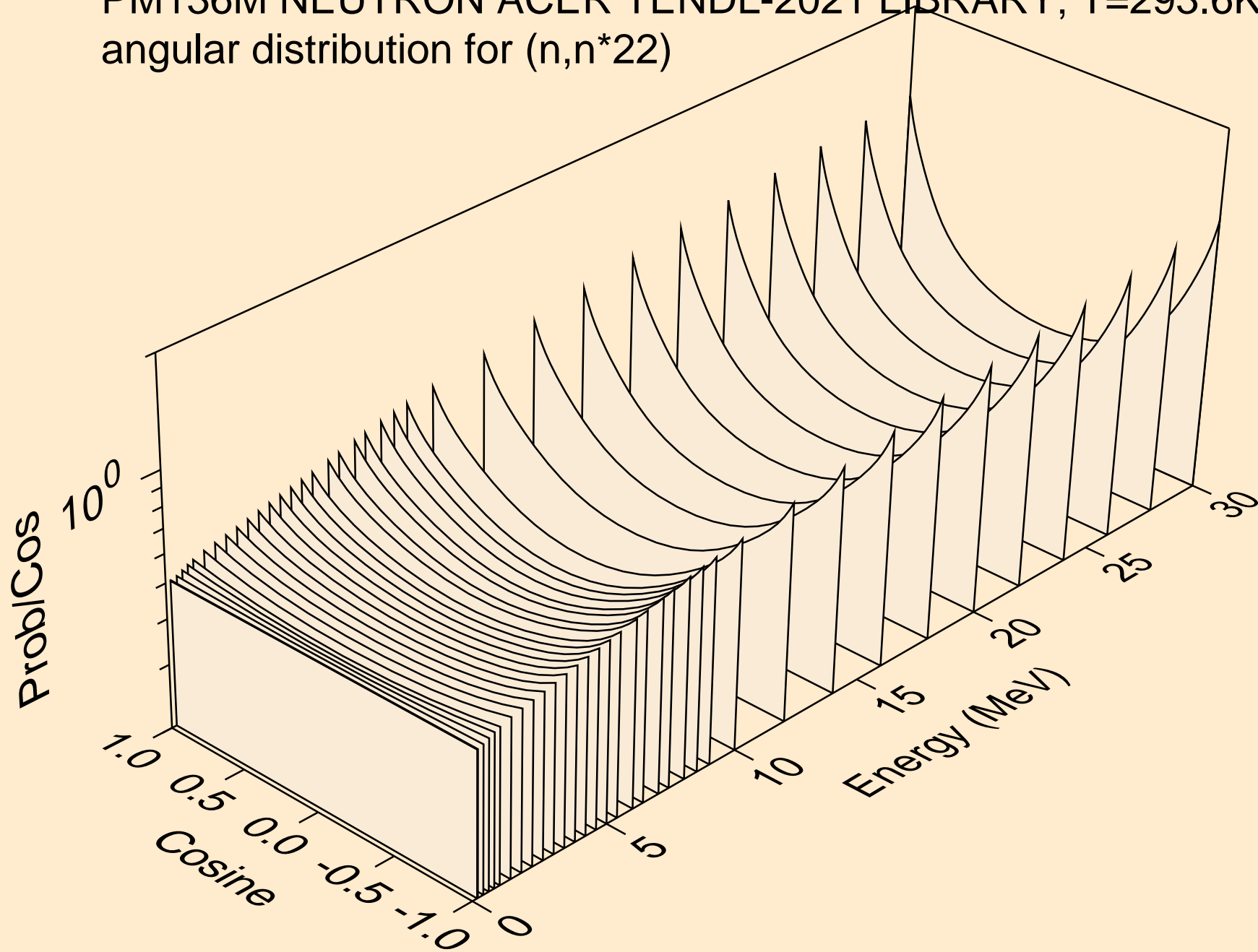

PM136M NEUTRON ACER TENDL-2021 LIBRARY; T=293.6K  
angular distribution for (n,n\*23)

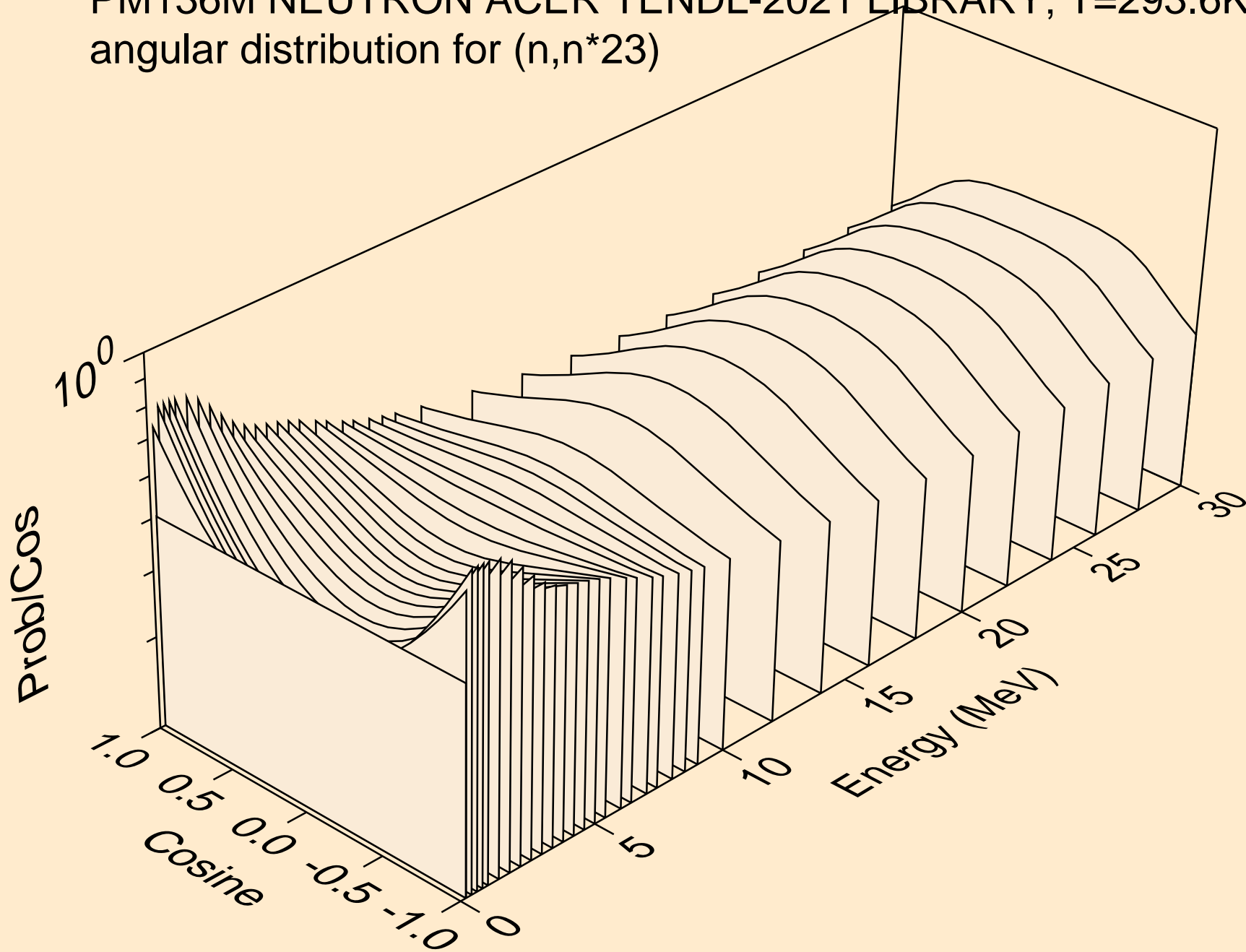

PM136M NEUTRON ACER TENDL-2021 LIBRARY; T=293.6K  
angular distribution for (n,n\*24)

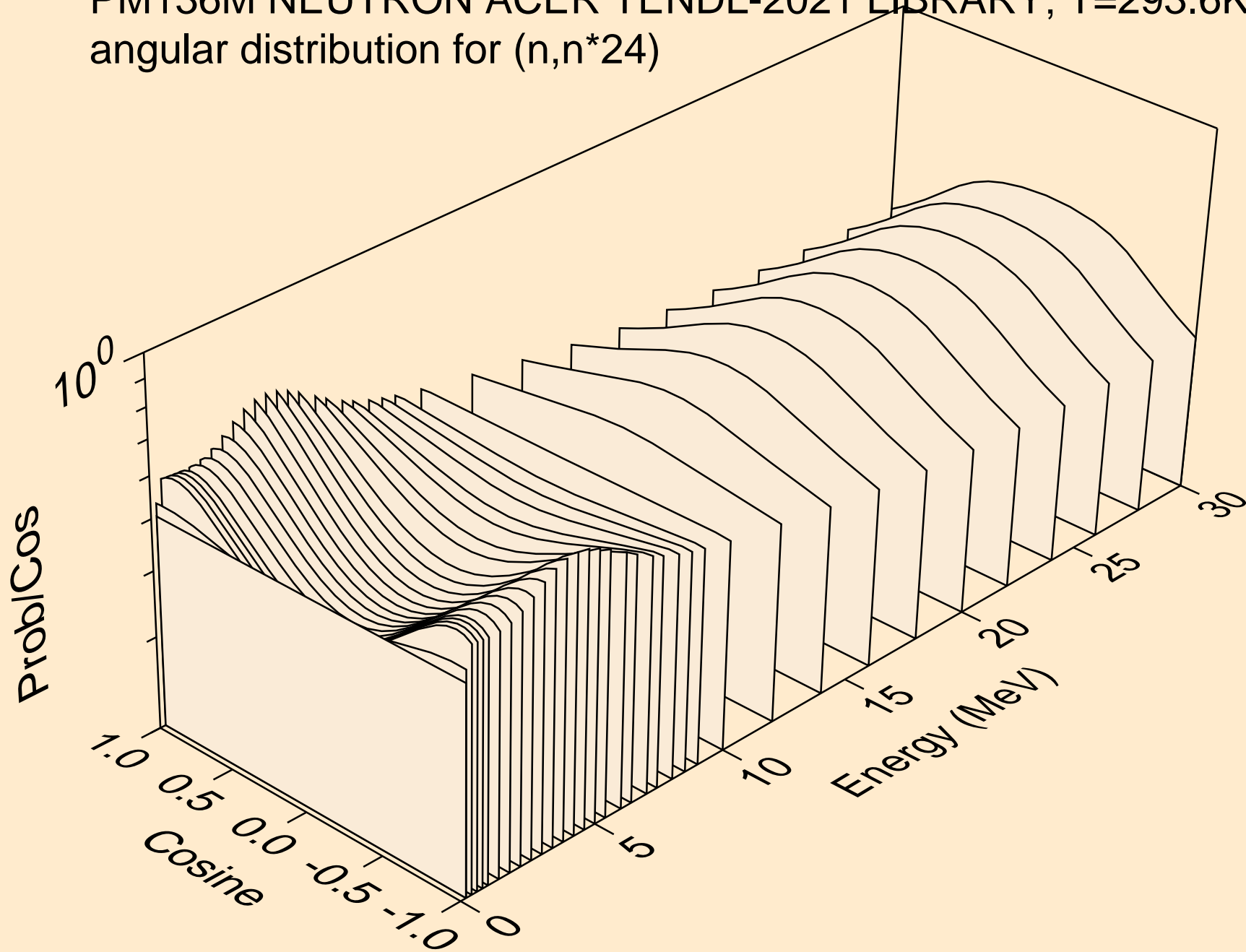



PM136M NEUTRON ACER TENDL-2021 LIBRARY; T=293.6K  
angular distribution for (n,n\*25)

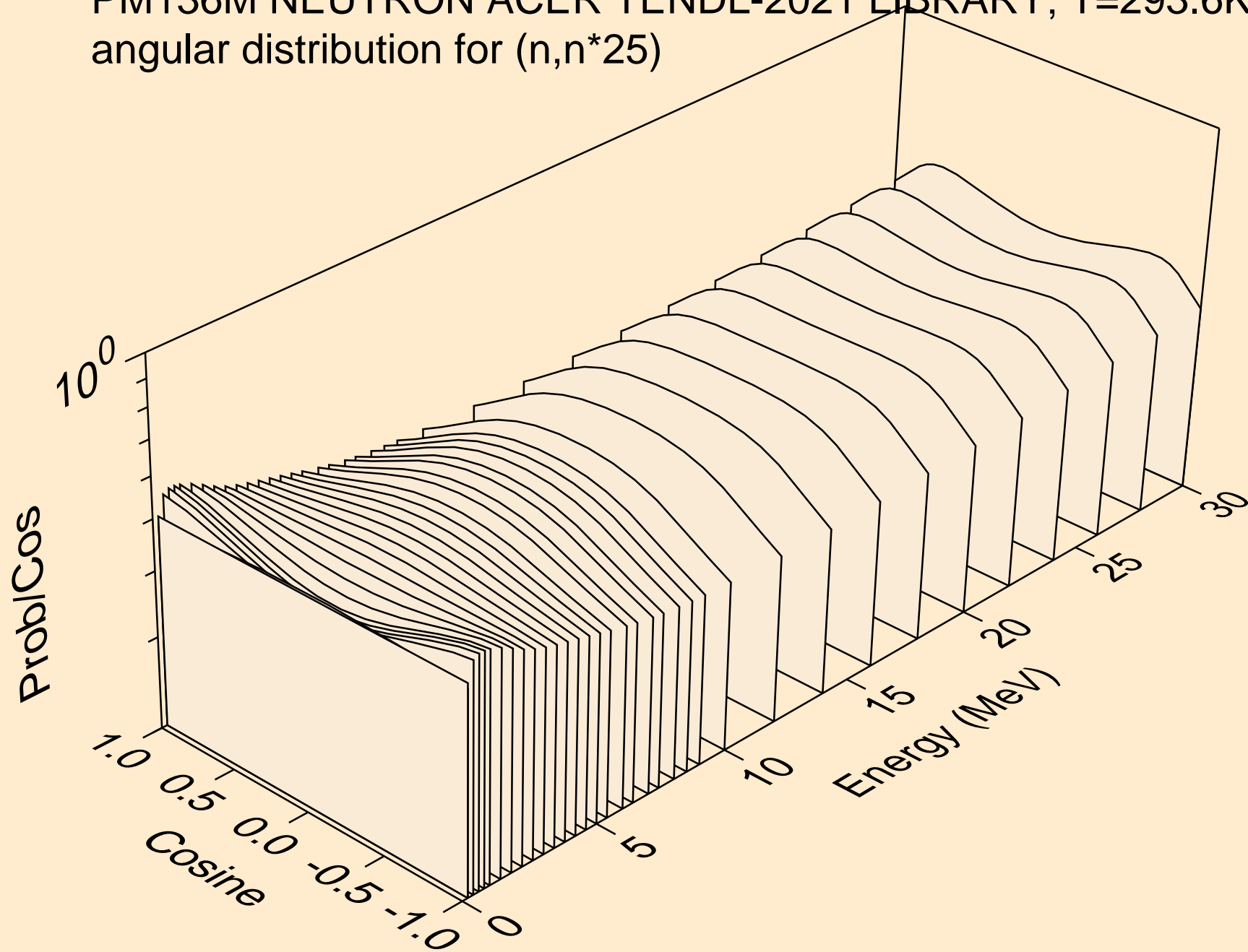

PM136M NEUTRON ACER TENDL-2021 LIBRARY; T=293.6K  
angular distribution for (n,n\*26)

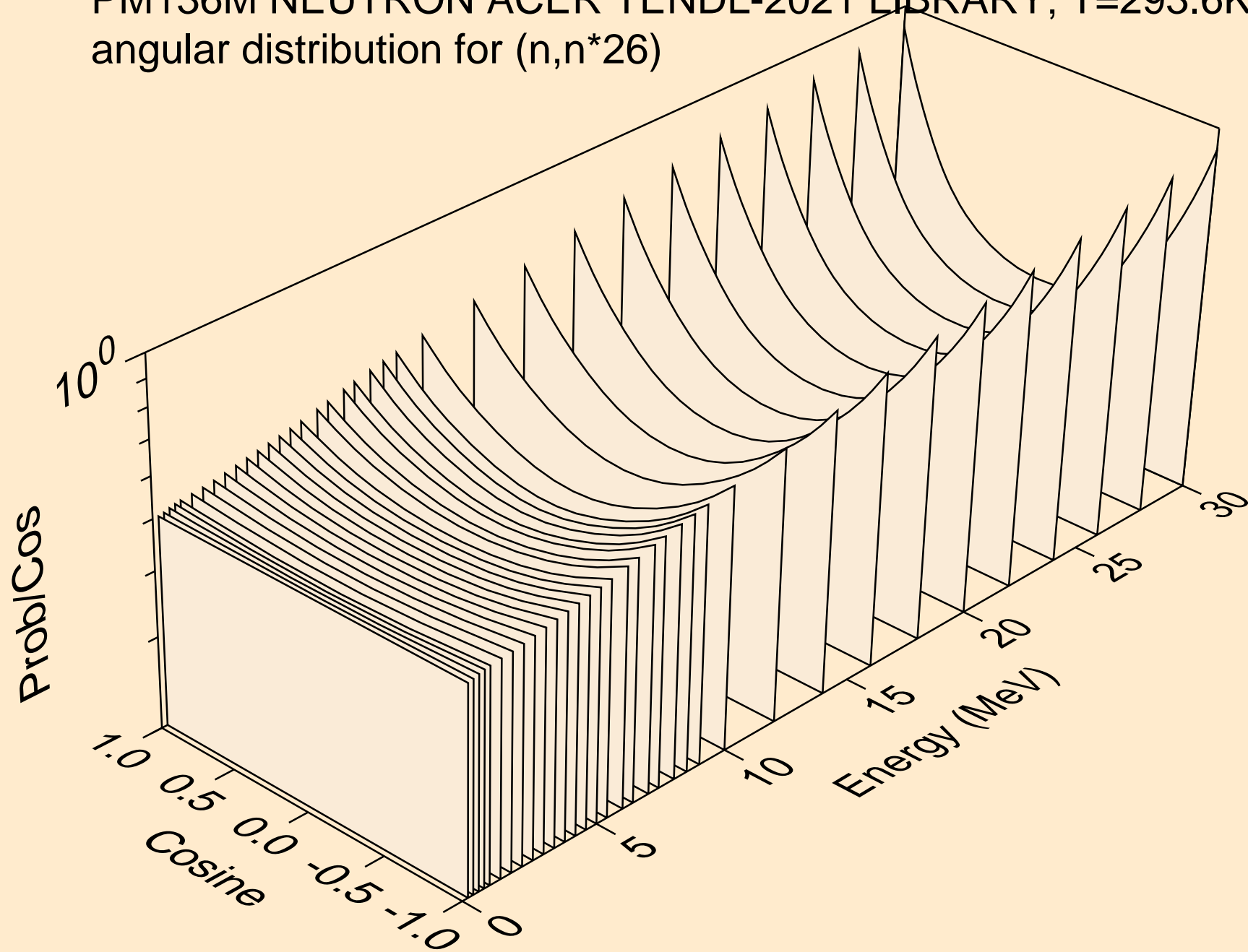

PM136M NEUTRON ACER TENDL-2021 LIBRARY; T=293.6K  
angular distribution for (n,n\*27)

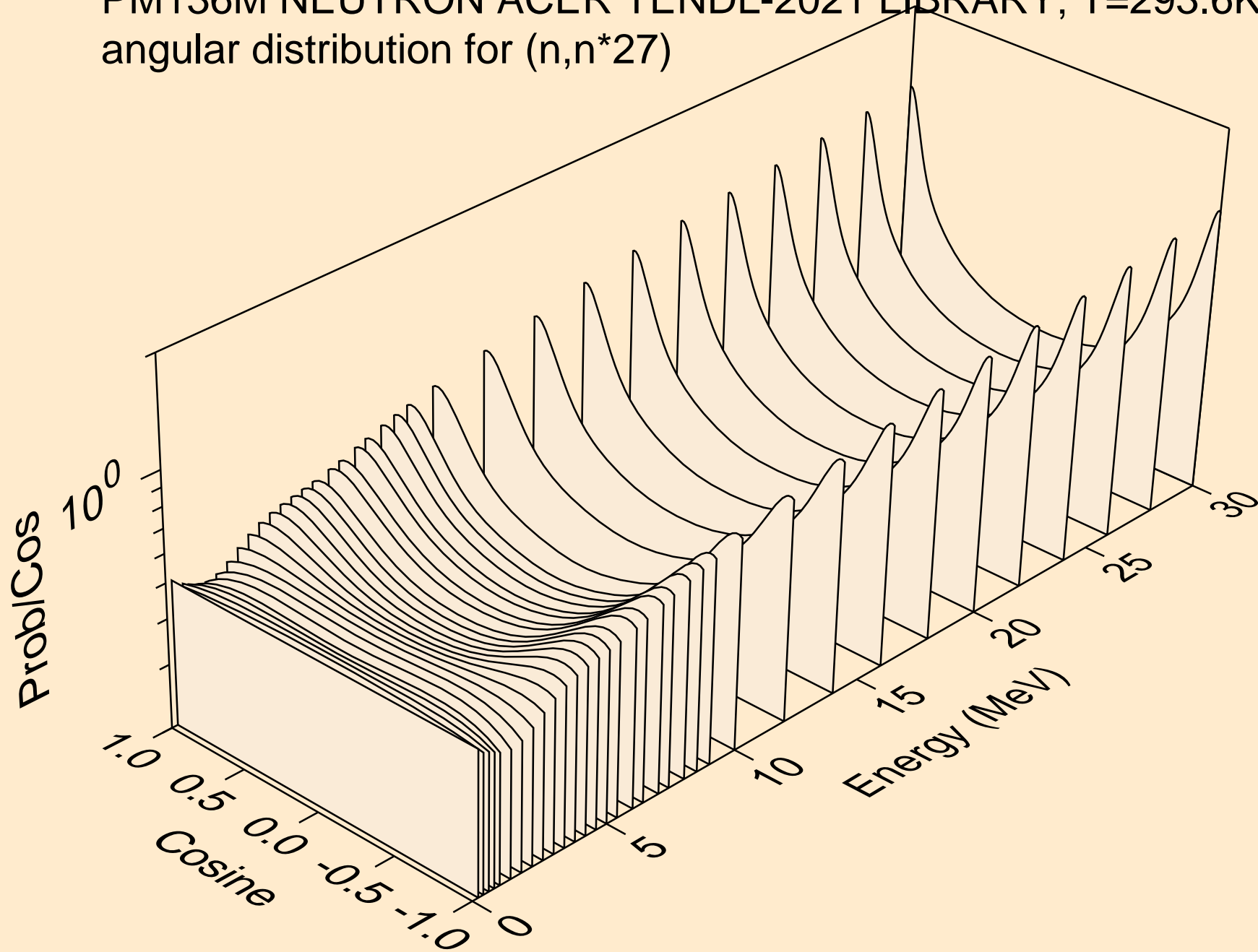

PM136M NEUTRON ACER TENDL-2021 LIBRARY; T=293.6K  
angular distribution for (n,n\*28)

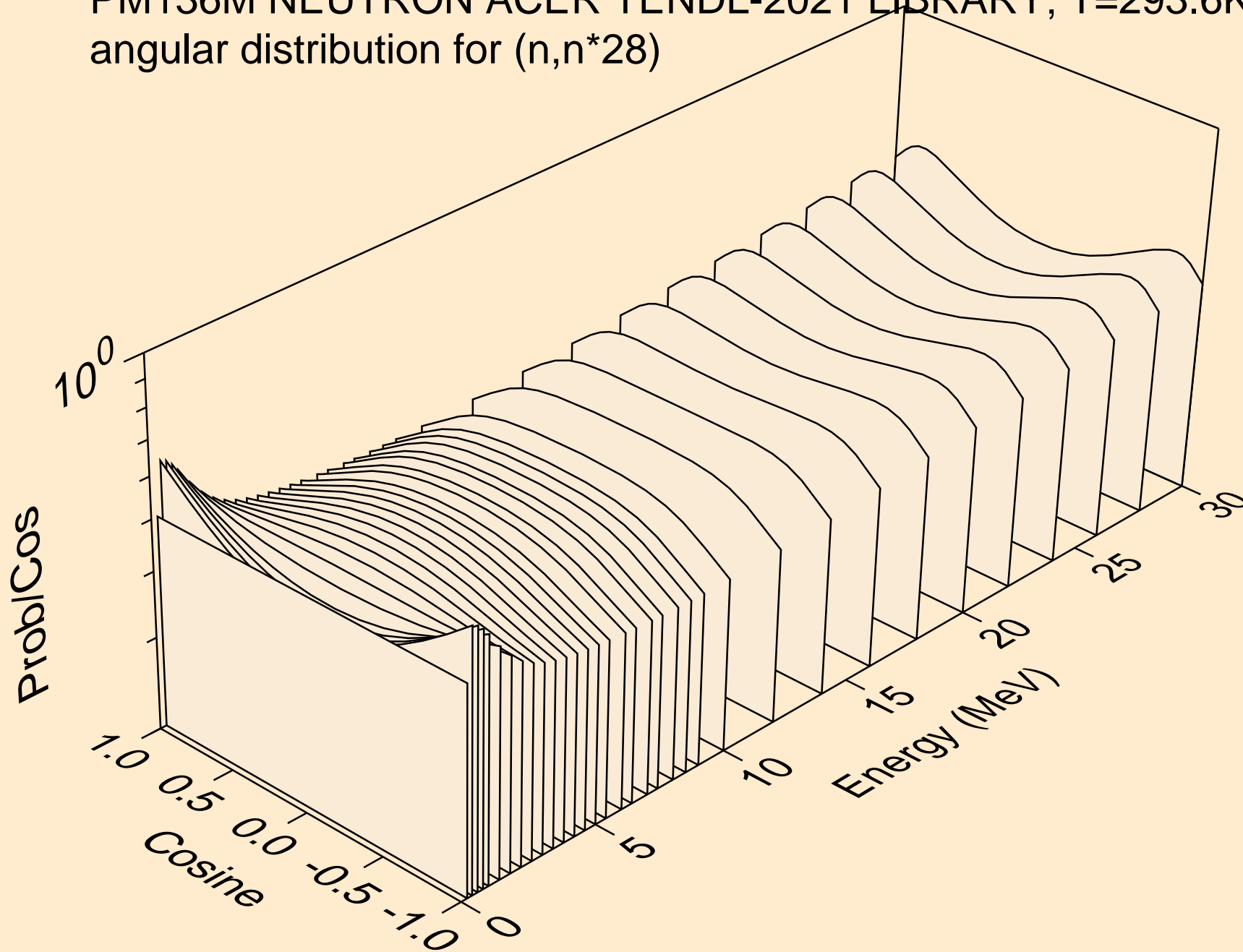

PM136M NEUTRON ACER TENDL-2021 LIBRARY; T=293.6K  
angular distribution for (n,n\*29)

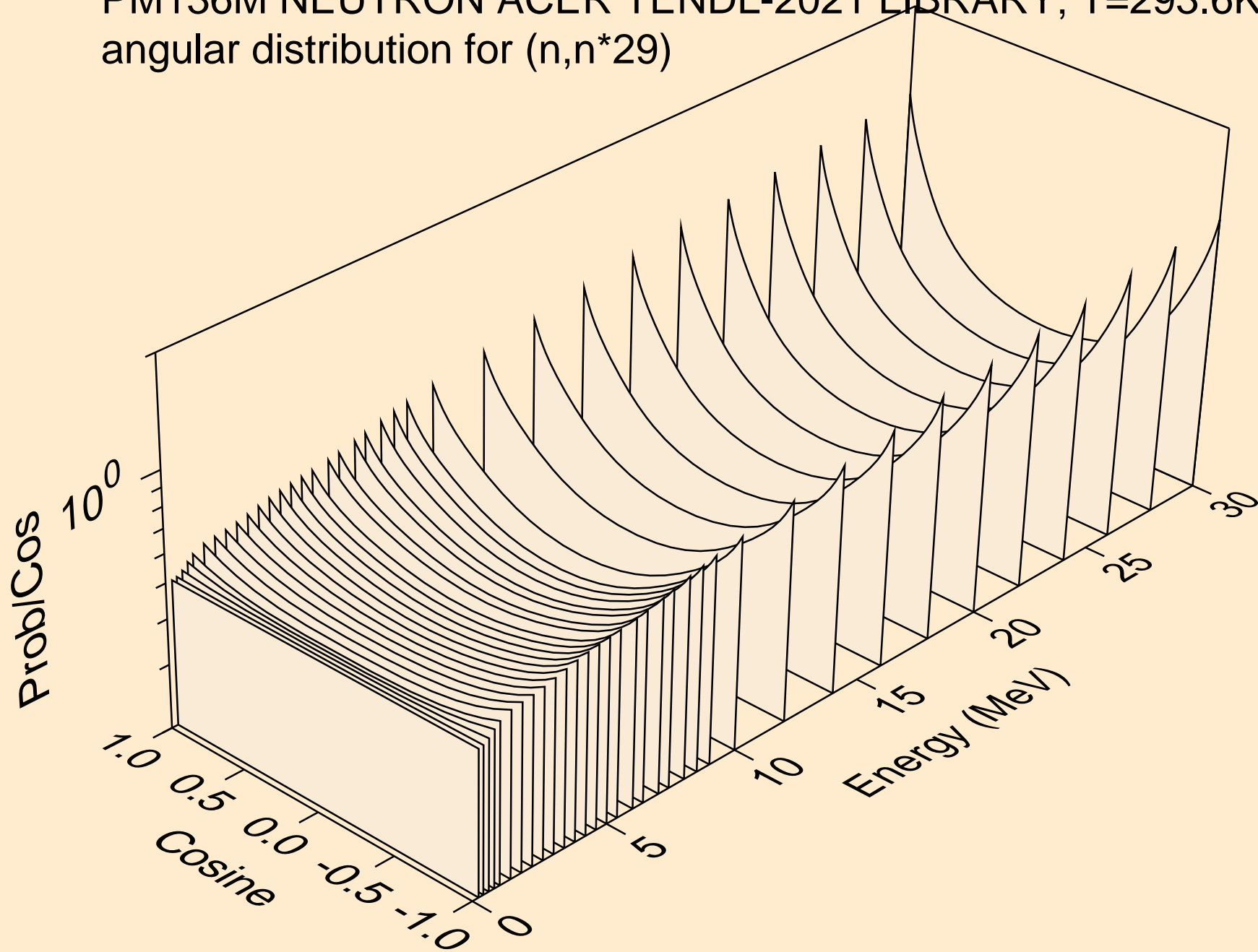

PM136M NEUTRON ACER TENDL-2021 LIBRARY; T=293.6K  
Neutron emission for (n,x)

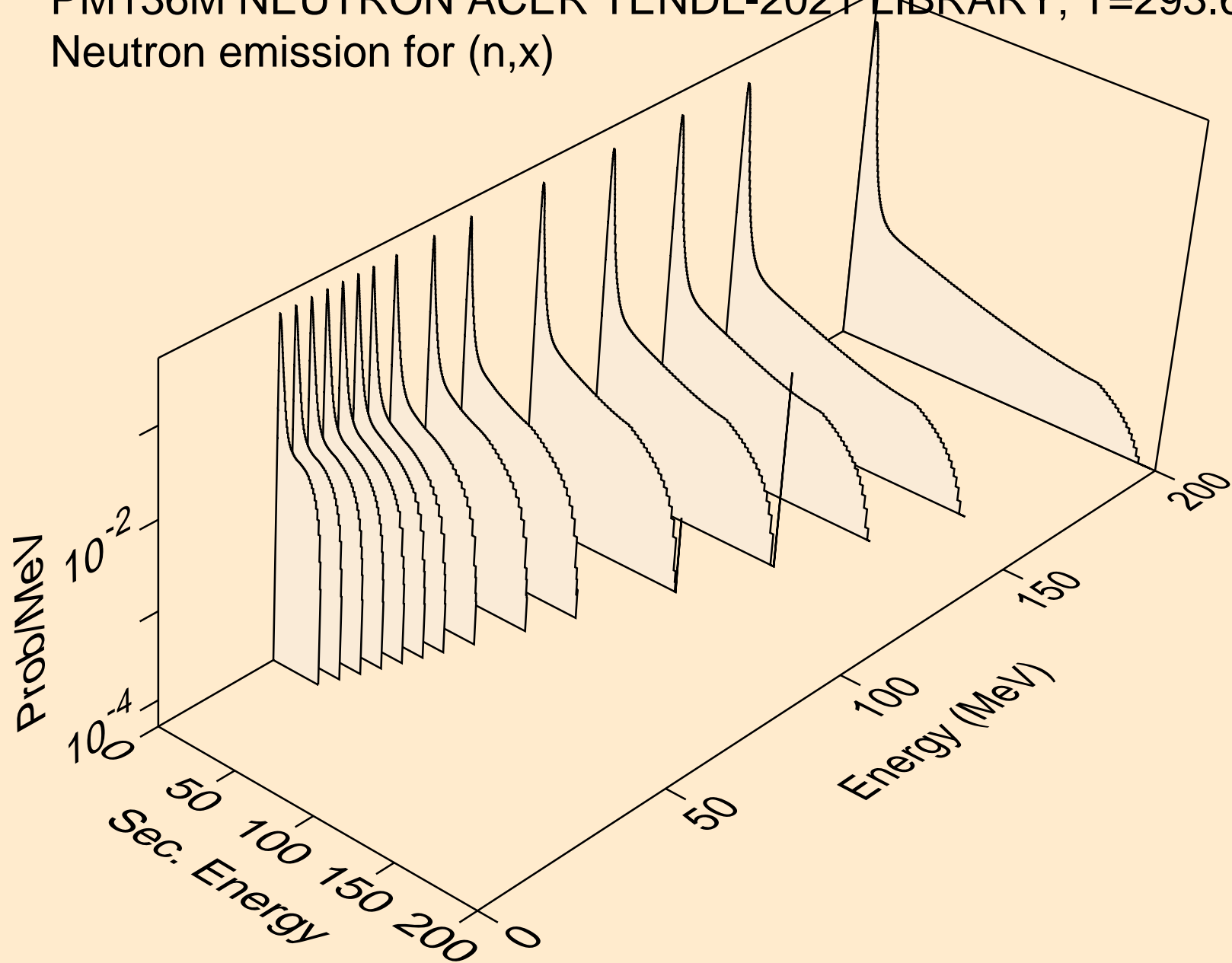

PM136M NEUTRON ACER TENDL-2021 LIBRARY; T=293.6K  
Neutron emission for (n,2nd)

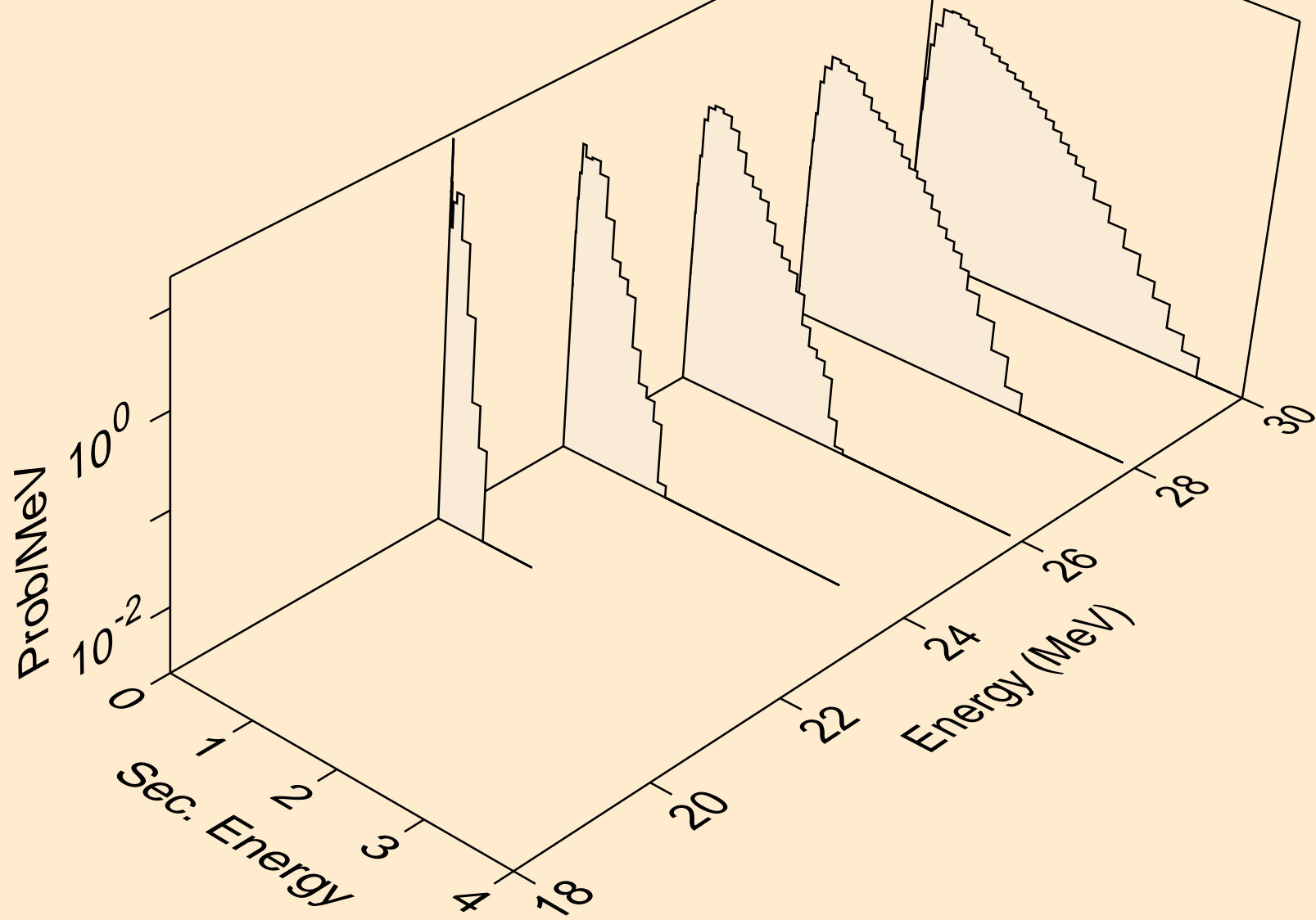

PM136M NEUTRON ACER TENDL-2021 LIBRARY; T=293.6K  
Neutron emission for (n,2n)

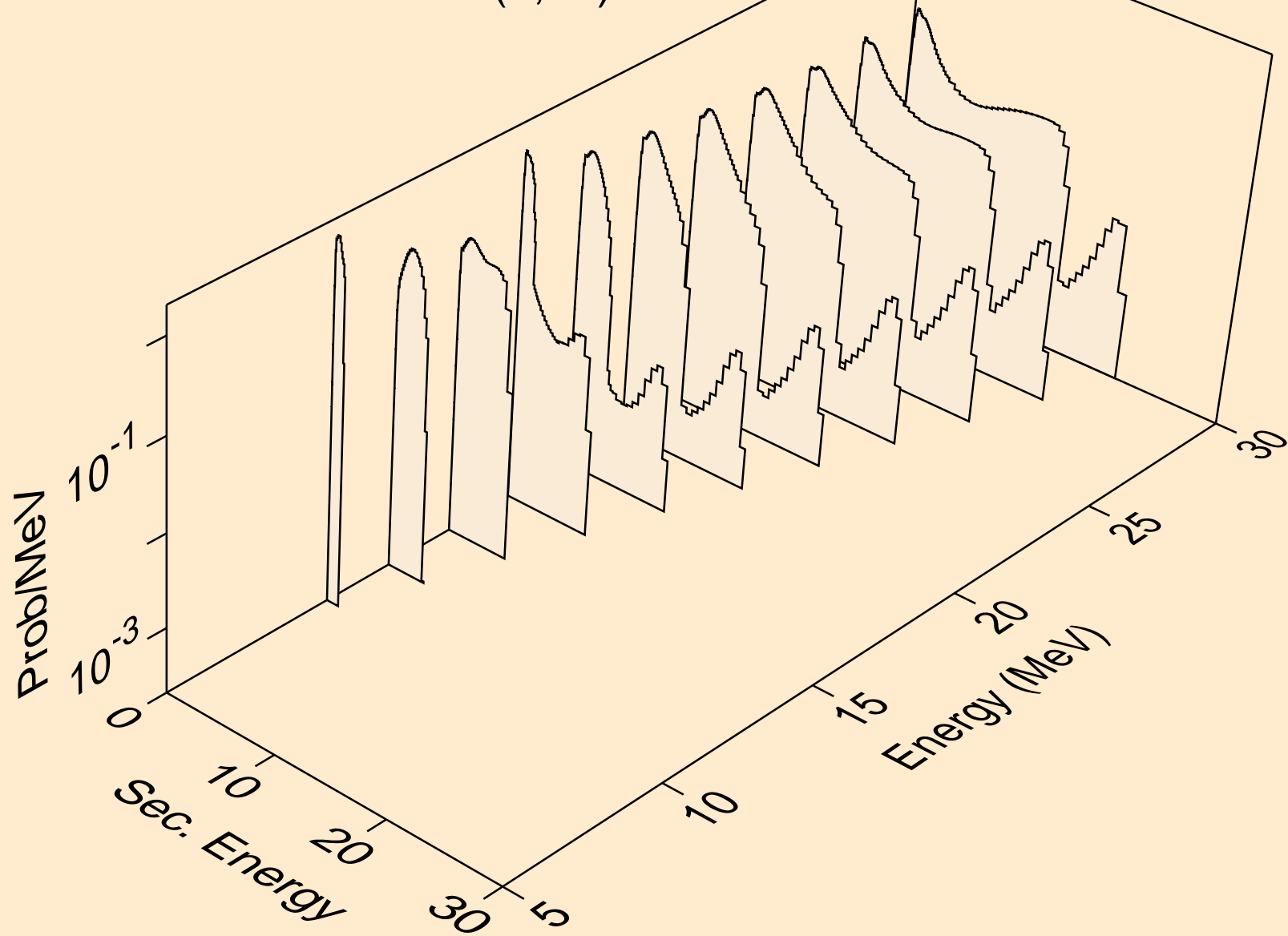



PM136M NEUTRON ACER TENDL-2021 LIBRARY; T=293.6K  
Neutron emission for (n,3n)

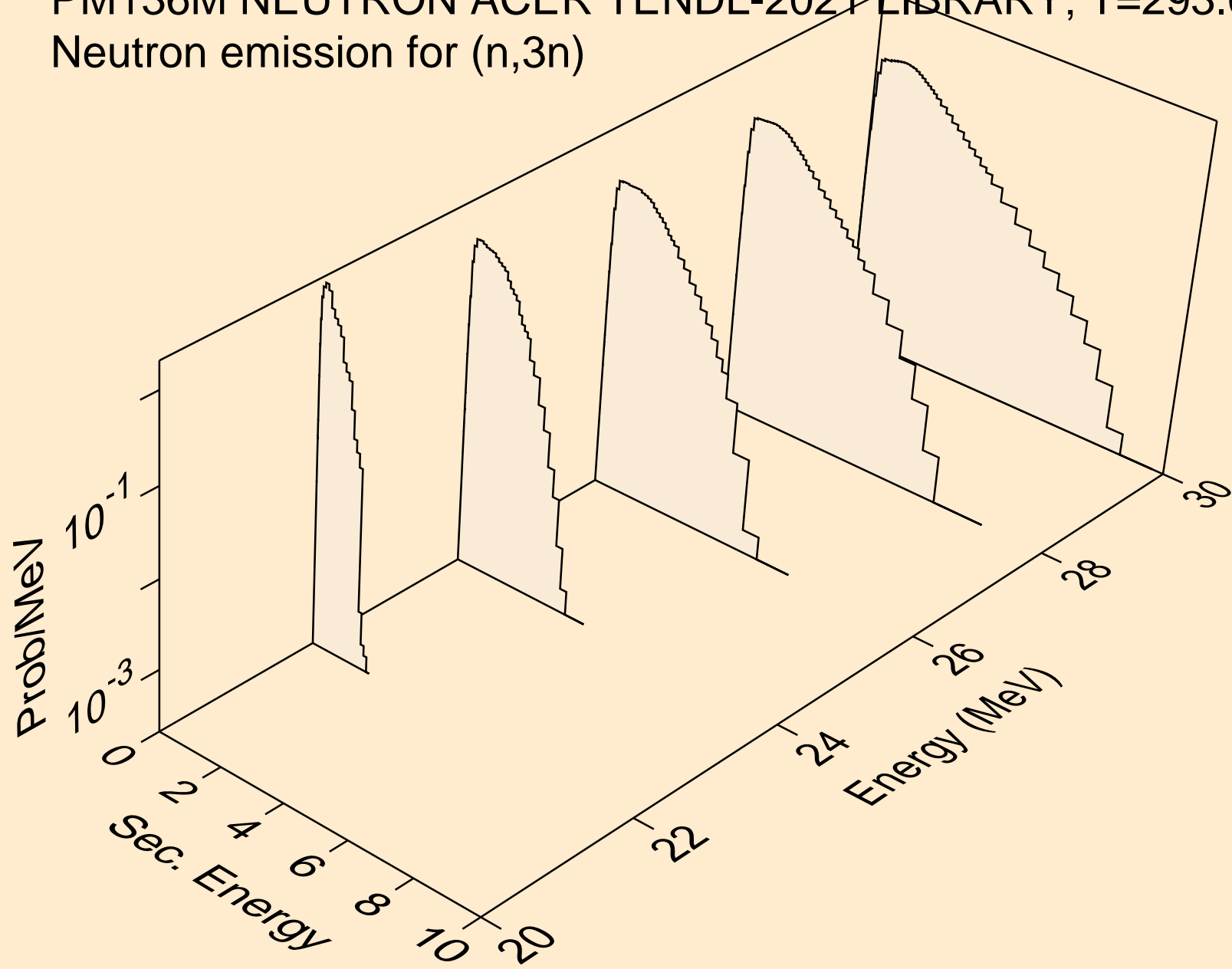

PM136M NEUTRON ACER TENDL-2021 LIBRARY; T=293.6K  
Neutron emission for (n,n\*)a

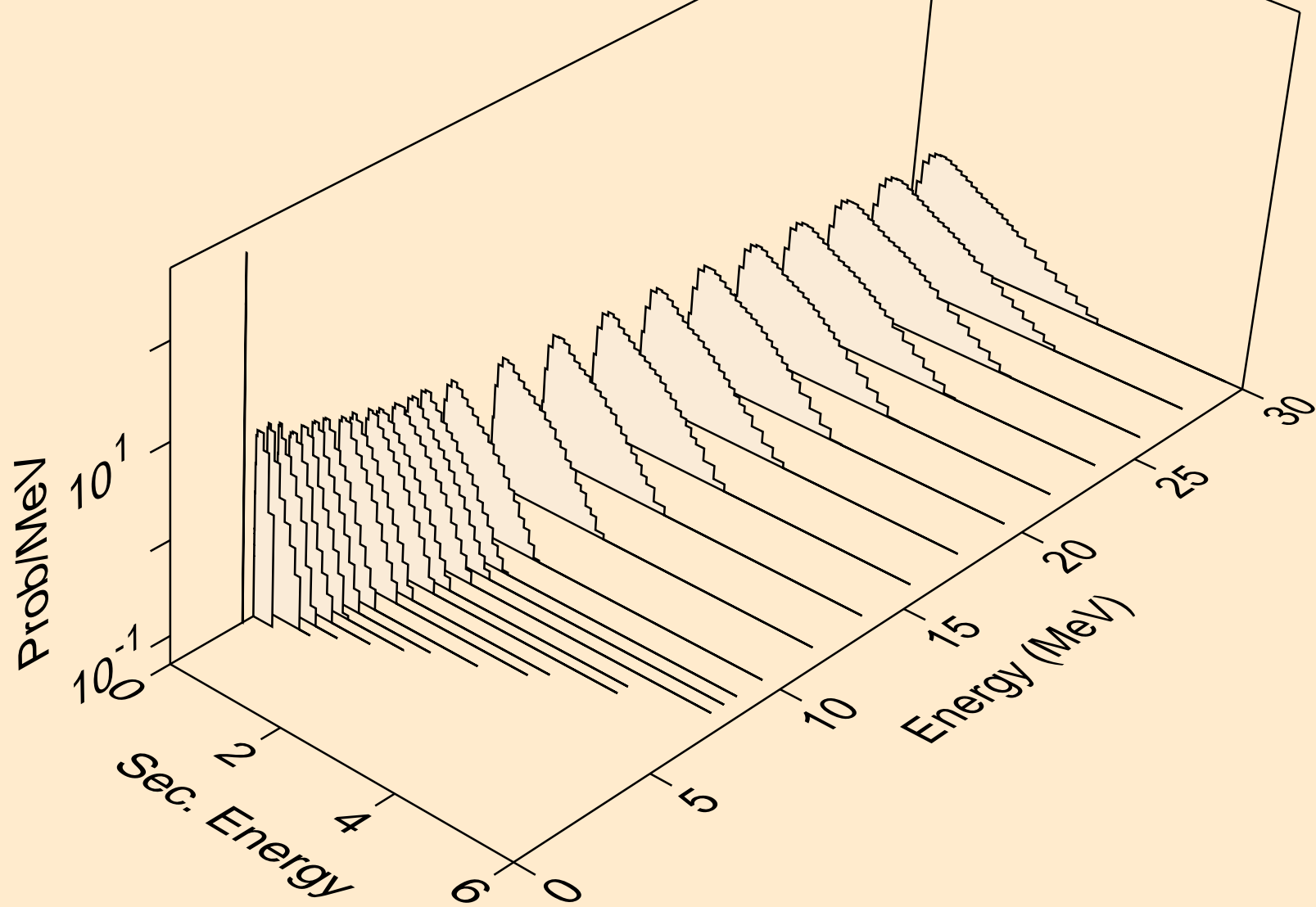

PM136M NEUTRON ACER TENDL-2021 LIBRARY; T=293.6K  
Neutron emission for (n,2n)<sub>a</sub>

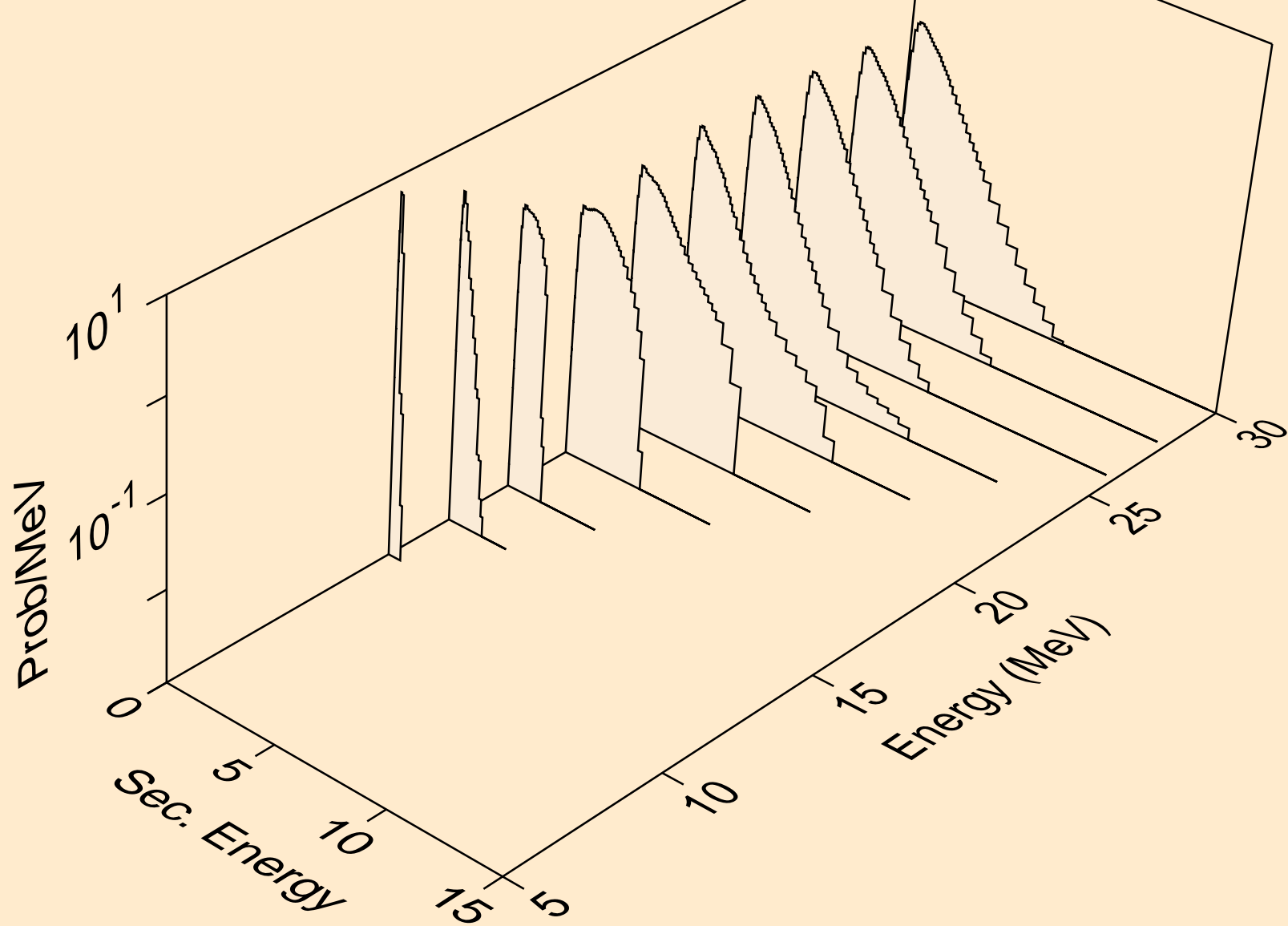

PM136M NEUTRON ACER TENDL-2021 LIBRARY; T=293.6K  
Neutron emission for (n,3n)a

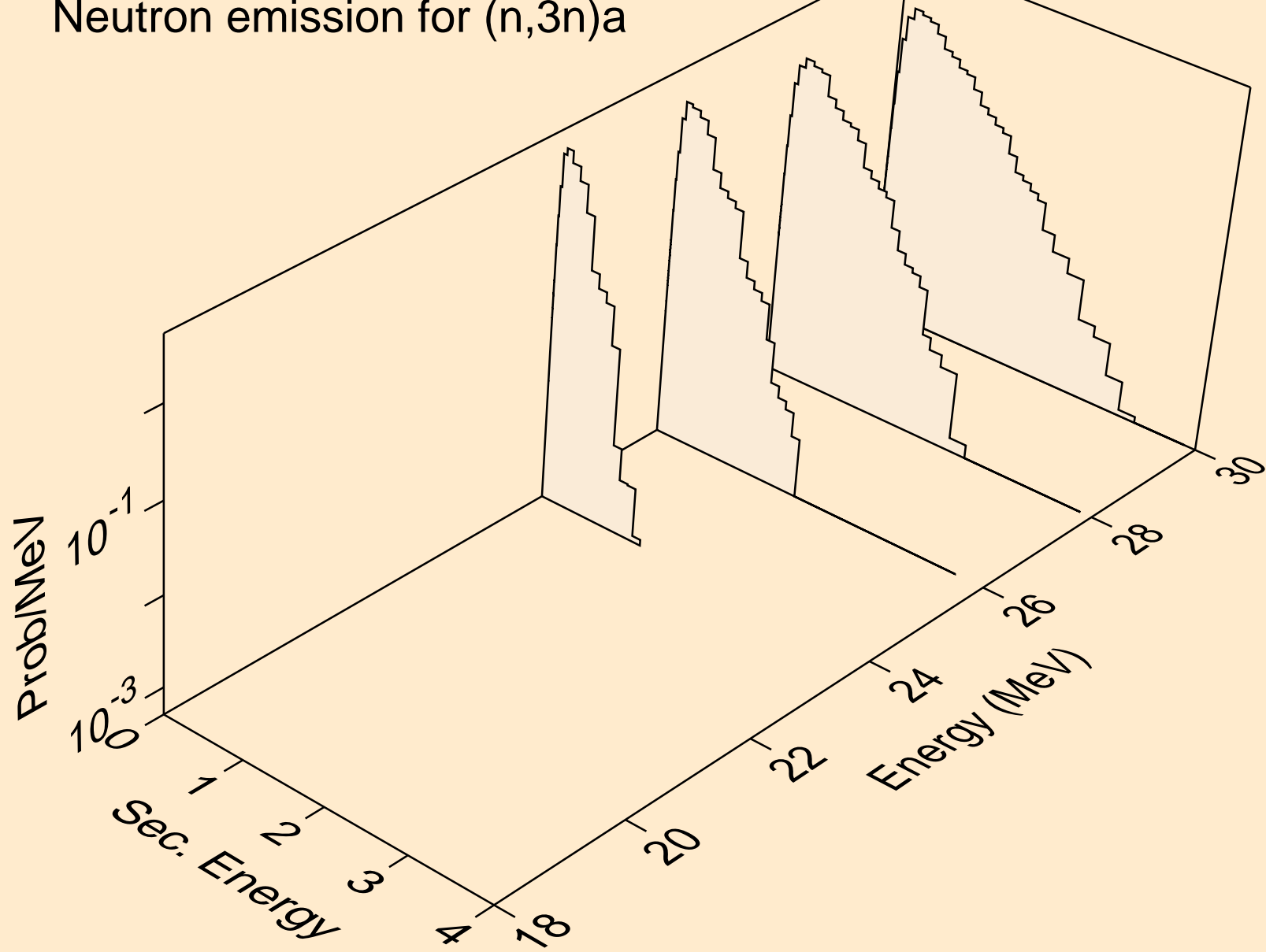

PM136M NEUTRON ACER TENDL-2021 LIBRARY; T=293.6K  
Neutron emission for (n,n\*)p

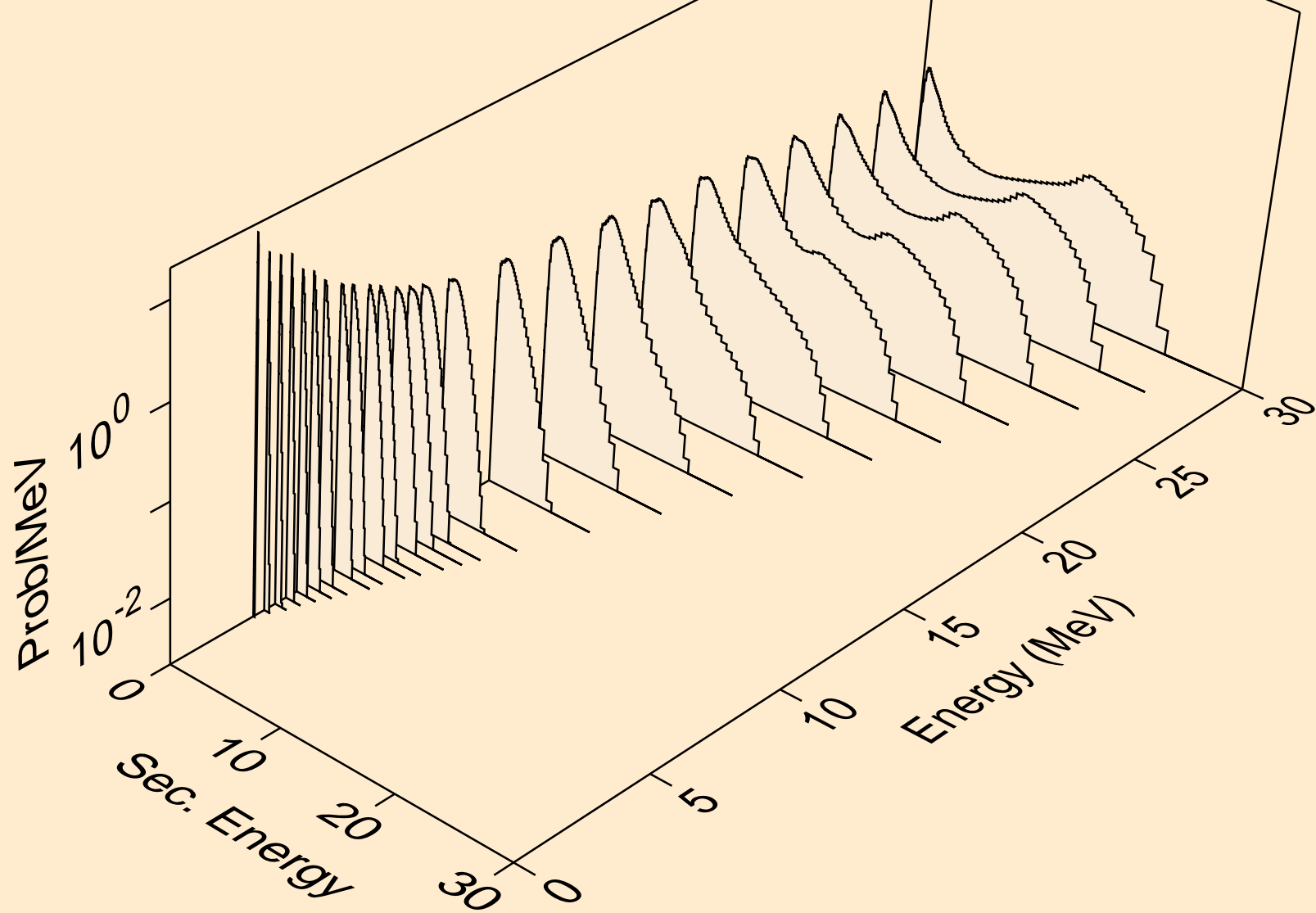

PM136M NEUTRON ACER TENDL-2021 LIBRARY; T=293.6K  
Neutron emission for (n,n\*)2a

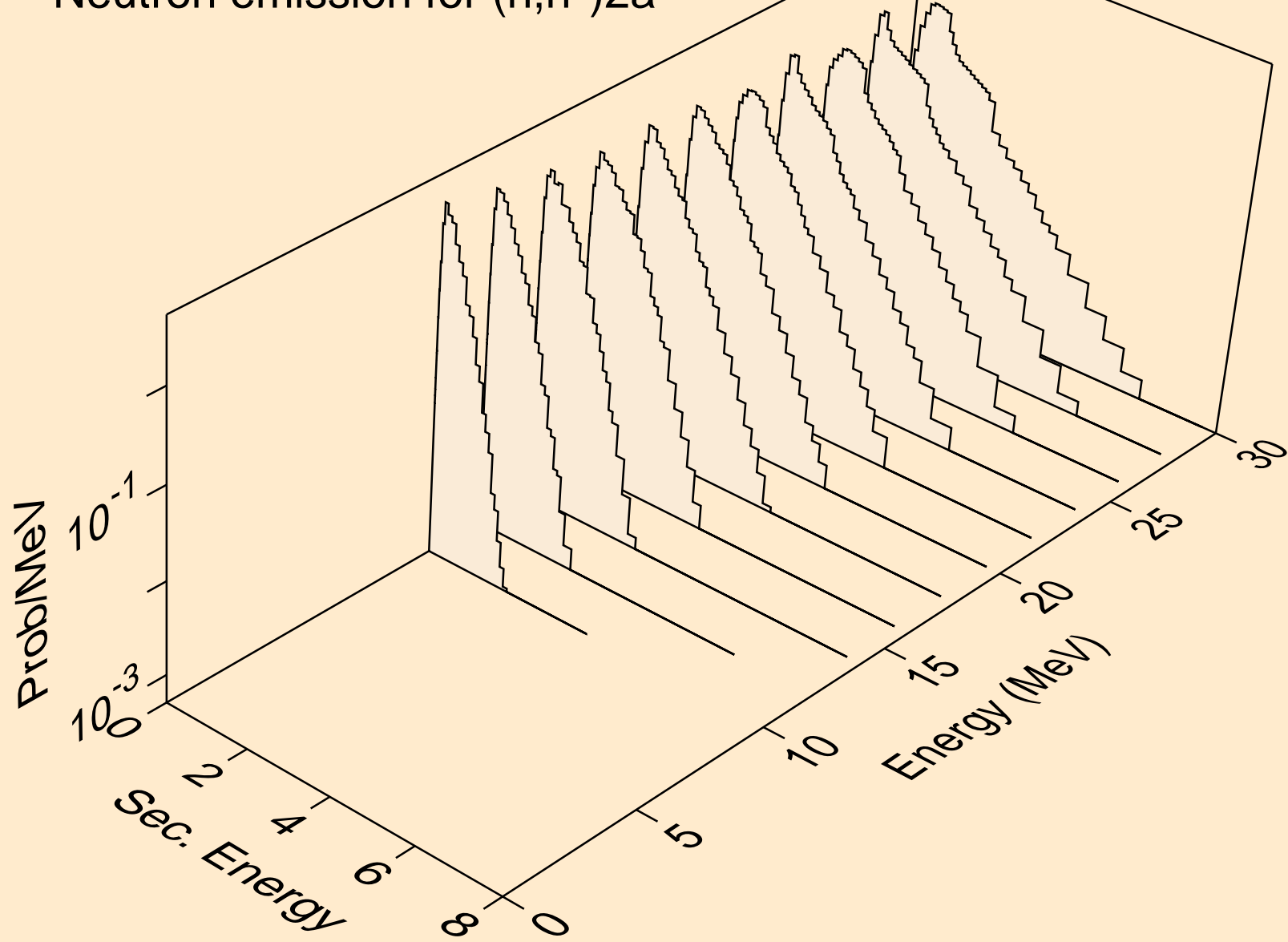

PM136M NEUTRON ACER TENDL-2021 LIBRARY; T=293.6K  
Neutron emission for (n,2n)2a

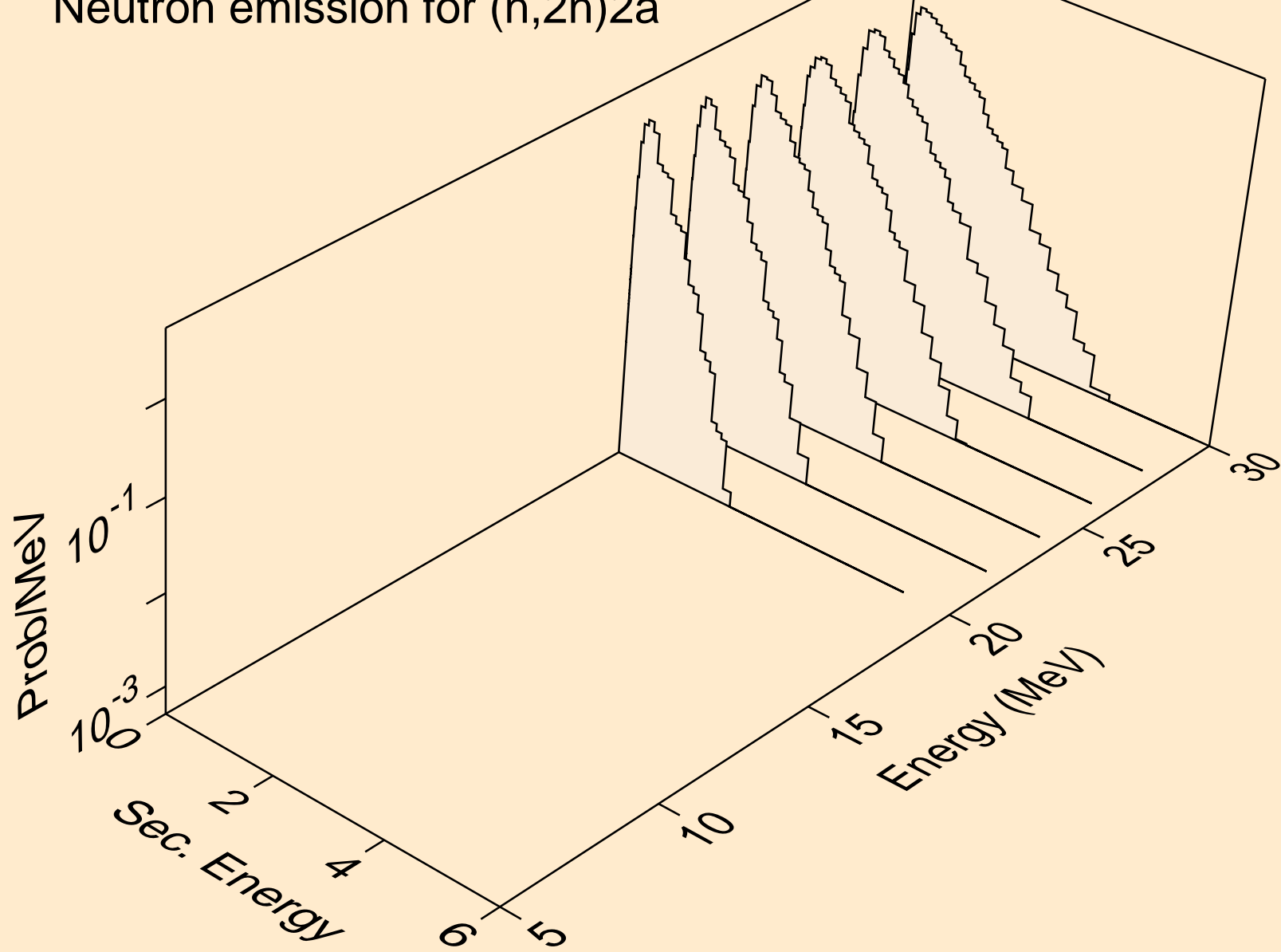

PM136M NEUTRON ACER TENDL-2021 LIBRARY; T=293.6K  
Neutron emission for (n,n\*)d

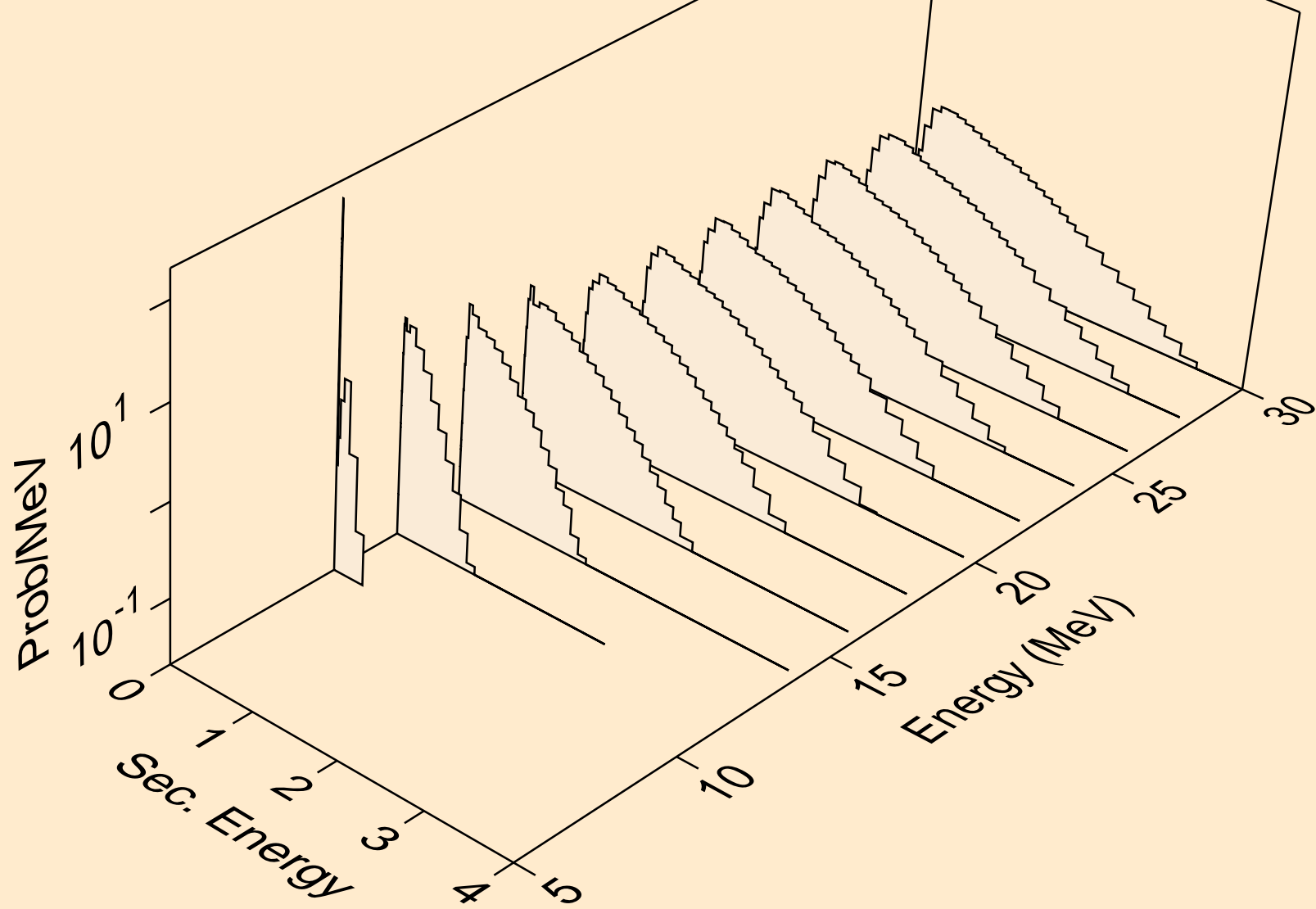



PM136M NEUTRON ACER TENDL-2021 LIBRARY; T=293.6K  
Neutron emission for (n,n\*)t

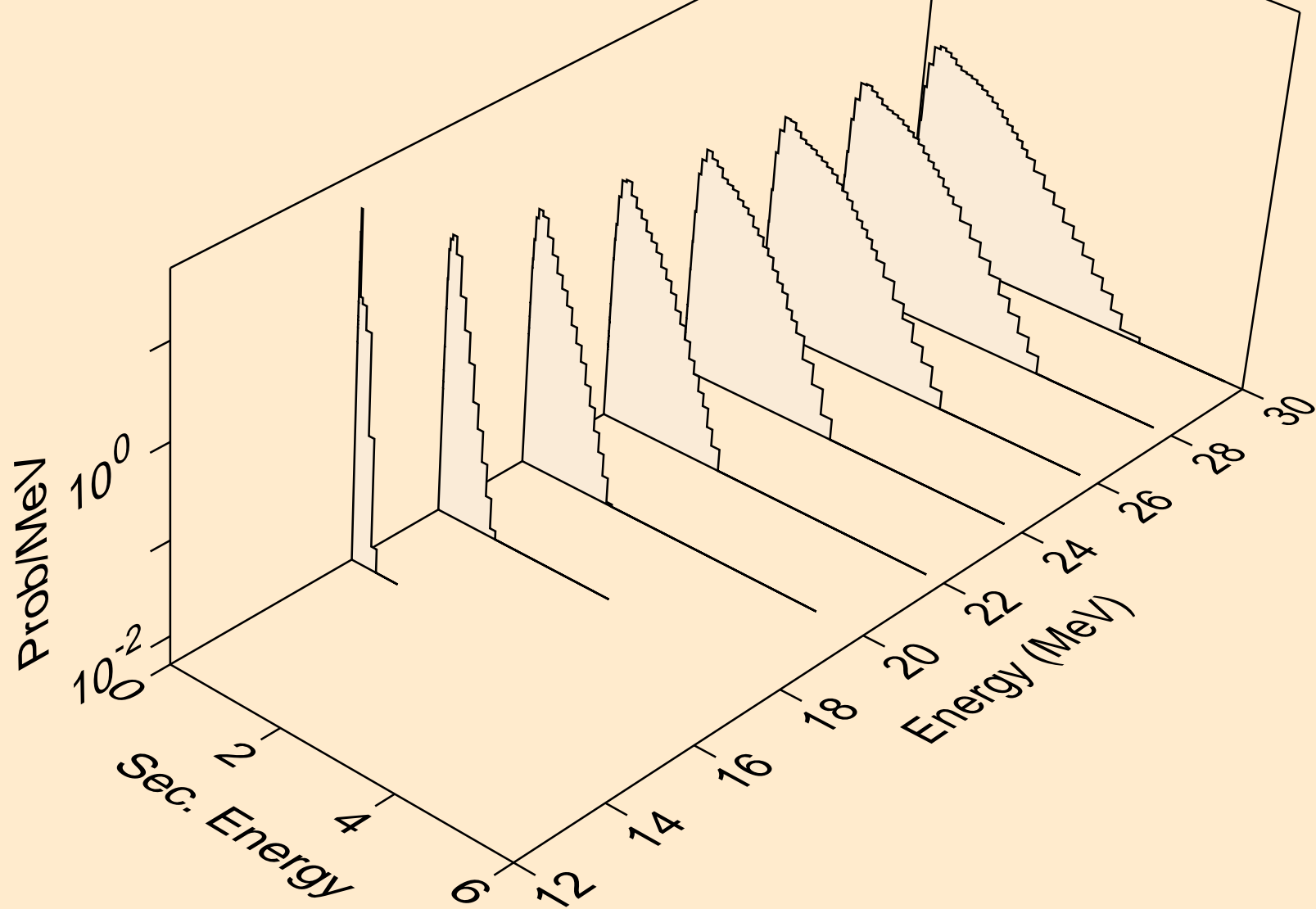

PM136M NEUTRON ACER TENDL-2021 LIBRARY; T=293.6K  
Neutron emission for (n,n\*)he3

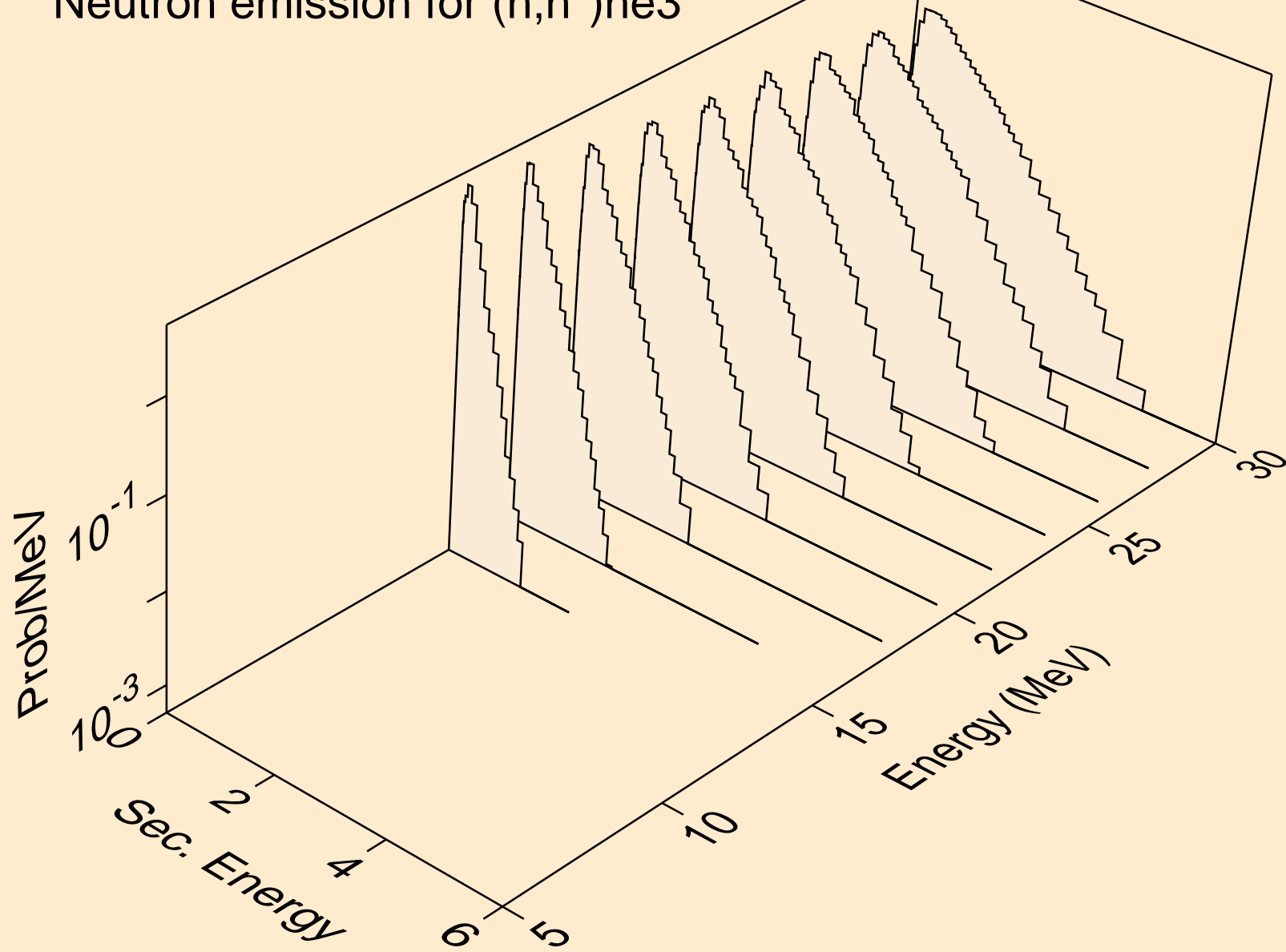

PM136M NEUTRON ACER TENDL-2021 LIBRARY; T=293.6K  
Neutron emission for (n,2np)

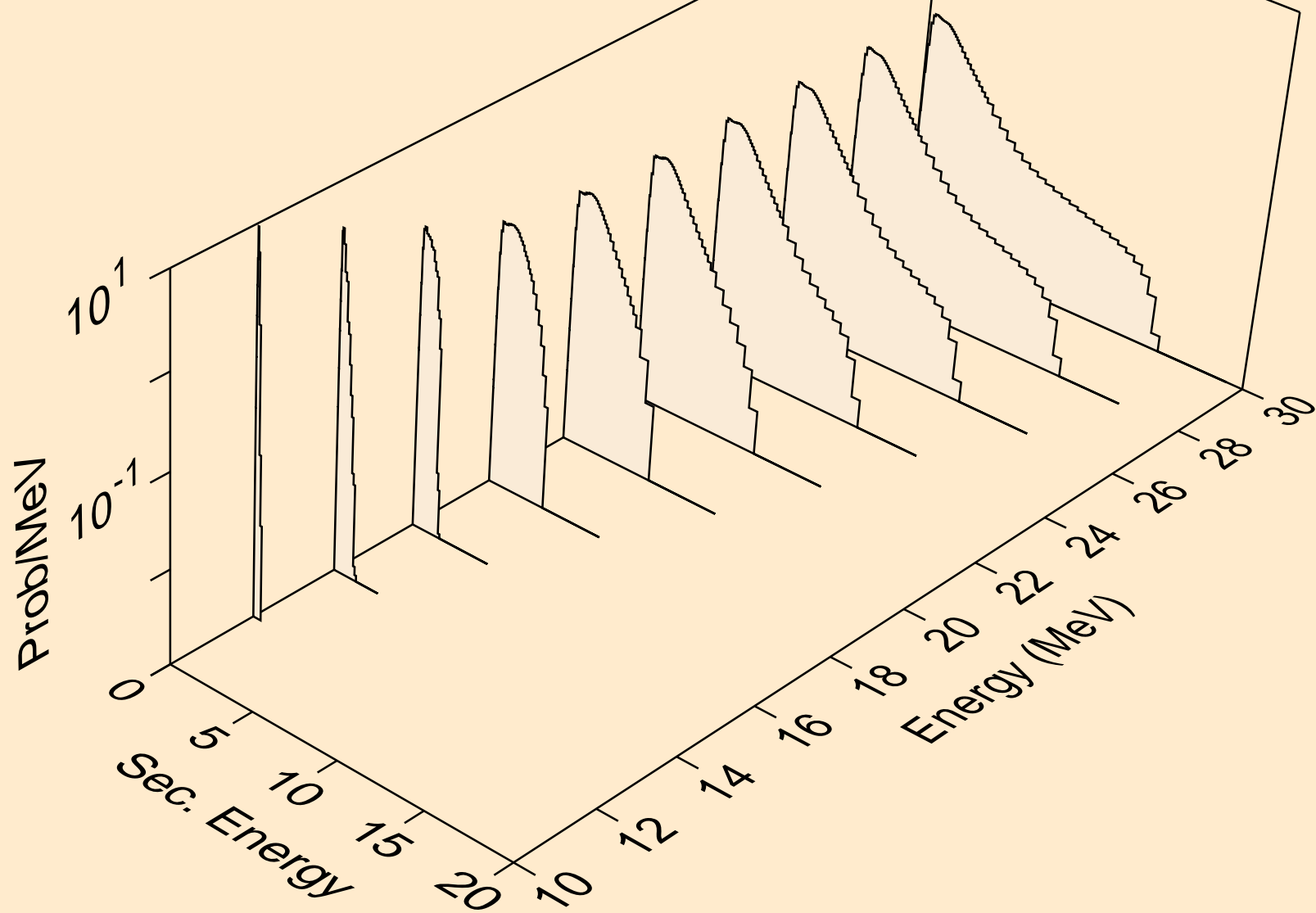

PM136M NEUTRON ACER TENDL-2021 LIBRARY; T=293.6K  
Neutron emission for (n,3np)

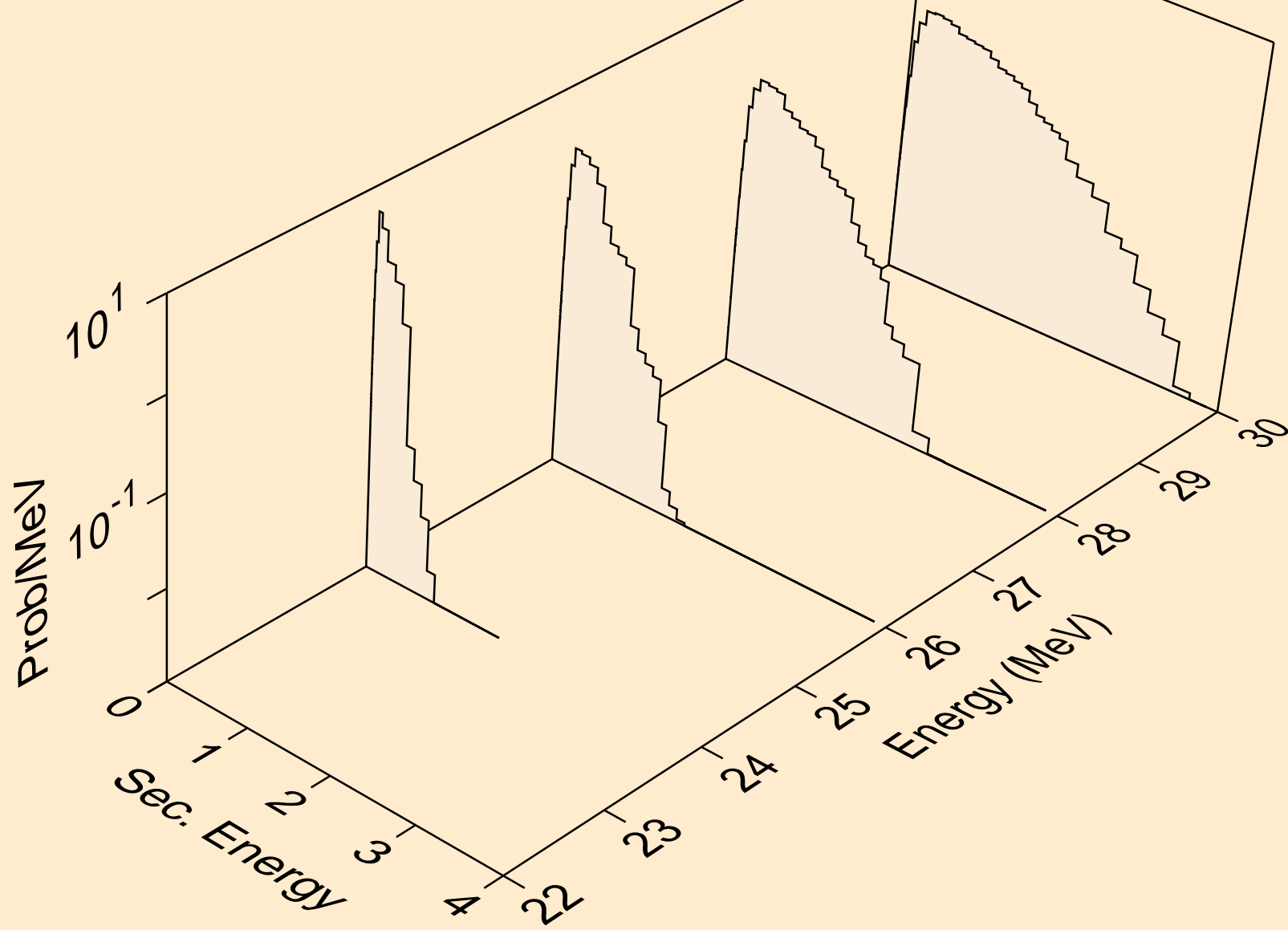

PM136M NEUTRON ACER TENDL-2021 LIBRARY; T=293.6K  
Neutron emission for (n,2np)

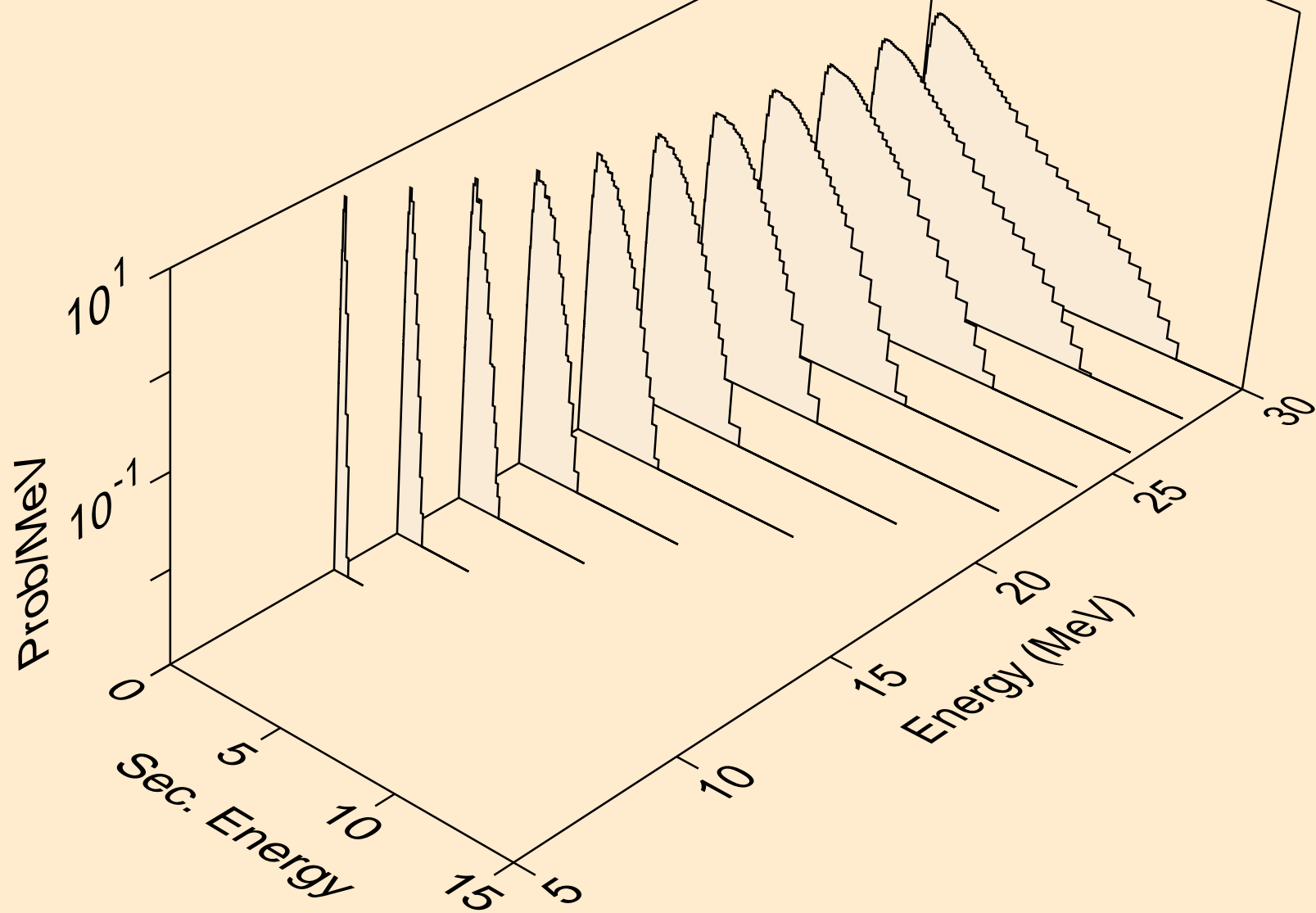

PM136M NEUTRON ACER TENDL-2021 LIBRARY; T=293.6K  
Neutron emission for (n,npa)

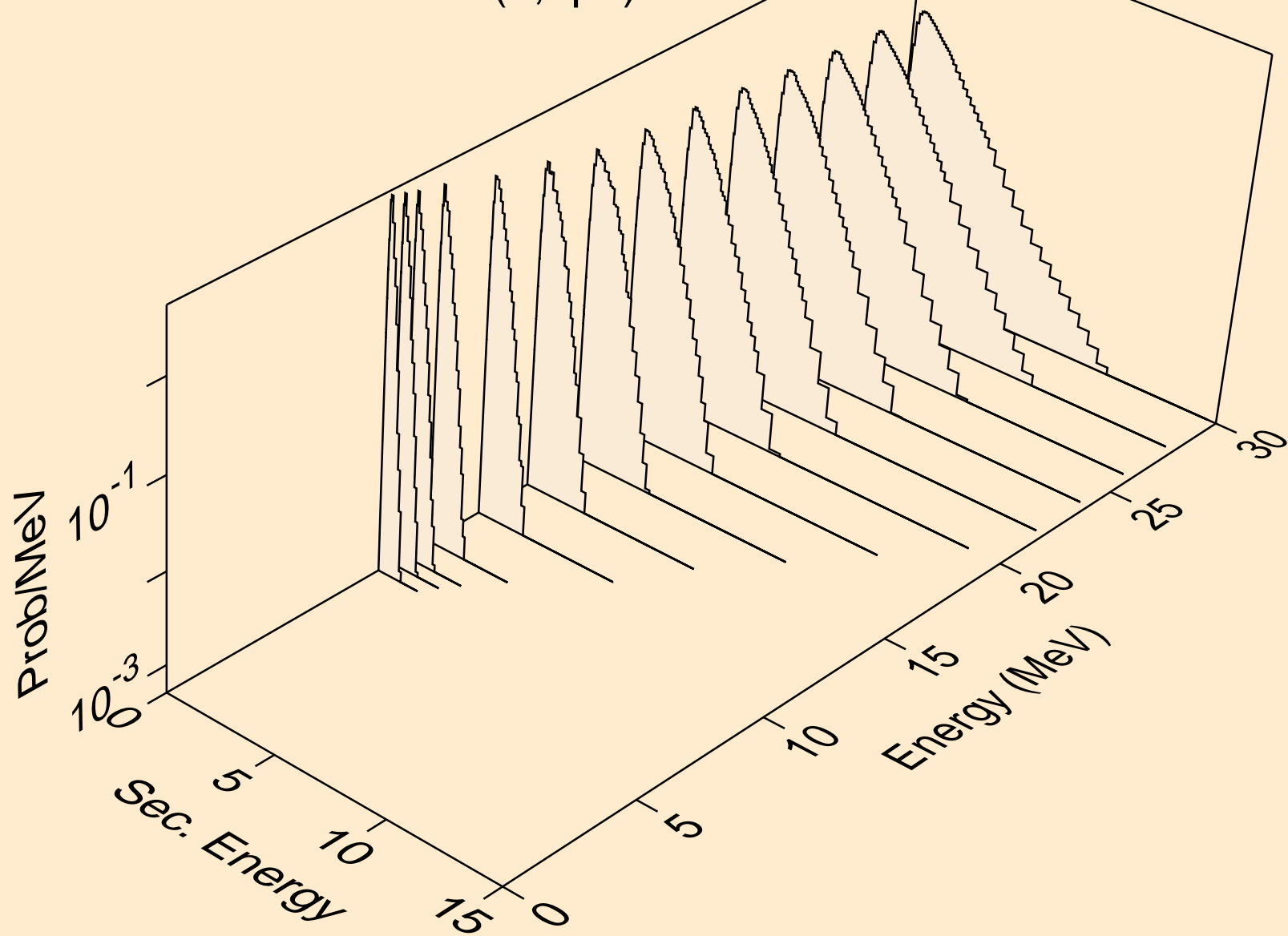

PM136M NEUTRON ACER TENDL-2021 LIBRARY; T=293.6K  
Neutron emission for (n,n\*c)

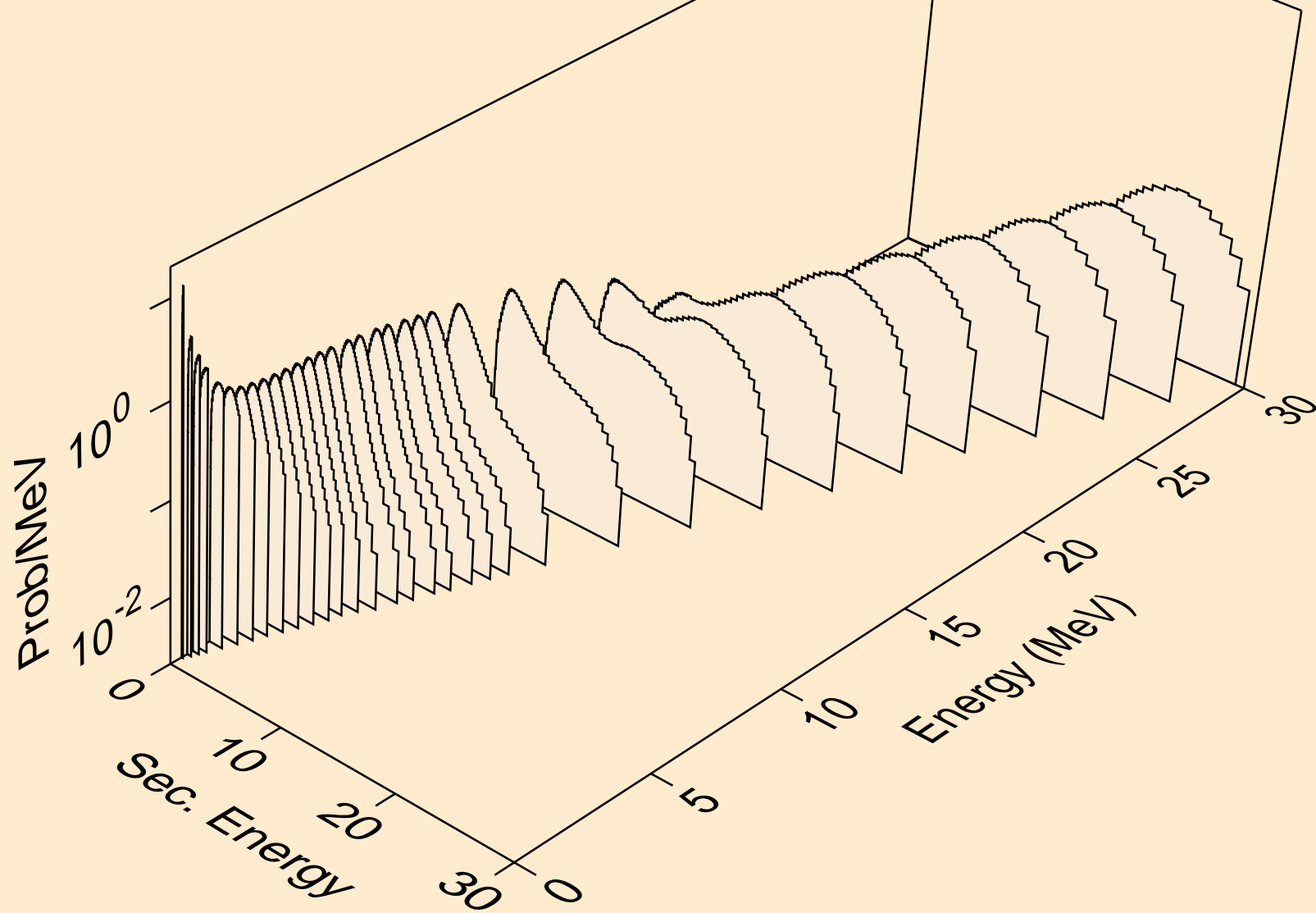

PM136M NEUTRON ACER TENDL-2021 LIBRARY; T=293.6K  
Photon emission for (n,x)

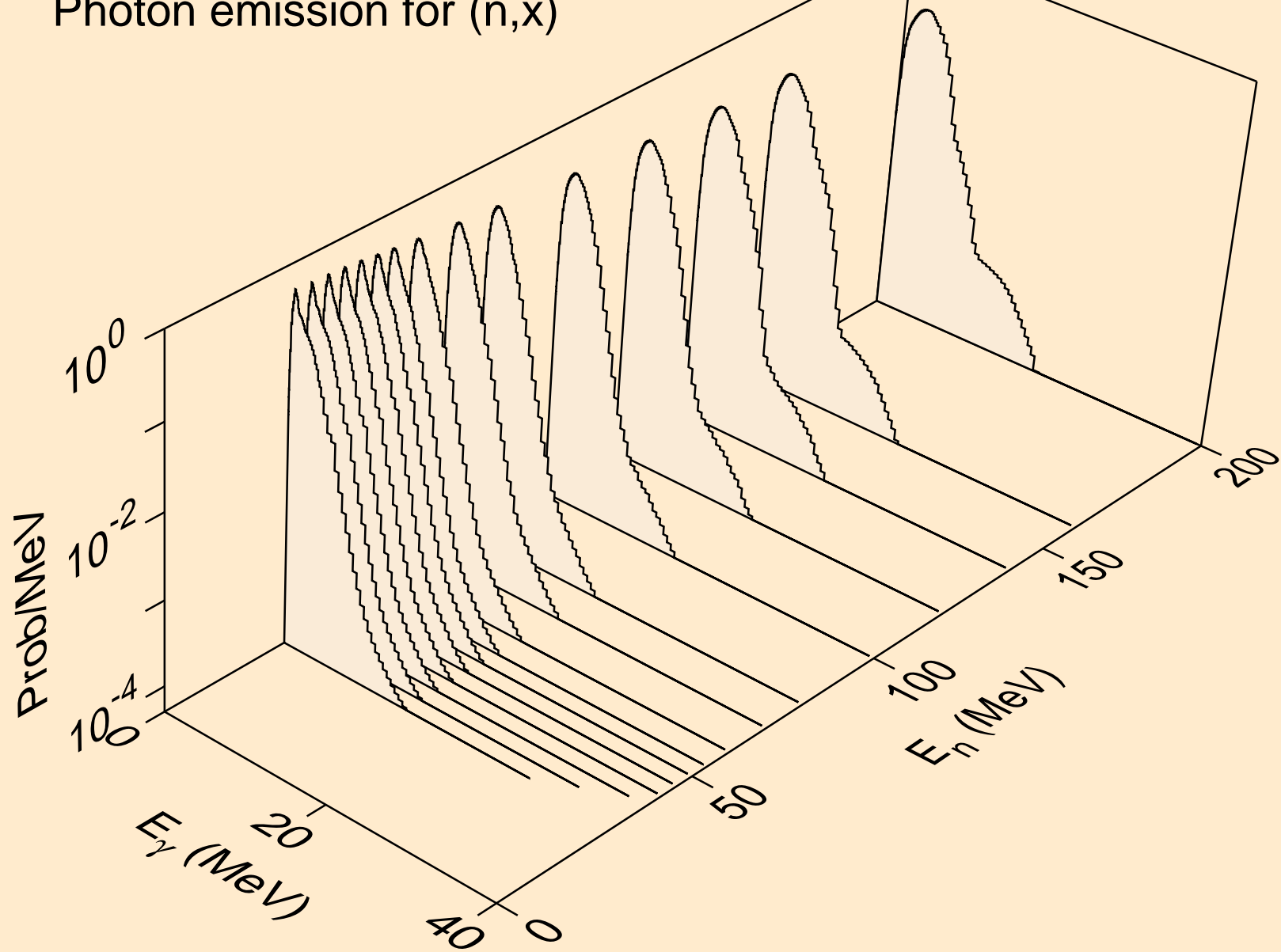



PM136M NEUTRON ACER TENDL-2021 LIBRARY; T=293.6K  
Photon emission for (n,2nd)

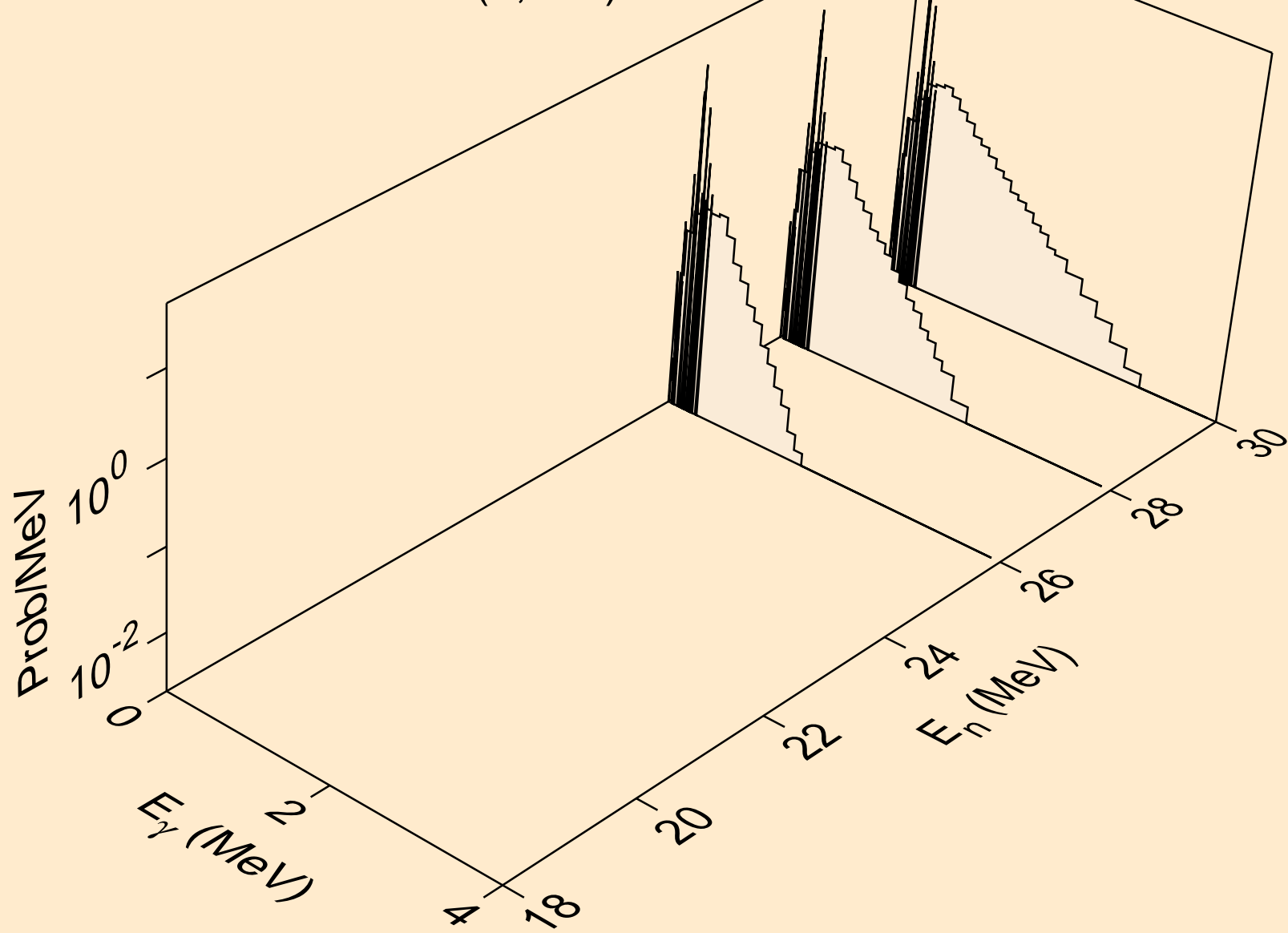

PM136M NEUTRON ACER TENDL-2021 LIBRARY; T=293.6K  
Photon emission for (n,2n)

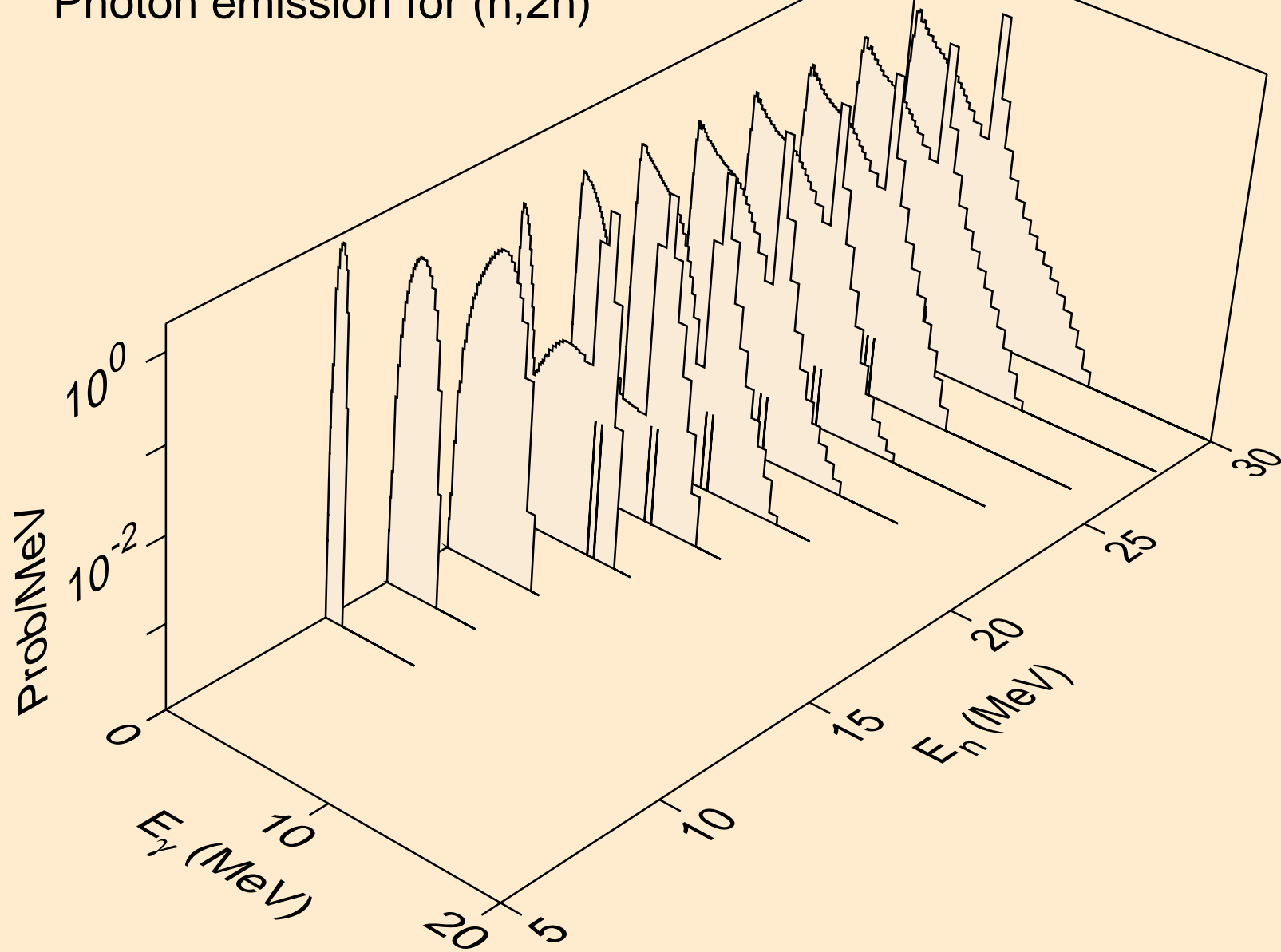

PM136M NEUTRON ACER TENDL-2021 LIBRARY; T=293.6K  
Photon emission for (n,3n)

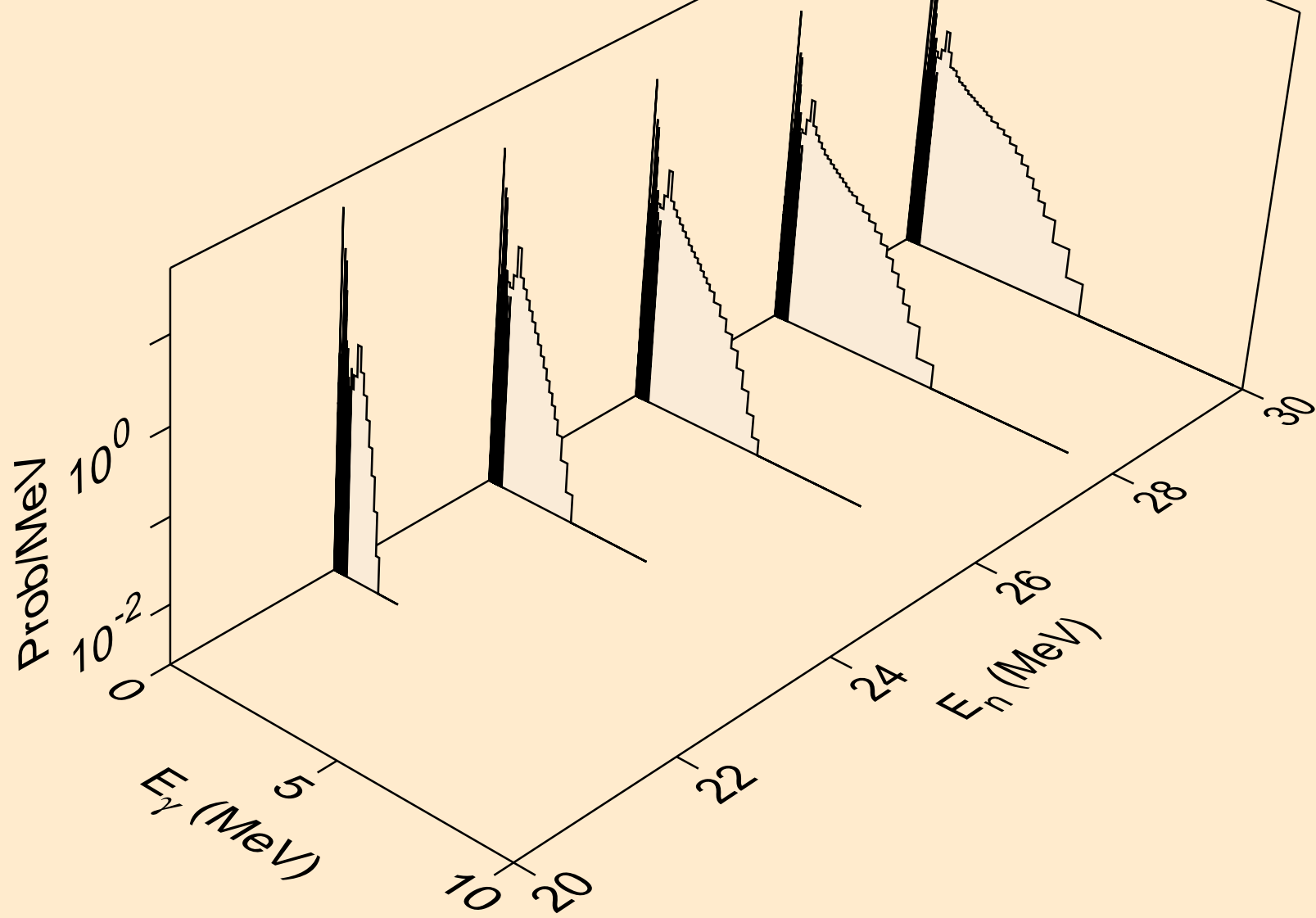

PM136M NEUTRON ACER TENDL-2021 LIBRARY; T=293.6K  
Photon emission for (n,n\*)a

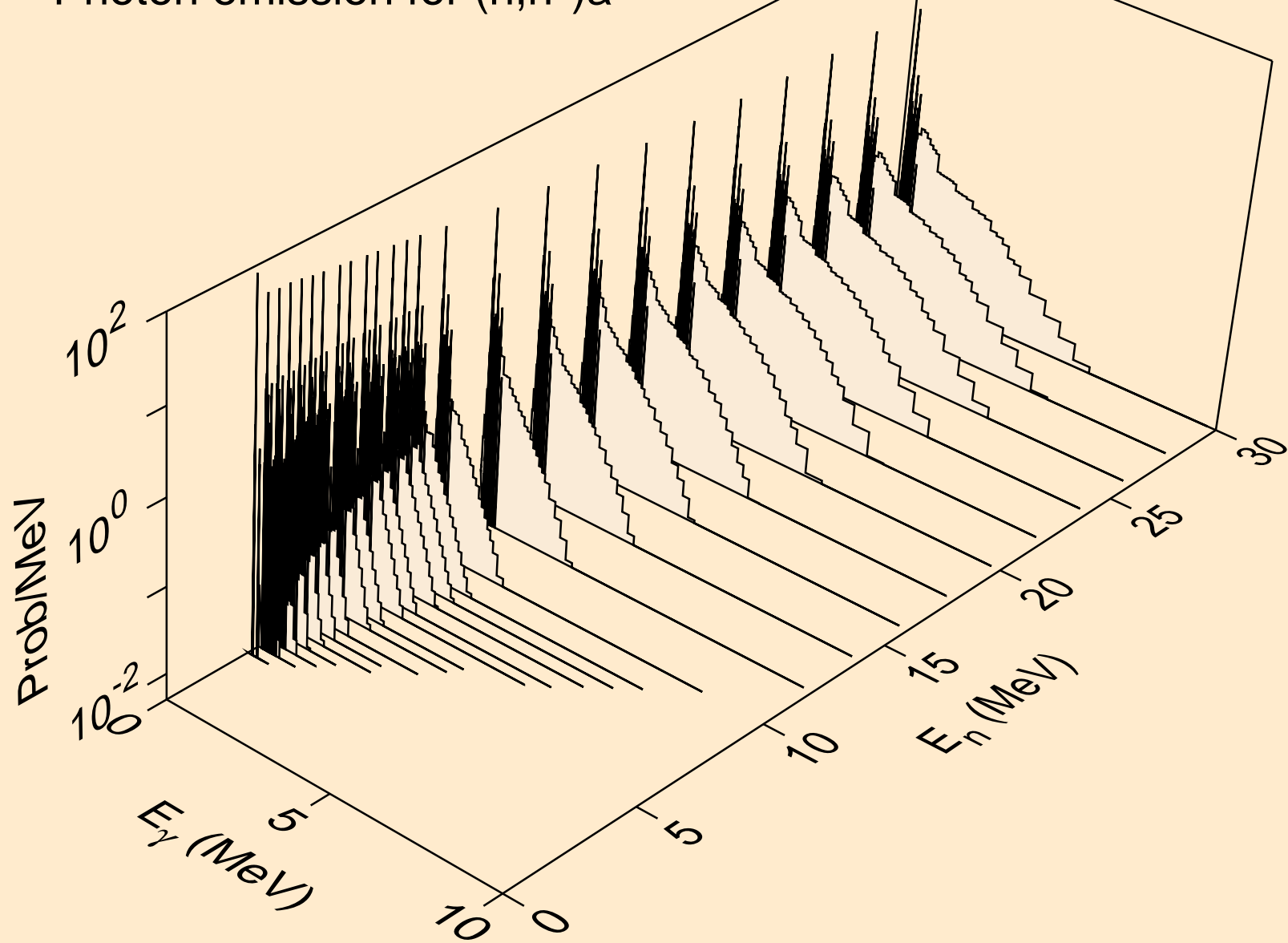

PM136M NEUTRON ACER TENDL-2021 LIBRARY; T=293.6K  
Photon emission for (n,2n)a

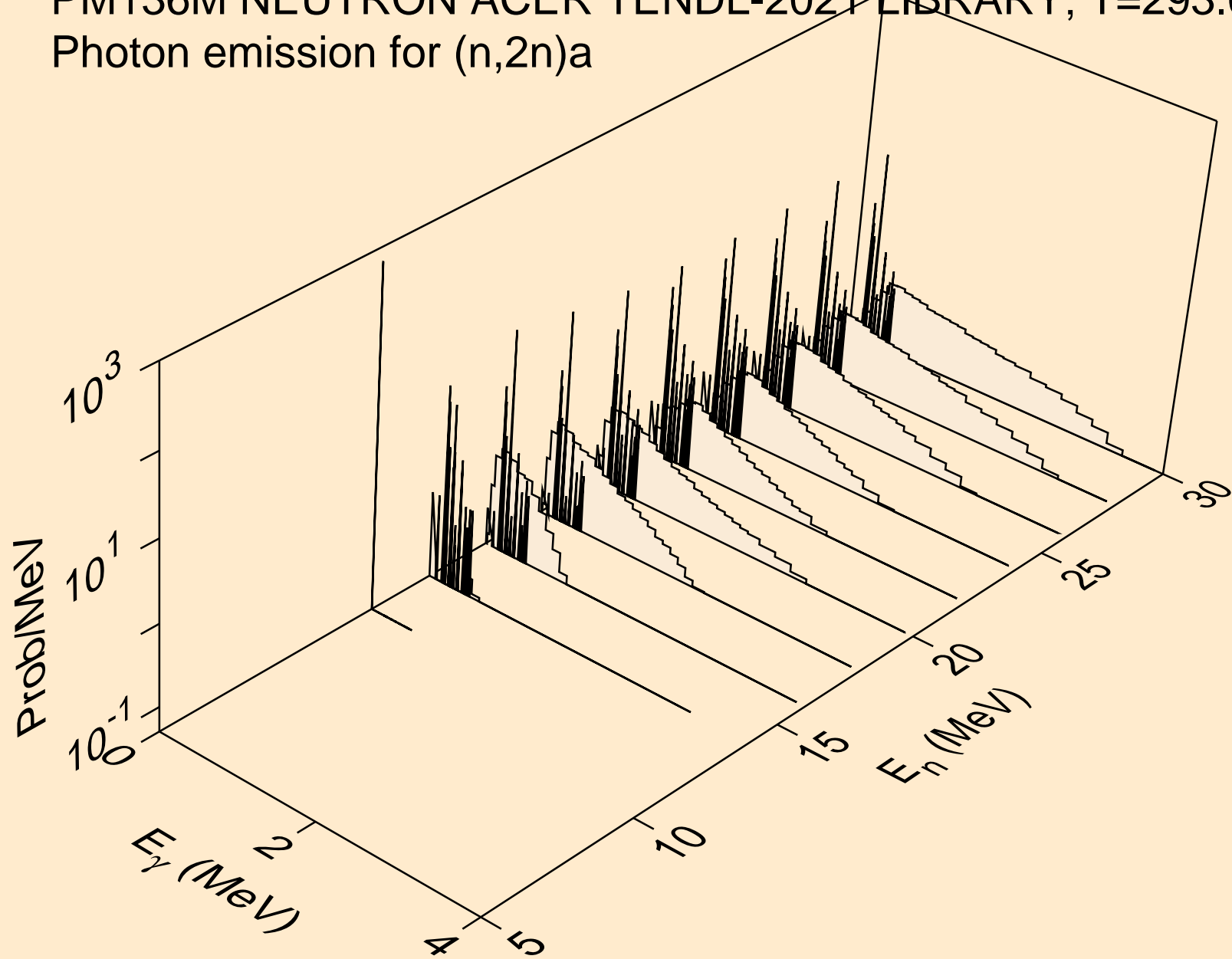

PM136M NEUTRON ACER TENDL-2021 LIBRARY; T=293.6K  
Photon emission for (n,3n)a

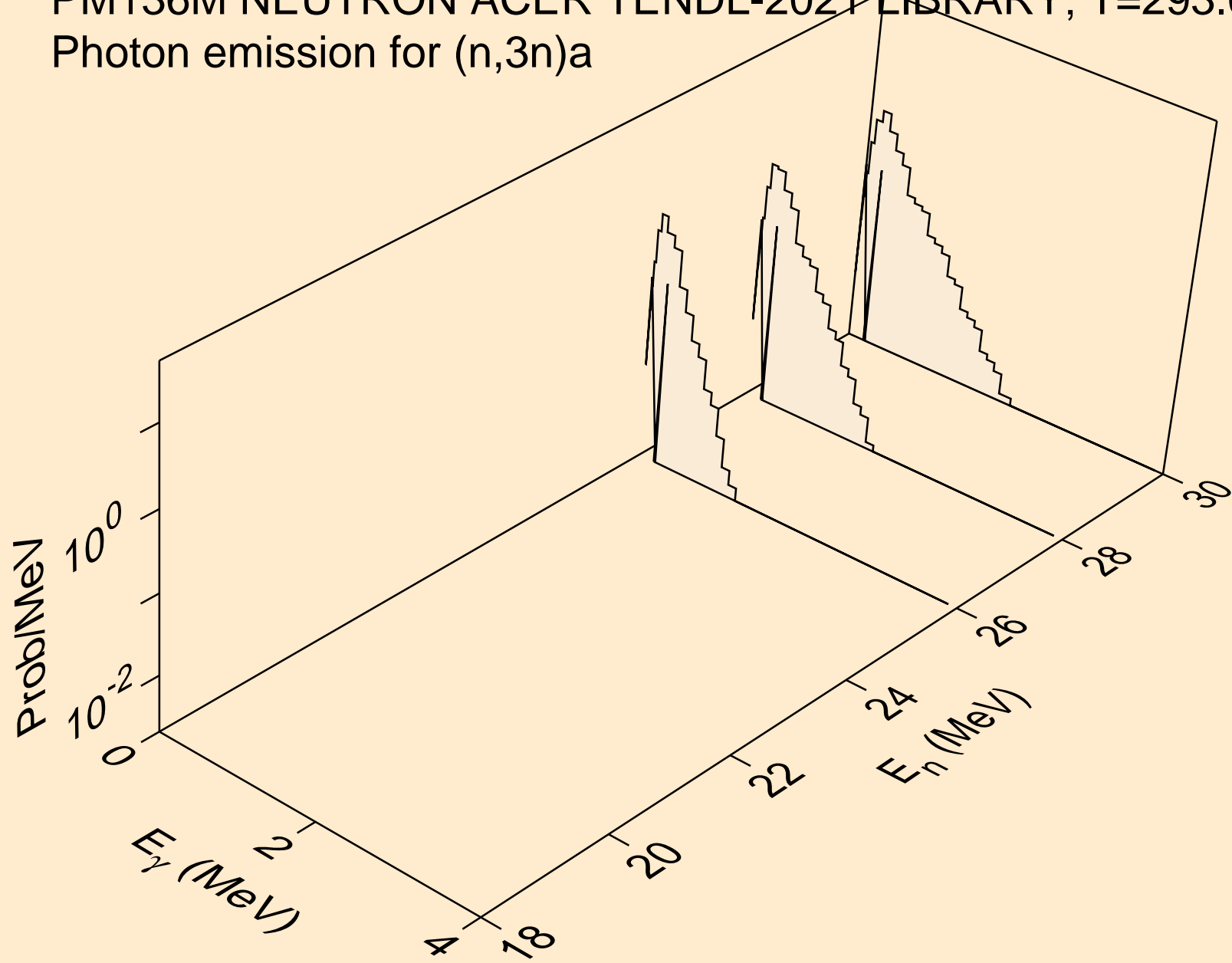

PM136M NEUTRON ACER TENDL-2021 LIBRARY; T=293.6K  
Photon emission for (n,n\*)p

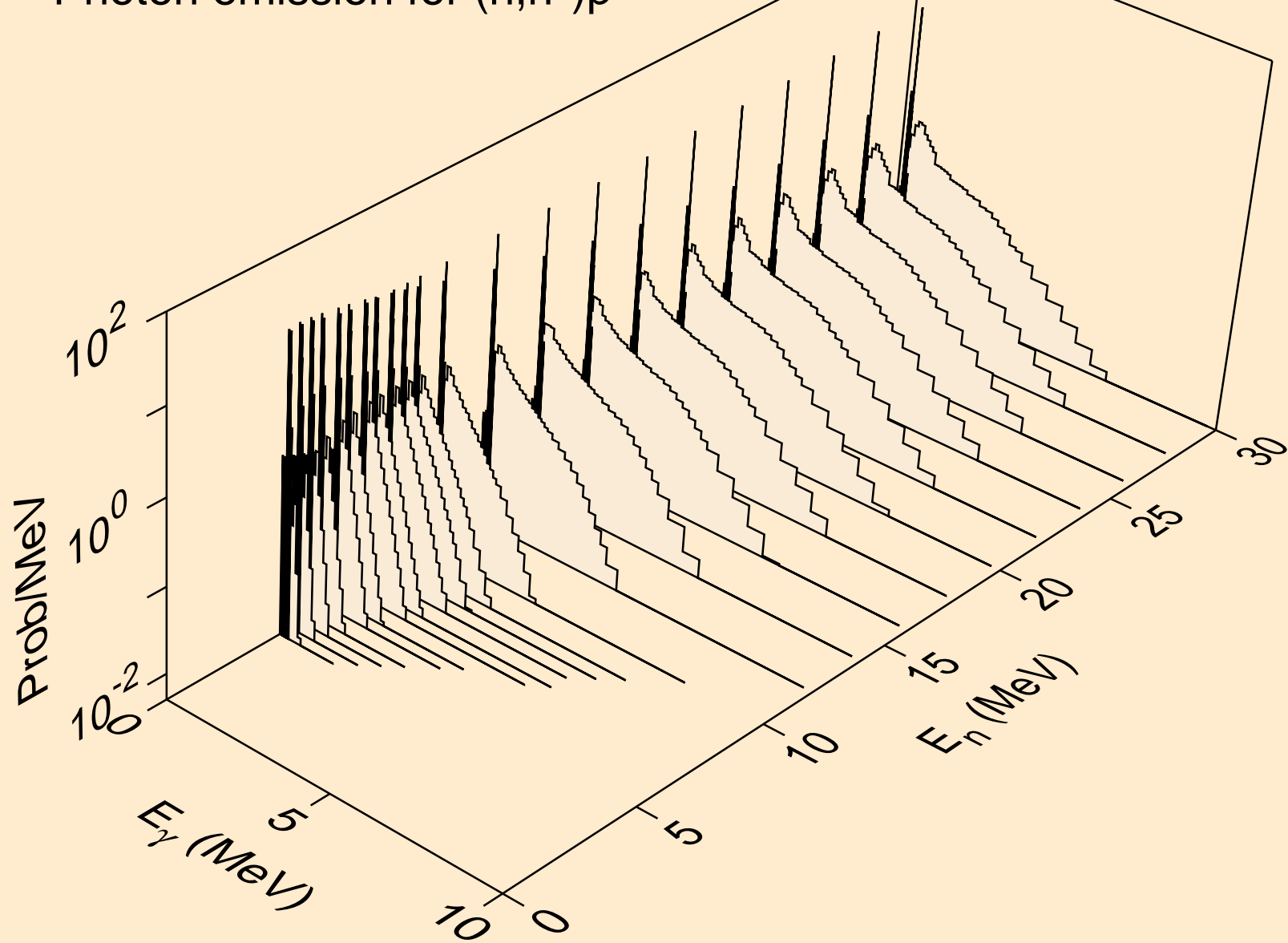

PM136M NEUTRON ACER TENDL-2021 LIBRARY; T=293.6K  
Photon emission for (n,n\*)2a

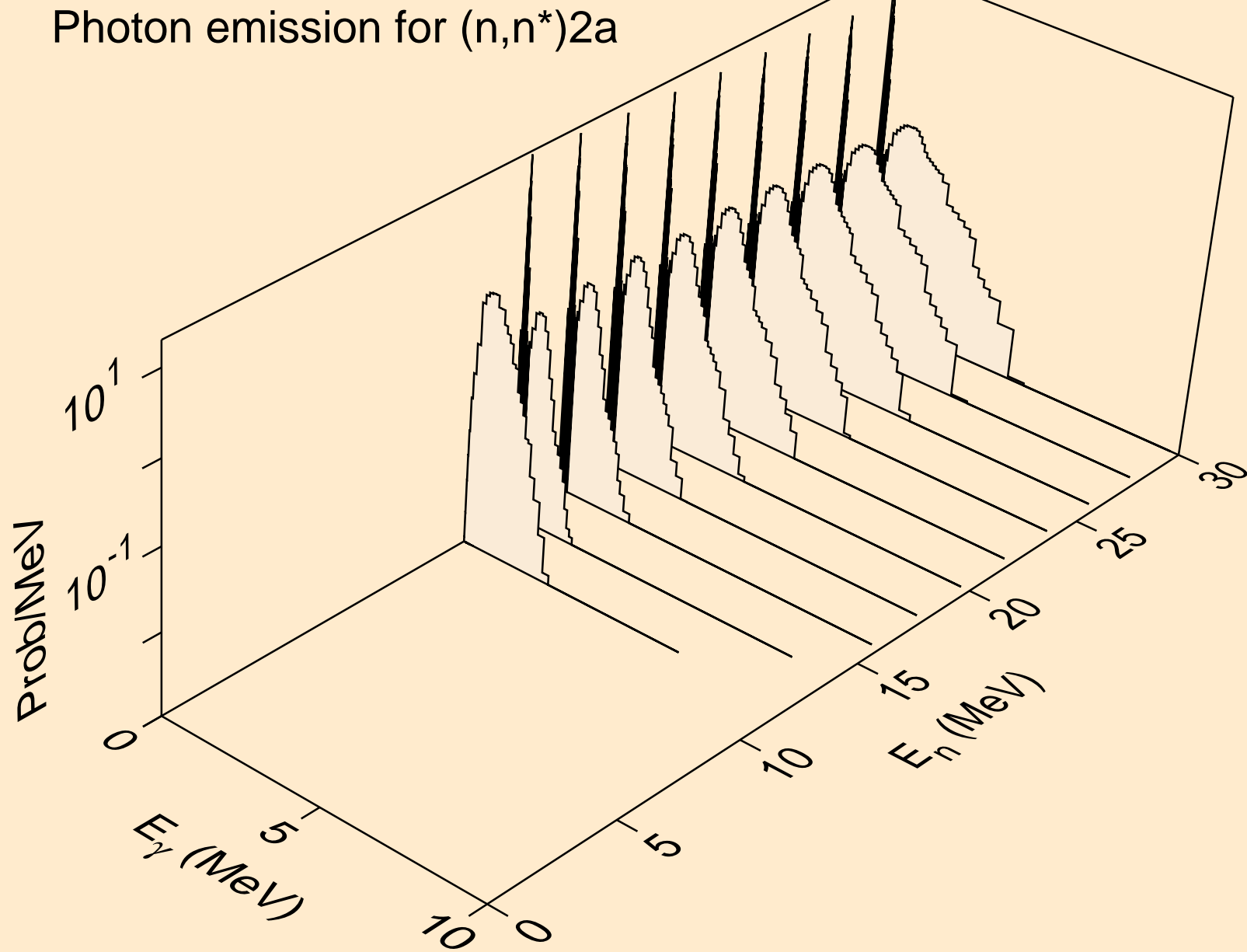



PM136M NEUTRON ACER TENDL-2021 LIBRARY; T=293.6K  
Photon emission for (n,2n)2a

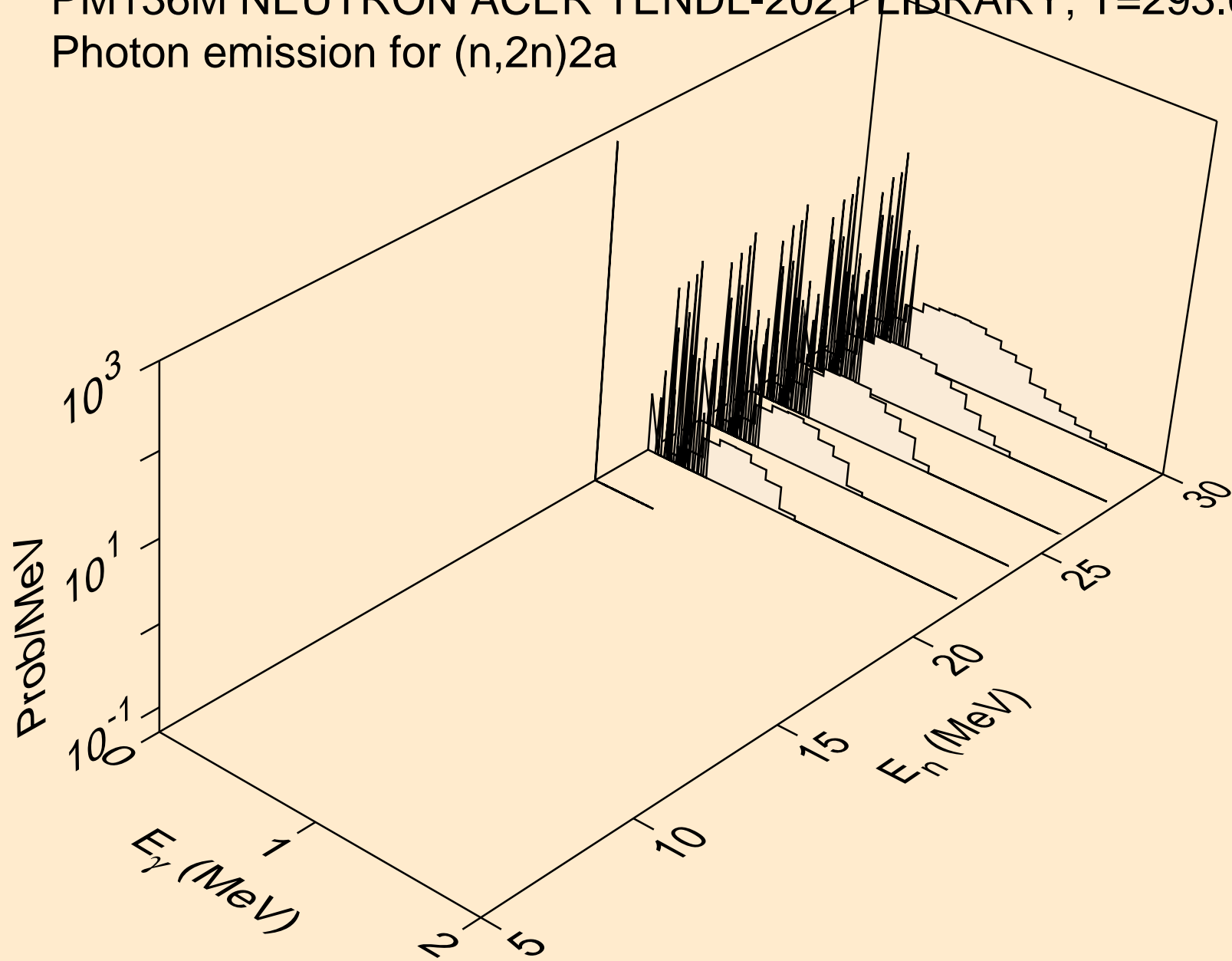

PM136M NEUTRON ACER TENDL-2021 LIBRARY; T=293.6K  
Photon emission for (n,n\*)d

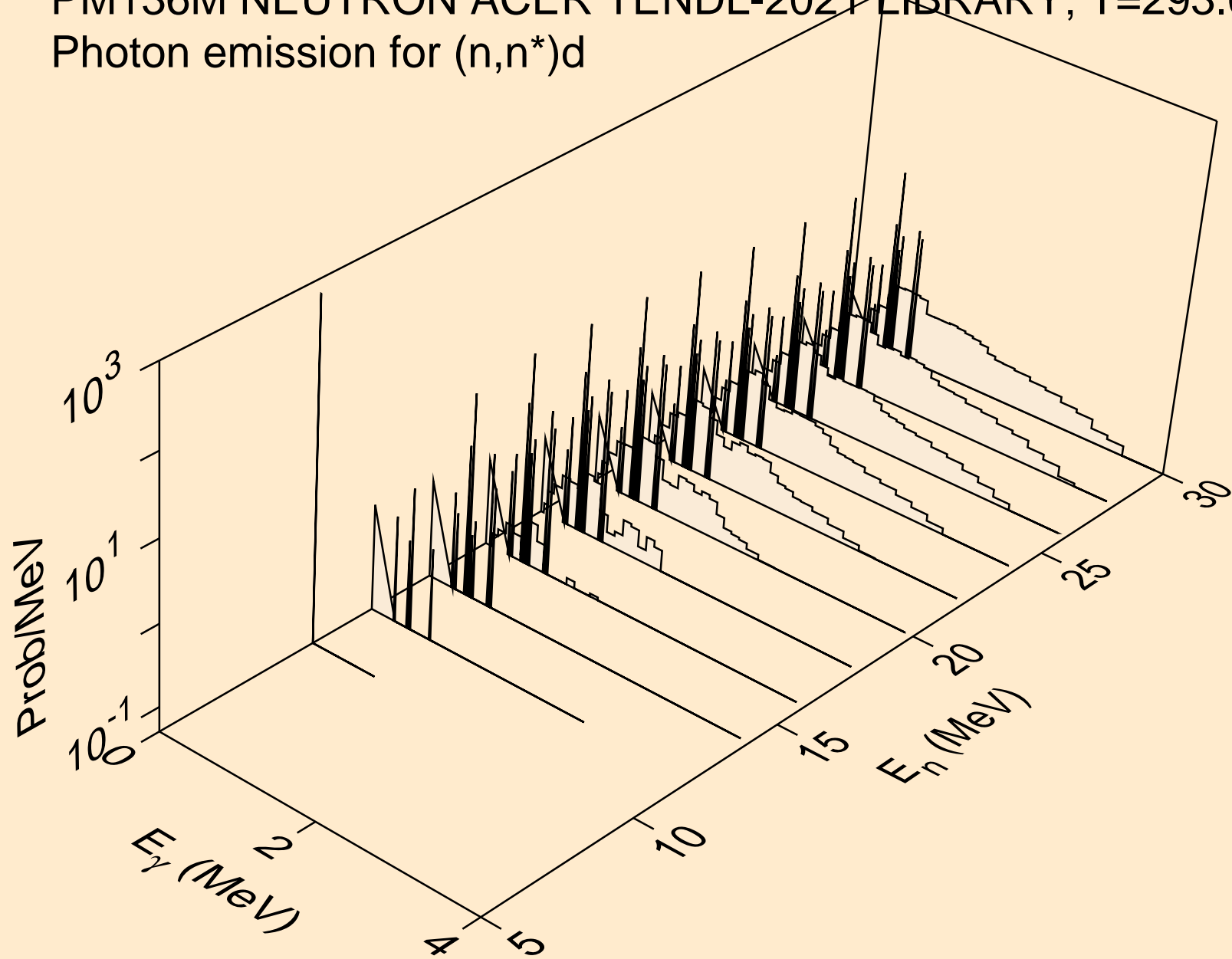

PM136M NEUTRON ACER TENDL-2021 LIBRARY; T=293.6K  
Photon emission for (n,n\*)t

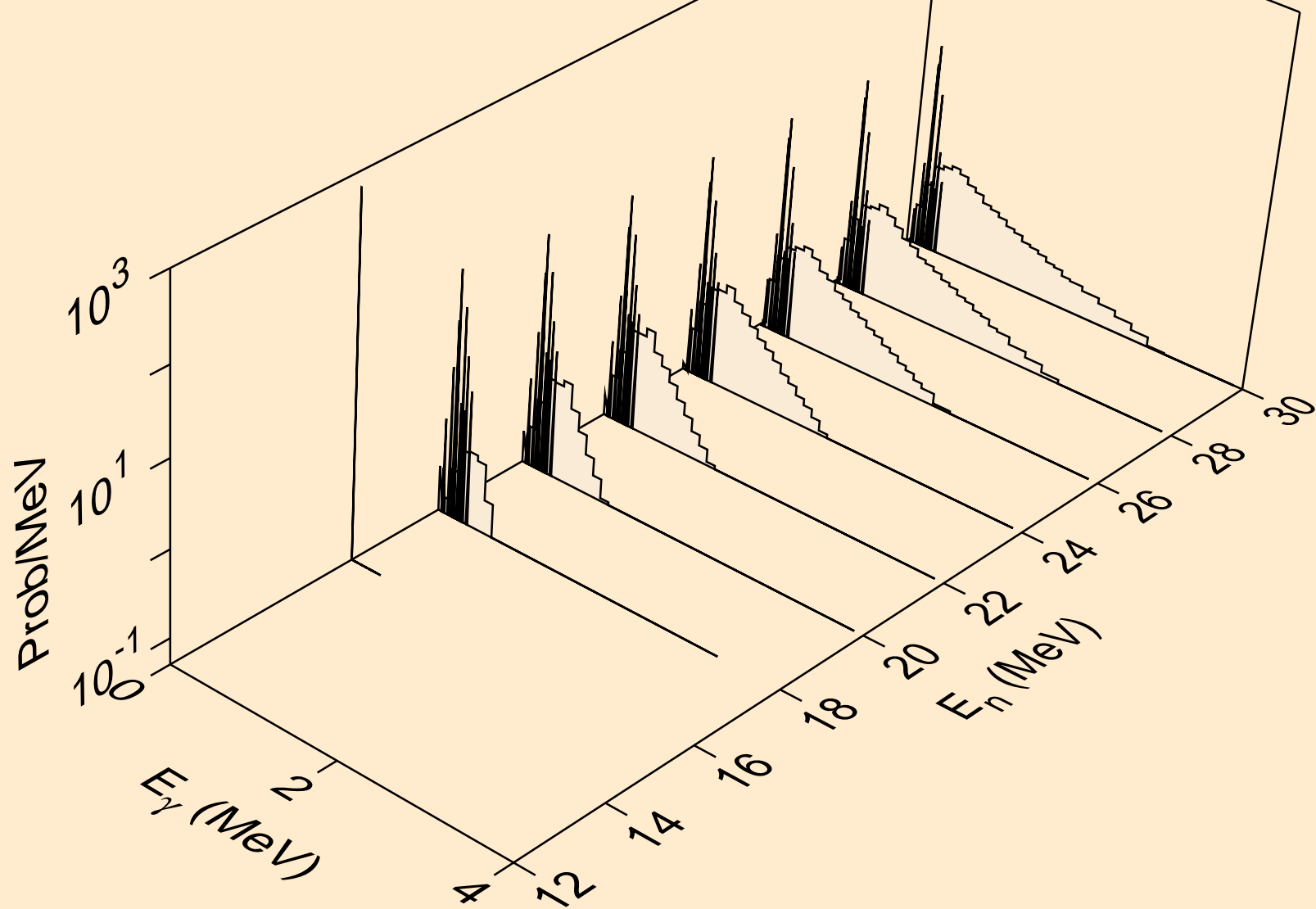

PM136M NEUTRON ACER TENDL-2021 LIBRARY; T=293.6K  
Photon emission for (n,n\*)he3

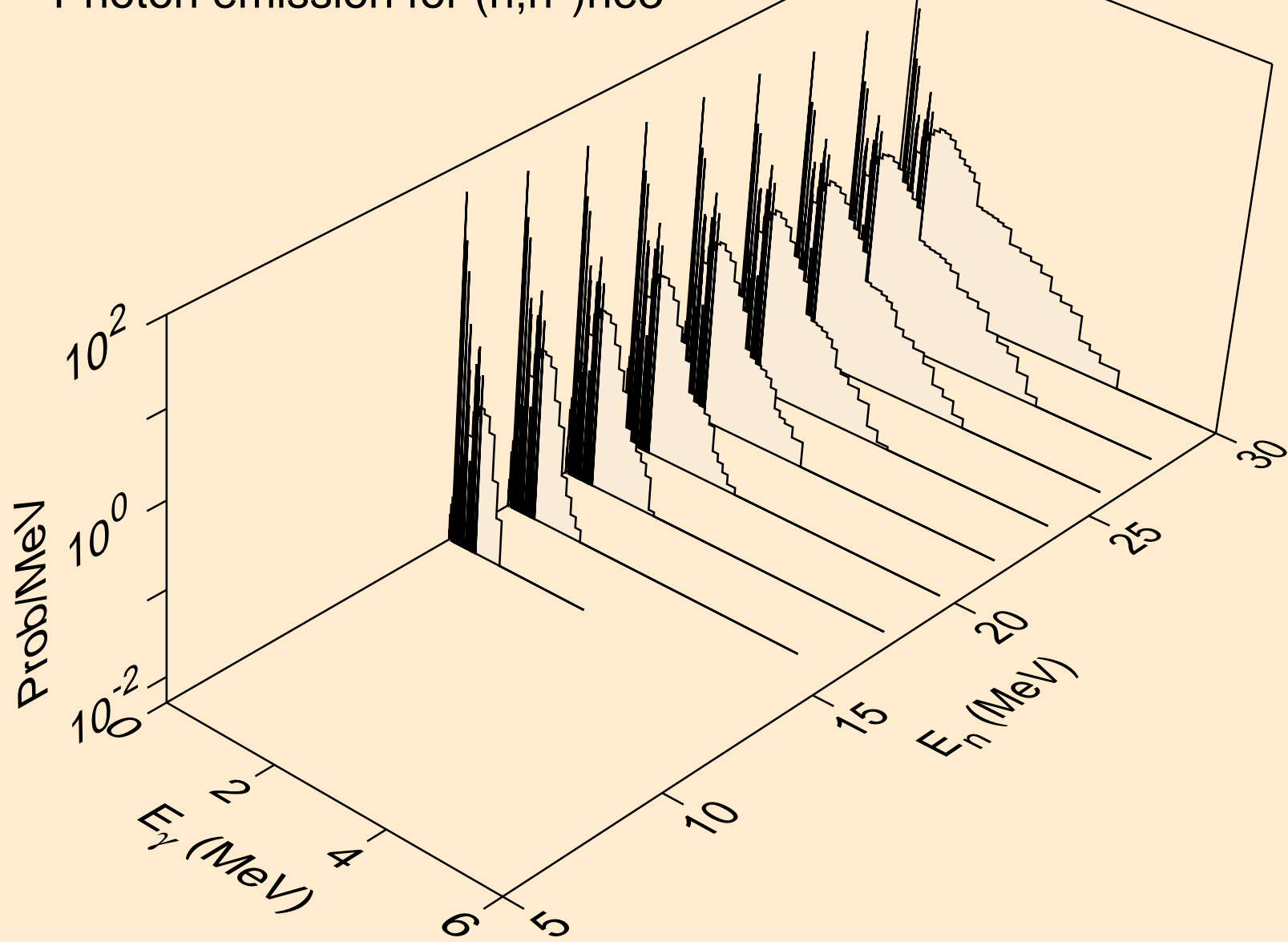

PM136M NEUTRON ACER TENDL-2021 LIBRARY; T=293.6K  
Photon emission for (n,2np)

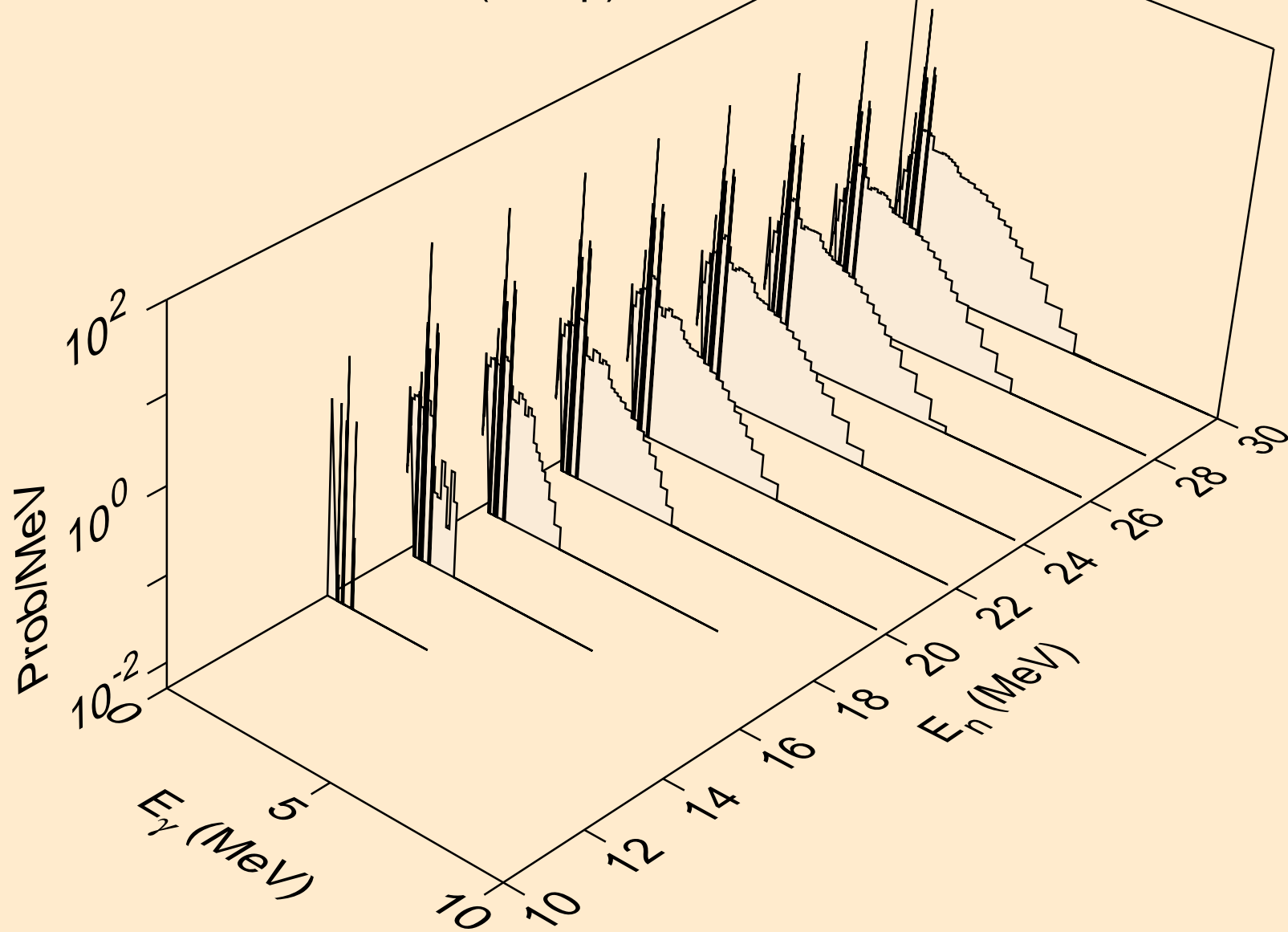

PM136M NEUTRON ACER TENDL-2021 LIBRARY; T=293.6K  
Photon emission for (n,3np)

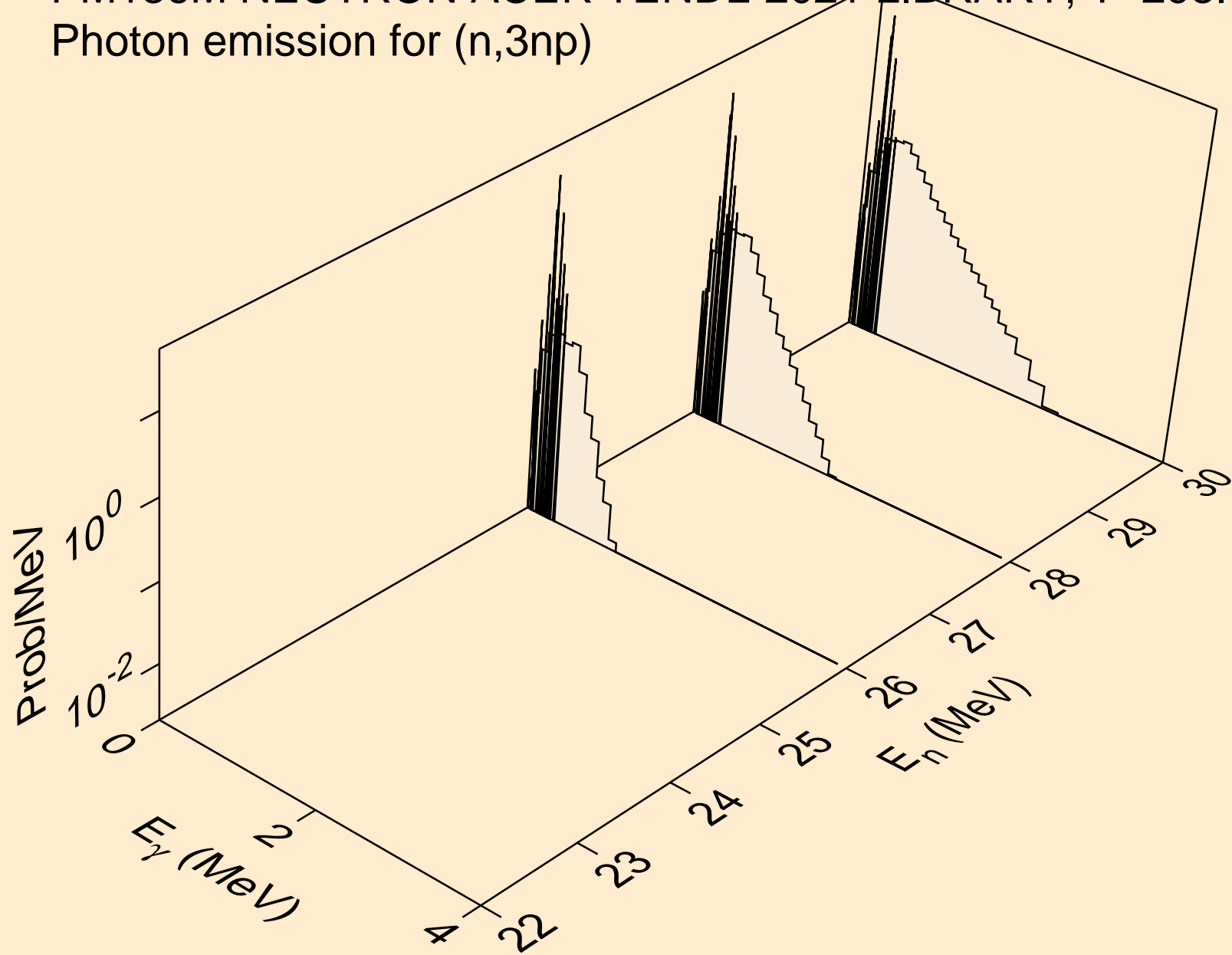

PM136M NEUTRON ACER TENDL-2021 LIBRARY; T=293.6K  
Photon emission for (n,2np)

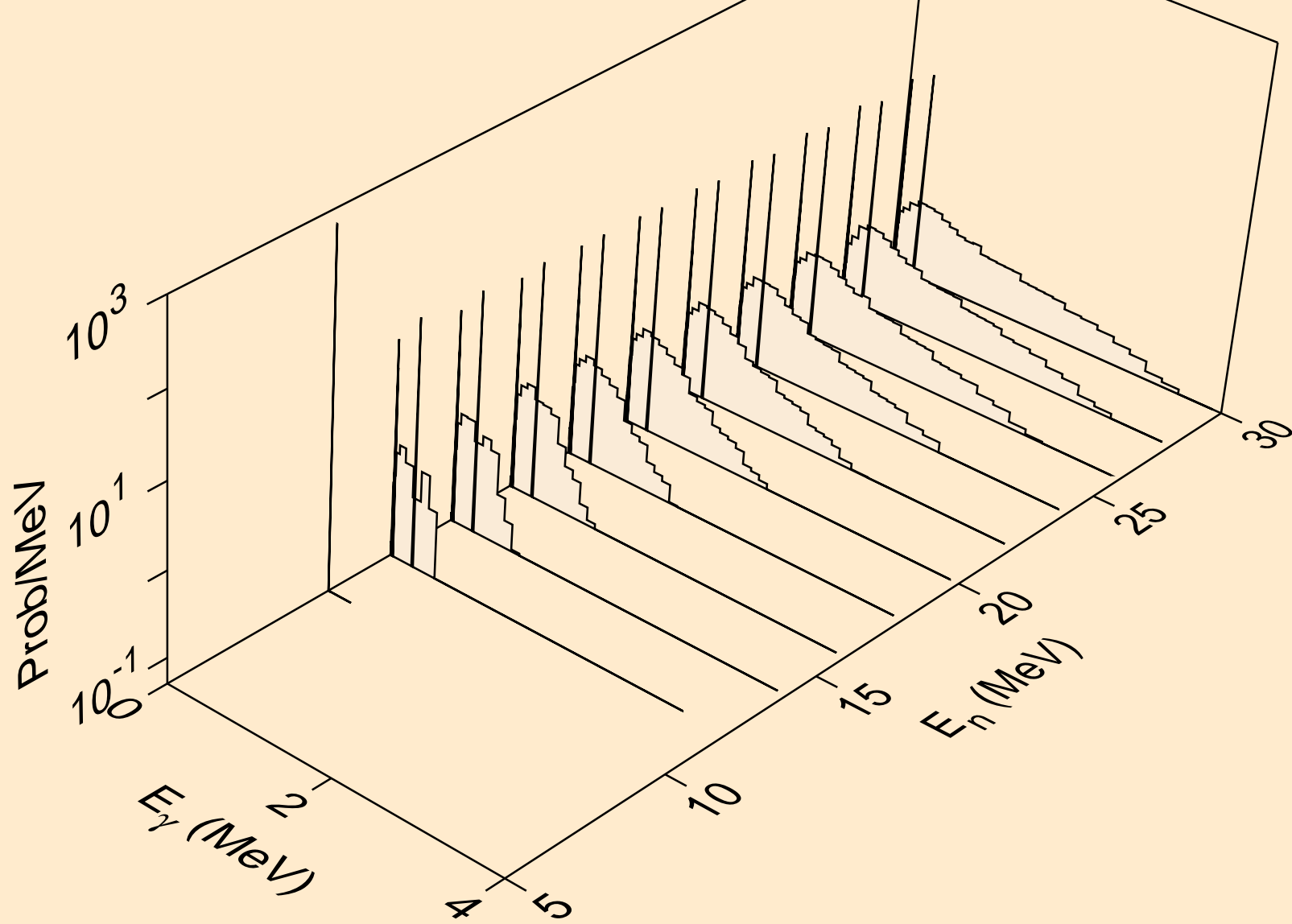

PM136M NEUTRON ACER TENDL-2021 LIBRARY; T=293.6K  
Photon emission for (n,npa)

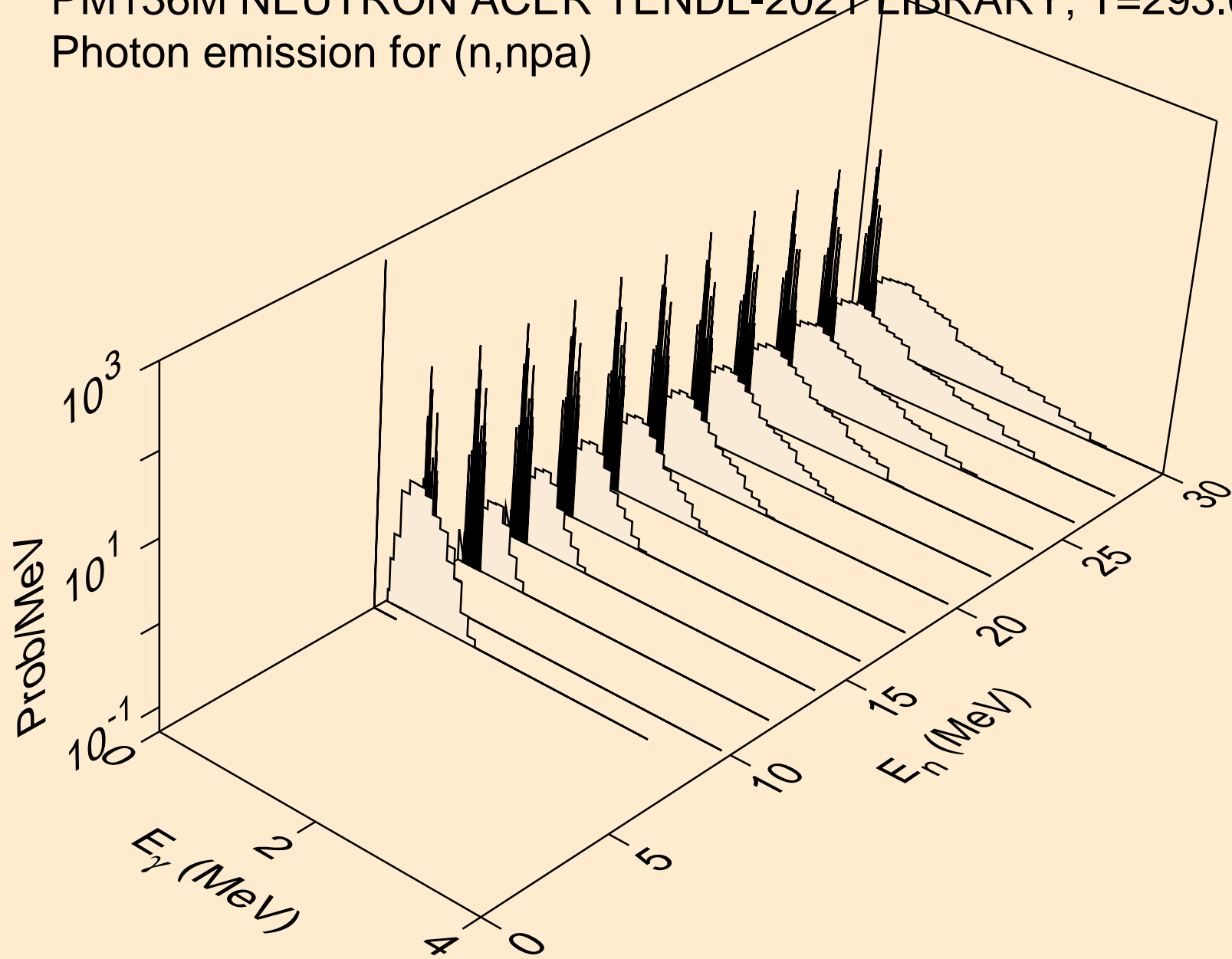



PM136M NEUTRON ACER TENDL-2021 LIBRARY; T=293.6K  
Photon emission for (n,n\*2)

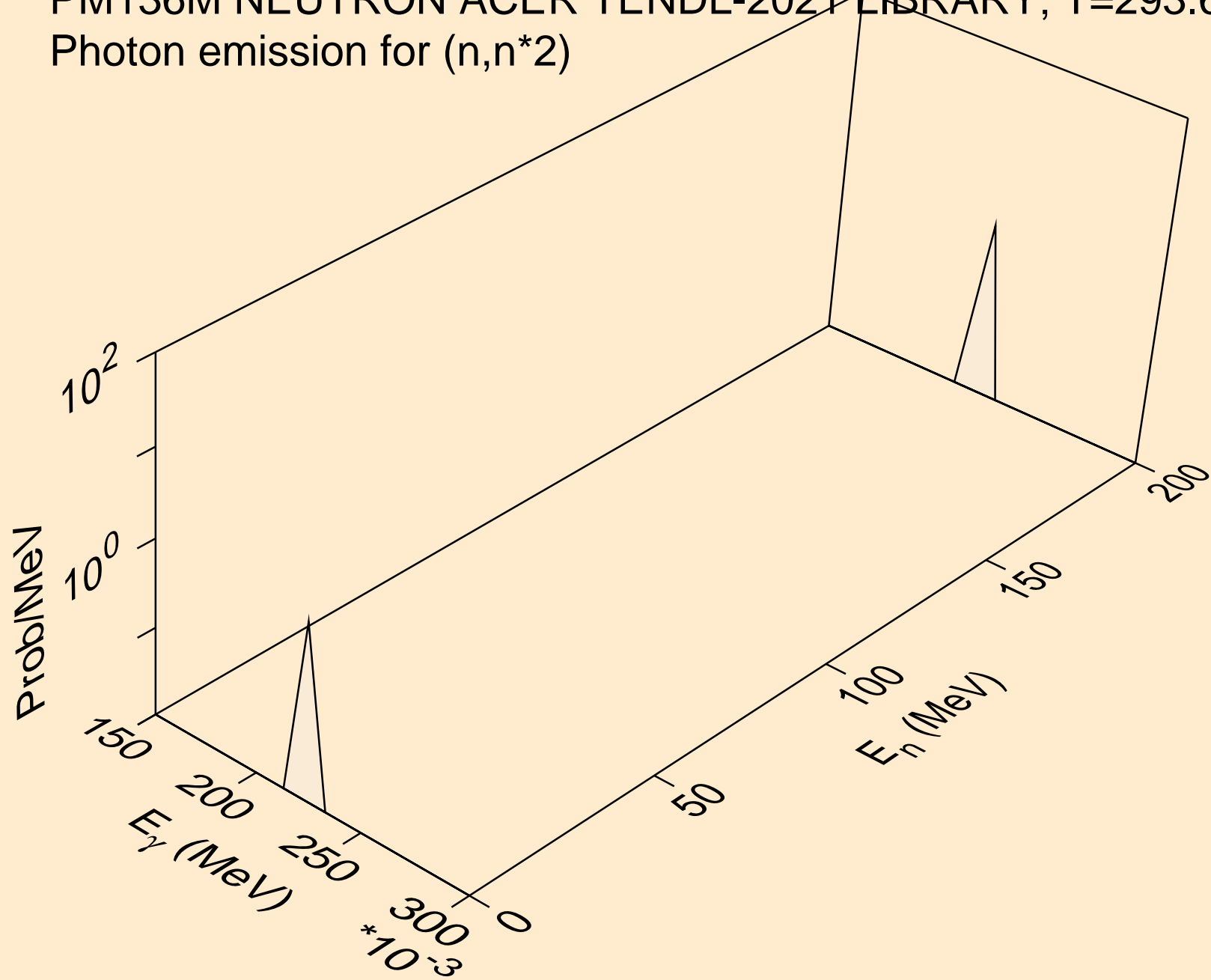

PM136M NEUTRON ACER TENDL-2021 LIBRARY; T=293.6K  
Photon emission for (n,n\*3)

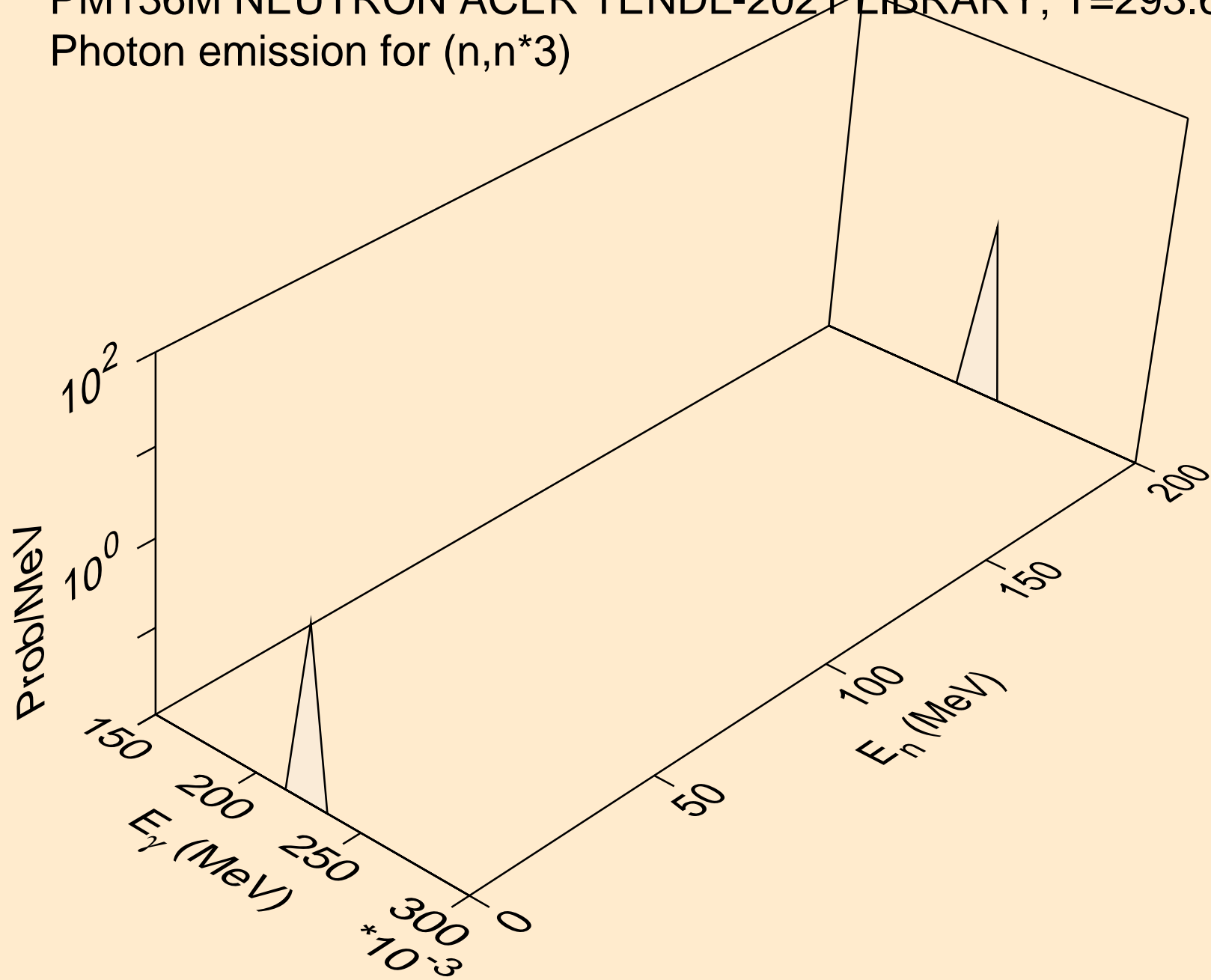

PM136M NEUTRON ACER TENDL-2021 LIBRARY; T=293.6K  
Photon emission for (n,n\*4)

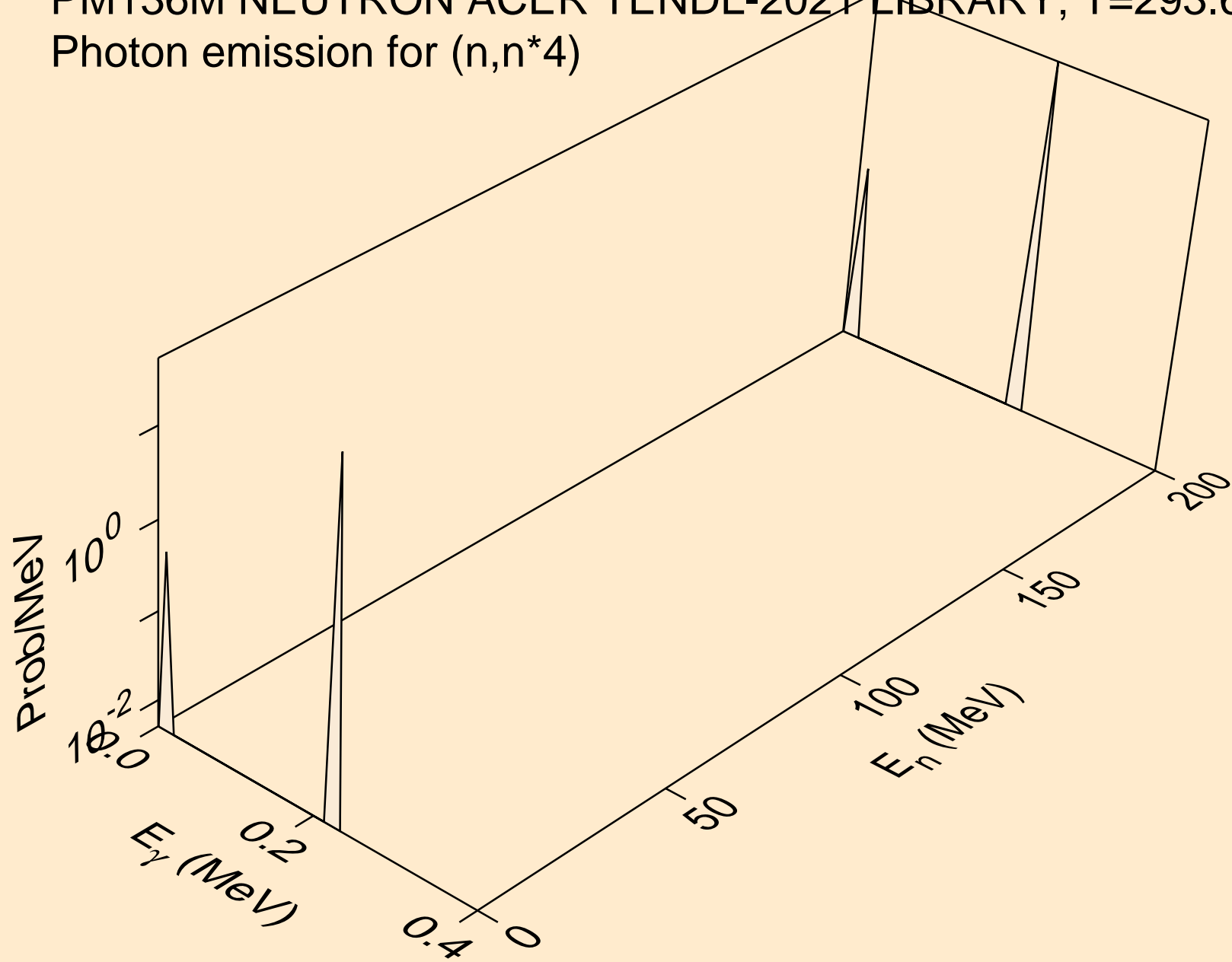

PM136M NEUTRON ACER TENDL-2021 LIBRARY; T=293.6K  
Photon emission for (n,n\*5)

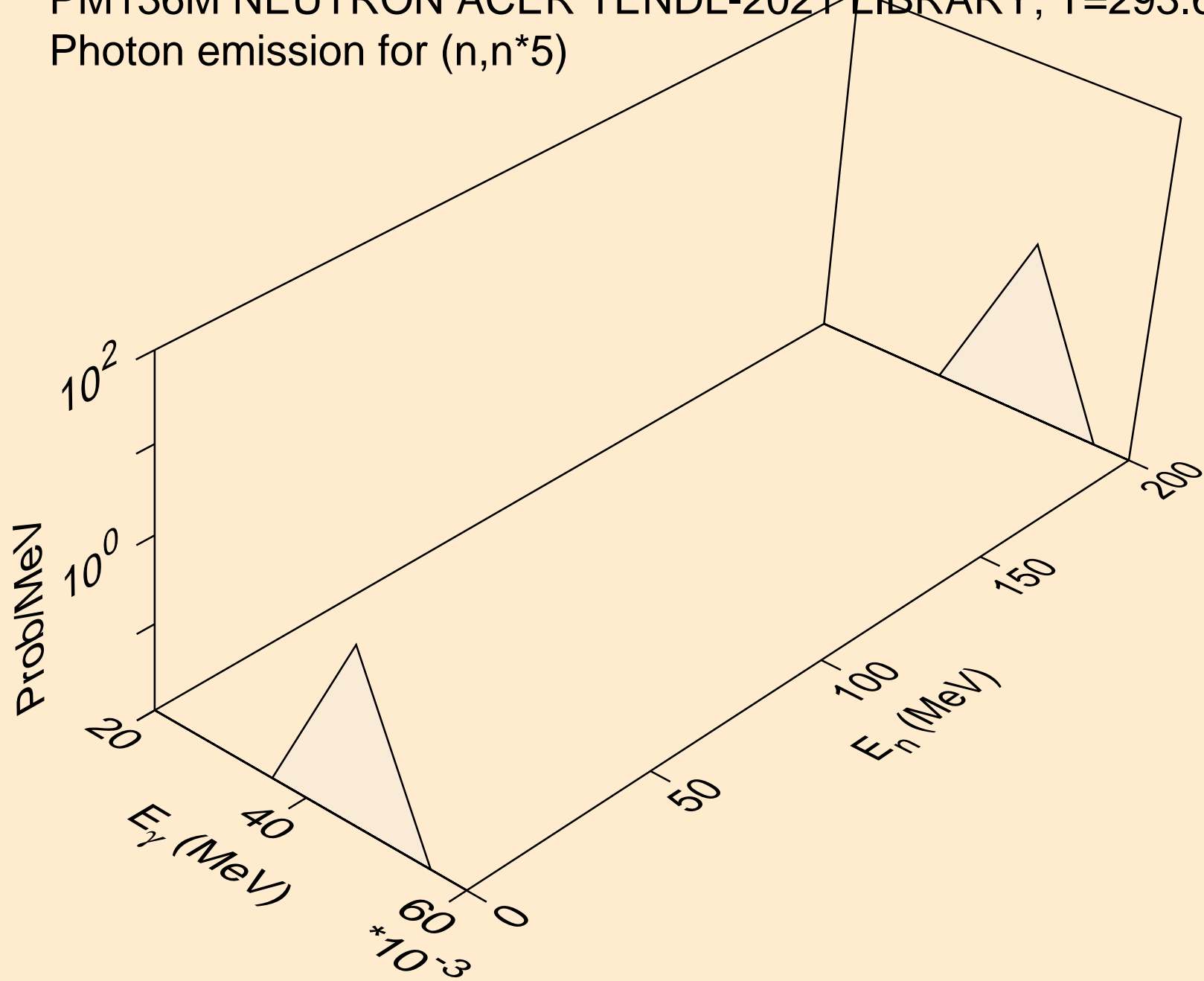

PM136M NEUTRON ACER TENDL-2021 LIBRARY; T=293.6K  
Photon emission for (n,n\*6)

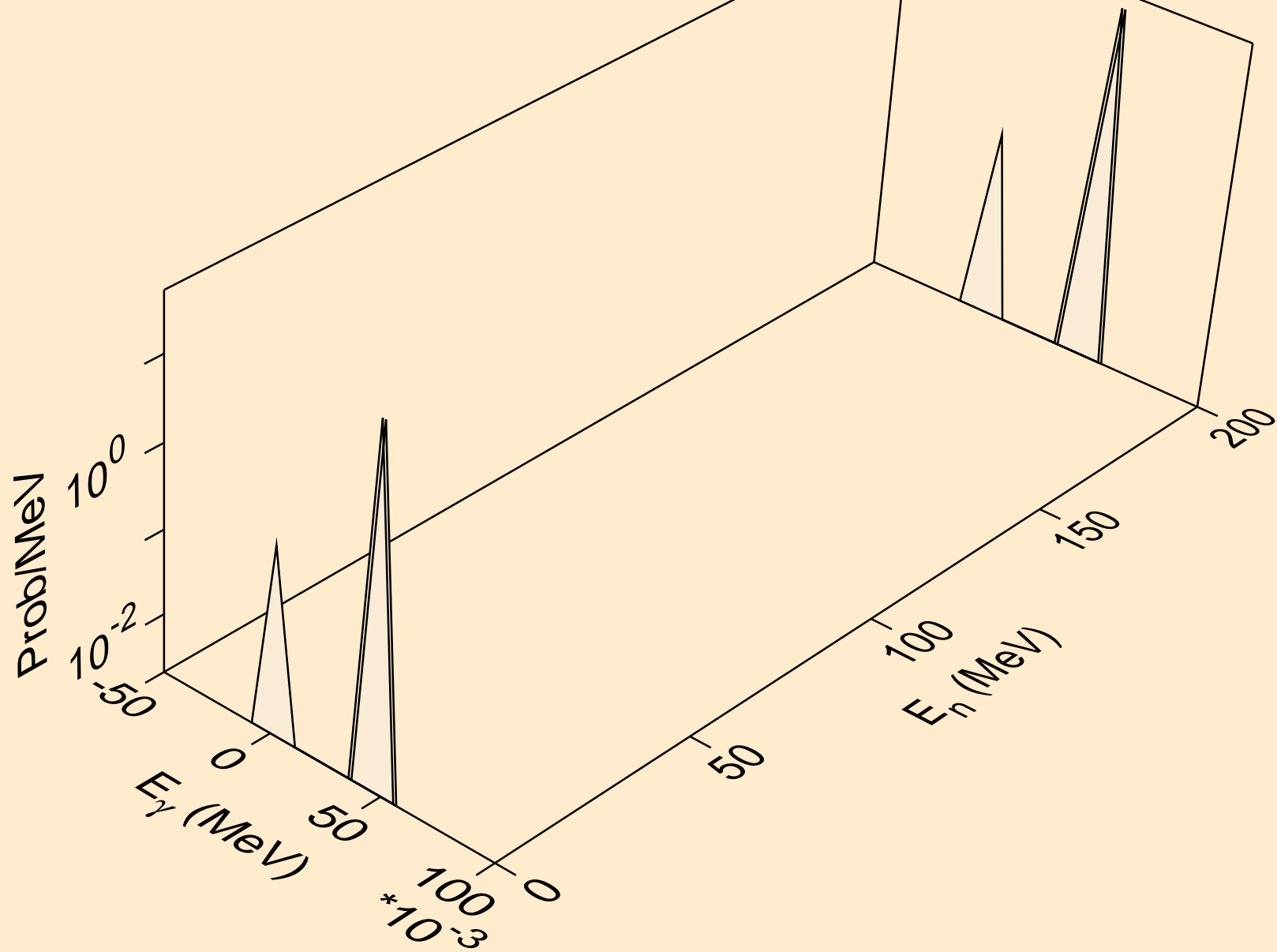

PM136M NEUTRON ACER TENDL-2021 LIBRARY; T=293.6K  
Photon emission for (n,n\*7)

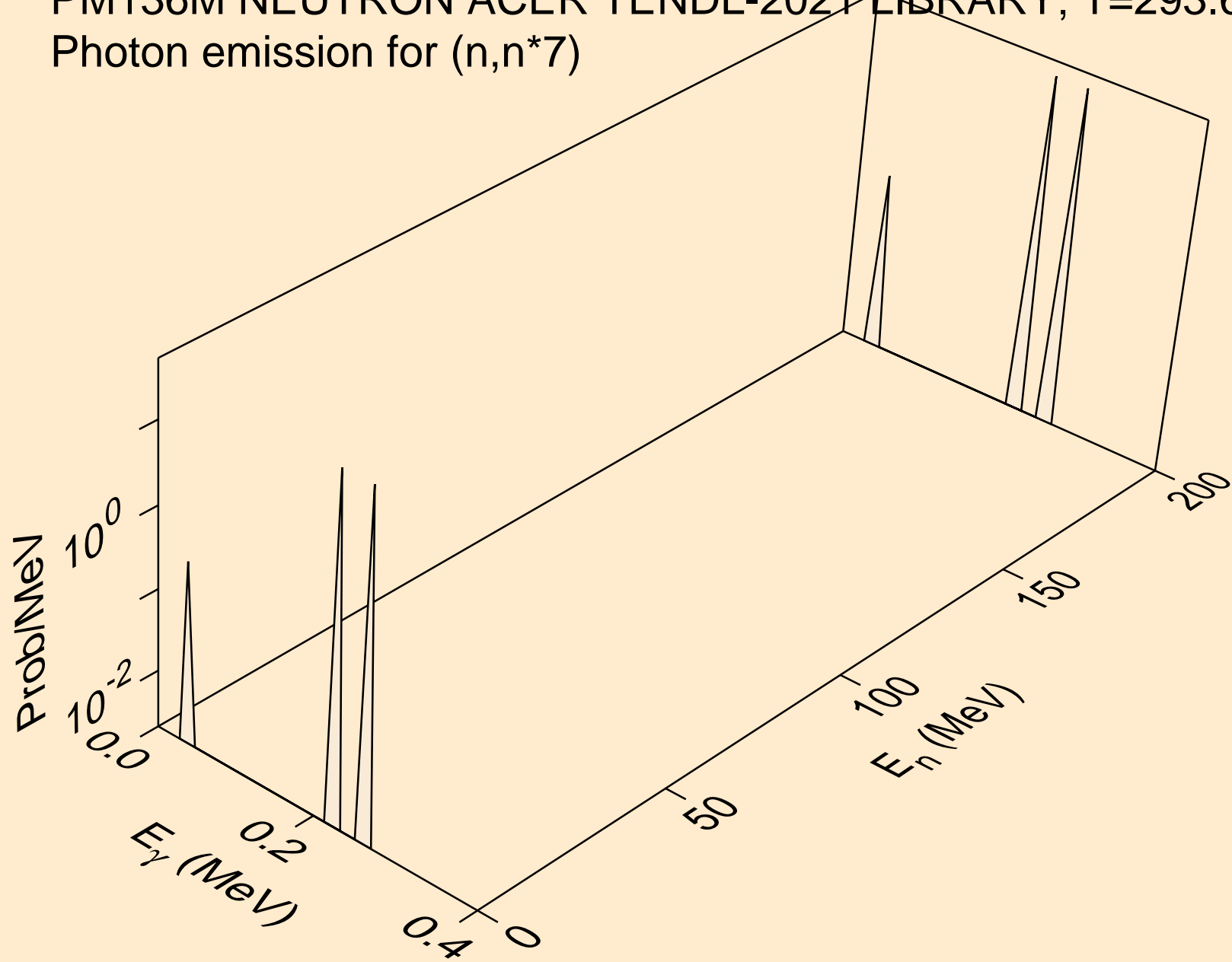

PM136M NEUTRON ACER TENDL-2021 LIBRARY; T=293.6K  
Photon emission for (n,n\*8)

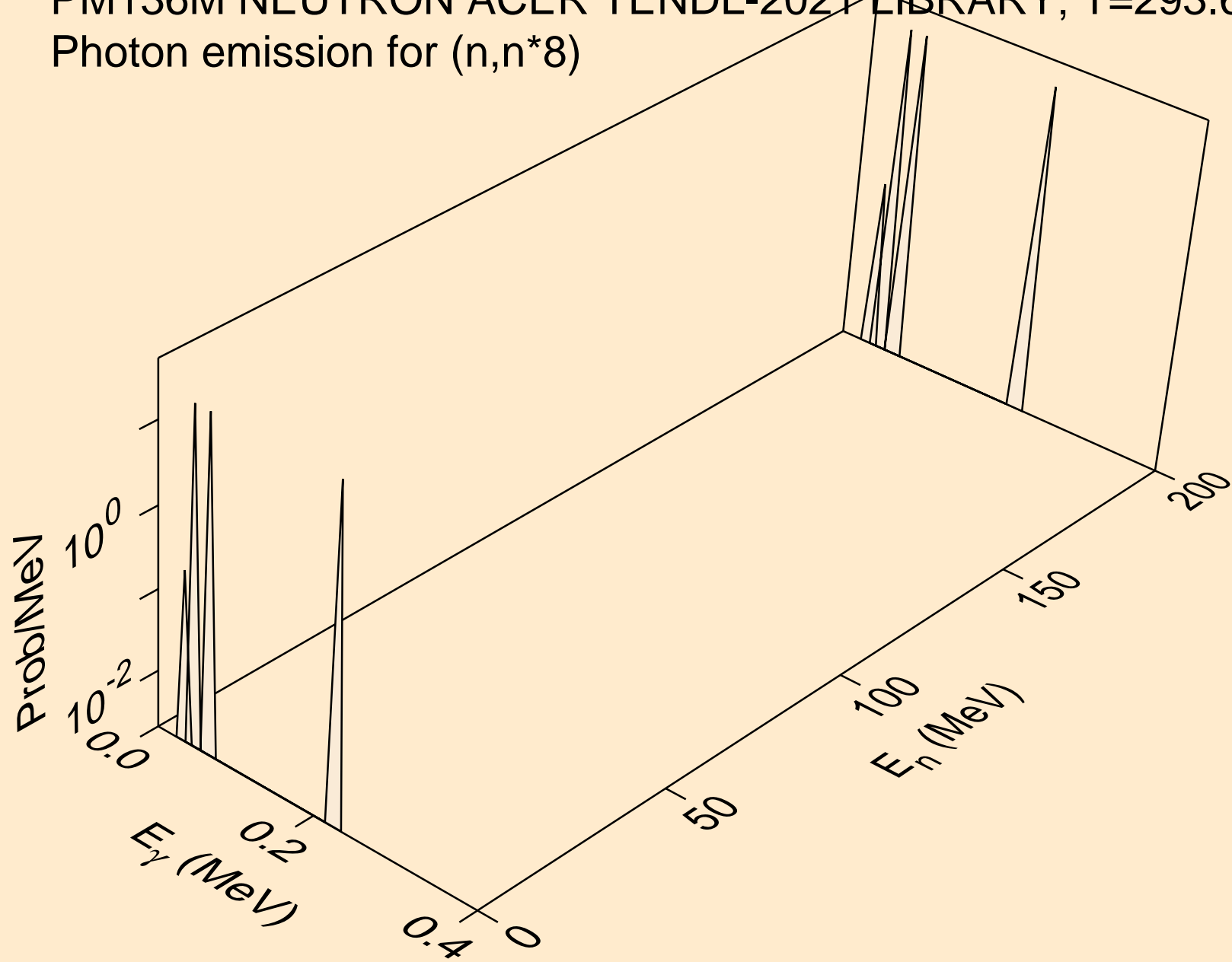

PM136M NEUTRON ACER TENDL-2021 LIBRARY; T=293.6K  
Photon emission for (n,n\*9)

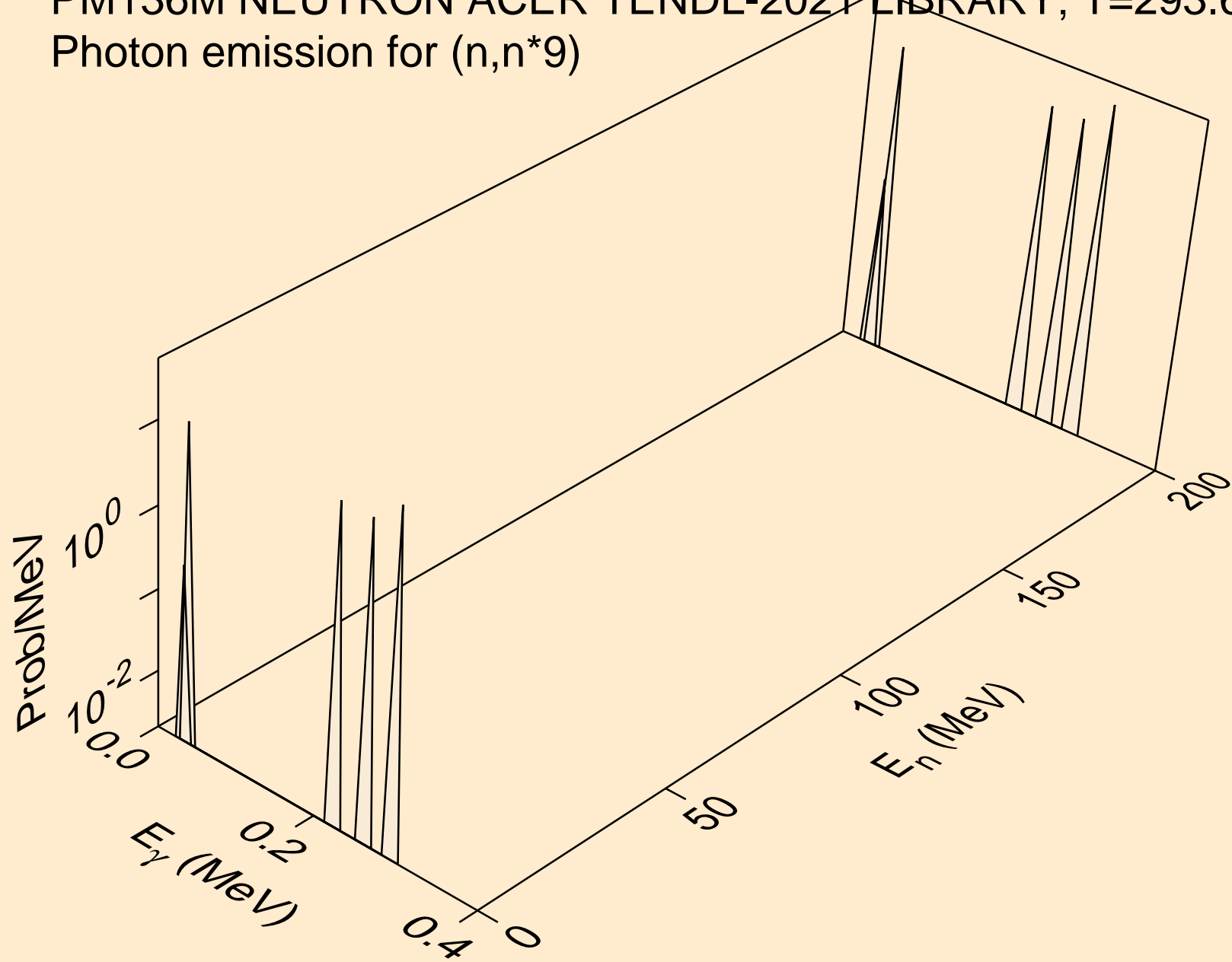



PM136M NEUTRON ACER TENDL-2021 LIBRARY; T=293.6K  
Photon emission for (n,n\*10)

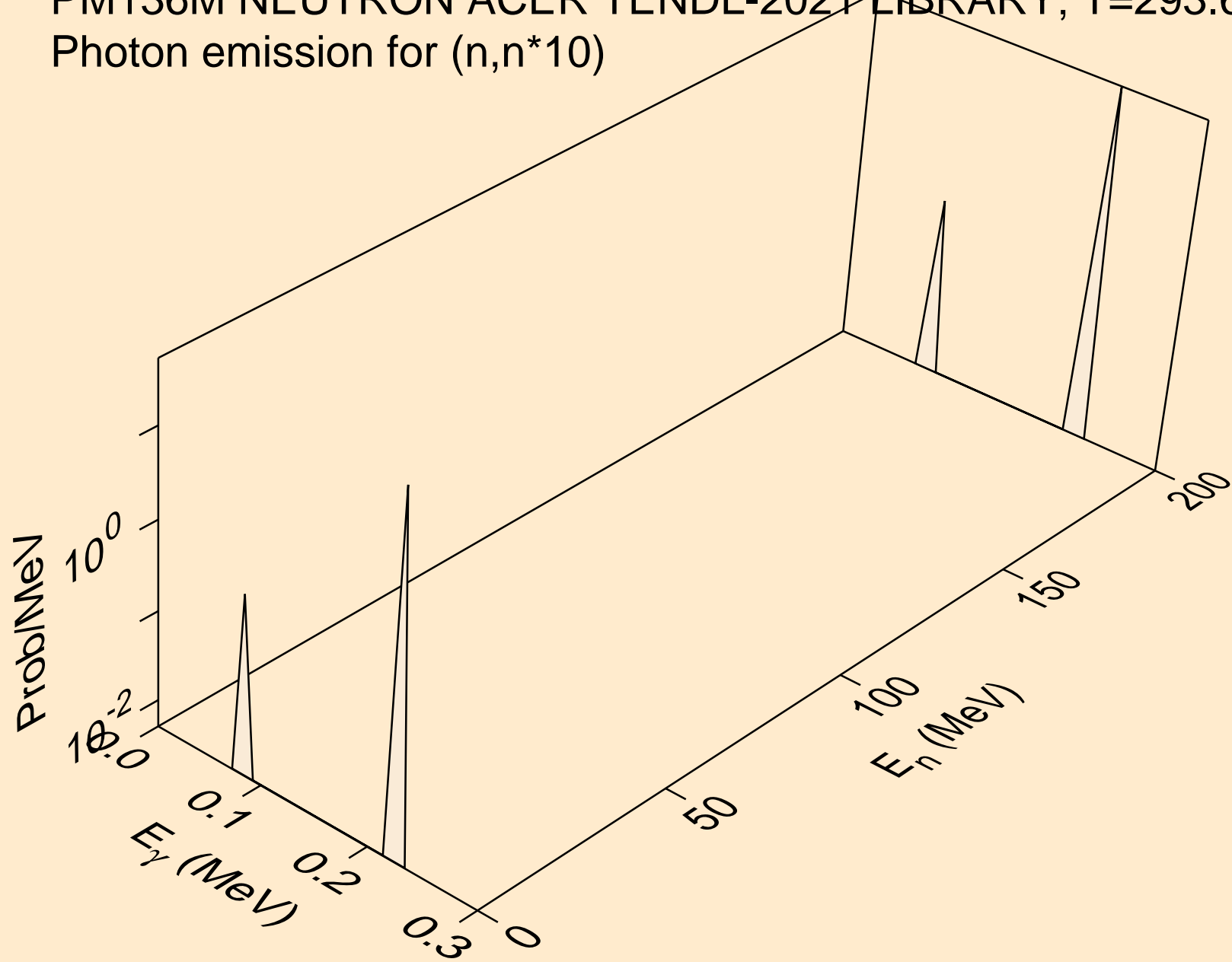

PM136M NEUTRON ACER TENDL-2021 LIBRARY; T=293.6K  
Photon emission for (n,n\*11)

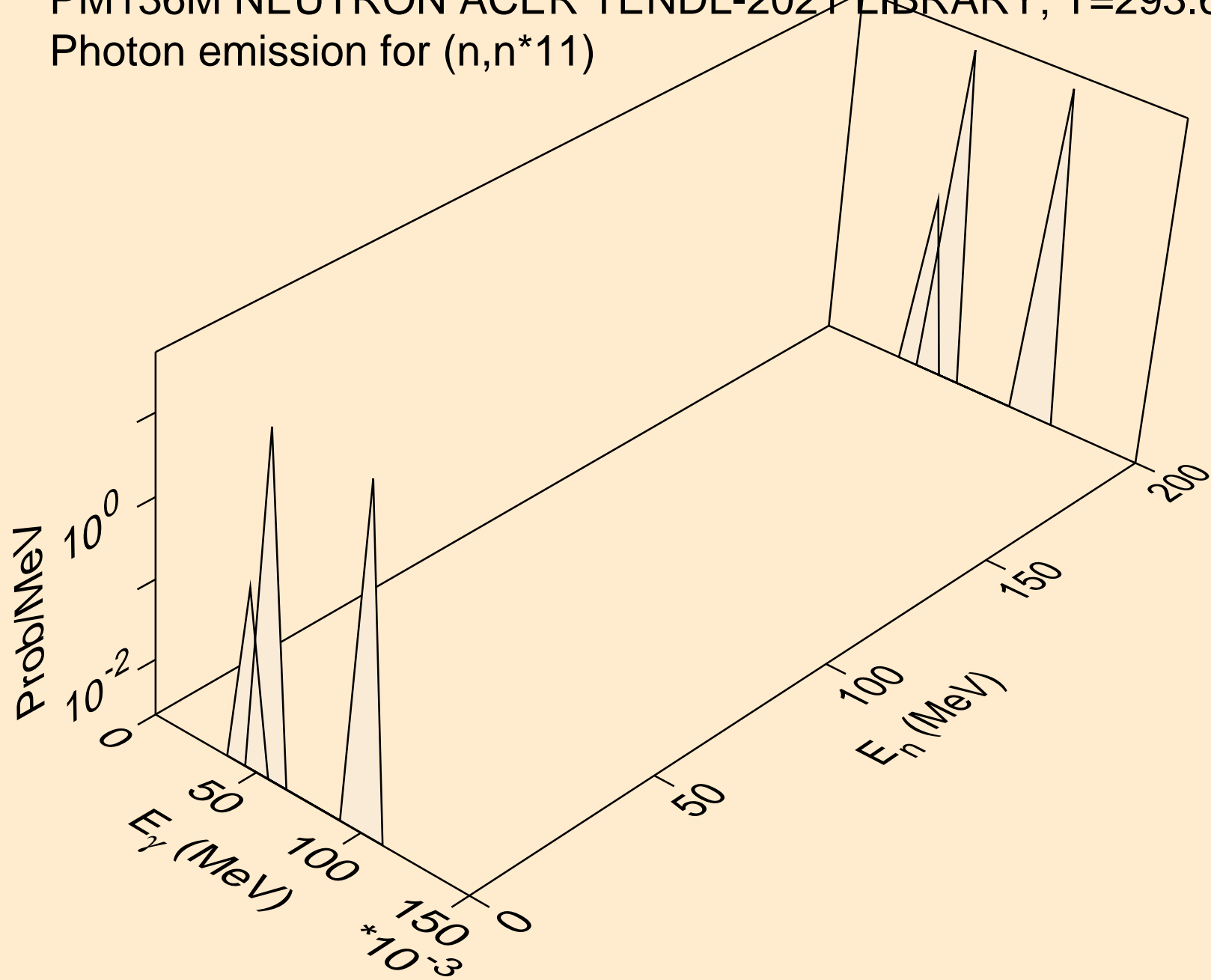

PM136M NEUTRON ACER TENDL-2021 LIBRARY; T=293.6K  
Photon emission for (n,n\*12)

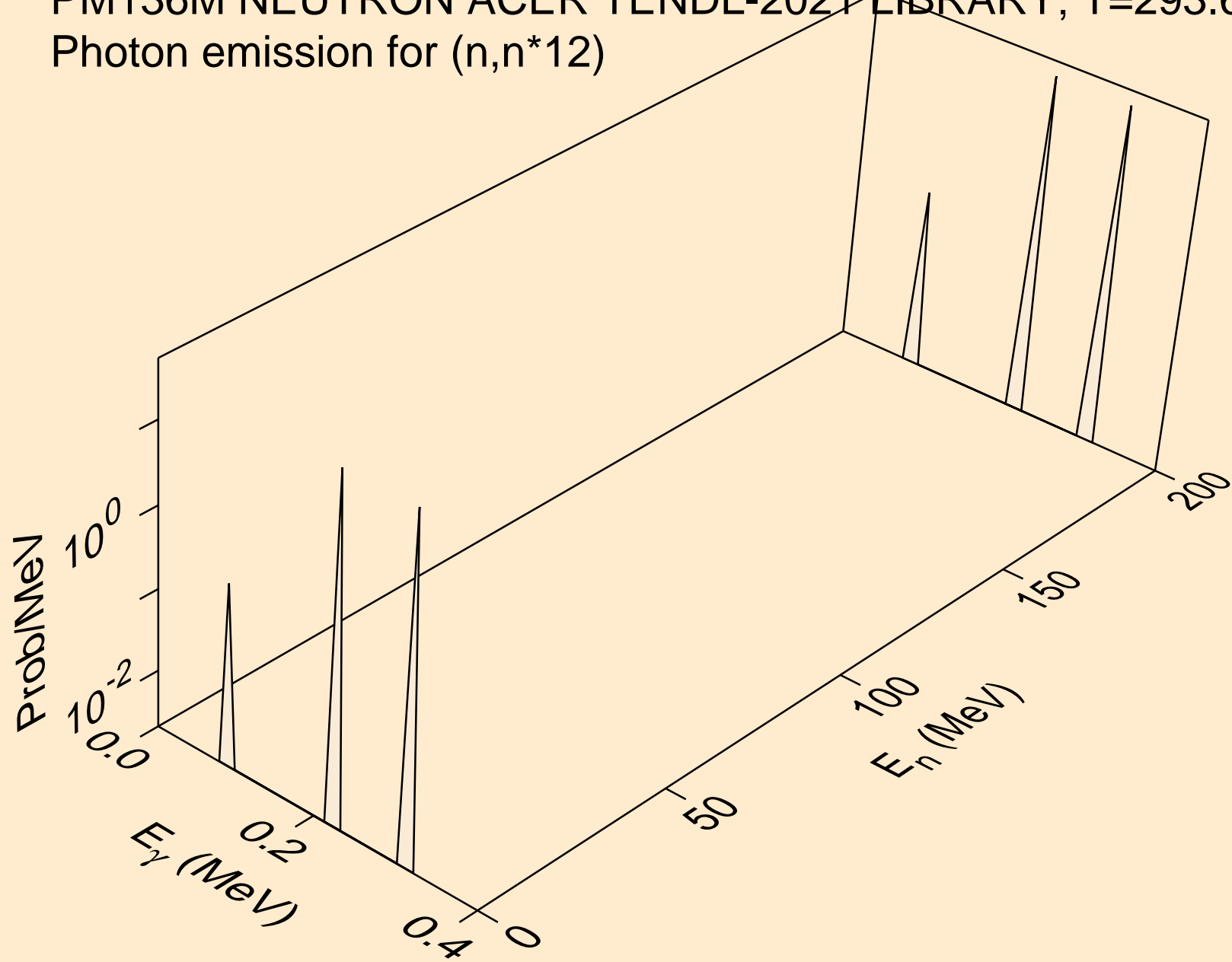

PM136M NEUTRON ACER TENDL-2021 LIBRARY; T=293.6K  
Photon emission for (n,n\*13)

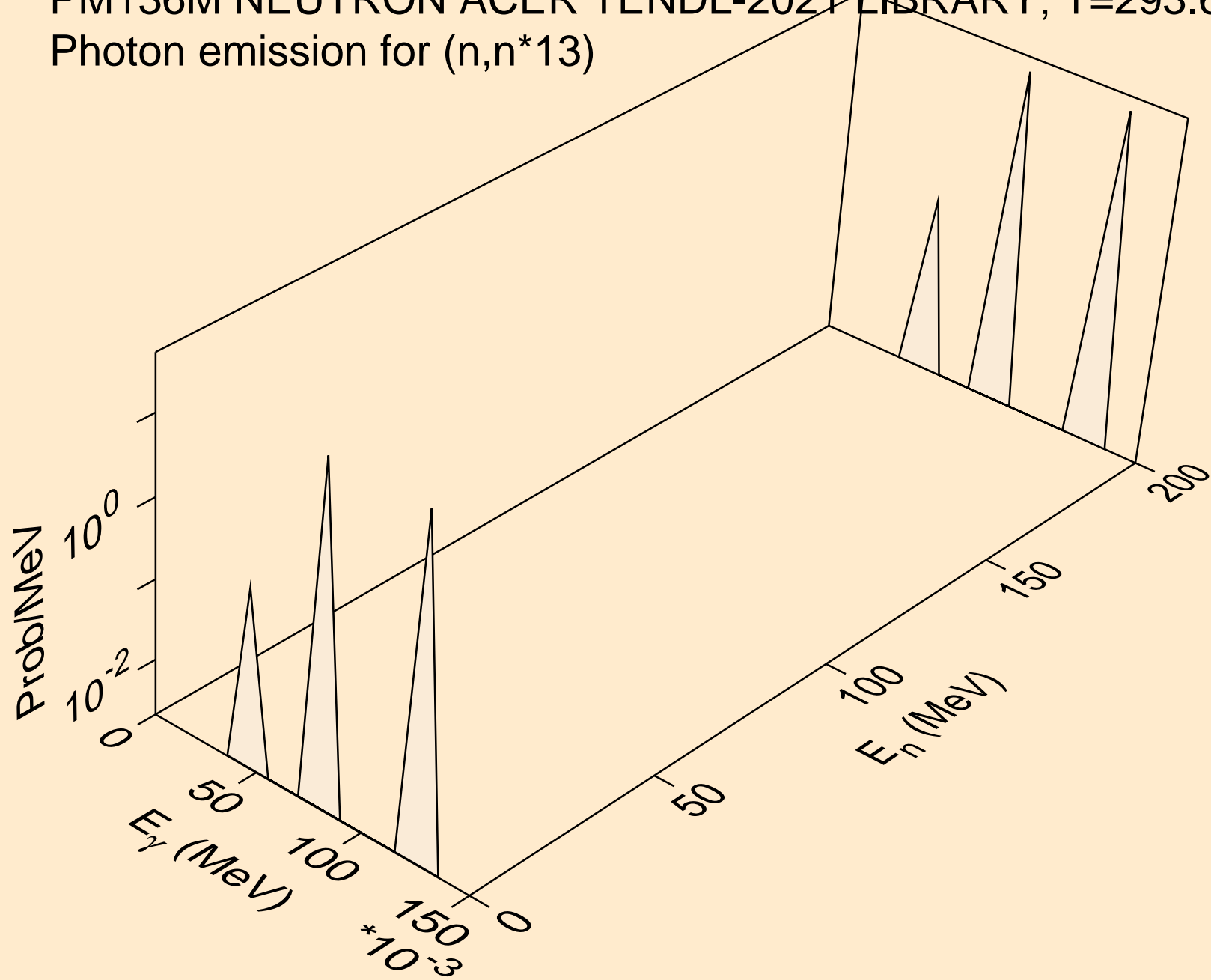

PM136M NEUTRON ACER TENDL-2021 LIBRARY; T=293.6K  
Photon emission for (n,n\*14)

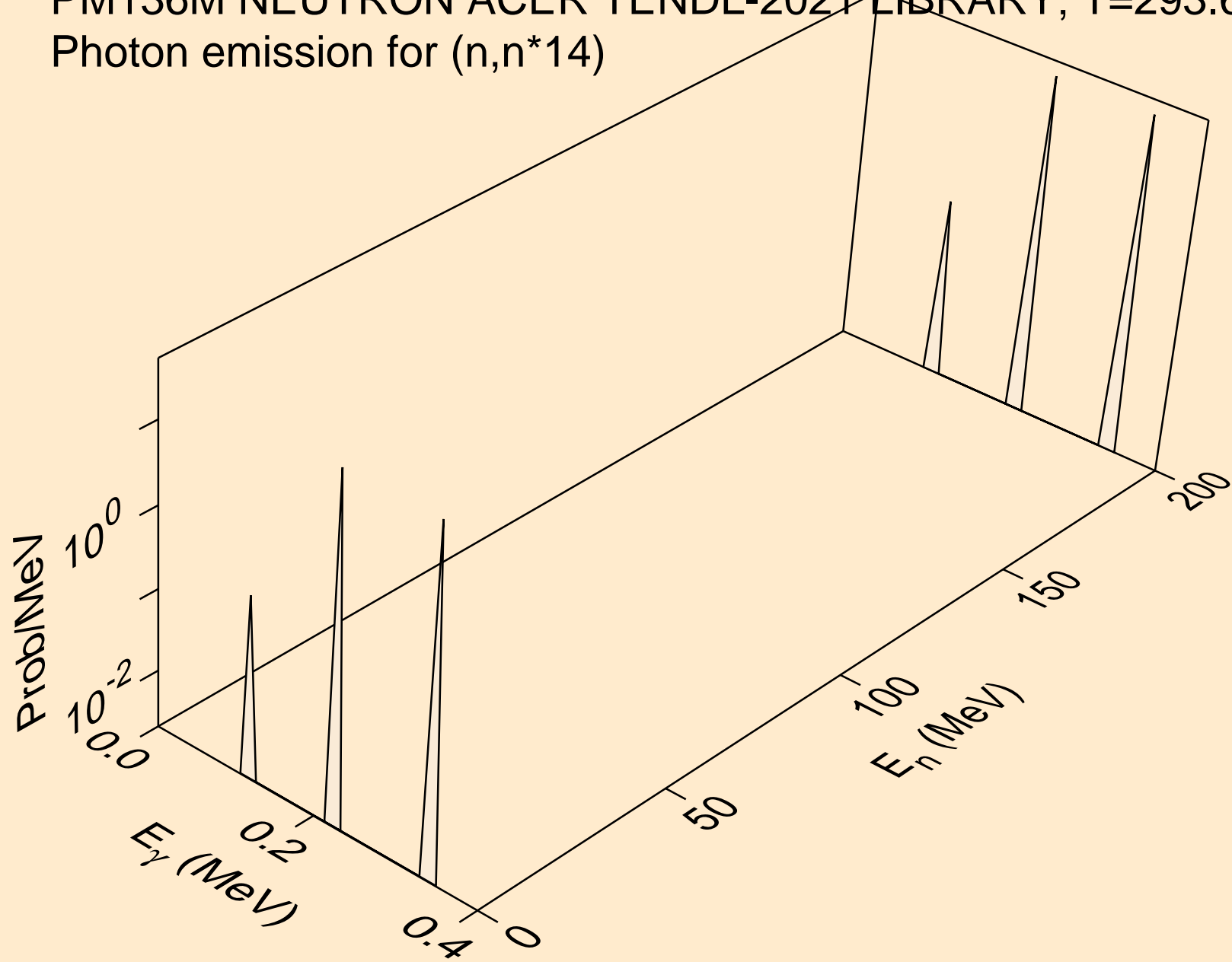

PM136M NEUTRON ACER TENDL-2021 LIBRARY; T=293.6K  
Photon emission for (n,n\*15)

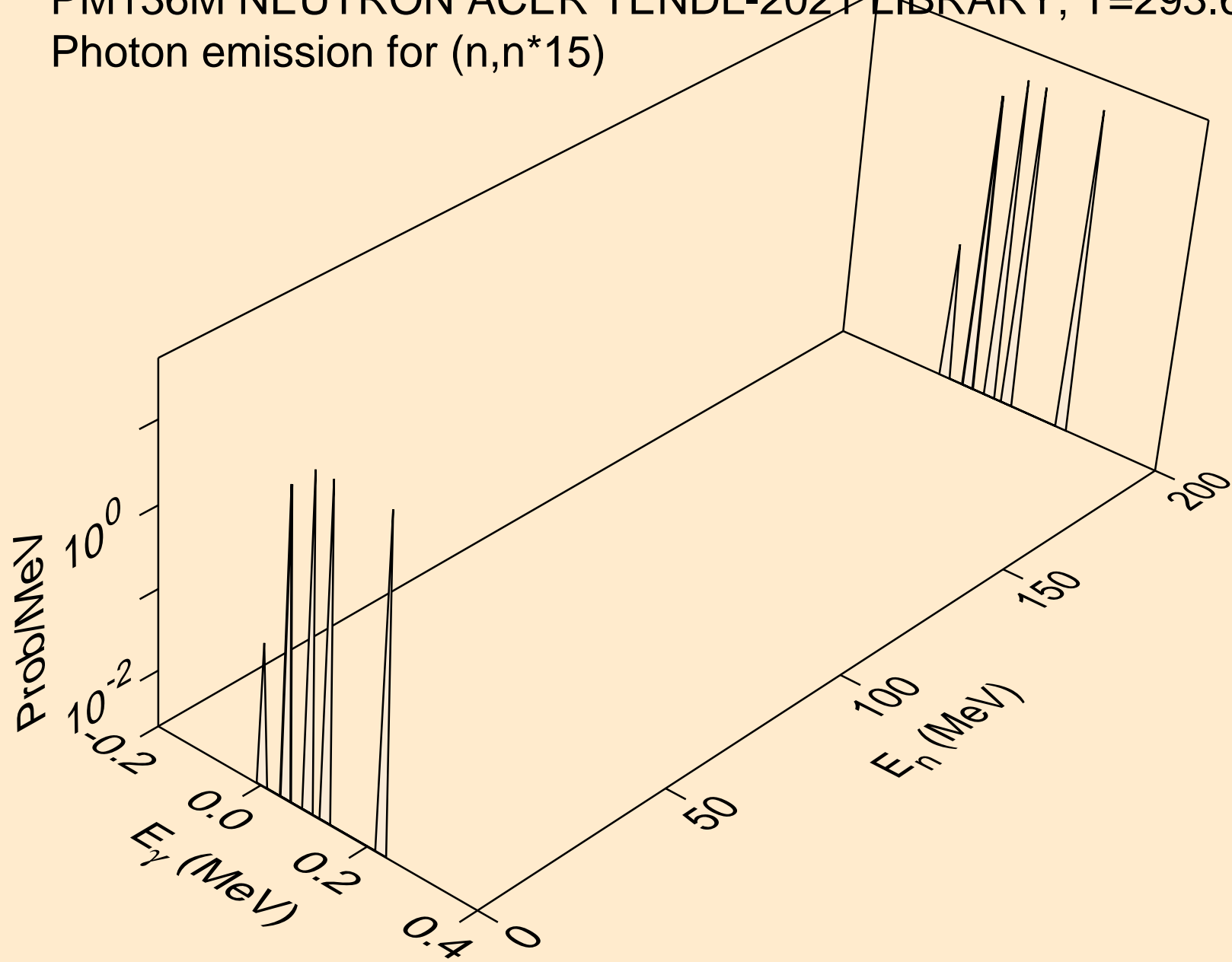

PM136M NEUTRON ACER TENDL-2021 LIBRARY; T=293.6K  
Photon emission for (n,n\*16)

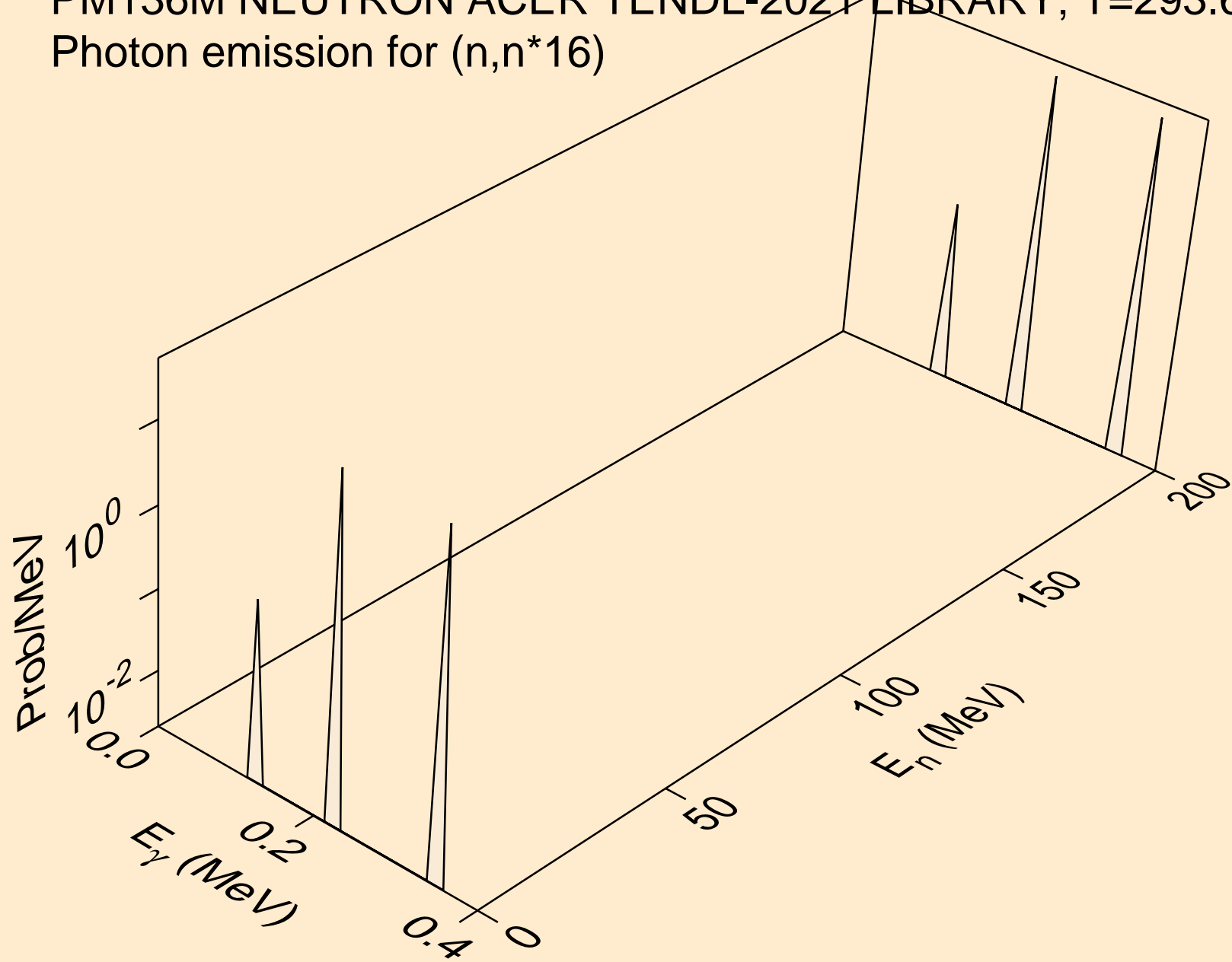

PM136M NEUTRON ACER TENDL-2021 LIBRARY; T=293.6K  
Photon emission for (n,n\*17)

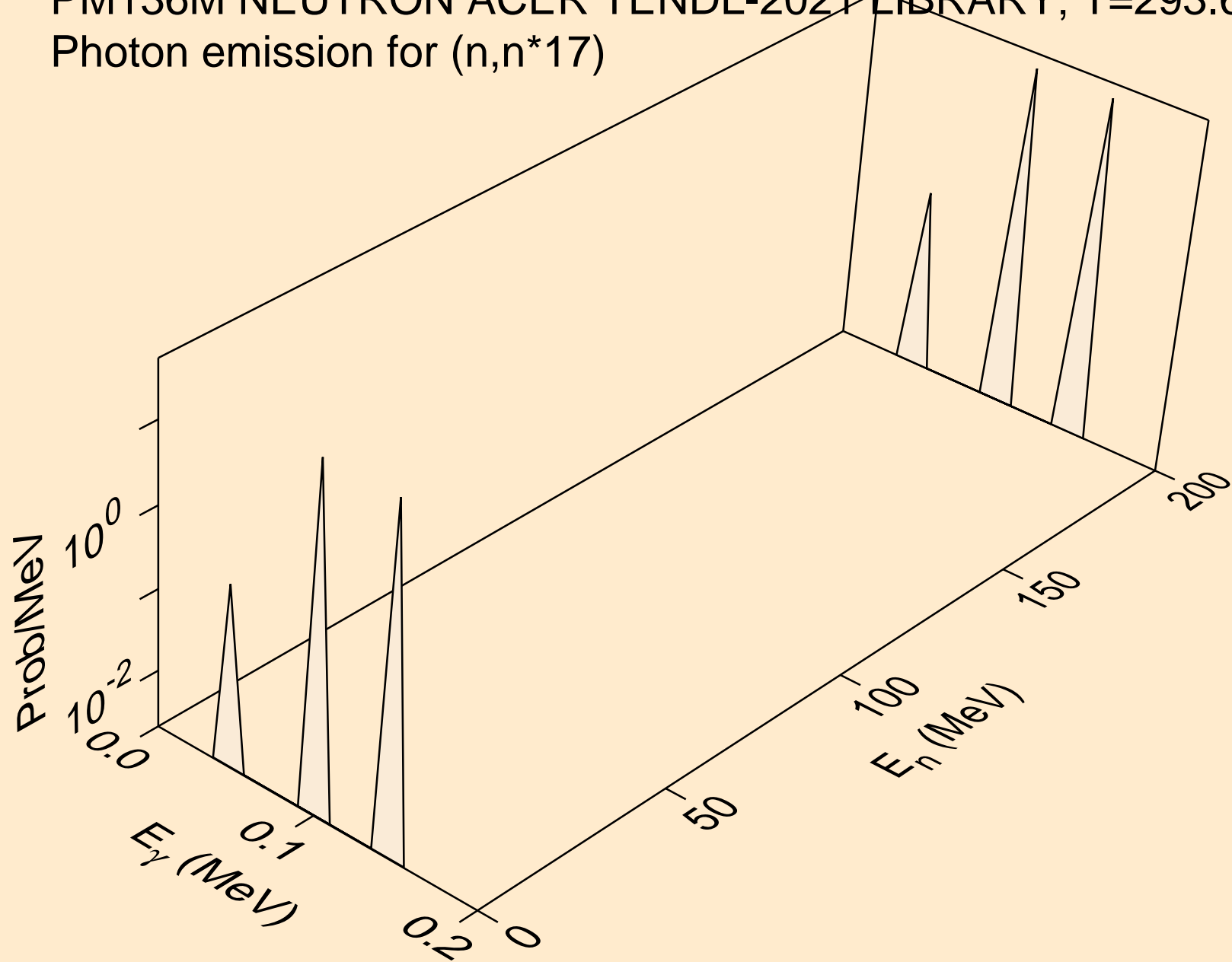



PM136M NEUTRON ACER TENDL-2021 LIBRARY; T=293.6K  
Photon emission for (n,n\*18)

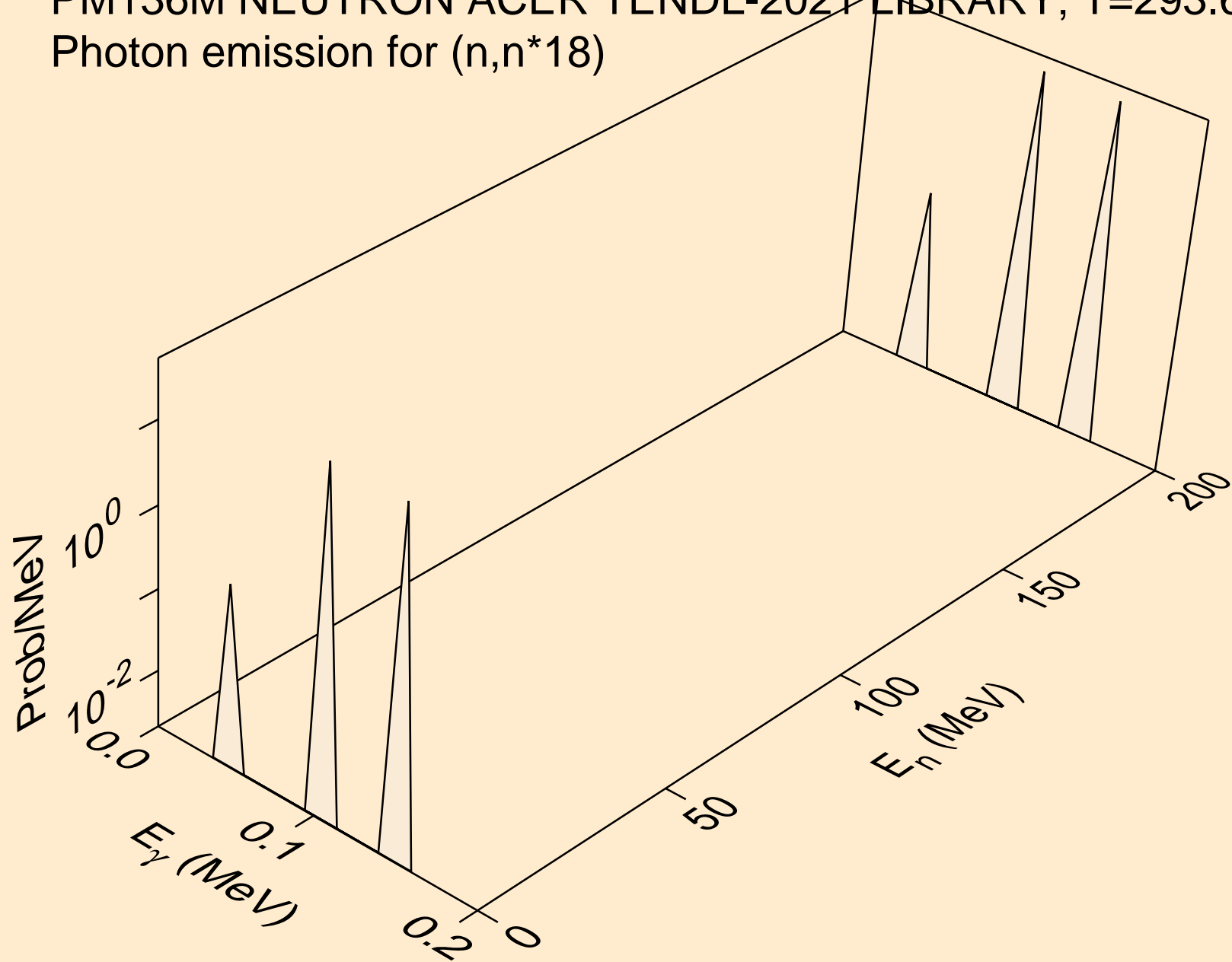

PM136M NEUTRON ACER TENDL-2021 LIBRARY; T=293.6K  
Photon emission for (n,n\*19)

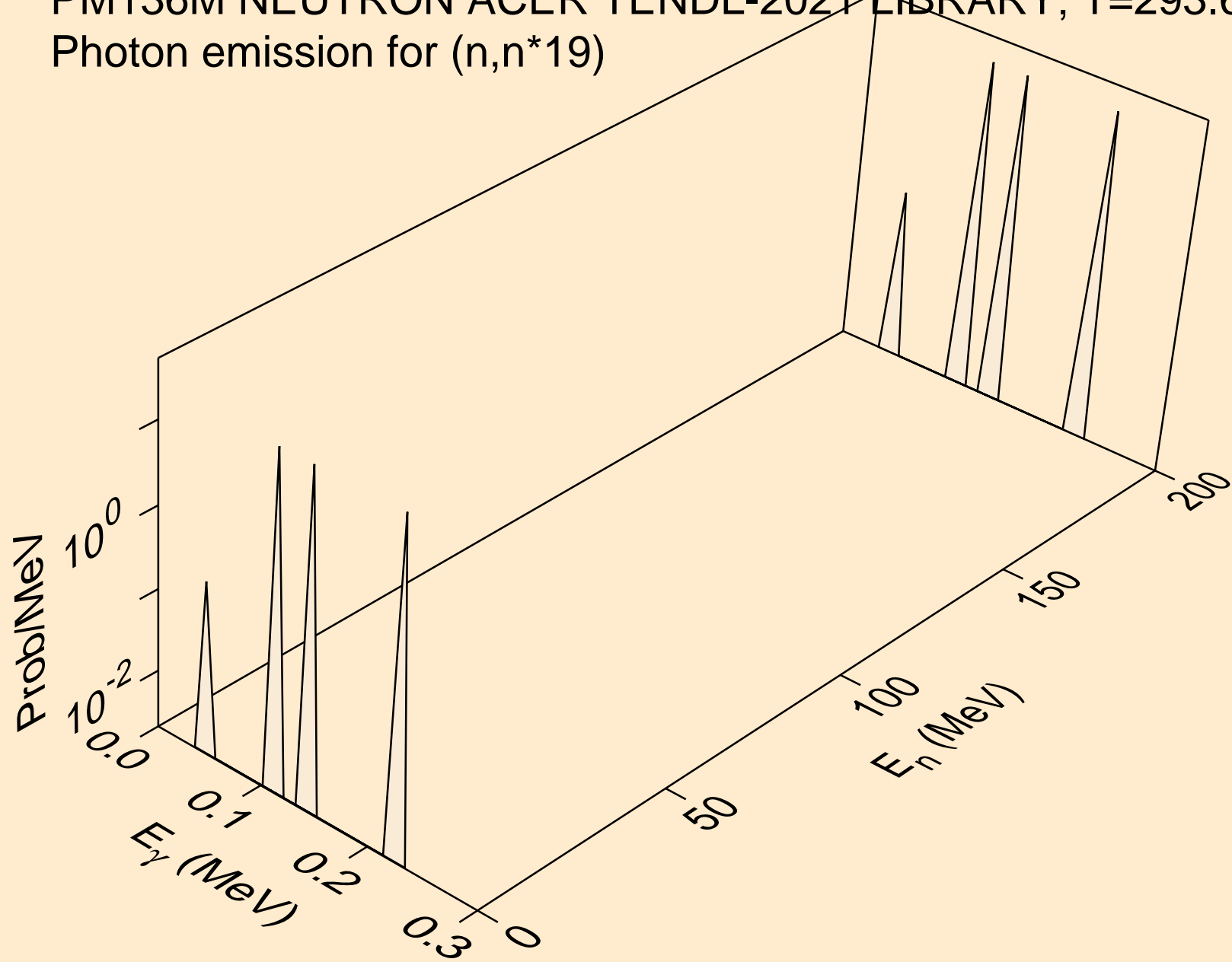

PM136M NEUTRON ACER TENDL-2021 LIBRARY; T=293.6K  
Photon emission for (n,n\*20)

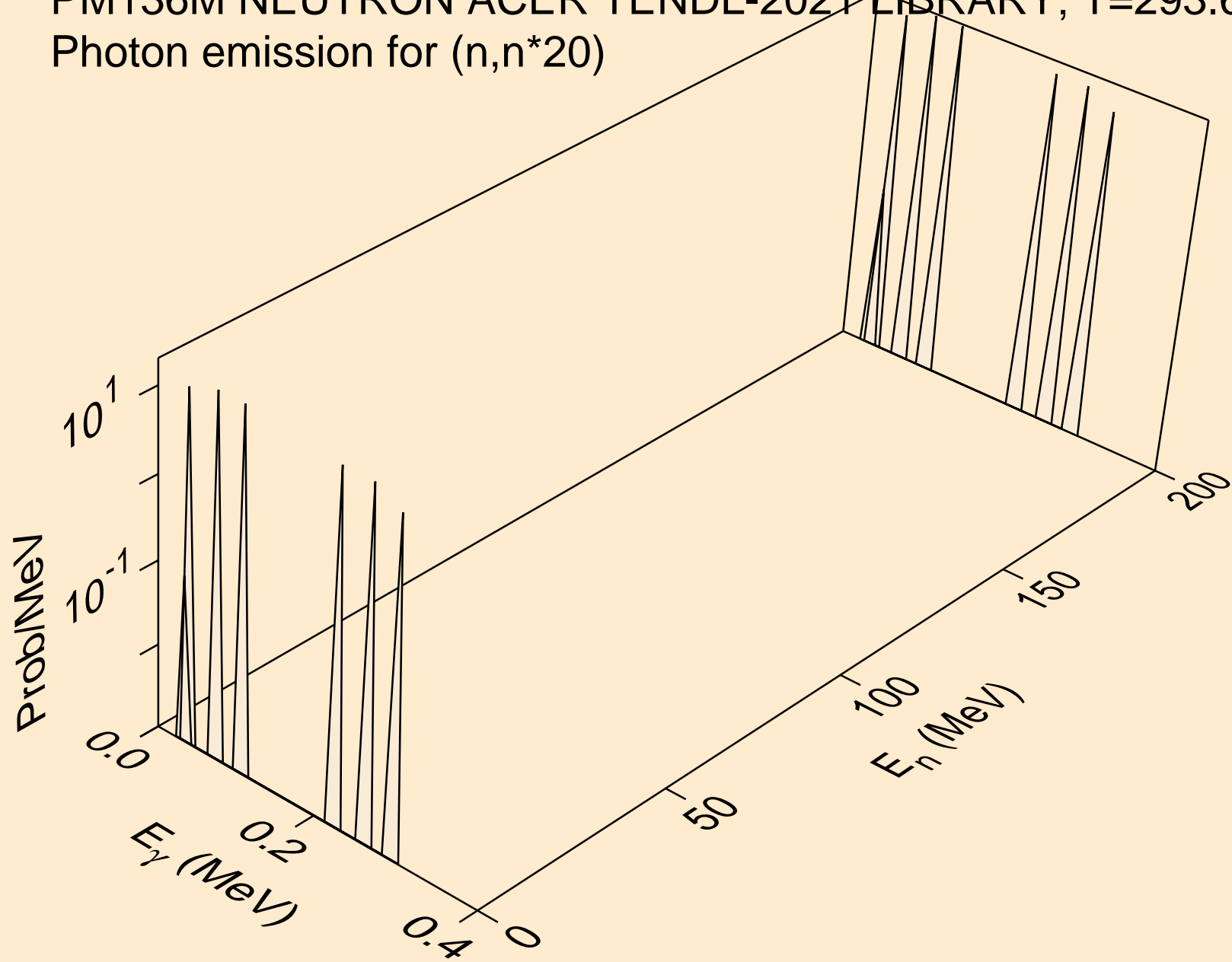

PM136M NEUTRON ACER TENDL-2021 LIBRARY; T=293.6K  
Photon emission for (n,n\*21)

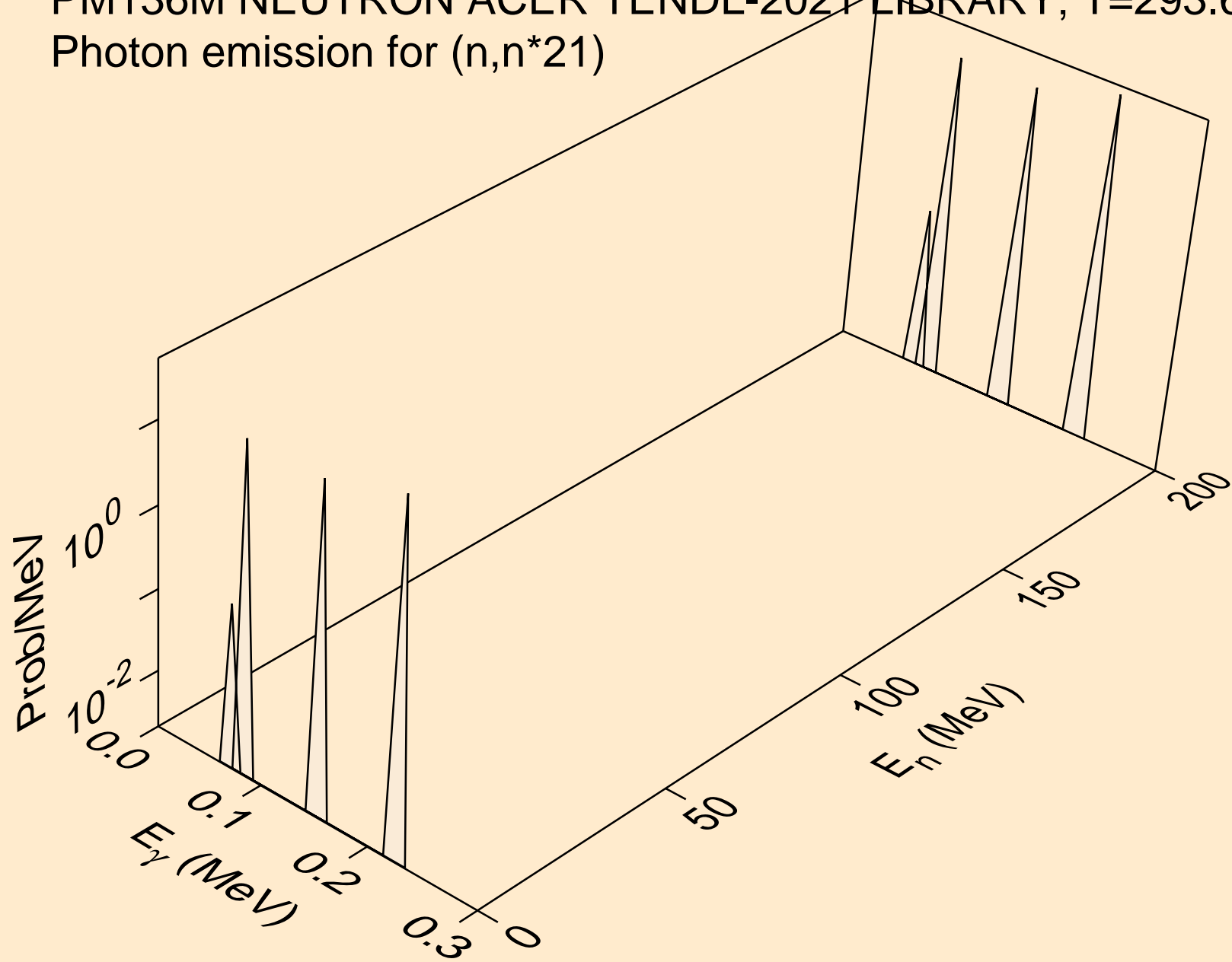

PM136M NEUTRON ACER TENDL-2021 LIBRARY; T=293.6K  
Photon emission for (n,n\*22)

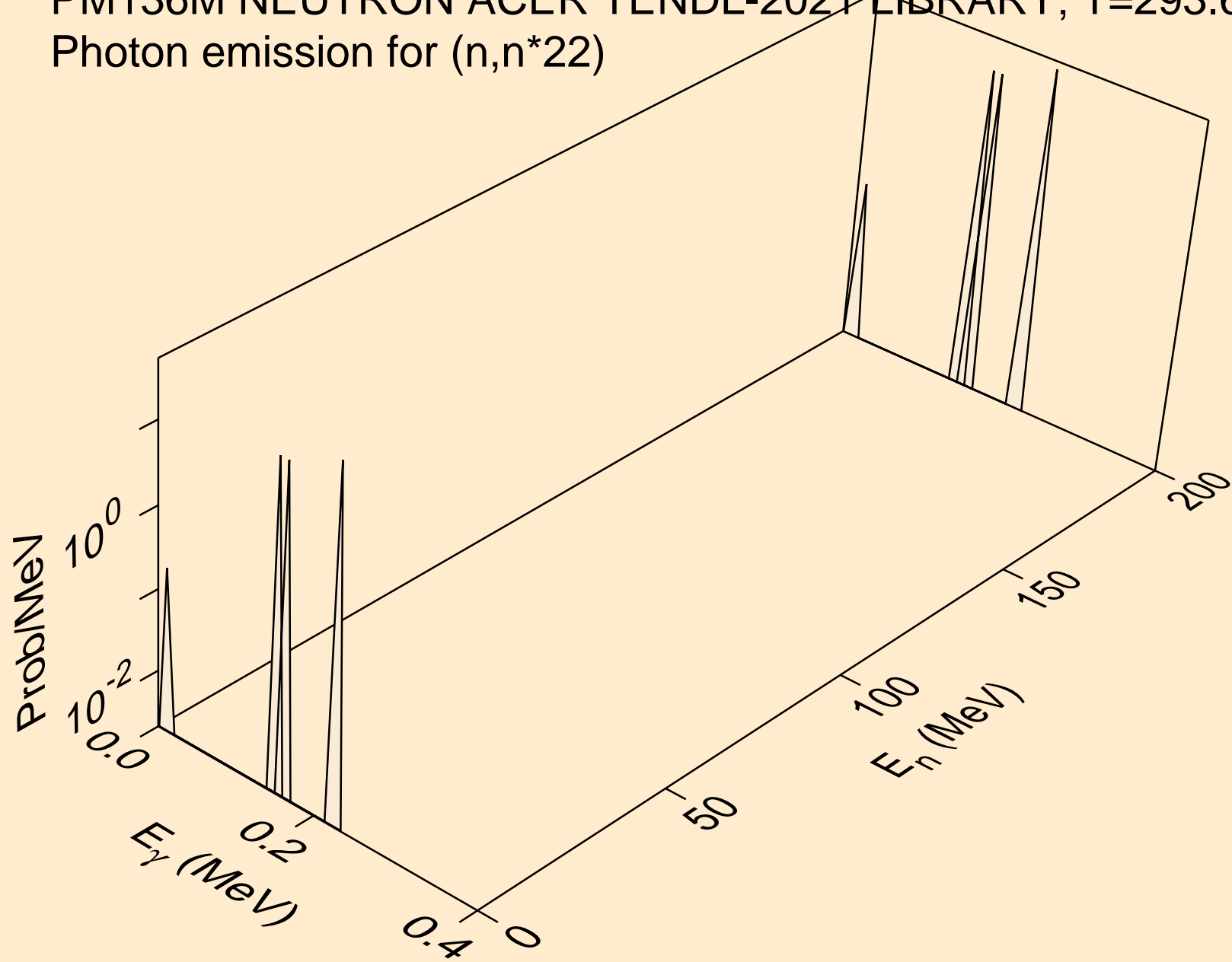

PM136M NEUTRON ACER TENDL-2021 LIBRARY; T=293.6K  
Photon emission for (n,n\*23)

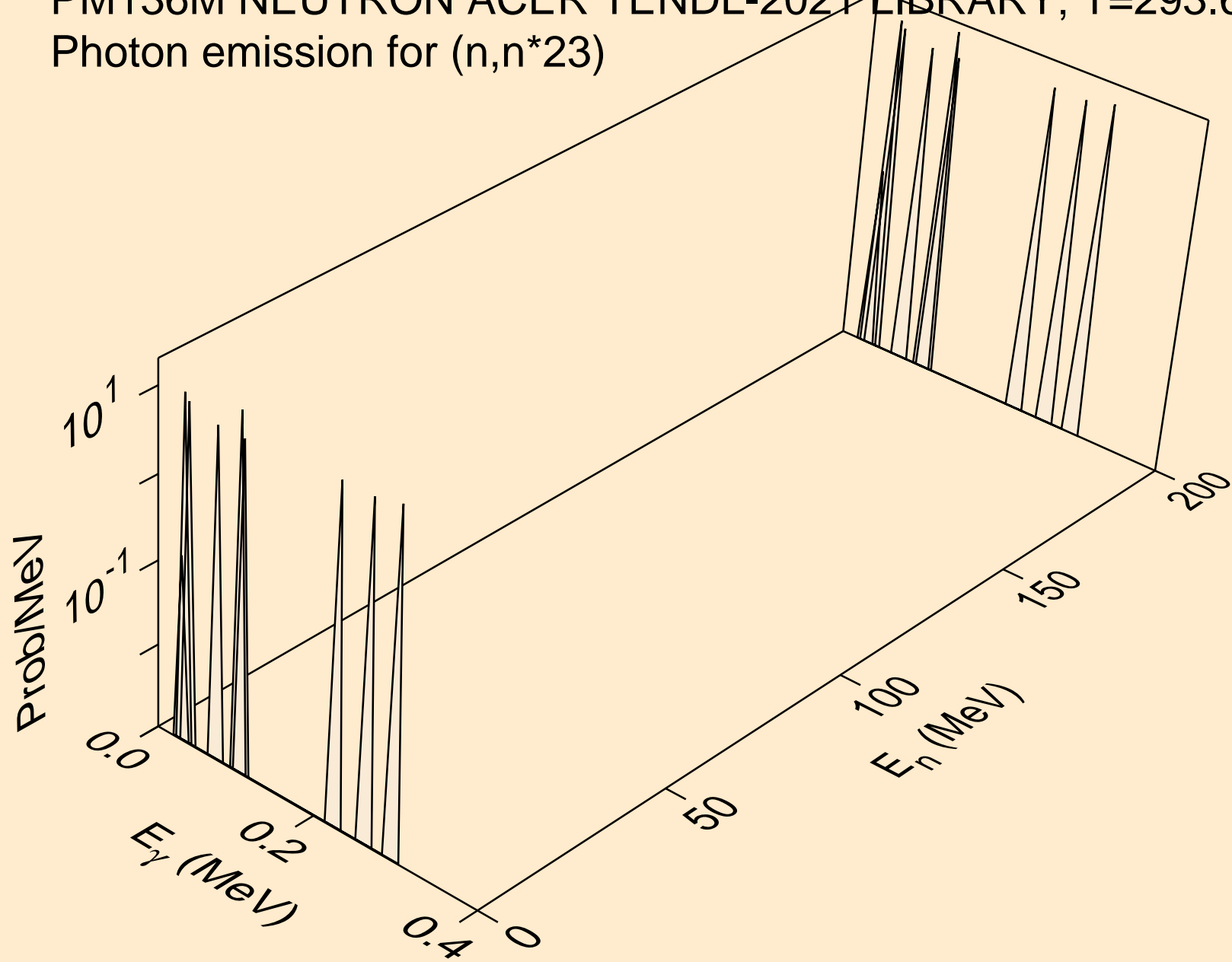

PM136M NEUTRON ACER TENDL-2021 LIBRARY; T=293.6K  
Photon emission for (n,n\*24)

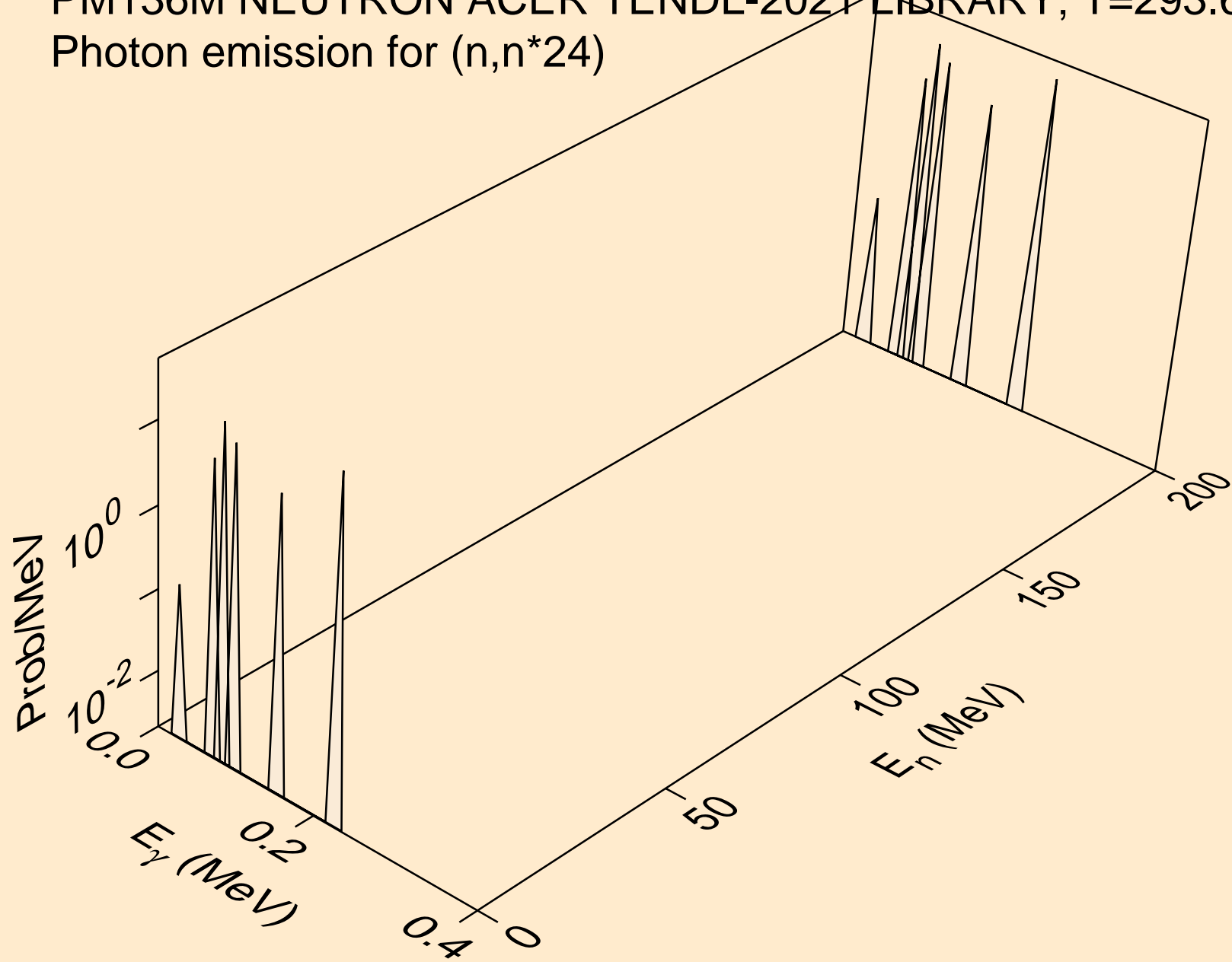

PM136M NEUTRON ACER TENDL-2021 LIBRARY; T=293.6K  
Photon emission for (n,n\*25)

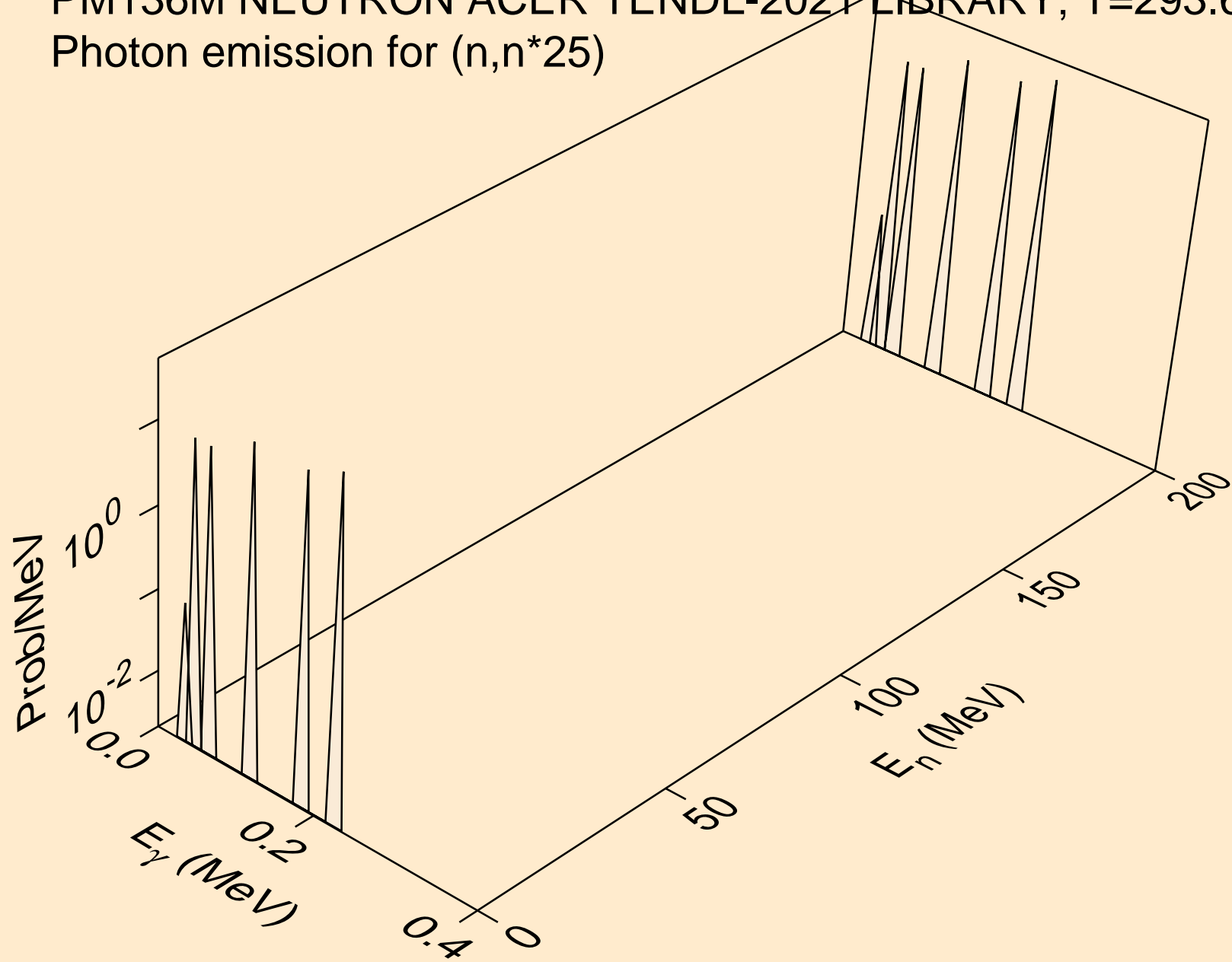



PM136M NEUTRON ACER TENDL-2021 LIBRARY; T=293.6K  
Photon emission for (n,n\*26)

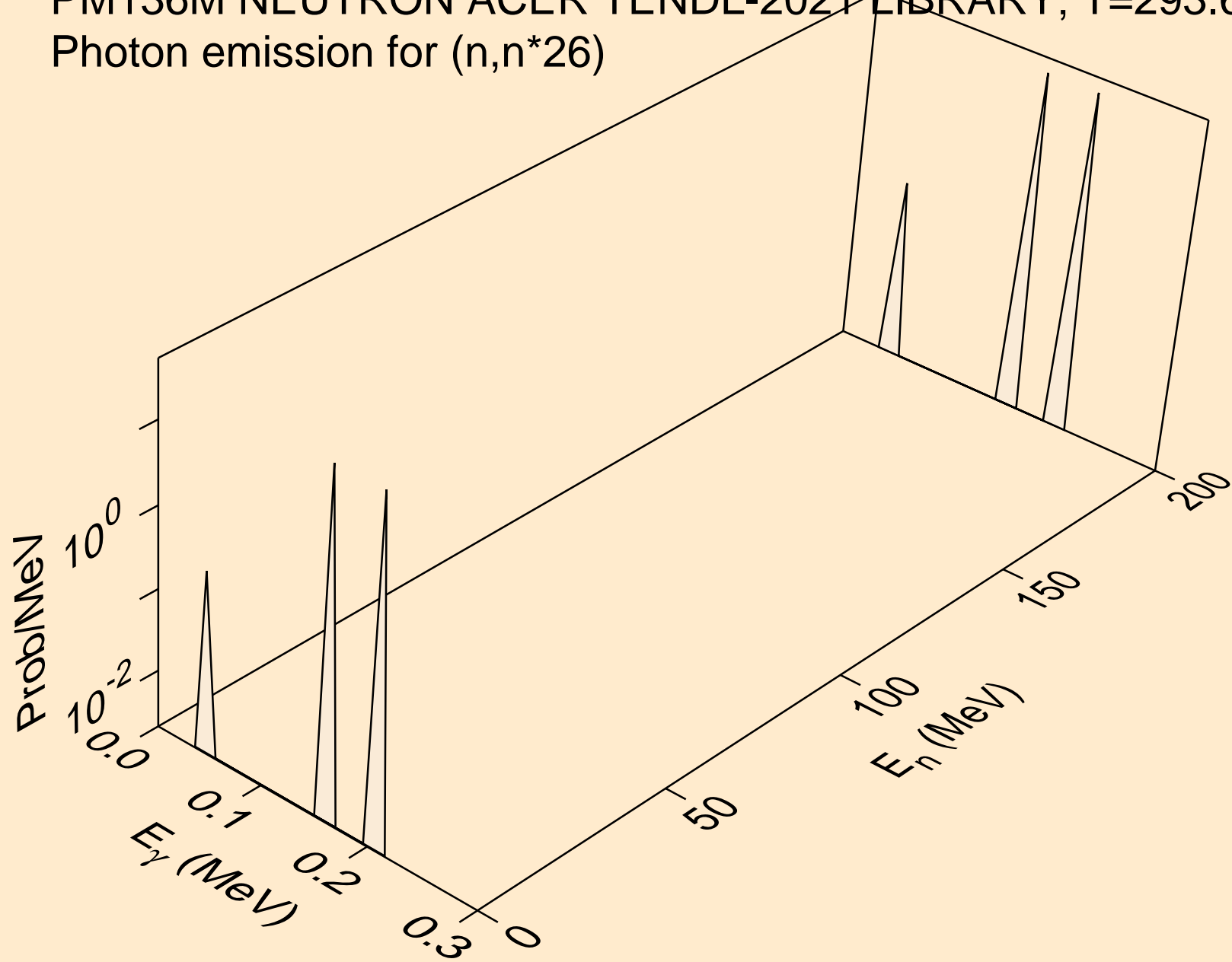

PM136M NEUTRON ACER TENDL-2021 LIBRARY; T=293.6K  
Photon emission for (n,n\*27)

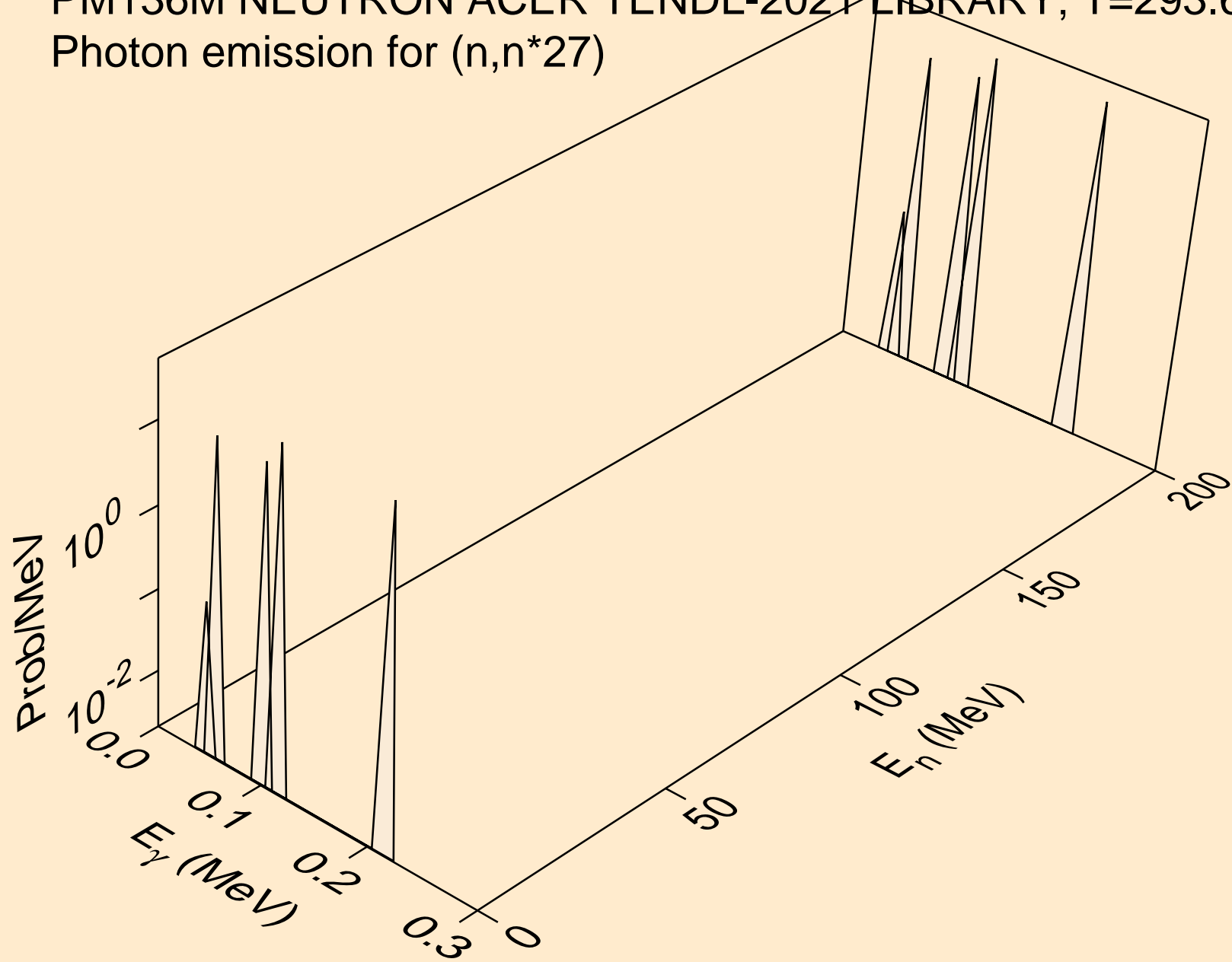

PM136M NEUTRON ACER TENDL-2021 LIBRARY; T=293.6K  
Photon emission for (n,n\*28)

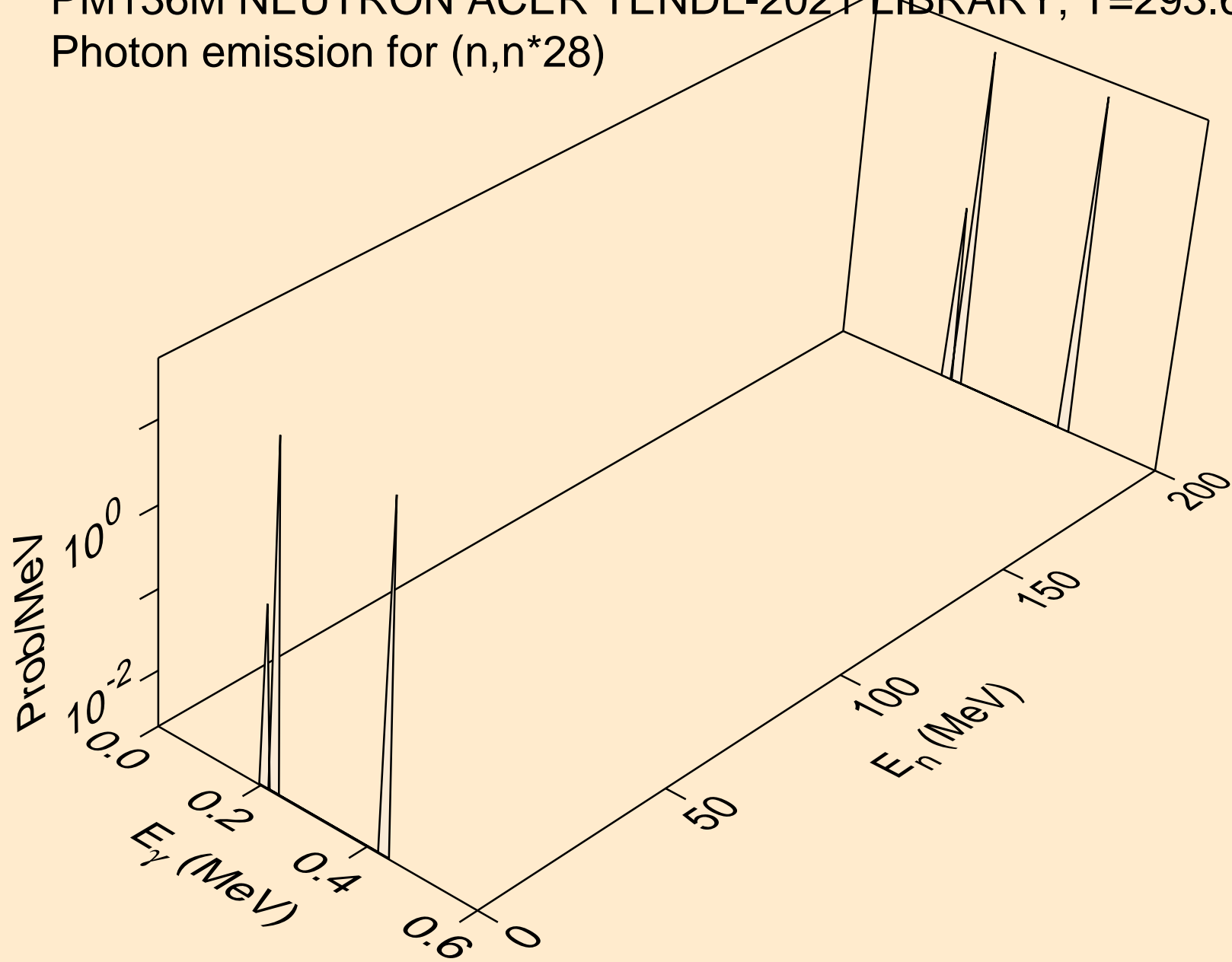

PM136M NEUTRON ACER TENDL-2021 LIBRARY; T=293.6K  
Photon emission for (n,n\*29)

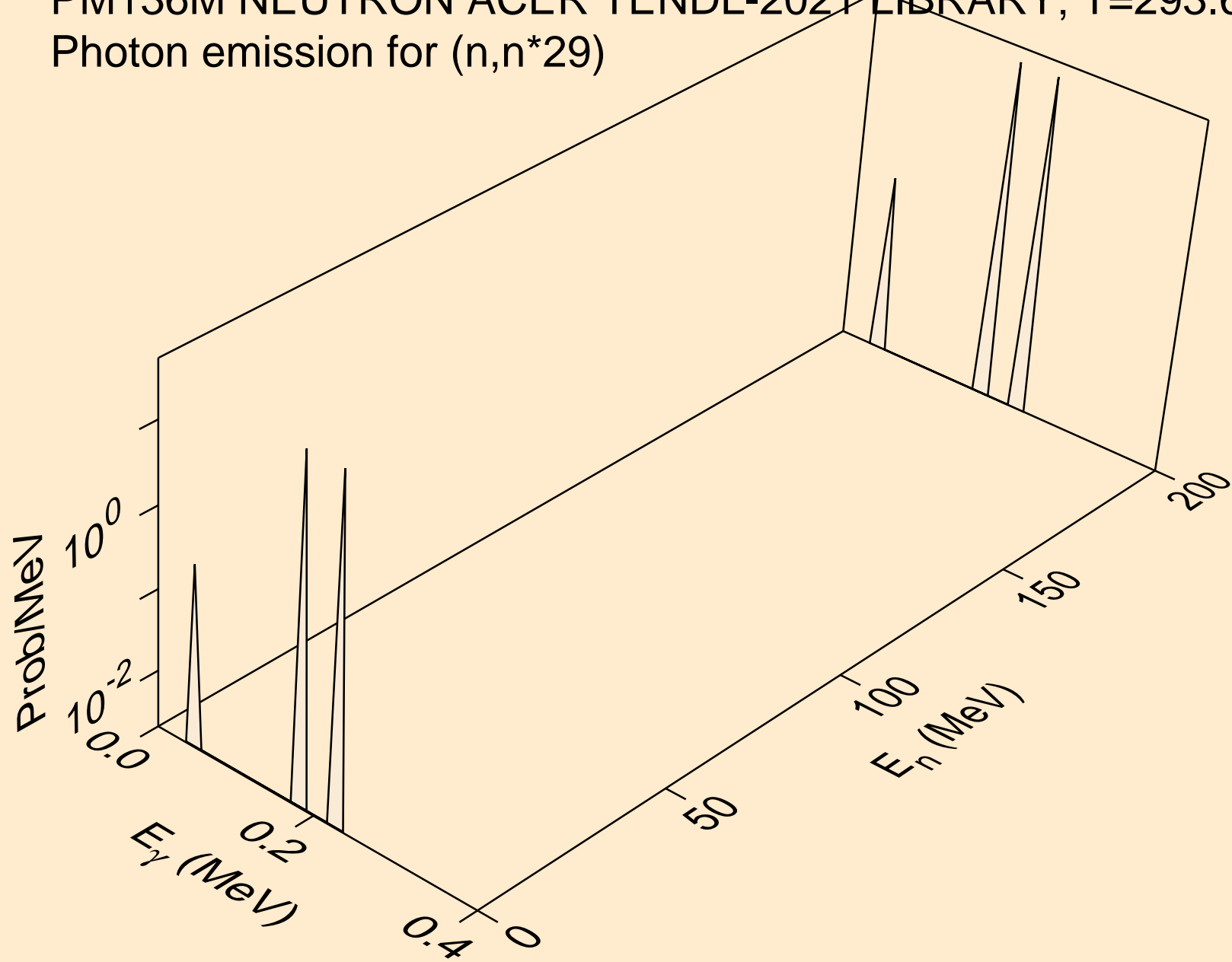

PM136M NEUTRON ACER TENDL-2021 LIBRARY; T=293.6K  
Photon emission for (n,n\*c)

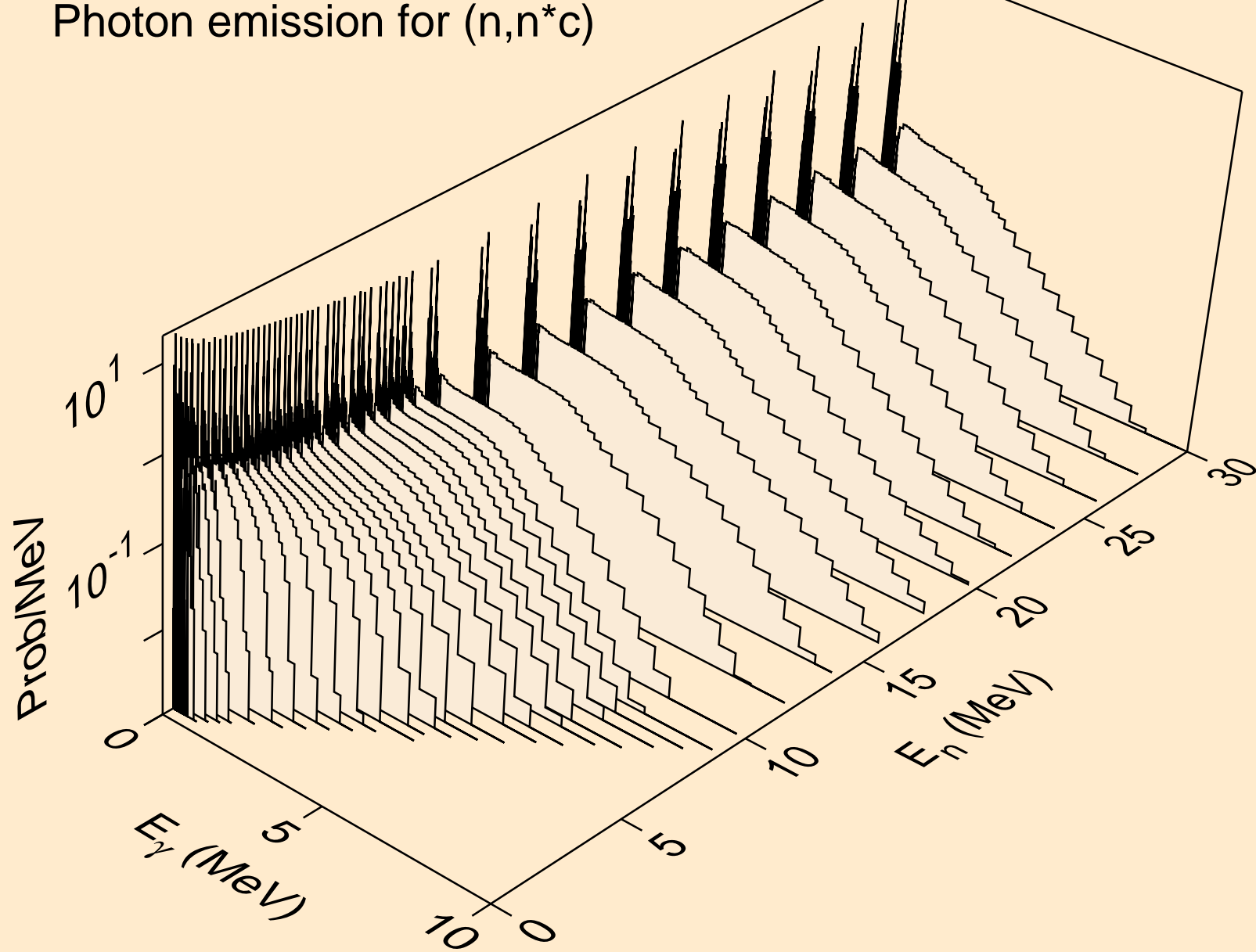

PM136M NEUTRON ACER TENDL-2021 LIBRARY; T=293.6K  
Photon emission for (n,gma)

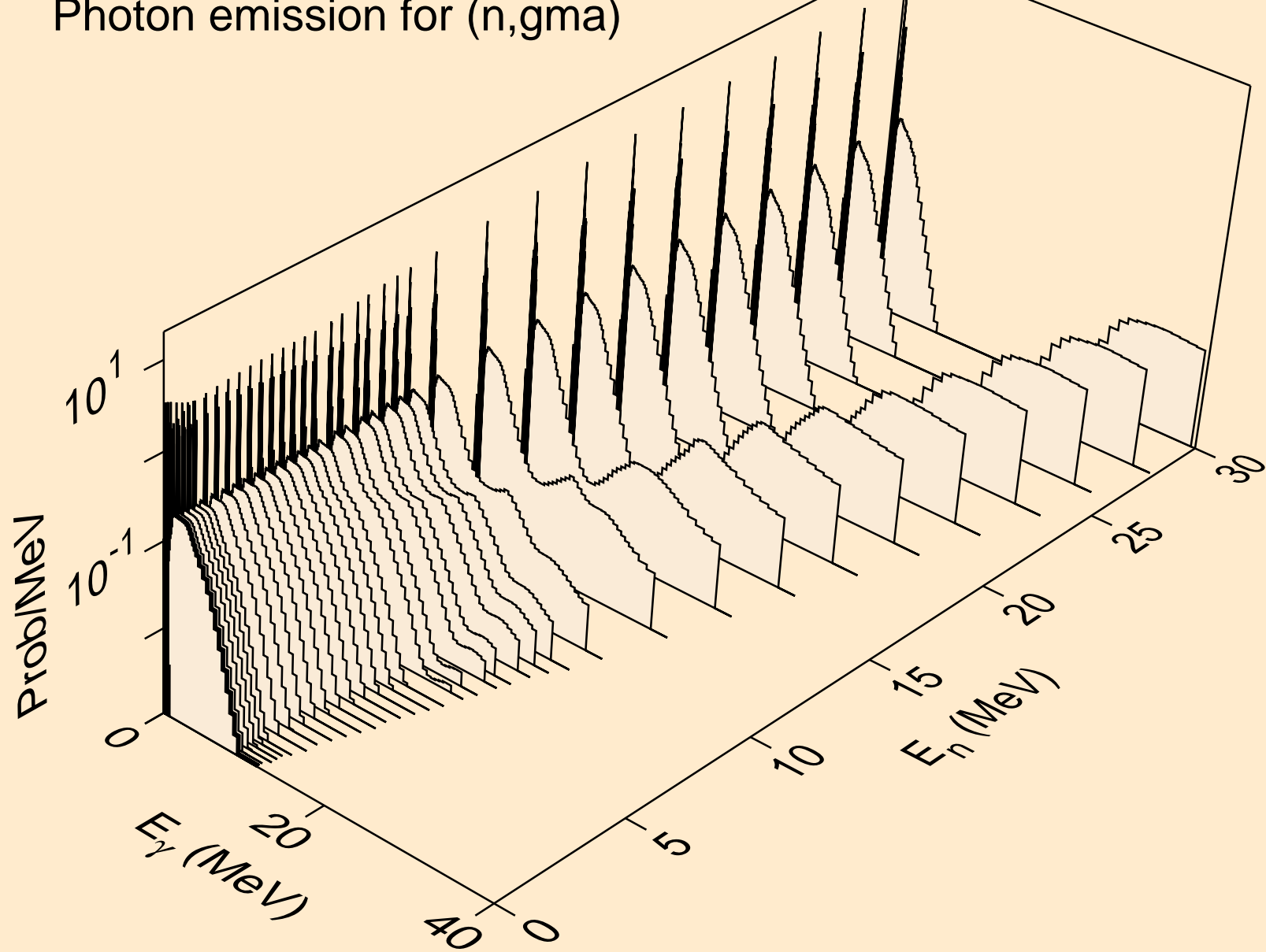

PM136M NEUTRON ACER TENDL-2021 LIBRARY; T=293.6K  
Photon emission for (n,p)

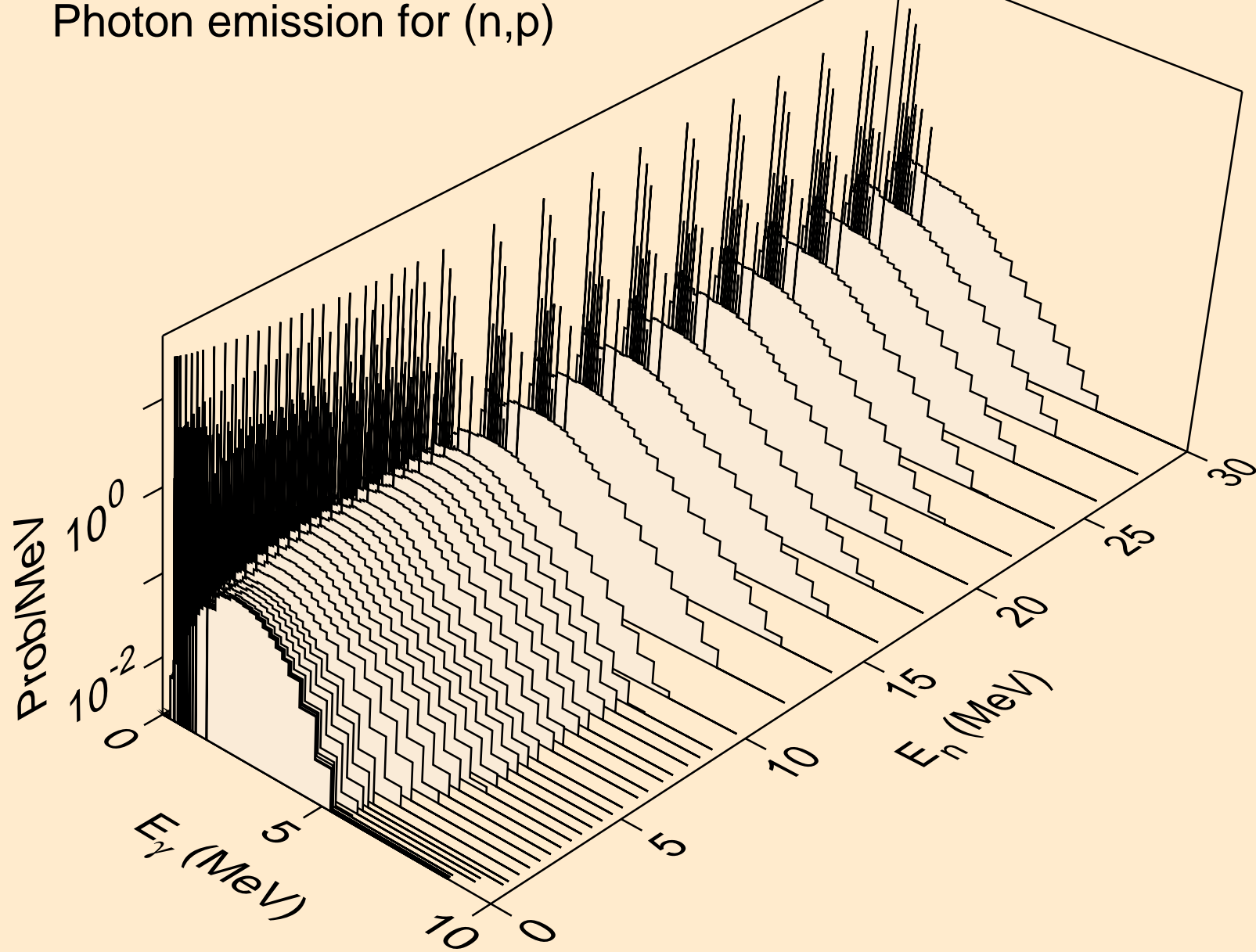

PM136M NEUTRON ACER TENDL-2021 LIBRARY; T=293.6K  
Photon emission for (n,d)

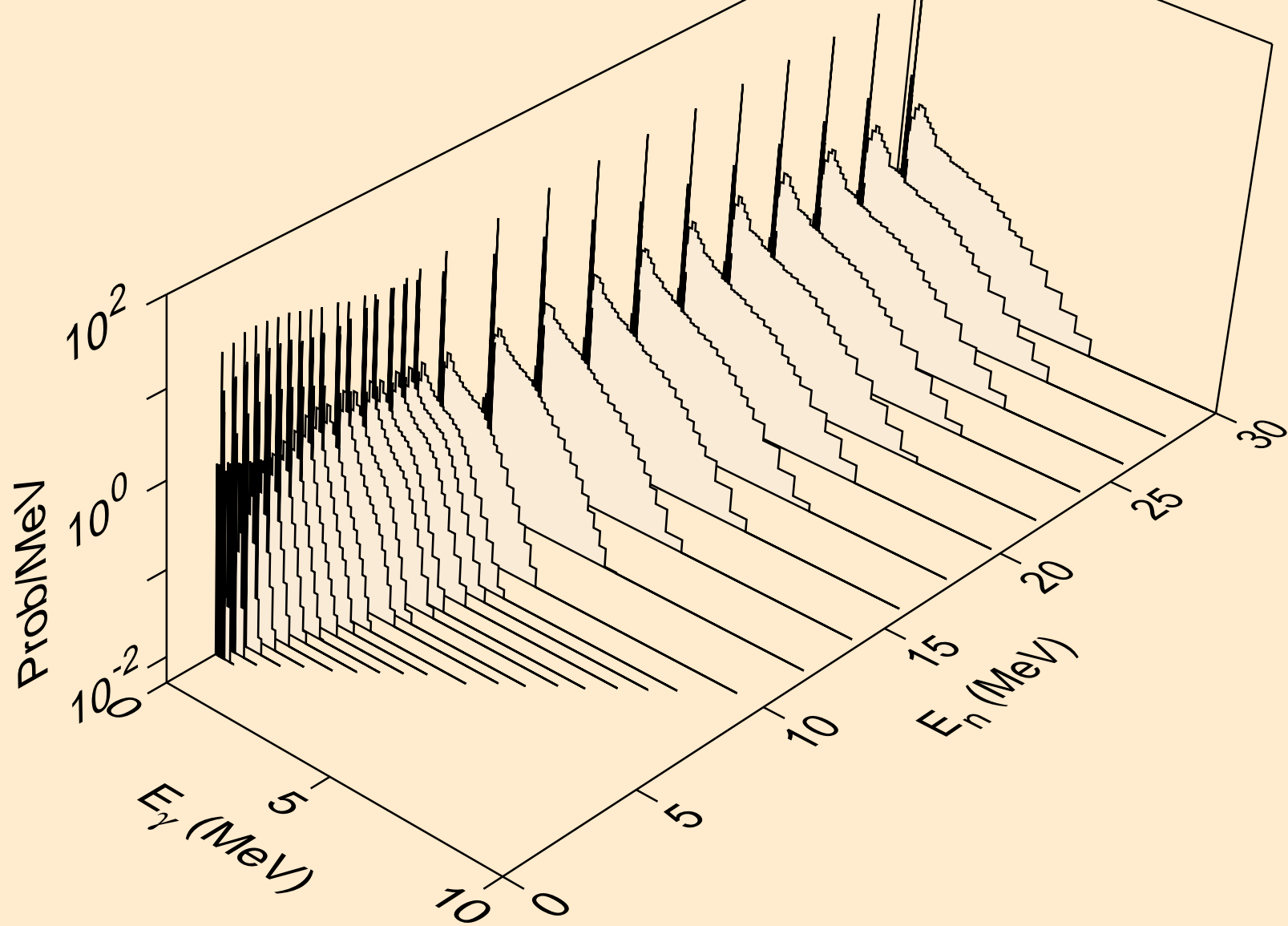



PM136M NEUTRON ACER TENDL-2021 LIBRARY; T=293.6K  
Photon emission for (n,t)

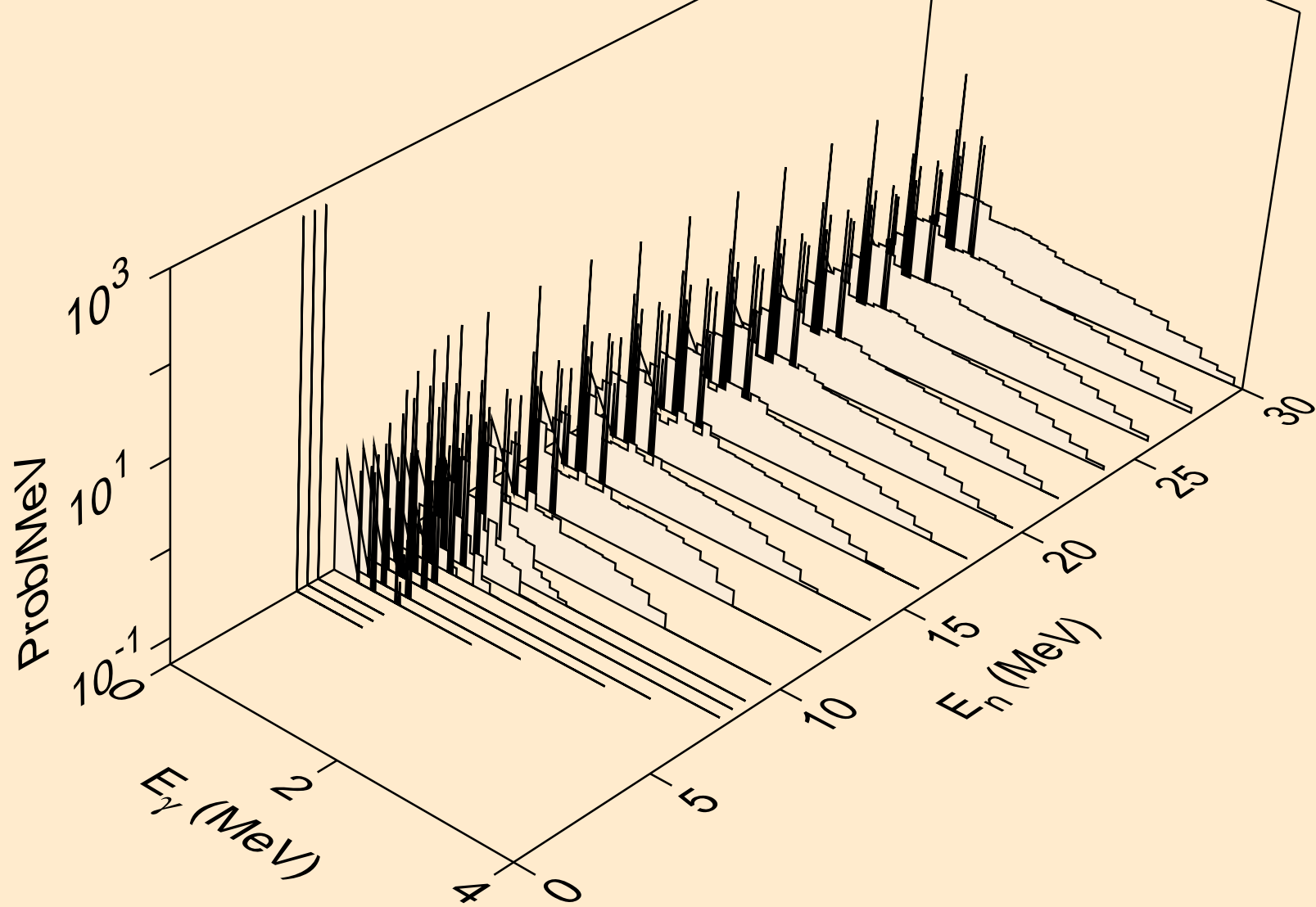

PM136M NEUTRON ACER TENDL-2021 LIBRARY; T=293.6K  
Photon emission for (n,he3)

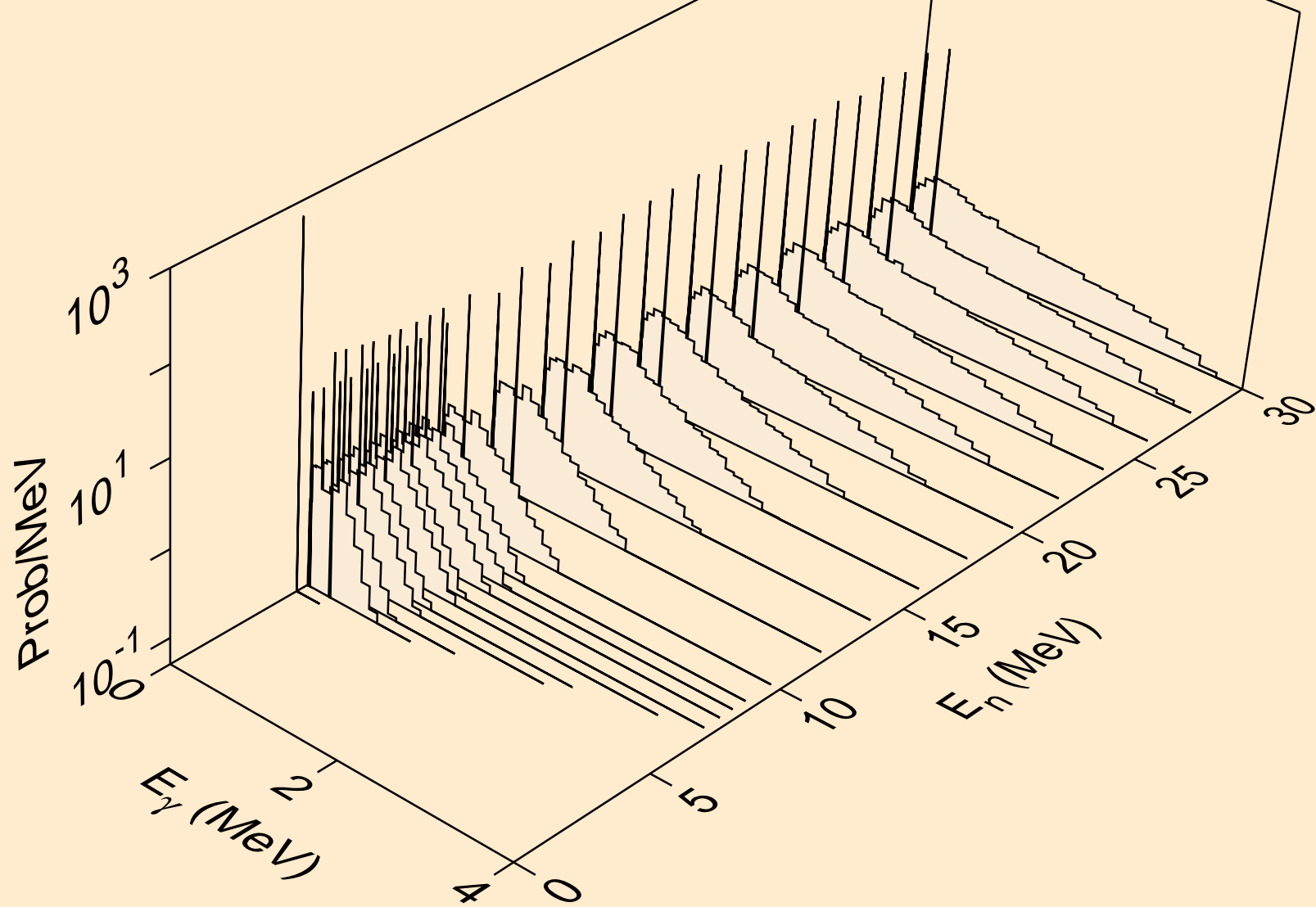

PM136M NEUTRON ACER TENDL-2021 LIBRARY; T=293.6K  
Photon emission for (n,a)

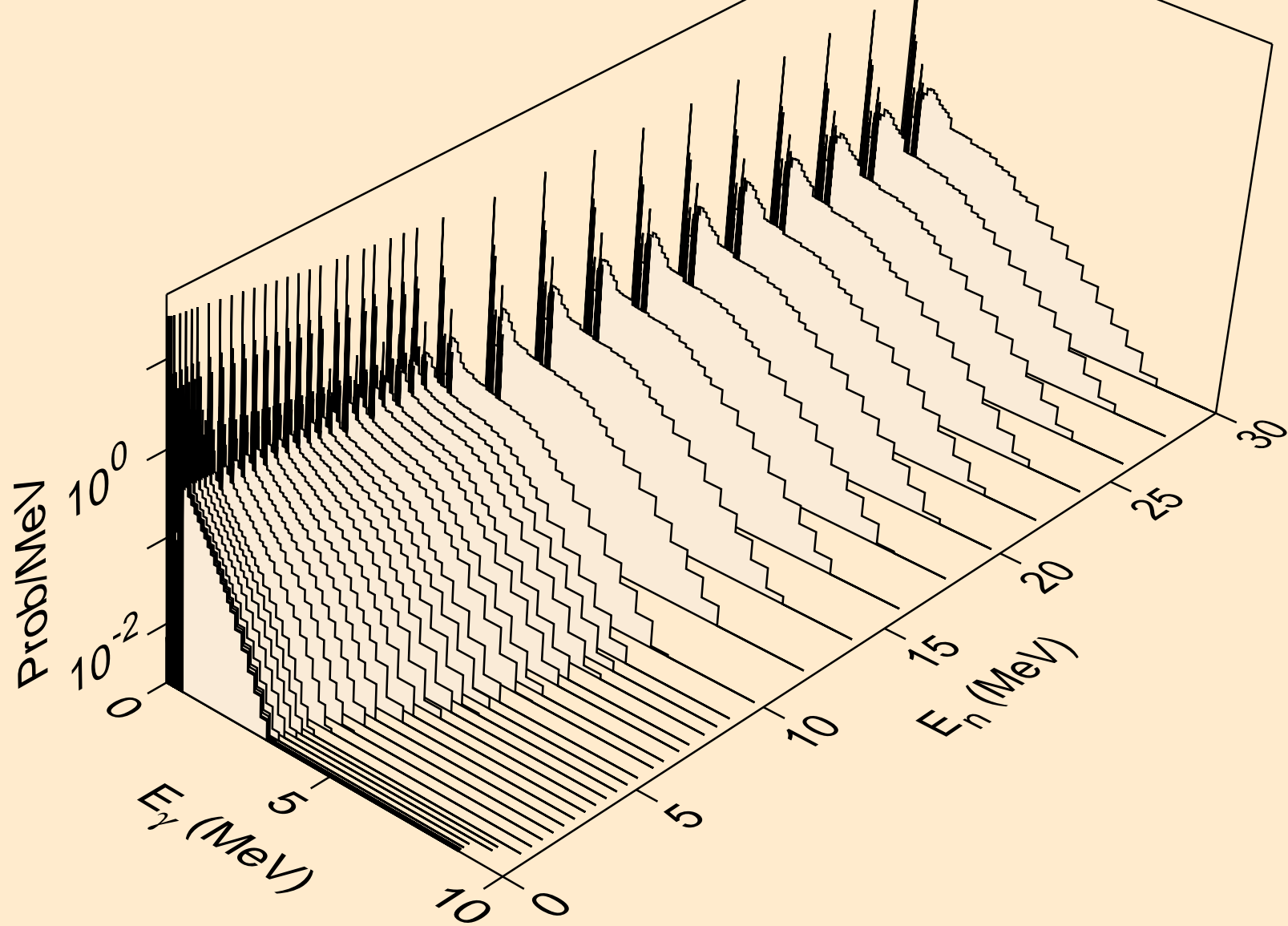

PM136M NEUTRON ACER TENDL-2021 LIBRARY; T=293.6K  
Photon emission for (n,2a)

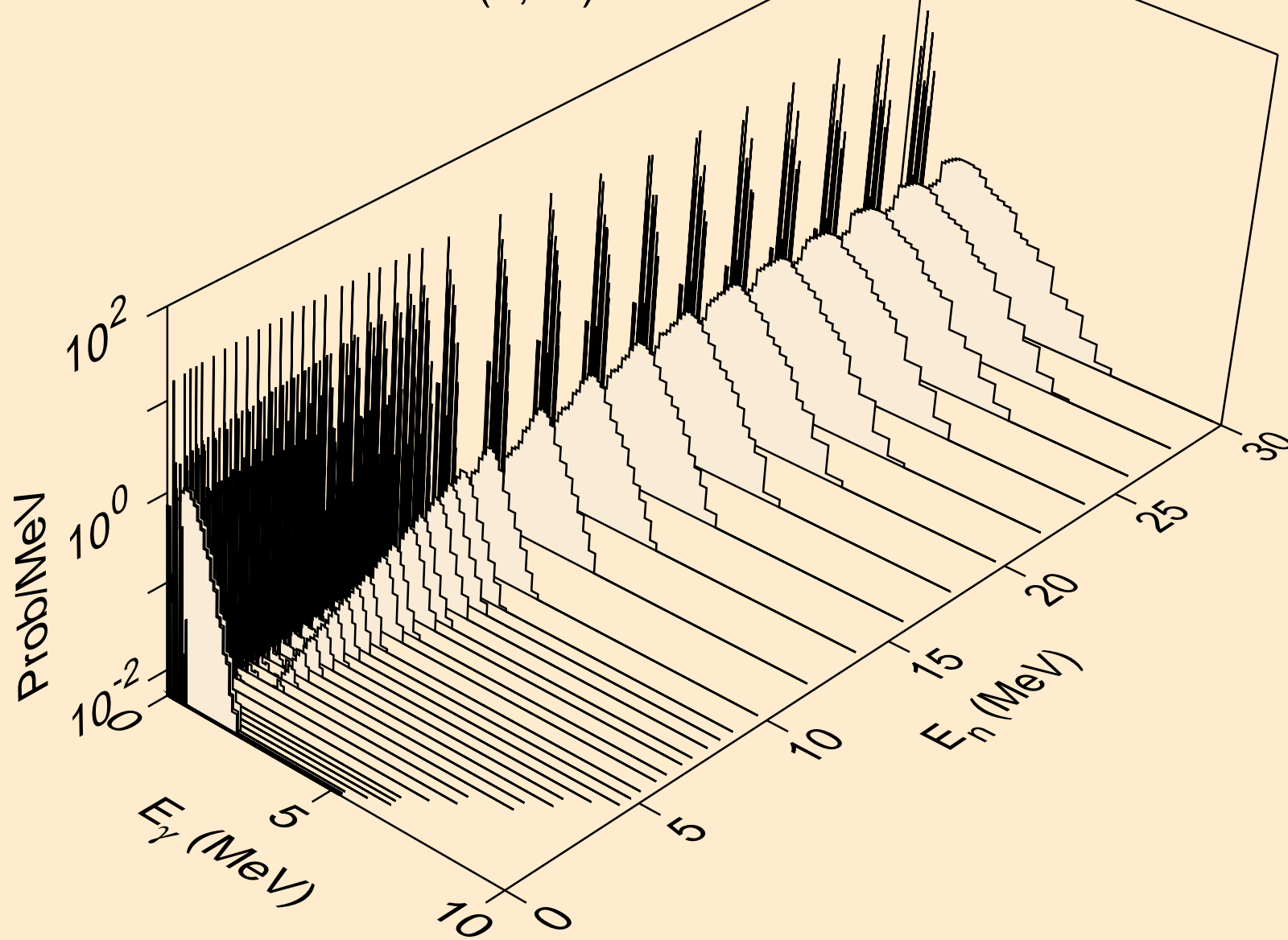

PM136M NEUTRON ACER TENDL-2021 LIBRARY; T=293.6K  
Photon emission for (n,3a)

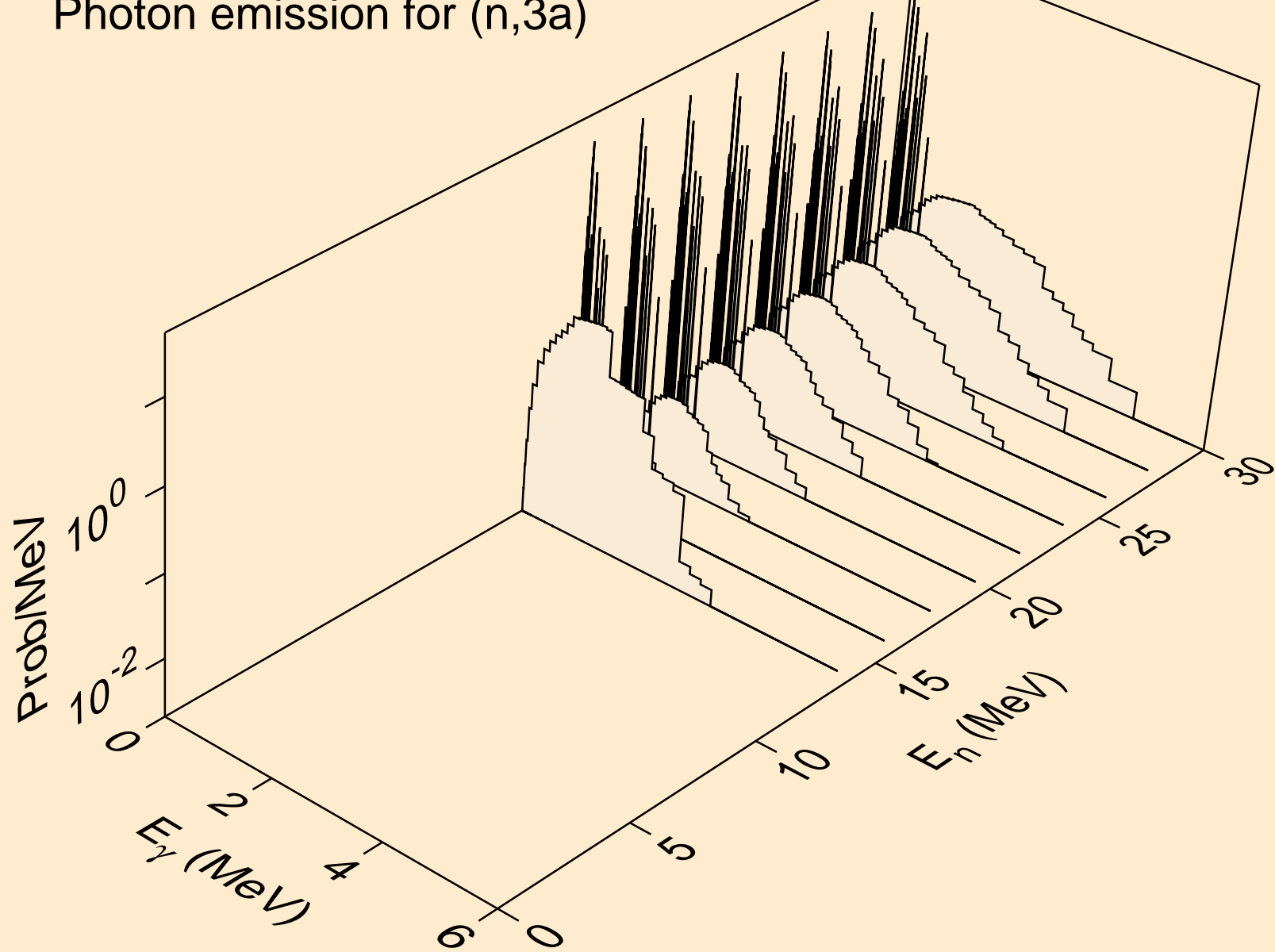

PM136M NEUTRON ACER TENDL-2021 LIBRARY; T=293.6K  
Photon emission for (n,2p)

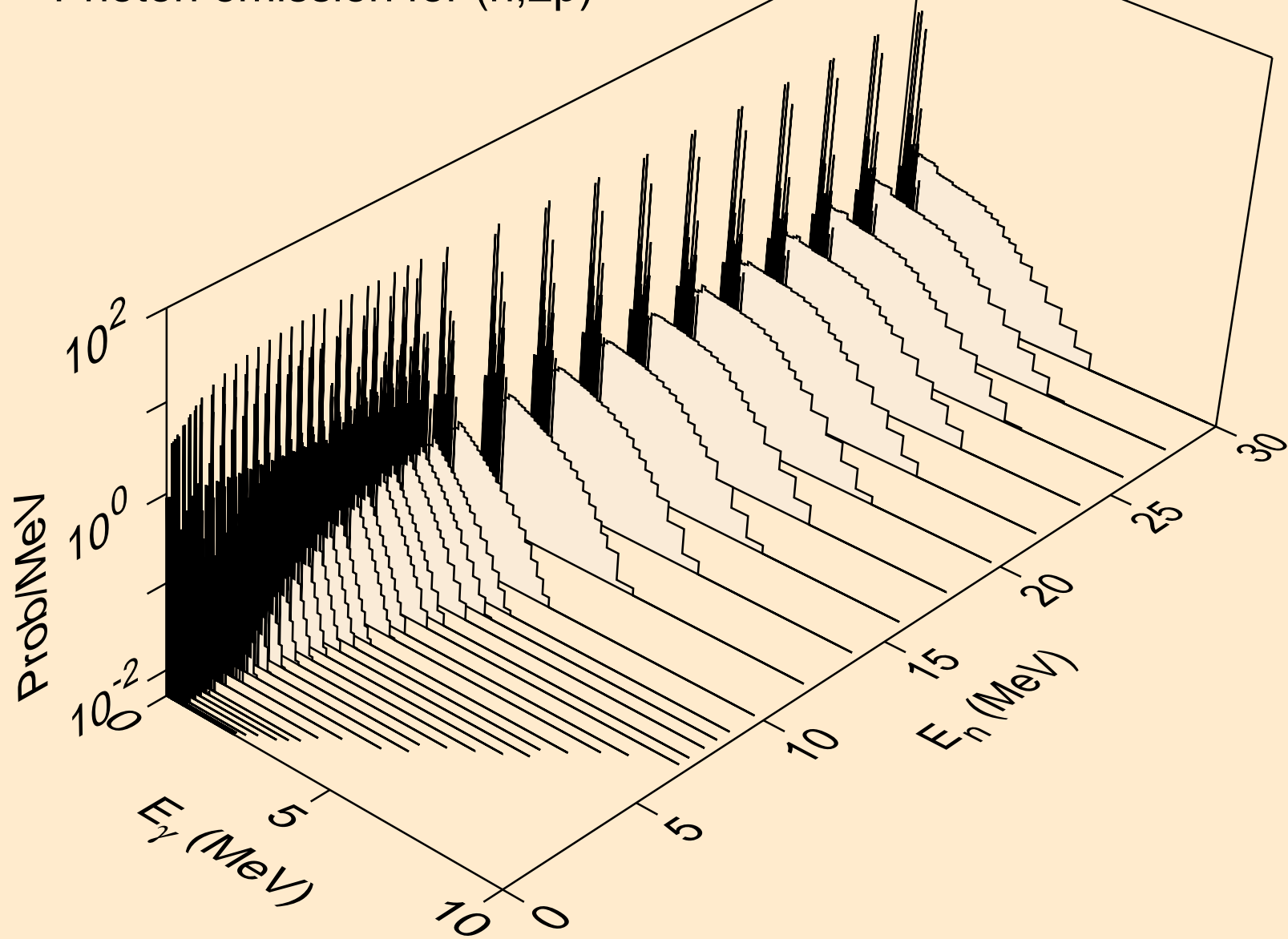

PM136M NEUTRON ACER TENDL-2021 LIBRARY; T=293.6K  
Photon emission for (n,p $\alpha$ )

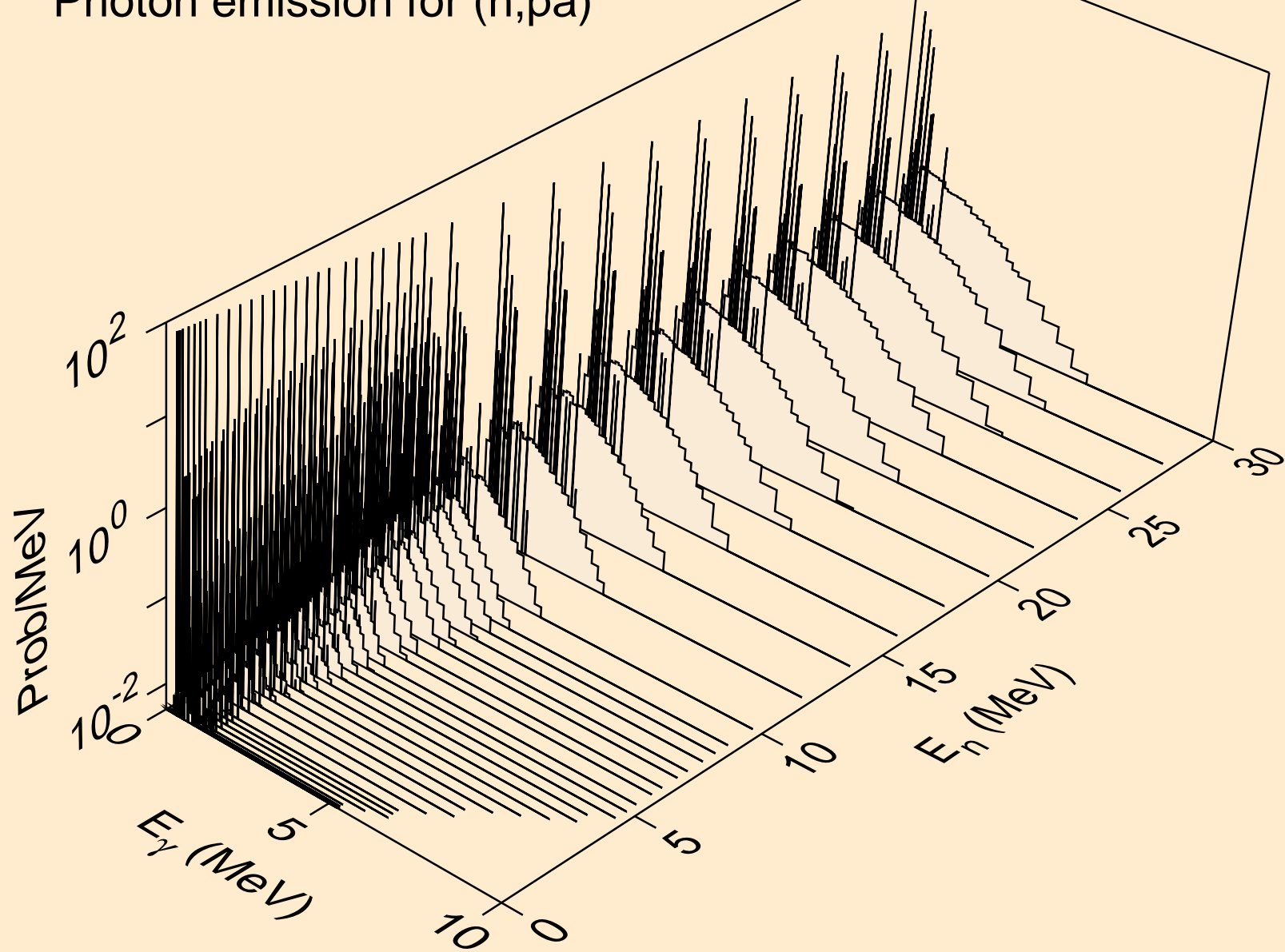

PM136M NEUTRON ACER TENDL-2021 LIBRARY; T=293.6K  
Photon emission for (n,pd)

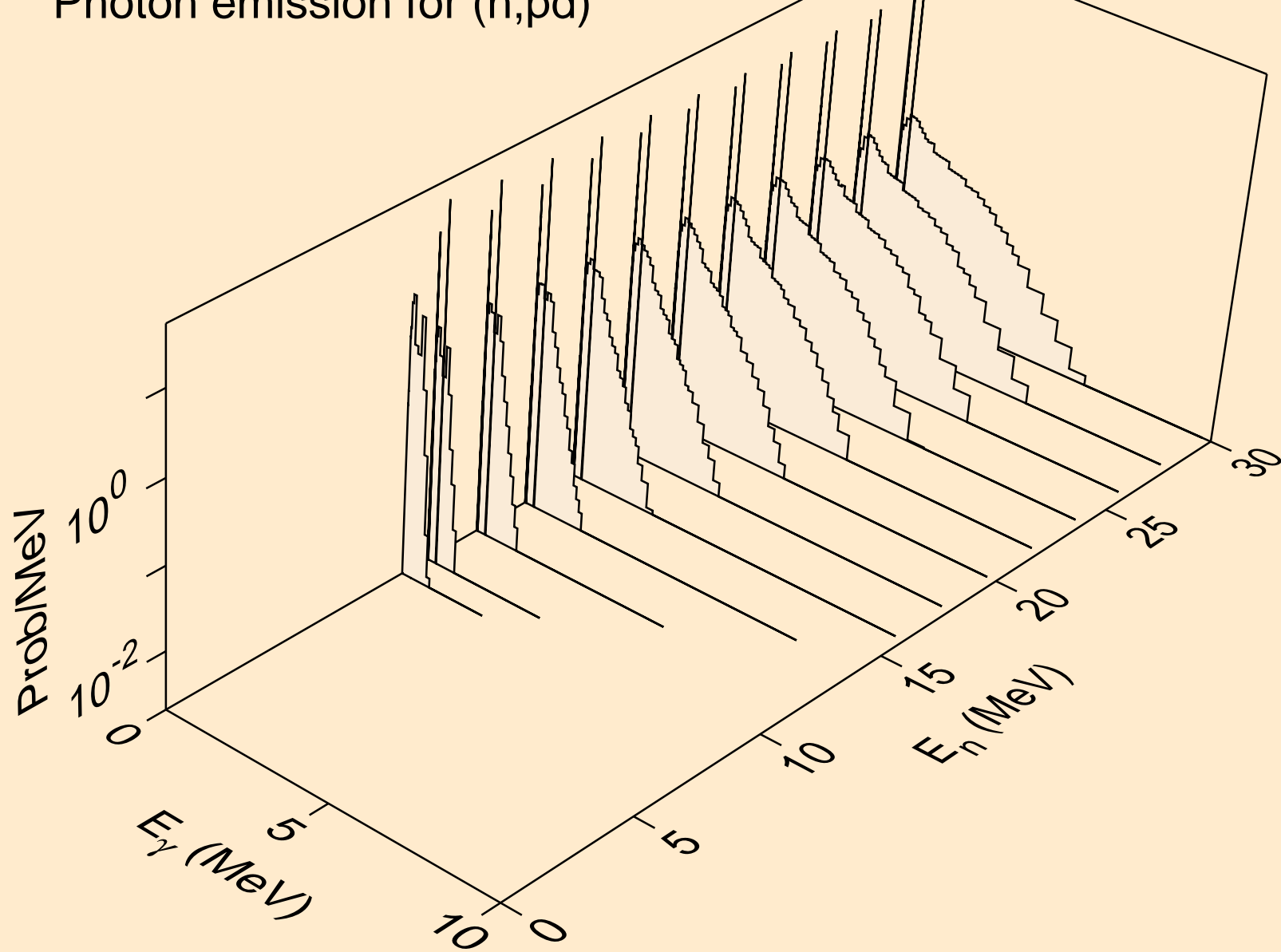



PM136M NEUTRON ACER TENDL-2021 LIBRARY; T=293.6K  
Photon emission for (n,pt)

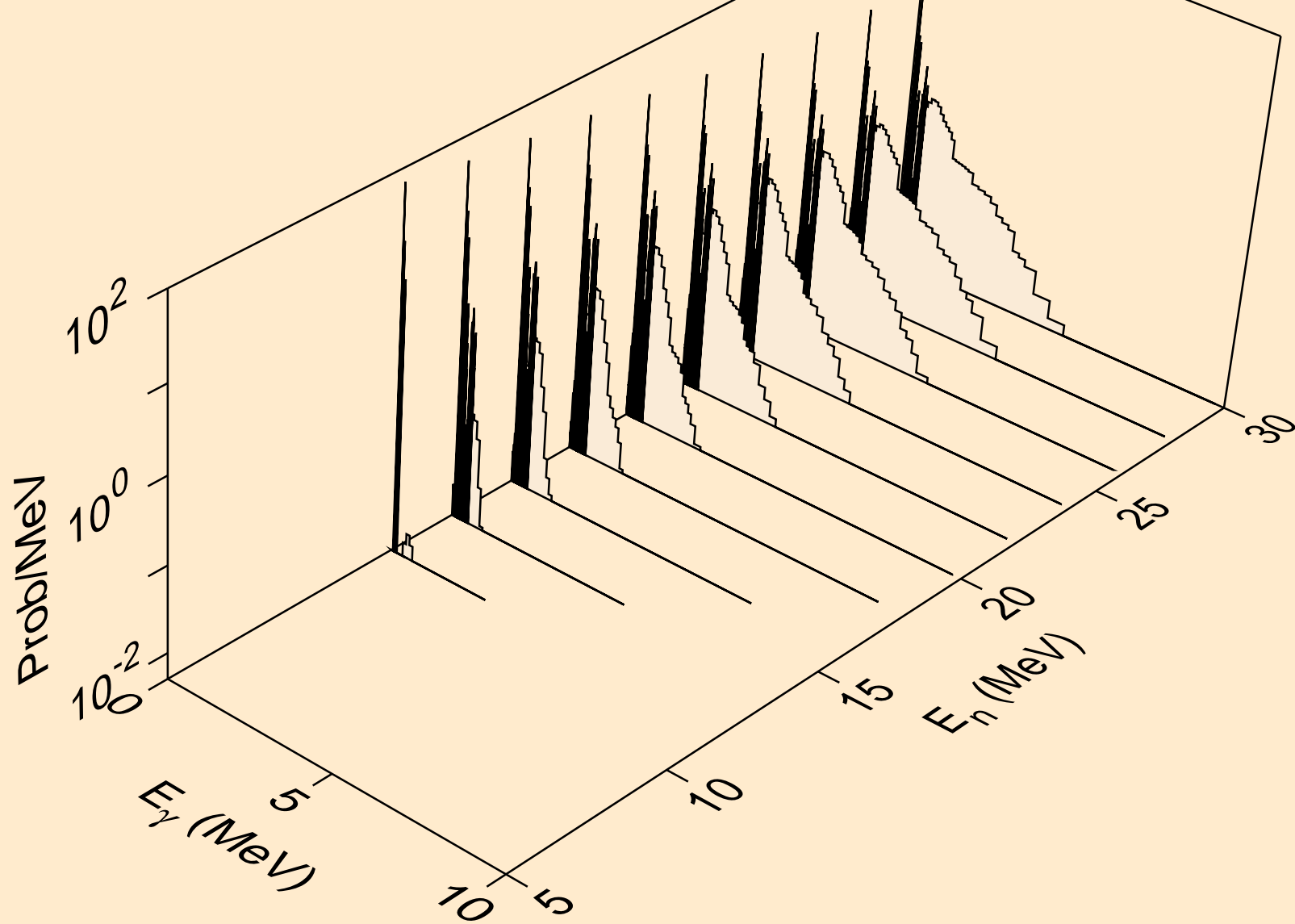

PM136M NEUTRON ACER TENDL-2021 LIBRARY; T=293.6K  
Photon emission for (n,da)

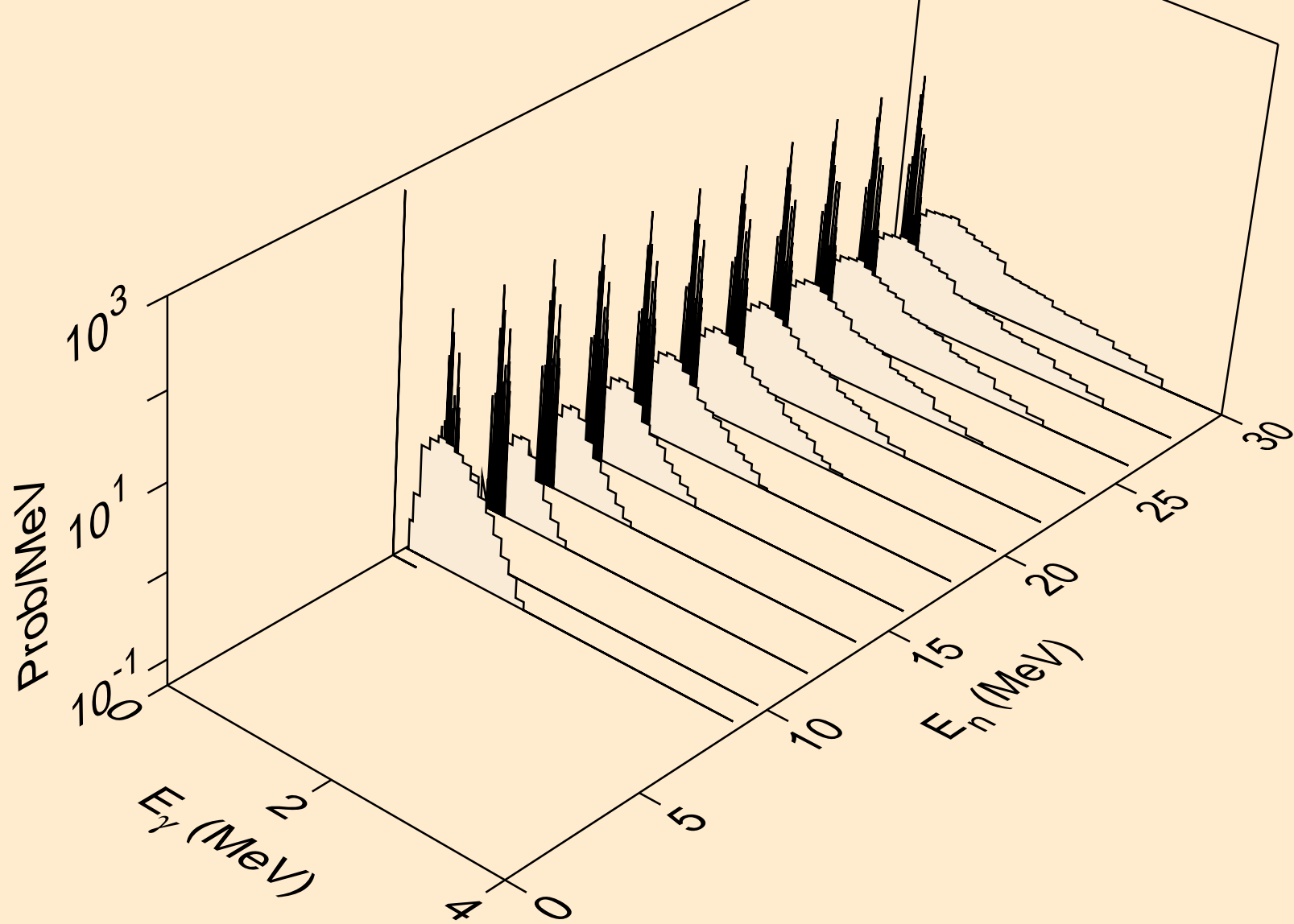

PM136M NEUTRON ACER TENDL-2021 LIBRARY; T=293.6K  
thermal capture photon spectrum

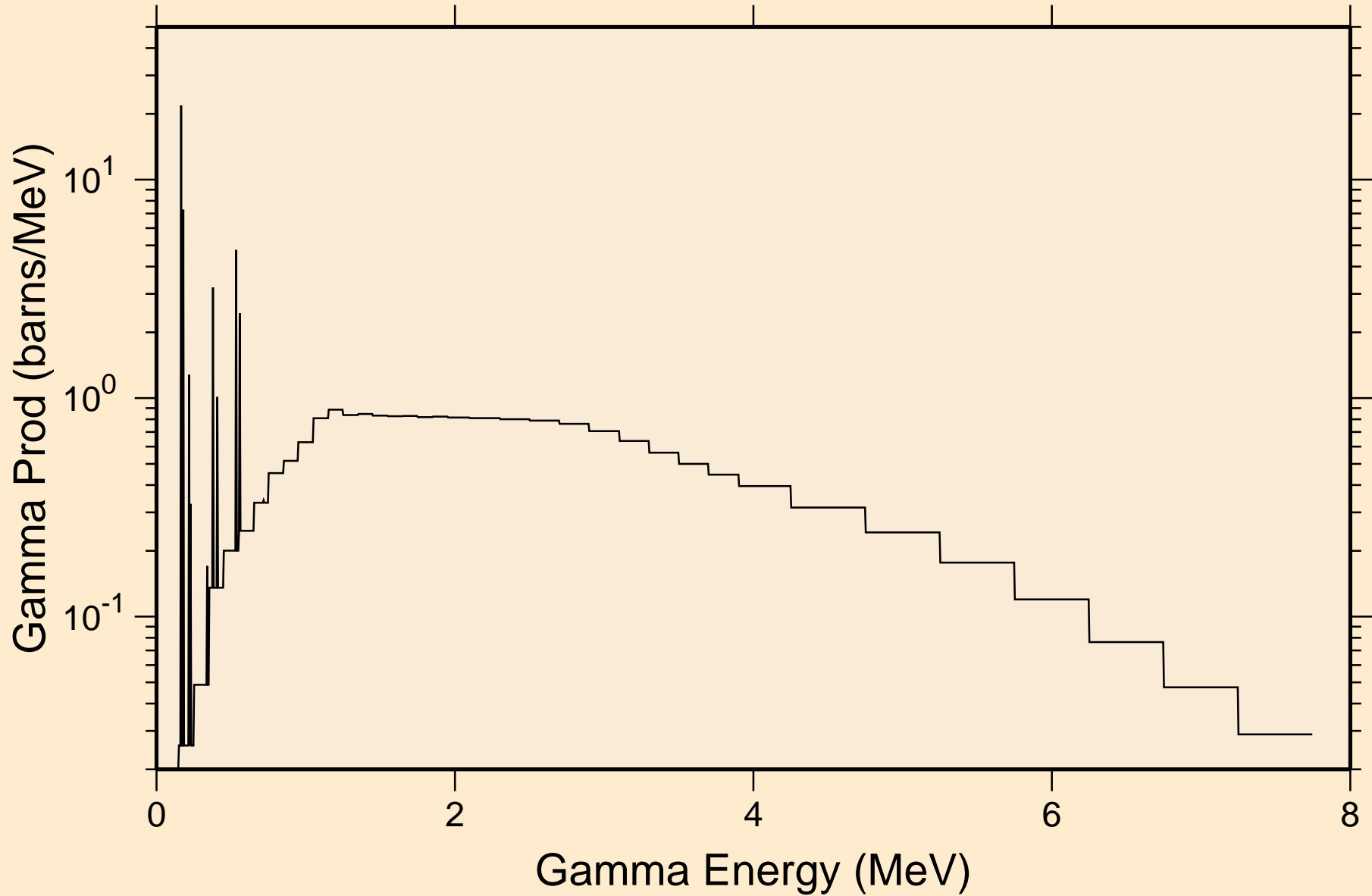

PM136M NEUTRON ACER TENDL-2021 LIBRARY; T=293.6K  
14 MeV photon spectrum

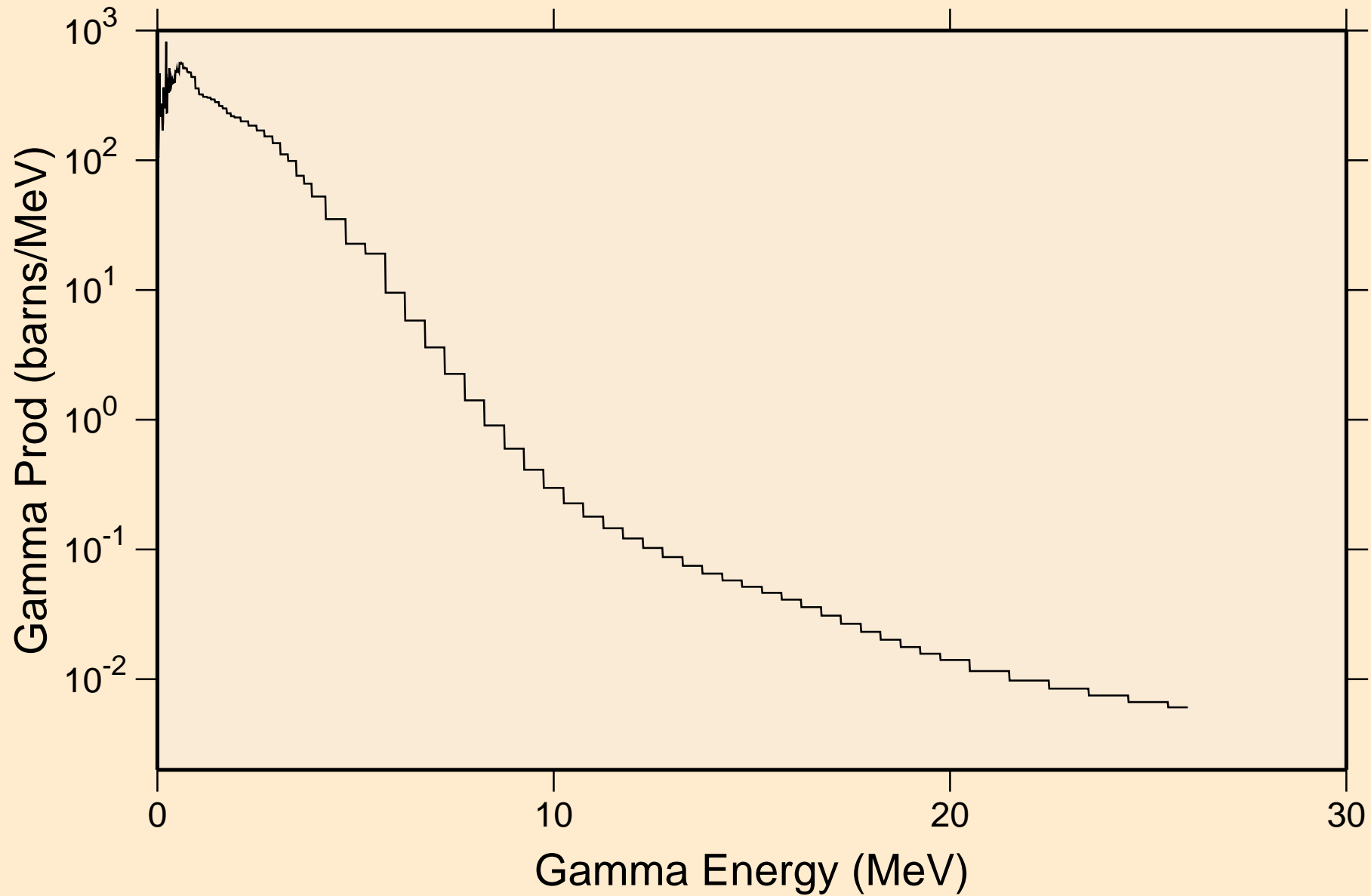

PM136M NEUTRON ACER TENDL-2021 LIBRARY; T=293.6K  
Particle heating contributions

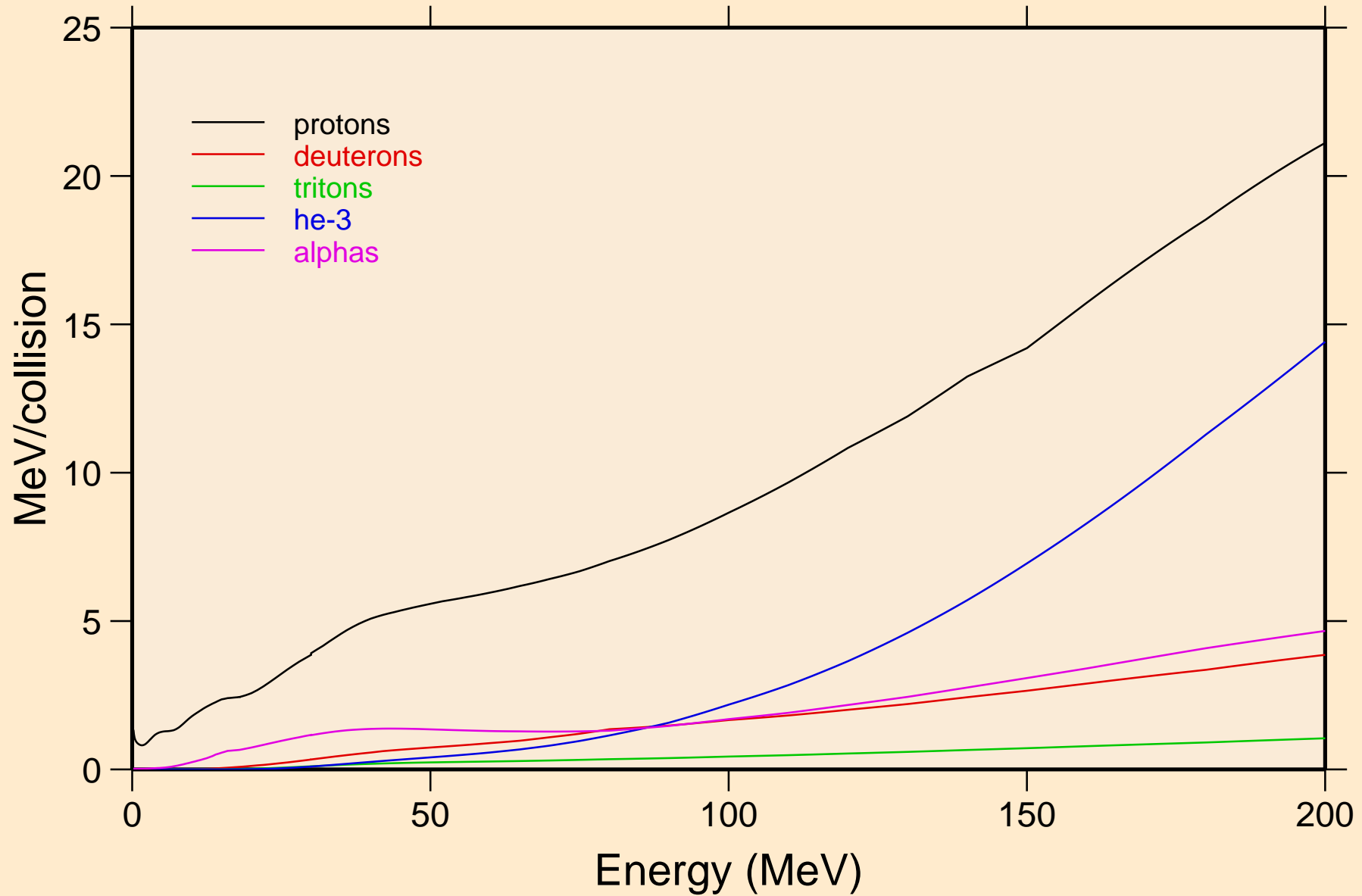

PM136M NEUTRON ACER TENDL-2021 LIBRARY; T=293.6K  
Recoil Heating

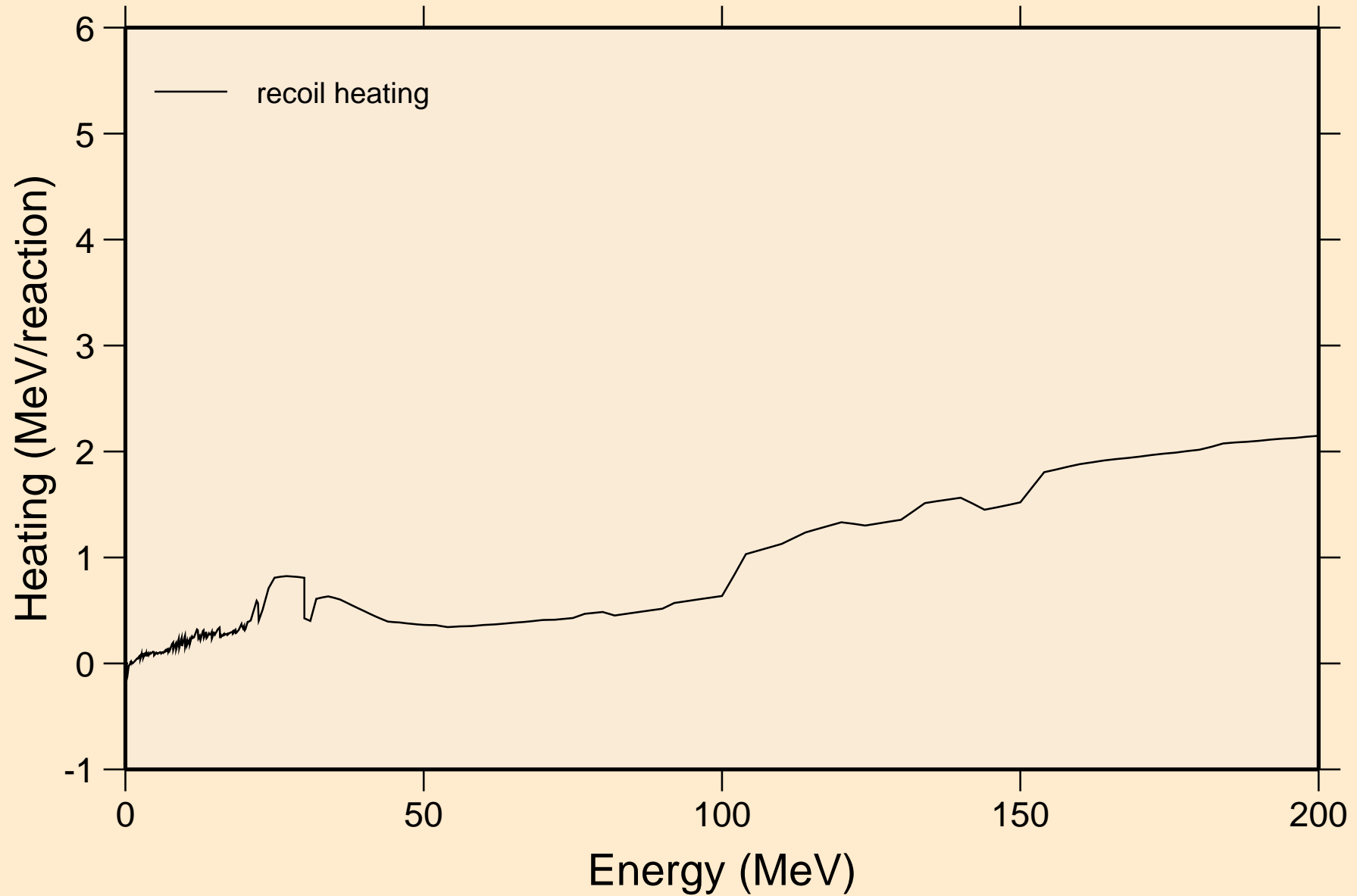

PM136M NEUTRON ACER TENDL-2021 LIBRARY; T=293.6K  
Particle production cross sections

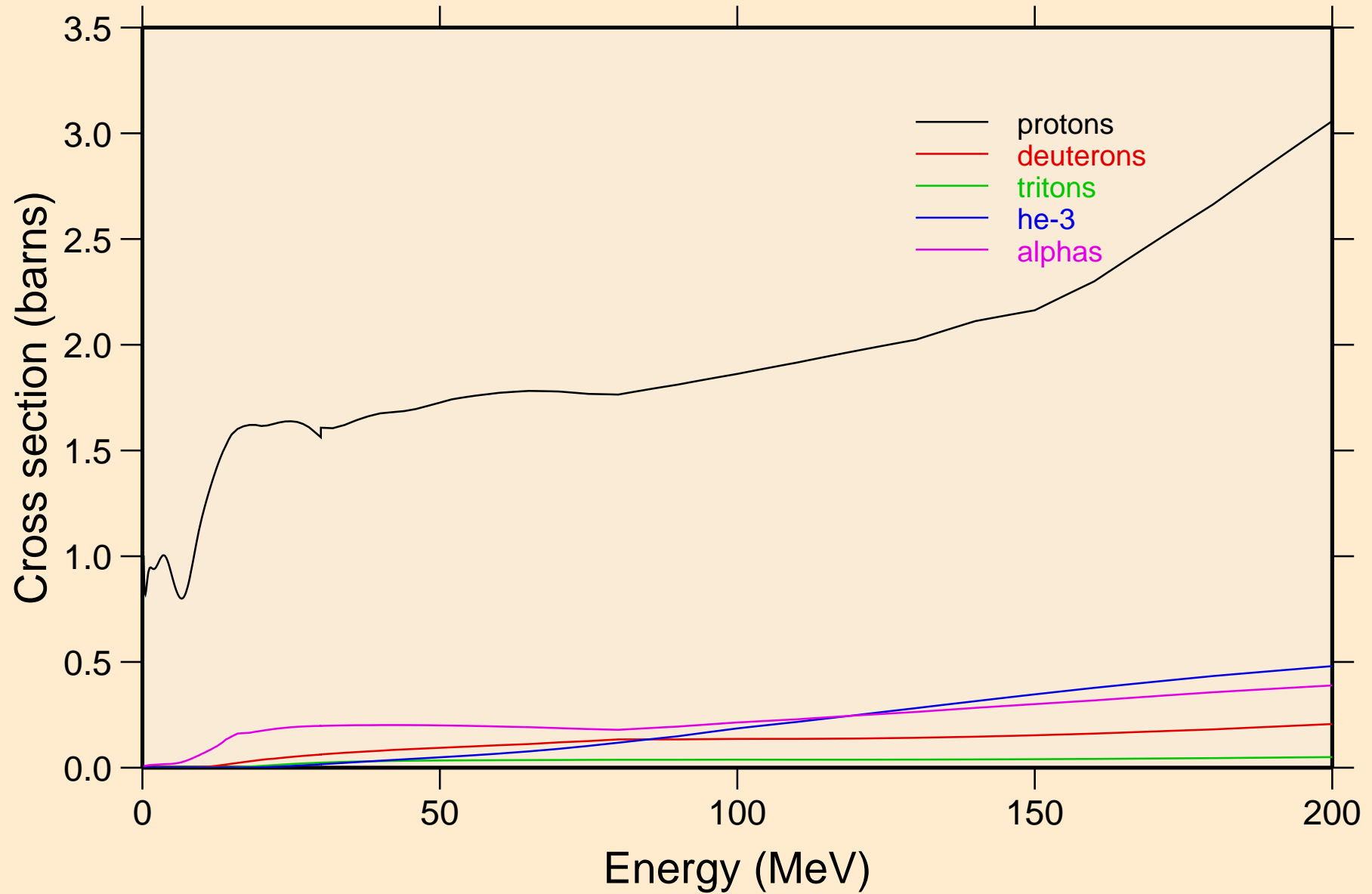

PM136M NEUTRON ACER TENDL-2021 LIBRARY; T=293.6K  
protons from (n,x)

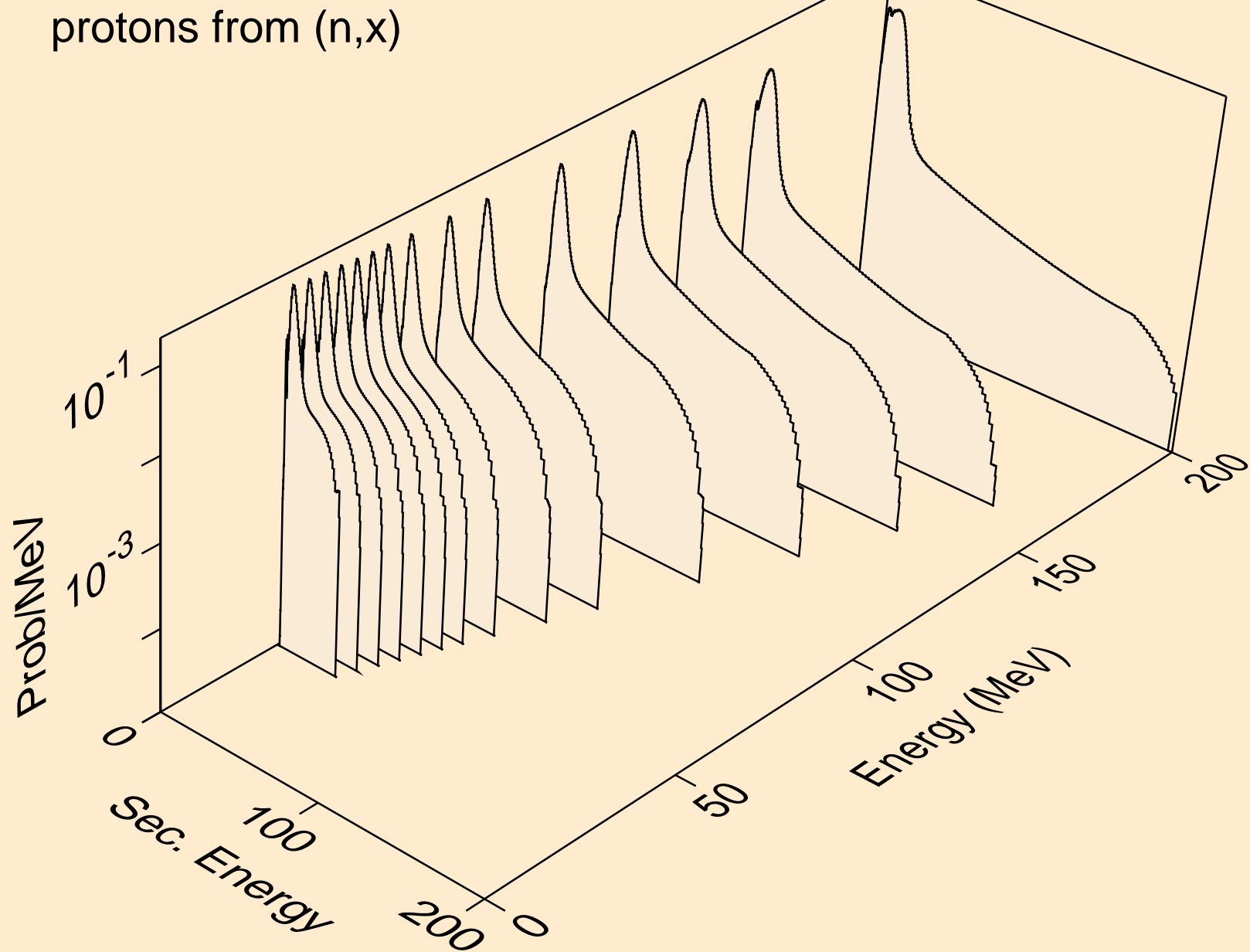



PM136M NEUTRON ACER TENDL-2021 LIBRARY; T=293.6K  
protons from (n,n\*)p

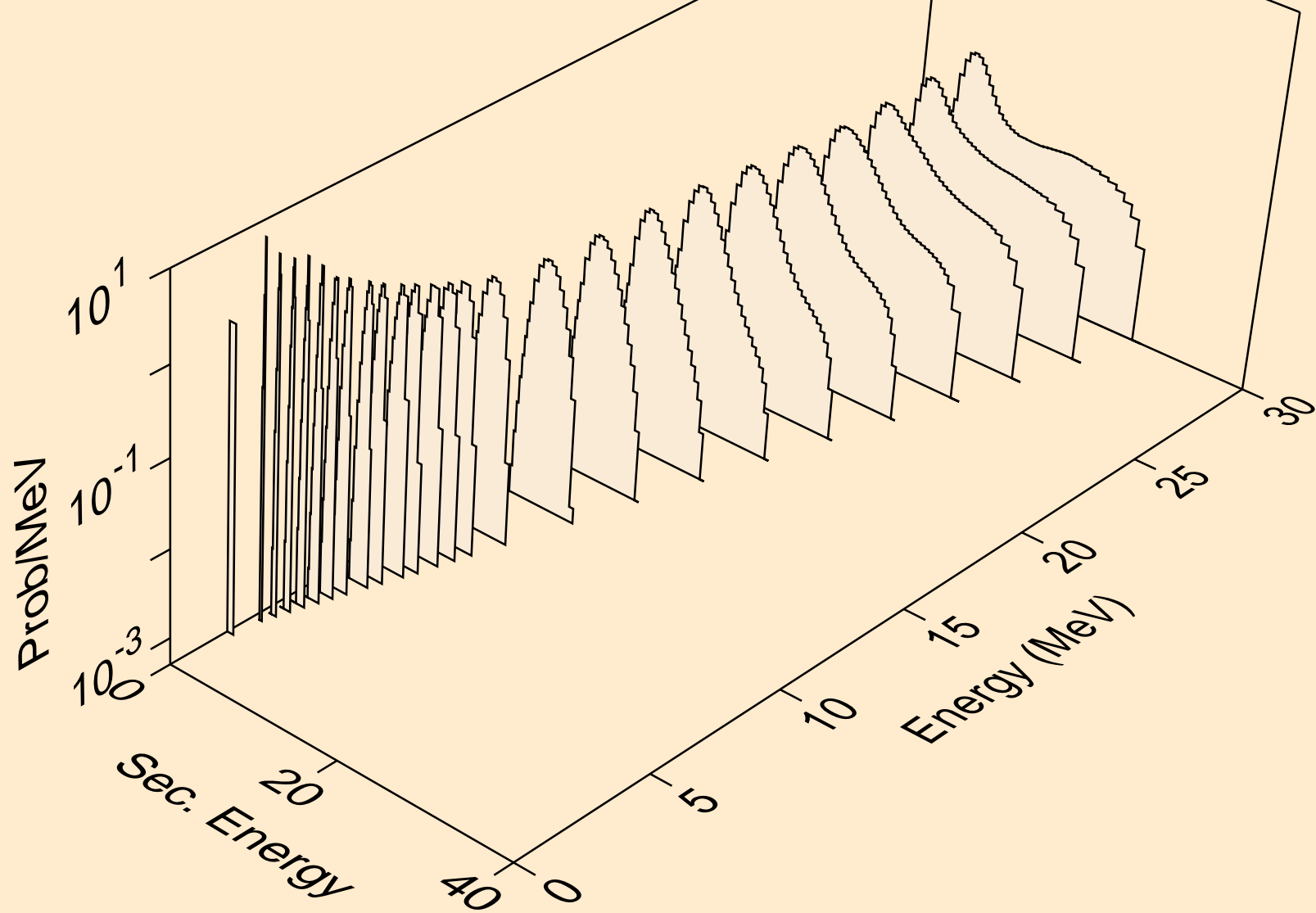

PM136M NEUTRON ACER TENDL-2021 LIBRARY; T=293.6K  
protons from (n,2np)

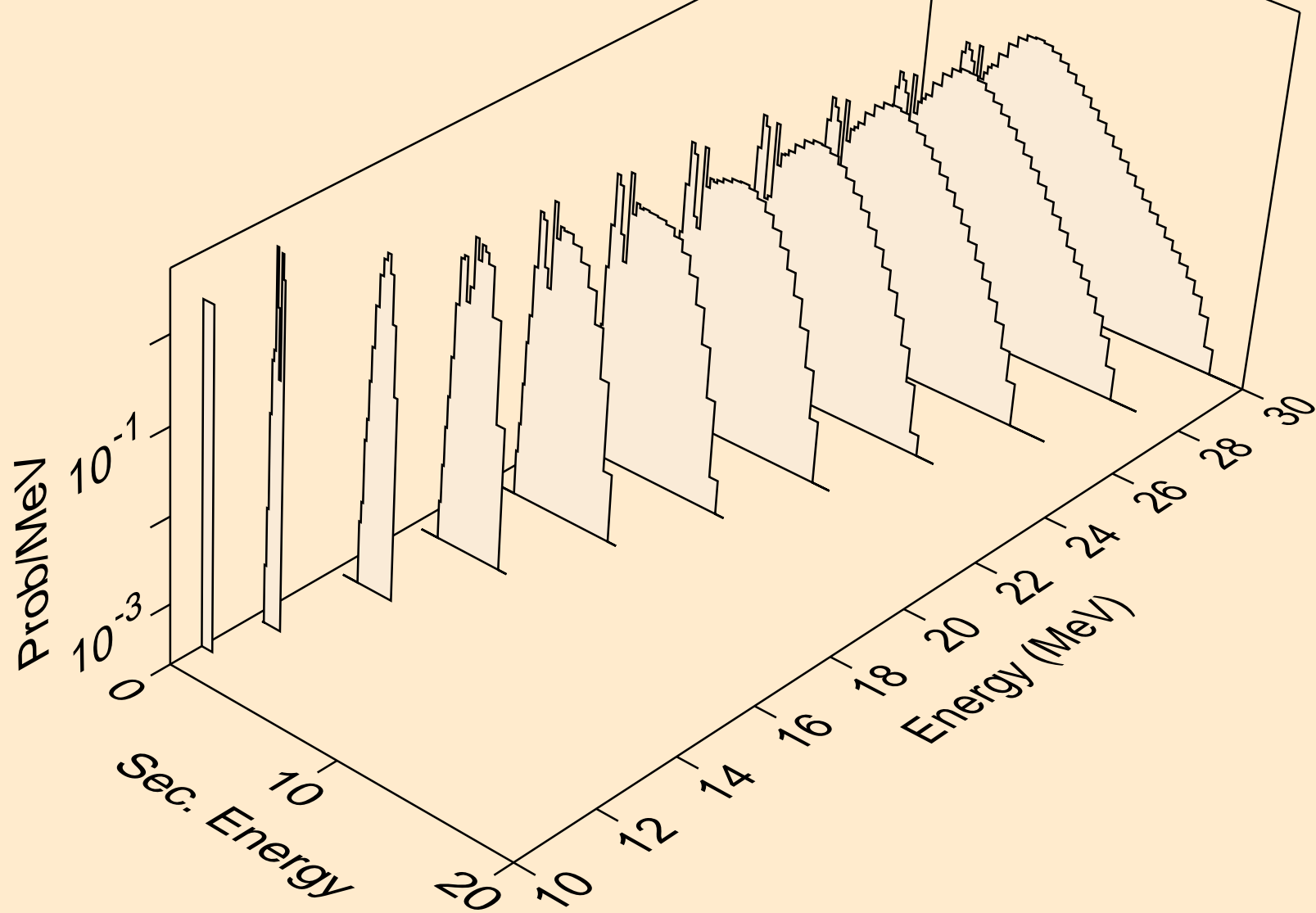

PM136M NEUTRON ACER TENDL-2021 LIBRARY; T=293.6K  
protons from (n,3np)

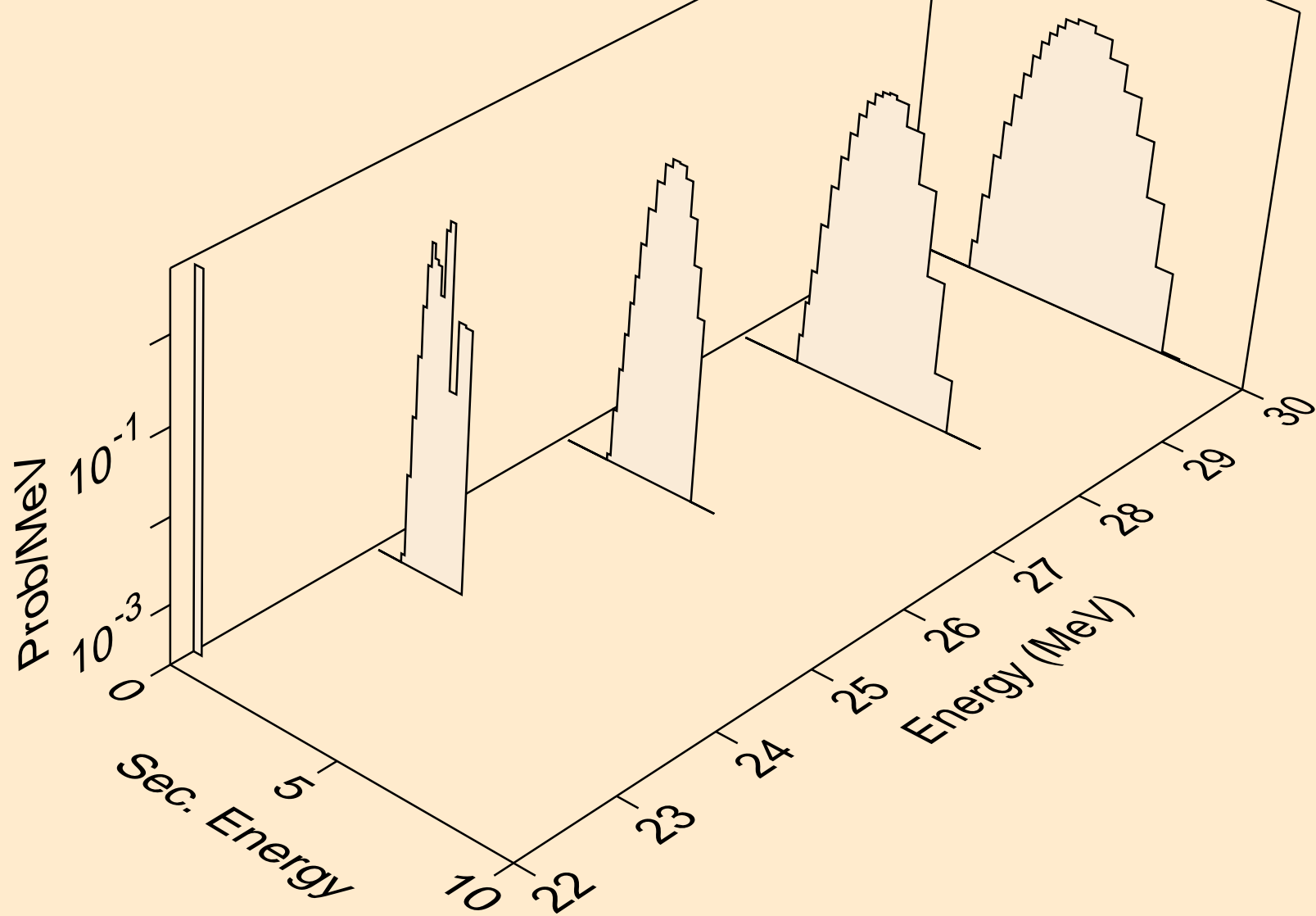

PM136M NEUTRON ACER TENDL-2021 LIBRARY; T=293.6K  
protons from (n,2np)

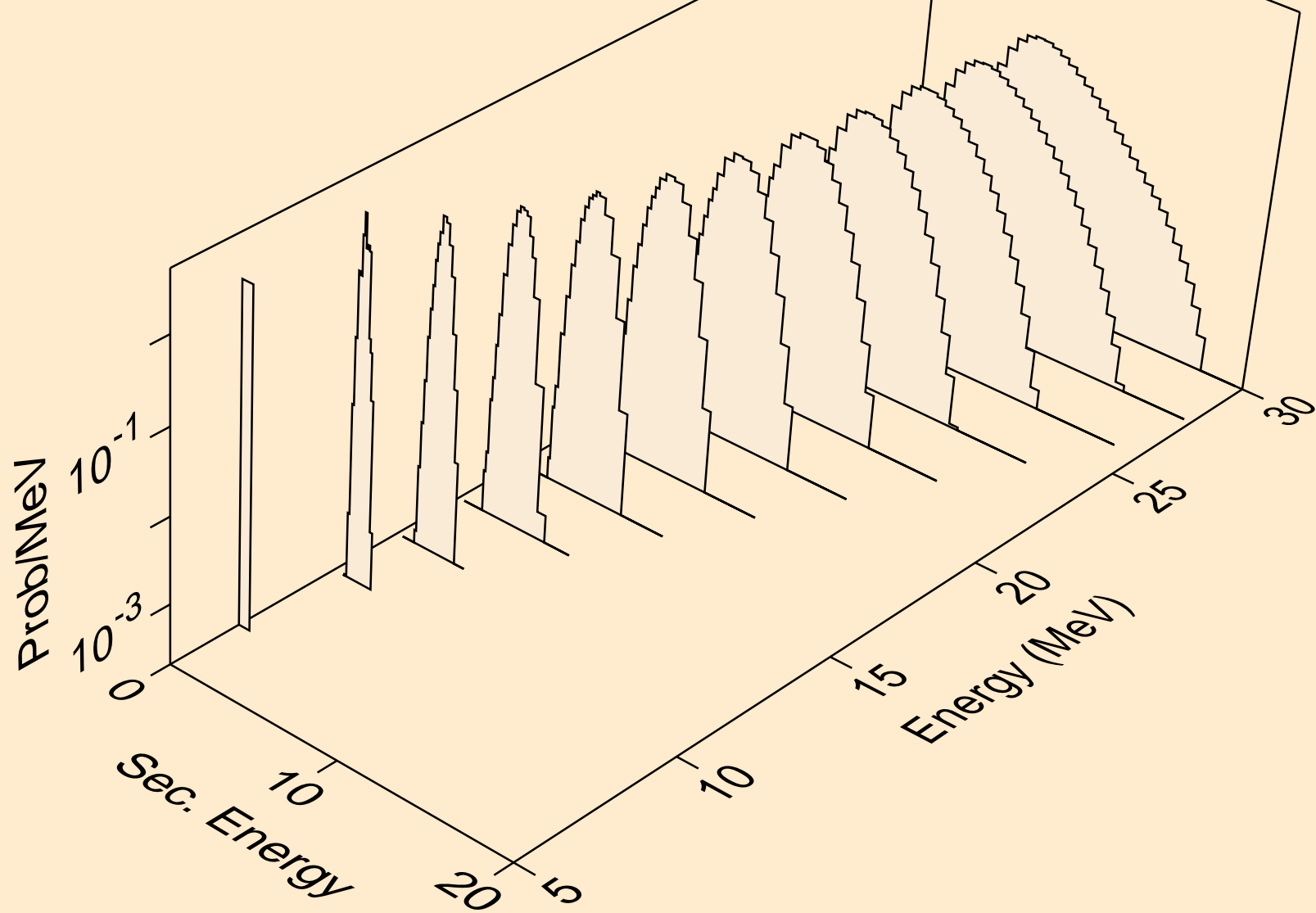

PM136M NEUTRON ACER TENDL-2021 LIBRARY; T=293.6K  
protons from (n,npa)

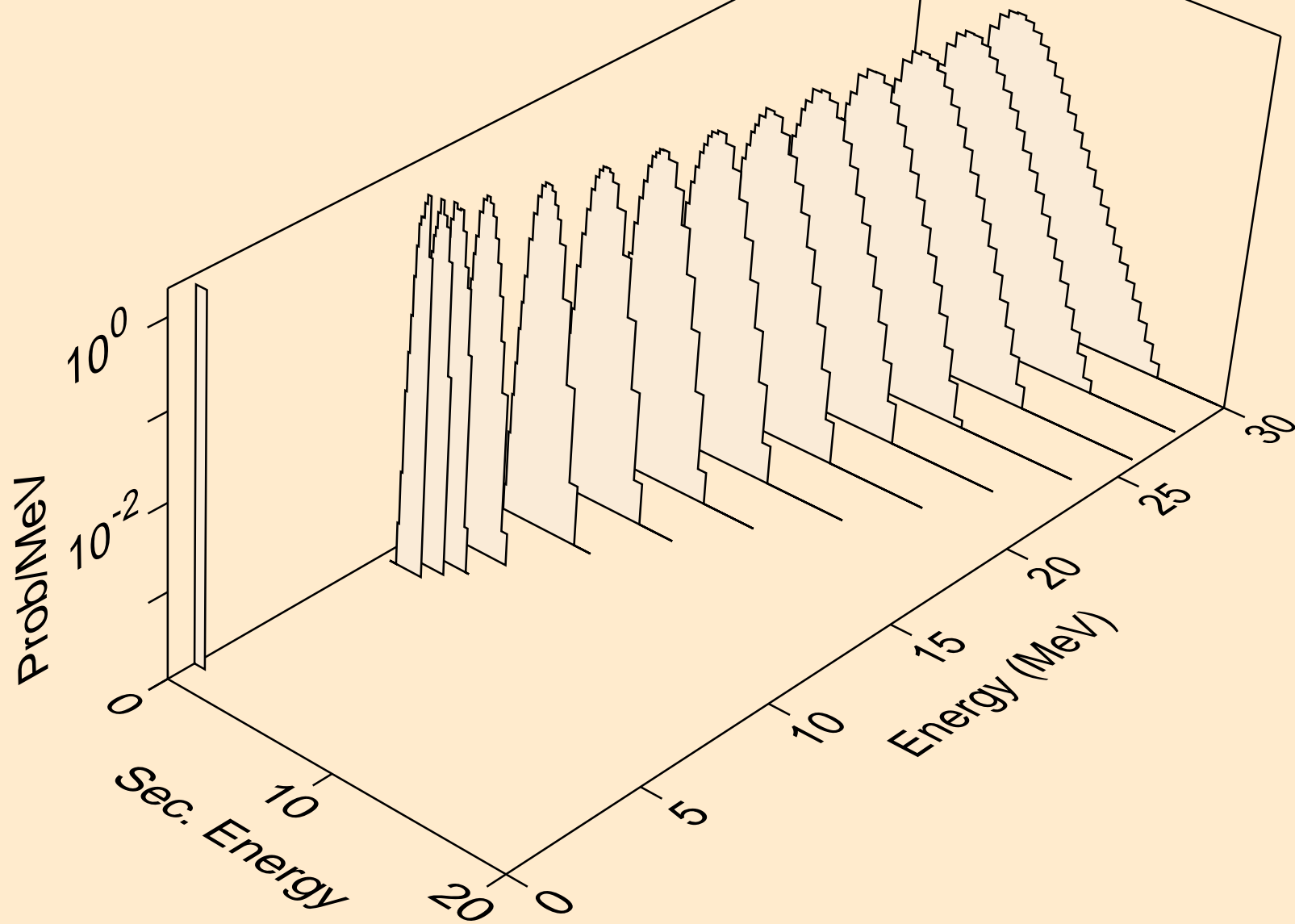

PM136M NEUTRON ACER TENDL-2021 LIBRARY; T=293.6K  
protons from (n,p)

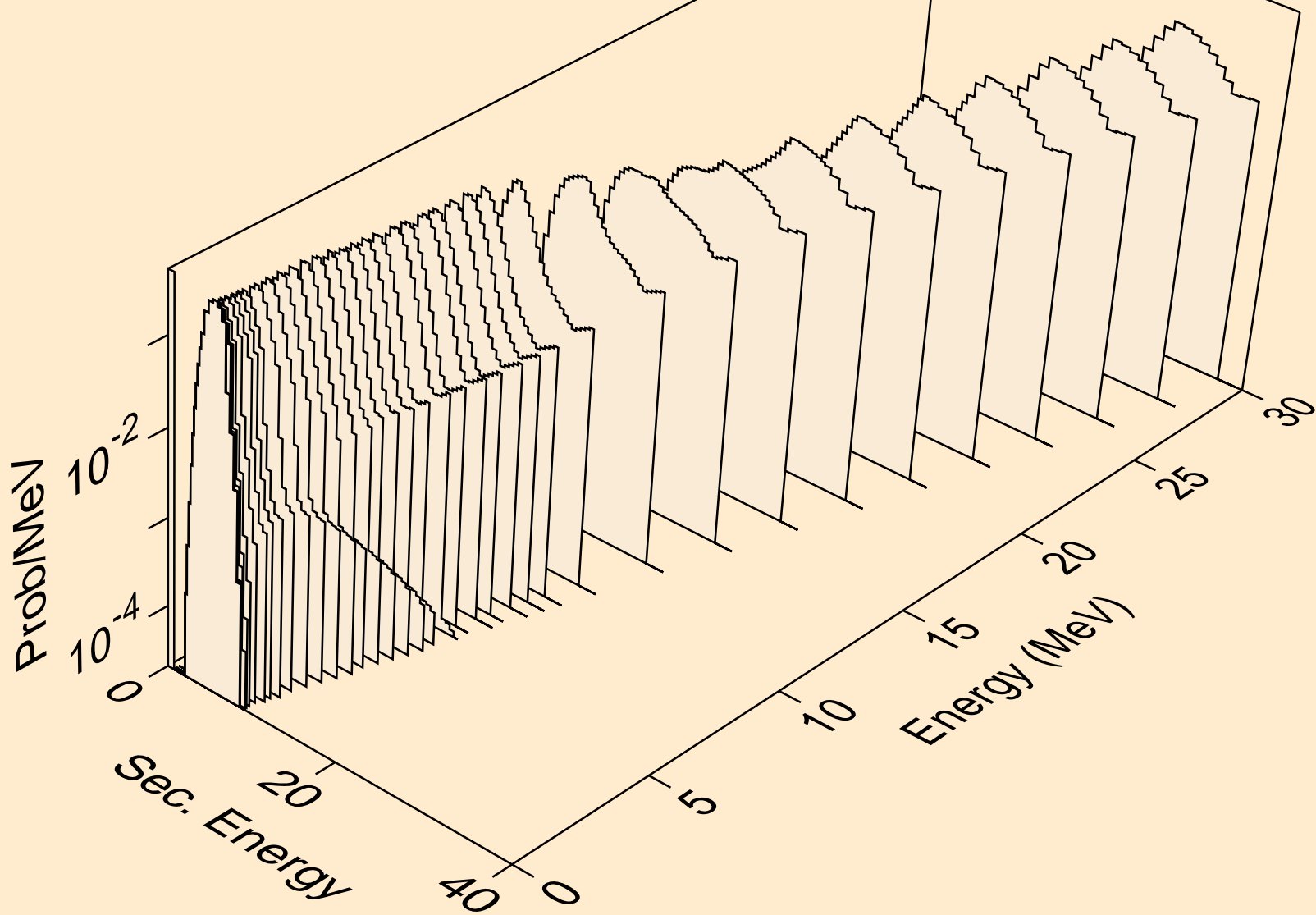

PM136M NEUTRON ACER TENDL-2021 LIBRARY; T=293.6K  
protons from (n,2p)

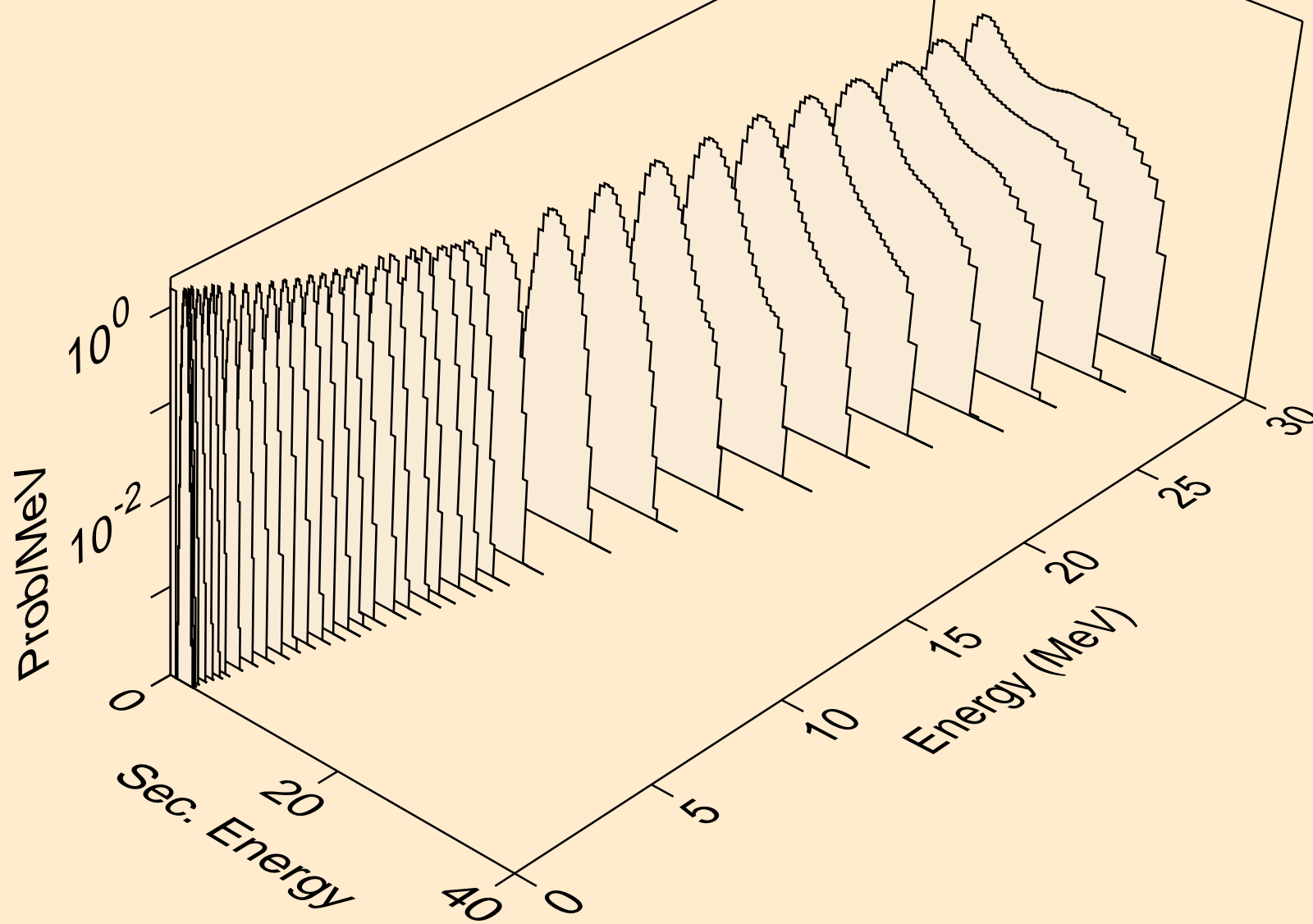

PM136M NEUTRON ACER TENDL-2021 LIBRARY; T=293.6K  
protons from (n,p)

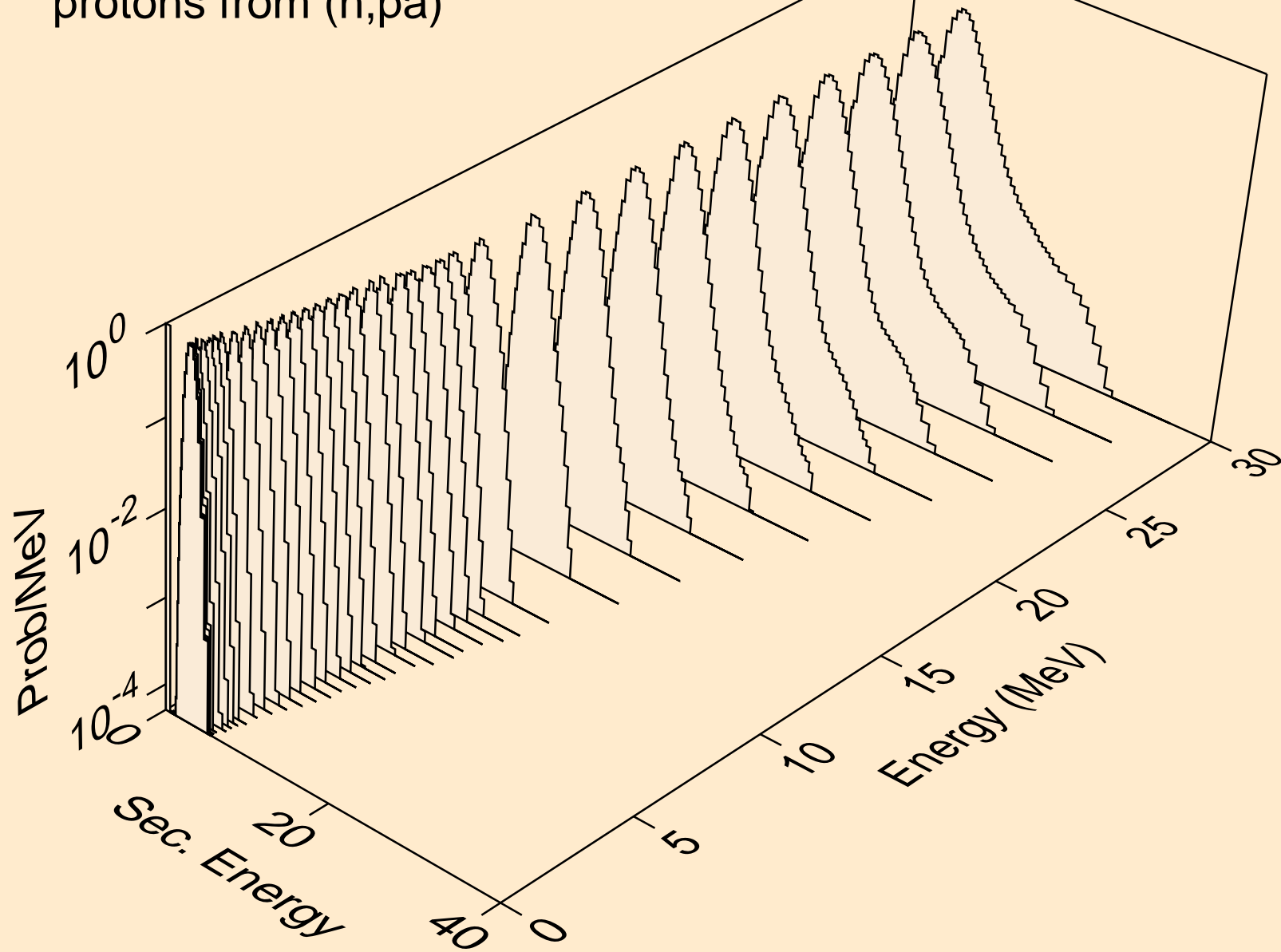



PM136M NEUTRON ACER TENDL-2021 LIBRARY; T=293.6K  
protons from (n,pd)

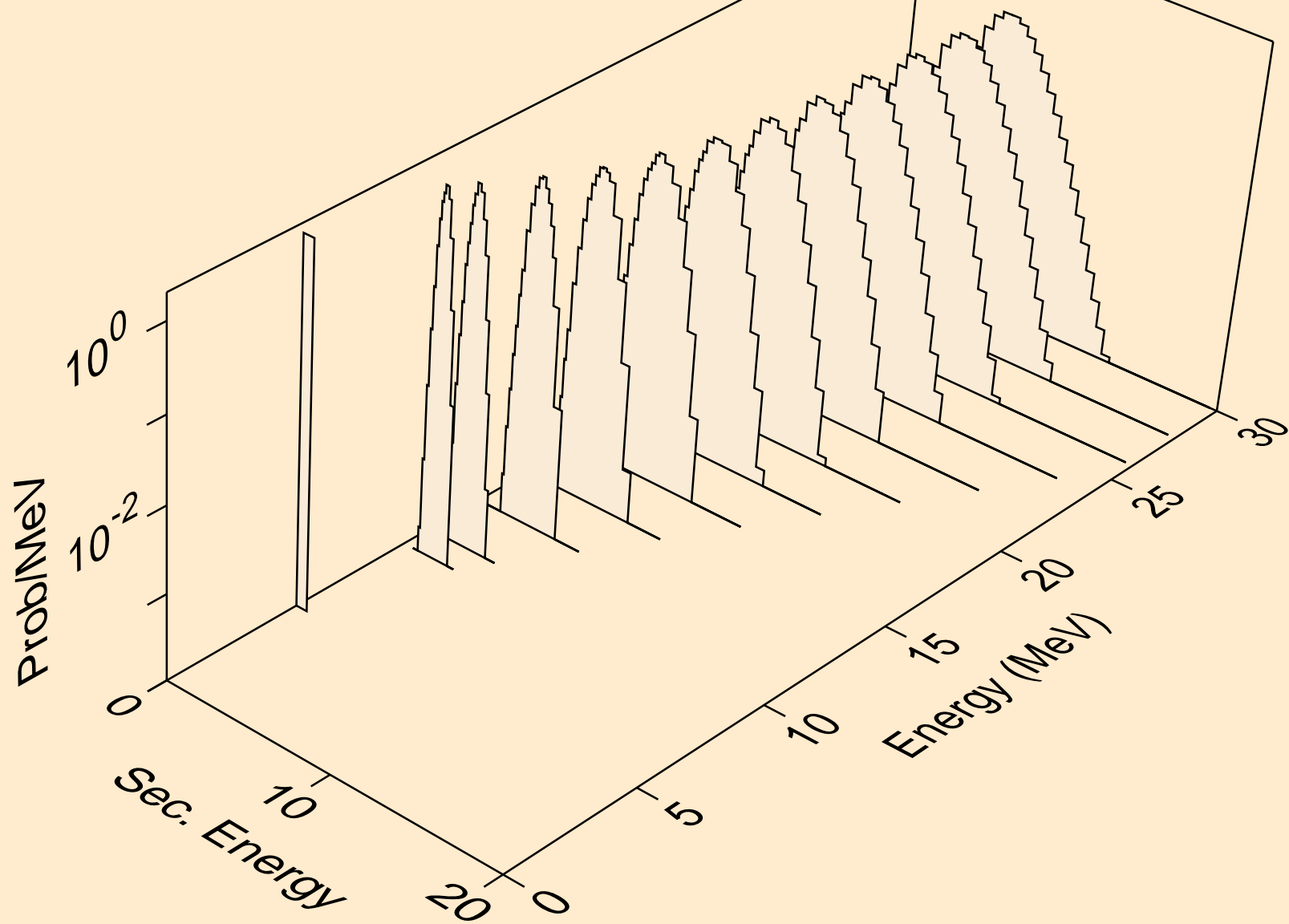

PM136M NEUTRON ACER TENDL-2021 LIBRARY; T=293.6K  
protons from (n,pt)

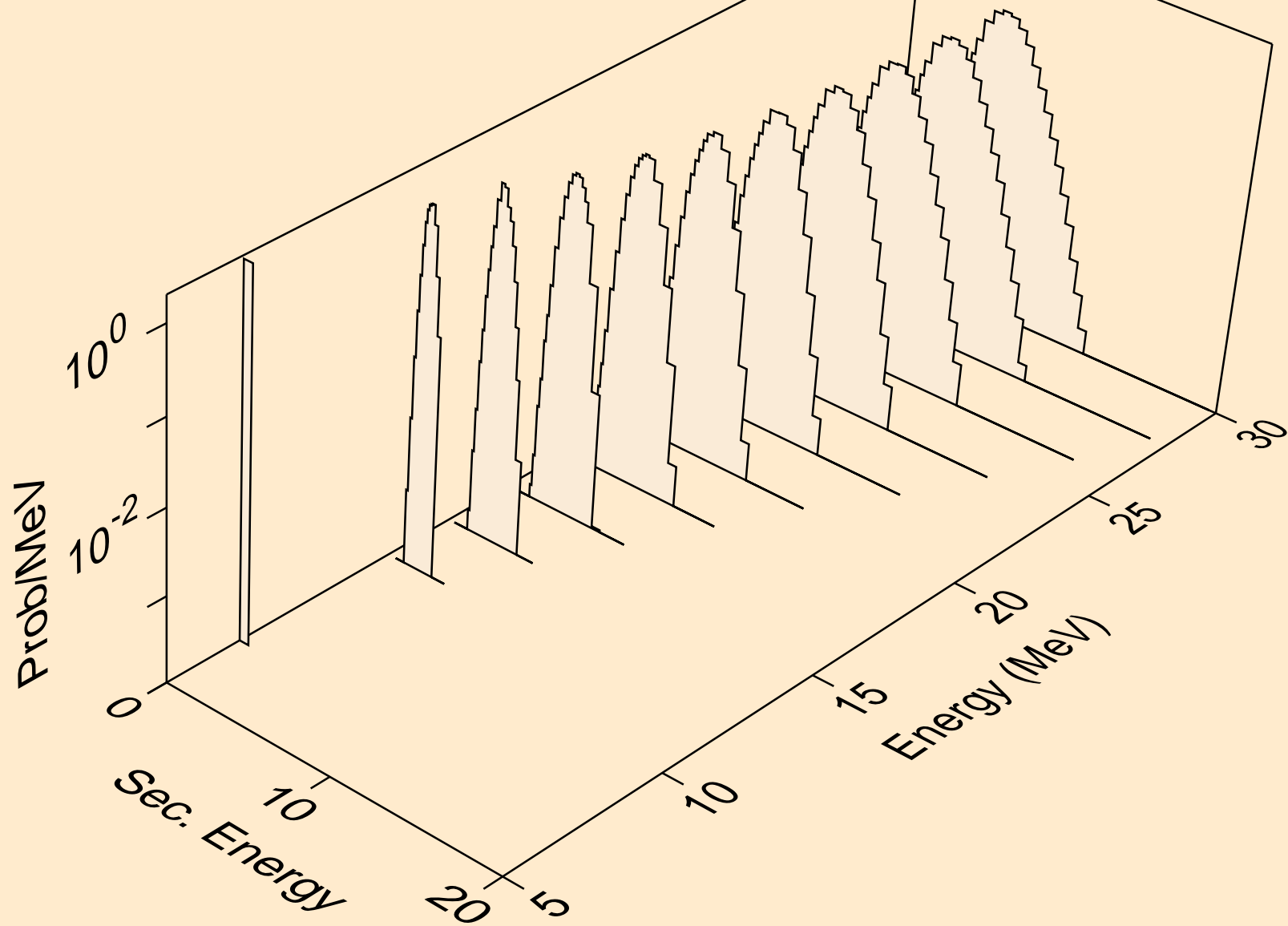

PM136M NEUTRON ACER TENDL-2021 LIBRARY; T=293.6K  
deuterons from (n,x)

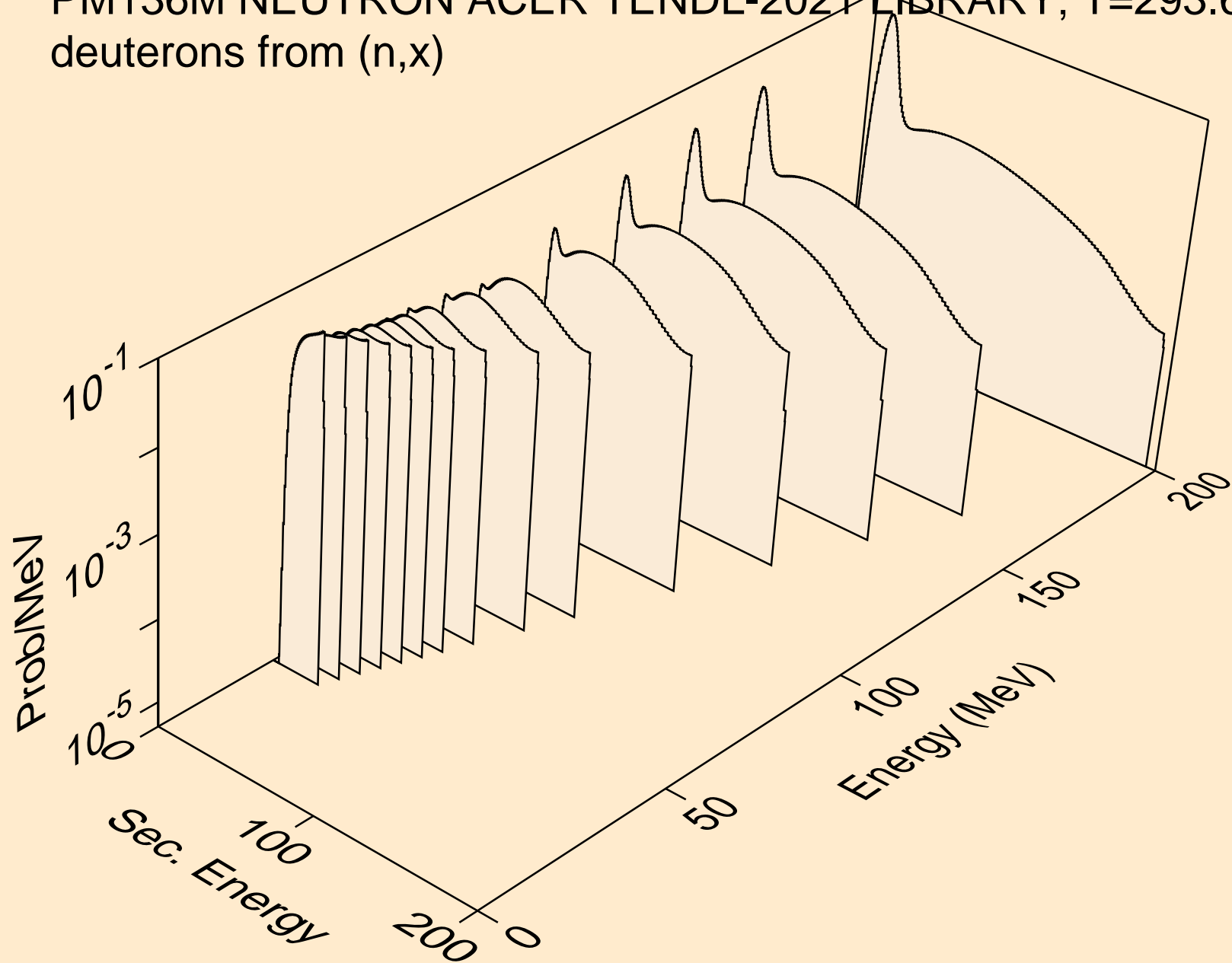

PM136M NEUTRON ACER TENDL-2021 LIBRARY; T=293.6K  
deuterons from (n,2nd)

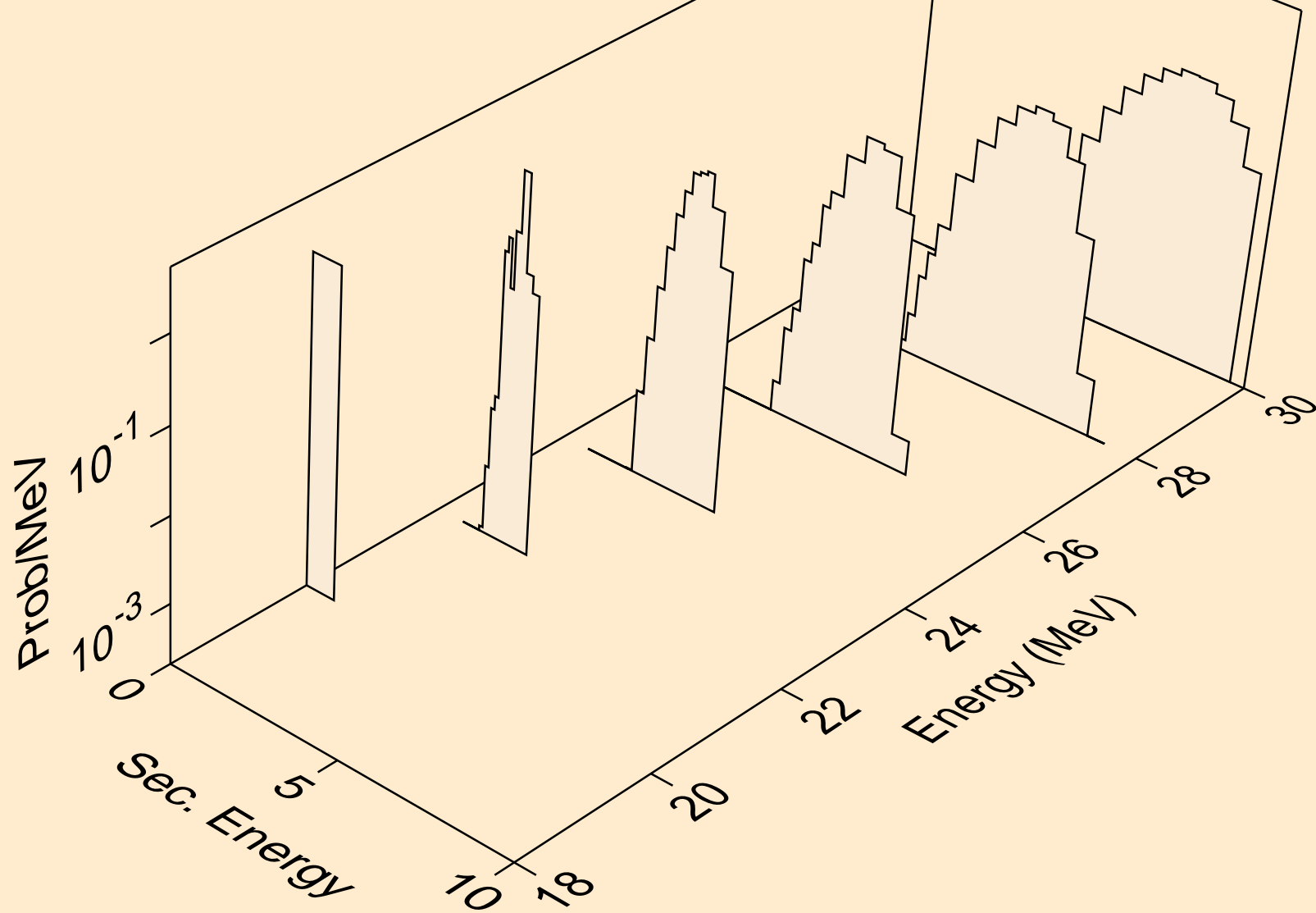

PM136M NEUTRON ACER TENDL-2021 LIBRARY; T=293.6K  
deuterons from (n,n\*)d

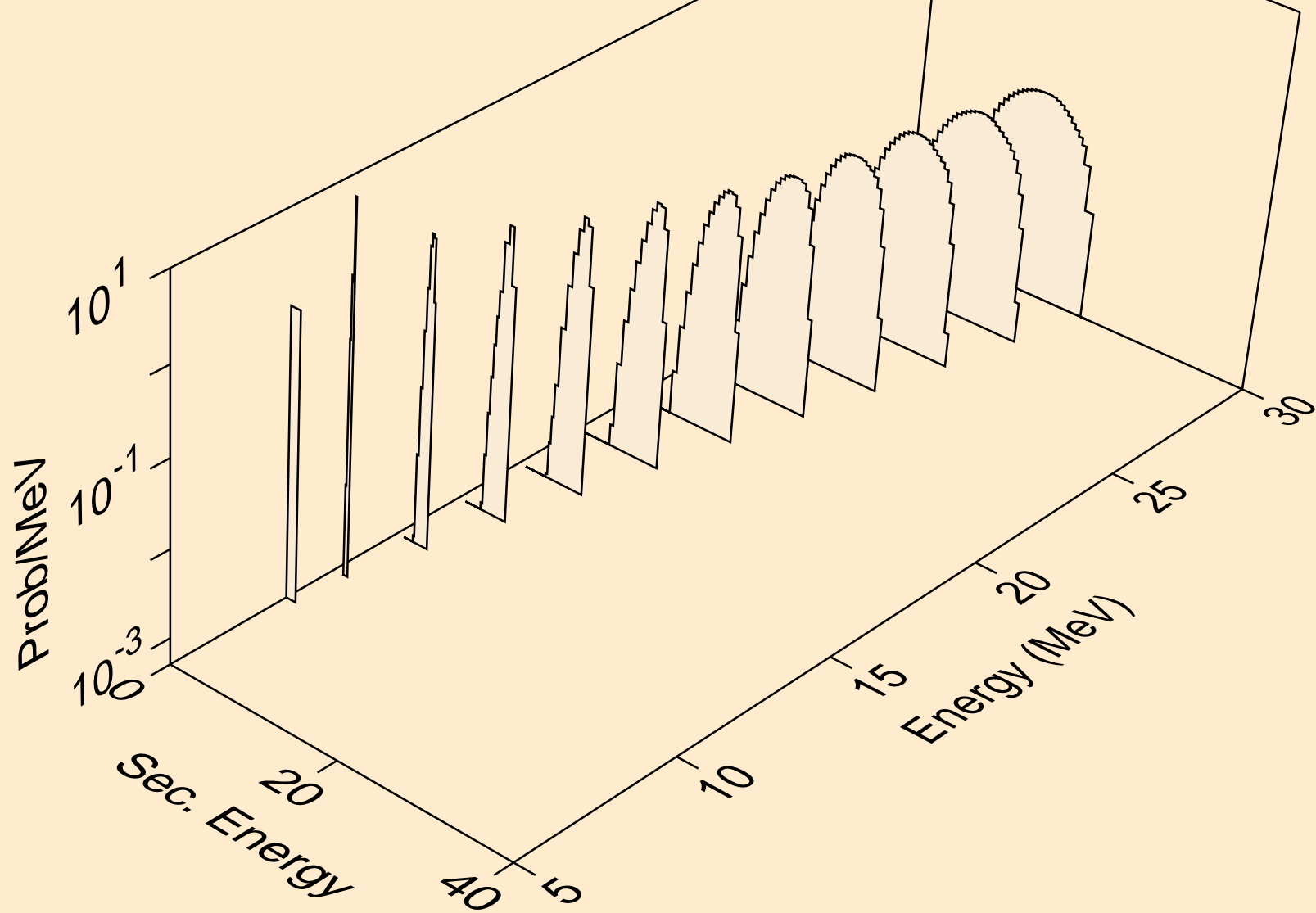

PM136M NEUTRON ACER TENDL-2021 LIBRARY; T=293.6K  
deuterons from (n,d)

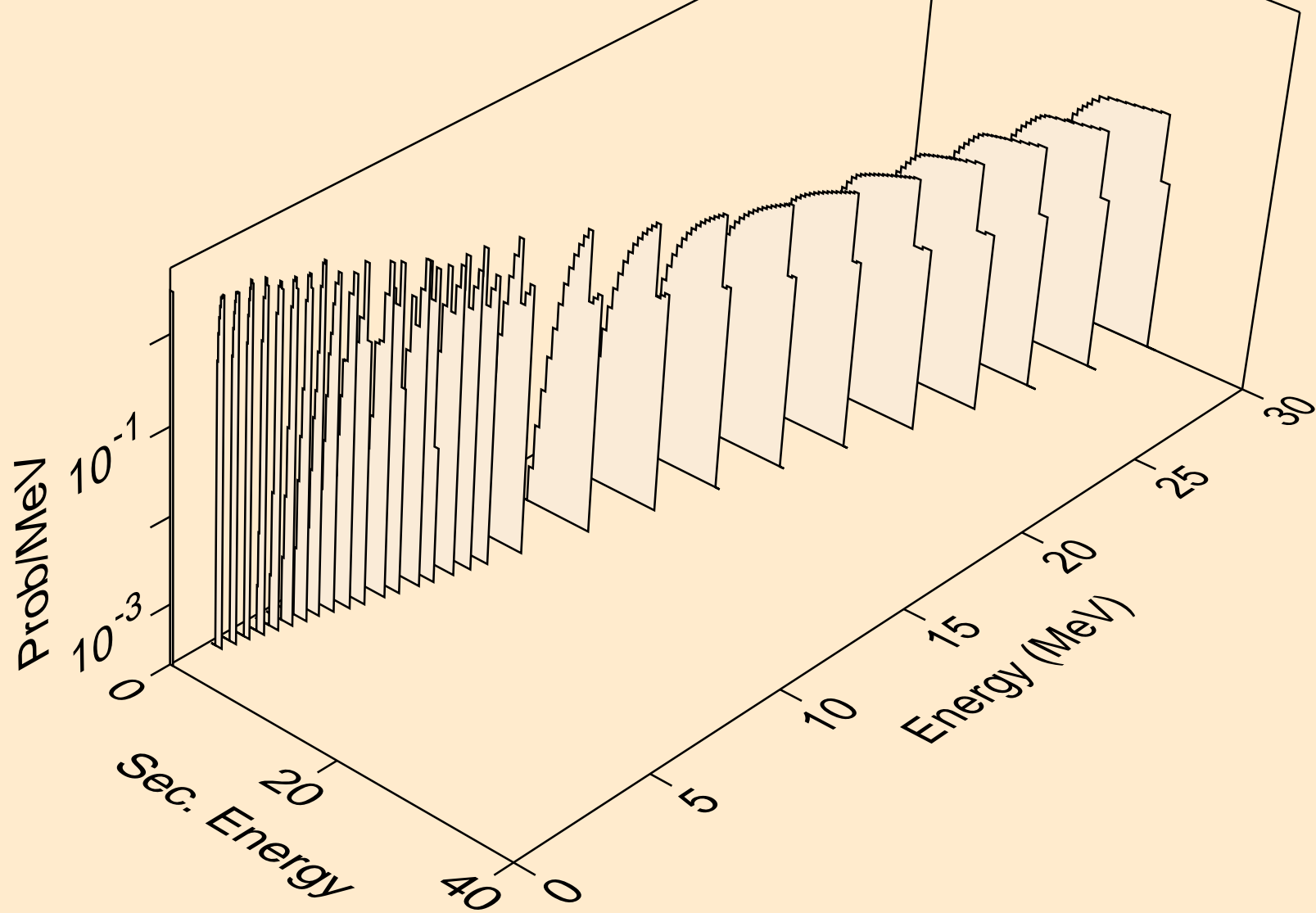

PM136M NEUTRON ACER TENDL-2021 LIBRARY; T=293.6K  
deuterons from (n,pd)

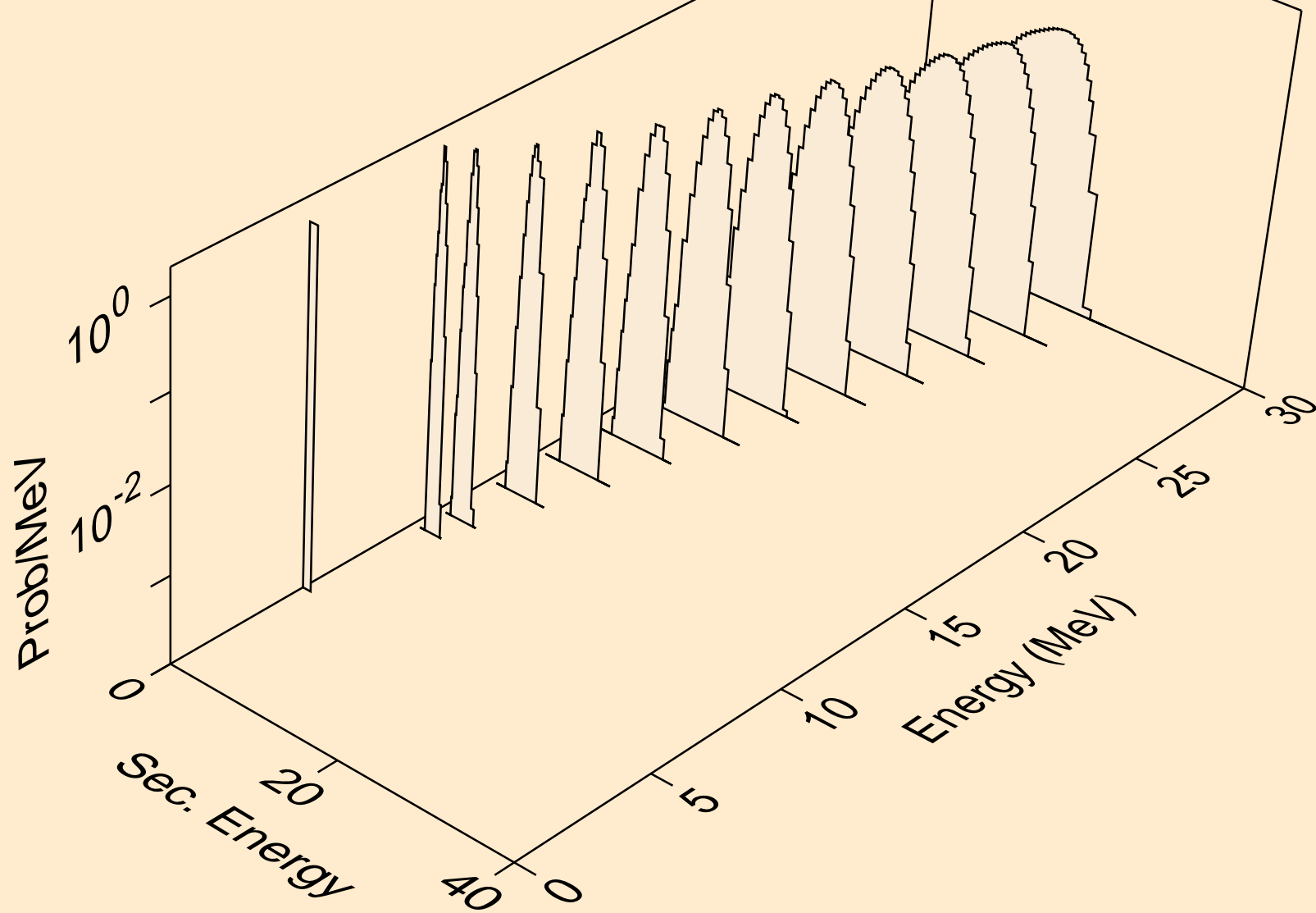

PM136M NEUTRON ACER TENDL-2021 LIBRARY; T=293.6K  
deuterons from (n,da)

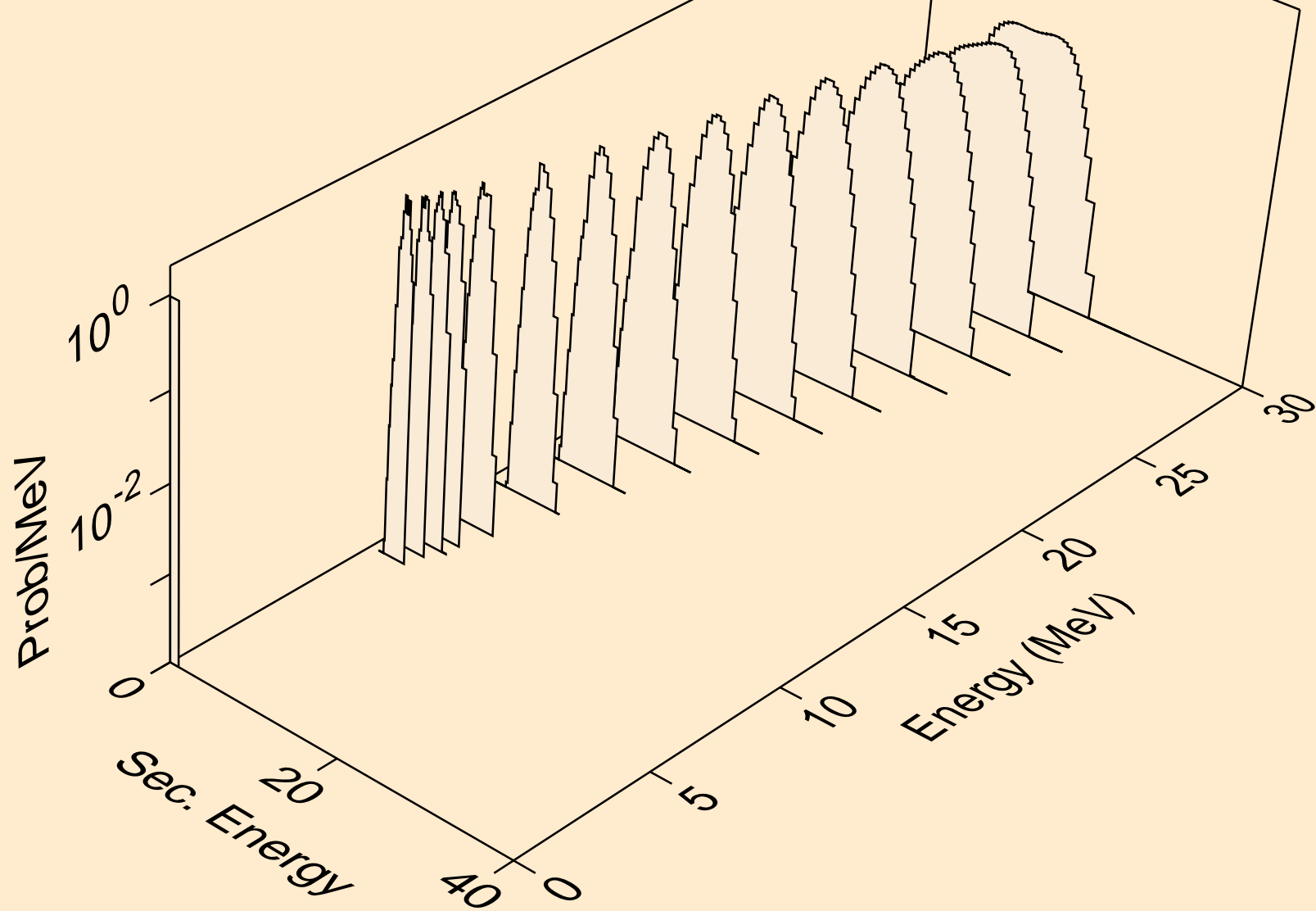



PM136M NEUTRON ACER TENDL-2021 LIBRARY; T=293.6K  
tritons from (n,x)

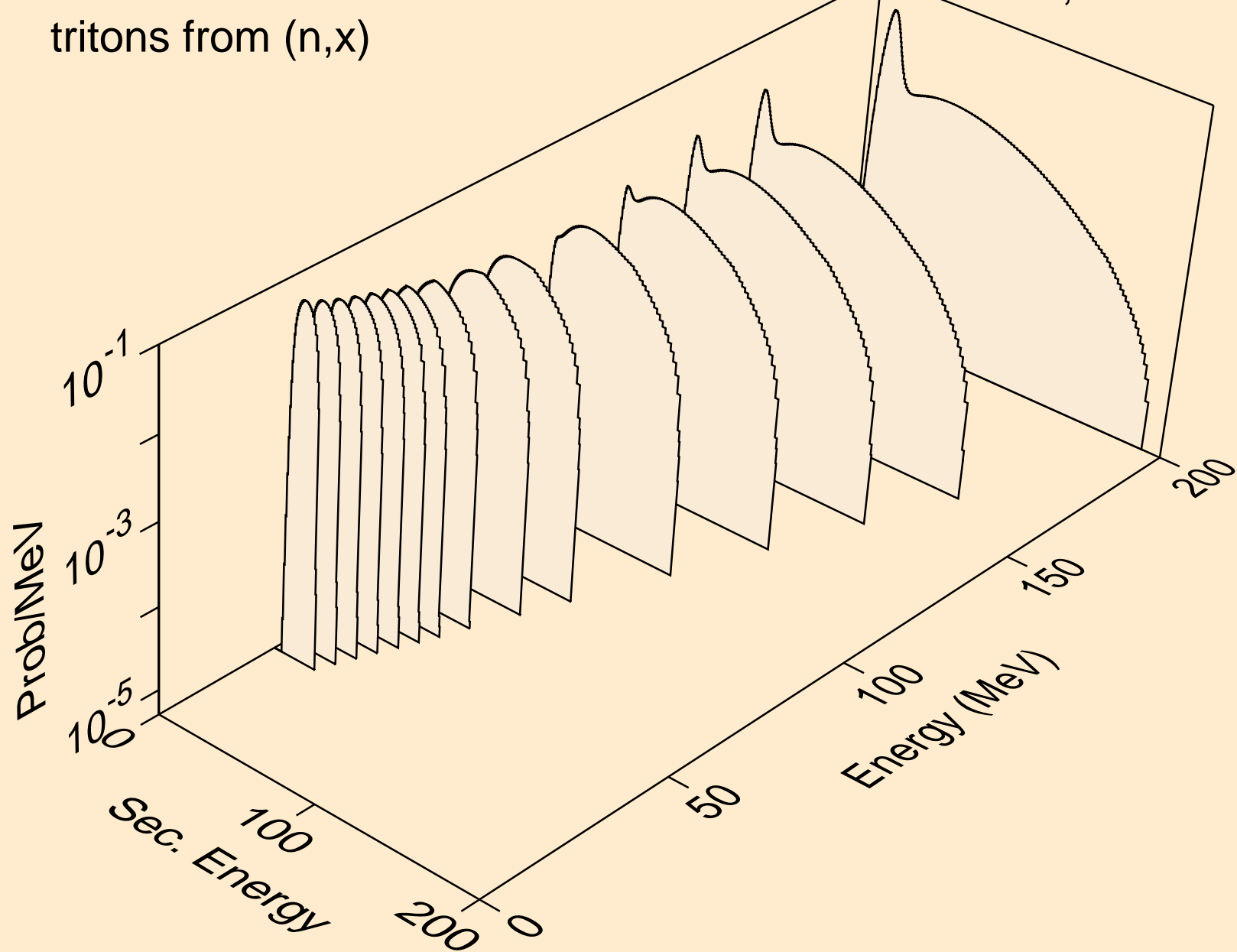

PM136M NEUTRON ACER TENDL-2021 LIBRARY; T=293.6K  
tritons from (n,n\*)t

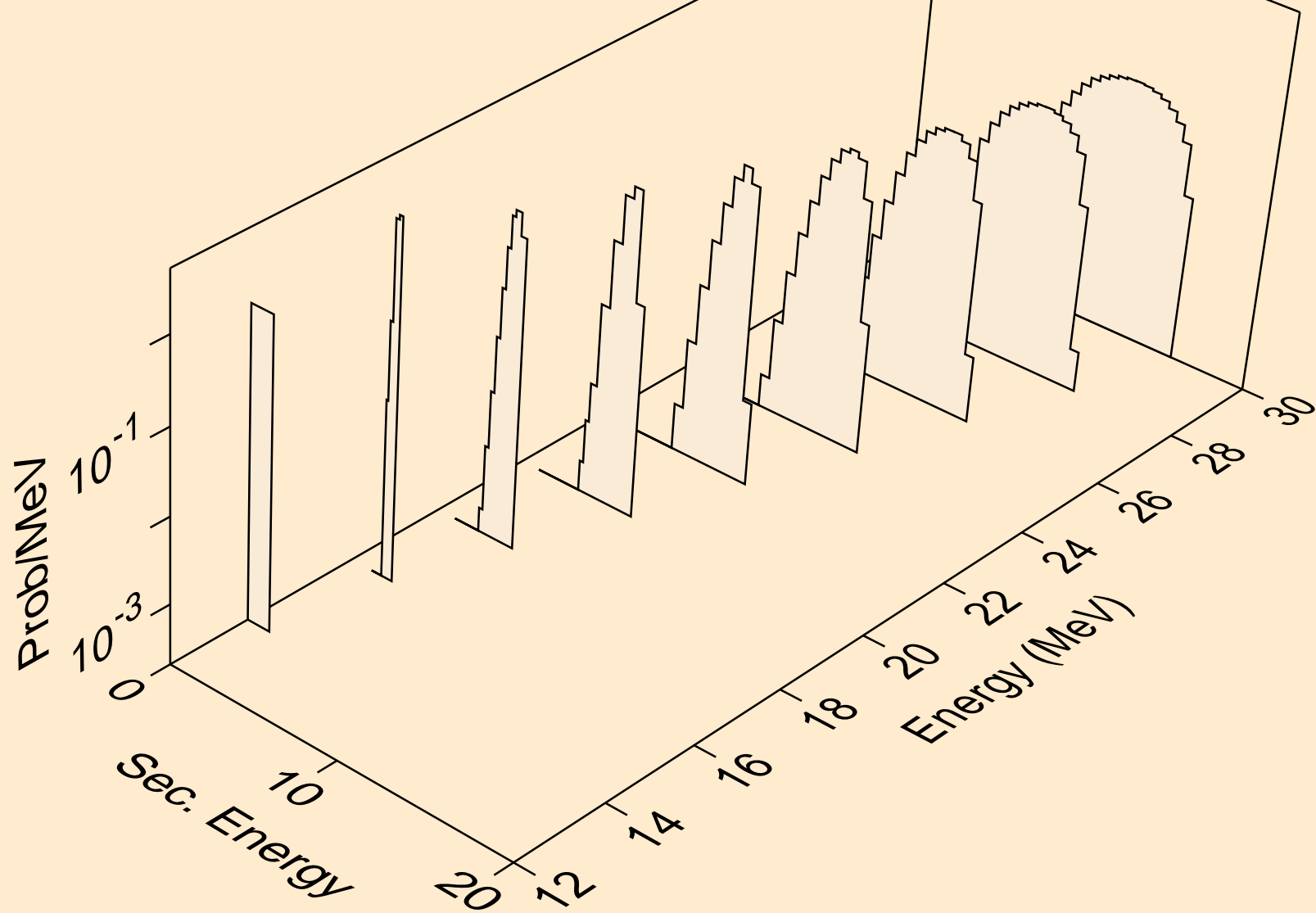

PM136M NEUTRON ACER TENDL-2021 LIBRARY; T=293.6K  
tritons from (n,t)

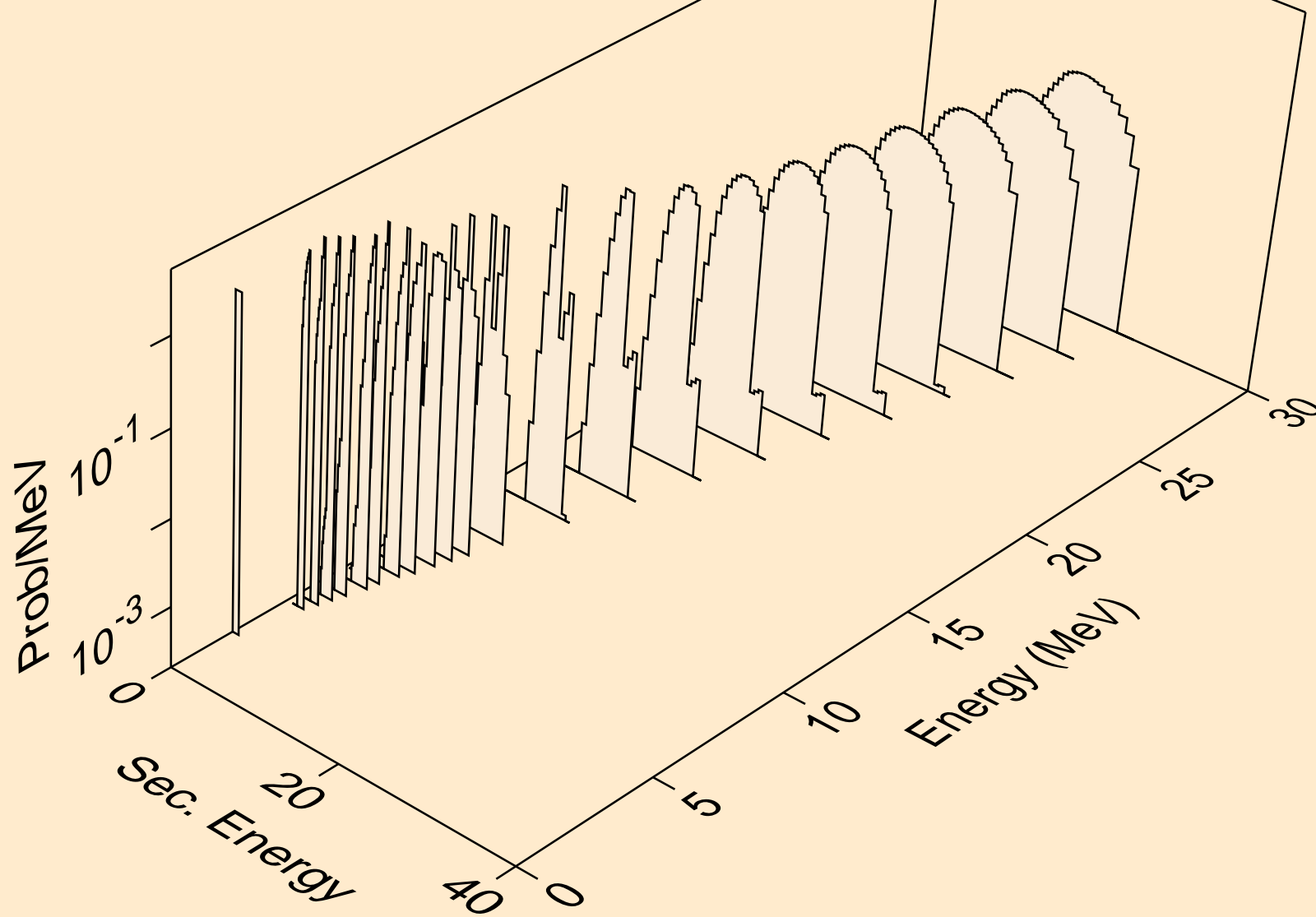

PM136M NEUTRON ACER TENDL-2021 LIBRARY; T=293.6K  
tritons from (n,pt)

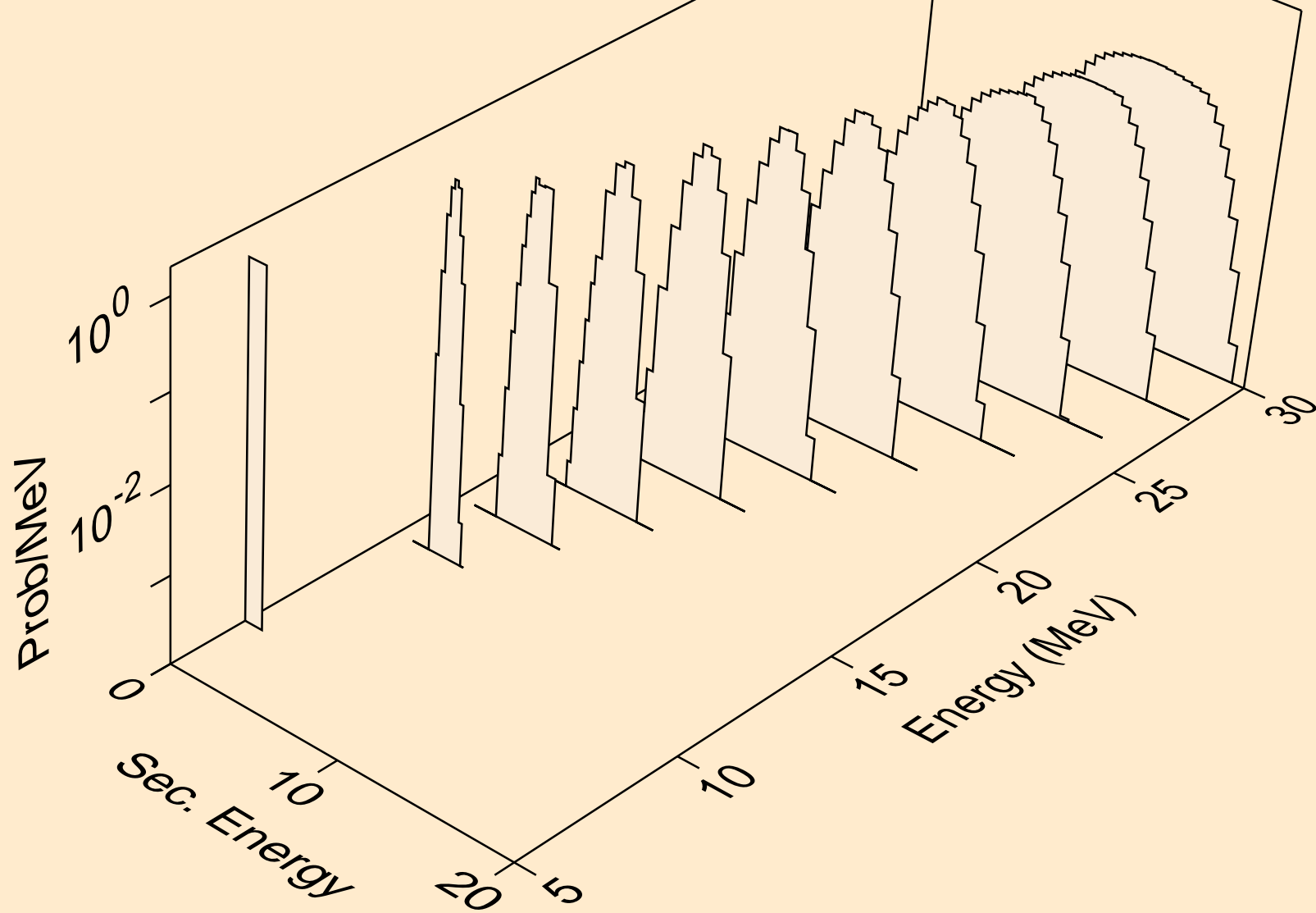

PM136M NEUTRON ACER TENDL-2021 LIBRARY; T=293.6K  
he3s from (n,x)

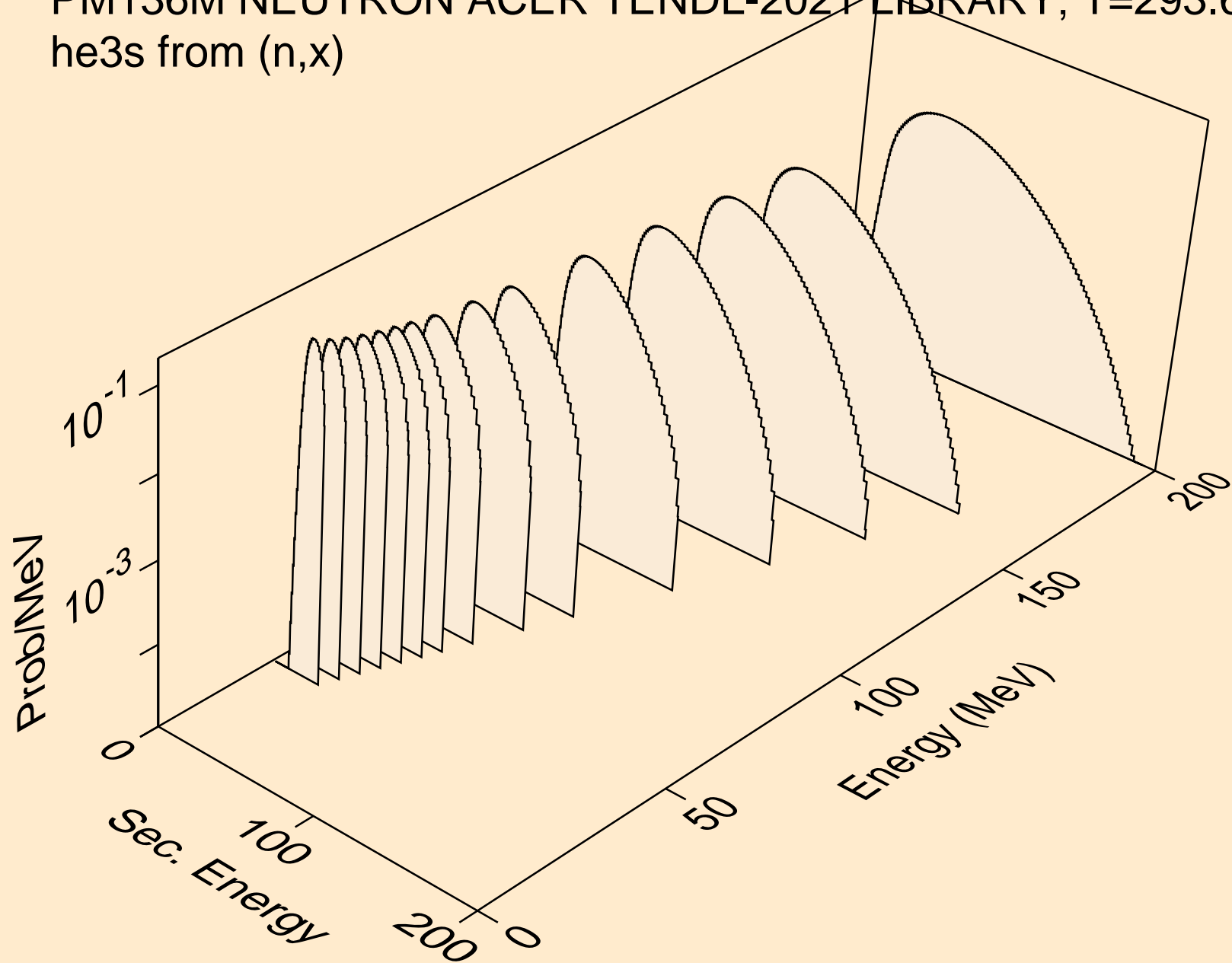

PM136M NEUTRON ACER TENDL-2021 LIBRARY; T=293.6K  
he3s from (n,n\*)he3

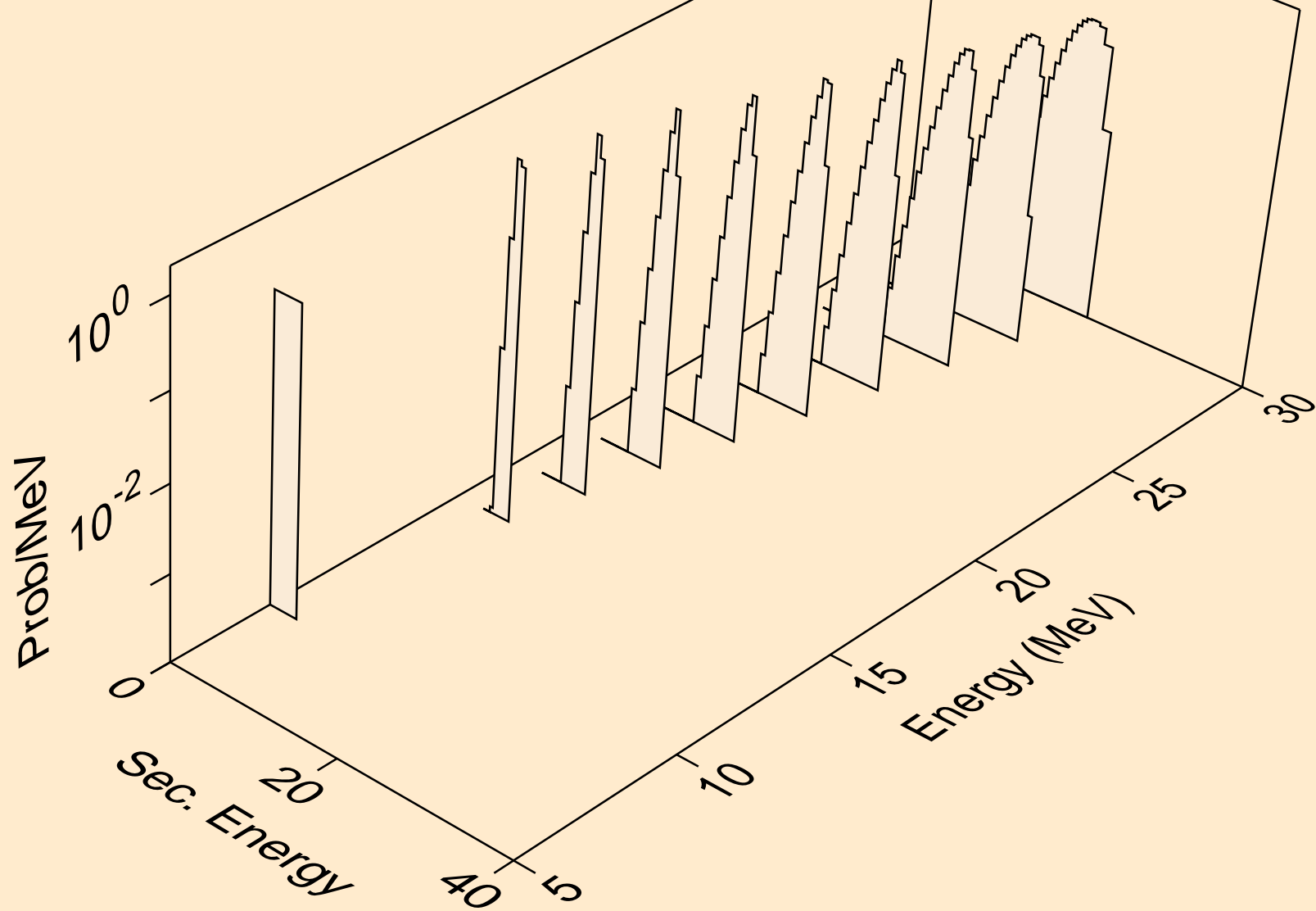

PM136M NEUTRON ACER TENDL-2021 LIBRARY; T=293.6K  
he3s from (n,he3)

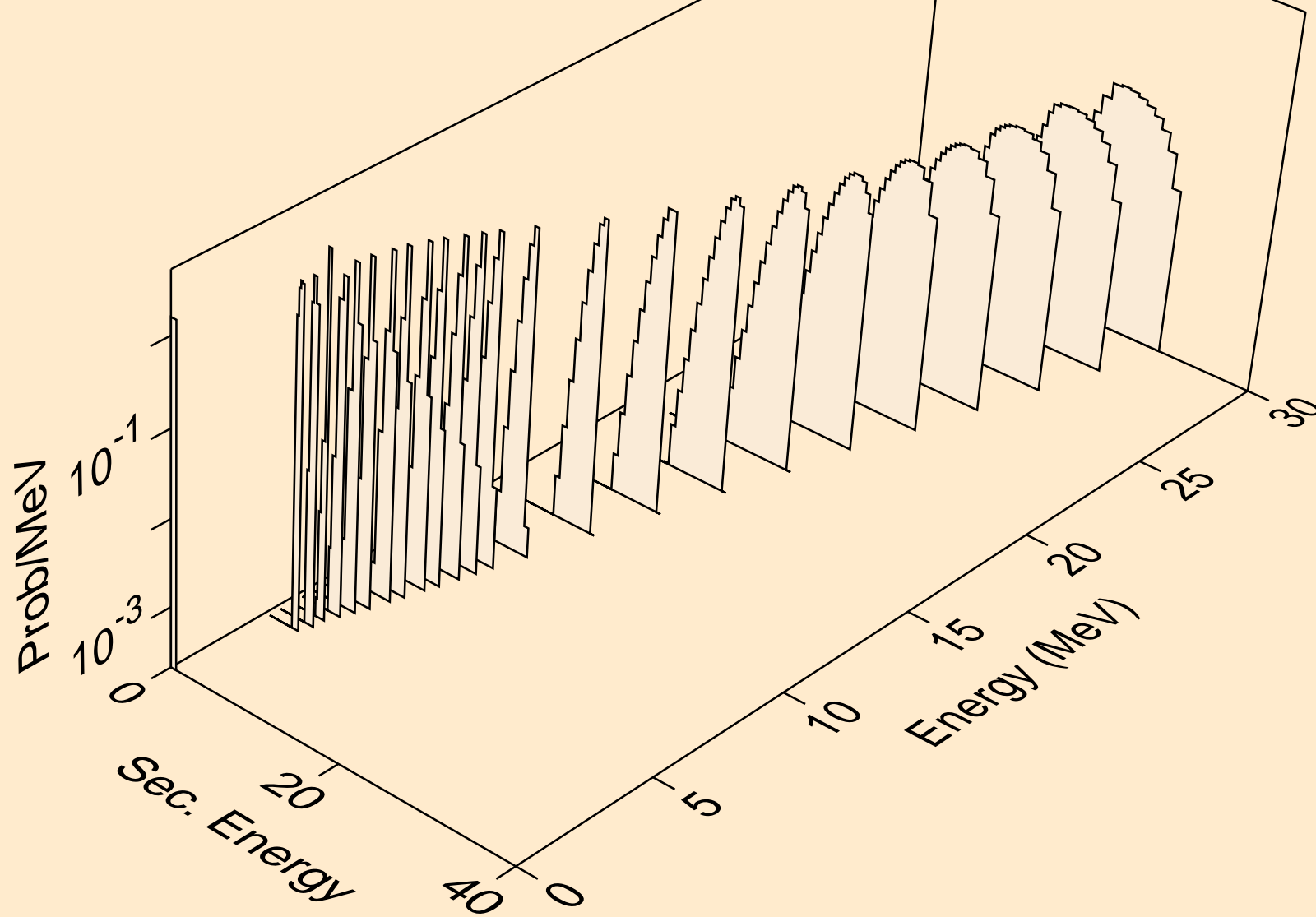

PM136M NEUTRON ACER TENDL-2021 LIBRARY; T=293.6K  
alphas from (n,x)

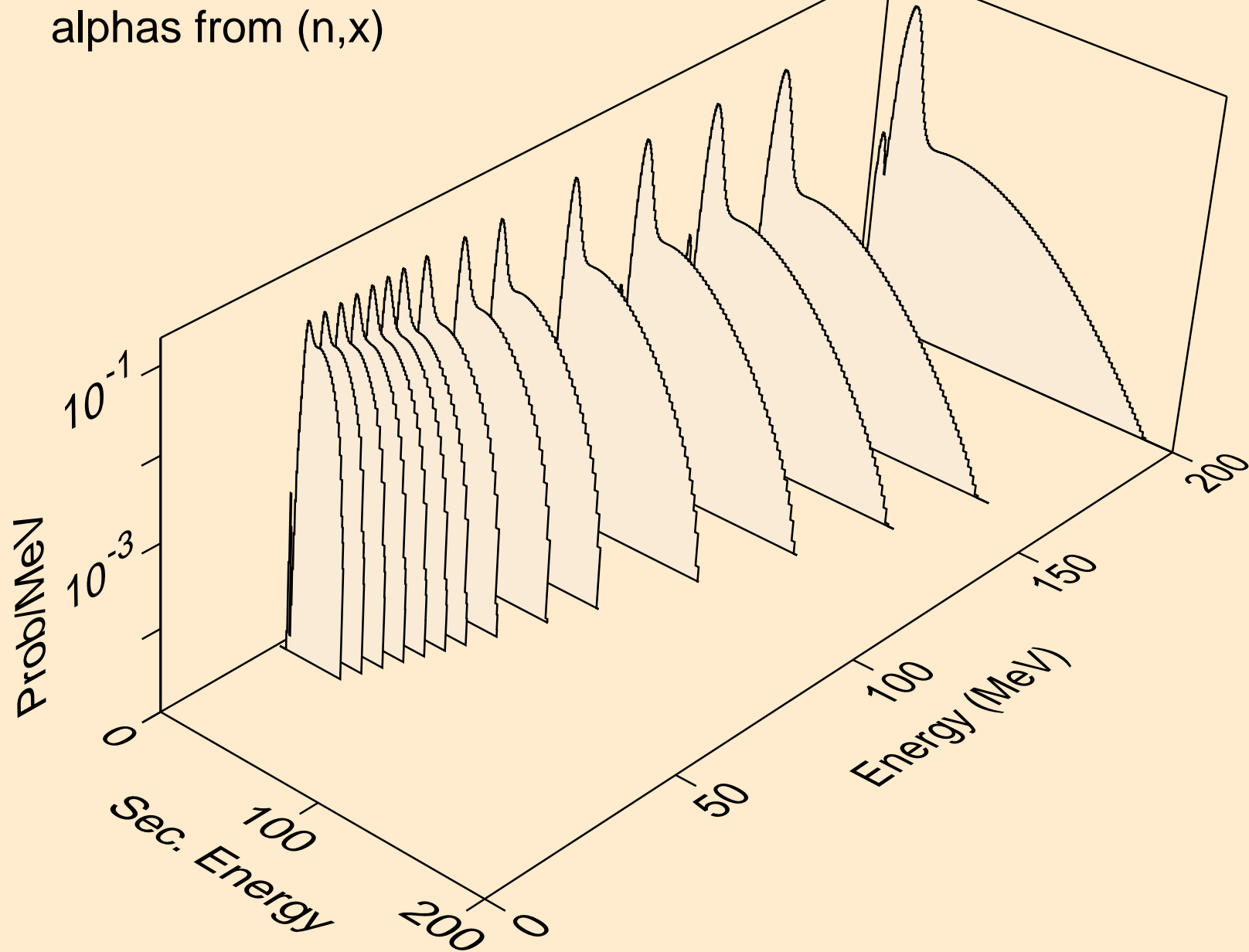



PM136M NEUTRON ACER TENDL-2021 LIBRARY; T=293.6K  
alphas from (n,n\*)a

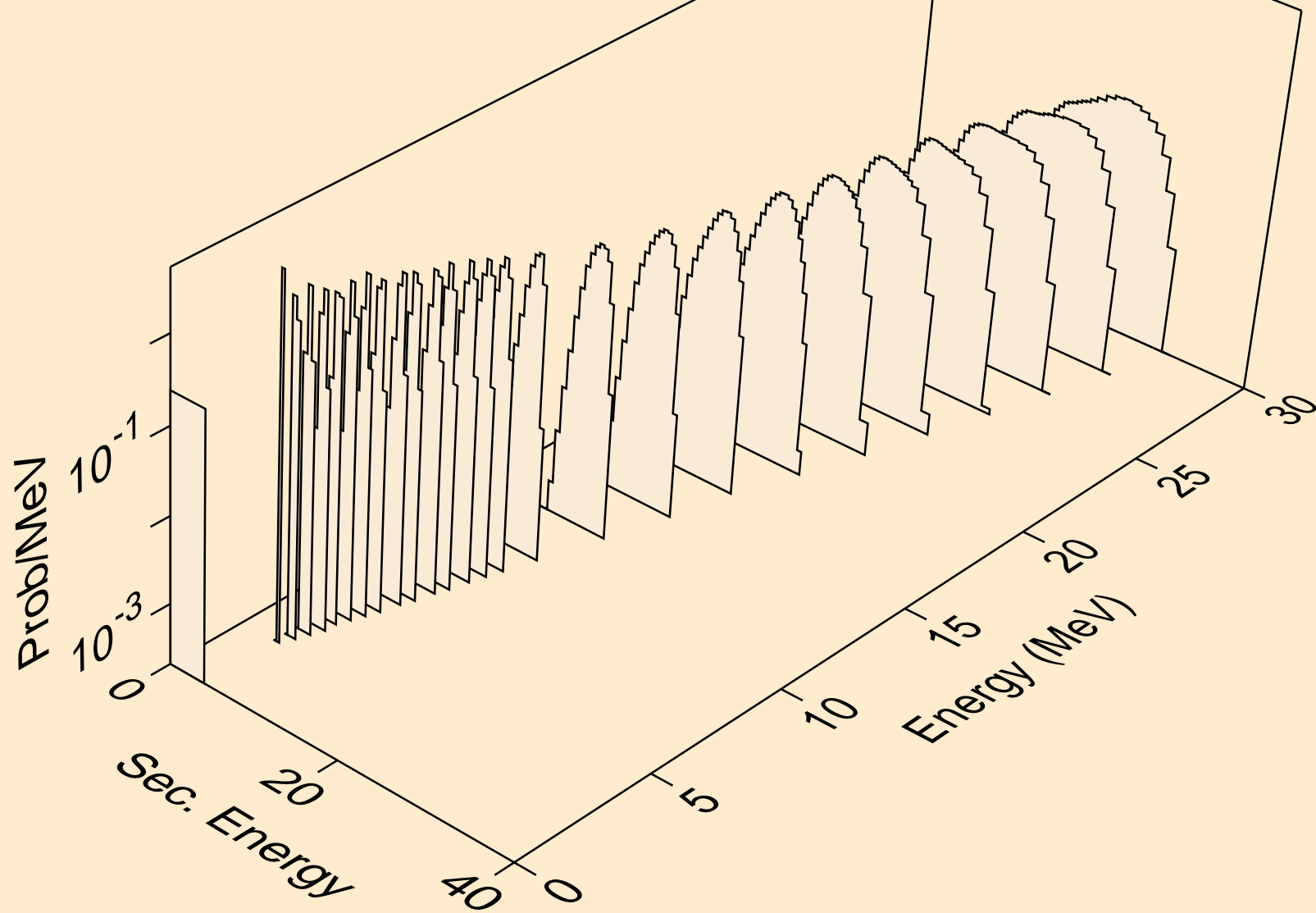

PM136M NEUTRON ACER TENDL-2021 LIBRARY; T=293.6K  
alphas from (n,2n)a

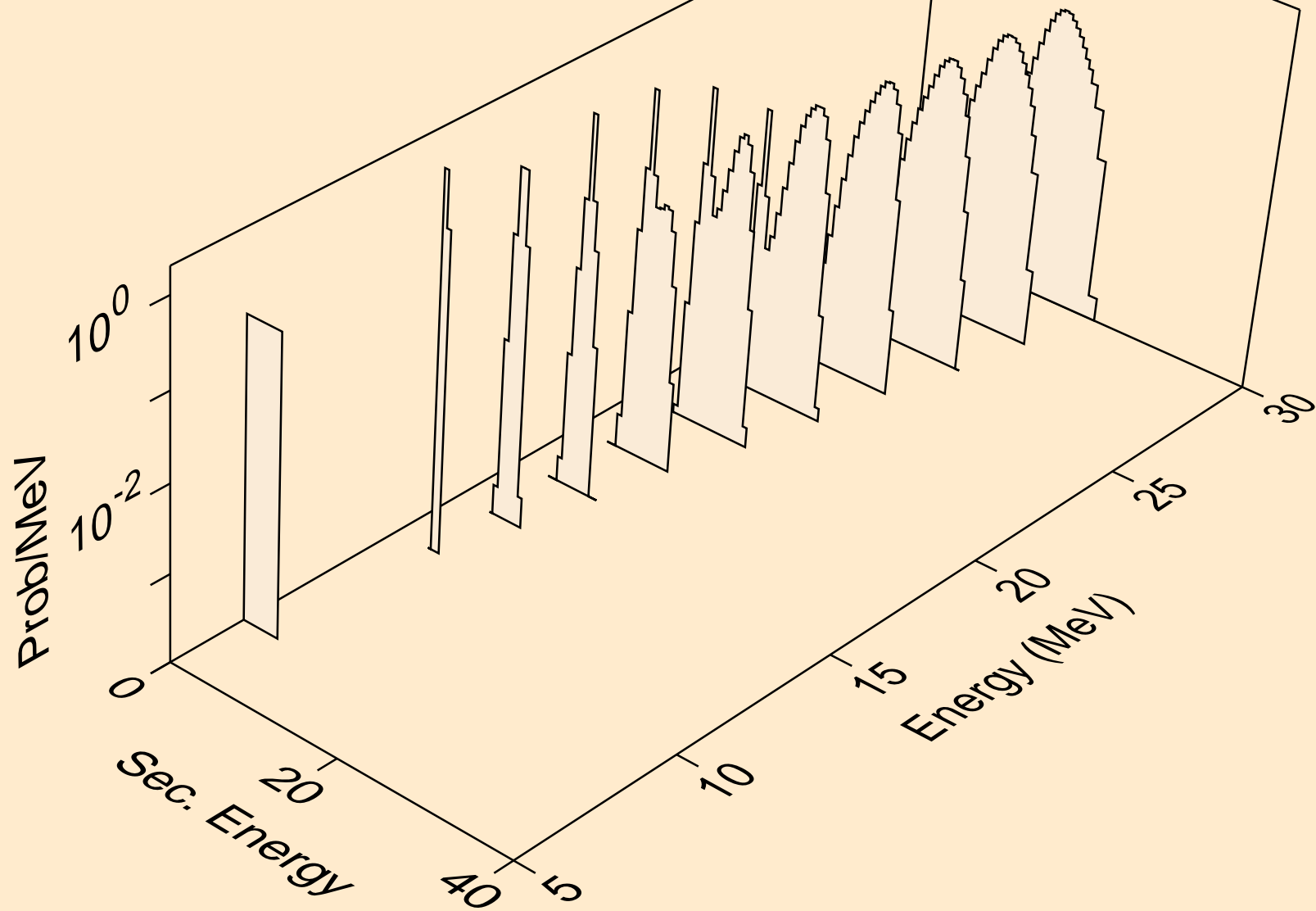

PM136M NEUTRON ACER TENDL-2021 LIBRARY; T=293.6K  
alphas from (n,3n)a

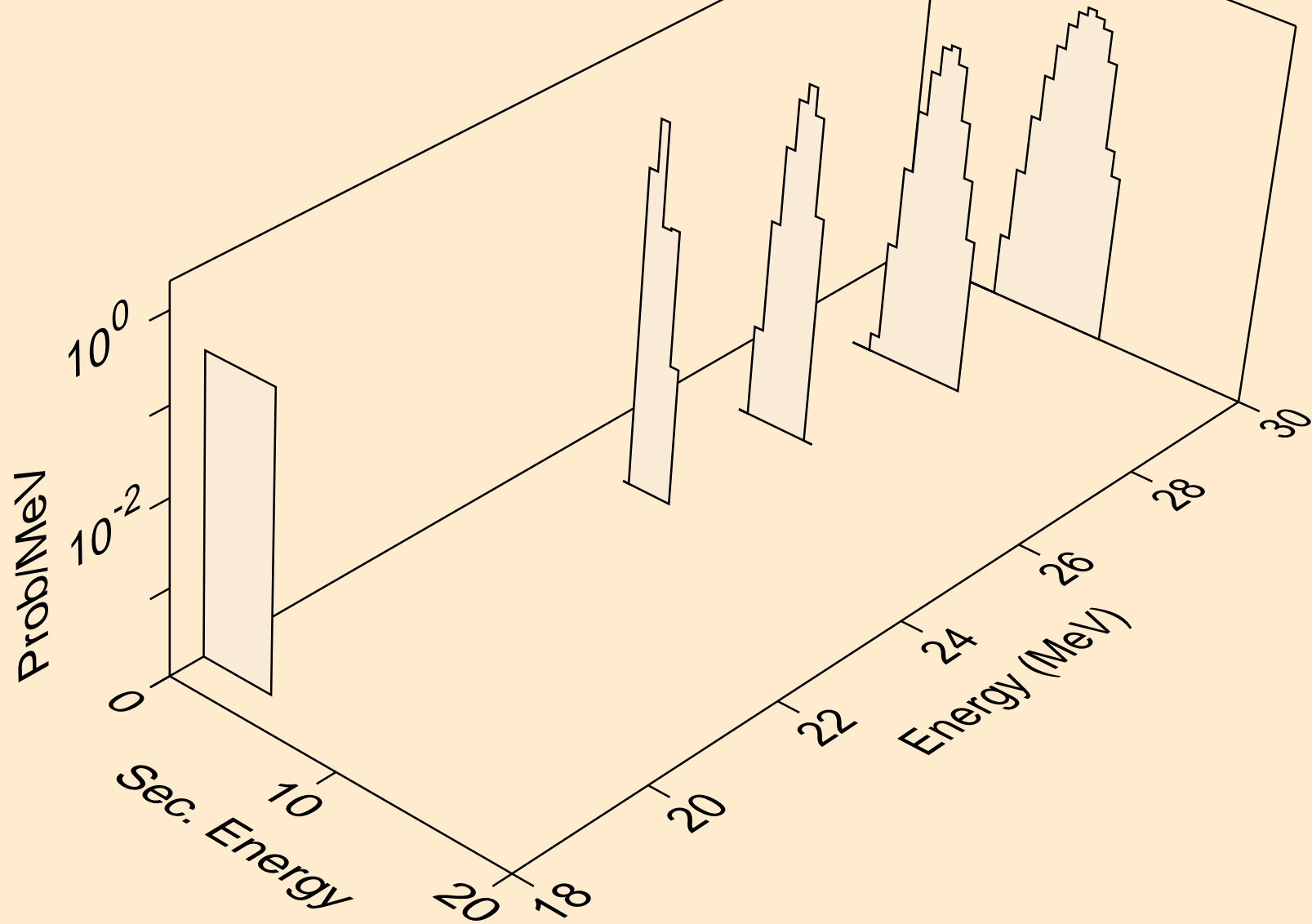

PM136M NEUTRON ACER TENDL-2021 LIBRARY; T=293.6K  
alphas from (n,n\*)2a

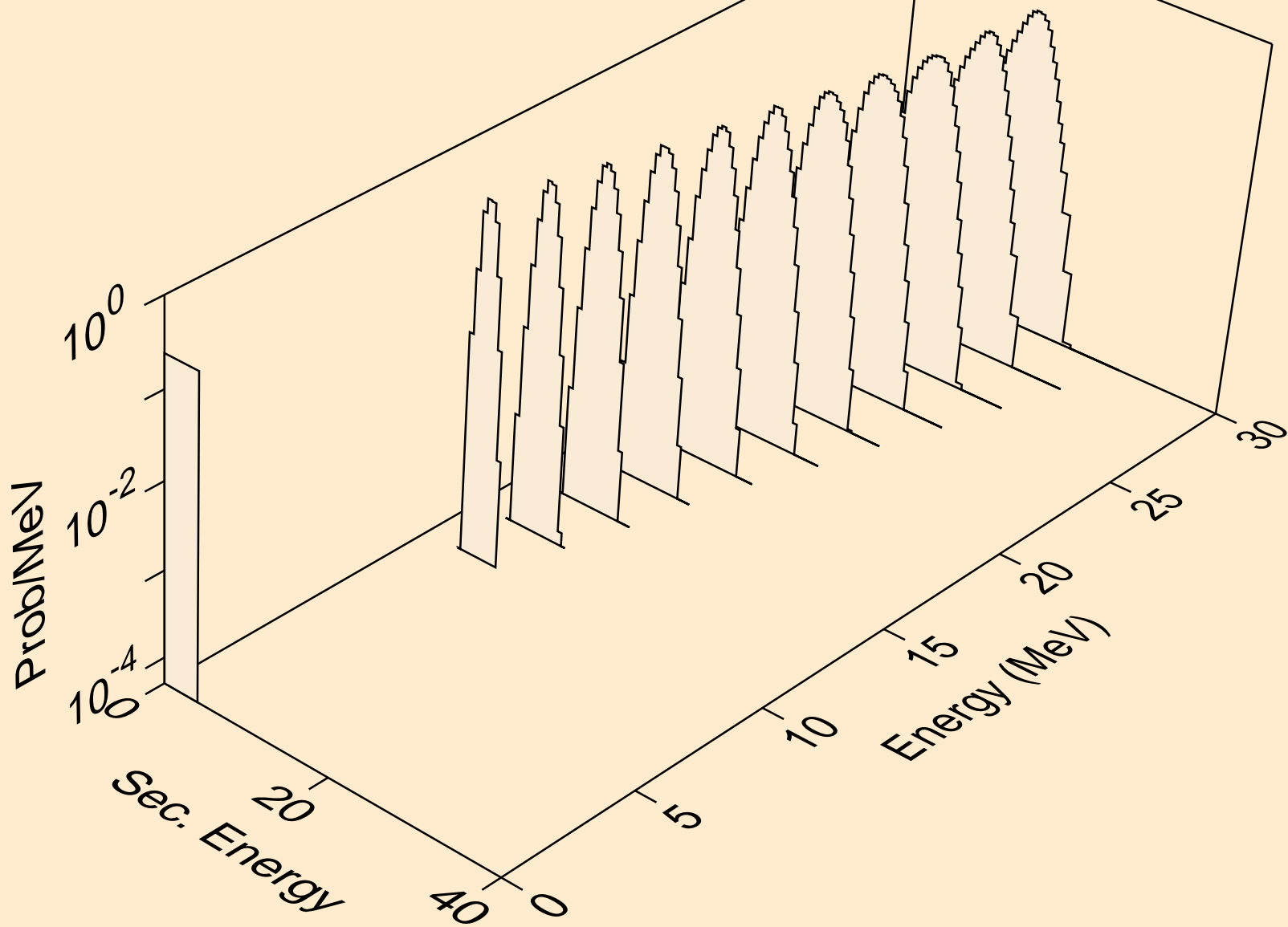

PM136M NEUTRON ACER TENDL-2021 LIBRARY; T=293.6K  
alphas from (n,2n)2a

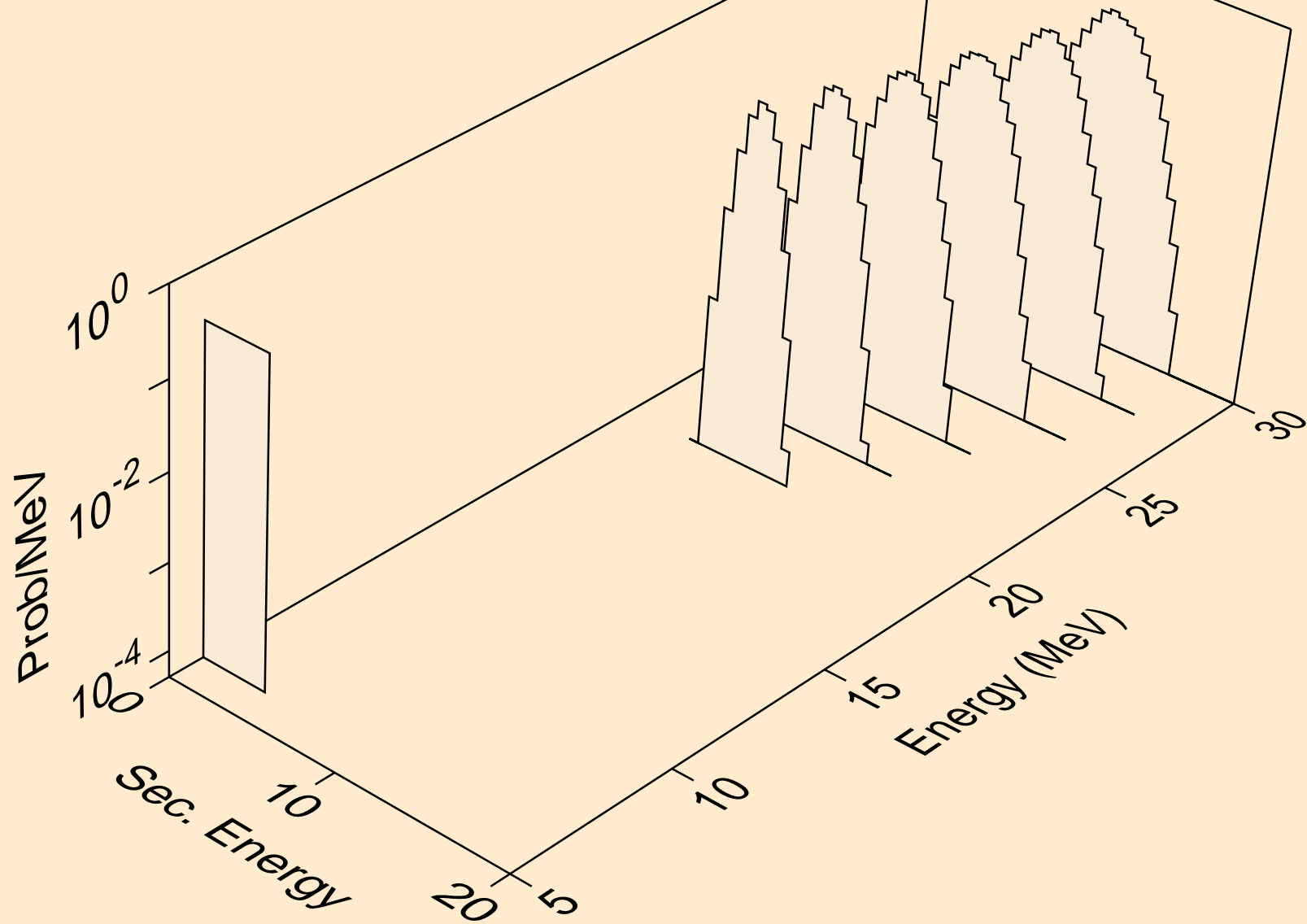

PM136M NEUTRON ACER TENDL-2021 LIBRARY; T=293.6K  
alphas from (n,npa)

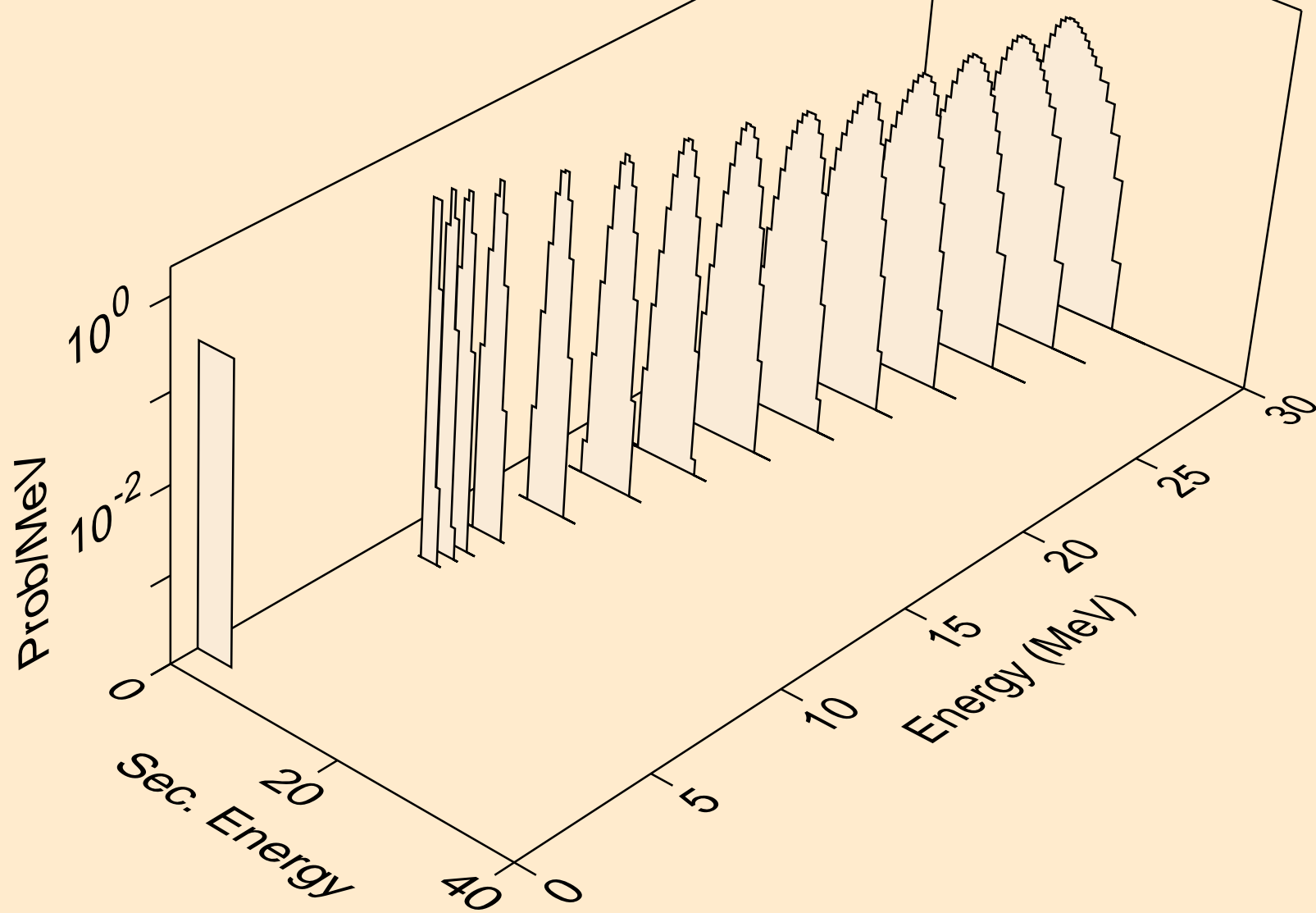

PM136M NEUTRON ACER TENDL-2021 LIBRARY; T=293.6K  
alphas from (n,a)

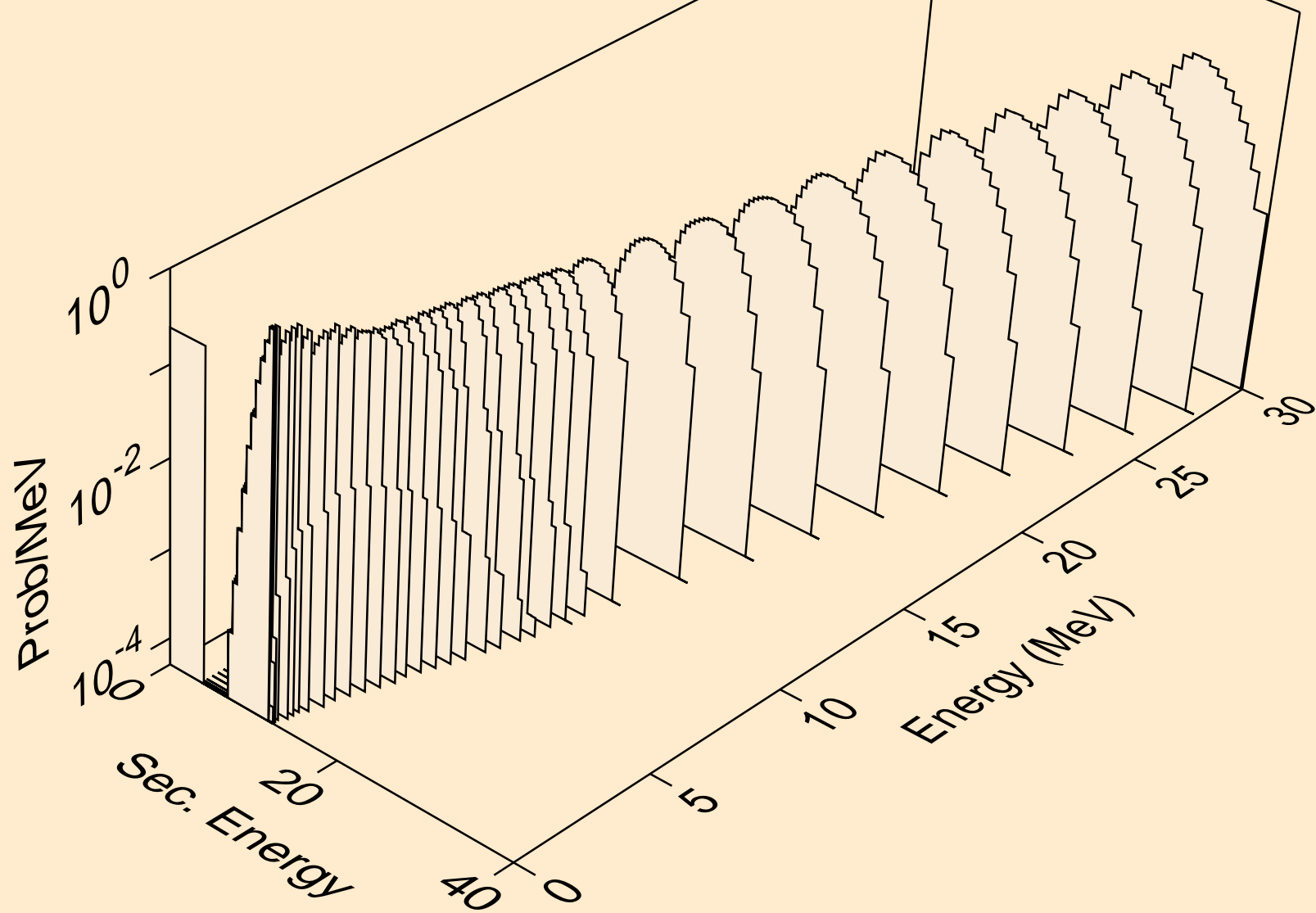

PM136M NEUTRON ACER TENDL-2021 LIBRARY; T=293.6K  
alphas from (n,2a)

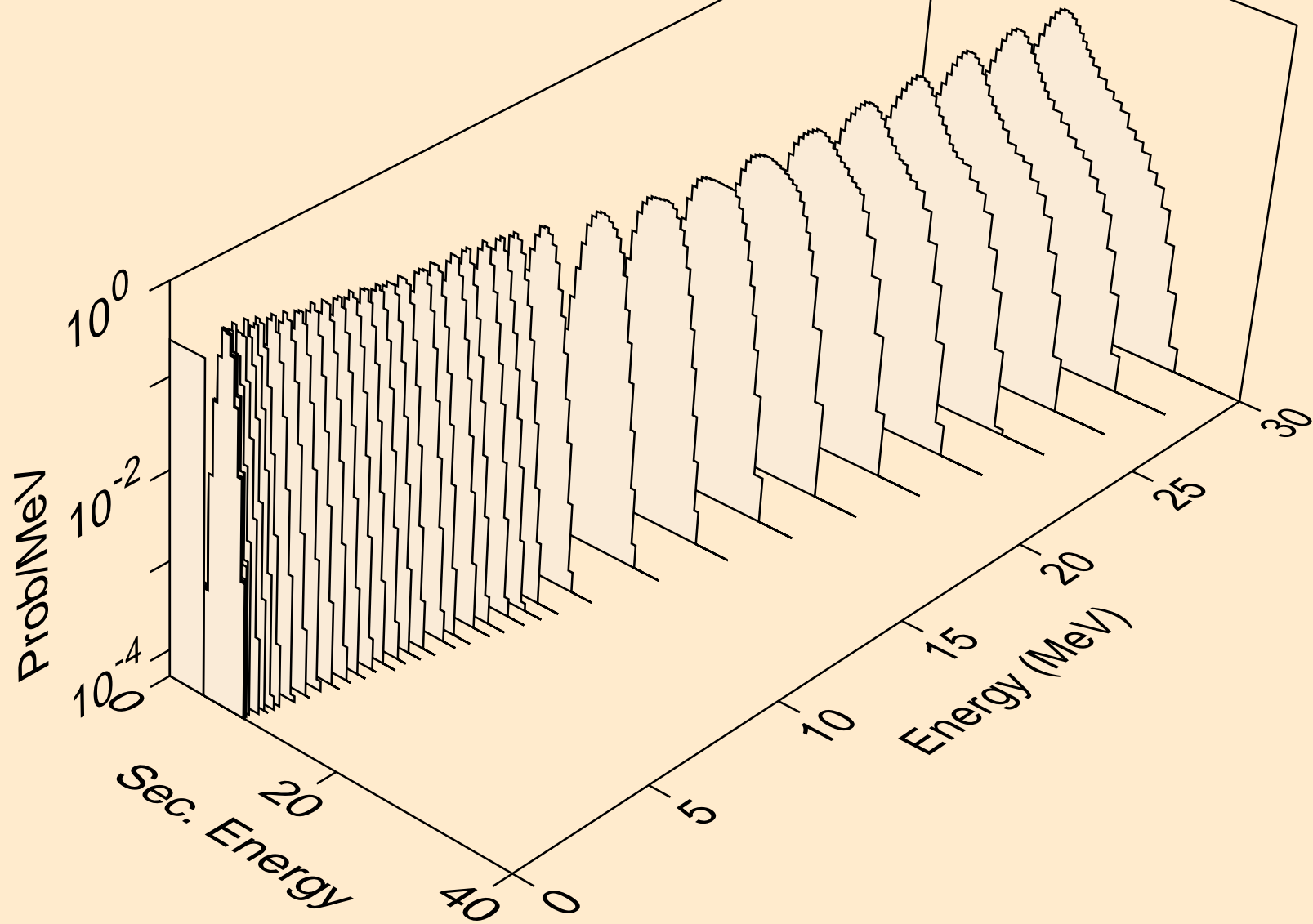



PM136M NEUTRON ACER TENDL-2021 LIBRARY; T=293.6K  
alphas from (n,3a)

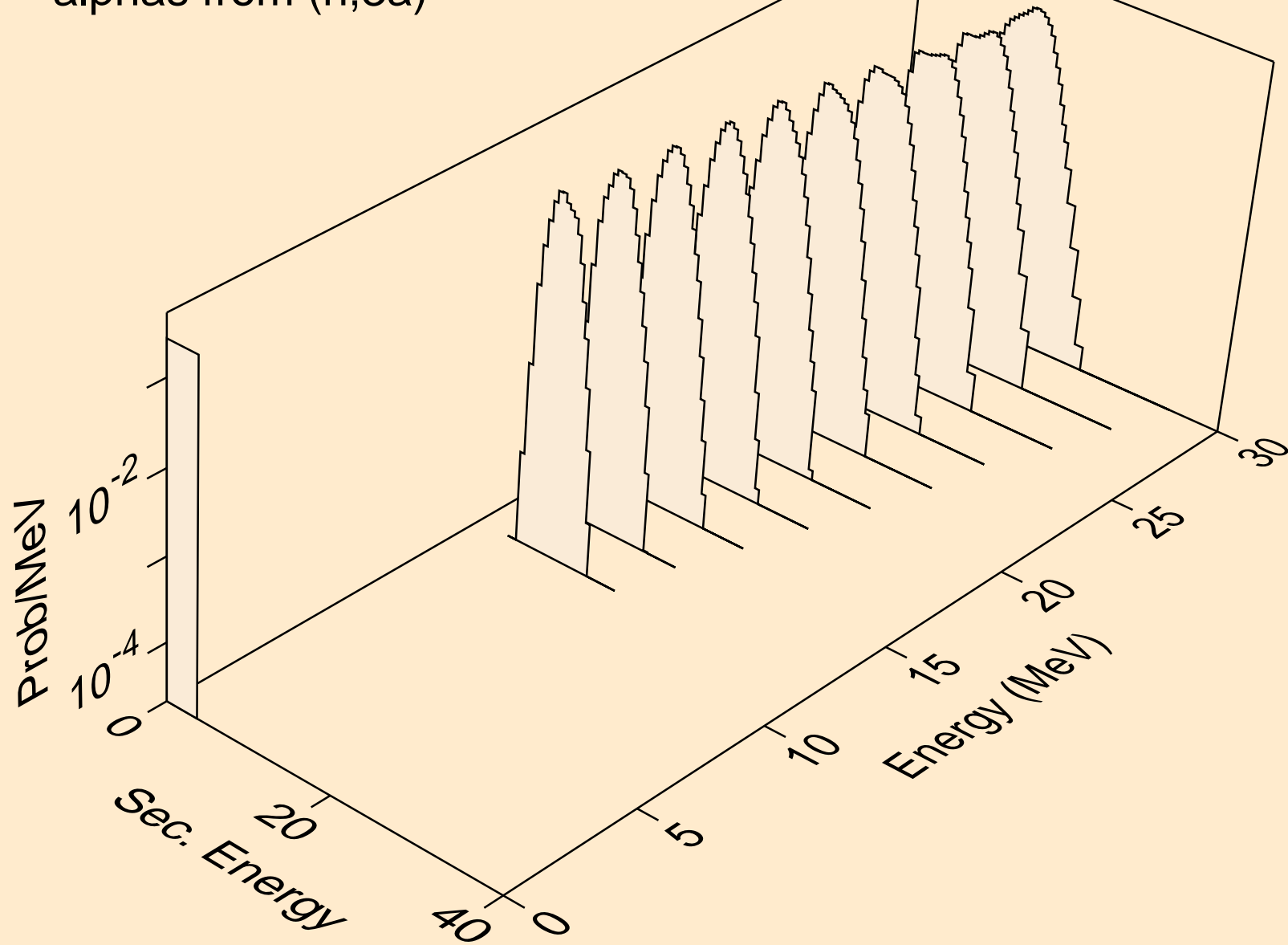

PM136M NEUTRON ACER TENDL-2021 LIBRARY; T=293.6K  
alphas from (n,pa)

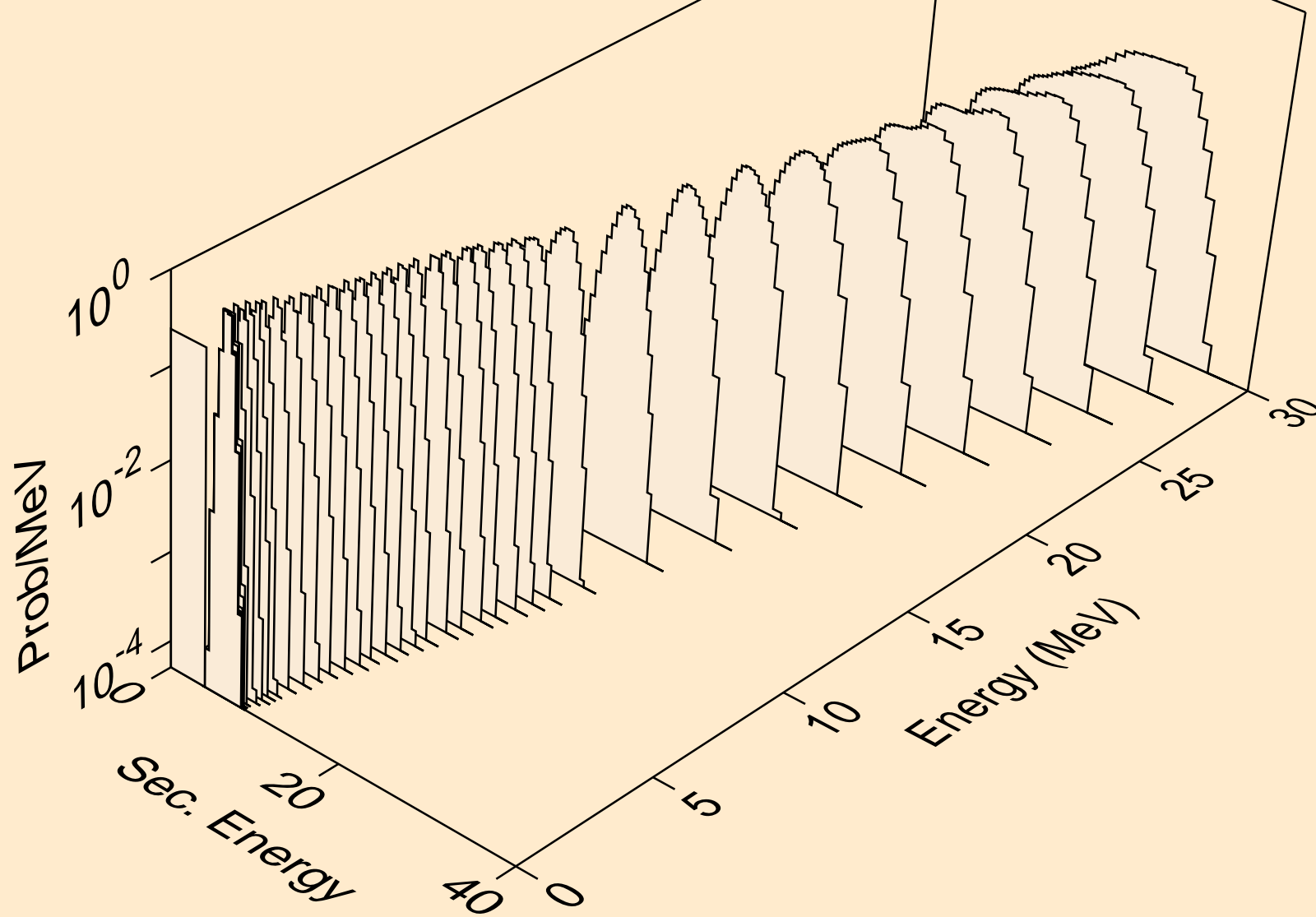

PM136M NEUTRON ACER TENDL-2021 LIBRARY; T=293.6K  
alphas from (n,da)

