

PM145 NEUTRON ACER TENDL-2021 LIBRARY; T=293.6K
Principal cross sections

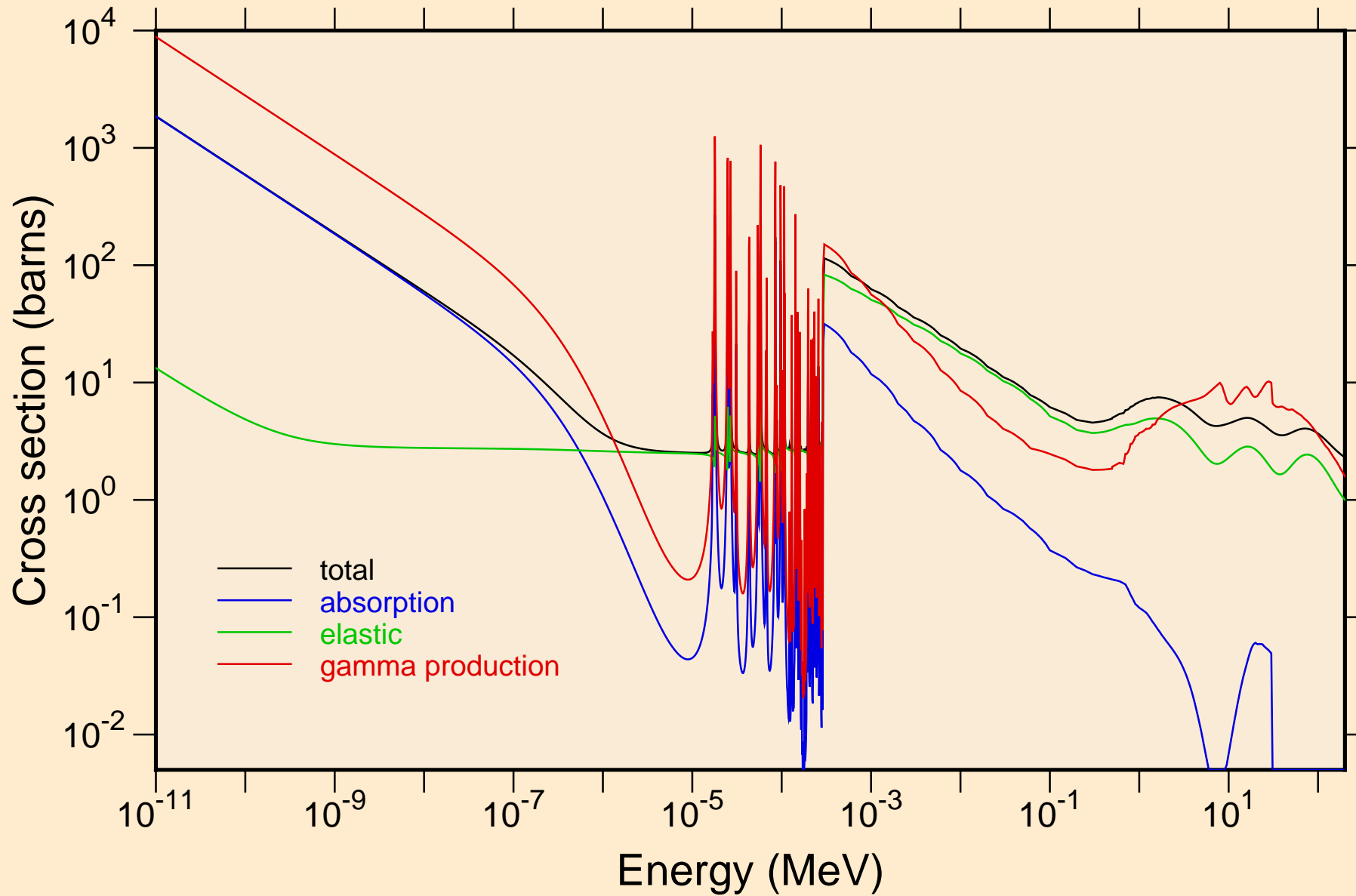

PM145 NEUTRON ACER TENDL-2021 LIBRARY; T=293.6K
resonance total cross section

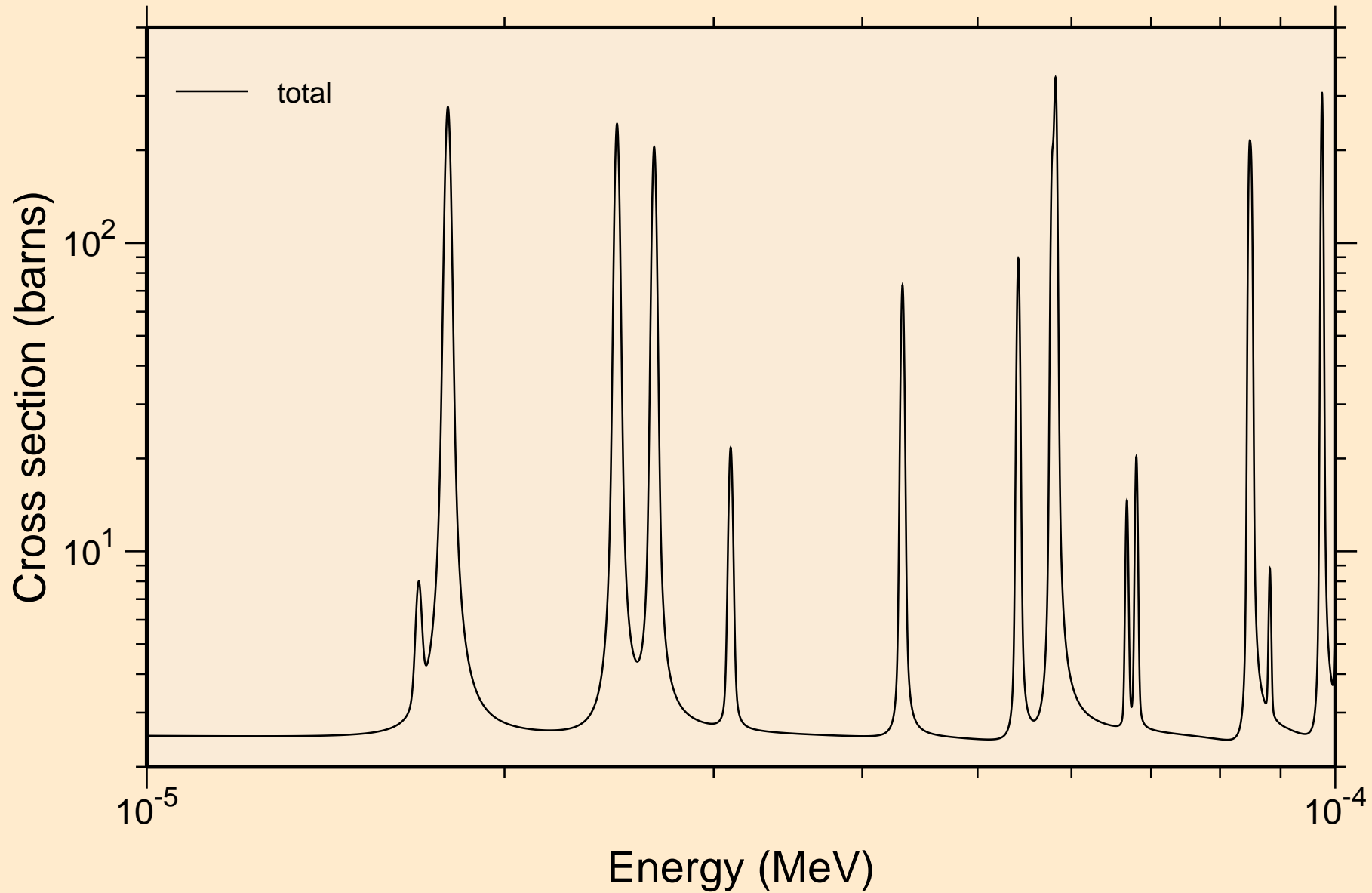

PM145 NEUTRON ACER TENDL-2021 LIBRARY; T=293.6K
resonance total cross section

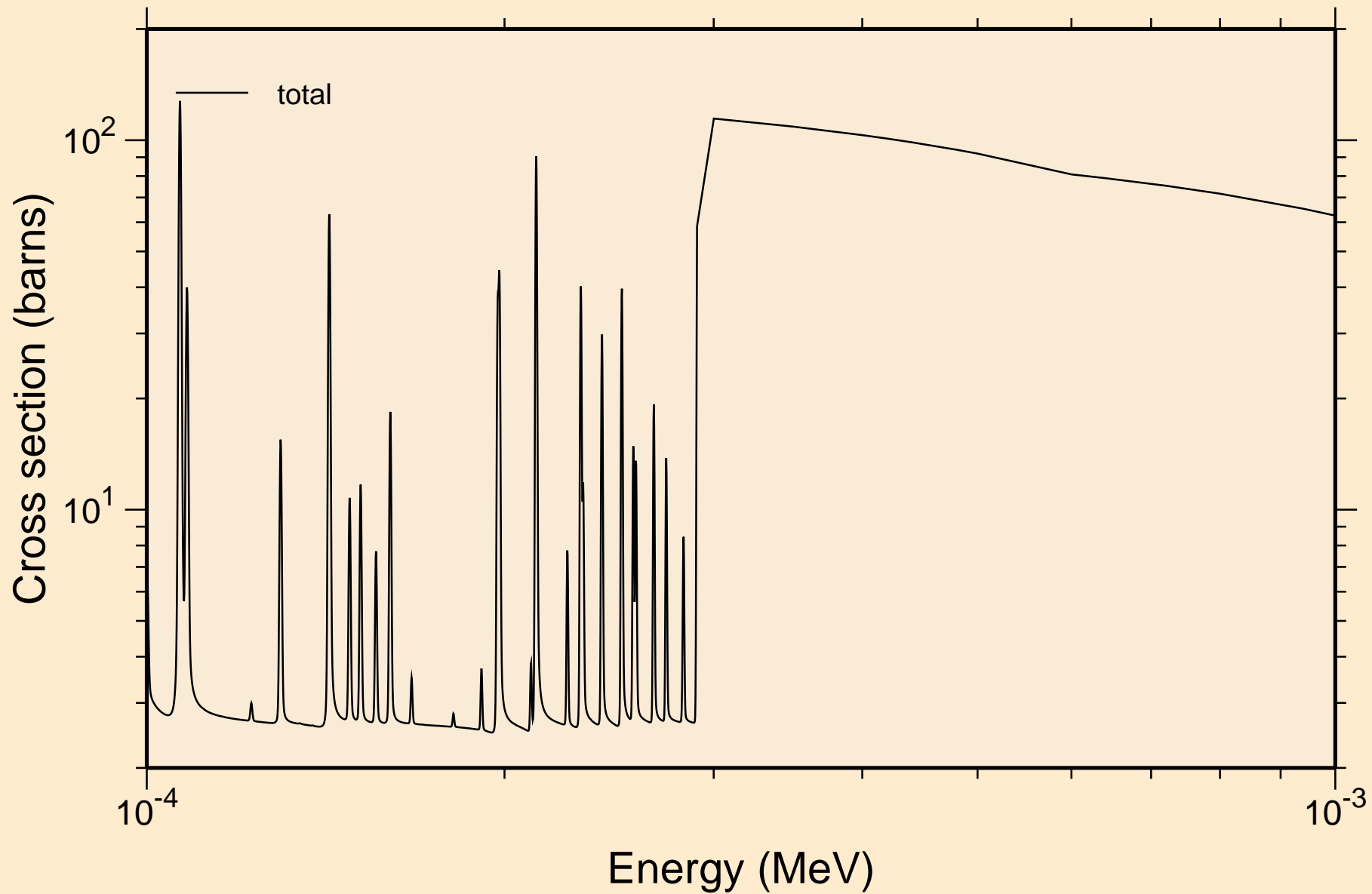

PM145 NEUTRON ACER TENDL-2021 LIBRARY; T=293.6K
resonance total cross section

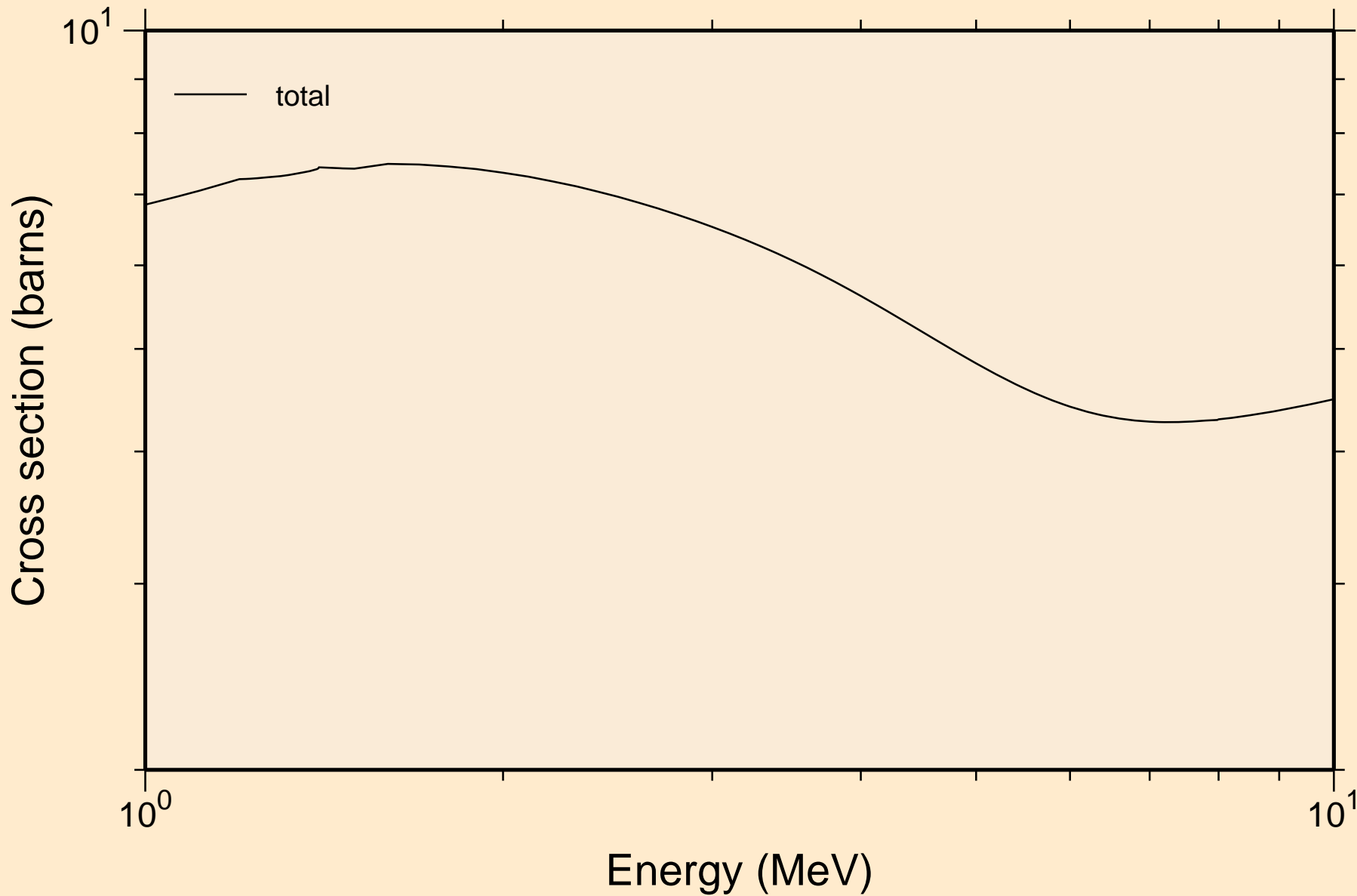

PM145 NEUTRON ACER TENDL-2021 LIBRARY; T=293.6K
resonance absorption cross sections

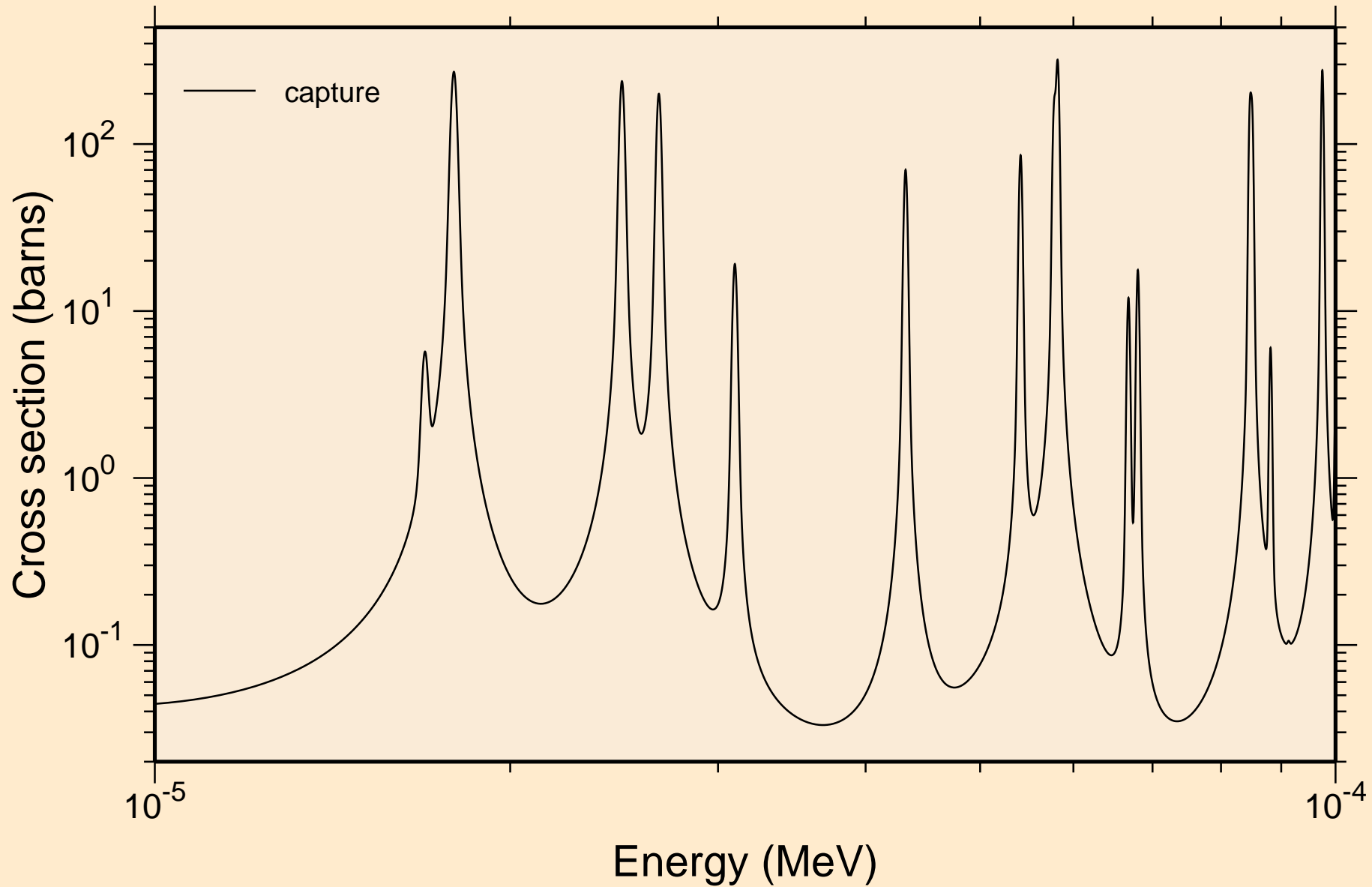

PM145 NEUTRON ACER TENDL-2021 LIBRARY; T=293.6K
resonance absorption cross sections

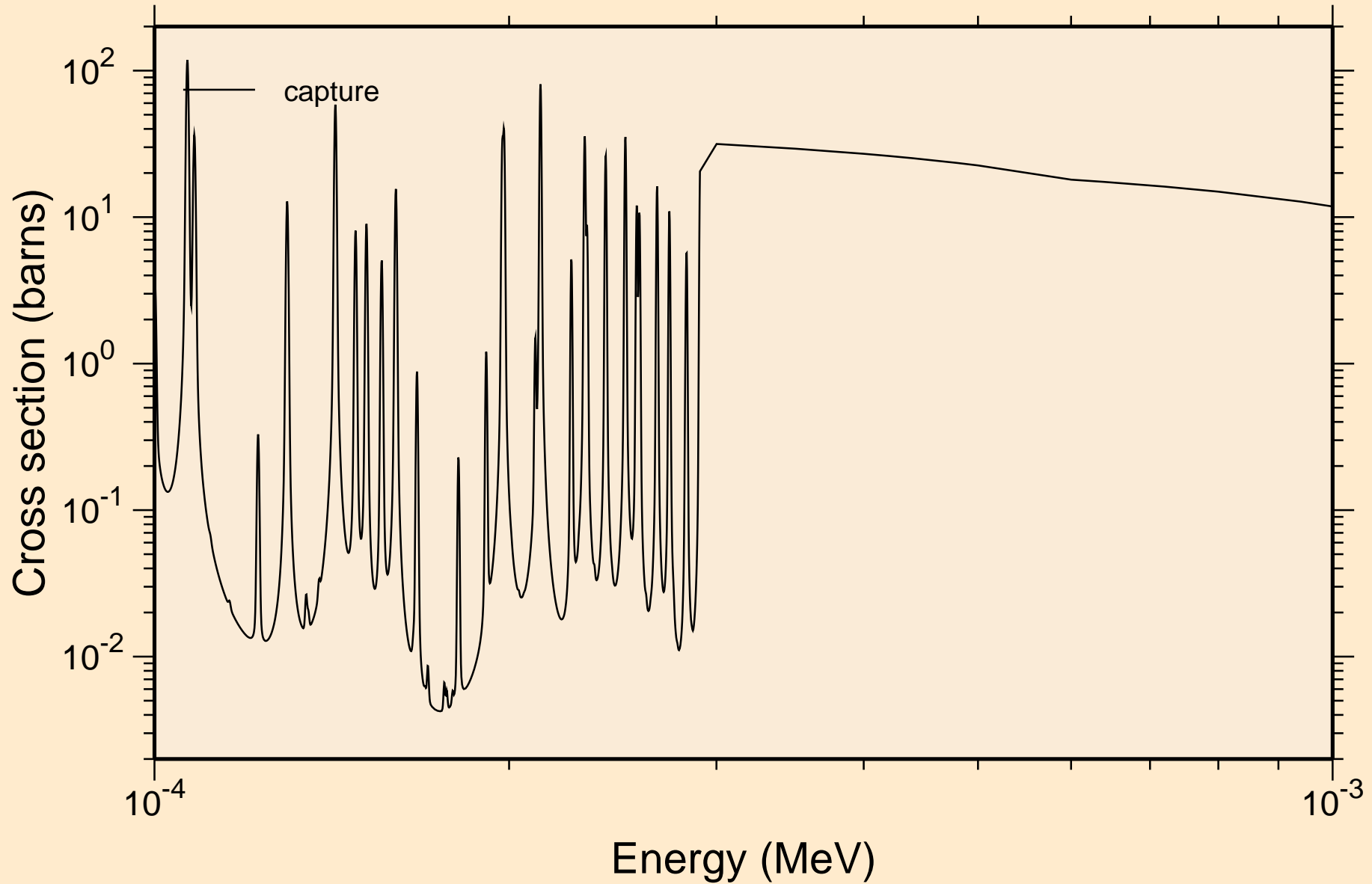

PM145 NEUTRON ACER TENDL-2021 LIBRARY; T=293.6K
resonance absorption cross sections

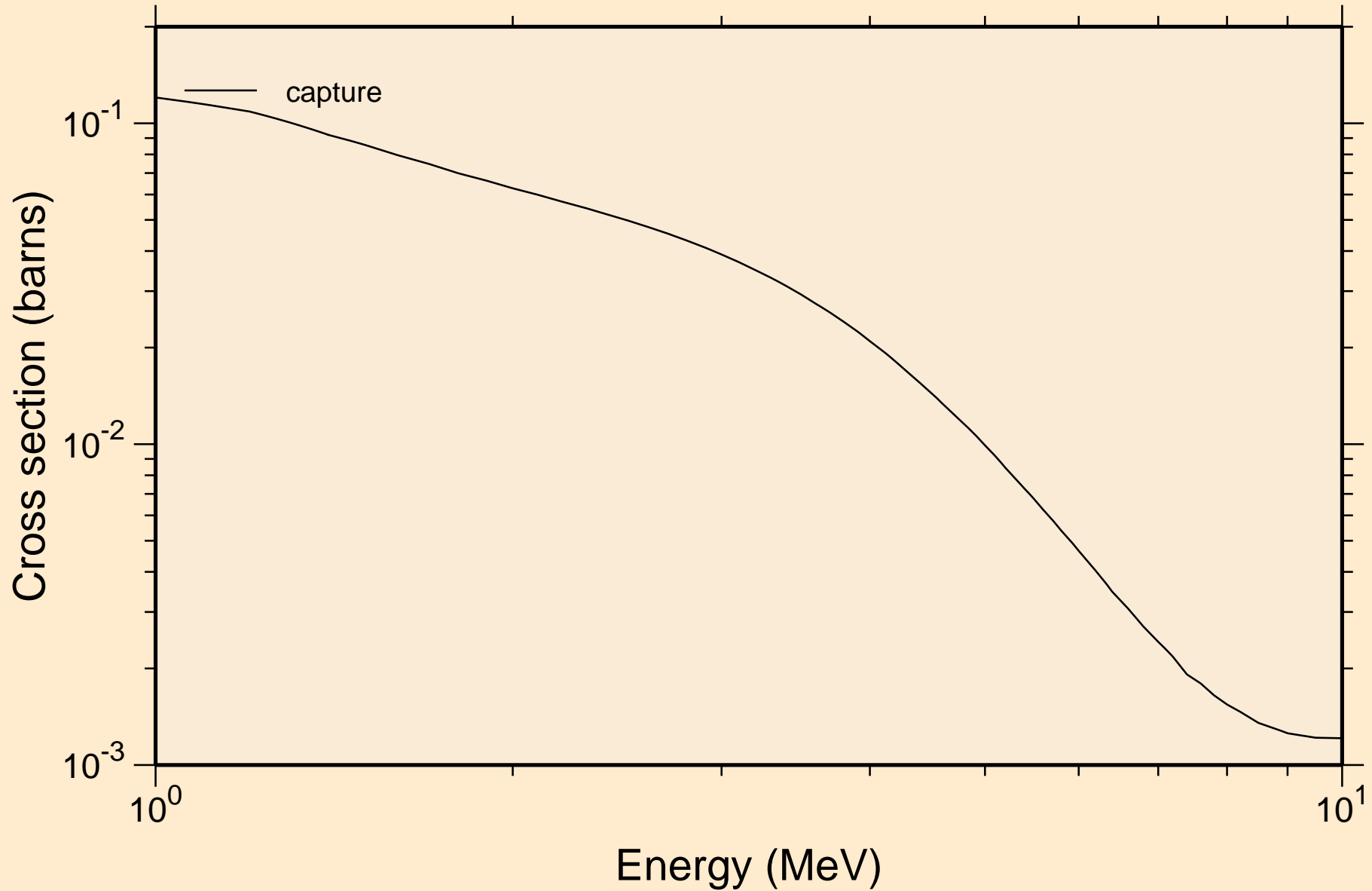

PM145 NEUTRON ACER TENDL-2021 LIBRARY; T=293.6K
Heating

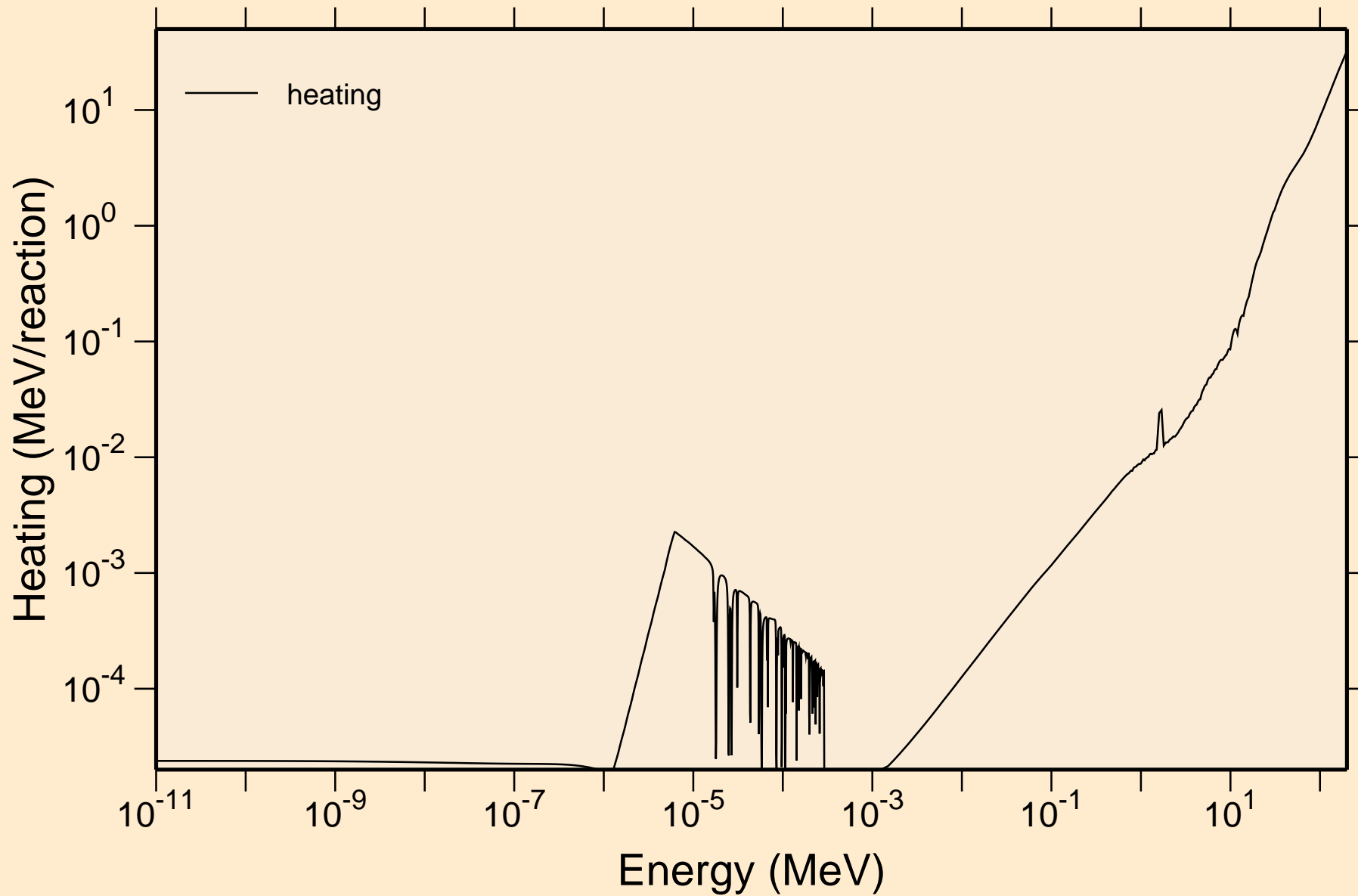

PM145 NEUTRON ACER TENDL-2021 LIBRARY; T=293.6K
Damage

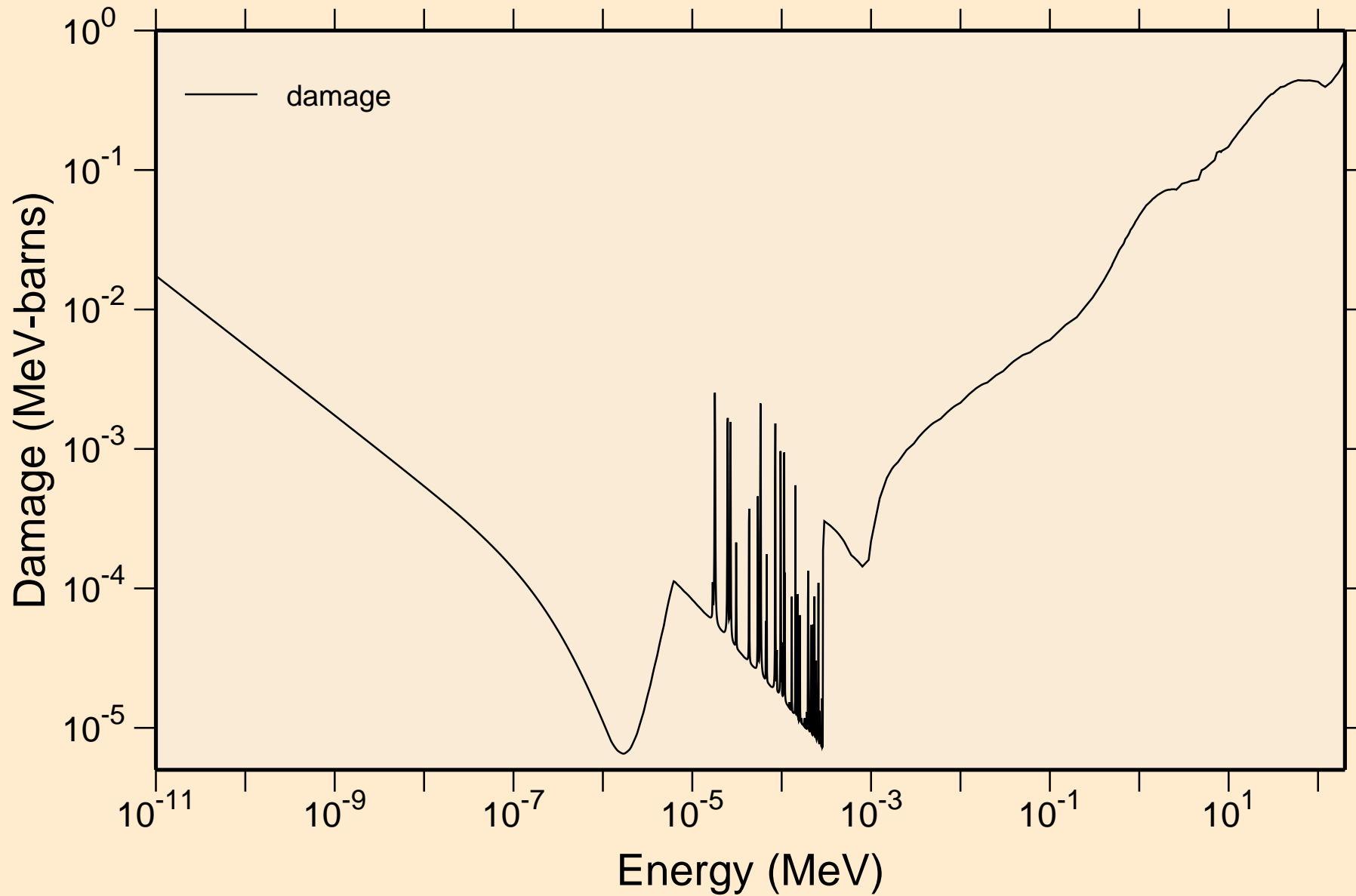

PM145 NEUTRON ACER TENDL-2021 LIBRARY; T=293.6K
Non-threshold reactions

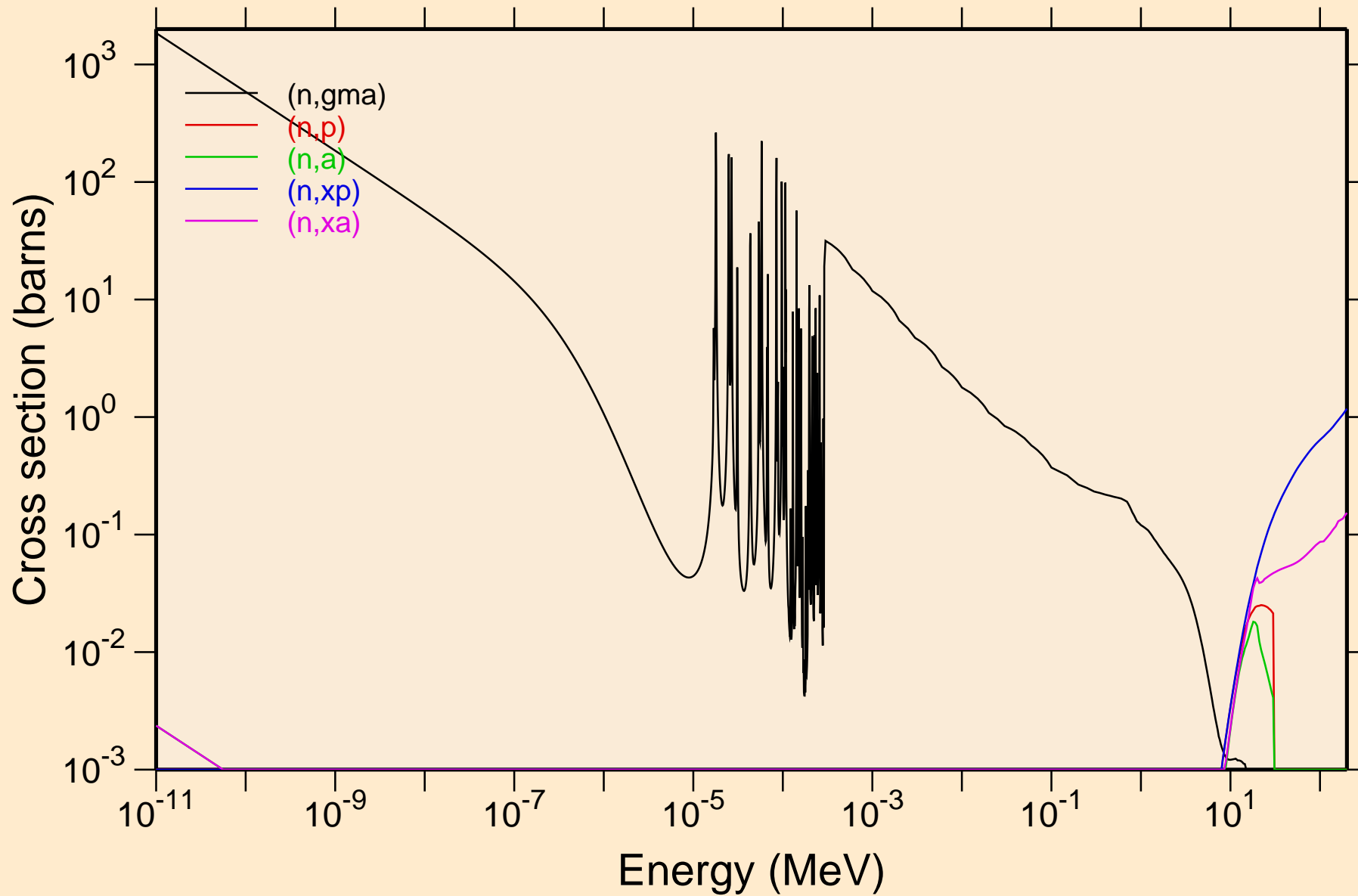

PM145 NEUTRON ACER TENDL-2021 LIBRARY; T=293.6K
Principal cross sections

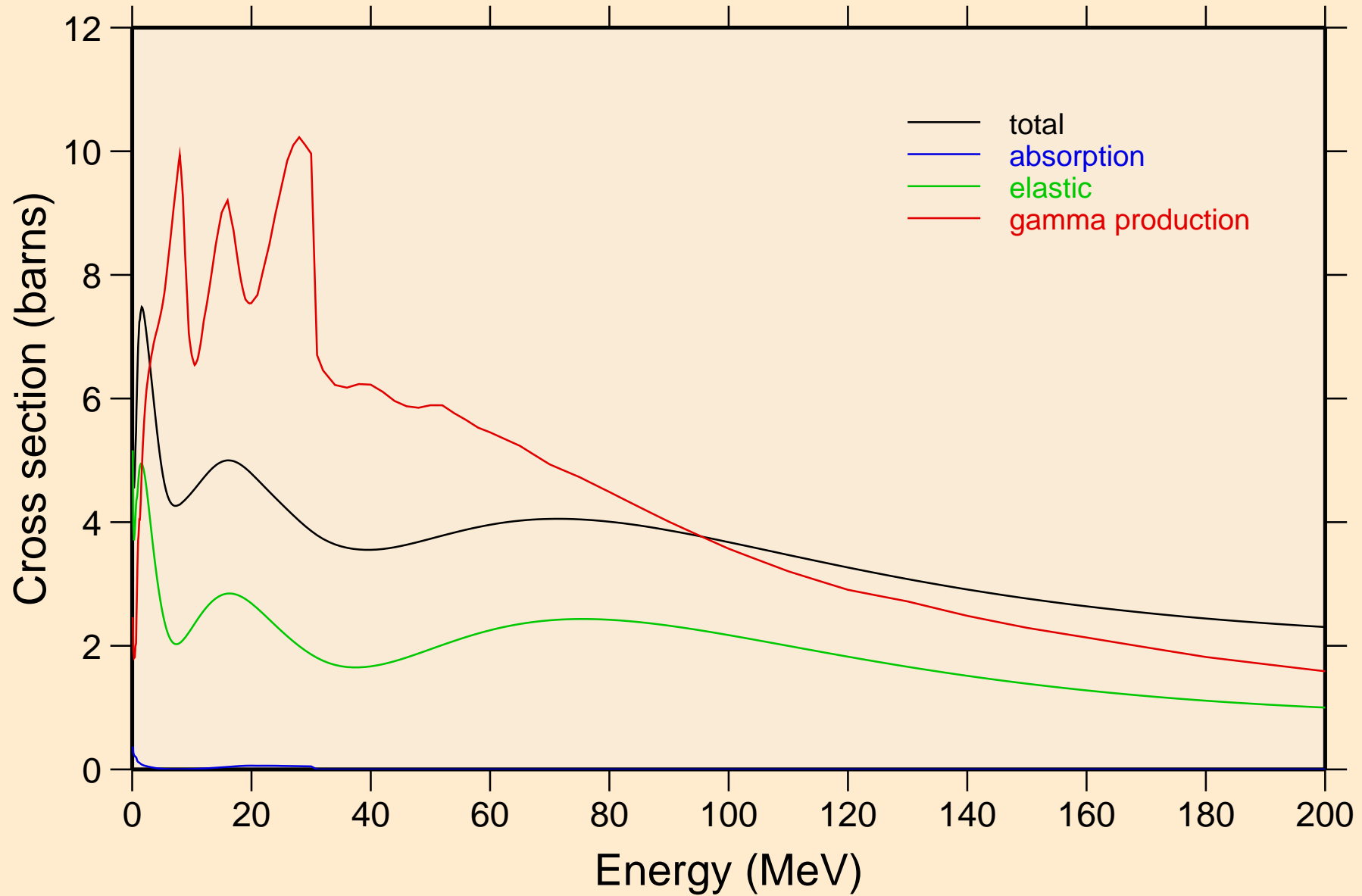

PM145 NEUTRON ACER TENDL-2021 LIBRARY; T=293.6K
Heating

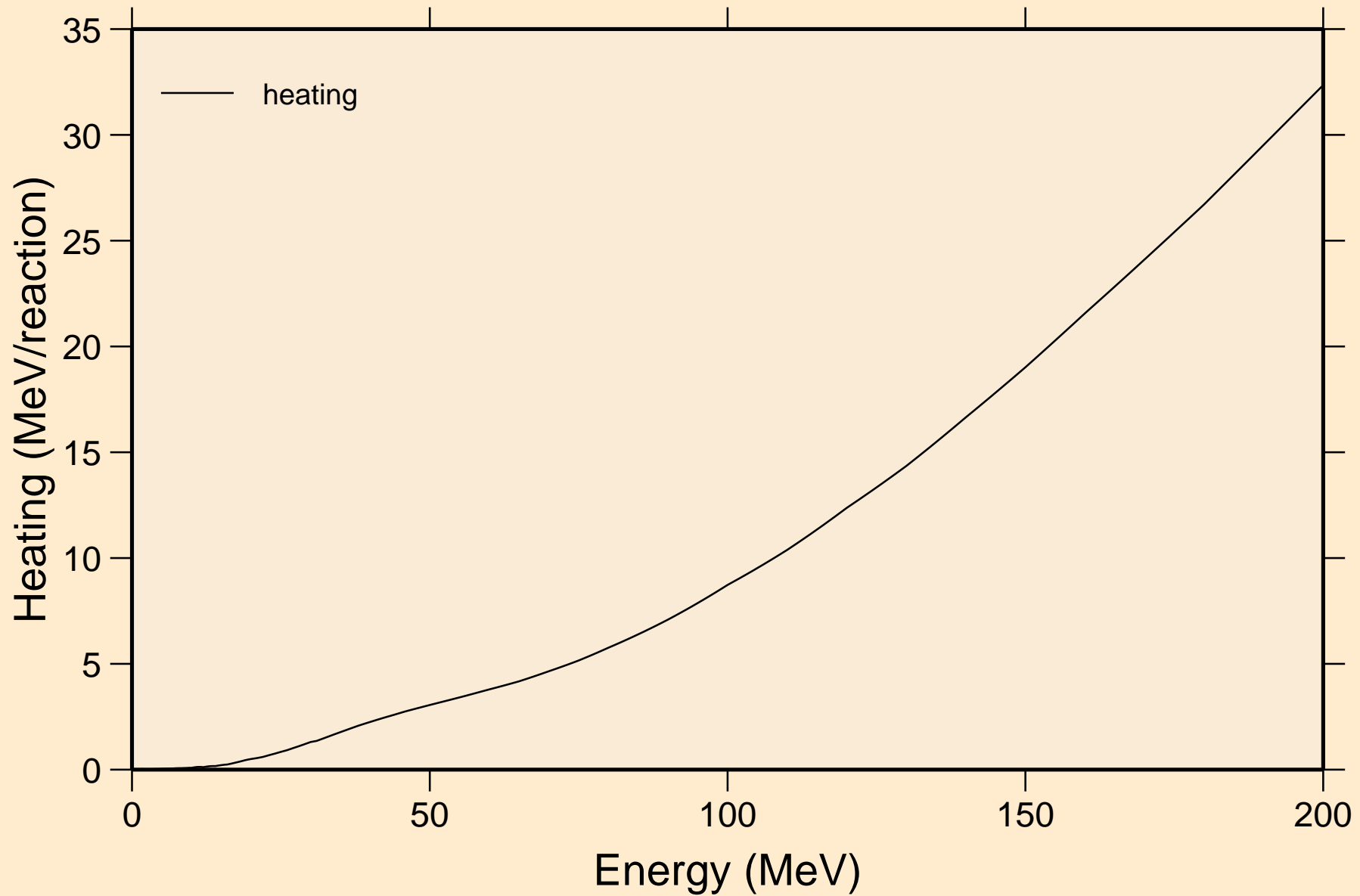

PM145 NEUTRON ACER TENDL-2021 LIBRARY; T=293.6K
Damage

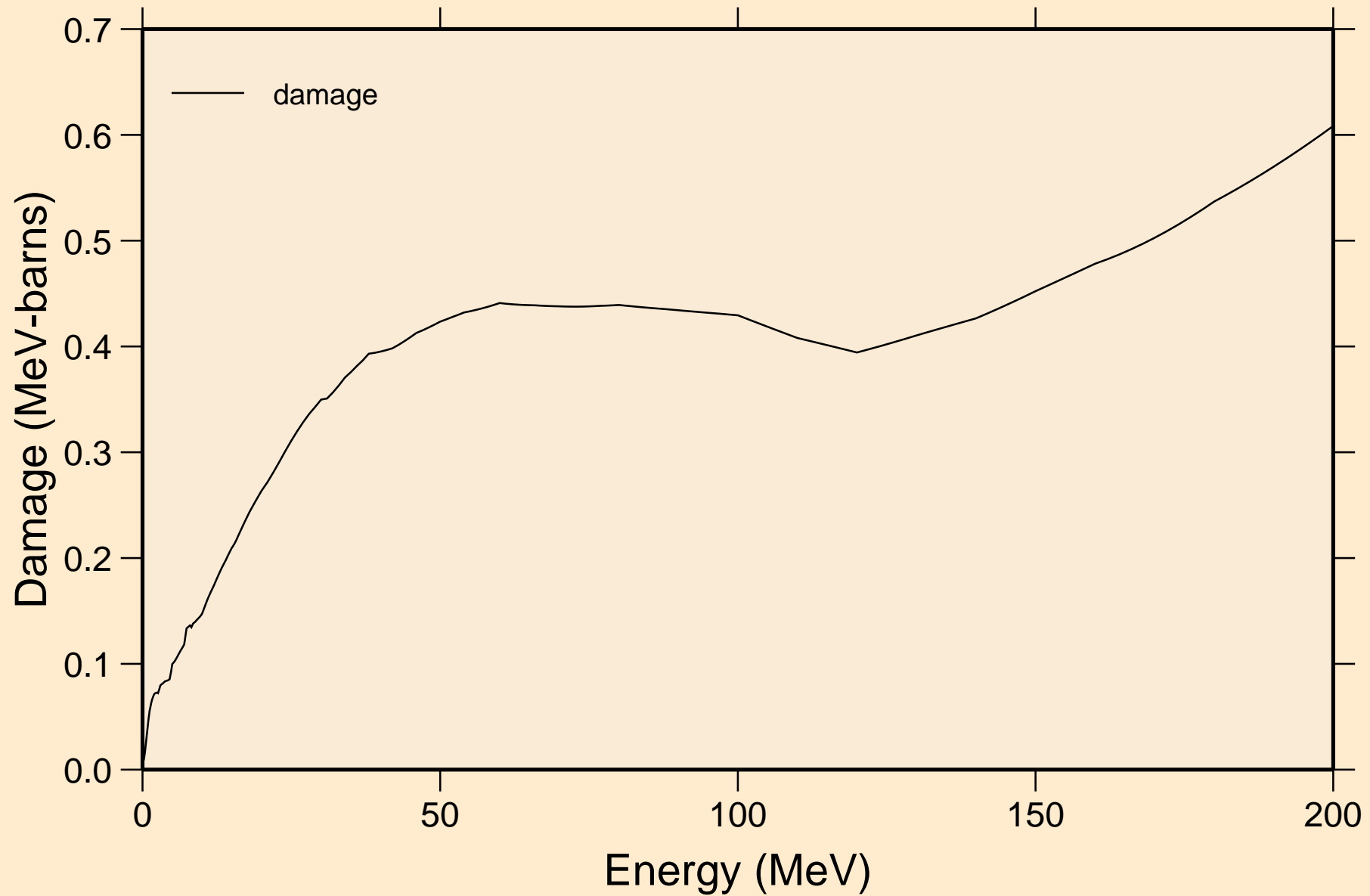

PM145 NEUTRON ACER TENDL-2021 LIBRARY; T=293.6K
Non-threshold reactions

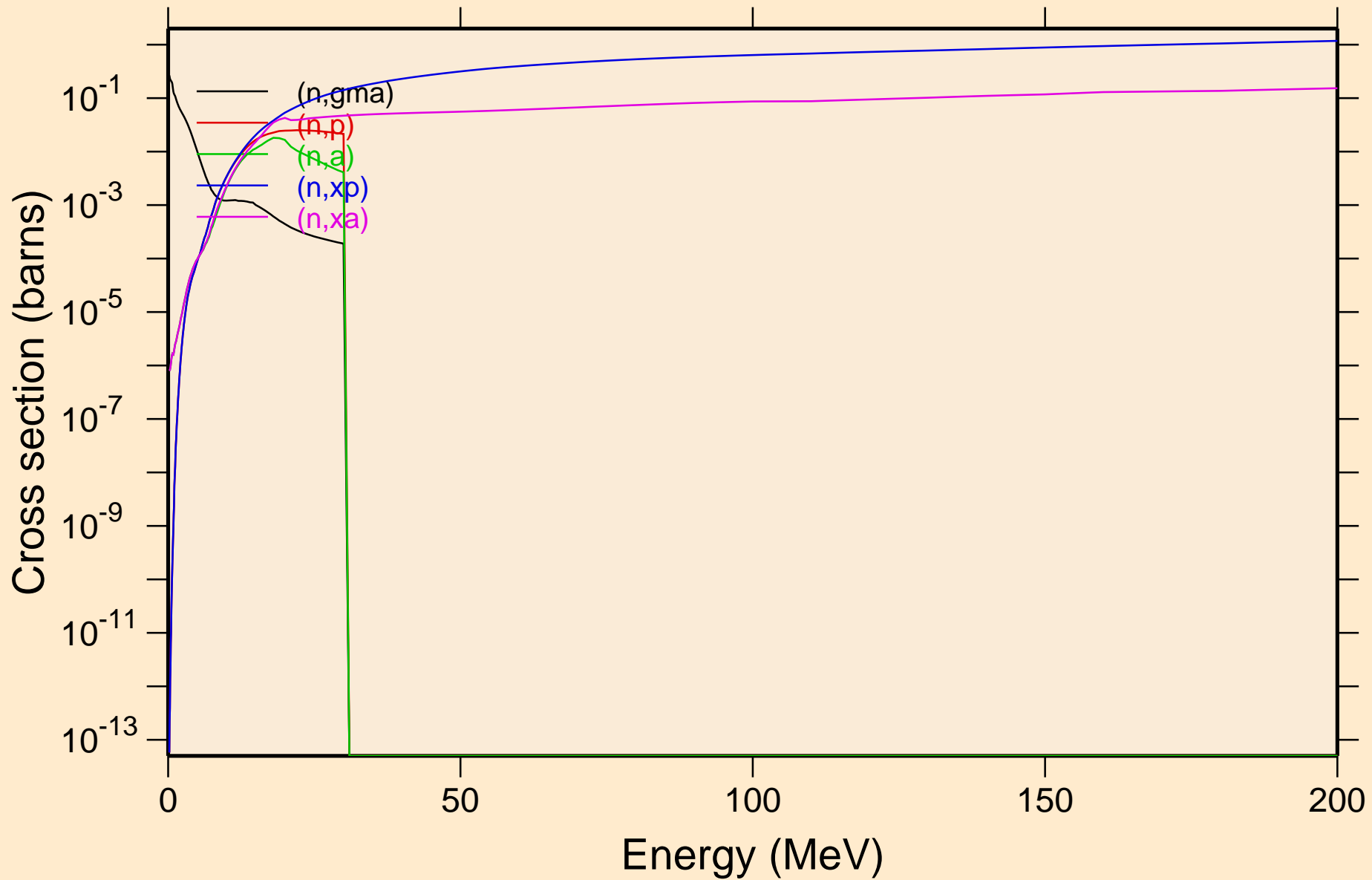

PM145 NEUTRON ACER TENDL-2021 LIBRARY; T=293.6K
Inelastic levels

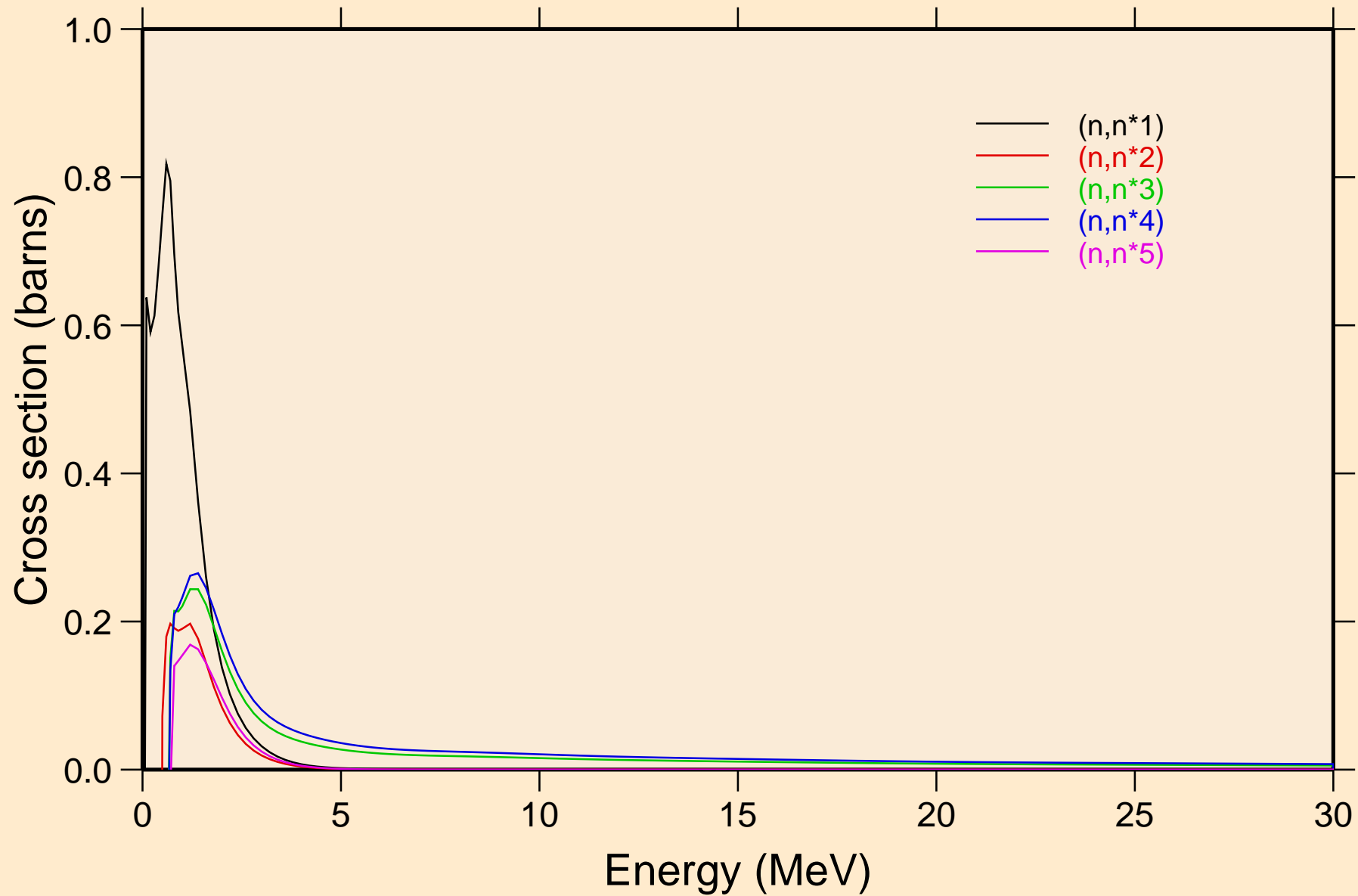

PM145 NEUTRON ACER TENDL-2021 LIBRARY; T=293.6K
Inelastic levels

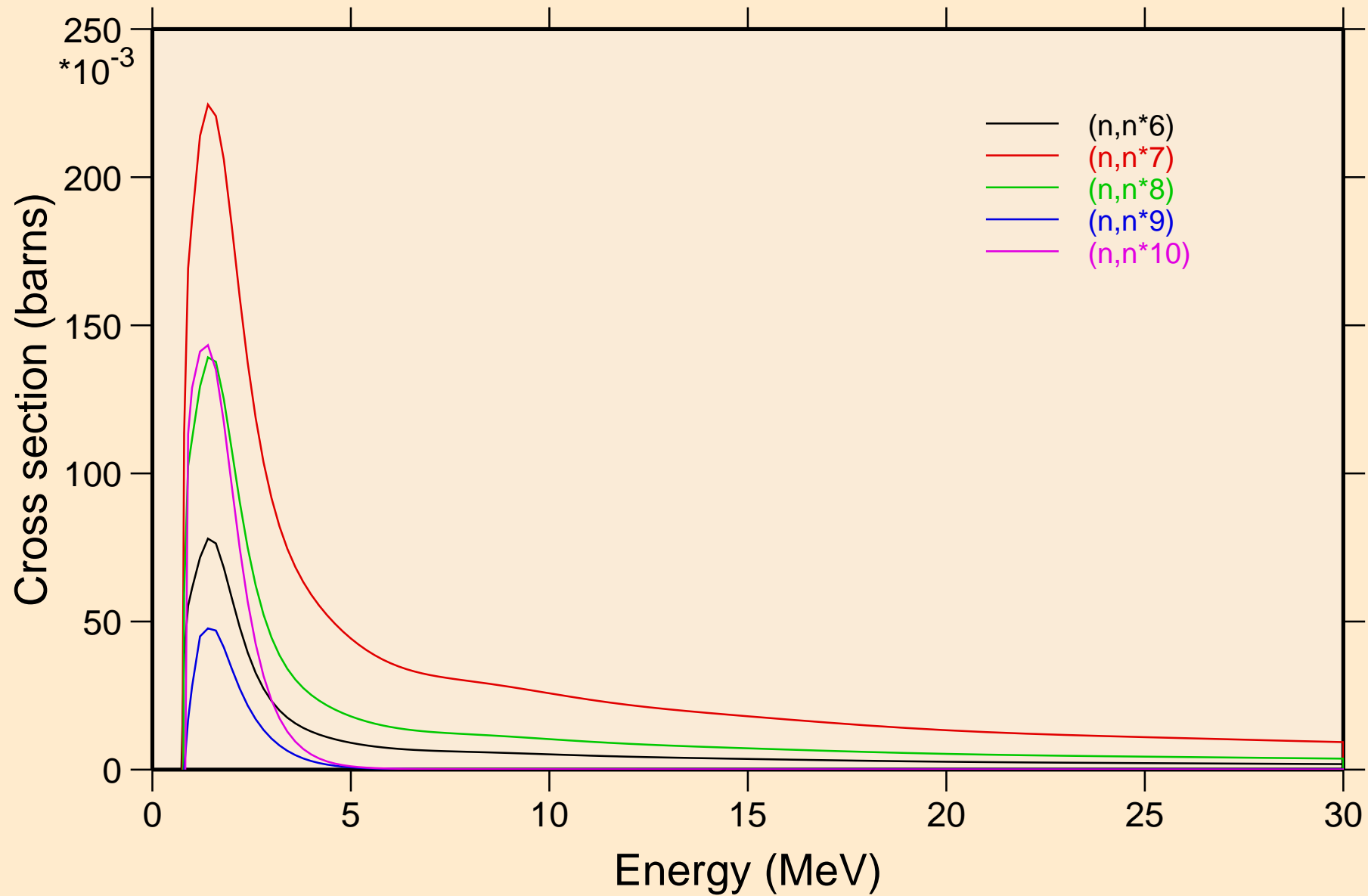

PM145 NEUTRON ACER TENDL-2021 LIBRARY; T=293.6K
Inelastic levels

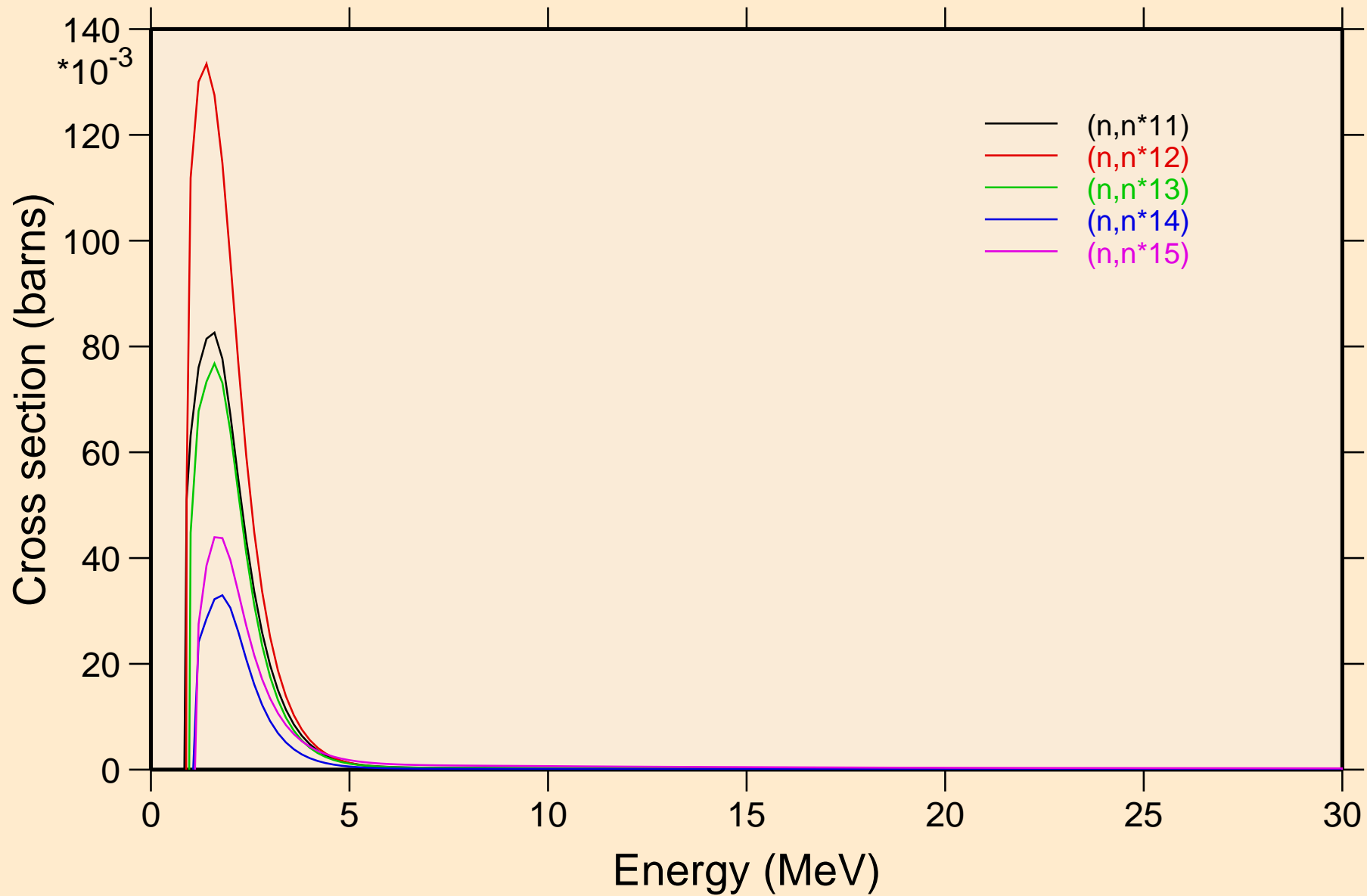

PM145 NEUTRON ACER TENDL-2021 LIBRARY; T=293.6K
Inelastic levels

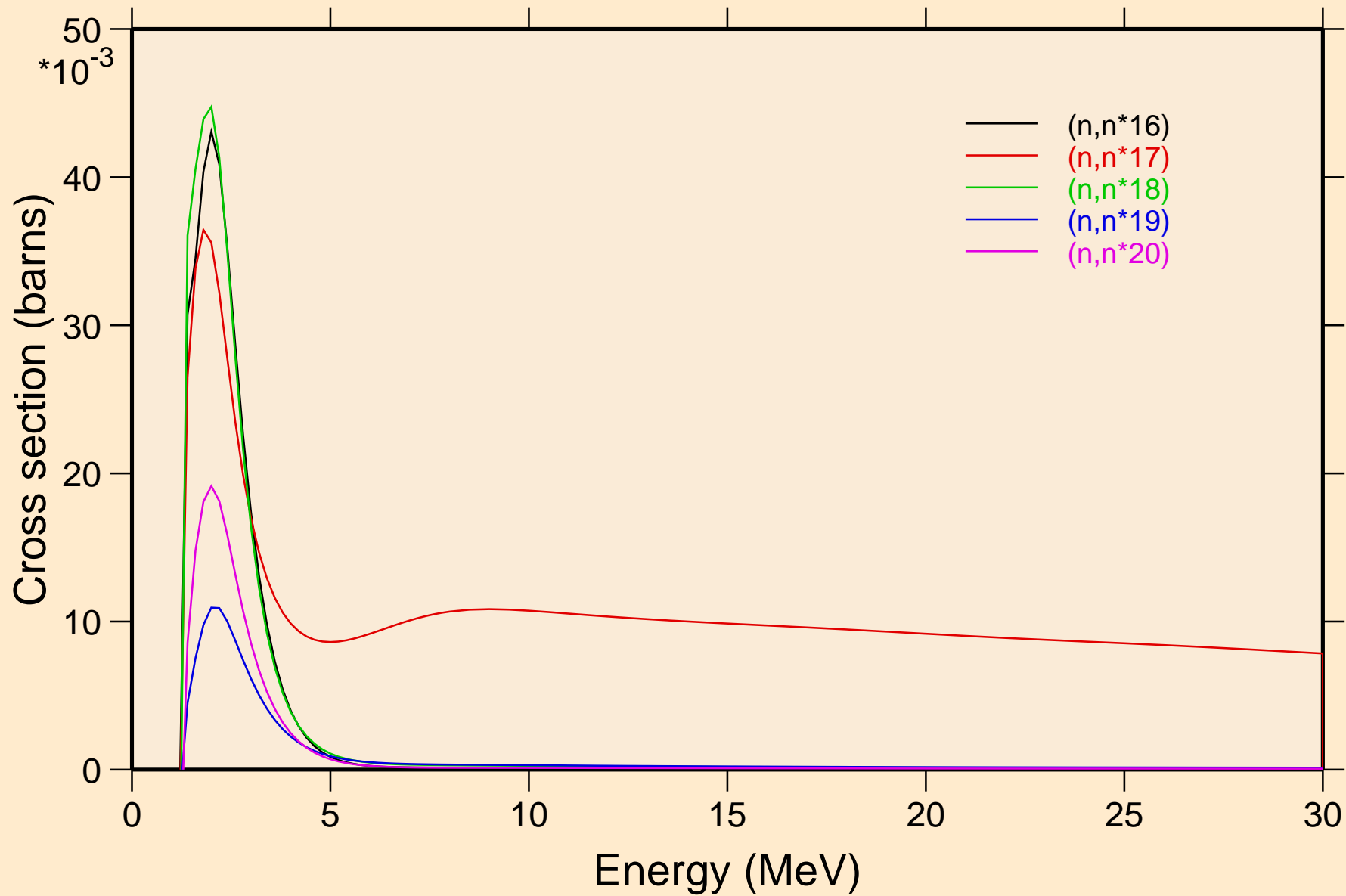

PM145 NEUTRON ACER TENDL-2021 LIBRARY; T=293.6K
Inelastic levels

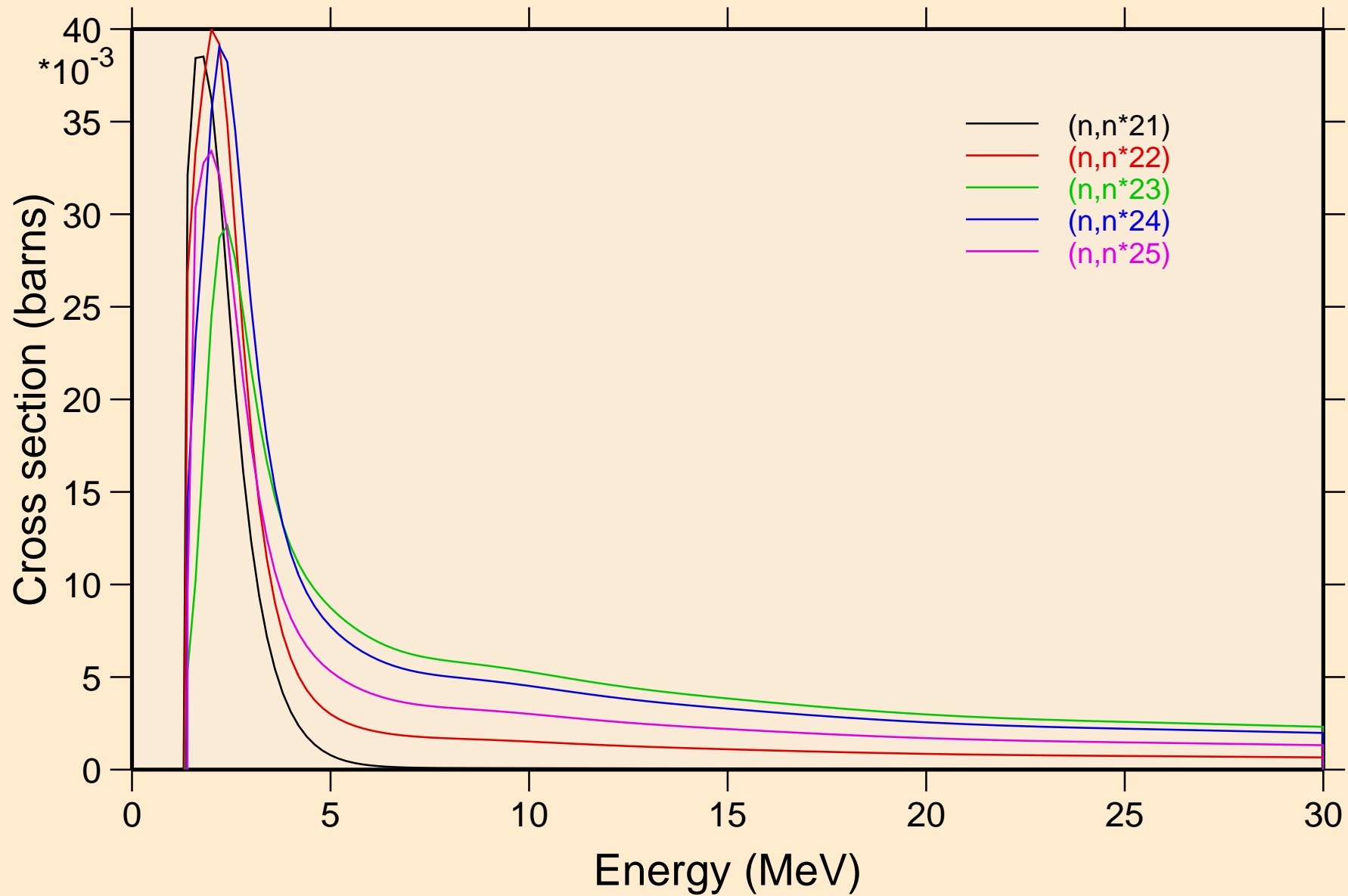

PM145 NEUTRON ACER TENDL-2021 LIBRARY; T=293.6K
Inelastic levels

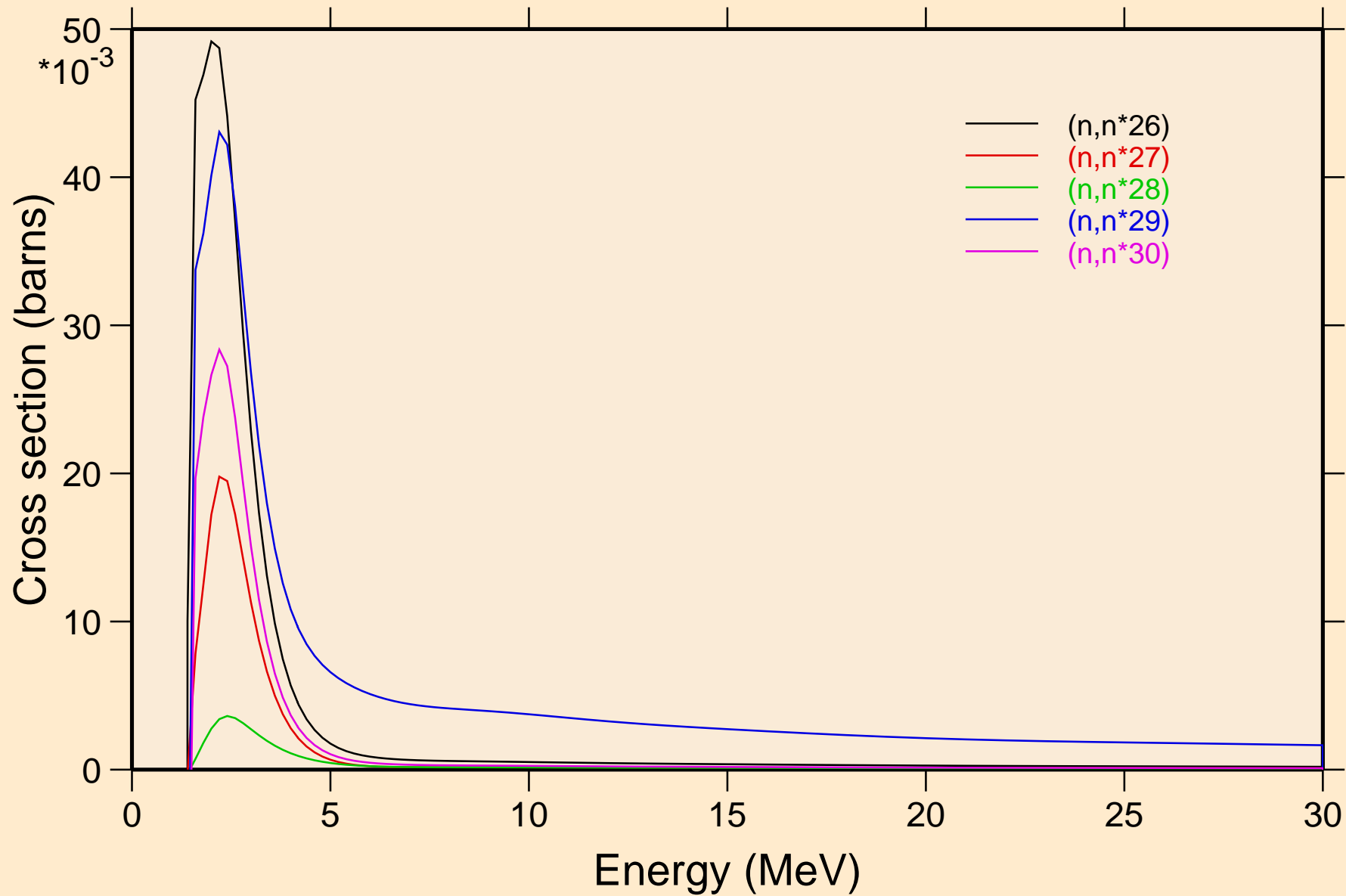

PM145 NEUTRON ACER TENDL-2021 LIBRARY; T=293.6K
Threshold reactions

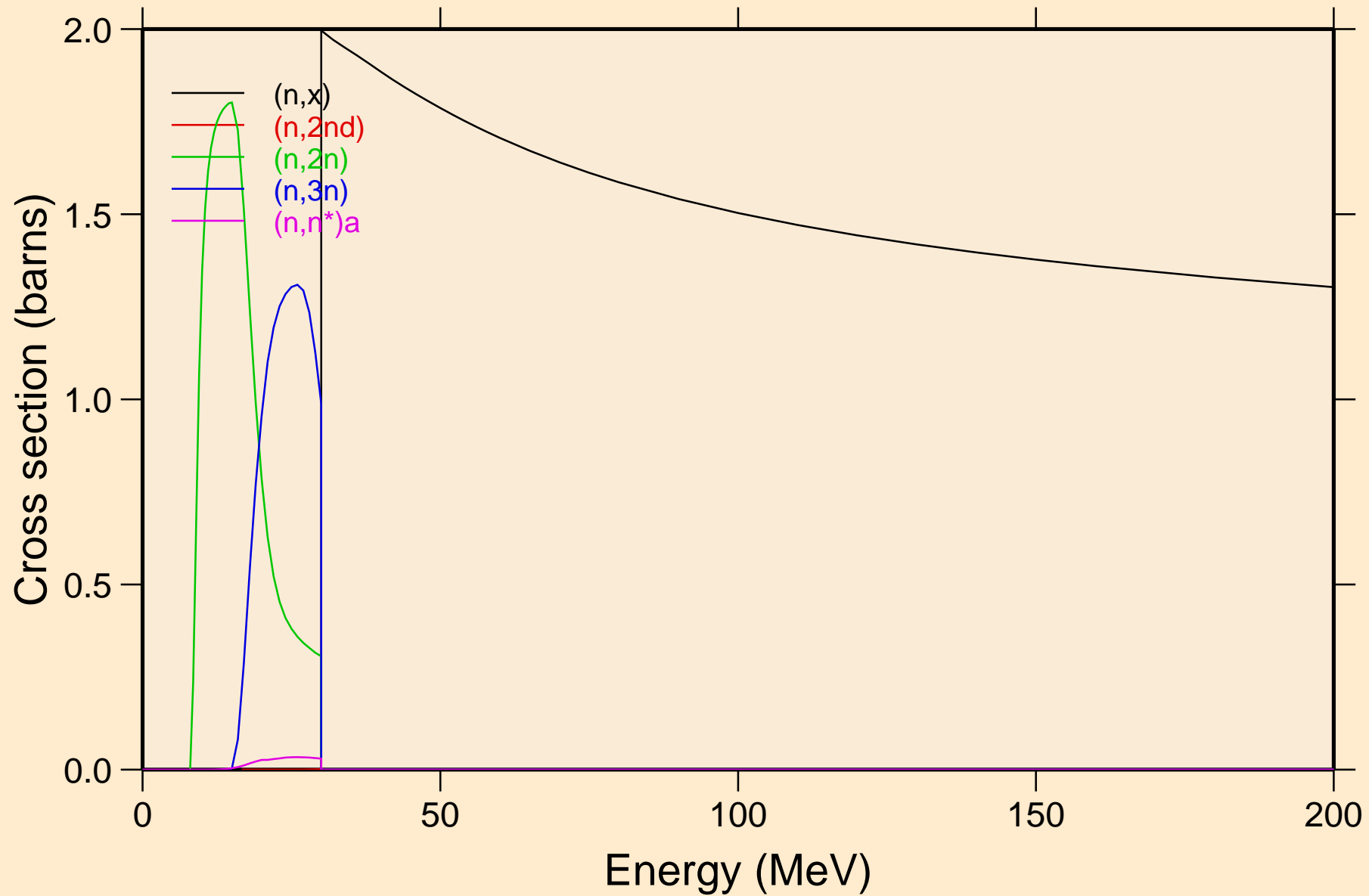

PM145 NEUTRON ACER TENDL-2021 LIBRARY; T=293.6K
Threshold reactions

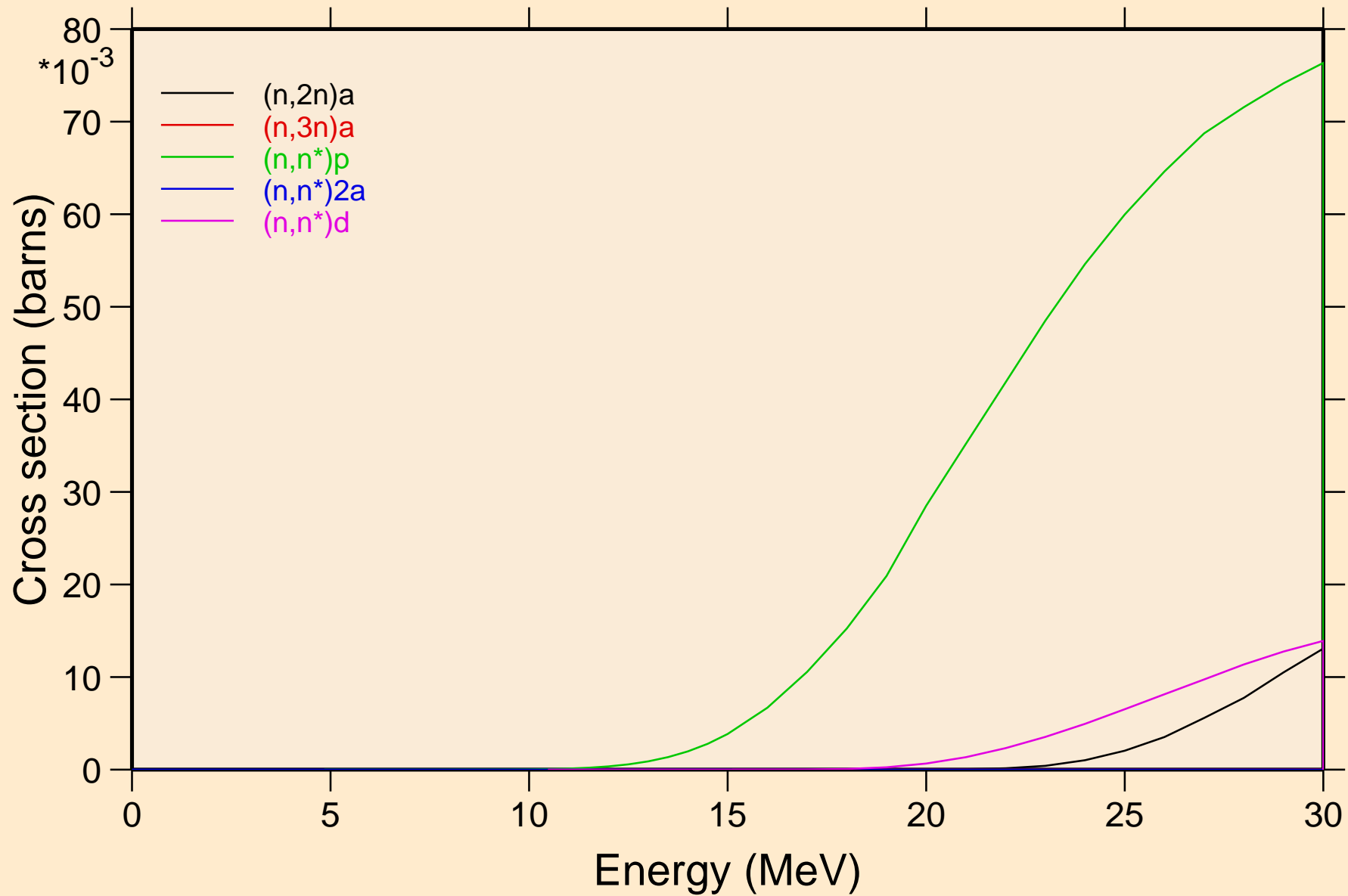

PM145 NEUTRON ACER TENDL-2021 LIBRARY; T=293.6K
Threshold reactions

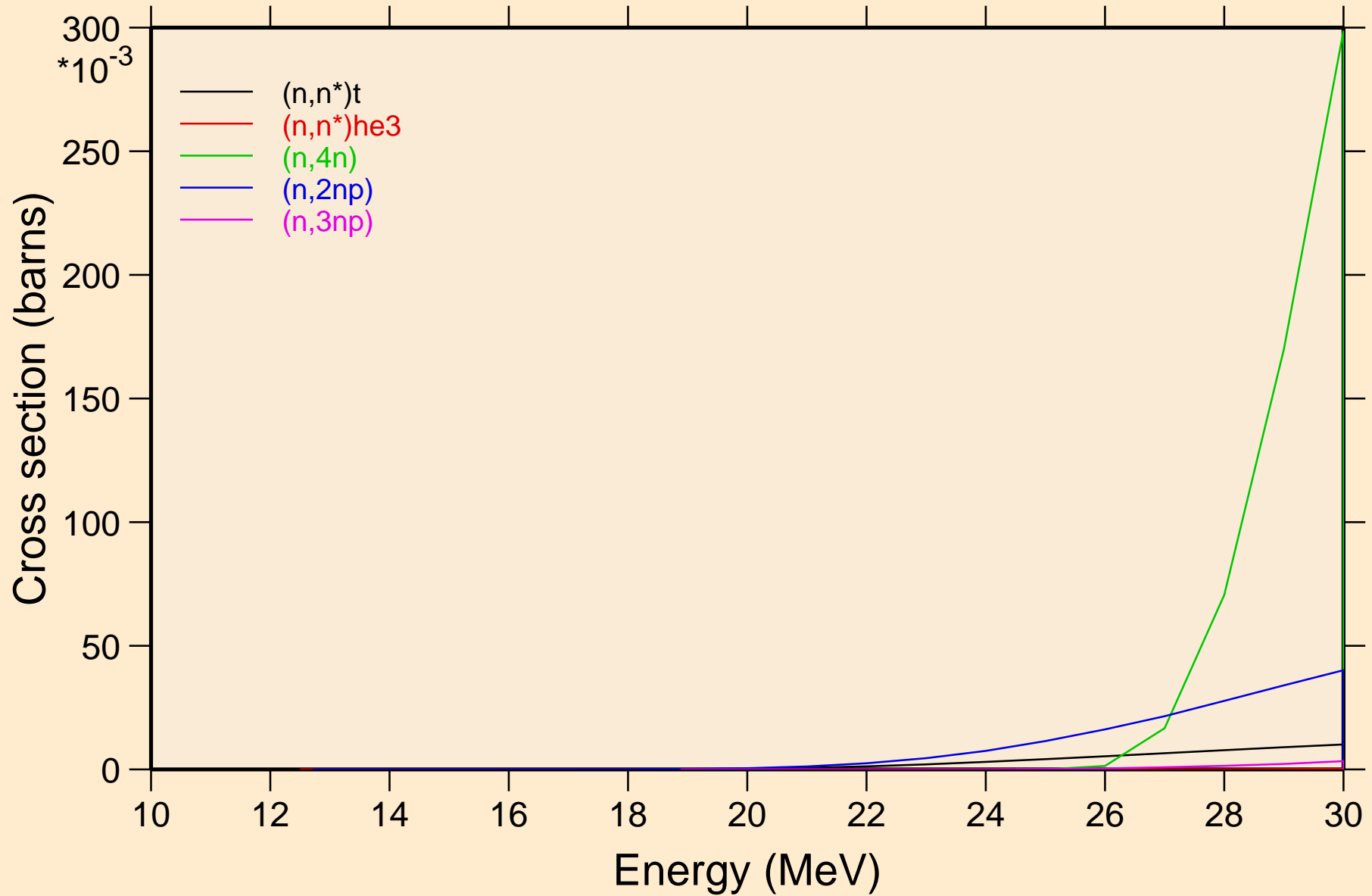

PM145 NEUTRON ACER TENDL-2021 LIBRARY; T=293.6K
Threshold reactions

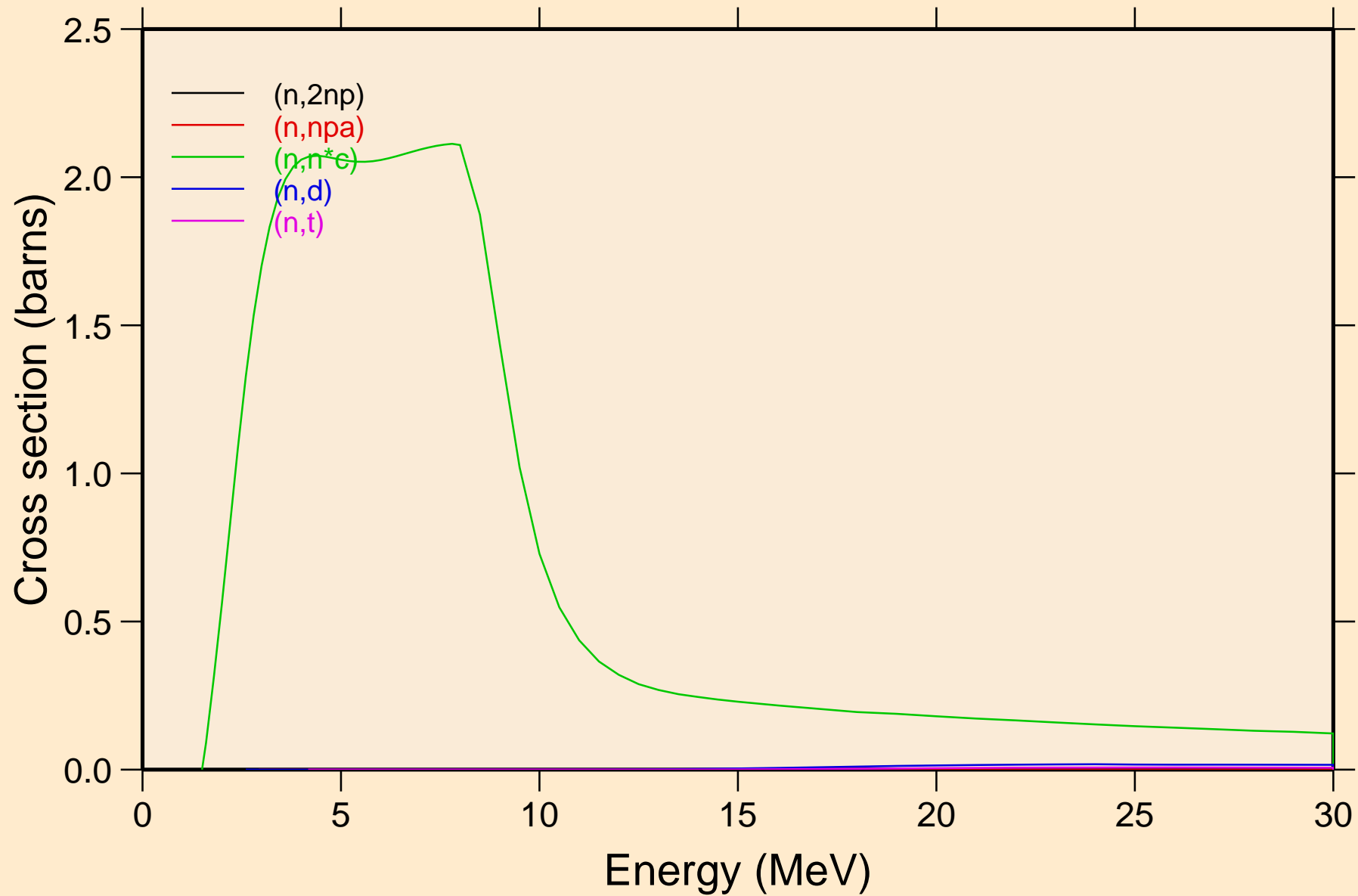

PM145 NEUTRON ACER TENDL-2021 LIBRARY; T=293.6K
Threshold reactions

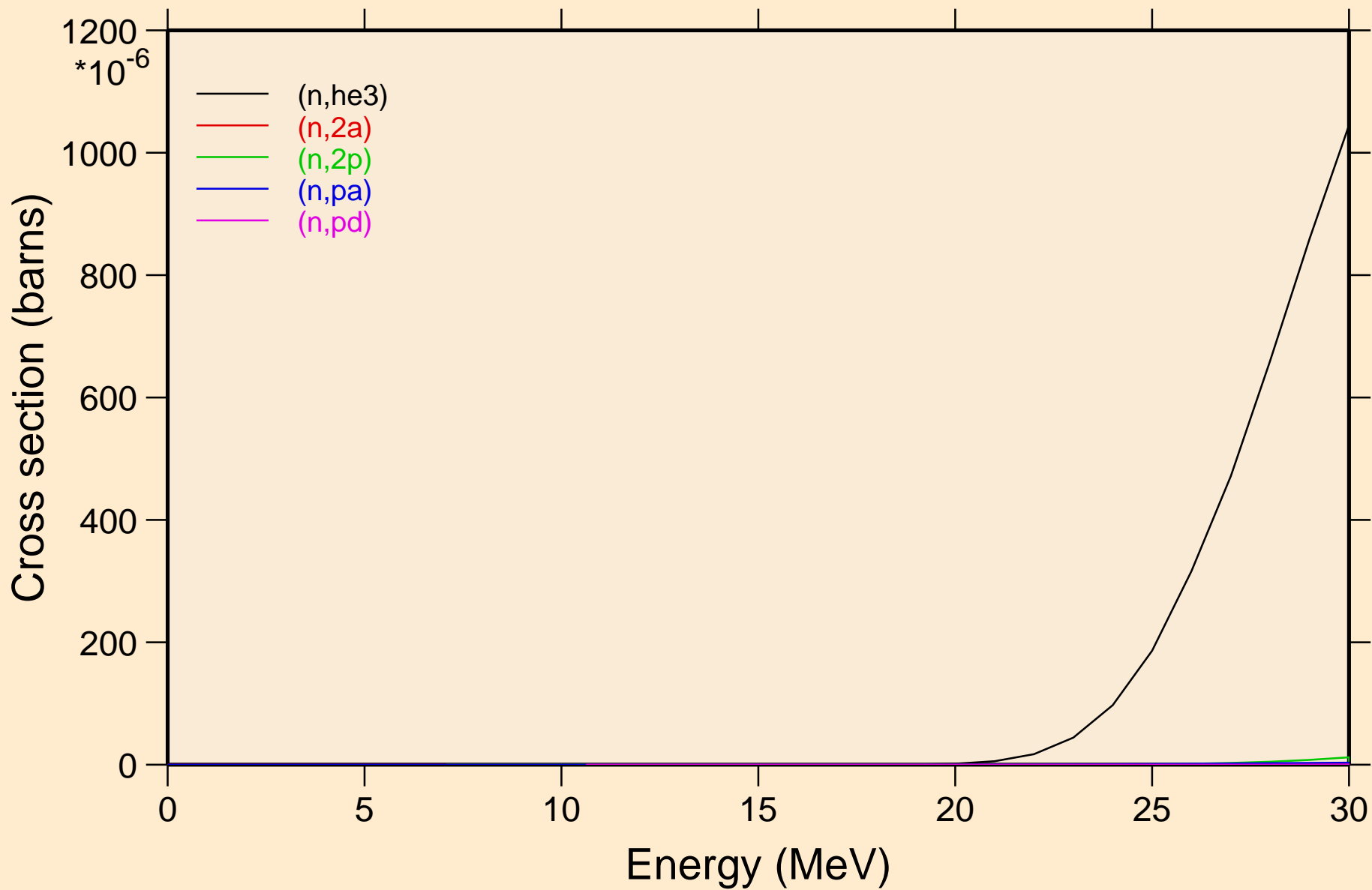

PM145 NEUTRON ACER TENDL-2021 LIBRARY; T=293.6K
Threshold reactions

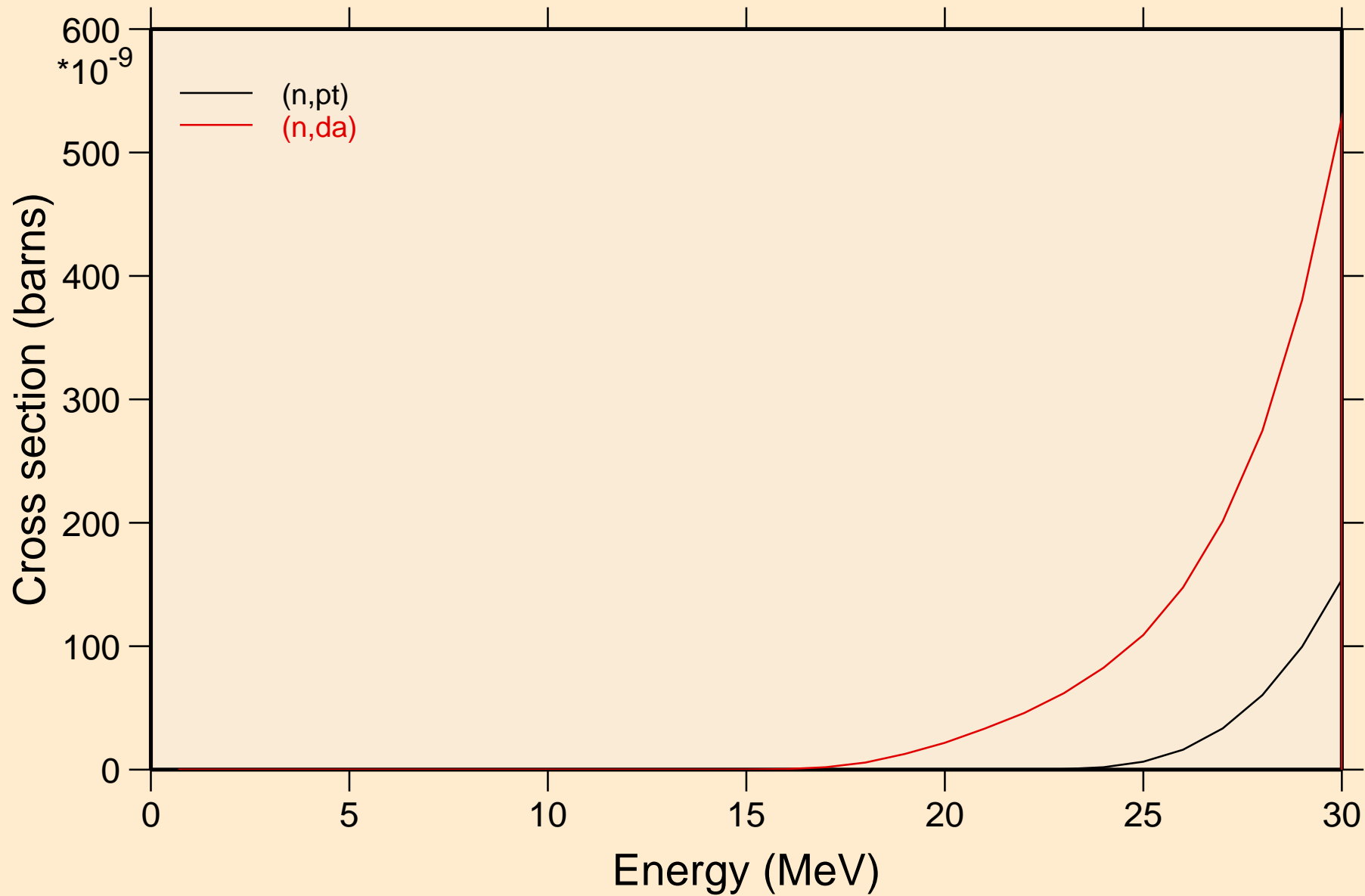

PM145 NEUTRON ACER TENDL-2021 LIBRARY; T=293.6K
Threshold reactions

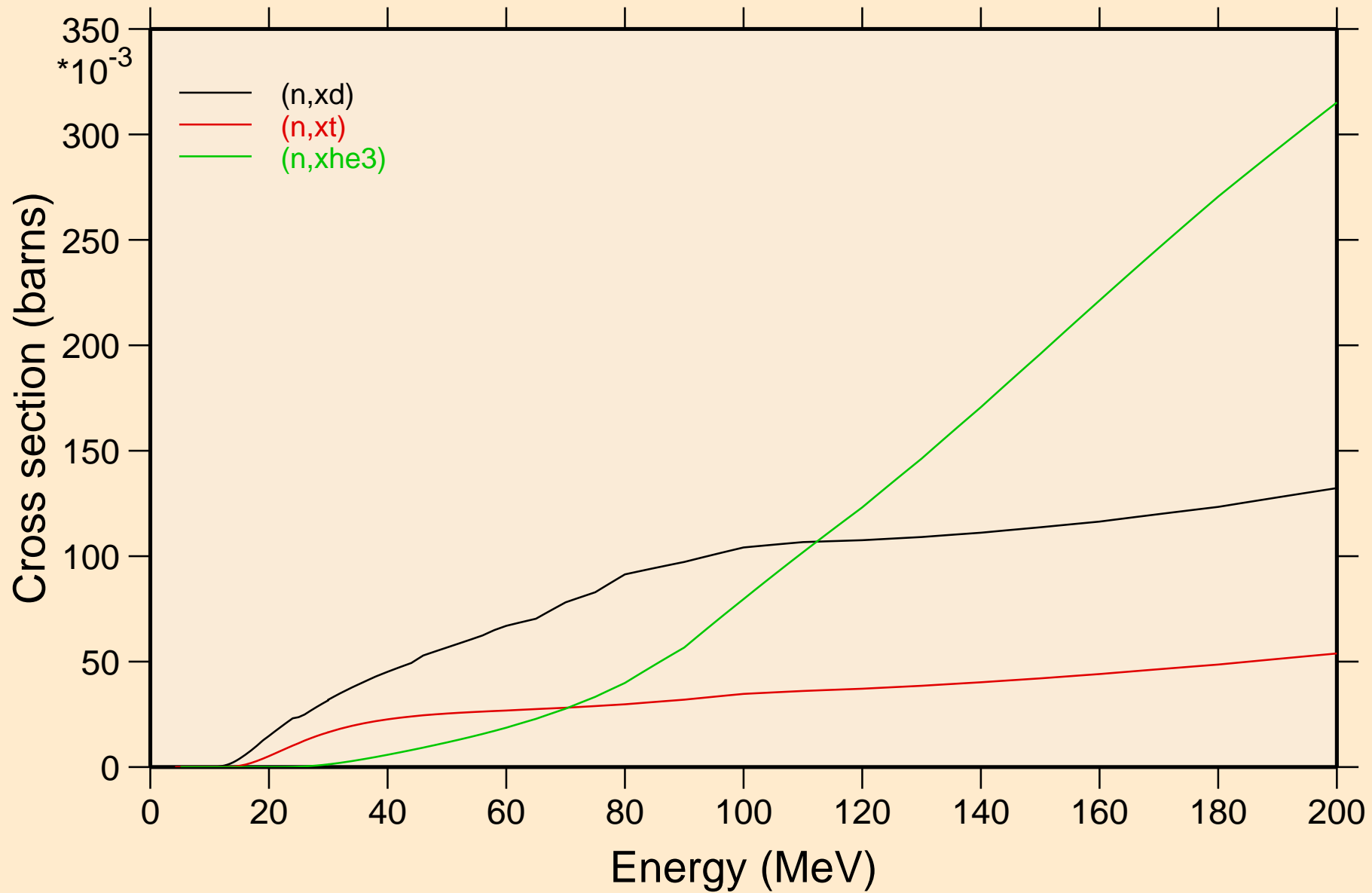

PM145 NEUTRON ACER TENDL-2021 LIBRARY; T=293.6K
angular distribution for elastic

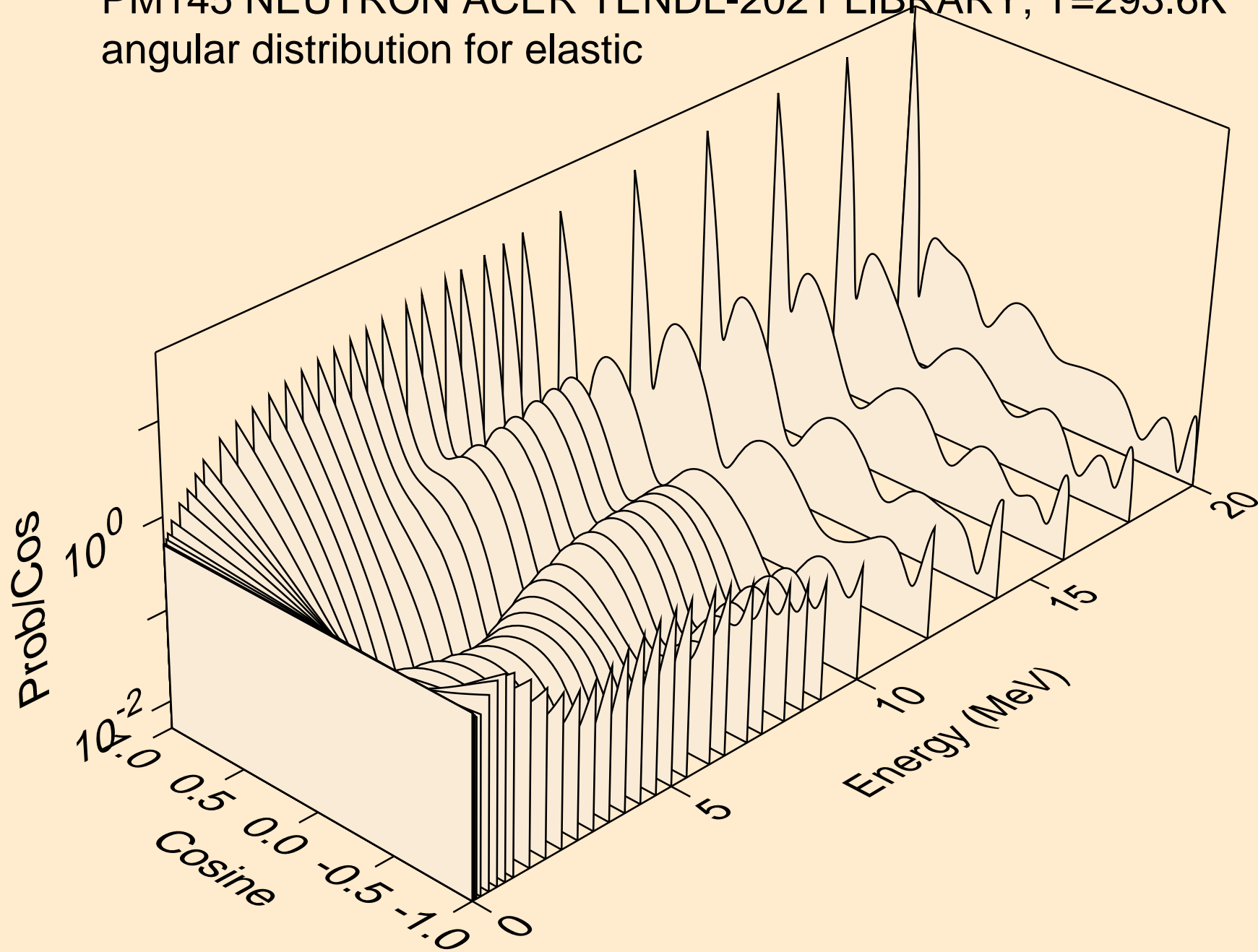

PM145 NEUTRON ACER TENDL-2021 LIBRARY; T=293.6K
angular distribution for elastic

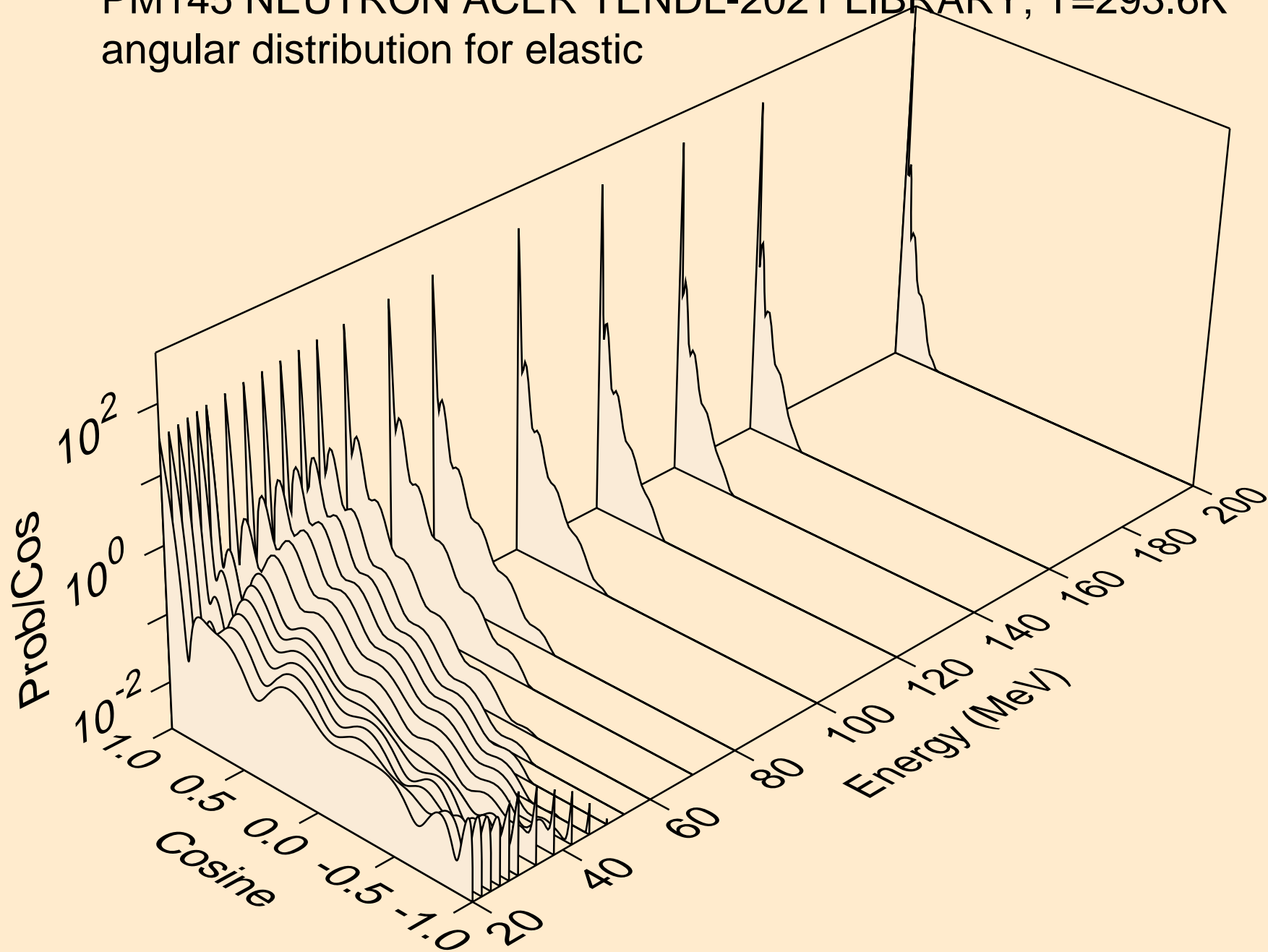

PM145 NEUTRON ACER TENDL-2021 LIBRARY; T=293.6K
angular distribution for (n,n*1)

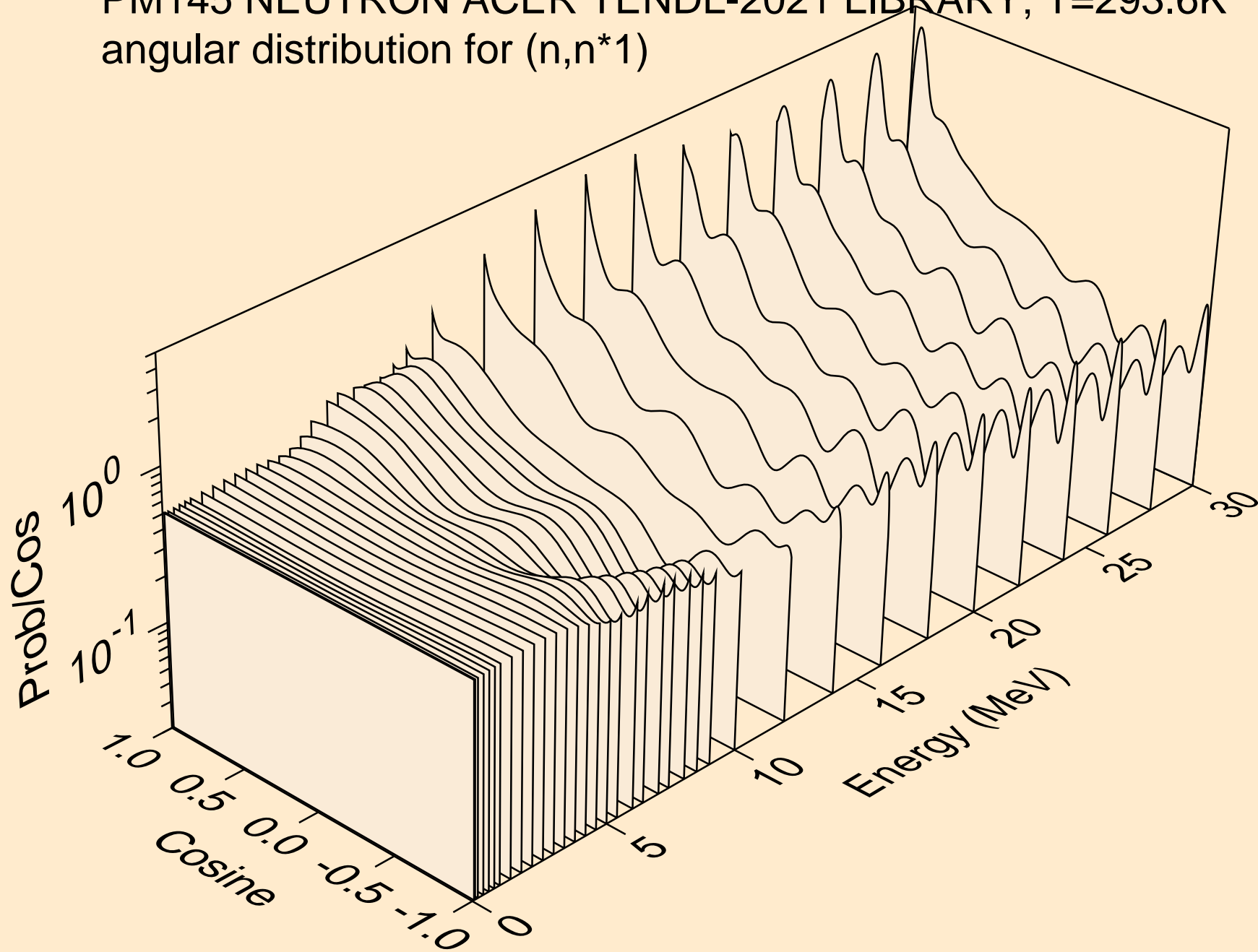

PM145 NEUTRON ACER TENDL-2021 LIBRARY; T=293.6K
angular distribution for (n,n*2)

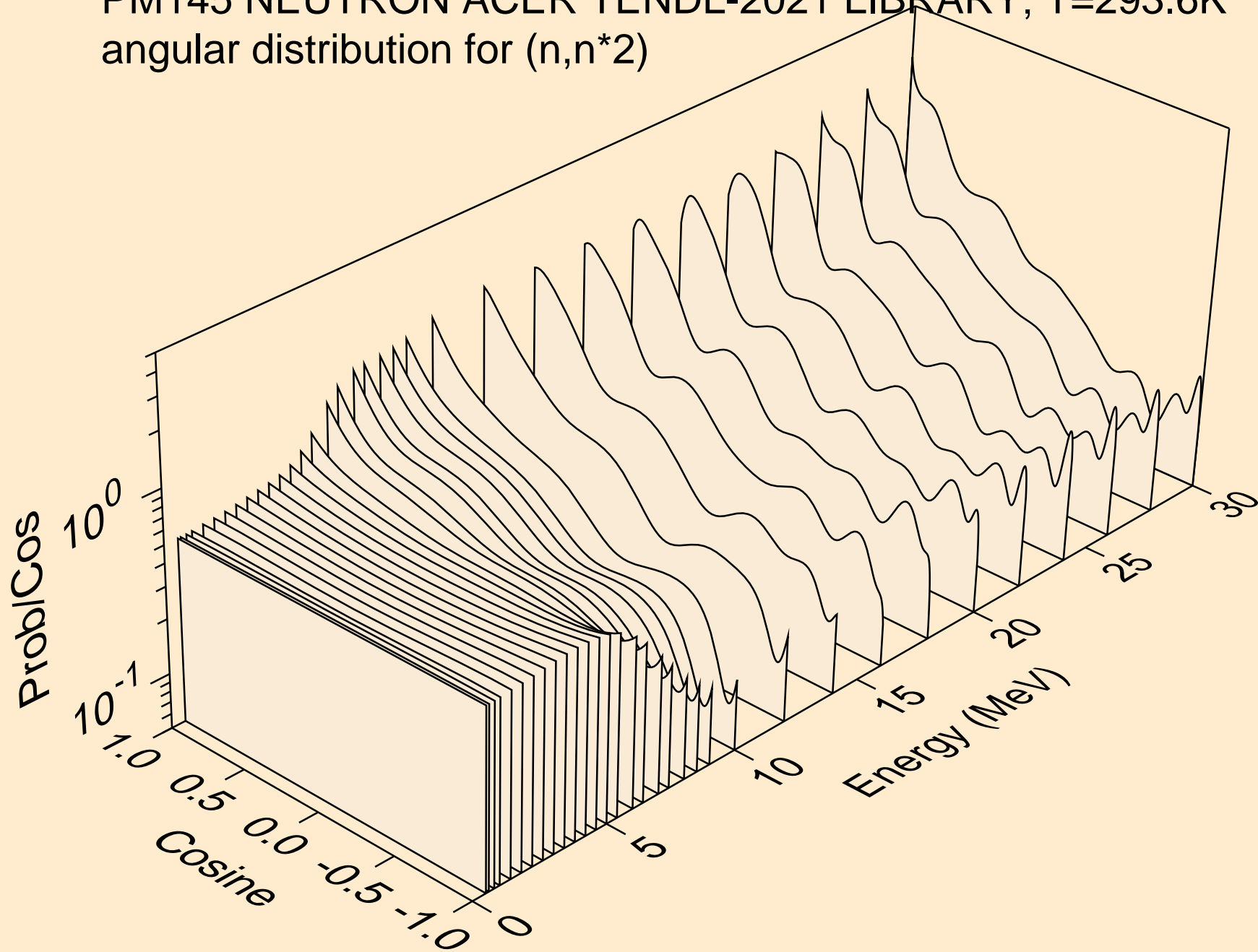

PM145 NEUTRON ACER TENDL-2021 LIBRARY; T=293.6K
angular distribution for (n,n*3)

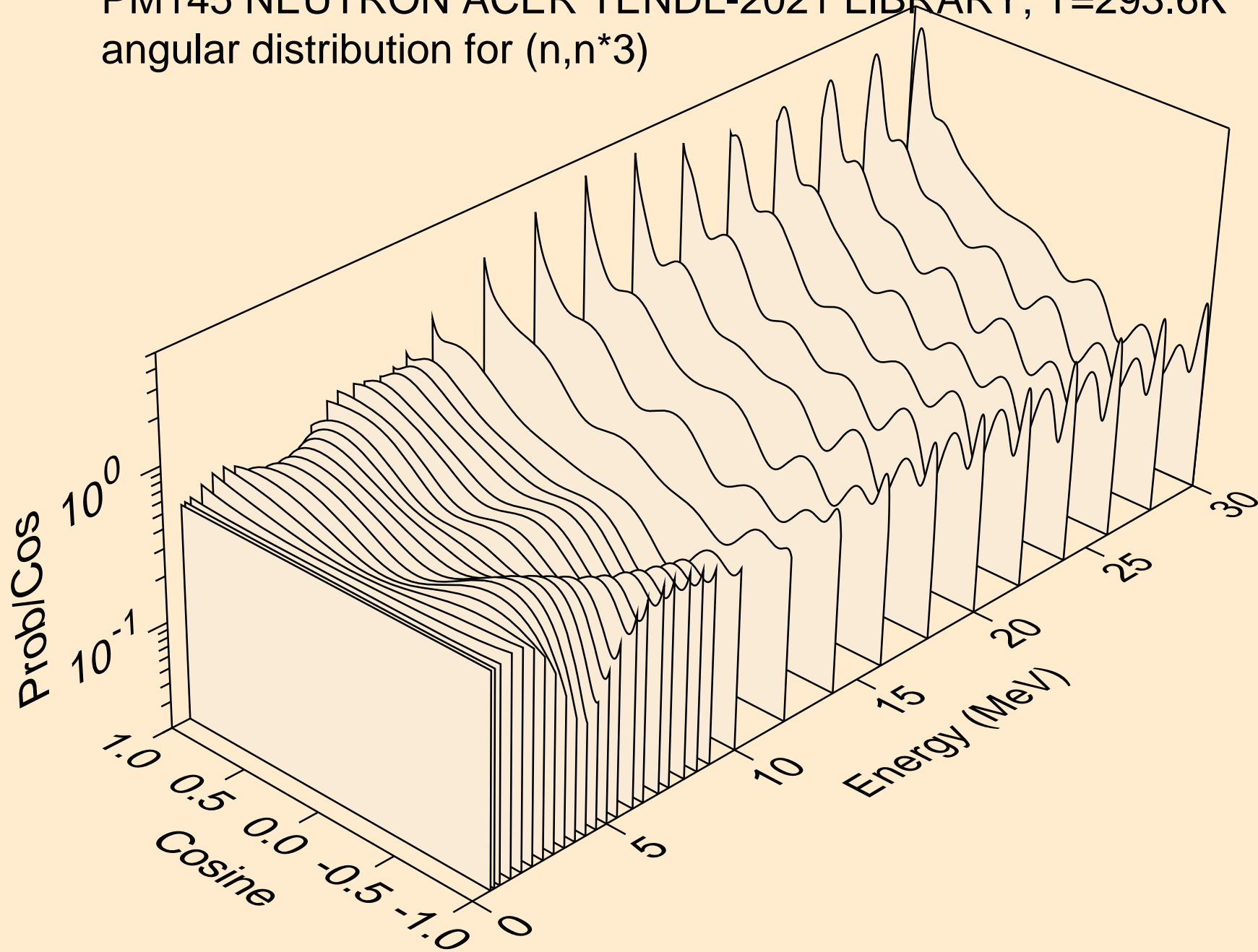

PM145 NEUTRON ACER TENDL-2021 LIBRARY; T=293.6K
angular distribution for (n,n*4)

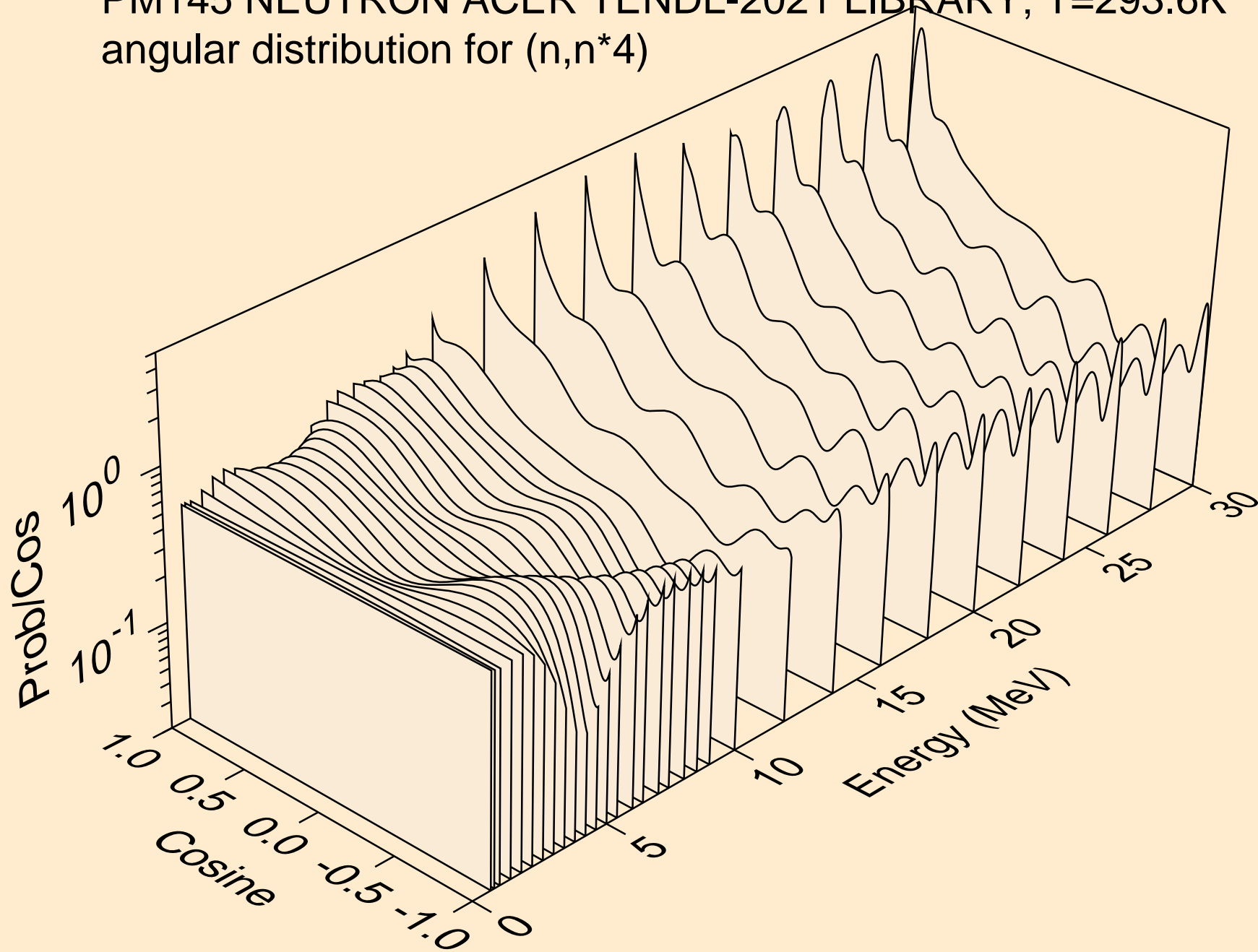

PM145 NEUTRON ACER TENDL-2021 LIBRARY; T=293.6K
angular distribution for (n,n*5)

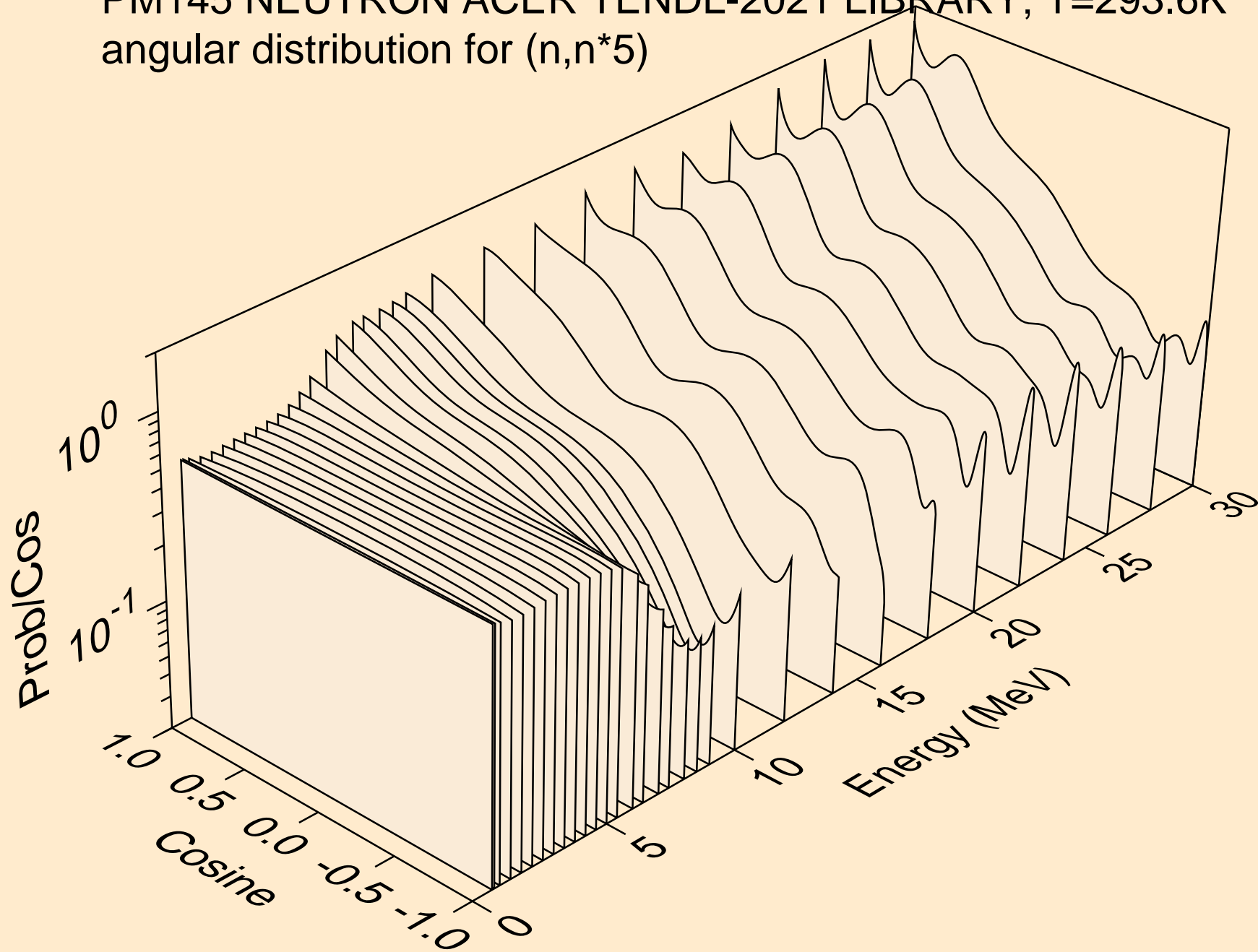

PM145 NEUTRON ACER TENDL-2021 LIBRARY; T=293.6K
angular distribution for (n,n*6)

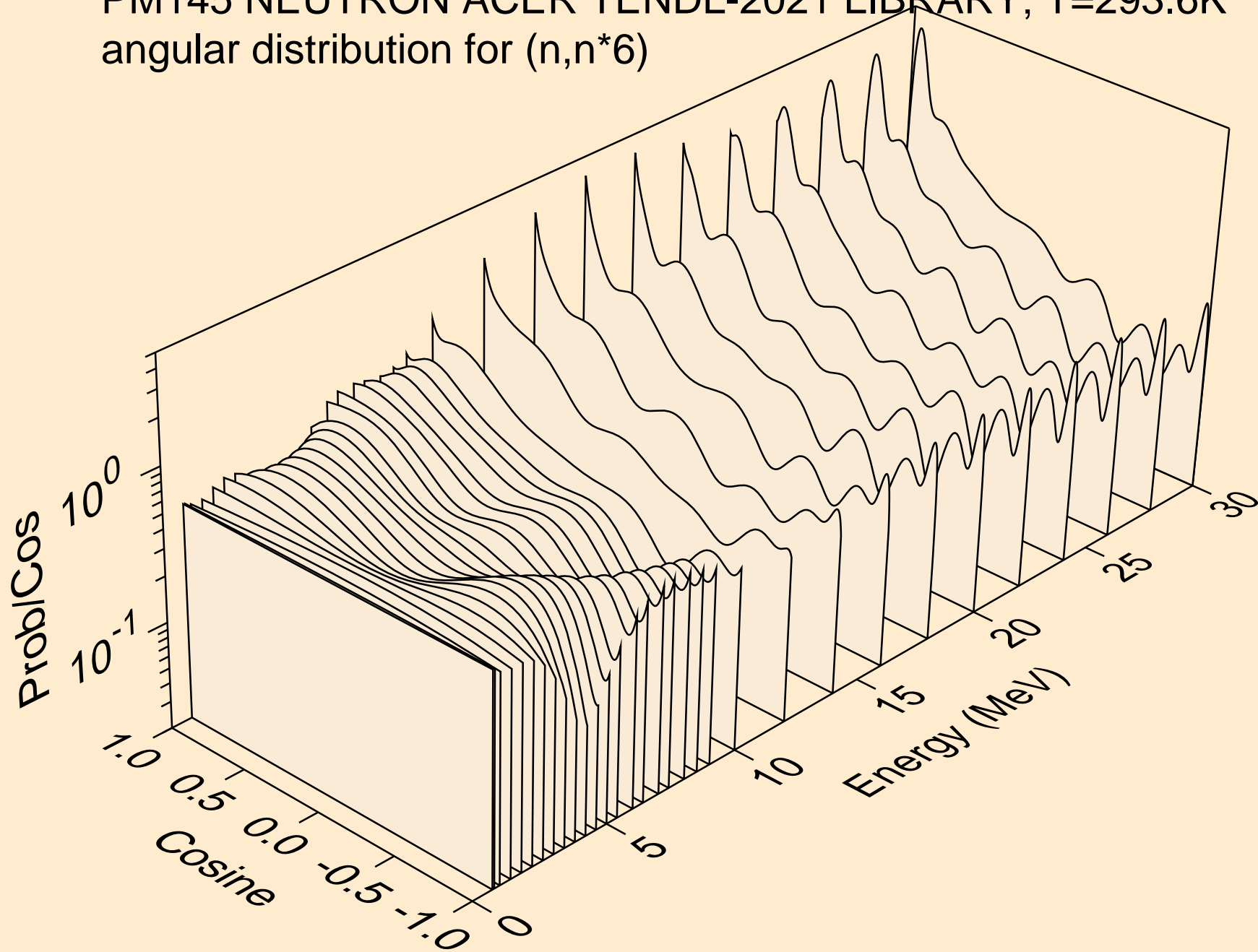

PM145 NEUTRON ACER TENDL-2021 LIBRARY; T=293.6K
angular distribution for (n,n*7)

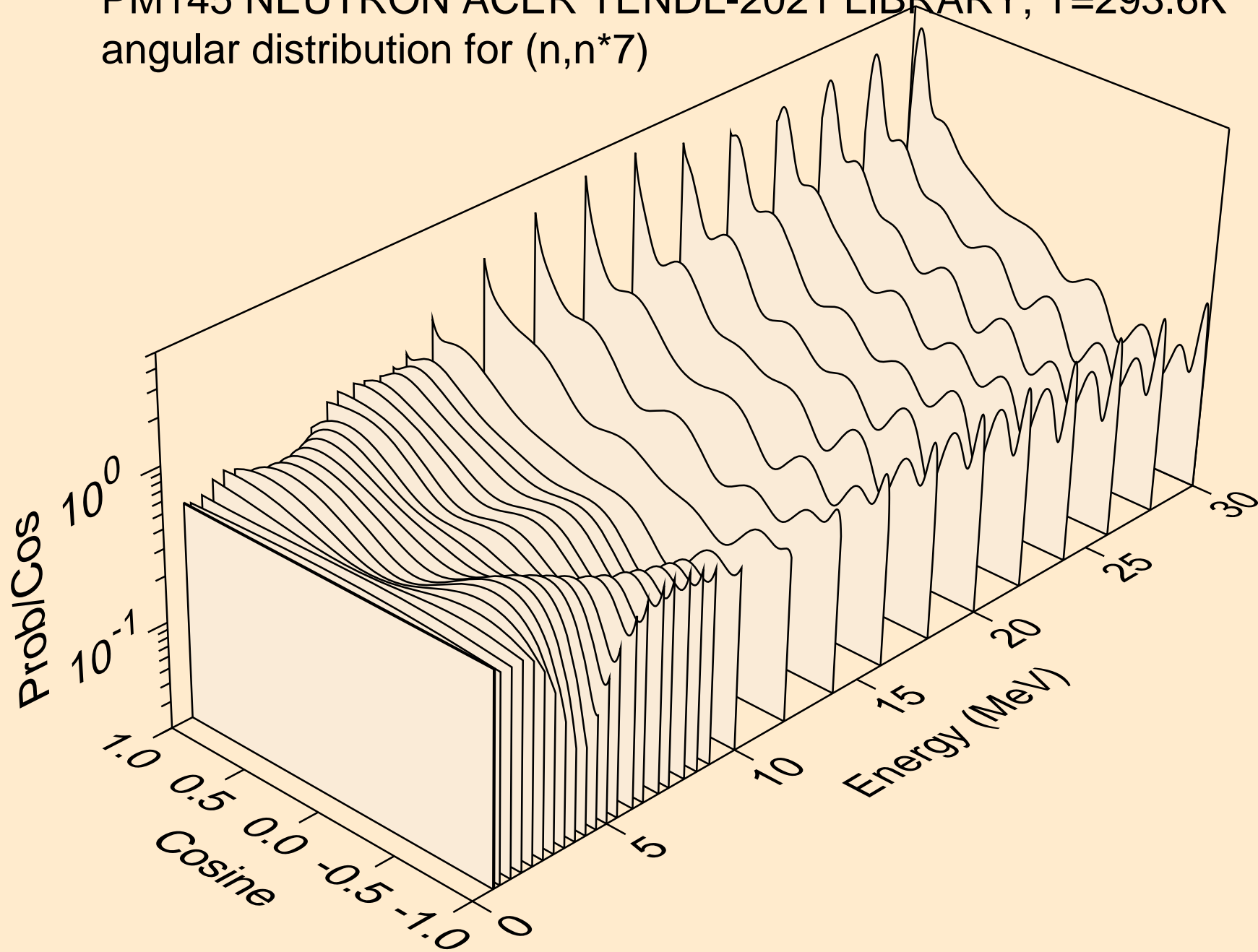

PM145 NEUTRON ACER TENDL-2021 LIBRARY; T=293.6K
angular distribution for (n,n*8)

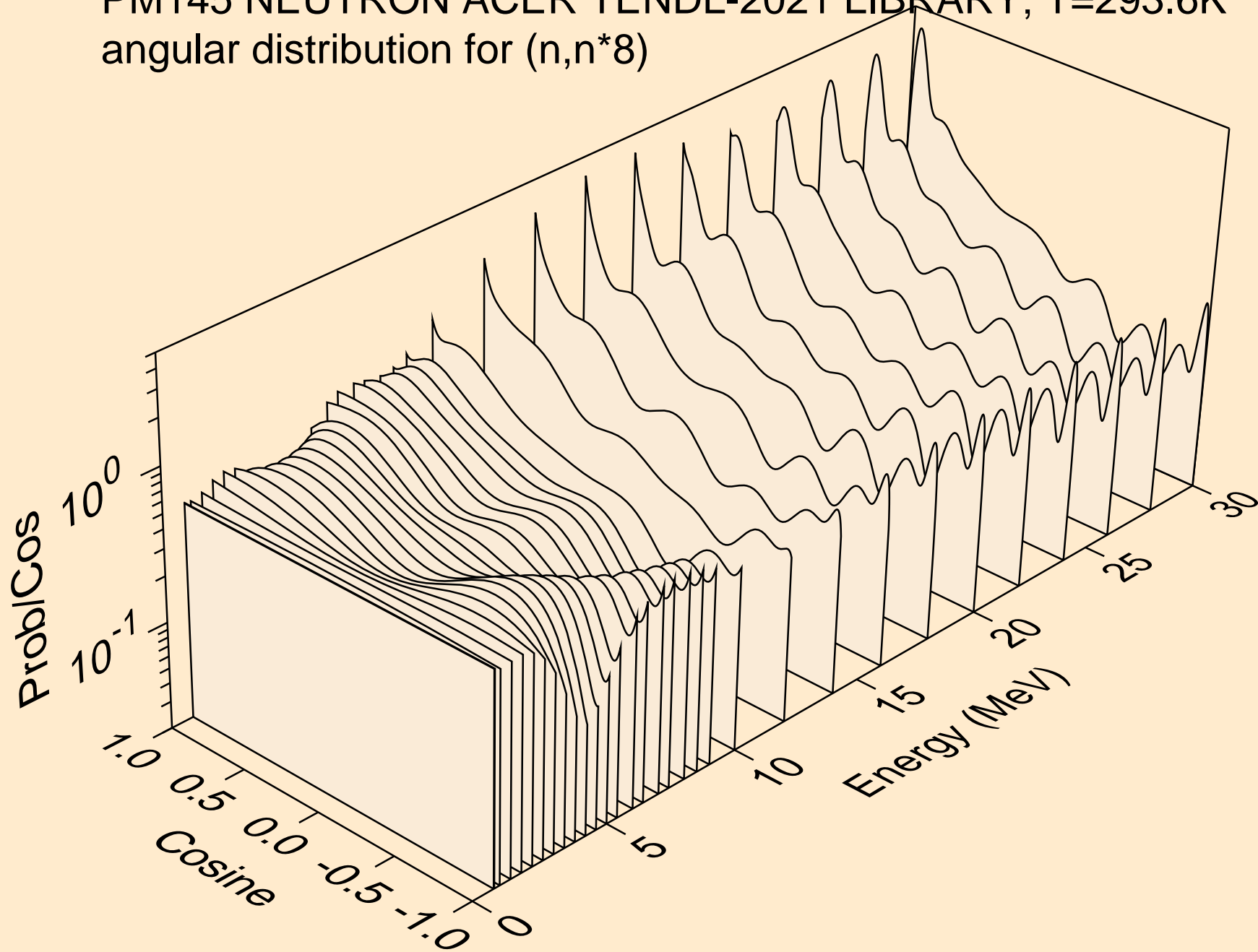

PM145 NEUTRON ACER TENDL-2021 LIBRARY; T=293.6K
angular distribution for (n,n*9)

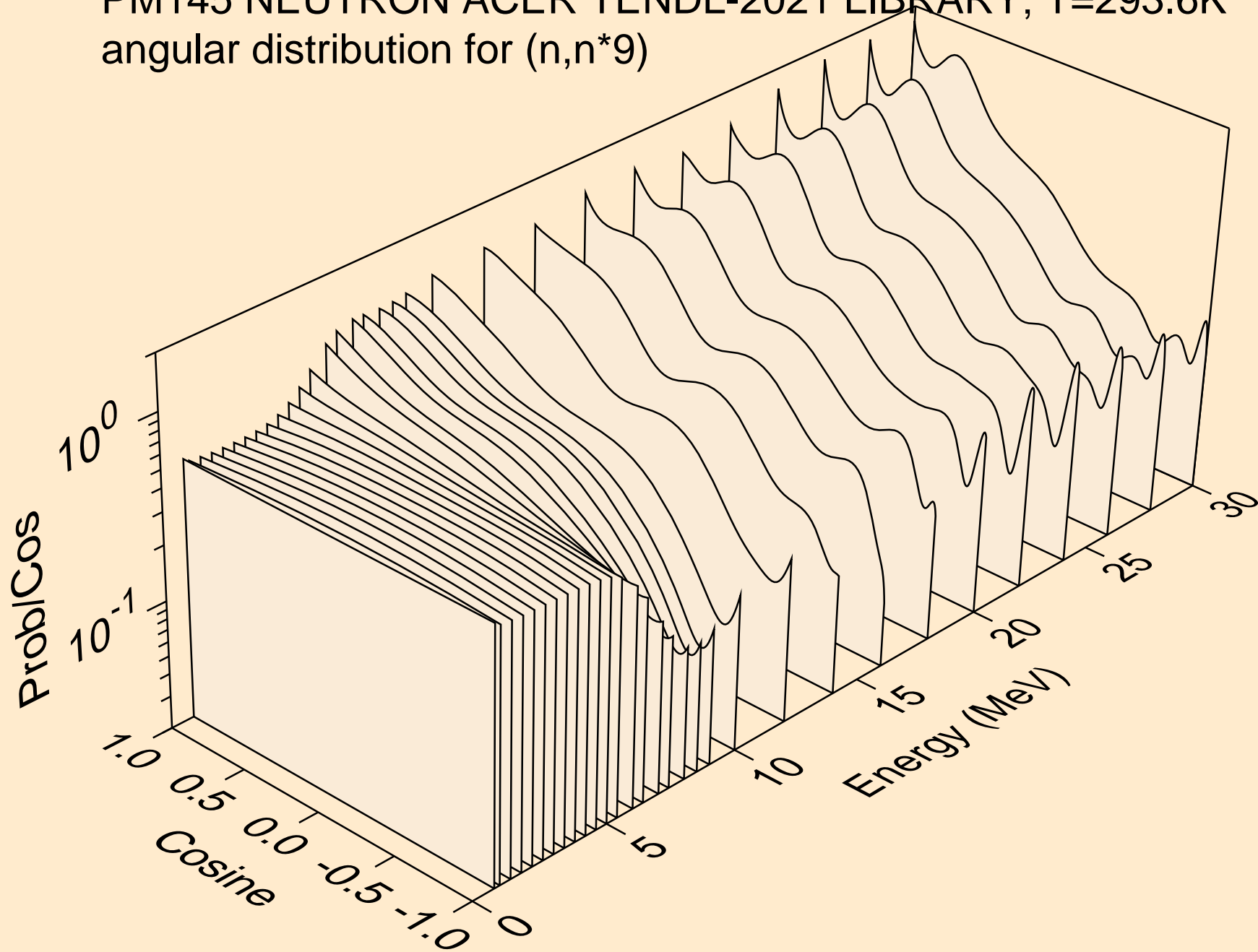

PM145 NEUTRON ACER TENDL-2021 LIBRARY; T=293.6K
angular distribution for (n,n*10)

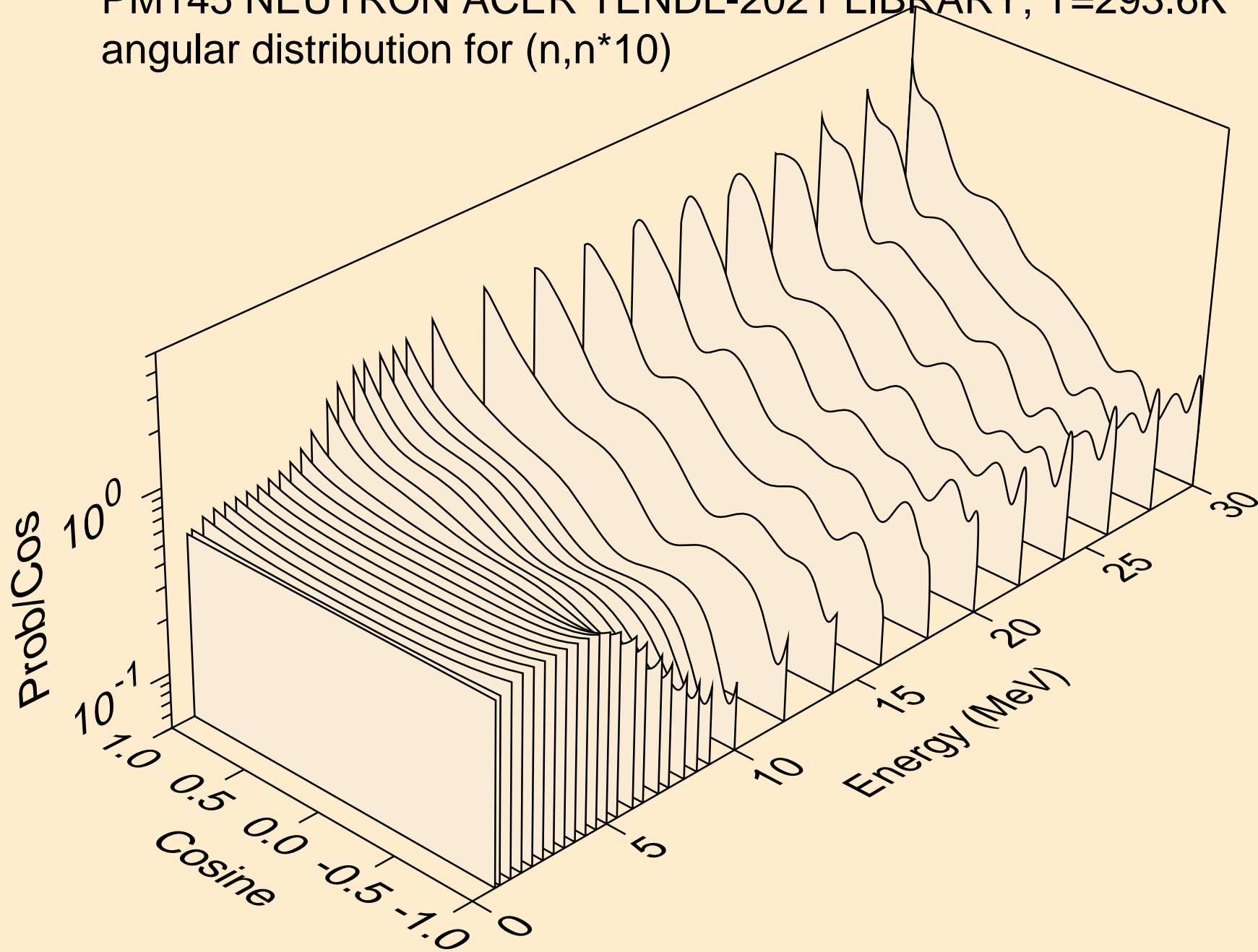

PM145 NEUTRON ACER TENDL-2021 LIBRARY; T=293.6K
angular distribution for (n,n*11)

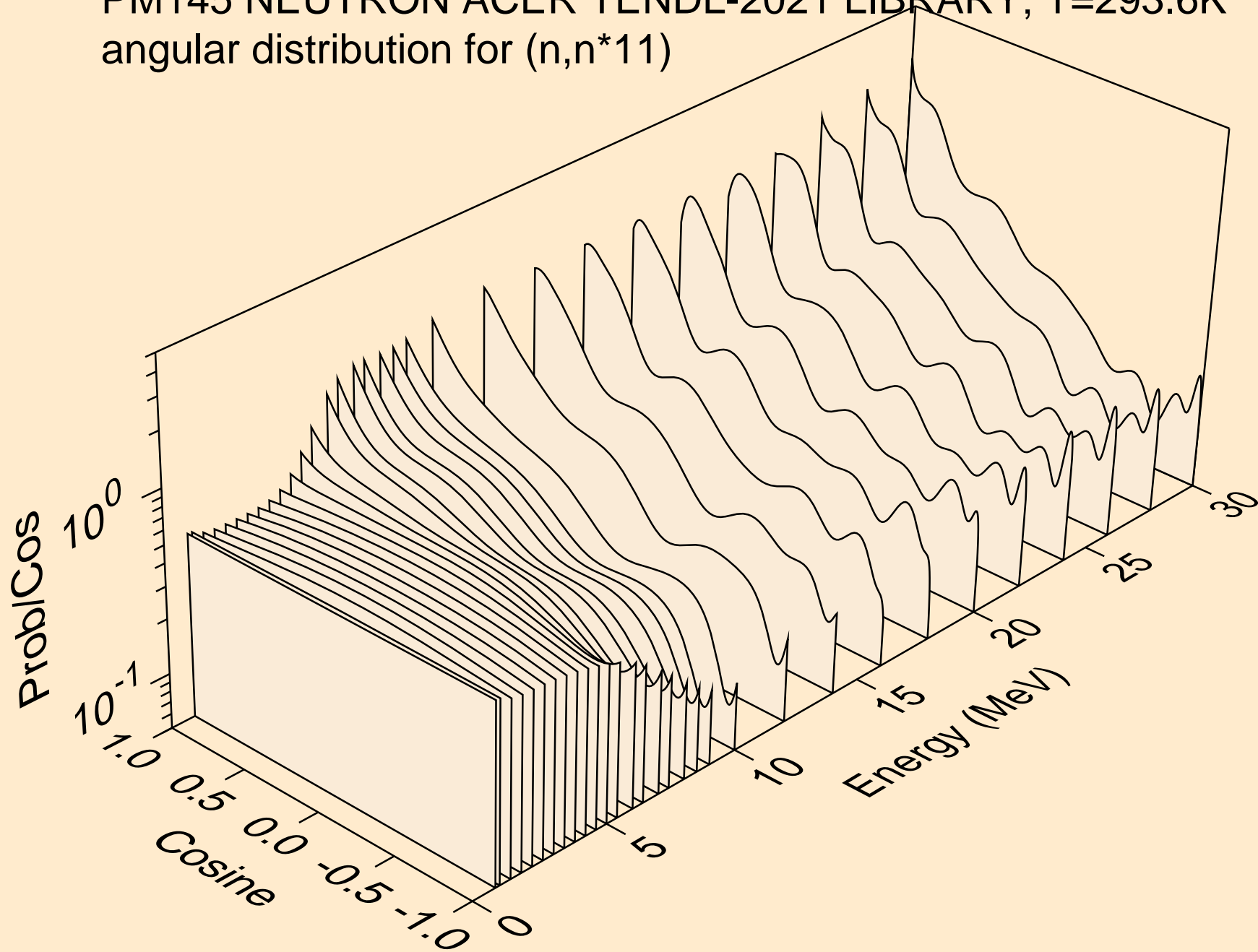

PM145 NEUTRON ACER TENDL-2021 LIBRARY; T=293.6K
angular distribution for (n,n*12)

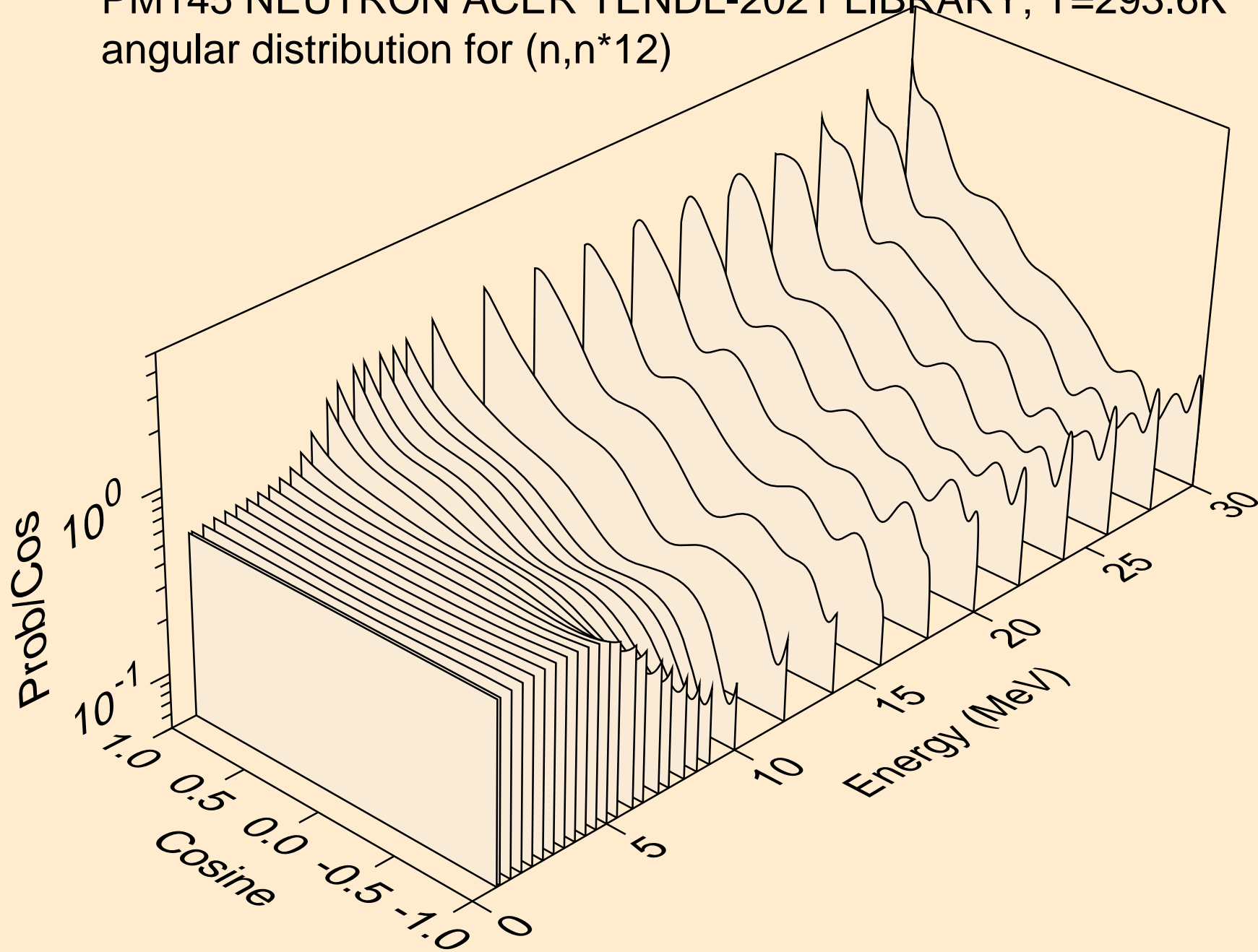

PM145 NEUTRON ACER TENDL-2021 LIBRARY; T=293.6K
angular distribution for (n,n*13)

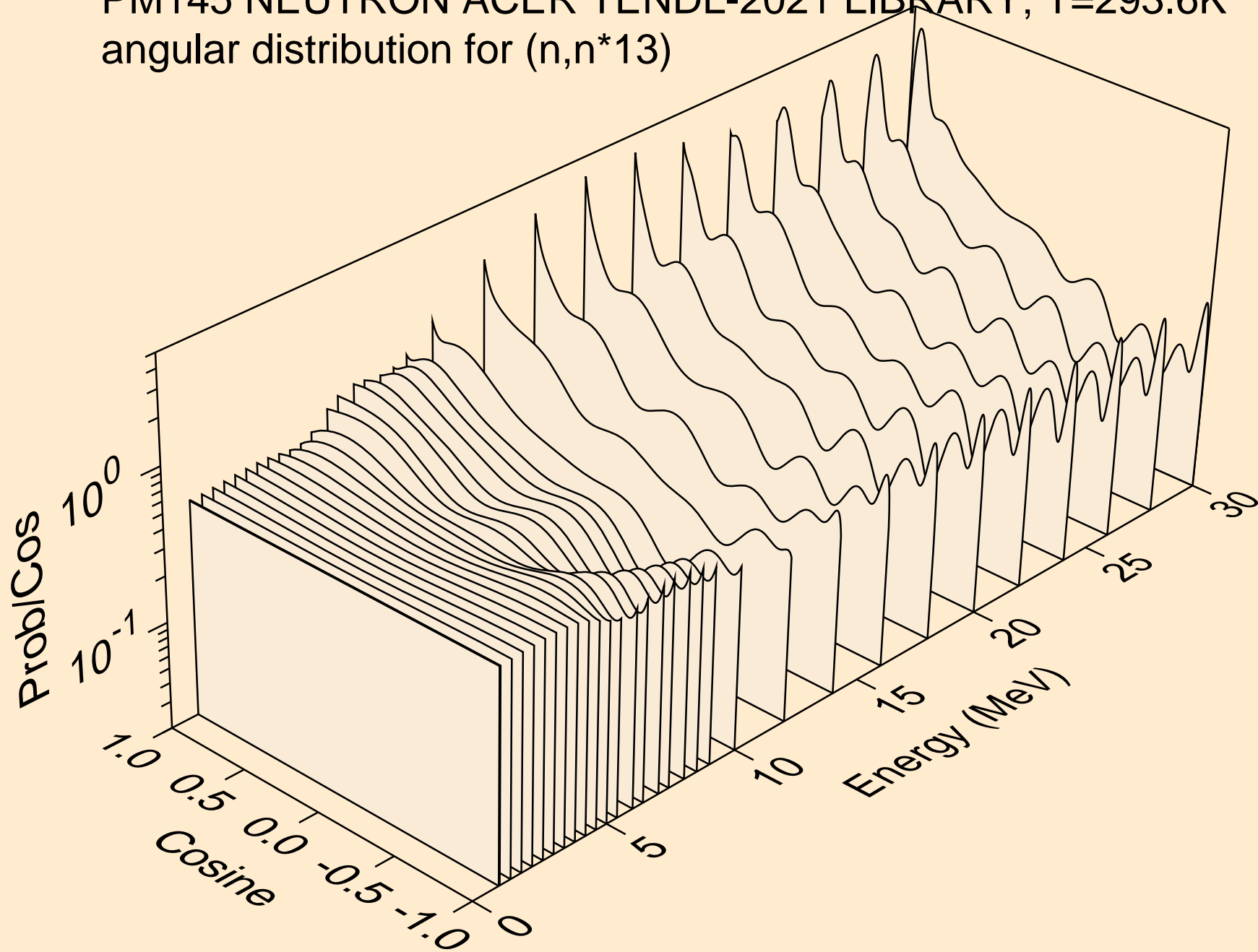

PM145 NEUTRON ACER TENDL-2021 LIBRARY; T=293.6K
angular distribution for (n,n*14)

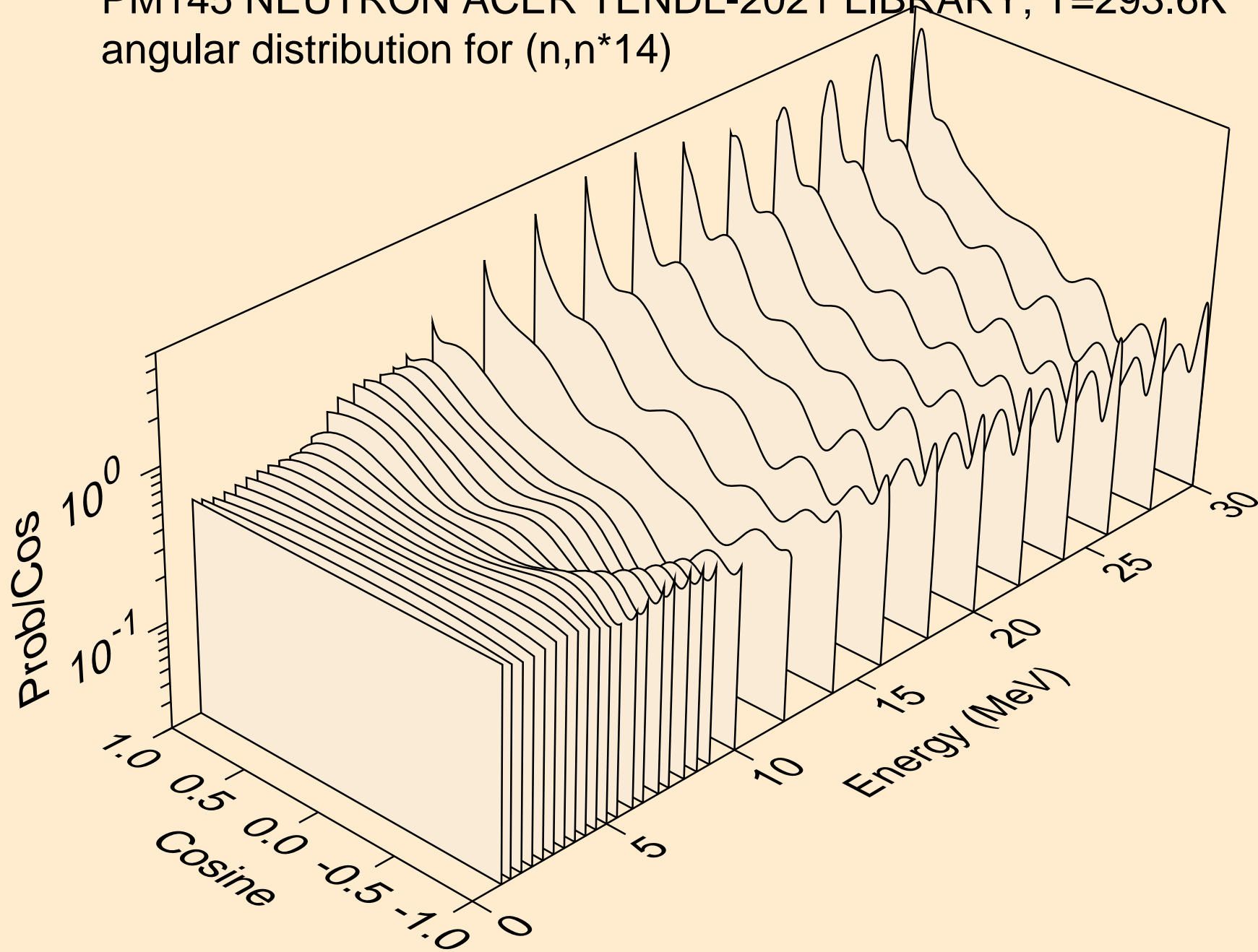

PM145 NEUTRON ACER TENDL-2021 LIBRARY; T=293.6K
angular distribution for (n,n*15)

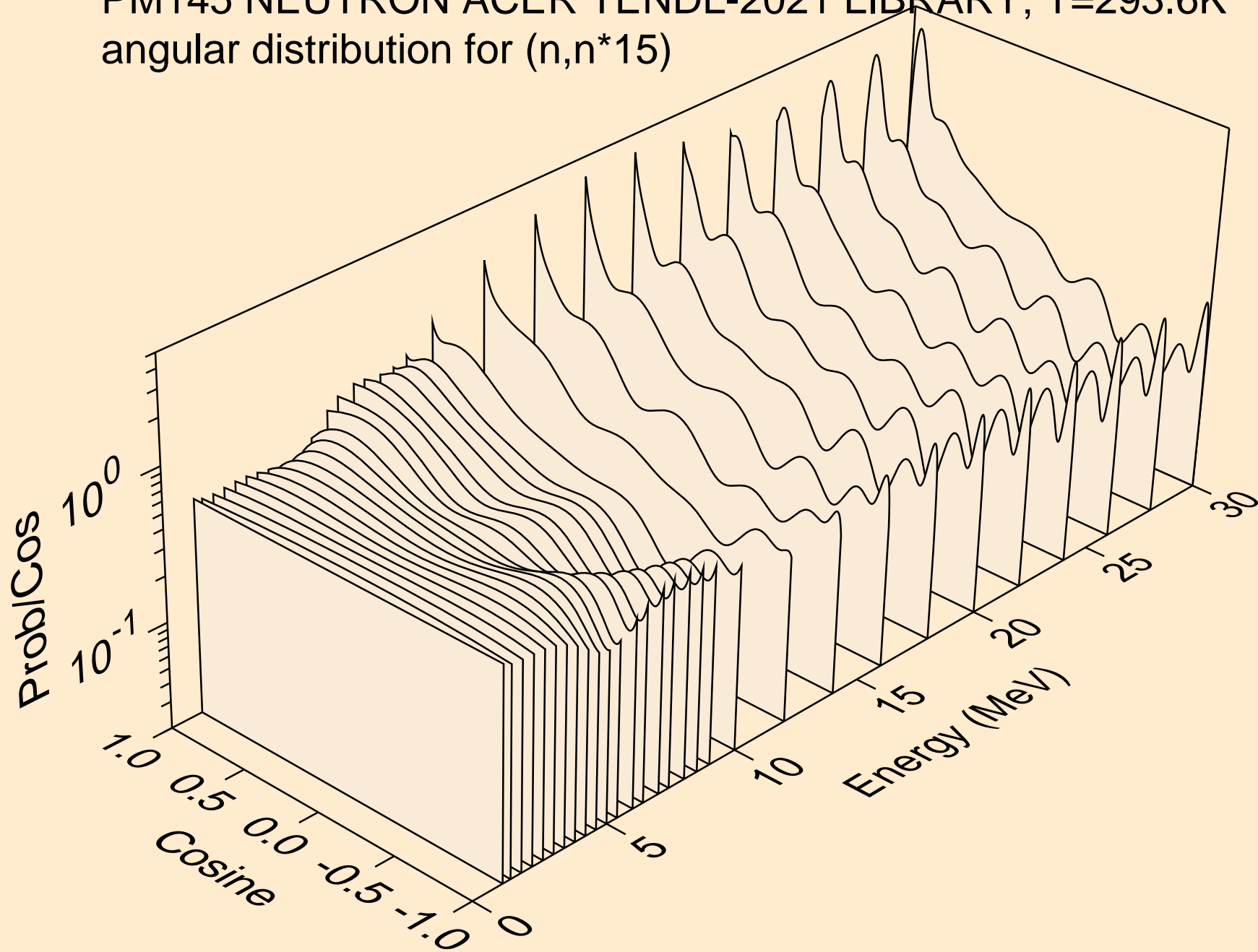

PM145 NEUTRON ACER TENDL-2021 LIBRARY; T=293.6K
angular distribution for (n,n*16)

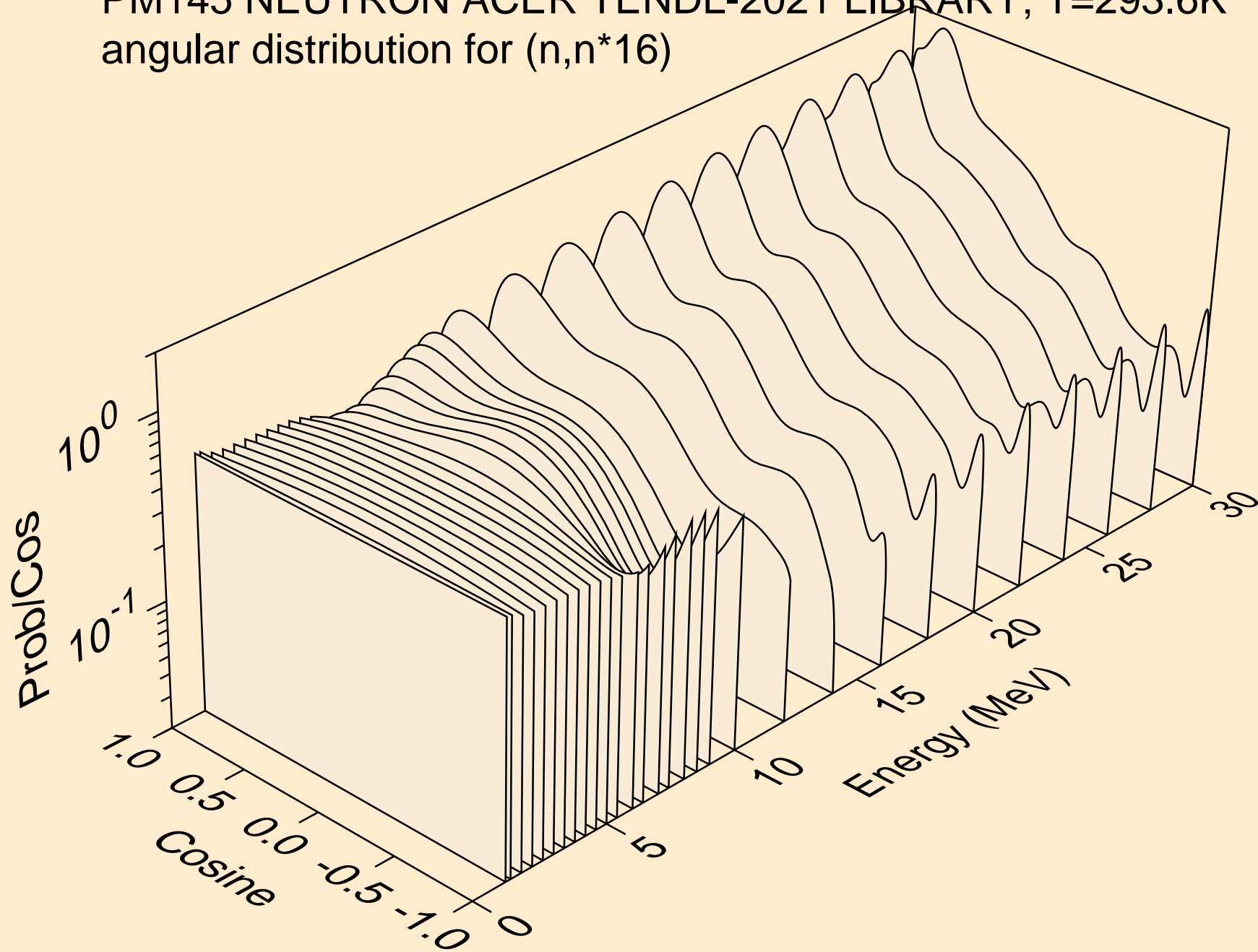

PM145 NEUTRON ACER TENDL-2021 LIBRARY; T=293.6K
angular distribution for (n,n*17)

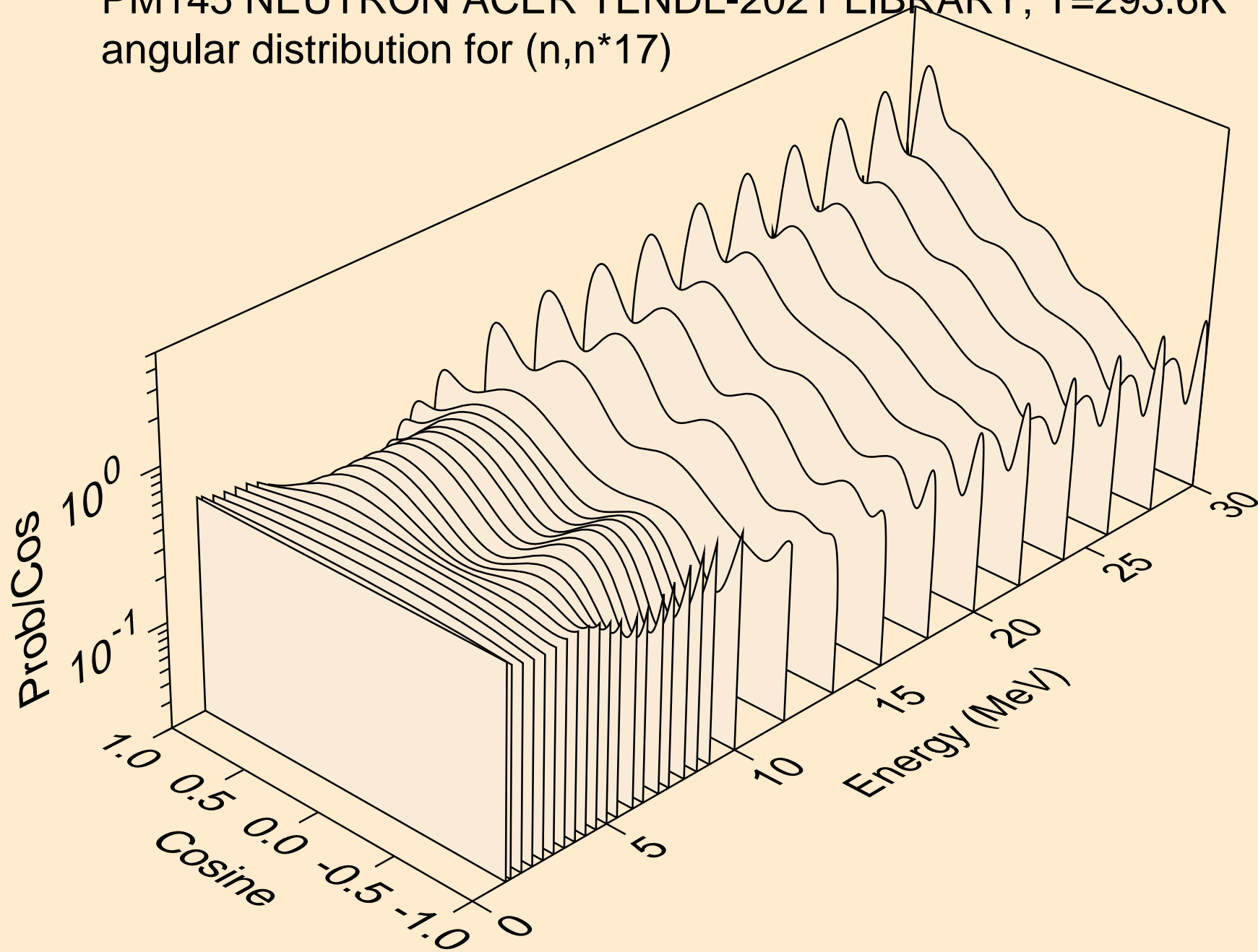

PM145 NEUTRON ACER TENDL-2021 LIBRARY; T=293.6K
angular distribution for (n,n*18)

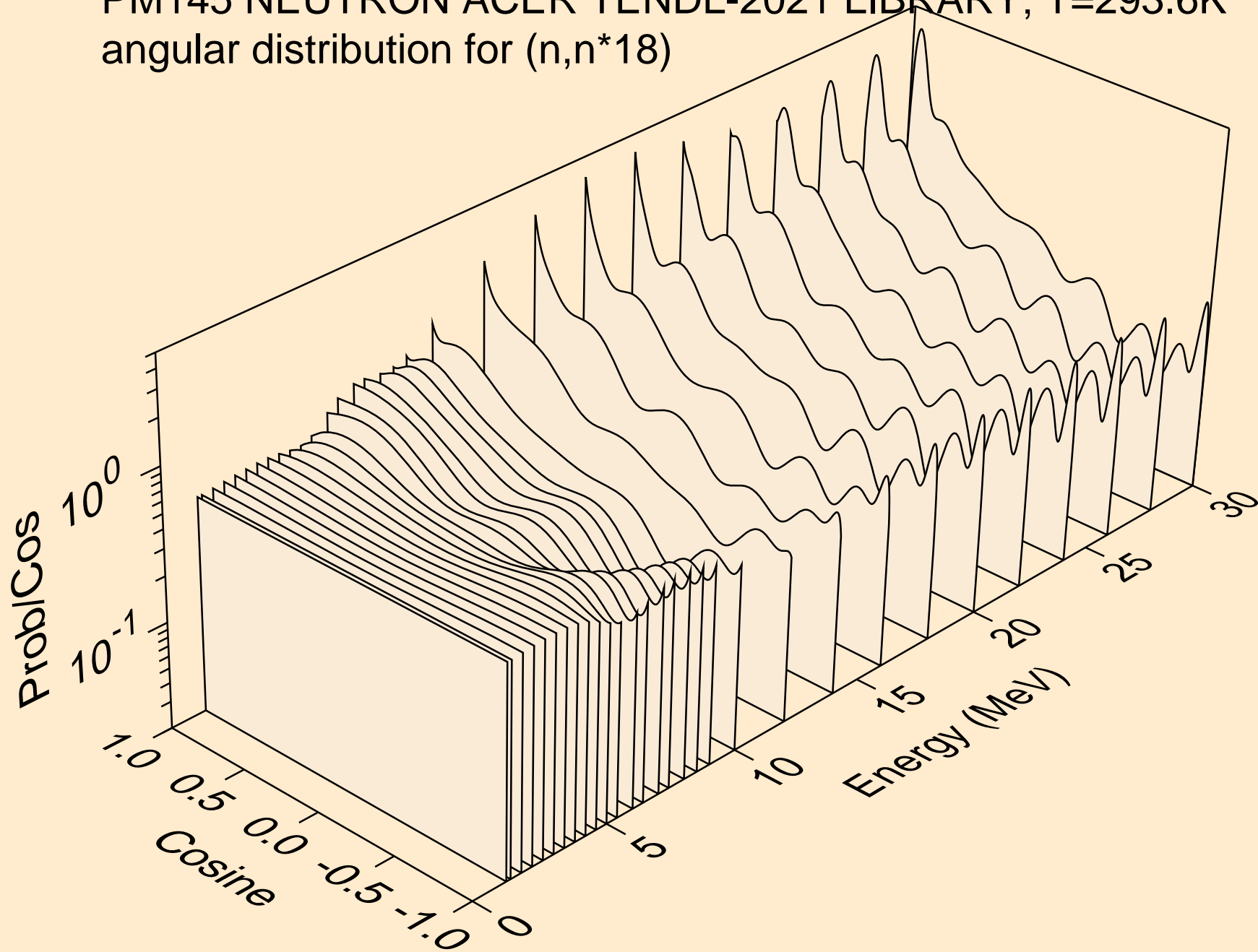

PM145 NEUTRON ACER TENDL-2021 LIBRARY; T=293.6K
angular distribution for (n,n*19)

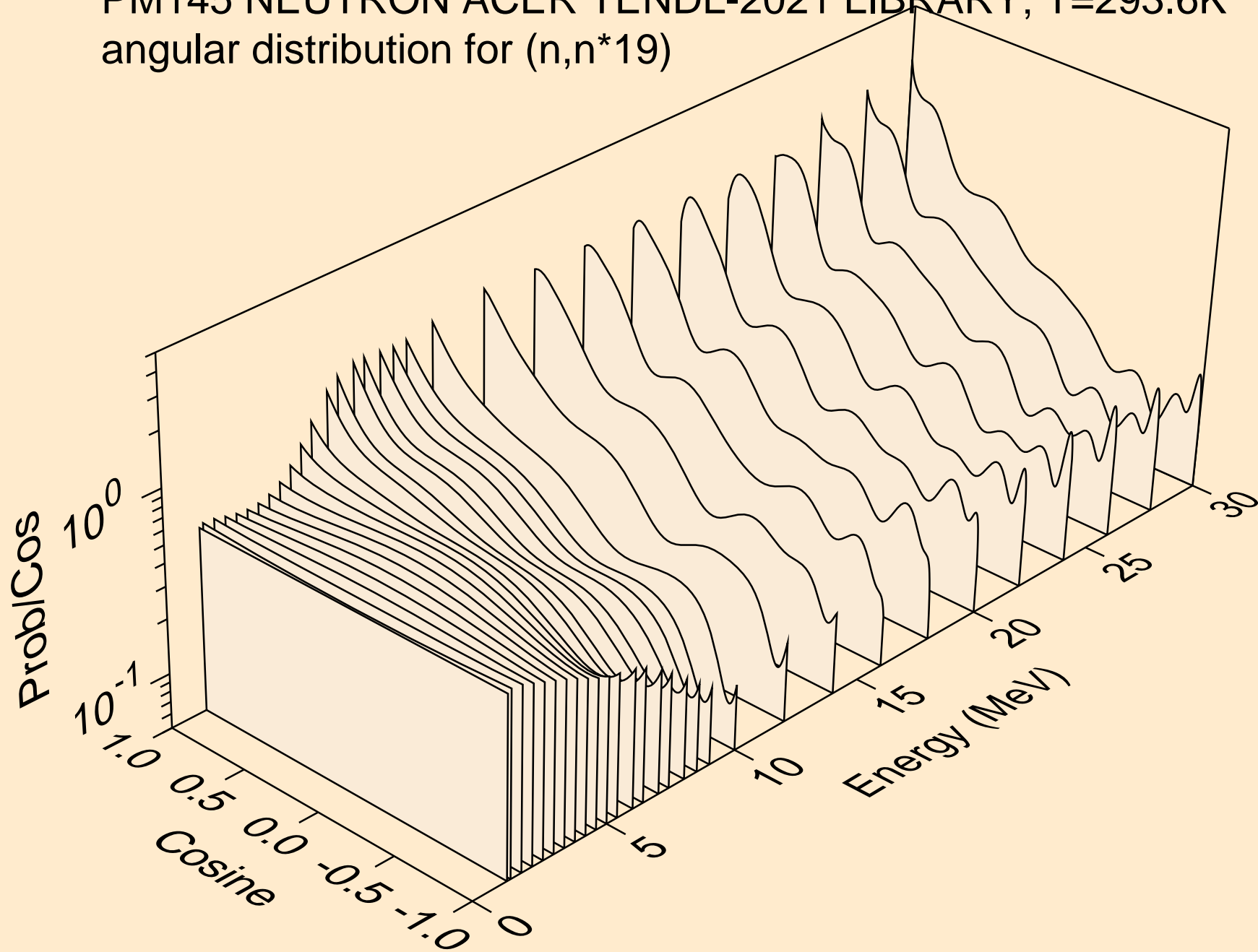

PM145 NEUTRON ACER TENDL-2021 LIBRARY; T=293.6K
angular distribution for (n,n*20)

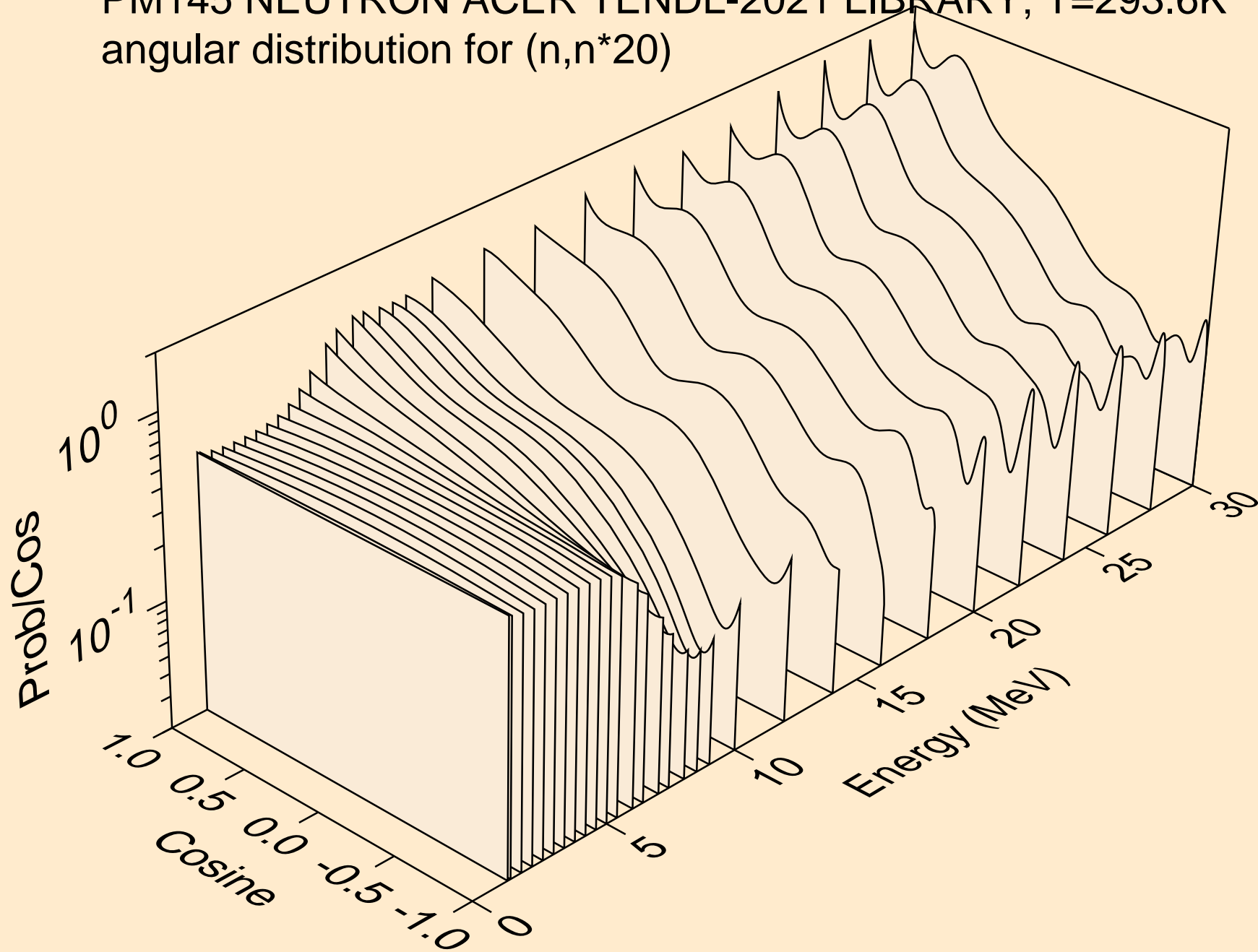

PM145 NEUTRON ACER TENDL-2021 LIBRARY; T=293.6K
angular distribution for (n,n*21)

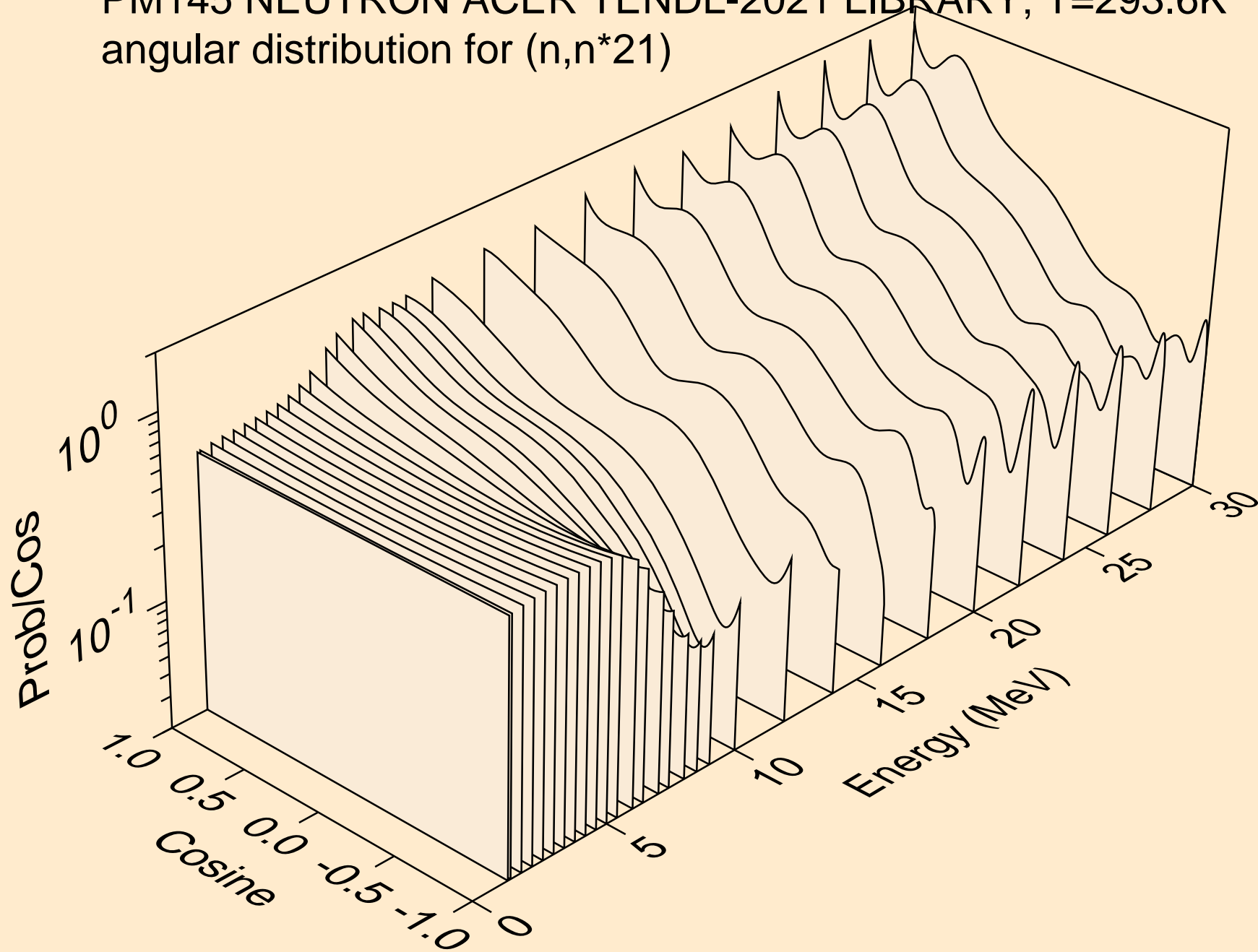

PM145 NEUTRON ACER TENDL-2021 LIBRARY; T=293.6K
angular distribution for (n,n*22)

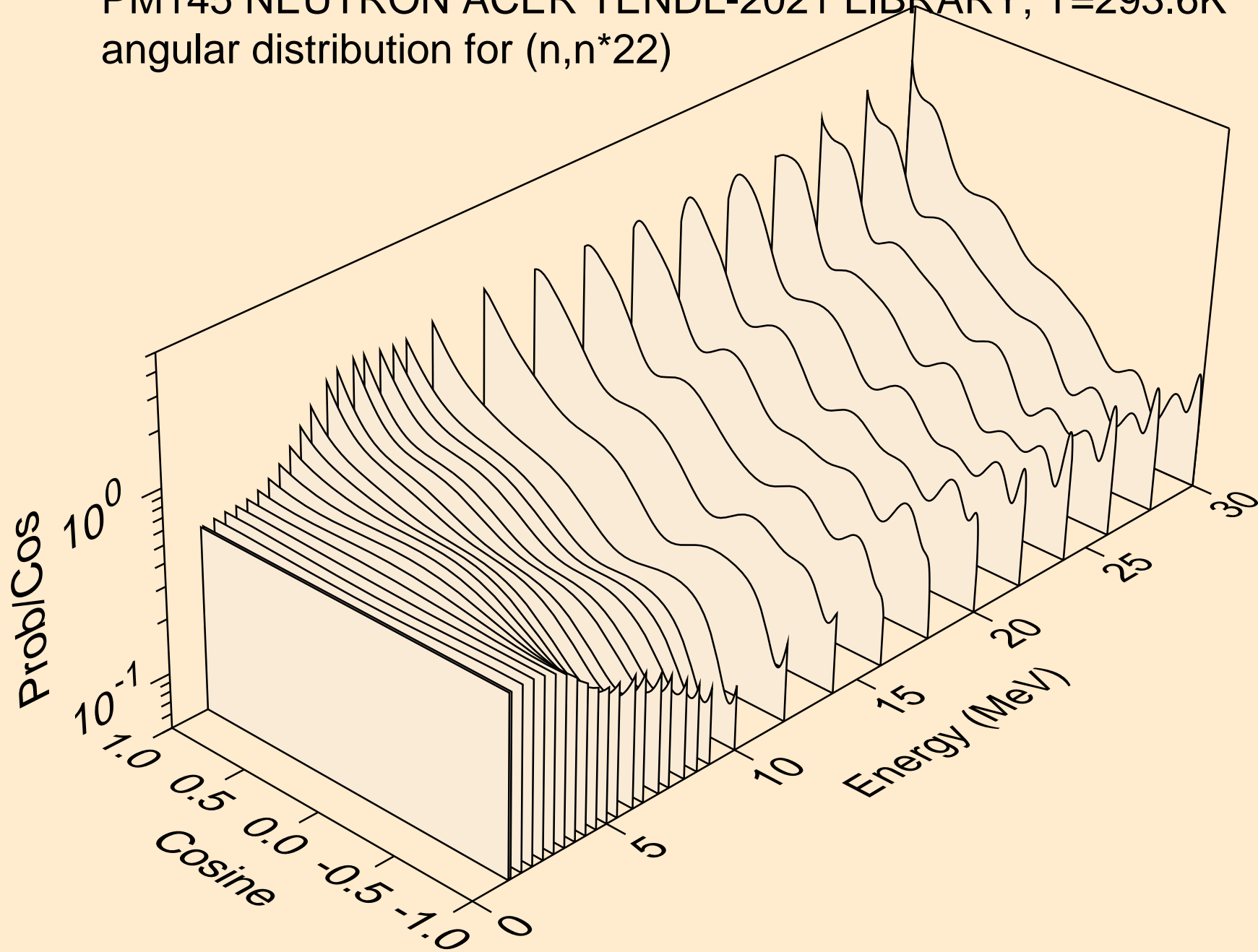

PM145 NEUTRON ACER TENDL-2021 LIBRARY; T=293.6K
angular distribution for (n,n*23)

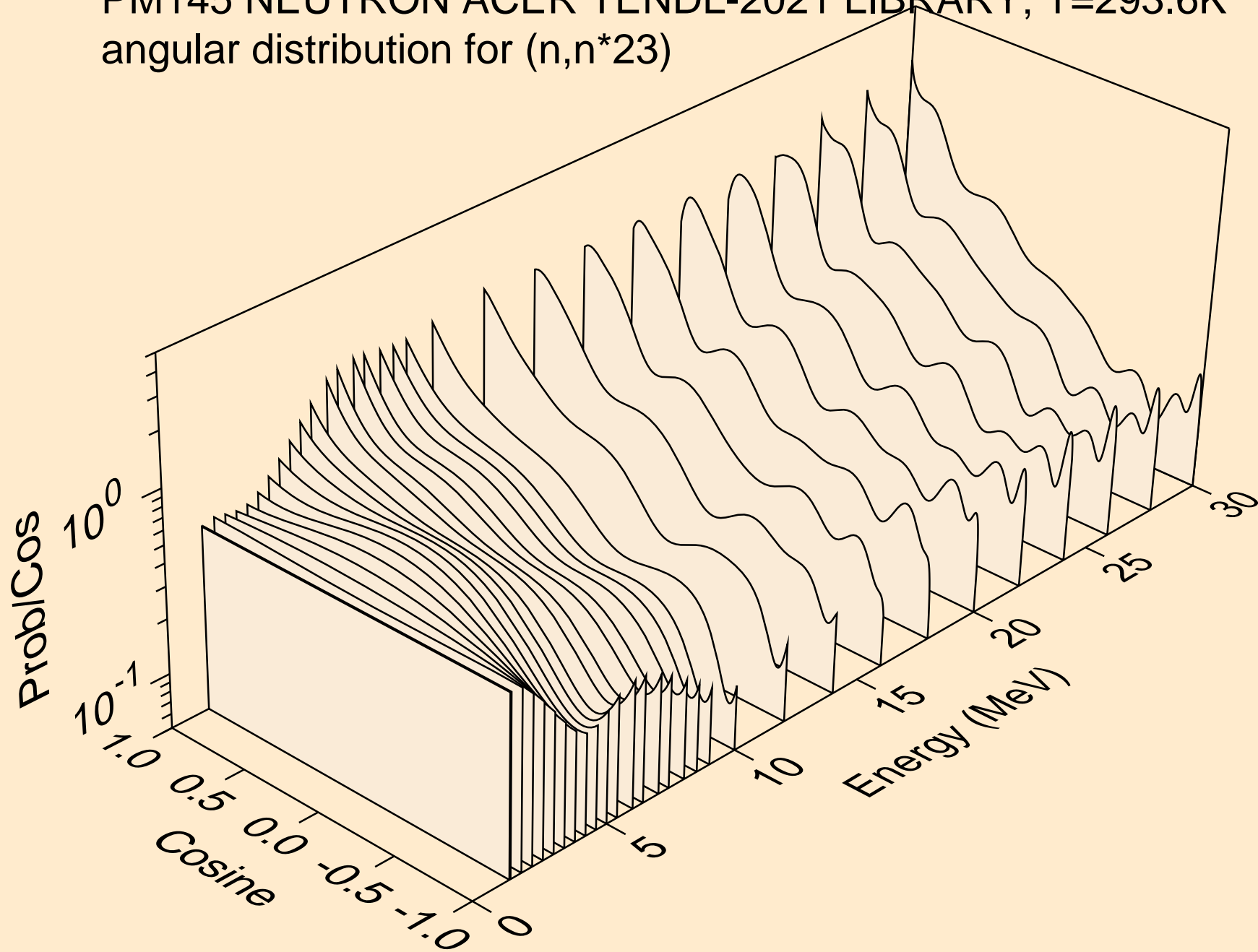

PM145 NEUTRON ACER TENDL-2021 LIBRARY; T=293.6K
angular distribution for (n,n*24)

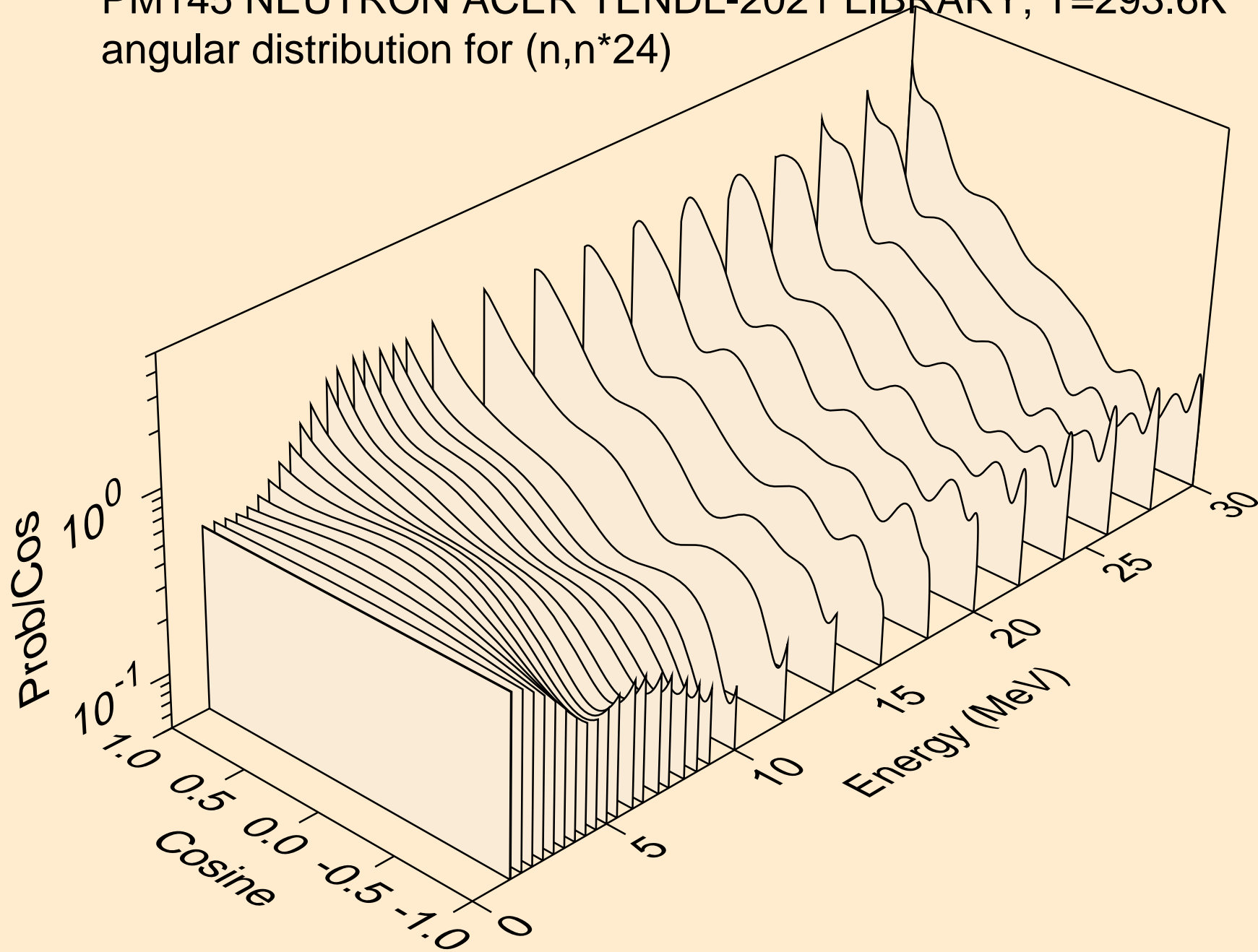

PM145 NEUTRON ACER TENDL-2021 LIBRARY; T=293.6K
angular distribution for (n,n*25)

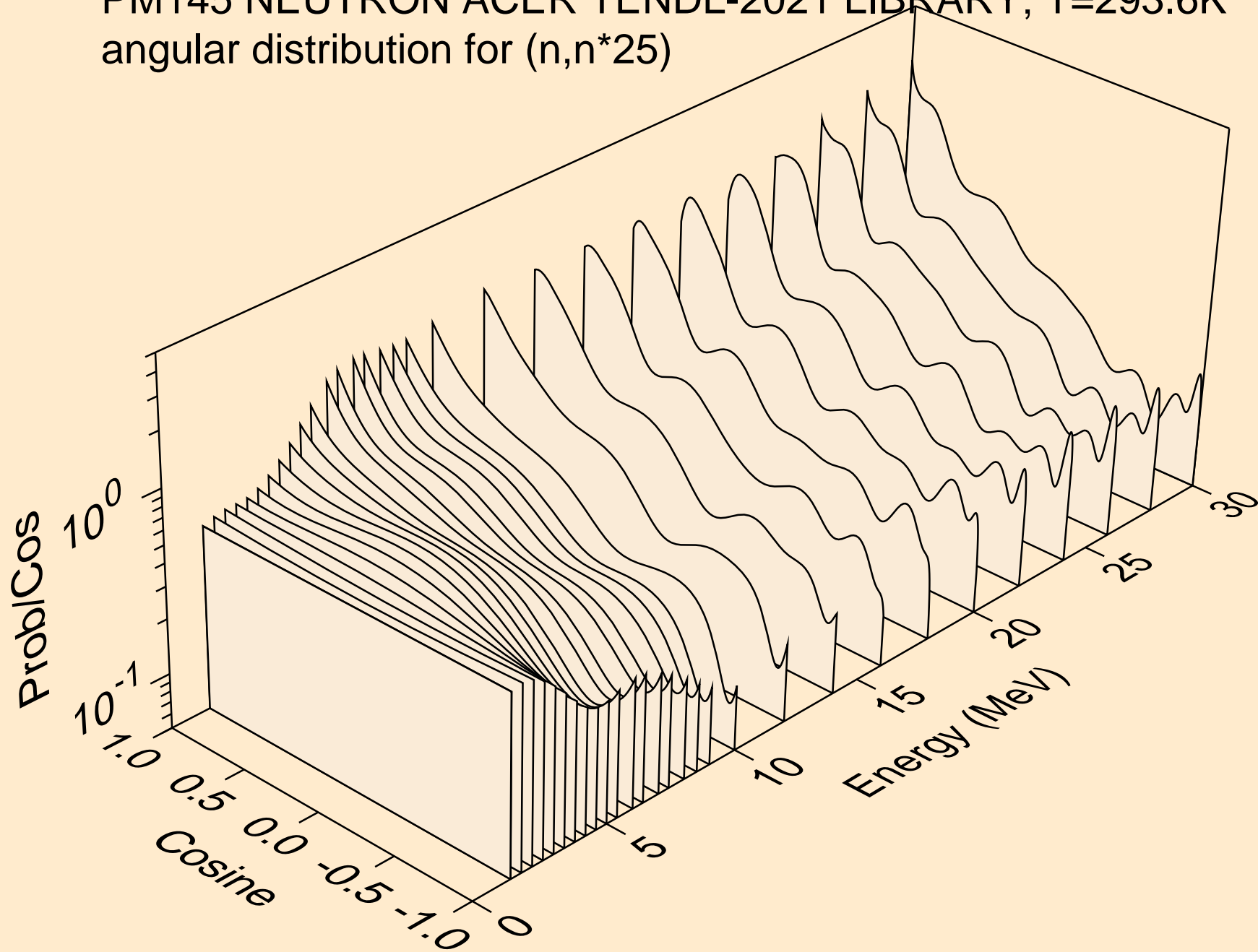

PM145 NEUTRON ACER TENDL-2021 LIBRARY; T=293.6K
angular distribution for (n,n*26)

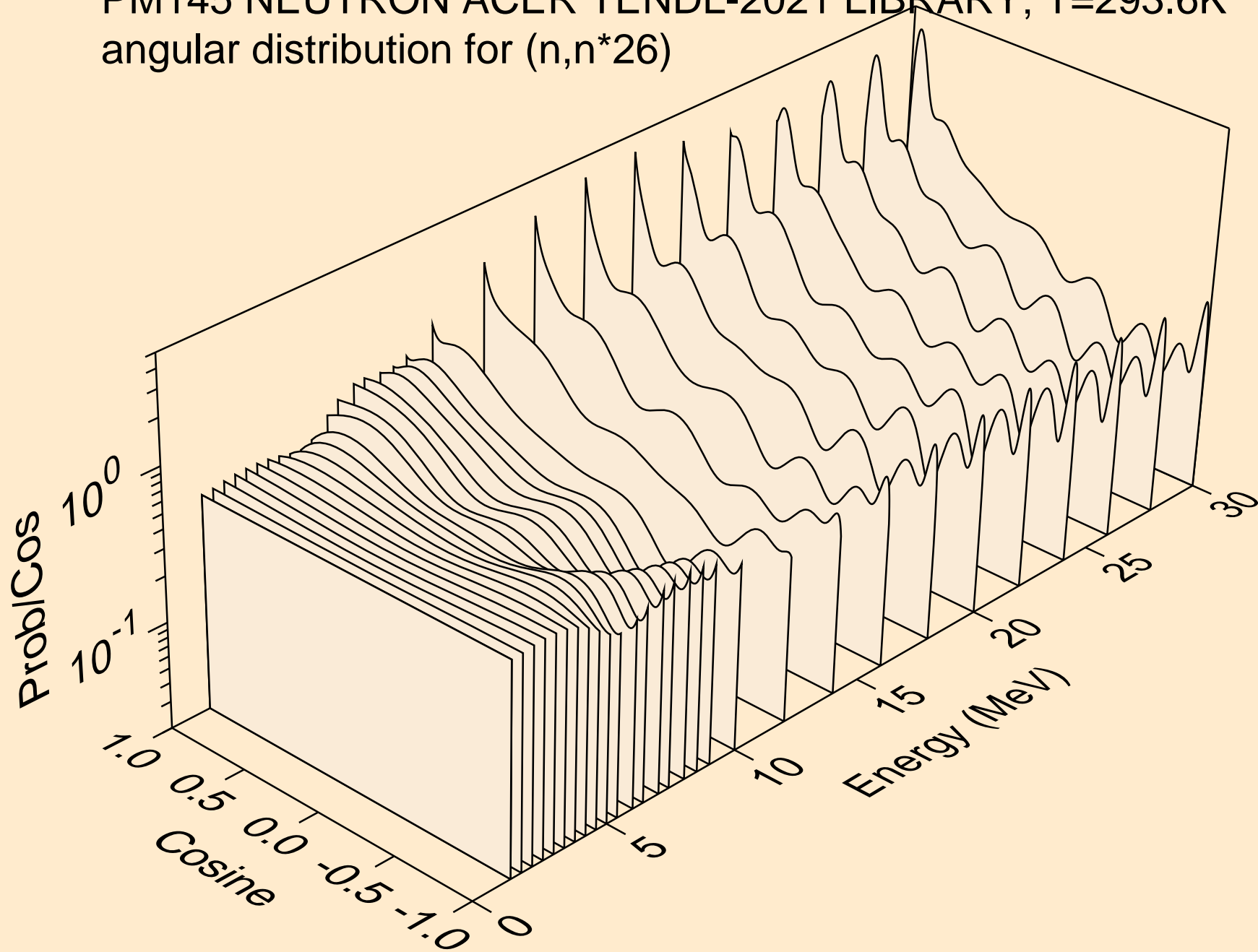

PM145 NEUTRON ACER TENDL-2021 LIBRARY; T=293.6K
angular distribution for (n,n*27)

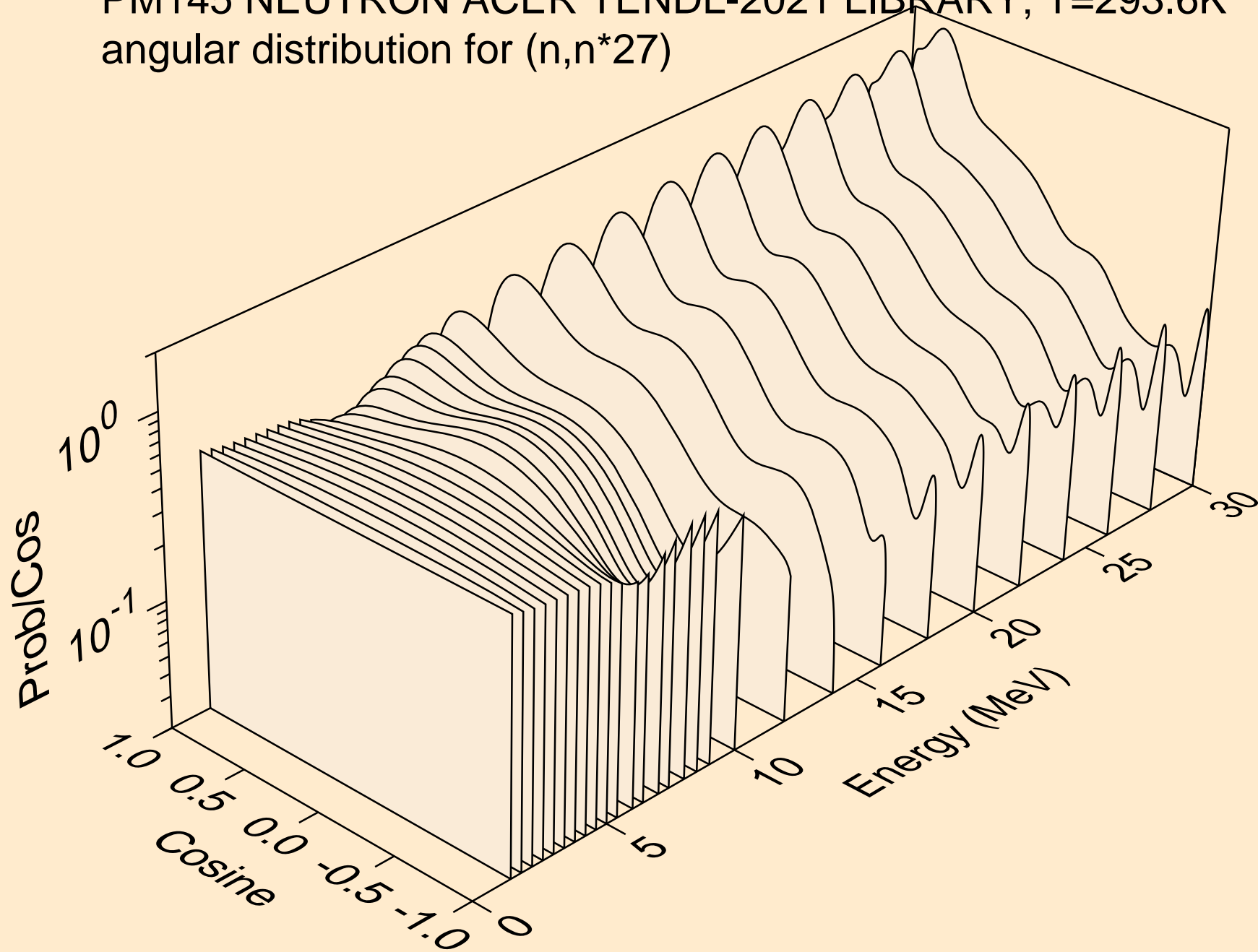

PM145 NEUTRON ACER TENDL-2021 LIBRARY; T=293.6K
angular distribution for (n,n*28)

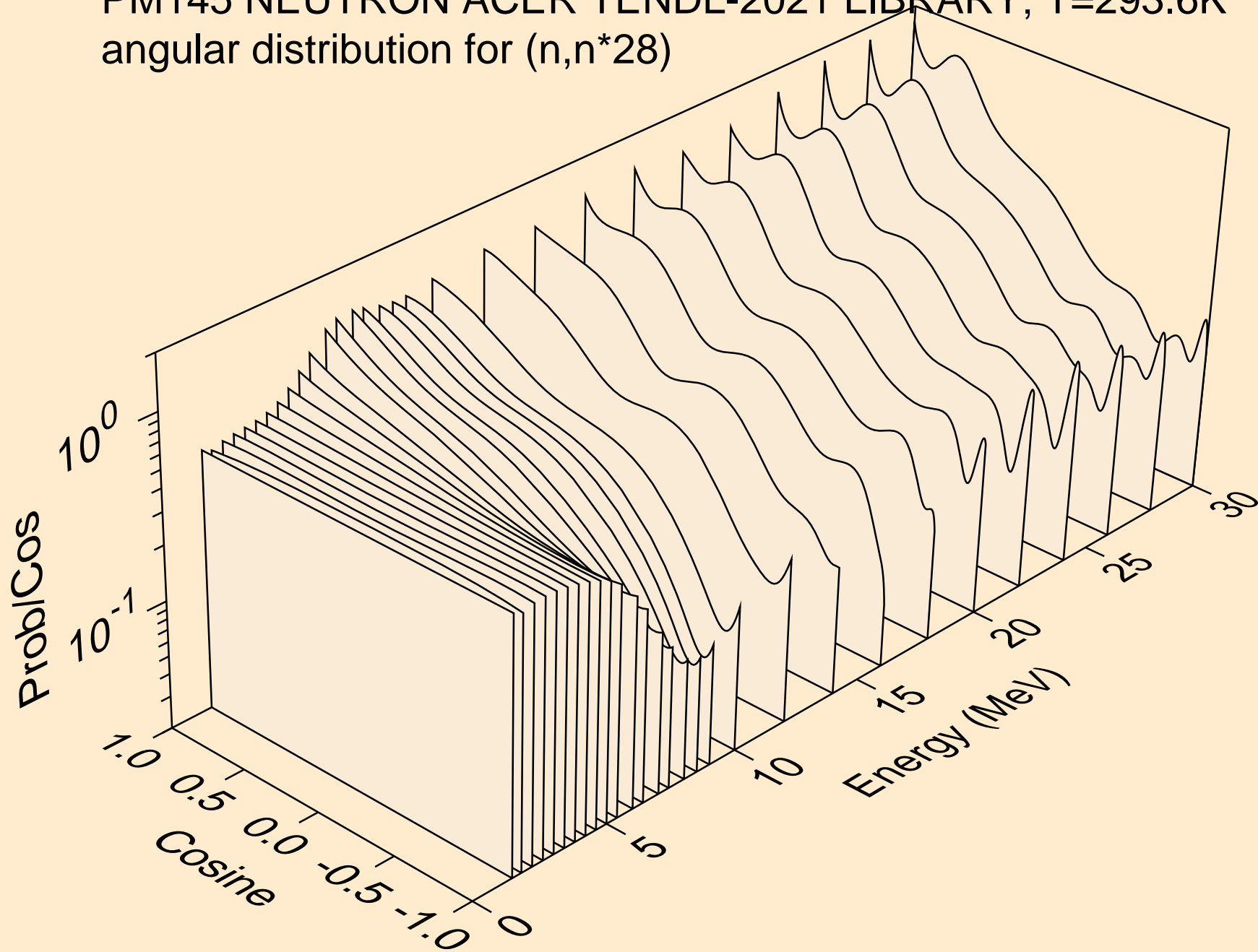

PM145 NEUTRON ACER TENDL-2021 LIBRARY; T=293.6K
angular distribution for (n,n*29)

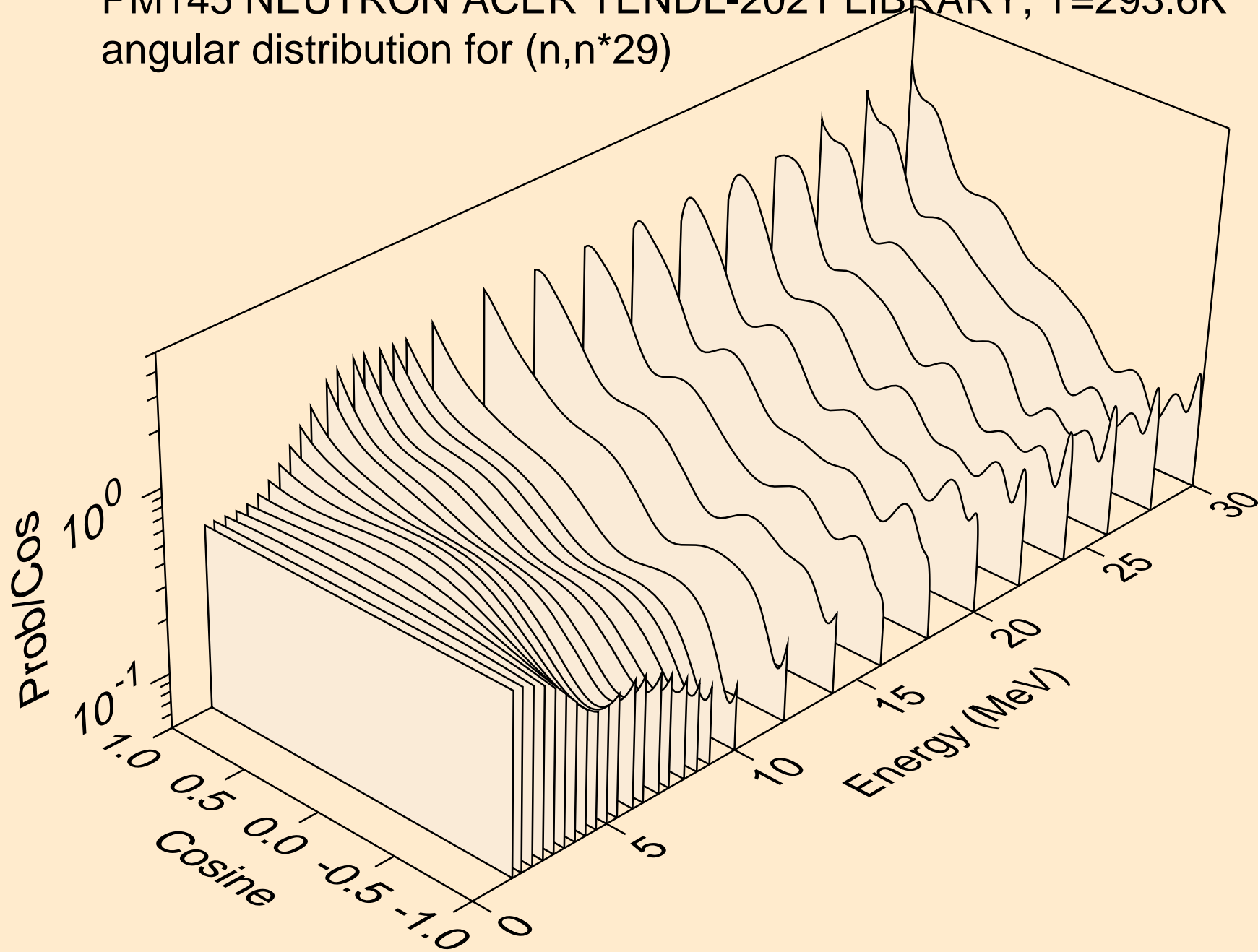

PM145 NEUTRON ACER TENDL-2021 LIBRARY; T=293.6K
angular distribution for (n,n*30)

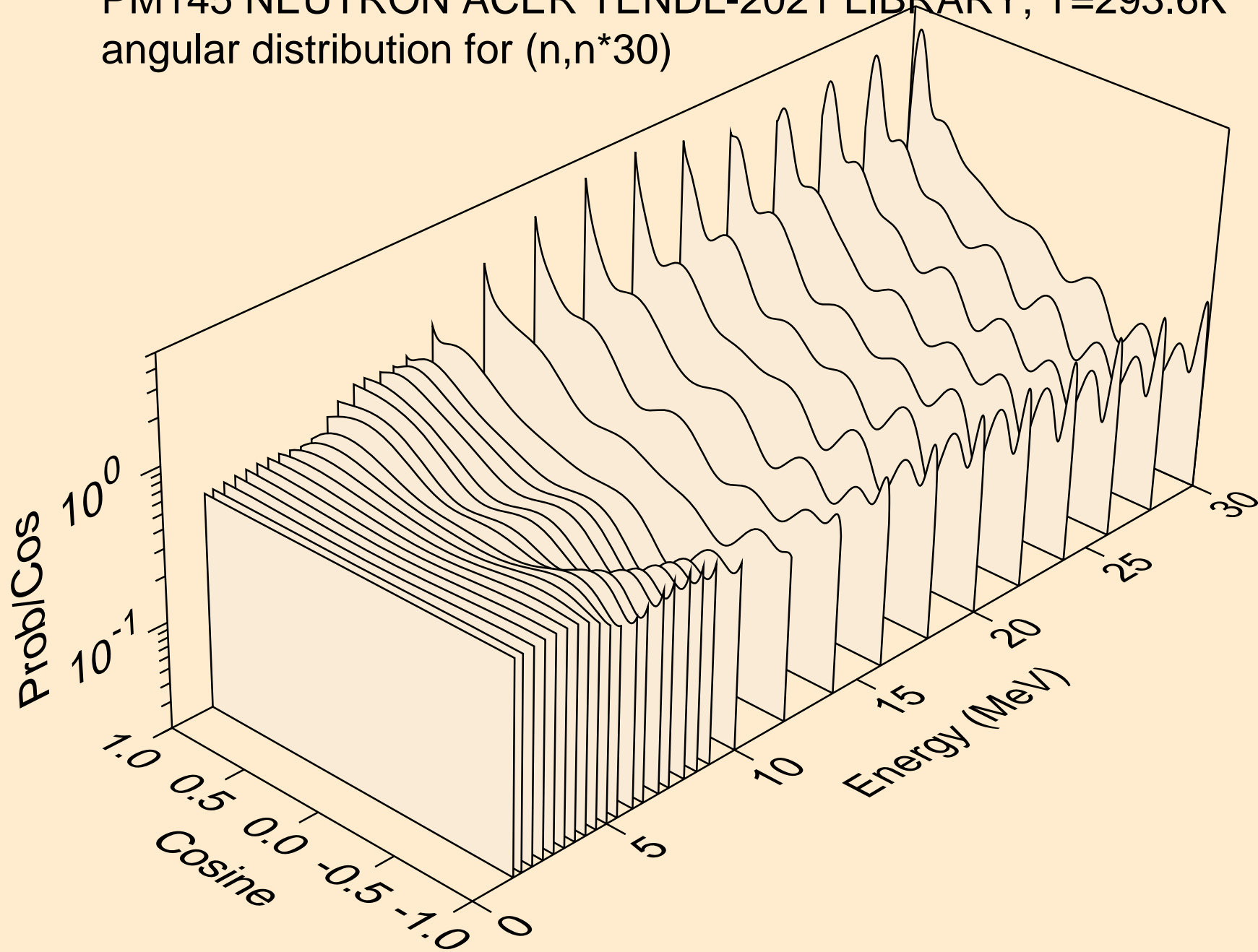

PM145 NEUTRON ACER TENDL-2021 LIBRARY; T=293.6K
Neutron emission for (n,x)

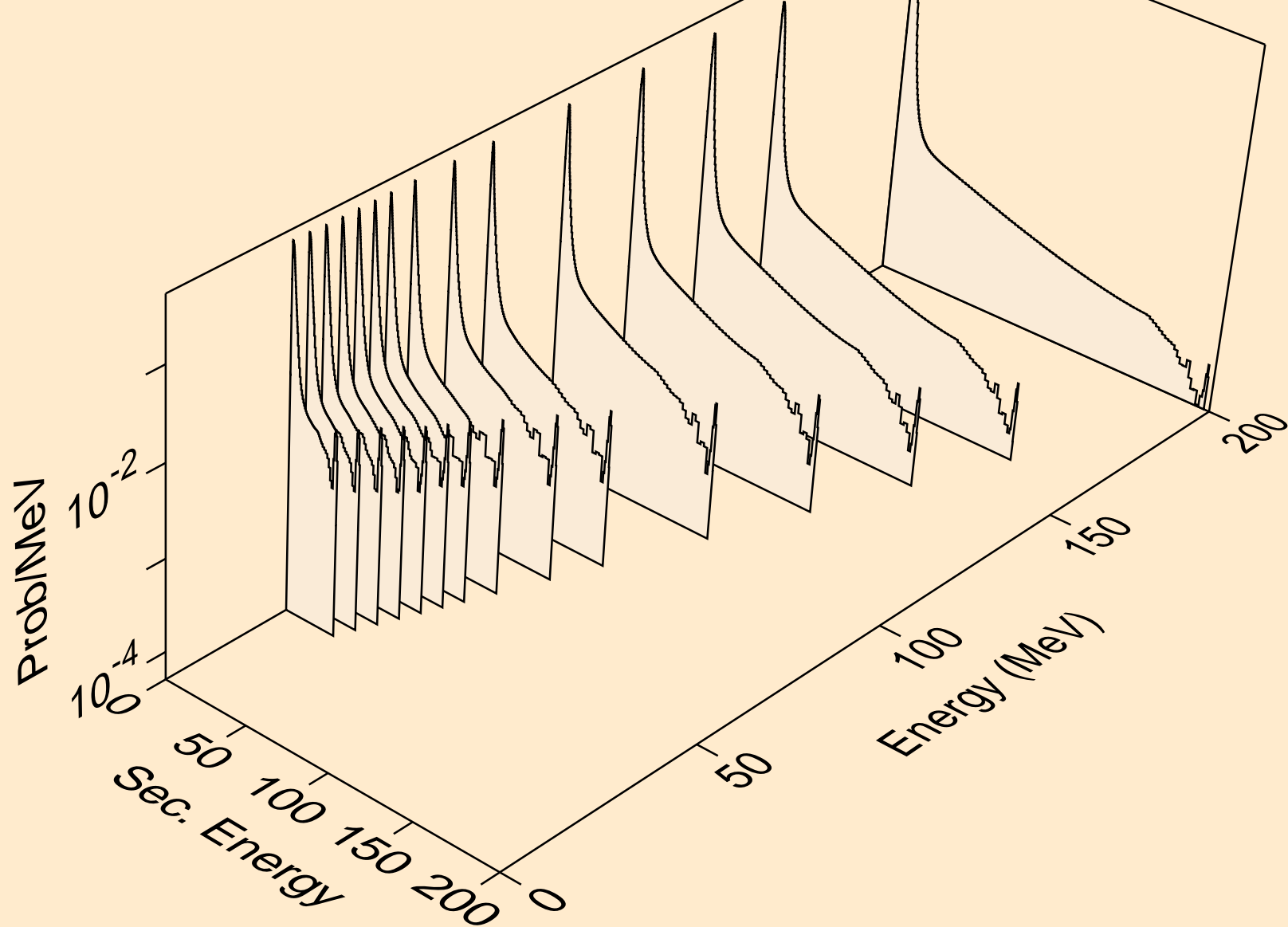

PM145 NEUTRON ACER TENDL-2021 LIBRARY; T=293.6K
Neutron emission for (n,2nd)

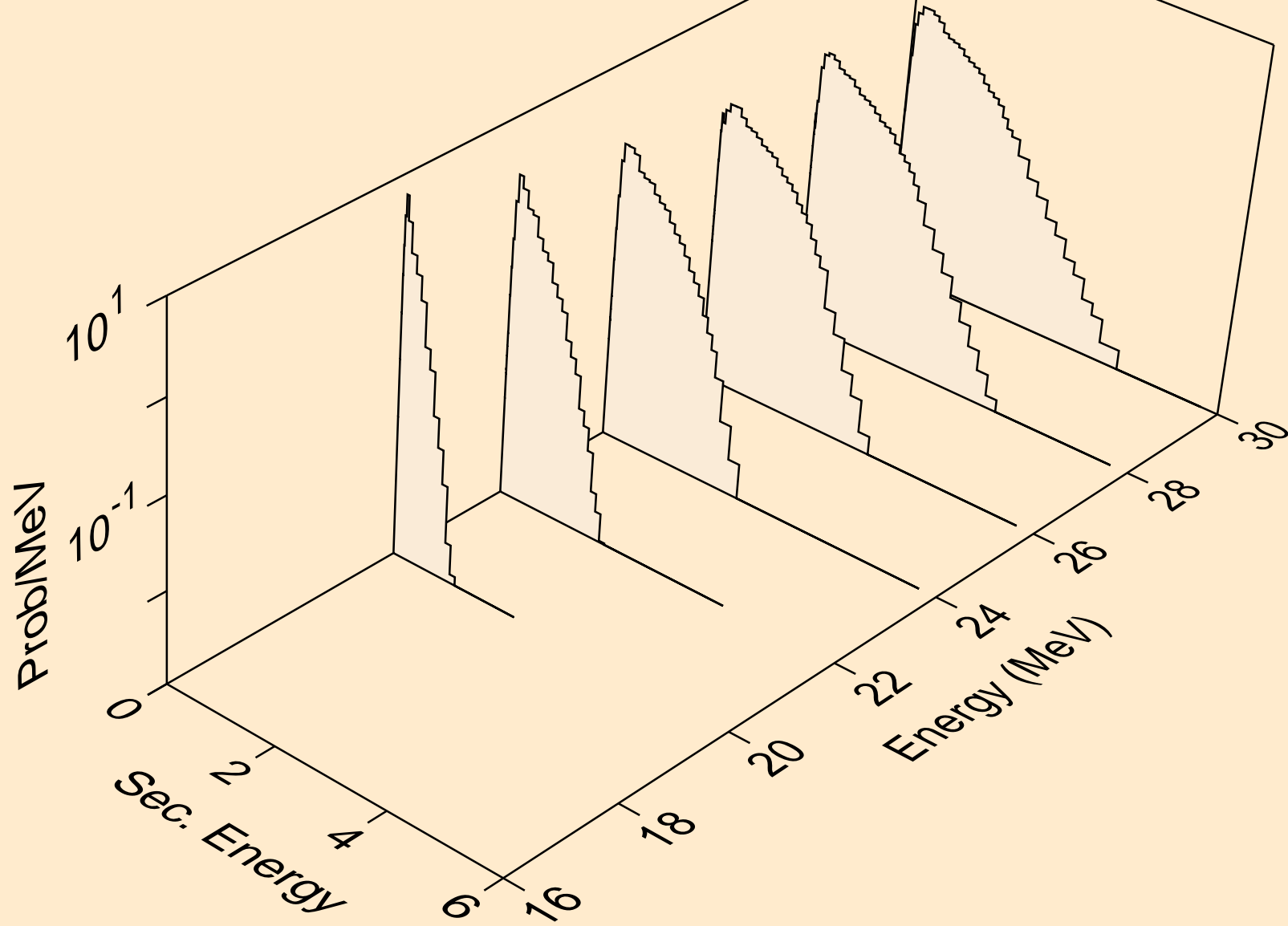

PM145 NEUTRON ACER TENDL-2021 LIBRARY; T=293.6K
Neutron emission for (n,2n)

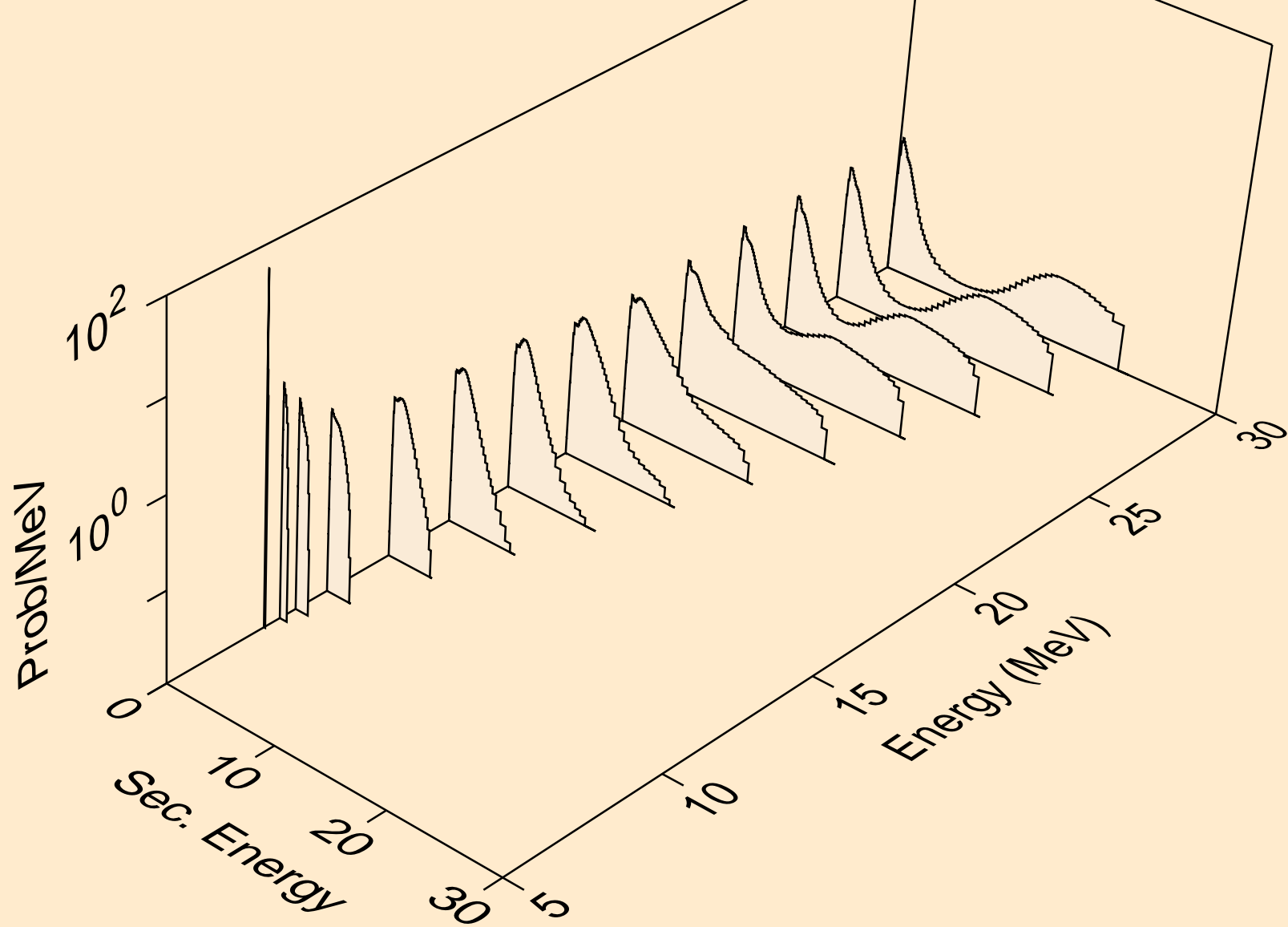

PM145 NEUTRON ACER TENDL-2021 LIBRARY; T=293.6K
Neutron emission for (n,3n)

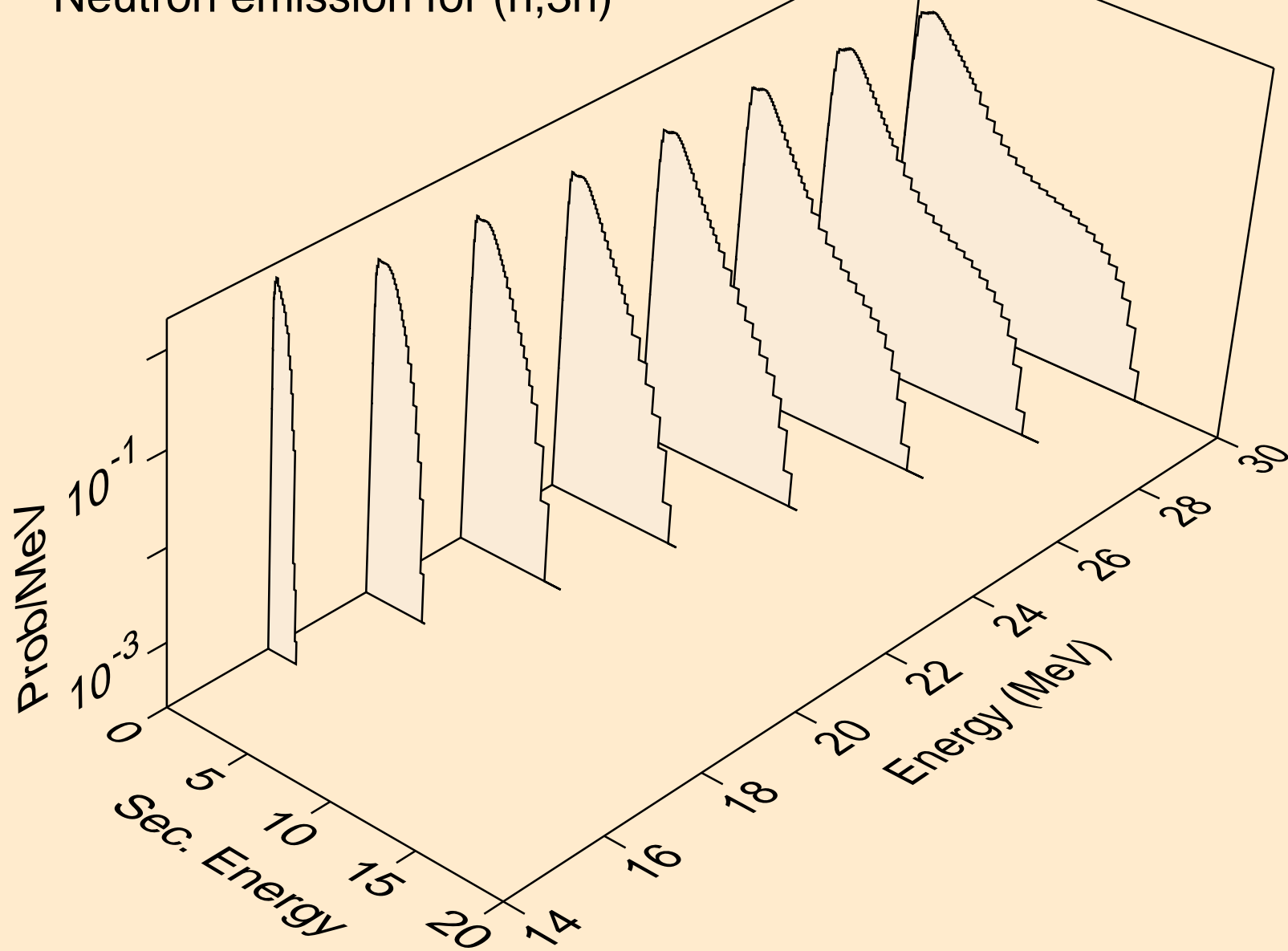

PM145 NEUTRON ACER TENDL-2021 LIBRARY; T=293.6K
Neutron emission for (n,n*)a

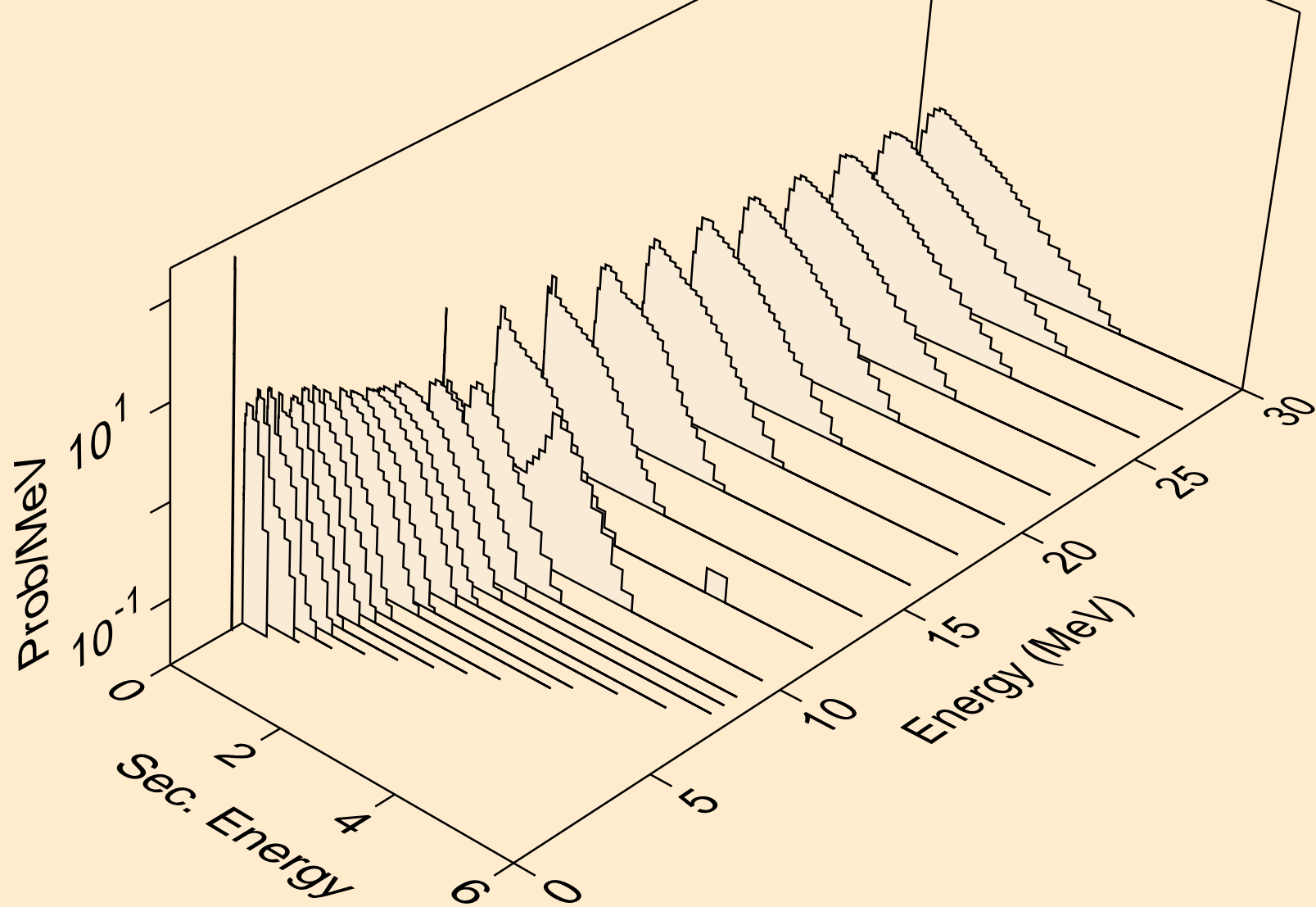

PM145 NEUTRON ACER TENDL-2021 LIBRARY; T=293.6K
Neutron emission for (n,2n)_a

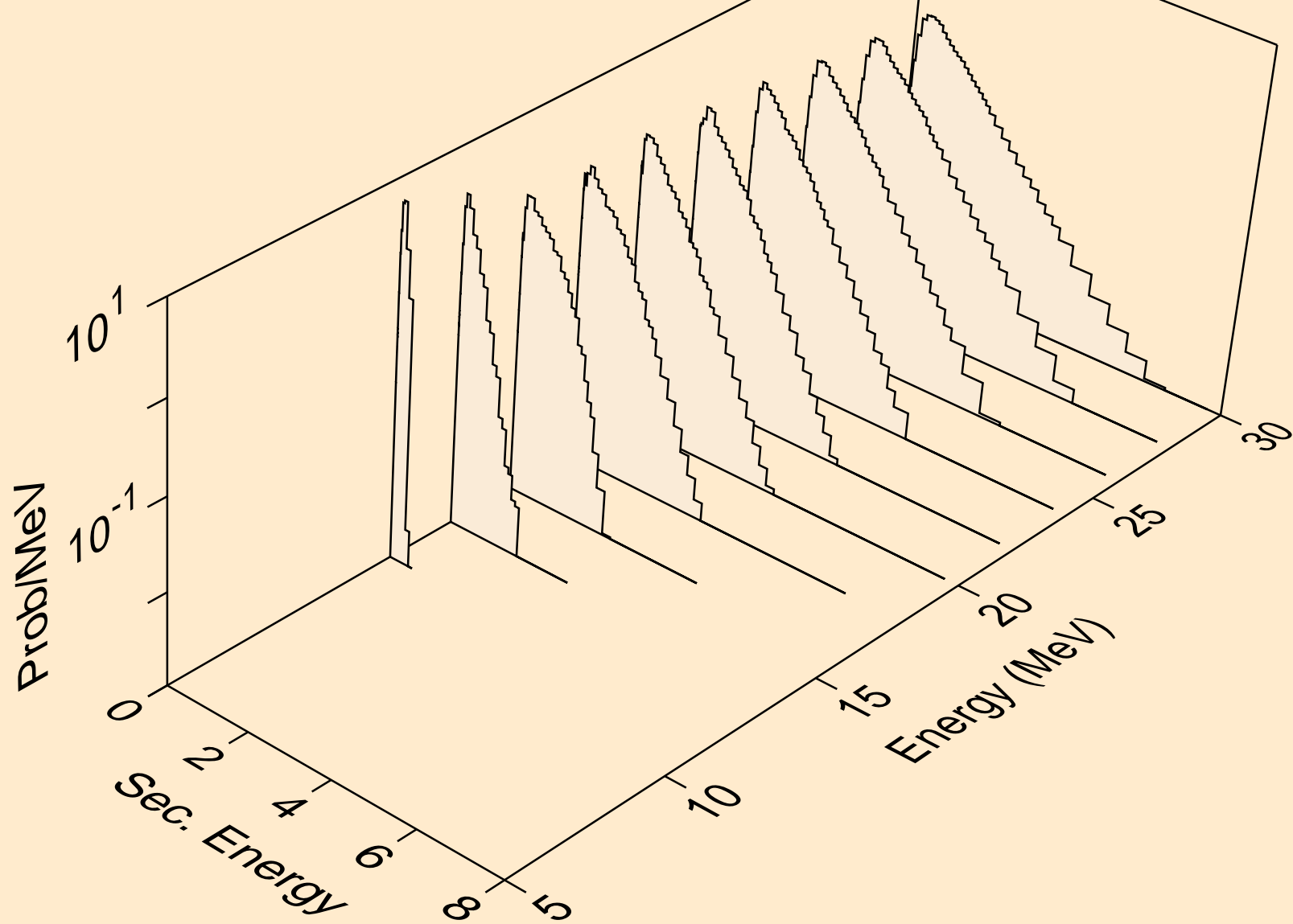

PM145 NEUTRON ACER TENDL-2021 LIBRARY; T=293.6K
Neutron emission for (n,3n)a

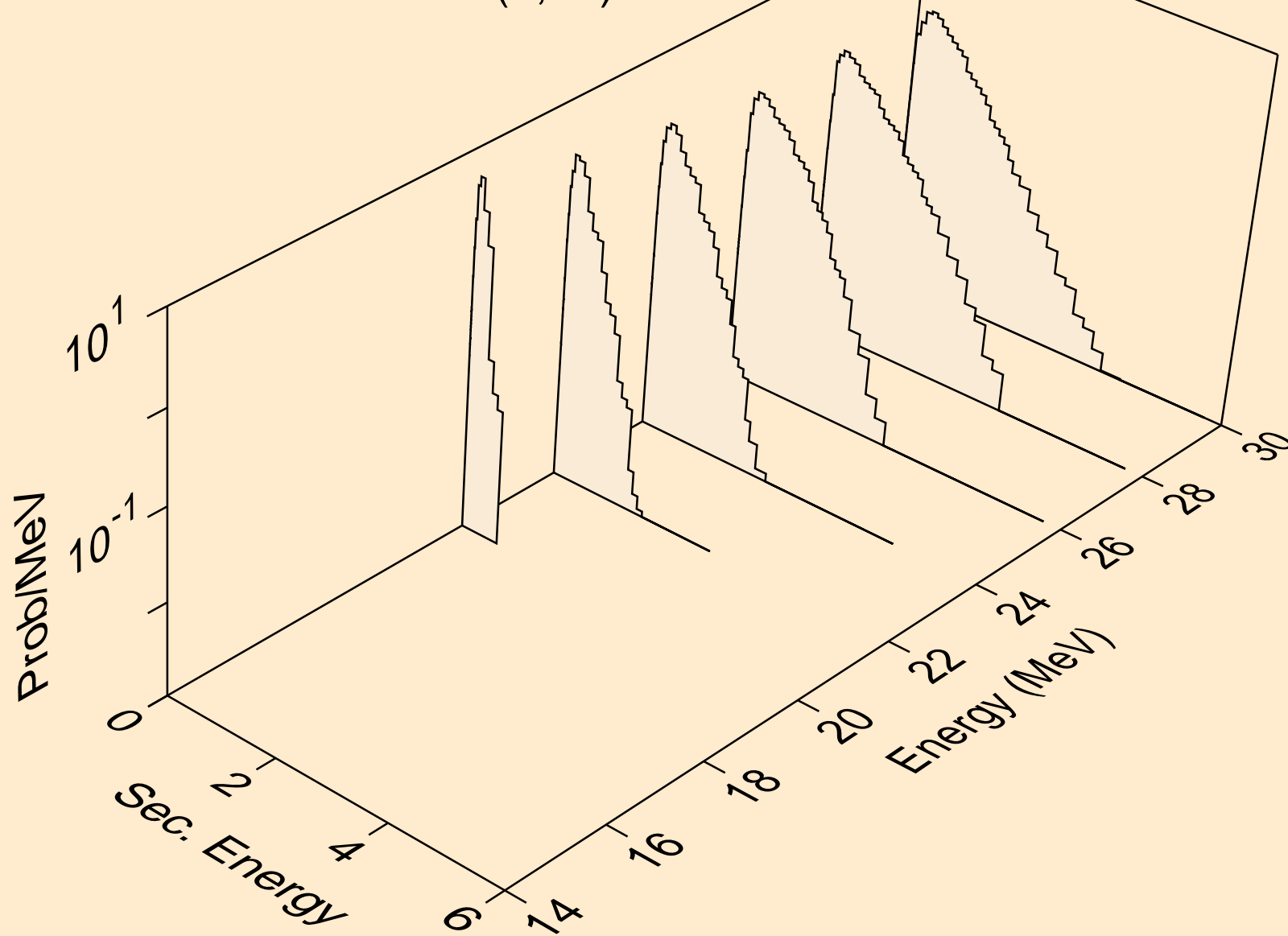

PM145 NEUTRON ACER TENDL-2021 LIBRARY; T=293.6K
Neutron emission for (n,n*)p

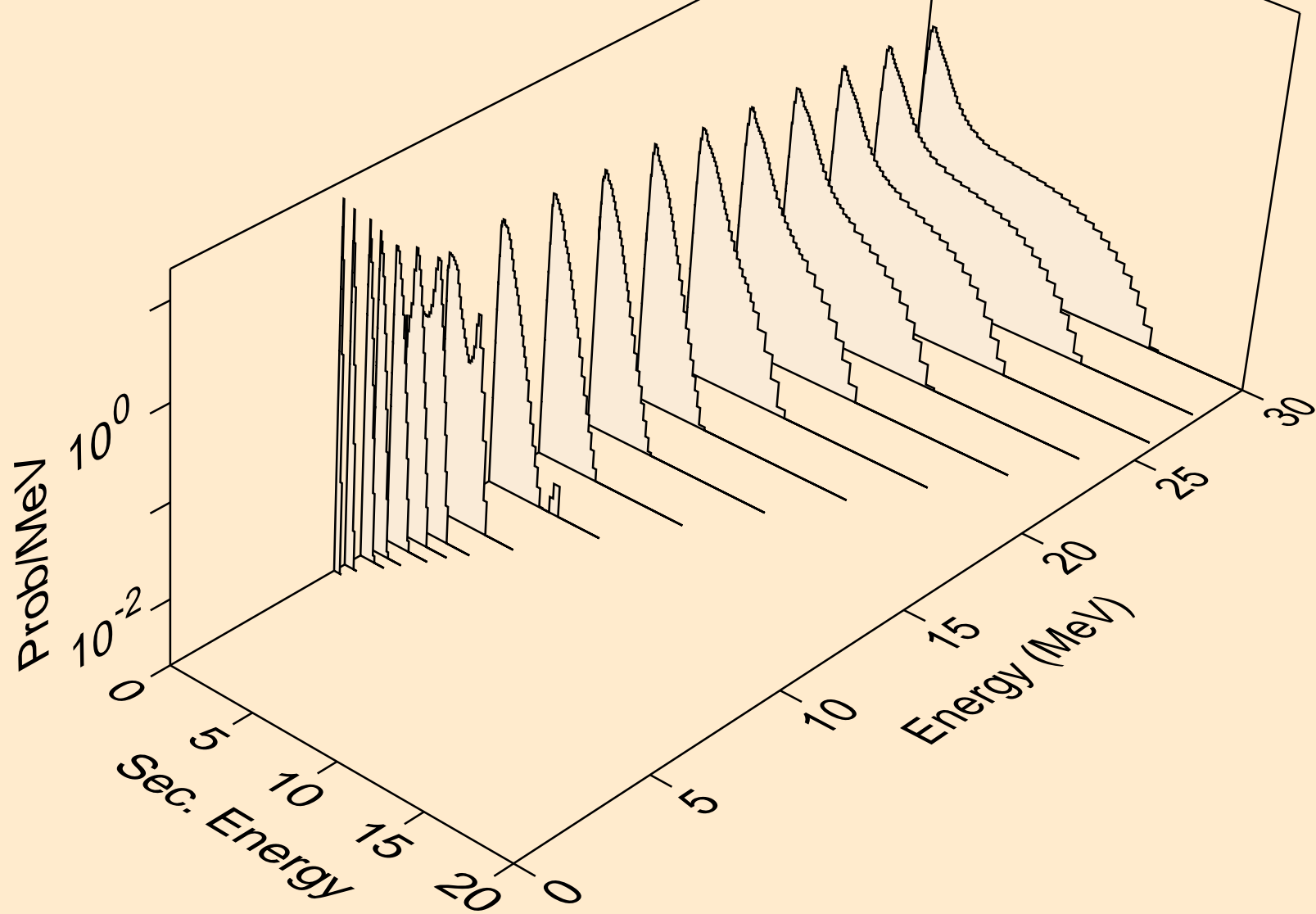

PM145 NEUTRON ACER TENDL-2021 LIBRARY; T=293.6K
Neutron emission for (n,n*)2a

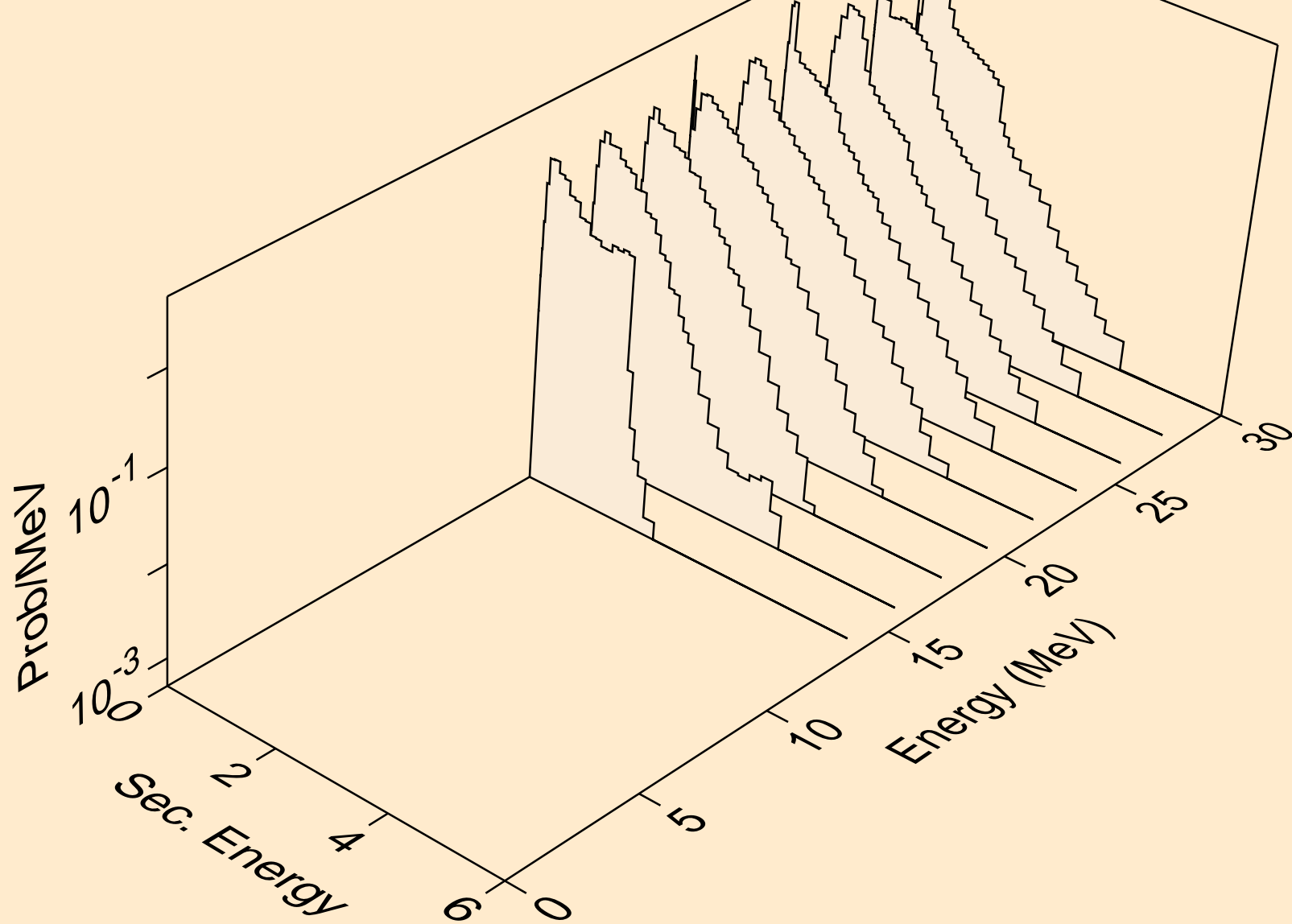

PM145 NEUTRON ACER TENDL-2021 LIBRARY; T=293.6K
Neutron emission for (n,n*)d

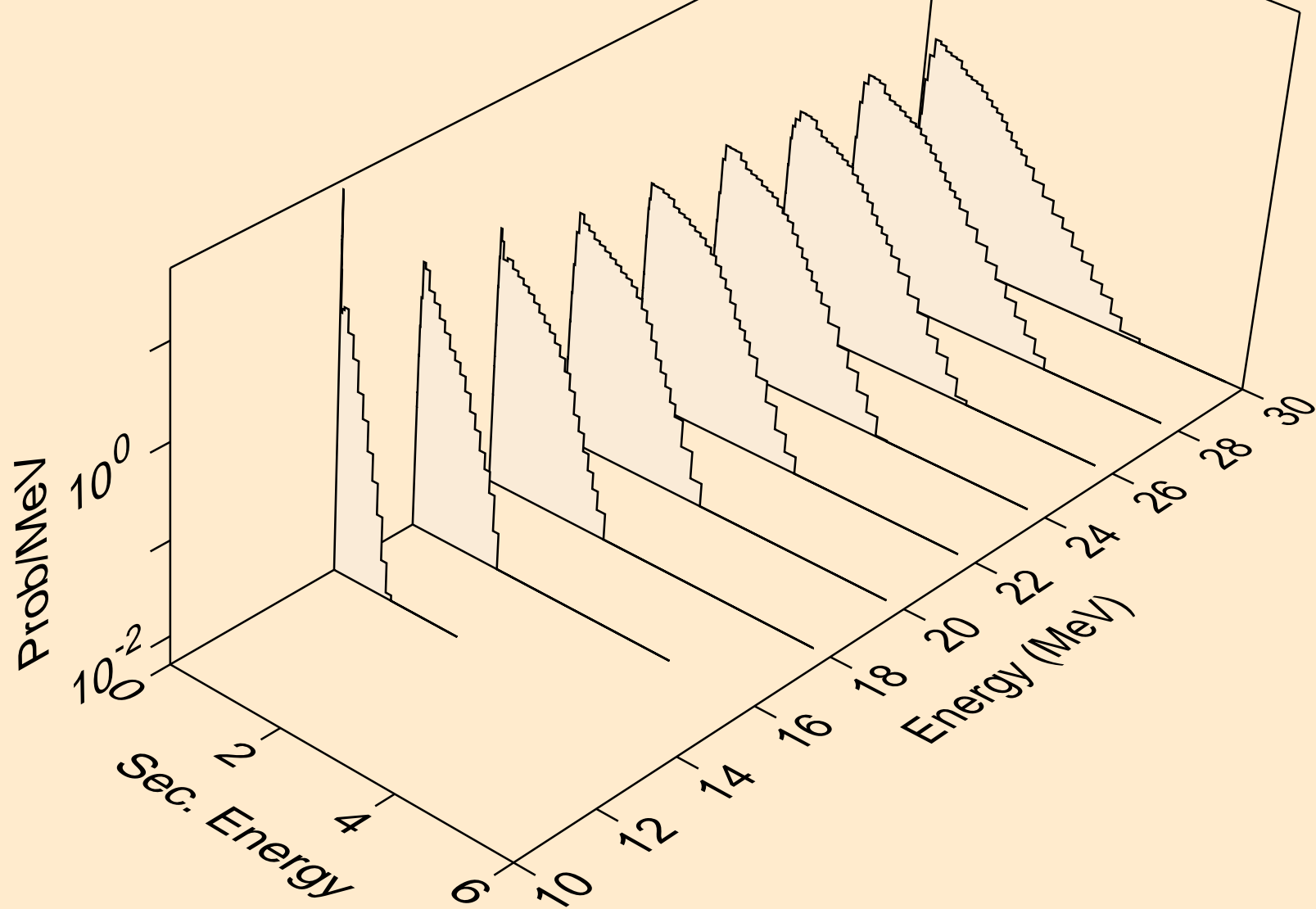

PM145 NEUTRON ACER TENDL-2021 LIBRARY; T=293.6K
Neutron emission for (n,n*)t

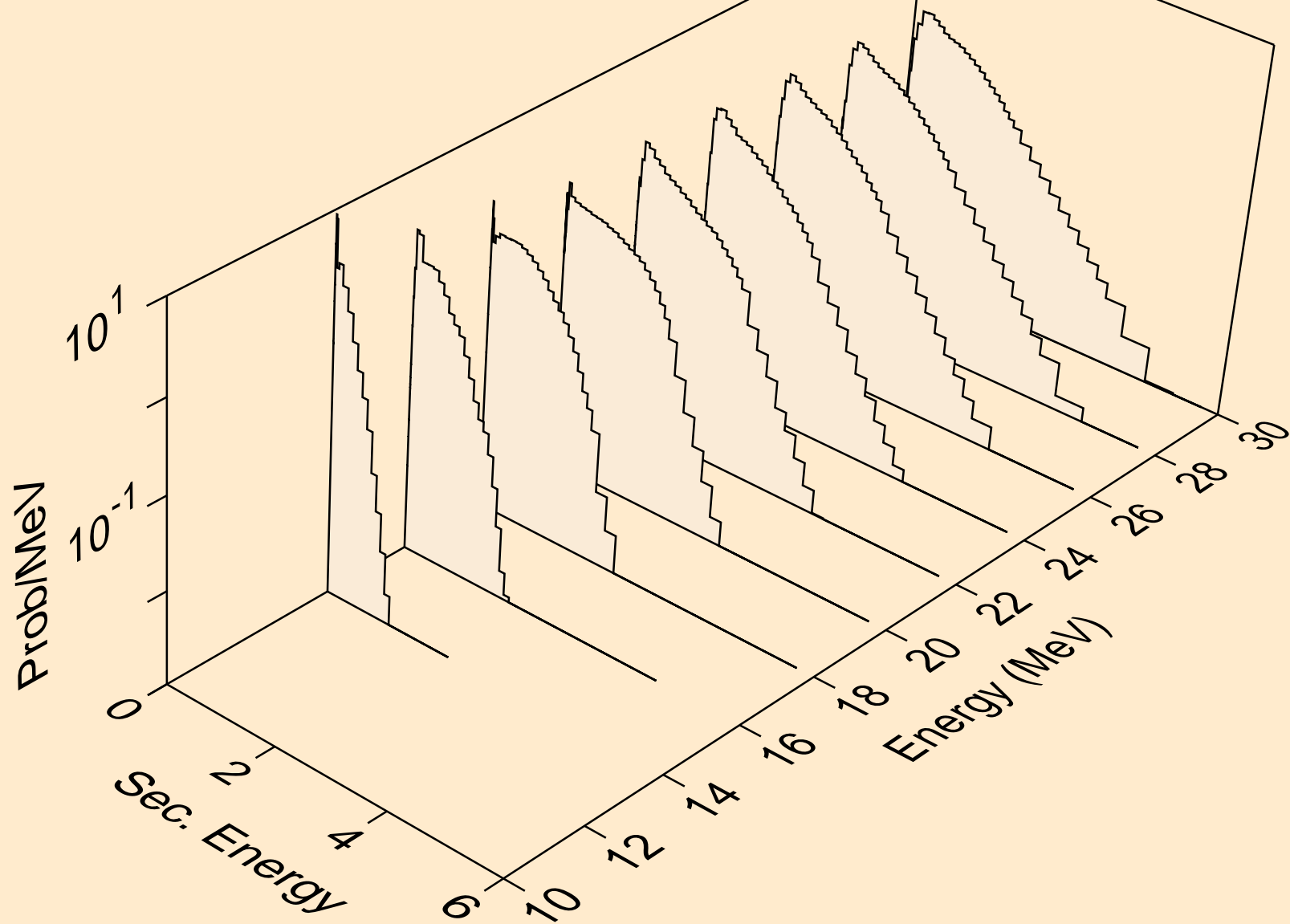

PM145 NEUTRON ACER TENDL-2021 LIBRARY; T=293.6K
Neutron emission for (n,n*)he3

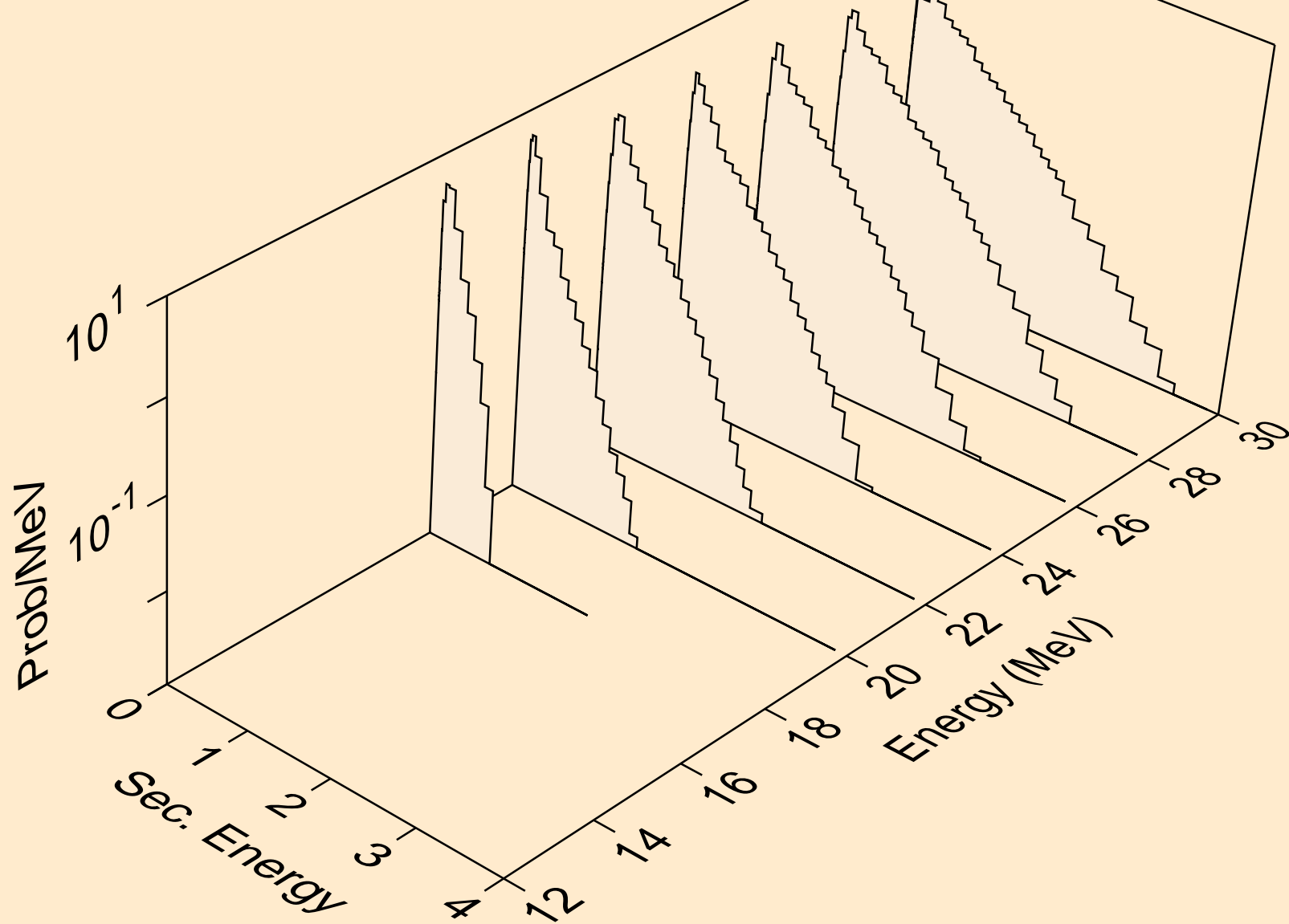

PM145 NEUTRON ACER TENDL-2021 LIBRARY; T=293.6K
Neutron emission for (n,4n)

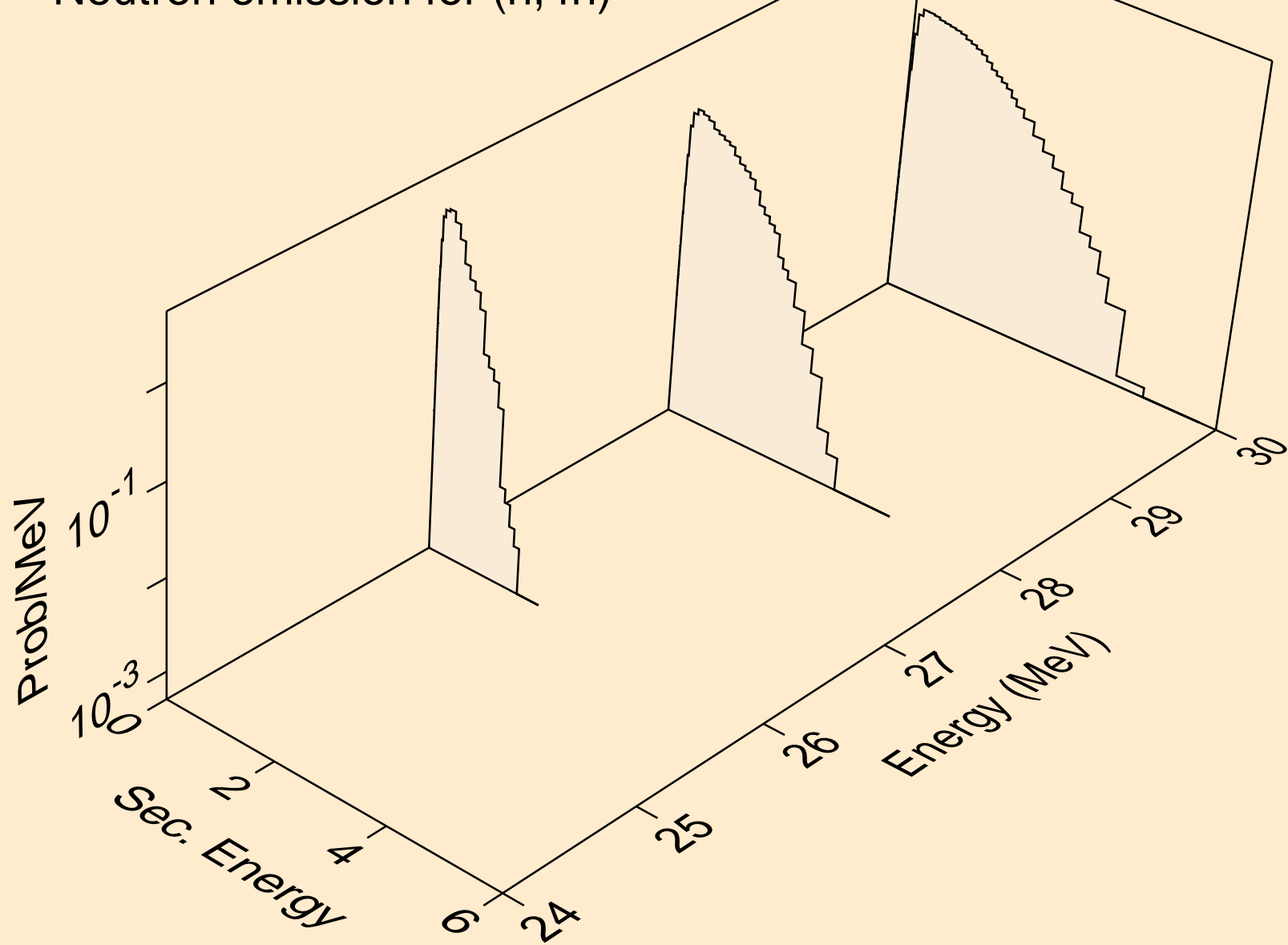

PM145 NEUTRON ACER TENDL-2021 LIBRARY; T=293.6K
Neutron emission for (n,2np)

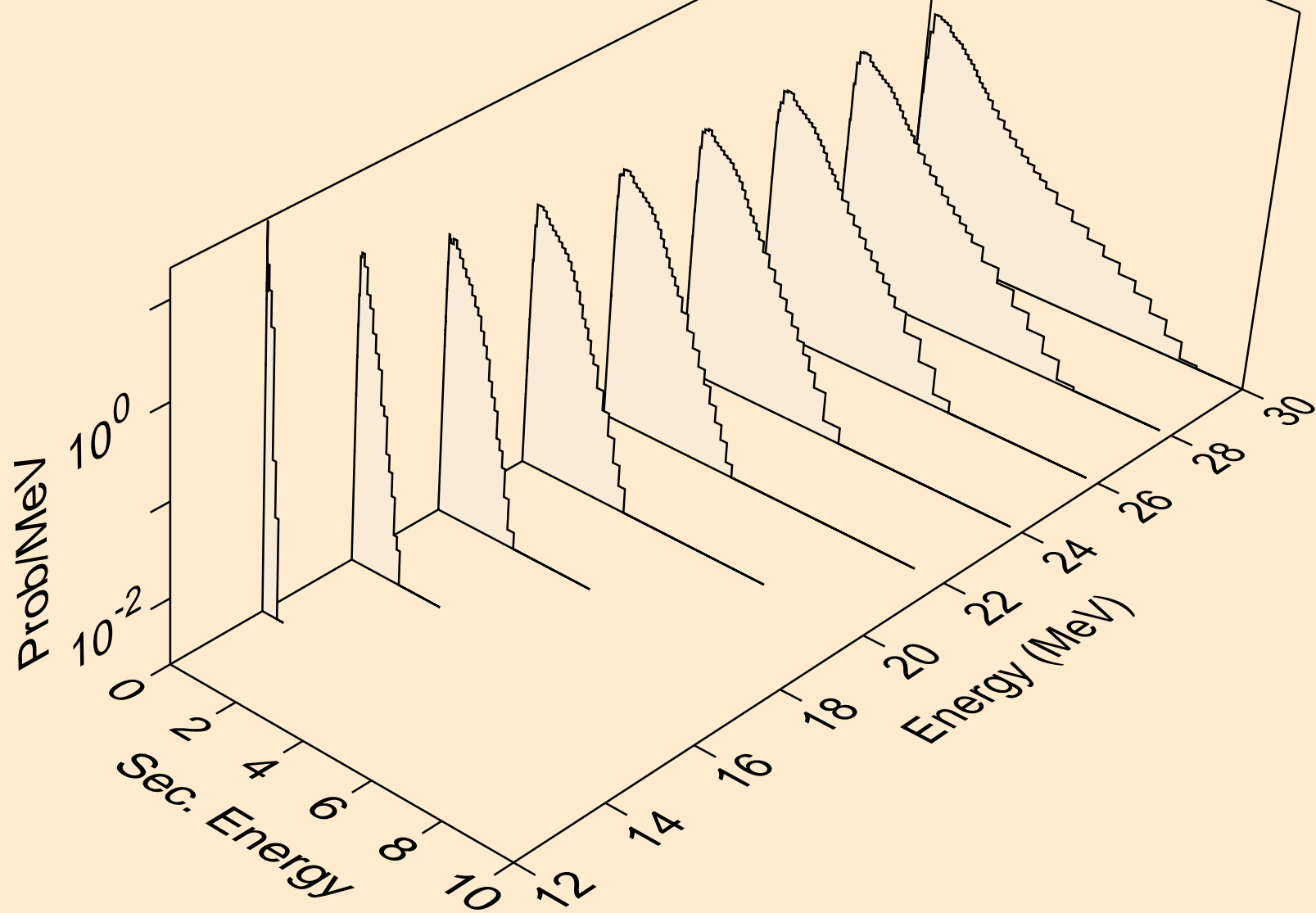

PM145 NEUTRON ACER TENDL-2021 LIBRARY; T=293.6K
Neutron emission for (n,3np)

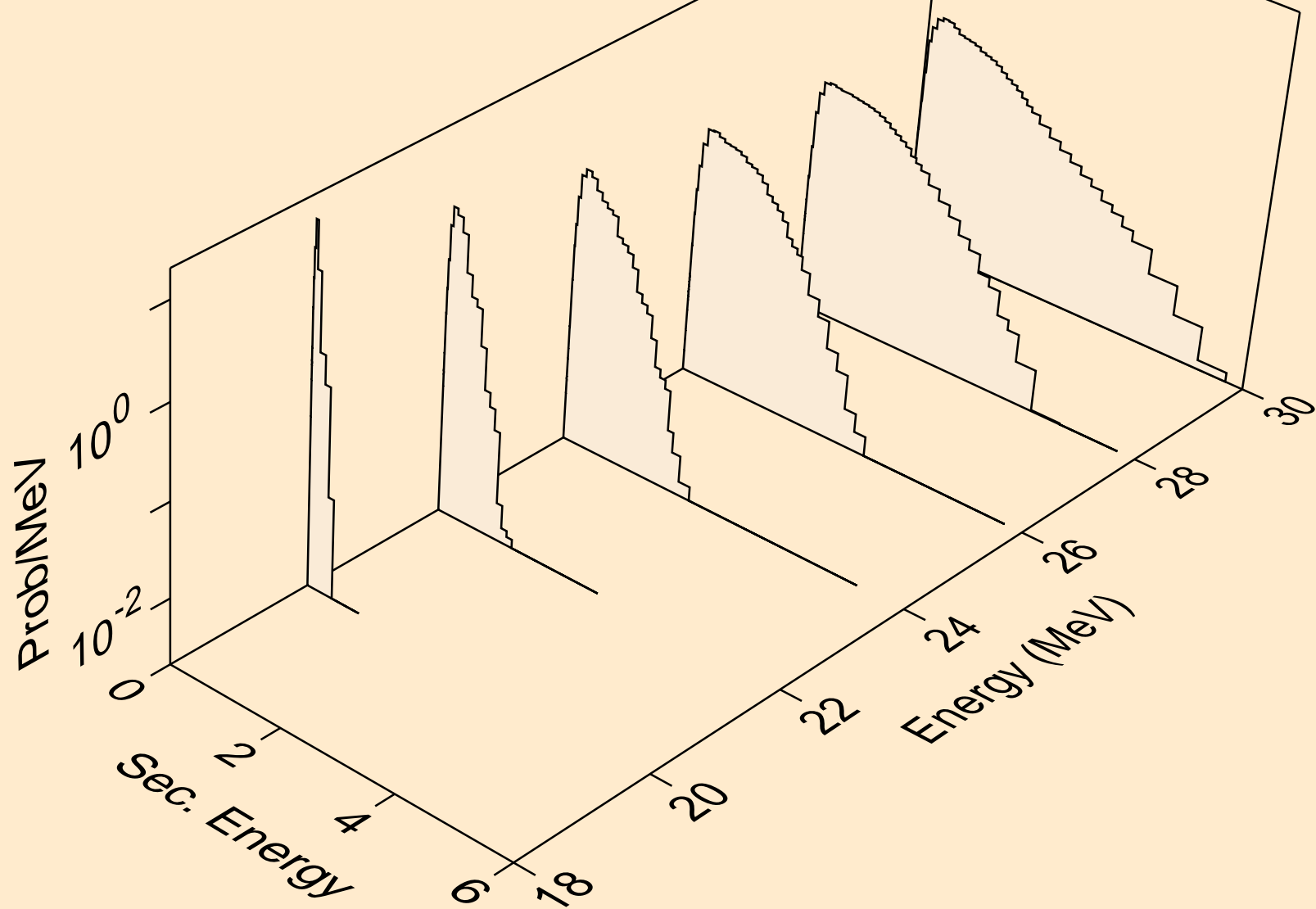

PM145 NEUTRON ACER TENDL-2021 LIBRARY; T=293.6K
Neutron emission for (n,2np)

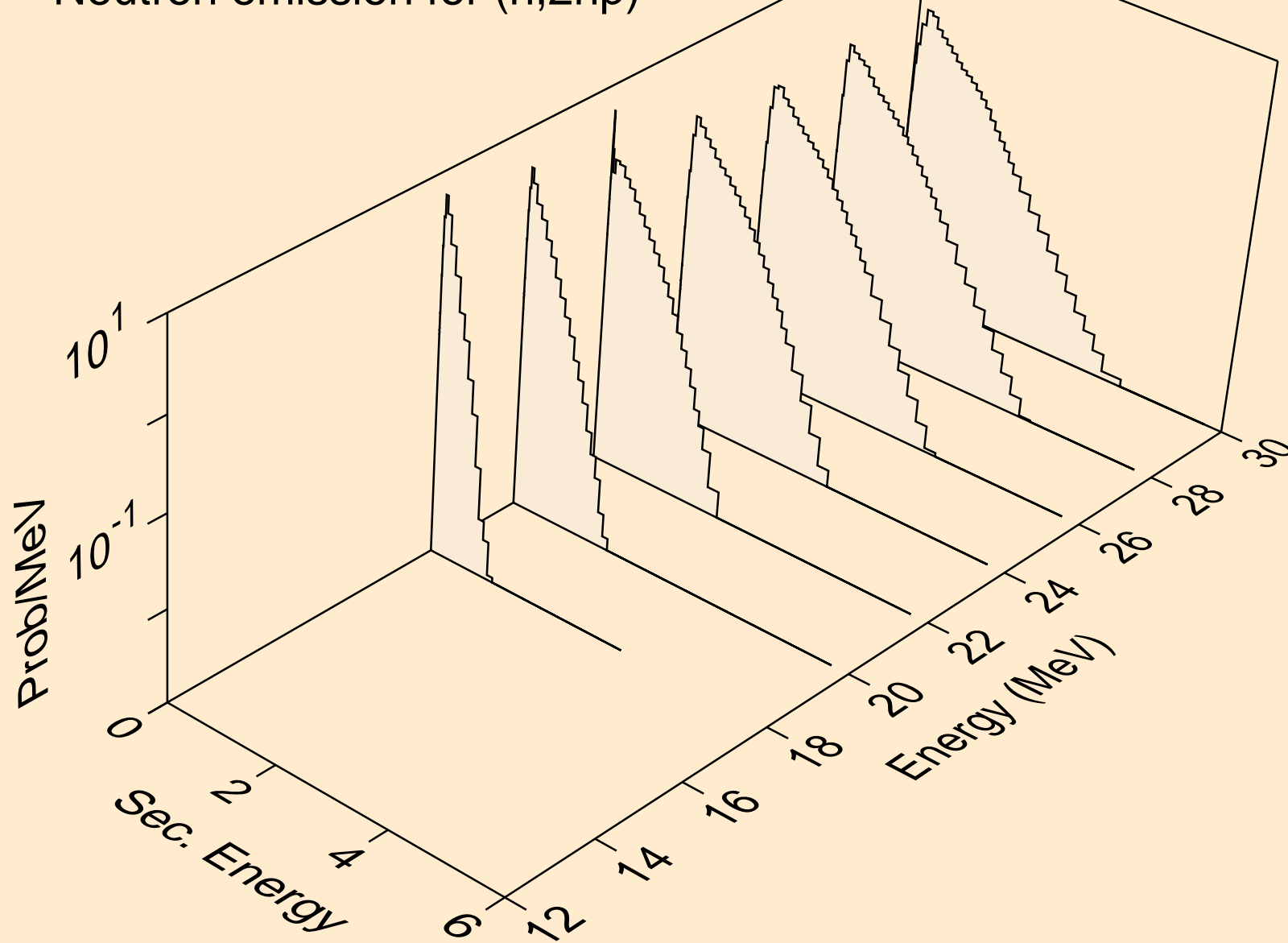

PM145 NEUTRON ACER TENDL-2021 LIBRARY; T=293.6K
Neutron emission for (n,npa)

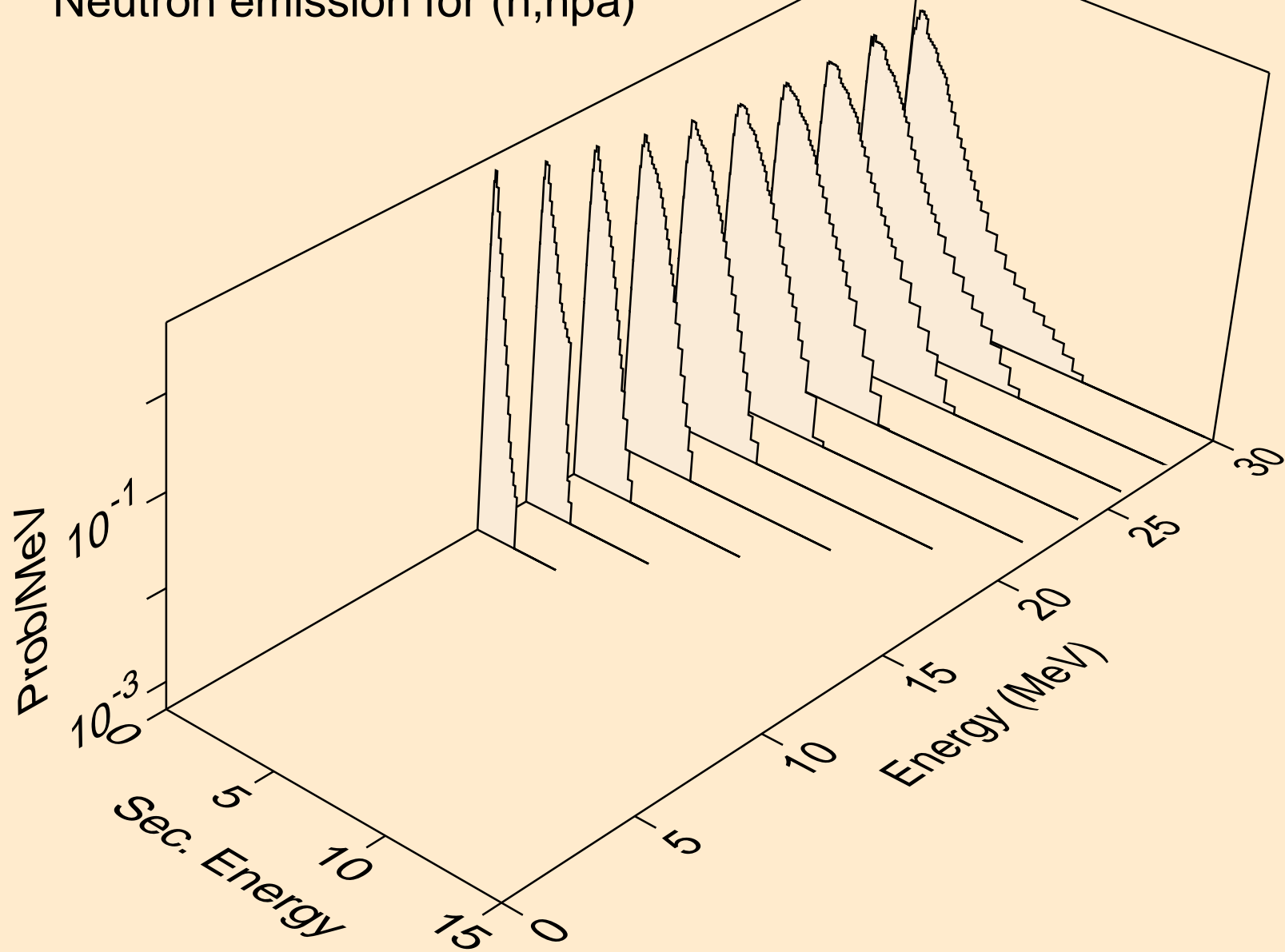

PM145 NEUTRON ACER TENDL-2021 LIBRARY; T=293.6K
Neutron emission for (n,n*c)

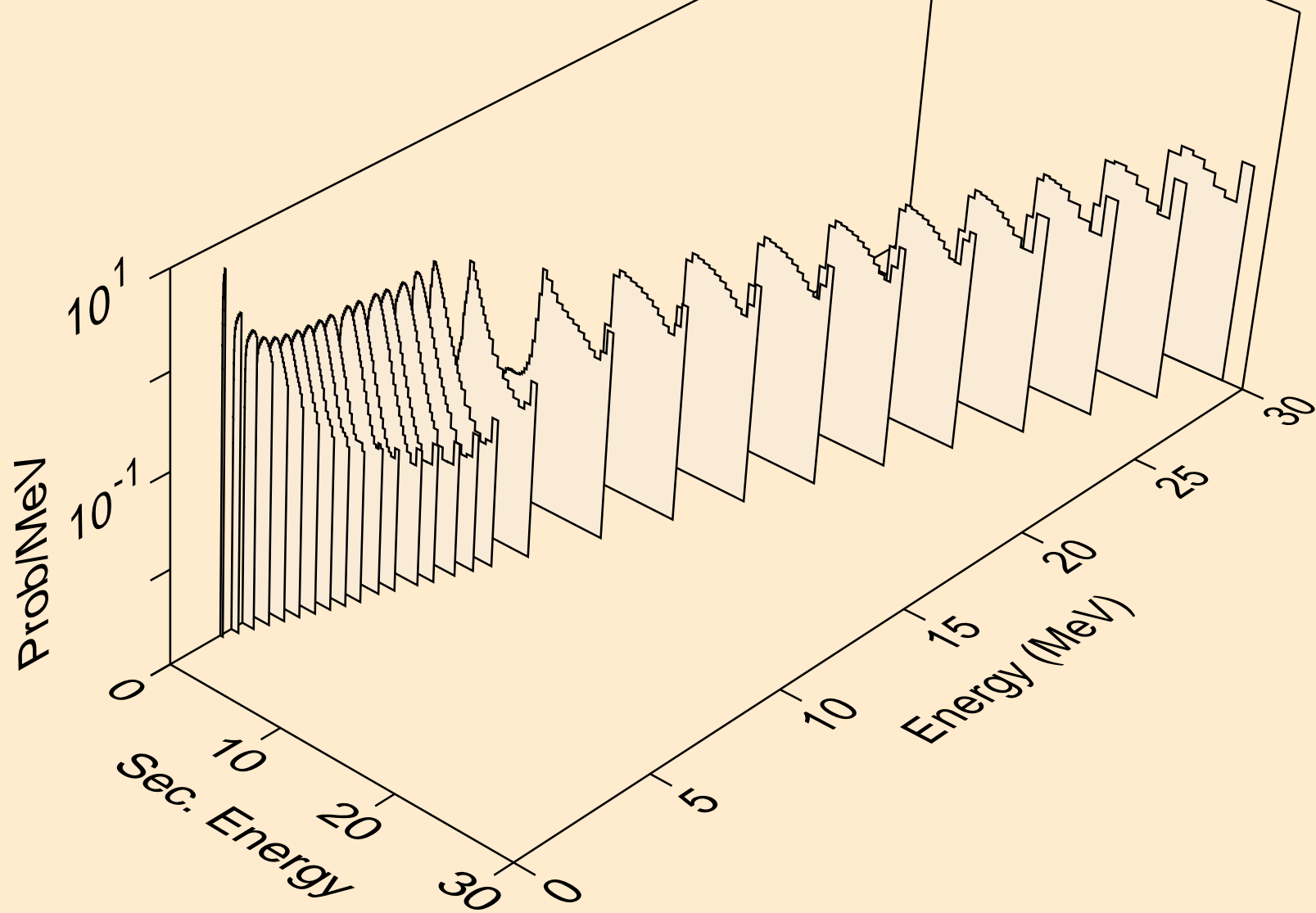

PM145 NEUTRON ACER TENDL-2021 LIBRARY; T=293.6K
Photon emission for (n,x)

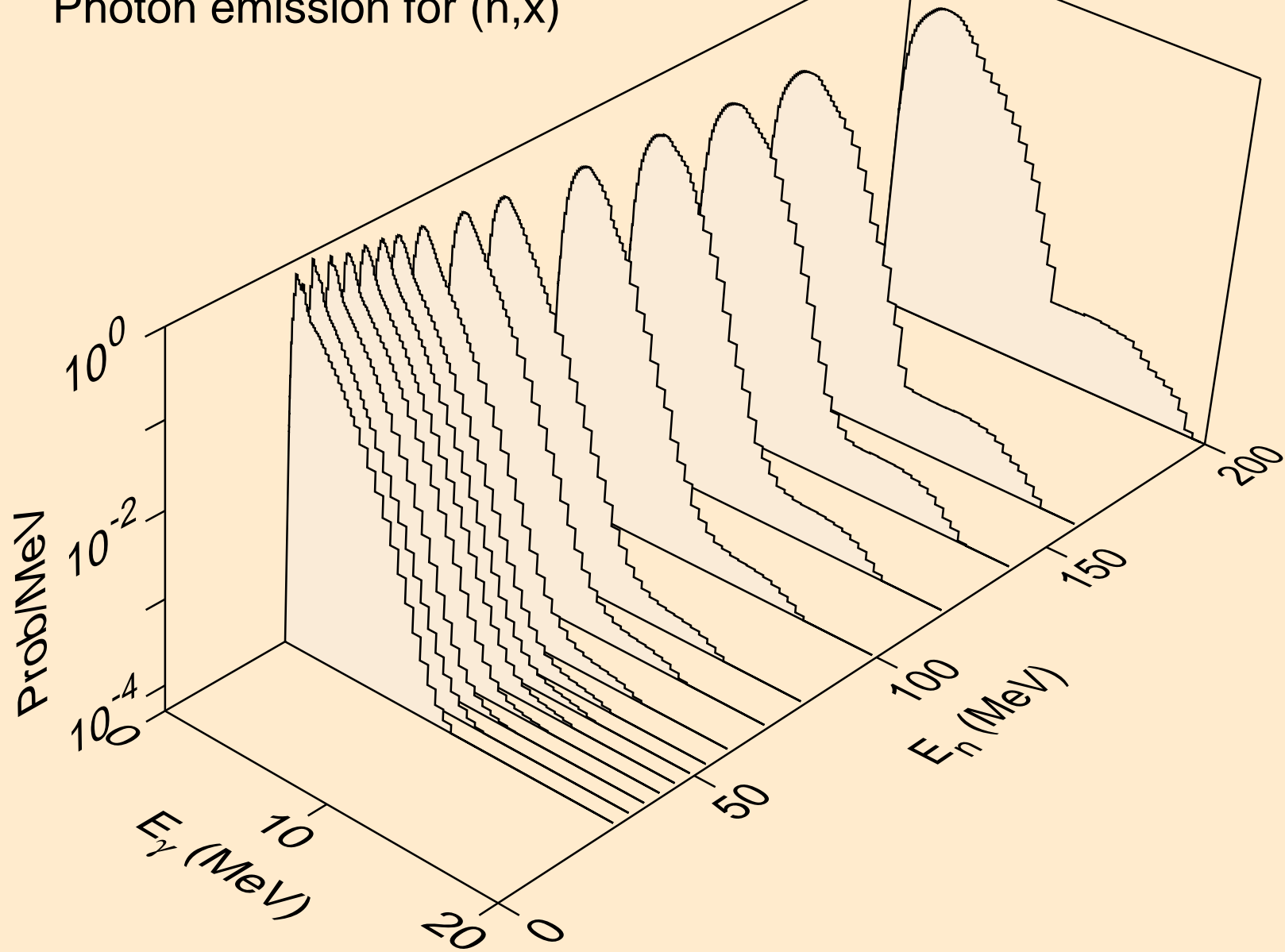

PM145 NEUTRON ACER TENDL-2021 LIBRARY; T=293.6K
Photon emission for (n,2nd)

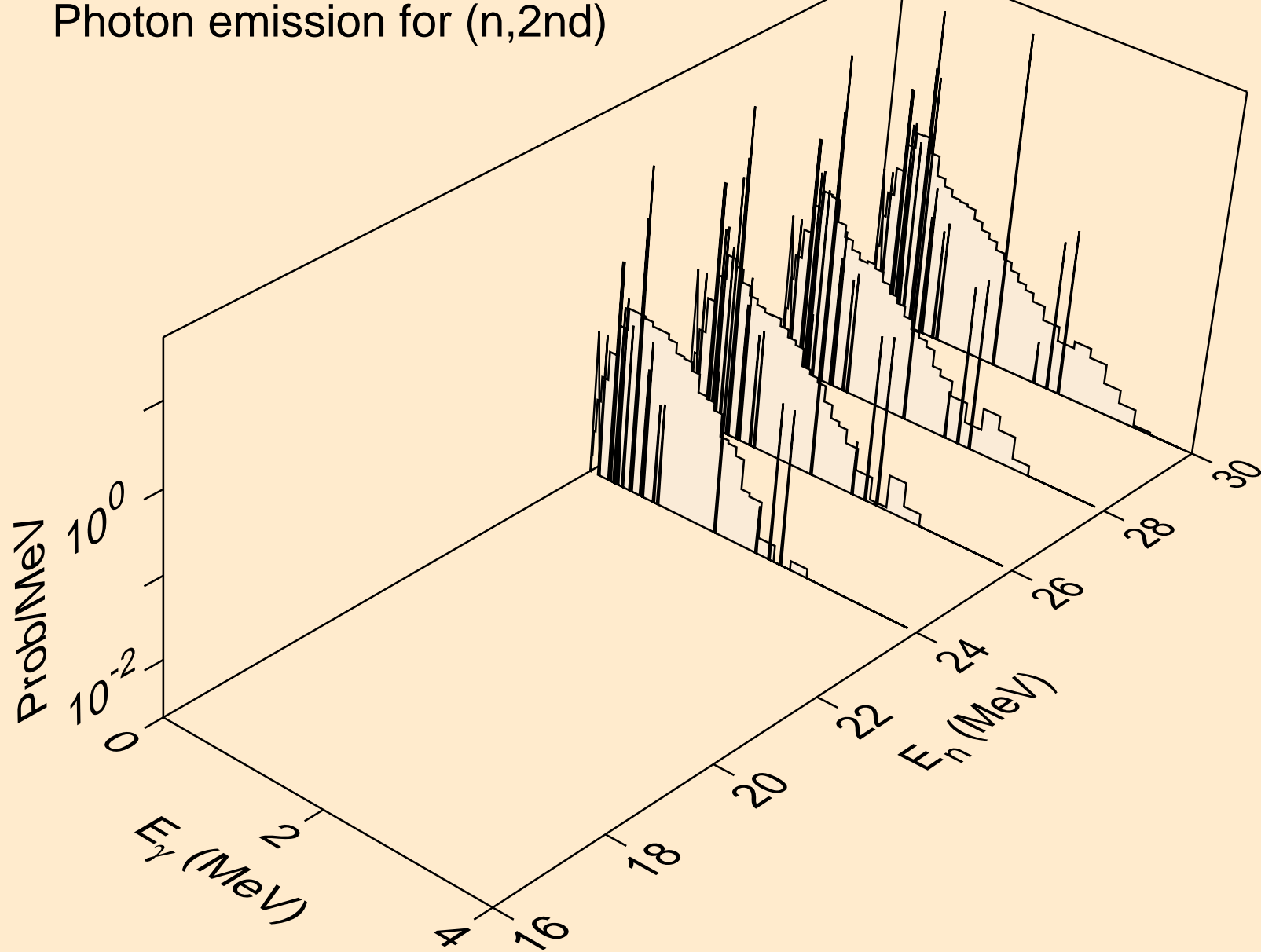

PM145 NEUTRON ACER TENDL-2021 LIBRARY; T=293.6K
Photon emission for (n,2n)

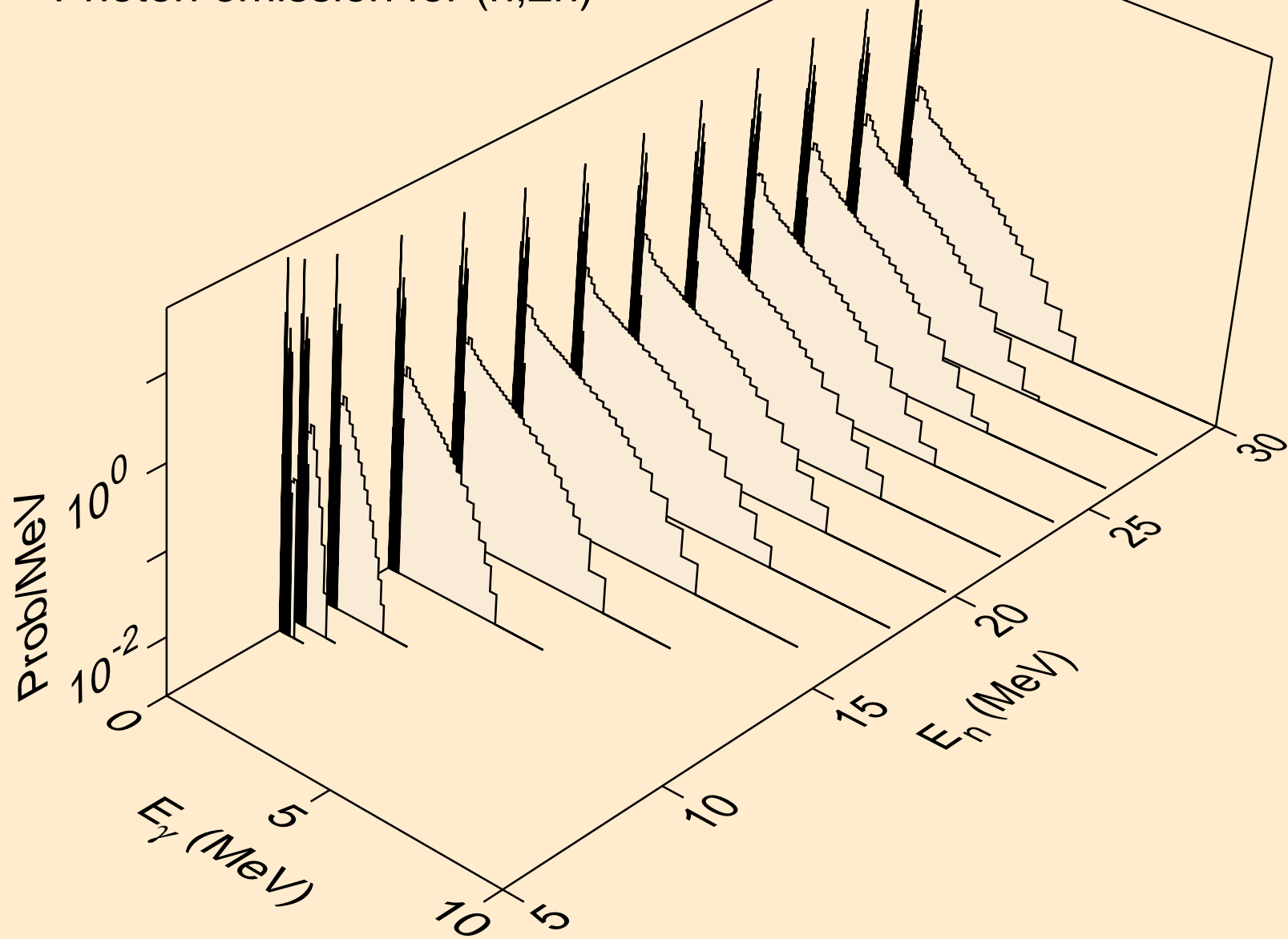

PM145 NEUTRON ACER TENDL-2021 LIBRARY; T=293.6K
Photon emission for (n,3n)

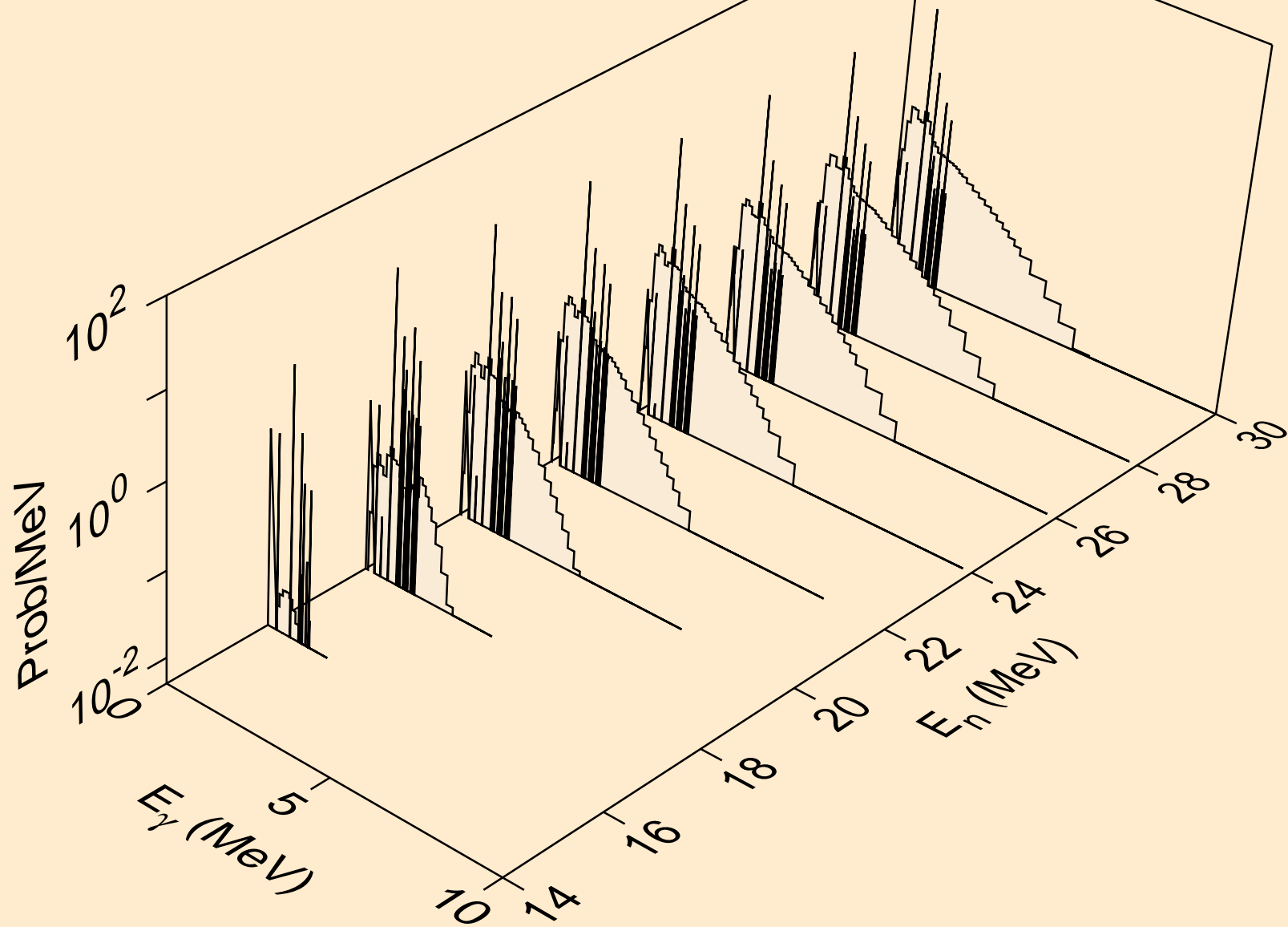

PM145 NEUTRON ACER TENDL-2021 LIBRARY; T=293.6K
Photon emission for (n,n*)a

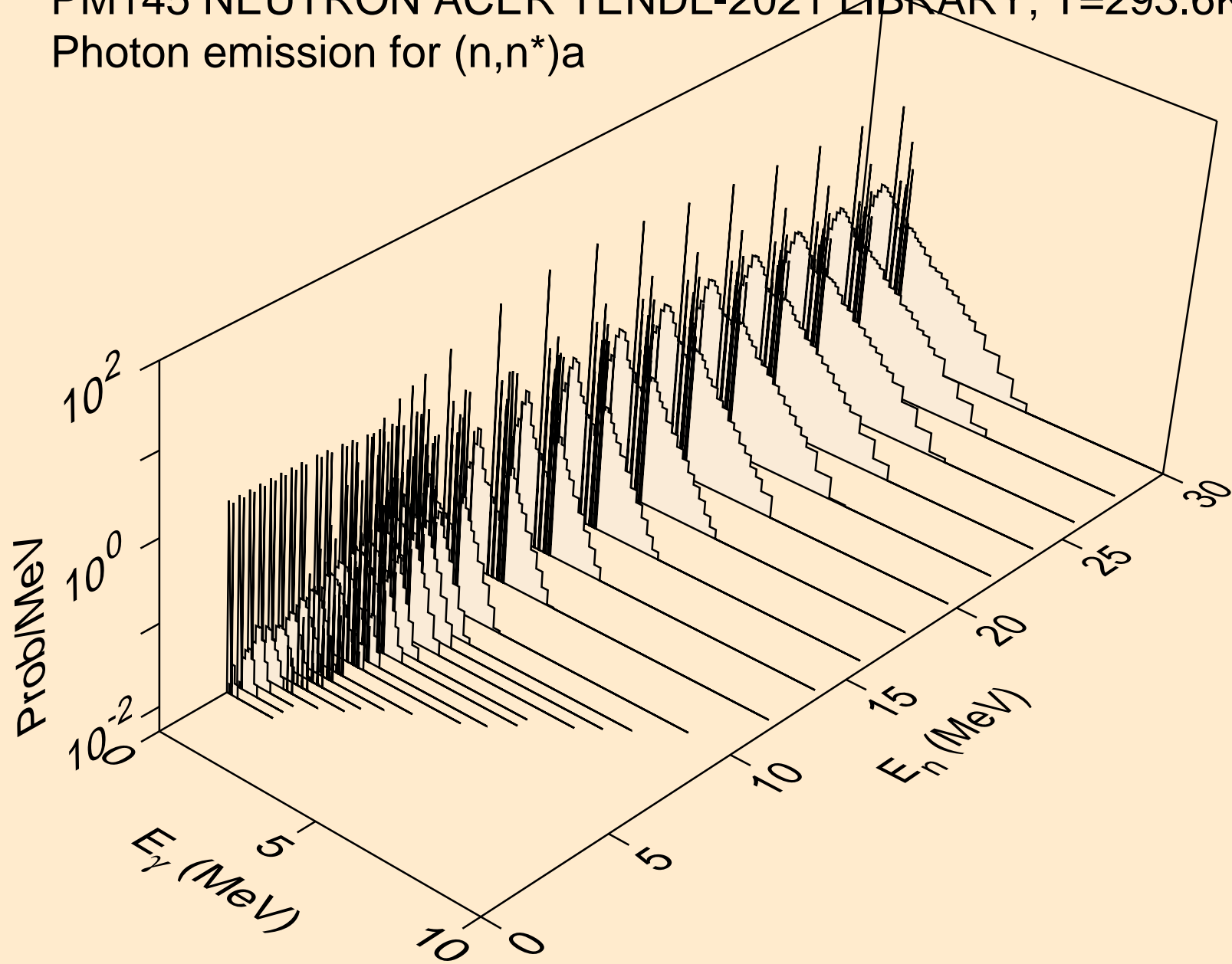

PM145 NEUTRON ACER TENDL-2021 LIBRARY; T=293.6K
Photon emission for (n,2n)a

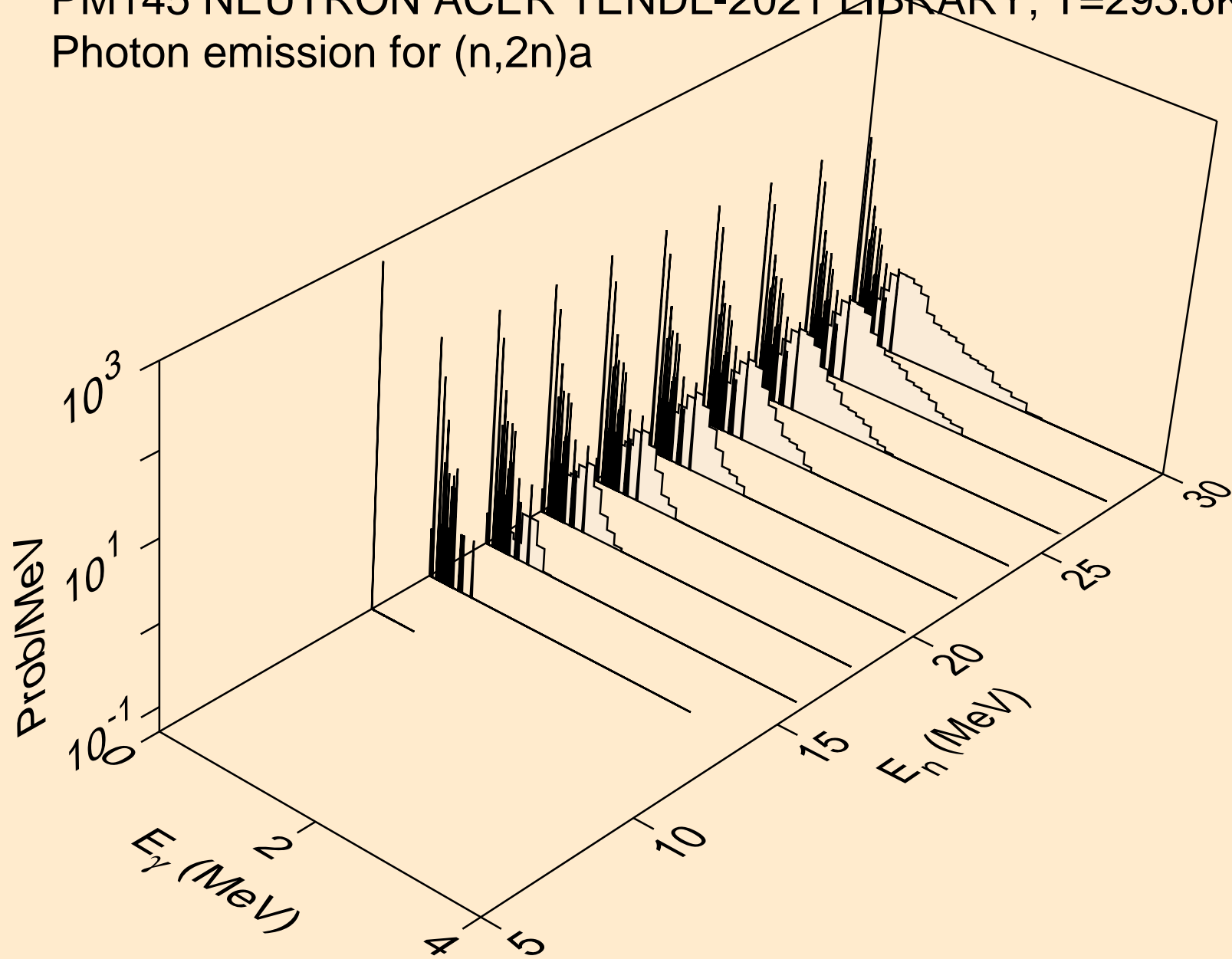

PM145 NEUTRON ACER TENDL-2021 LIBRARY; T=293.6K
Photon emission for (n,3n)a

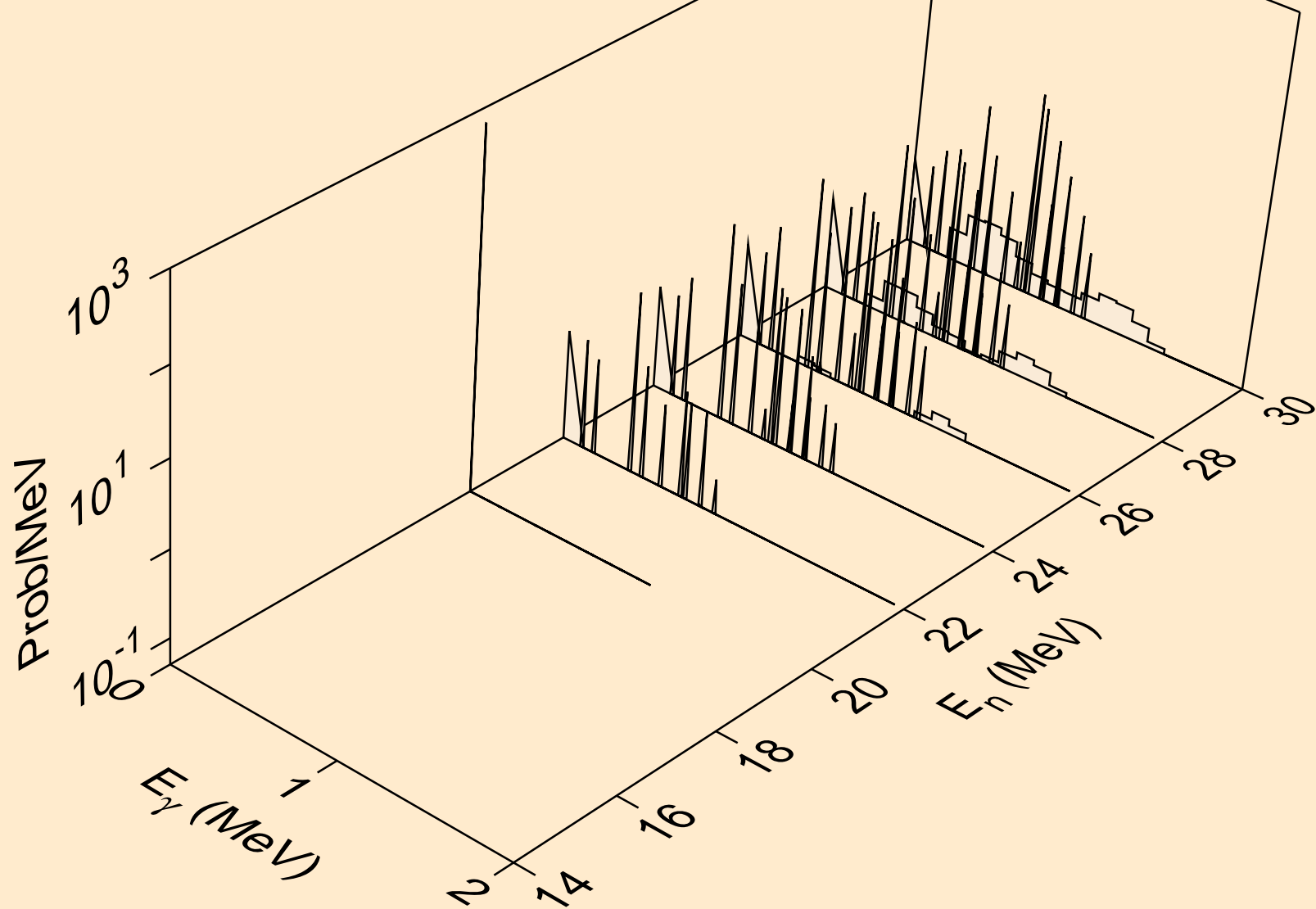

PM145 NEUTRON ACER TENDL-2021 LIBRARY; T=293.6K
Photon emission for (n,n*)p

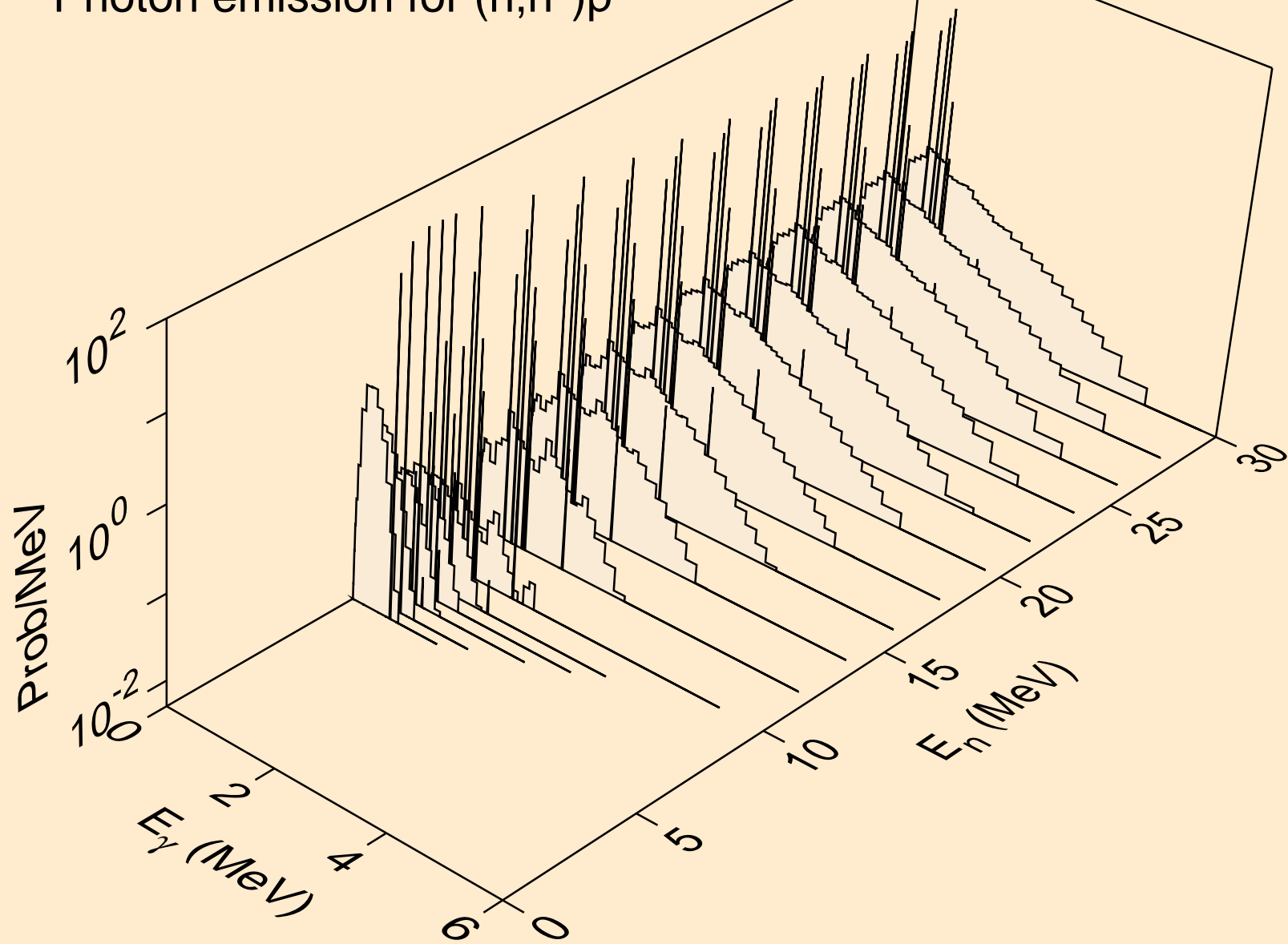

PM145 NEUTRON ACER TENDL-2021 LIBRARY; T=293.6K
Photon emission for (n,n*)2a

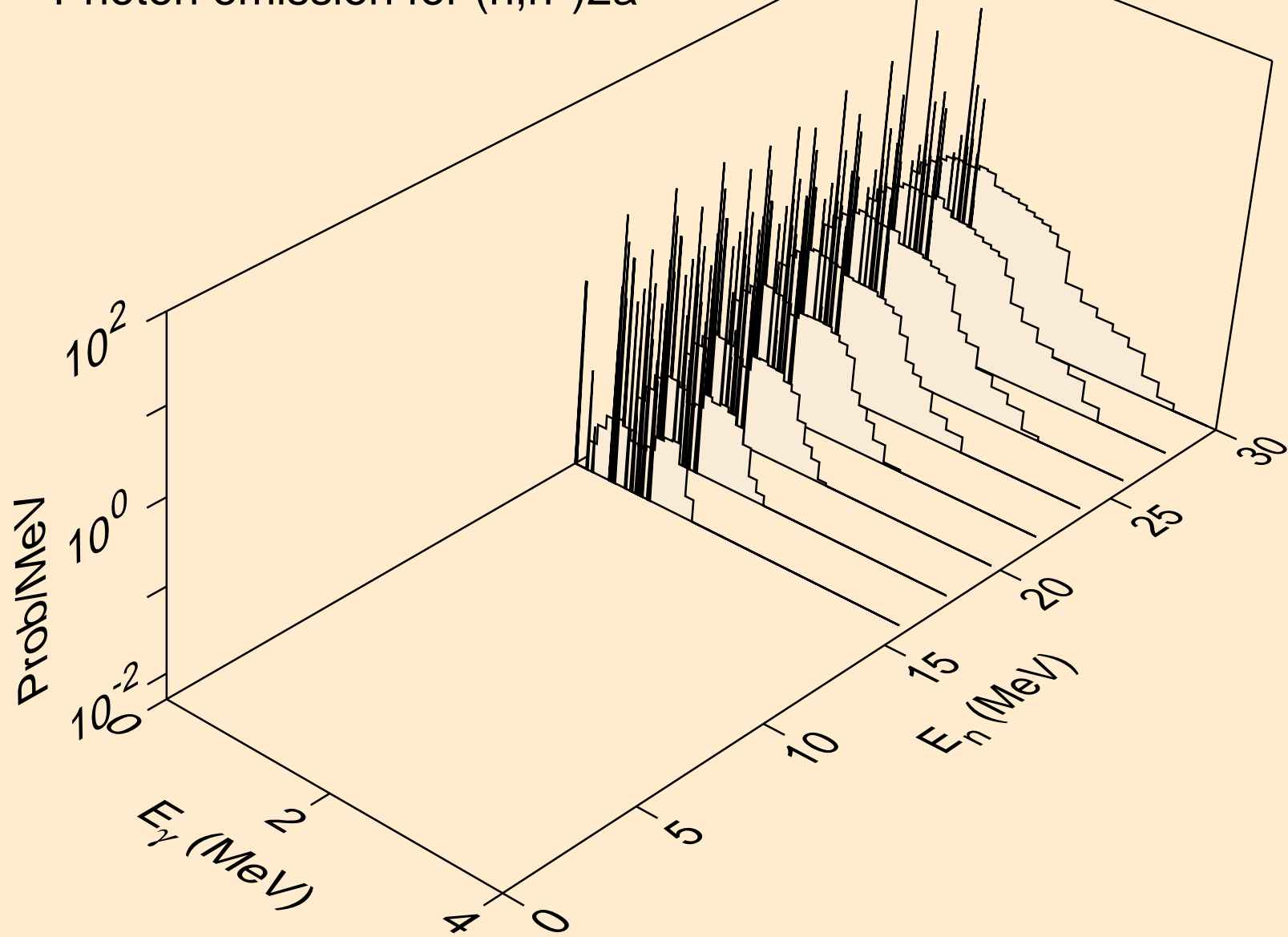

PM145 NEUTRON ACER TENDL-2021 LIBRARY; T=293.6K
Photon emission for (n,n*)d

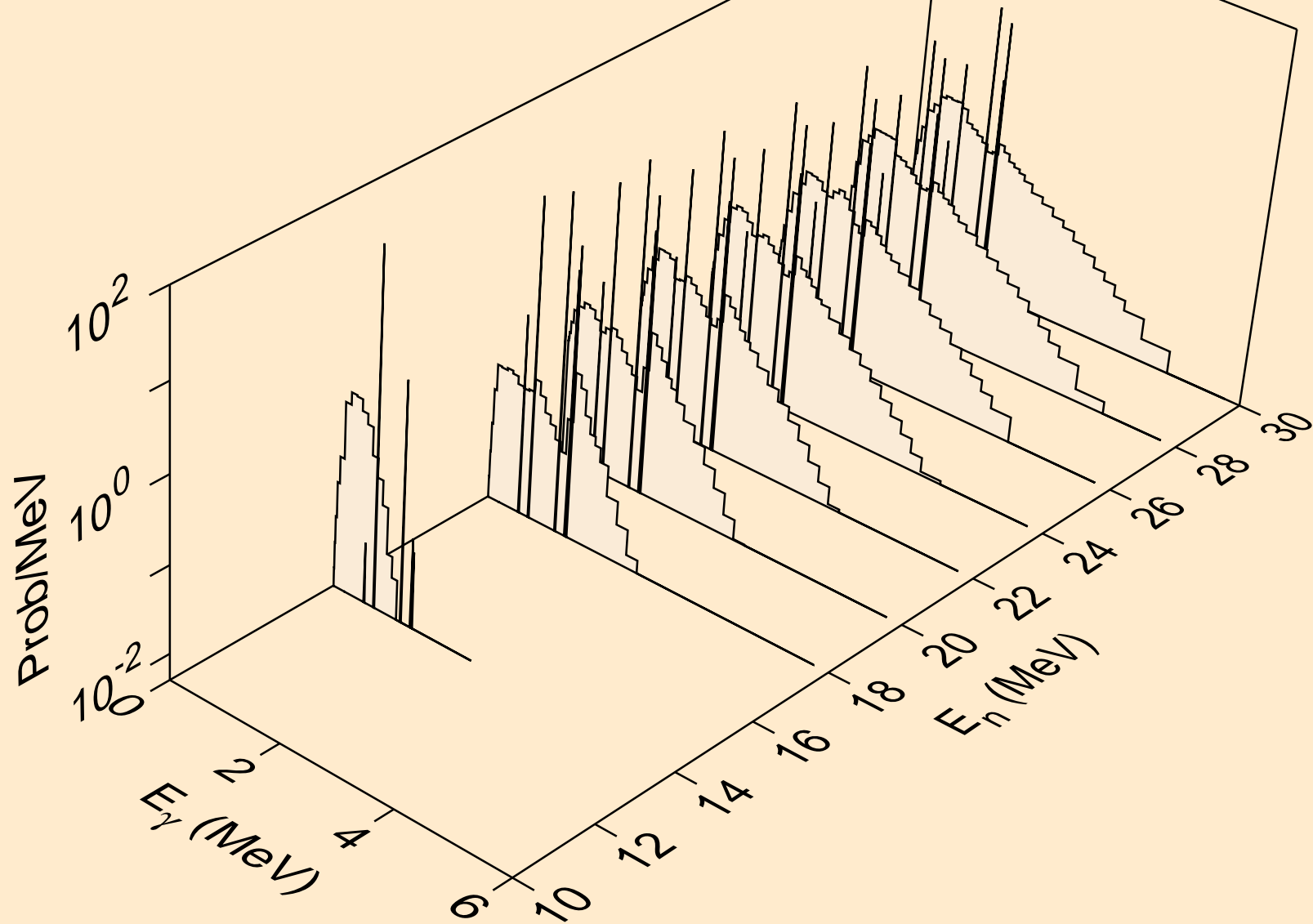

PM145 NEUTRON ACER TENDL-2021 LIBRARY; T=293.6K
Photon emission for (n,n*)t

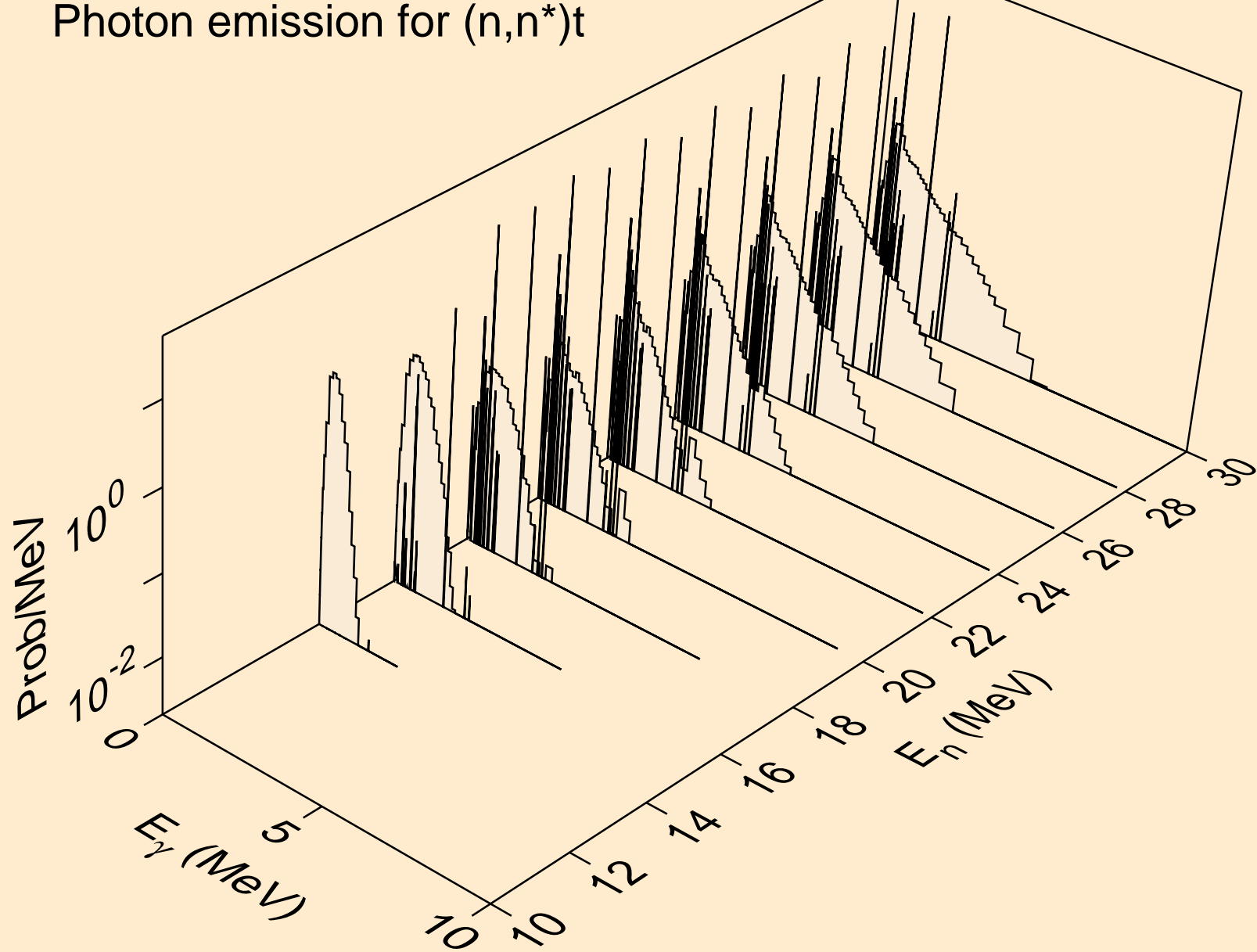

PM145 NEUTRON ACER TENDL-2021 LIBRARY; T=293.6K
Photon emission for (n,n*)he3

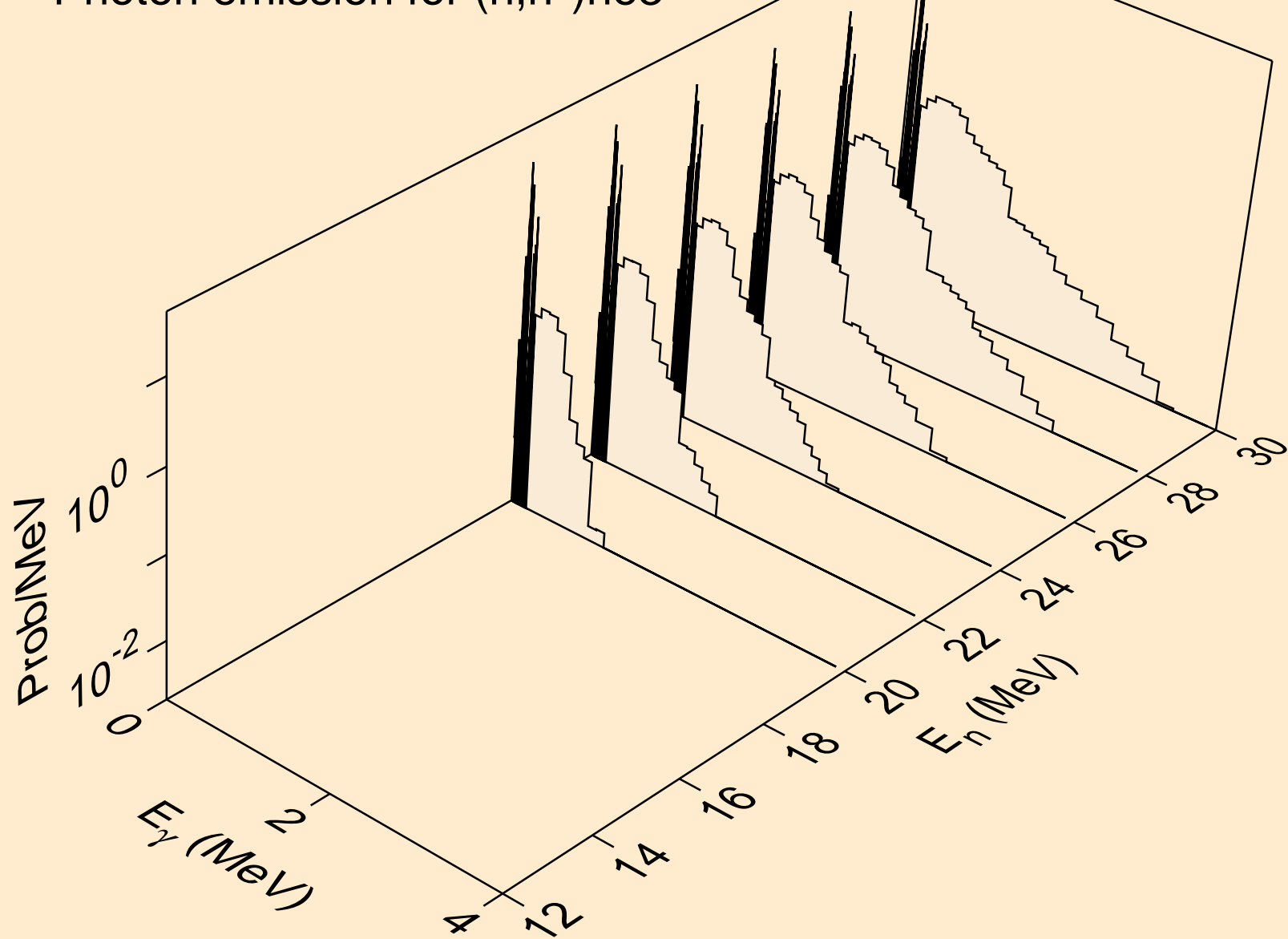

PM145 NEUTRON ACER TENDL-2021 LIBRARY; T=293.6K
Photon emission for (n,4n)

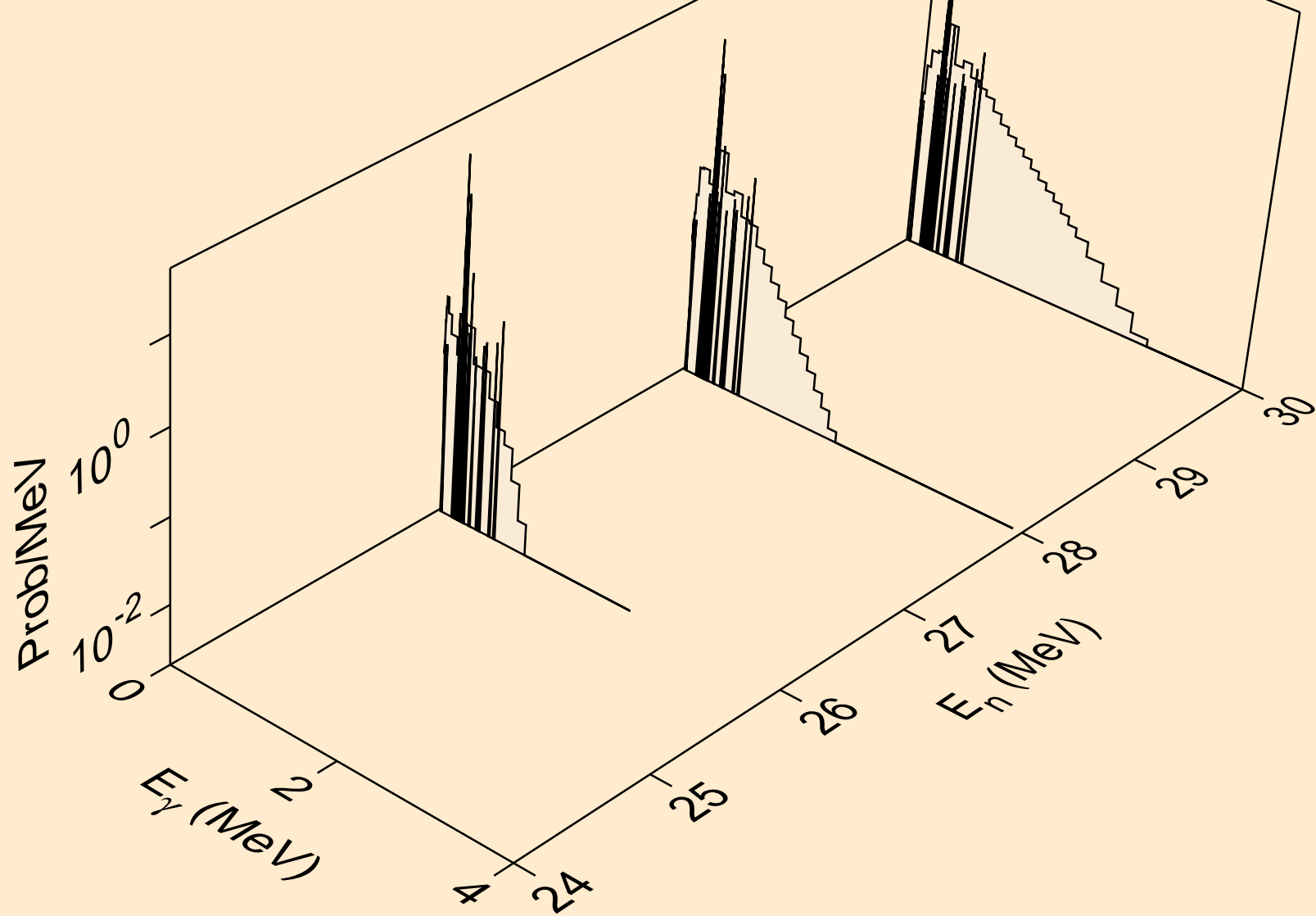

PM145 NEUTRON ACER TENDL-2021 LIBRARY; T=293.6K
Photon emission for (n,2np)

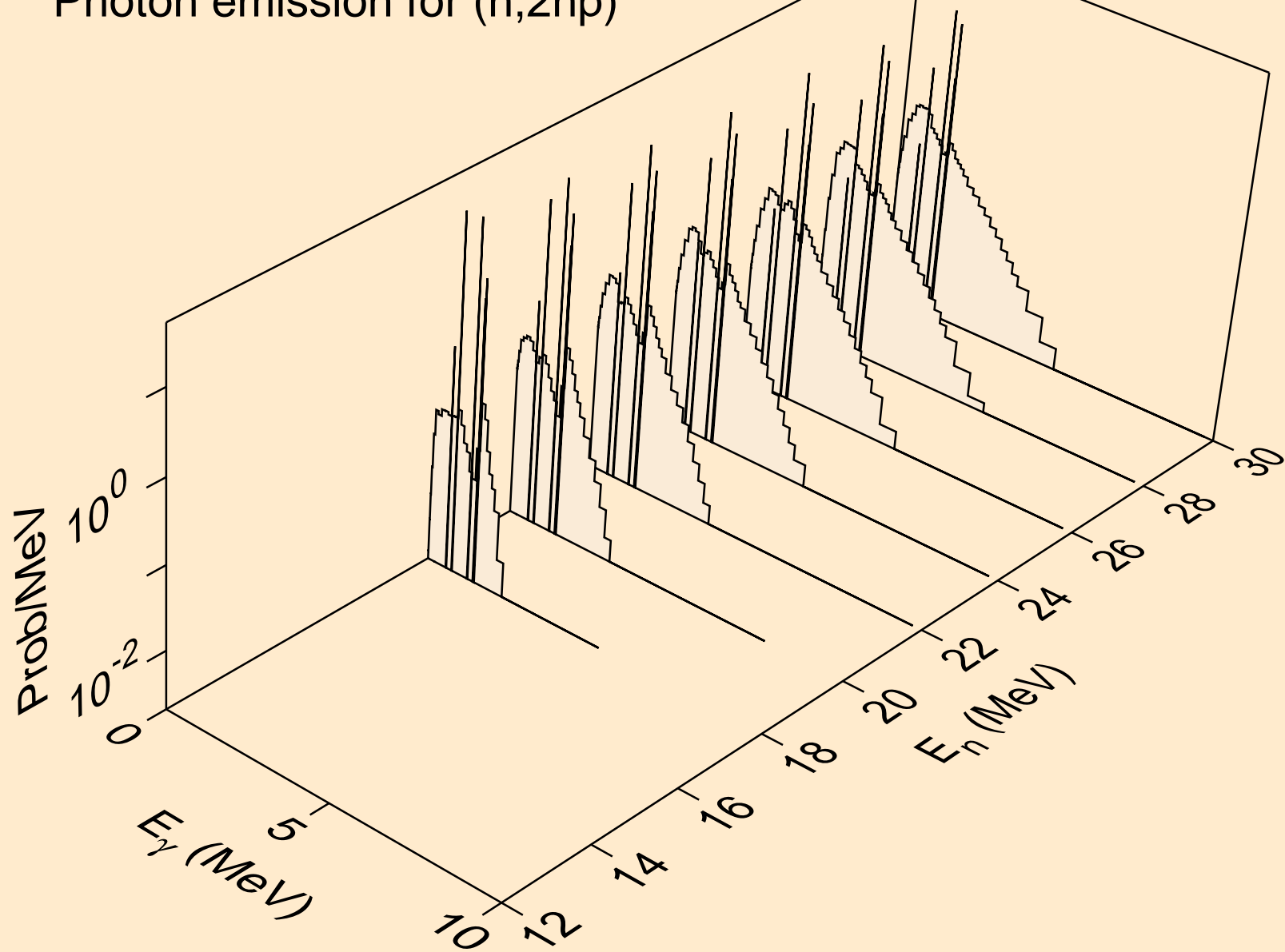

PM145 NEUTRON ACER TENDL-2021 LIBRARY; T=293.6K
Photon emission for (n,3np)

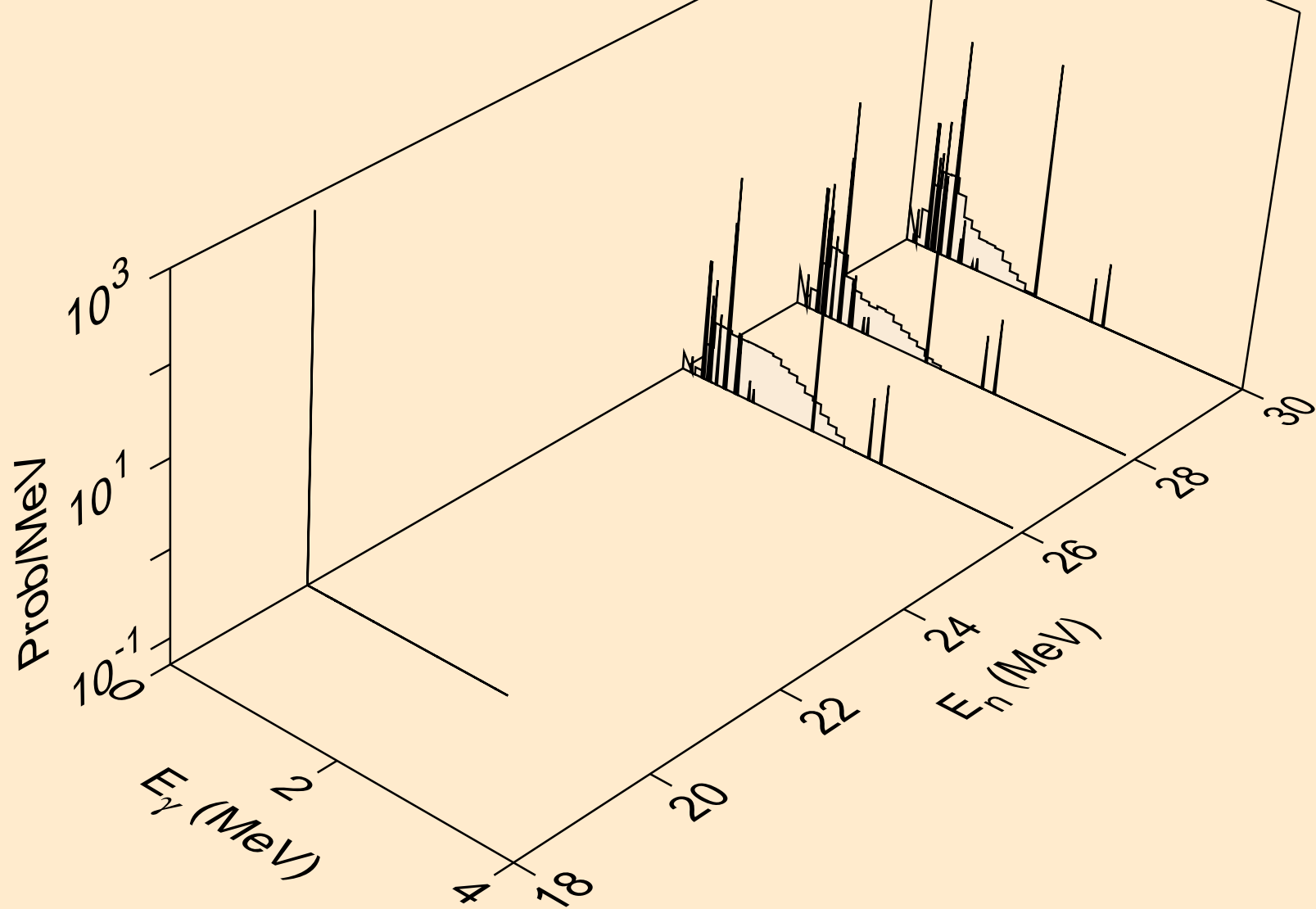

PM145 NEUTRON ACER TENDL-2021 LIBRARY; T=293.6K
Photon emission for (n,2np)

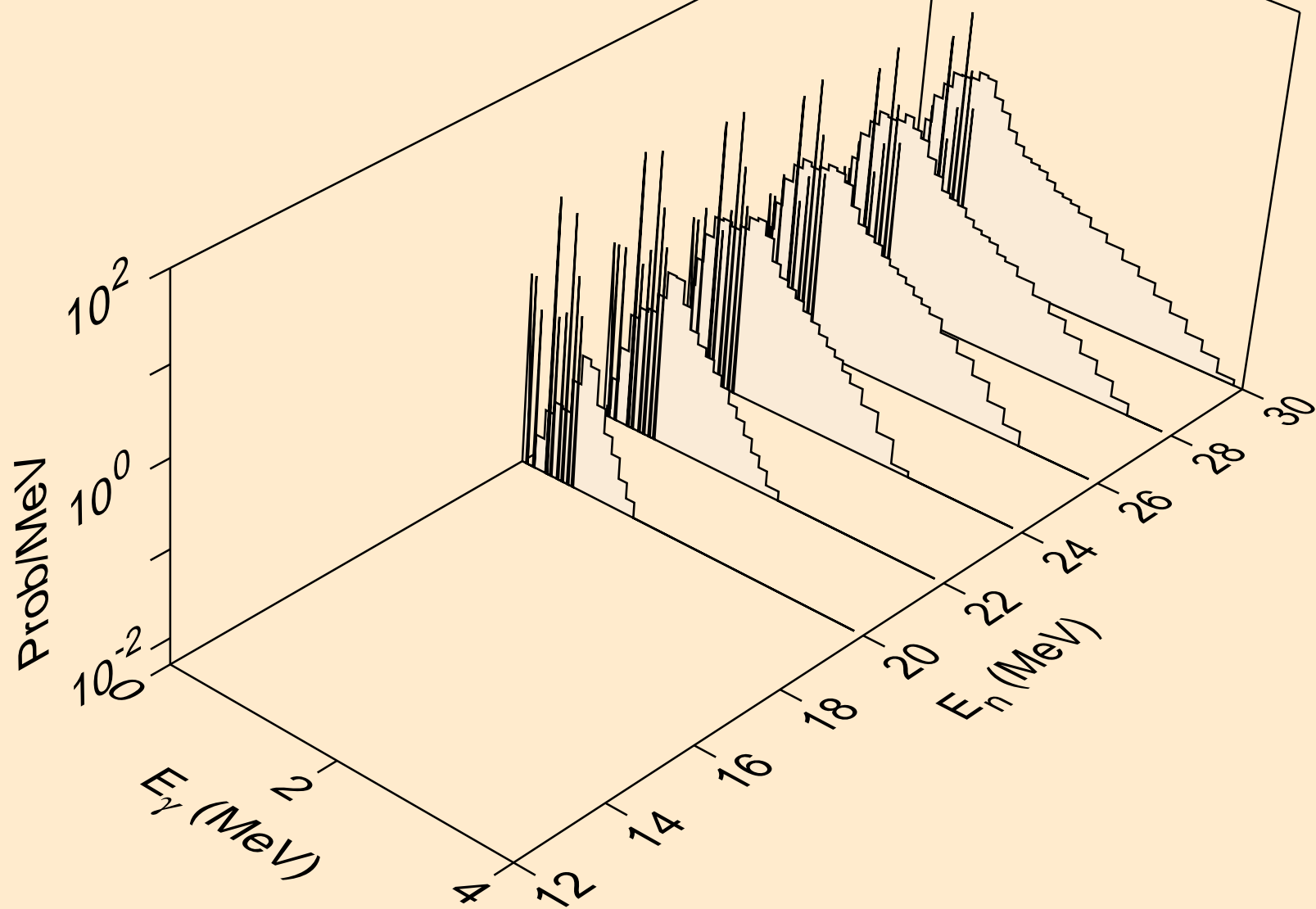

PM145 NEUTRON ACER TENDL-2021 LIBRARY; T=293.6K
Photon emission for (n,npa)

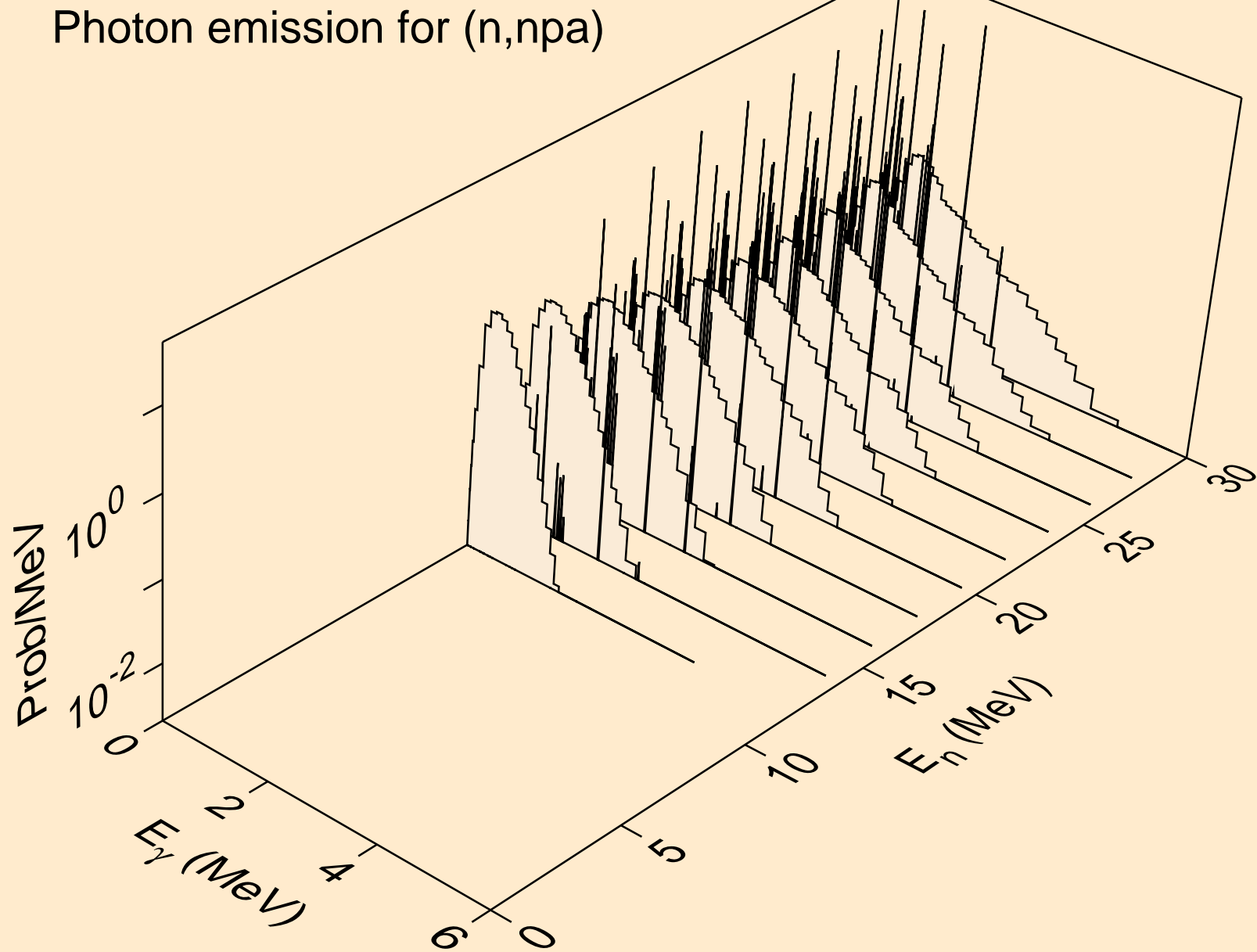

PM145 NEUTRON ACER TENDL-2021 LIBRARY; T=293.6K
Photon emission for (n,n*c)

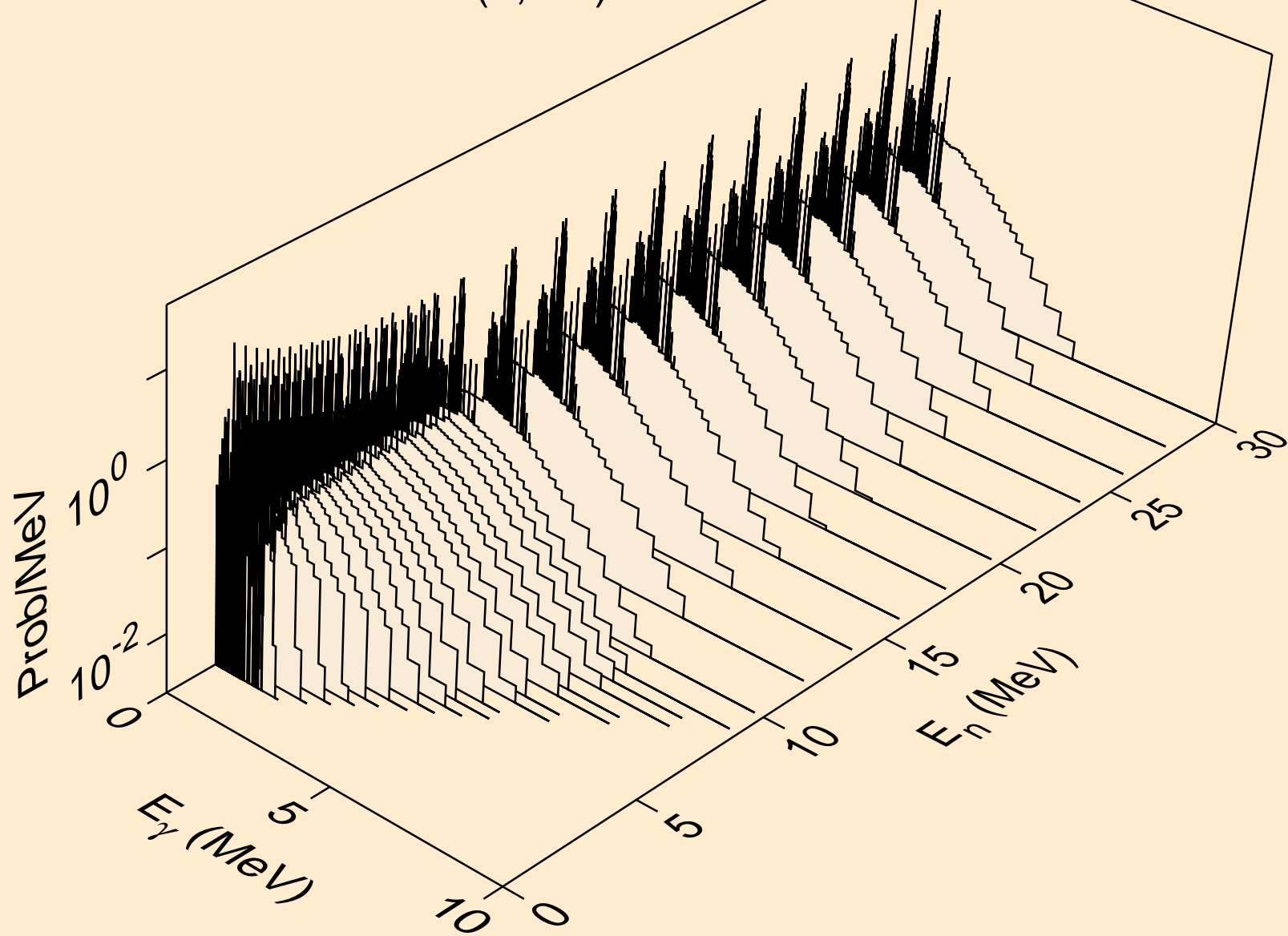

PM145 NEUTRON ACER TENDL-2021 LIBRARY; T=293.6K
Photon emission for (n,gma)

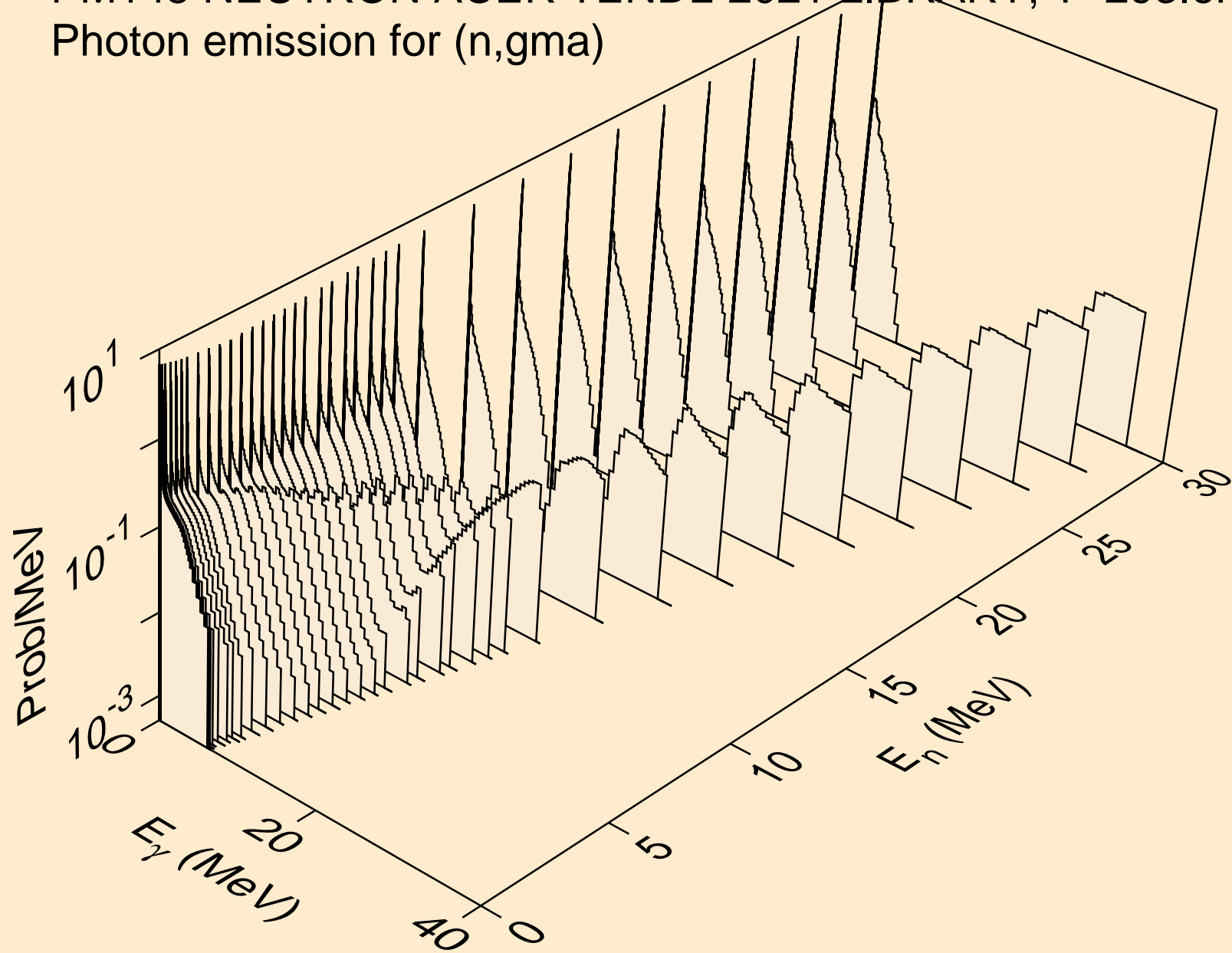

PM145 NEUTRON ACER TENDL-2021 LIBRARY; T=293.6K
Photon emission for (n,p)

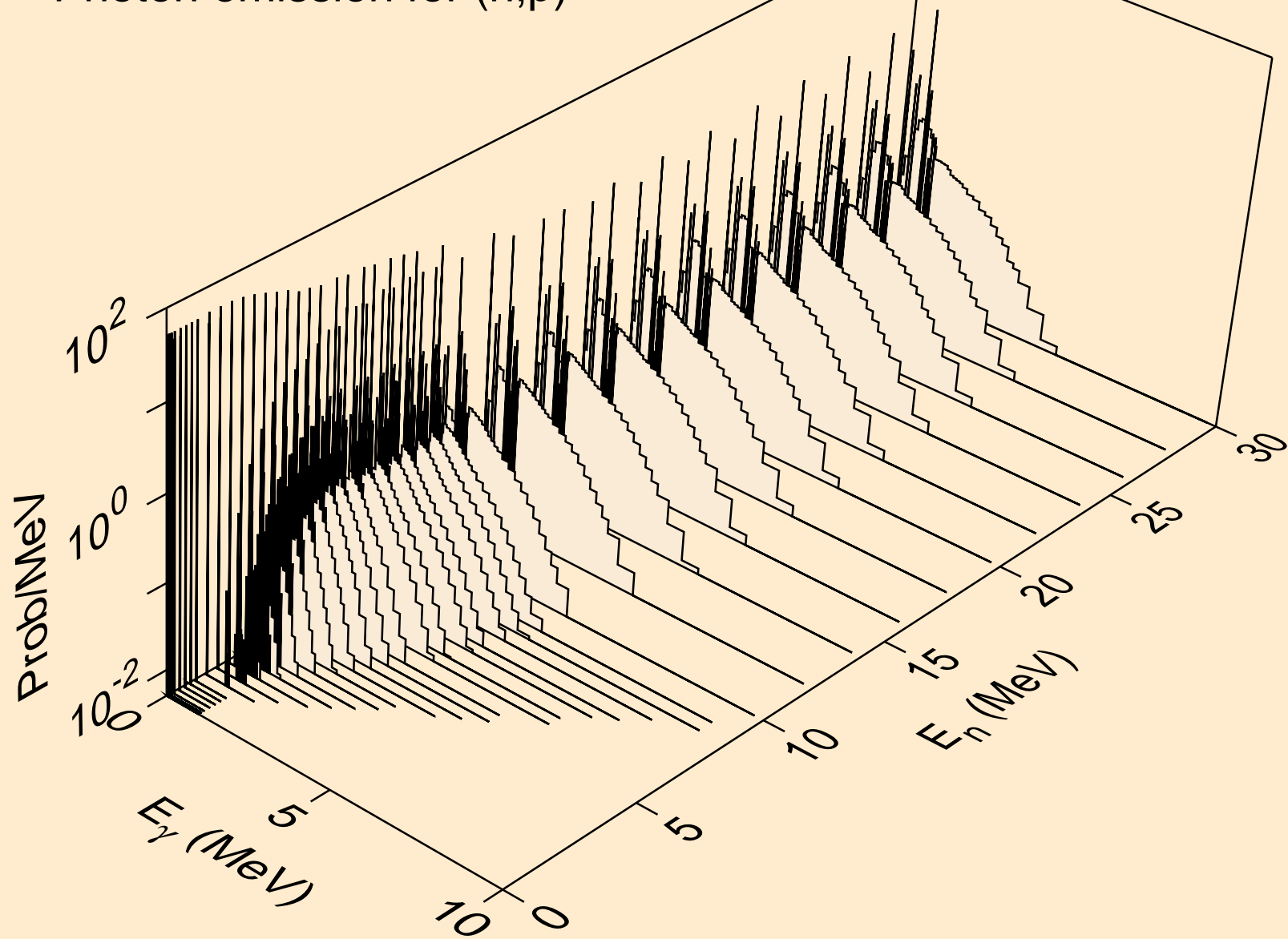

PM145 NEUTRON ACER TENDL-2021 LIBRARY; T=293.6K
Photon emission for (n,d)

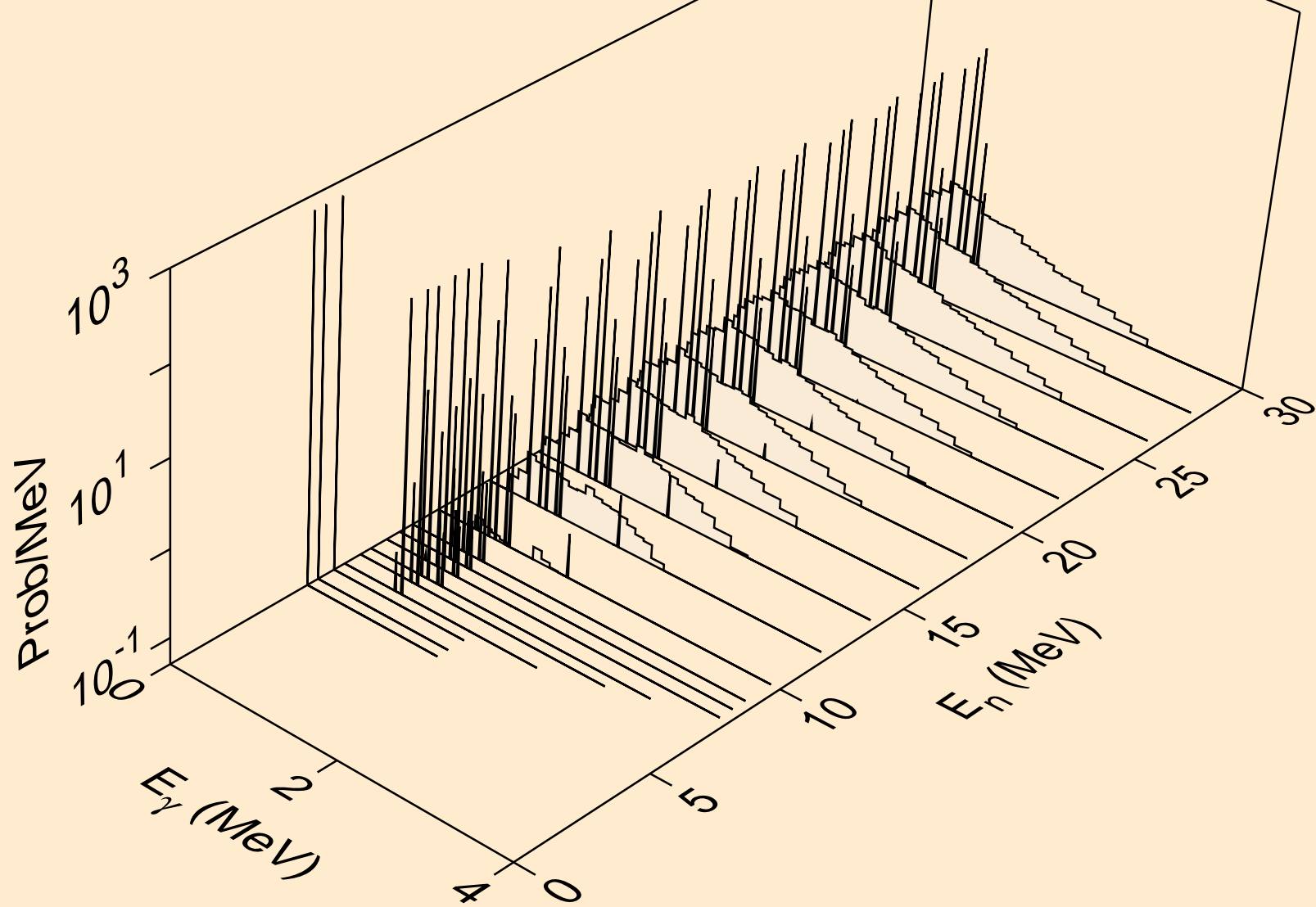

PM145 NEUTRON ACER TENDL-2021 LIBRARY; T=293.6K
Photon emission for (n,t)

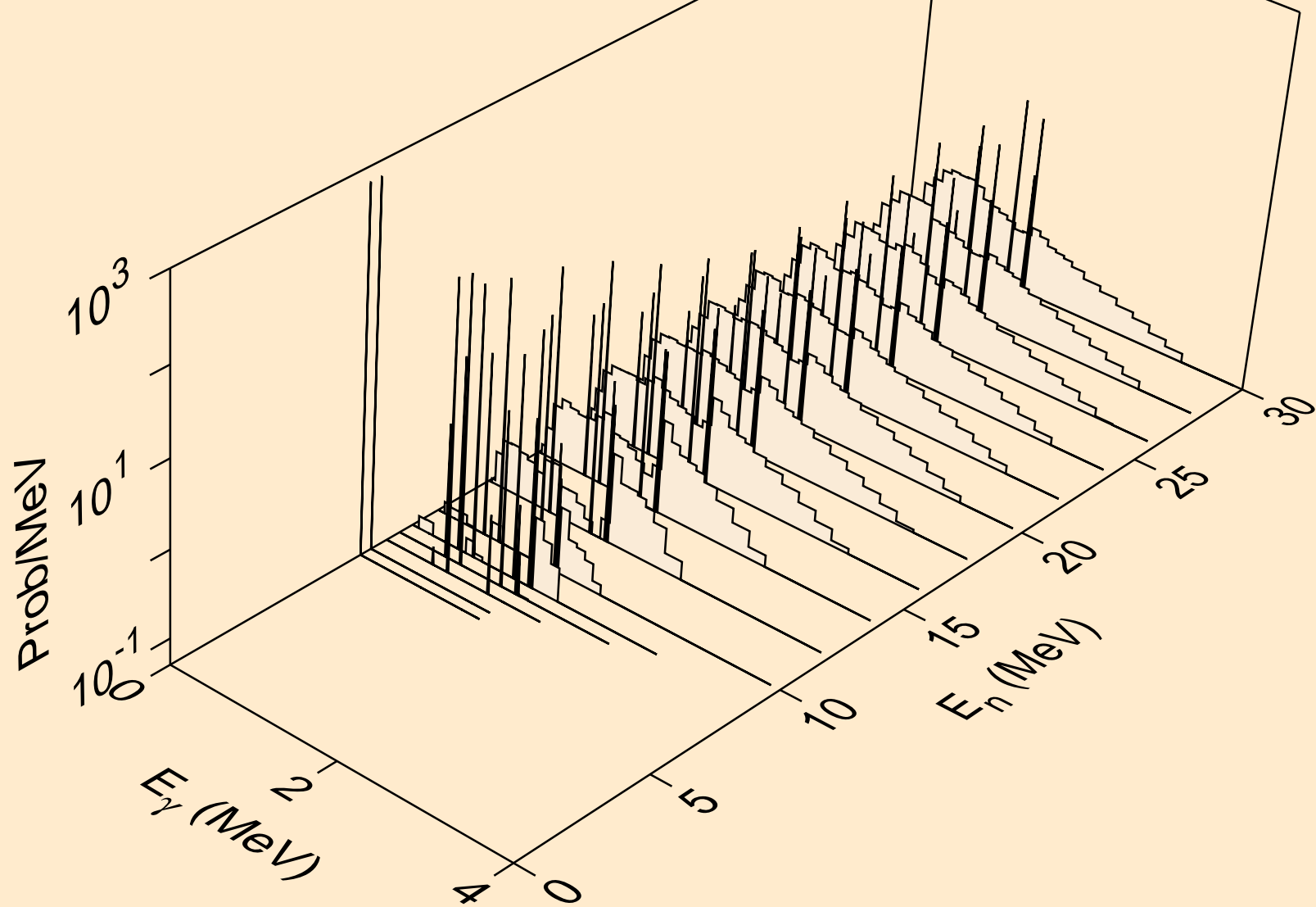

PM145 NEUTRON ACER TENDL-2021 LIBRARY; T=293.6K
Photon emission for (n,he3)

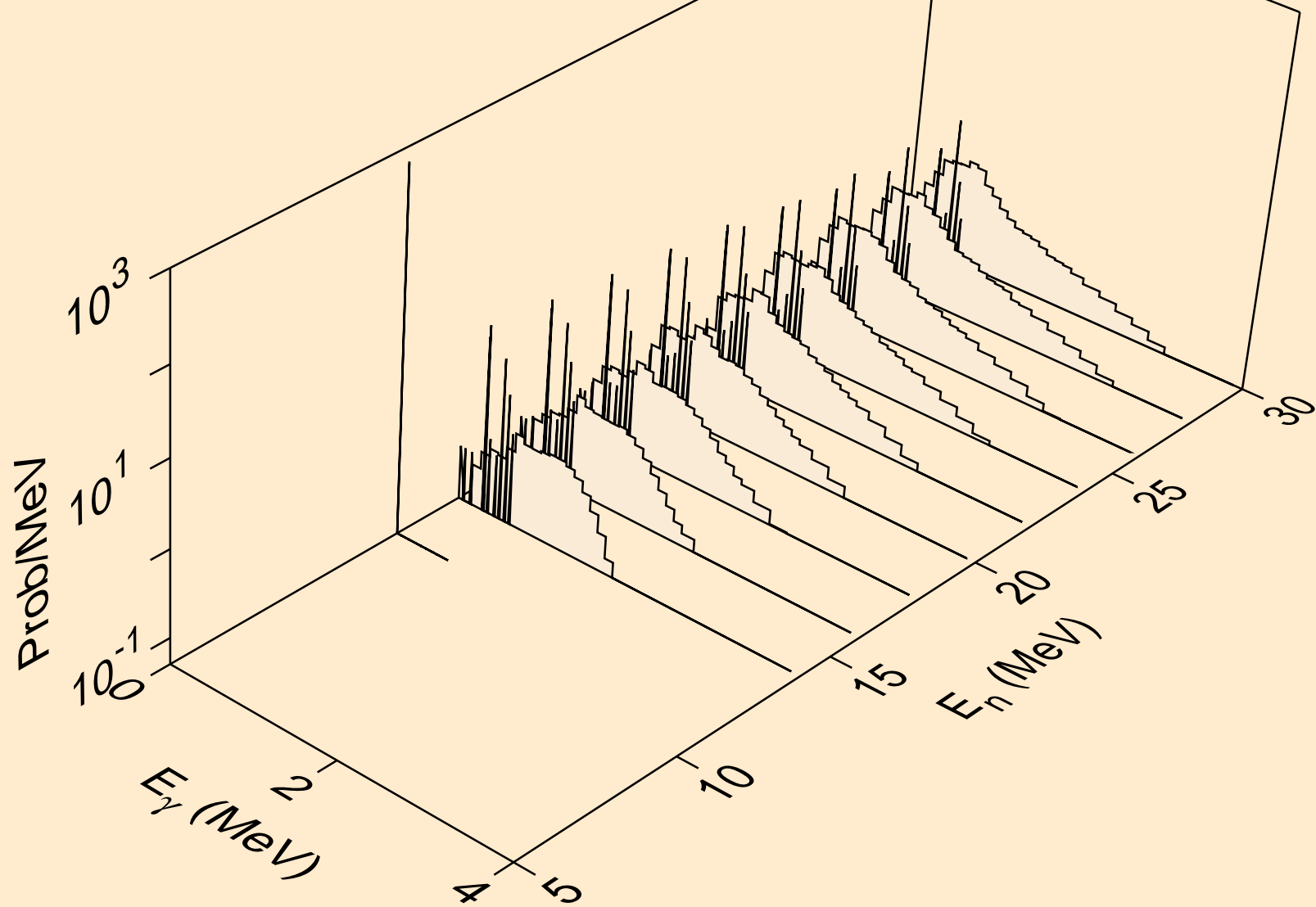

PM145 NEUTRON ACER TENDL-2021 LIBRARY; T=293.6K
Photon emission for (n,a)

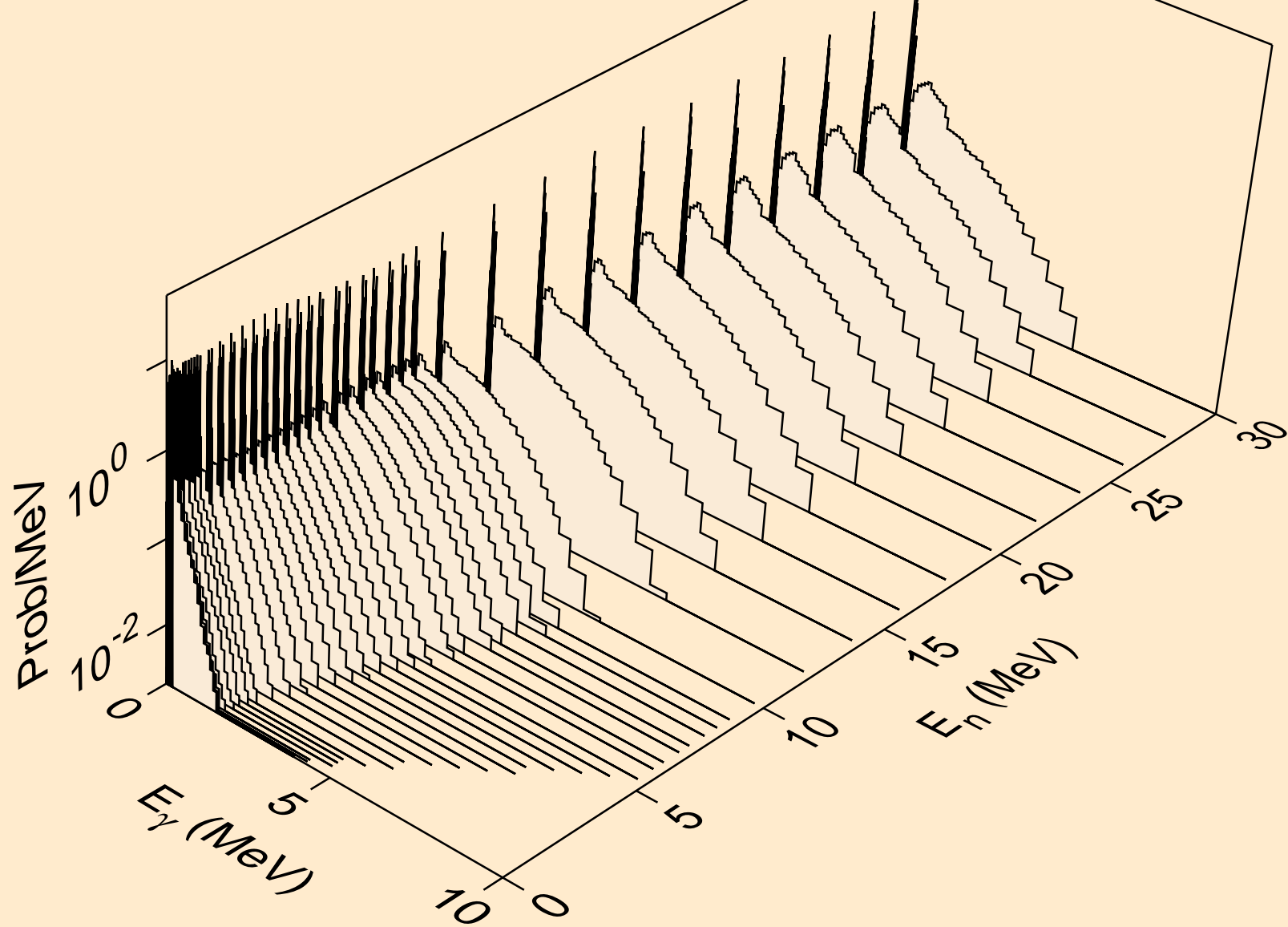

PM145 NEUTRON ACER TENDL-2021 LIBRARY; T=293.6K
Photon emission for (n,2a)

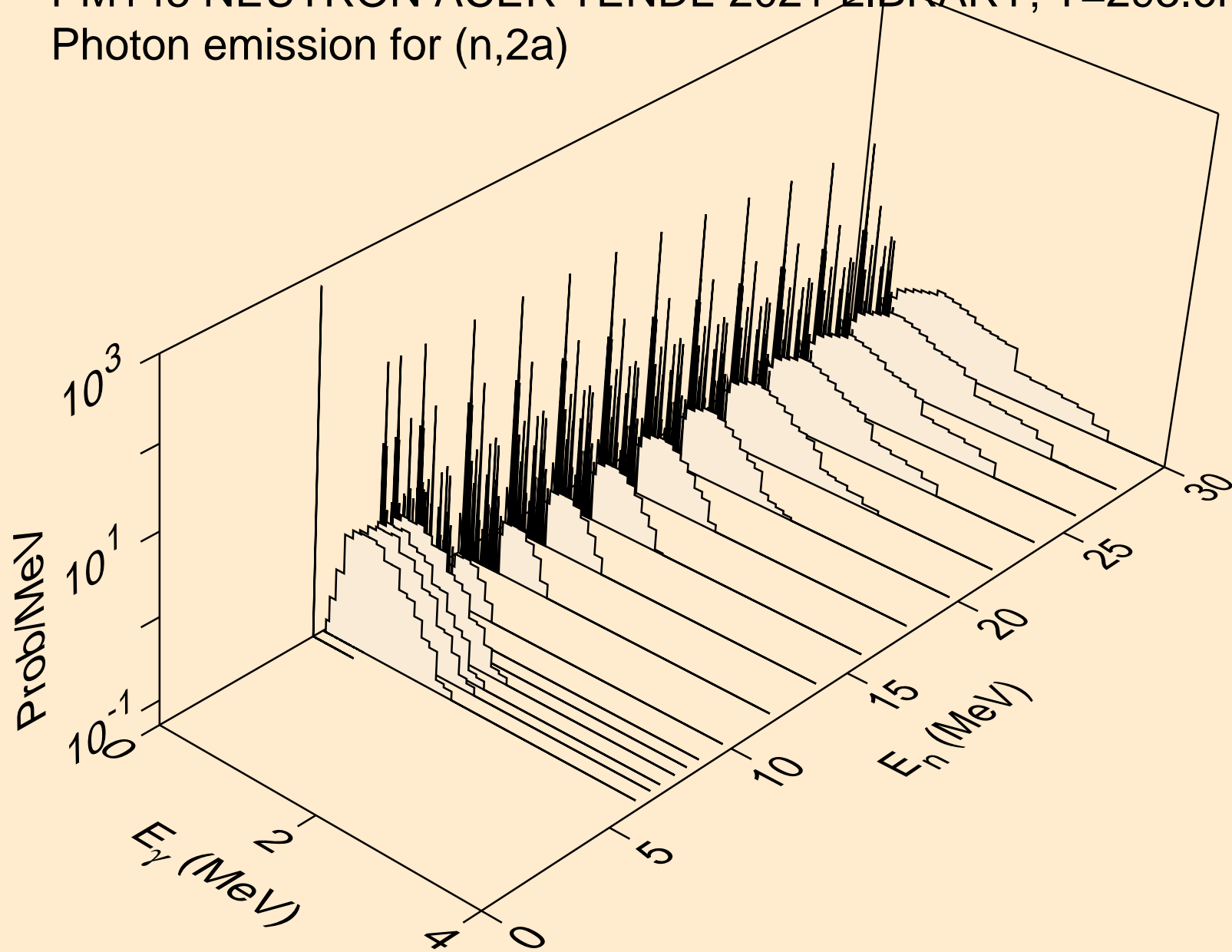

PM145 NEUTRON ACER TENDL-2021 LIBRARY; T=293.6K
Photon emission for (n,2p)

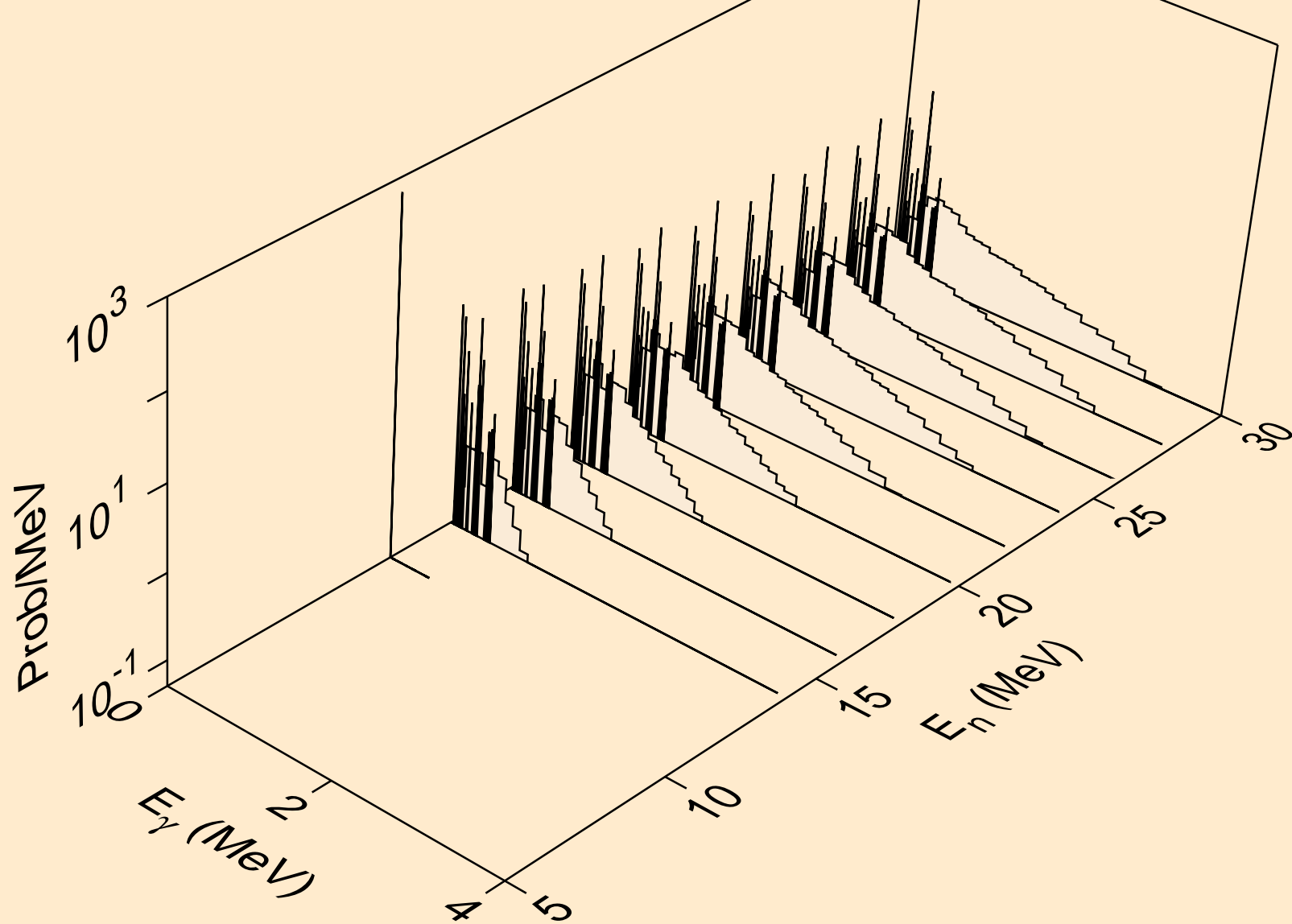

PM145 NEUTRON ACER TENDL-2021 LIBRARY; T=293.6K
Photon emission for (n,p)

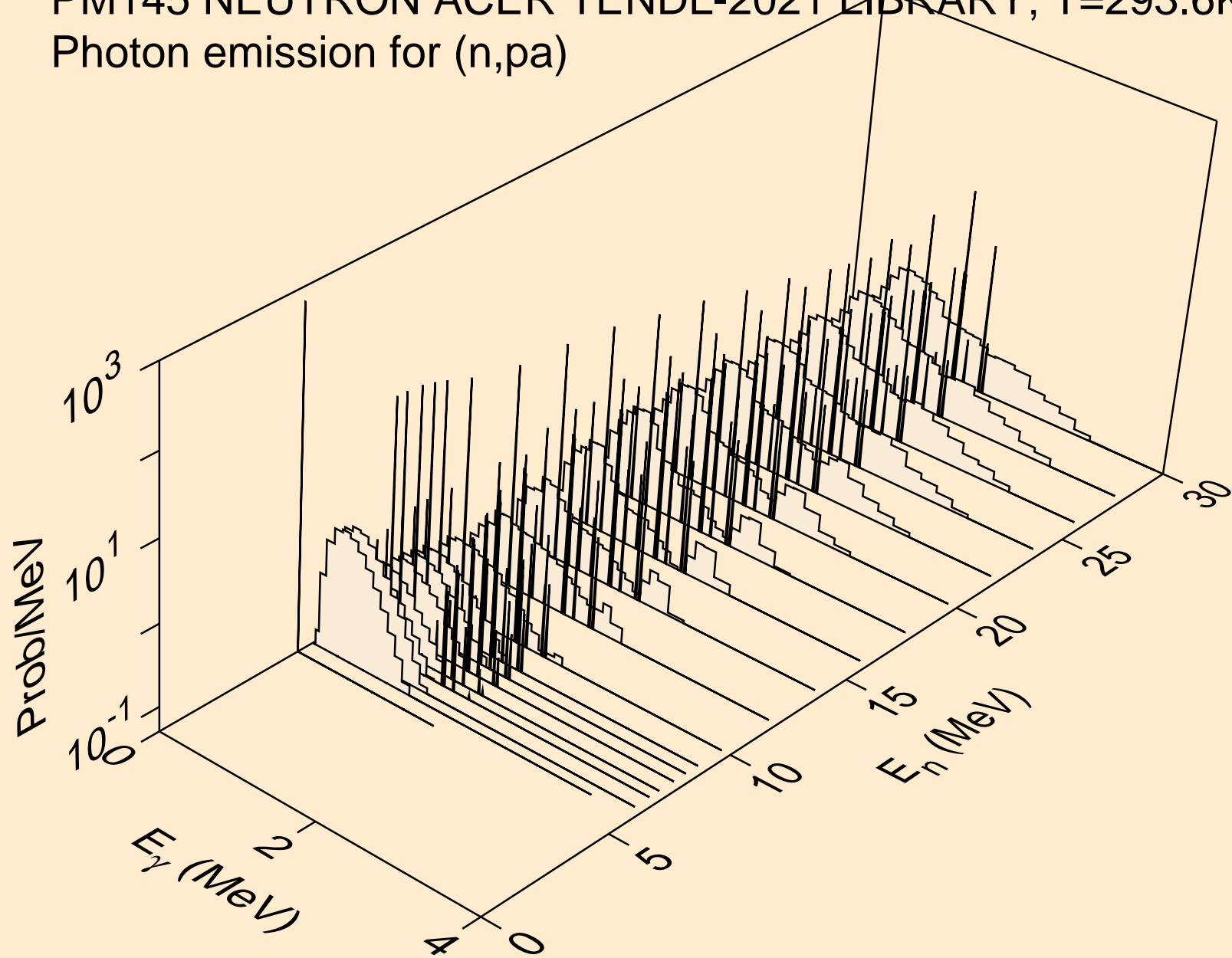

PM145 NEUTRON ACER TENDL-2021 LIBRARY; T=293.6K
Photon emission for (n,pd)

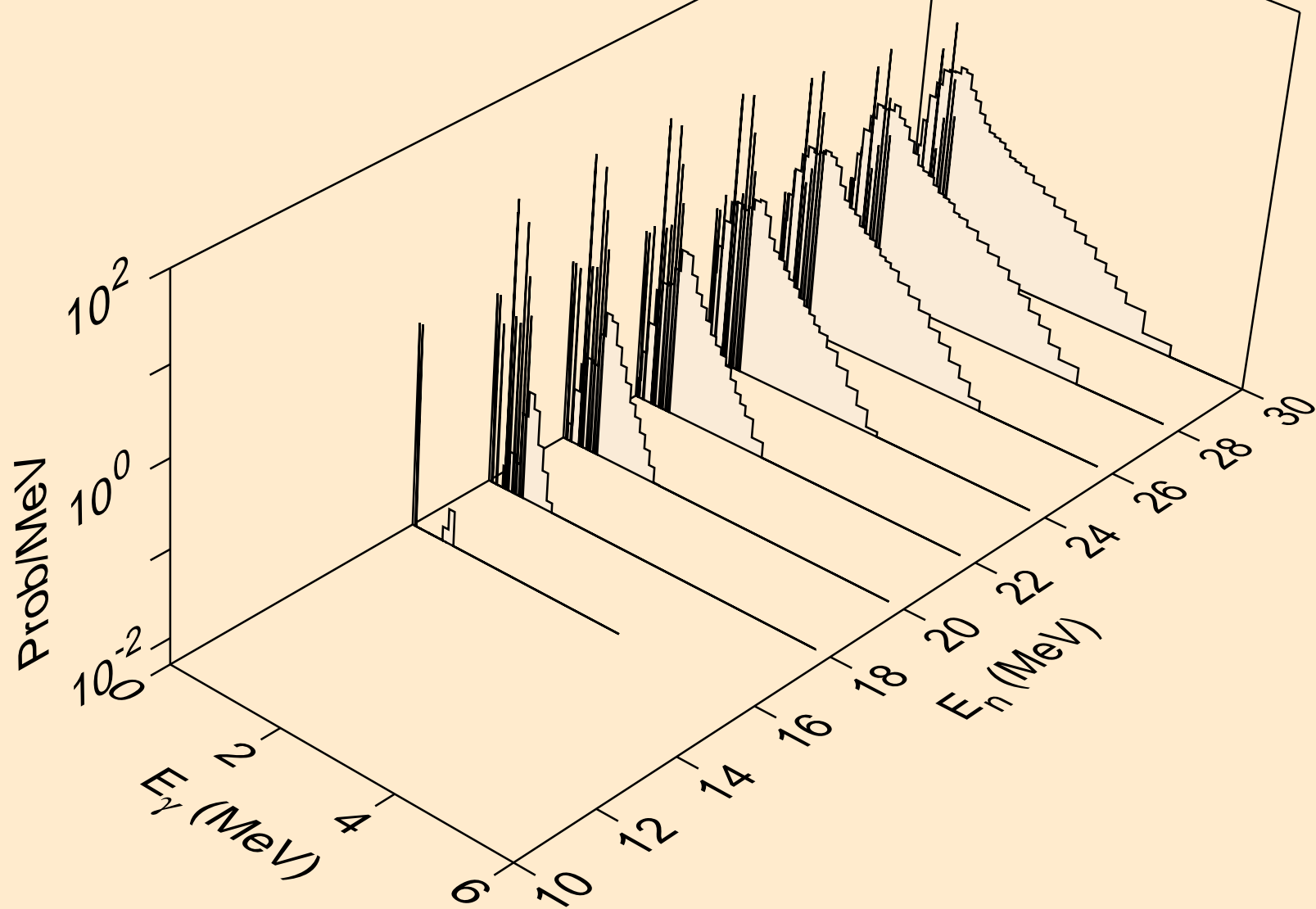

PM145 NEUTRON ACER TENDL-2021 LIBRARY; T=293.6K
Photon emission for (n,pt)

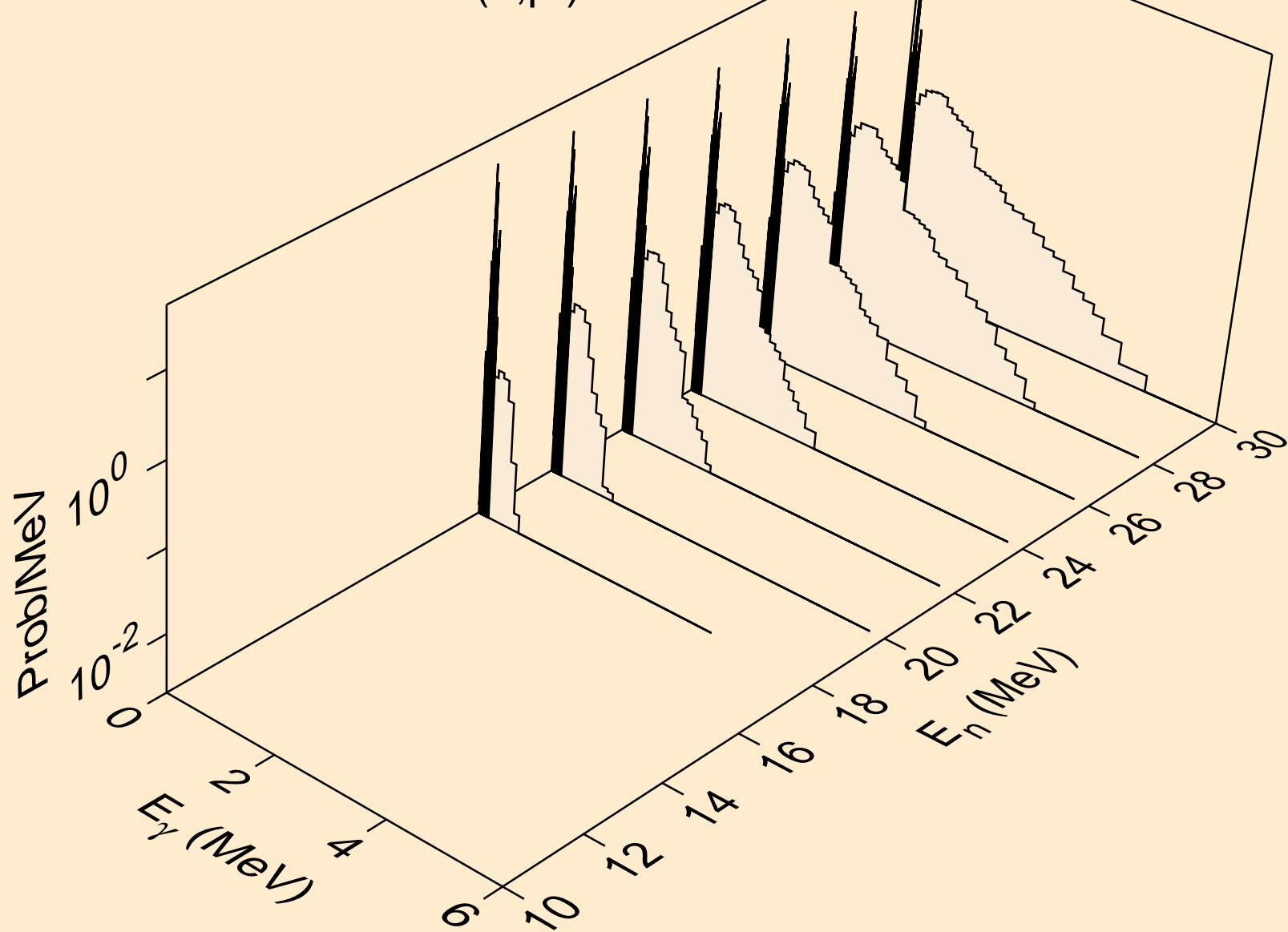

PM145 NEUTRON ACER TENDL-2021 LIBRARY; T=293.6K
Photon emission for (n,da)

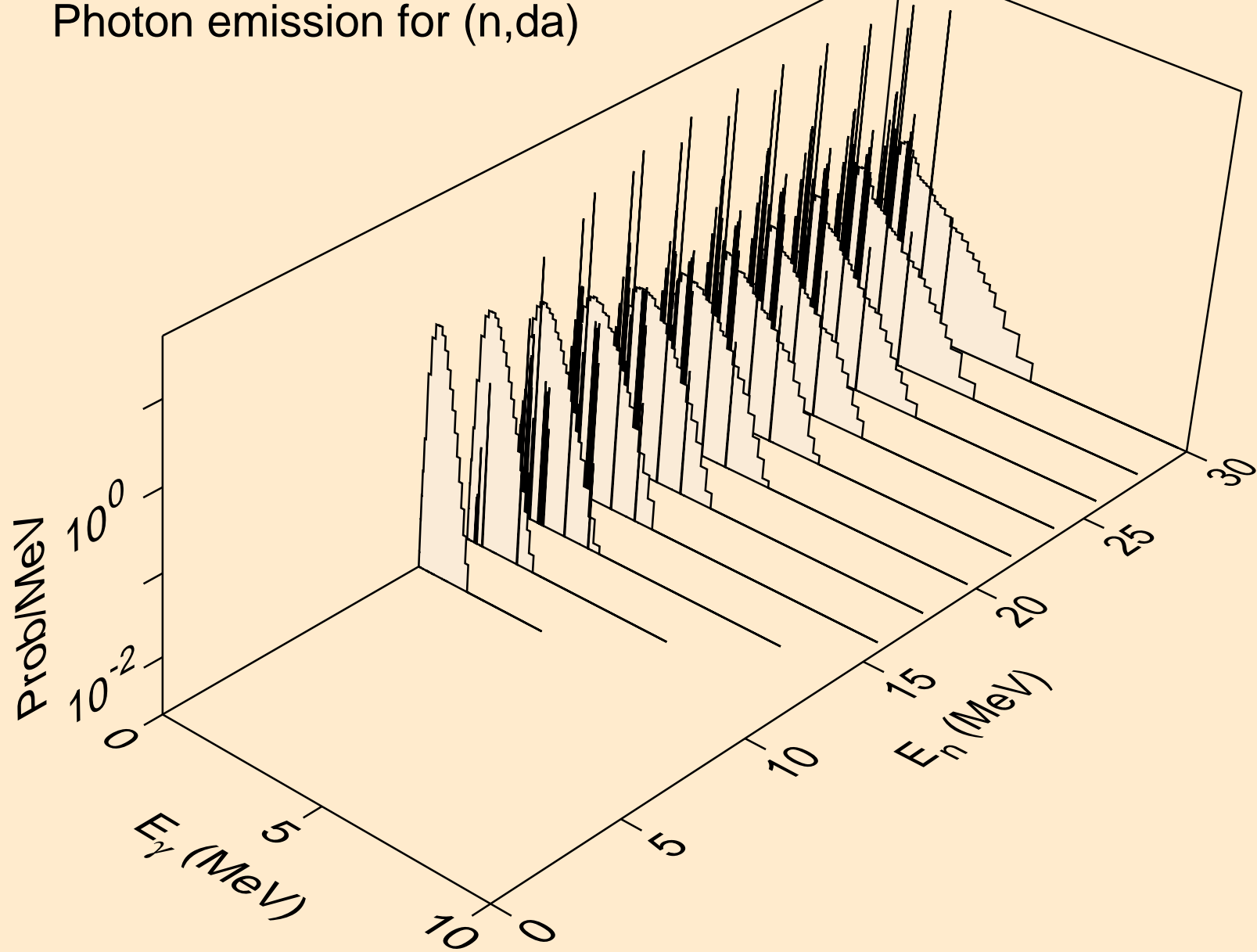

PM145 NEUTRON ACER TENDL-2021 LIBRARY; T=293.6K
thermal capture photon spectrum

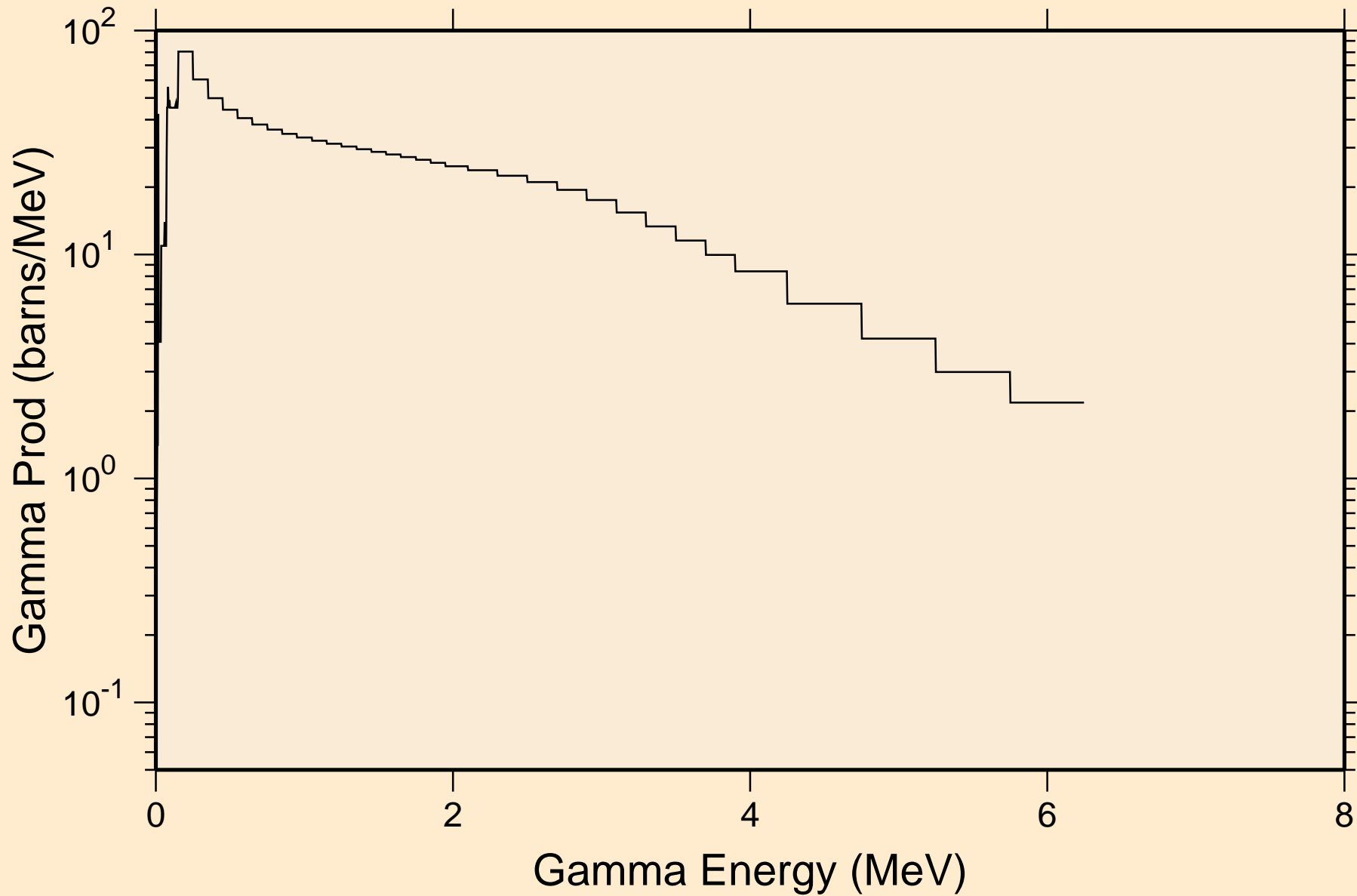

PM145 NEUTRON ACER TENDL-2021 LIBRARY; T=293.6K
14 MeV photon spectrum

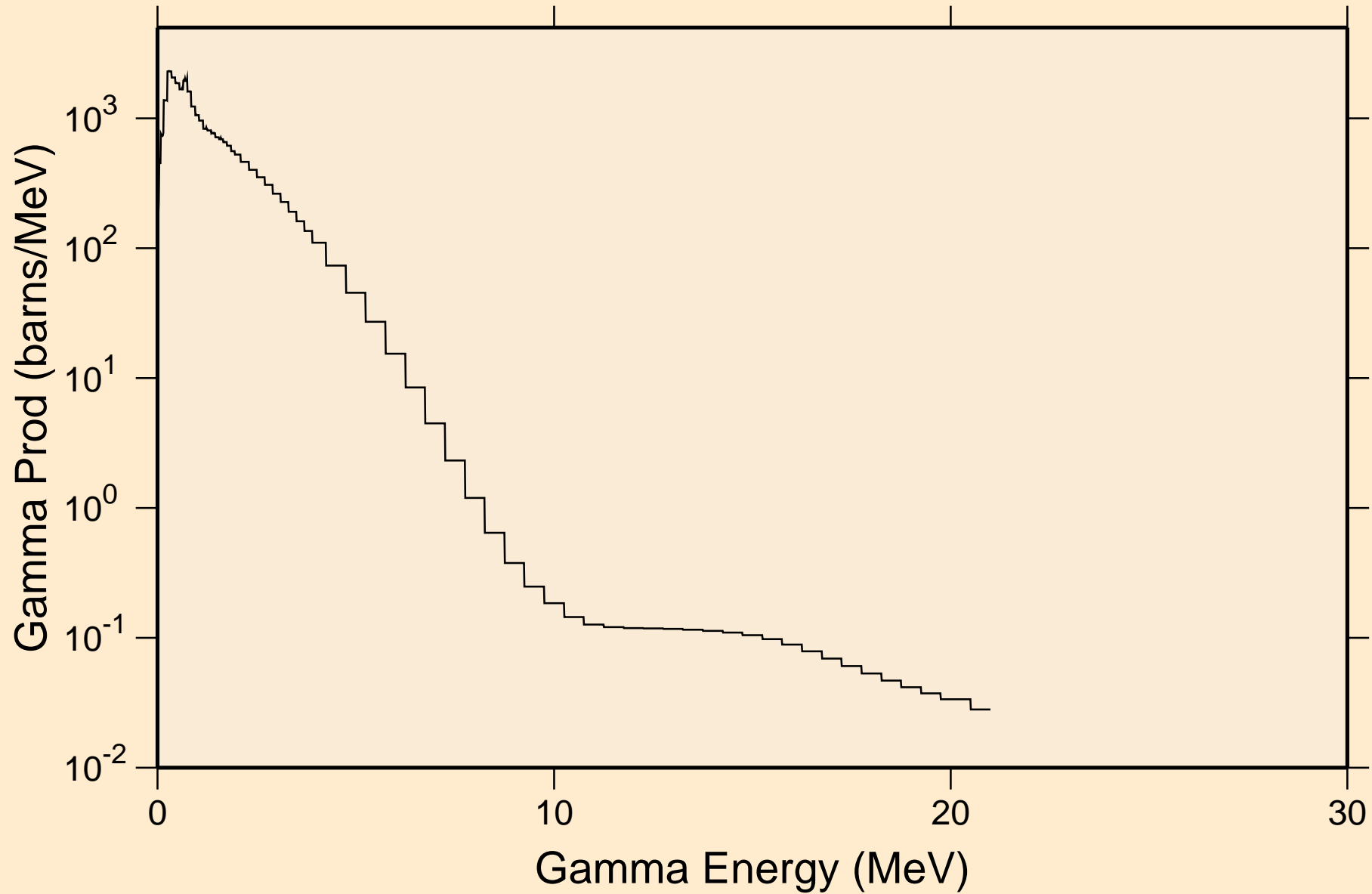

PM145 NEUTRON ACER TENDL-2021 LIBRARY; T=293.6K

Particle heating contributions

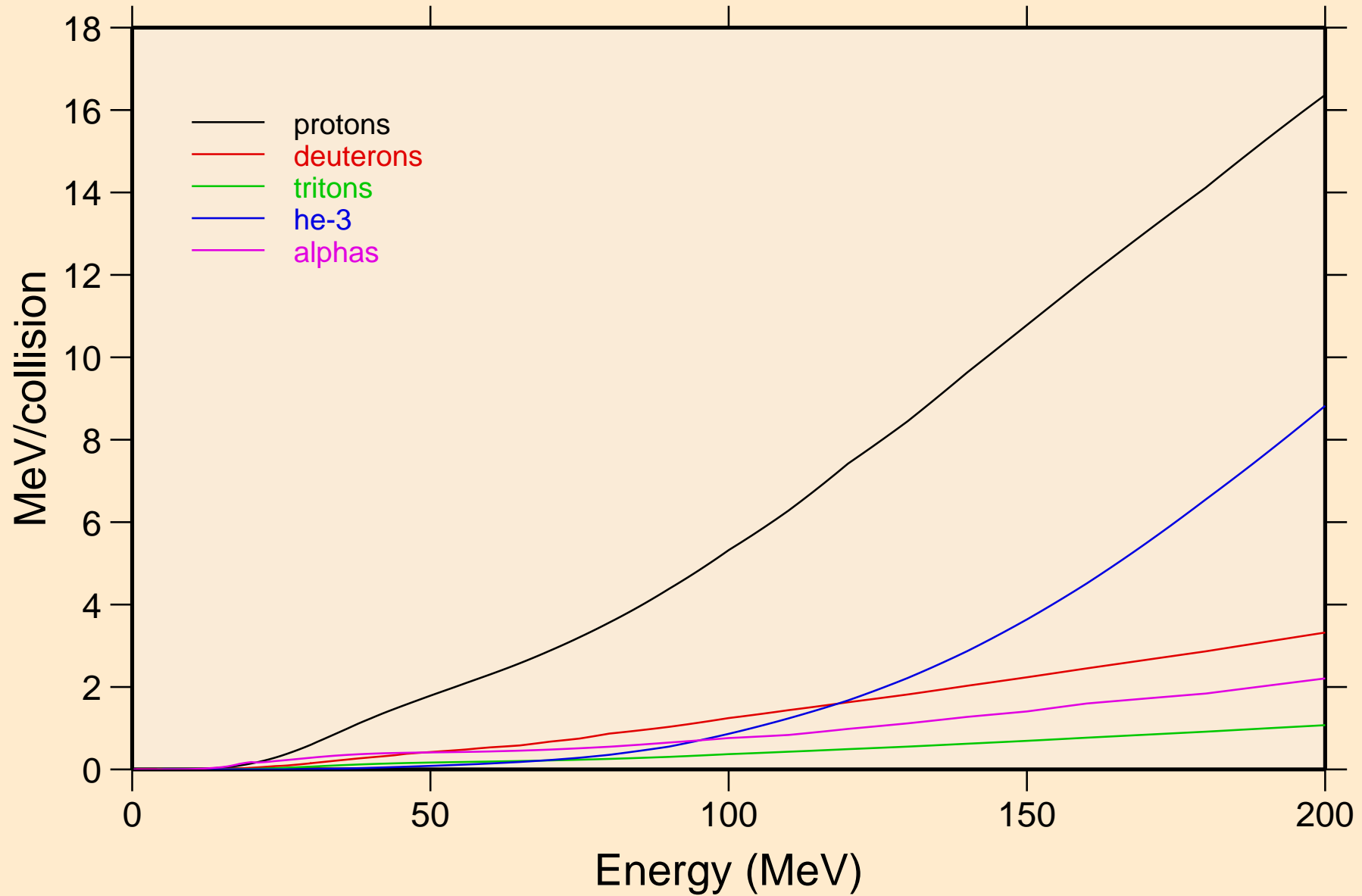

PM145 NEUTRON ACER TENDL-2021 LIBRARY; T=293.6K
Recoil Heating

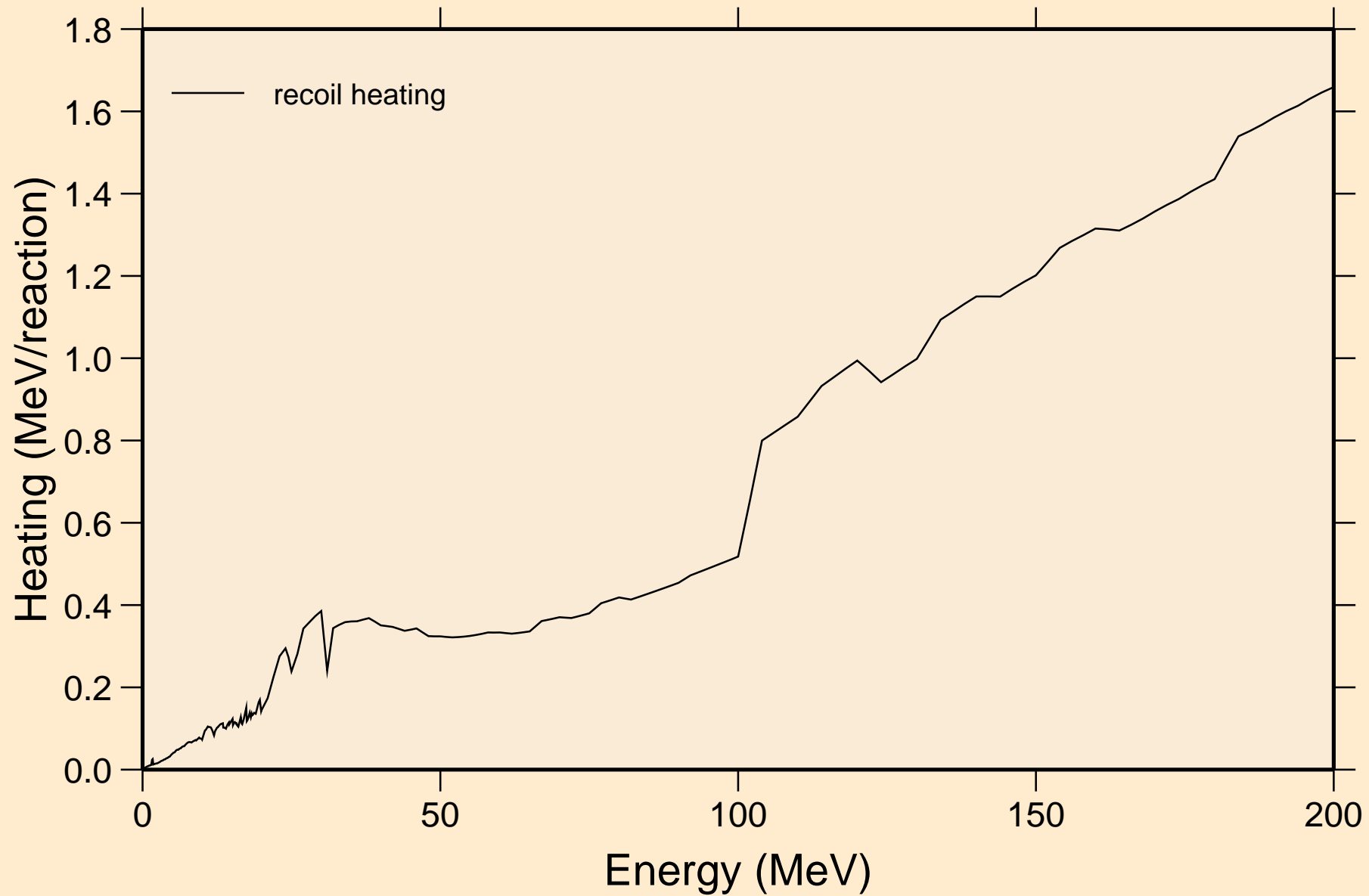

PM145 NEUTRON ACER TENDL-2021 LIBRARY; T=293.6K
Particle production cross sections

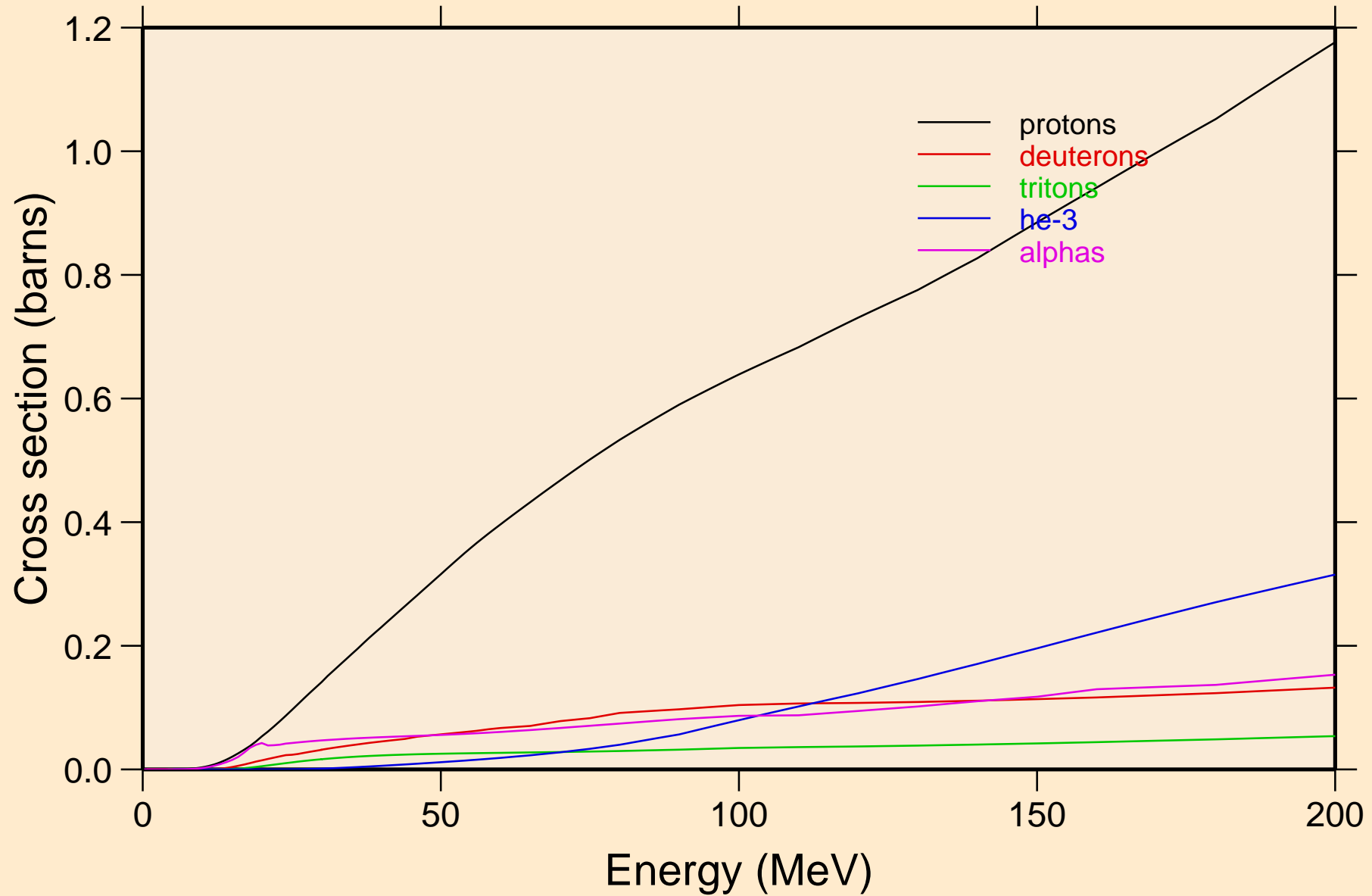

PM145 NEUTRON ACER TENDL-2021 LIBRARY; T=293.6K
protons from (n,x)

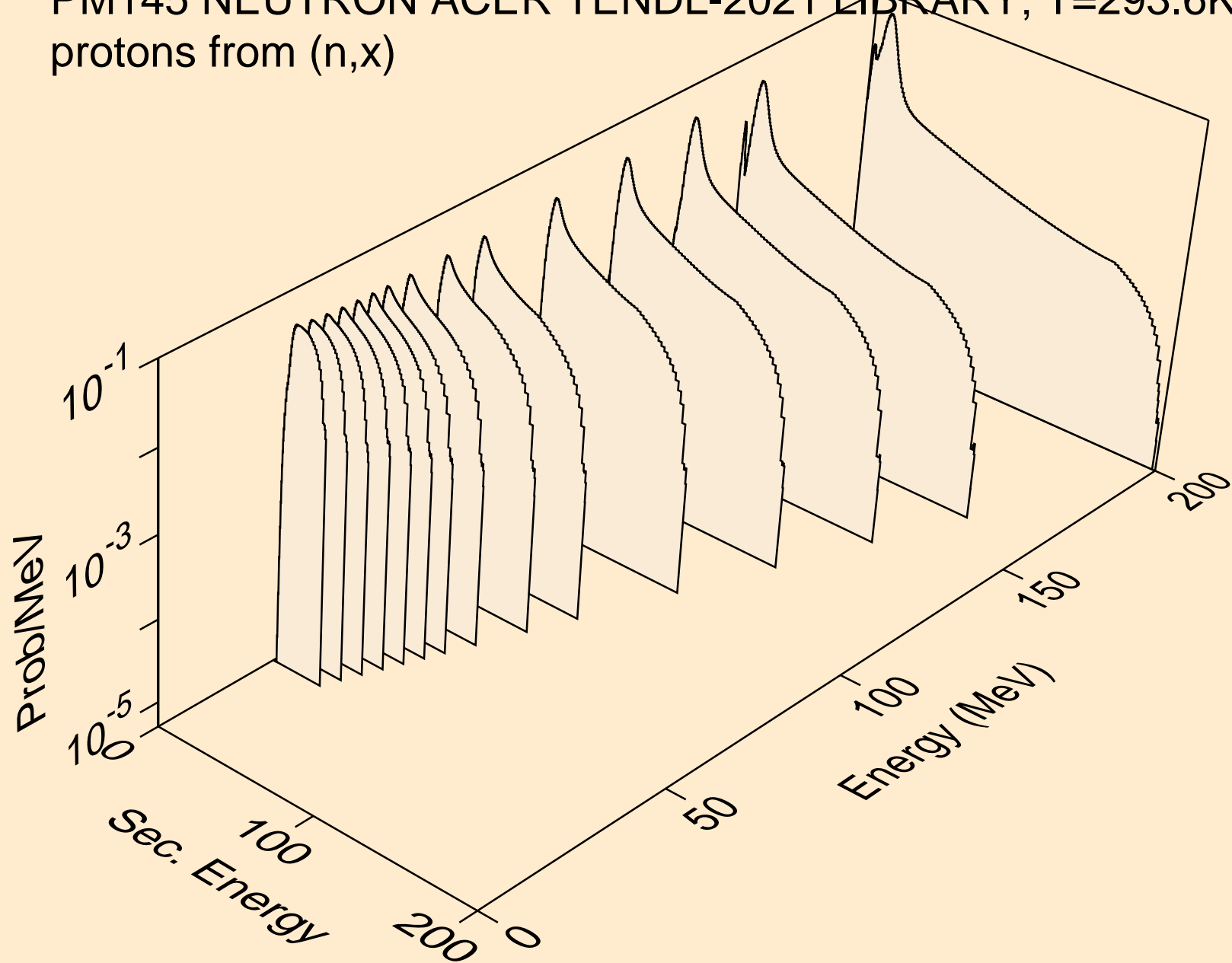

PM145 NEUTRON ACER TENDL-2021 LIBRARY; T=293.6K
protons from (n,n*)p

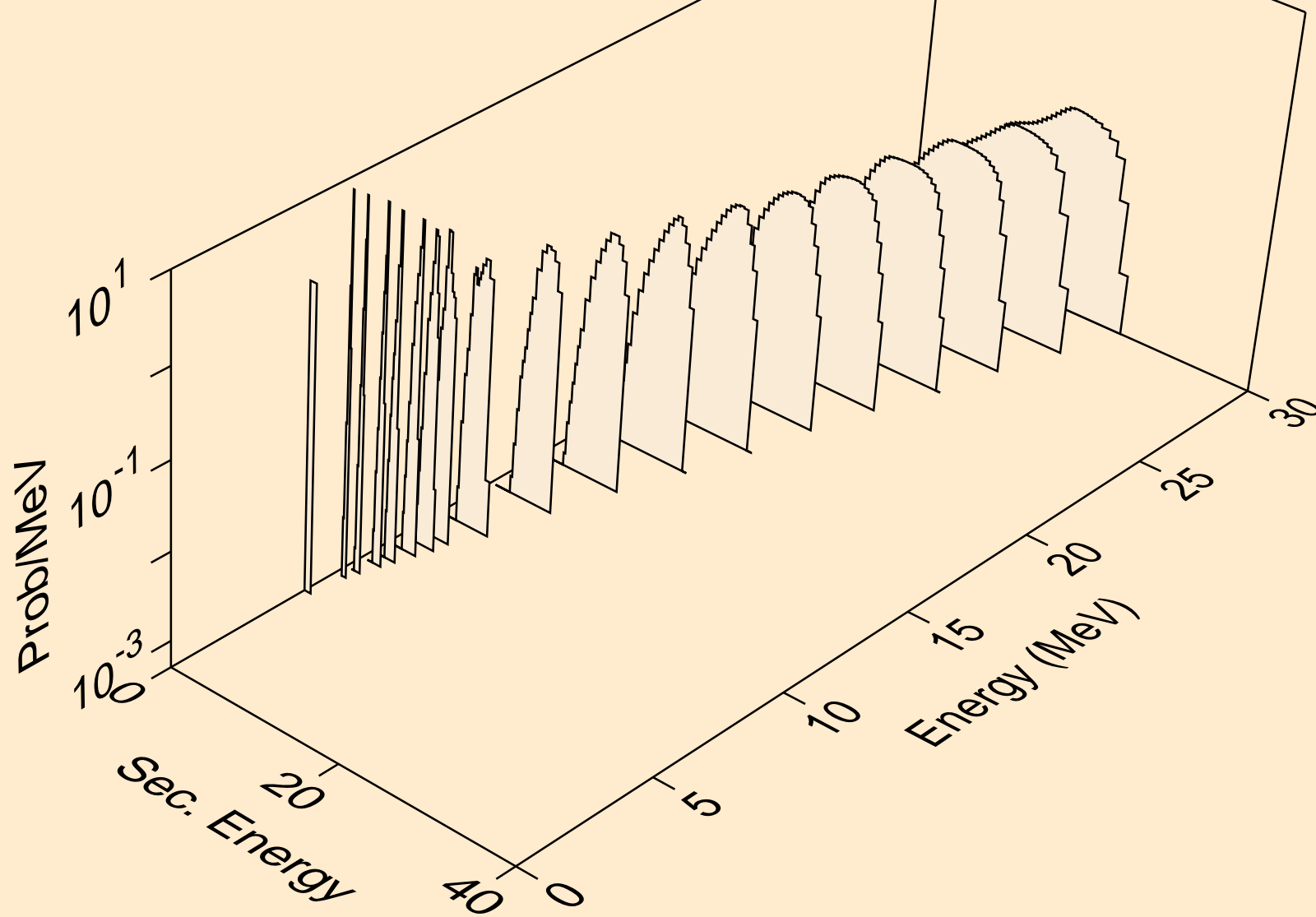

PM145 NEUTRON ACER TENDL-2021 LIBRARY; T=293.6K
protons from (n,2np)

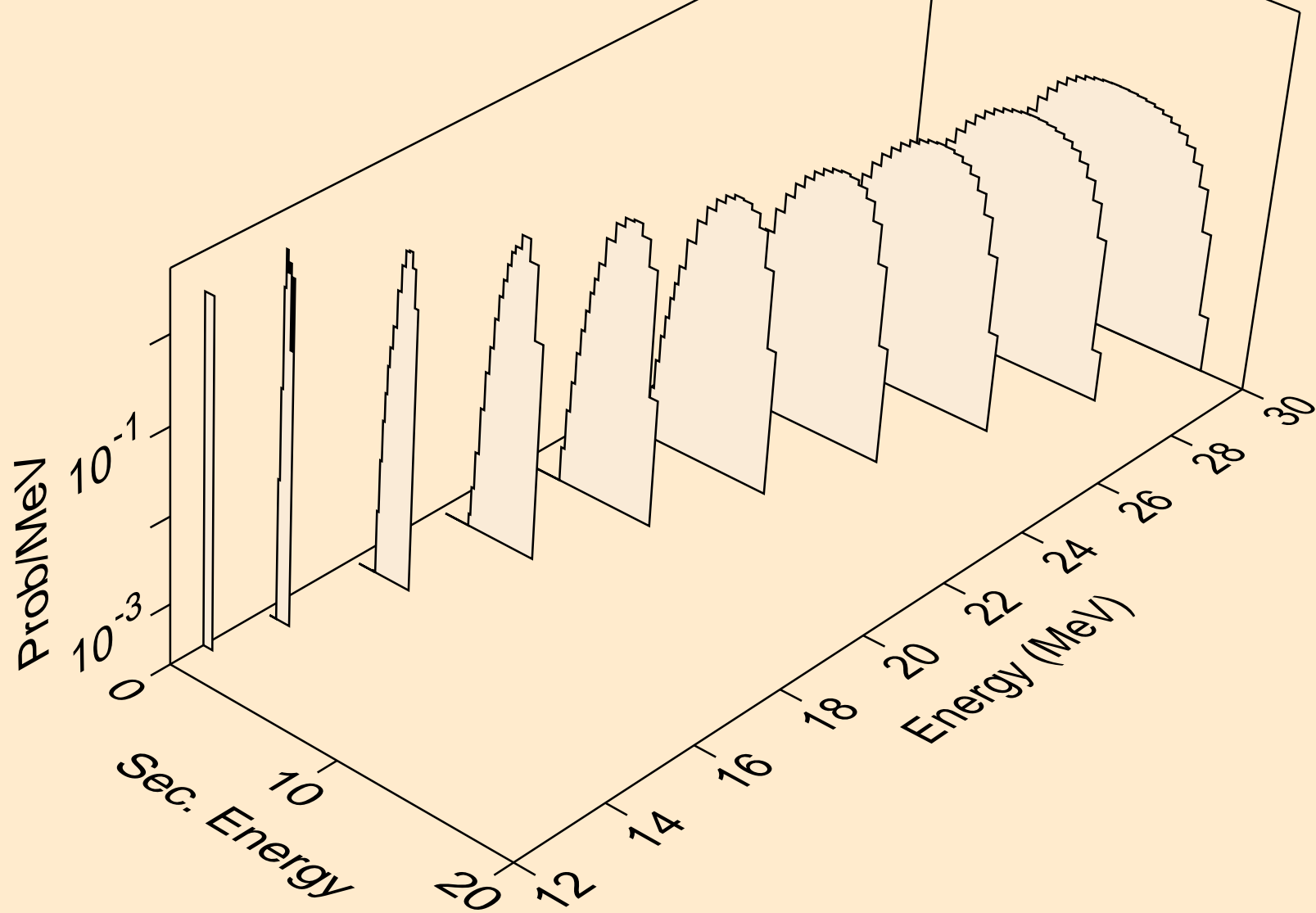

PM145 NEUTRON ACER TENDL-2021 LIBRARY; T=293.6K
protons from (n,3np)

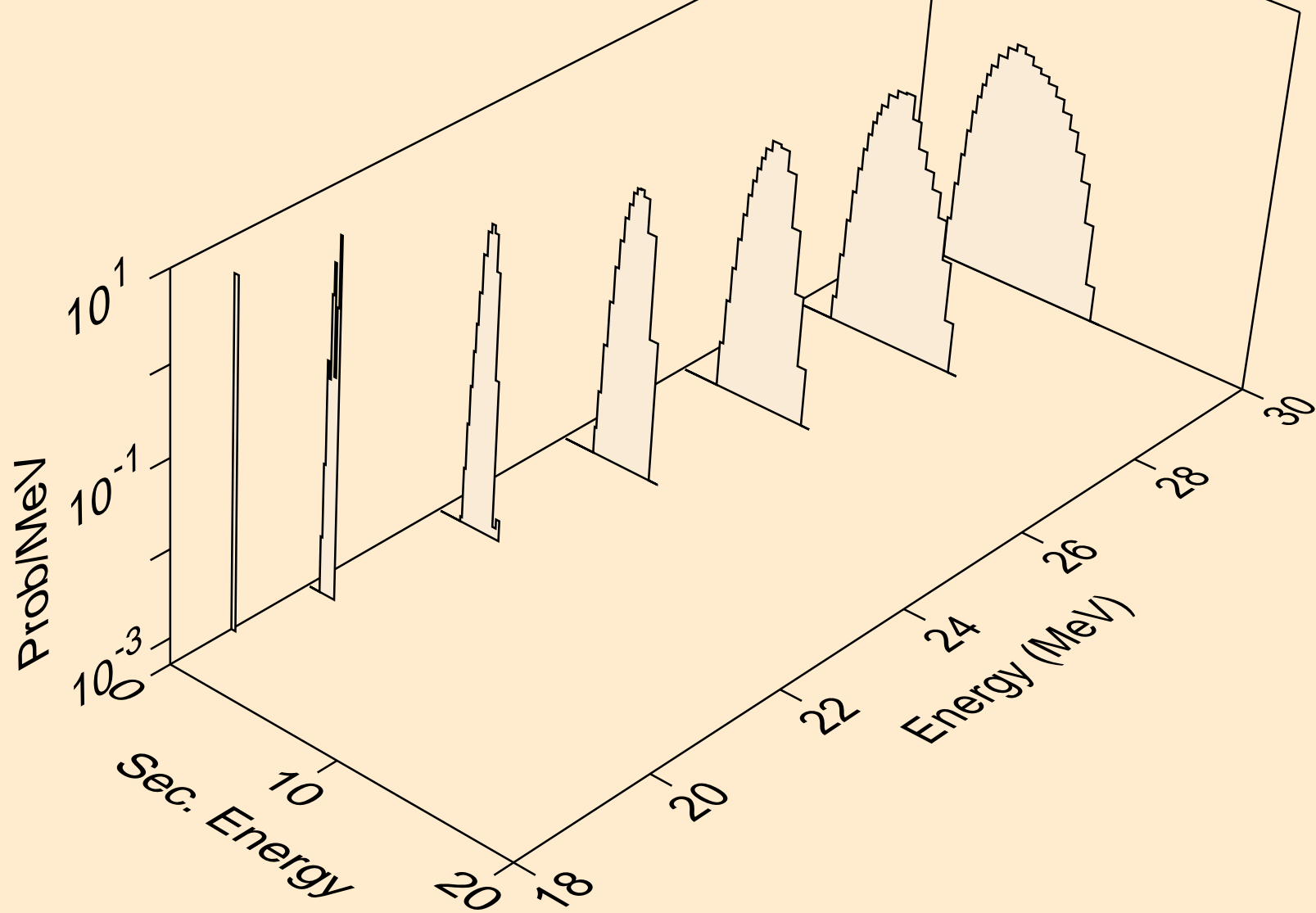

PM145 NEUTRON ACER TENDL-2021 LIBRARY; T=293.6K
protons from (n,2np)

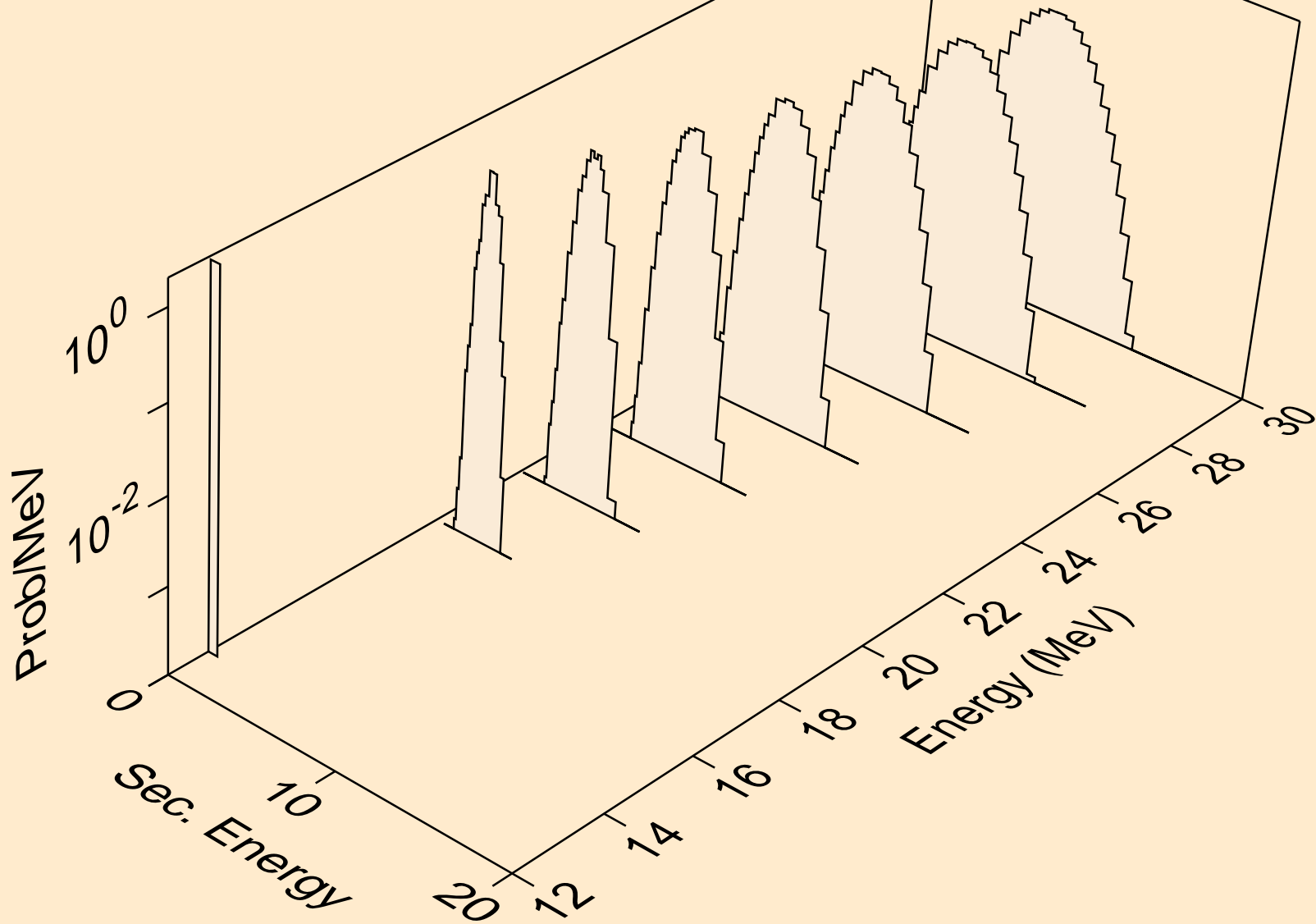

PM145 NEUTRON ACER TENDL-2021 LIBRARY; T=293.6K
protons from (n,npa)

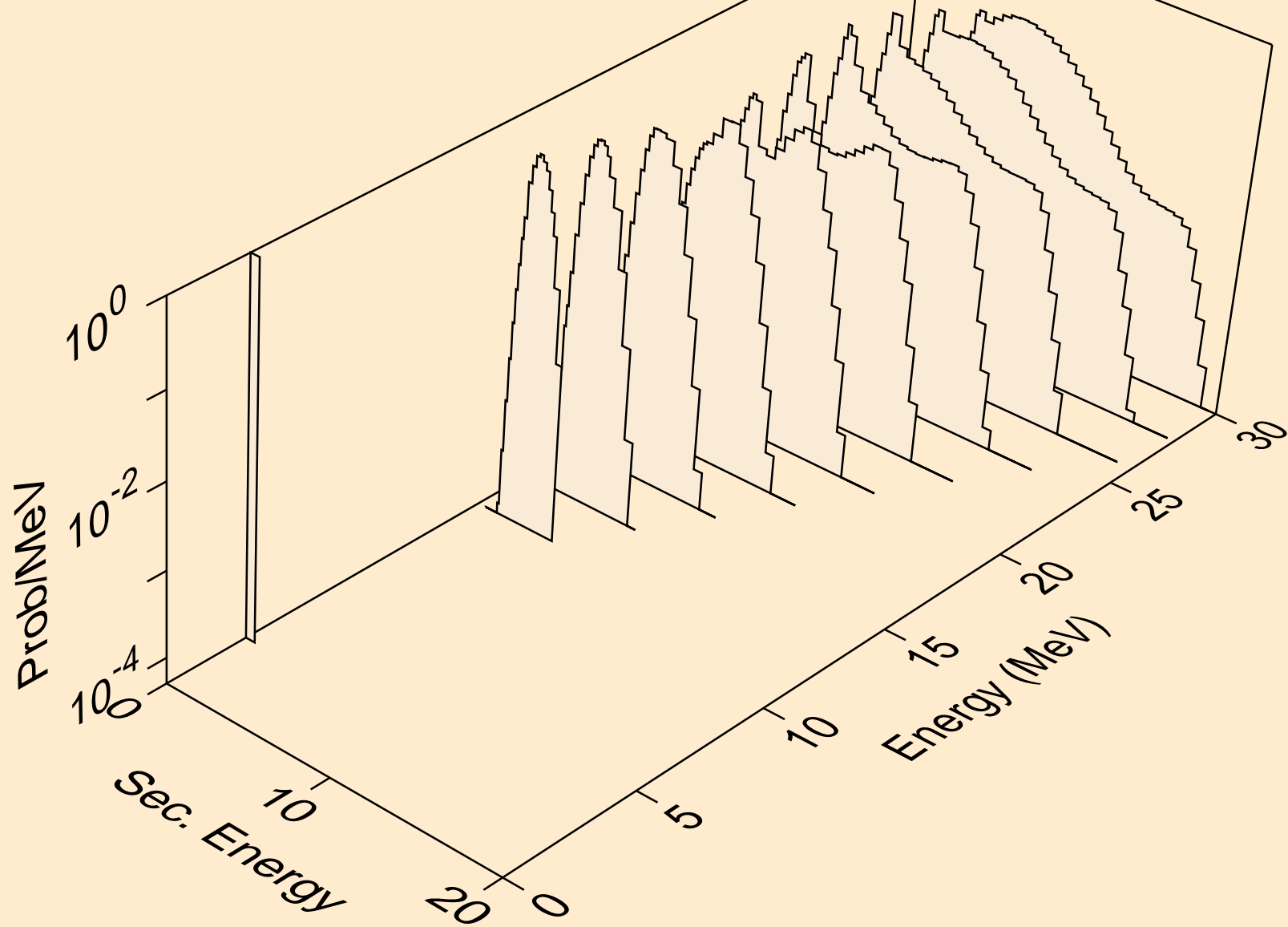

PM145 NEUTRON ACER TENDL-2021 LIBRARY; T=293.6K
protons from (n,p)

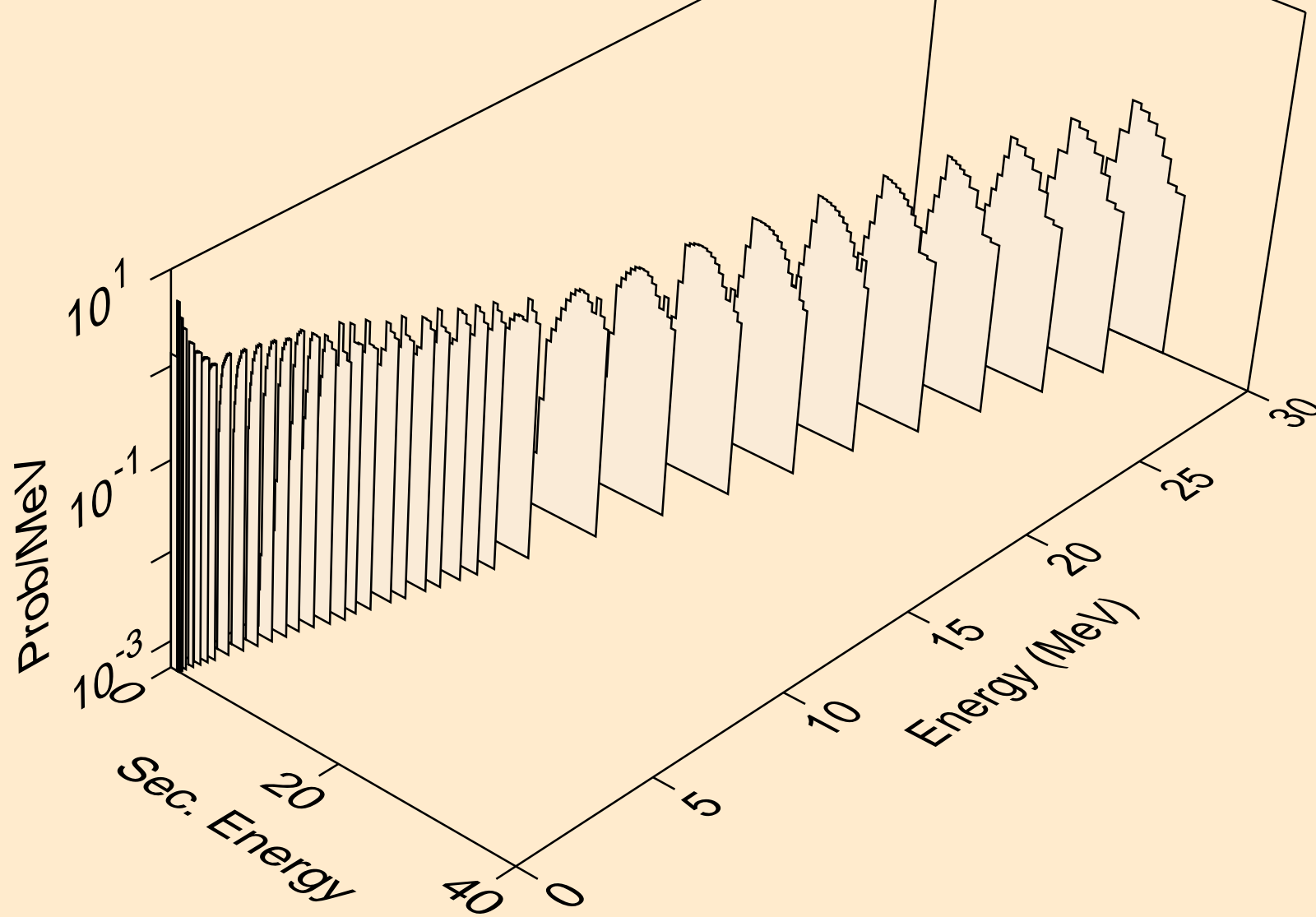

PM145 NEUTRON ACER TENDL-2021 LIBRARY; T=293.6K
protons from (n,2p)

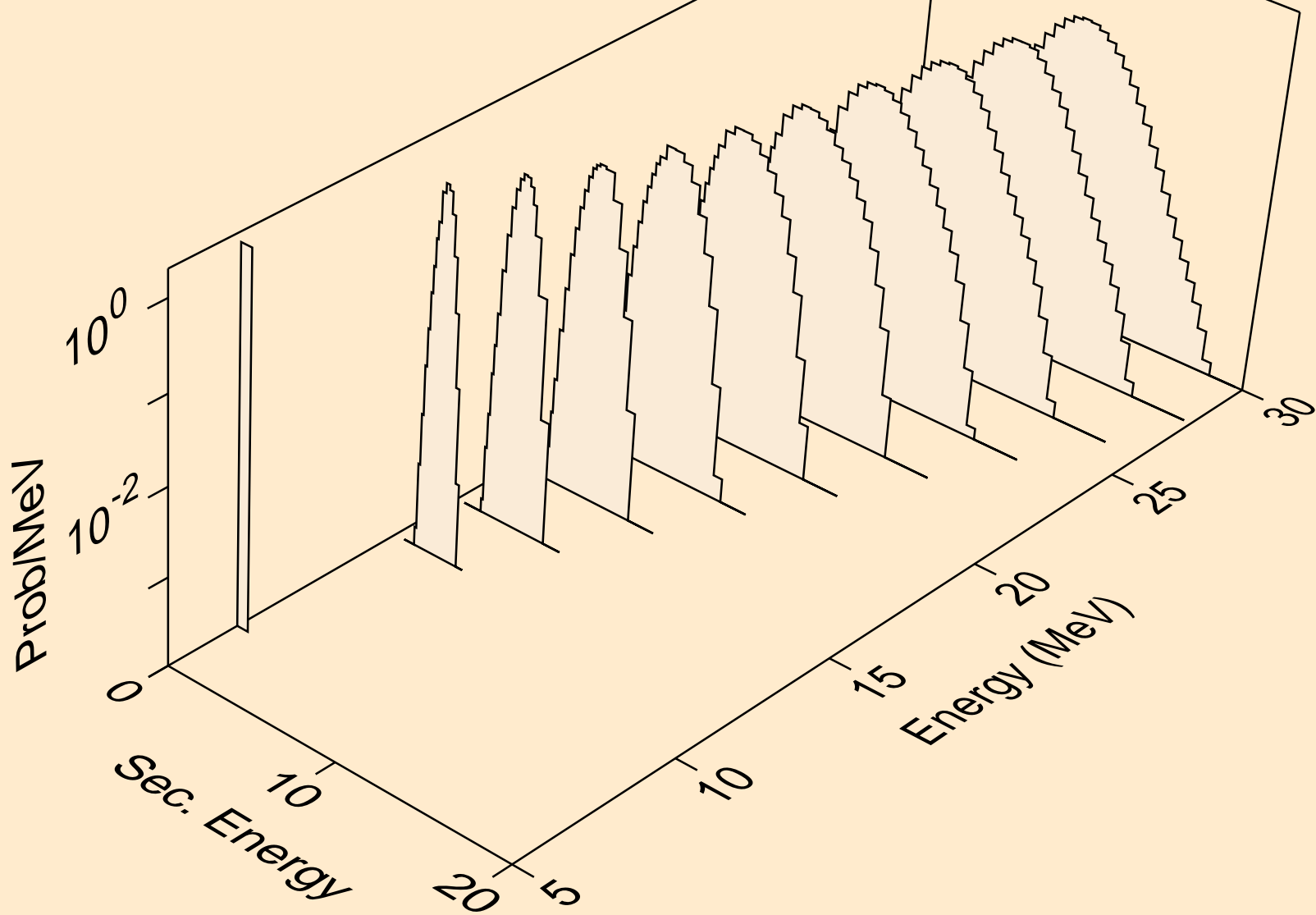

PM145 NEUTRON ACER TENDL-2021 LIBRARY; T=293.6K
protons from (n,p)

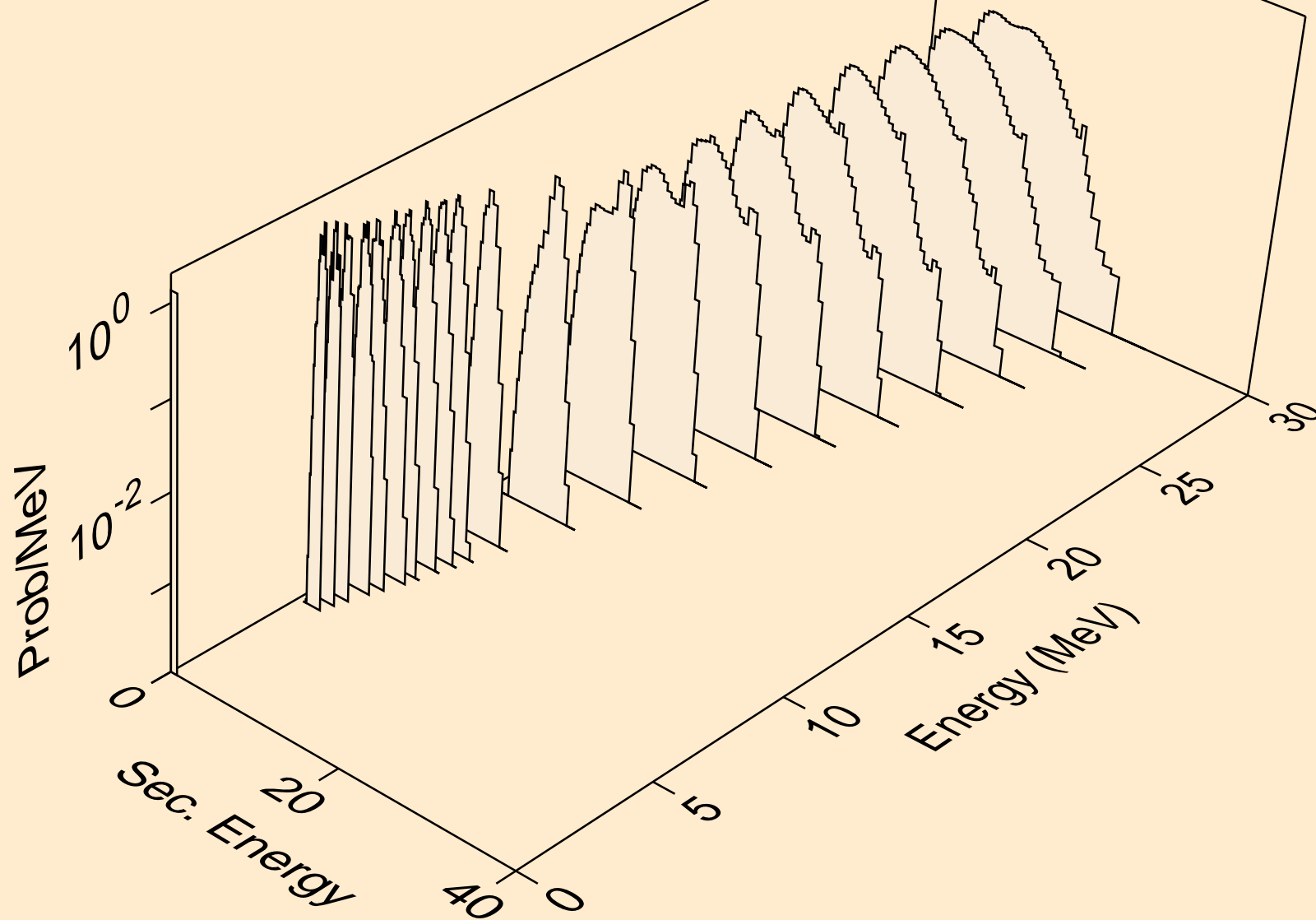

PM145 NEUTRON ACER TENDL-2021 LIBRARY; T=293.6K
protons from (n,pd)

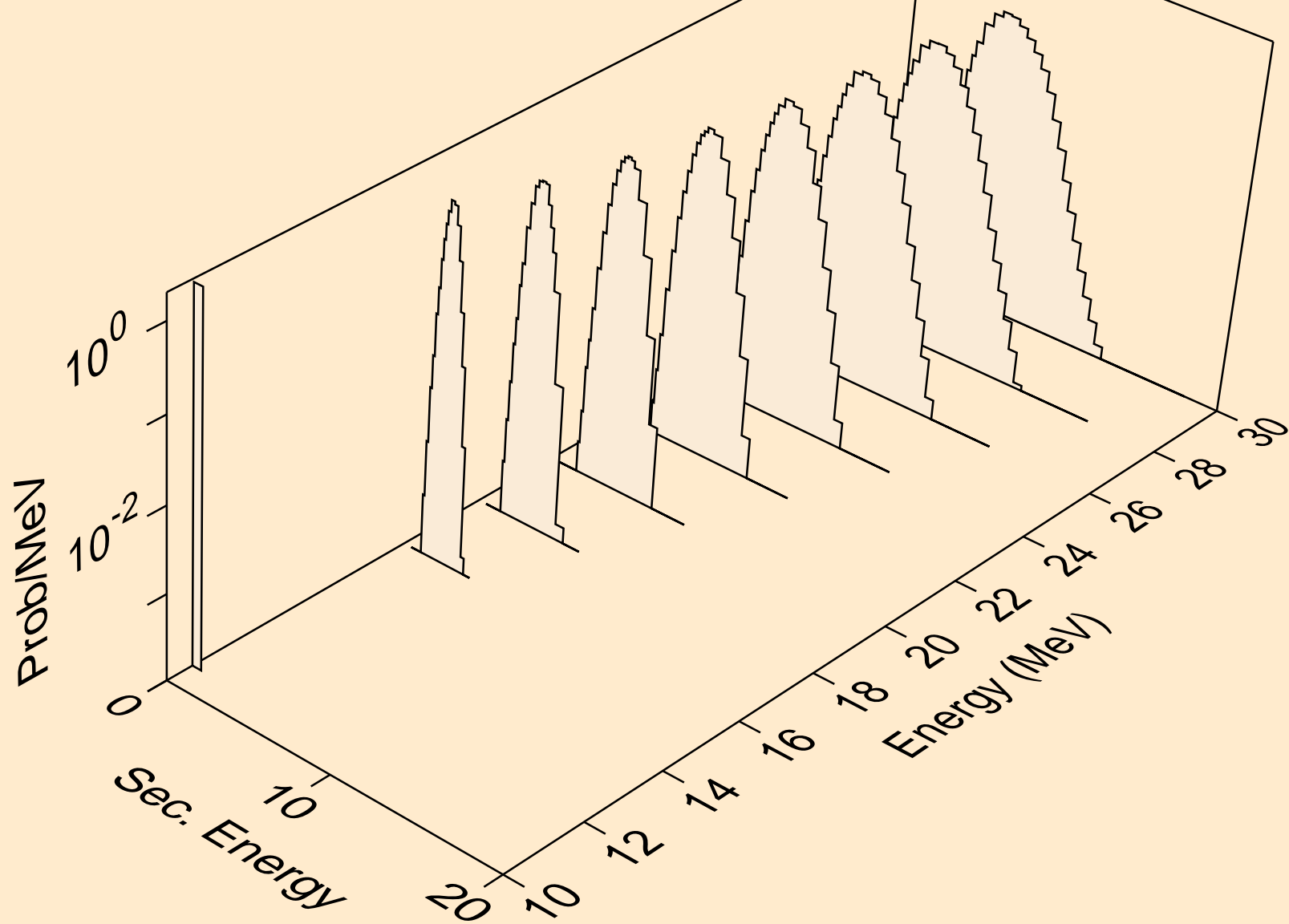

PM145 NEUTRON ACER TENDL-2021 LIBRARY; T=293.6K
protons from (n,pt)

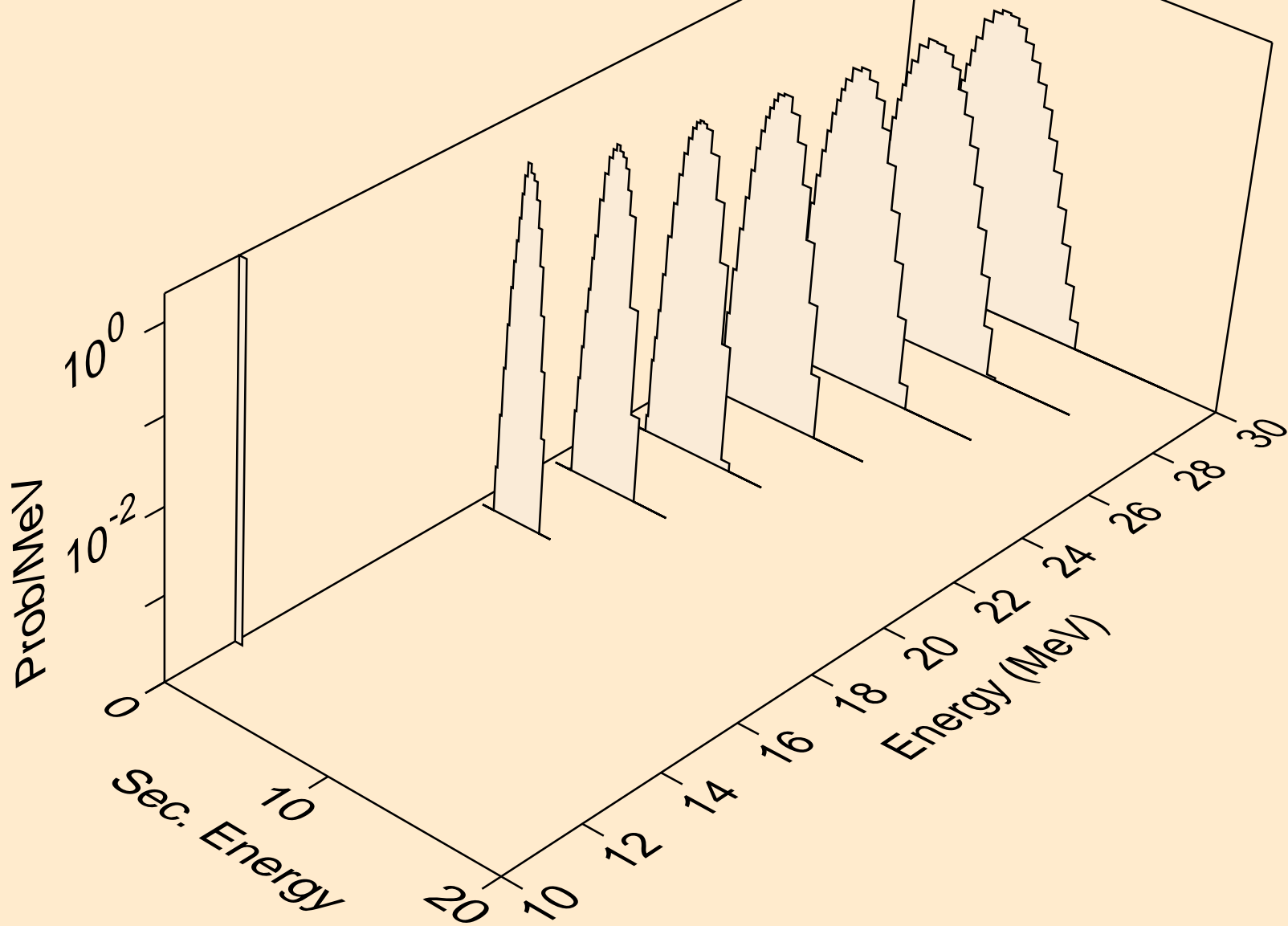

PM145 NEUTRON ACER TENDL-2021 LIBRARY; T=293.6K
deuterons from (n,x)

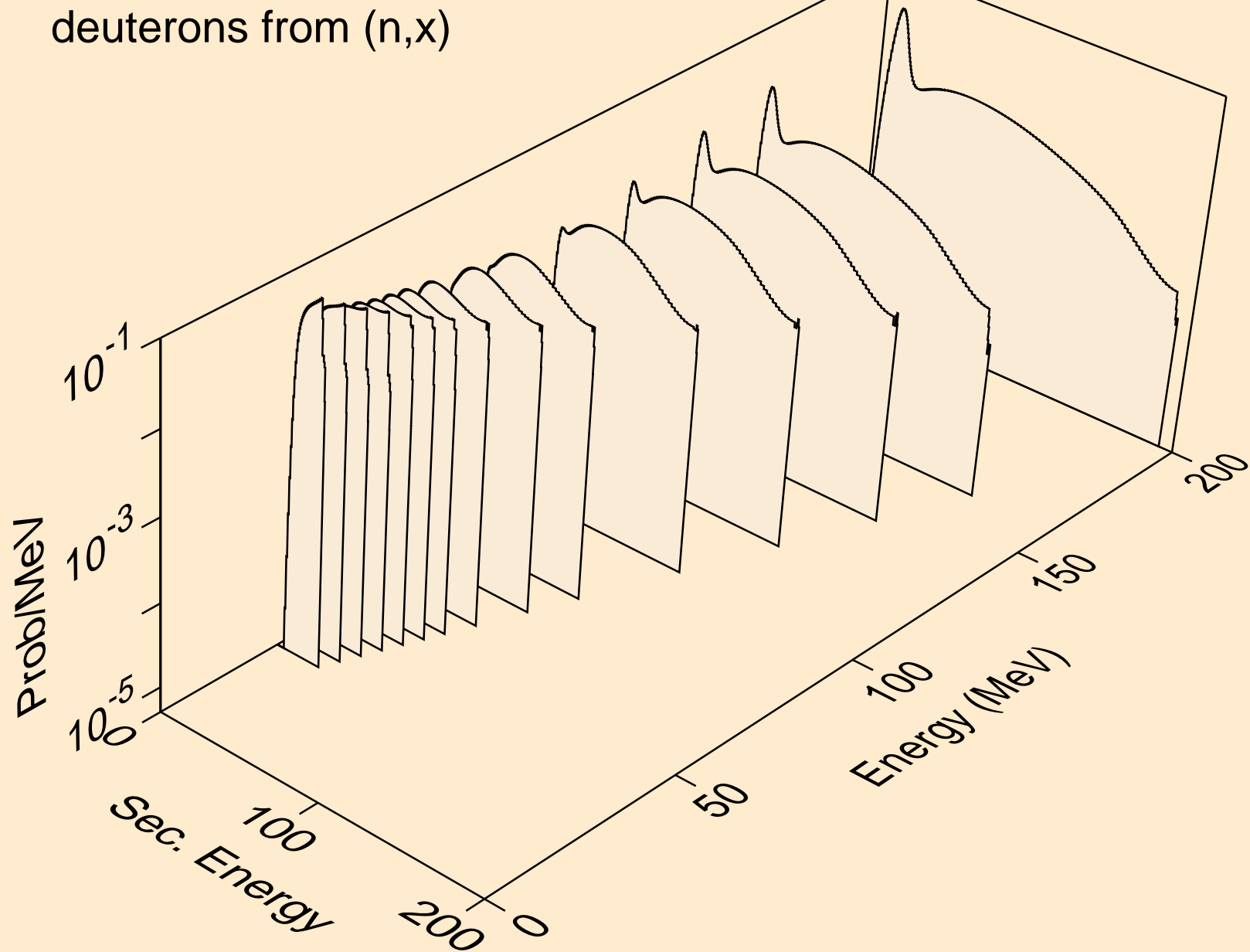

PM145 NEUTRON ACER TENDL-2021 LIBRARY; T=293.6K
deuterons from (n,2nd)

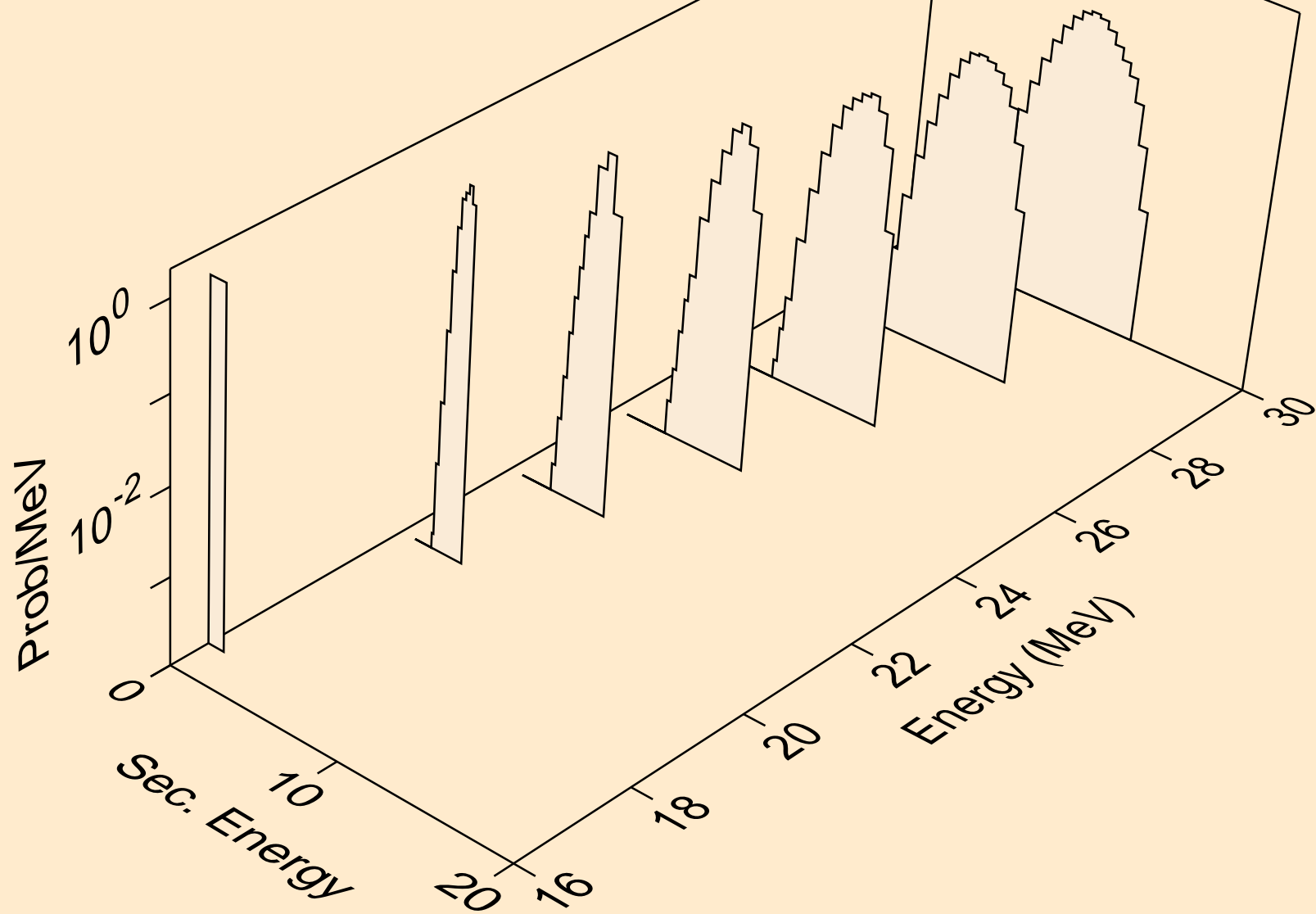

PM145 NEUTRON ACER TENDL-2021 LIBRARY; T=293.6K
deuterons from (n,n*)d

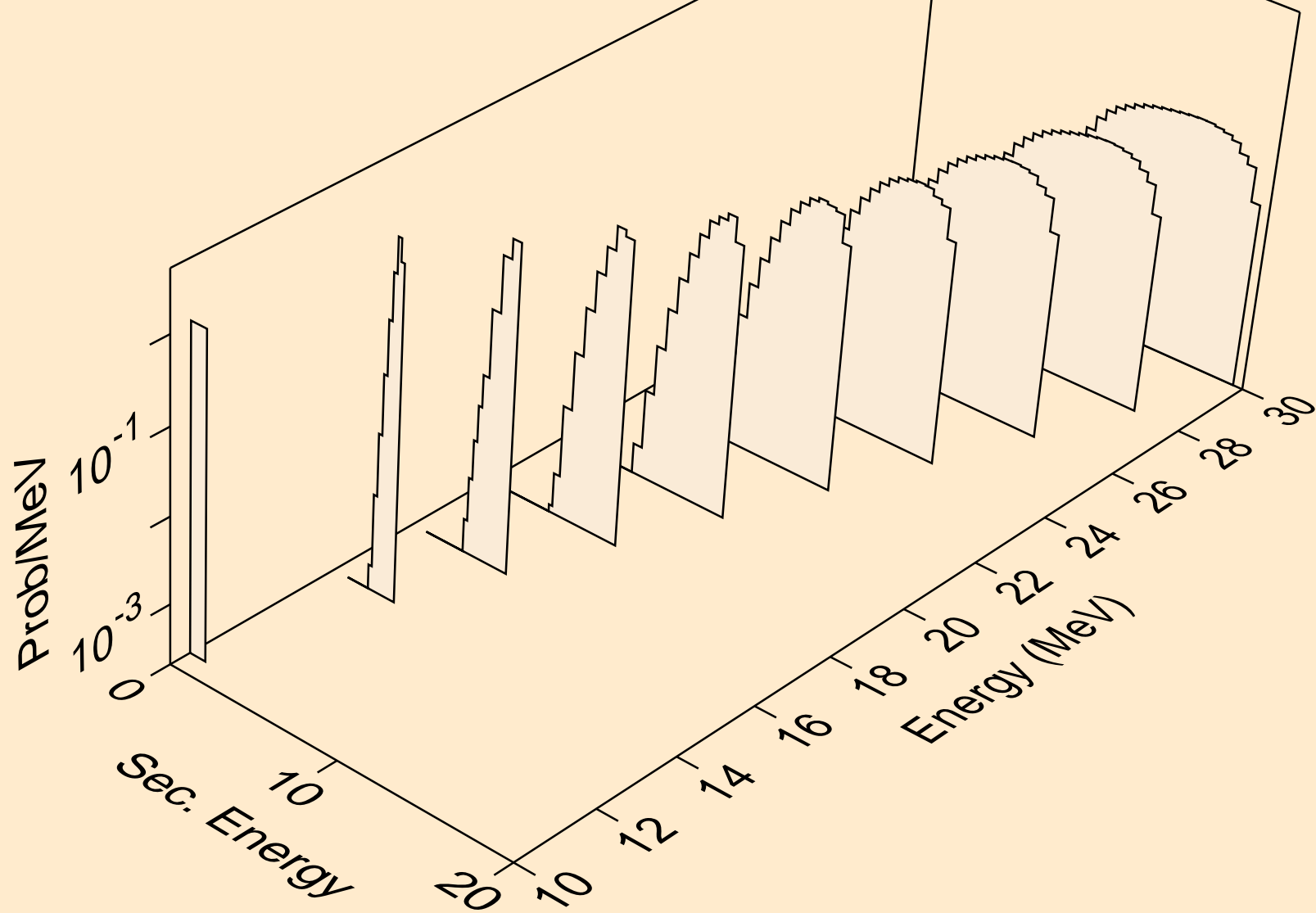

PM145 NEUTRON ACER TENDL-2021 LIBRARY; T=293.6K
deuterons from (n,d)

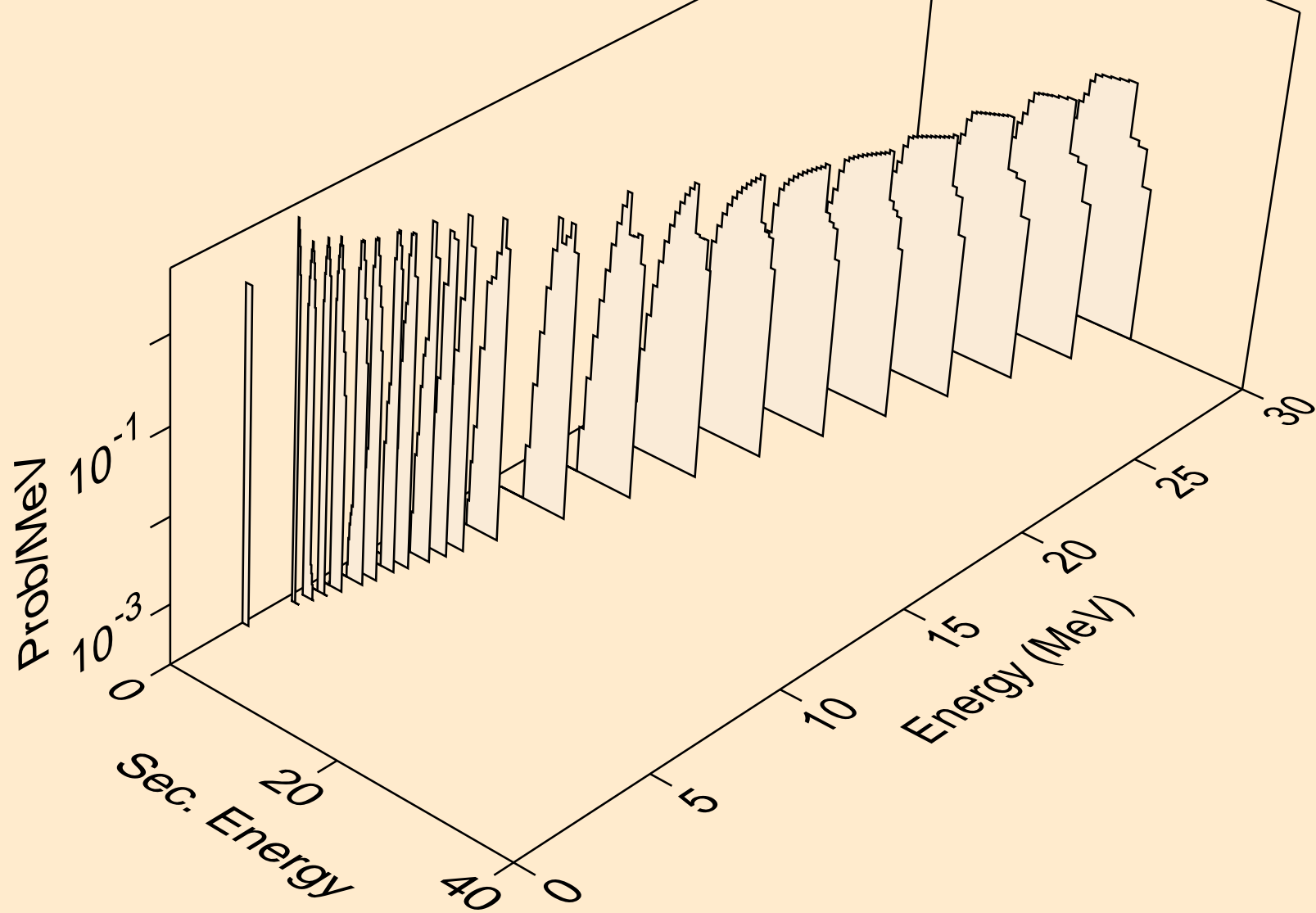

PM145 NEUTRON ACER TENDL-2021 LIBRARY; T=293.6K
deuterons from (n,pd)

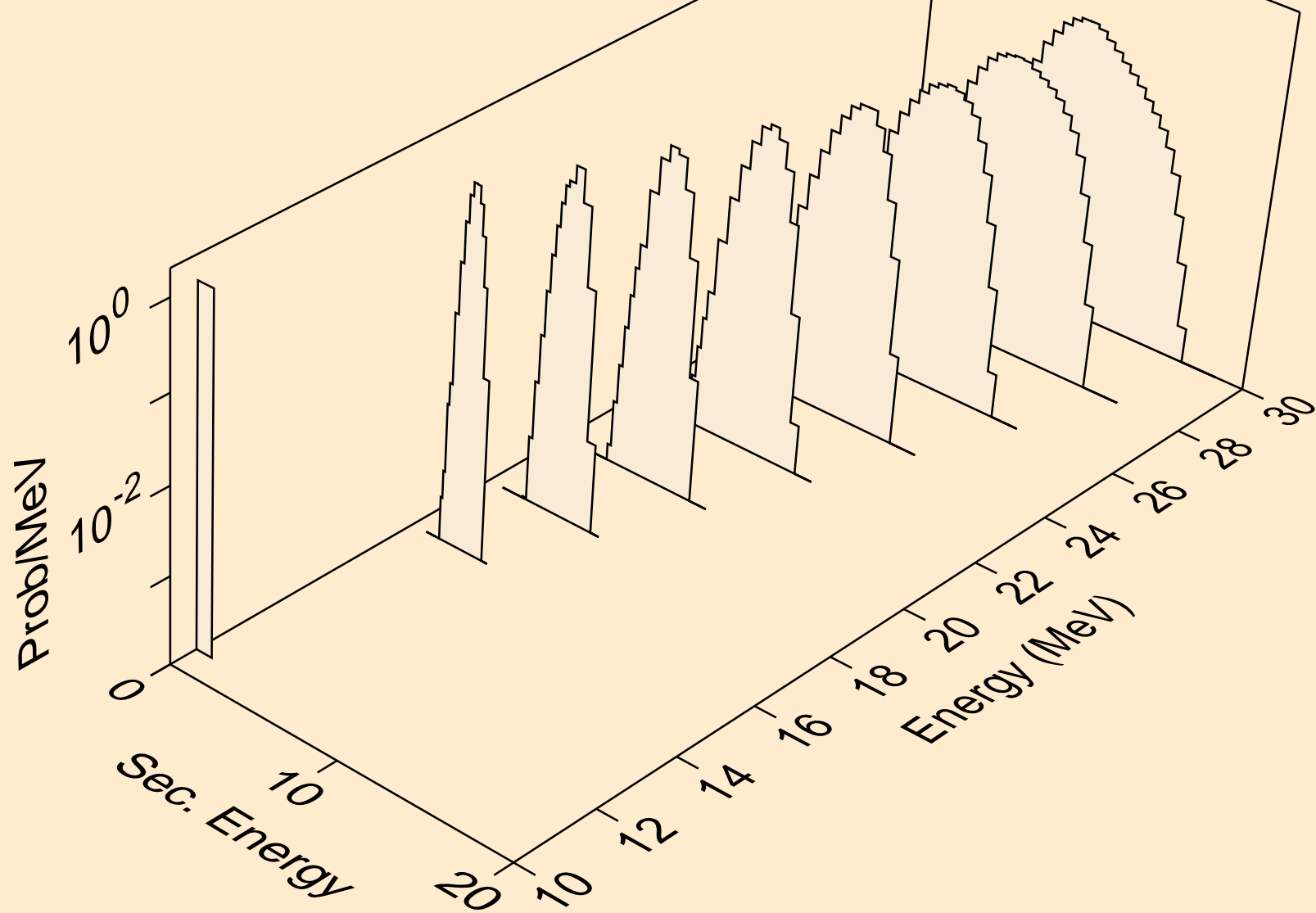

PM145 NEUTRON ACER TENDL-2021 LIBRARY; T=293.6K
deuterons from (n,da)

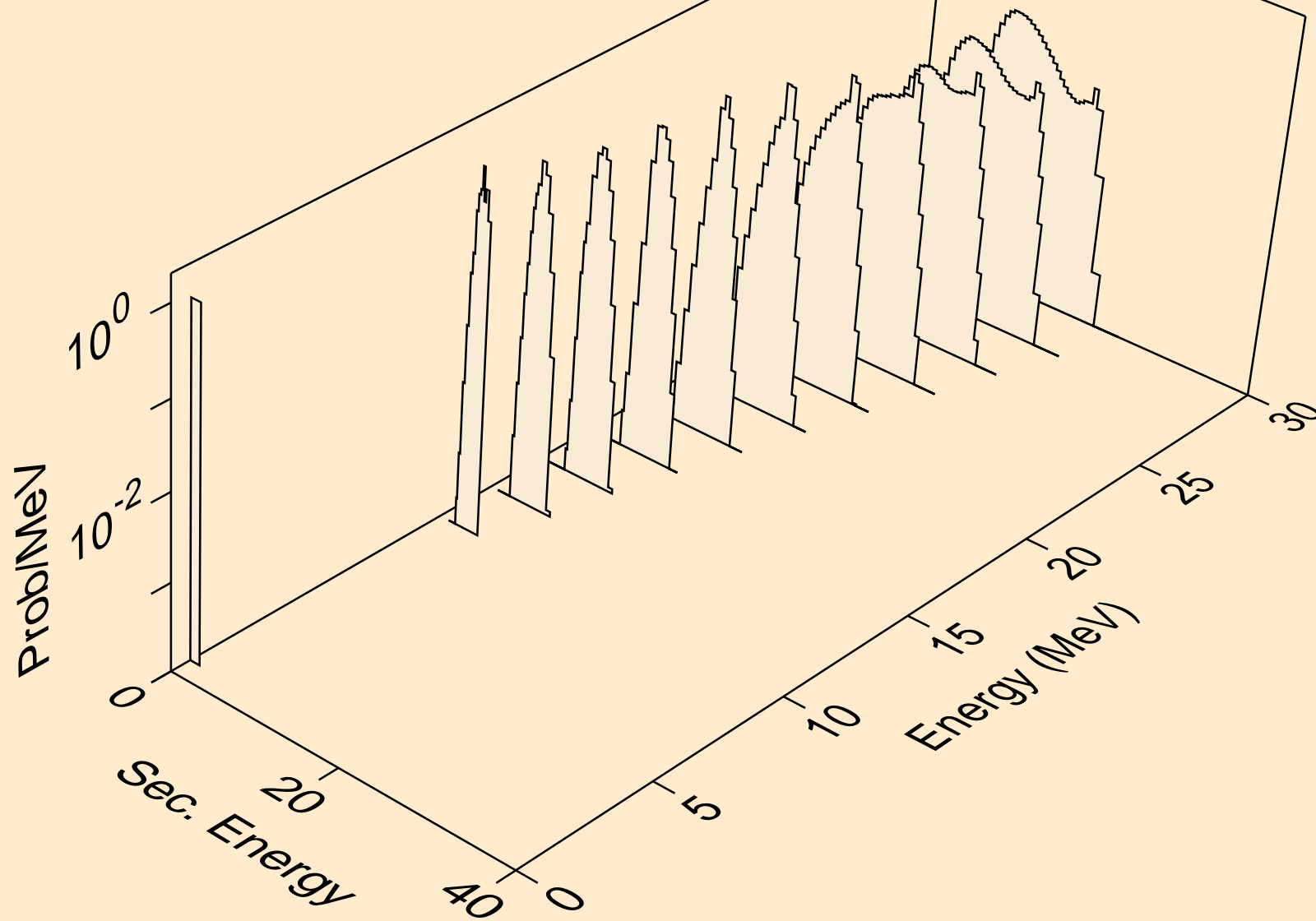

PM145 NEUTRON ACER TENDL-2021 LIBRARY; T=293.6K
tritons from (n,x)

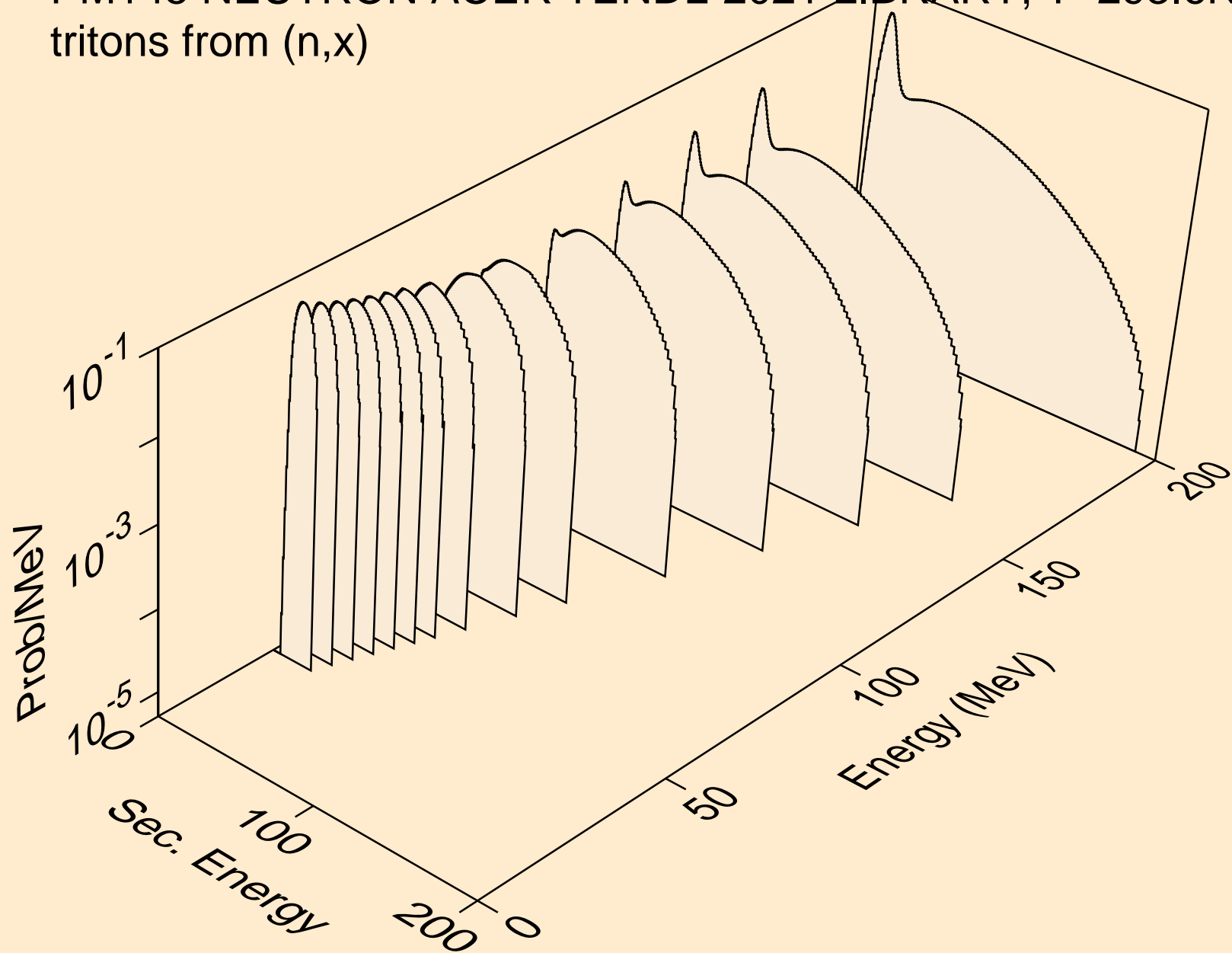

PM145 NEUTRON ACER TENDL-2021 LIBRARY; T=293.6K
tritons from (n,n*)t

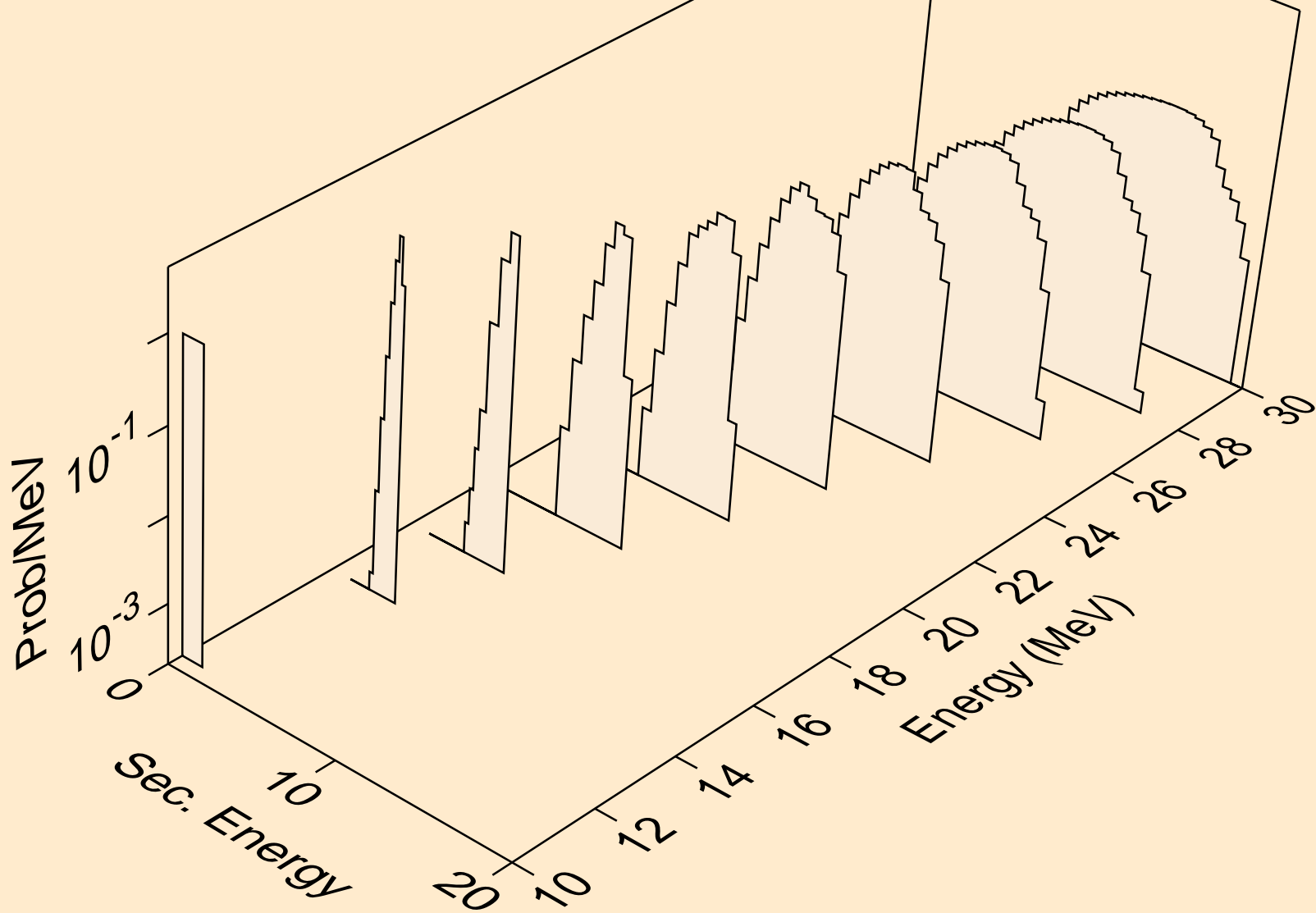

PM145 NEUTRON ACER TENDL-2021 LIBRARY; T=293.6K
tritons from (n,t)

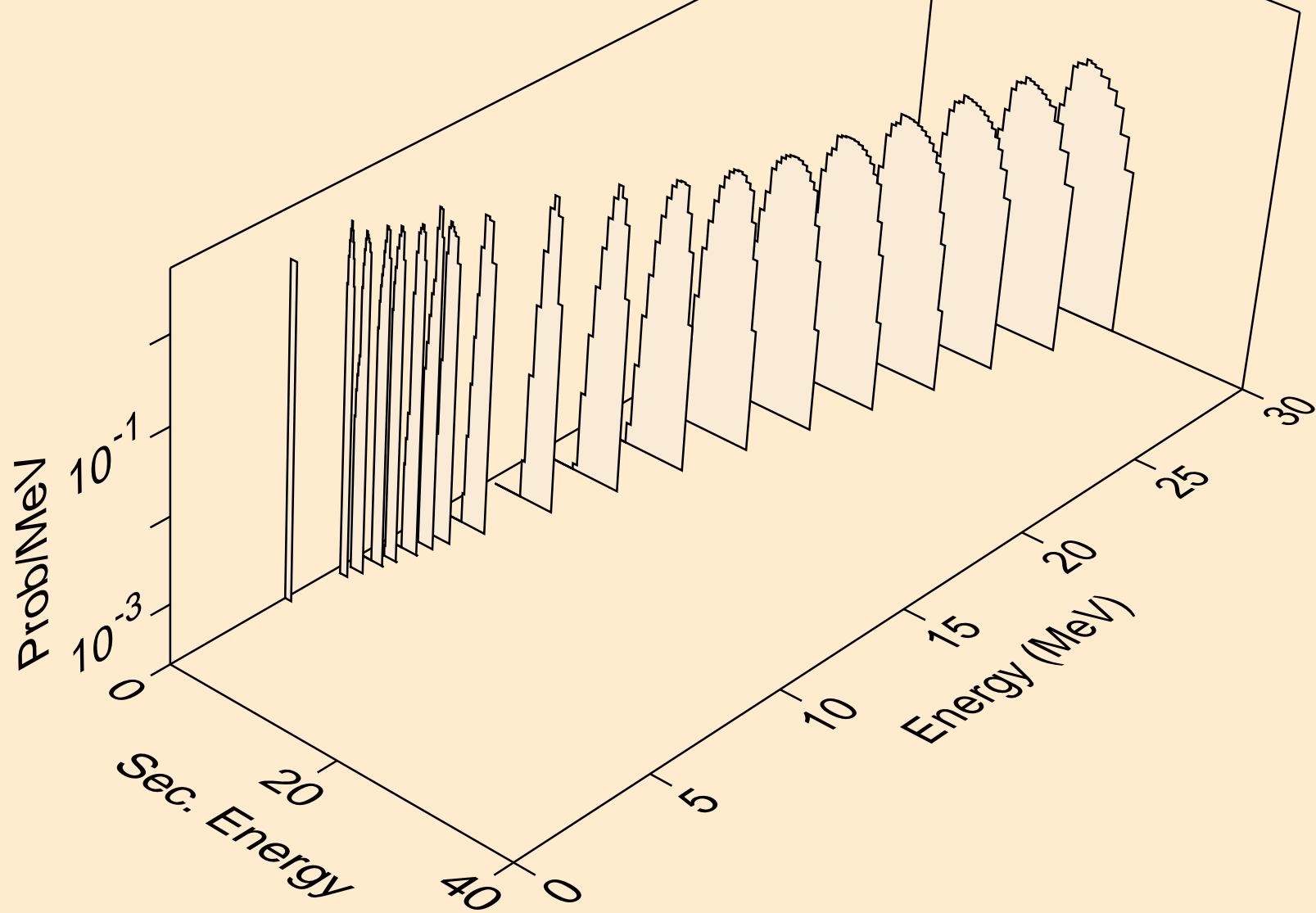

PM145 NEUTRON ACER TENDL-2021 LIBRARY; T=293.6K
tritons from (n,pt)

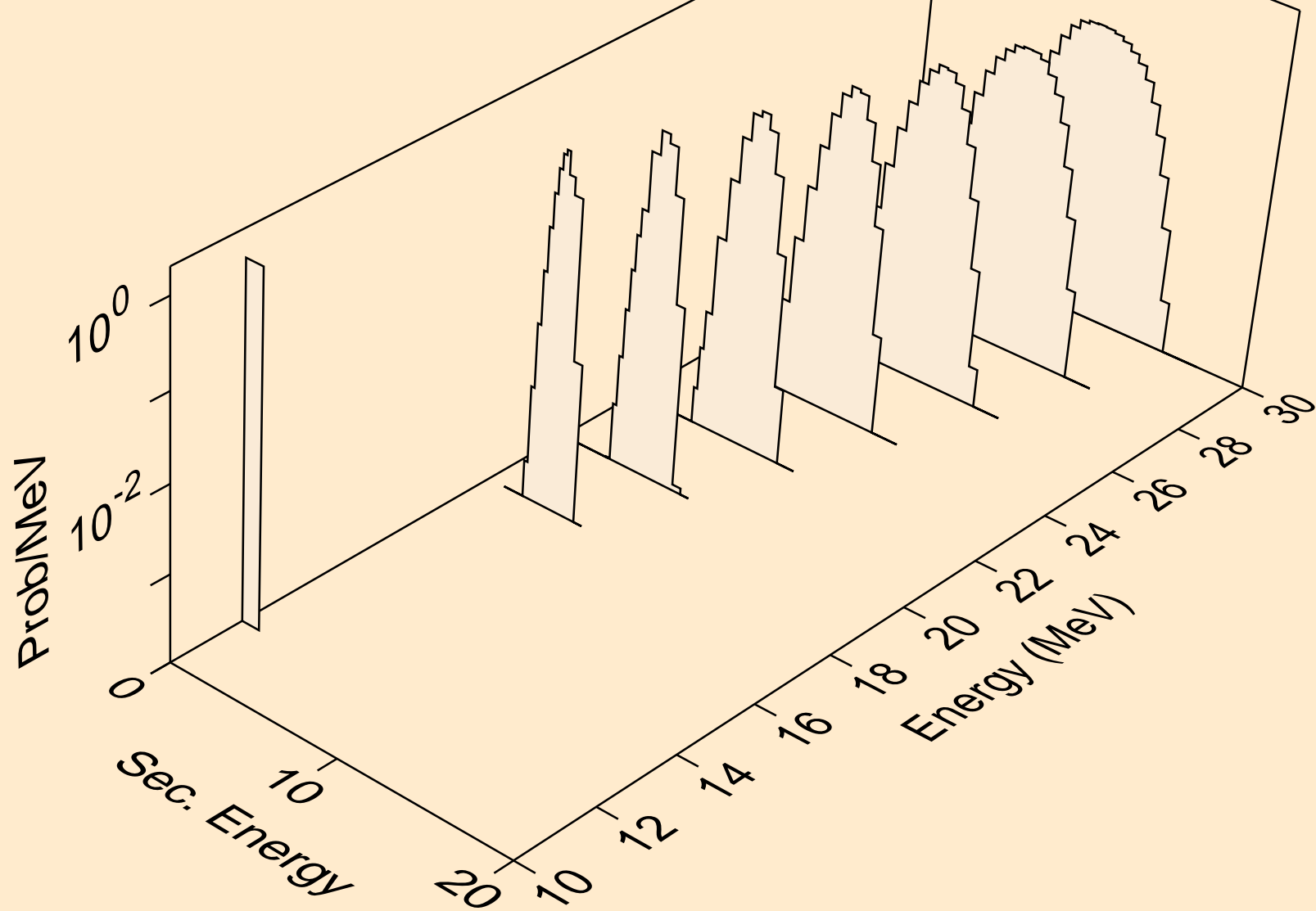

PM145 NEUTRON ACER TENDL-2021 LIBRARY; T=293.6K
he3s from (n,x)

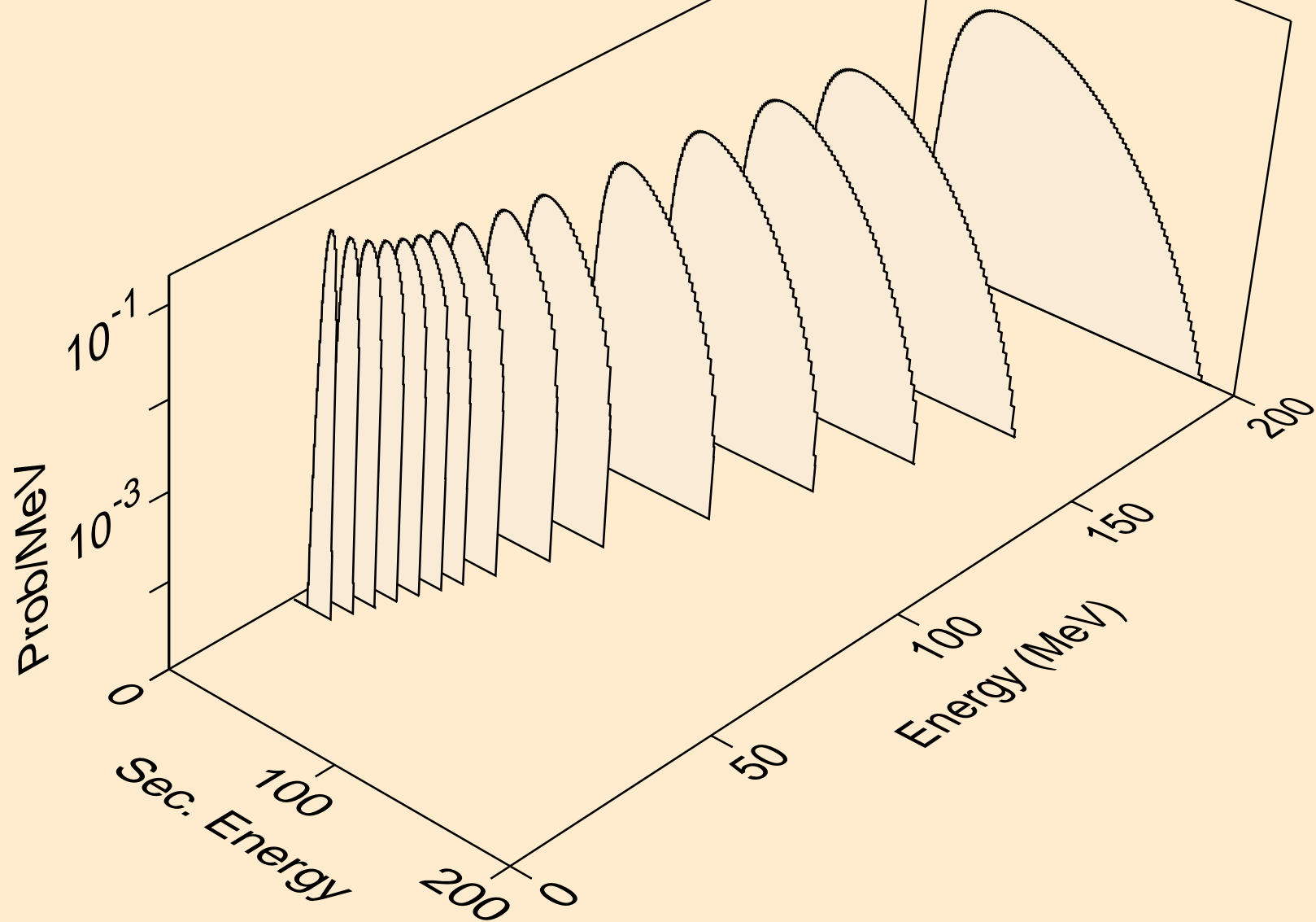

PM145 NEUTRON ACER TENDL-2021 LIBRARY; T=293.6K
he3s from (n,n*)he3

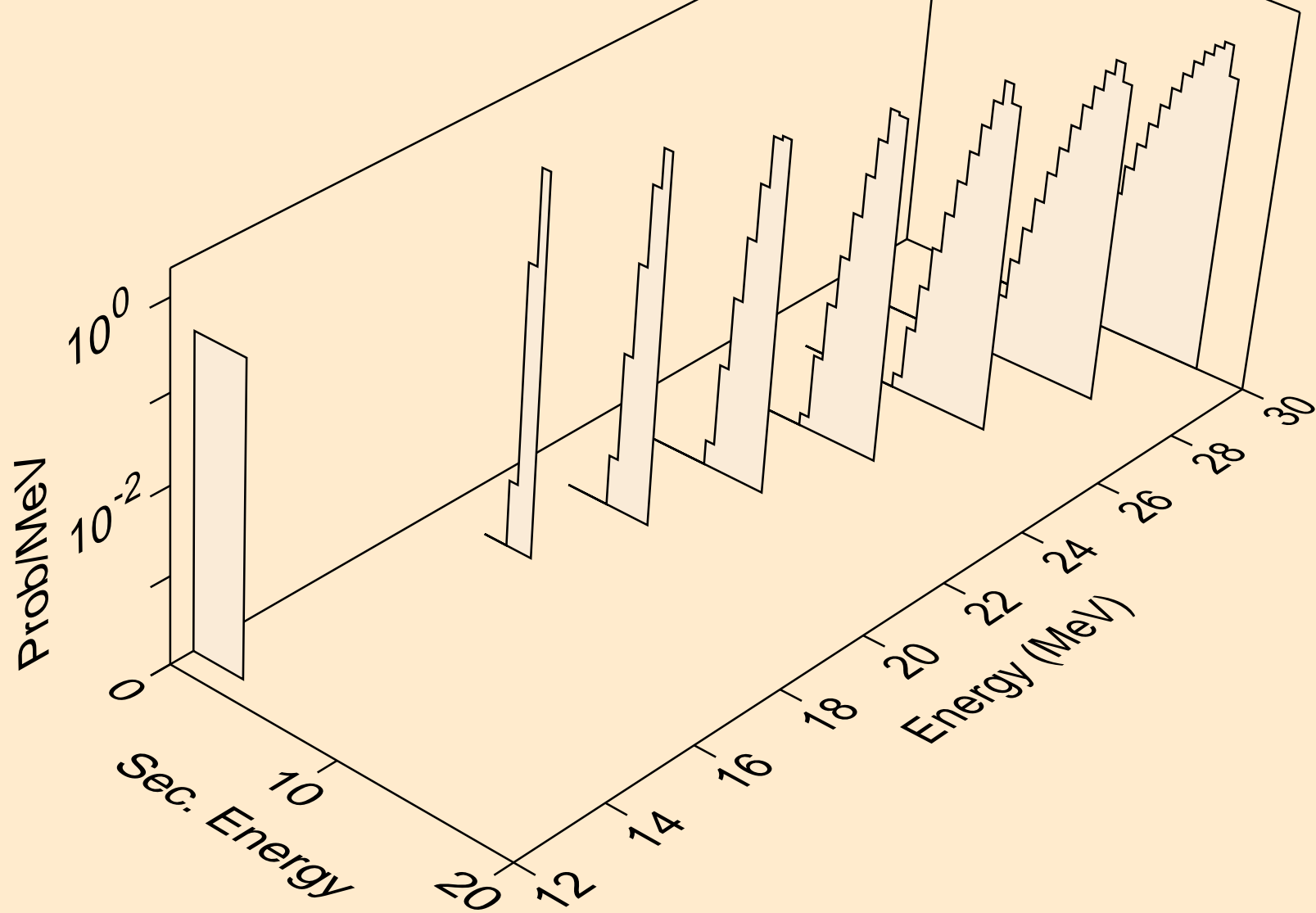

PM145 NEUTRON ACER TENDL-2021 LIBRARY; T=293.6K
he3s from (n,he3)

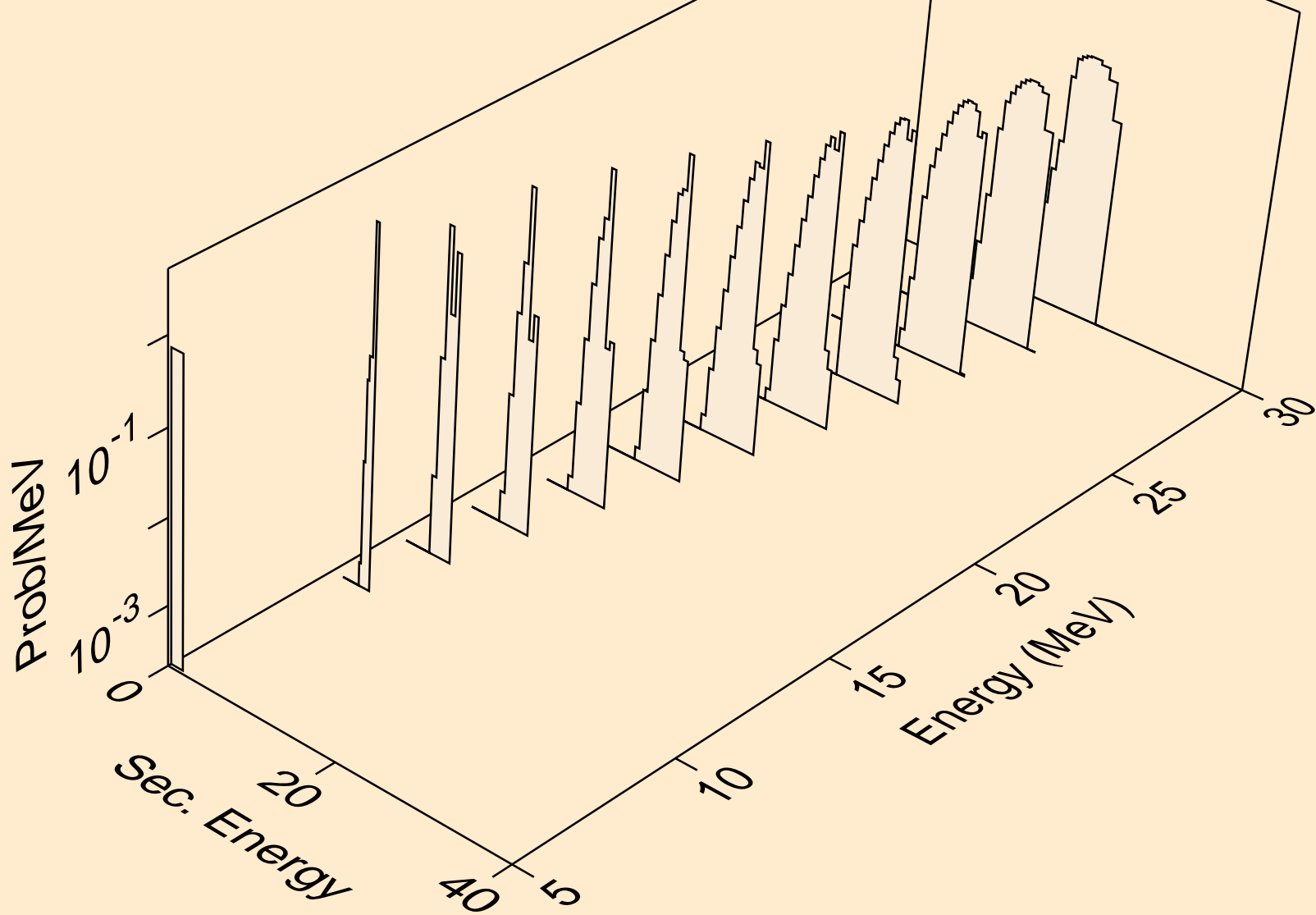

PM145 NEUTRON ACER TENDL-2021 LIBRARY; T=293.6K
alphas from (n,x)

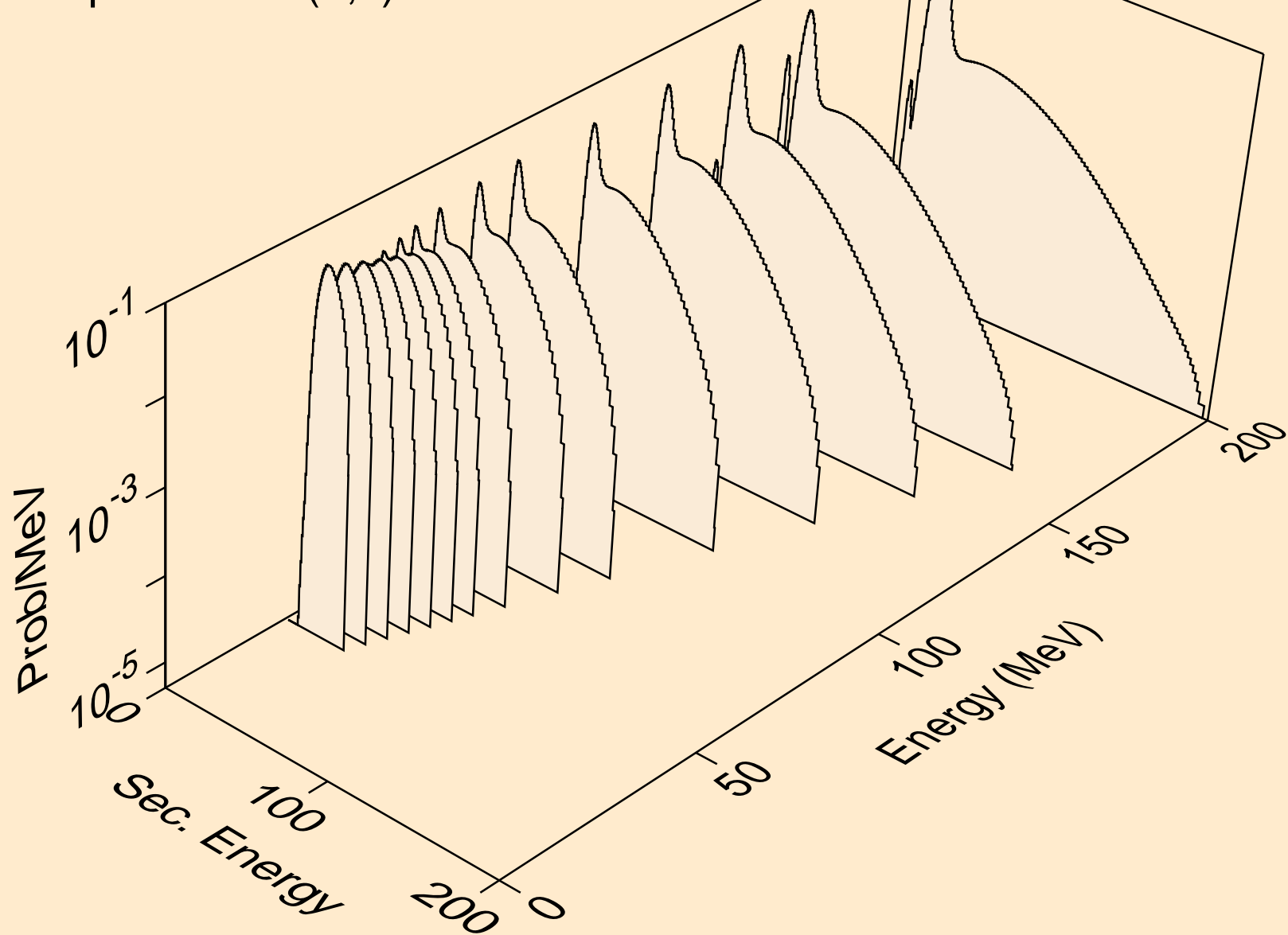

PM145 NEUTRON ACER TENDL-2021 LIBRARY; T=293.6K
alphas from (n,n*)a

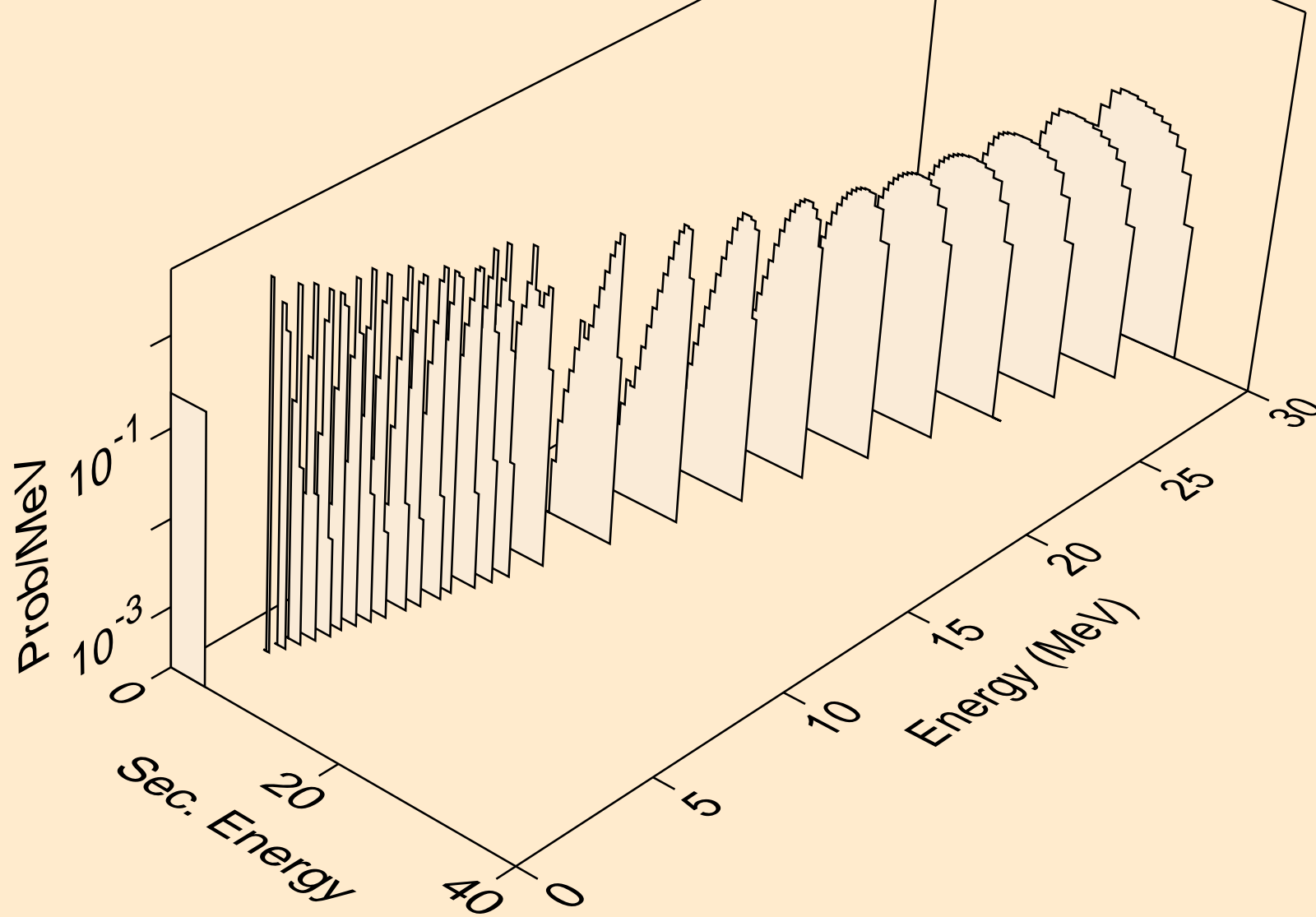

PM145 NEUTRON ACER TENDL-2021 LIBRARY; T=293.6K
alphas from (n,2n)a

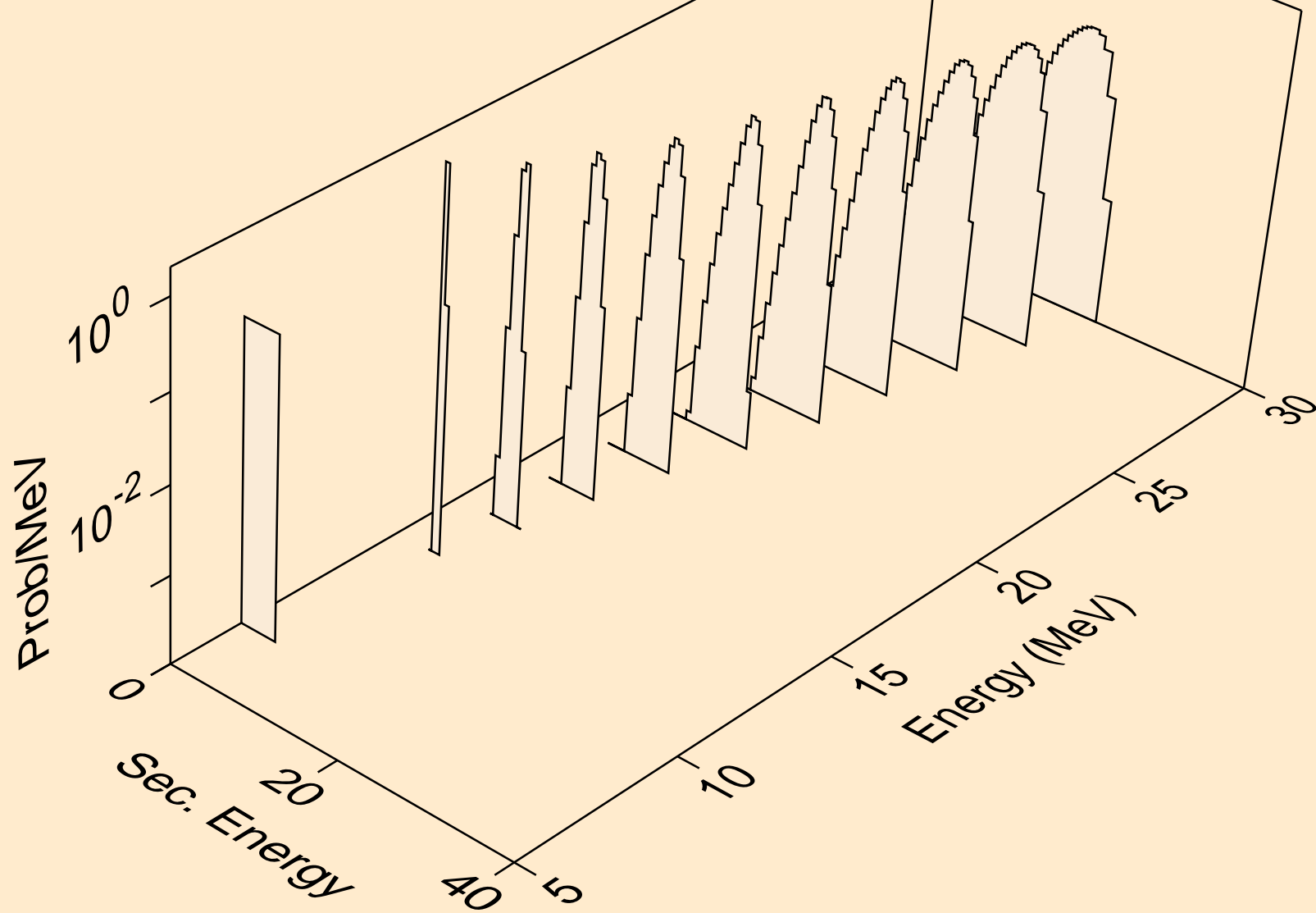

PM145 NEUTRON ACER TENDL-2021 LIBRARY; T=293.6K
alphas from (n,3n)a

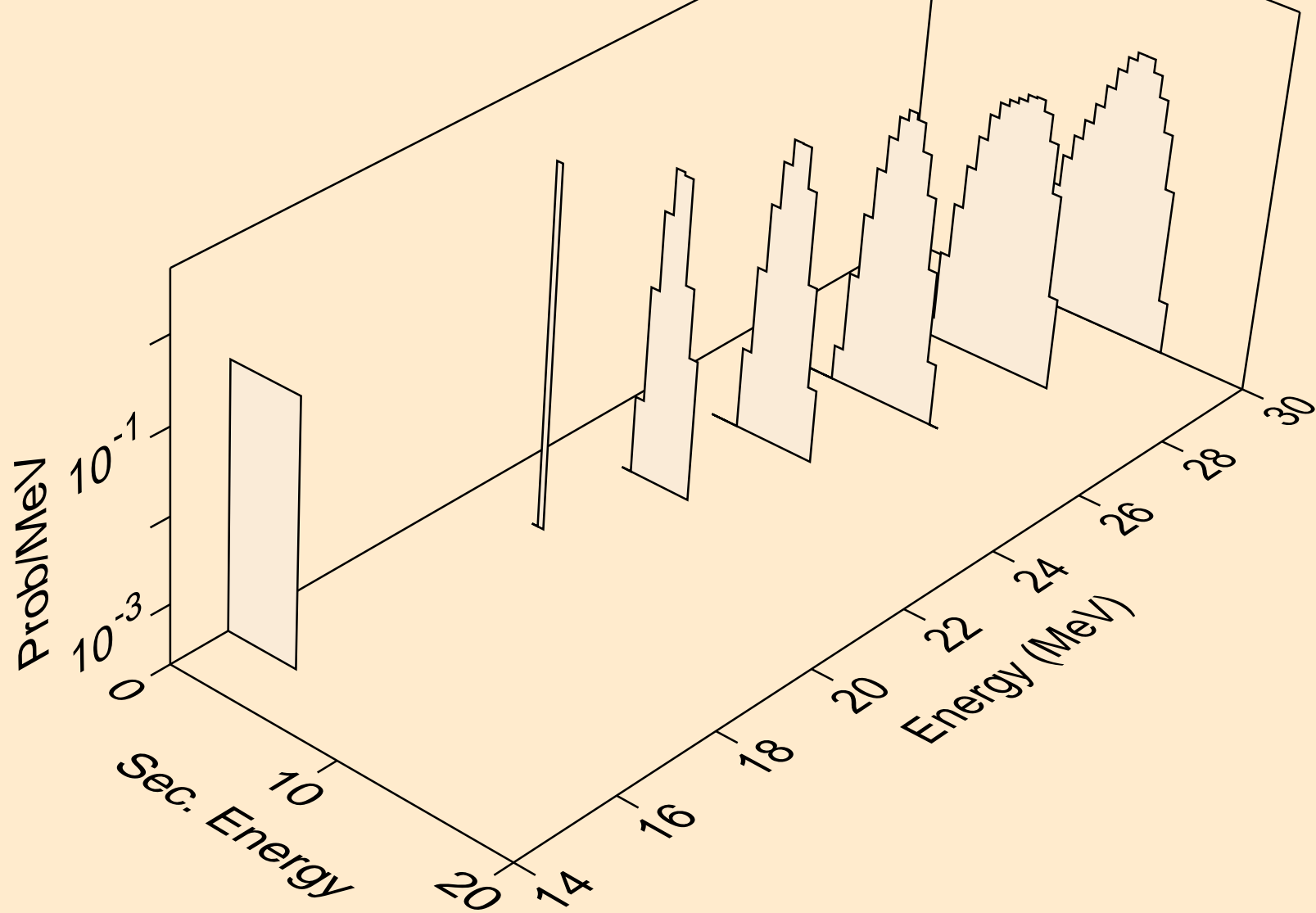

PM145 NEUTRON ACER TENDL-2021 LIBRARY; T=293.6K
alphas from (n,n*)2a

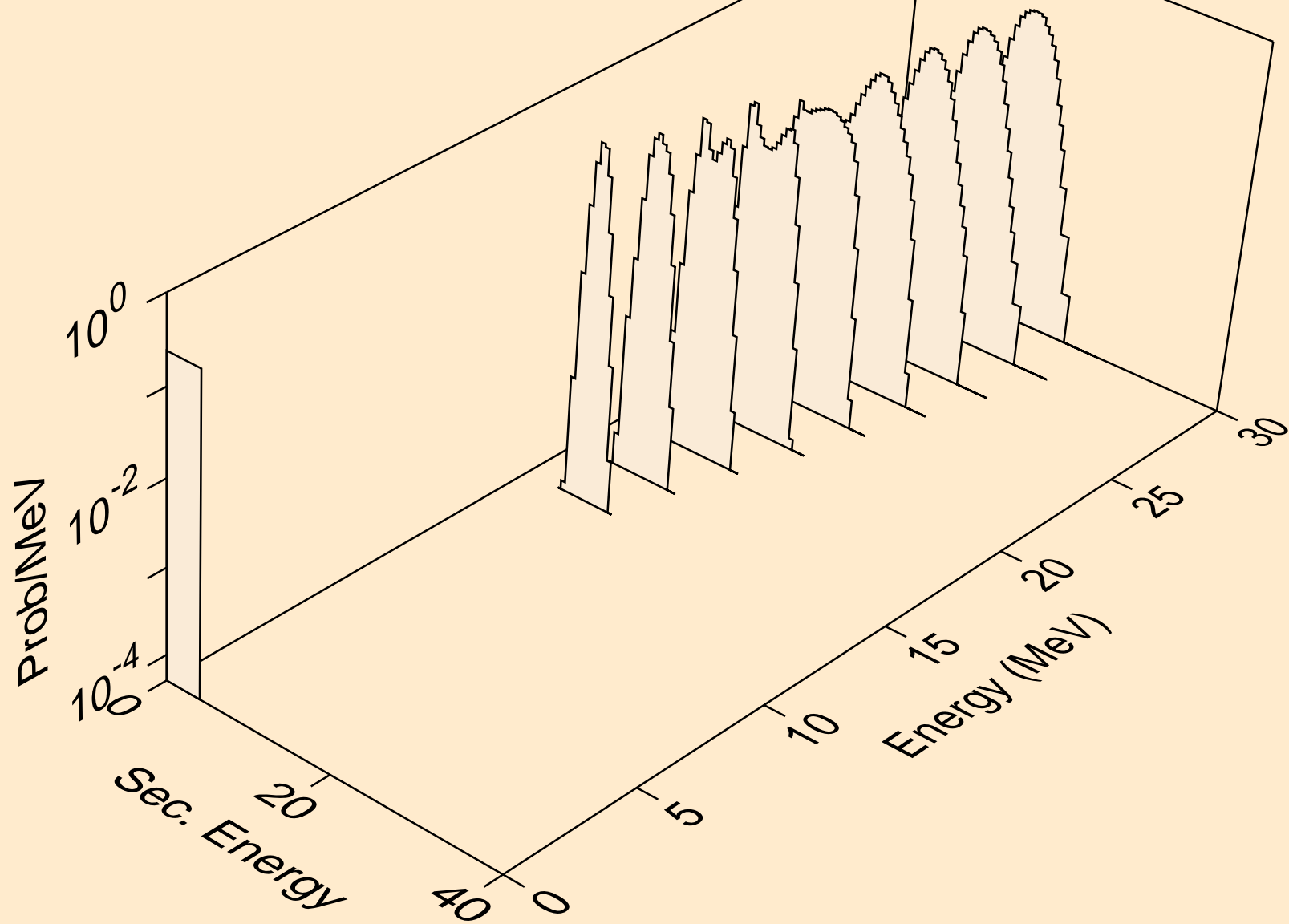

PM145 NEUTRON ACER TENDL-2021 LIBRARY; T=293.6K
alphas from (n,npa)

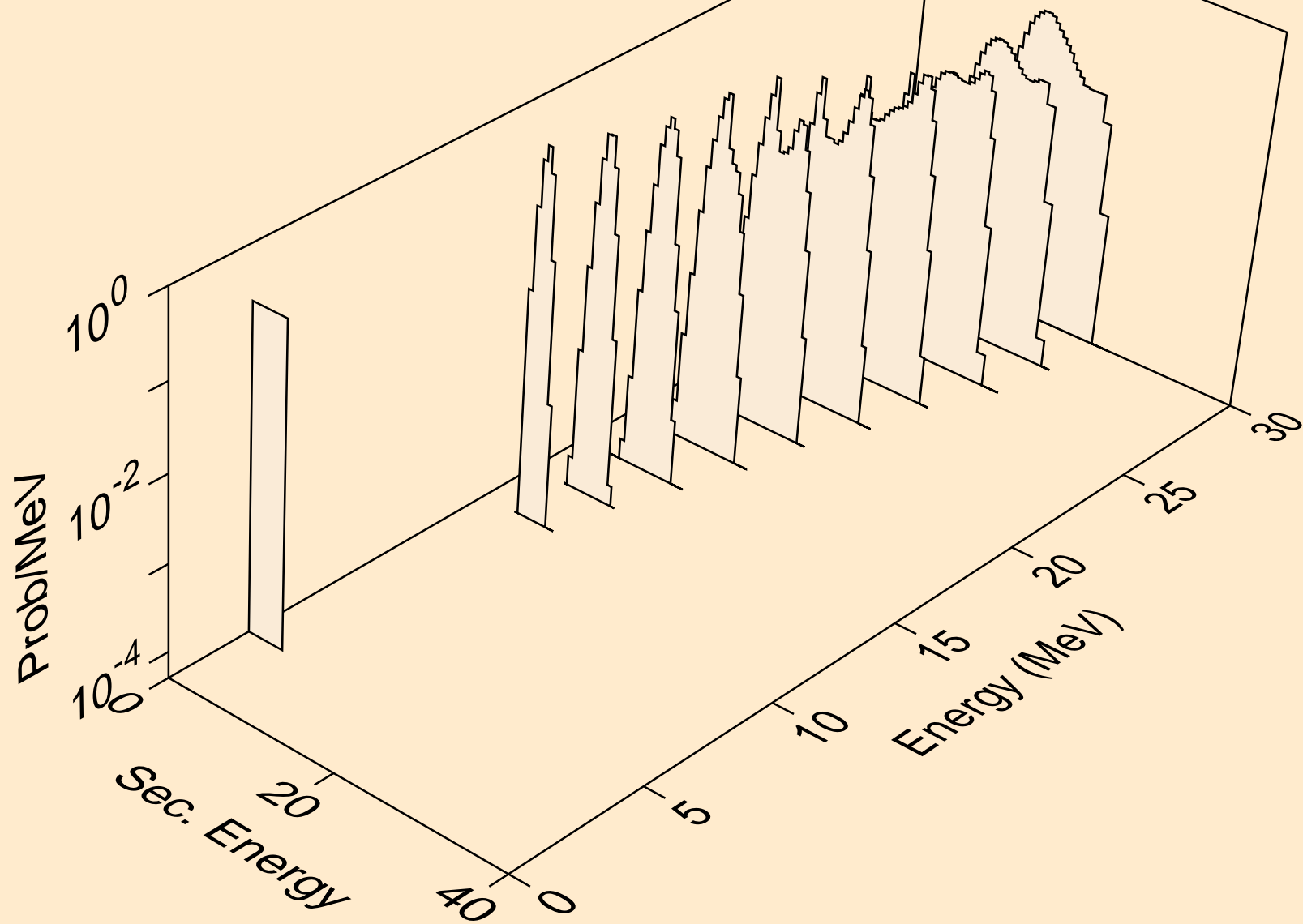

PM145 NEUTRON ACER TENDL-2021 LIBRARY; T=293.6K
alphas from (n,a)

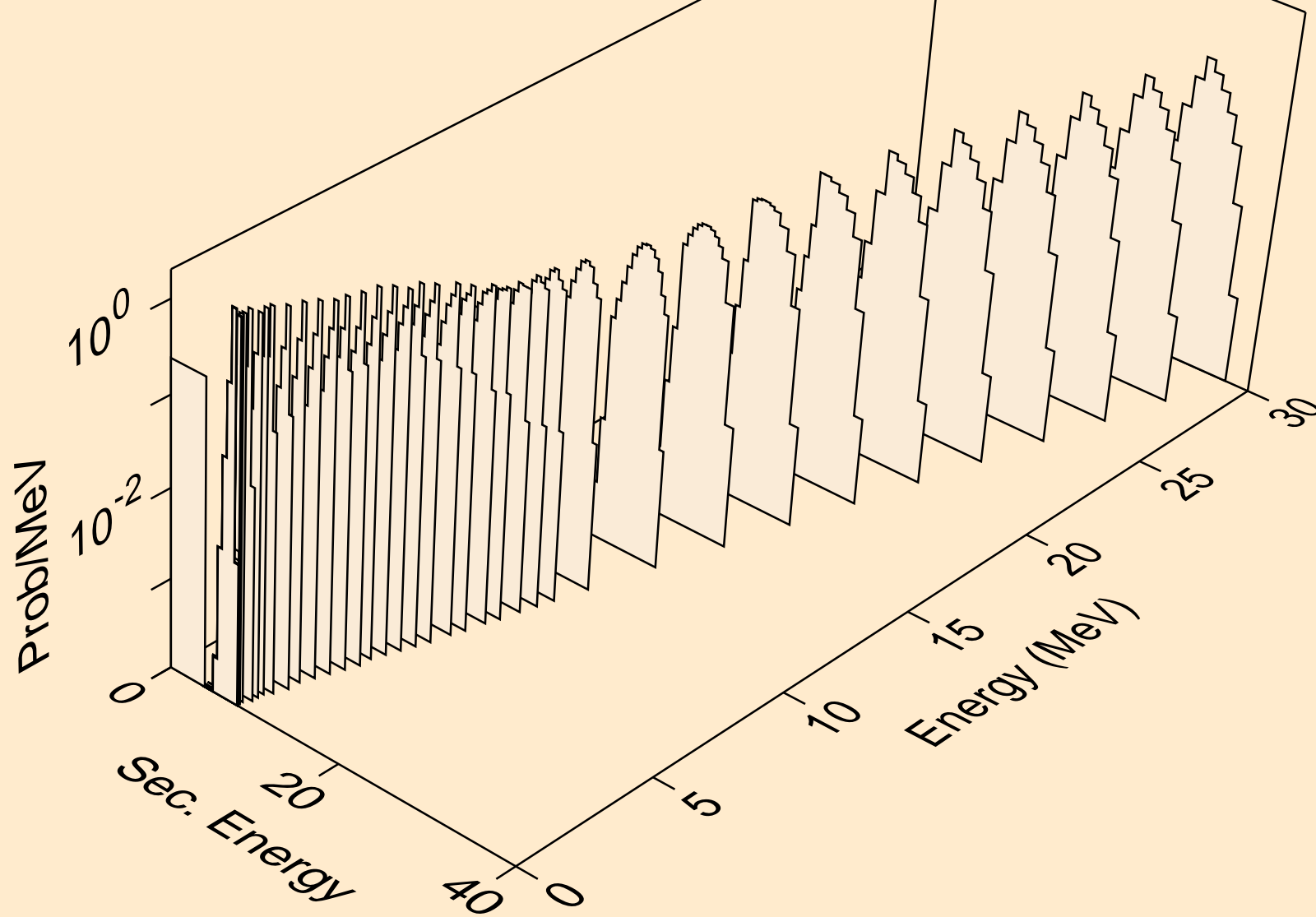

PM145 NEUTRON ACER TENDL-2021 LIBRARY; T=293.6K
alphas from (n,2a)

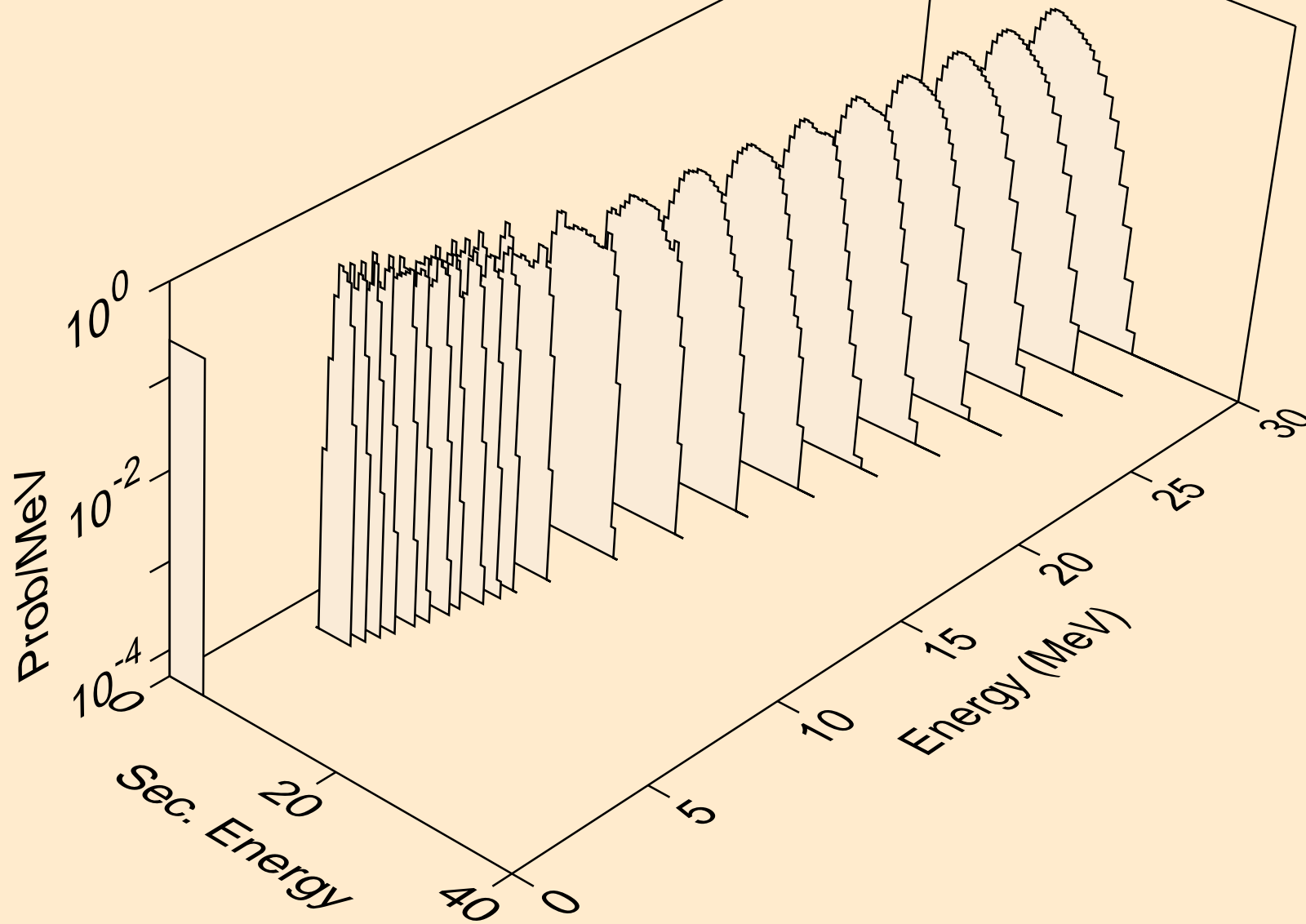

PM145 NEUTRON ACER TENDL-2021 LIBRARY; T=293.6K
alphas from (n,pa)

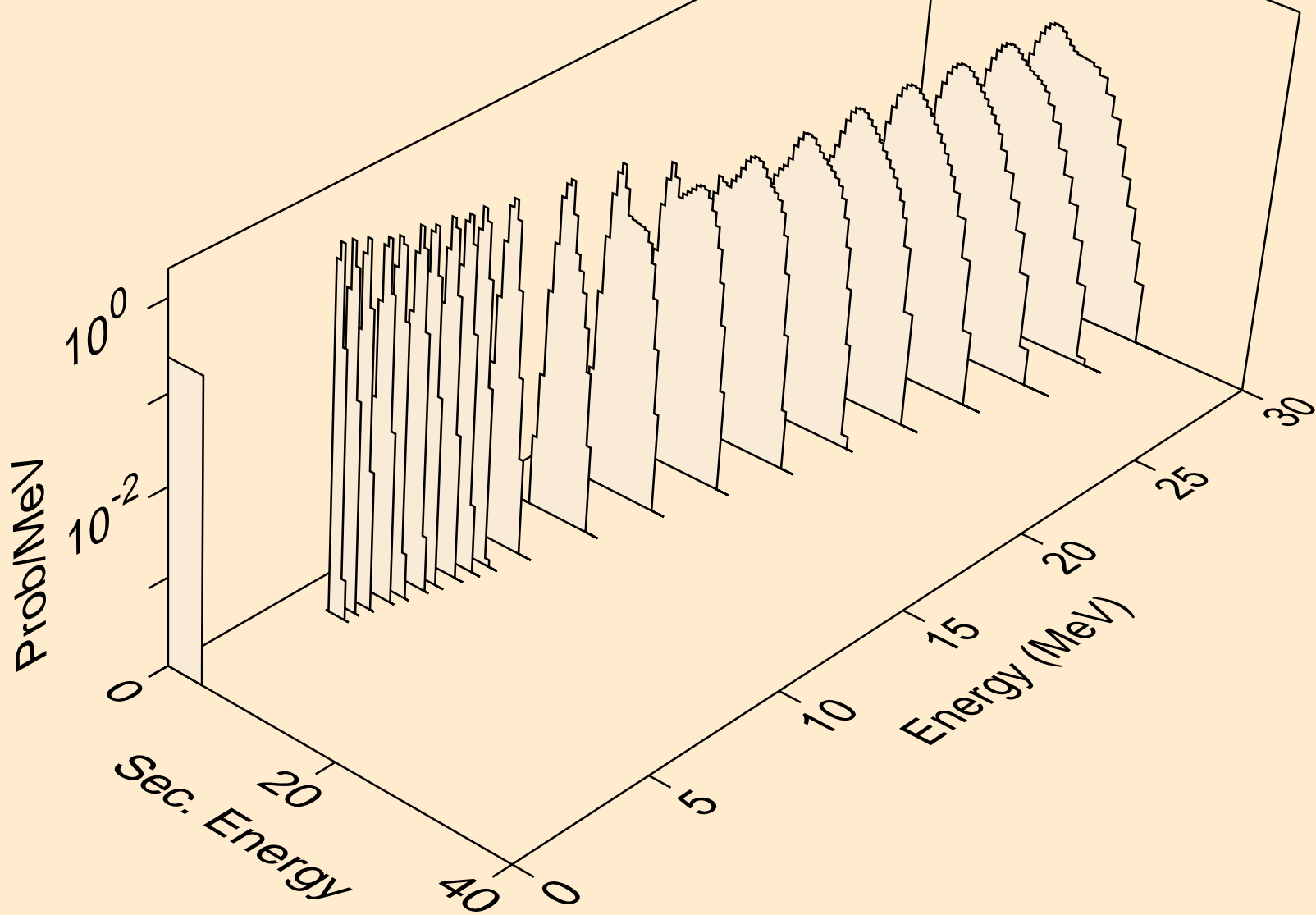

PM145 NEUTRON ACER TENDL-2021 LIBRARY; T=293.6K
alphas from (n,da)

