

PM159 NEUTRON ACER TENDL-2021 LIBRARY; T=293.6K
Principal cross sections

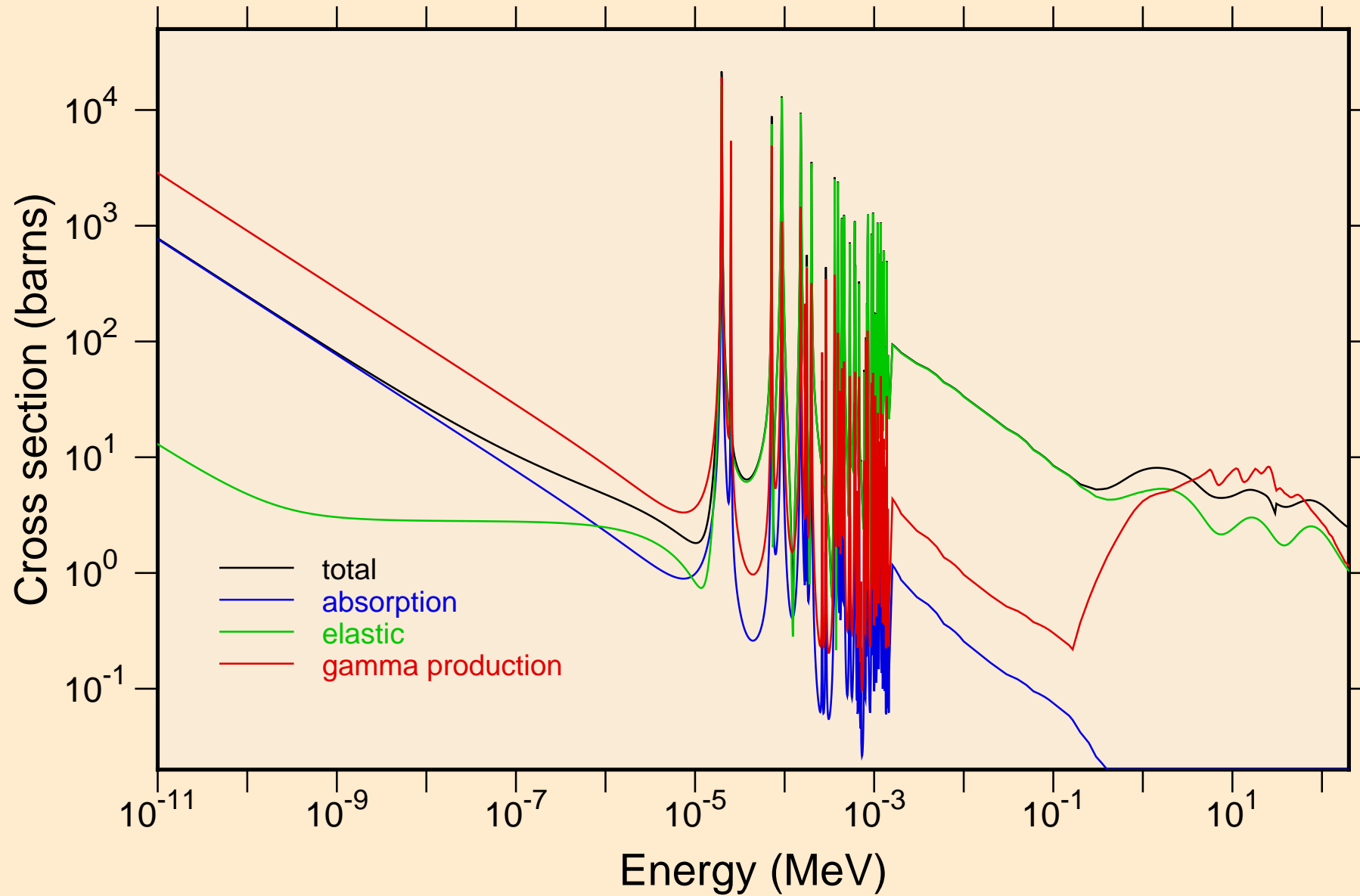

PM159 NEUTRON ACER TENDL-2021 LIBRARY; T=293.6K
resonance total cross section

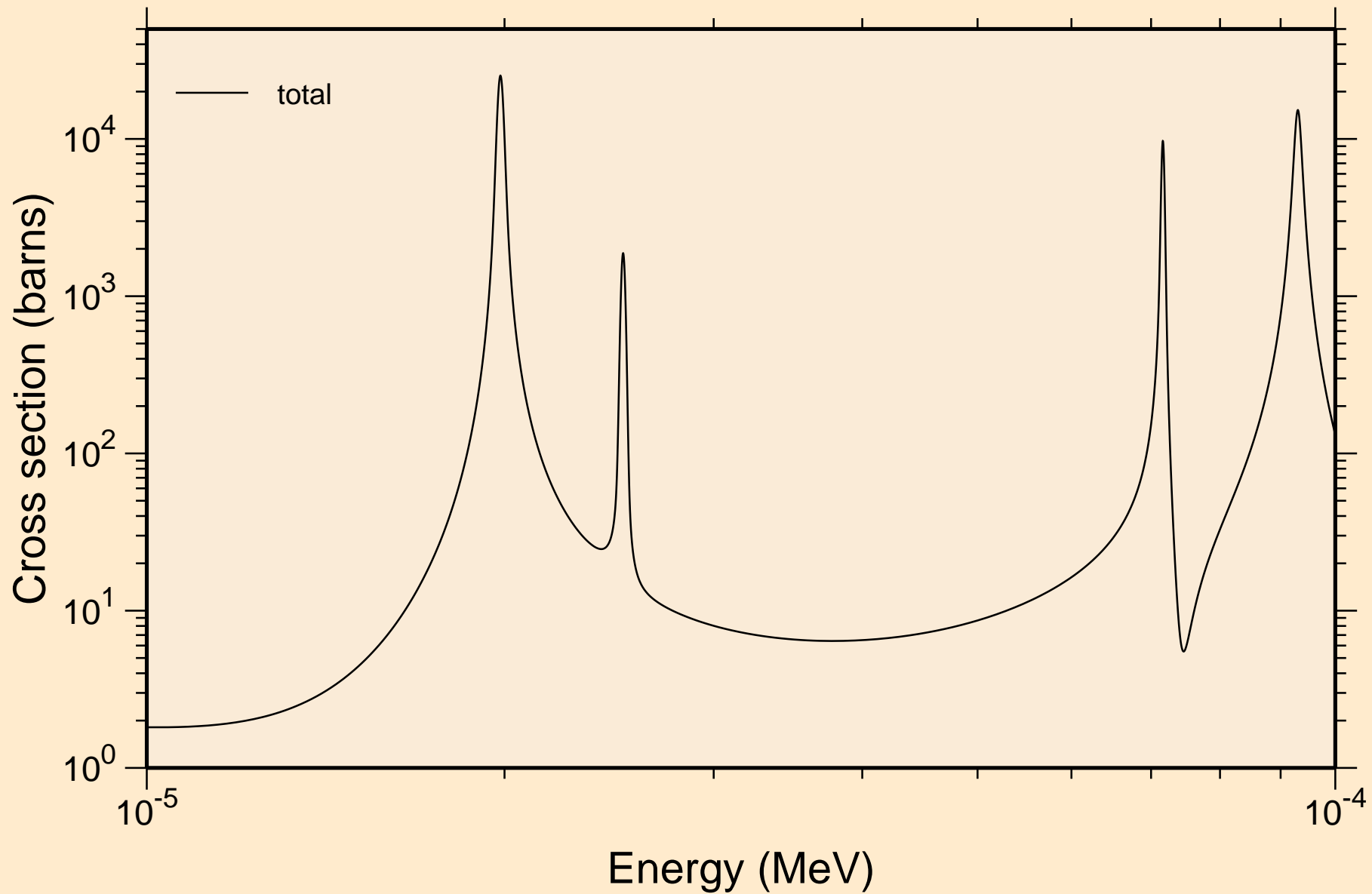

PM159 NEUTRON ACER TENDL-2021 LIBRARY; T=293.6K
resonance total cross section

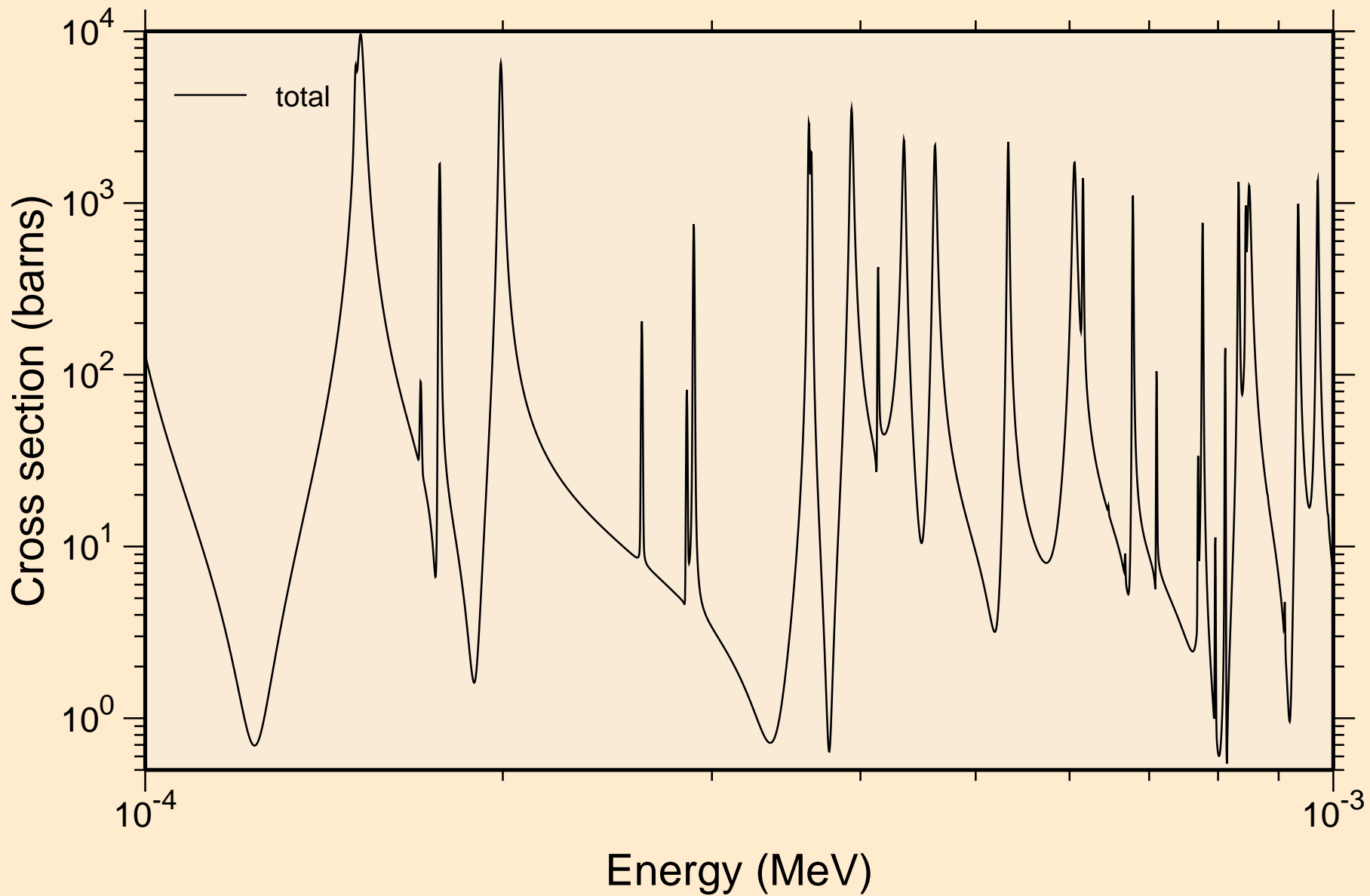

PM159 NEUTRON ACER TENDL-2021 LIBRARY; T=293.6K
resonance total cross section

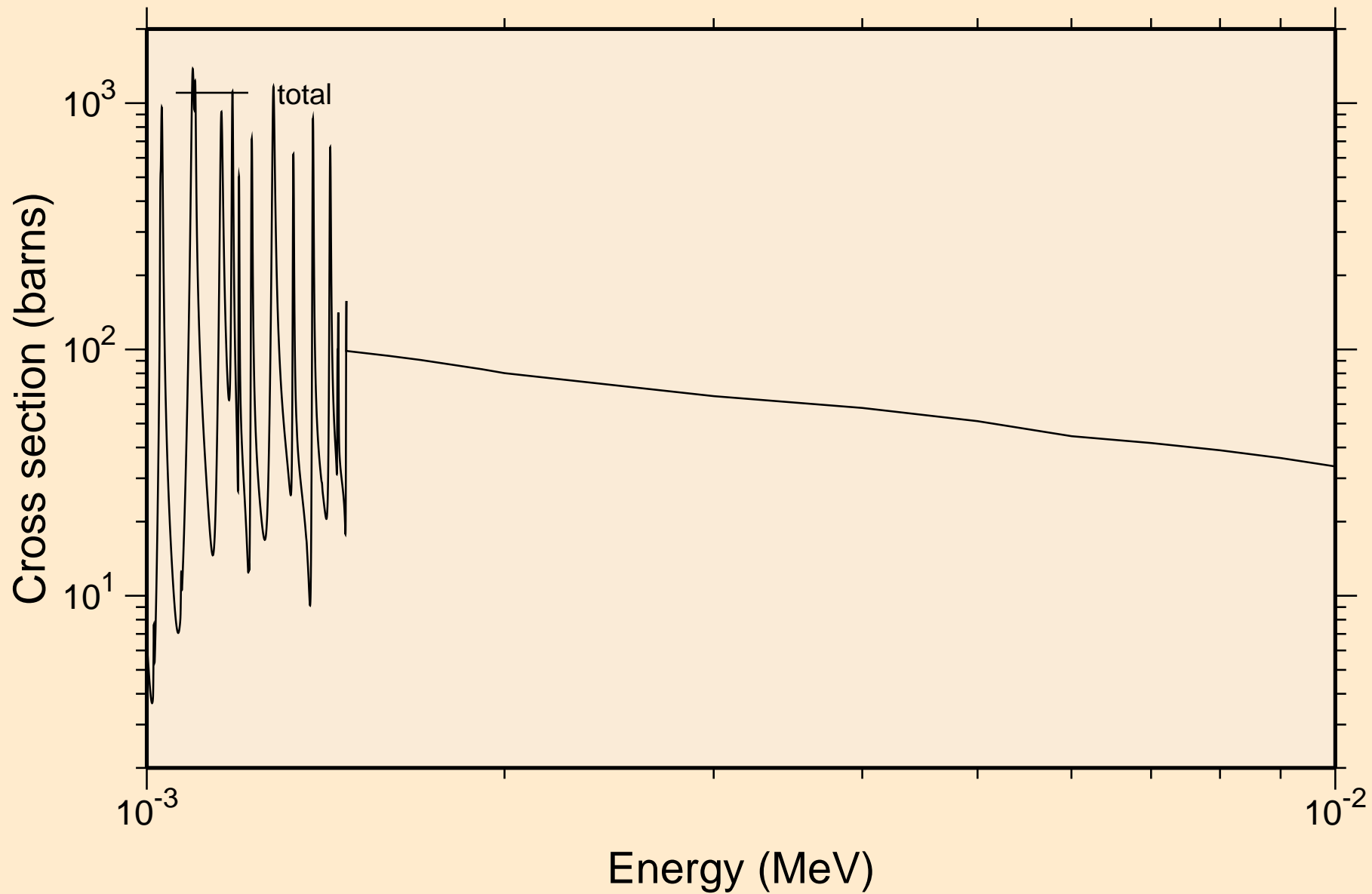

PM159 NEUTRON ACER TENDL-2021 LIBRARY; T=293.6K
resonance total cross section

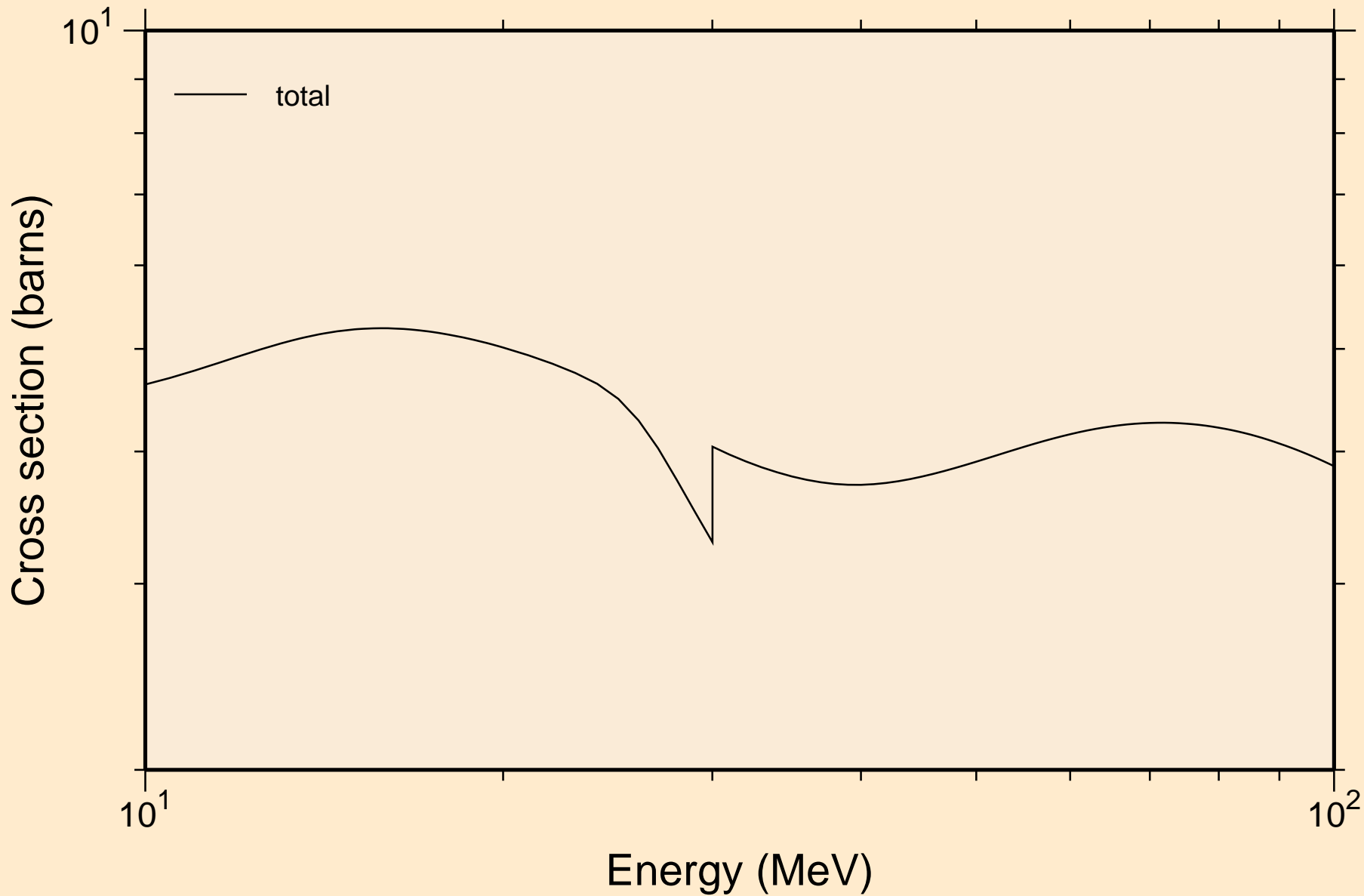

PM159 NEUTRON ACER TENDL-2021 LIBRARY; T=293.6K
resonance absorption cross sections

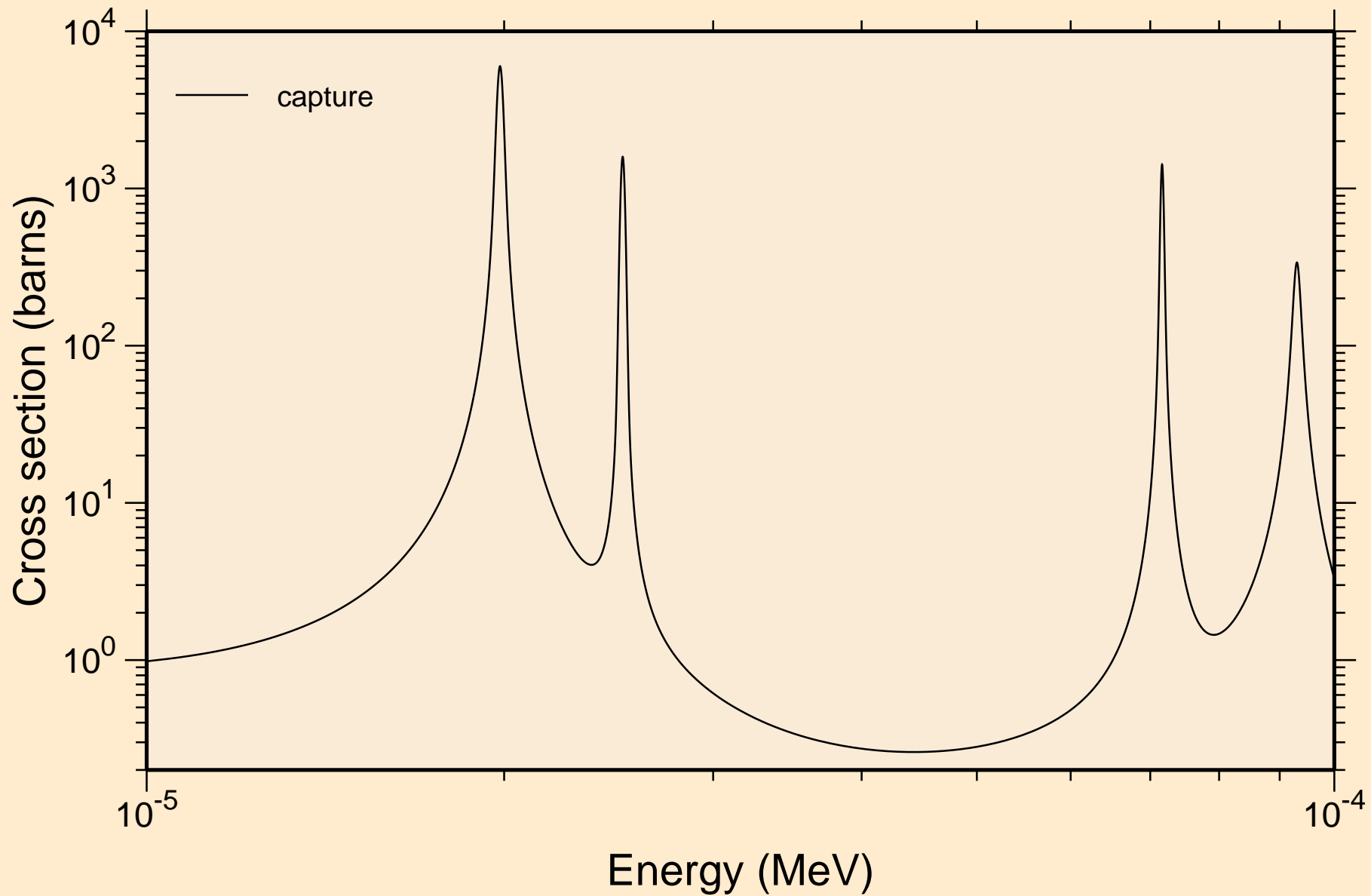

PM159 NEUTRON ACER TENDL-2021 LIBRARY; T=293.6K
resonance absorption cross sections

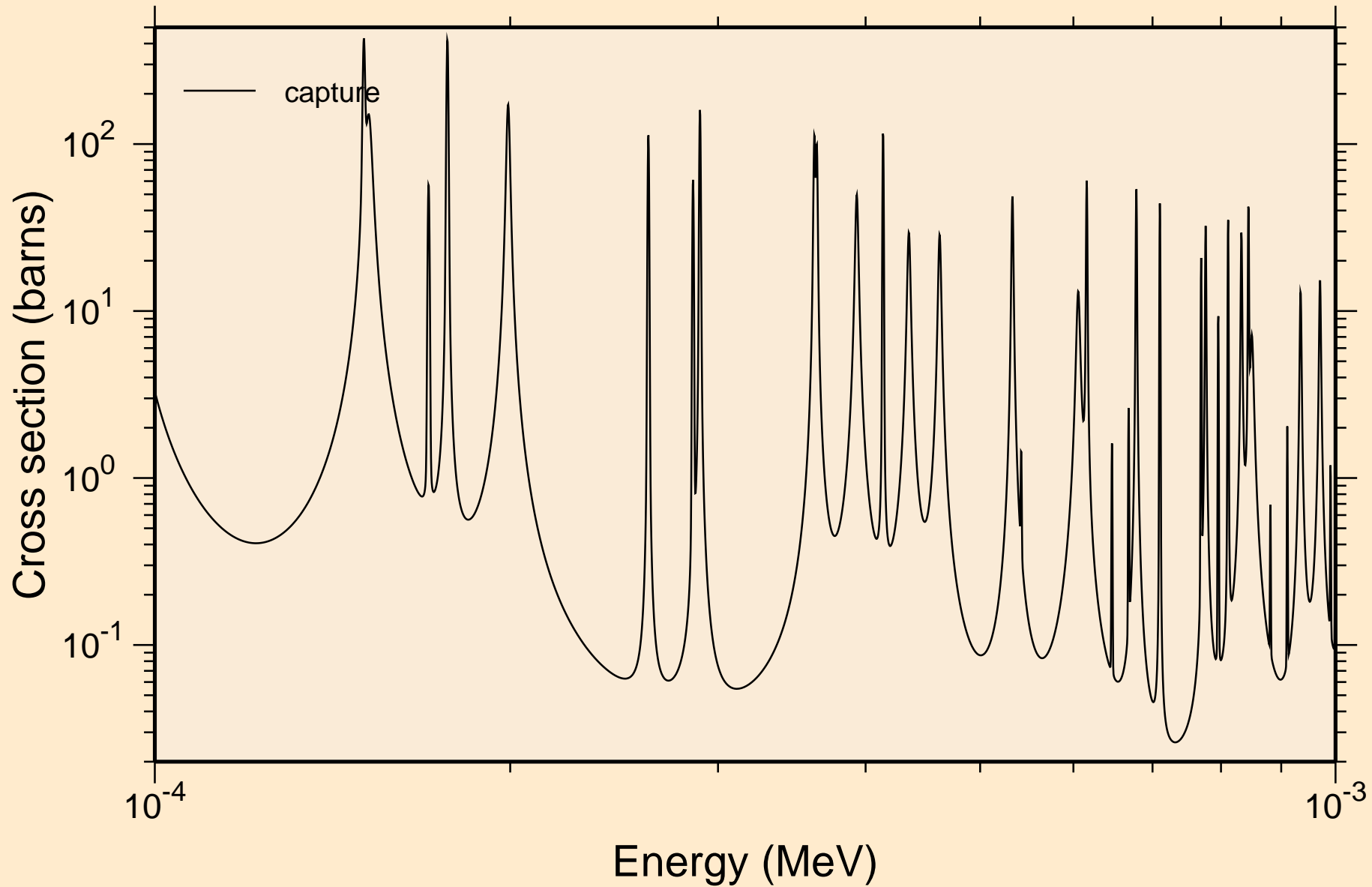

PM159 NEUTRON ACER TENDL-2021 LIBRARY; T=293.6K
resonance absorption cross sections

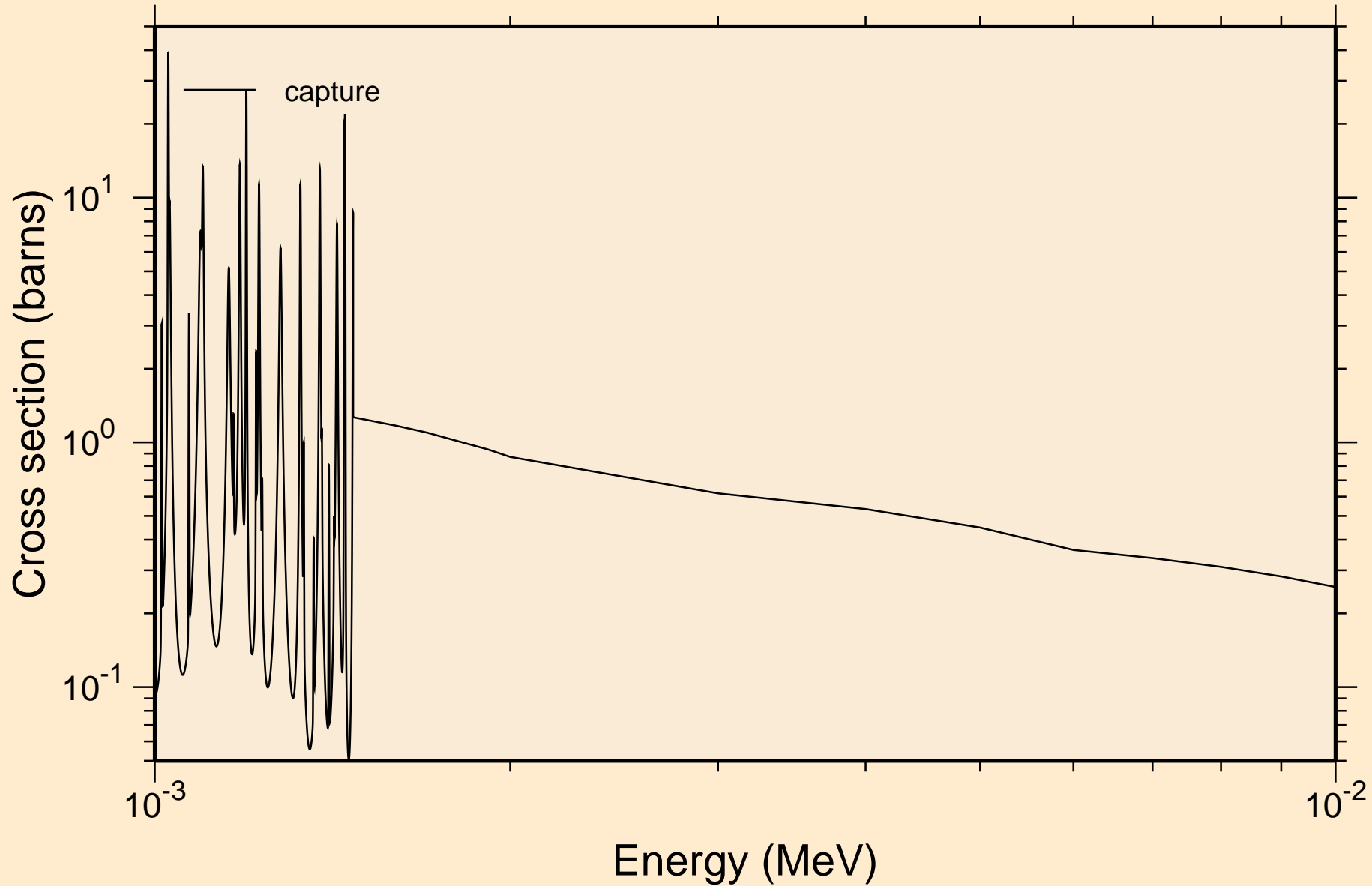

PM159 NEUTRON ACER TENDL-2021 LIBRARY; T=293.6K
resonance absorption cross sections

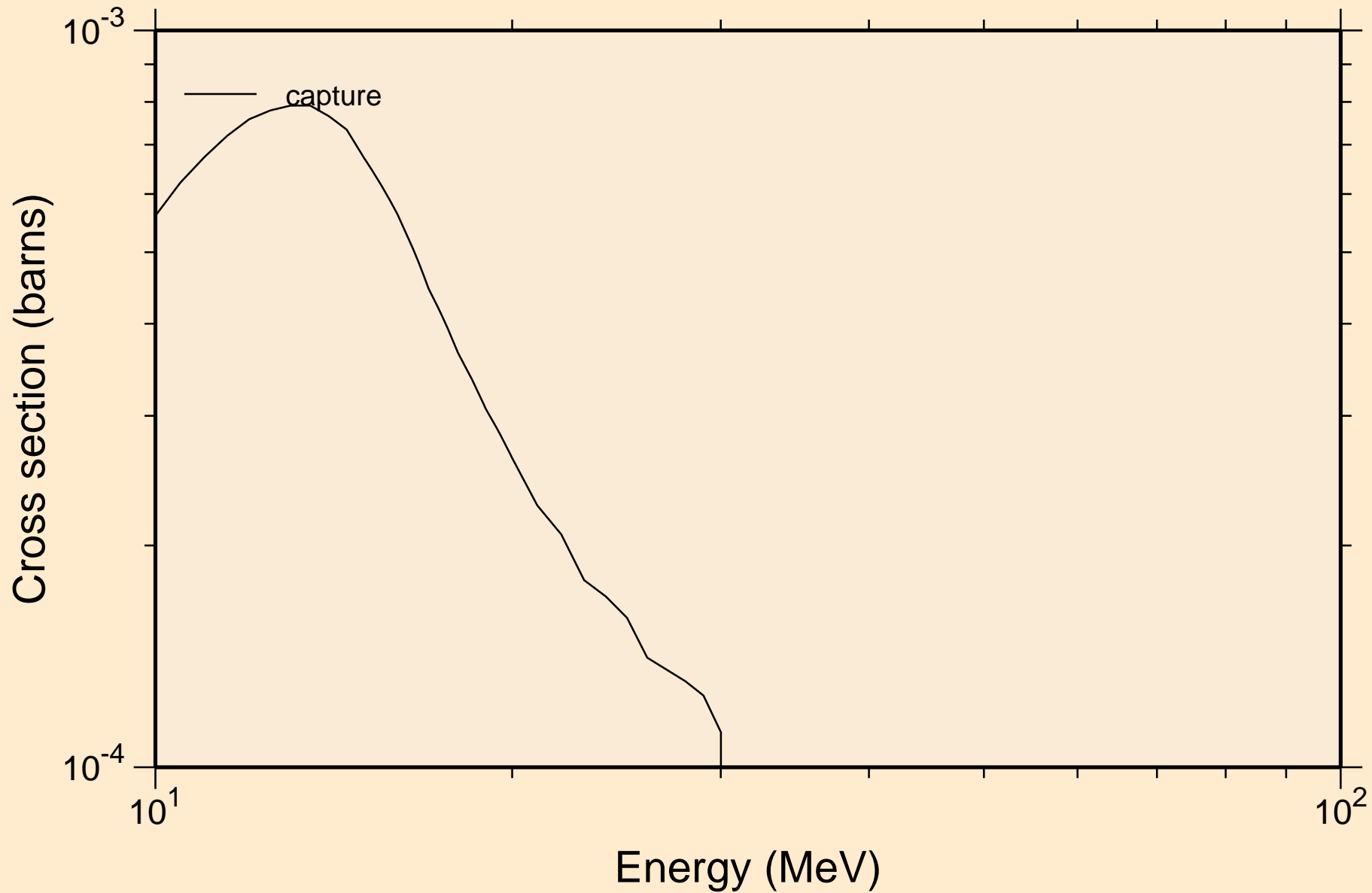

PM159 NEUTRON ACER TENDL-2021 LIBRARY; T=293.6K
Heating

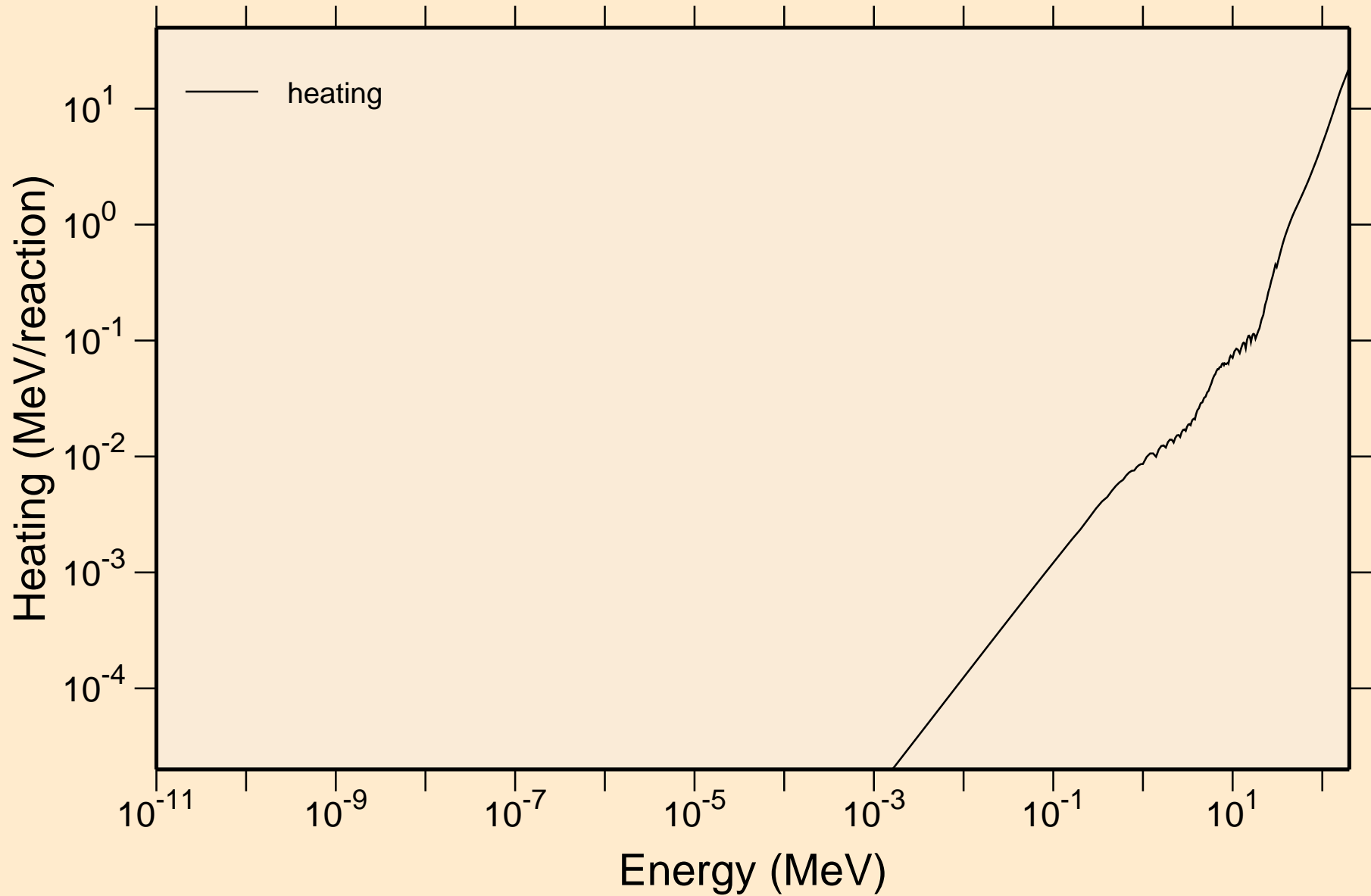

PM159 NEUTRON ACER TENDL-2021 LIBRARY; T=293.6K
Damage

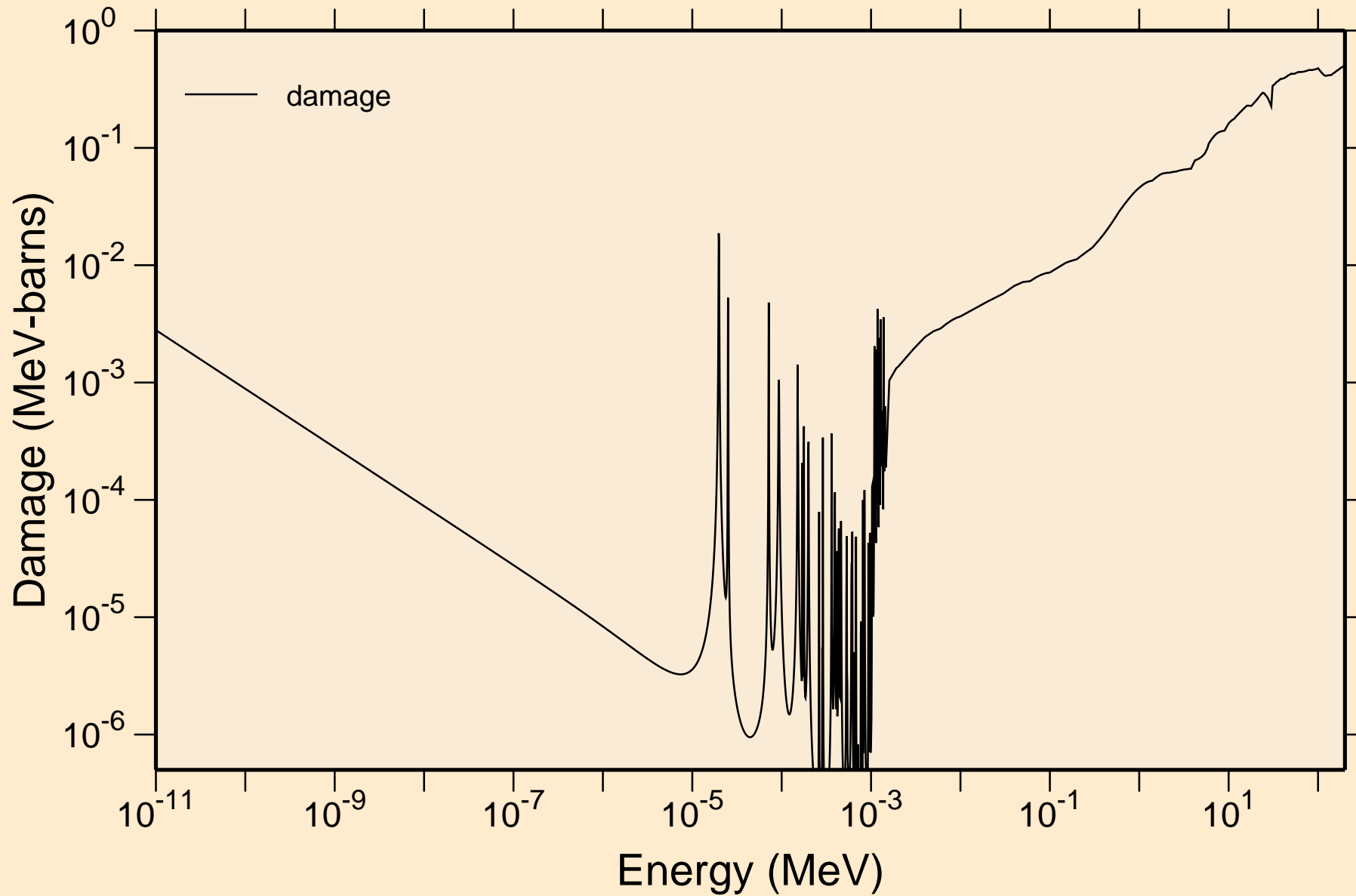

PM159 NEUTRON ACER TENDL-2021 LIBRARY; T=293.6K
Non-threshold reactions

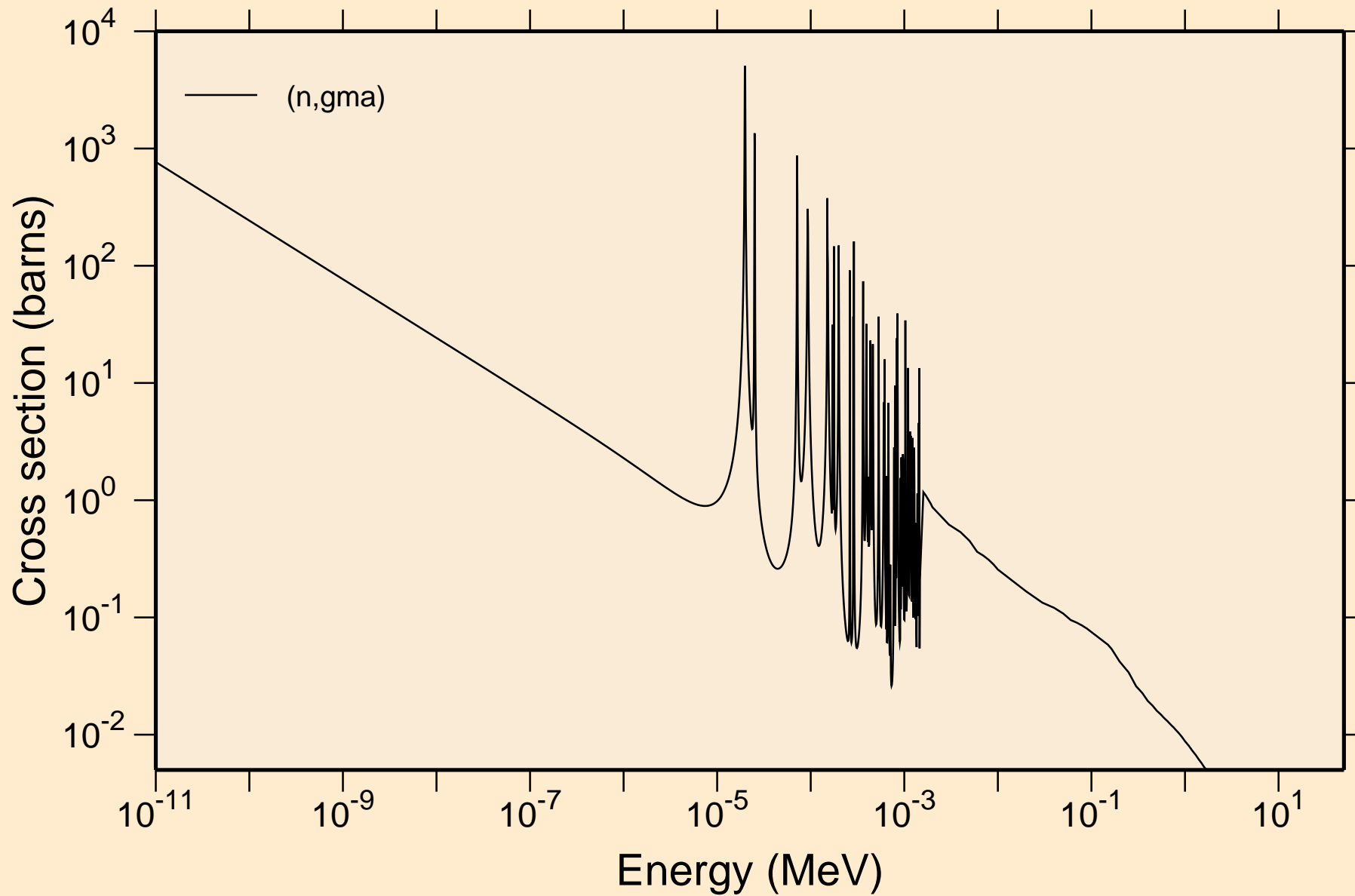

PM159 NEUTRON ACER TENDL-2021 LIBRARY; T=293.6K
Principal cross sections

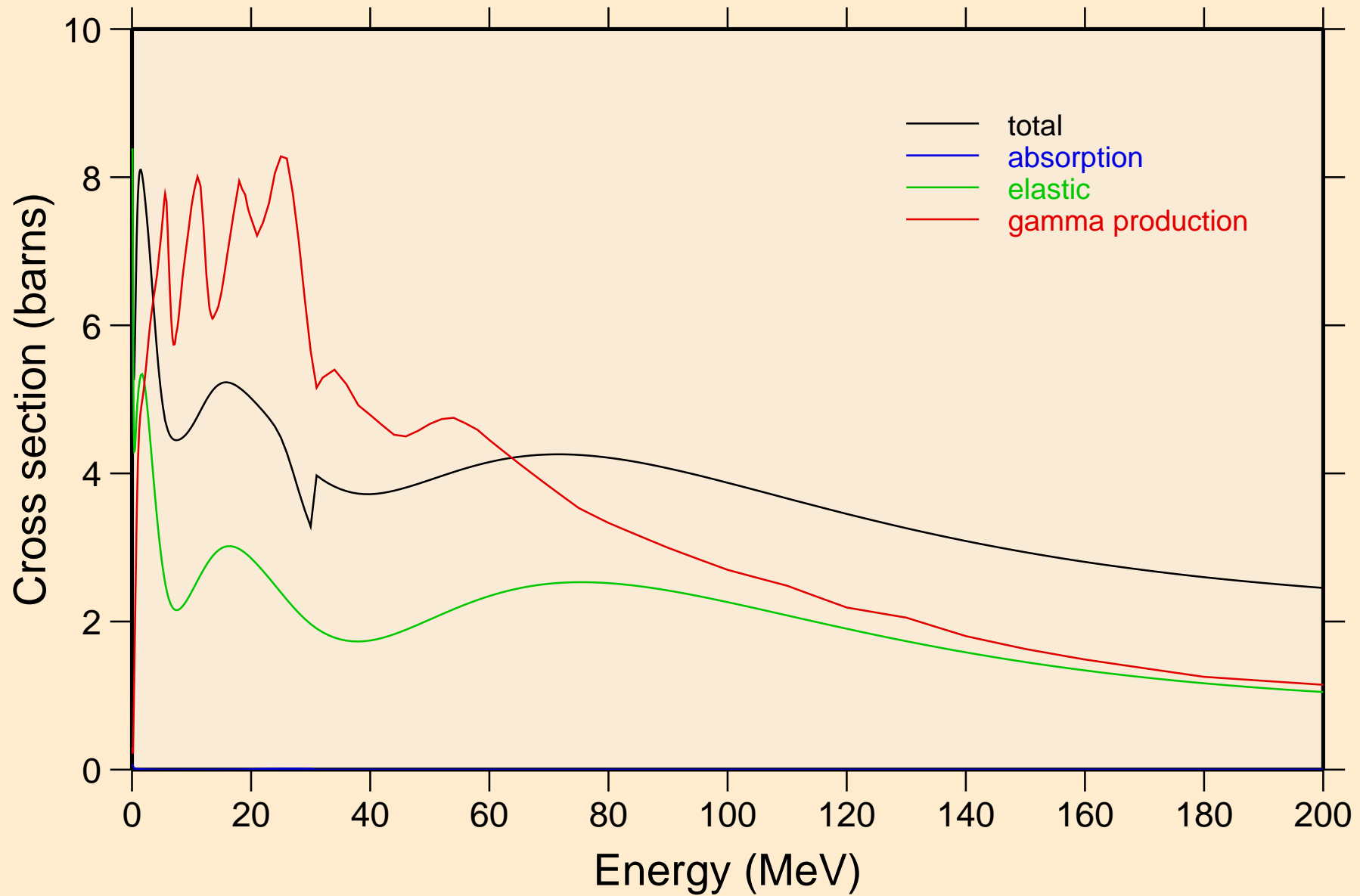

PM159 NEUTRON ACER TENDL-2021 LIBRARY; T=293.6K
Heating

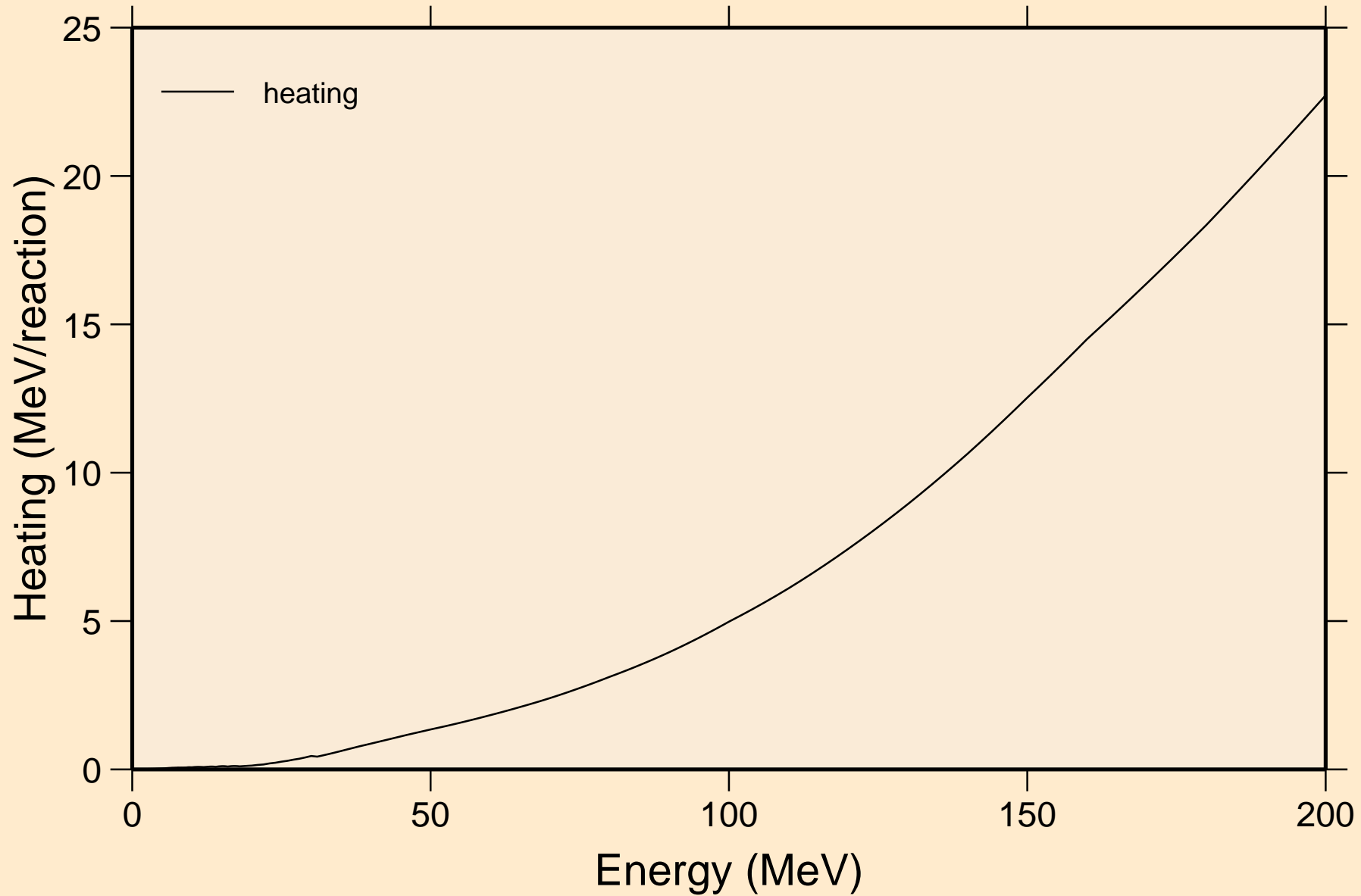

PM159 NEUTRON ACER TENDL-2021 LIBRARY; T=293.6K
Damage

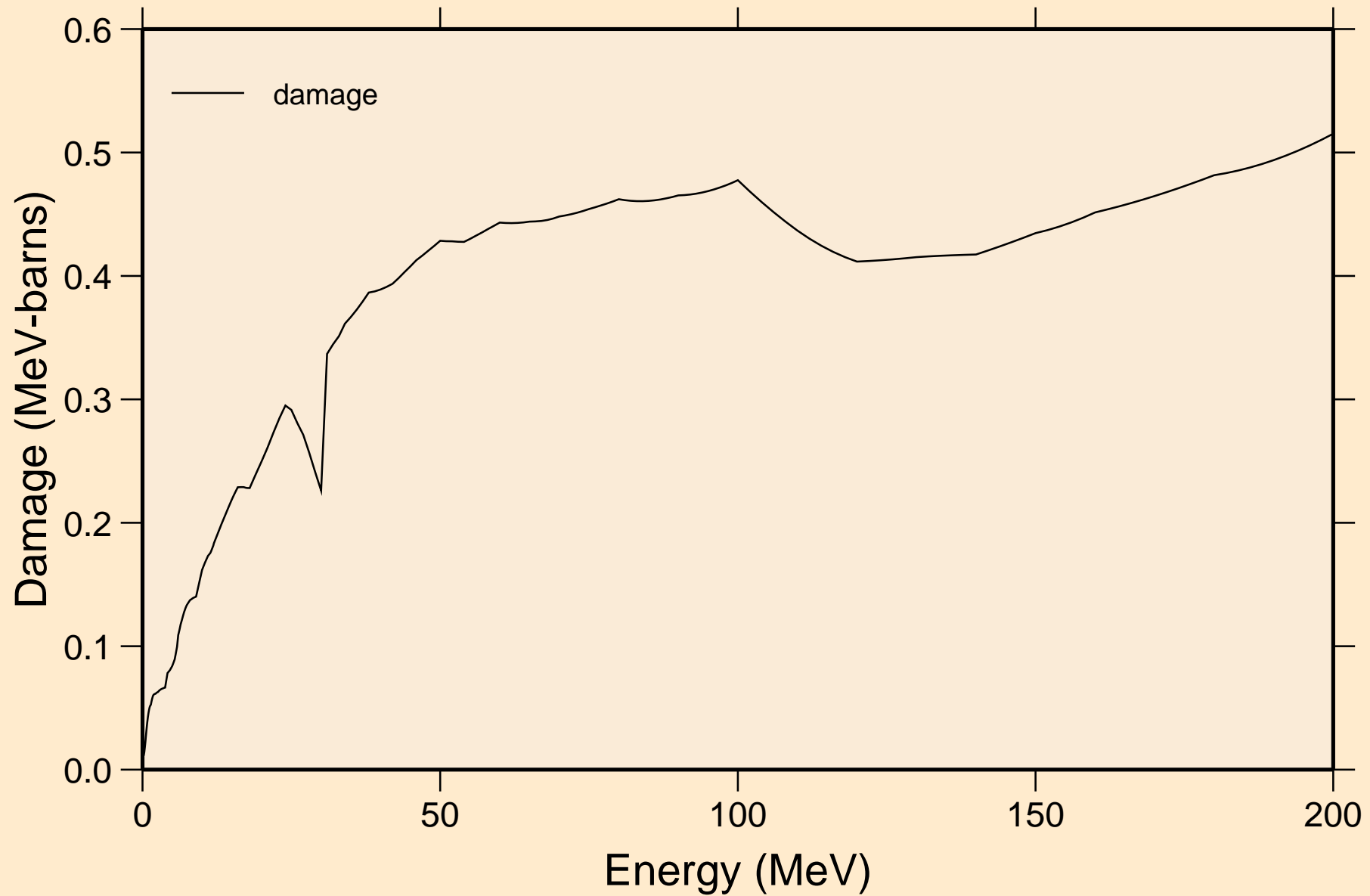

PM159 NEUTRON ACER TENDL-2021 LIBRARY; T=293.6K
Non-threshold reactions

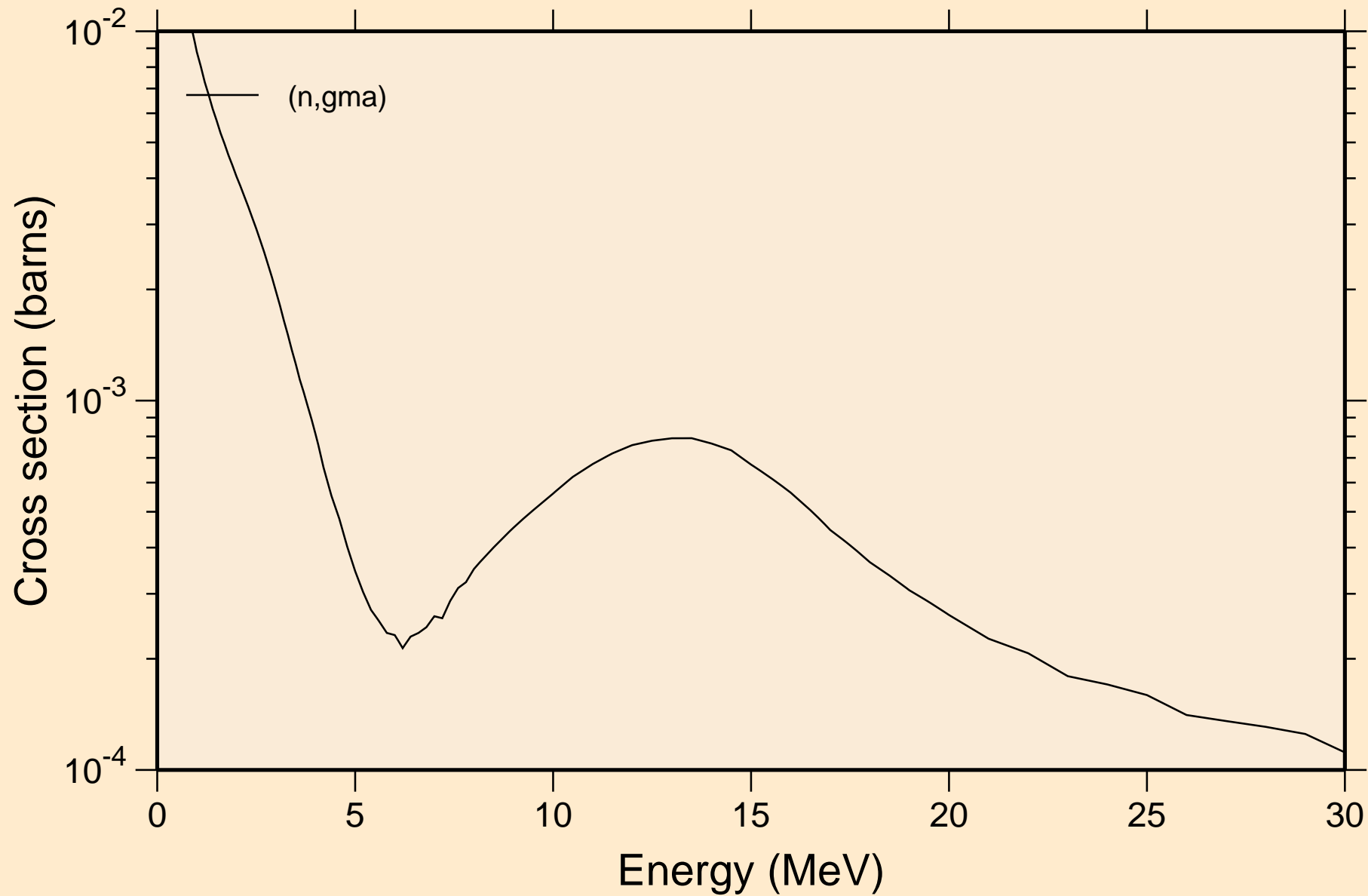

PM159 NEUTRON ACER TENDL-2021 LIBRARY; T=293.6K
Inelastic levels

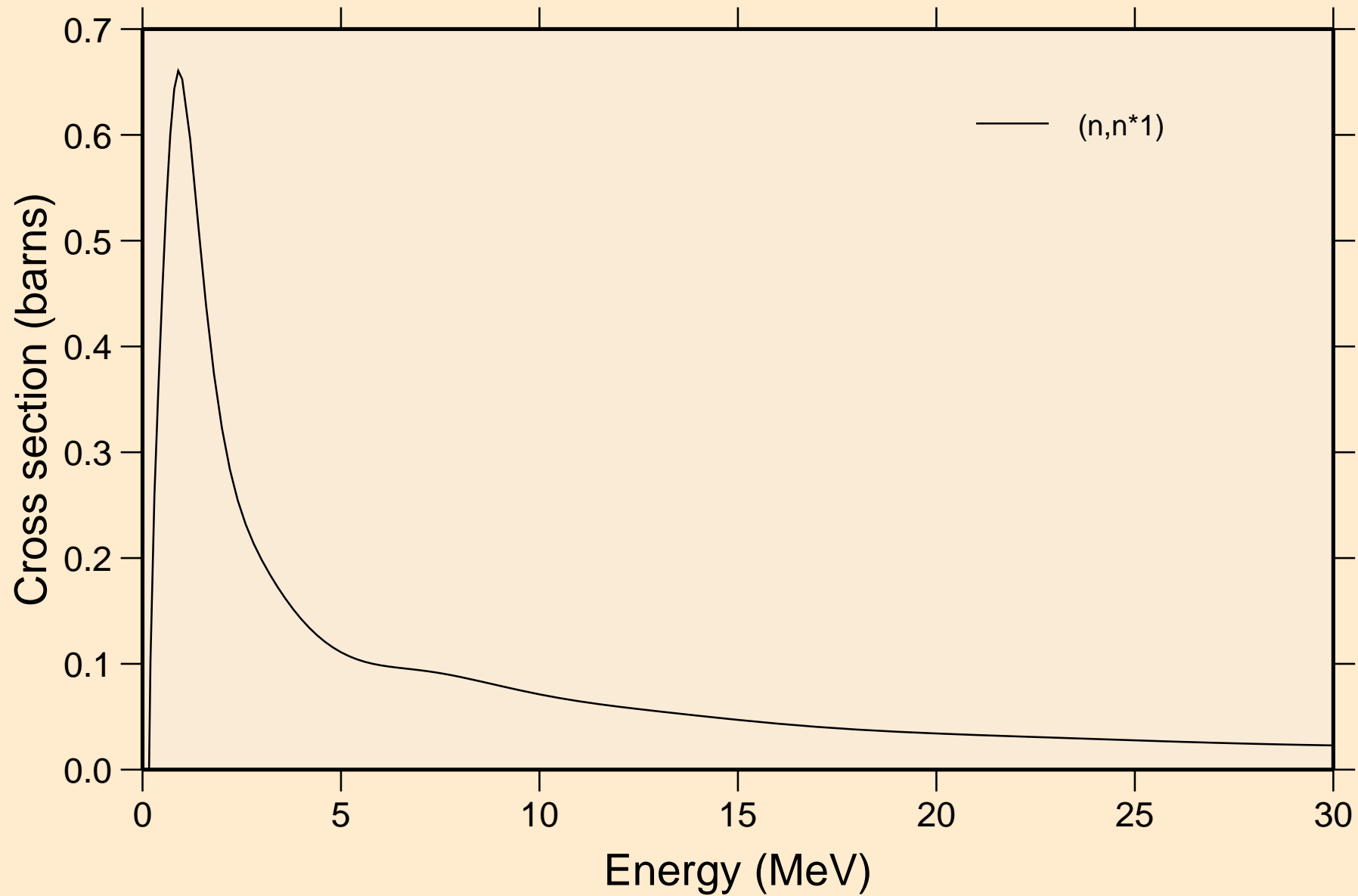

PM159 NEUTRON ACER TENDL-2021 LIBRARY; T=293.6K
Threshold reactions

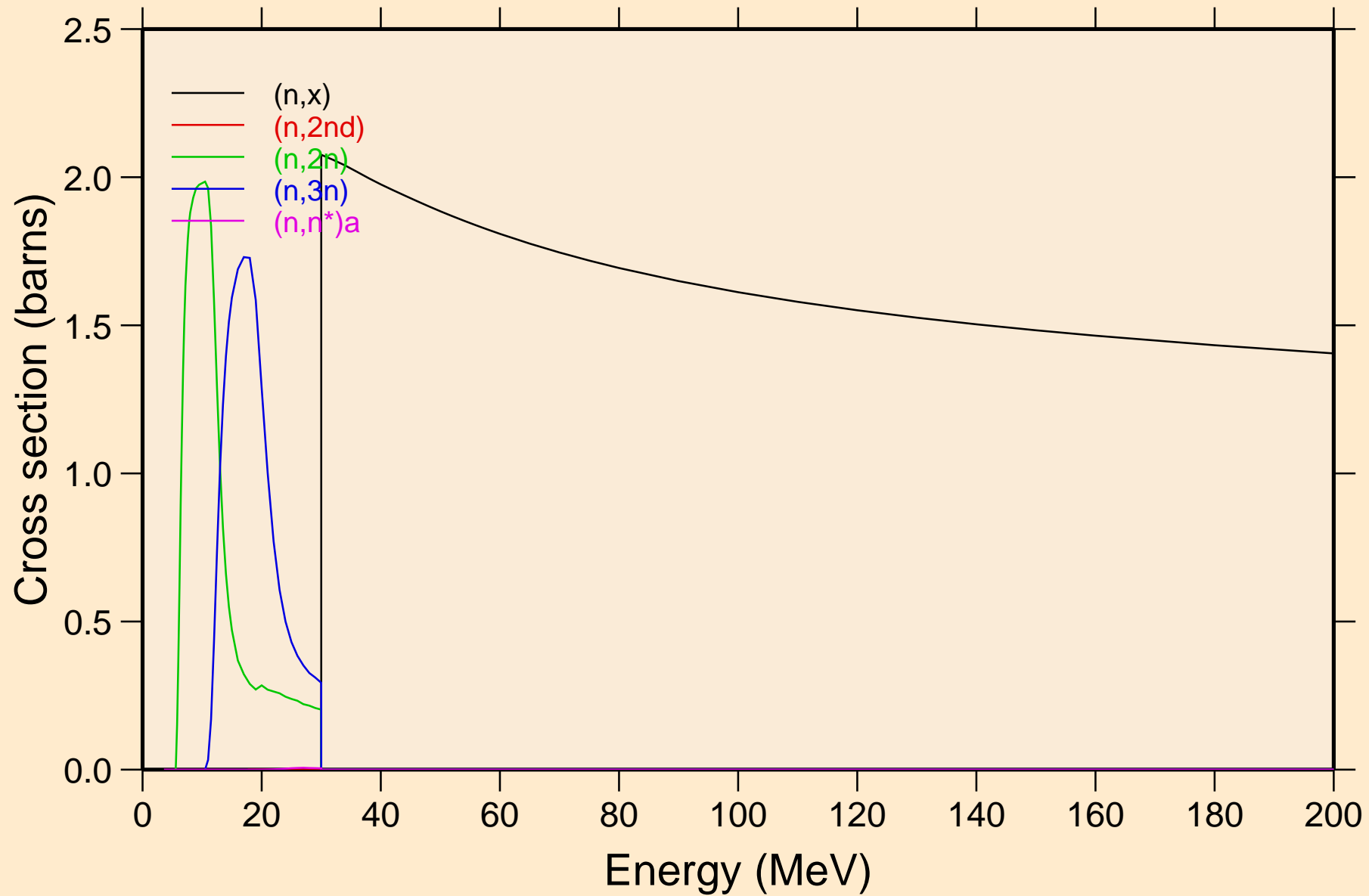

PM159 NEUTRON ACER TENDL-2021 LIBRARY; T=293.6K
Threshold reactions

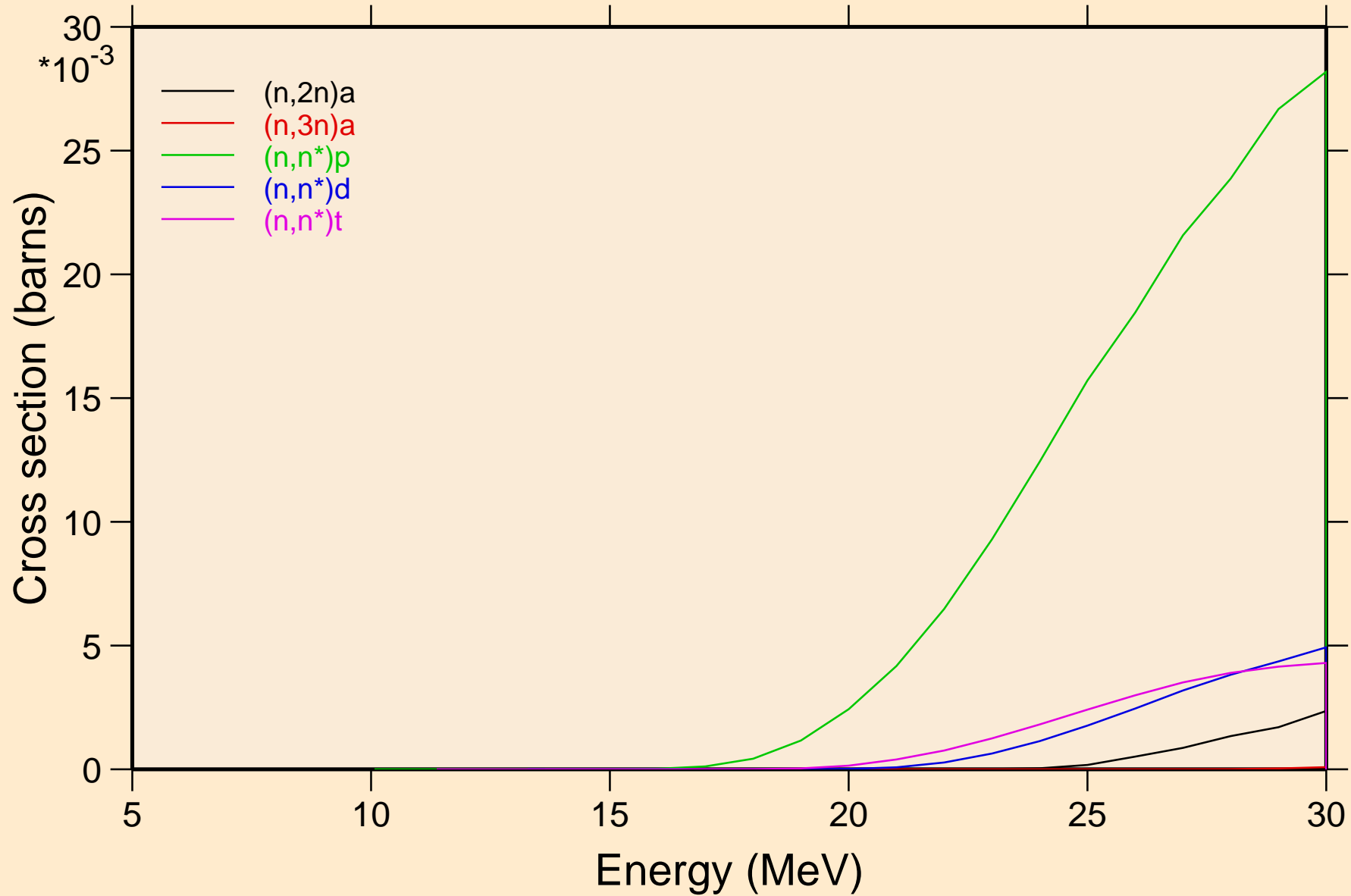

PM159 NEUTRON ACER TENDL-2021 LIBRARY; T=293.6K
Threshold reactions

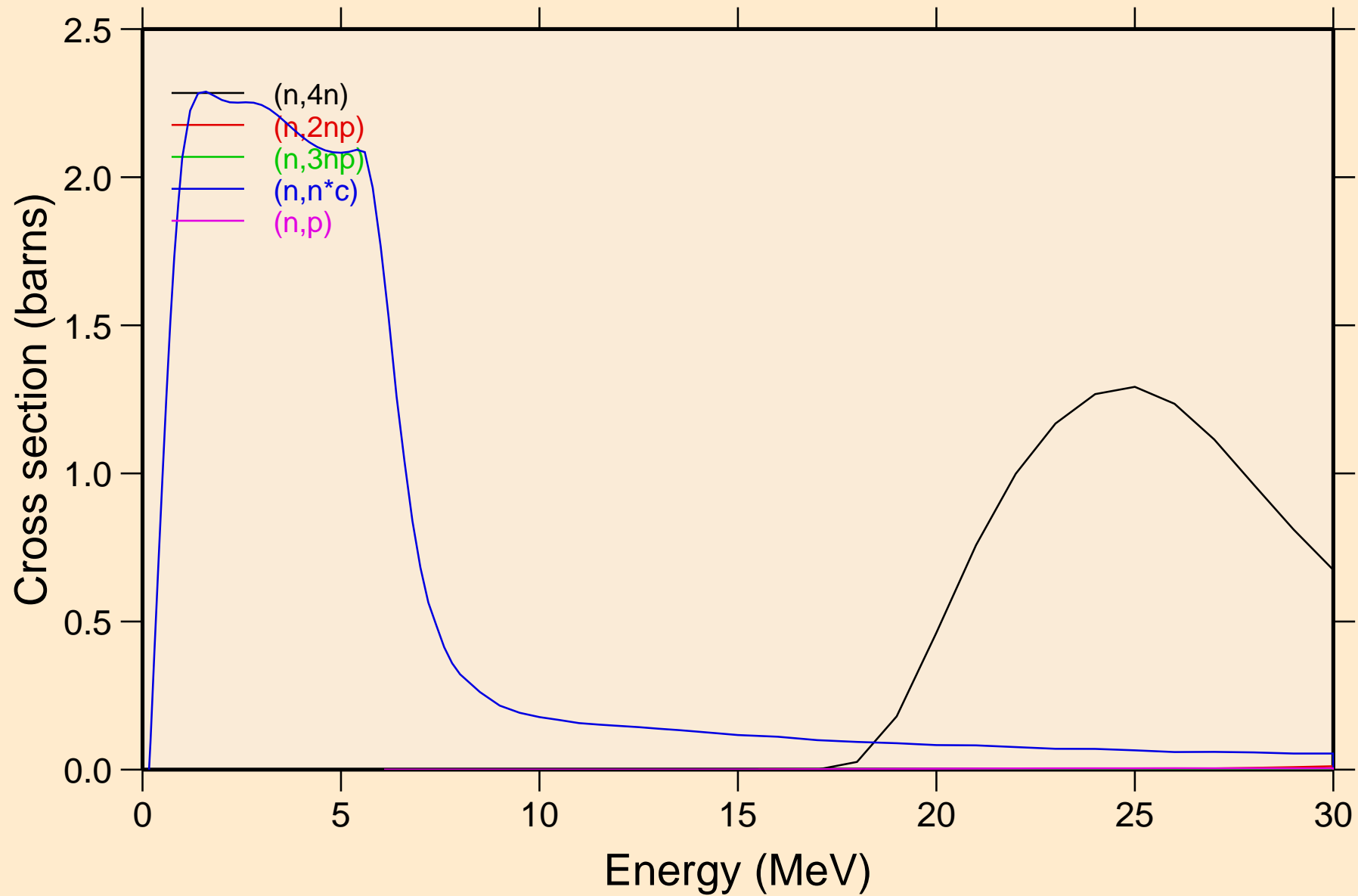

PM159 NEUTRON ACER TENDL-2021 LIBRARY; T=293.6K
Threshold reactions

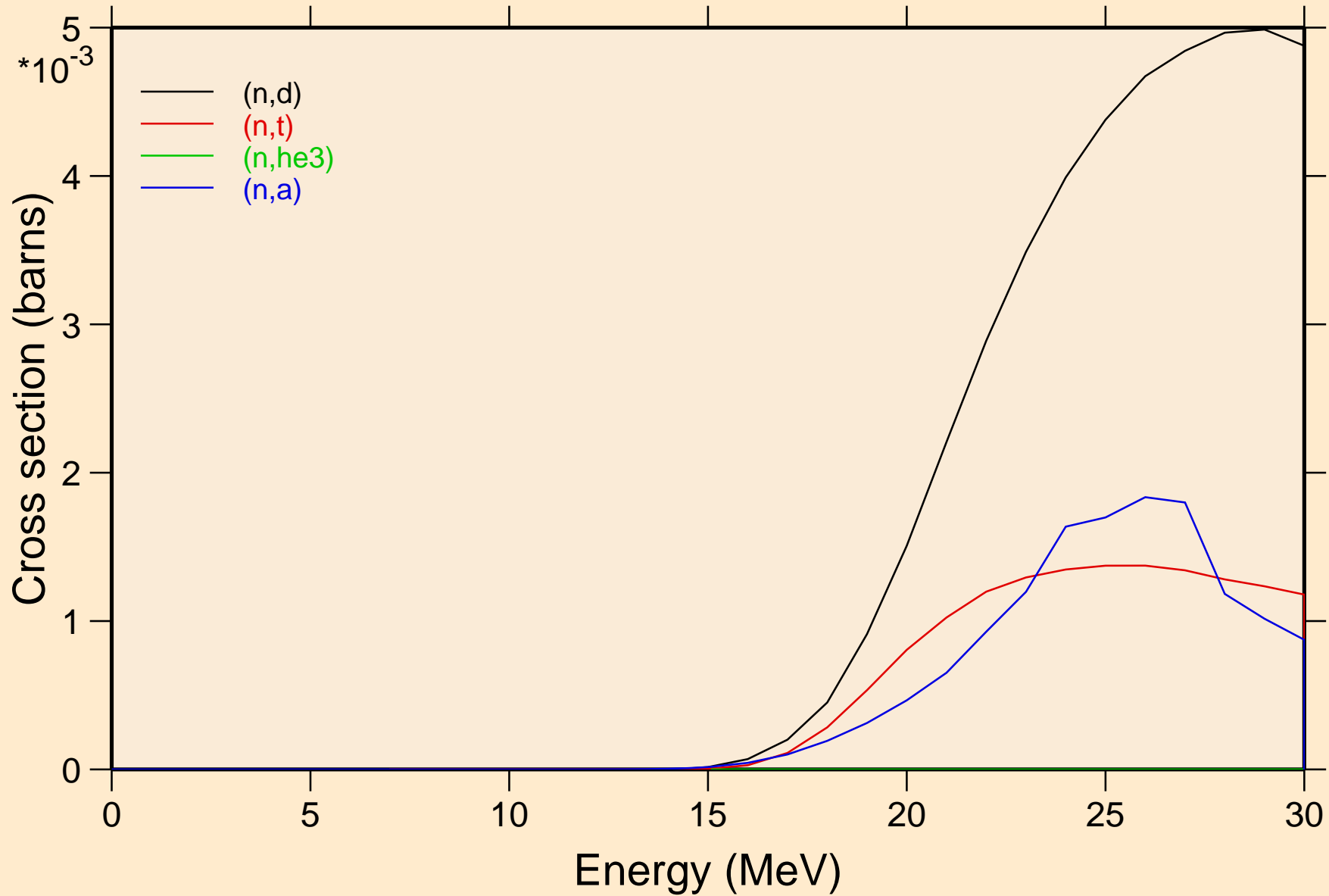

PM159 NEUTRON ACER TENDL-2021 LIBRARY; T=293.6K
Threshold reactions

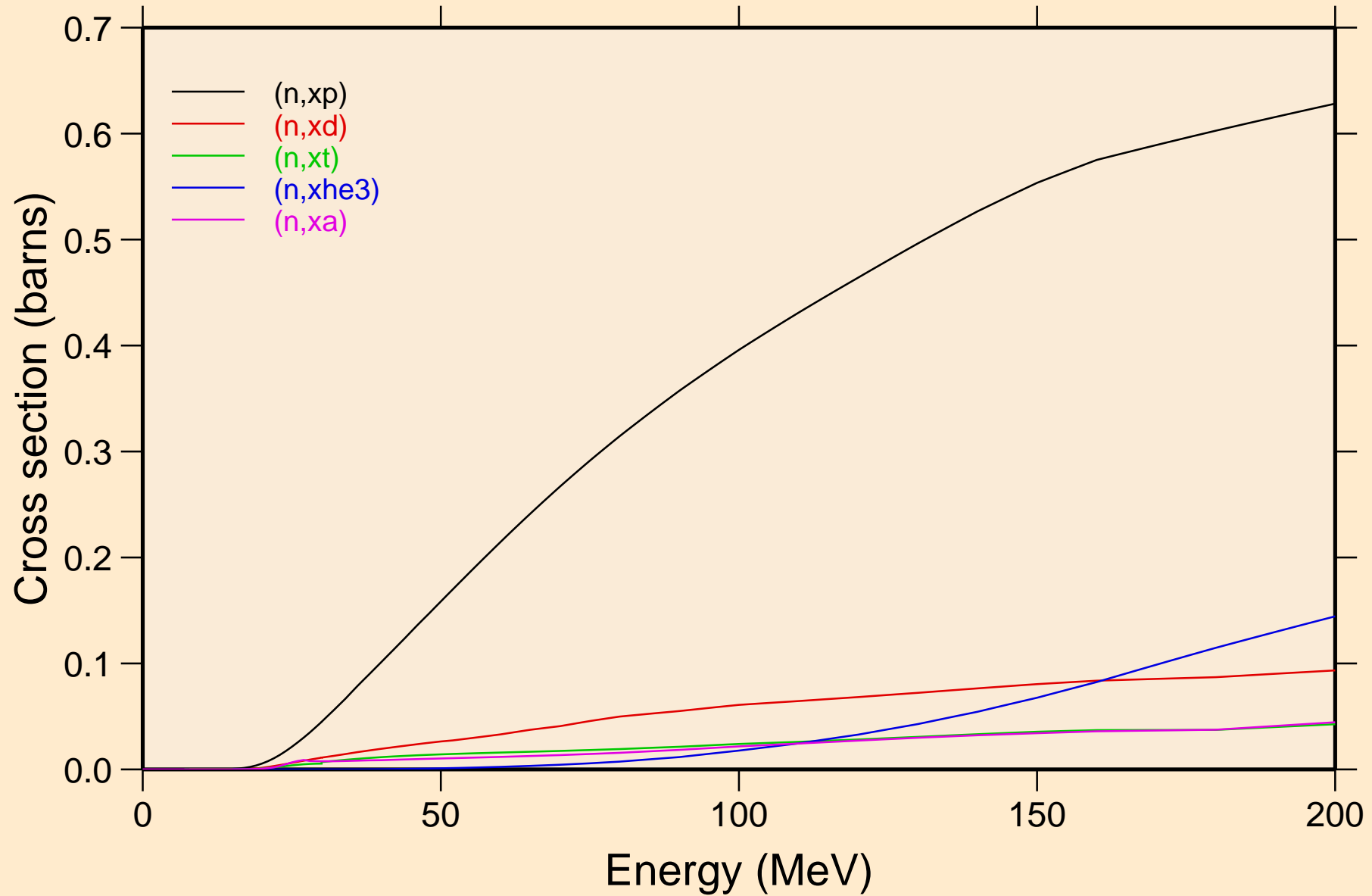

PM159 NEUTRON ACER TENDL-2021 LIBRARY; T=293.6K
angular distribution for elastic

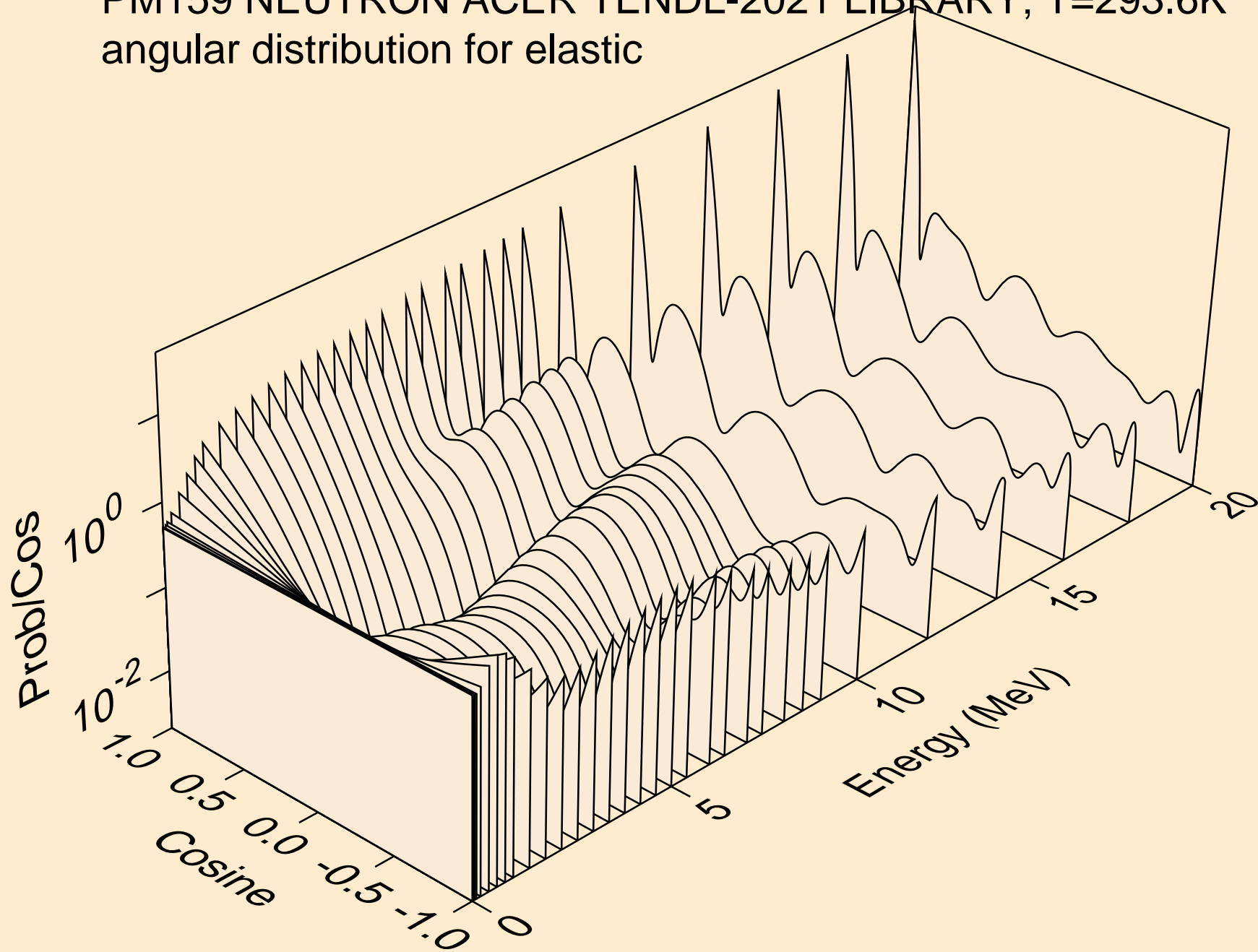

PM159 NEUTRON ACER TENDL-2021 LIBRARY; T=293.6K
angular distribution for elastic

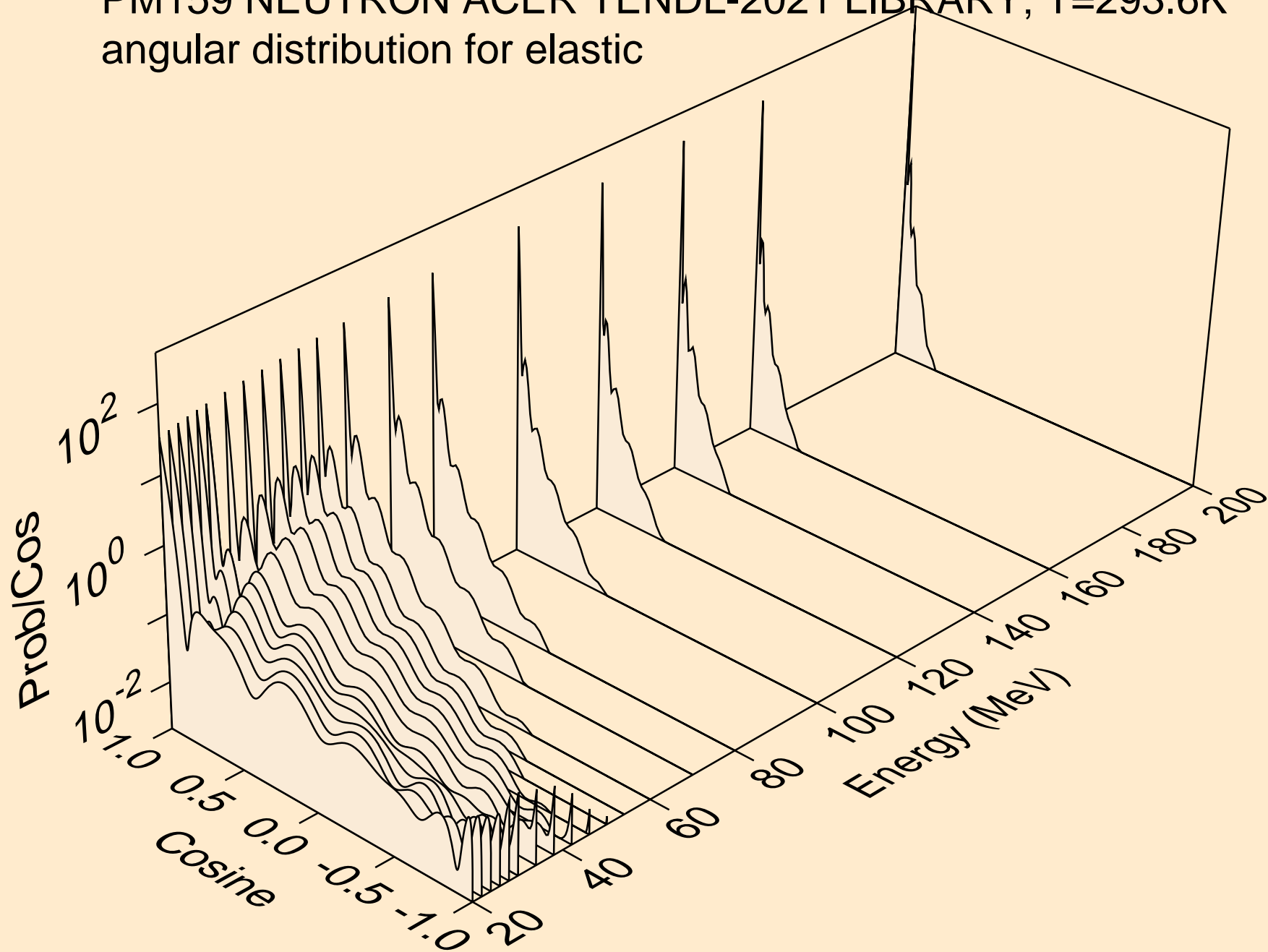

PM159 NEUTRON ACER TENDL-2021 LIBRARY; T=293.6K
angular distribution for (n,n*1)

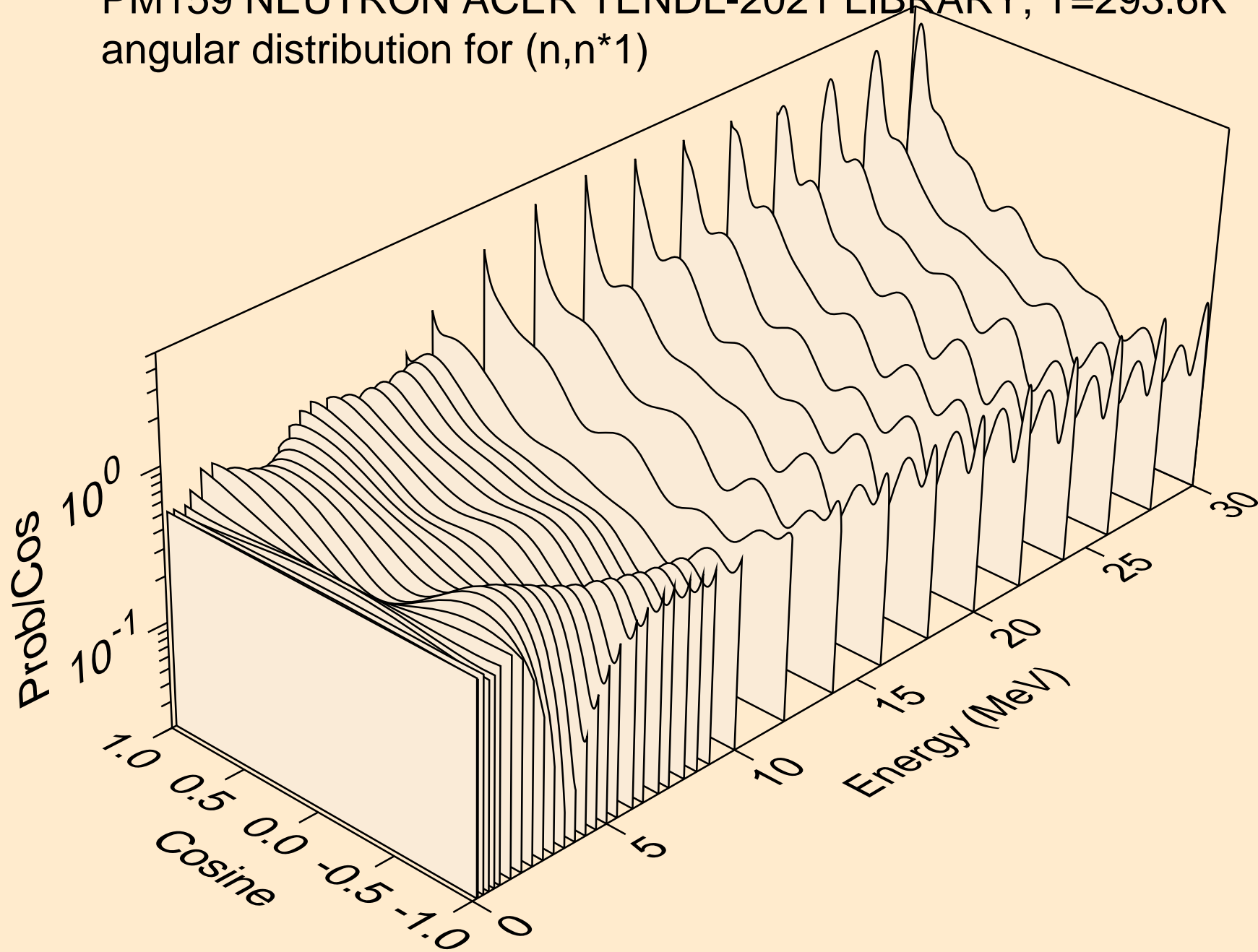

PM159 NEUTRON ACER TENDL-2021 LIBRARY; T=293.6K
Neutron emission for (n,x)

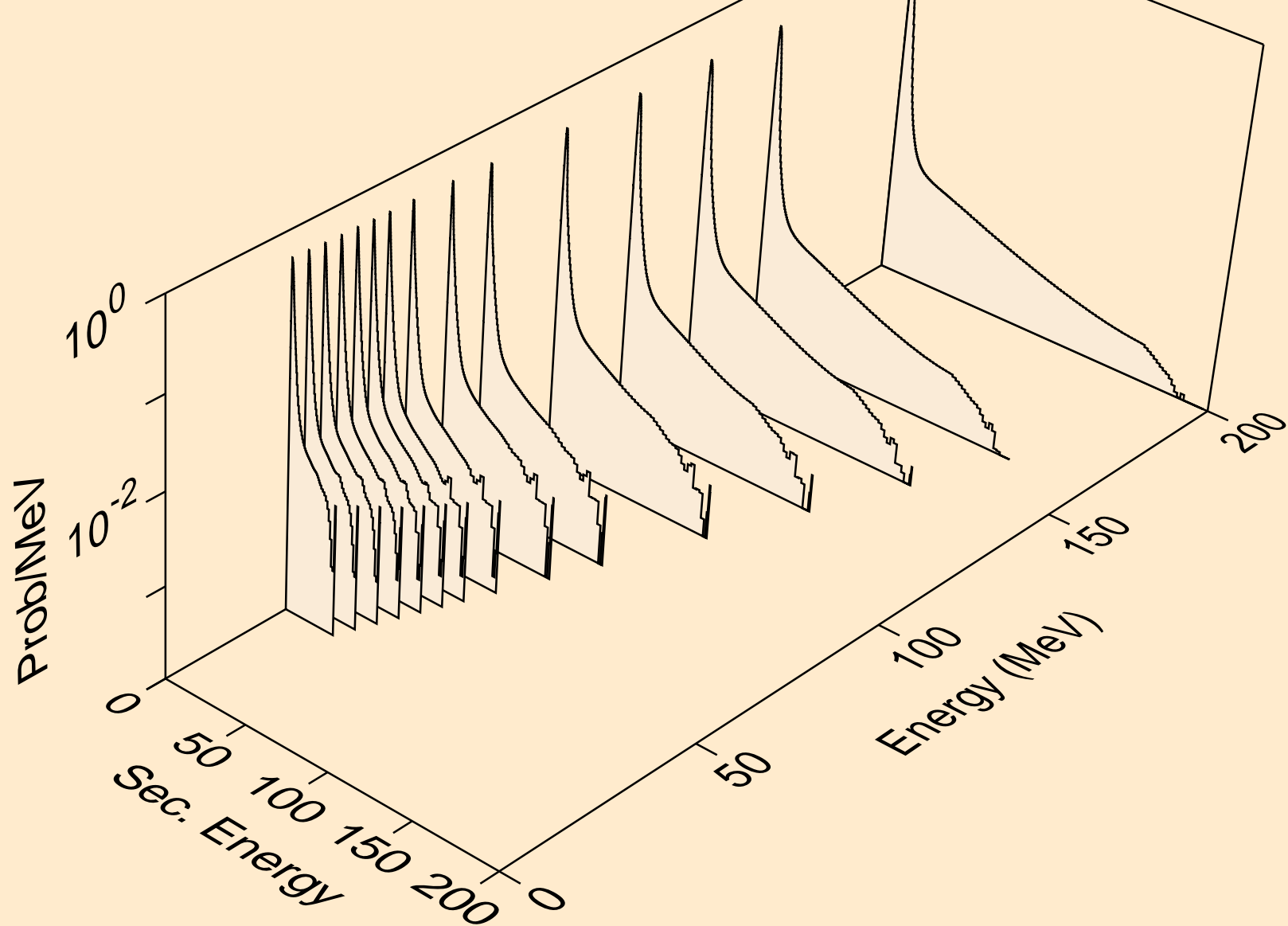

PM159 NEUTRON ACER TENDL-2021 LIBRARY; T=293.6K
Neutron emission for (n,2nd)

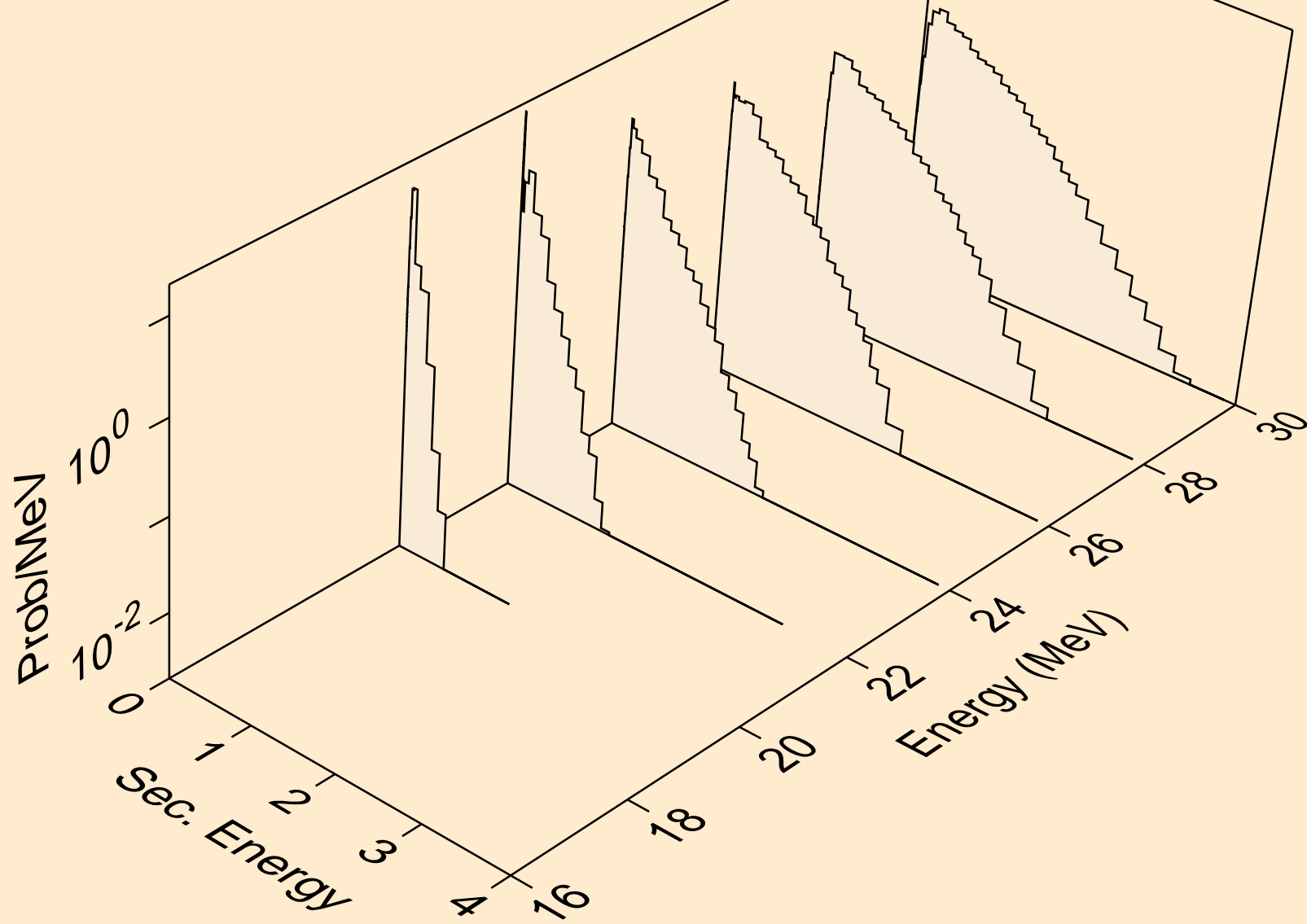

PM159 NEUTRON ACER TENDL-2021 LIBRARY; T=293.6K
Neutron emission for (n,2n)

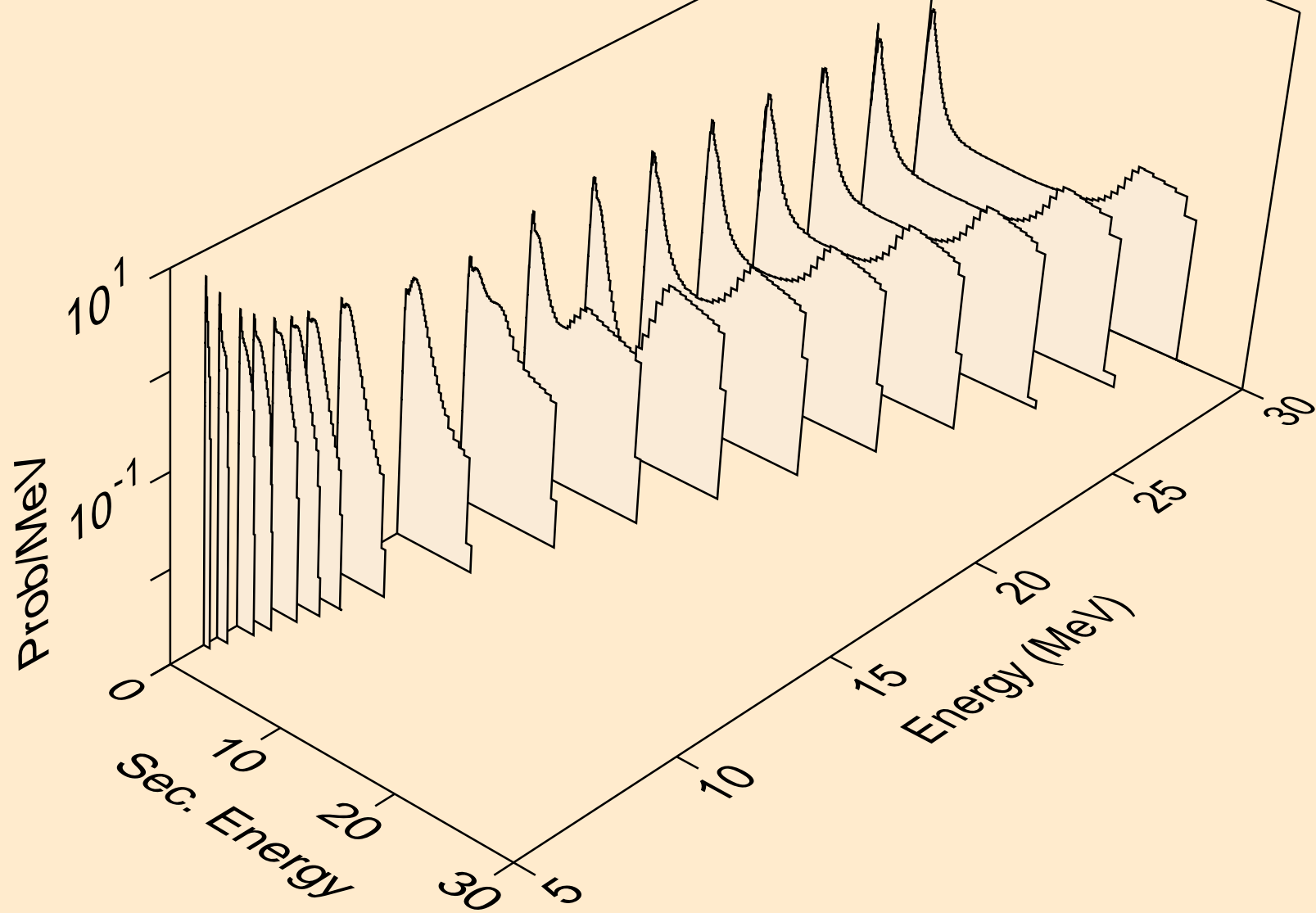

PM159 NEUTRON ACER TENDL-2021 LIBRARY; T=293.6K
Neutron emission for (n,3n)

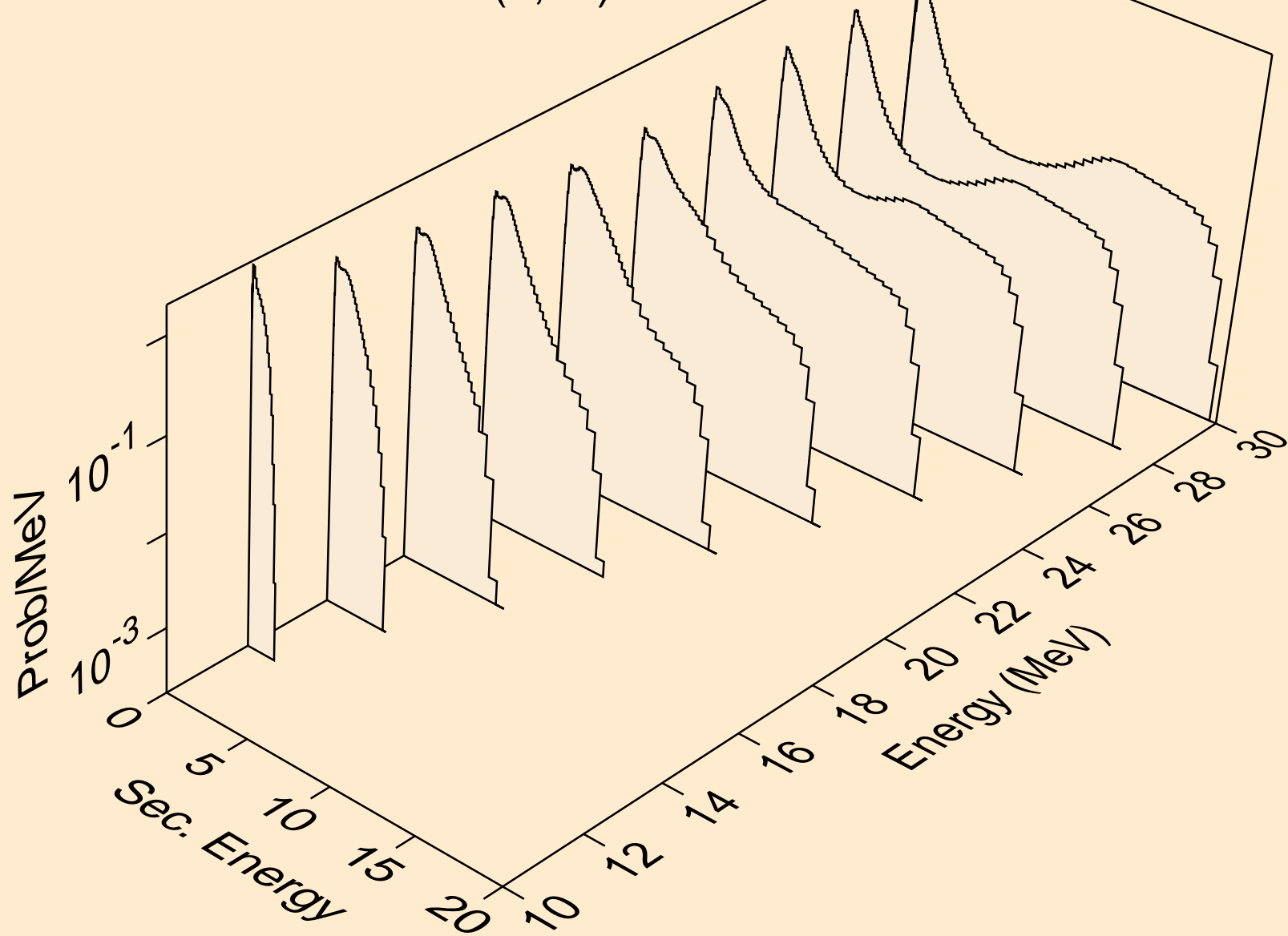

PM159 NEUTRON ACER TENDL-2021 LIBRARY; T=293.6K
Neutron emission for (n,n*)a

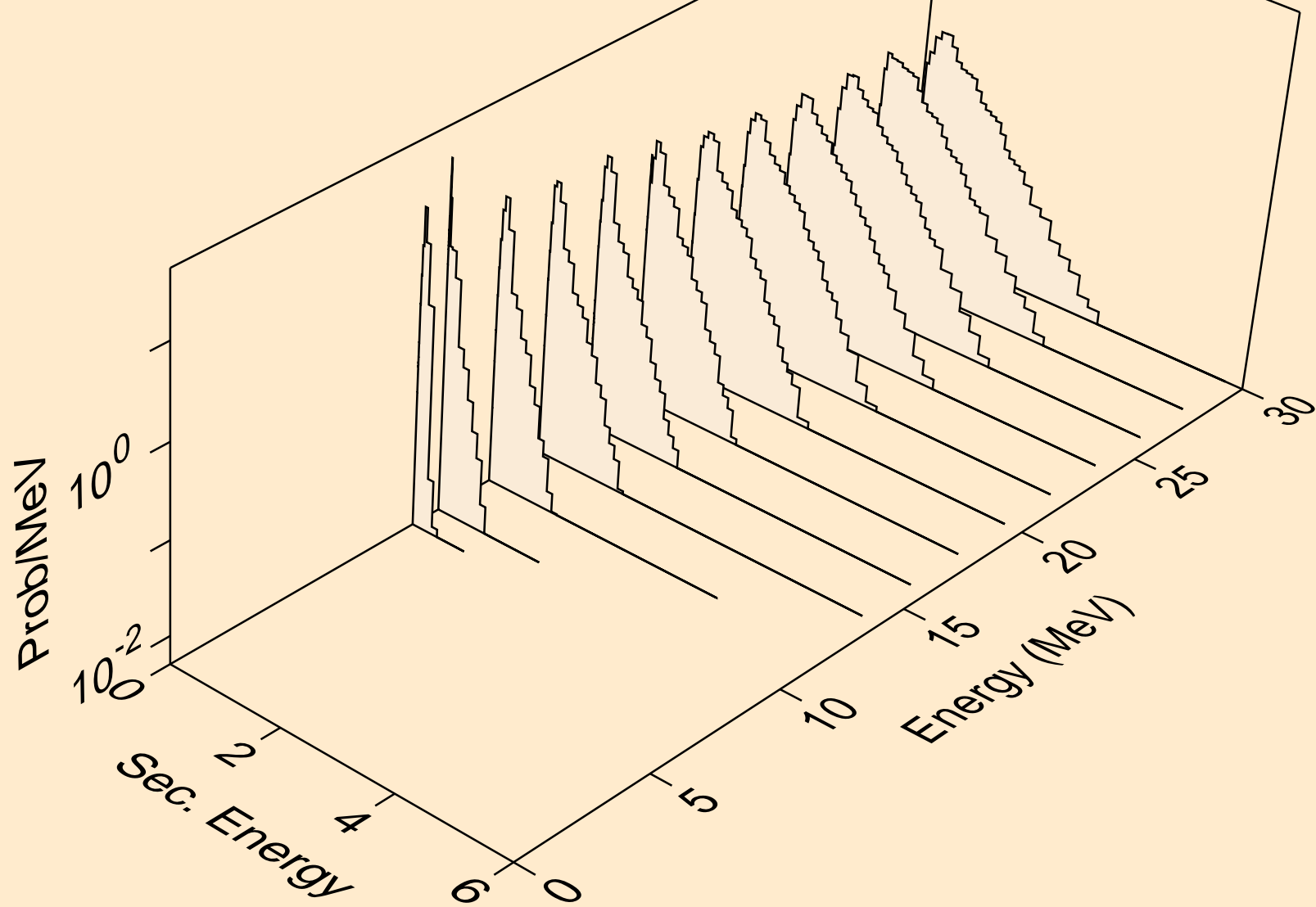

PM159 NEUTRON ACER TENDL-2021 LIBRARY; T=293.6K
Neutron emission for (n,2n)a

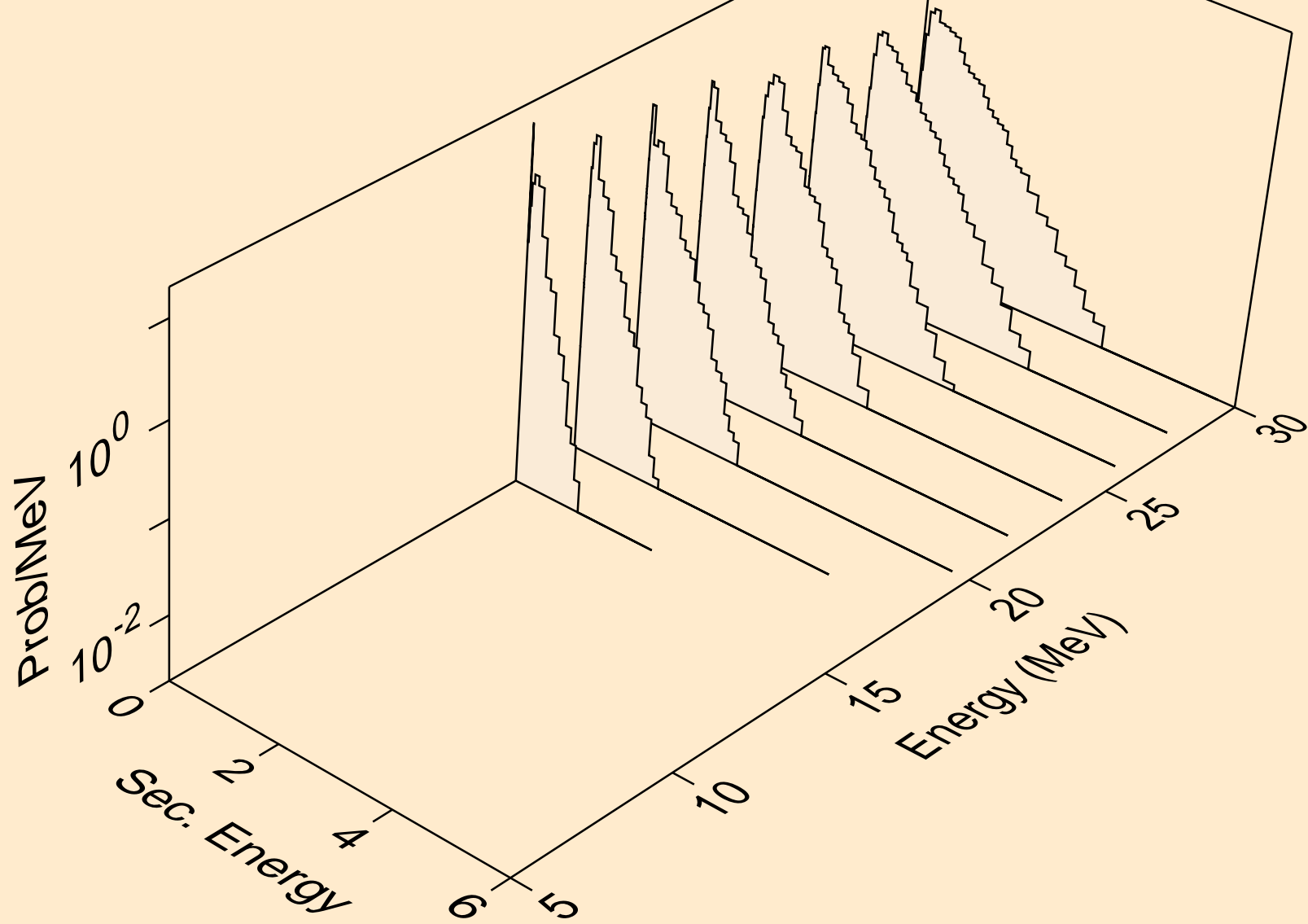

PM159 NEUTRON ACER TENDL-2021 LIBRARY; T=293.6K
Neutron emission for (n,3n)a

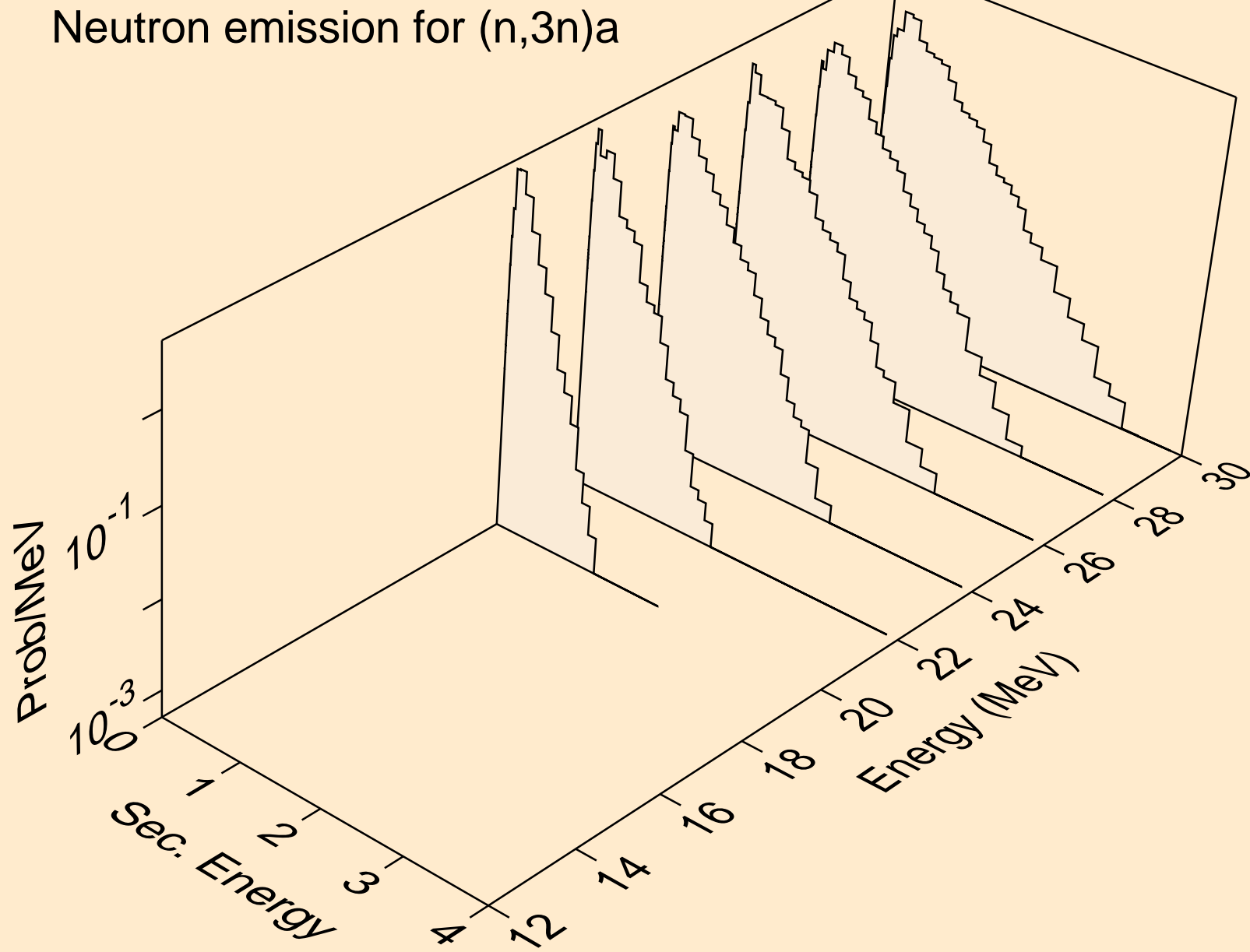

PM159 NEUTRON ACER TENDL-2021 LIBRARY; T=293.6K
Neutron emission for (n,n*)p

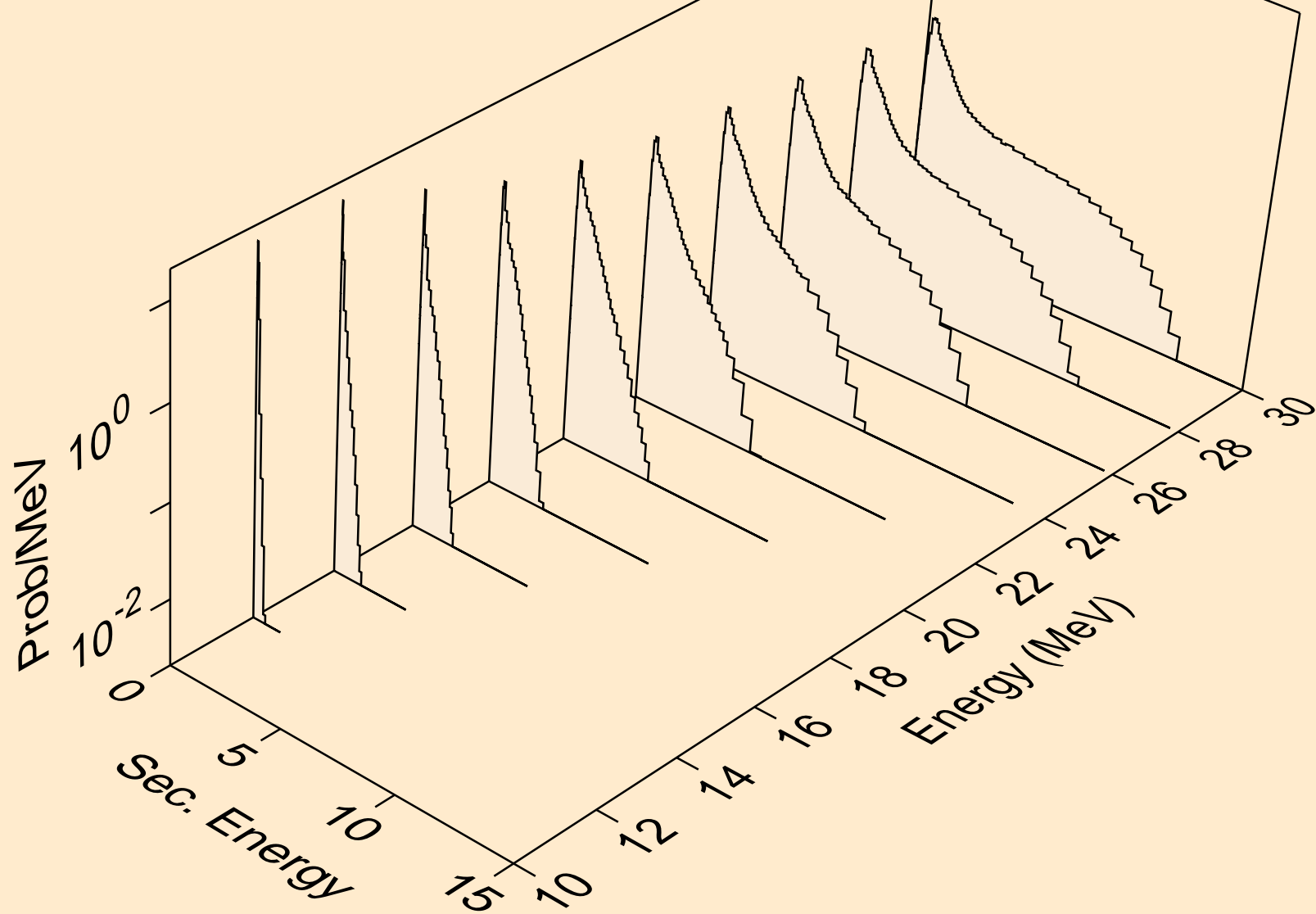

PM159 NEUTRON ACER TENDL-2021 LIBRARY; T=293.6K
Neutron emission for (n,n*)d

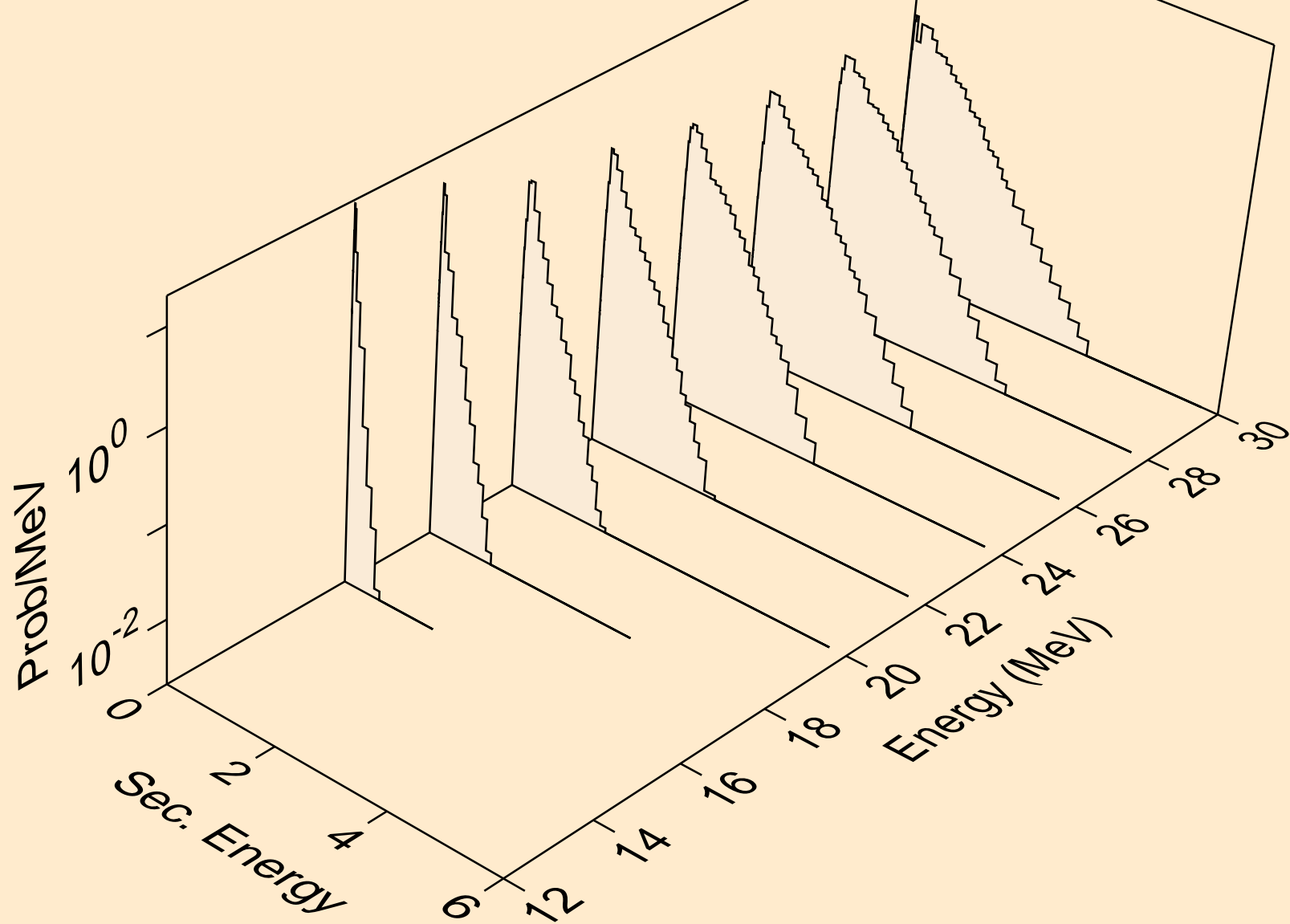

PM159 NEUTRON ACER TENDL-2021 LIBRARY; T=293.6K
Neutron emission for (n,n*)t

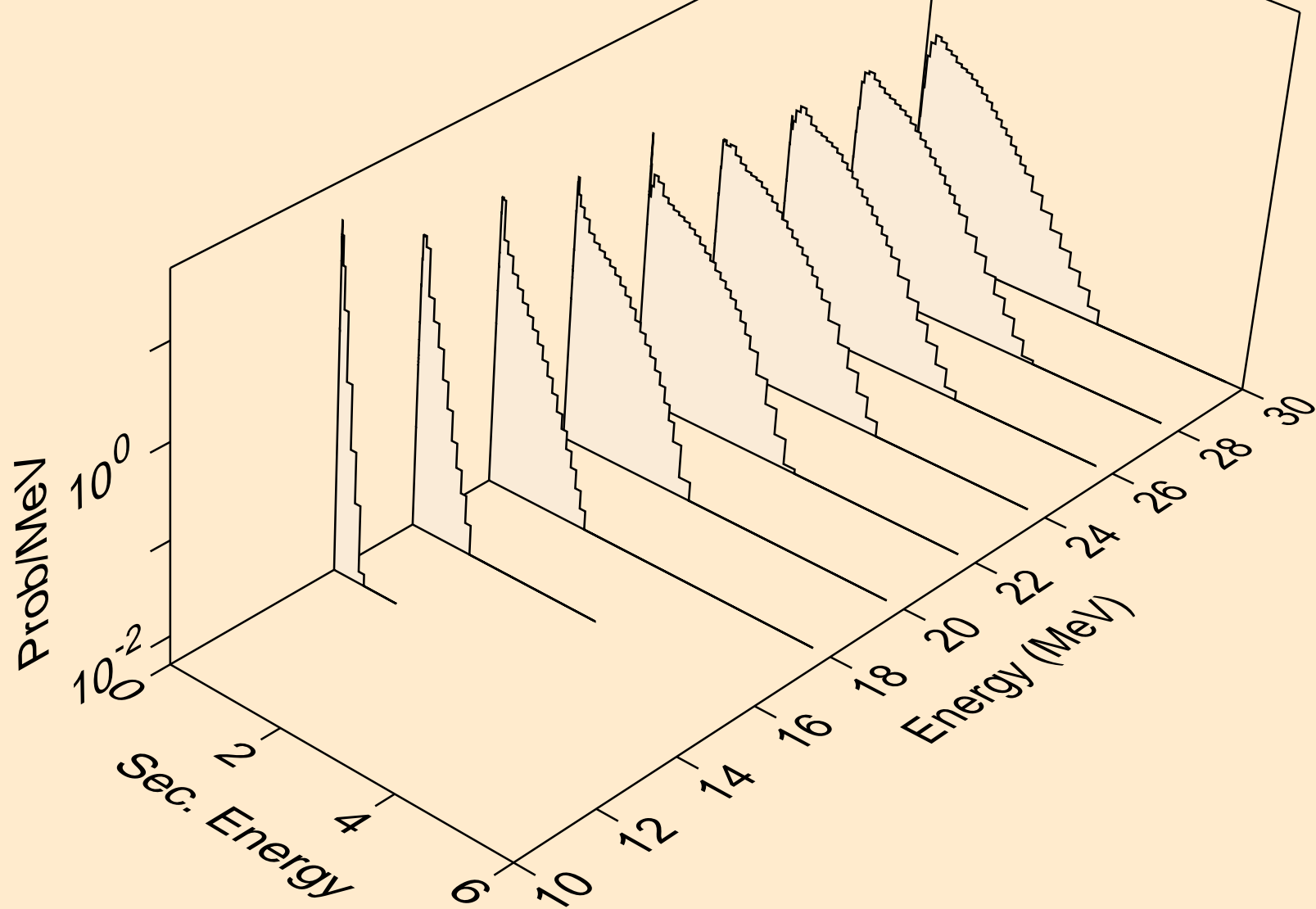

PM159 NEUTRON ACER TENDL-2021 LIBRARY; T=293.6K
Neutron emission for (n,4n)

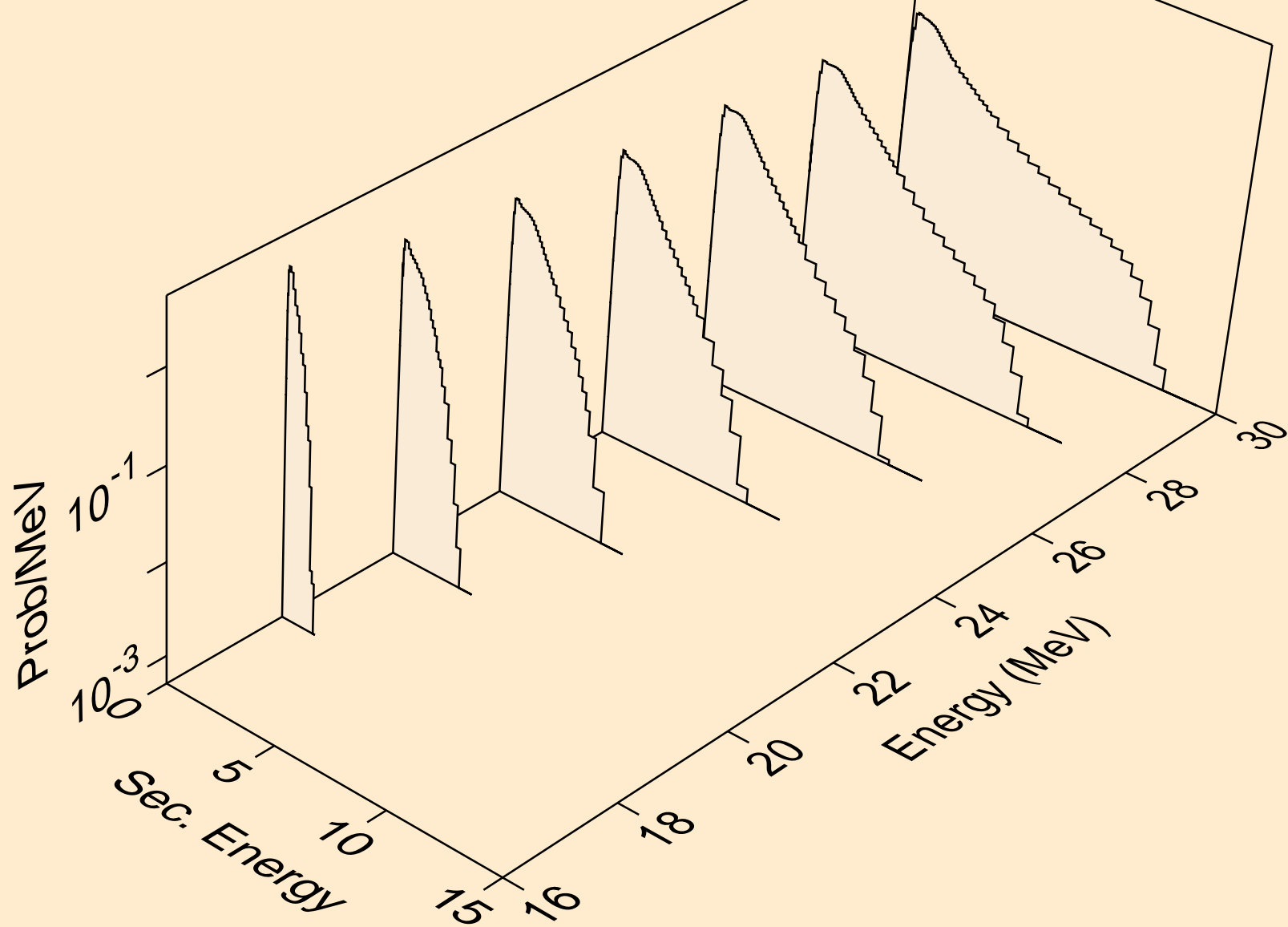

PM159 NEUTRON ACER TENDL-2021 LIBRARY; T=293.6K
Neutron emission for (n,2np)

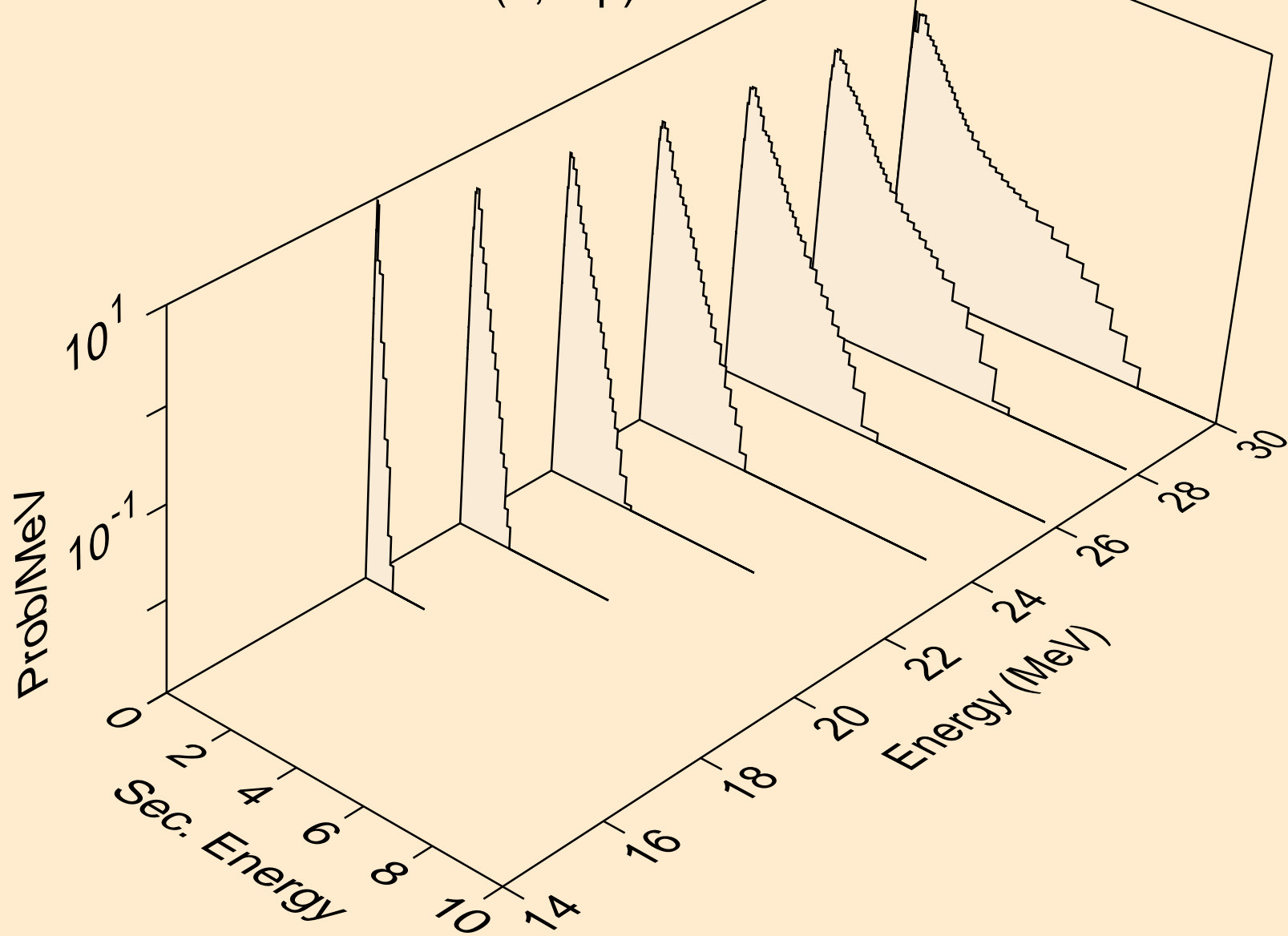

PM159 NEUTRON ACER TENDL-2021 LIBRARY; T=293.6K
Neutron emission for (n,3np)

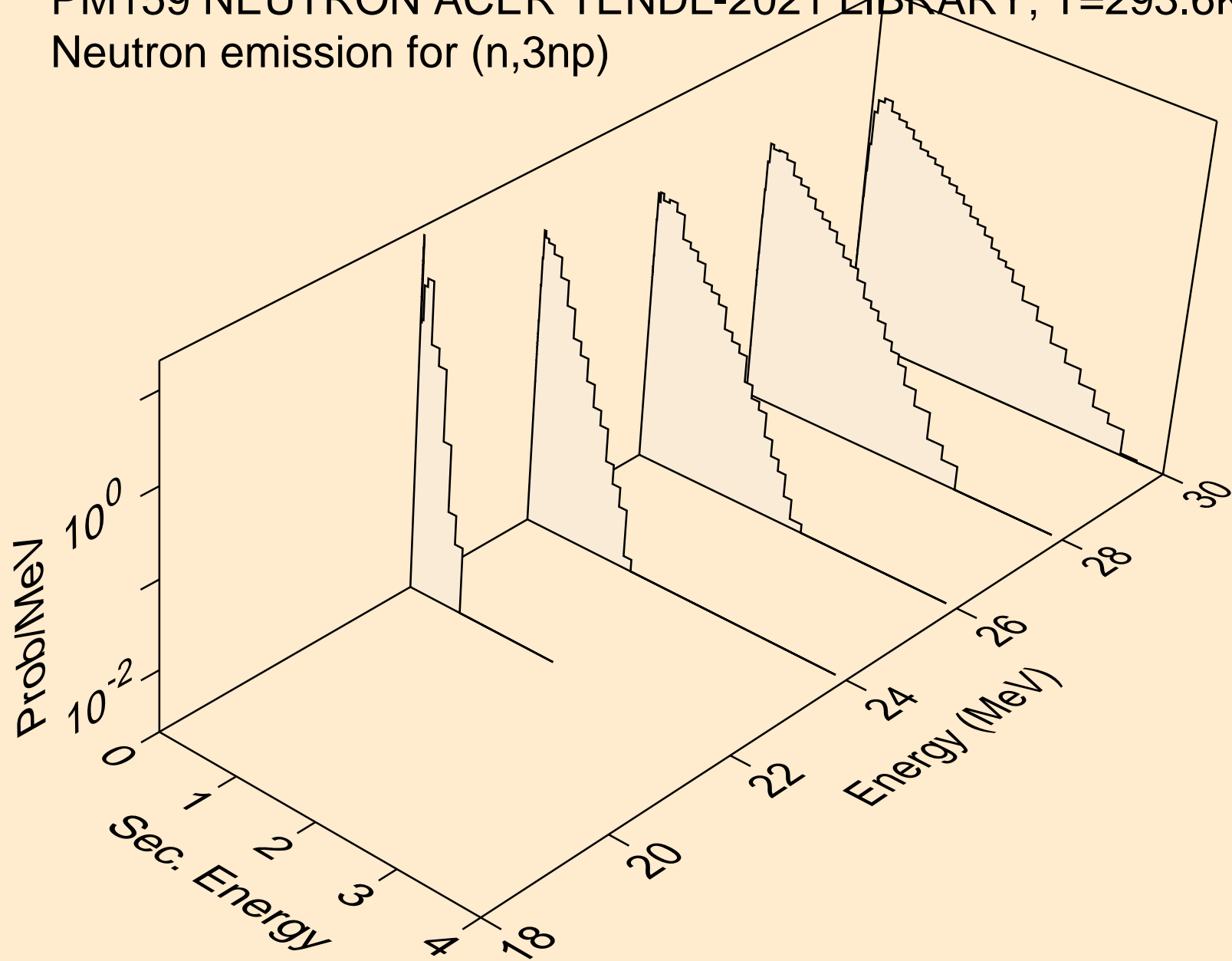

PM159 NEUTRON ACER TENDL-2021 LIBRARY; T=293.6K
Neutron emission for (n,n*c)

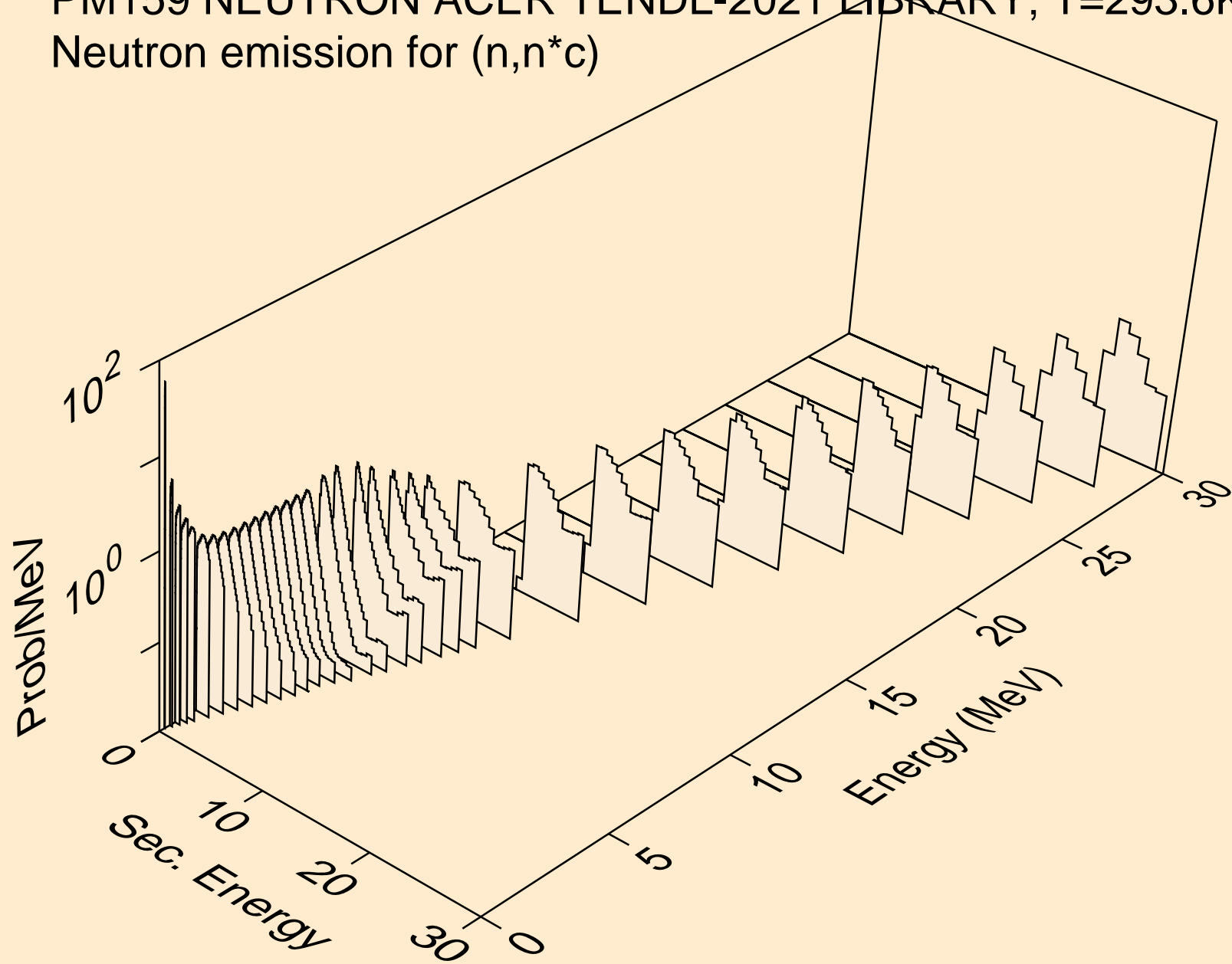

PM159 NEUTRON ACER TENDL-2021 LIBRARY; T=293.6K
Photon emission for (n,x)

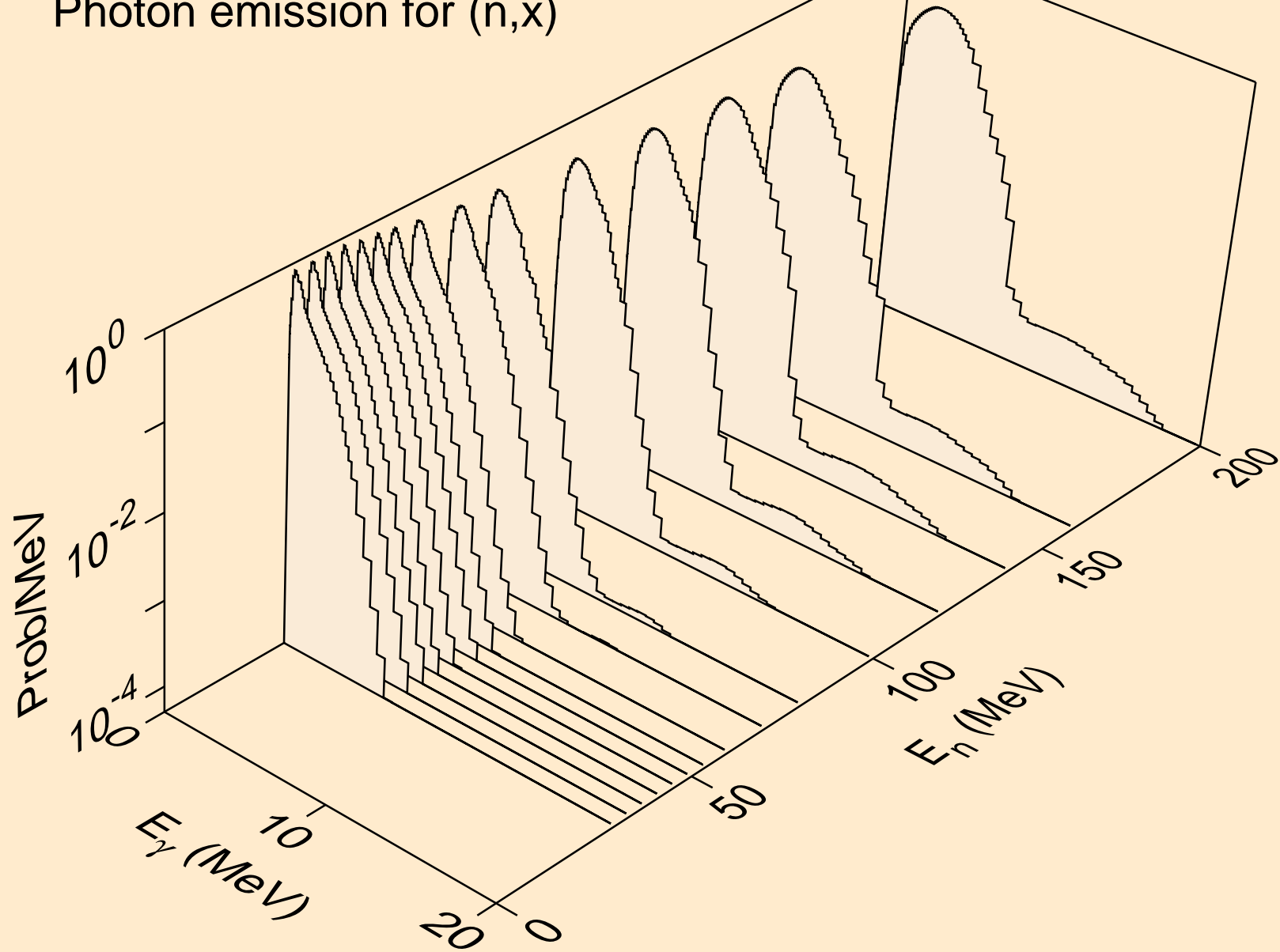

PM159 NEUTRON ACER TENDL-2021 LIBRARY; T=293.6K
Photon emission for (n,2nd)

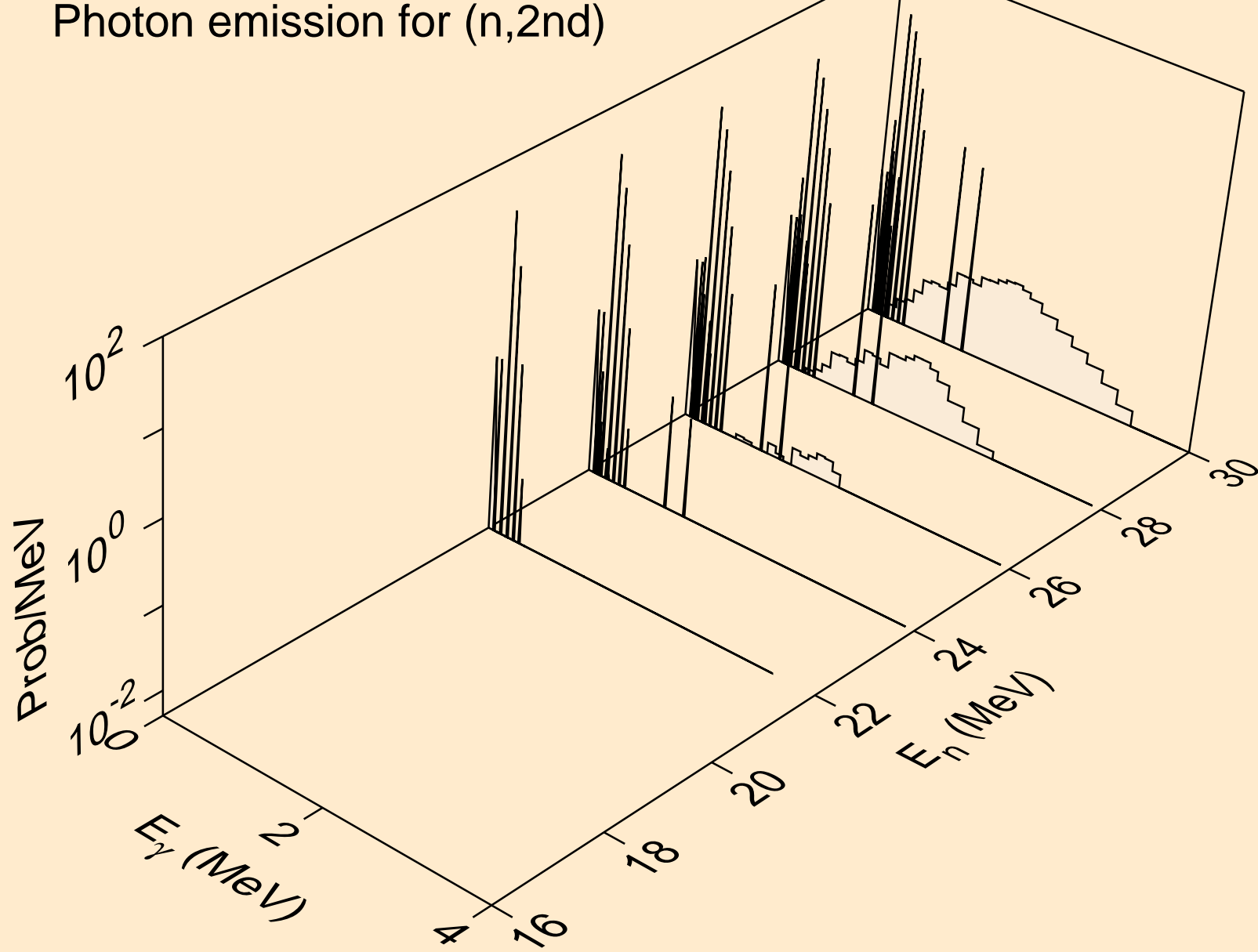

PM159 NEUTRON ACER TENDL-2021 LIBRARY; T=293.6K
Photon emission for (n,2n)

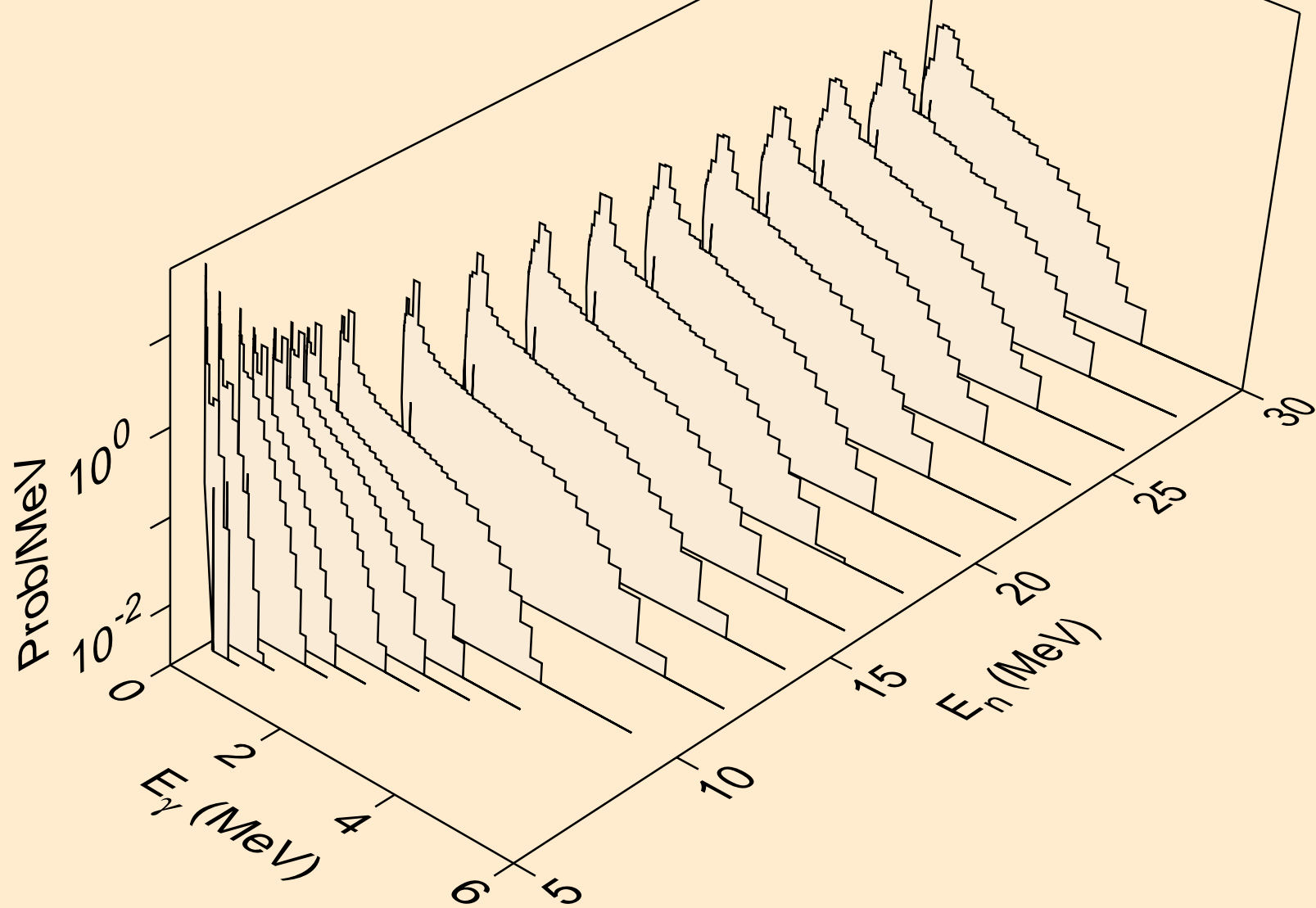

PM159 NEUTRON ACER TENDL-2021 LIBRARY; T=293.6K
Photon emission for (n,3n)

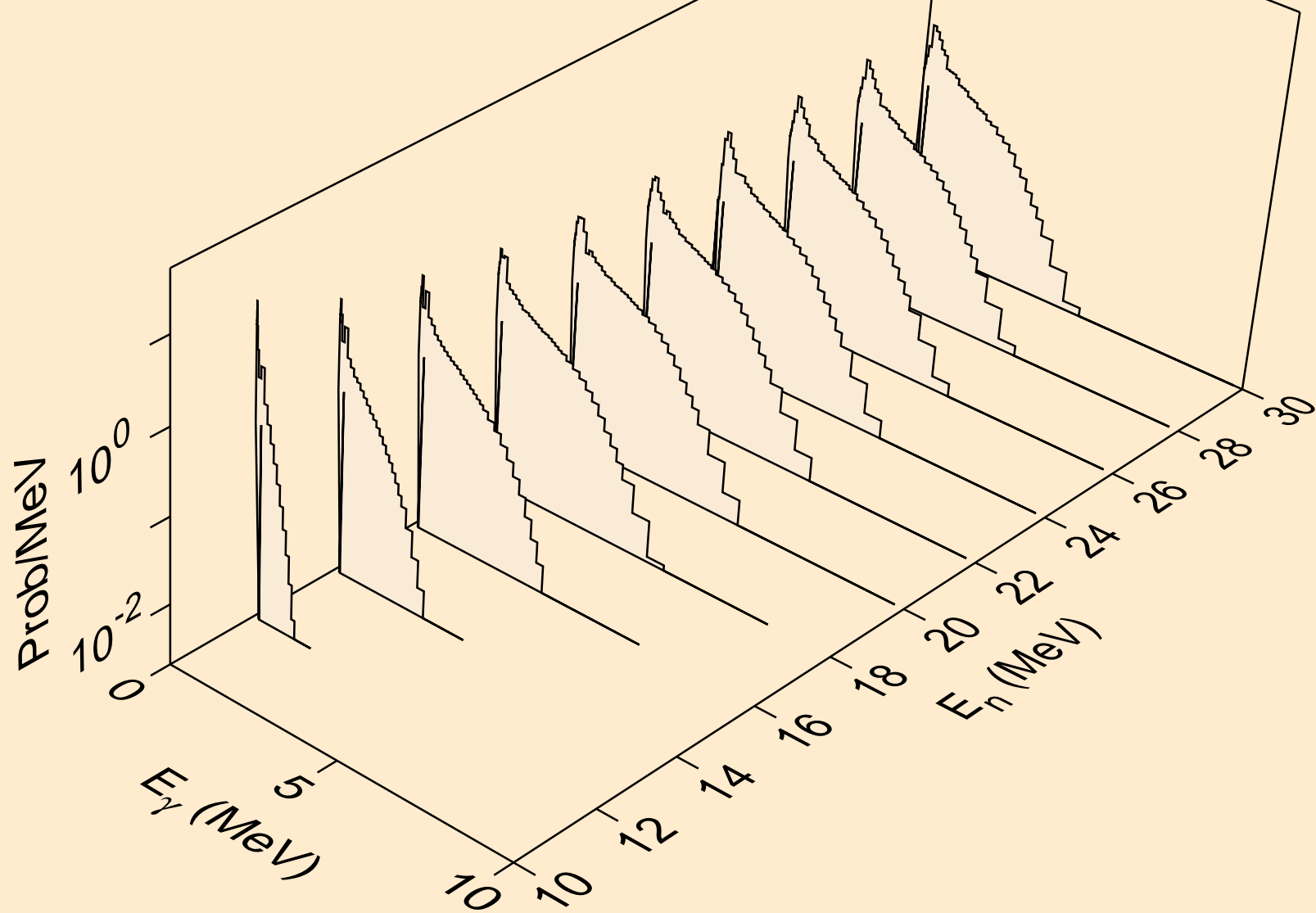

PM159 NEUTRON ACER TENDL-2021 LIBRARY; T=293.6K
Photon emission for (n,n*)a

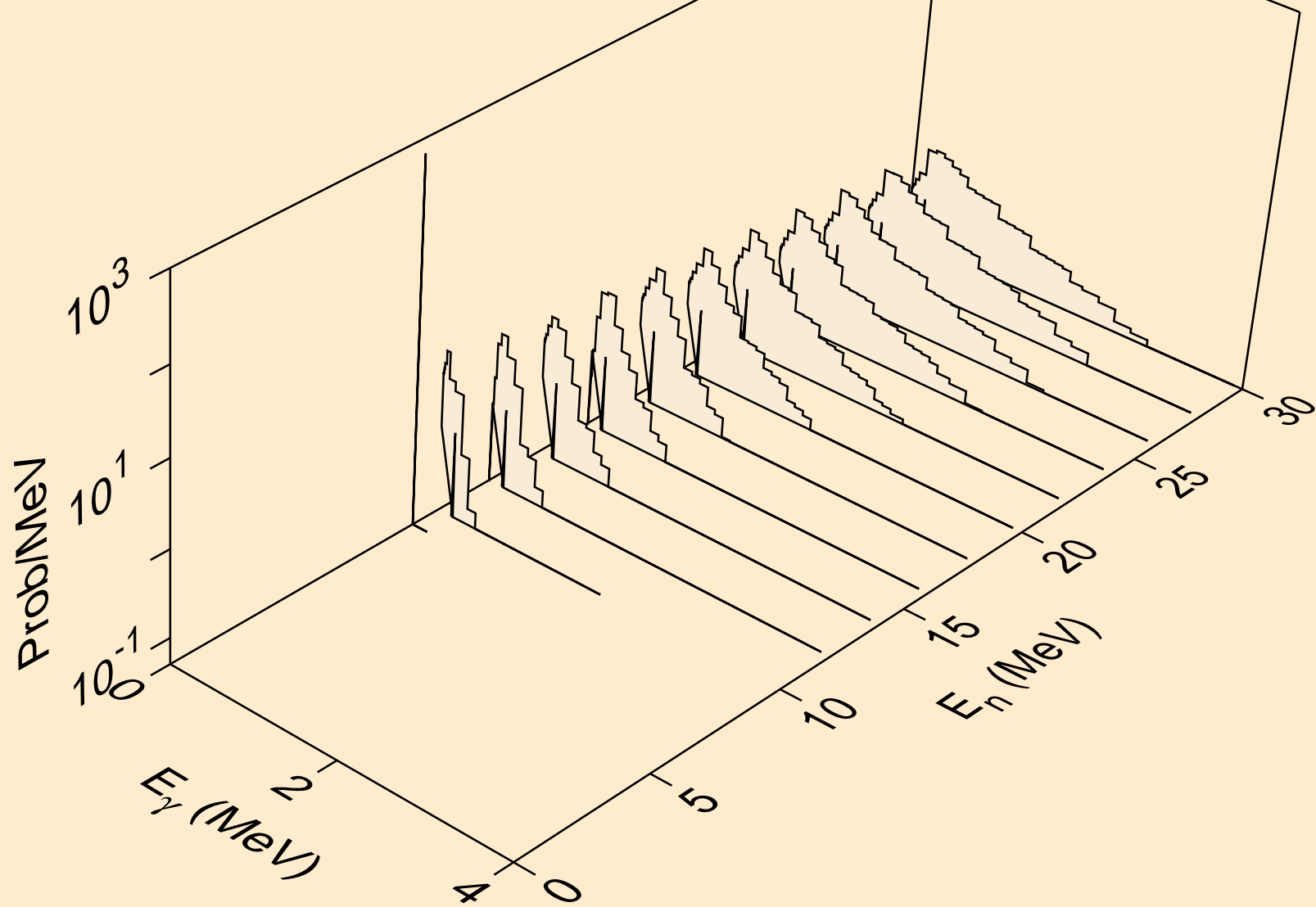

PM159 NEUTRON ACER TENDL-2021 LIBRARY; T=293.6K
Photon emission for (n,2n)a

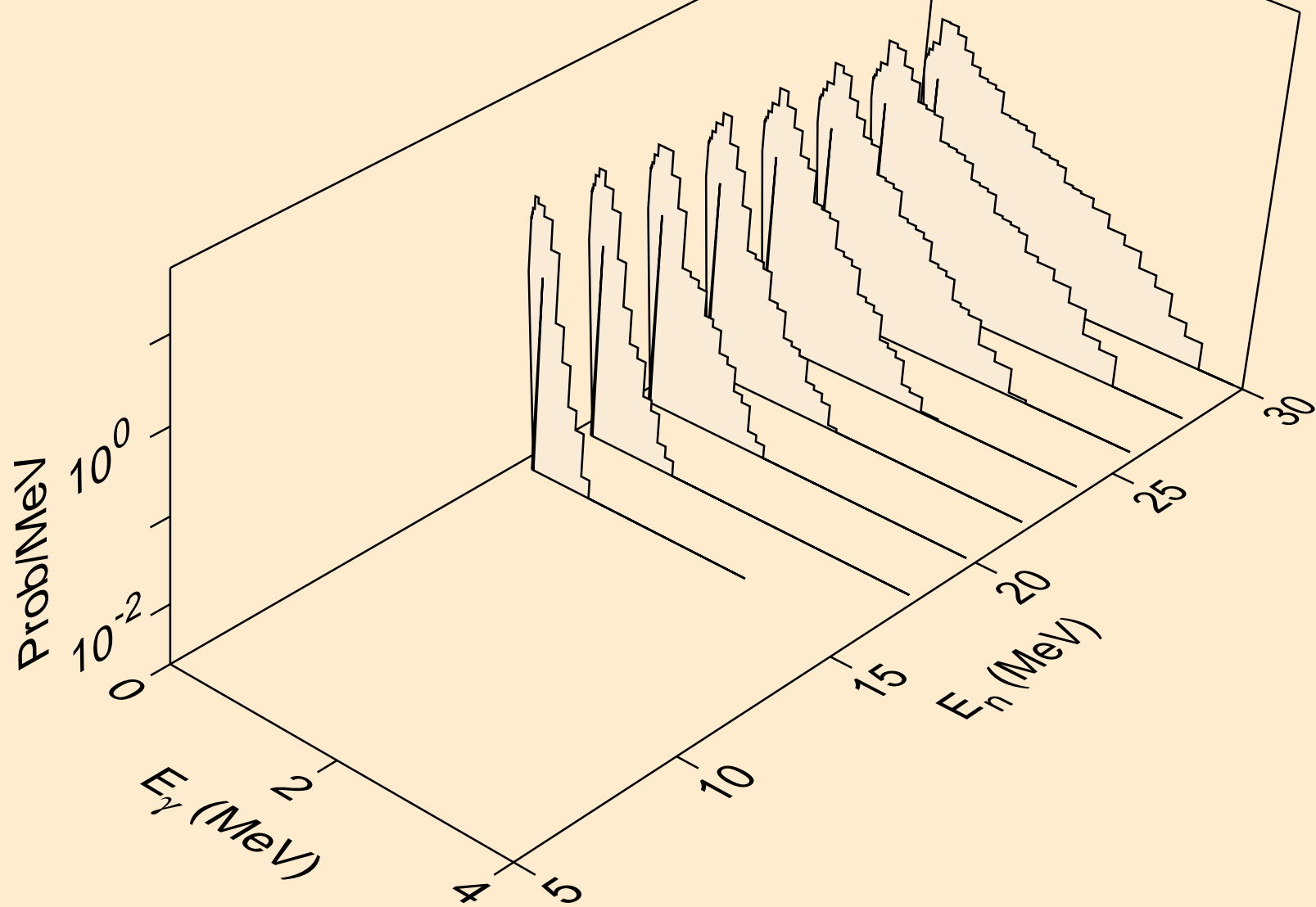

PM159 NEUTRON ACER TENDL-2021 LIBRARY; T=293.6K
Photon emission for (n,3n)a

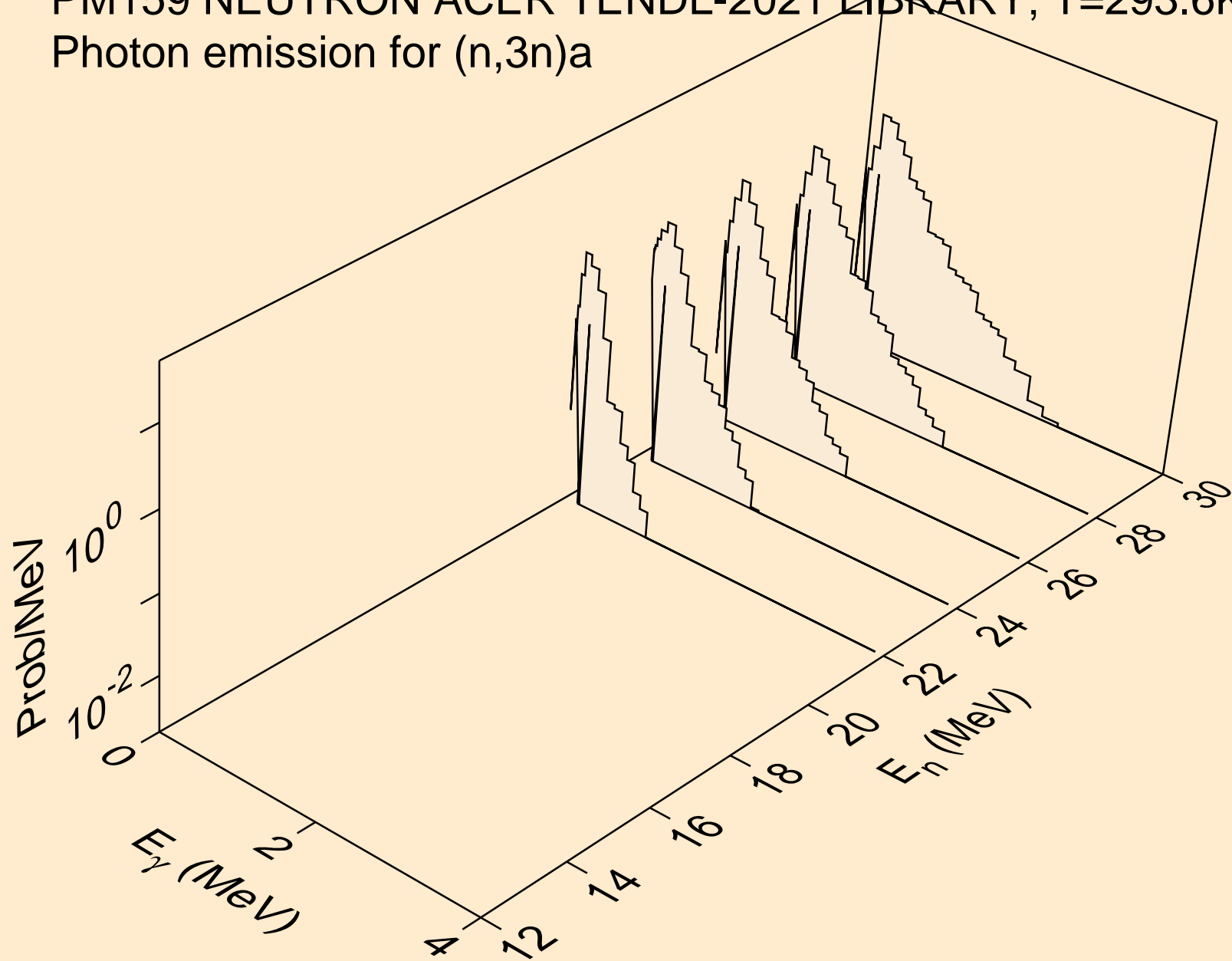

PM159 NEUTRON ACER TENDL-2021 LIBRARY; T=293.6K
Photon emission for (n,n*)p

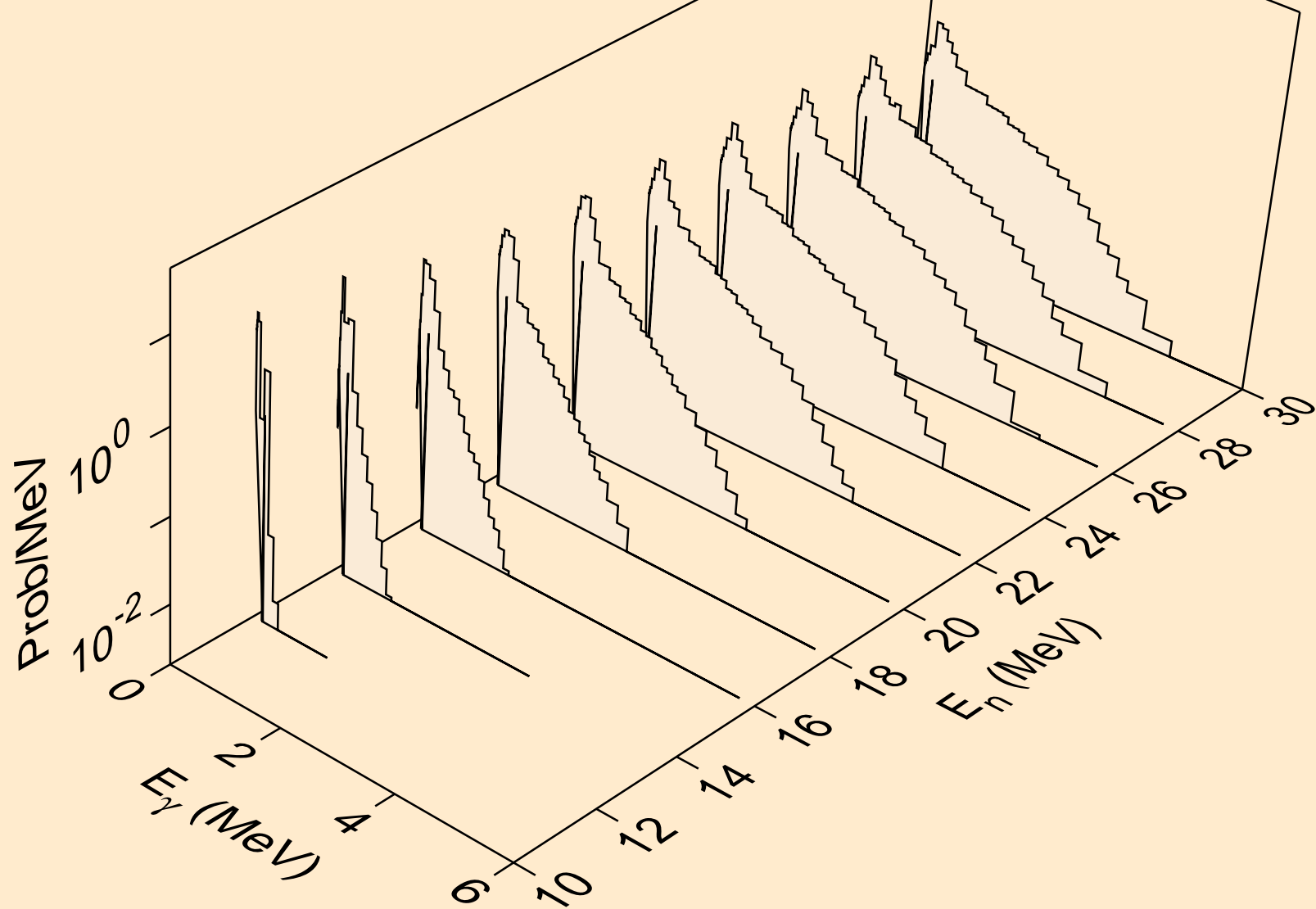

PM159 NEUTRON ACER TENDL-2021 LIBRARY; T=293.6K
Photon emission for (n,n*)d

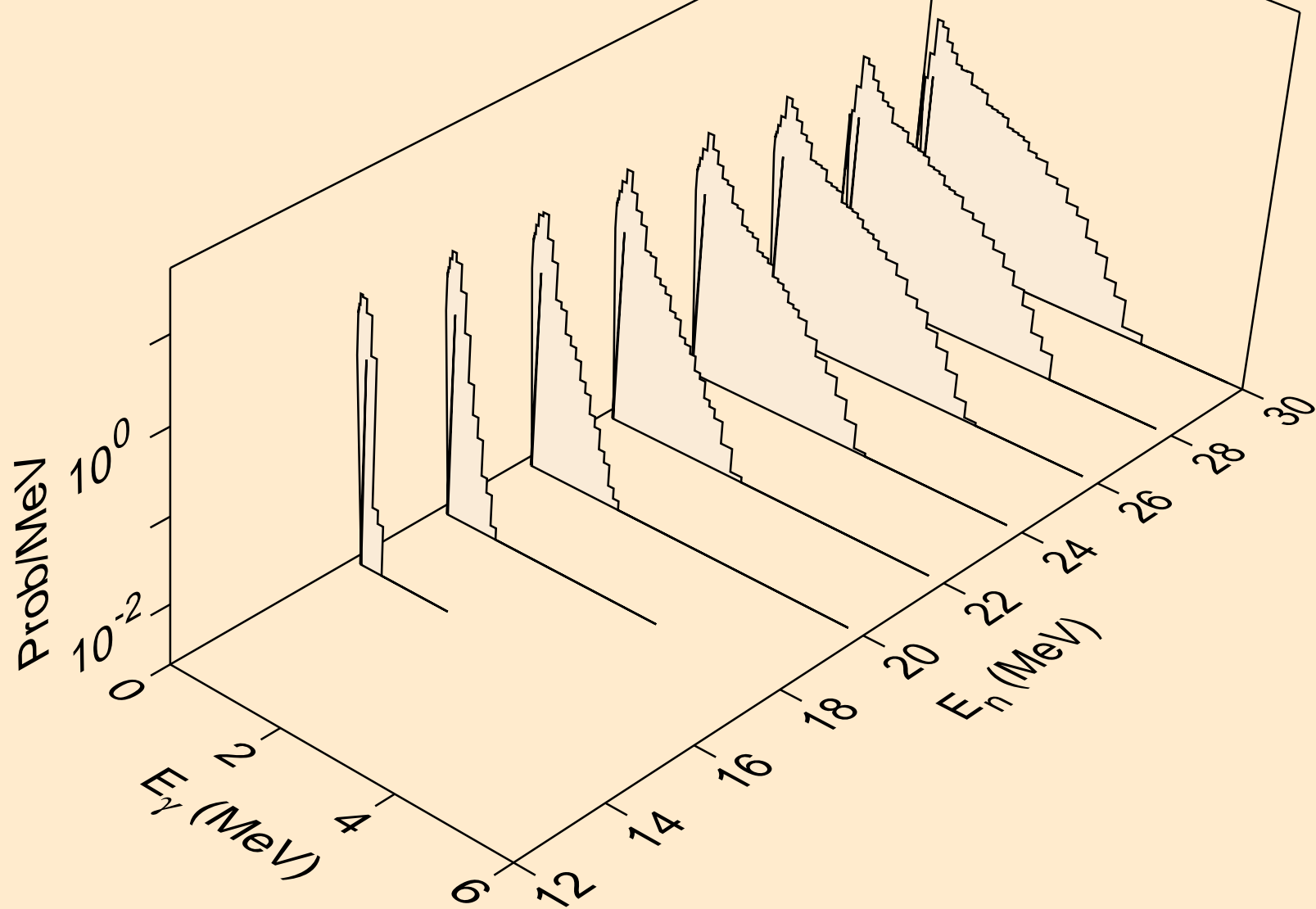

PM159 NEUTRON ACER TENDL-2021 LIBRARY; T=293.6K
Photon emission for (n,n*)t

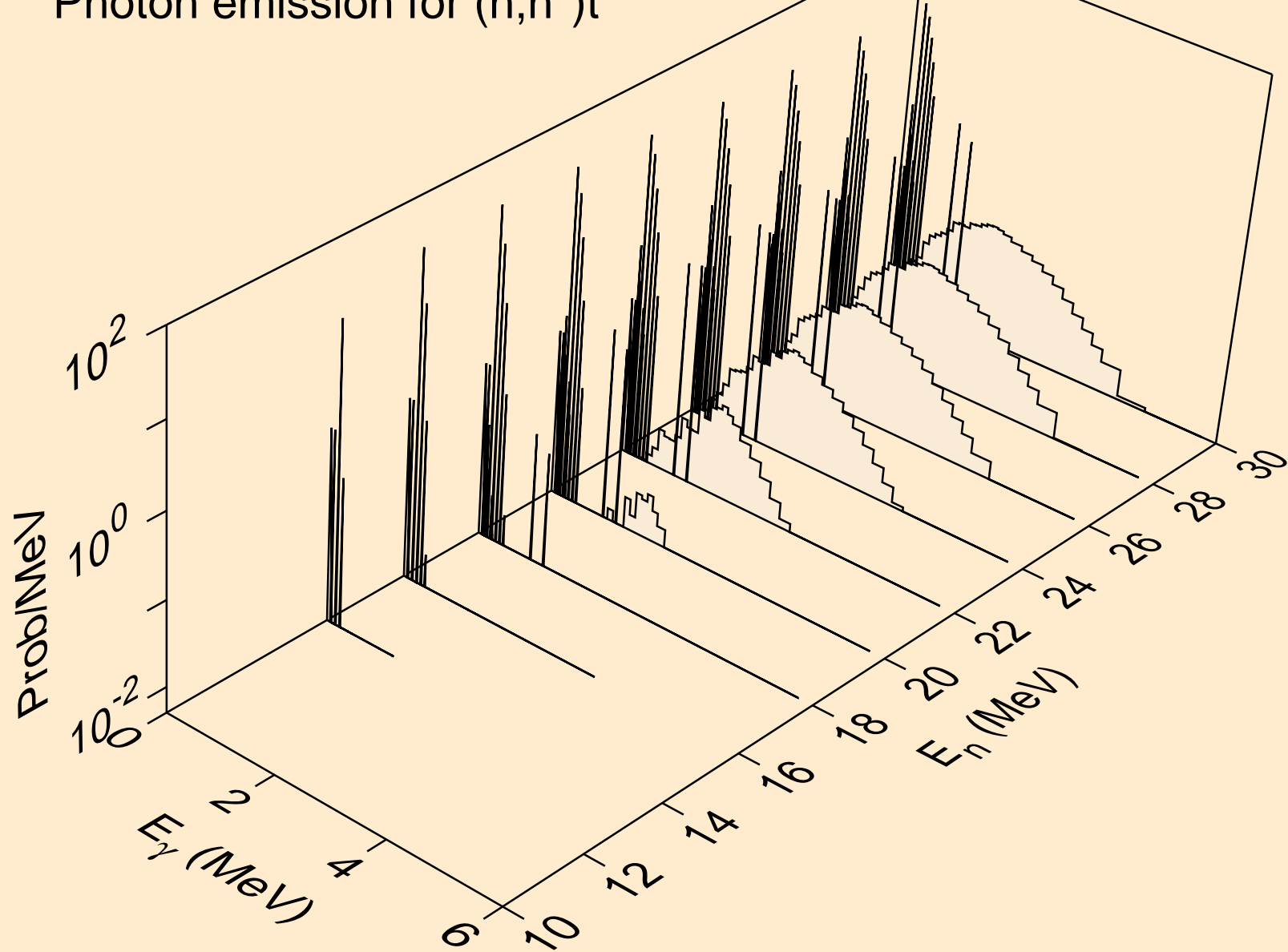

PM159 NEUTRON ACER TENDL-2021 LIBRARY; T=293.6K
Photon emission for (n,4n)

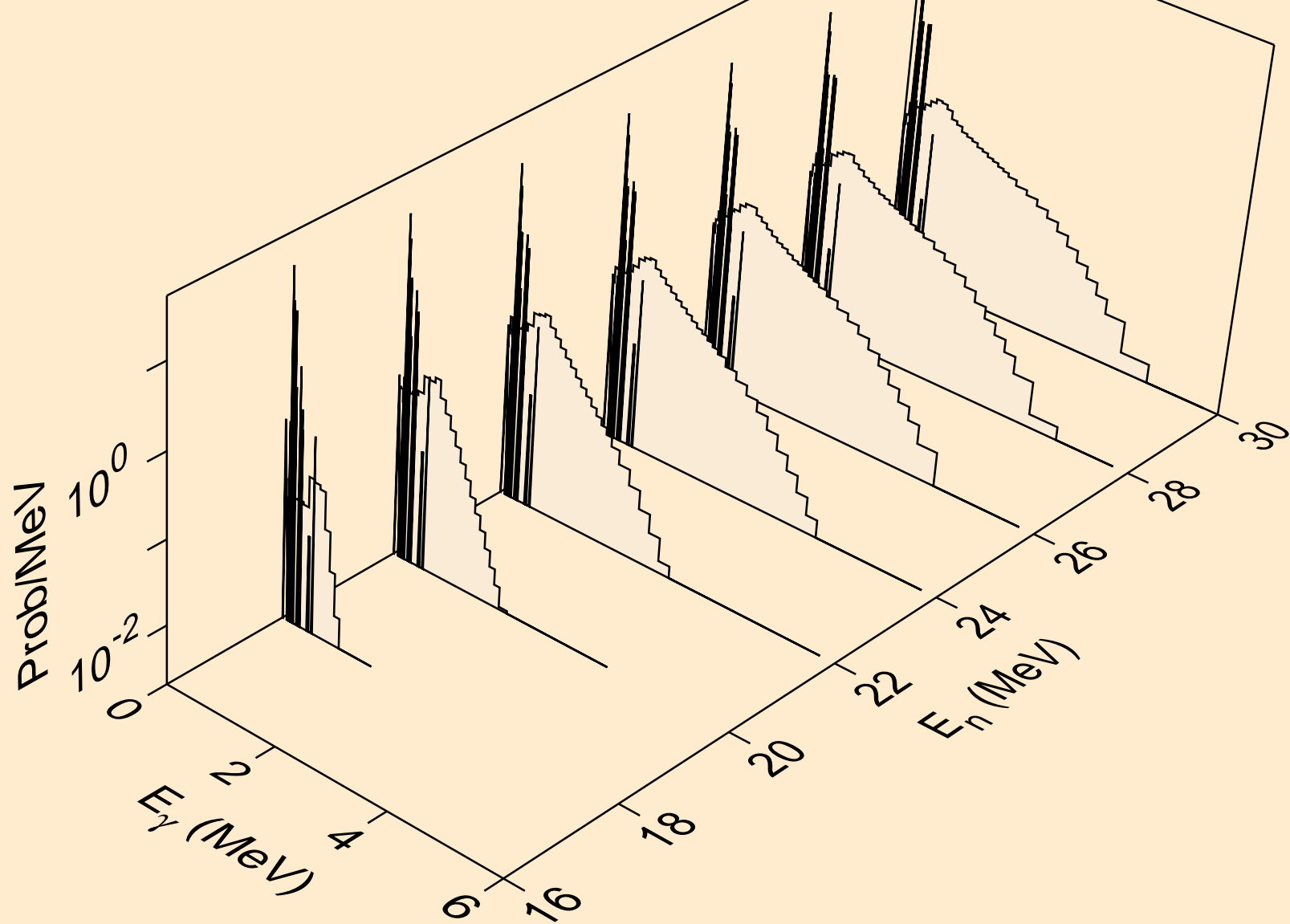

PM159 NEUTRON ACER TENDL-2021 LIBRARY; T=293.6K
Photon emission for (n,2np)

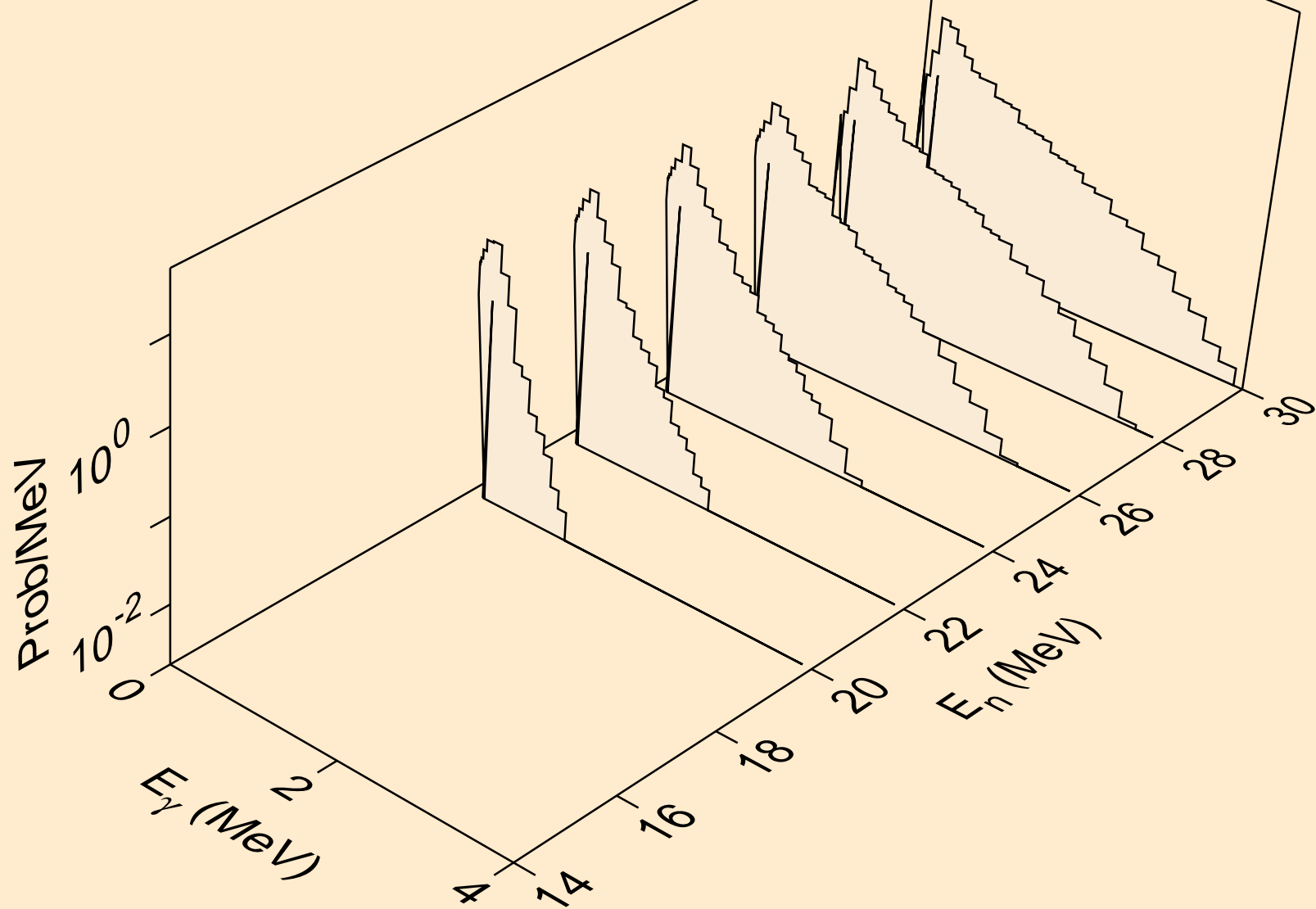

PM159 NEUTRON ACER TENDL-2021 LIBRARY; T=293.6K
Photon emission for (n,3np)

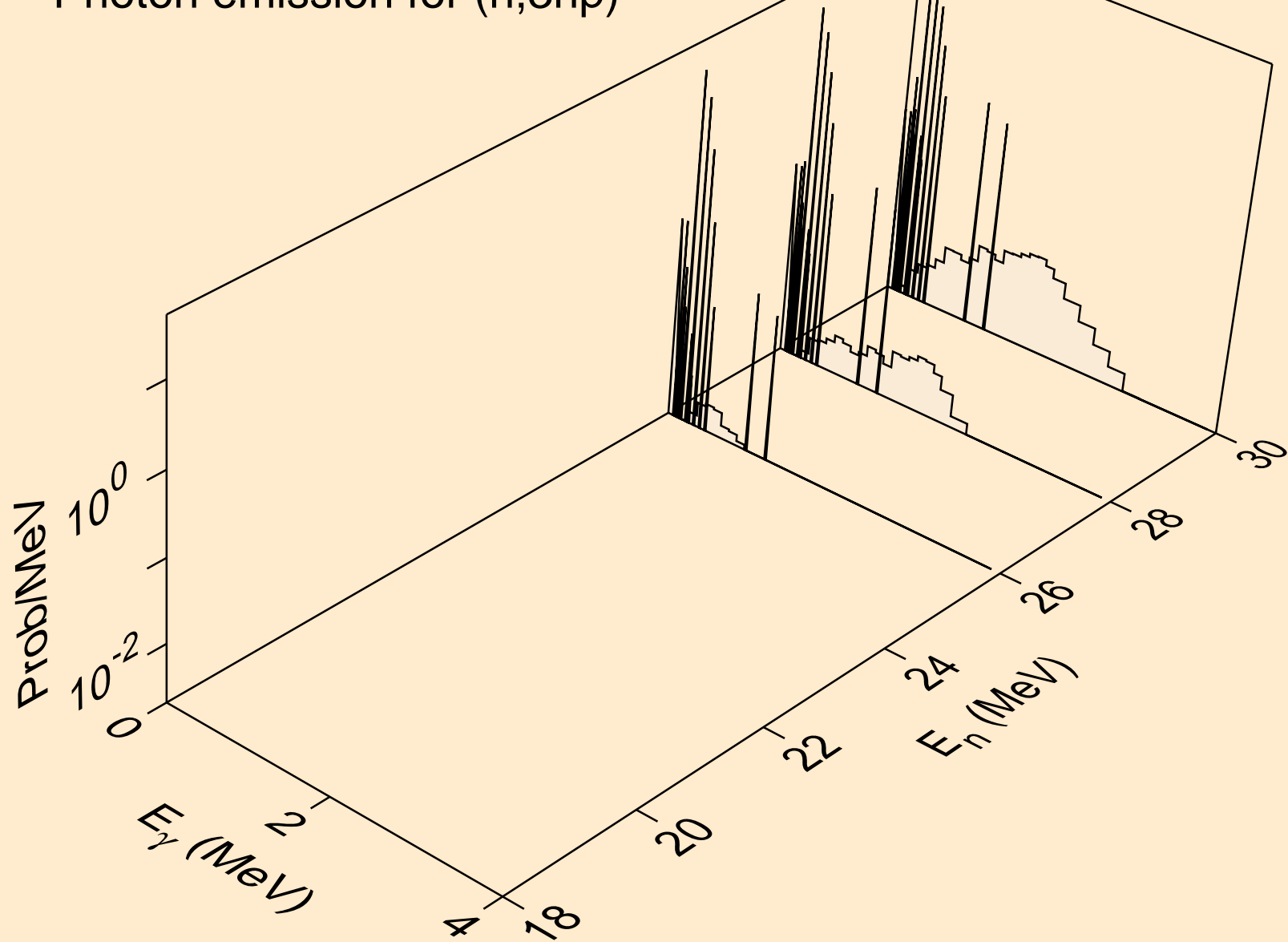

PM159 NEUTRON ACER TENDL-2021 LIBRARY; T=293.6K
Photon emission for (n,n*c)

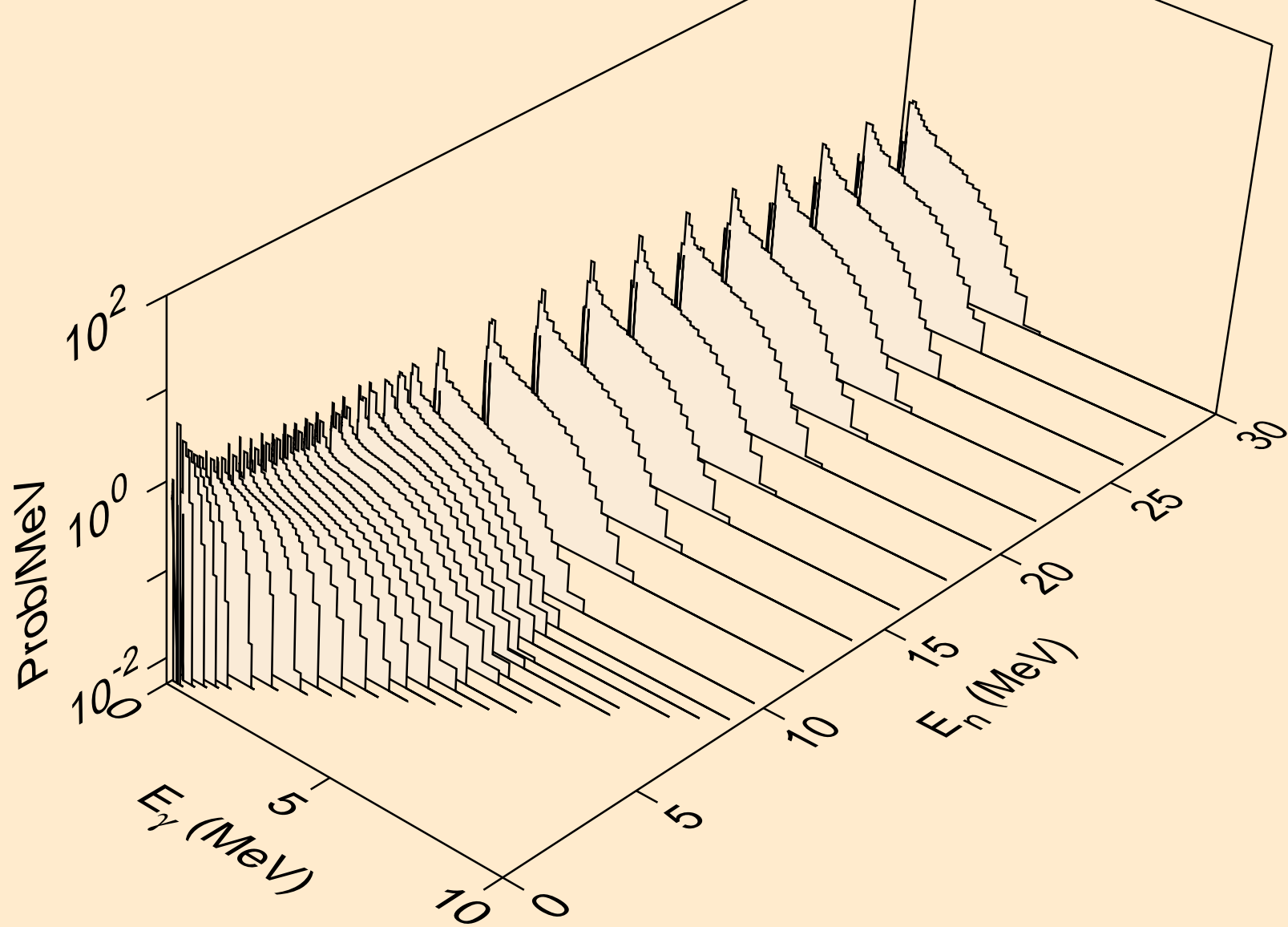

PM159 NEUTRON ACER TENDL-2021 LIBRARY; T=293.6K
Photon emission for (n,gma)

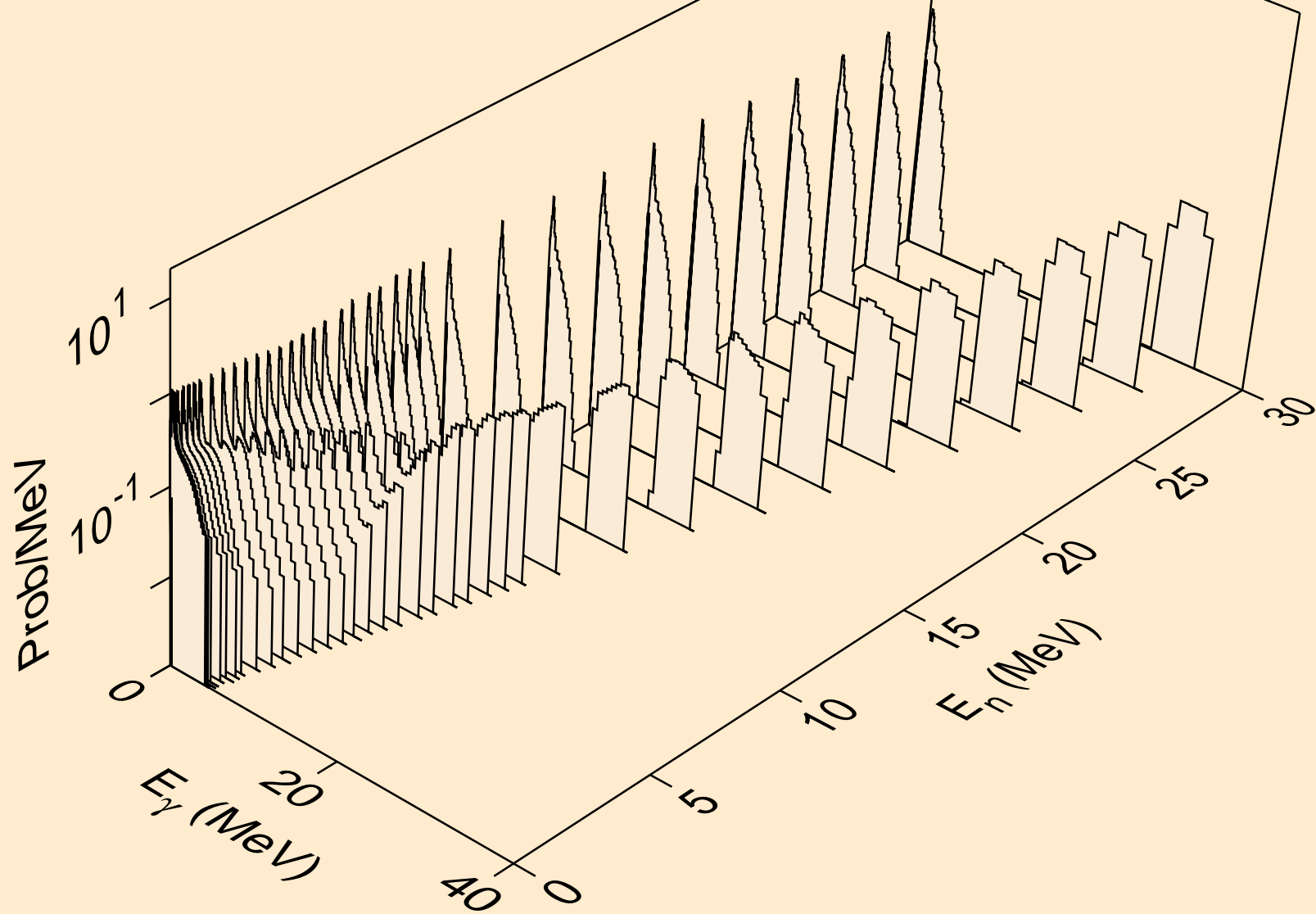

PM159 NEUTRON ACER TENDL-2021 LIBRARY; T=293.6K
Photon emission for (n,p)

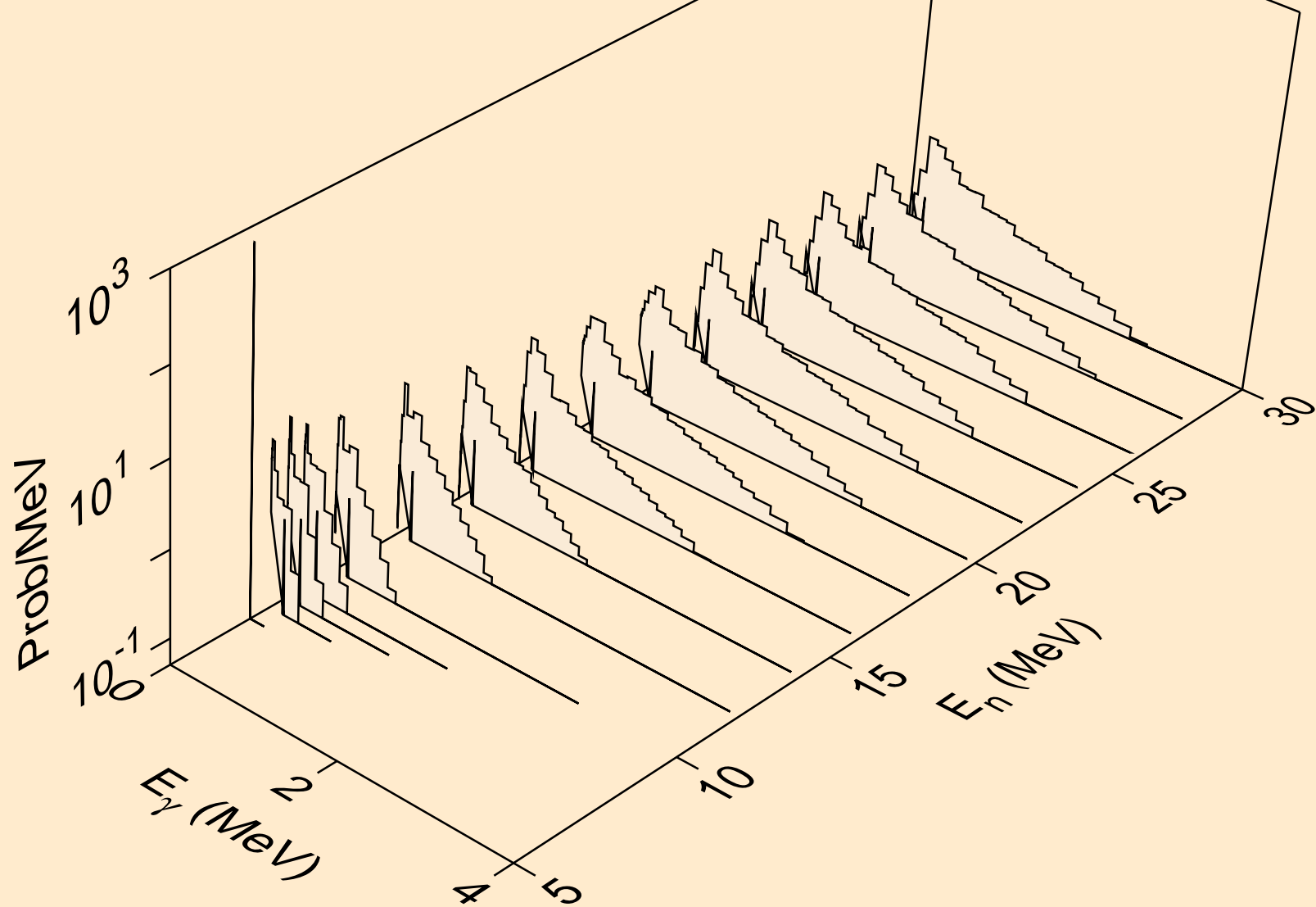

PM159 NEUTRON ACER TENDL-2021 LIBRARY; T=293.6K
Photon emission for (n,d)

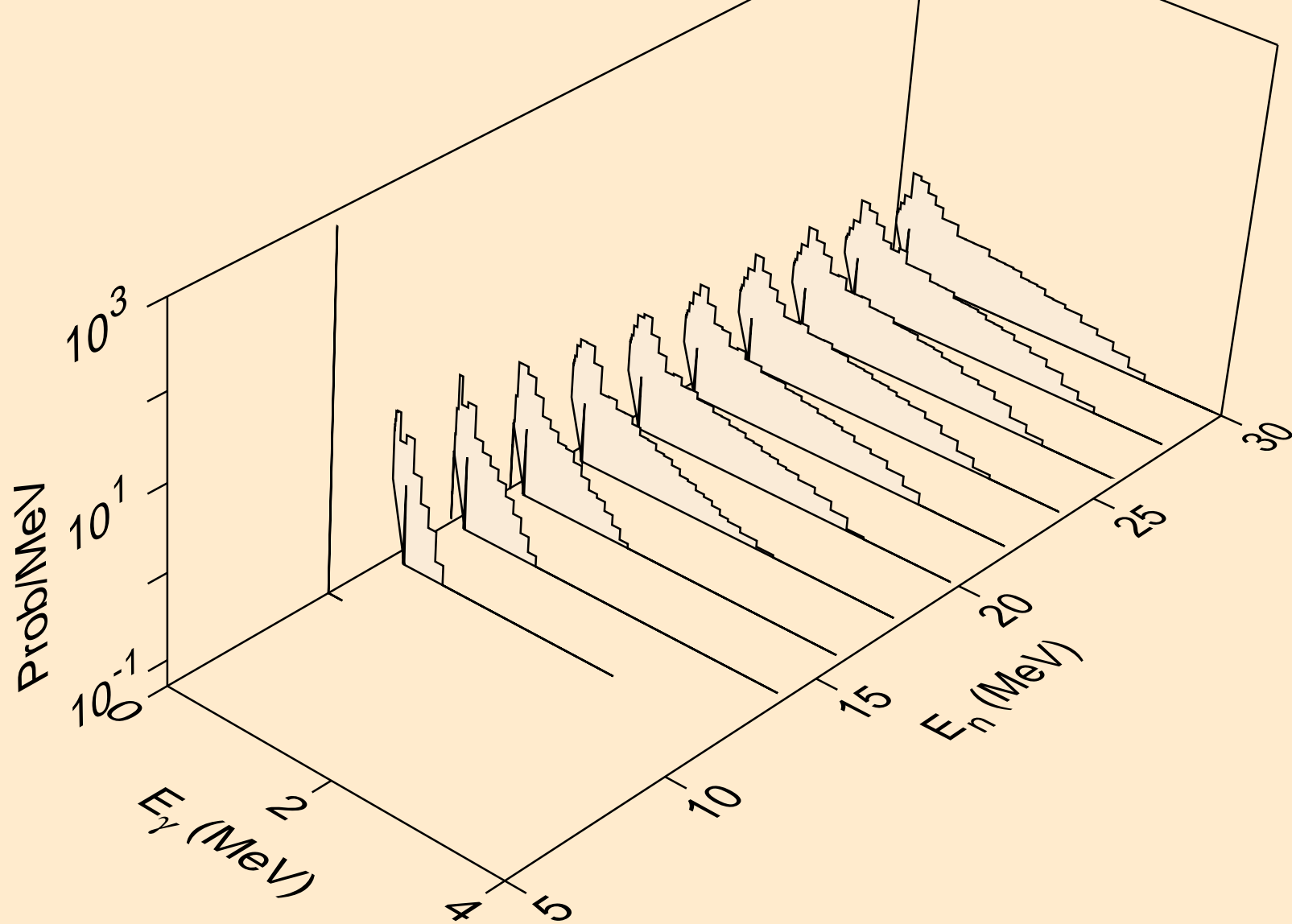

PM159 NEUTRON ACER TENDL-2021 LIBRARY; T=293.6K
Photon emission for (n,t)

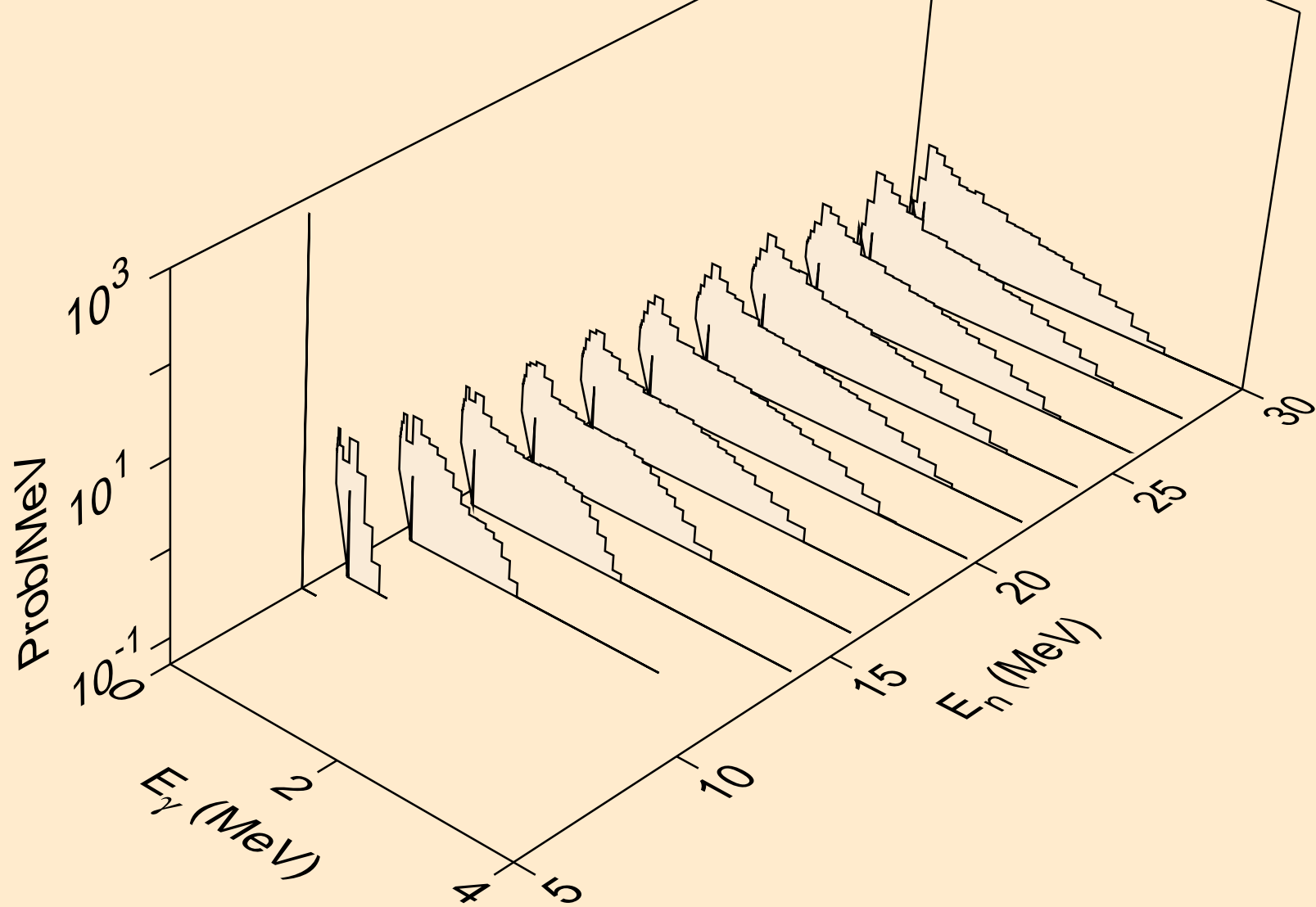

PM159 NEUTRON ACER TENDL-2021 LIBRARY; T=293.6K
Photon emission for (n,he3)

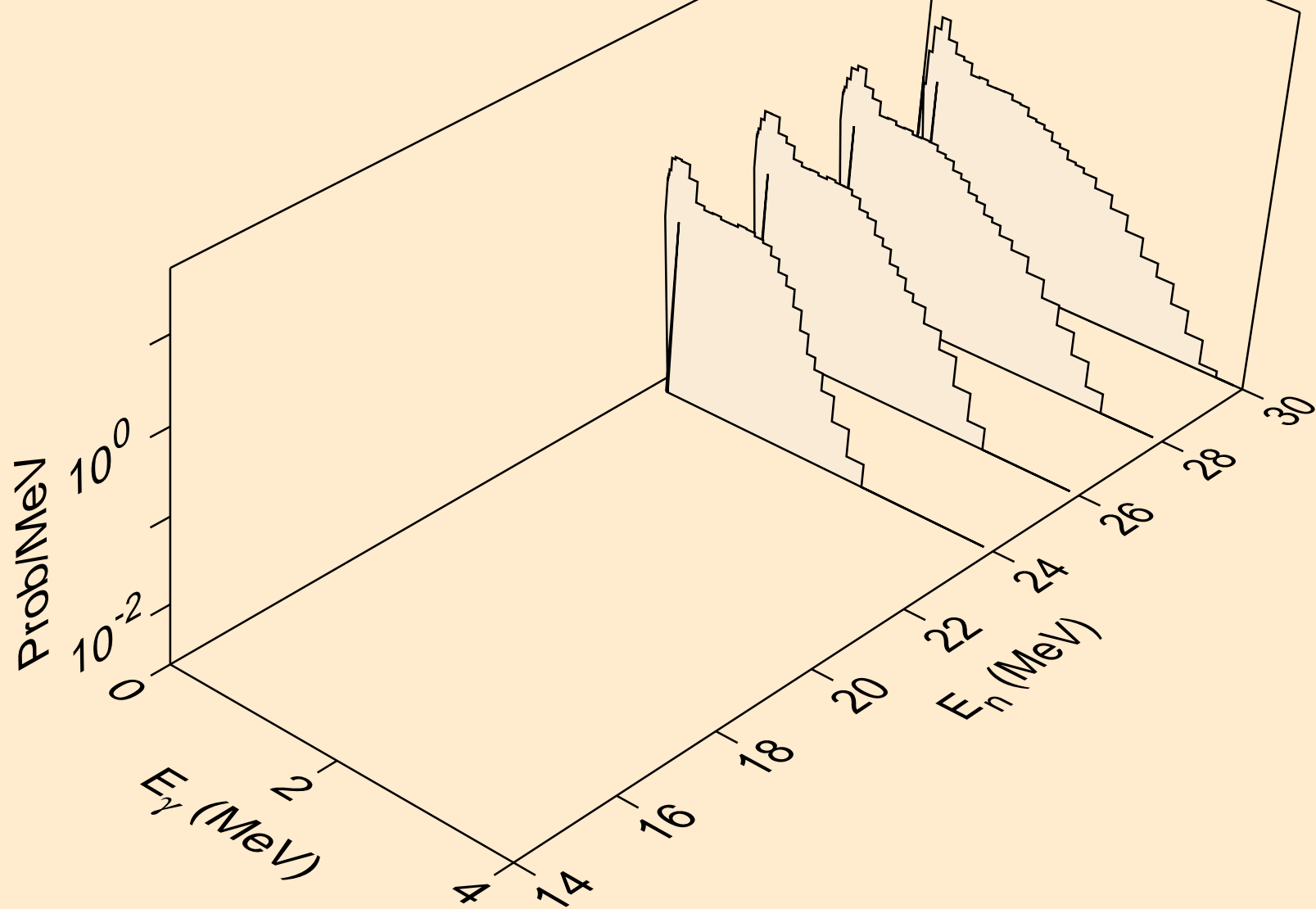

PM159 NEUTRON ACER TENDL-2021 LIBRARY; T=293.6K
Photon emission for (n,a)

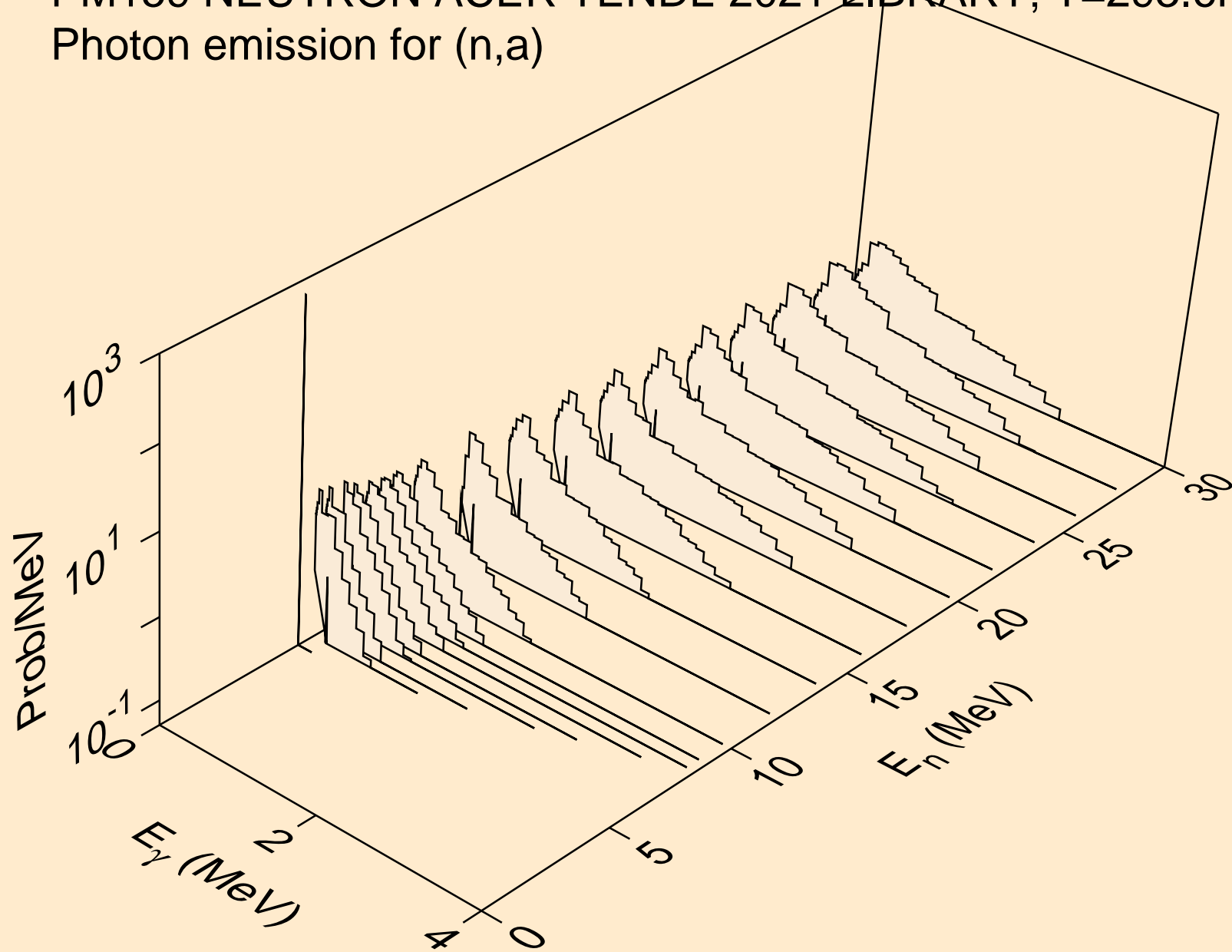

PM159 NEUTRON ACER TENDL-2021 LIBRARY; T=293.6K
thermal capture photon spectrum

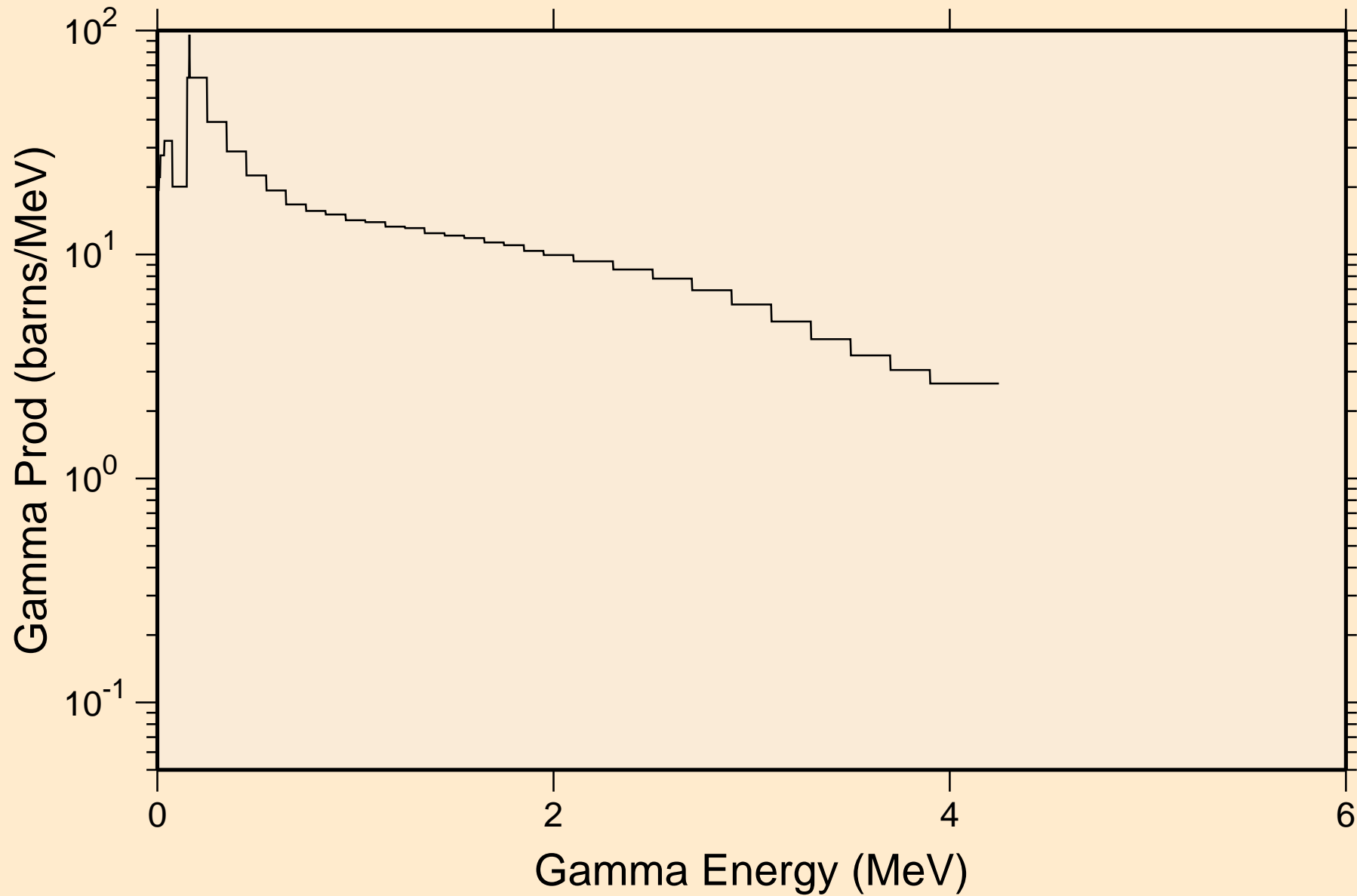

PM159 NEUTRON ACER TENDL-2021 LIBRARY; T=293.6K
14 MeV photon spectrum

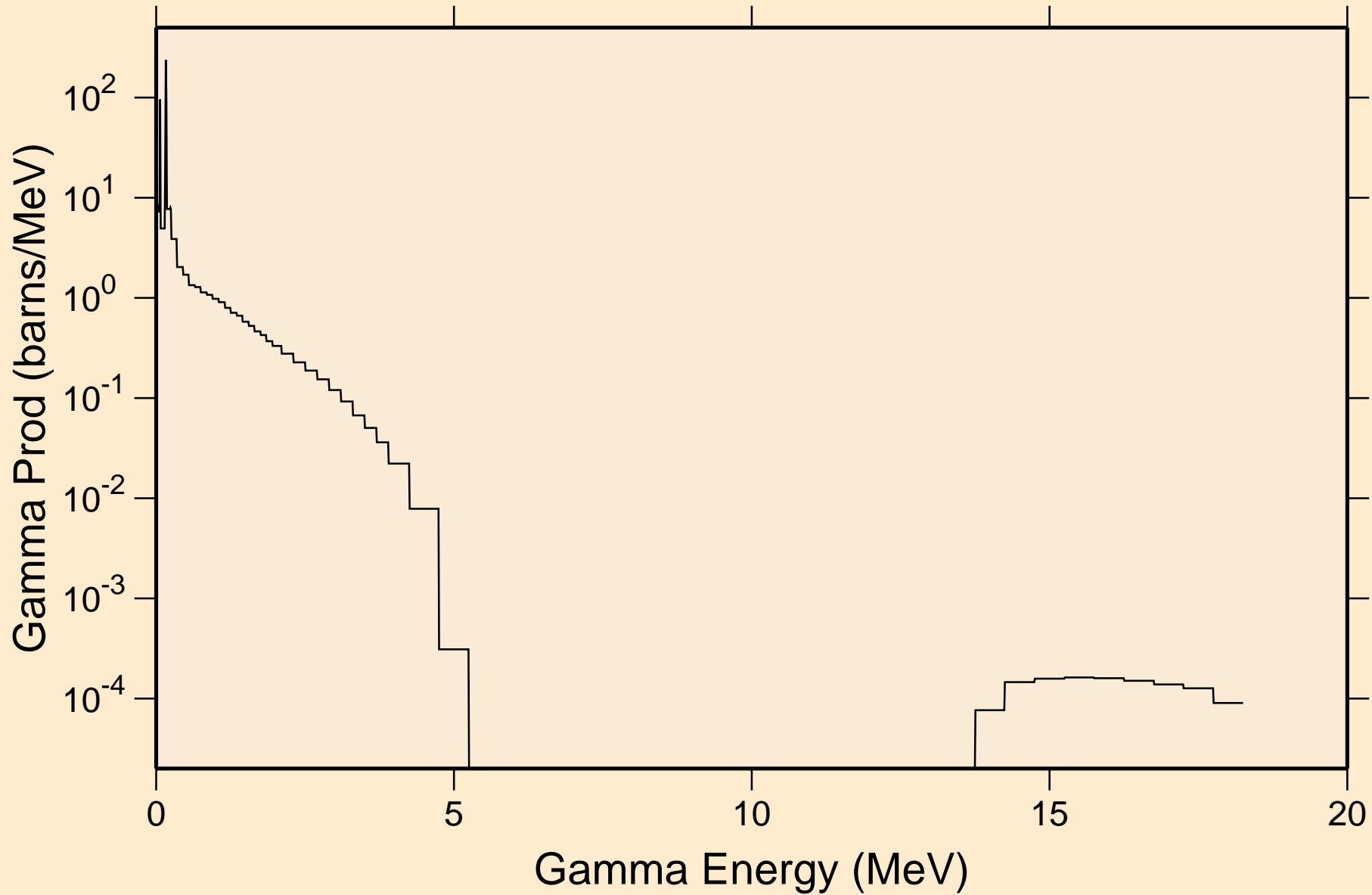

PM159 NEUTRON ACER TENDL-2021 LIBRARY; T=293.6K
Particle heating contributions

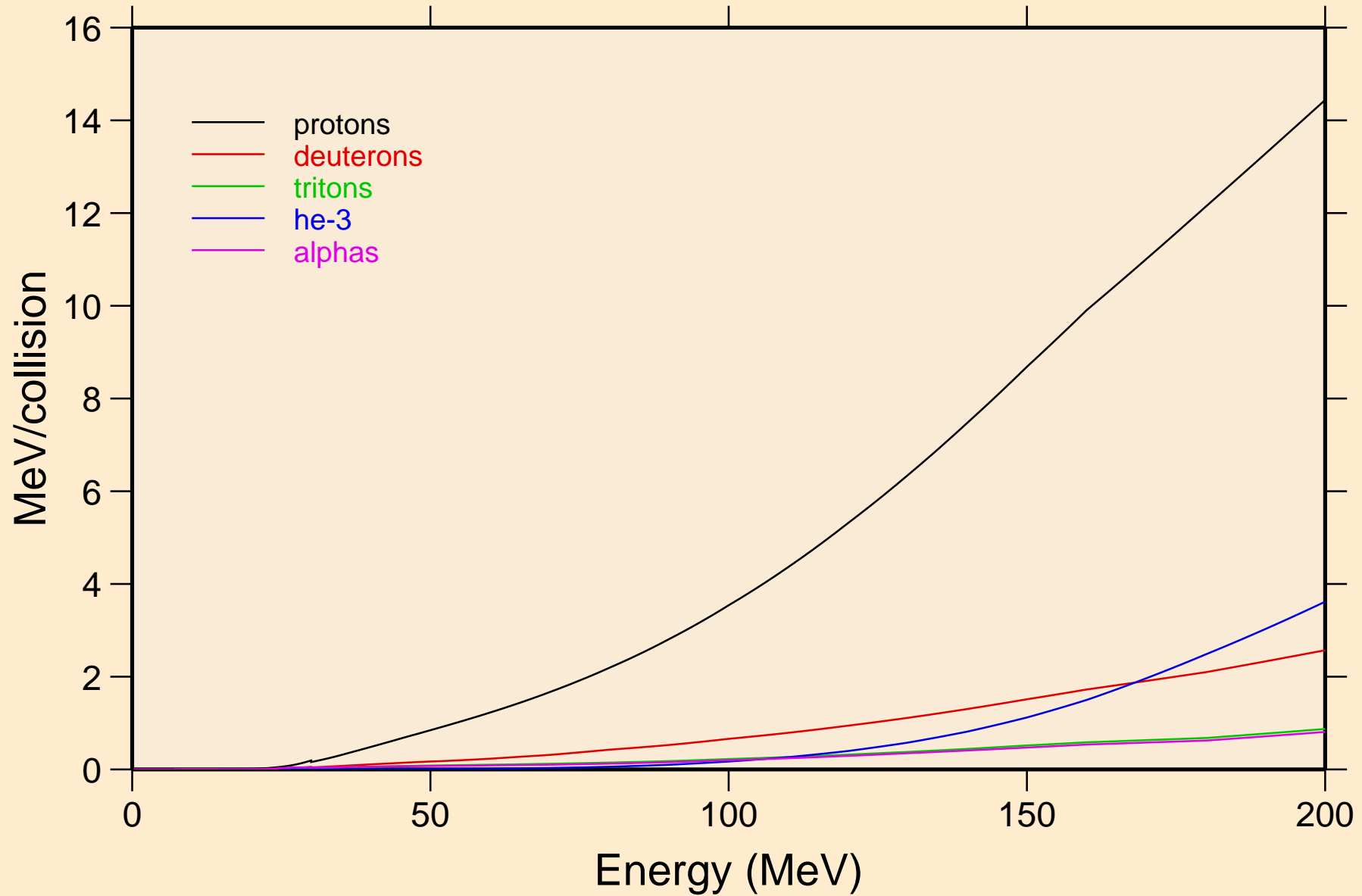

PM159 NEUTRON ACER TENDL-2021 LIBRARY; T=293.6K
Recoil Heating

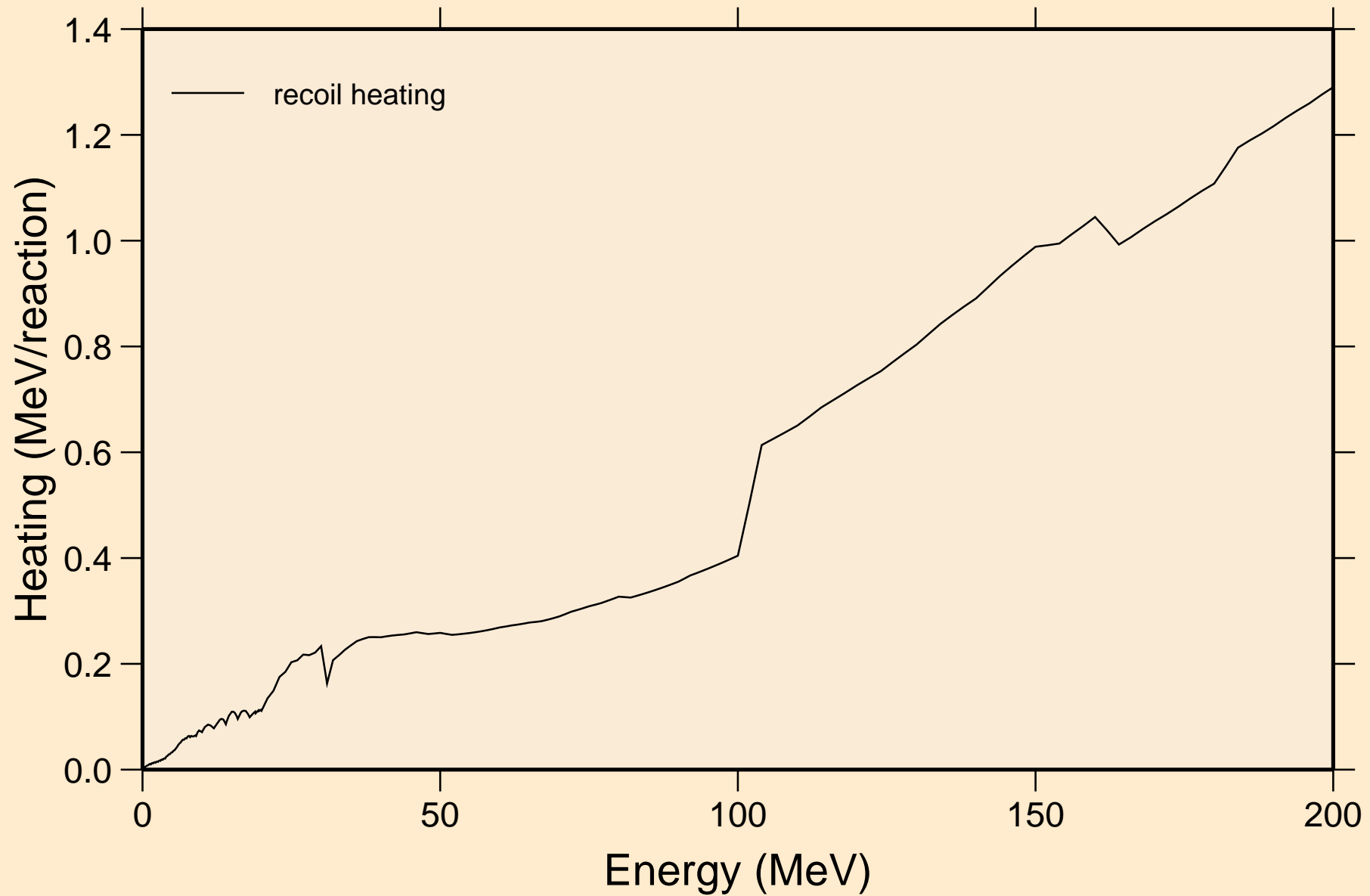

PM159 NEUTRON ACER TENDL-2021 LIBRARY; T=293.6K
Particle production cross sections

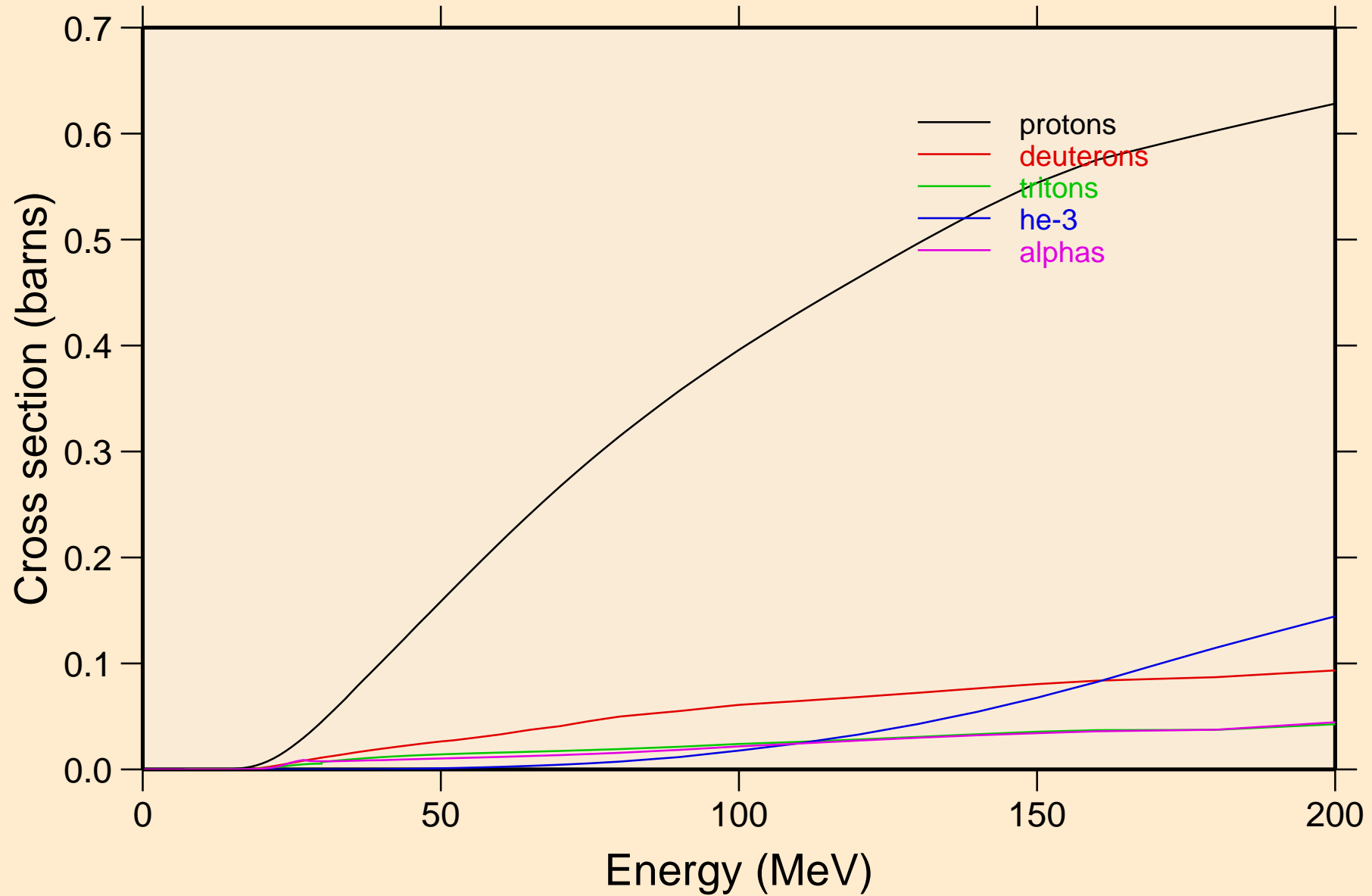

PM159 NEUTRON ACER TENDL-2021 LIBRARY; T=293.6K
protons from (n,x)

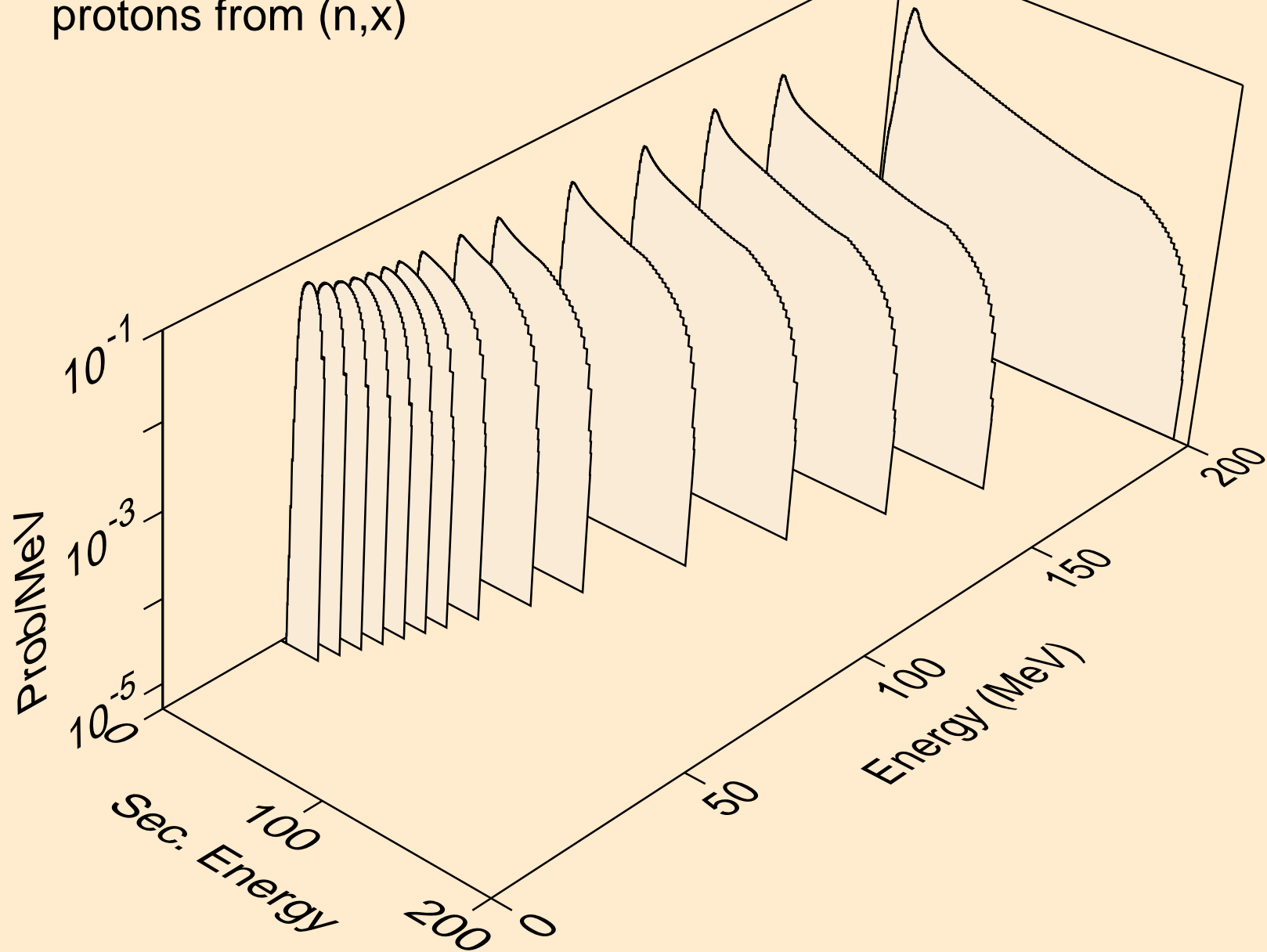

PM159 NEUTRON ACER TENDL-2021 LIBRARY; T=293.6K
protons from (n,n*)p

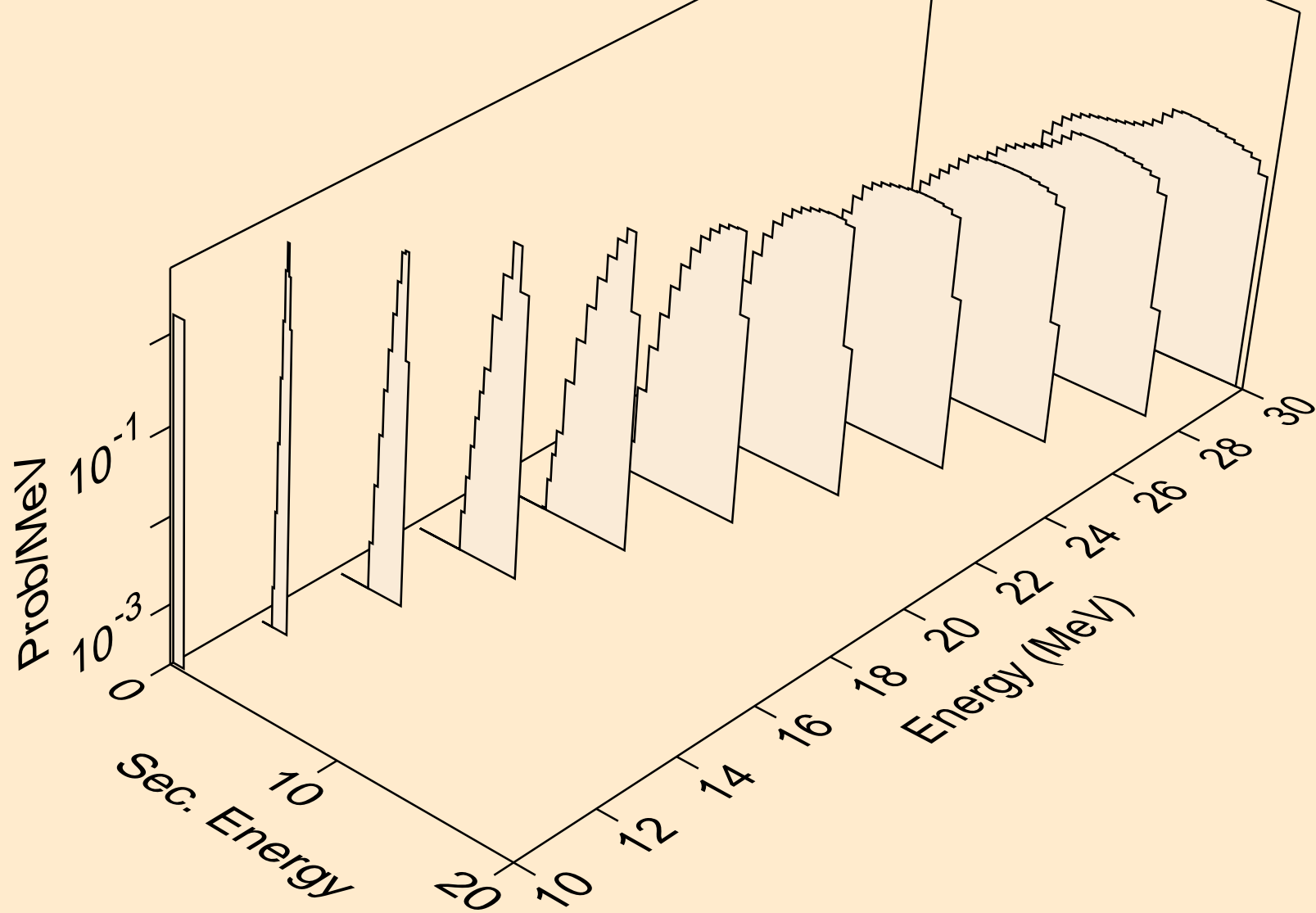

PM159 NEUTRON ACER TENDL-2021 LIBRARY; T=293.6K
protons from (n,2np)

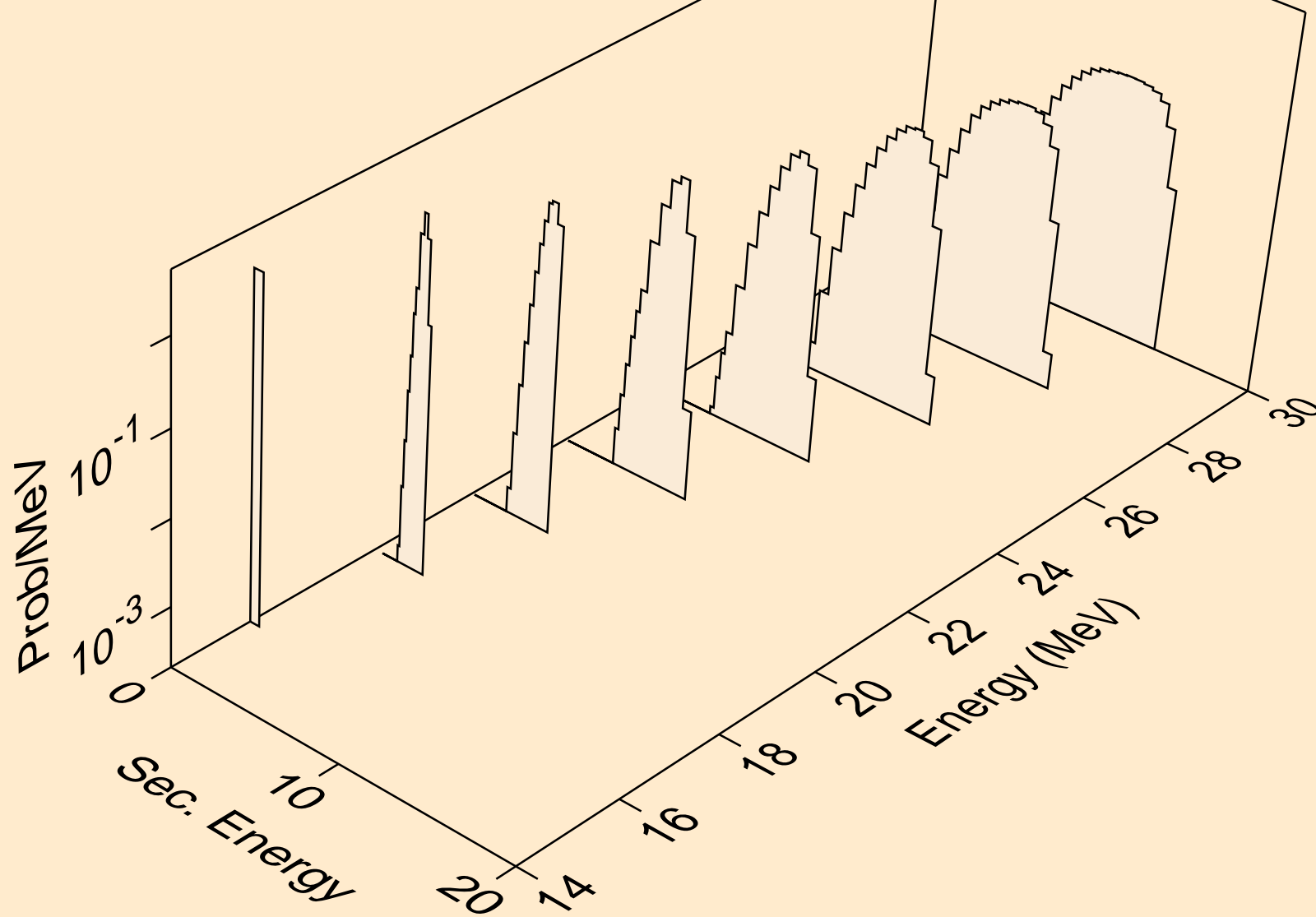

PM159 NEUTRON ACER TENDL-2021 LIBRARY; T=293.6K
protons from (n,3np)

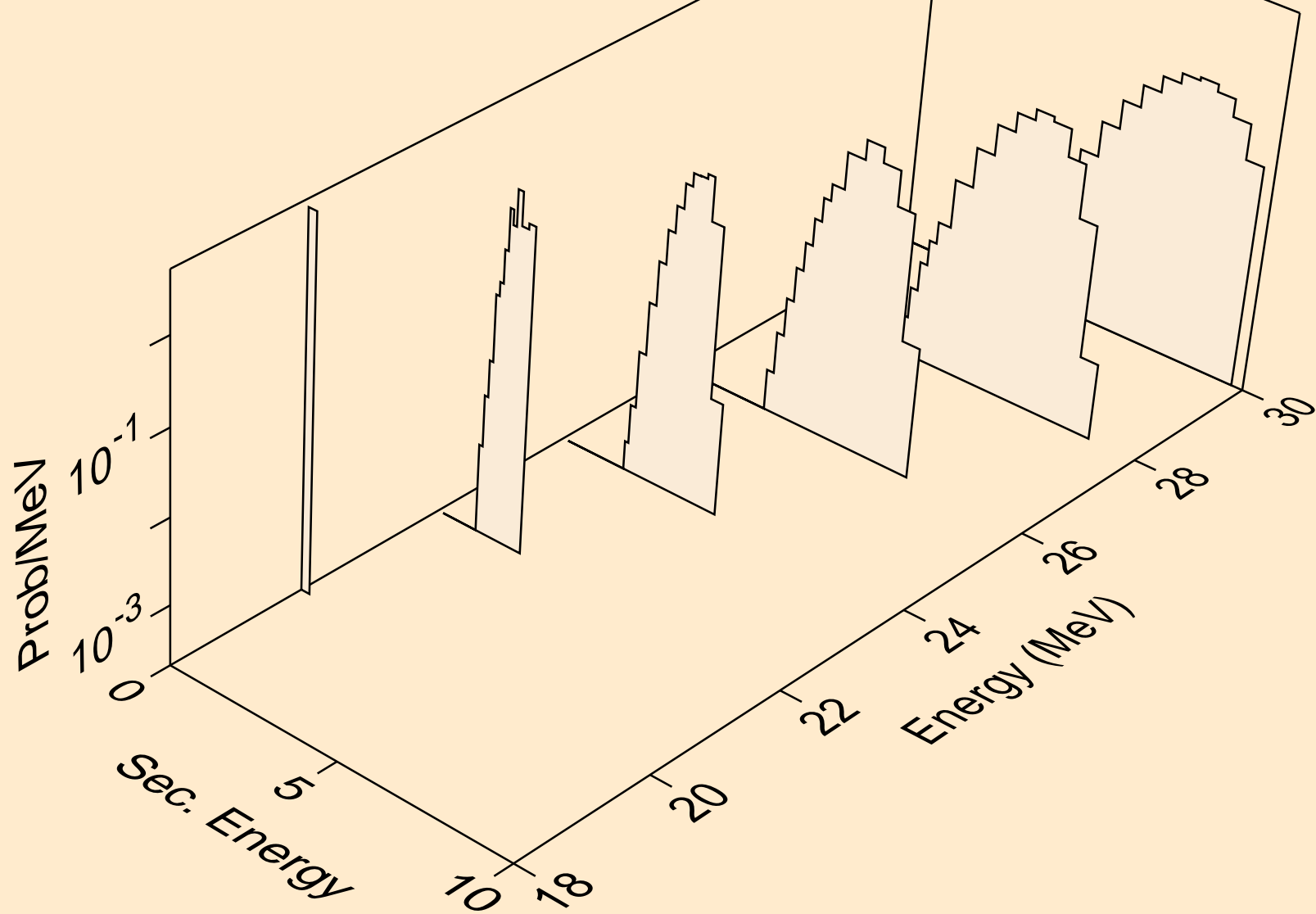

PM159 NEUTRON ACER TENDL-2021 LIBRARY; T=293.6K
protons from (n,p)

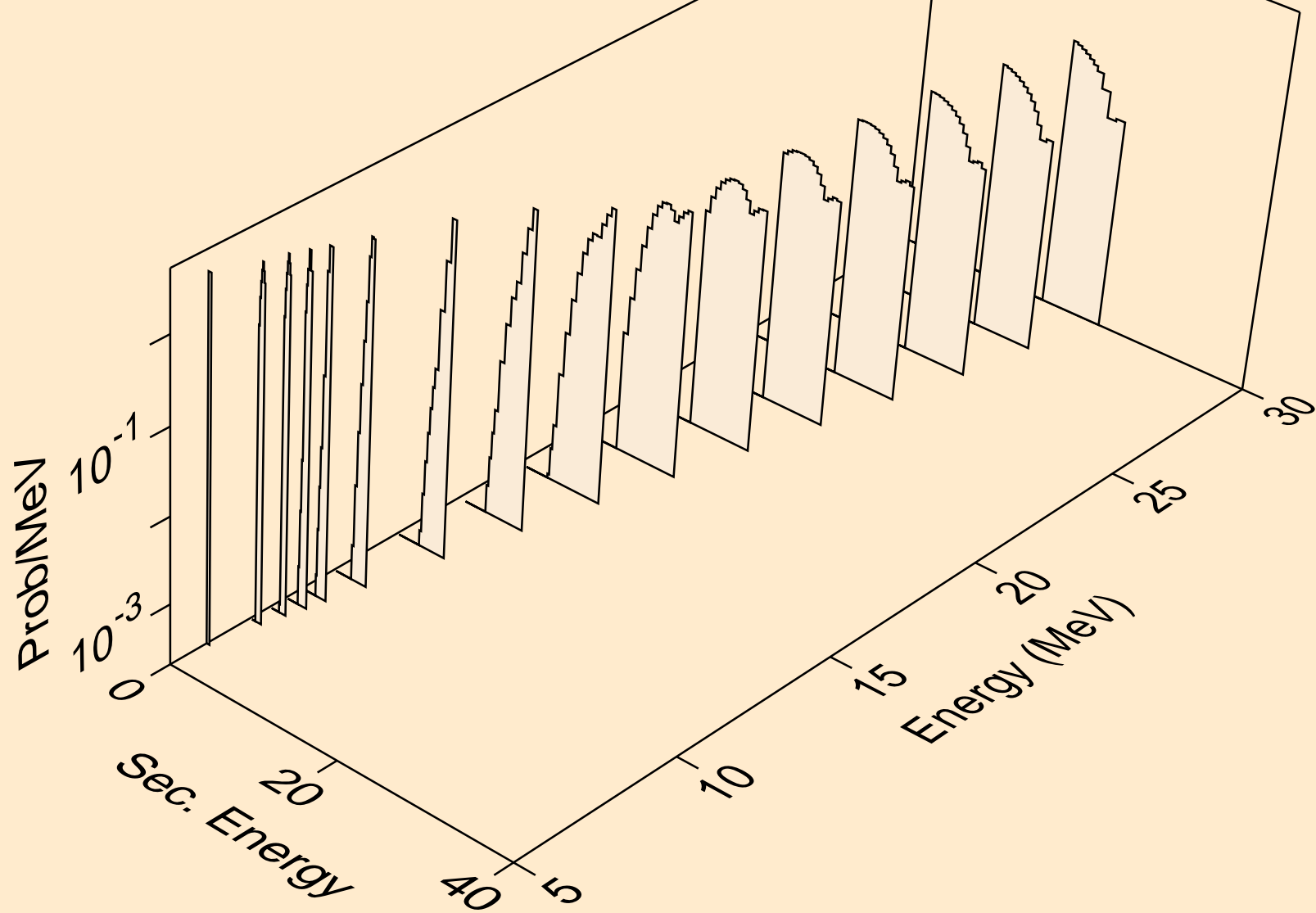

PM159 NEUTRON ACER TENDL-2021 LIBRARY; T=293.6K
deuterons from (n,x)

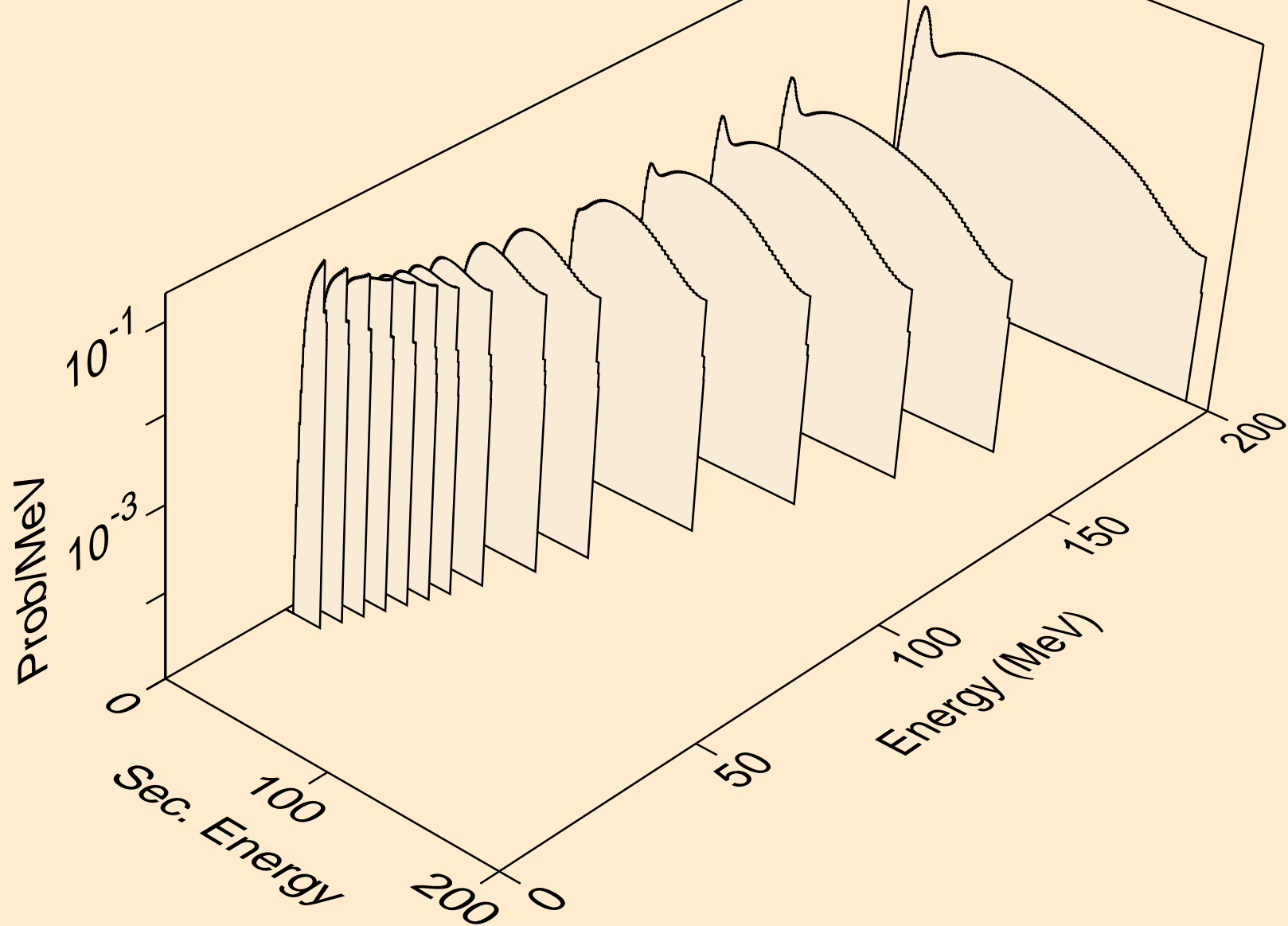

PM159 NEUTRON ACER TENDL-2021 LIBRARY; T=293.6K
deuterons from (n,2nd)

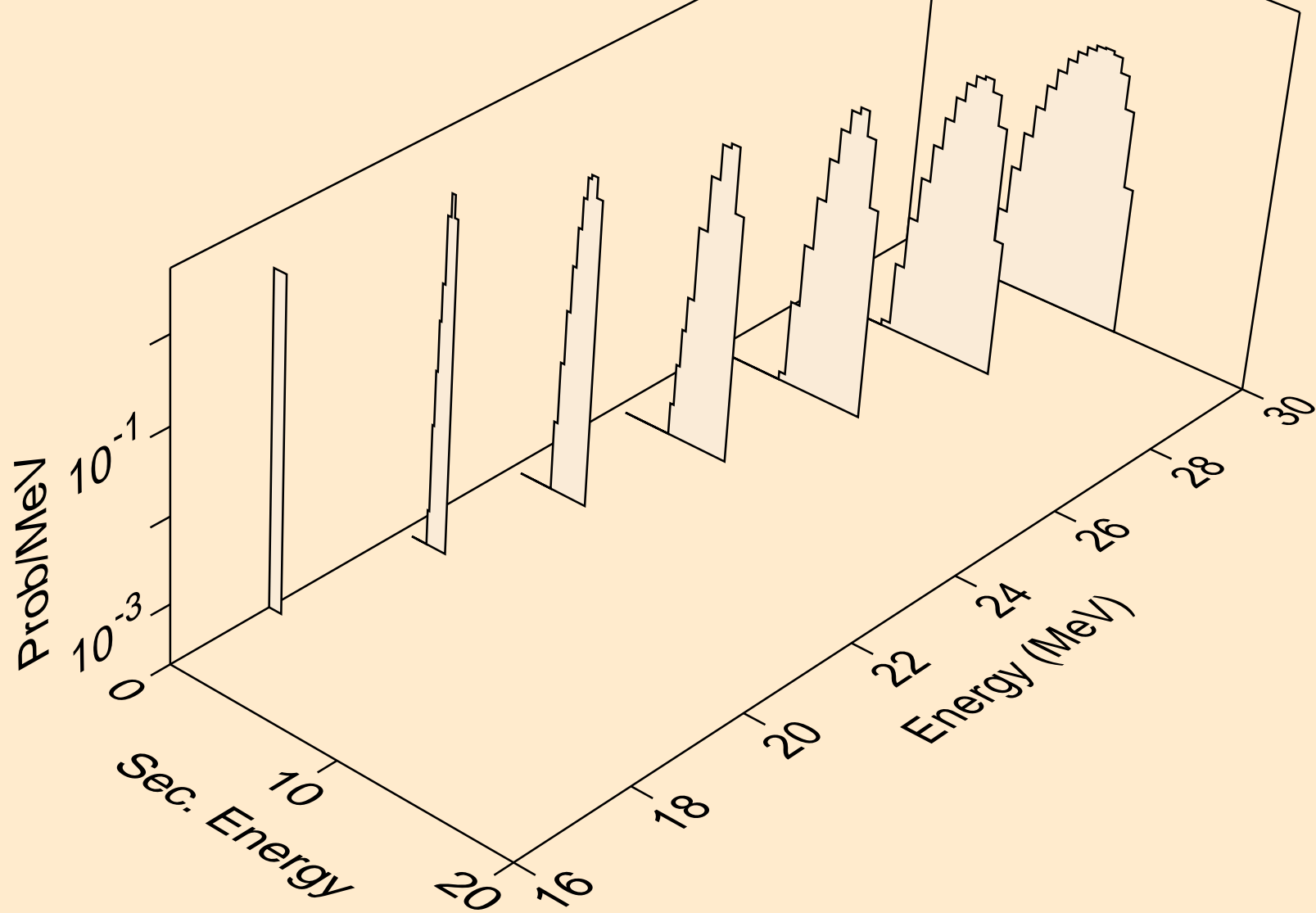

PM159 NEUTRON ACER TENDL-2021 LIBRARY; T=293.6K
deuterons from (n,n*)d

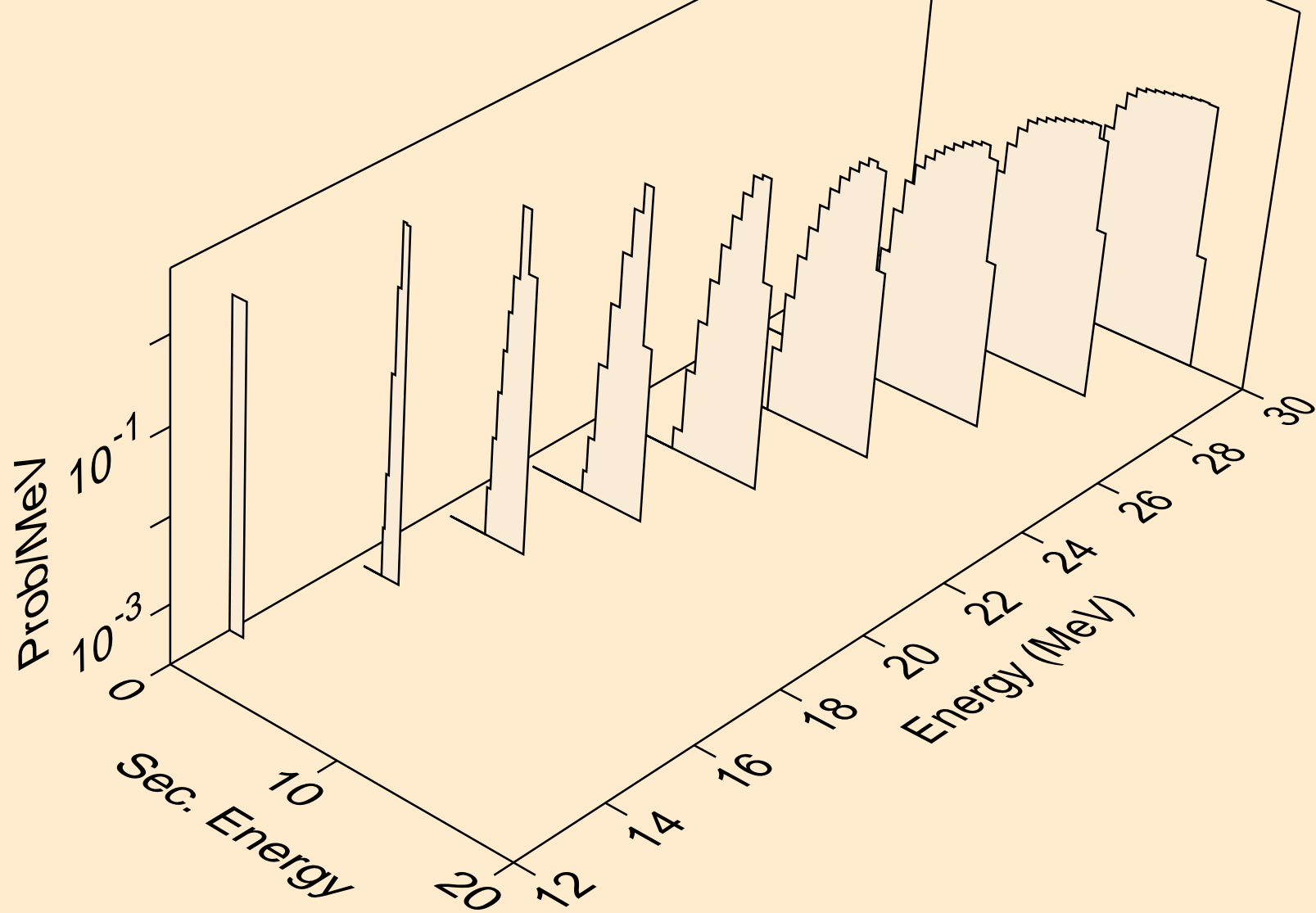

PM159 NEUTRON ACER TENDL-2021 LIBRARY; T=293.6K
deuterons from (n,d)

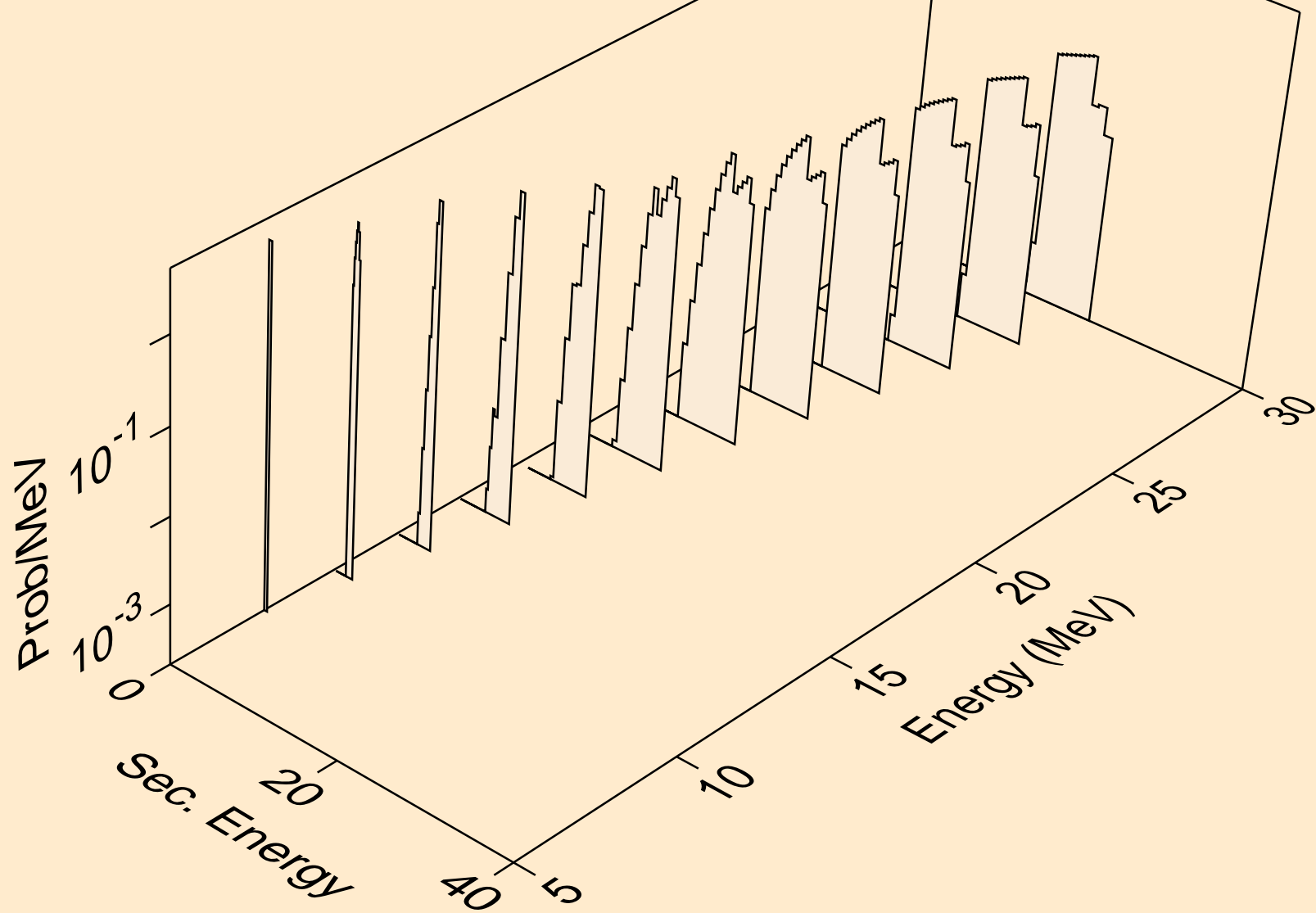

PM159 NEUTRON ACER TENDL-2021 LIBRARY; T=293.6K
tritons from (n,x)

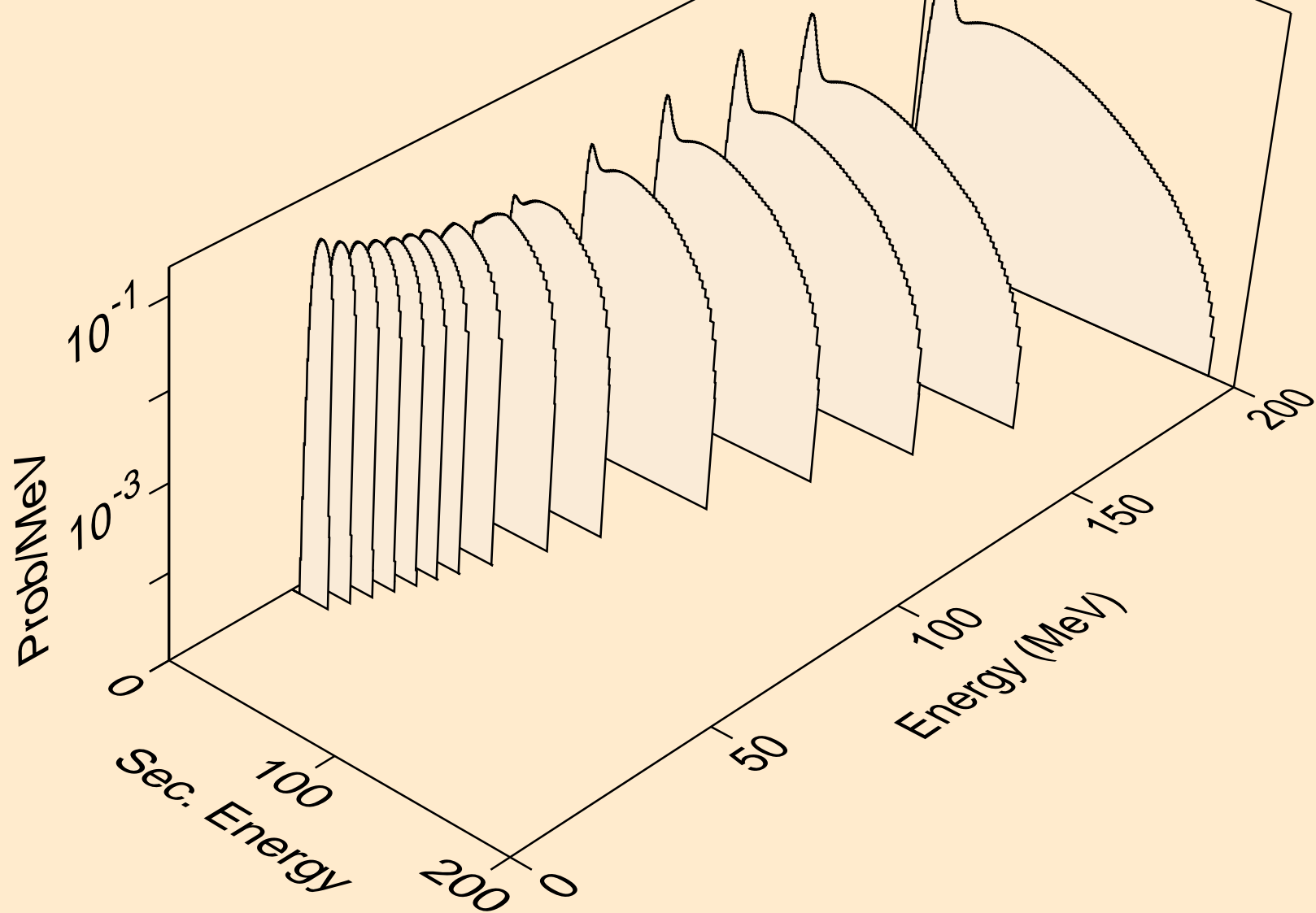

PM159 NEUTRON ACER TENDL-2021 LIBRARY; T=293.6K
tritons from (n,n*)t

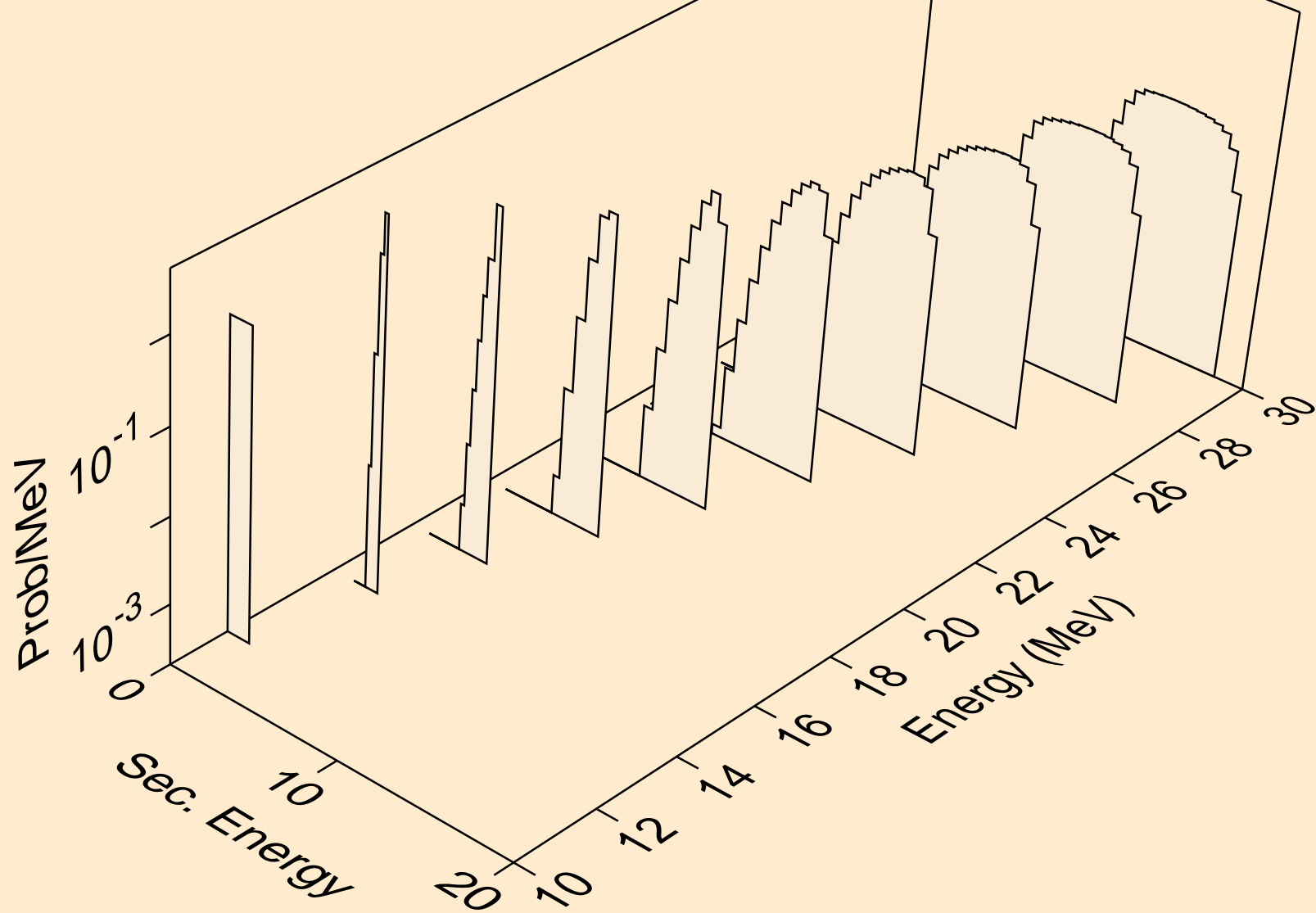

PM159 NEUTRON ACER TENDL-2021 LIBRARY; T=293.6K
tritons from (n,t)

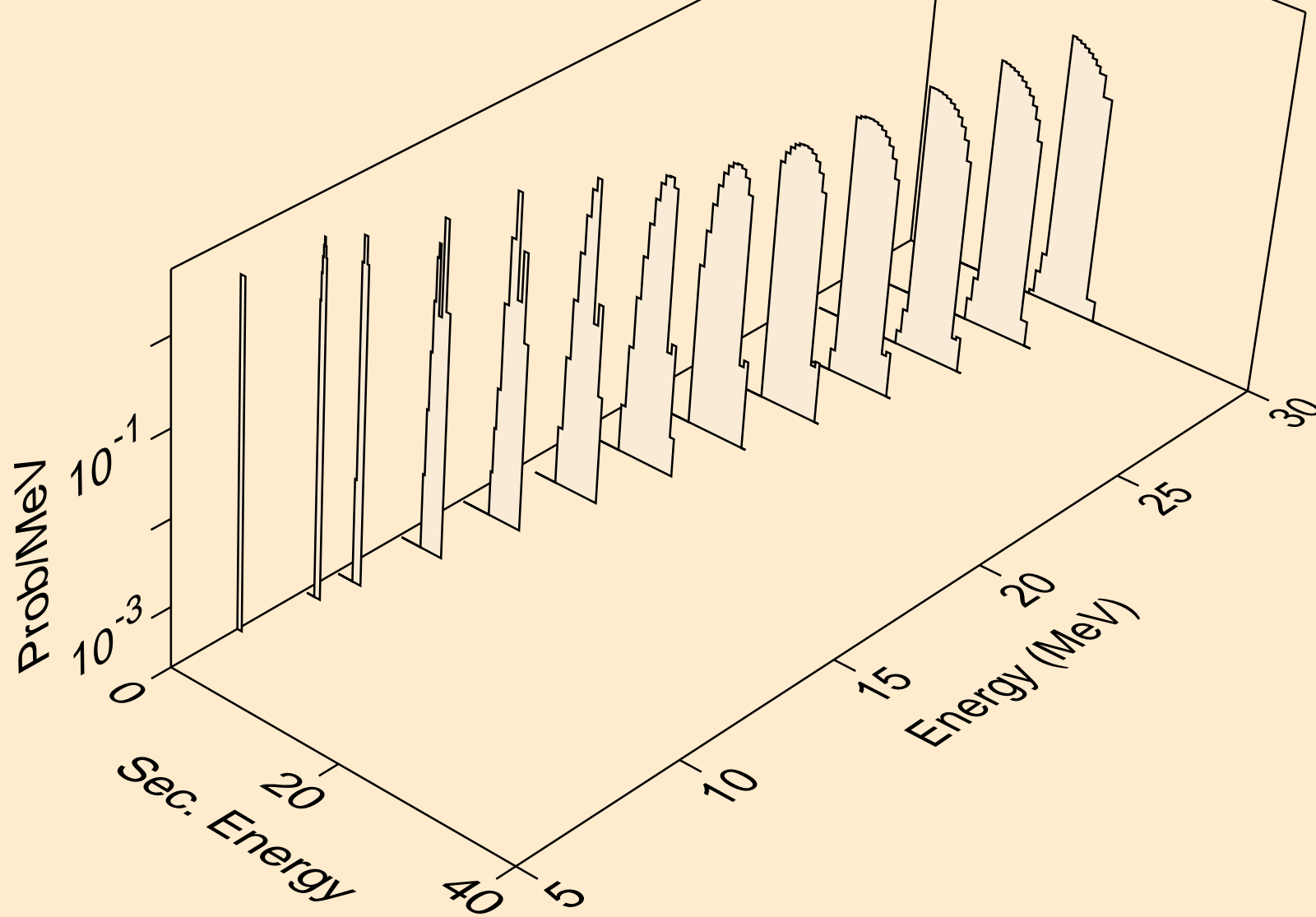

PM159 NEUTRON ACER TENDL-2021 LIBRARY; T=293.6K
he3s from (n,x)

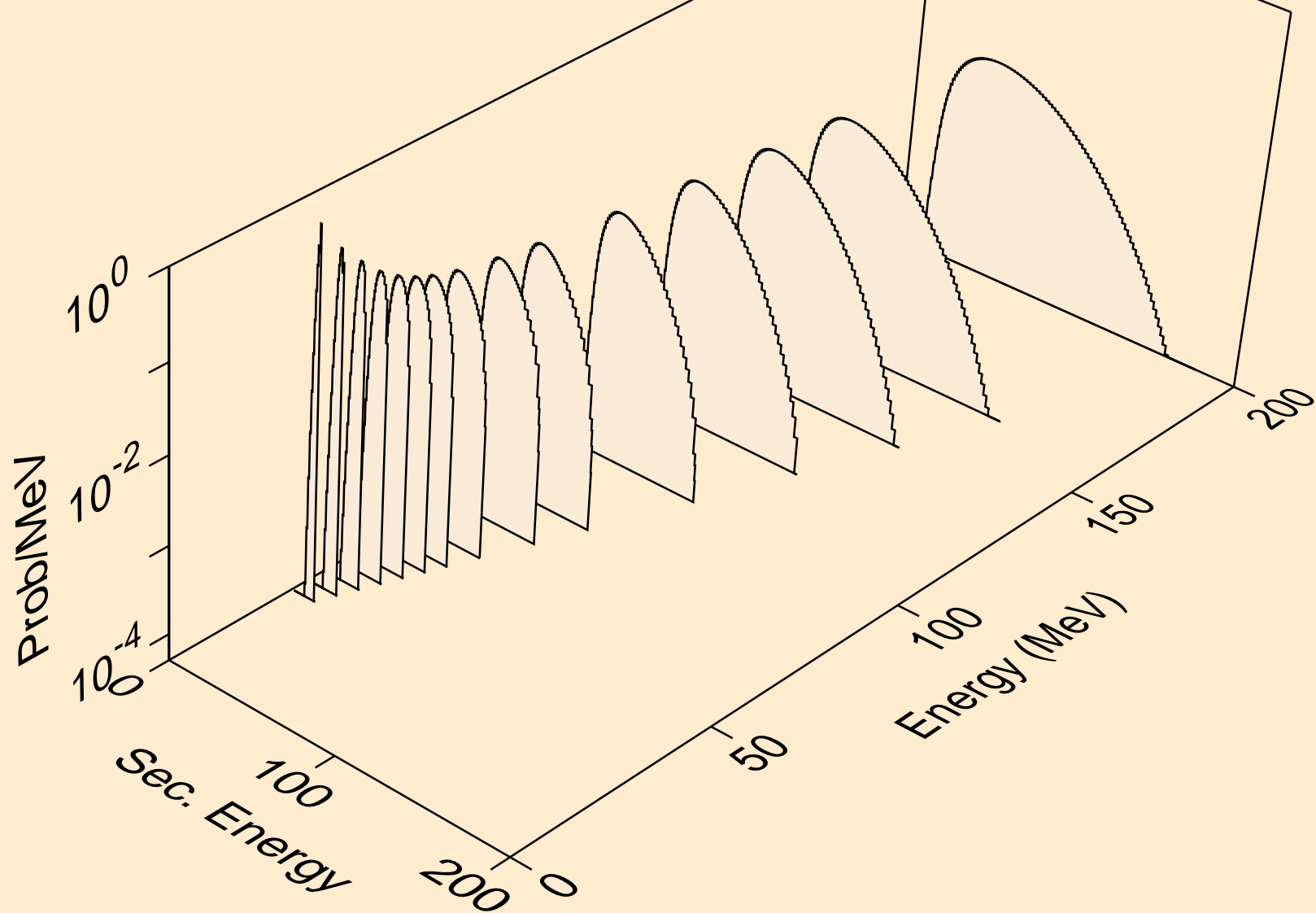

PM159 NEUTRON ACER TENDL-2021 LIBRARY; T=293.6K
he3s from (n,he3)

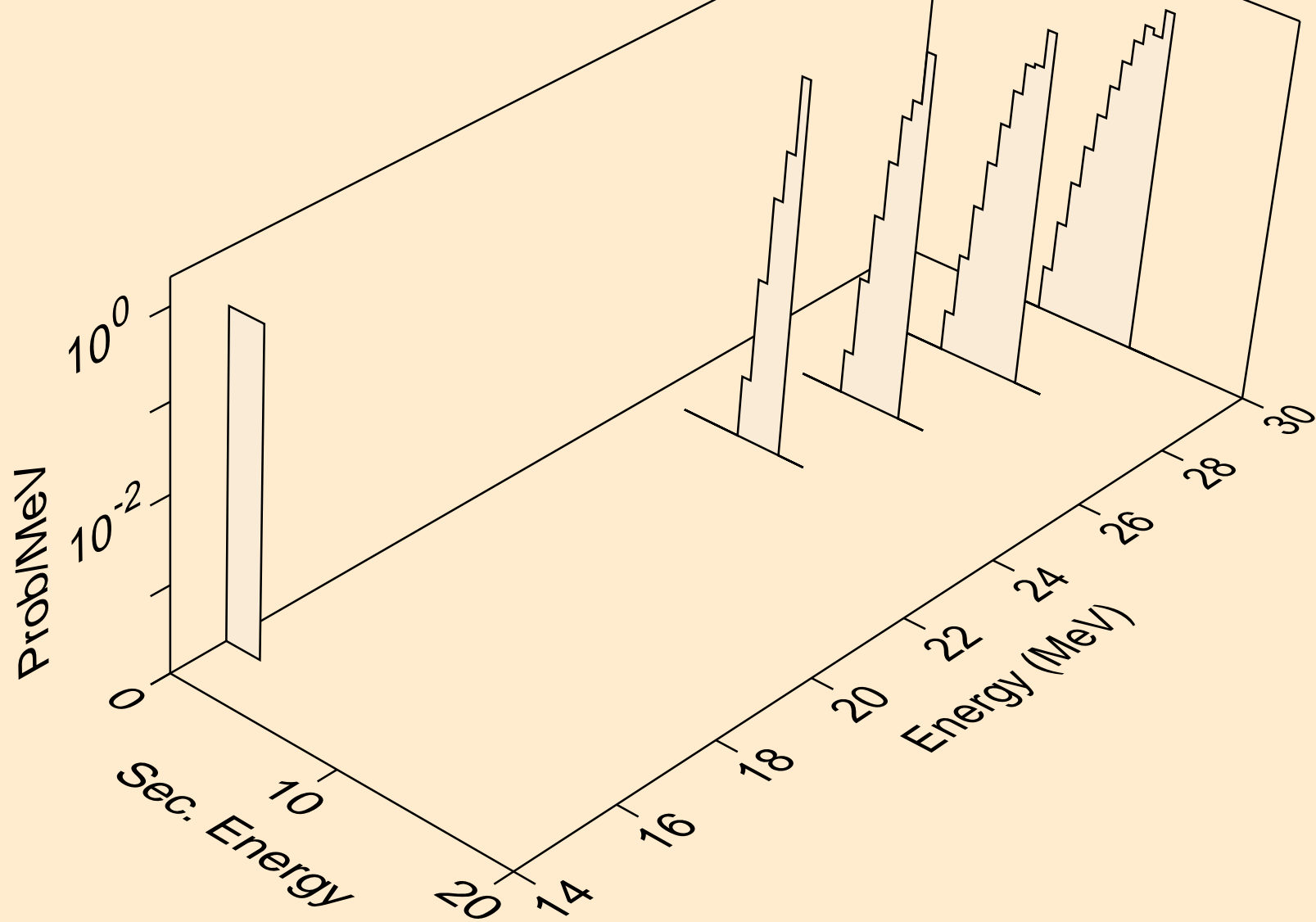

PM159 NEUTRON ACER TENDL-2021 LIBRARY; T=293.6K
alphas from (n,x)

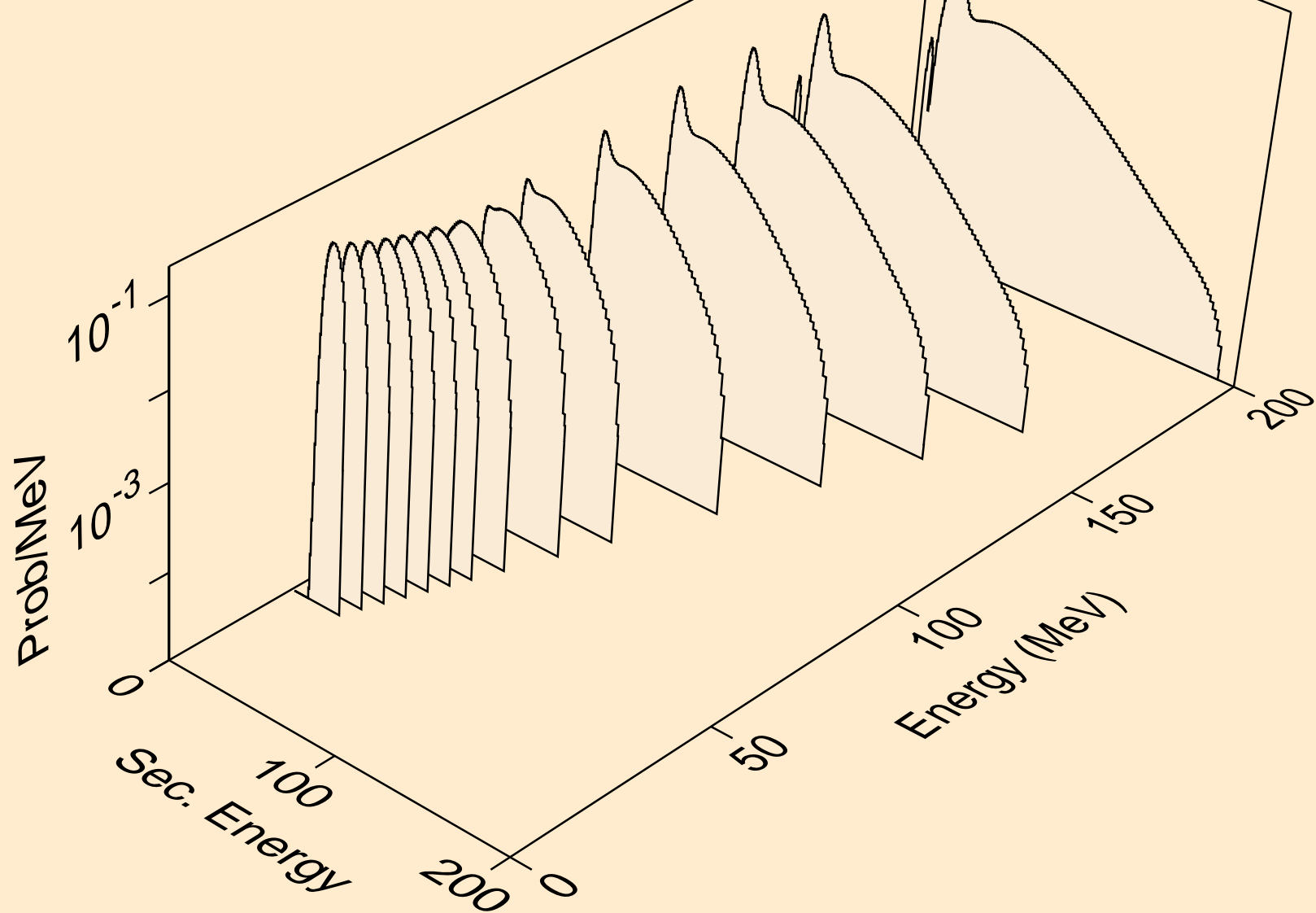

PM159 NEUTRON ACER TENDL-2021 LIBRARY; T=293.6K
alphas from (n,n*)a

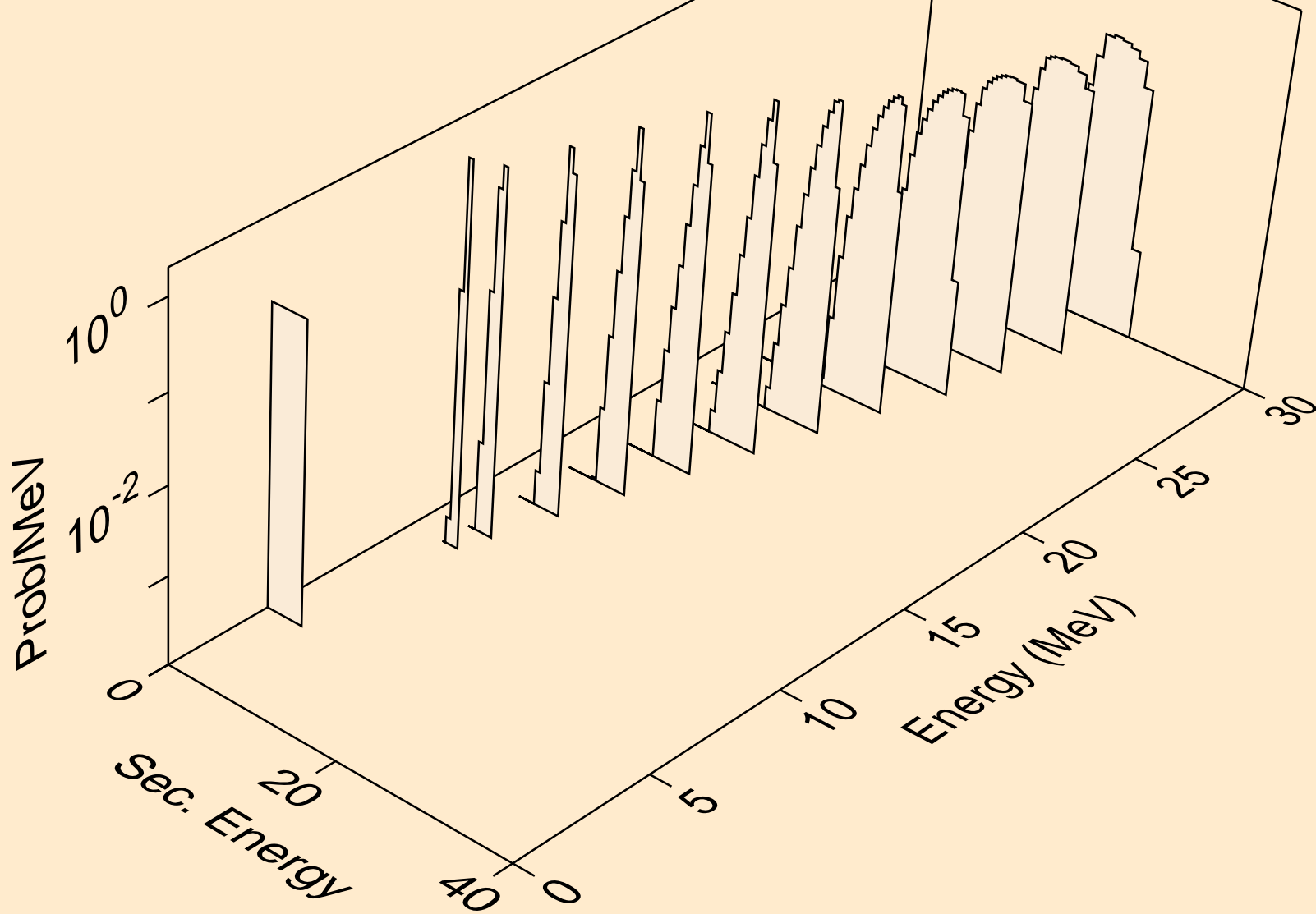

PM159 NEUTRON ACER TENDL-2021 LIBRARY; T=293.6K
alphas from (n,2n)a

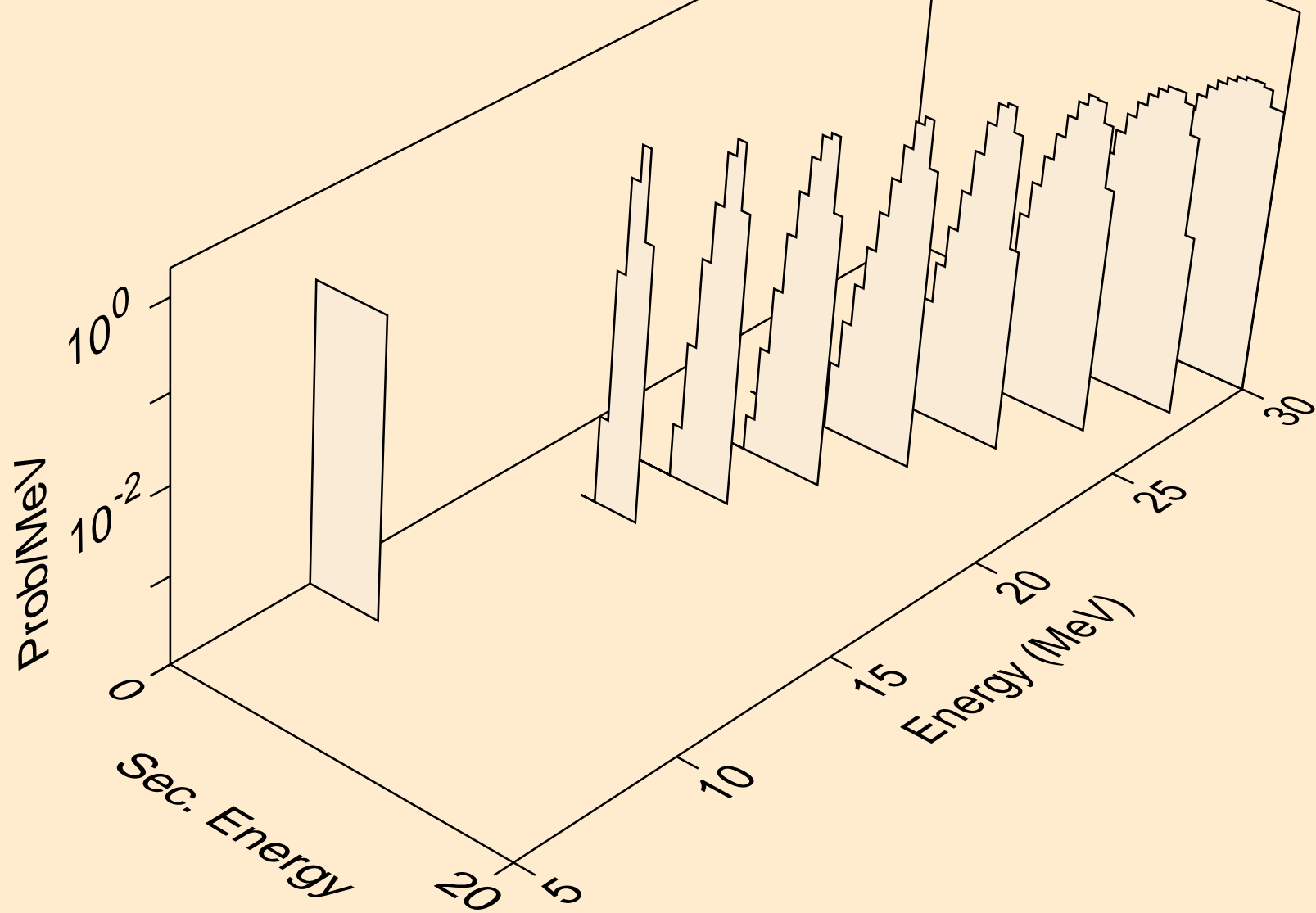

PM159 NEUTRON ACER TENDL-2021 LIBRARY; T=293.6K
alphas from (n,3n)a

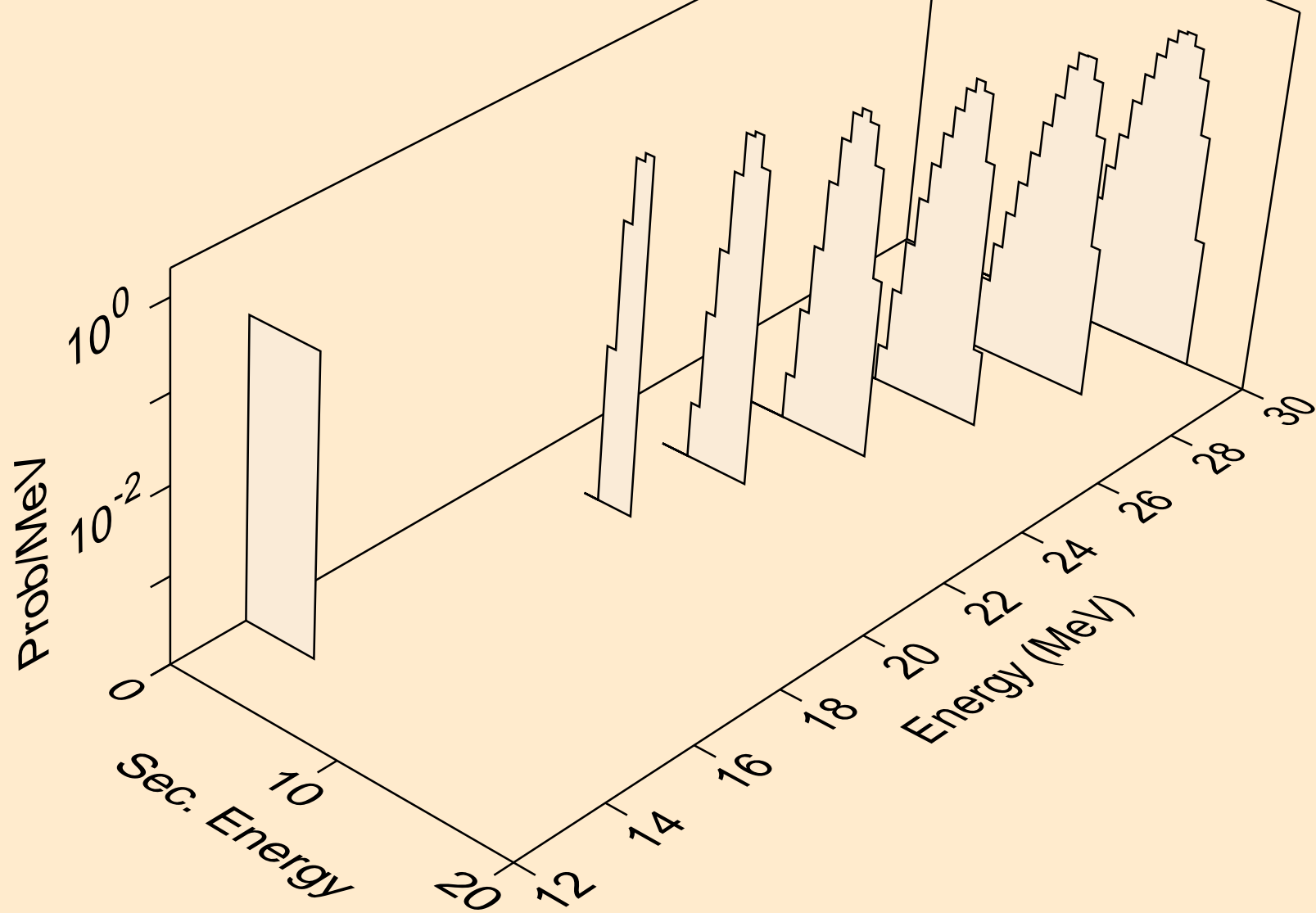

PM159 NEUTRON ACER TENDL-2021 LIBRARY; T=293.6K
alphas from (n,a)

