

PO195 NEUTRON ACER TENDL-2021 LIBRARY; T=293.6K
Principal cross sections

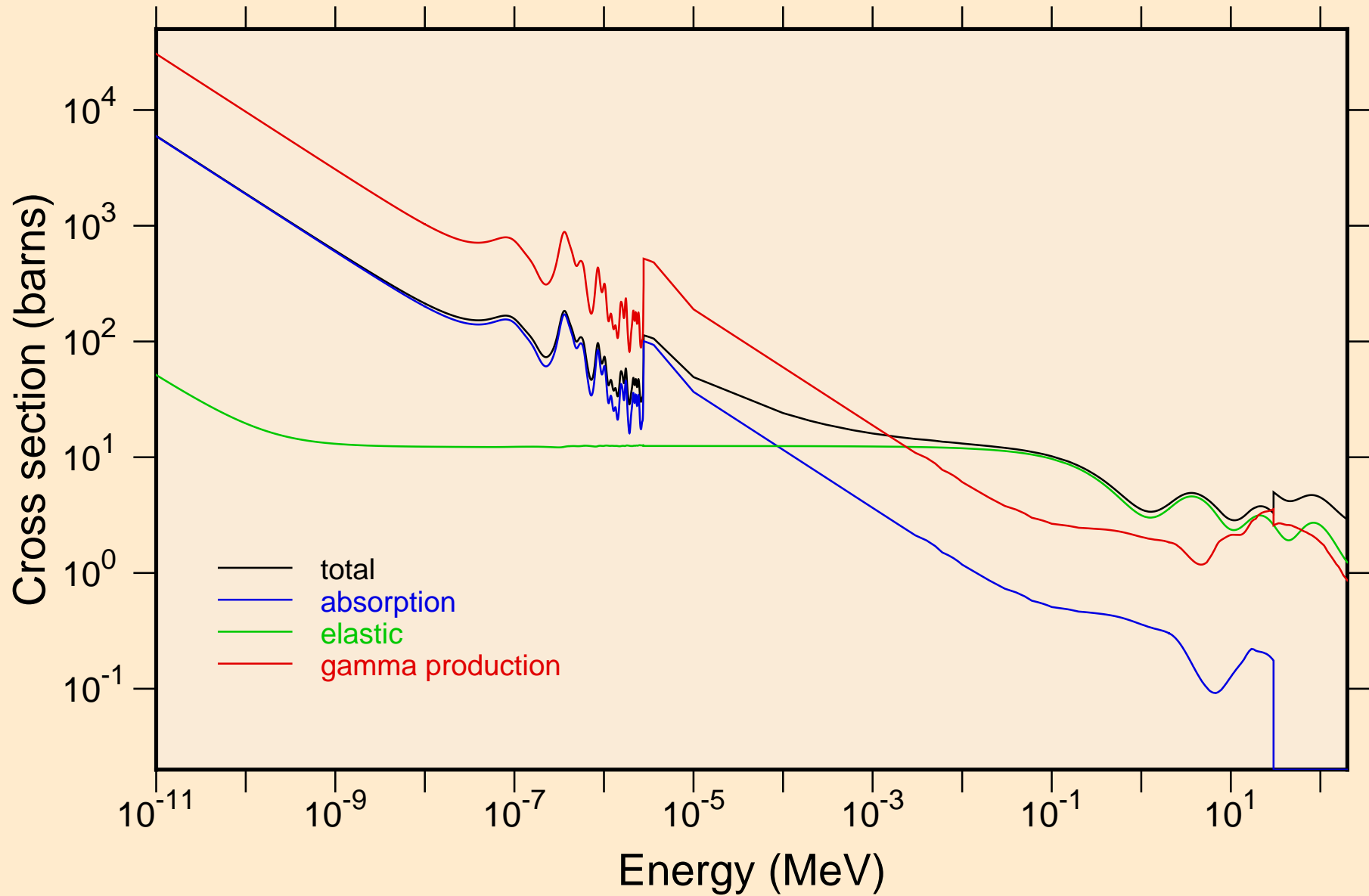

PO195 NEUTRON ACER TENDL-2021 LIBRARY; T=293.6K
Heating

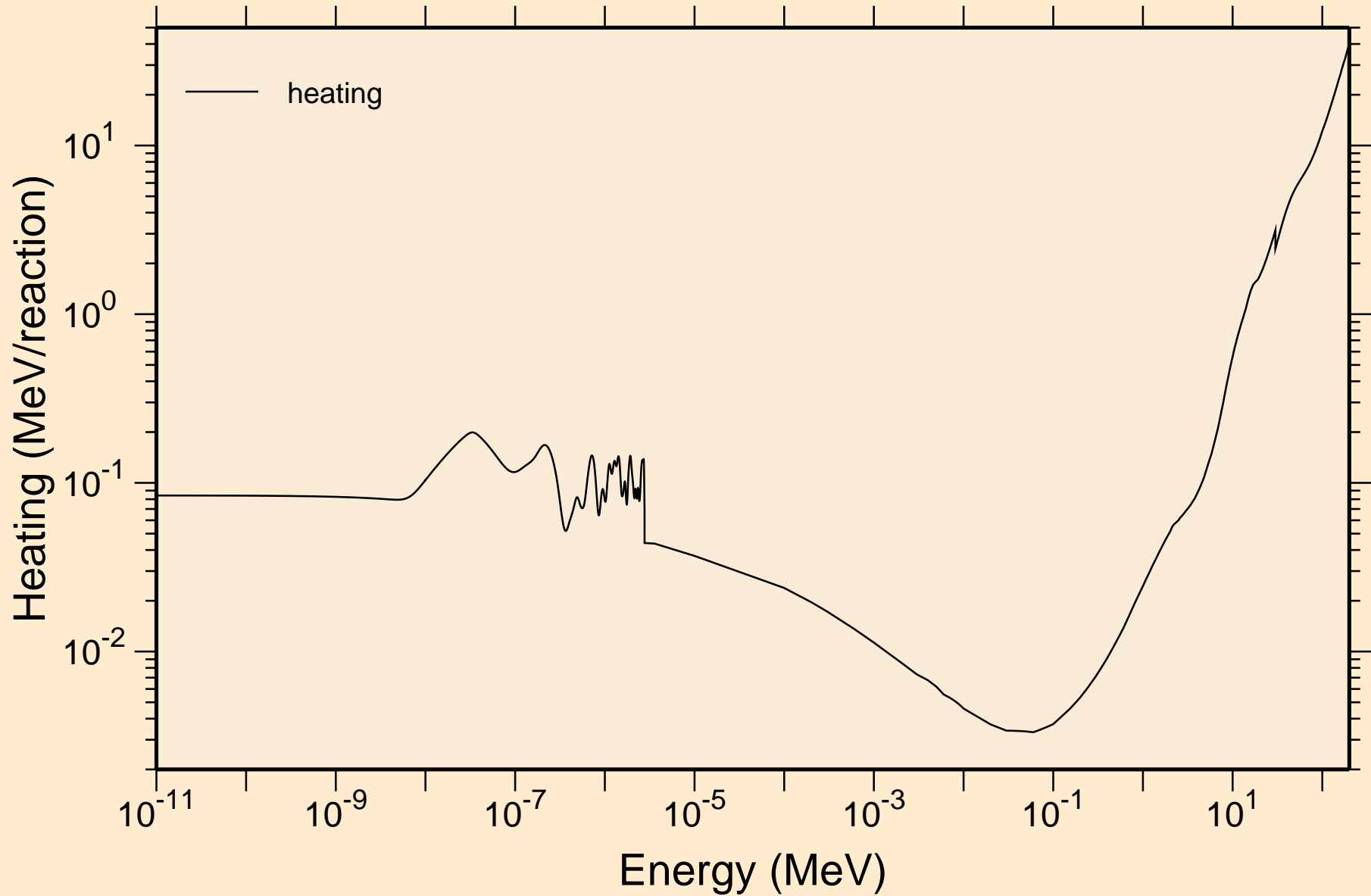

PO195 NEUTRON ACER TENDL-2021 LIBRARY; T=293.6K
Damage

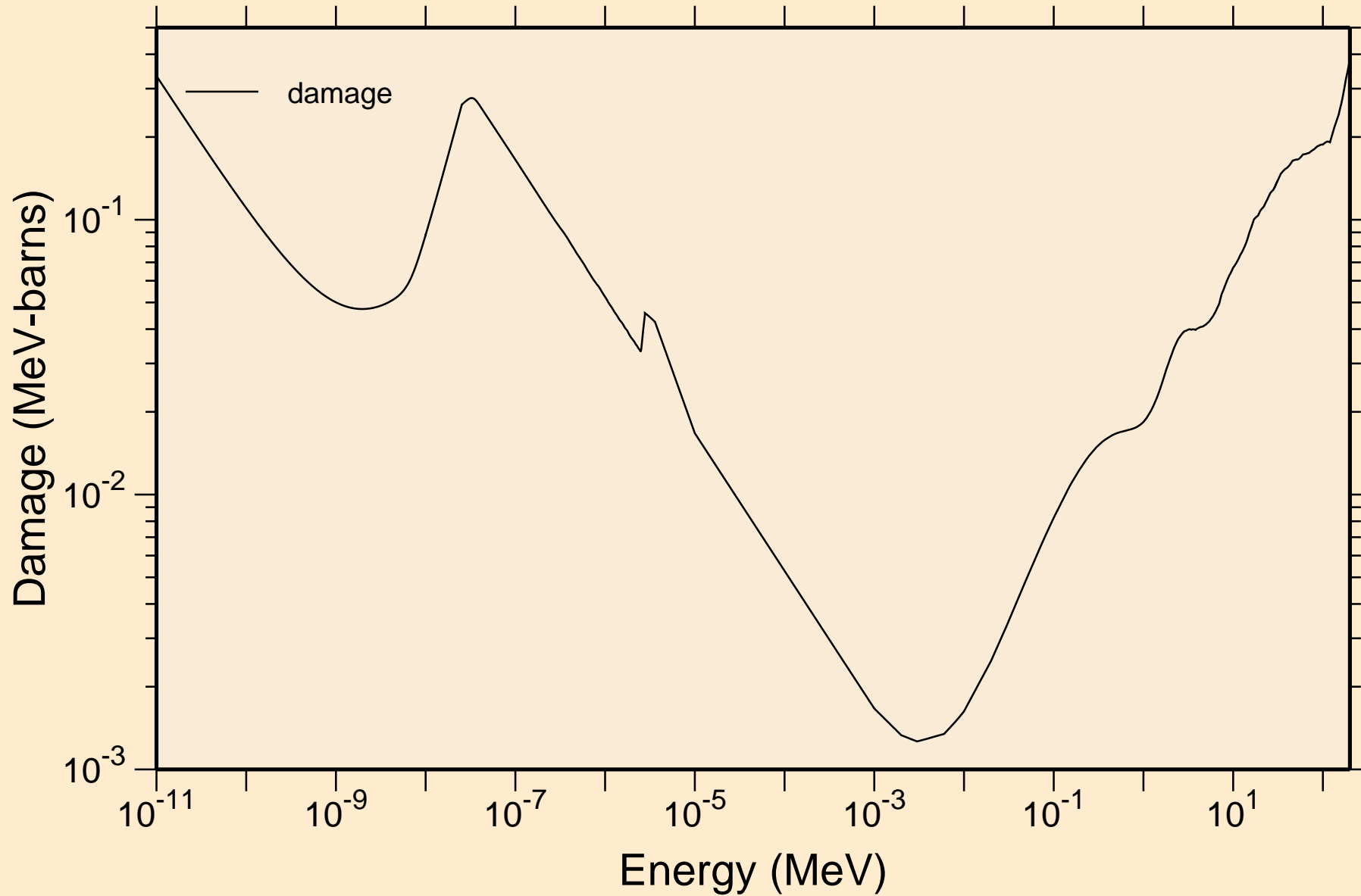

PO195 NEUTRON ACER TENDL-2021 LIBRARY; T=293.6K
Non-threshold reactions

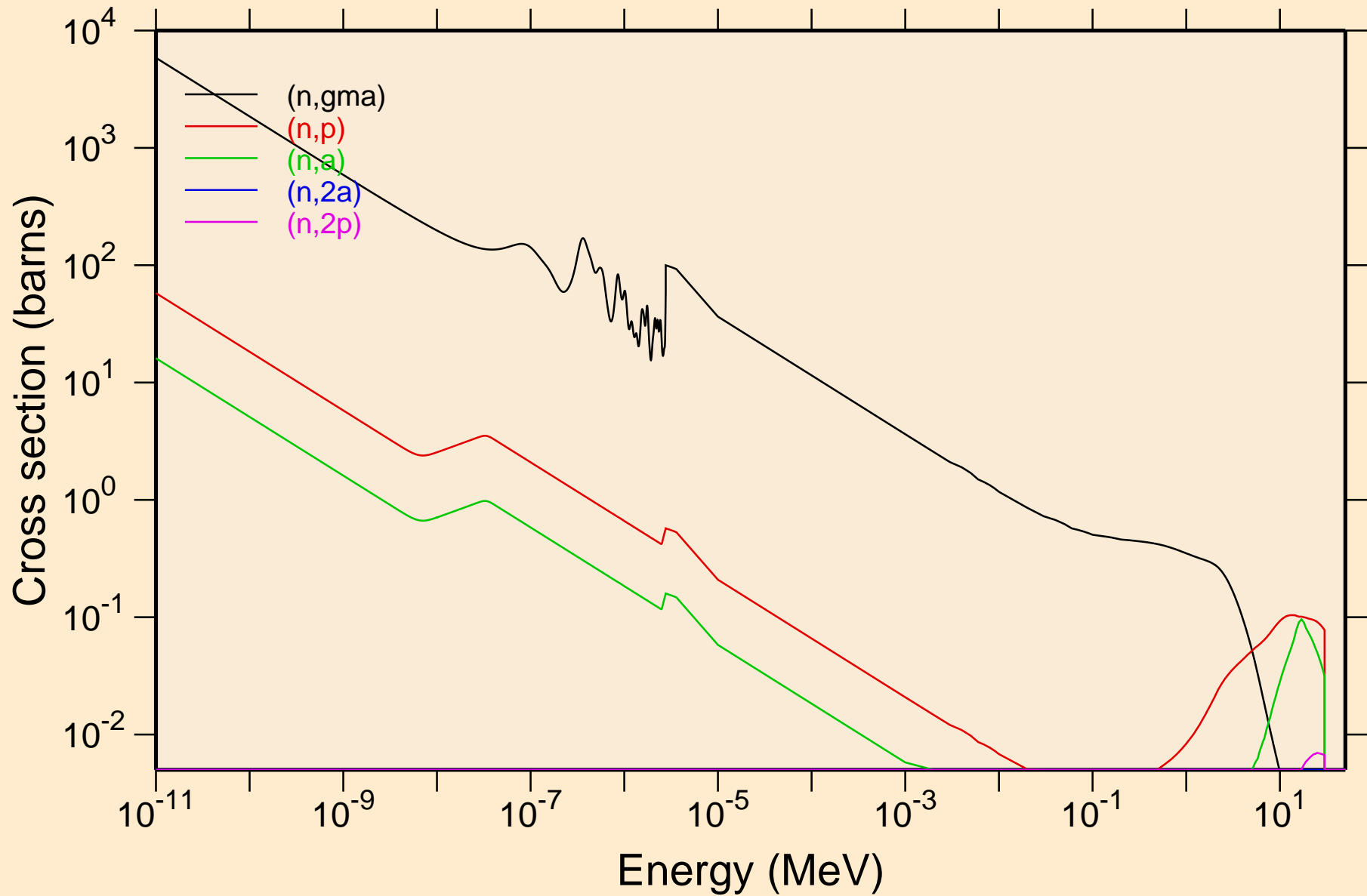

PO195 NEUTRON ACER TENDL-2021 LIBRARY; T=293.6K
Non-threshold reactions

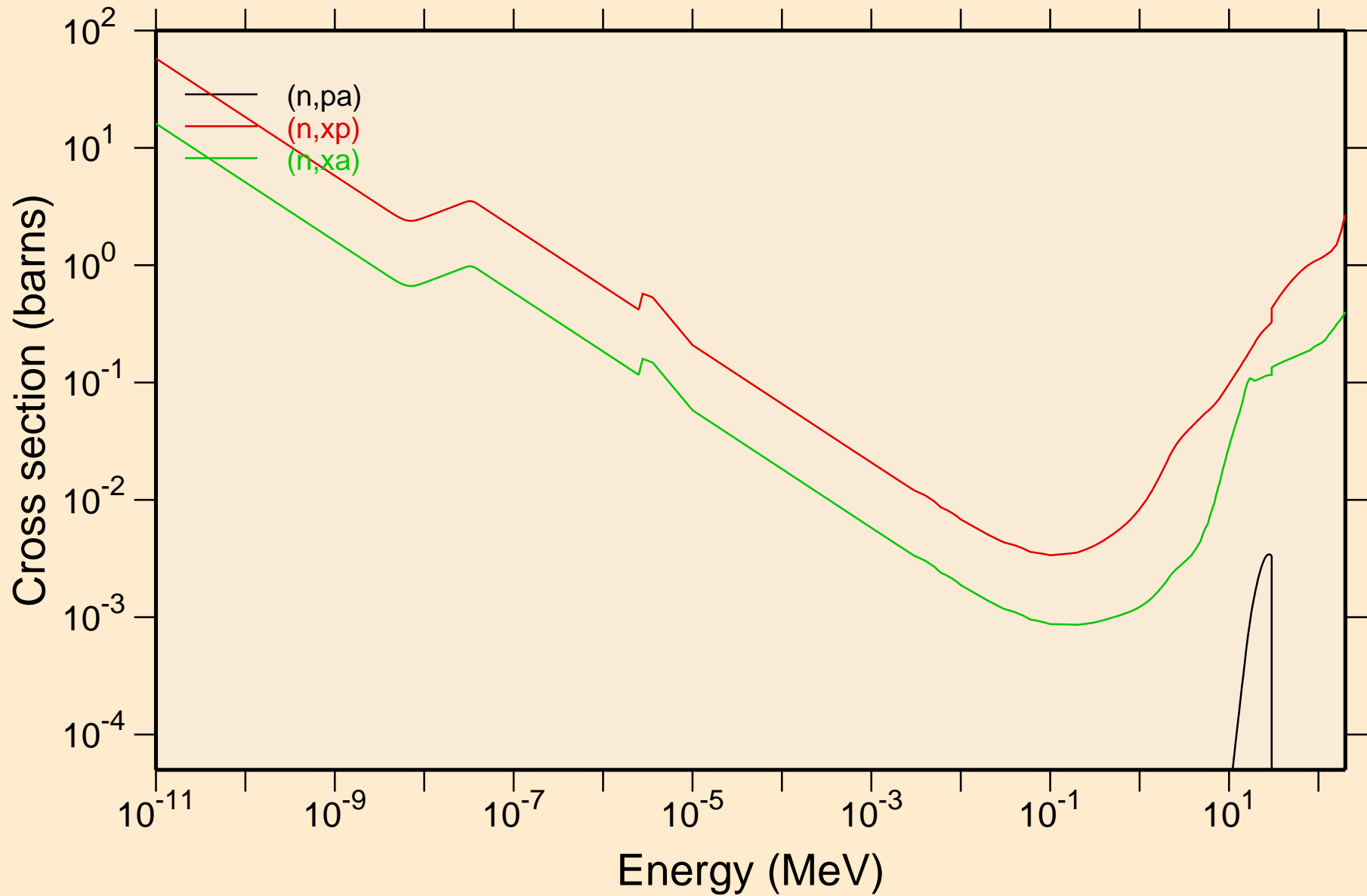

PO195 NEUTRON ACER TENDL-2021 LIBRARY; T=293.6K
Principal cross sections

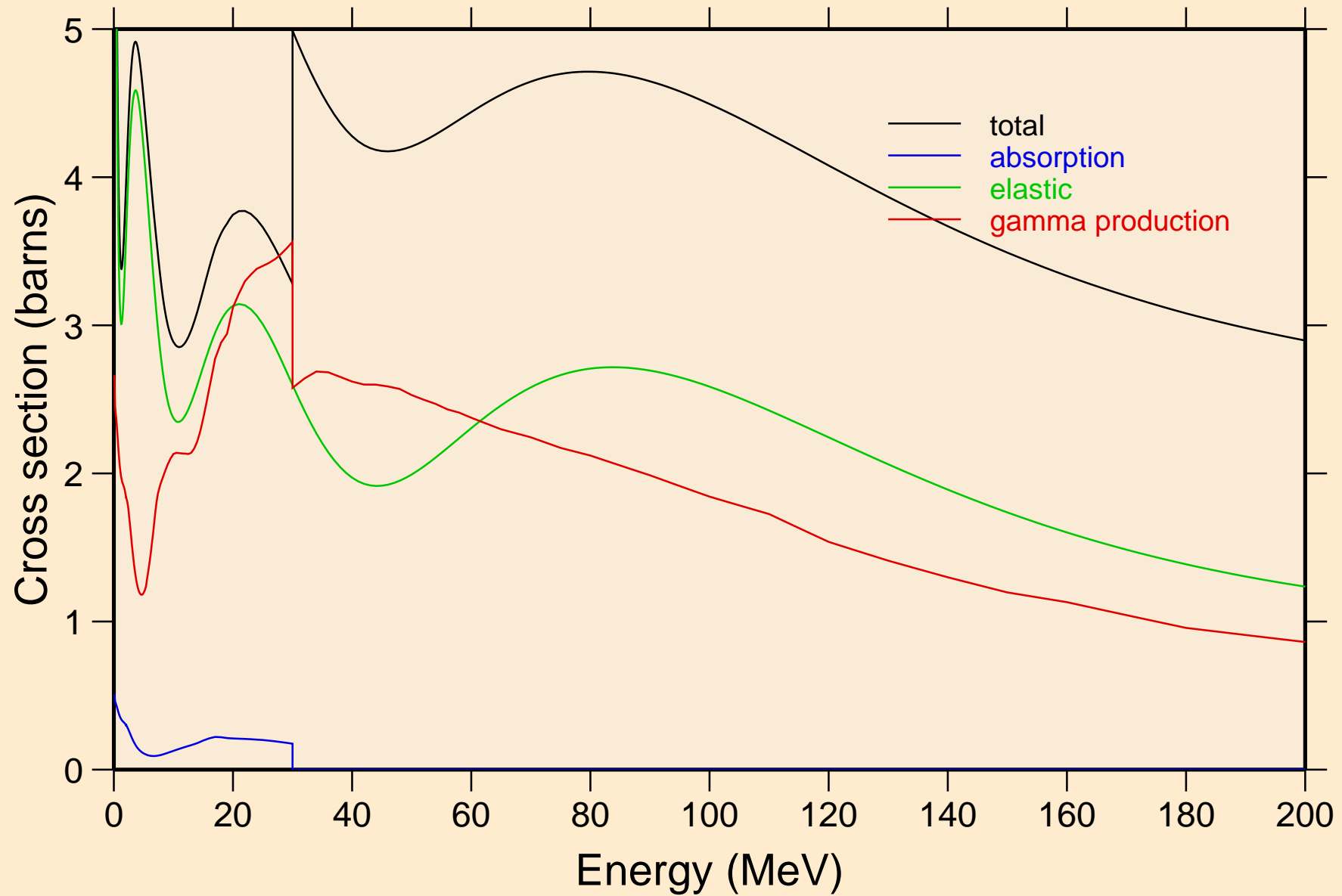

PO195 NEUTRON ACER TENDL-2021 LIBRARY; T=293.6K
Heating

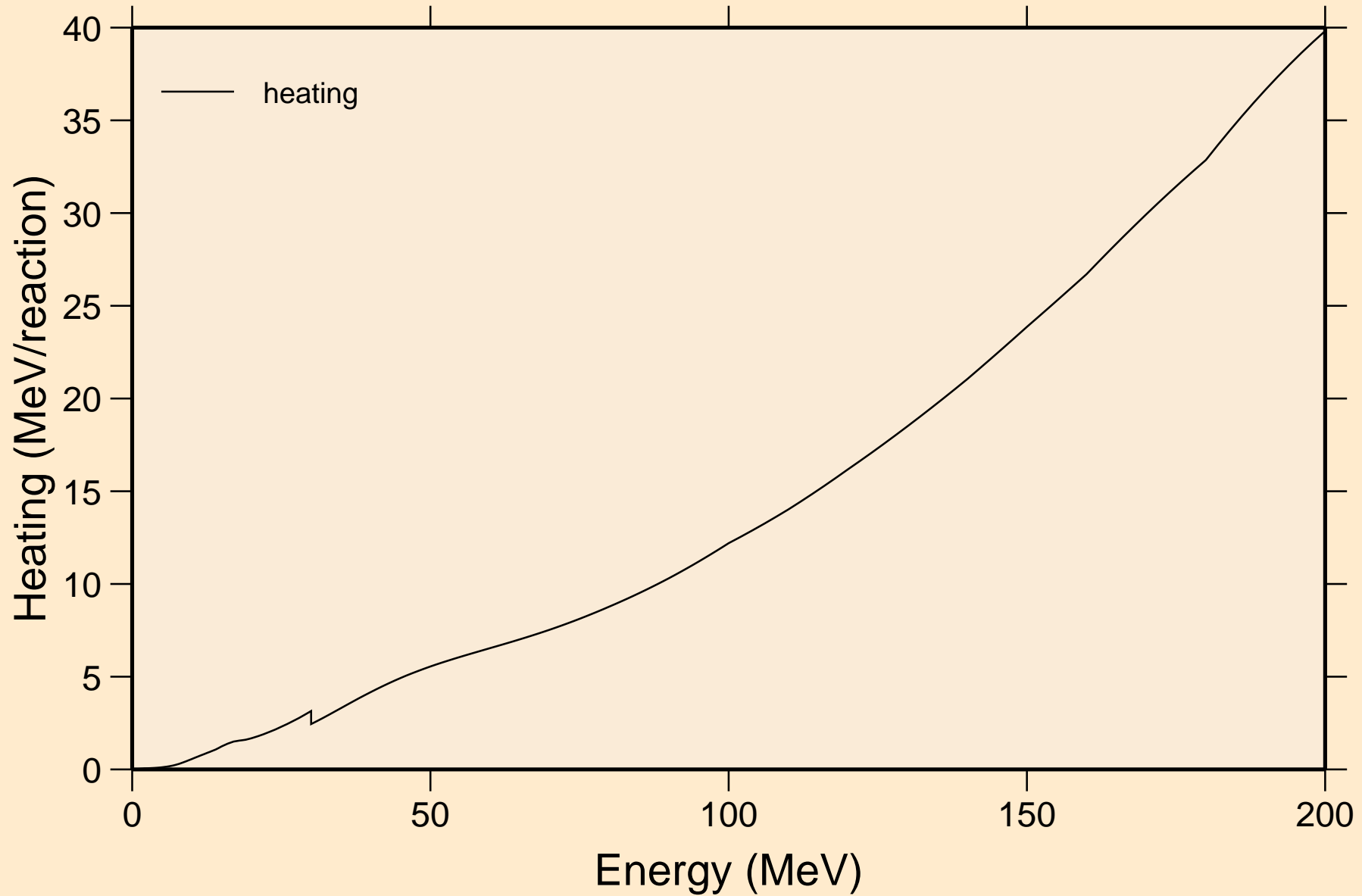

PO195 NEUTRON ACER TENDL-2021 LIBRARY; T=293.6K
Damage

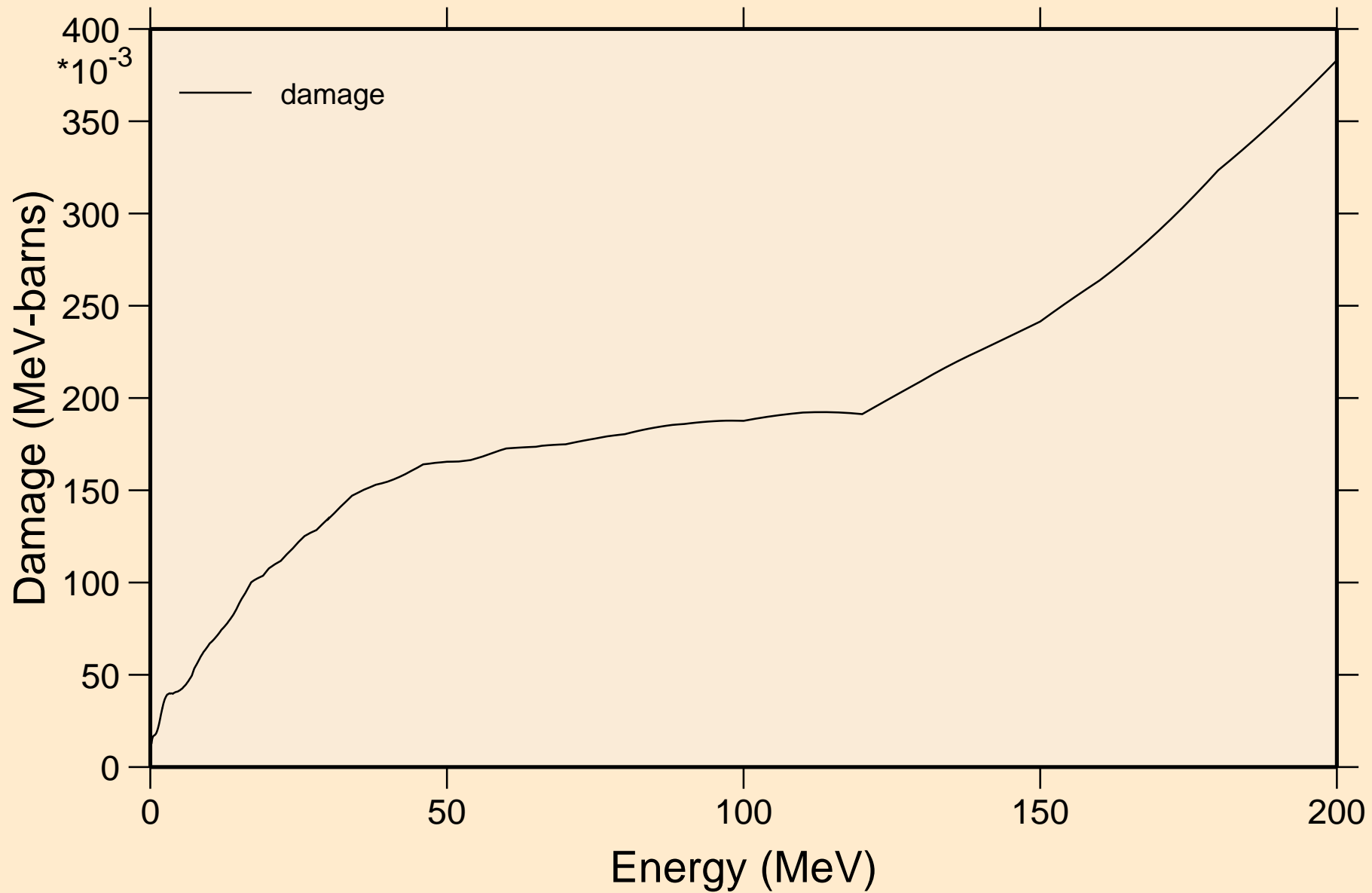

PO195 NEUTRON ACER TENDL-2021 LIBRARY; T=293.6K
Non-threshold reactions

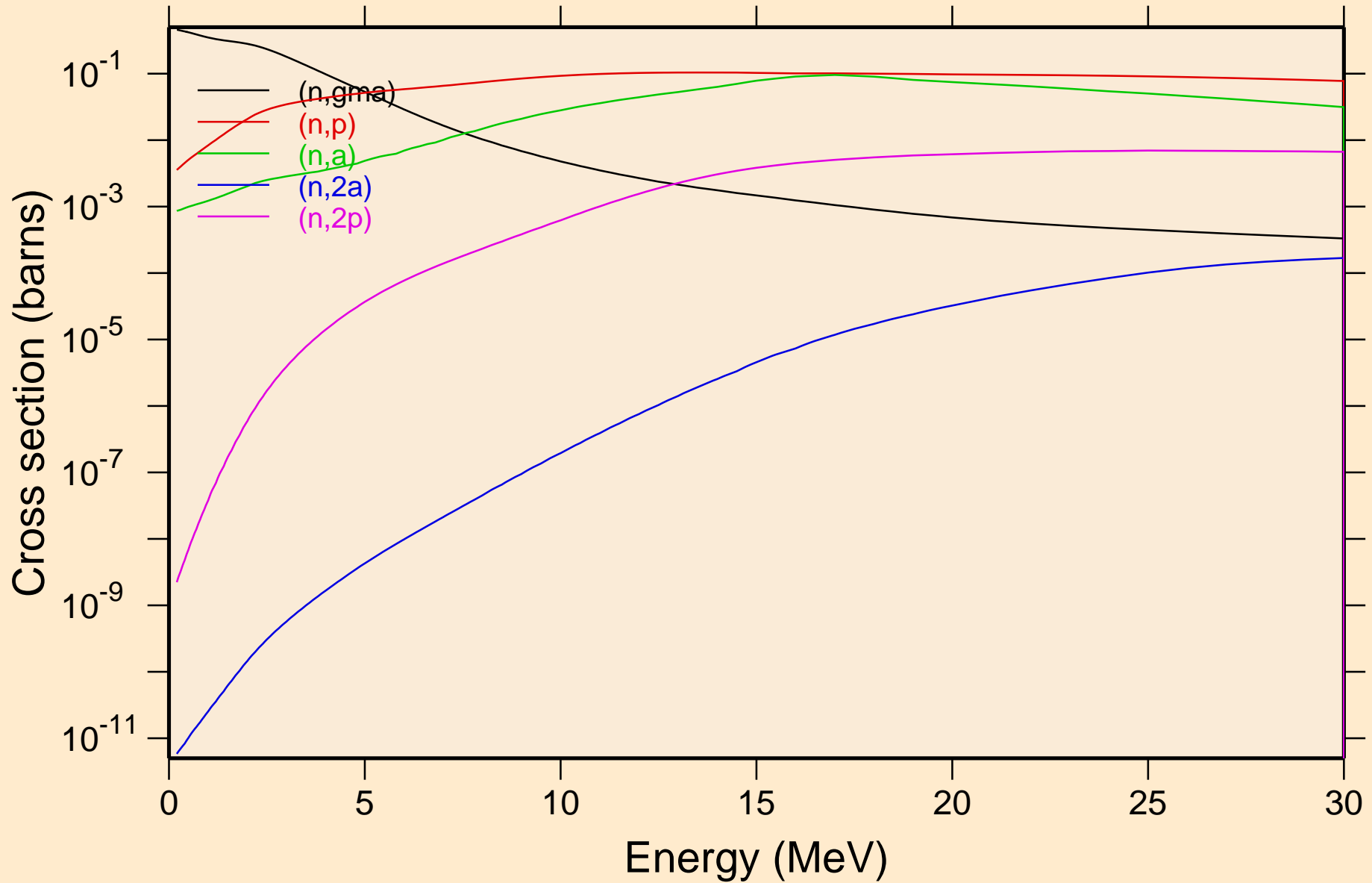

PO195 NEUTRON ACER TENDL-2021 LIBRARY; T=293.6K
Non-threshold reactions

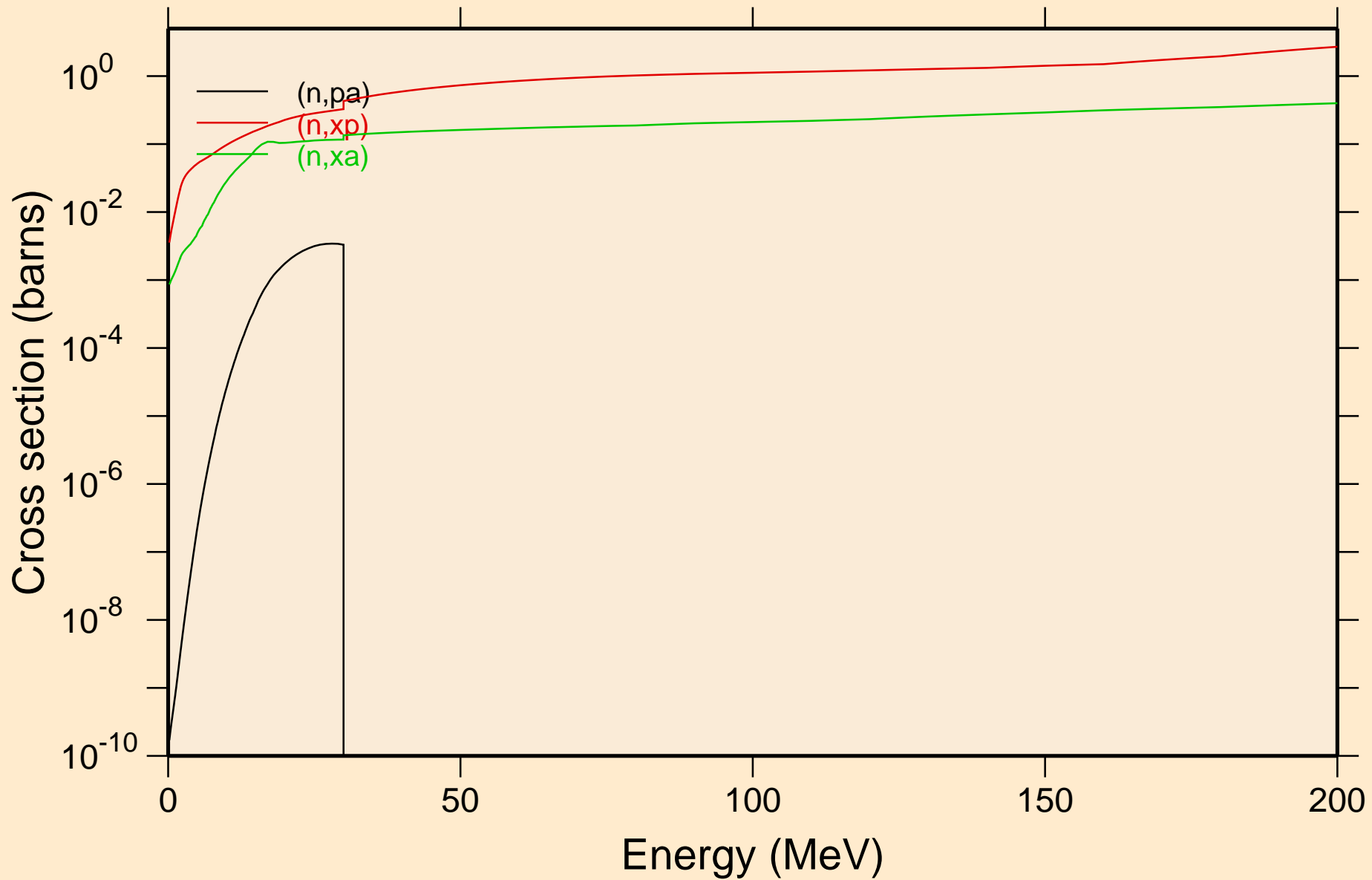

PO195 NEUTRON ACER TENDL-2021 LIBRARY; T=293.6K
Inelastic levels

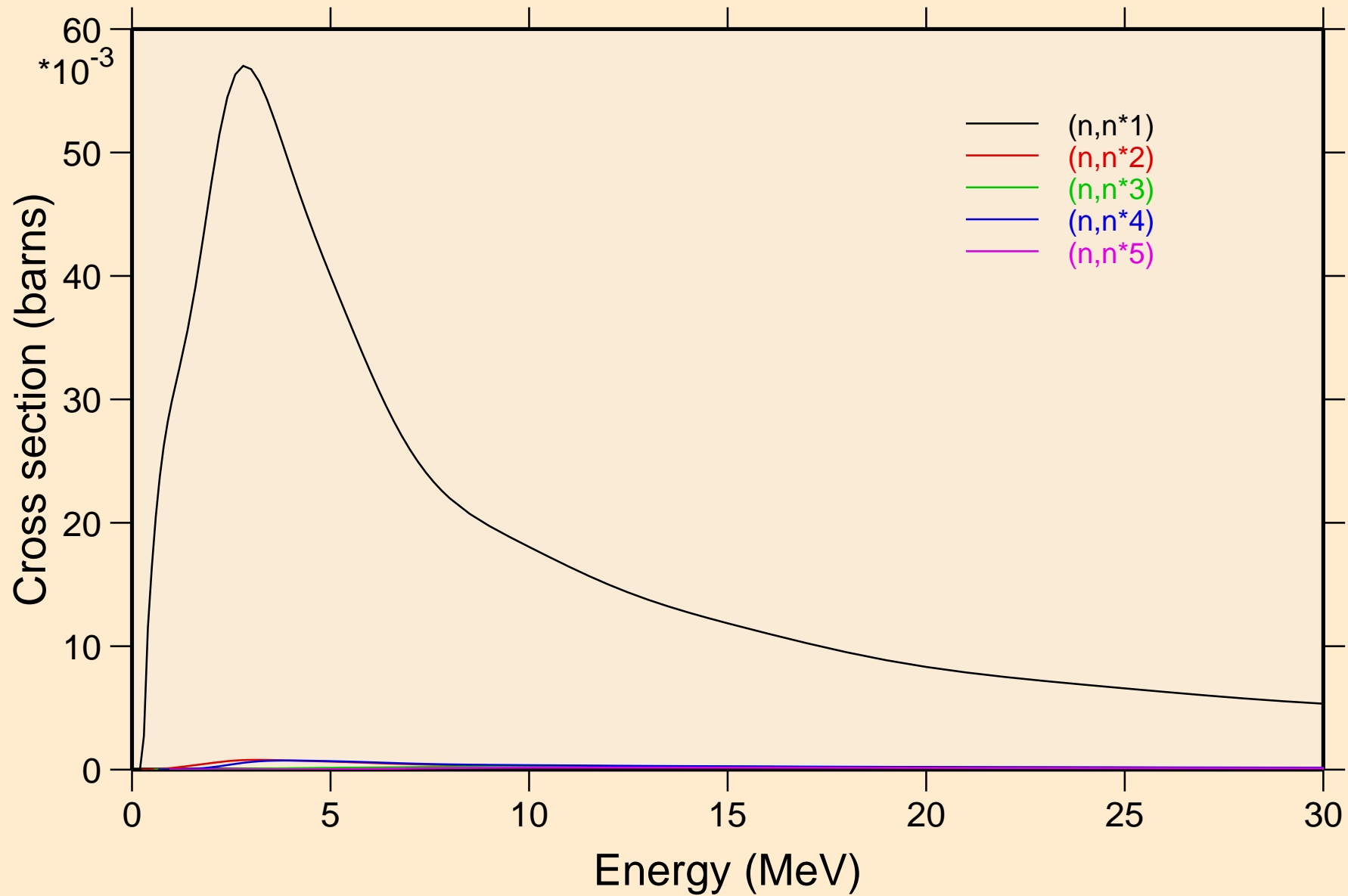

PO195 NEUTRON ACER TENDL-2021 LIBRARY; T=293.6K
Inelastic levels

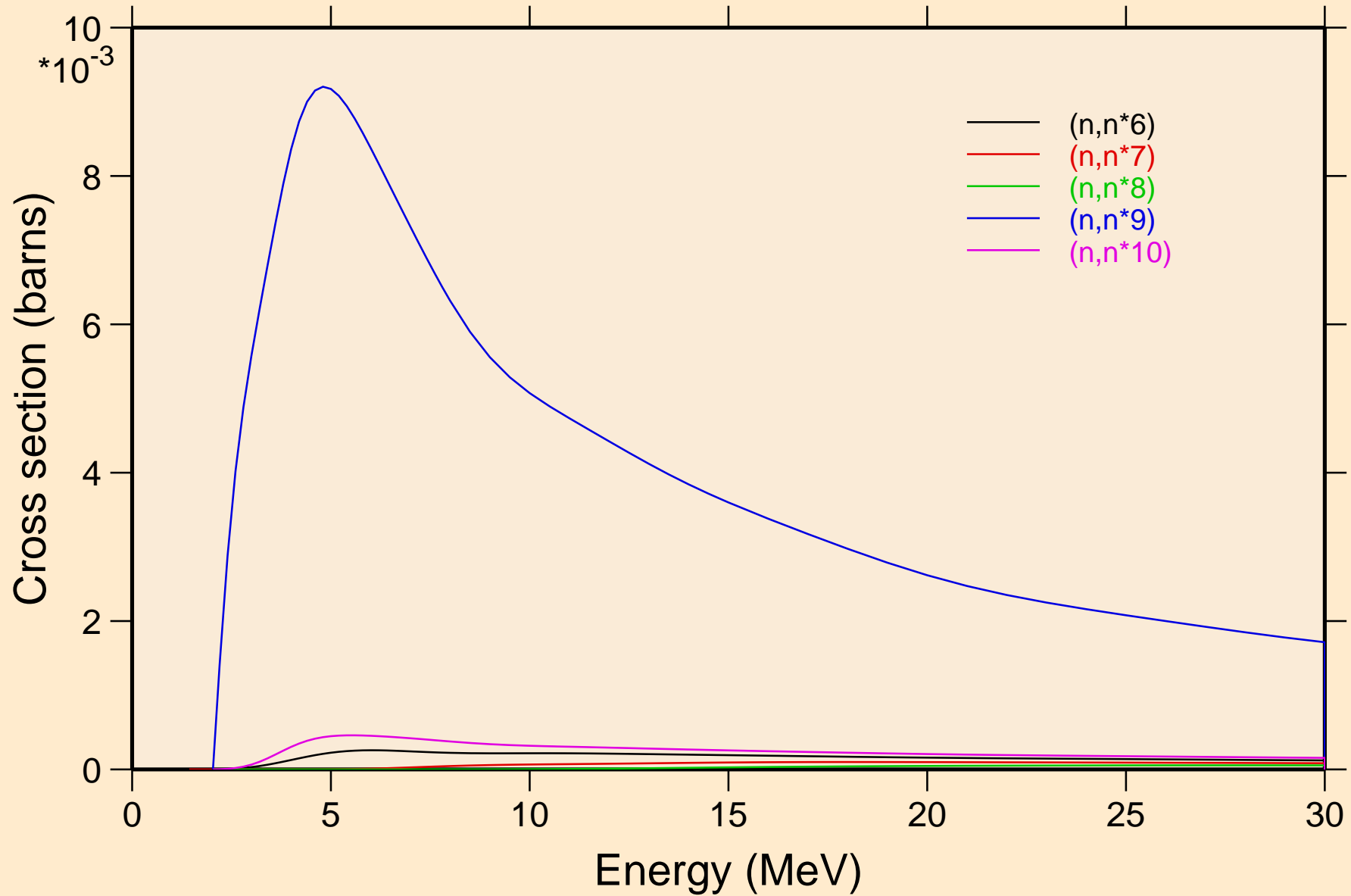

PO195 NEUTRON ACER TENDL-2021 LIBRARY; T=293.6K
Inelastic levels

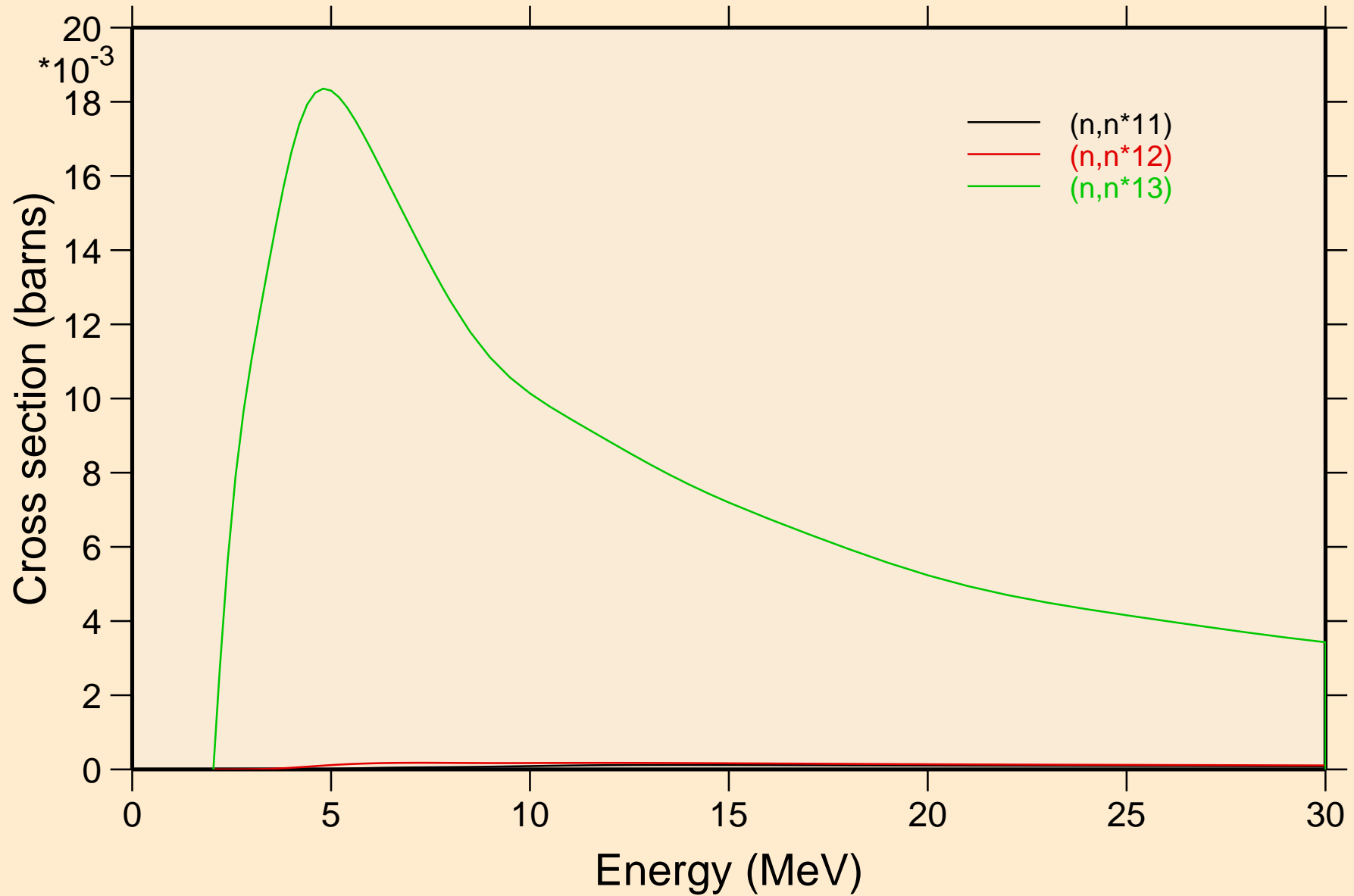

PO195 NEUTRON ACER TENDL-2021 LIBRARY; T=293.6K
Threshold reactions

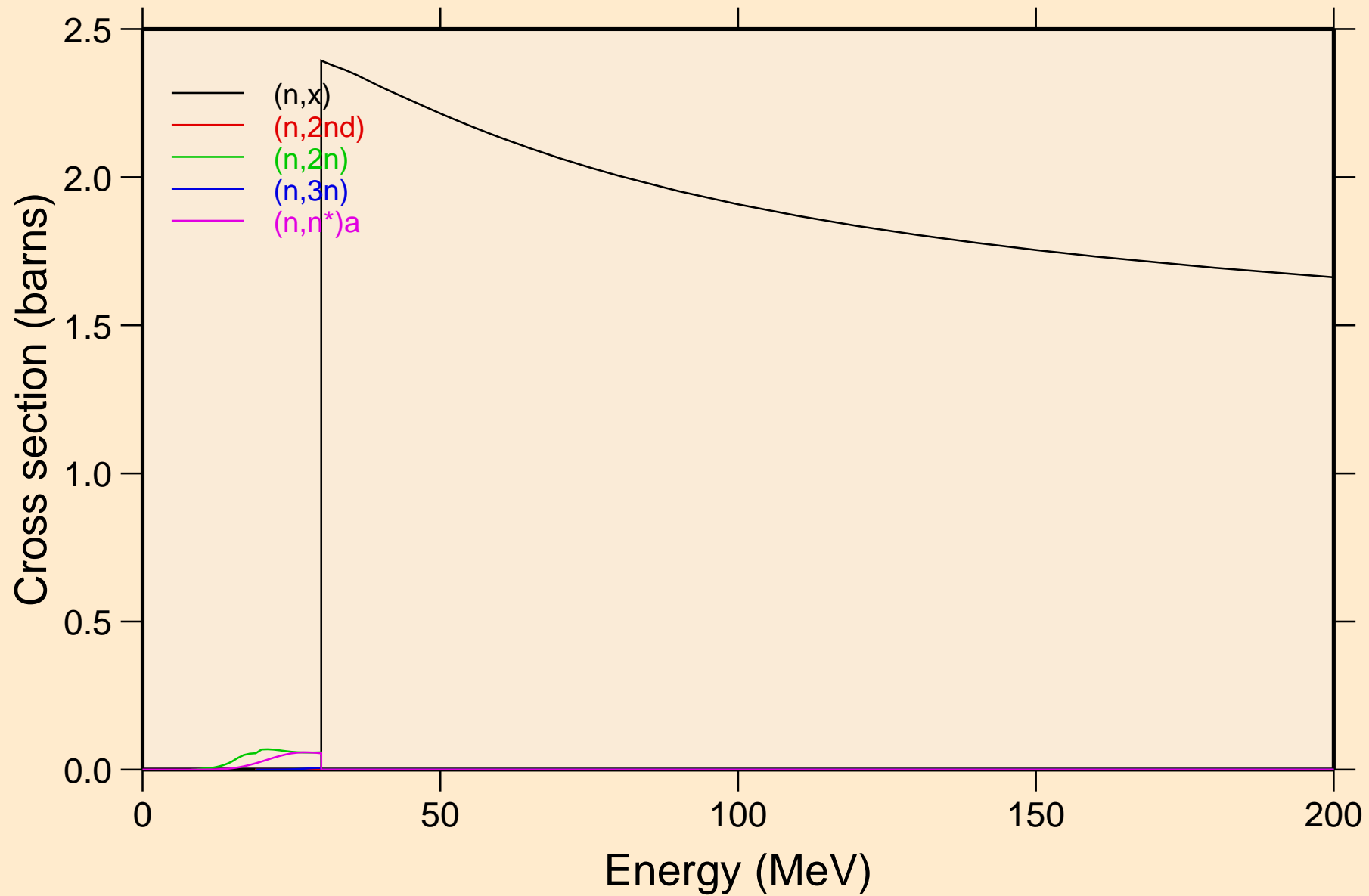

PO195 NEUTRON ACER TENDL-2021 LIBRARY; T=293.6K
Threshold reactions

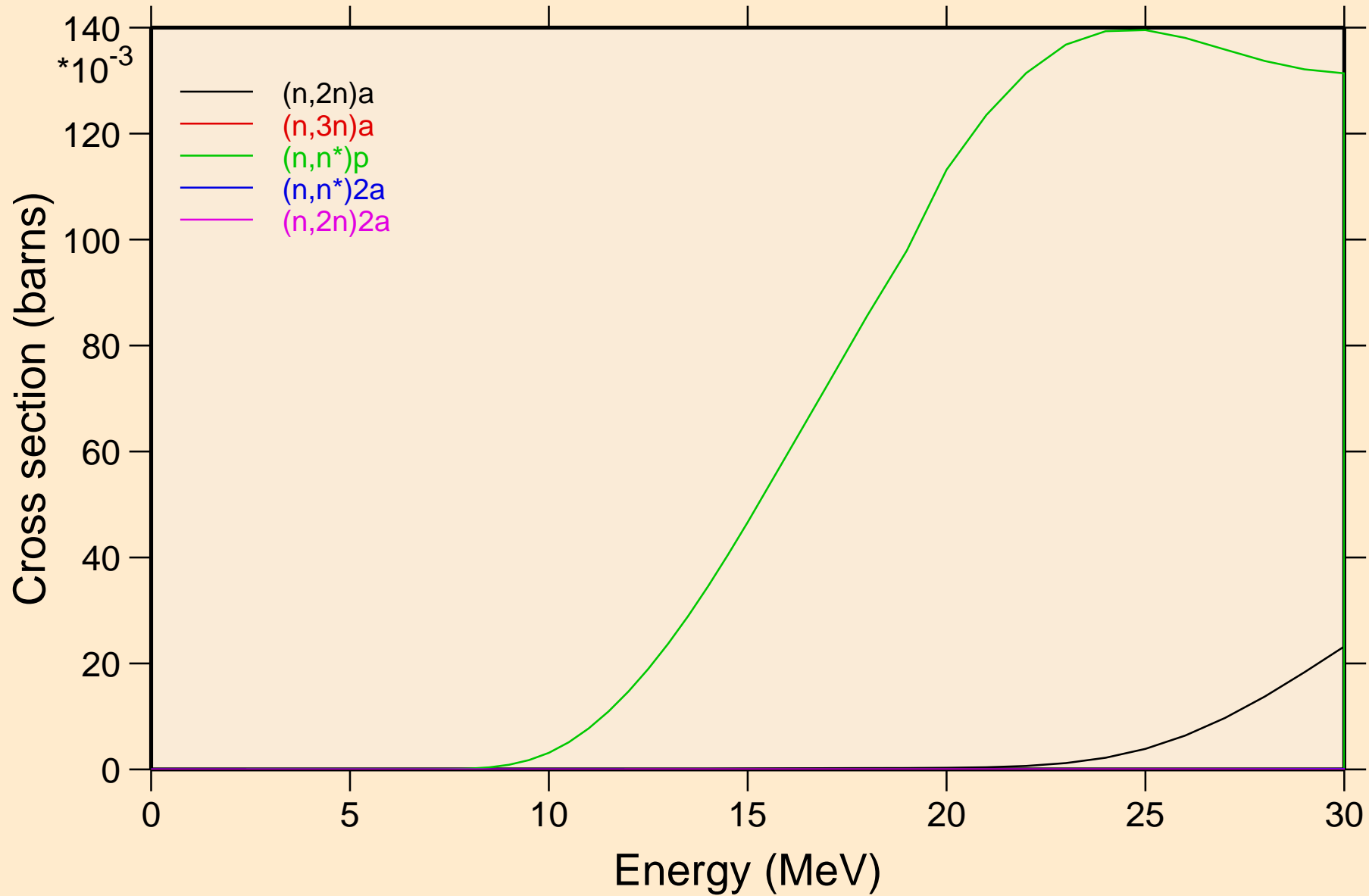

PO195 NEUTRON ACER TENDL-2021 LIBRARY; T=293.6K
Threshold reactions

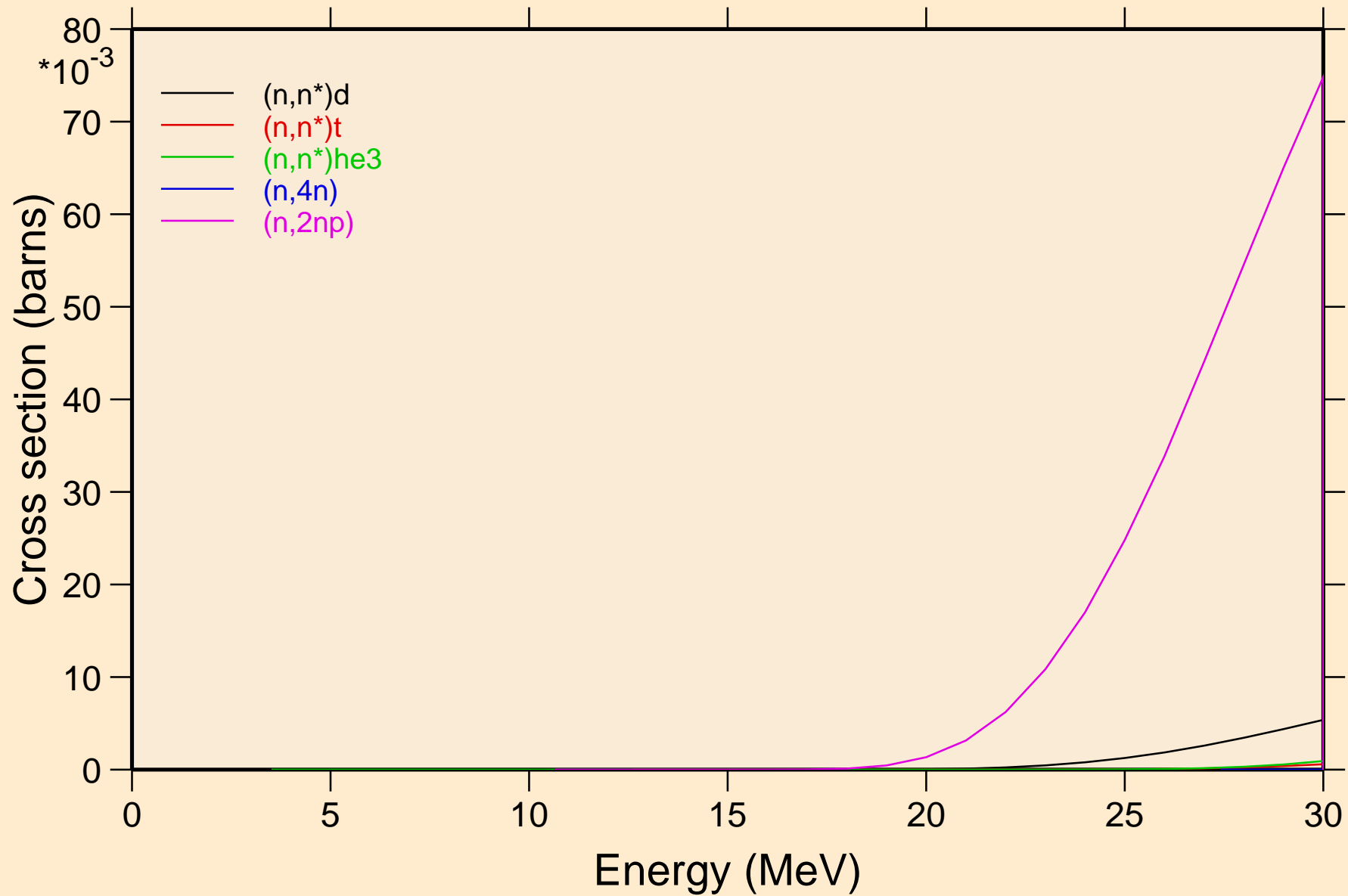

PO195 NEUTRON ACER TENDL-2021 LIBRARY; T=293.6K
Threshold reactions

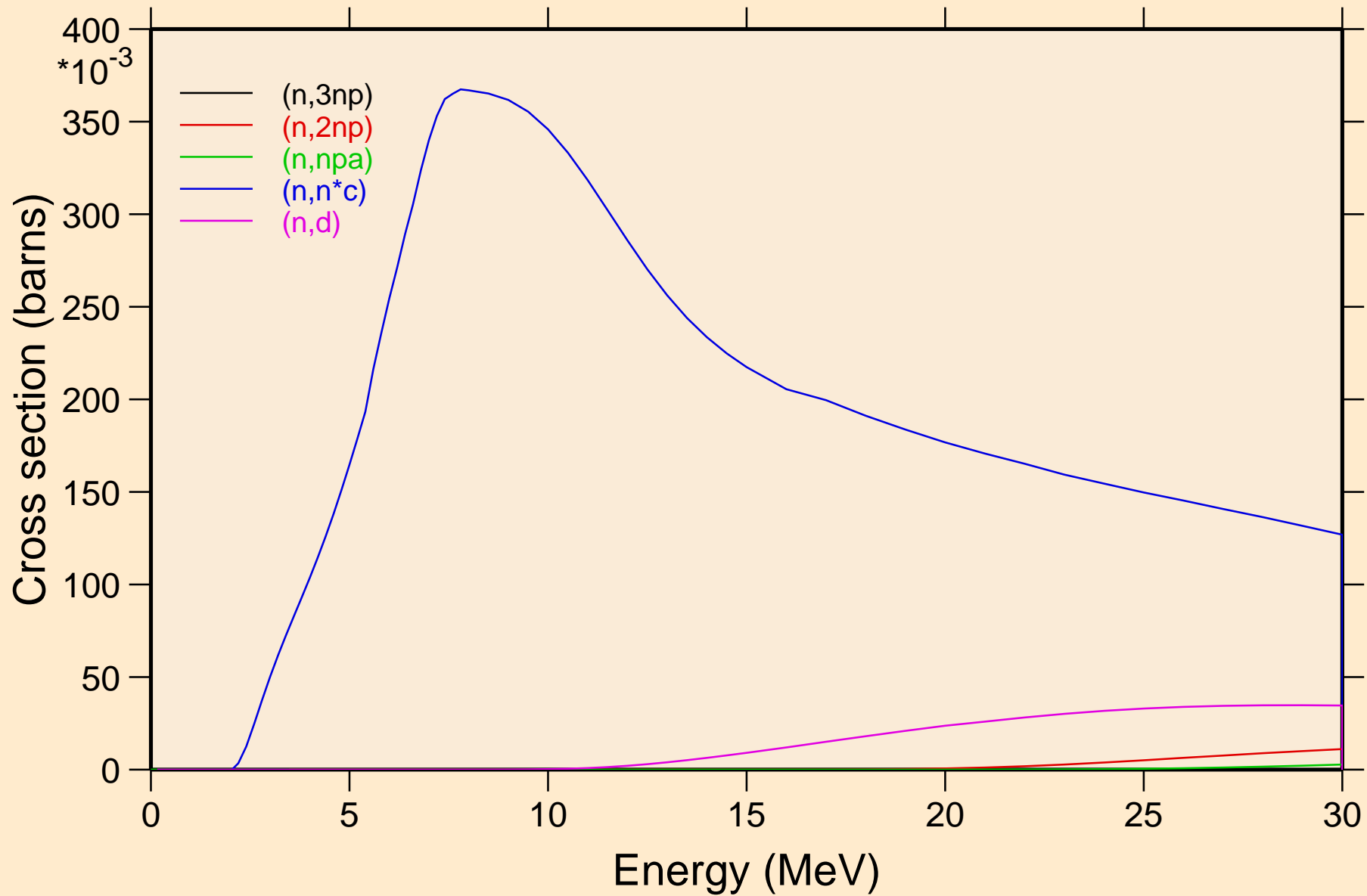

PO195 NEUTRON ACER TENDL-2021 LIBRARY; T=293.6K
Threshold reactions

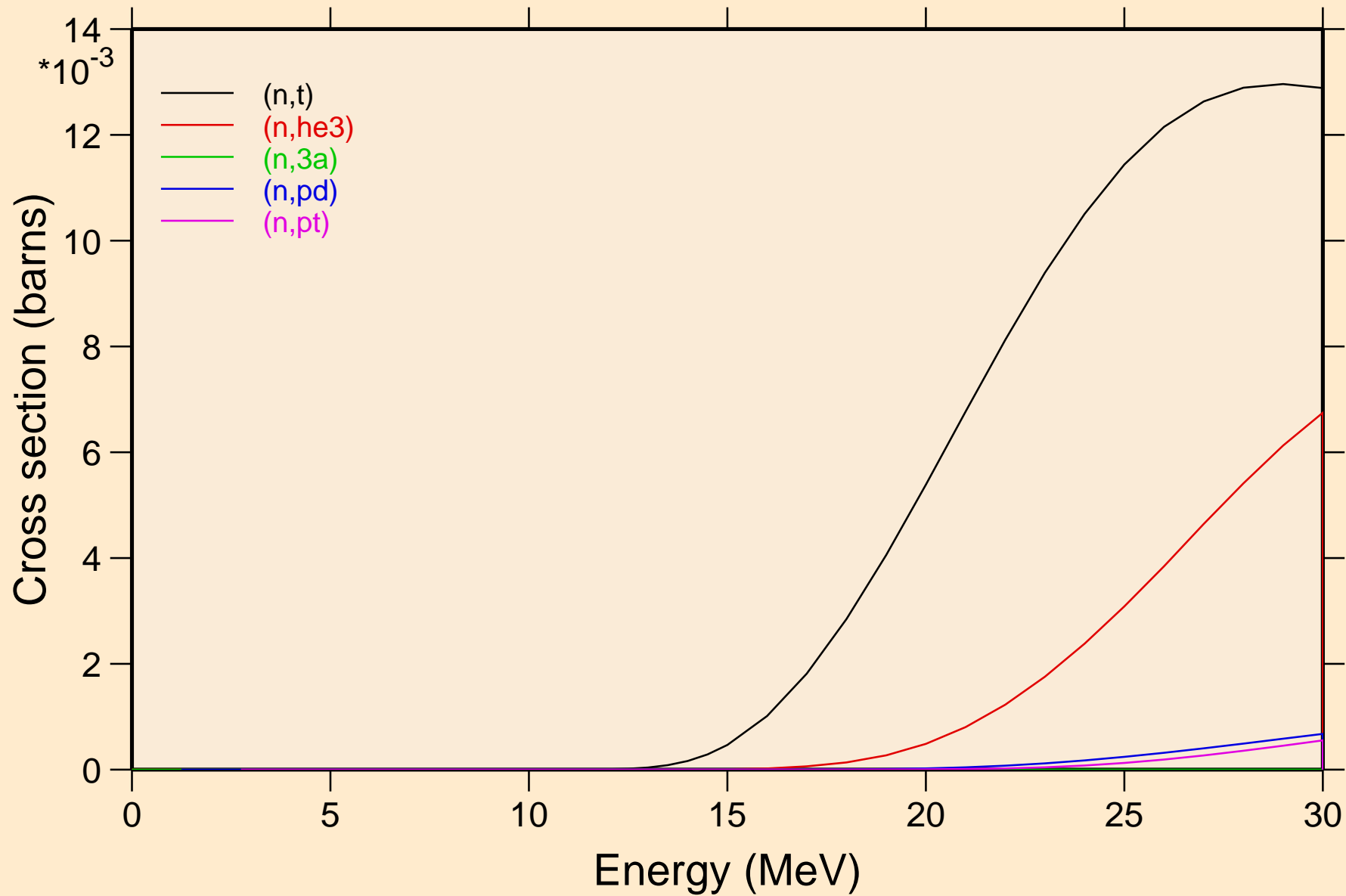

PO195 NEUTRON ACER TENDL-2021 LIBRARY; T=293.6K
Threshold reactions

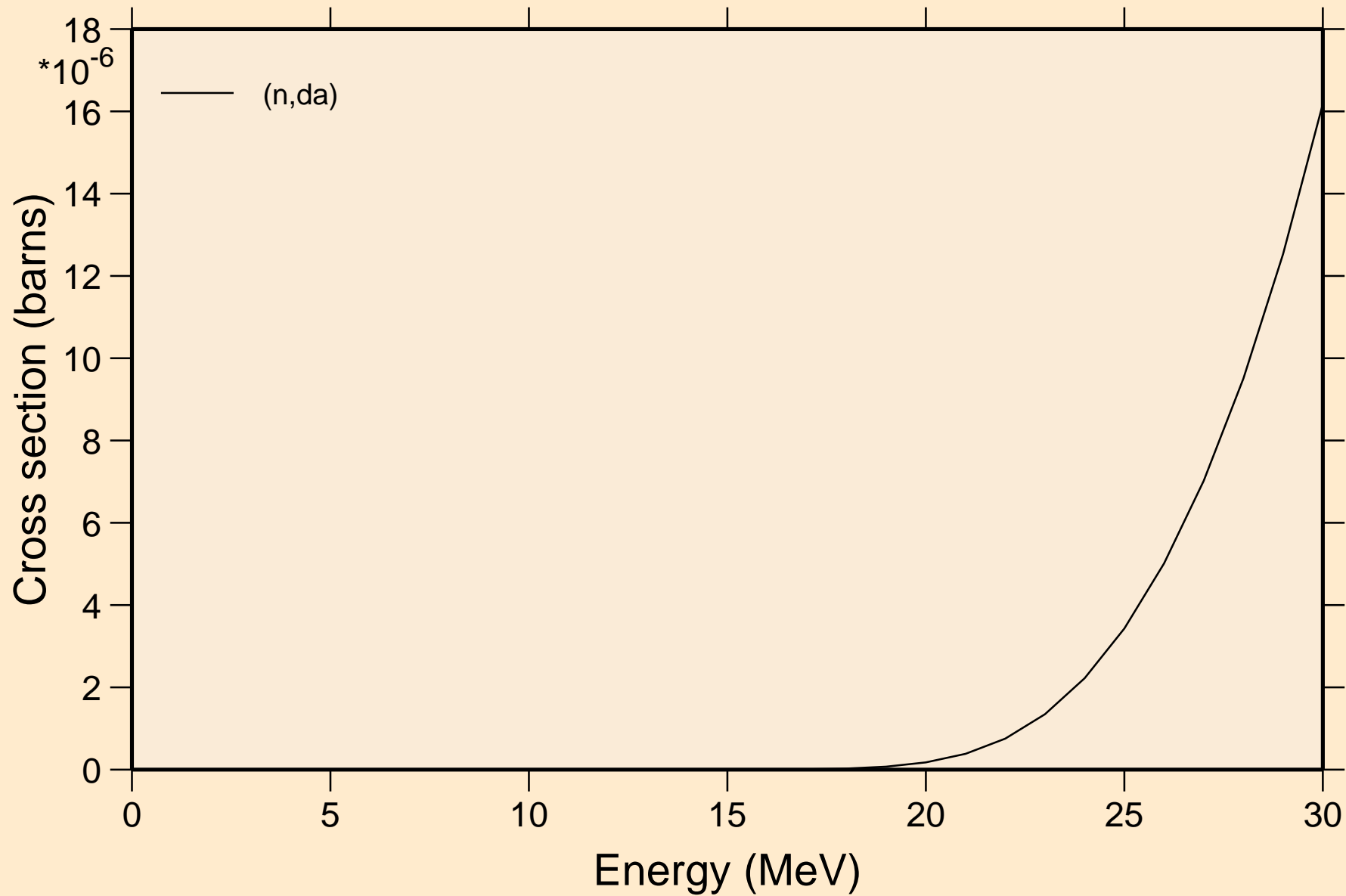

PO195 NEUTRON ACER TENDL-2021 LIBRARY; T=293.6K
Threshold reactions

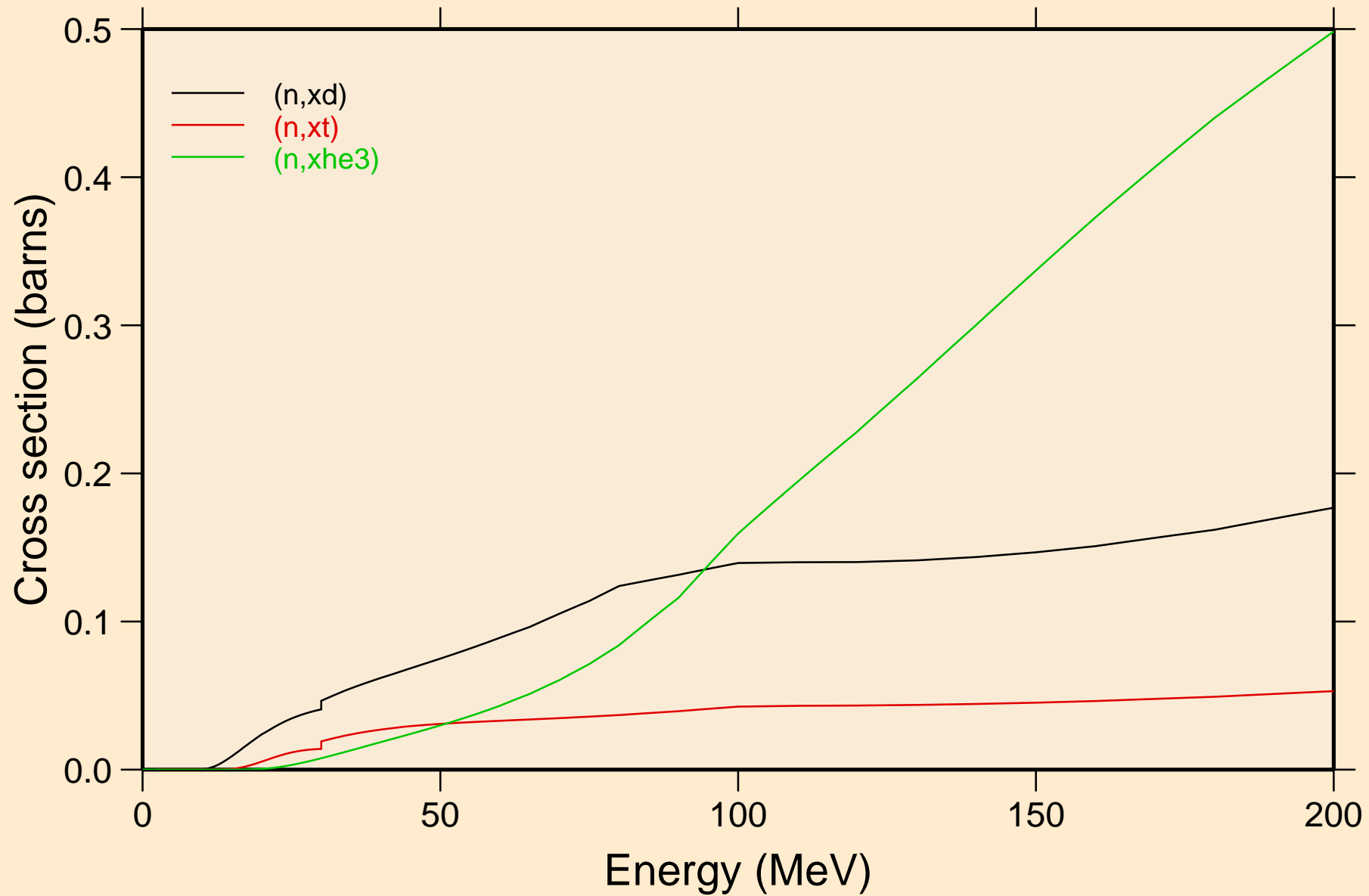

PO195 NEUTRON ACER TENDL-2021 LIBRARY; T=293.6K
angular distribution for elastic

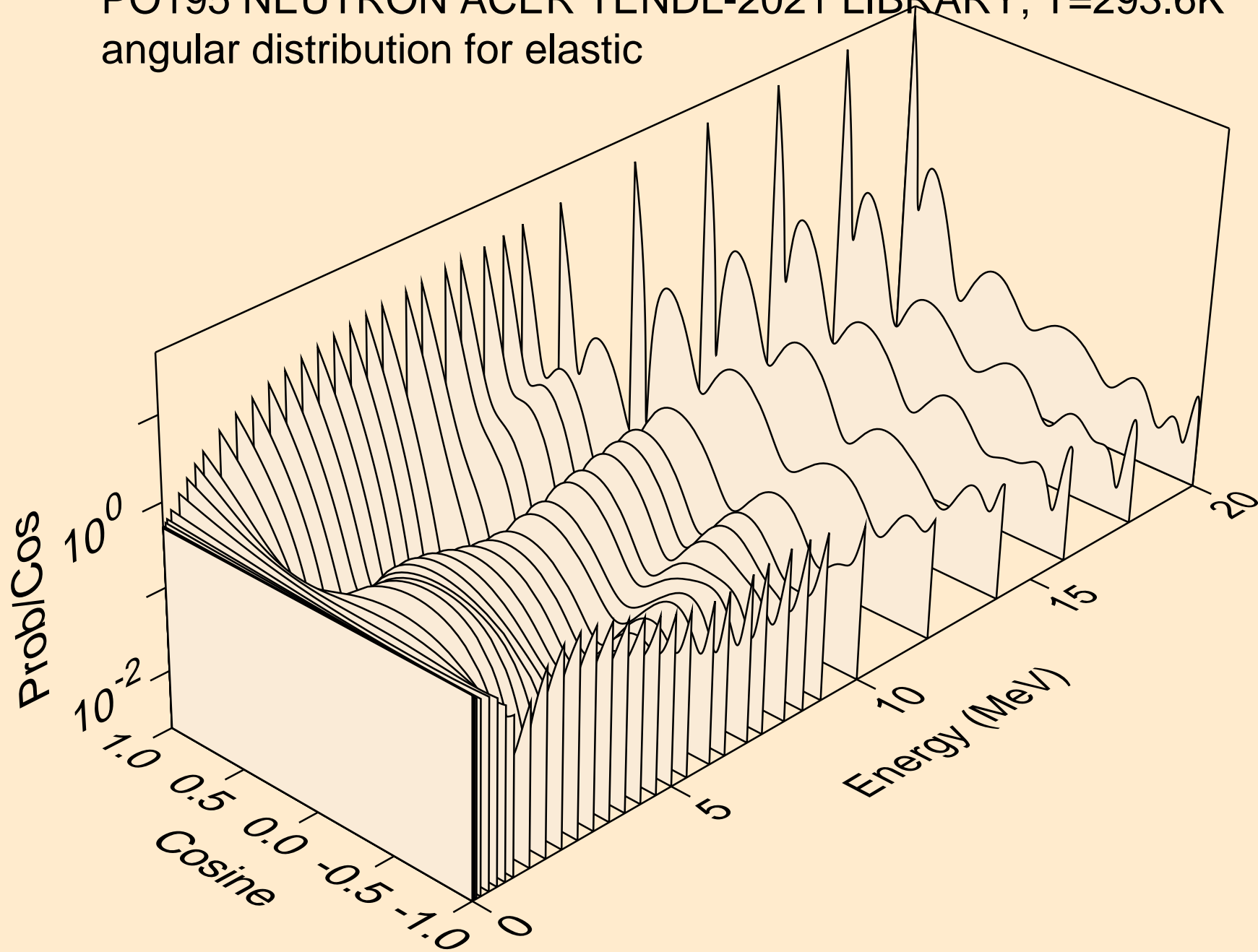

PO195 NEUTRON ACER TENDL-2021 LIBRARY; T=293.6K
angular distribution for elastic

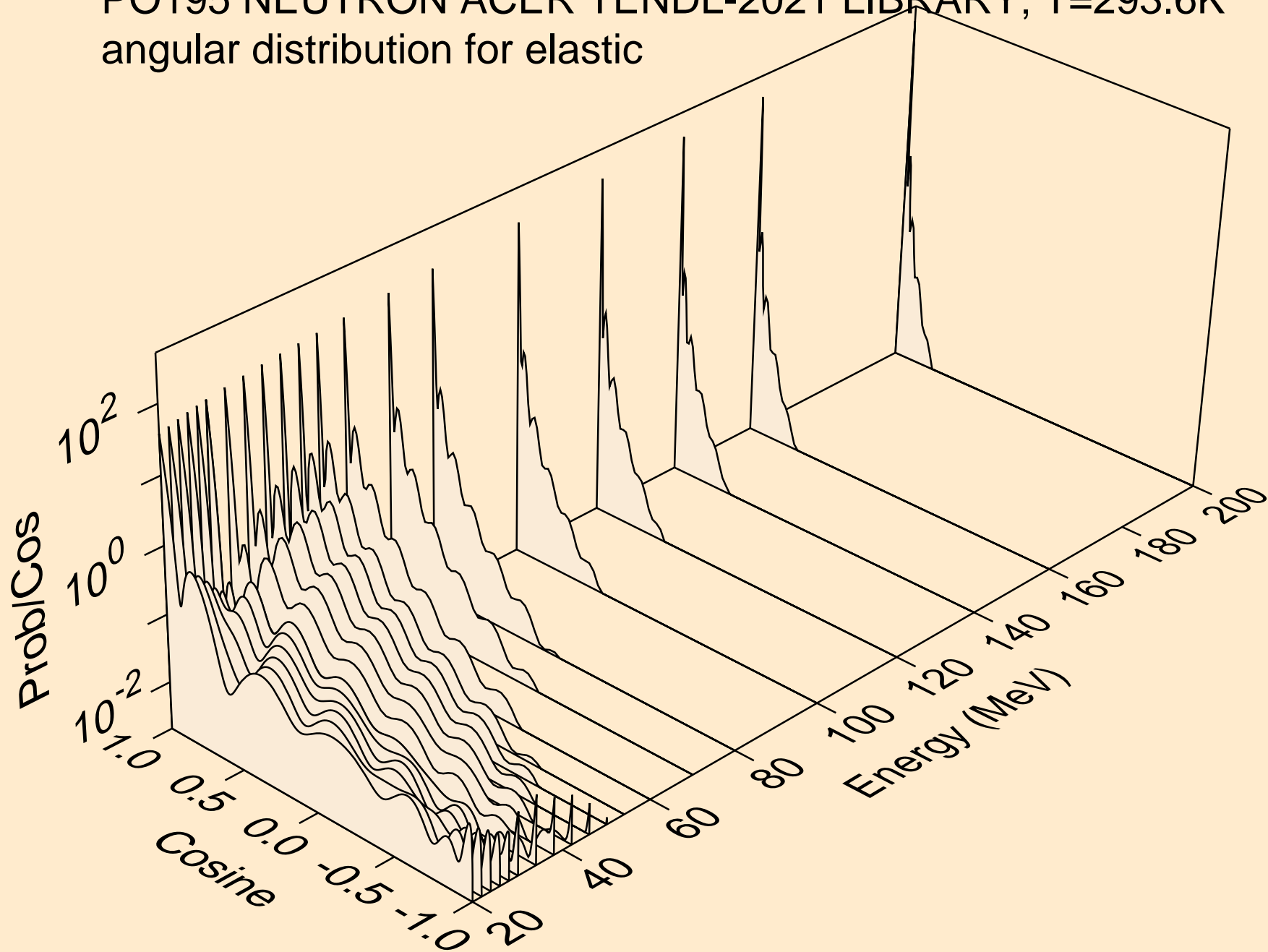

PO195 NEUTRON ACER TENDL-2021 LIBRARY; T=293.6K
angular distribution for (n,n*1)

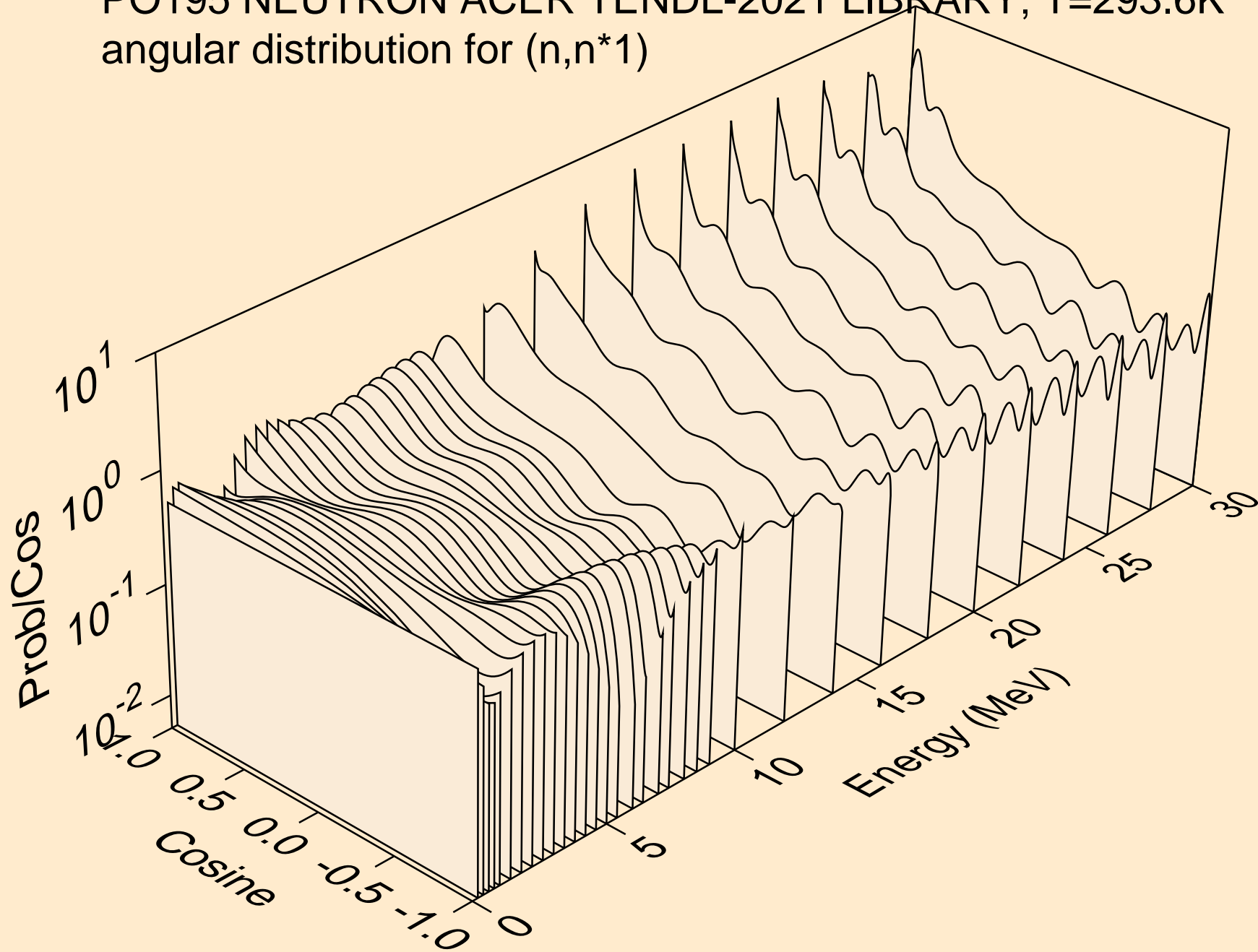

PO195 NEUTRON ACER TENDL-2021 LIBRARY; T=293.6K
angular distribution for (n,n*2)

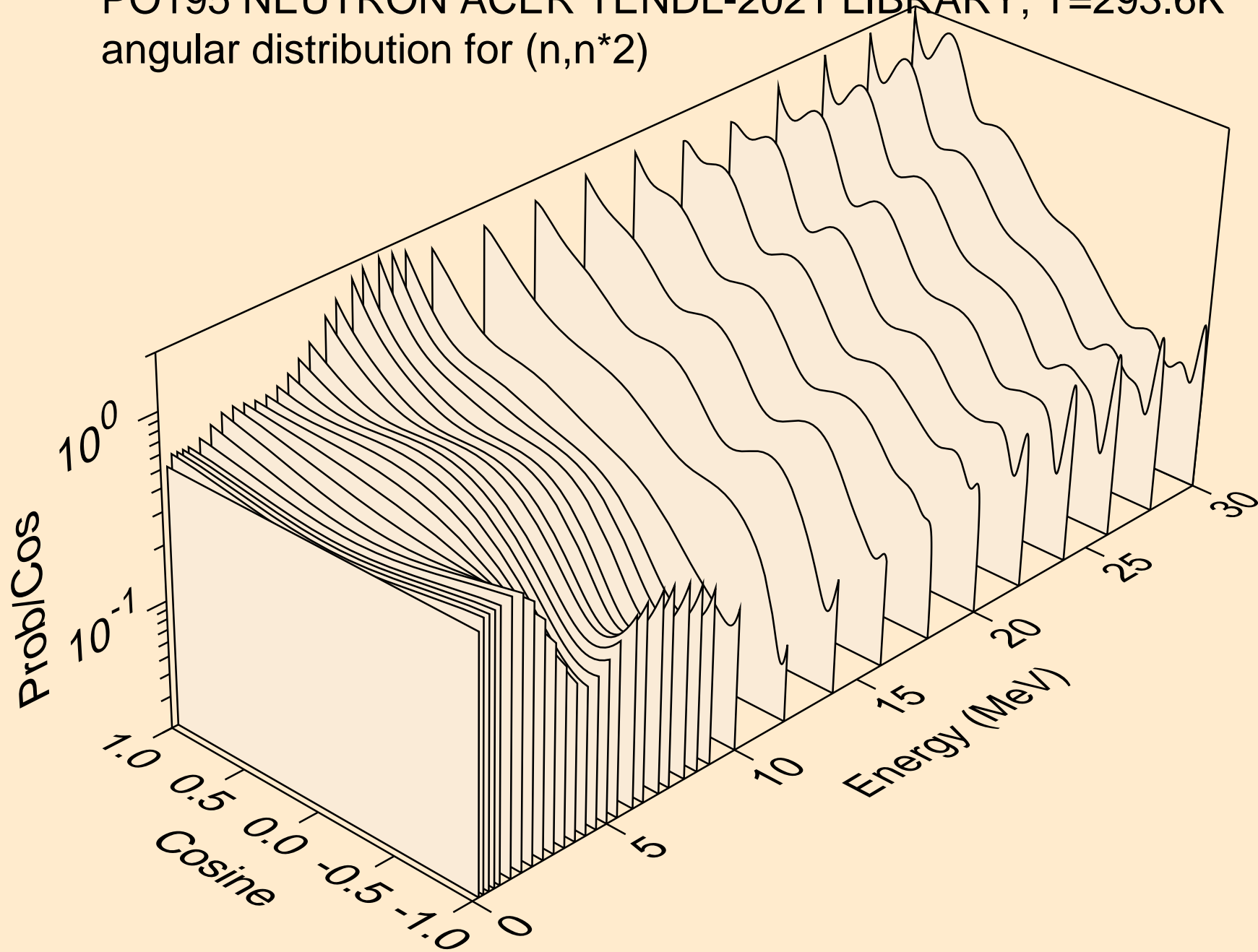

PO195 NEUTRON ACER TENDL-2021 LIBRARY; T=293.6K
angular distribution for (n,n*3)

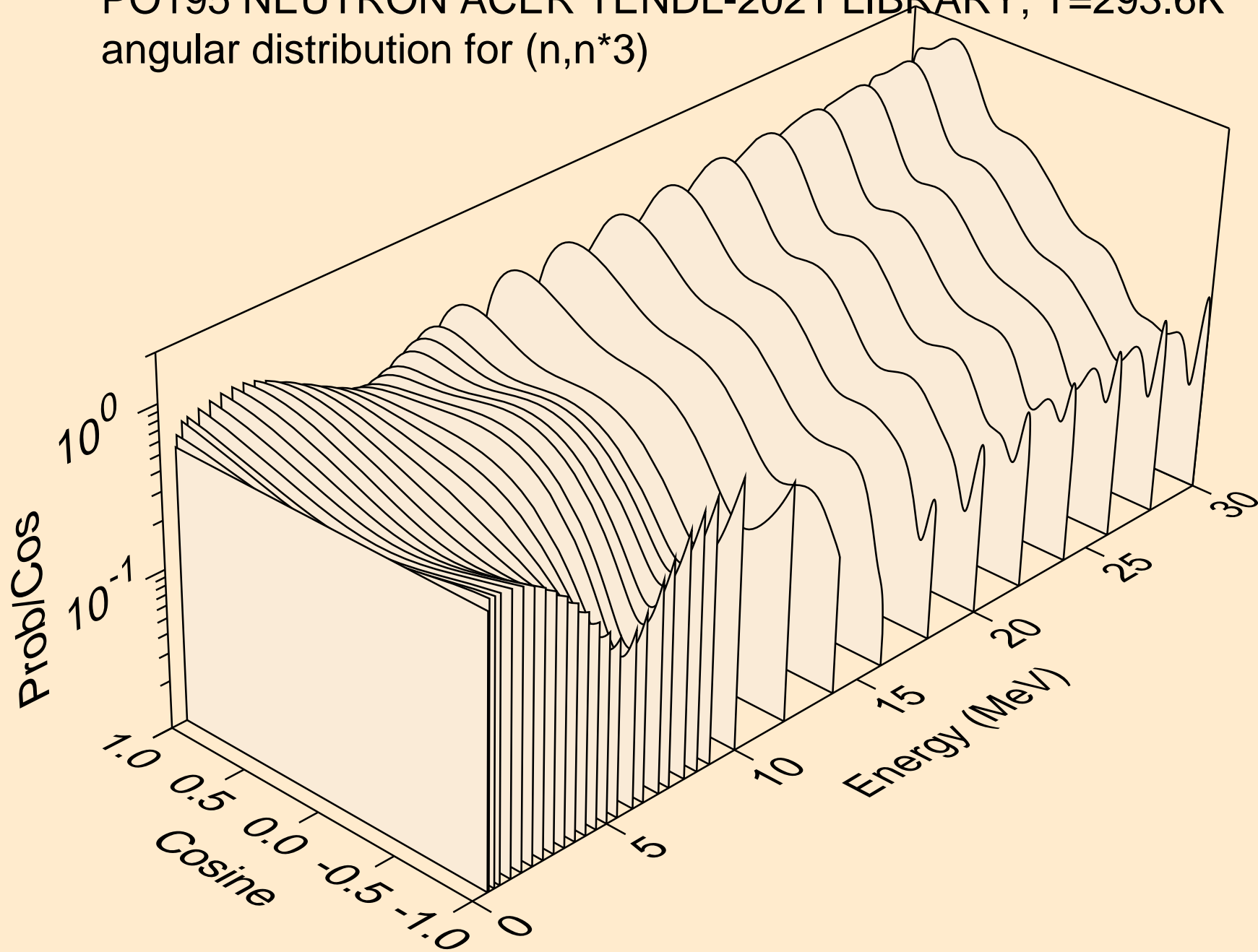

PO195 NEUTRON ACER TENDL-2021 LIBRARY; T=293.6K
angular distribution for (n,n*4)

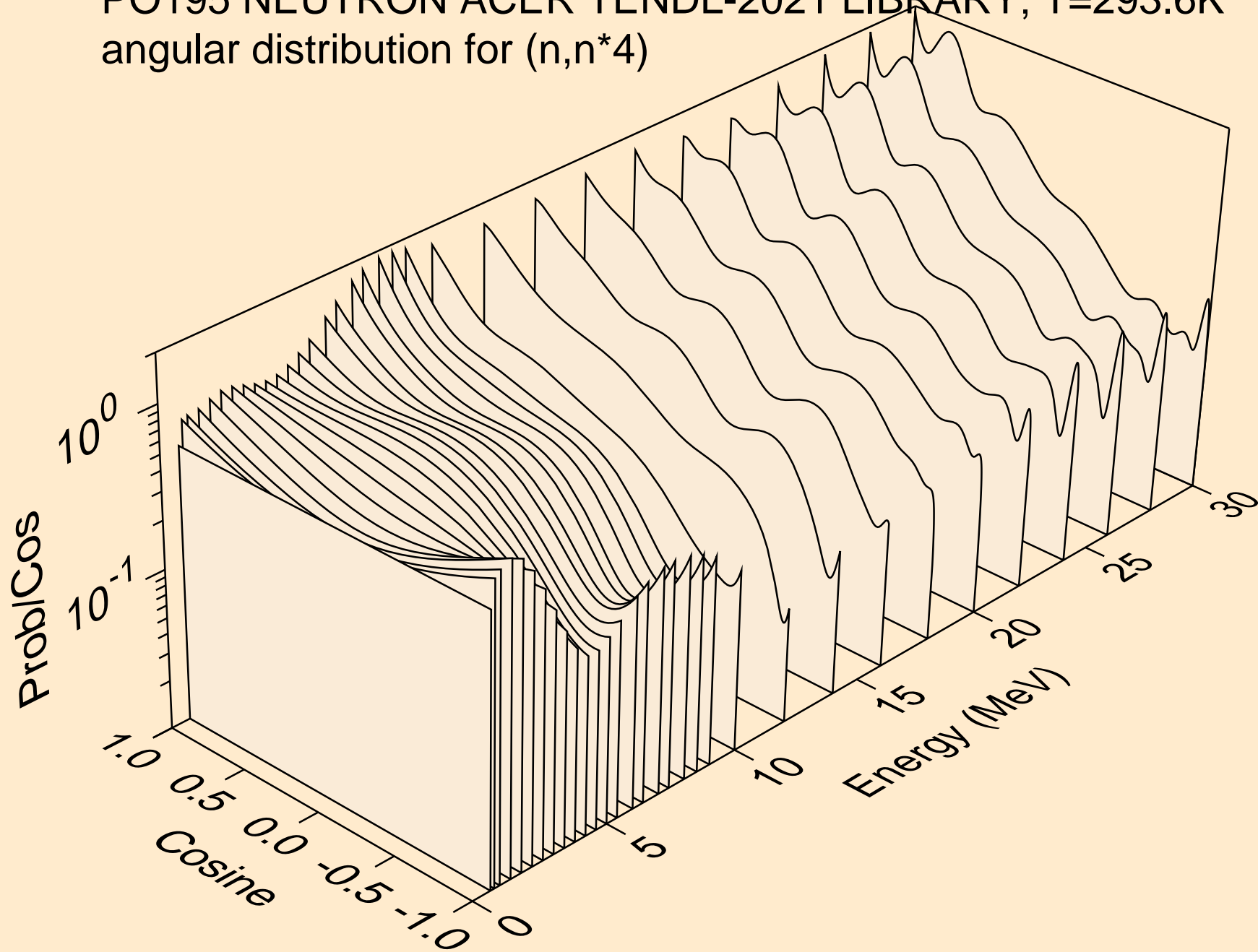

PO195 NEUTRON ACER TENDL-2021 LIBRARY; T=293.6K
angular distribution for (n,n*5)

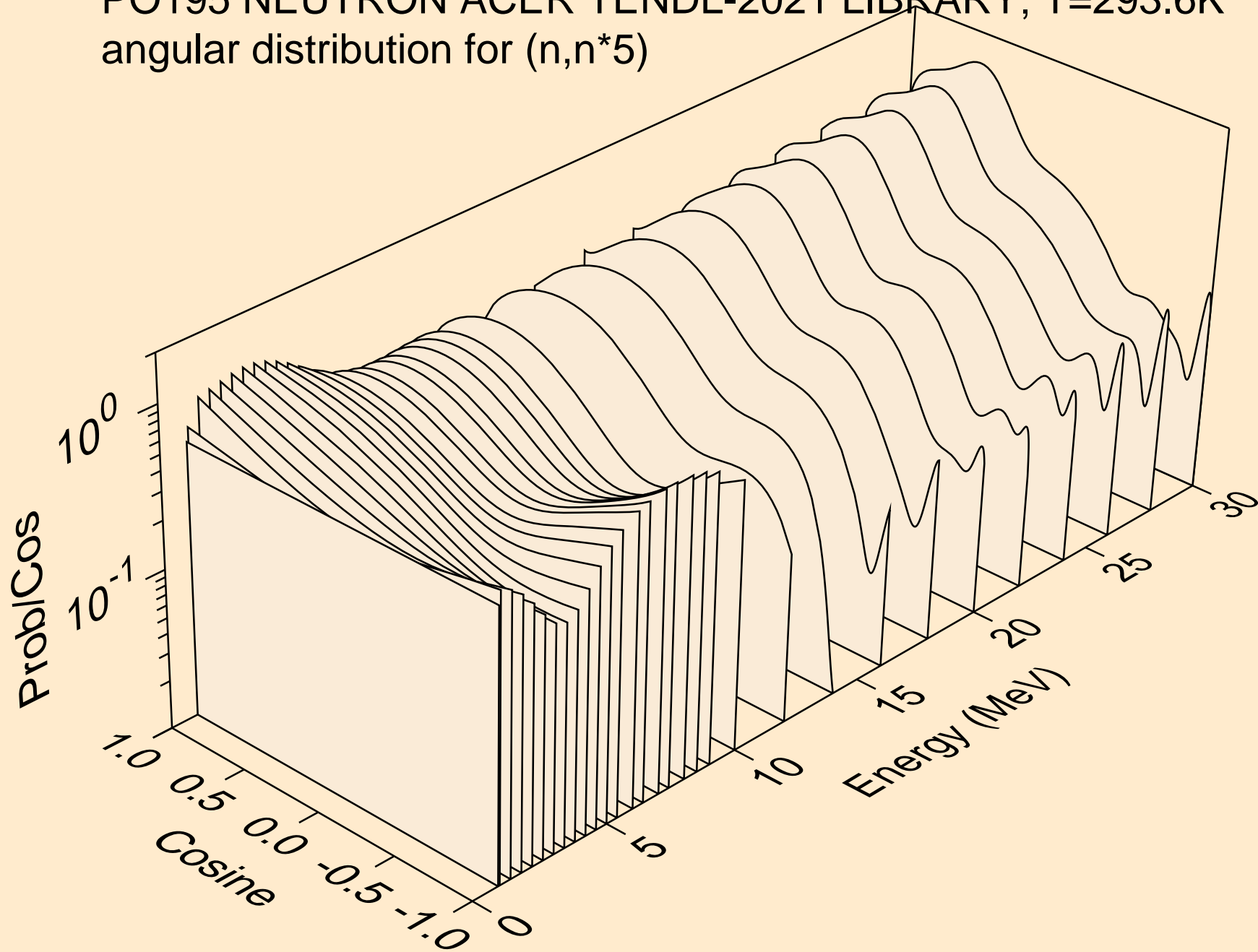

PO195 NEUTRON ACER TENDL-2021 LIBRARY; T=293.6K
angular distribution for (n,n*6)

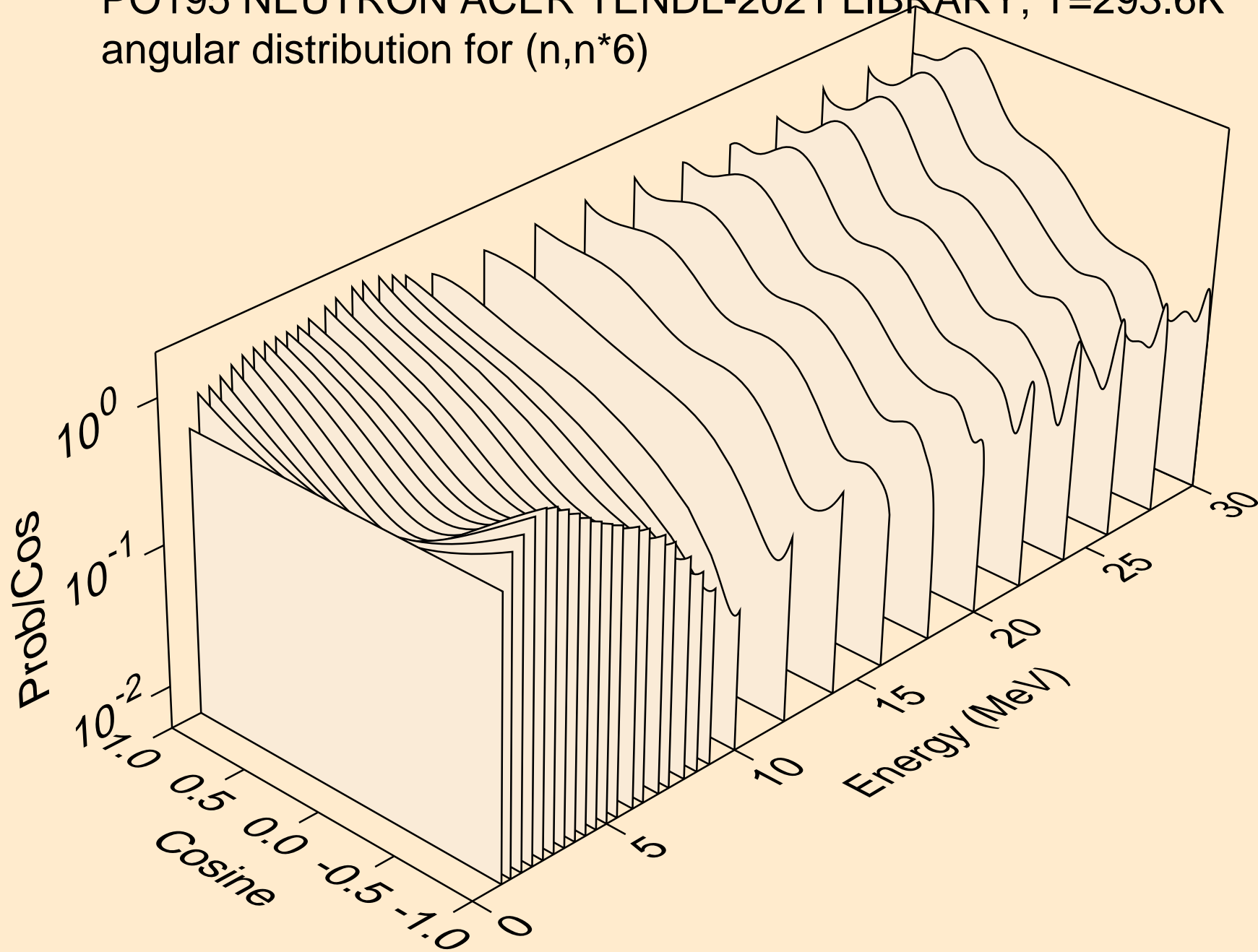

PO195 NEUTRON ACER TENDL-2021 LIBRARY; T=293.6K
angular distribution for (n,n*7)

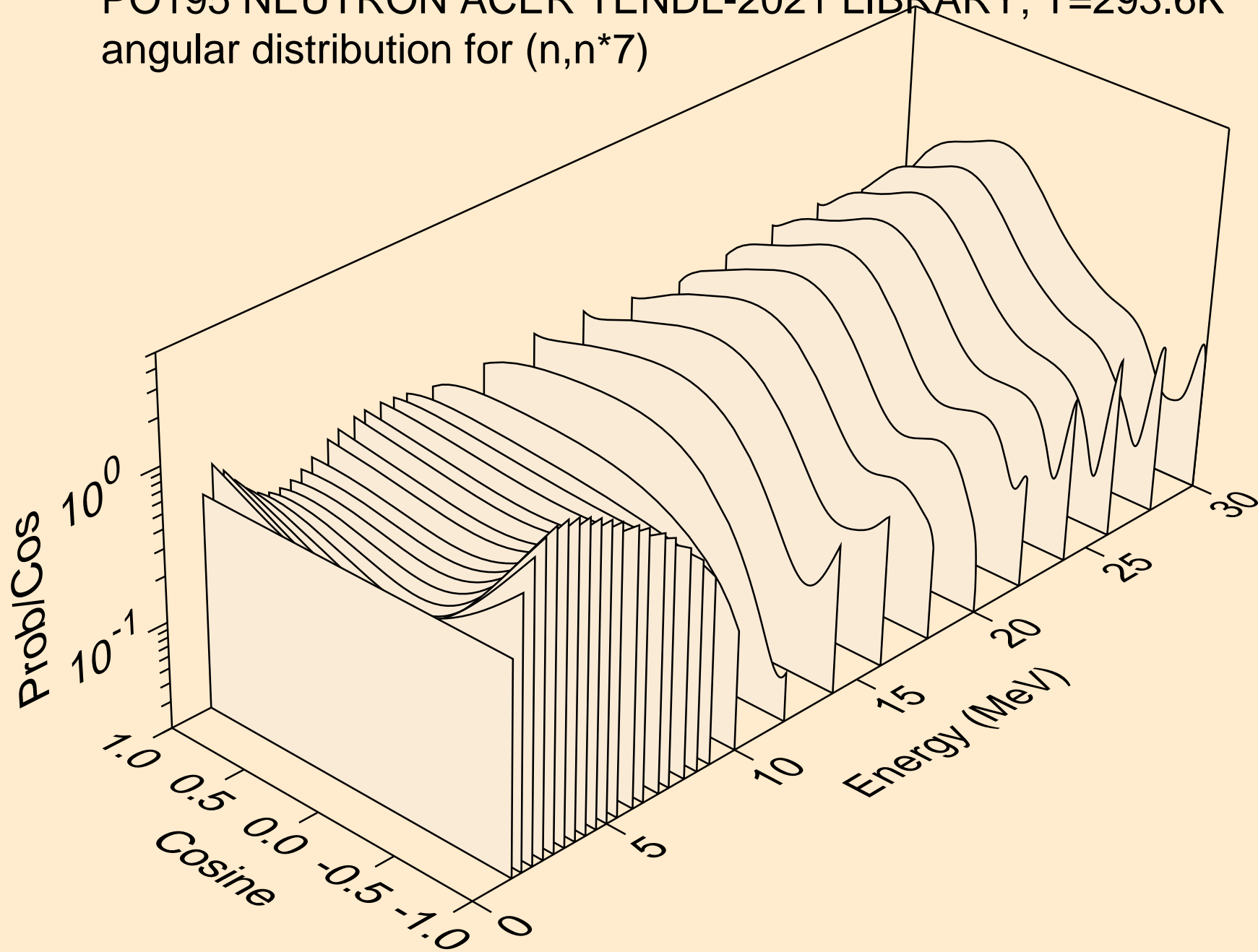

PO195 NEUTRON ACER TENDL-2021 LIBRARY; T=293.6K
angular distribution for (n,n*8)

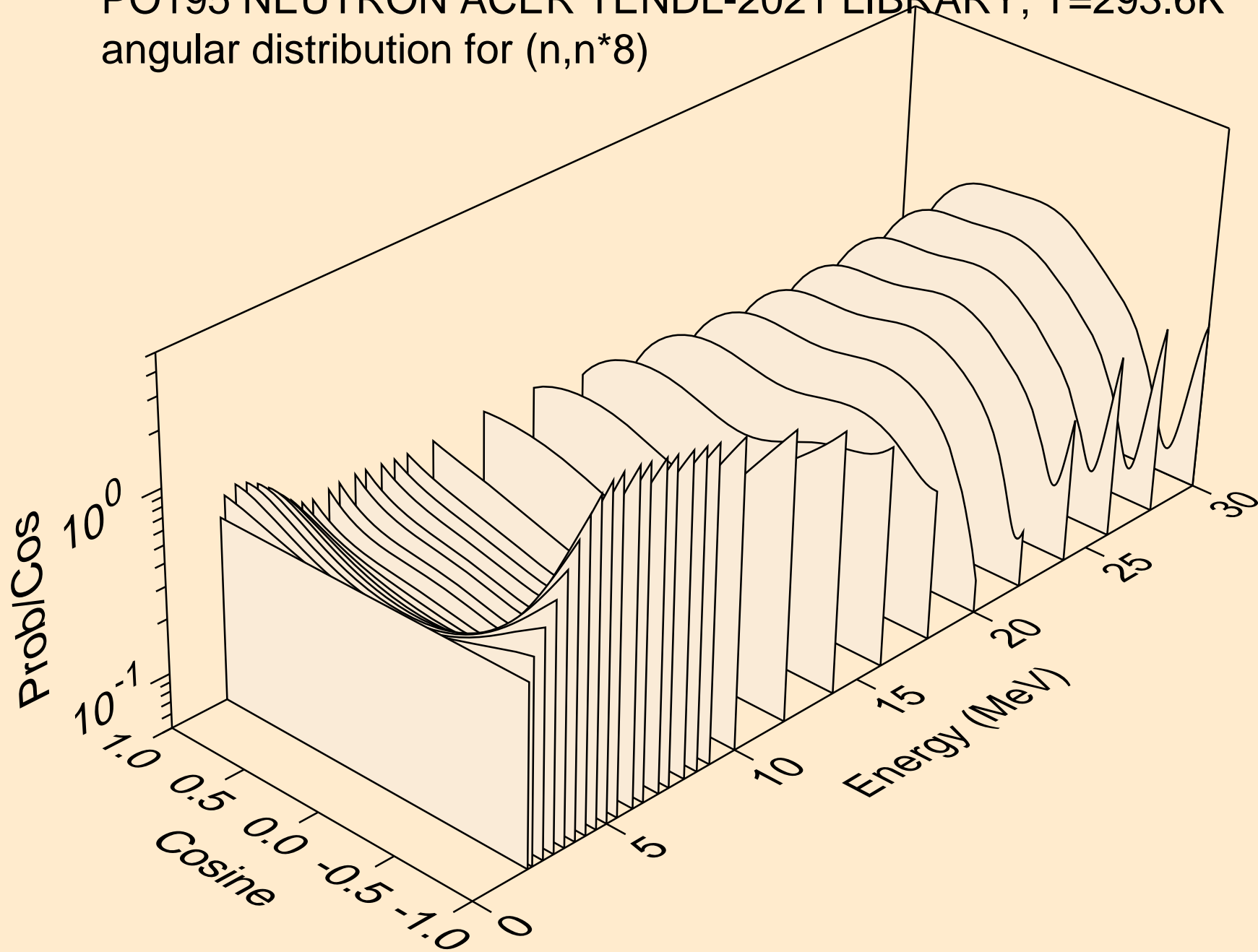

PO195 NEUTRON ACER TENDL-2021 LIBRARY; T=293.6K
angular distribution for (n,n*9)

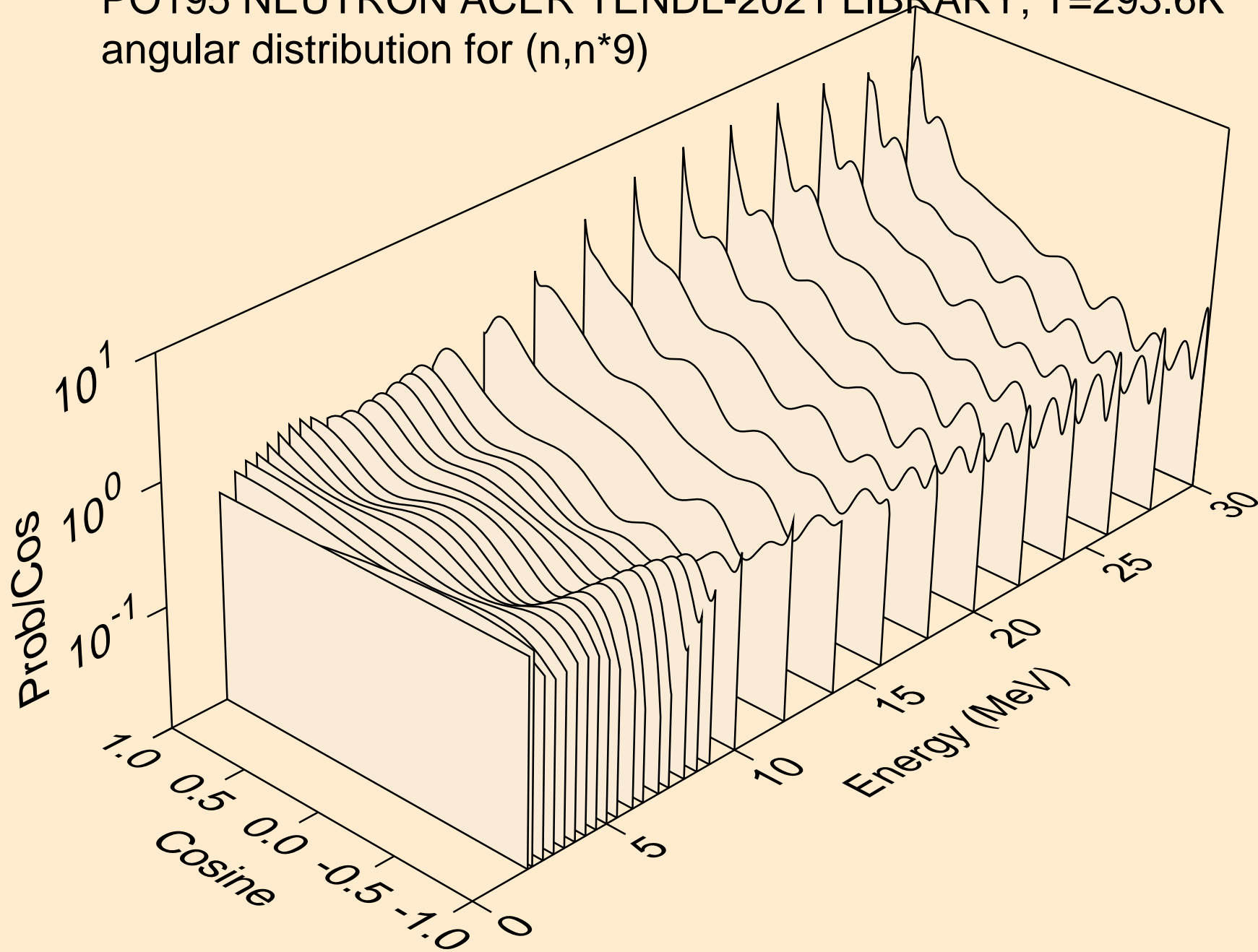

PO195 NEUTRON ACER TENDL-2021 LIBRARY; T=293.6K
angular distribution for (n,n*10)

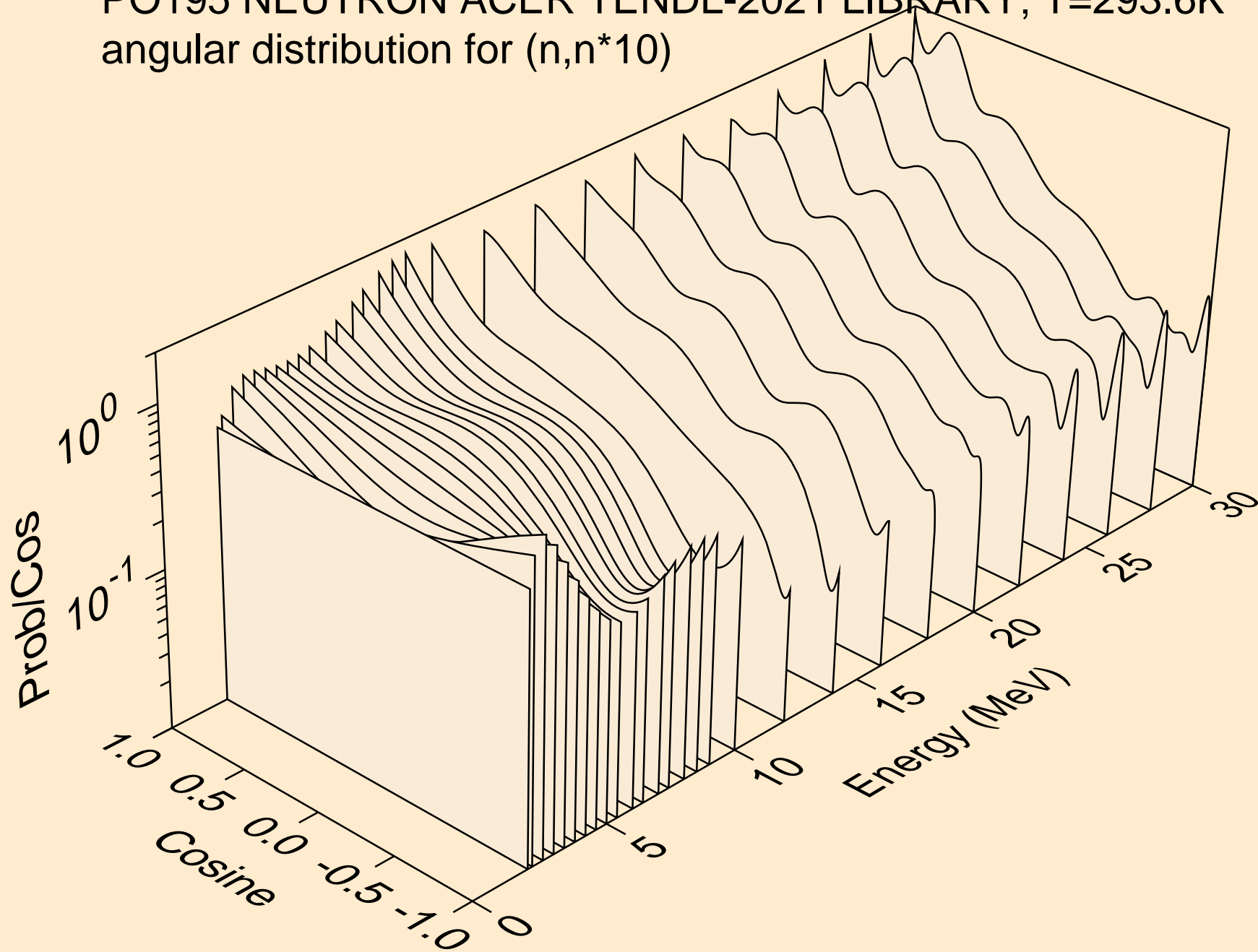

PO195 NEUTRON ACER TENDL-2021 LIBRARY; T=293.6K
angular distribution for (n,n*11)

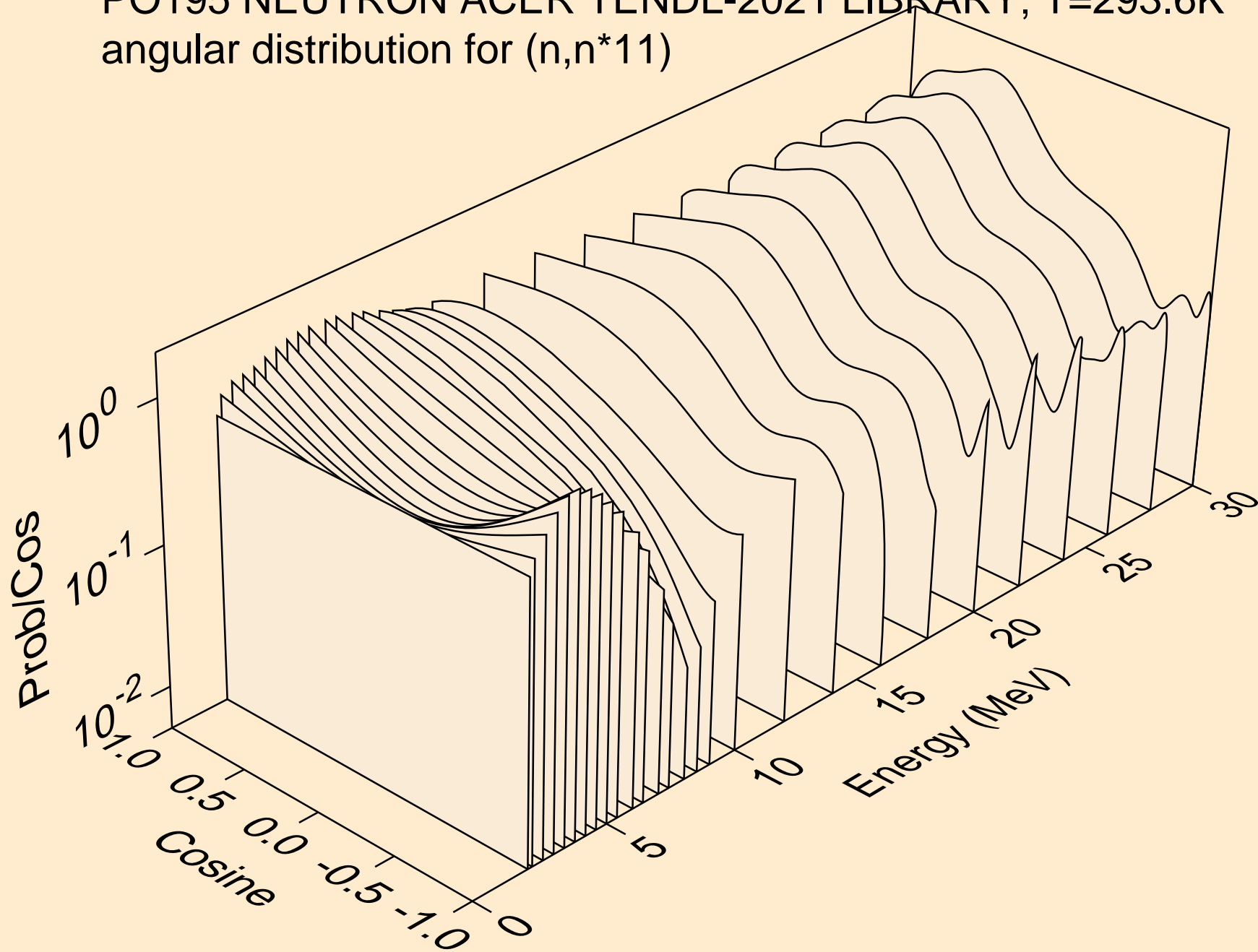

PO195 NEUTRON ACER TENDL-2021 LIBRARY; T=293.6K
angular distribution for (n,n*12)

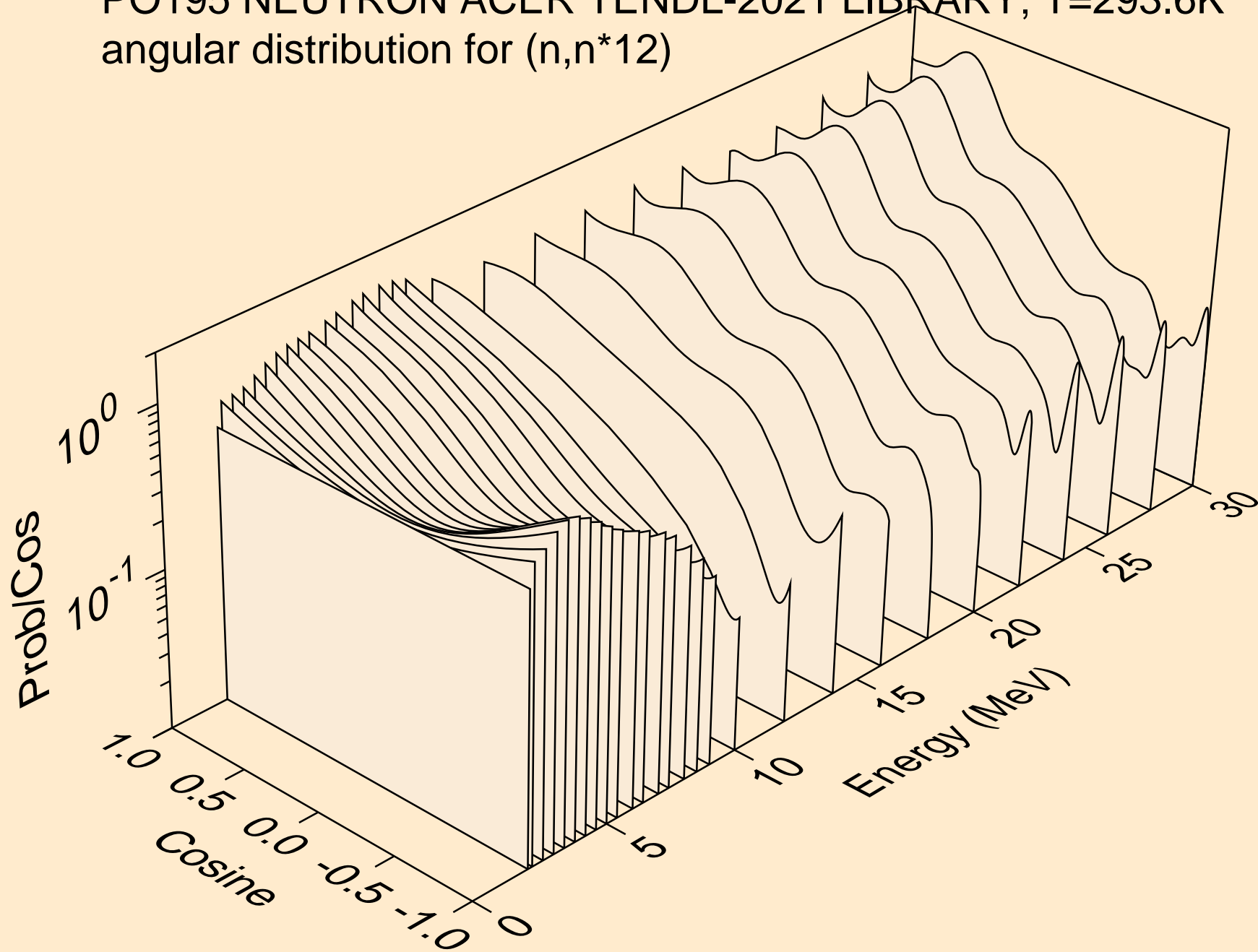

PO195 NEUTRON ACER TENDL-2021 LIBRARY; T=293.6K
angular distribution for (n,n*13)

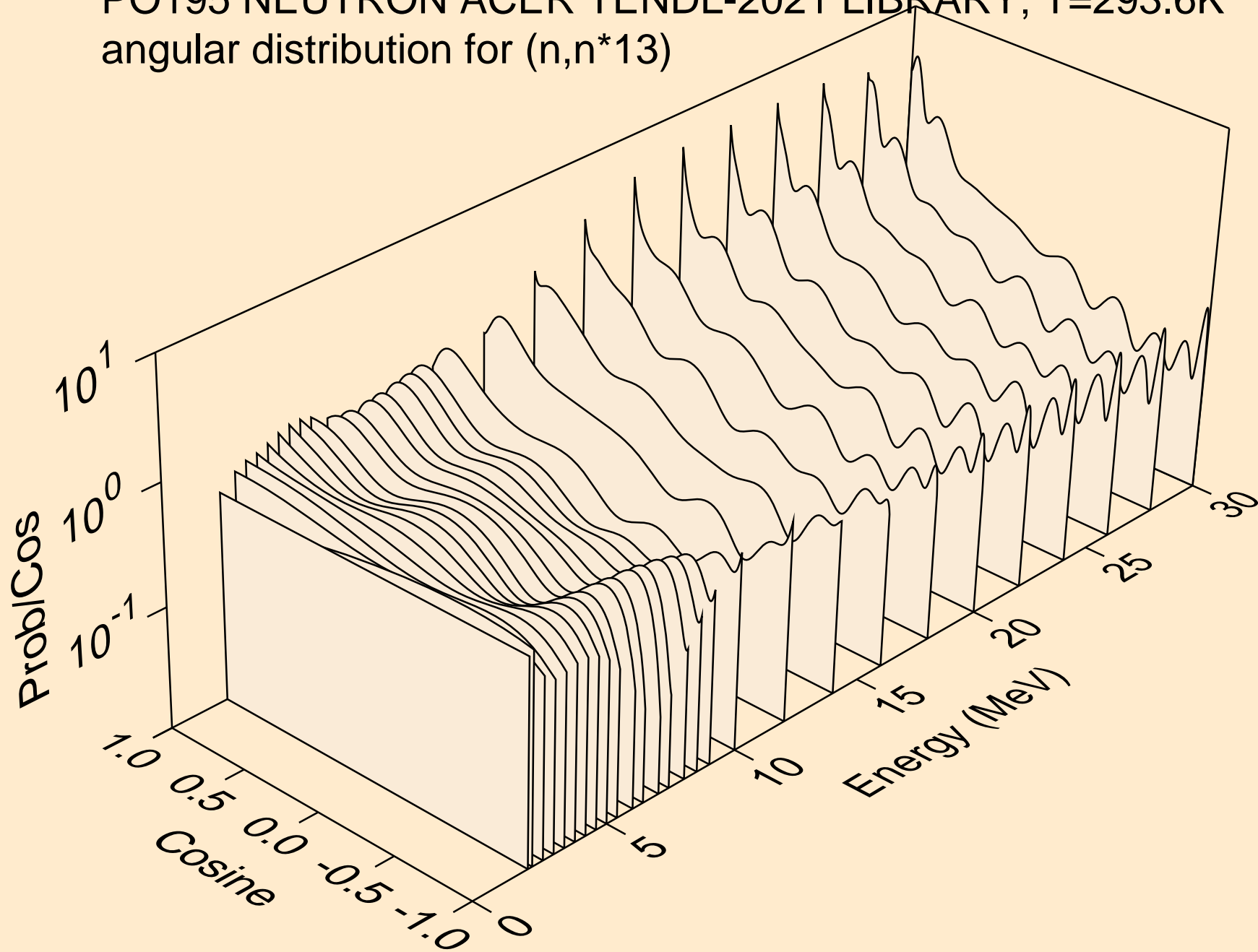

PO195 NEUTRON ACER TENDL-2021 LIBRARY; T=293.6K
Neutron emission for (n,x)

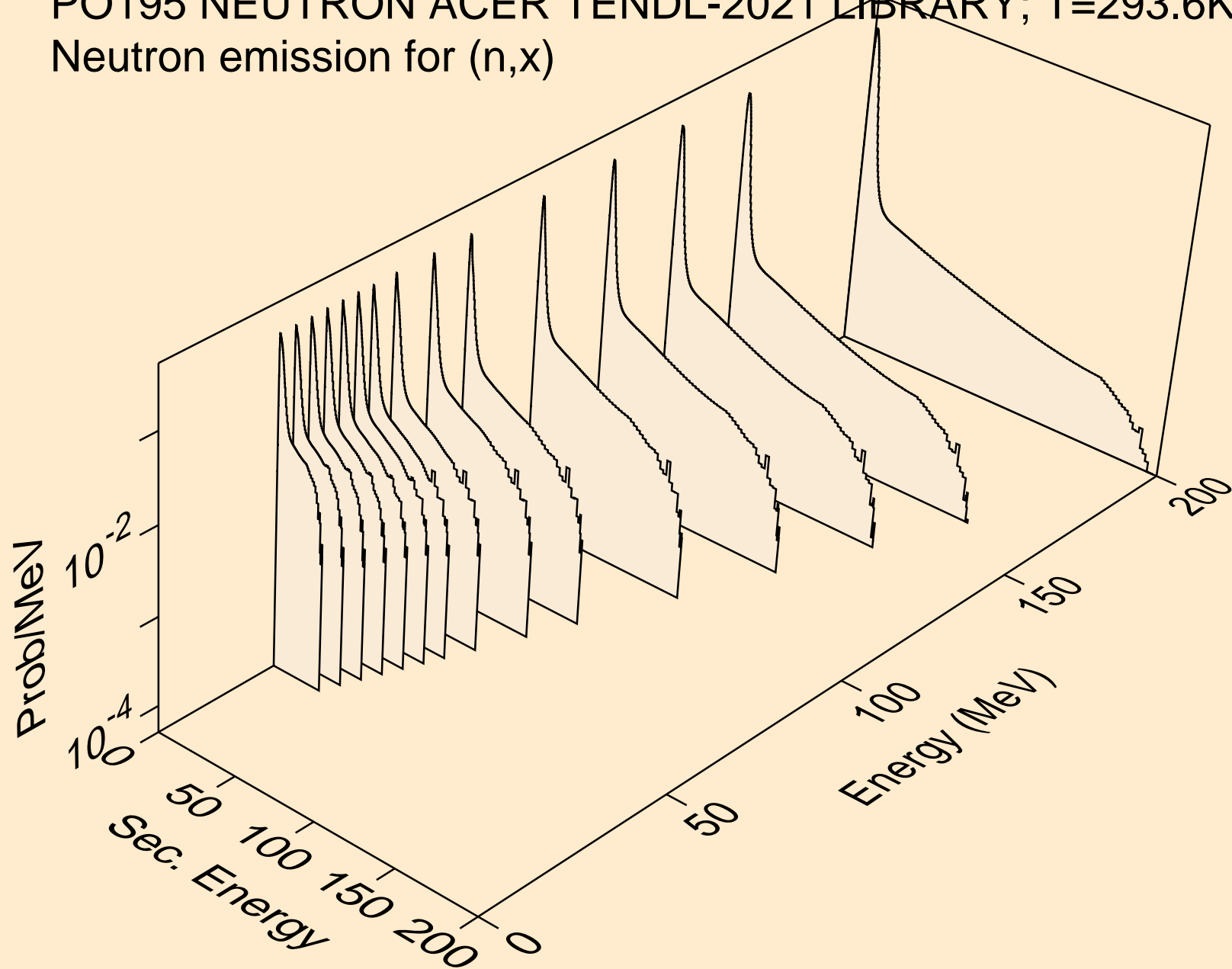

PO195 NEUTRON ACER TENDL-2021 LIBRARY; T=293.6K
Neutron emission for (n,2nd)

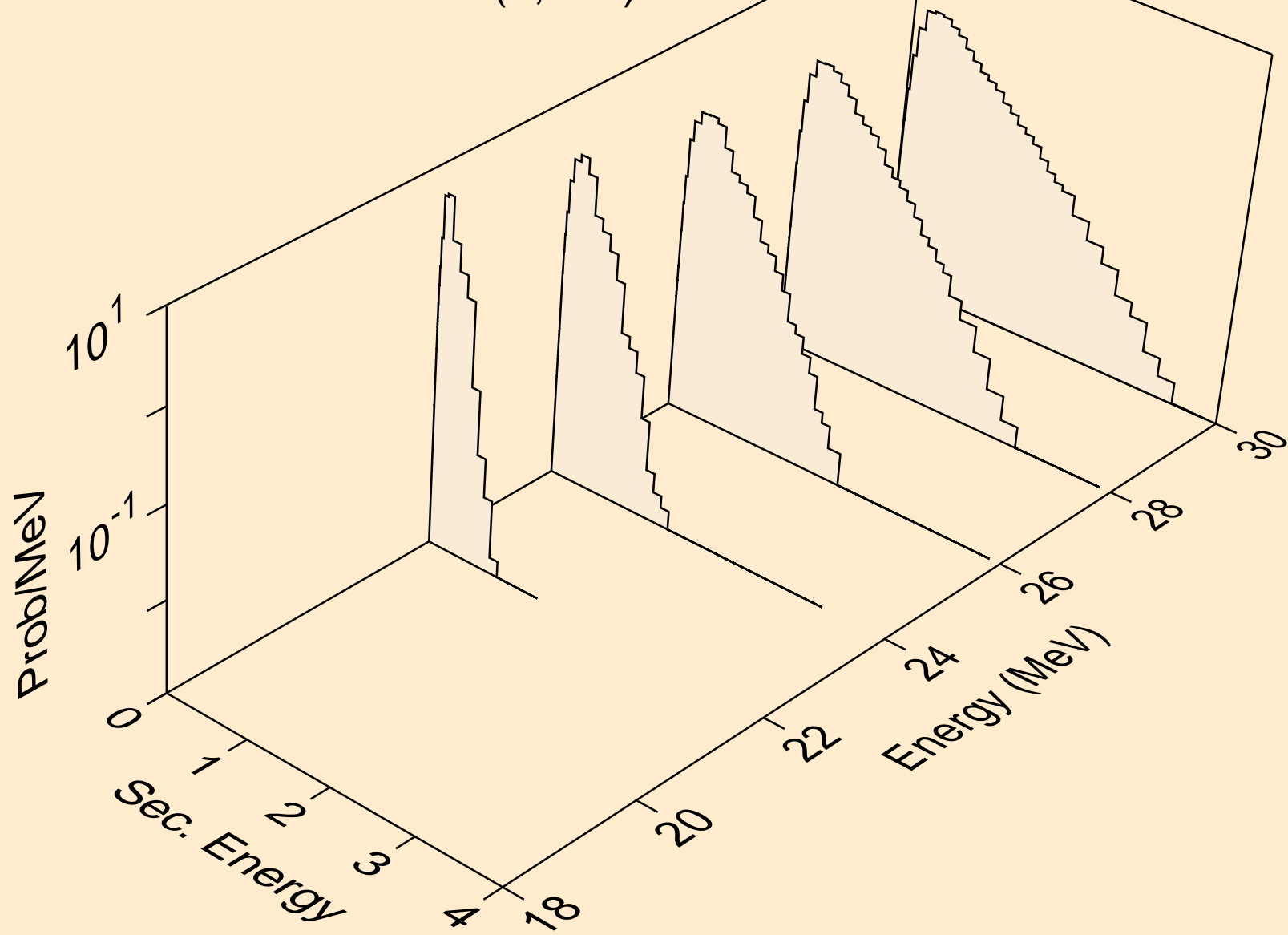

PO195 NEUTRON ACER TENDL-2021 LIBRARY; T=293.6K
Neutron emission for (n,2n)

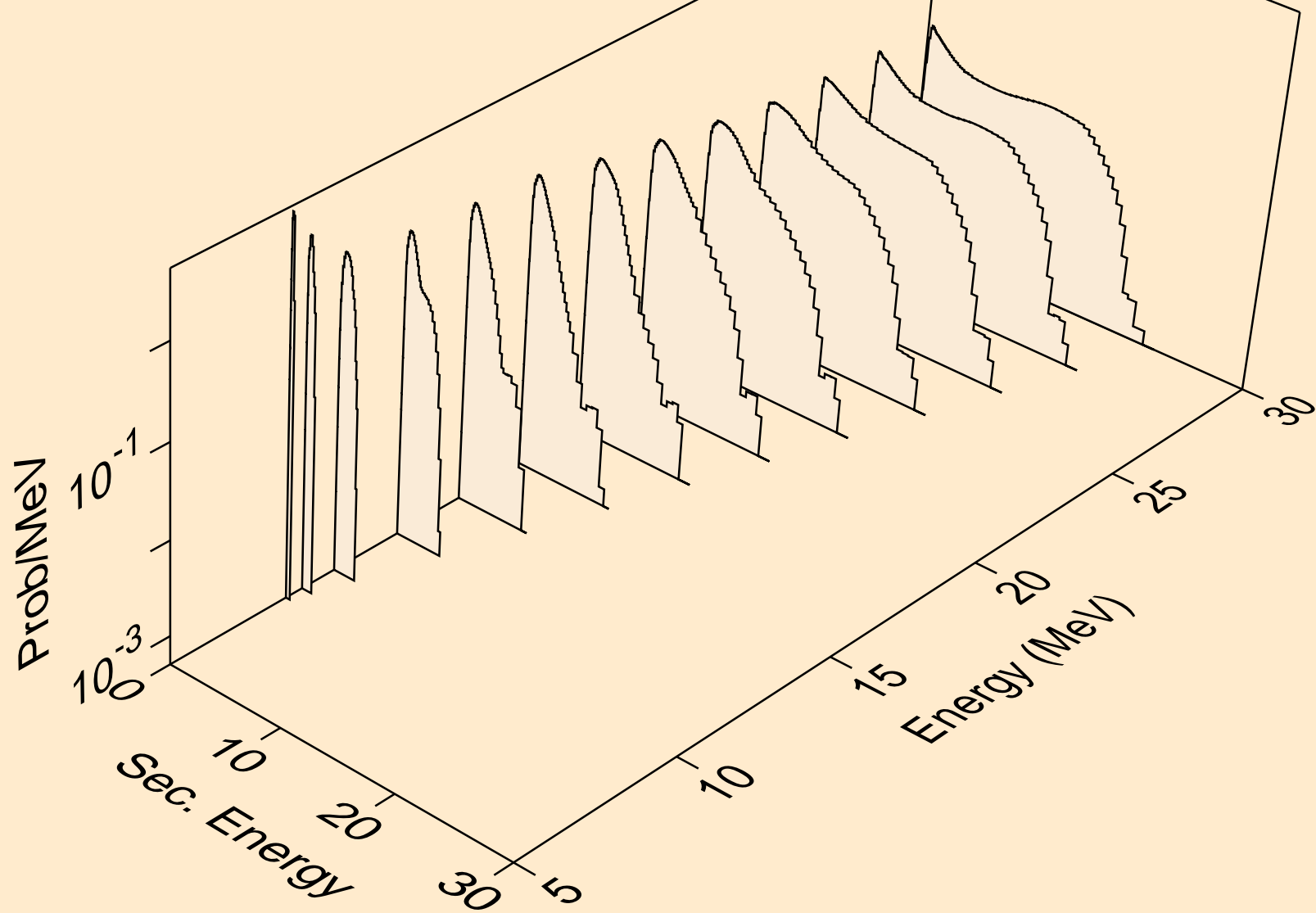

PO195 NEUTRON ACER TENDL-2021 LIBRARY; T=293.6K
Neutron emission for (n,3n)

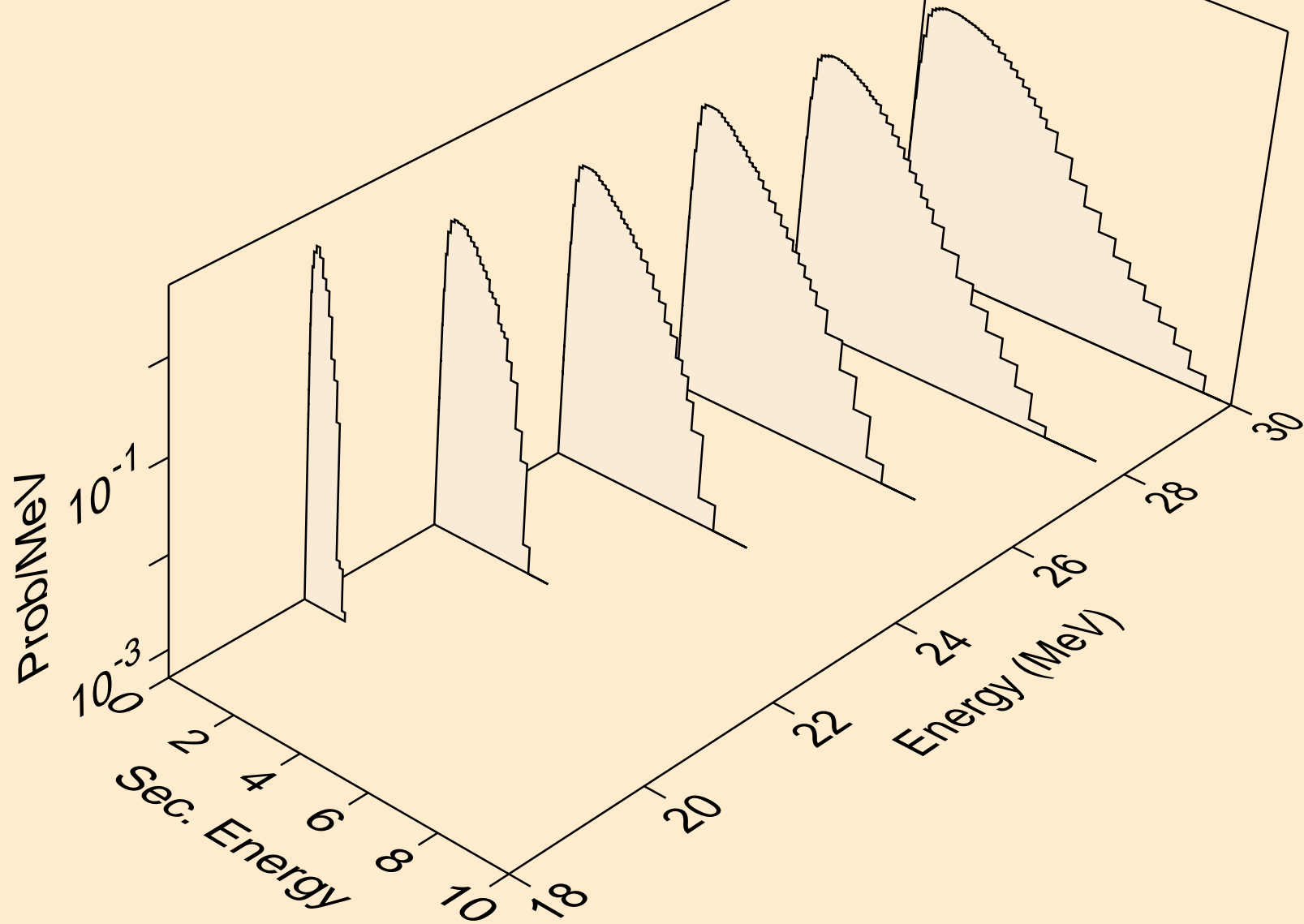

PO195 NEUTRON ACER TENDL-2021 LIBRARY; T=293.6K
Neutron emission for (n,n*)a

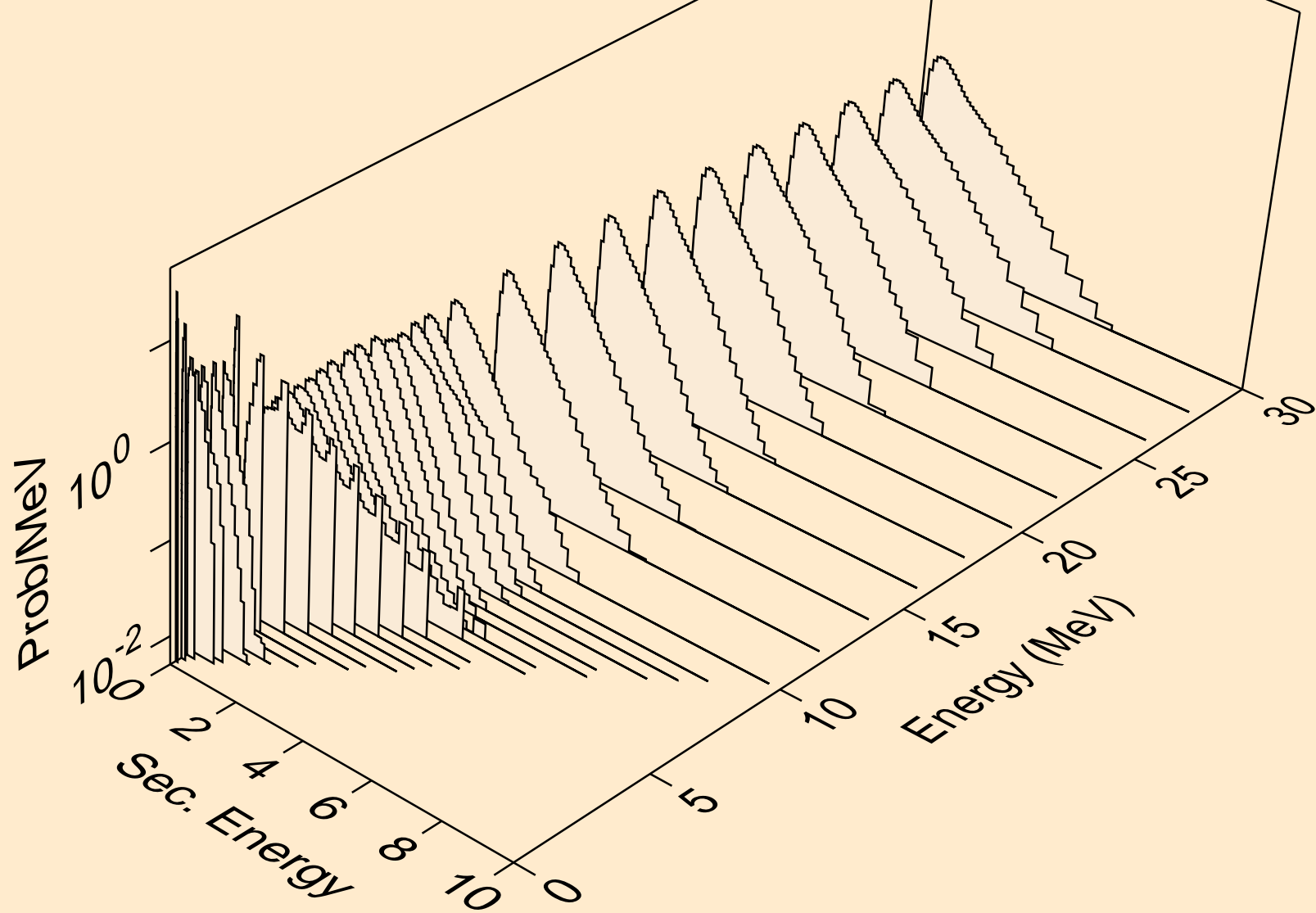

PO195 NEUTRON ACER TENDL-2021 LIBRARY; T=293.6K
Neutron emission for (n,2n)a

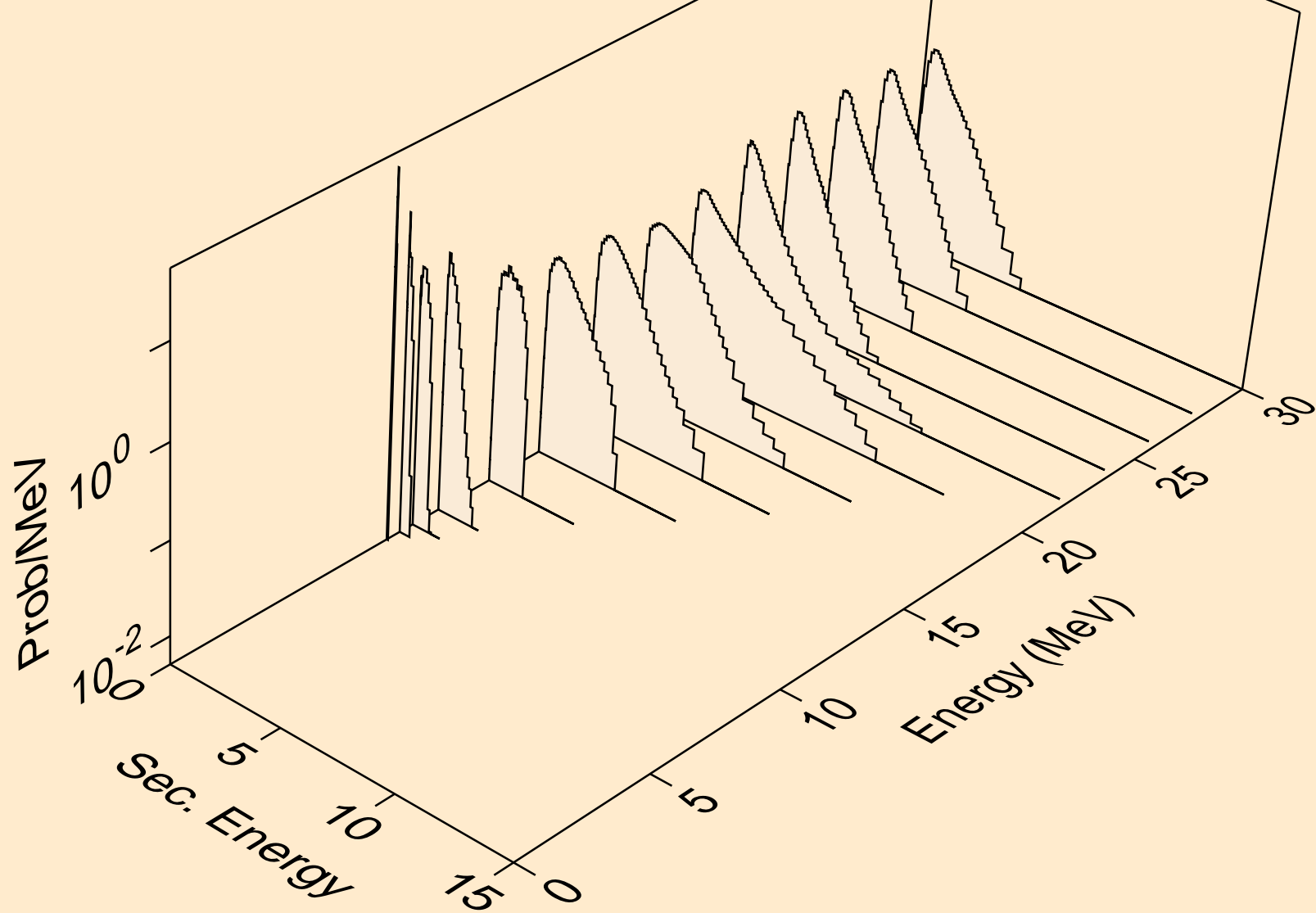

PO195 NEUTRON ACER TENDL-2021 LIBRARY; T=293.6K
Neutron emission for (n,3n)a

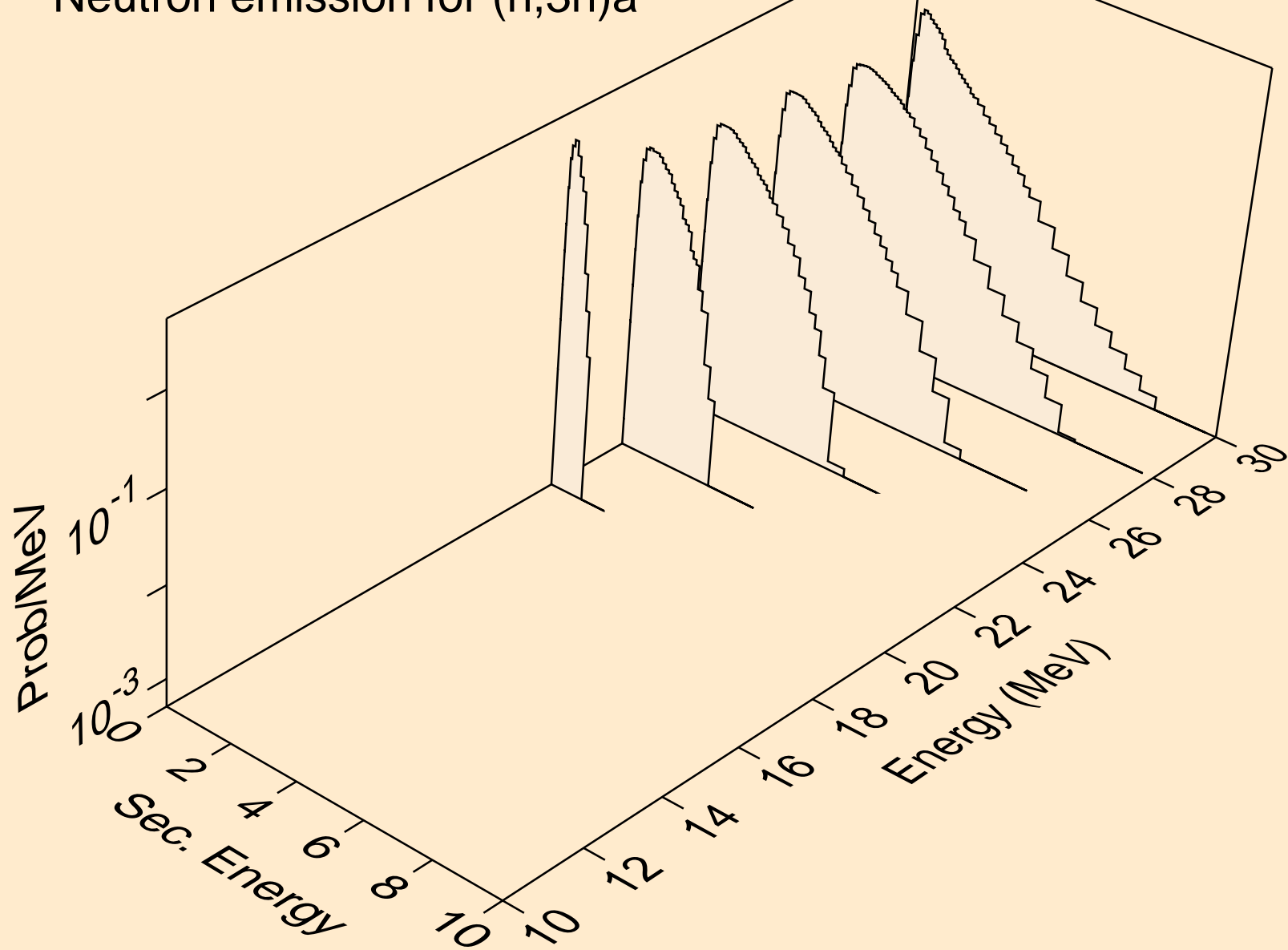

PO195 NEUTRON ACER TENDL-2021 LIBRARY; T=293.6K
Neutron emission for (n,n*)p

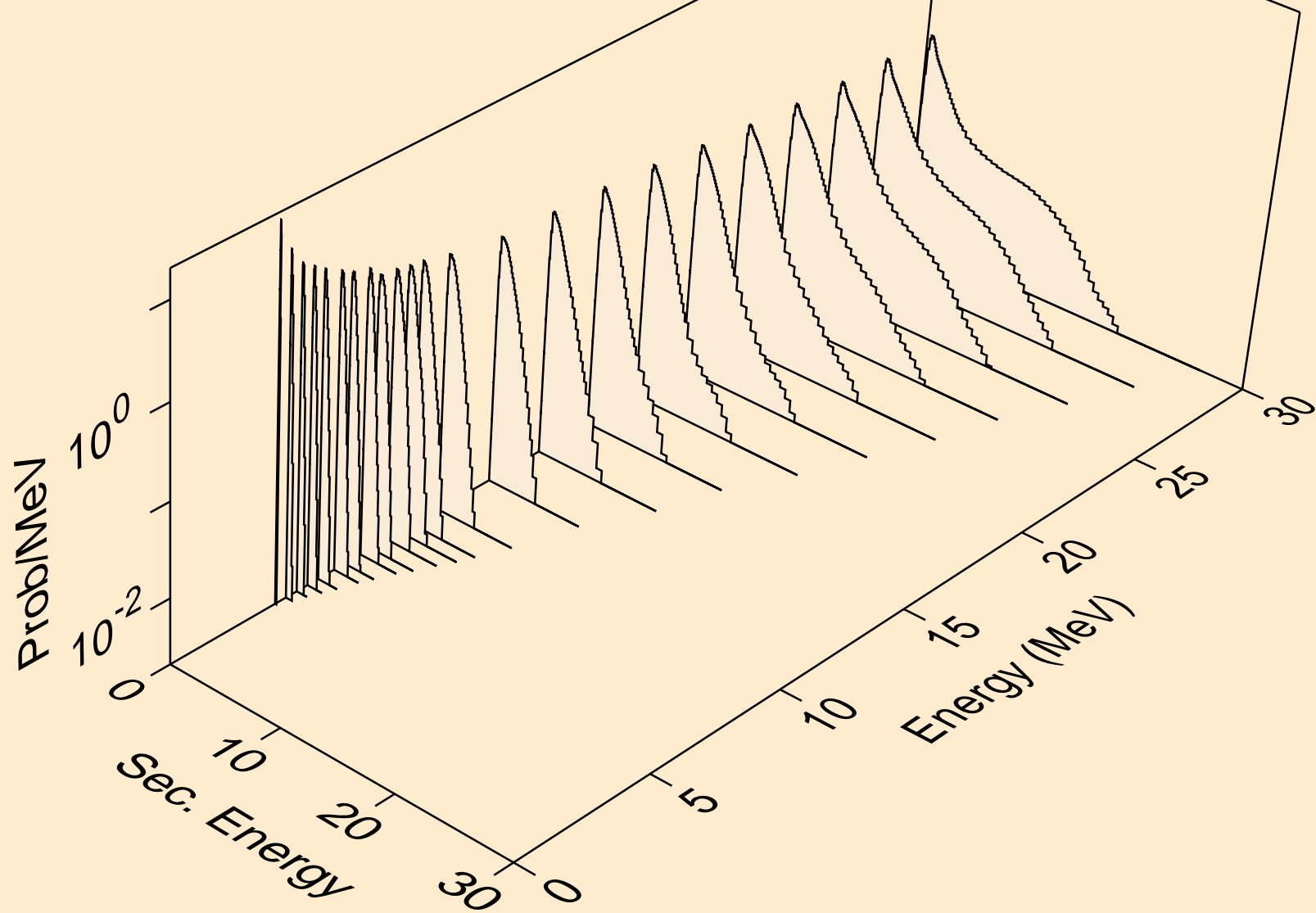

PO195 NEUTRON ACER TENDL-2021 LIBRARY; T=293.6K
Neutron emission for (n,n*)2a

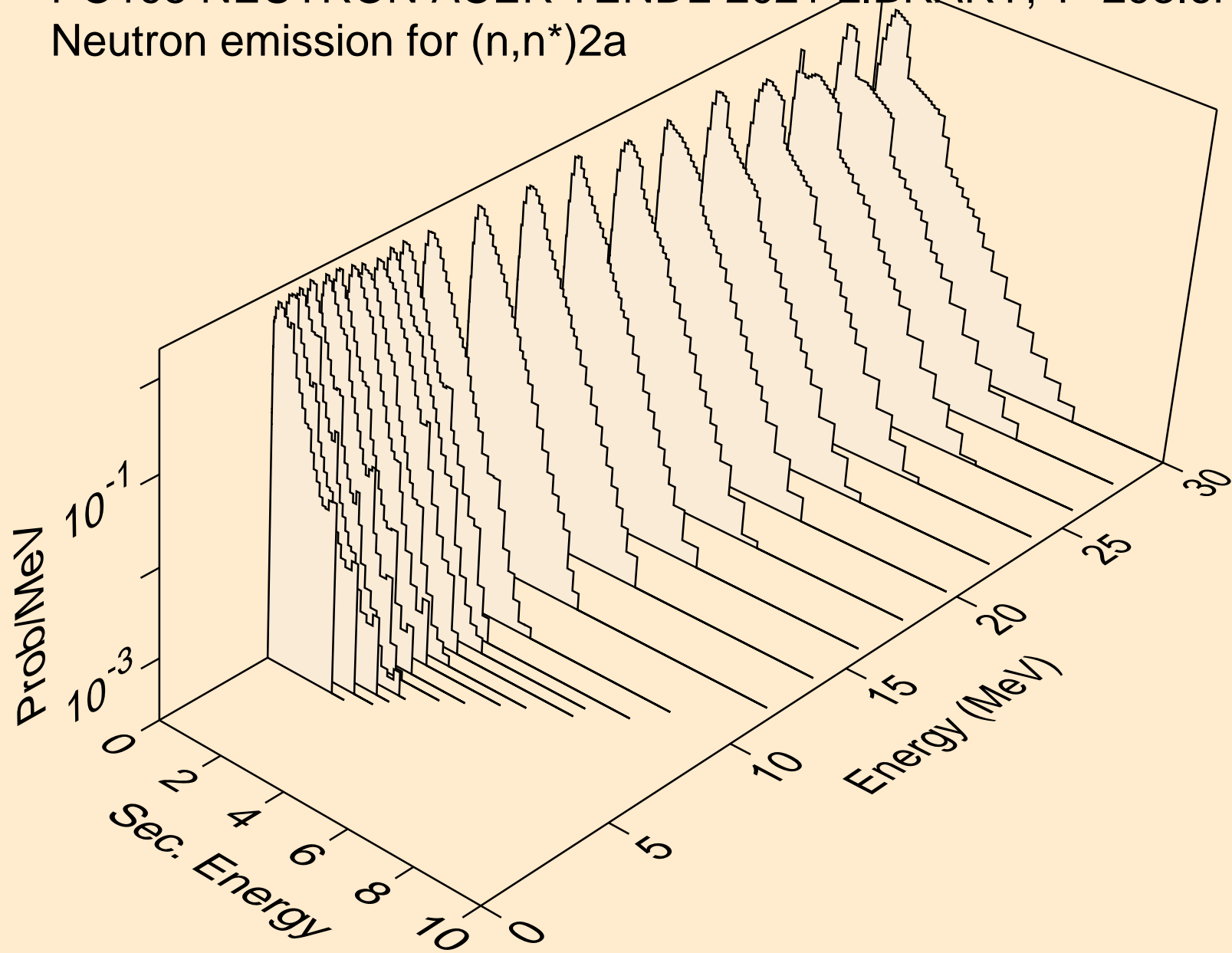

PO195 NEUTRON ACER TENDL-2021 LIBRARY; T=293.6K
Neutron emission for (n,2n)2a

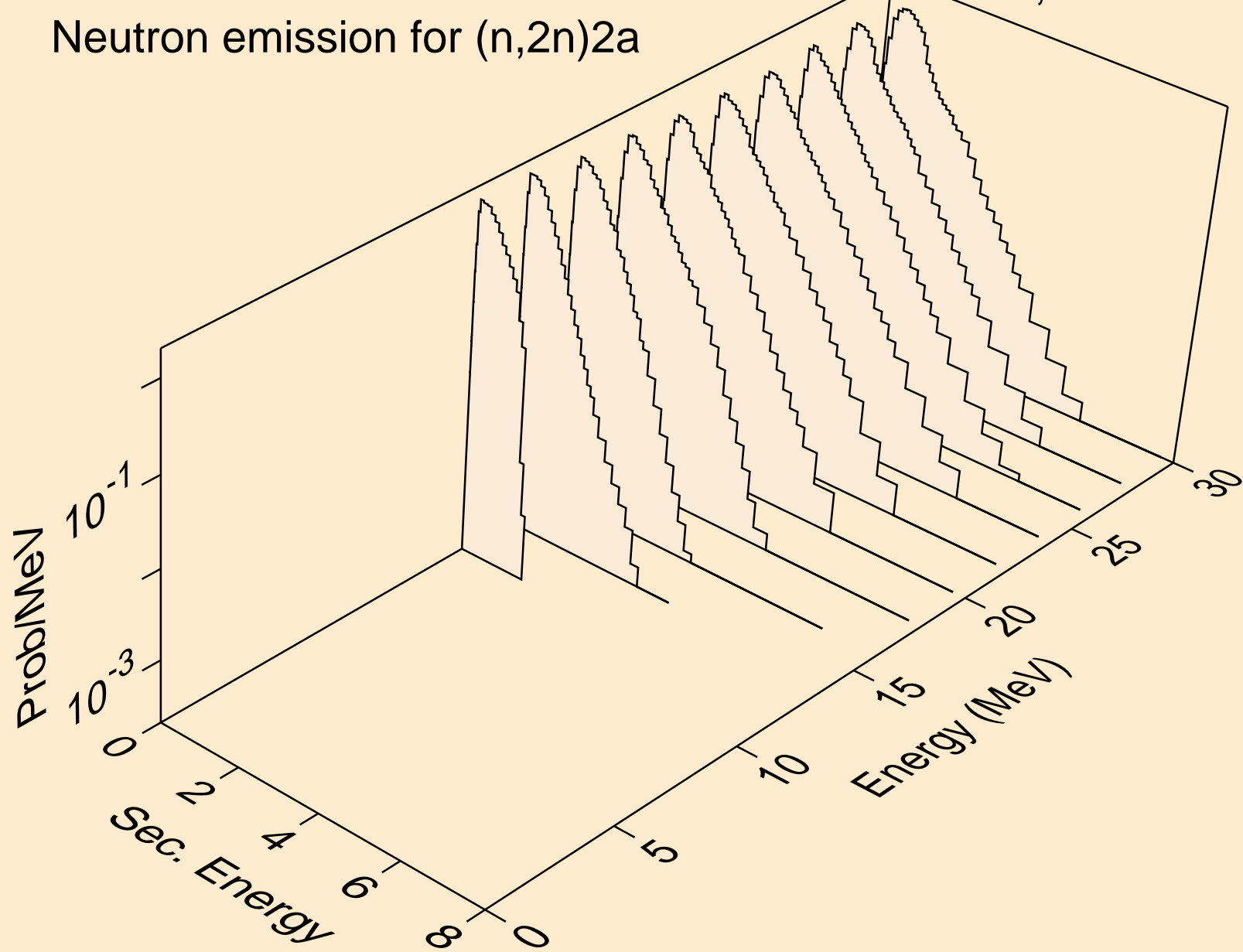

PO195 NEUTRON ACER TENDL-2021 LIBRARY; T=293.6K
Neutron emission for (n,n*)d

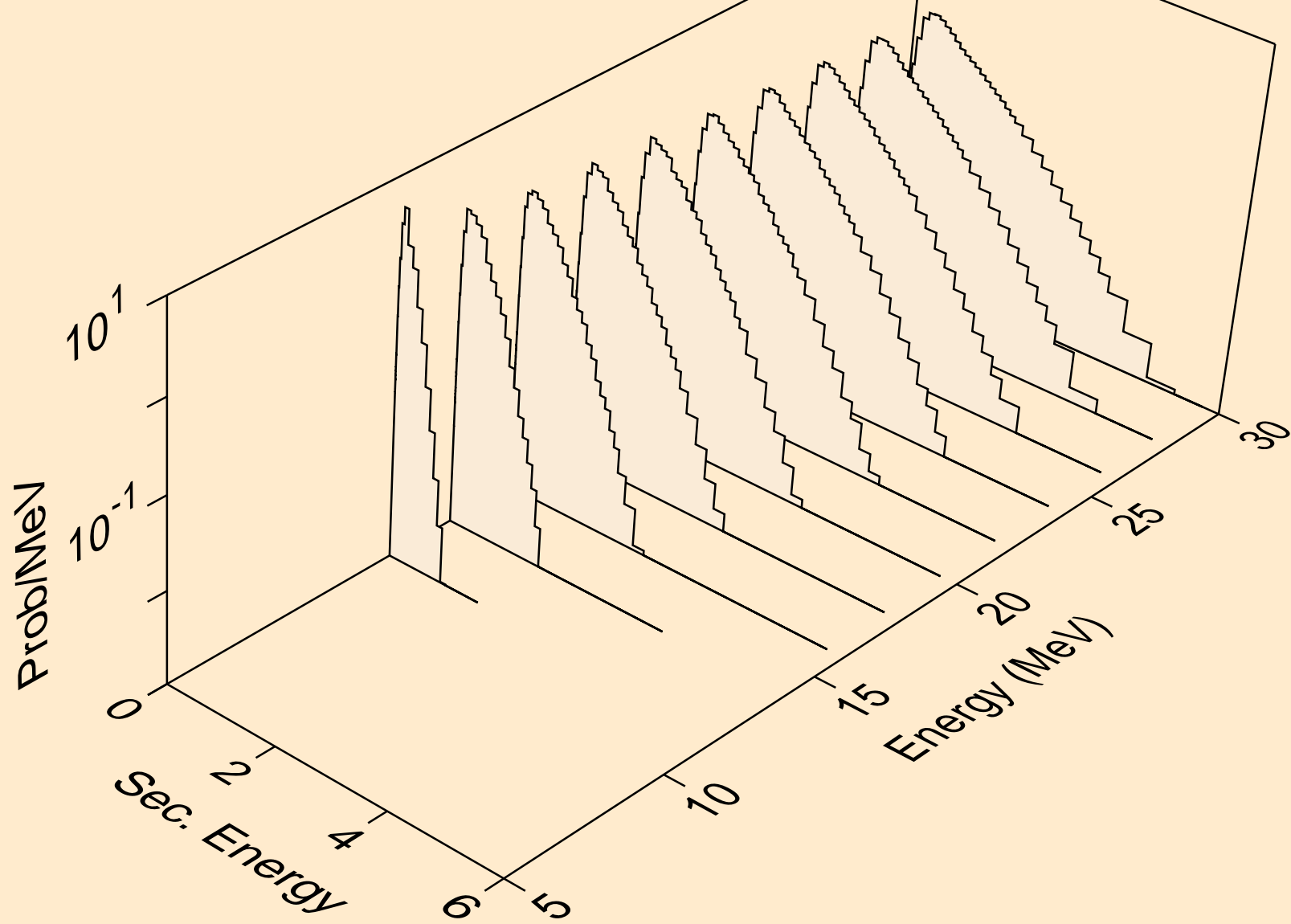

PO195 NEUTRON ACER TENDL-2021 LIBRARY; T=293.6K
Neutron emission for (n,n*)t

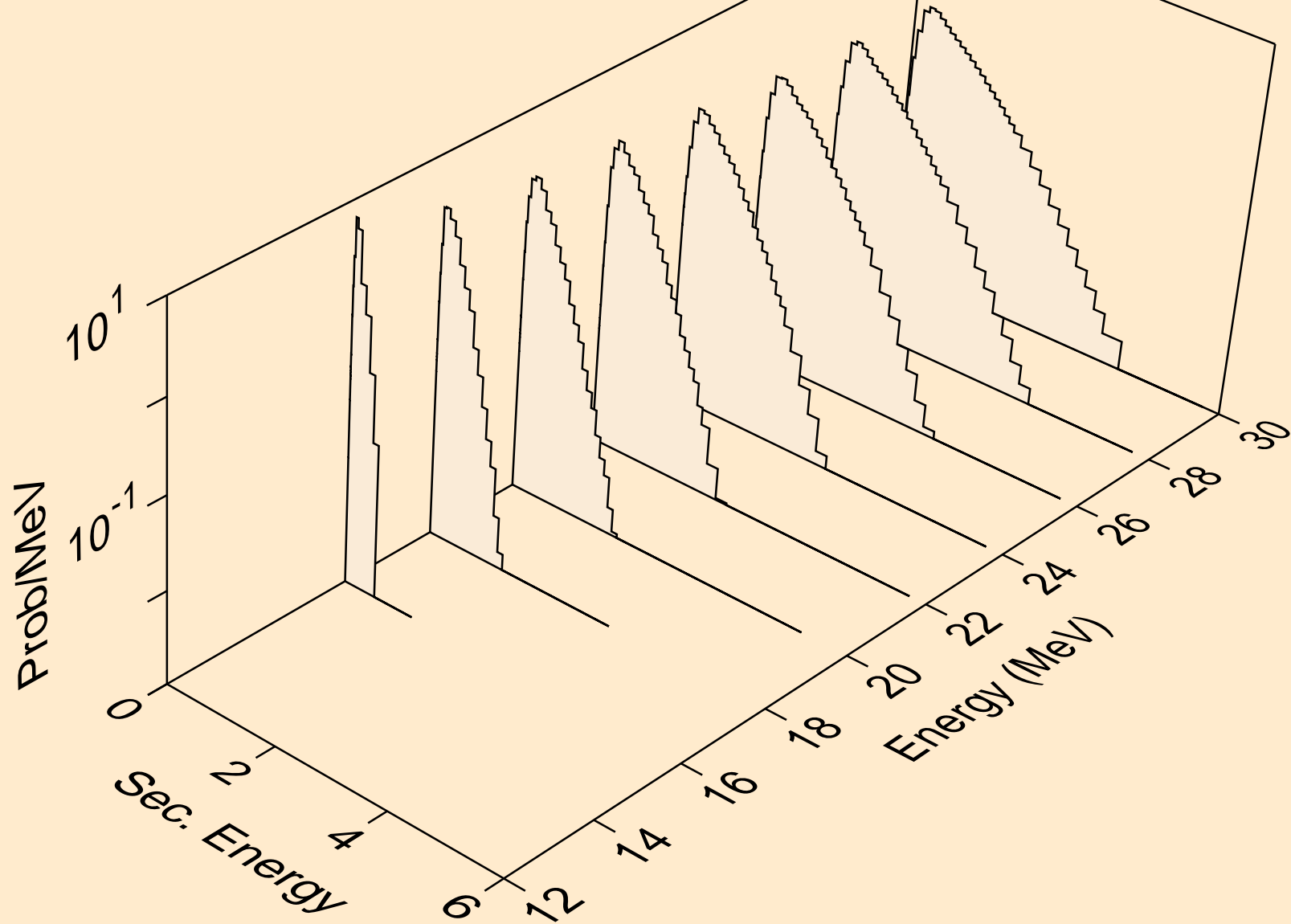

PO195 NEUTRON ACER TENDL-2021 LIBRARY; T=293.6K
Neutron emission for (n,n*)he3

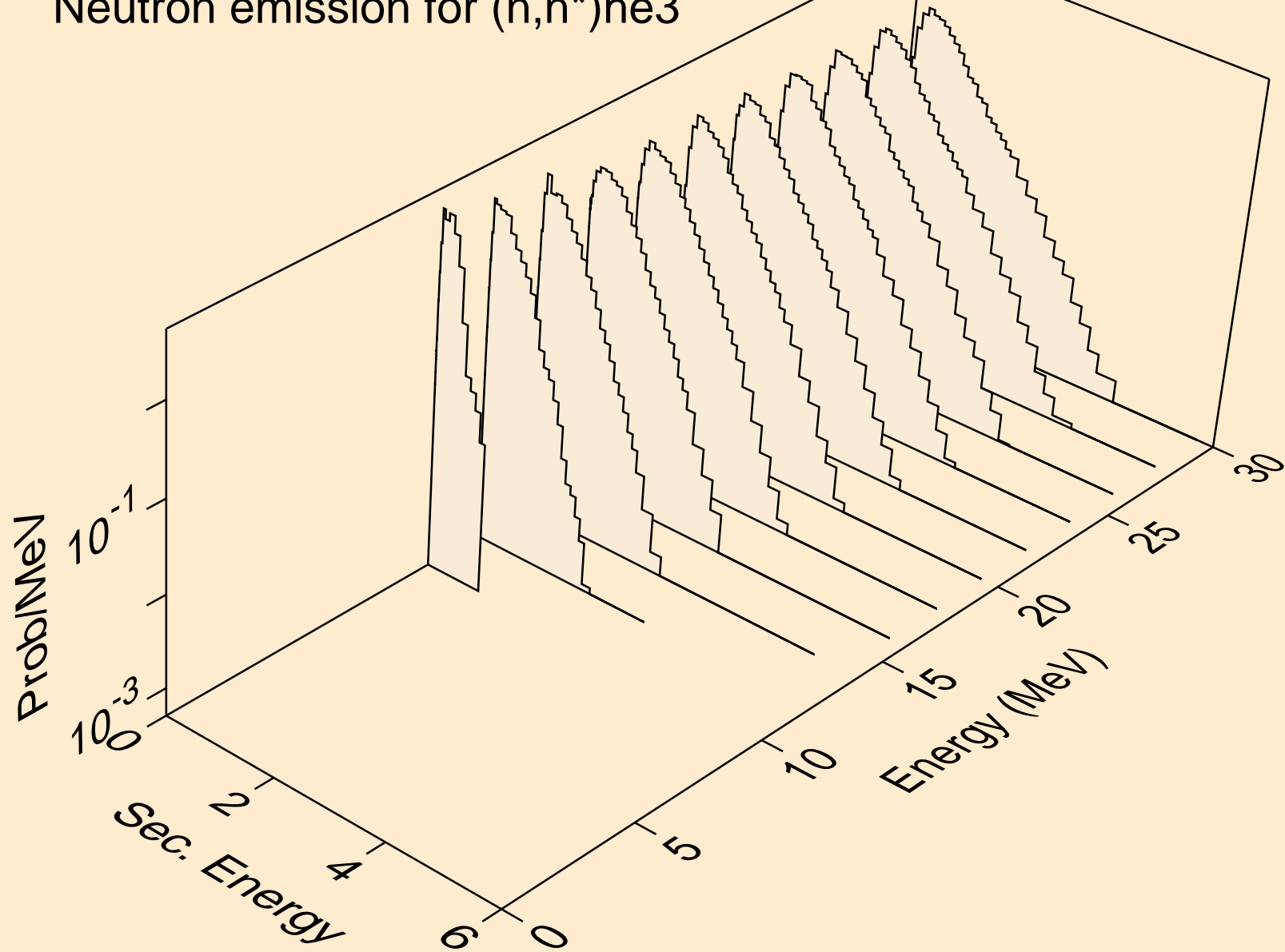

PO195 NEUTRON ACER TENDL-2021 LIBRARY; T=293.6K
Neutron emission for (n,4n)

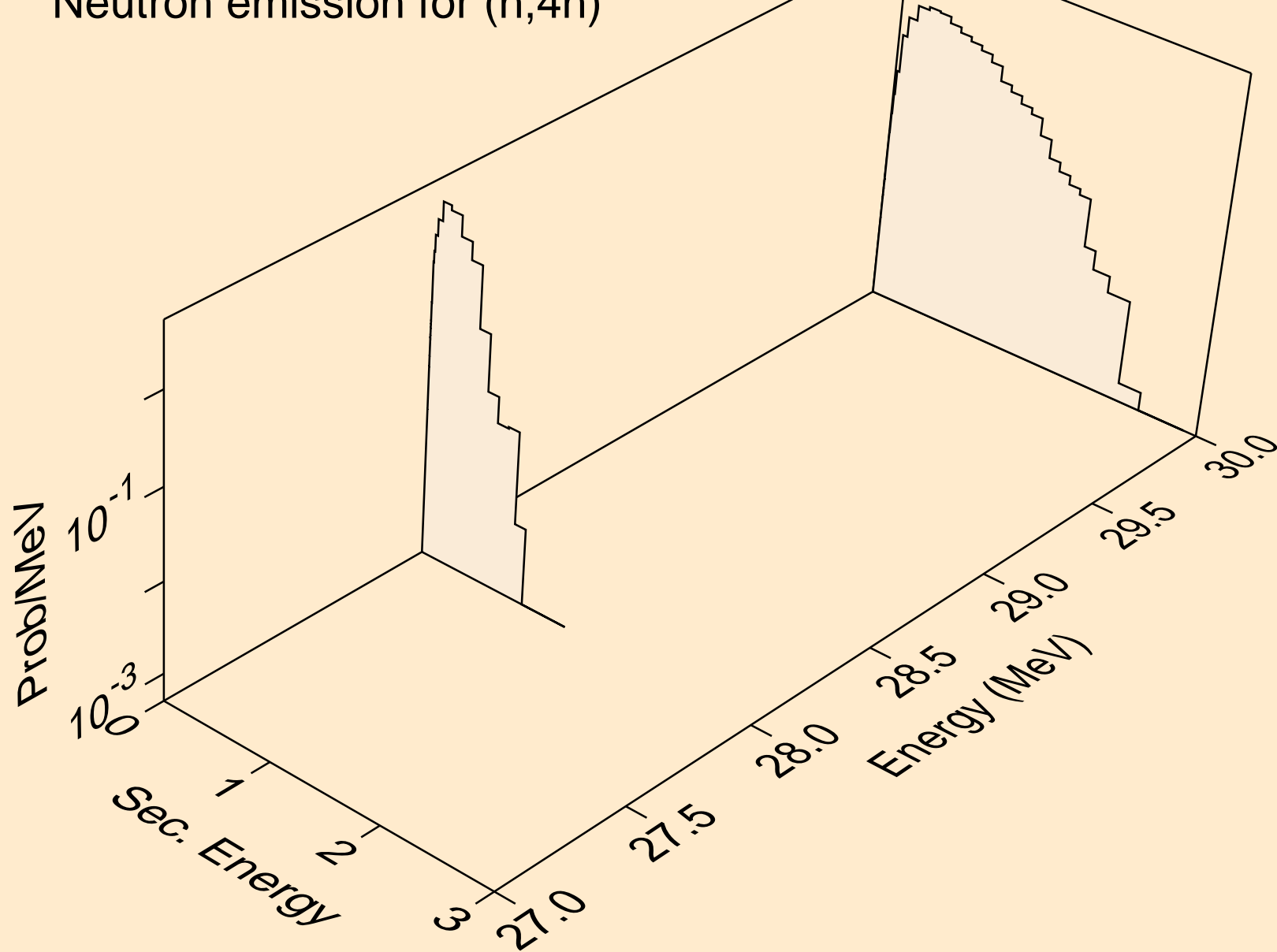

PO195 NEUTRON ACER TENDL-2021 LIBRARY; T=293.6K
Neutron emission for (n,2np)

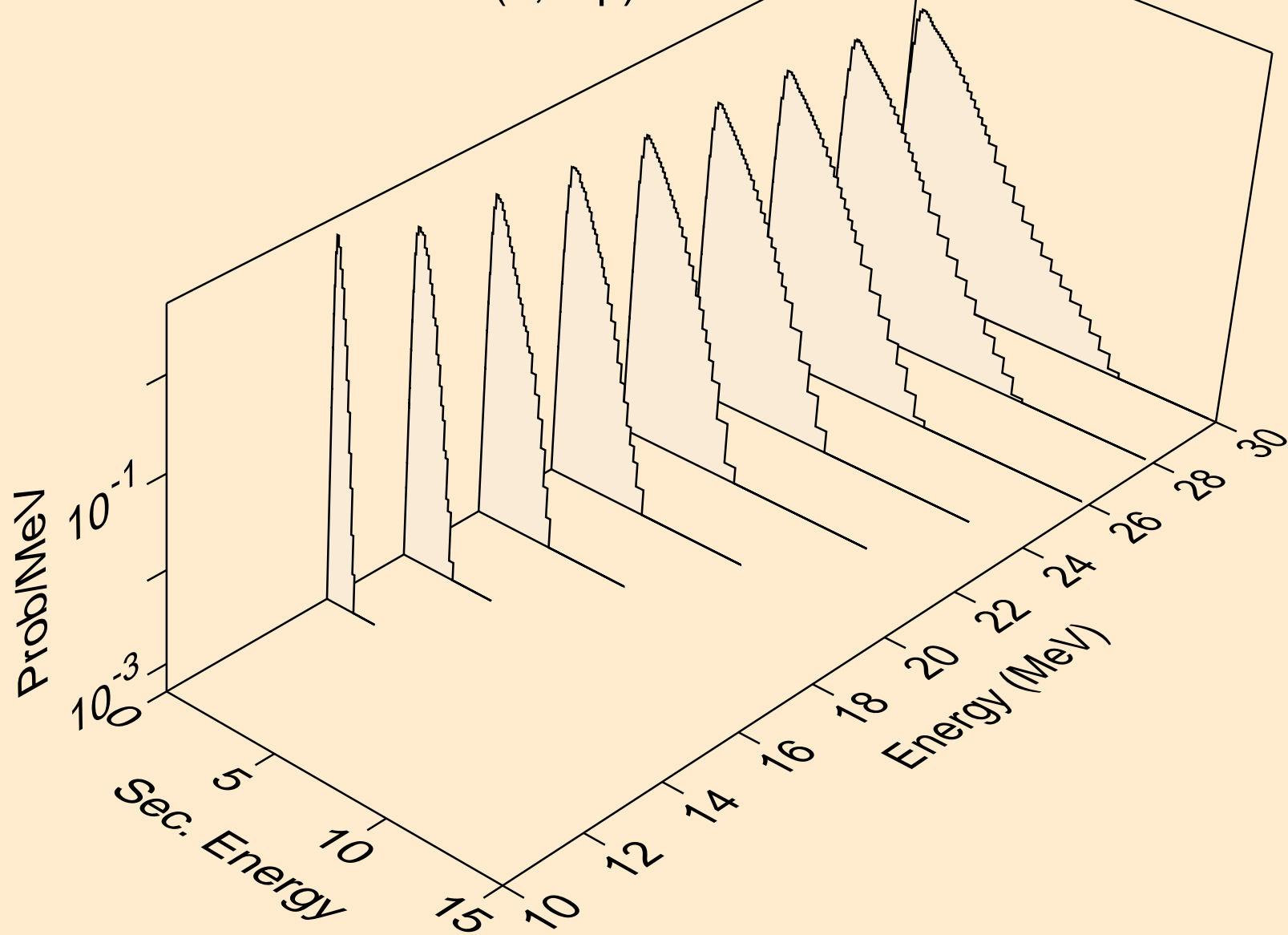

PO195 NEUTRON ACER TENDL-2021 LIBRARY; T=293.6K
Neutron emission for (n,3np)

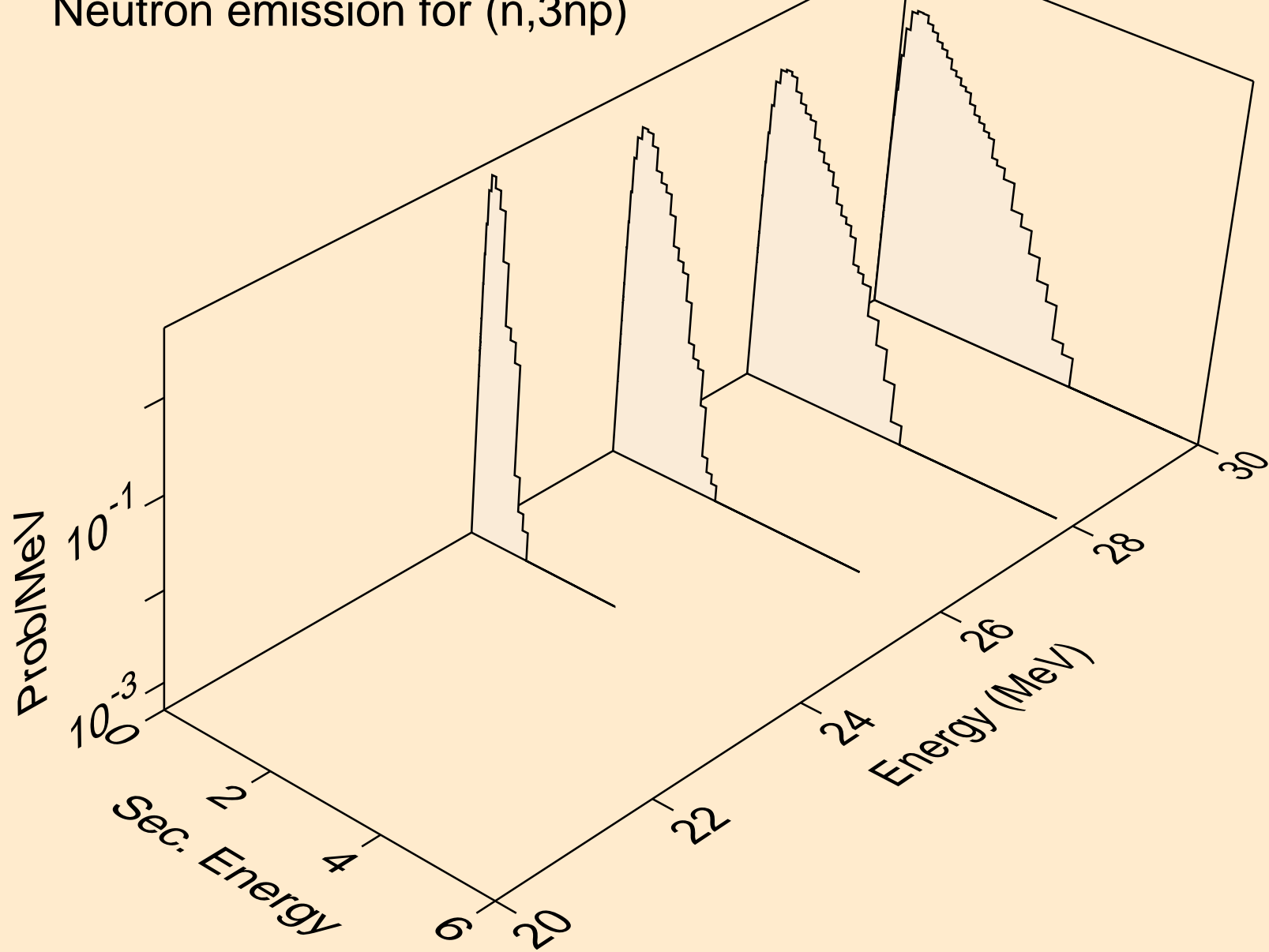

PO195 NEUTRON ACER TENDL-2021 LIBRARY; T=293.6K
Neutron emission for (n,2np)

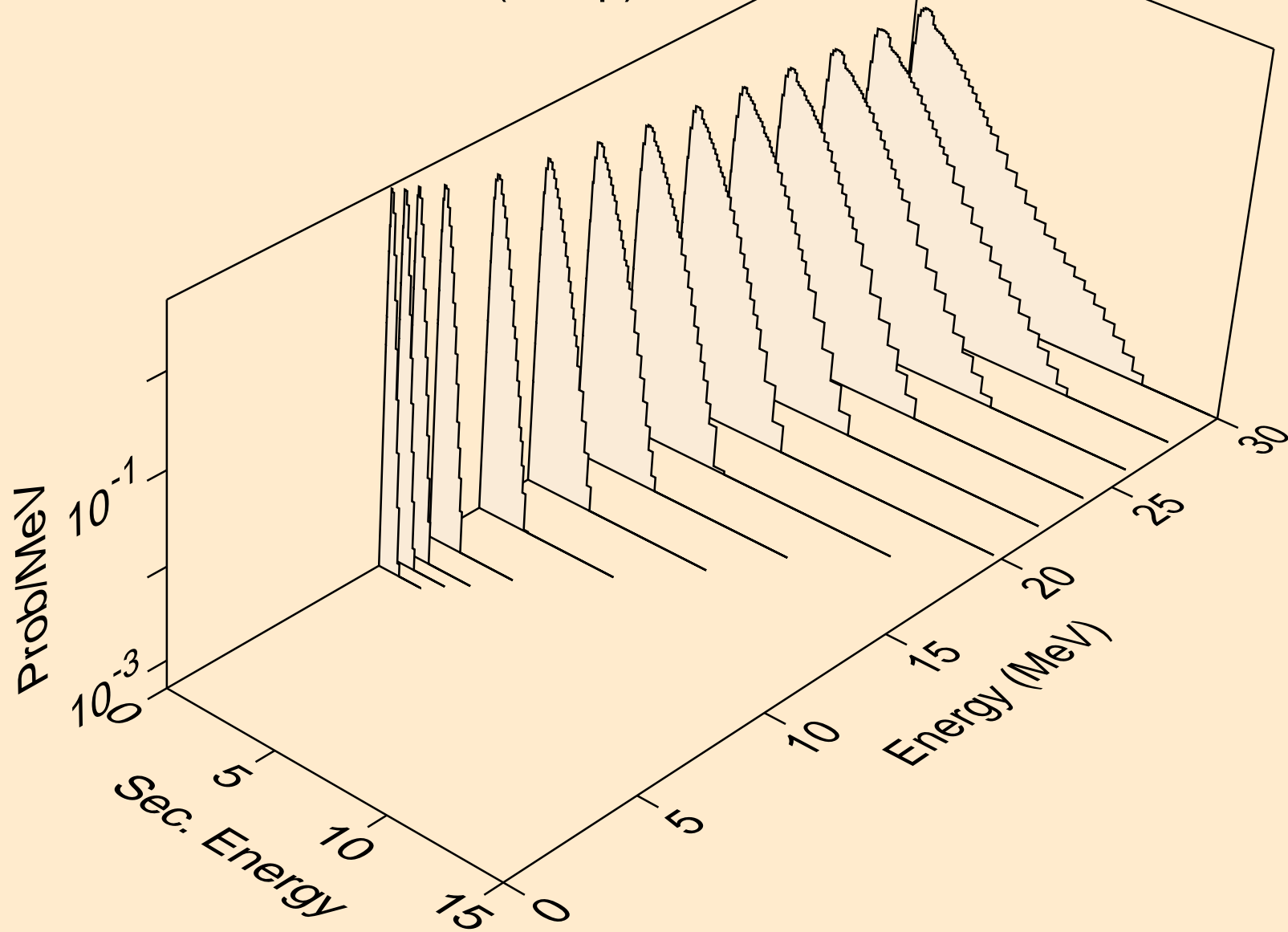

PO195 NEUTRON ACER TENDL-2021 LIBRARY; T=293.6K
Neutron emission for (n,npa)

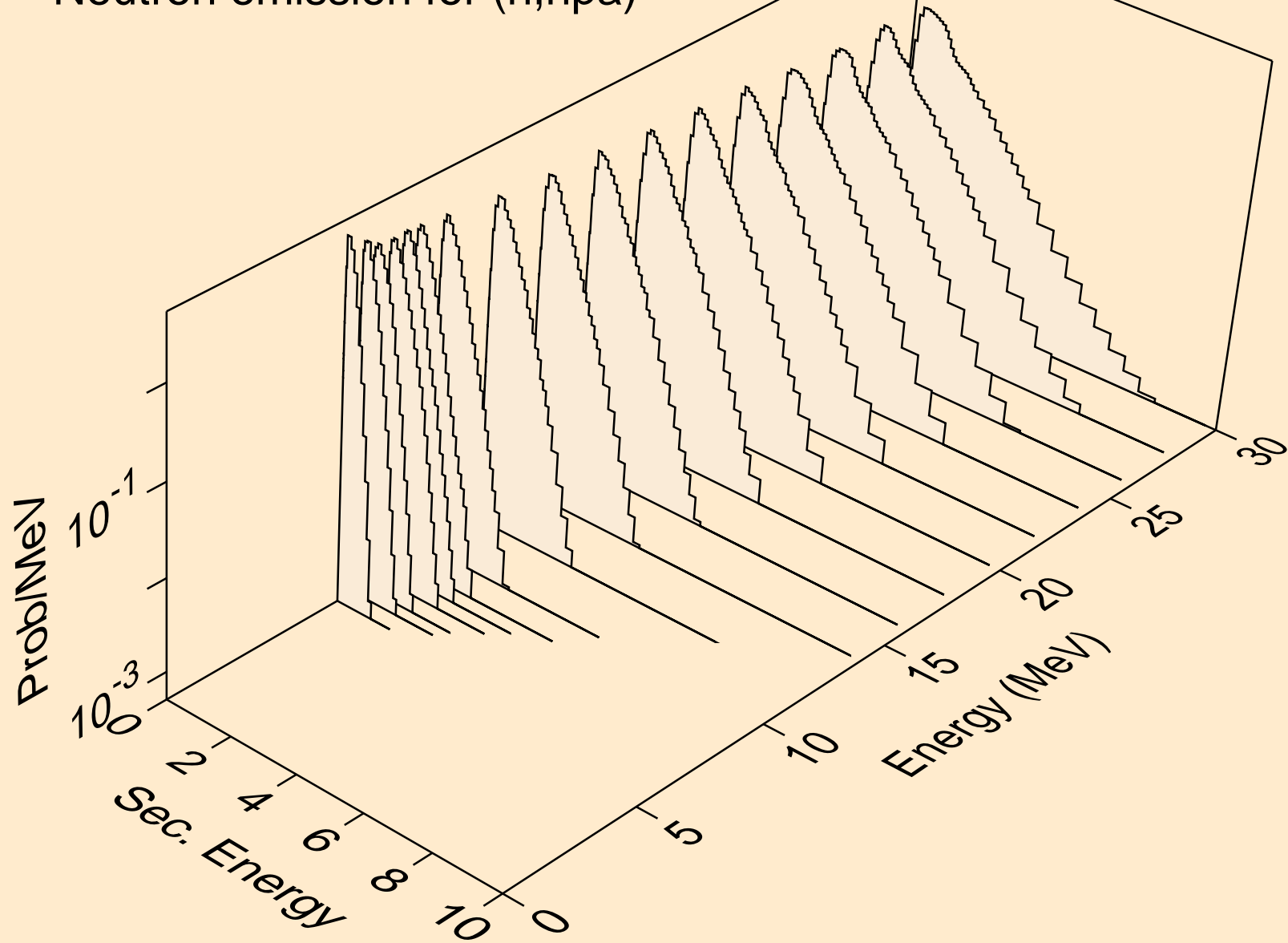

PO195 NEUTRON ACER TENDL-2021 LIBRARY; T=293.6K
Neutron emission for (n,n*c)

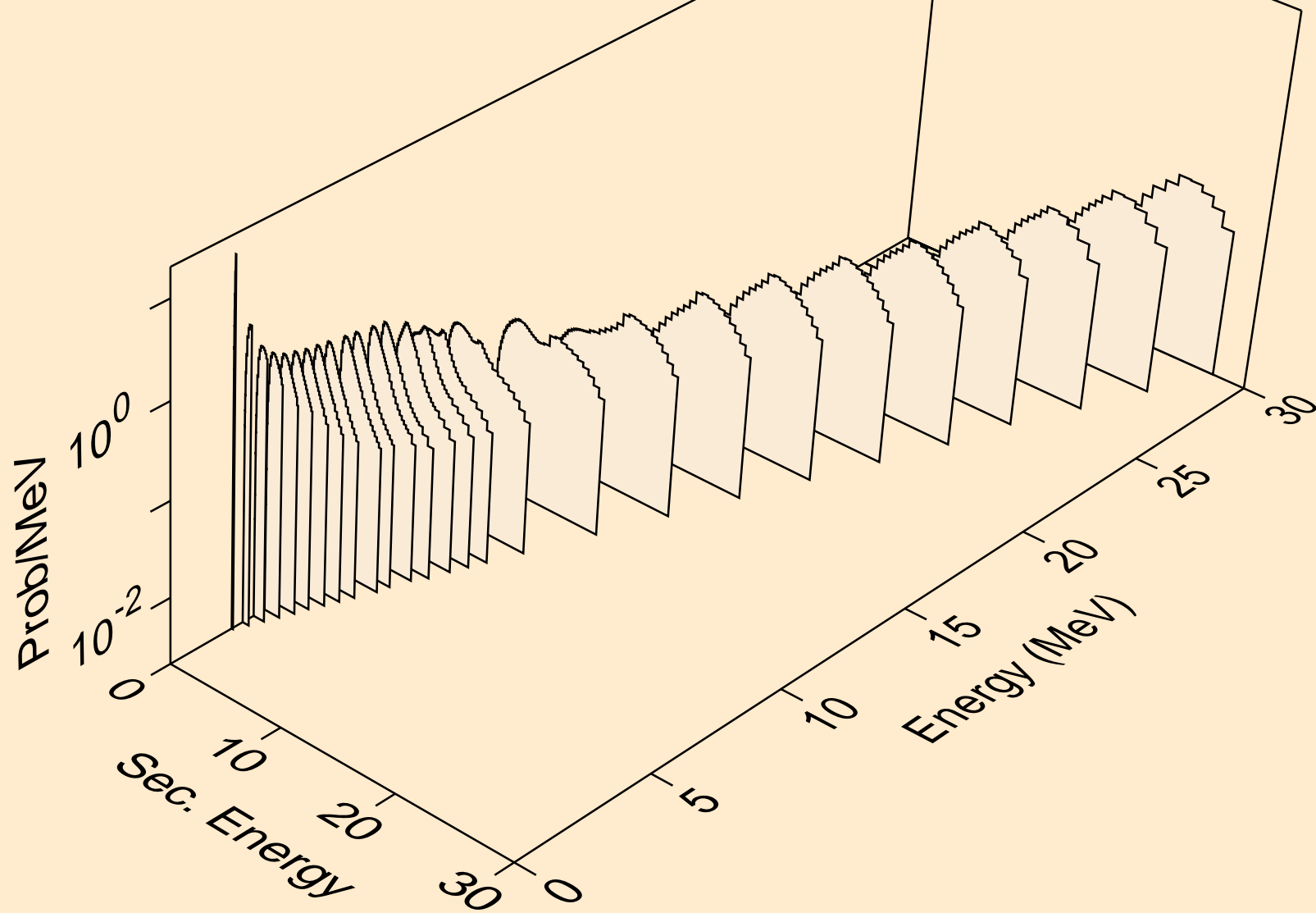

PO195 NEUTRON ACER TENDL-2021 LIBRARY; T=293.6K
Photon emission for (n,x)

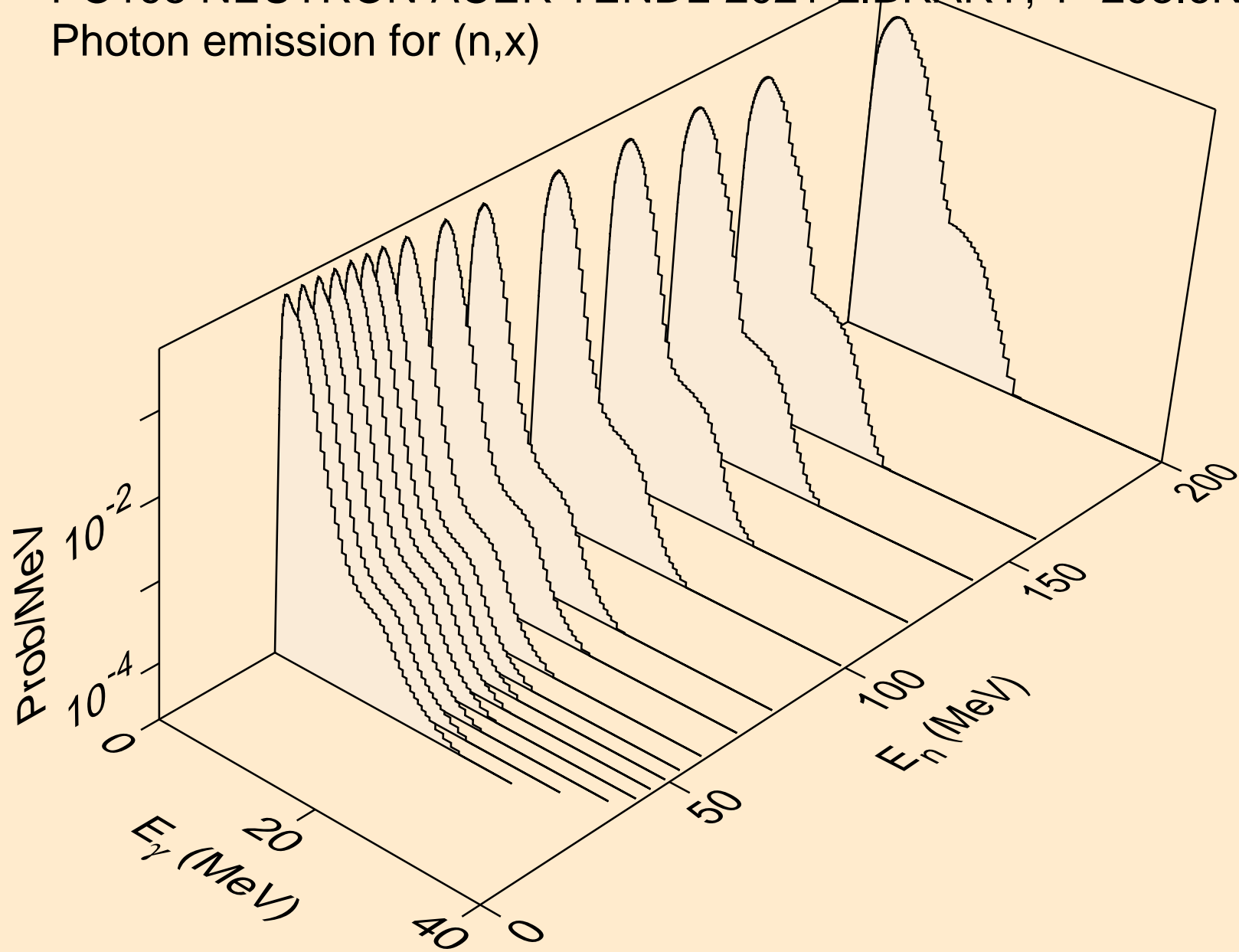

PO195 NEUTRON ACER TENDL-2021 LIBRARY; T=293.6K
Photon emission for (n,2nd)

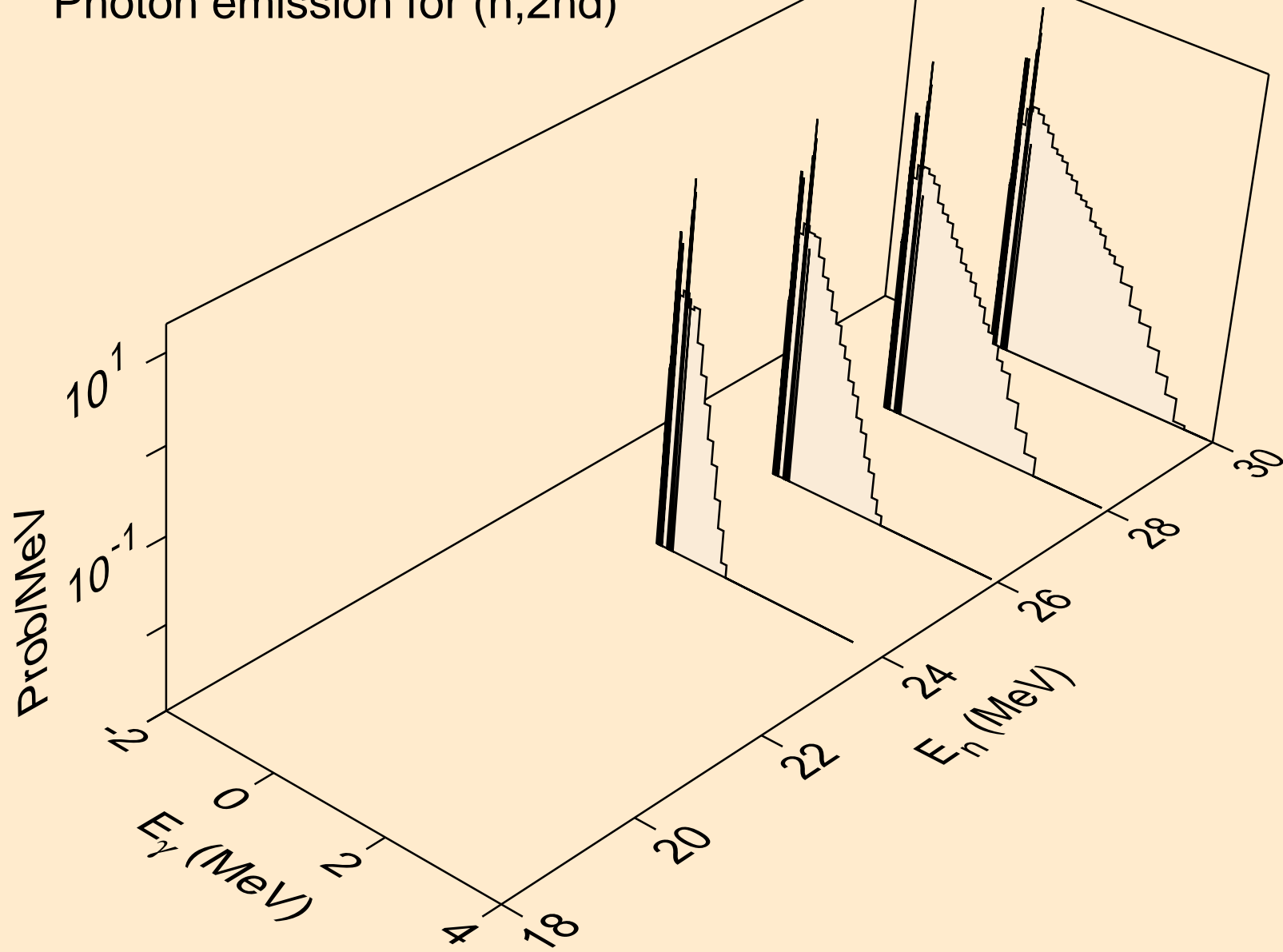

PO195 NEUTRON ACER TENDL-2021 LIBRARY; T=293.6K
Photon emission for (n,2n)

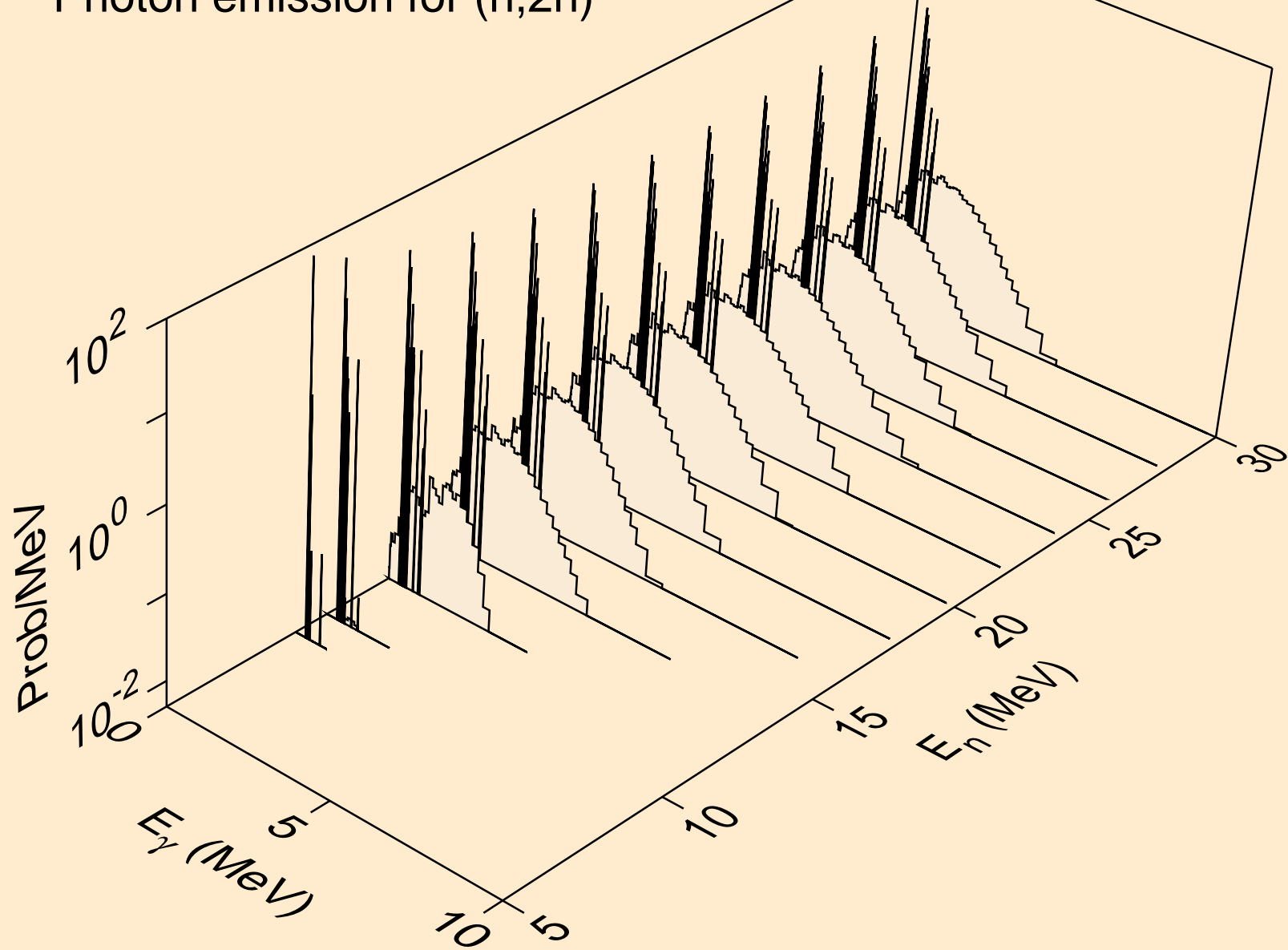

PO195 NEUTRON ACER TENDL-2021 LIBRARY; T=293.6K
Photon emission for (n,3n)

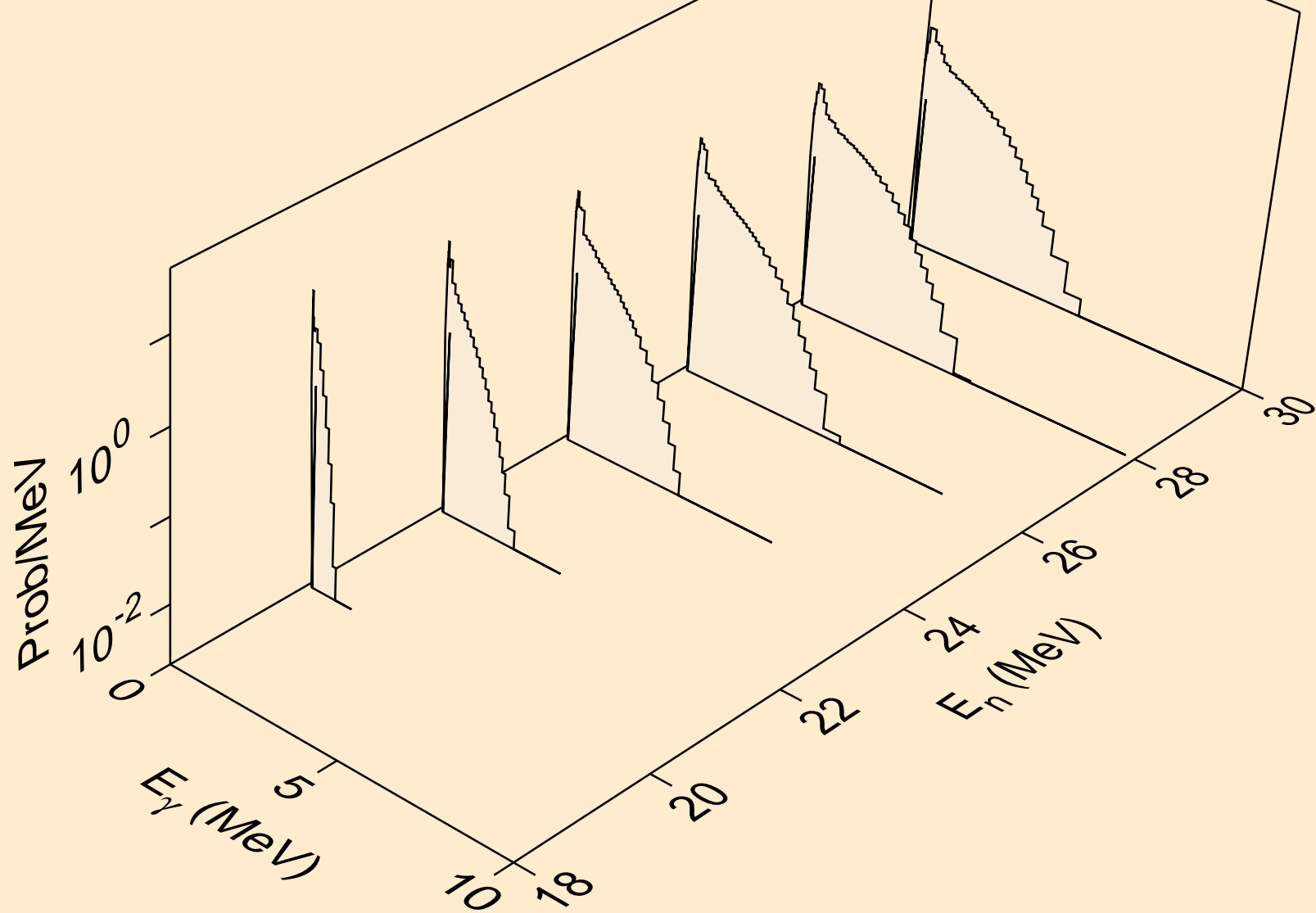

PO195 NEUTRON ACER TENDL-2021 LIBRARY; T=293.6K
Photon emission for (n,n*)a

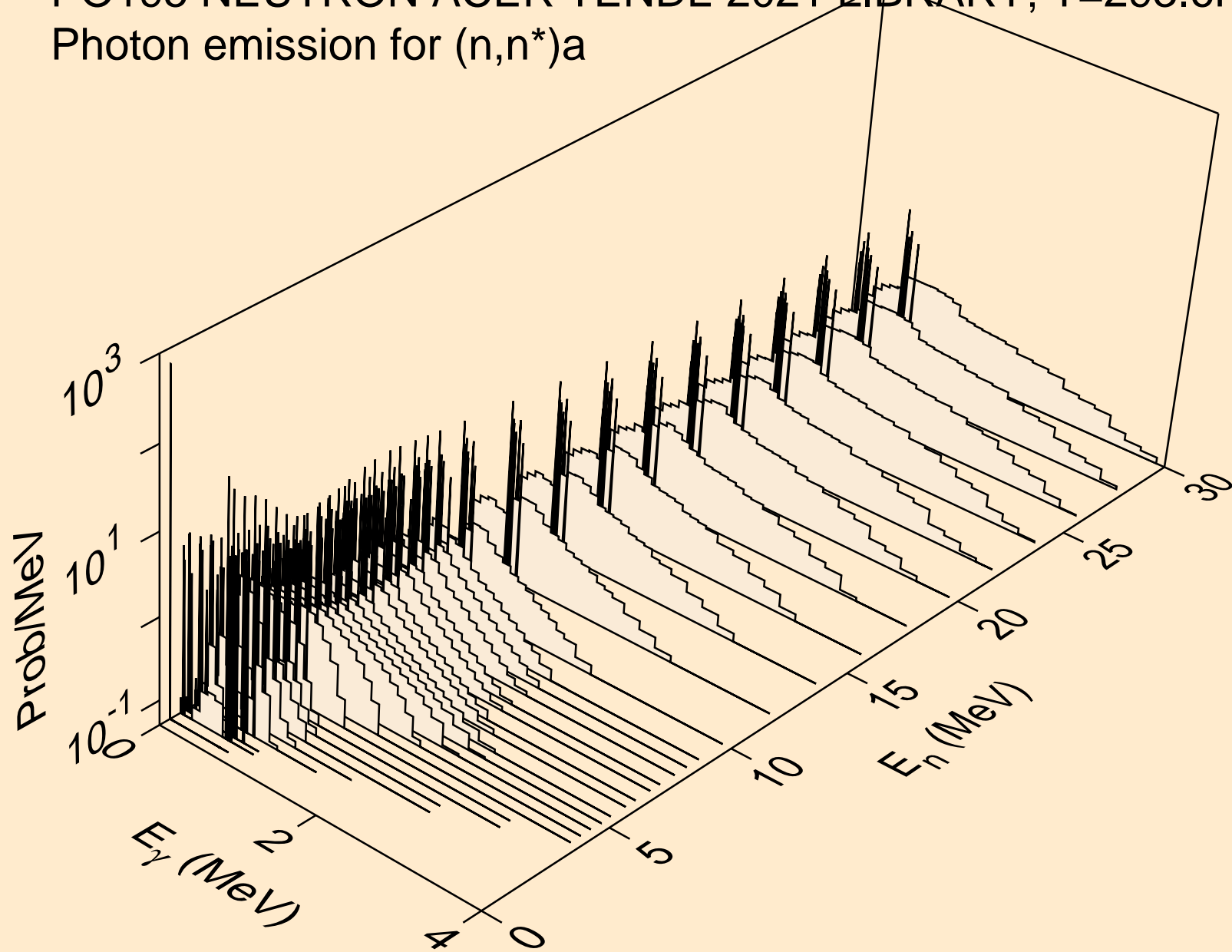

PO195 NEUTRON ACER TENDL-2021 LIBRARY; T=293.6K
Photon emission for (n,2n)a

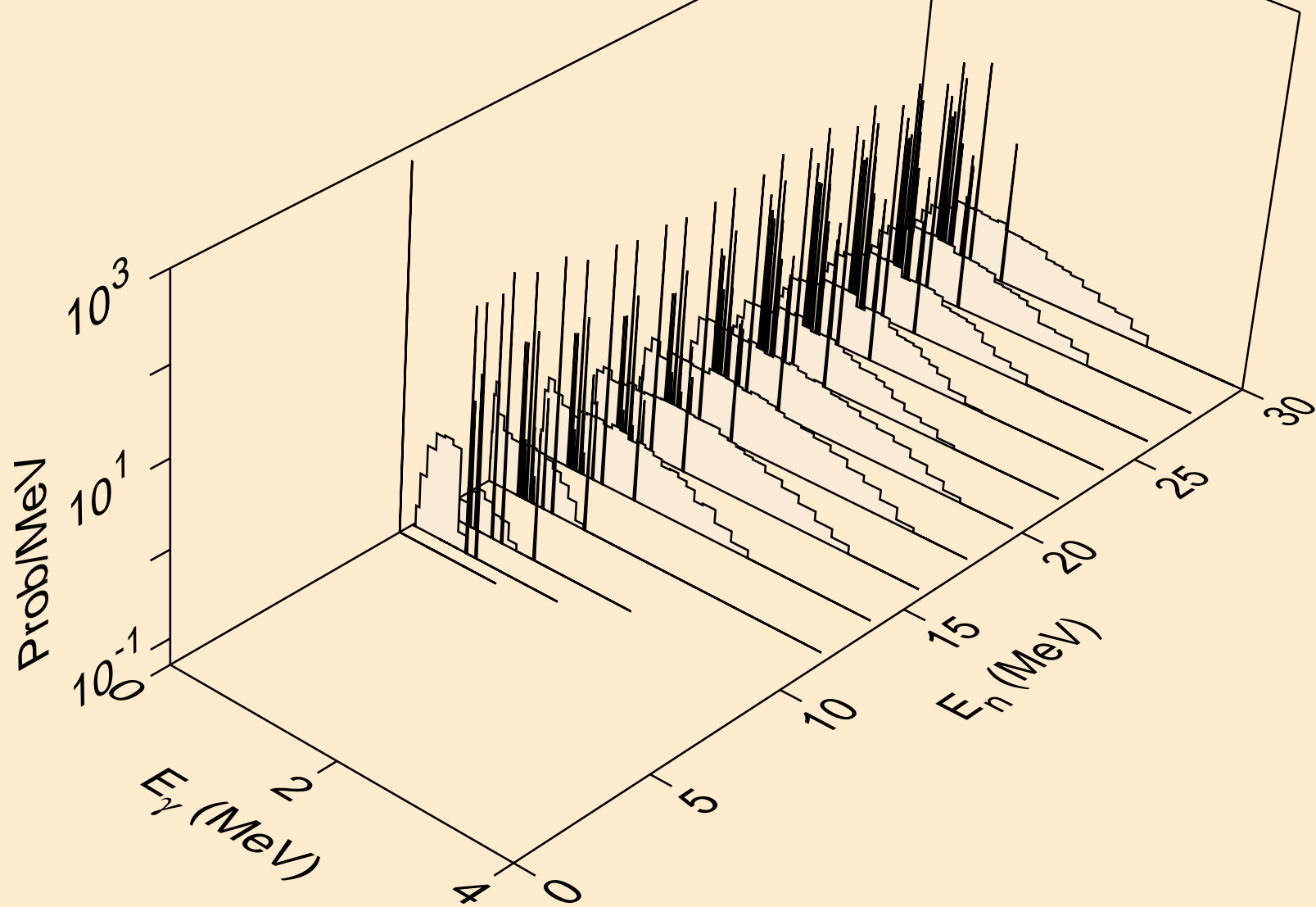

PO195 NEUTRON ACER TENDL-2021 LIBRARY; T=293.6K
Photon emission for (n,3n)a

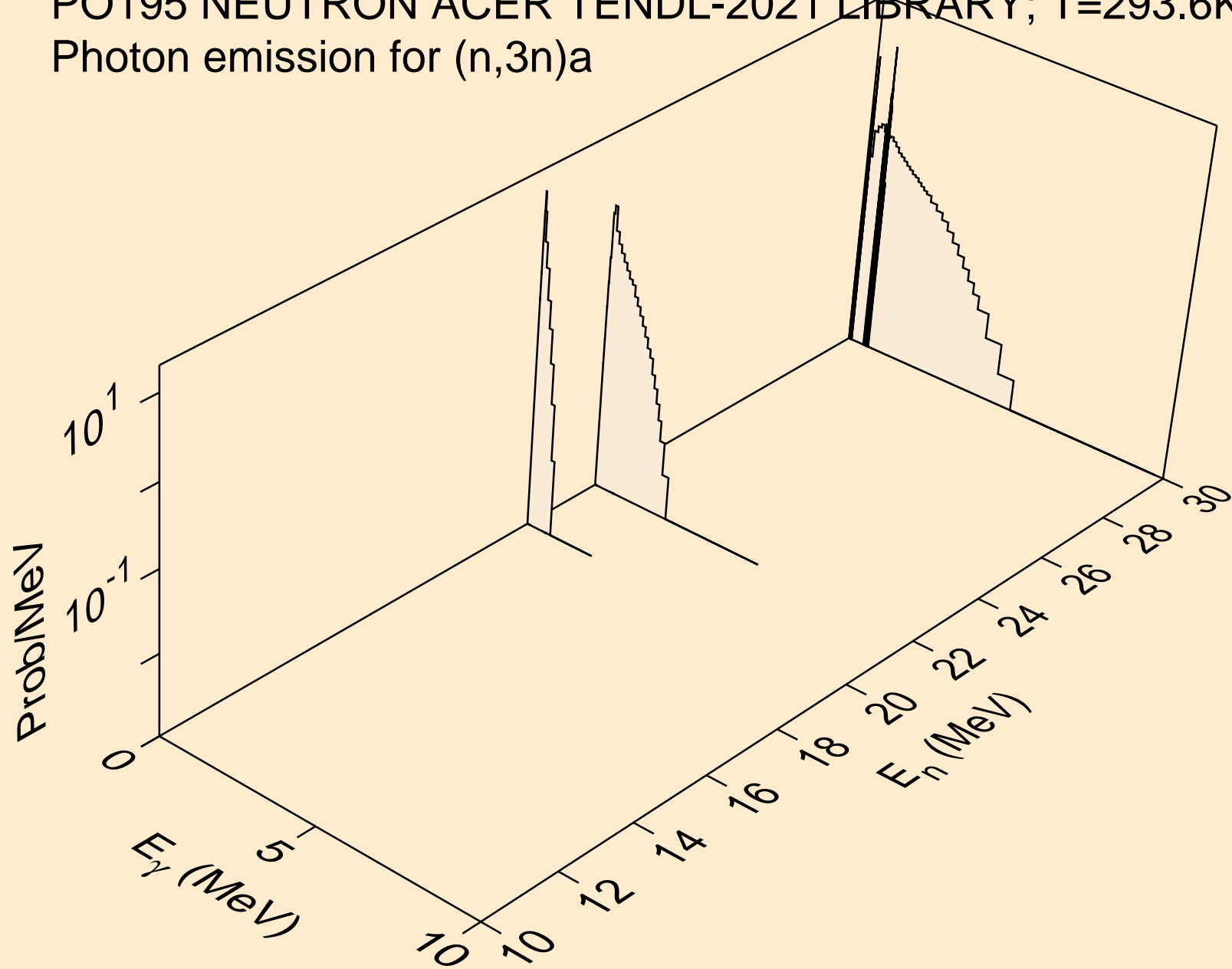

PO195 NEUTRON ACER TENDL-2021 LIBRARY; T=293.6K
Photon emission for (n,n*)p

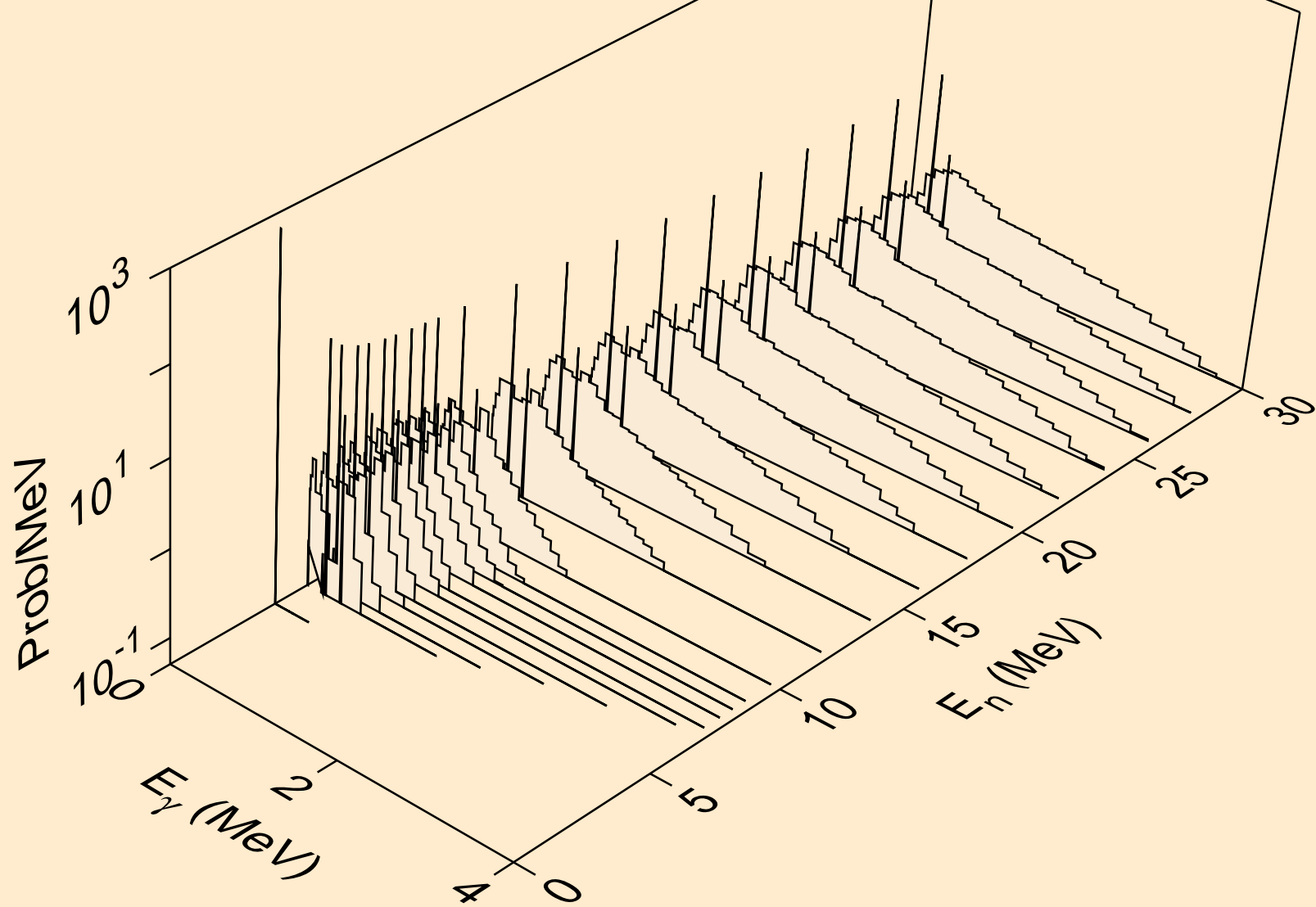

PO195 NEUTRON ACER TENDL-2021 LIBRARY; T=293.6K
Photon emission for (n,n*)2a

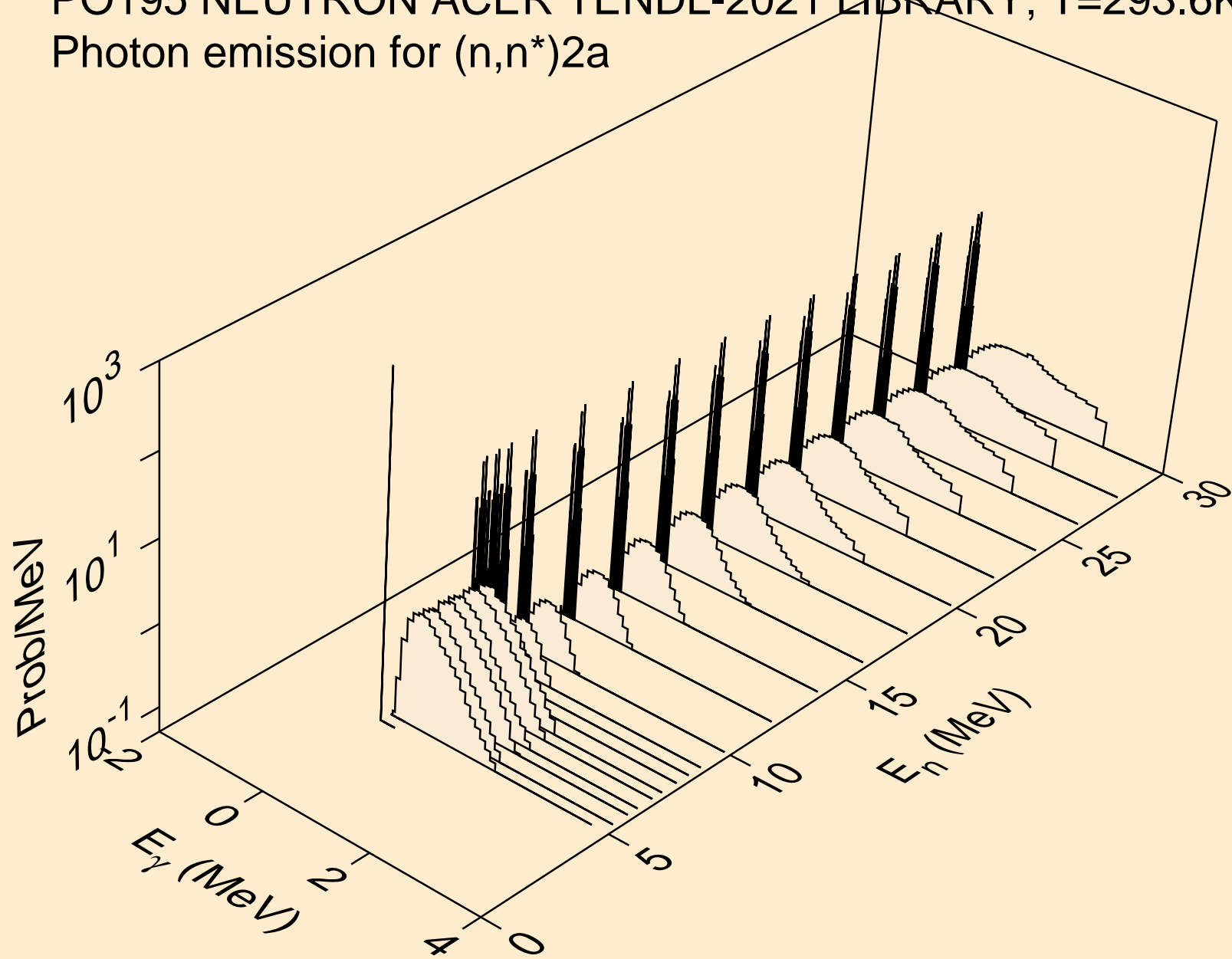

PO195 NEUTRON ACER TENDL-2021 LIBRARY; T=293.6K
Photon emission for (n,2n)2a

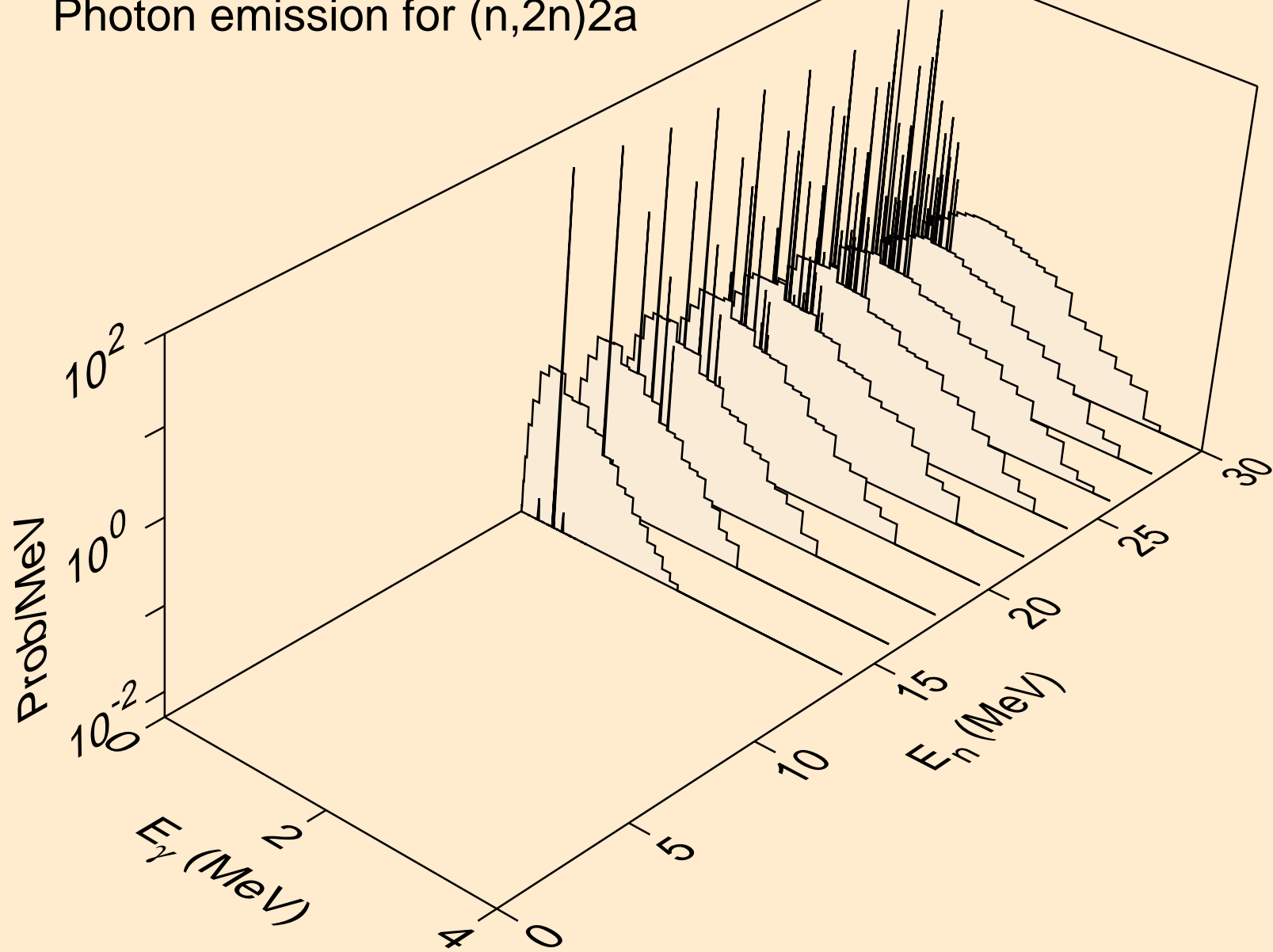

PO195 NEUTRON ACER TENDL-2021 LIBRARY; T=293.6K
Photon emission for (n,n*)d

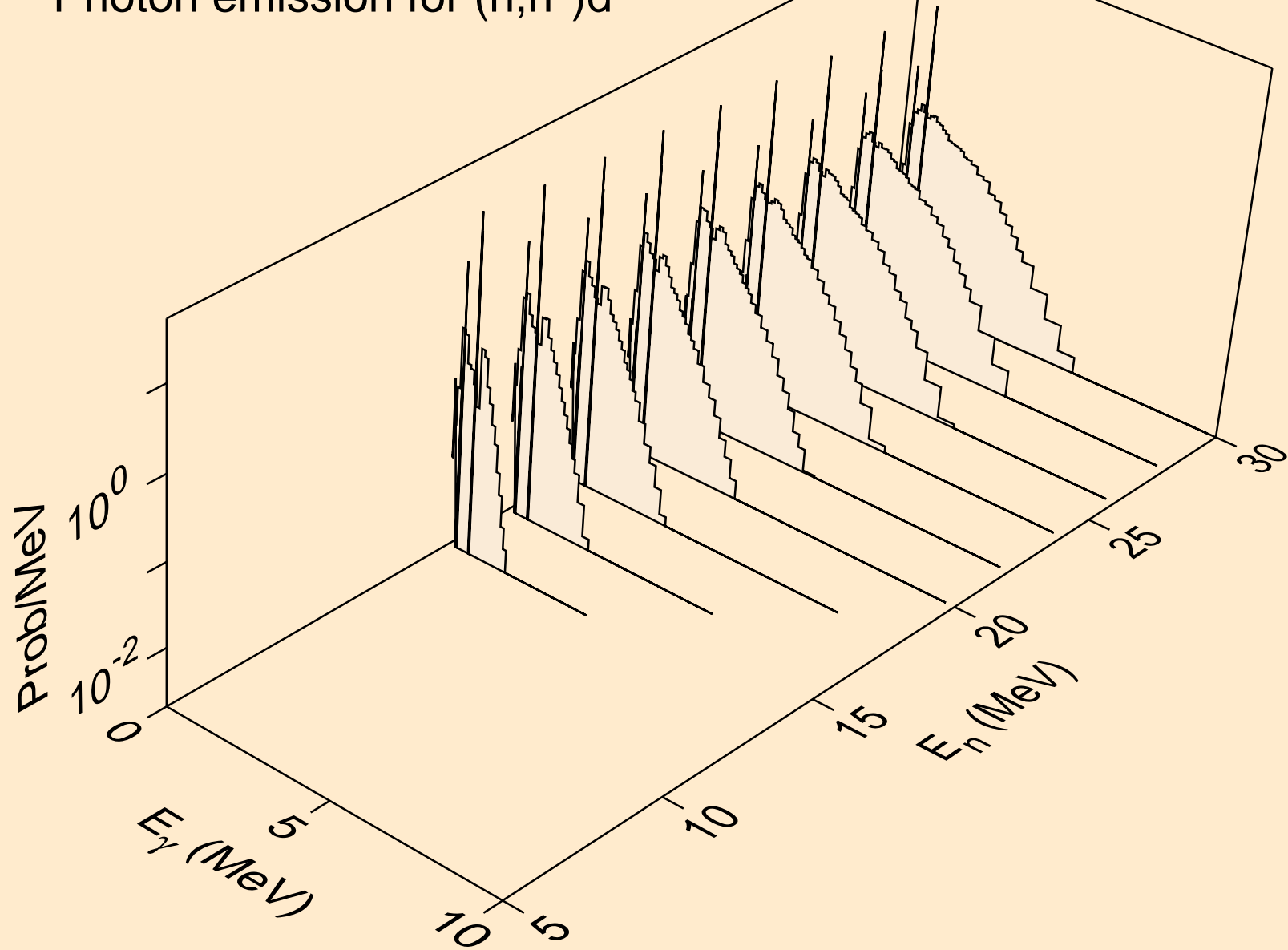

PO195 NEUTRON ACER TENDL-2021 LIBRARY; T=293.6K
Photon emission for (n,n*)t

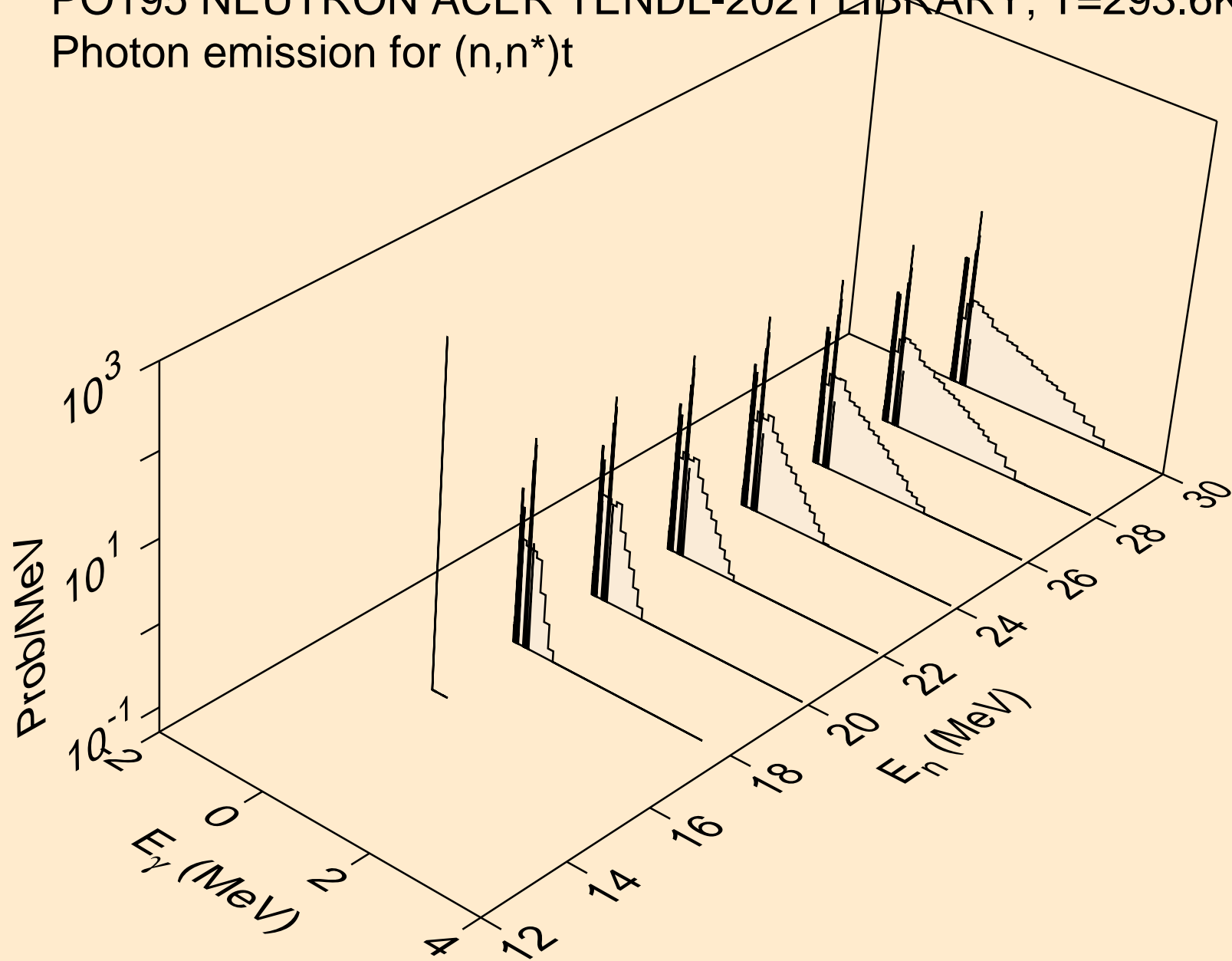

PO195 NEUTRON ACER TENDL-2021 LIBRARY; T=293.6K
Photon emission for (n,n*)he3

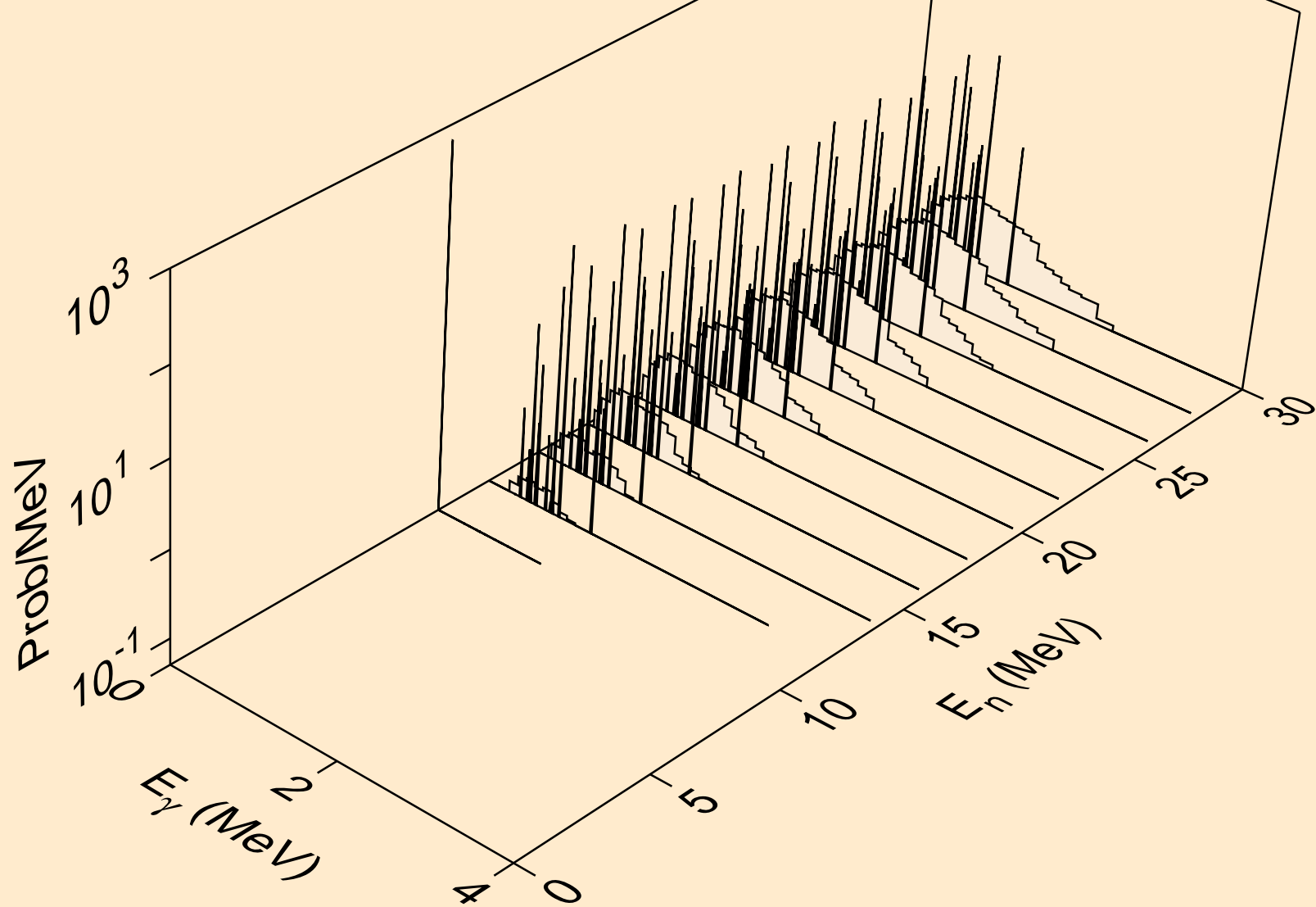

PO195 NEUTRON ACER TENDL-2021 LIBRARY; T=293.6K
Photon emission for (n,4n)

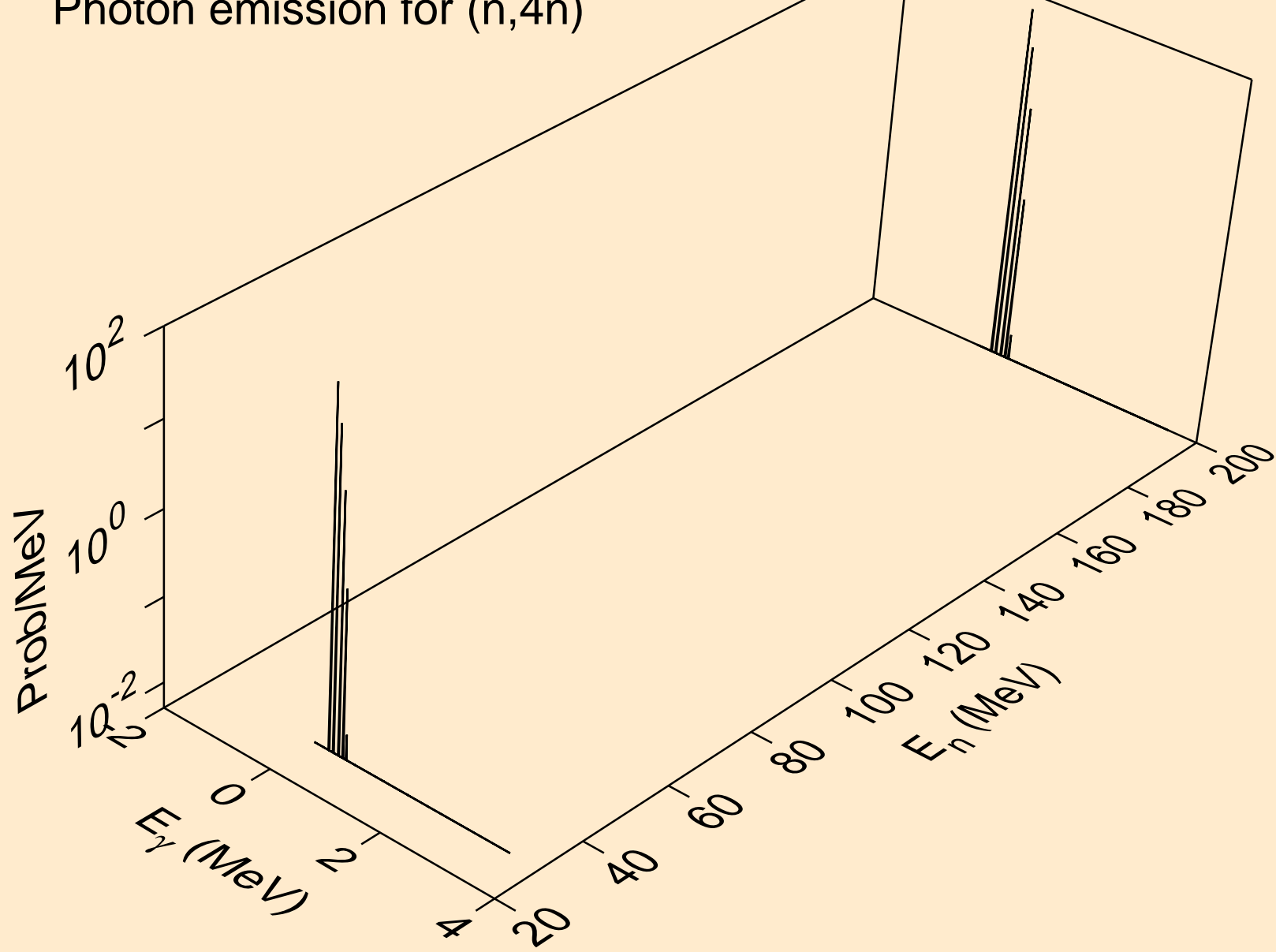

PO195 NEUTRON ACER TENDL-2021 LIBRARY; T=293.6K
Photon emission for (n,2np)

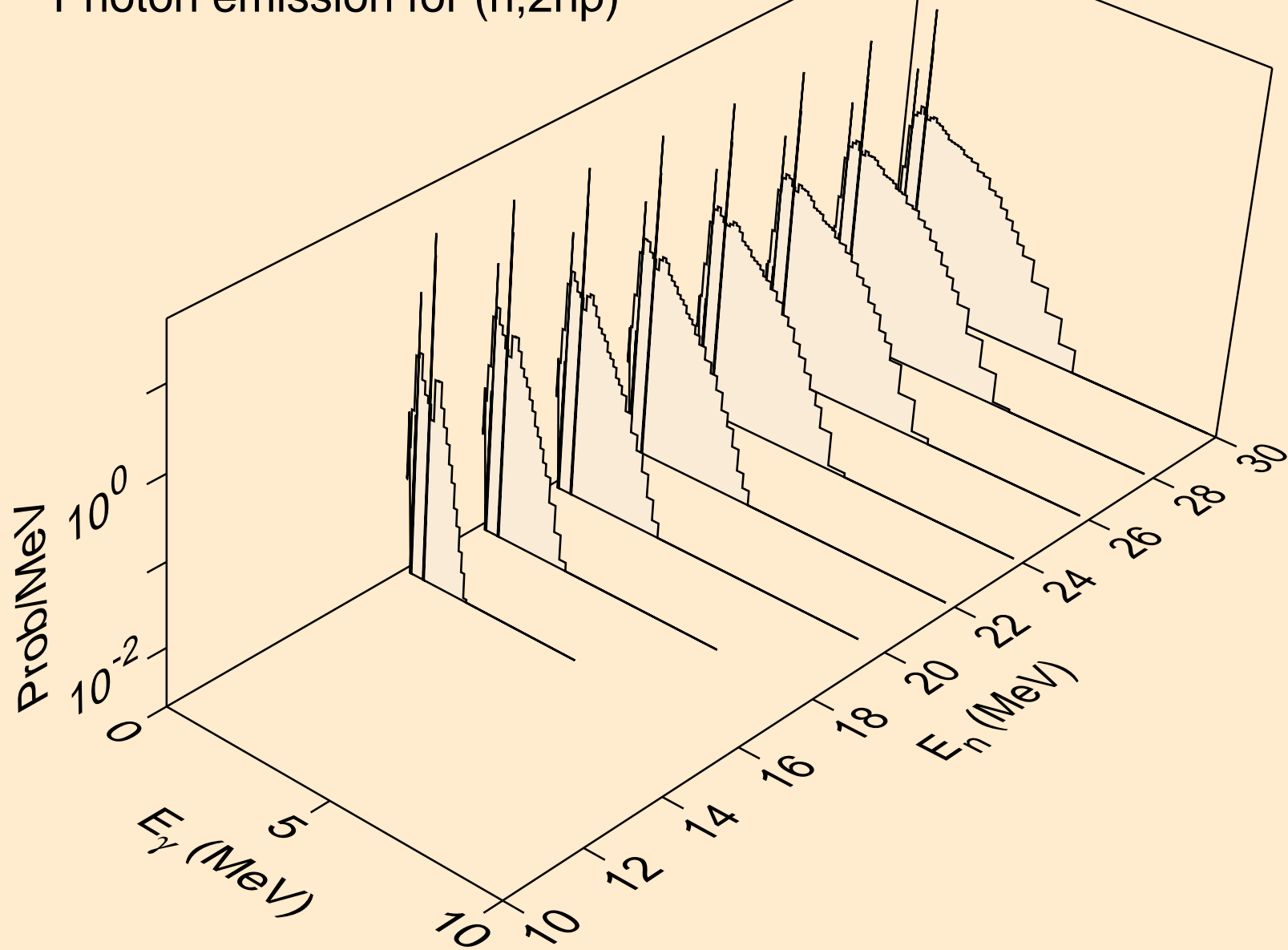

PO195 NEUTRON ACER TENDL-2021 LIBRARY; T=293.6K
Photon emission for (n,3np)

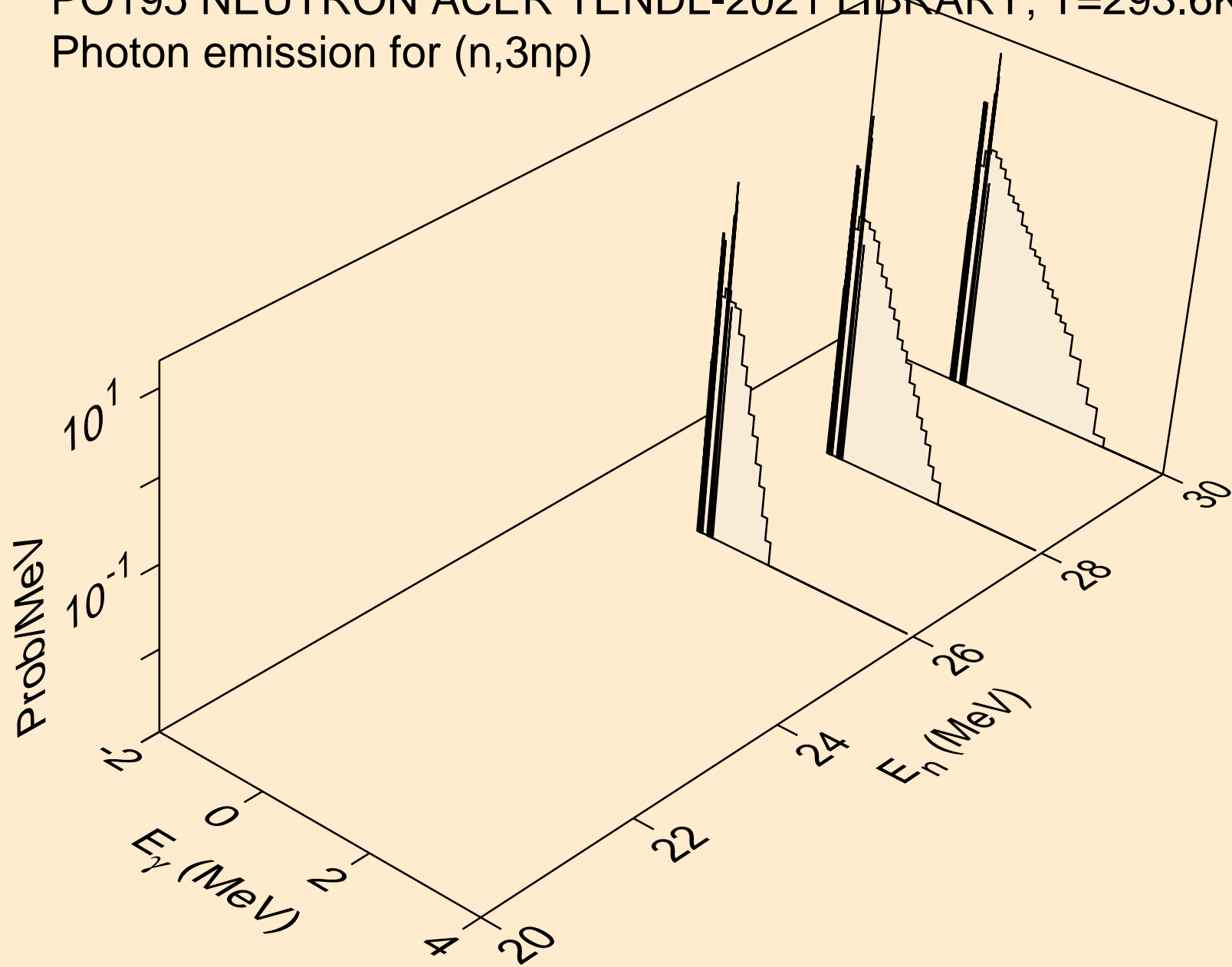

PO195 NEUTRON ACER TENDL-2021 LIBRARY; T=293.6K
Photon emission for (n,2np)

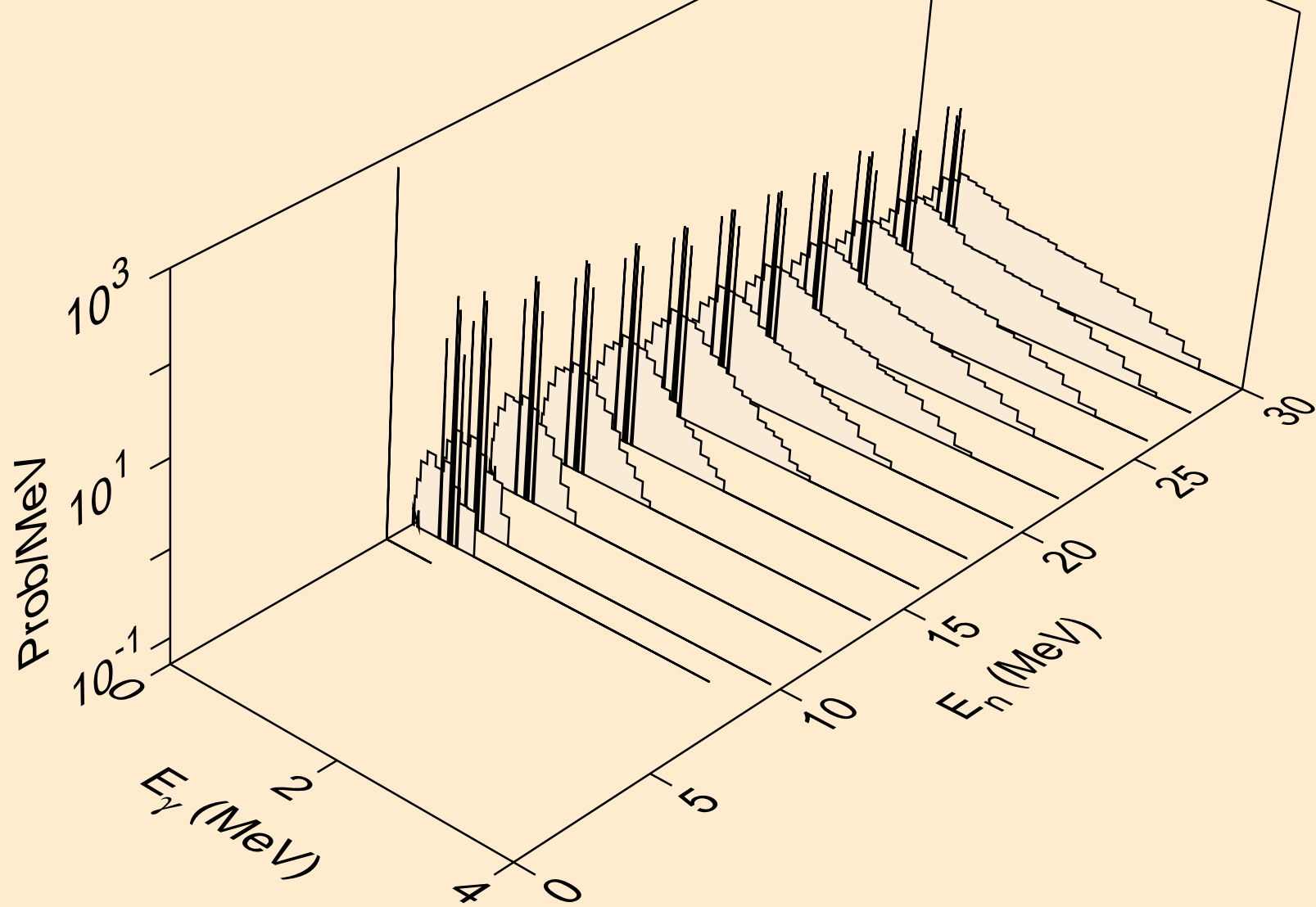

PO195 NEUTRON ACER TENDL-2021 LIBRARY; T=293.6K
Photon emission for (n,npa)

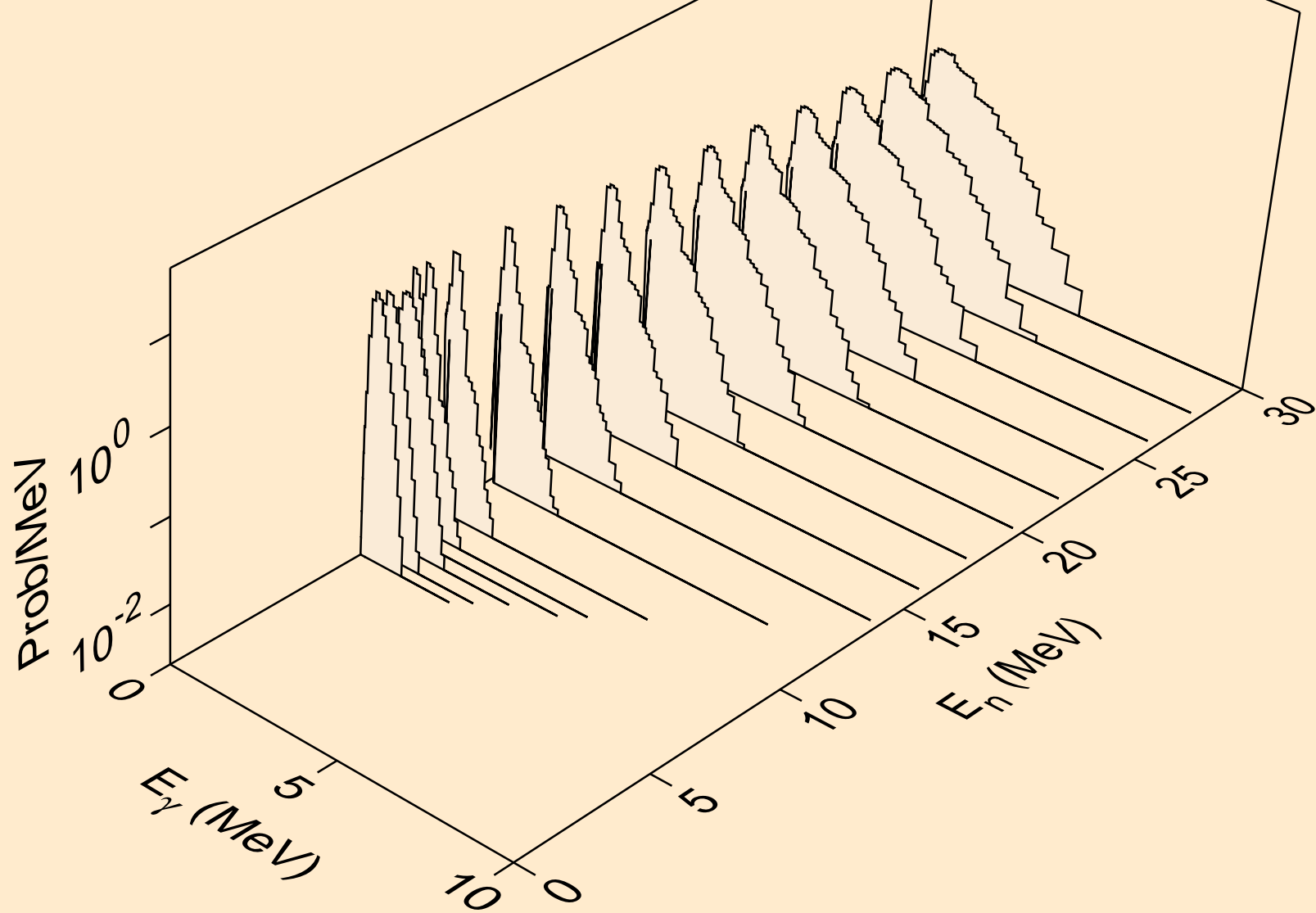

PO195 NEUTRON ACER TENDL-2021 LIBRARY; T=293.6K
Photon emission for (n,n*c)

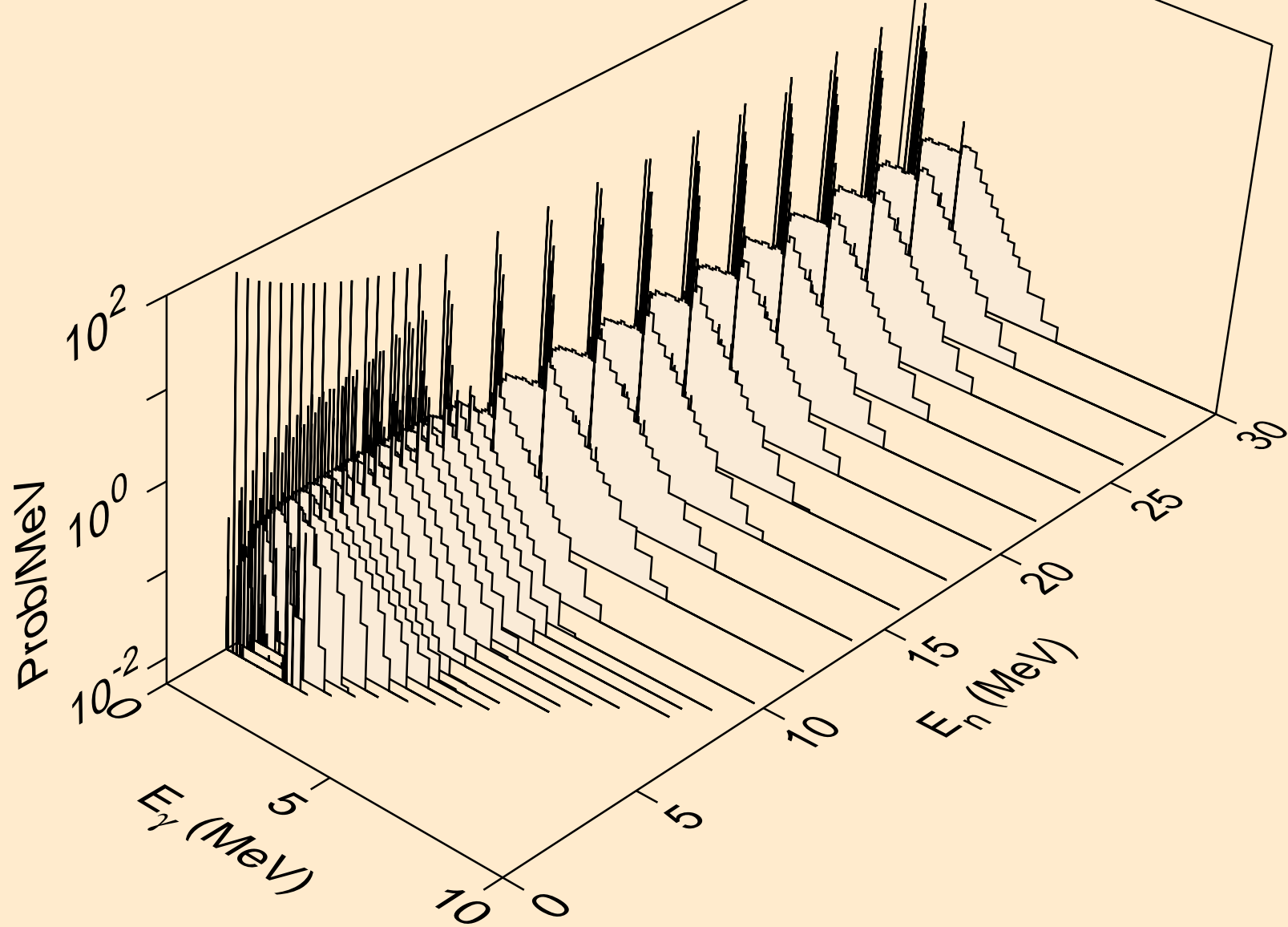

PO195 NEUTRON ACER TENDL-2021 LIBRARY; T=293.6K
Photon emission for (n,gma)

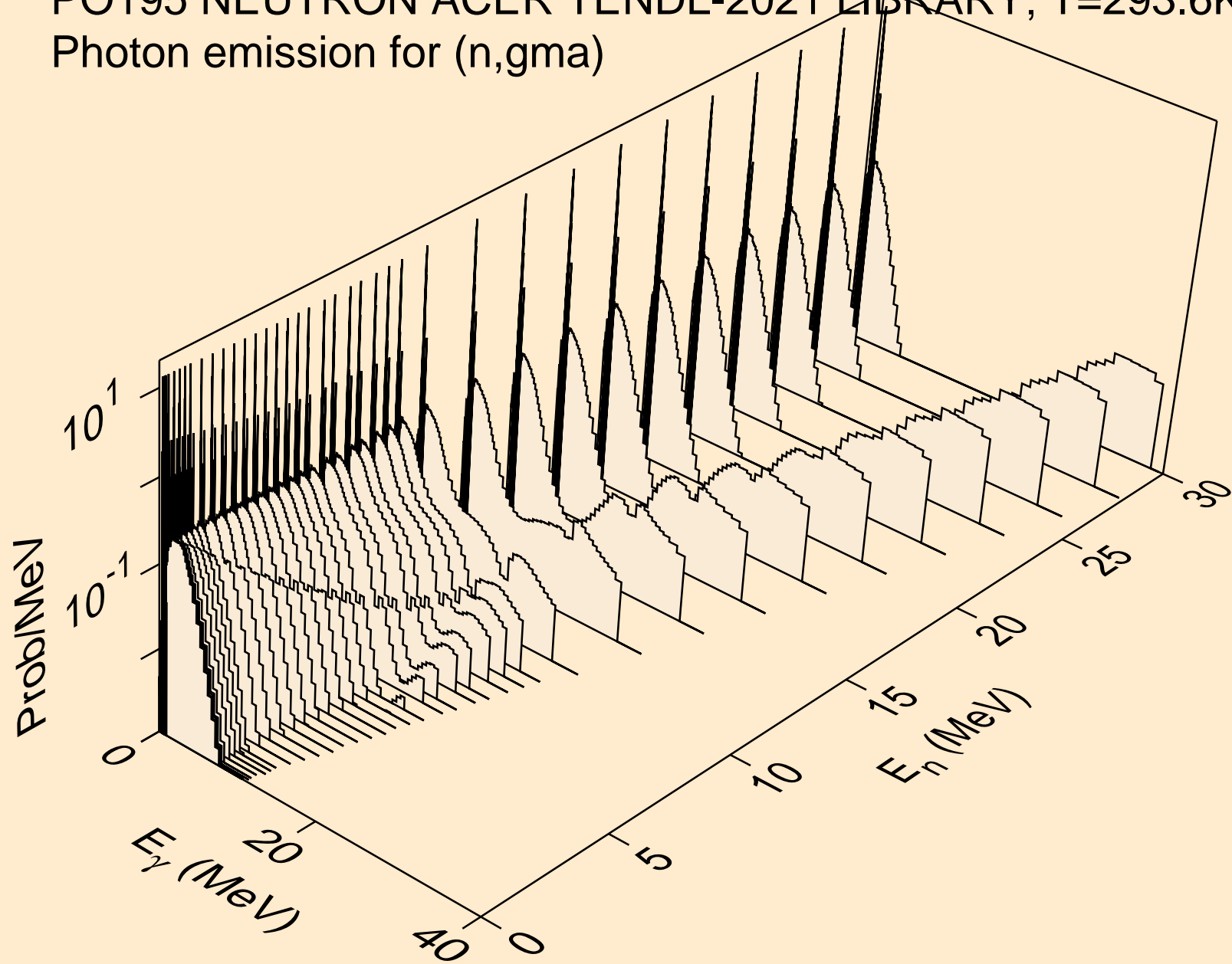

PO195 NEUTRON ACER TENDL-2021 LIBRARY; T=293.6K
Photon emission for (n,p)

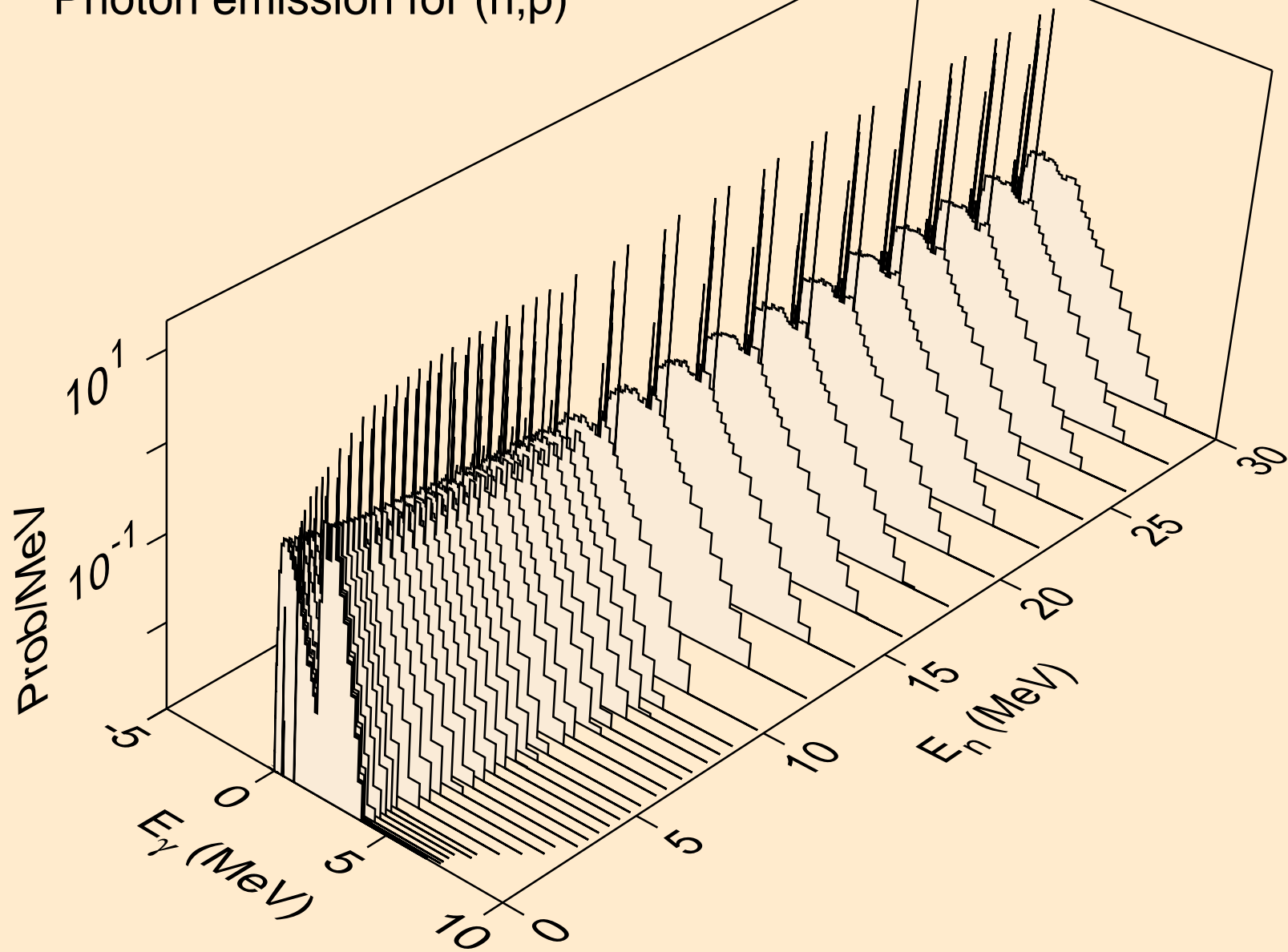

PO195 NEUTRON ACER TENDL-2021 LIBRARY; T=293.6K
Photon emission for (n,d)

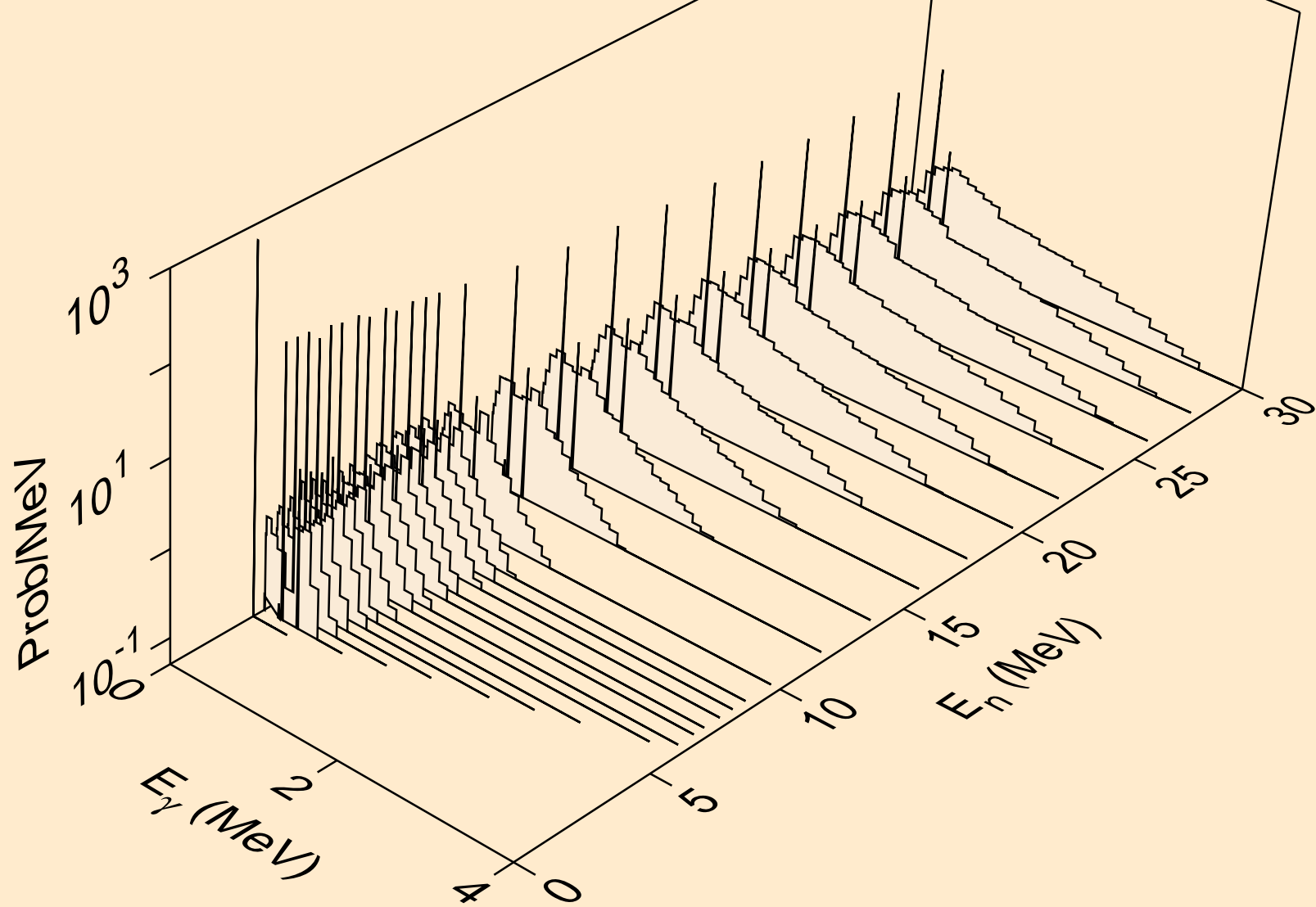

PO195 NEUTRON ACER TENDL-2021 LIBRARY; T=293.6K
Photon emission for (n,t)

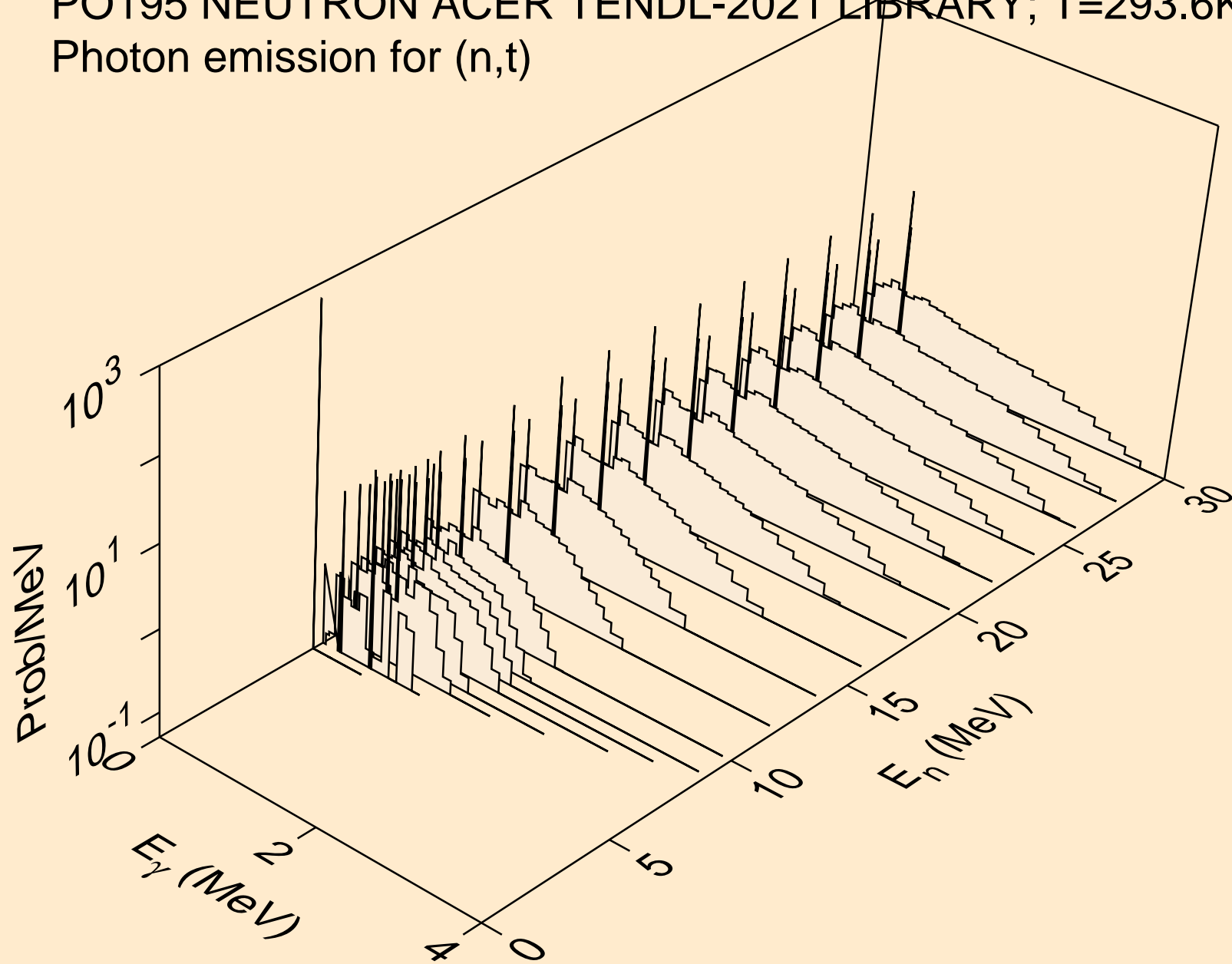

PO195 NEUTRON ACER TENDL-2021 LIBRARY; T=293.6K
Photon emission for (n,he3)

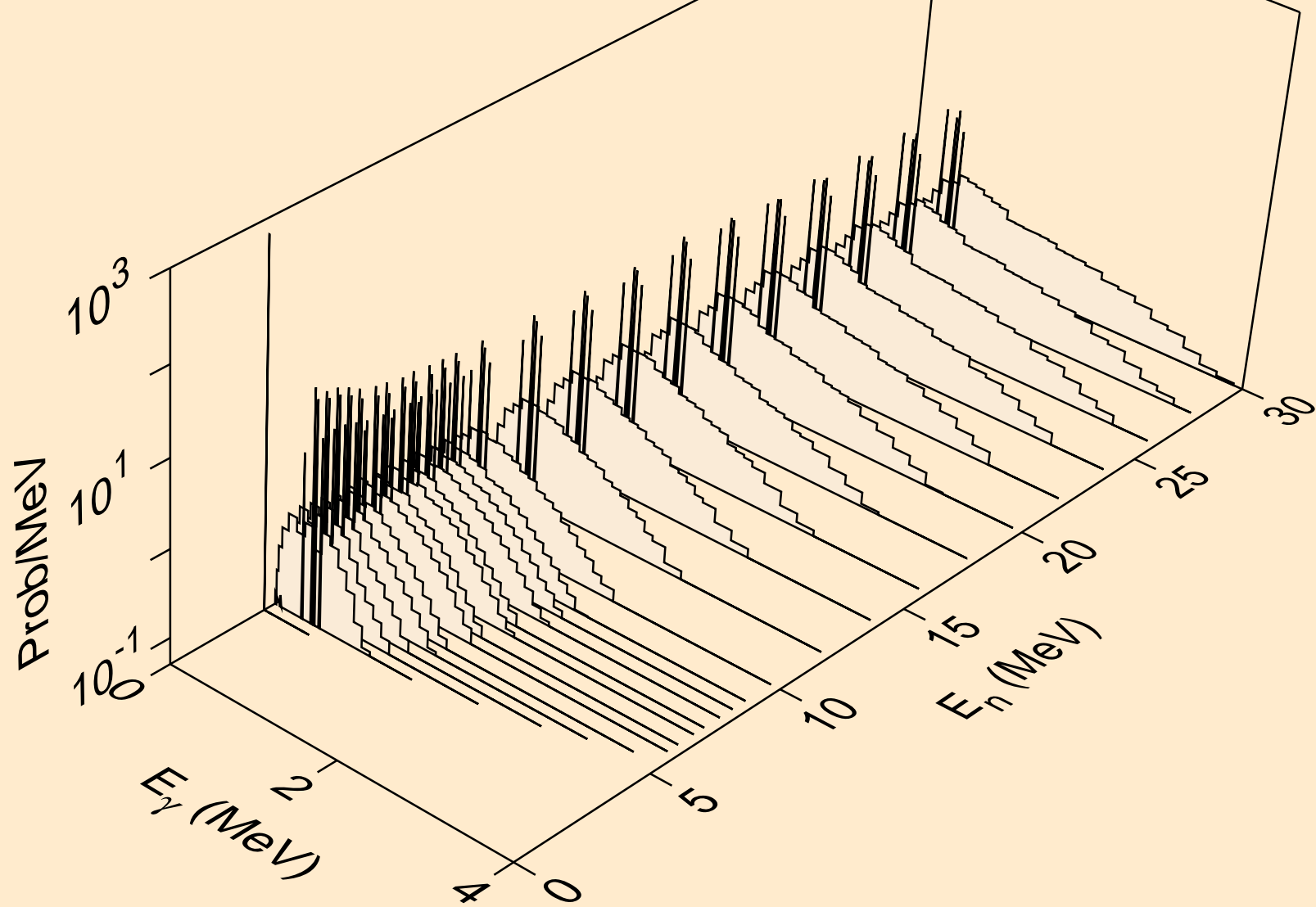

PO195 NEUTRON ACER TENDL-2021 LIBRARY; T=293.6K
Photon emission for (n,a)

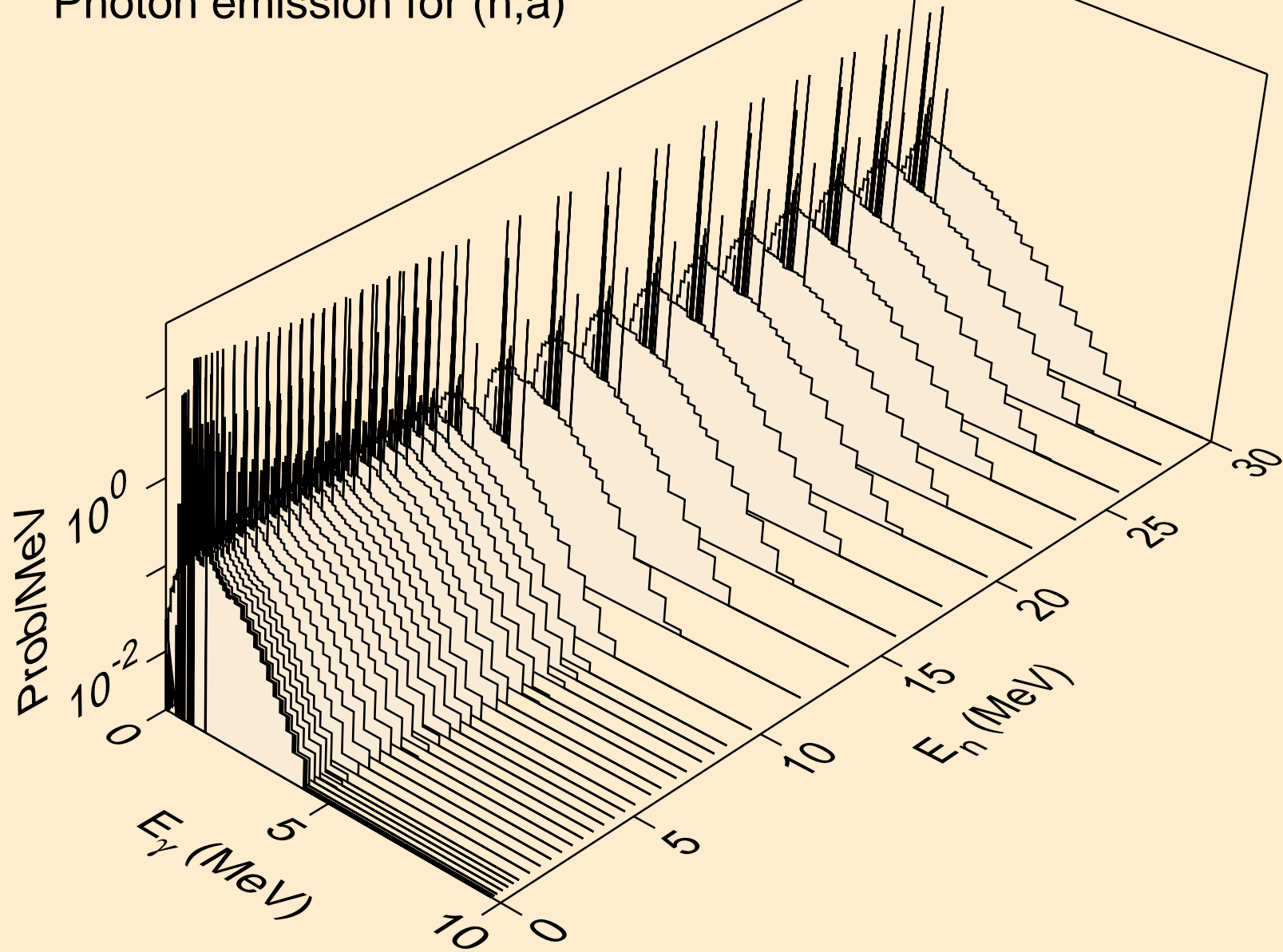

PO195 NEUTRON ACER TENDL-2021 LIBRARY; T=293.6K
Photon emission for (n,2a)

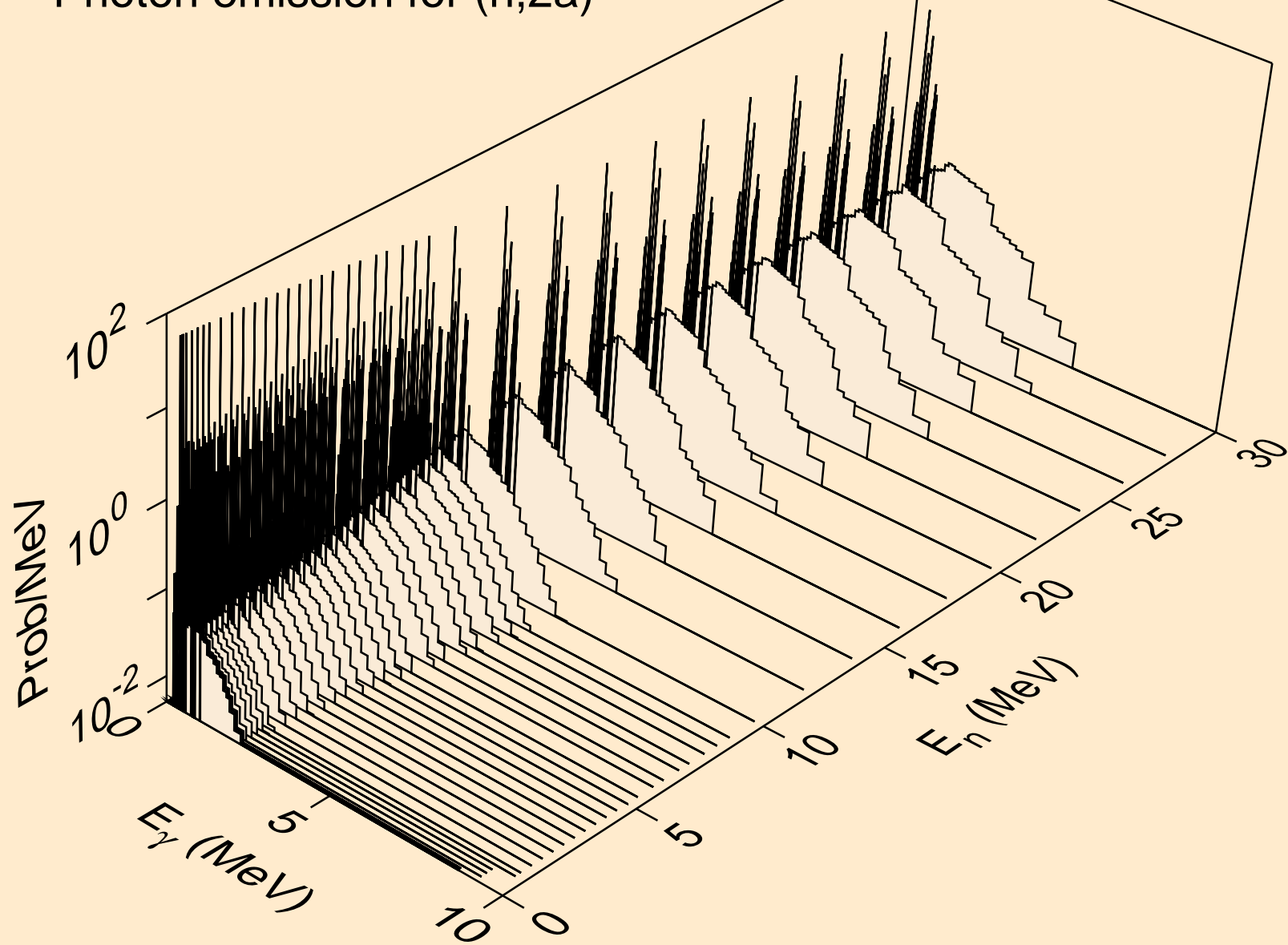

PO195 NEUTRON ACER TENDL-2021 LIBRARY; T=293.6K
Photon emission for (n,3a)

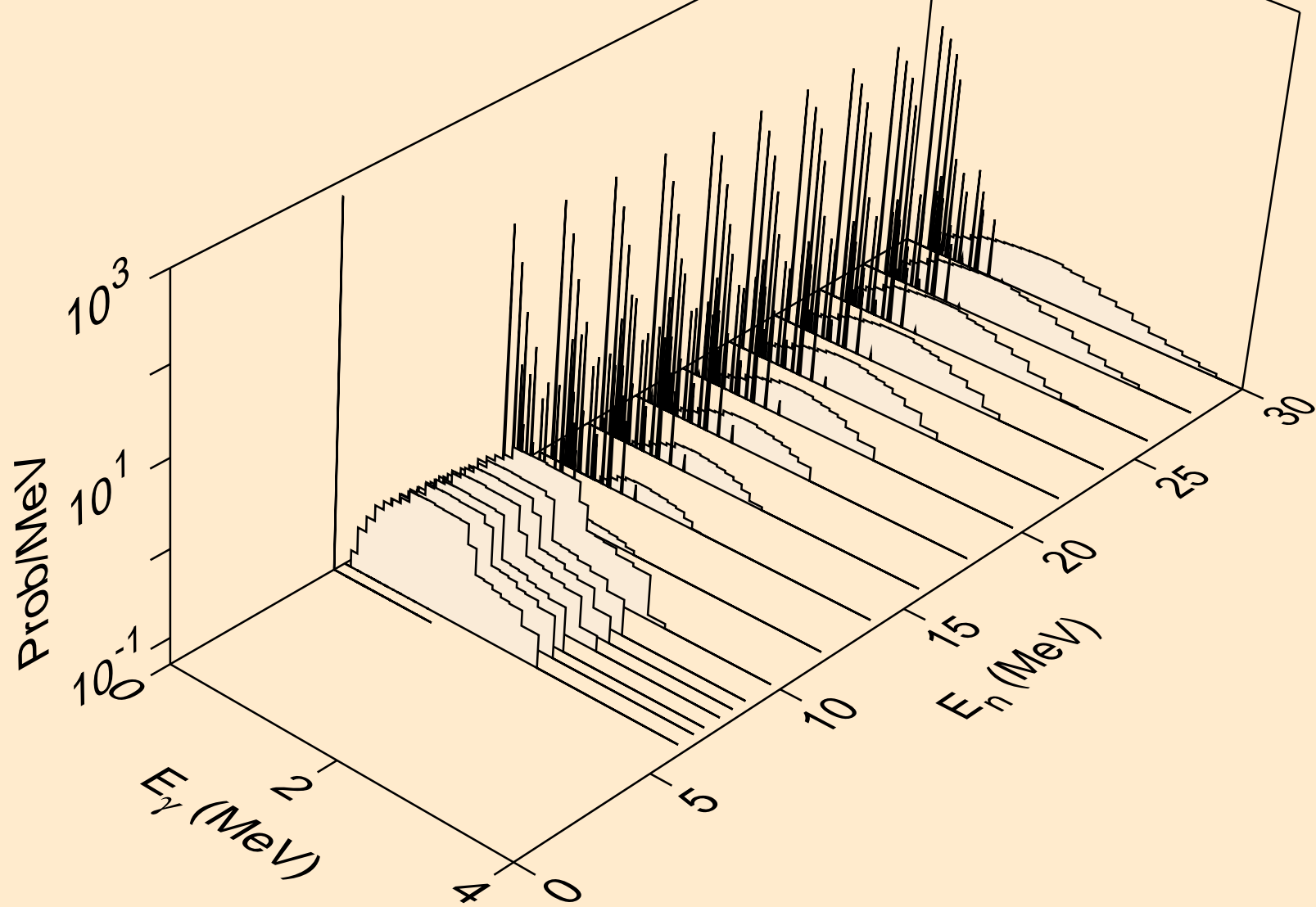

PO195 NEUTRON ACER TENDL-2021 LIBRARY; T=293.6K
Photon emission for (n,2p)

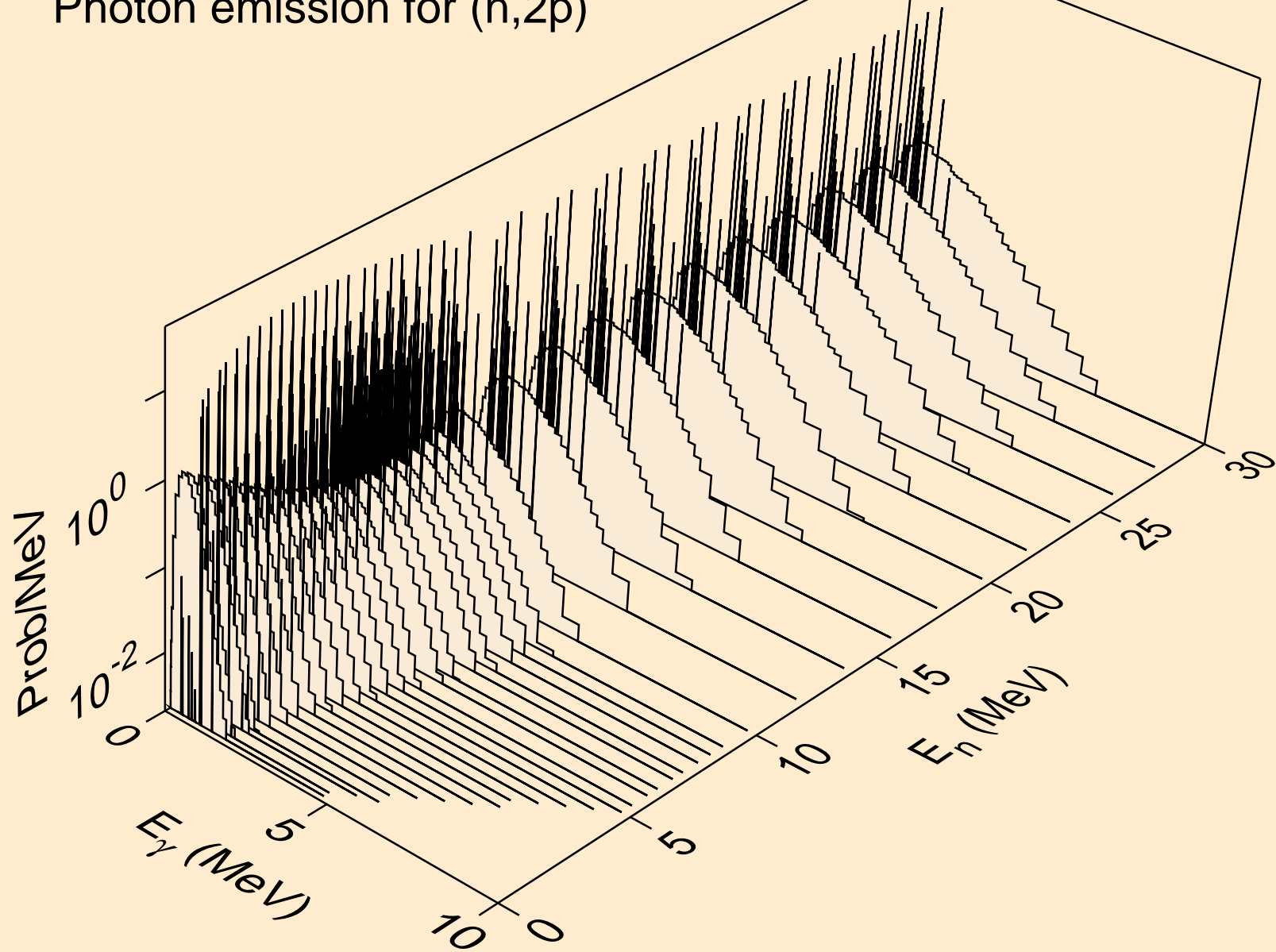

PO195 NEUTRON ACER TENDL-2021 LIBRARY; T=293.6K
Photon emission for (n,p)

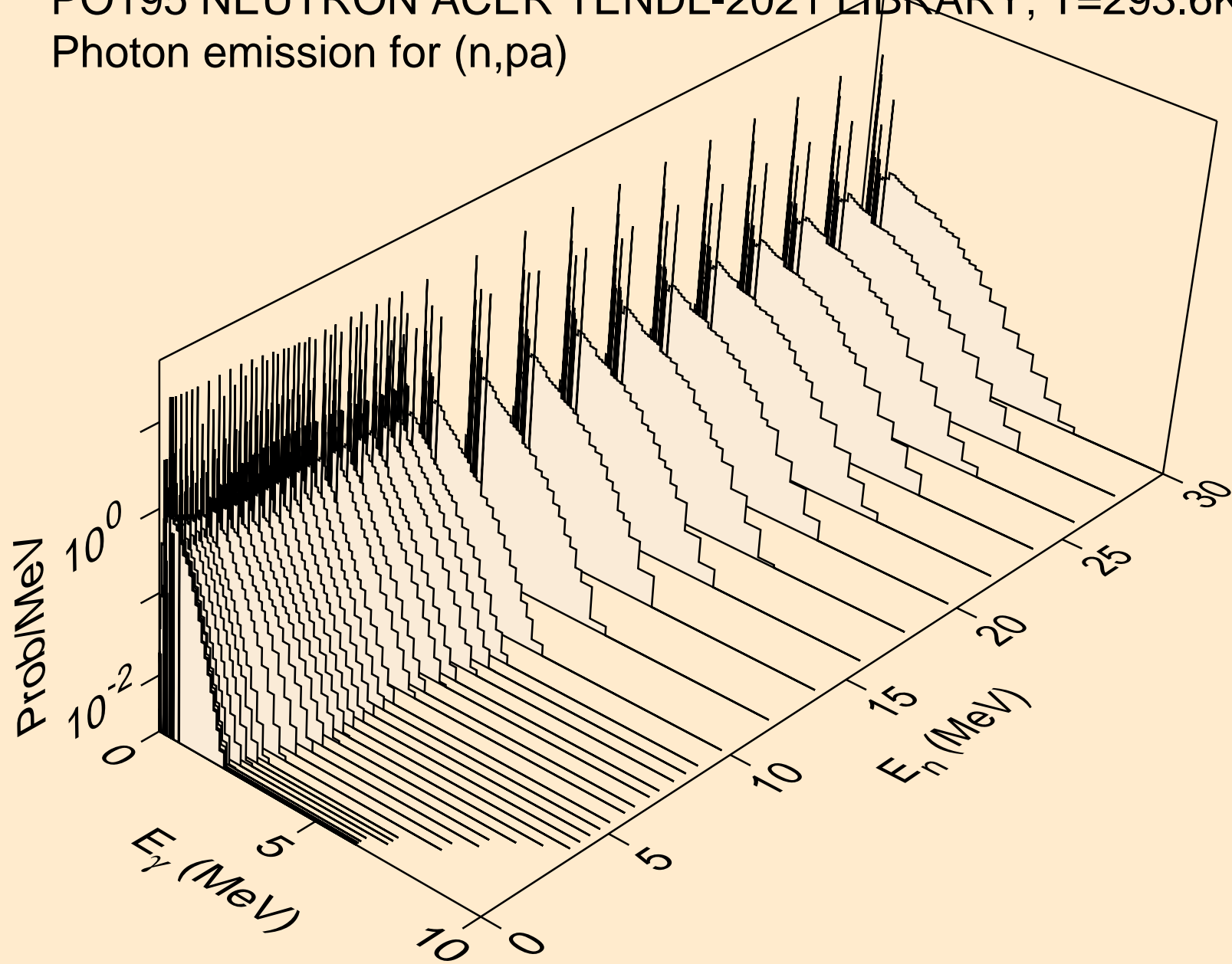

PO195 NEUTRON ACER TENDL-2021 LIBRARY; T=293.6K
Photon emission for (n,pd)

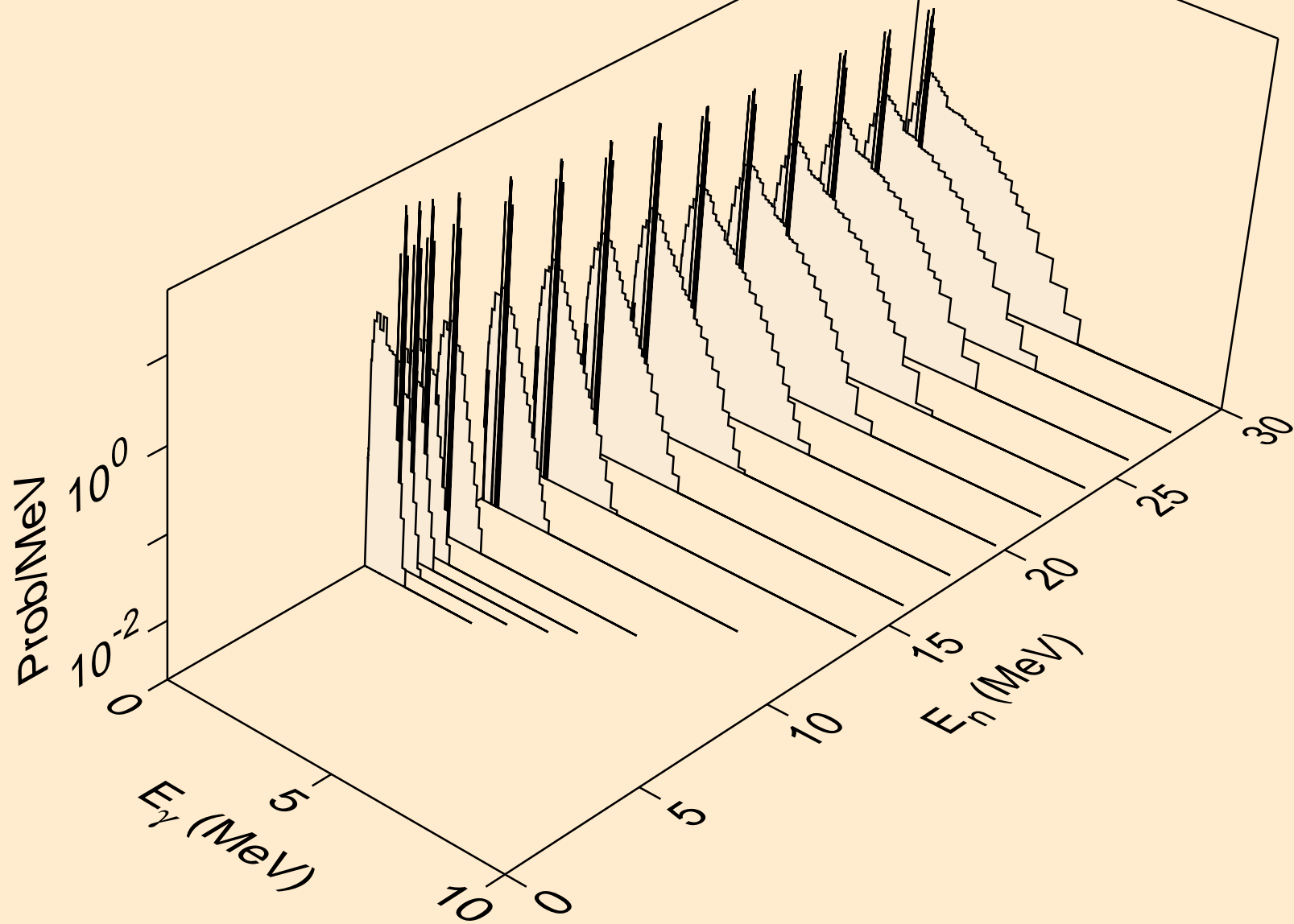

PO195 NEUTRON ACER TENDL-2021 LIBRARY; T=293.6K
Photon emission for (n,pt)

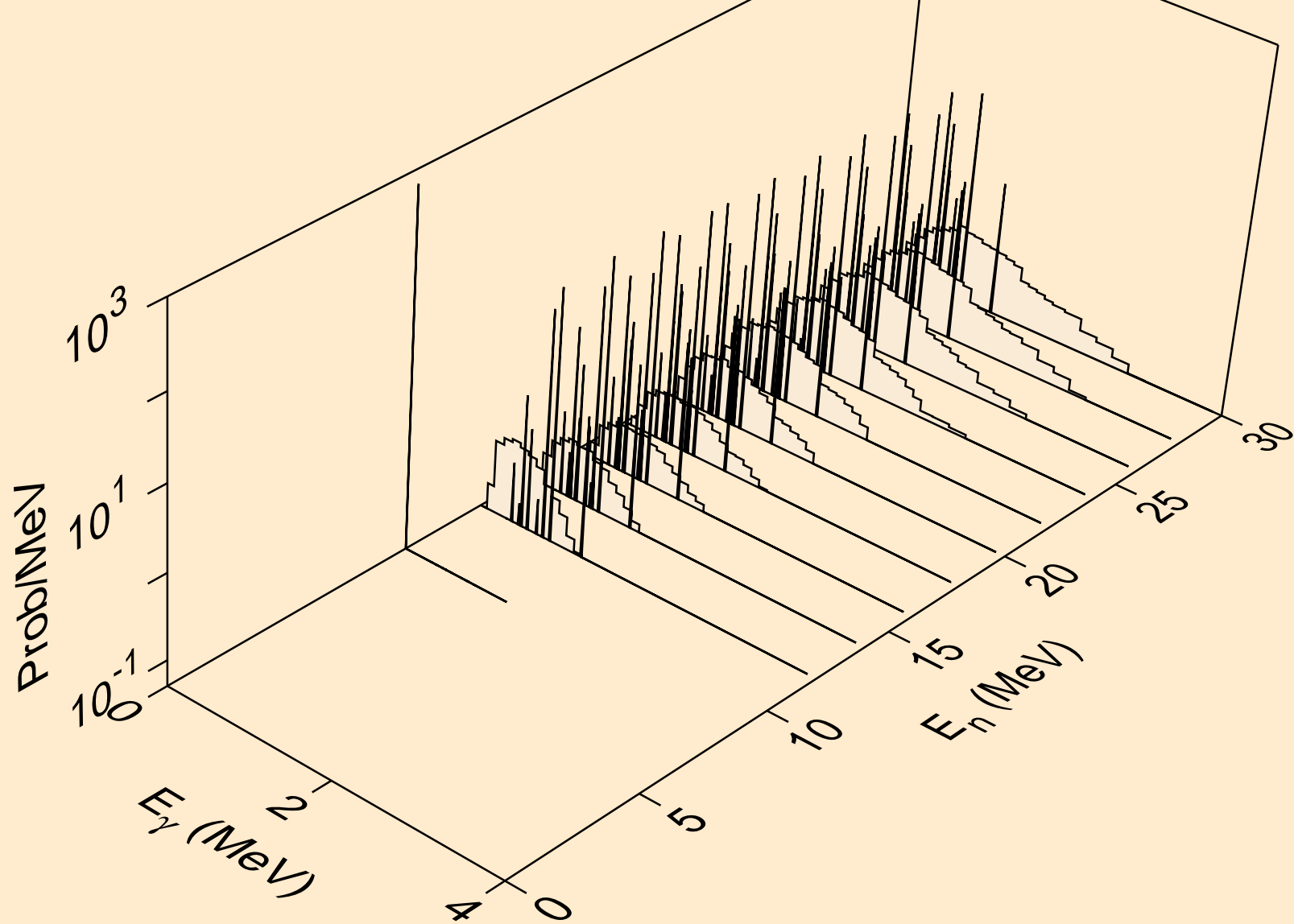

PO195 NEUTRON ACER TENDL-2021 LIBRARY; T=293.6K
Photon emission for (n,da)

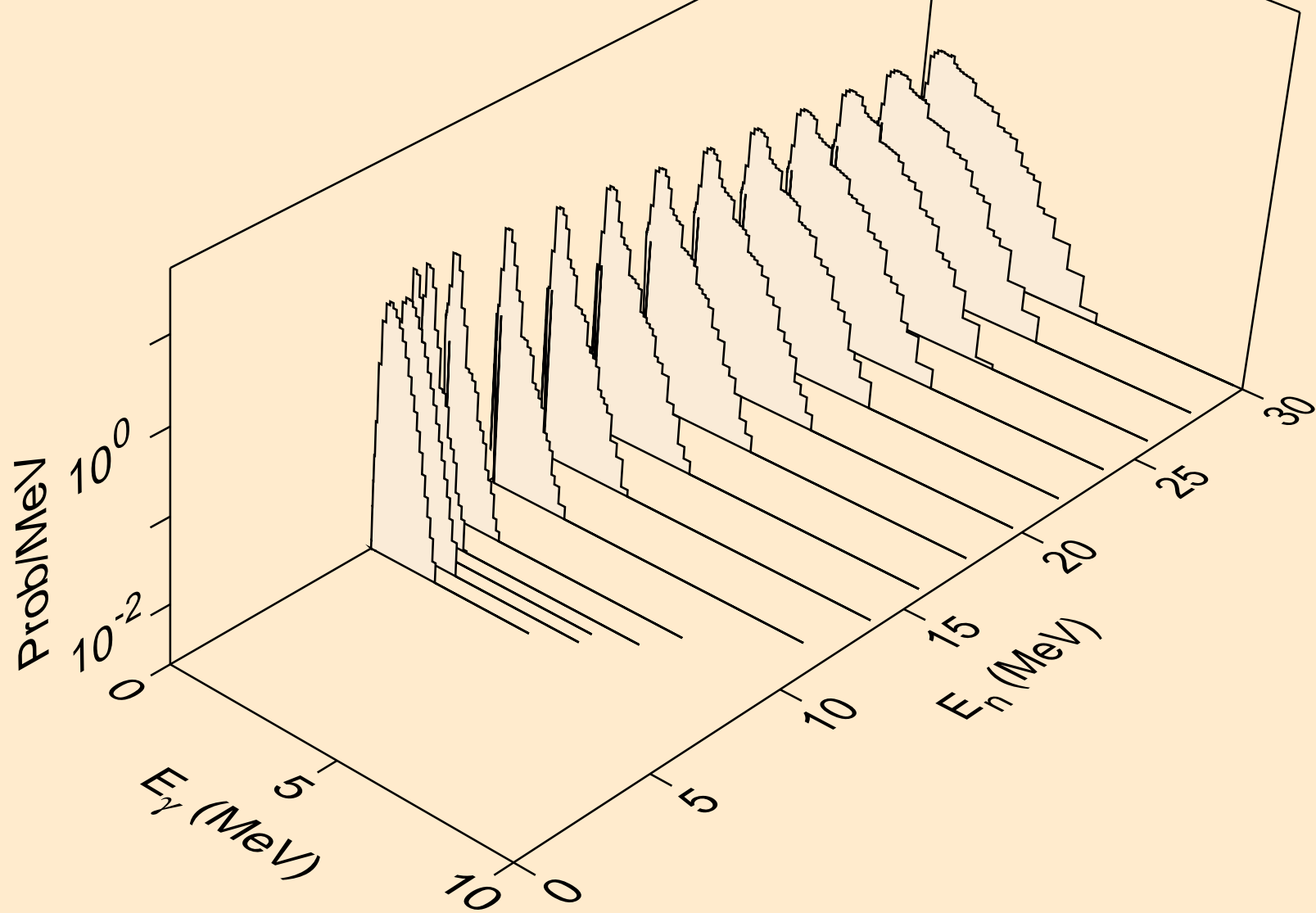

PO195 NEUTRON ACER TENDL-2021 LIBRARY; T=293.6K
thermal capture photon spectrum

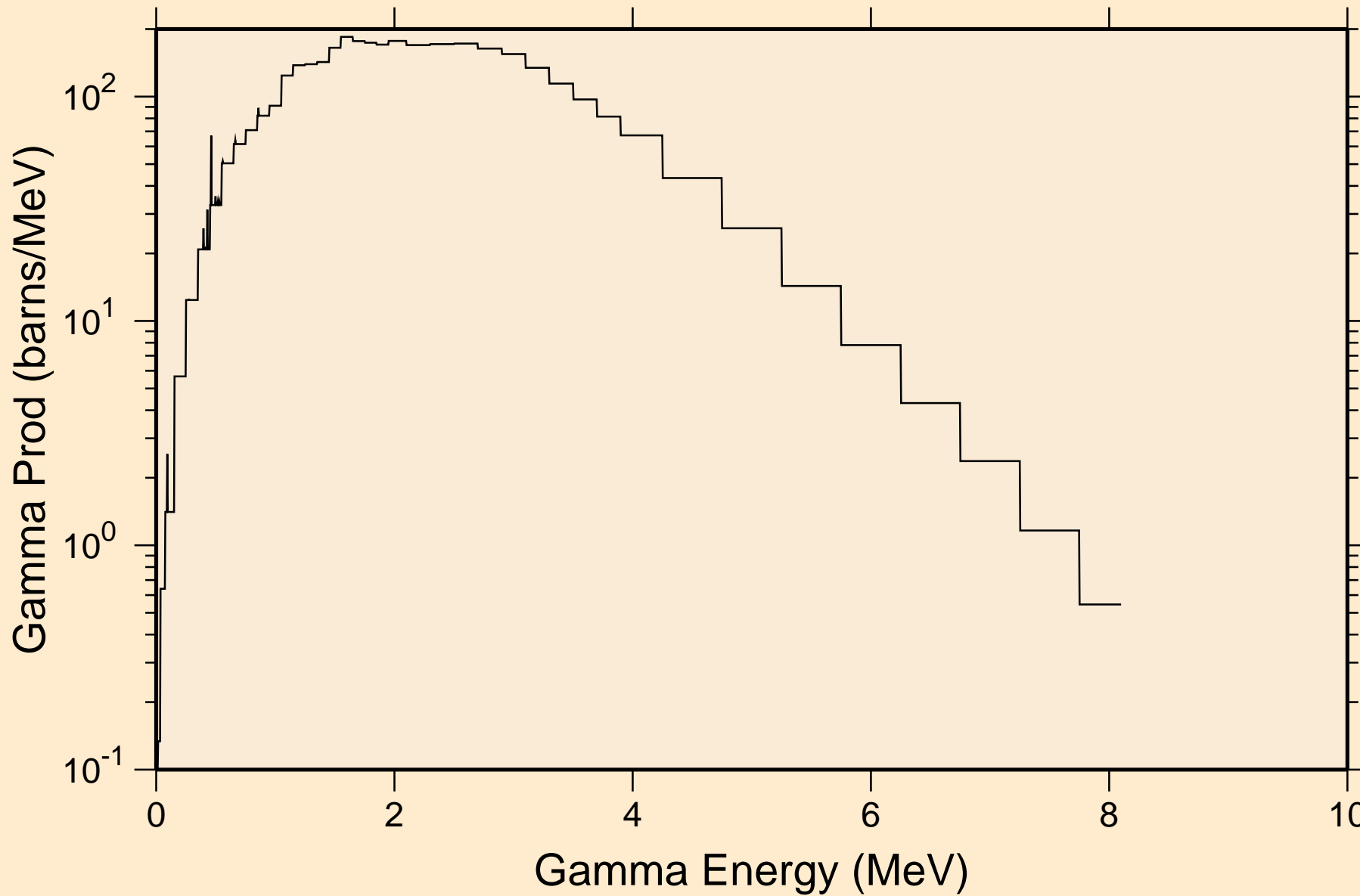

PO195 NEUTRON ACER TENDL-2021 LIBRARY; T=293.6K
14 MeV photon spectrum

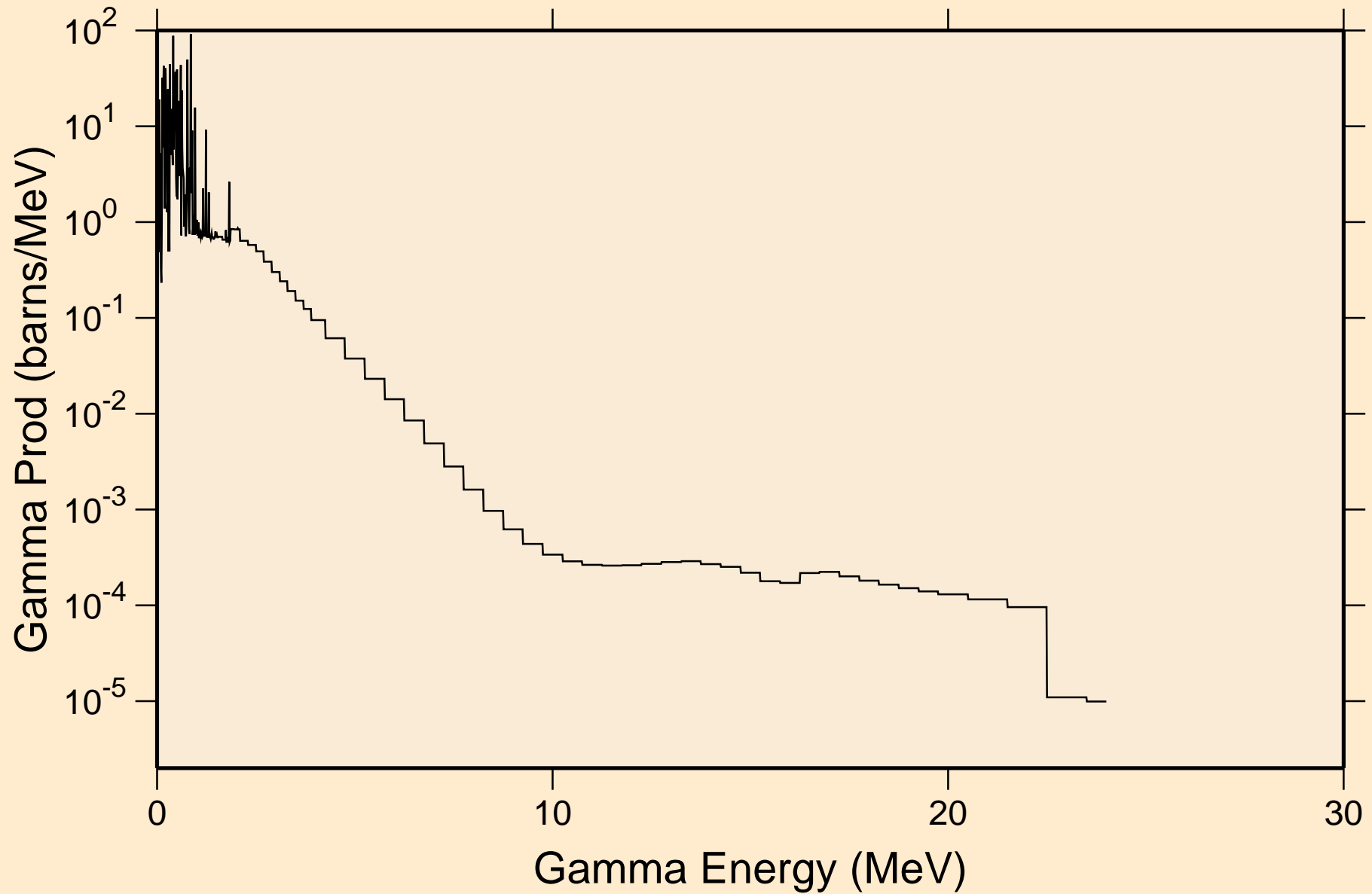

PO195 NEUTRON ACER TENDL-2021 LIBRARY; T=293.6K
Particle heating contributions

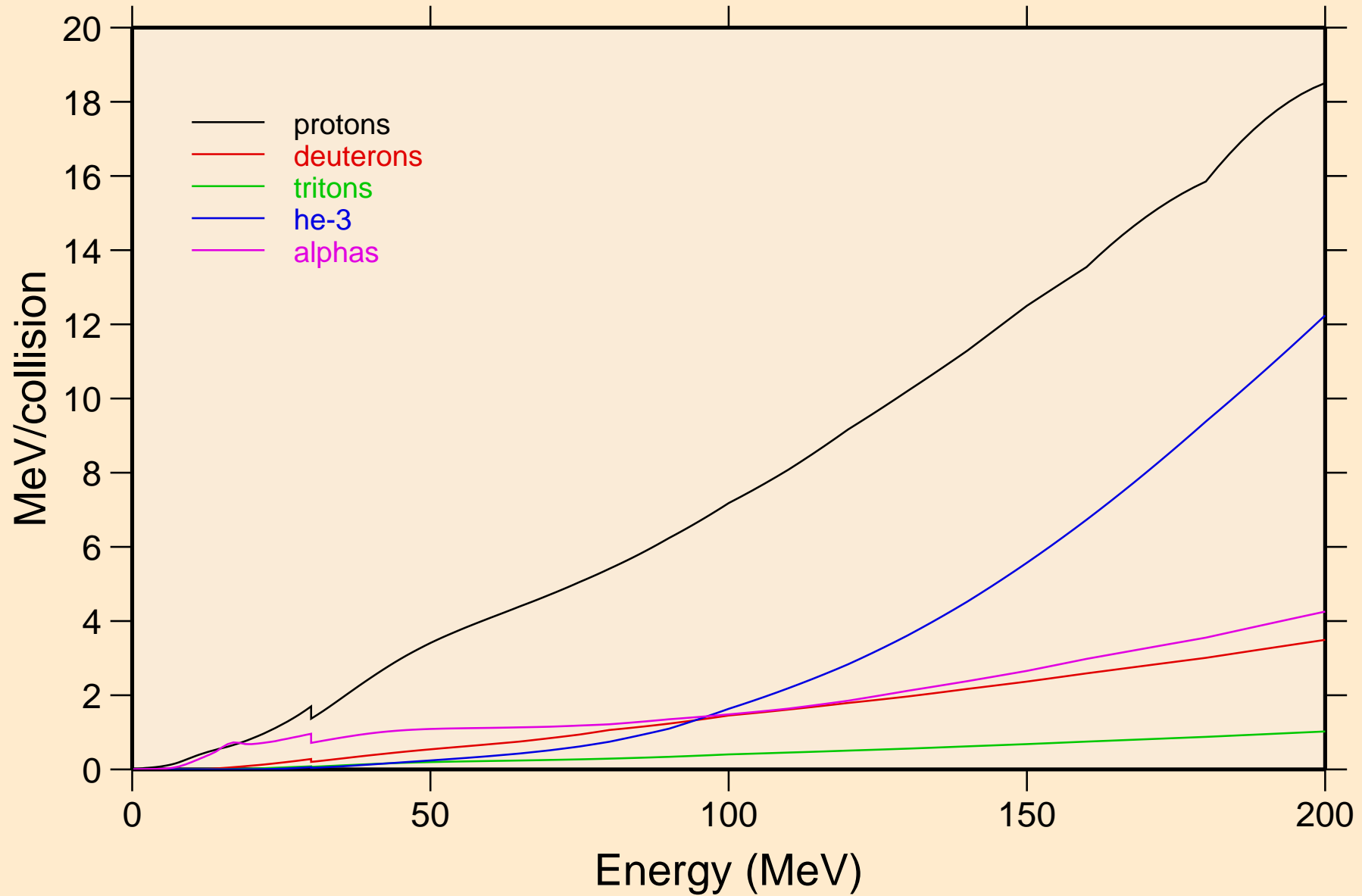

PO195 NEUTRON ACER TENDL-2021 LIBRARY; T=293.6K
Recoil Heating

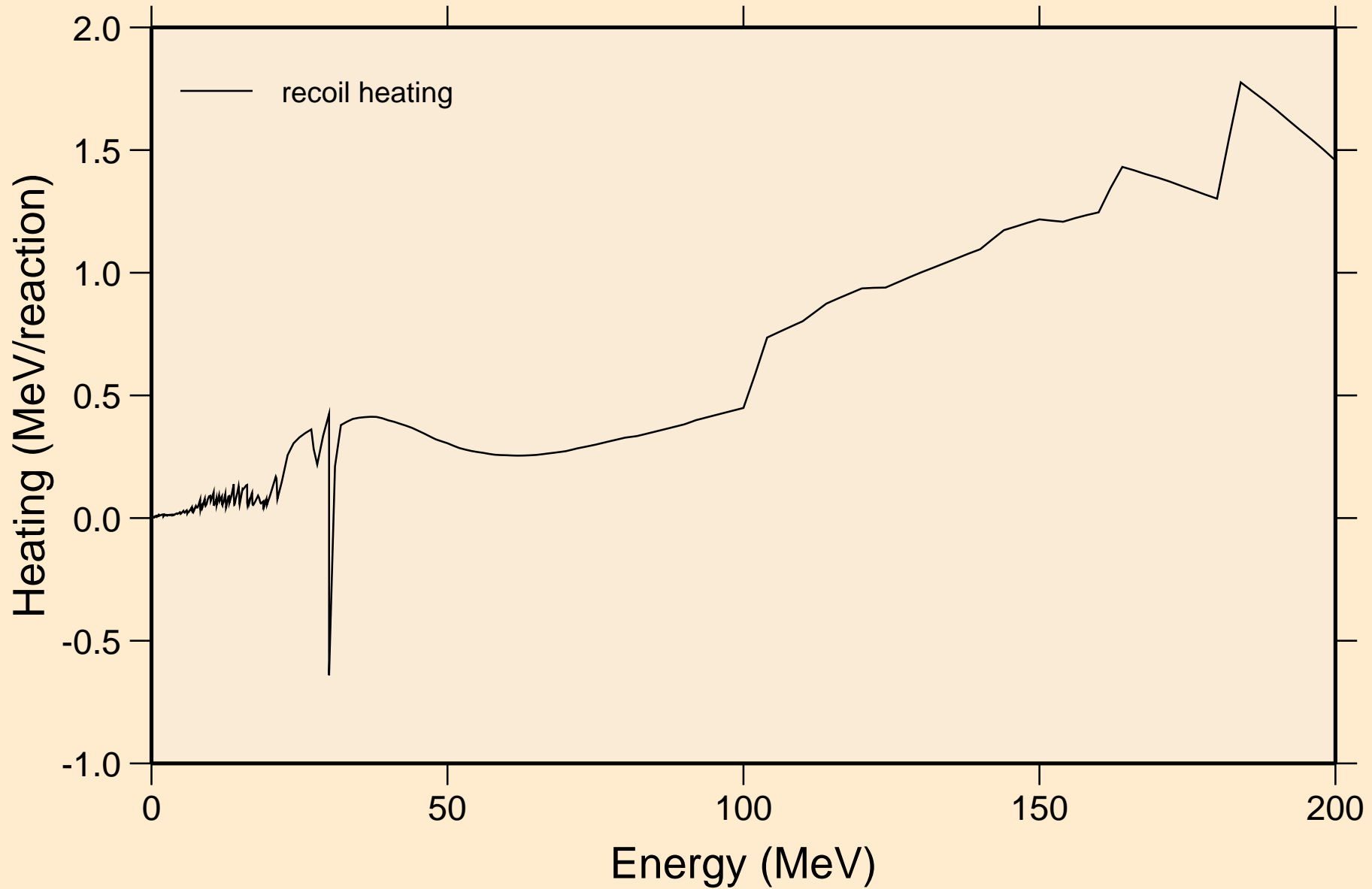

PO195 NEUTRON ACER TENDL-2021 LIBRARY; T=293.6K
Particle production cross sections

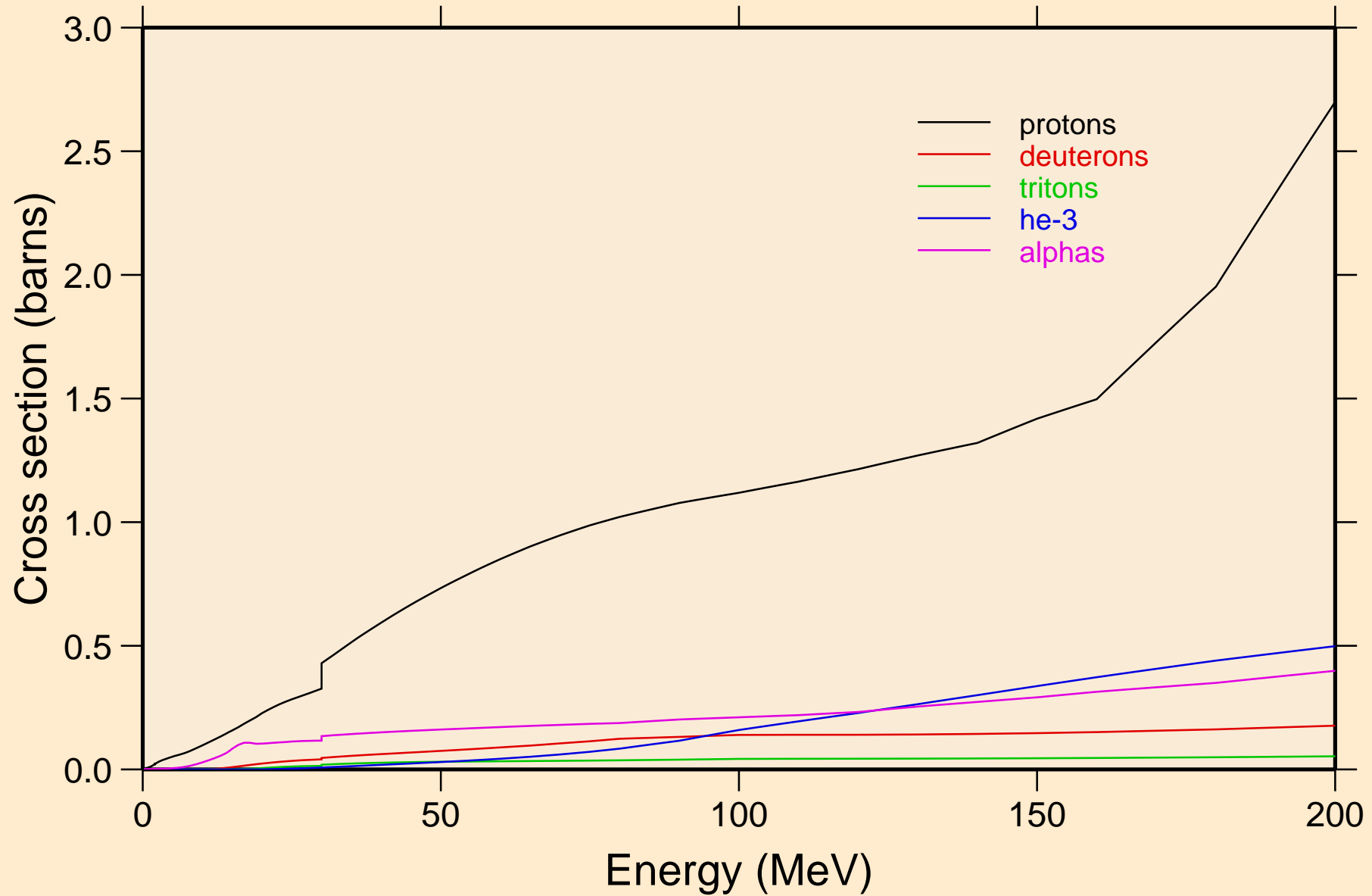

PO195 NEUTRON ACER TENDL-2021 LIBRARY; T=293.6K
protons from (n,x)

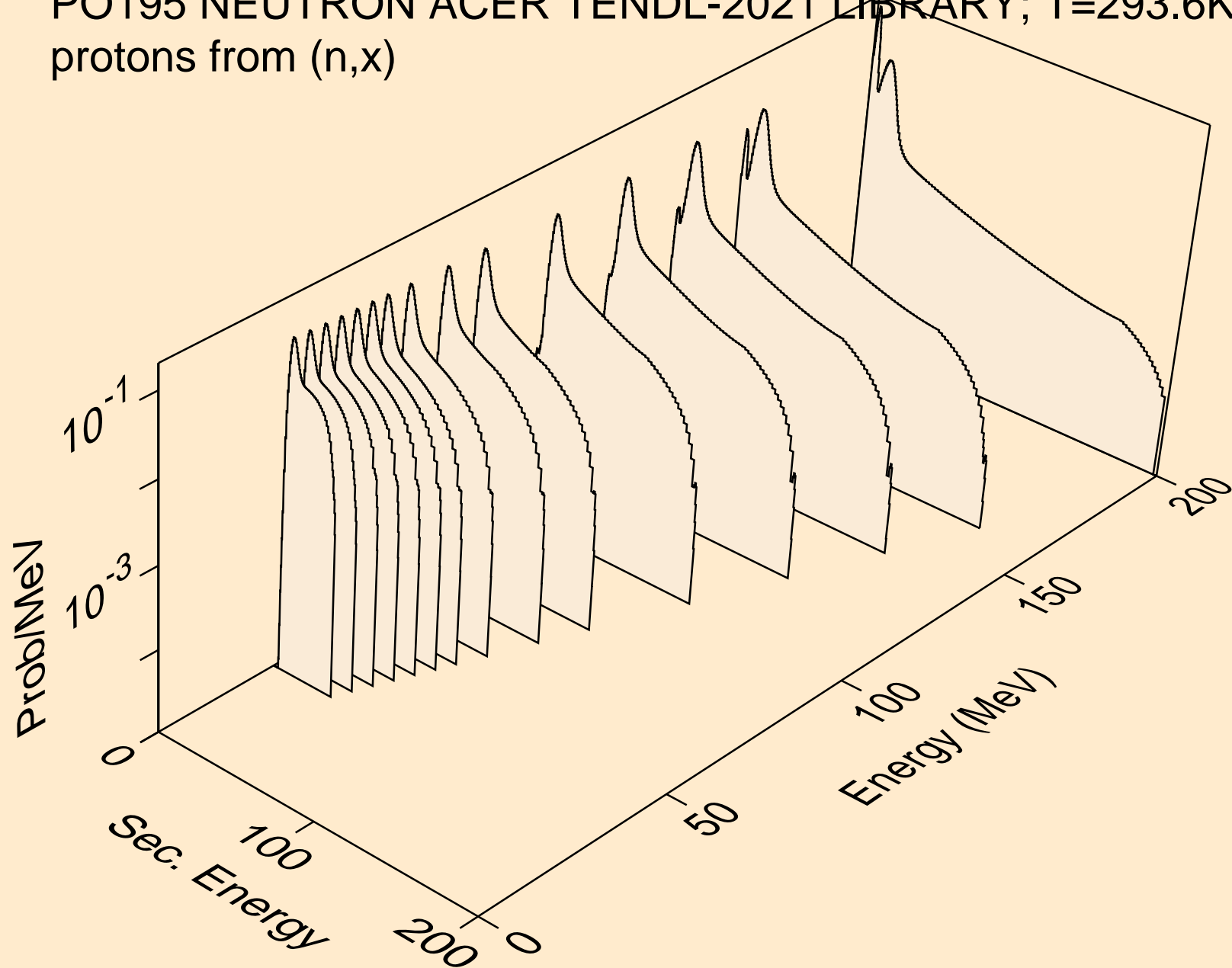

PO195 NEUTRON ACER TENDL-2021 LIBRARY; T=293.6K
protons from (n,n*)p

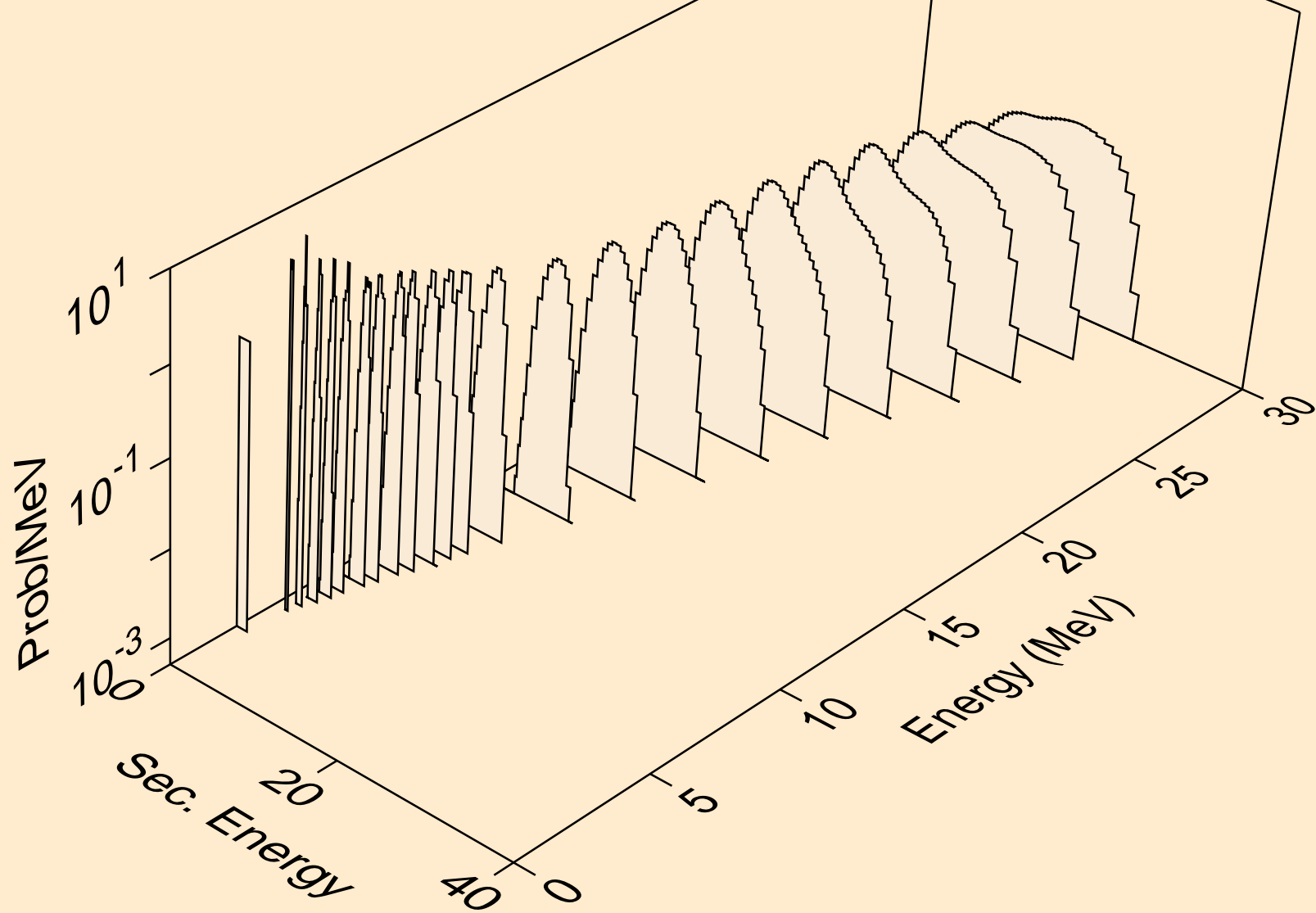

PO195 NEUTRON ACER TENDL-2021 LIBRARY; T=293.6K
protons from (n,2np)

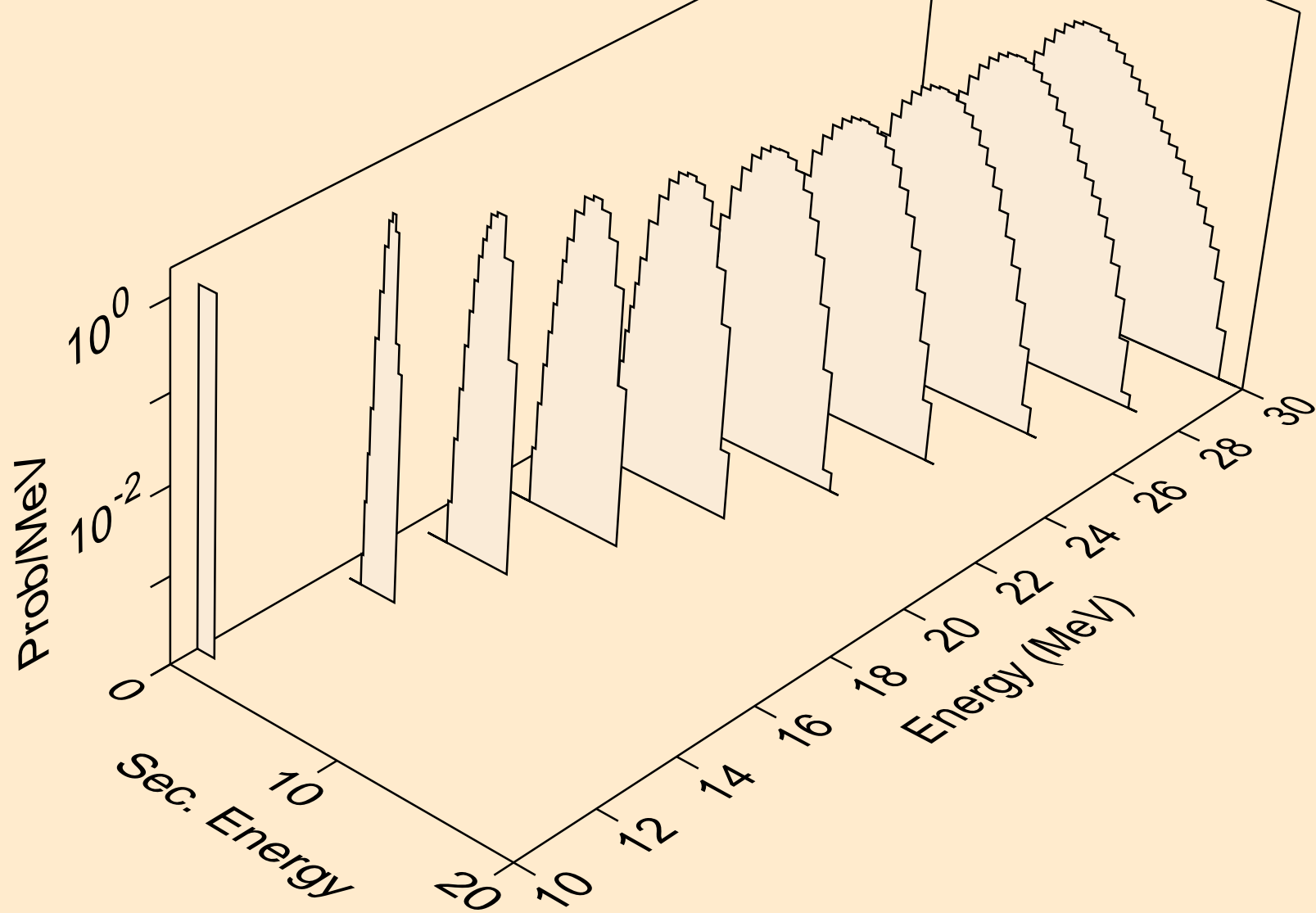

PO195 NEUTRON ACER TENDL-2021 LIBRARY; T=293.6K
protons from (n,3np)

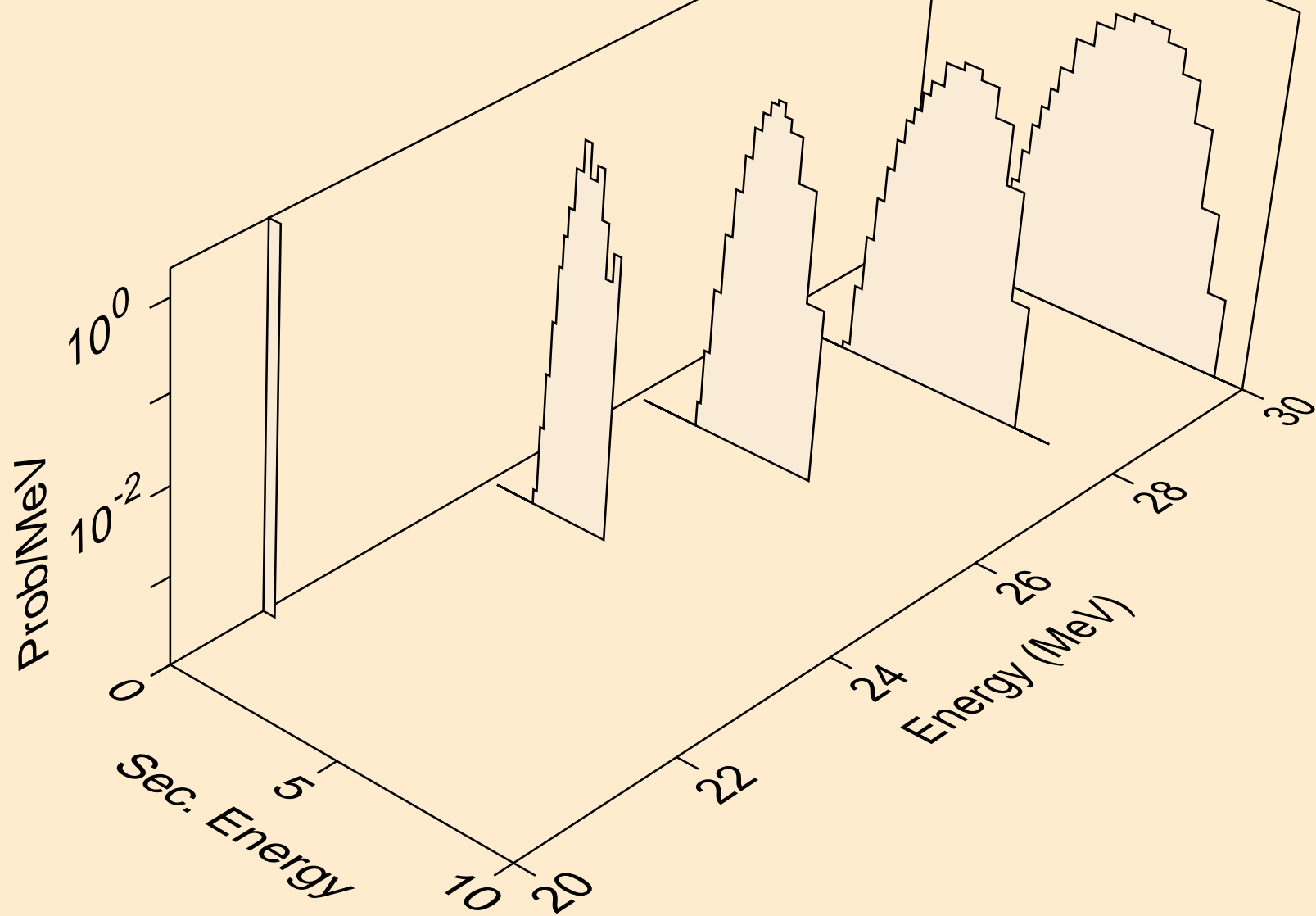

PO195 NEUTRON ACER TENDL-2021 LIBRARY; T=293.6K
protons from (n,2np)

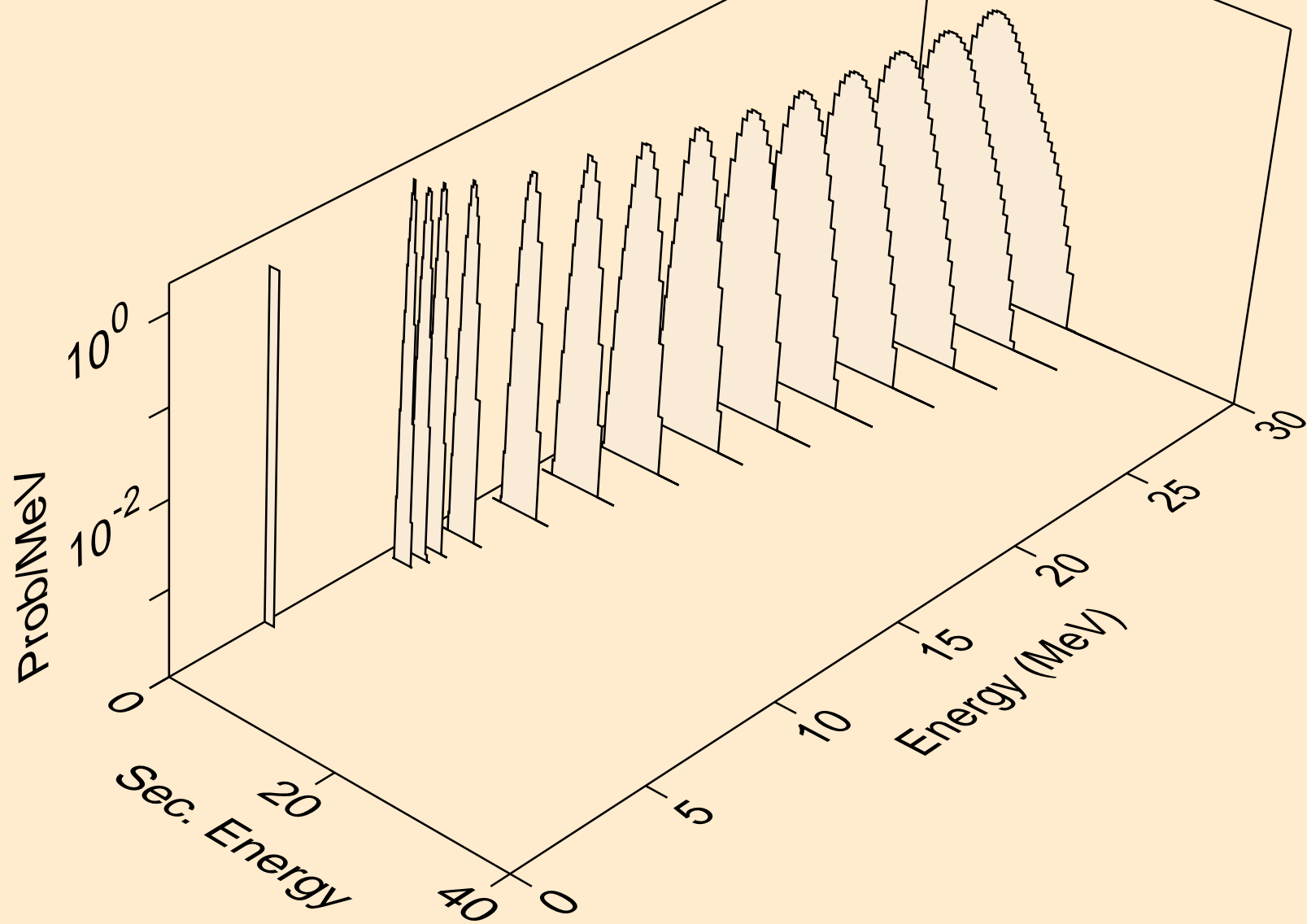

PO195 NEUTRON ACER TENDL-2021 LIBRARY; T=293.6K
protons from (n,npa)

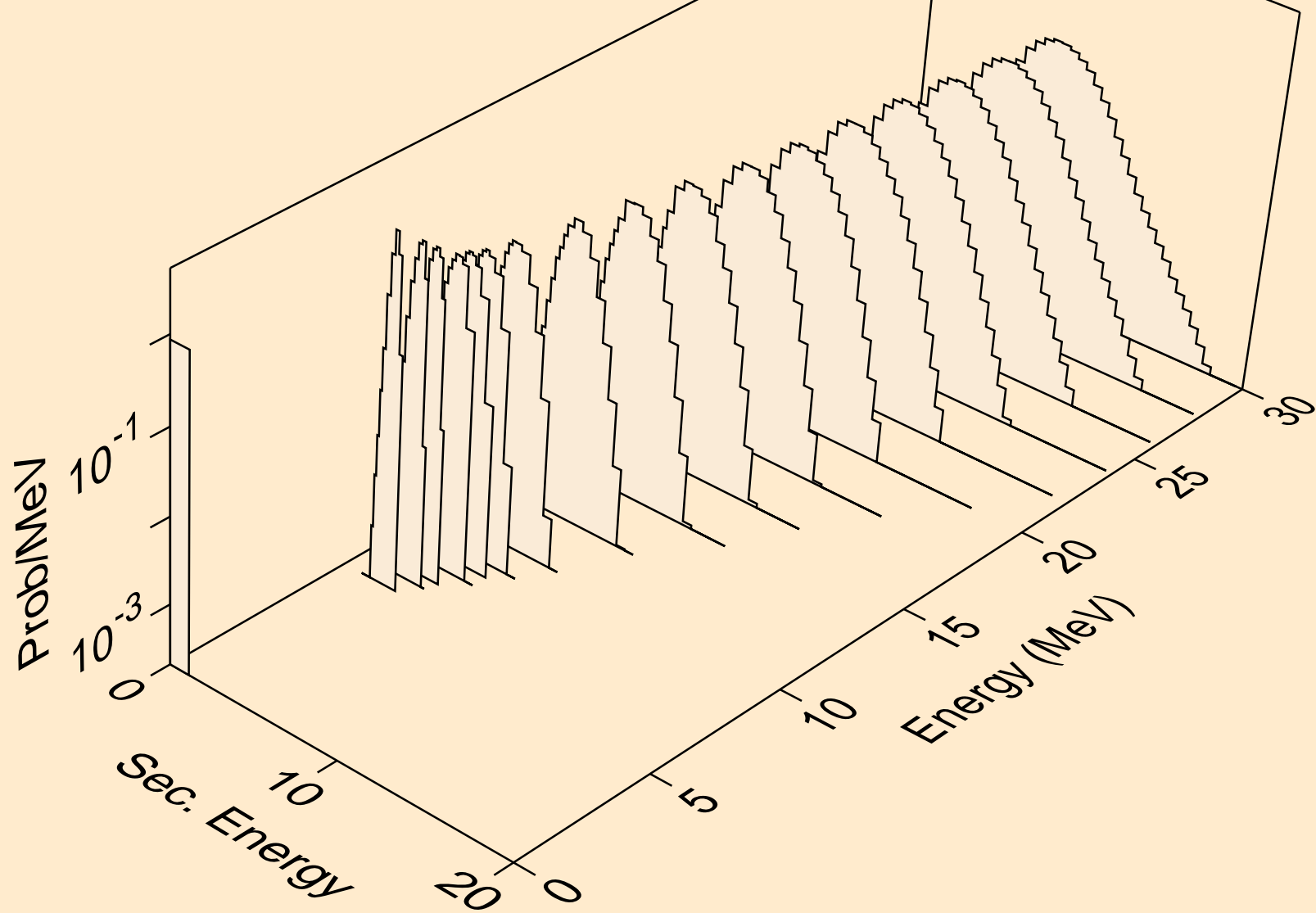

PO195 NEUTRON ACER TENDL-2021 LIBRARY; T=293.6K
protons from (n,p)

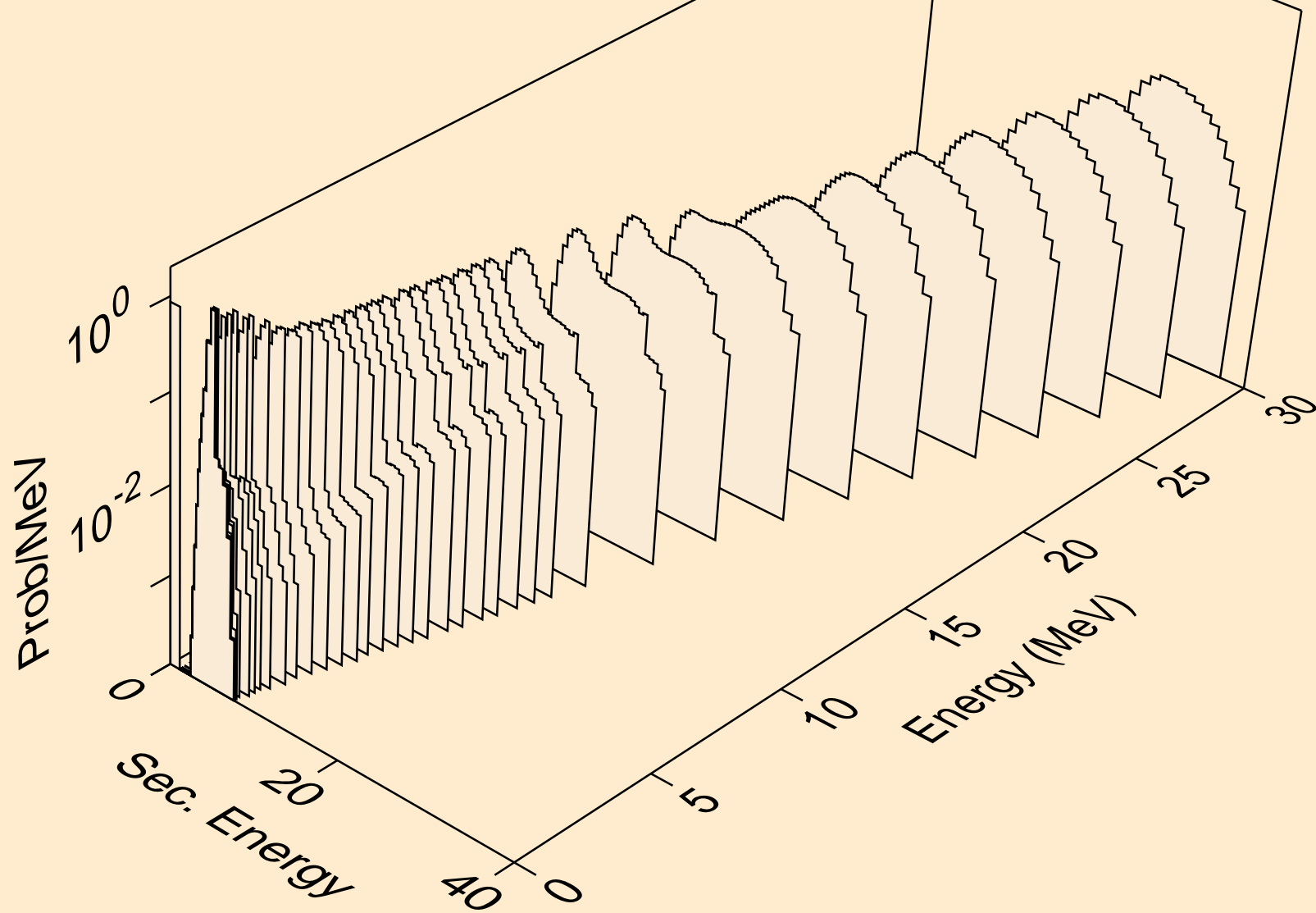

PO195 NEUTRON ACER TENDL-2021 LIBRARY; T=293.6K
protons from (n,2p)

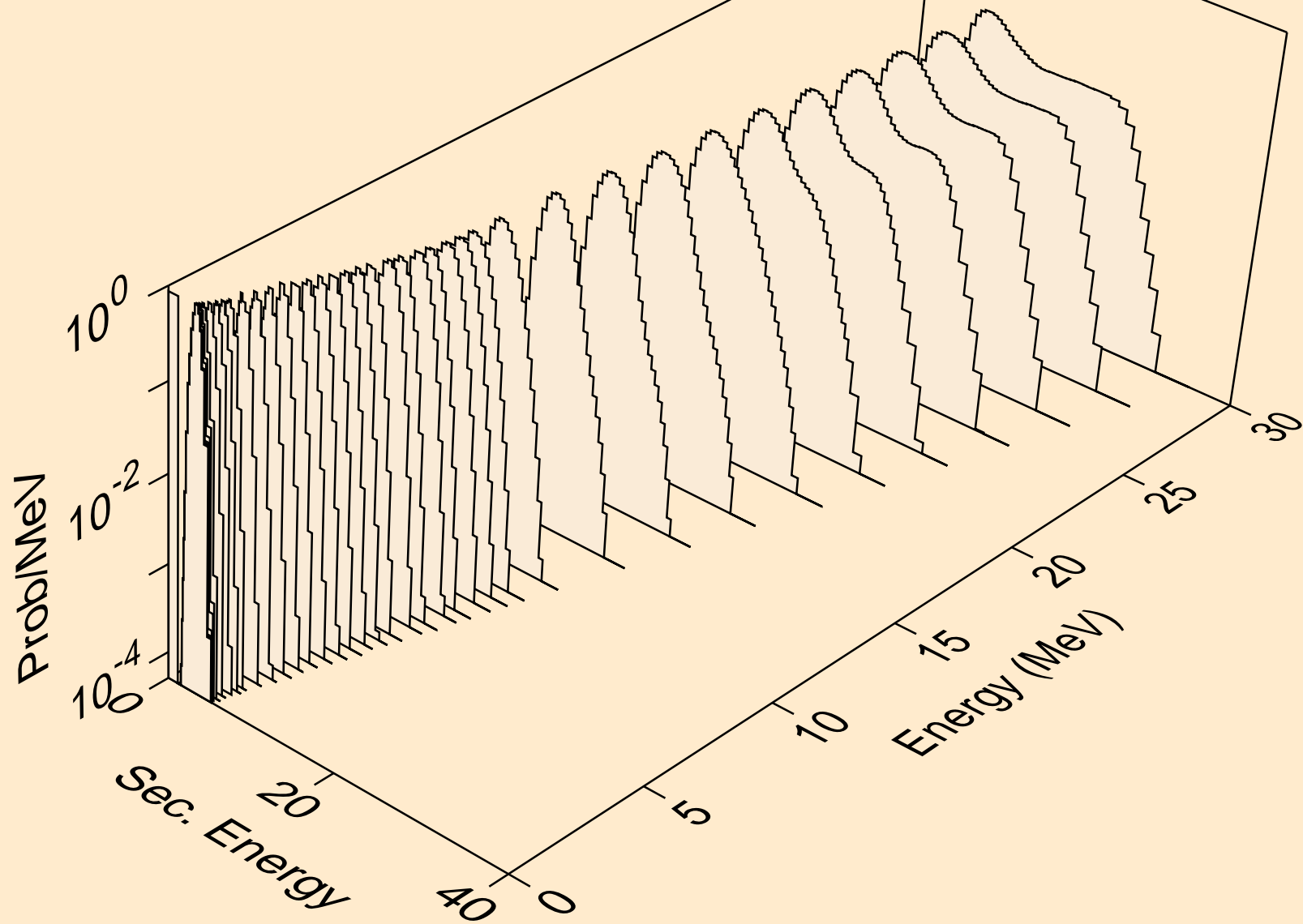

PO195 NEUTRON ACER TENDL-2021 LIBRARY; T=293.6K
protons from (n,p)

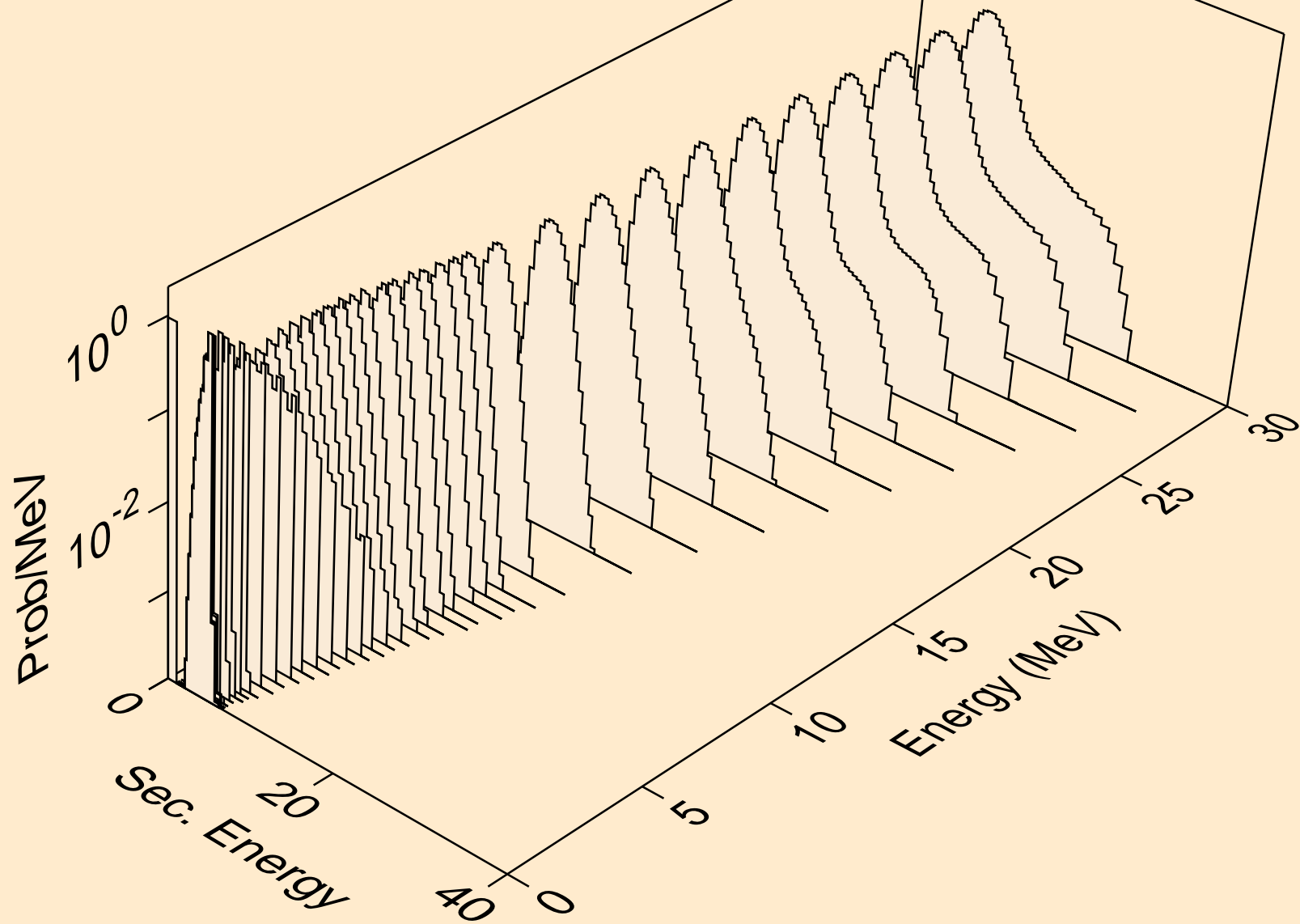

PO195 NEUTRON ACER TENDL-2021 LIBRARY; T=293.6K
protons from (n,pd)

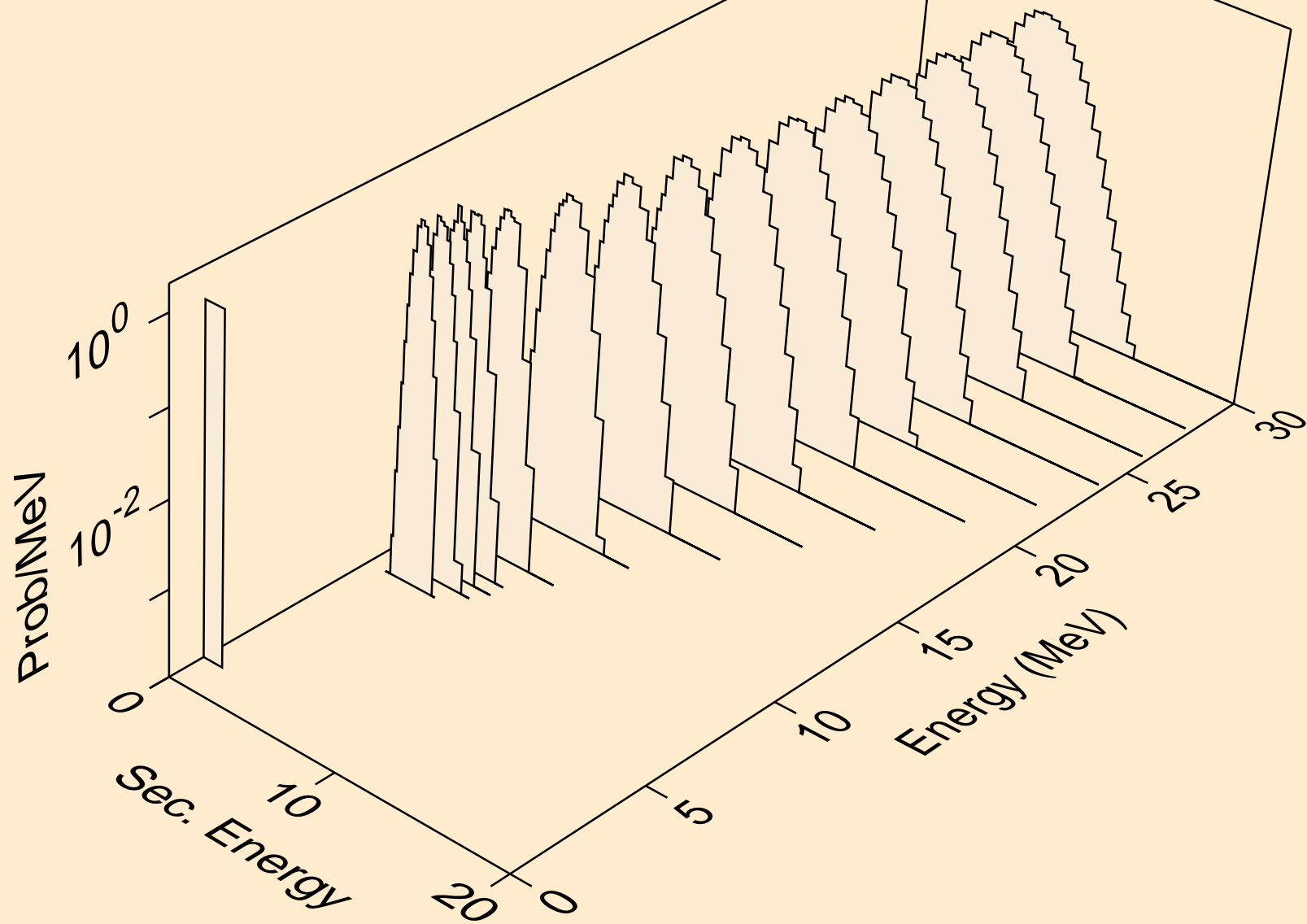

PO195 NEUTRON ACER TENDL-2021 LIBRARY; T=293.6K
protons from (n,pt)

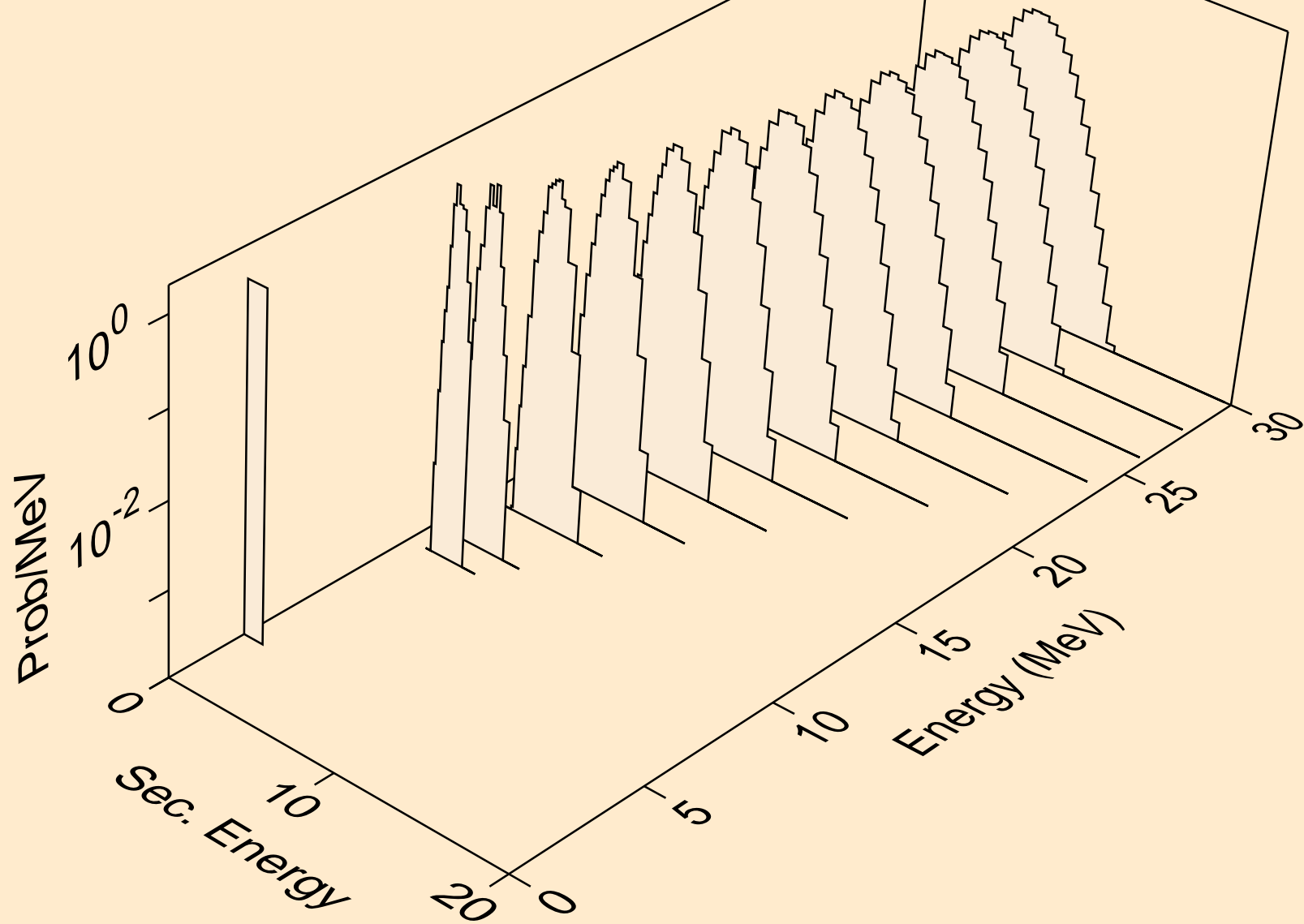

PO195 NEUTRON ACER TENDL-2021 LIBRARY; T=293.6K
deuterons from (n,x)

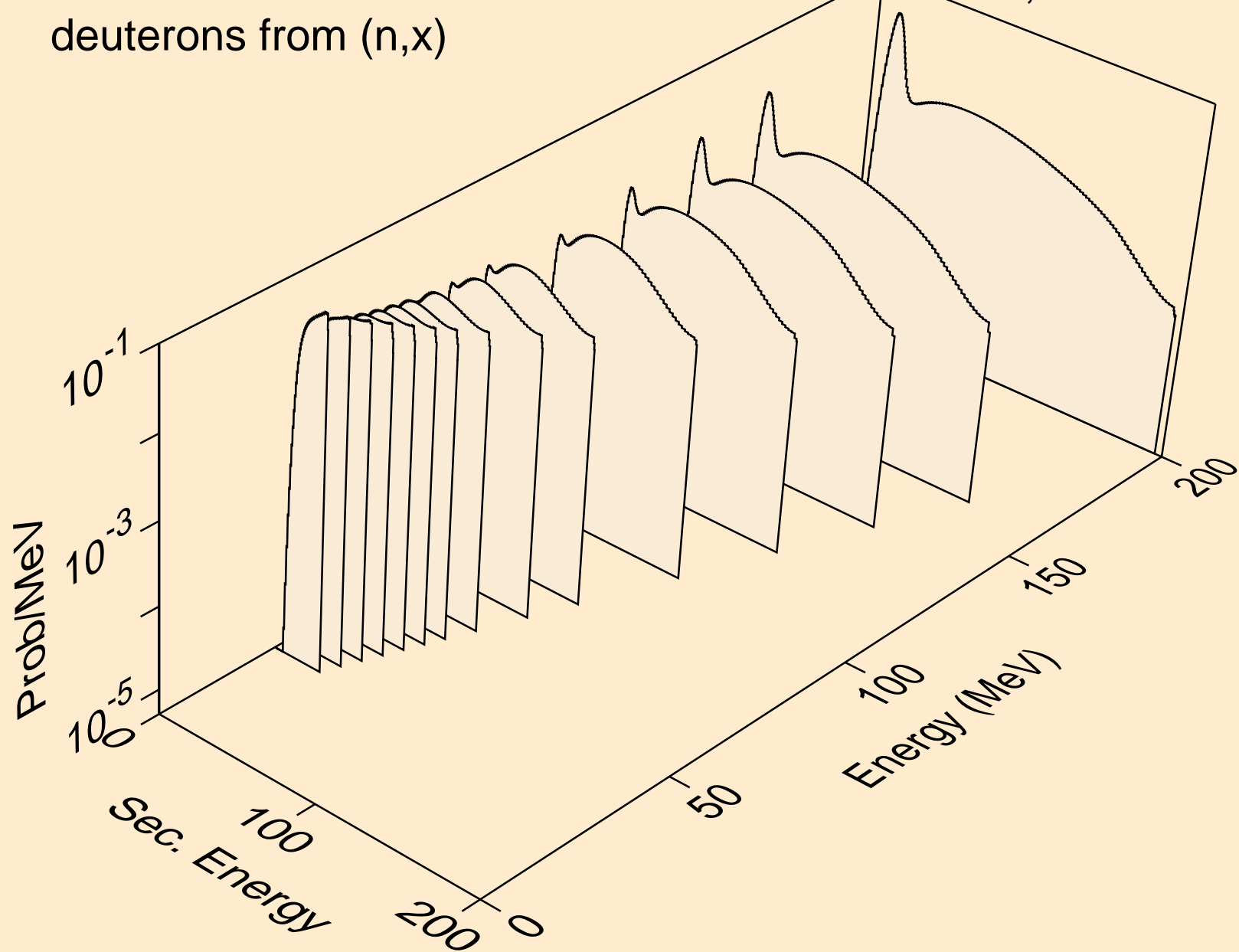

PO195 NEUTRON ACER TENDL-2021 LIBRARY; T=293.6K
deuterons from (n,2nd)

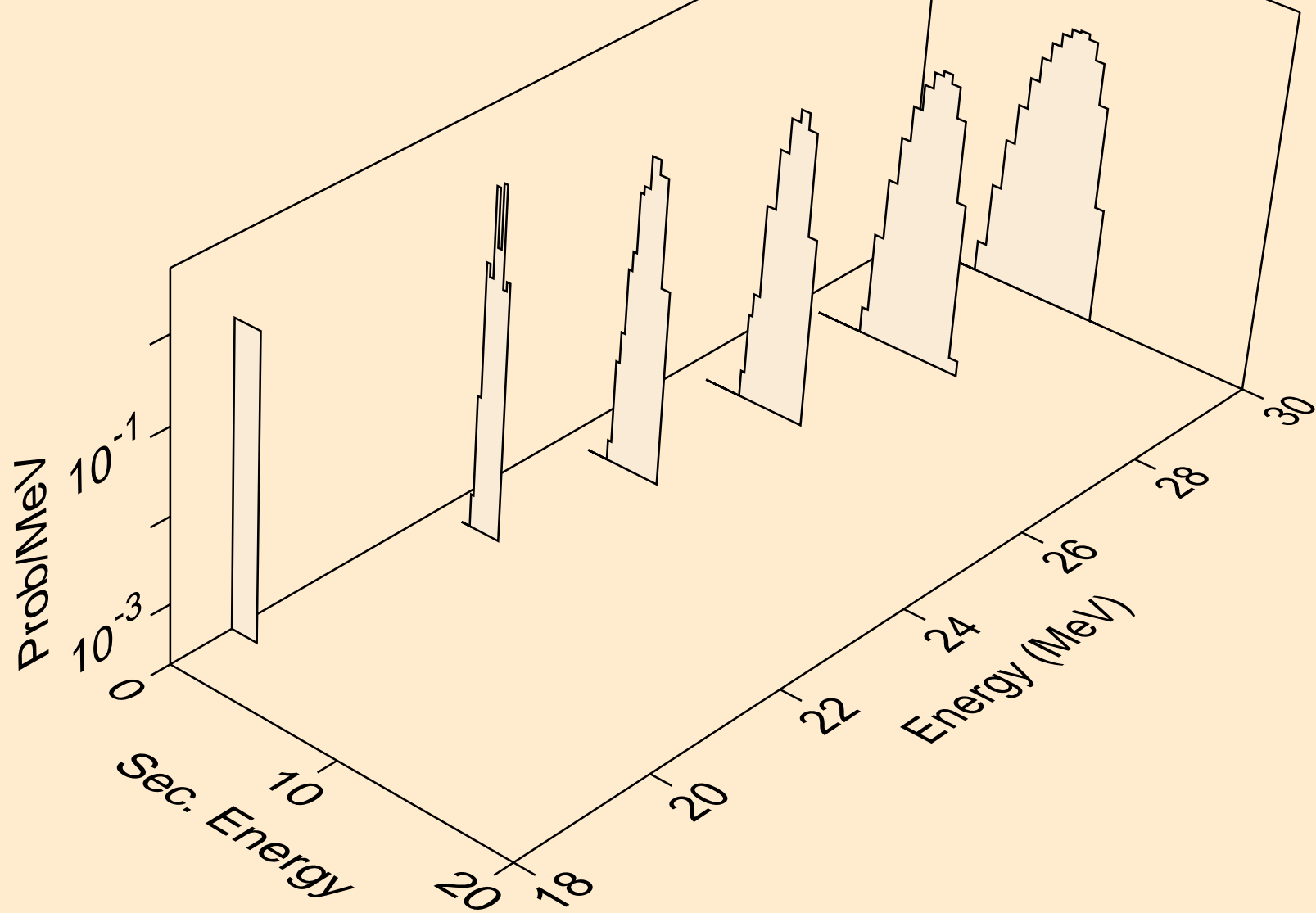

PO195 NEUTRON ACER TENDL-2021 LIBRARY; T=293.6K
deuterons from (n,n*)d

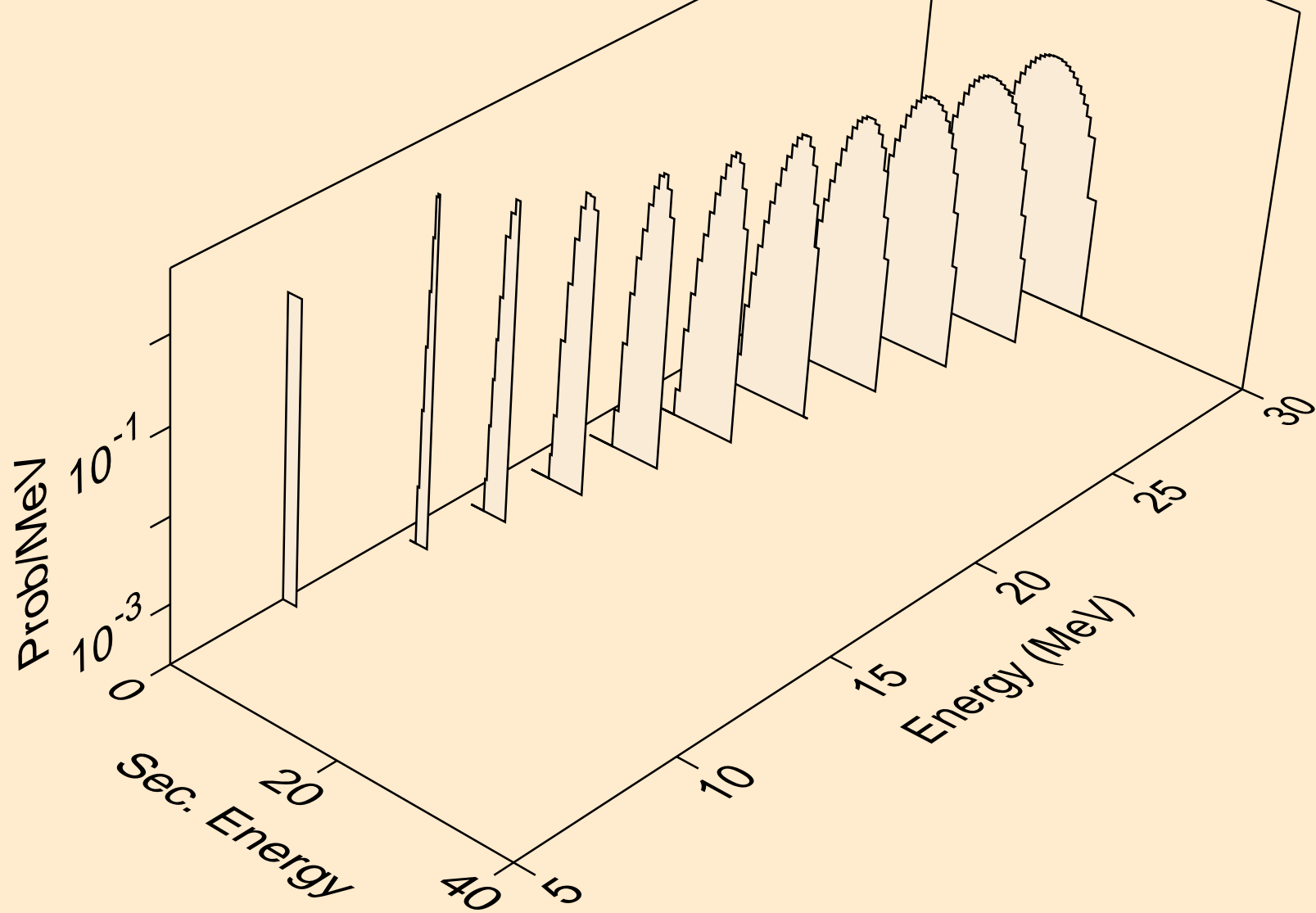

PO195 NEUTRON ACER TENDL-2021 LIBRARY; T=293.6K
deuterons from (n,d)

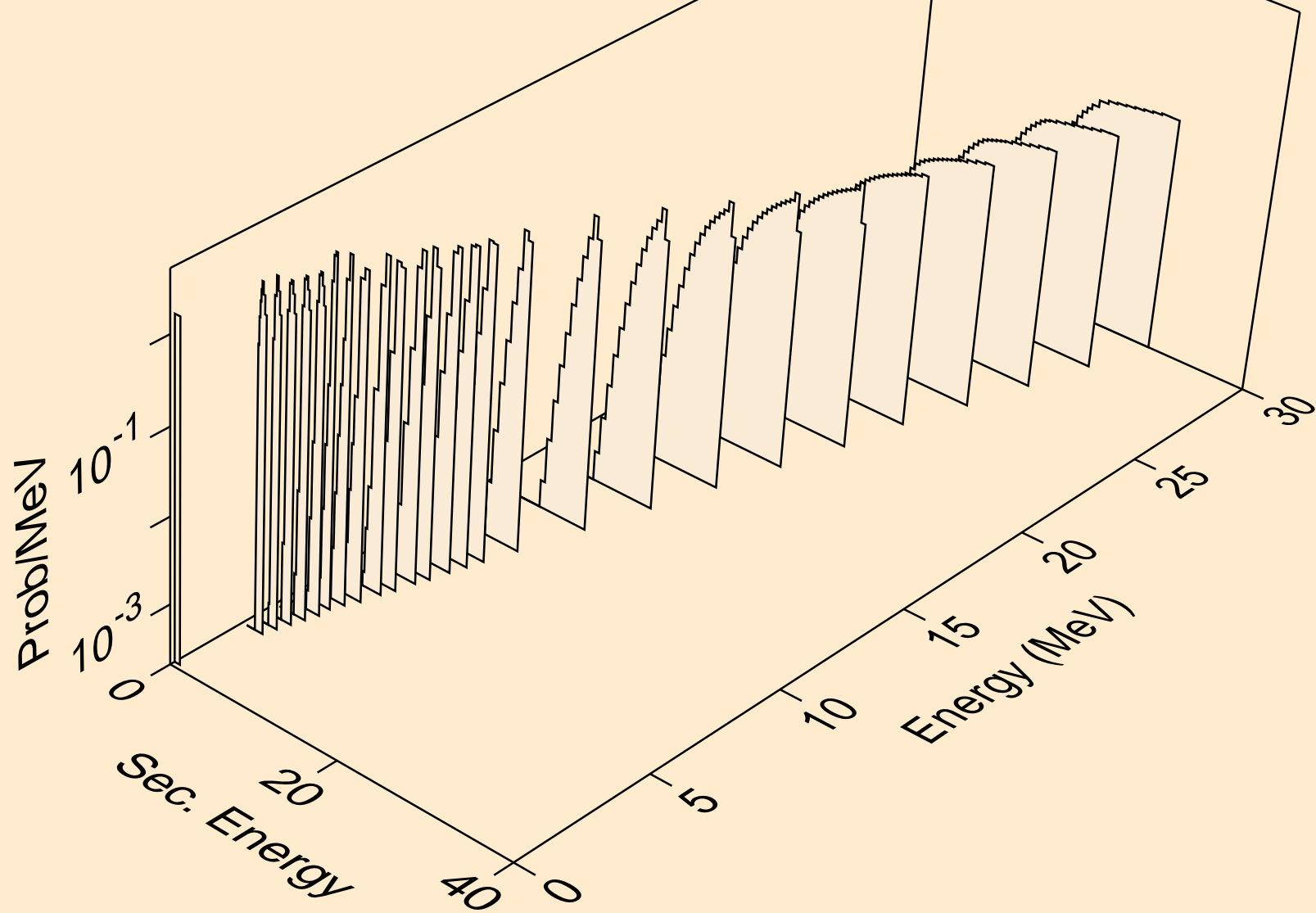

PO195 NEUTRON ACER TENDL-2021 LIBRARY; T=293.6K
deuterons from (n,pd)

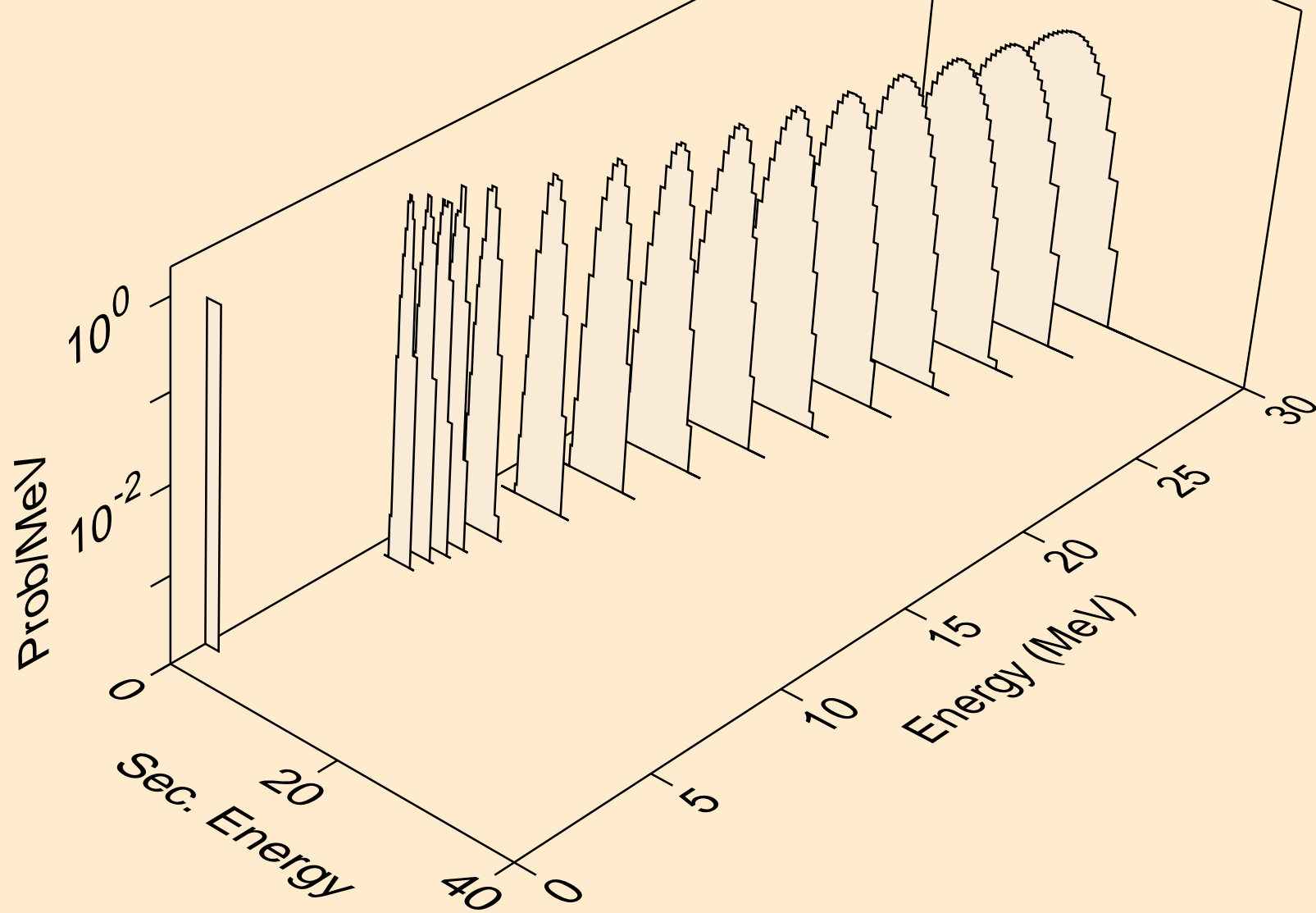

PO195 NEUTRON ACER TENDL-2021 LIBRARY; T=293.6K
deuterons from (n,da)

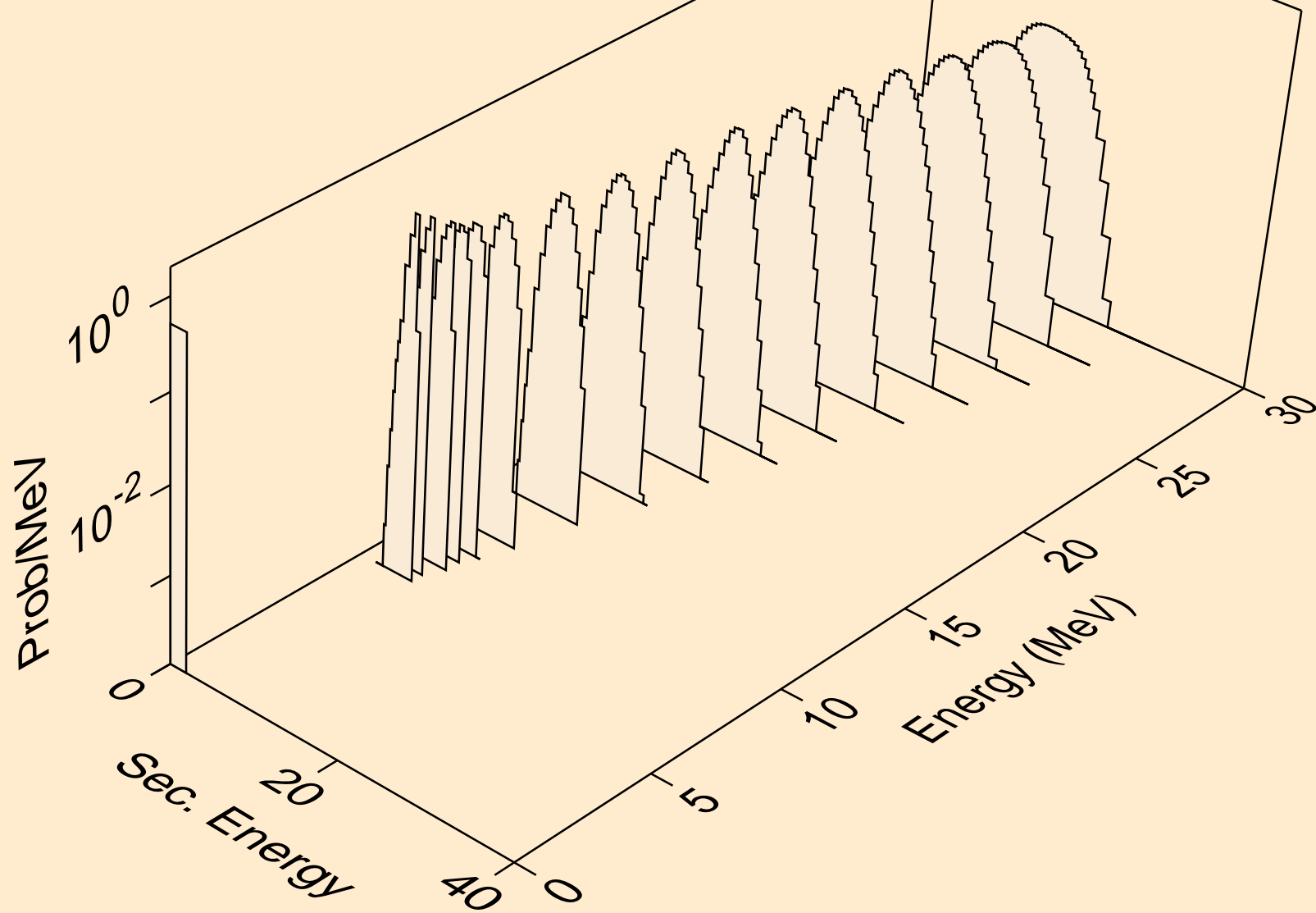

PO195 NEUTRON ACER TENDL-2021 LIBRARY; T=293.6K
tritons from (n,x)

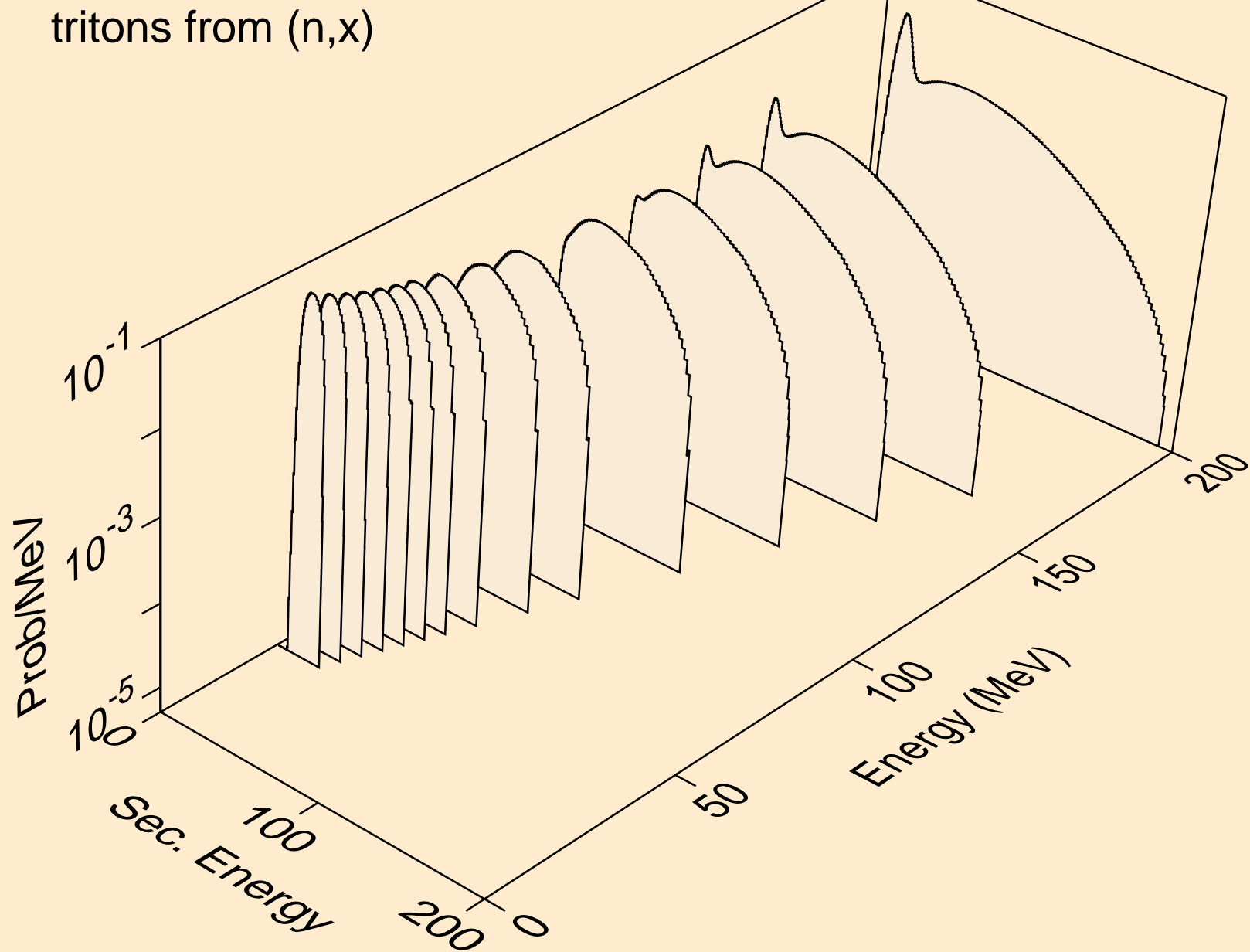

PO195 NEUTRON ACER TENDL-2021 LIBRARY; T=293.6K
tritons from (n,n*)t

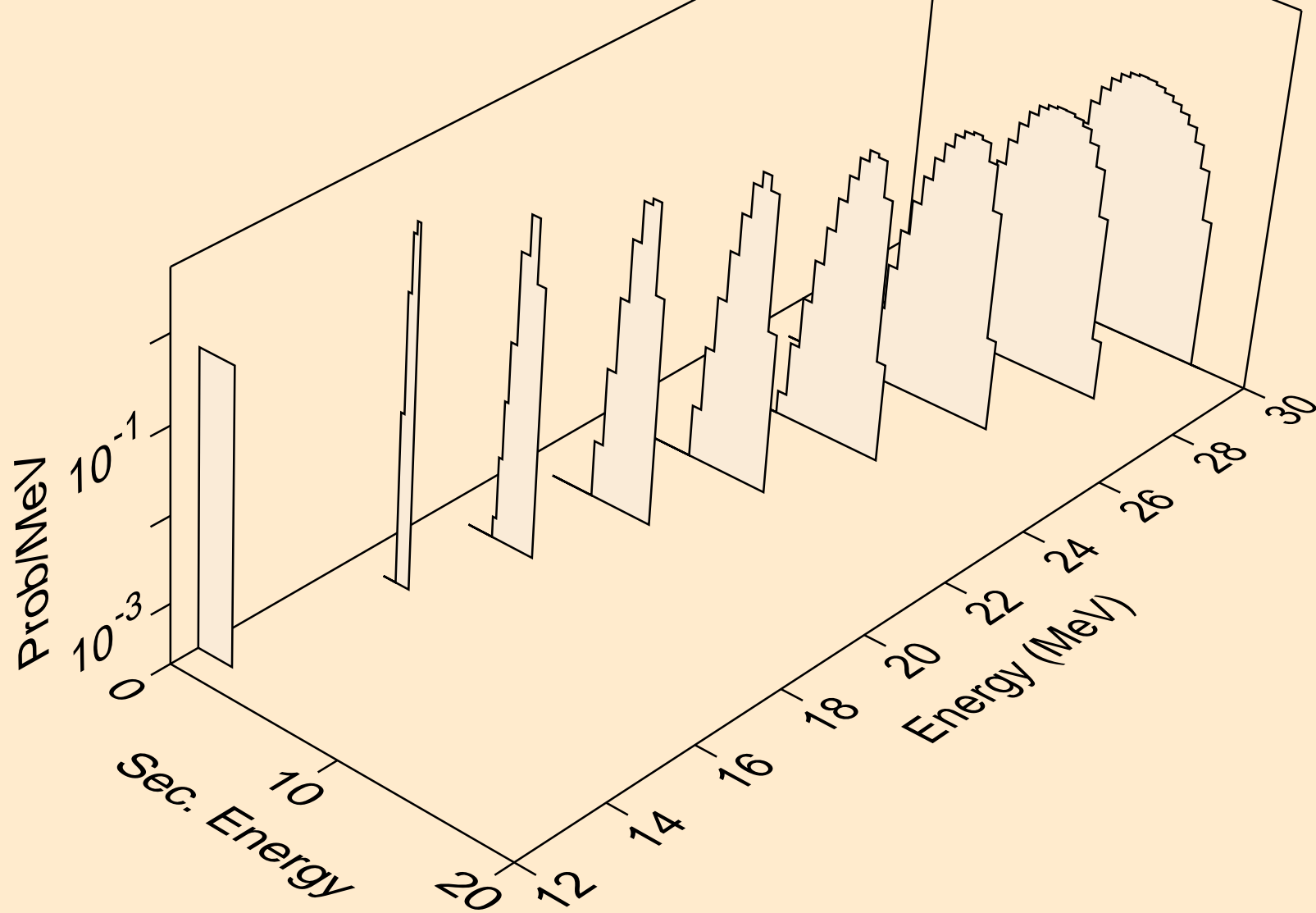

PO195 NEUTRON ACER TENDL-2021 LIBRARY; T=293.6K
tritons from (n,t)

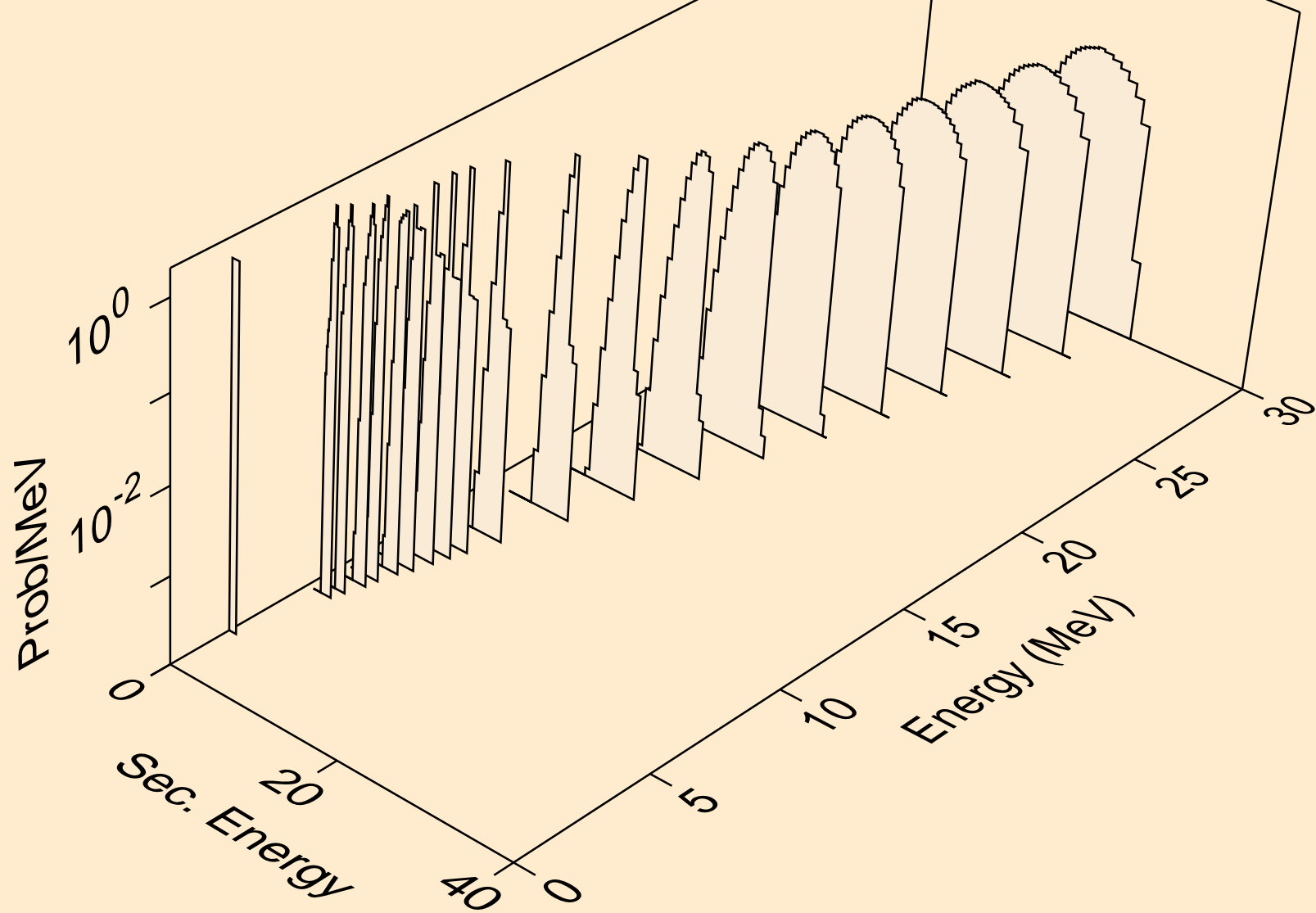

PO195 NEUTRON ACER TENDL-2021 LIBRARY; T=293.6K
tritons from (n,pt)

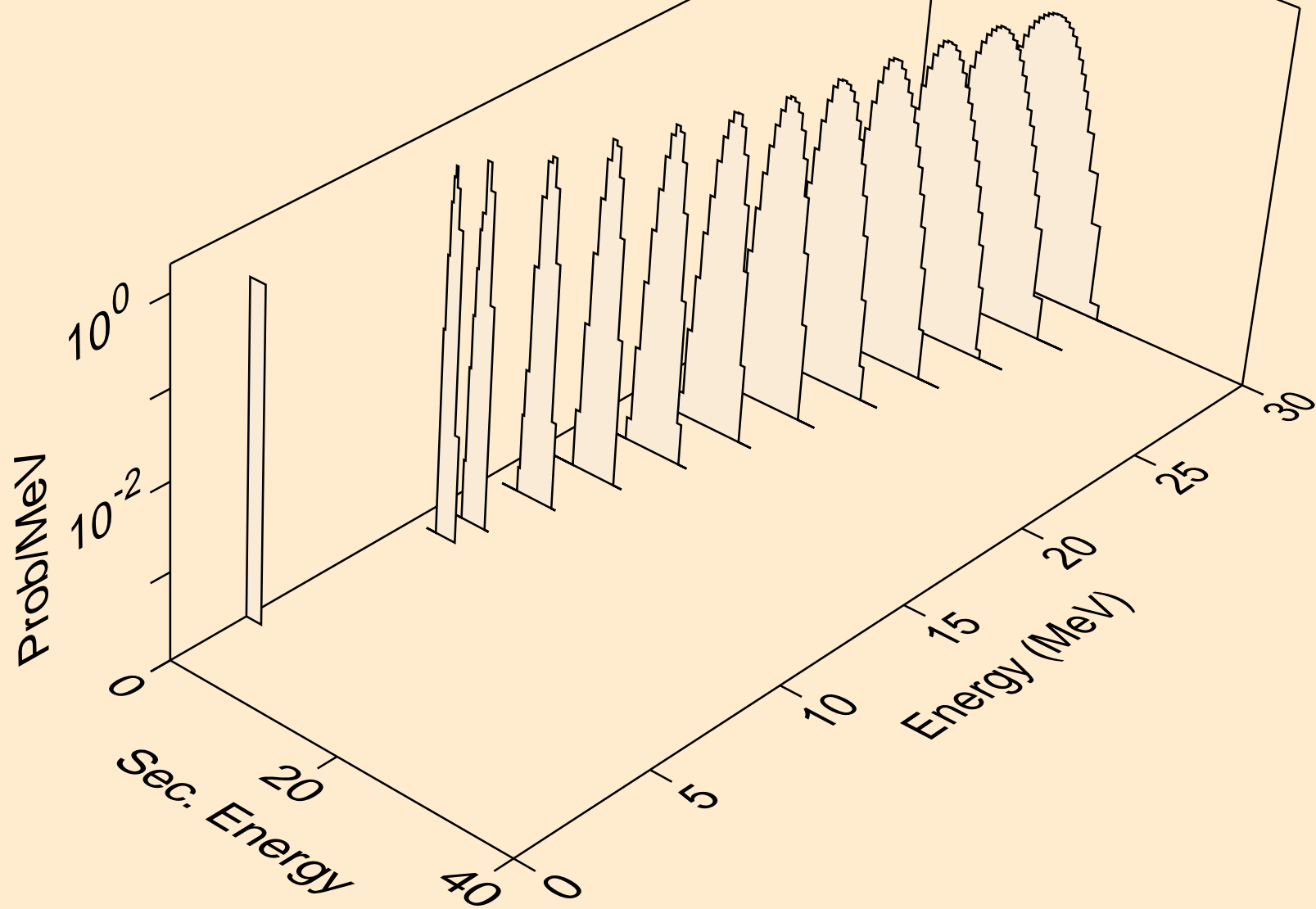

PO195 NEUTRON ACER TENDL-2021 LIBRARY; T=293.6K
he3s from (n,x)

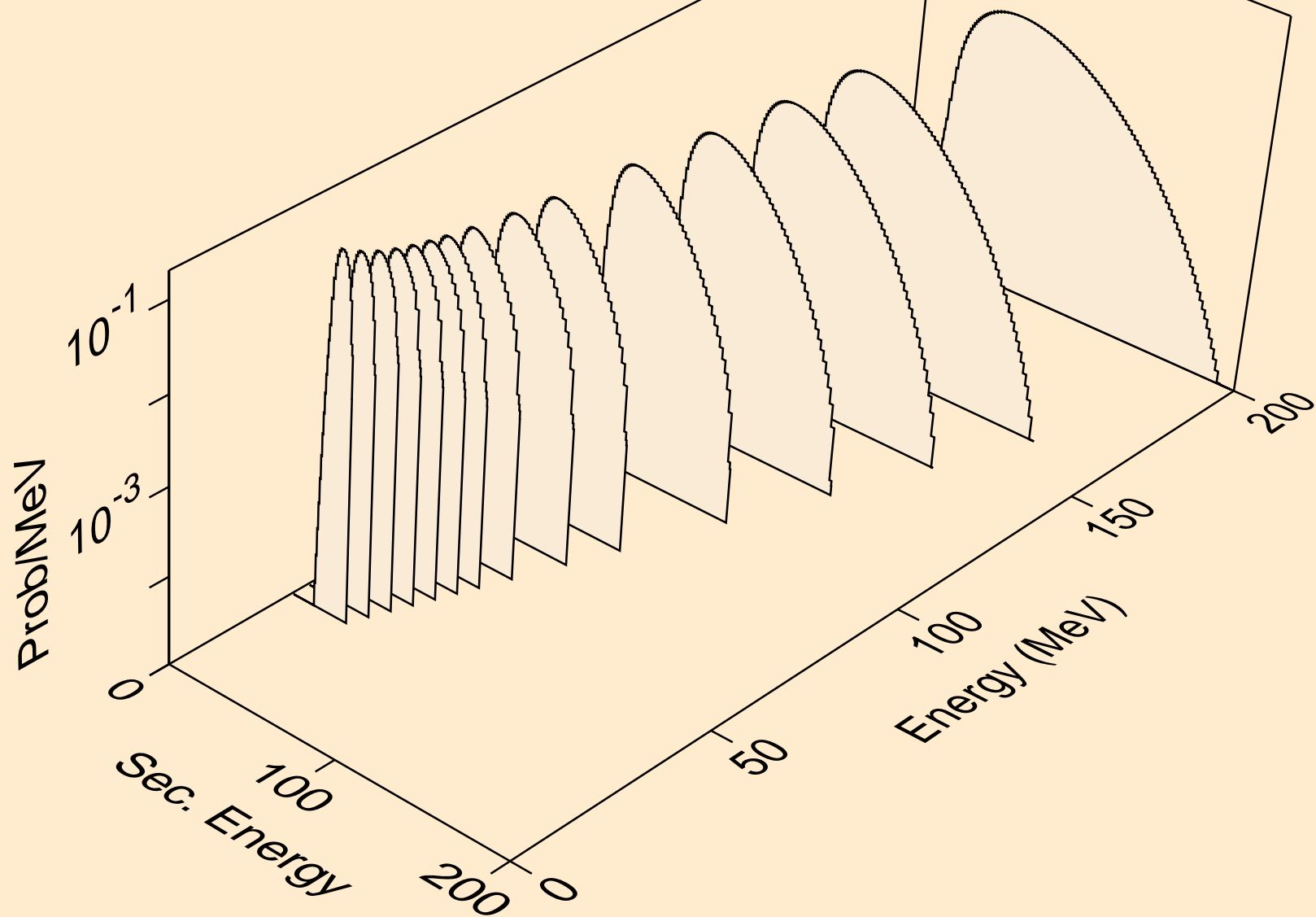

PO195 NEUTRON ACER TENDL-2021 LIBRARY; T=293.6K
he3s from (n,n*)he3

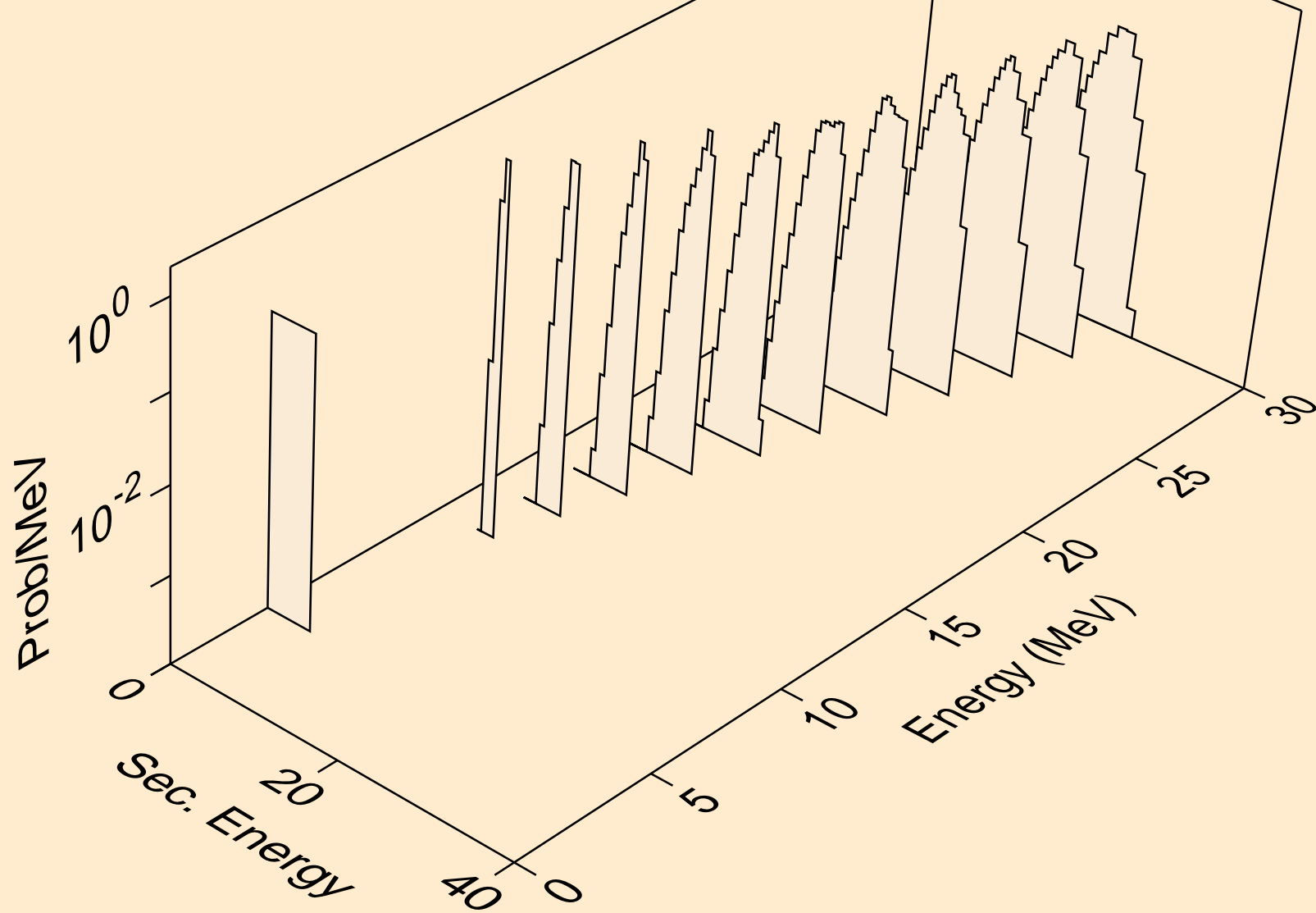

PO195 NEUTRON ACER TENDL-2021 LIBRARY; T=293.6K
he3s from (n,he3)

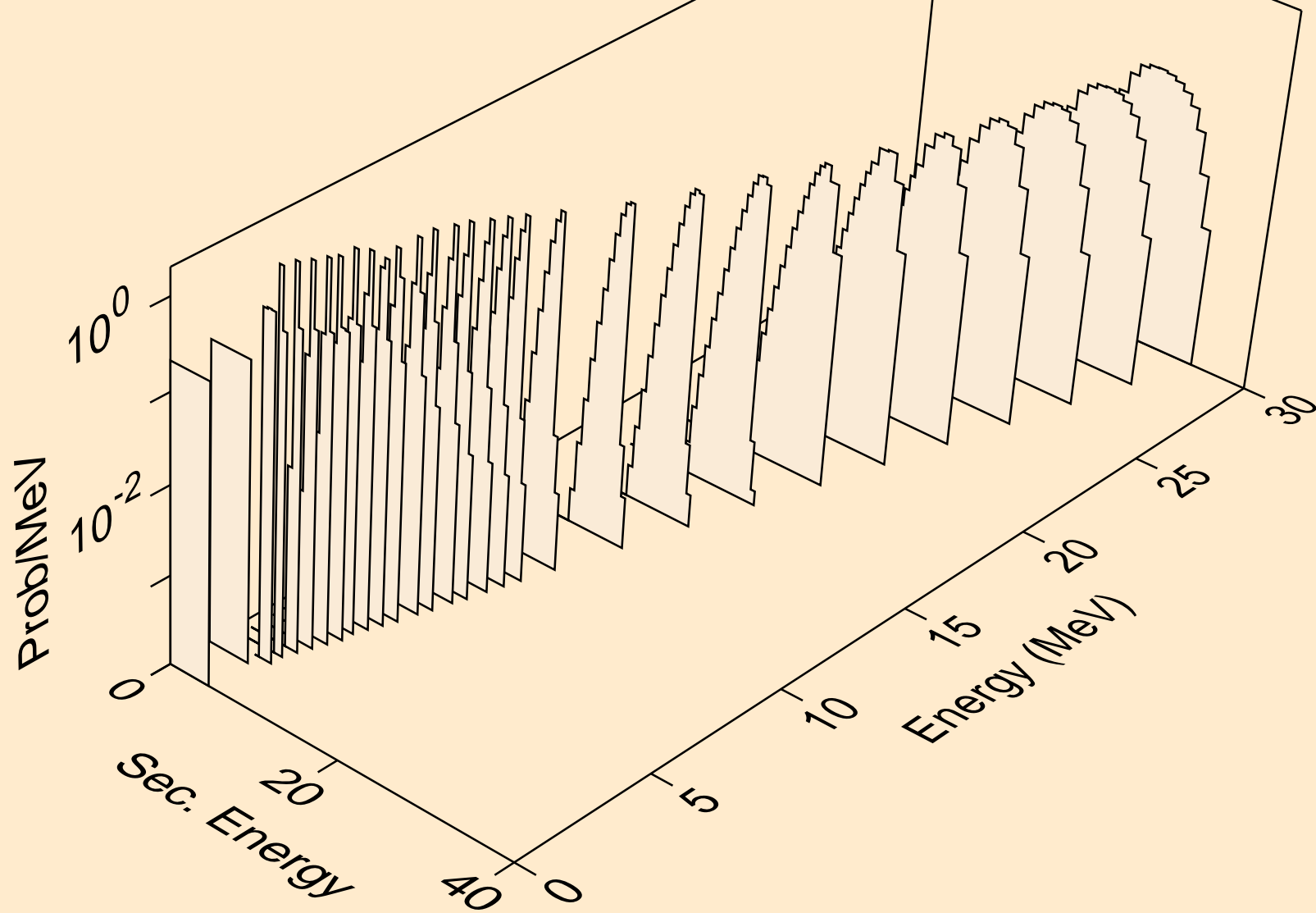

PO195 NEUTRON ACER TENDL-2021 LIBRARY; T=293.6K
alphas from (n,x)

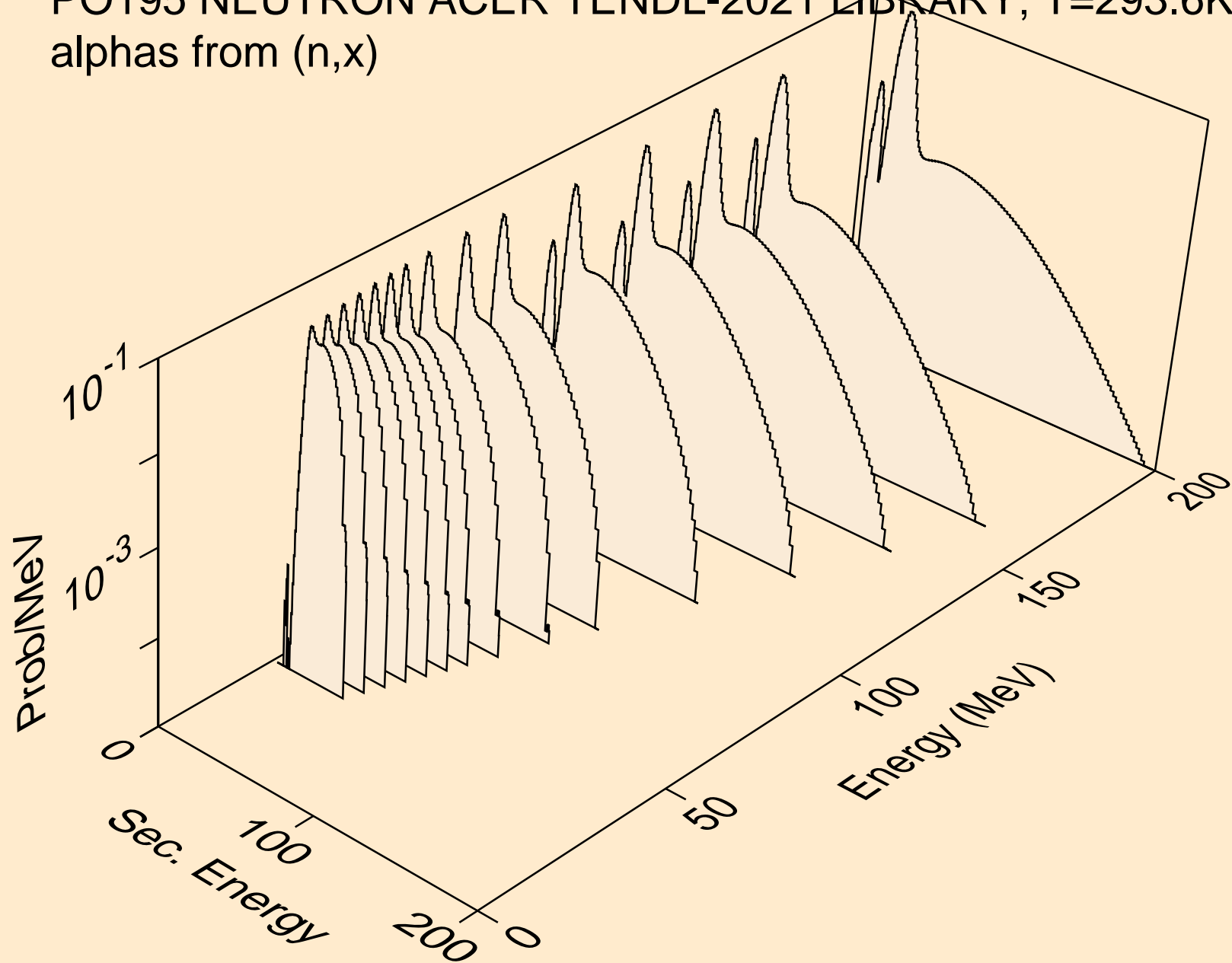

PO195 NEUTRON ACER TENDL-2021 LIBRARY; T=293.6K
alphas from (n,n*)a

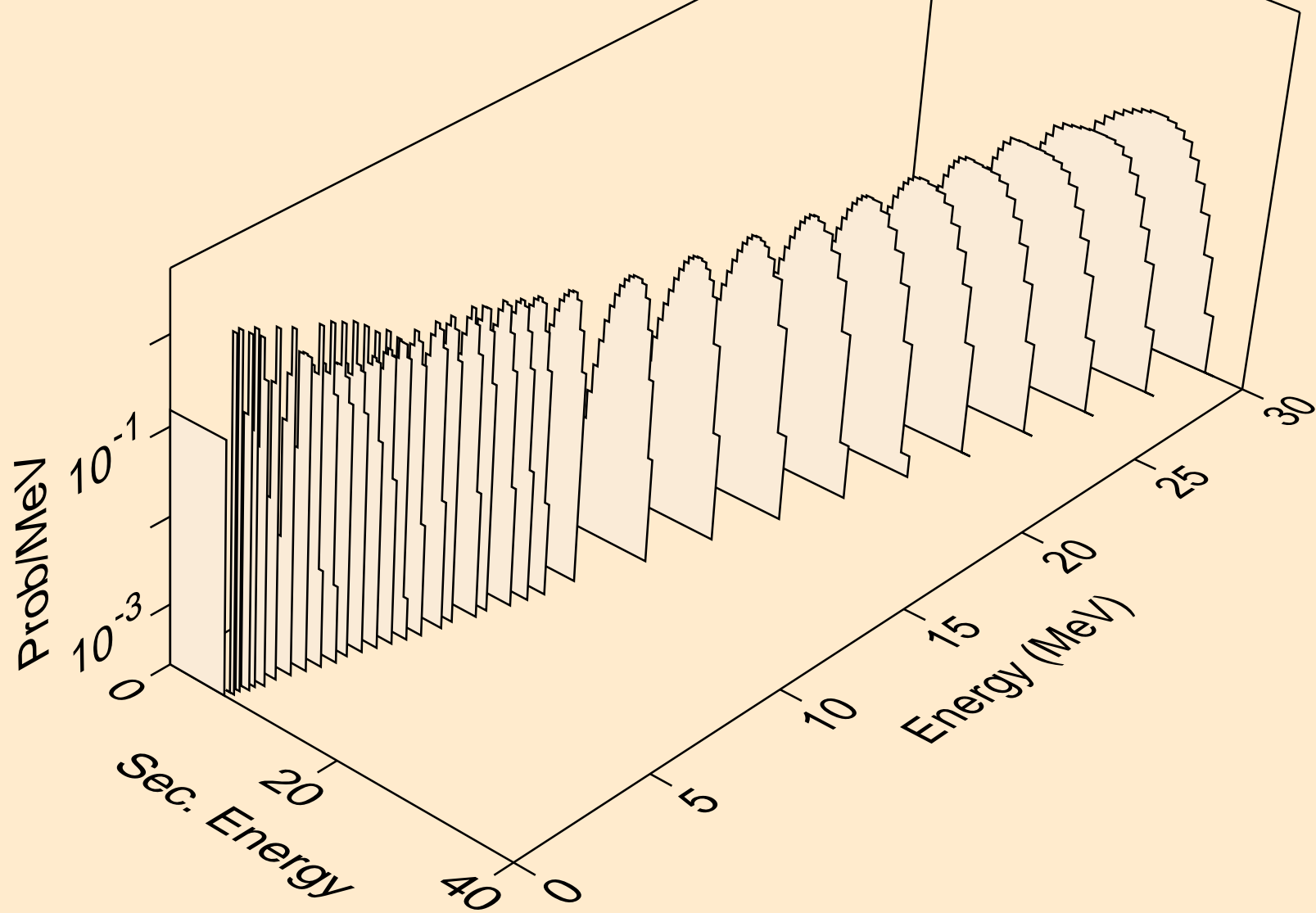

PO195 NEUTRON ACER TENDL-2021 LIBRARY; T=293.6K
alphas from (n,2n)a

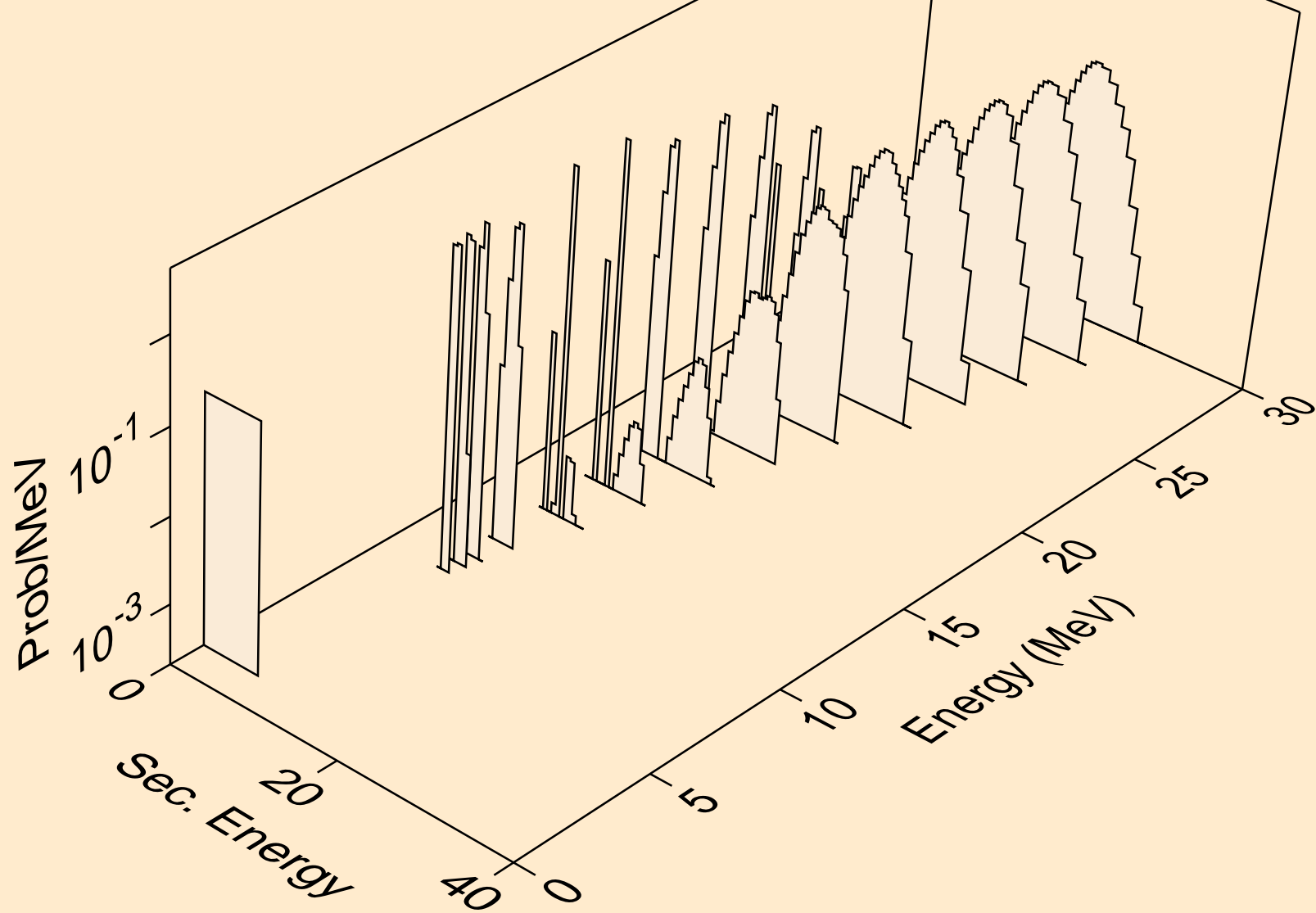

PO195 NEUTRON ACER TENDL-2021 LIBRARY; T=293.6K
alphas from (n,3n)a

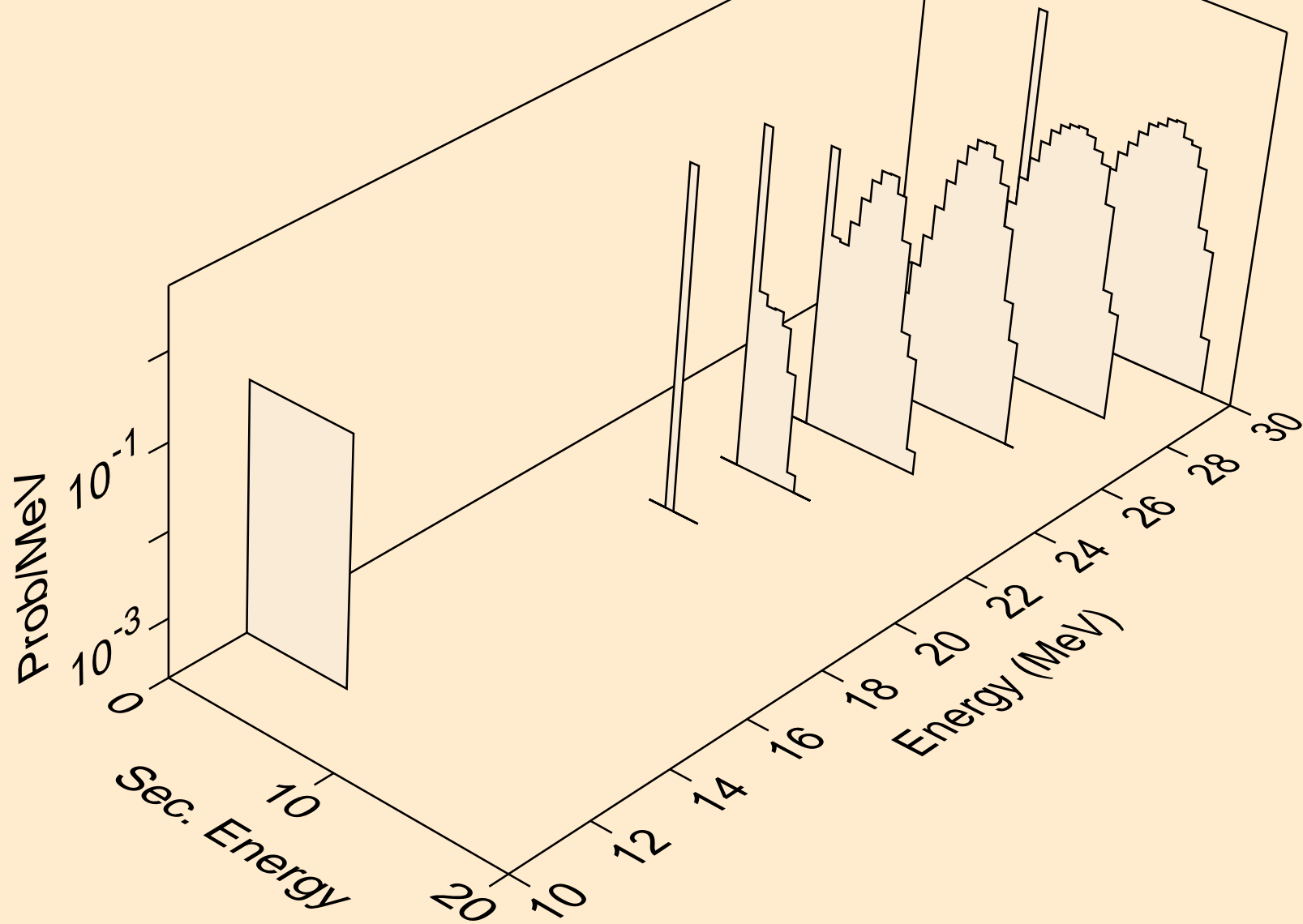

PO195 NEUTRON ACER TENDL-2021 LIBRARY; T=293.6K
alphas from (n,n*)2a

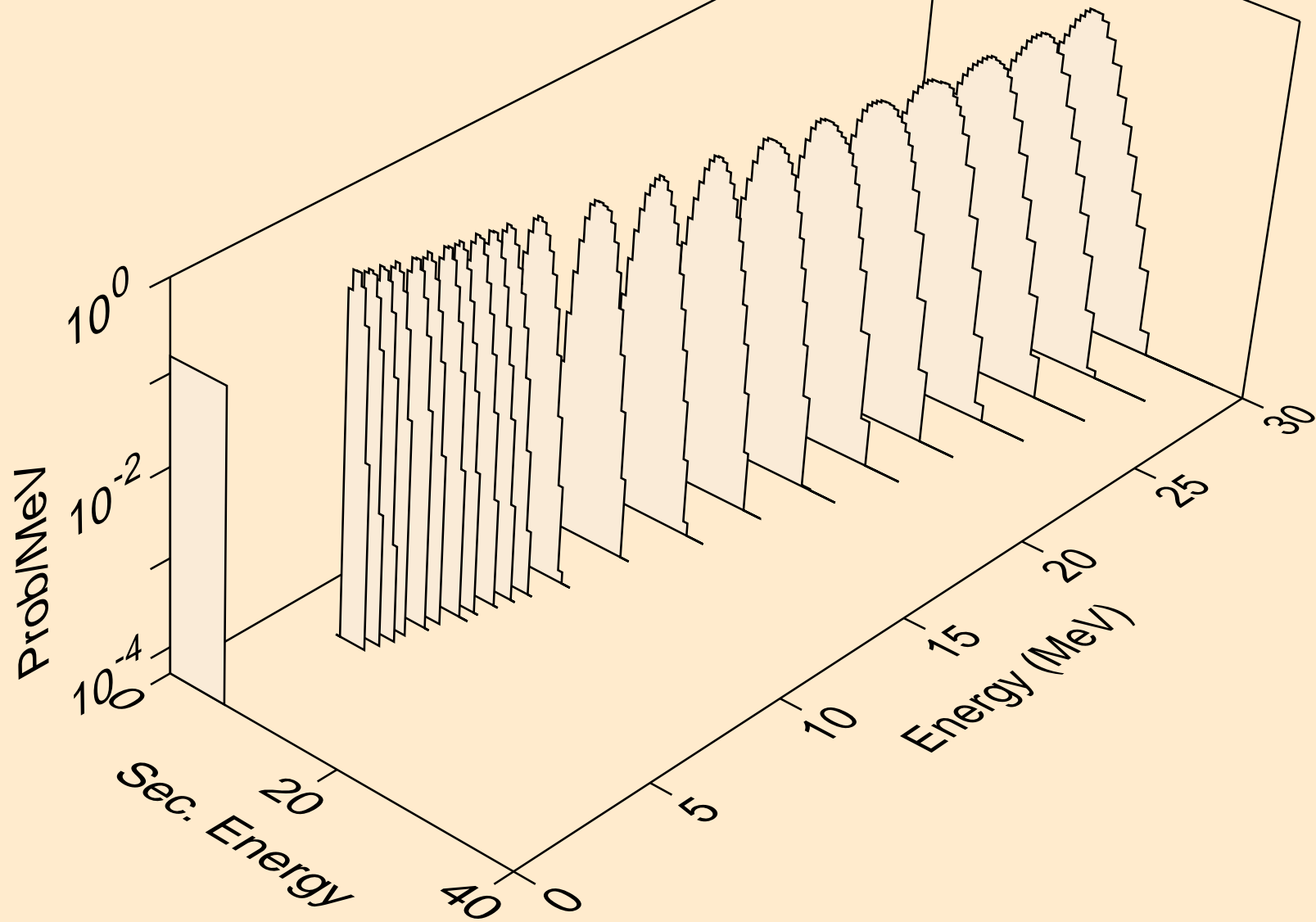

PO195 NEUTRON ACER TENDL-2021 LIBRARY; T=293.6K
alphas from (n,2n)2a

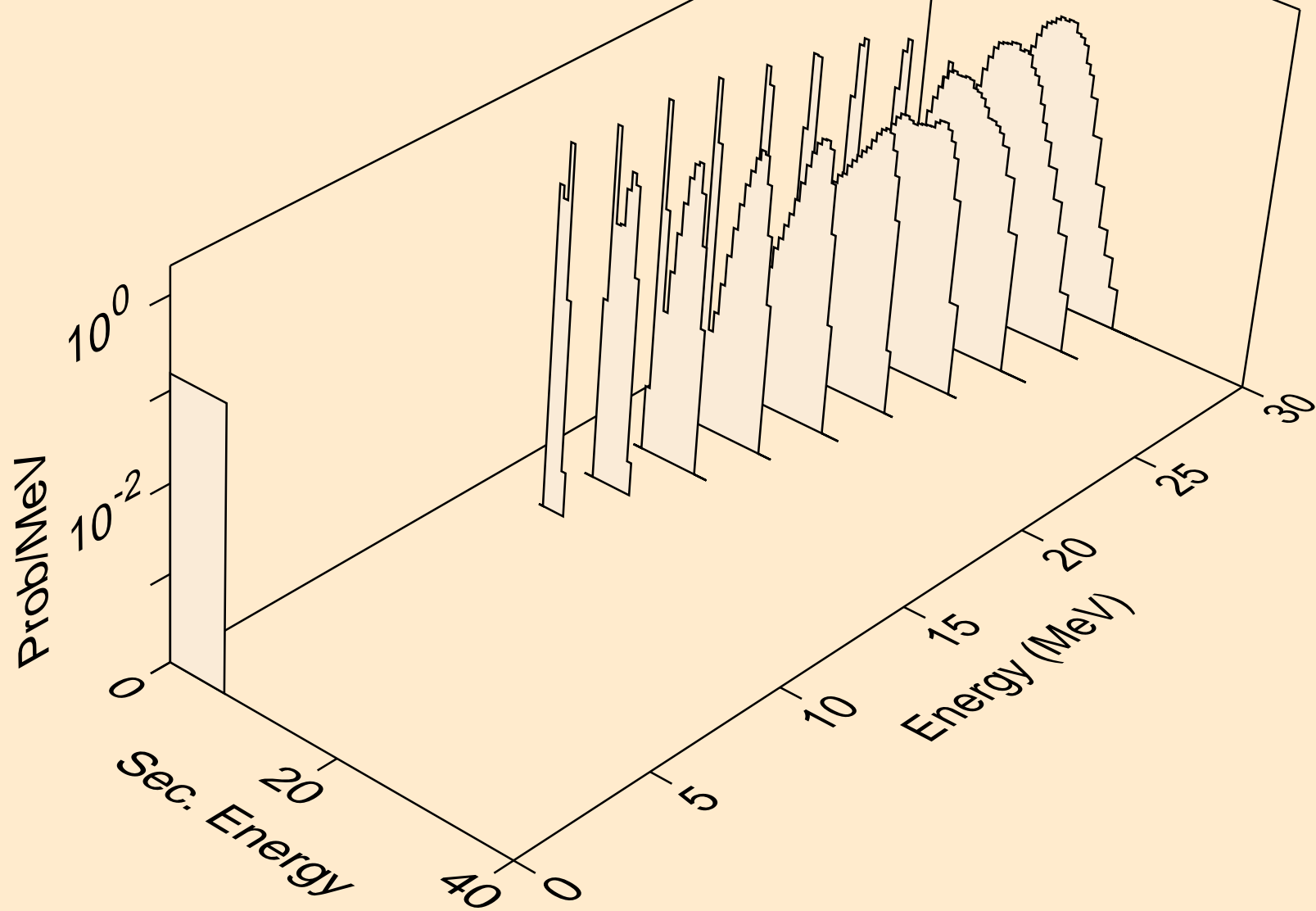

PO195 NEUTRON ACER TENDL-2021 LIBRARY; T=293.6K
alphas from (n,npa)

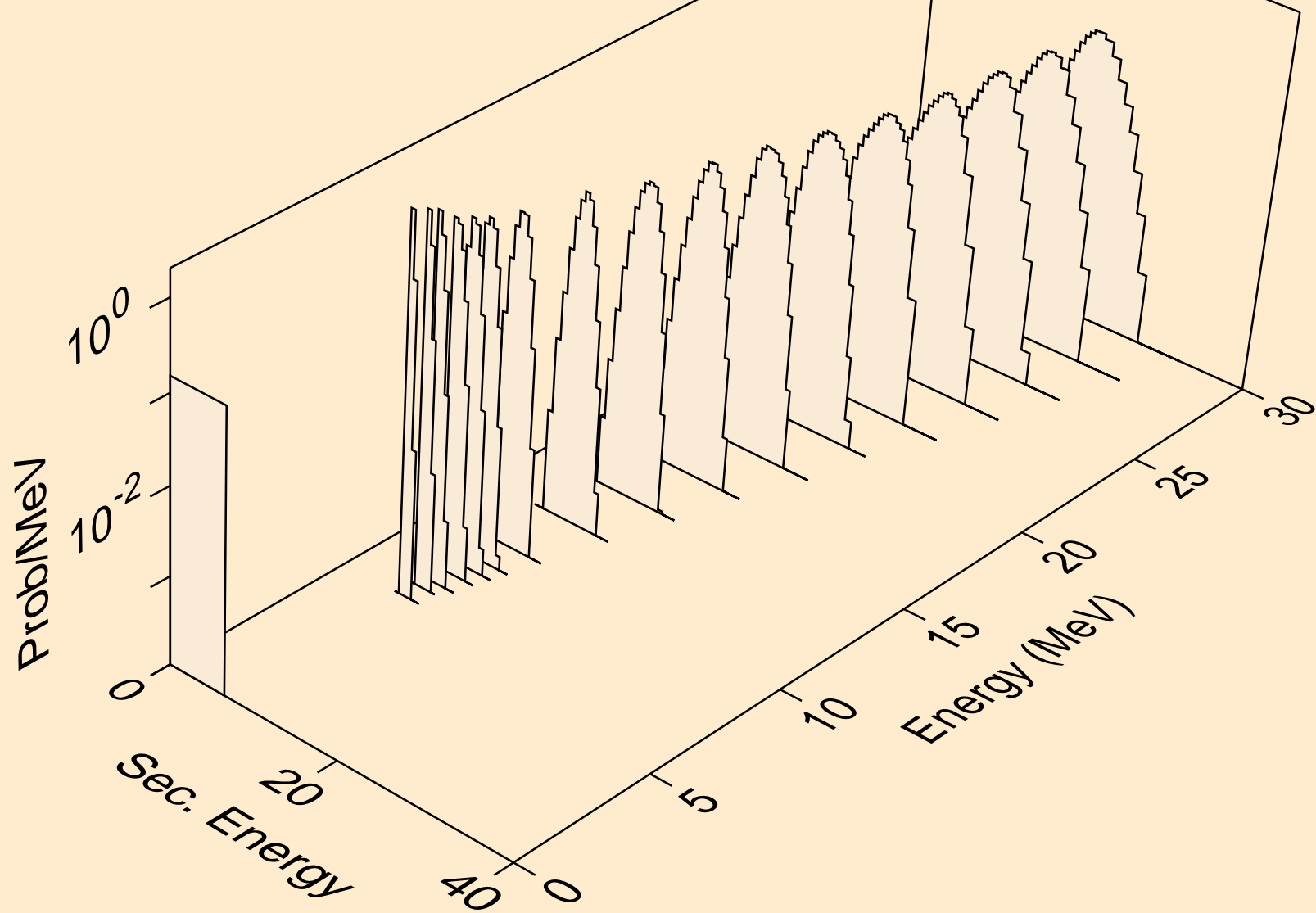

PO195 NEUTRON ACER TENDL-2021 LIBRARY; T=293.6K
alphas from (n,a)

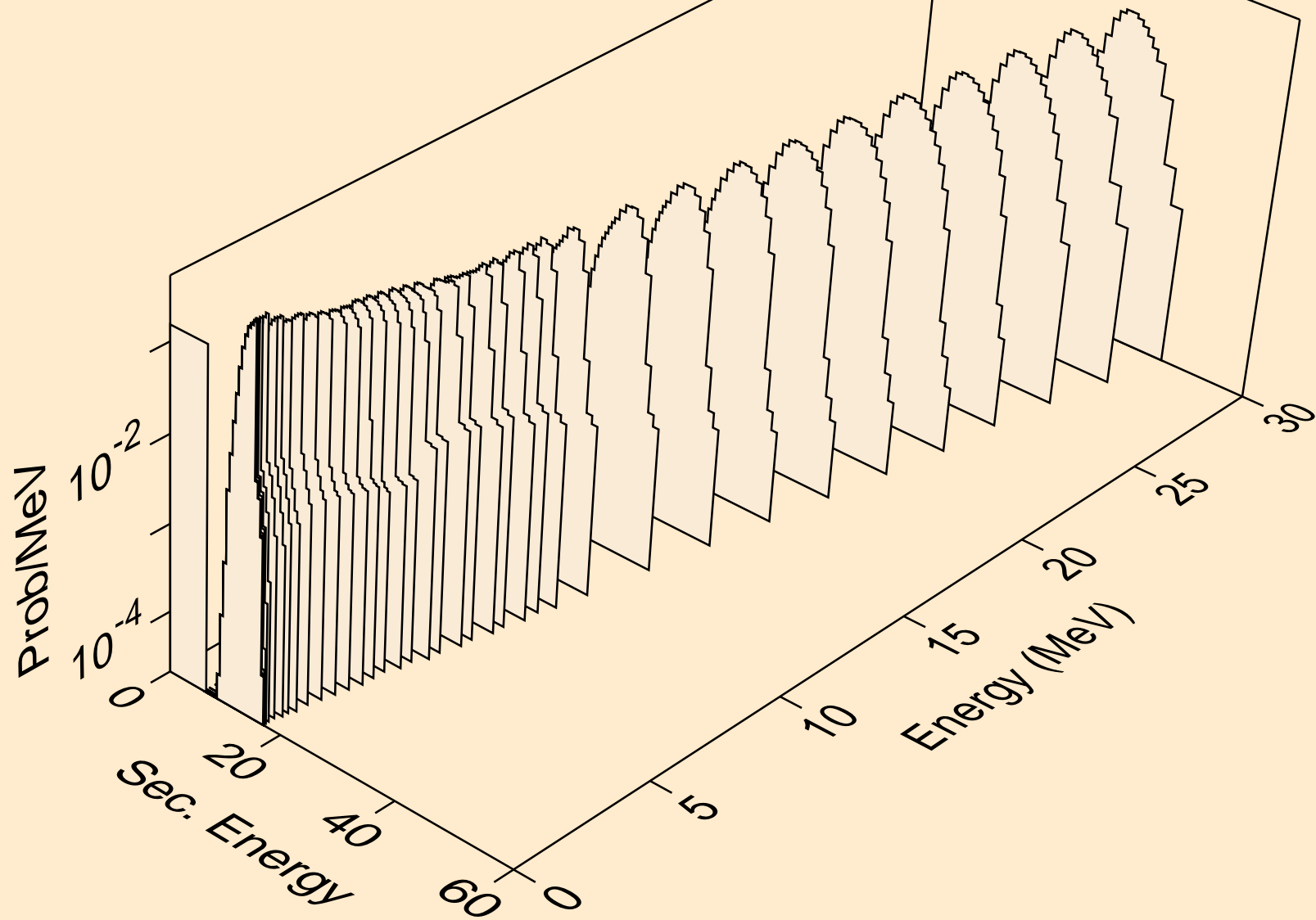

PO195 NEUTRON ACER TENDL-2021 LIBRARY; T=293.6K
alphas from (n,2a)

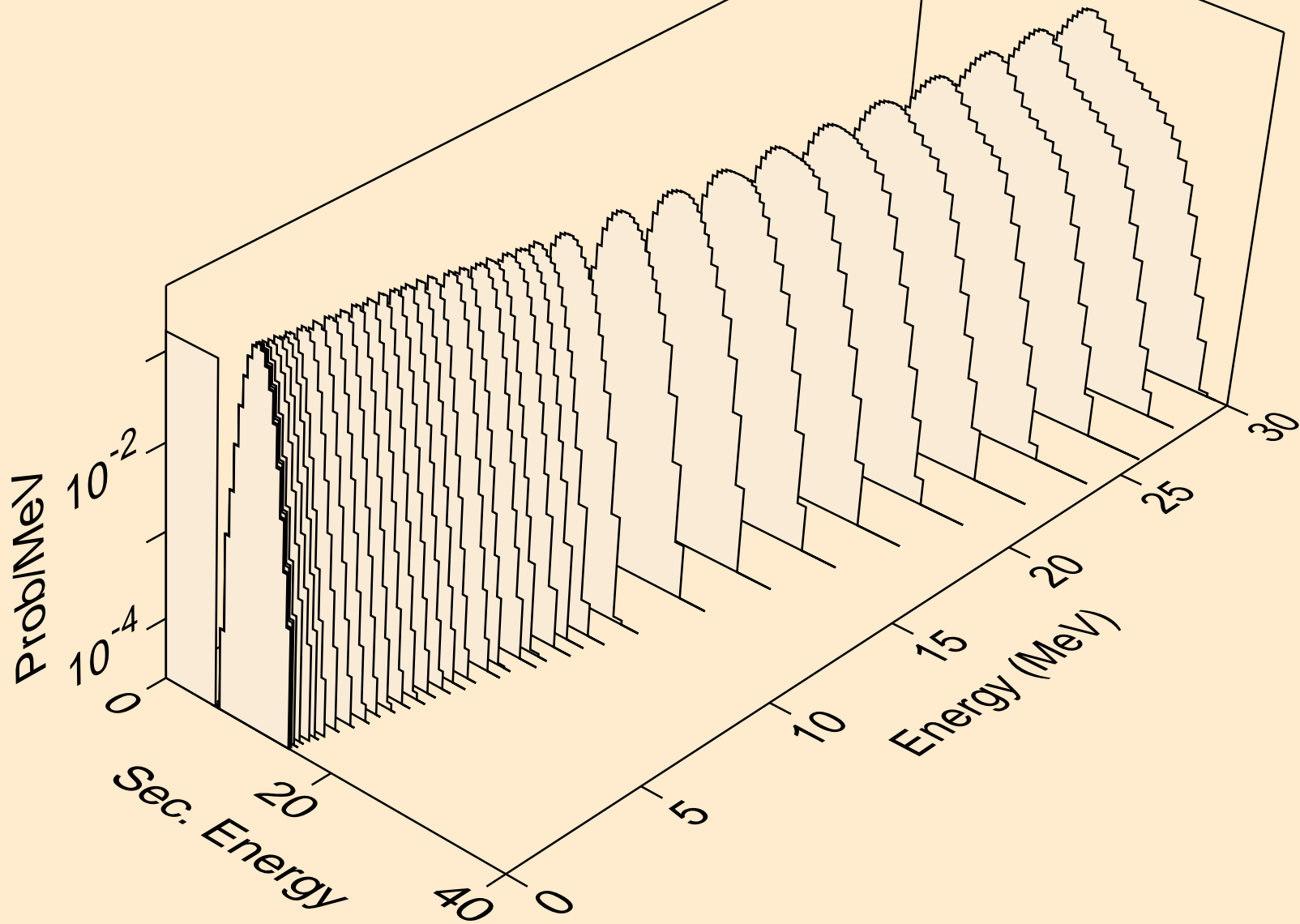

PO195 NEUTRON ACER TENDL-2021 LIBRARY; T=293.6K
alphas from (n,3a)

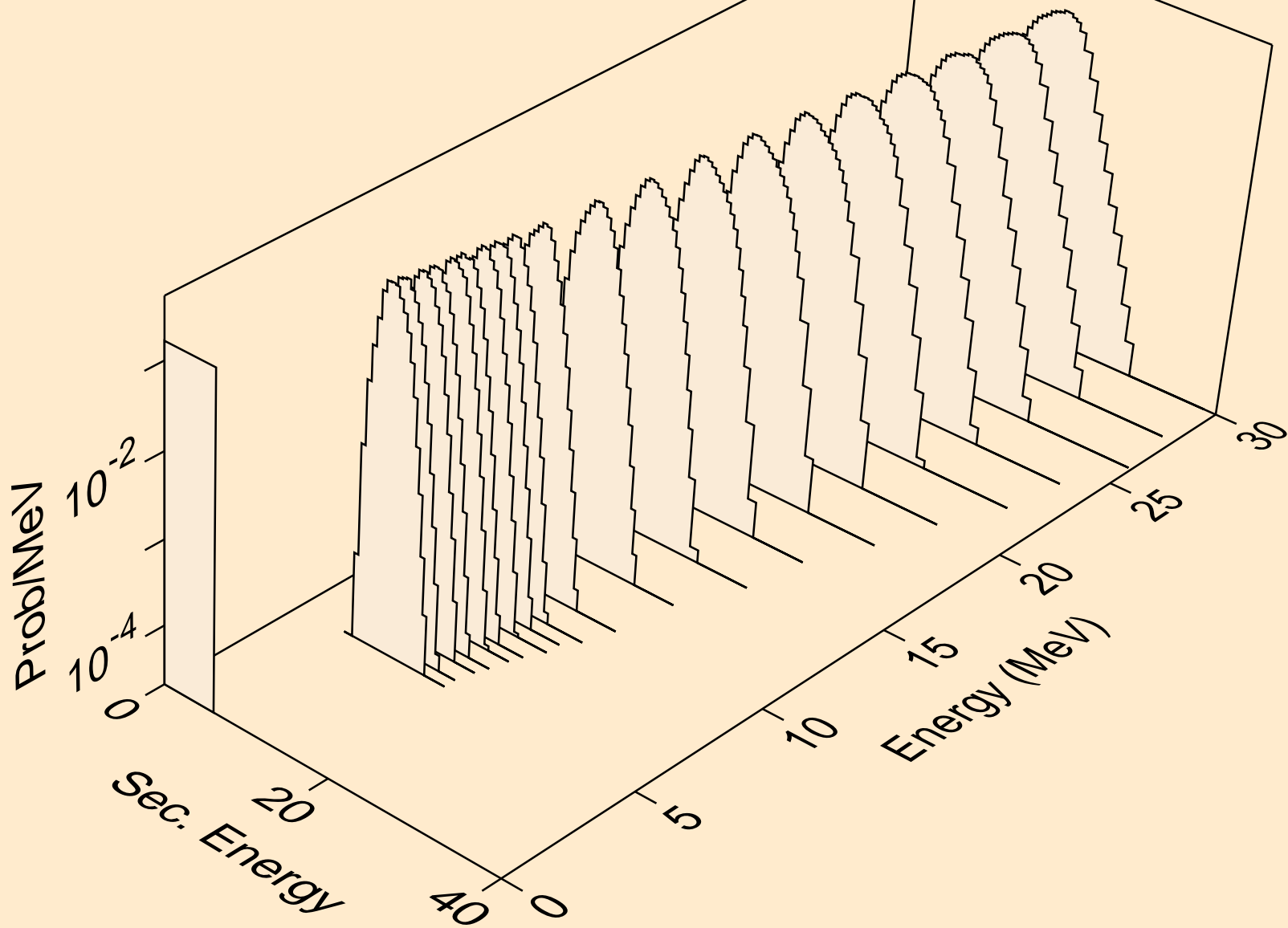

PO195 NEUTRON ACER TENDL-2021 LIBRARY; T=293.6K
alphas from (n,pa)

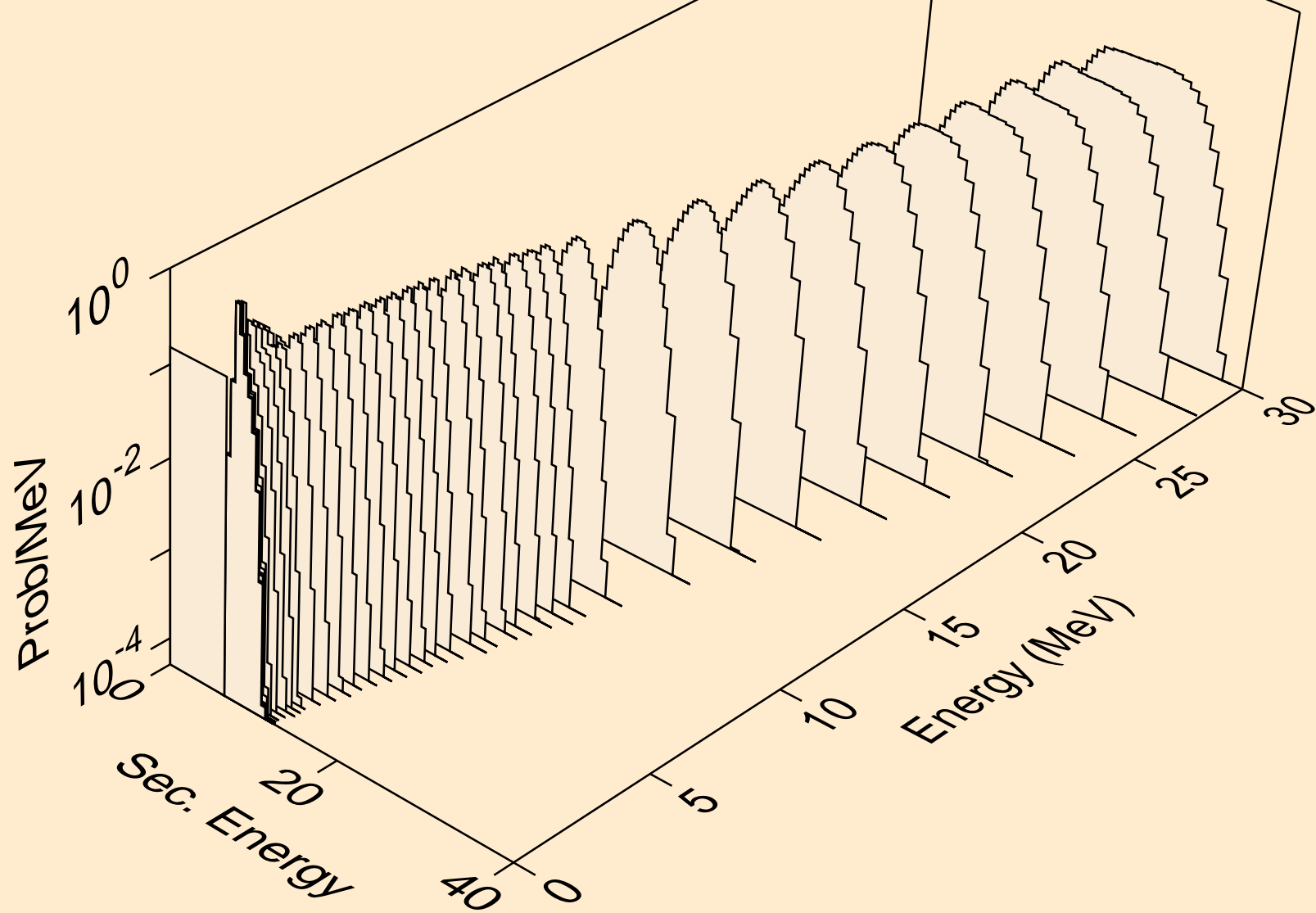

PO195 NEUTRON ACER TENDL-2021 LIBRARY; T=293.6K
alphas from (n,da)

