

PO220 NEUTRON ACER TENDL-2021 LIBRARY; T=293.6K
Principal cross sections

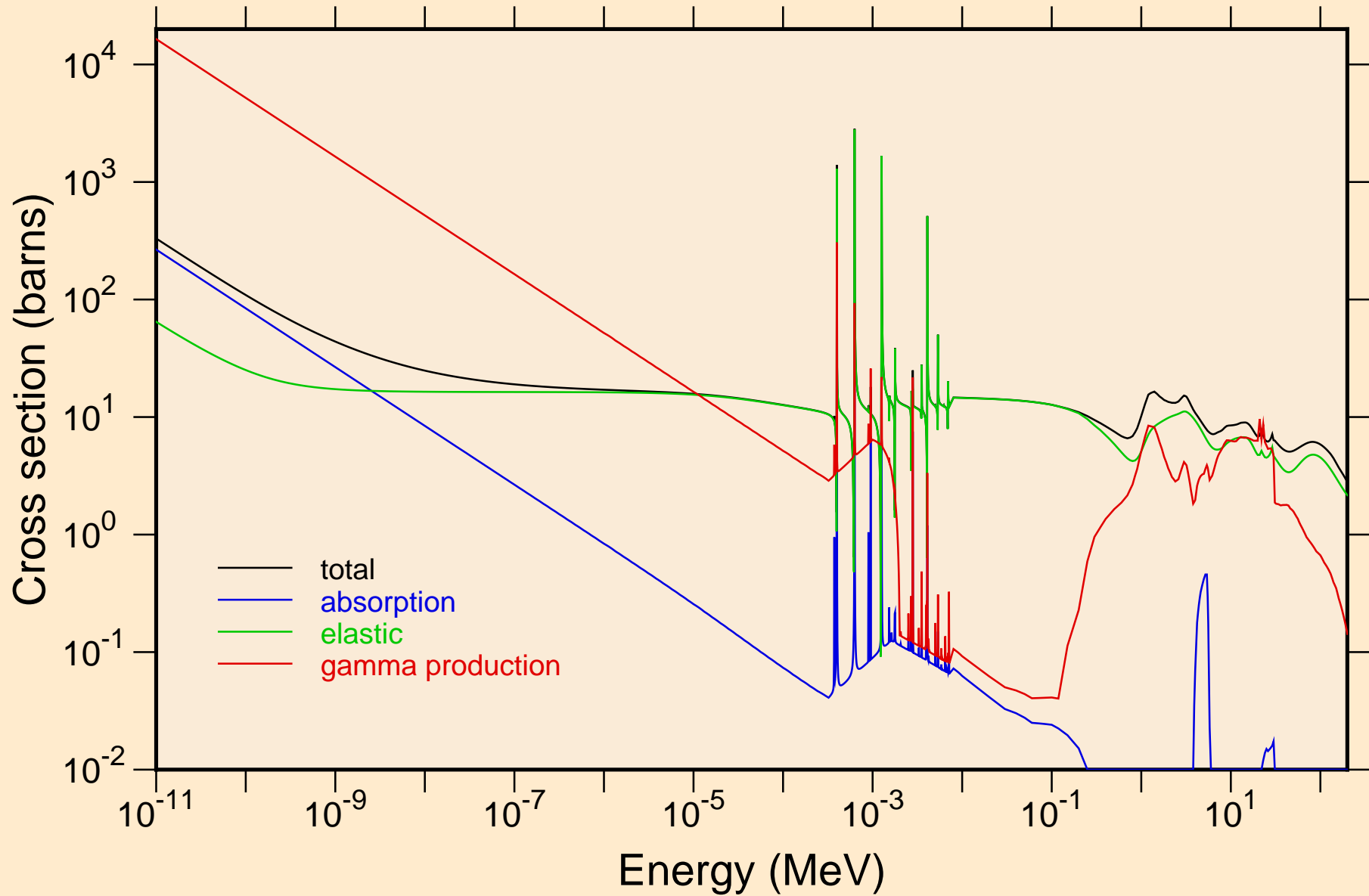

PO220 NEUTRON ACER TENDL-2021 LIBRARY; T=293.6K
resonance total cross section

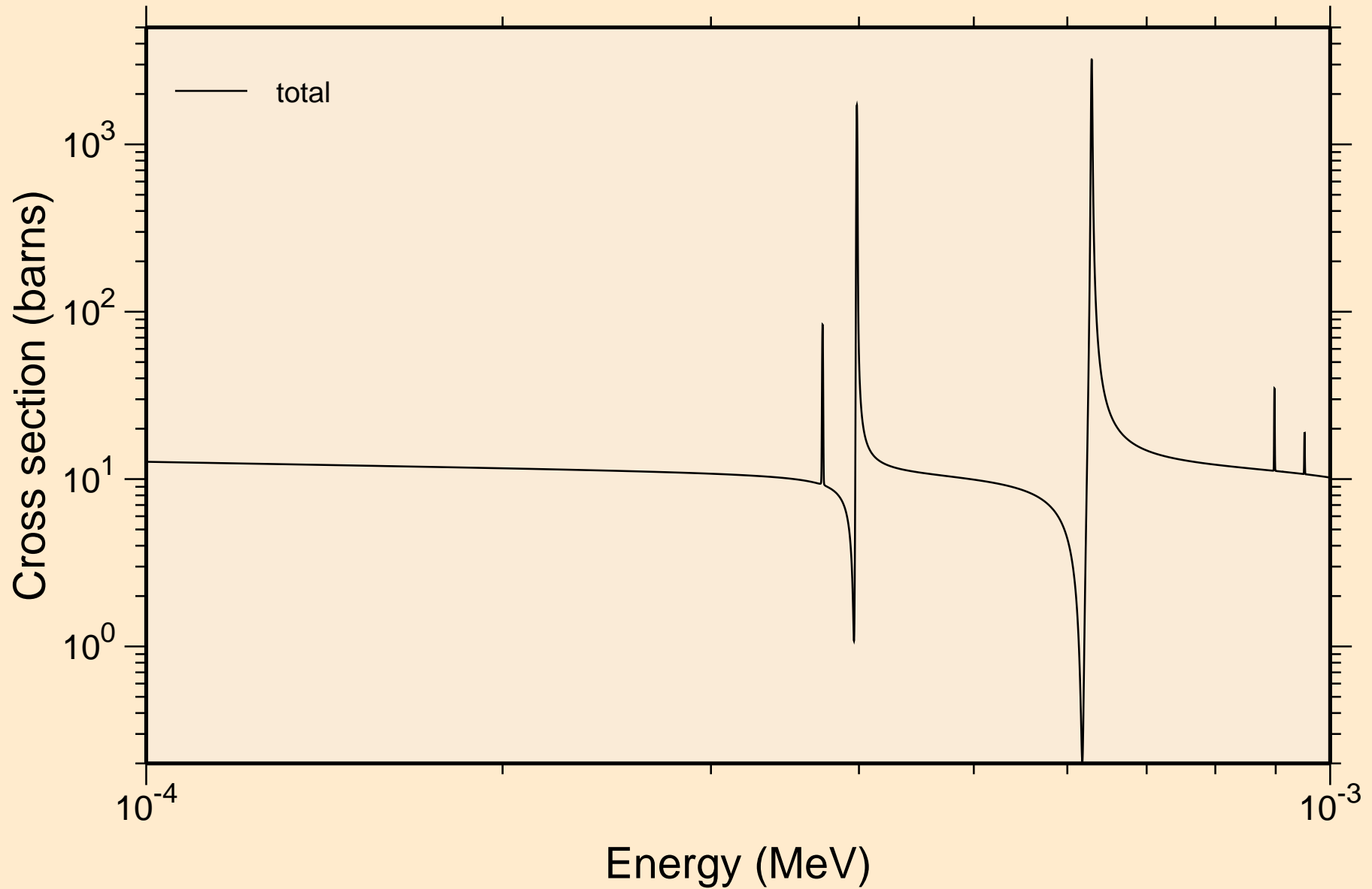

PO220 NEUTRON ACER TENDL-2021 LIBRARY; T=293.6K
resonance total cross section

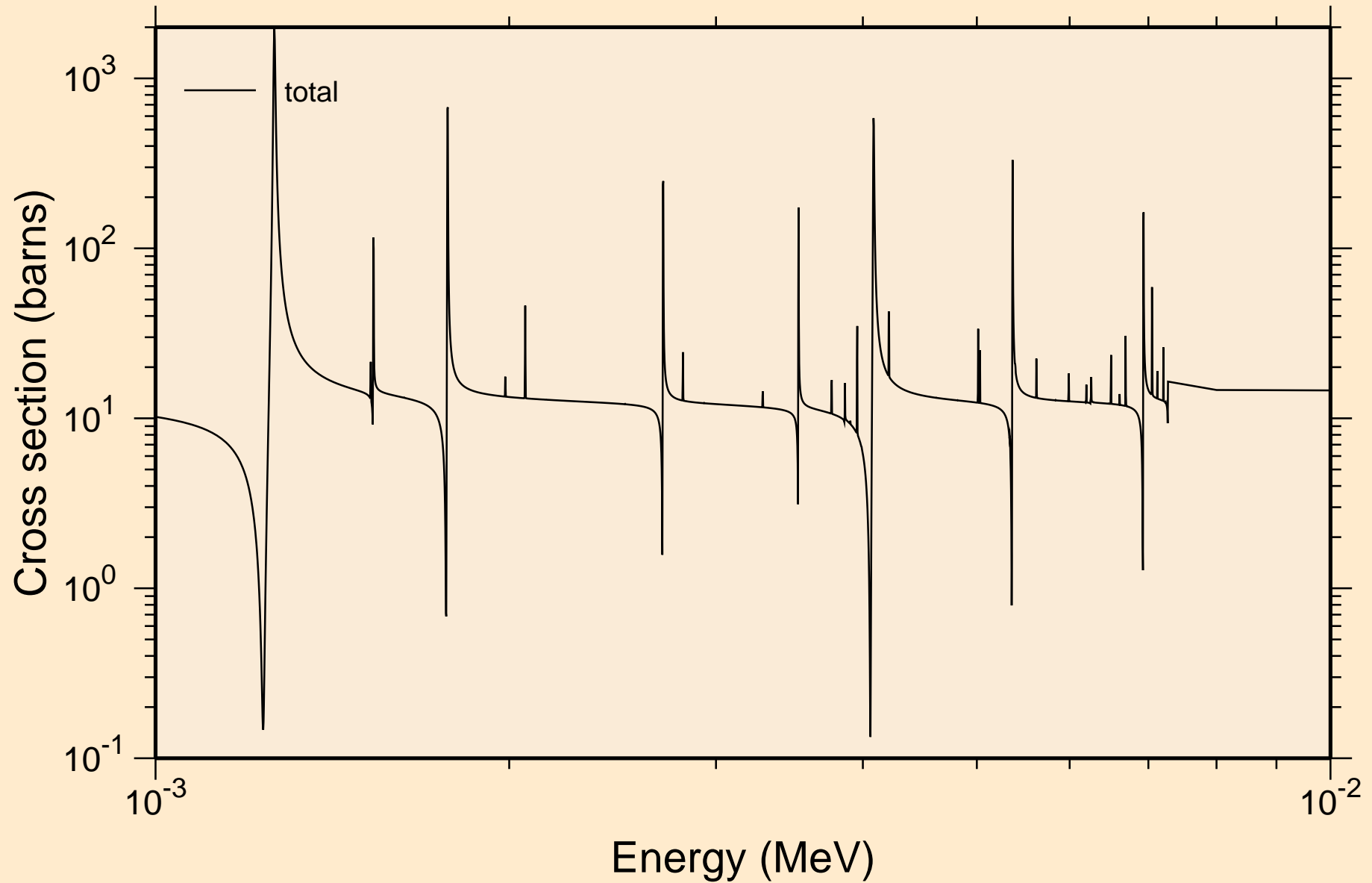

PO220 NEUTRON ACER TENDL-2021 LIBRARY; T=293.6K
resonance total cross section

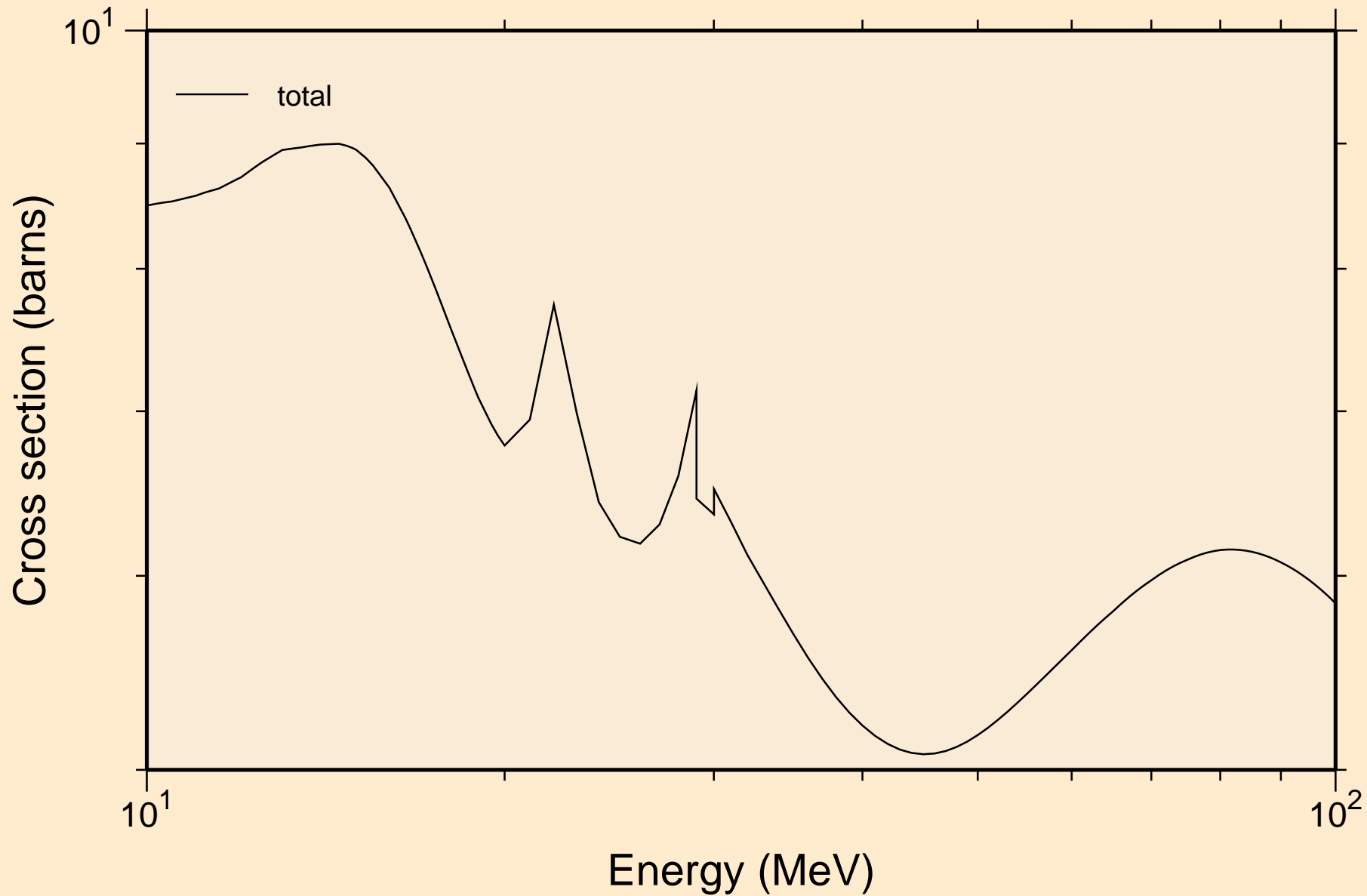

PO220 NEUTRON ACER TENDL-2021 LIBRARY; T=293.6K
resonance absorption cross sections

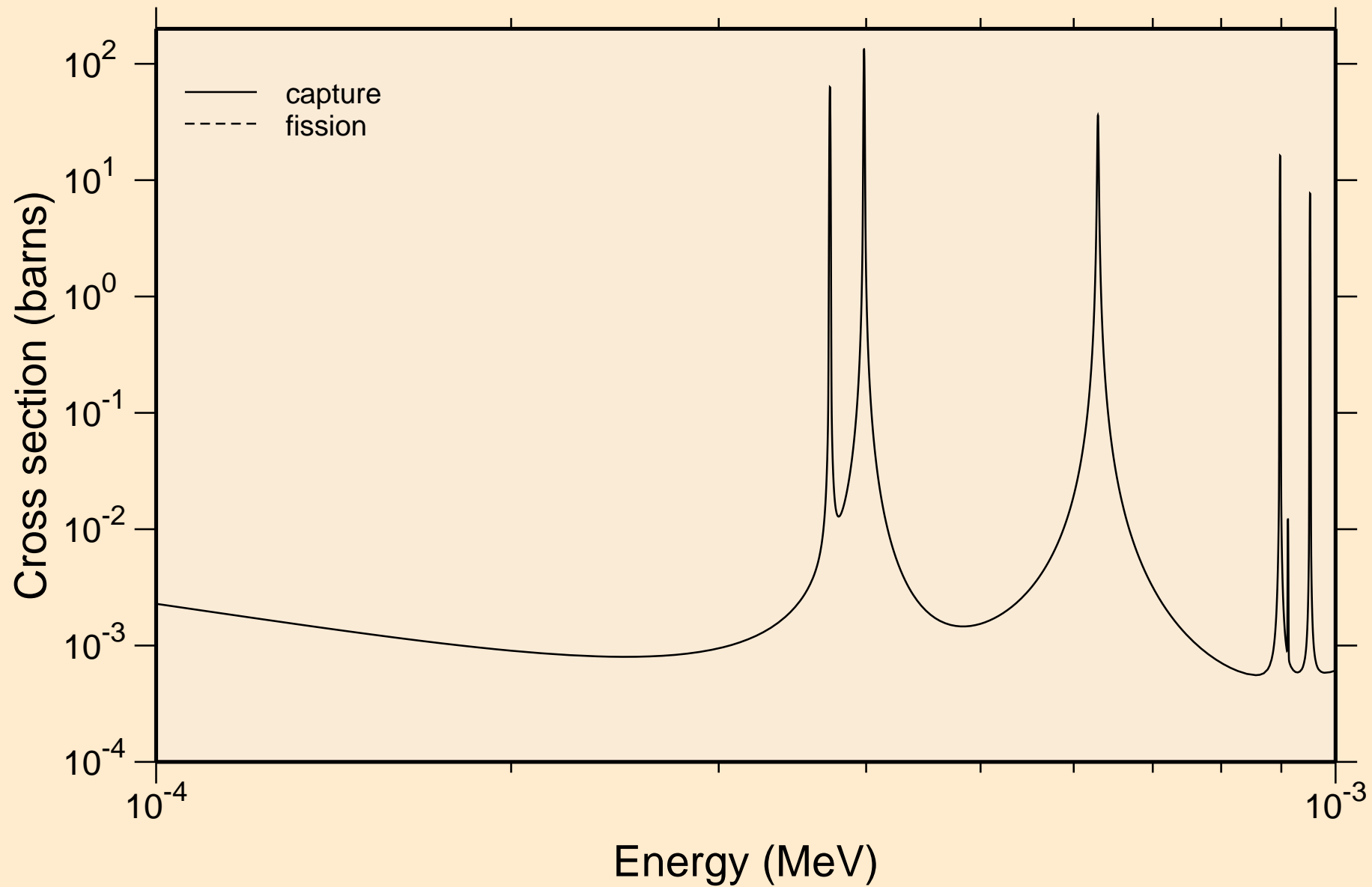

PO220 NEUTRON ACER TENDL-2021 LIBRARY; T=293.6K
resonance absorption cross sections

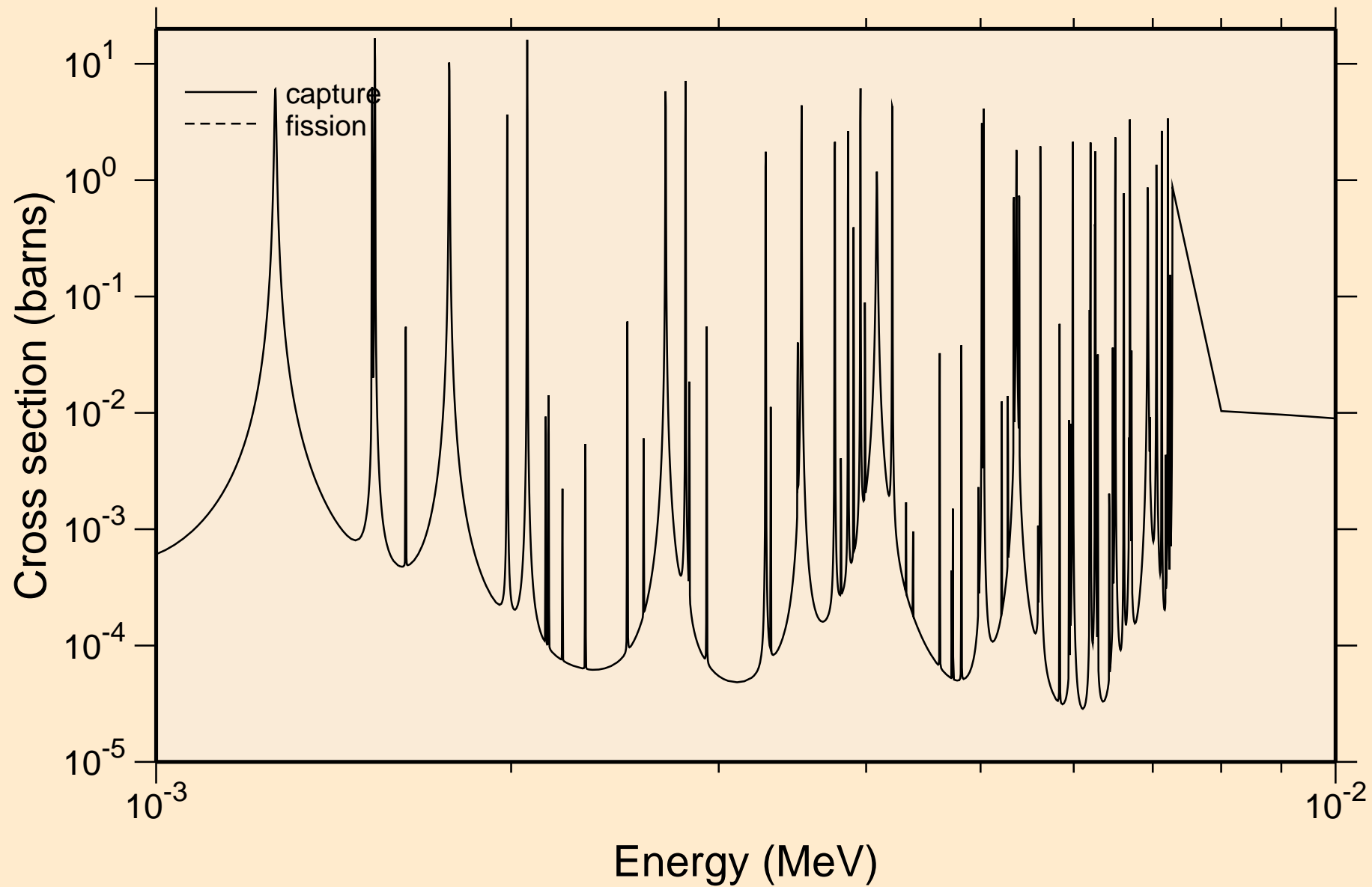

PO220 NEUTRON ACER TENDL-2021 LIBRARY; T=293.6K
resonance absorption cross sections

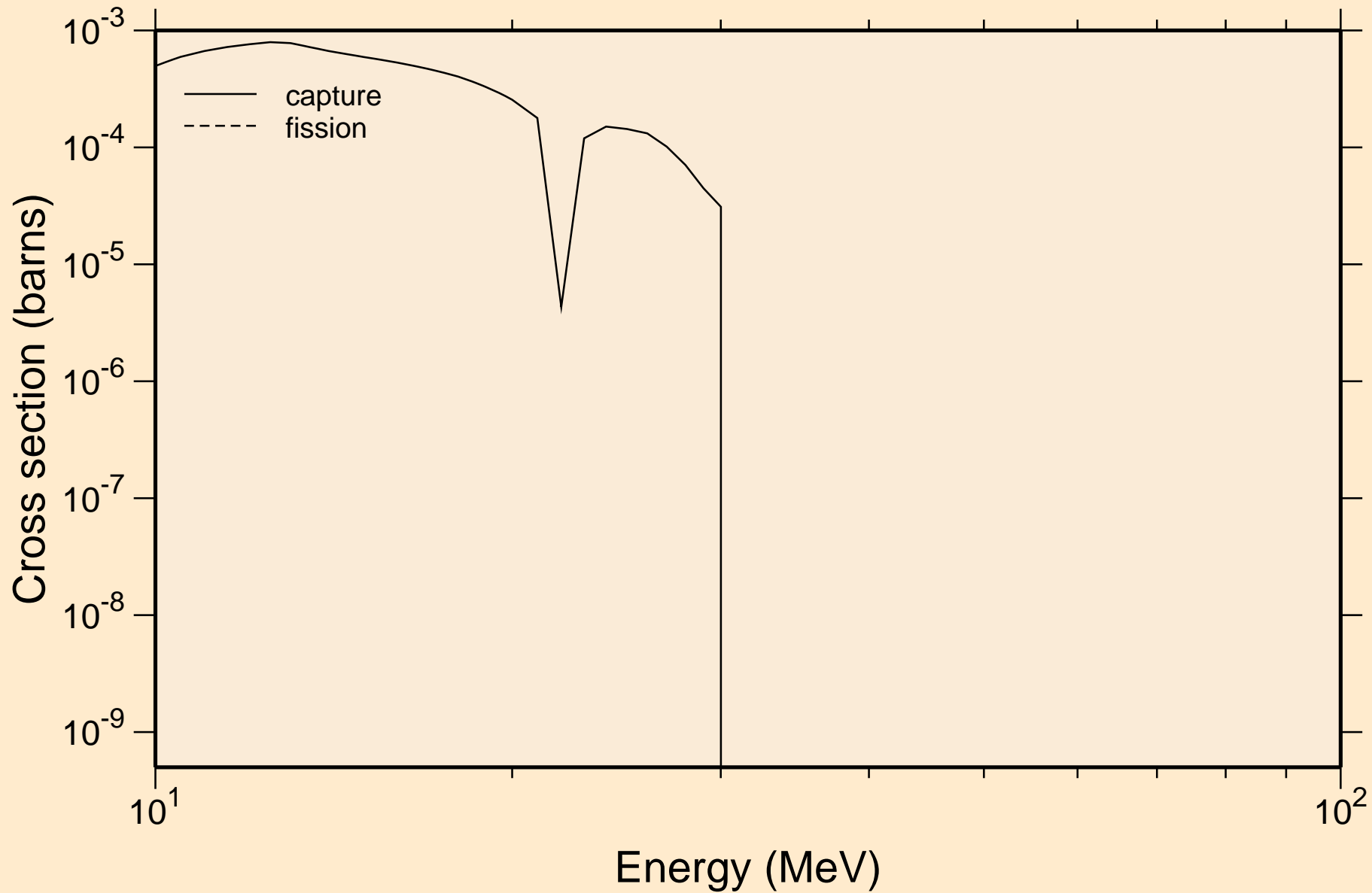

PO220 NEUTRON ACER TENDL-2021 LIBRARY; T=293.6K
Heating

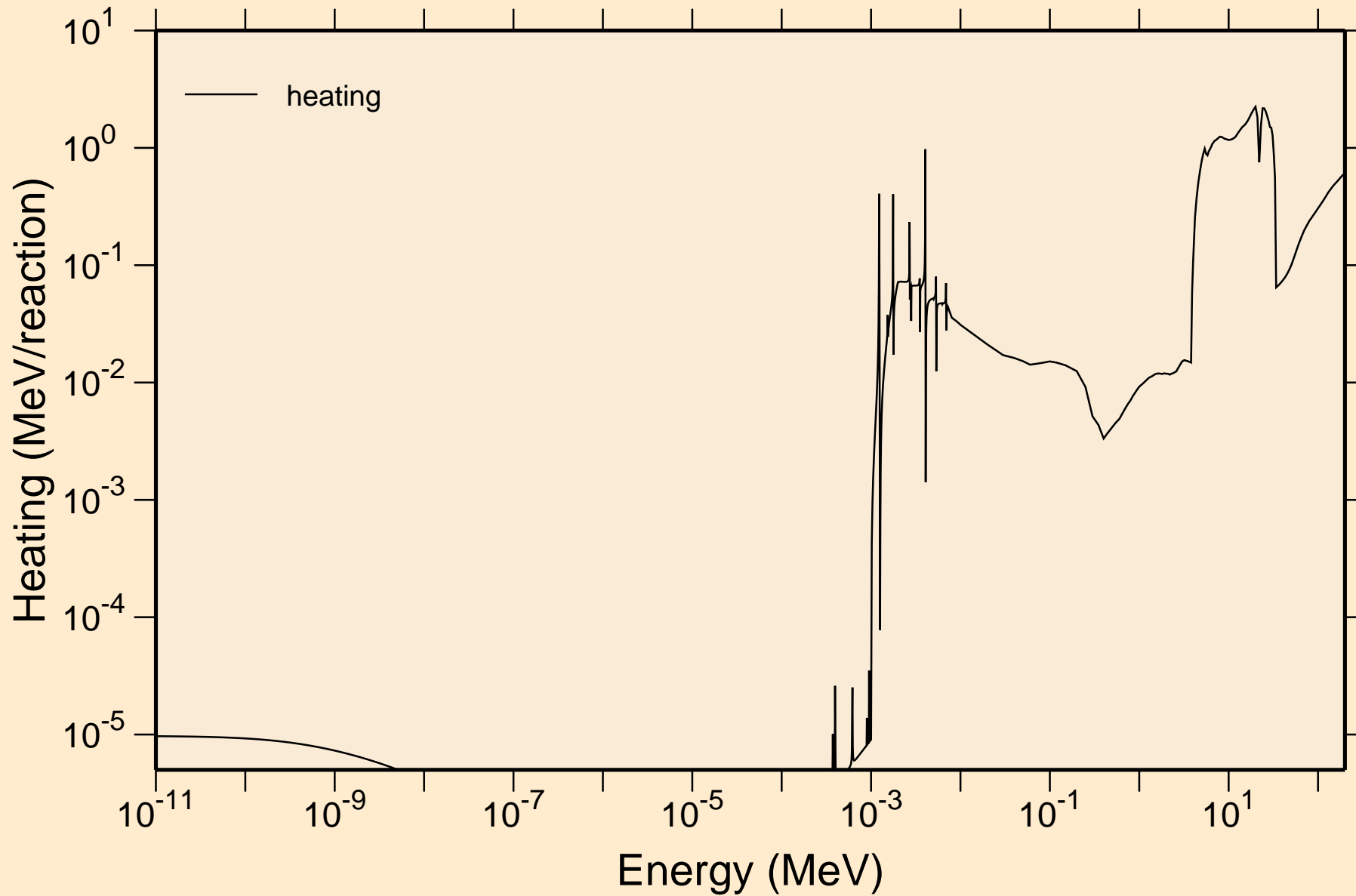

PO220 NEUTRON ACER TENDL-2021 LIBRARY; T=293.6K
Damage

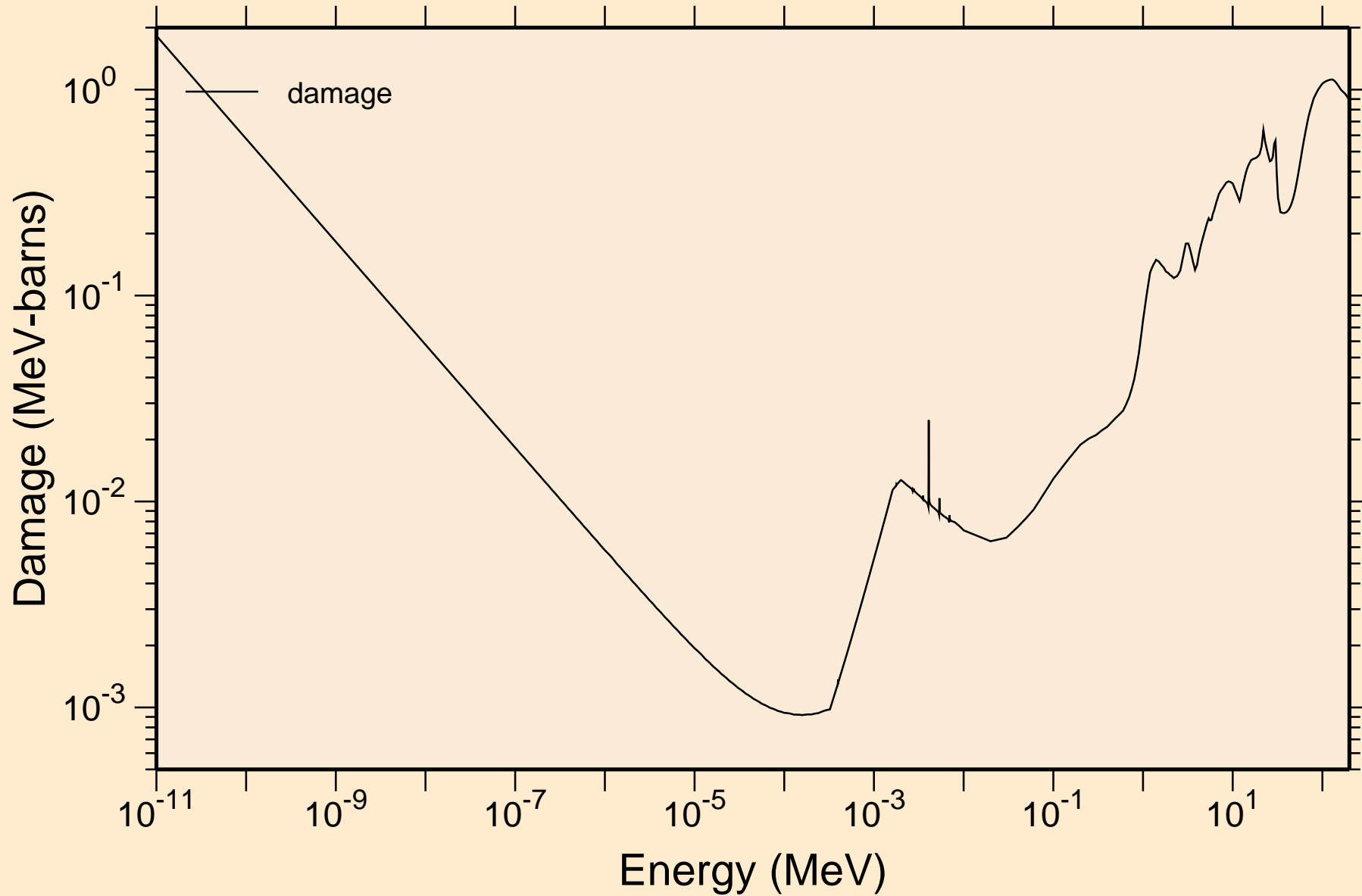

PO220 NEUTRON ACER TENDL-2021 LIBRARY; T=293.6K
Non-threshold reactions

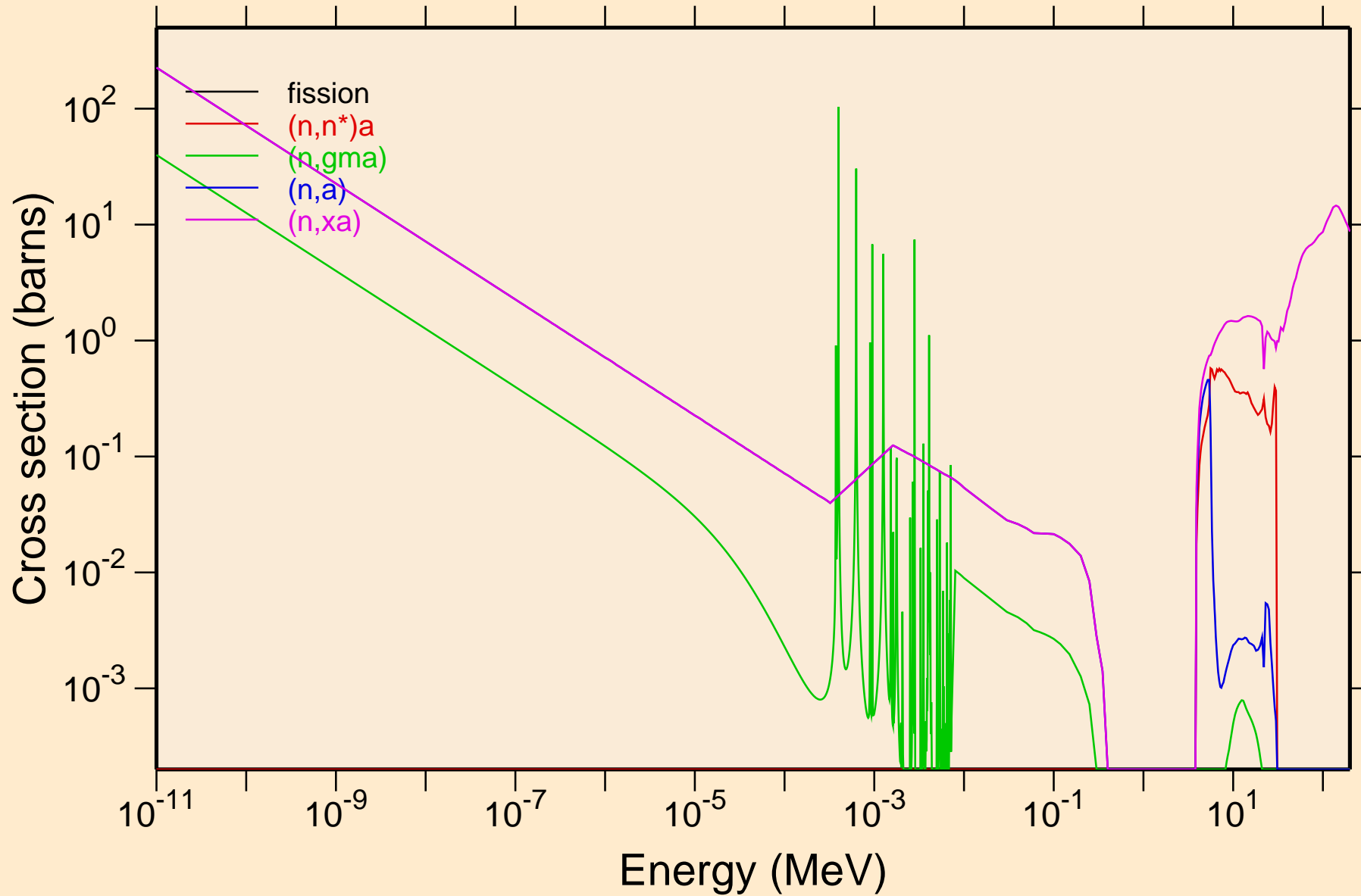

PO220 NEUTRON ACER TENDL-2021 LIBRARY; T=293.6K

Principal cross sections

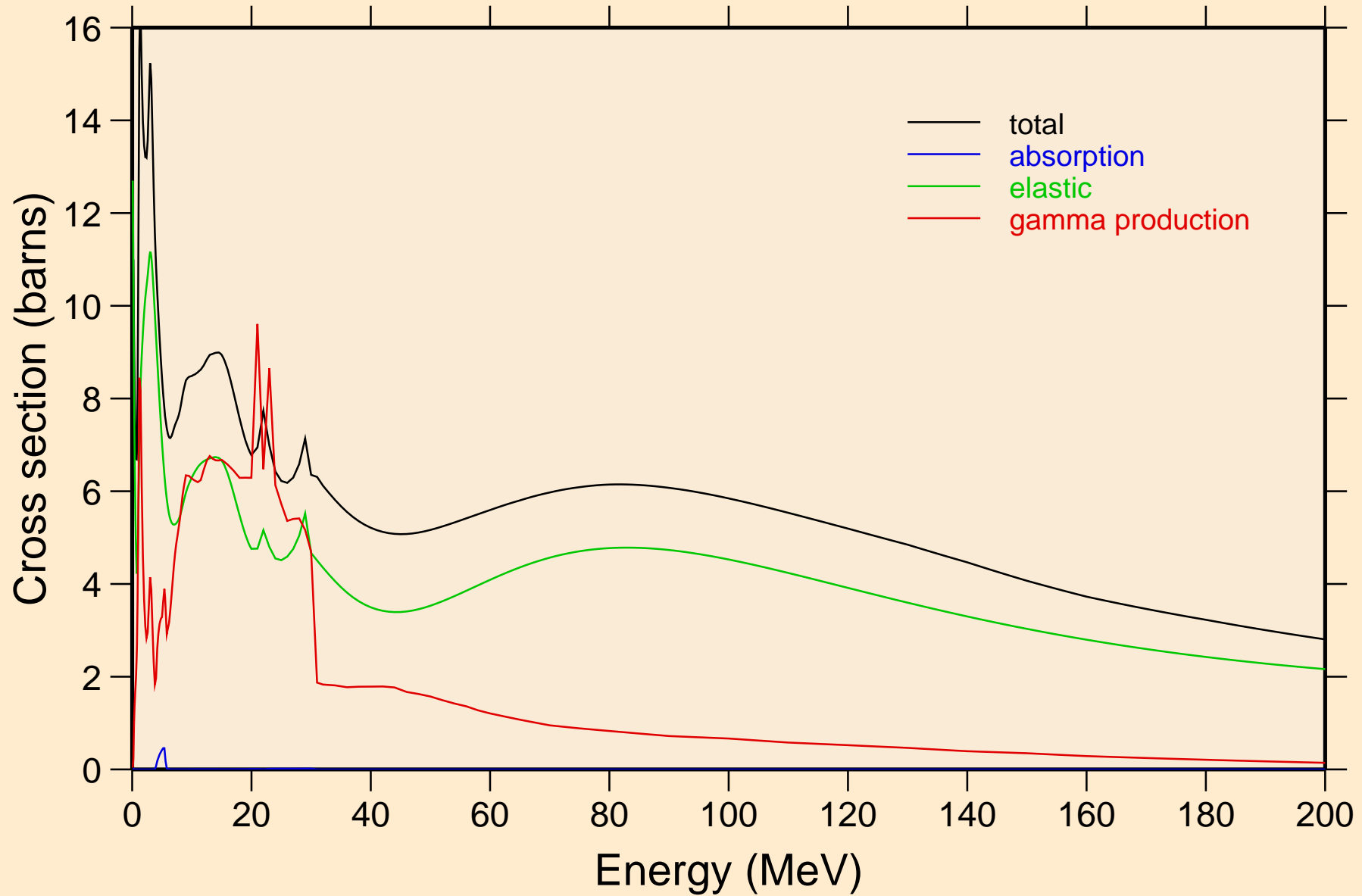

PO220 NEUTRON ACER TENDL-2021 LIBRARY; T=293.6K
Heating

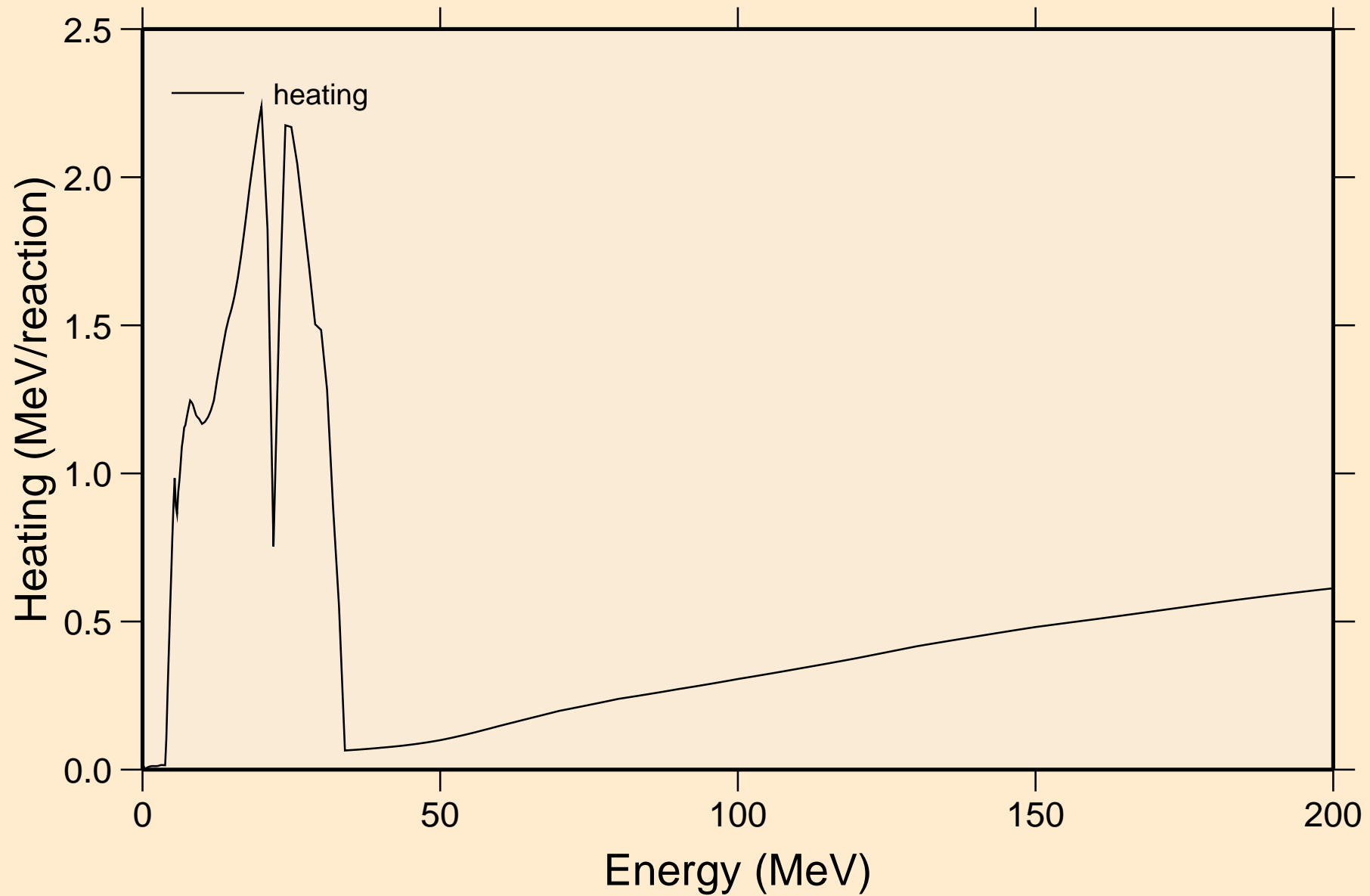

PO220 NEUTRON ACER TENDL-2021 LIBRARY; T=293.6K
Damage

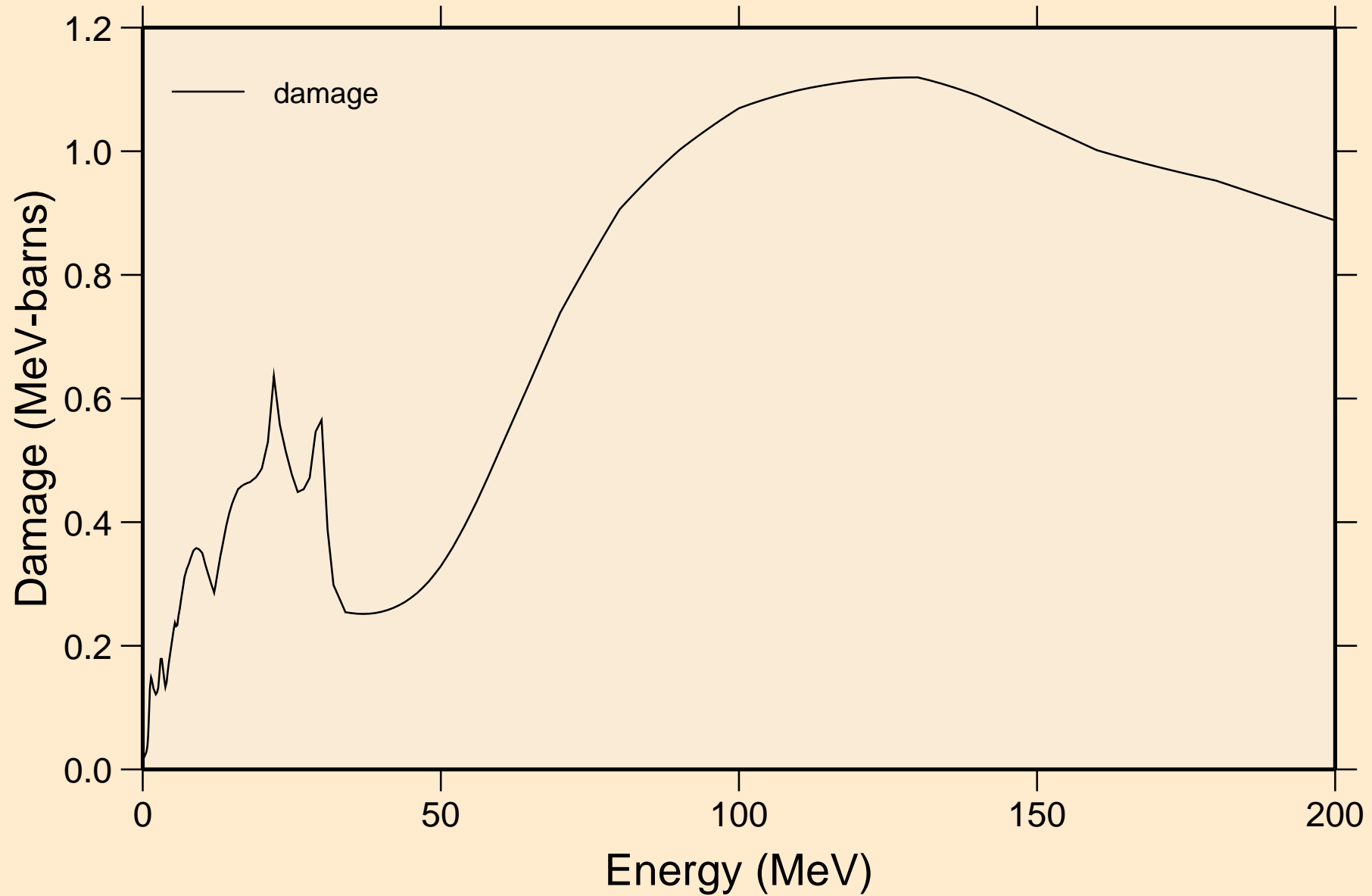

PO220 NEUTRON ACER TENDL-2021 LIBRARY; T=293.6K
Non-threshold reactions

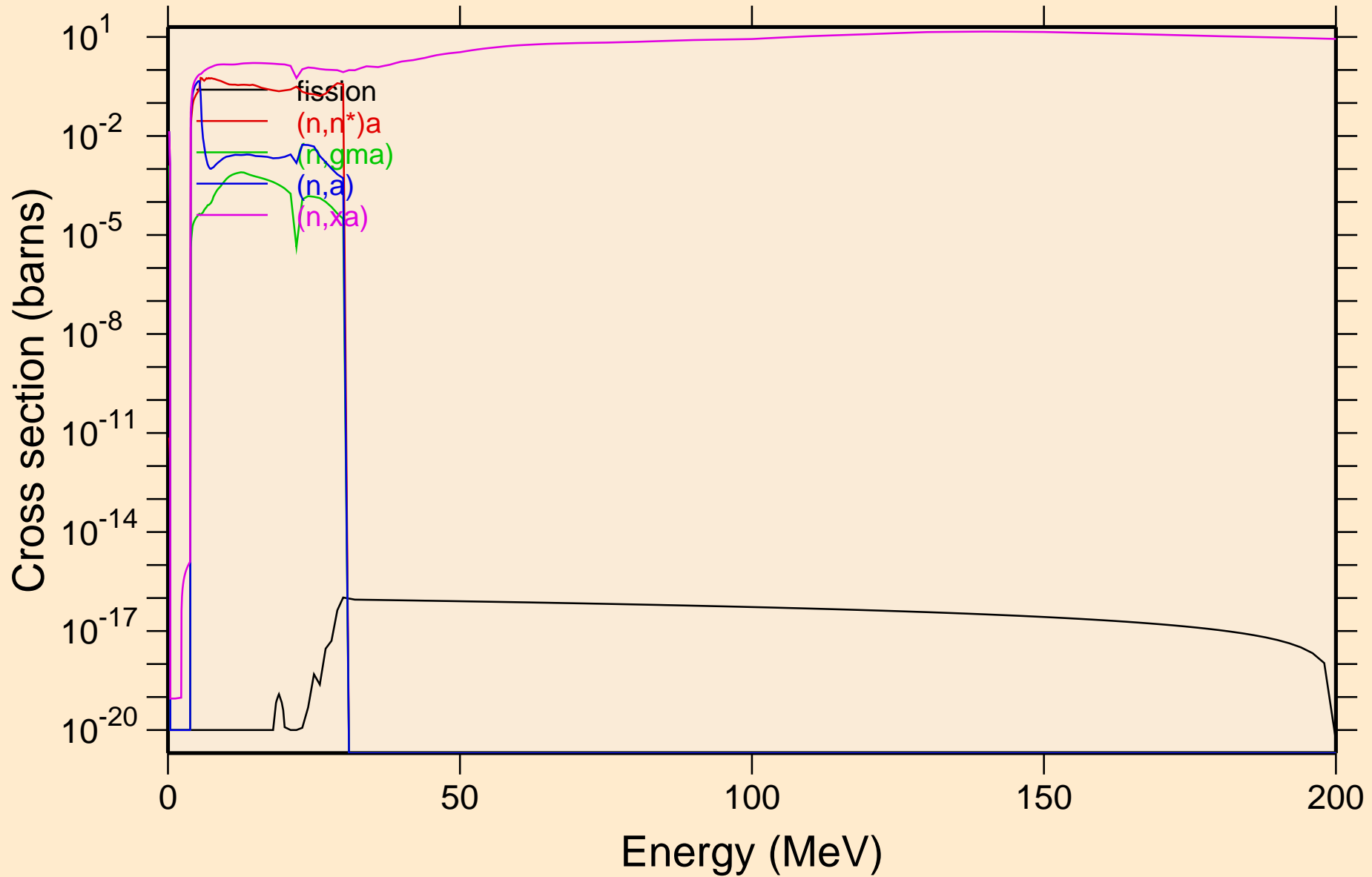

PO220 NEUTRON ACER TENDL-2021 LIBRARY; T=293.6K
Inelastic levels

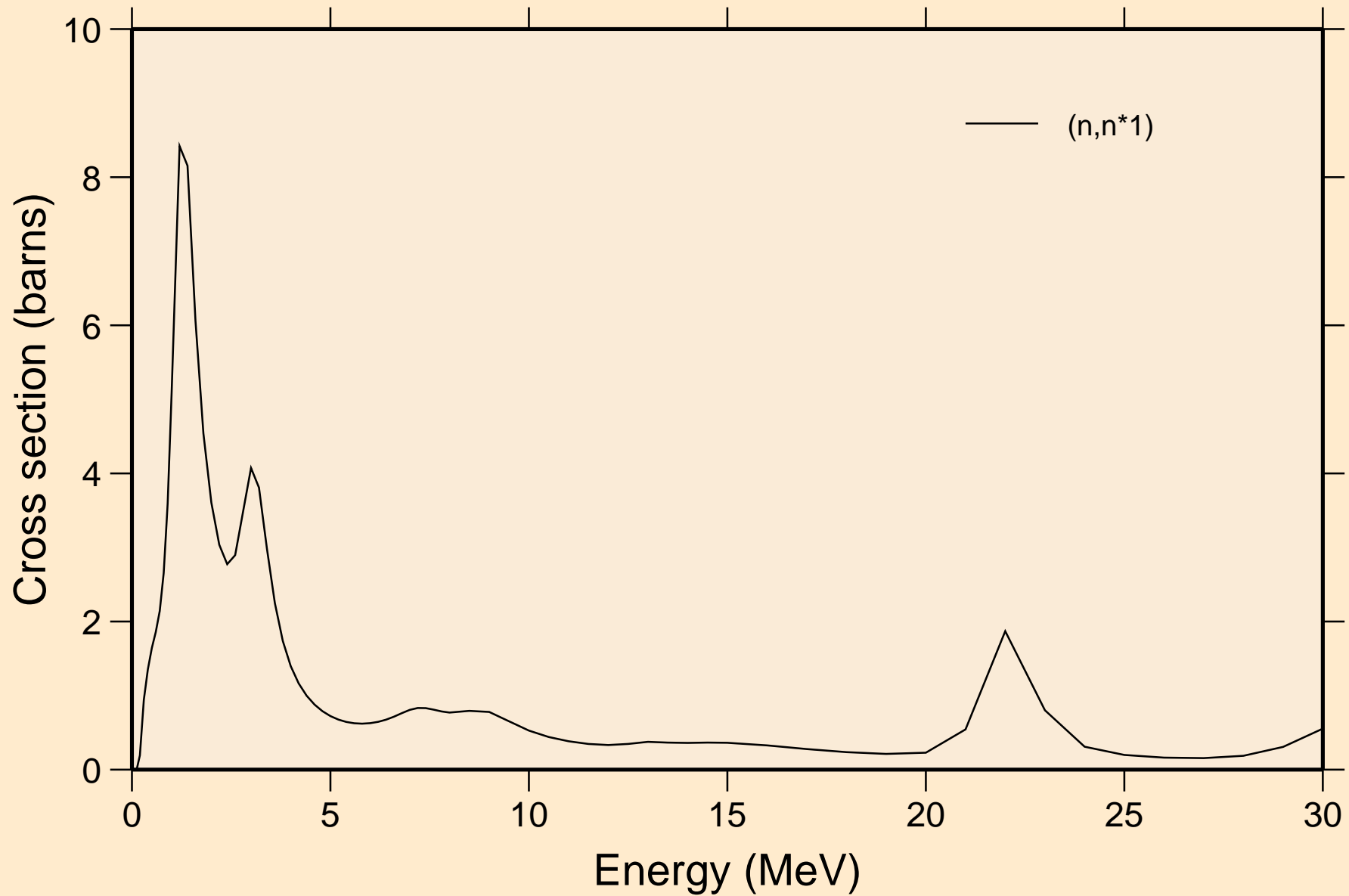

PO220 NEUTRON ACER TENDL-2021 LIBRARY; T=293.6K
Threshold reactions

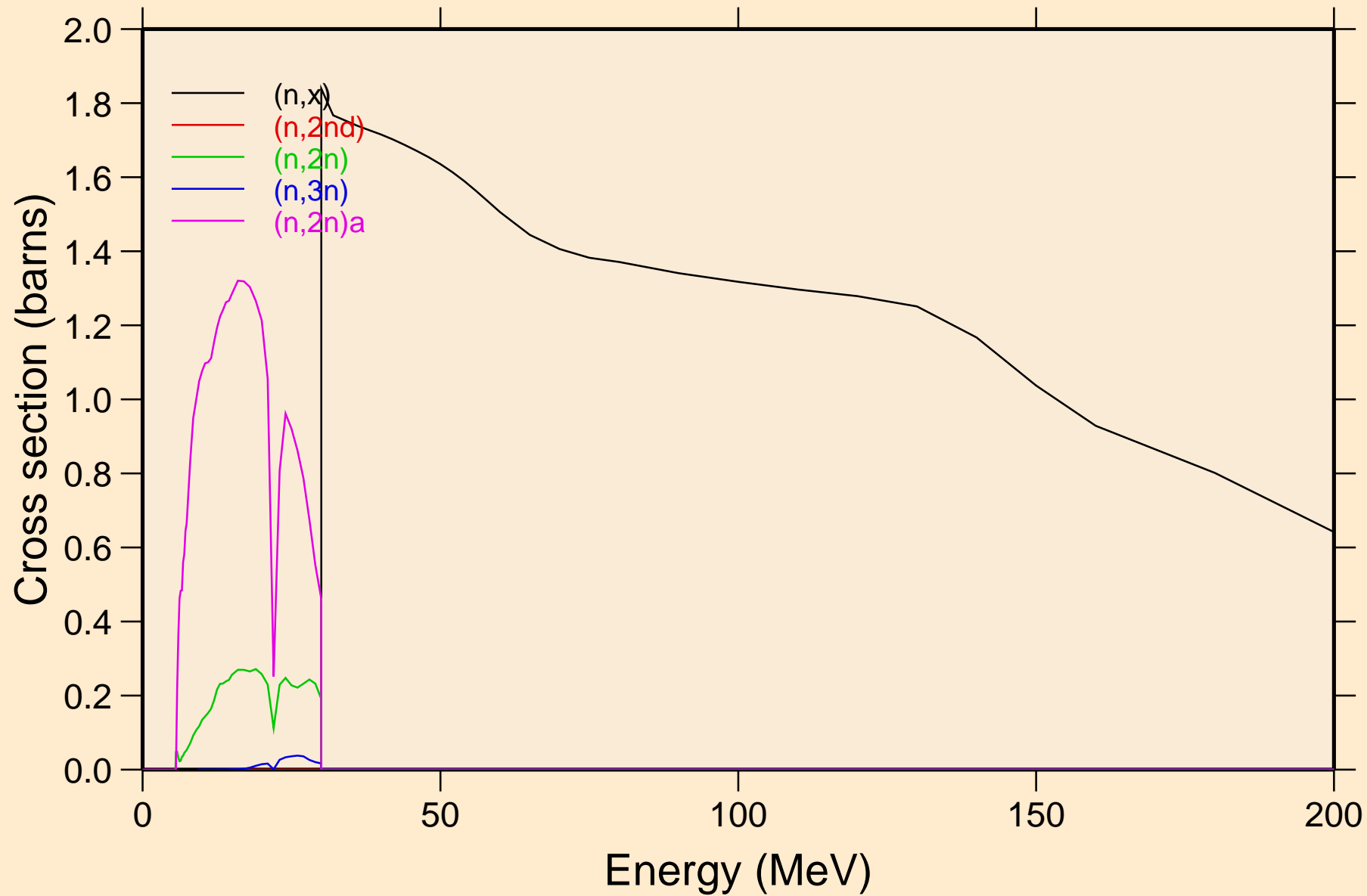

PO220 NEUTRON ACER TENDL-2021 LIBRARY; T=293.6K
Threshold reactions

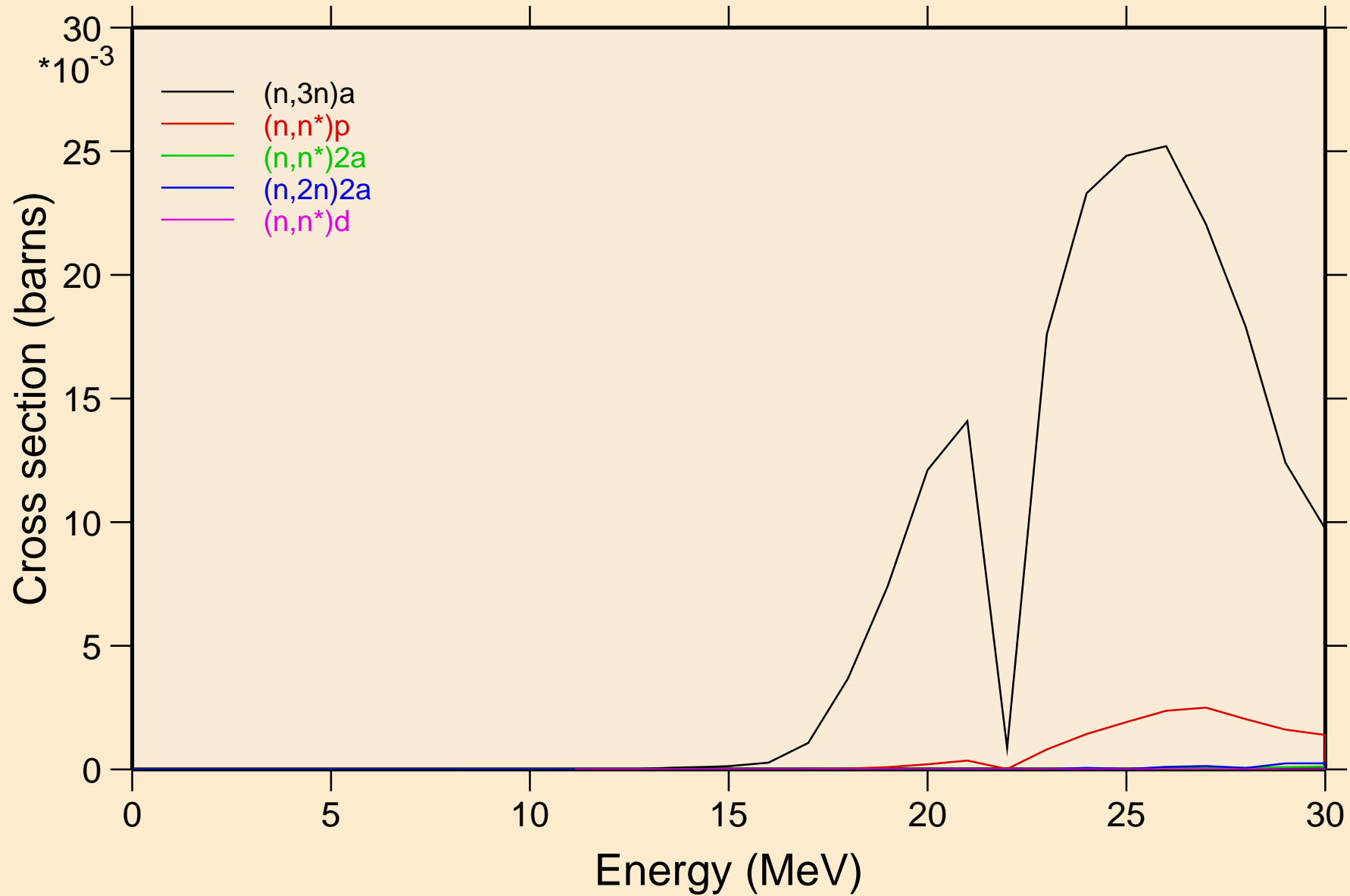

PO220 NEUTRON ACER TENDL-2021 LIBRARY; T=293.6K

Threshold reactions

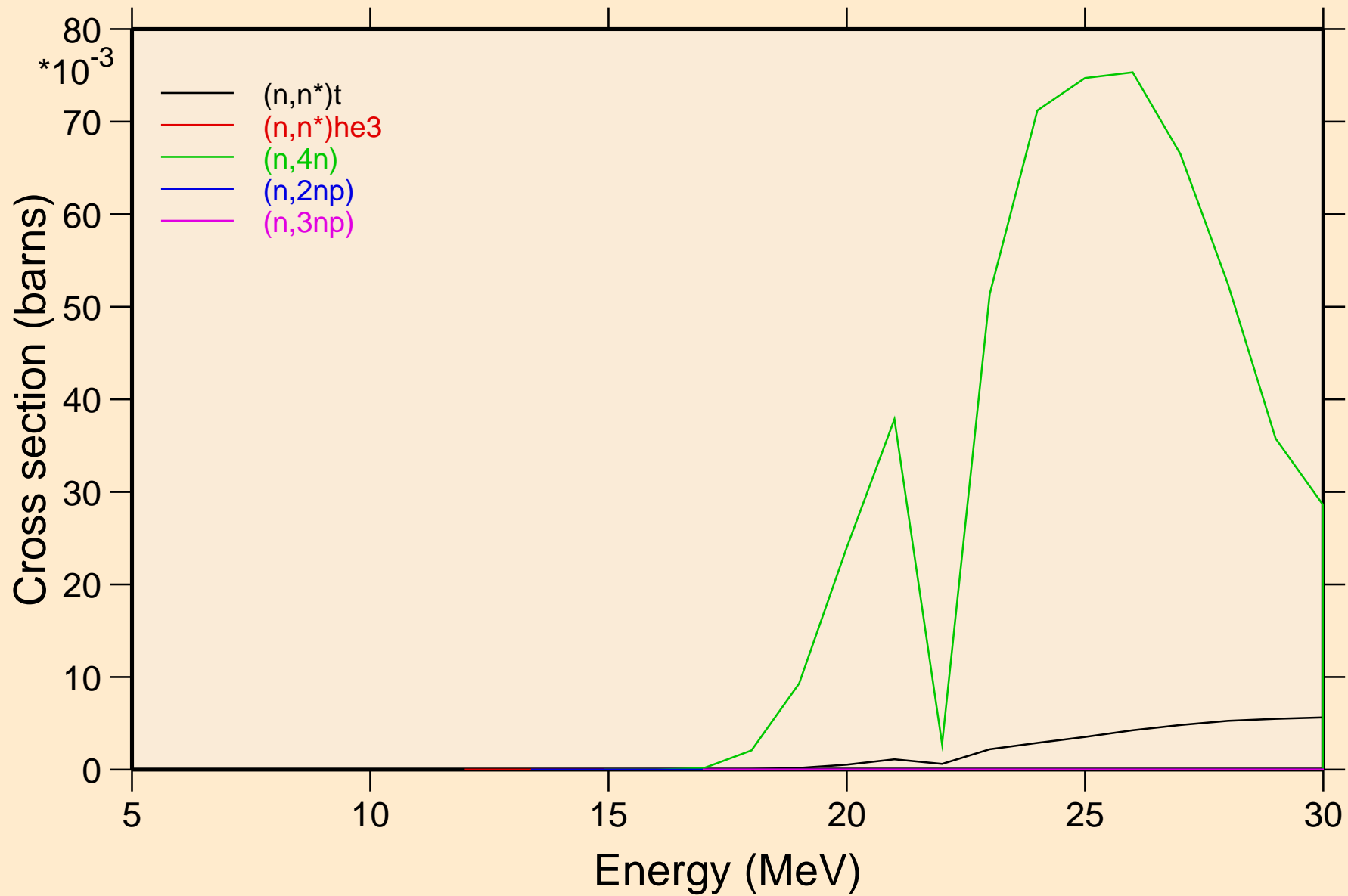

PO220 NEUTRON ACER TENDL-2021 LIBRARY; T=293.6K
Threshold reactions

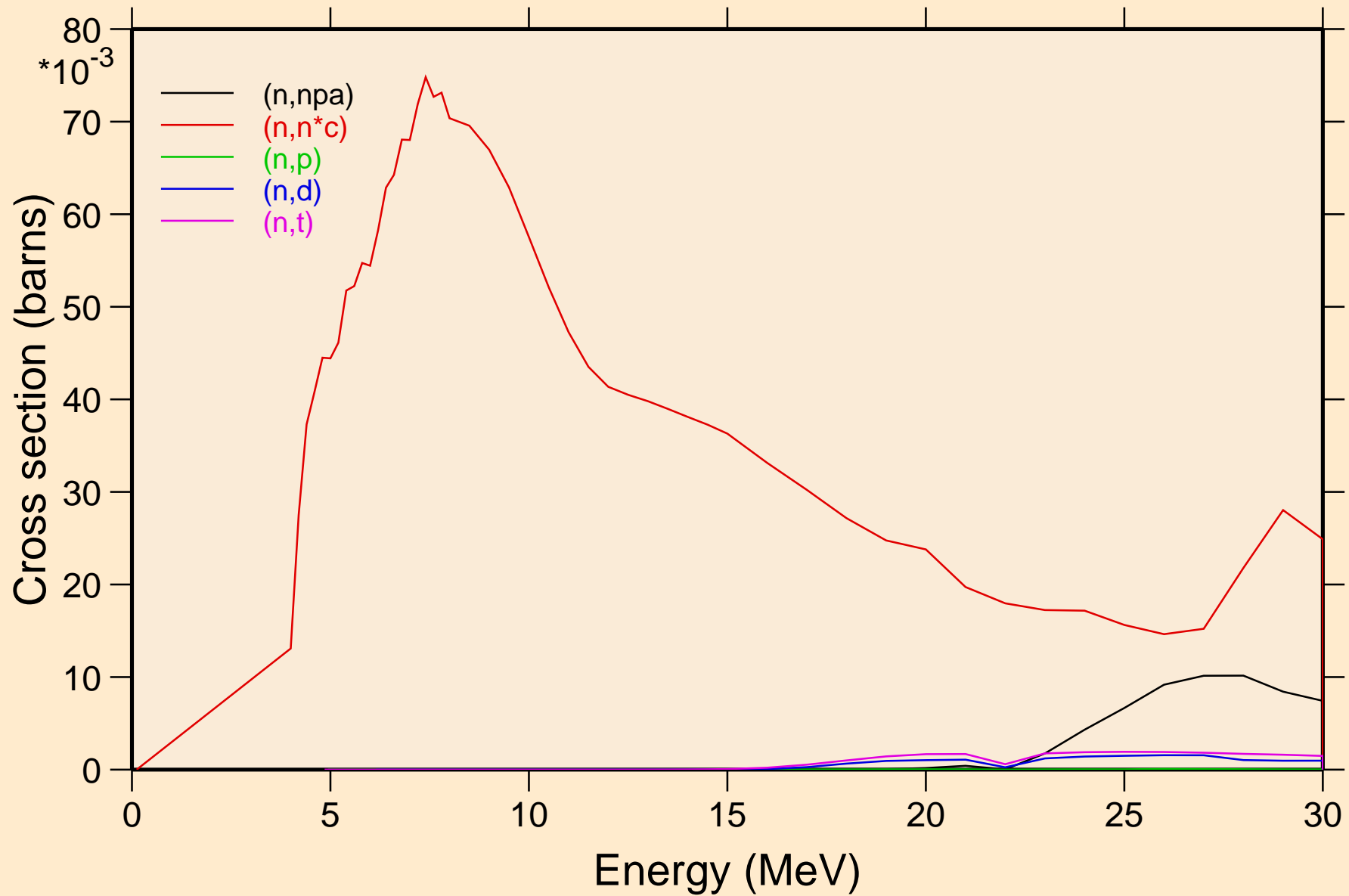

PO220 NEUTRON ACER TENDL-2021 LIBRARY; T=293.6K
Threshold reactions

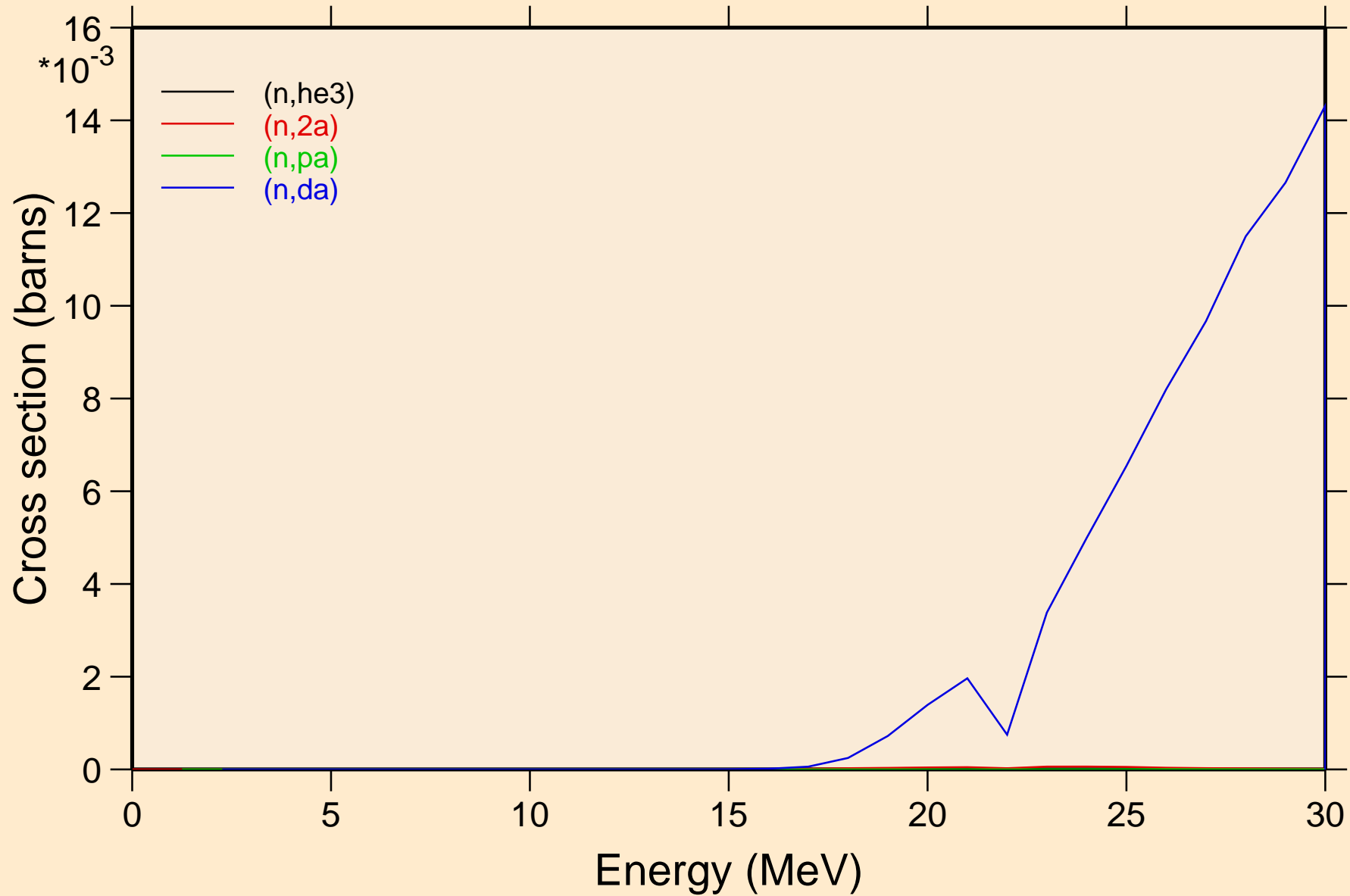

PO220 NEUTRON ACER TENDL-2021 LIBRARY; T=293.6K
Threshold reactions

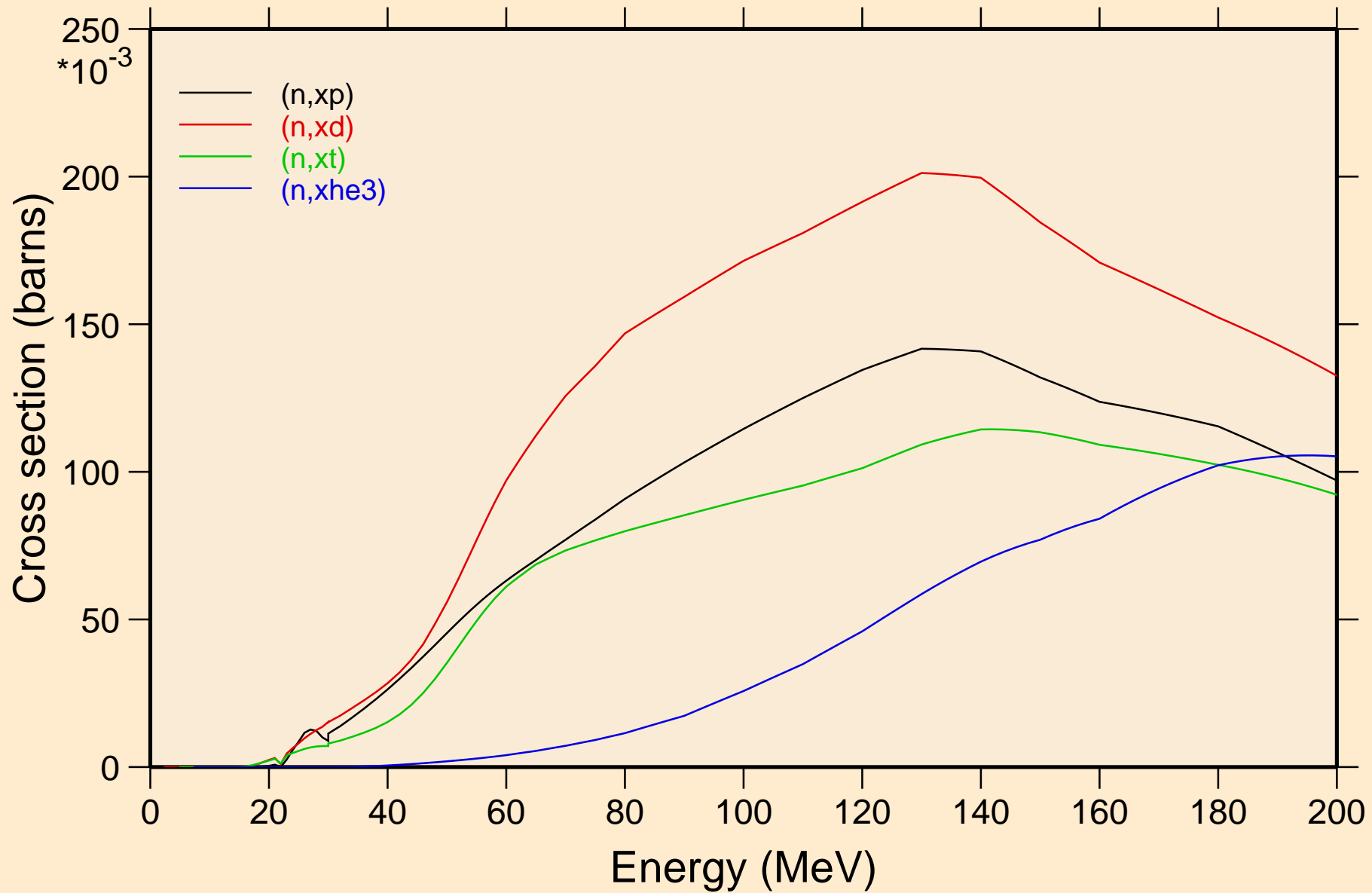

PO220 NEUTRON ACER TENDL-2021 LIBRARY; T=293.6K
angular distribution for elastic

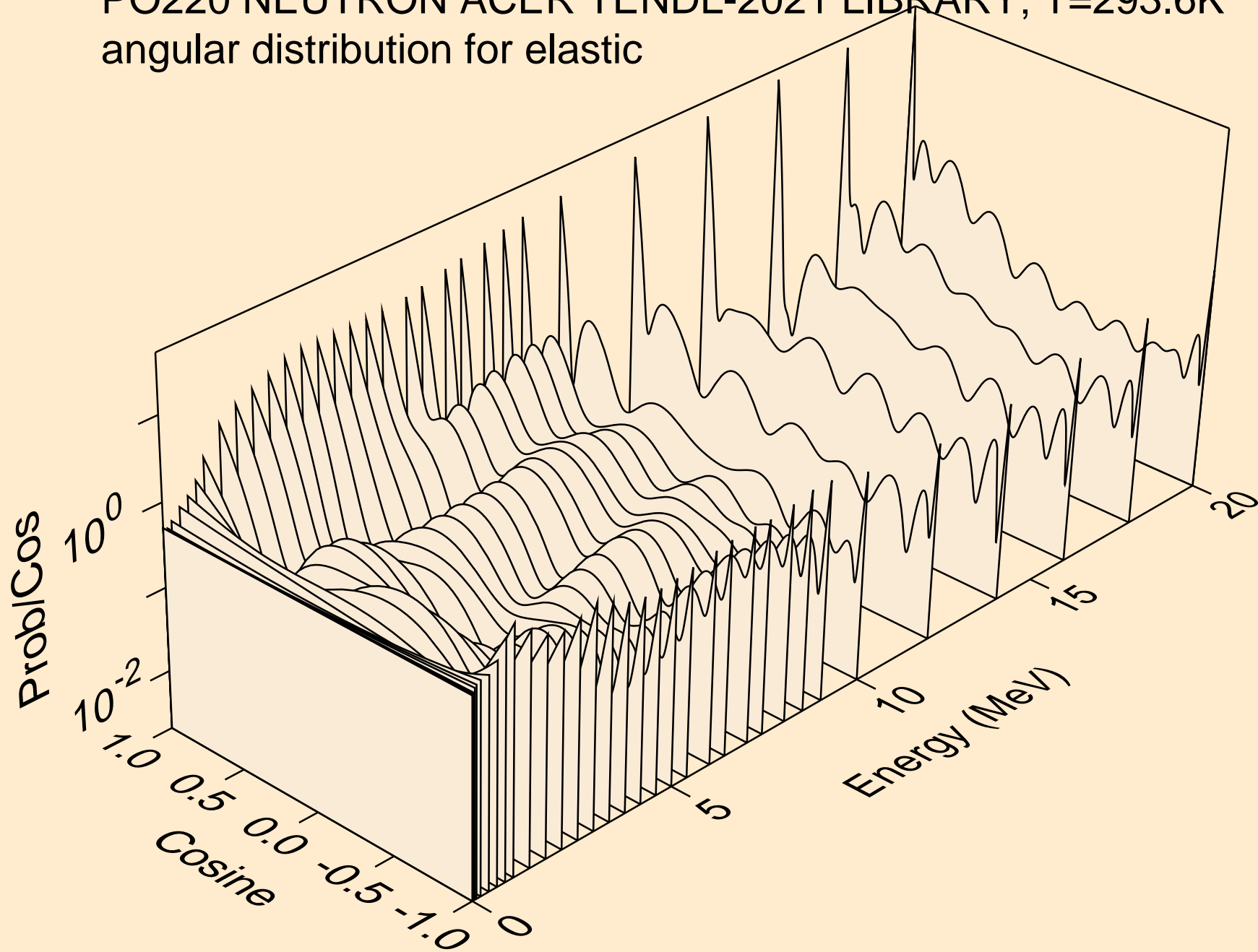

PO220 NEUTRON ACER TENDL-2021 LIBRARY; T=293.6K
angular distribution for elastic

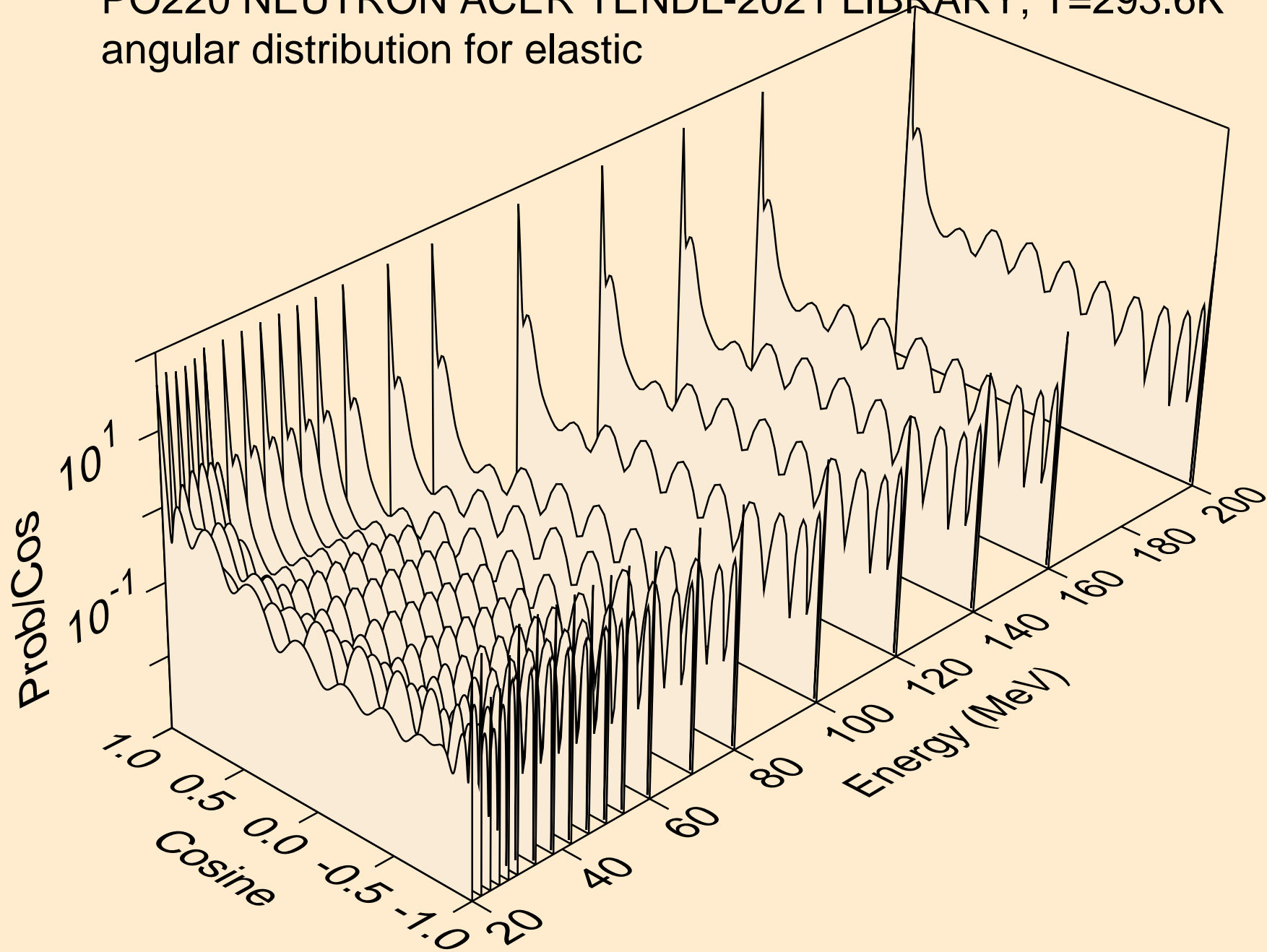

PO220 NEUTRON ACER TENDL-2021 LIBRARY; T=293.6K
angular distribution for (n,n*1)

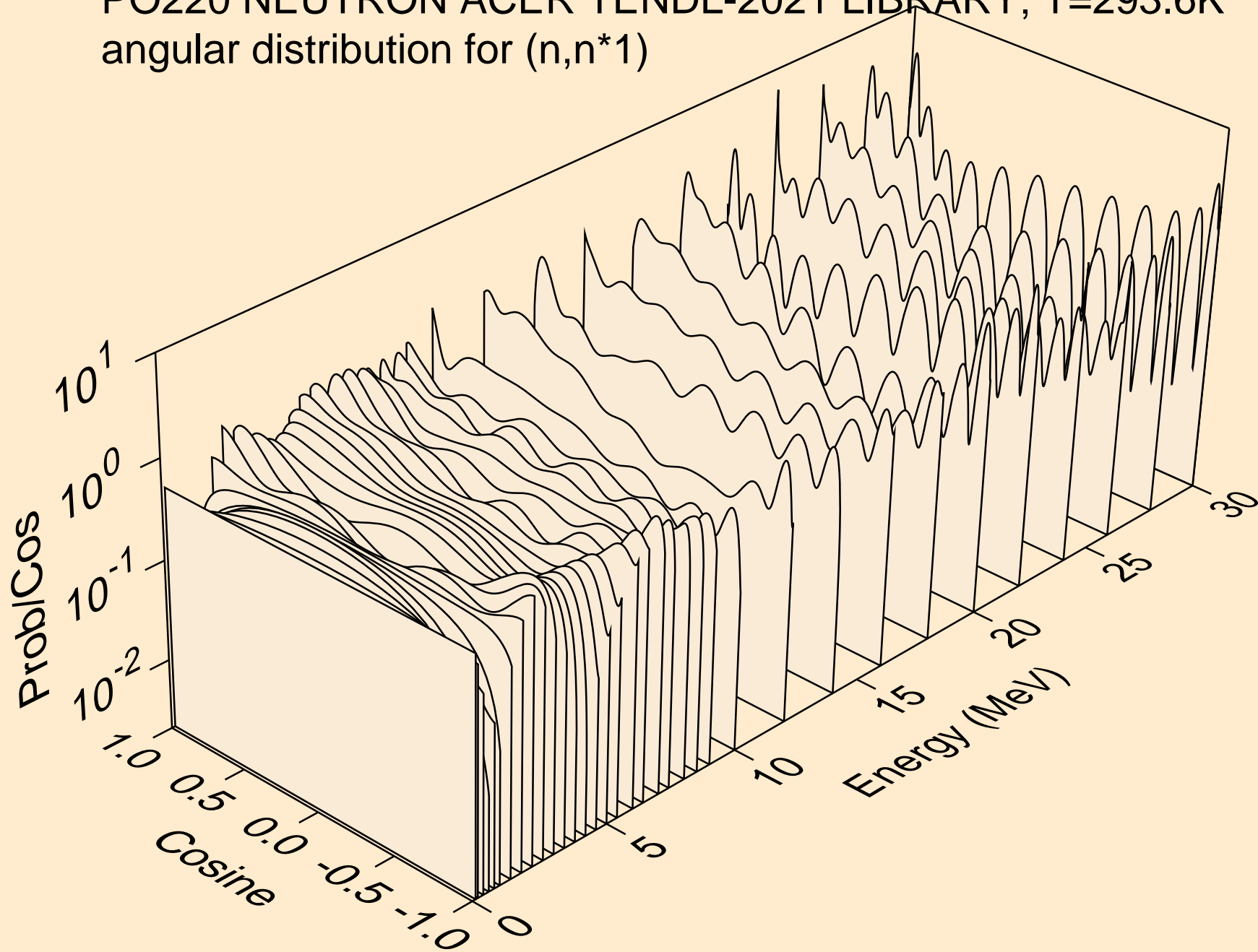

PO220 NEUTRON ACER TENDL-2021 LIBRARY; T=293.6K
Total fission nubar

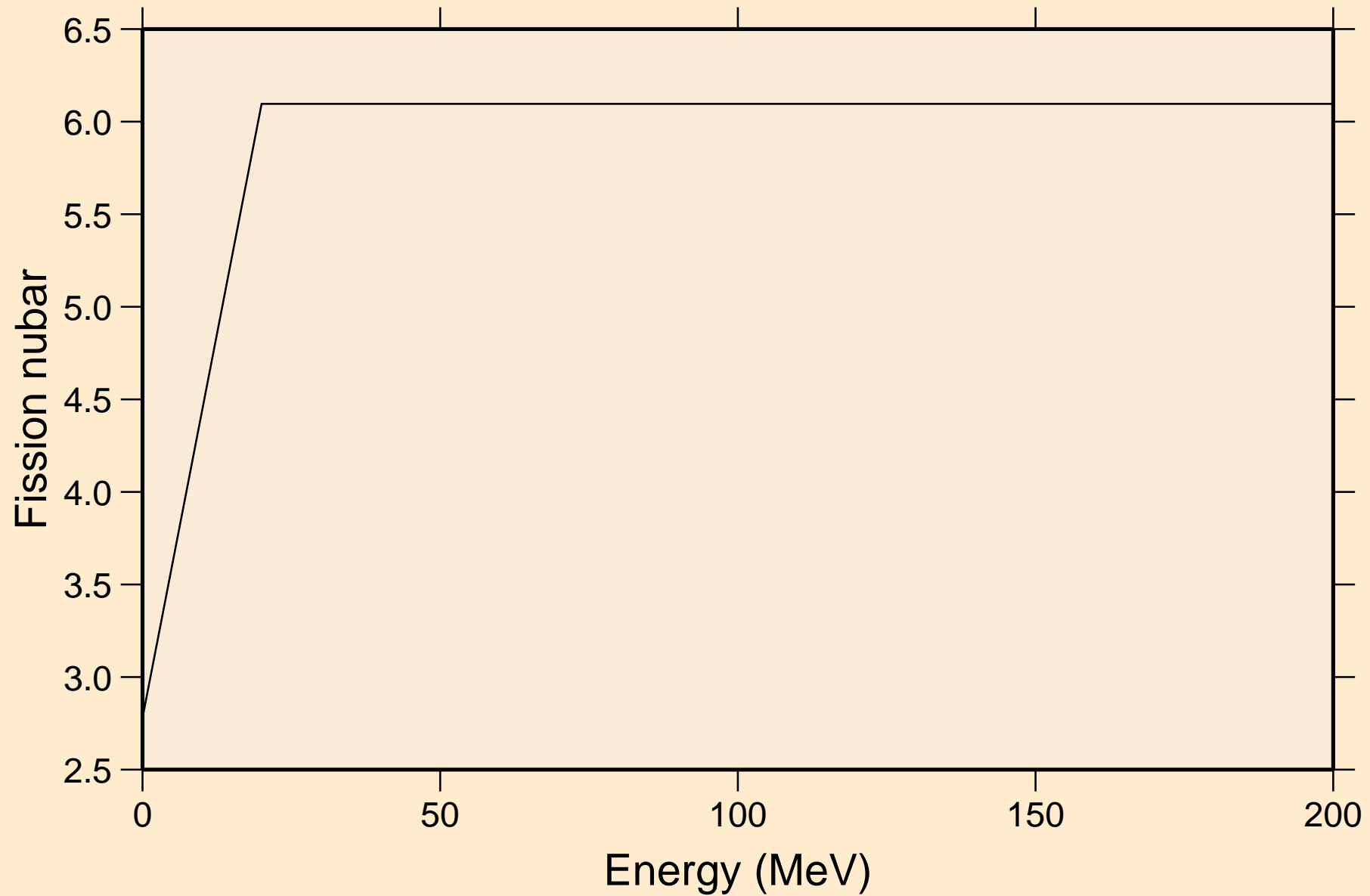

PO220 NEUTRON ACER TENDL-2021 LIBRARY; T=293.6K
Neutron emission for (n,x)

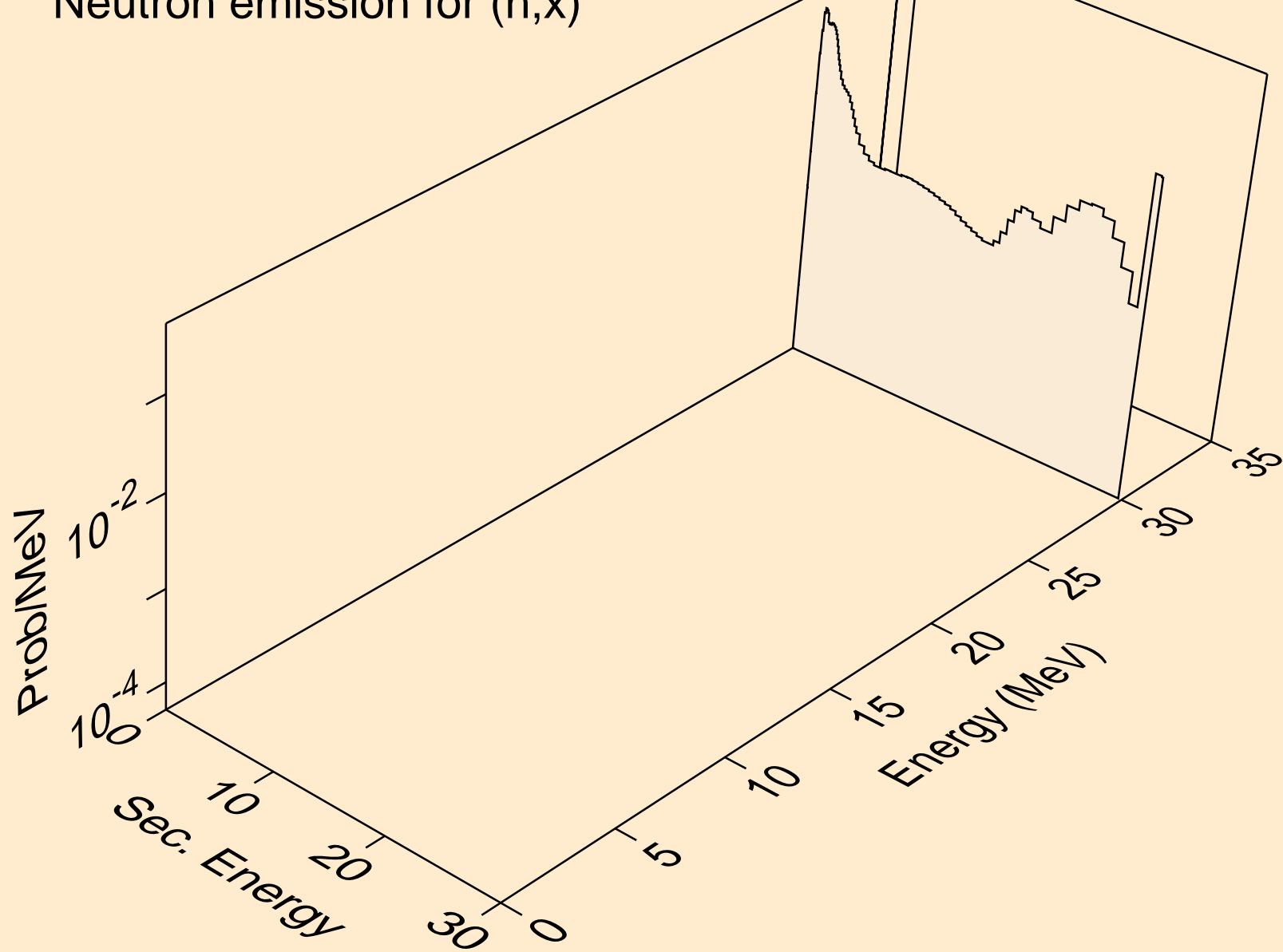

PO220 NEUTRON ACER TENDL-2021 LIBRARY; T=293.6K
Neutron emission for (n,2nd)

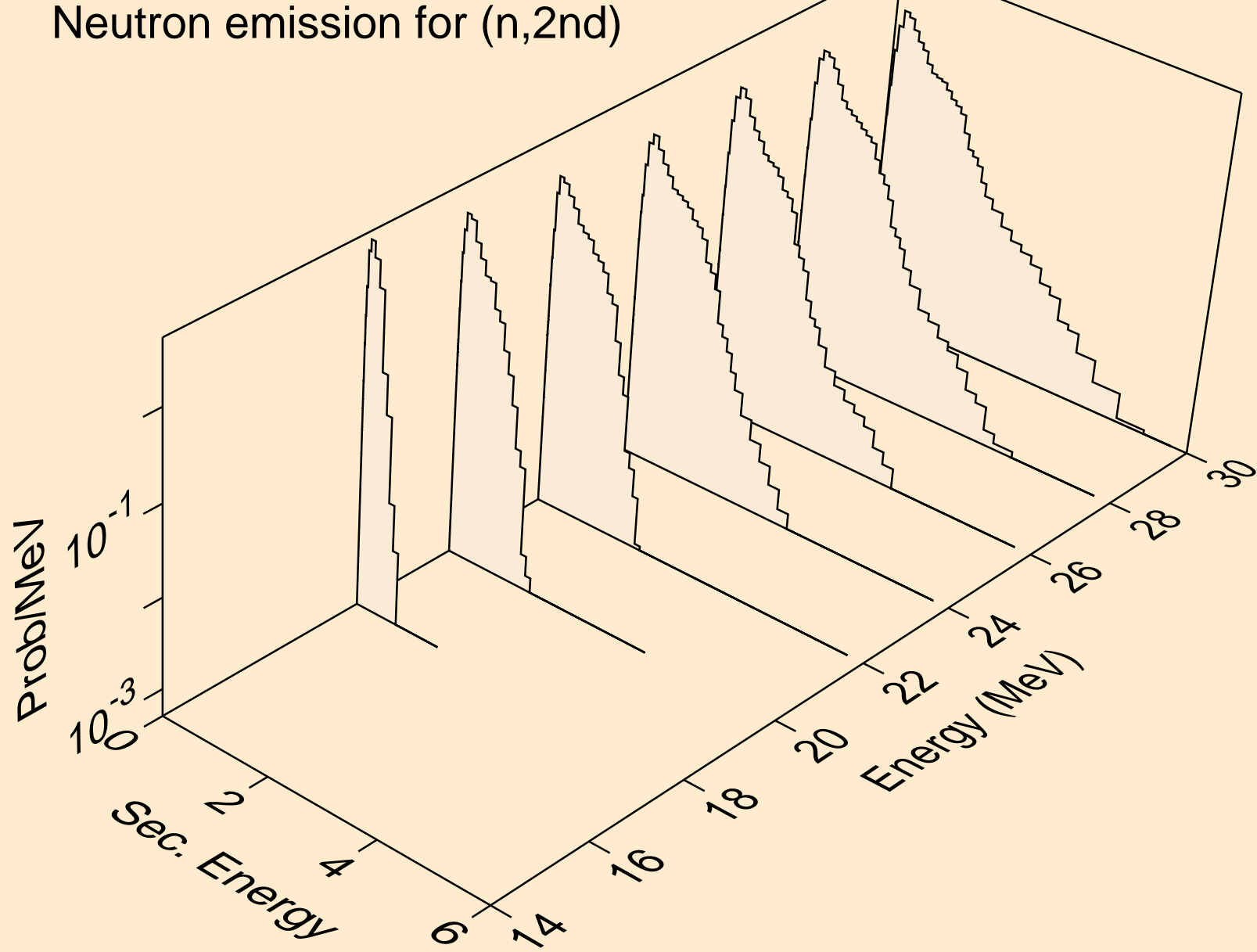

PO220 NEUTRON ACER TENDL-2021 LIBRARY; T=293.6K
Neutron emission for (n,2n)

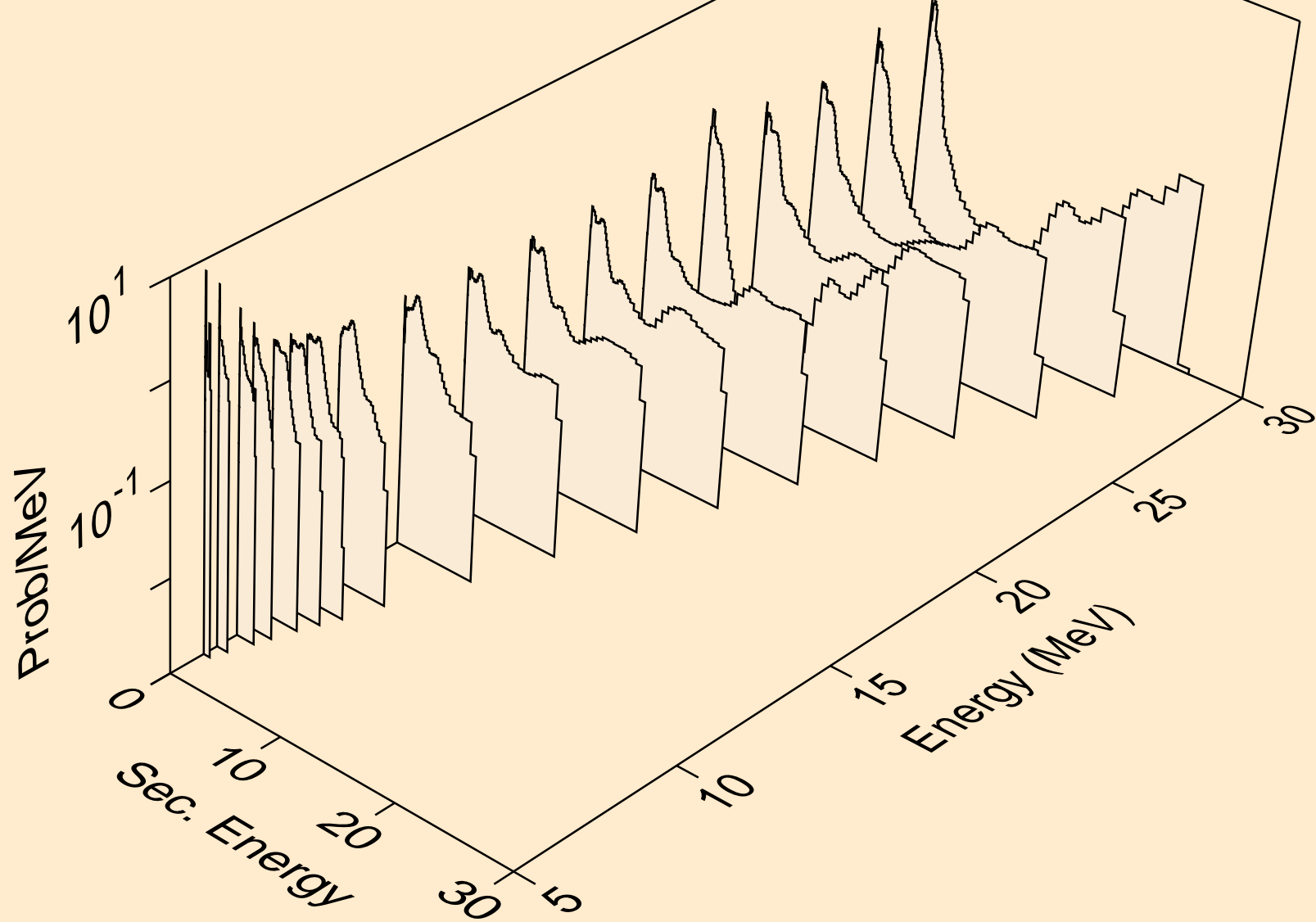

PO220 NEUTRON ACER TENDL-2021 LIBRARY; T=293.6K
Neutron emission for (n,3n)

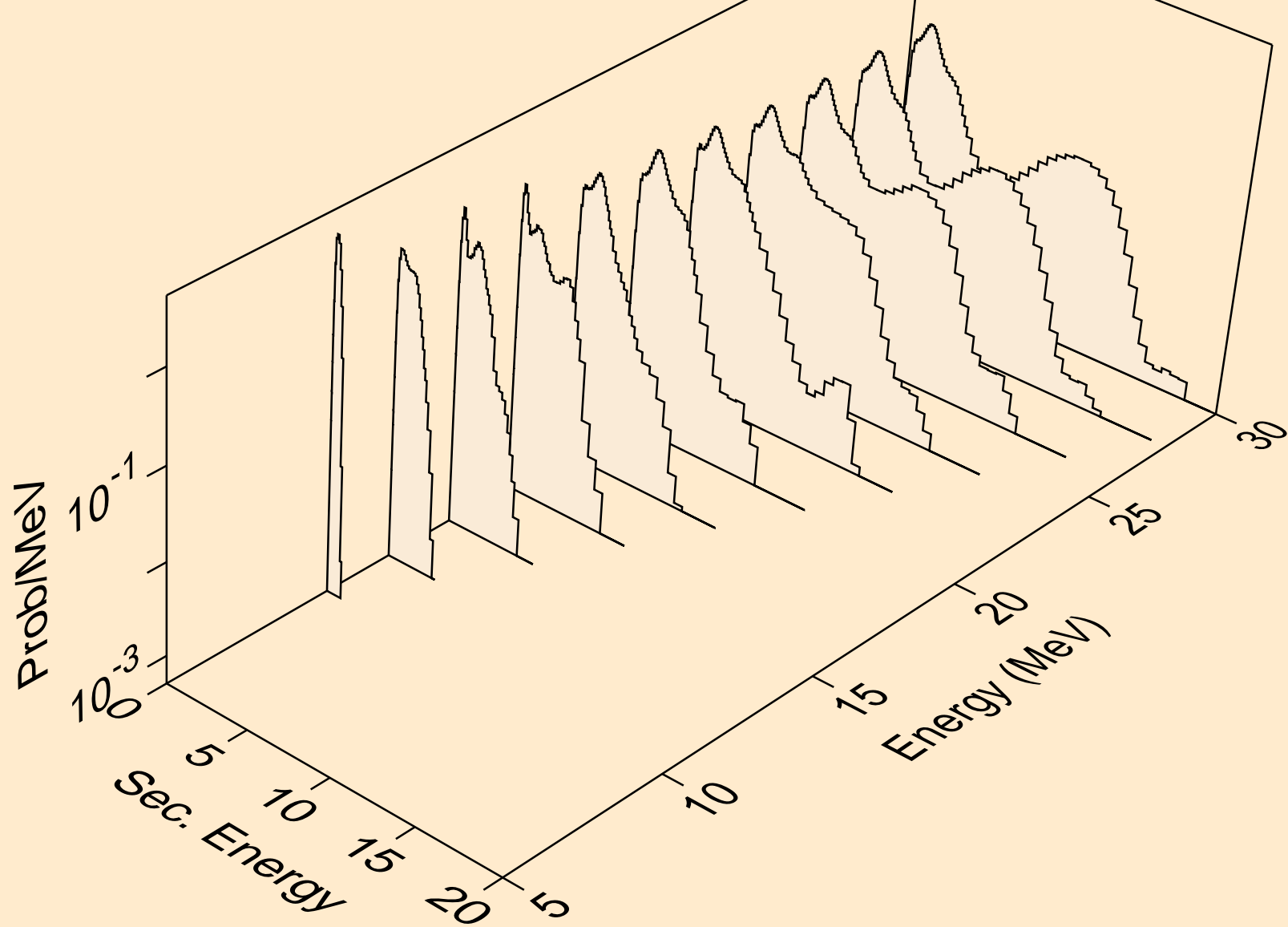

PO220 NEUTRON ACER TENDL-2021 LIBRARY; T=293.6K
Neutron emission for fission

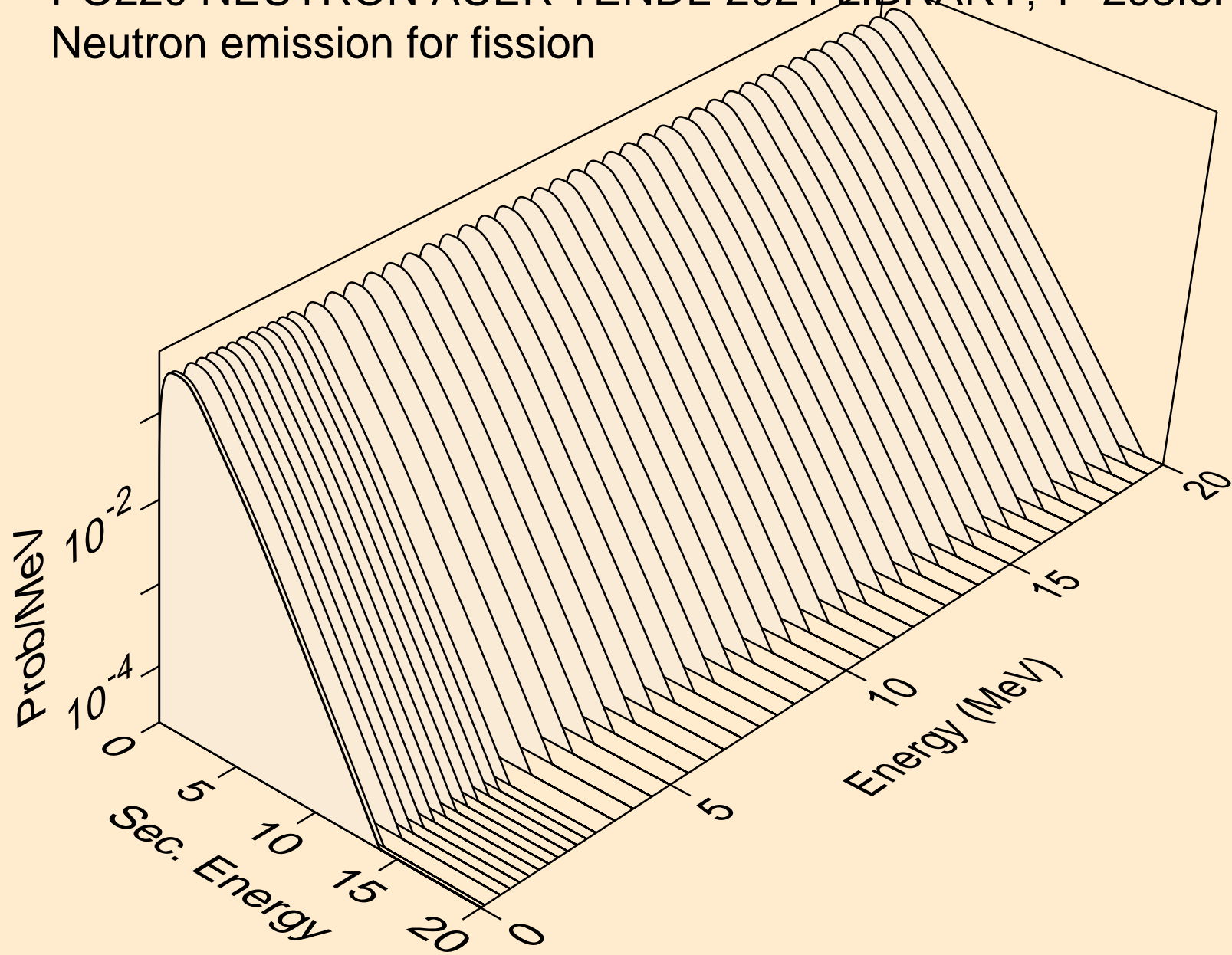

PO220 NEUTRON ACER TENDL-2021 LIBRARY; T=293.6K
Neutron emission for (n,n*)a

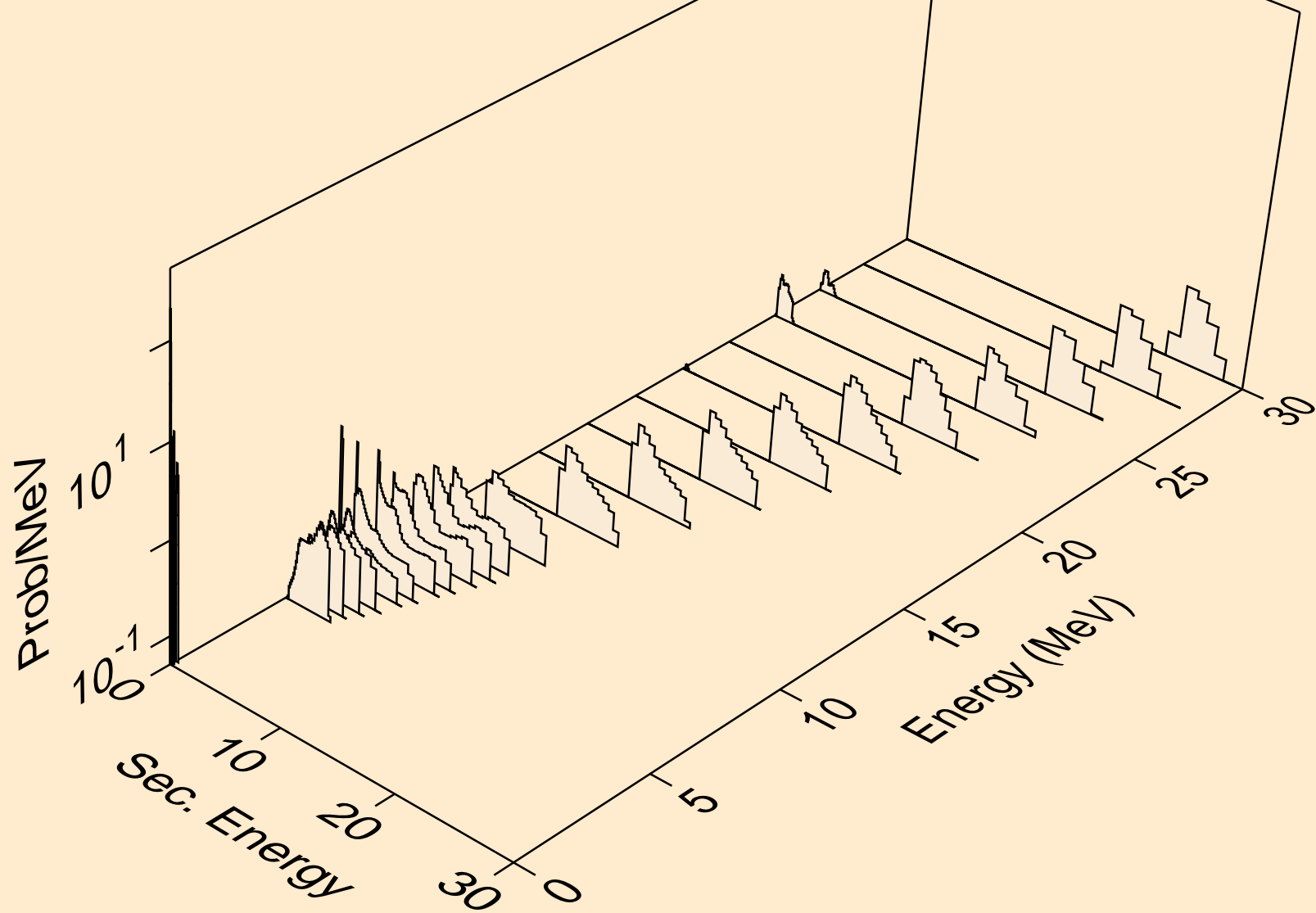

PO220 NEUTRON ACER TENDL-2021 LIBRARY; T=293.6K
Neutron emission for (n,2n)a

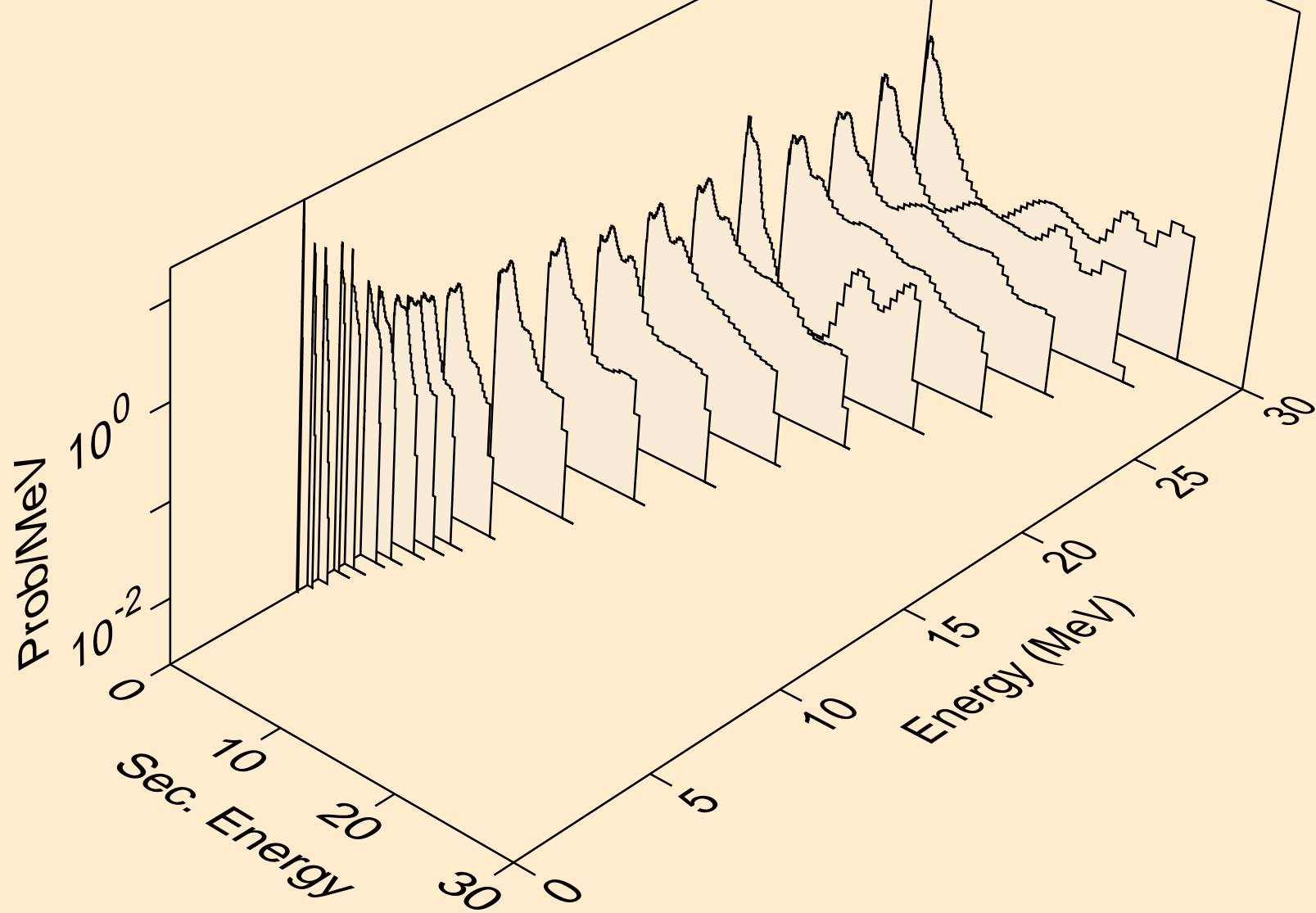

PO220 NEUTRON ACER TENDL-2021 LIBRARY; T=293.6K
Neutron emission for (n,3n)a

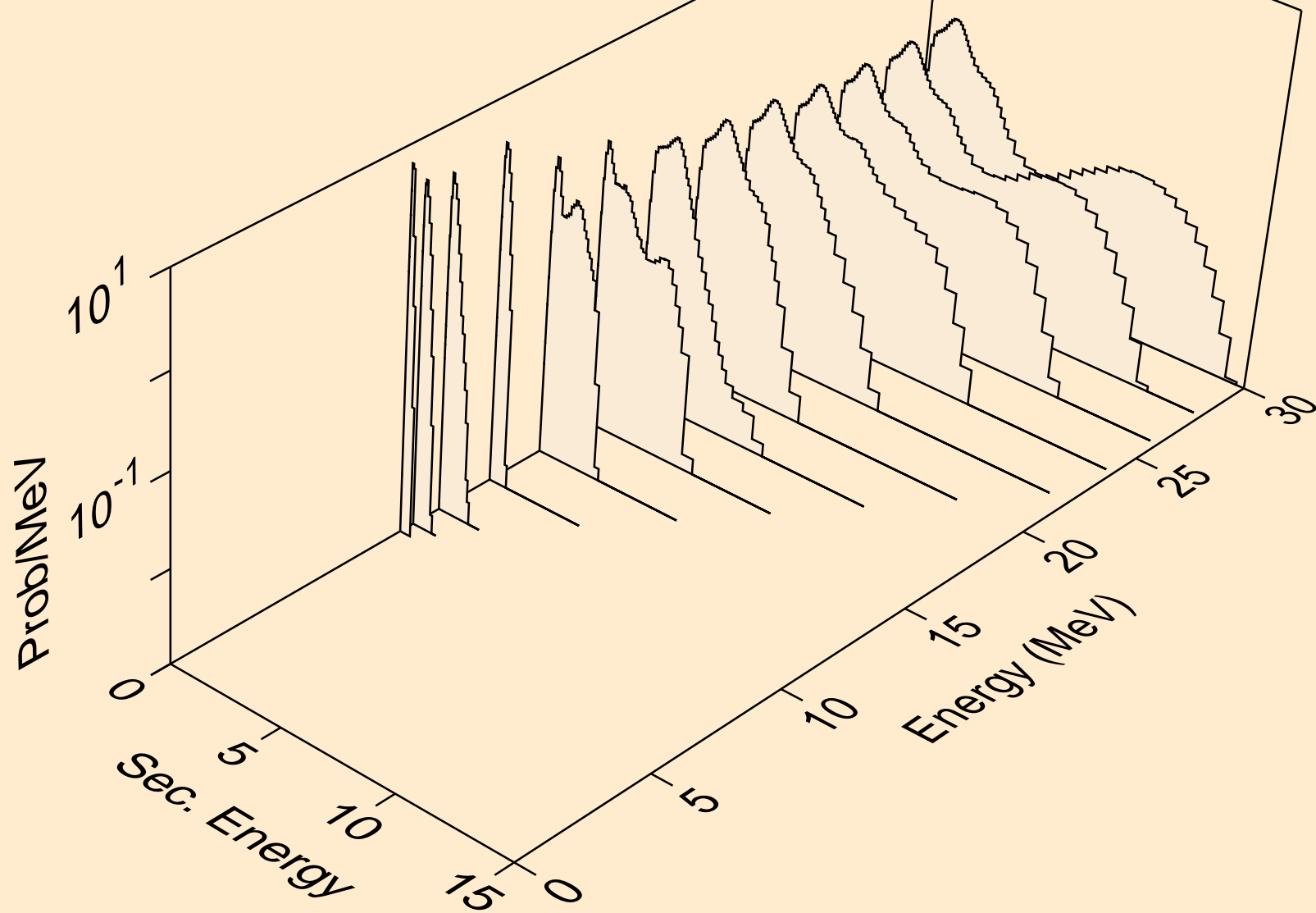

PO220 NEUTRON ACER TENDL-2021 LIBRARY; T=293.6K
Neutron emission for (n,n*)p

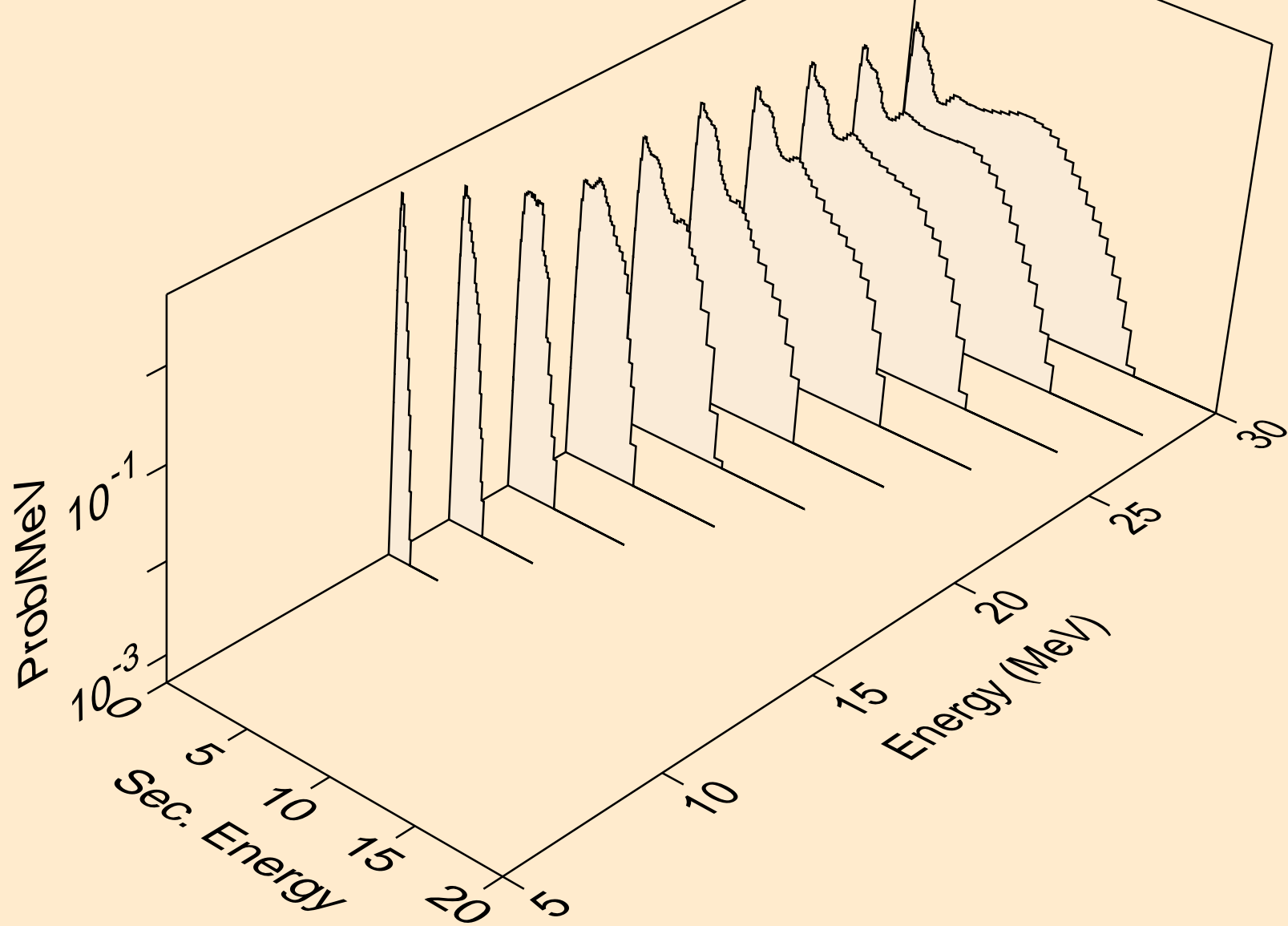

PO220 NEUTRON ACER TENDL-2021 LIBRARY; T=293.6K
Neutron emission for (n,n*)2a

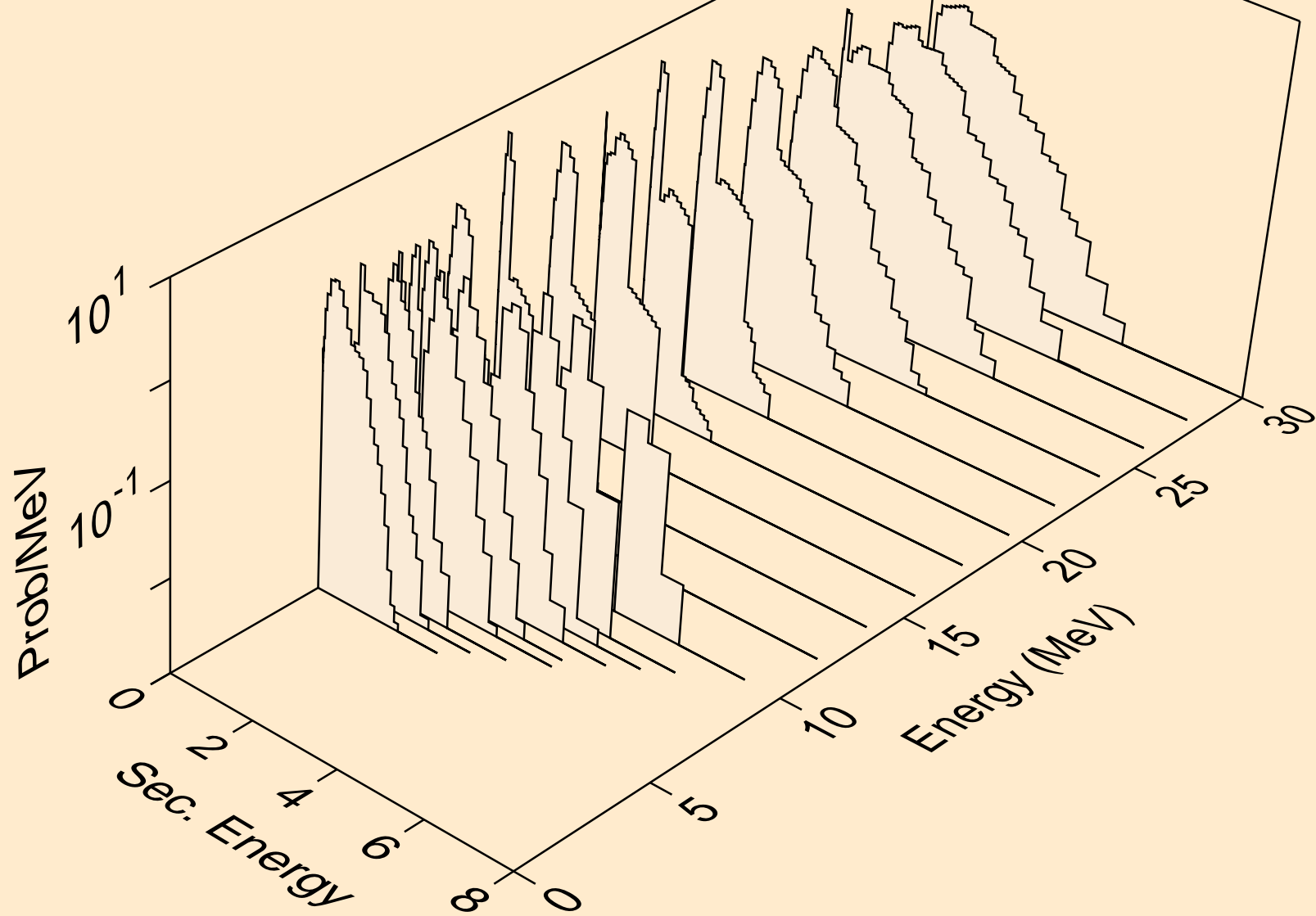

PO220 NEUTRON ACER TENDL-2021 LIBRARY; T=293.6K
Neutron emission for (n,2n)2a

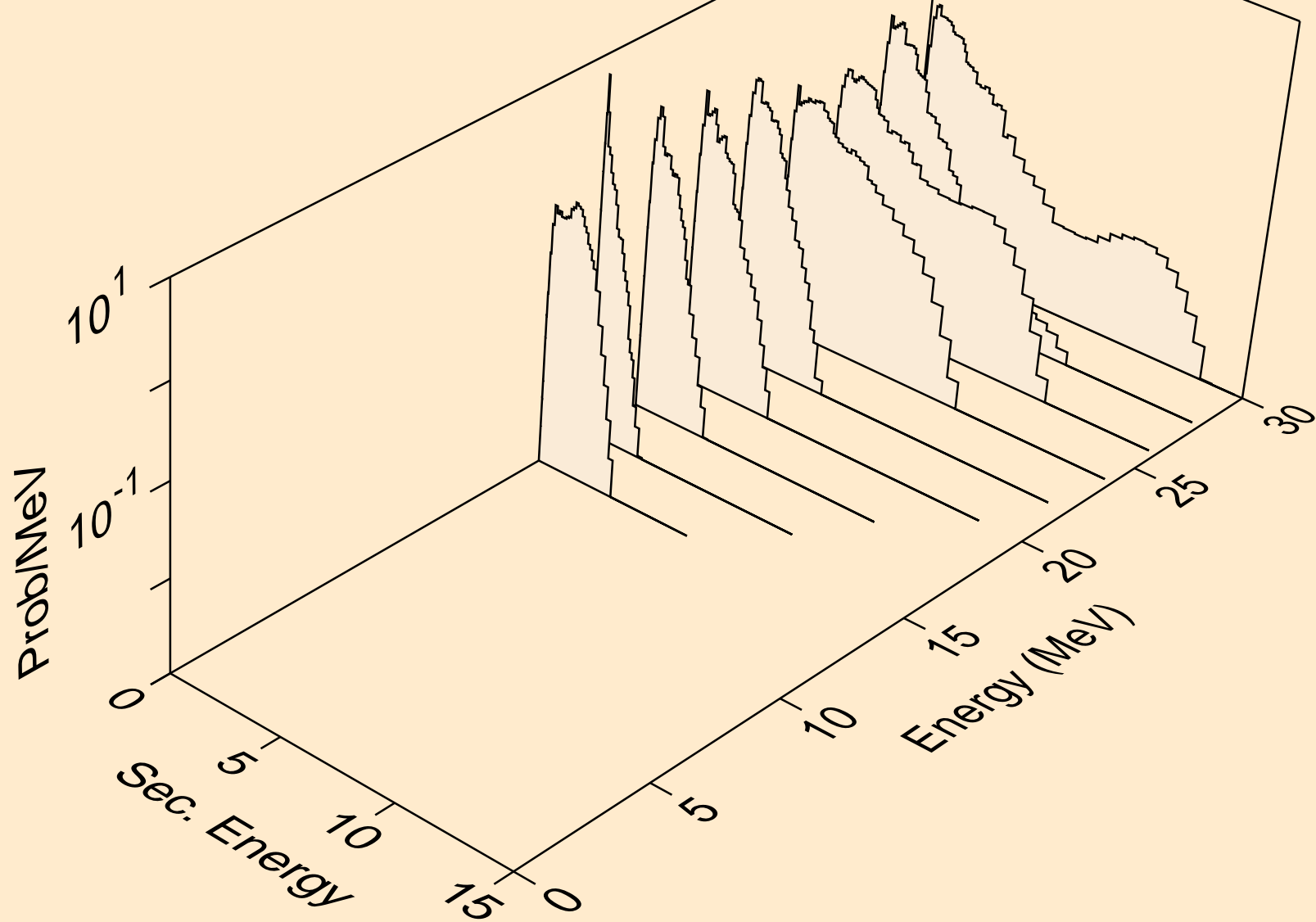

PO220 NEUTRON ACER TENDL-2021 LIBRARY; T=293.6K
Neutron emission for (n,n*)d

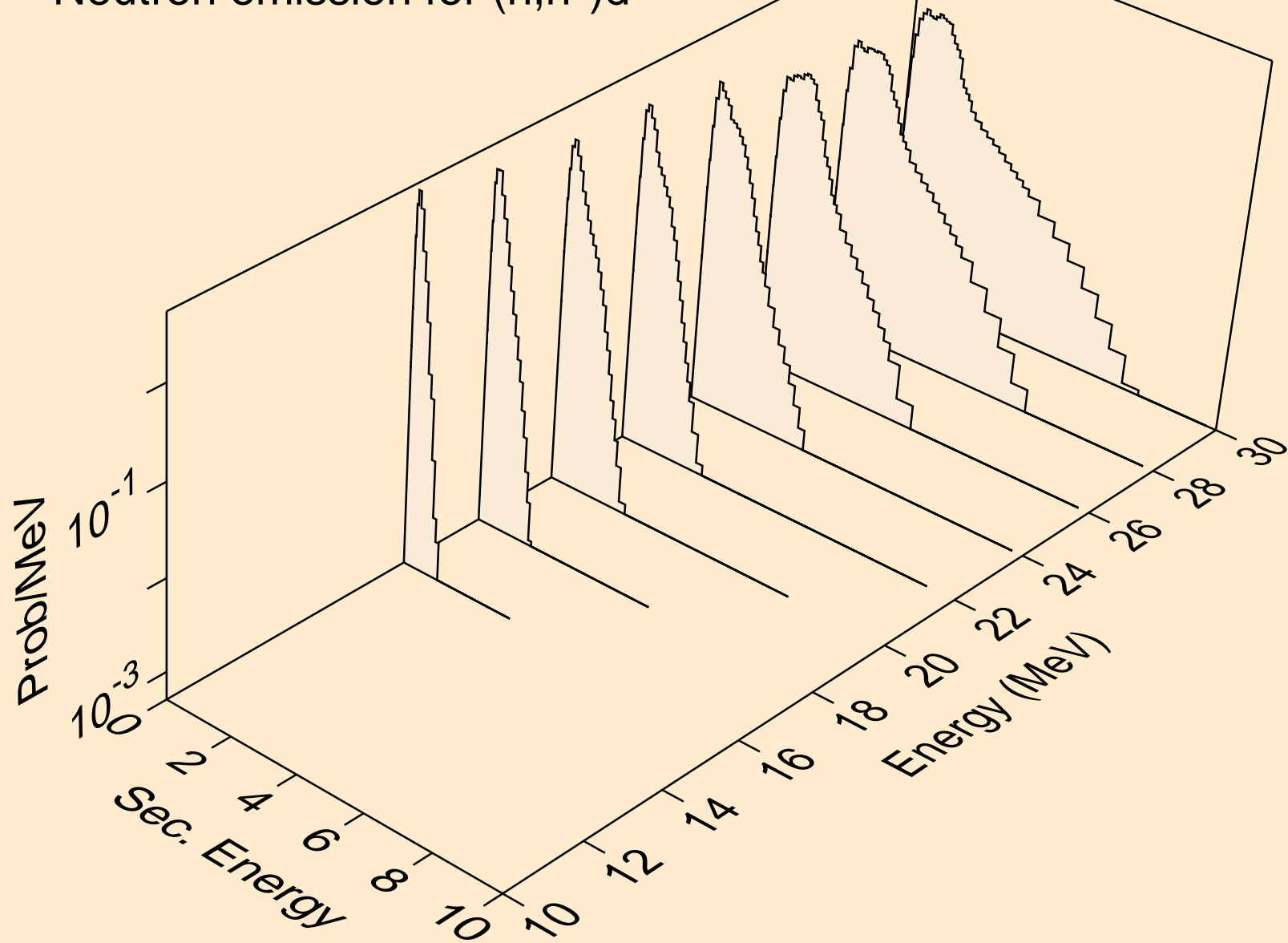

PO220 NEUTRON ACER TENDL-2021 LIBRARY; T=293.6K
Neutron emission for (n,n*)t

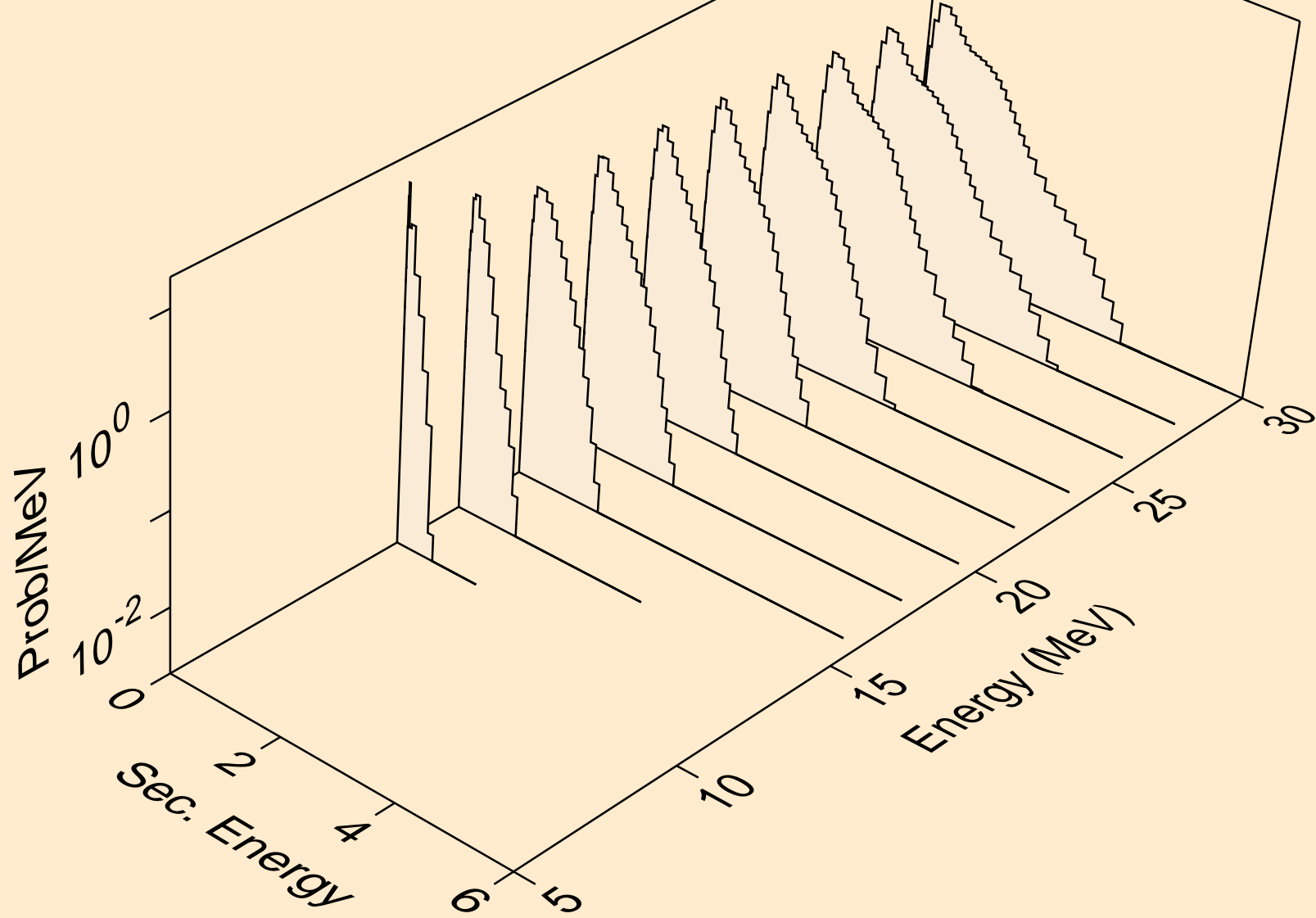

PO220 NEUTRON ACER TENDL-2021 LIBRARY; T=293.6K
Neutron emission for (n,n*)he3

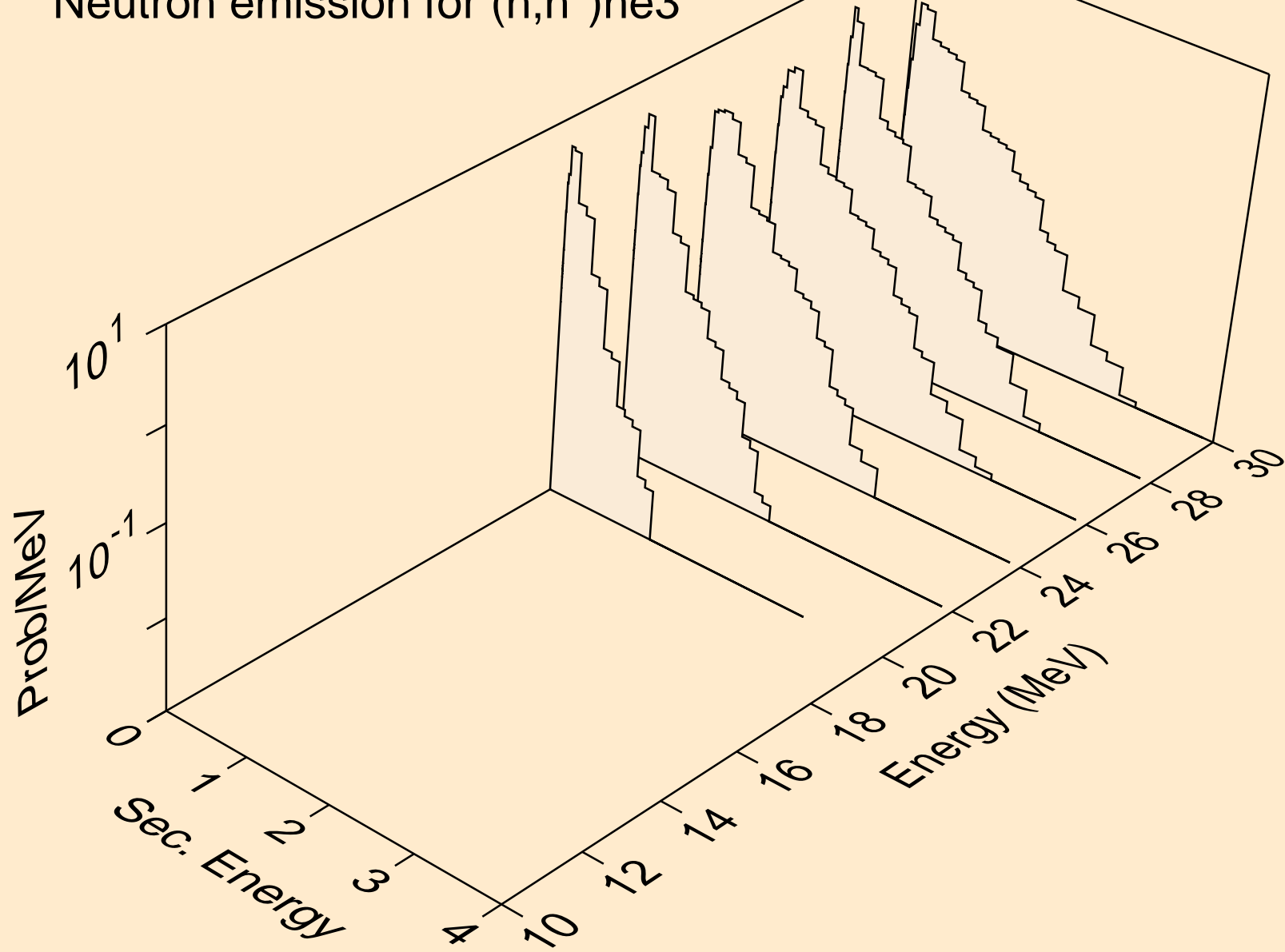

PO220 NEUTRON ACER TENDL-2021 LIBRARY; T=293.6K
Neutron emission for (n,4n)

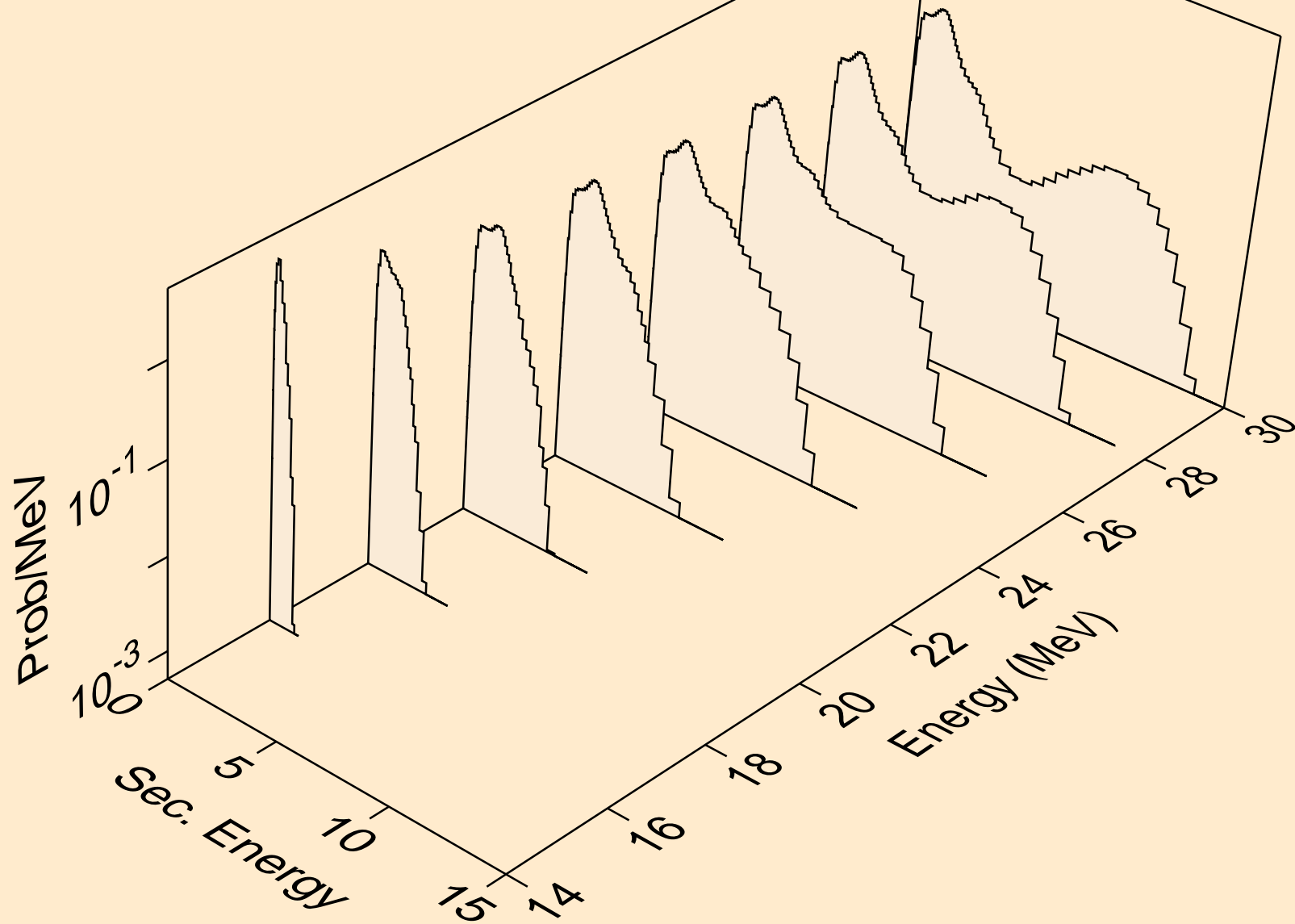

PO220 NEUTRON ACER TENDL-2021 LIBRARY; T=293.6K
Neutron emission for (n,2np)

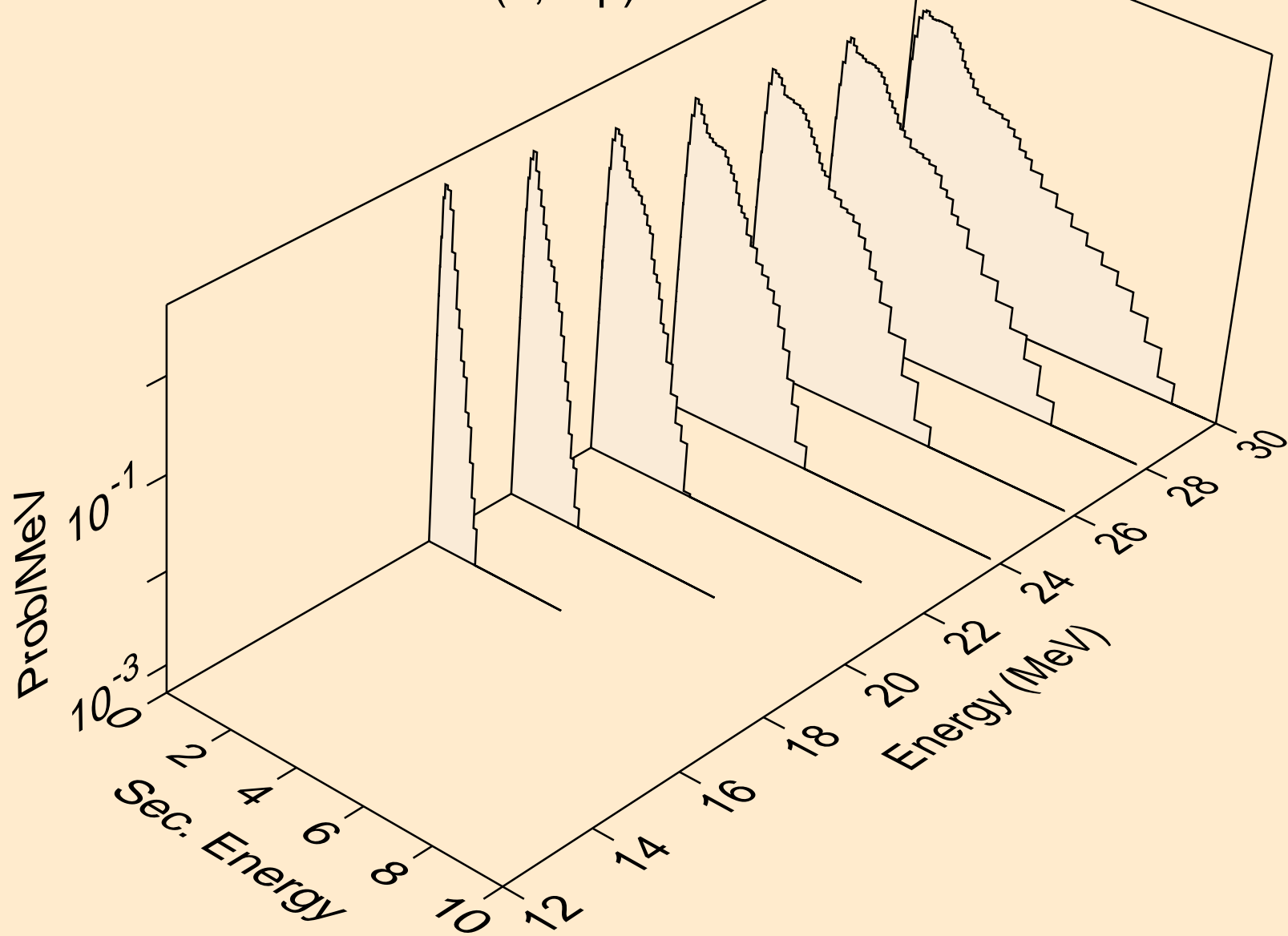

PO220 NEUTRON ACER TENDL-2021 LIBRARY; T=293.6K
Neutron emission for (n,3np)

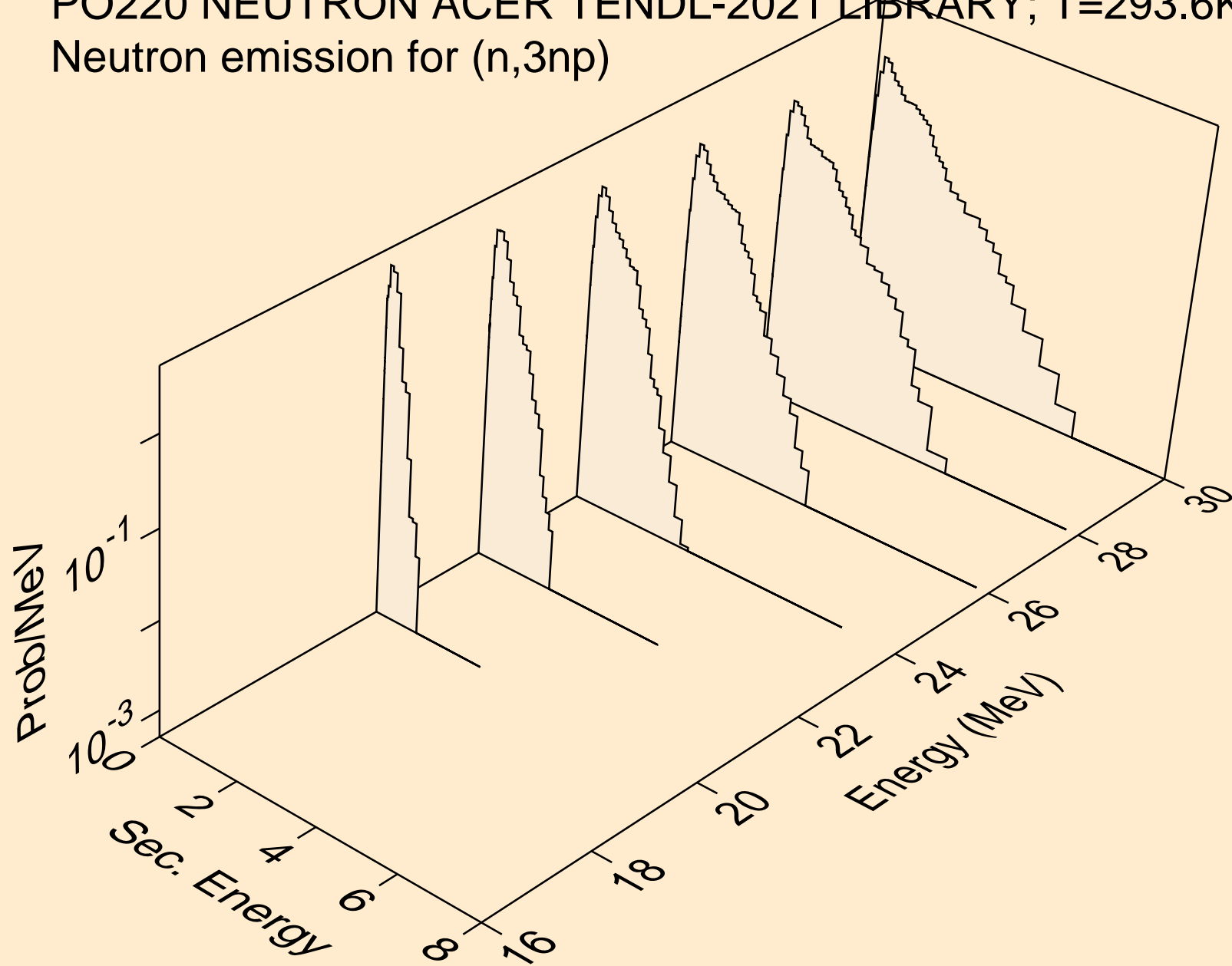

PO220 NEUTRON ACER TENDL-2021 LIBRARY; T=293.6K
Neutron emission for (n,npa)

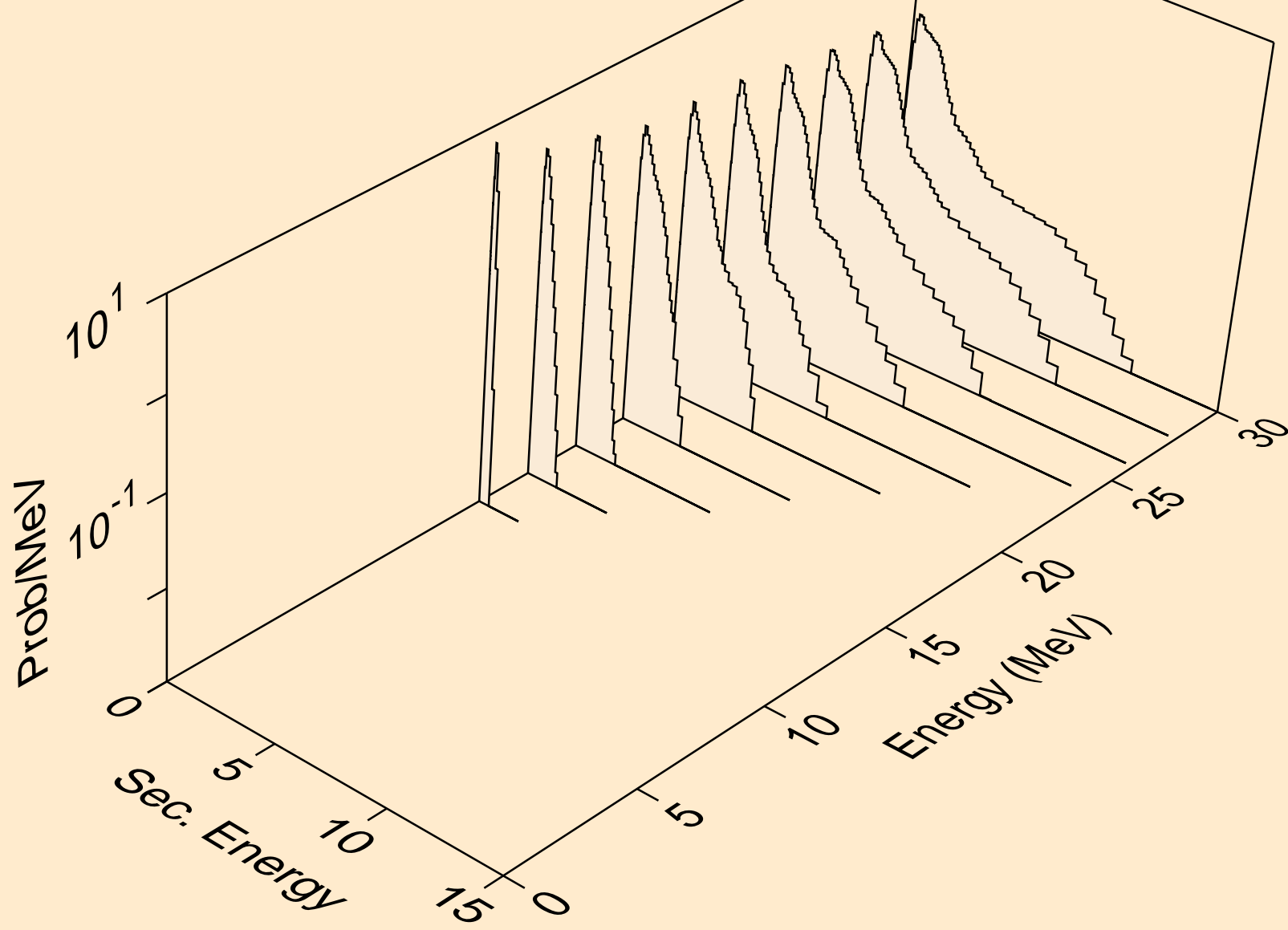

PO220 NEUTRON ACER TENDL-2021 LIBRARY; T=293.6K
Neutron emission for (n,n*c)

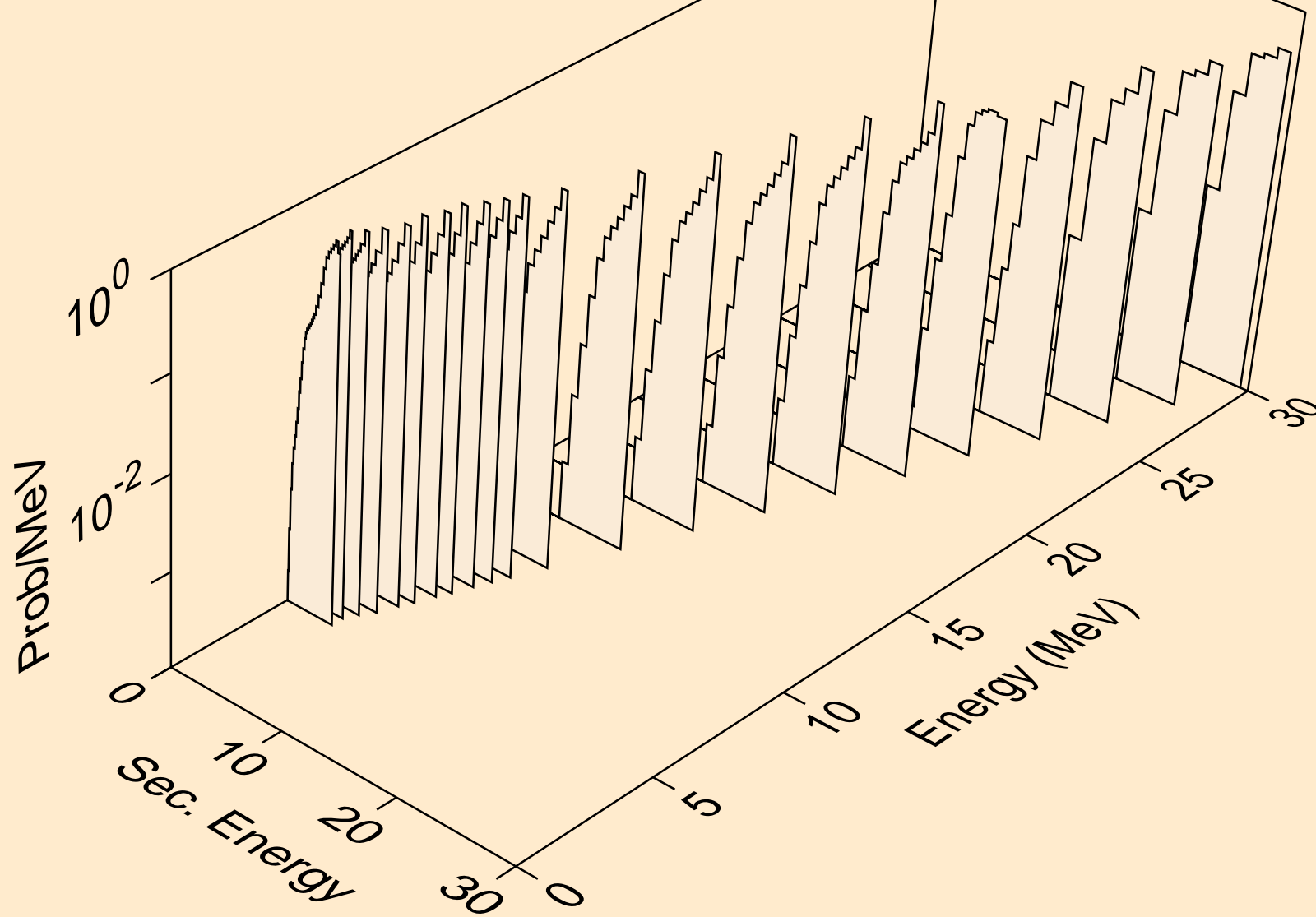

PO220 NEUTRON ACER TENDL-2021 LIBRARY; T=293.6K
Delayed nubar

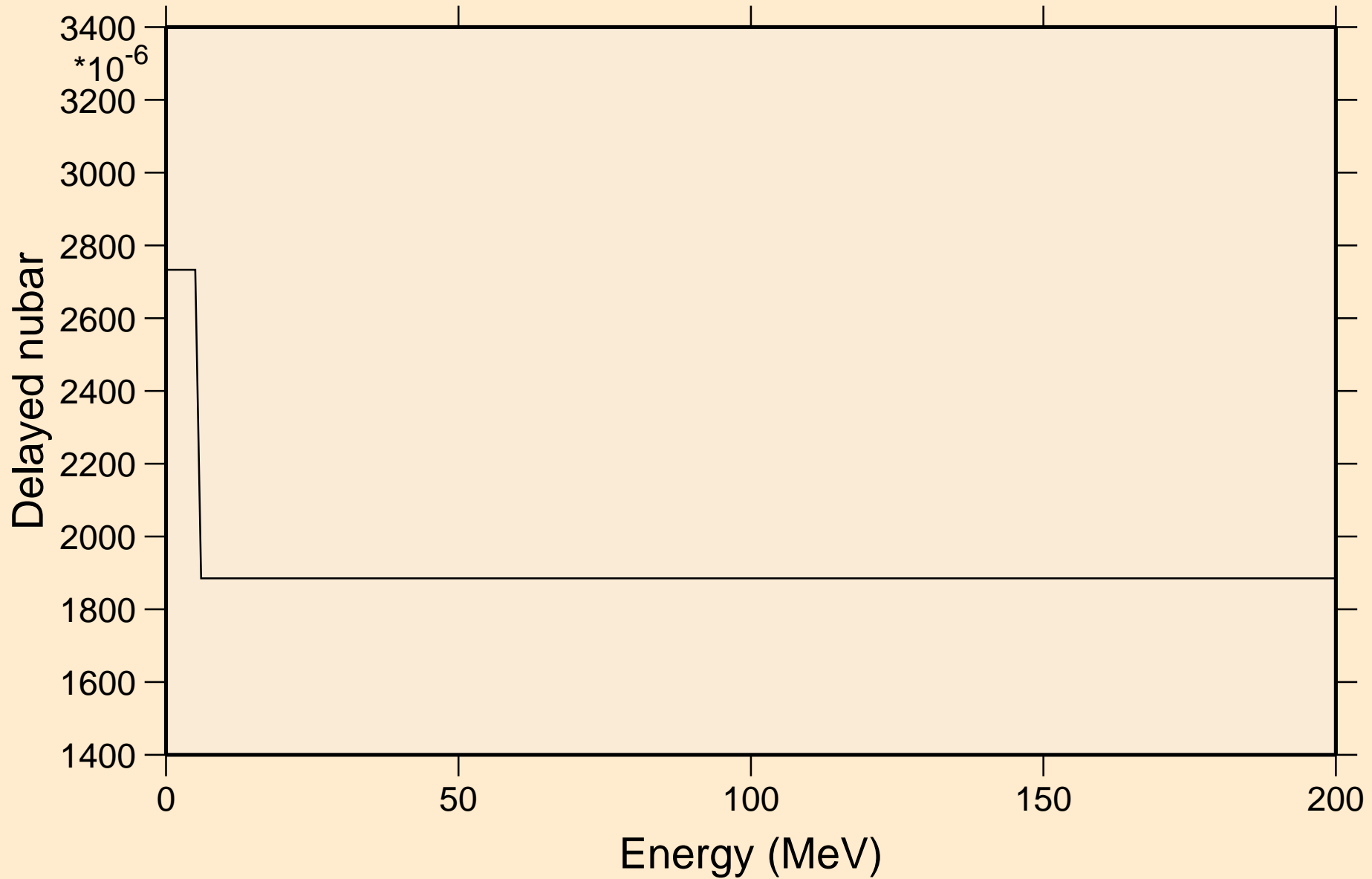

PO220 NEUTRON ACER TENDL-2021 LIBRARY; T=293.6K

Delayed neutron spectra

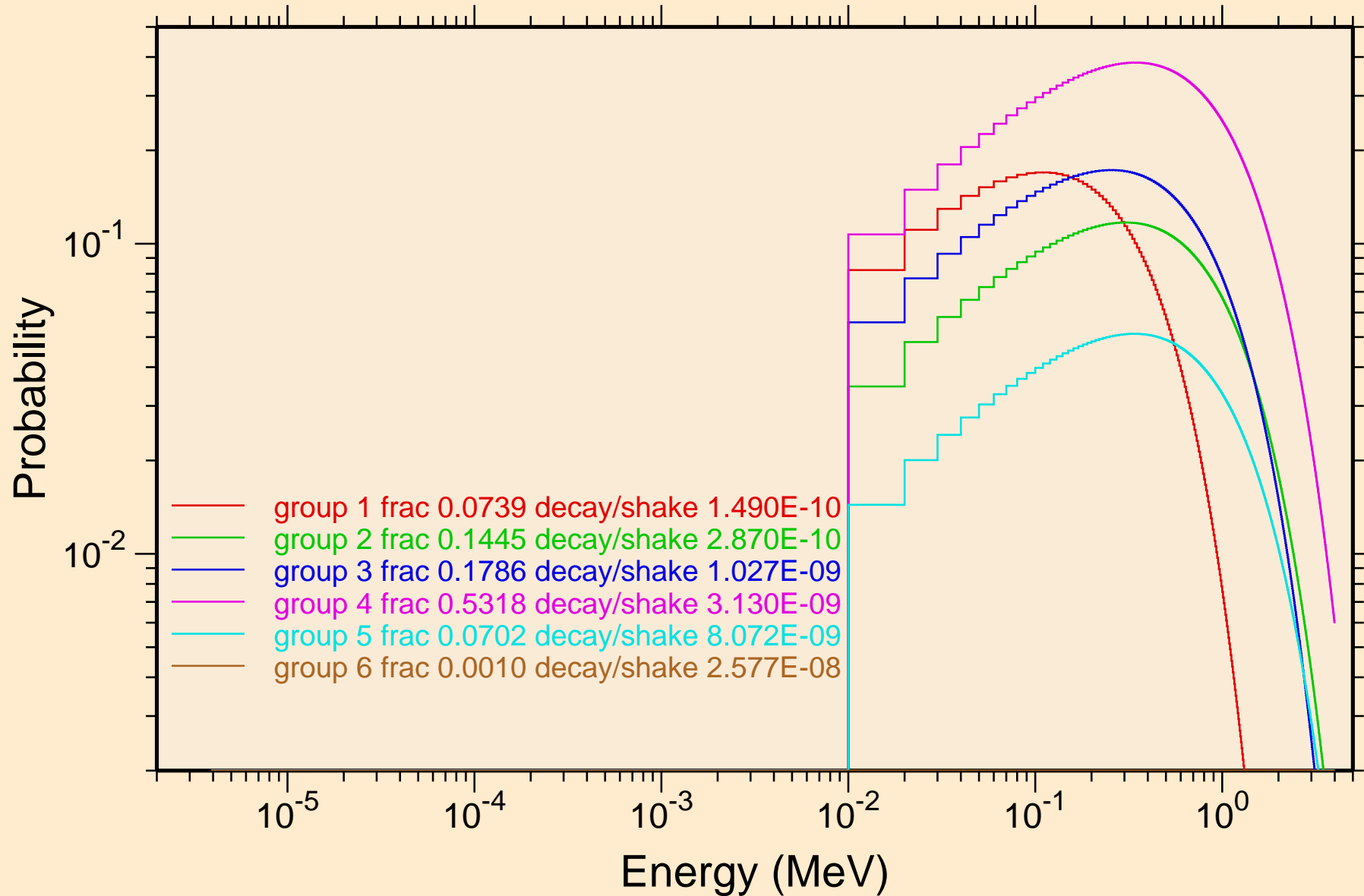

PO220 NEUTRON ACER TENDL-2021 LIBRARY; T=293.6K
Photon emission for (n,x)

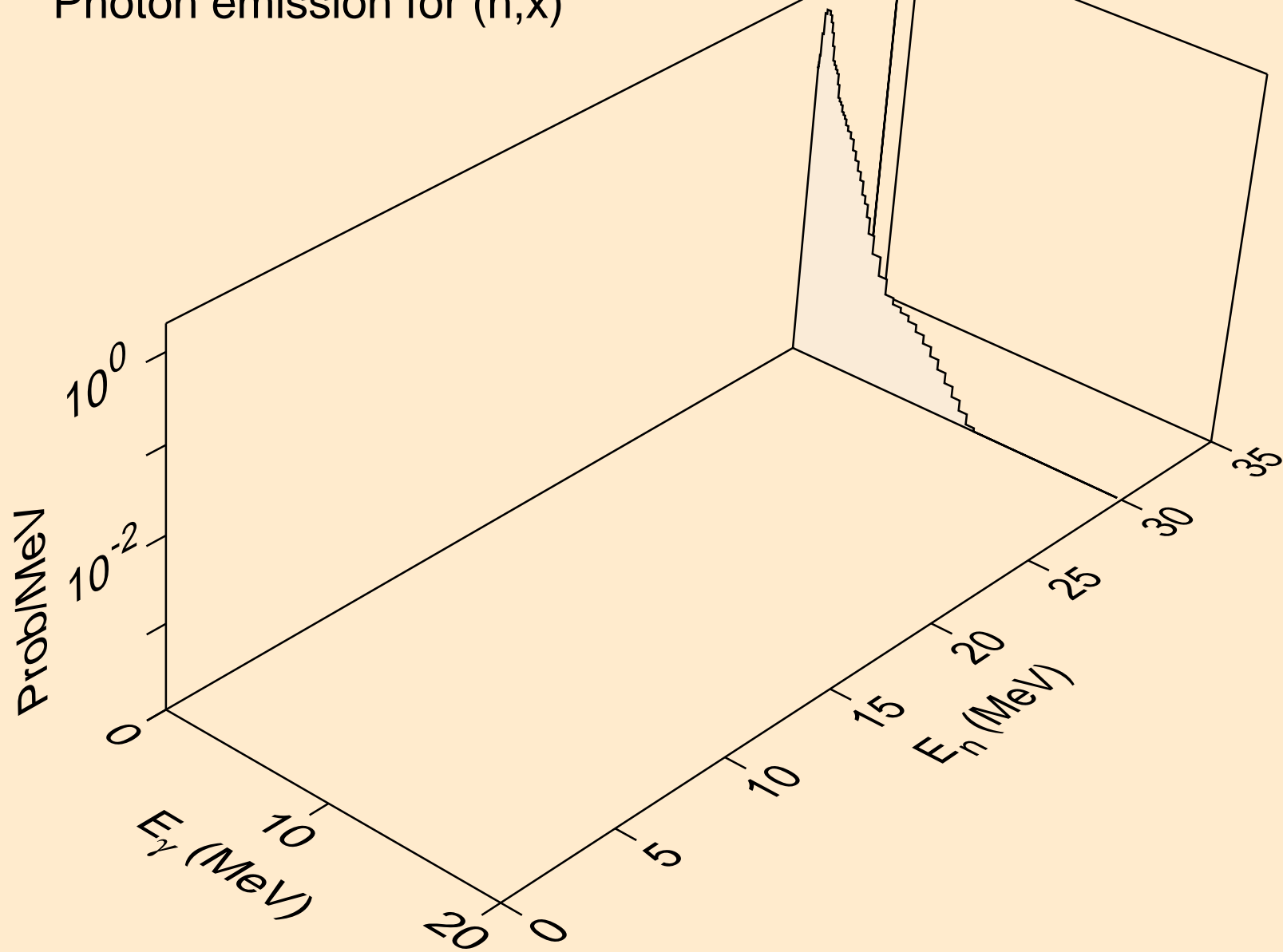

PO220 NEUTRON ACER TENDL-2021 LIBRARY; T=293.6K
Photon emission for (n,2nd)

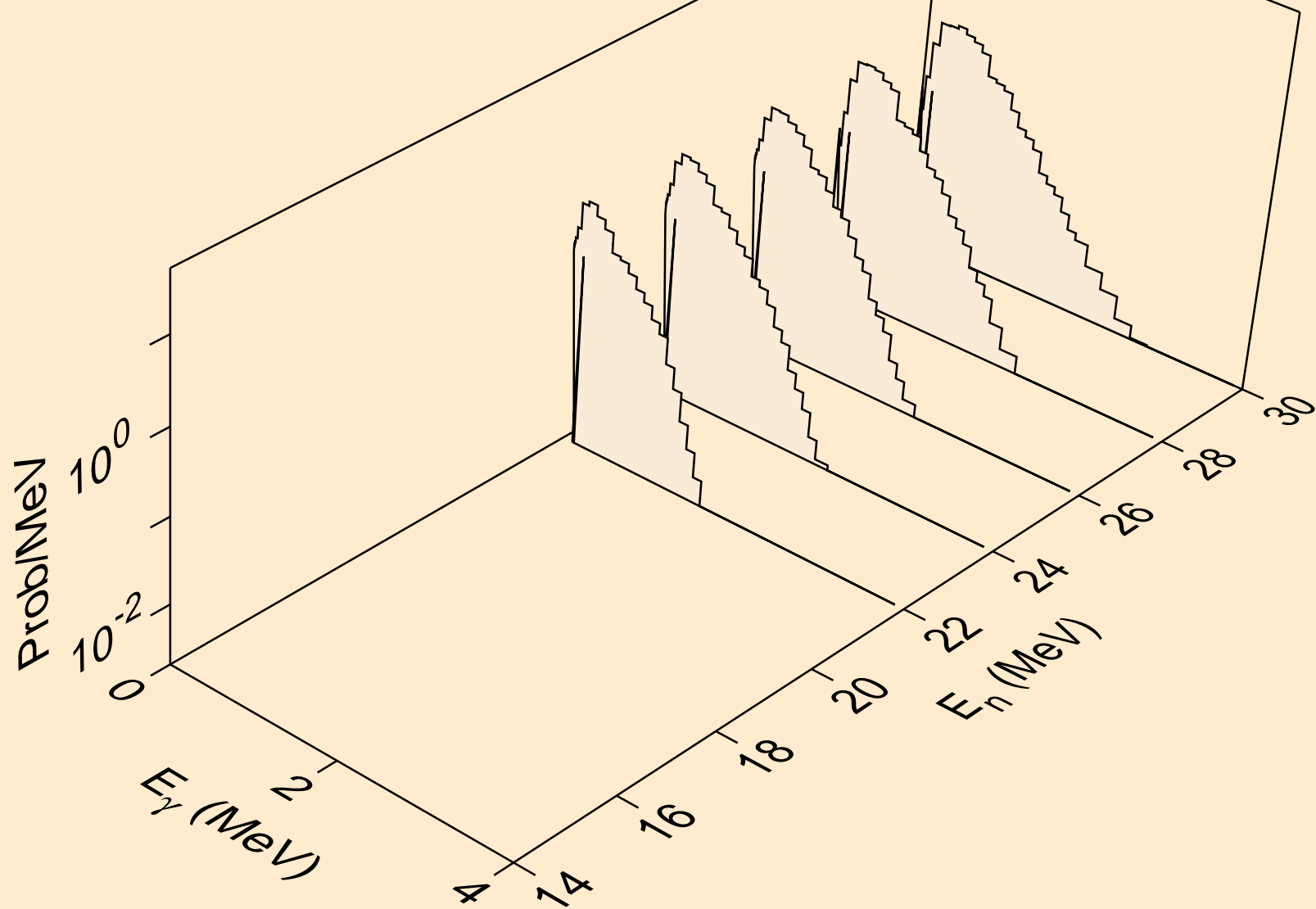

PO220 NEUTRON ACER TENDL-2021 LIBRARY; T=293.6K
Photon emission for (n,2n)

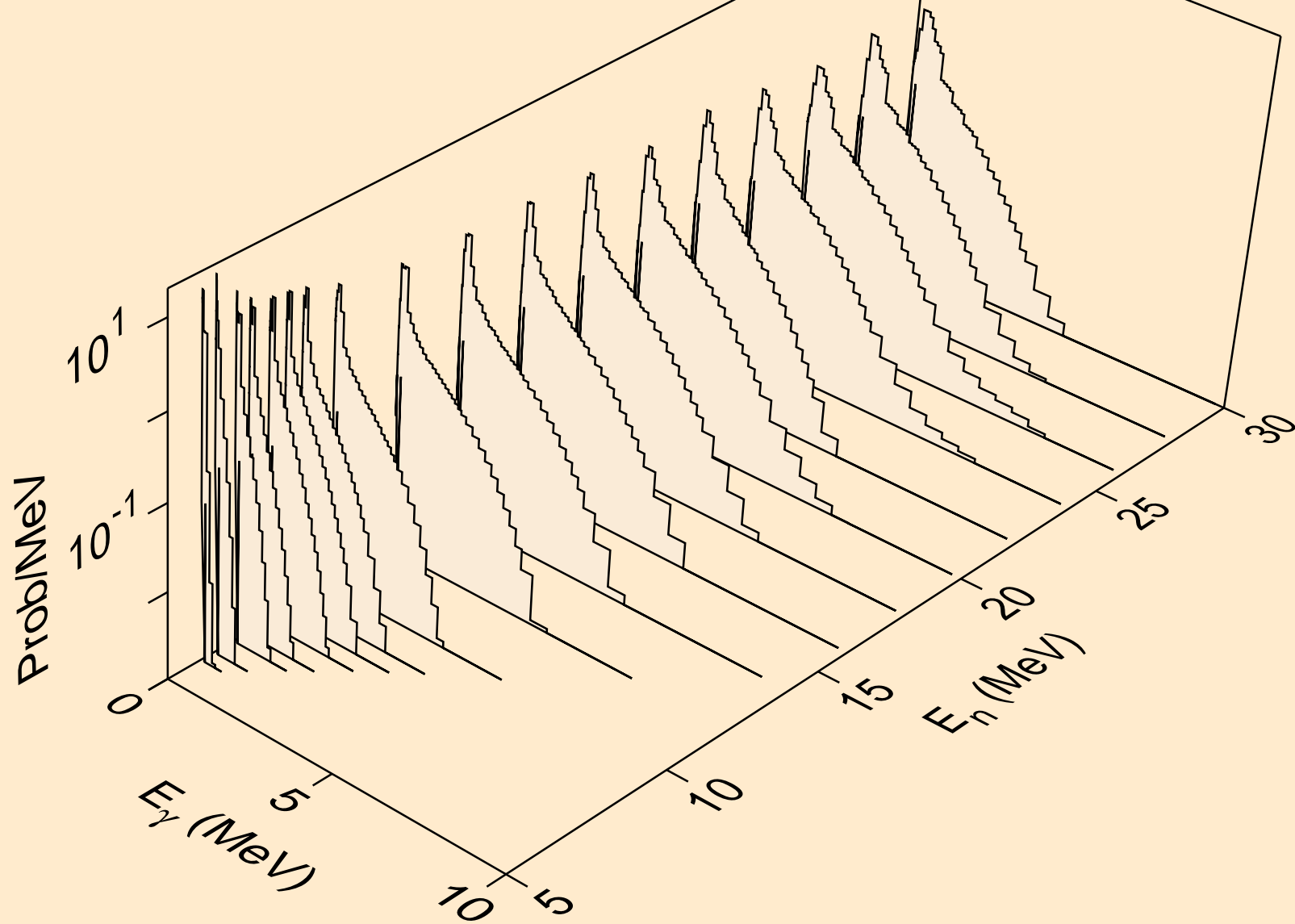

PO220 NEUTRON ACER TENDL-2021 LIBRARY; T=293.6K
Photon emission for (n,3n)

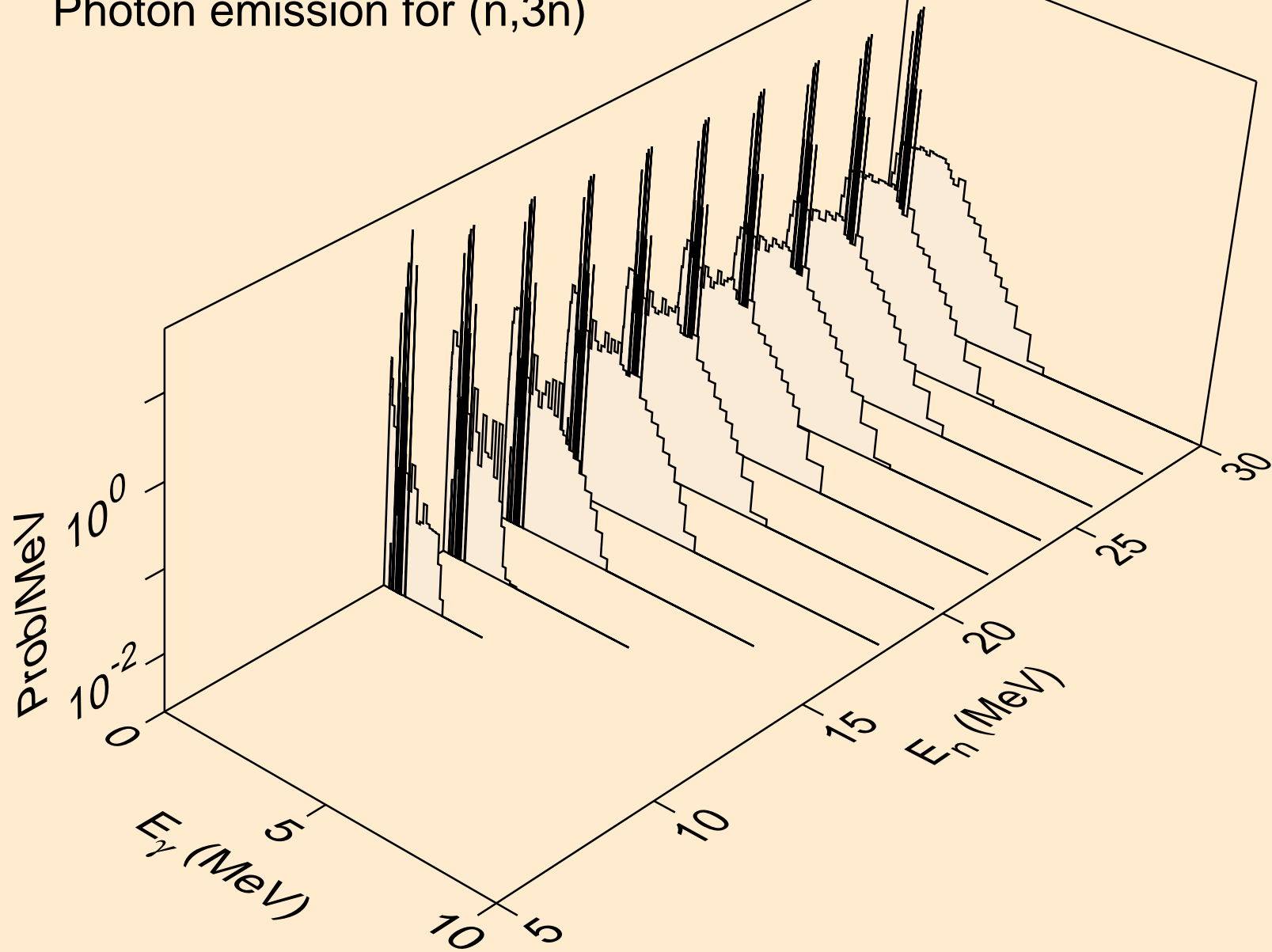

PO220 NEUTRON ACER TENDL-2021 LIBRARY; T=293.6K
Photon emission for (n,n*)a

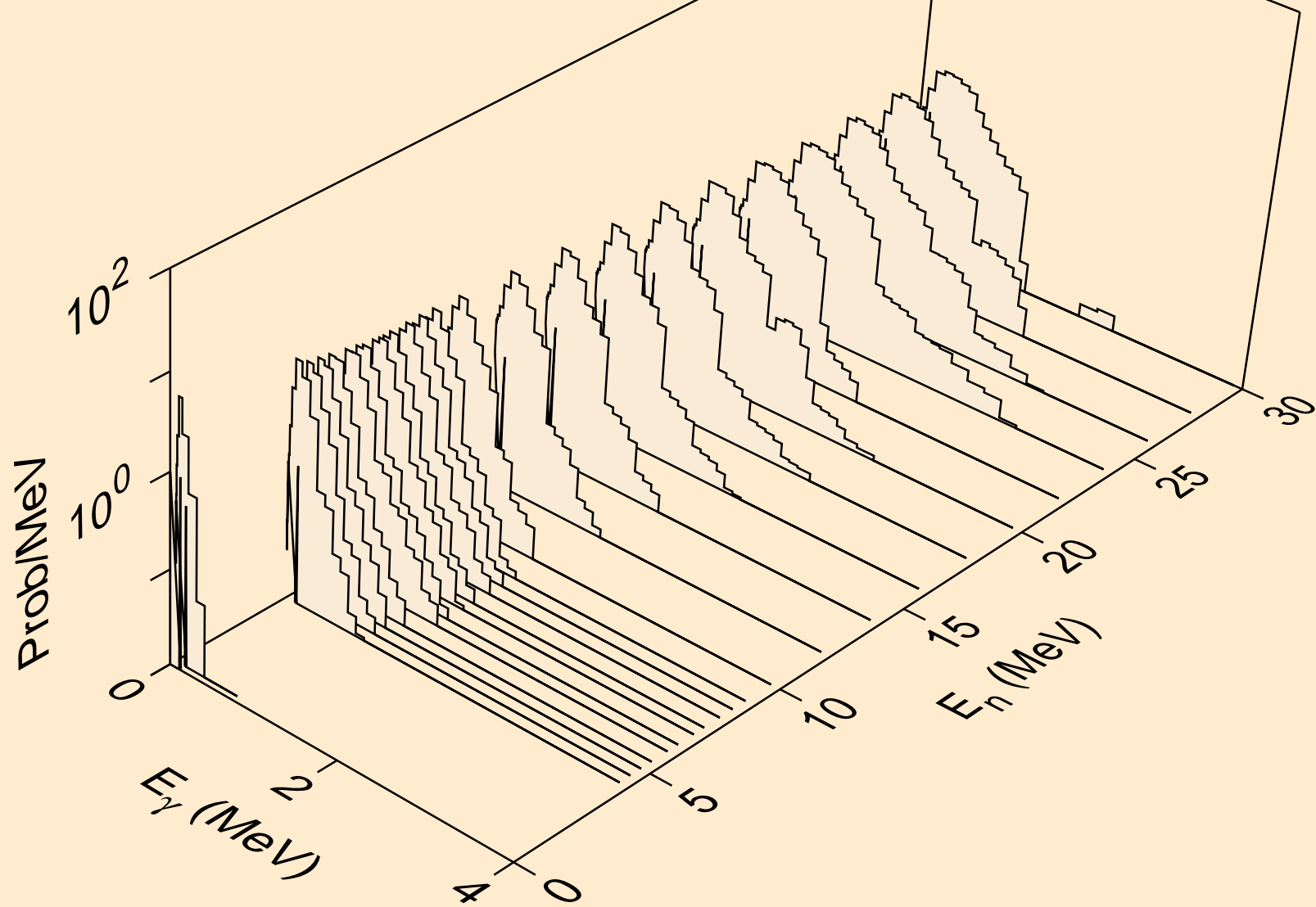

PO220 NEUTRON ACER TENDL-2021 LIBRARY; T=293.6K
Photon emission for (n,2n)a

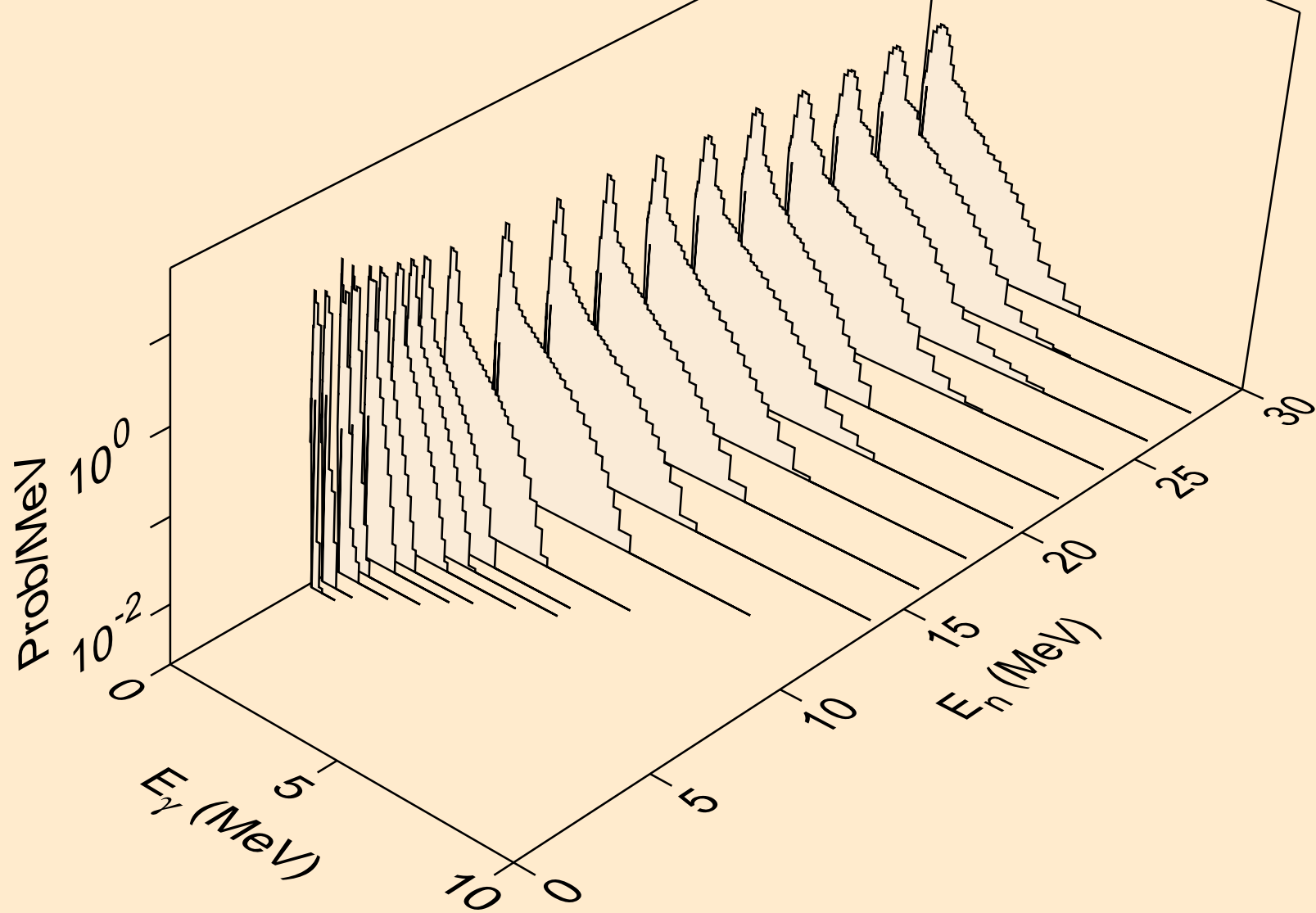

PO220 NEUTRON ACER TENDL-2021 LIBRARY; T=293.6K
Photon emission for (n,3n)a

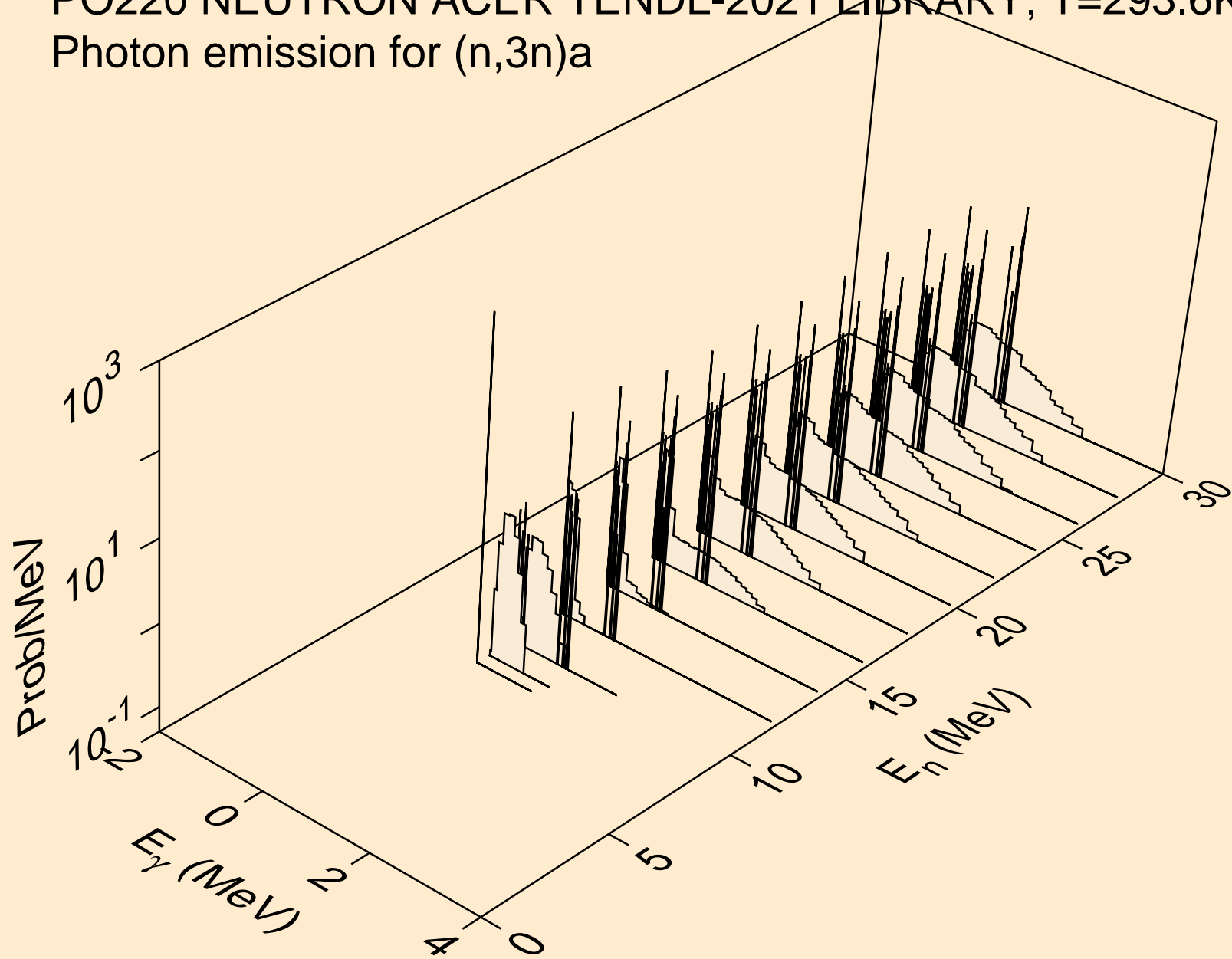

PO220 NEUTRON ACER TENDL-2021 LIBRARY; T=293.6K
Photon emission for (n,n*)p

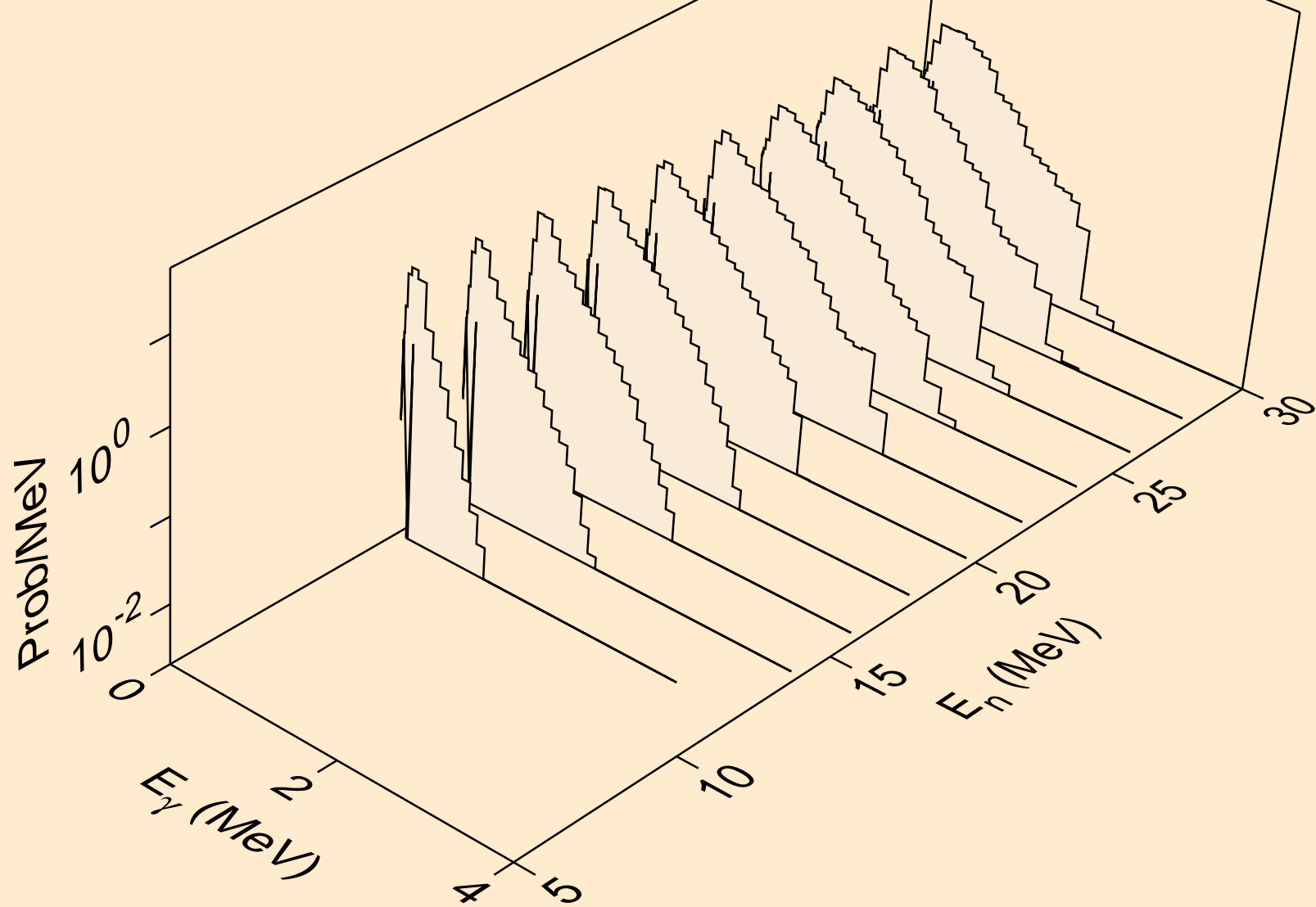

PO220 NEUTRON ACER TENDL-2021 LIBRARY; T=293.6K
Photon emission for (n,n*)2a

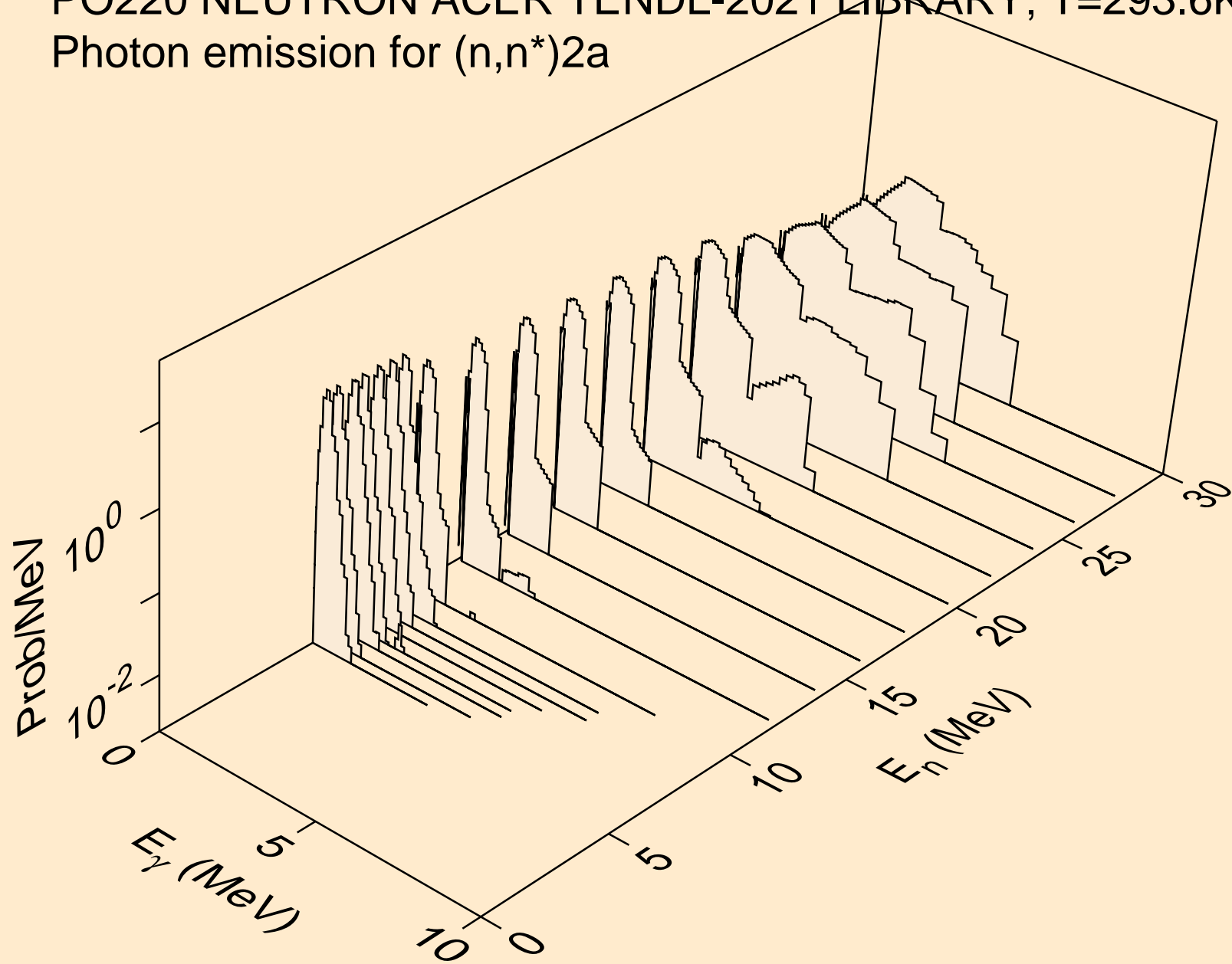

PO220 NEUTRON ACER TENDL-2021 LIBRARY; T=293.6K
Photon emission for (n,2n)2a

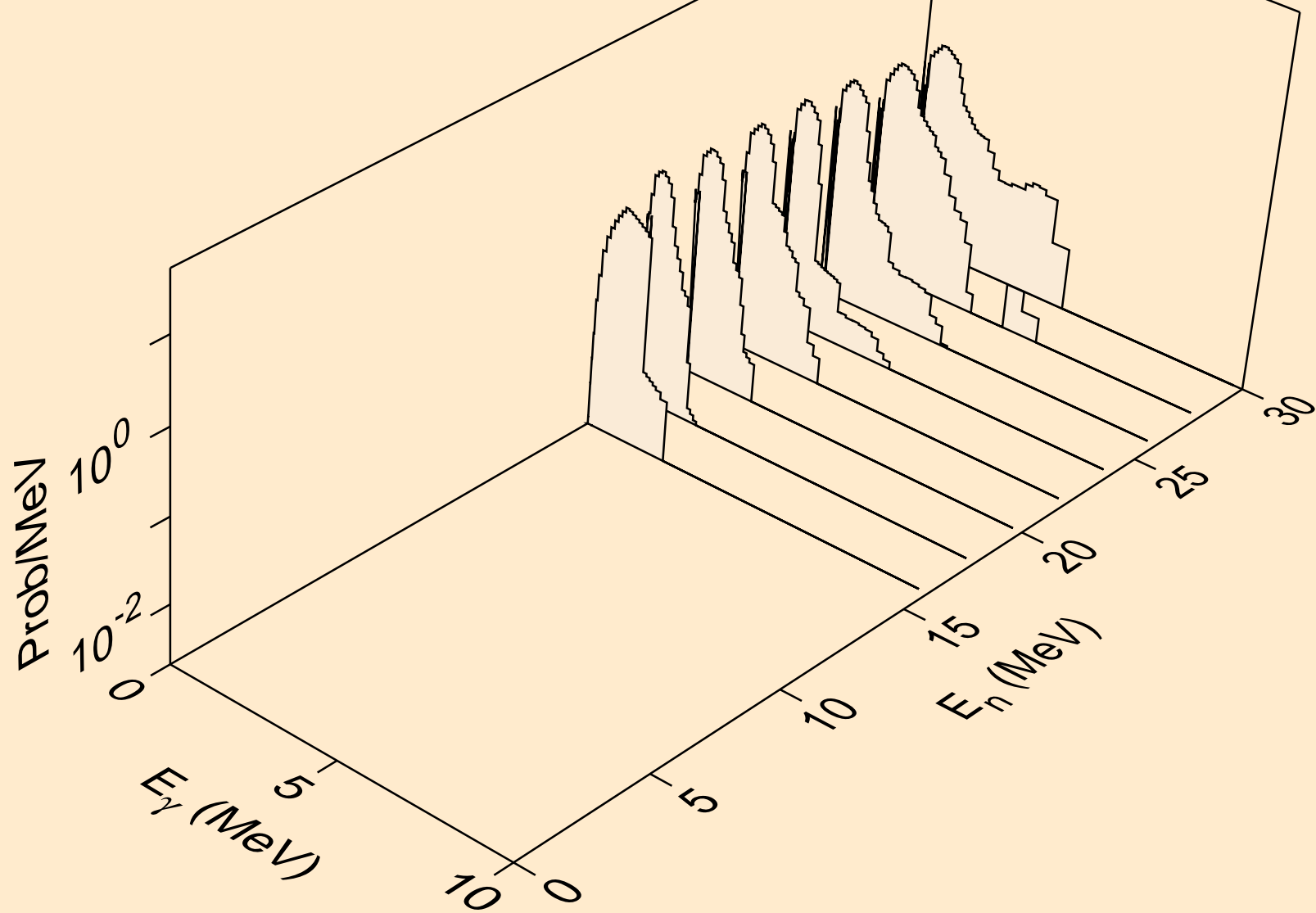

PO220 NEUTRON ACER TENDL-2021 LIBRARY; T=293.6K
Photon emission for (n,n*)d

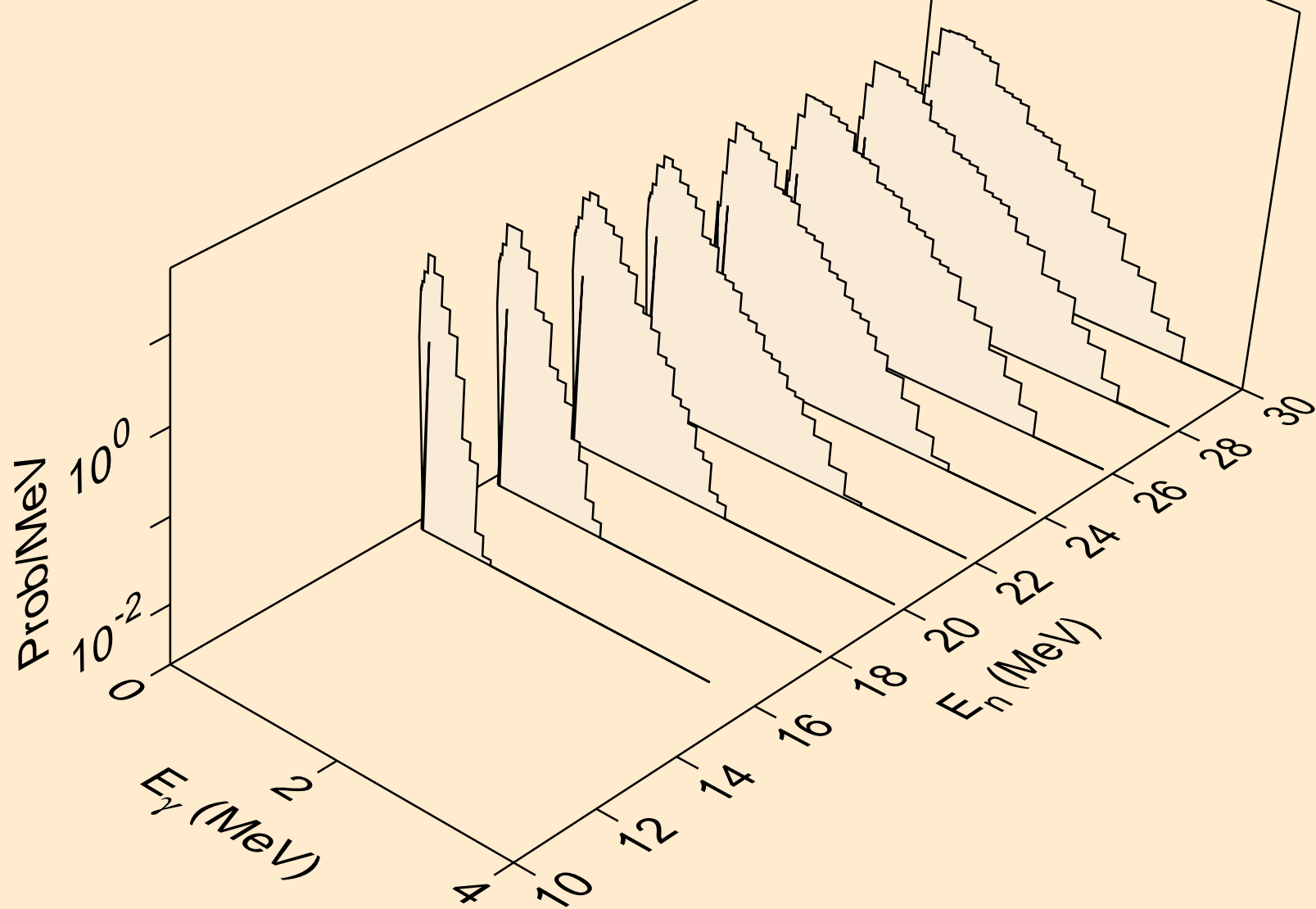

PO220 NEUTRON ACER TENDL-2021 LIBRARY; T=293.6K
Photon emission for (n,n*)t

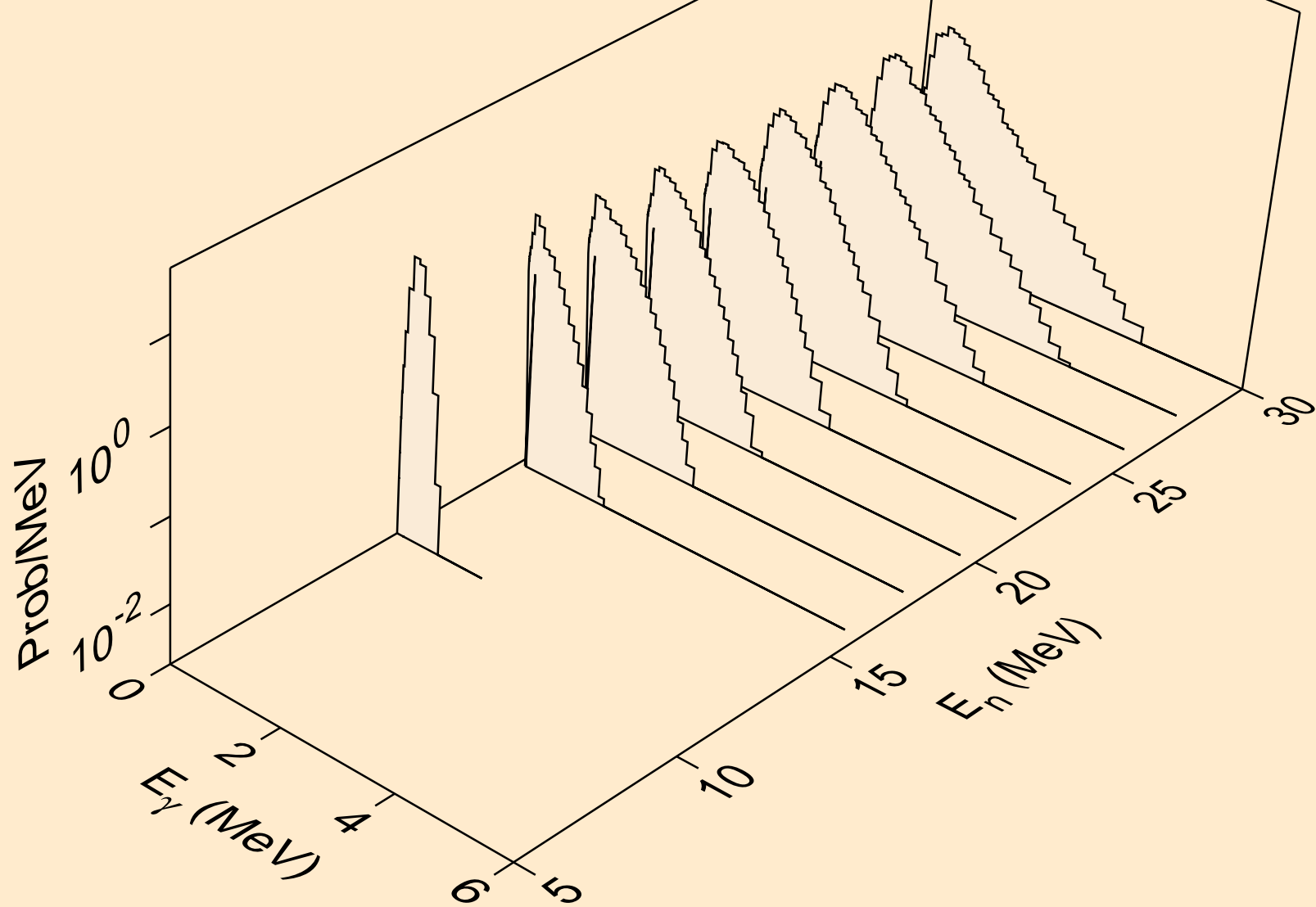

PO220 NEUTRON ACER TENDL-2021 LIBRARY; T=293.6K
Photon emission for (n,n*)he3

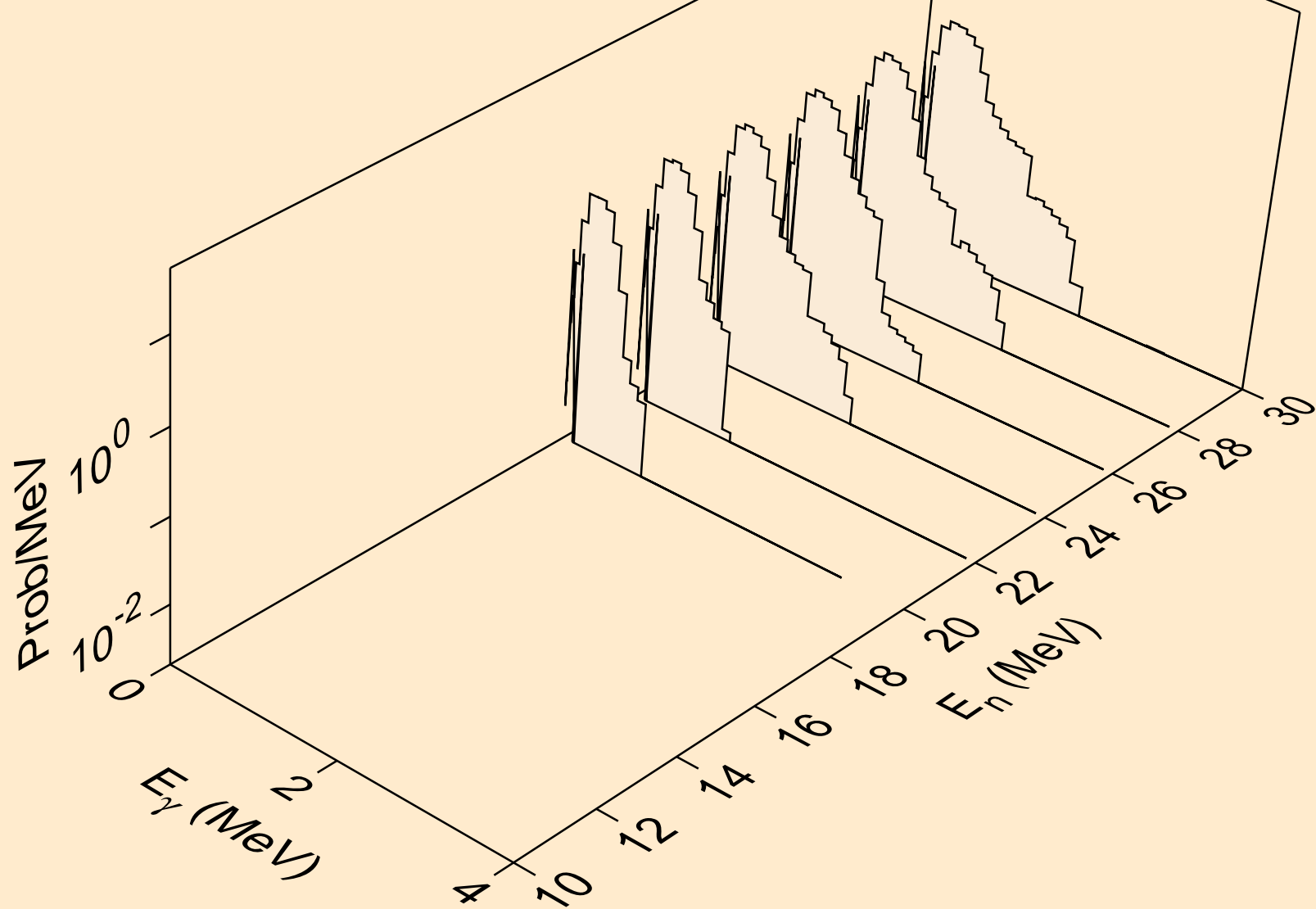

PO220 NEUTRON ACER TENDL-2021 LIBRARY; T=293.6K
Photon emission for (n,4n)

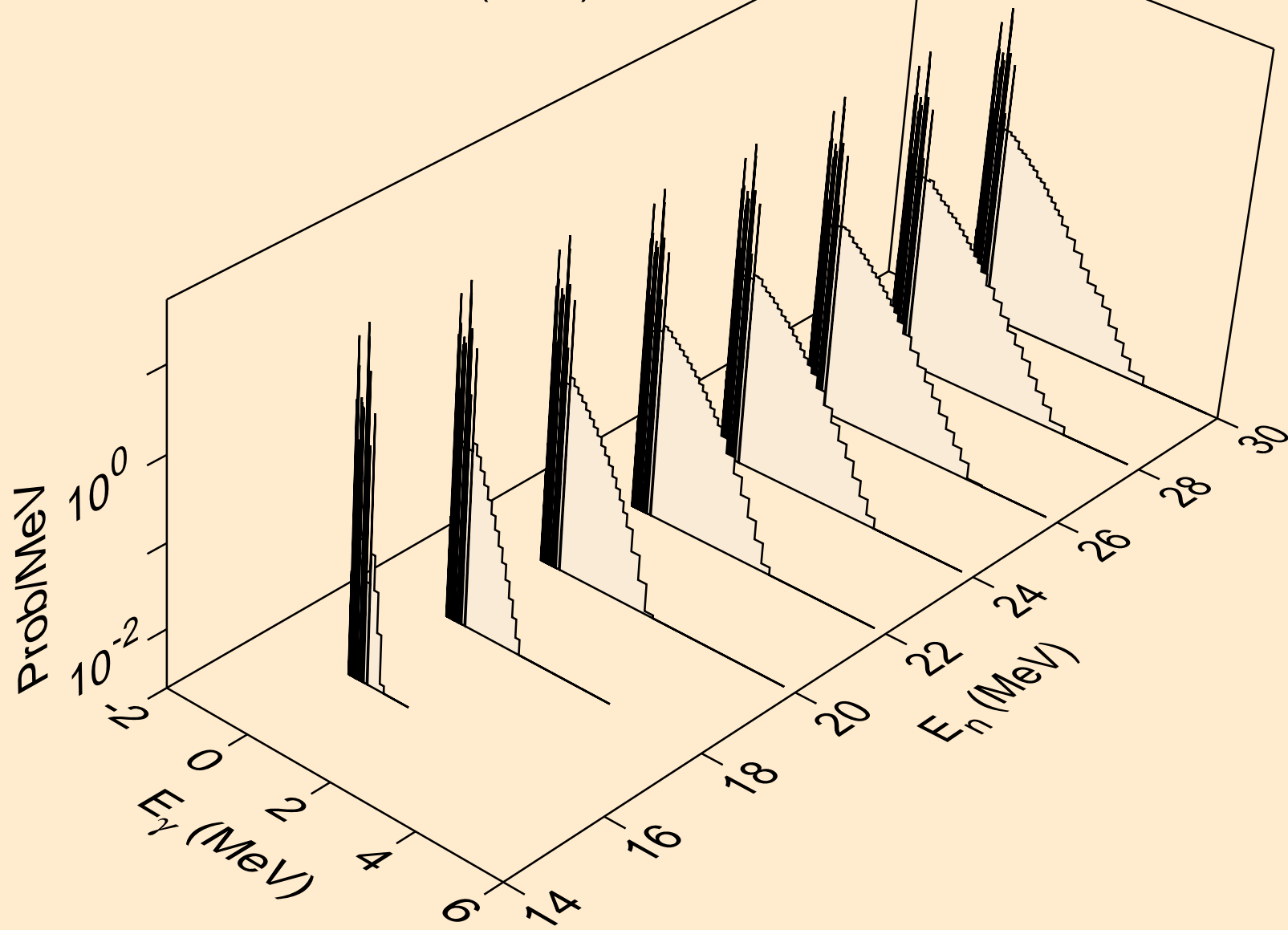

PO220 NEUTRON ACER TENDL-2021 LIBRARY; T=293.6K
Photon emission for (n,2np)

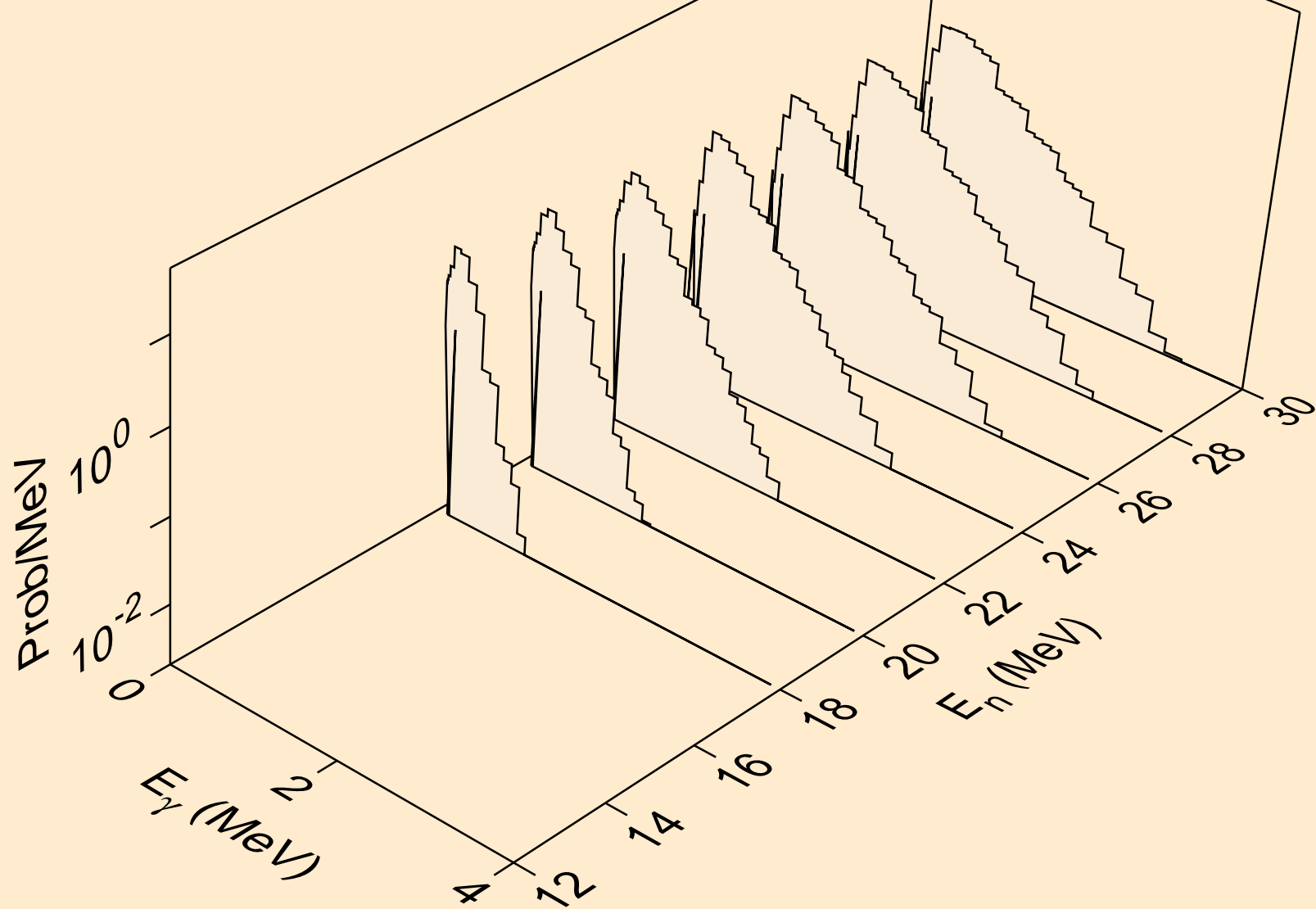

PO220 NEUTRON ACER TENDL-2021 LIBRARY; T=293.6K
Photon emission for (n,3np)

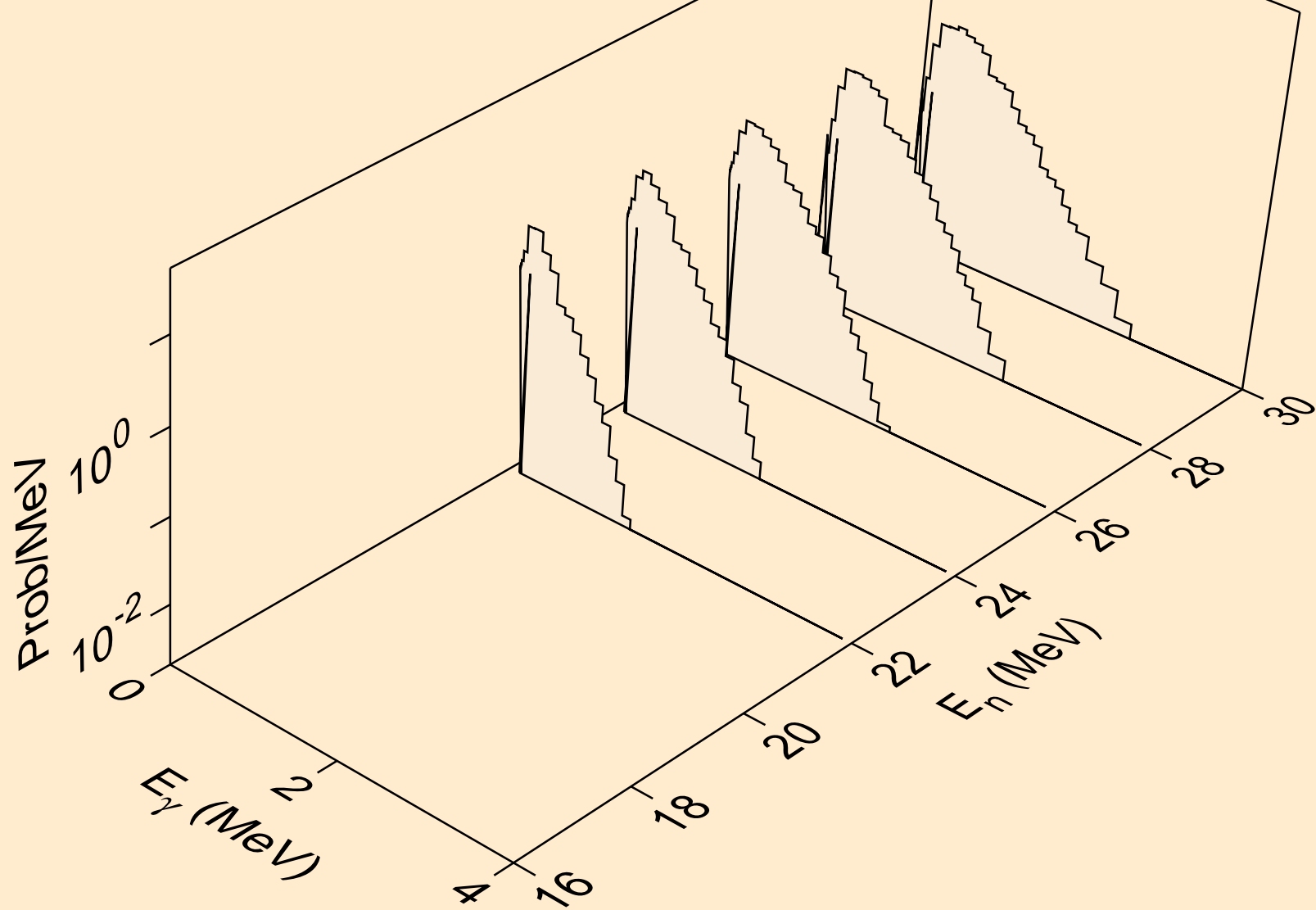

PO220 NEUTRON ACER TENDL-2021 LIBRARY; T=293.6K
Photon emission for (n,npa)

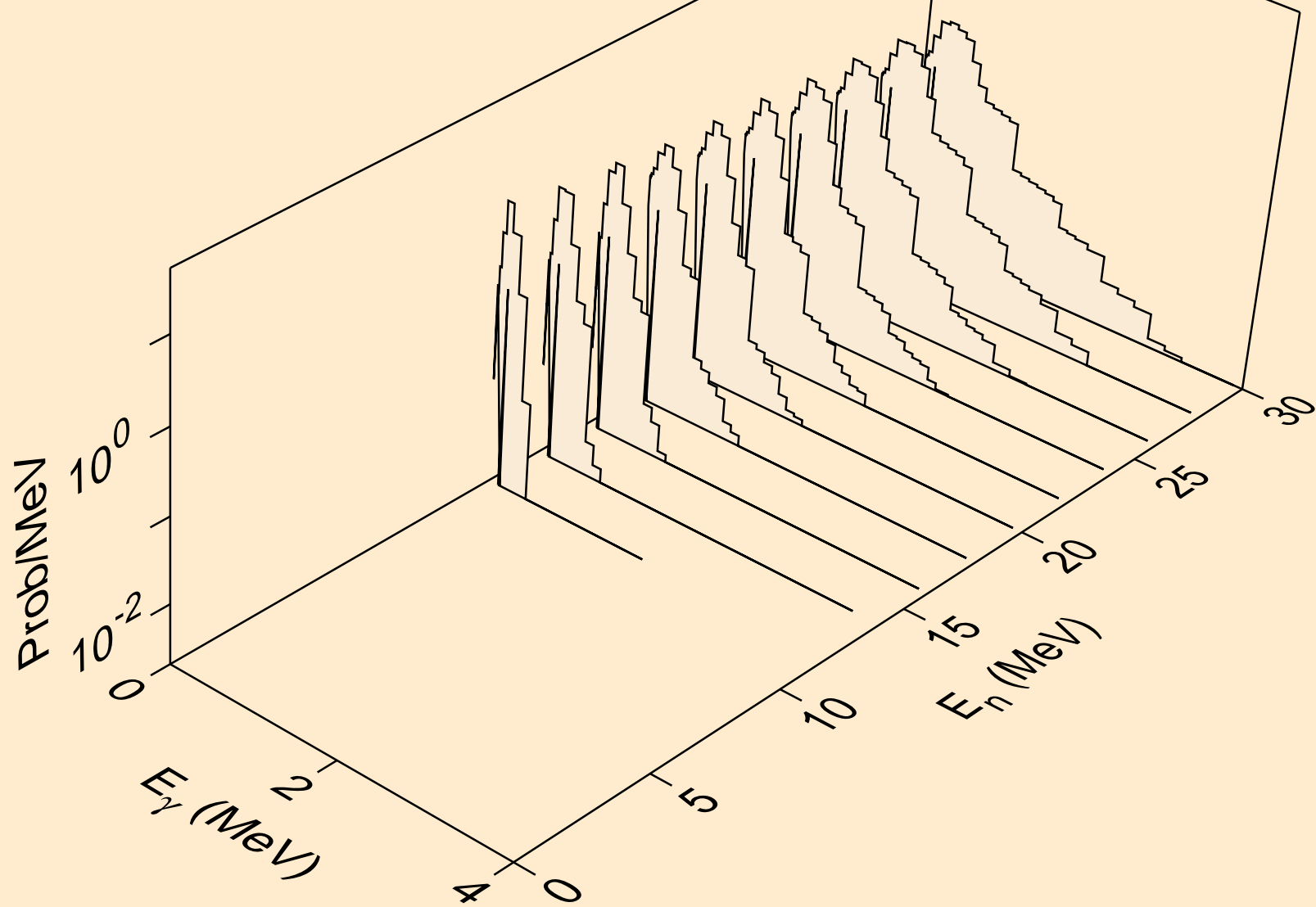

PO220 NEUTRON ACER TENDL-2021 LIBRARY; T=293.6K
Photon emission for (n,n*c)

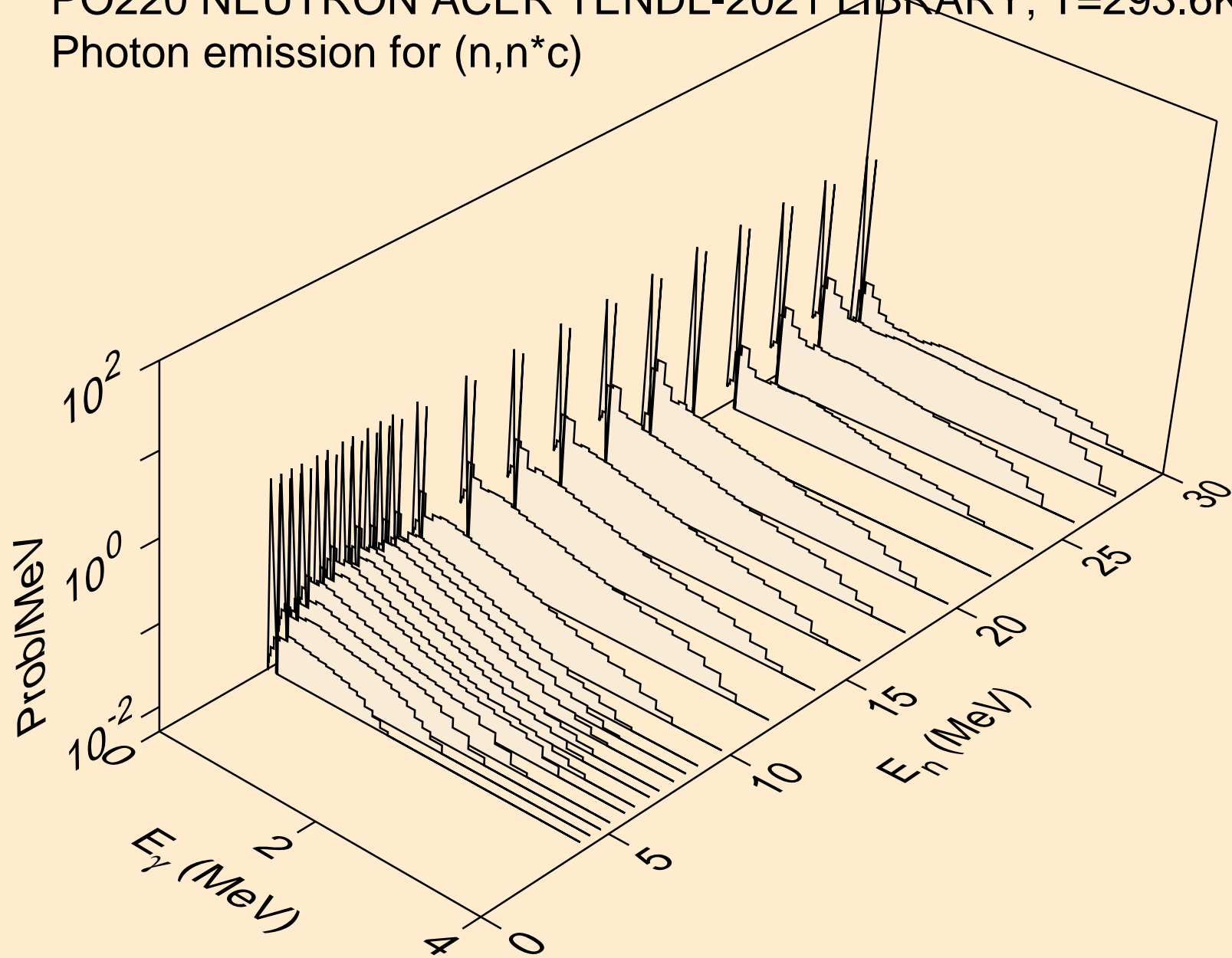

PO220 NEUTRON ACER TENDL-2021 LIBRARY; T=293.6K
Photon emission for (n,gma)

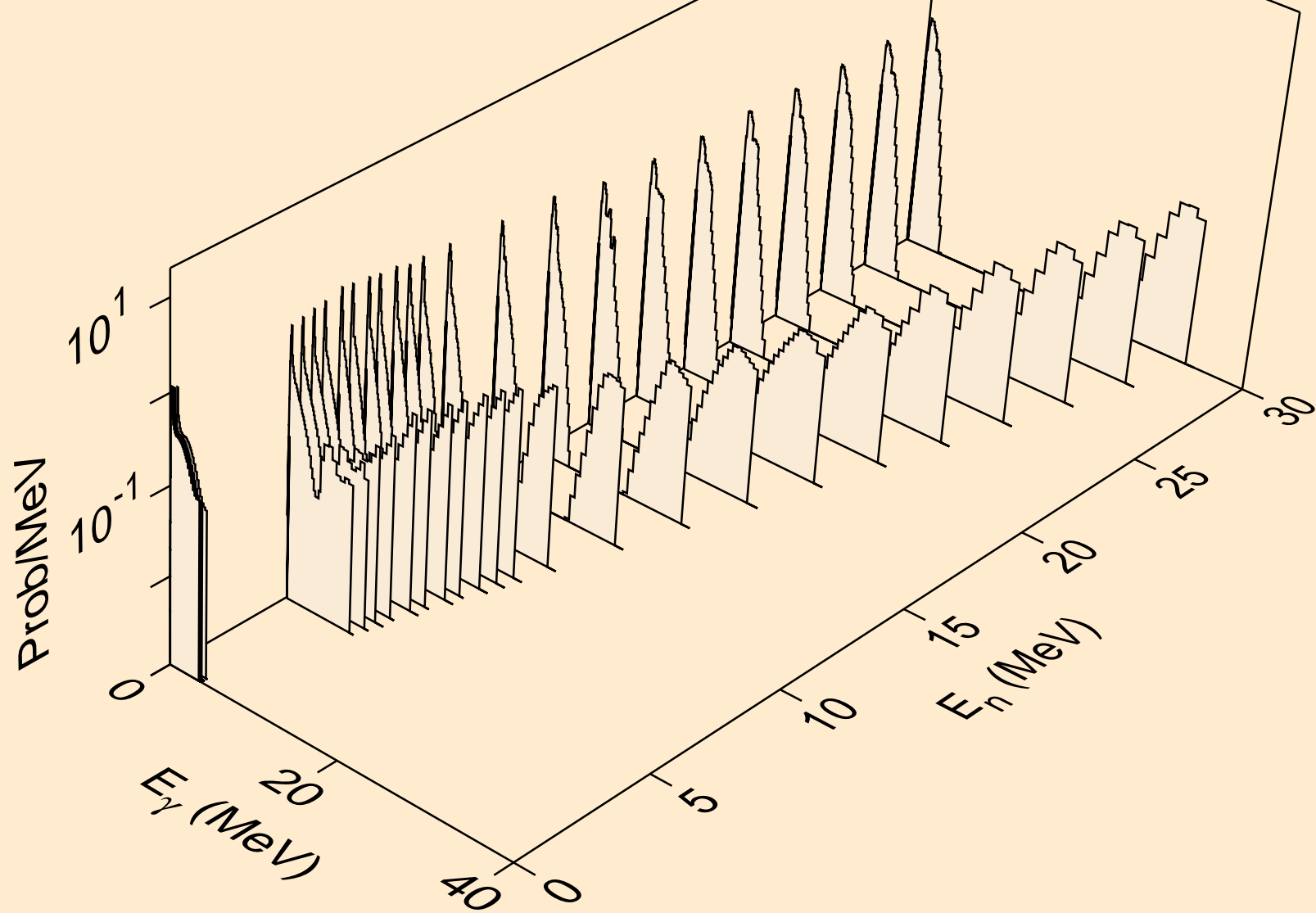

PO220 NEUTRON ACER TENDL-2021 LIBRARY; T=293.6K
Photon emission for (n,p)

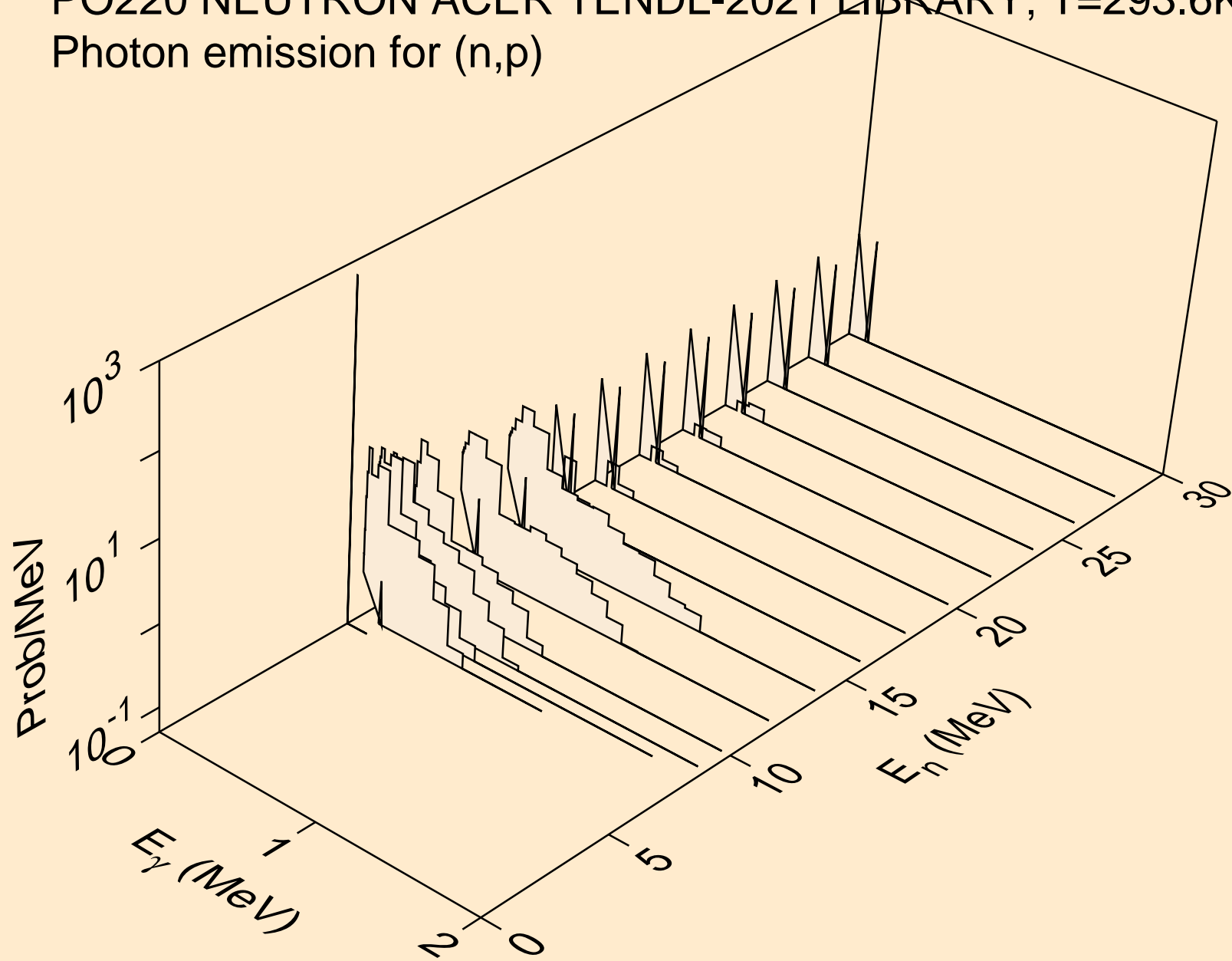

PO220 NEUTRON ACER TENDL-2021 LIBRARY; T=293.6K
Photon emission for (n,d)

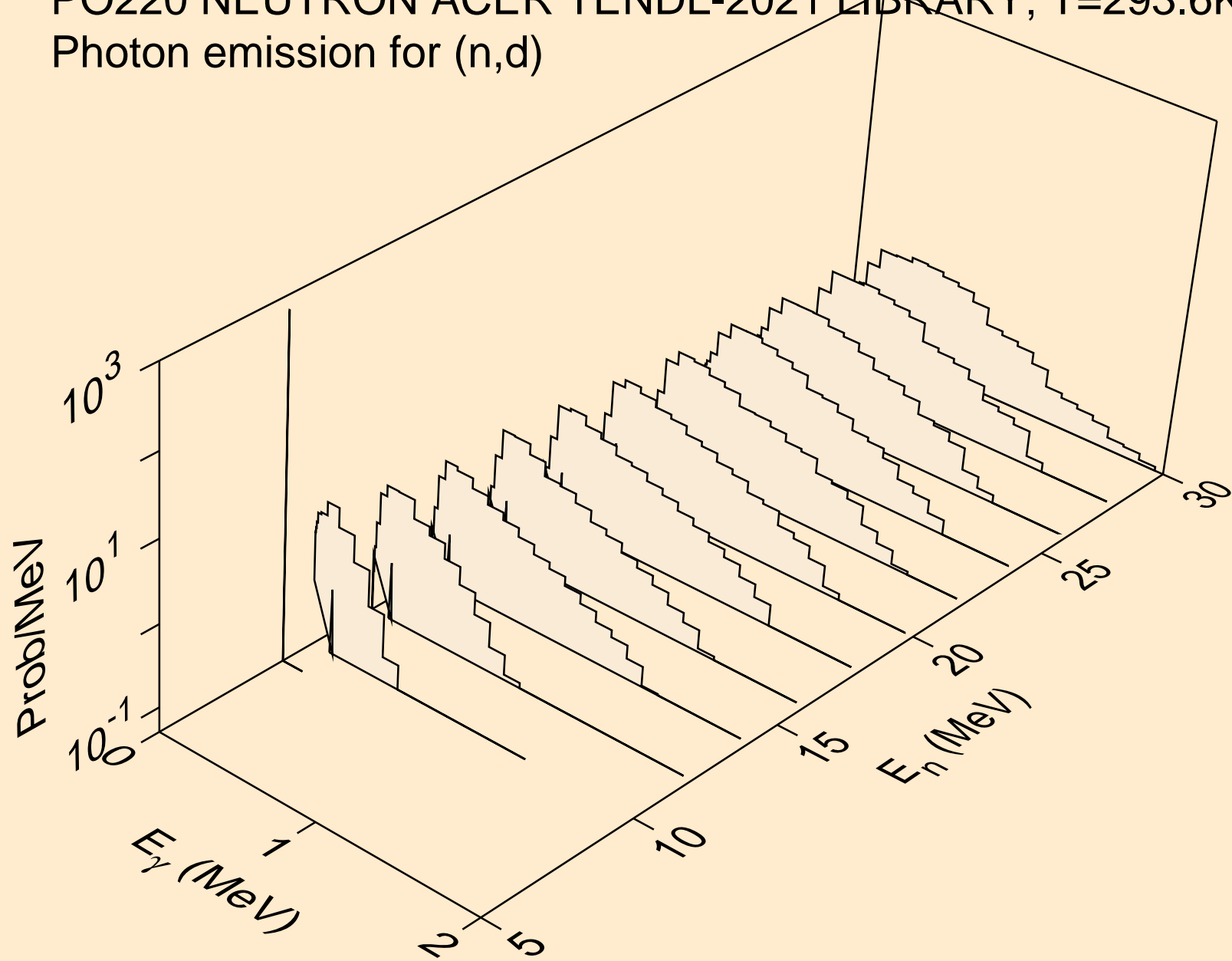

PO220 NEUTRON ACER TENDL-2021 LIBRARY; T=293.6K
Photon emission for (n,t)

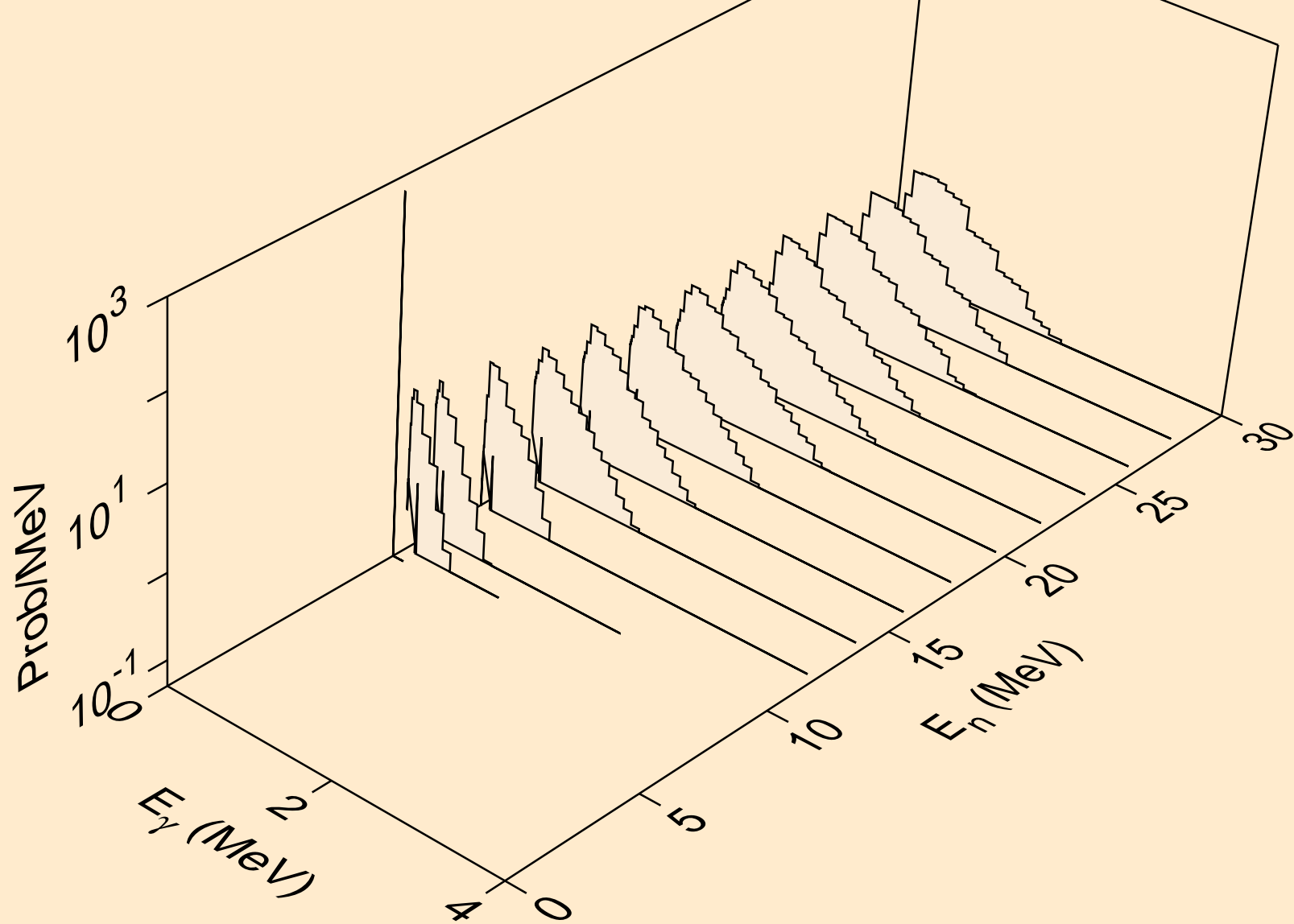

PO220 NEUTRON ACER TENDL-2021 LIBRARY; T=293.6K
Photon emission for (n,he3)

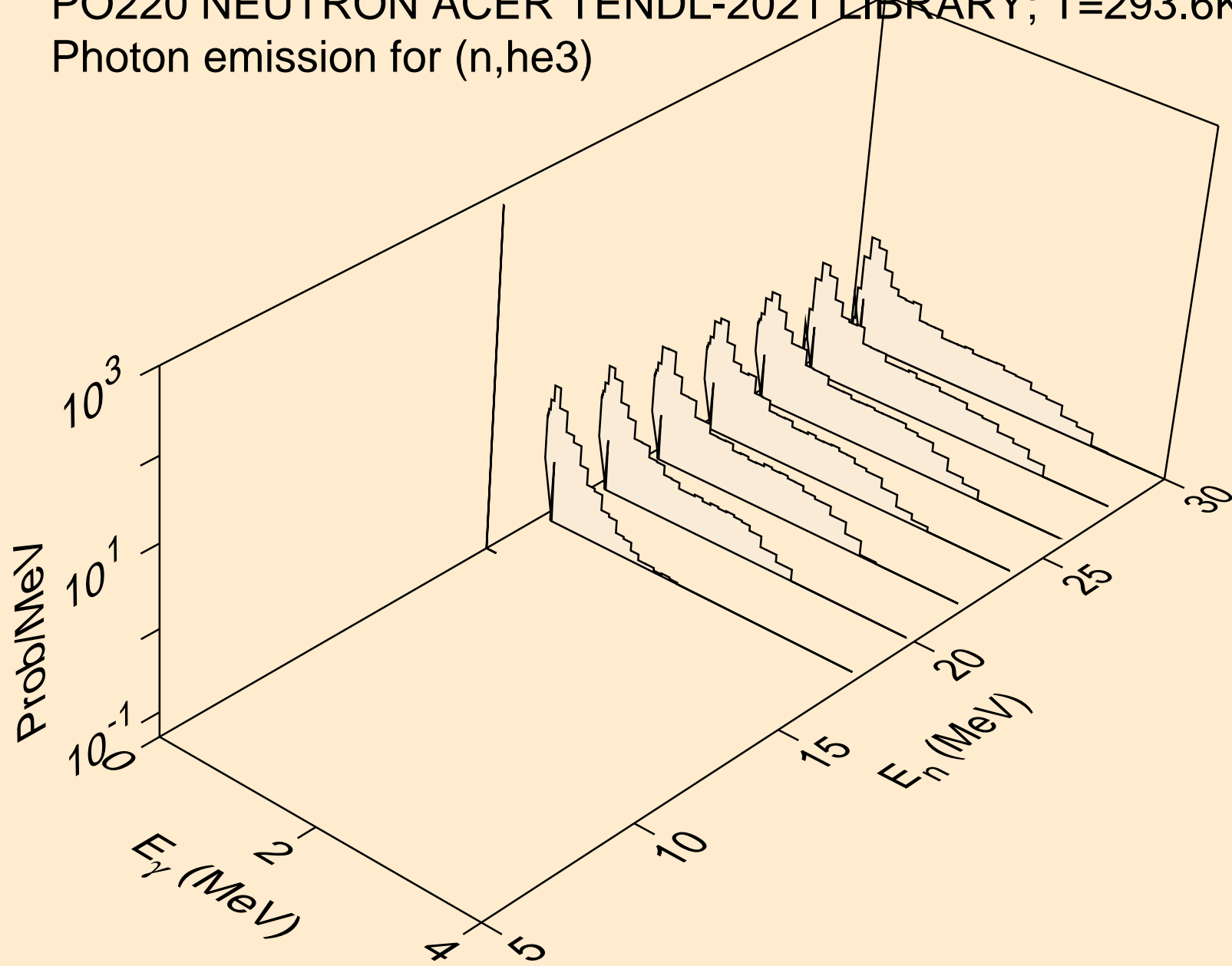

PO220 NEUTRON ACER TENDL-2021 LIBRARY; T=293.6K
Photon emission for (n,a)

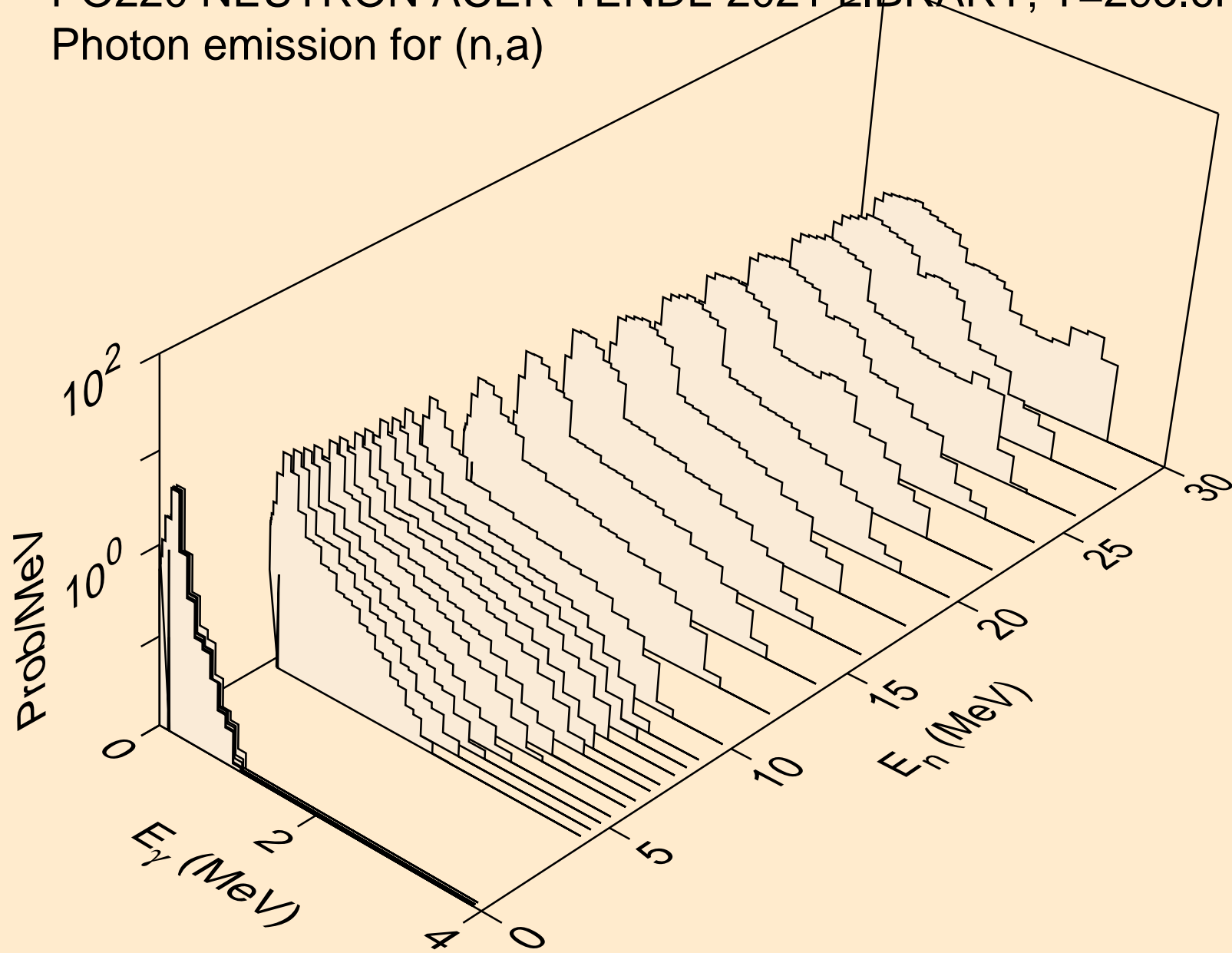

PO220 NEUTRON ACER TENDL-2021 LIBRARY; T=293.6K
Photon emission for (n,2a)

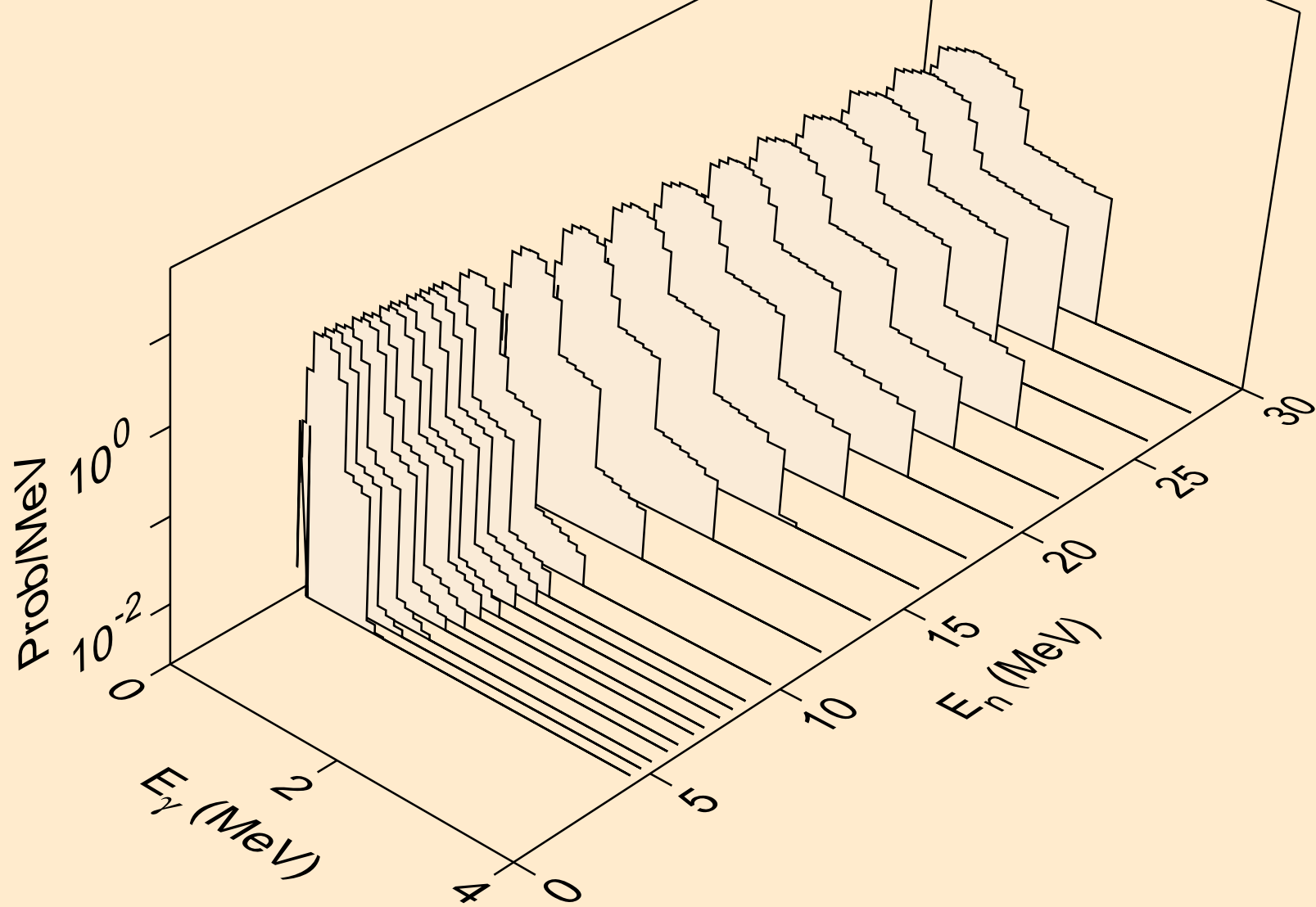

PO220 NEUTRON ACER TENDL-2021 LIBRARY; T=293.6K
Photon emission for (n,p α)

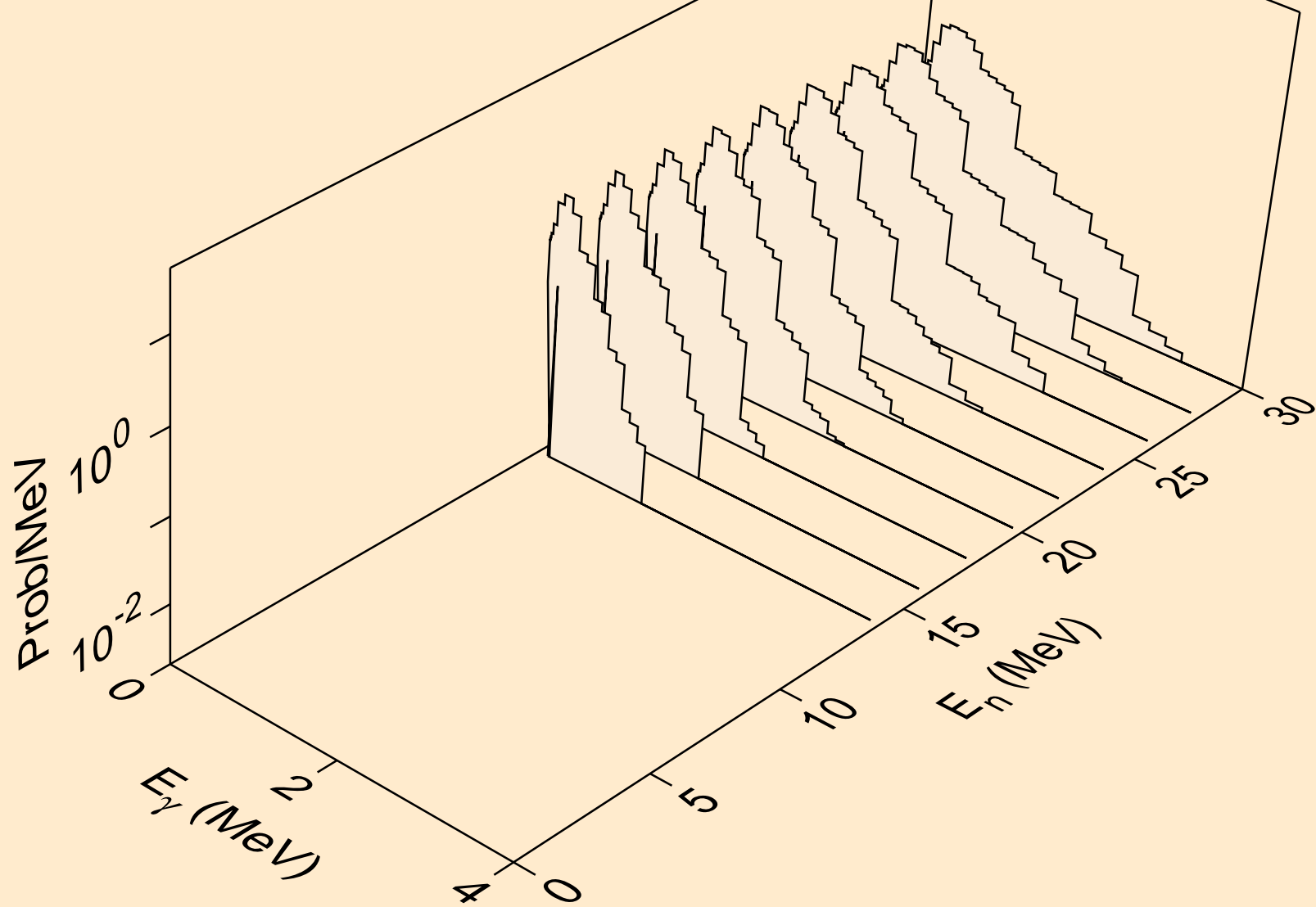

PO220 NEUTRON ACER TENDL-2021 LIBRARY; T=293.6K
Photon emission for (n,da)

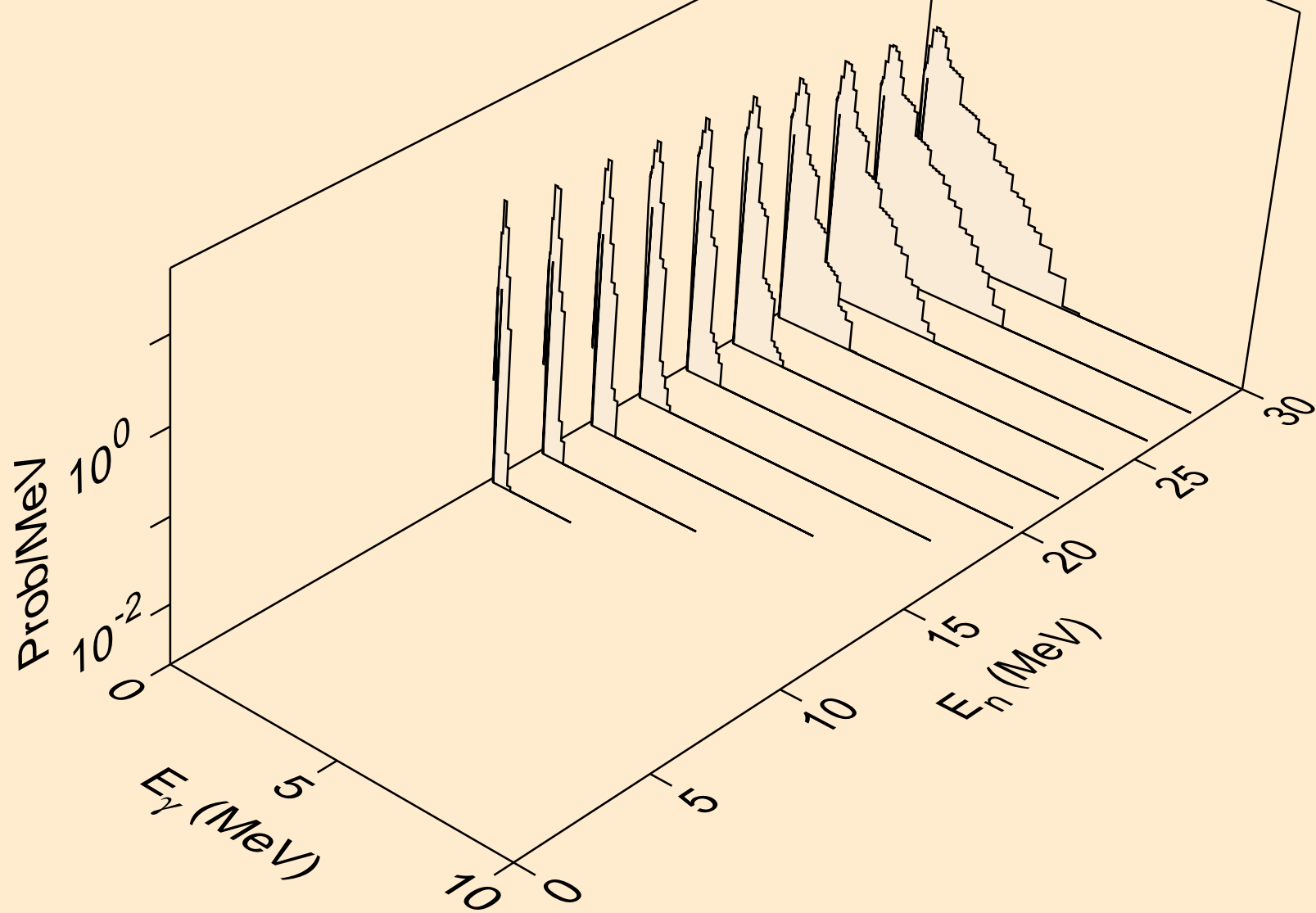

PO220 NEUTRON ACER TENDL-2021 LIBRARY; T=293.6K
thermal capture photon spectrum

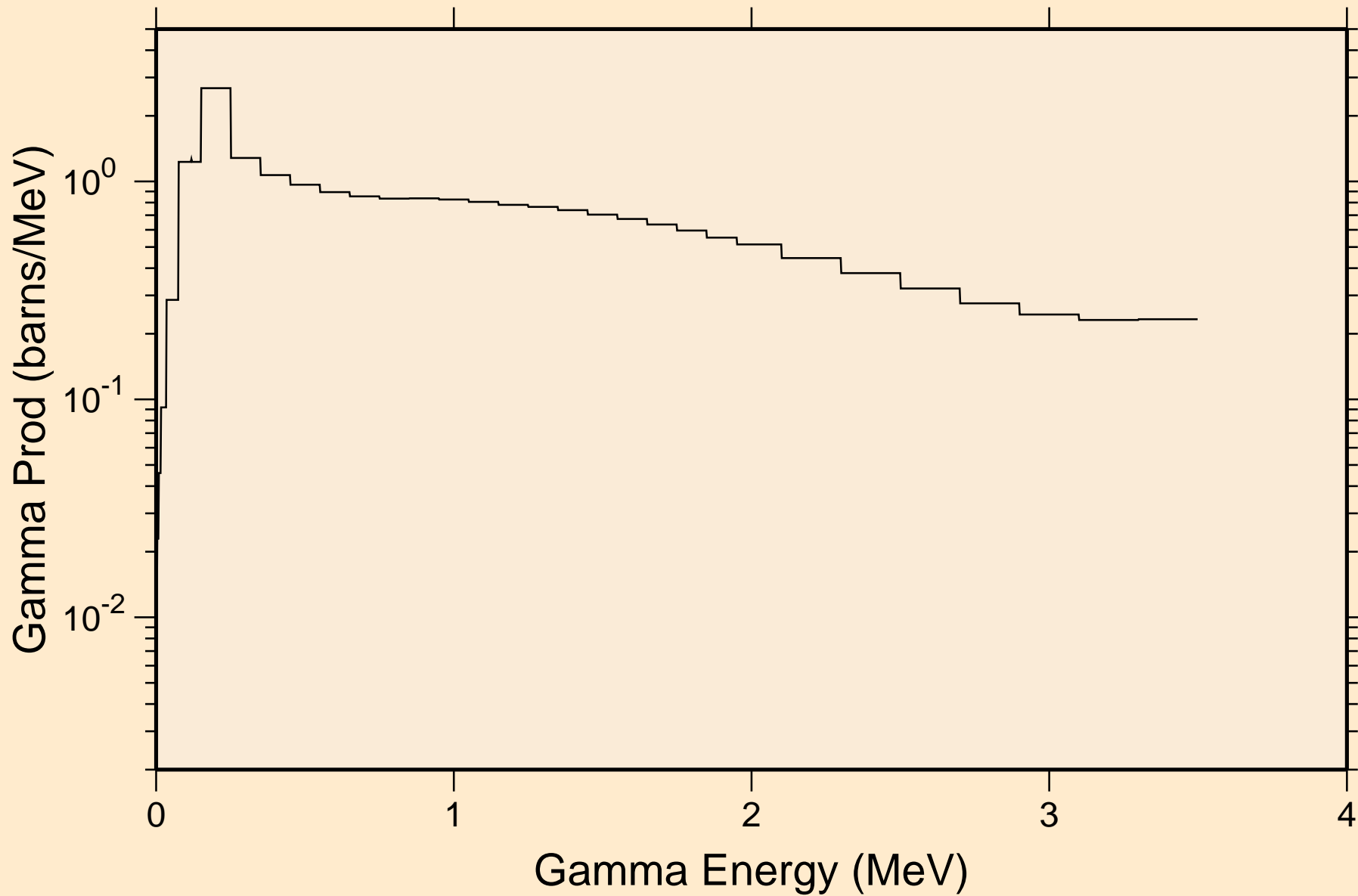

PO220 NEUTRON ACER TENDL-2021 LIBRARY; T=293.6K
14 MeV photon spectrum

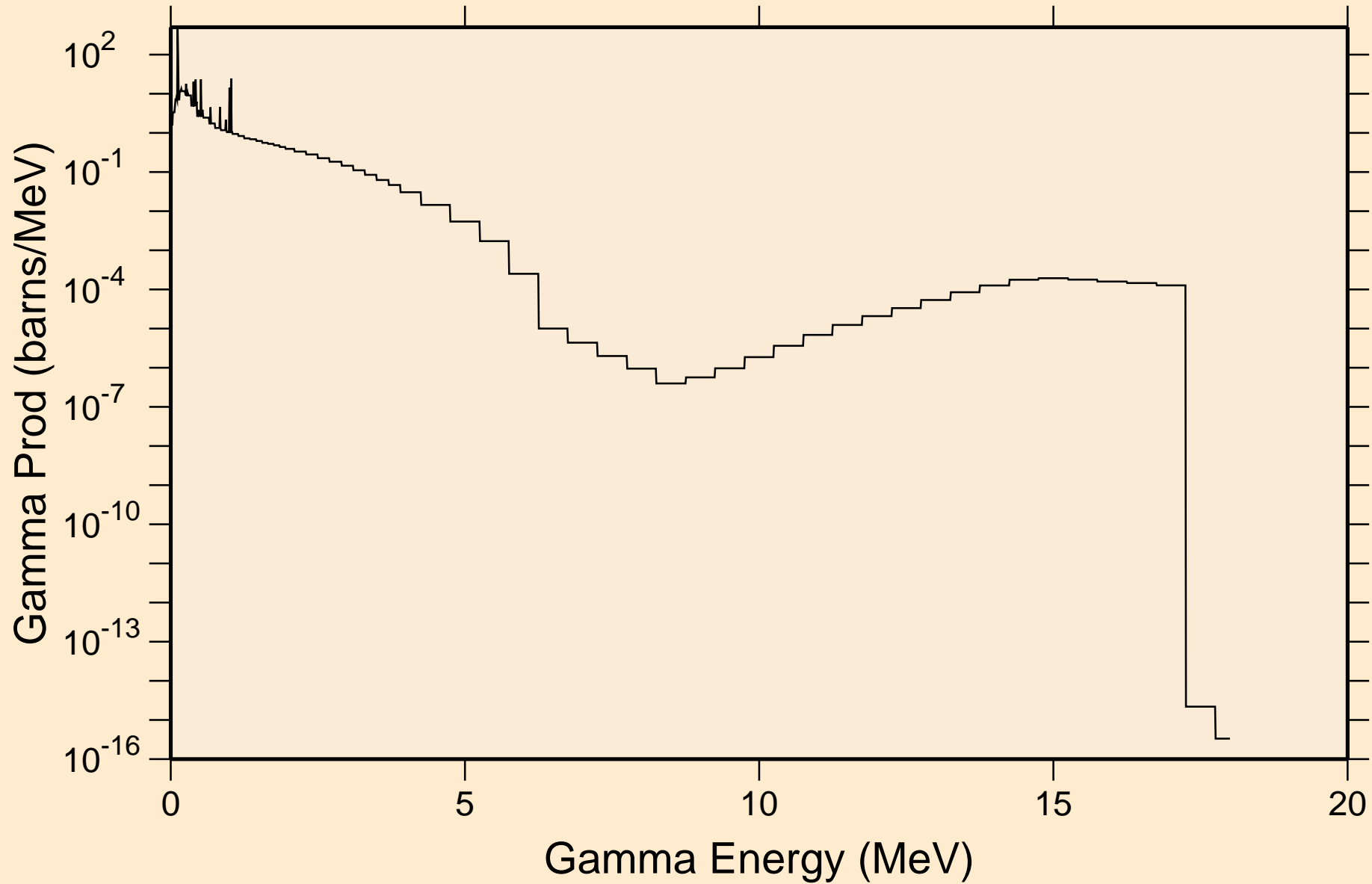

PO220 NEUTRON ACER TENDL-2021 LIBRARY; T=293.6K

Particle heating contributions

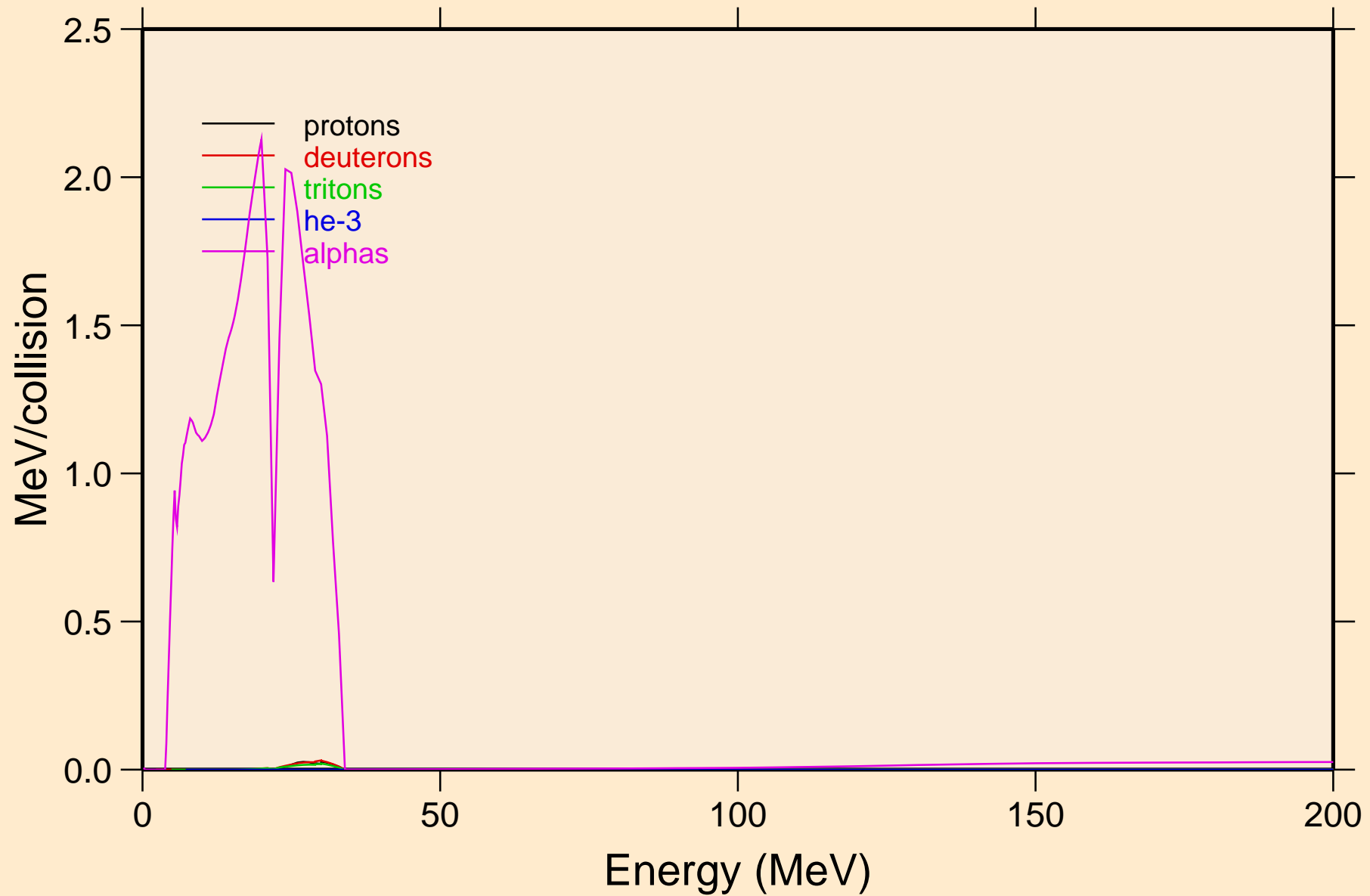

PO220 NEUTRON ACER TENDL-2021 LIBRARY; T=293.6K
Recoil Heating

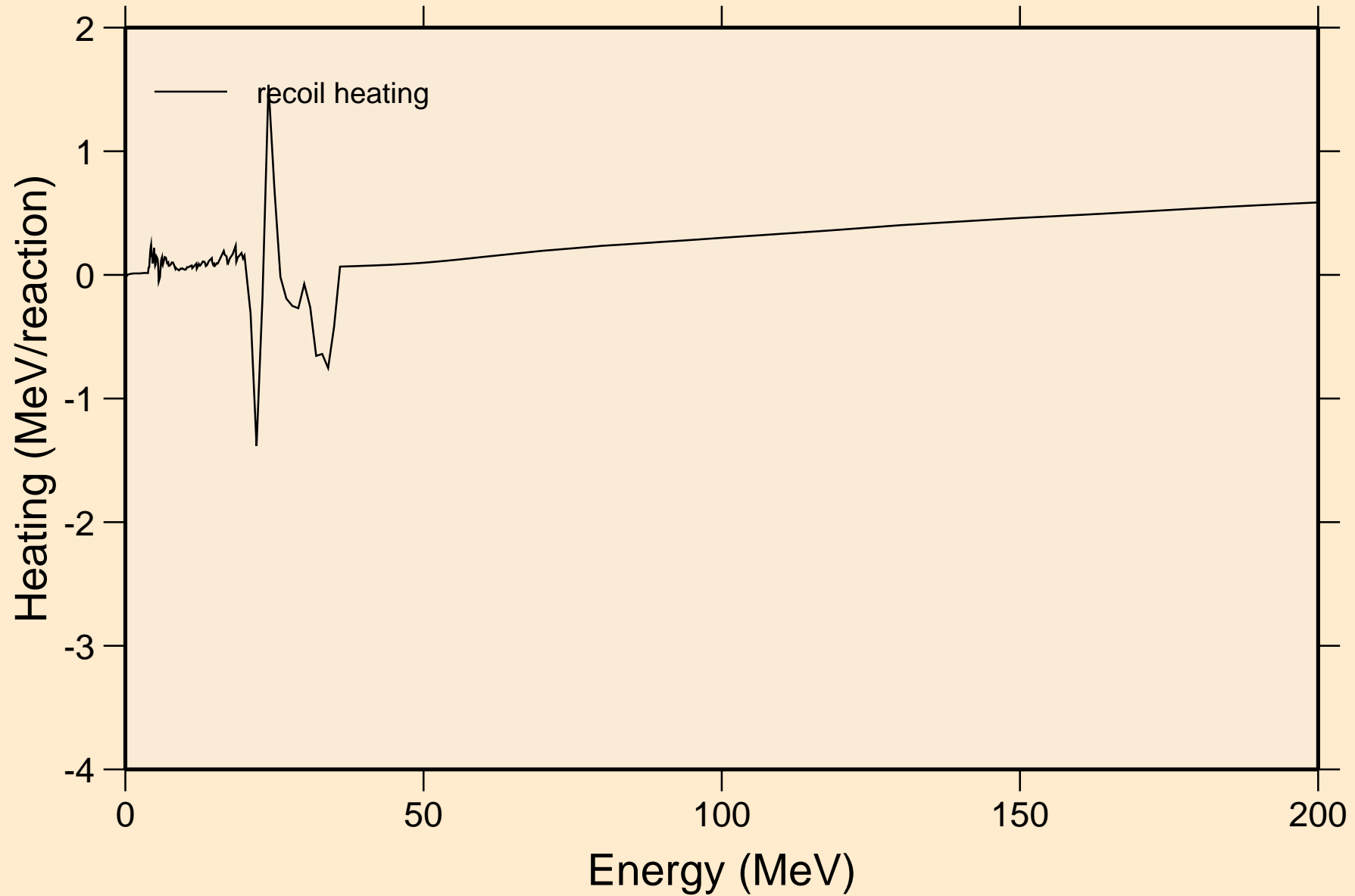

PO220 NEUTRON ACER TENDL-2021 LIBRARY; T=293.6K
Particle production cross sections

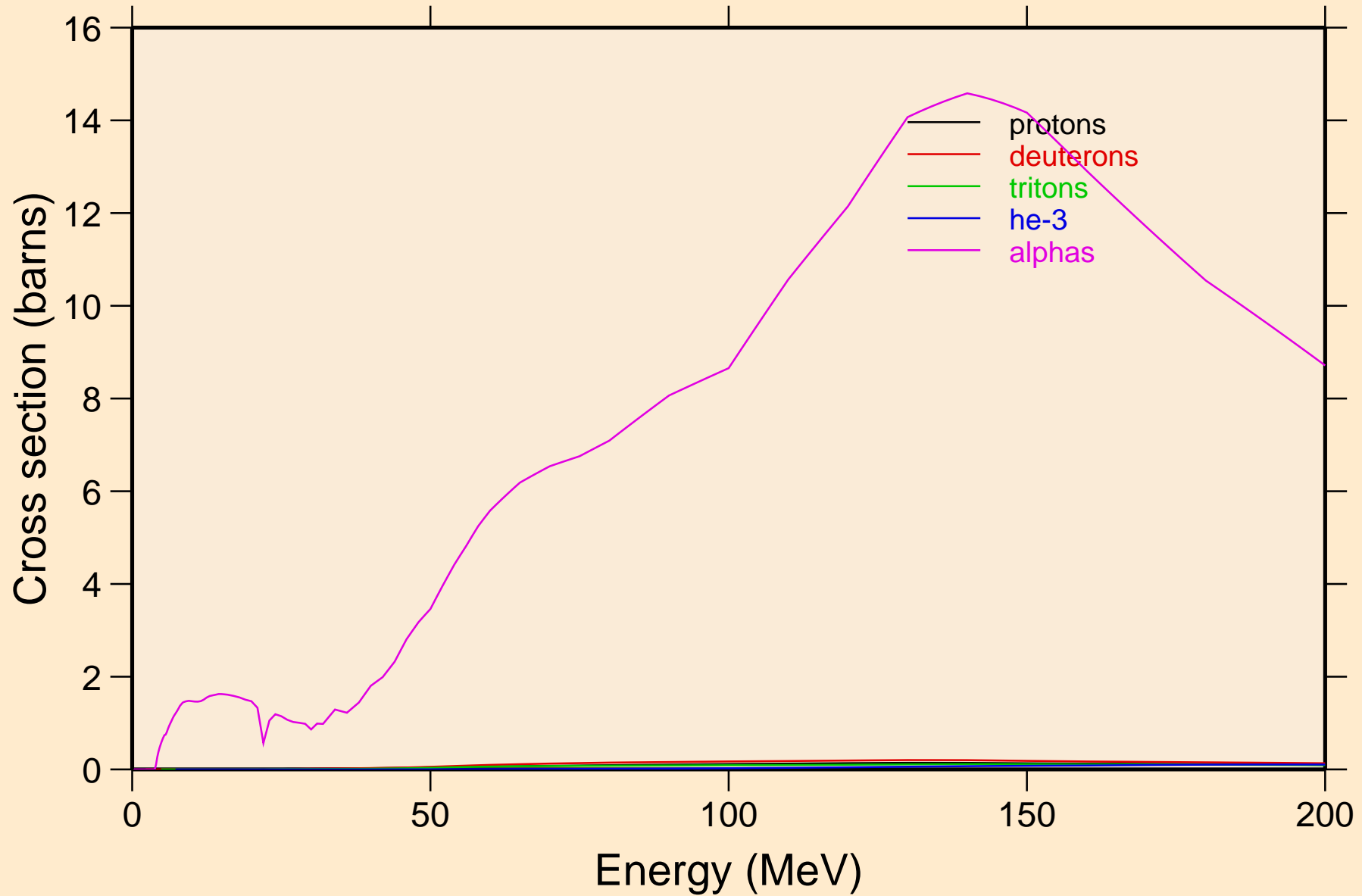

PO220 NEUTRON ACER TENDL-2021 LIBRARY; T=293.6K
protons from (n,x)

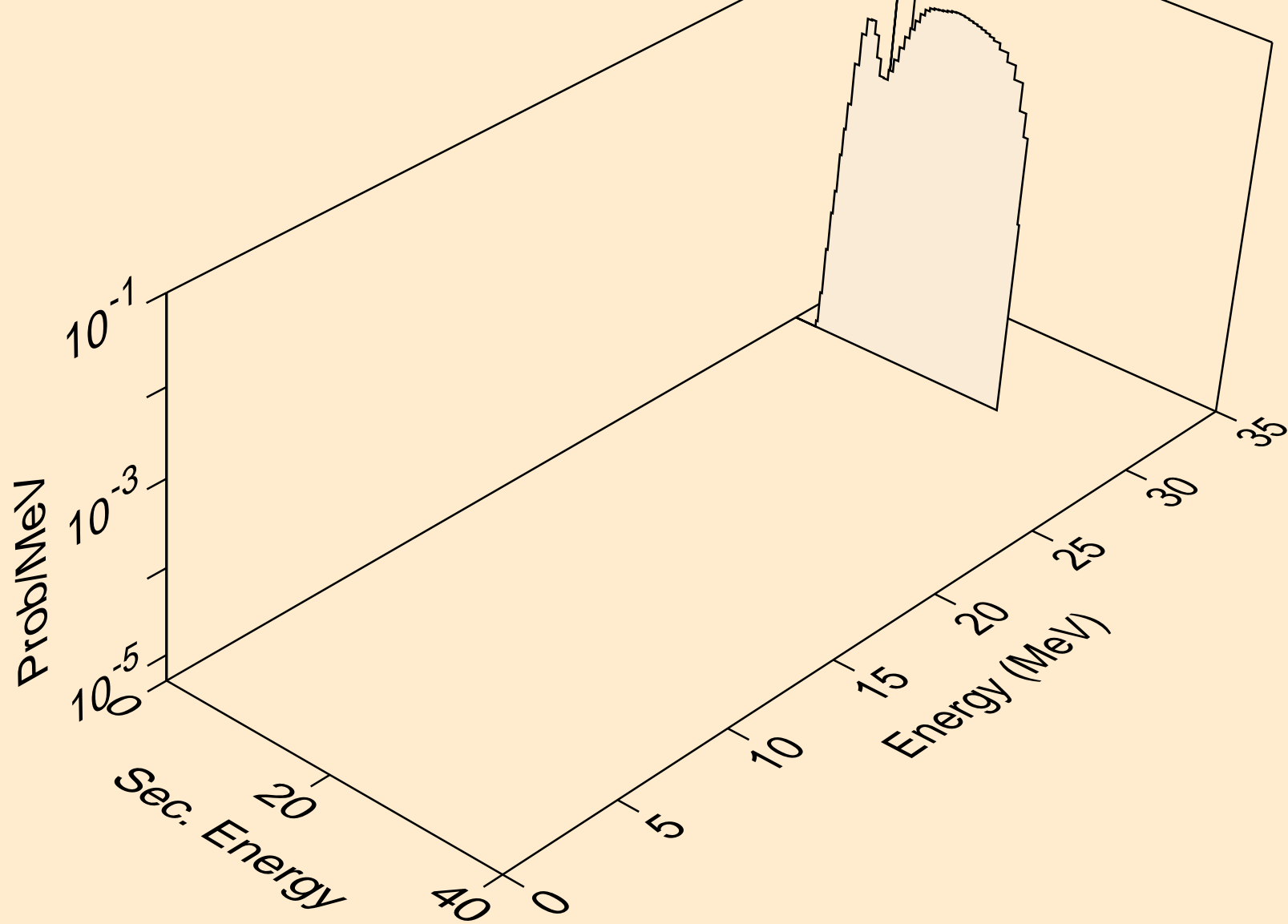

PO220 NEUTRON ACER TENDL-2021 LIBRARY; T=293.6K
protons from (n,n*)p

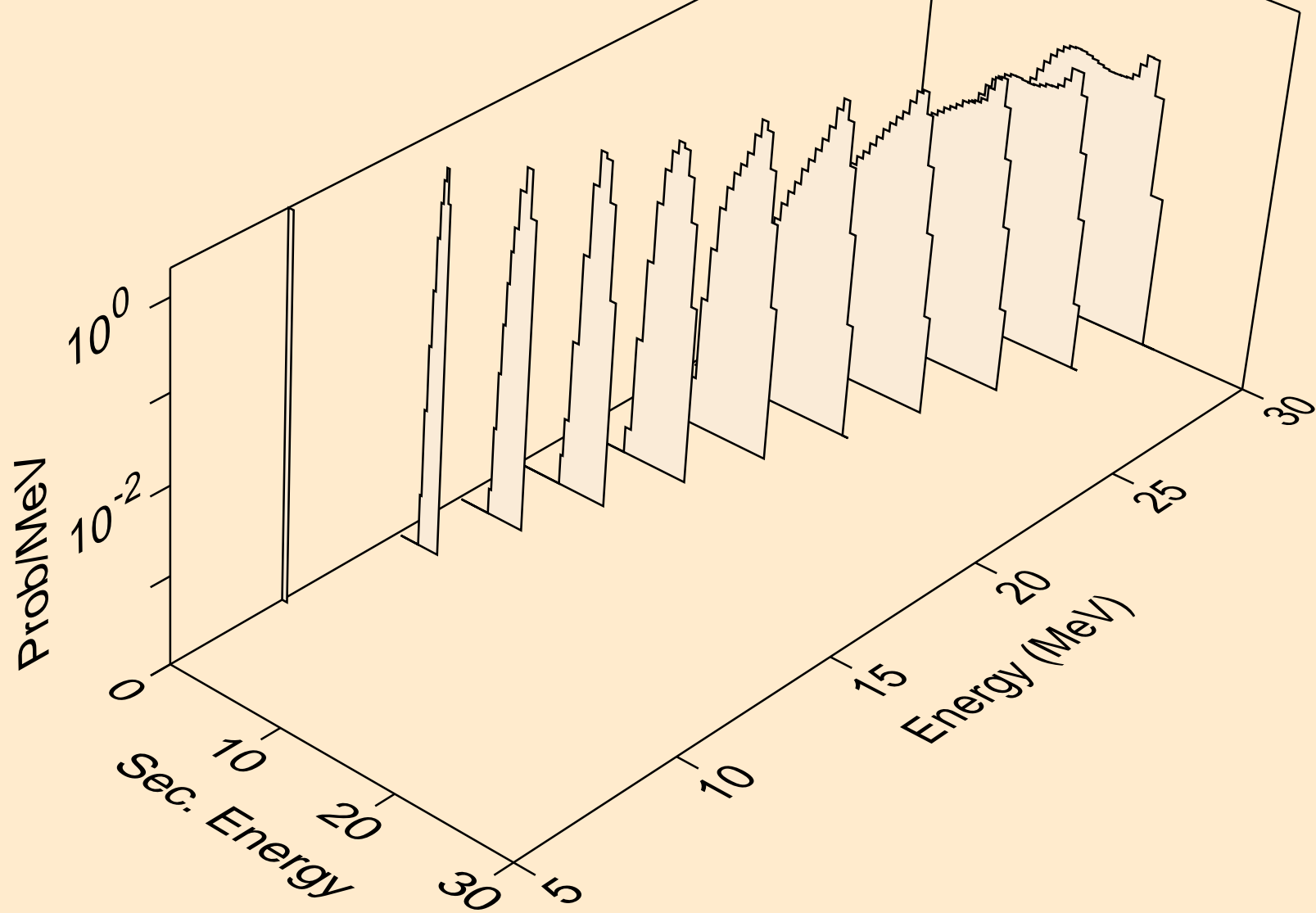

PO220 NEUTRON ACER TENDL-2021 LIBRARY; T=293.6K
protons from (n,2np)

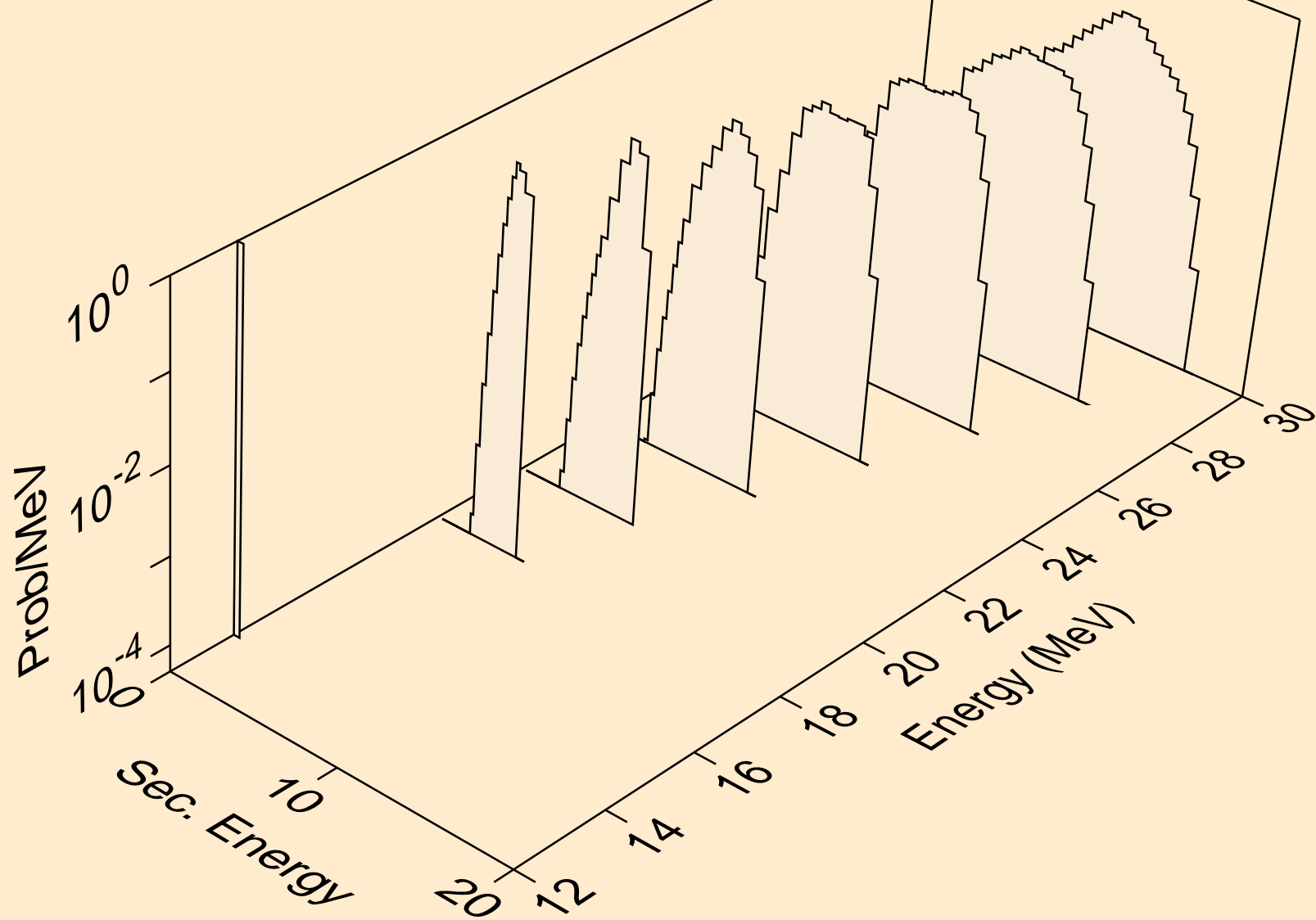

PO220 NEUTRON ACER TENDL-2021 LIBRARY; T=293.6K
protons from (n,3np)

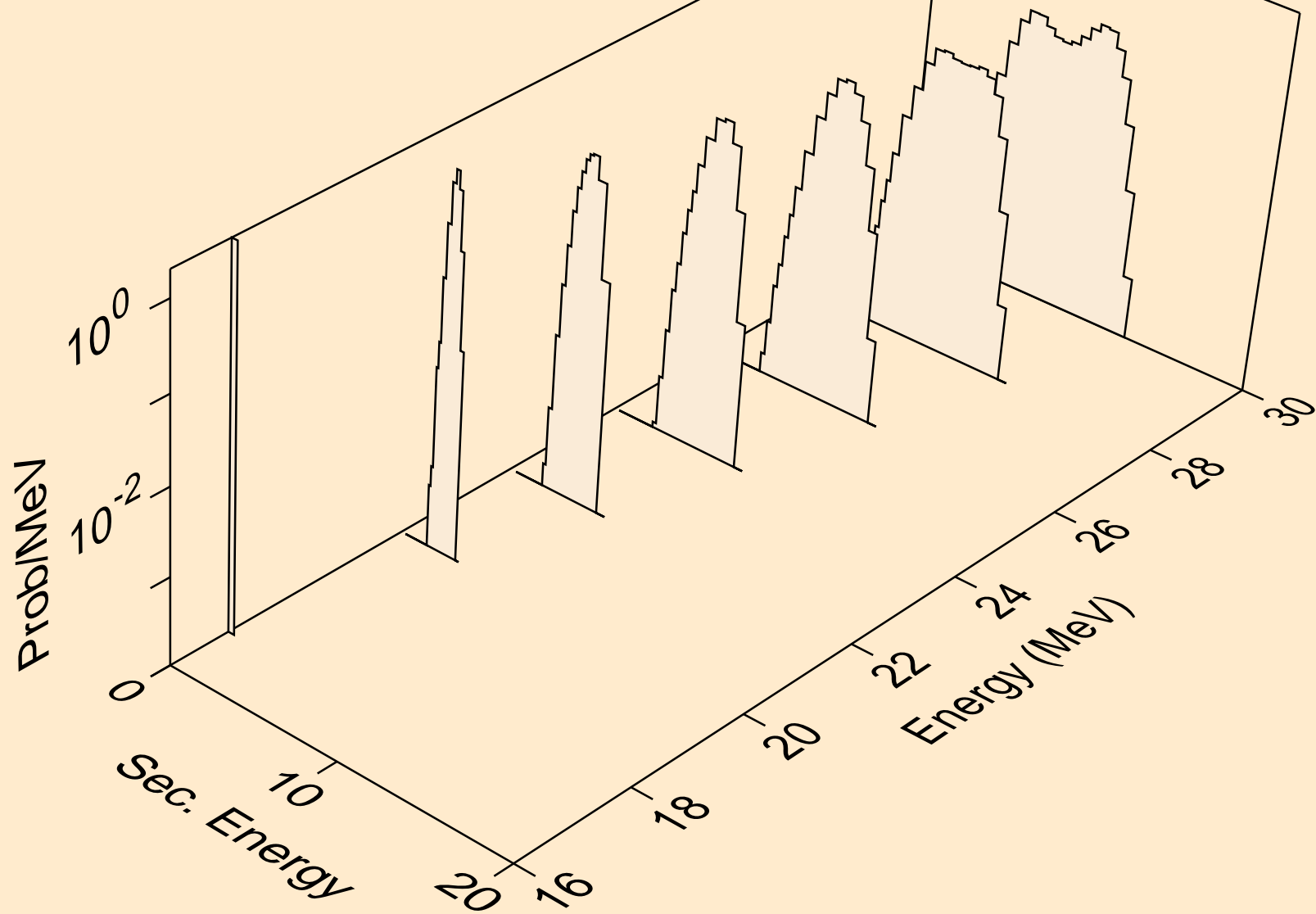

PO220 NEUTRON ACER TENDL-2021 LIBRARY; T=293.6K
protons from (n,npa)

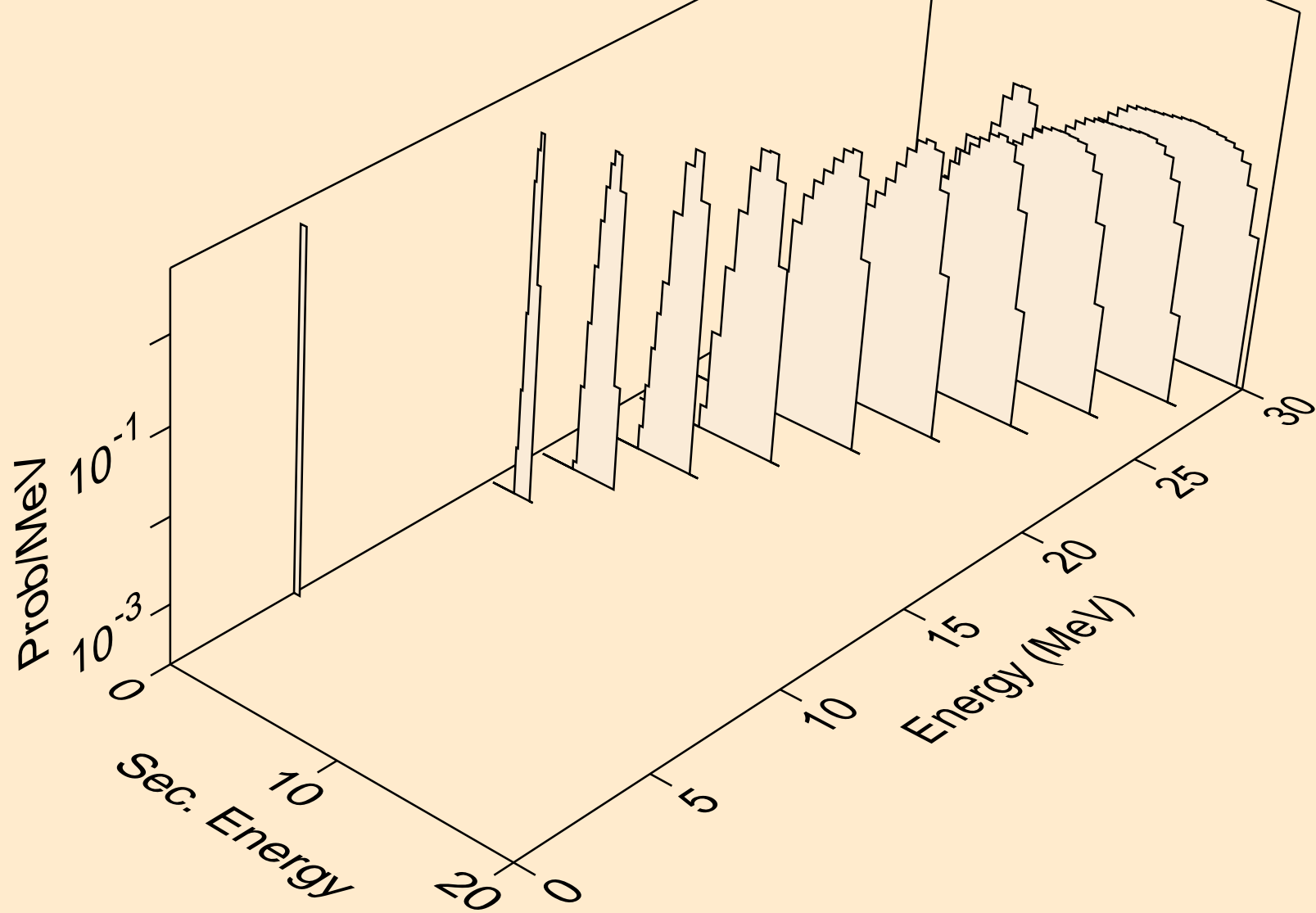

PO220 NEUTRON ACER TENDL-2021 LIBRARY; T=293.6K
protons from (n,p)

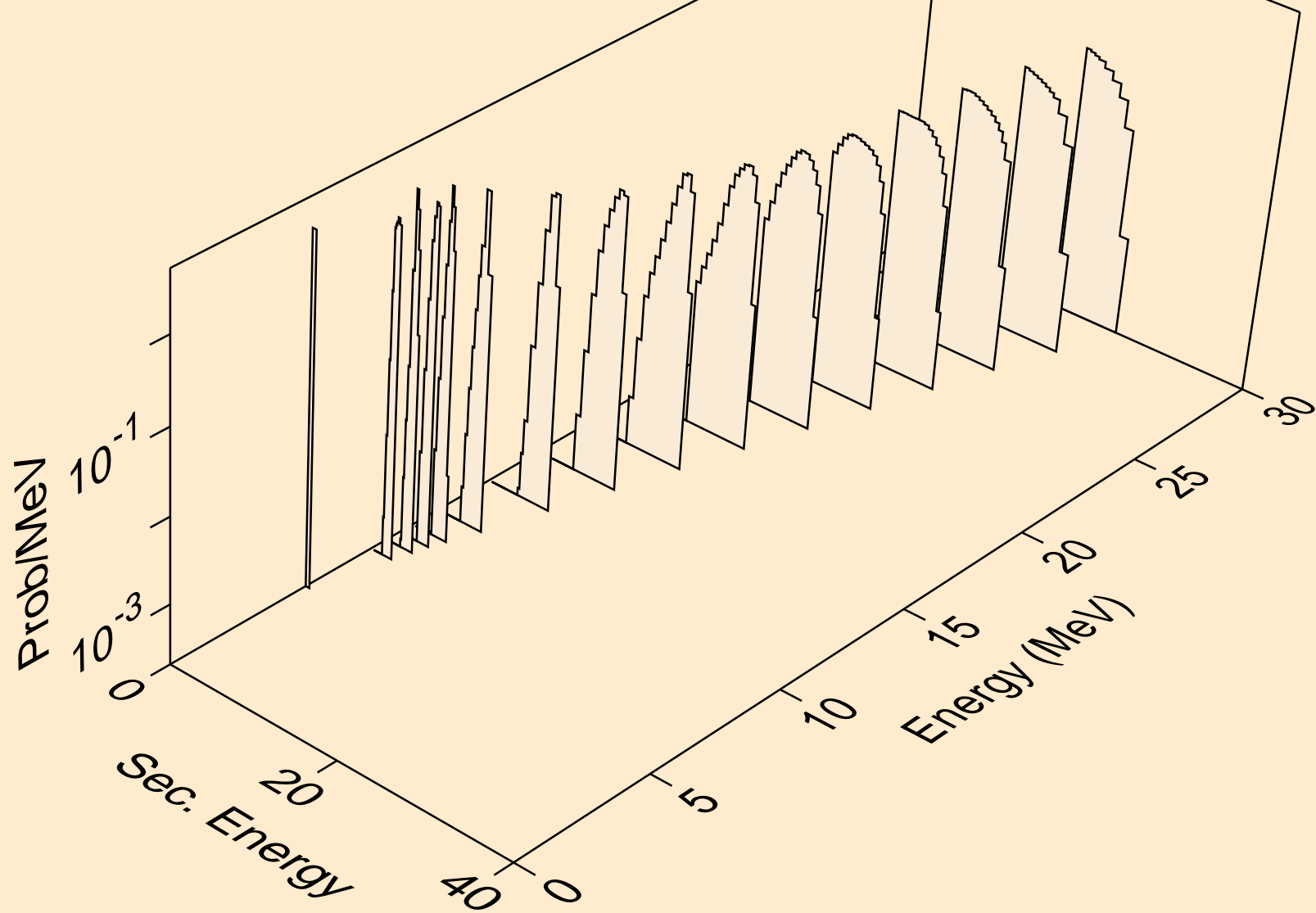

PO220 NEUTRON ACER TENDL-2021 LIBRARY; T=293.6K
protons from (n,p)

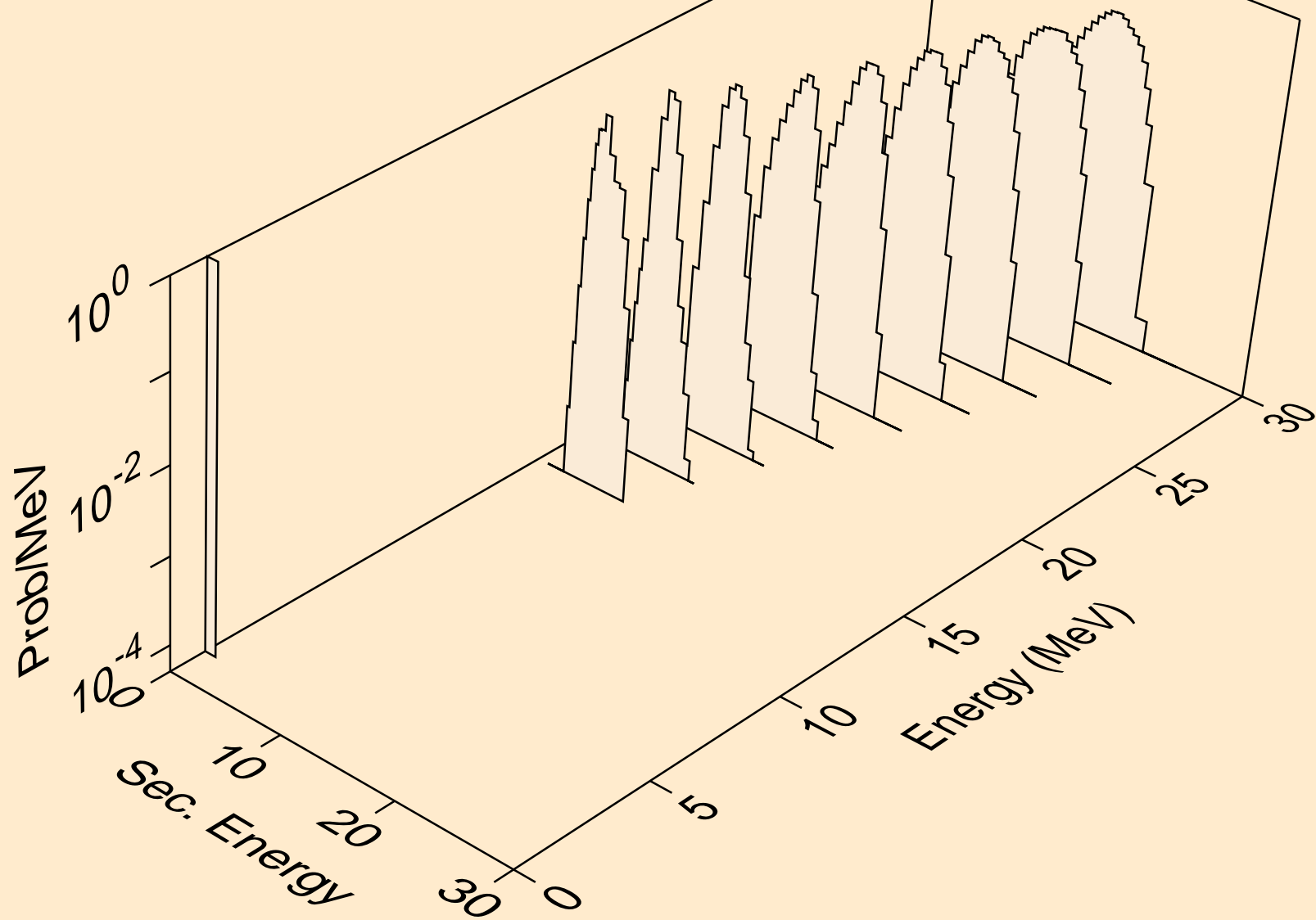

PO220 NEUTRON ACER TENDL-2021 LIBRARY; T=293.6K
deuterons from (n,x)

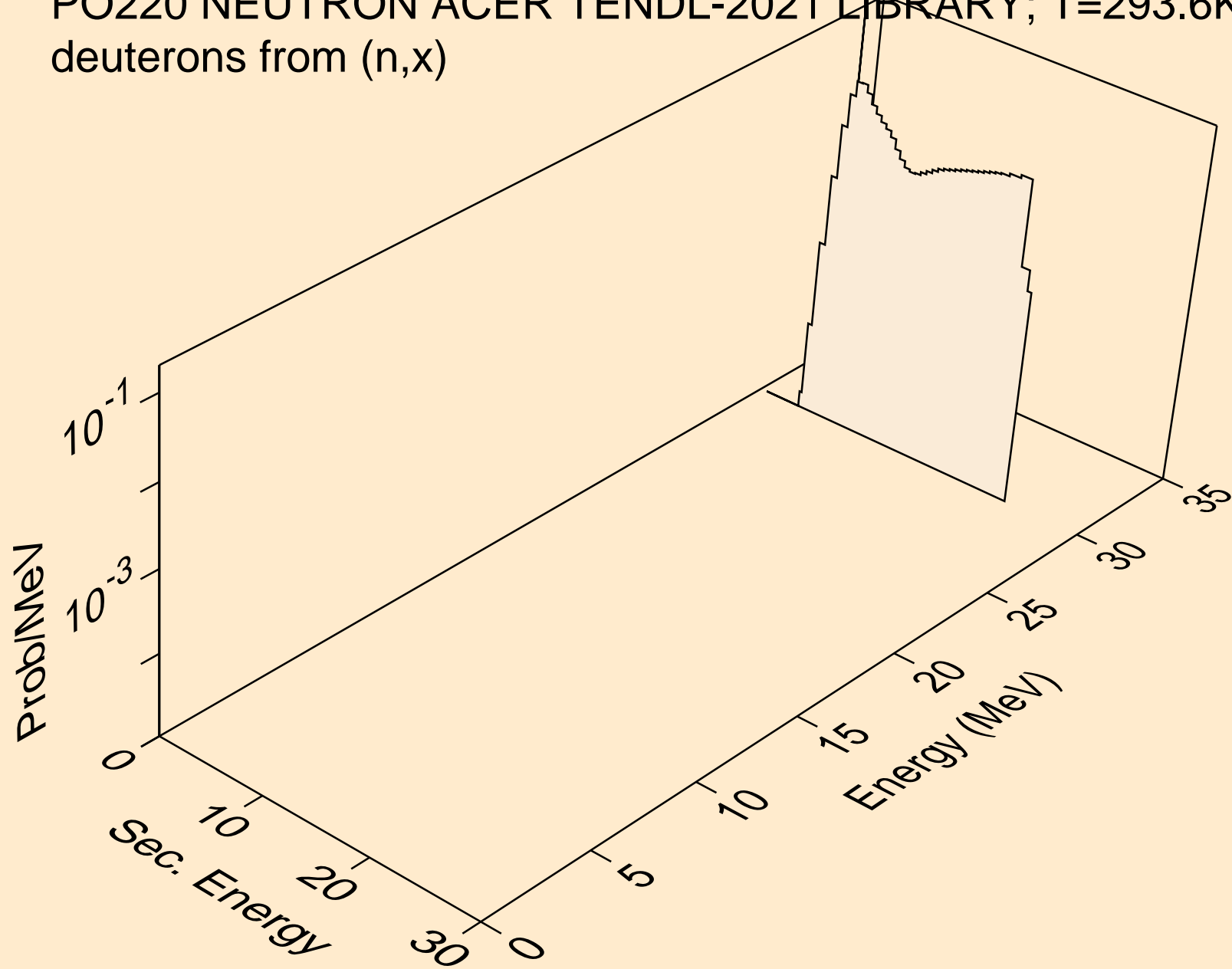

PO220 NEUTRON ACER TENDL-2021 LIBRARY; T=293.6K
deuterons from (n,2nd)

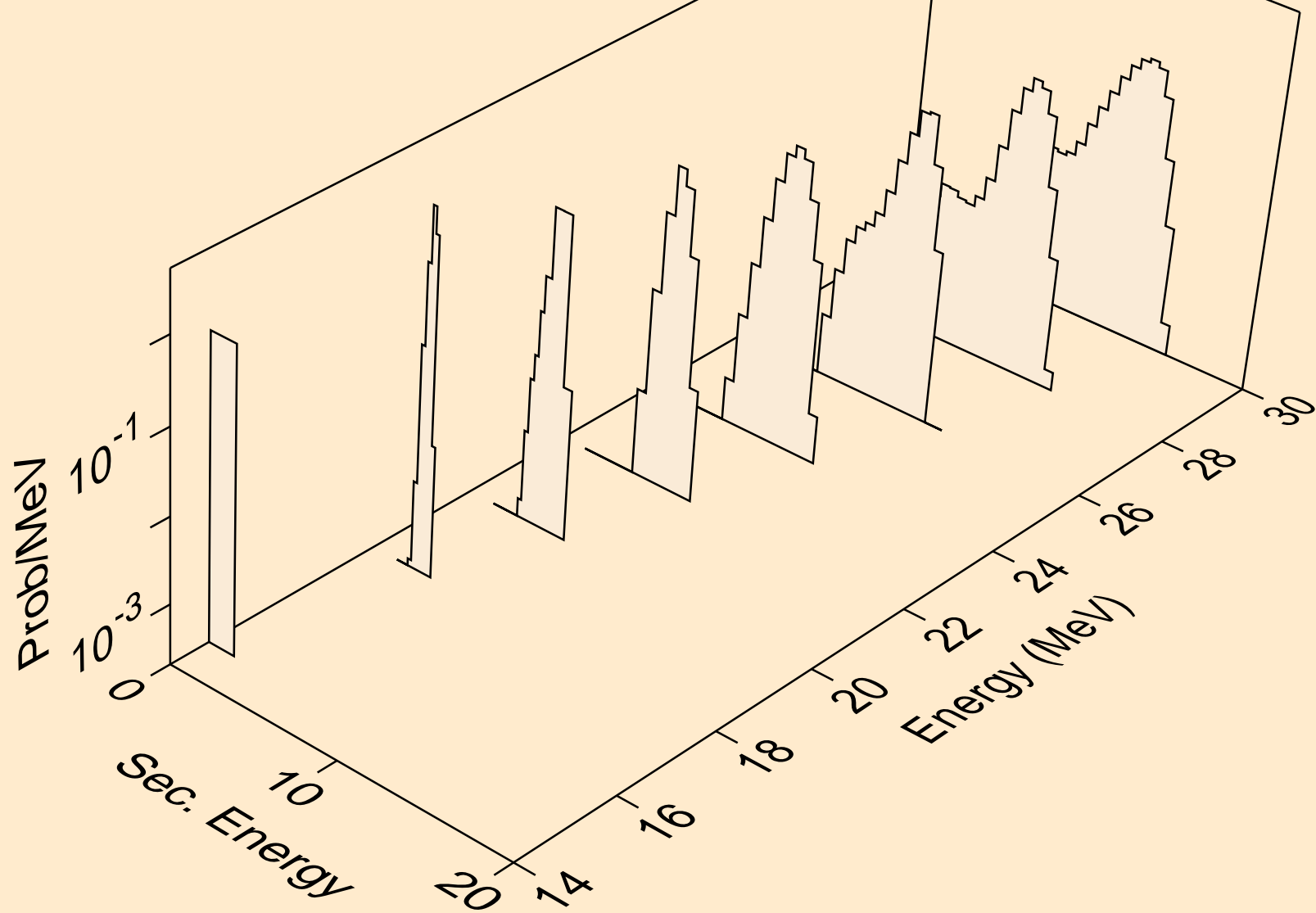

PO220 NEUTRON ACER TENDL-2021 LIBRARY; T=293.6K
deuterons from (n,n*)d

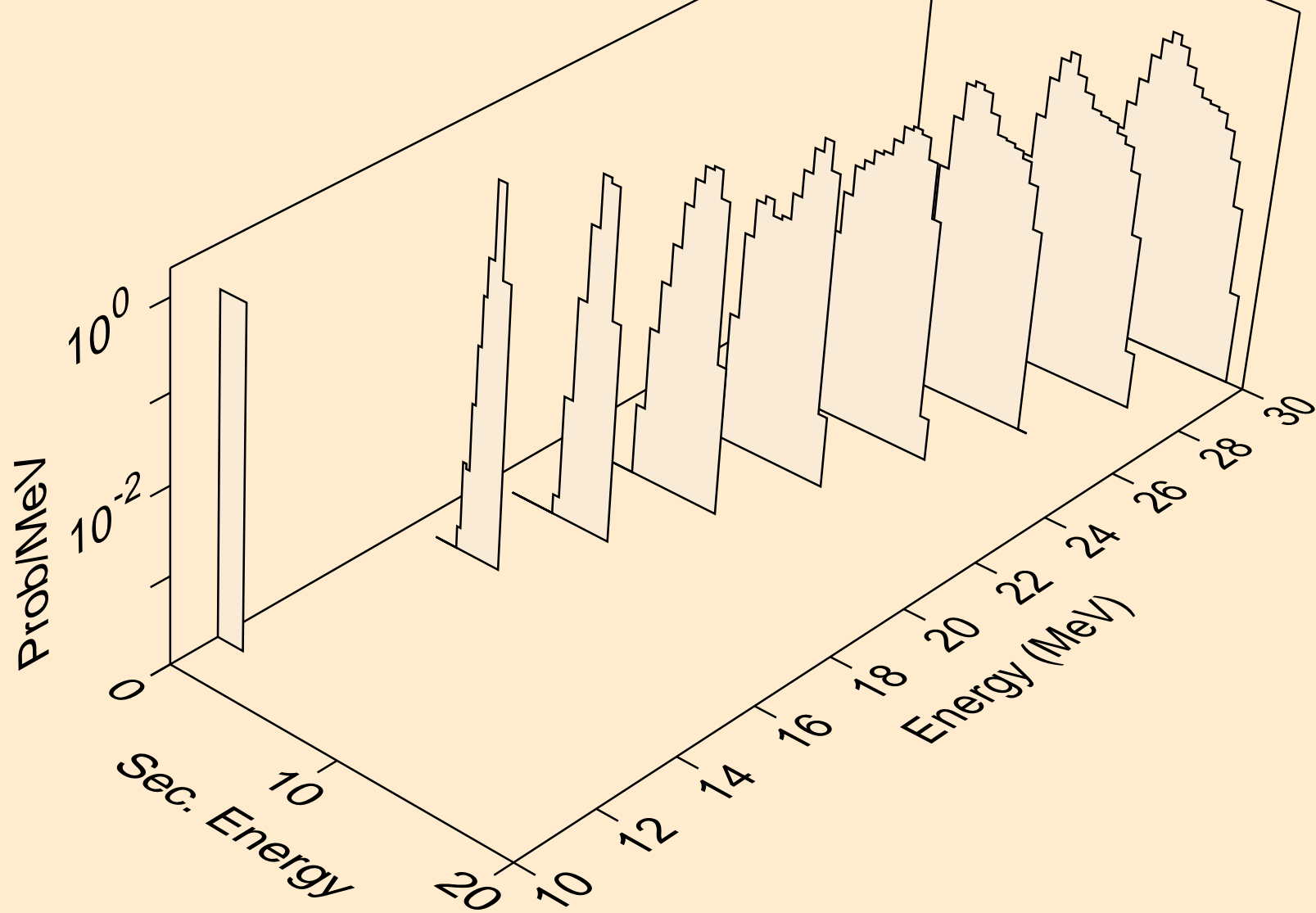

PO220 NEUTRON ACER TENDL-2021 LIBRARY; T=293.6K
deuterons from (n,d)

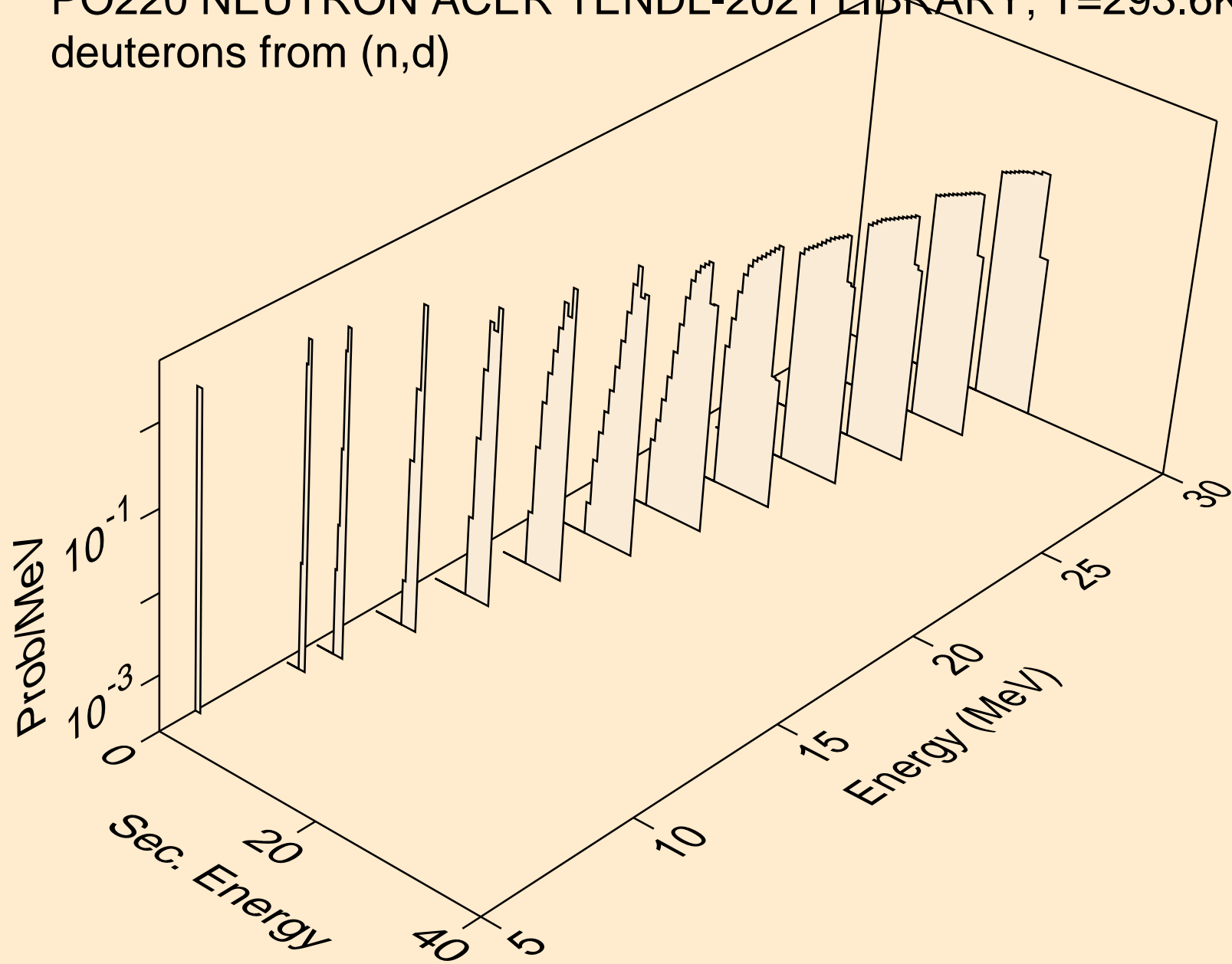

PO220 NEUTRON ACER TENDL-2021 LIBRARY; T=293.6K
deuterons from (n,da)

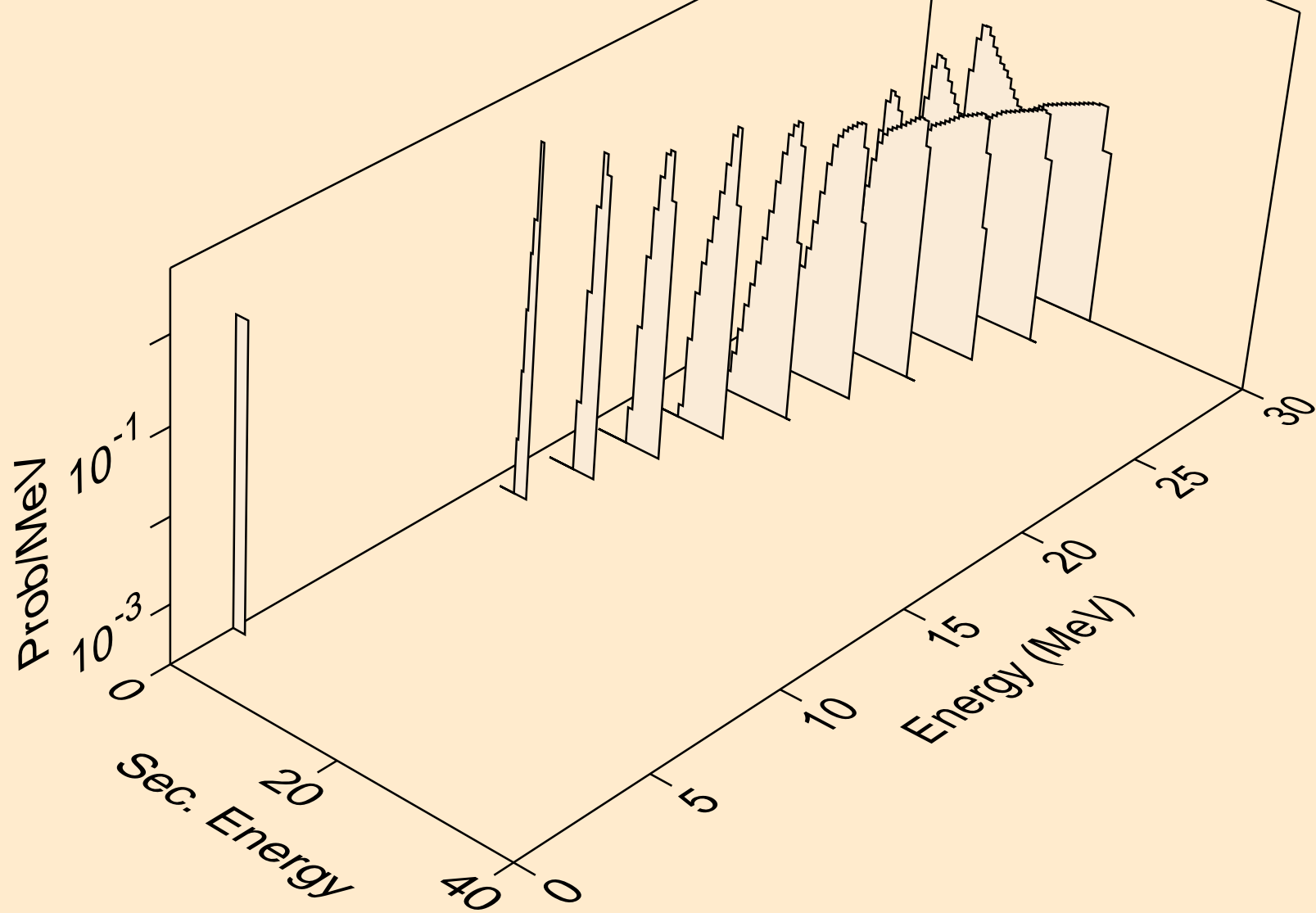

PO220 NEUTRON ACER TENDL-2021 LIBRARY; T=293.6K
tritons from (n,x)

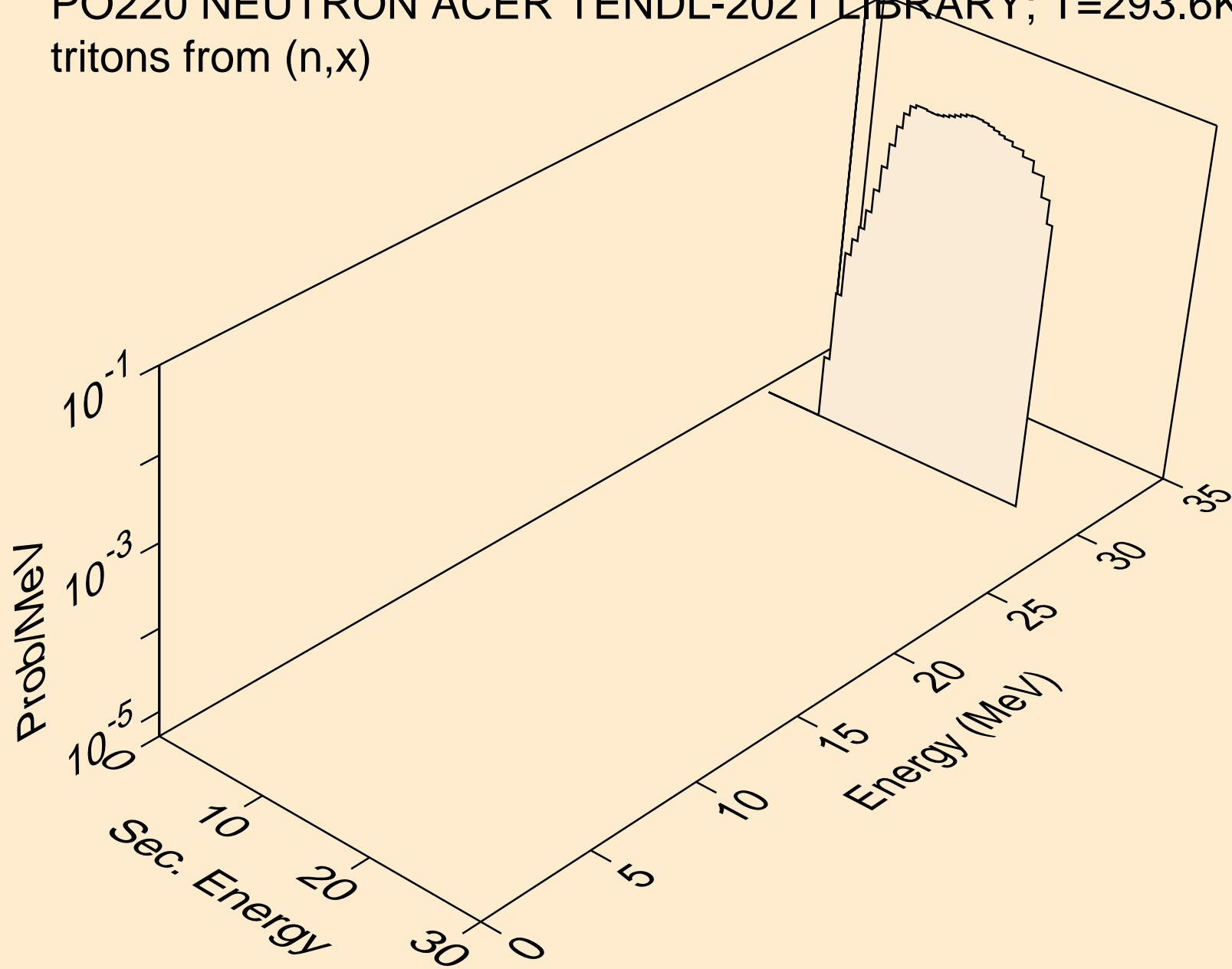

PO220 NEUTRON ACER TENDL-2021 LIBRARY; T=293.6K
tritons from (n,n*)t

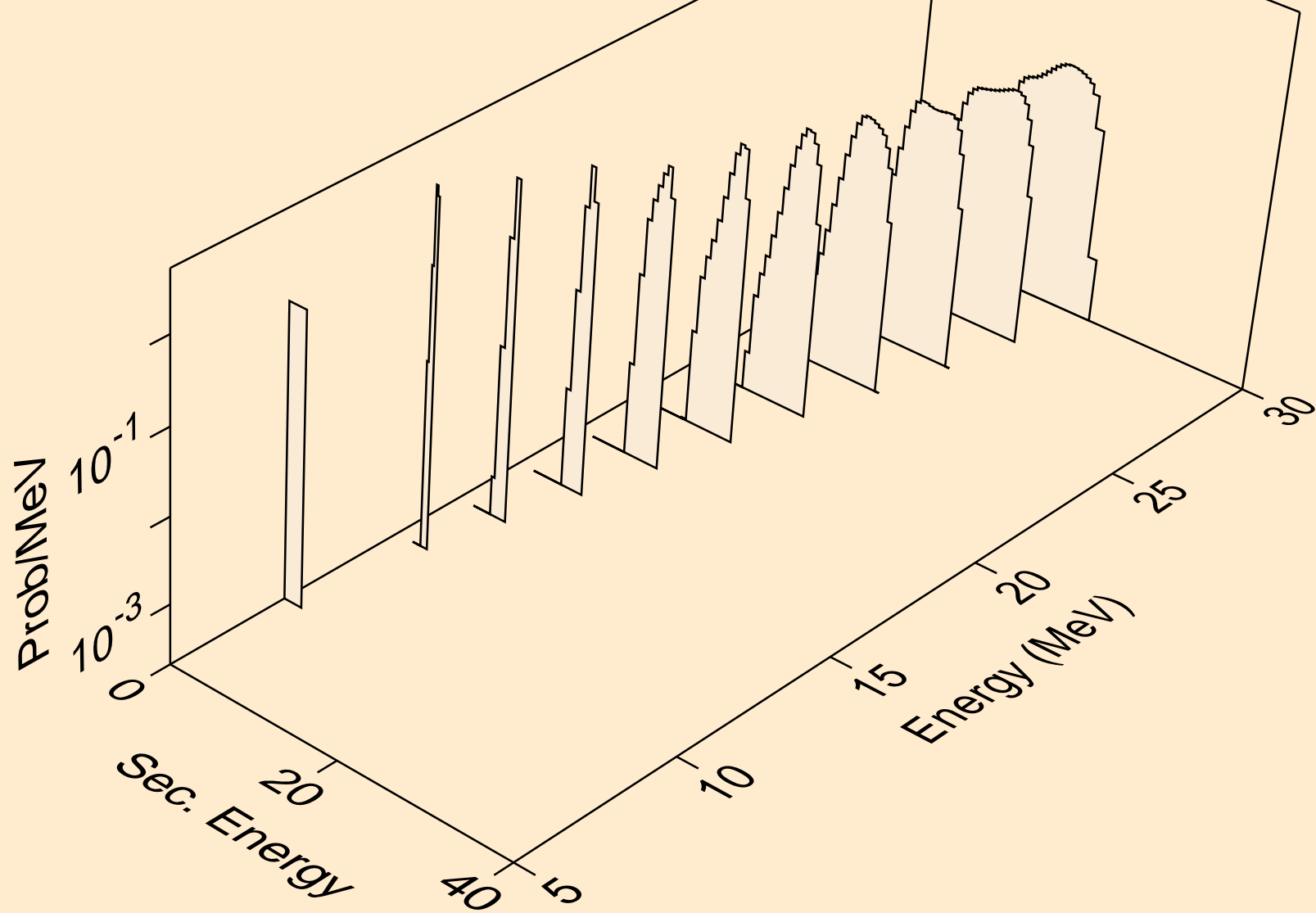

PO220 NEUTRON ACER TENDL-2021 LIBRARY; T=293.6K
tritons from (n,t)

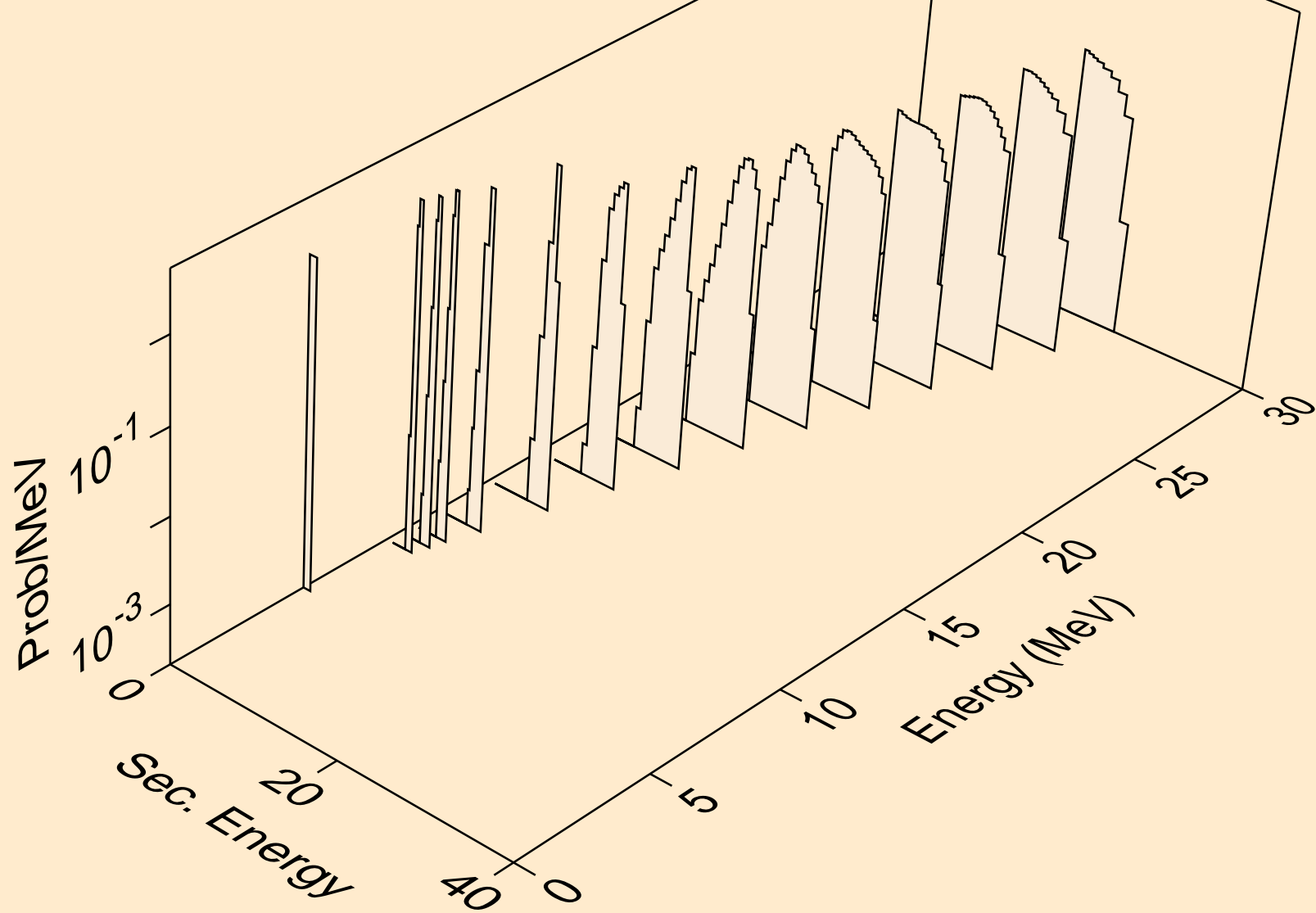

PO220 NEUTRON ACER TENDL-2021 LIBRARY; T=293.6K
he3s from (n,x)

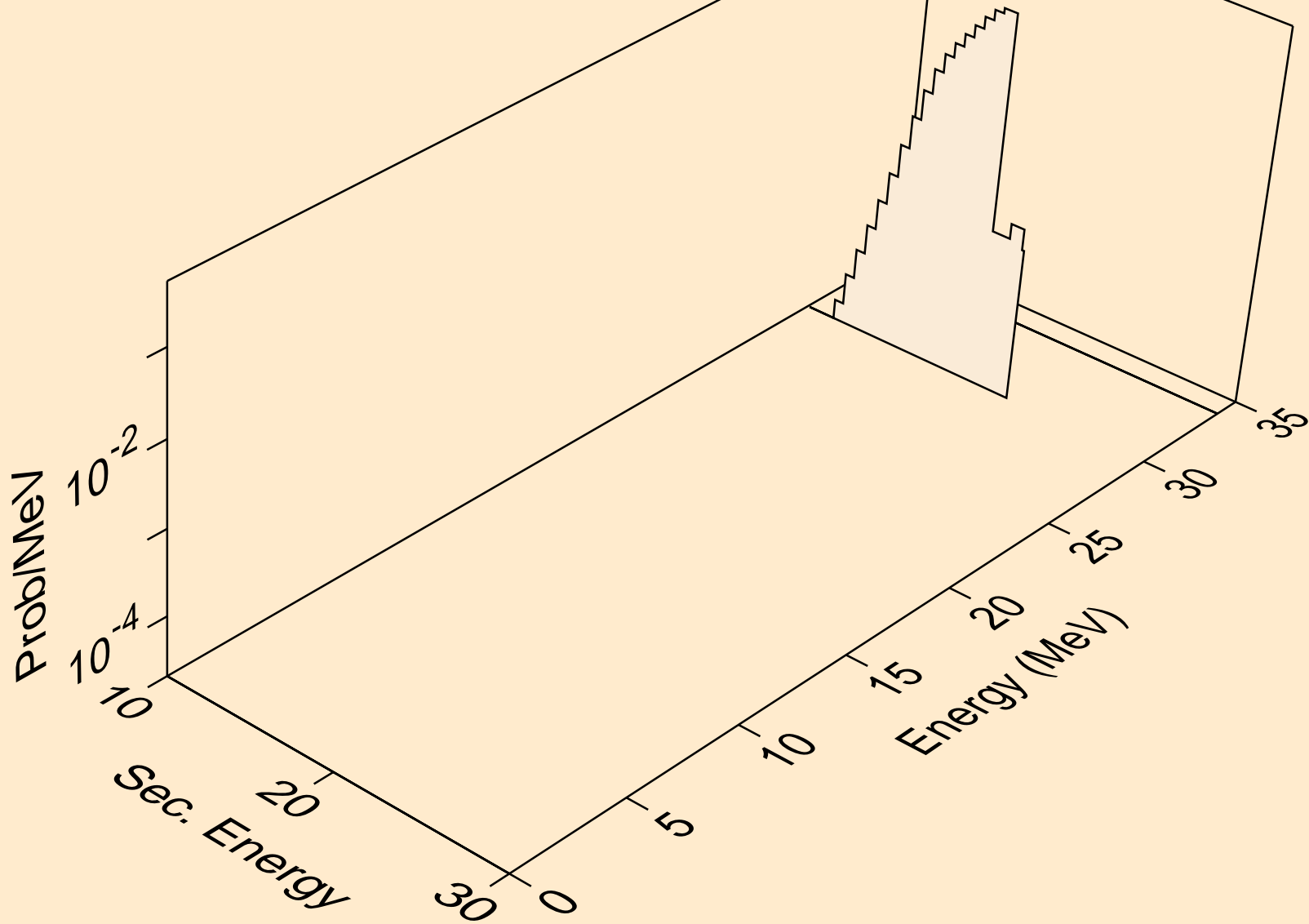

PO220 NEUTRON ACER TENDL-2021 LIBRARY; T=293.6K
he3s from (n,n*)he3

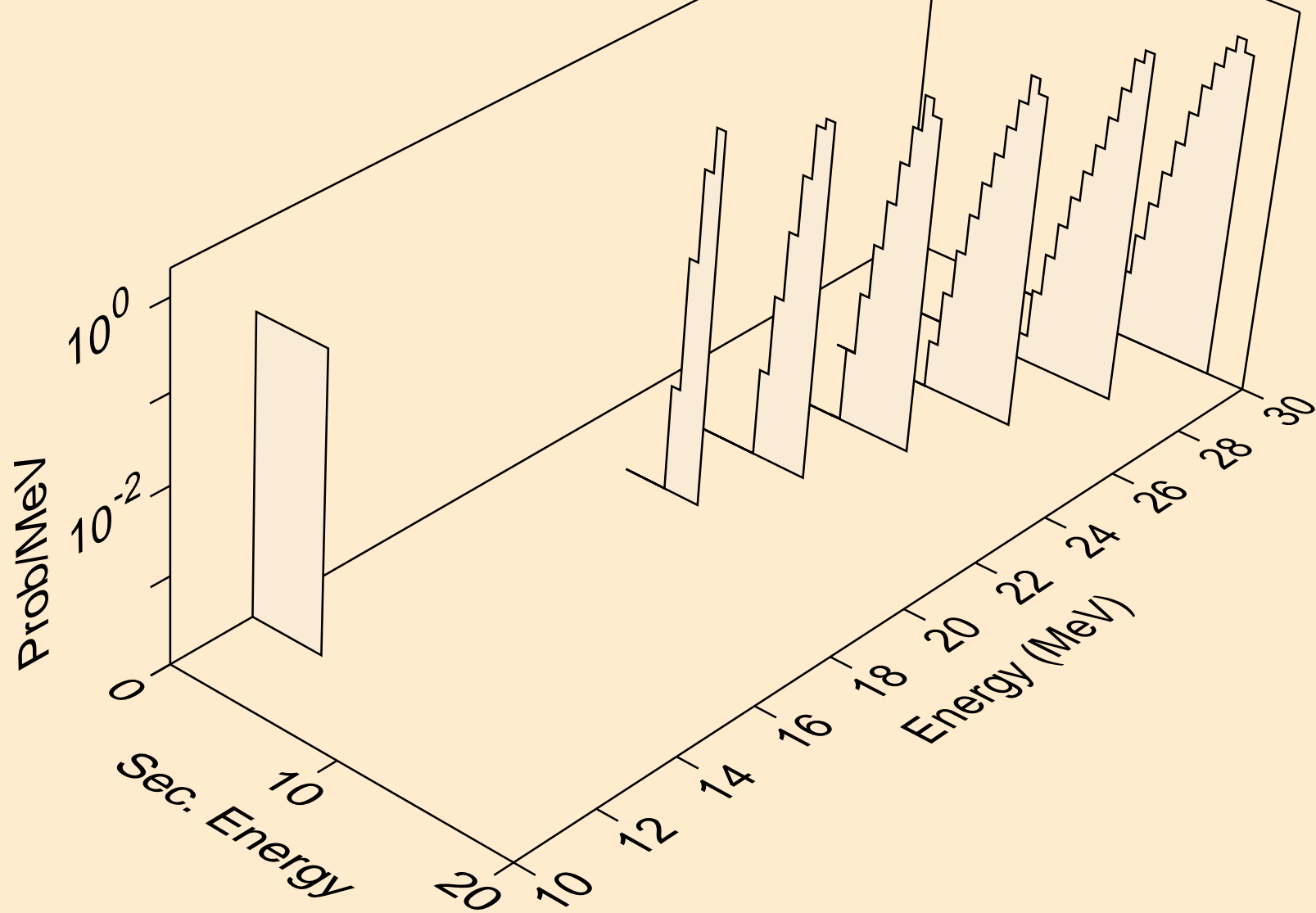

PO220 NEUTRON ACER TENDL-2021 LIBRARY; T=293.6K
he3s from (n,he3)

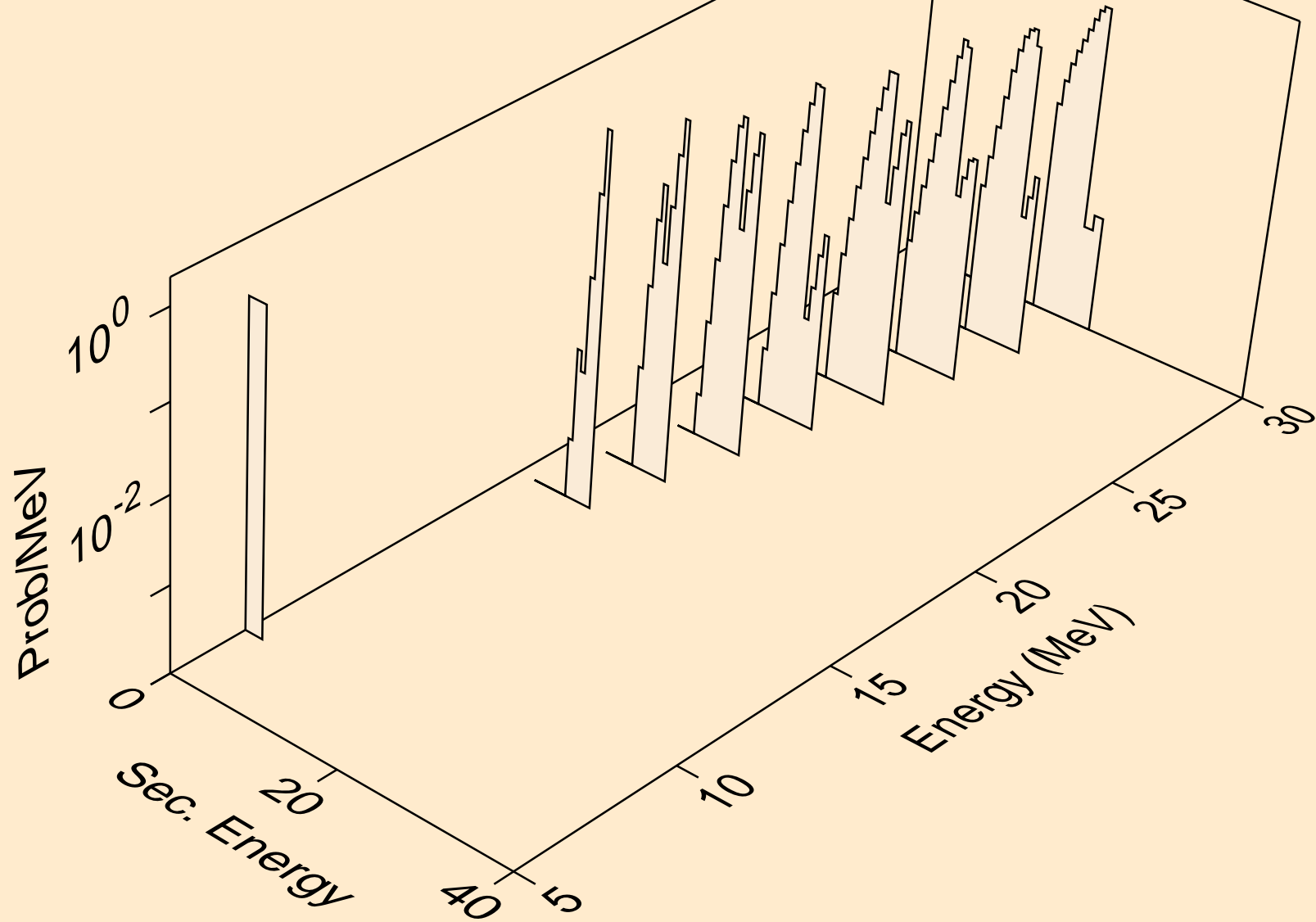

PO220 NEUTRON ACER TENDL-2021 LIBRARY; T=293.6K
alphas from (n,x)

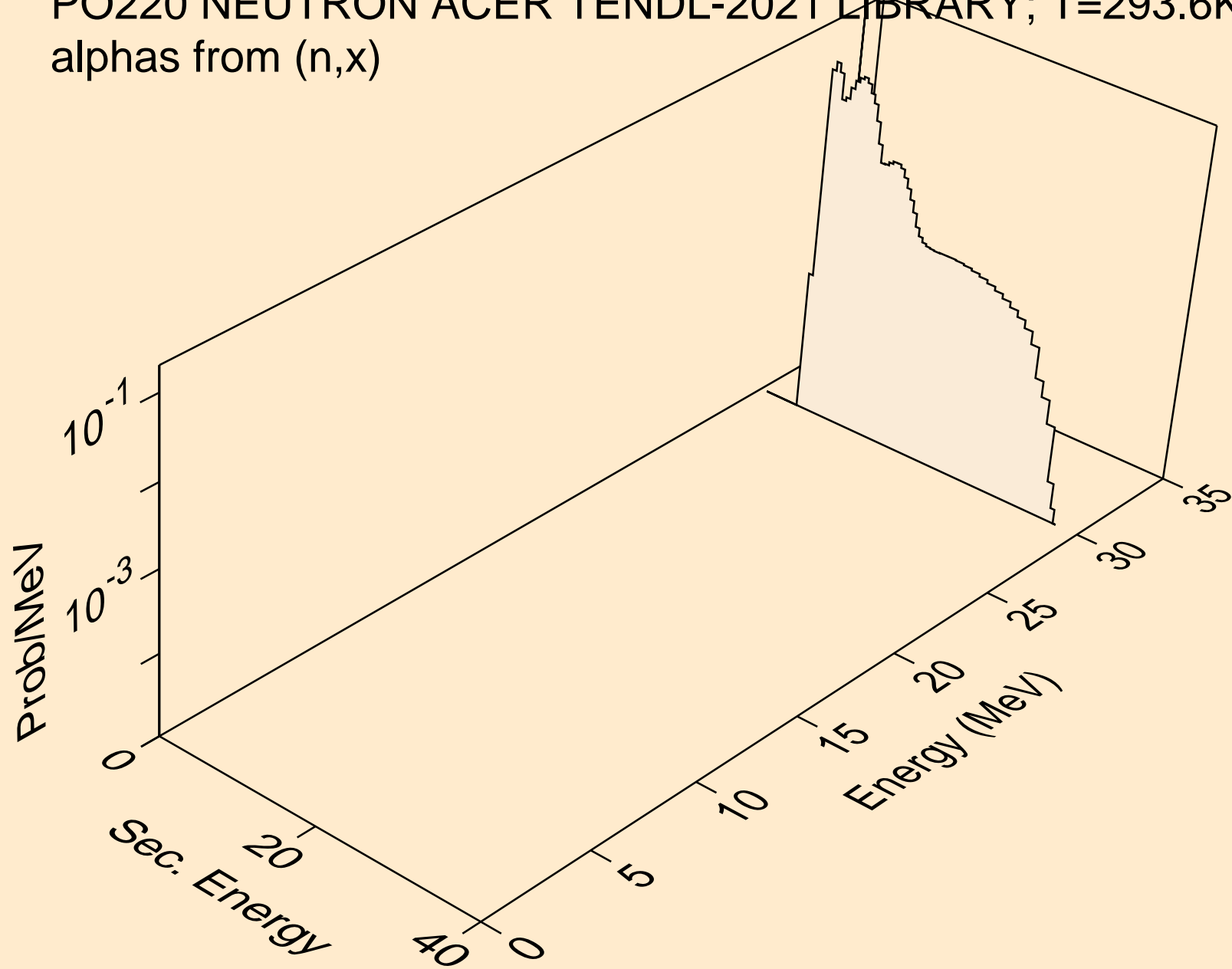

PO220 NEUTRON ACER TENDL-2021 LIBRARY; T=293.6K
alphas from (n,n*)a

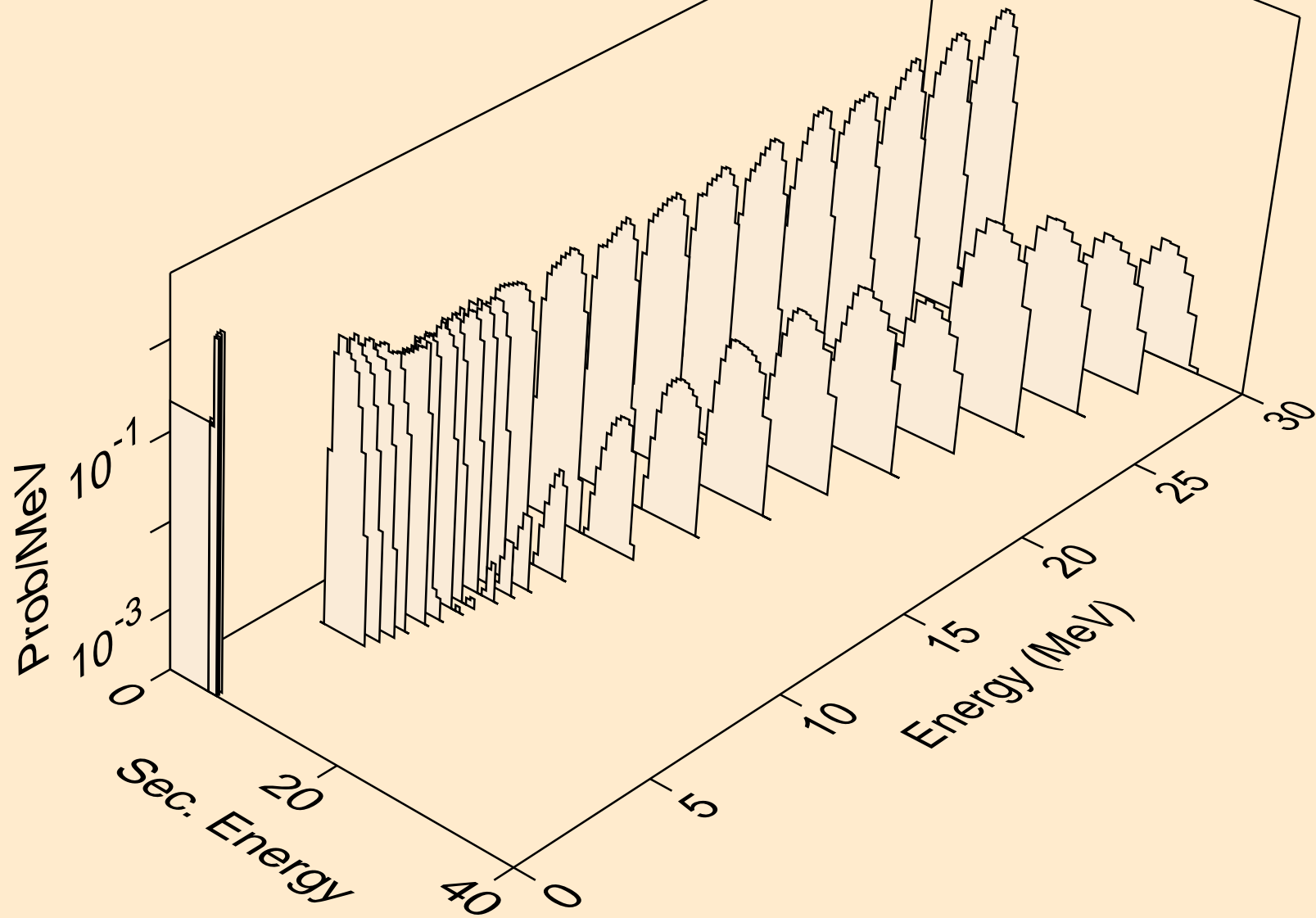

PO220 NEUTRON ACER TENDL-2021 LIBRARY; T=293.6K
alphas from (n,2n)a

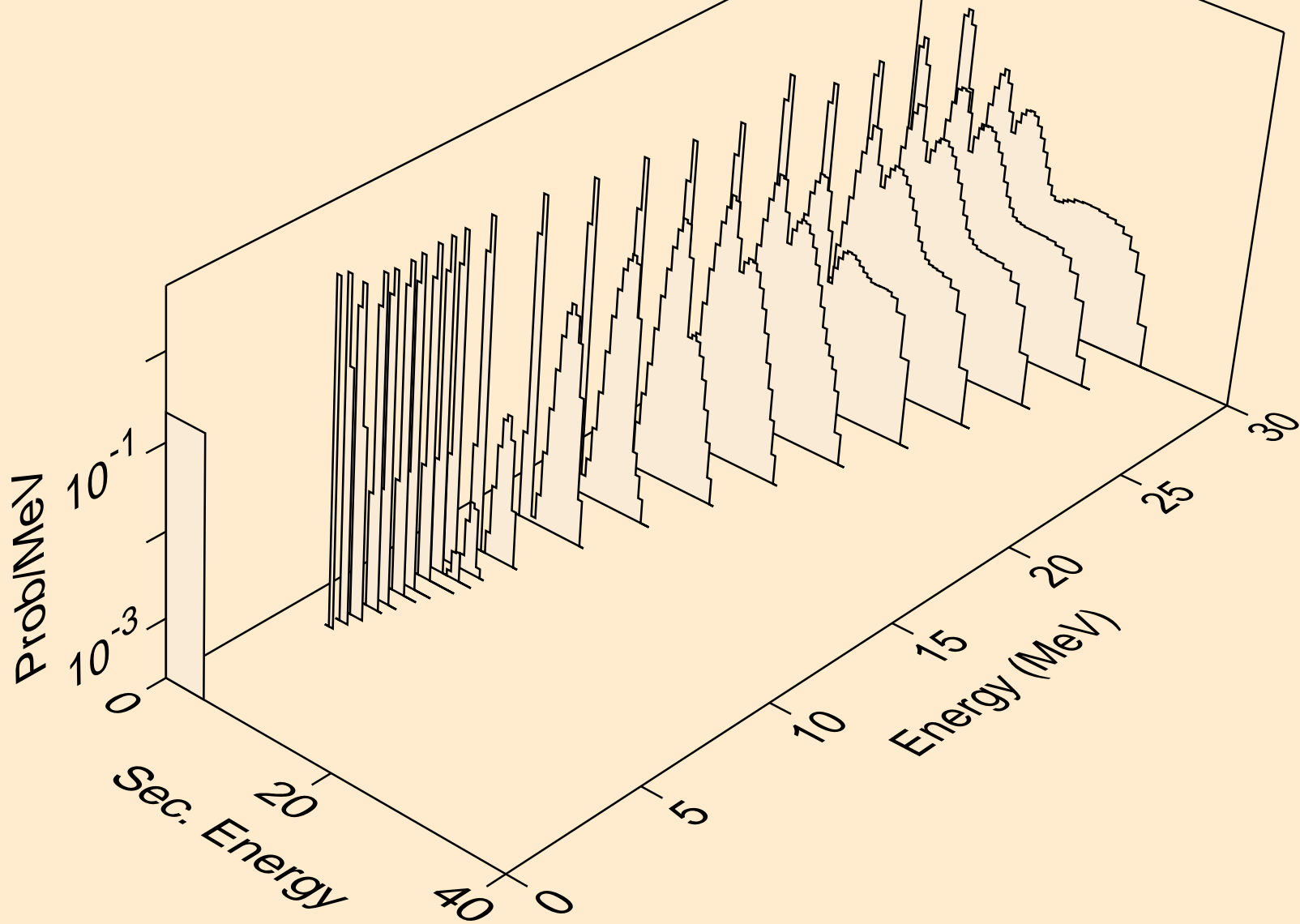

PO220 NEUTRON ACER TENDL-2021 LIBRARY; T=293.6K
alphas from (n,3n)a

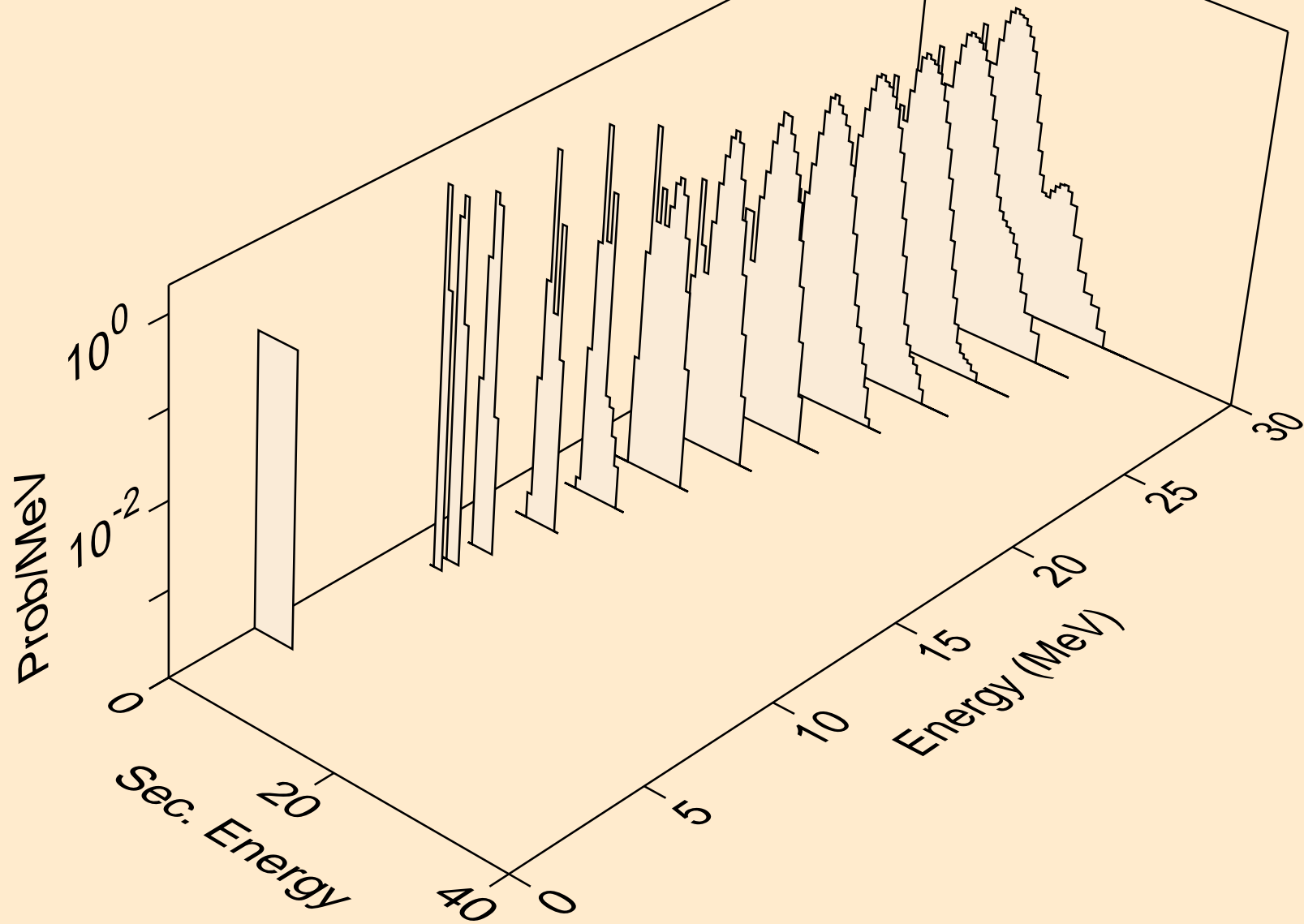

PO220 NEUTRON ACER TENDL-2021 LIBRARY; T=293.6K
alphas from (n,n*)2a

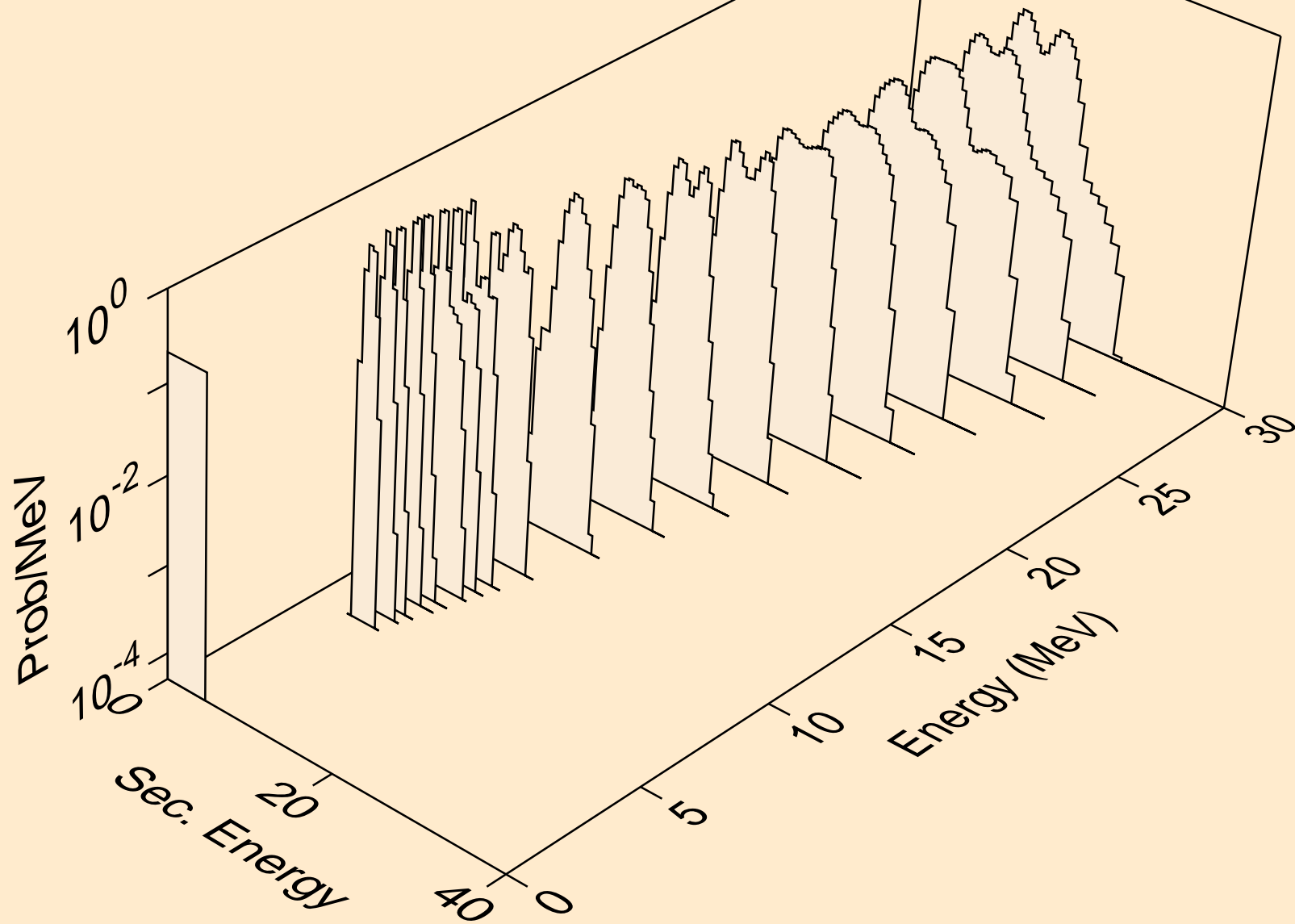

PO220 NEUTRON ACER TENDL-2021 LIBRARY; T=293.6K
alphas from (n,2n)2a

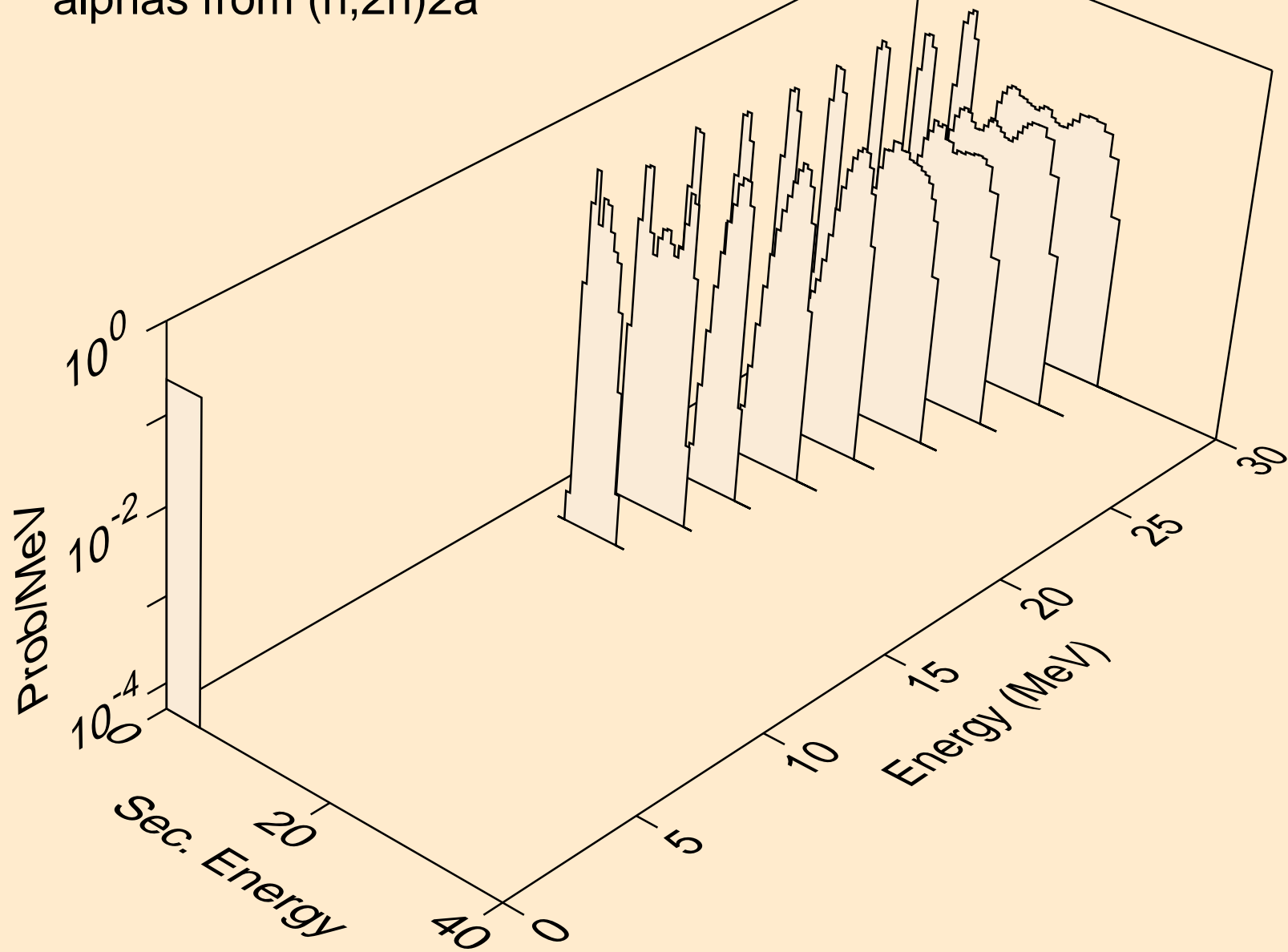

PO220 NEUTRON ACER TENDL-2021 LIBRARY; T=293.6K
alphas from (n,npa)

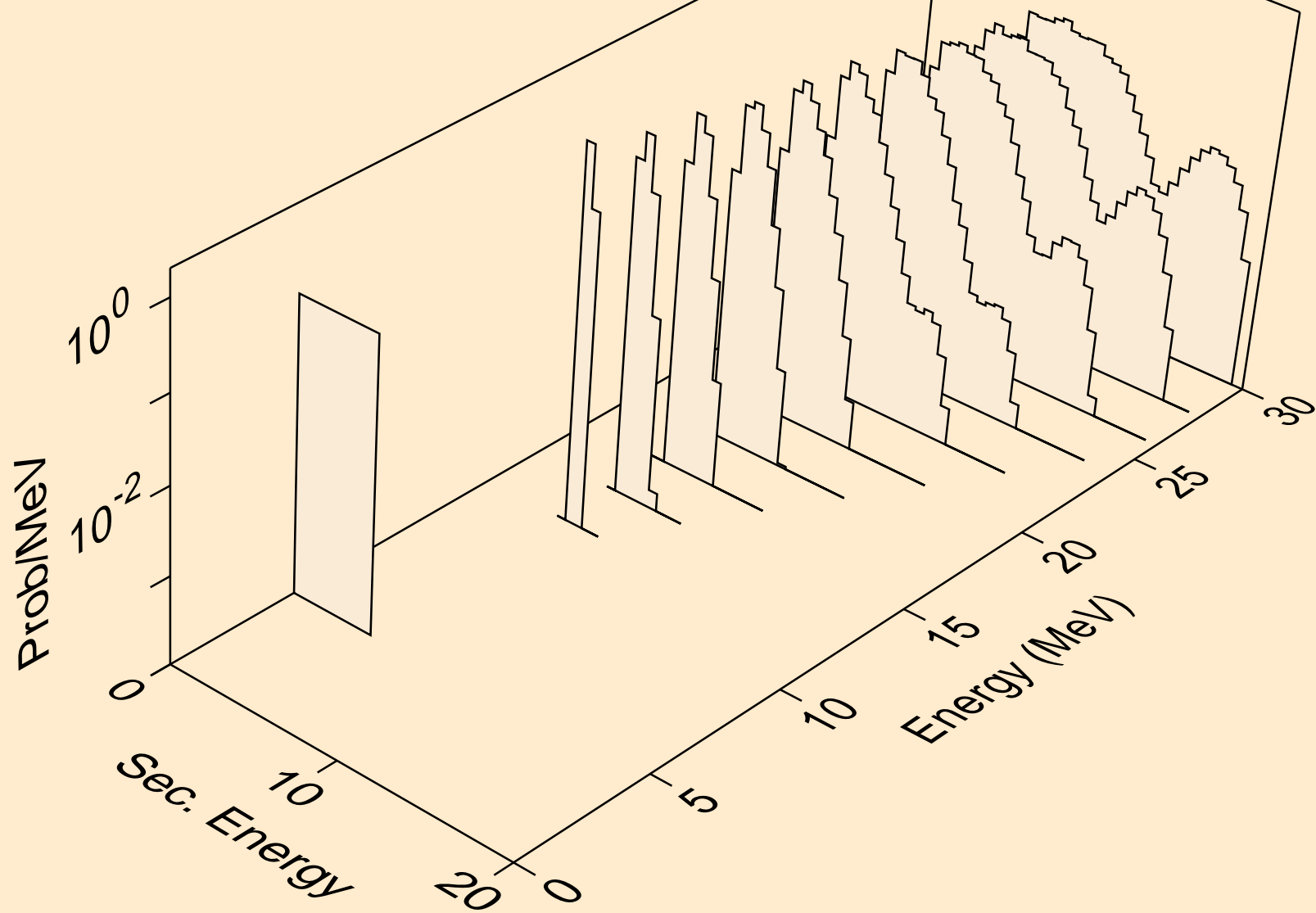

PO220 NEUTRON ACER TENDL-2021 LIBRARY; T=293.6K
alphas from (n,a)

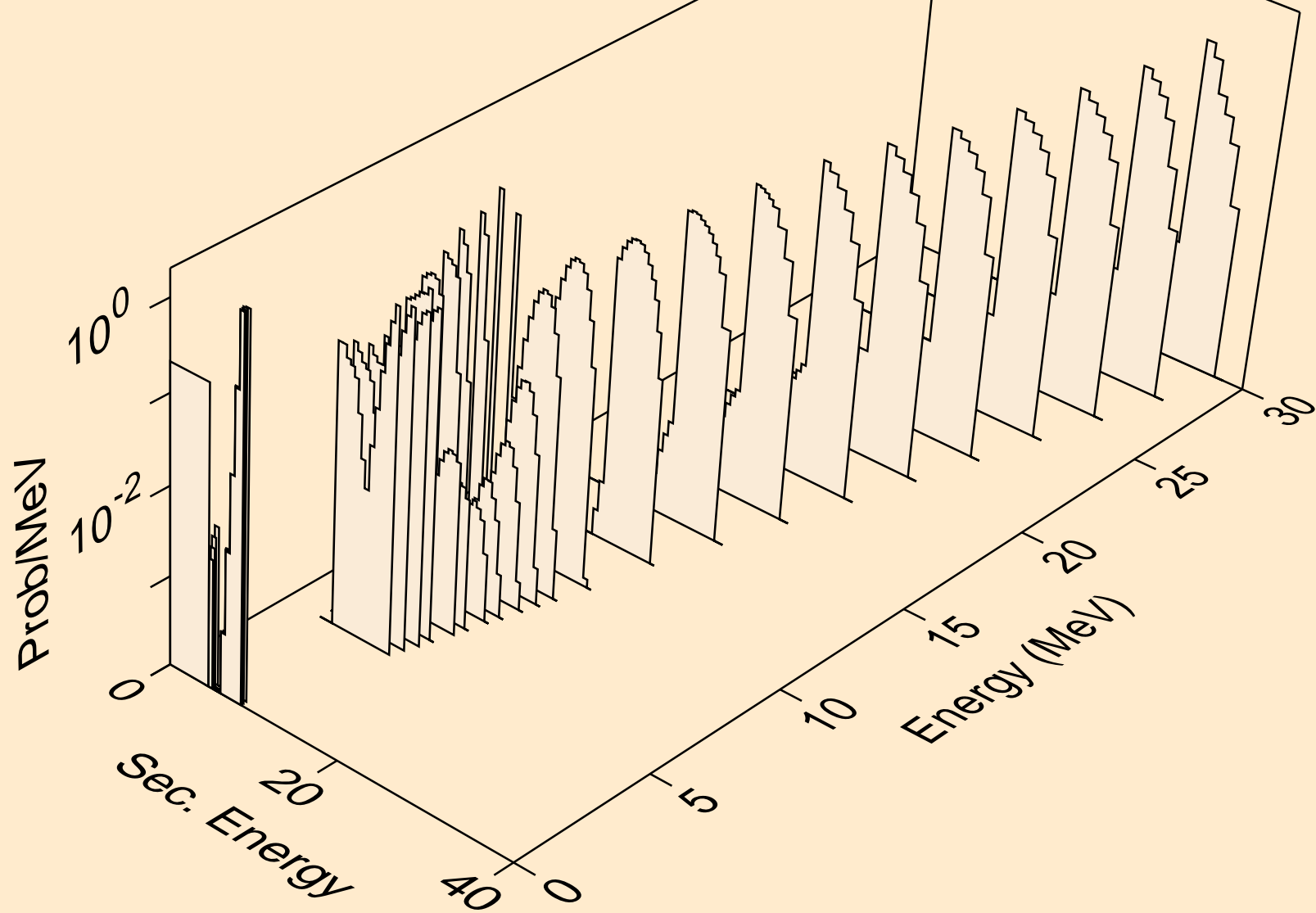

PO220 NEUTRON ACER TENDL-2021 LIBRARY; T=293.6K
alphas from (n,2a)

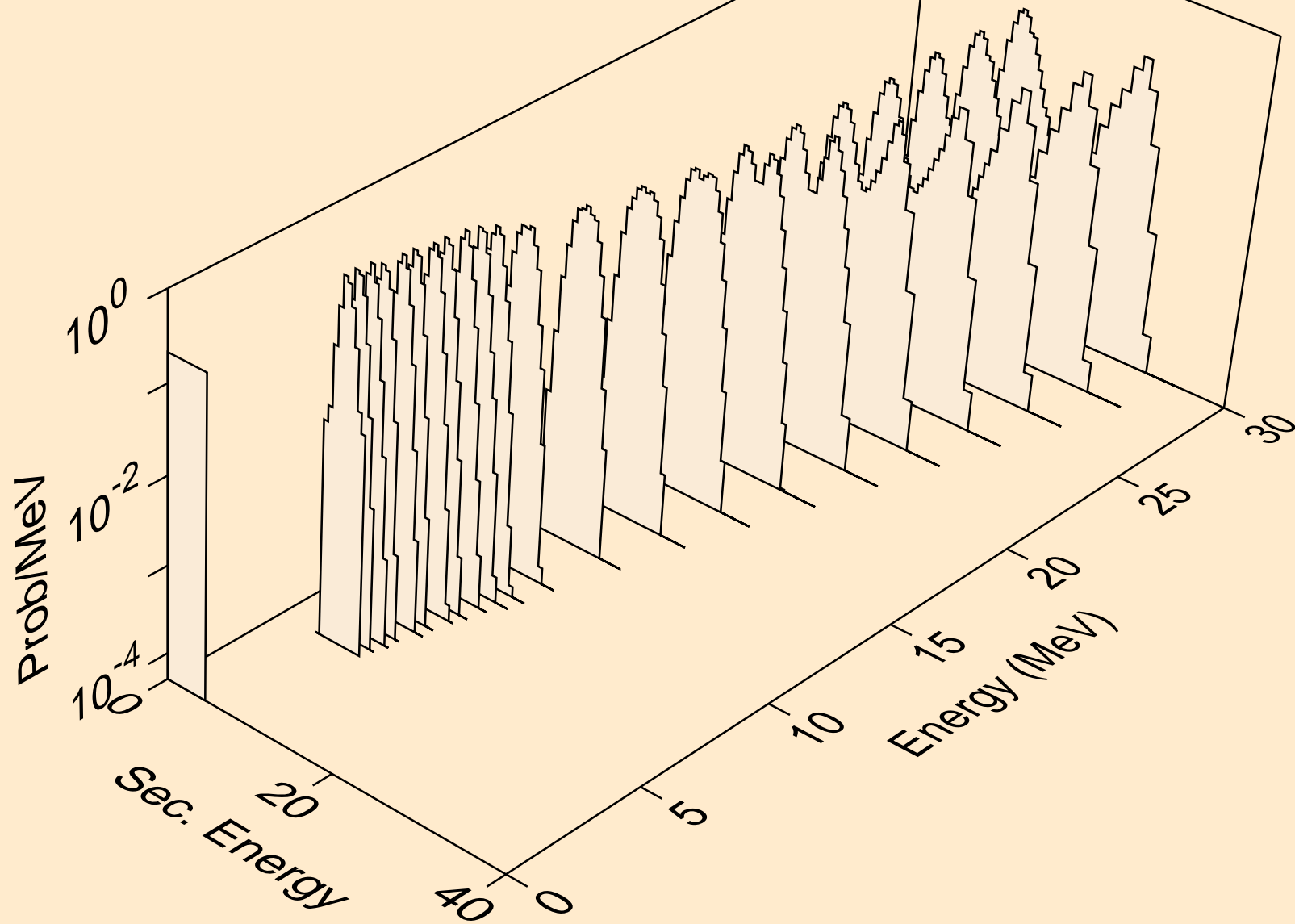

PO220 NEUTRON ACER TENDL-2021 LIBRARY; T=293.6K
alphas from (n,pa)

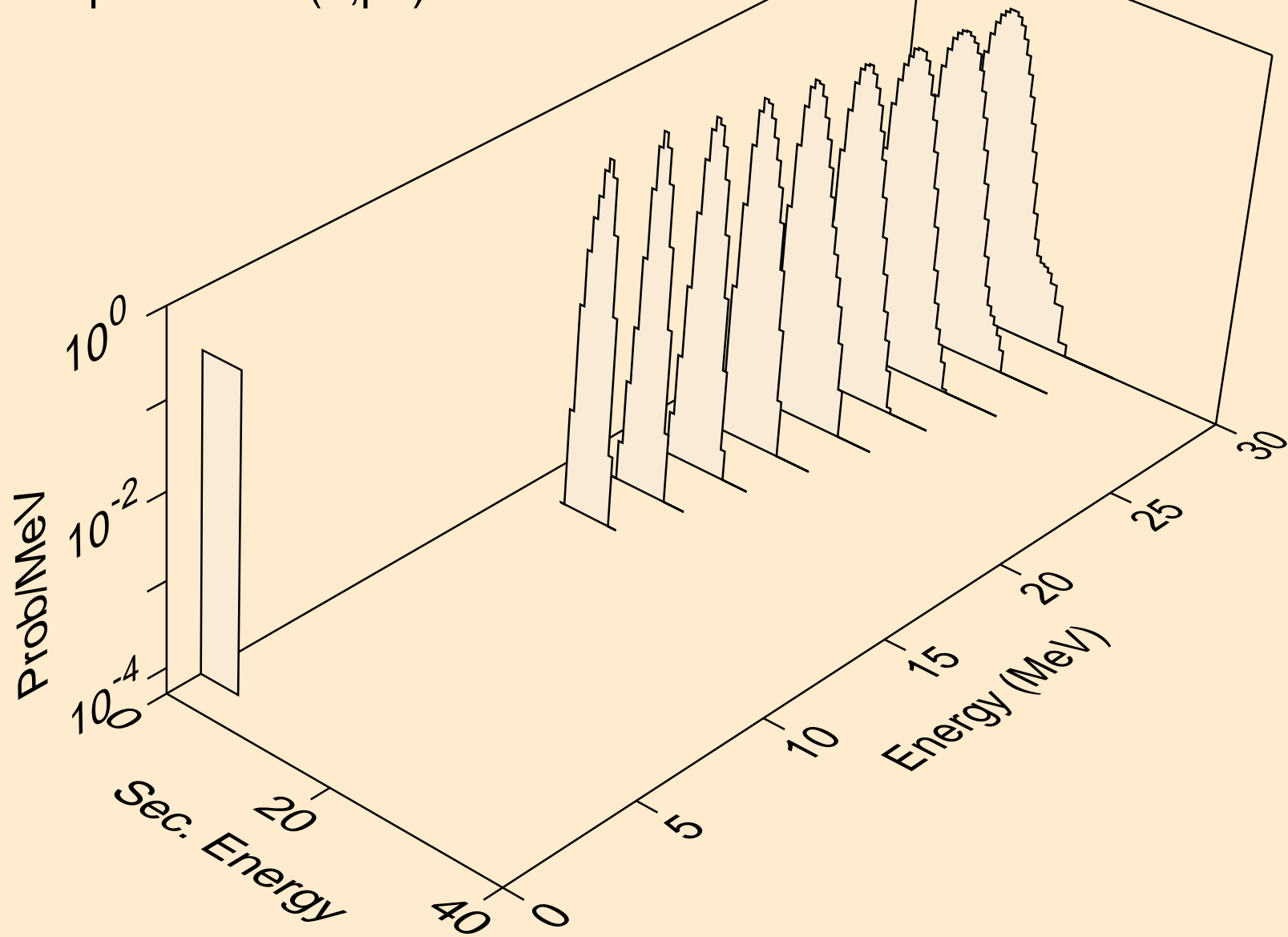

PO220 NEUTRON ACER TENDL-2021 LIBRARY; T=293.6K
alphas from (n,da)

