

# PO224 NEUTRON ACER TENDL-2021 LIBRARY; T=293.6K

## Principal cross sections

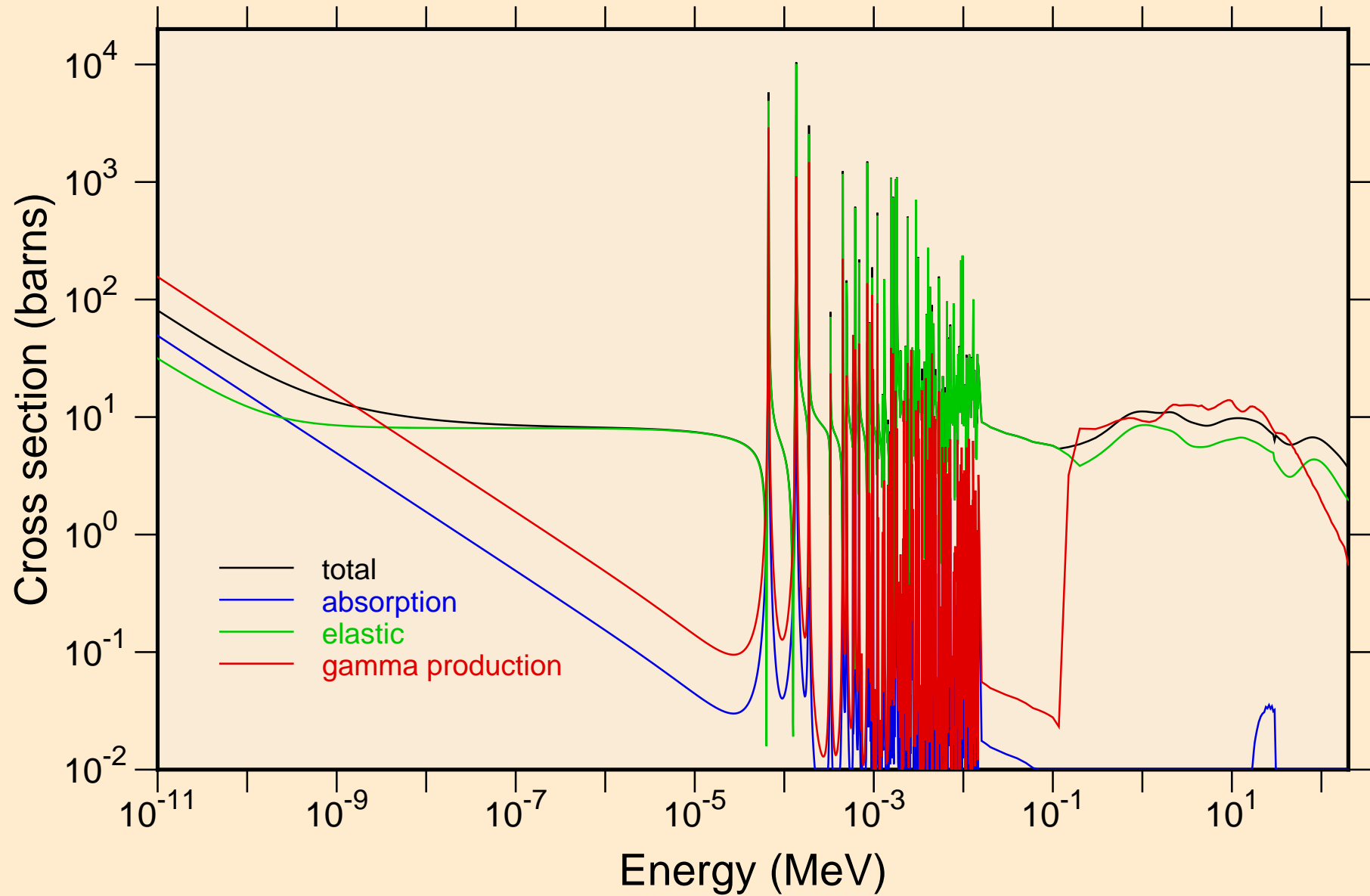

PO224 NEUTRON ACER TENDL-2021 LIBRARY; T=293.6K  
resonance total cross section

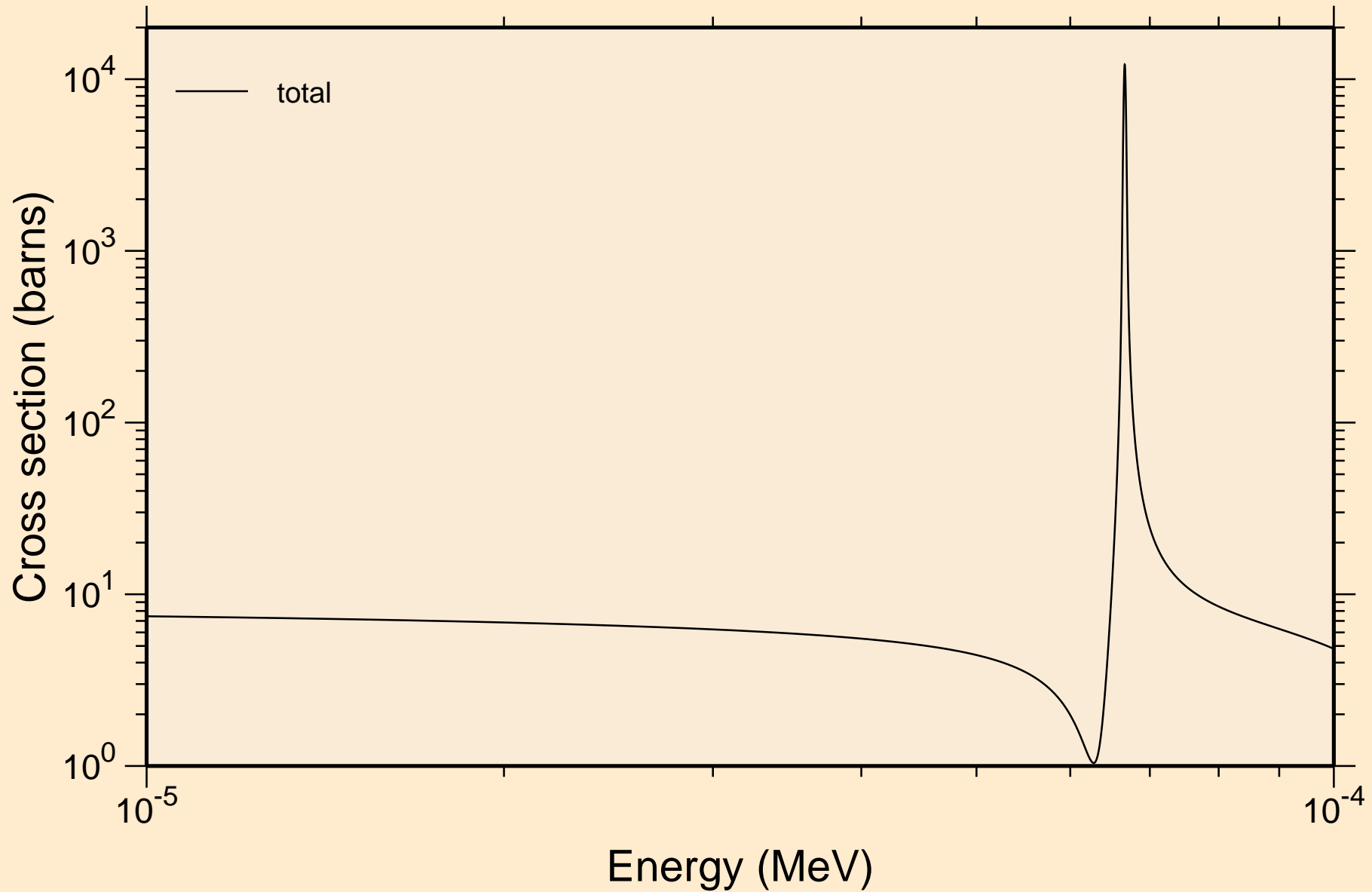

PO224 NEUTRON ACER TENDL-2021 LIBRARY; T=293.6K  
resonance total cross section

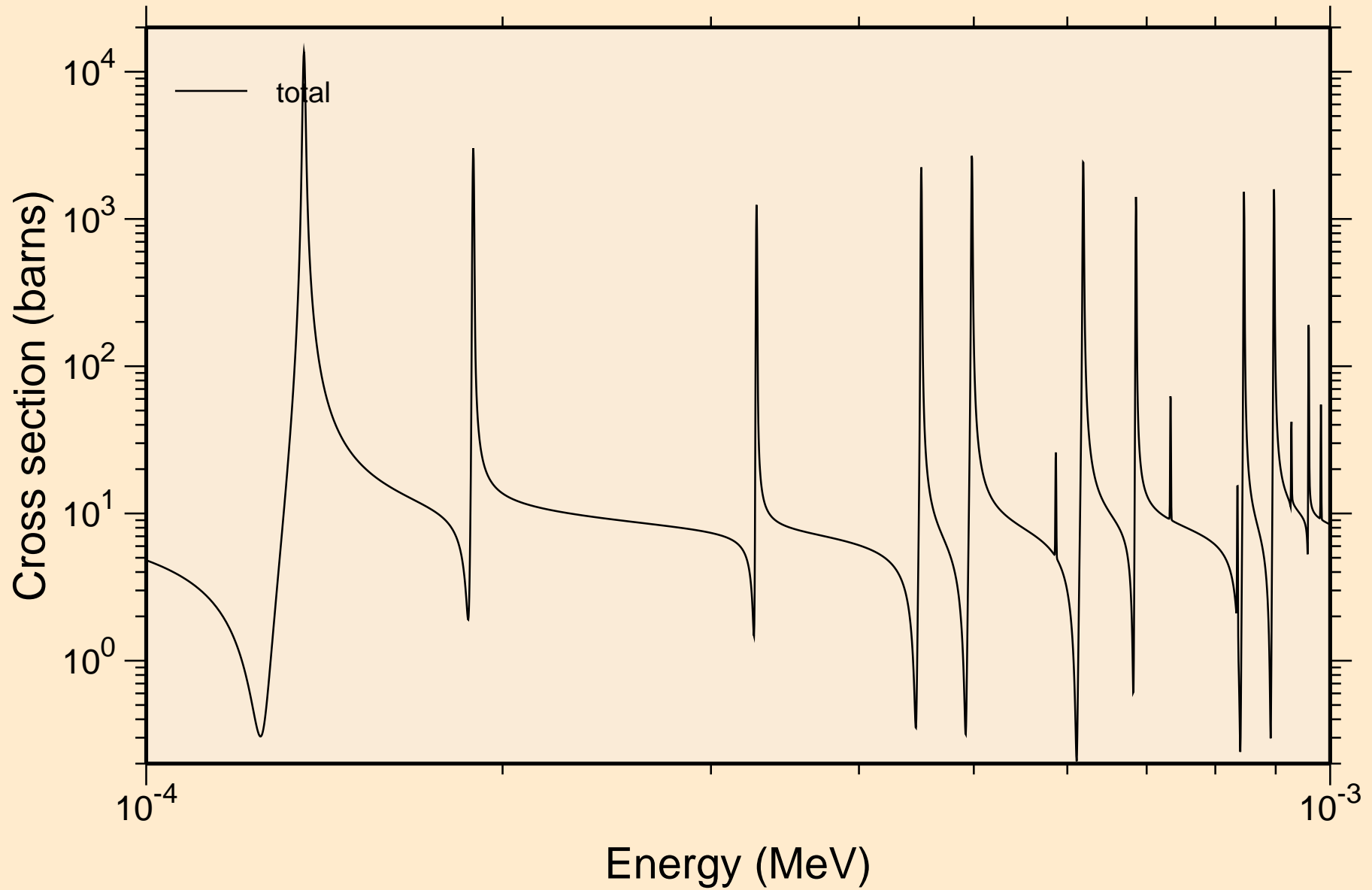

PO224 NEUTRON ACER TENDL-2021 LIBRARY; T=293.6K  
resonance total cross section

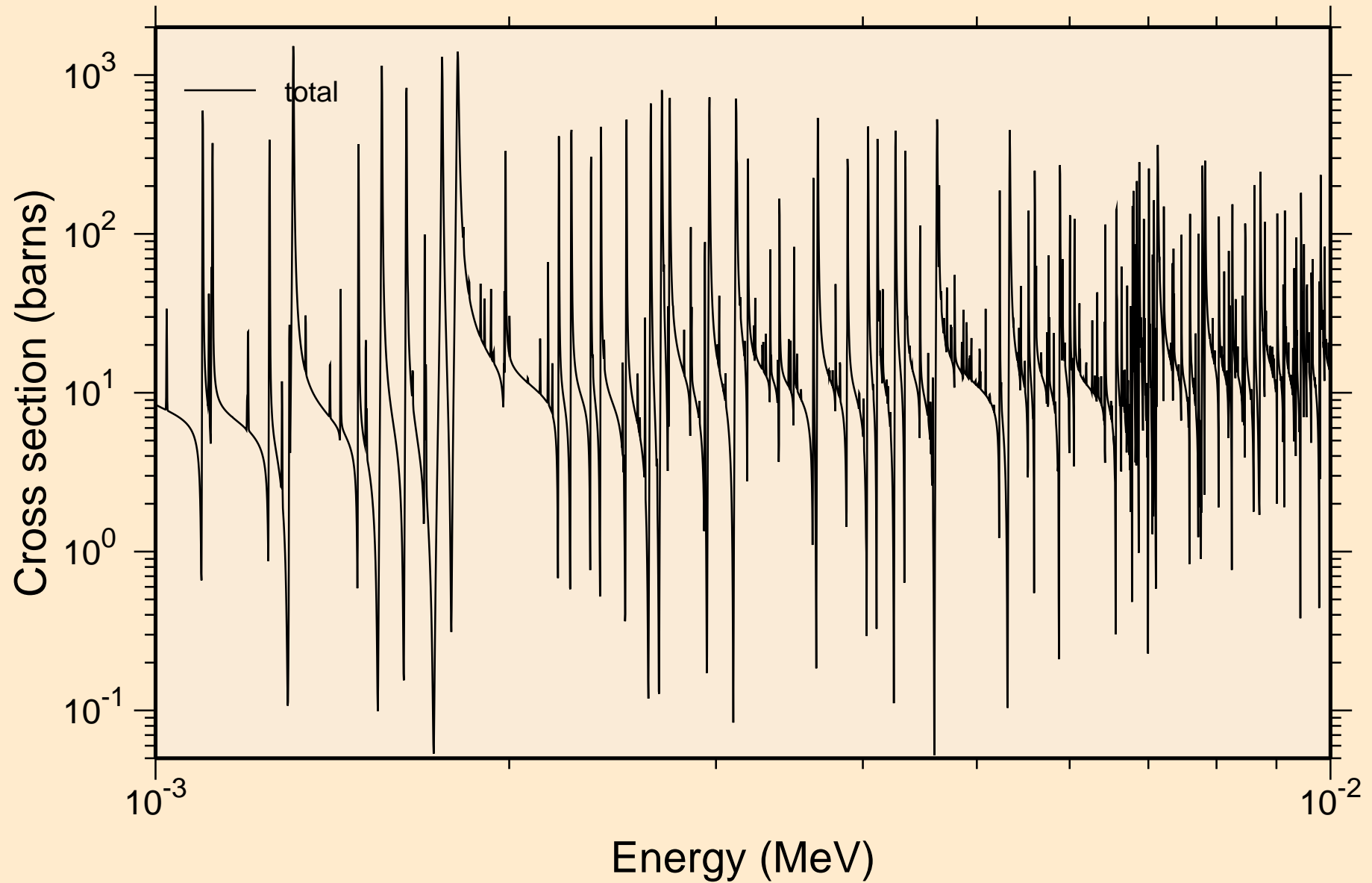

PO224 NEUTRON ACER TENDL-2021 LIBRARY; T=293.6K  
resonance total cross section

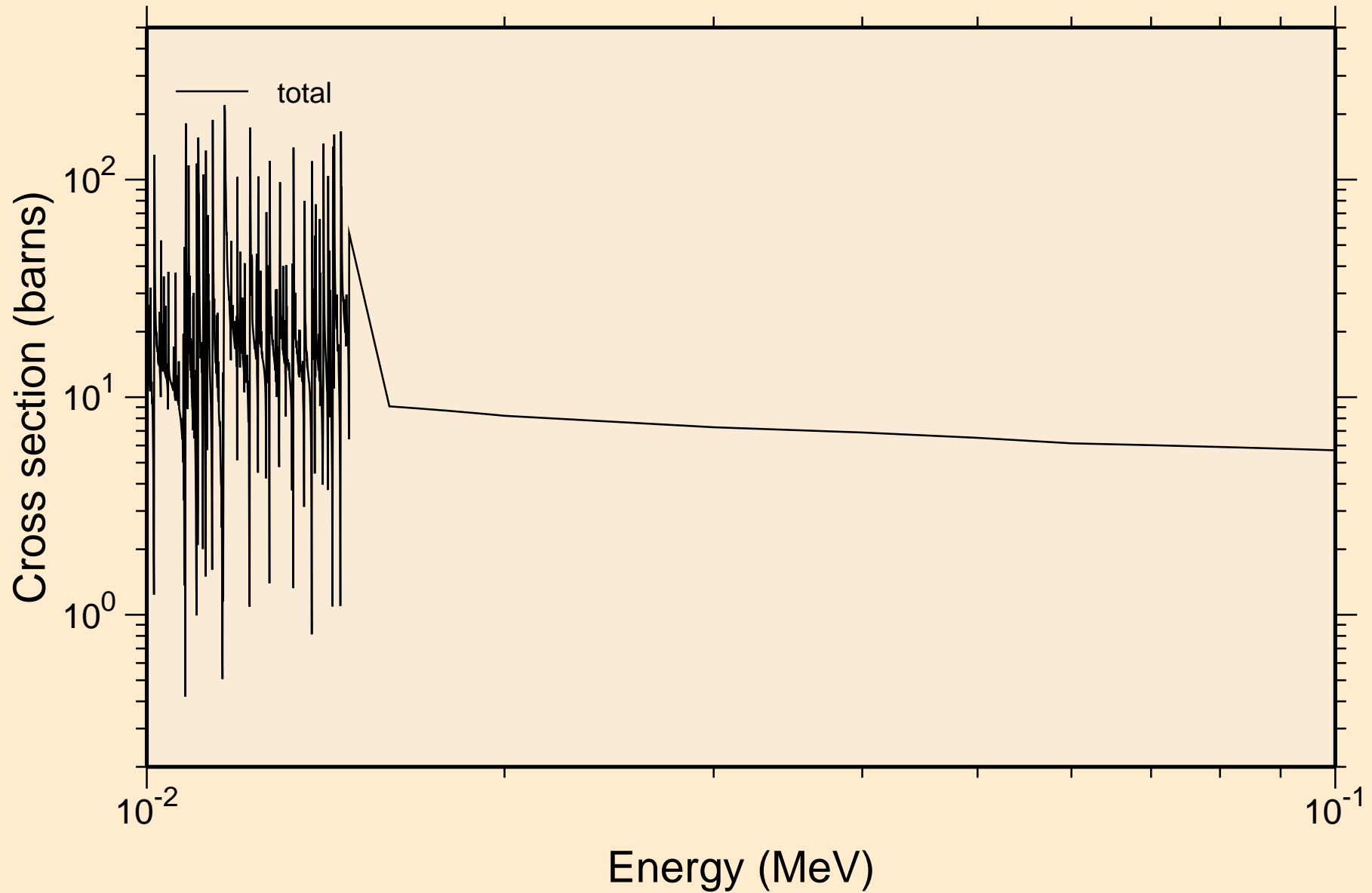

PO224 NEUTRON ACER TENDL-2021 LIBRARY; T=293.6K  
resonance total cross section

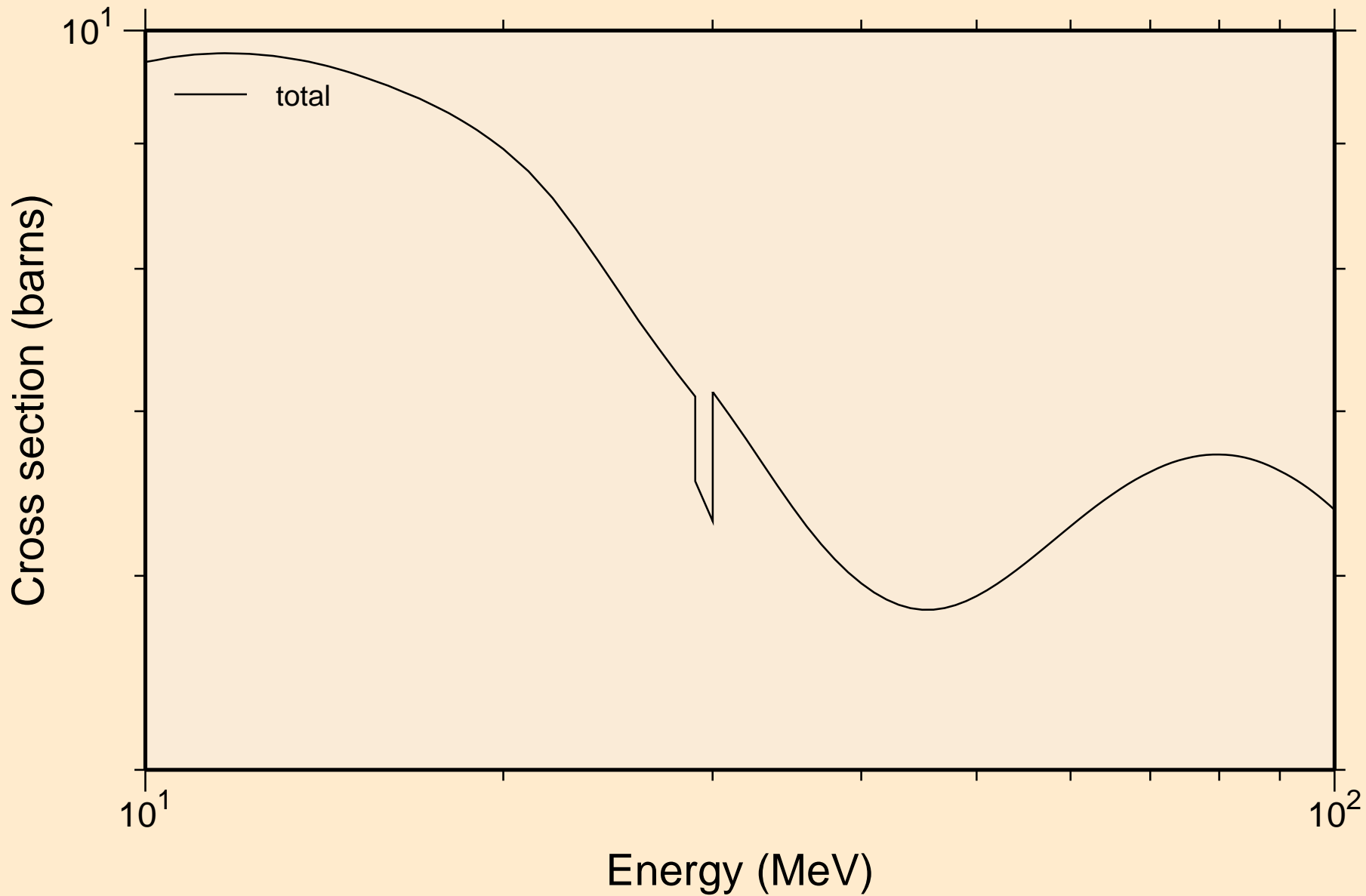

PO224 NEUTRON ACER TENDL-2021 LIBRARY; T=293.6K  
resonance absorption cross sections

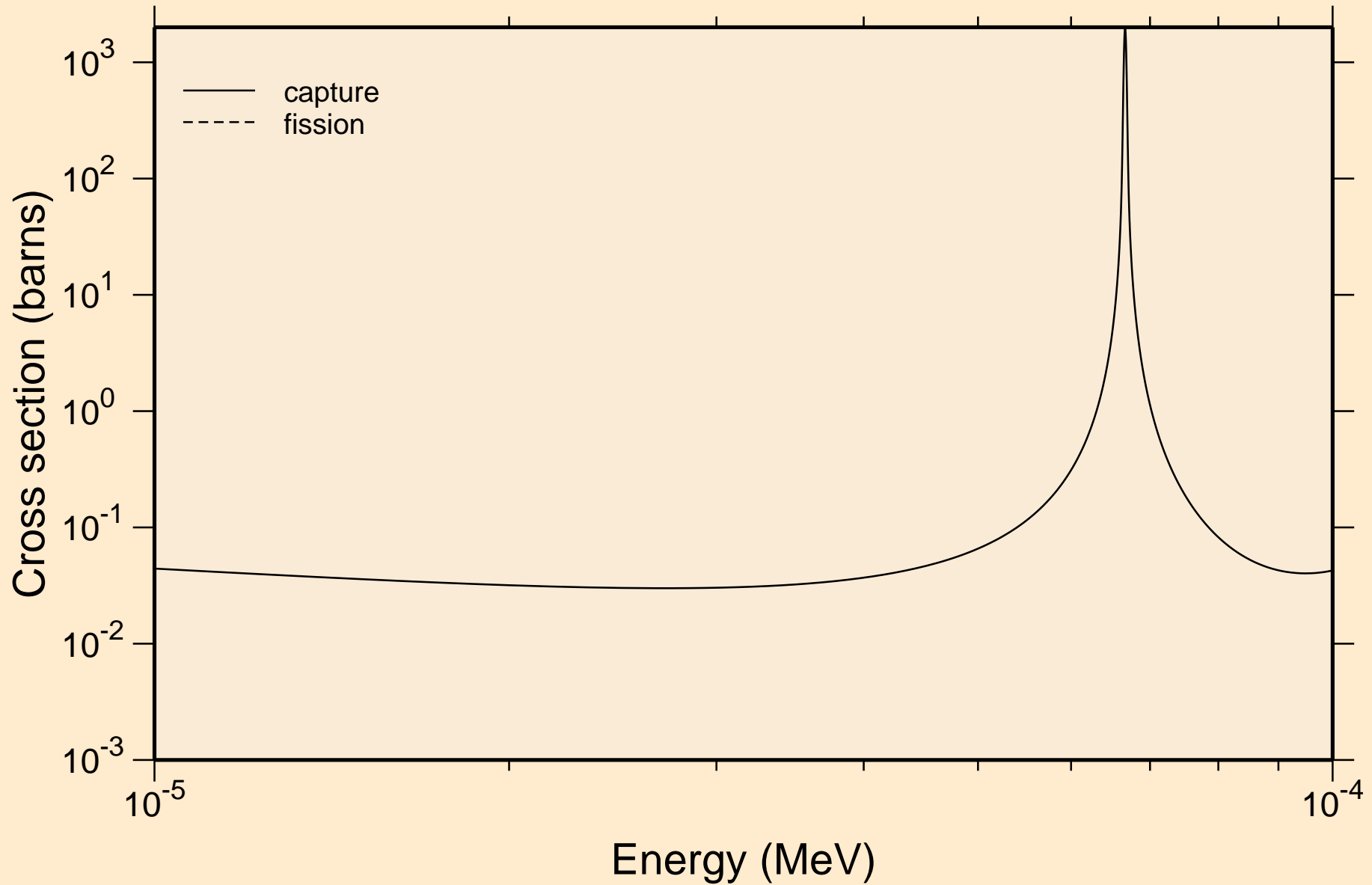

PO224 NEUTRON ACER TENDL-2021 LIBRARY; T=293.6K  
resonance absorption cross sections

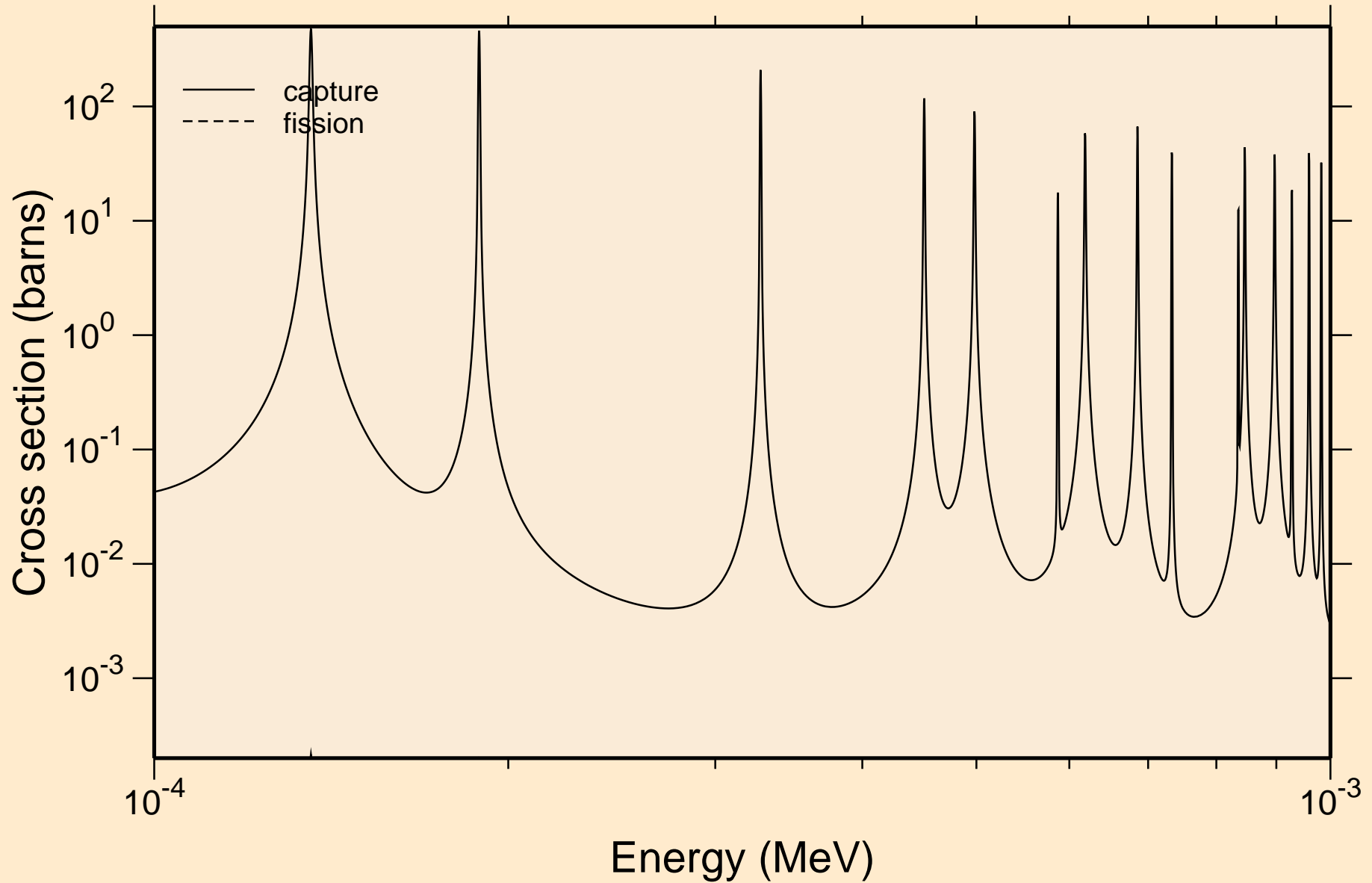



PO224 NEUTRON ACER TENDL-2021 LIBRARY; T=293.6K  
resonance absorption cross sections

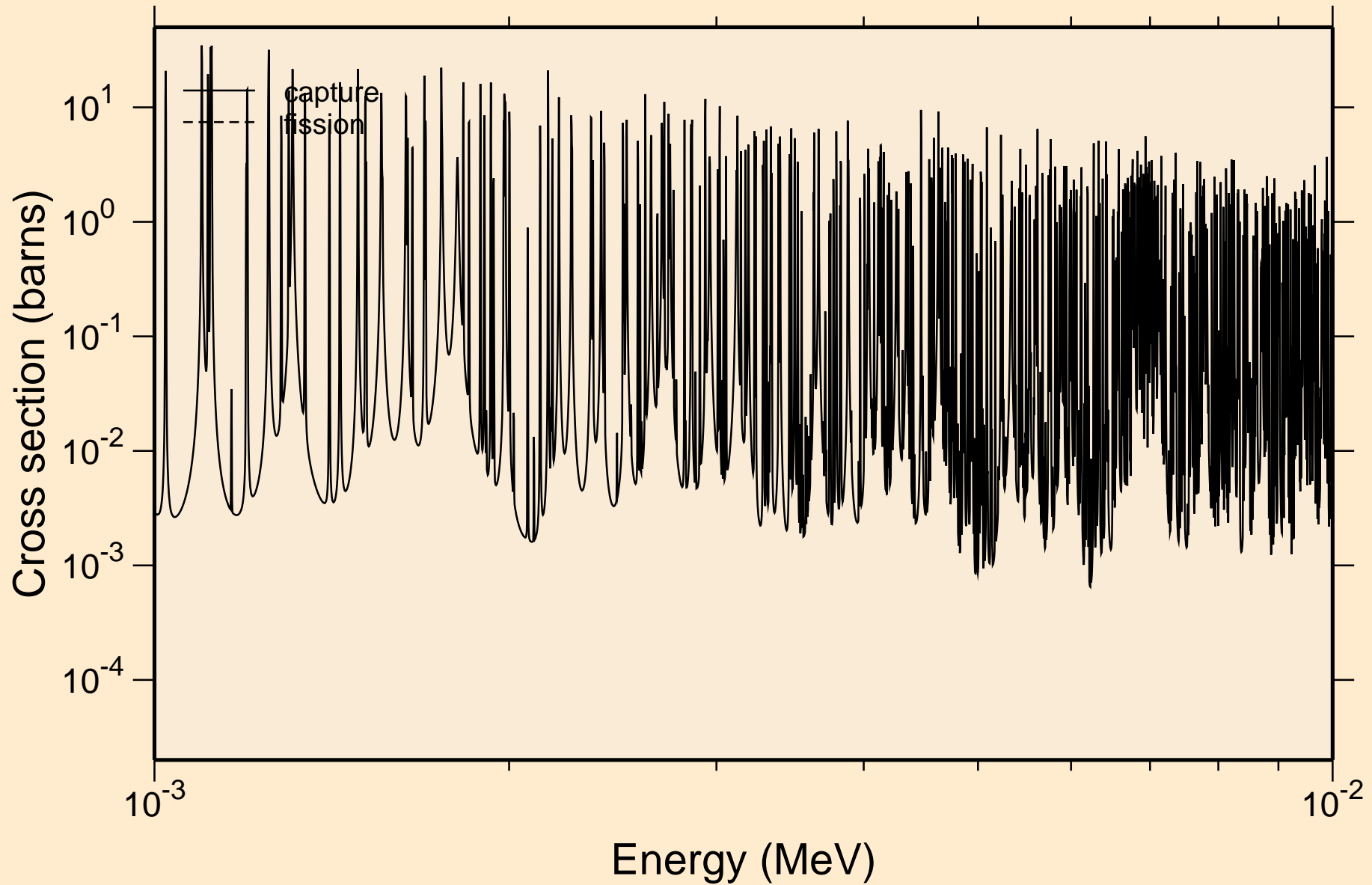

PO224 NEUTRON ACER TENDL-2021 LIBRARY; T=293.6K  
resonance absorption cross sections

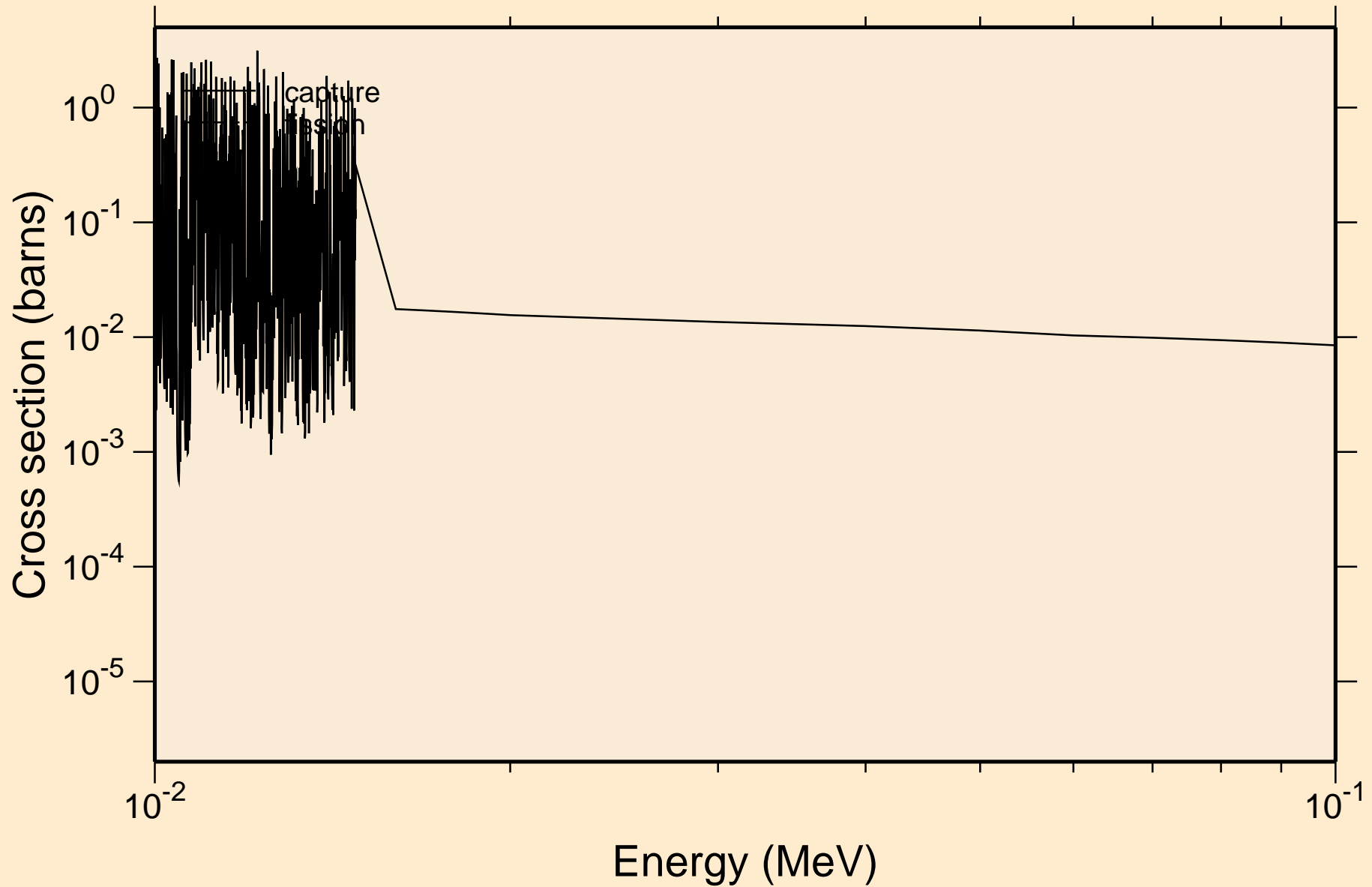

PO224 NEUTRON ACER TENDL-2021 LIBRARY; T=293.6K  
resonance absorption cross sections

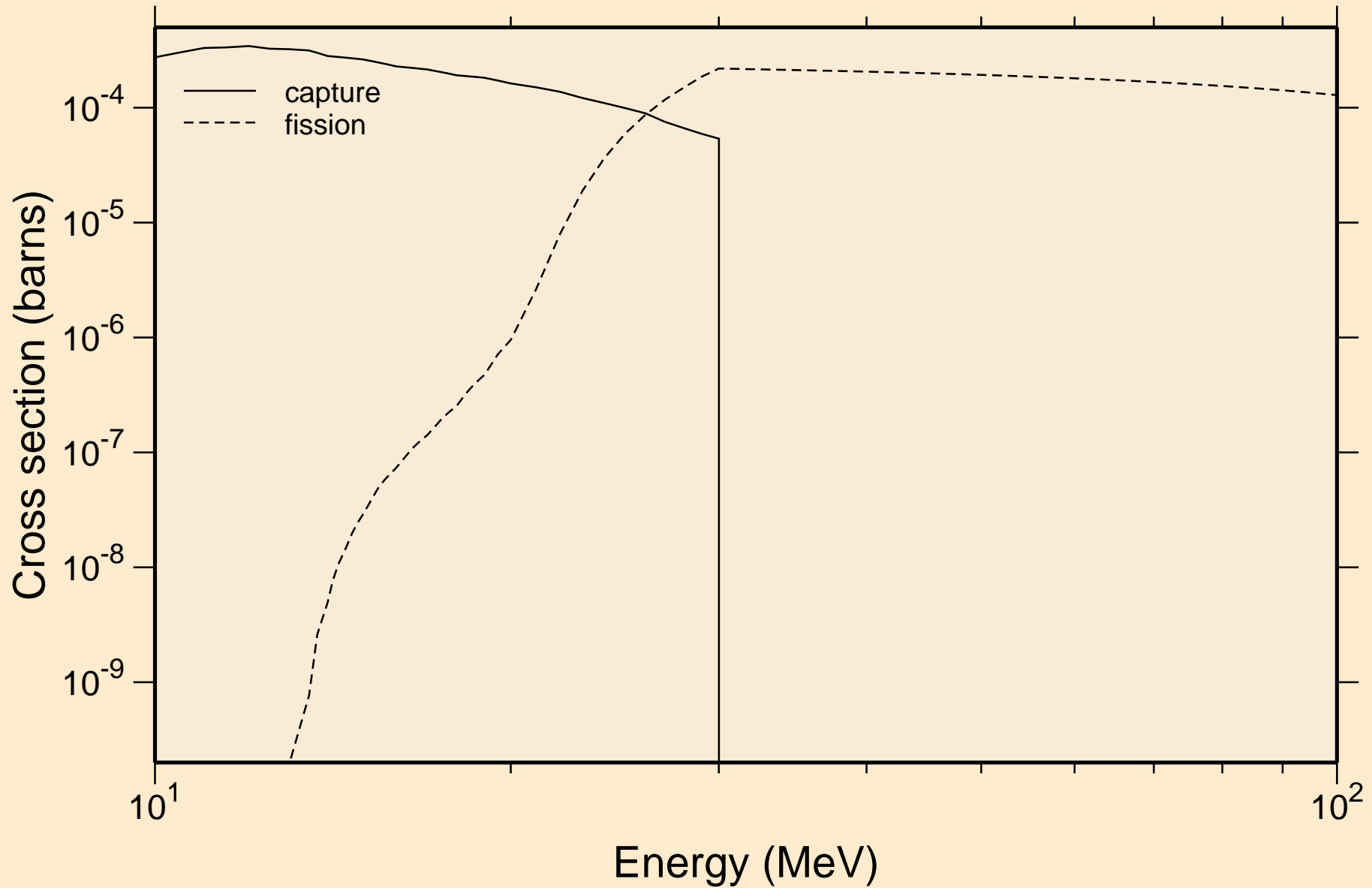

PO224 NEUTRON ACER TENDL-2021 LIBRARY; T=293.6K  
Heating

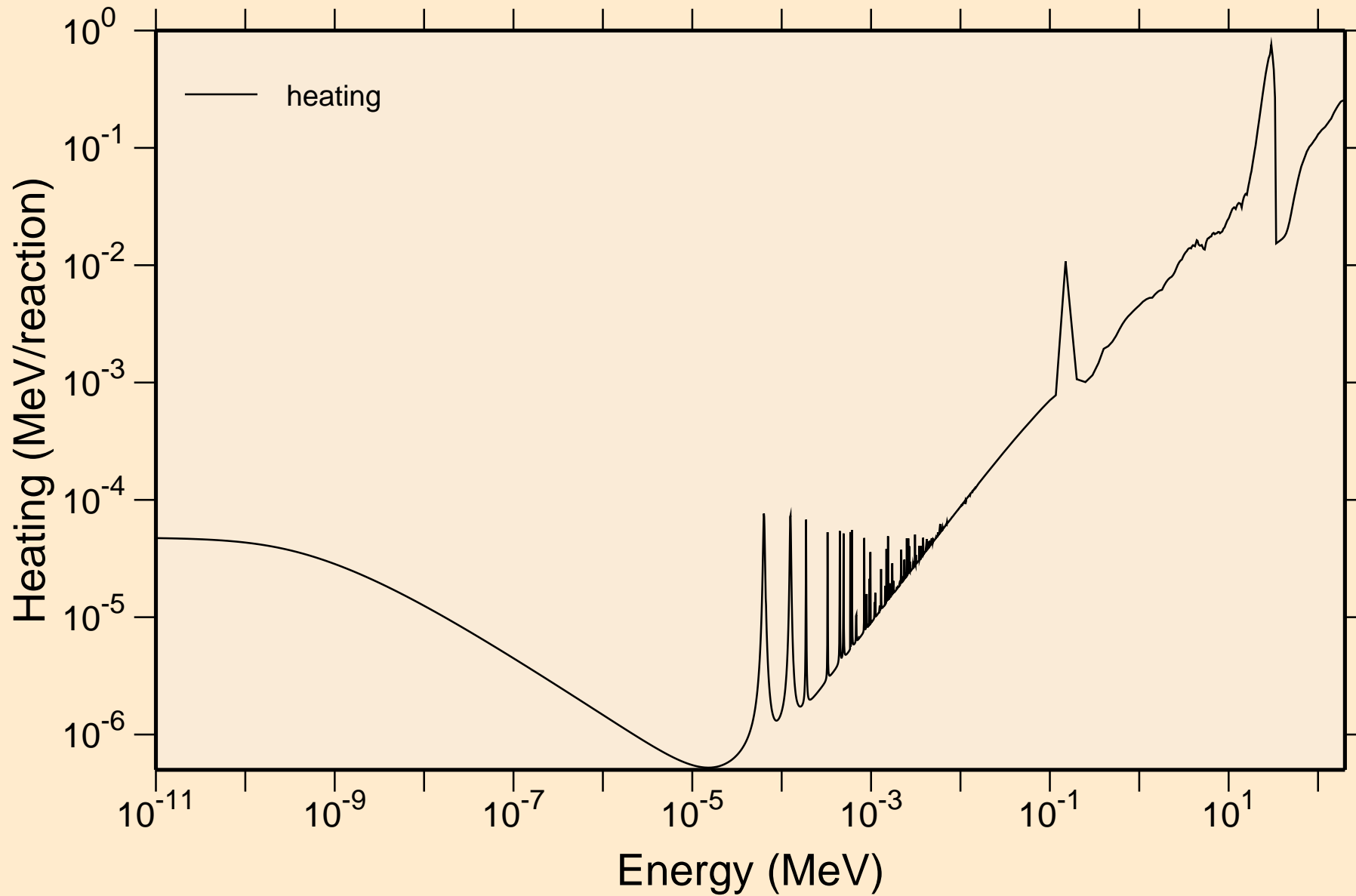

PO224 NEUTRON ACER TENDL-2021 LIBRARY; T=293.6K  
Damage

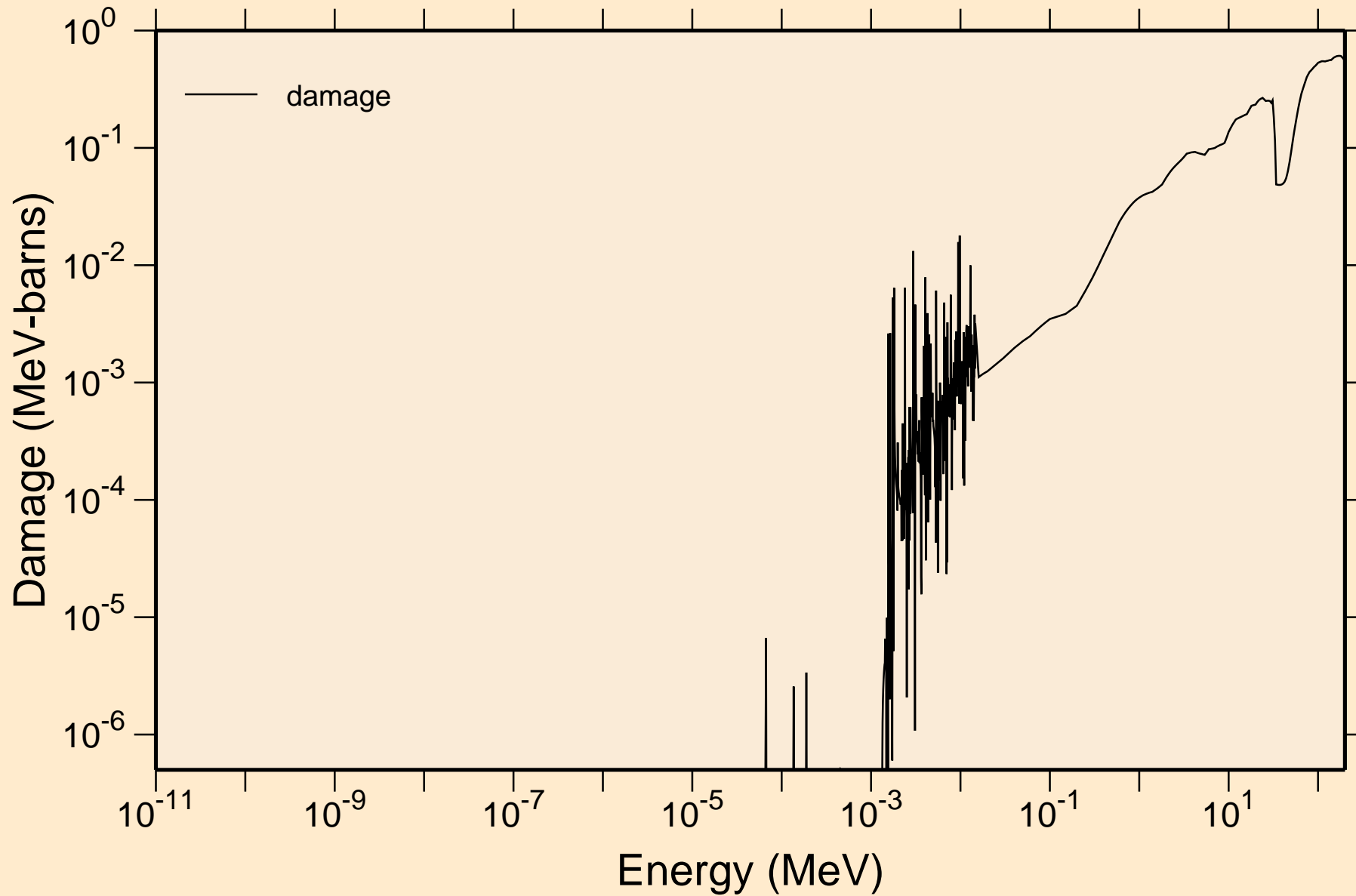

PO224 NEUTRON ACER TENDL-2021 LIBRARY; T=293.6K  
Non-threshold reactions

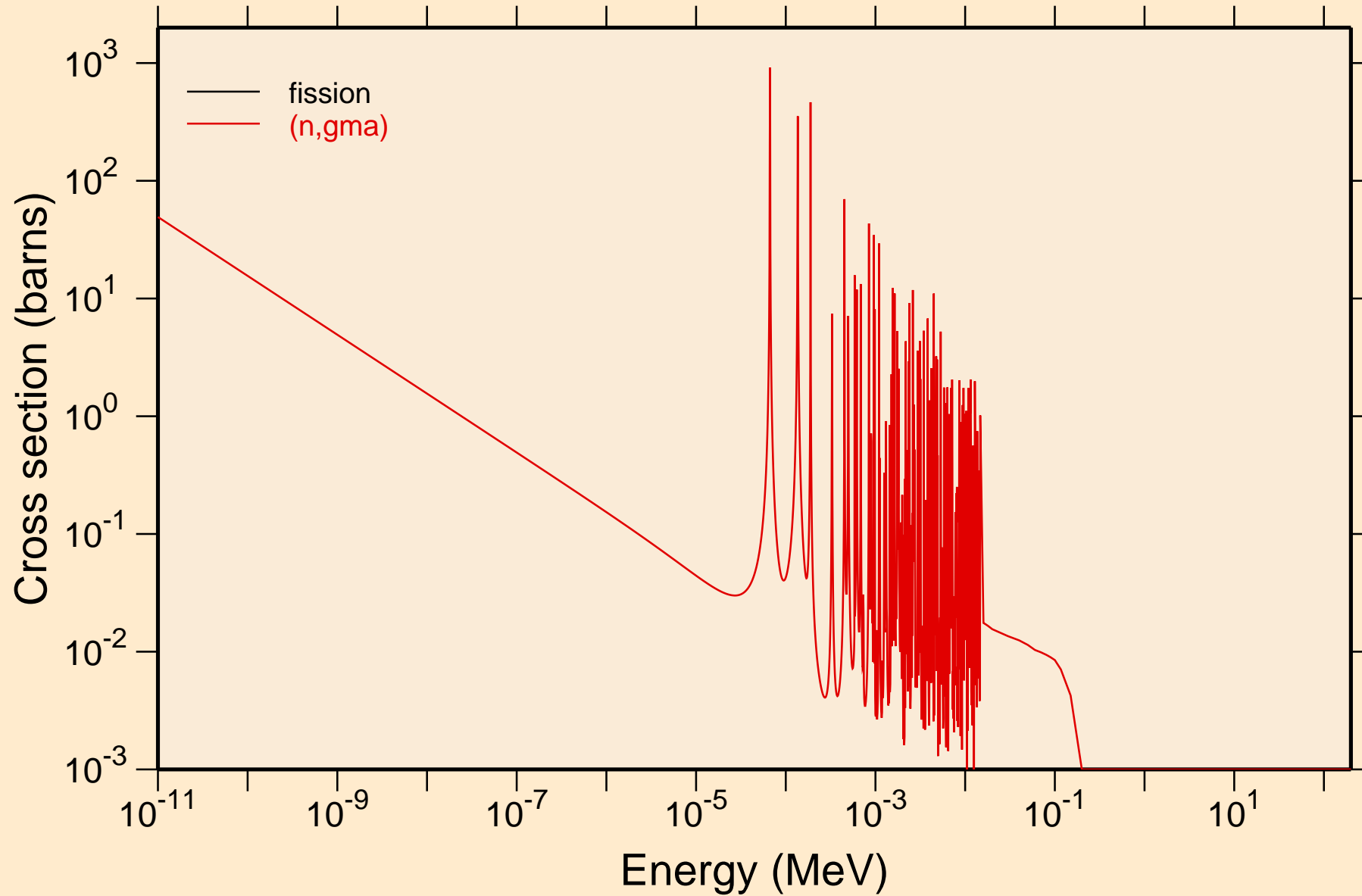

PO224 NEUTRON ACER TENDL-2021 LIBRARY; T=293.6K  
Principal cross sections

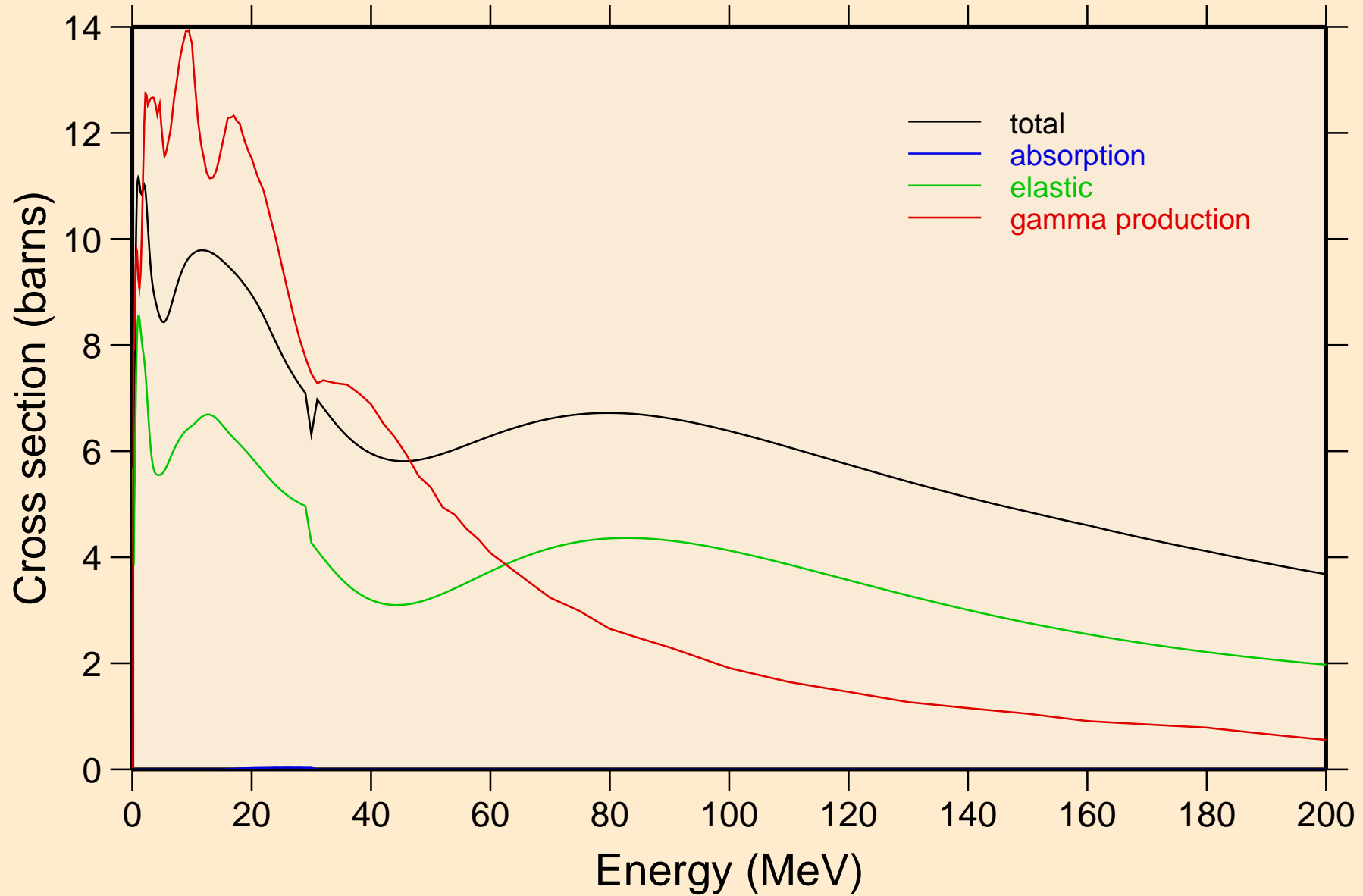

PO224 NEUTRON ACER TENDL-2021 LIBRARY; T=293.6K  
Heating

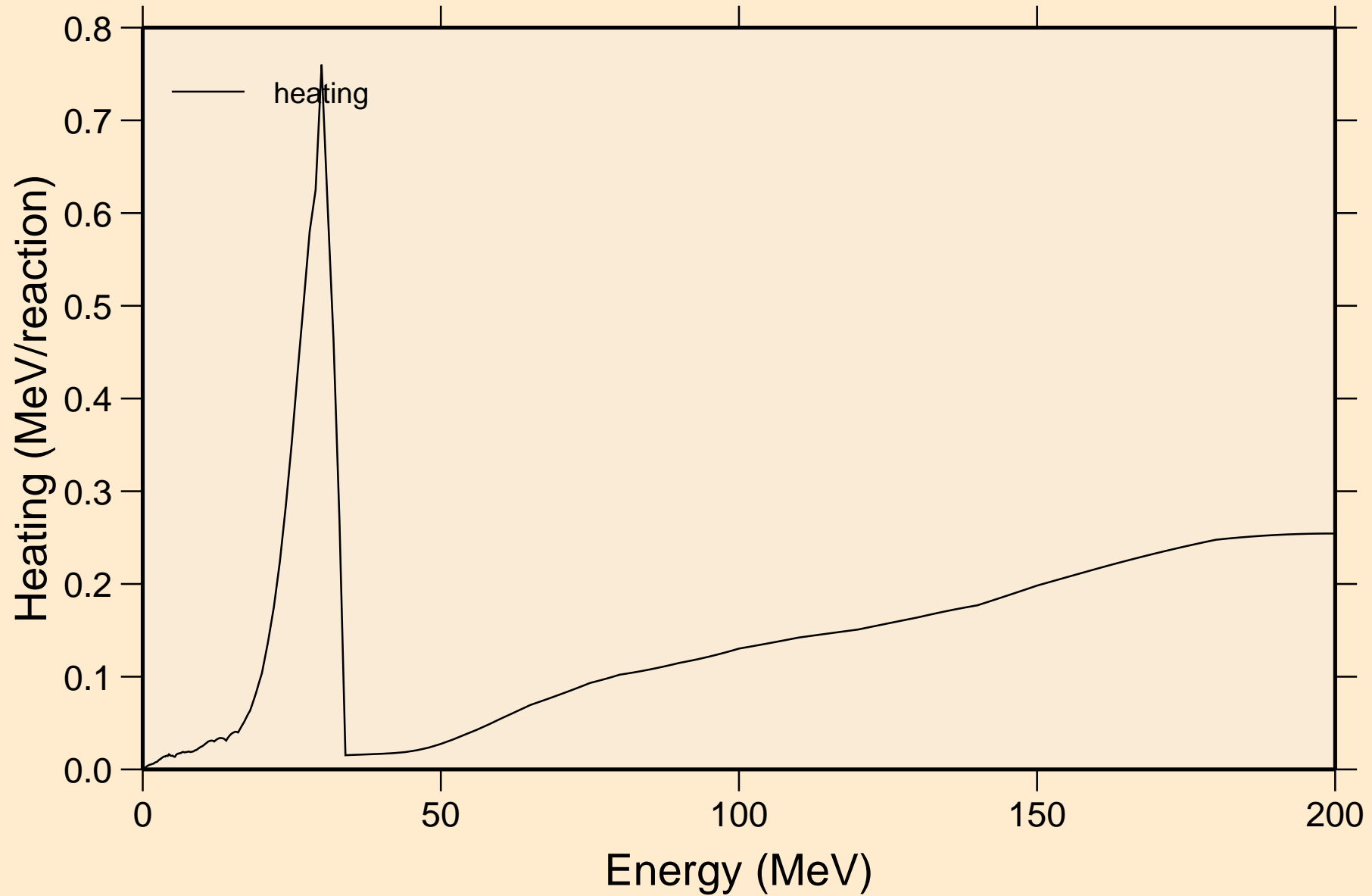



PO224 NEUTRON ACER TENDL-2021 LIBRARY; T=293.6K  
Damage

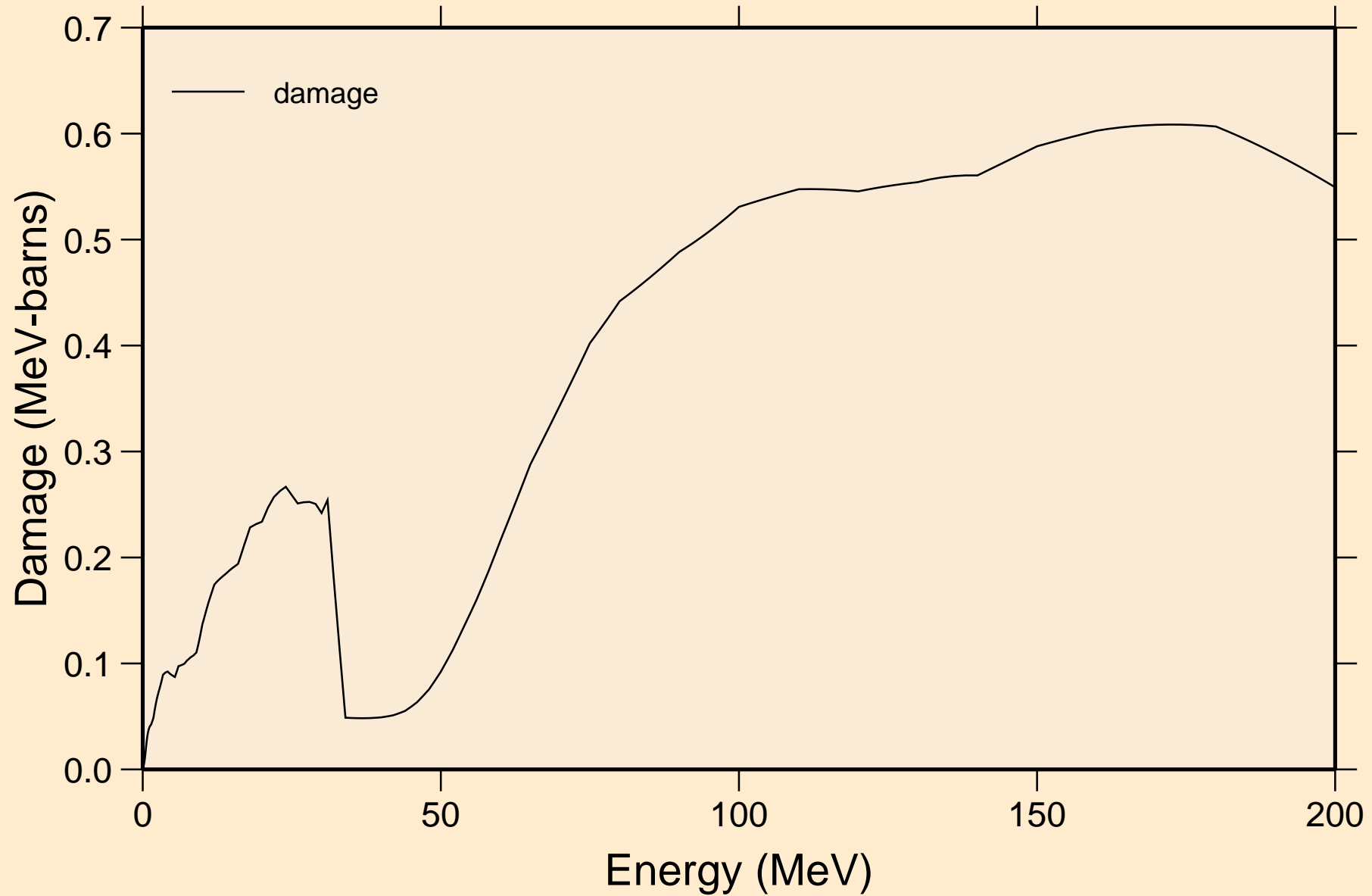

PO224 NEUTRON ACER TENDL-2021 LIBRARY; T=293.6K  
Non-threshold reactions

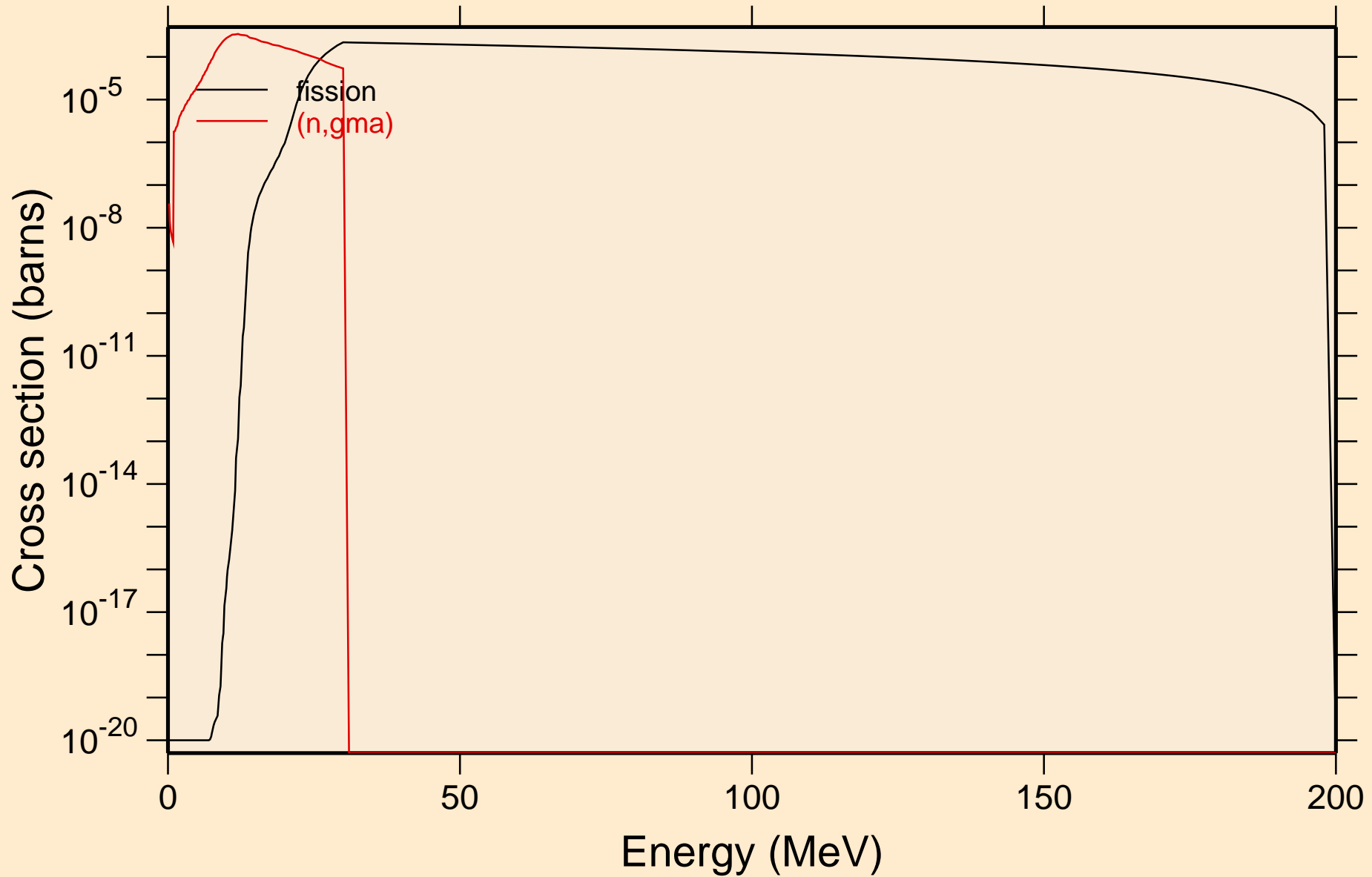

PO224 NEUTRON ACER TENDL-2021 LIBRARY; T=293.6K  
Inelastic levels

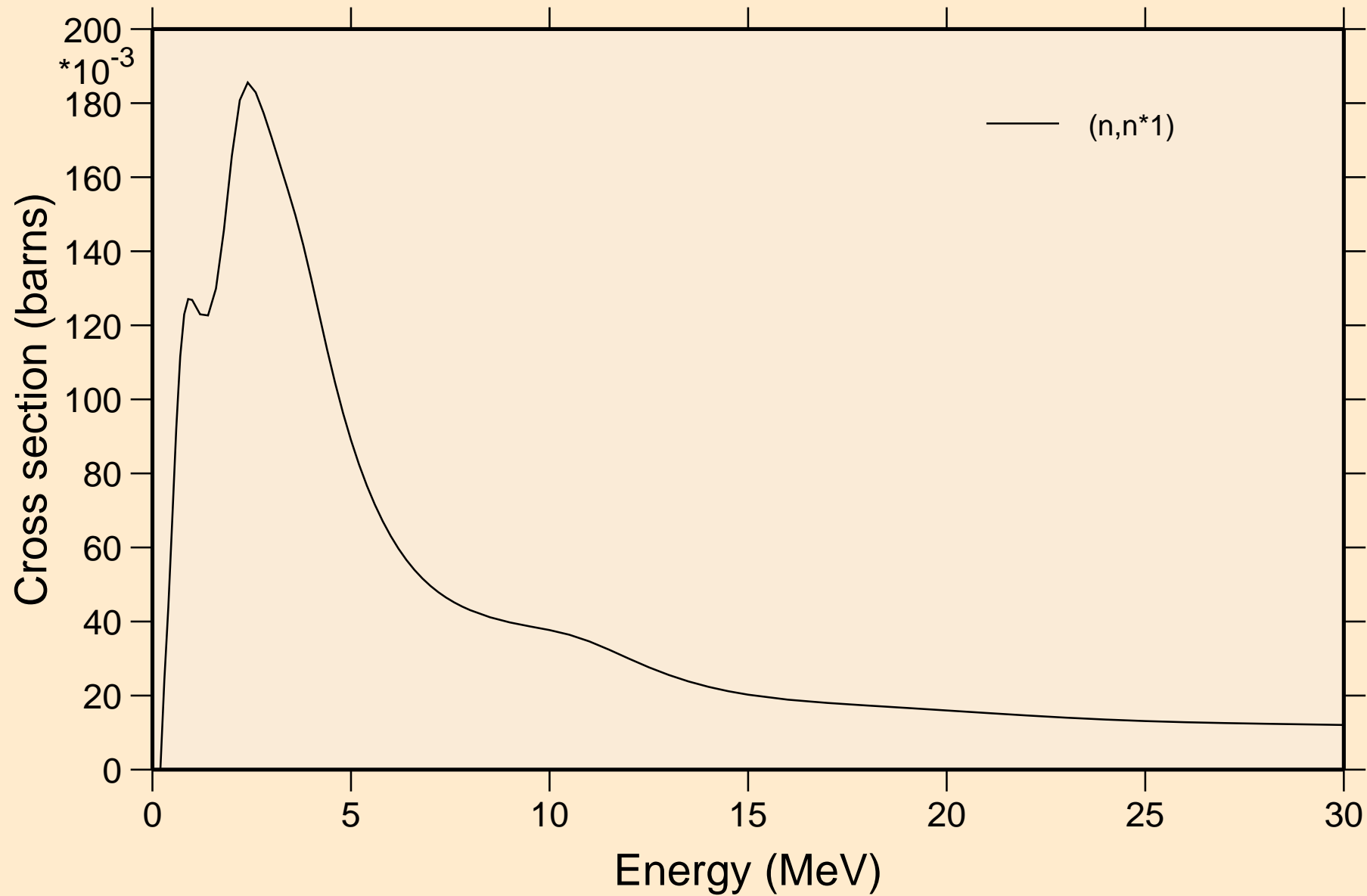

PO224 NEUTRON ACER TENDL-2021 LIBRARY; T=293.6K  
Threshold reactions

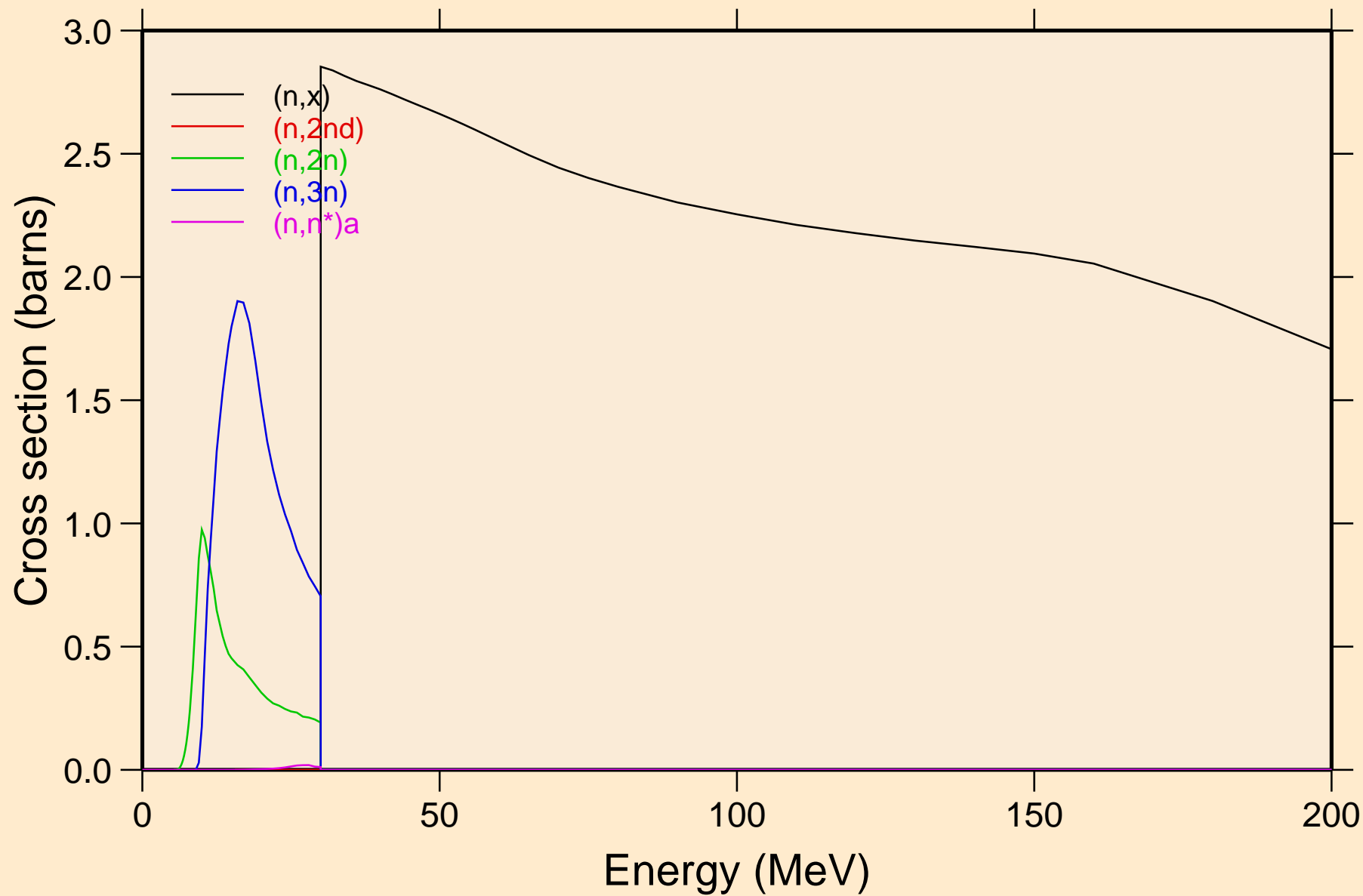

PO224 NEUTRON ACER TENDL-2021 LIBRARY; T=293.6K  
Threshold reactions

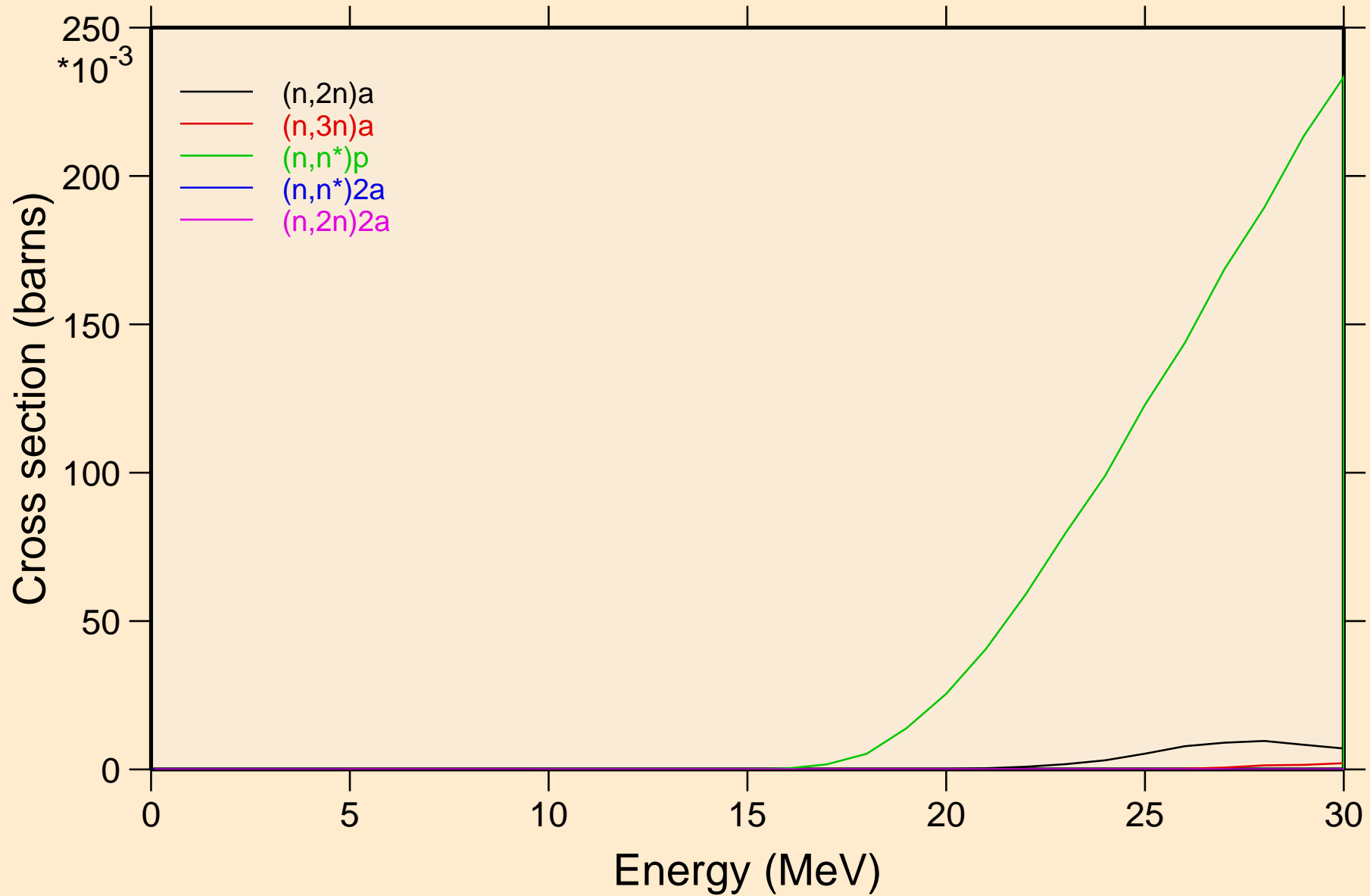

PO224 NEUTRON ACER TENDL-2021 LIBRARY; T=293.6K  
Threshold reactions

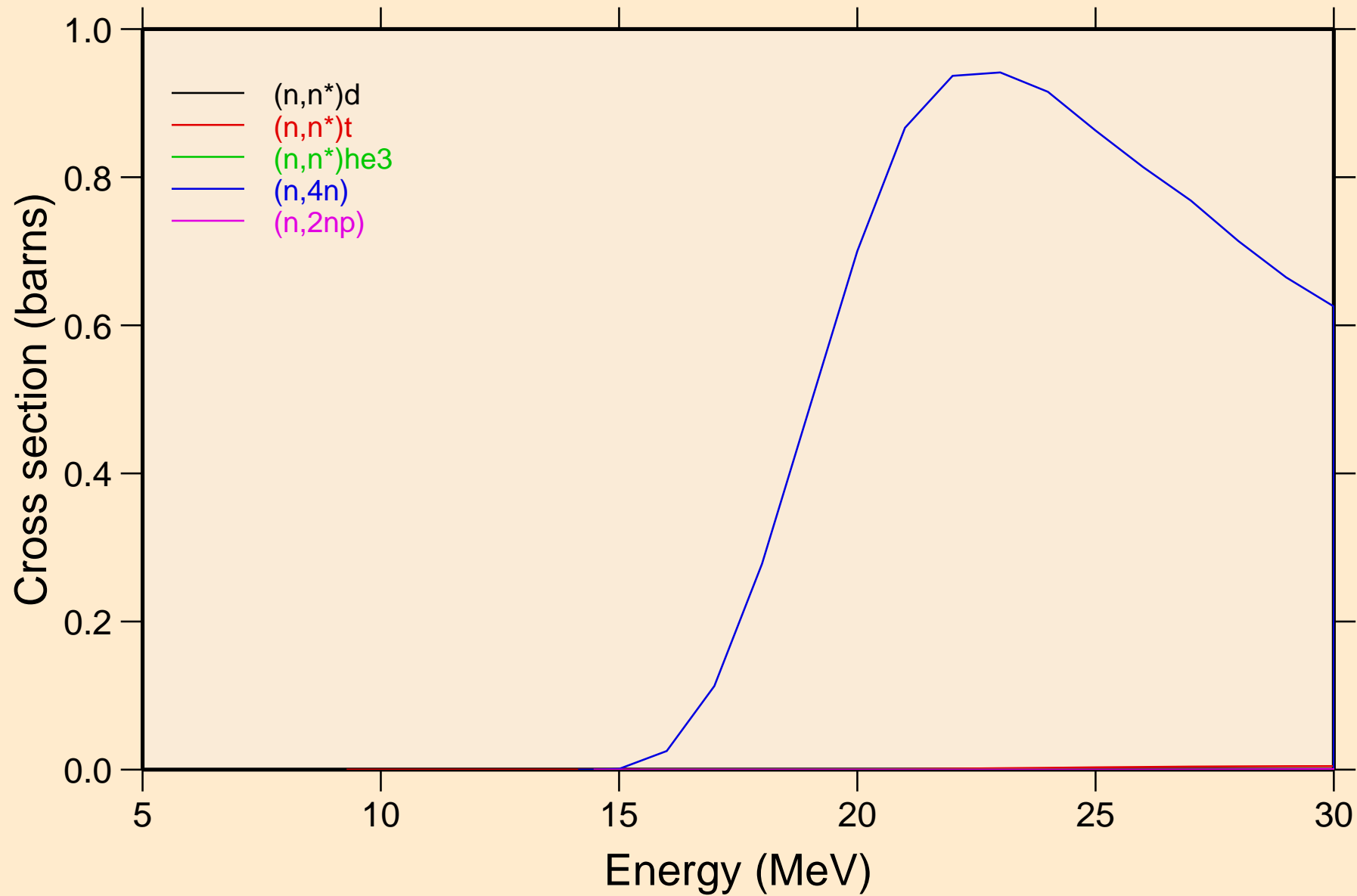

PO224 NEUTRON ACER TENDL-2021 LIBRARY; T=293.6K  
Threshold reactions

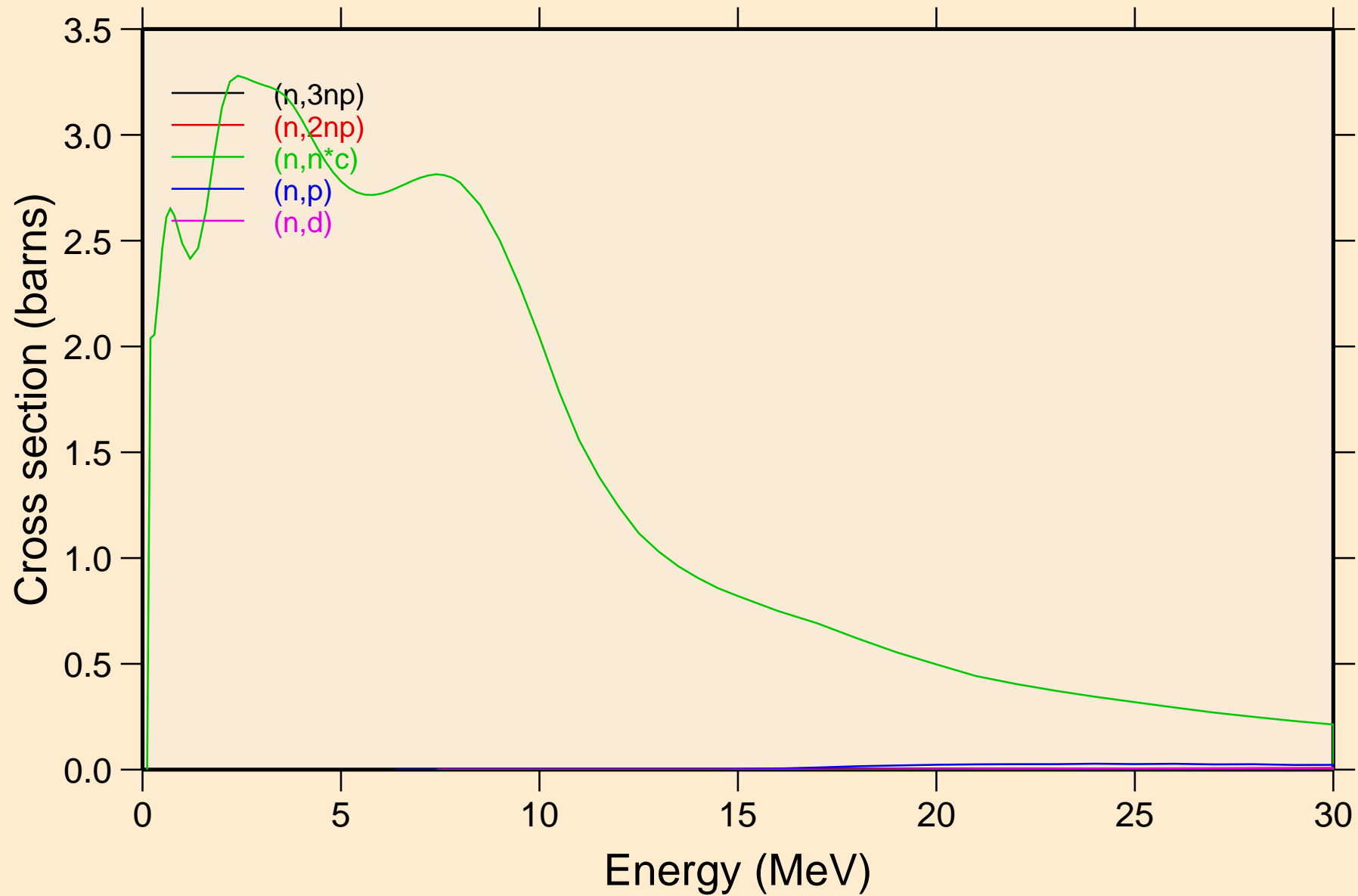

PO224 NEUTRON ACER TENDL-2021 LIBRARY; T=293.6K  
Threshold reactions

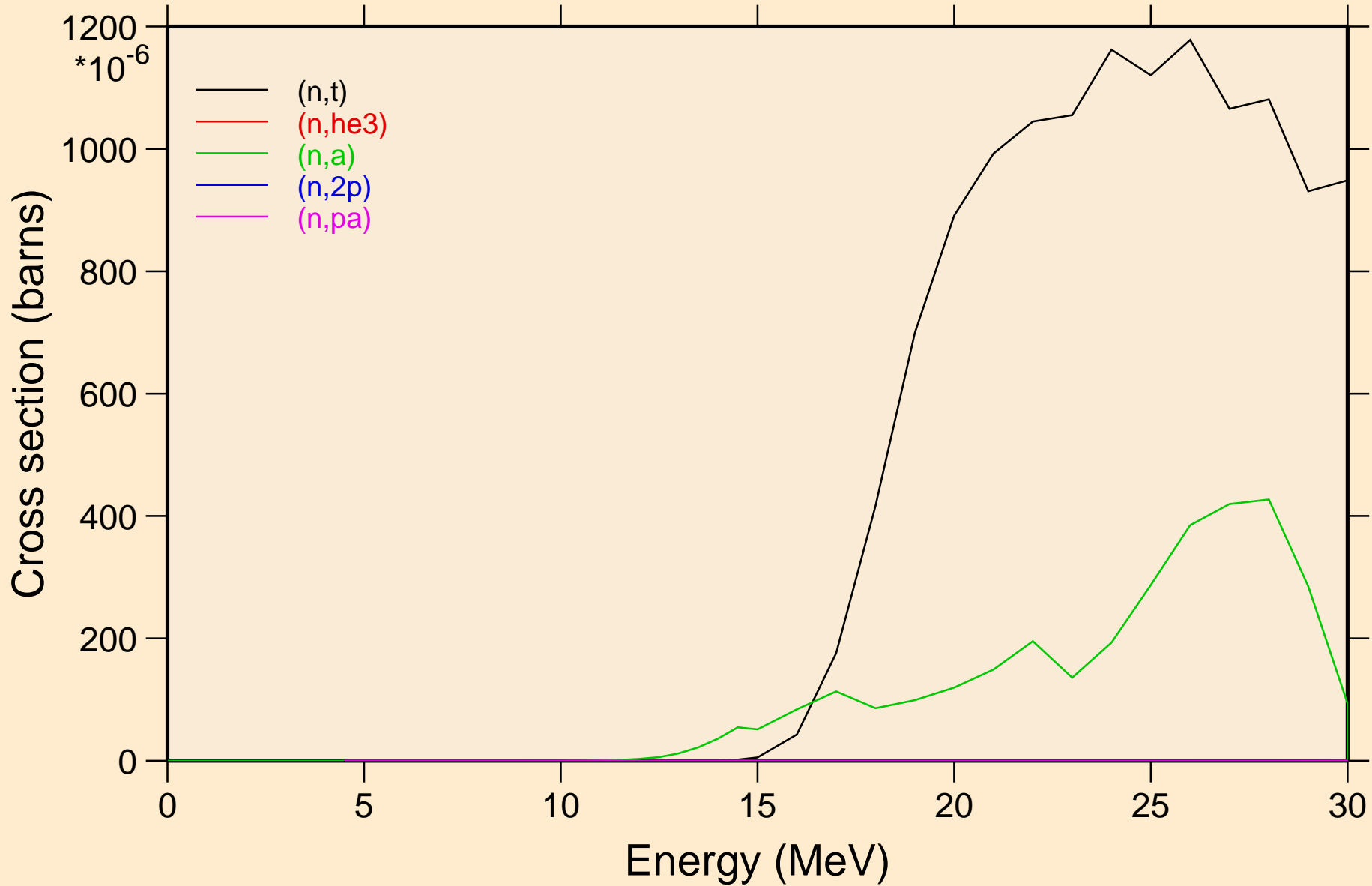



PO224 NEUTRON ACER TENDL-2021 LIBRARY; T=293.6K  
Threshold reactions

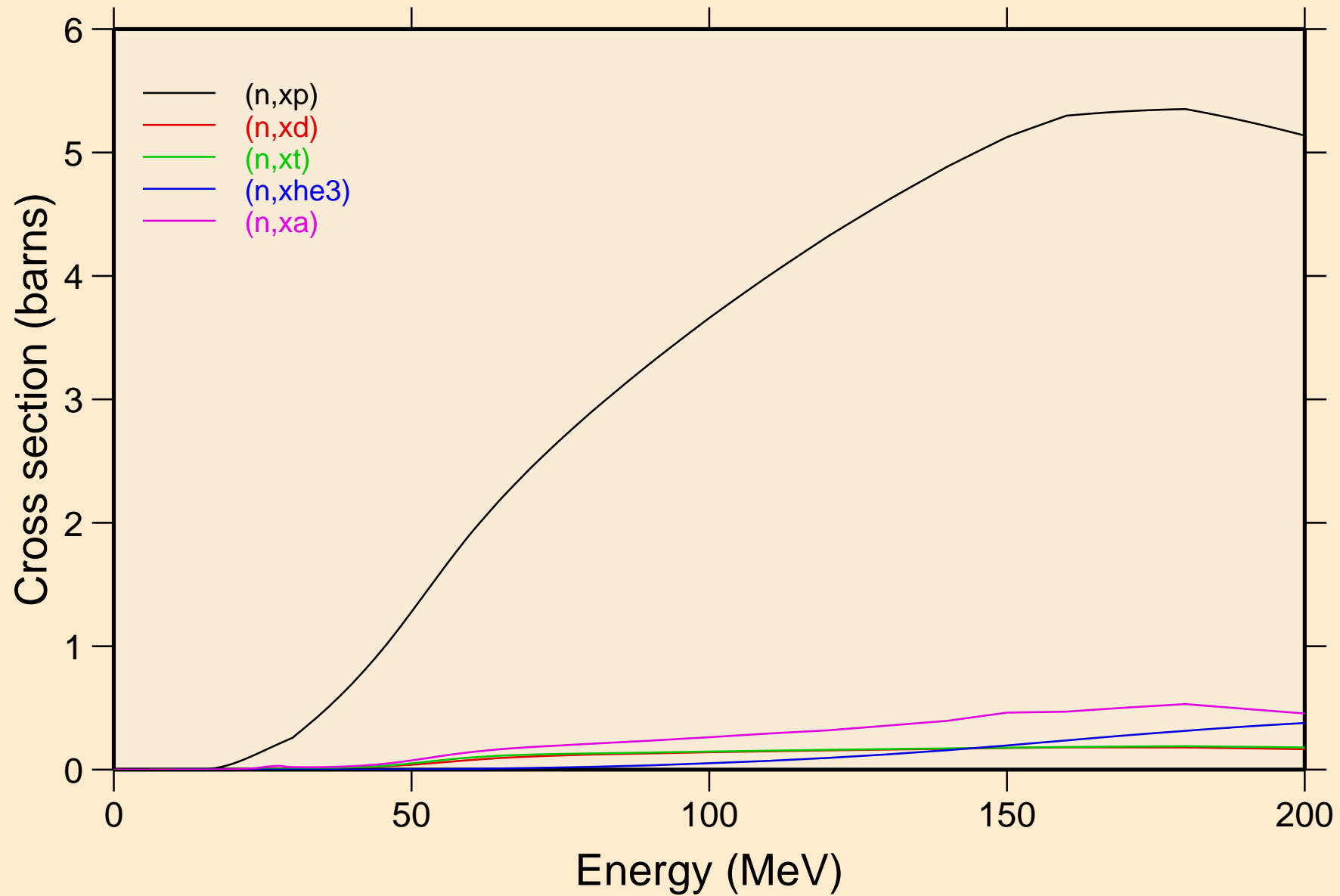

PO224 NEUTRON ACER TENDL-2021 LIBRARY; T=293.6K  
angular distribution for elastic

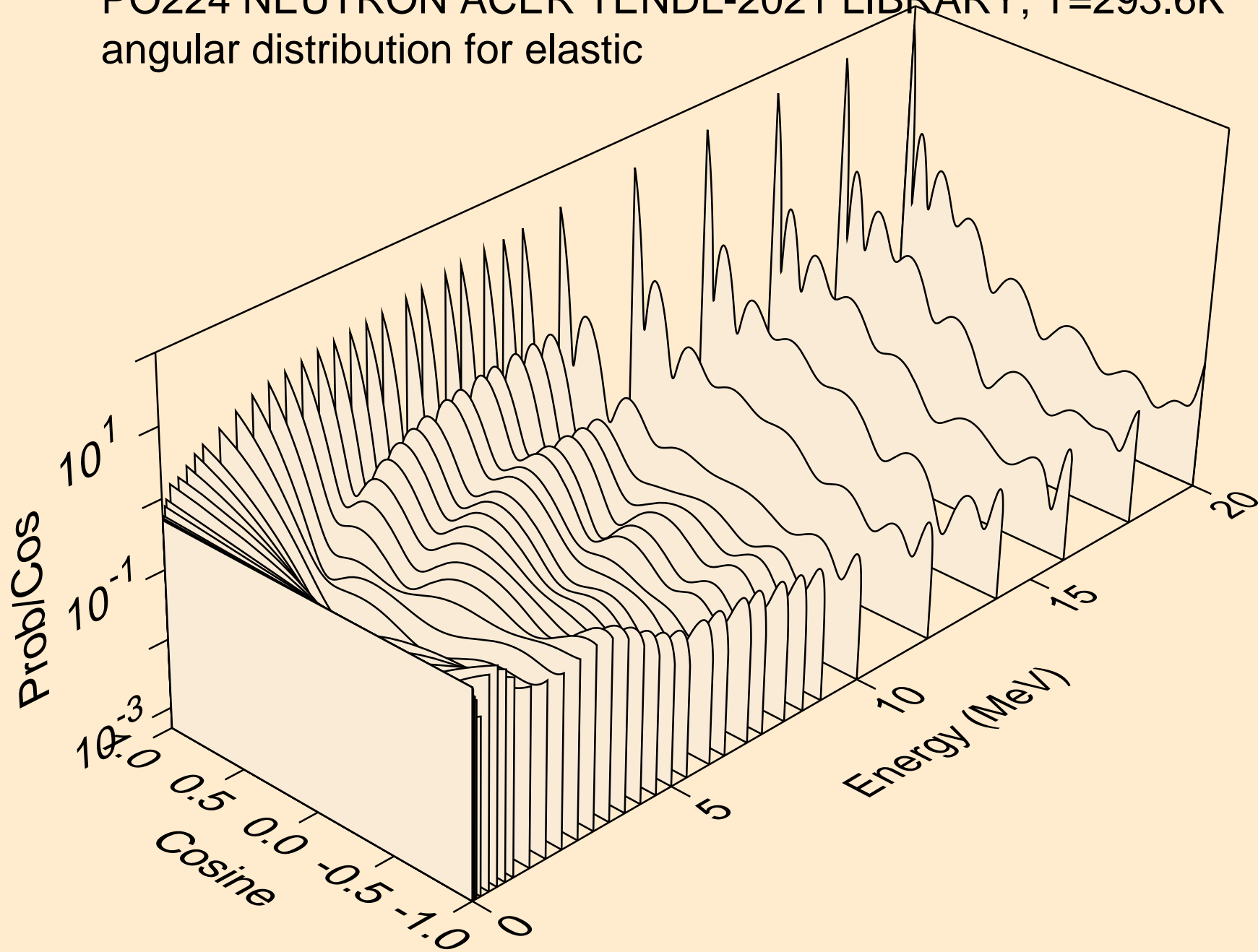

PO224 NEUTRON ACER TENDL-2021 LIBRARY; T=293.6K  
angular distribution for elastic

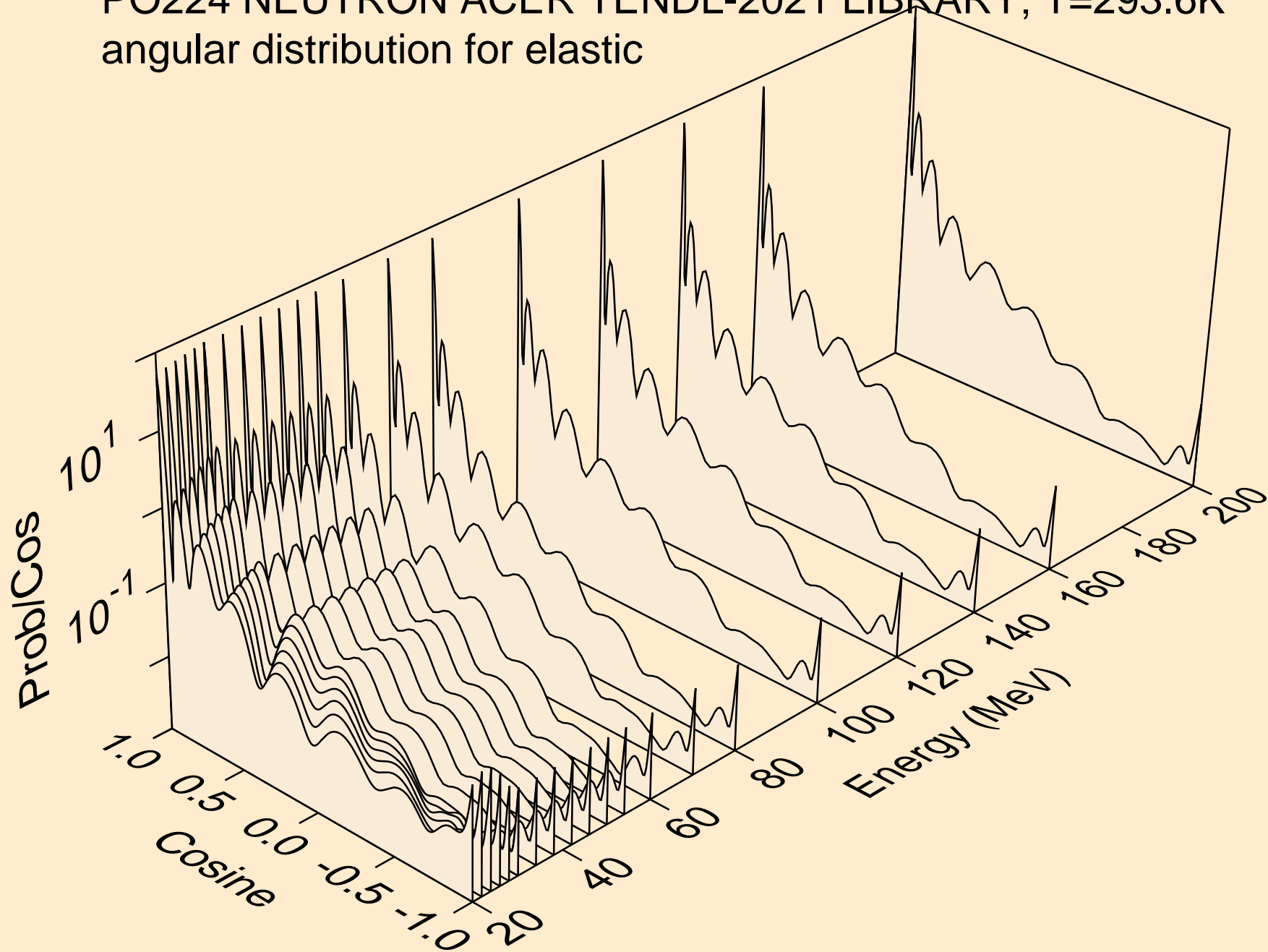

PO224 NEUTRON ACER TENDL-2021 LIBRARY; T=293.6K  
angular distribution for (n,n\*1)

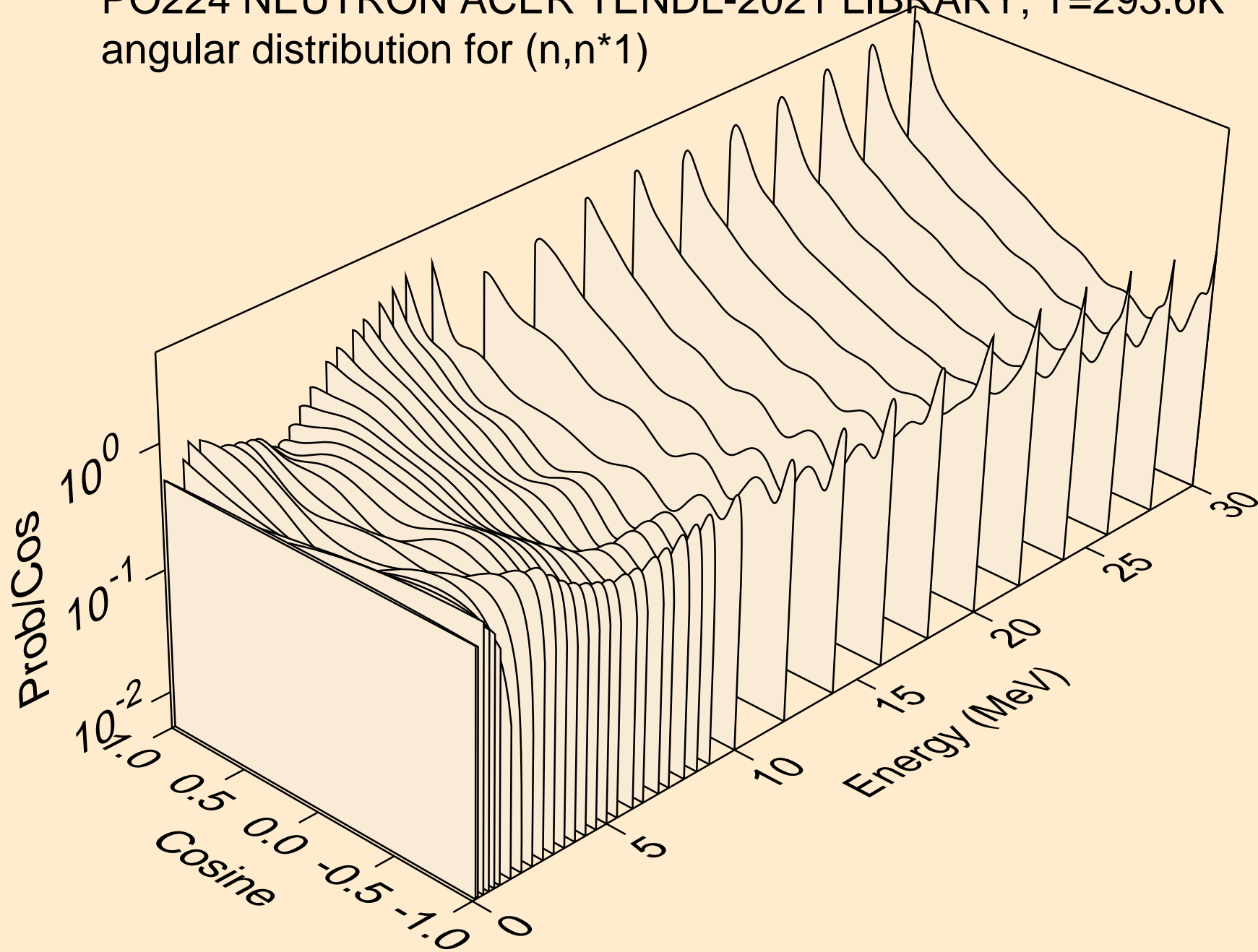

PO224 NEUTRON ACER TENDL-2021 LIBRARY; T=293.6K  
Total fission nubar

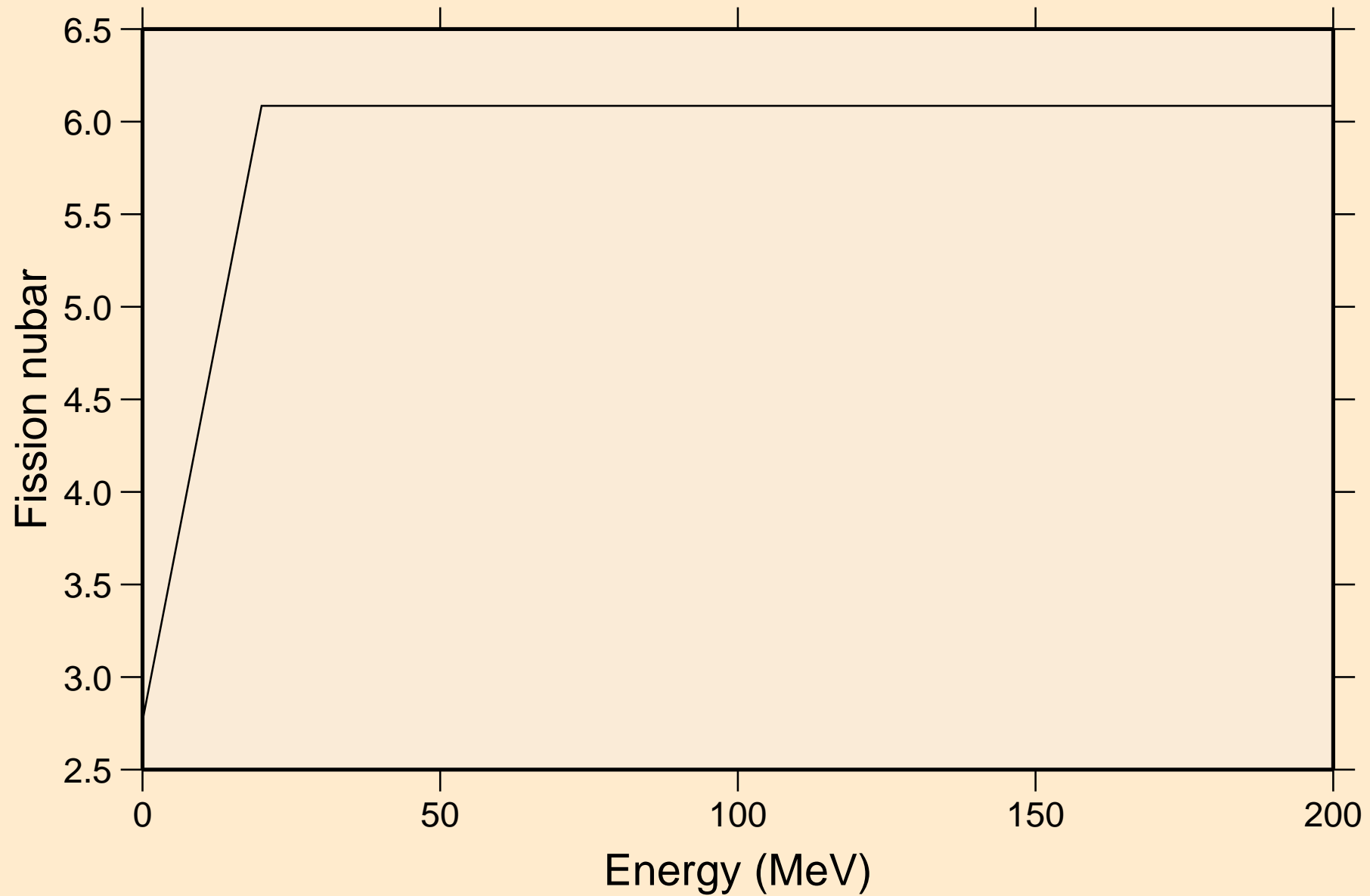

PO224 NEUTRON ACER TENDL-2021 LIBRARY; T=293.6K  
Neutron emission for (n,x)

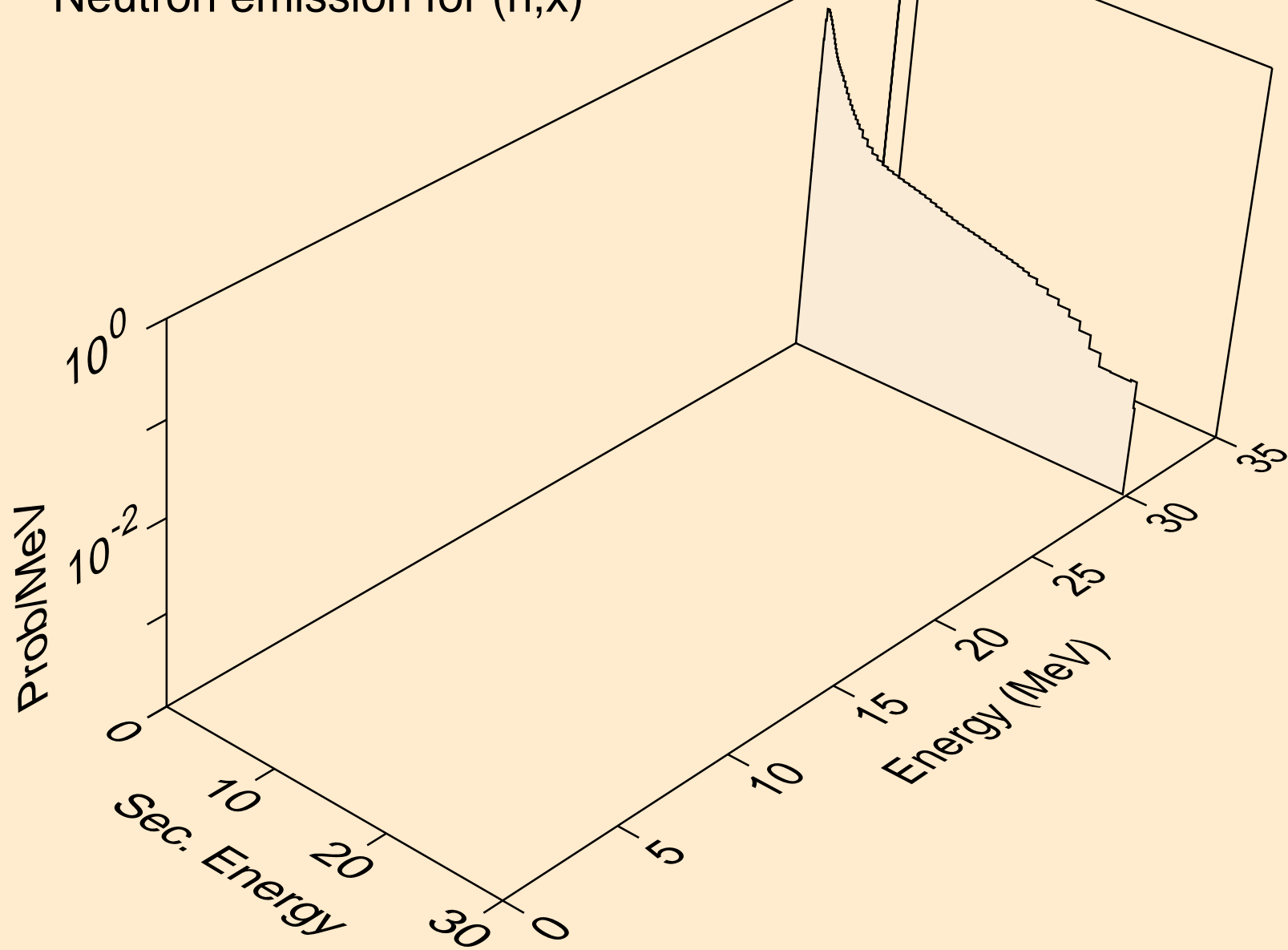

PO224 NEUTRON ACER TENDL-2021 LIBRARY; T=293.6K  
Neutron emission for (n,2nd)

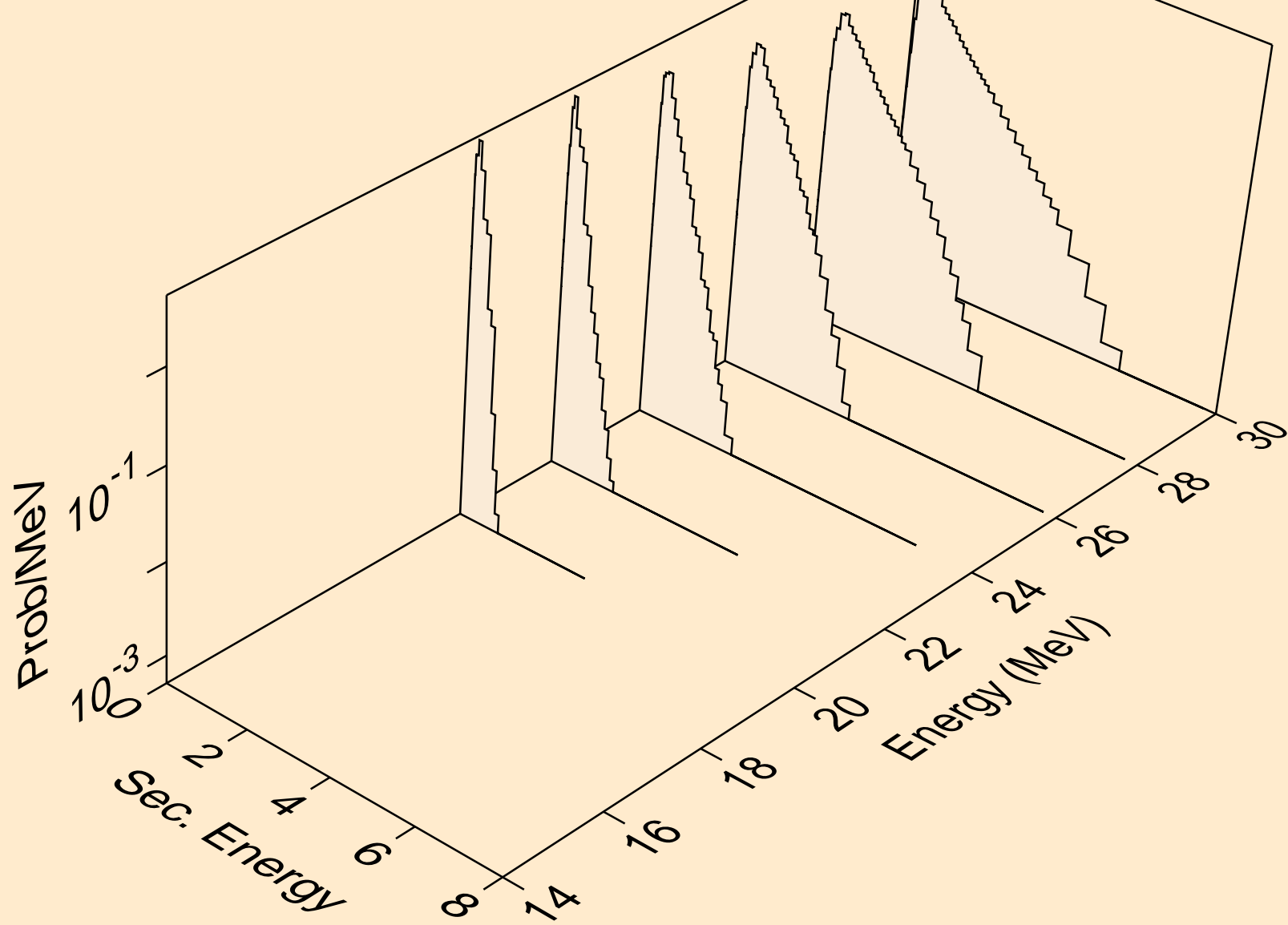

PO224 NEUTRON ACER TENDL-2021 LIBRARY; T=293.6K  
Neutron emission for (n,2n)

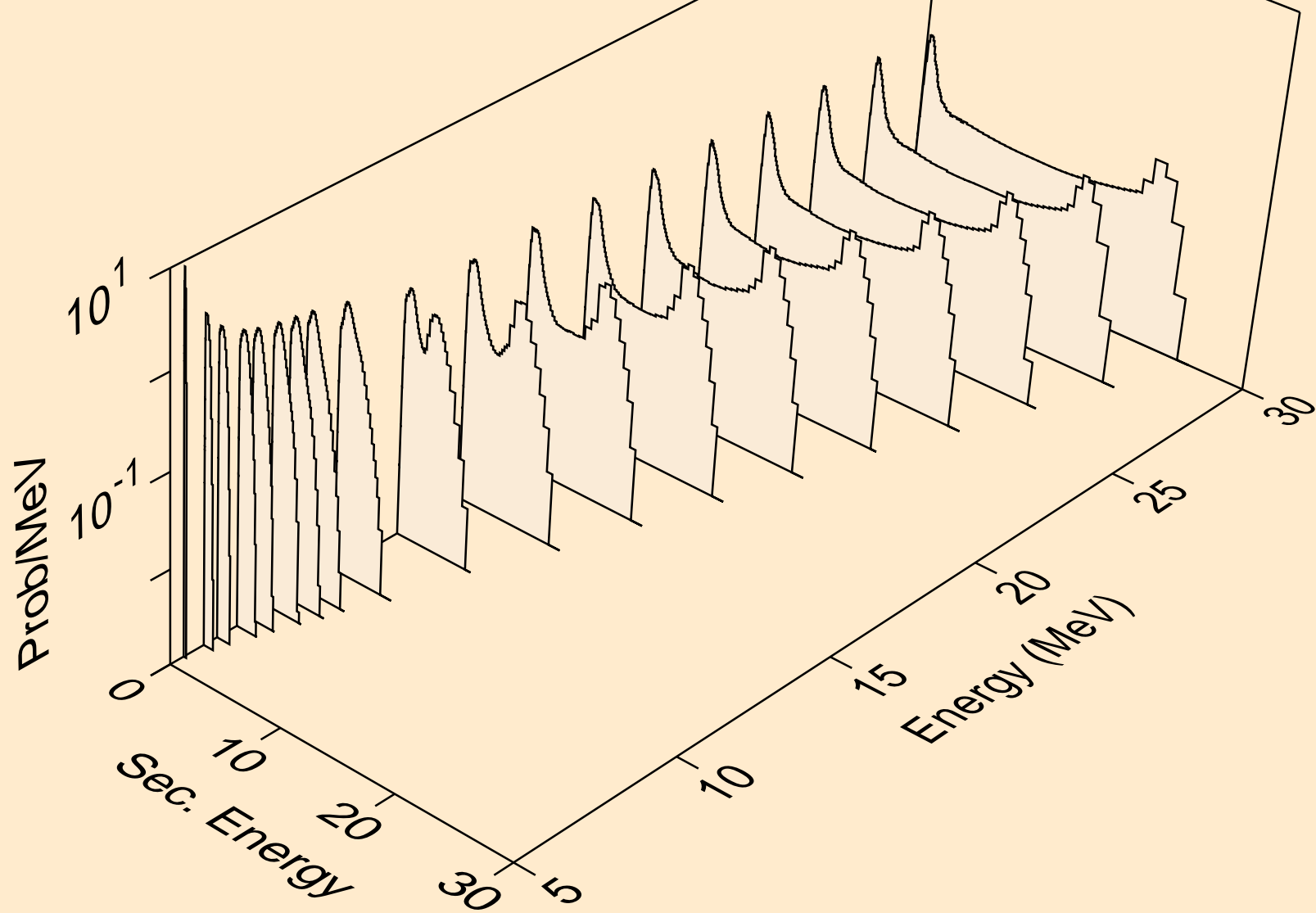



PO224 NEUTRON ACER TENDL-2021 LIBRARY; T=293.6K  
Neutron emission for (n,3n)

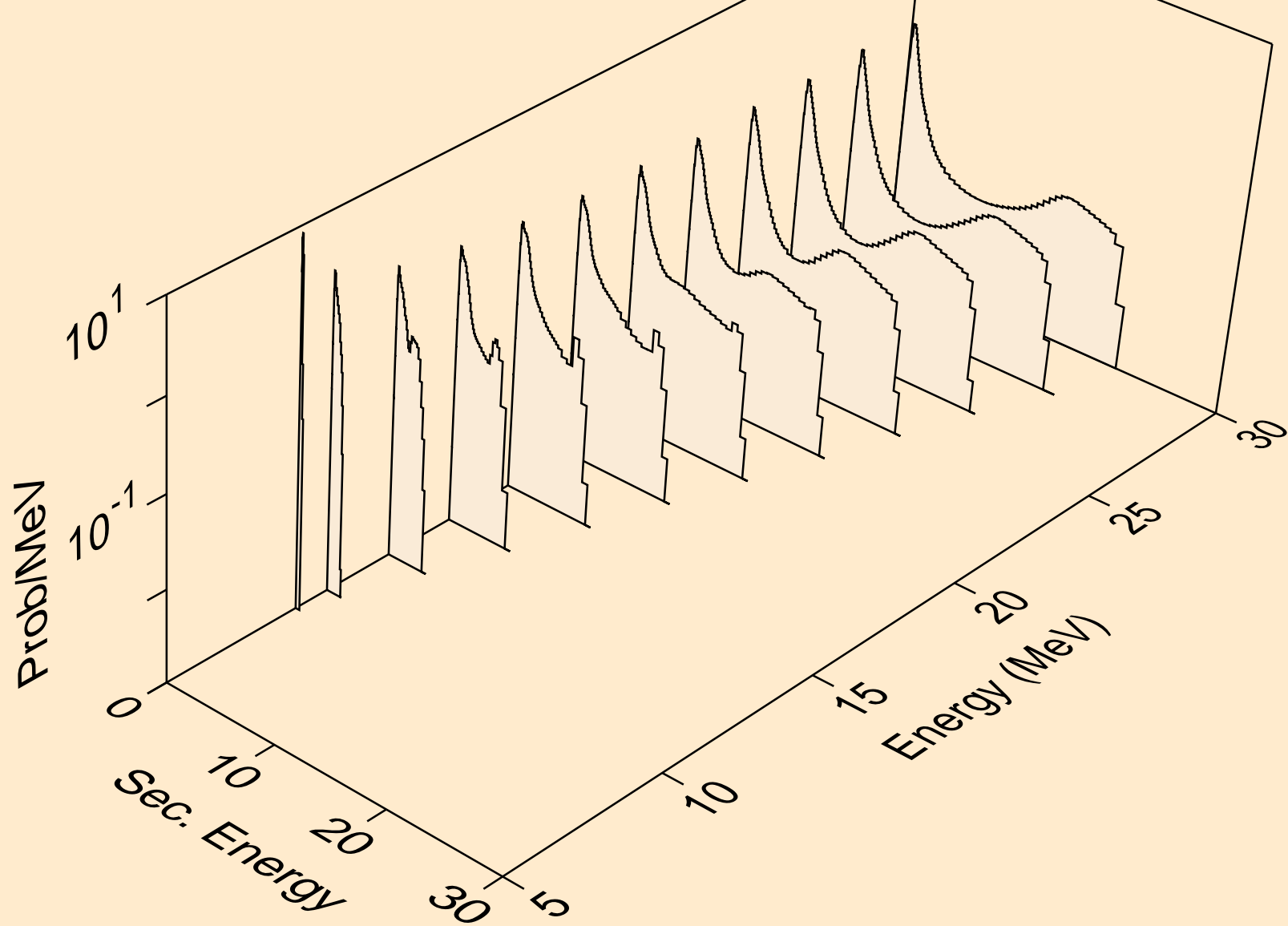

PO224 NEUTRON ACER TENDL-2021 LIBRARY; T=293.6K  
Neutron emission for fission

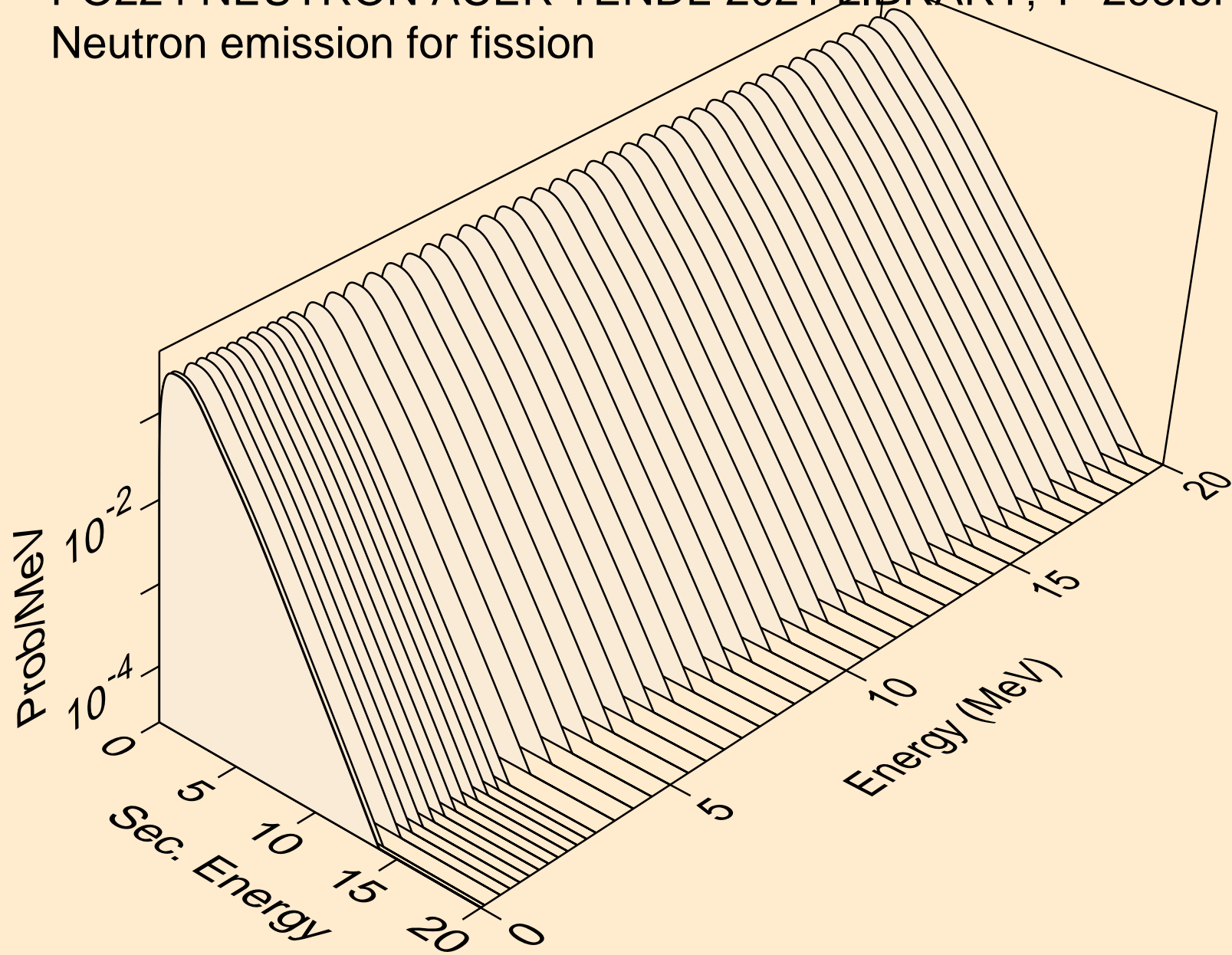

PO224 NEUTRON ACER TENDL-2021 LIBRARY; T=293.6K  
Neutron emission for (n,n\*)a

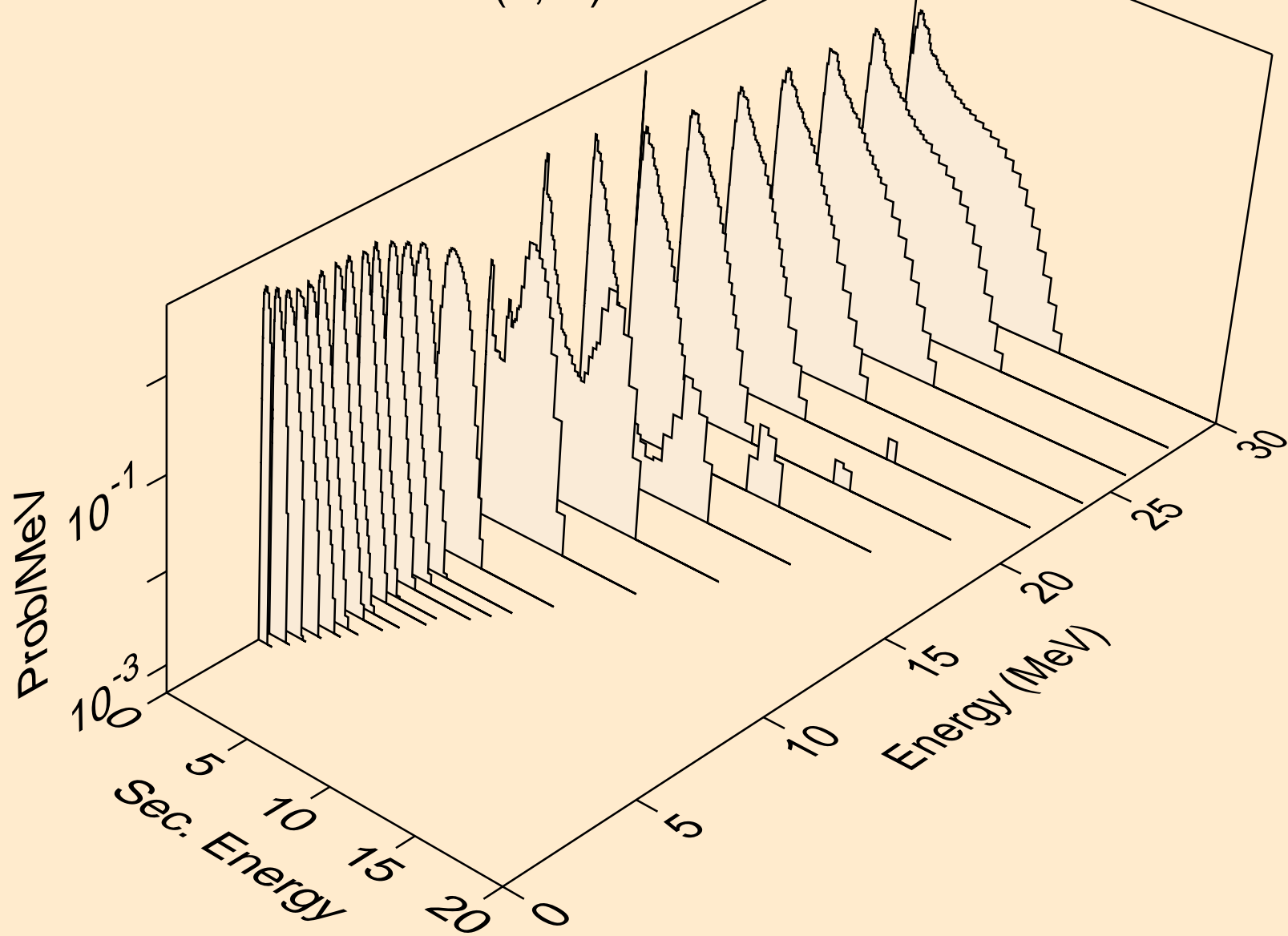

PO224 NEUTRON ACER TENDL-2021 LIBRARY; T=293.6K  
Neutron emission for (n,2n)a

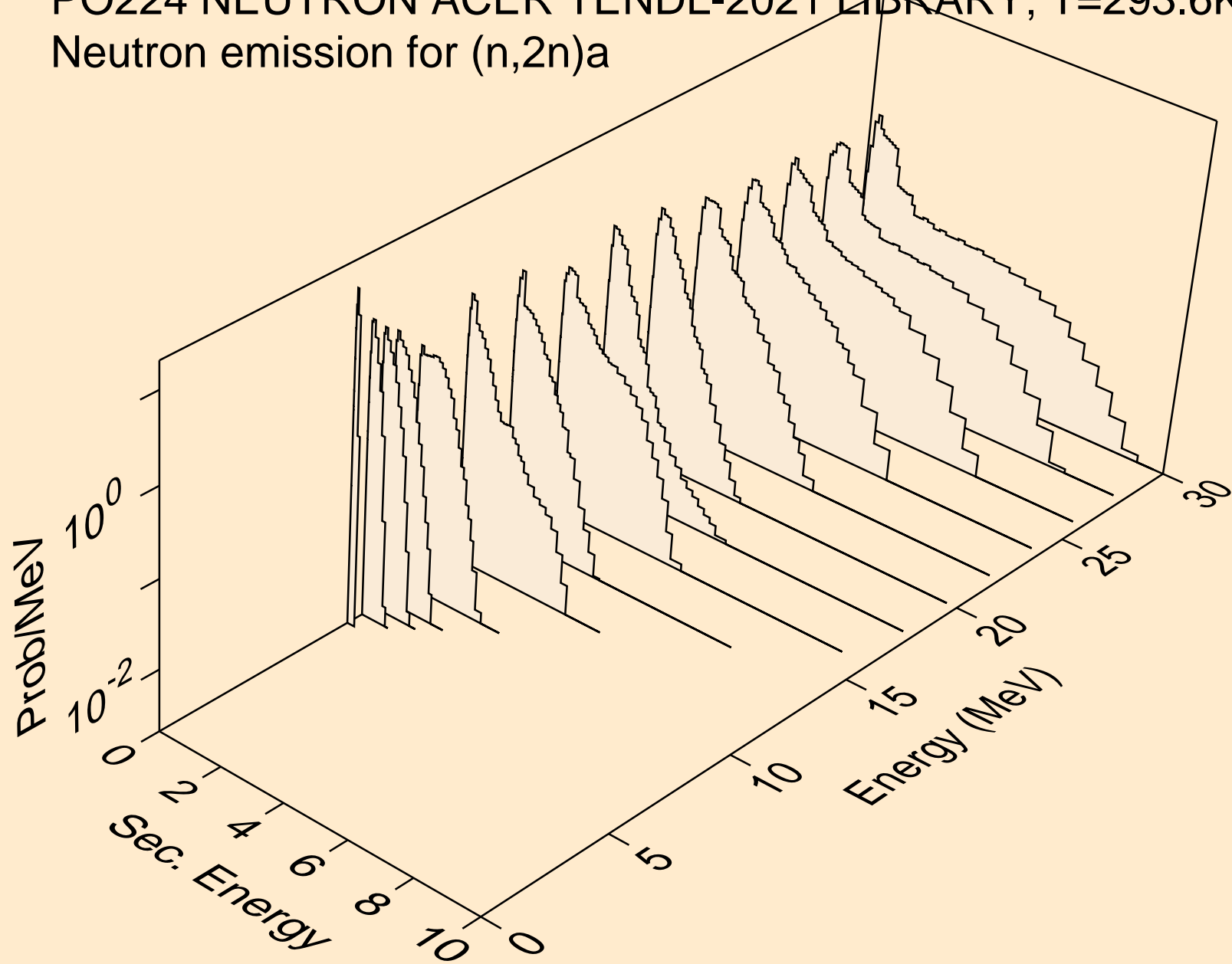

PO224 NEUTRON ACER TENDL-2021 LIBRARY; T=293.6K  
Neutron emission for (n,3n)a

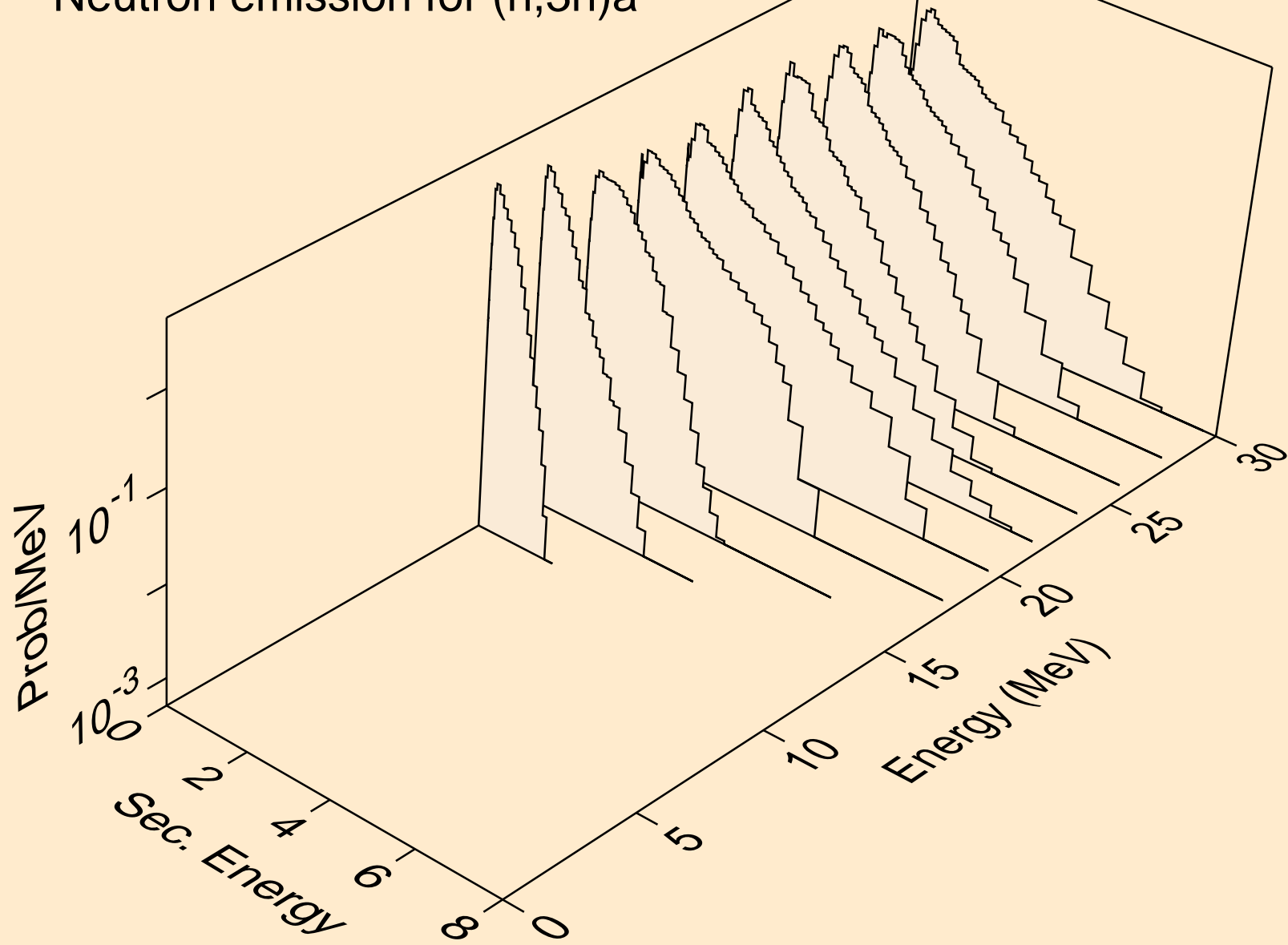

PO224 NEUTRON ACER TENDL-2021 LIBRARY; T=293.6K  
Neutron emission for (n,n\*)p

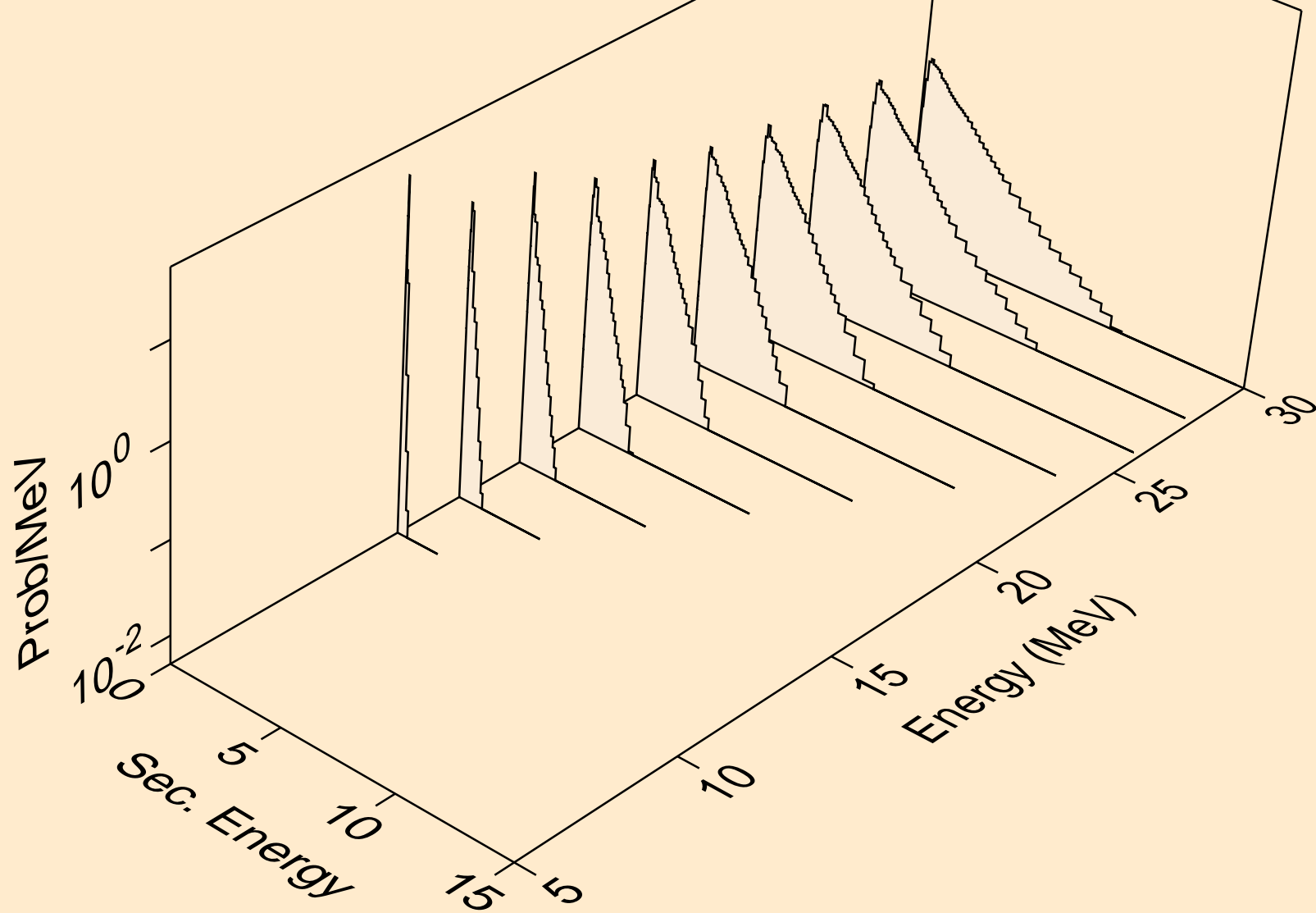

PO224 NEUTRON ACER TENDL-2021 LIBRARY; T=293.6K  
Neutron emission for (n,n\*)2a

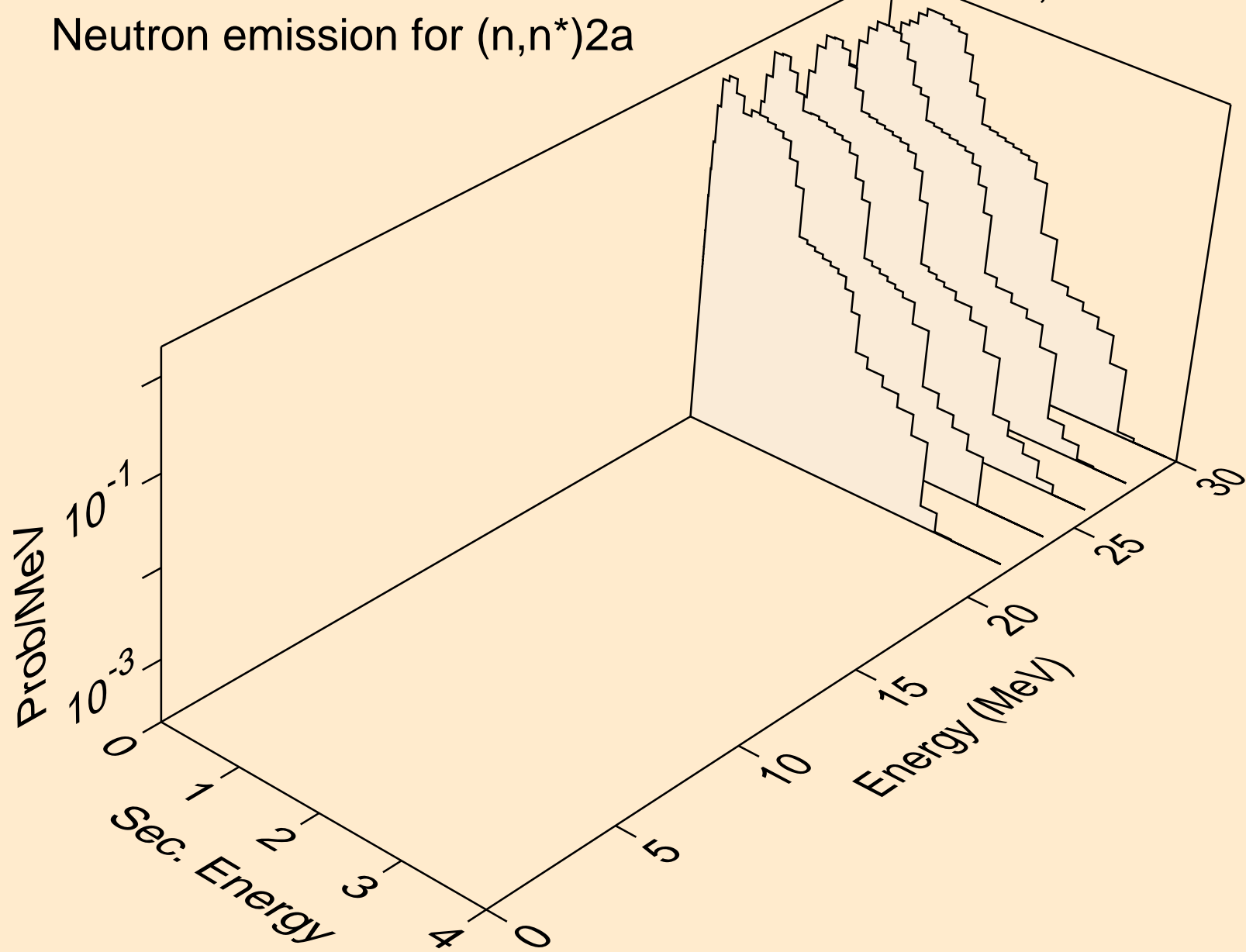

PO224 NEUTRON ACER TENDL-2021 LIBRARY; T=293.6K  
Neutron emission for (n,2n)2a

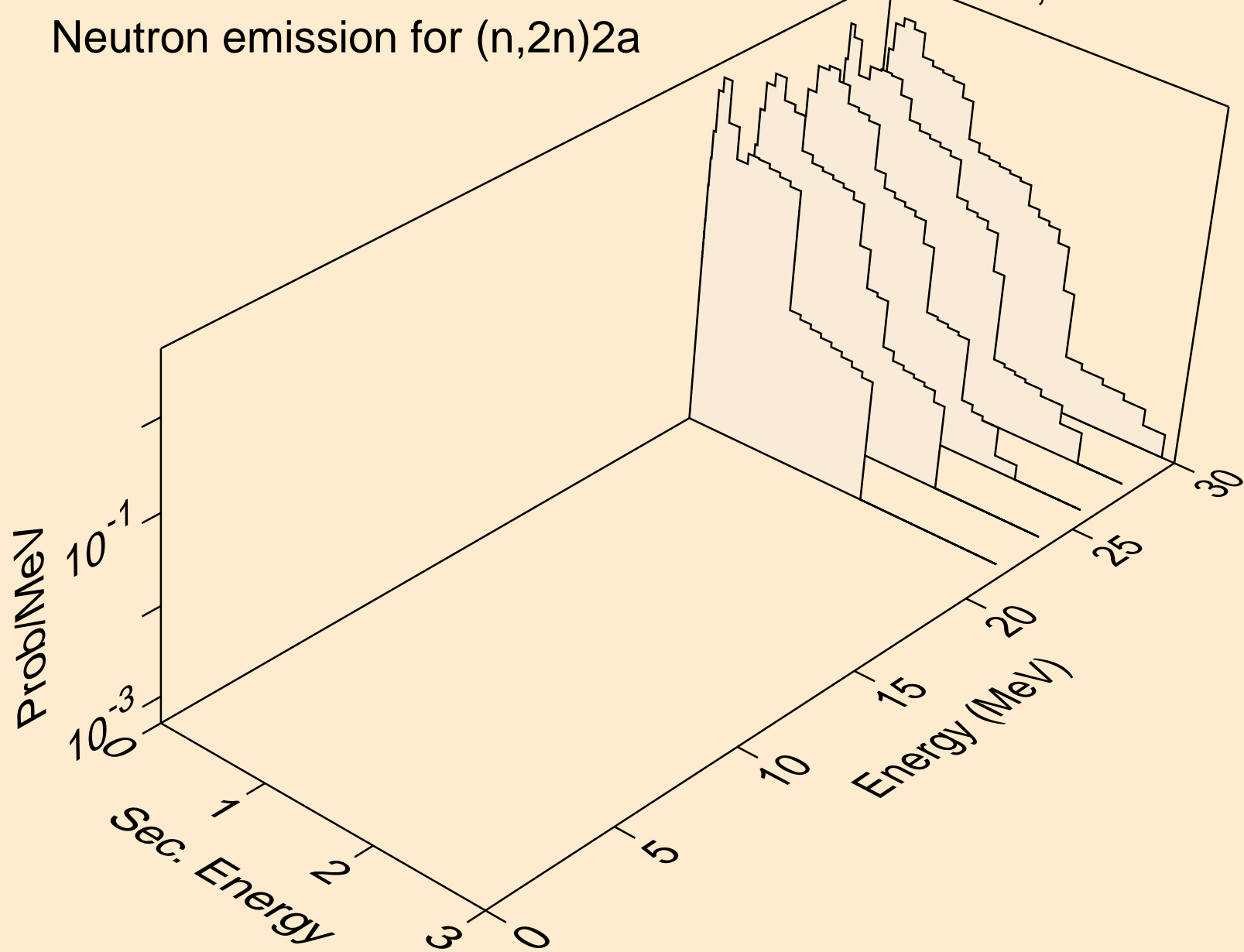



PO224 NEUTRON ACER TENDL-2021 LIBRARY; T=293.6K  
Neutron emission for (n,n\*)d

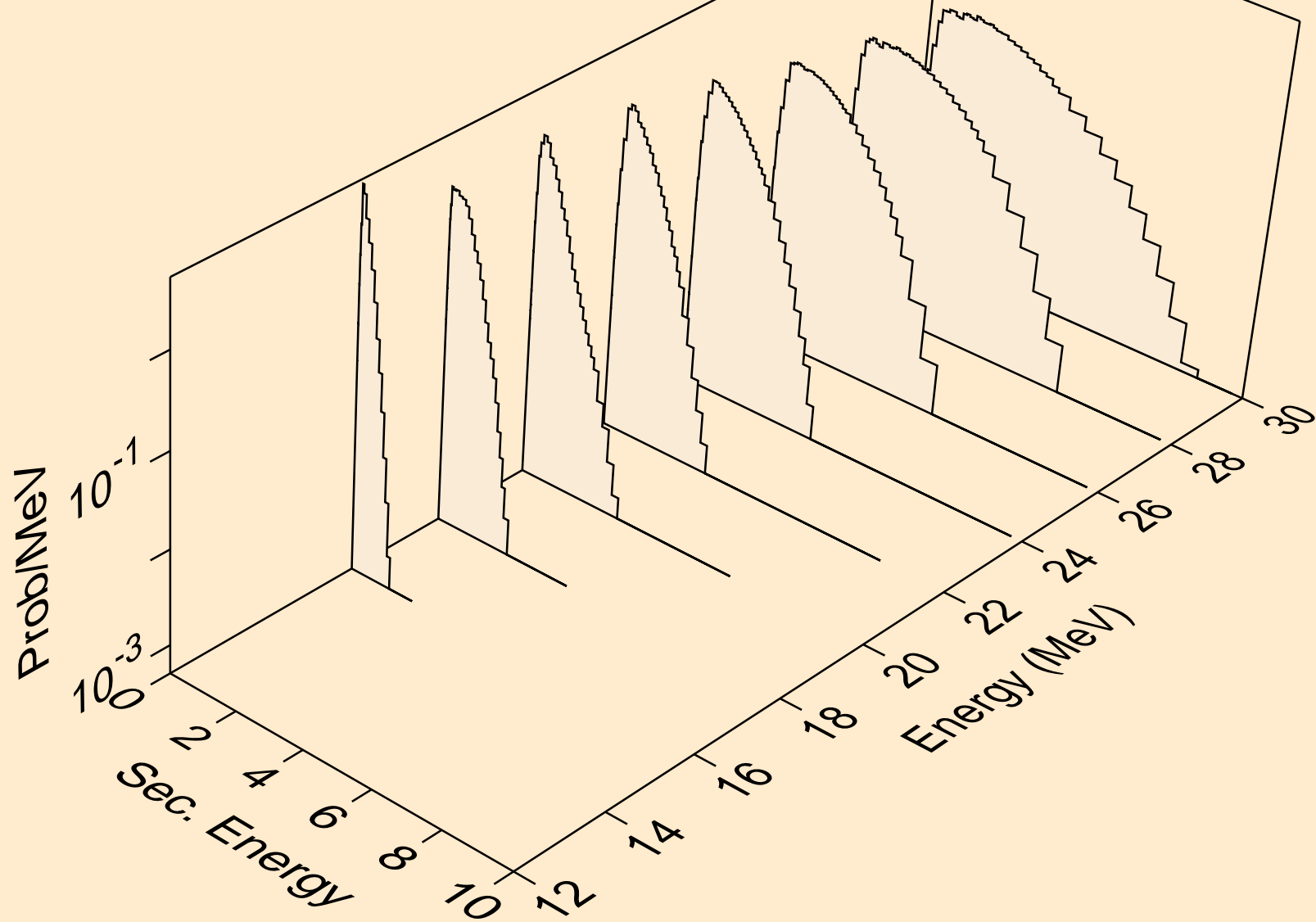

PO224 NEUTRON ACER TENDL-2021 LIBRARY; T=293.6K  
Neutron emission for (n,n\*)t

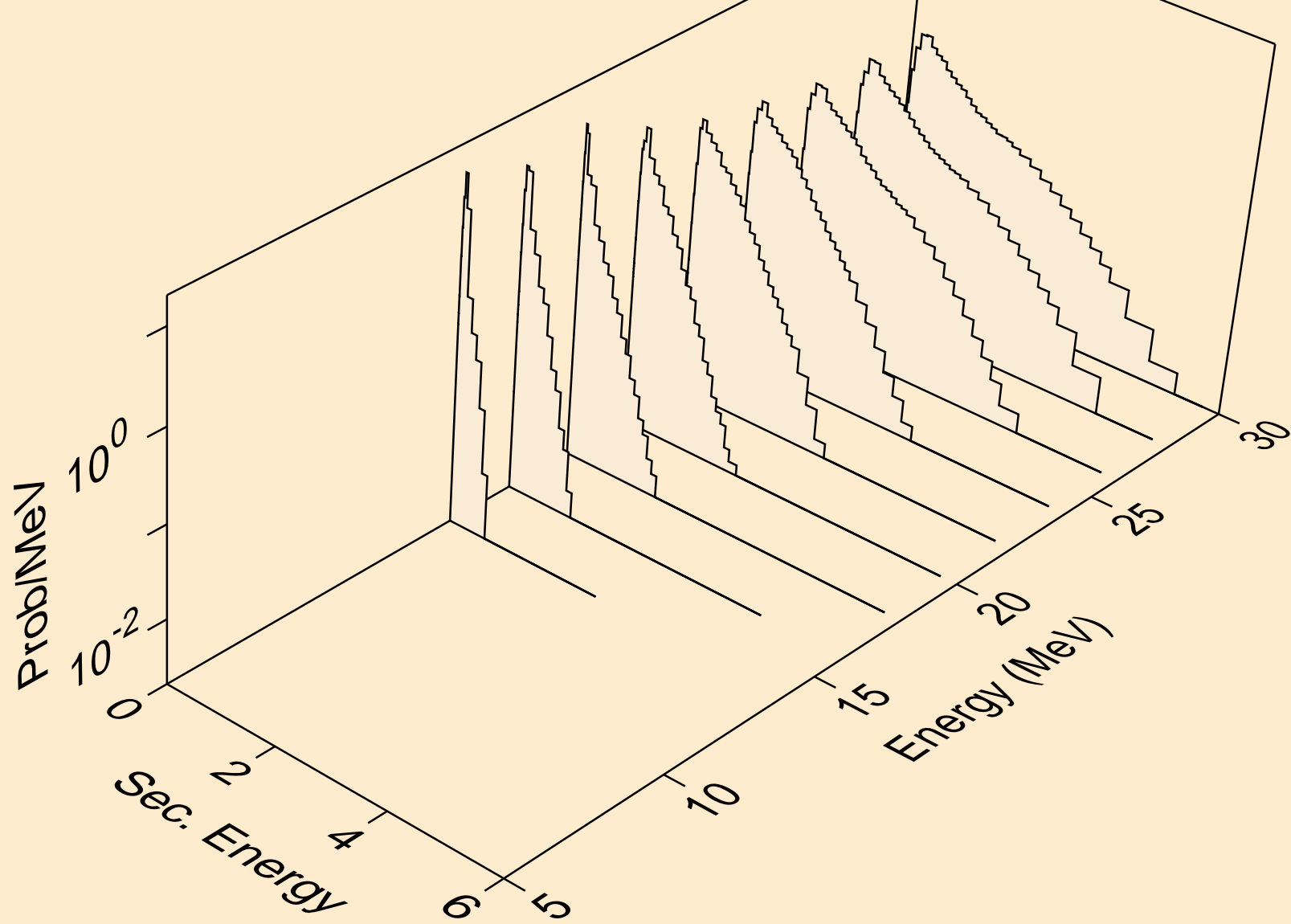

PO224 NEUTRON ACER TENDL-2021 LIBRARY; T=293.6K  
Neutron emission for (n,n\*)he3

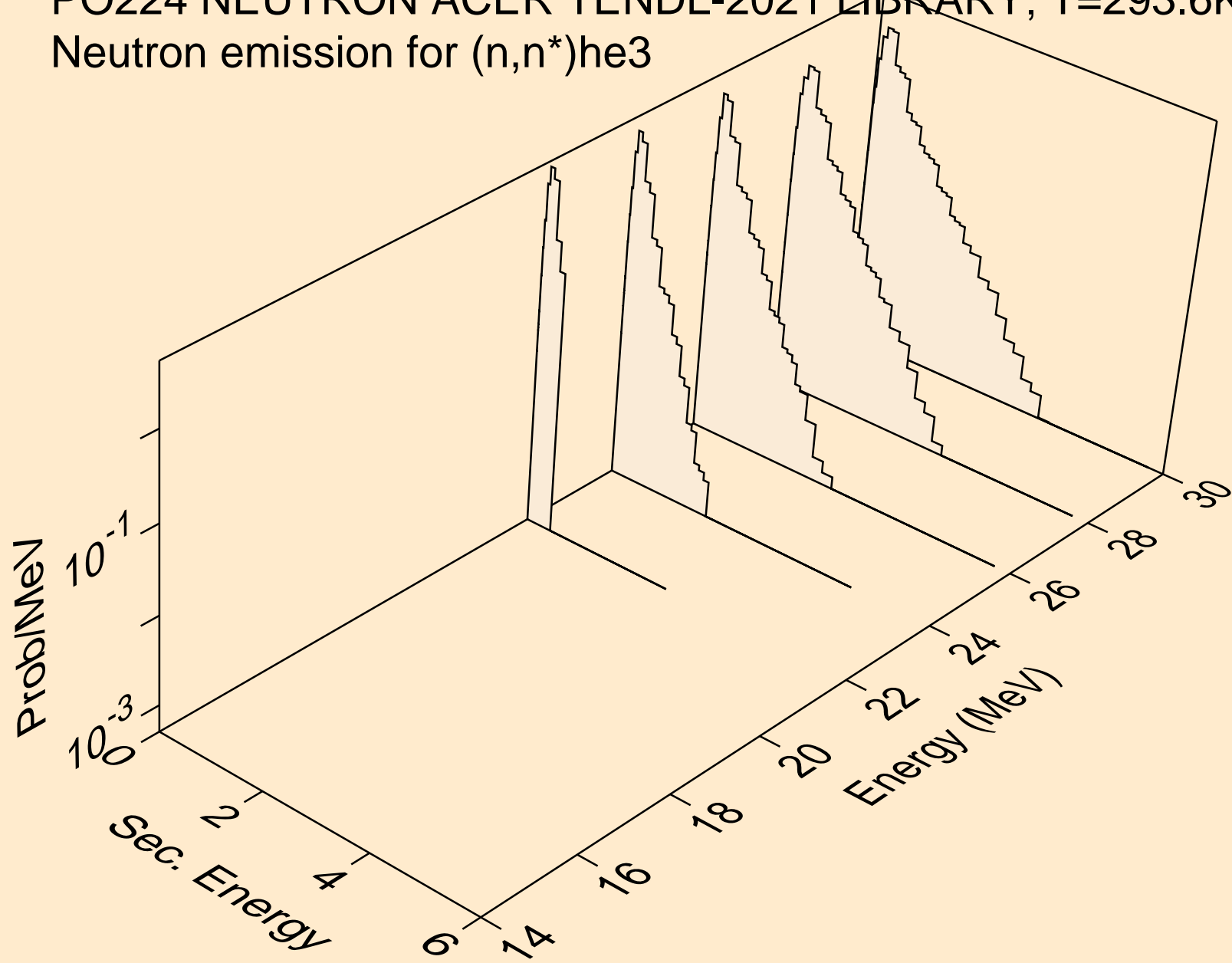

PO224 NEUTRON ACER TENDL-2021 LIBRARY; T=293.6K  
Neutron emission for (n,4n)

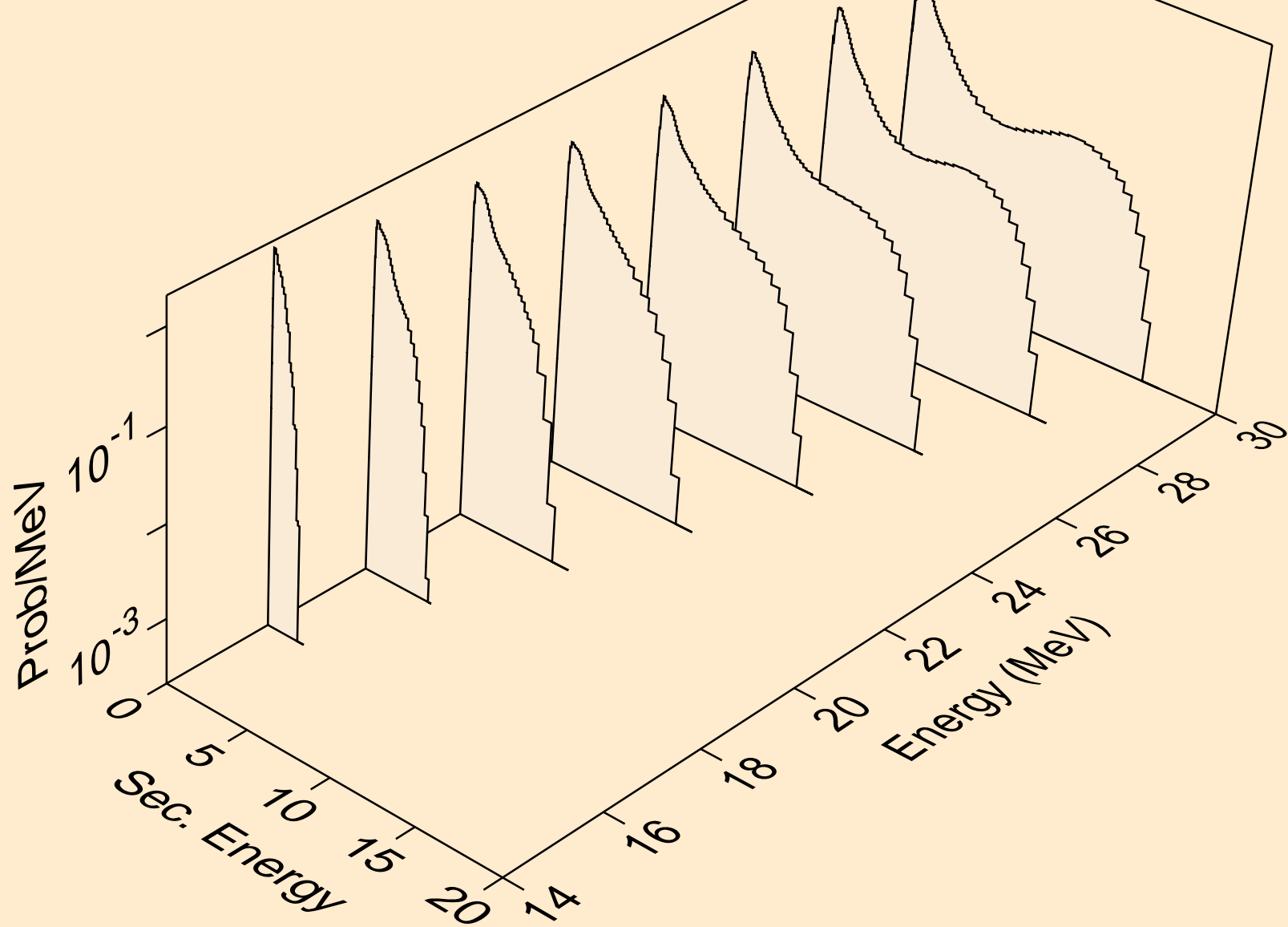

PO224 NEUTRON ACER TENDL-2021 LIBRARY; T=293.6K  
Neutron emission for (n,2np)

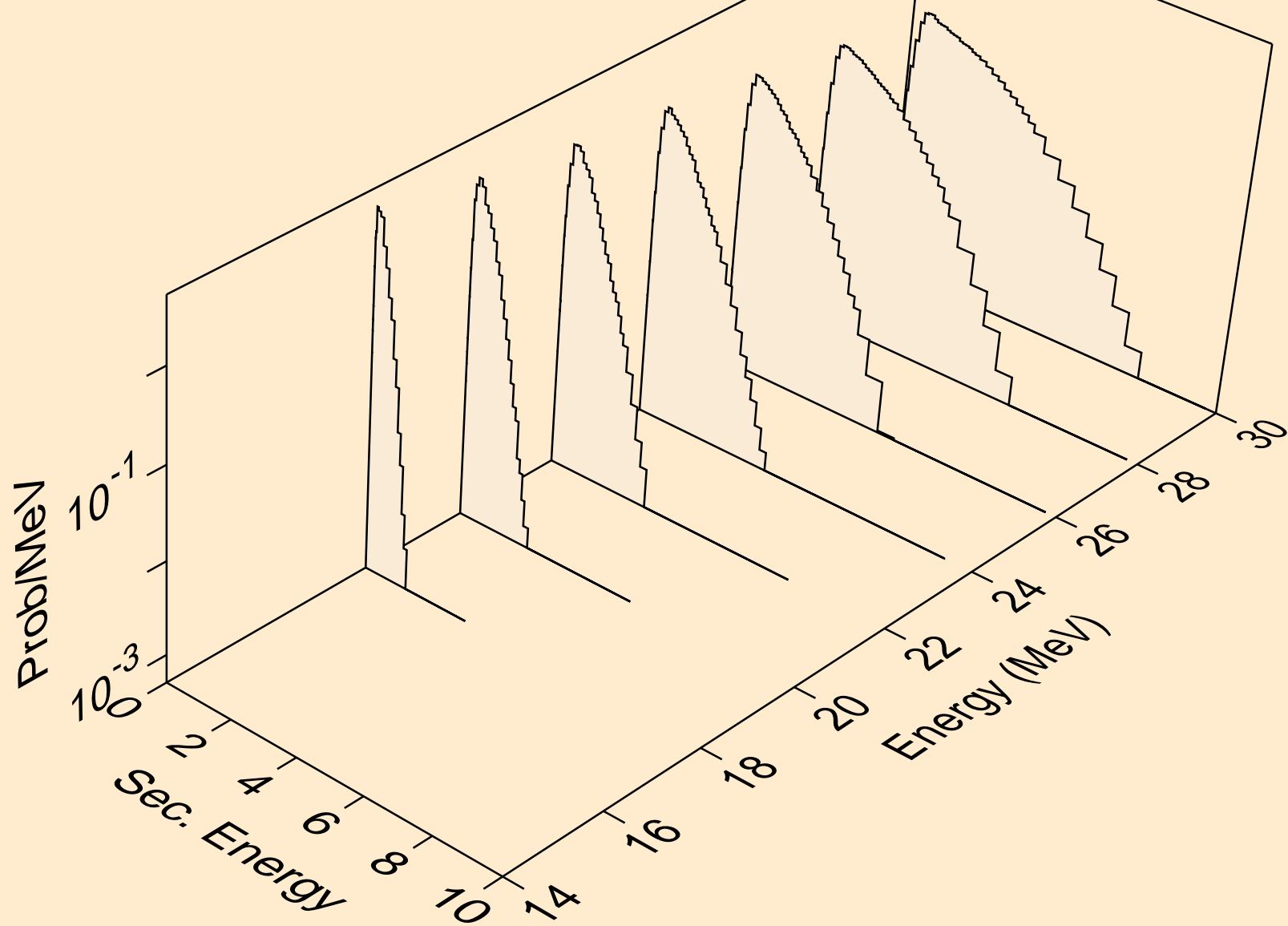

PO224 NEUTRON ACER TENDL-2021 LIBRARY; T=293.6K  
Neutron emission for (n,3np)

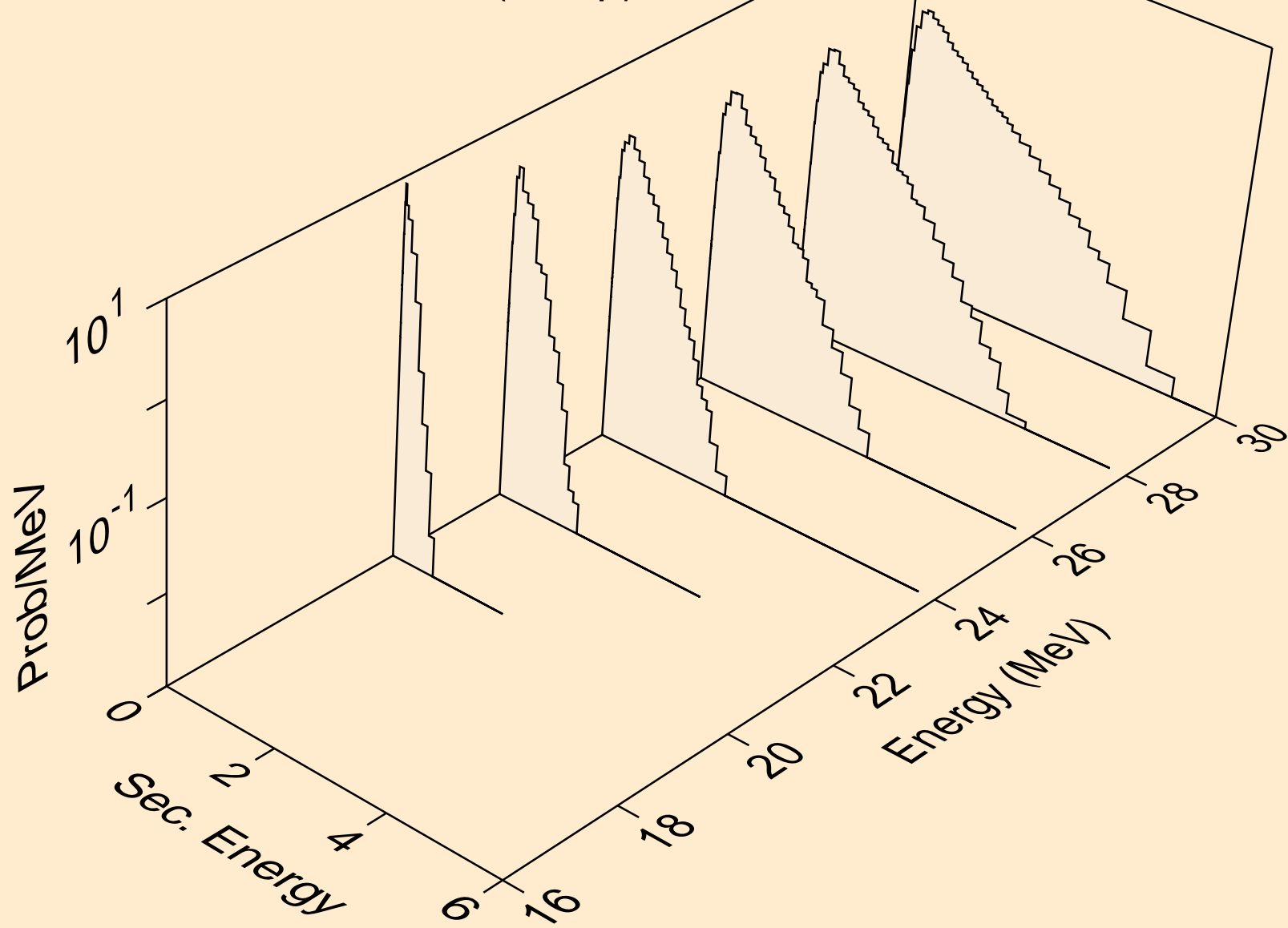

PO224 NEUTRON ACER TENDL-2021 LIBRARY; T=293.6K  
Neutron emission for (n,2np)

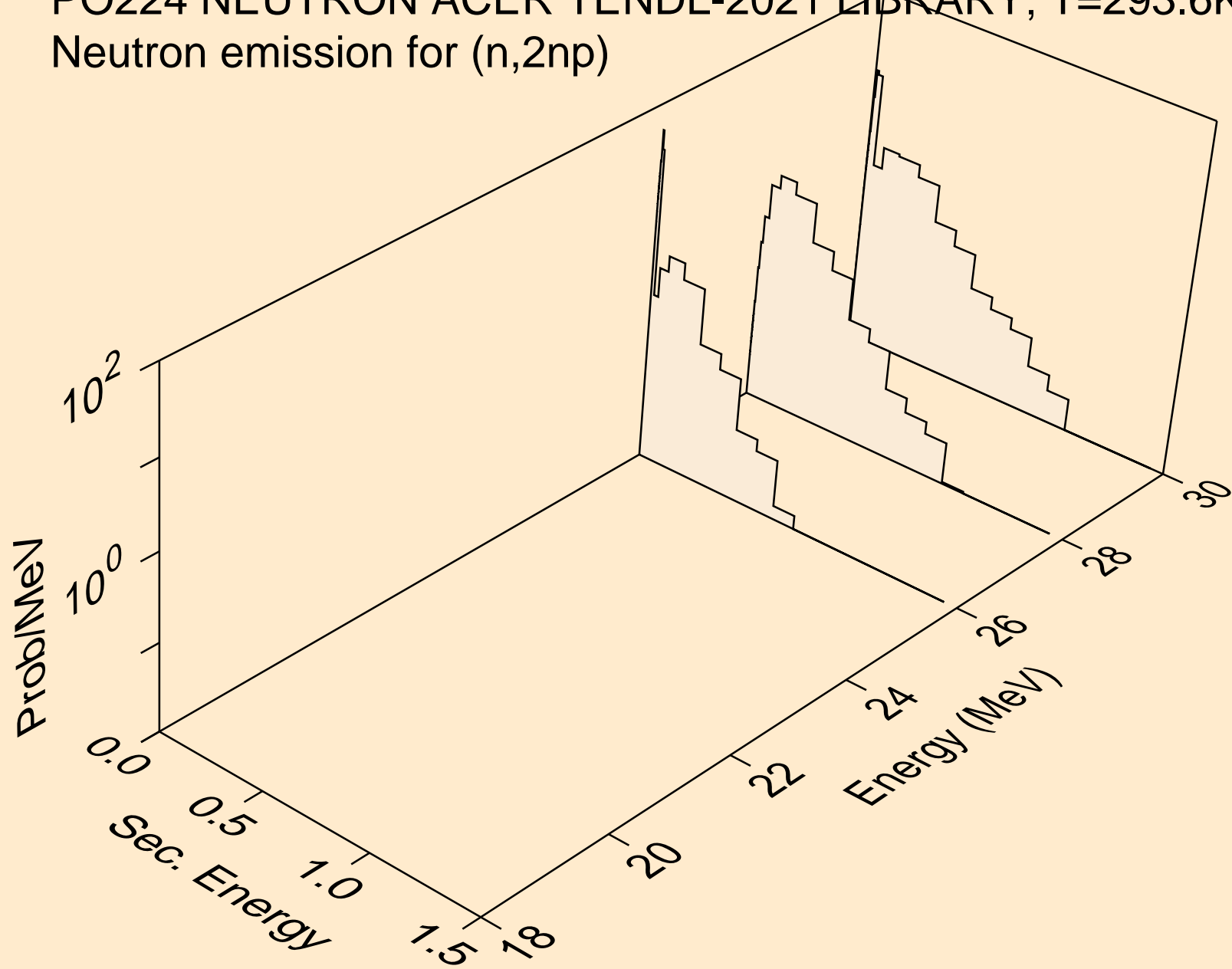

PO224 NEUTRON ACER TENDL-2021 LIBRARY; T=293.6K  
Neutron emission for (n,n\*c)

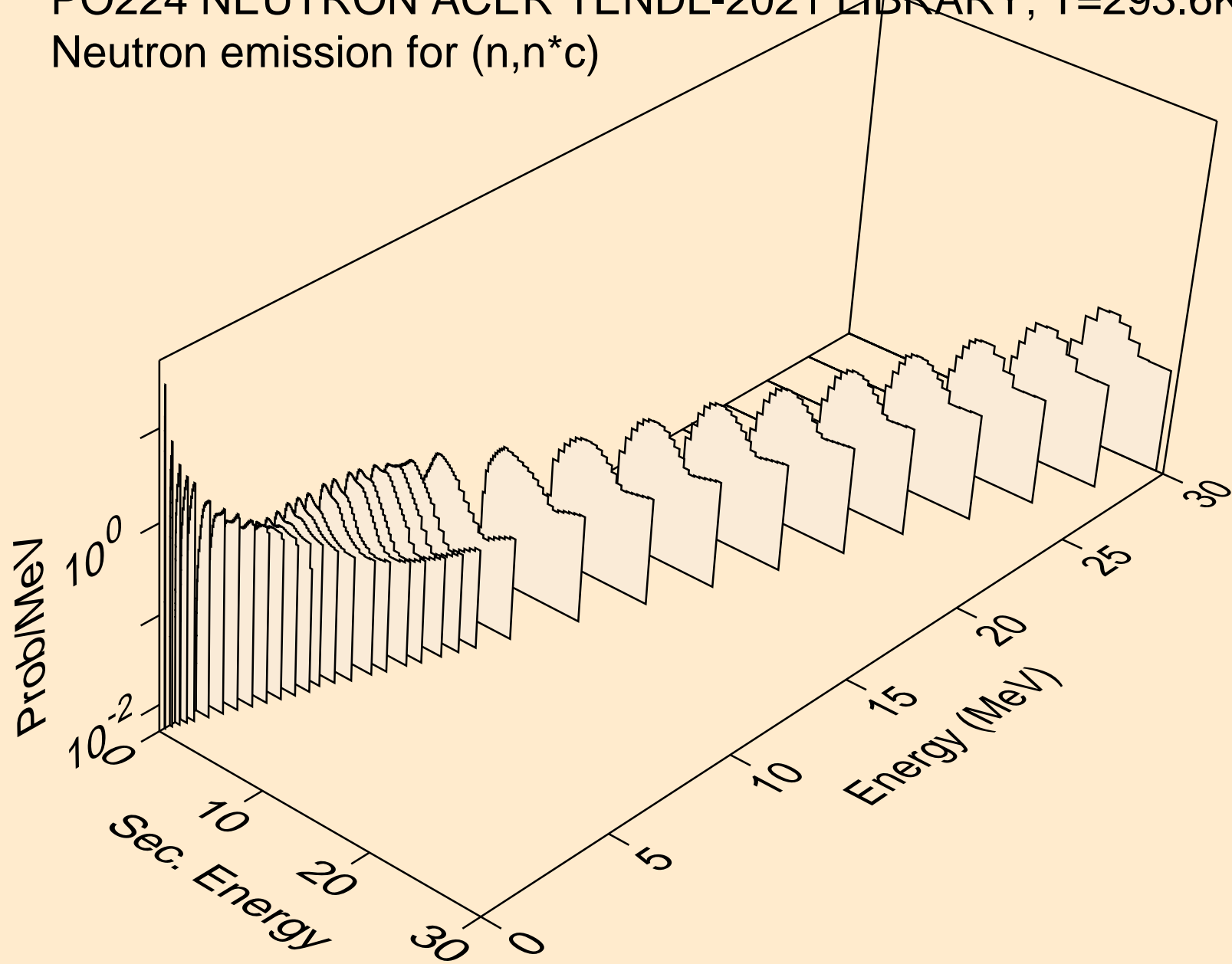



PO224 NEUTRON ACER TENDL-2021 LIBRARY; T=293.6K  
Delayed nubar

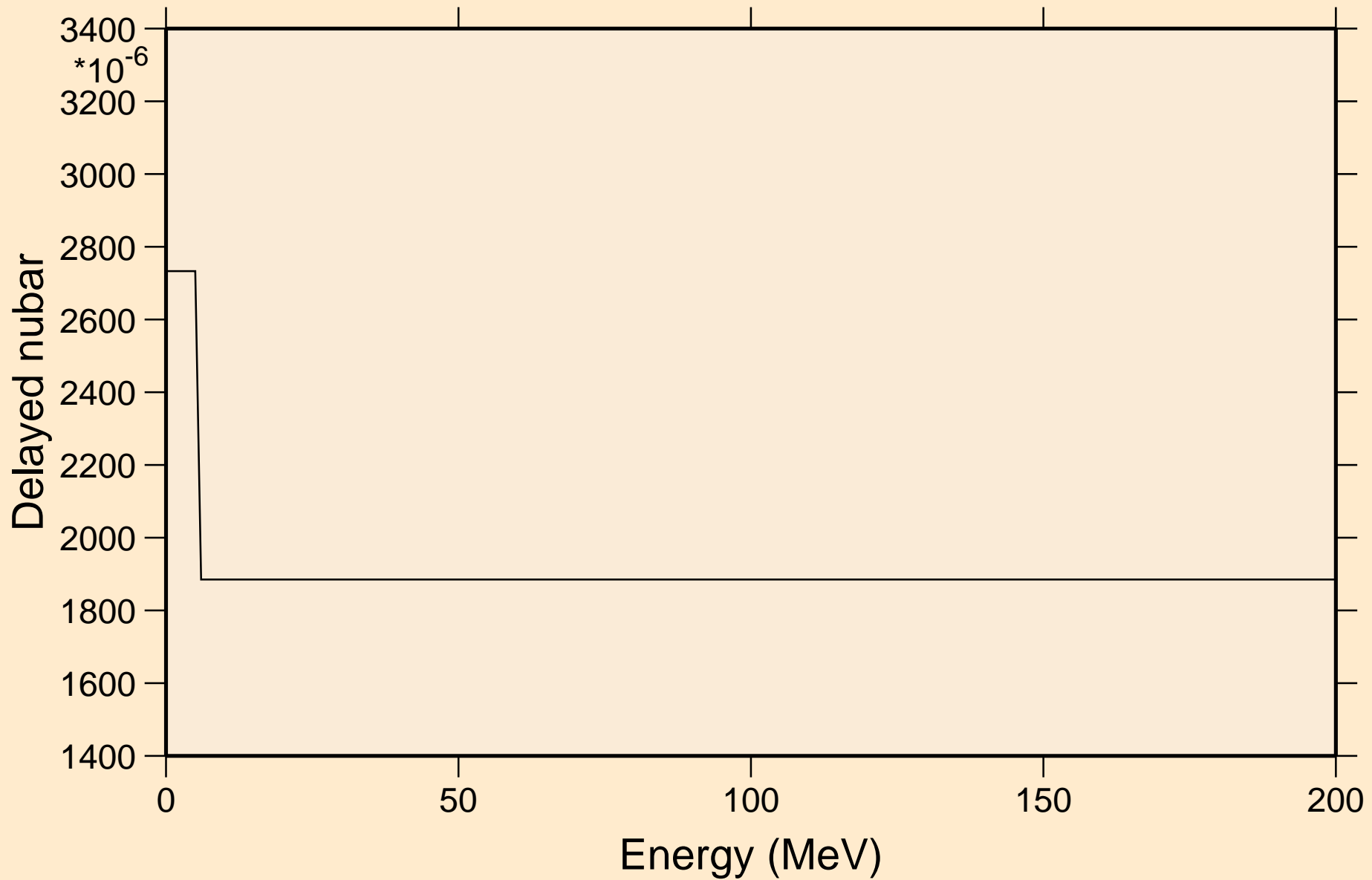

# PO224 NEUTRON ACER TENDL-2021 LIBRARY; T=293.6K

## Delayed neutron spectra

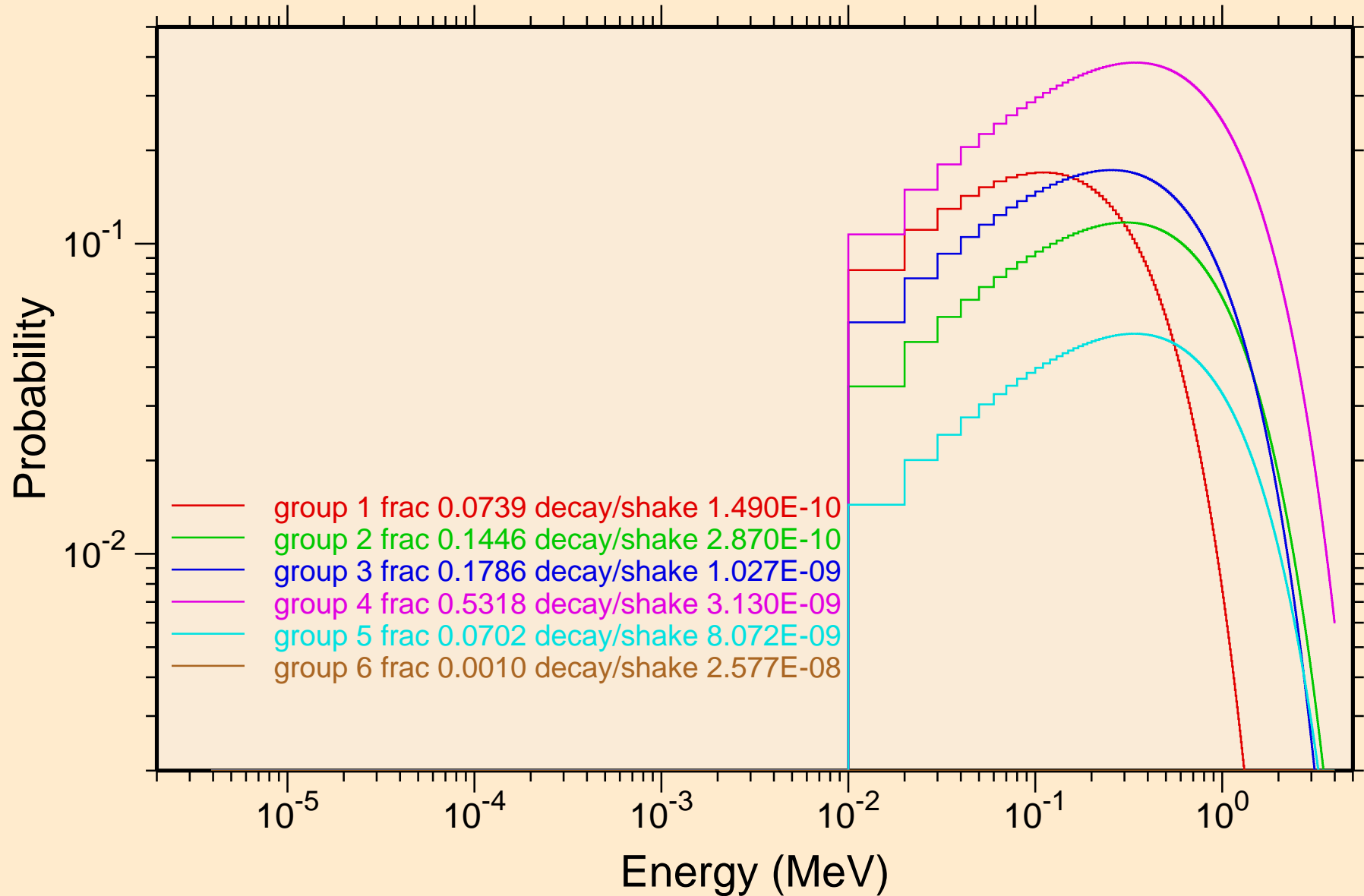

PO224 NEUTRON ACER TENDL-2021 LIBRARY; T=293.6K  
Photon emission for (n,x)

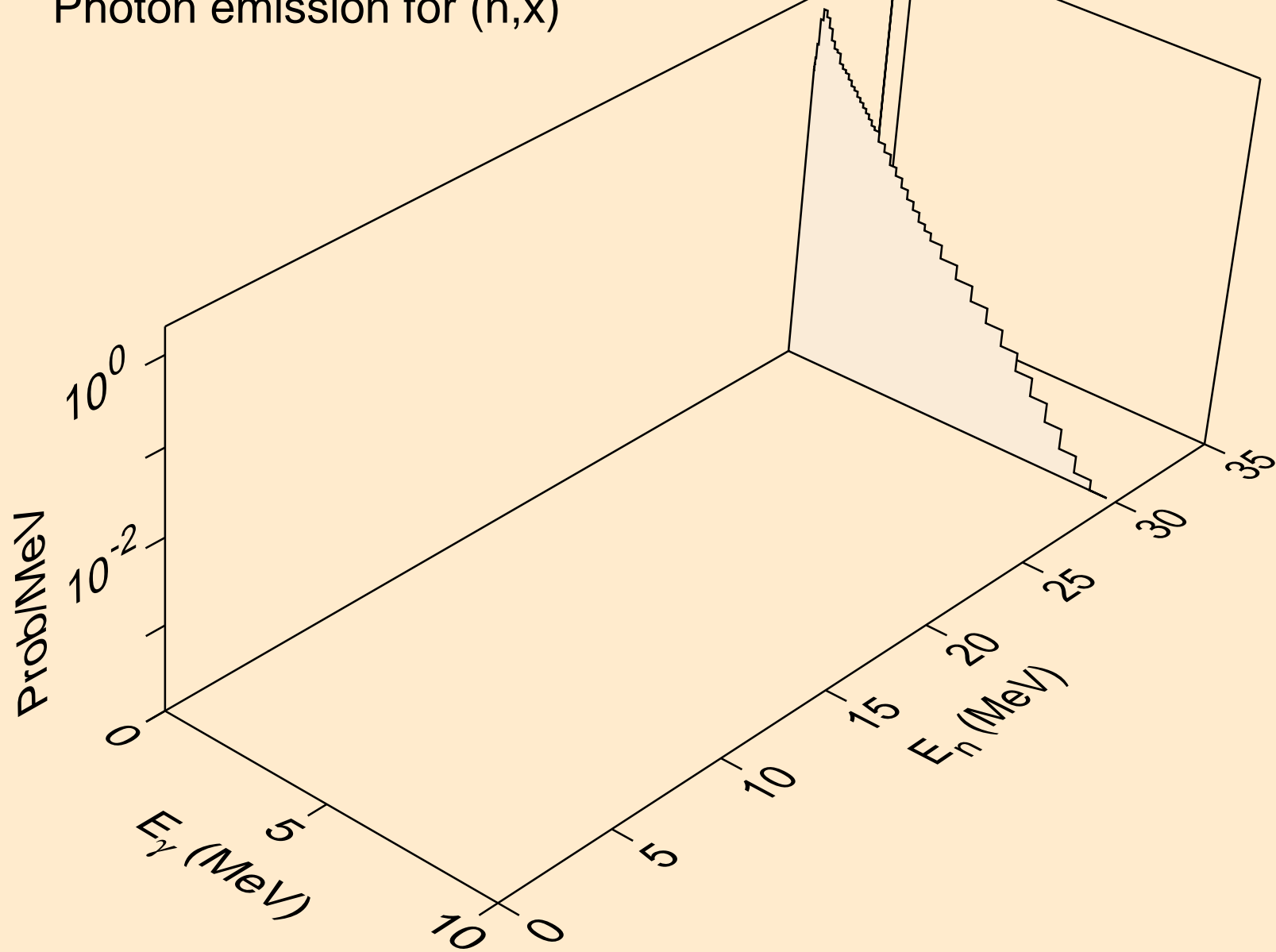

PO224 NEUTRON ACER TENDL-2021 LIBRARY; T=293.6K  
Photon emission for (n,2nd)

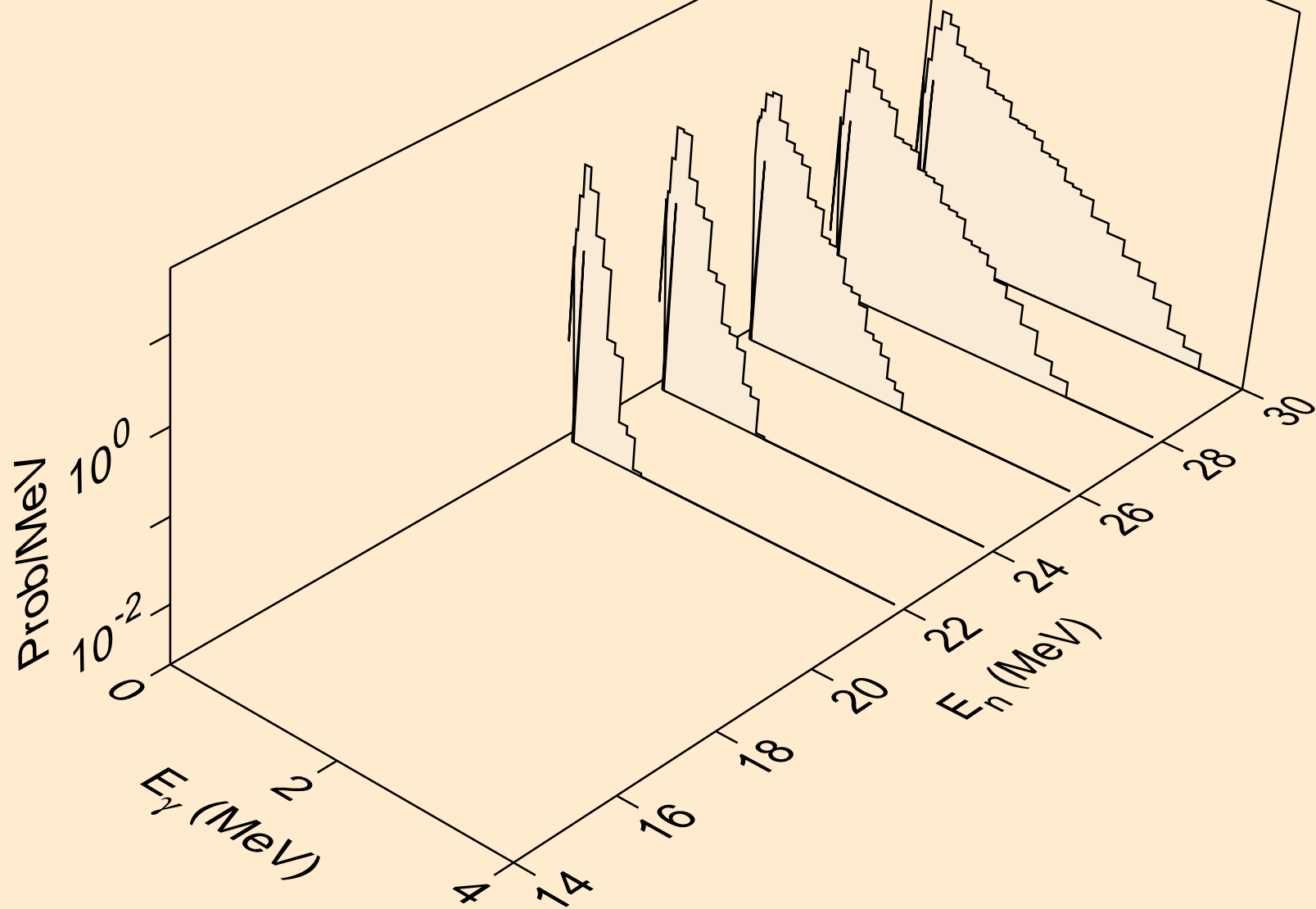

PO224 NEUTRON ACER TENDL-2021 LIBRARY; T=293.6K  
Photon emission for (n,2n)

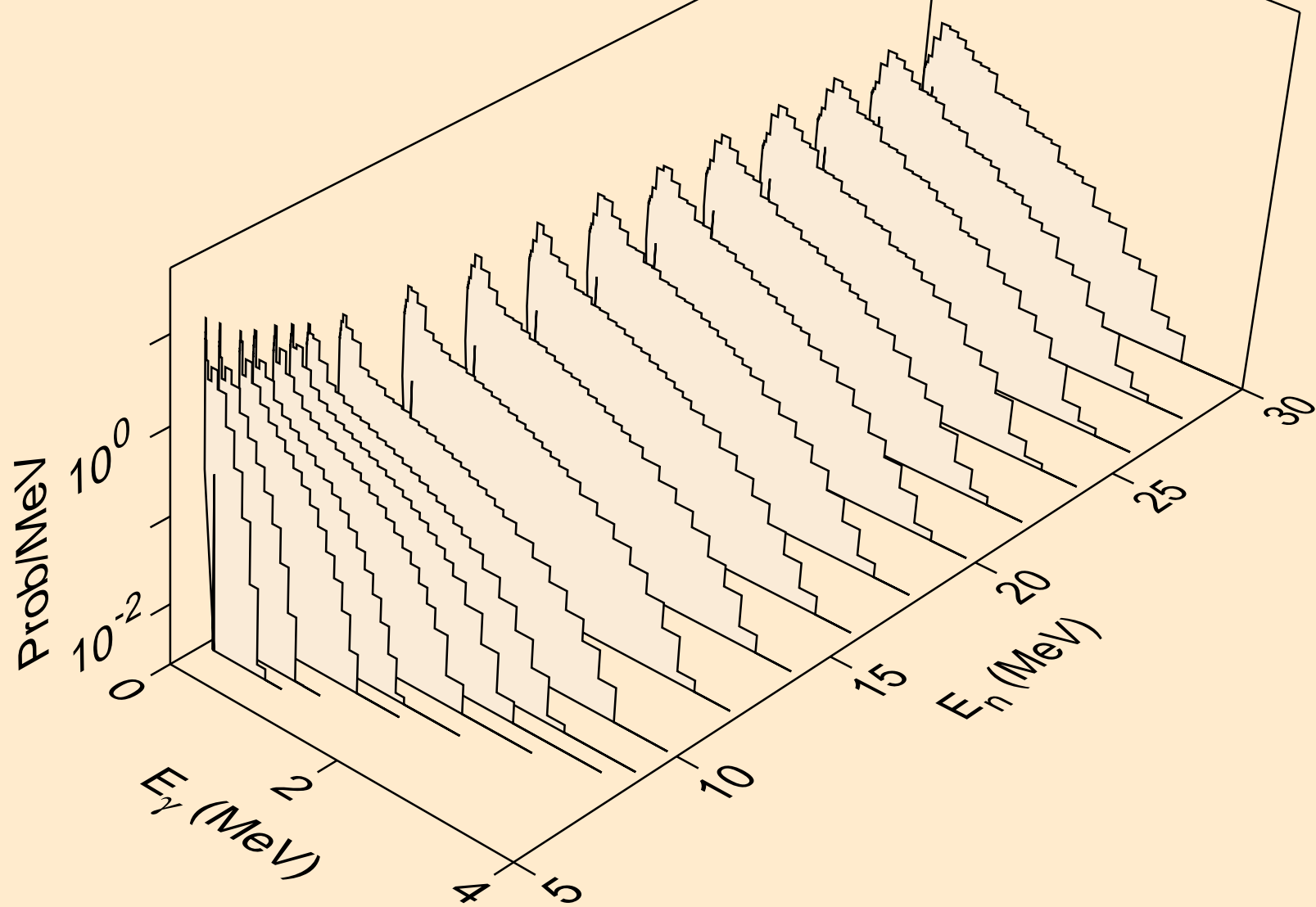

PO224 NEUTRON ACER TENDL-2021 LIBRARY; T=293.6K  
Photon emission for (n,3n)

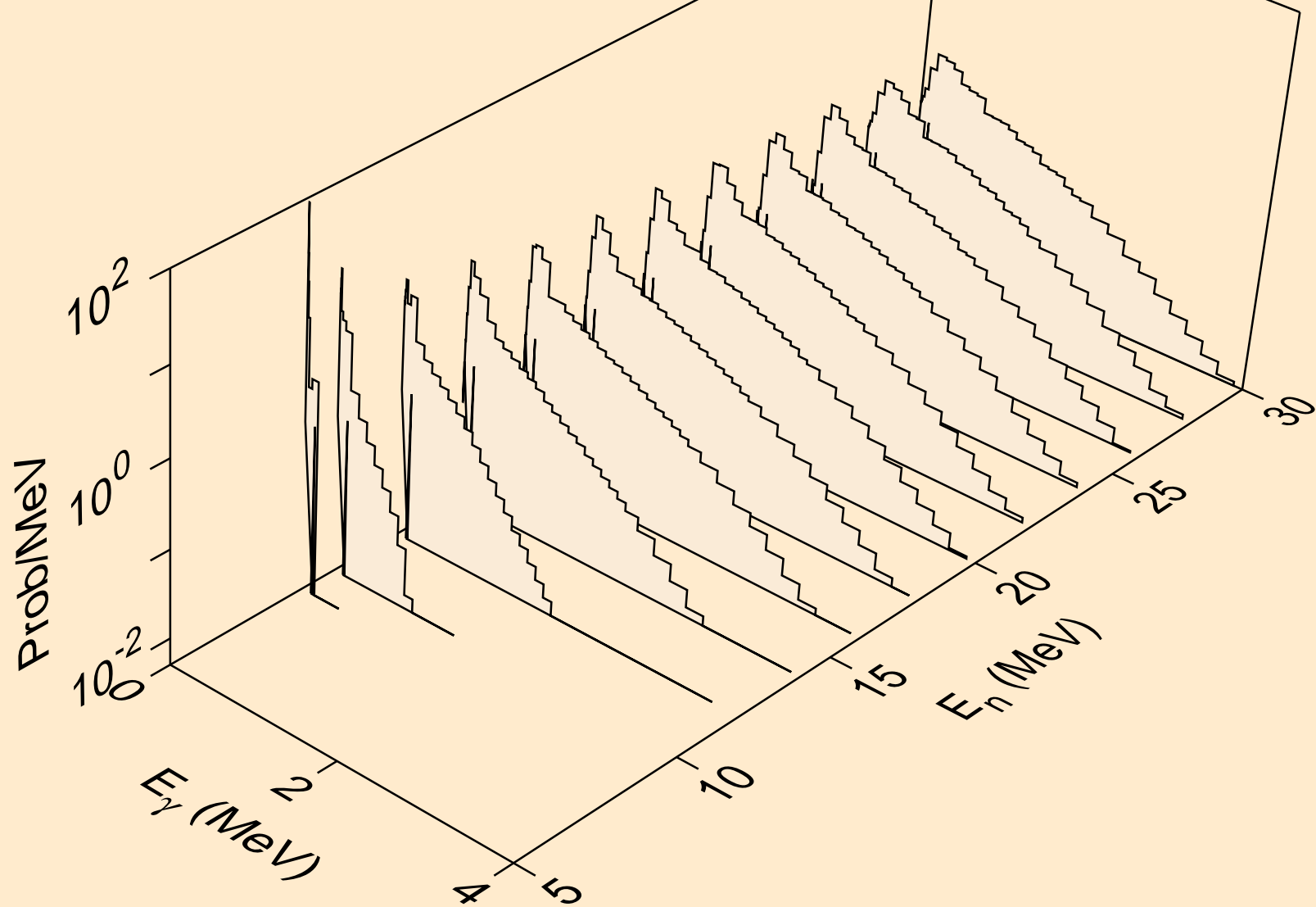

PO224 NEUTRON ACER TENDL-2021 LIBRARY; T=293.6K  
Photon emission for (n,n\*)a

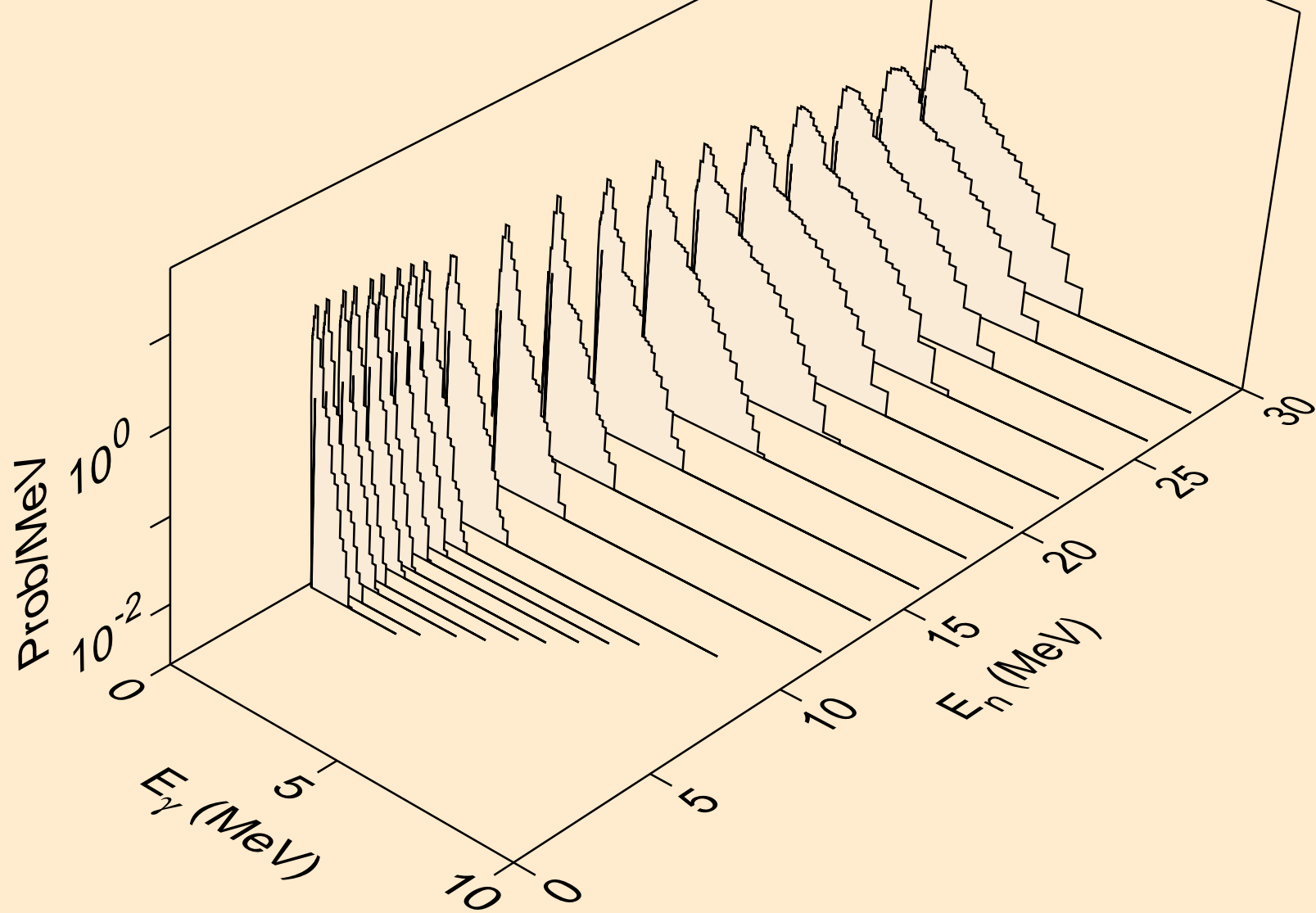

PO224 NEUTRON ACER TENDL-2021 LIBRARY; T=293.6K  
Photon emission for (n,2n)a

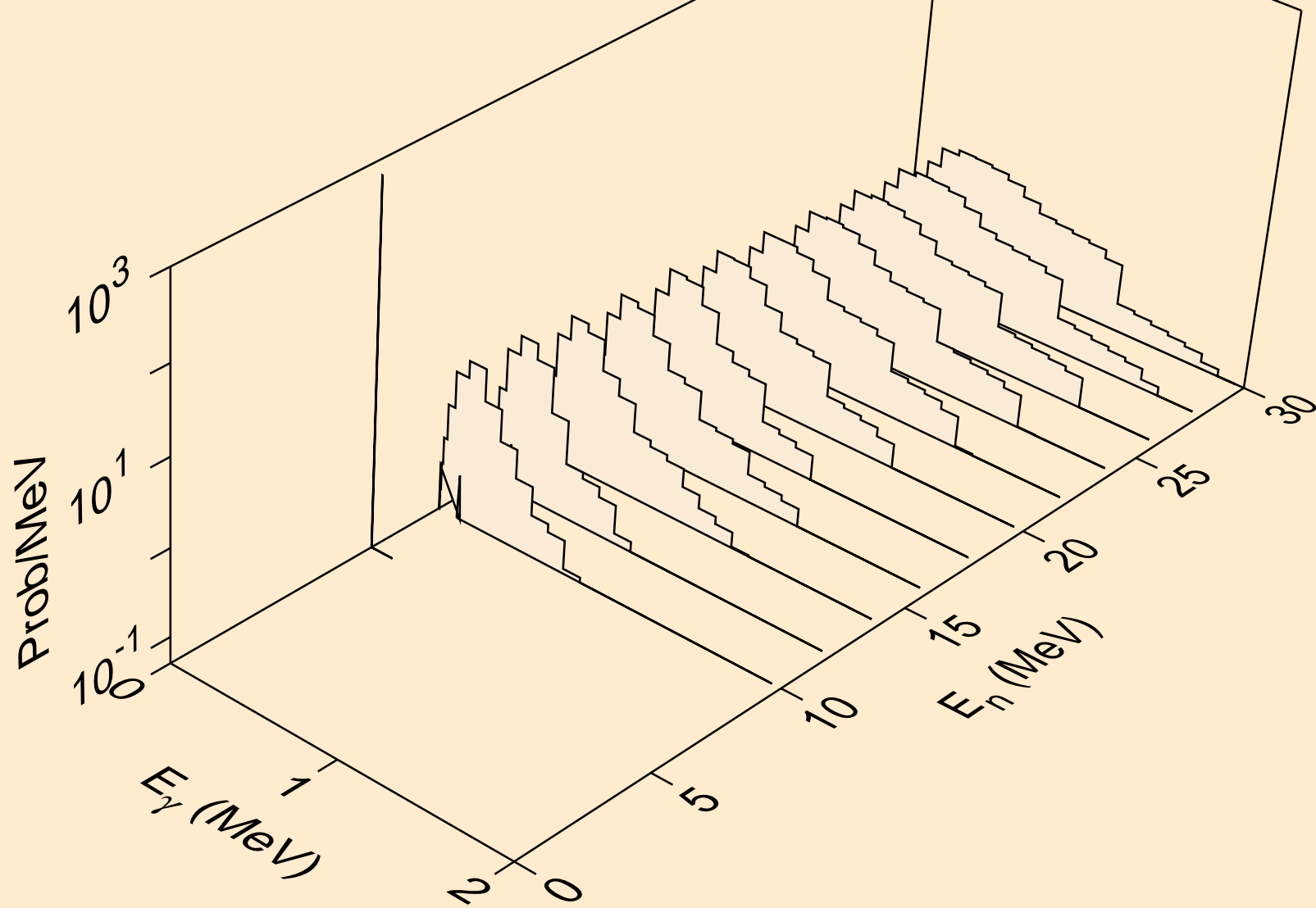



PO224 NEUTRON ACER TENDL-2021 LIBRARY; T=293.6K  
Photon emission for (n,3n)a

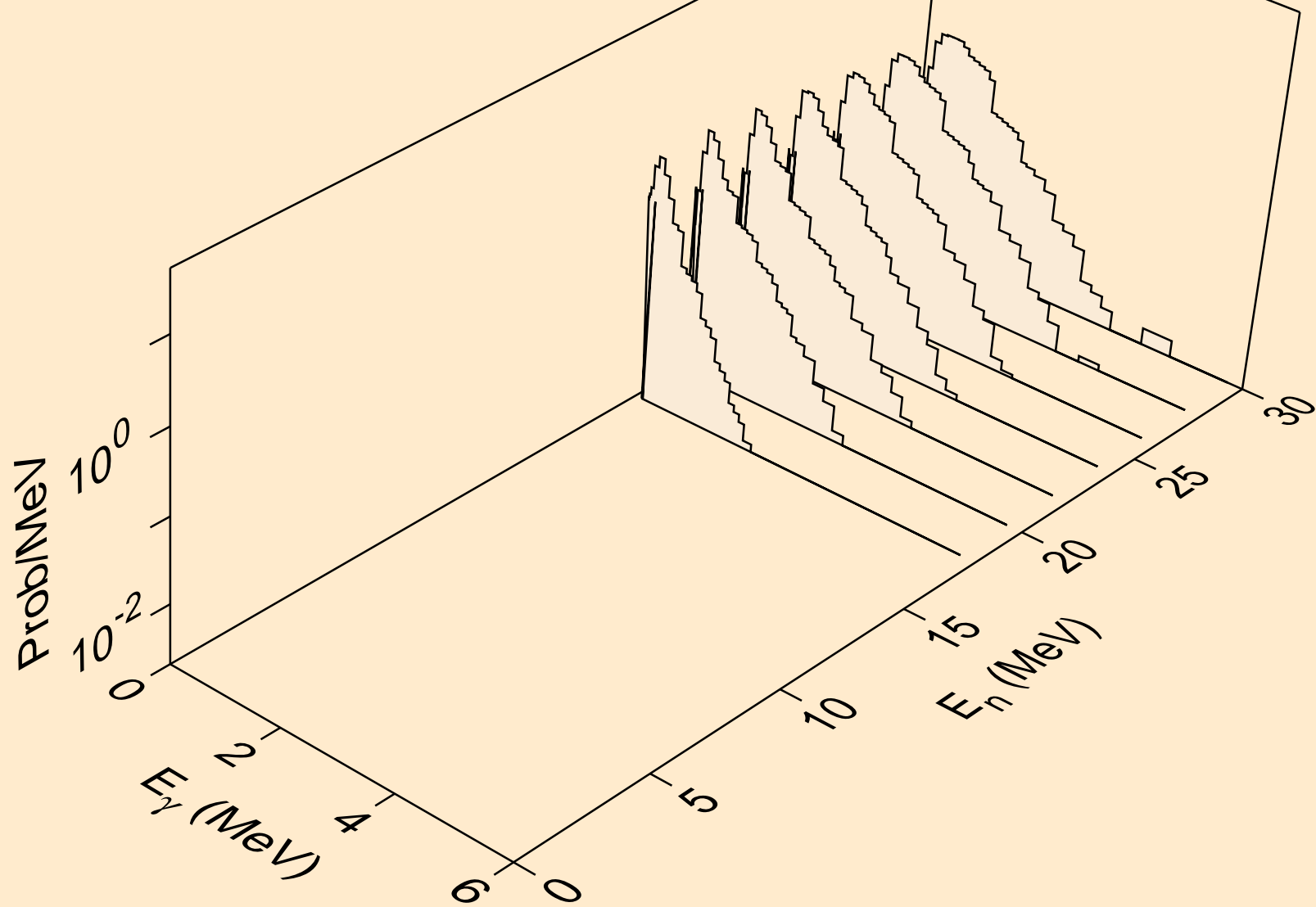

PO224 NEUTRON ACER TENDL-2021 LIBRARY; T=293.6K  
Photon emission for (n,n\*)p

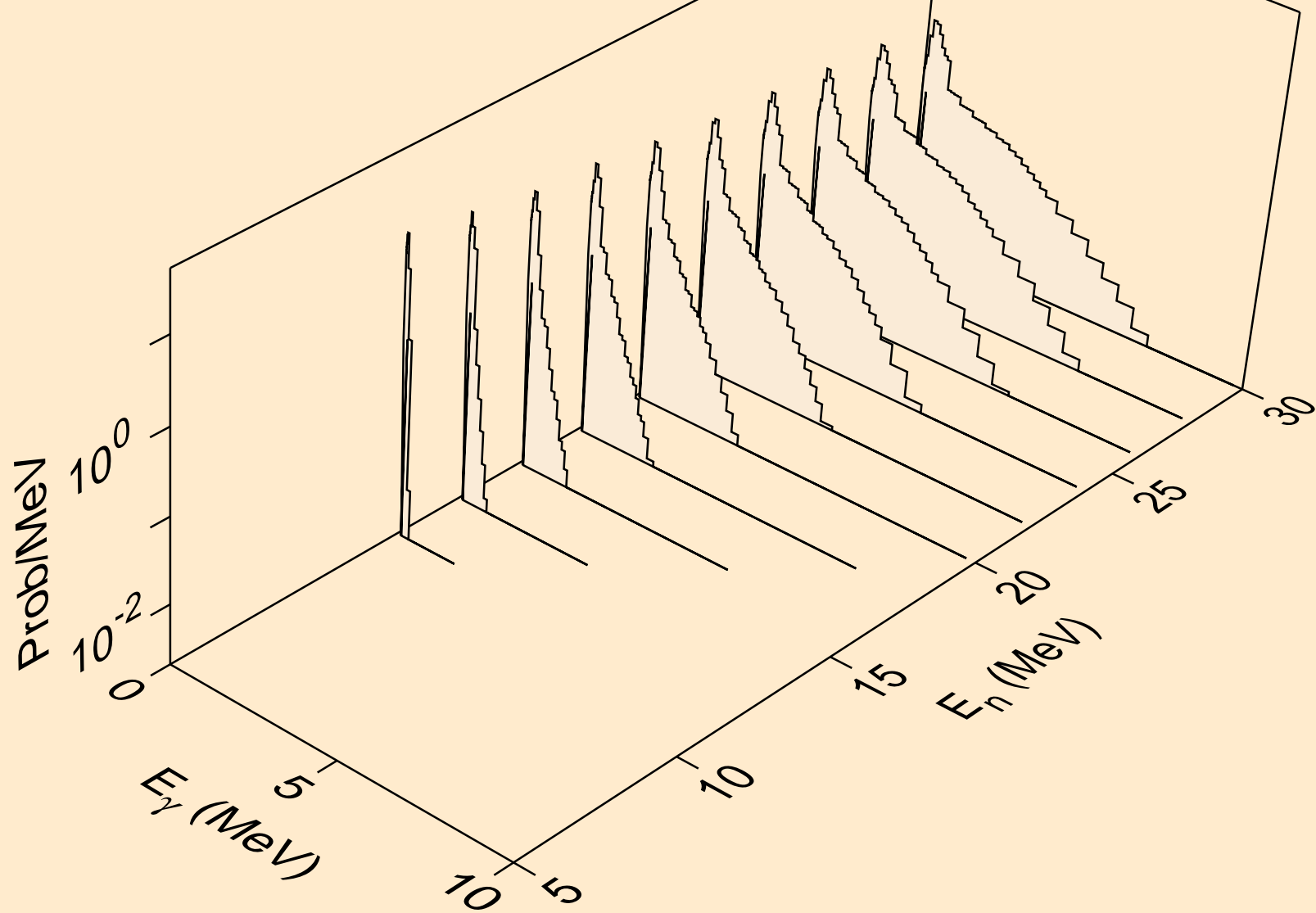

PO224 NEUTRON ACER TENDL-2021 LIBRARY; T=293.6K  
Photon emission for (n,n\*)2a

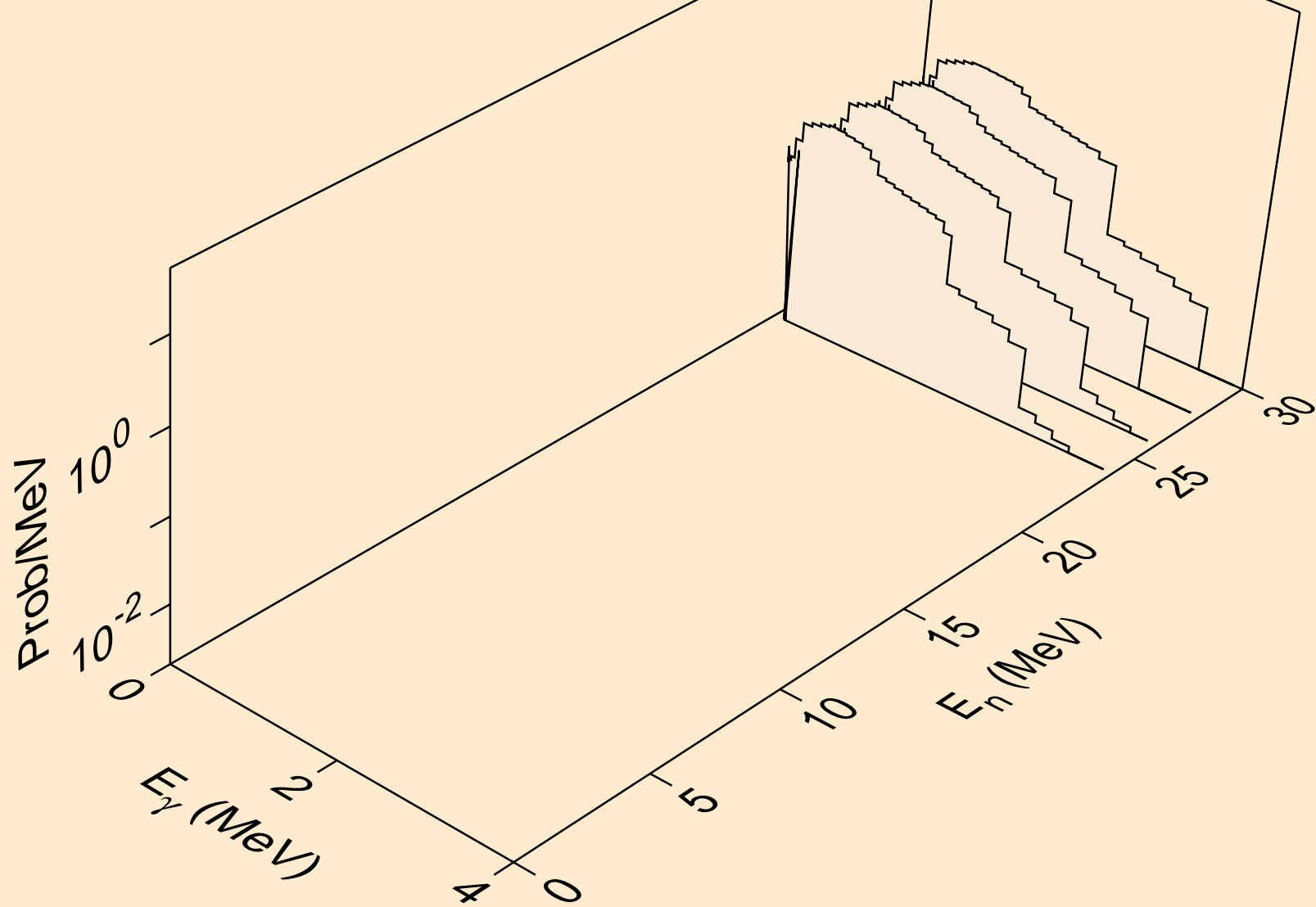

PO224 NEUTRON ACER TENDL-2021 LIBRARY; T=293.6K  
Photon emission for (n,2n)2a

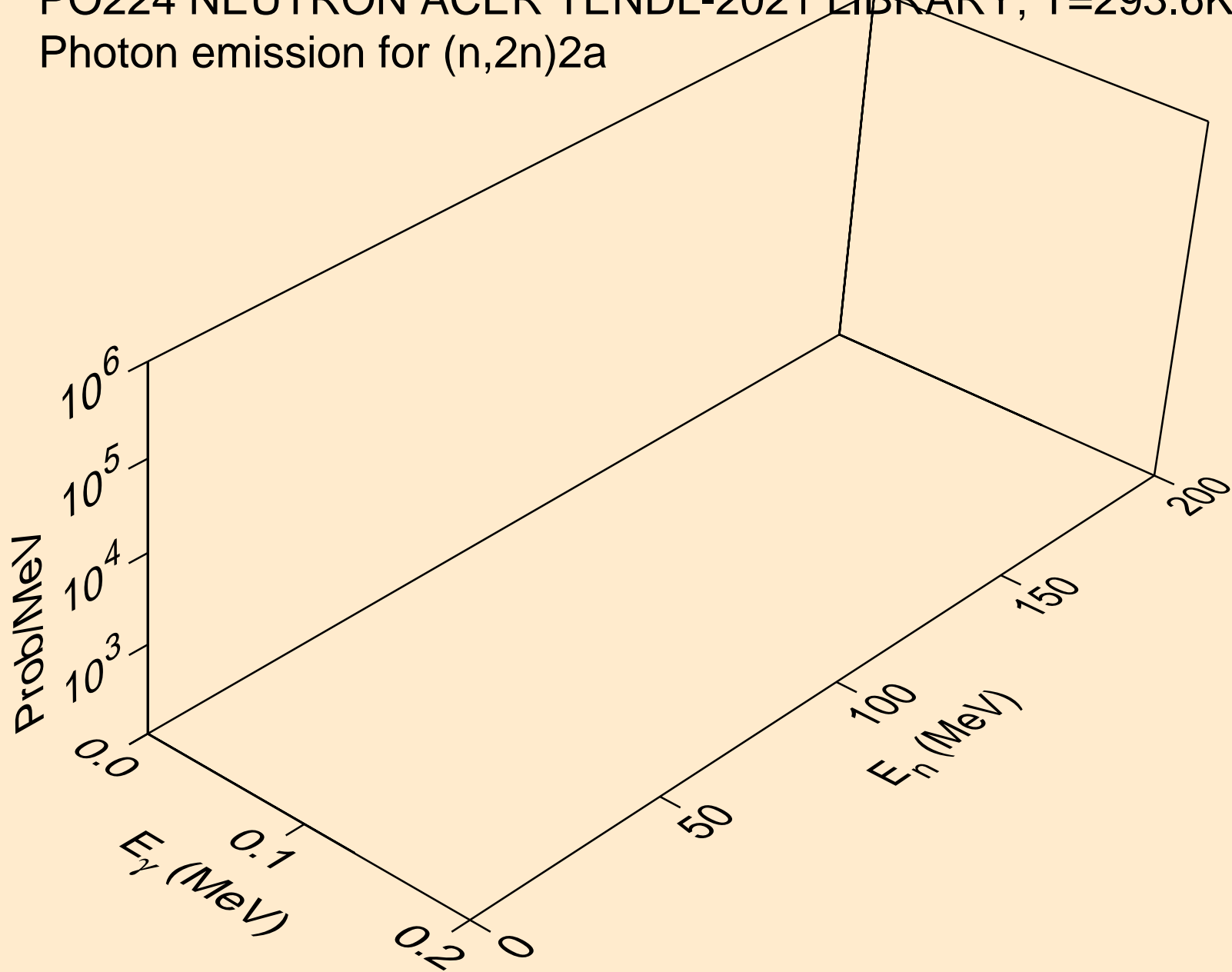

PO224 NEUTRON ACER TENDL-2021 LIBRARY; T=293.6K  
Photon emission for (n,n\*)d

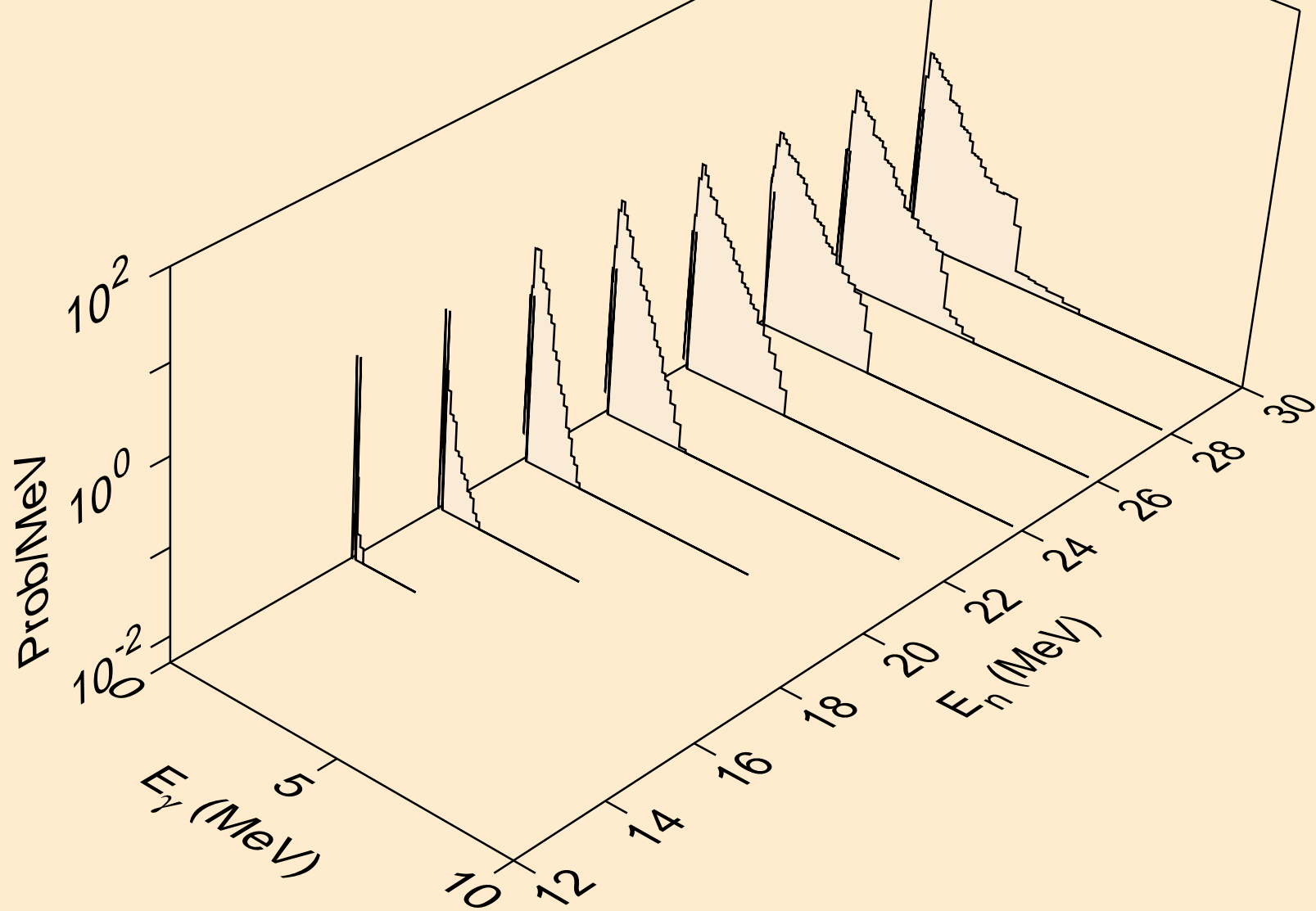

PO224 NEUTRON ACER TENDL-2021 LIBRARY; T=293.6K  
Photon emission for (n,n\*)t

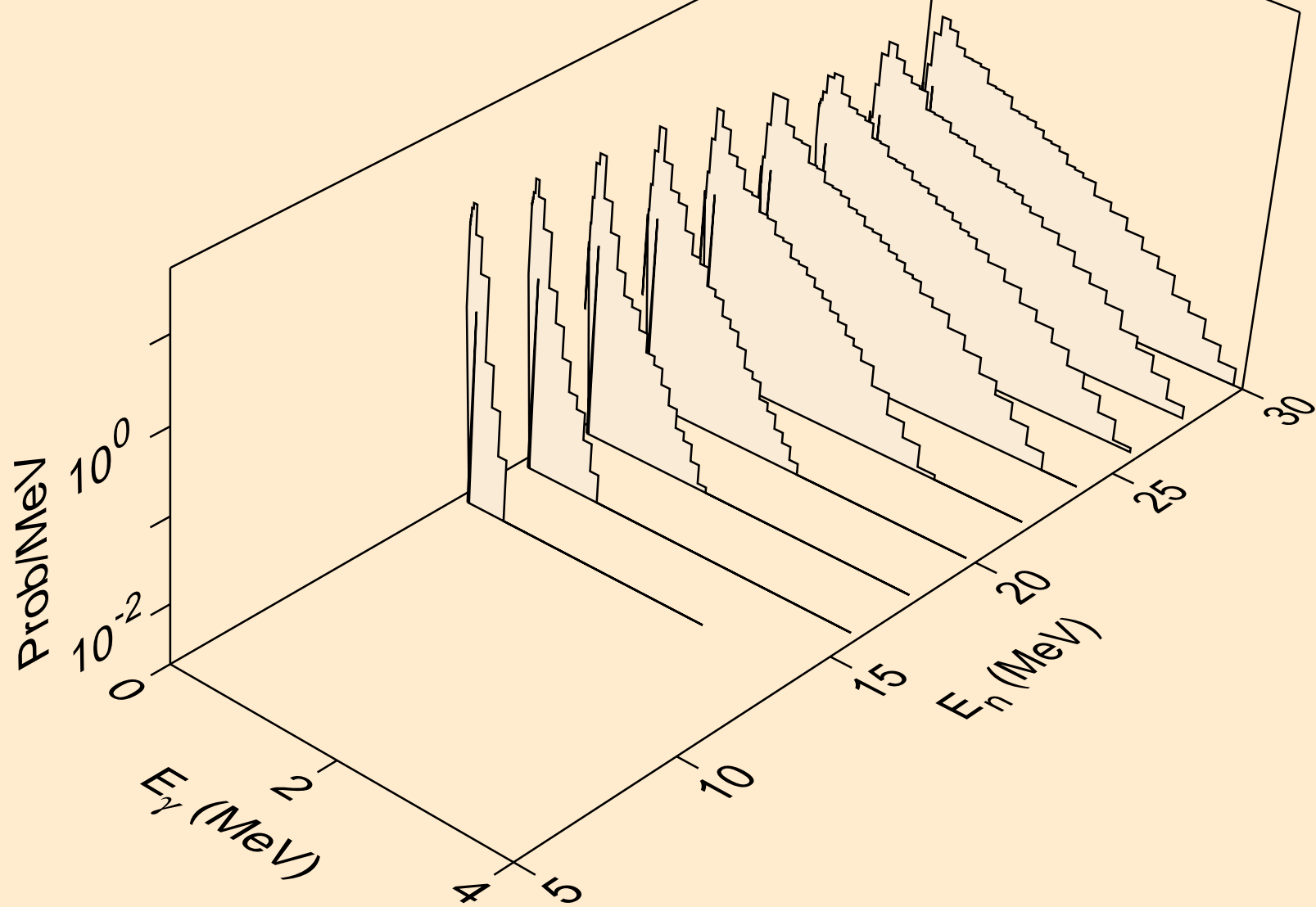

PO224 NEUTRON ACER TENDL-2021 LIBRARY; T=293.6K  
Photon emission for (n,n\*)he3

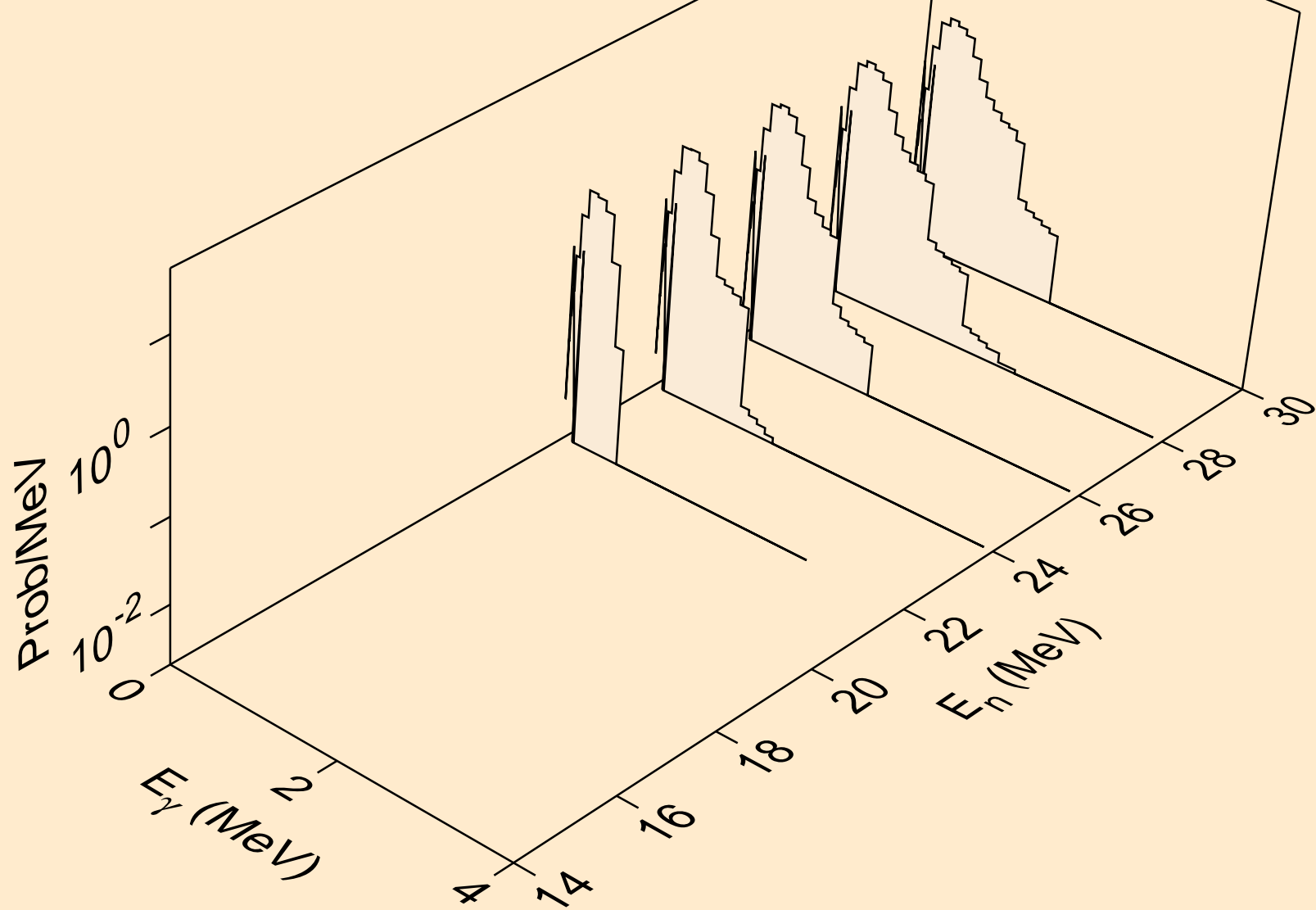

PO224 NEUTRON ACER TENDL-2021 LIBRARY; T=293.6K  
Photon emission for (n,4n)

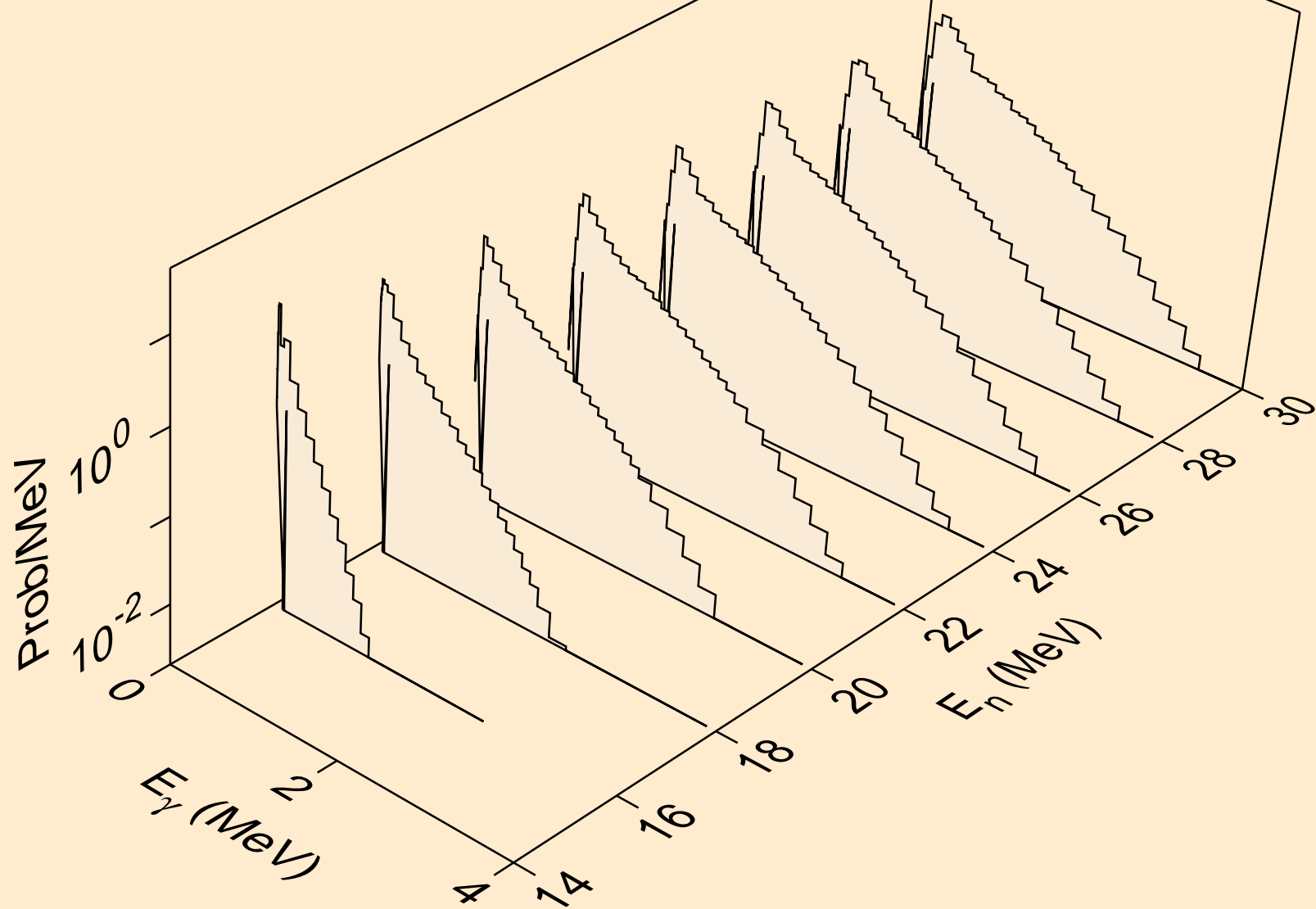



PO224 NEUTRON ACER TENDL-2021 LIBRARY; T=293.6K  
Photon emission for (n,2np)

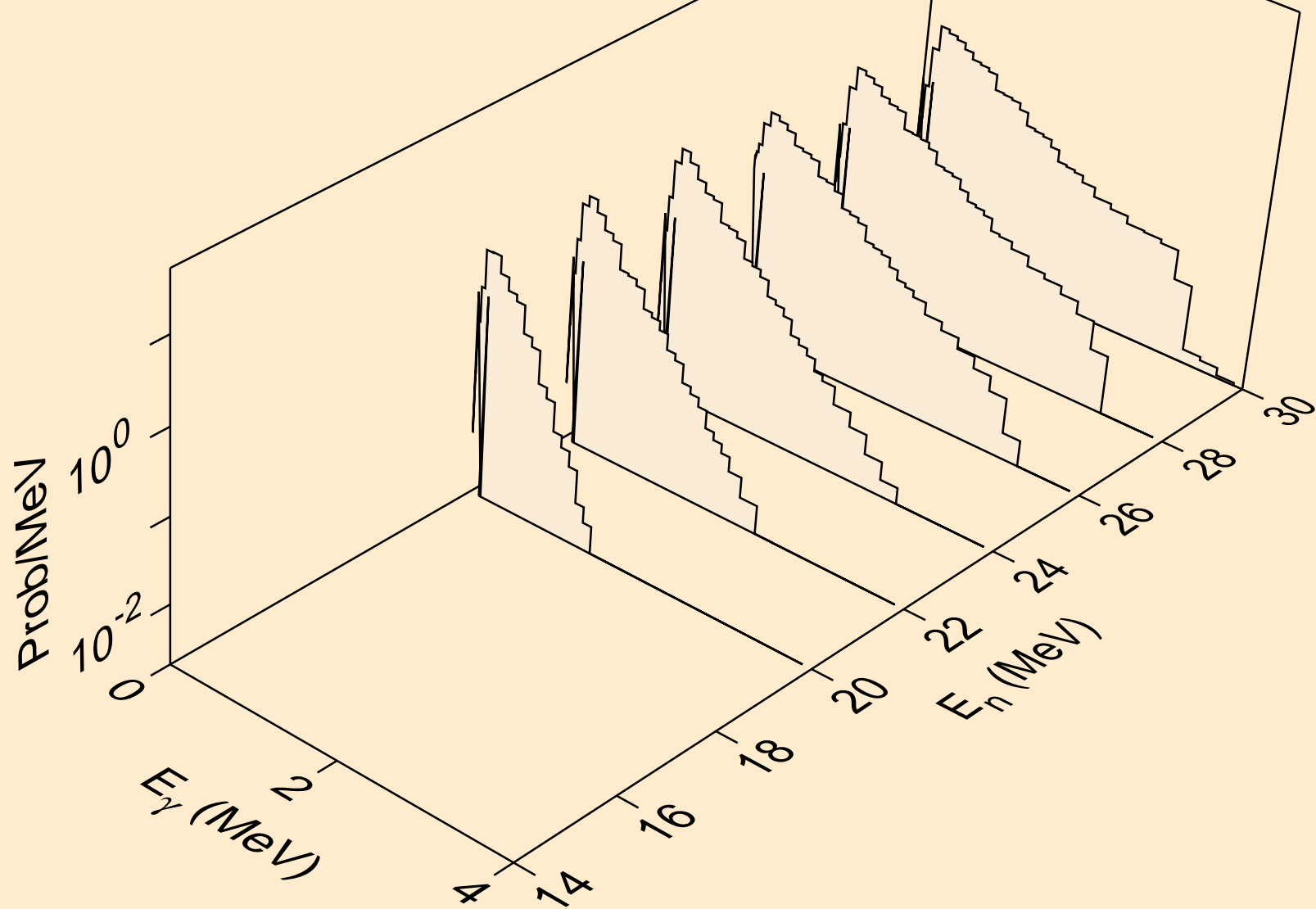

PO224 NEUTRON ACER TENDL-2021 LIBRARY; T=293.6K  
Photon emission for (n,3np)

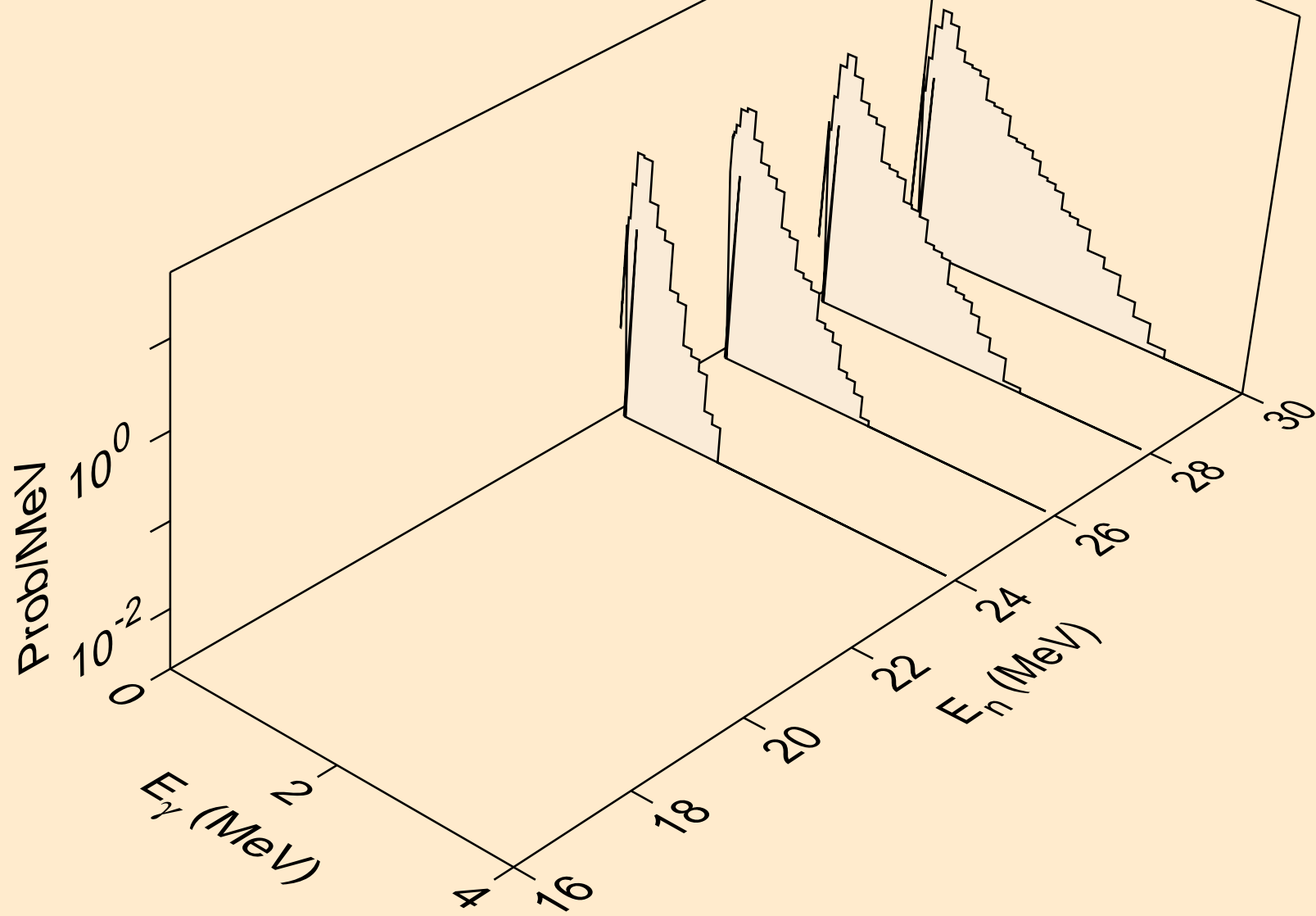

PO224 NEUTRON ACER TENDL-2021 LIBRARY; T=293.6K  
Photon emission for (n,2np)

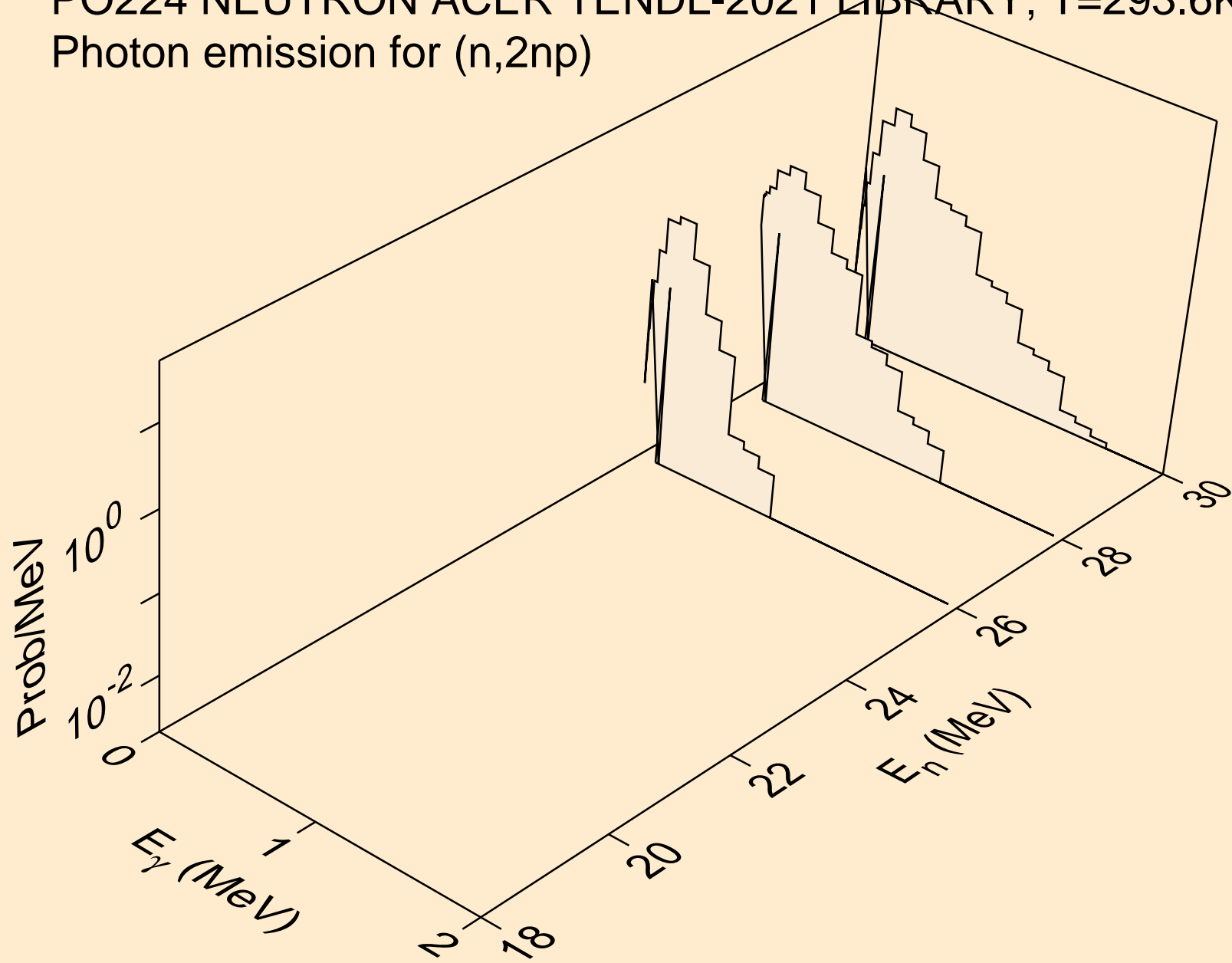

PO224 NEUTRON ACER TENDL-2021 LIBRARY; T=293.6K  
Photon emission for (n,n\*c)

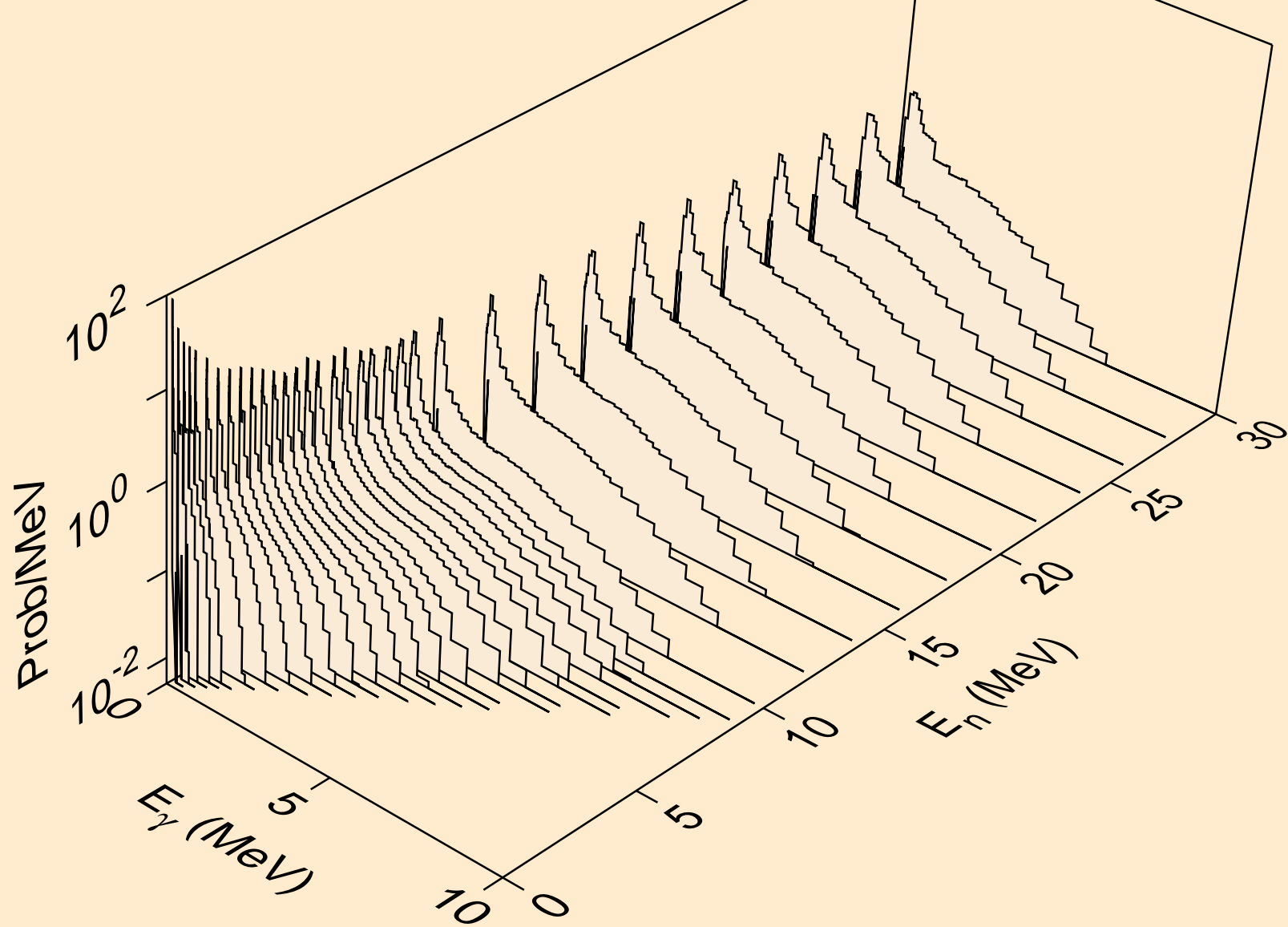

PO224 NEUTRON ACER TENDL-2021 LIBRARY; T=293.6K  
Photon emission for (n,gma)

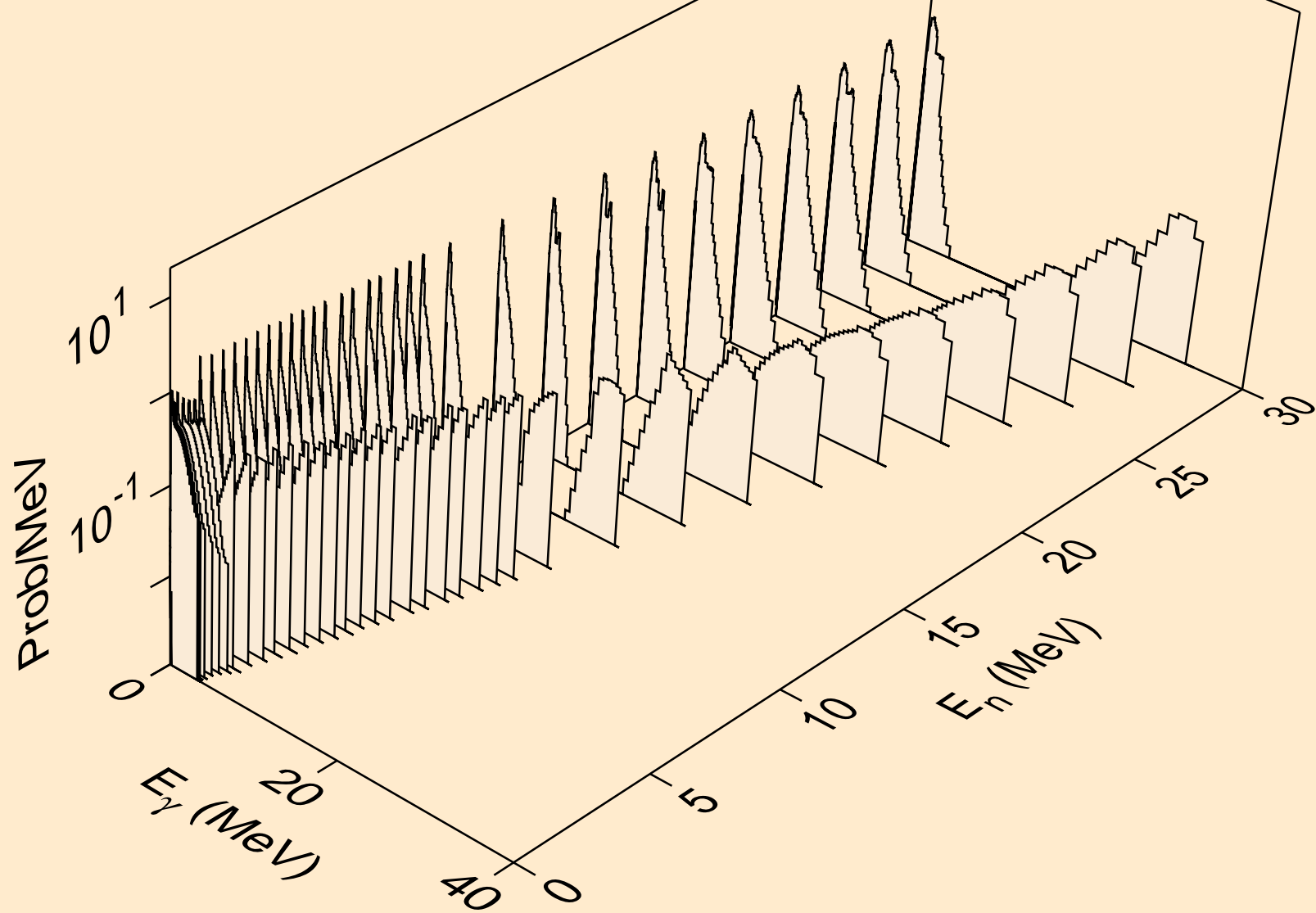

PO224 NEUTRON ACER TENDL-2021 LIBRARY; T=293.6K  
Photon emission for (n,p)

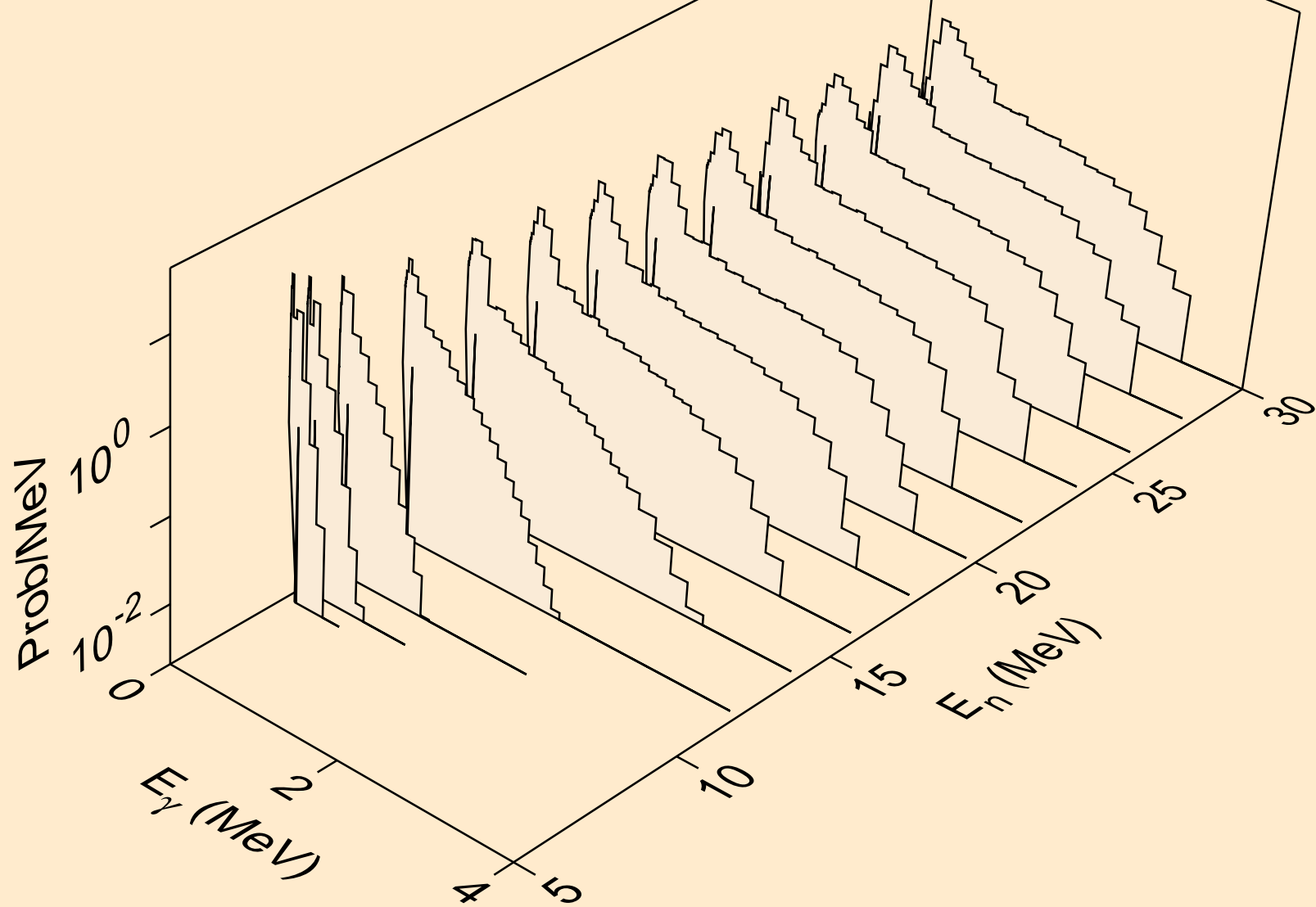

PO224 NEUTRON ACER TENDL-2021 LIBRARY; T=293.6K  
Photon emission for (n,d)

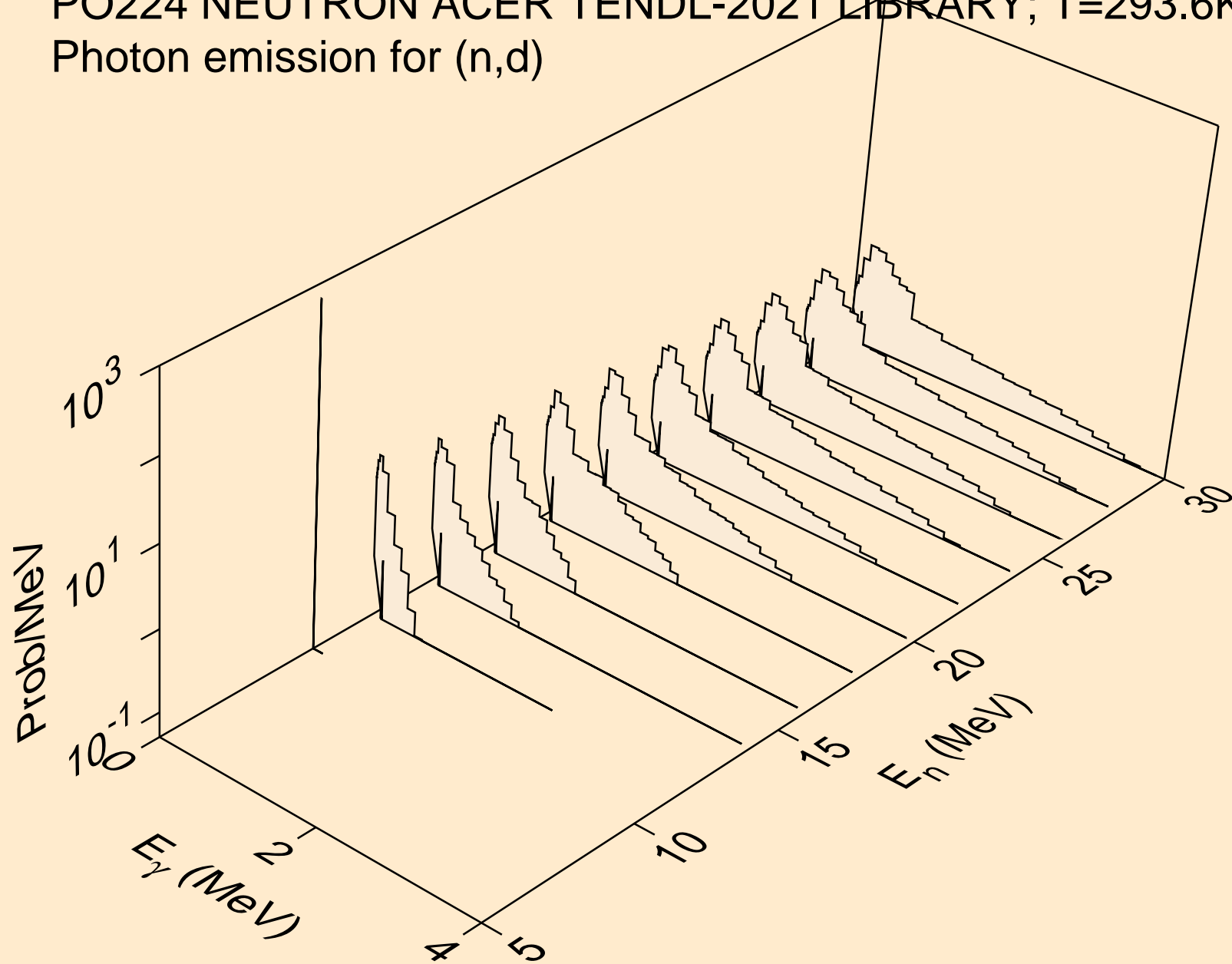

PO224 NEUTRON ACER TENDL-2021 LIBRARY; T=293.6K  
Photon emission for (n,t)

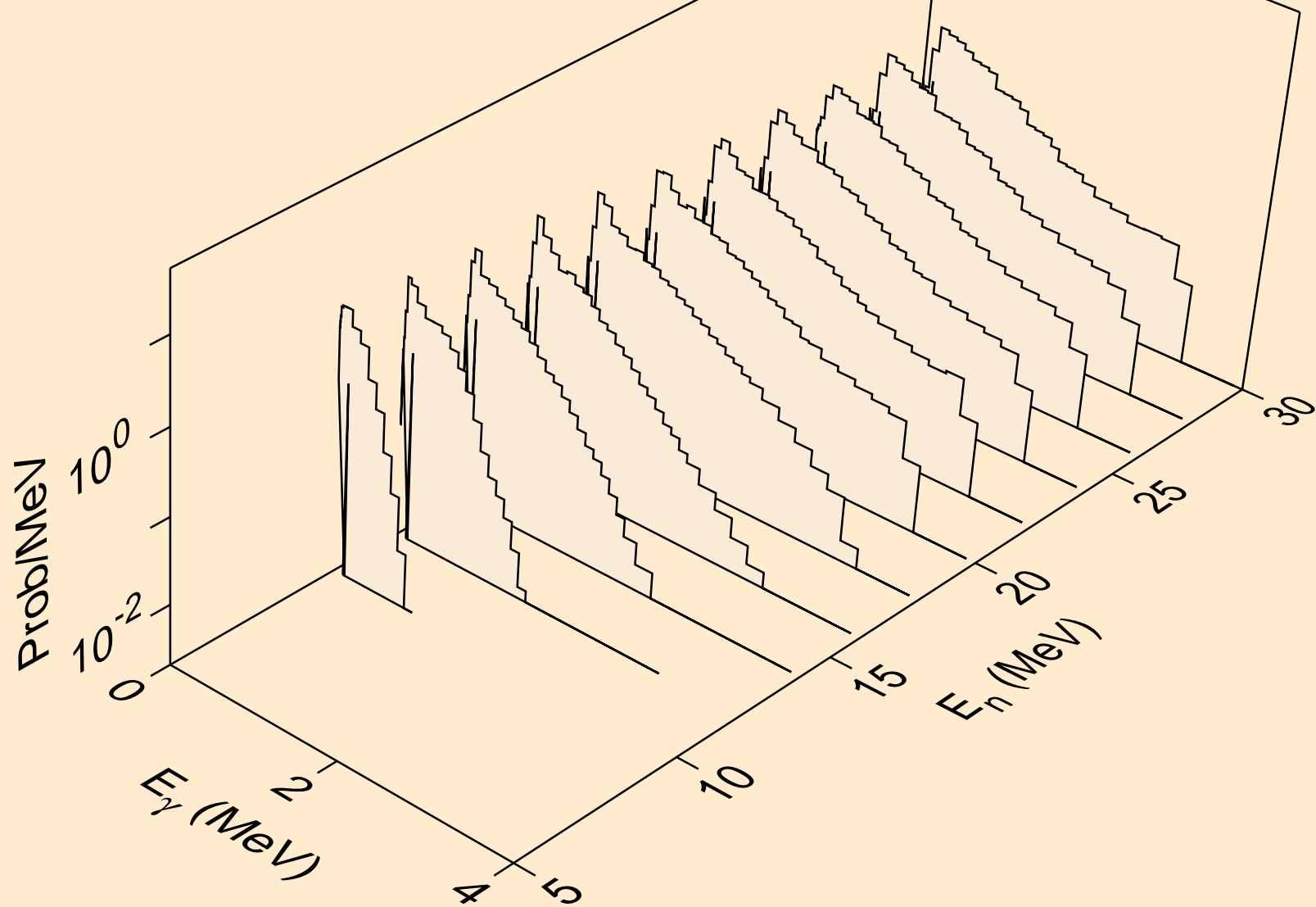



PO224 NEUTRON ACER TENDL-2021 LIBRARY; T=293.6K  
Photon emission for (n,he3)

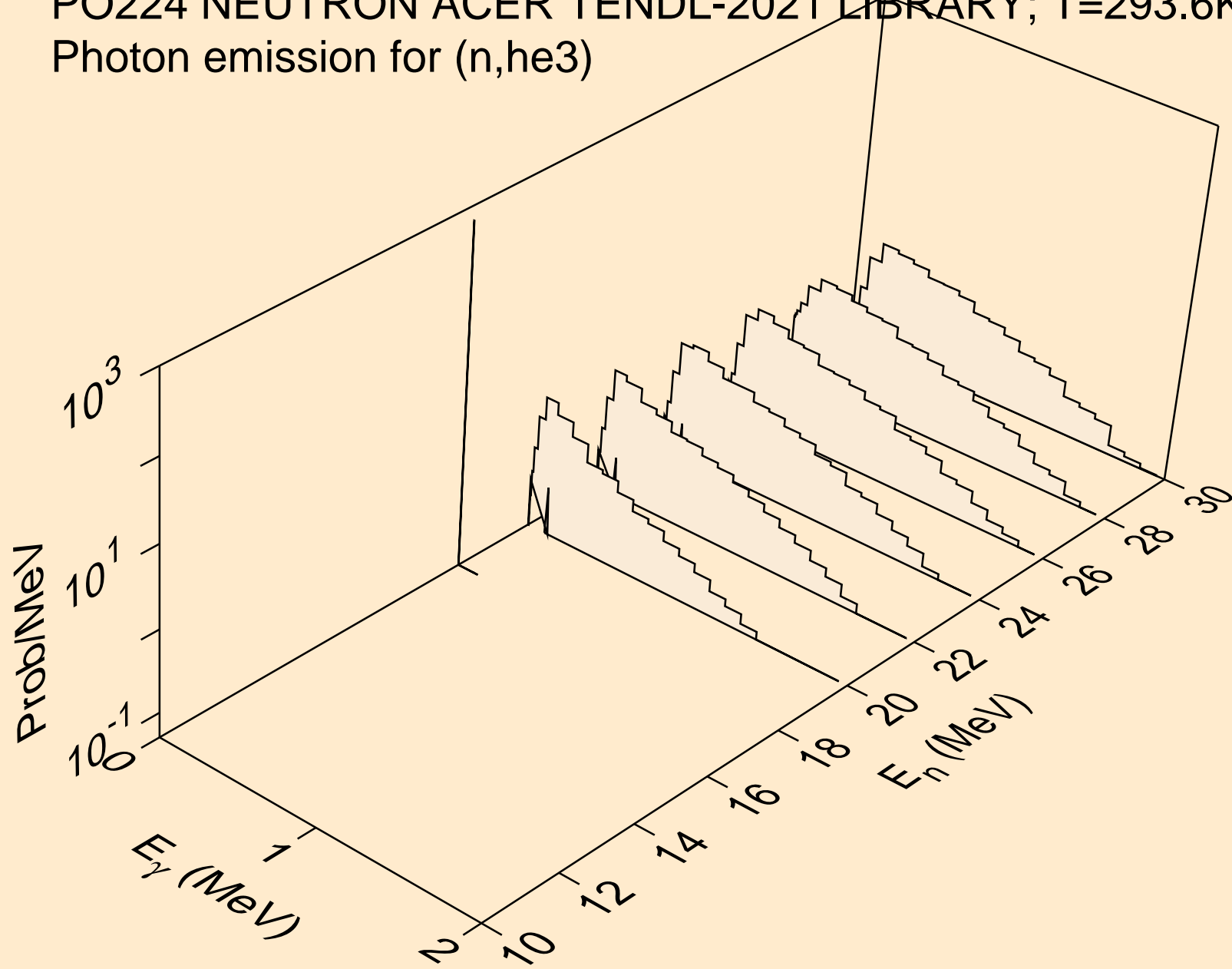

PO224 NEUTRON ACER TENDL-2021 LIBRARY; T=293.6K  
Photon emission for (n,a)

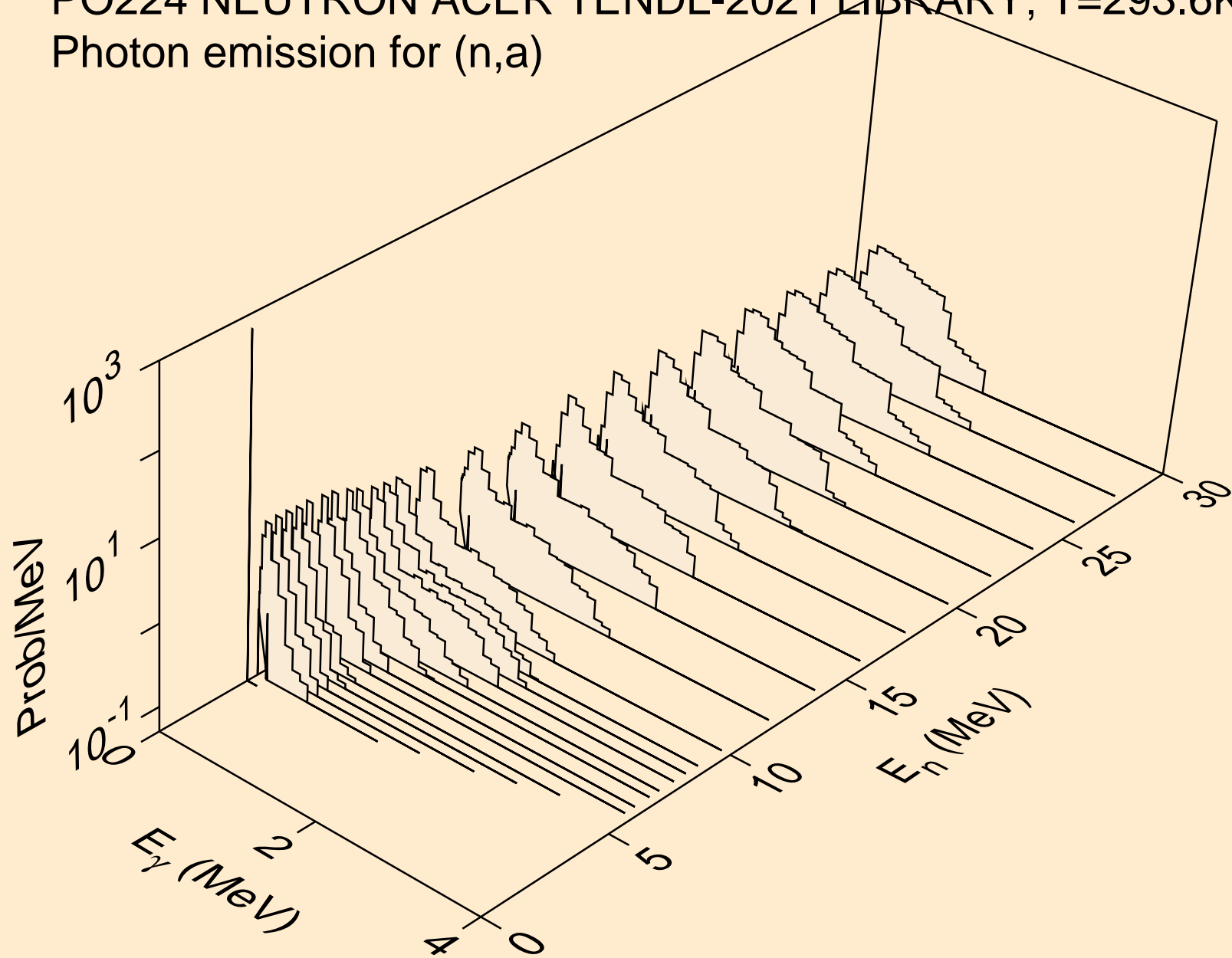

PO224 NEUTRON ACER TENDL-2021 LIBRARY; T=293.6K  
Photon emission for (n,2p)

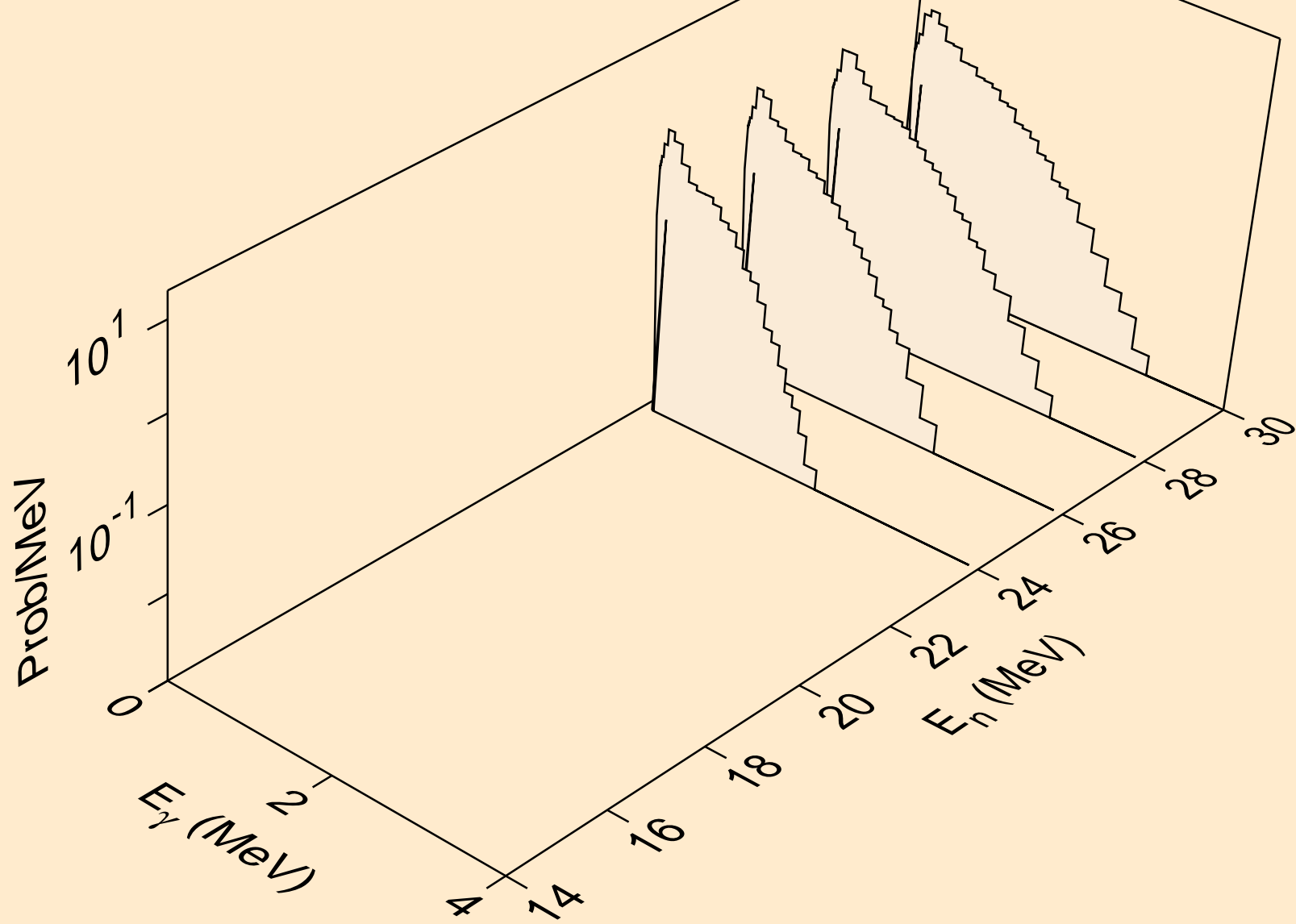

PO224 NEUTRON ACER TENDL-2021 LIBRARY; T=293.6K  
Photon emission for (n,p)

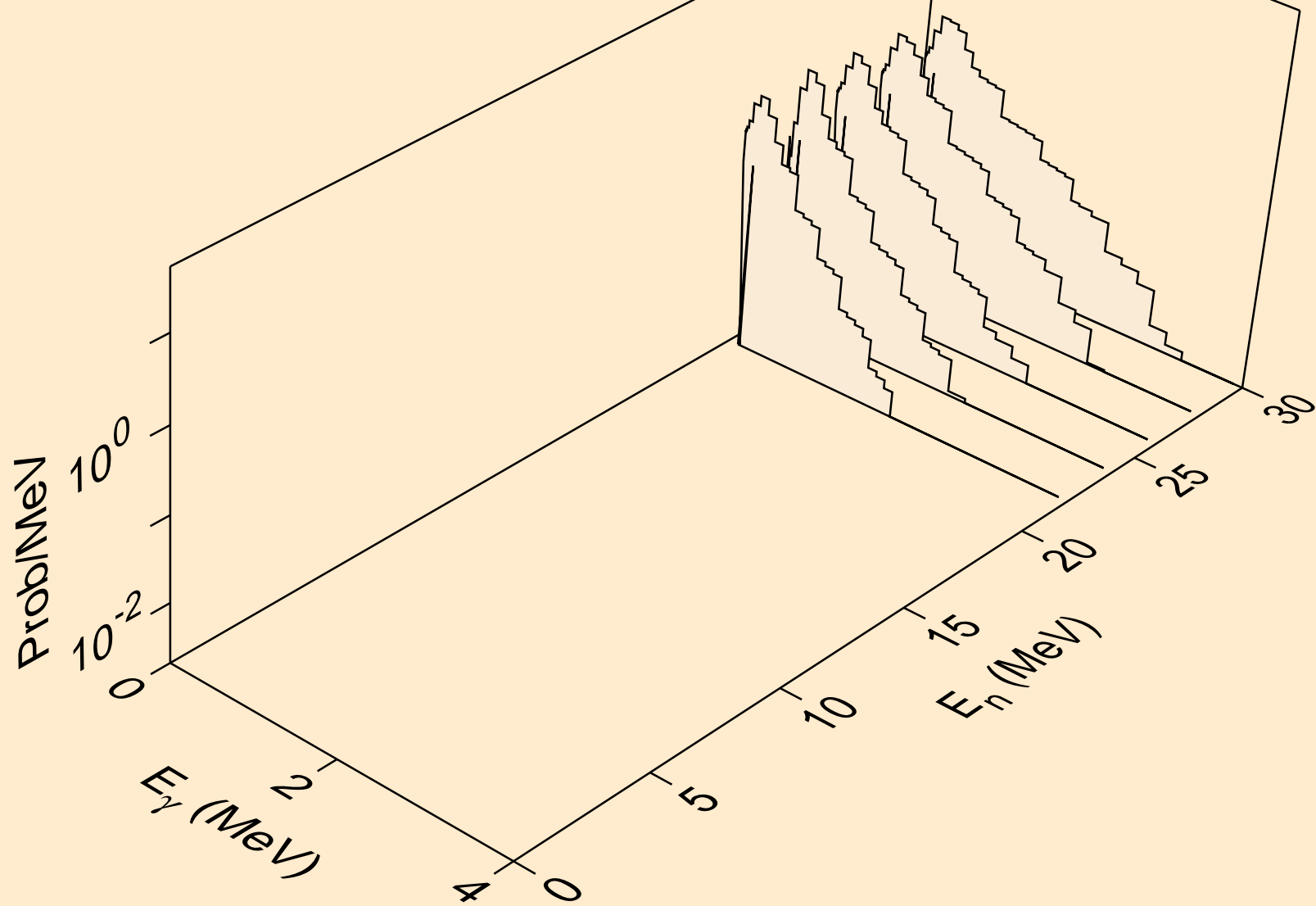

PO224 NEUTRON ACER TENDL-2021 LIBRARY; T=293.6K  
thermal capture photon spectrum

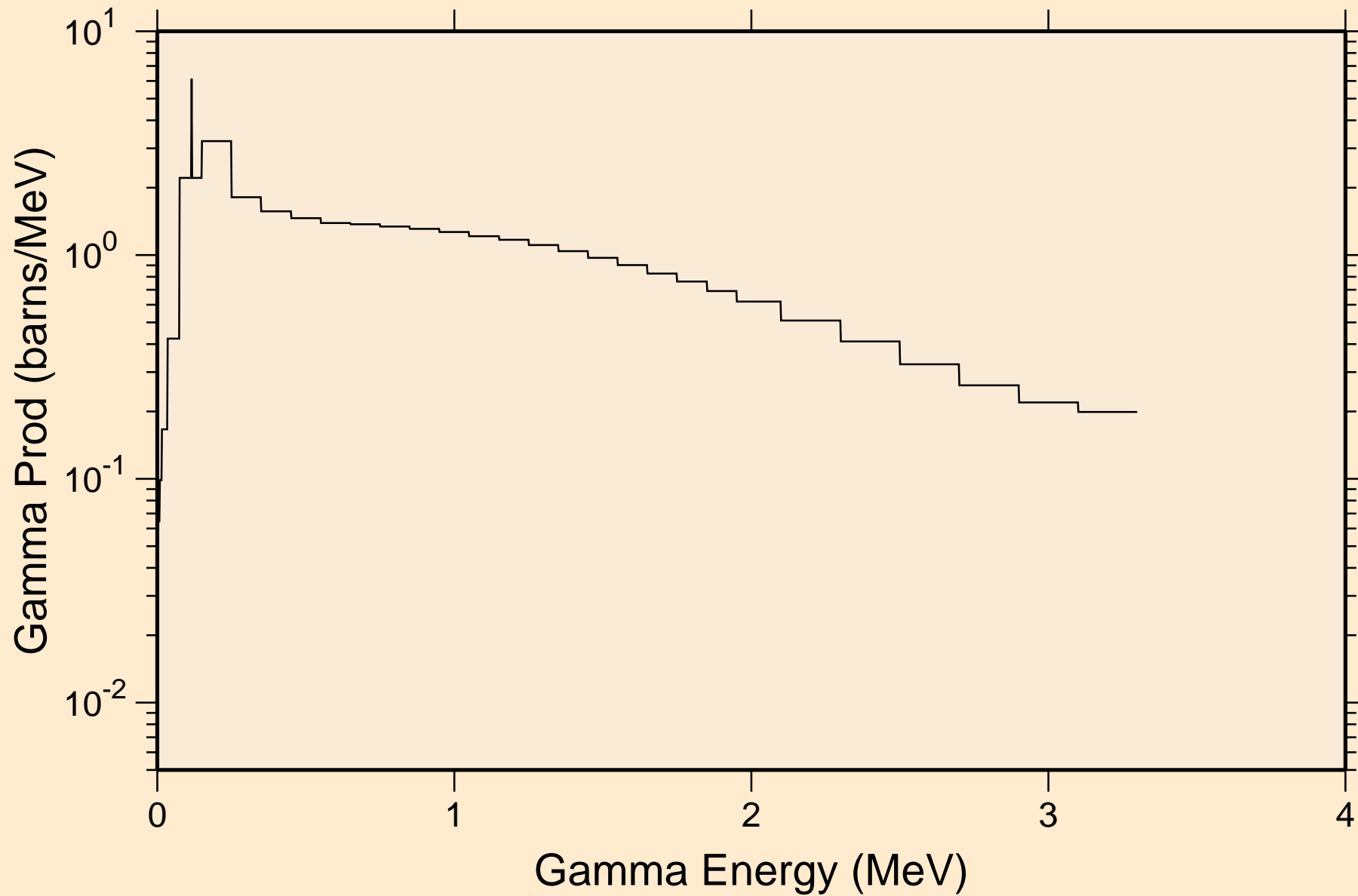

PO224 NEUTRON ACER TENDL-2021 LIBRARY; T=293.6K  
14 MeV photon spectrum

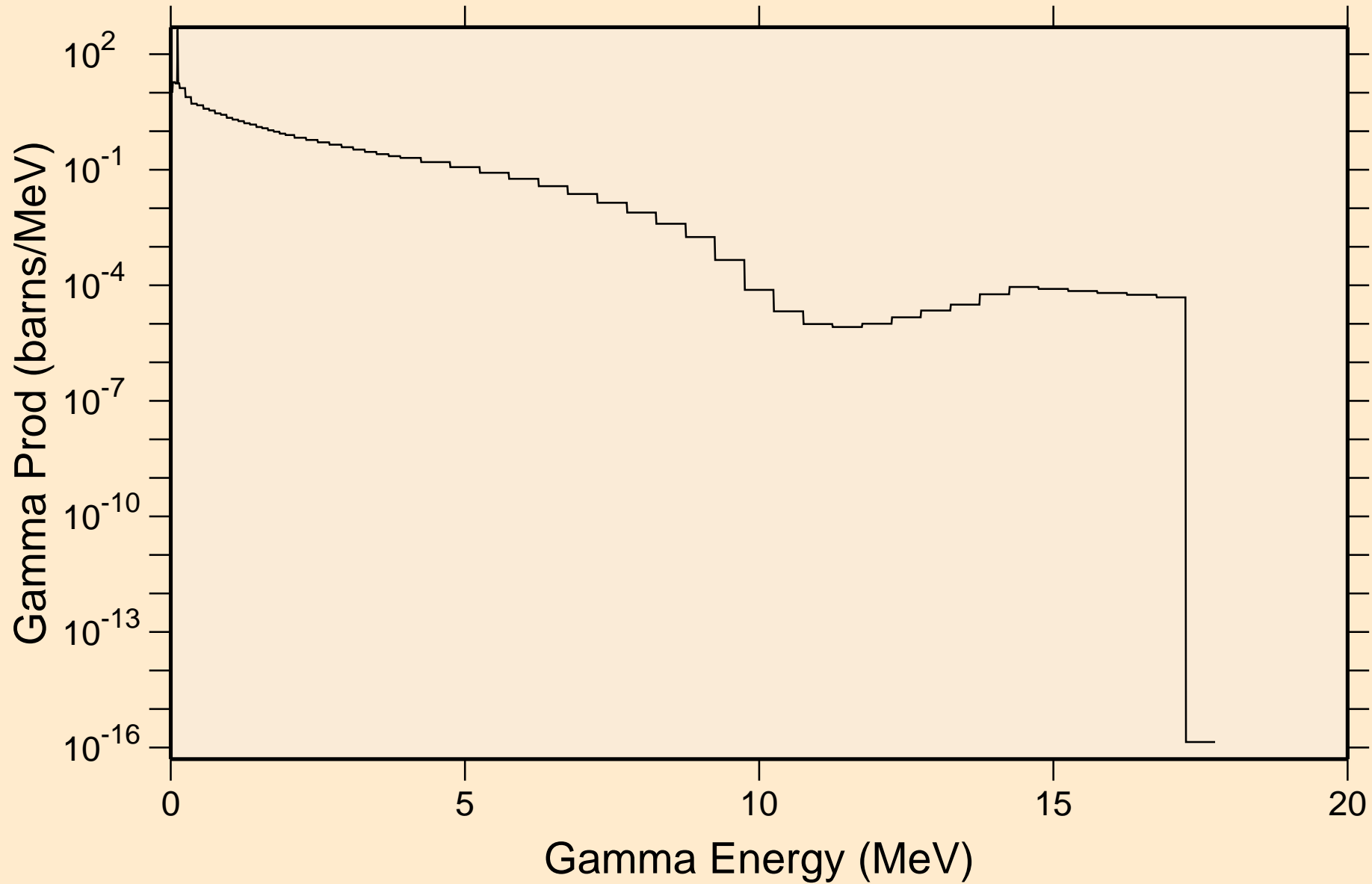

PO224 NEUTRON ACER TENDL-2021 LIBRARY; T=293.6K  
Particle heating contributions

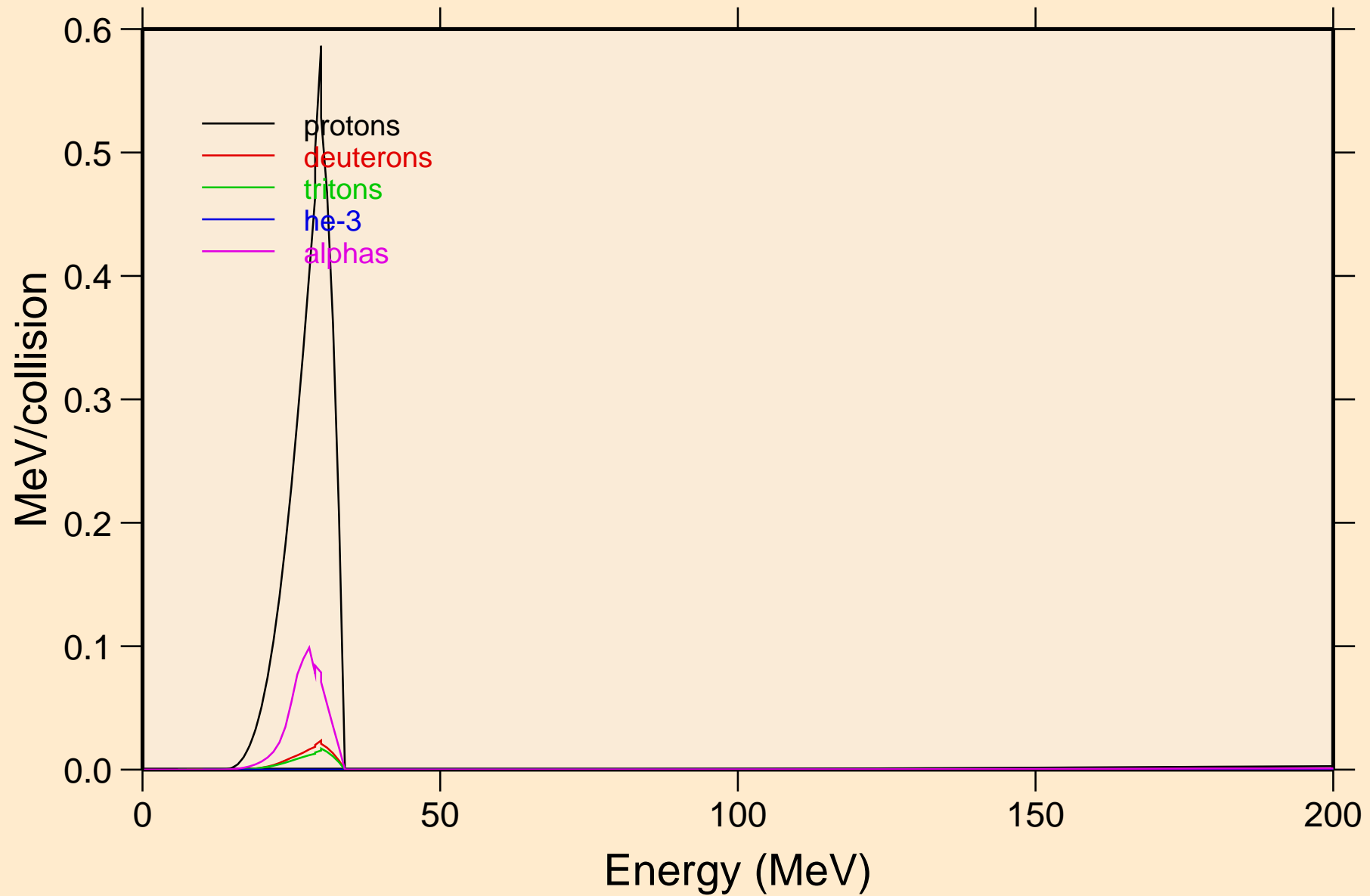

PO224 NEUTRON ACER TENDL-2021 LIBRARY; T=293.6K  
Recoil Heating

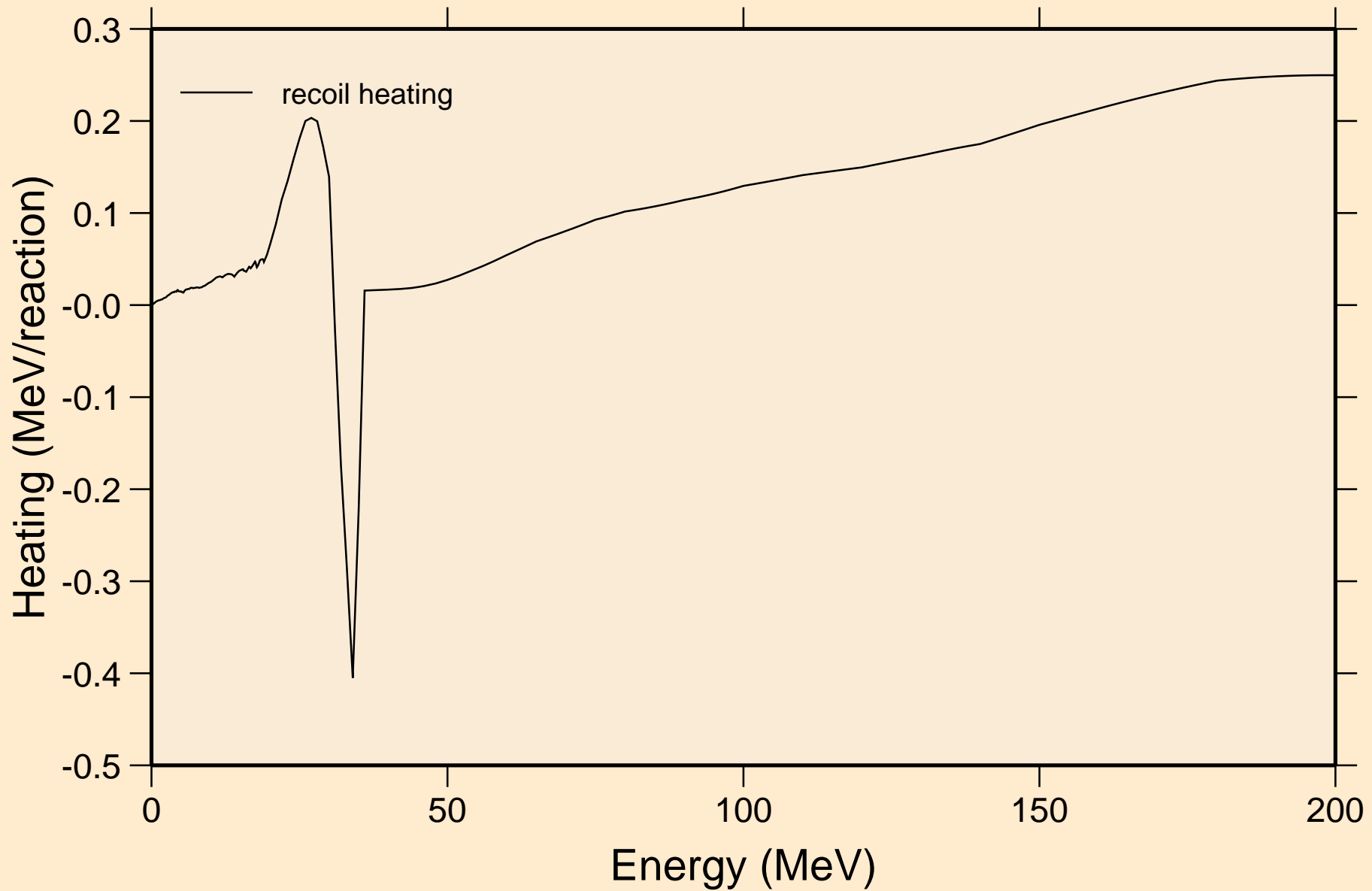



PO224 NEUTRON ACER TENDL-2021 LIBRARY; T=293.6K  
Particle production cross sections

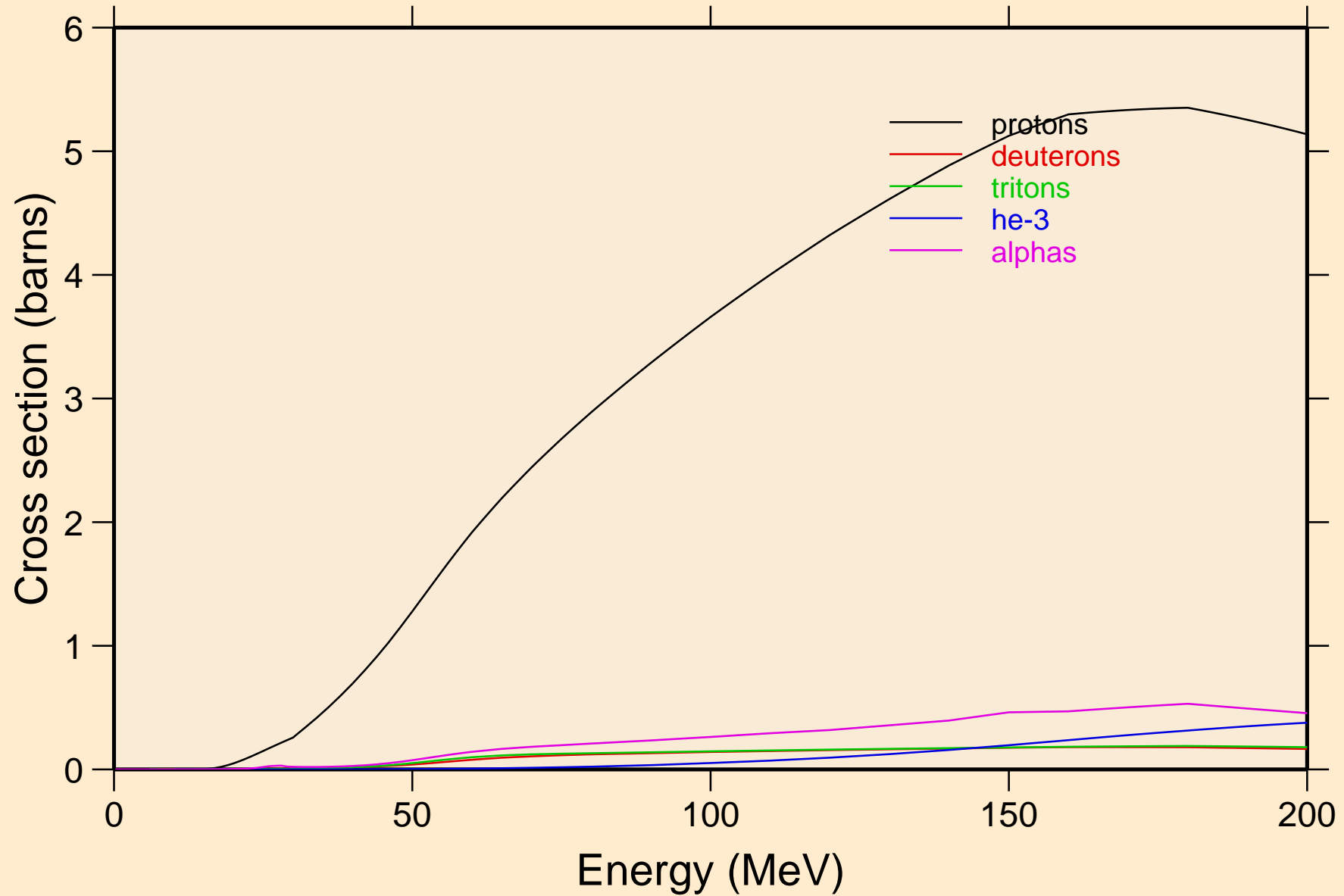

PO224 NEUTRON ACER TENDL-2021 LIBRARY; T=293.6K  
protons from (n,x)

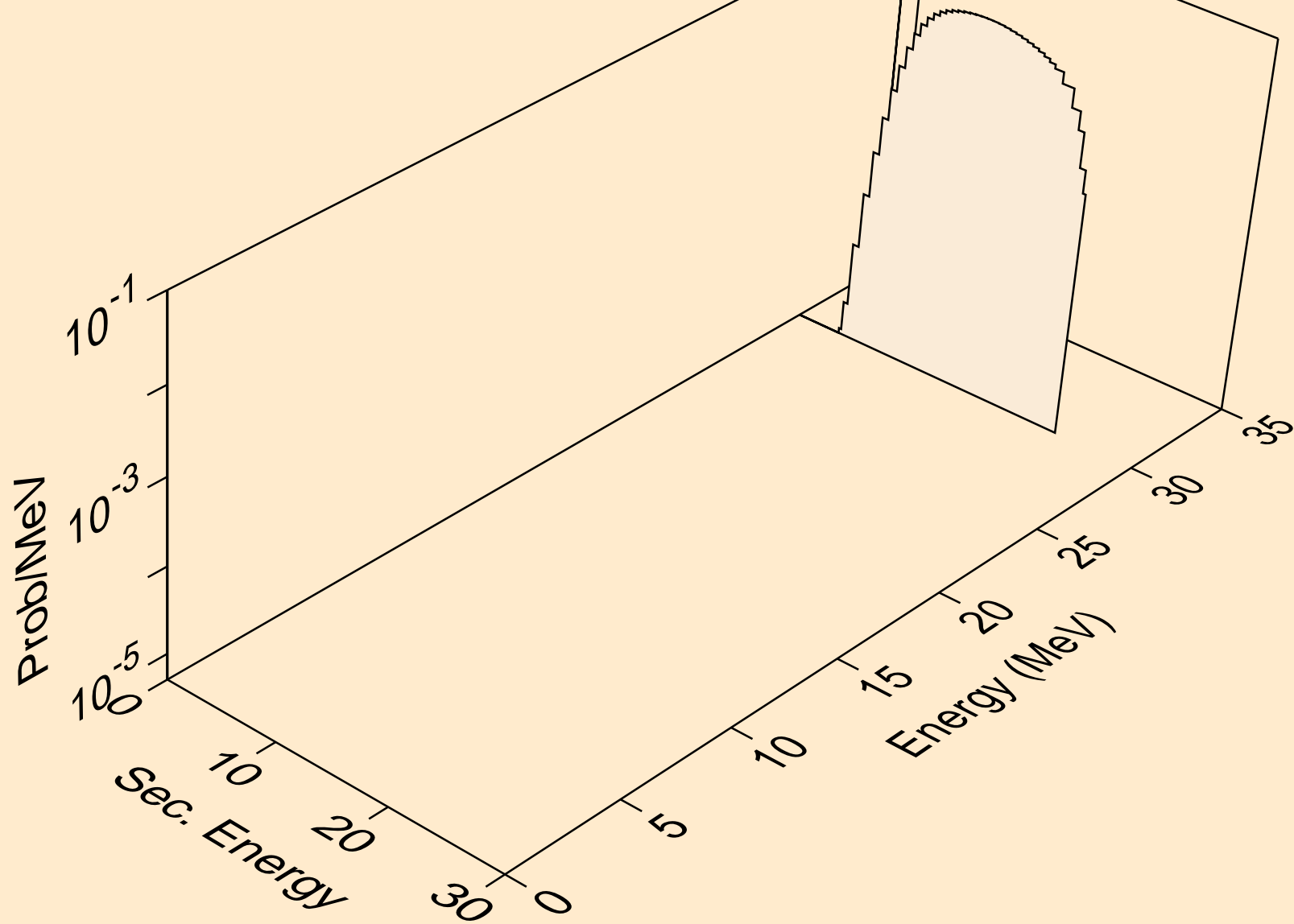

PO224 NEUTRON ACER TENDL-2021 LIBRARY; T=293.6K  
protons from (n,n\*)p

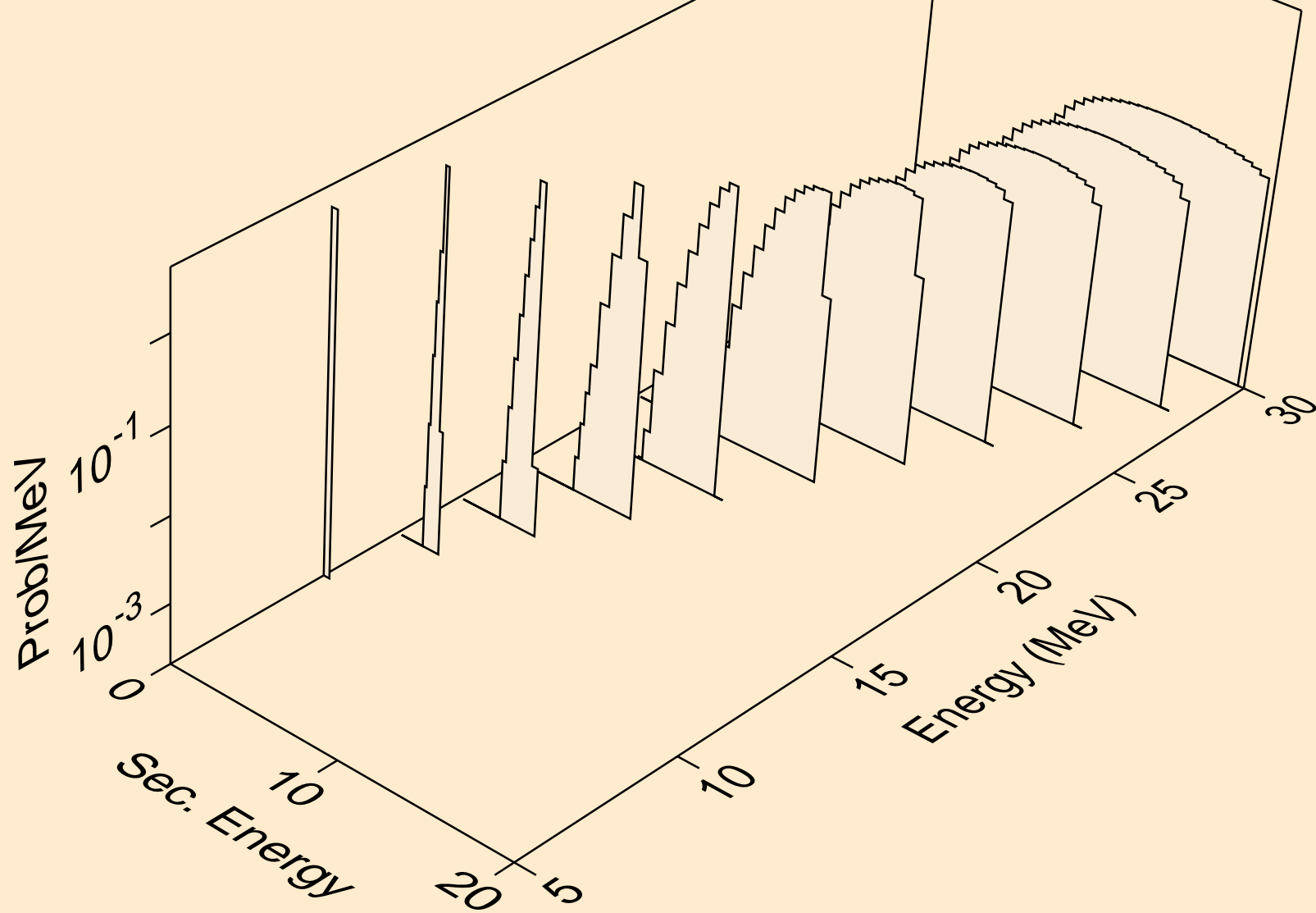

PO224 NEUTRON ACER TENDL-2021 LIBRARY; T=293.6K  
protons from (n,2np)

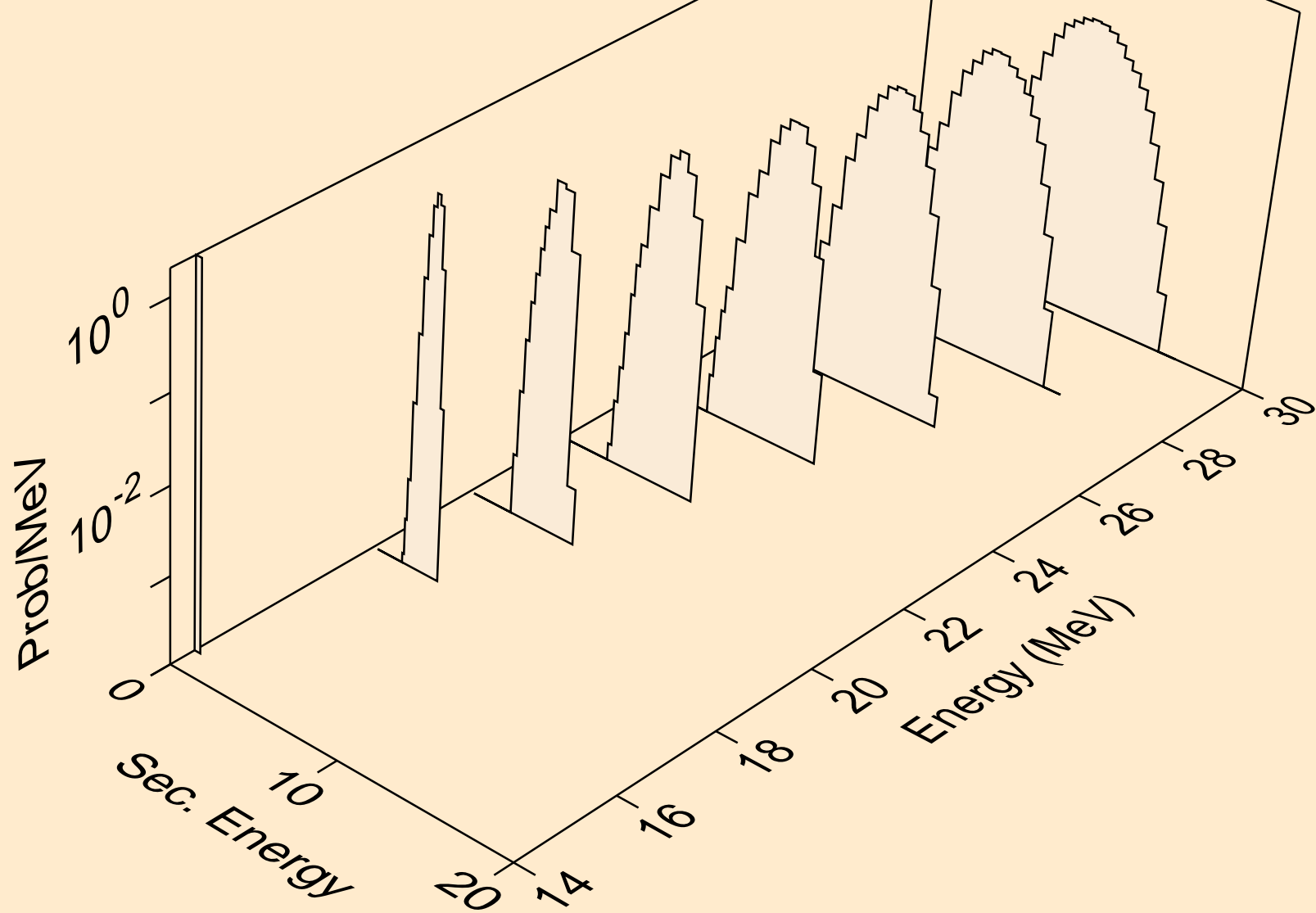

PO224 NEUTRON ACER TENDL-2021 LIBRARY; T=293.6K  
protons from (n,3np)

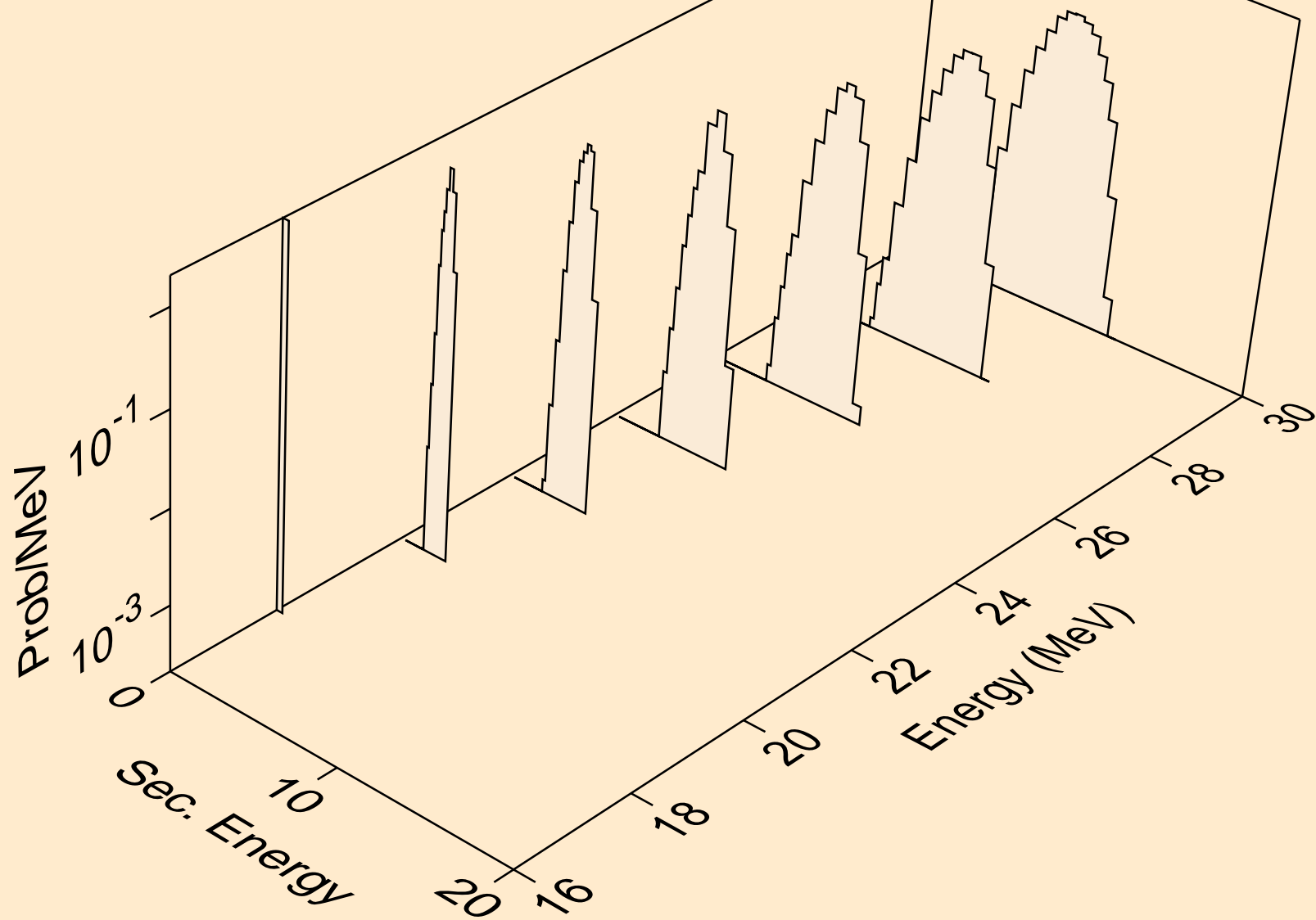

PO224 NEUTRON ACER TENDL-2021 LIBRARY; T=293.6K  
protons from (n,2np)

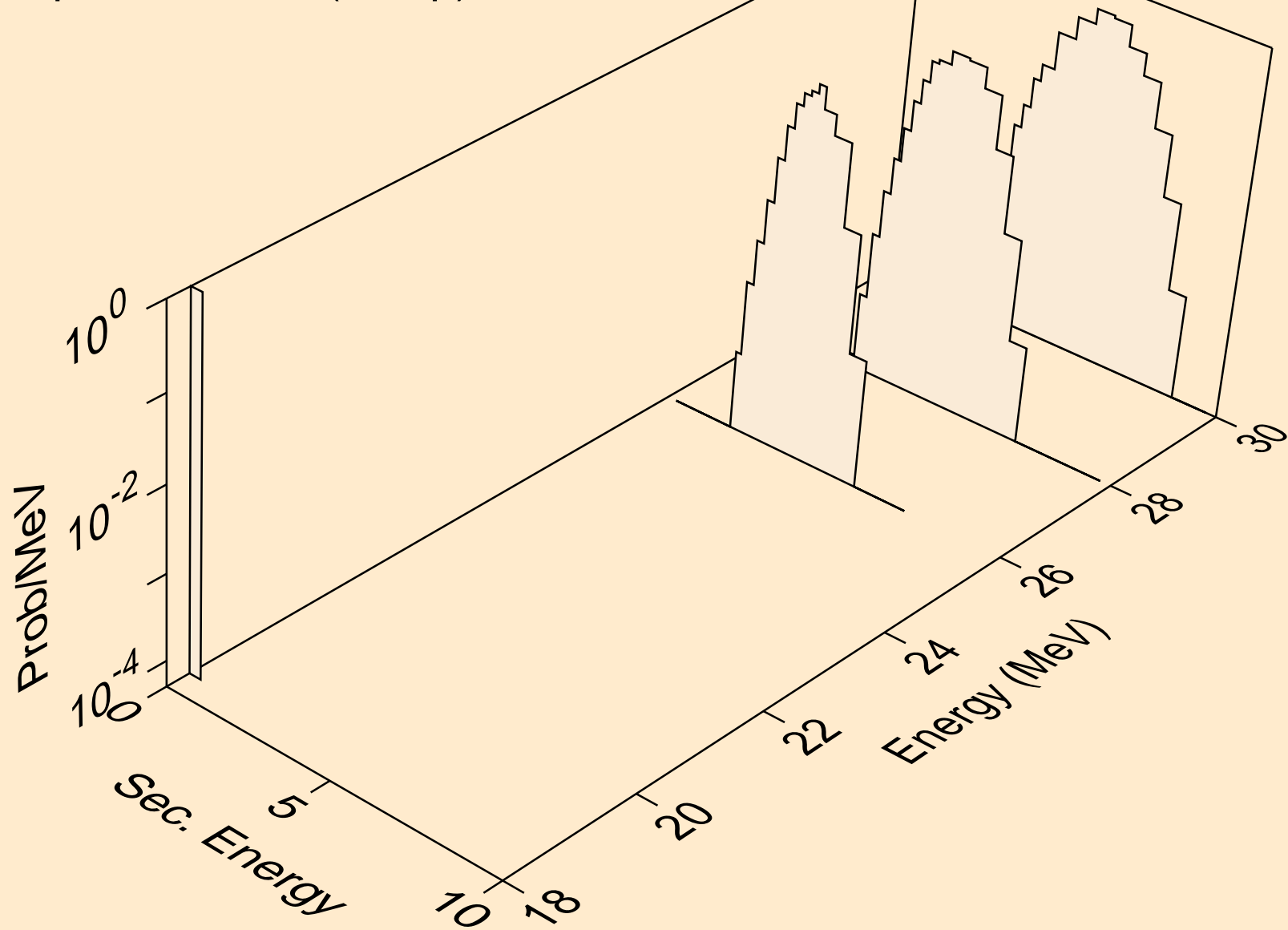

PO224 NEUTRON ACER TENDL-2021 LIBRARY; T=293.6K  
protons from (n,p)

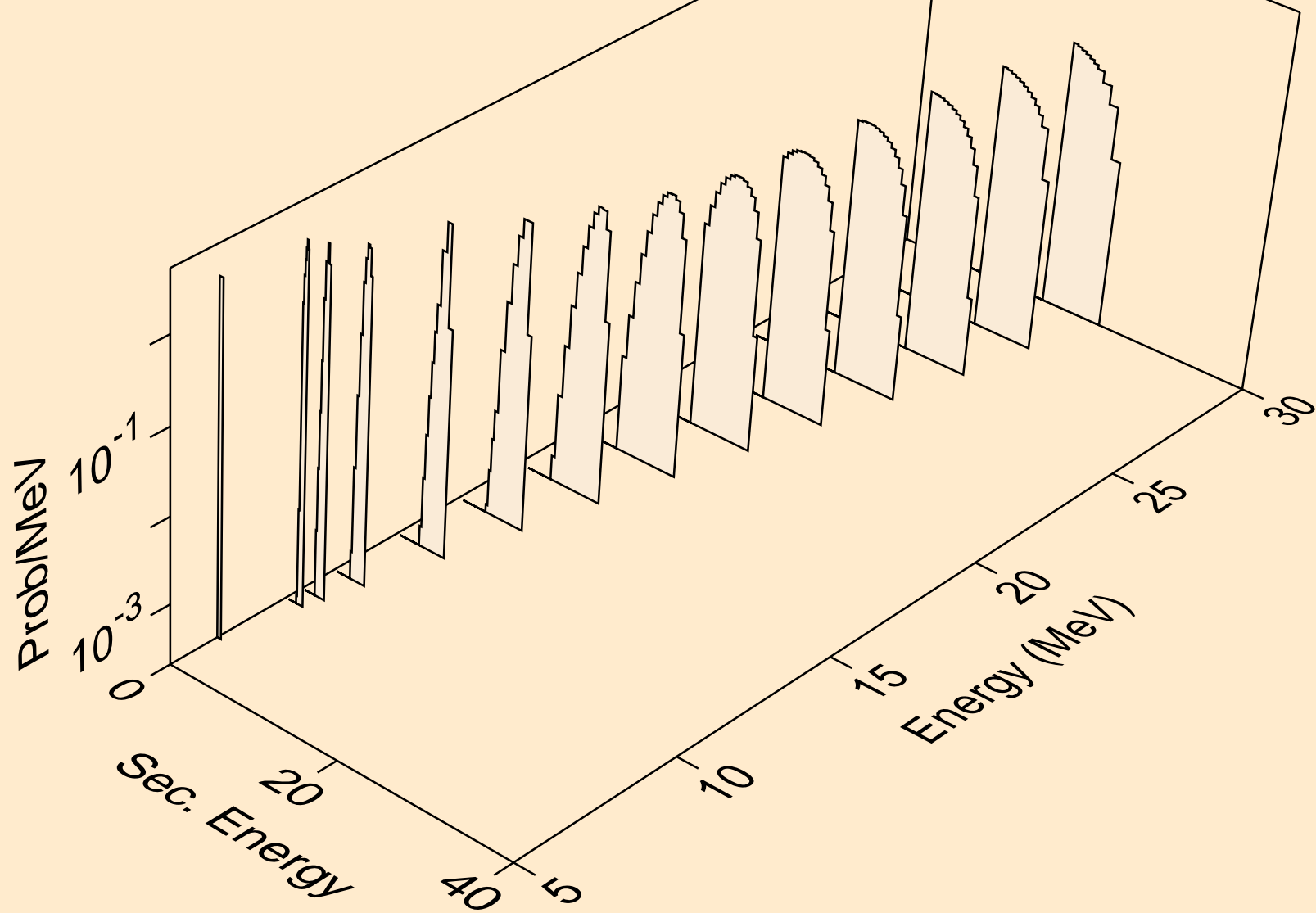

PO224 NEUTRON ACER TENDL-2021 LIBRARY; T=293.6K  
protons from (n,2p)

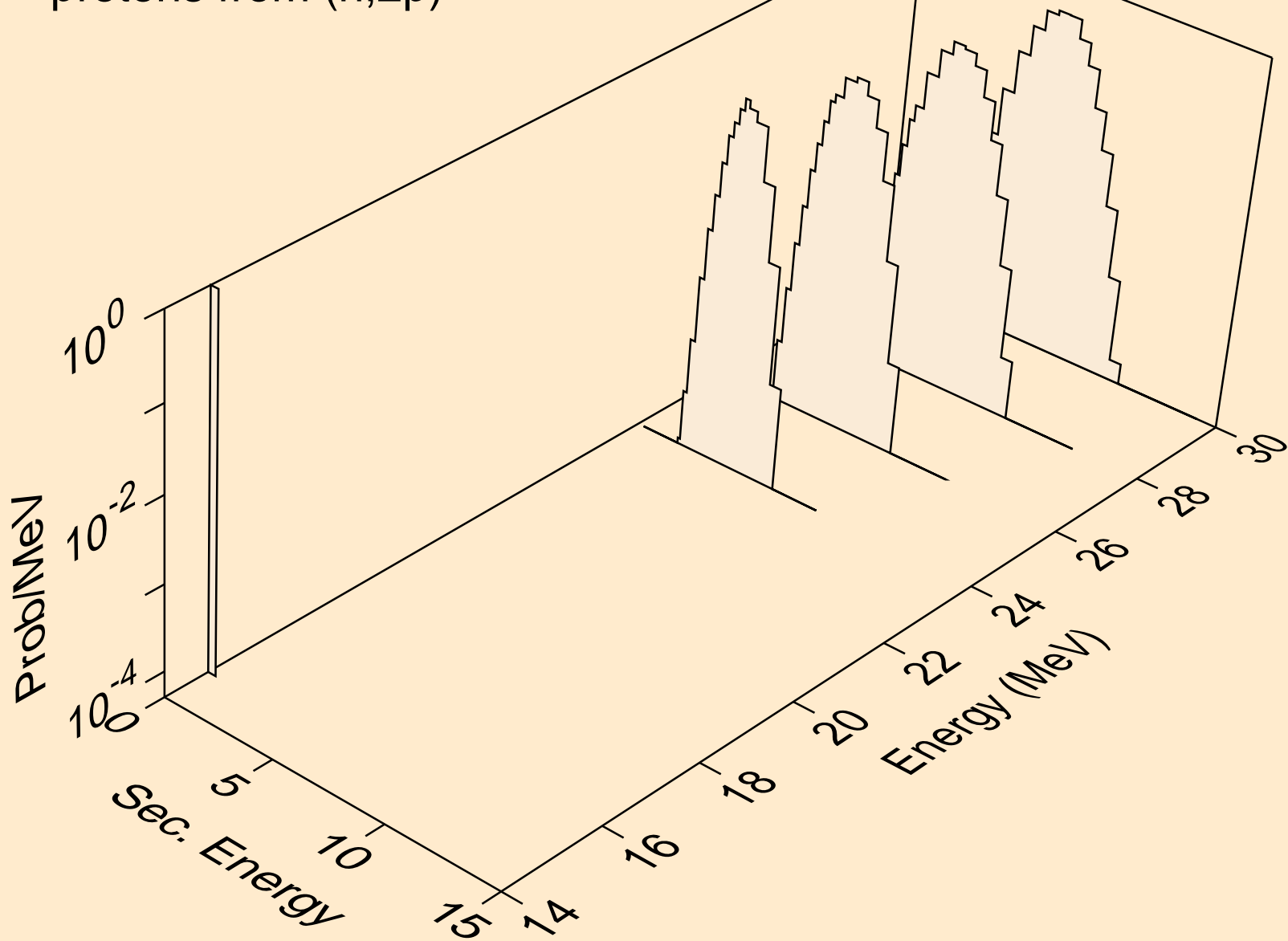



PO224 NEUTRON ACER TENDL-2021 LIBRARY; T=293.6K  
protons from (n,p)

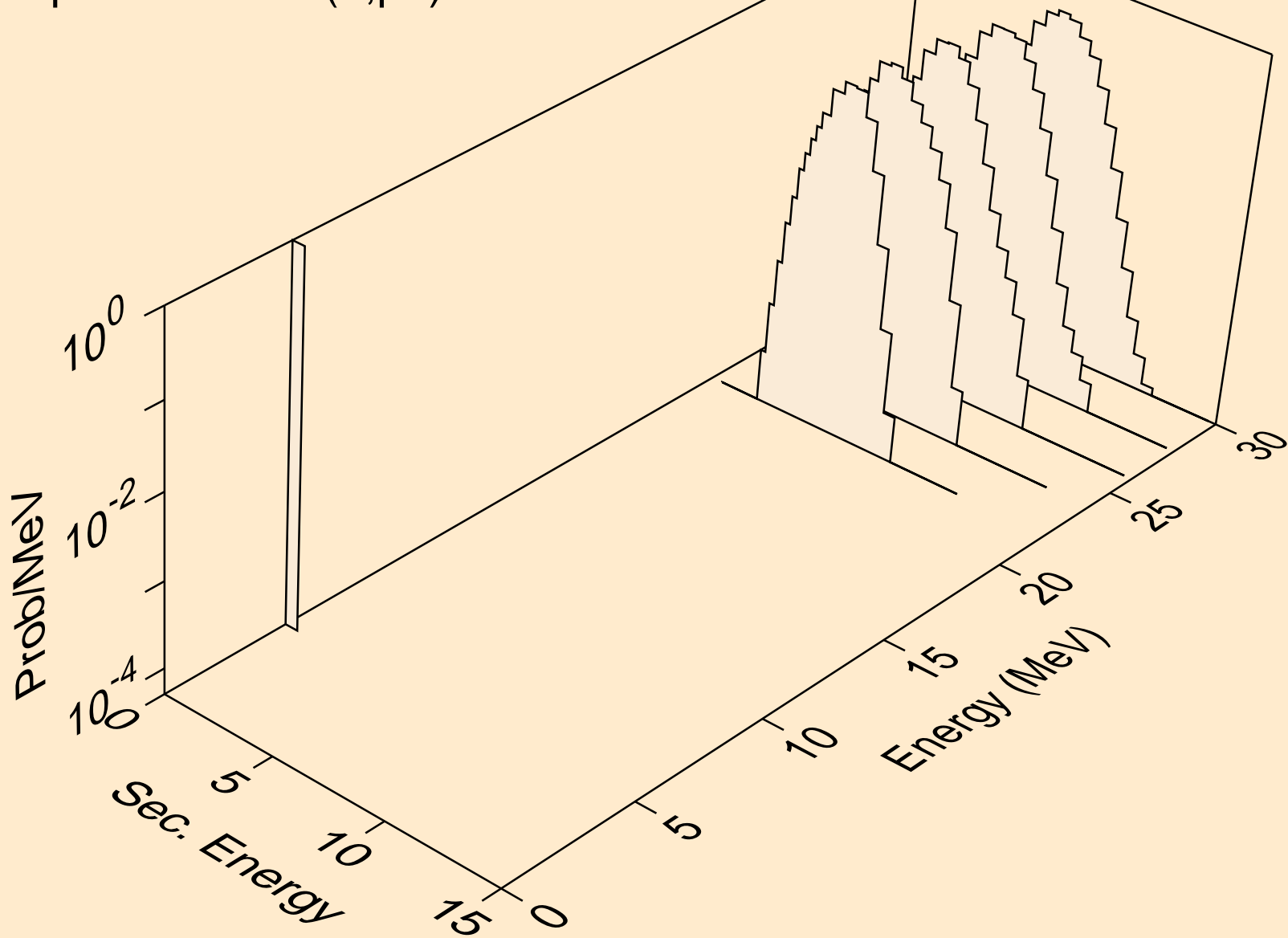

PO224 NEUTRON ACER TENDL-2021 LIBRARY; T=293.6K  
deuterons from (n,x)

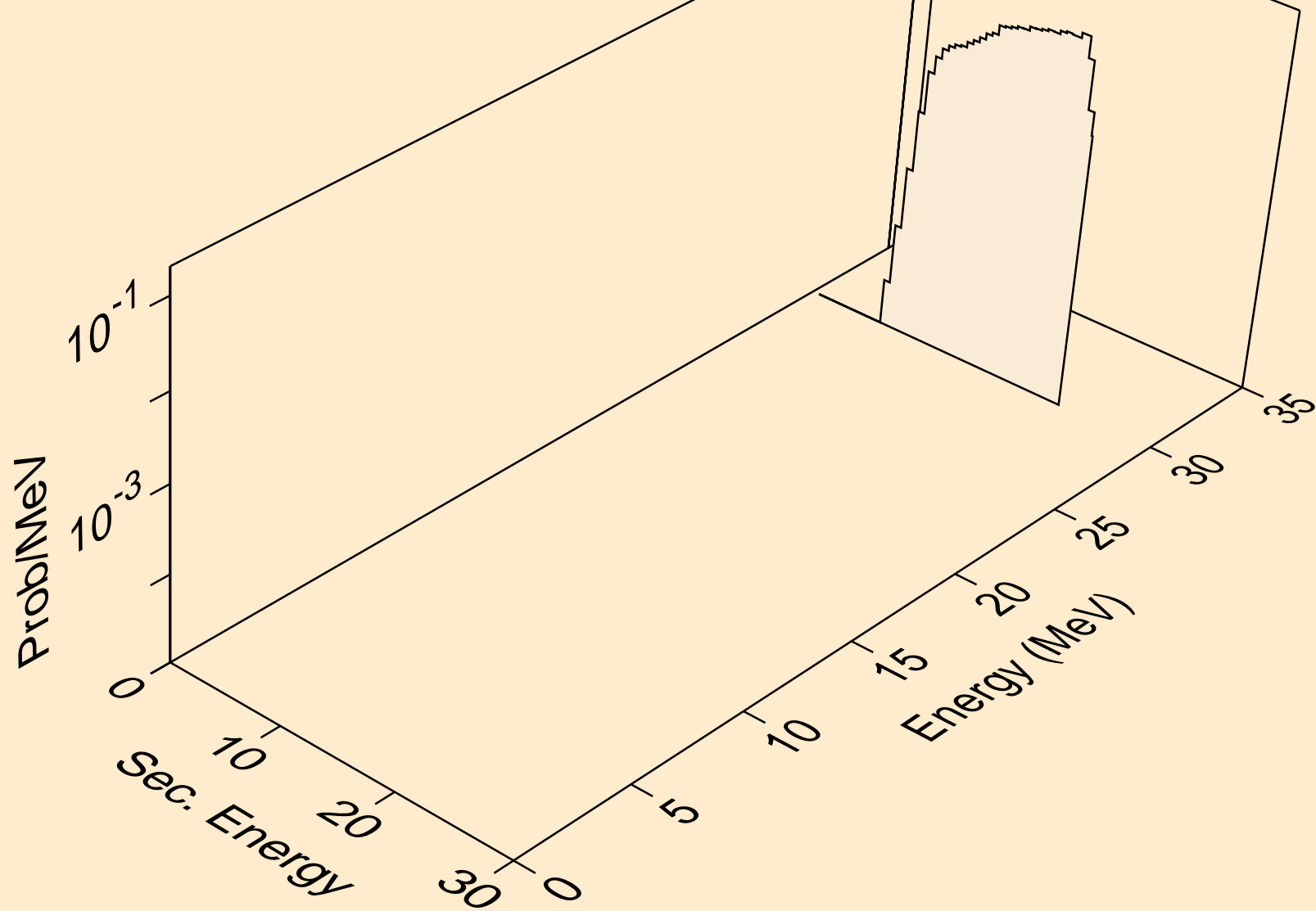

PO224 NEUTRON ACER TENDL-2021 LIBRARY; T=293.6K  
deuterons from (n,2nd)

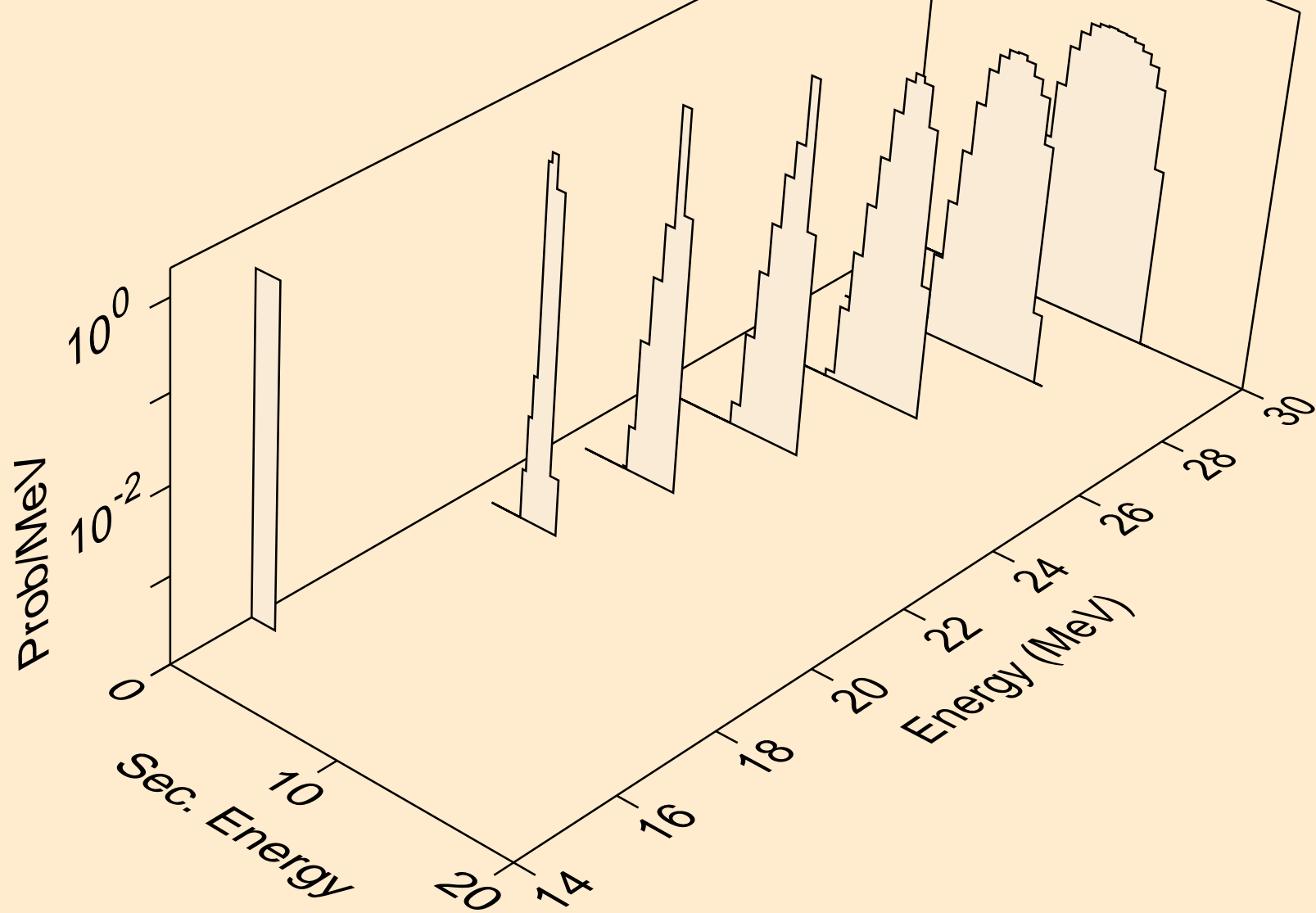

PO224 NEUTRON ACER TENDL-2021 LIBRARY; T=293.6K  
deuterons from (n,n\*)d

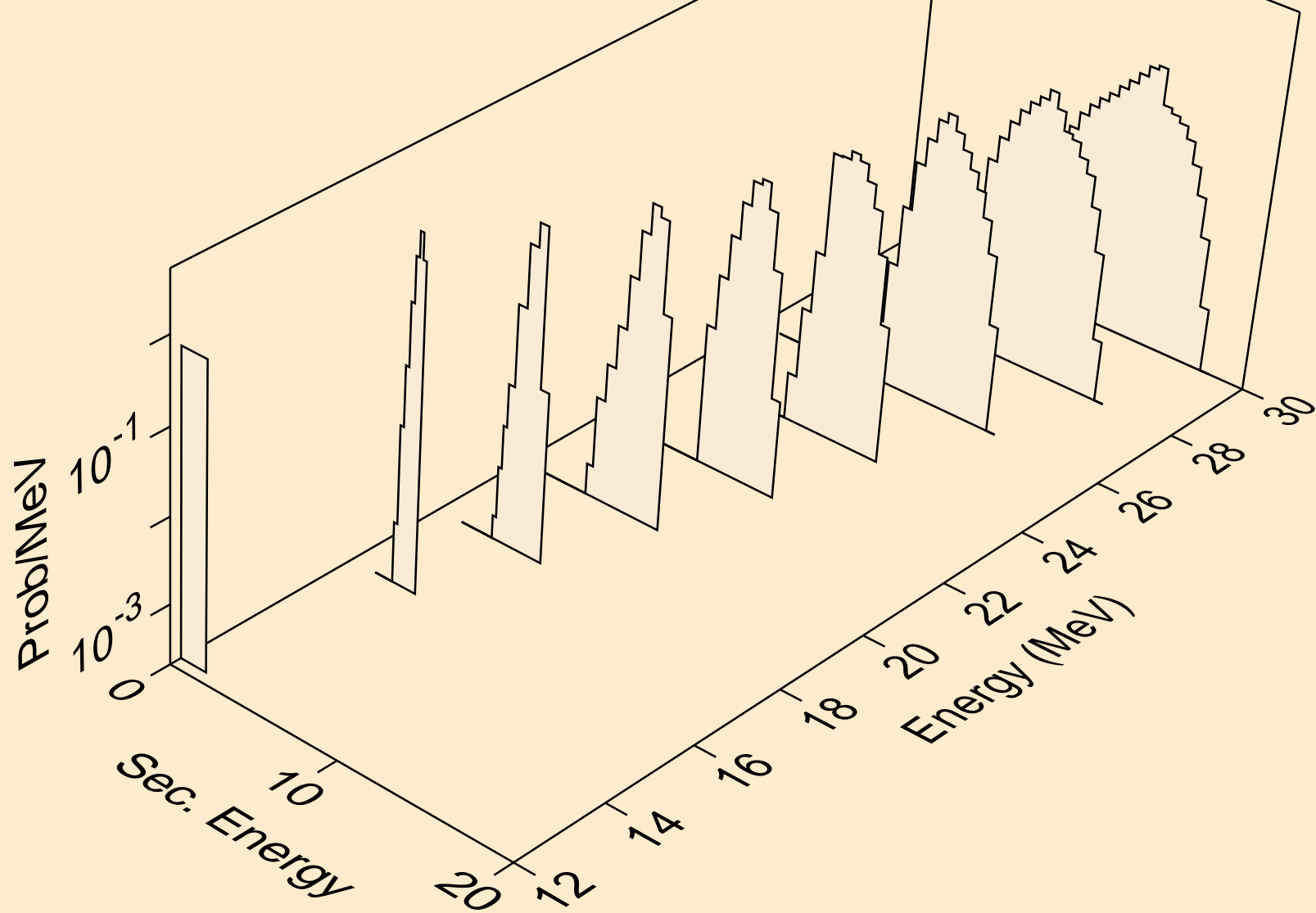

PO224 NEUTRON ACER TENDL-2021 LIBRARY; T=293.6K  
deuterons from (n,d)

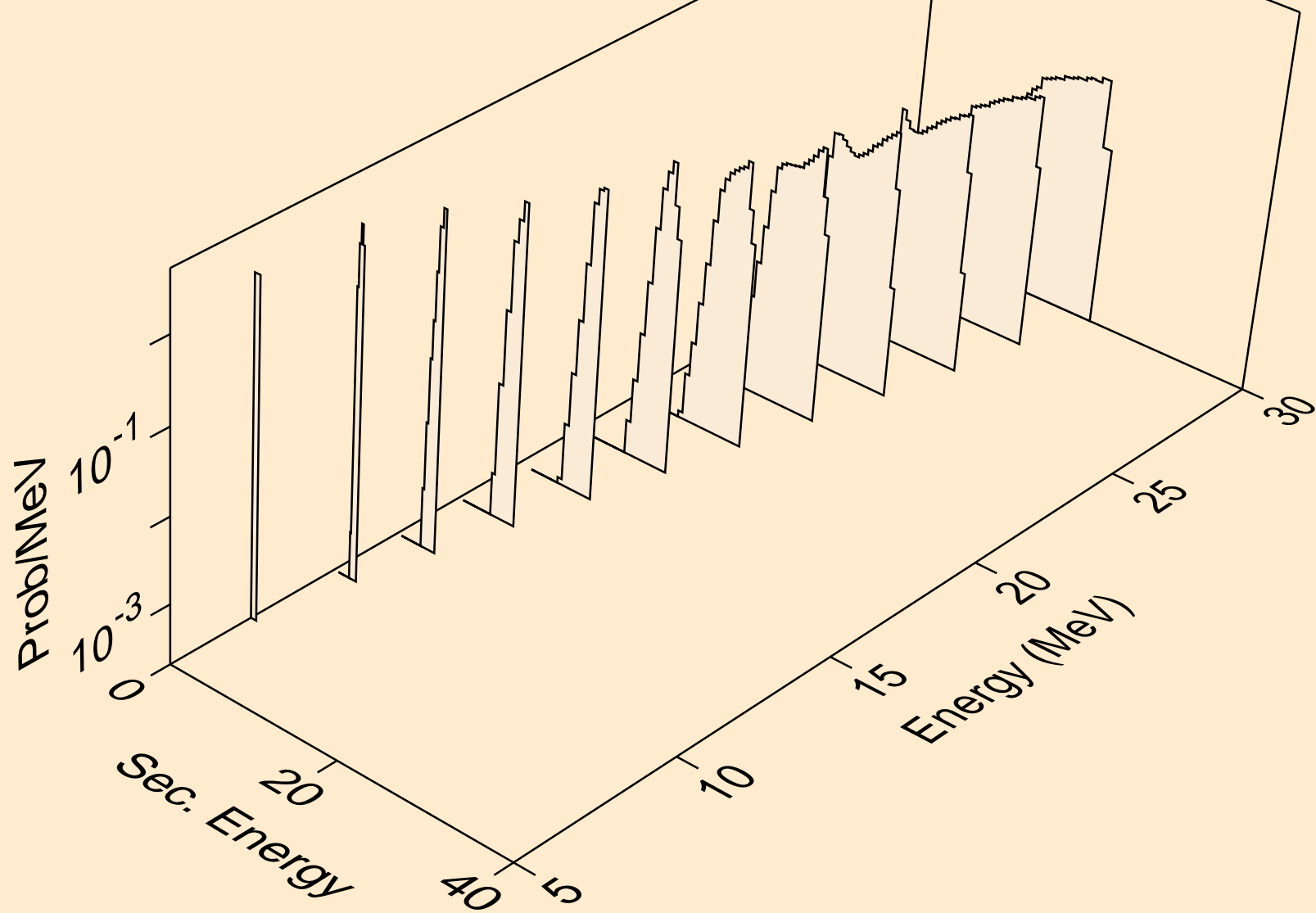

PO224 NEUTRON ACER TENDL-2021 LIBRARY; T=293.6K  
tritons from (n,x)

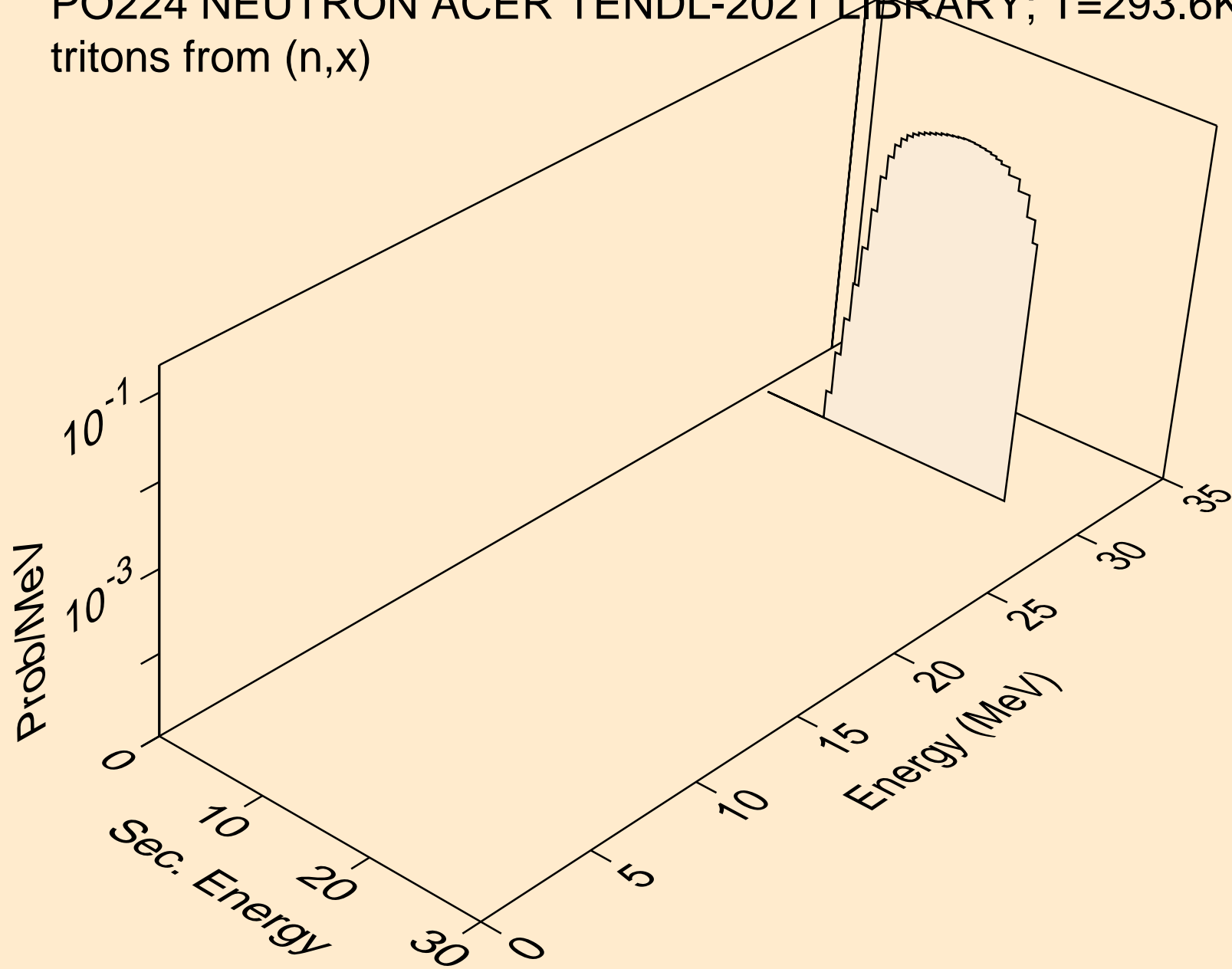

PO224 NEUTRON ACER TENDL-2021 LIBRARY; T=293.6K  
tritons from (n,n\*)t

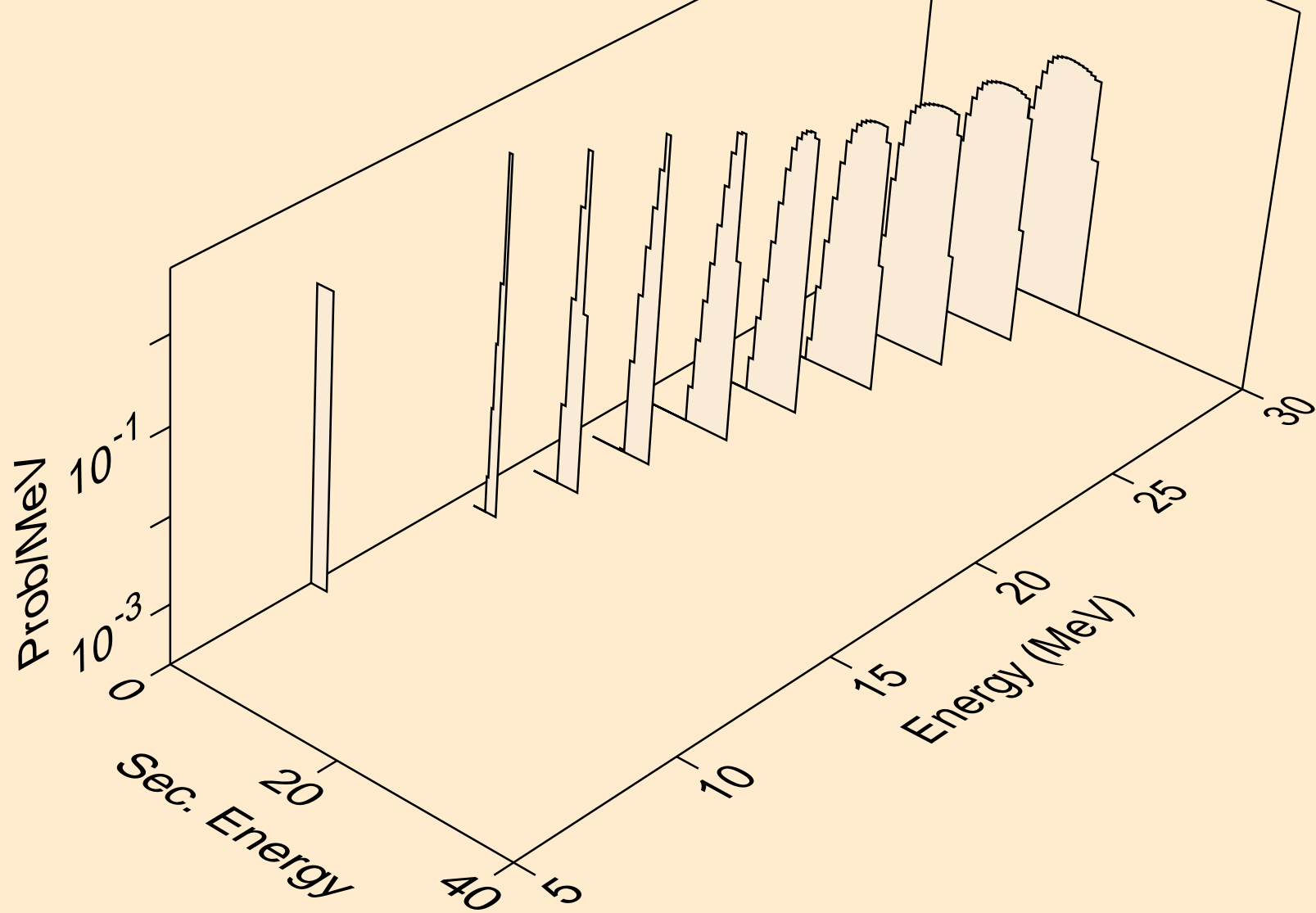

PO224 NEUTRON ACER TENDL-2021 LIBRARY; T=293.6K  
tritons from (n,t)

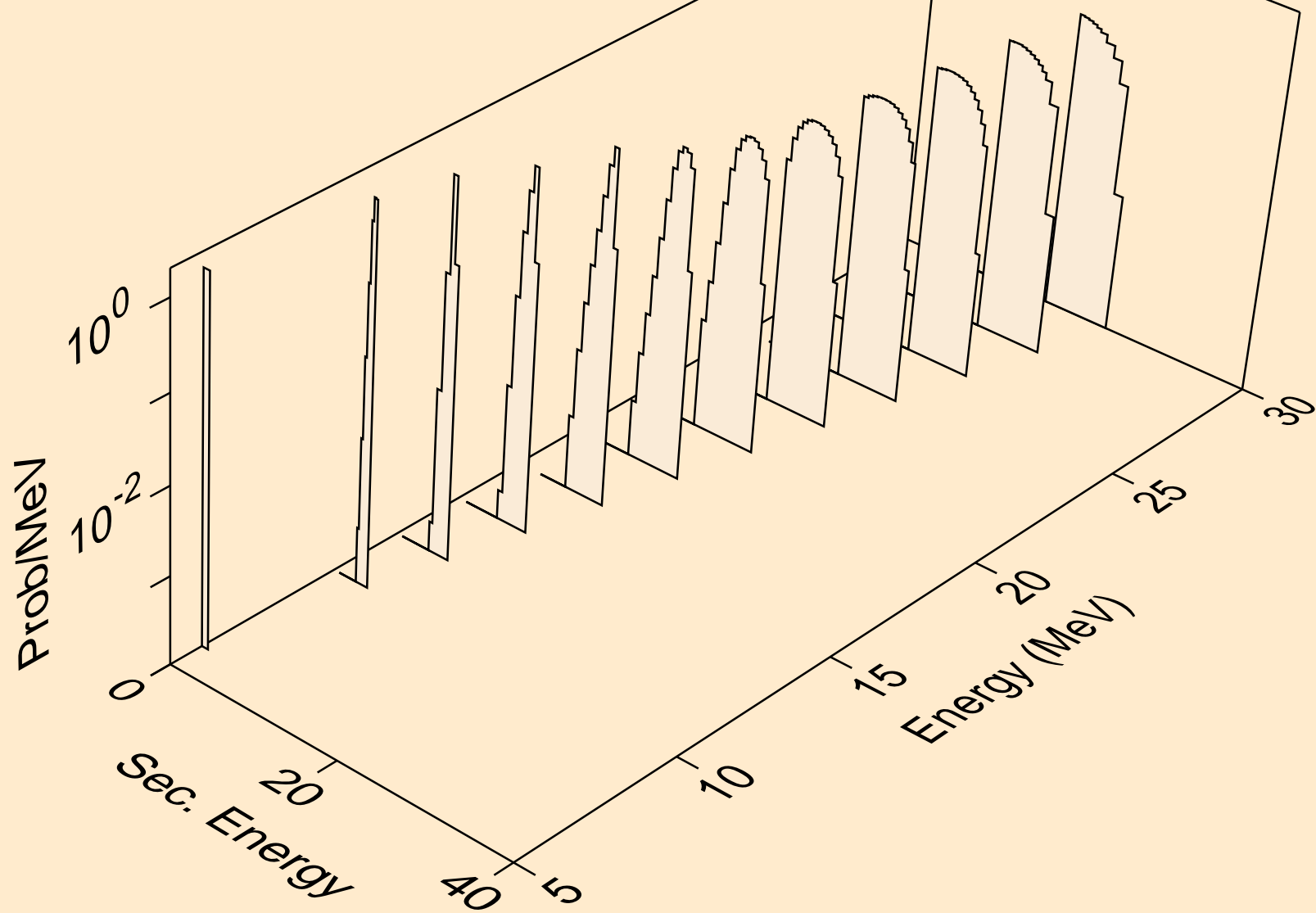



PO224 NEUTRON ACER TENDL-2021 LIBRARY; T=293.6K  
he3s from (n,x)

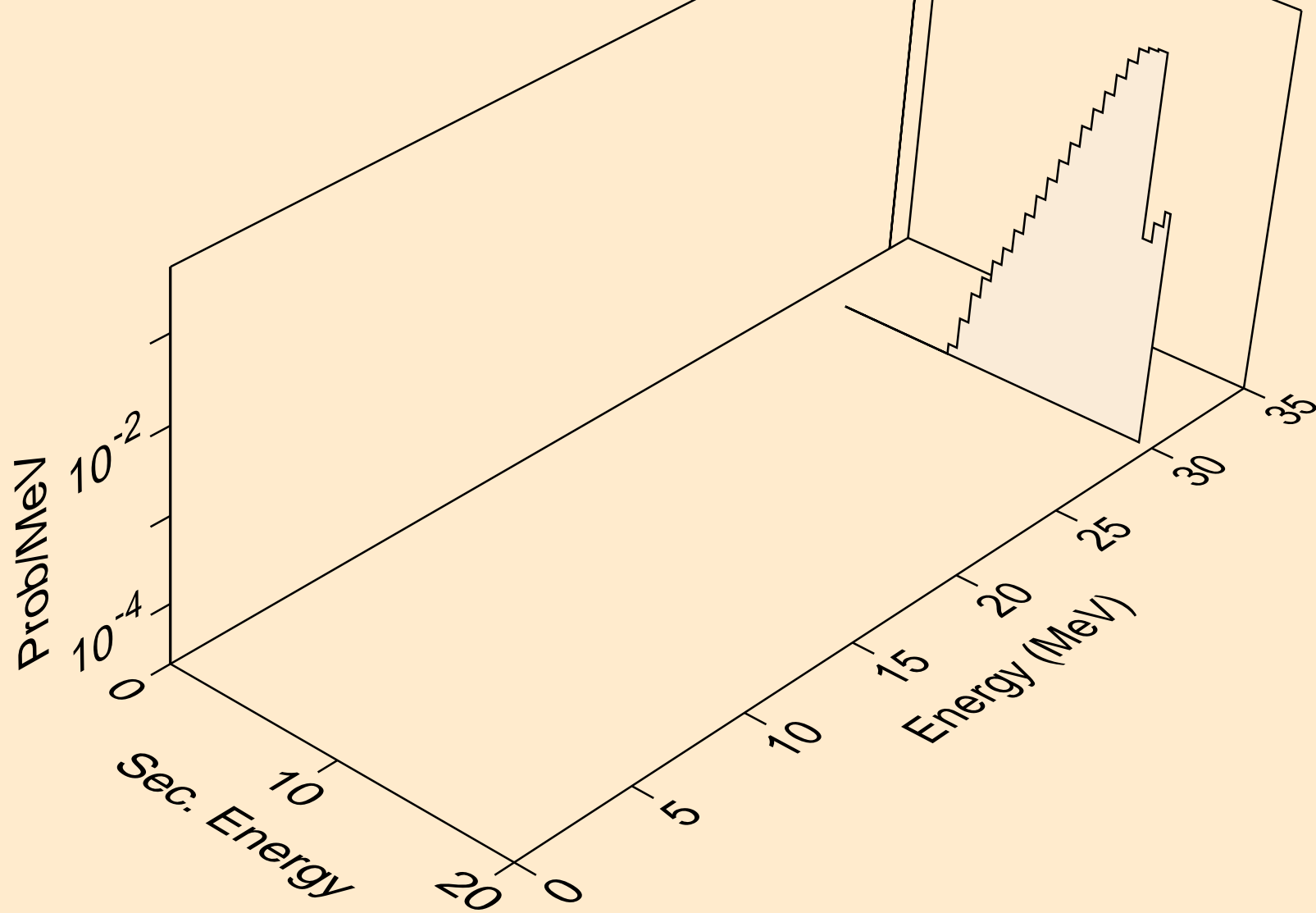

PO224 NEUTRON ACER TENDL-2021 LIBRARY; T=293.6K  
he3s from (n,n\*)he3

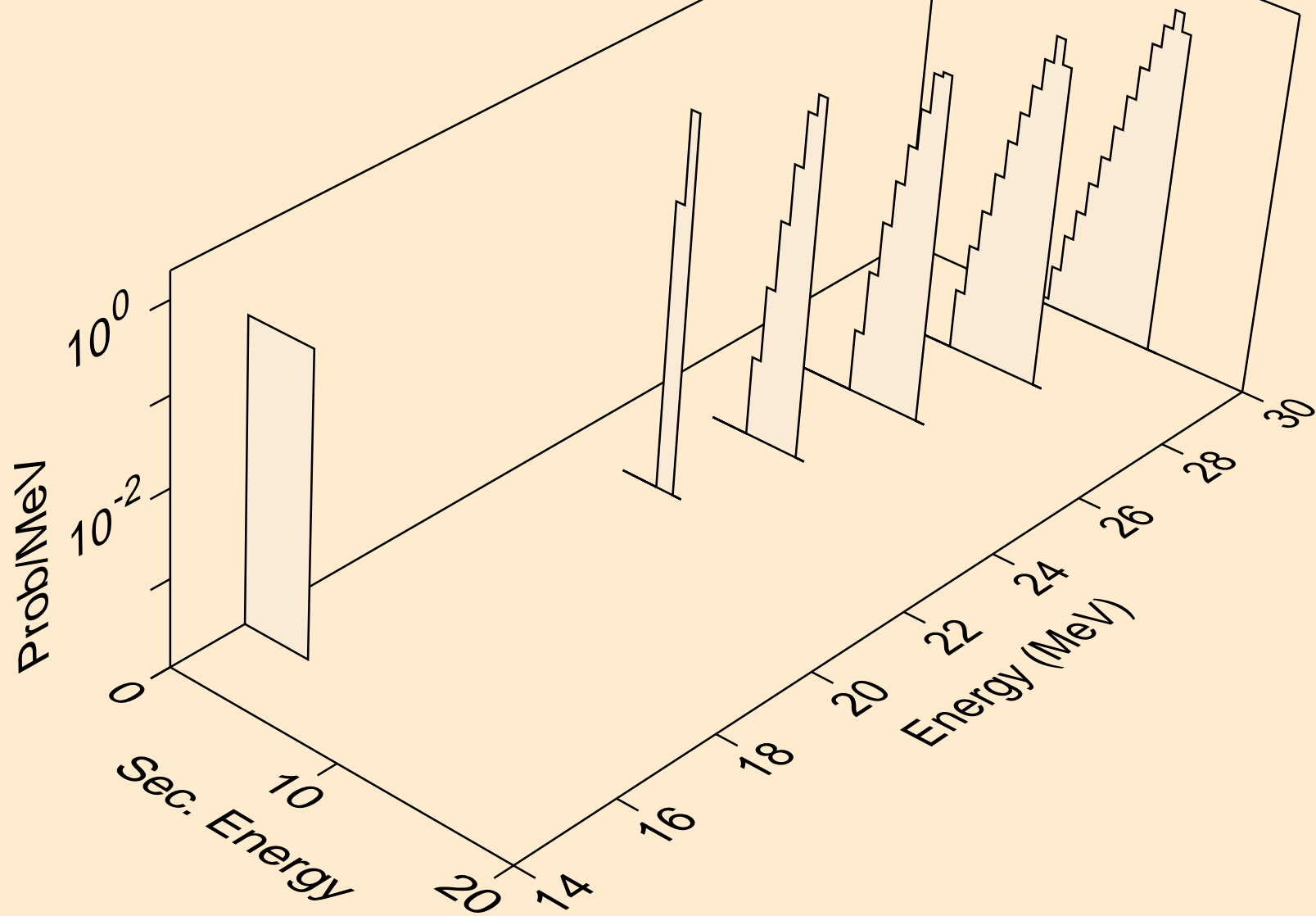

PO224 NEUTRON ACER TENDL-2021 LIBRARY; T=293.6K  
he3s from (n,he3)

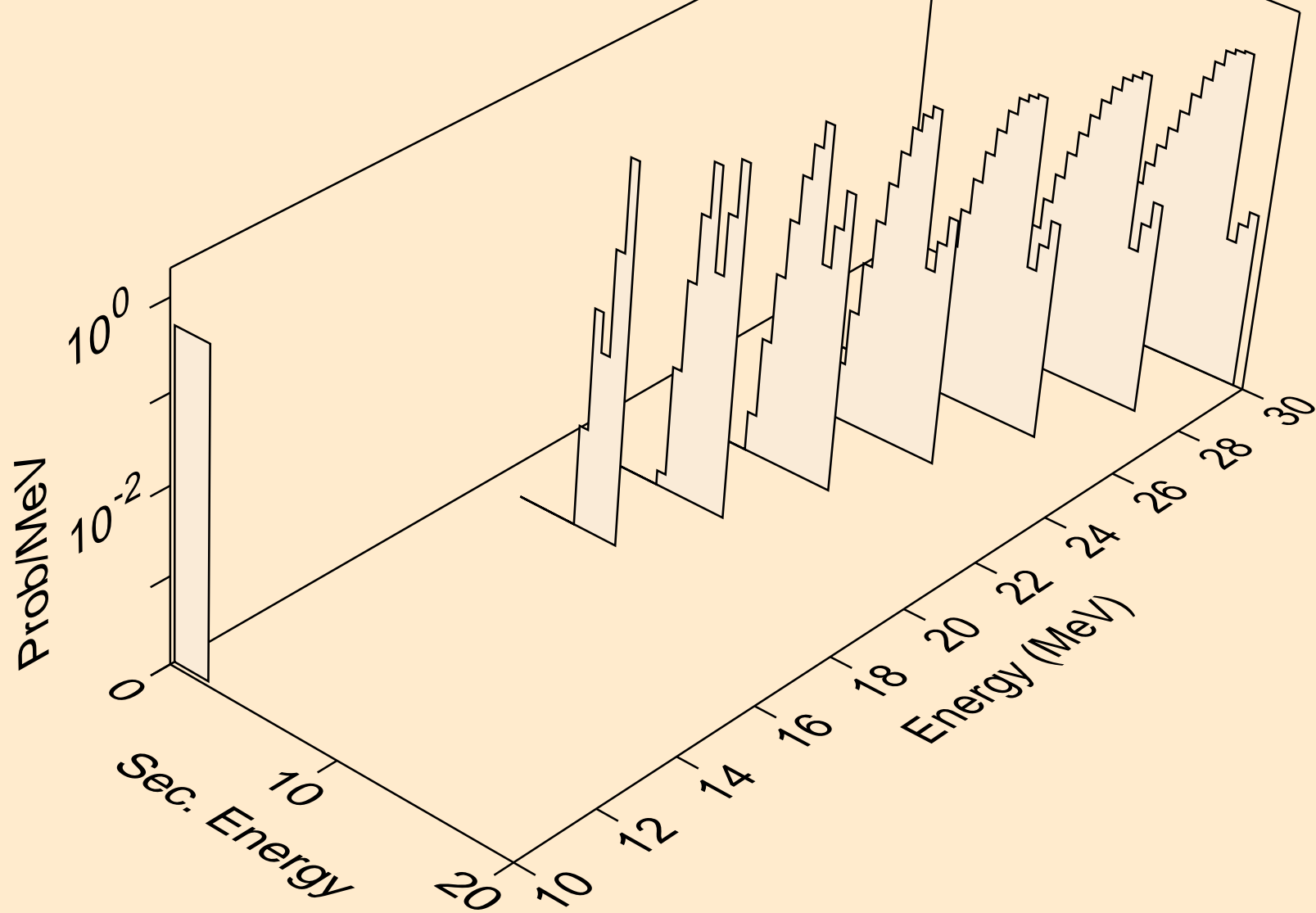

PO224 NEUTRON ACER TENDL-2021 LIBRARY; T=293.6K  
alphas from (n,x)

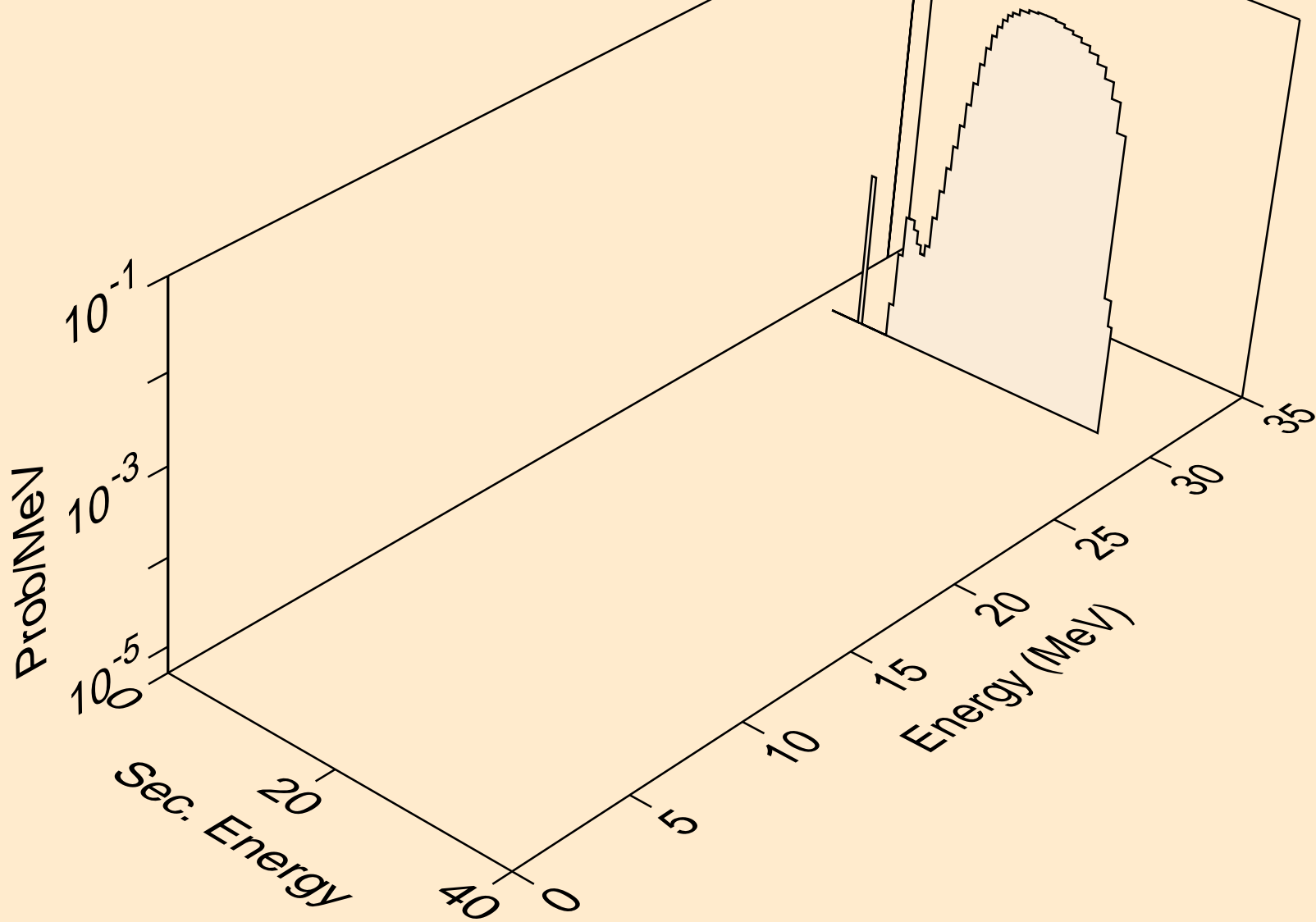

PO224 NEUTRON ACER TENDL-2021 LIBRARY; T=293.6K  
alphas from (n,n\*)a

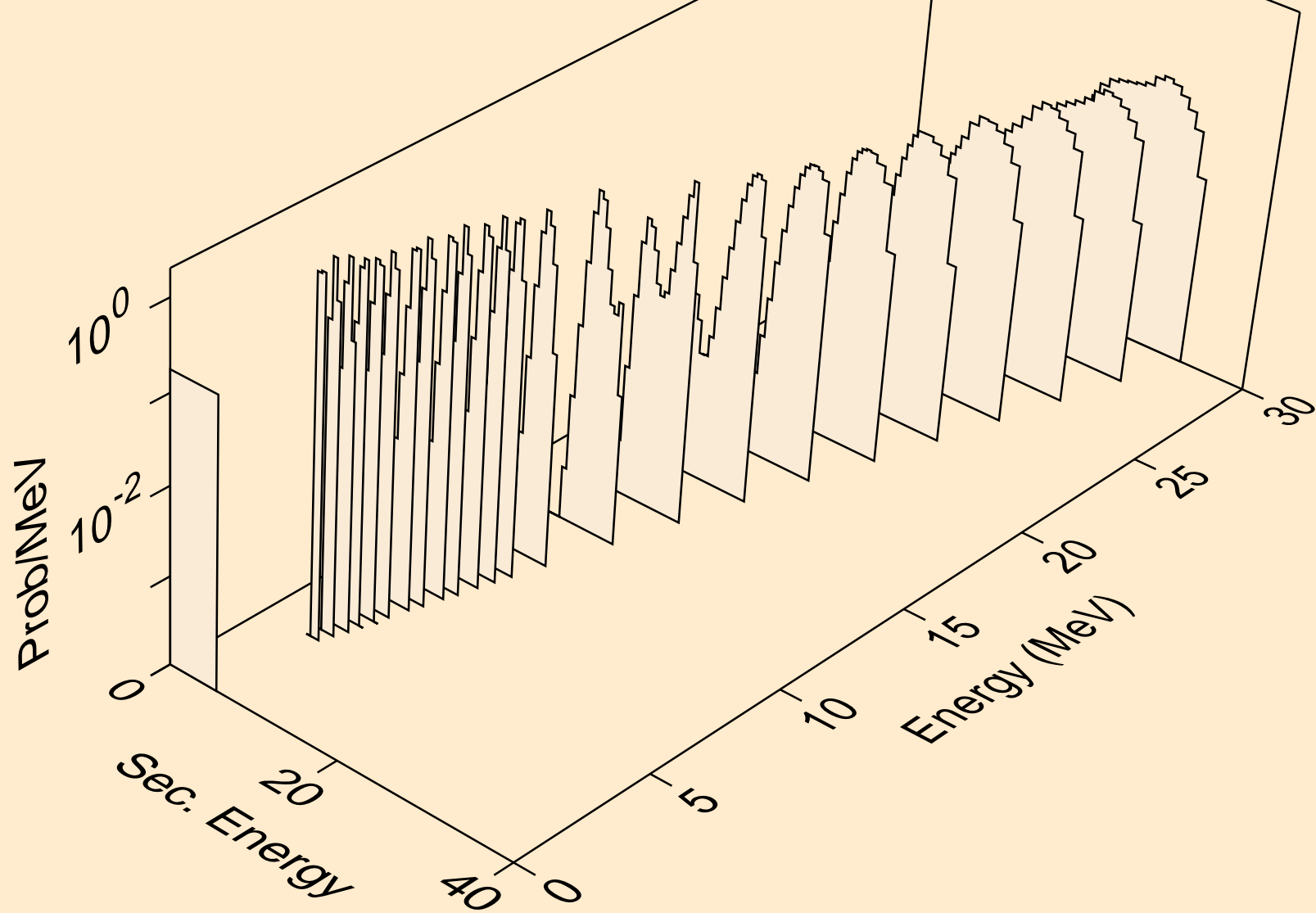

PO224 NEUTRON ACER TENDL-2021 LIBRARY; T=293.6K  
alphas from (n,2n)a

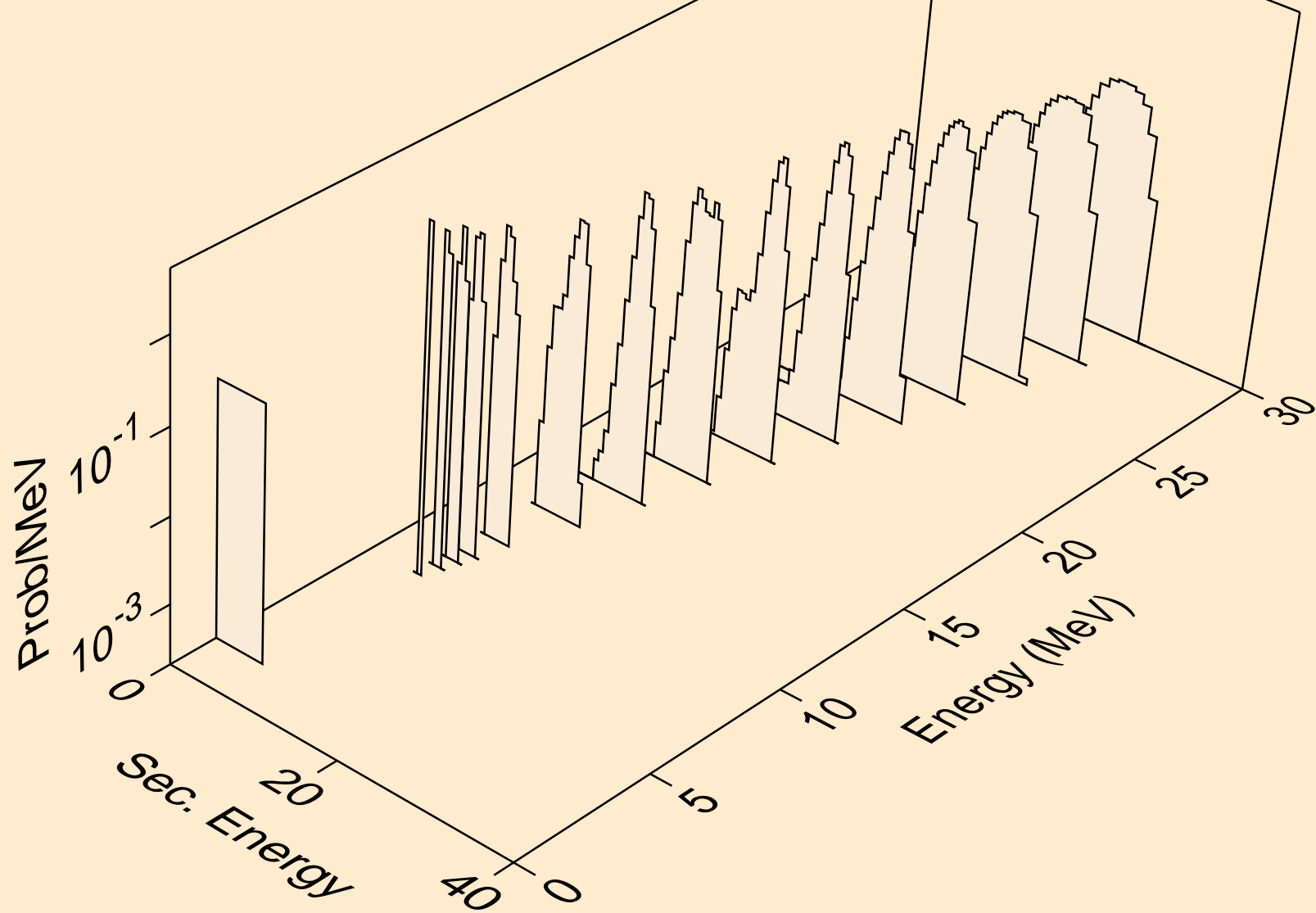

PO224 NEUTRON ACER TENDL-2021 LIBRARY; T=293.6K  
alphas from (n,3n)a

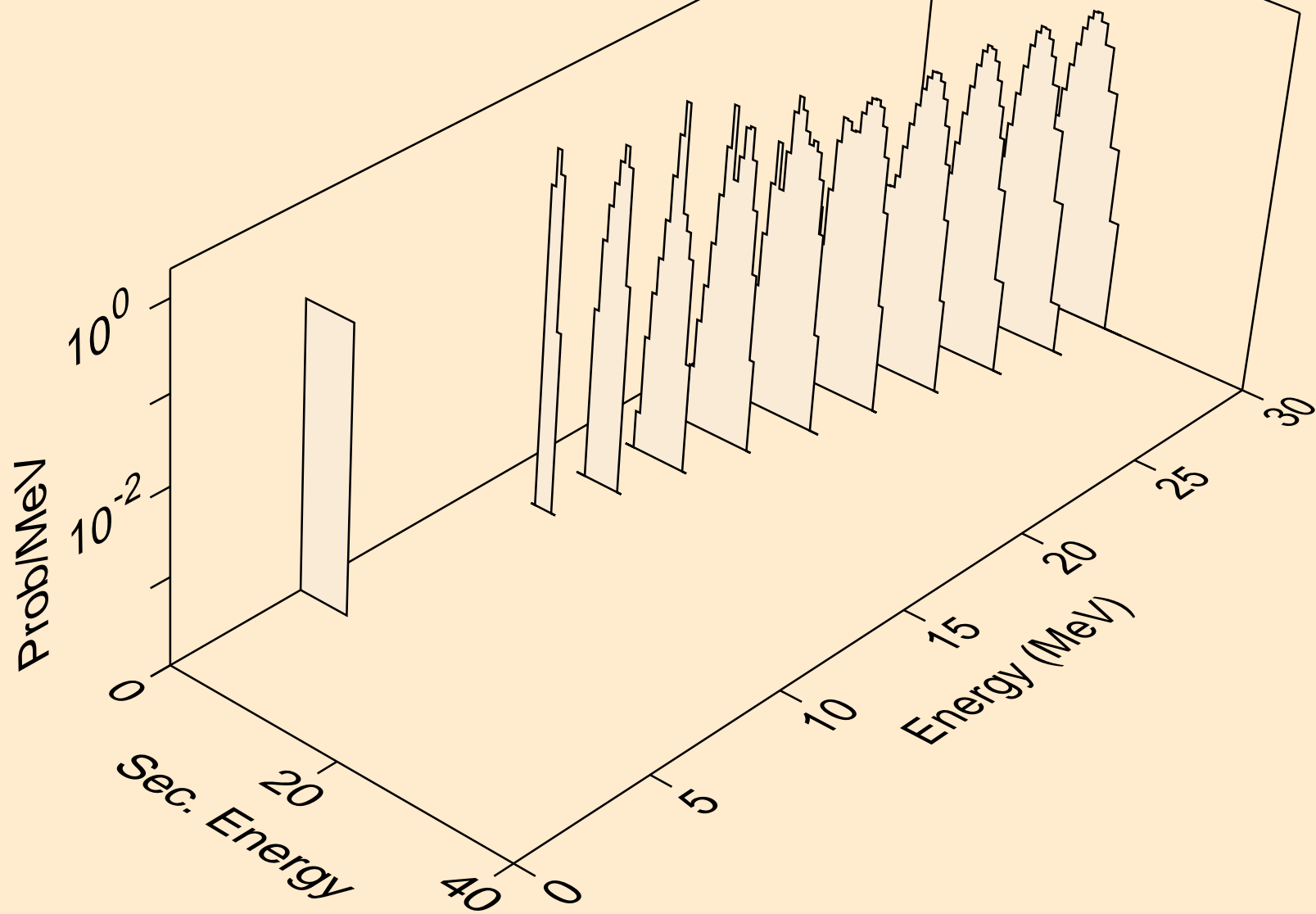

PO224 NEUTRON ACER TENDL-2021 LIBRARY; T=293.6K  
alphas from (n,n\*)2a

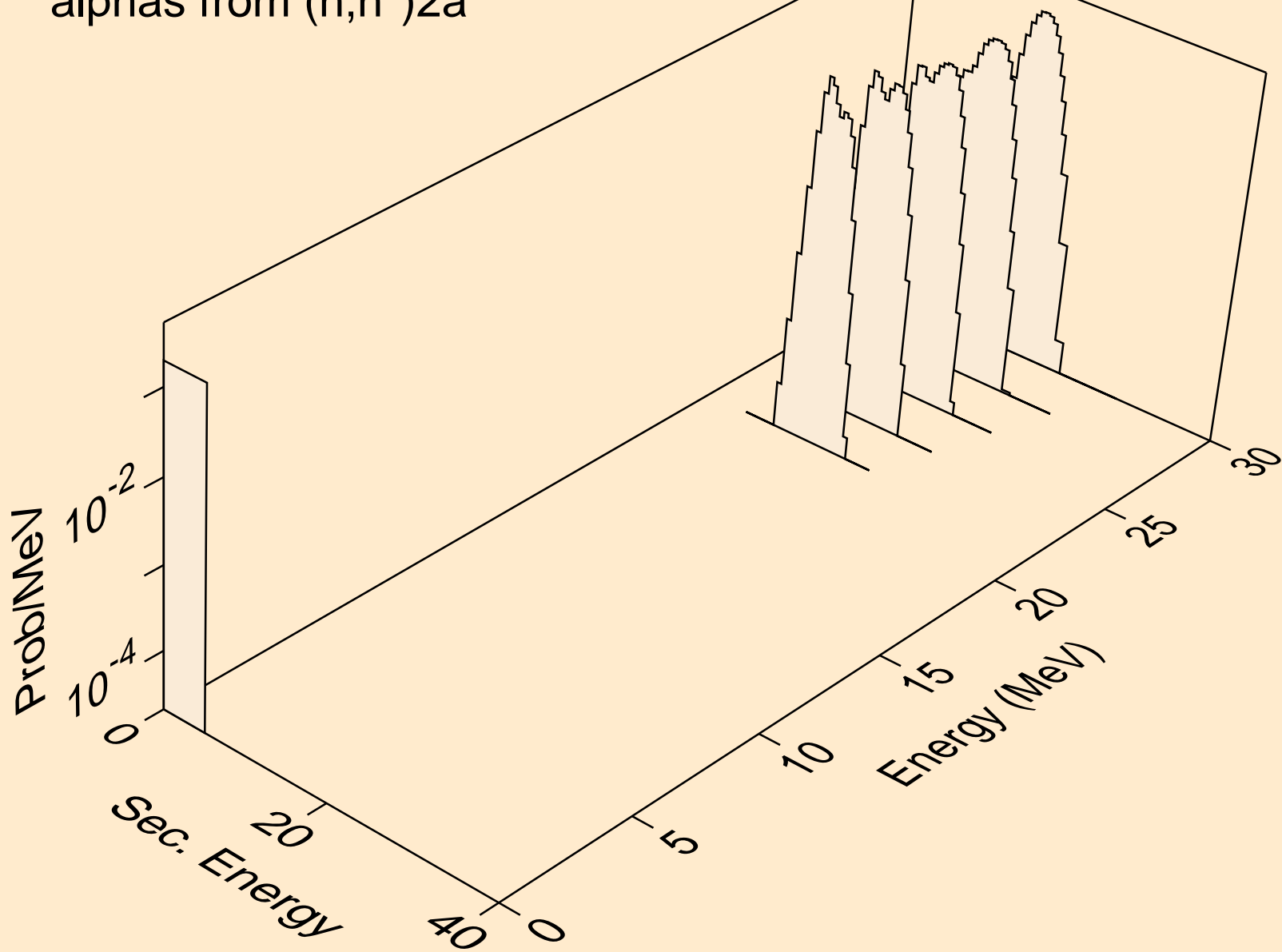



PO224 NEUTRON ACER TENDL-2021 LIBRARY; T=293.6K  
alphas from (n,2n)2a

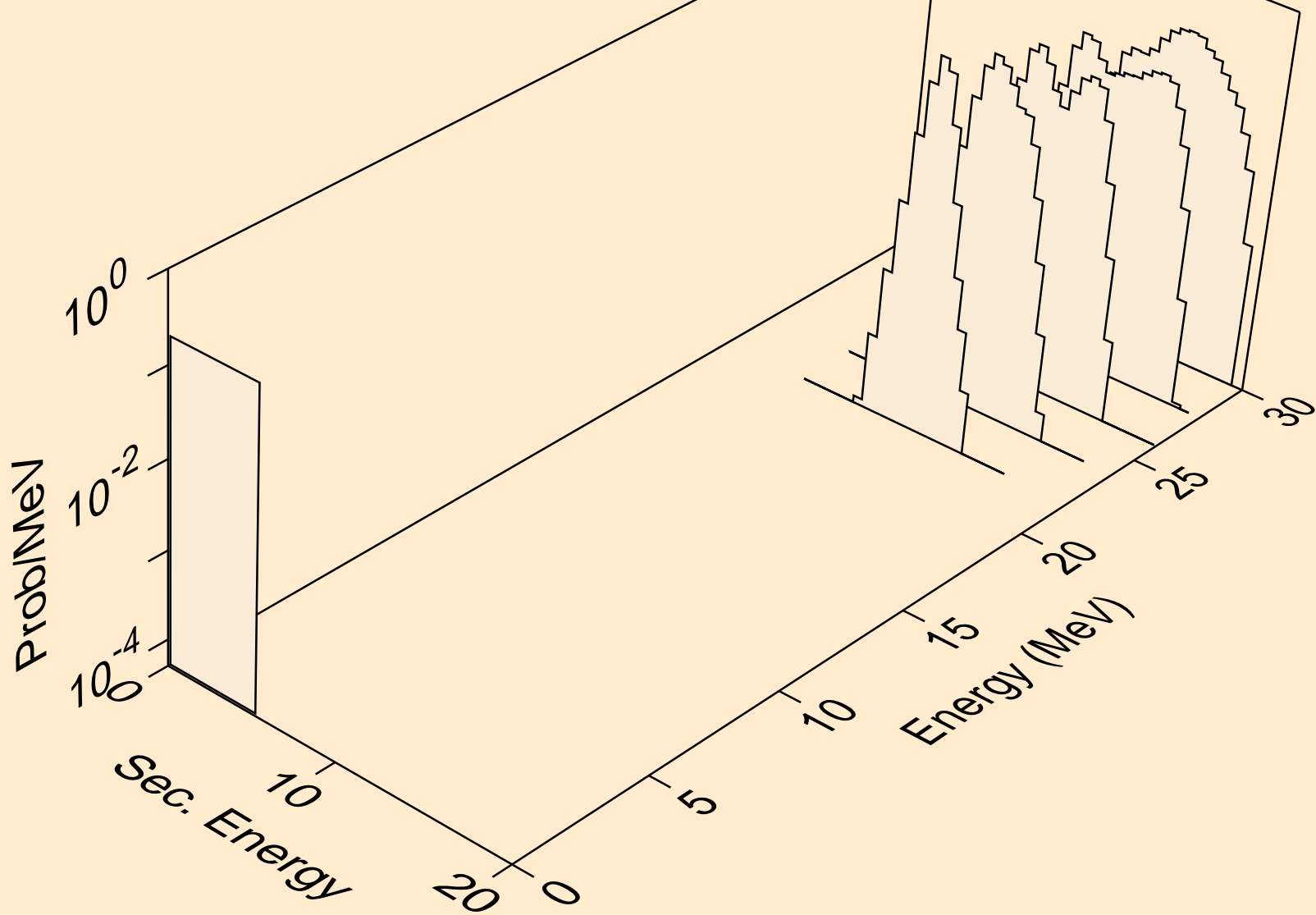

PO224 NEUTRON ACER TENDL-2021 LIBRARY; T=293.6K  
alphas from (n,a)

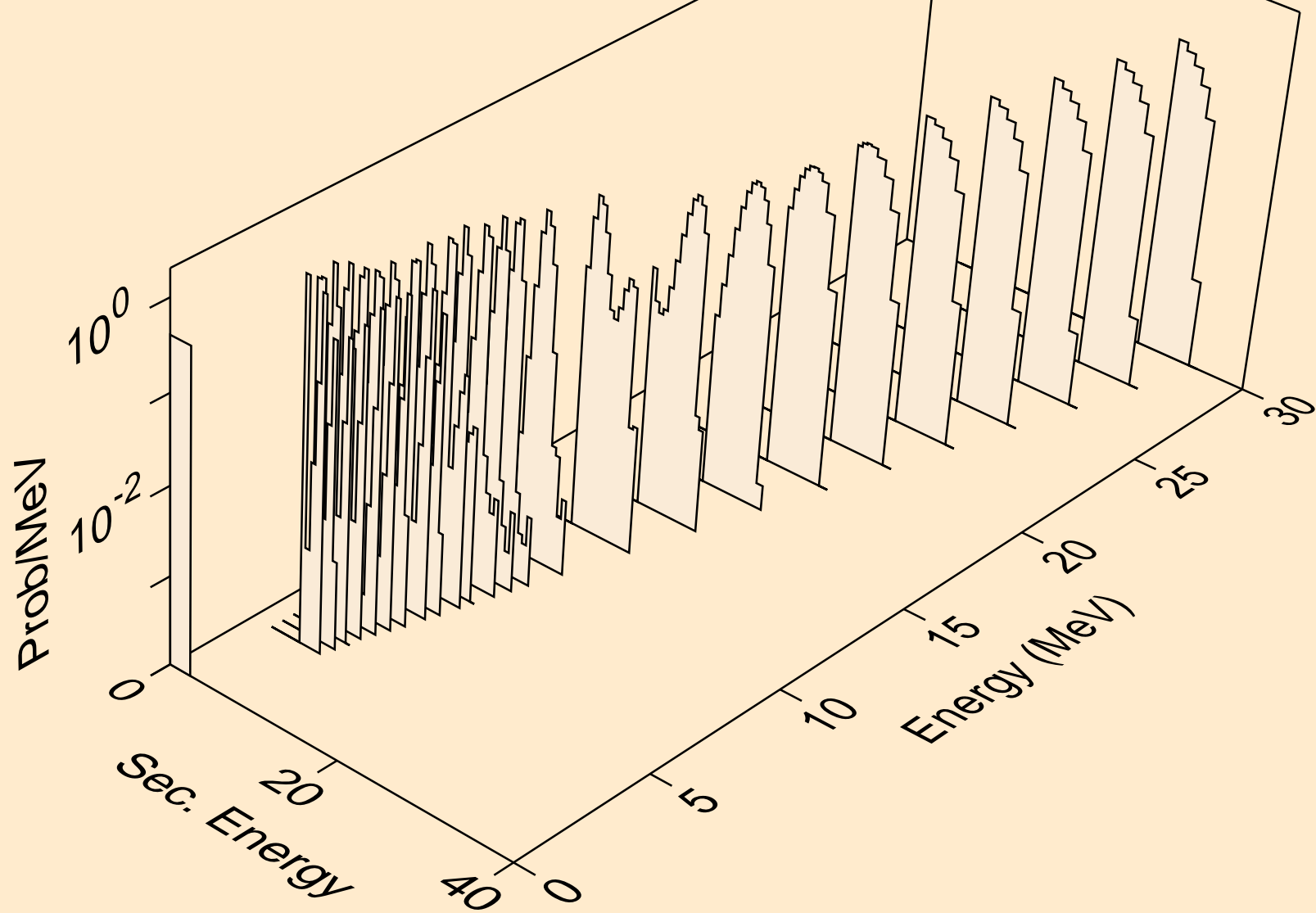

PO224 NEUTRON ACER TENDL-2021 LIBRARY; T=293.6K  
alphas from (n,pa)

