

PR126 NEUTRON ACER TENDL-2021 LIBRARY; T=293.6K
Principal cross sections

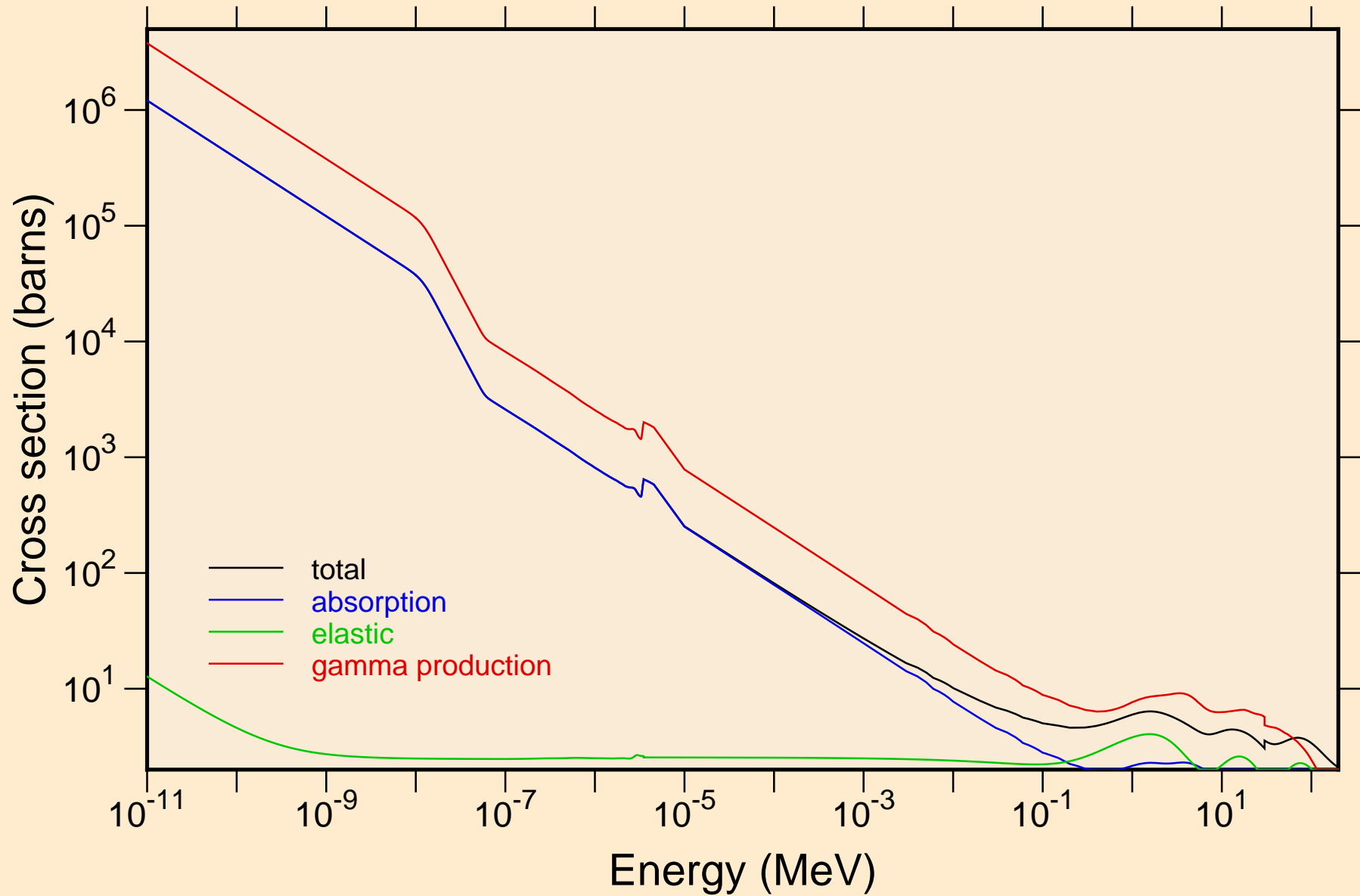

PR126 NEUTRON ACER TENDL-2021 LIBRARY; T=293.6K
Heating

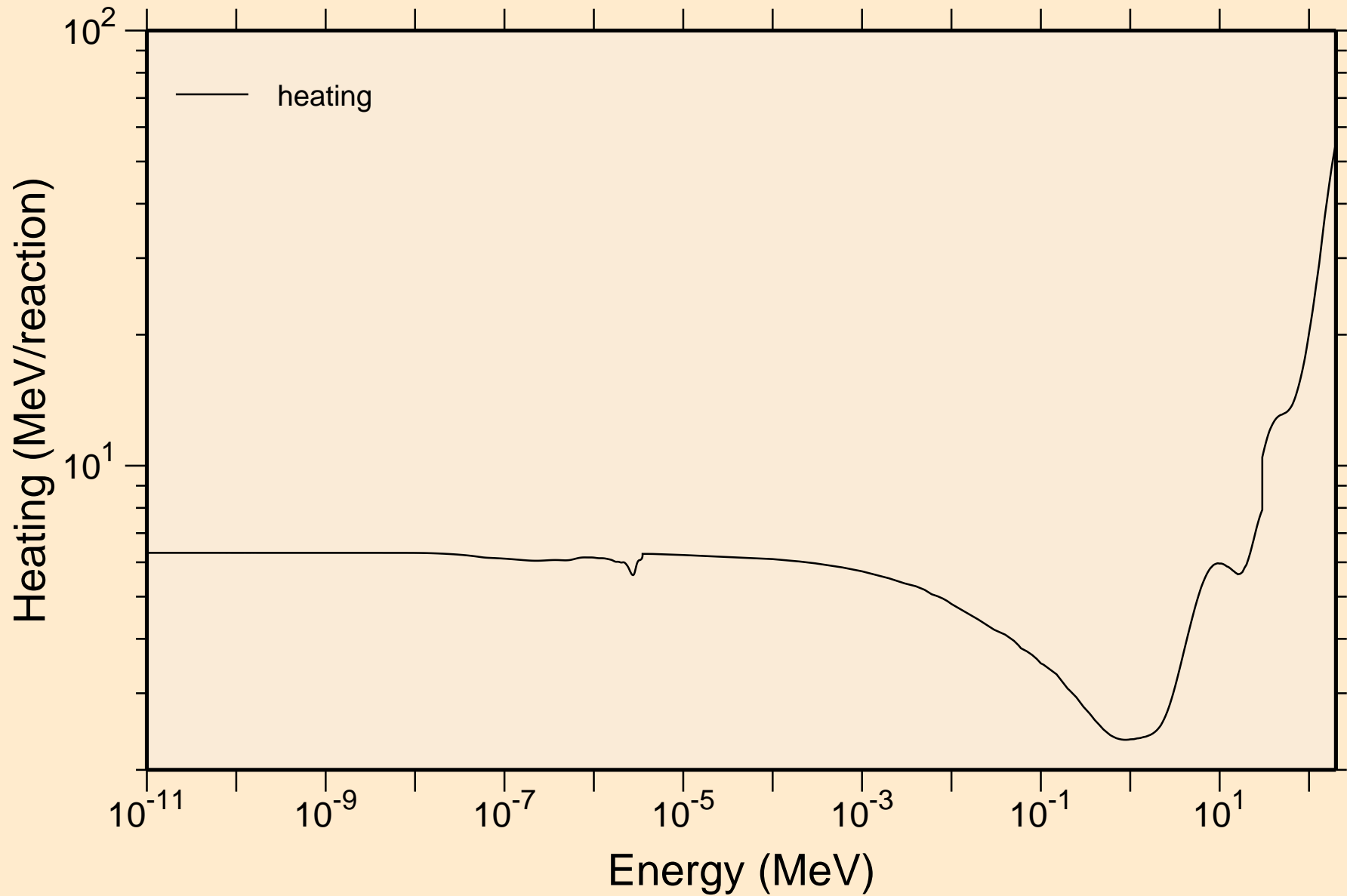

PR126 NEUTRON ACER TENDL-2021 LIBRARY; T=293.6K
Damage

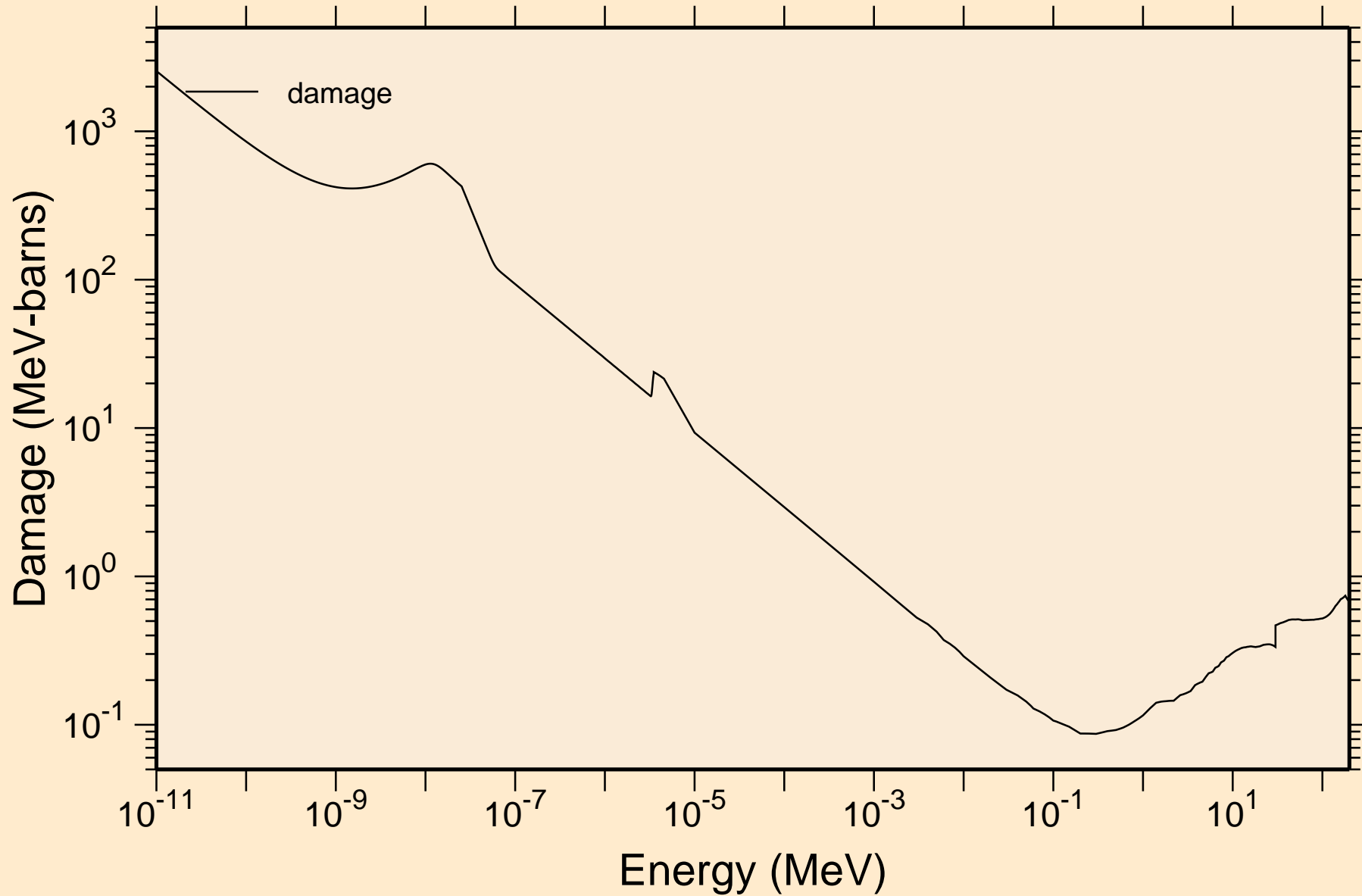

PR126 NEUTRON ACER TENDL-2021 LIBRARY; T=293.6K
Non-threshold reactions

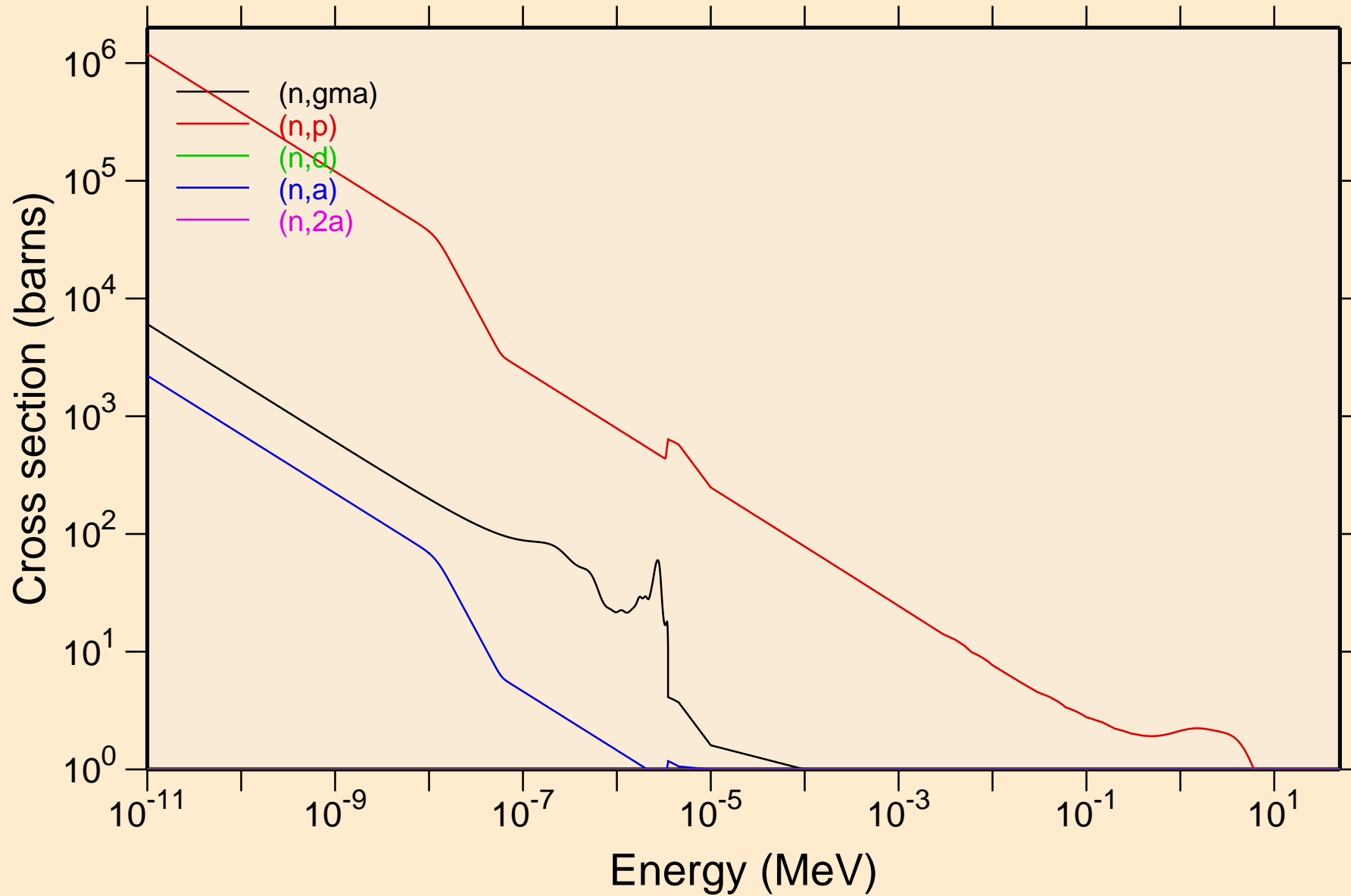

PR126 NEUTRON ACER TENDL-2021 LIBRARY; T=293.6K
Non-threshold reactions

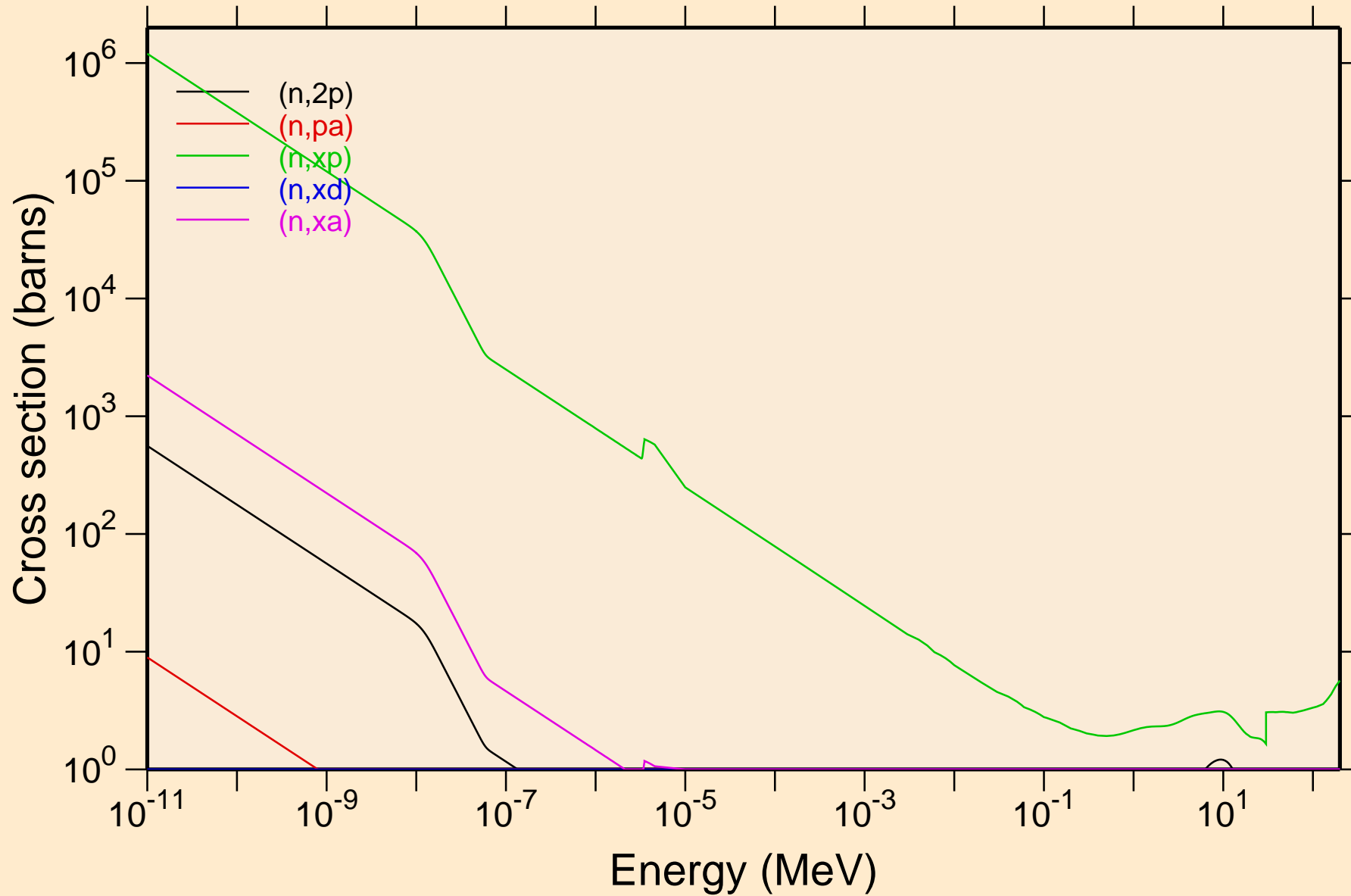

PR126 NEUTRON ACER TENDL-2021 LIBRARY; T=293.6K
Principal cross sections

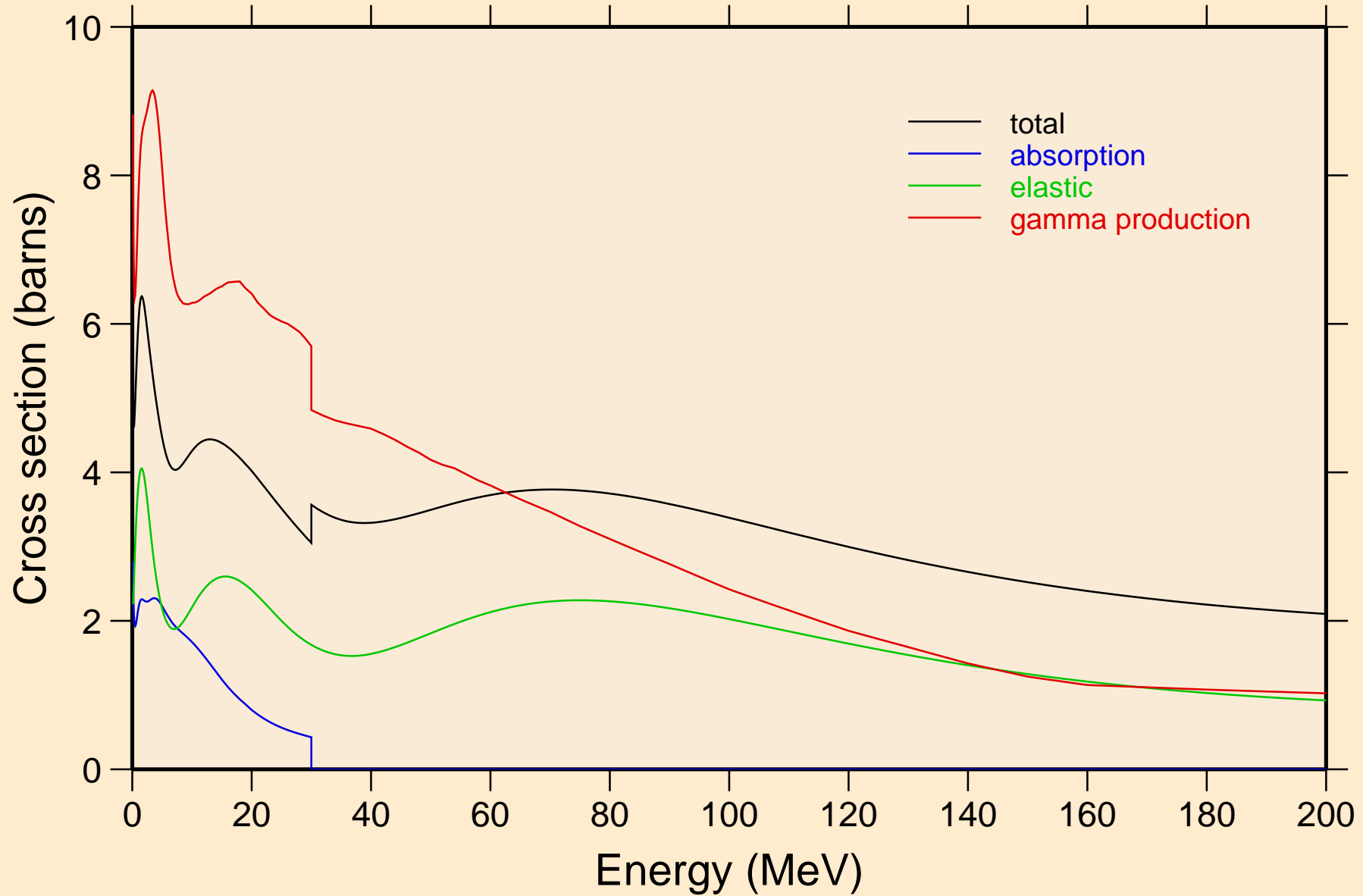

PR126 NEUTRON ACER TENDL-2021 LIBRARY; T=293.6K
Heating

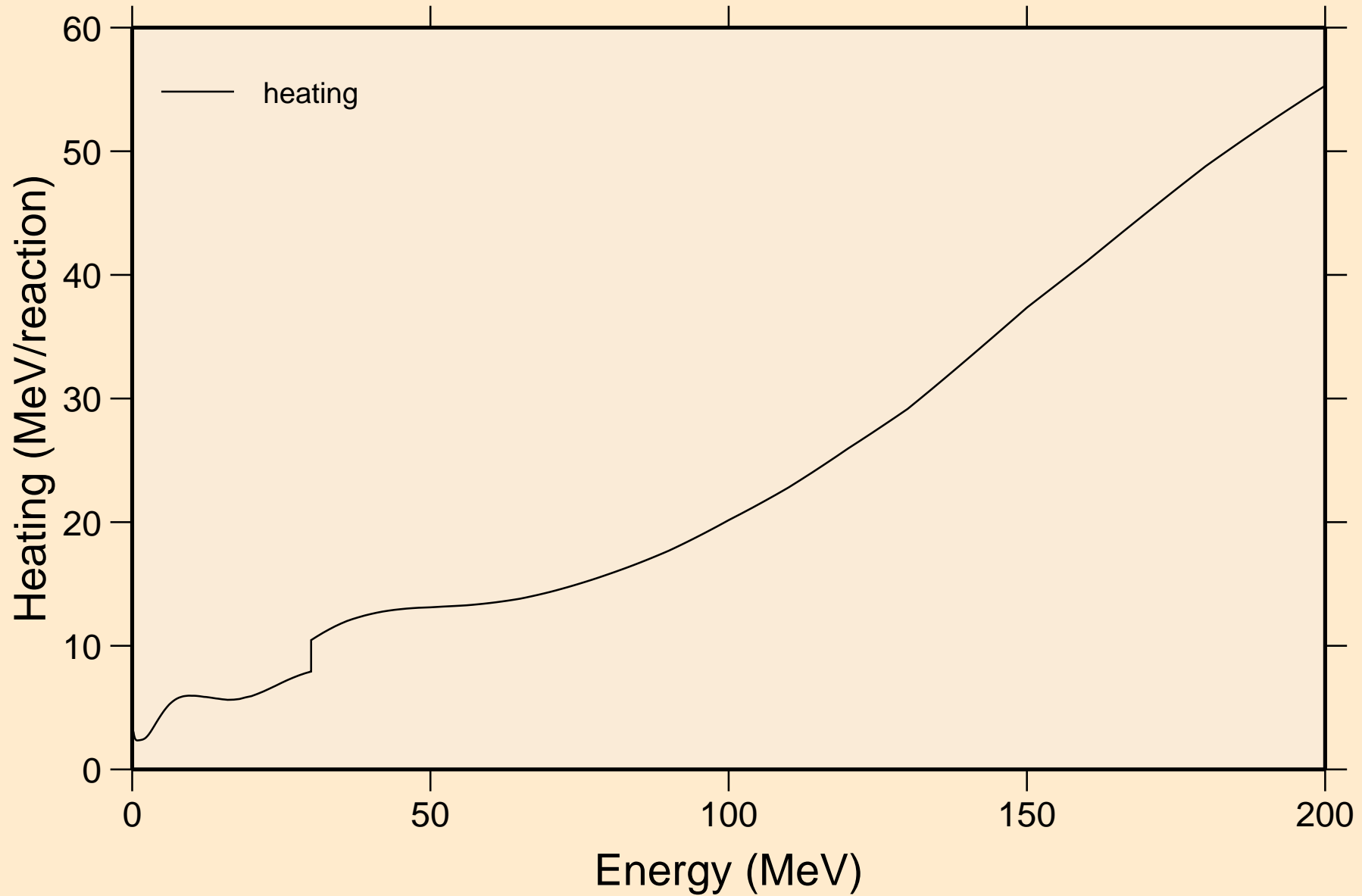

PR126 NEUTRON ACER TENDL-2021 LIBRARY; T=293.6K
Damage

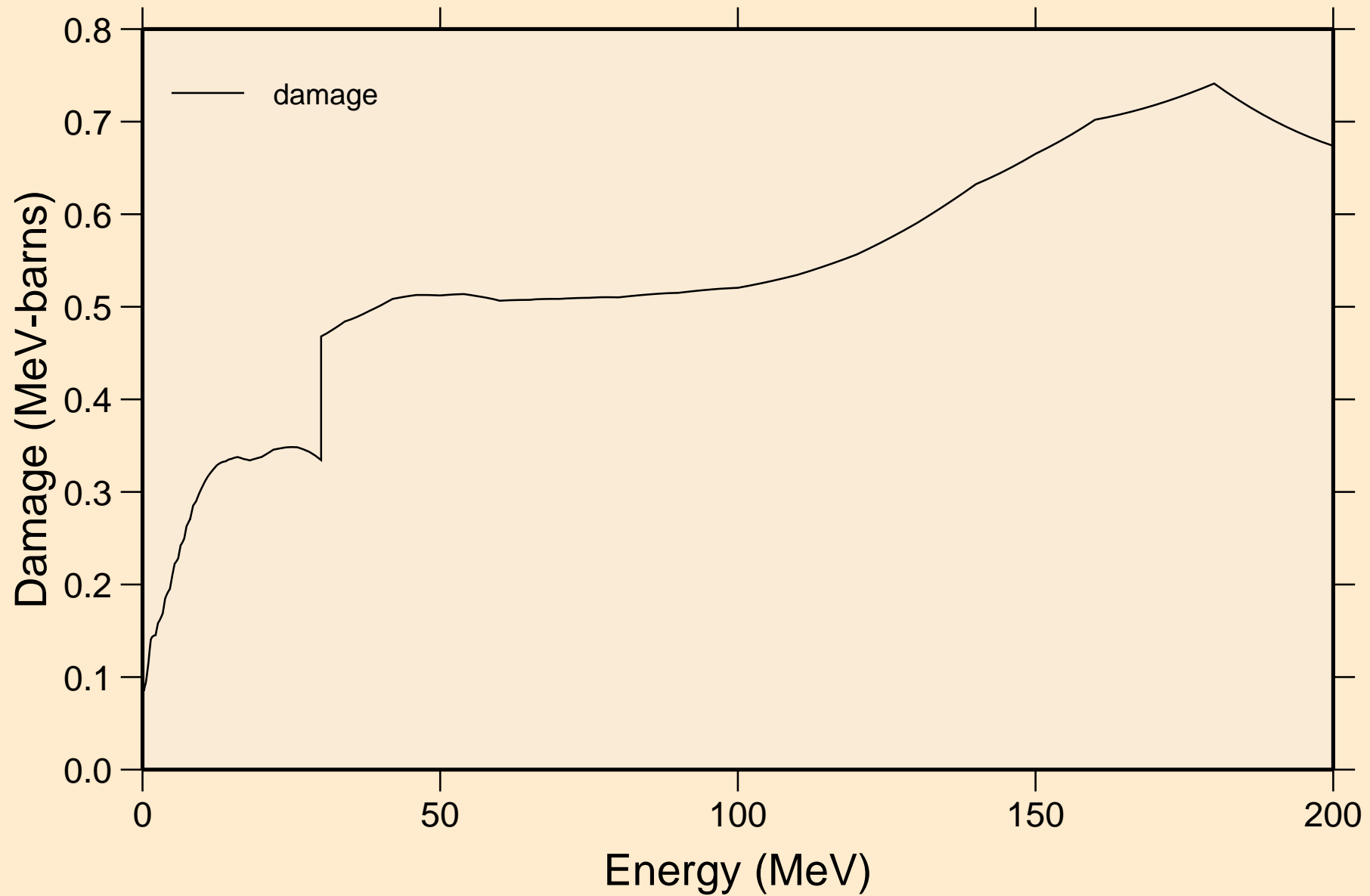

PR126 NEUTRON ACER TENDL-2021 LIBRARY; T=293.6K
Non-threshold reactions

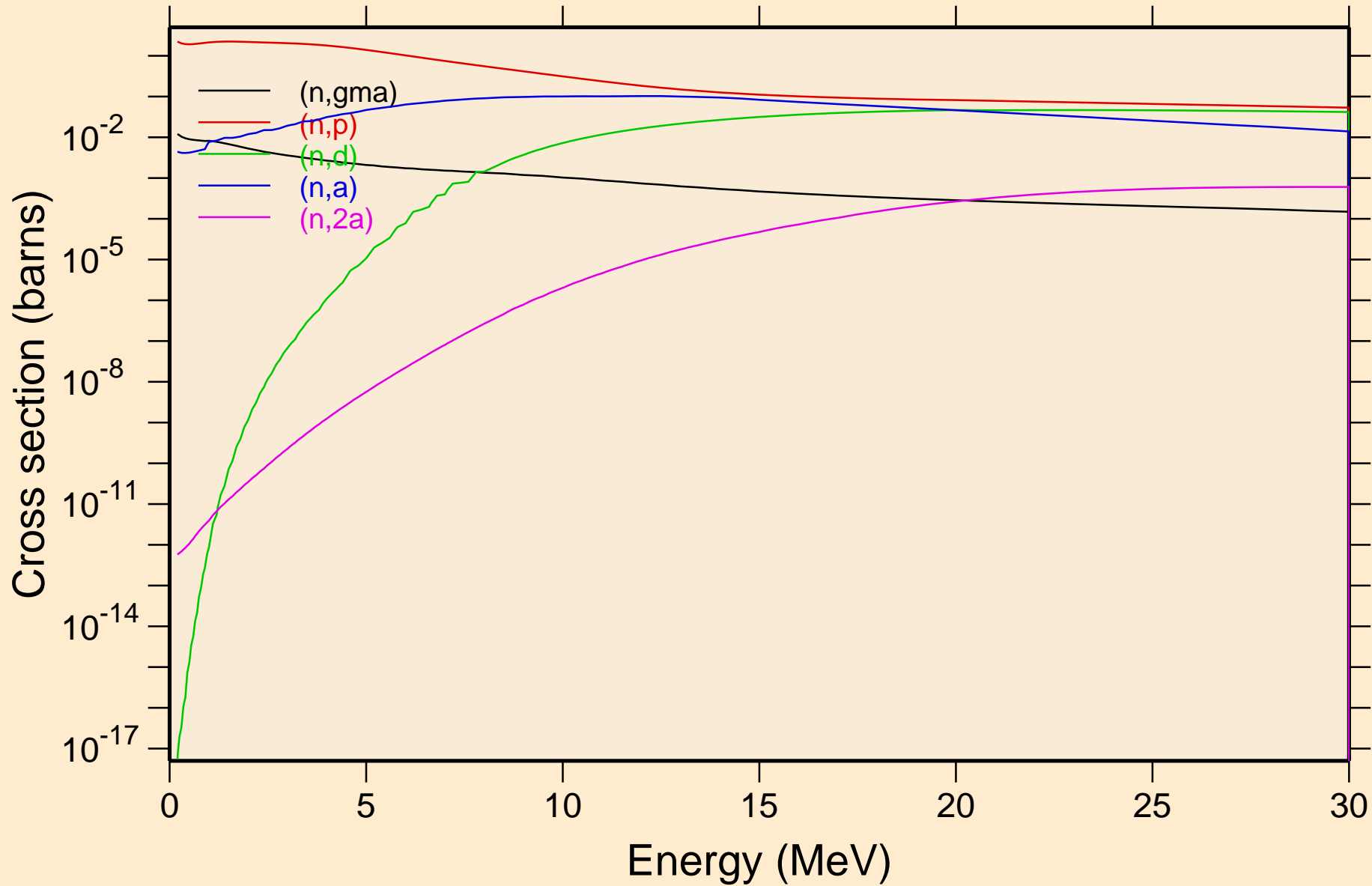

PR126 NEUTRON ACER TENDL-2021 LIBRARY; T=293.6K
Non-threshold reactions

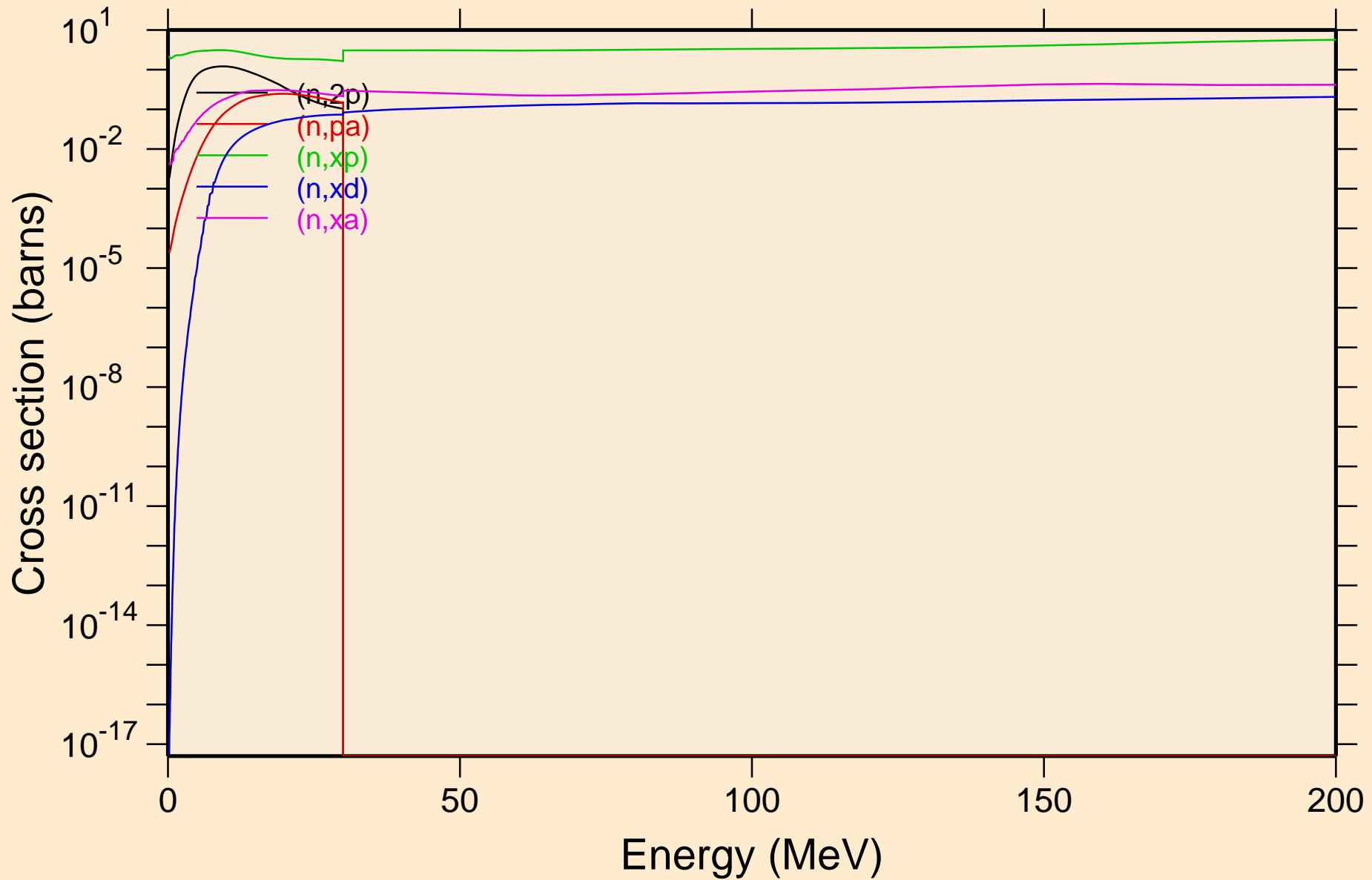

PR126 NEUTRON ACER TENDL-2021 LIBRARY; T=293.6K
Inelastic levels

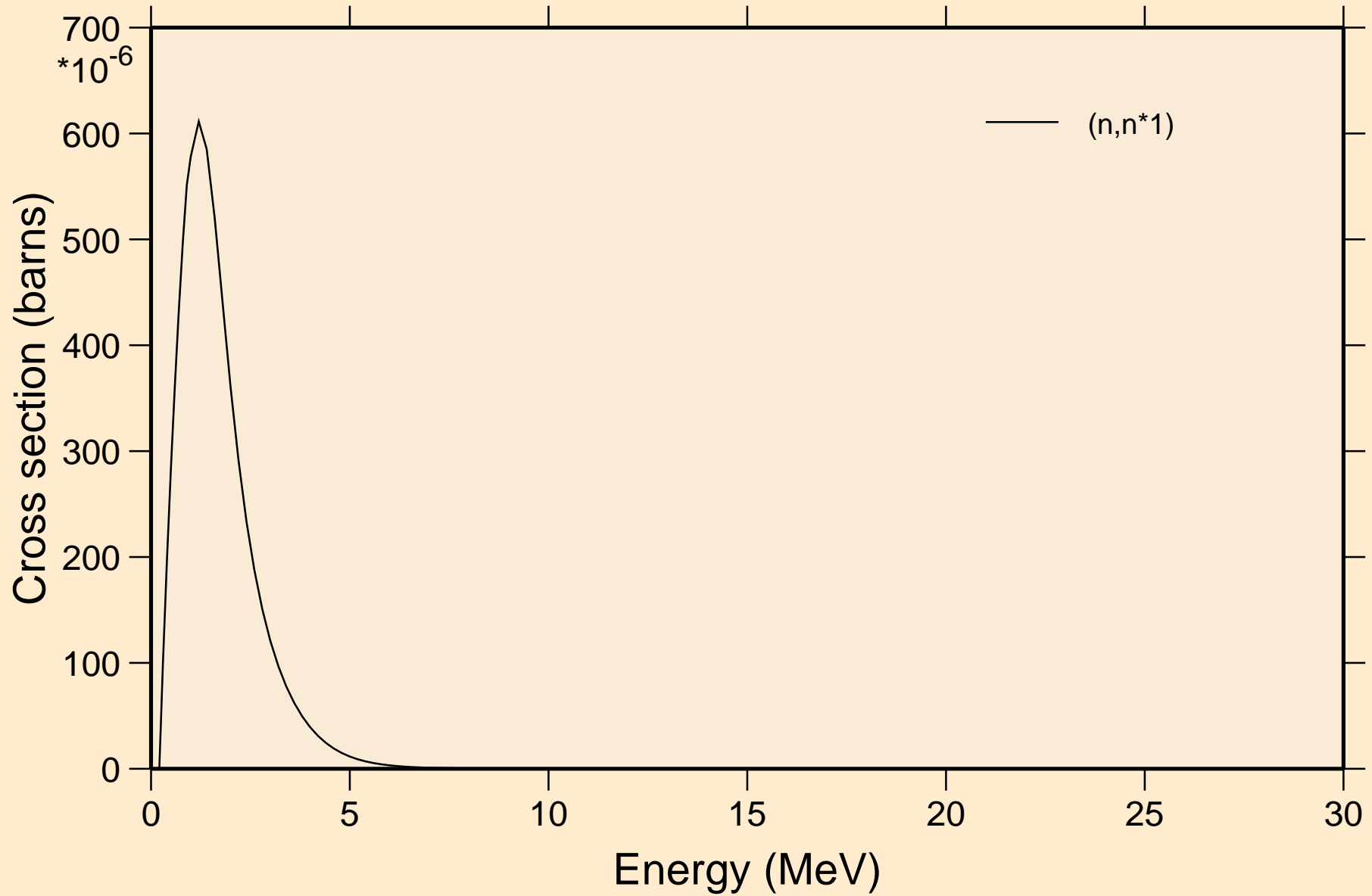

PR126 NEUTRON ACER TENDL-2021 LIBRARY; T=293.6K
Threshold reactions

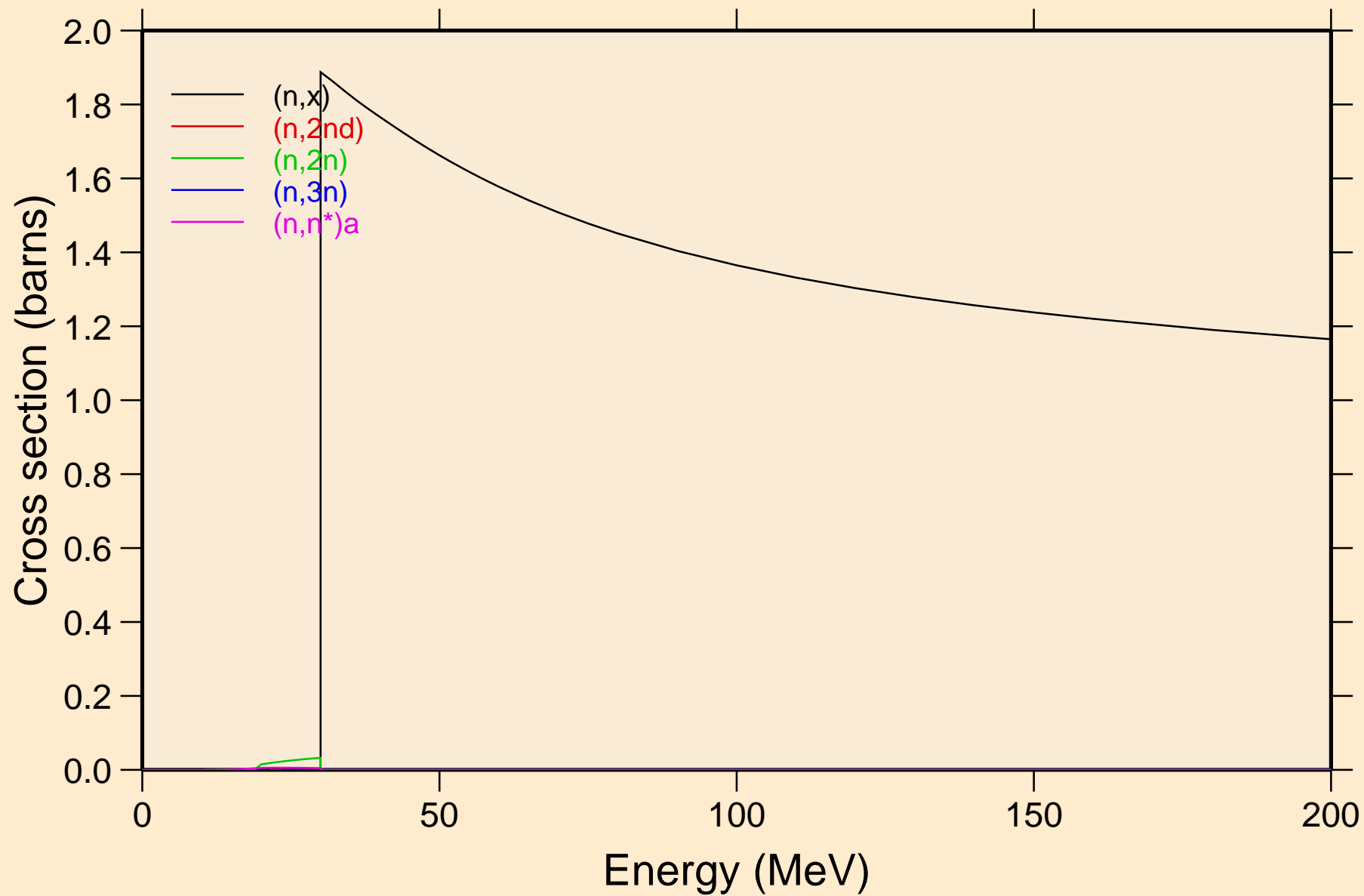

PR126 NEUTRON ACER TENDL-2021 LIBRARY; T=293.6K
Threshold reactions

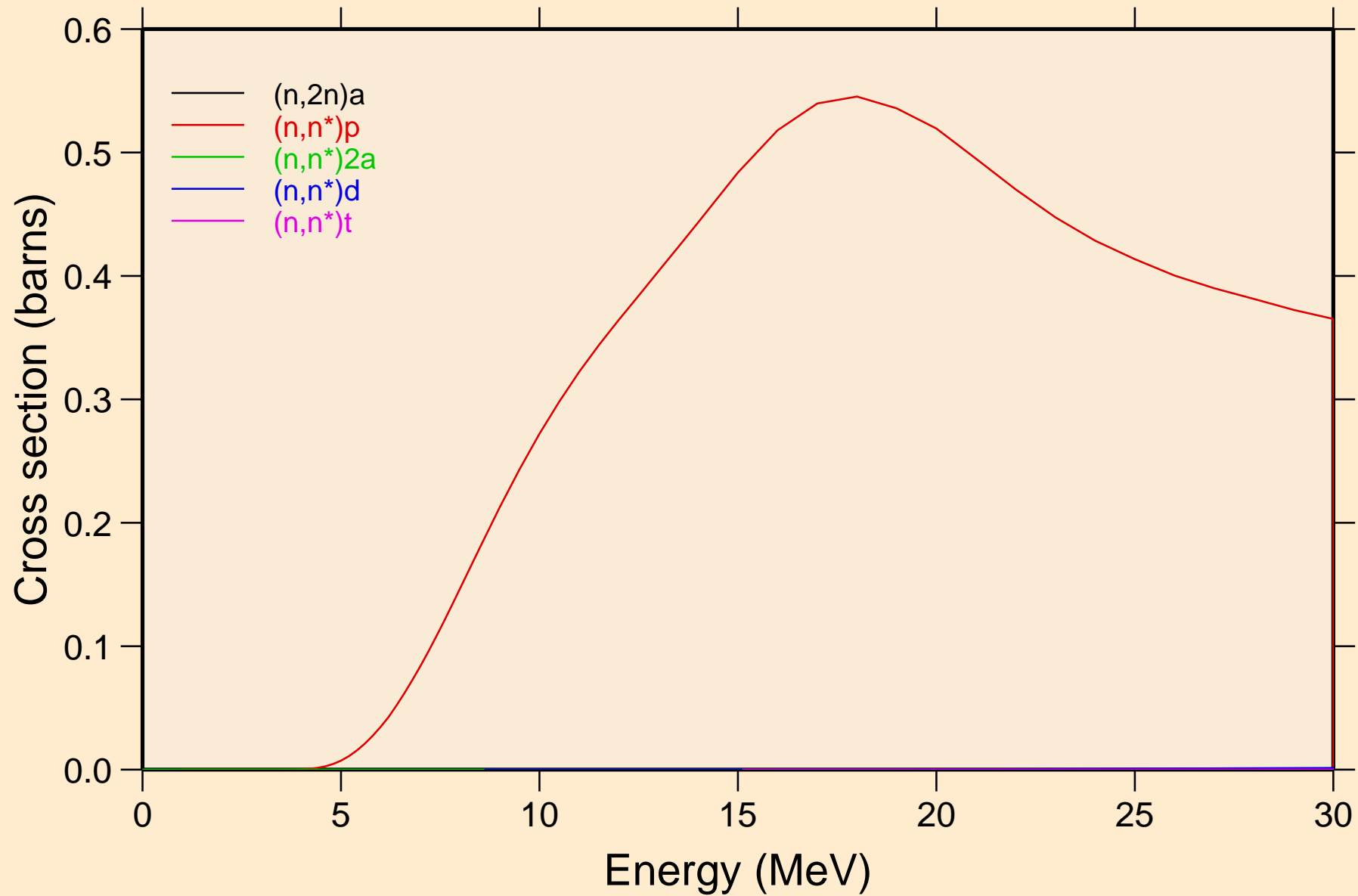

PR126 NEUTRON ACER TENDL-2021 LIBRARY; T=293.6K
Threshold reactions

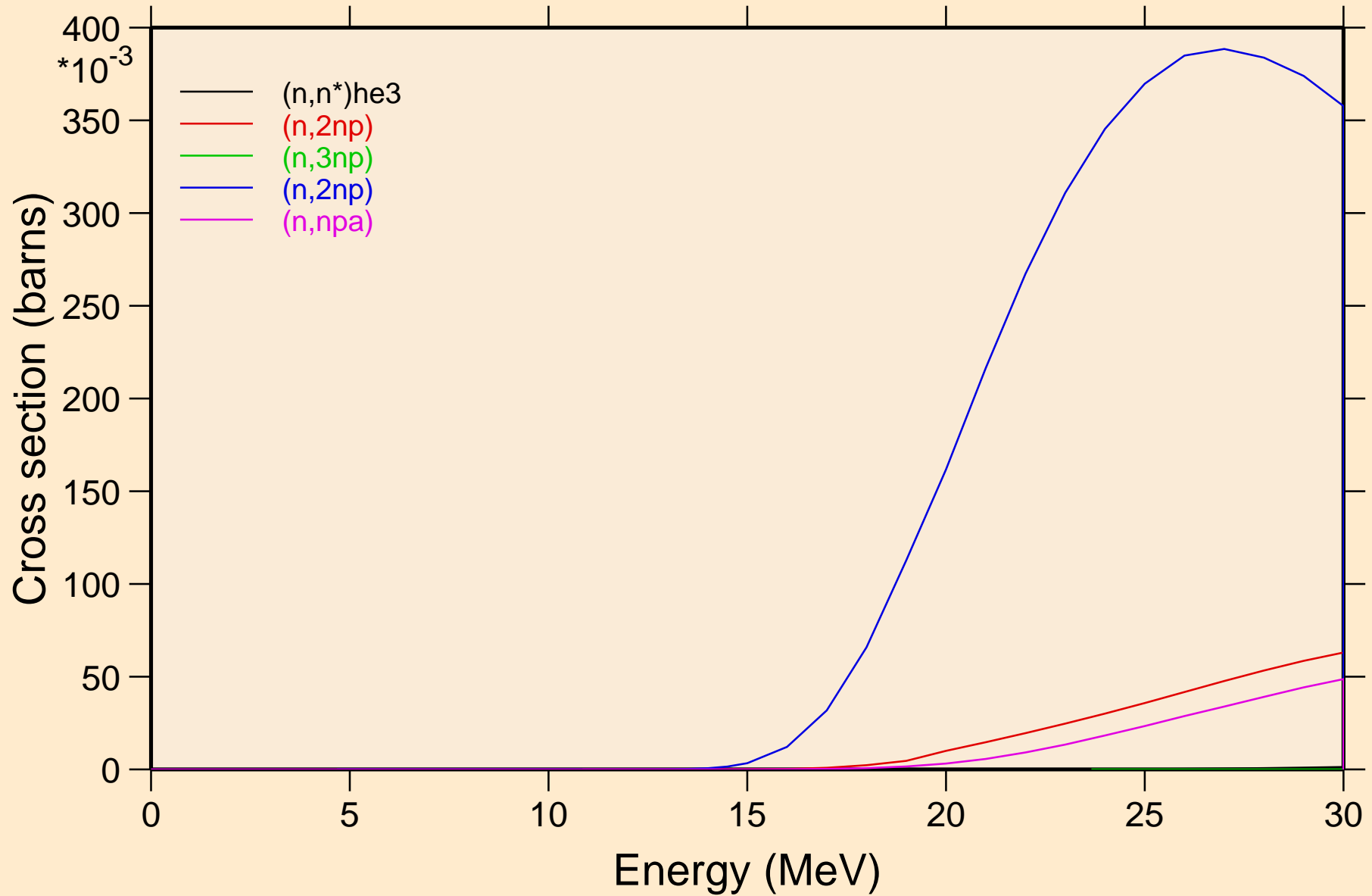

PR126 NEUTRON ACER TENDL-2021 LIBRARY; T=293.6K
Threshold reactions

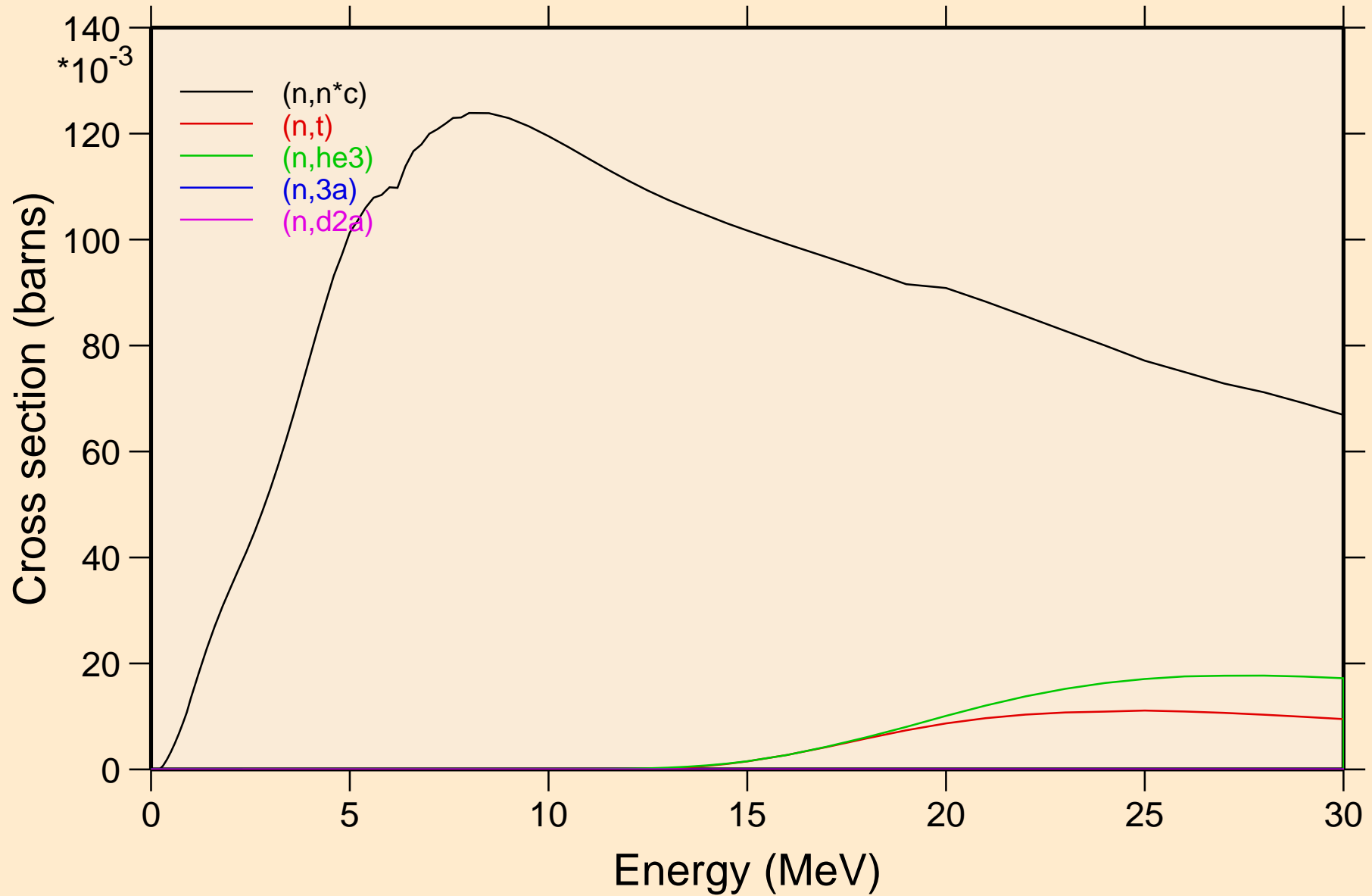

PR126 NEUTRON ACER TENDL-2021 LIBRARY; T=293.6K
Threshold reactions

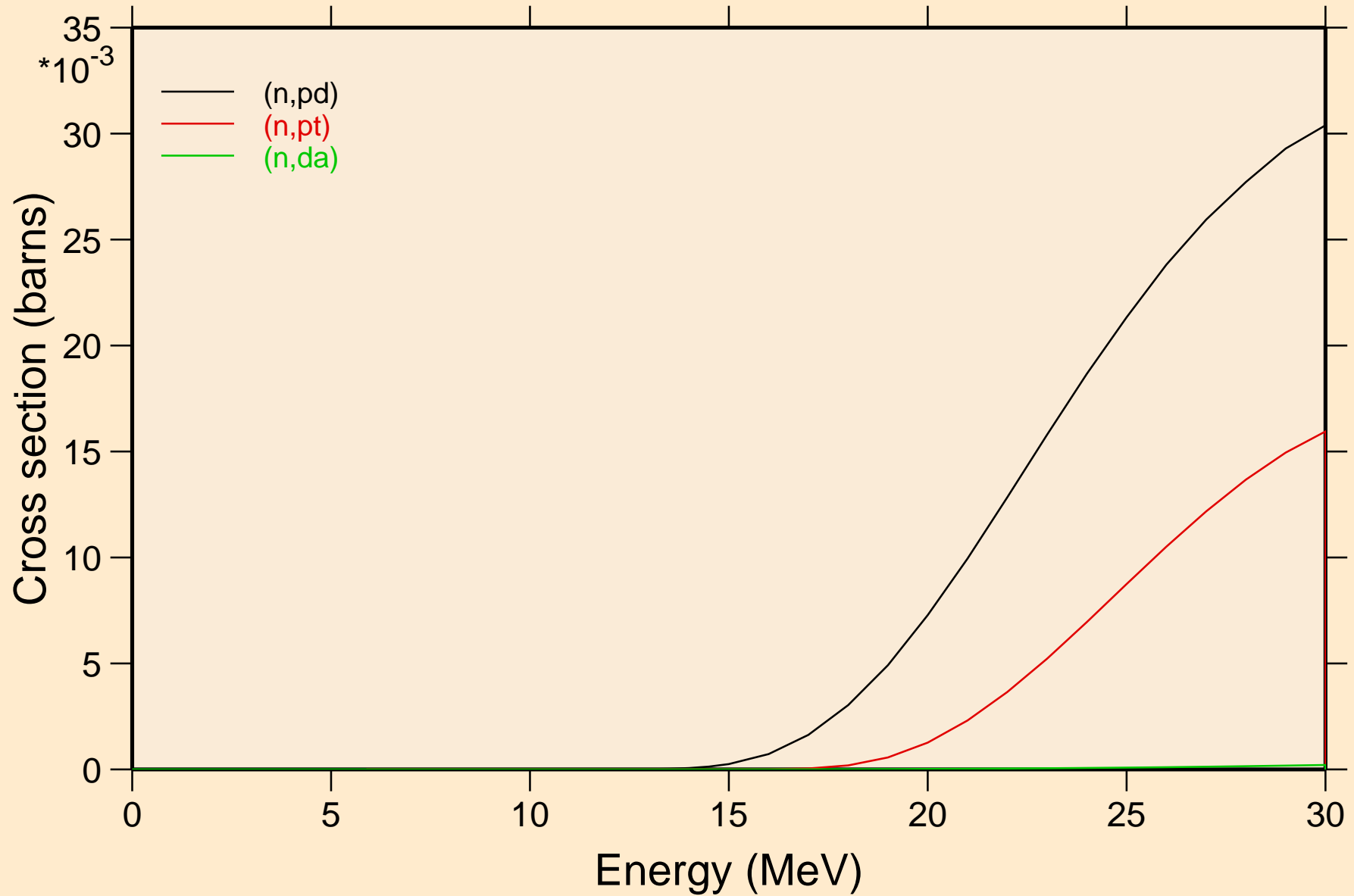

PR126 NEUTRON ACER TENDL-2021 LIBRARY; T=293.6K
Threshold reactions

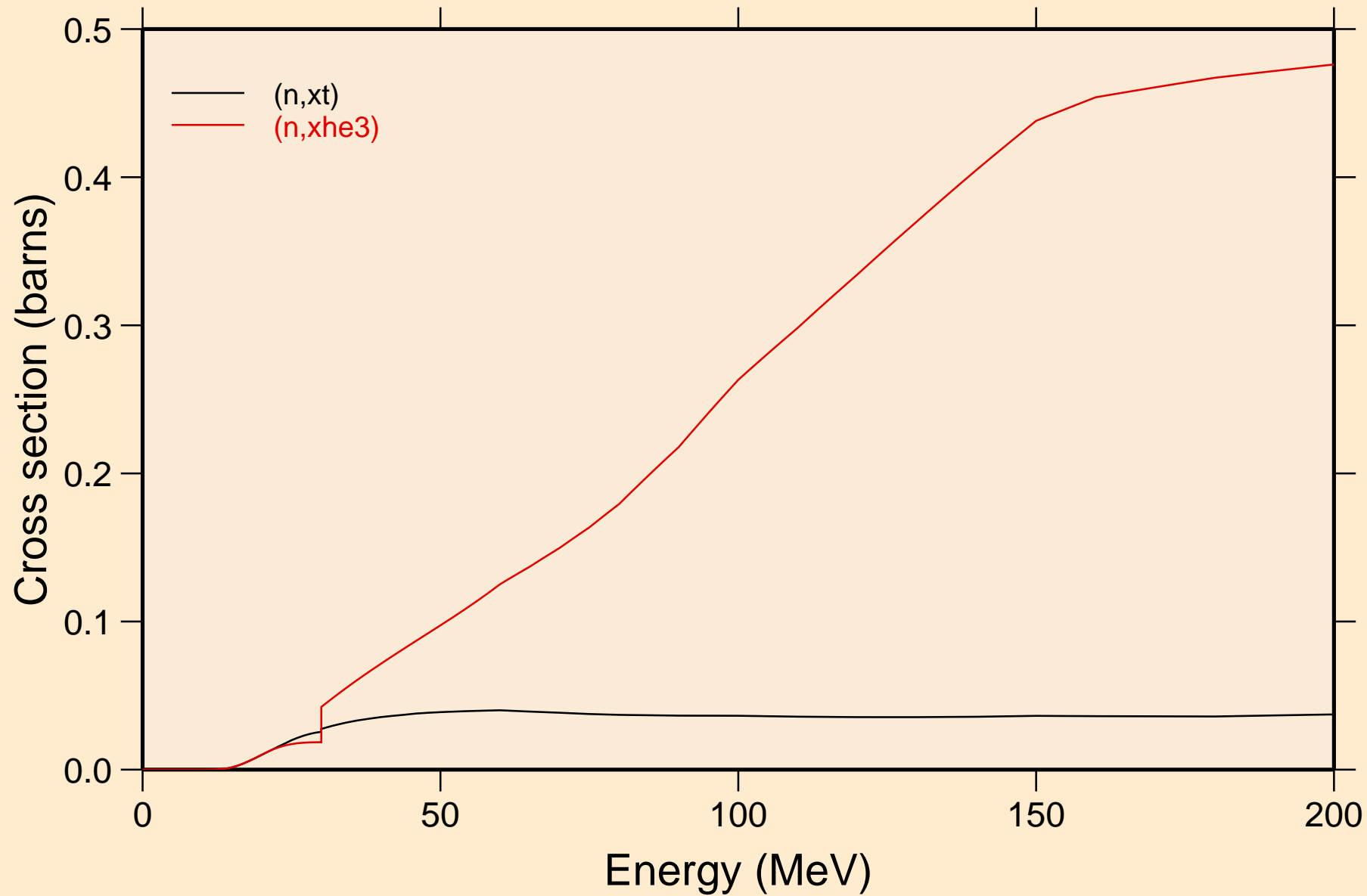

PR126 NEUTRON ACER TENDL-2021 LIBRARY; T=293.6K
angular distribution for elastic

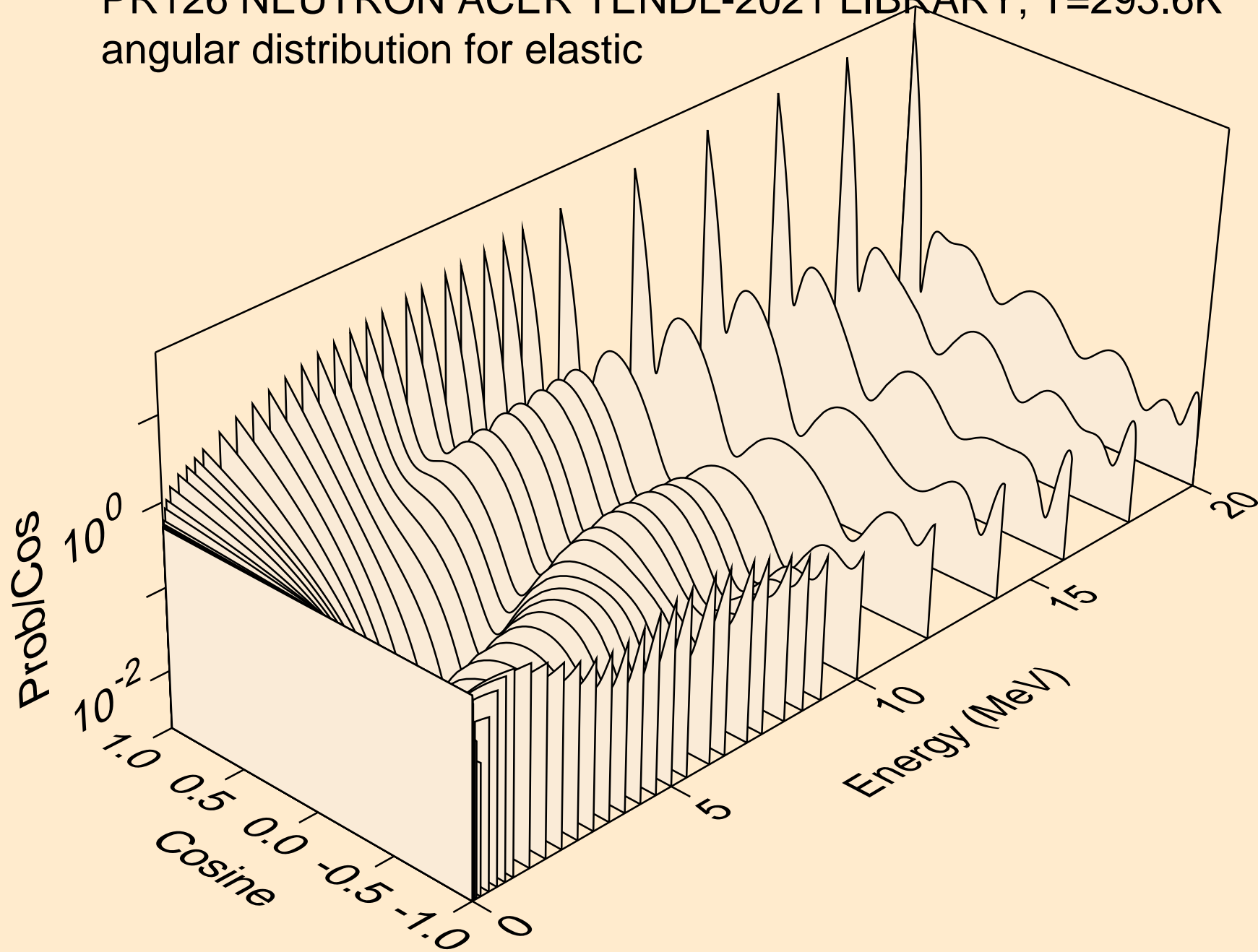

PR126 NEUTRON ACER TENDL-2021 LIBRARY; T=293.6K
angular distribution for elastic

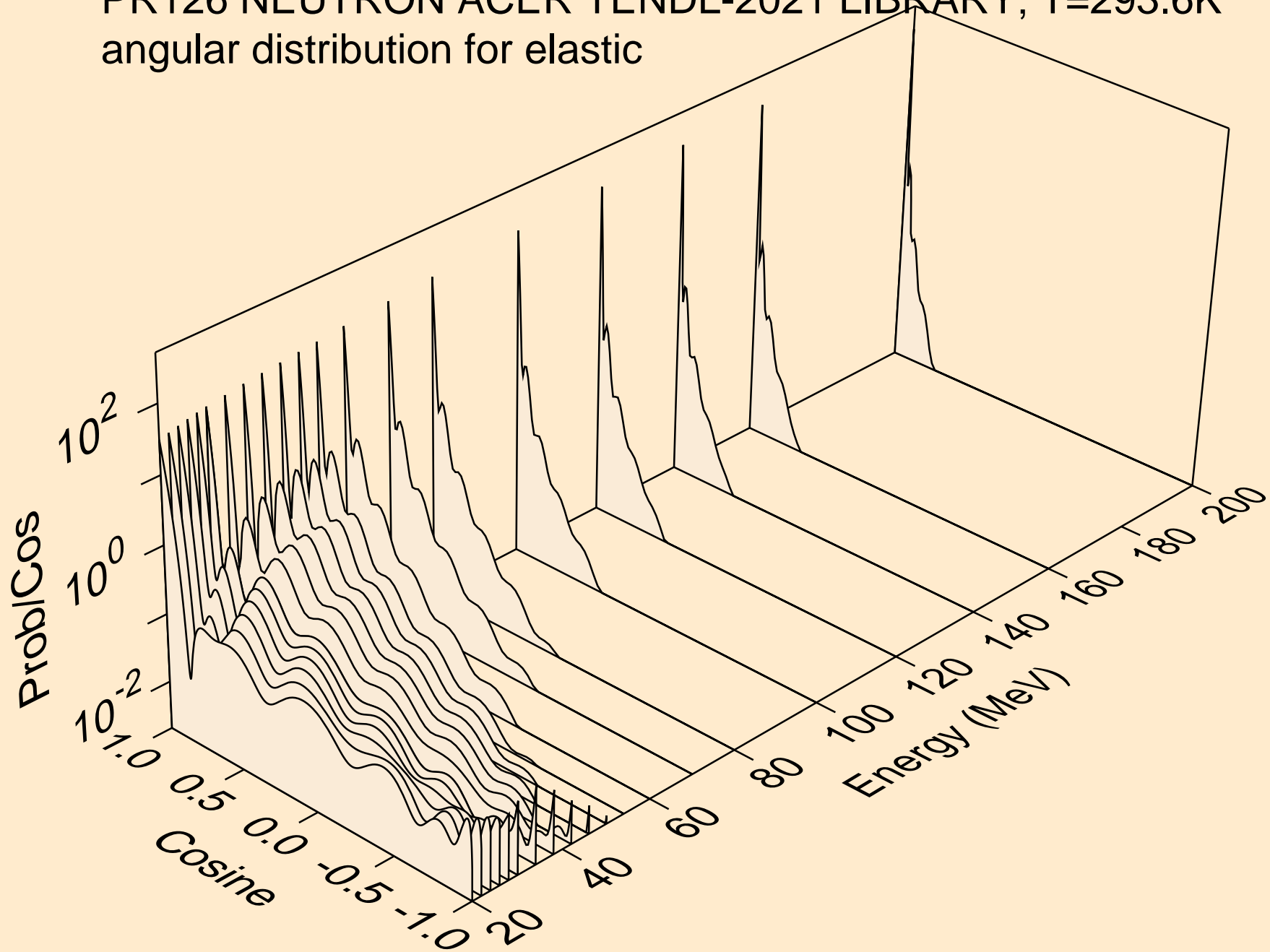

PR126 NEUTRON ACER TENDL-2021 LIBRARY; T=293.6K
angular distribution for (n,n*1)

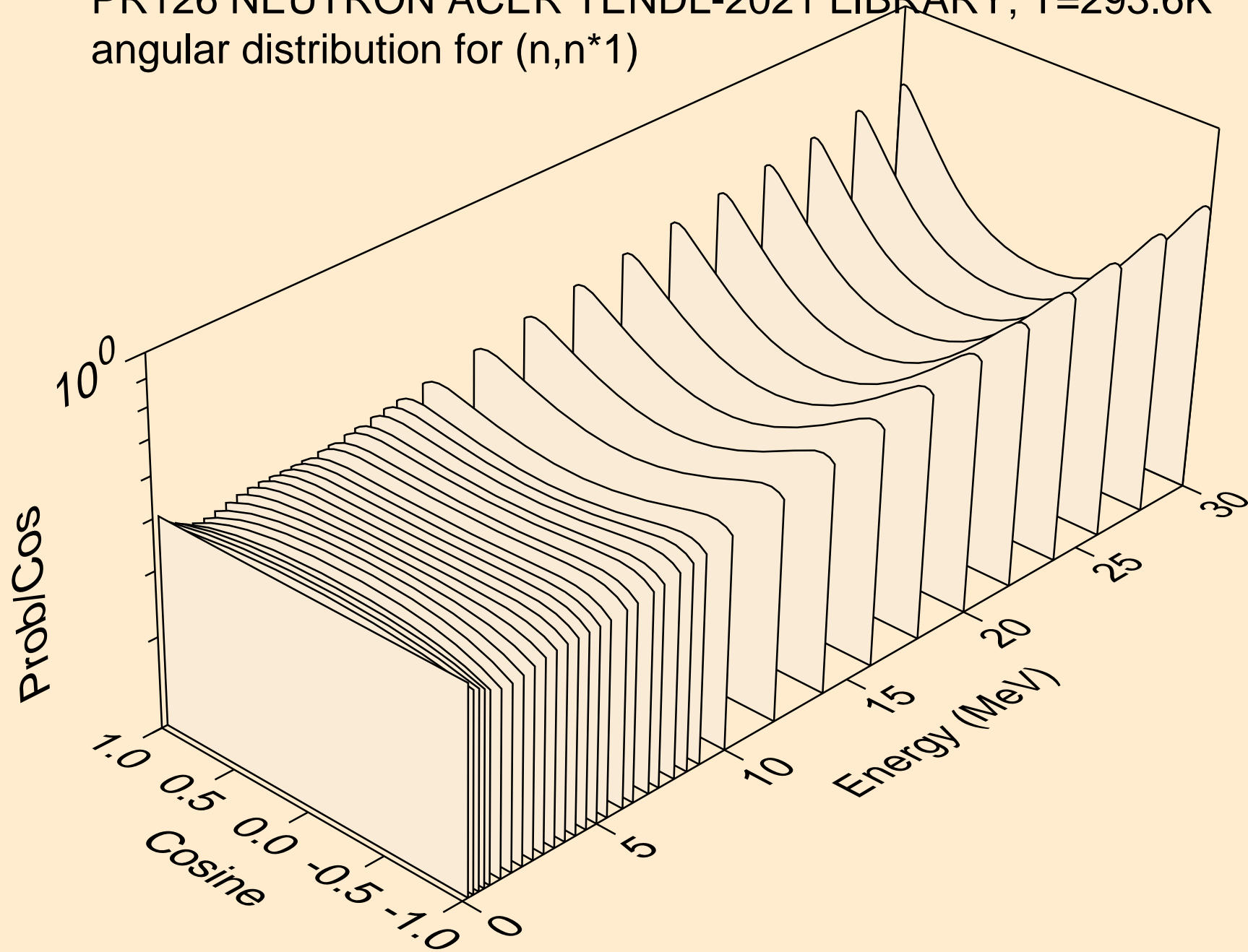

PR126 NEUTRON ACER TENDL-2021 LIBRARY; T=293.6K
Neutron emission for (n,x)

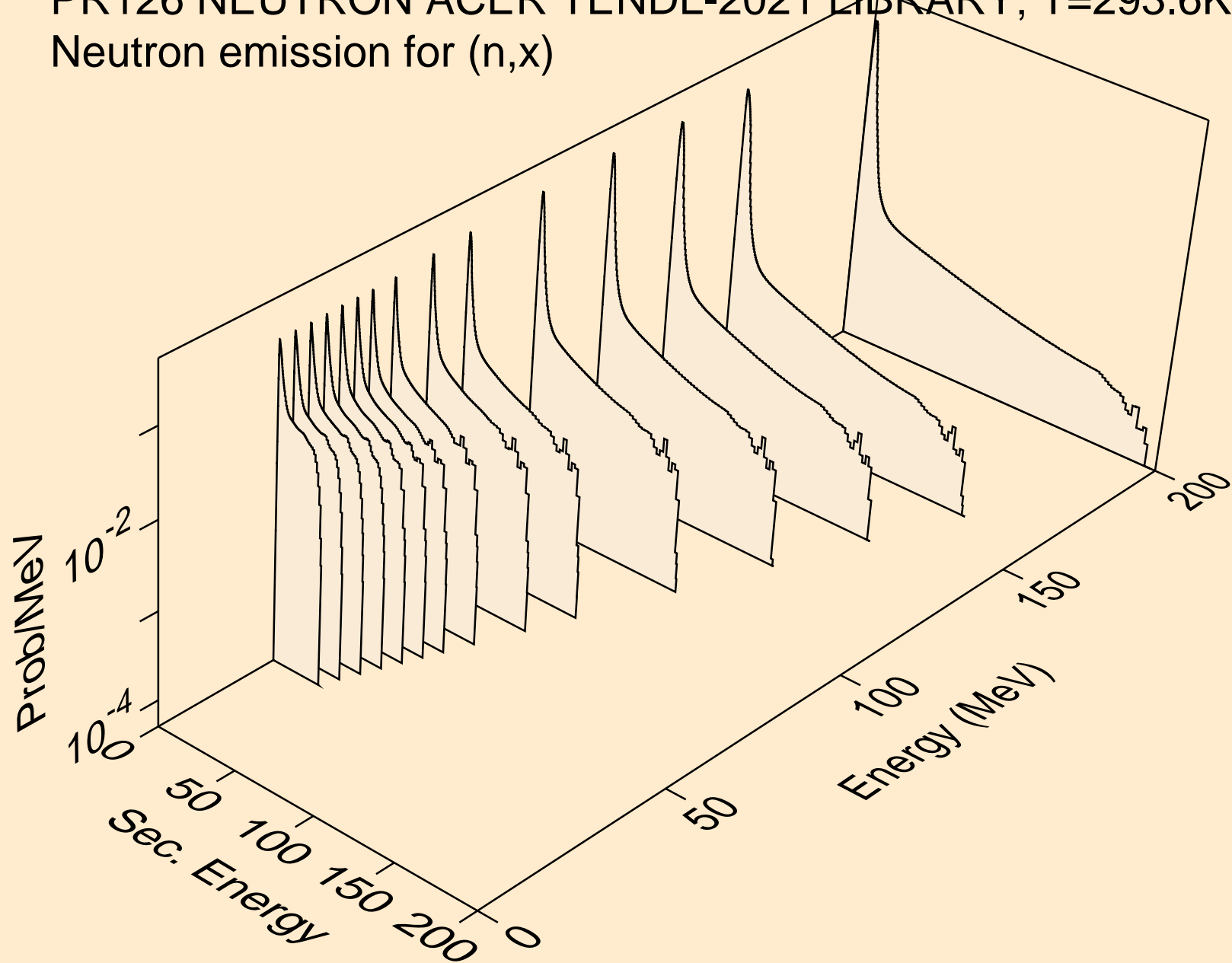

PR126 NEUTRON ACER TENDL-2021 LIBRARY; T=293.6K
Neutron emission for (n,2nd)

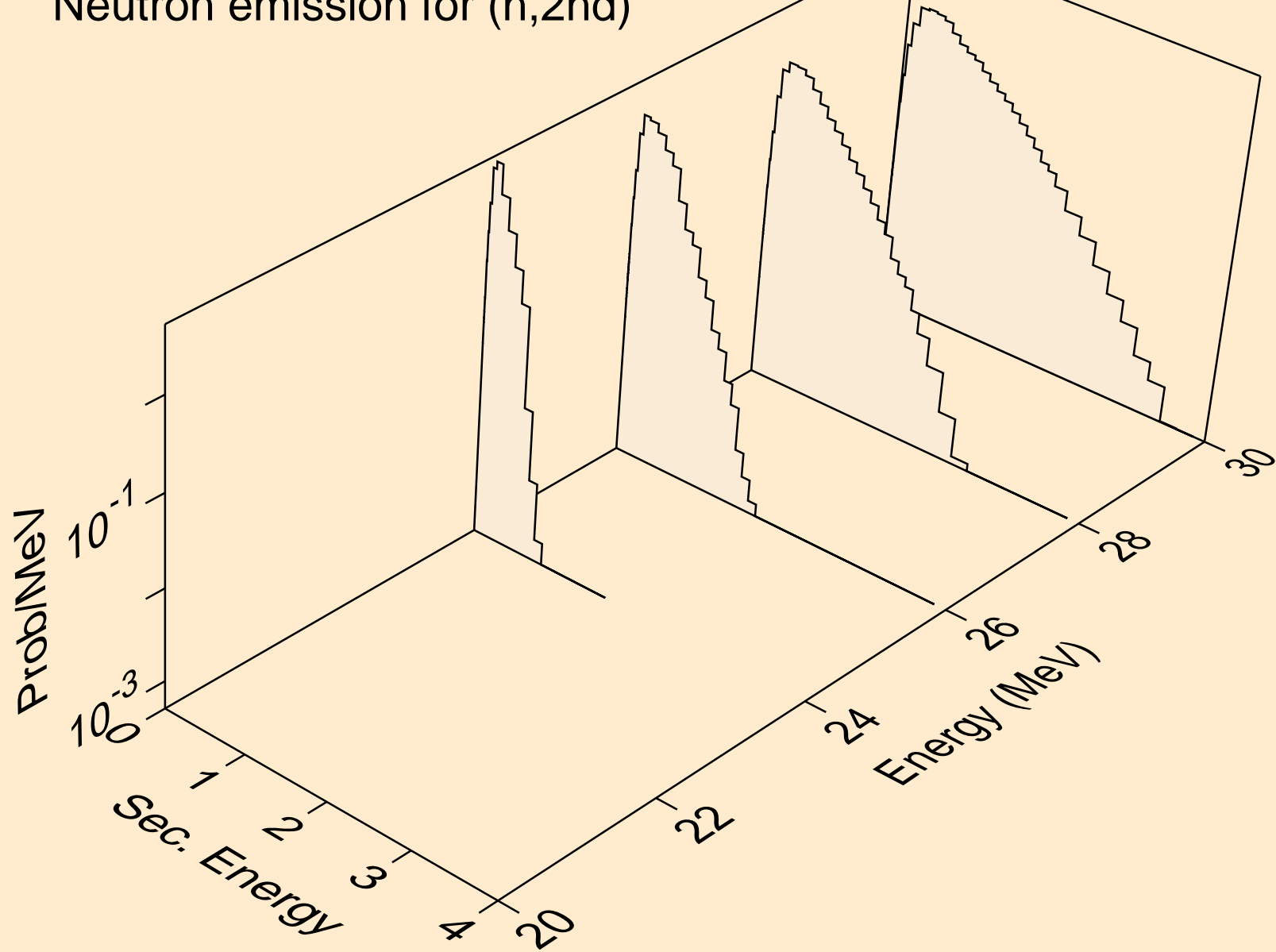

PR126 NEUTRON ACER TENDL-2021 LIBRARY; T=293.6K
Neutron emission for (n,2n)

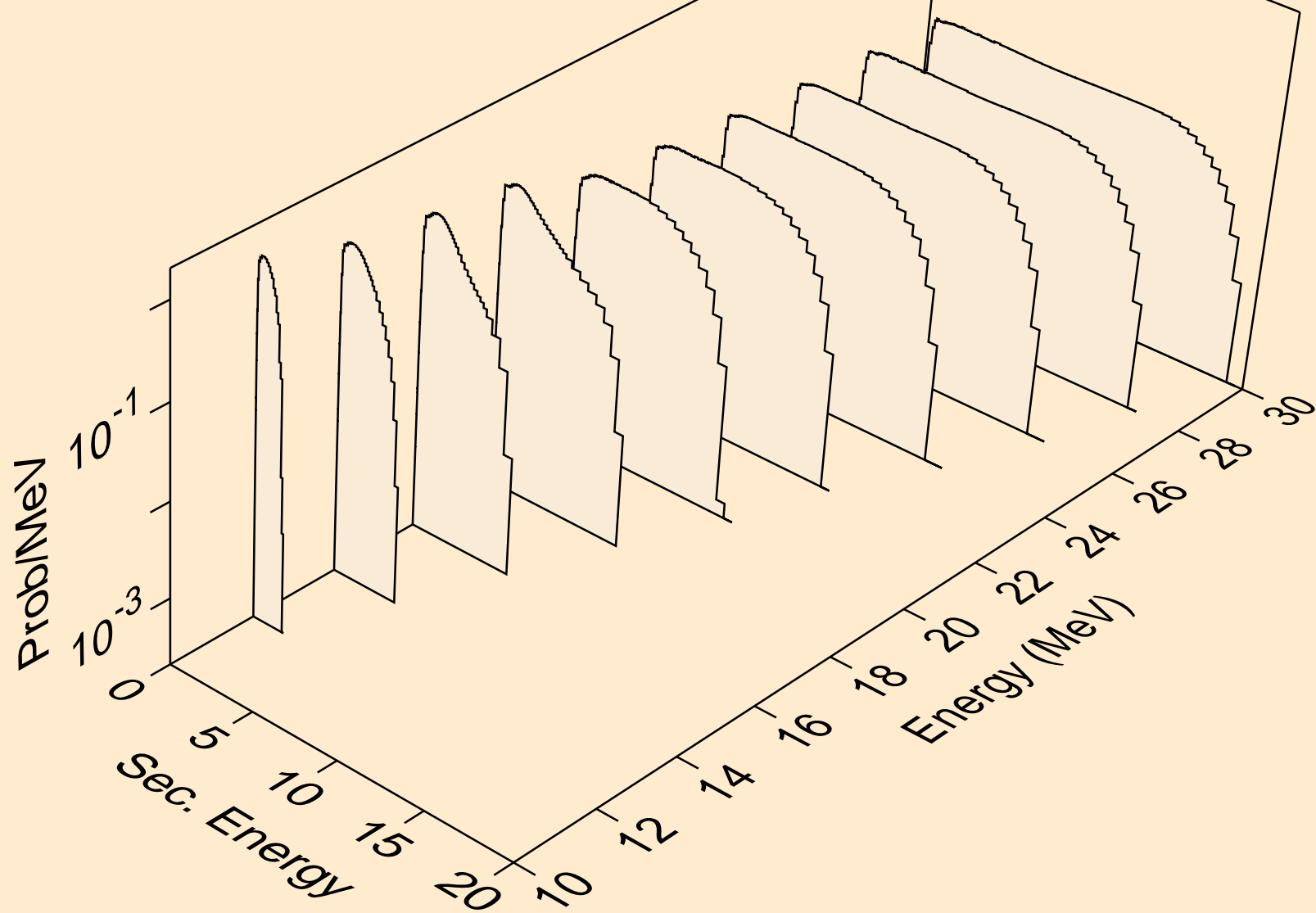

PR126 NEUTRON ACER TENDL-2021 LIBRARY; T=293.6K
Neutron emission for (n,3n)

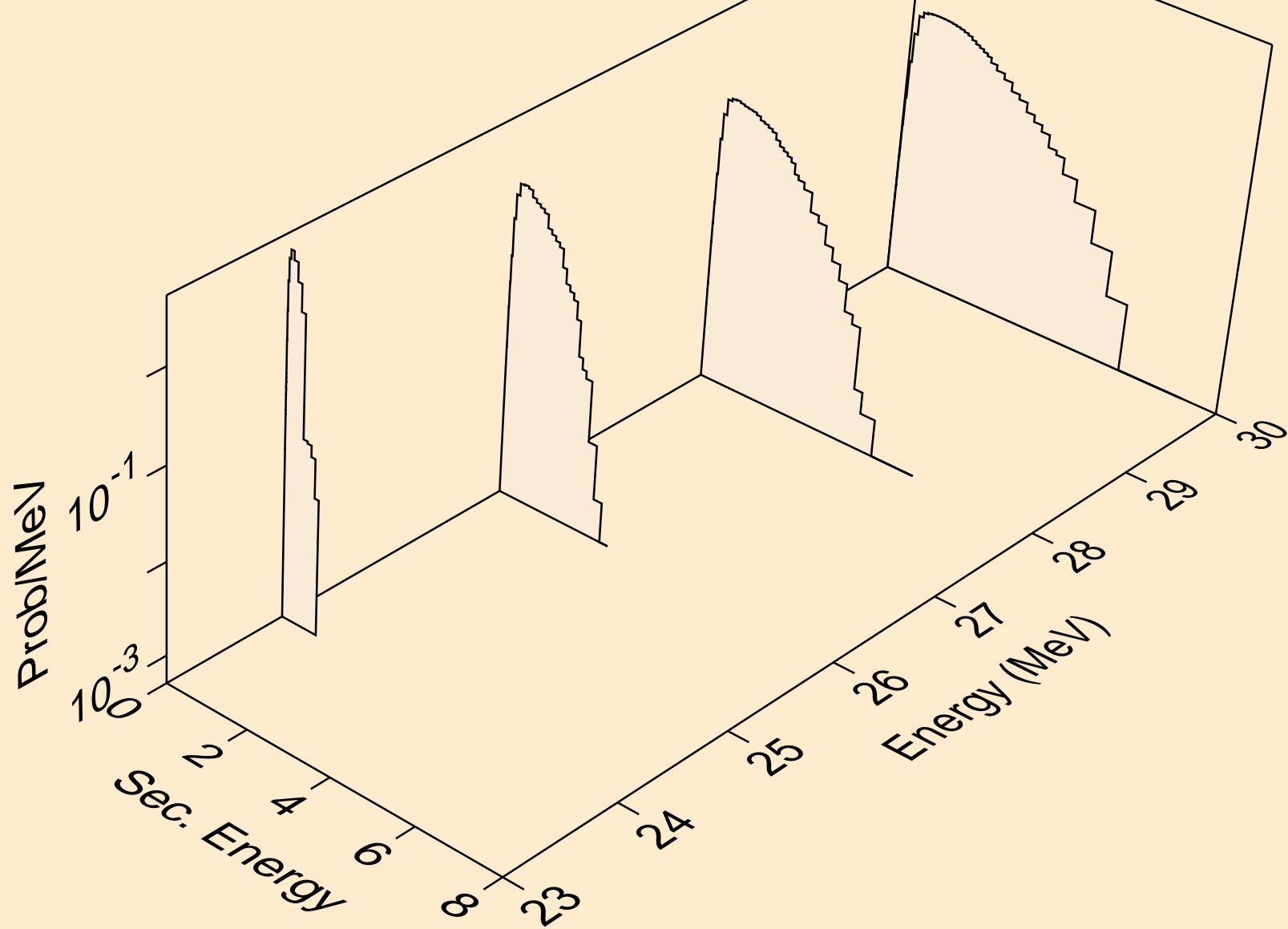

PR126 NEUTRON ACER TENDL-2021 LIBRARY; T=293.6K
Neutron emission for (n,n*)a

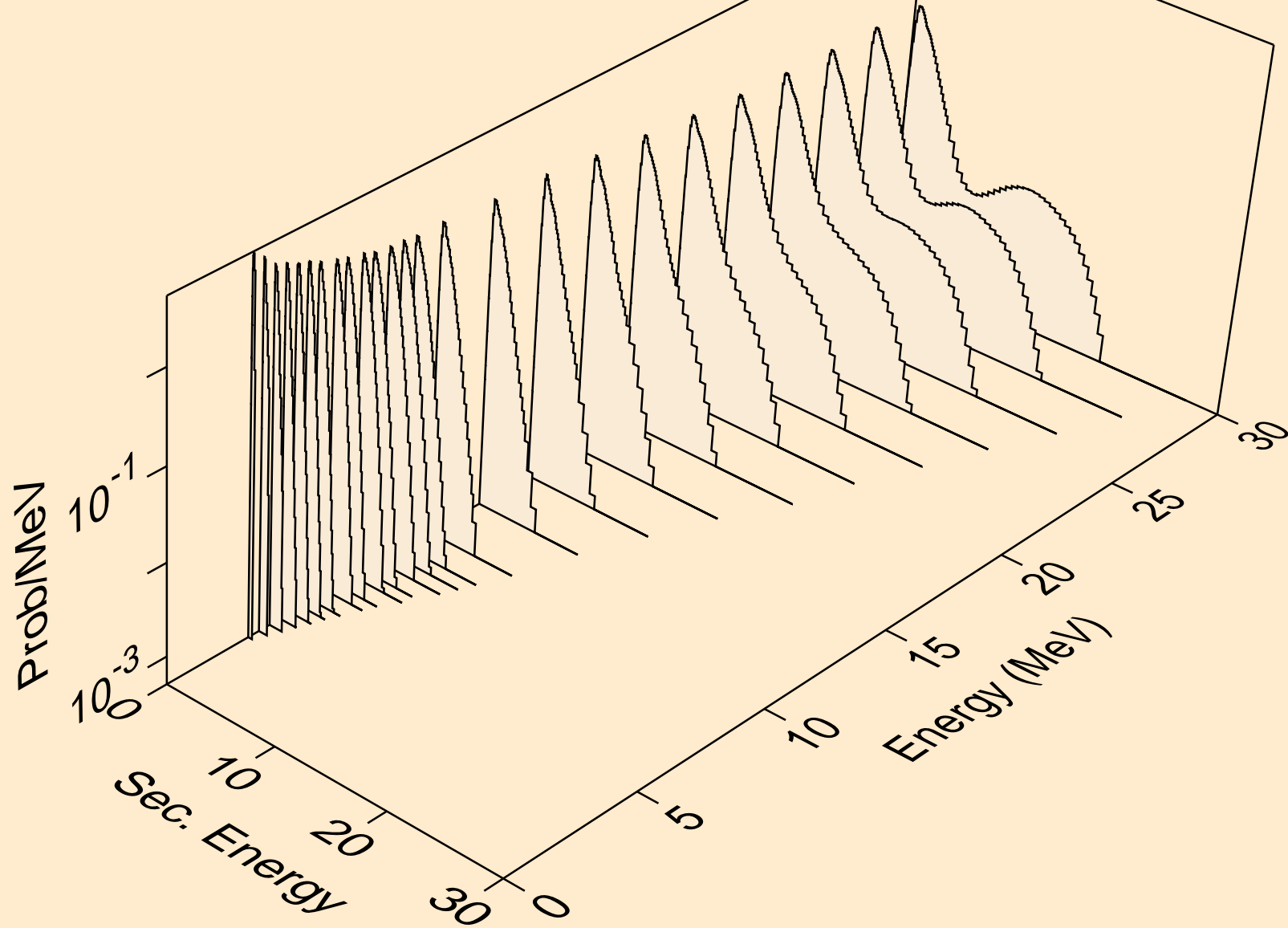

PR126 NEUTRON ACER TENDL-2021 LIBRARY; T=293.6K
Neutron emission for (n,2n)_a

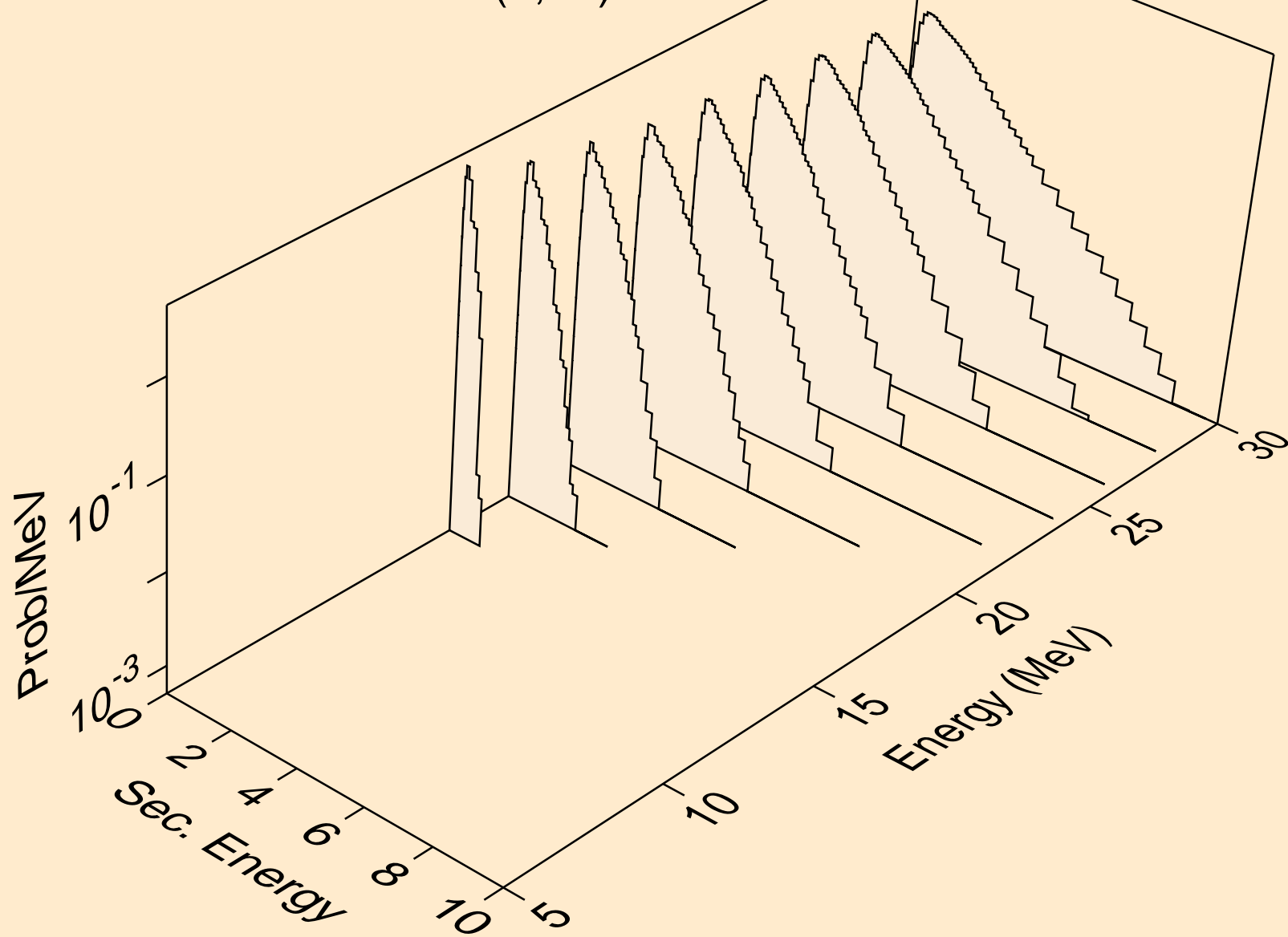

PR126 NEUTRON ACER TENDL-2021 LIBRARY; T=293.6K
Neutron emission for (n,n*)p

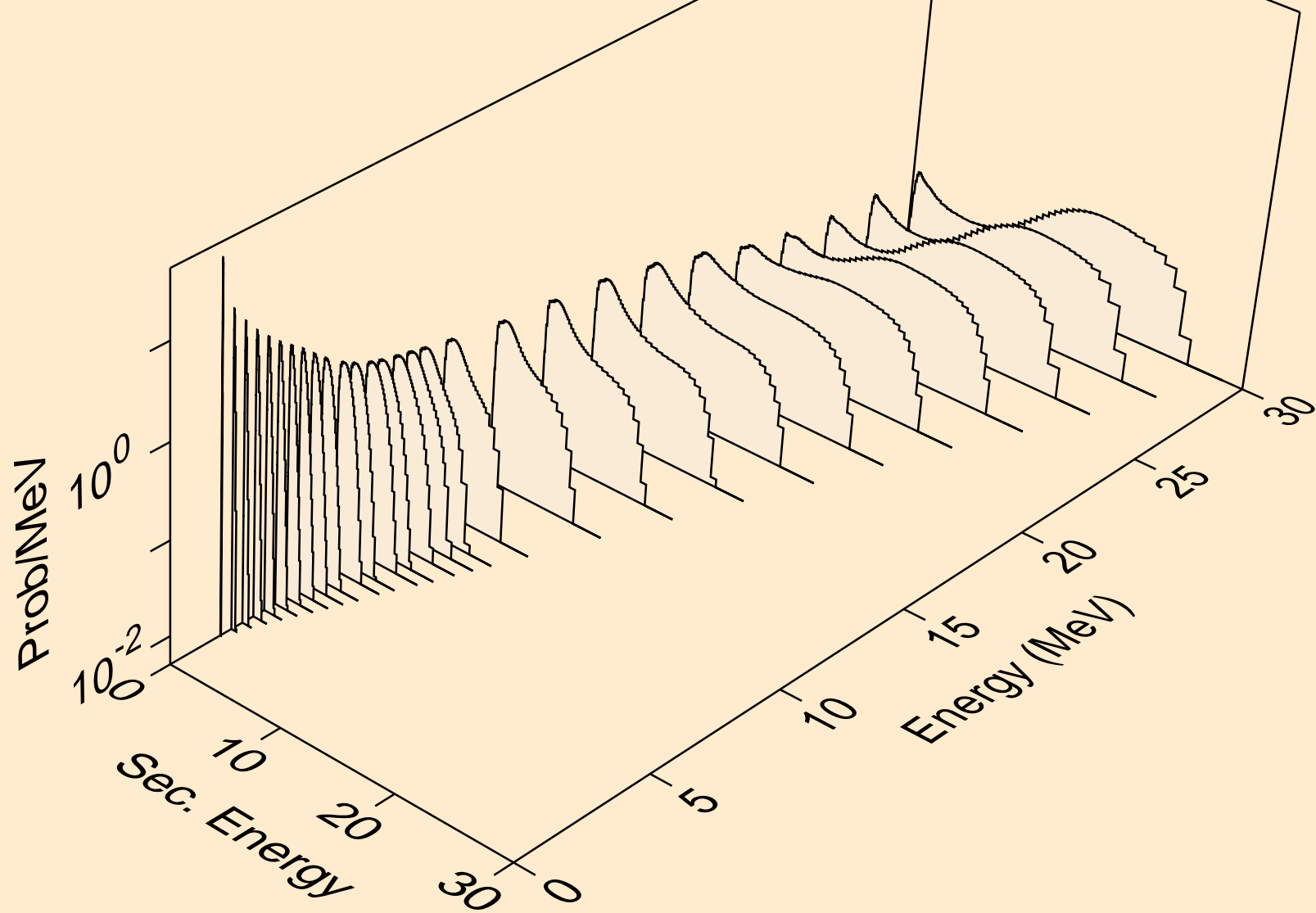

PR126 NEUTRON ACER TENDL-2021 LIBRARY; T=293.6K
Neutron emission for (n,n*)2a

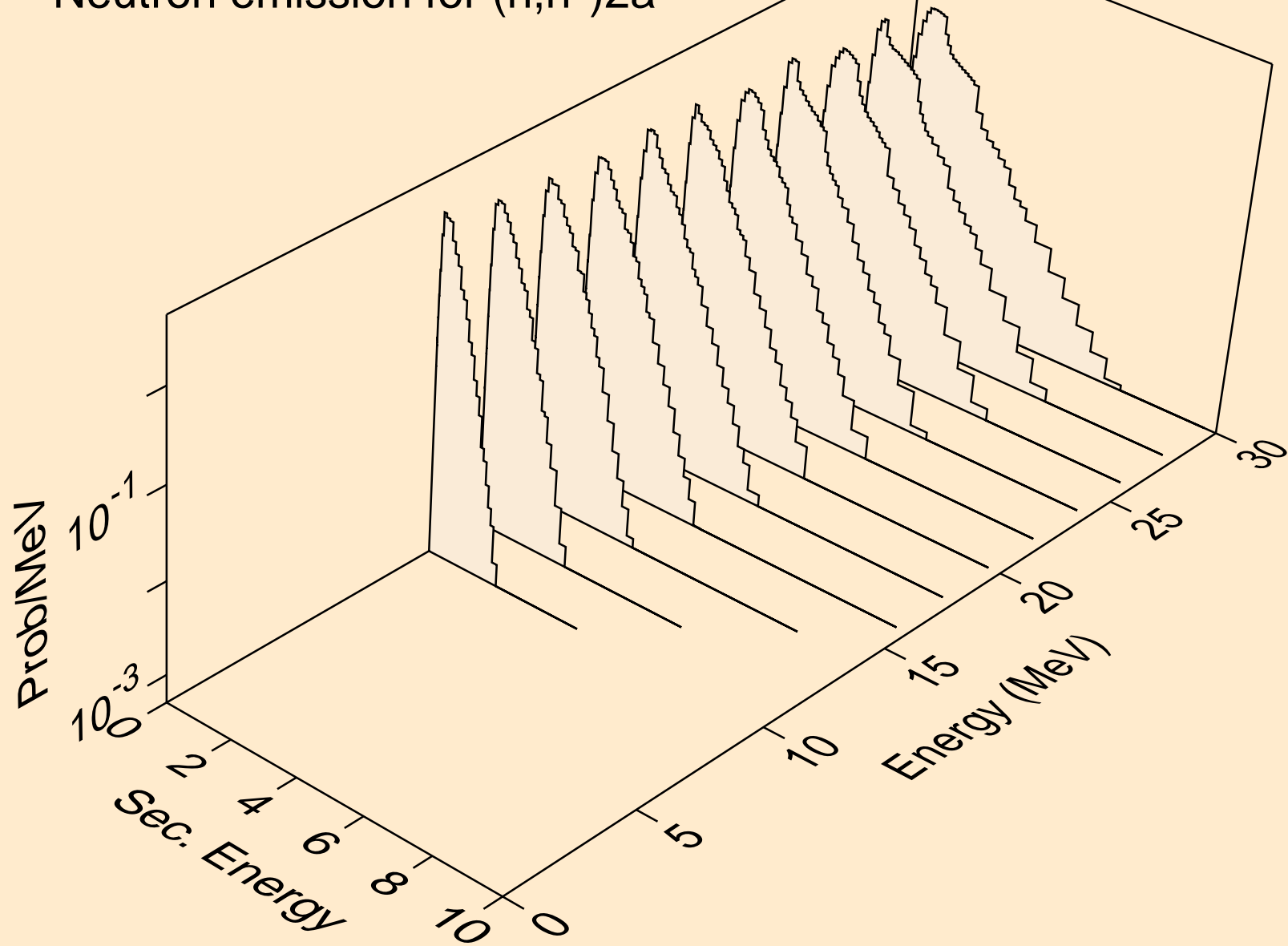

PR126 NEUTRON ACER TENDL-2021 LIBRARY; T=293.6K
Neutron emission for (n,n*)d

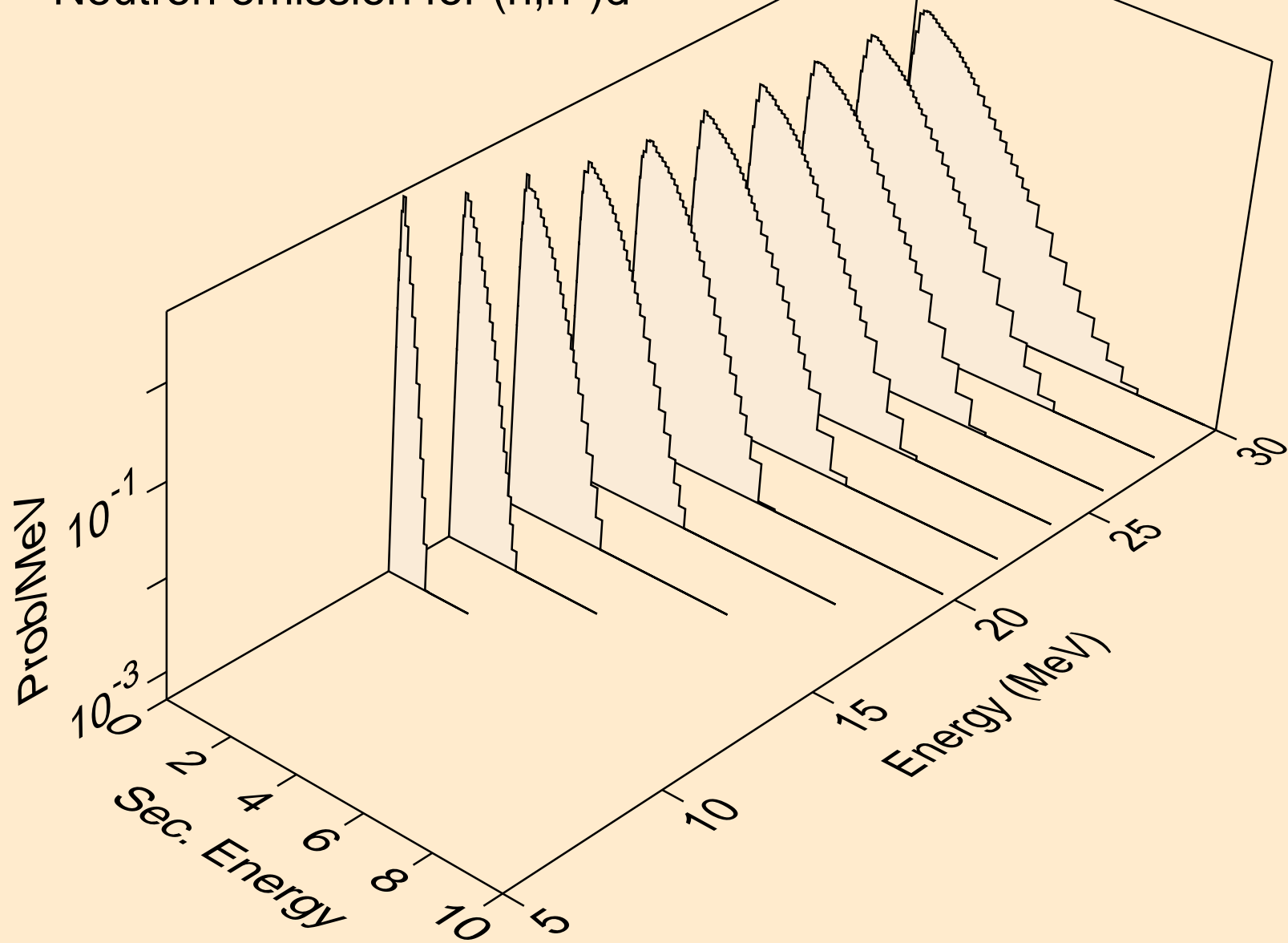

PR126 NEUTRON ACER TENDL-2021 LIBRARY; T=293.6K
Neutron emission for (n,n*)t

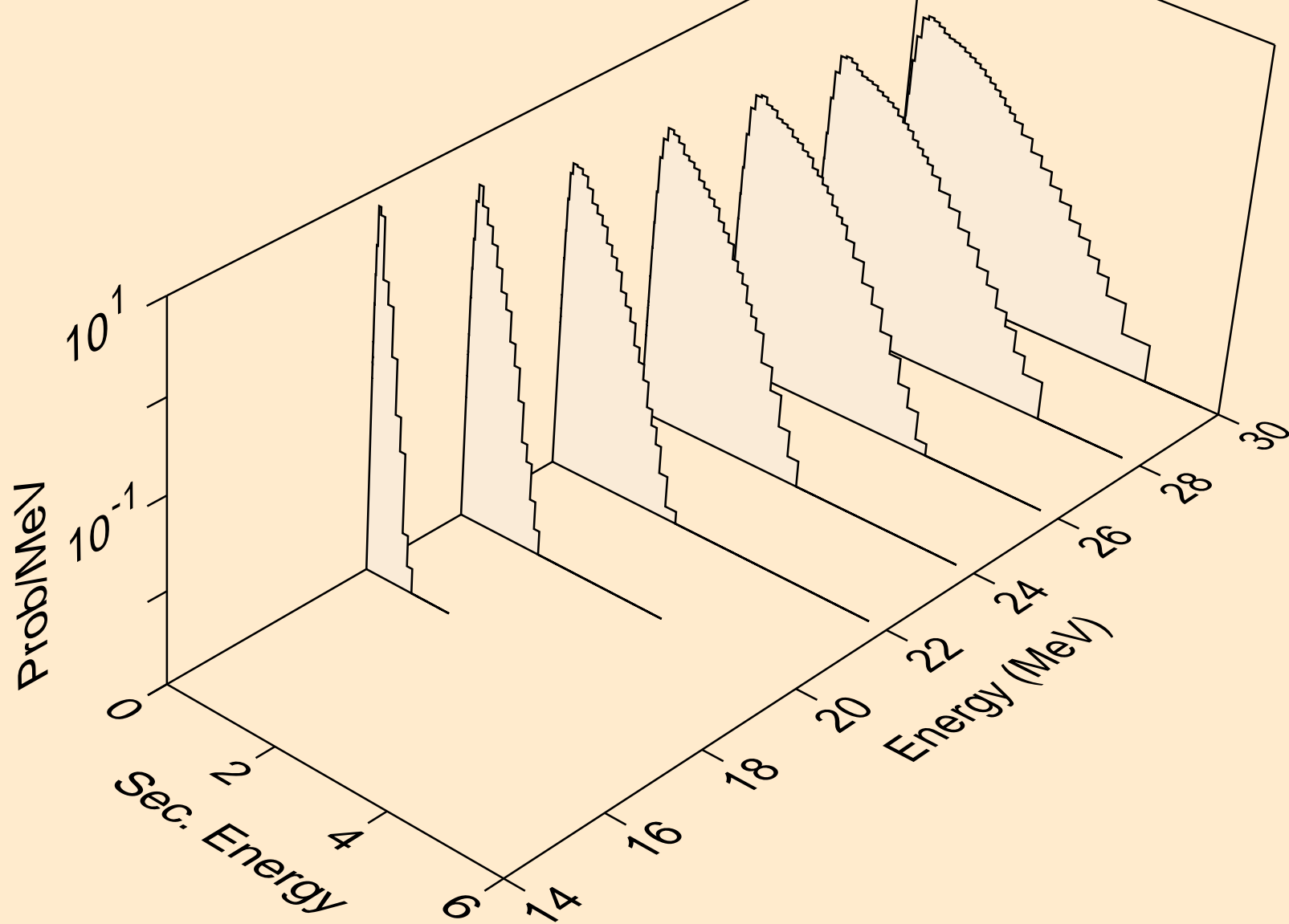

PR126 NEUTRON ACER TENDL-2021 LIBRARY; T=293.6K
Neutron emission for (n,n*)he3

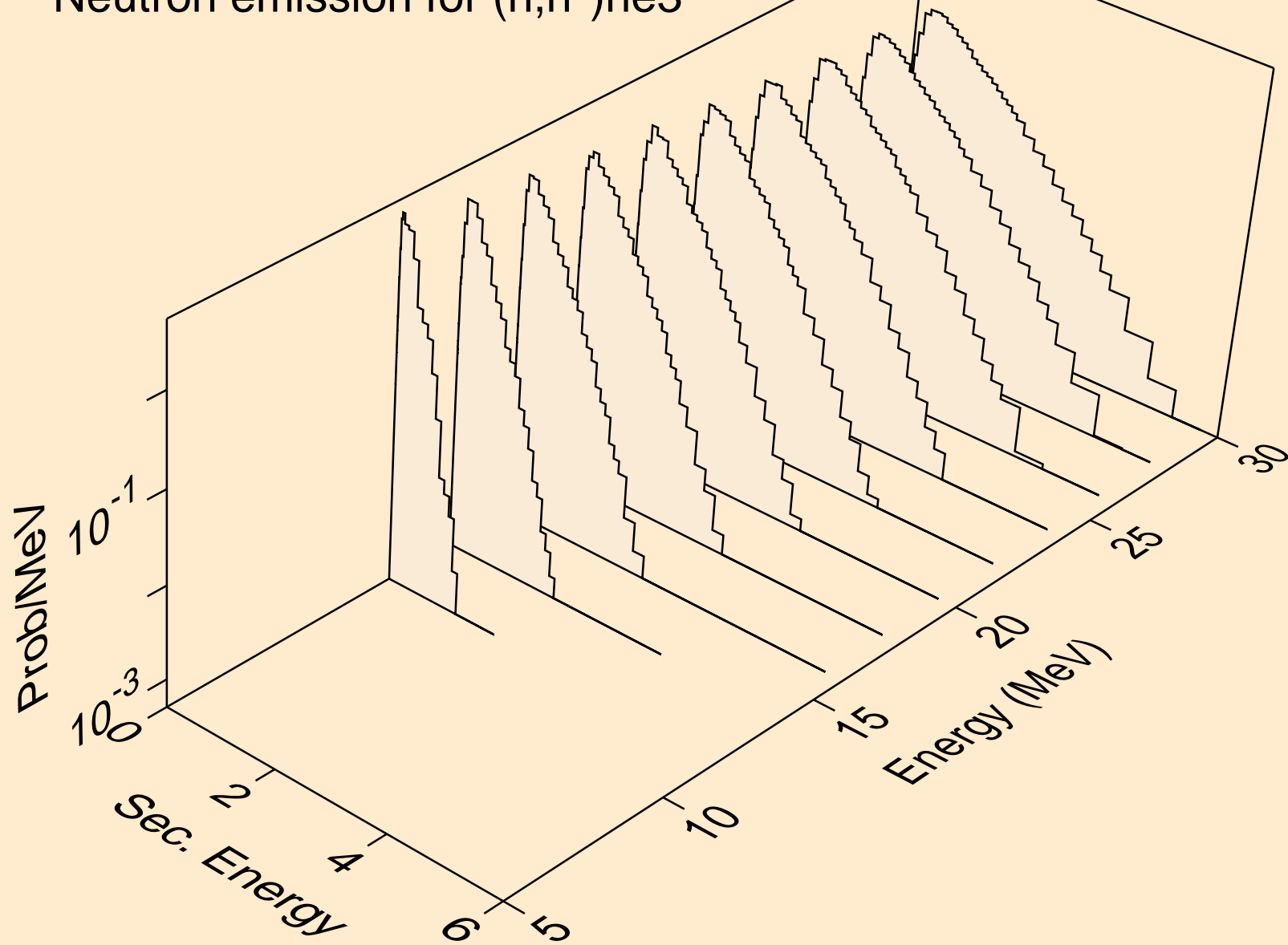

PR126 NEUTRON ACER TENDL-2021 LIBRARY; T=293.6K
Neutron emission for (n,2np)

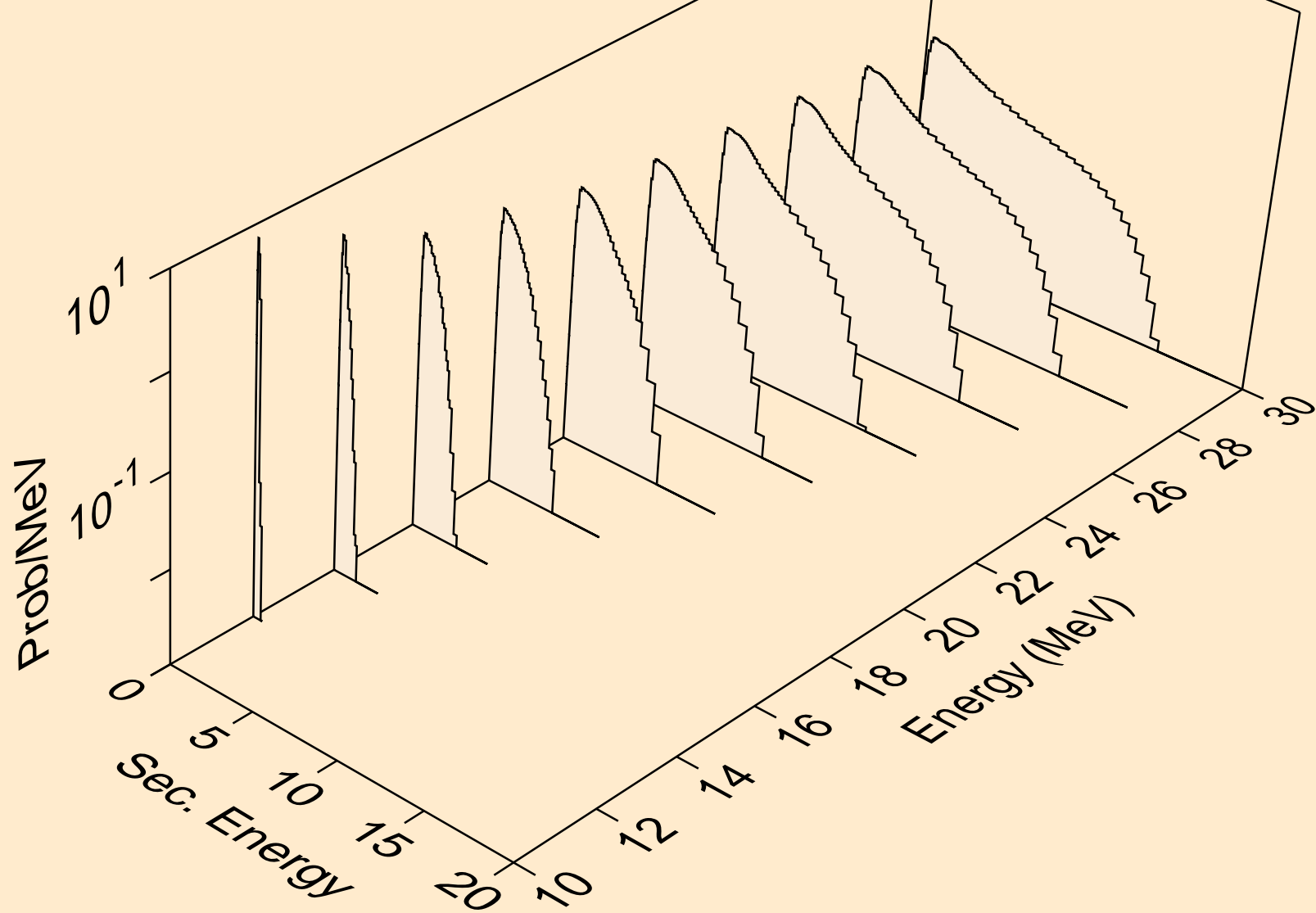

PR126 NEUTRON ACER TENDL-2021 LIBRARY; T=293.6K
Neutron emission for (n,3np)

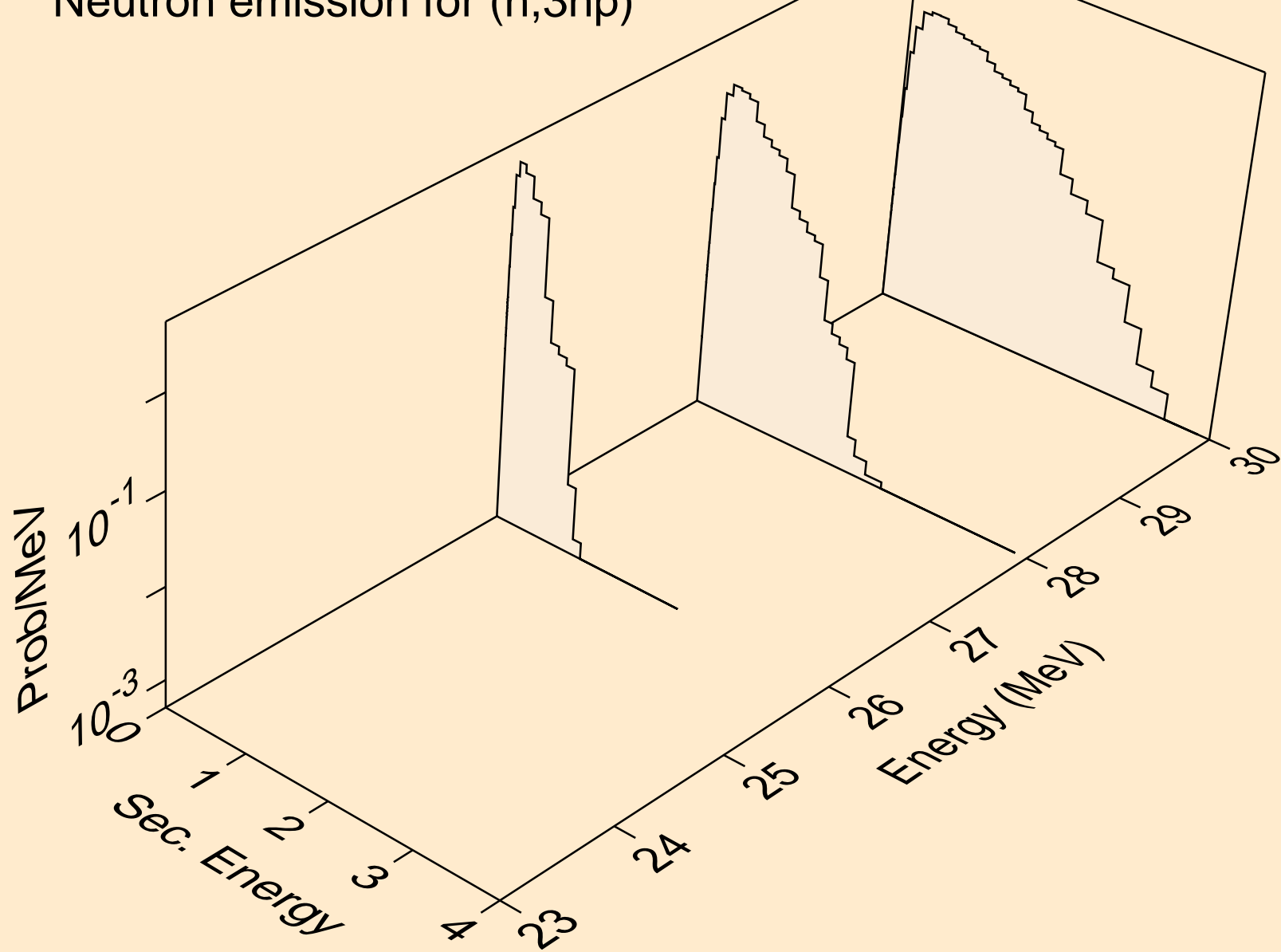

PR126 NEUTRON ACER TENDL-2021 LIBRARY; T=293.6K
Neutron emission for (n,2np)

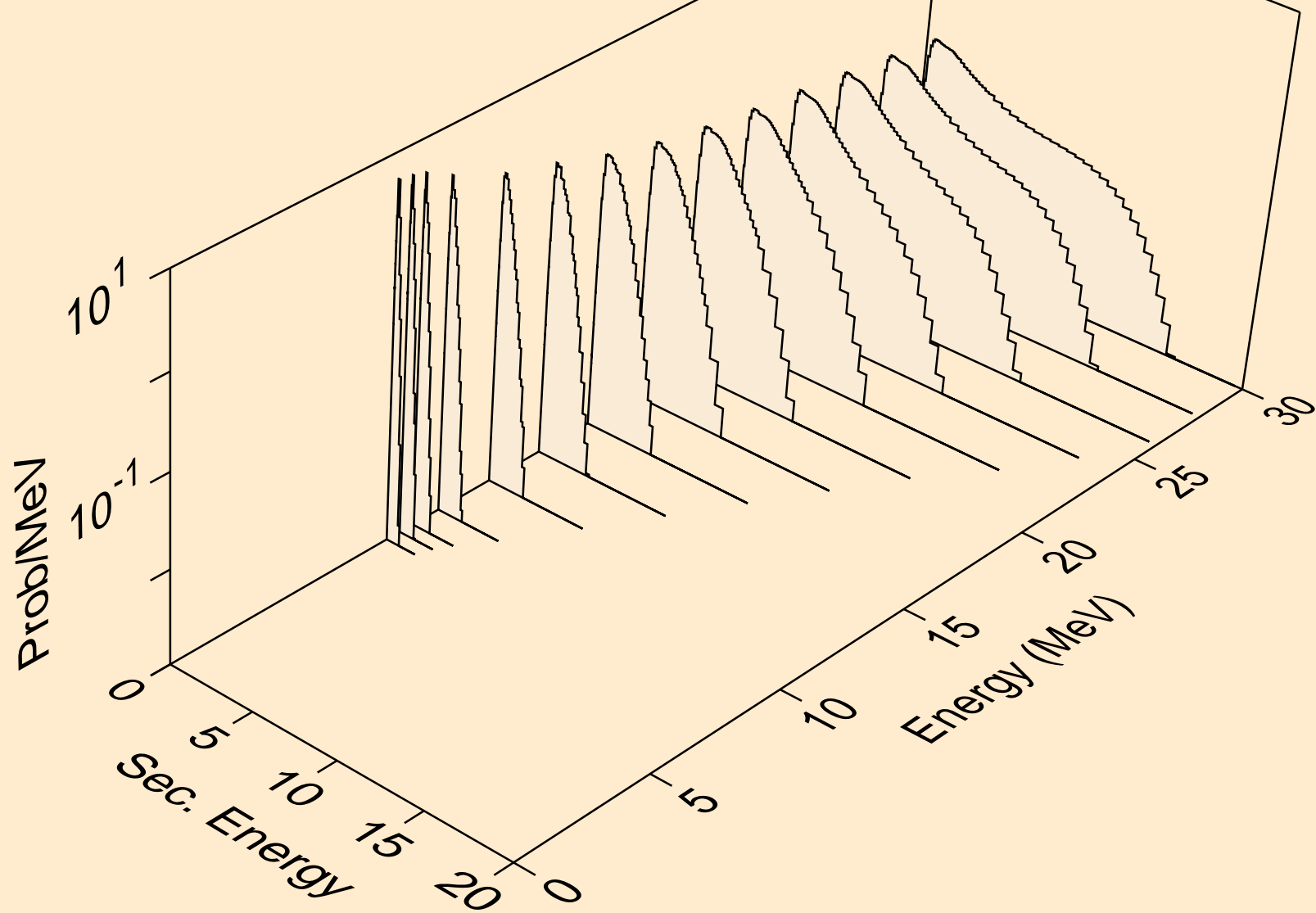

PR126 NEUTRON ACER TENDL-2021 LIBRARY; T=293.6K
Neutron emission for (n,npa)

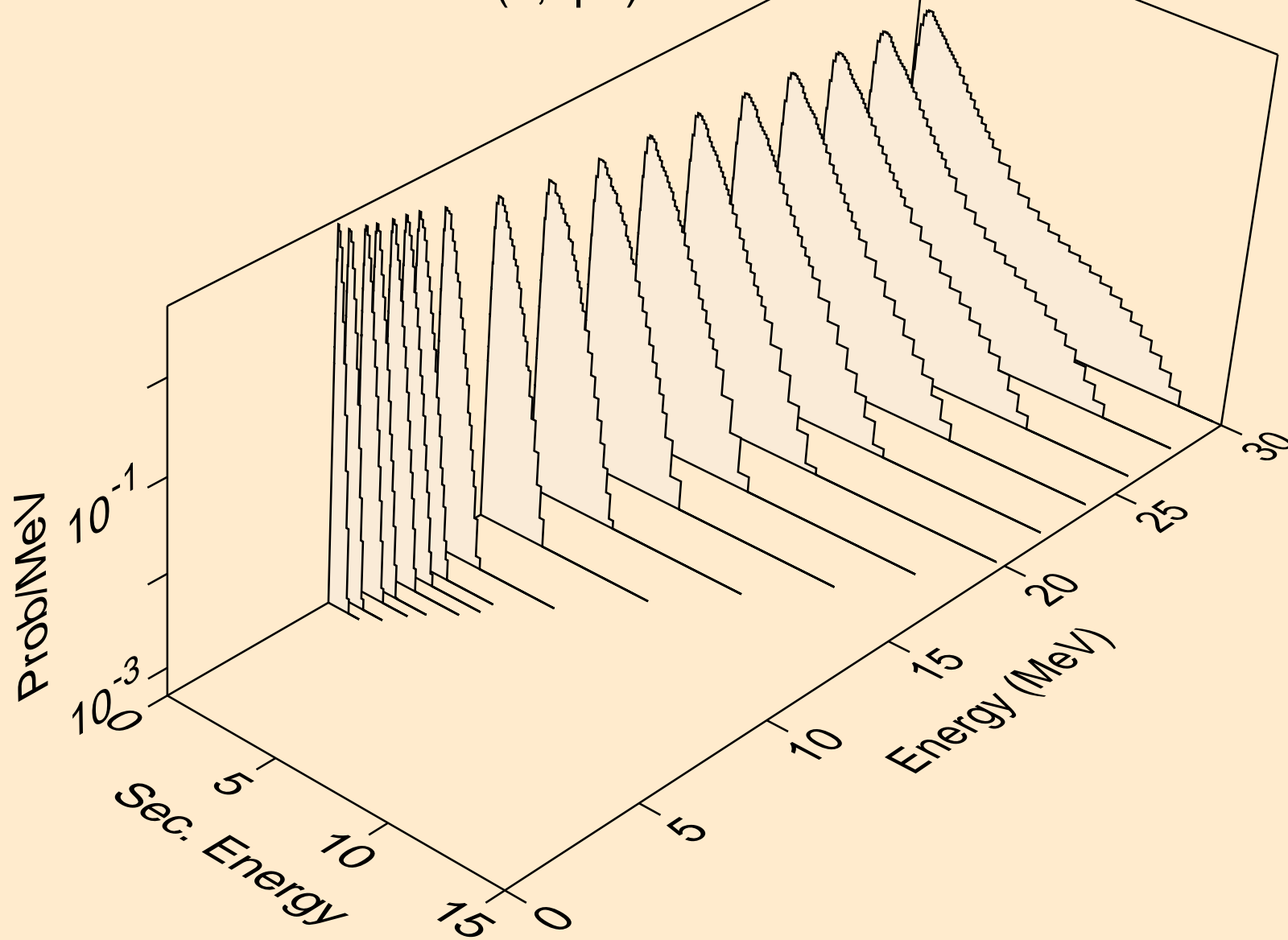

PR126 NEUTRON ACER TENDL-2021 LIBRARY; T=293.6K
Neutron emission for (n,n*c)

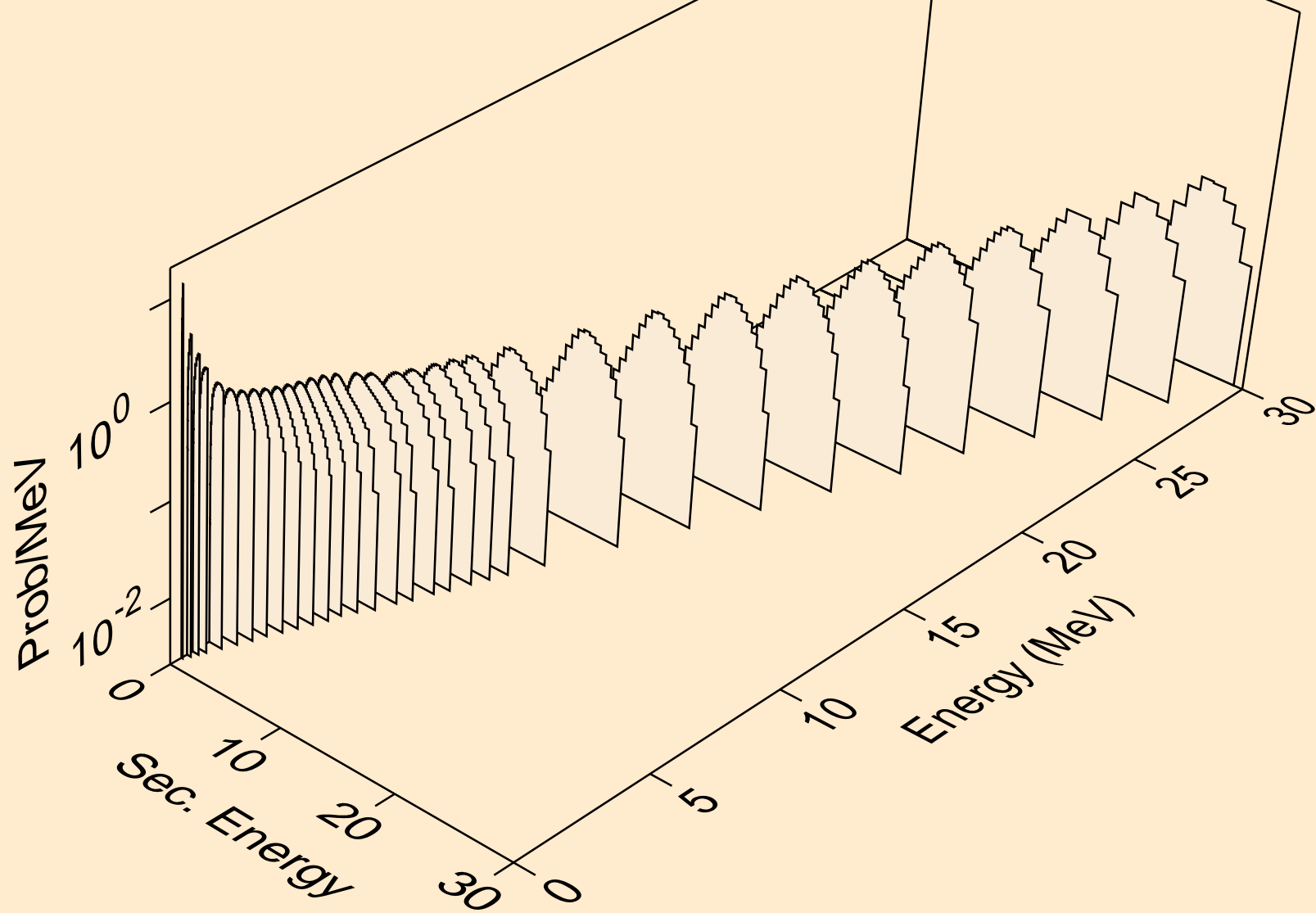

PR126 NEUTRON ACER TENDL-2021 LIBRARY; T=293.6K
Photon emission for (n,x)

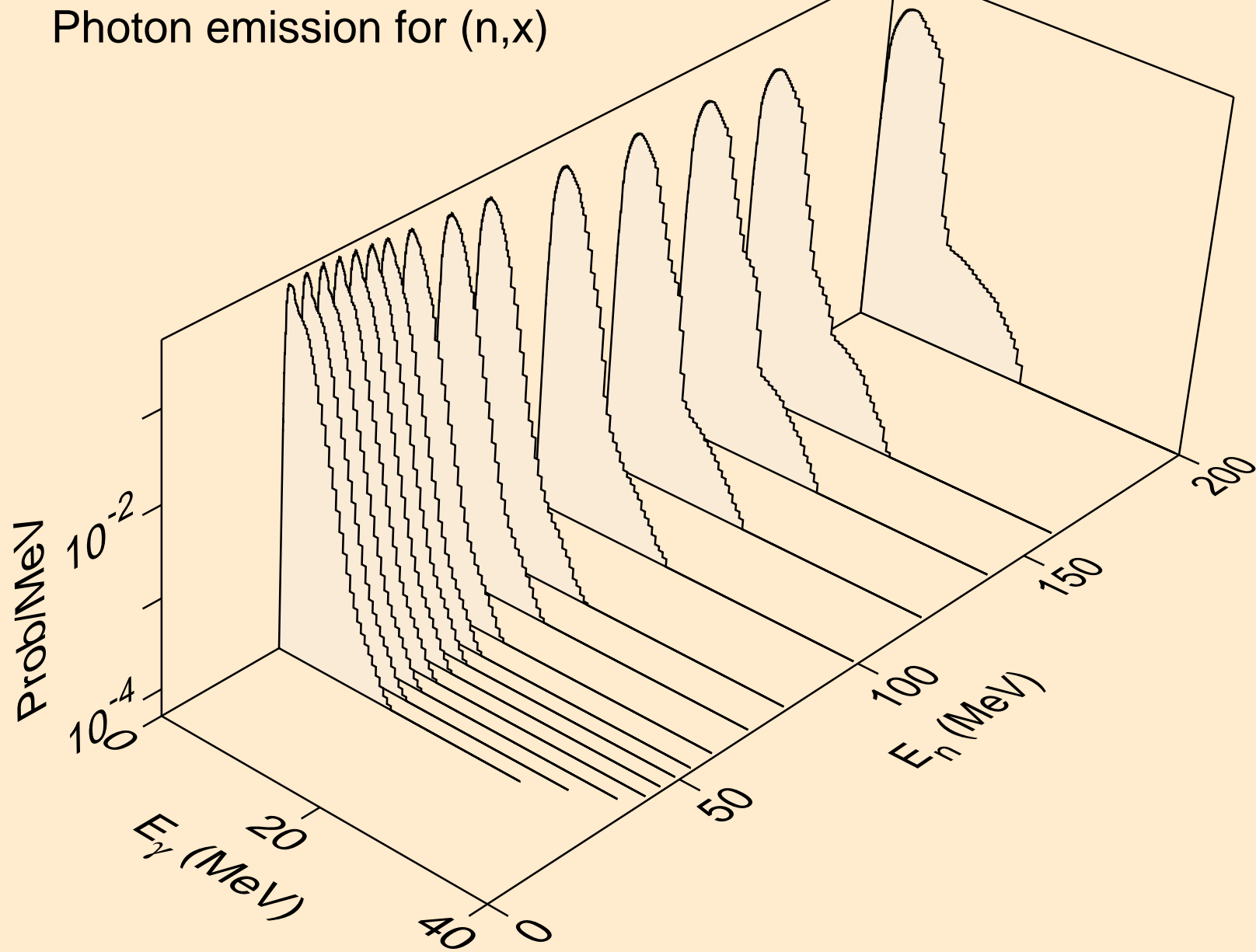

PR126 NEUTRON ACER TENDL-2021 LIBRARY; T=293.6K
Photon emission for (n,2nd)

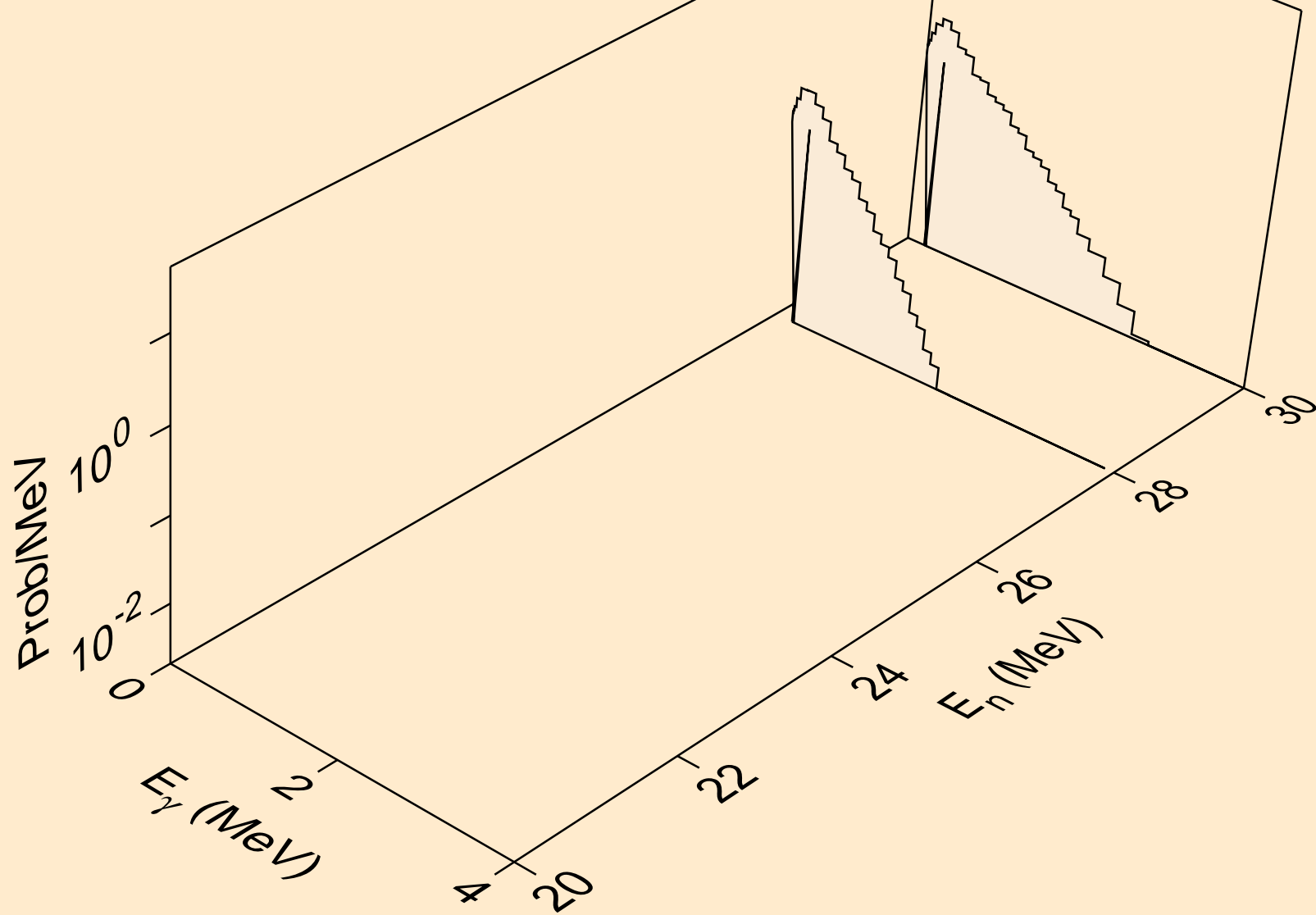

PR126 NEUTRON ACER TENDL-2021 LIBRARY; T=293.6K
Photon emission for (n,2n)

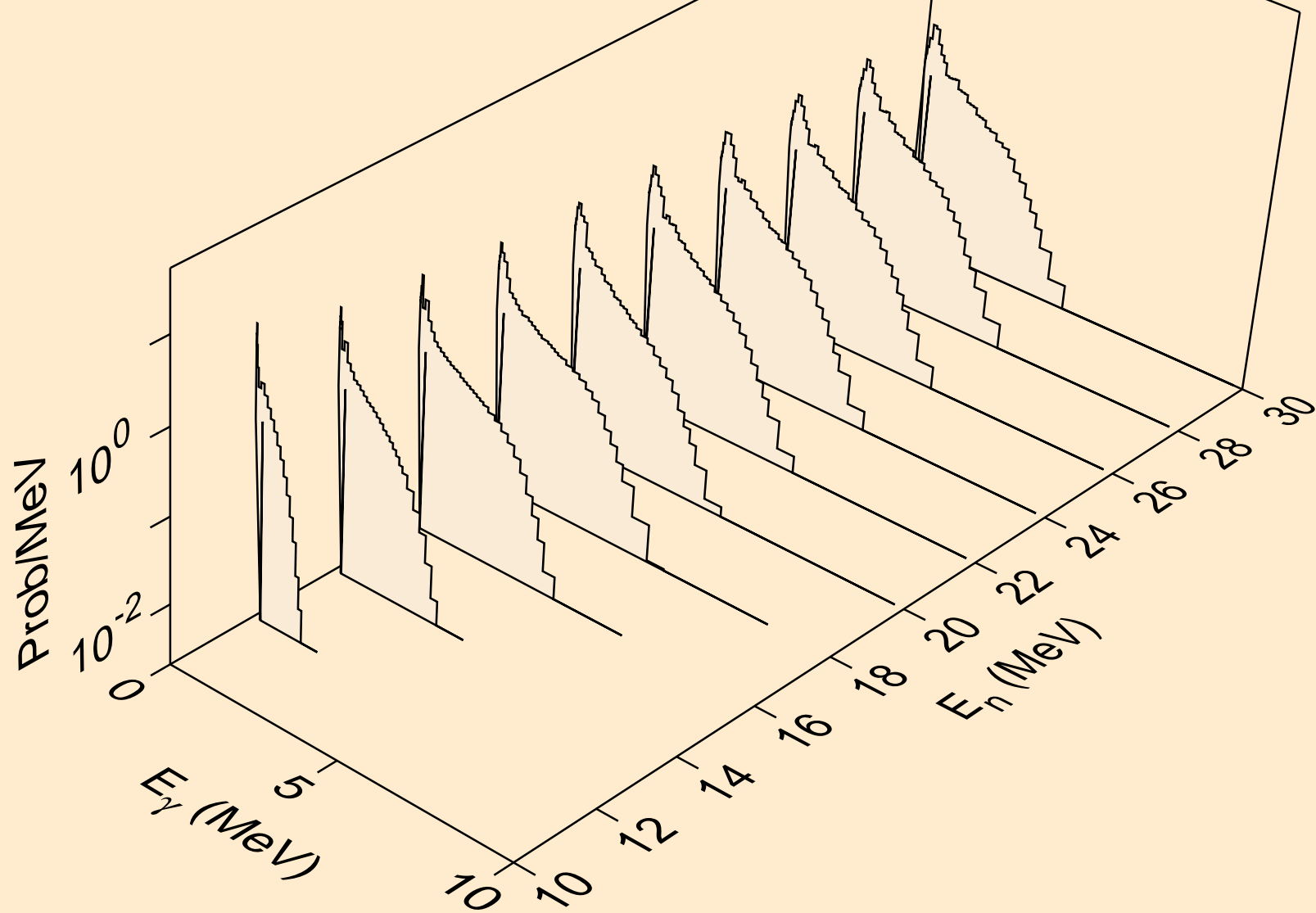

PR126 NEUTRON ACER TENDL-2021 LIBRARY; T=293.6K
Photon emission for (n,3n)

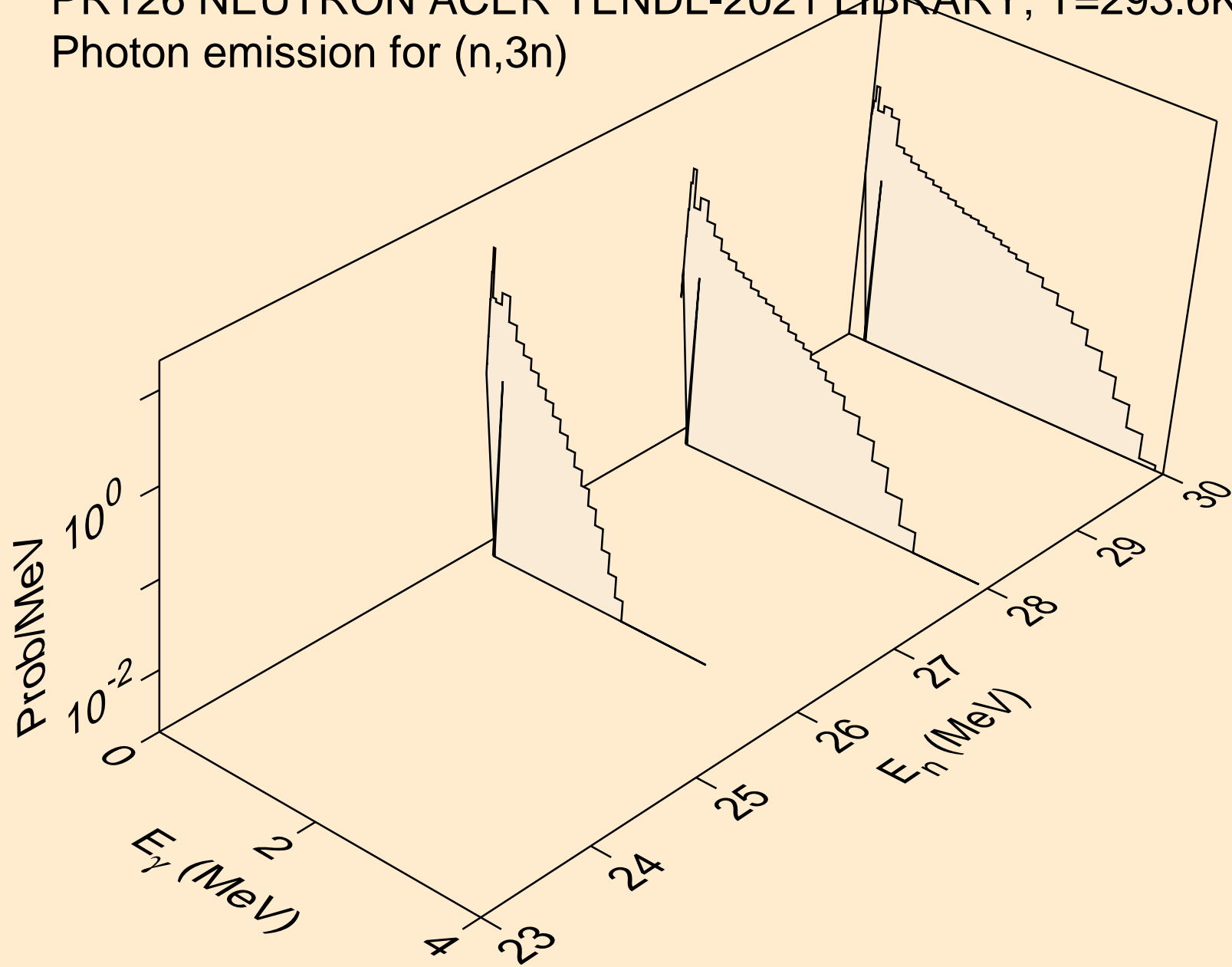

PR126 NEUTRON ACER TENDL-2021 LIBRARY; T=293.6K
Photon emission for (n,n*)a

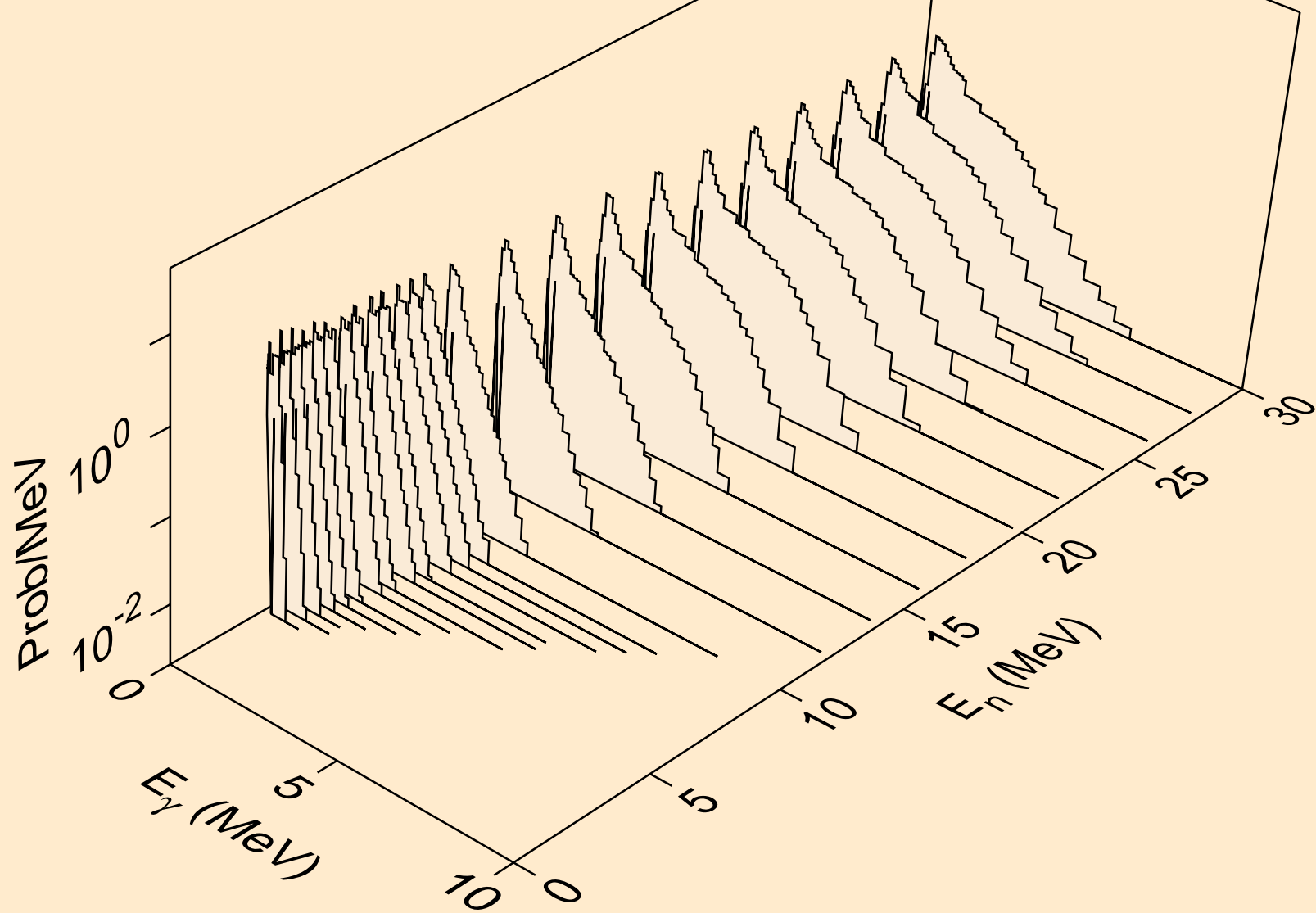

PR126 NEUTRON ACER TENDL-2021 LIBRARY; T=293.6K
Photon emission for (n,2n)a

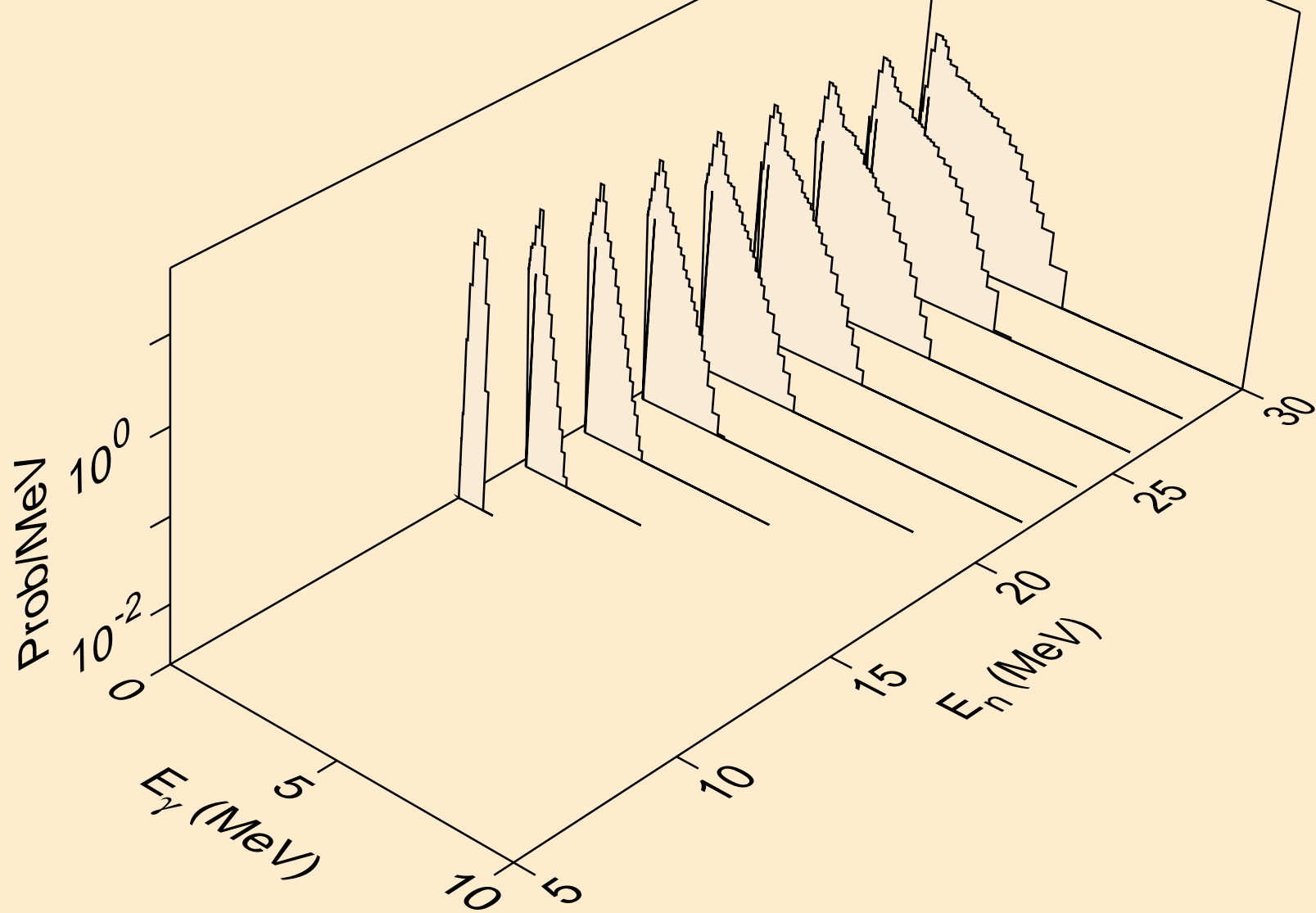

PR126 NEUTRON ACER TENDL-2021 LIBRARY; T=293.6K
Photon emission for (n,n*)p

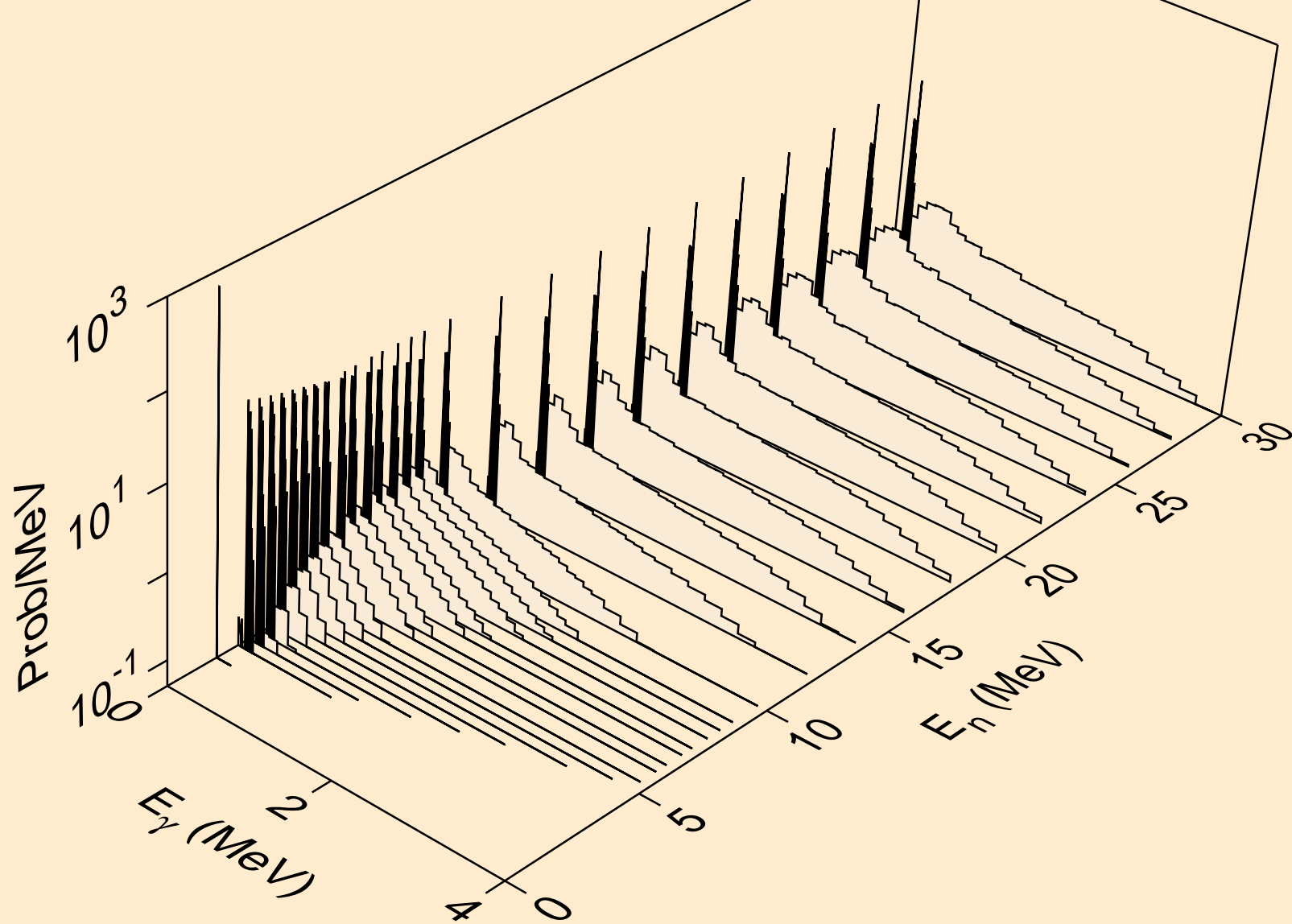

PR126 NEUTRON ACER TENDL-2021 LIBRARY; T=293.6K
Photon emission for (n,n*)2a

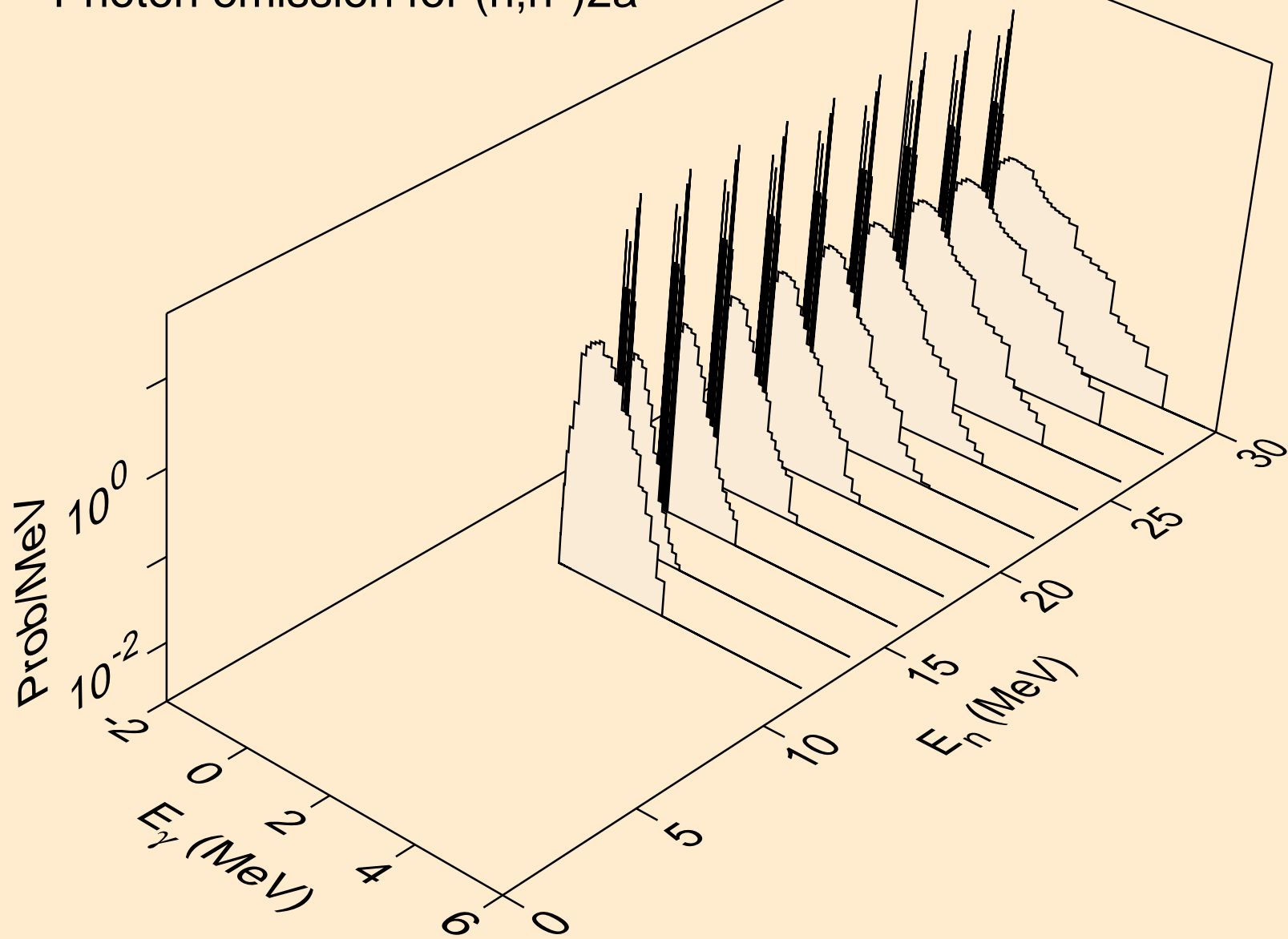

PR126 NEUTRON ACER TENDL-2021 LIBRARY; T=293.6K
Photon emission for (n,n*)d

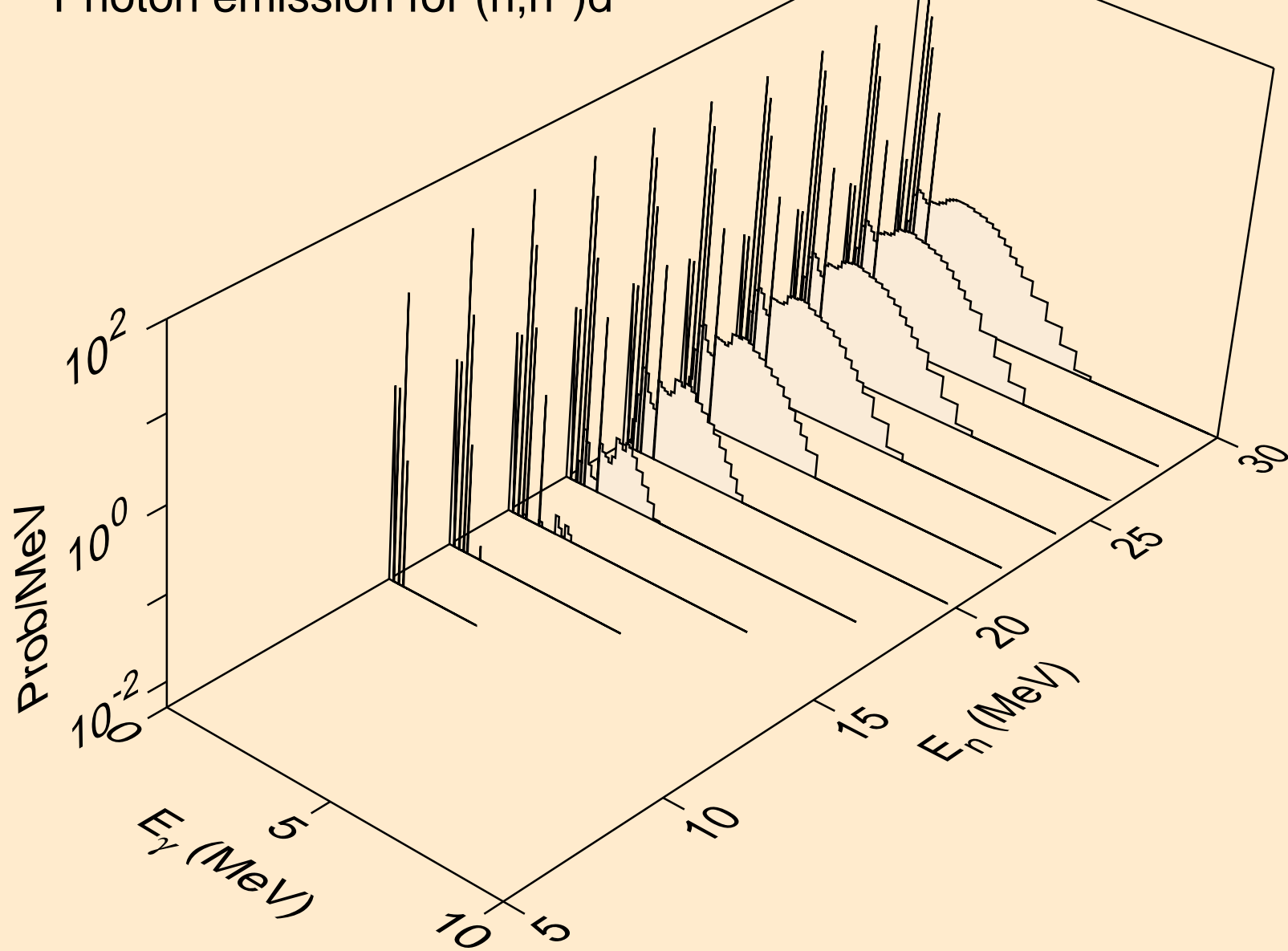

PR126 NEUTRON ACER TENDL-2021 LIBRARY; T=293.6K
Photon emission for (n,n*)t

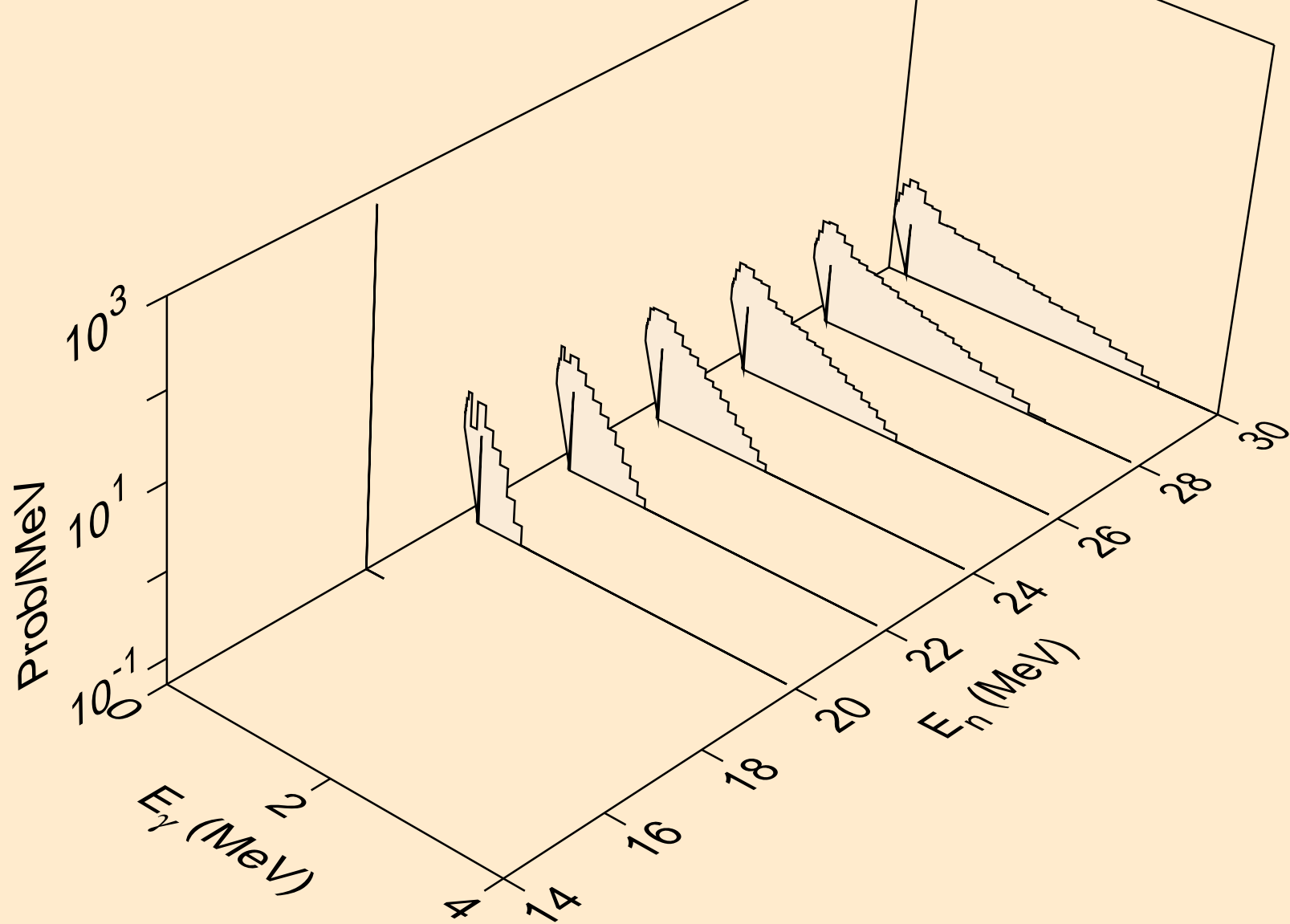

PR126 NEUTRON ACER TENDL-2021 LIBRARY; T=293.6K
Photon emission for (n,n*)he3

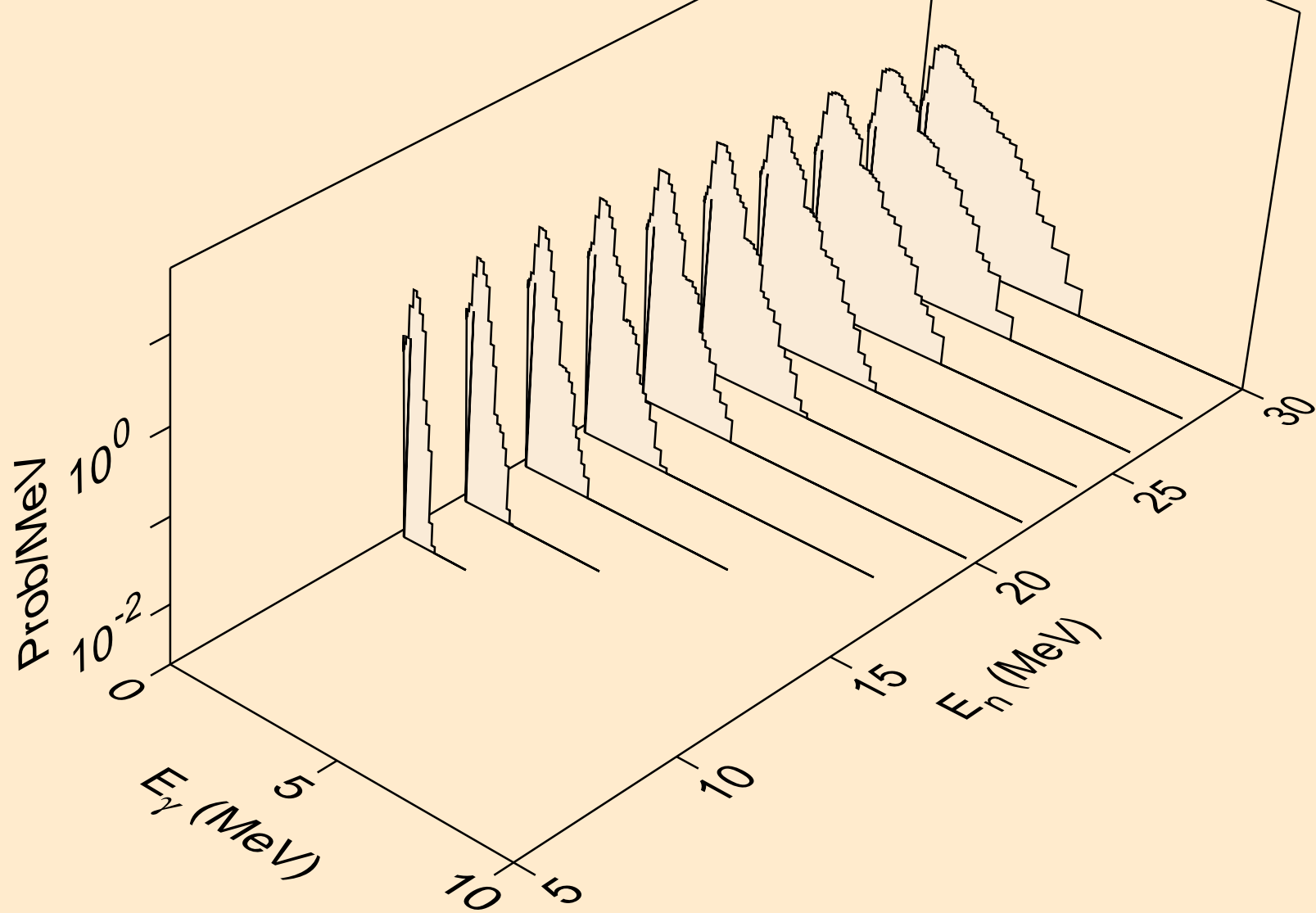

PR126 NEUTRON ACER TENDL-2021 LIBRARY; T=293.6K
Photon emission for (n,2np)

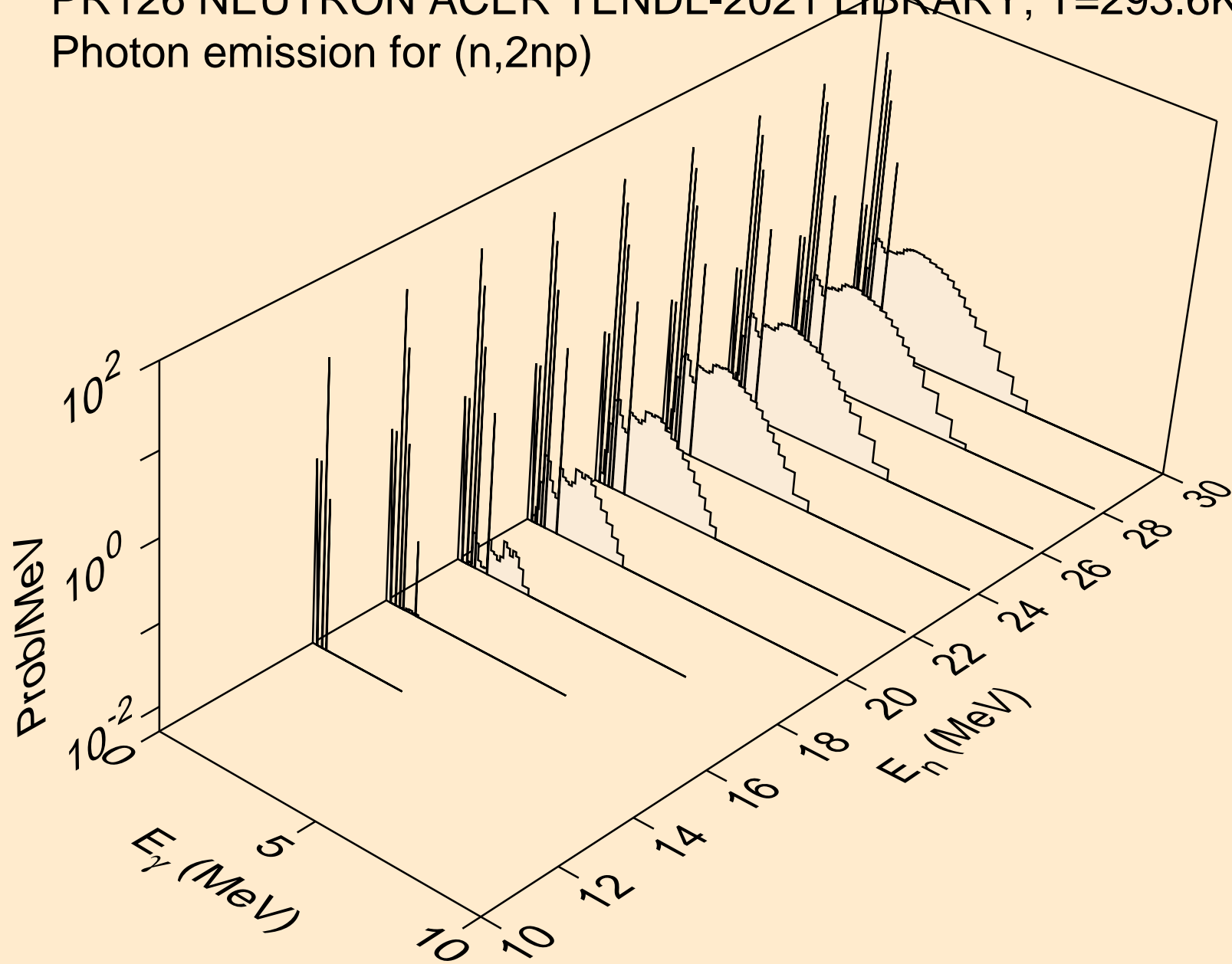

PR126 NEUTRON ACER TENDL-2021 LIBRARY; T=293.6K
Photon emission for (n,3np)

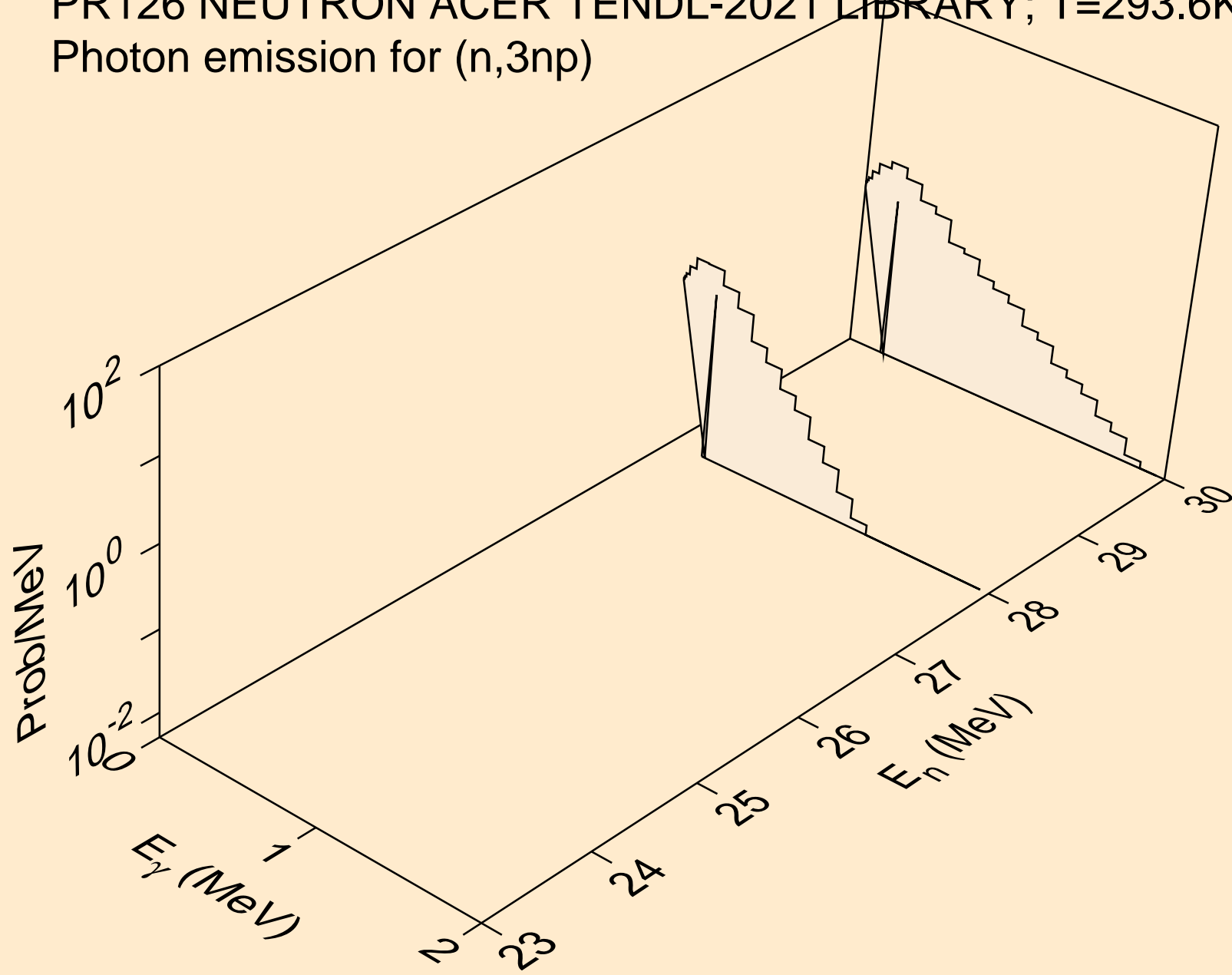

PR126 NEUTRON ACER TENDL-2021 LIBRARY; T=293.6K
Photon emission for (n,2np)

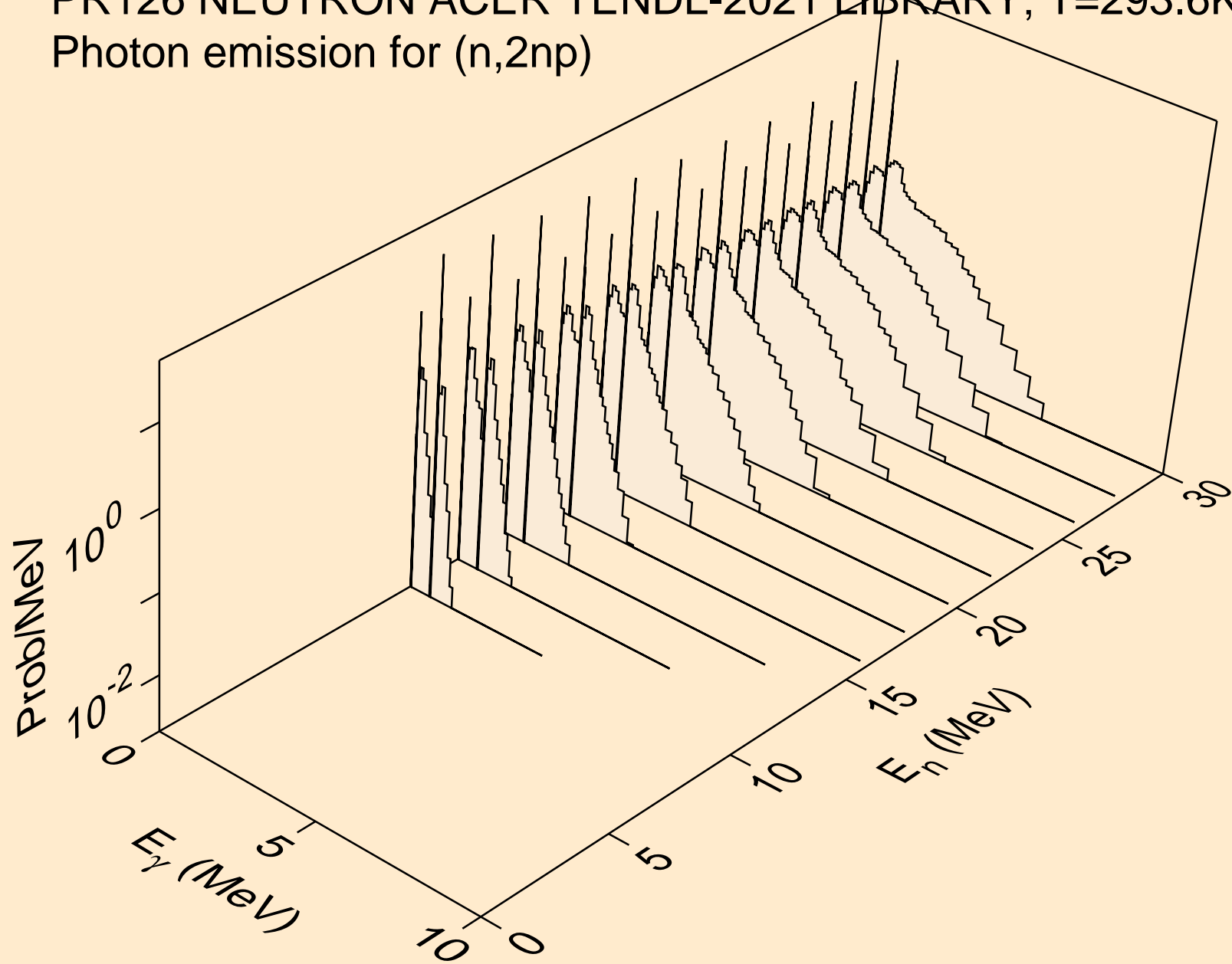

PR126 NEUTRON ACER TENDL-2021 LIBRARY; T=293.6K
Photon emission for (n,npa)

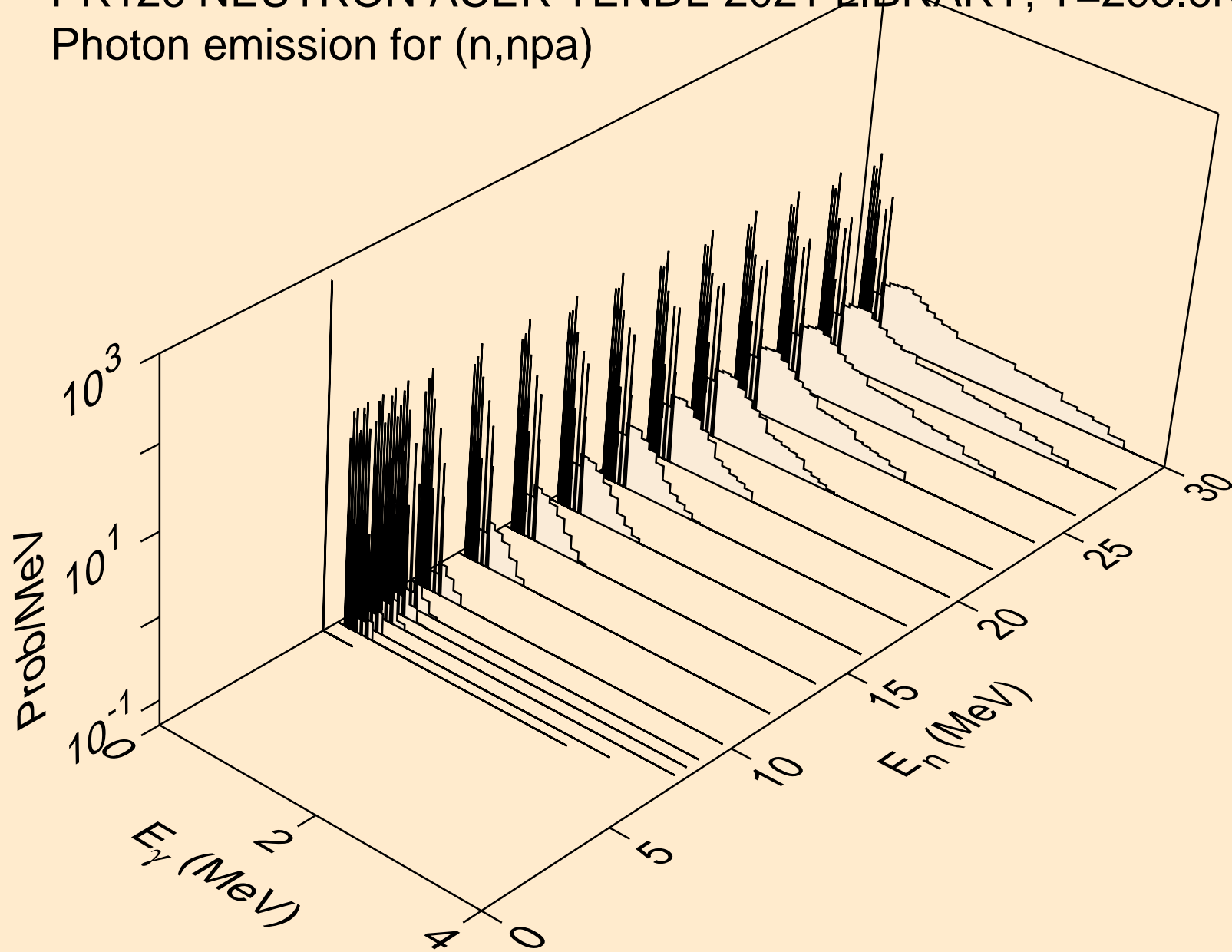

PR126 NEUTRON ACER TENDL-2021 LIBRARY; T=293.6K
Photon emission for (n,n*c)

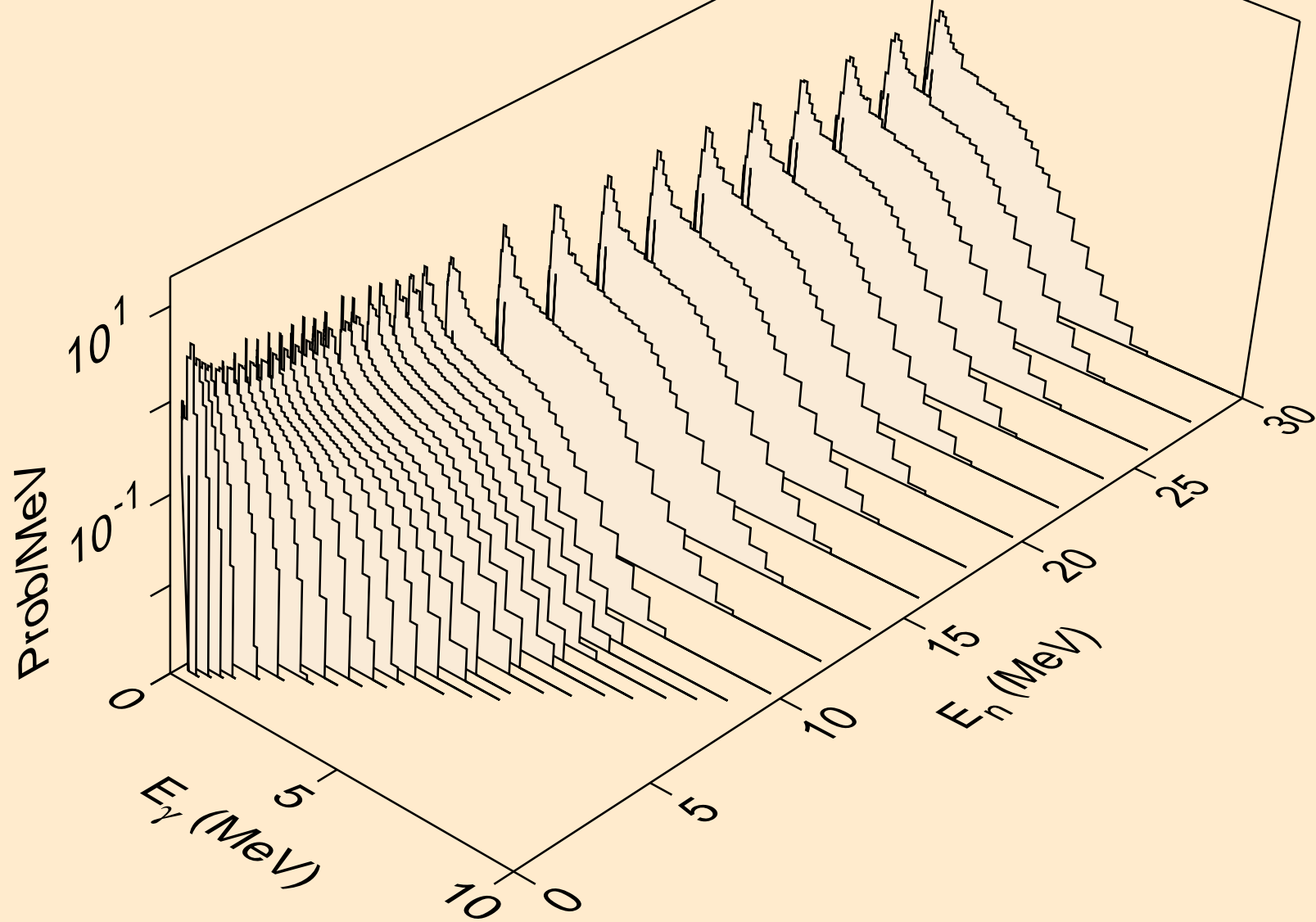

PR126 NEUTRON ACER TENDL-2021 LIBRARY; T=293.6K
Photon emission for (n,gma)

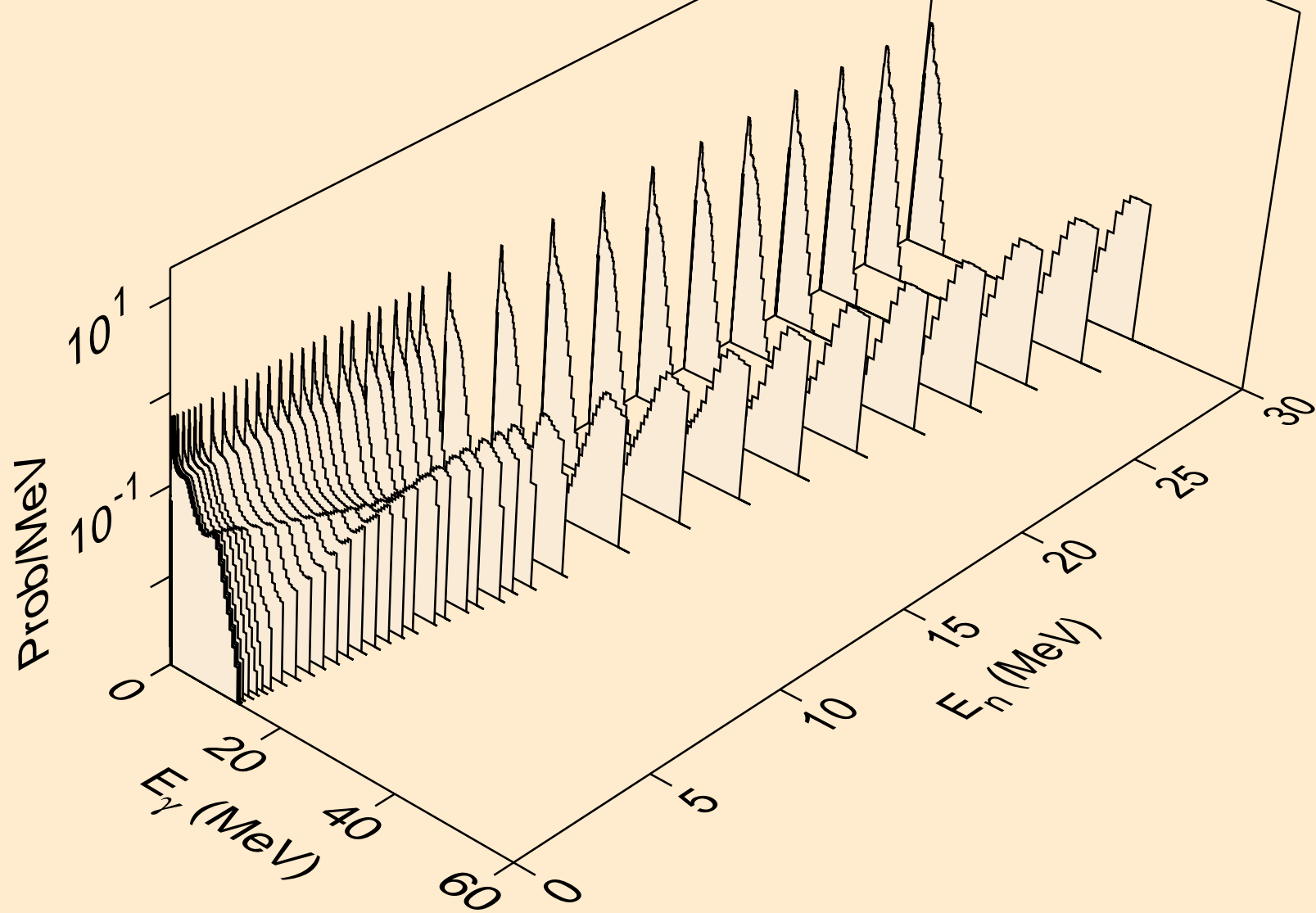

PR126 NEUTRON ACER TENDL-2021 LIBRARY; T=293.6K
Photon emission for (n,p)

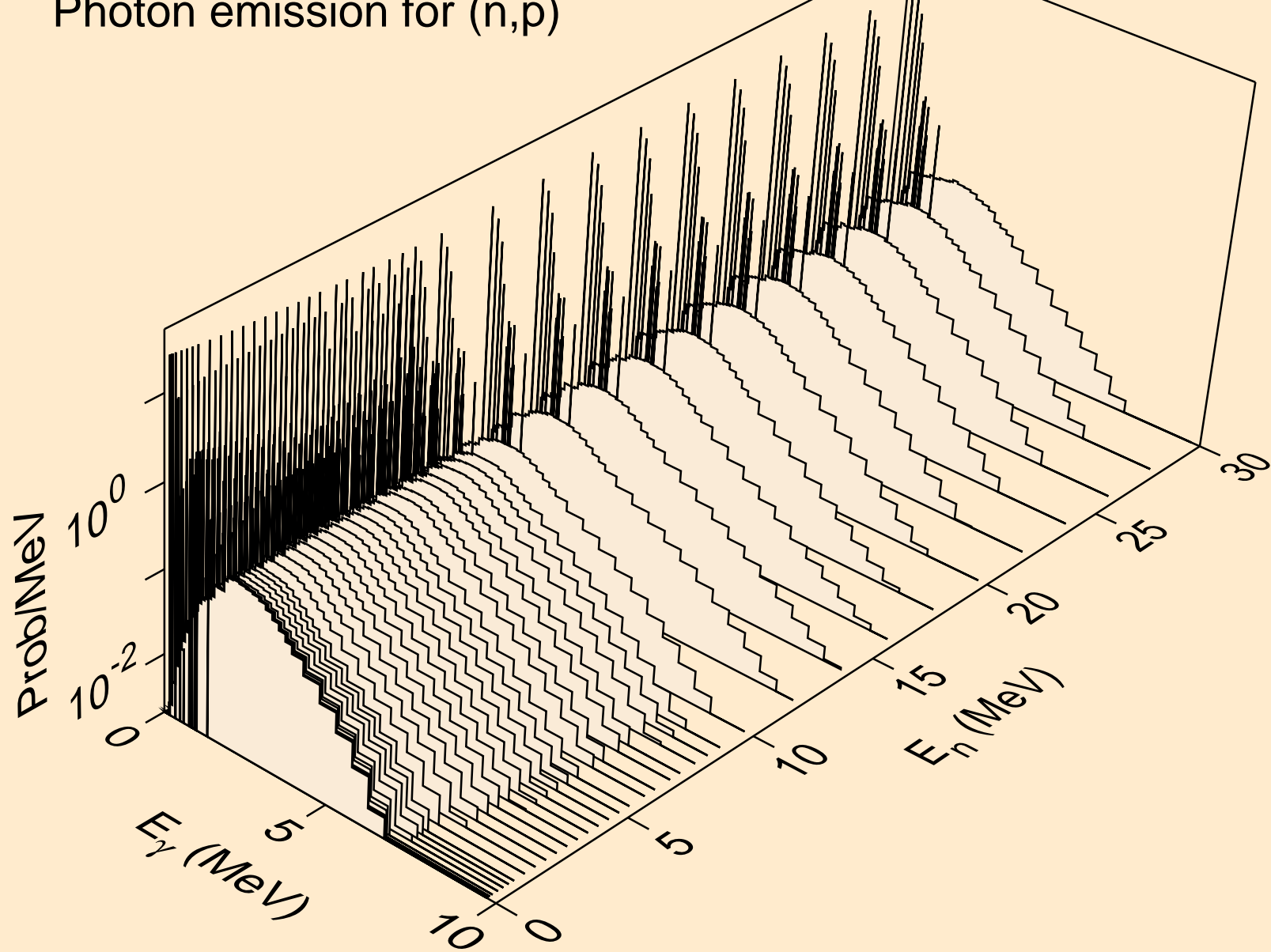

PR126 NEUTRON ACER TENDL-2021 LIBRARY; T=293.6K
Photon emission for (n,d)

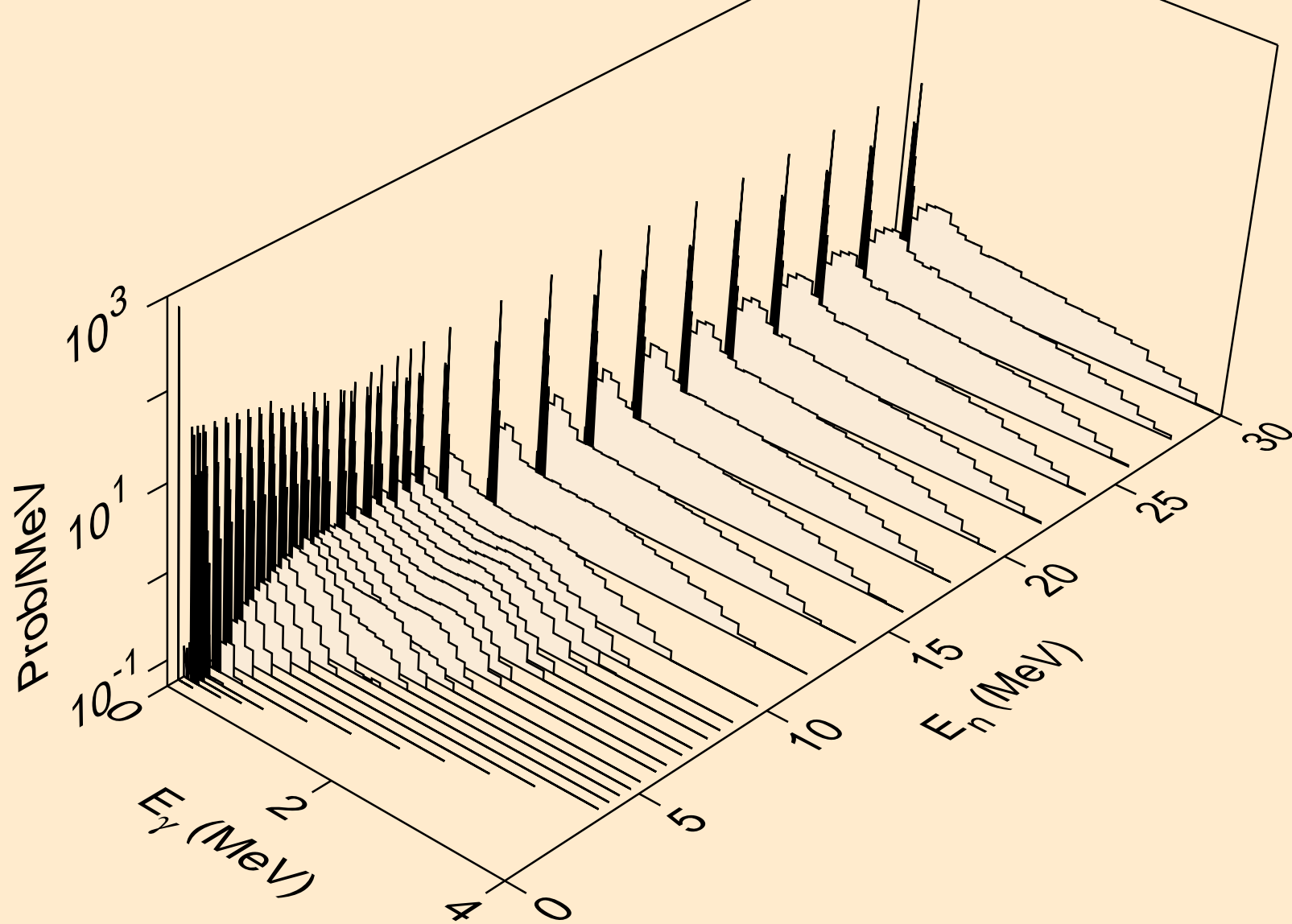

PR126 NEUTRON ACER TENDL-2021 LIBRARY; T=293.6K
Photon emission for (n,t)

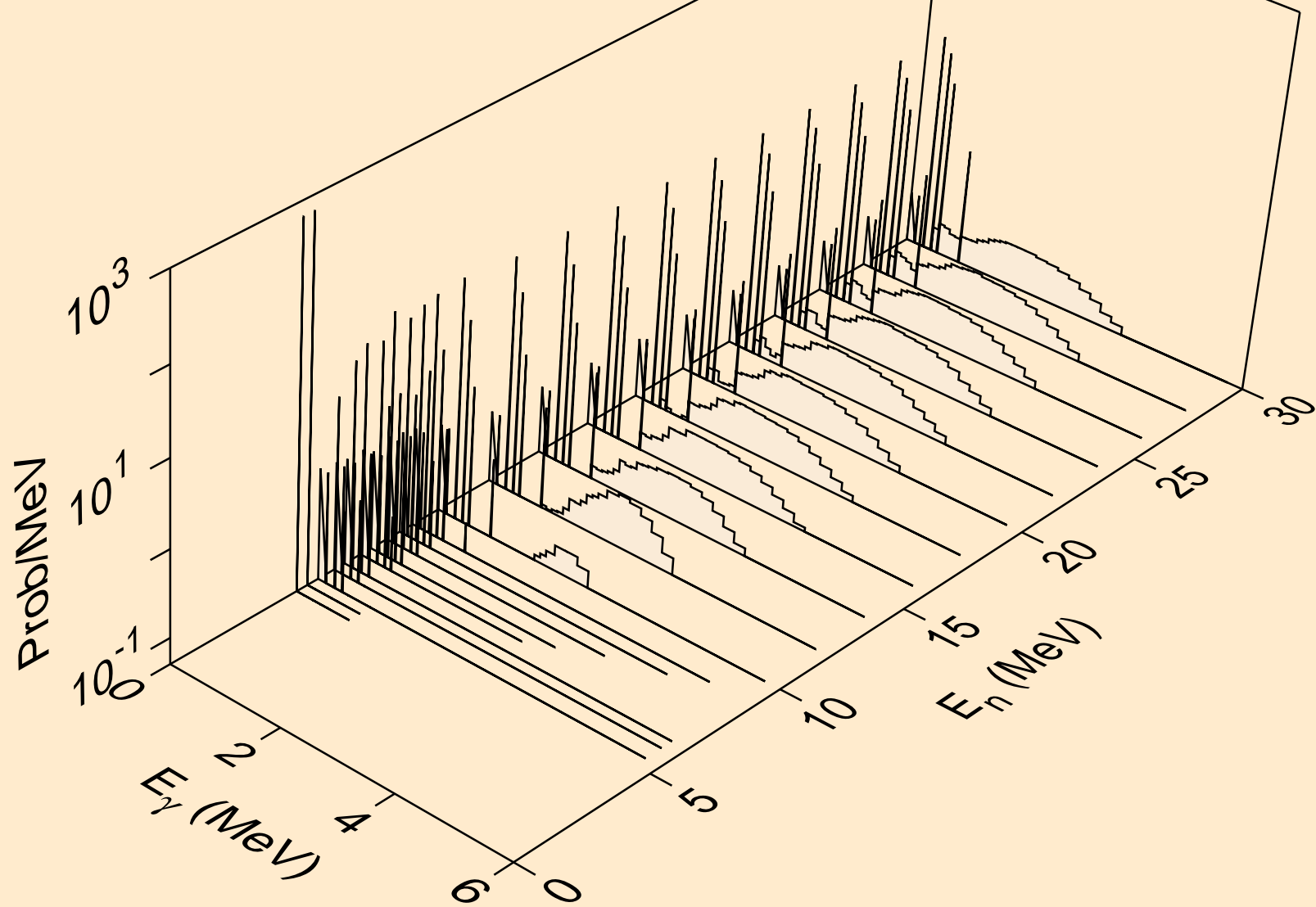

PR126 NEUTRON ACER TENDL-2021 LIBRARY; T=293.6K
Photon emission for (n,he3)

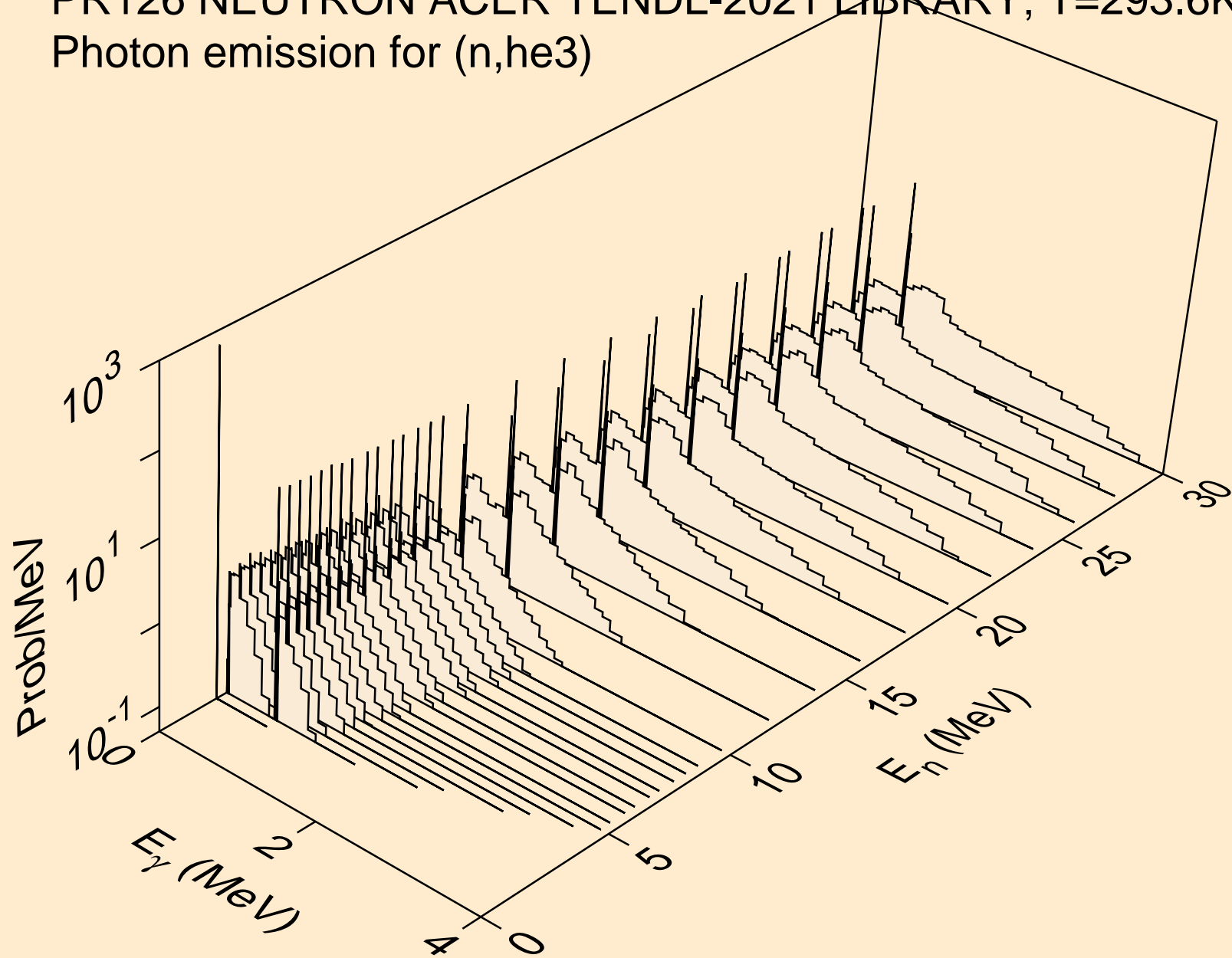

PR126 NEUTRON ACER TENDL-2021 LIBRARY; T=293.6K
Photon emission for (n,a)

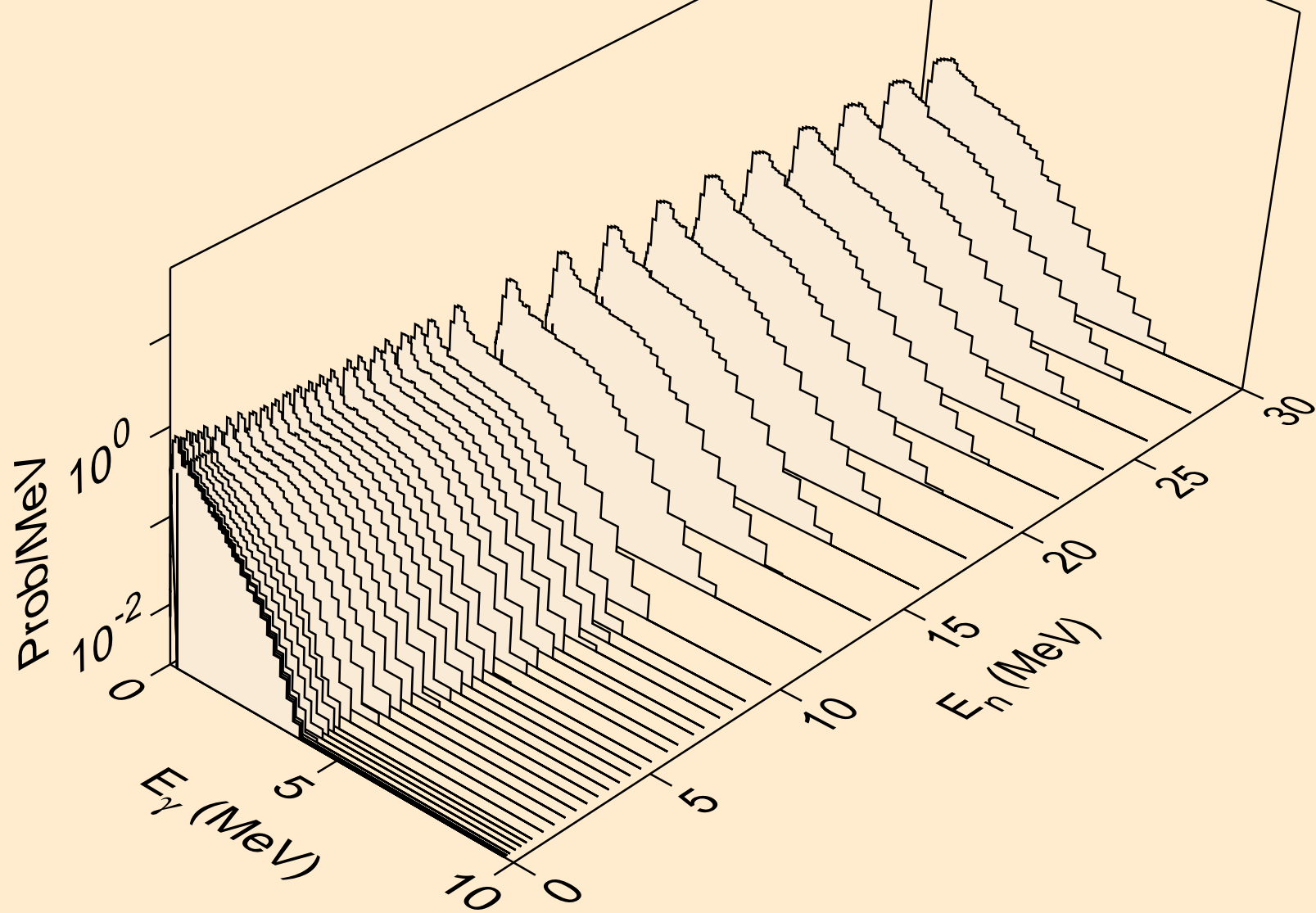

PR126 NEUTRON ACER TENDL-2021 LIBRARY; T=293.6K
Photon emission for (n,2a)

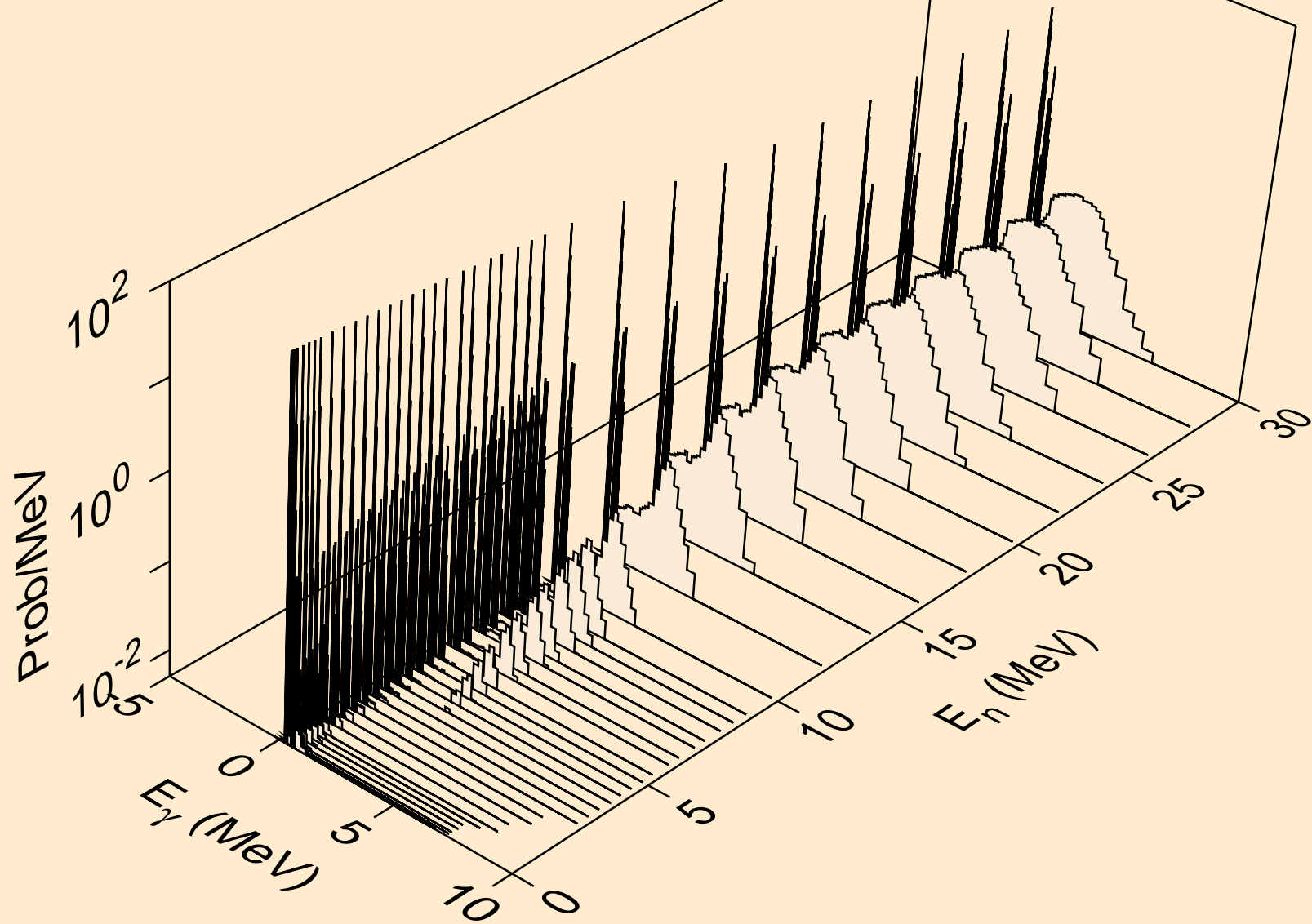

PR126 NEUTRON ACER TENDL-2021 LIBRARY; T=293.6K
Photon emission for (n,3a)

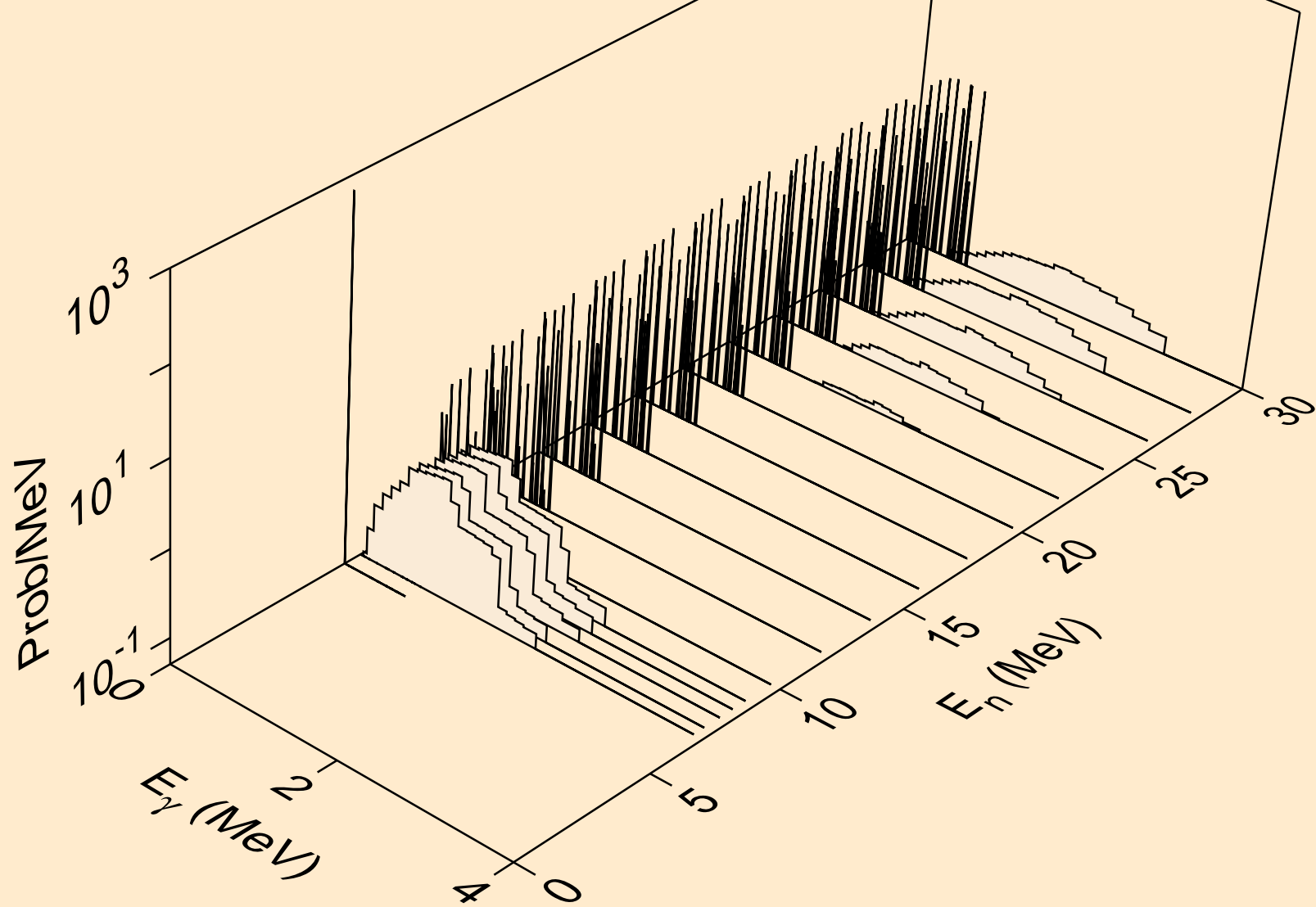

PR126 NEUTRON ACER TENDL-2021 LIBRARY; T=293.6K
Photon emission for (n,2p)

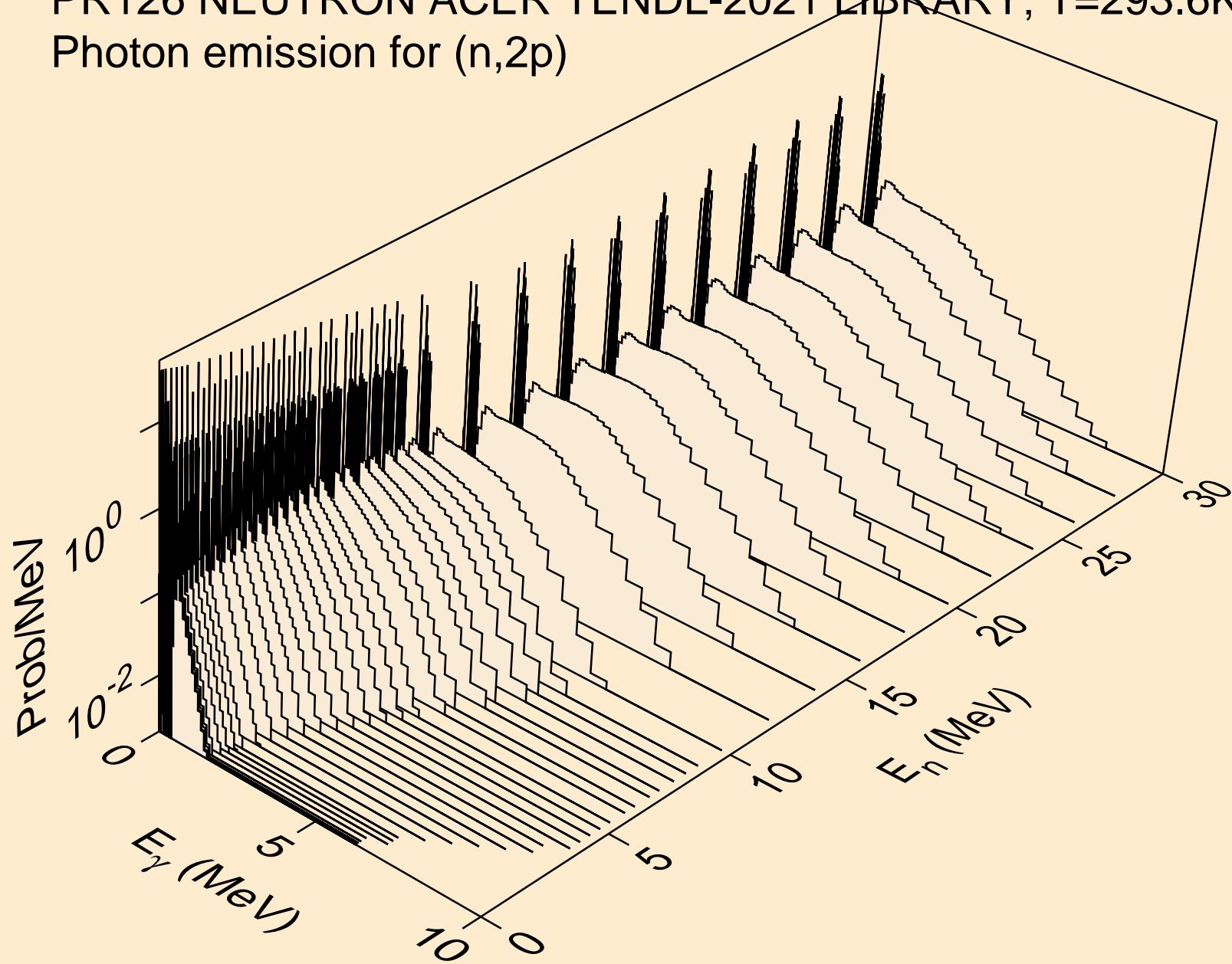

PR126 NEUTRON ACER TENDL-2021 LIBRARY; T=293.6K
Photon emission for (n,p α)

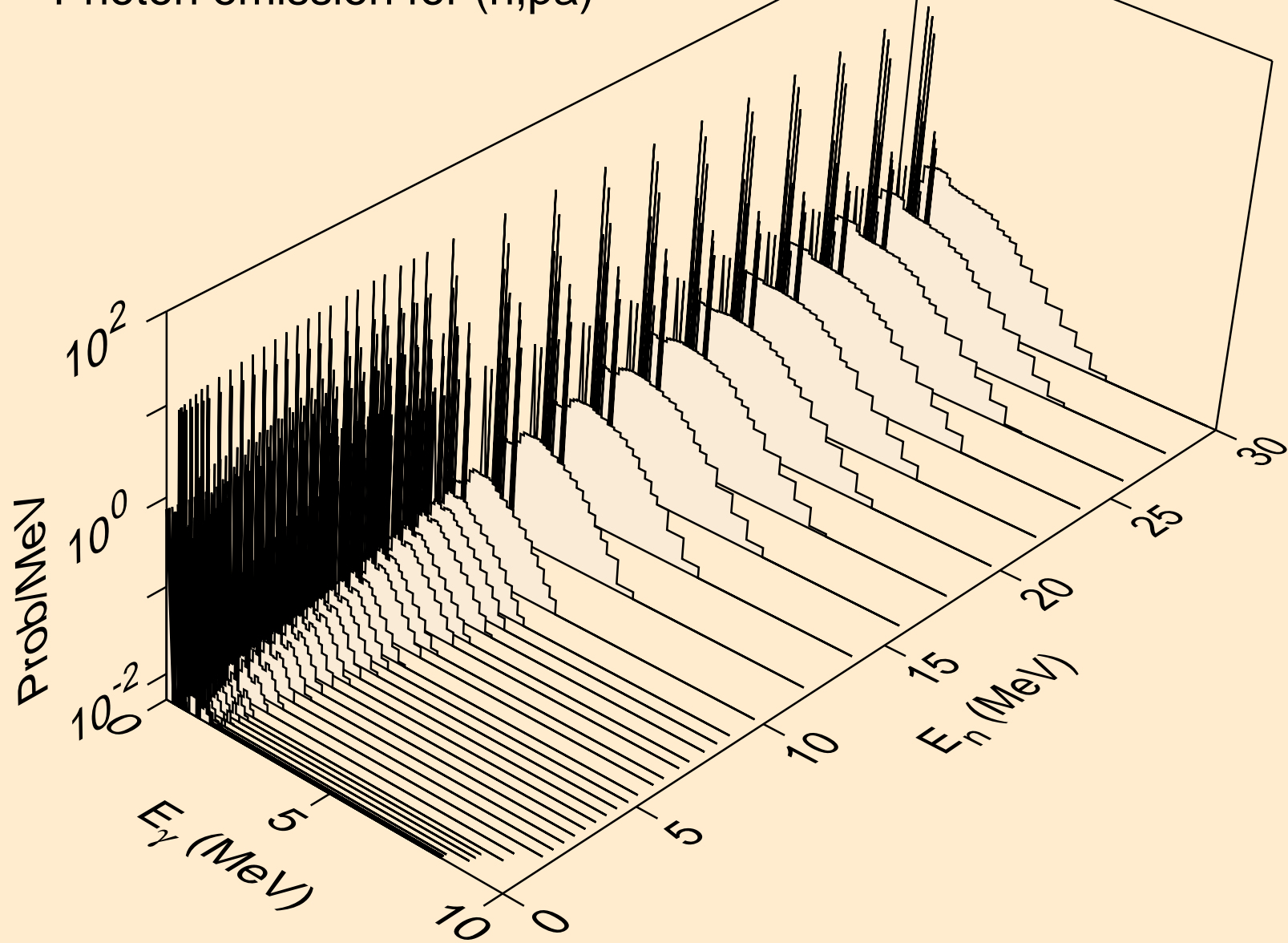

PR126 NEUTRON ACER TENDL-2021 LIBRARY; T=293.6K
Photon emission for (n,d2a)

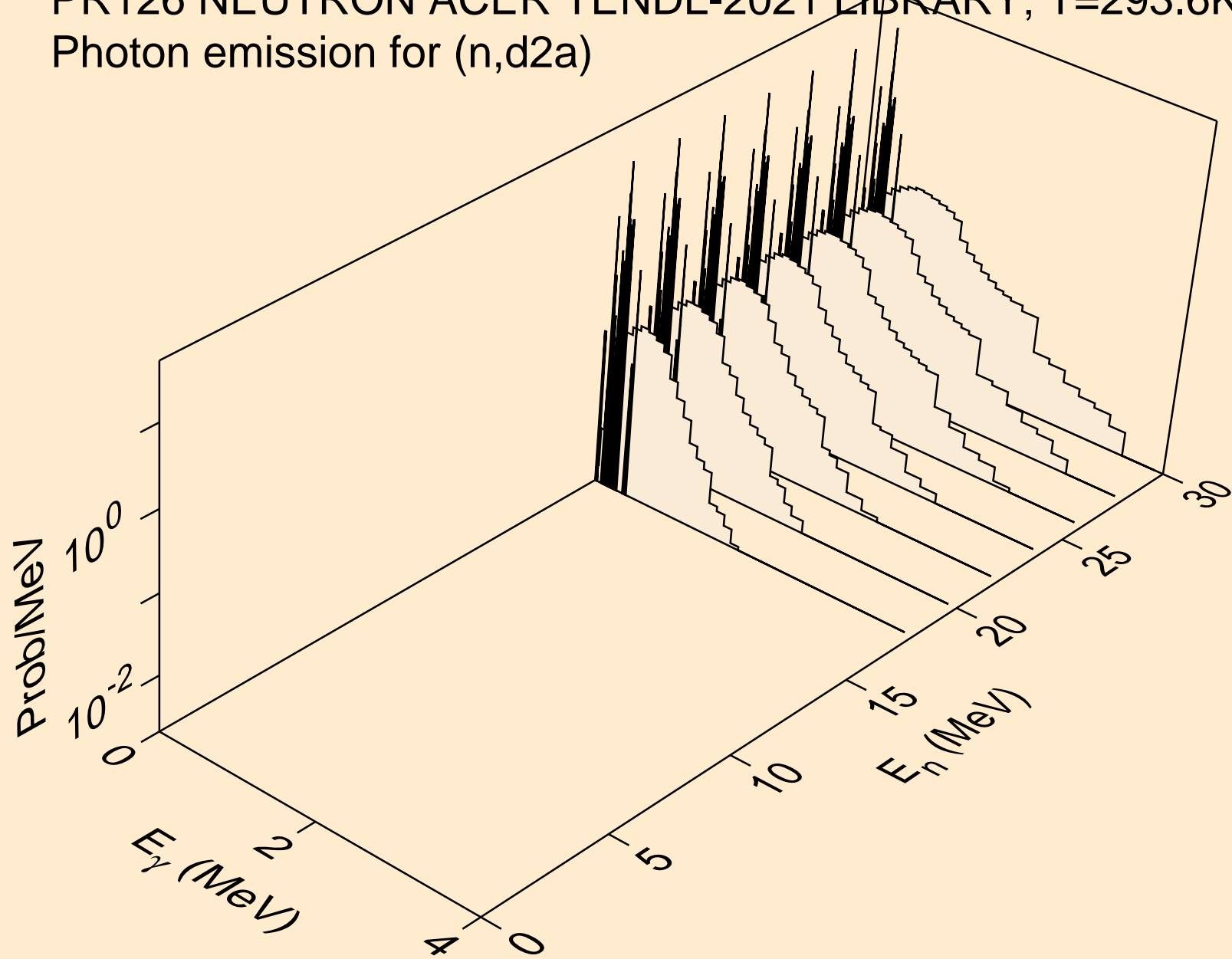

PR126 NEUTRON ACER TENDL-2021 LIBRARY; T=293.6K
Photon emission for (n,pd)

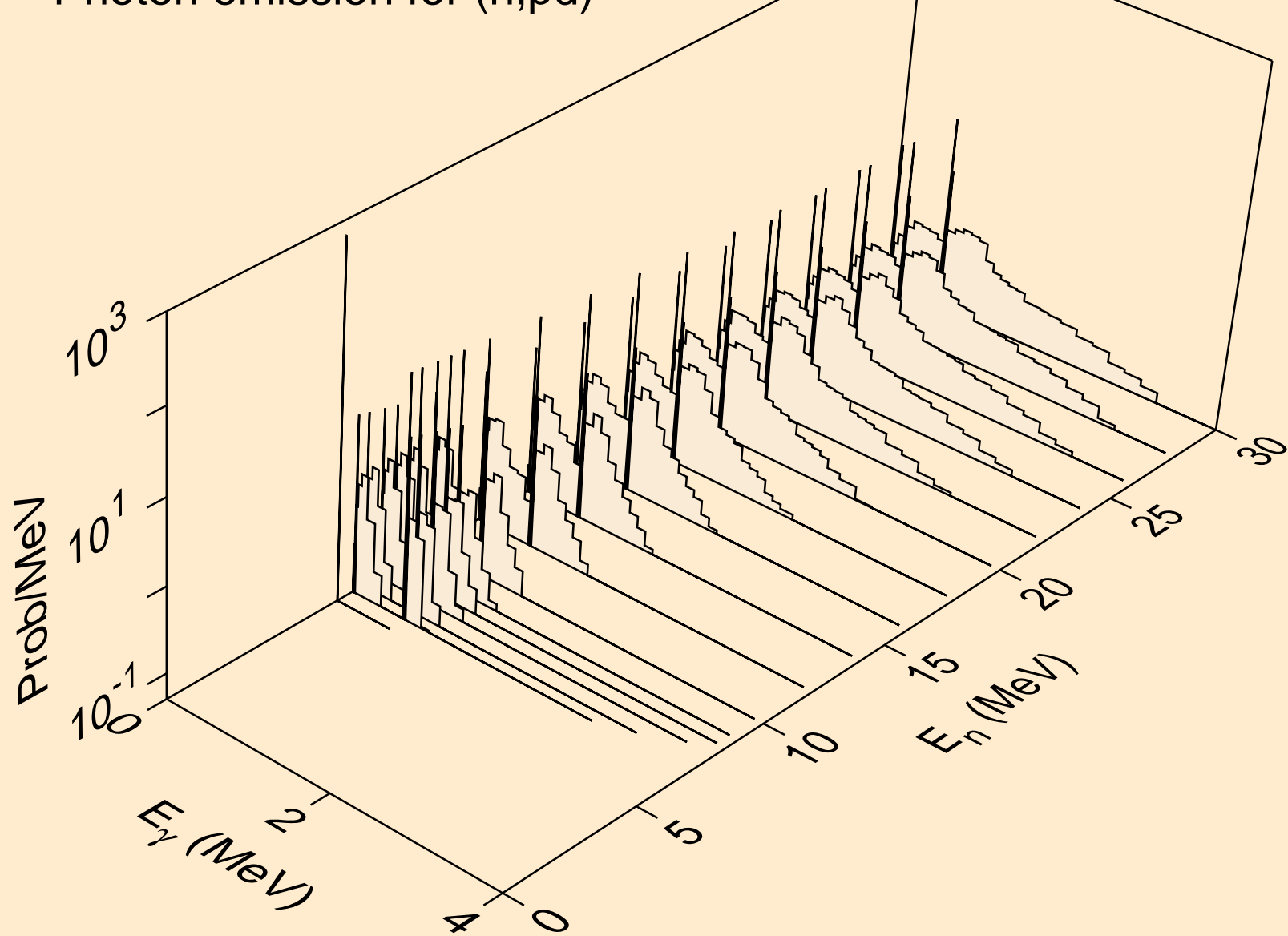

PR126 NEUTRON ACER TENDL-2021 LIBRARY; T=293.6K
Photon emission for (n,pt)

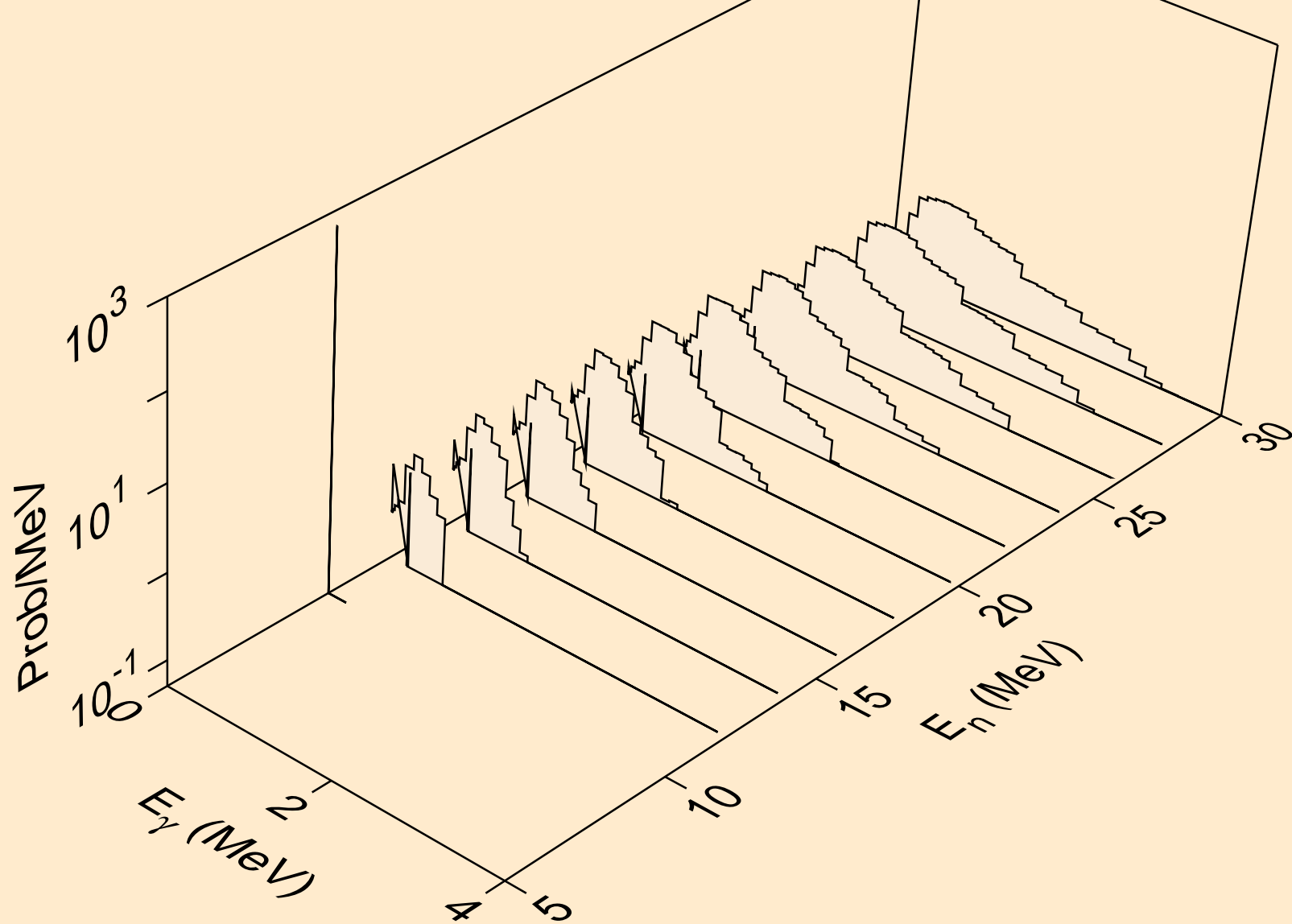

PR126 NEUTRON ACER TENDL-2021 LIBRARY; T=293.6K
Photon emission for (n,da)

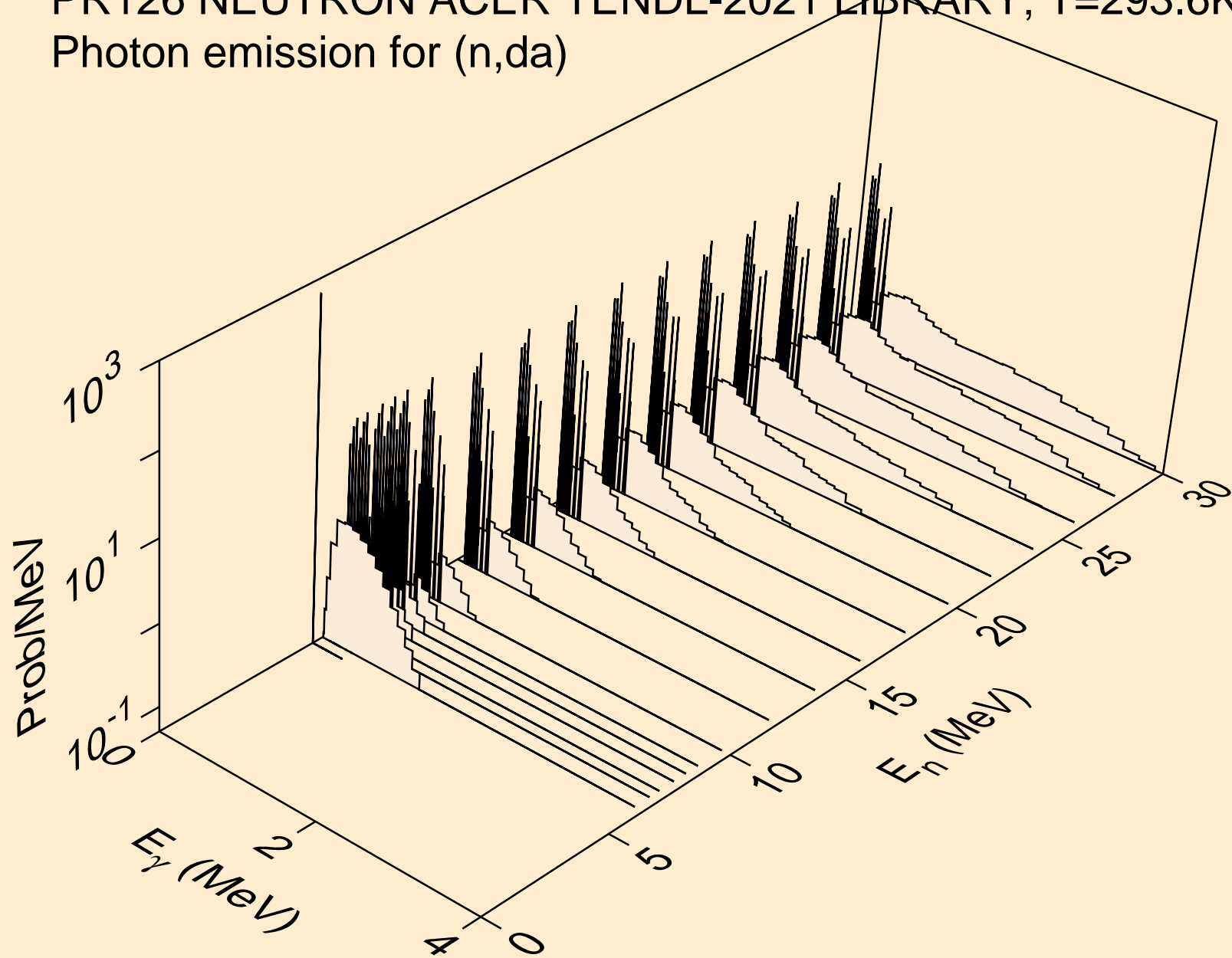

PR126 NEUTRON ACER TENDL-2021 LIBRARY; T=293.6K
thermal capture photon spectrum

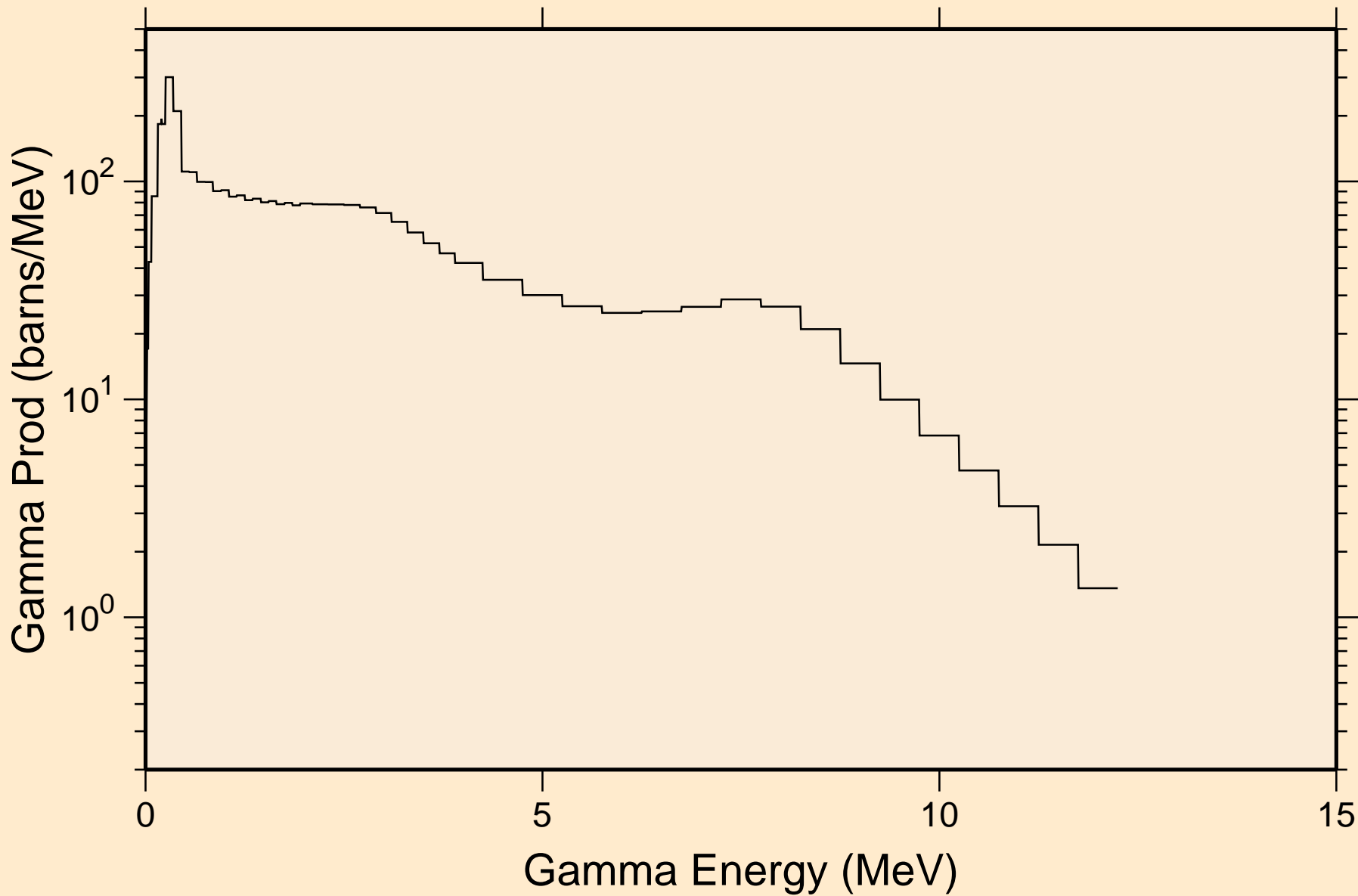

PR126 NEUTRON ACER TENDL-2021 LIBRARY; T=293.6K
14 MeV photon spectrum

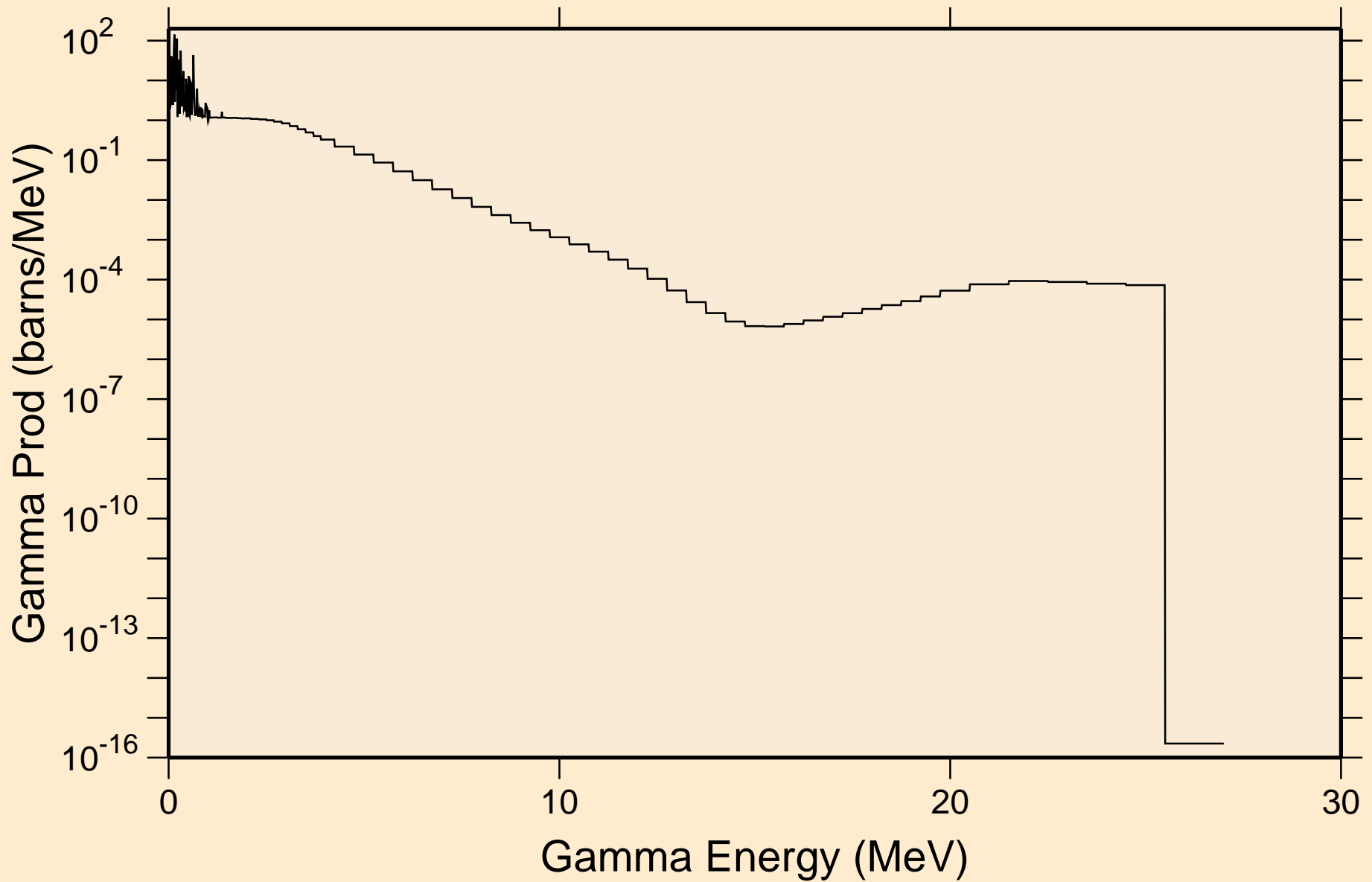

PR126 NEUTRON ACER TENDL-2021 LIBRARY; T=293.6K
Particle heating contributions

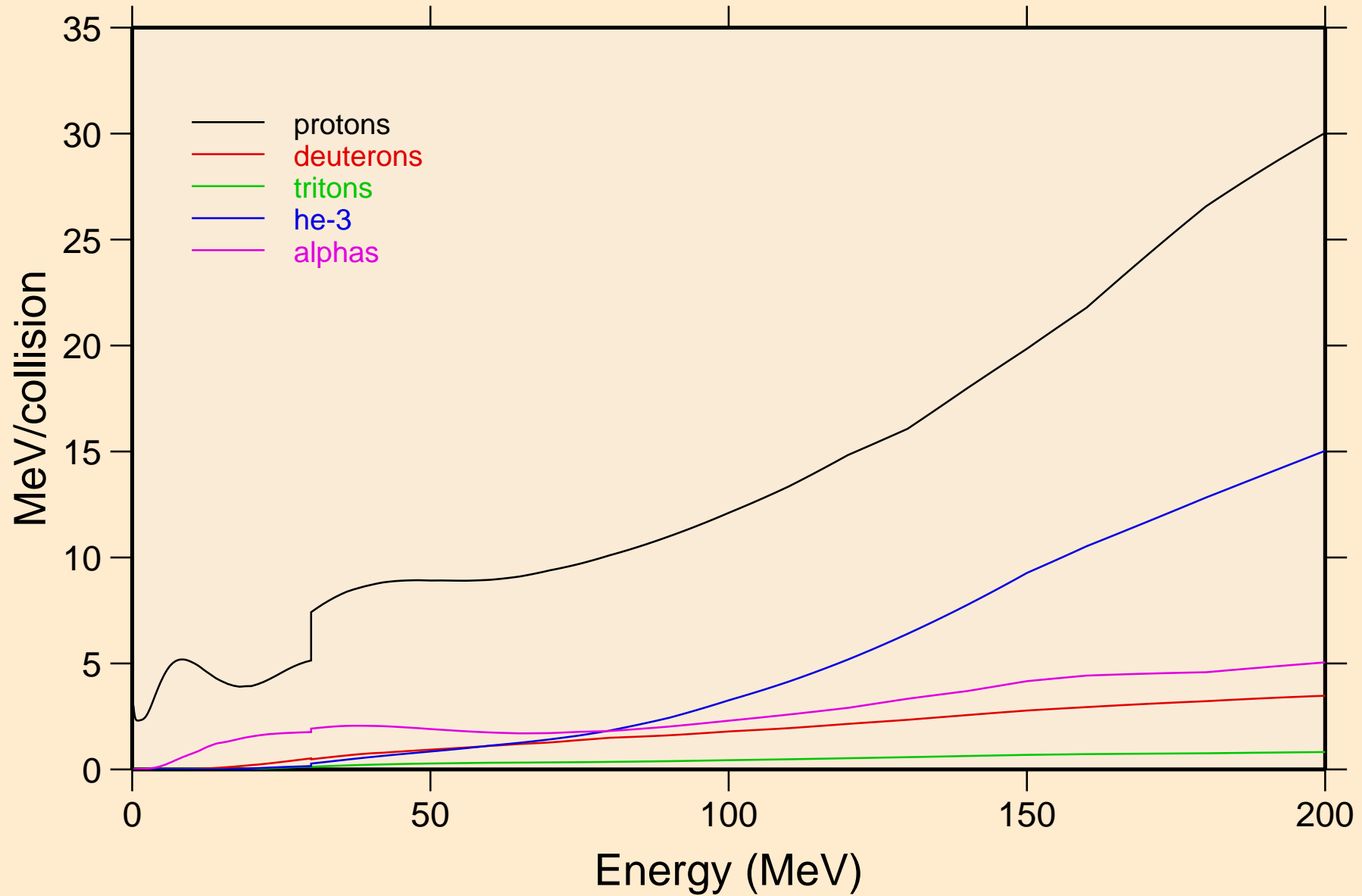

PR126 NEUTRON ACER TENDL-2021 LIBRARY; T=293.6K
Recoil Heating

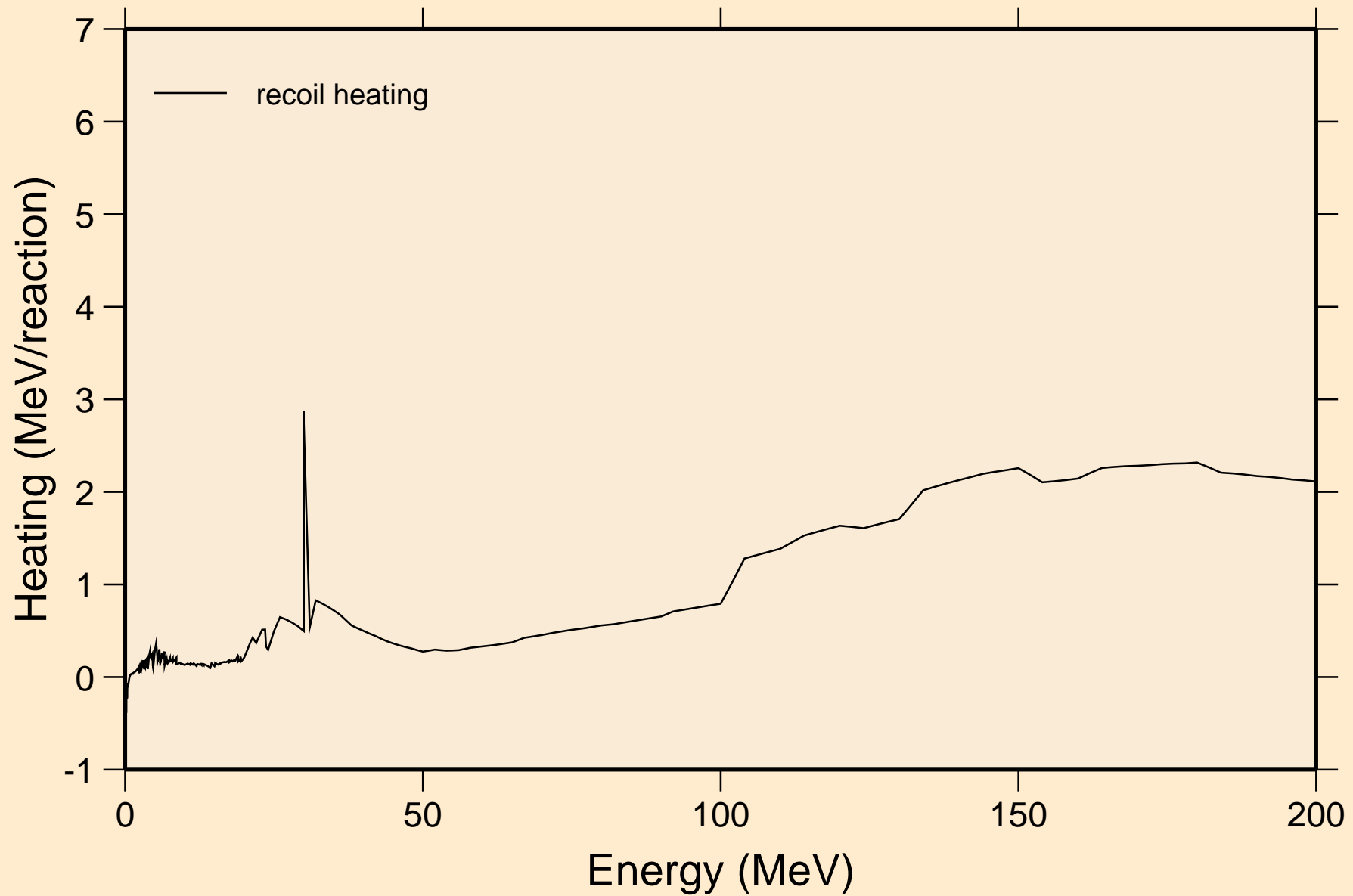

PR126 NEUTRON ACER TENDL-2021 LIBRARY; T=293.6K
Particle production cross sections

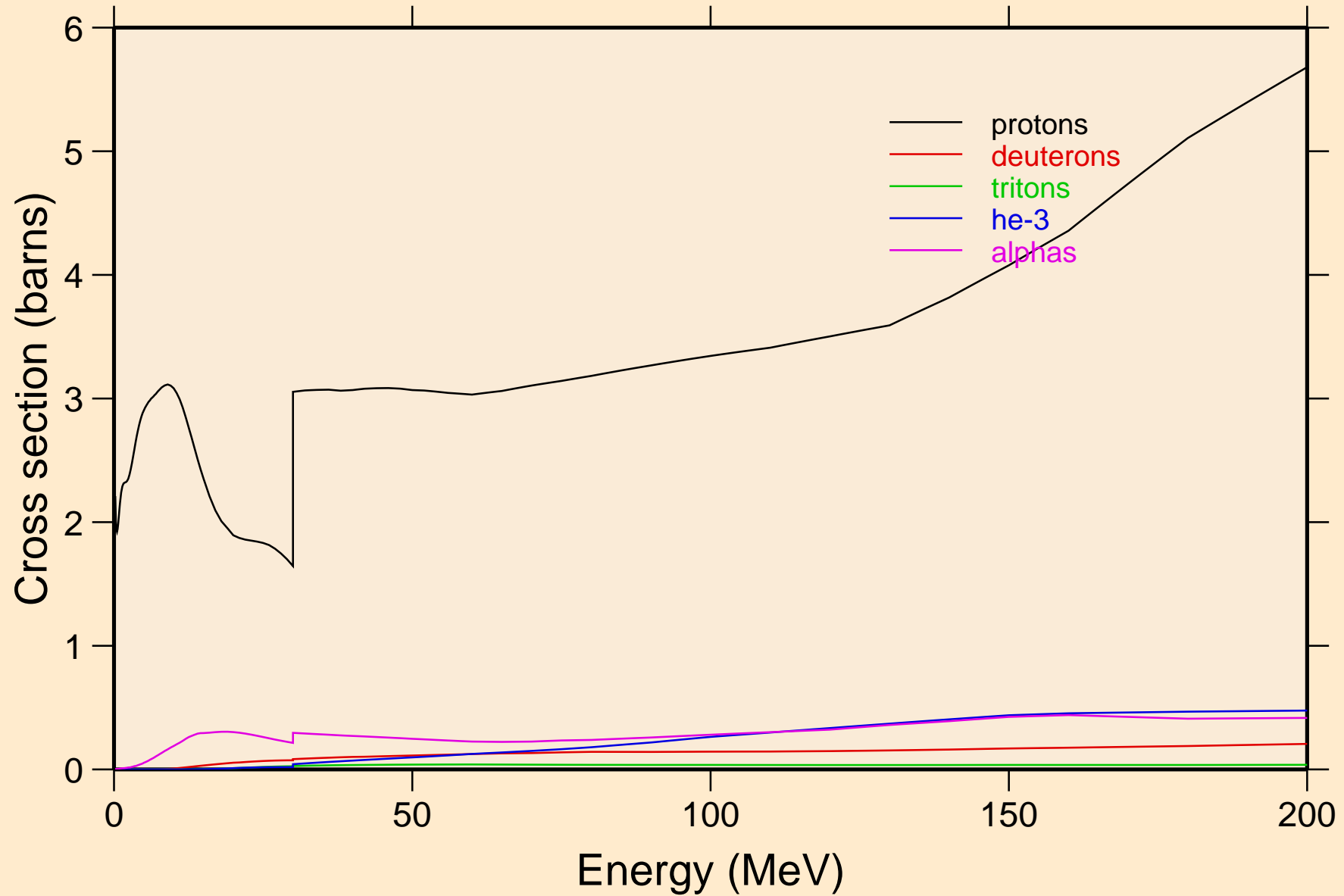

PR126 NEUTRON ACER TENDL-2021 LIBRARY; T=293.6K
protons from (n,x)

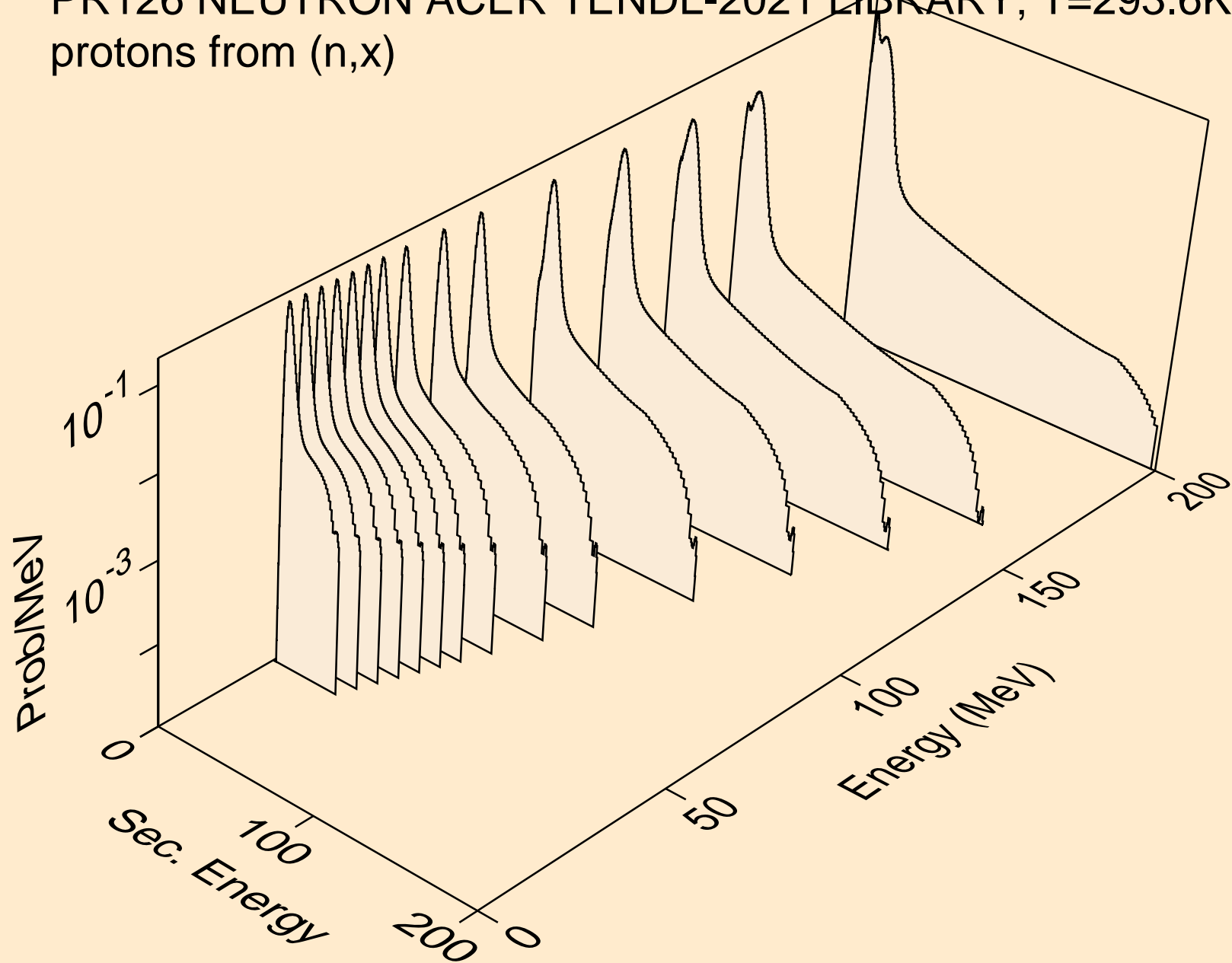

PR126 NEUTRON ACER TENDL-2021 LIBRARY; T=293.6K
protons from (n,n*)p

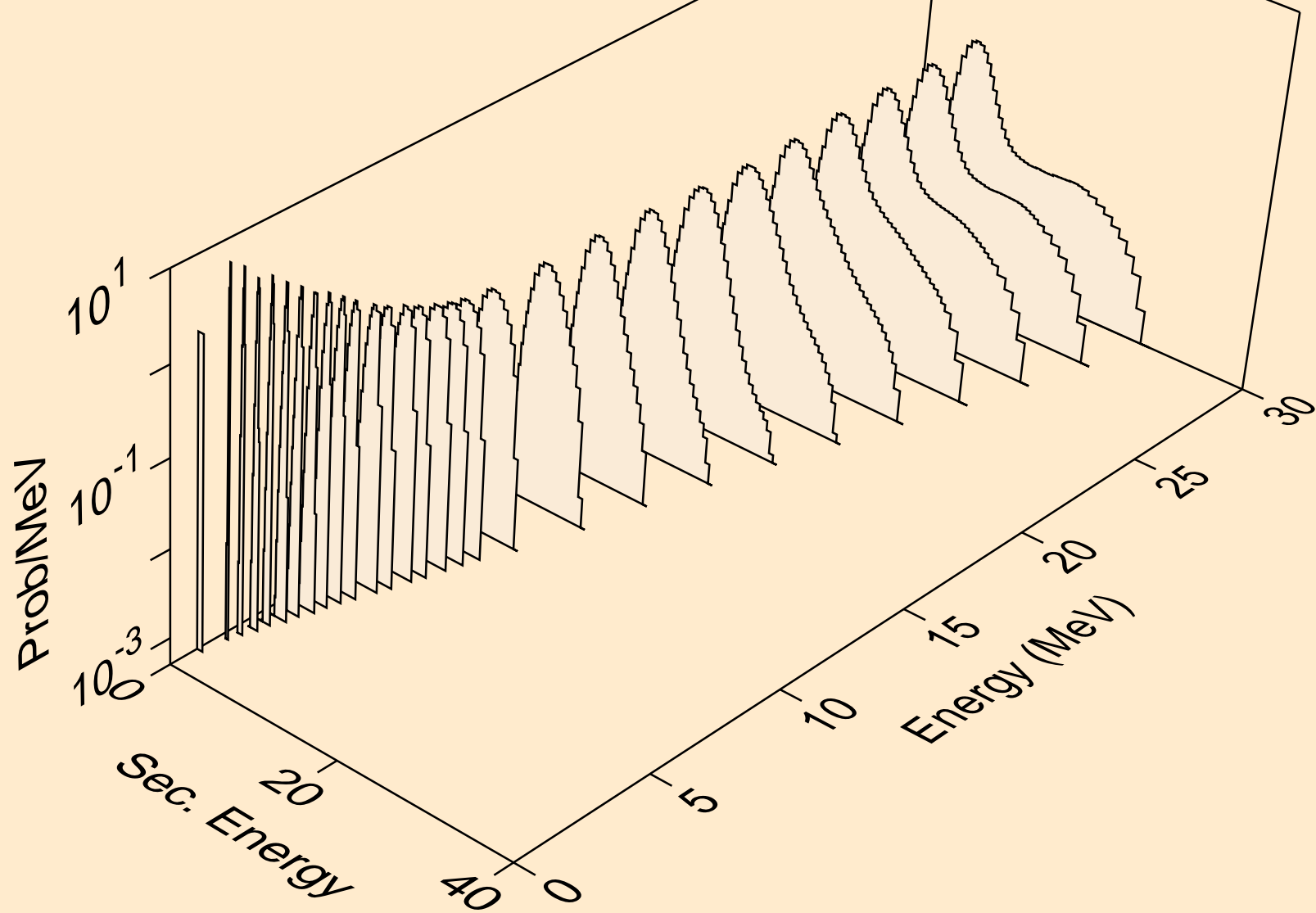

PR126 NEUTRON ACER TENDL-2021 LIBRARY; T=293.6K
protons from (n,2np)

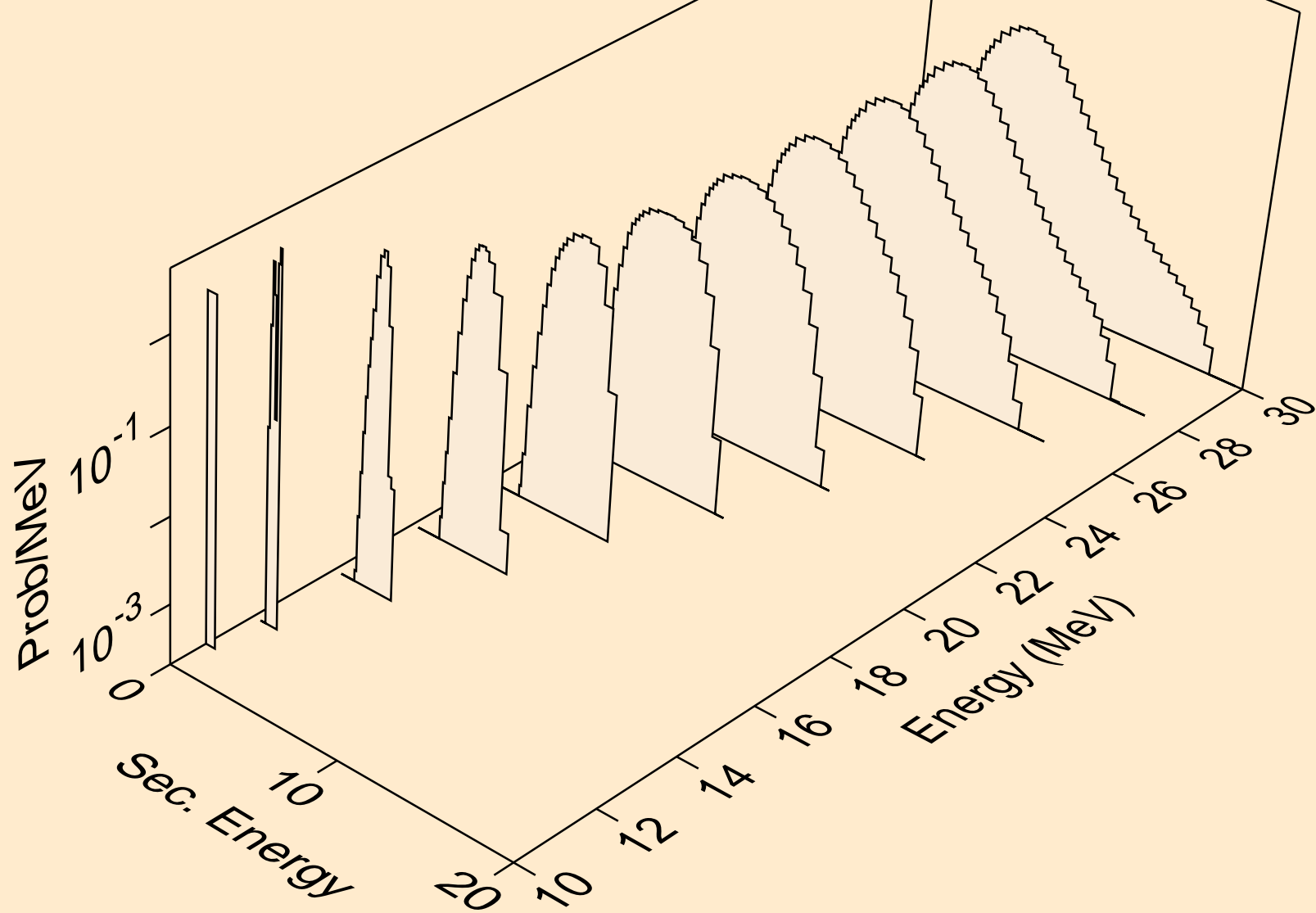

PR126 NEUTRON ACER TENDL-2021 LIBRARY; T=293.6K
protons from (n,3np)

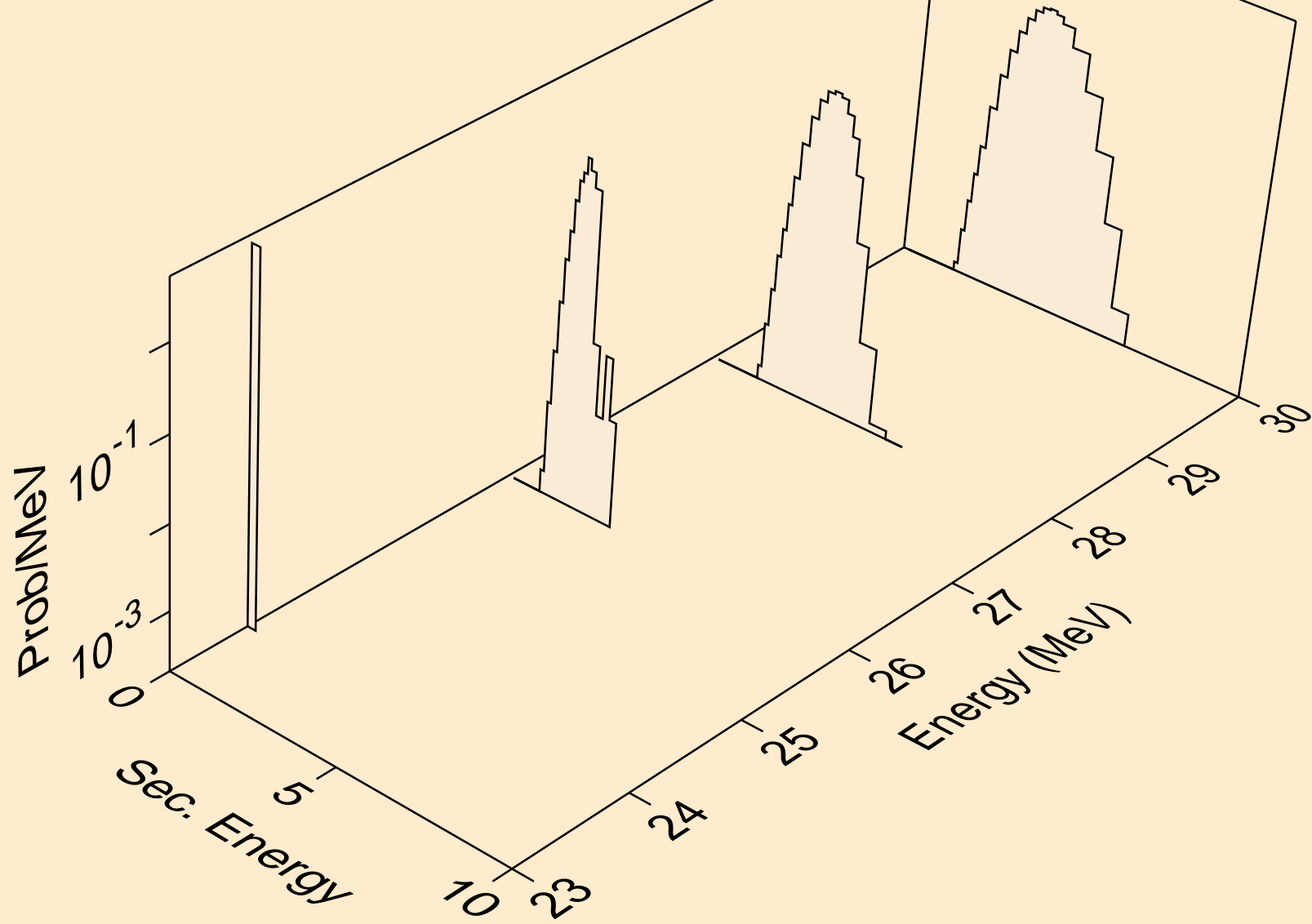

PR126 NEUTRON ACER TENDL-2021 LIBRARY; T=293.6K
protons from (n,2np)

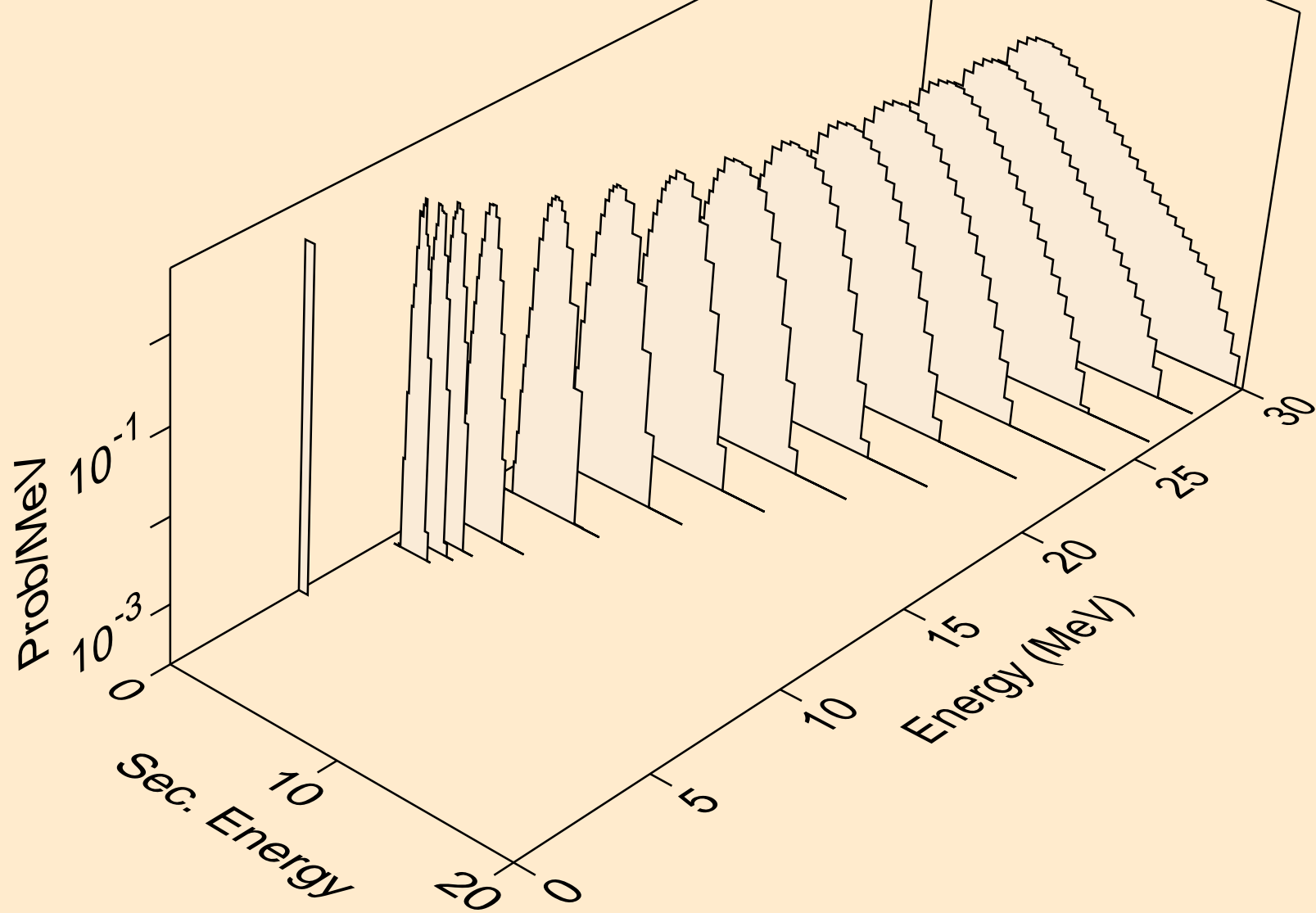

PR126 NEUTRON ACER TENDL-2021 LIBRARY; T=293.6K
protons from (n,npa)

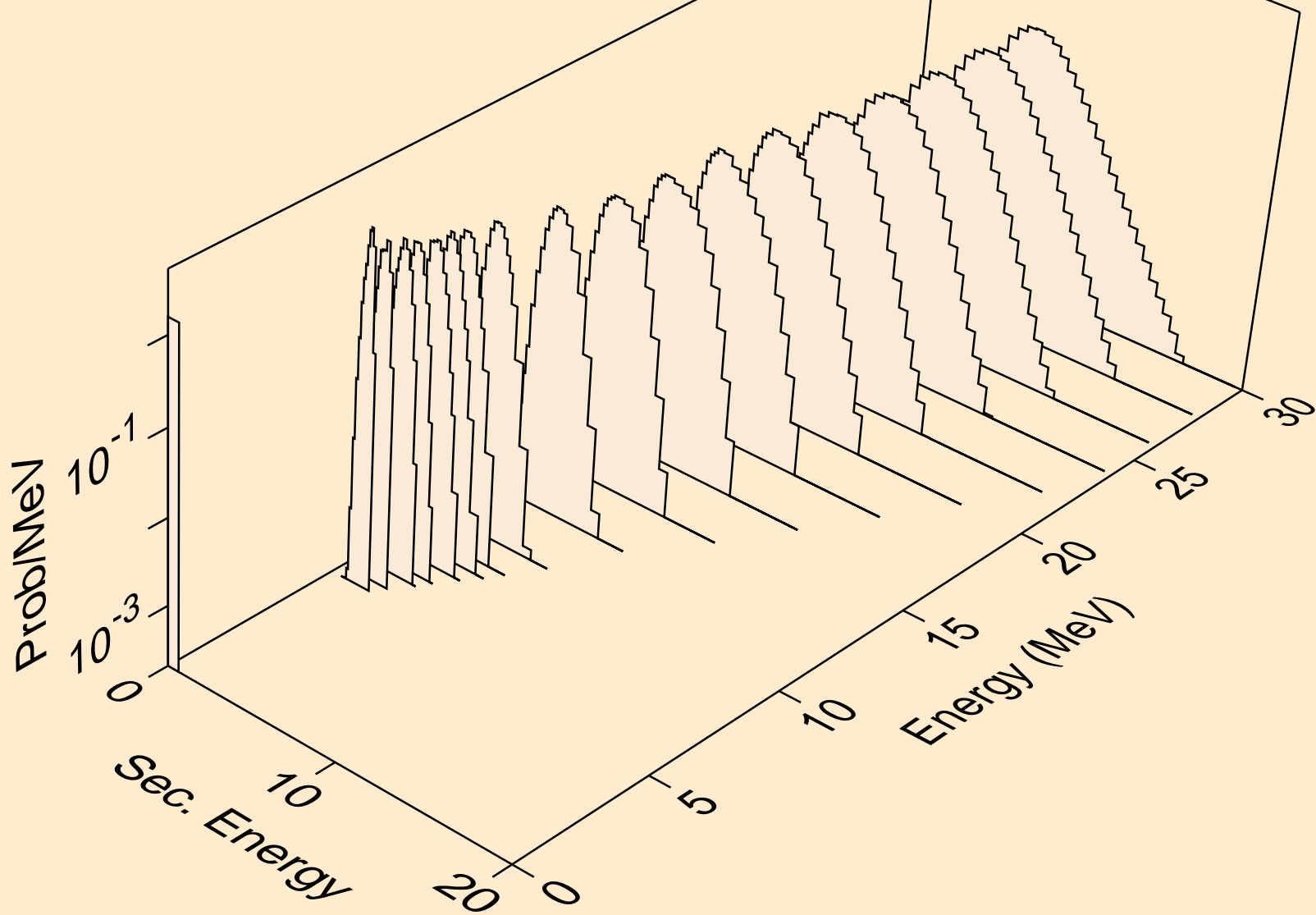

PR126 NEUTRON ACER TENDL-2021 LIBRARY; T=293.6K
protons from (n,p)

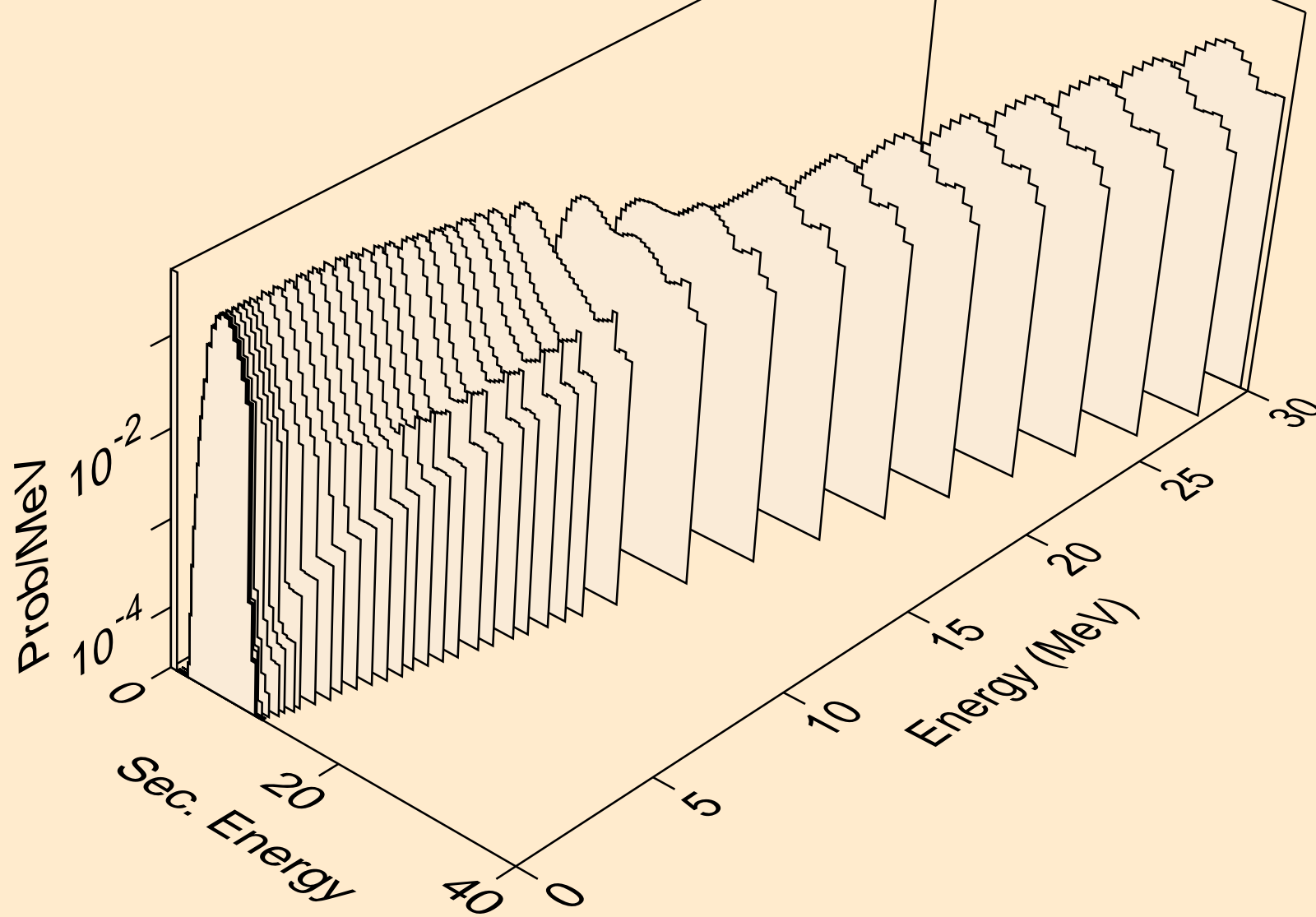

PR126 NEUTRON ACER TENDL-2021 LIBRARY; T=293.6K
protons from (n,2p)

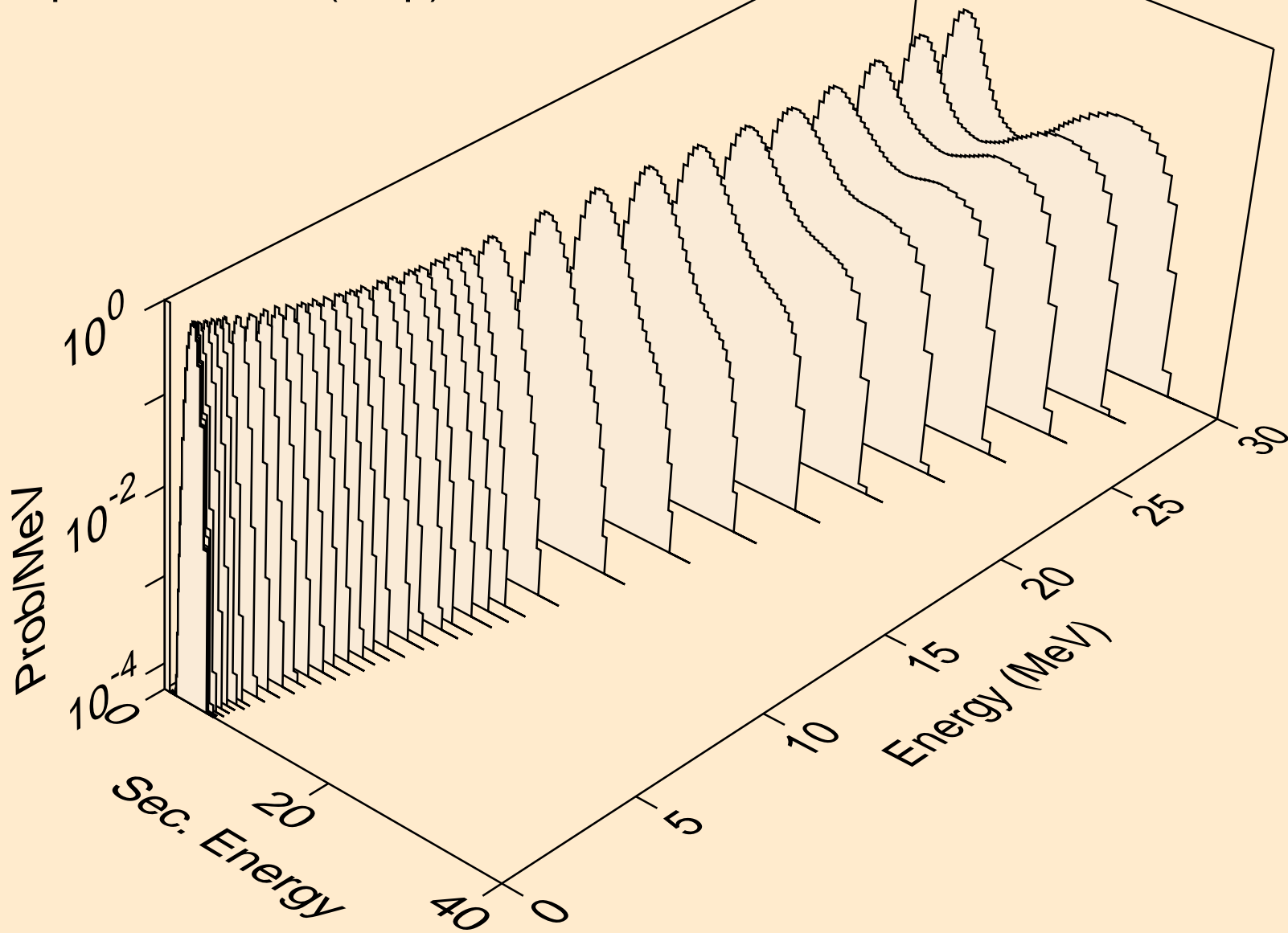

PR126 NEUTRON ACER TENDL-2021 LIBRARY; T=293.6K
protons from (n,p)

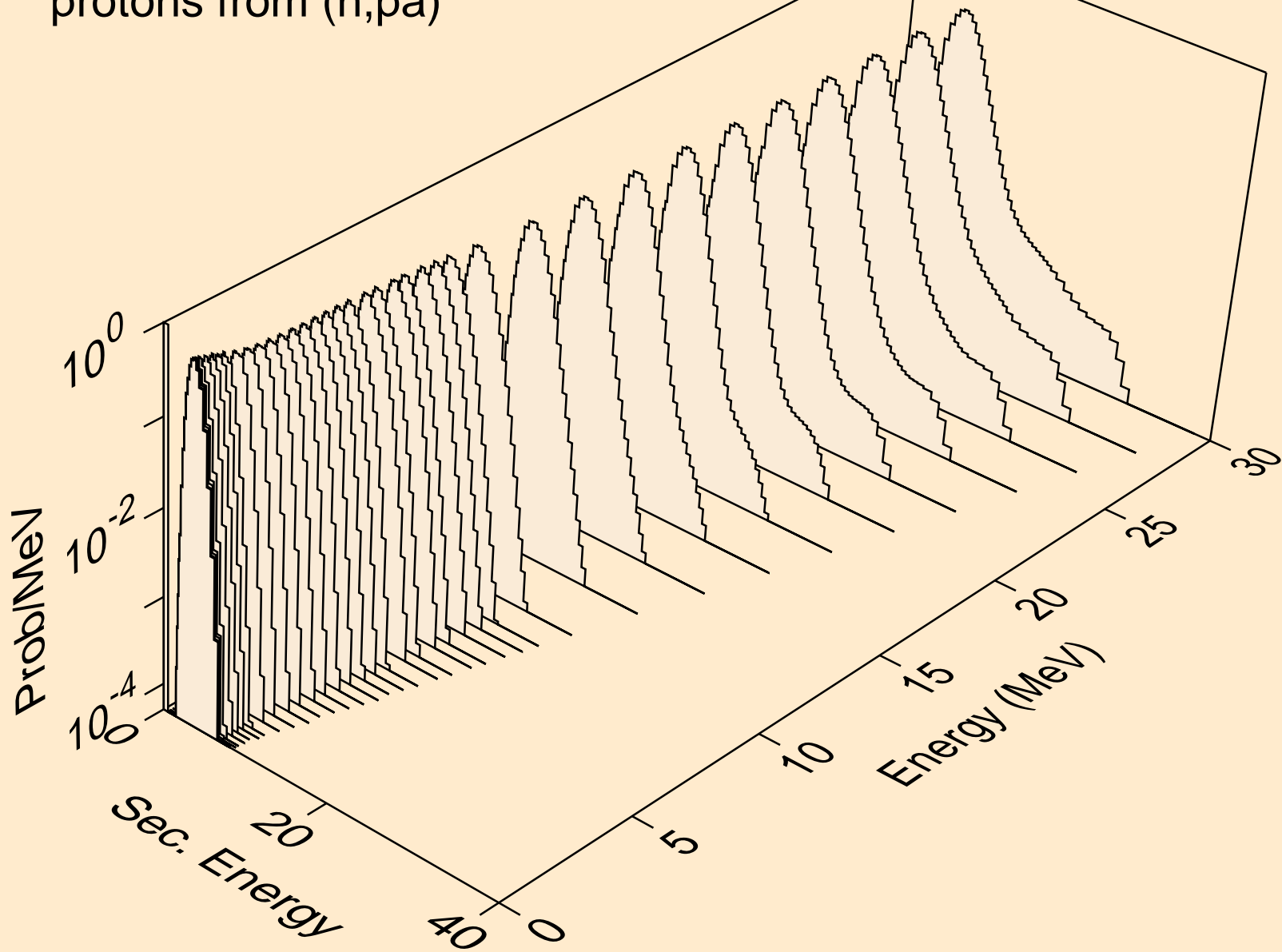

PR126 NEUTRON ACER TENDL-2021 LIBRARY; T=293.6K
protons from (n,pd)

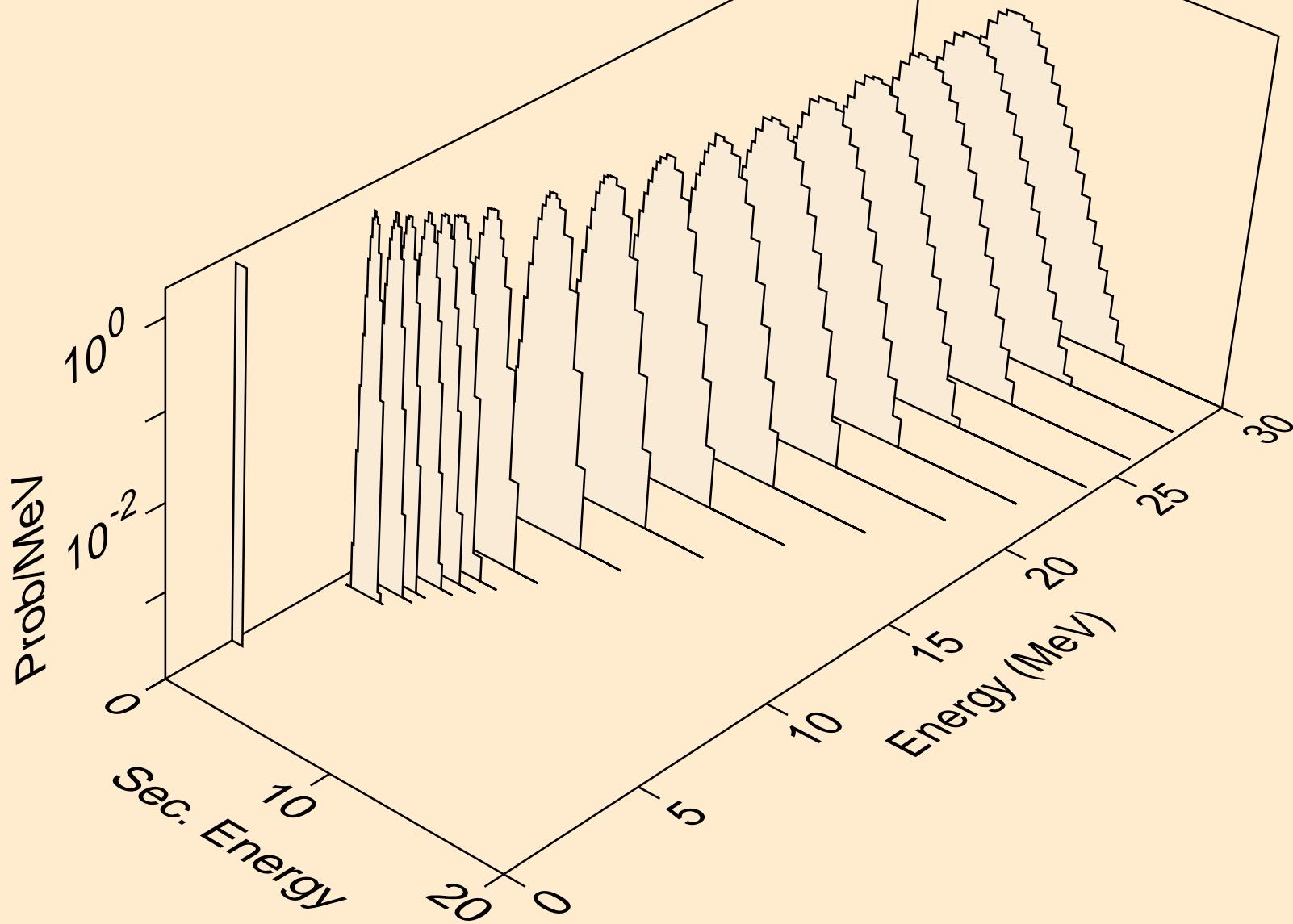

PR126 NEUTRON ACER TENDL-2021 LIBRARY; T=293.6K
protons from (n,pt)

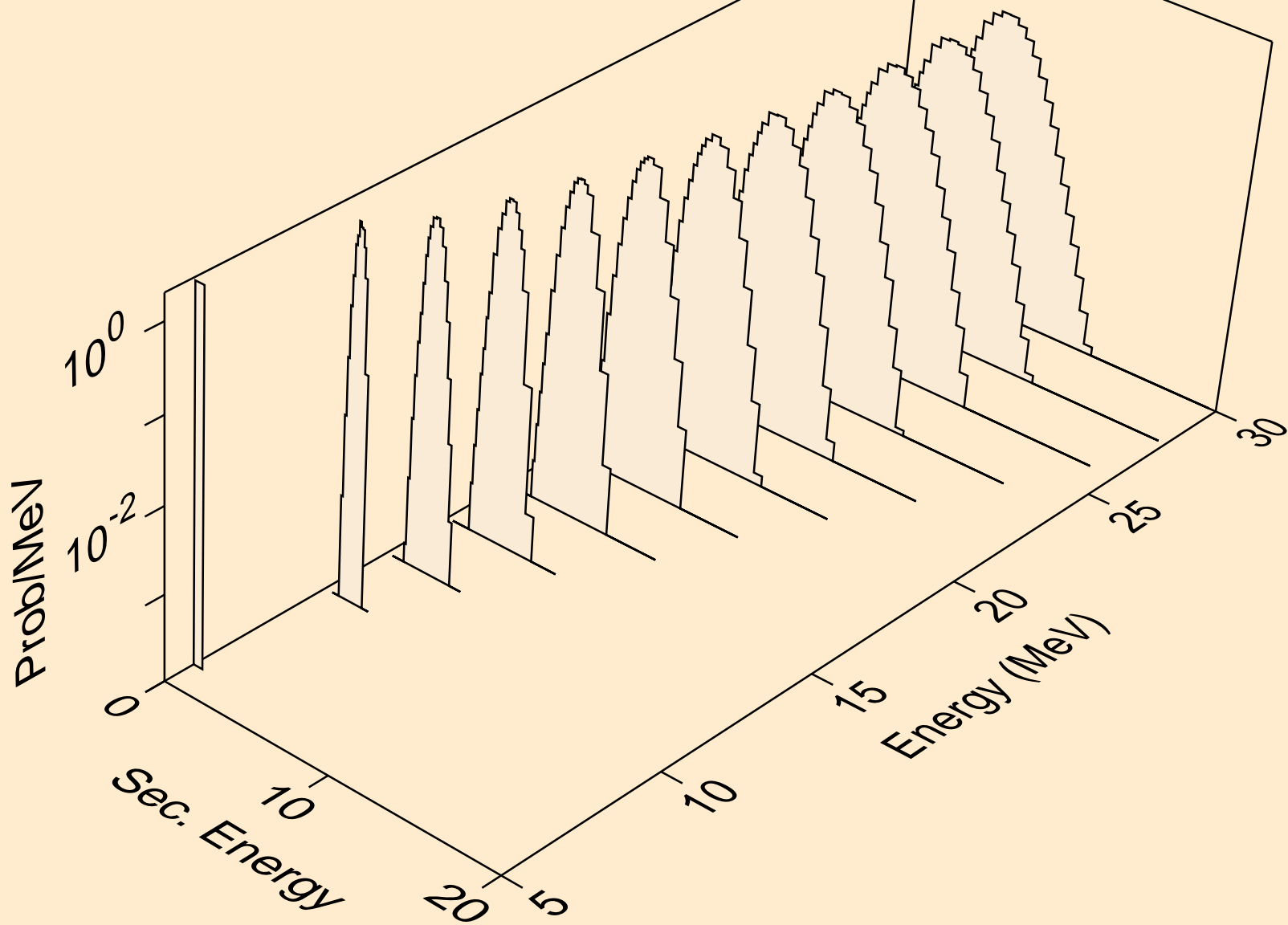

PR126 NEUTRON ACER TENDL-2021 LIBRARY; T=293.6K
deuterons from (n,x)

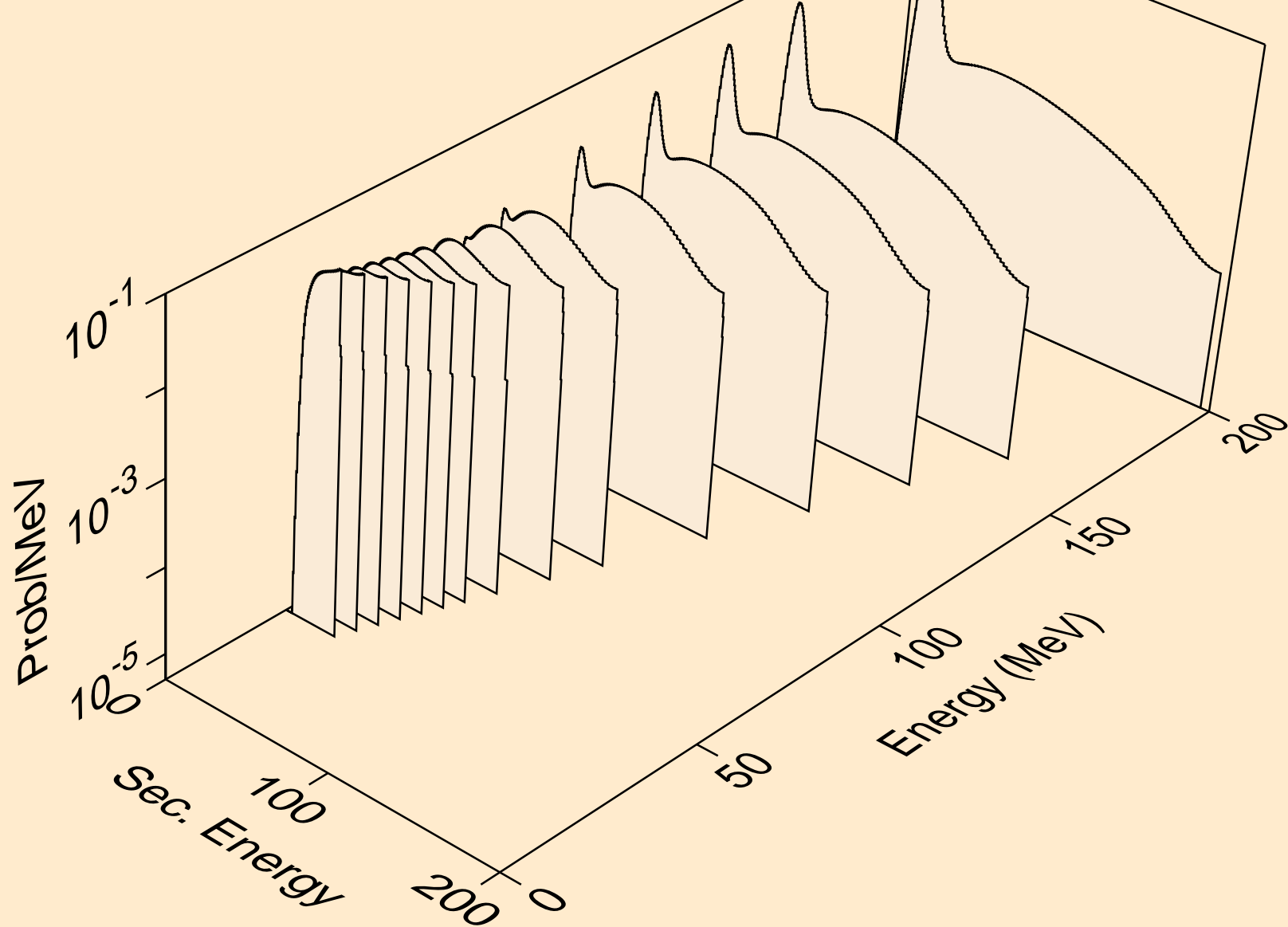

PR126 NEUTRON ACER TENDL-2021 LIBRARY; T=293.6K
deuterons from (n,2nd)

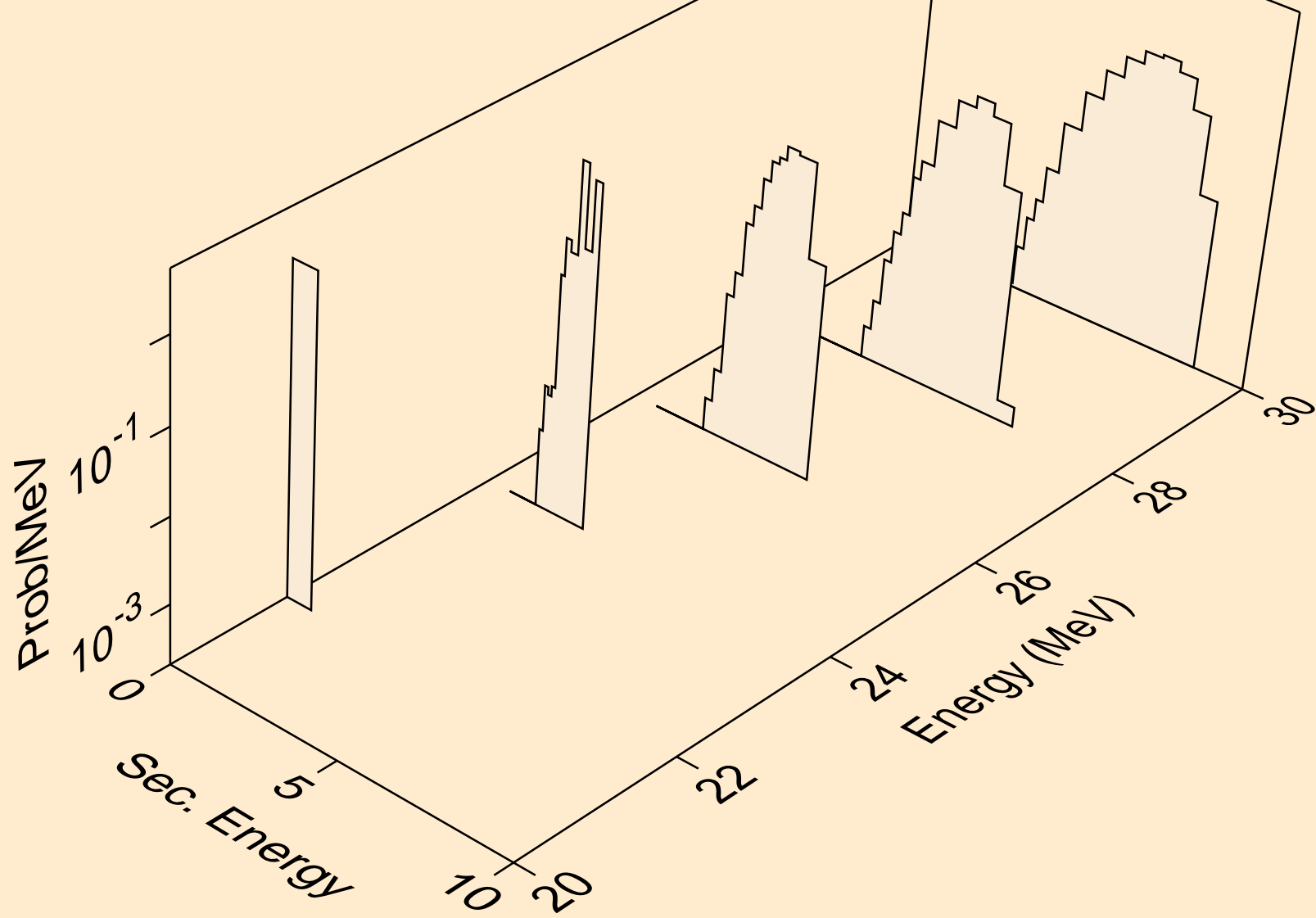

PR126 NEUTRON ACER TENDL-2021 LIBRARY; T=293.6K
deuterons from (n,n*)d

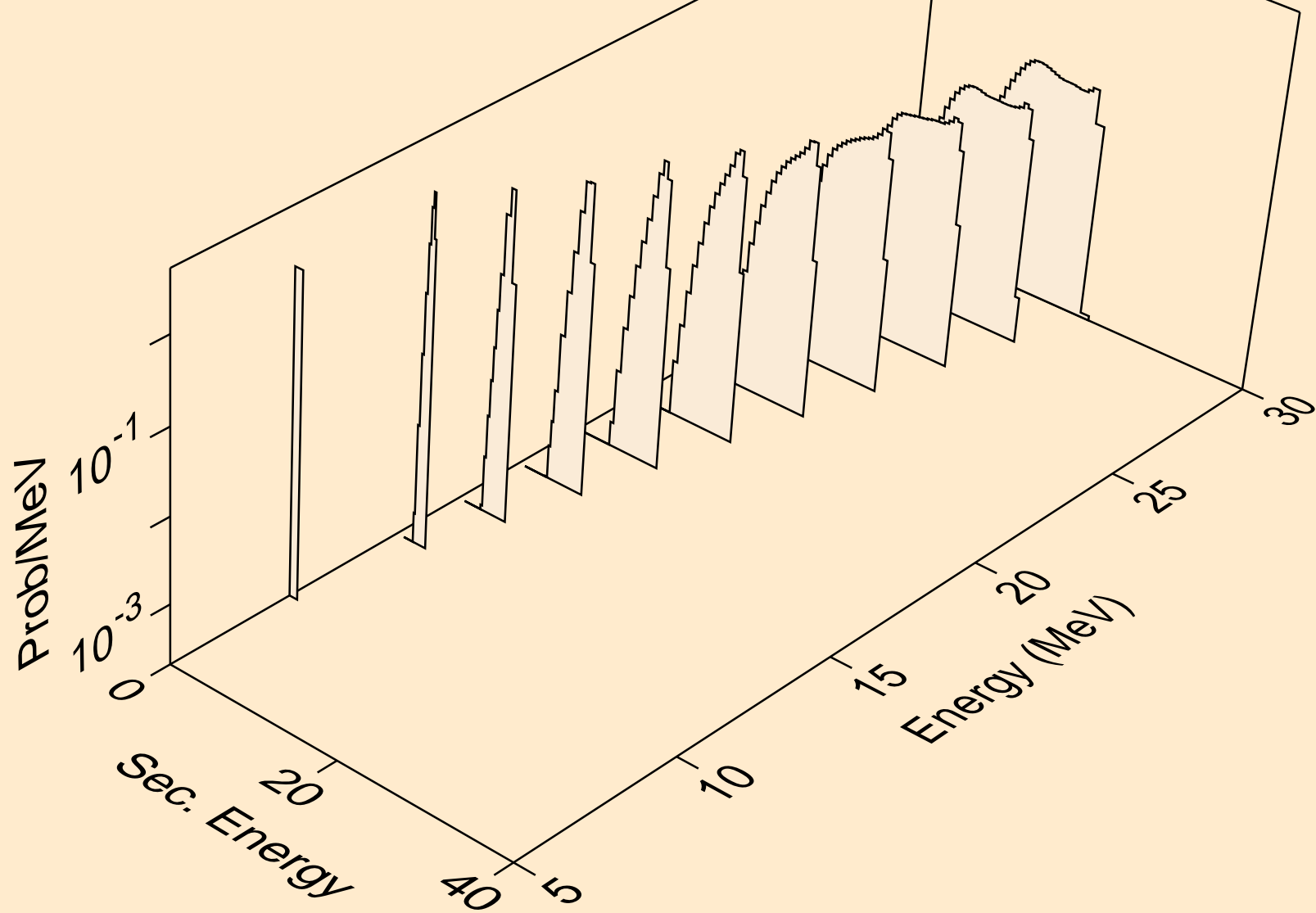

PR126 NEUTRON ACER TENDL-2021 LIBRARY; T=293.6K
deuterons from (n,d)

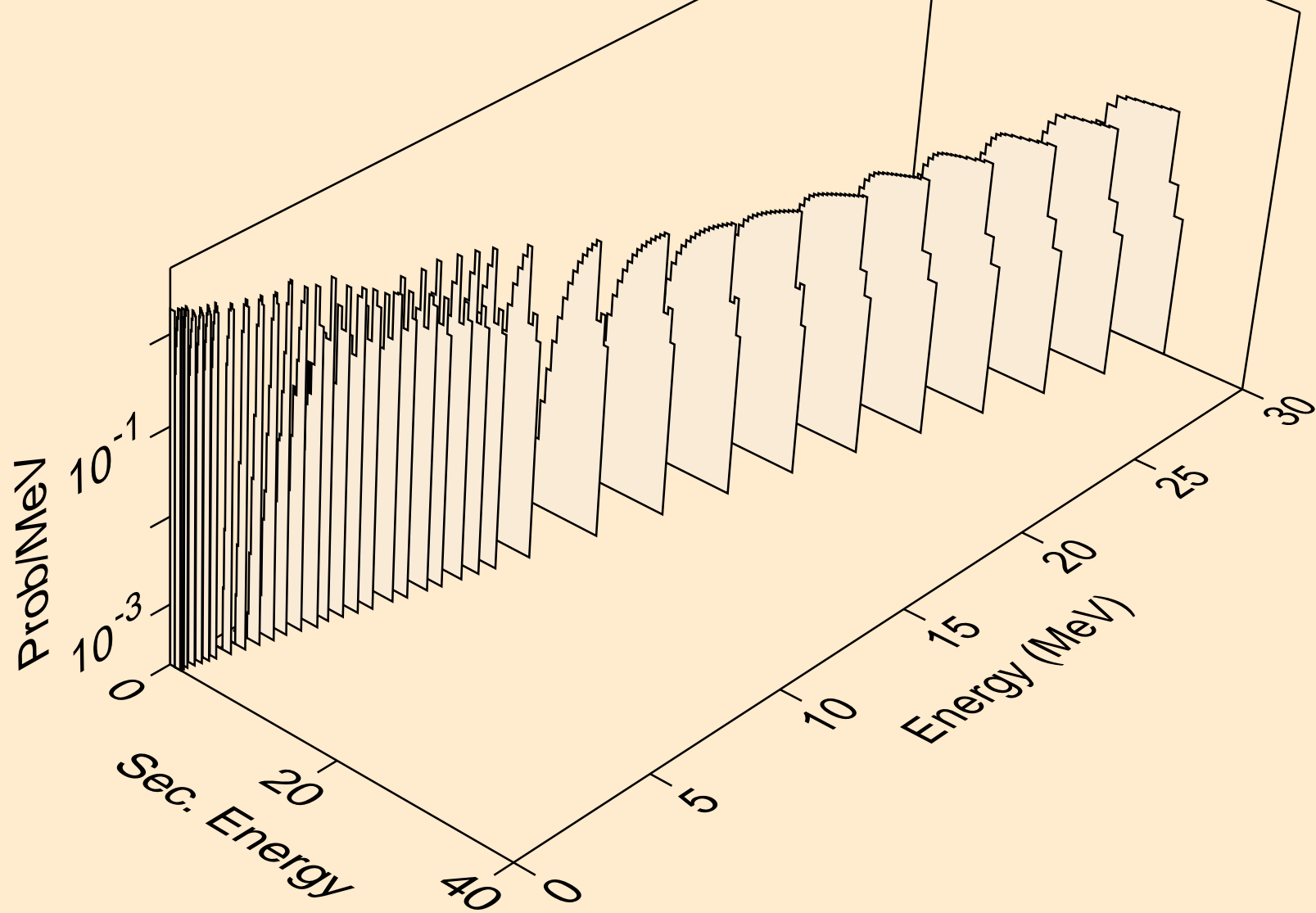

PR126 NEUTRON ACER TENDL-2021 LIBRARY; T=293.6K
deuterons from (n,d2a)

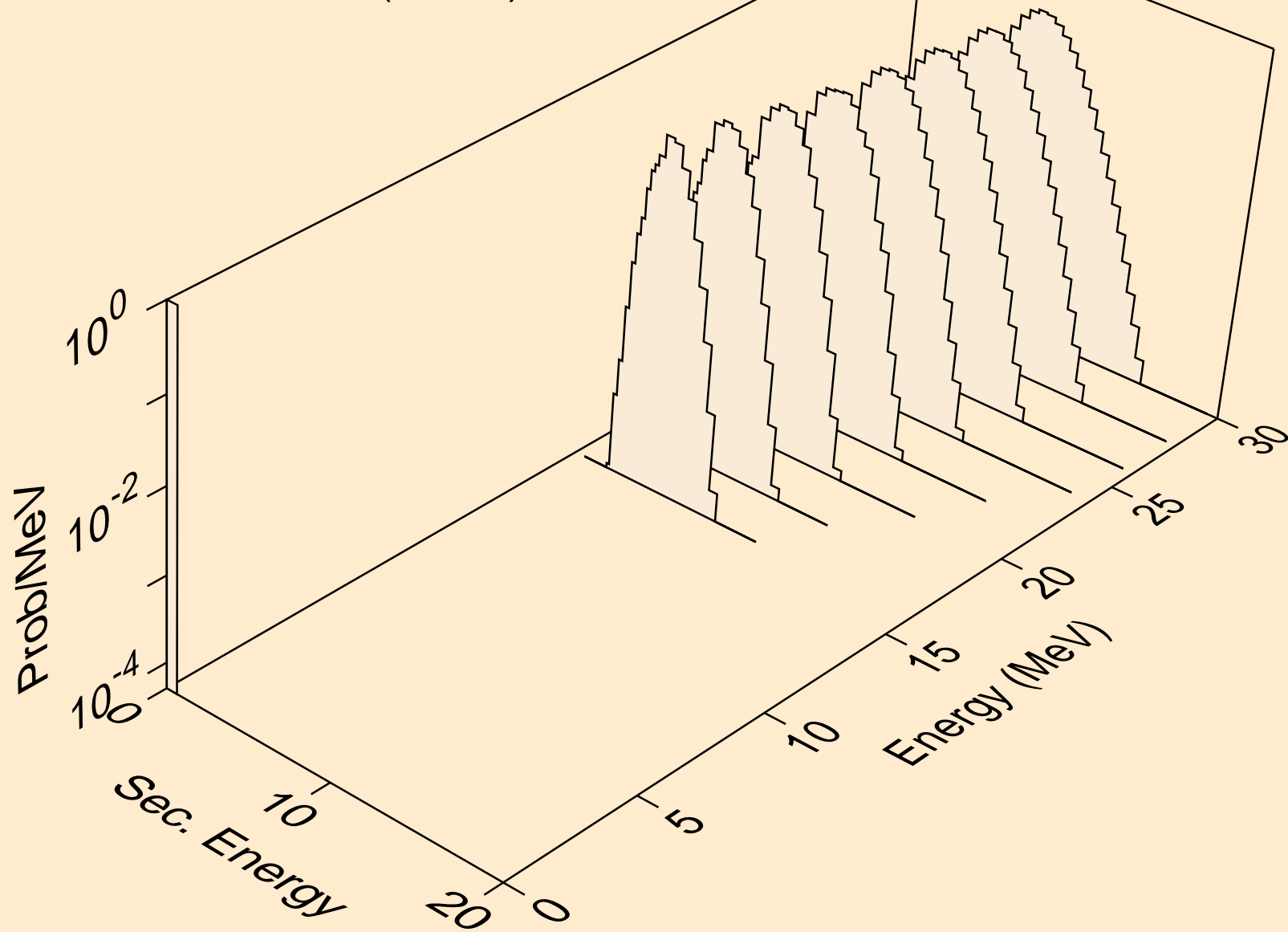

PR126 NEUTRON ACER TENDL-2021 LIBRARY; T=293.6K
deuterons from (n,pd)

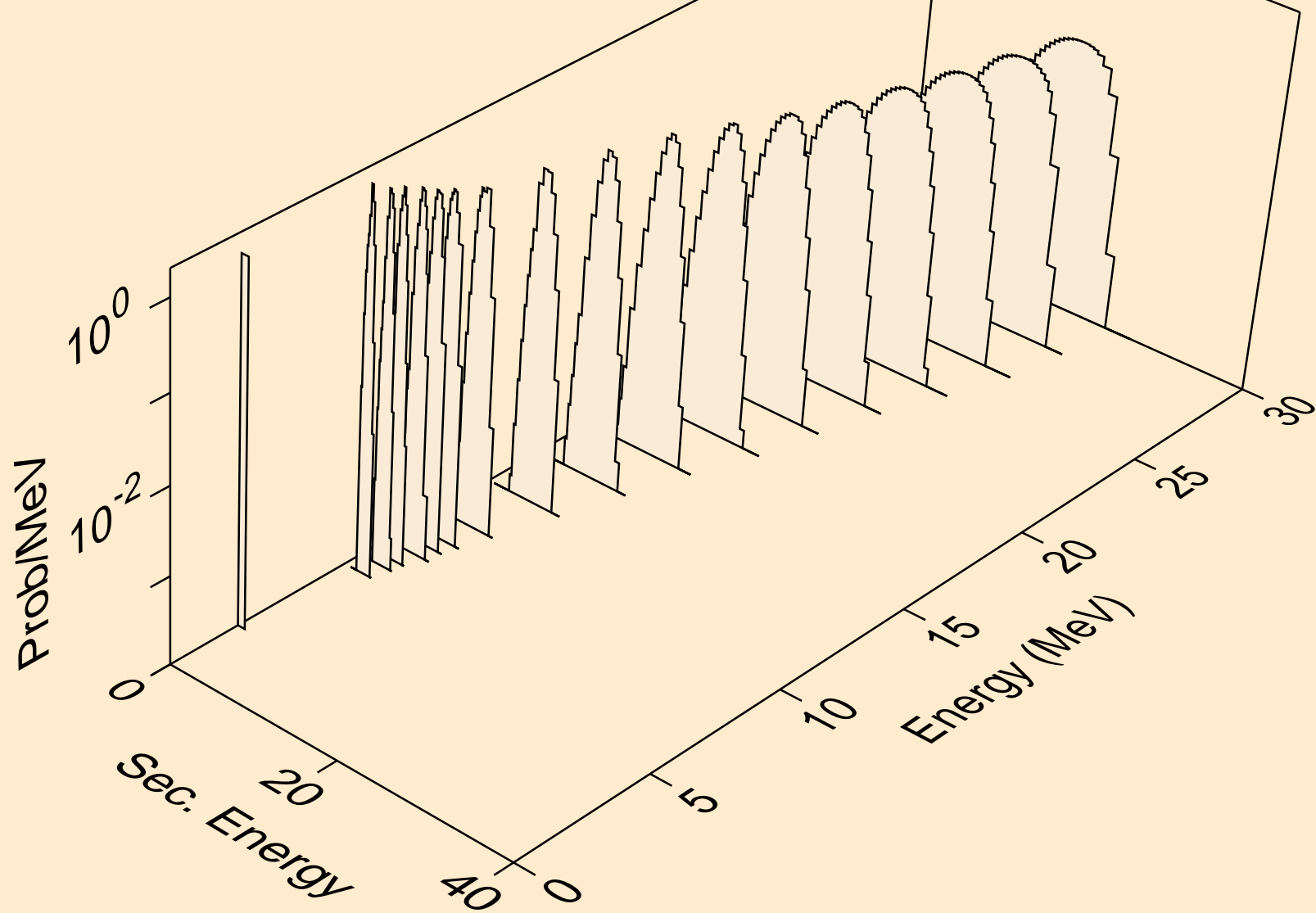

PR126 NEUTRON ACER TENDL-2021 LIBRARY; T=293.6K
deuterons from (n,da)

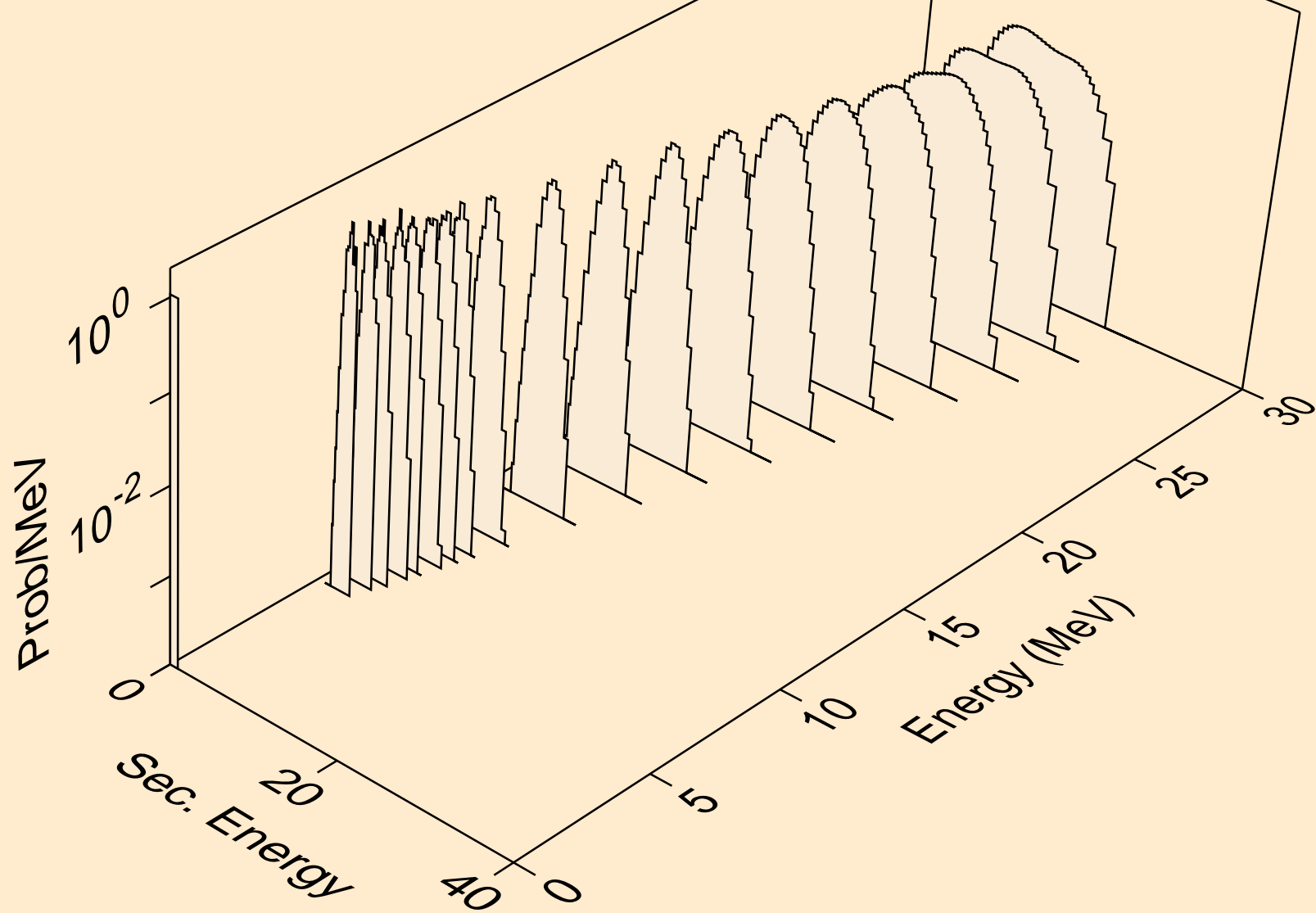

PR126 NEUTRON ACER TENDL-2021 LIBRARY; T=293.6K
tritons from (n,x)

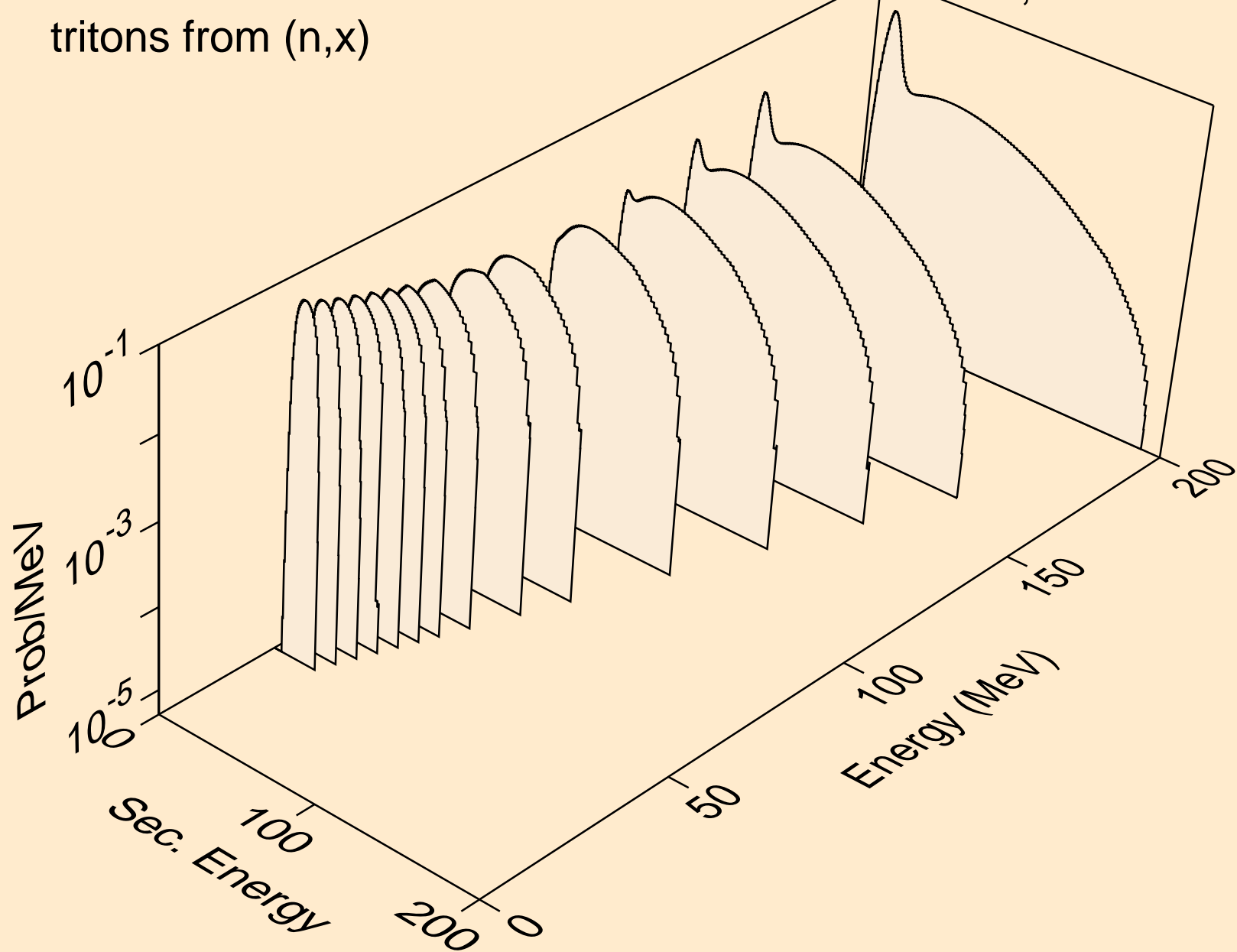

PR126 NEUTRON ACER TENDL-2021 LIBRARY; T=293.6K
tritons from (n,n*)t

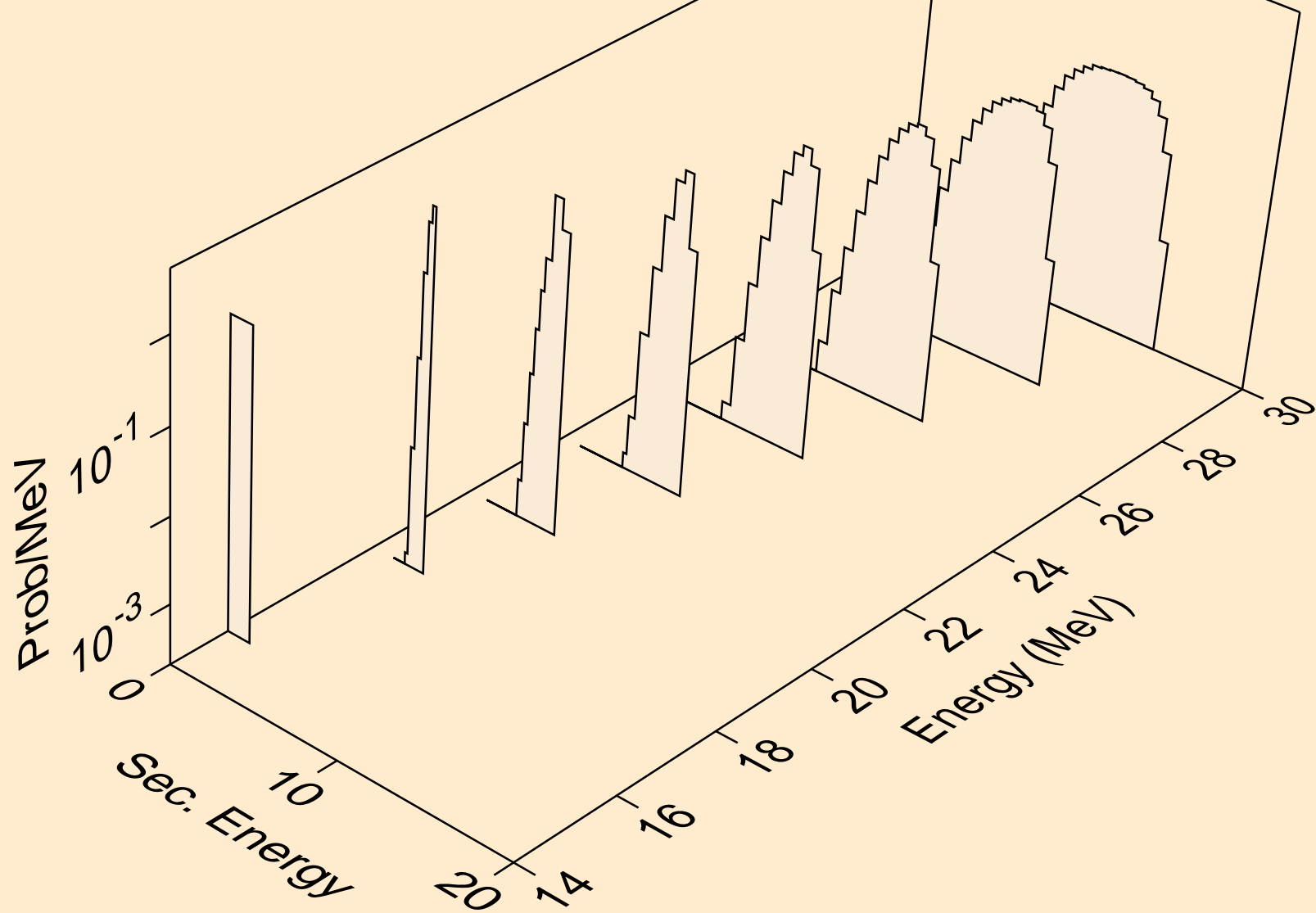

PR126 NEUTRON ACER TENDL-2021 LIBRARY; T=293.6K
tritons from (n,t)

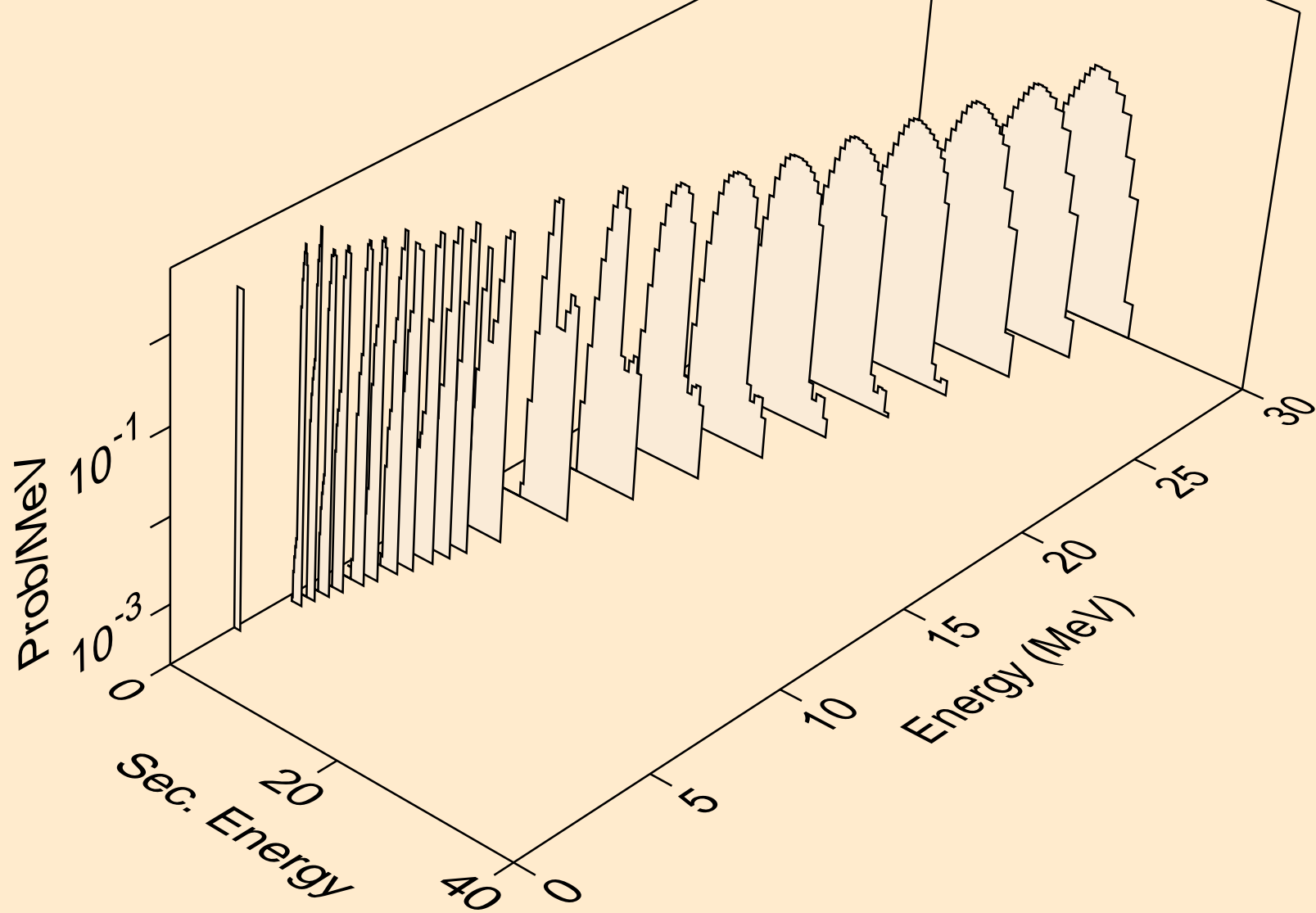

PR126 NEUTRON ACER TENDL-2021 LIBRARY; T=293.6K
tritons from (n,pt)

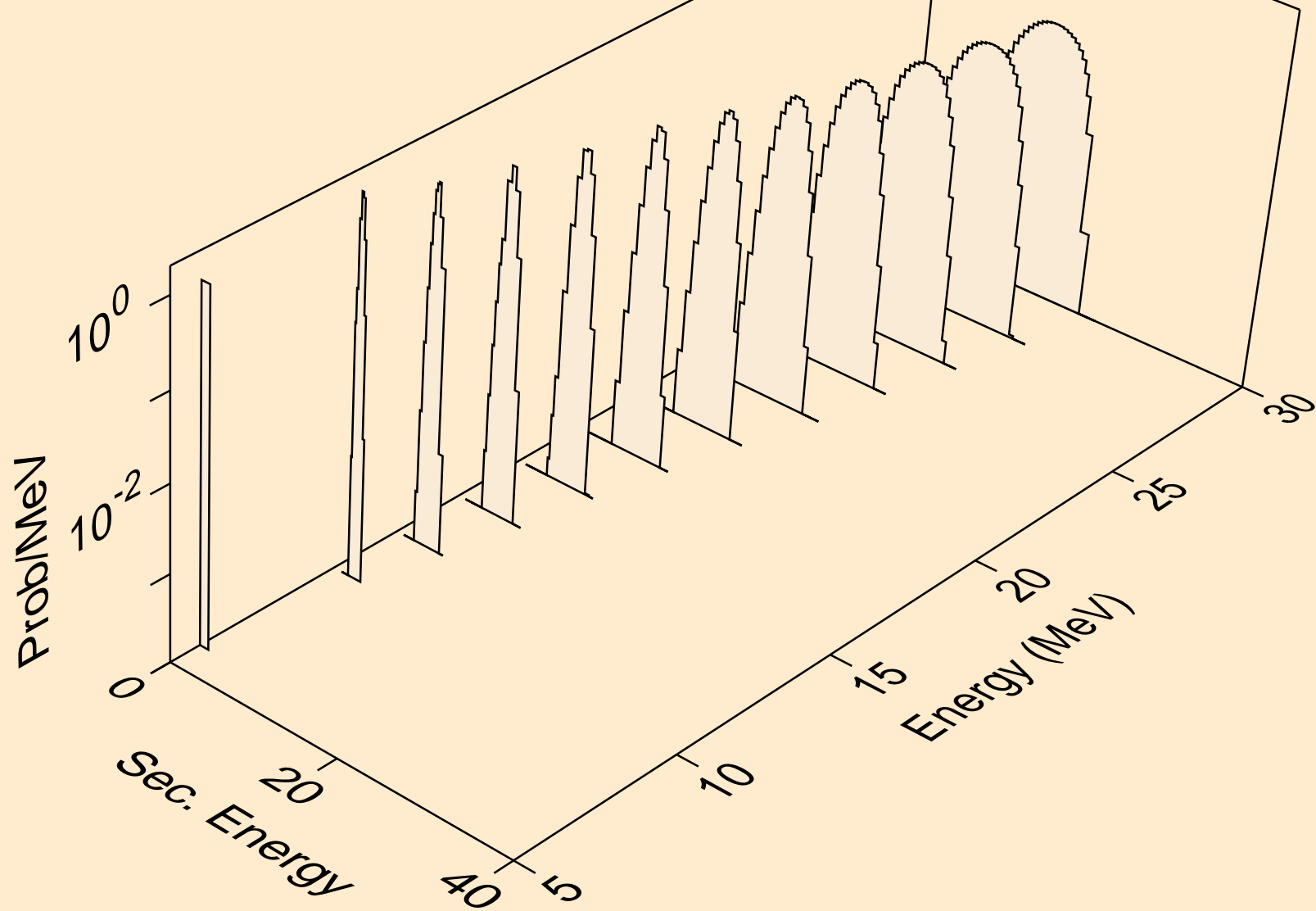

PR126 NEUTRON ACER TENDL-2021 LIBRARY; T=293.6K
he3s from (n,x)

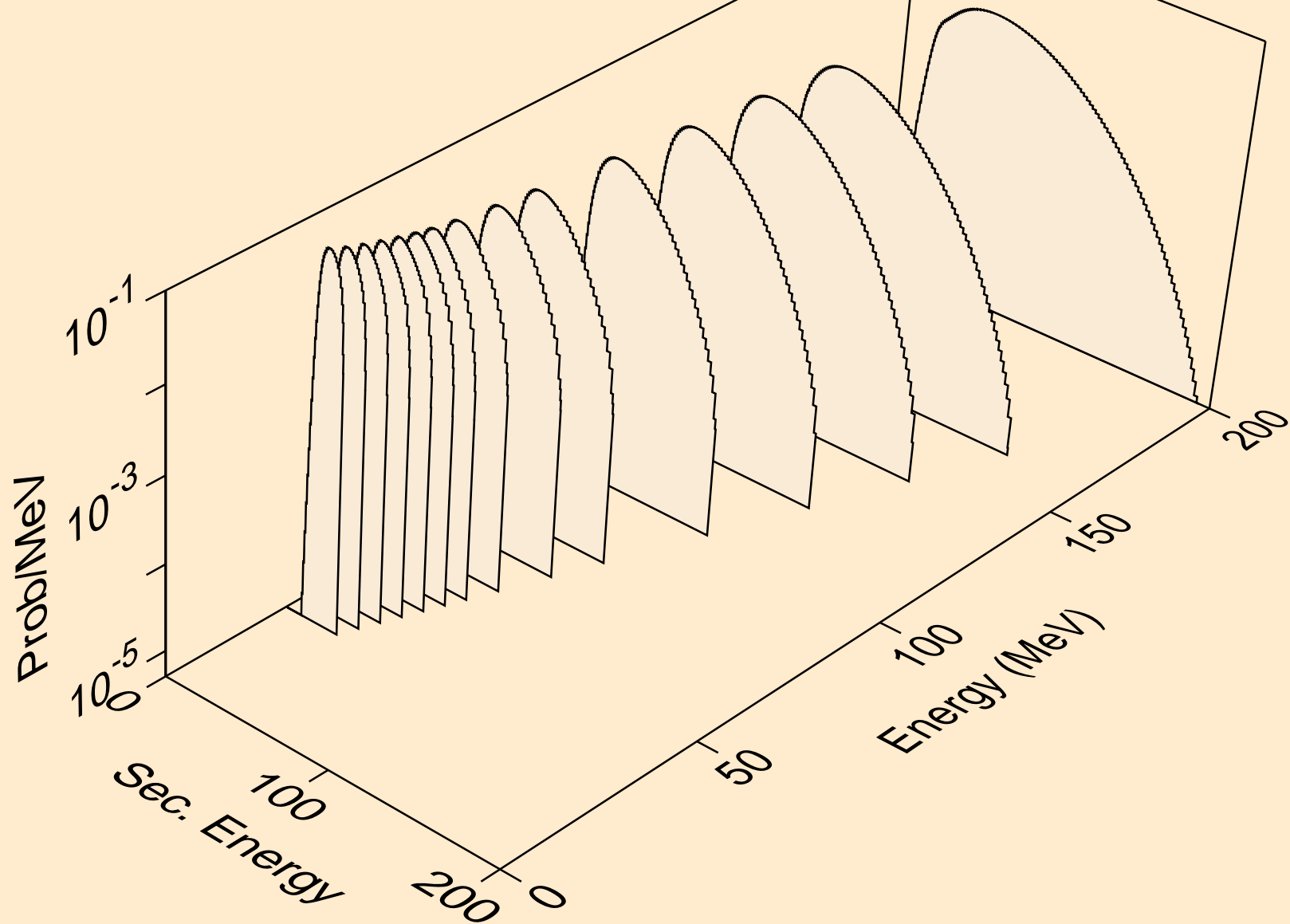

PR126 NEUTRON ACER TENDL-2021 LIBRARY; T=293.6K
he3s from (n,n*)he3

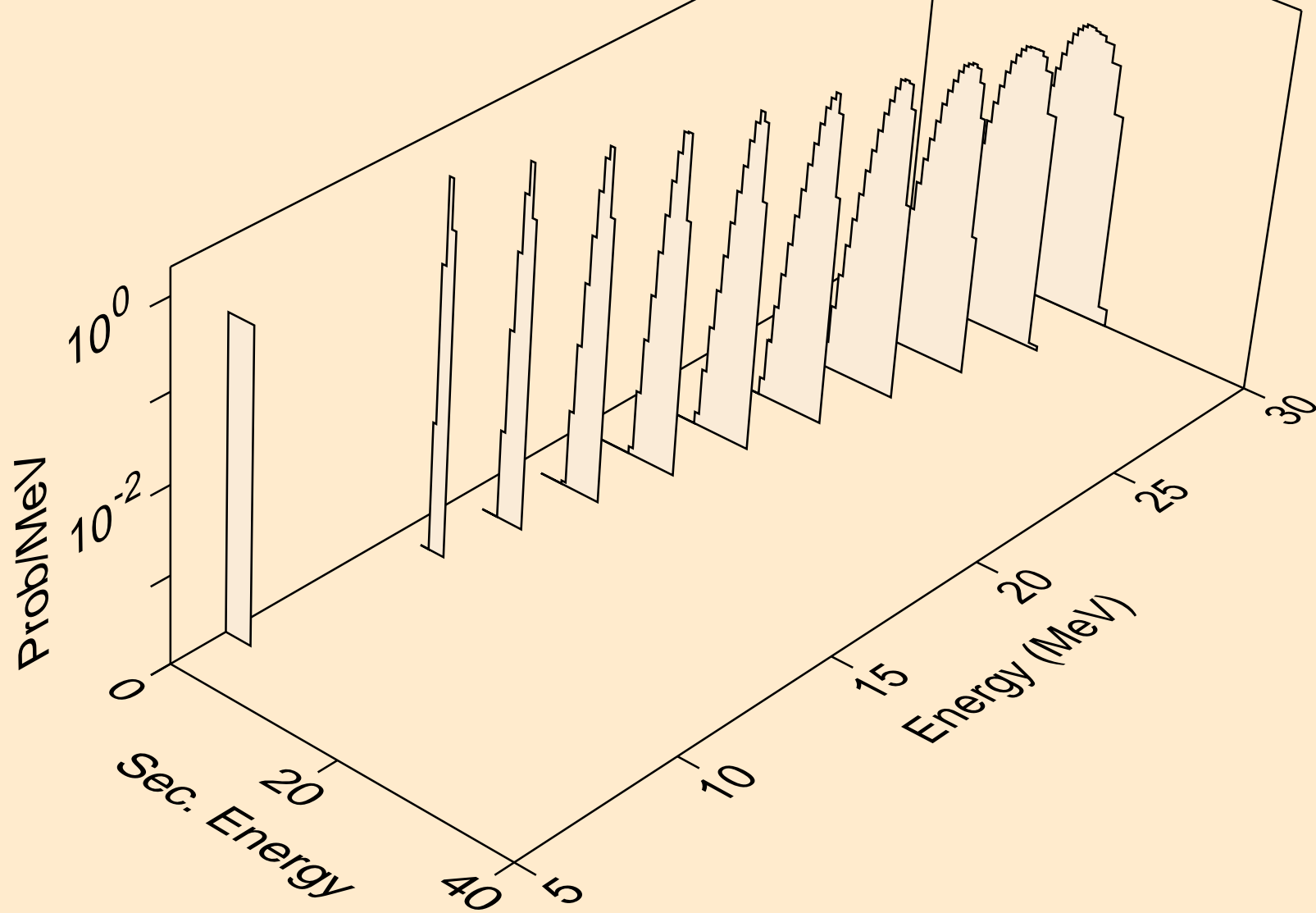

PR126 NEUTRON ACER TENDL-2021 LIBRARY; T=293.6K
he3s from (n,he3)

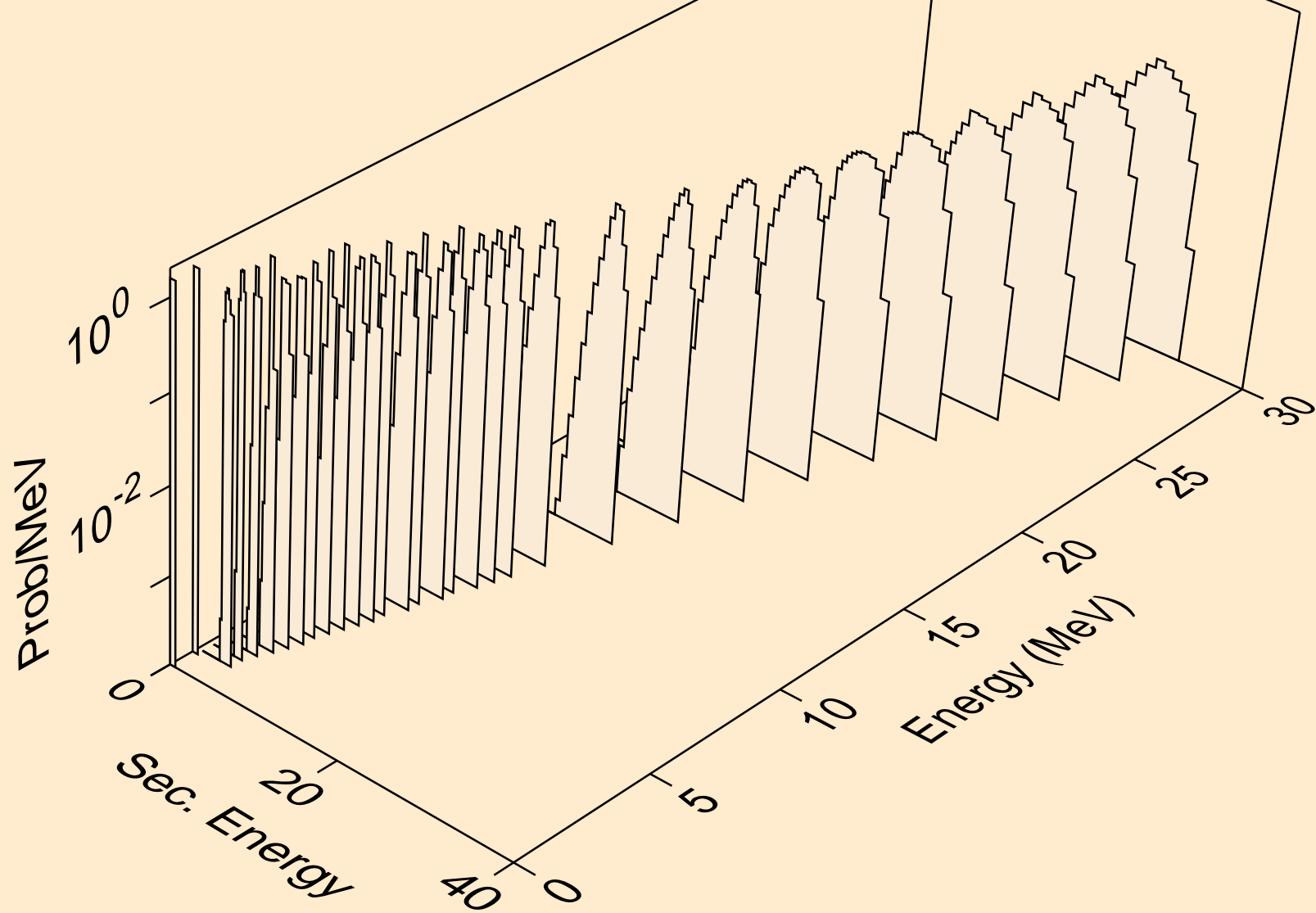

PR126 NEUTRON ACER TENDL-2021 LIBRARY; T=293.6K
alphas from (n,x)

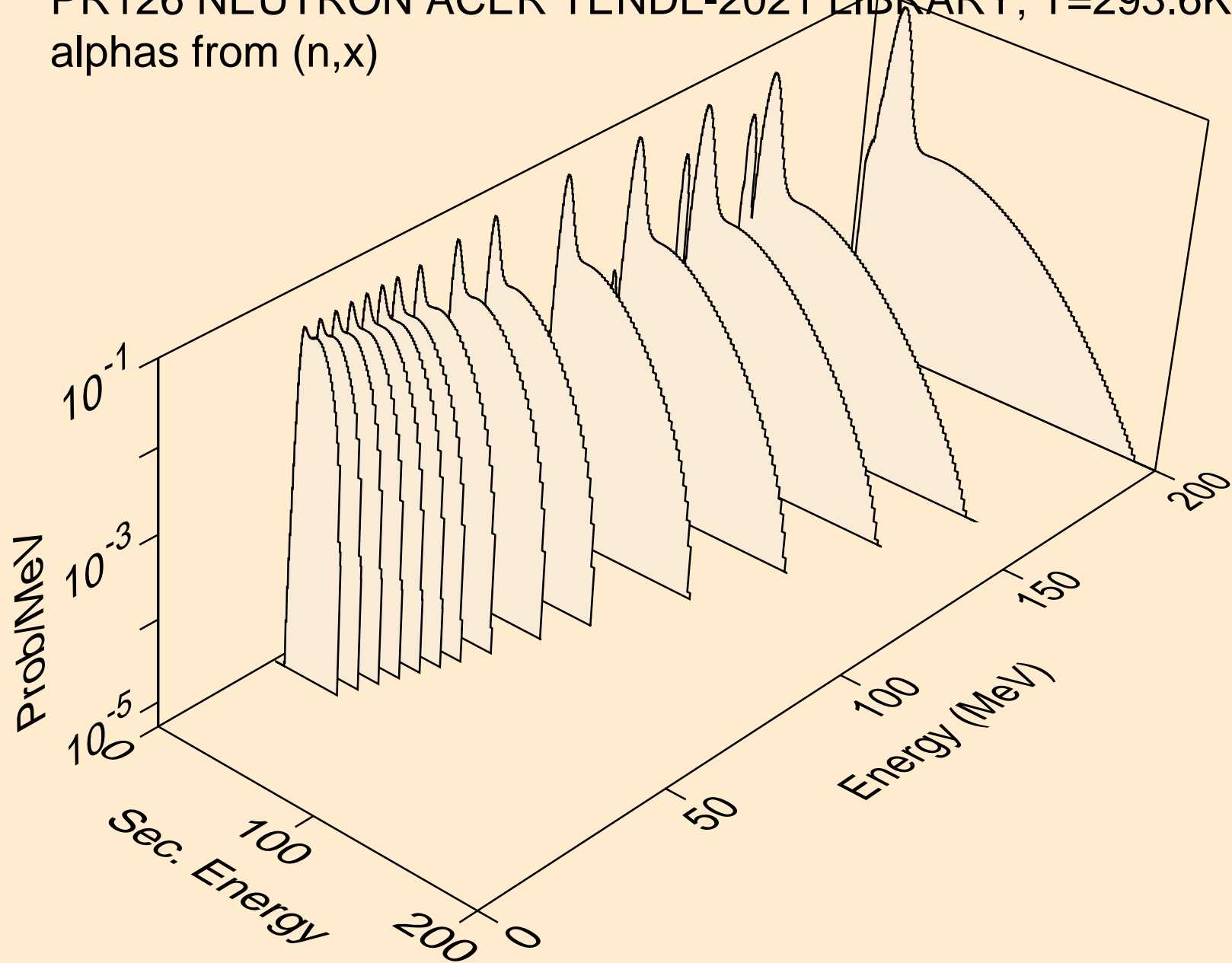

PR126 NEUTRON ACER TENDL-2021 LIBRARY; T=293.6K
alphas from (n,n*)a

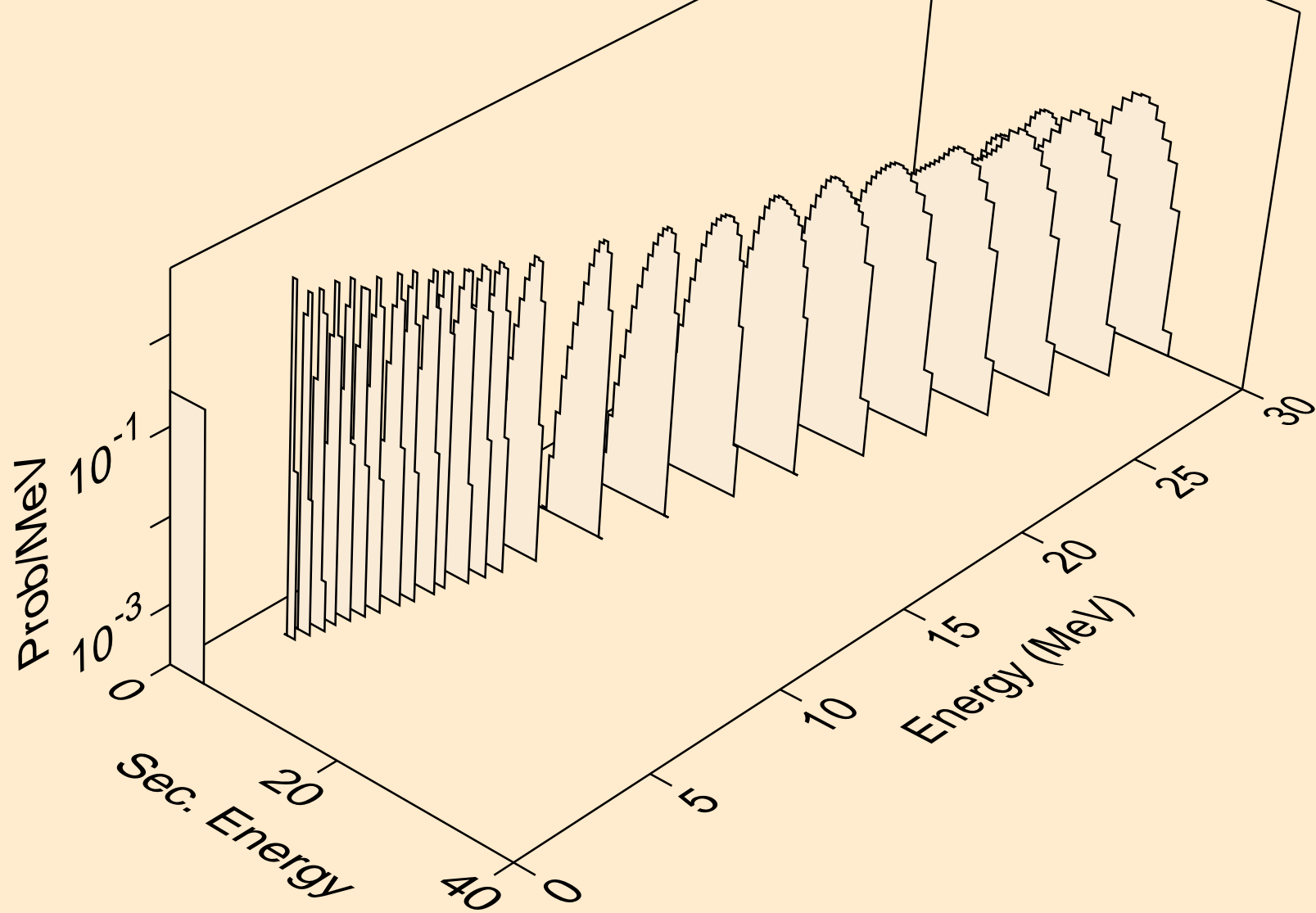

PR126 NEUTRON ACER TENDL-2021 LIBRARY; T=293.6K
alphas from (n,2n)a

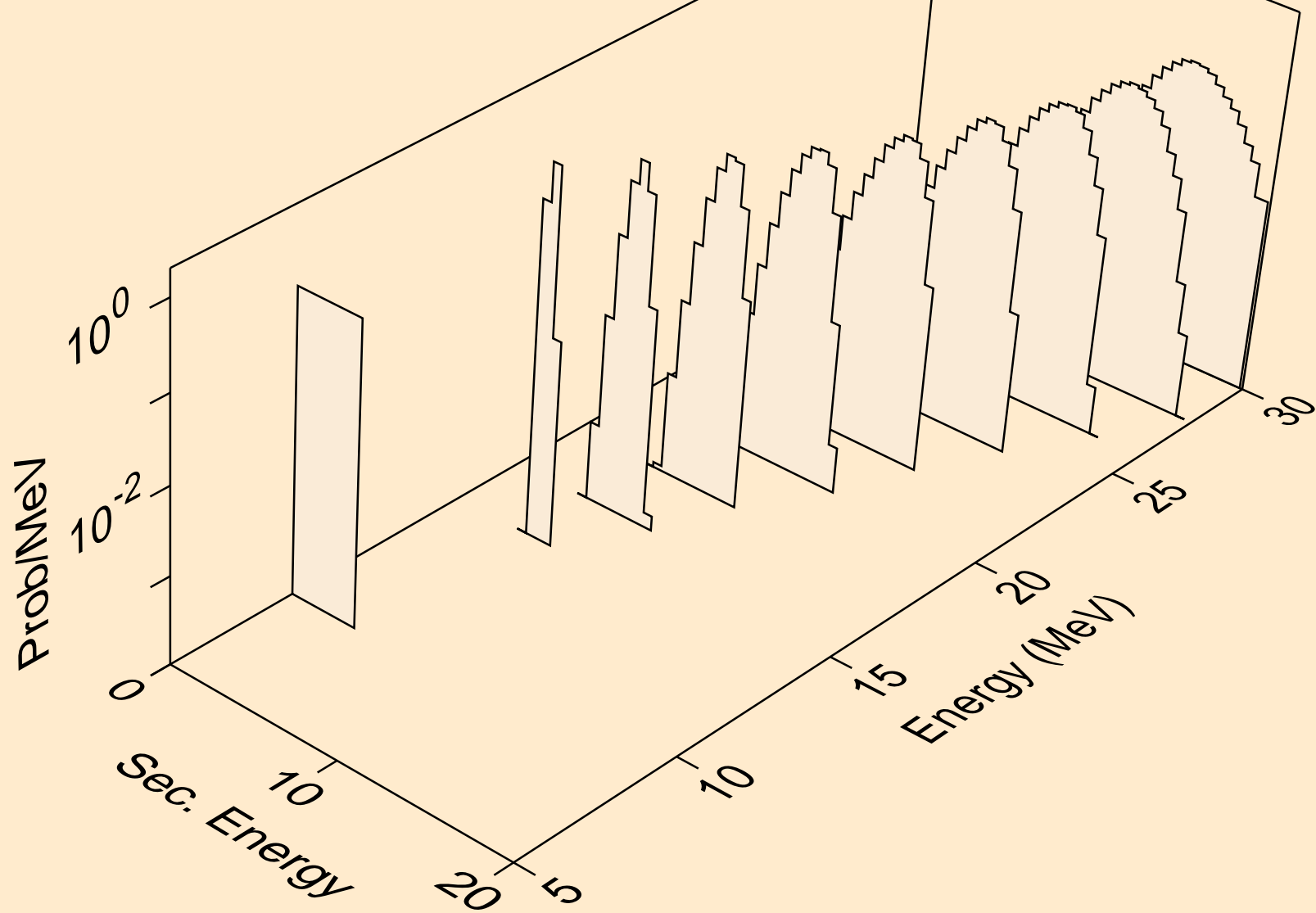

PR126 NEUTRON ACER TENDL-2021 LIBRARY; T=293.6K
alphas from (n,n*)2a

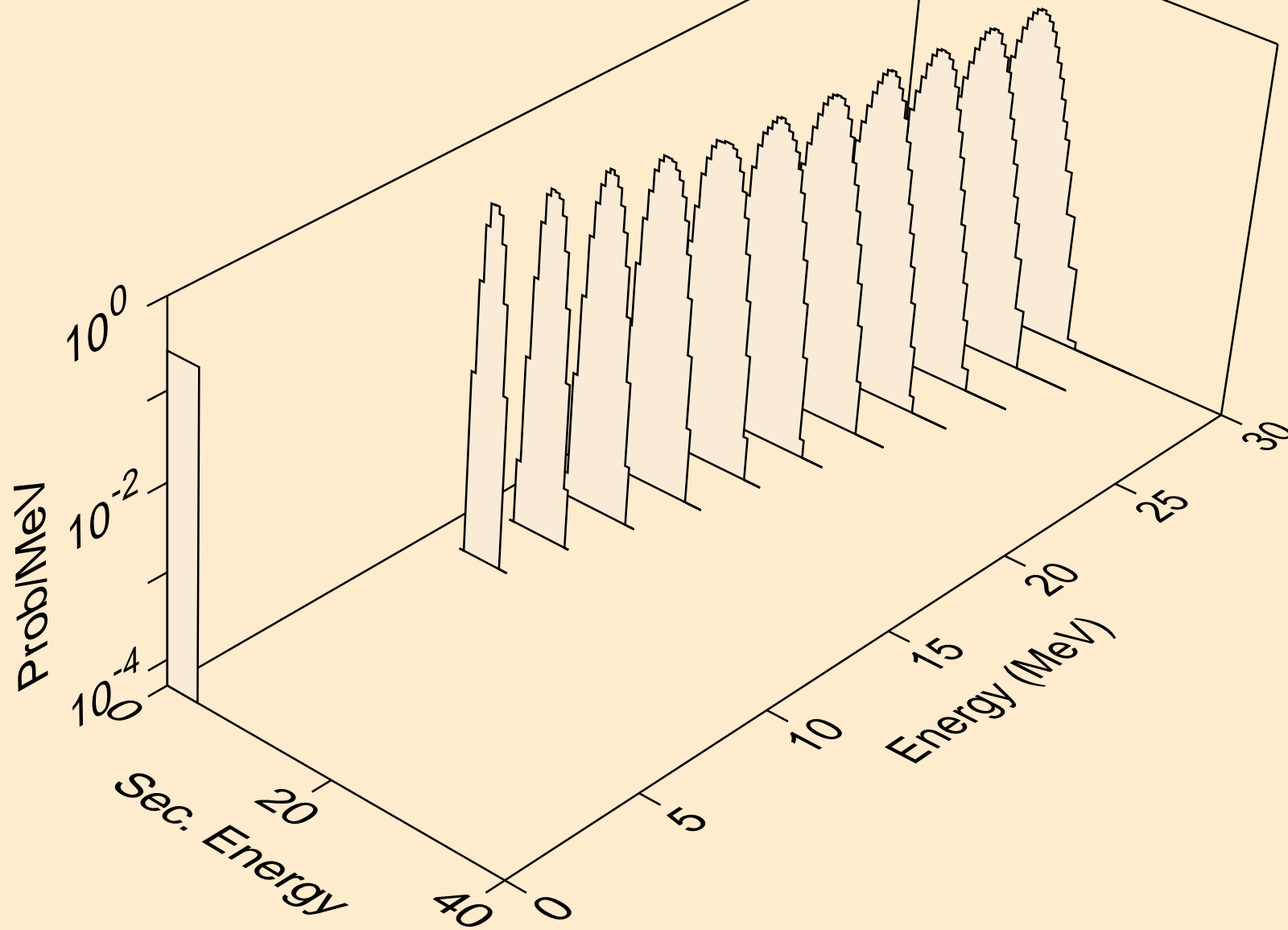

PR126 NEUTRON ACER TENDL-2021 LIBRARY; T=293.6K
alphas from (n,npa)

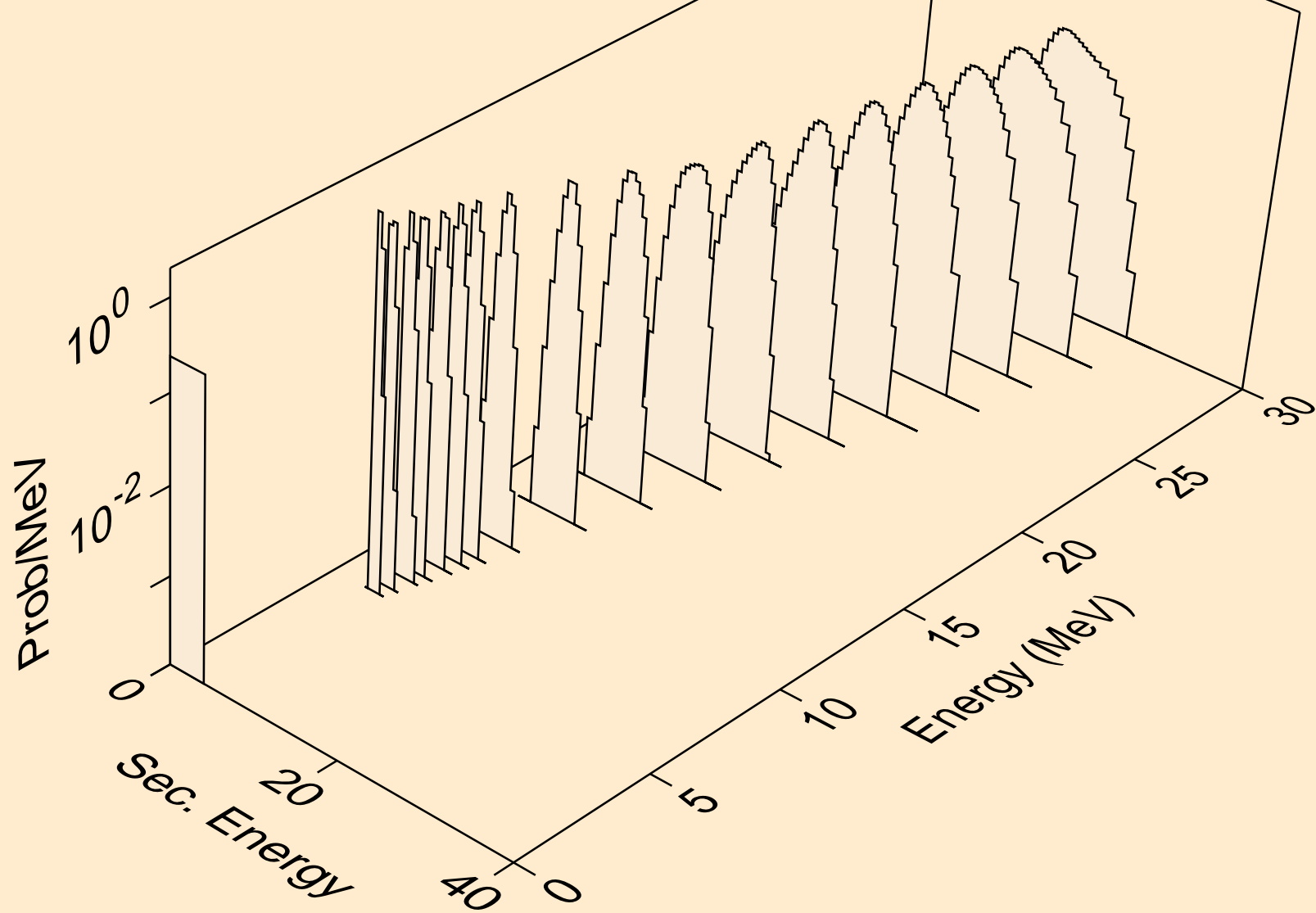

PR126 NEUTRON ACER TENDL-2021 LIBRARY; T=293.6K
alphas from (n,a)

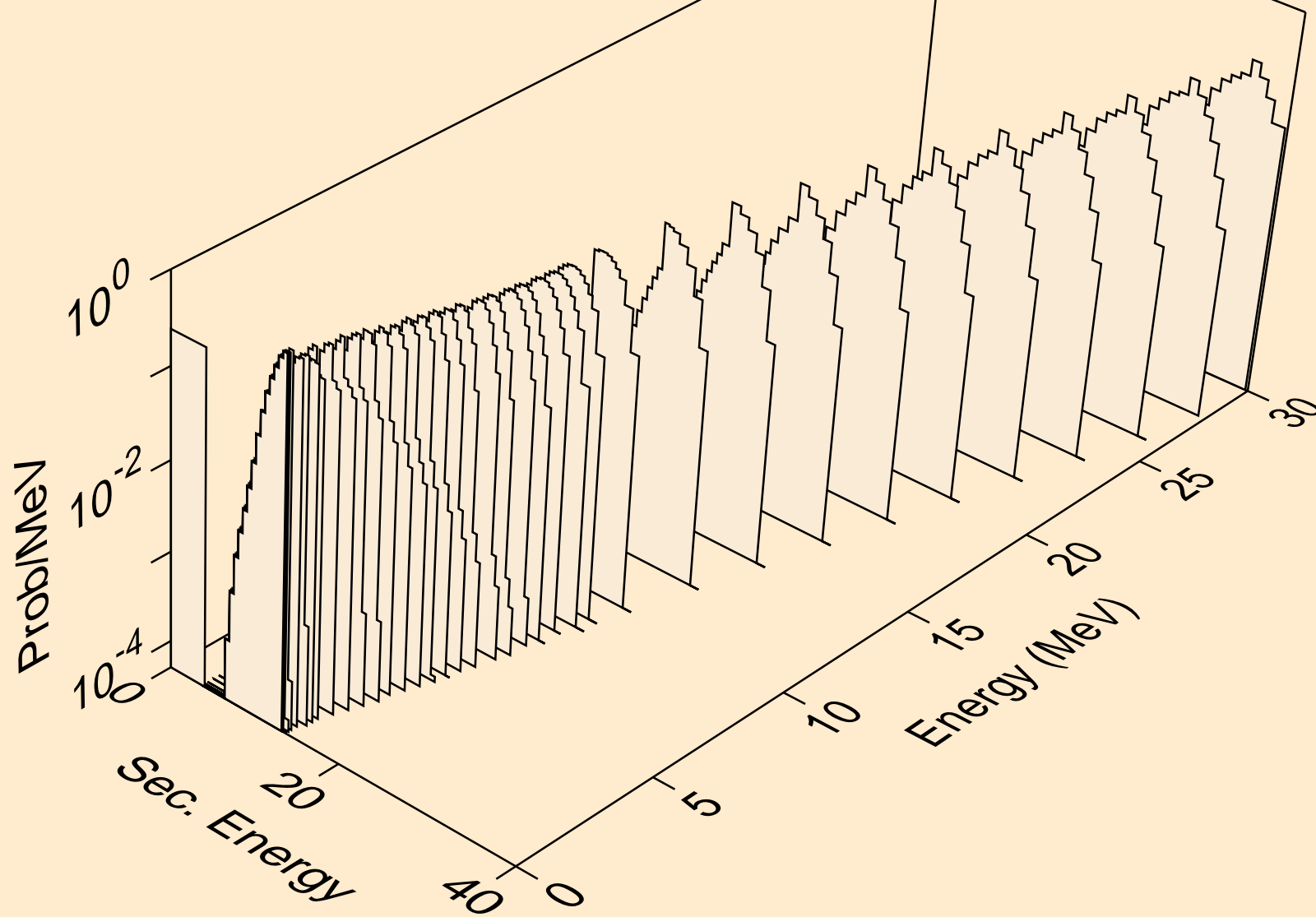

PR126 NEUTRON ACER TENDL-2021 LIBRARY; T=293.6K
alphas from (n,2a)

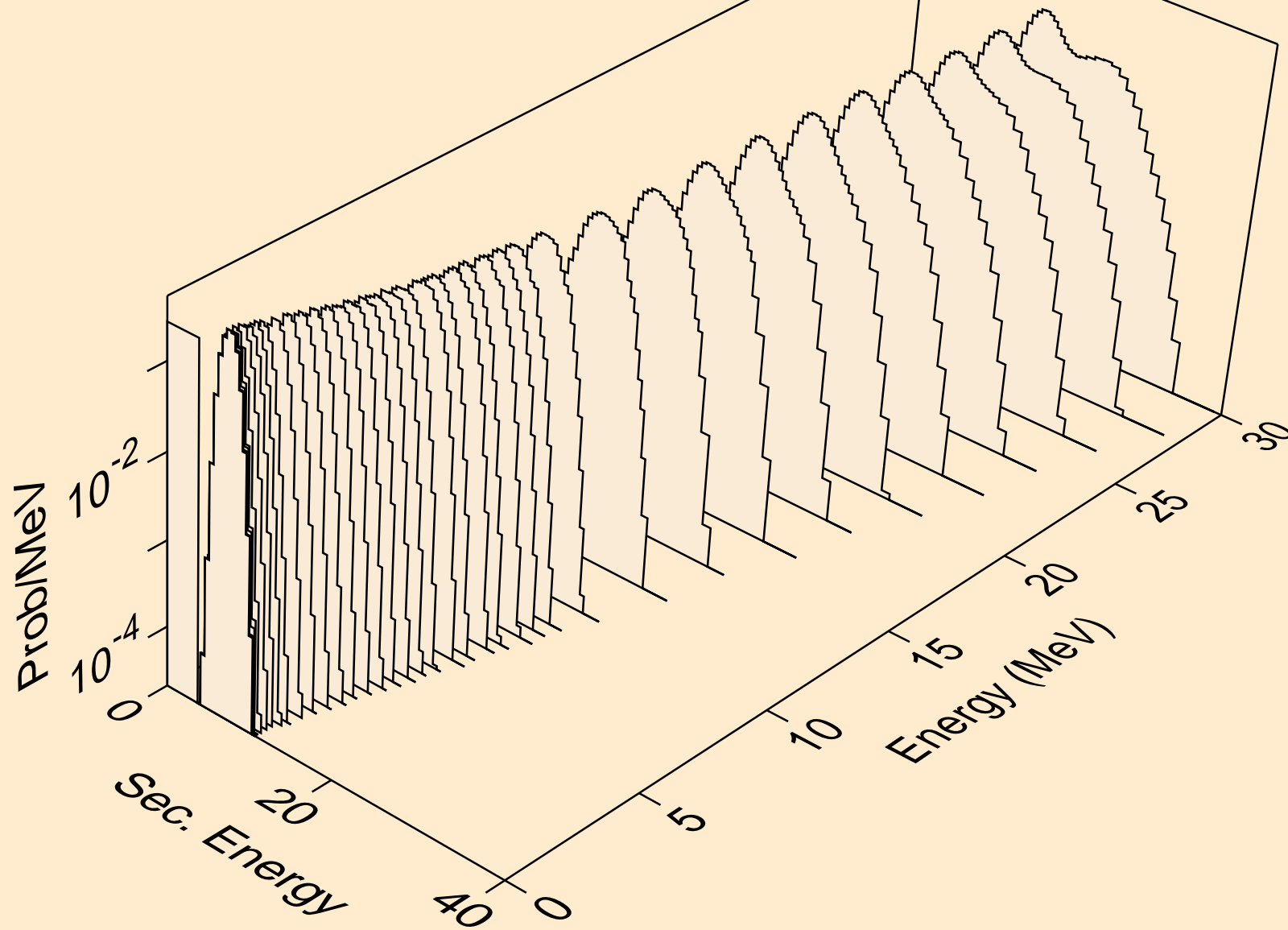

PR126 NEUTRON ACER TENDL-2021 LIBRARY; T=293.6K
alphas from (n,3a)

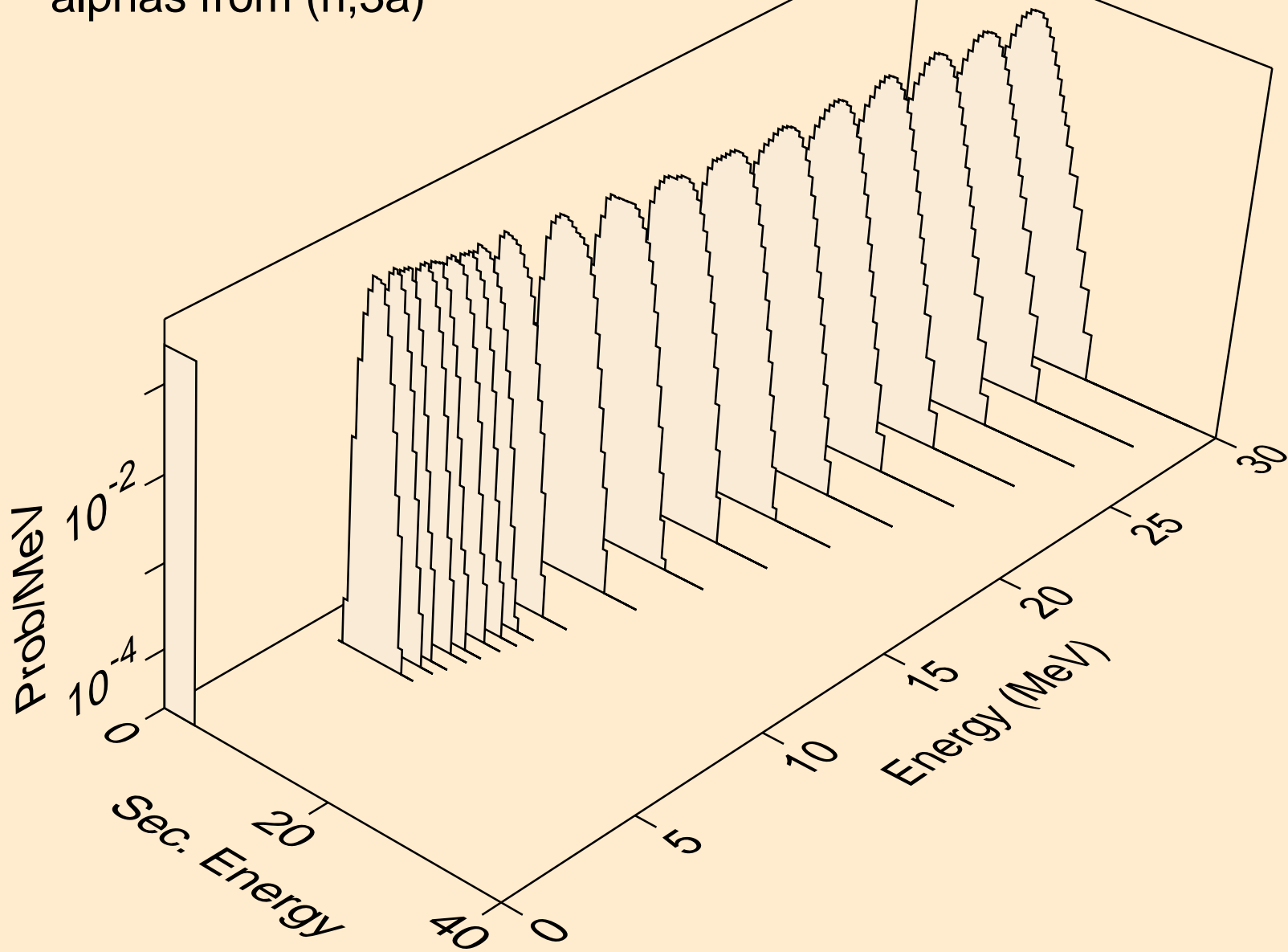

PR126 NEUTRON ACER TENDL-2021 LIBRARY; T=293.6K
alphas from (n,pa)

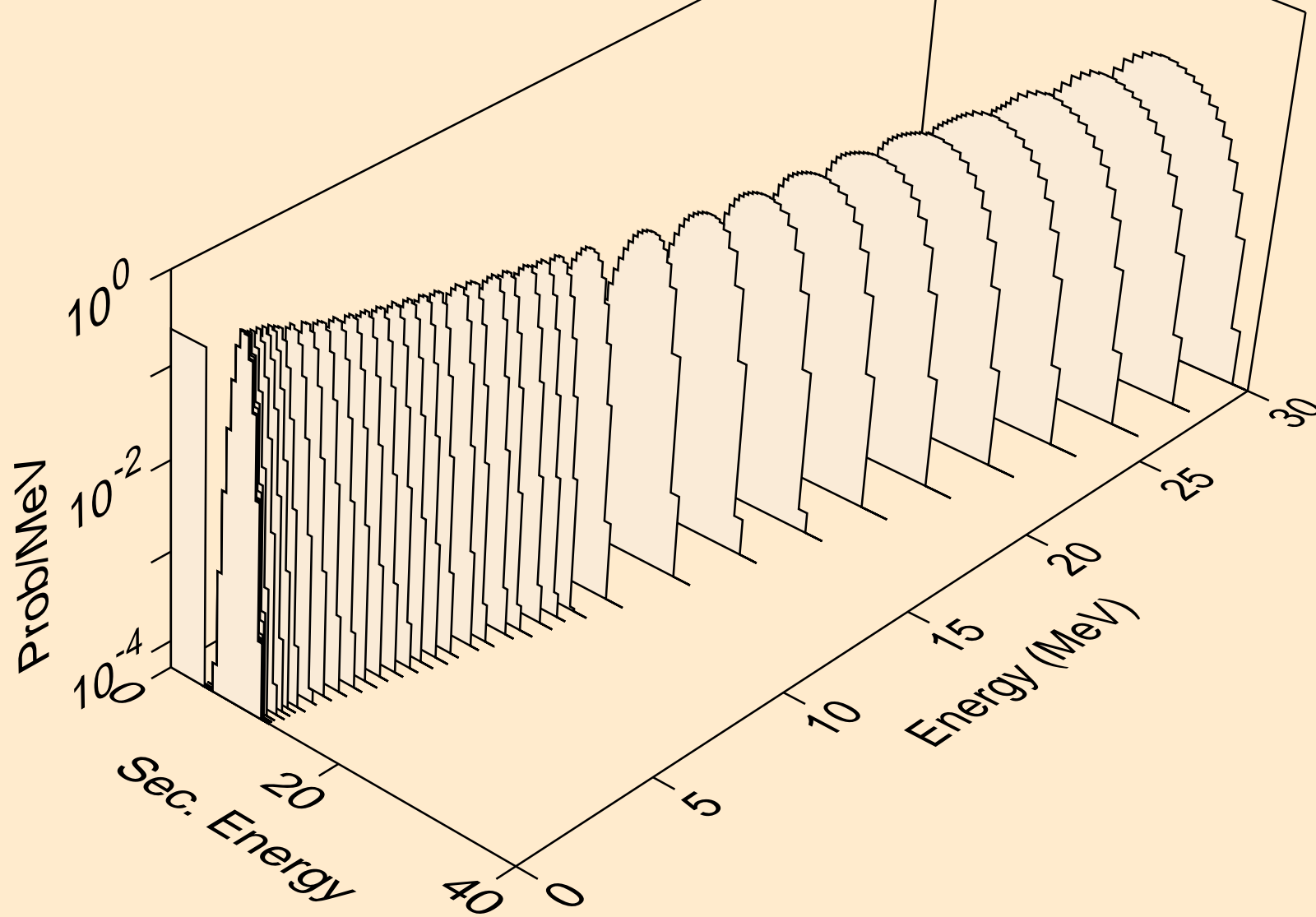

PR126 NEUTRON ACER TENDL-2021 LIBRARY; T=293.6K
alphas from (n,d2a)

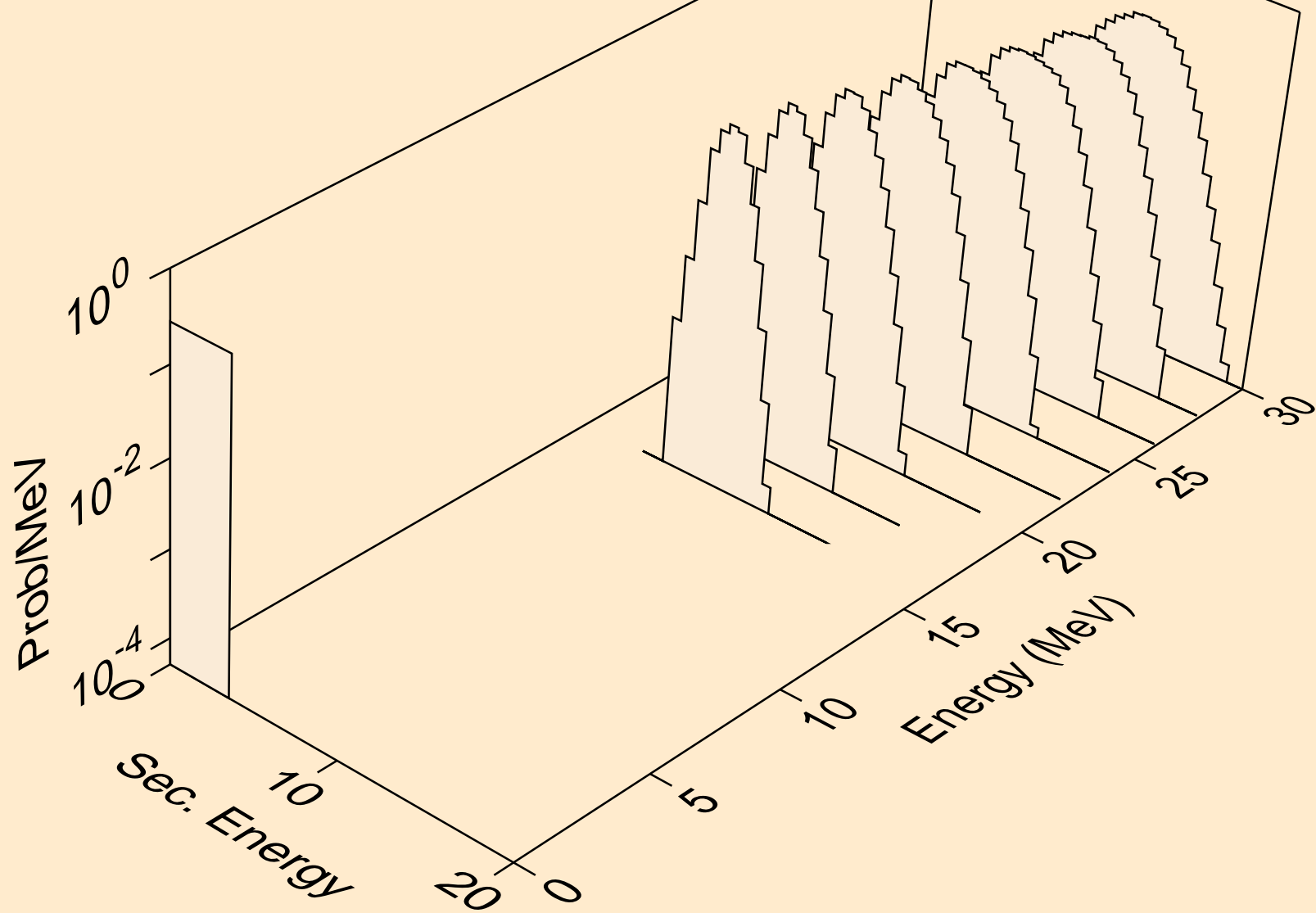

PR126 NEUTRON ACER TENDL-2021 LIBRARY; T=293.6K
alphas from (n,da)

