

PR134 NEUTRON ACER TENDL-2021 LIBRARY; T=293.6K
Principal cross sections

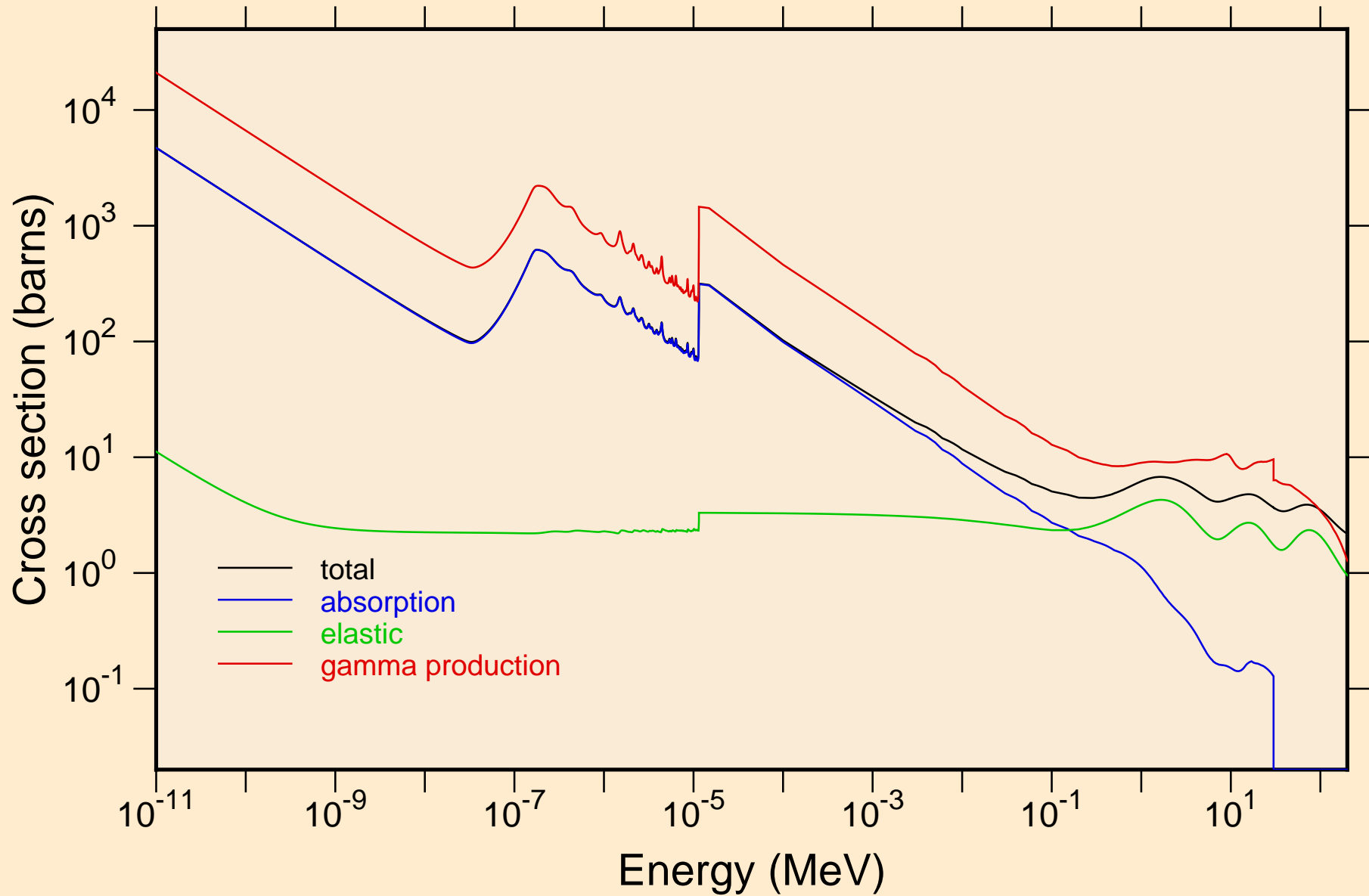

PR134 NEUTRON ACER TENDL-2021 LIBRARY; T=293.6K
resonance total cross section

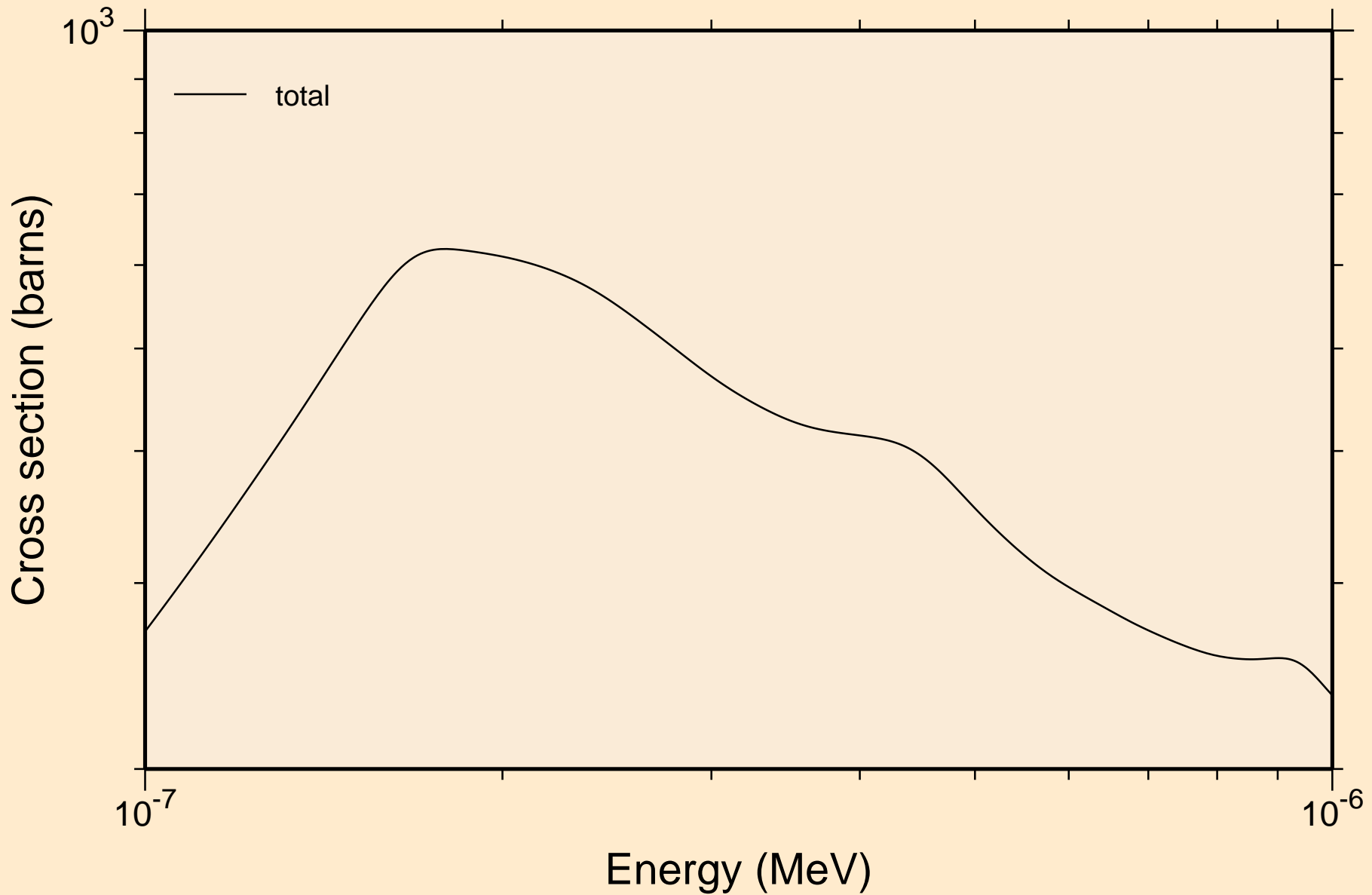

PR134 NEUTRON ACER TENDL-2021 LIBRARY; T=293.6K
resonance total cross section

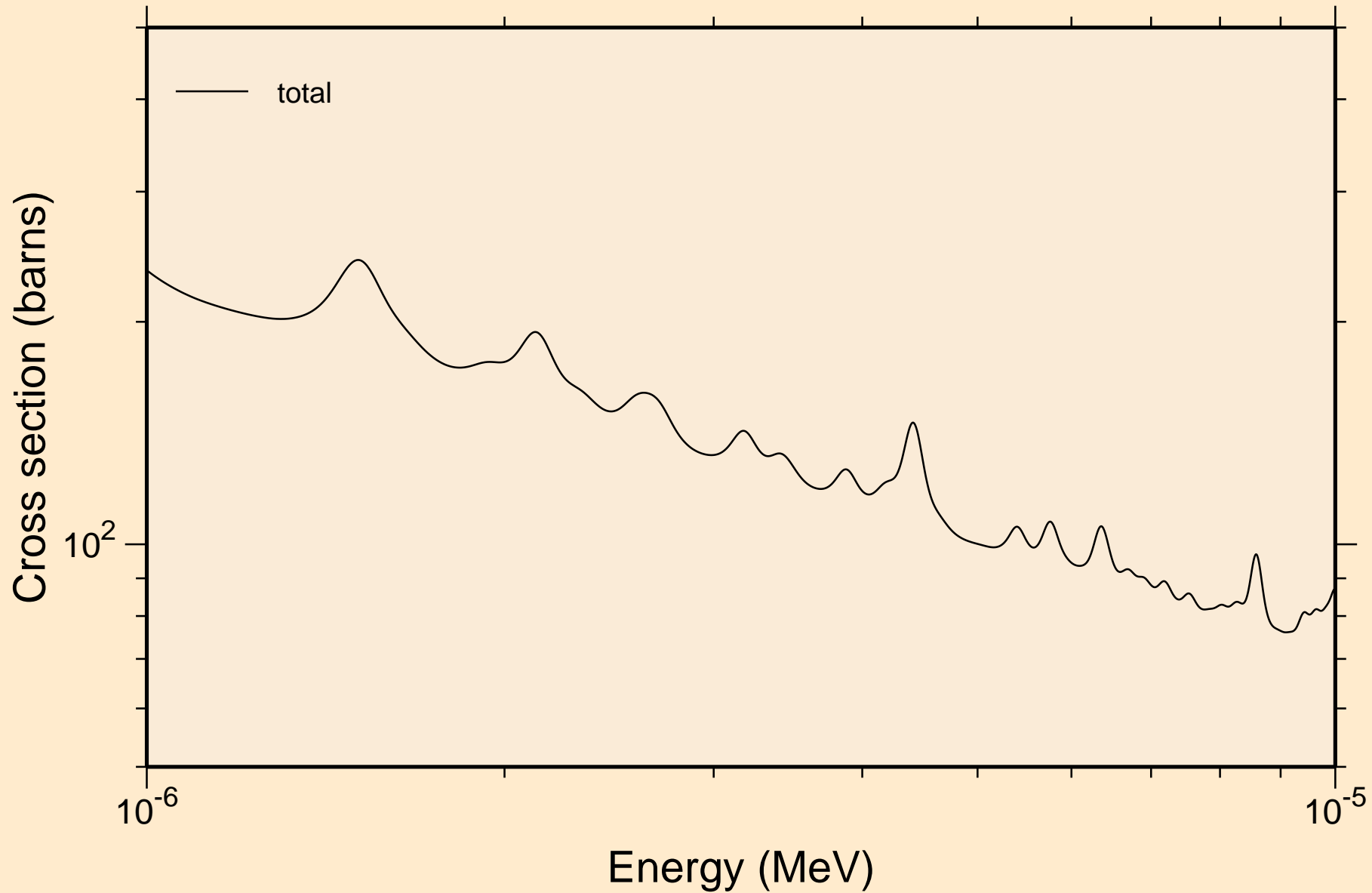

PR134 NEUTRON ACER TENDL-2021 LIBRARY; T=293.6K
resonance total cross section

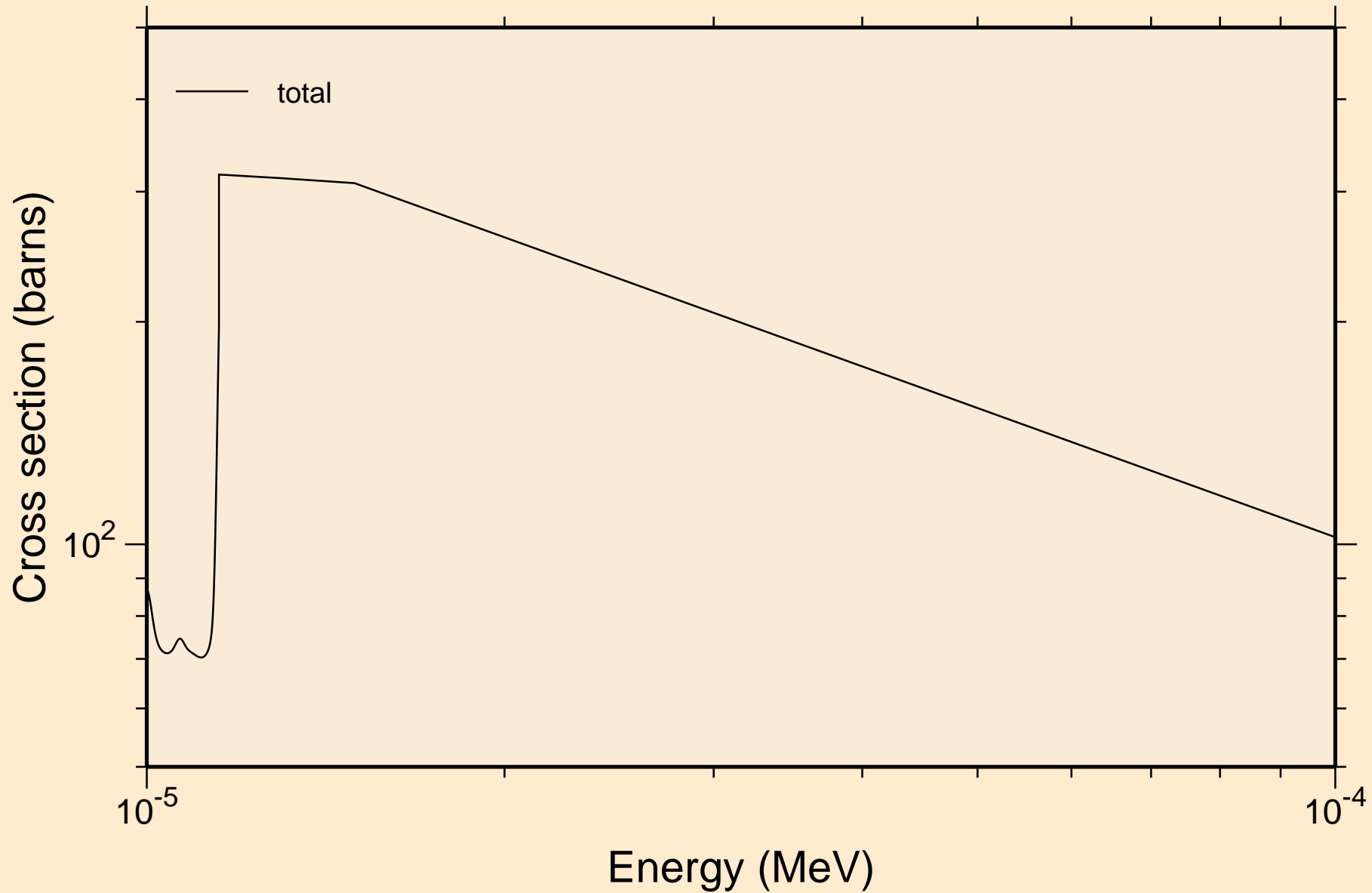

PR134 NEUTRON ACER TENDL-2021 LIBRARY; T=293.6K
resonance total cross section

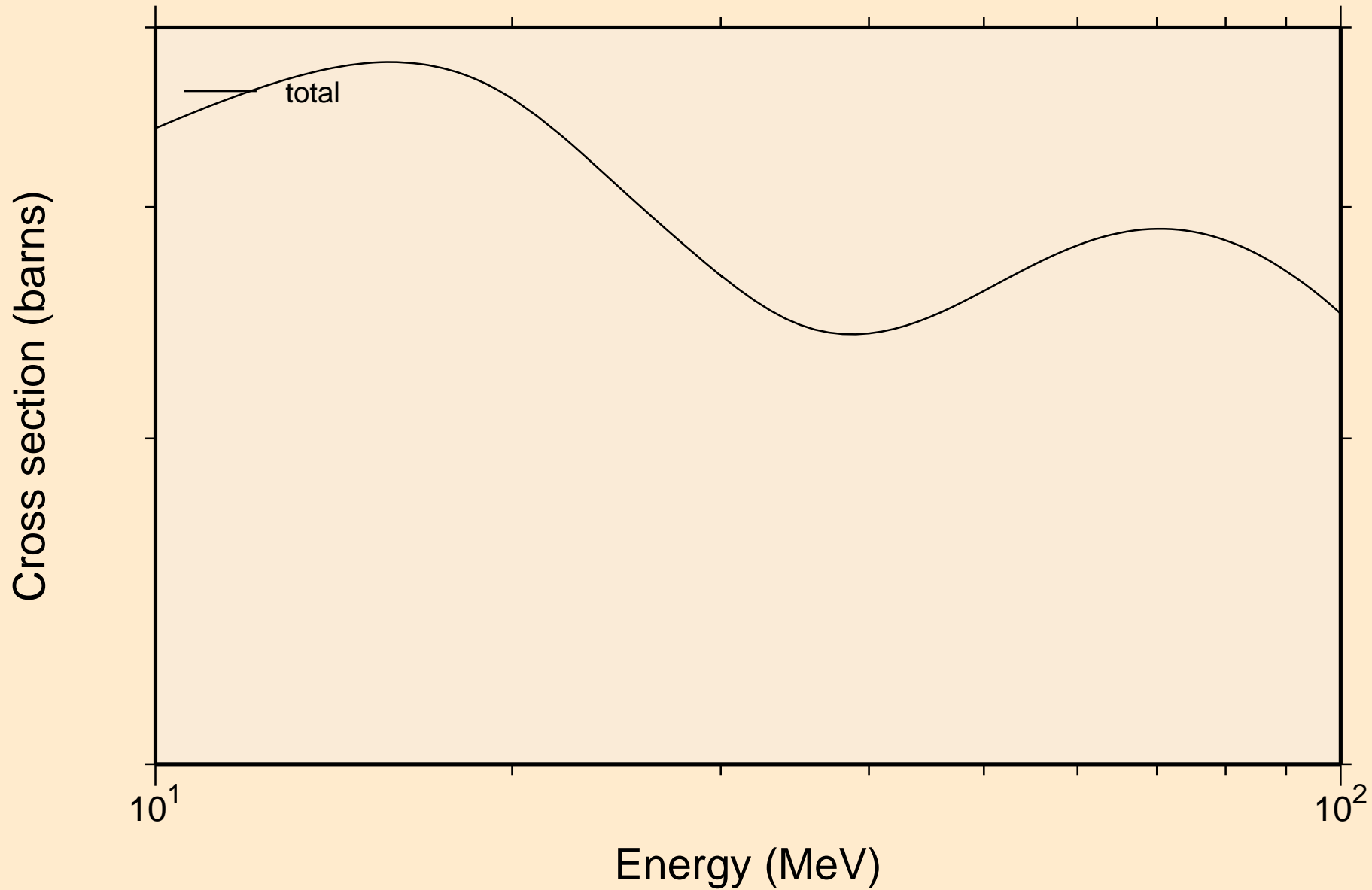

PR134 NEUTRON ACER TENDL-2021 LIBRARY; T=293.6K
resonance absorption cross sections

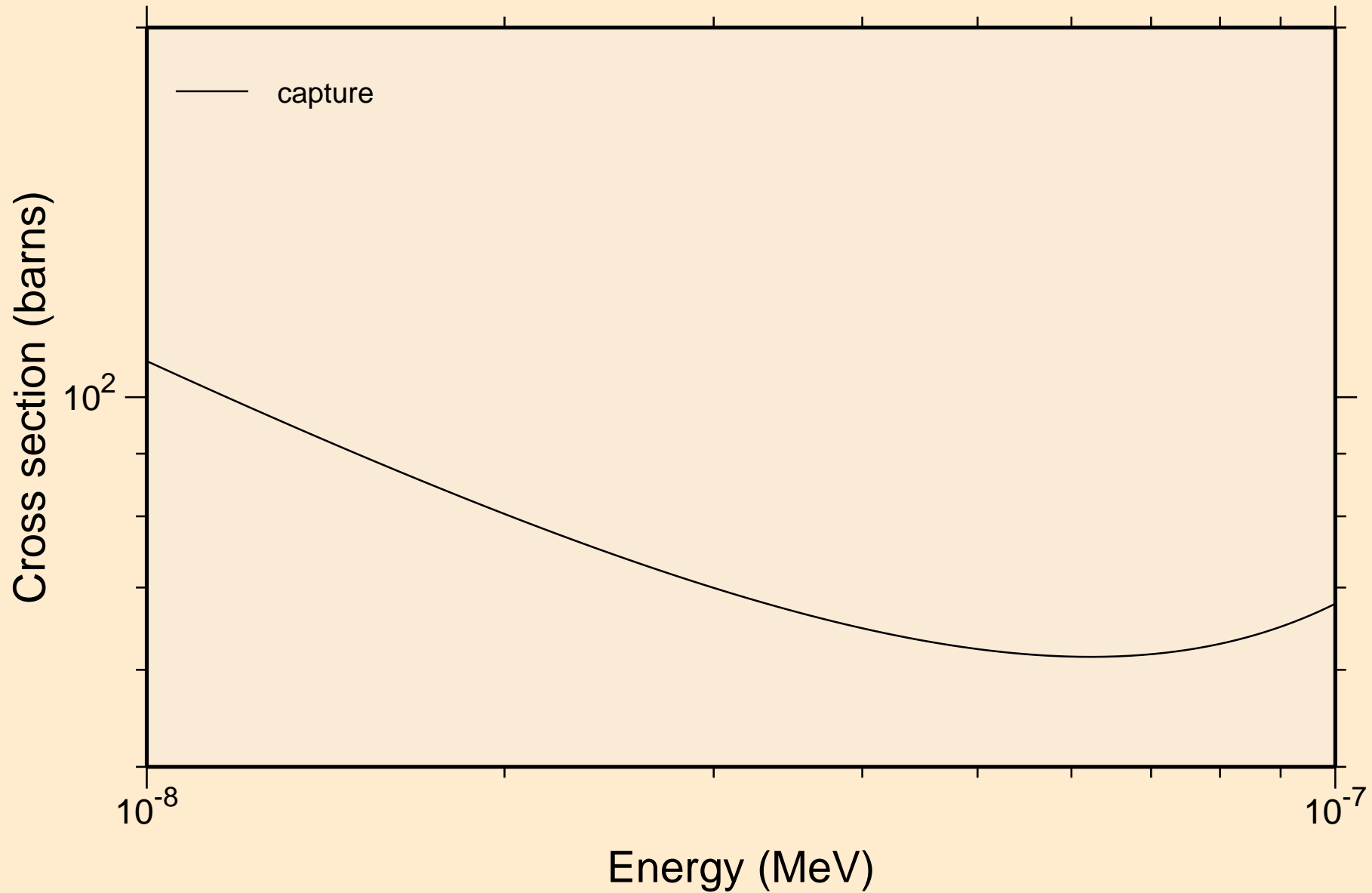

PR134 NEUTRON ACER TENDL-2021 LIBRARY; T=293.6K
resonance absorption cross sections

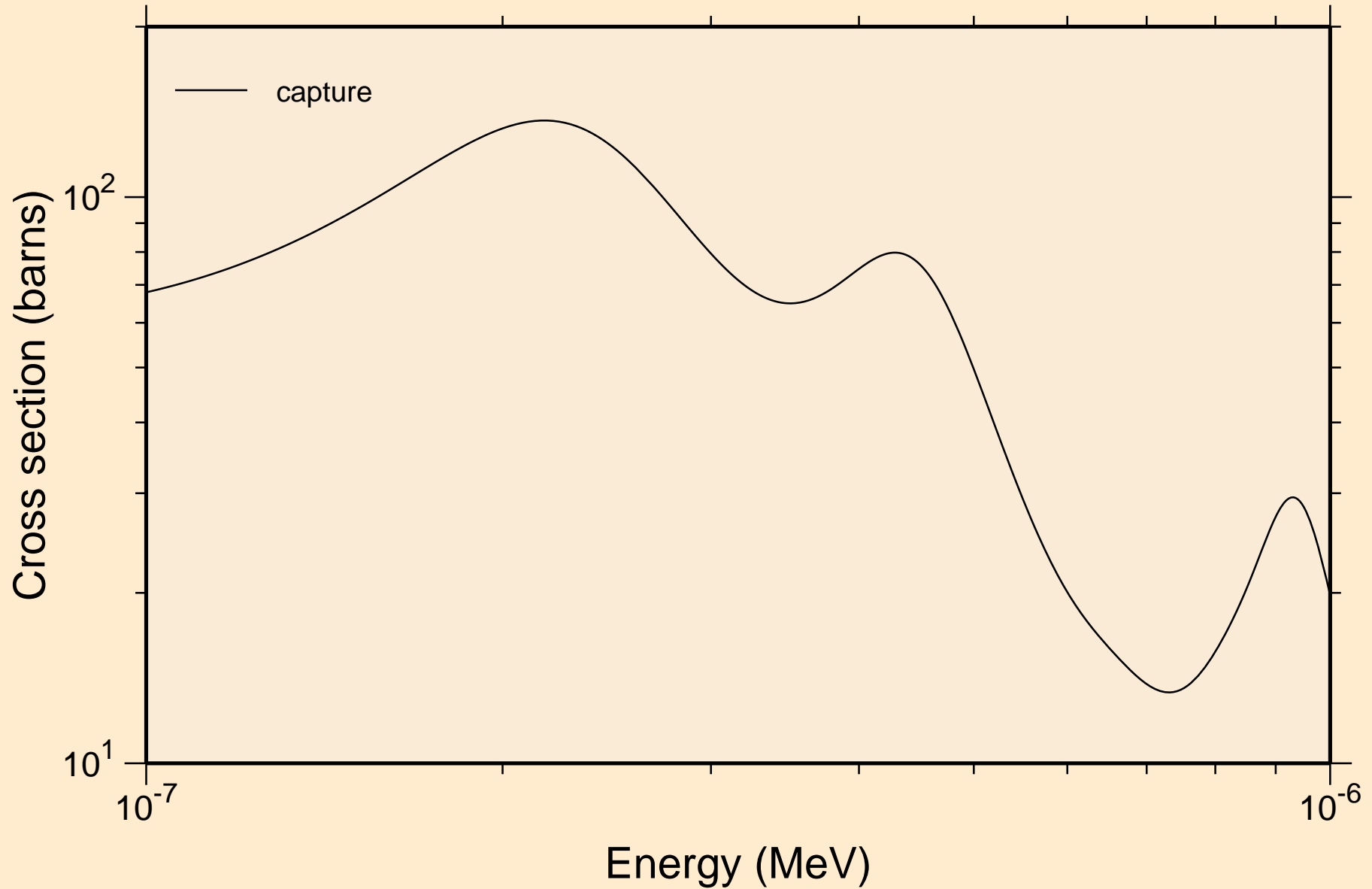

PR134 NEUTRON ACER TENDL-2021 LIBRARY; T=293.6K
resonance absorption cross sections

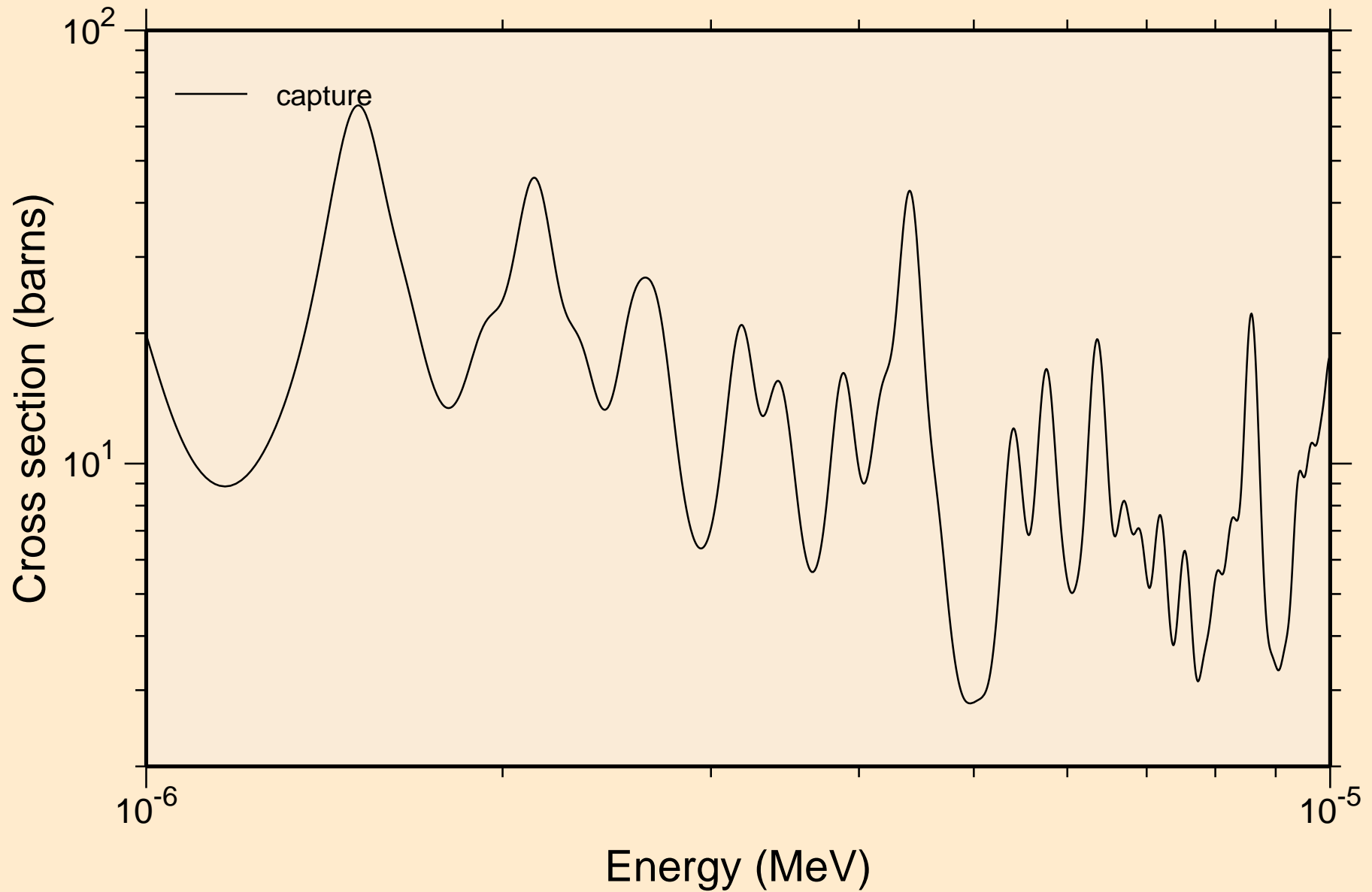

PR134 NEUTRON ACER TENDL-2021 LIBRARY; T=293.6K
resonance absorption cross sections

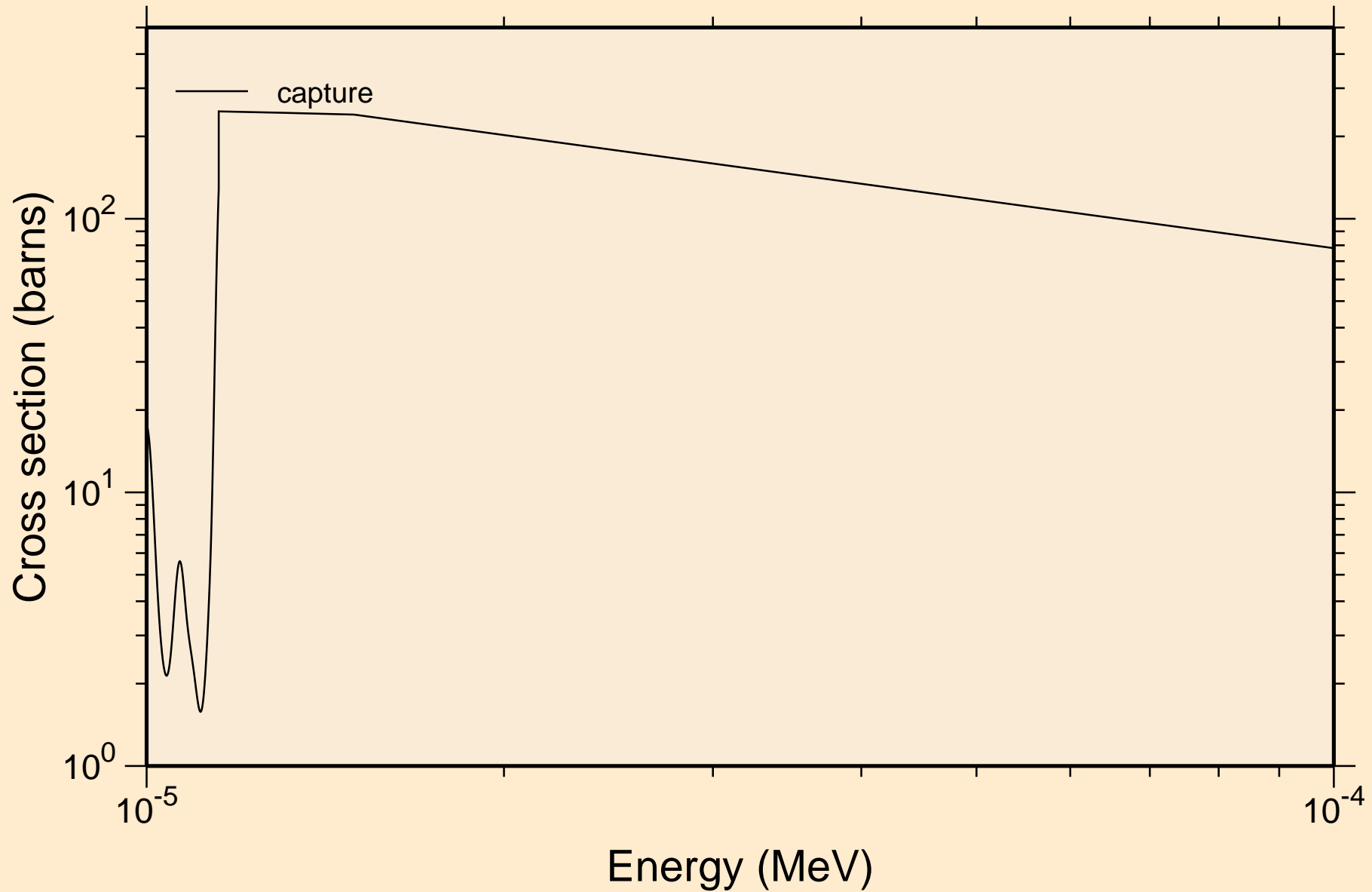

PR134 NEUTRON ACER TENDL-2021 LIBRARY; T=293.6K
resonance absorption cross sections

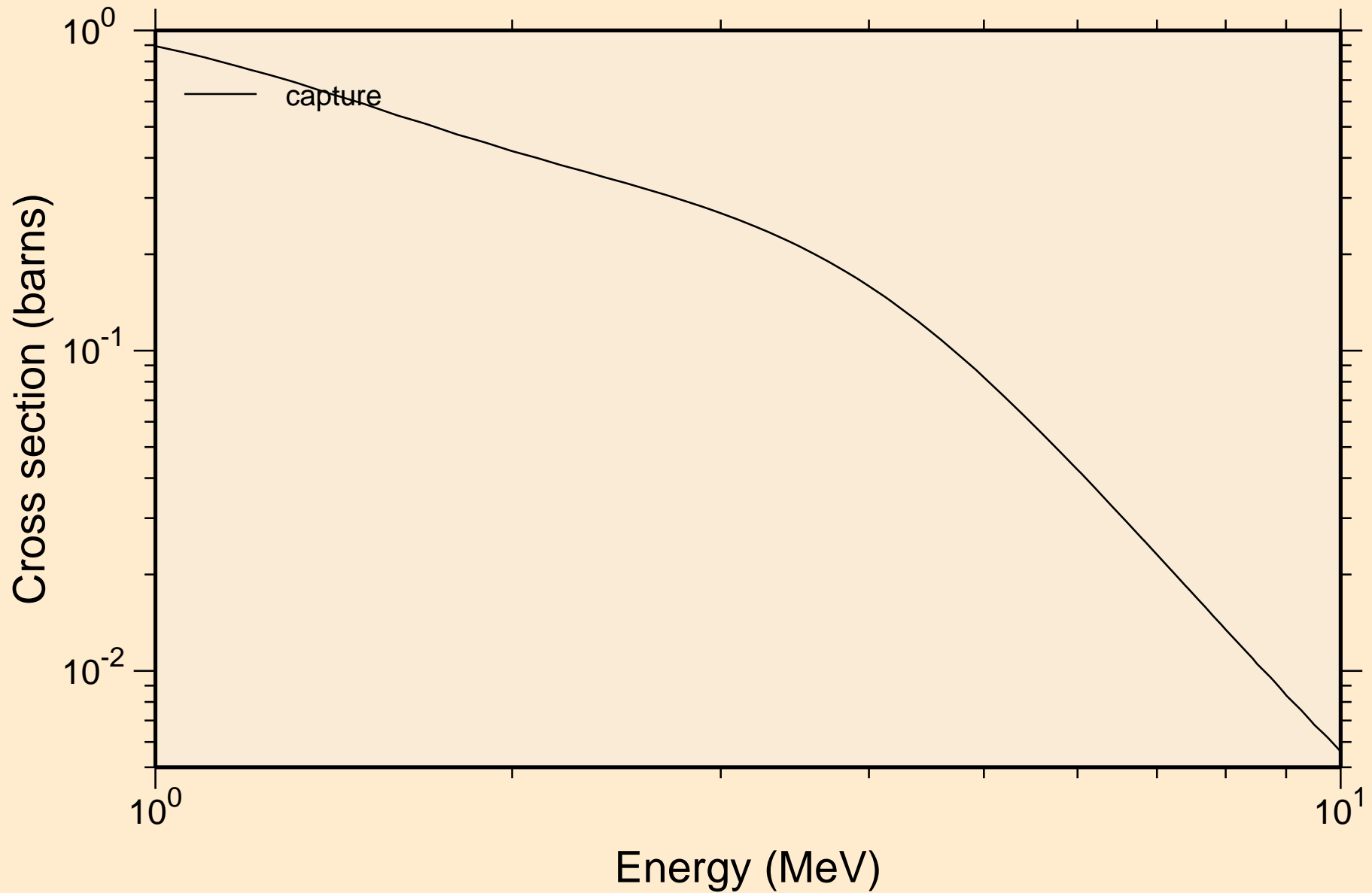

PR134 NEUTRON ACER TENDL-2021 LIBRARY; T=293.6K
Heating

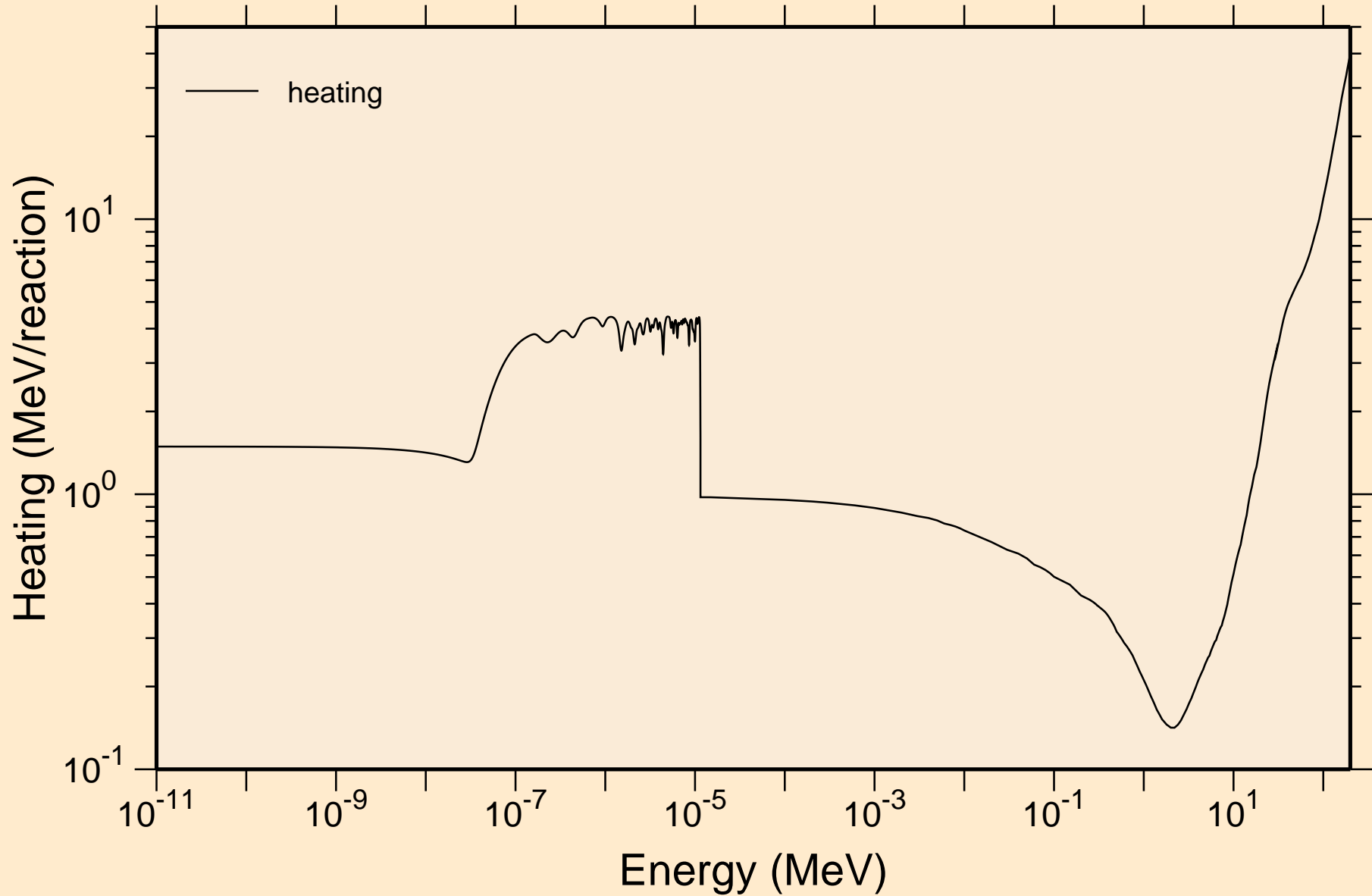

PR134 NEUTRON ACER TENDL-2021 LIBRARY; T=293.6K
Damage

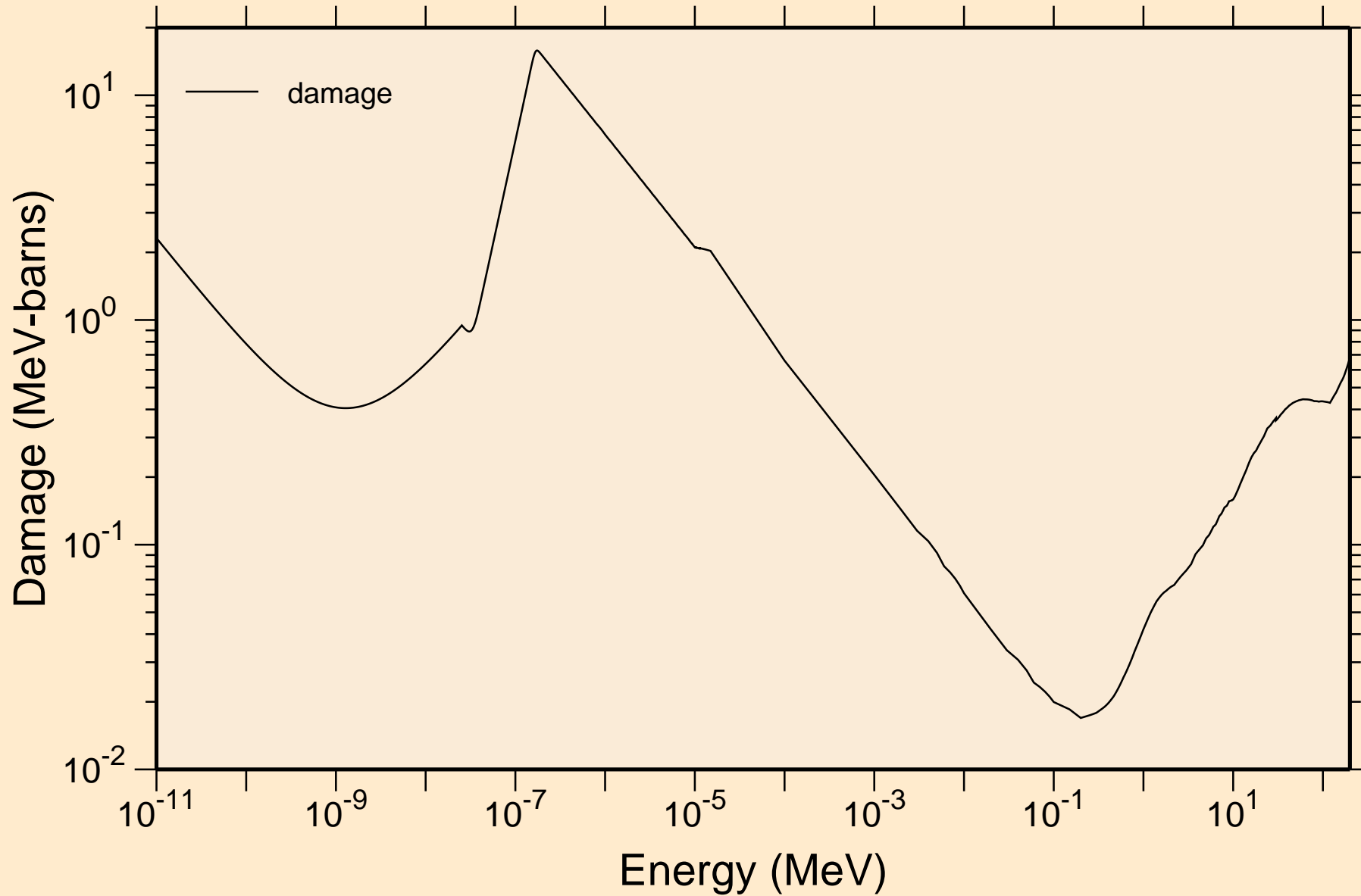

PR134 NEUTRON ACER TENDL-2021 LIBRARY; T=293.6K
Non-threshold reactions

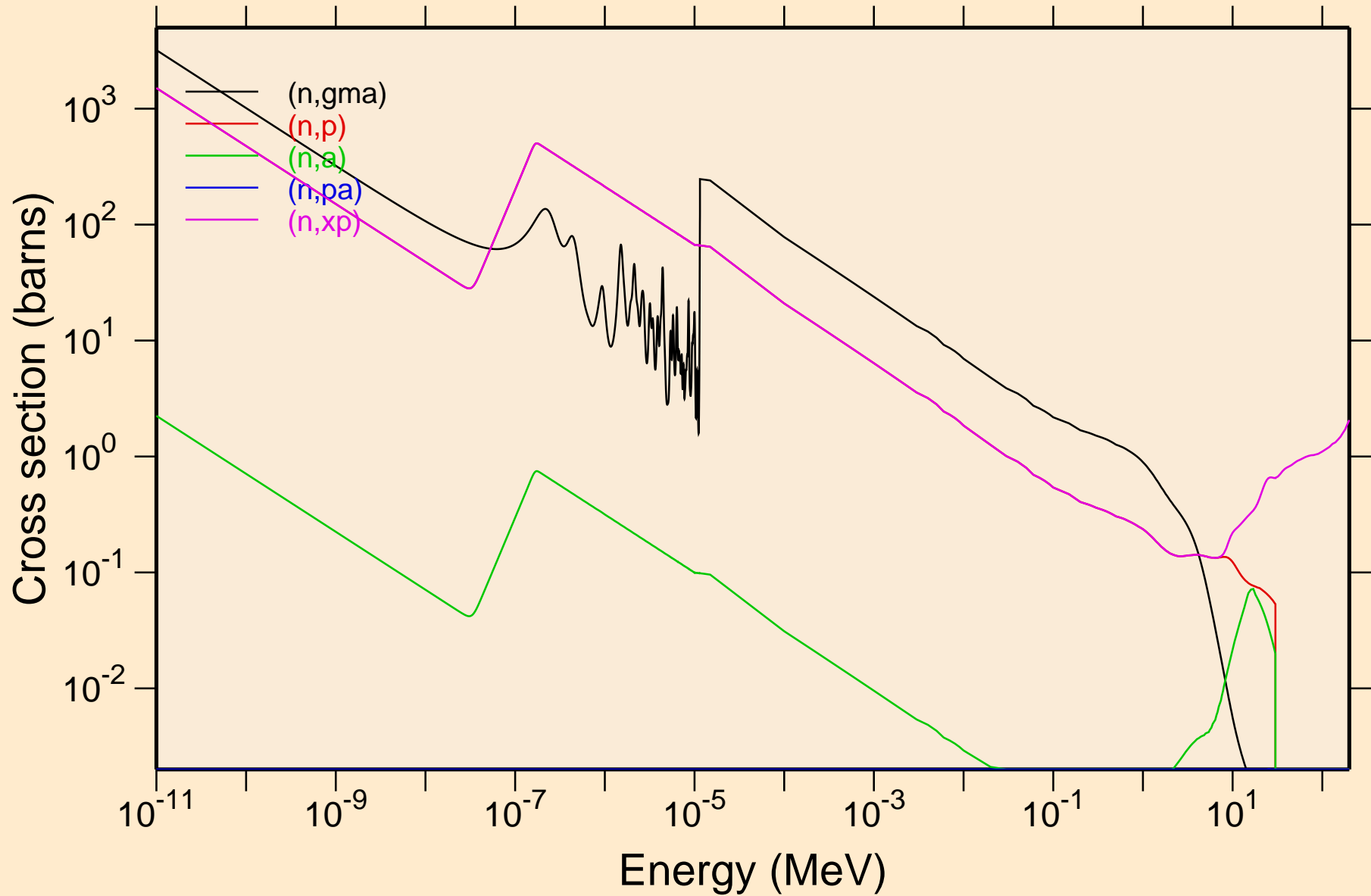

PR134 NEUTRON ACER TENDL-2021 LIBRARY; T=293.6K
Non-threshold reactions

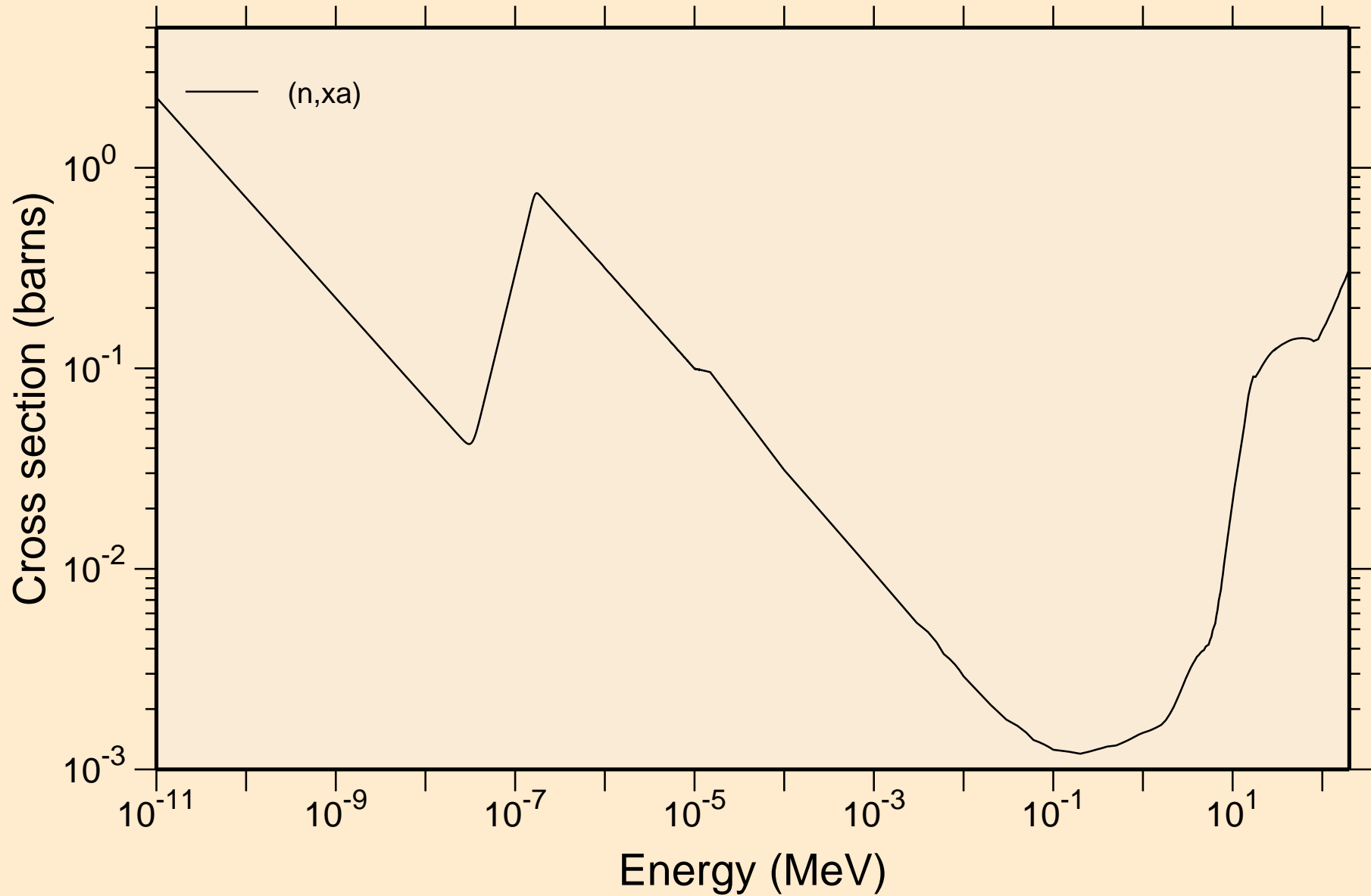

PR134 NEUTRON ACER TENDL-2021 LIBRARY; T=293.6K
Principal cross sections

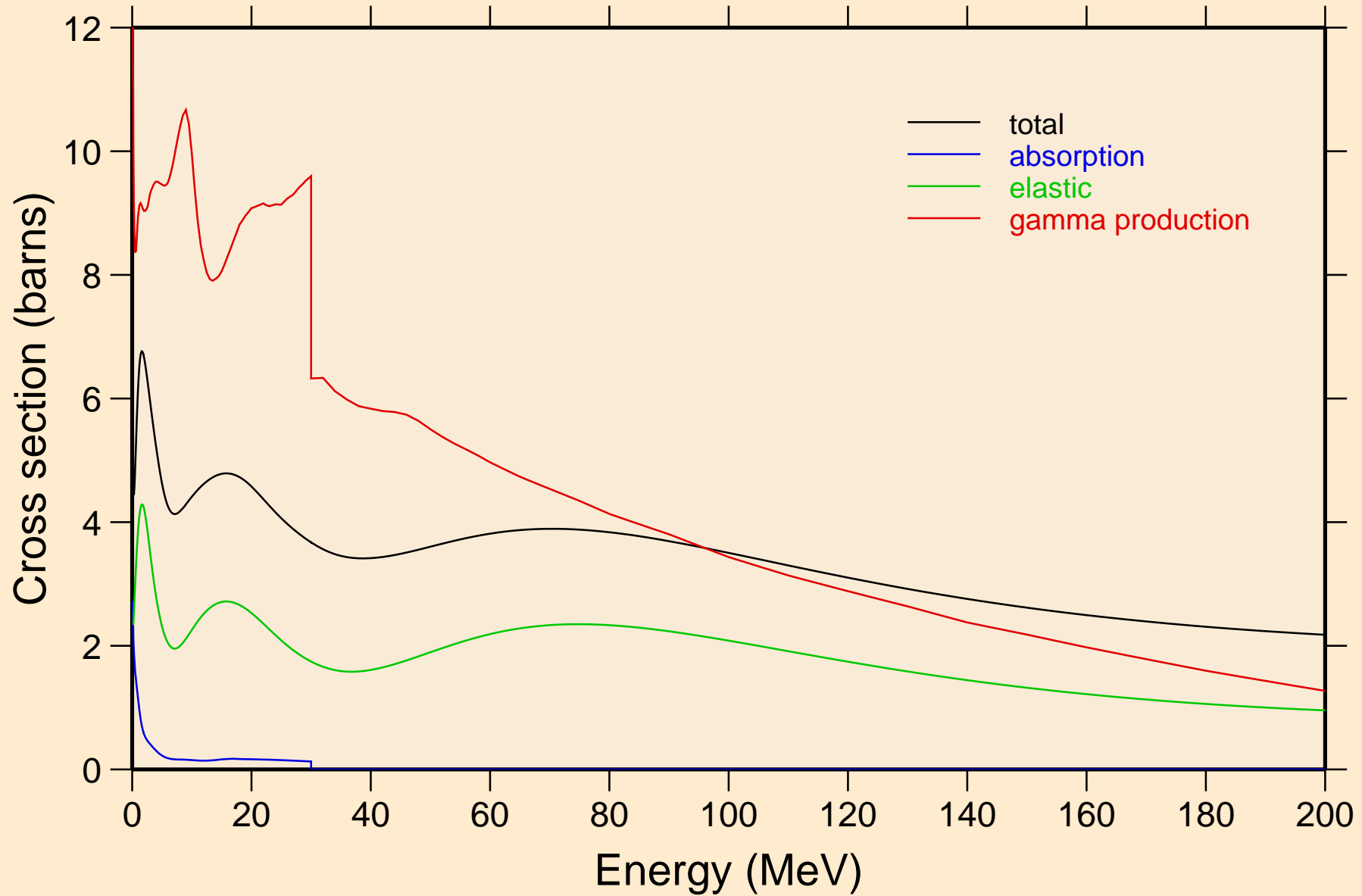

PR134 NEUTRON ACER TENDL-2021 LIBRARY; T=293.6K
Heating

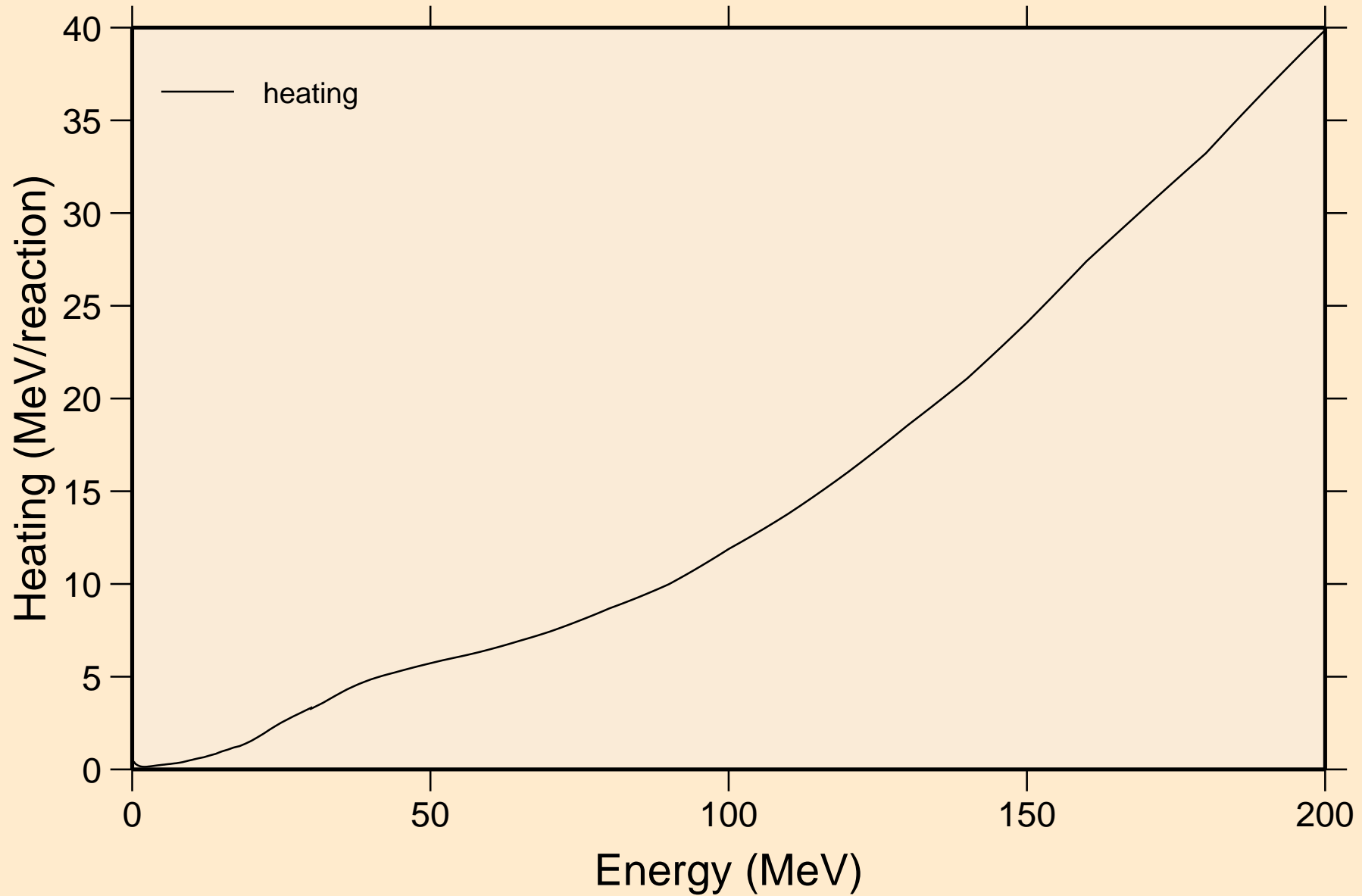

PR134 NEUTRON ACER TENDL-2021 LIBRARY; T=293.6K
Damage

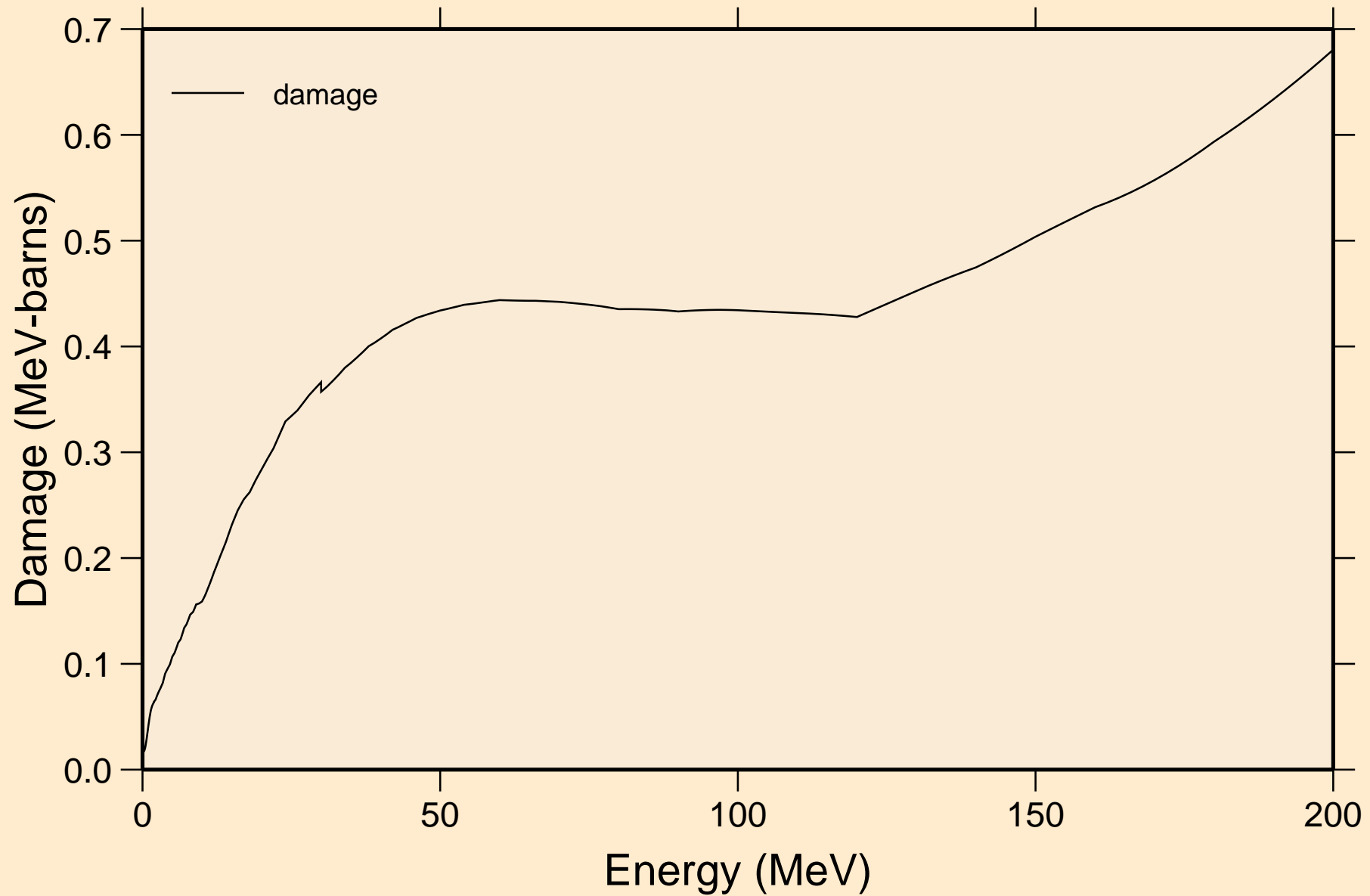

PR134 NEUTRON ACER TENDL-2021 LIBRARY; T=293.6K
Non-threshold reactions

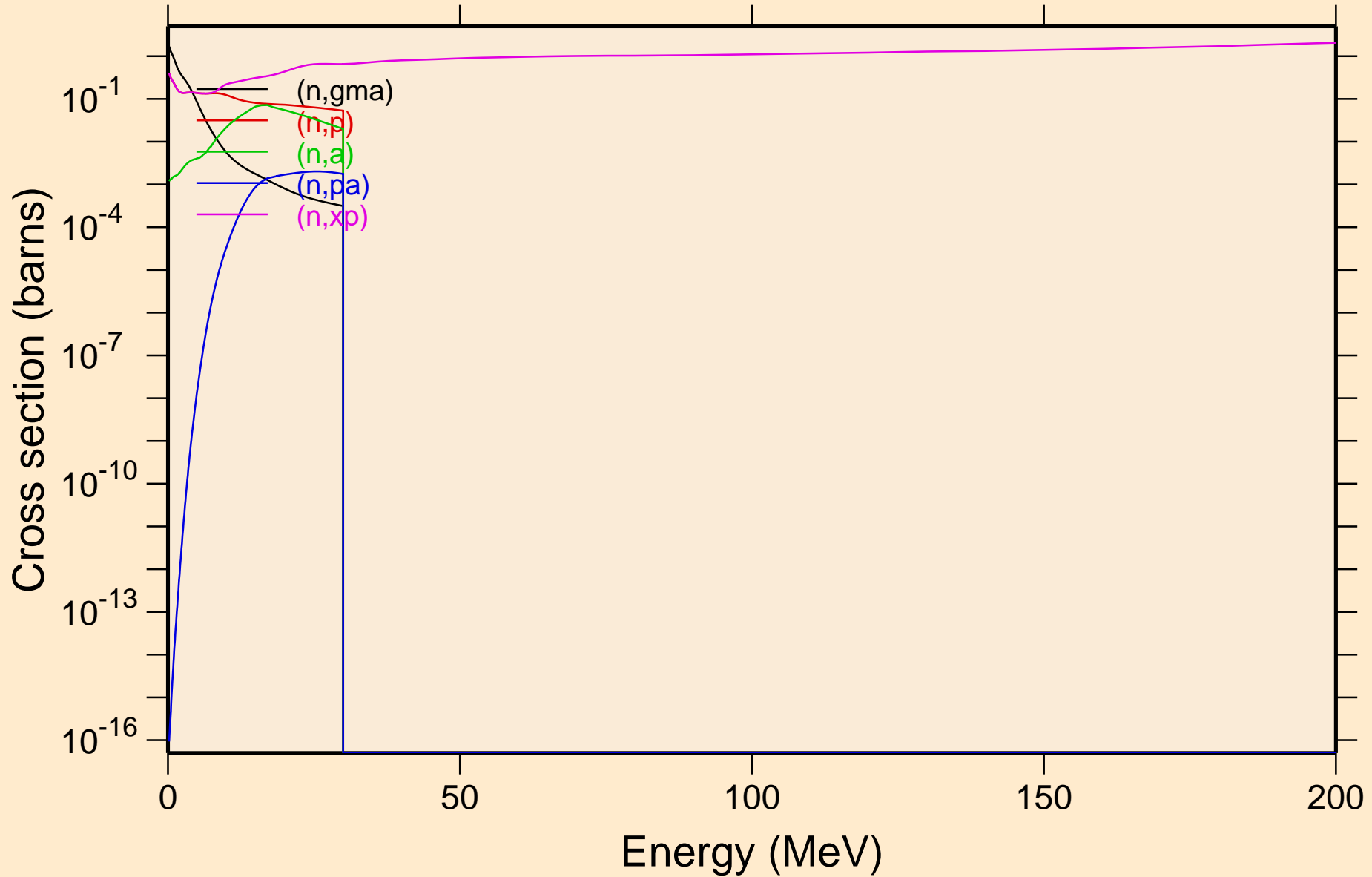

PR134 NEUTRON ACER TENDL-2021 LIBRARY; T=293.6K
Non-threshold reactions

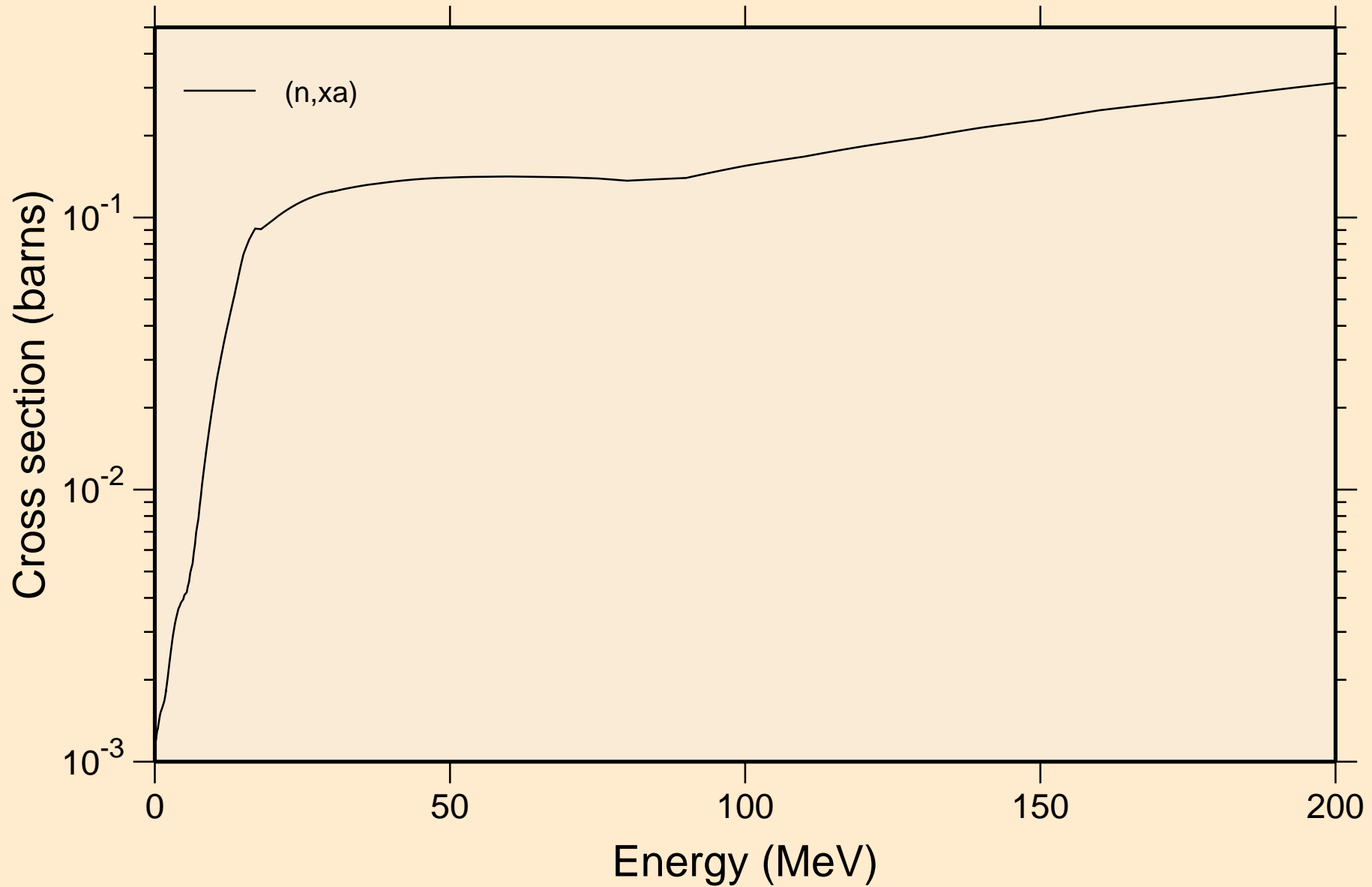

PR134 NEUTRON ACER TENDL-2021 LIBRARY; T=293.6K
Inelastic levels

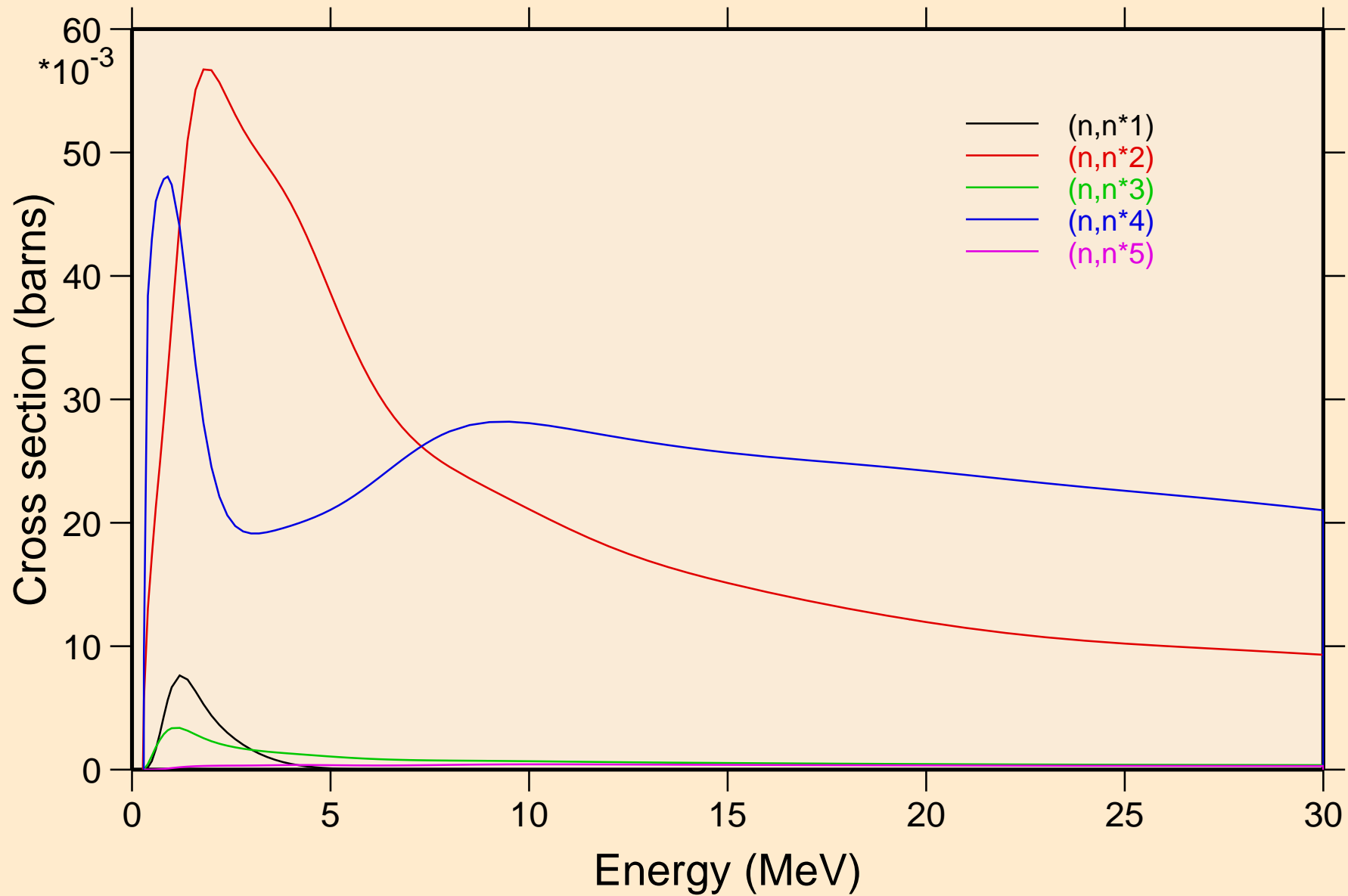

PR134 NEUTRON ACER TENDL-2021 LIBRARY; T=293.6K
Inelastic levels

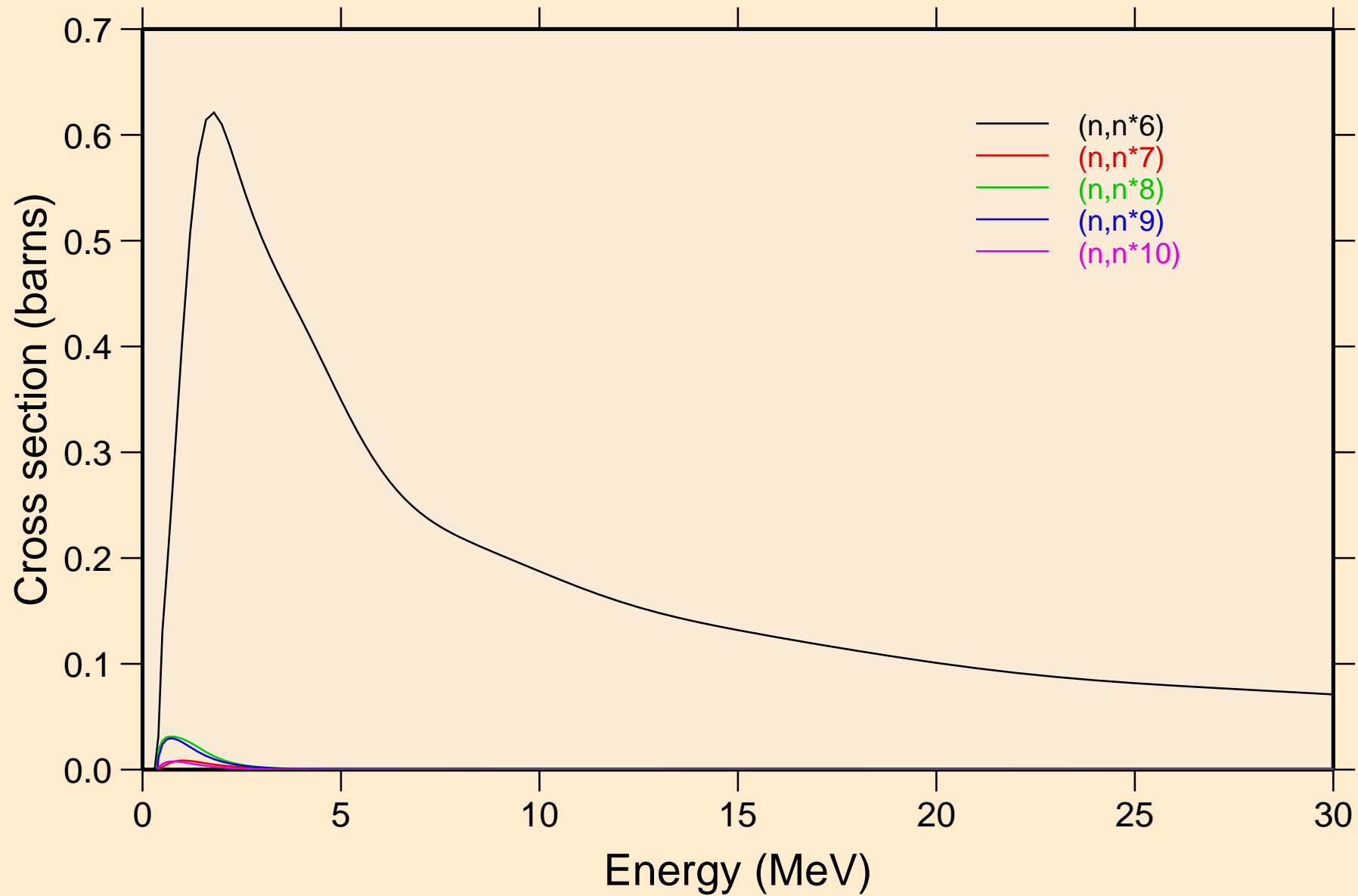

PR134 NEUTRON ACER TENDL-2021 LIBRARY; T=293.6K
Inelastic levels

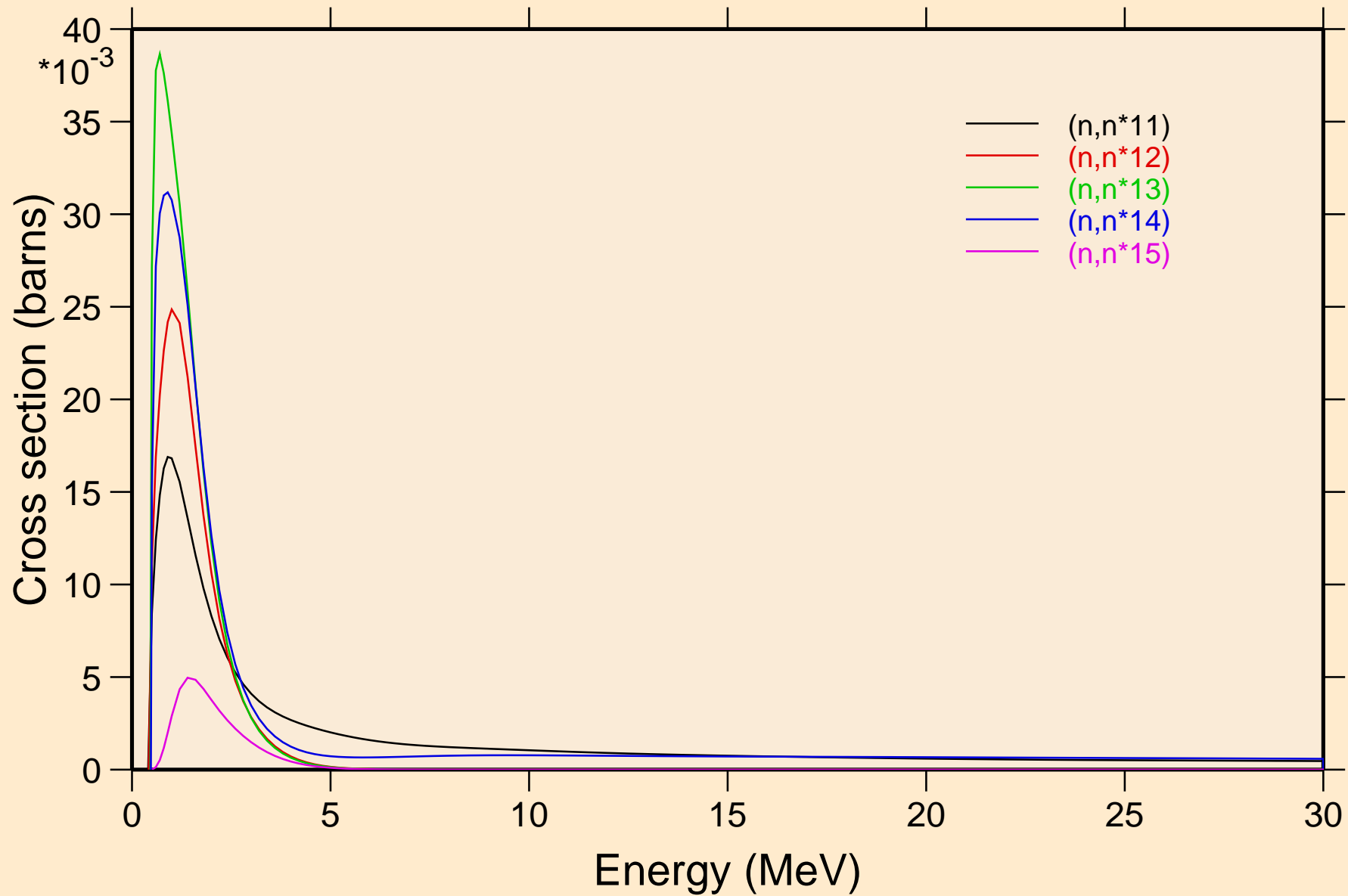

PR134 NEUTRON ACER TENDL-2021 LIBRARY; T=293.6K
Inelastic levels

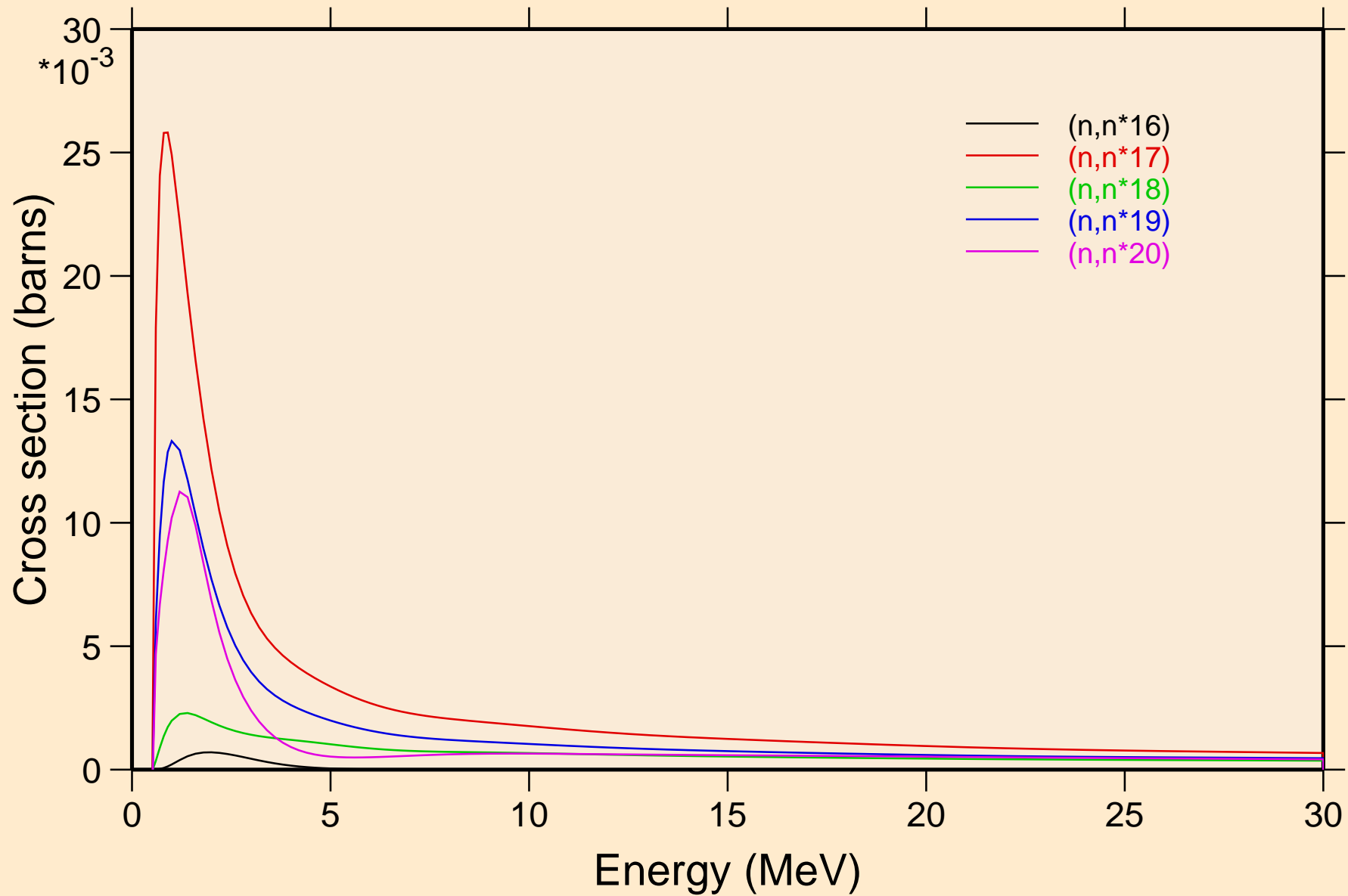

PR134 NEUTRON ACER TENDL-2021 LIBRARY; T=293.6K
Inelastic levels

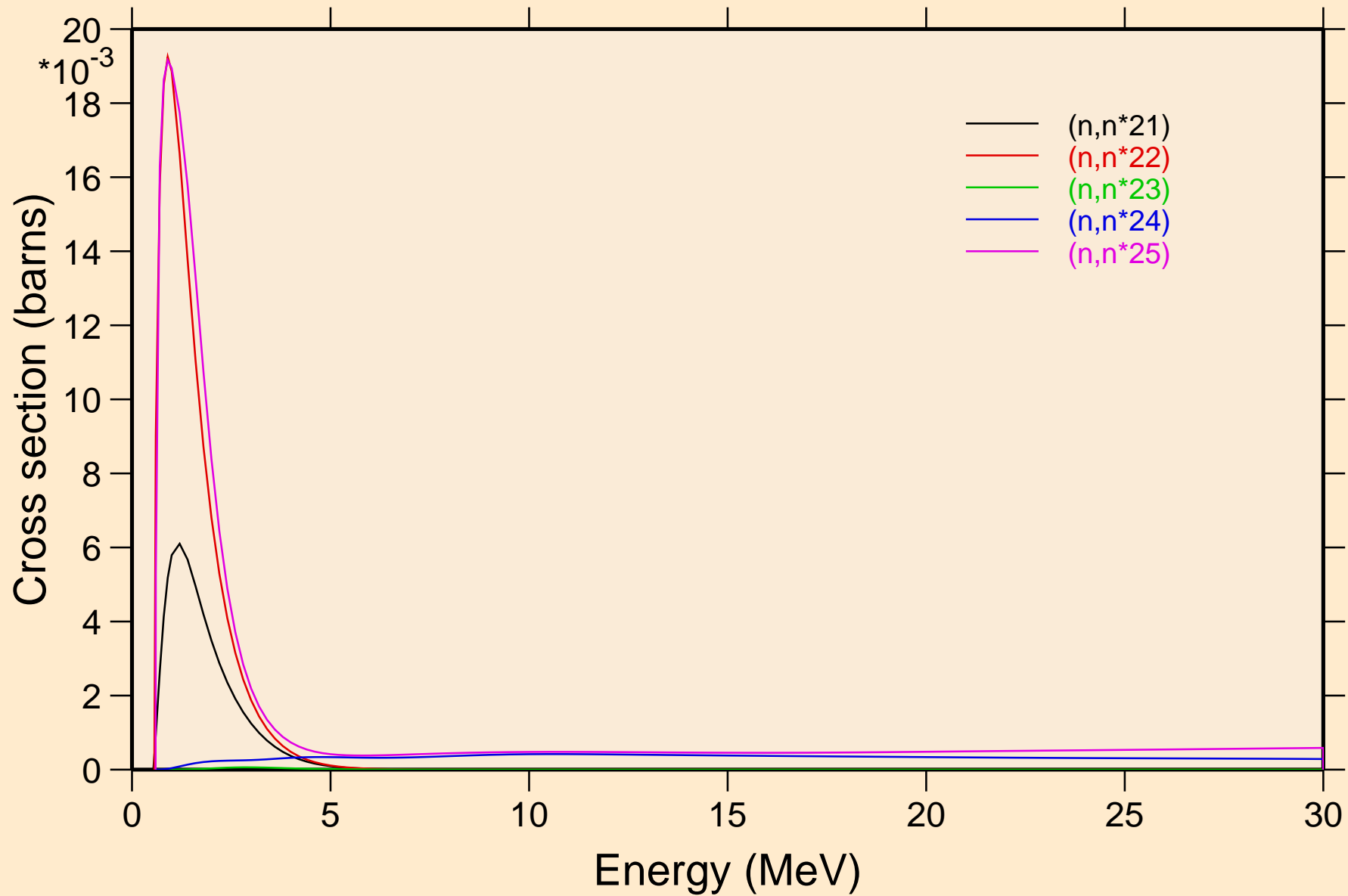

PR134 NEUTRON ACER TENDL-2021 LIBRARY; T=293.6K
Inelastic levels

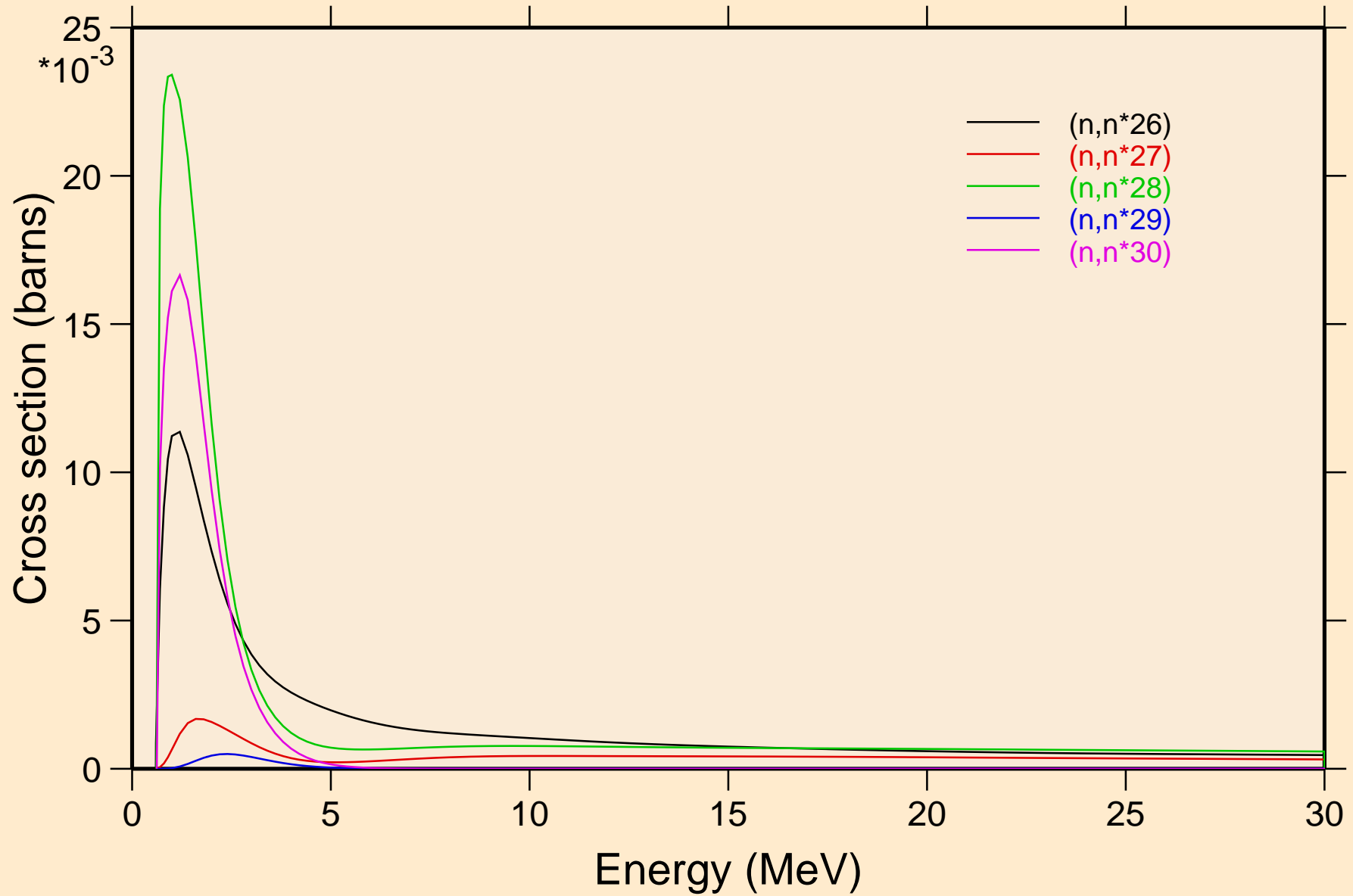

PR134 NEUTRON ACER TENDL-2021 LIBRARY; T=293.6K
Threshold reactions

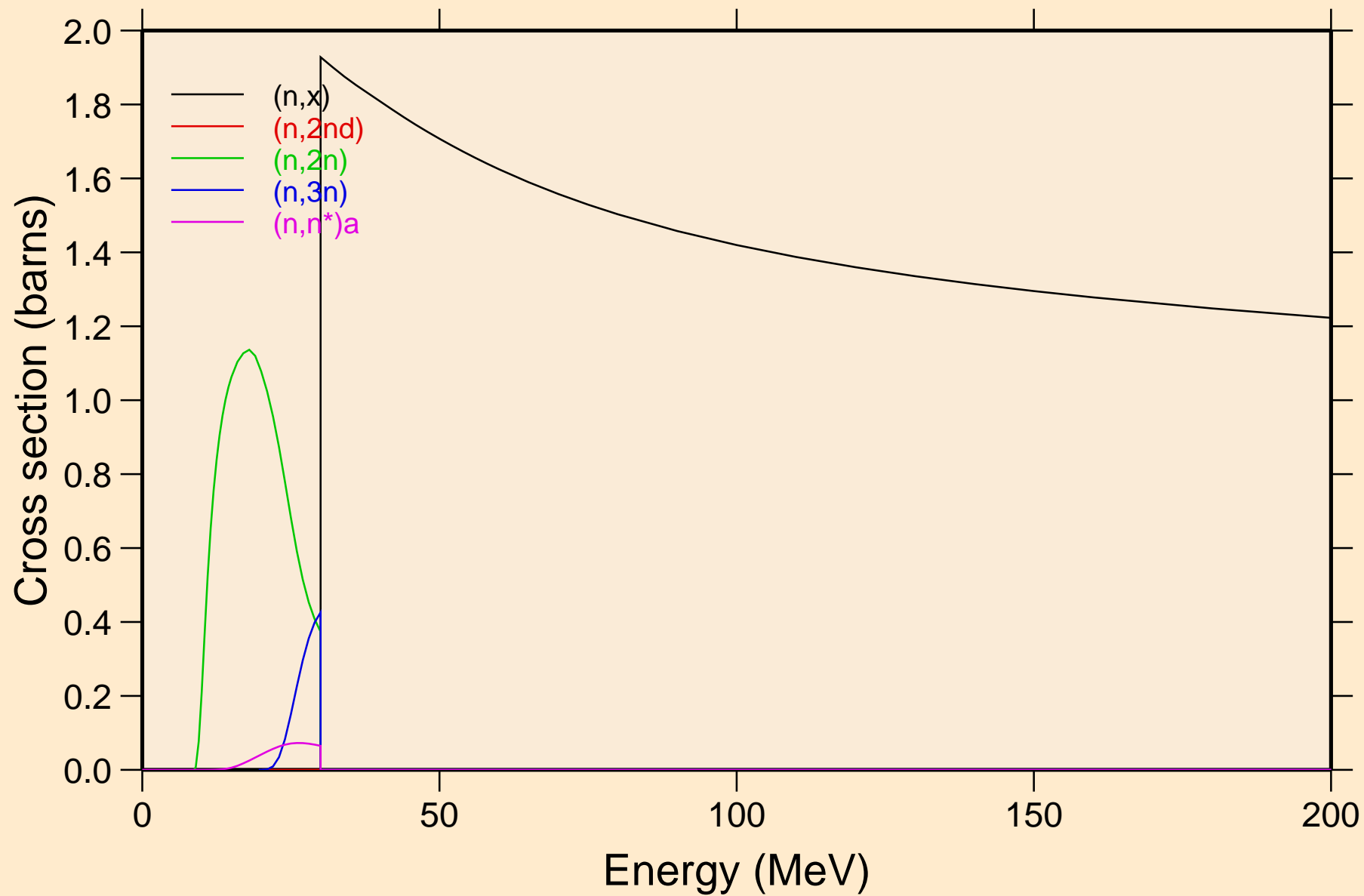

PR134 NEUTRON ACER TENDL-2021 LIBRARY; T=293.6K
Threshold reactions

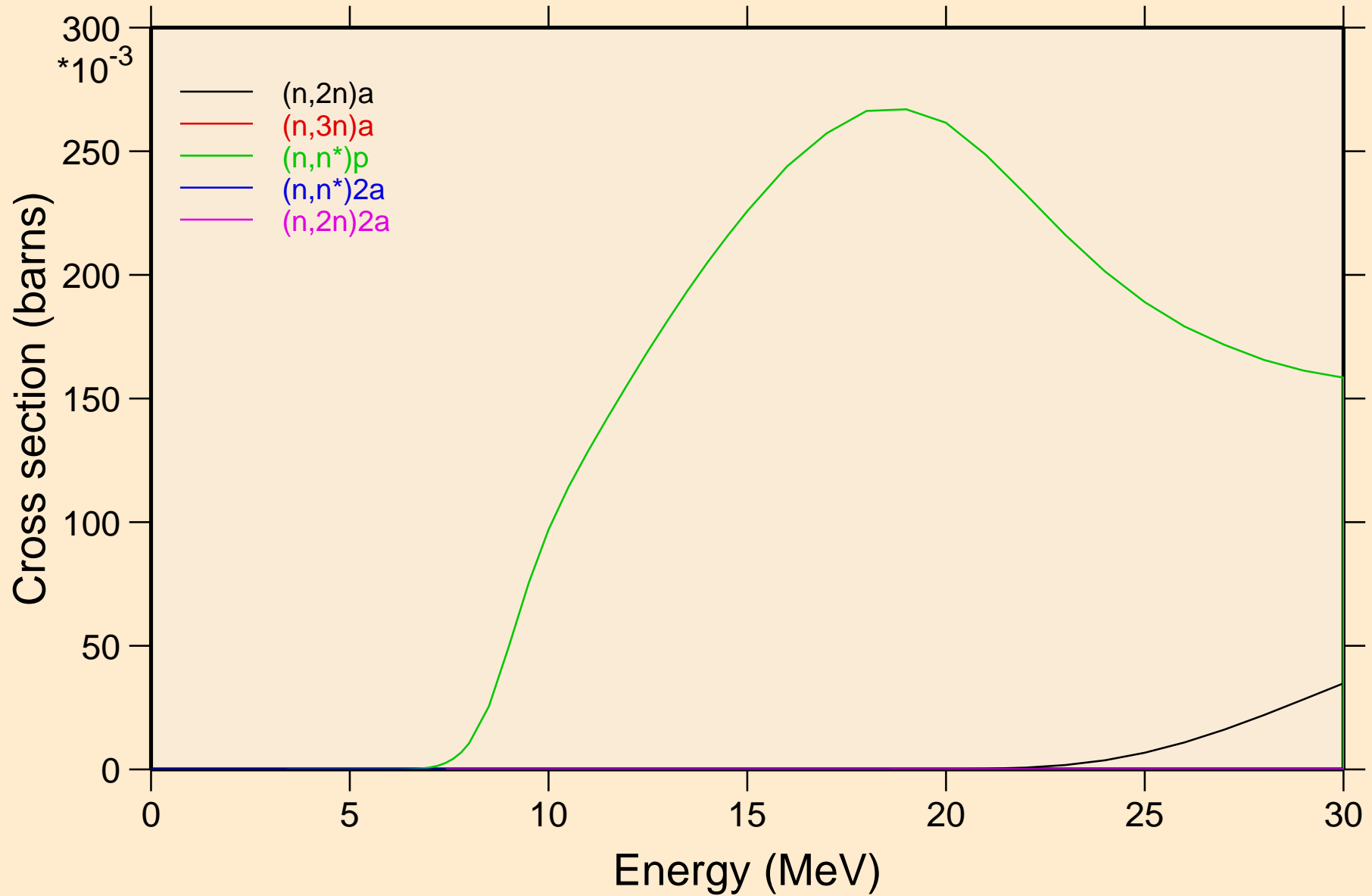

PR134 NEUTRON ACER TENDL-2021 LIBRARY; T=293.6K
Threshold reactions

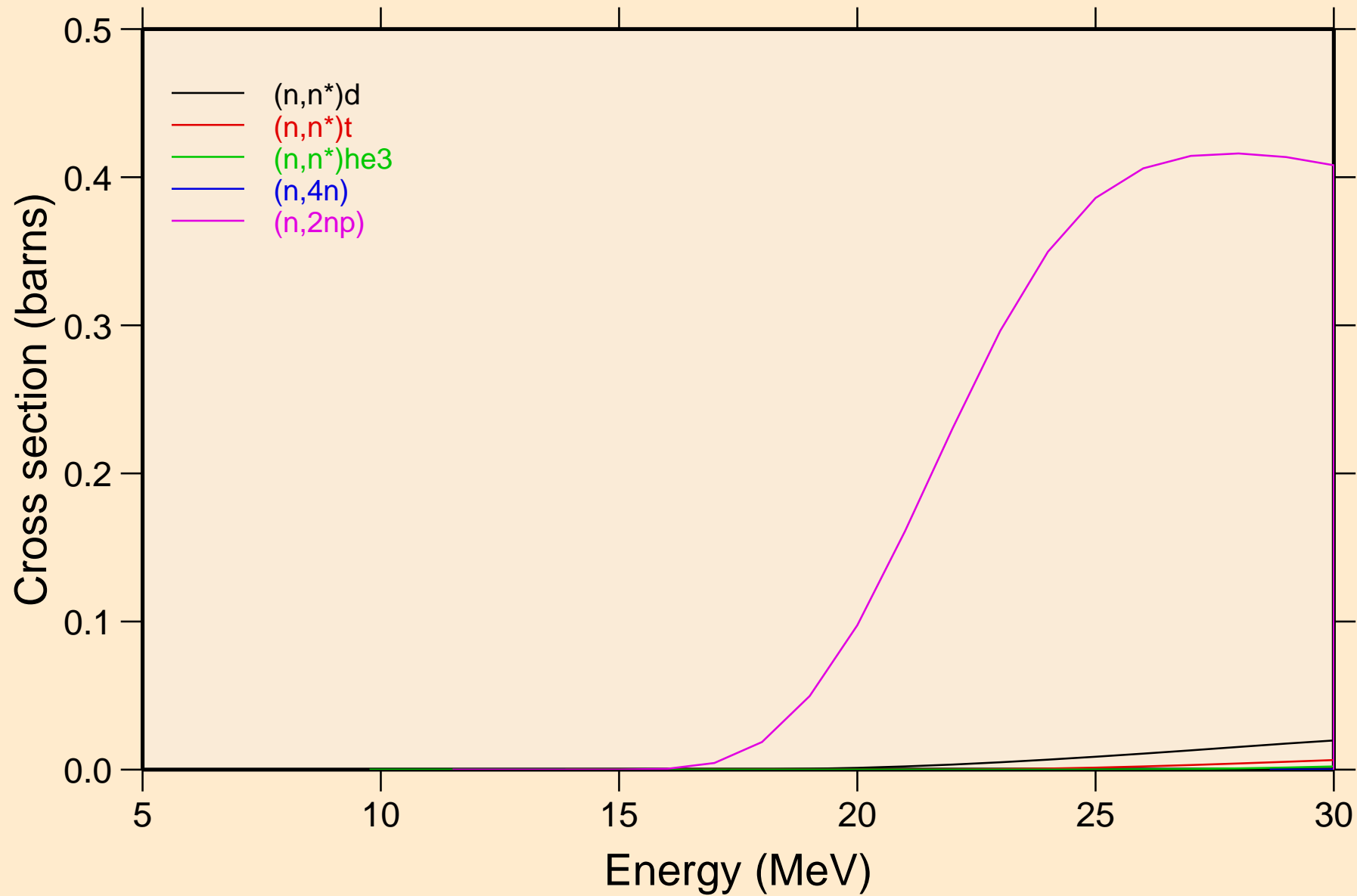

PR134 NEUTRON ACER TENDL-2021 LIBRARY; T=293.6K
Threshold reactions

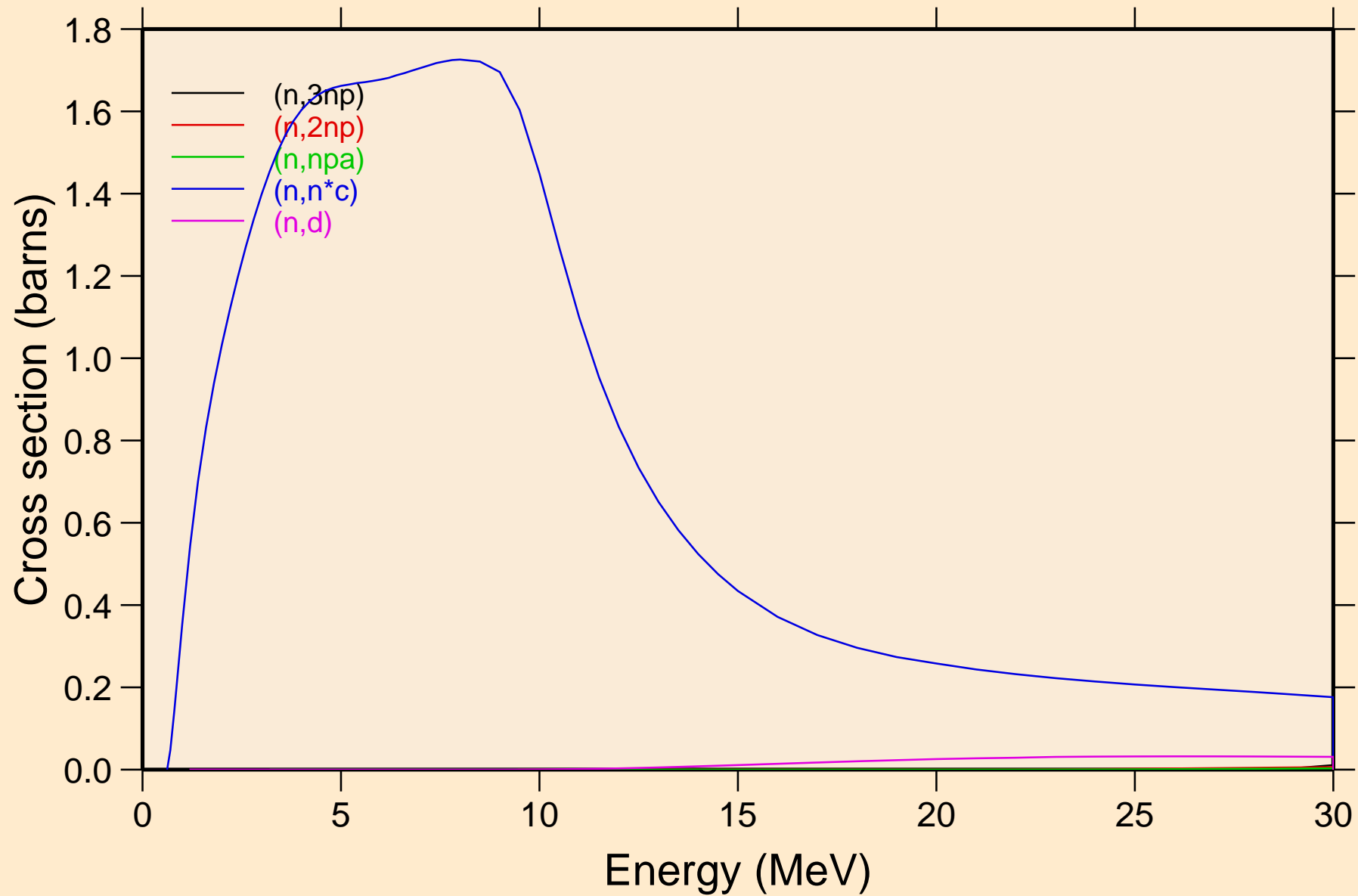

PR134 NEUTRON ACER TENDL-2021 LIBRARY; T=293.6K
Threshold reactions

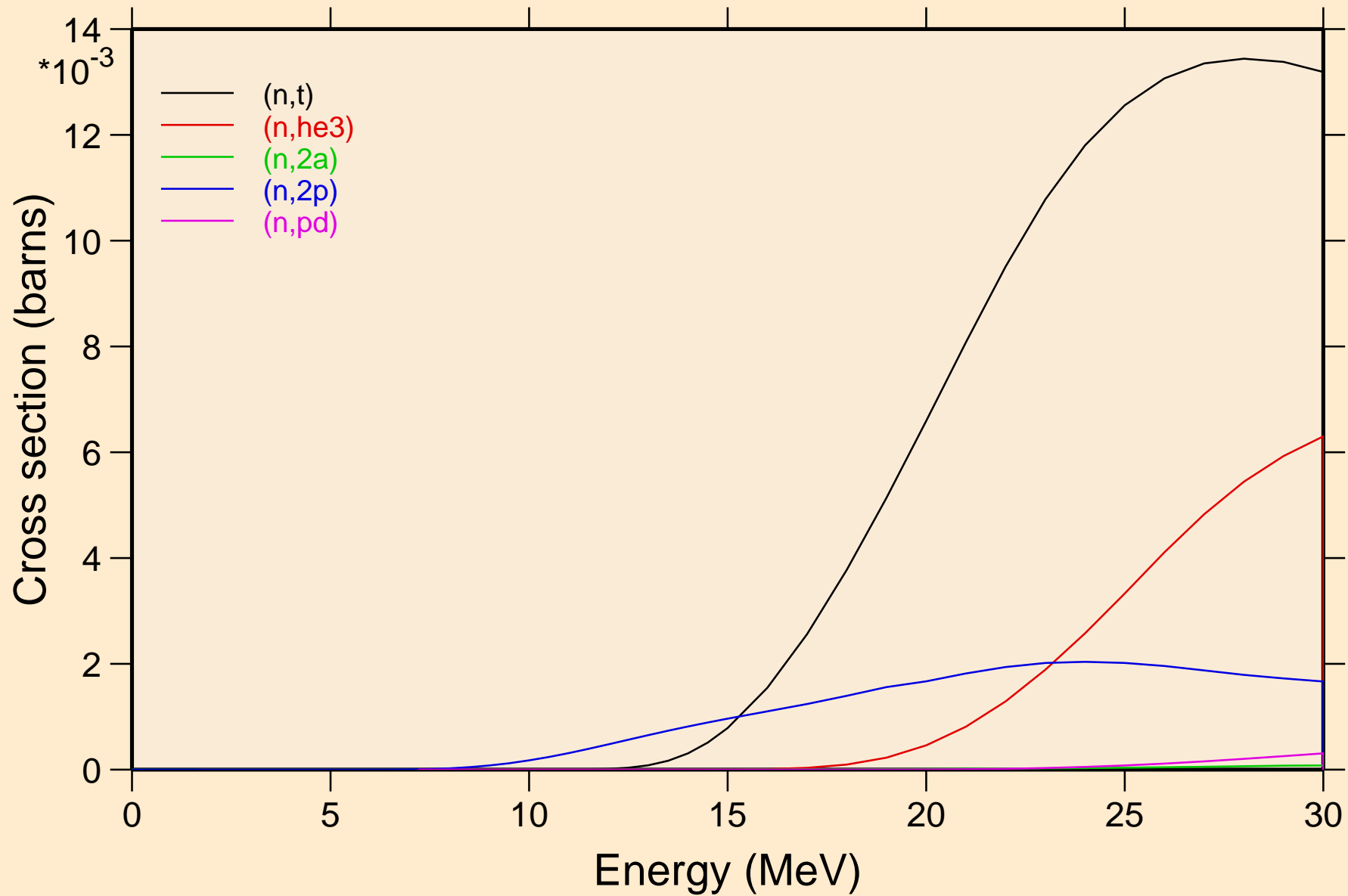

PR134 NEUTRON ACER TENDL-2021 LIBRARY; T=293.6K
Threshold reactions

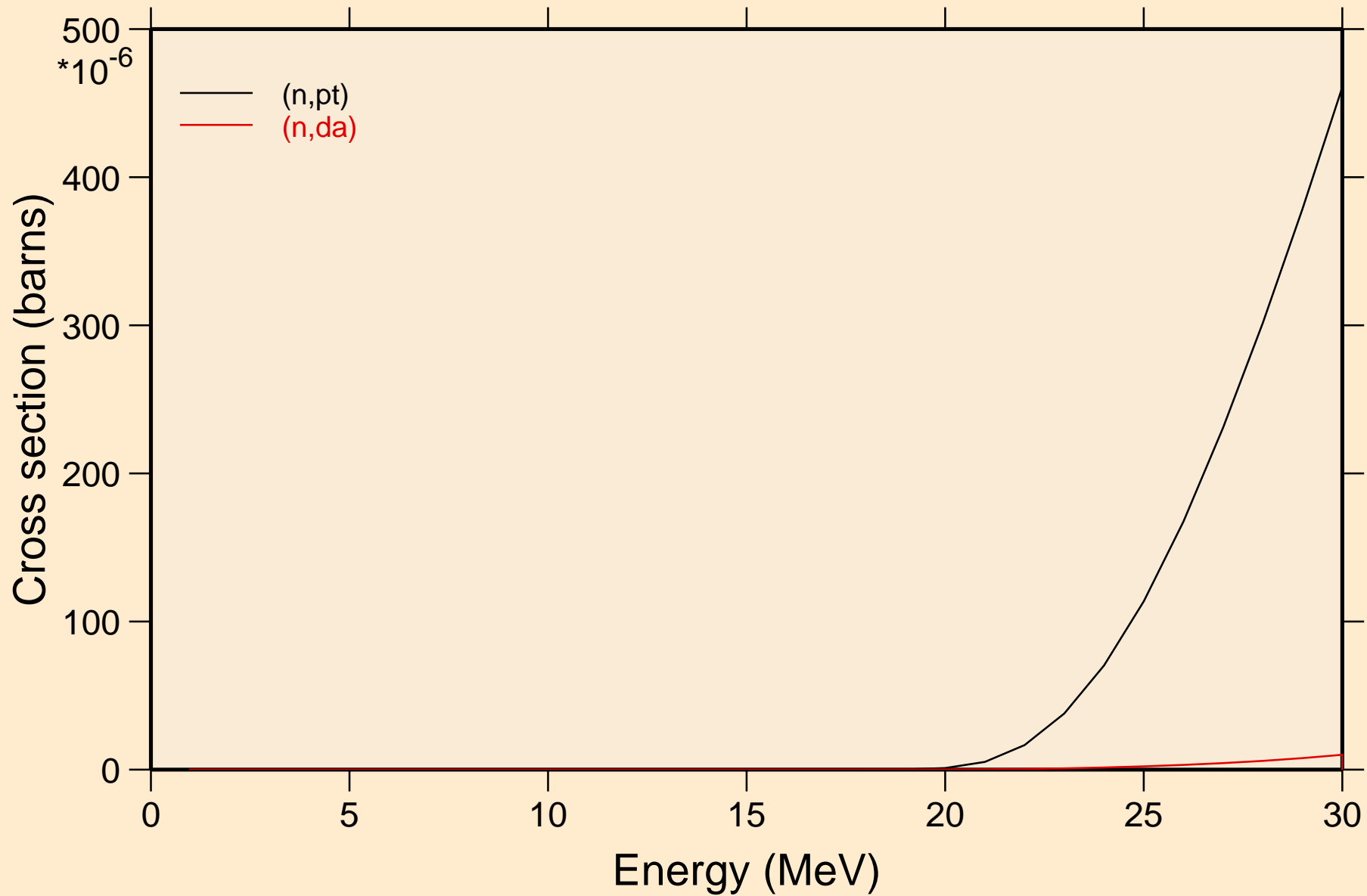

PR134 NEUTRON ACER TENDL-2021 LIBRARY; T=293.6K
Threshold reactions

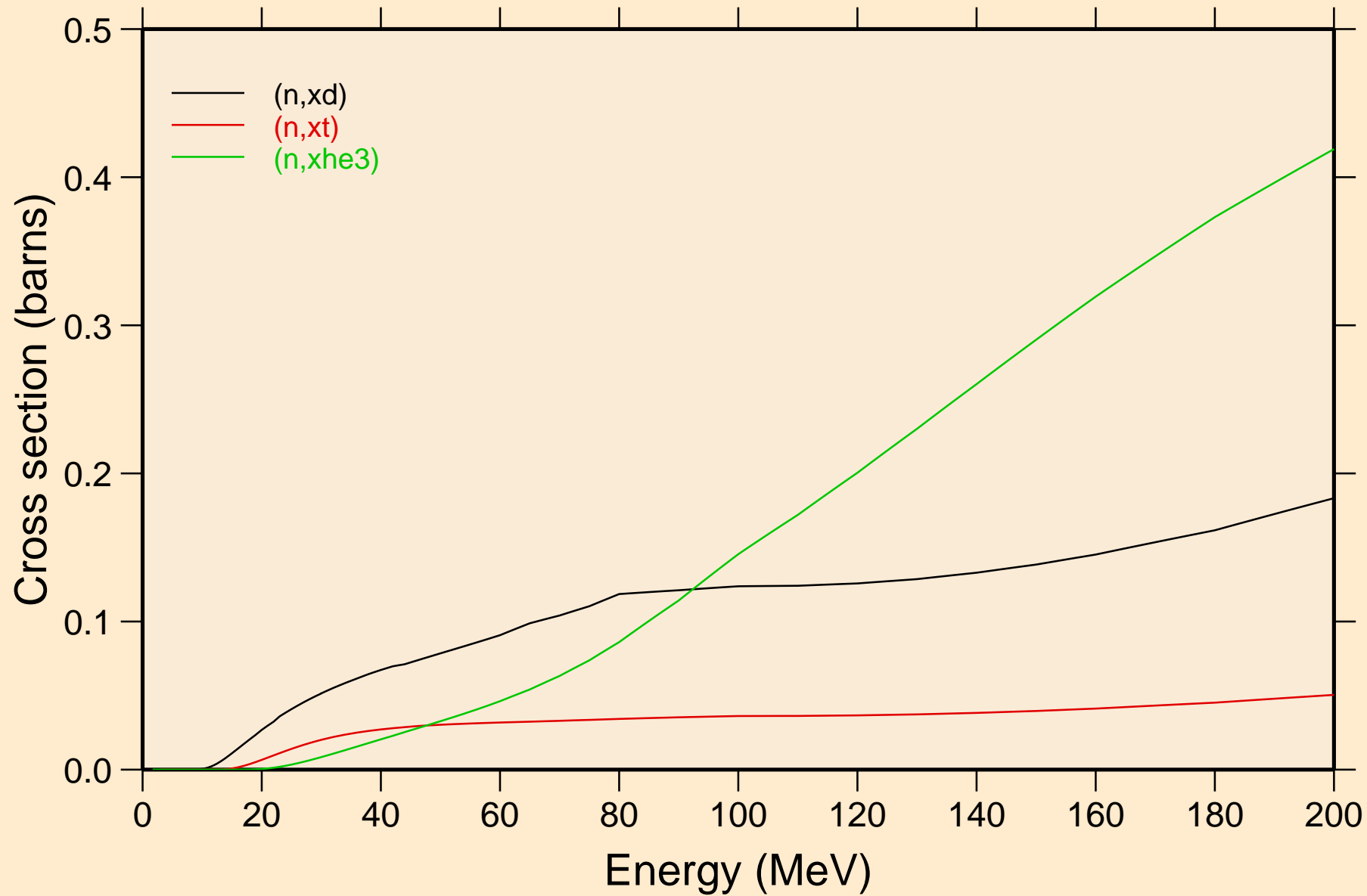

PR134 NEUTRON ACER TENDL-2021 LIBRARY; T=293.6K
angular distribution for elastic

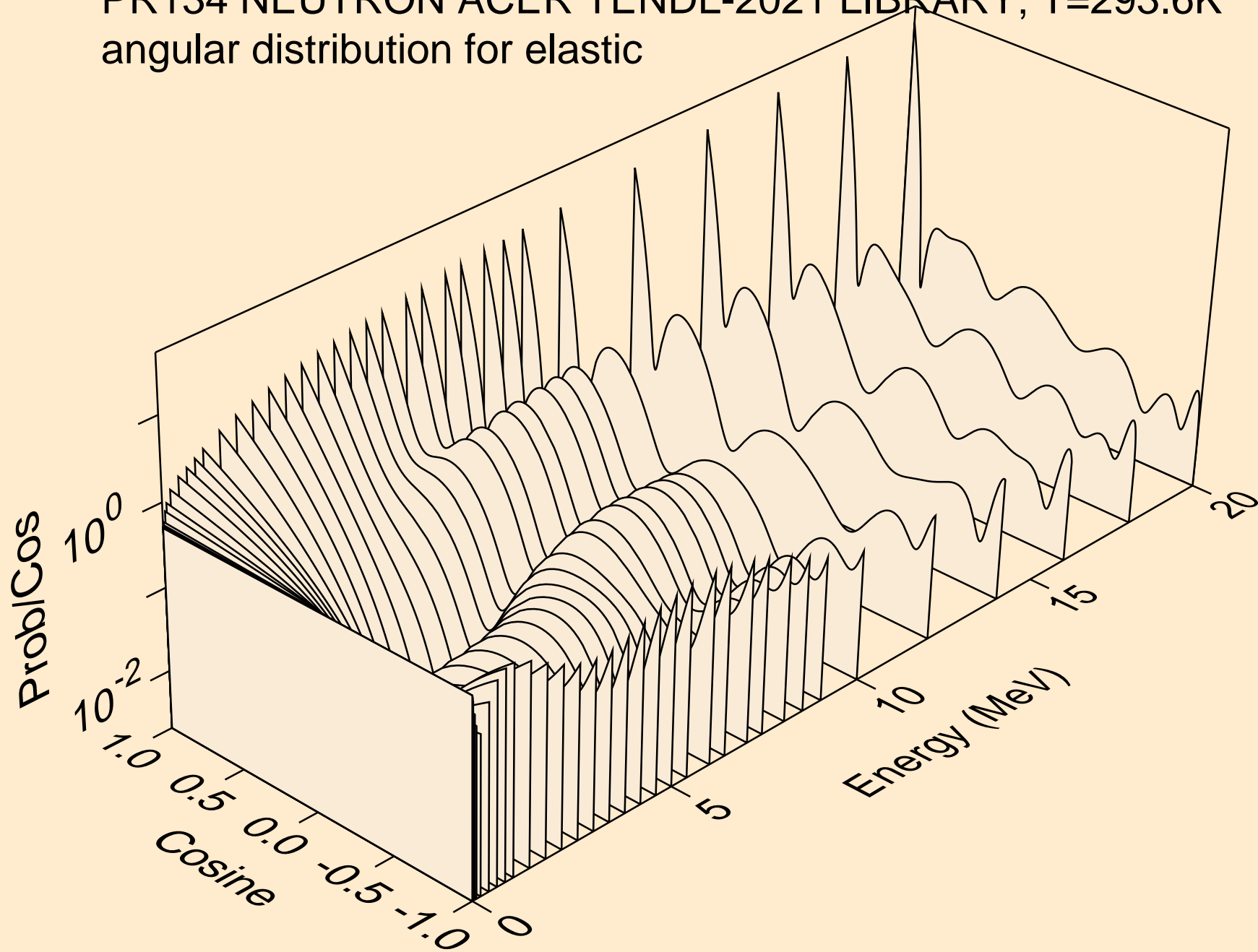

PR134 NEUTRON ACER TENDL-2021 LIBRARY; T=293.6K
angular distribution for elastic

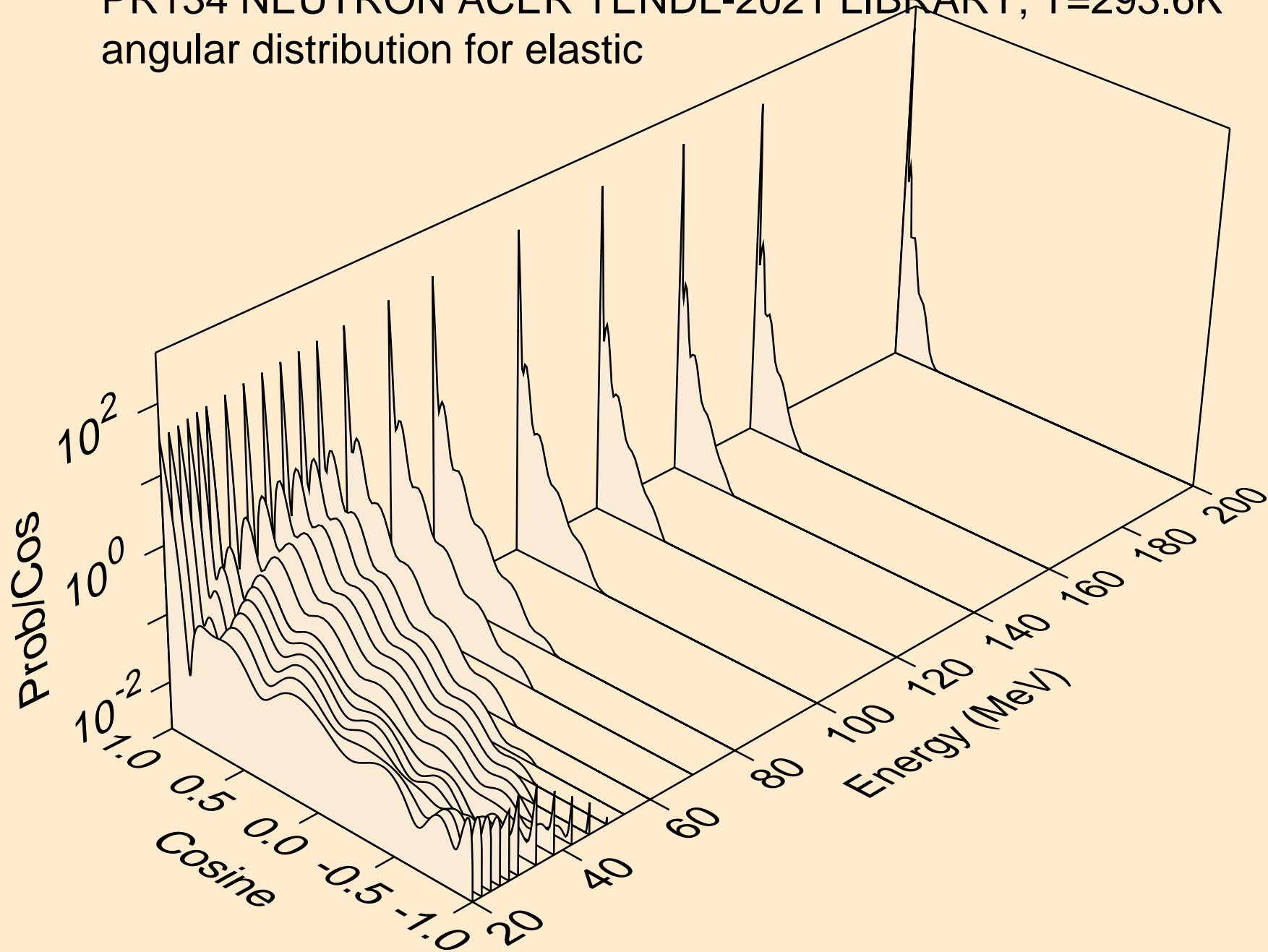

PR134 NEUTRON ACER TENDL-2021 LIBRARY; T=293.6K
angular distribution for (n,n*1)

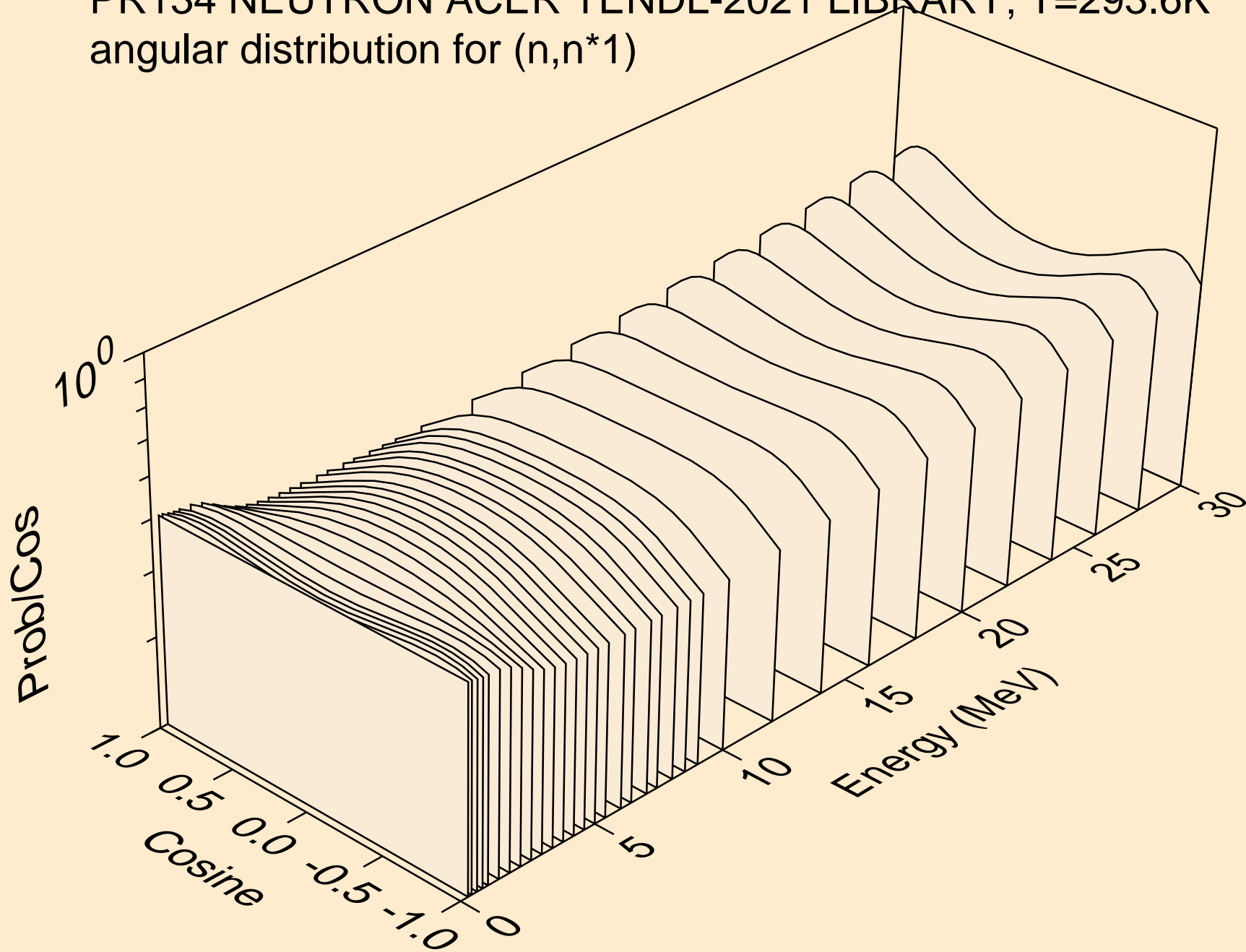

PR134 NEUTRON ACER TENDL-2021 LIBRARY; T=293.6K
angular distribution for (n,n*2)

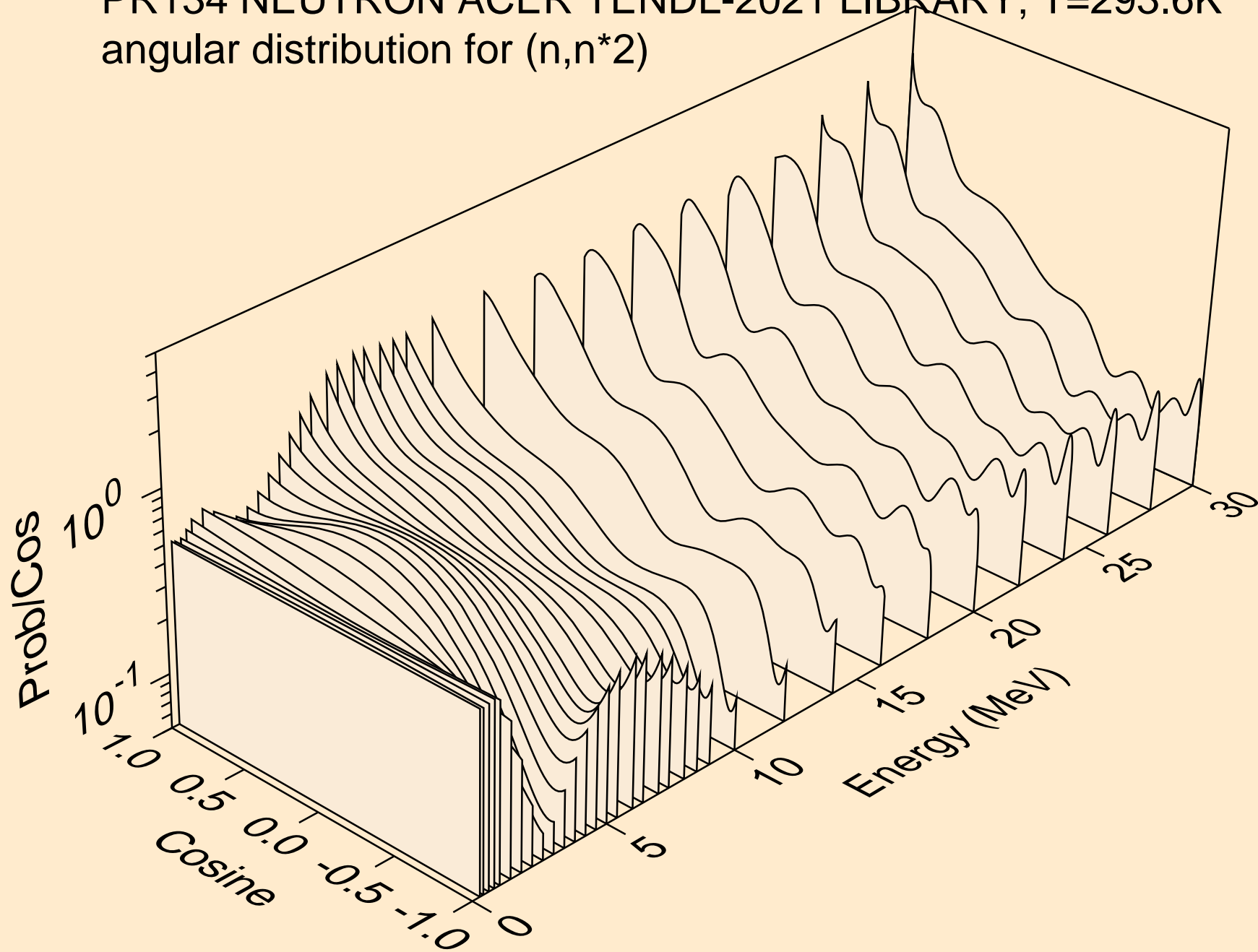

PR134 NEUTRON ACER TENDL-2021 LIBRARY; T=293.6K
angular distribution for (n,n*3)

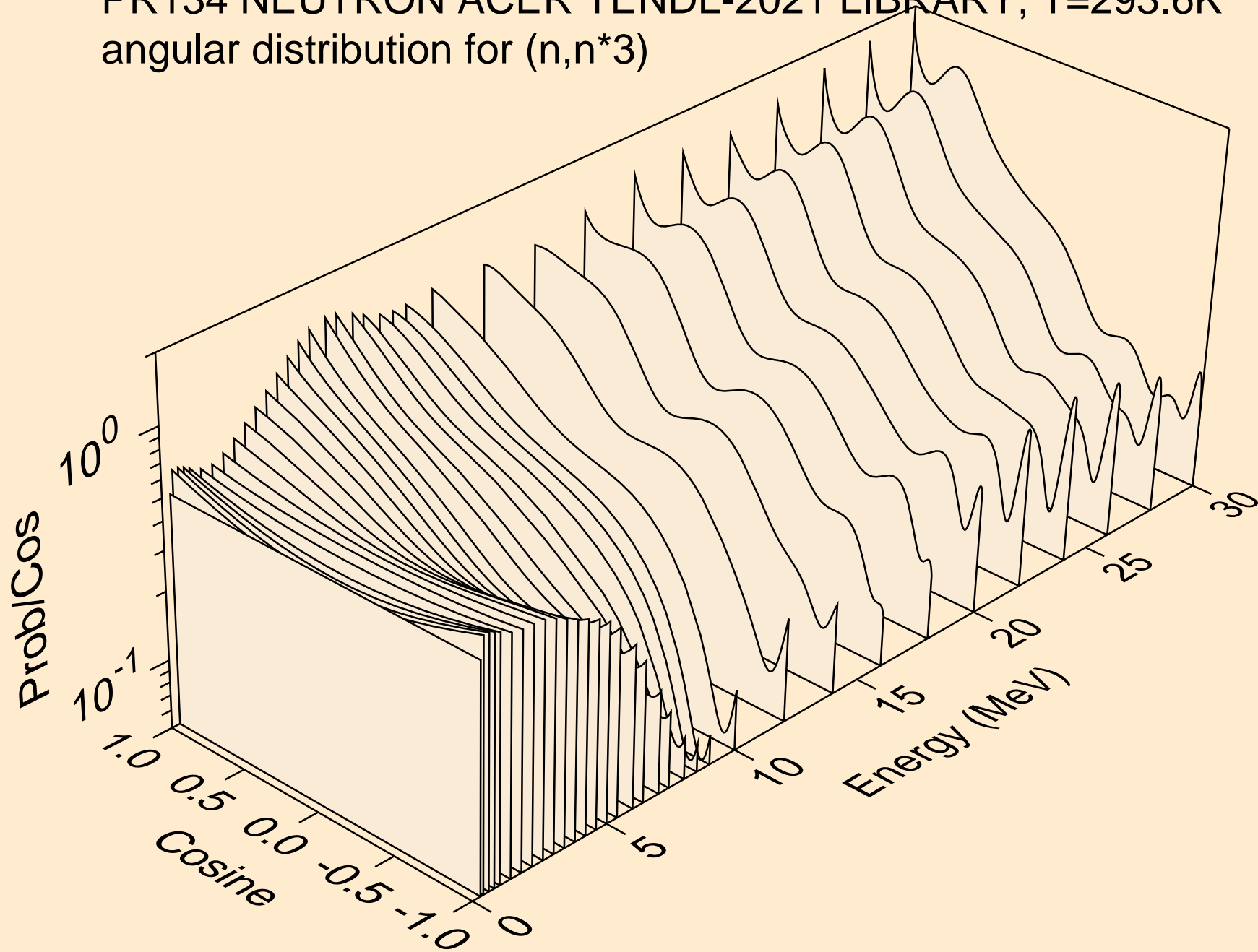

PR134 NEUTRON ACER TENDL-2021 LIBRARY; T=293.6K
angular distribution for (n,n*4)

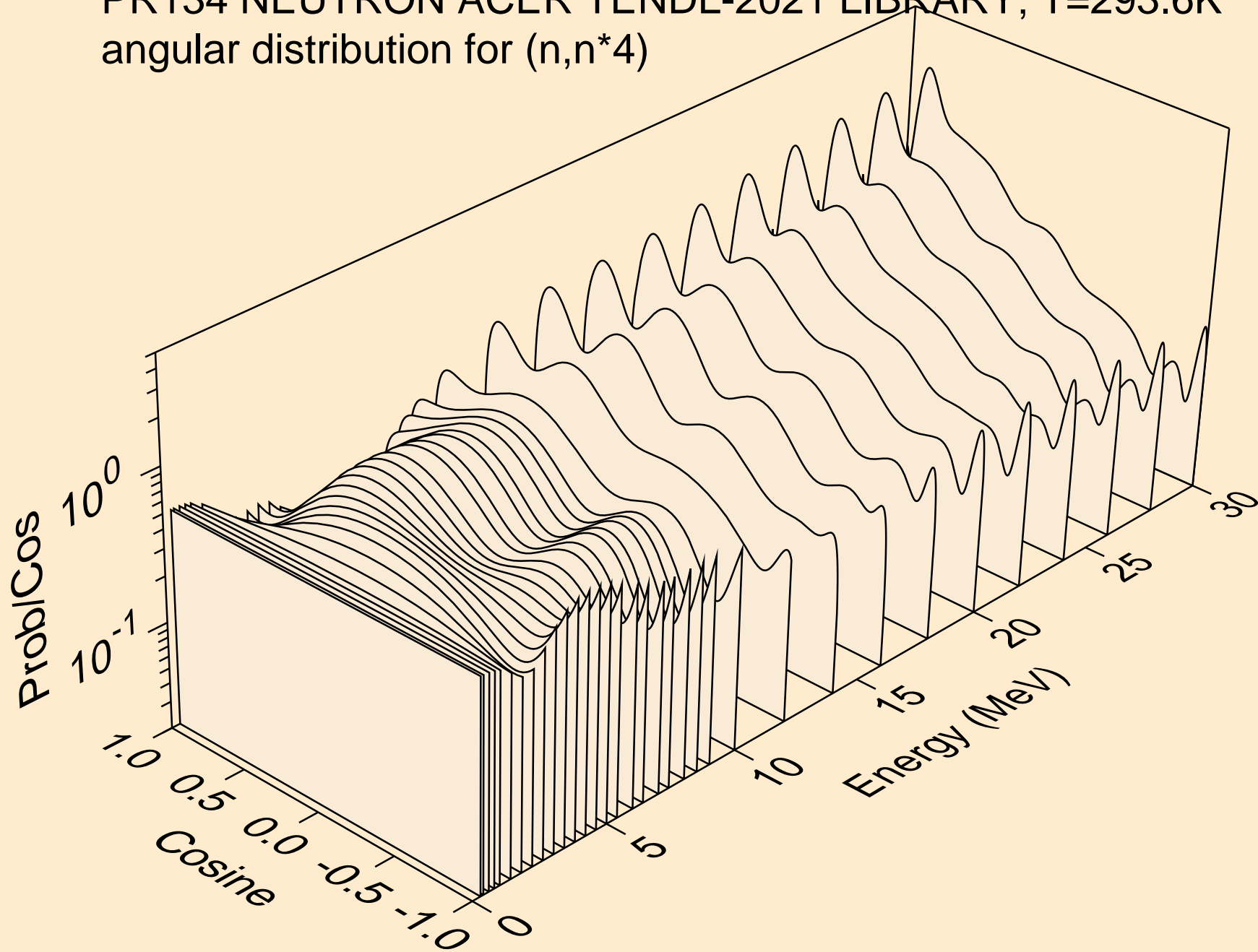

PR134 NEUTRON ACER TENDL-2021 LIBRARY; T=293.6K
angular distribution for (n,n*5)

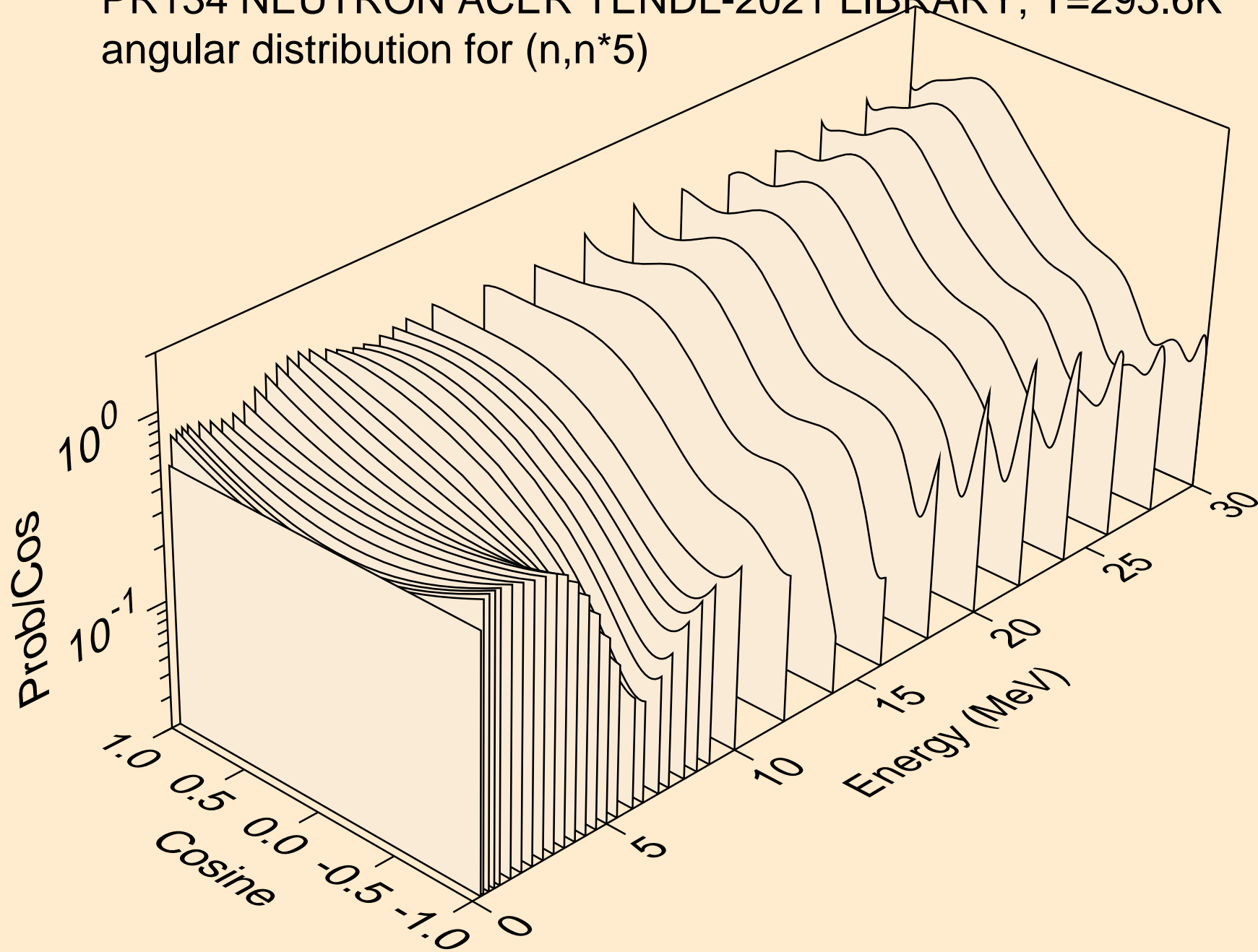

PR134 NEUTRON ACER TENDL-2021 LIBRARY; T=293.6K
angular distribution for (n,n*6)

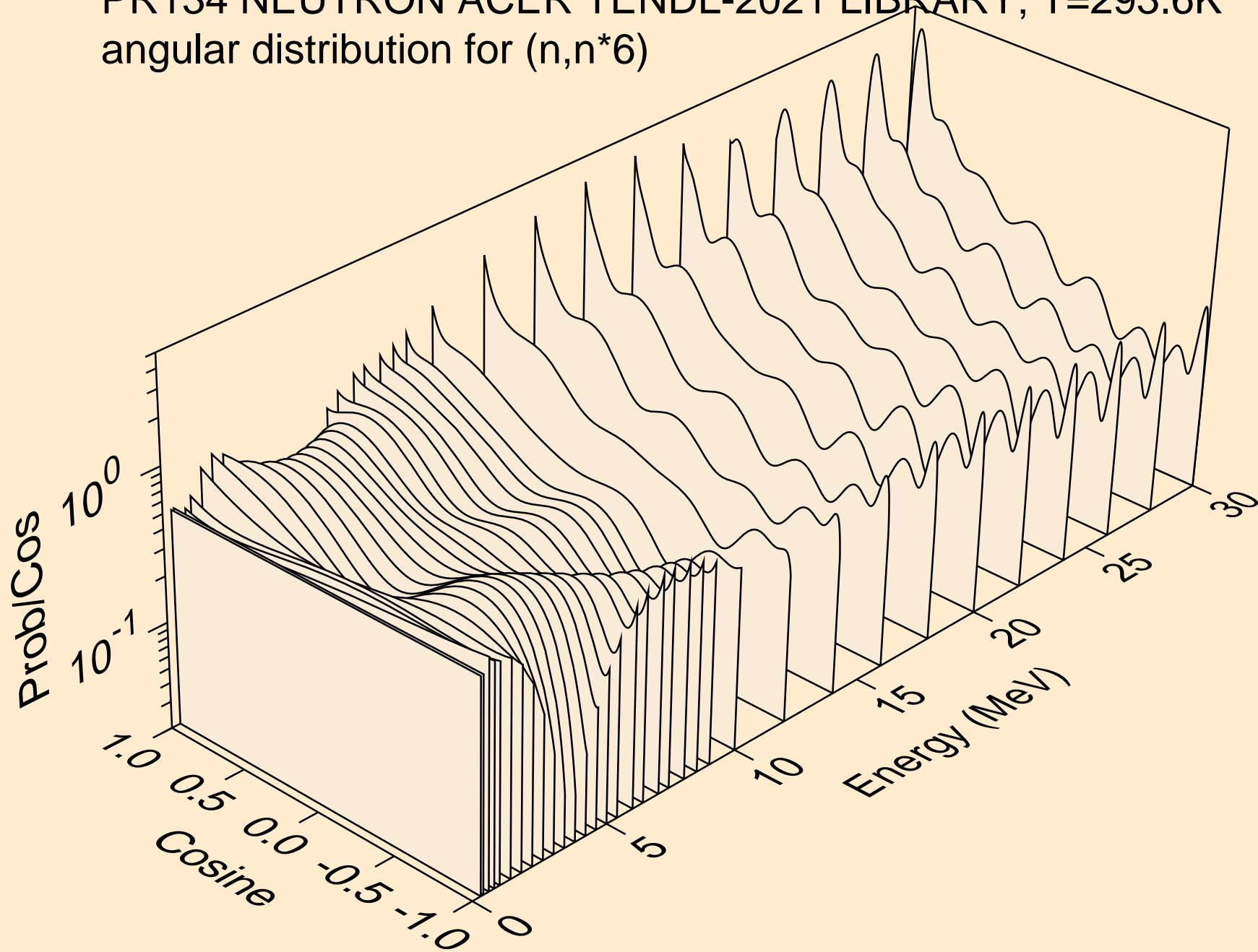

PR134 NEUTRON ACER TENDL-2021 LIBRARY; T=293.6K
angular distribution for (n,n*7)

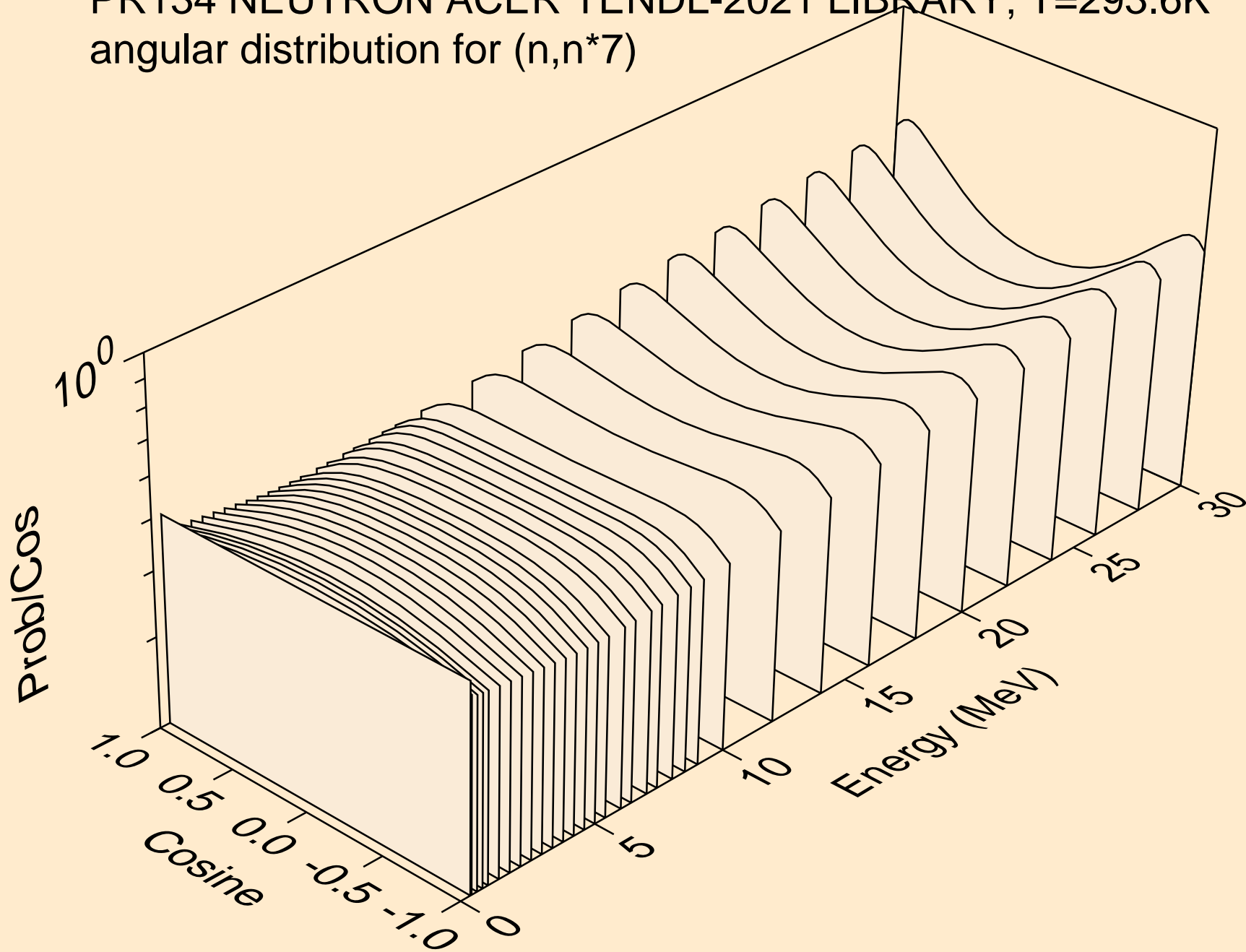

PR134 NEUTRON ACER TENDL-2021 LIBRARY; T=293.6K
angular distribution for (n,n*8)

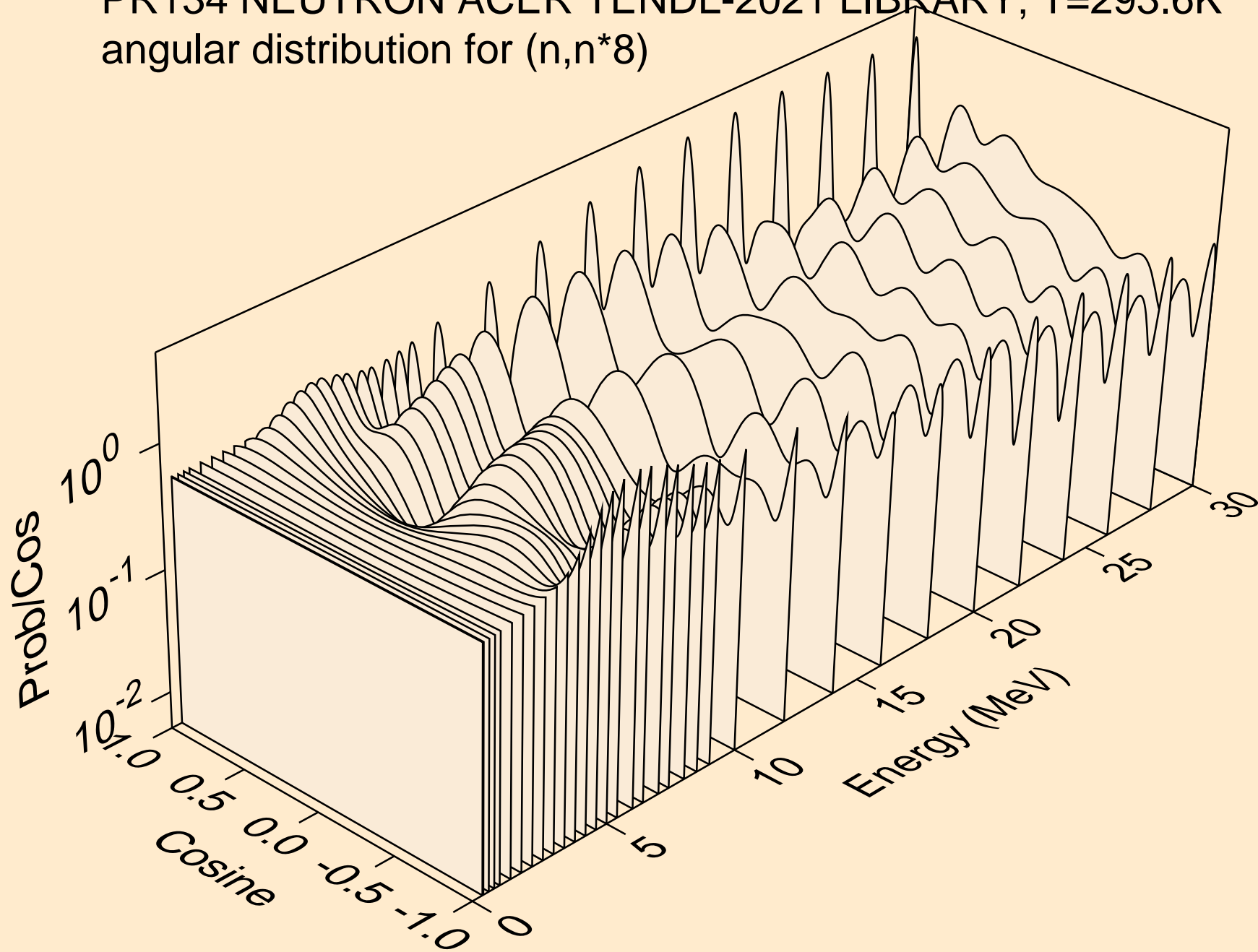

PR134 NEUTRON ACER TENDL-2021 LIBRARY; T=293.6K
angular distribution for (n,n*9)

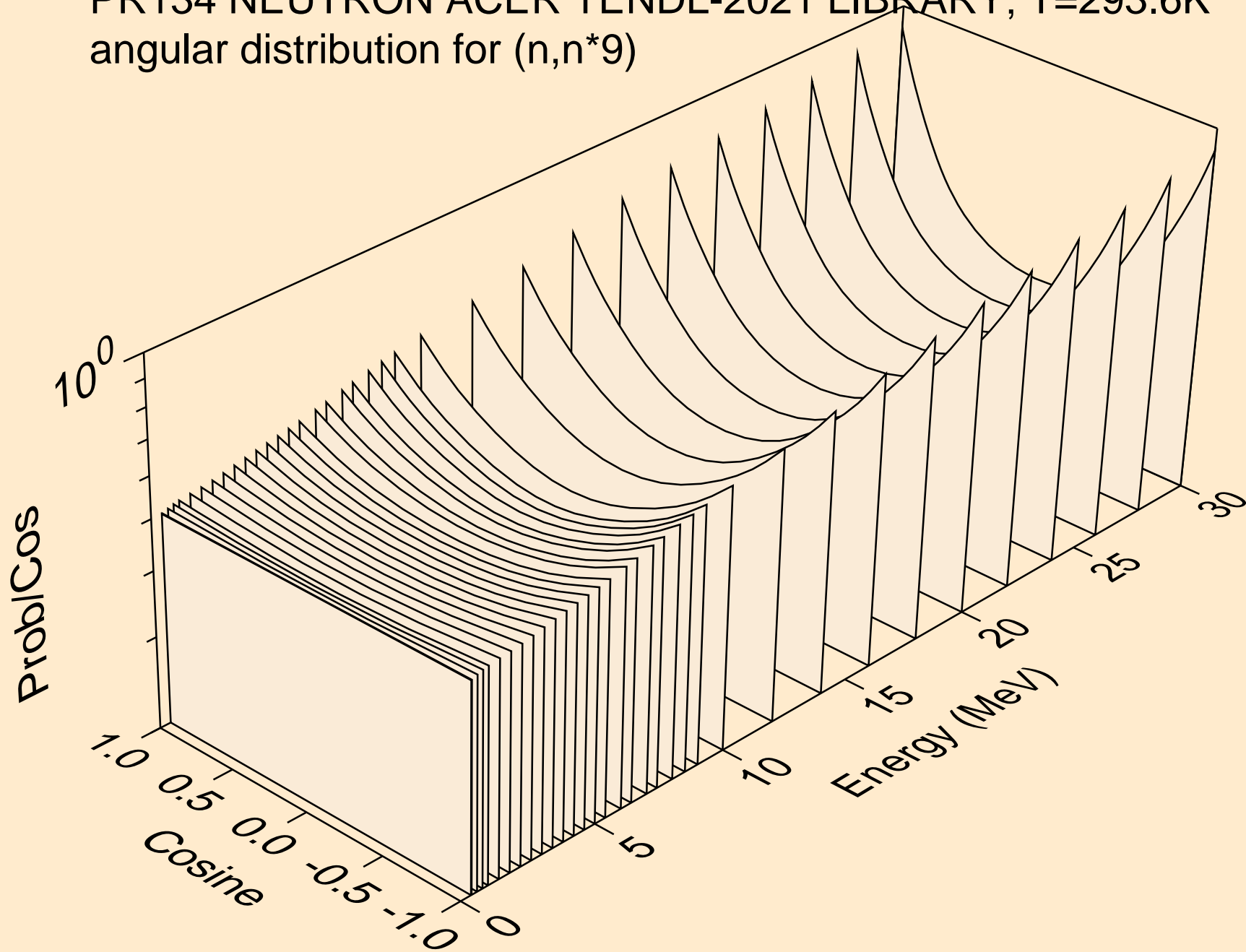

PR134 NEUTRON ACER TENDL-2021 LIBRARY; T=293.6K
angular distribution for (n,n*10)

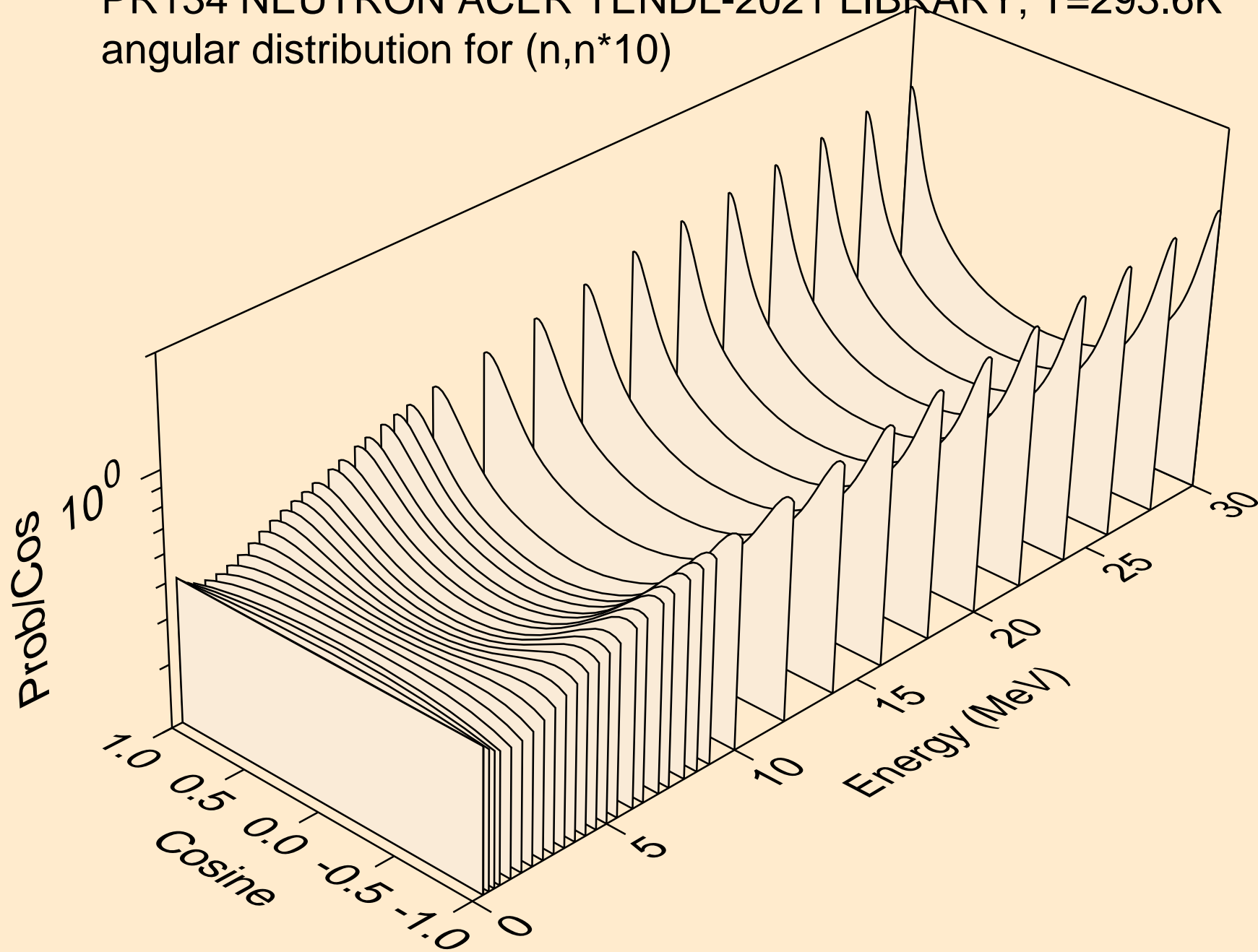

PR134 NEUTRON ACER TENDL-2021 LIBRARY; T=293.6K
angular distribution for (n,n*11)

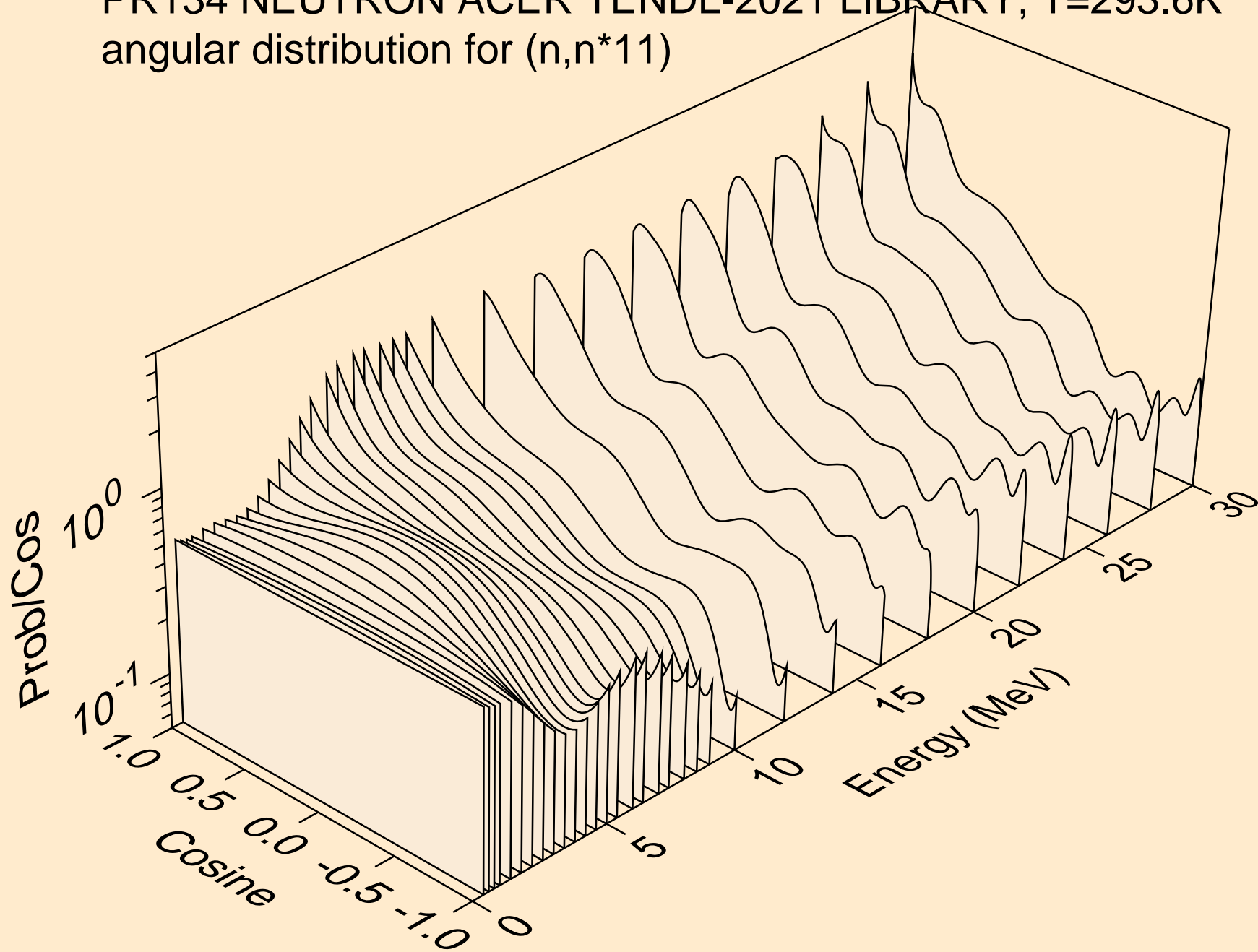

PR134 NEUTRON ACER TENDL-2021 LIBRARY; T=293.6K
angular distribution for (n,n*12)

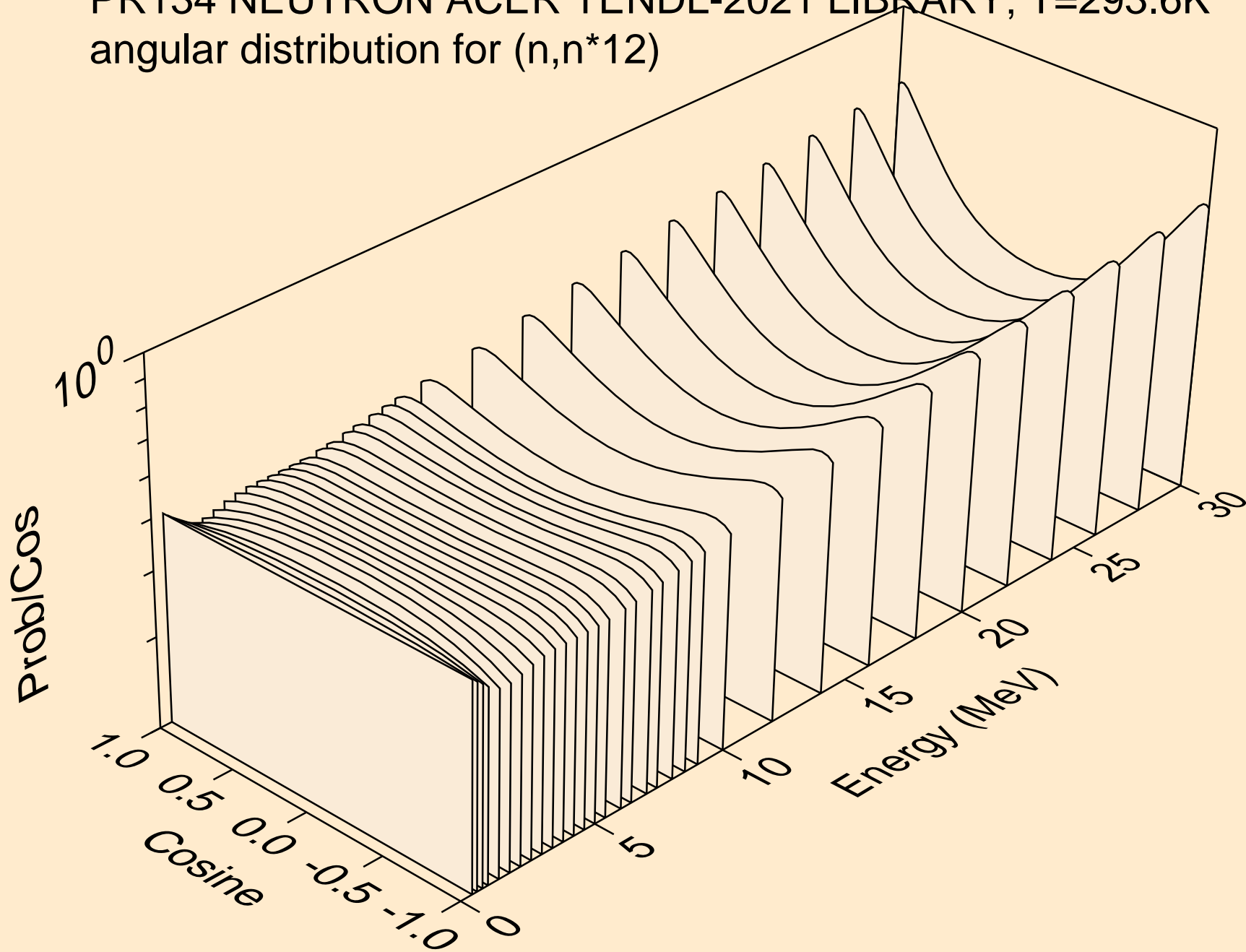

PR134 NEUTRON ACER TENDL-2021 LIBRARY; T=293.6K
angular distribution for (n,n*13)

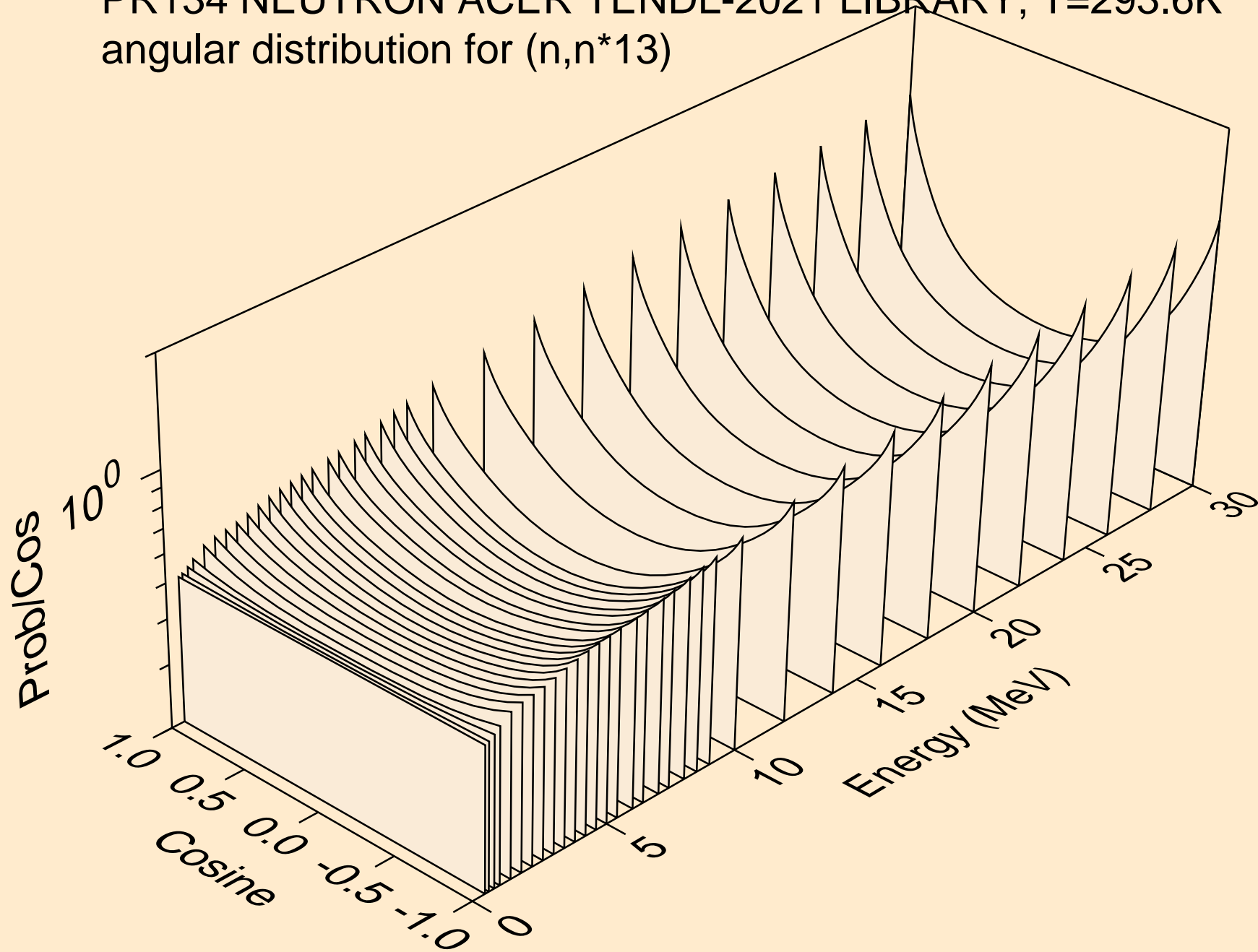

PR134 NEUTRON ACER TENDL-2021 LIBRARY; T=293.6K
angular distribution for (n,n*14)

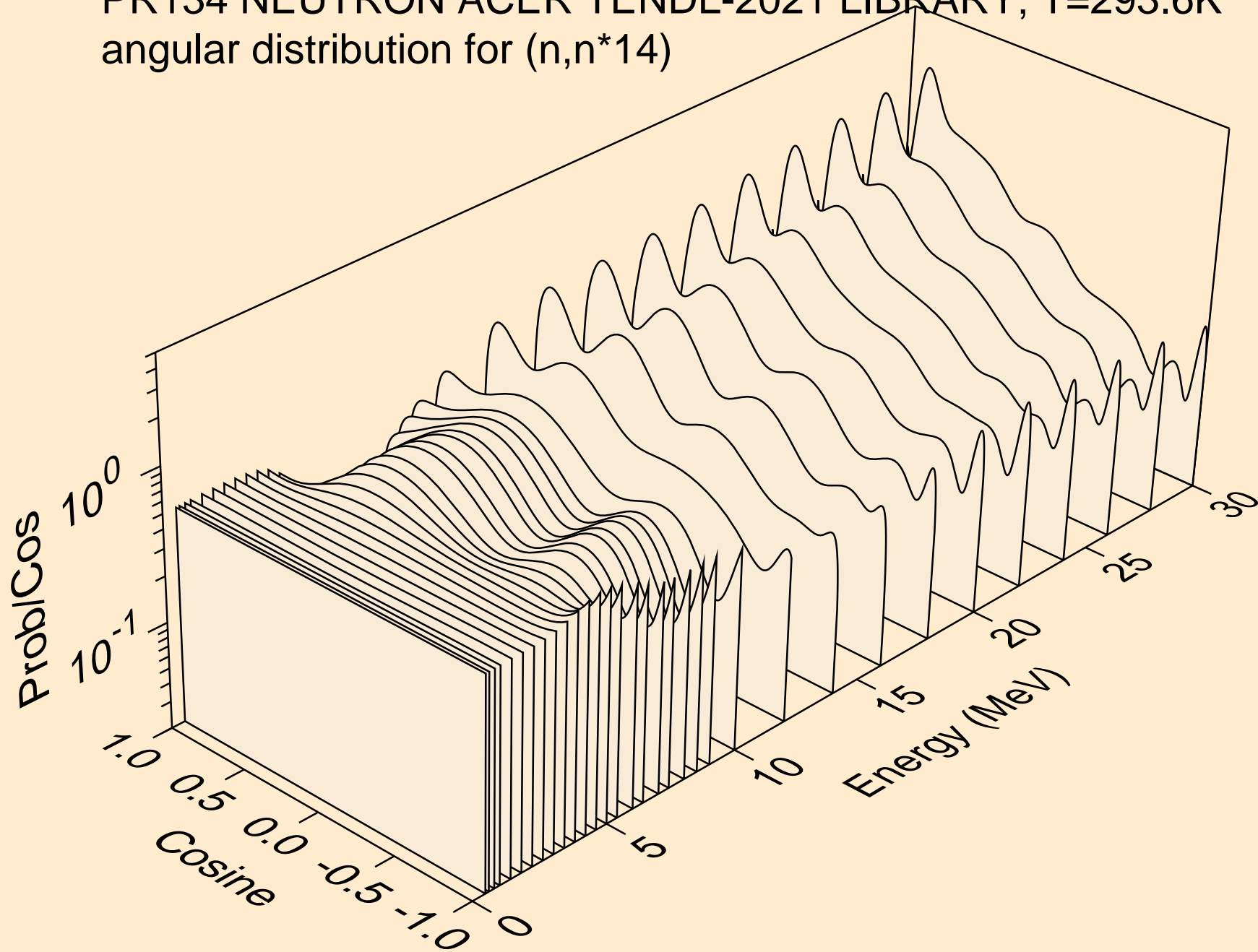

PR134 NEUTRON ACER TENDL-2021 LIBRARY; T=293.6K
angular distribution for (n,n*15)

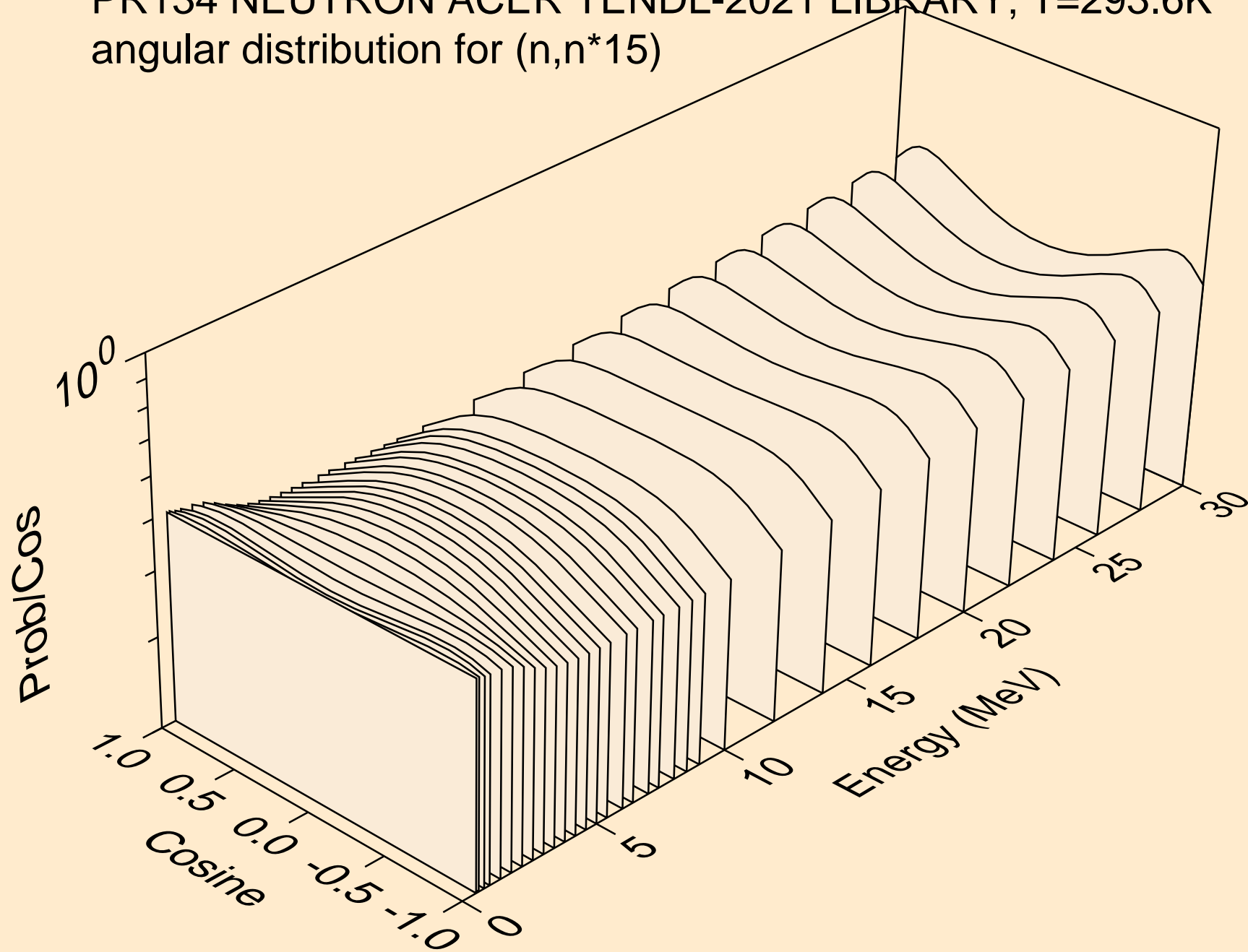

PR134 NEUTRON ACER TENDL-2021 LIBRARY; T=293.6K
angular distribution for (n,n*16)

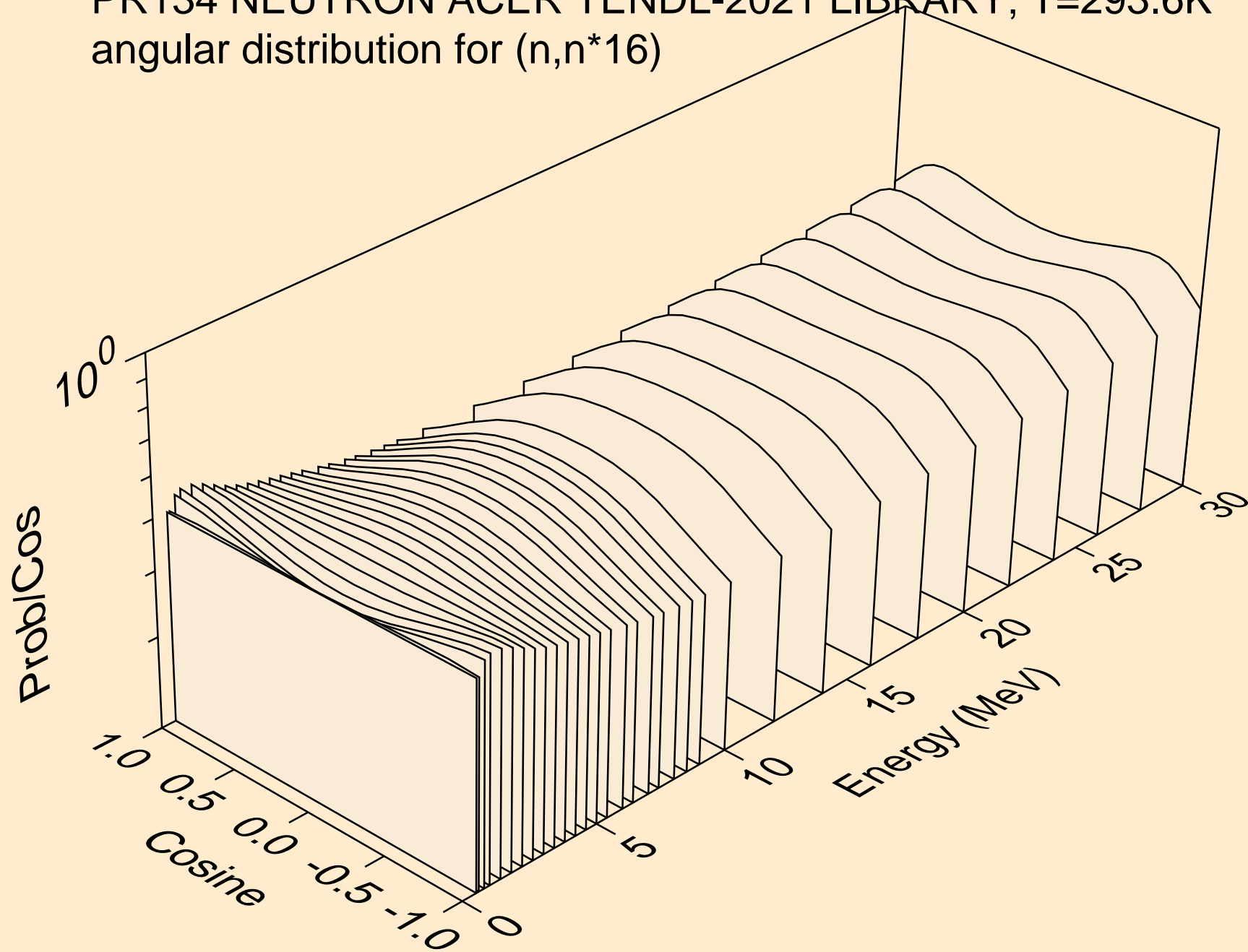

PR134 NEUTRON ACER TENDL-2021 LIBRARY; T=293.6K
angular distribution for (n,n*17)

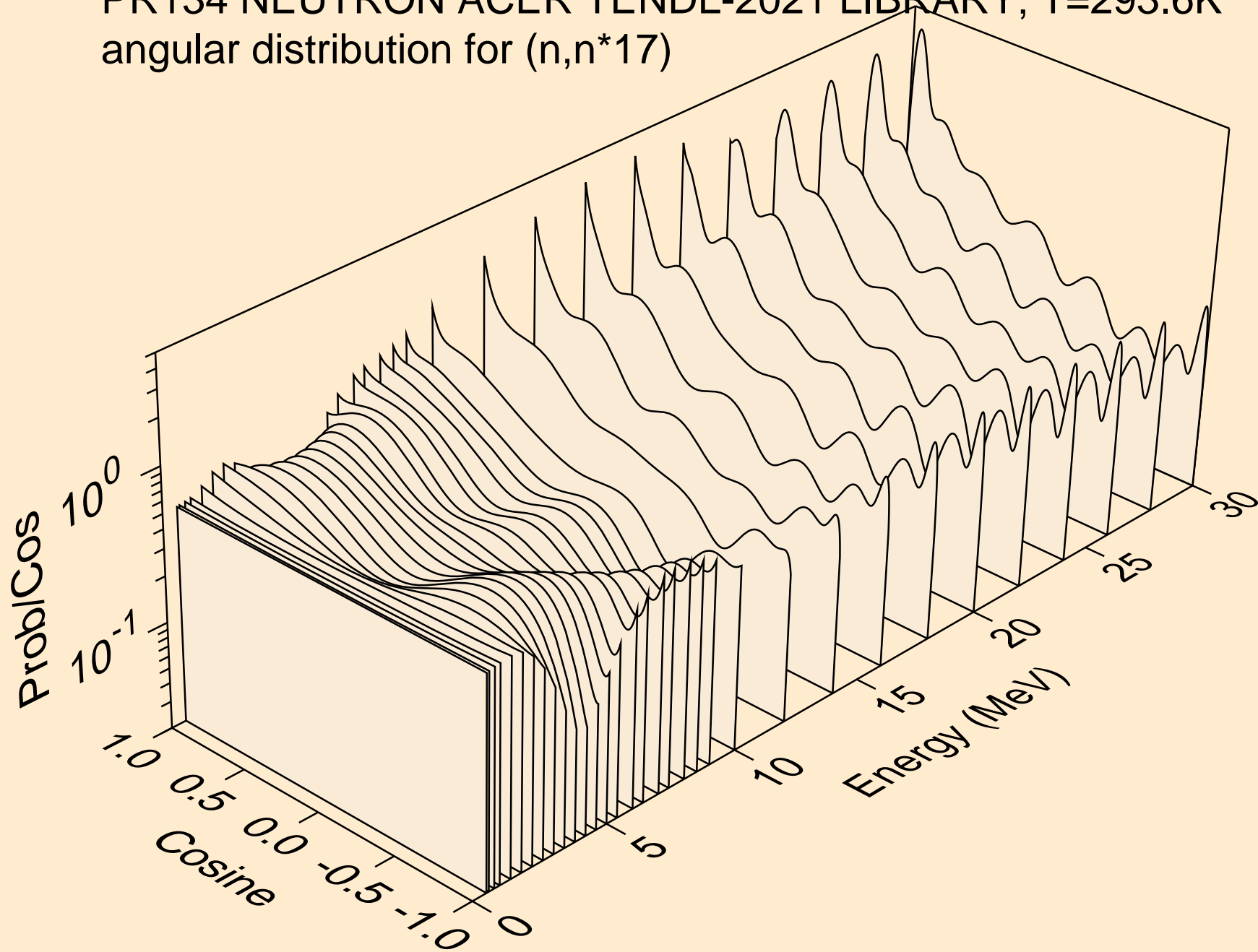

PR134 NEUTRON ACER TENDL-2021 LIBRARY; T=293.6K
angular distribution for (n,n*18)

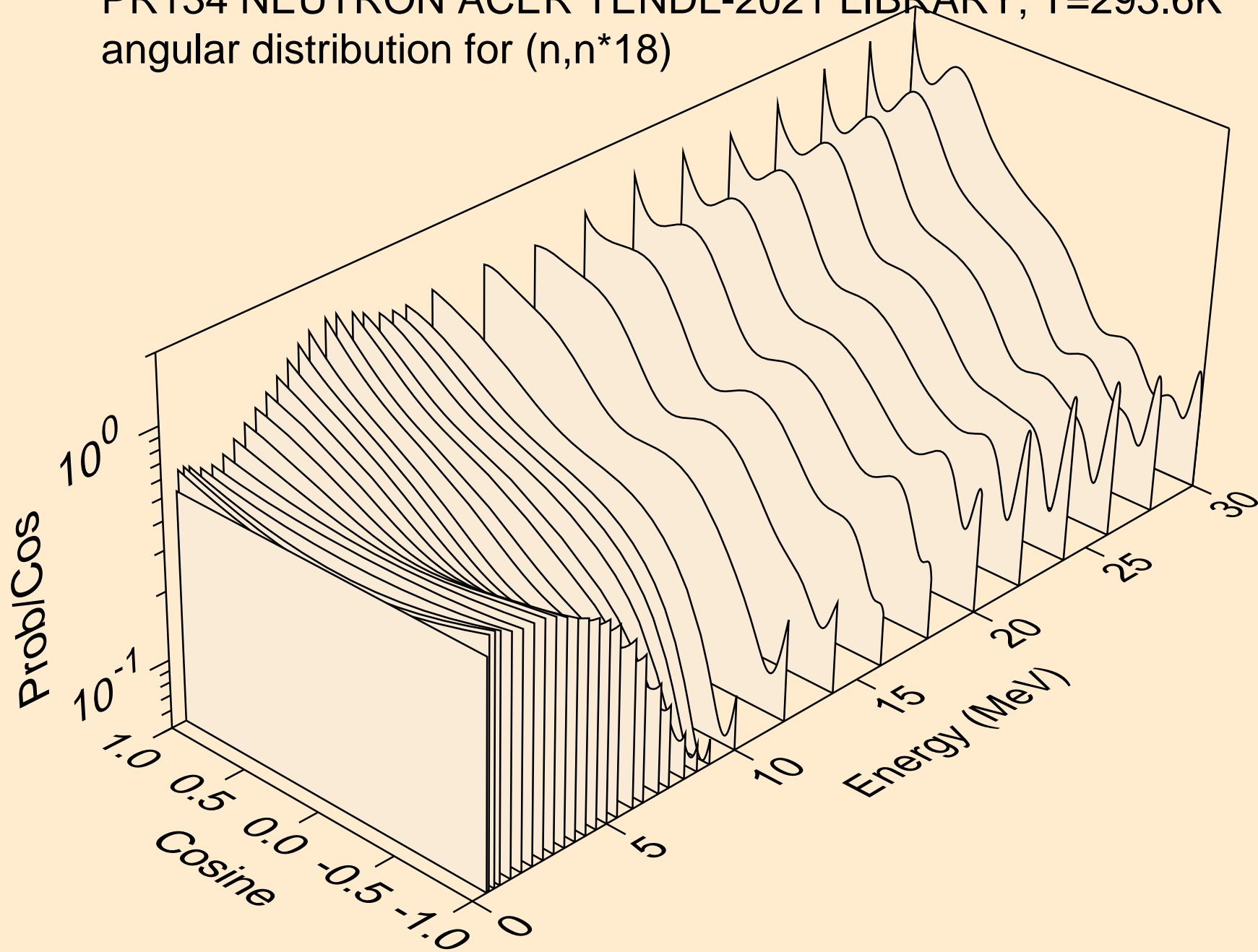

PR134 NEUTRON ACER TENDL-2021 LIBRARY; T=293.6K
angular distribution for (n,n*19)

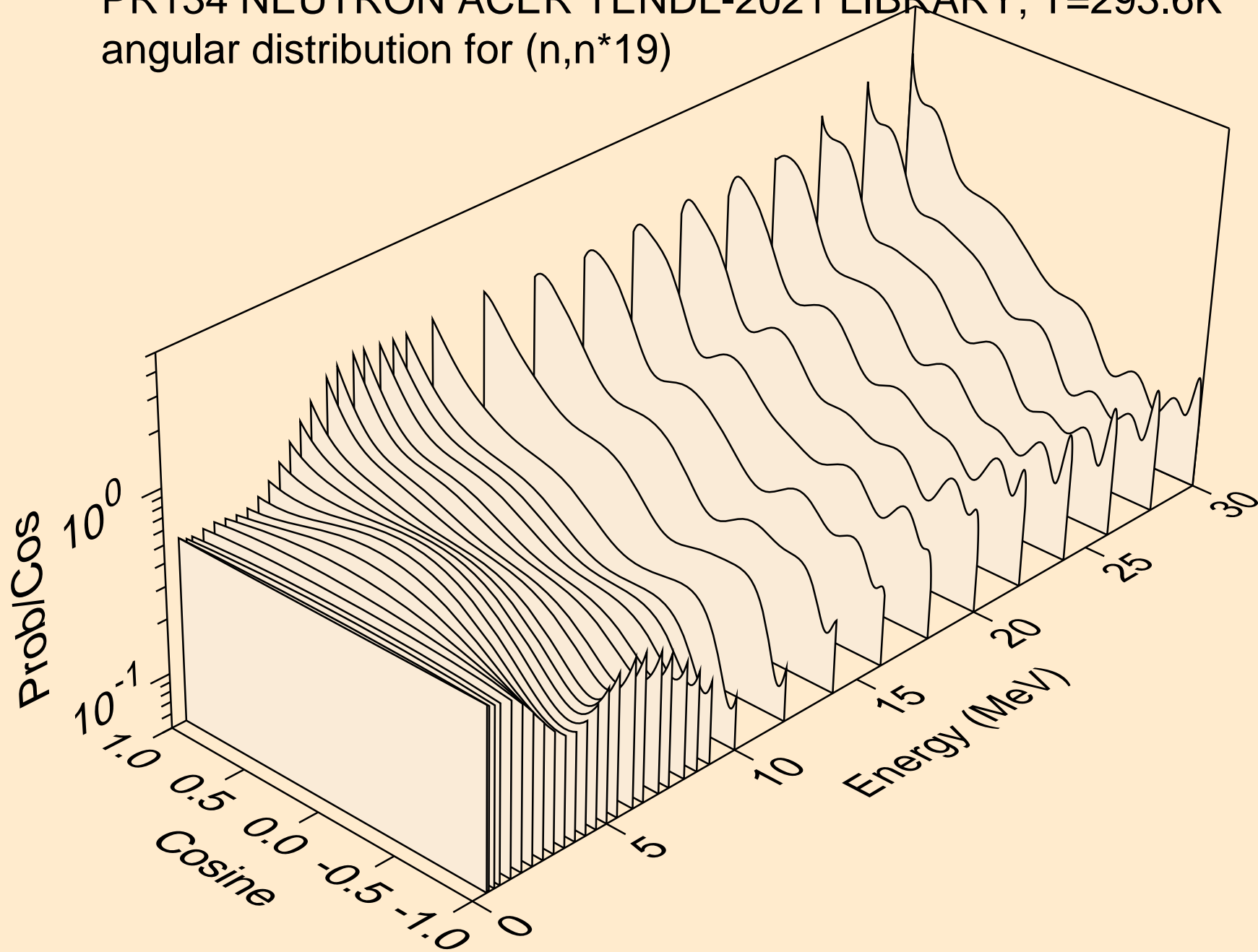

PR134 NEUTRON ACER TENDL-2021 LIBRARY; T=293.6K
angular distribution for (n,n*20)

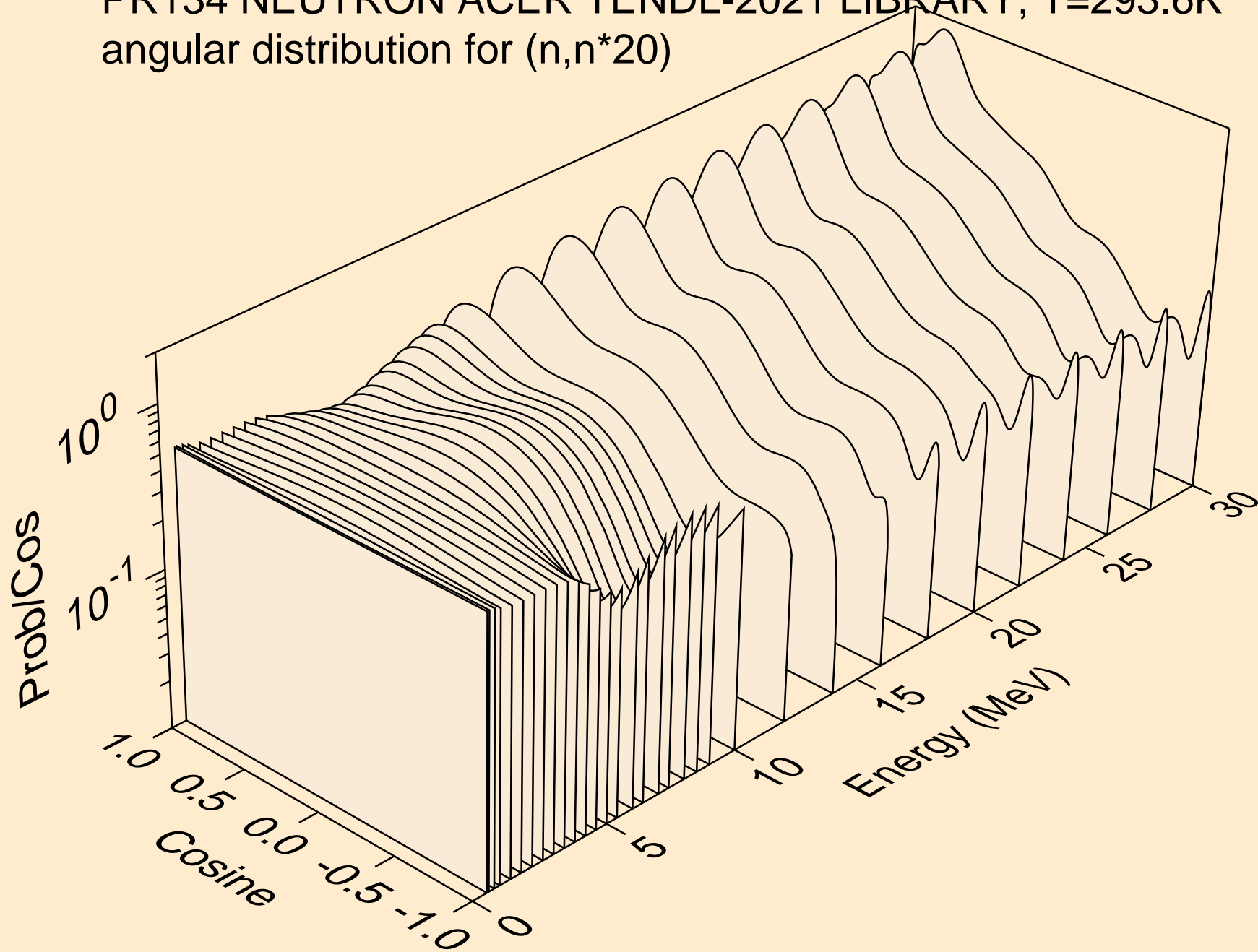

PR134 NEUTRON ACER TENDL-2021 LIBRARY; T=293.6K
angular distribution for (n,n*21)

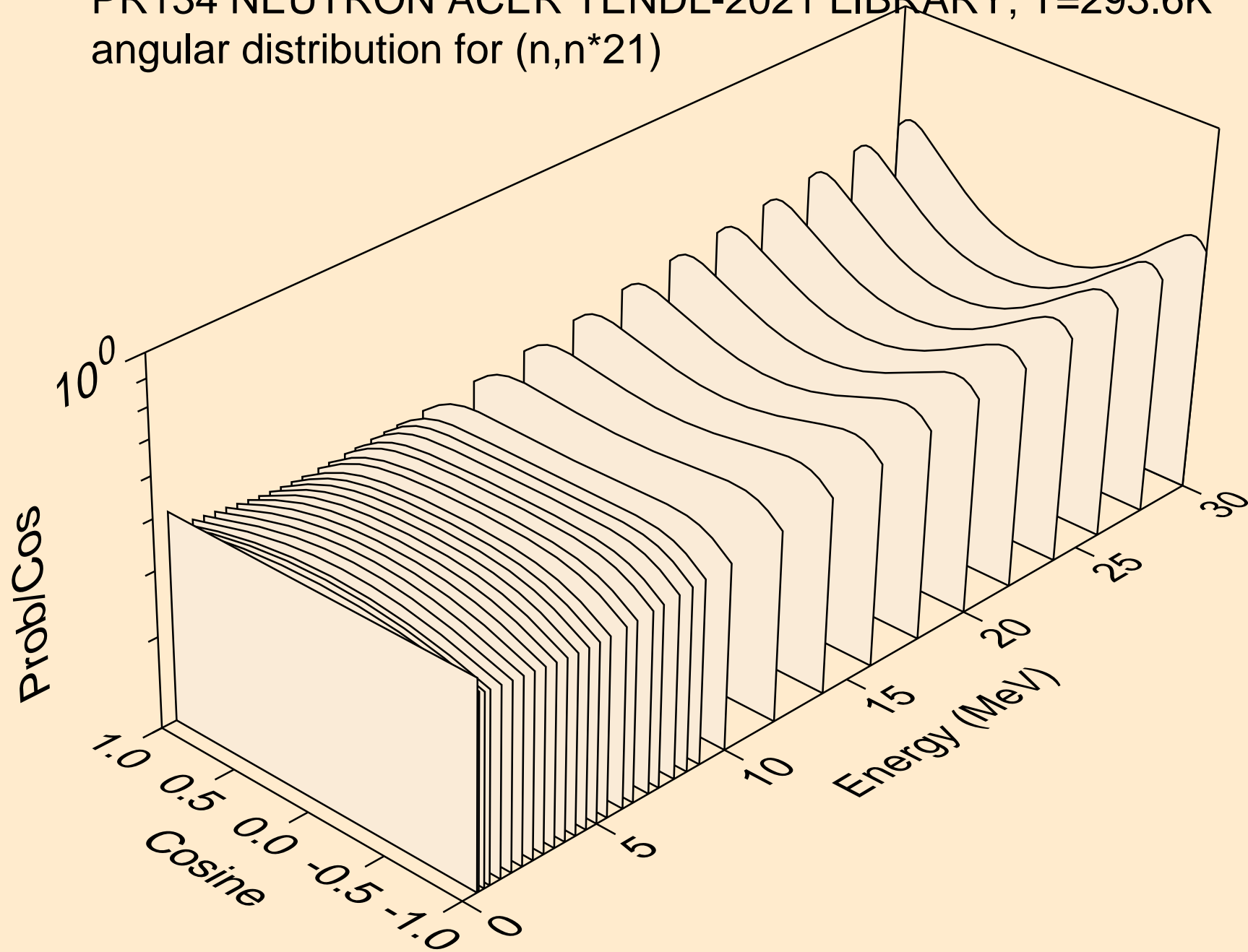

PR134 NEUTRON ACER TENDL-2021 LIBRARY; T=293.6K
angular distribution for (n,n*22)

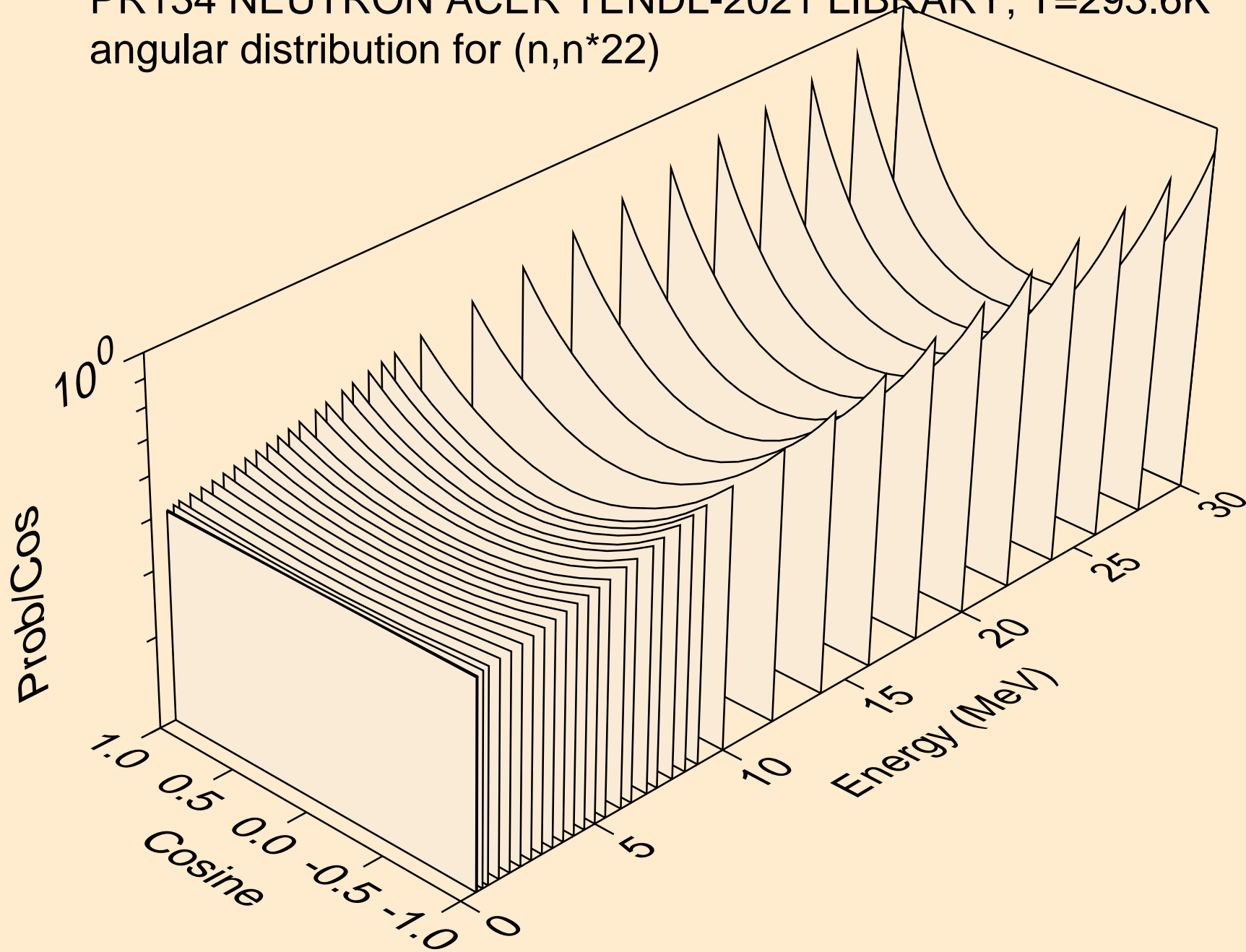

PR134 NEUTRON ACER TENDL-2021 LIBRARY; T=293.6K
angular distribution for (n,n*23)

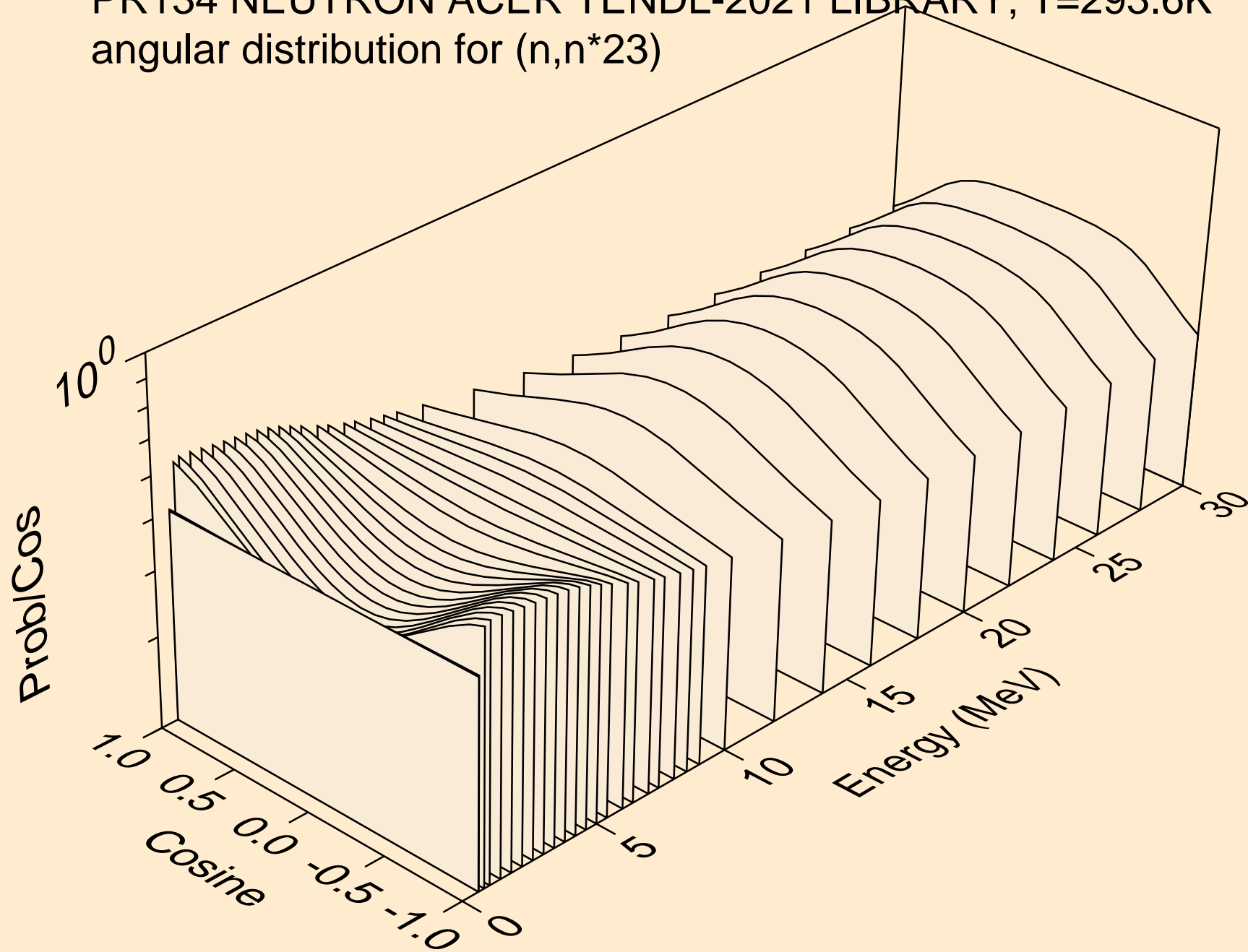

PR134 NEUTRON ACER TENDL-2021 LIBRARY; T=293.6K
angular distribution for (n,n*24)

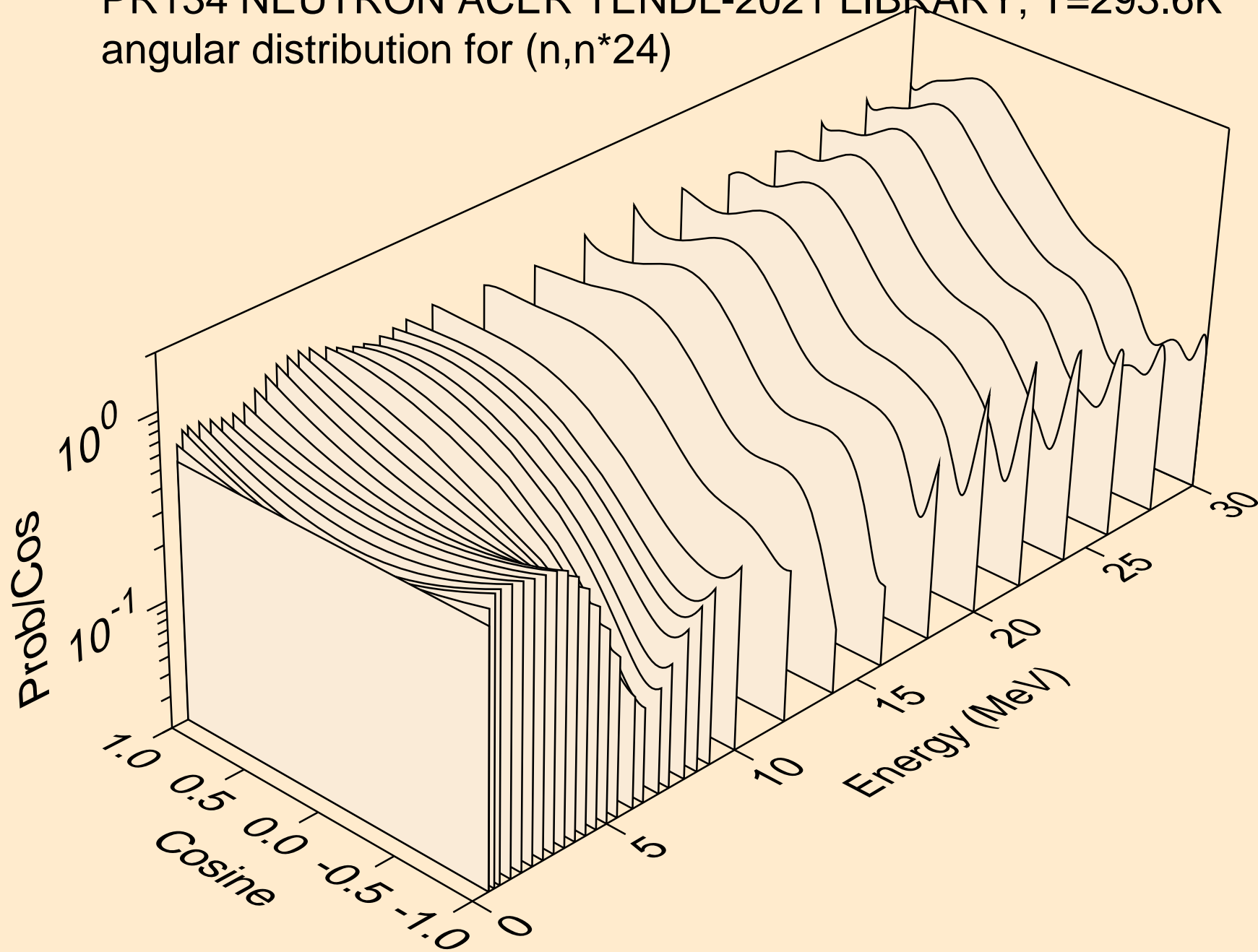

PR134 NEUTRON ACER TENDL-2021 LIBRARY; T=293.6K
angular distribution for (n,n*25)

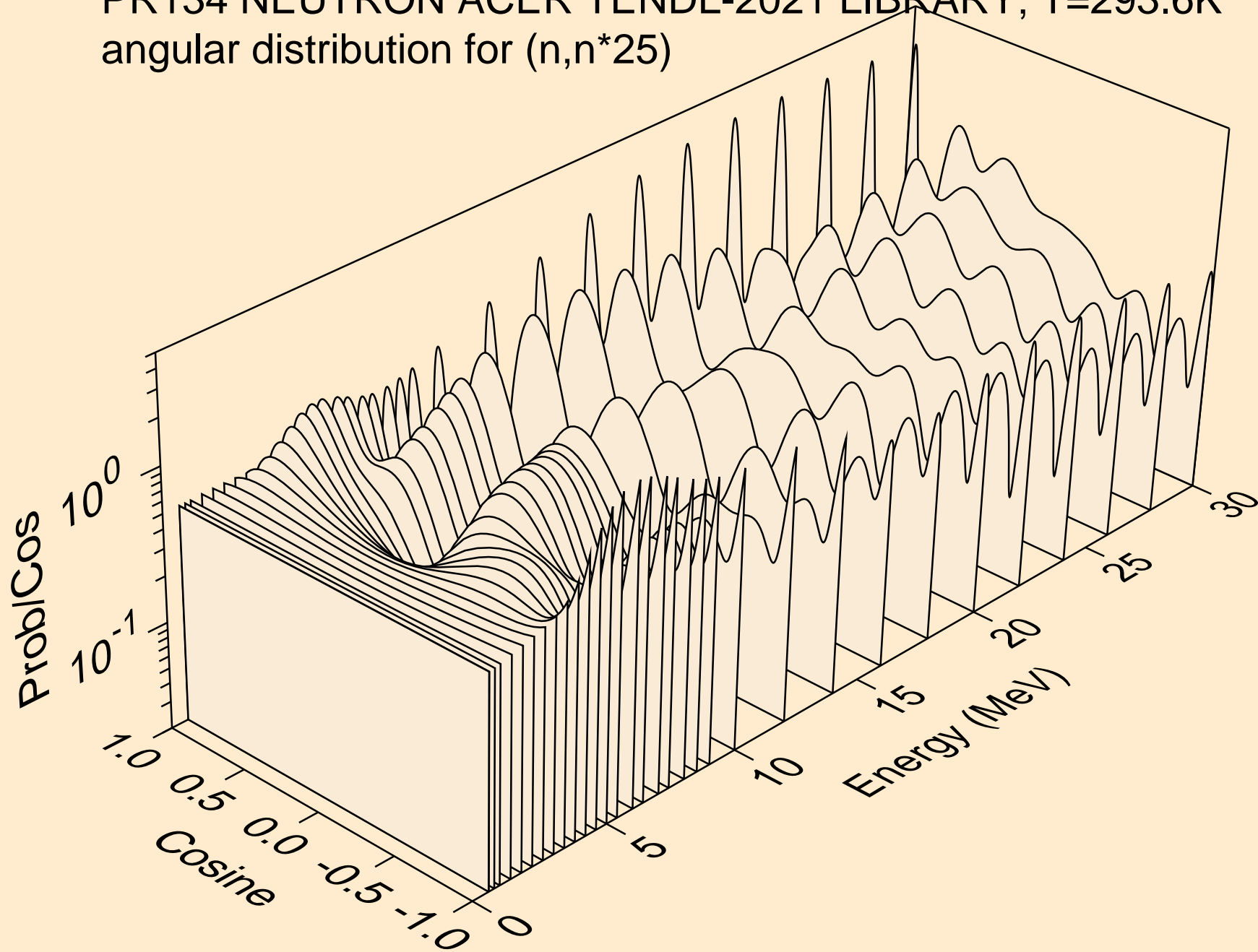

PR134 NEUTRON ACER TENDL-2021 LIBRARY; T=293.6K
angular distribution for (n,n*26)

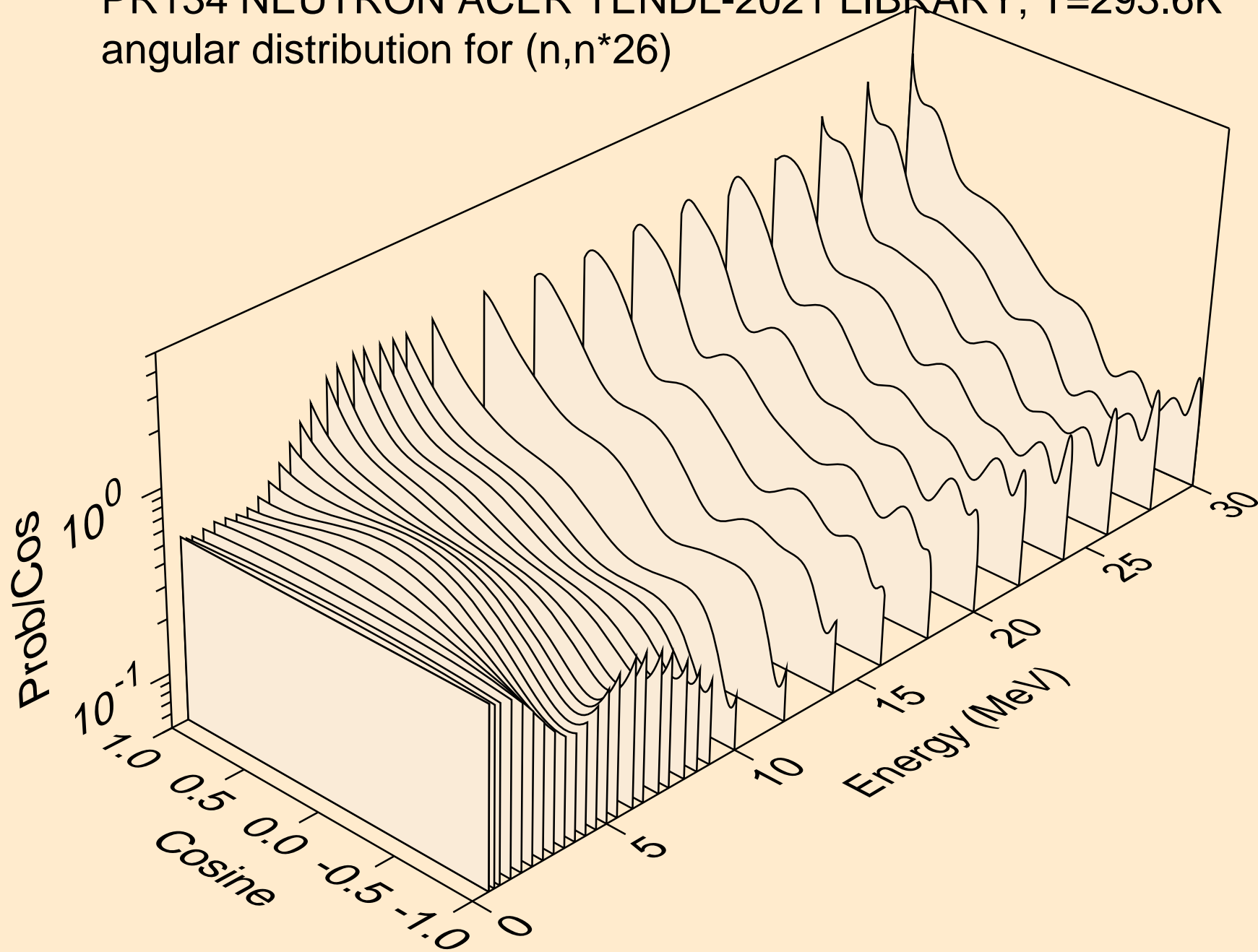

PR134 NEUTRON ACER TENDL-2021 LIBRARY; T=293.6K
angular distribution for (n,n*27)

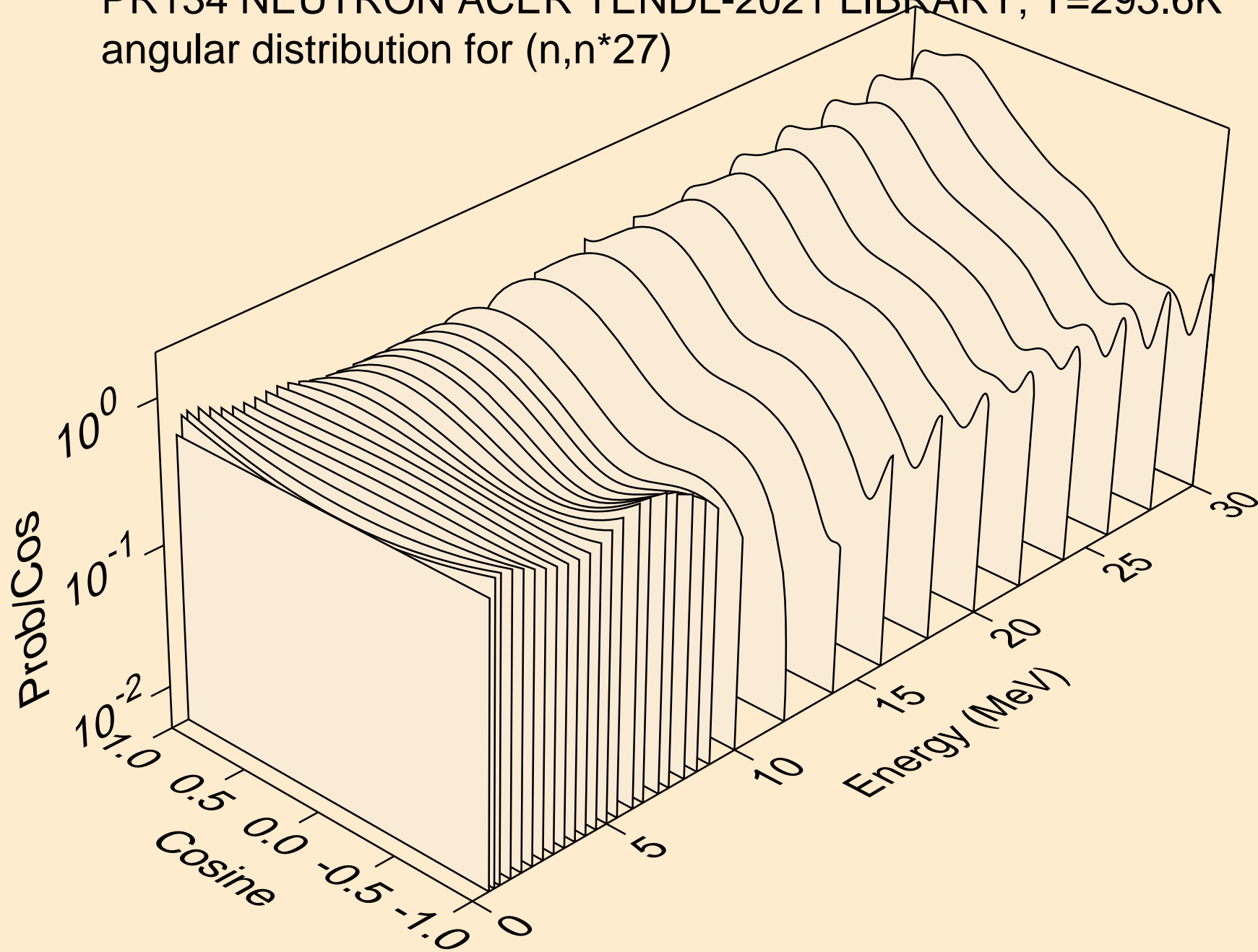

PR134 NEUTRON ACER TENDL-2021 LIBRARY; T=293.6K
angular distribution for (n,n*28)

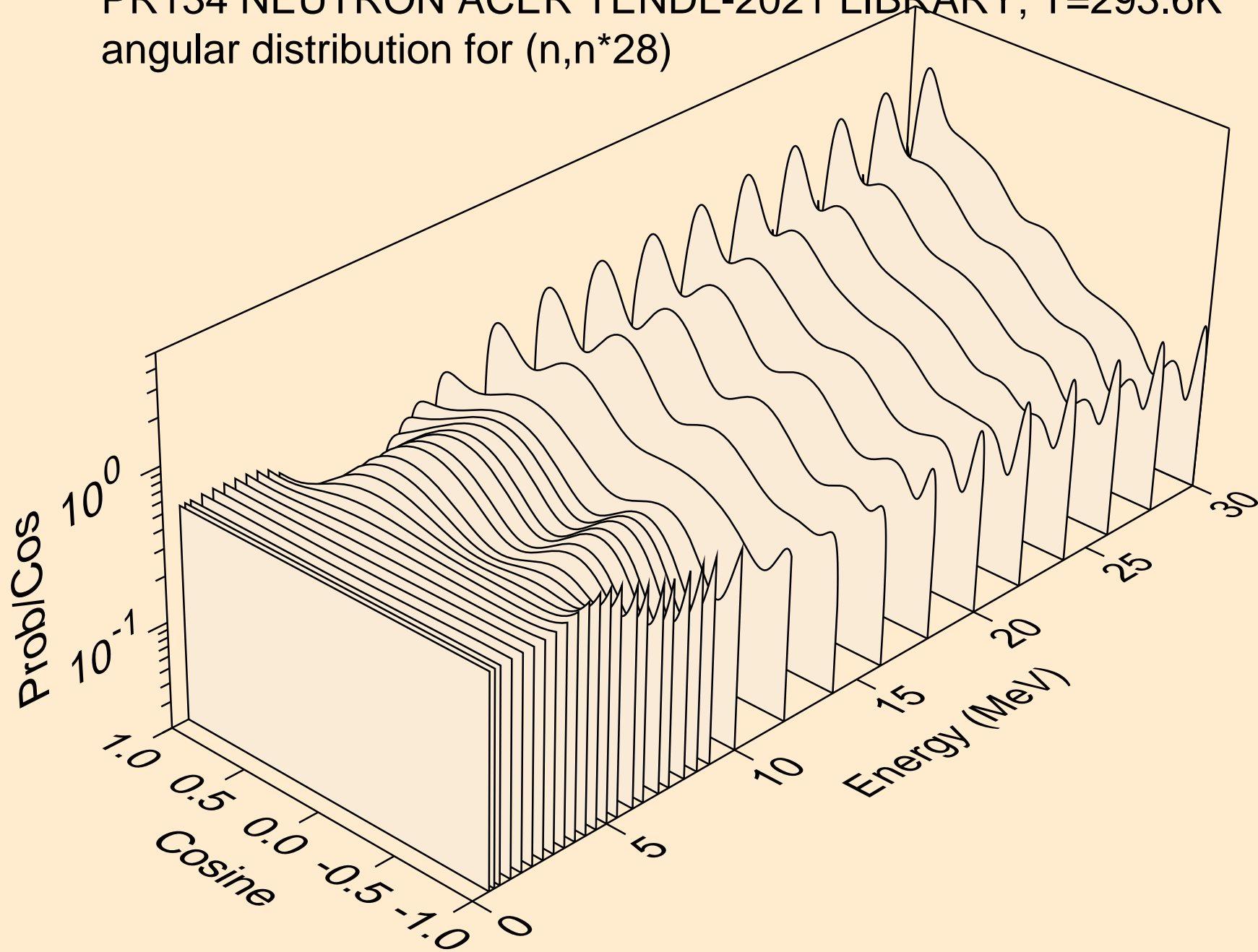

PR134 NEUTRON ACER TENDL-2021 LIBRARY; T=293.6K
angular distribution for (n,n*29)

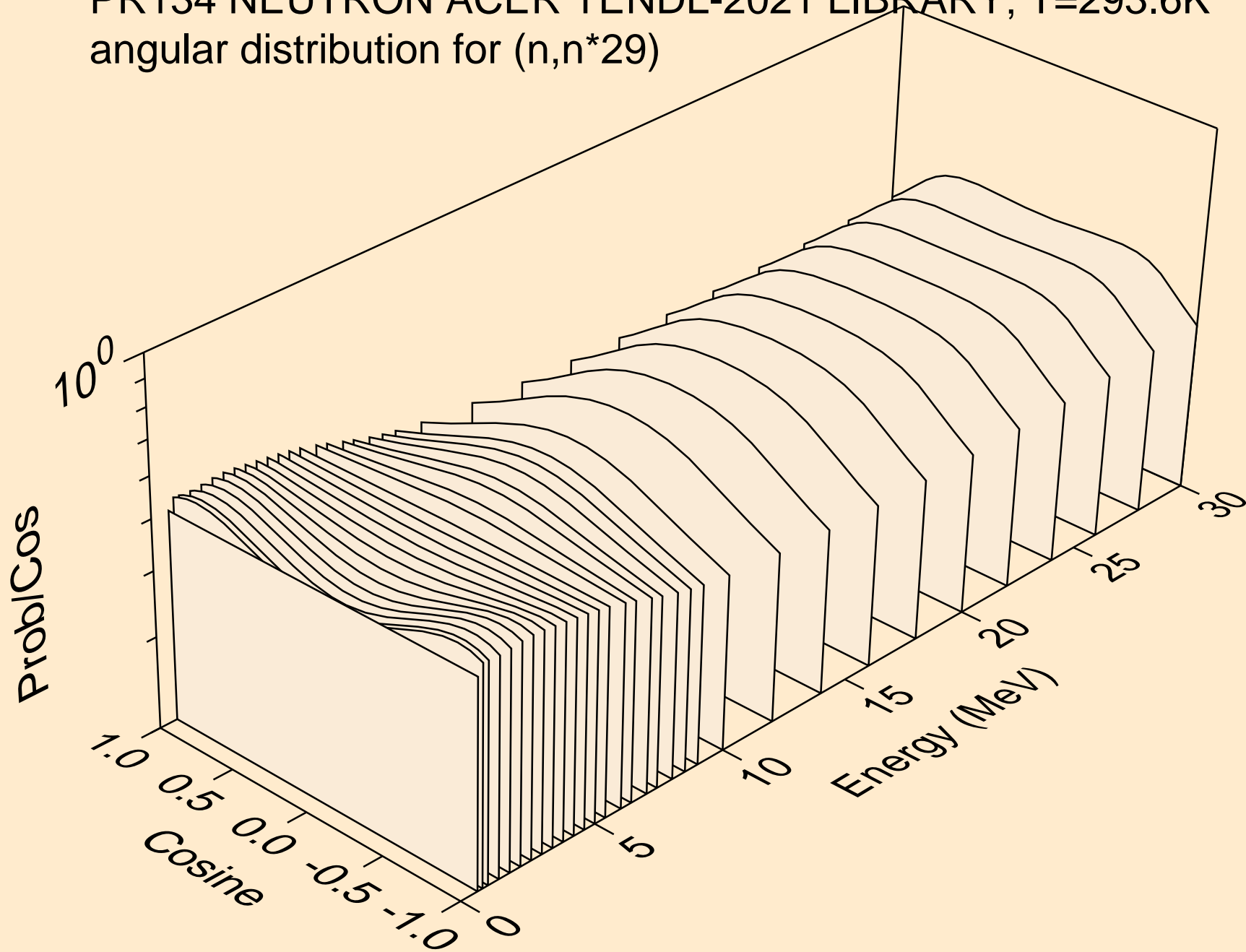

PR134 NEUTRON ACER TENDL-2021 LIBRARY; T=293.6K
angular distribution for (n,n*30)

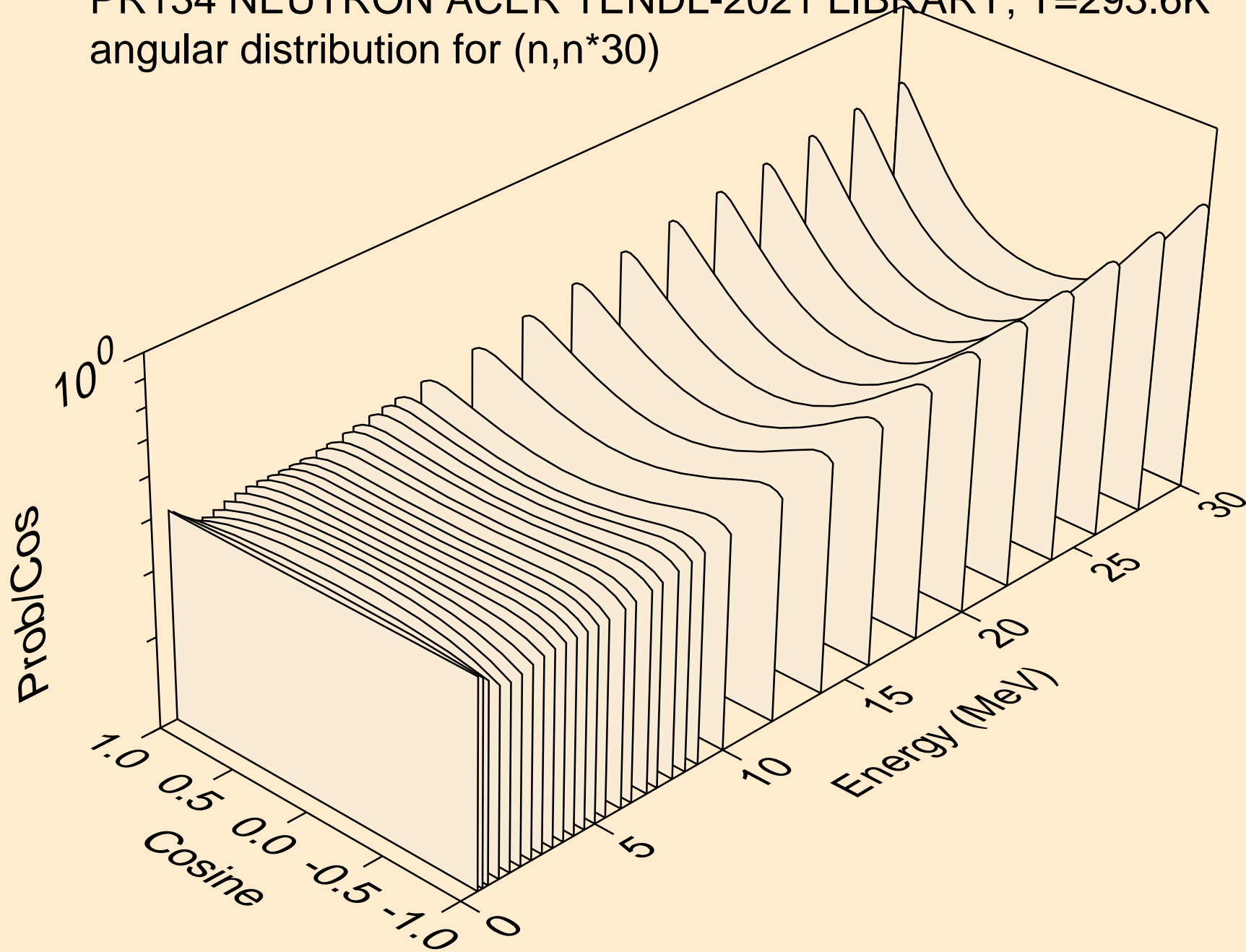

PR134 NEUTRON ACER TENDL-2021 LIBRARY; T=293.6K
Neutron emission for (n,x)

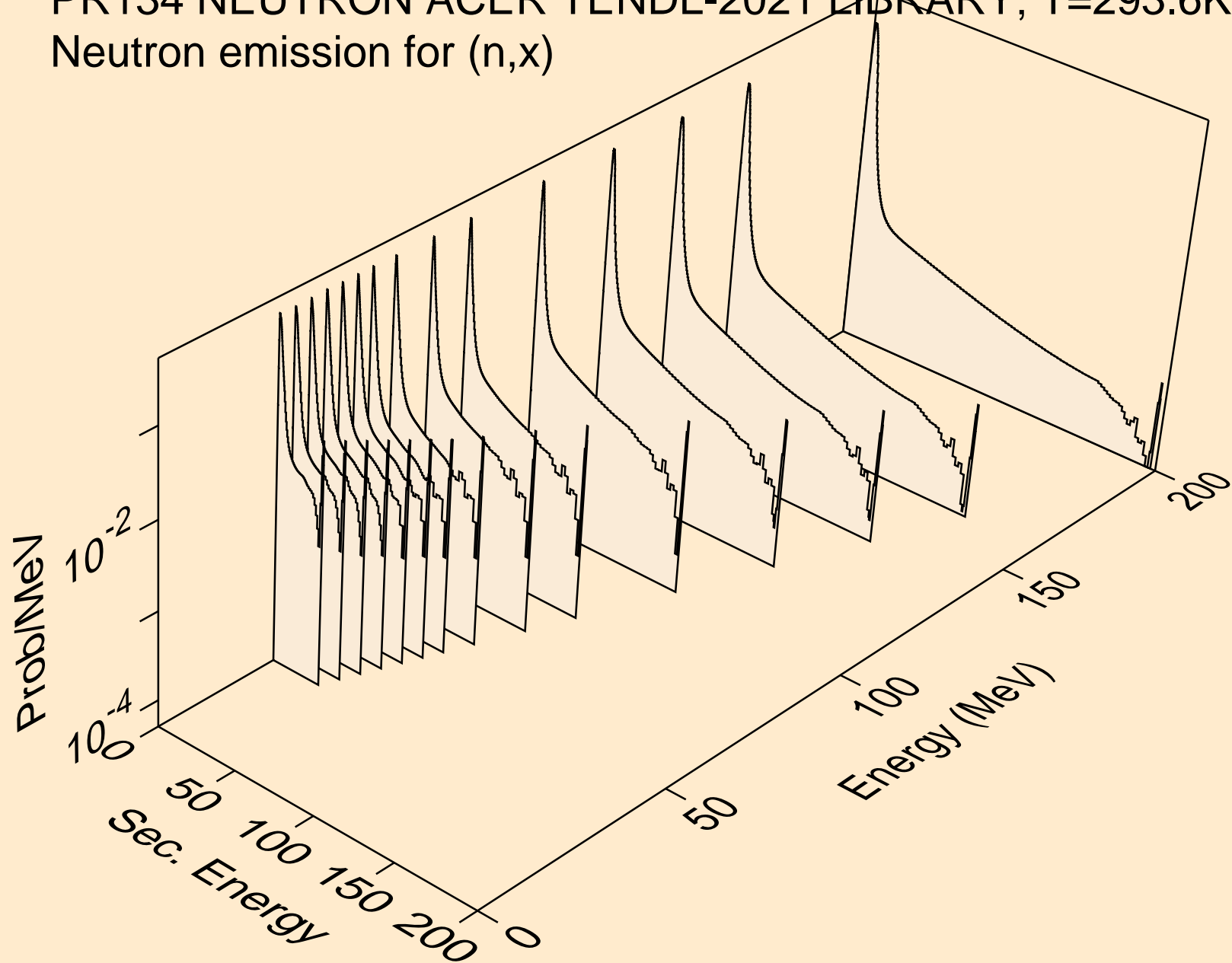

PR134 NEUTRON ACER TENDL-2021 LIBRARY; T=293.6K
Neutron emission for (n,2nd)

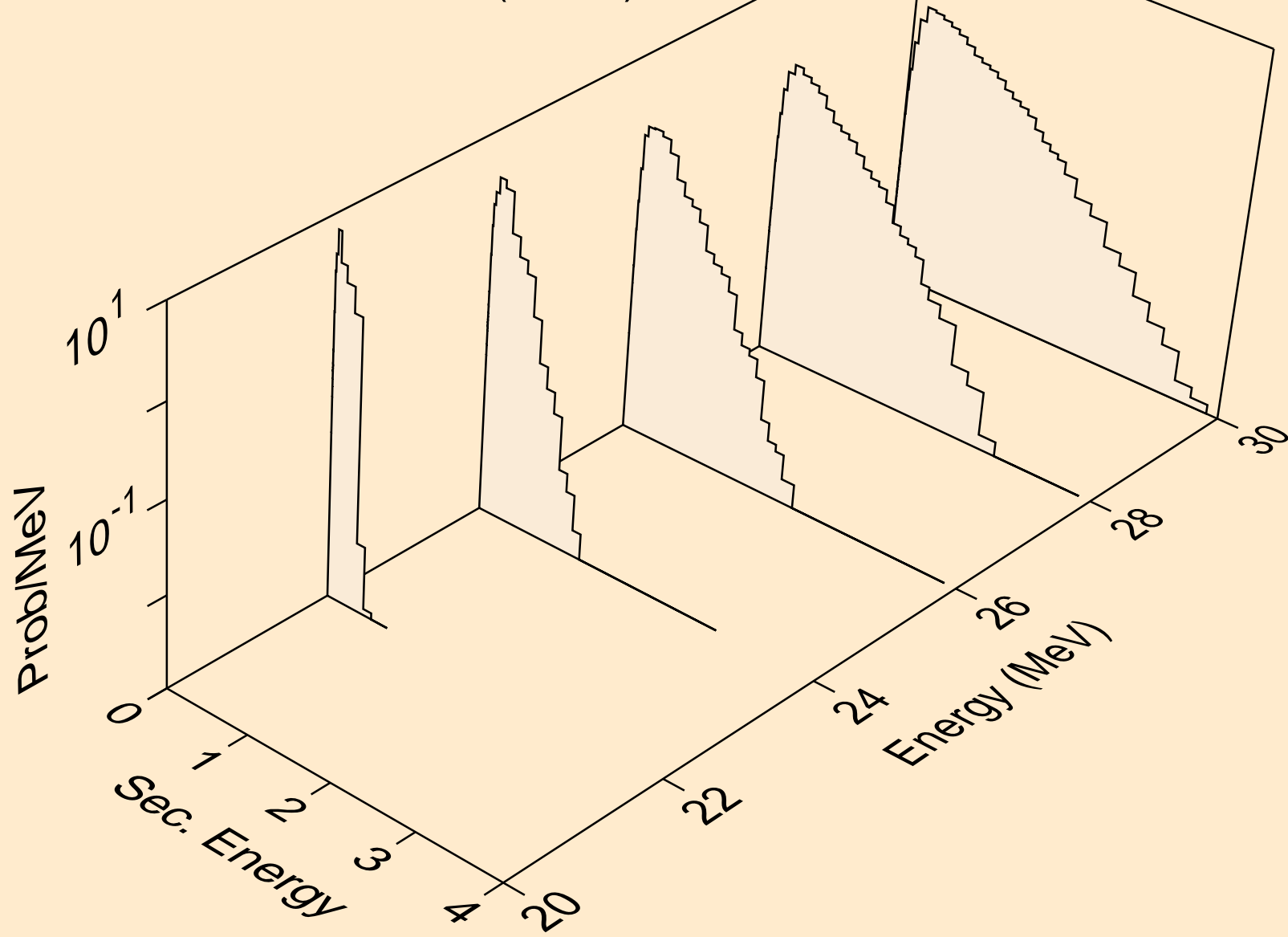

PR134 NEUTRON ACER TENDL-2021 LIBRARY; T=293.6K
Neutron emission for (n,2n)

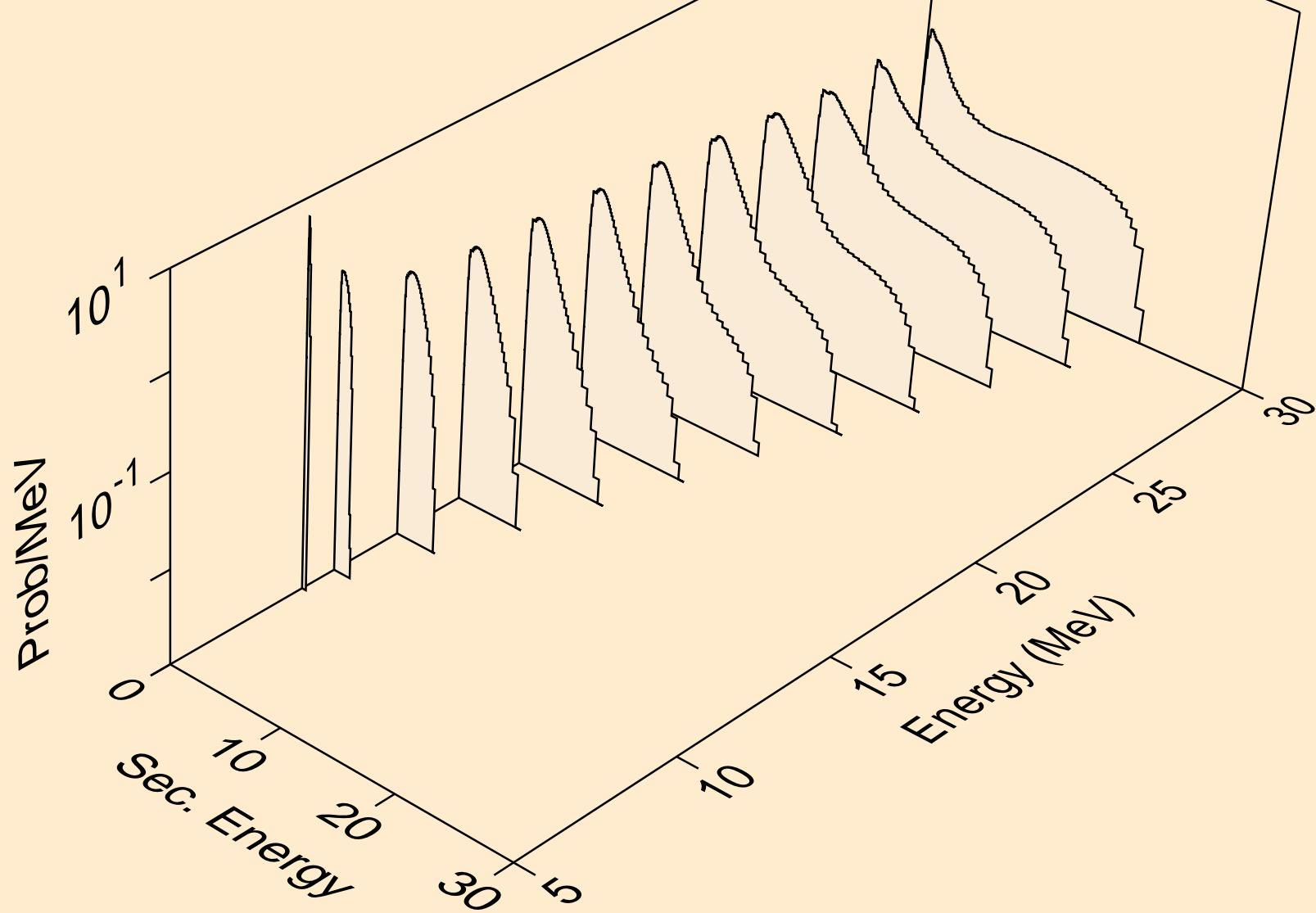

PR134 NEUTRON ACER TENDL-2021 LIBRARY; T=293.6K
Neutron emission for (n,3n)

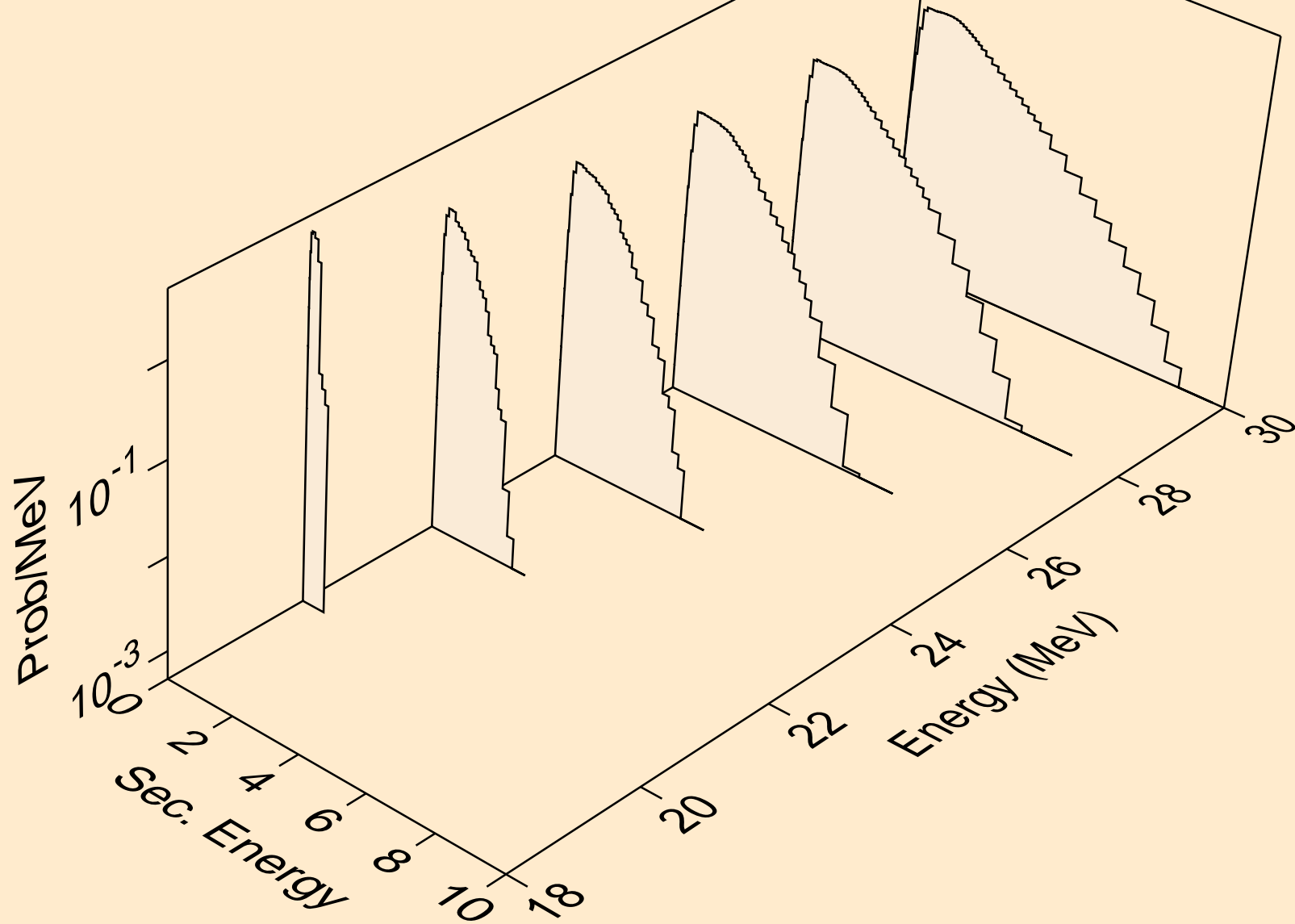

PR134 NEUTRON ACER TENDL-2021 LIBRARY; T=293.6K
Neutron emission for (n,n*)a

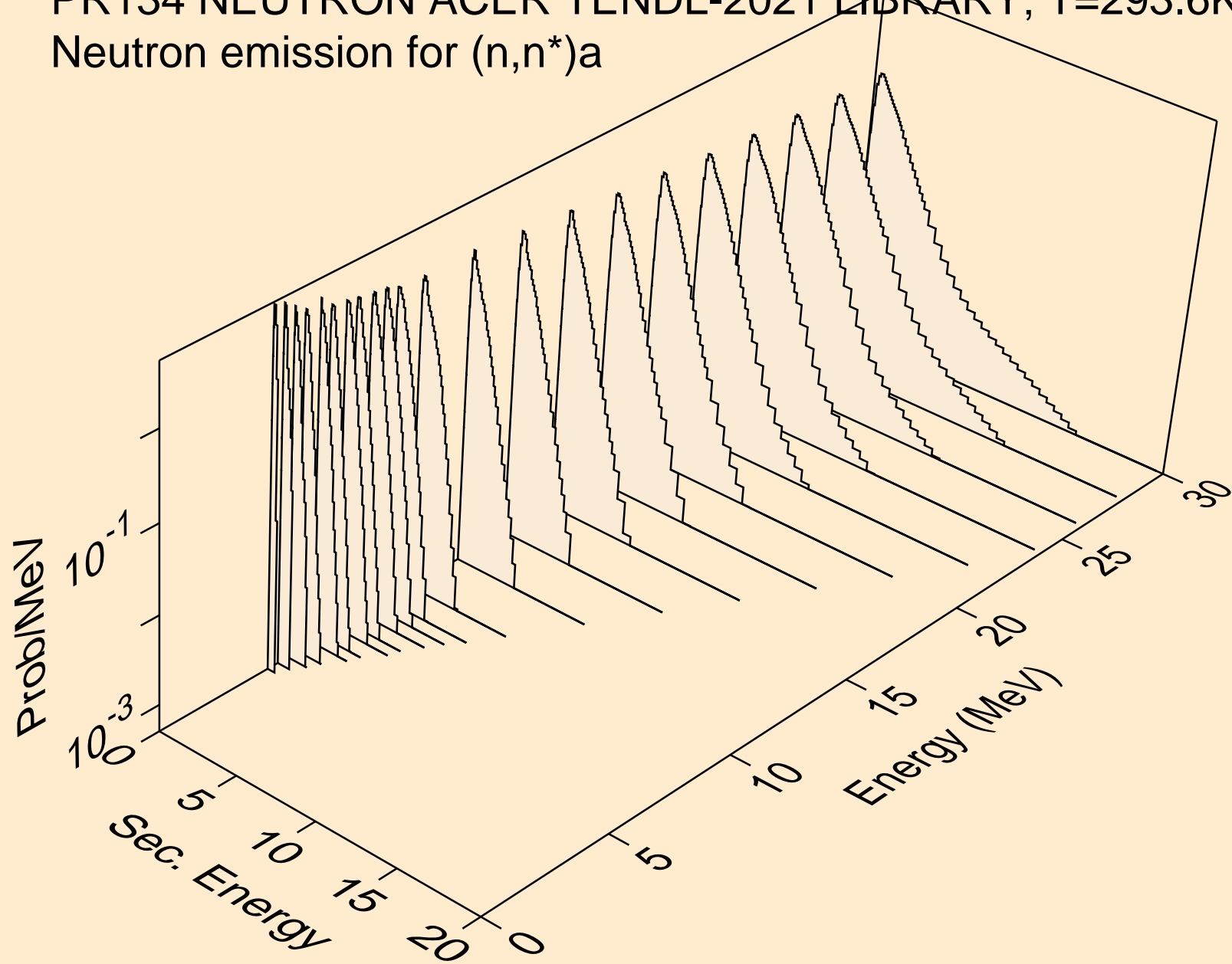

PR134 NEUTRON ACER TENDL-2021 LIBRARY; T=293.6K
Neutron emission for (n,2n)_a

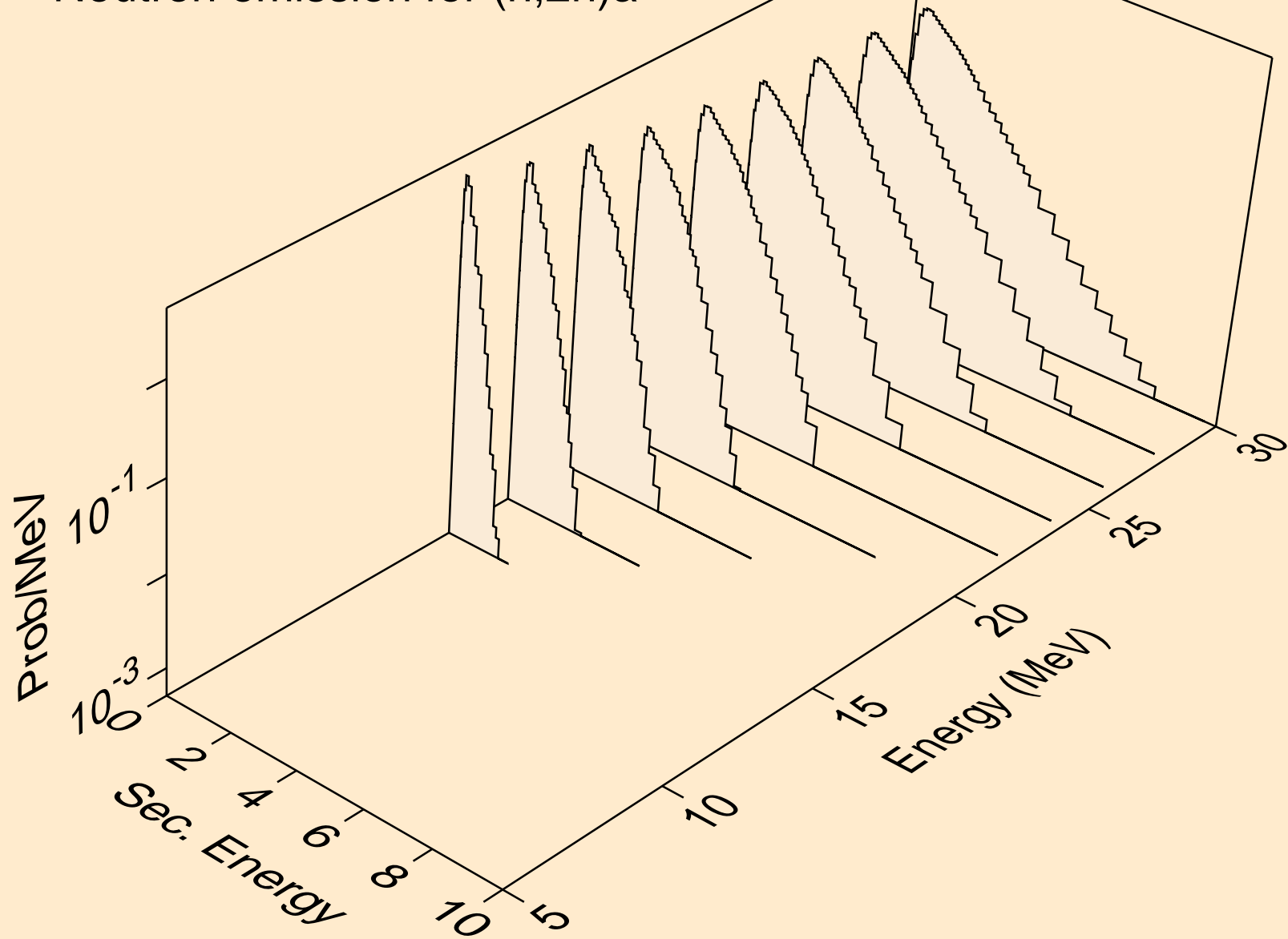

PR134 NEUTRON ACER TENDL-2021 LIBRARY; T=293.6K
Neutron emission for (n,3n)a

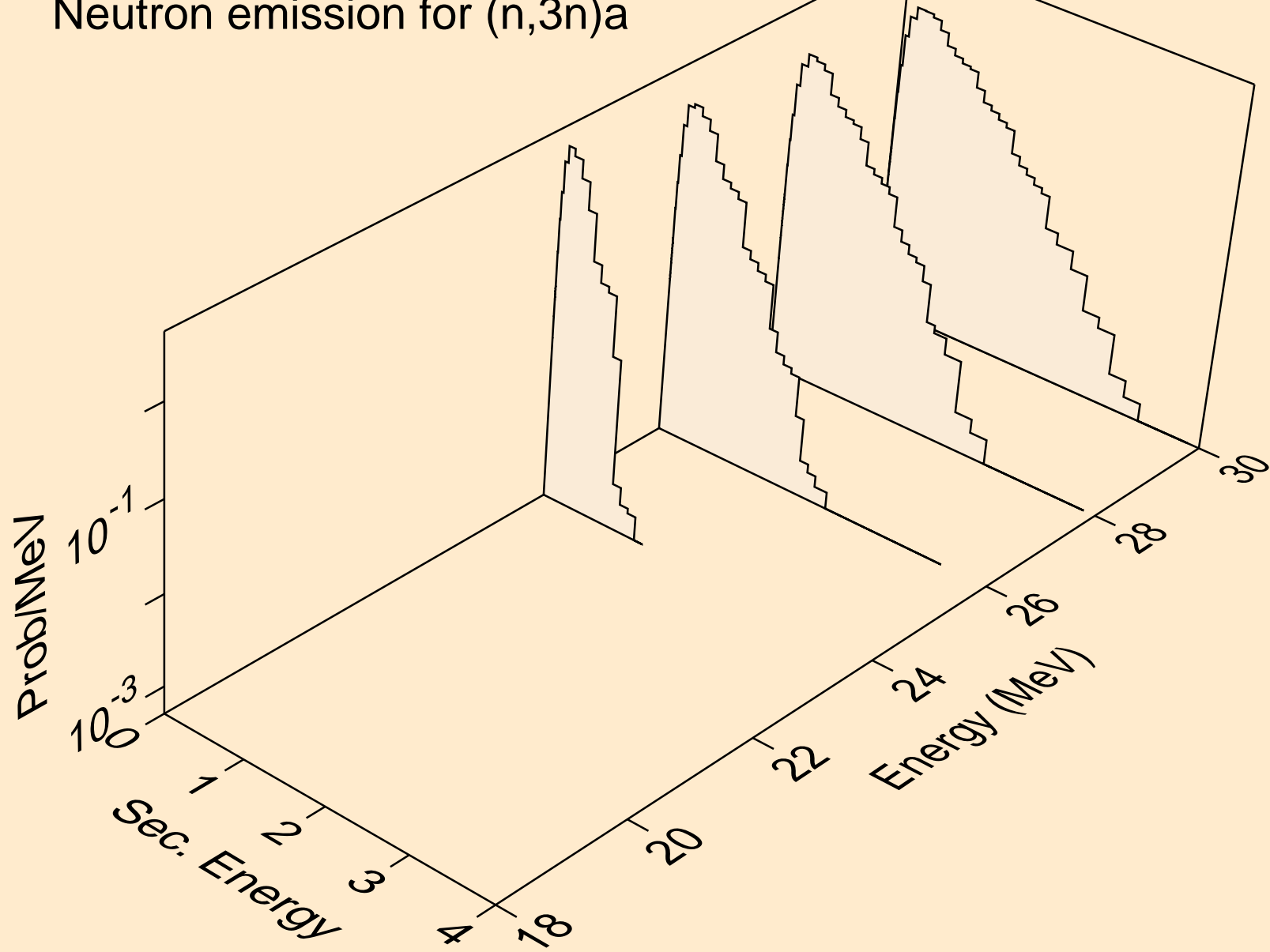

PR134 NEUTRON ACER TENDL-2021 LIBRARY; T=293.6K
Neutron emission for (n,n*)p

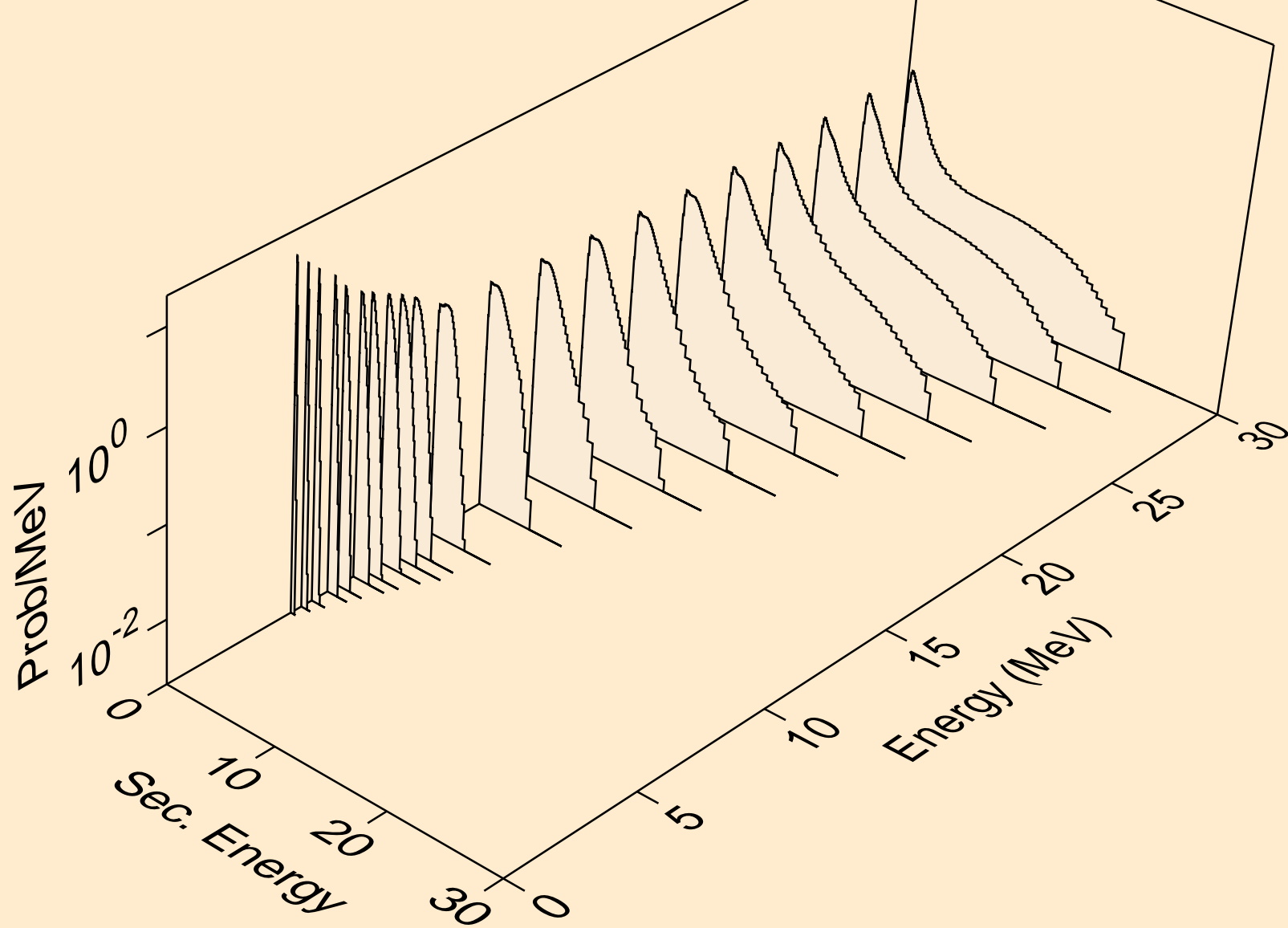

PR134 NEUTRON ACER TENDL-2021 LIBRARY; T=293.6K
Neutron emission for (n,n*)2a

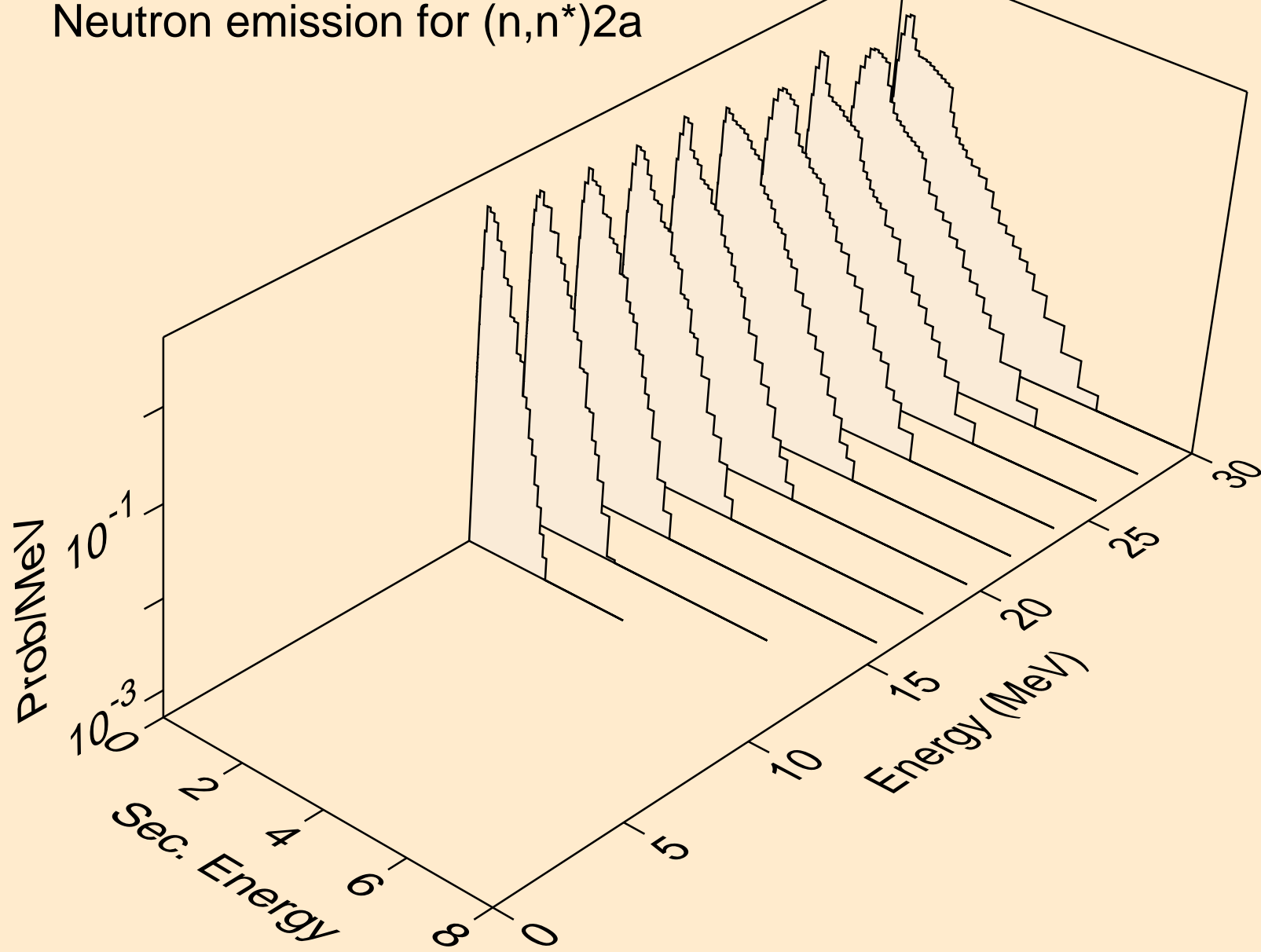

PR134 NEUTRON ACER TENDL-2021 LIBRARY; T=293.6K
Neutron emission for (n,2n)2a

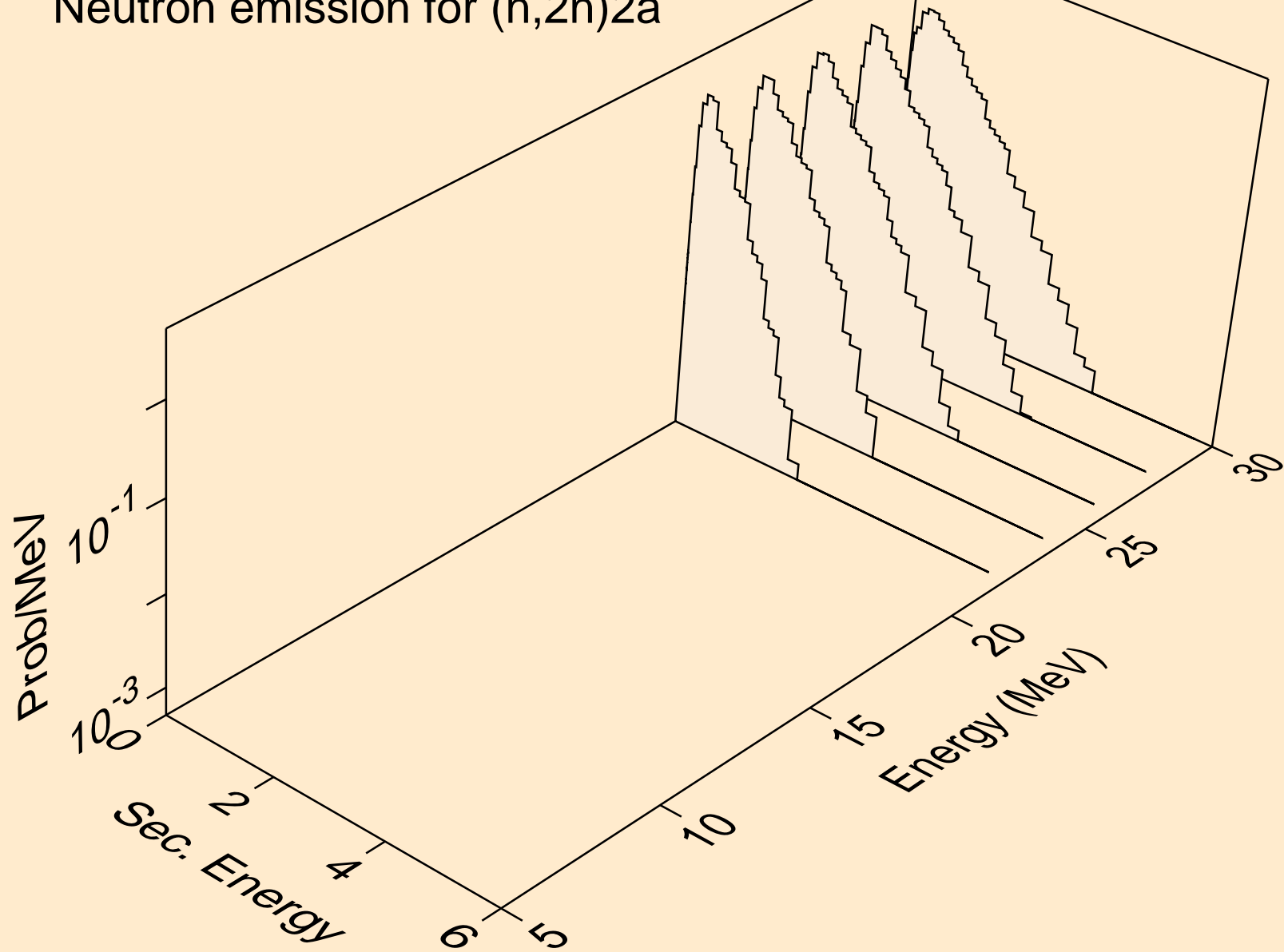

PR134 NEUTRON ACER TENDL-2021 LIBRARY; T=293.6K
Neutron emission for (n,n*)d

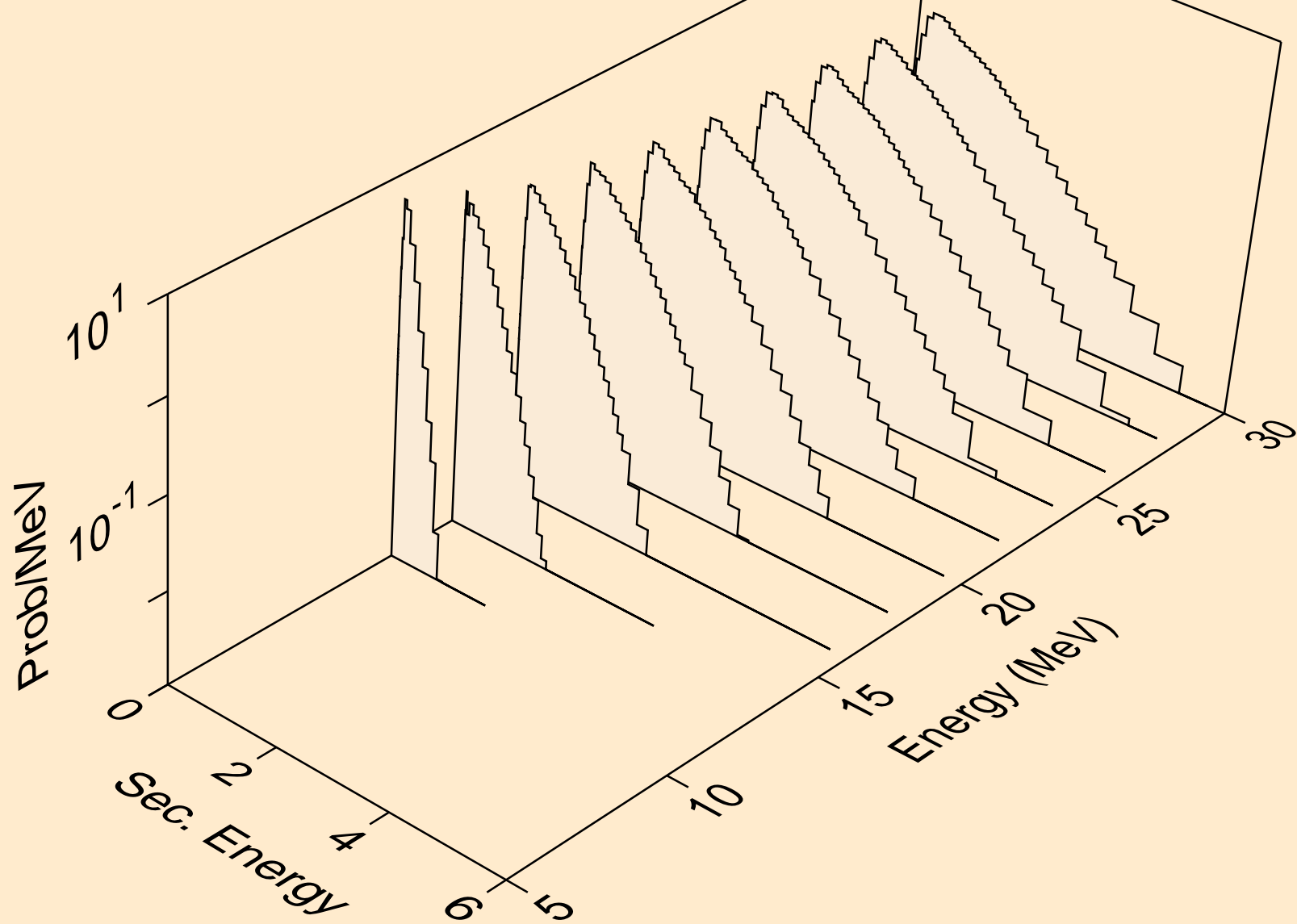

PR134 NEUTRON ACER TENDL-2021 LIBRARY; T=293.6K
Neutron emission for (n,n*)t

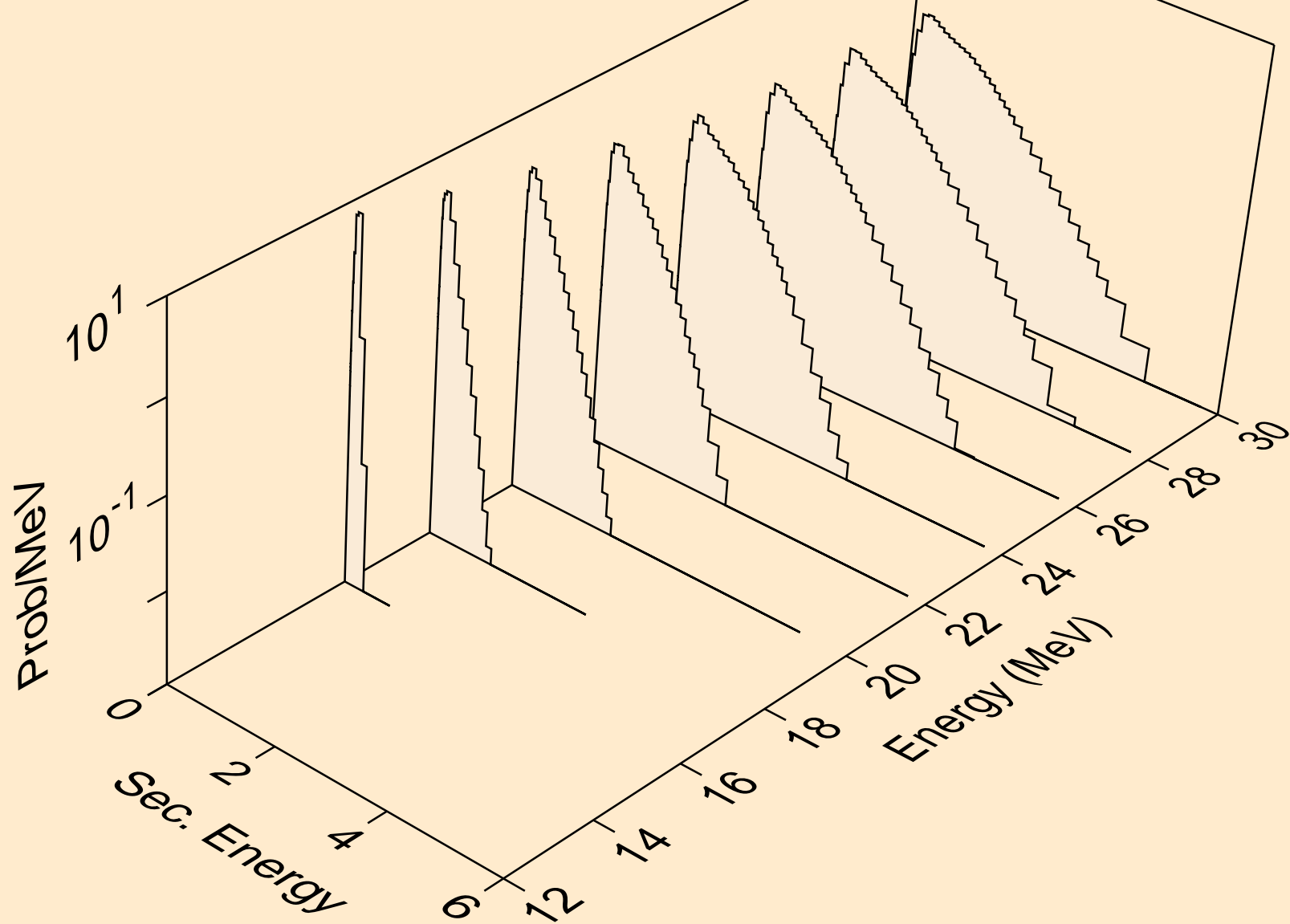

PR134 NEUTRON ACER TENDL-2021 LIBRARY; T=293.6K
Neutron emission for (n,n*)he3

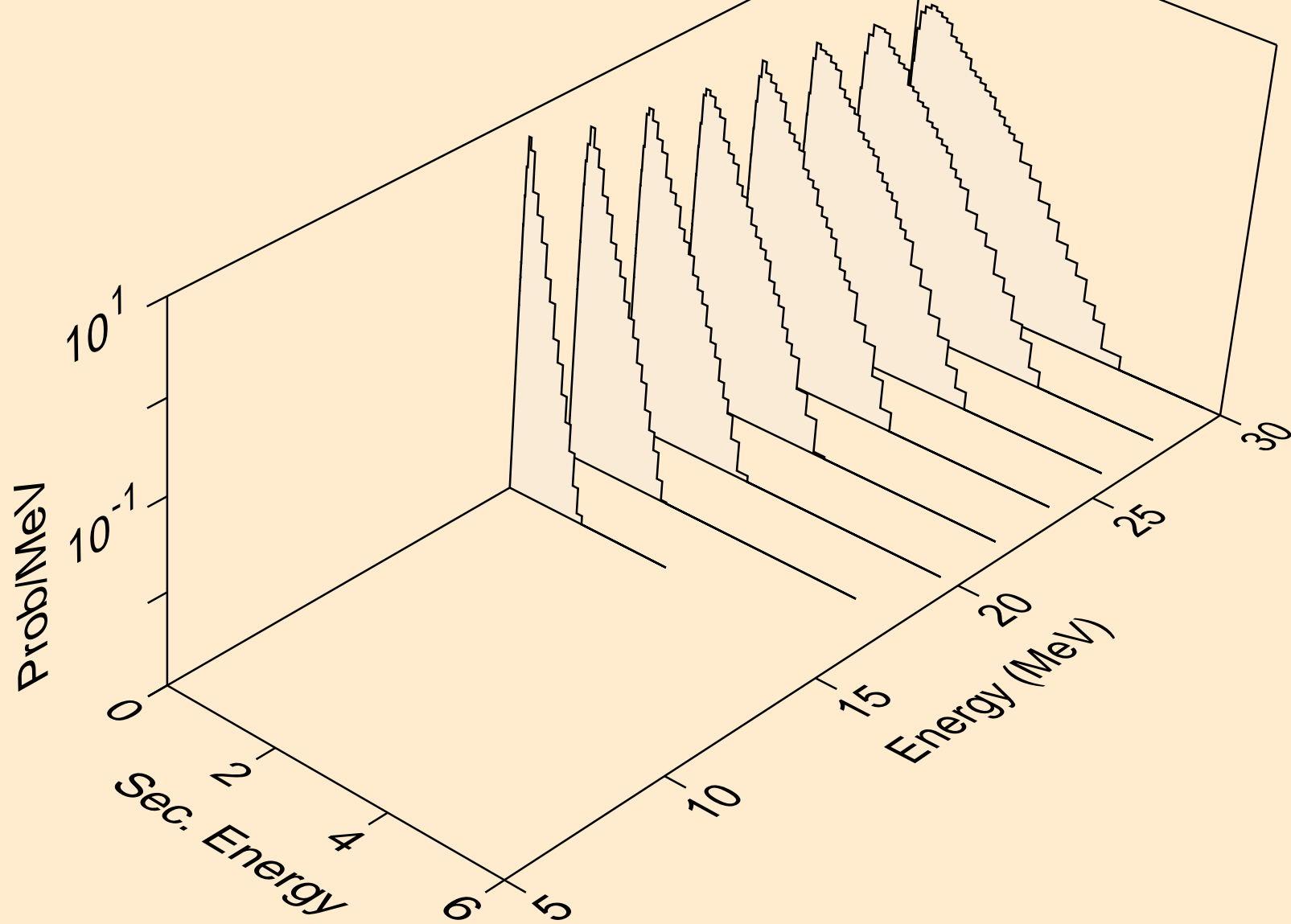

PR134 NEUTRON ACER TENDL-2021 LIBRARY; T=293.6K
Neutron emission for (n,4n)

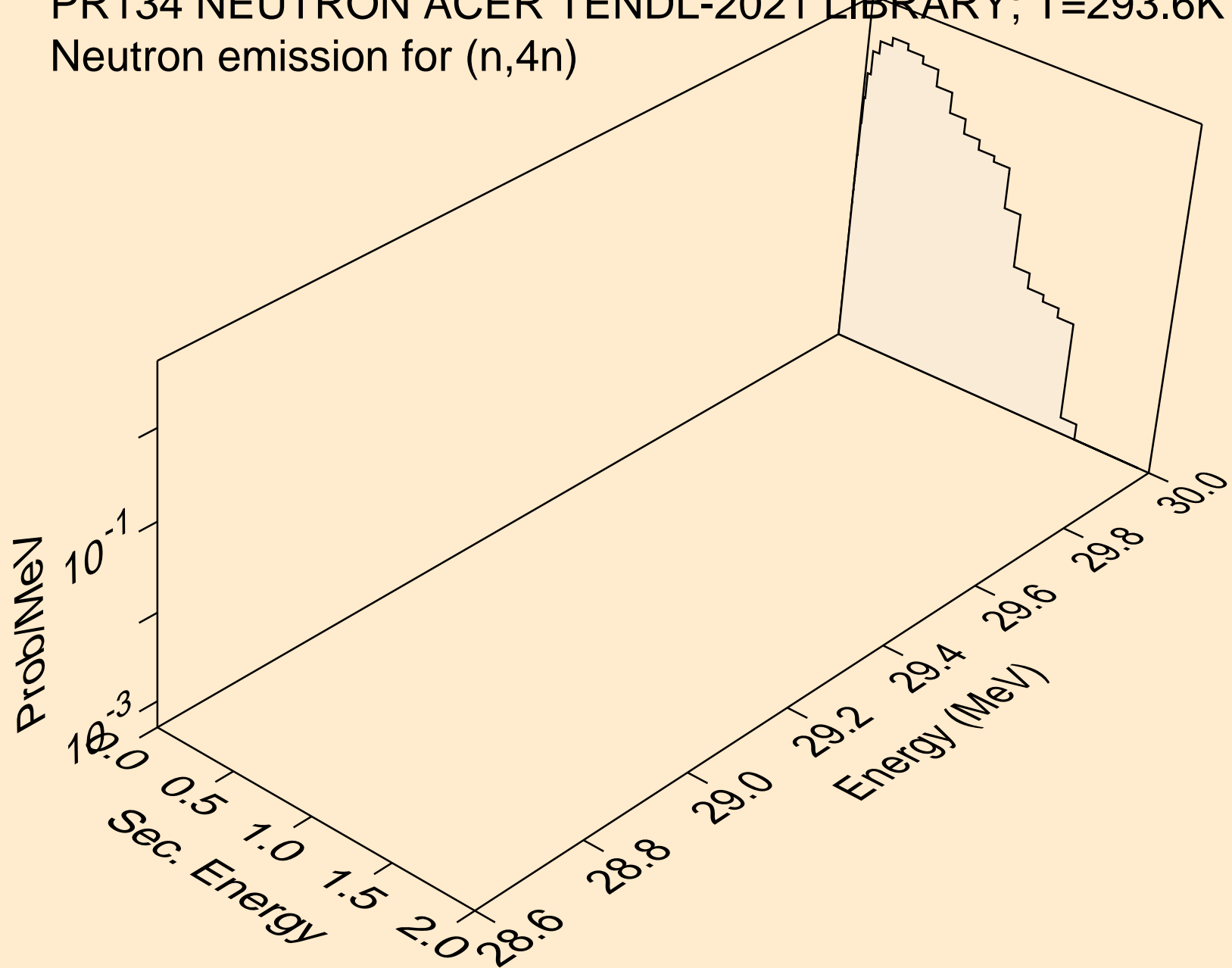

PR134 NEUTRON ACER TENDL-2021 LIBRARY; T=293.6K
Neutron emission for (n,2np)

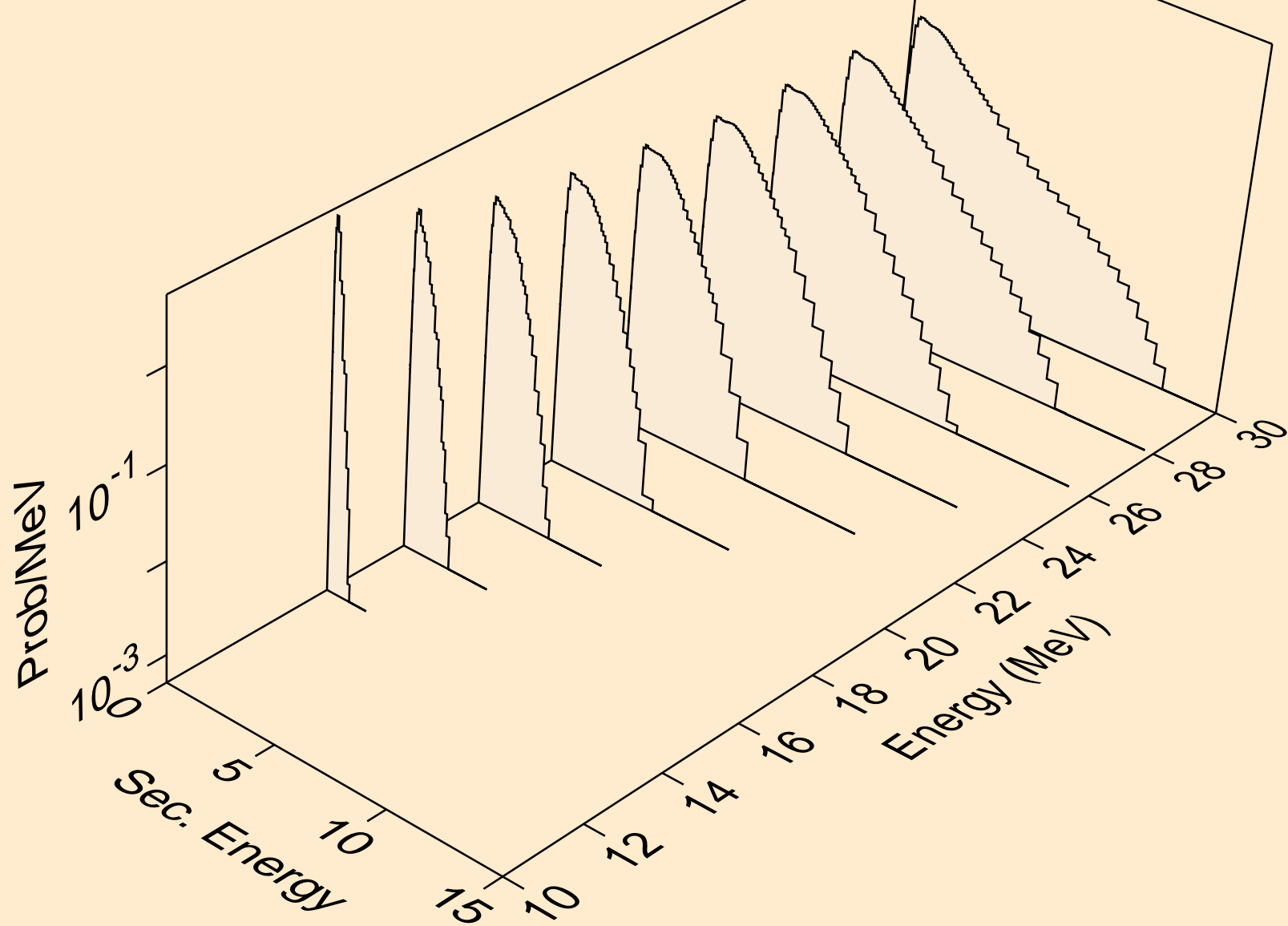

PR134 NEUTRON ACER TENDL-2021 LIBRARY; T=293.6K
Neutron emission for (n,3np)

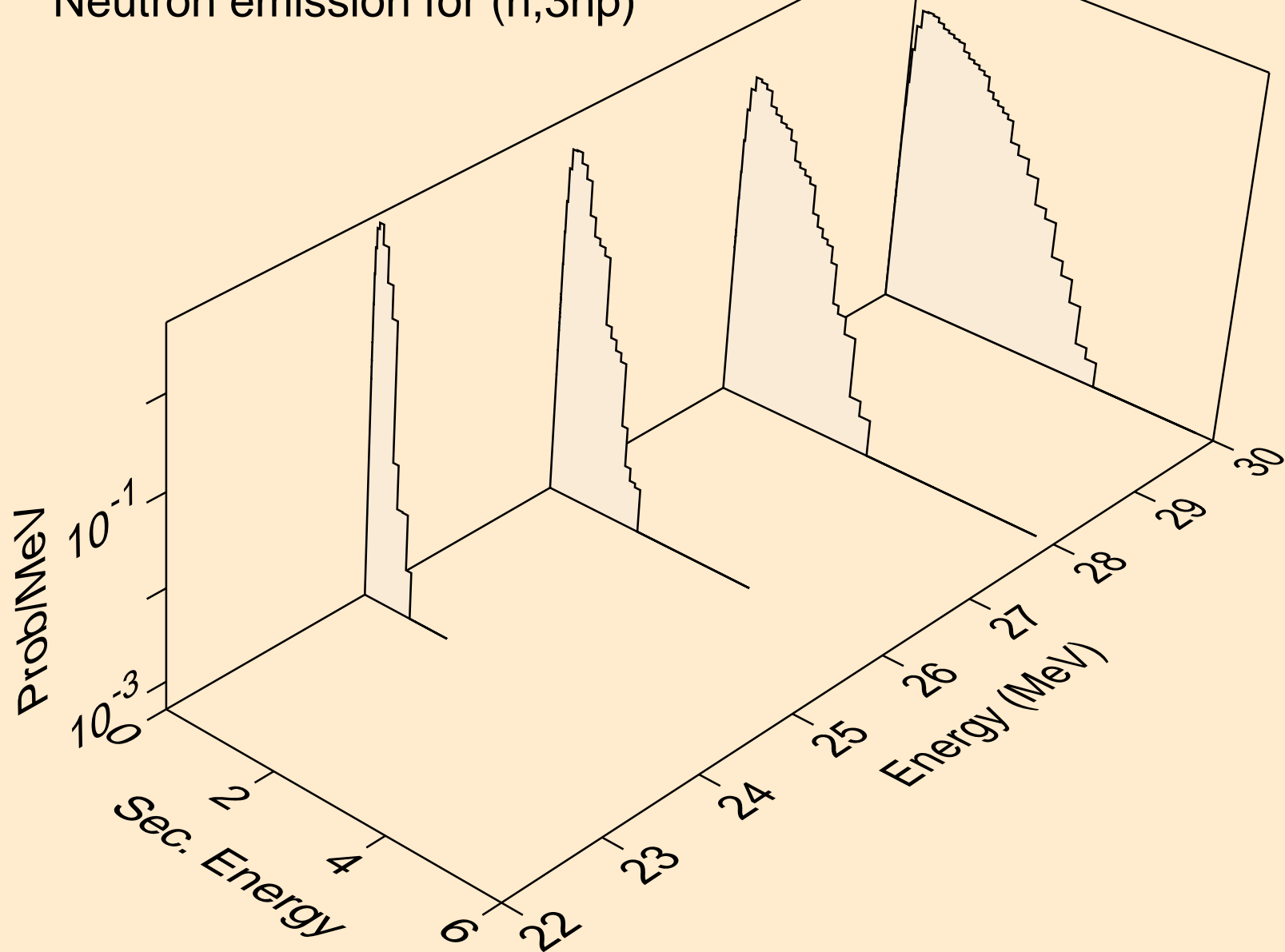

PR134 NEUTRON ACER TENDL-2021 LIBRARY; T=293.6K
Neutron emission for (n,2np)

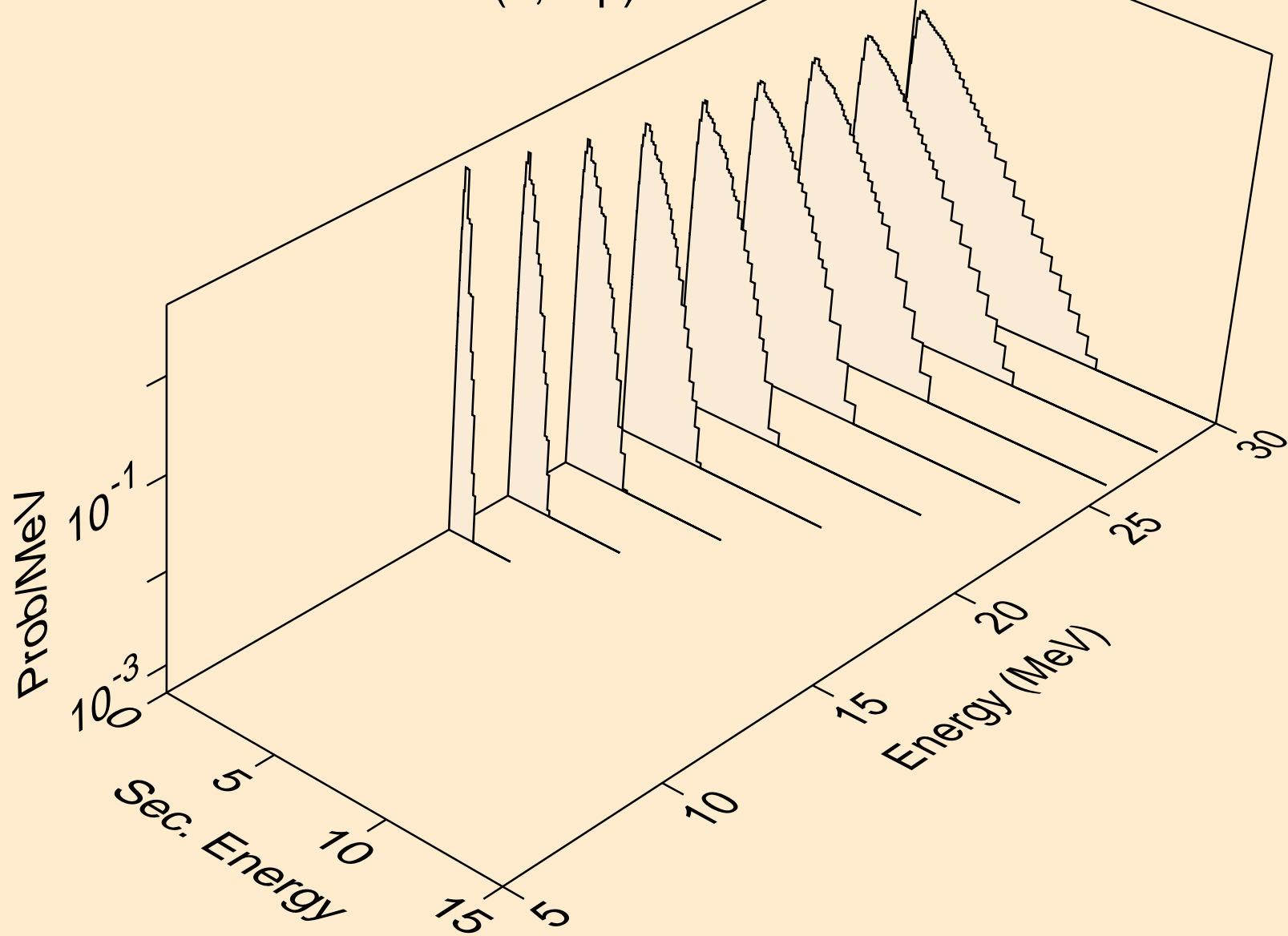

PR134 NEUTRON ACER TENDL-2021 LIBRARY; T=293.6K
Neutron emission for (n,npa)

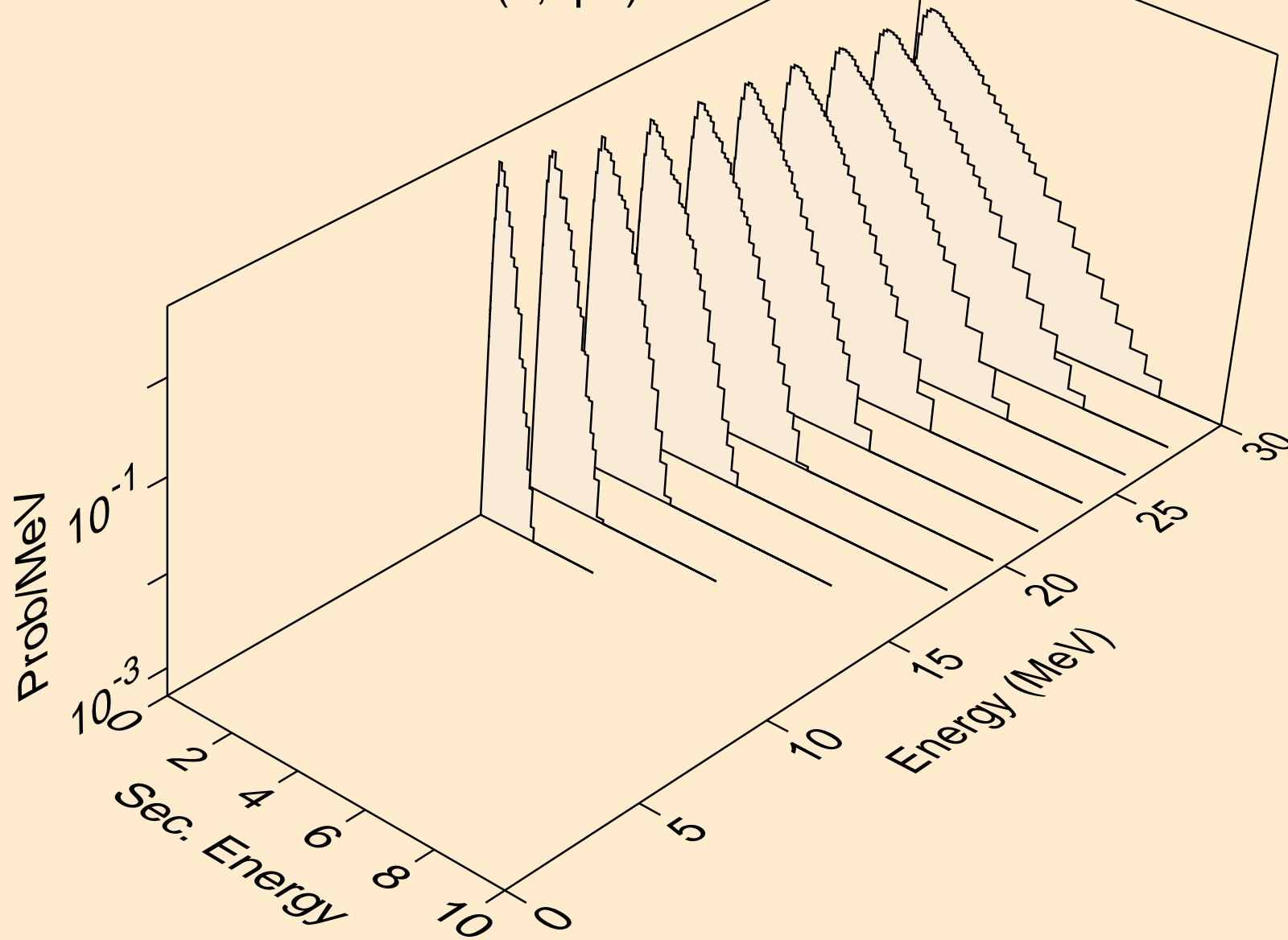

PR134 NEUTRON ACER TENDL-2021 LIBRARY; T=293.6K
Neutron emission for (n,n*c)

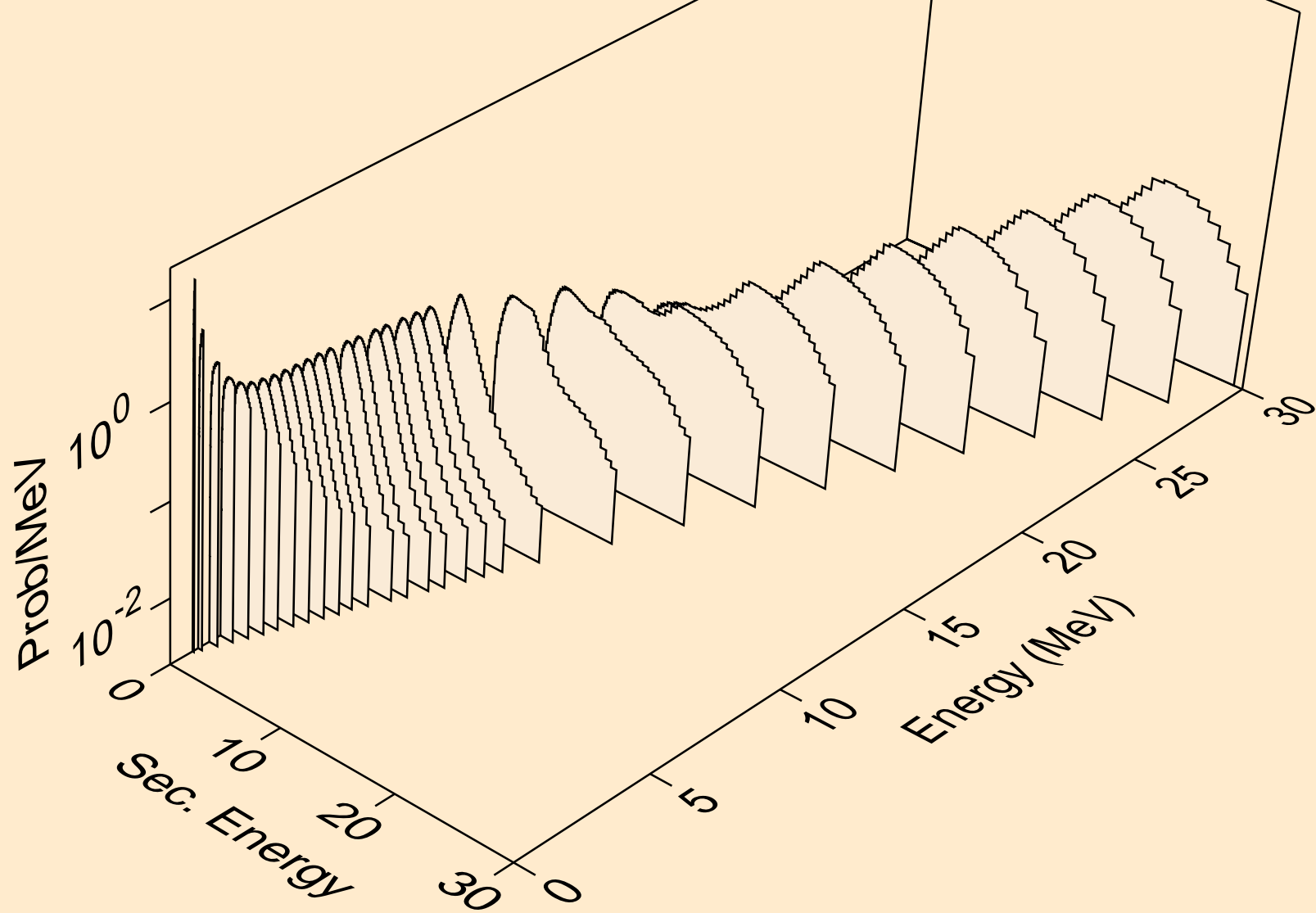

PR134 NEUTRON ACER TENDL-2021 LIBRARY; T=293.6K
Photon emission for (n,x)

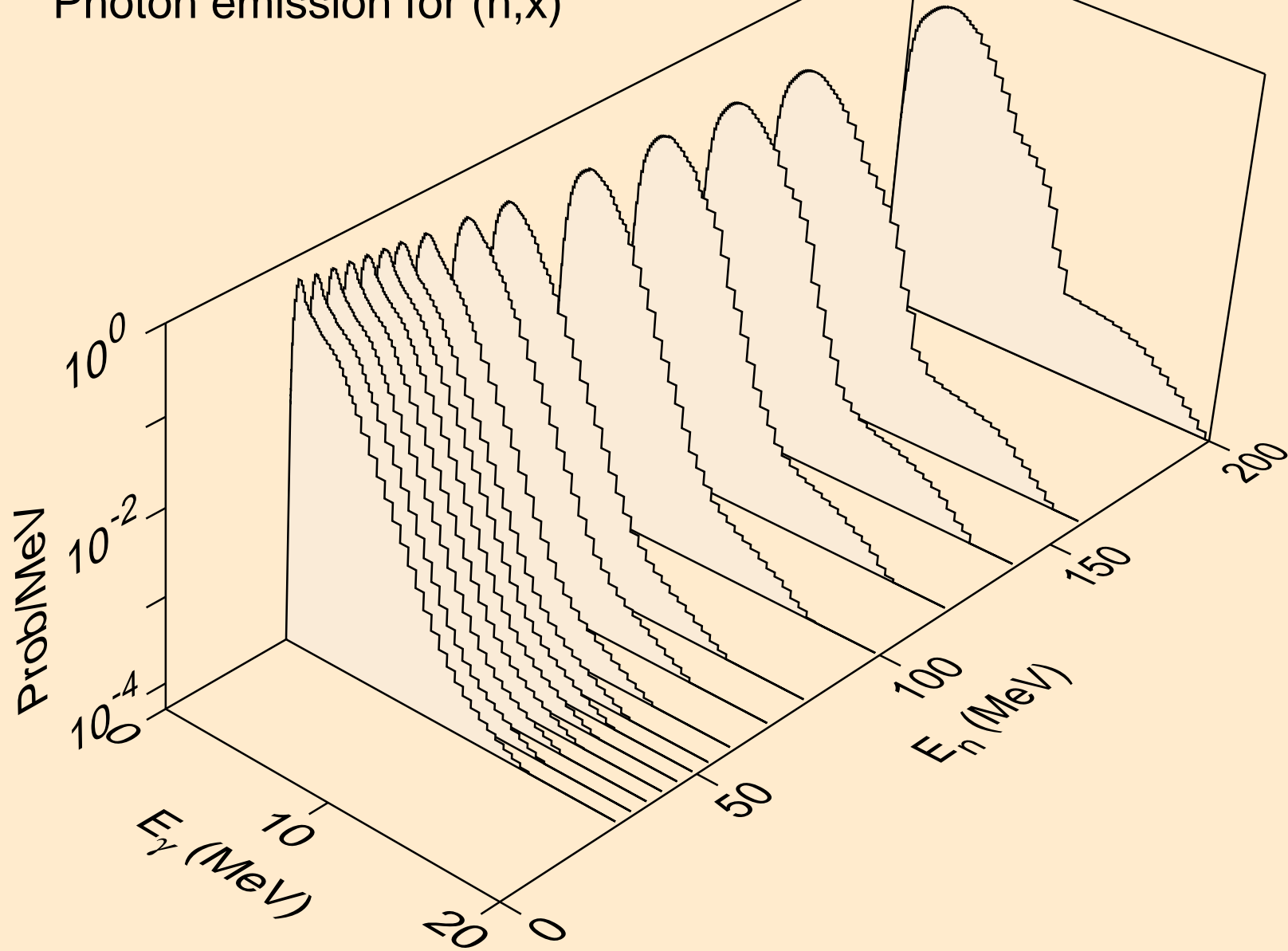

PR134 NEUTRON ACER TENDL-2021 LIBRARY; T=293.6K
Photon emission for (n,2nd)

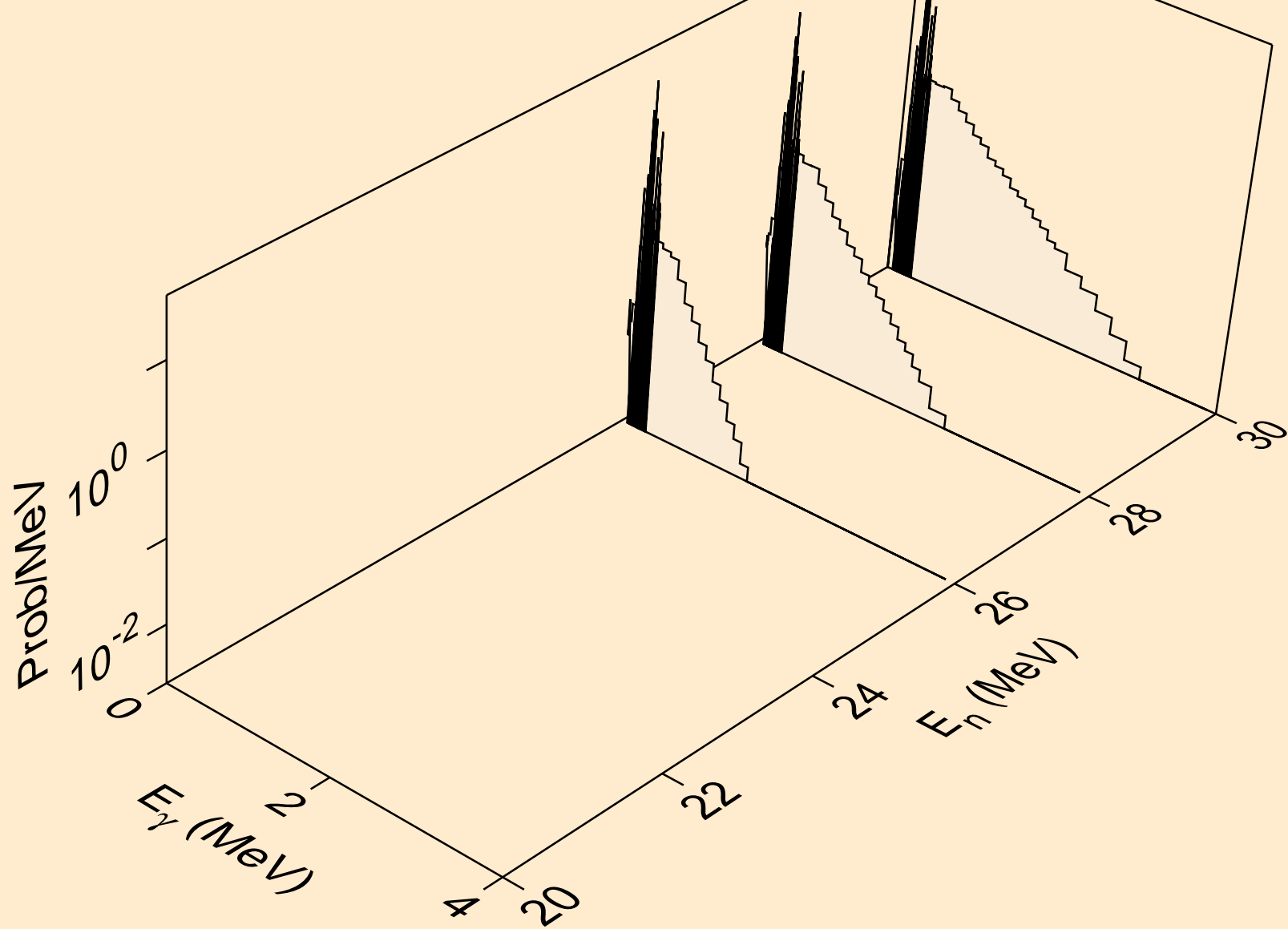

PR134 NEUTRON ACER TENDL-2021 LIBRARY; T=293.6K
Photon emission for (n,2n)

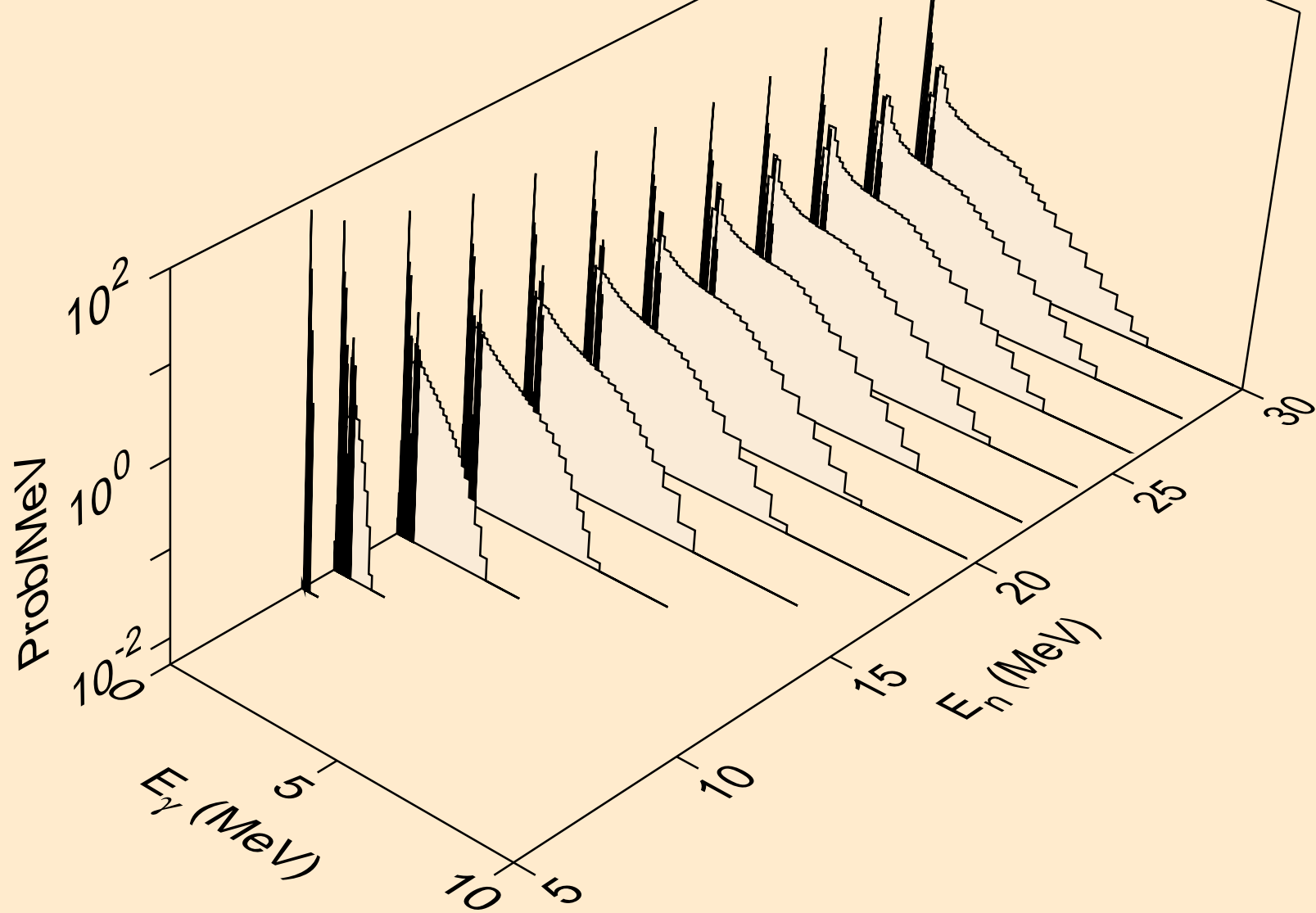

PR134 NEUTRON ACER TENDL-2021 LIBRARY; T=293.6K
Photon emission for (n,3n)

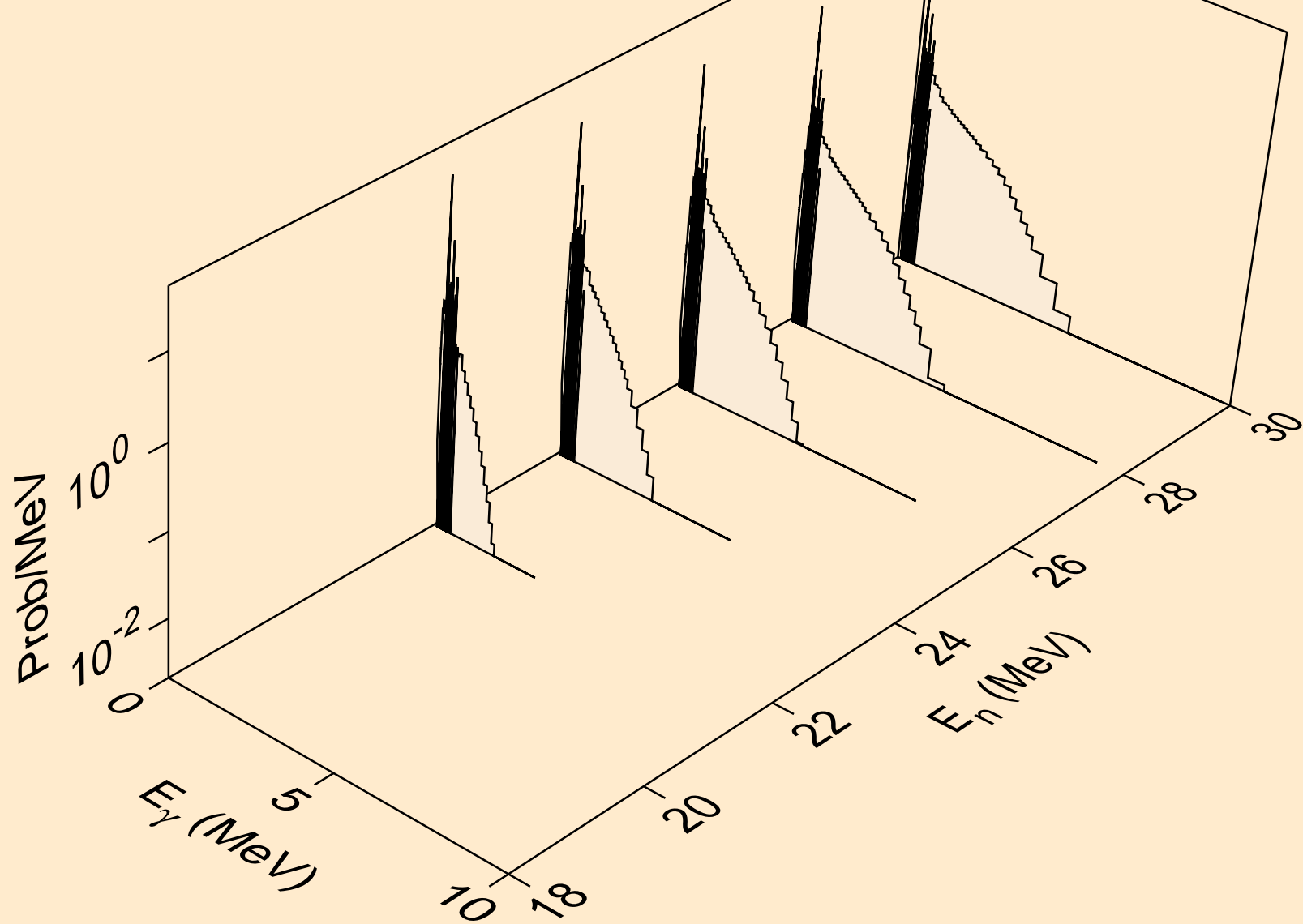

PR134 NEUTRON ACER TENDL-2021 LIBRARY; T=293.6K
Photon emission for (n,n*)a

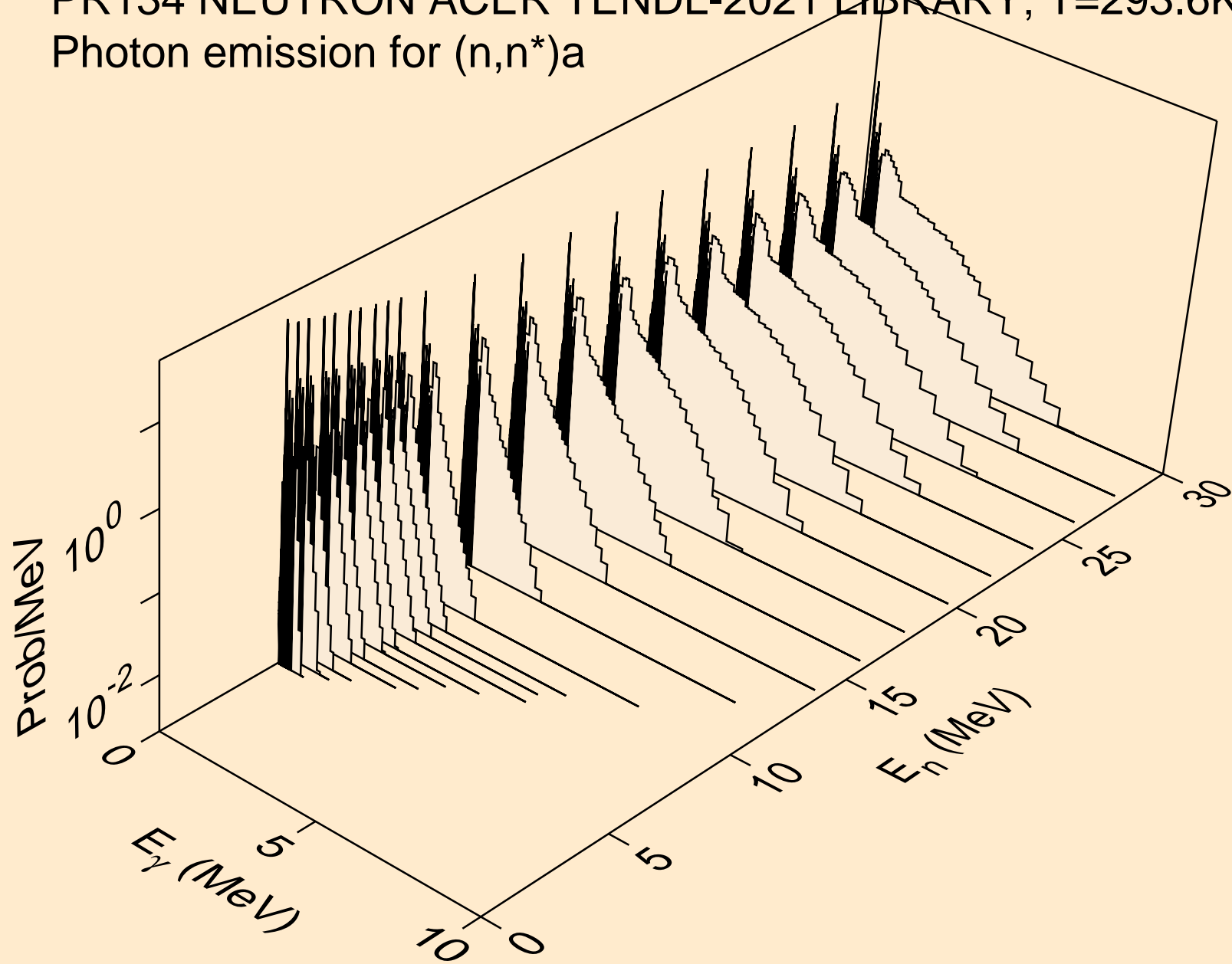

PR134 NEUTRON ACER TENDL-2021 LIBRARY; T=293.6K
Photon emission for (n,2n)a

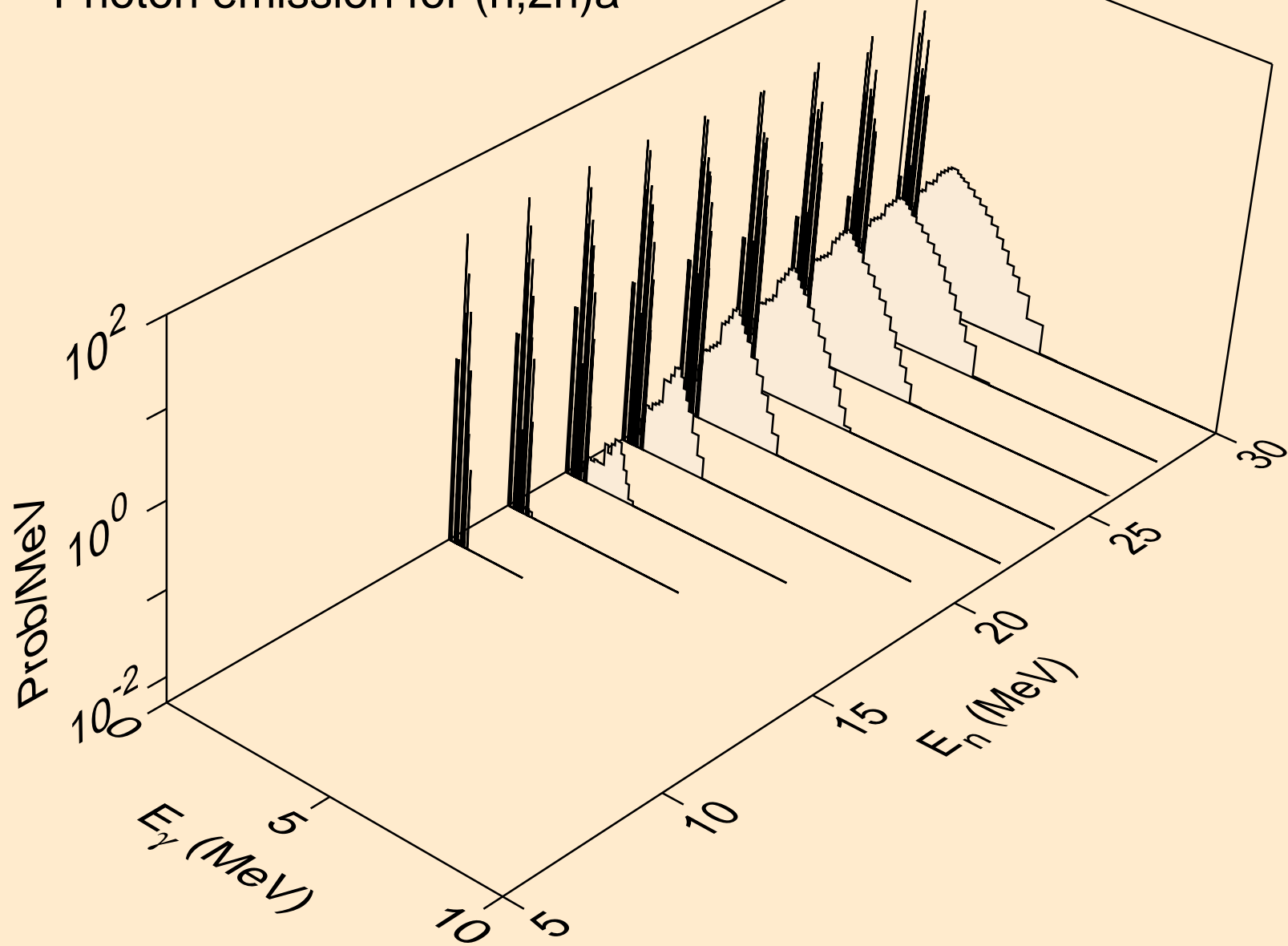

PR134 NEUTRON ACER TENDL-2021 LIBRARY; T=293.6K
Photon emission for (n,3n)a

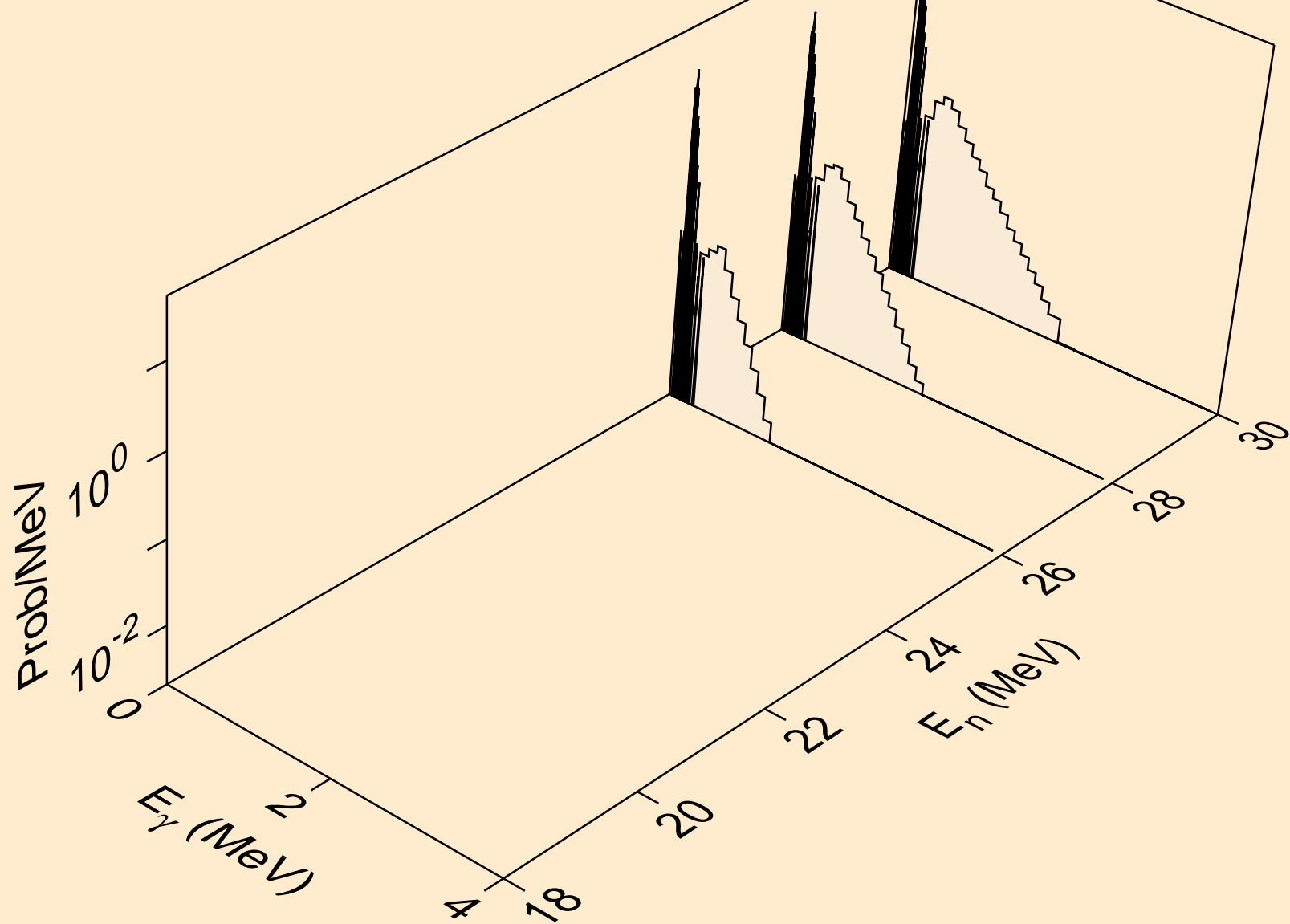

PR134 NEUTRON ACER TENDL-2021 LIBRARY; T=293.6K
Photon emission for (n,n*)p

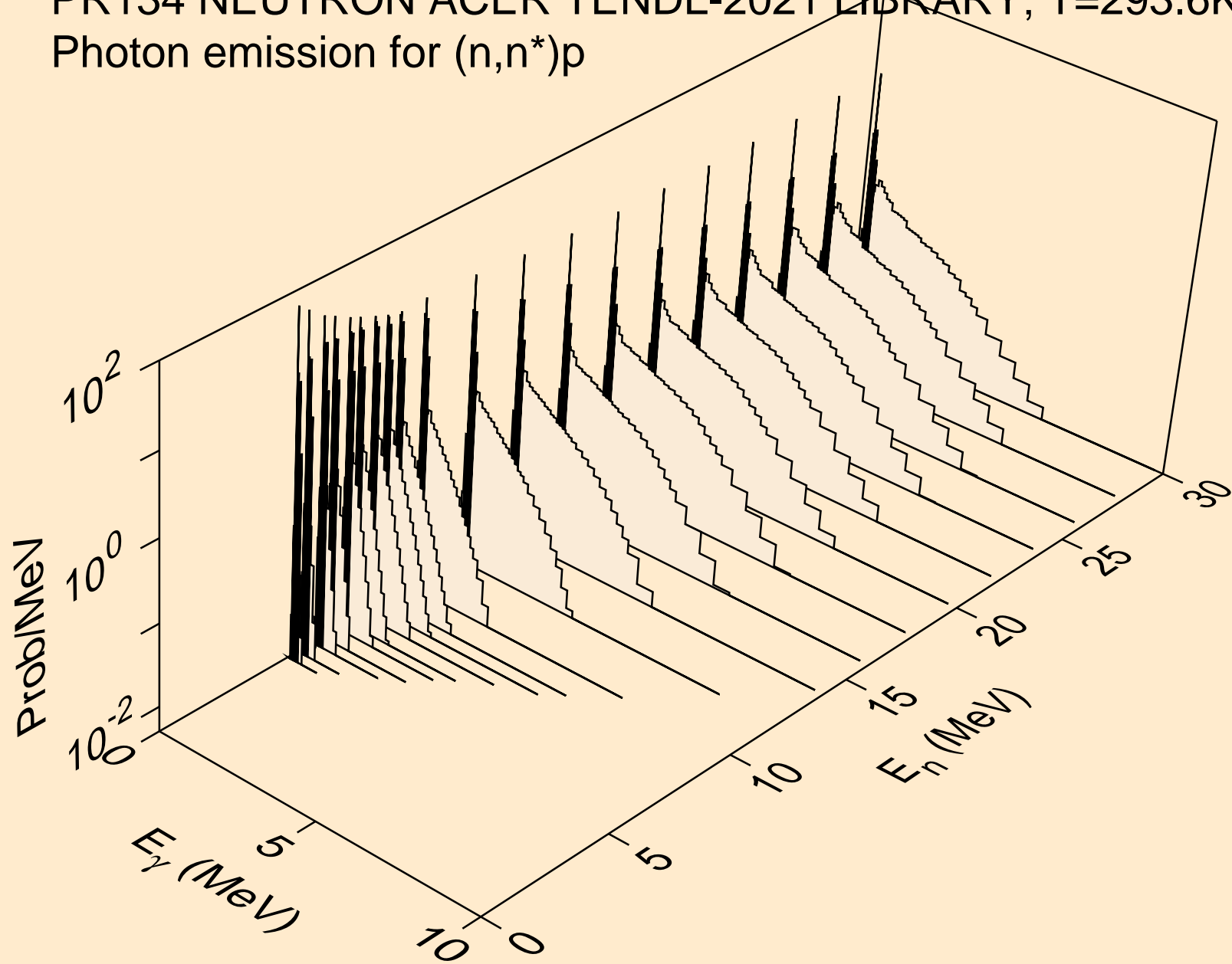

PR134 NEUTRON ACER TENDL-2021 LIBRARY; T=293.6K
Photon emission for (n,n*)2a

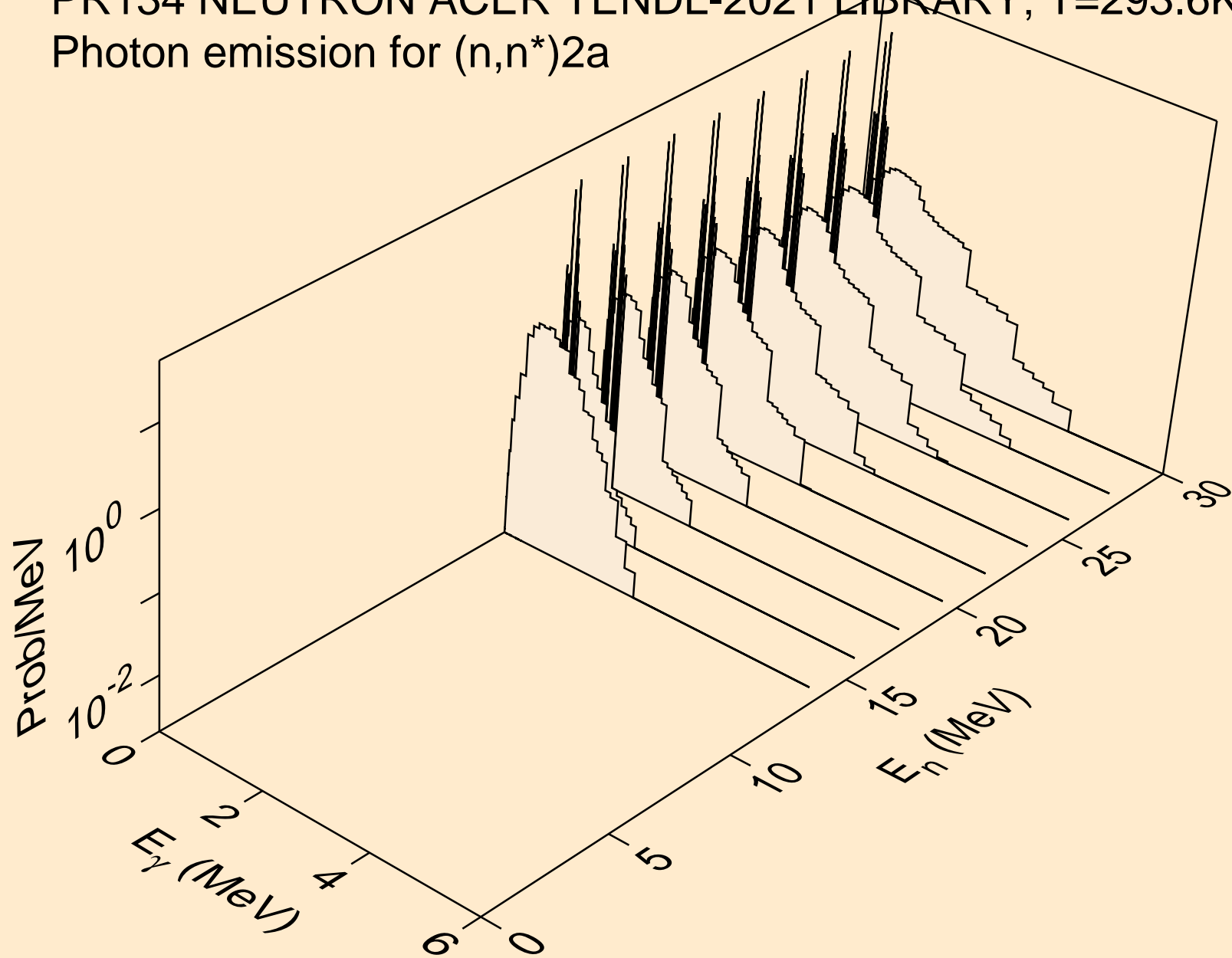

PR134 NEUTRON ACER TENDL-2021 LIBRARY; T=293.6K
Photon emission for (n,2n)2a

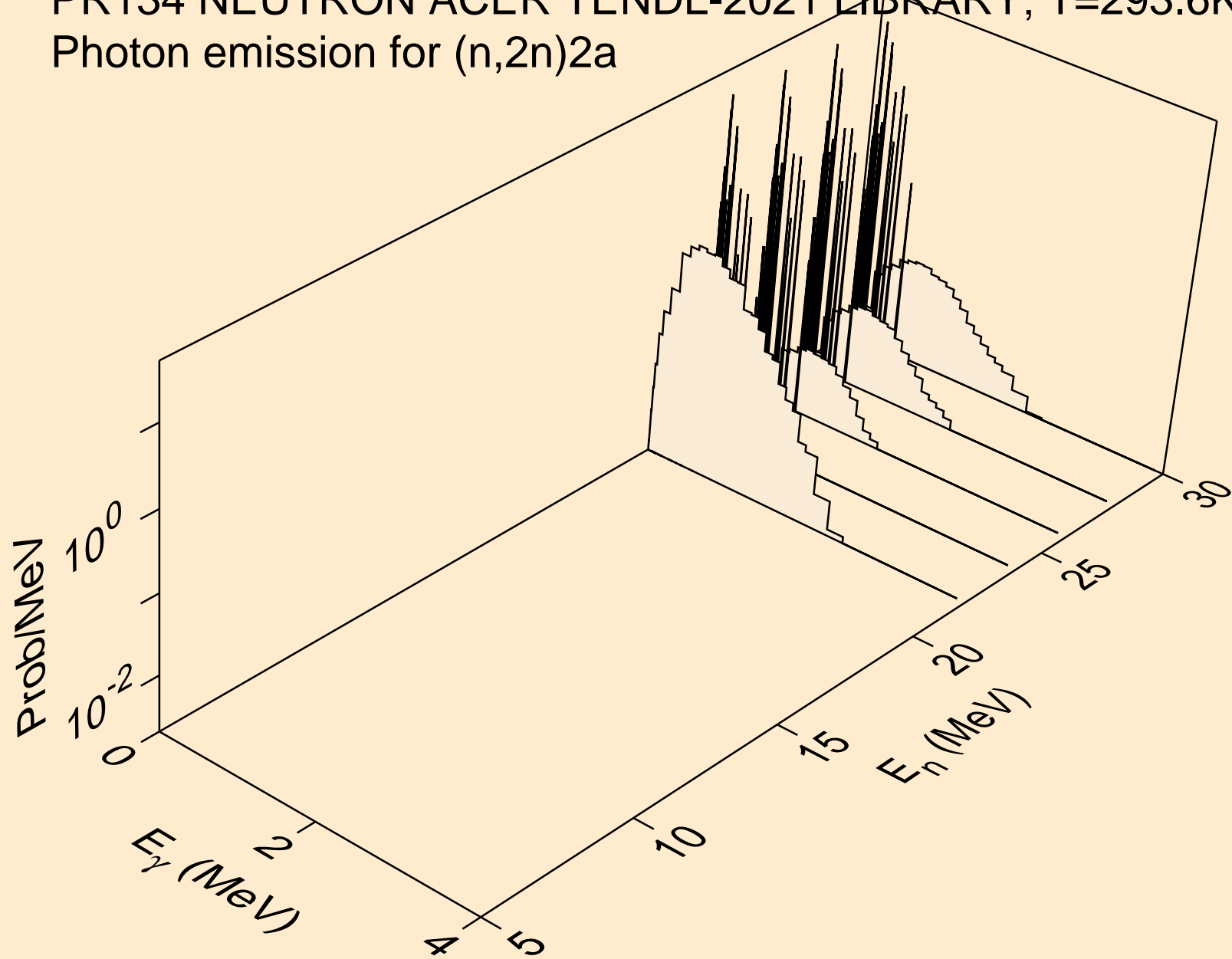

PR134 NEUTRON ACER TENDL-2021 LIBRARY; T=293.6K
Photon emission for (n,n*)d

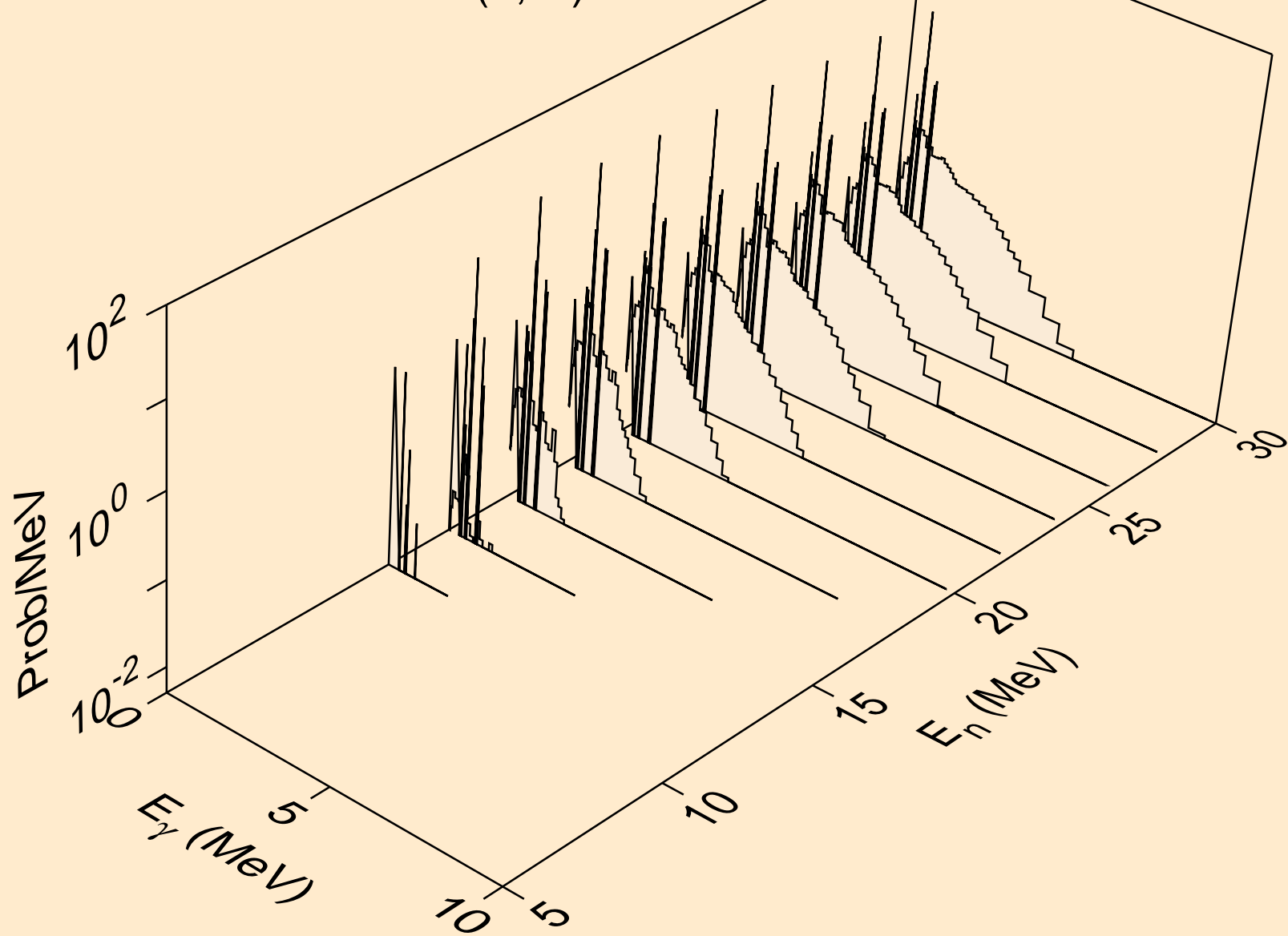

PR134 NEUTRON ACER TENDL-2021 LIBRARY; T=293.6K
Photon emission for (n,n*)t

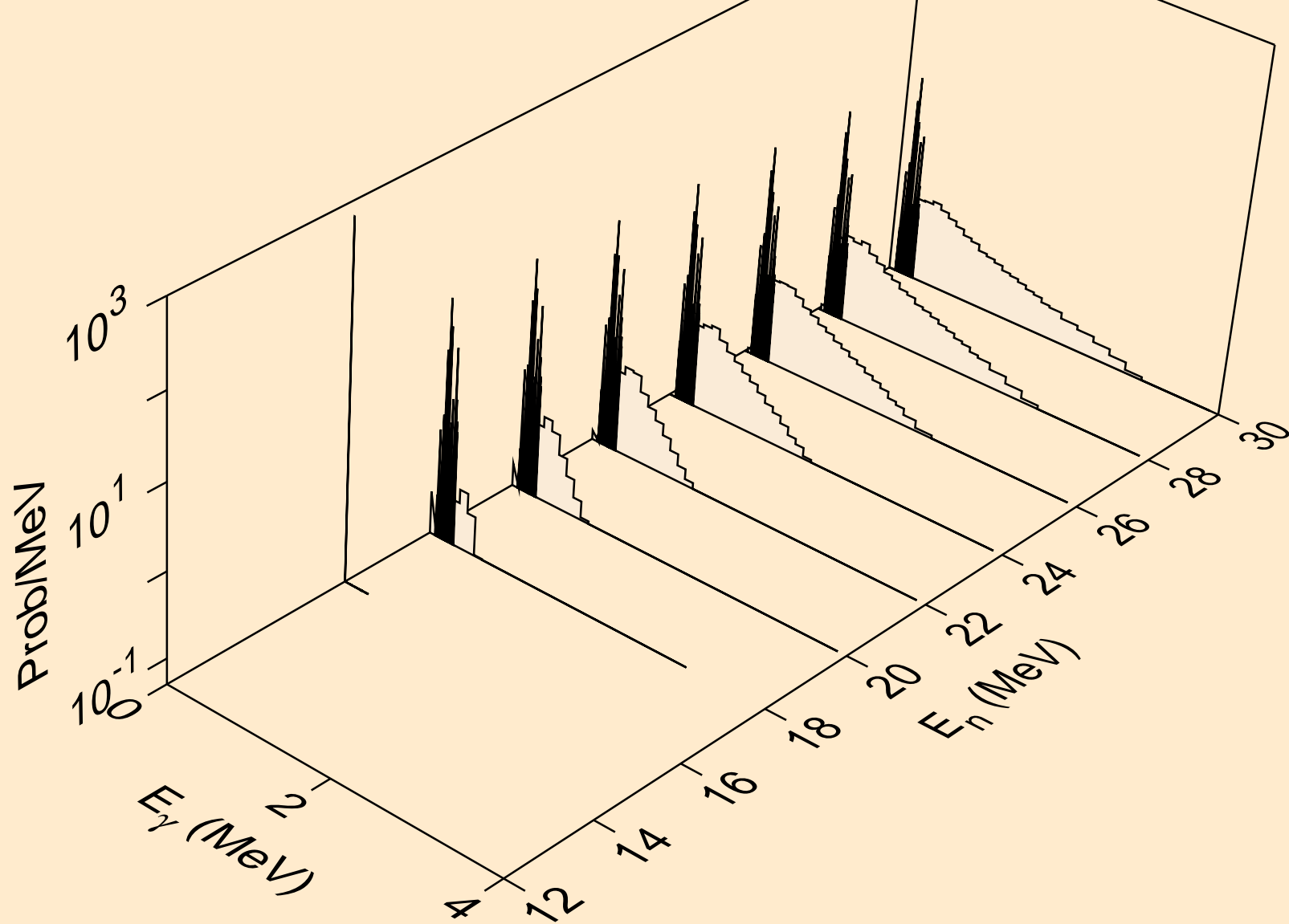

PR134 NEUTRON ACER TENDL-2021 LIBRARY; T=293.6K
Photon emission for (n,n*)he3

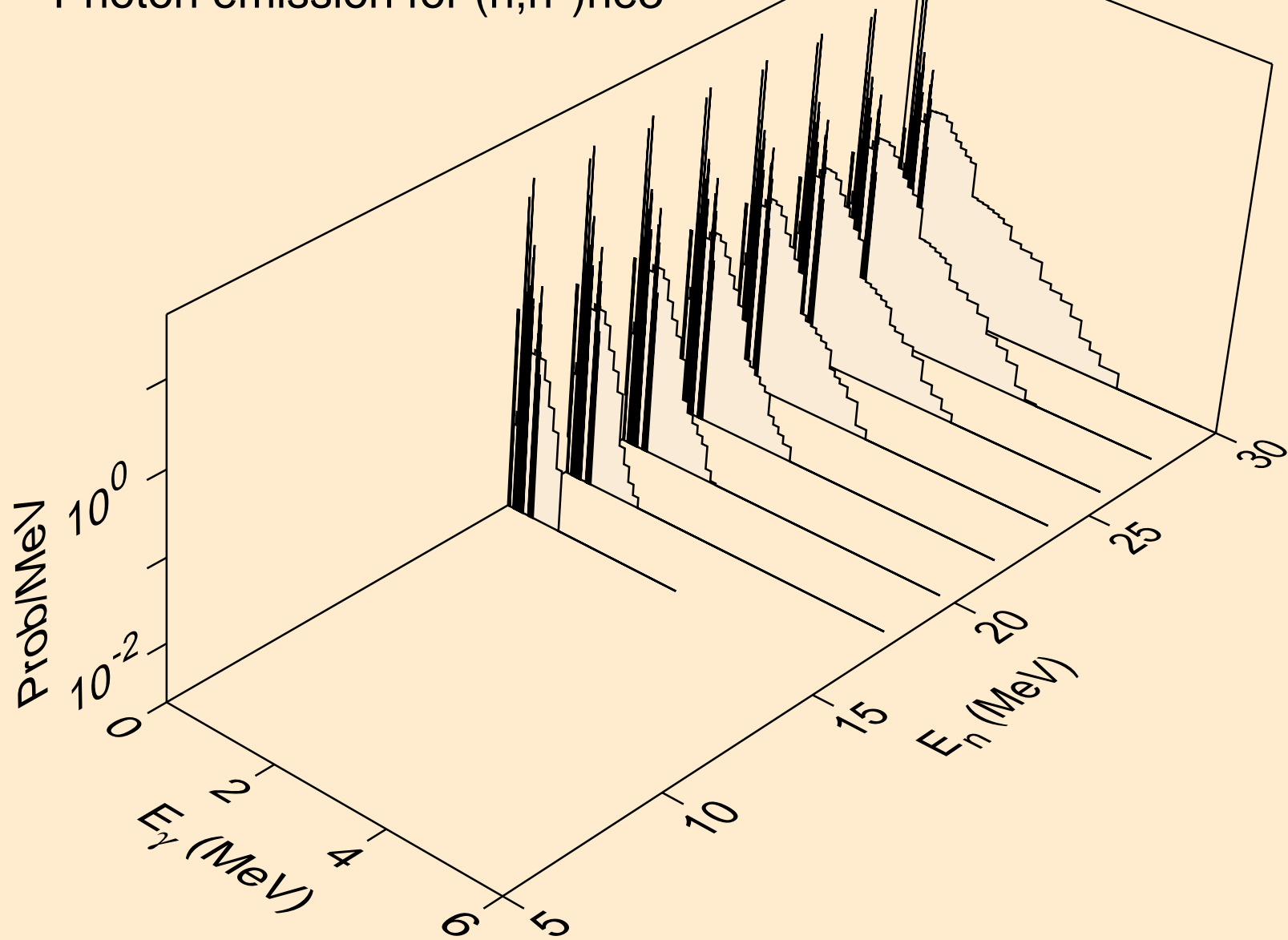

PR134 NEUTRON ACER TENDL-2021 LIBRARY; T=293.6K
Photon emission for (n,4n)

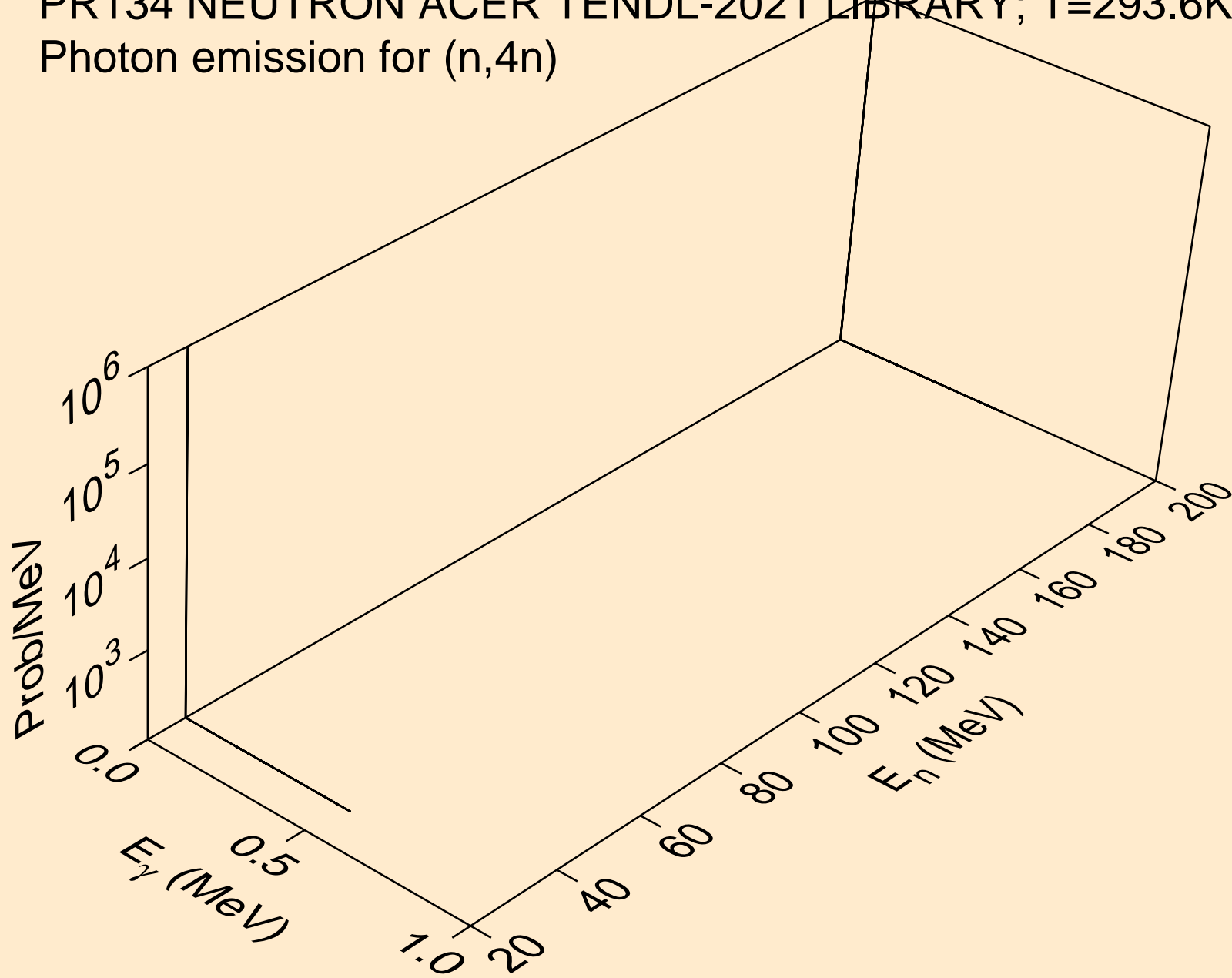

PR134 NEUTRON ACER TENDL-2021 LIBRARY; T=293.6K
Photon emission for (n,2np)

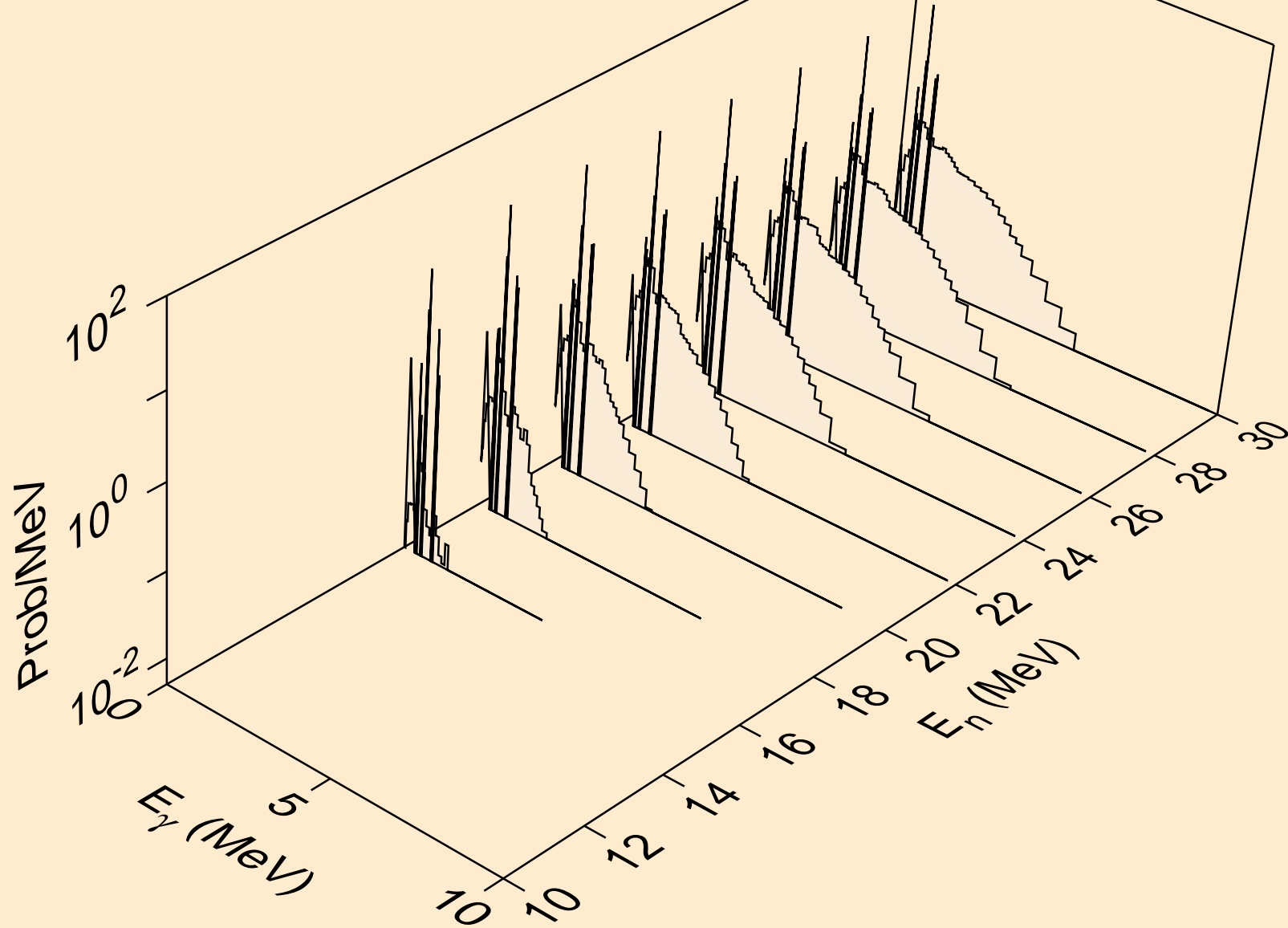

PR134 NEUTRON ACER TENDL-2021 LIBRARY; T=293.6K
Photon emission for (n,3np)

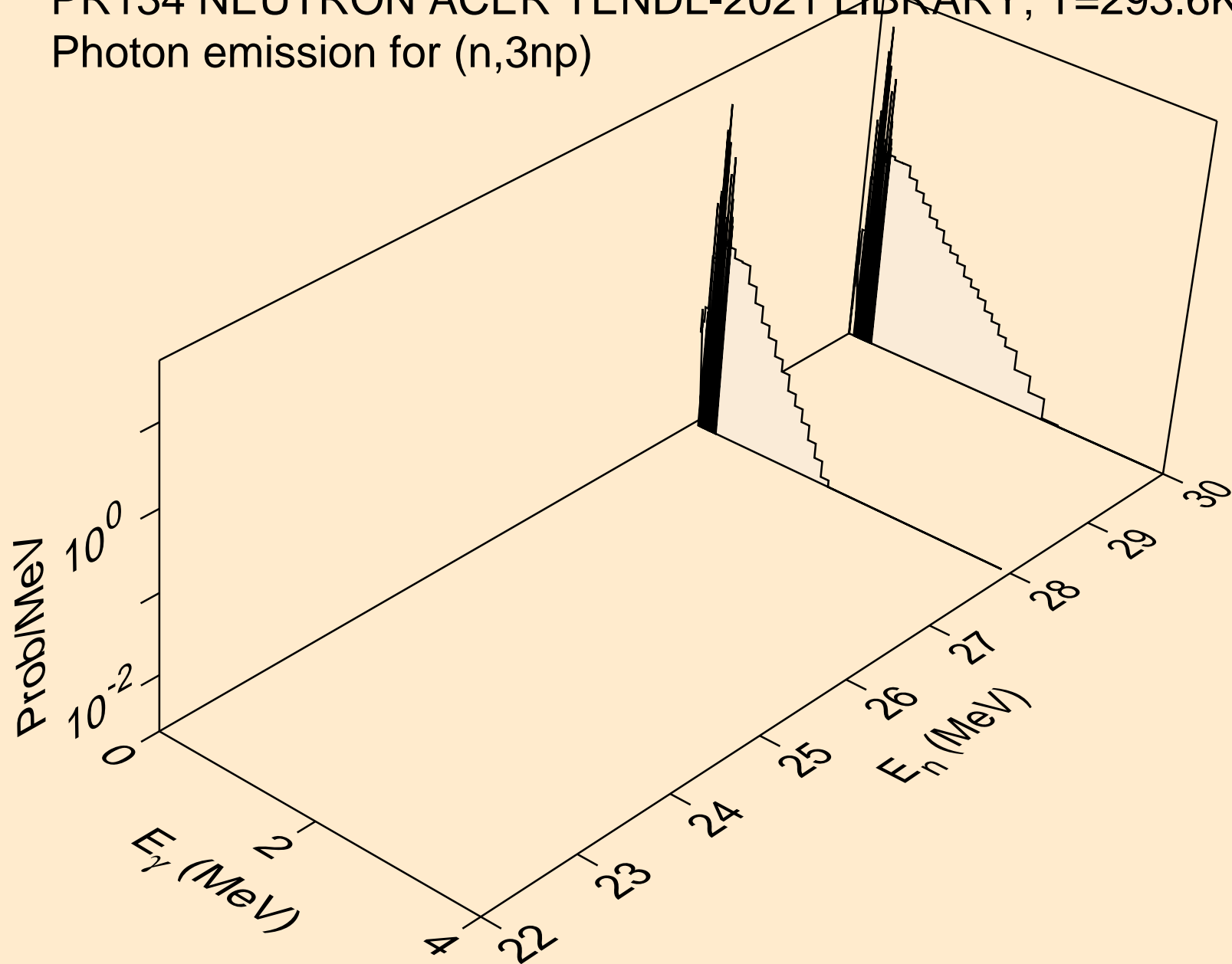

PR134 NEUTRON ACER TENDL-2021 LIBRARY; T=293.6K
Photon emission for (n,2np)

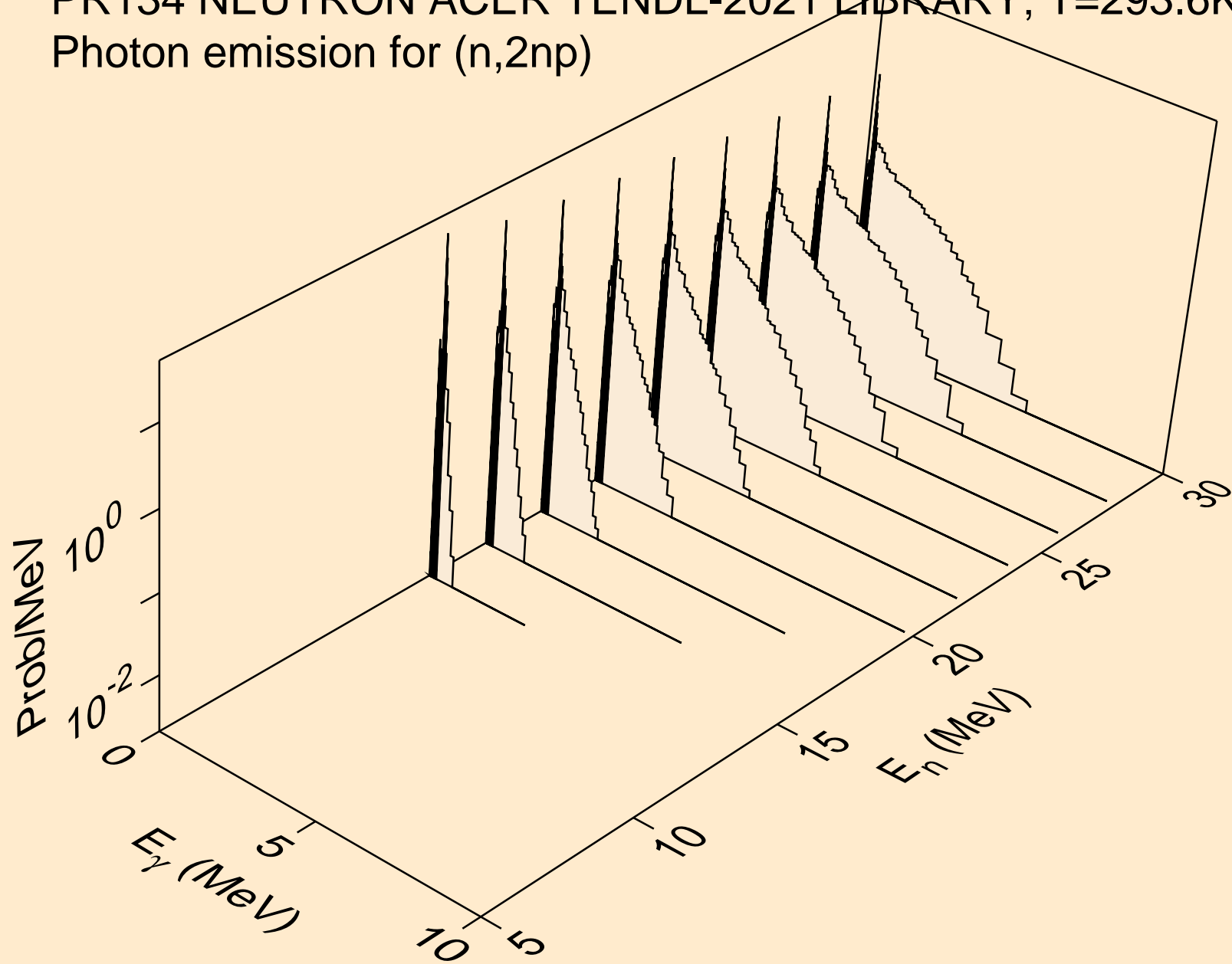

PR134 NEUTRON ACER TENDL-2021 LIBRARY; T=293.6K
Photon emission for (n,npa)

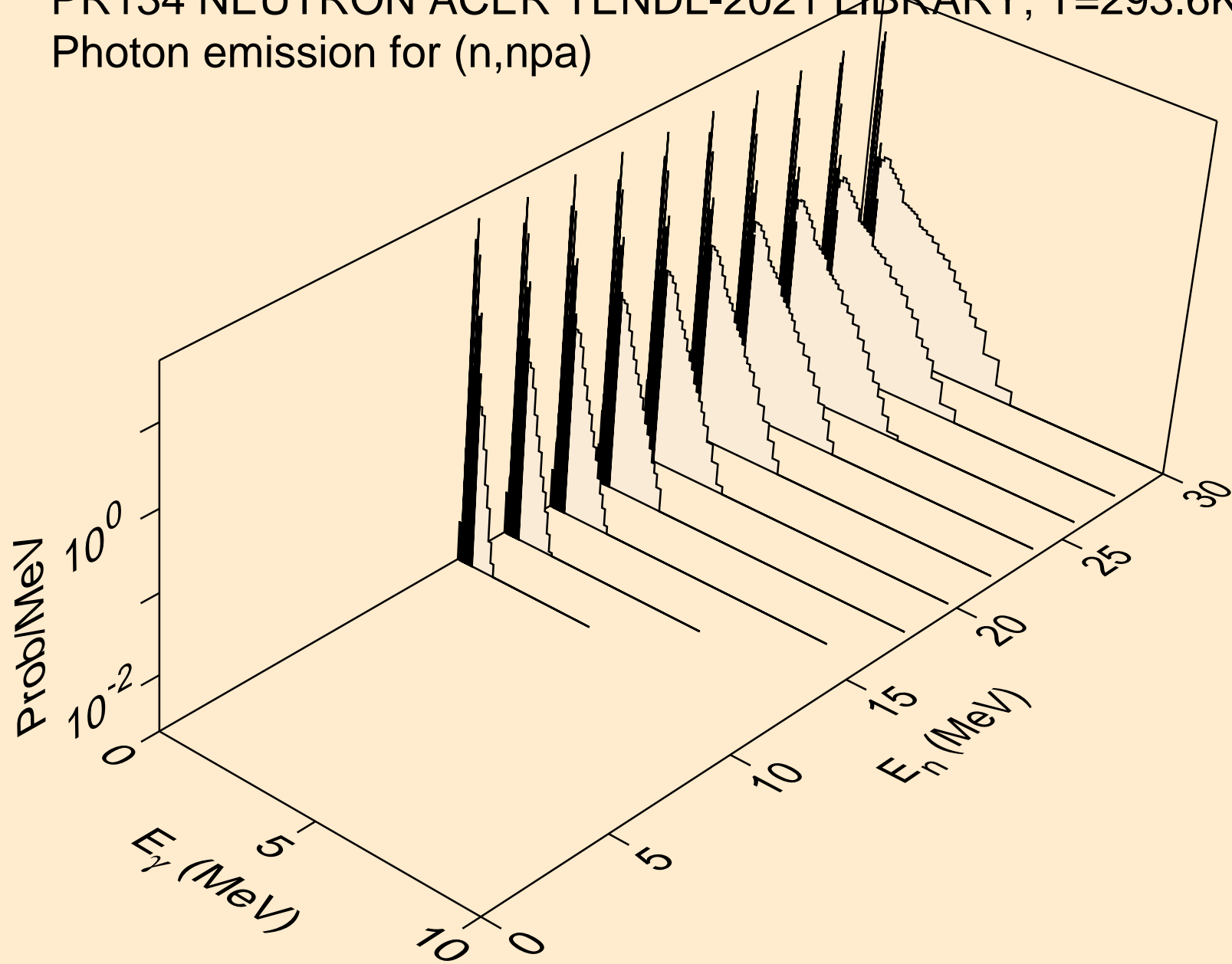

PR134 NEUTRON ACER TENDL-2021 LIBRARY; T=293.6K
Photon emission for (n,n*c)

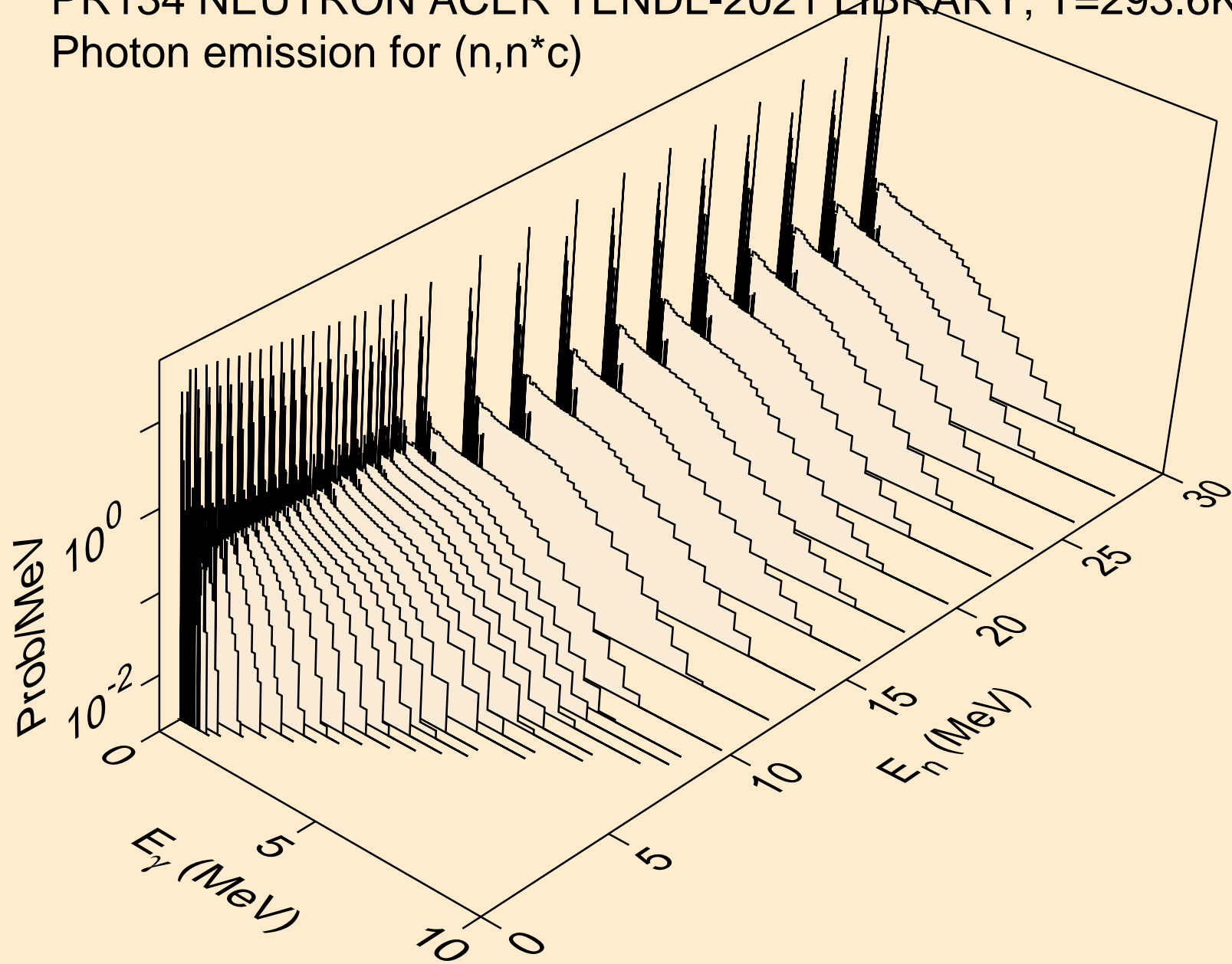

PR134 NEUTRON ACER TENDL-2021 LIBRARY; T=293.6K
Photon emission for (n,gma)

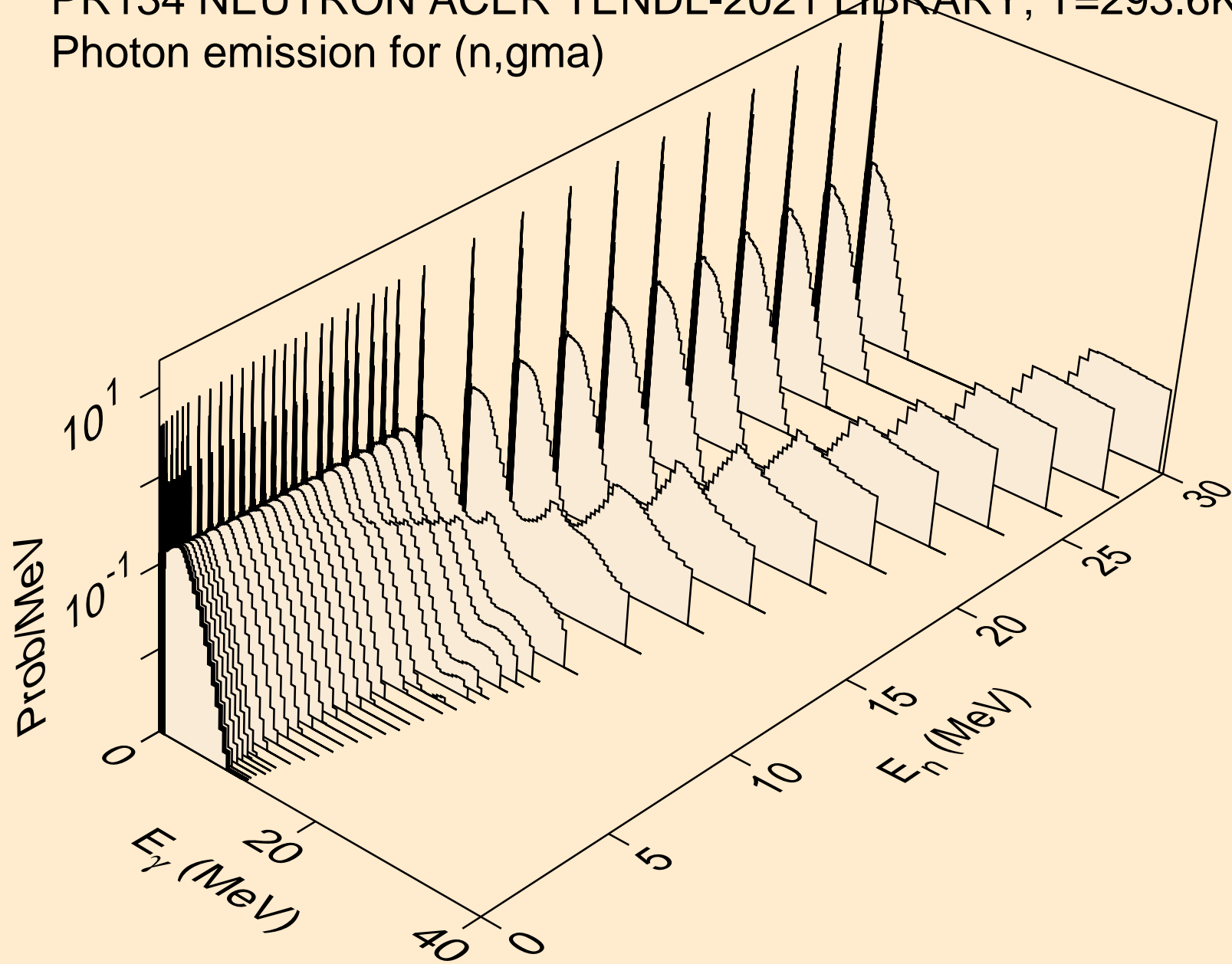

PR134 NEUTRON ACER TENDL-2021 LIBRARY; T=293.6K
Photon emission for (n,p)

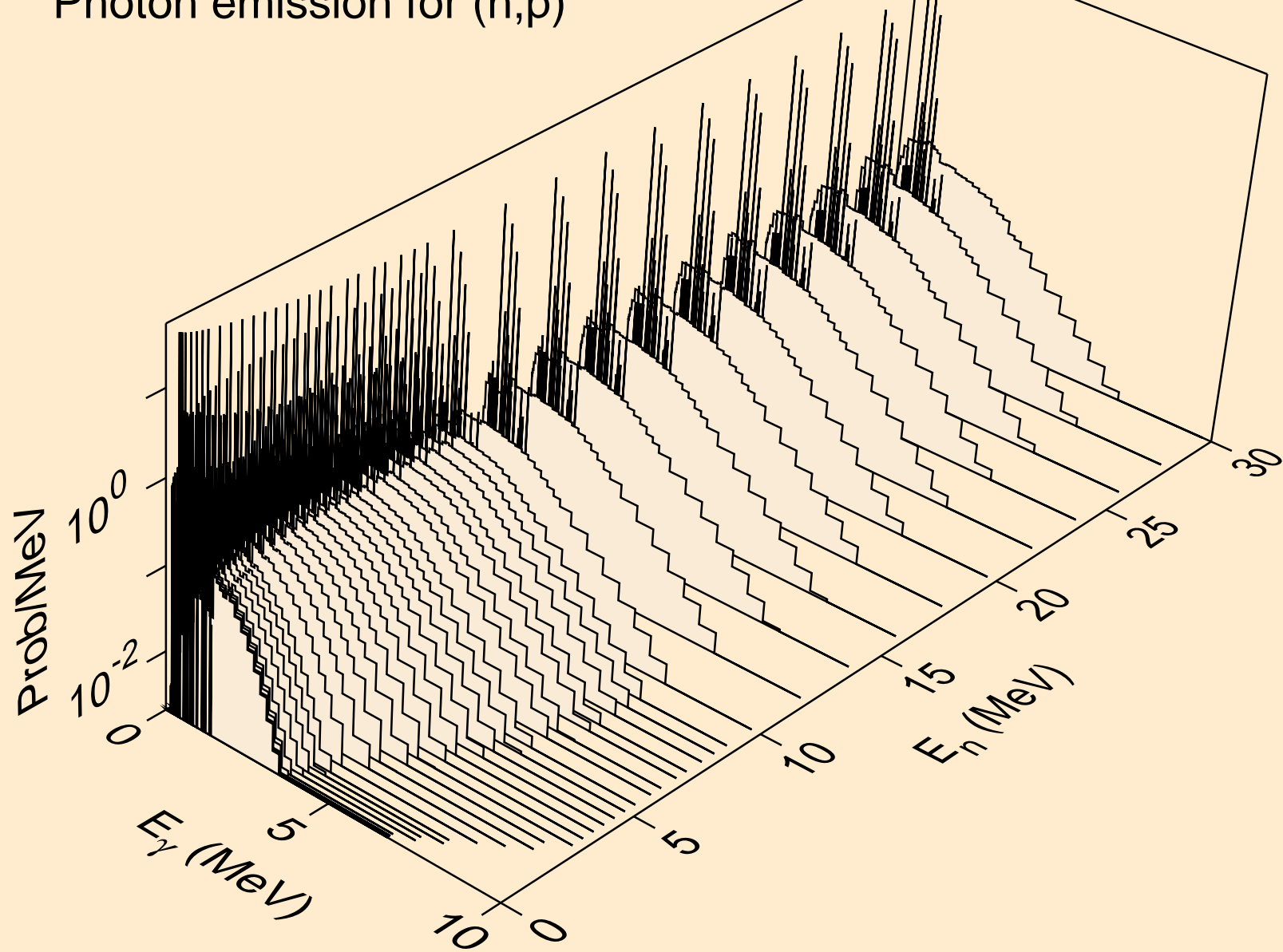

PR134 NEUTRON ACER TENDL-2021 LIBRARY; T=293.6K
Photon emission for (n,d)

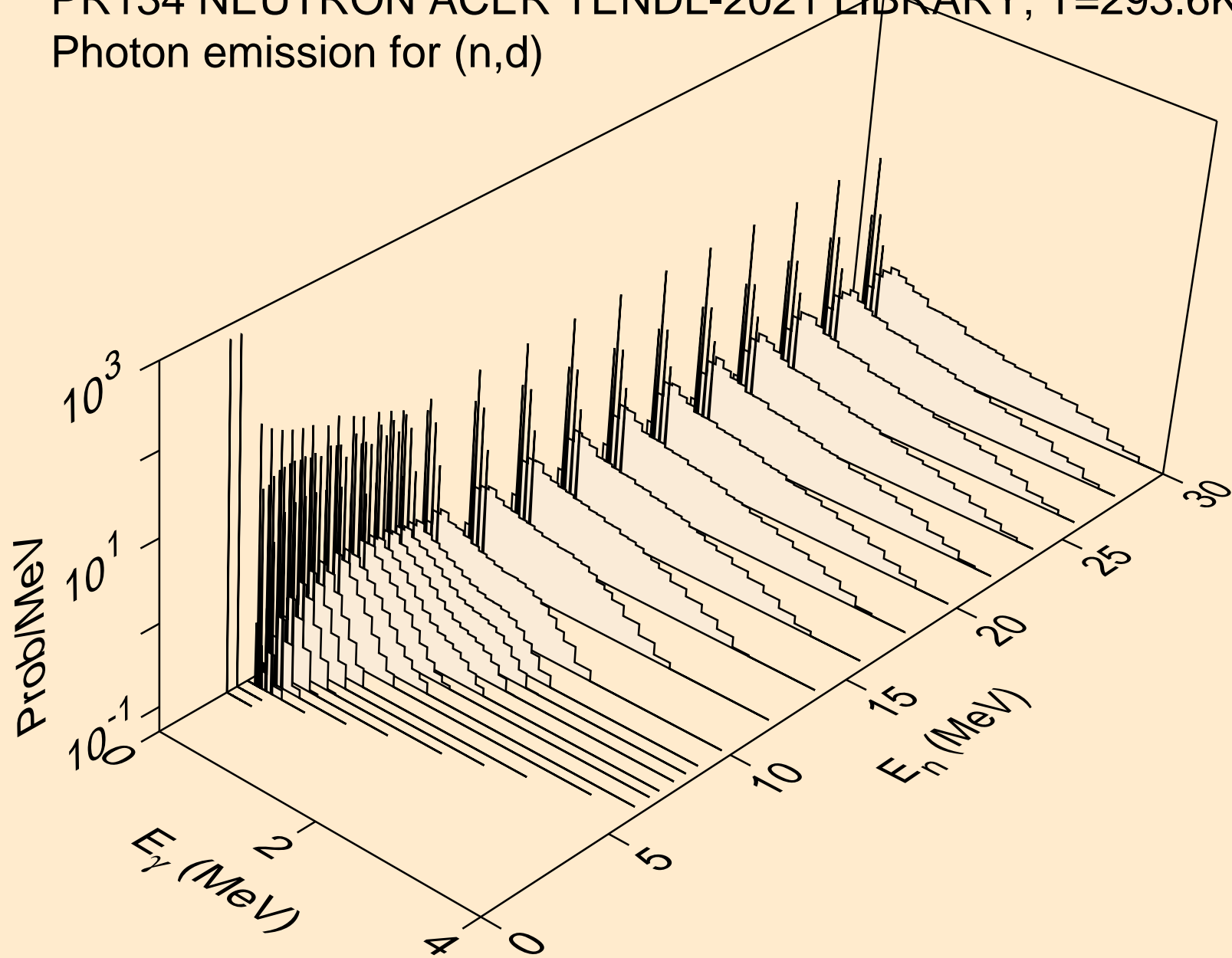

PR134 NEUTRON ACER TENDL-2021 LIBRARY; T=293.6K
Photon emission for (n,t)

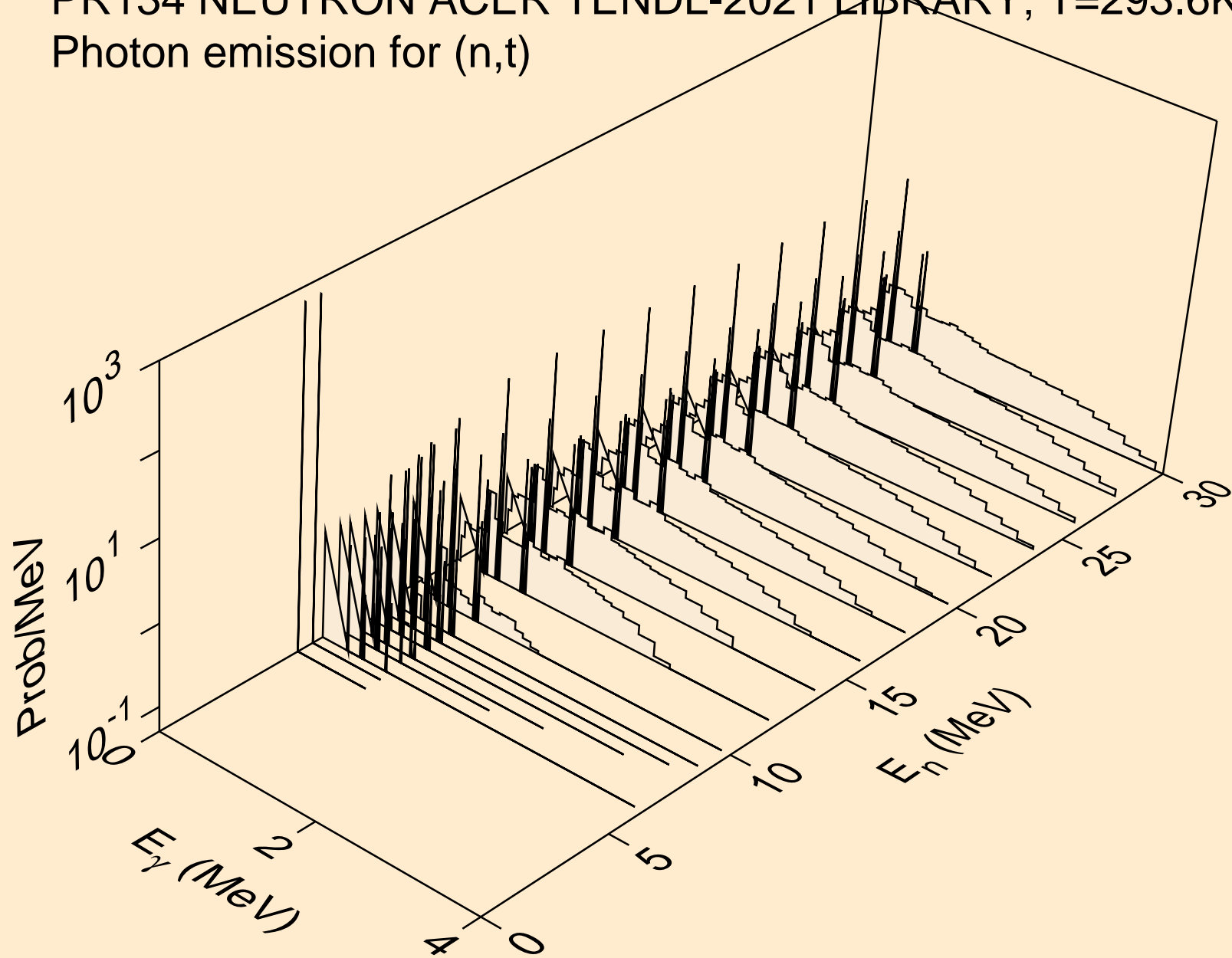

PR134 NEUTRON ACER TENDL-2021 LIBRARY; T=293.6K
Photon emission for (n,he3)

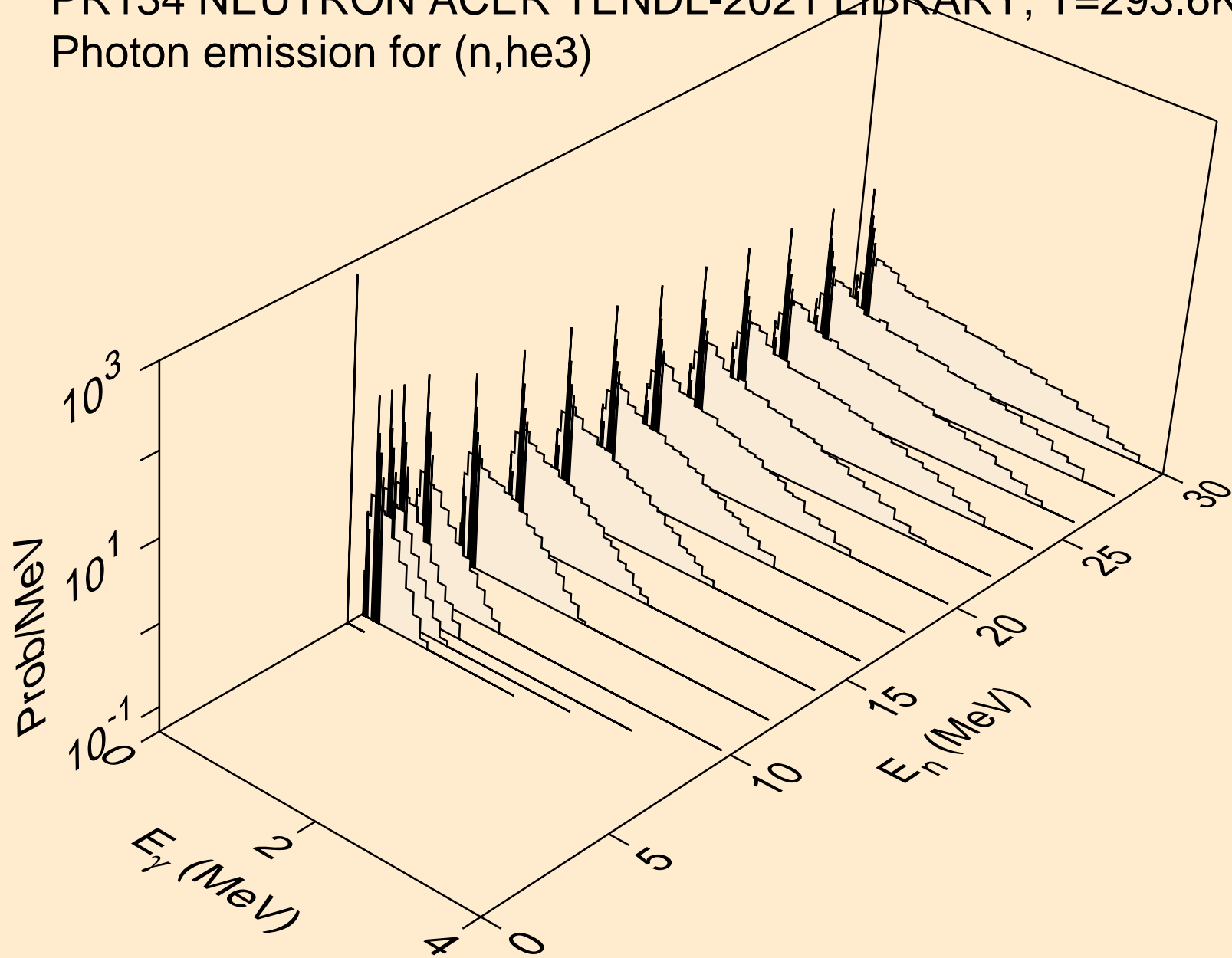

PR134 NEUTRON ACER TENDL-2021 LIBRARY; T=293.6K
Photon emission for (n,a)

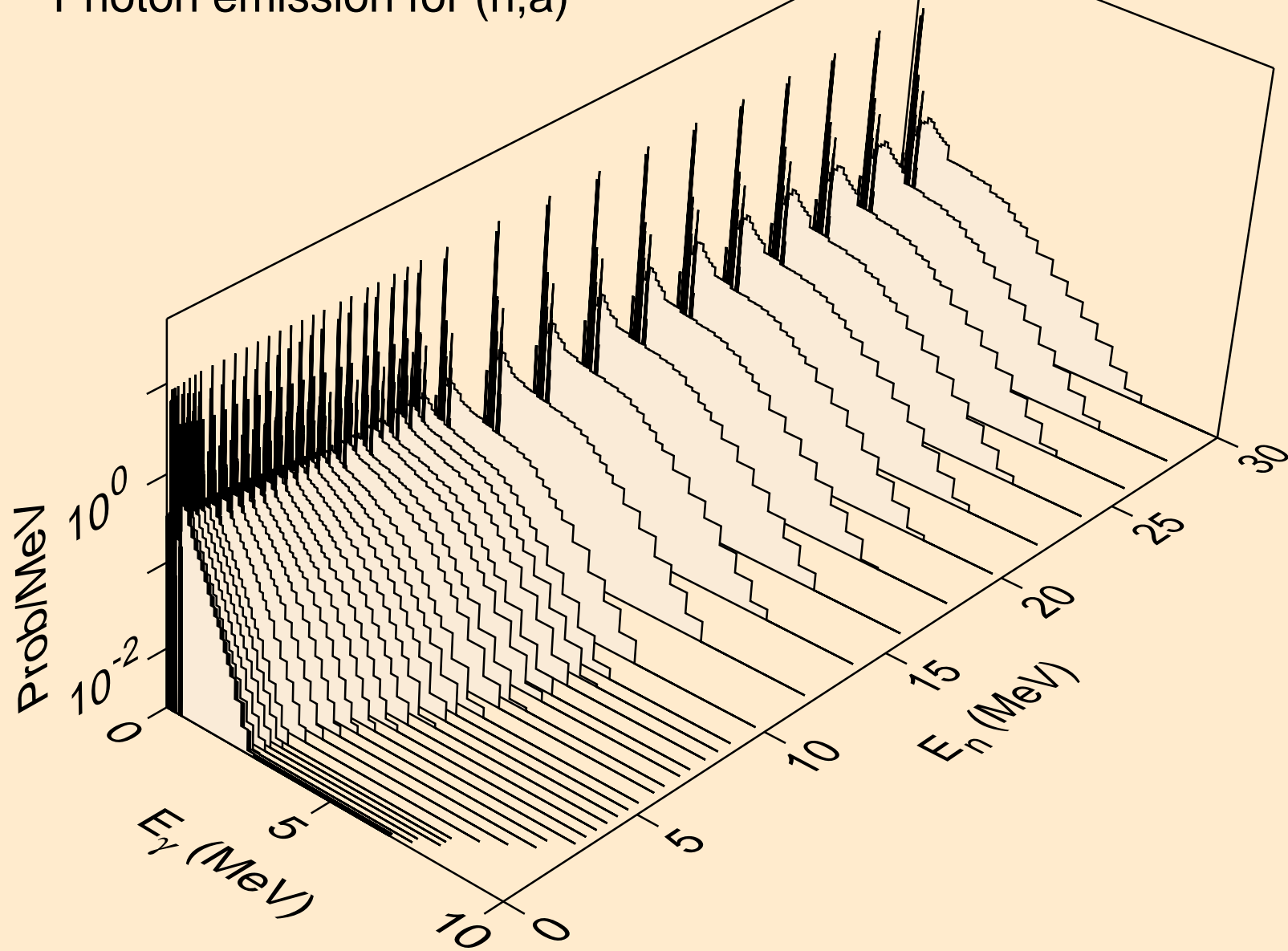

PR134 NEUTRON ACER TENDL-2021 LIBRARY; T=293.6K
Photon emission for (n,2a)

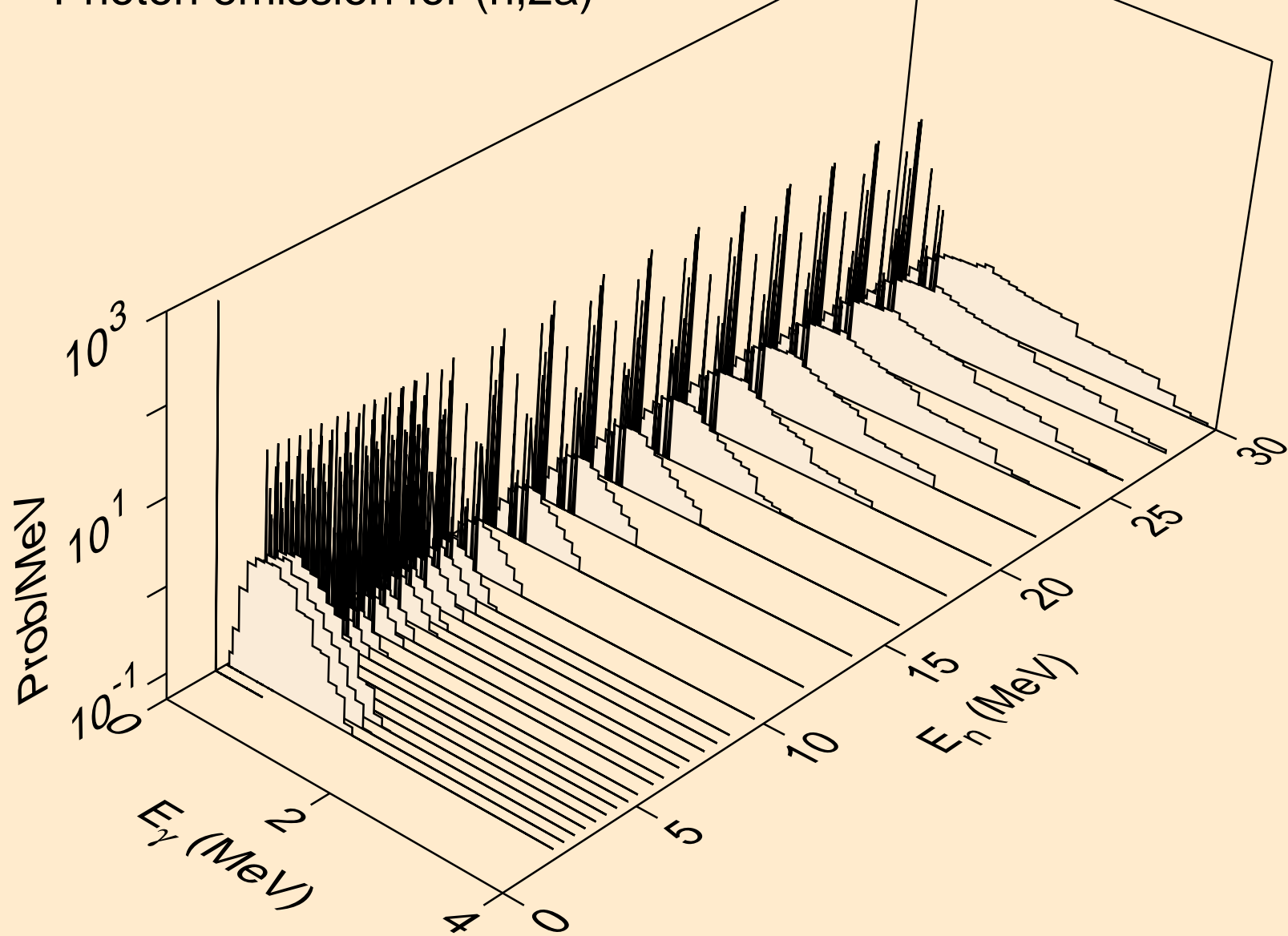

PR134 NEUTRON ACER TENDL-2021 LIBRARY; T=293.6K
Photon emission for (n,2p)

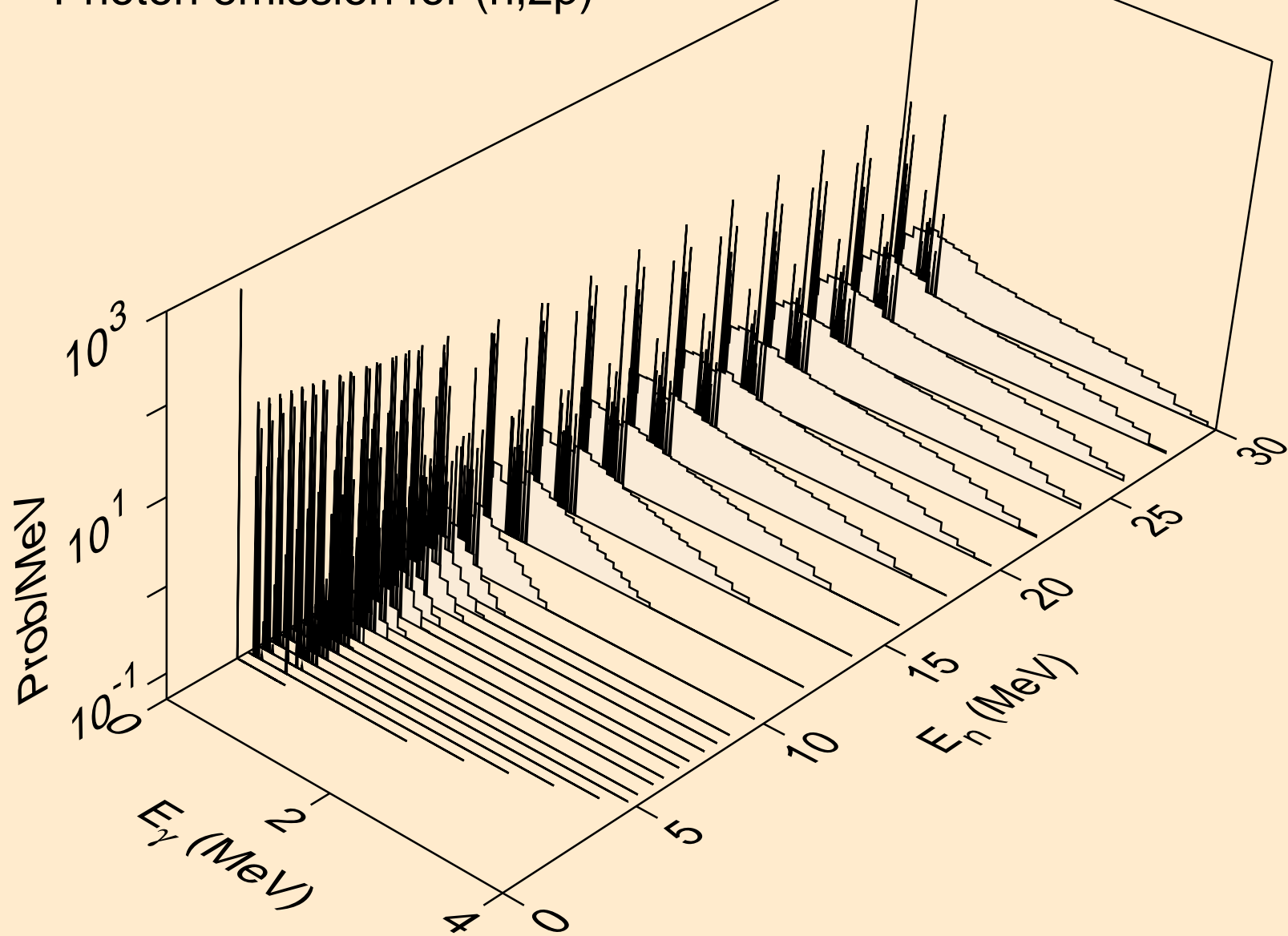

PR134 NEUTRON ACER TENDL-2021 LIBRARY; T=293.6K
Photon emission for (n,p α)

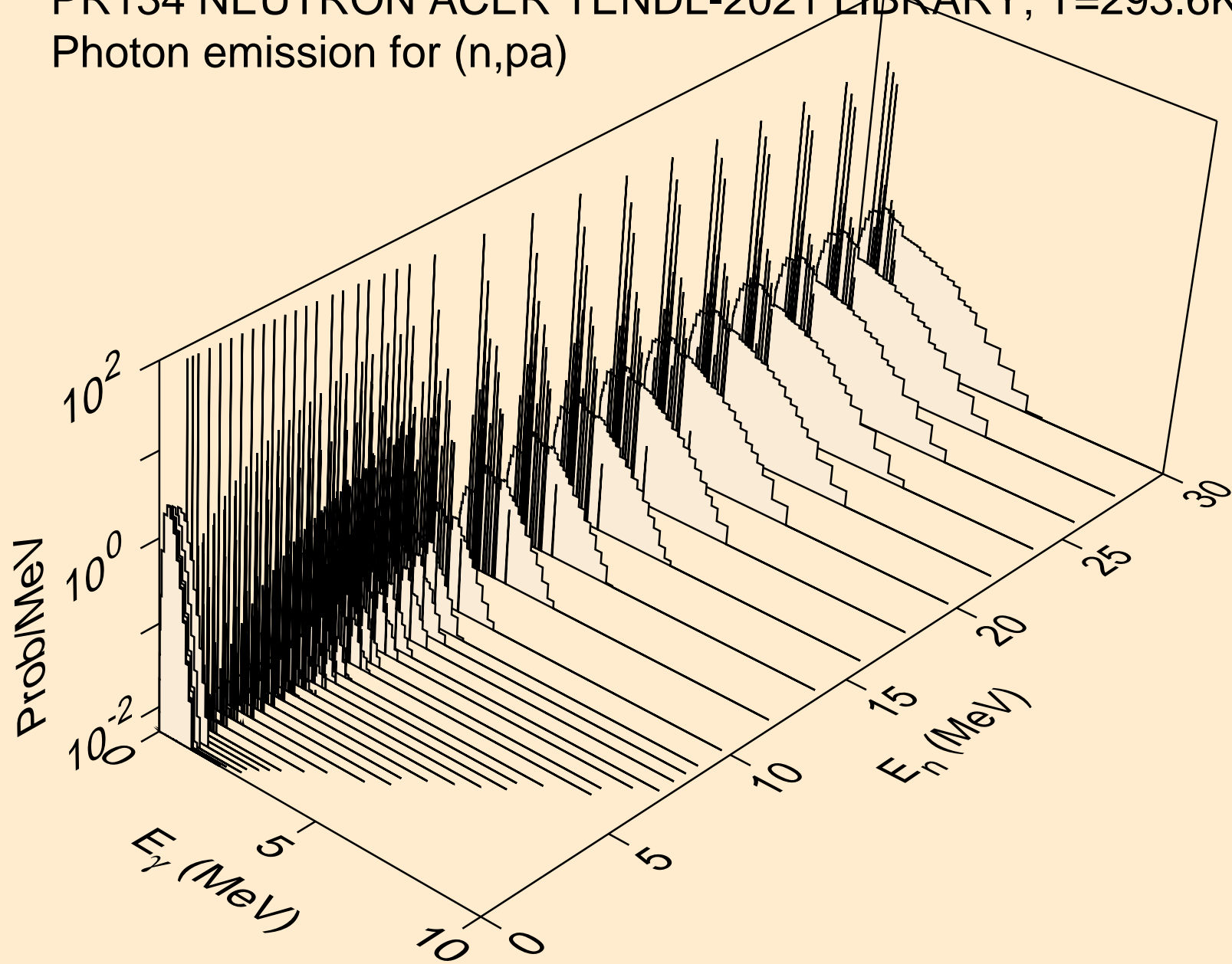

PR134 NEUTRON ACER TENDL-2021 LIBRARY; T=293.6K
Photon emission for (n,pd)

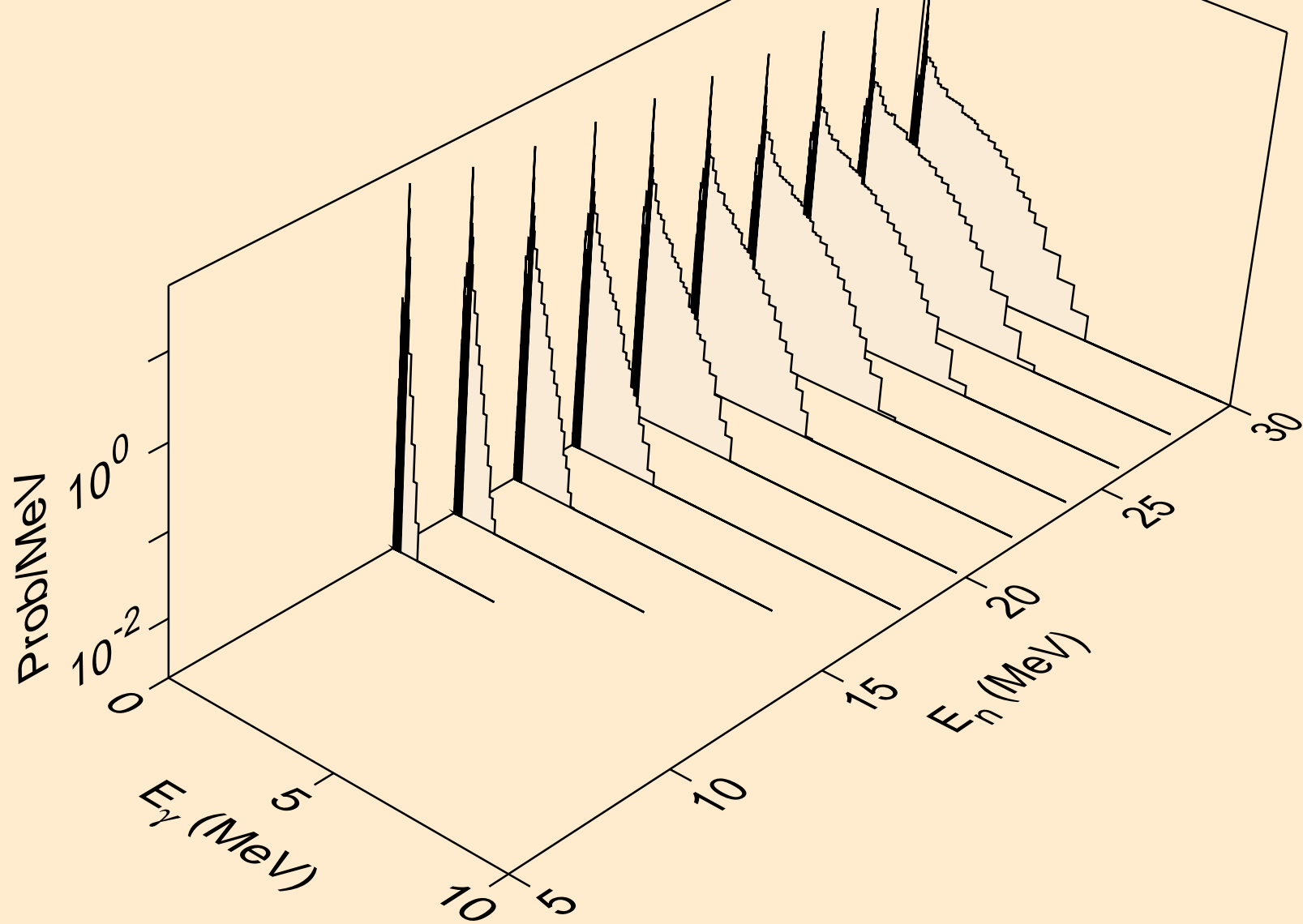

PR134 NEUTRON ACER TENDL-2021 LIBRARY; T=293.6K
Photon emission for (n,pt)

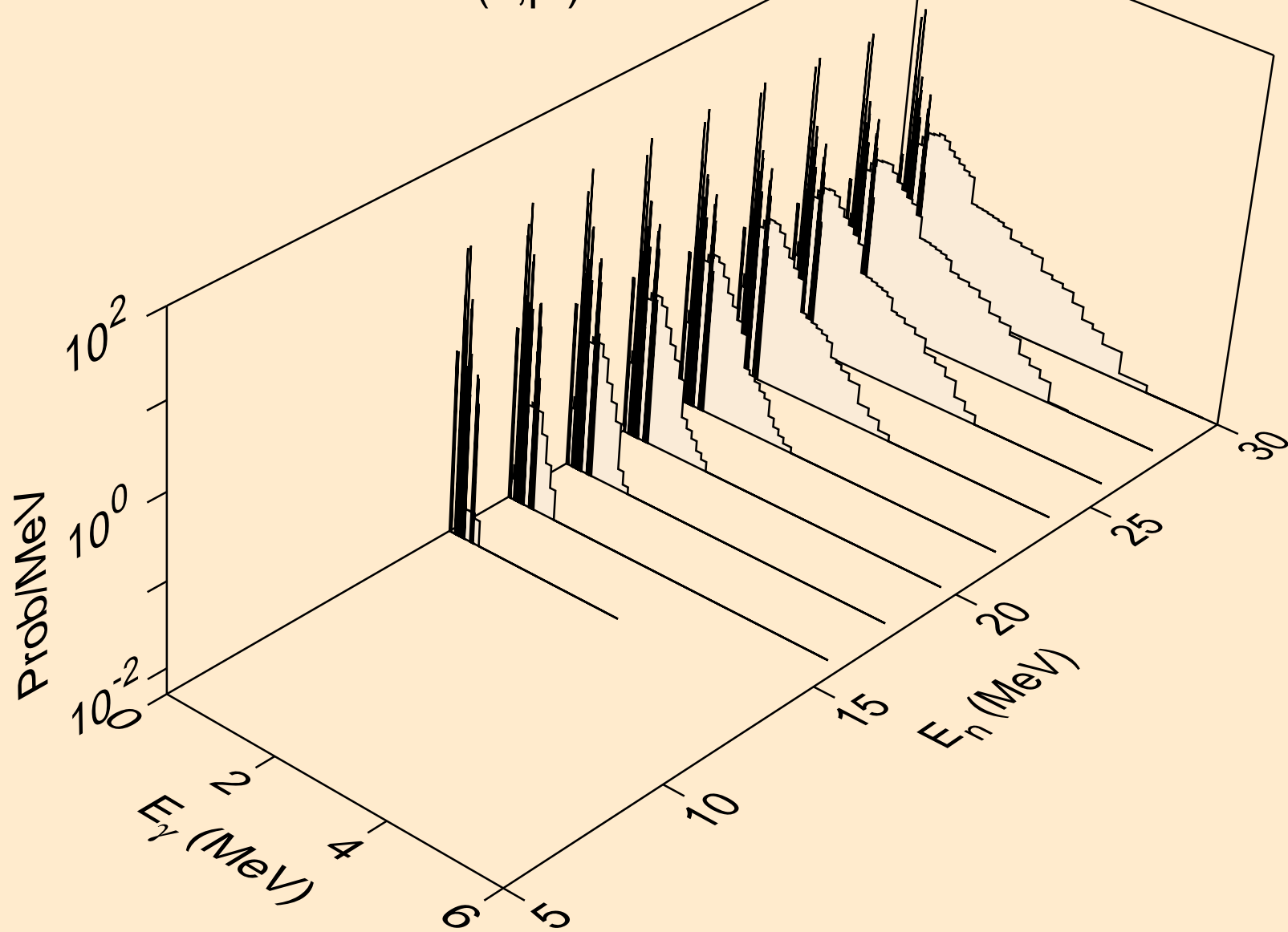

PR134 NEUTRON ACER TENDL-2021 LIBRARY; T=293.6K
Photon emission for (n,da)

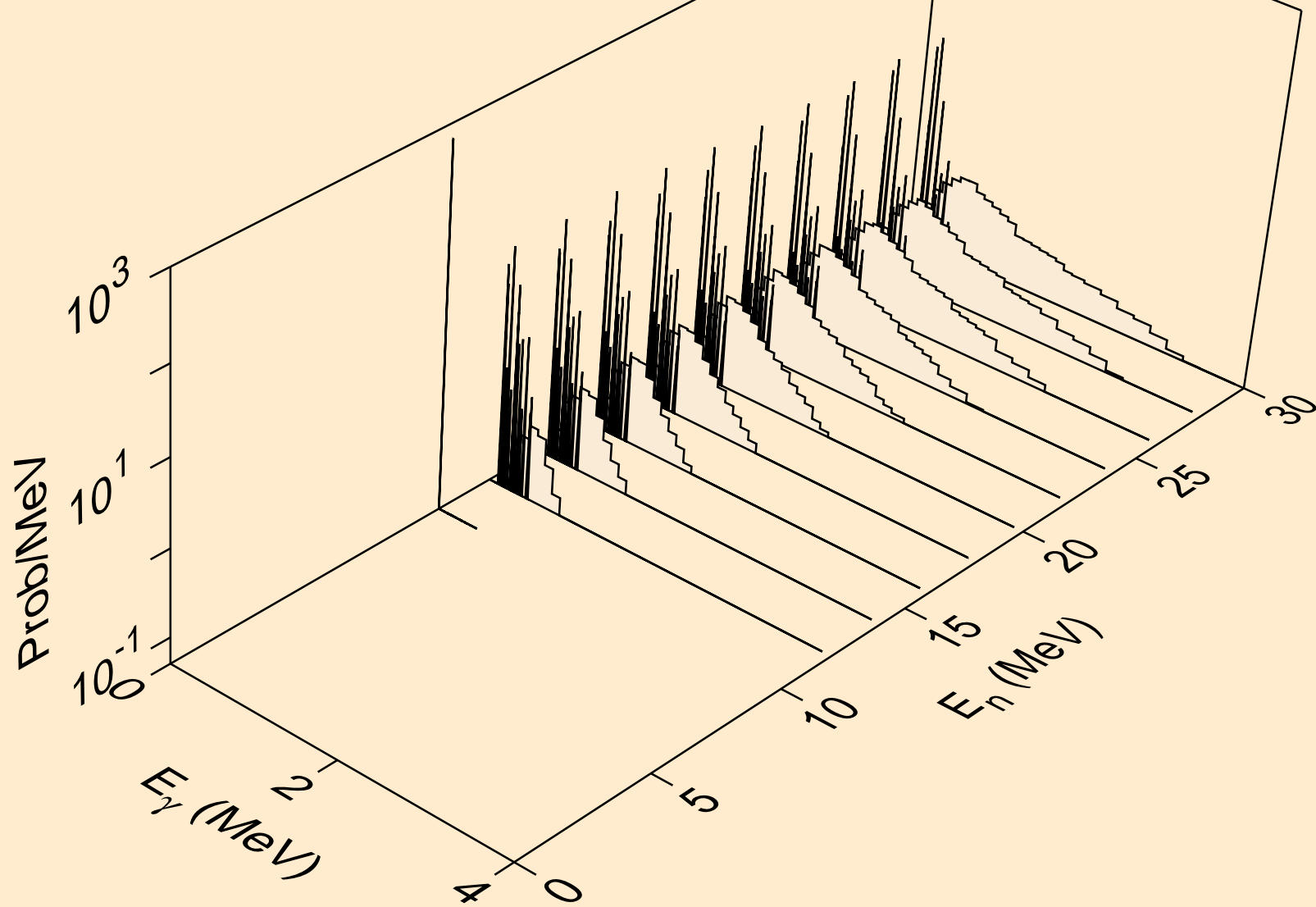

PR134 NEUTRON ACER TENDL-2021 LIBRARY; T=293.6K
thermal capture photon spectrum

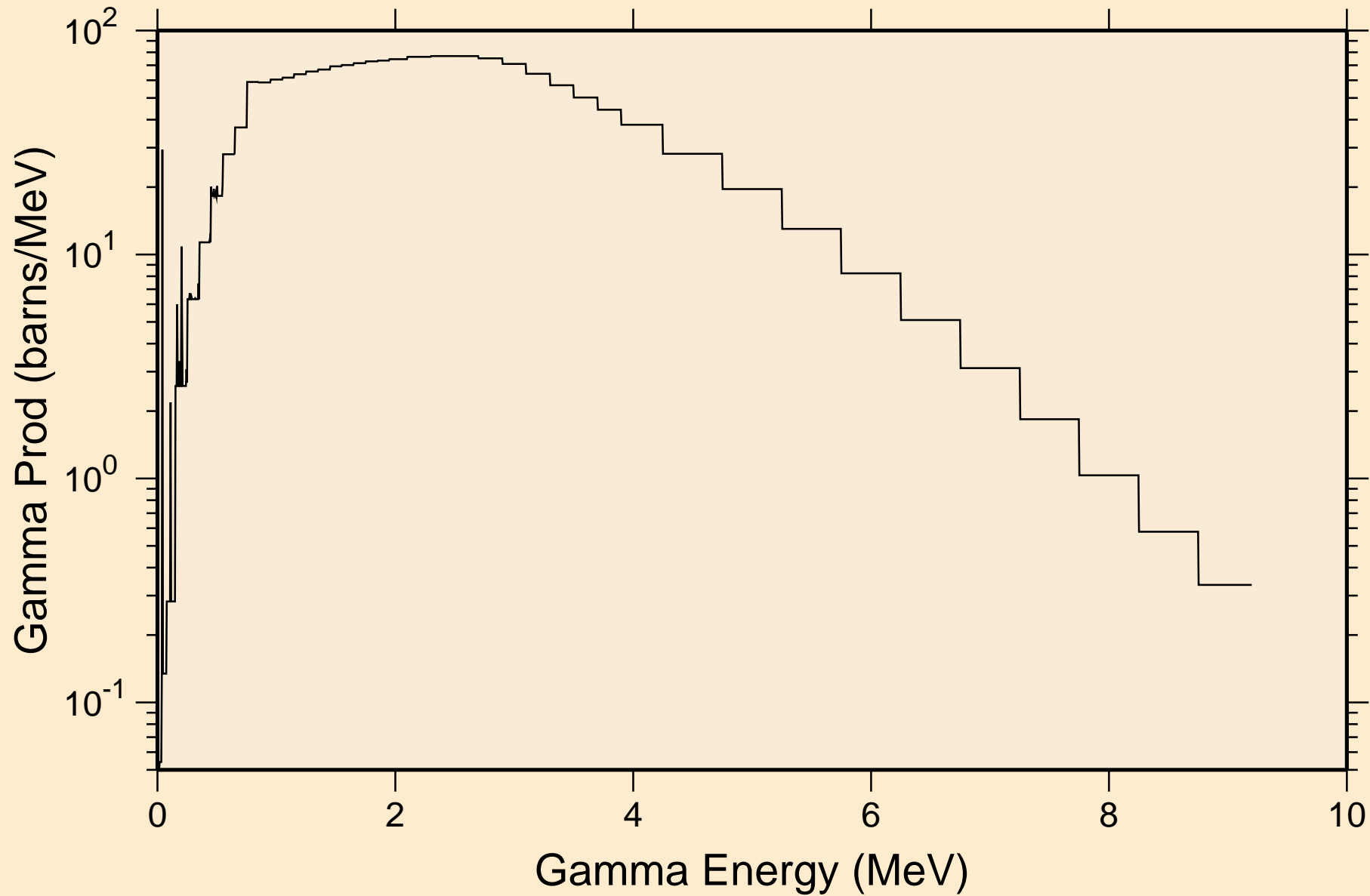

PR134 NEUTRON ACER TENDL-2021 LIBRARY; T=293.6K
14 MeV photon spectrum

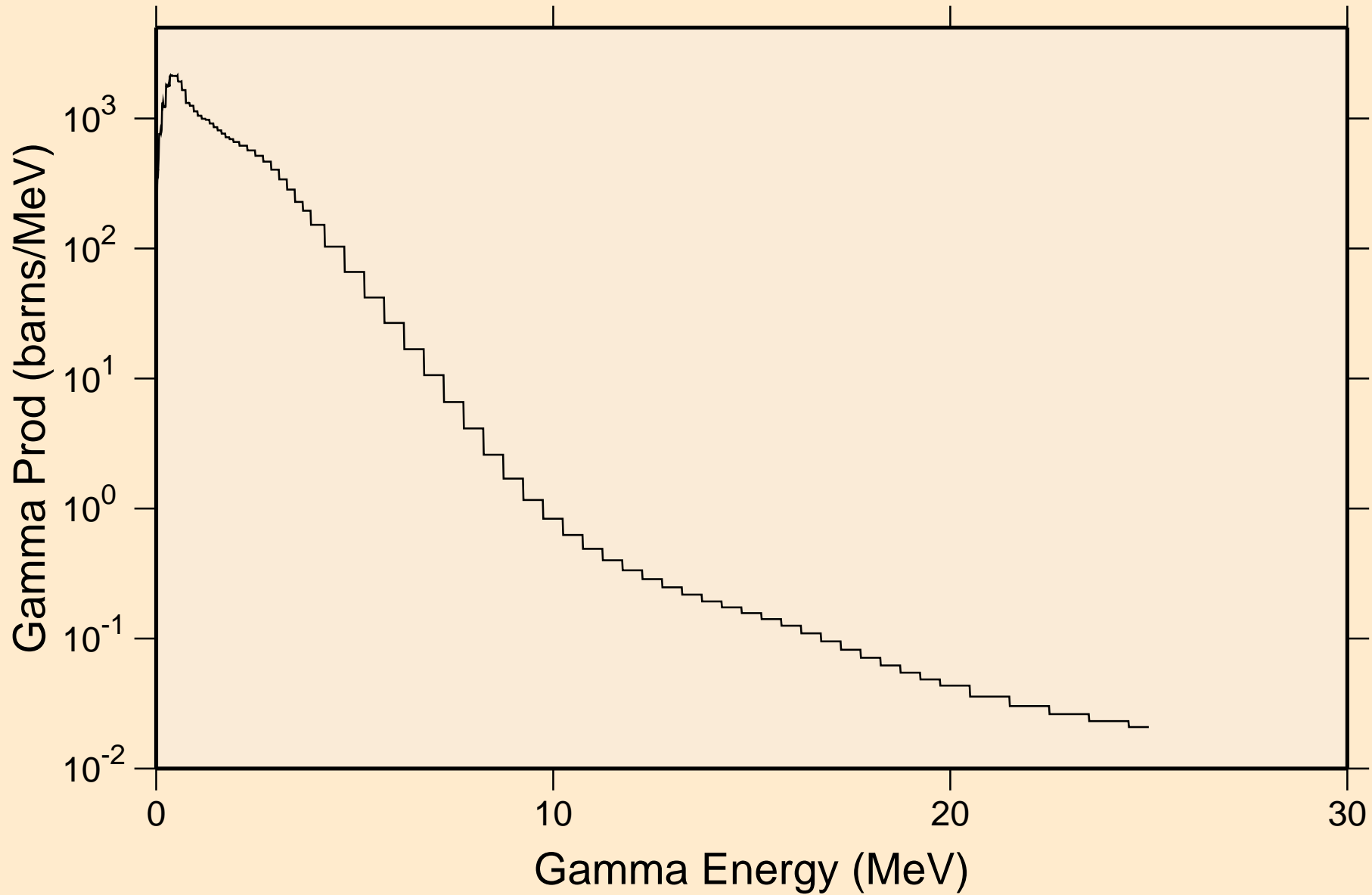

PR134 NEUTRON ACER TENDL-2021 LIBRARY; T=293.6K
Particle heating contributions

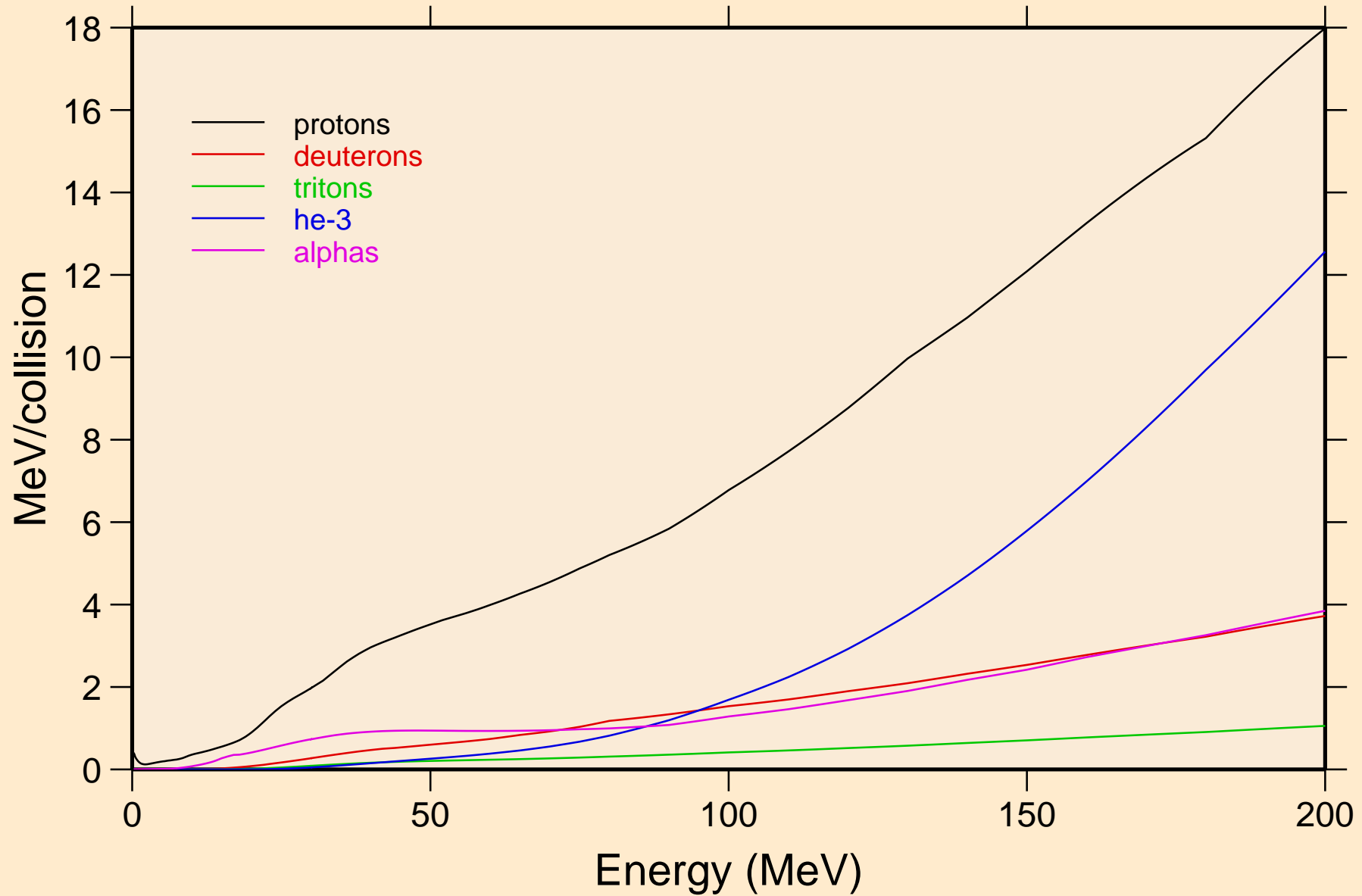

PR134 NEUTRON ACER TENDL-2021 LIBRARY; T=293.6K
Recoil Heating

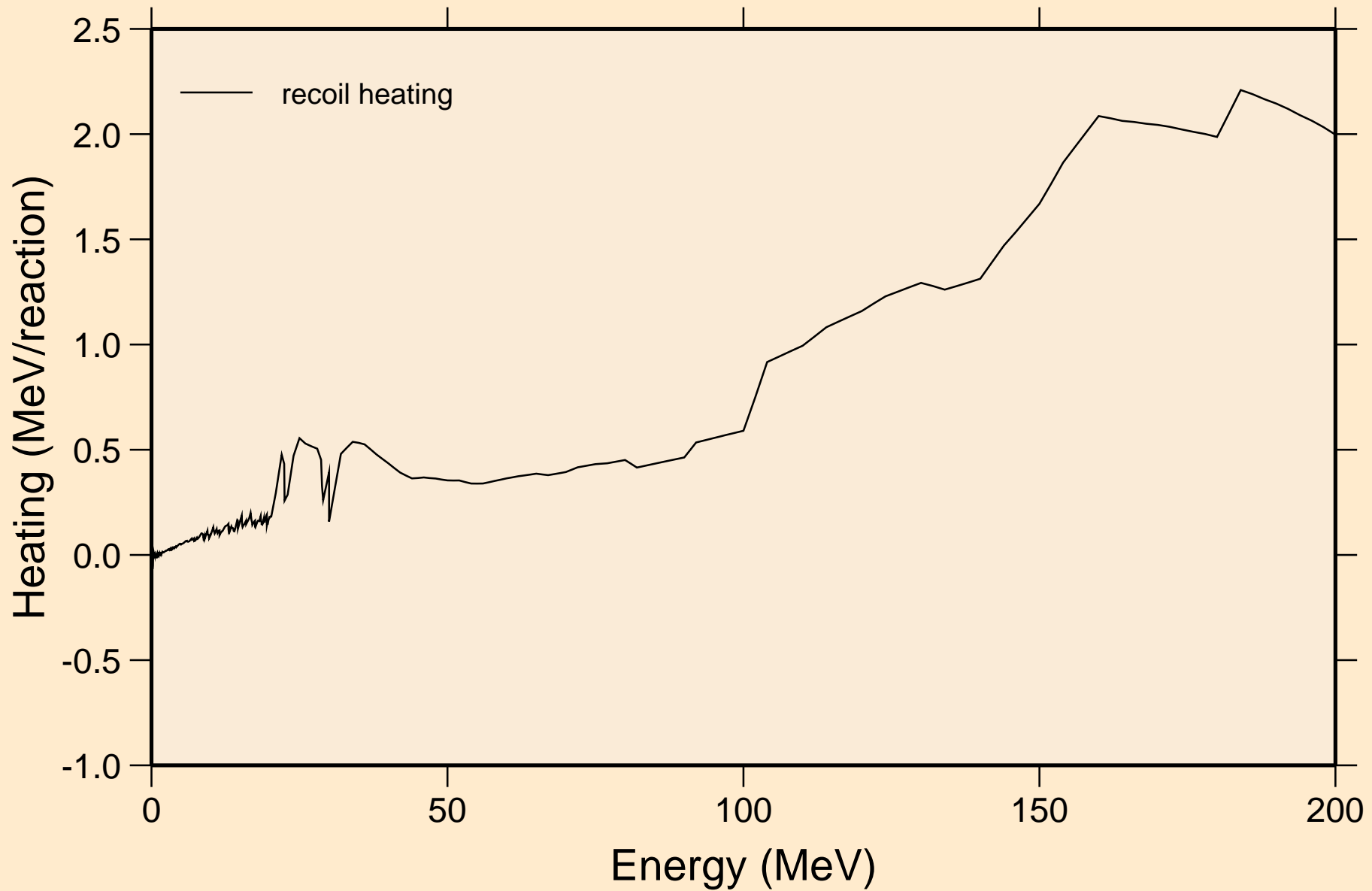

PR134 NEUTRON ACER TENDL-2021 LIBRARY; T=293.6K
Particle production cross sections

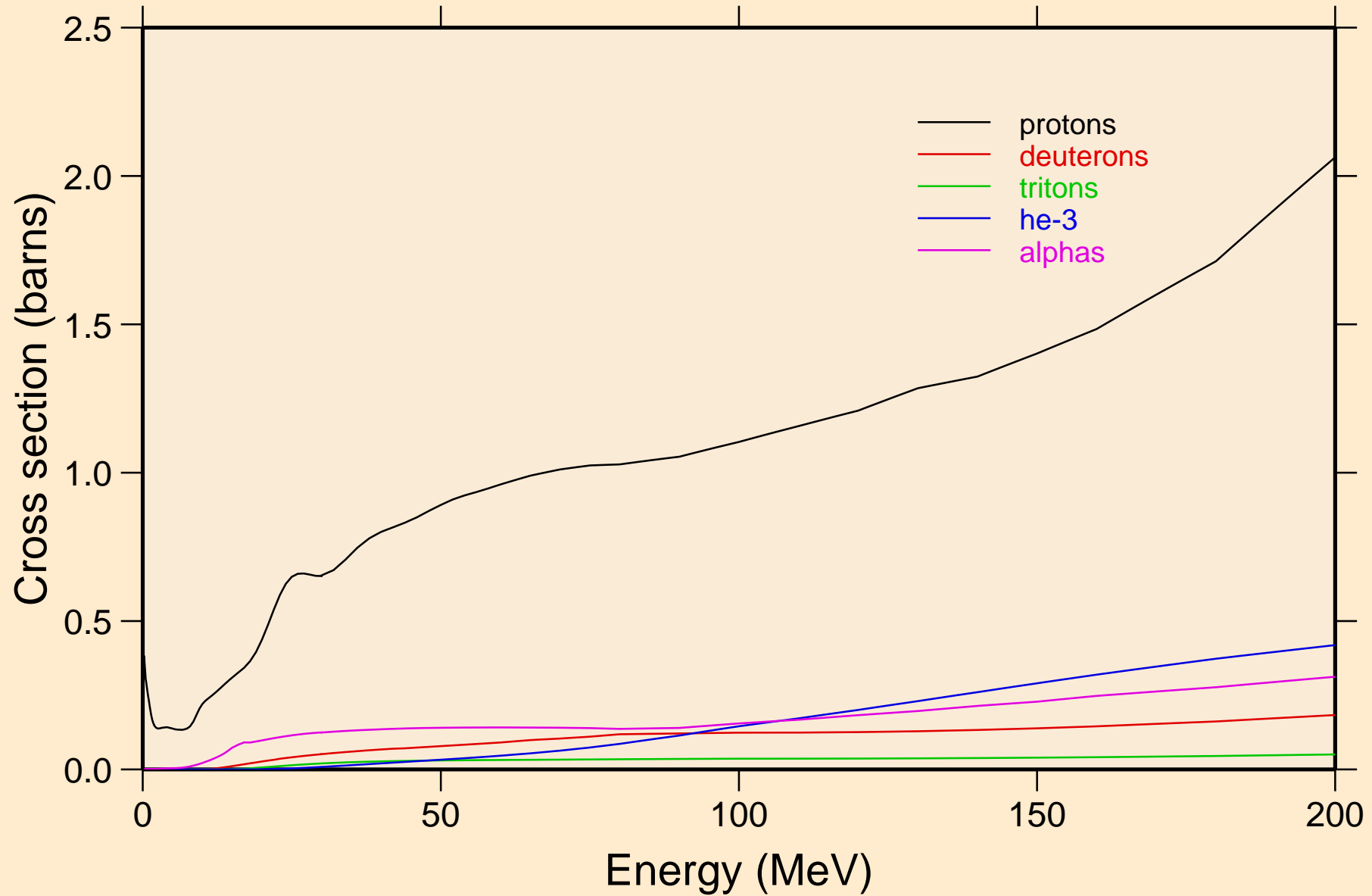

PR134 NEUTRON ACER TENDL-2021 LIBRARY; T=293.6K
protons from (n,x)

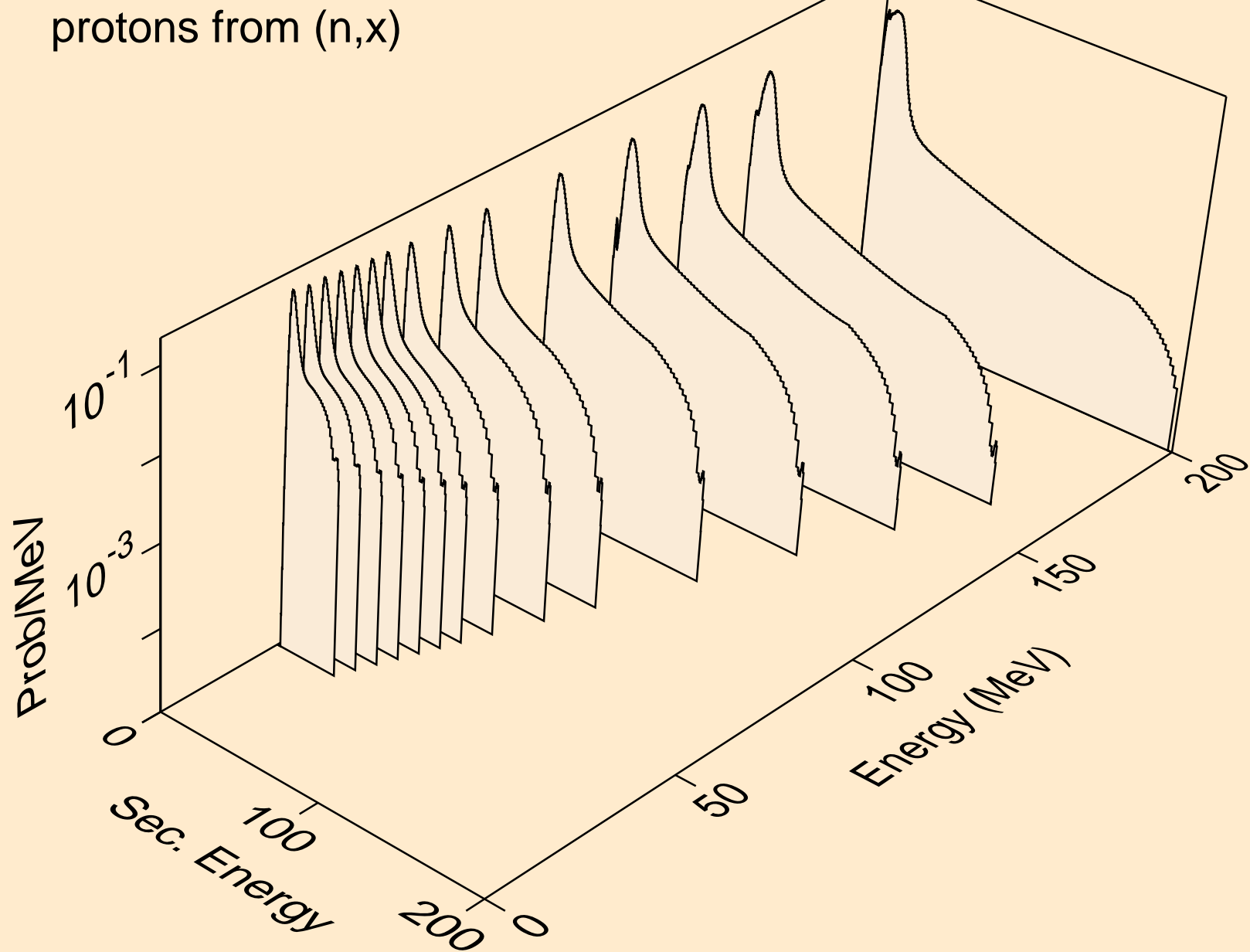

PR134 NEUTRON ACER TENDL-2021 LIBRARY; T=293.6K
protons from (n,n*)p

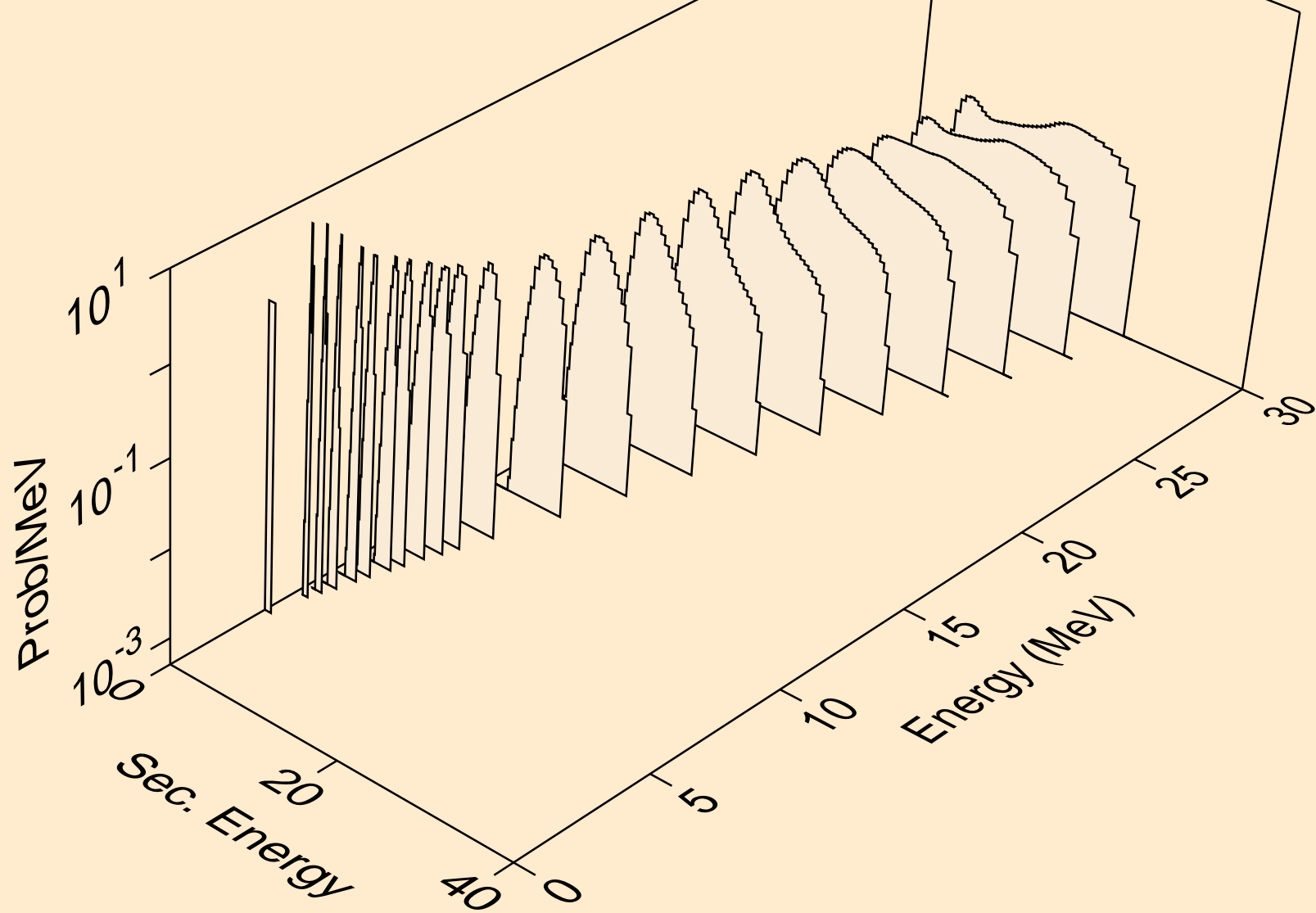

PR134 NEUTRON ACER TENDL-2021 LIBRARY; T=293.6K
protons from (n,2np)

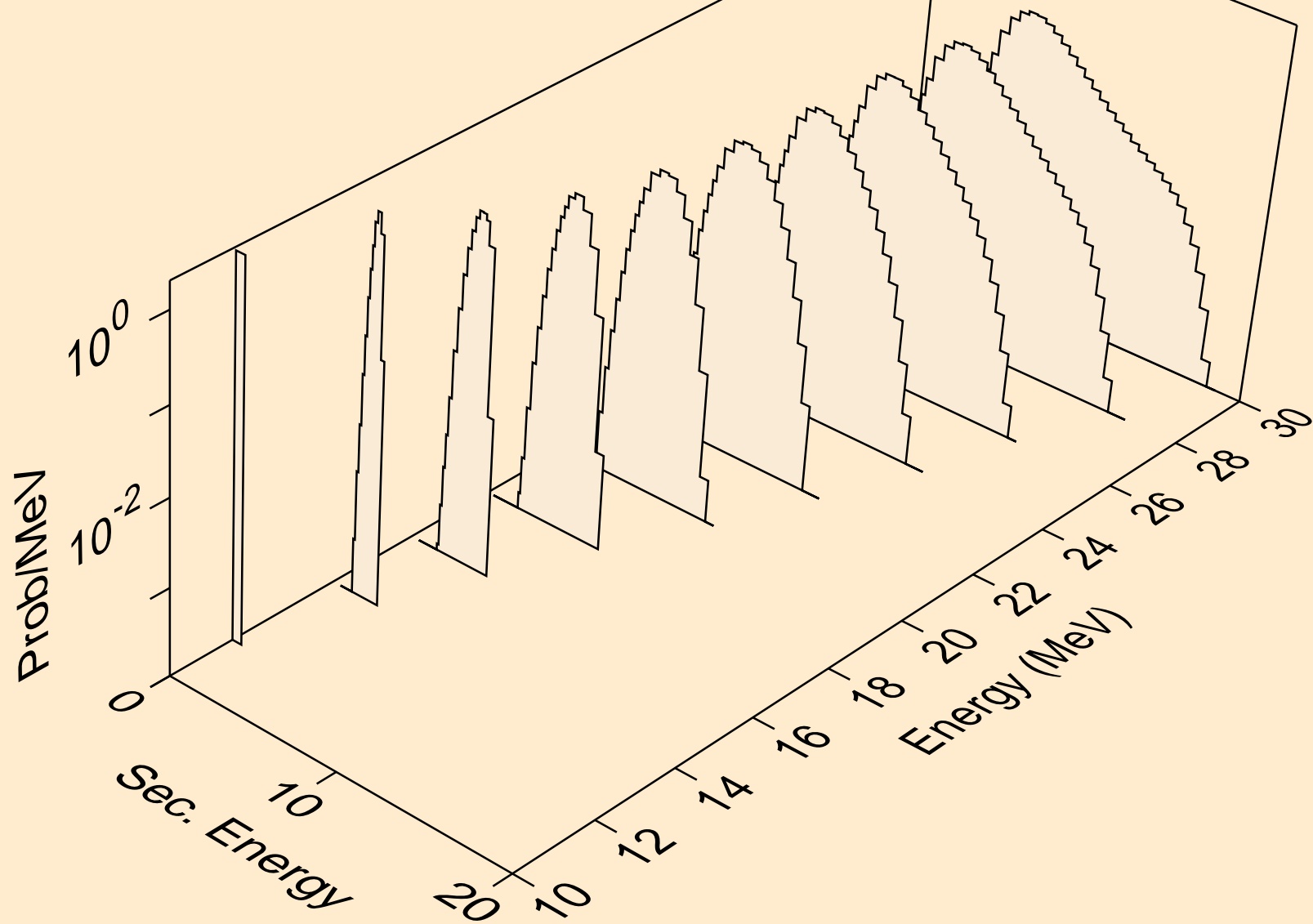

PR134 NEUTRON ACER TENDL-2021 LIBRARY; T=293.6K
protons from (n,3np)

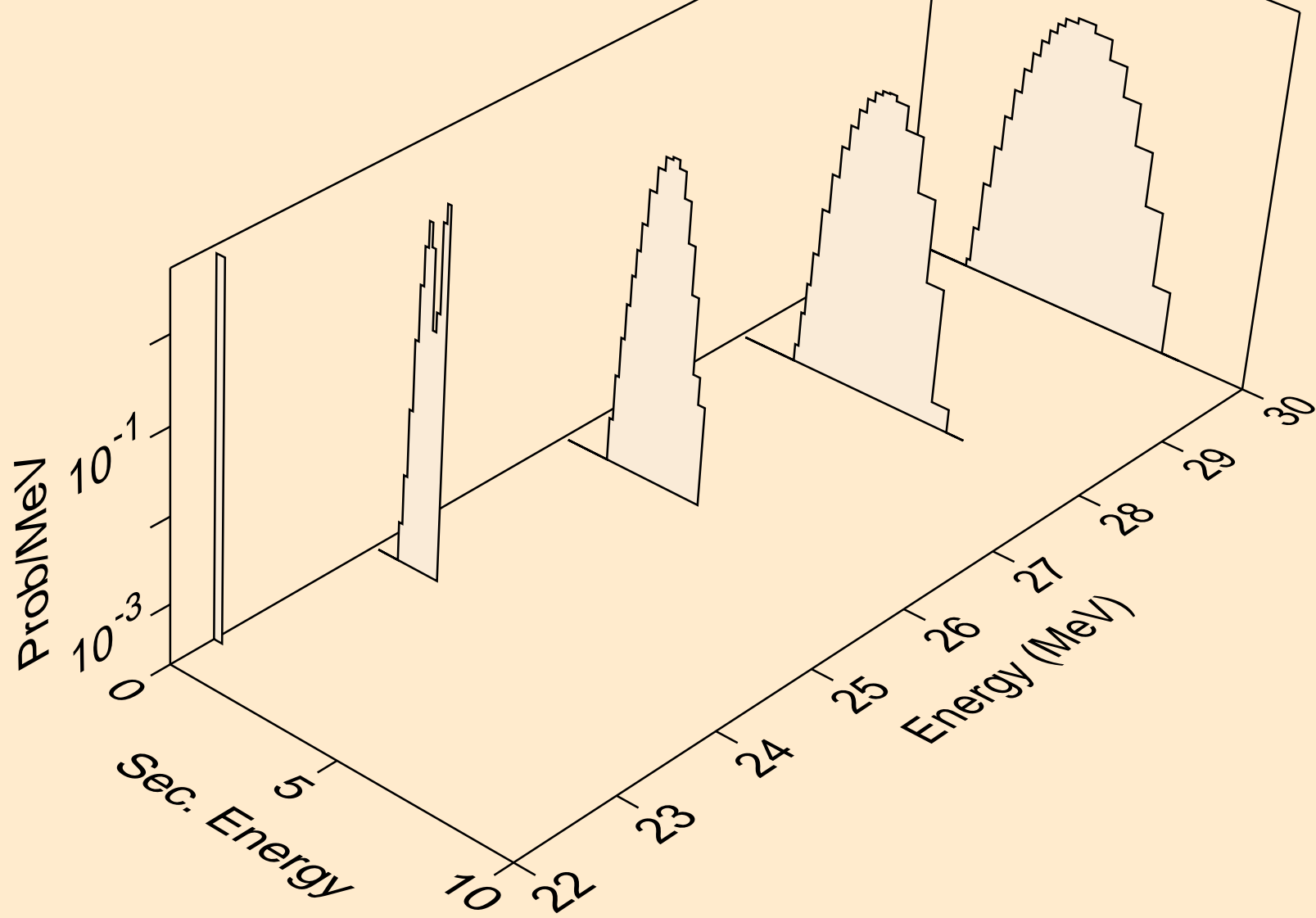

PR134 NEUTRON ACER TENDL-2021 LIBRARY; T=293.6K
protons from (n,2np)

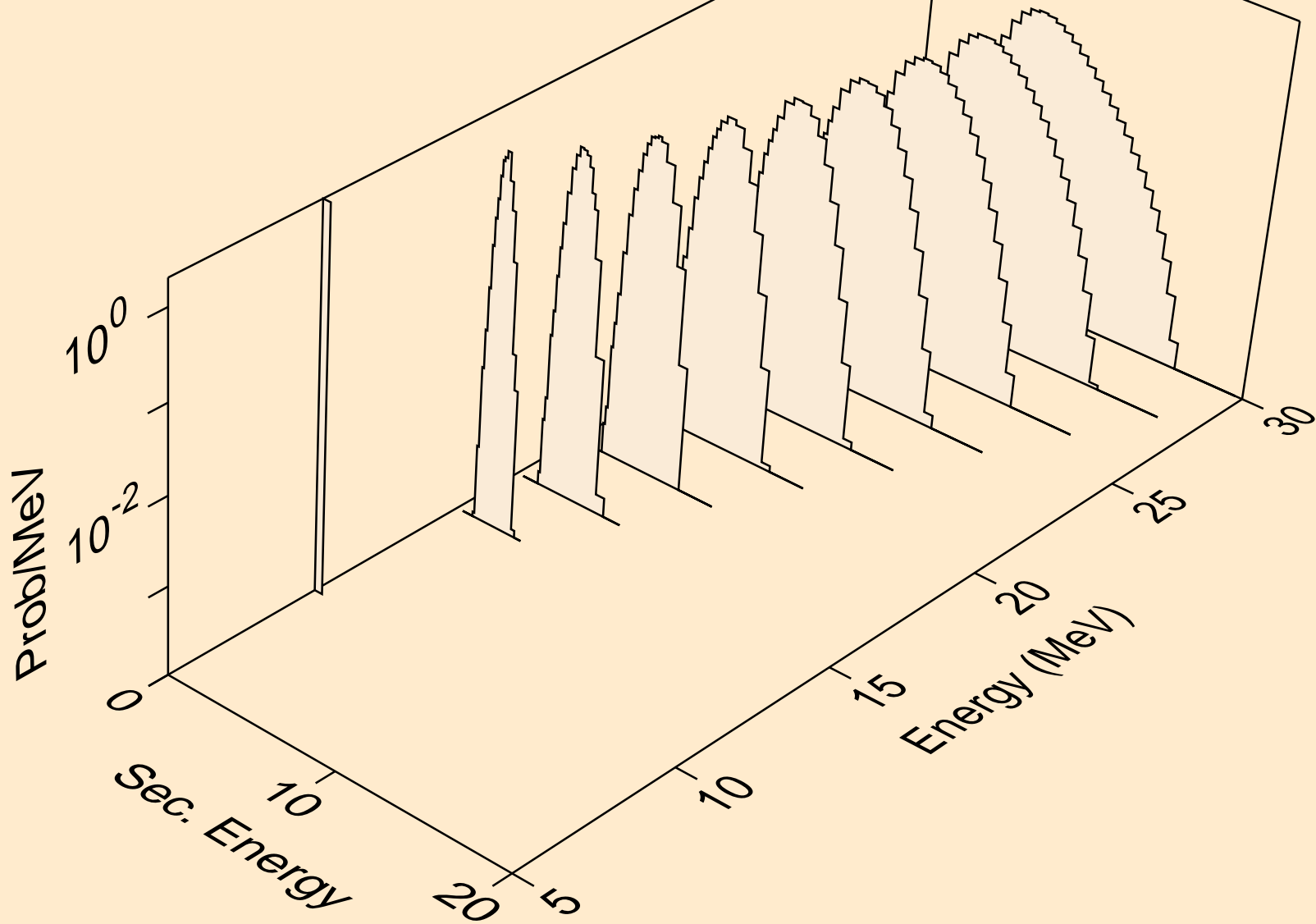

PR134 NEUTRON ACER TENDL-2021 LIBRARY; T=293.6K
protons from (n,npa)

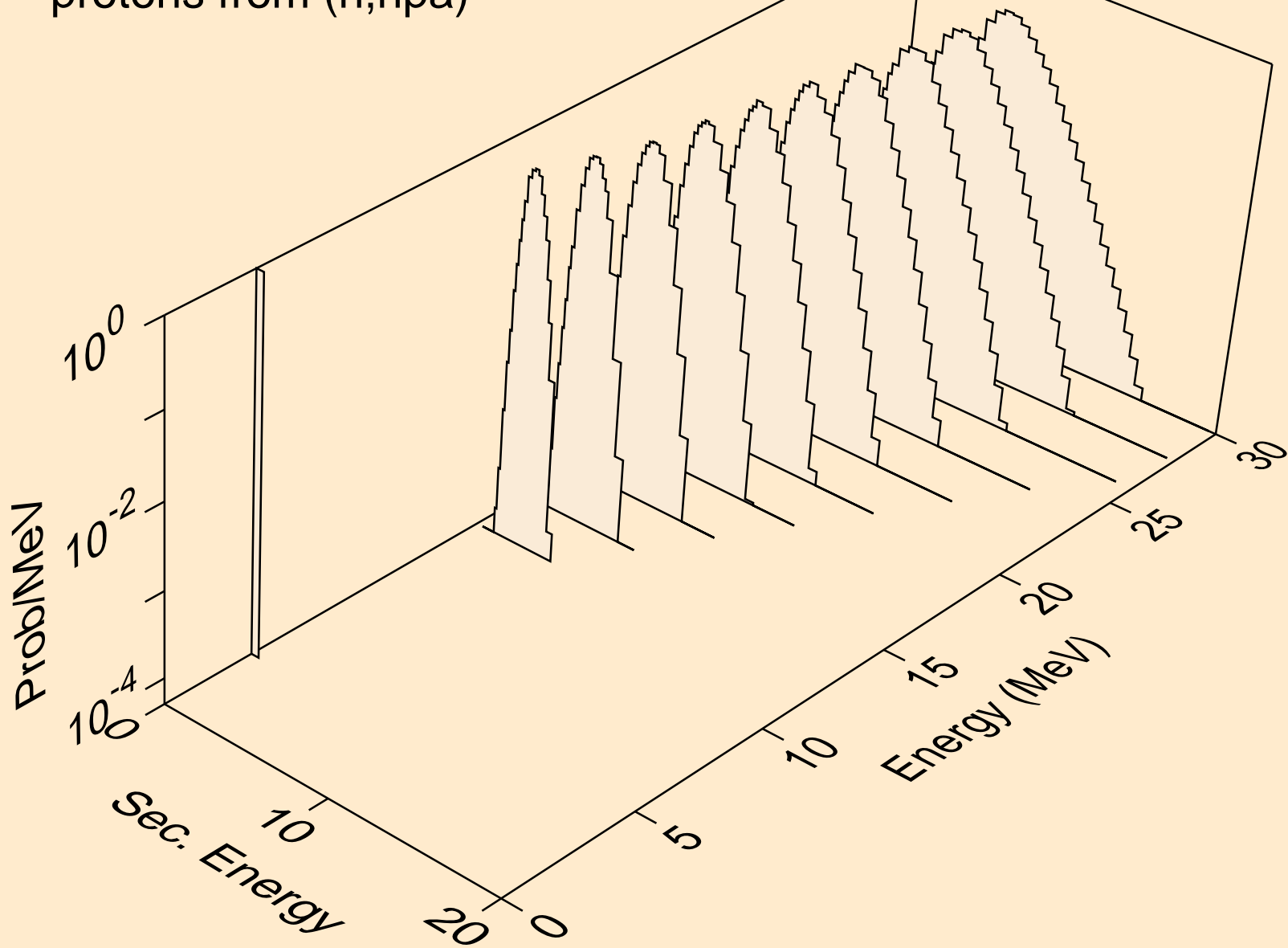

PR134 NEUTRON ACER TENDL-2021 LIBRARY; T=293.6K
protons from (n,p)

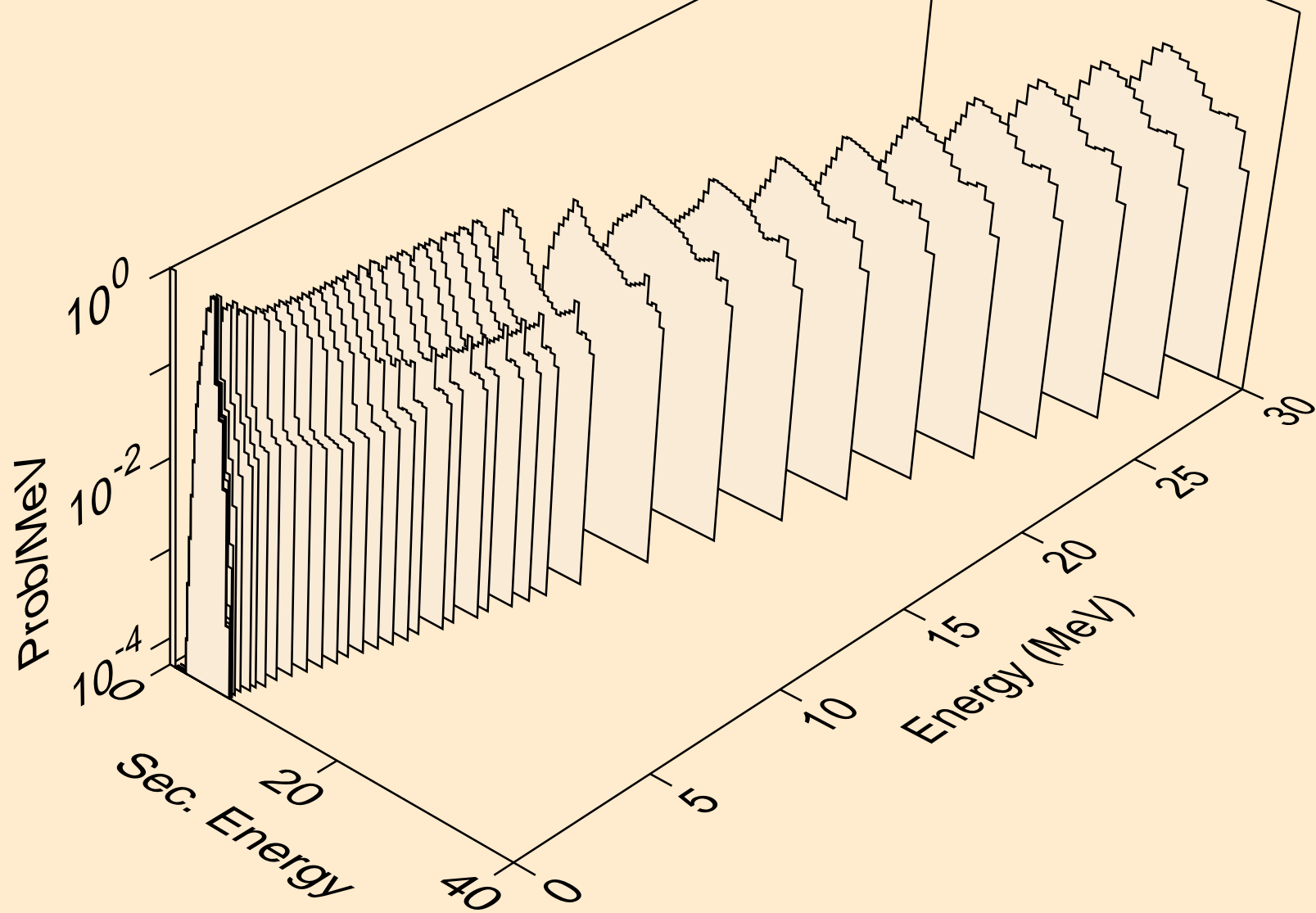

PR134 NEUTRON ACER TENDL-2021 LIBRARY; T=293.6K
protons from (n,2p)

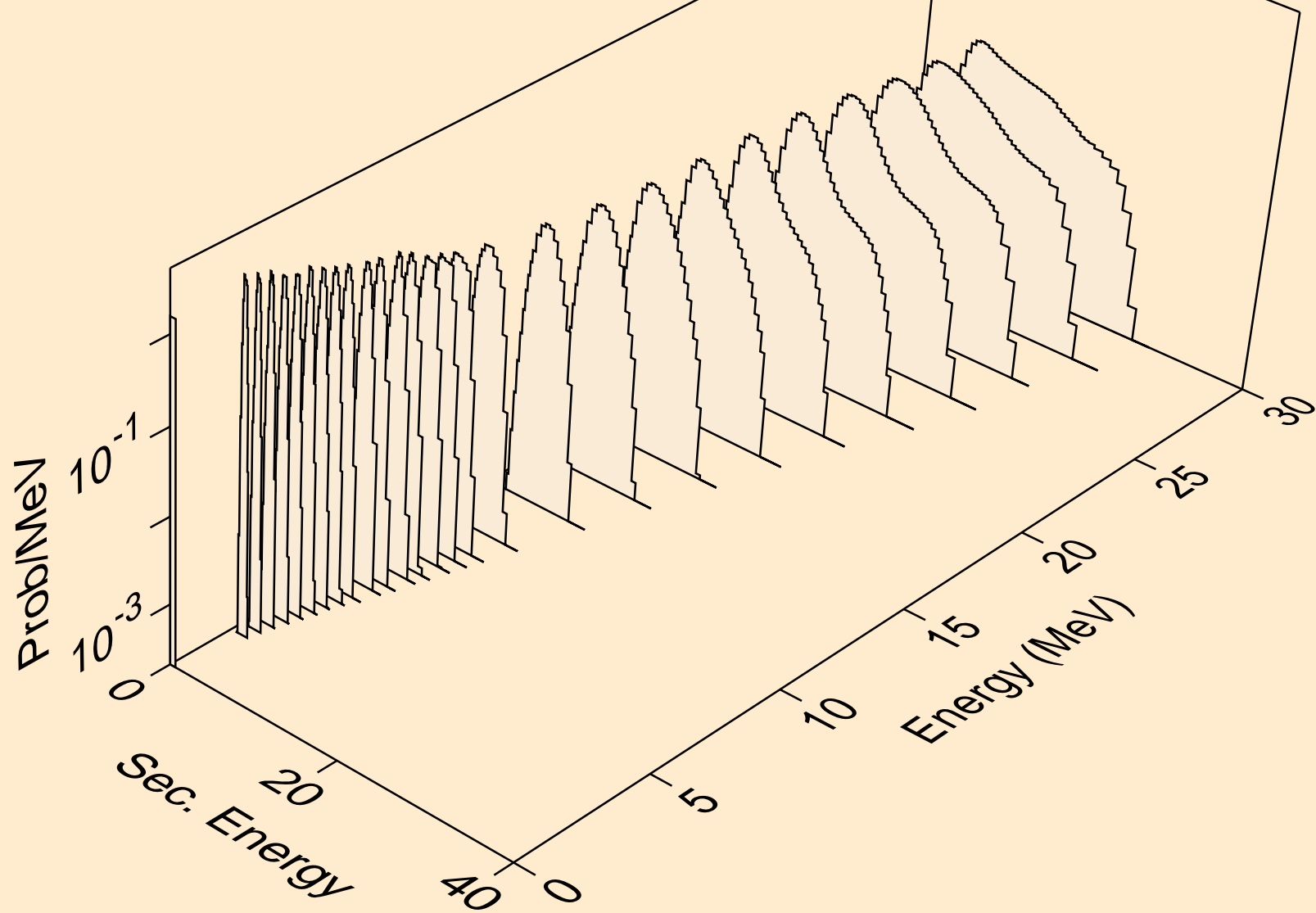

PR134 NEUTRON ACER TENDL-2021 LIBRARY; T=293.6K
protons from (n,p)

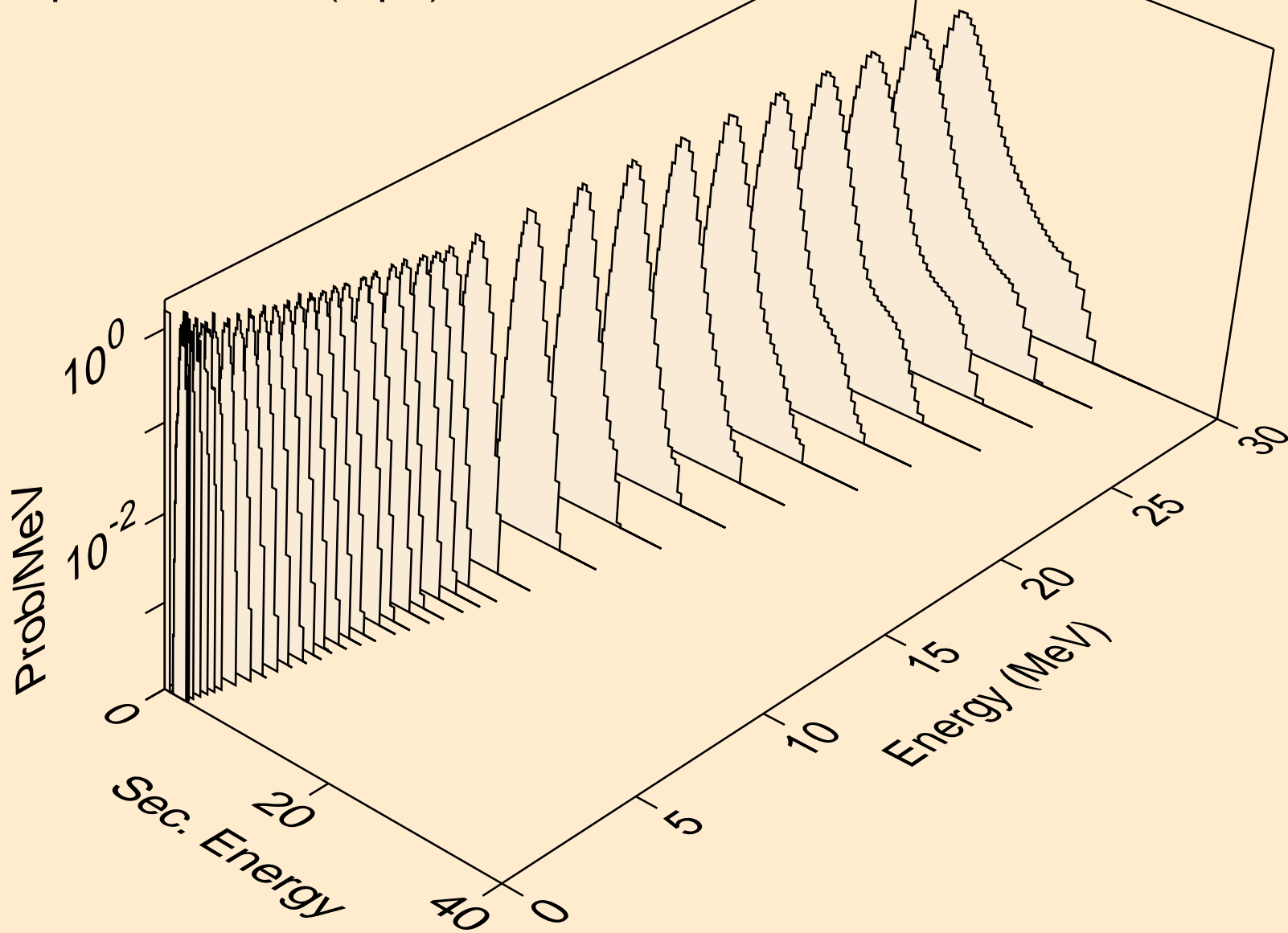

PR134 NEUTRON ACER TENDL-2021 LIBRARY; T=293.6K
protons from (n,pd)

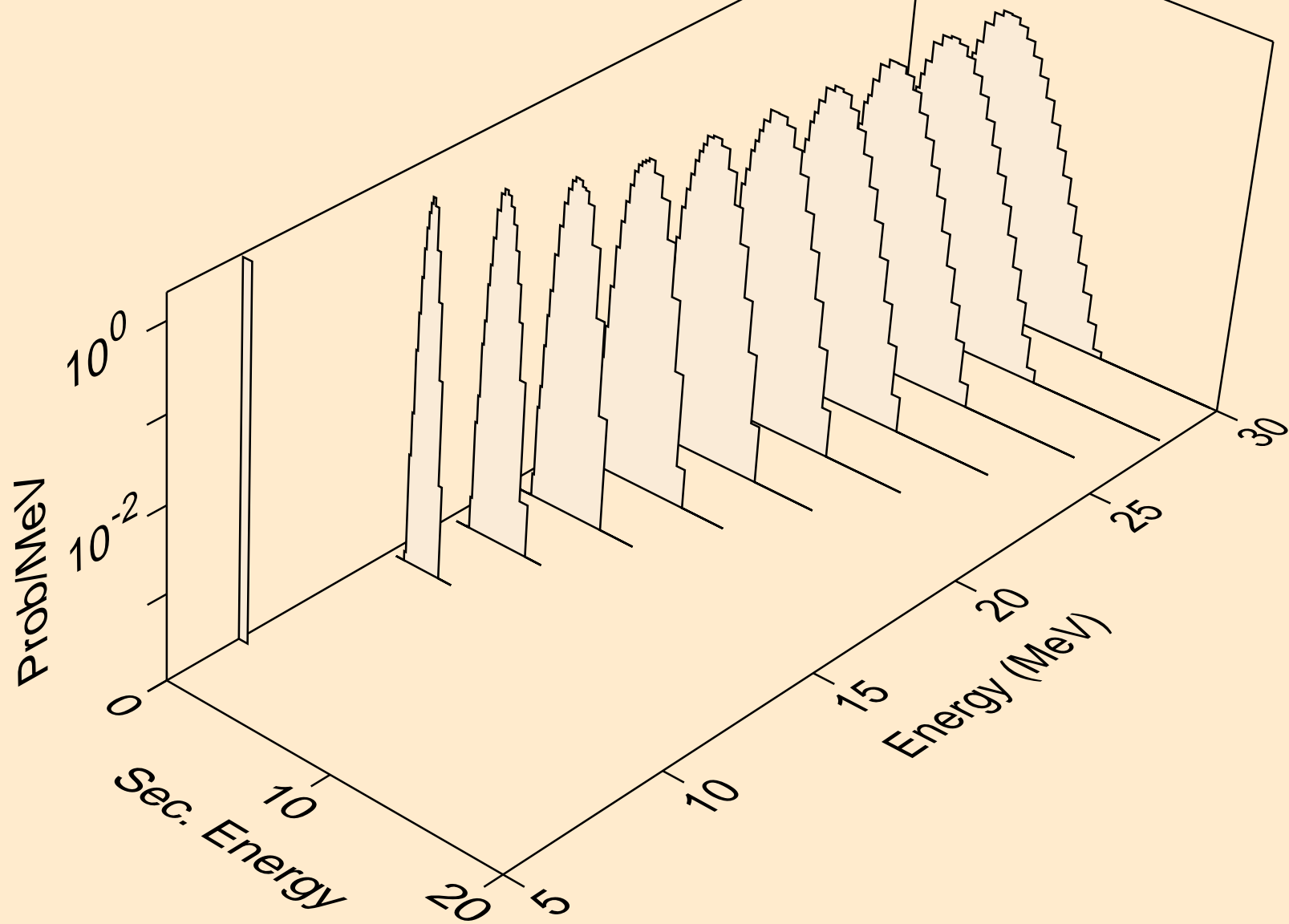

PR134 NEUTRON ACER TENDL-2021 LIBRARY; T=293.6K
protons from (n,pt)

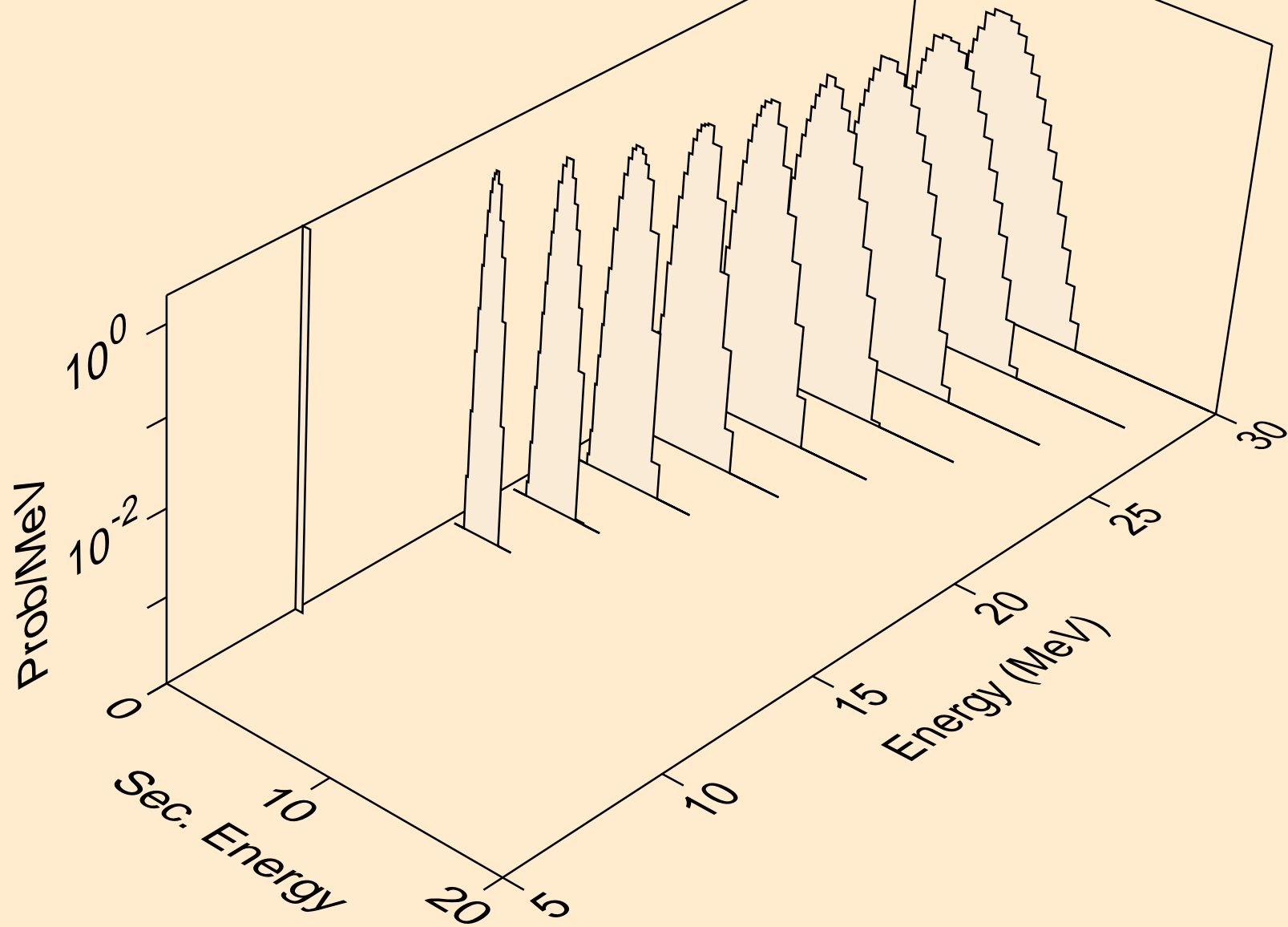

PR134 NEUTRON ACER TENDL-2021 LIBRARY; T=293.6K
deuterons from (n,x)

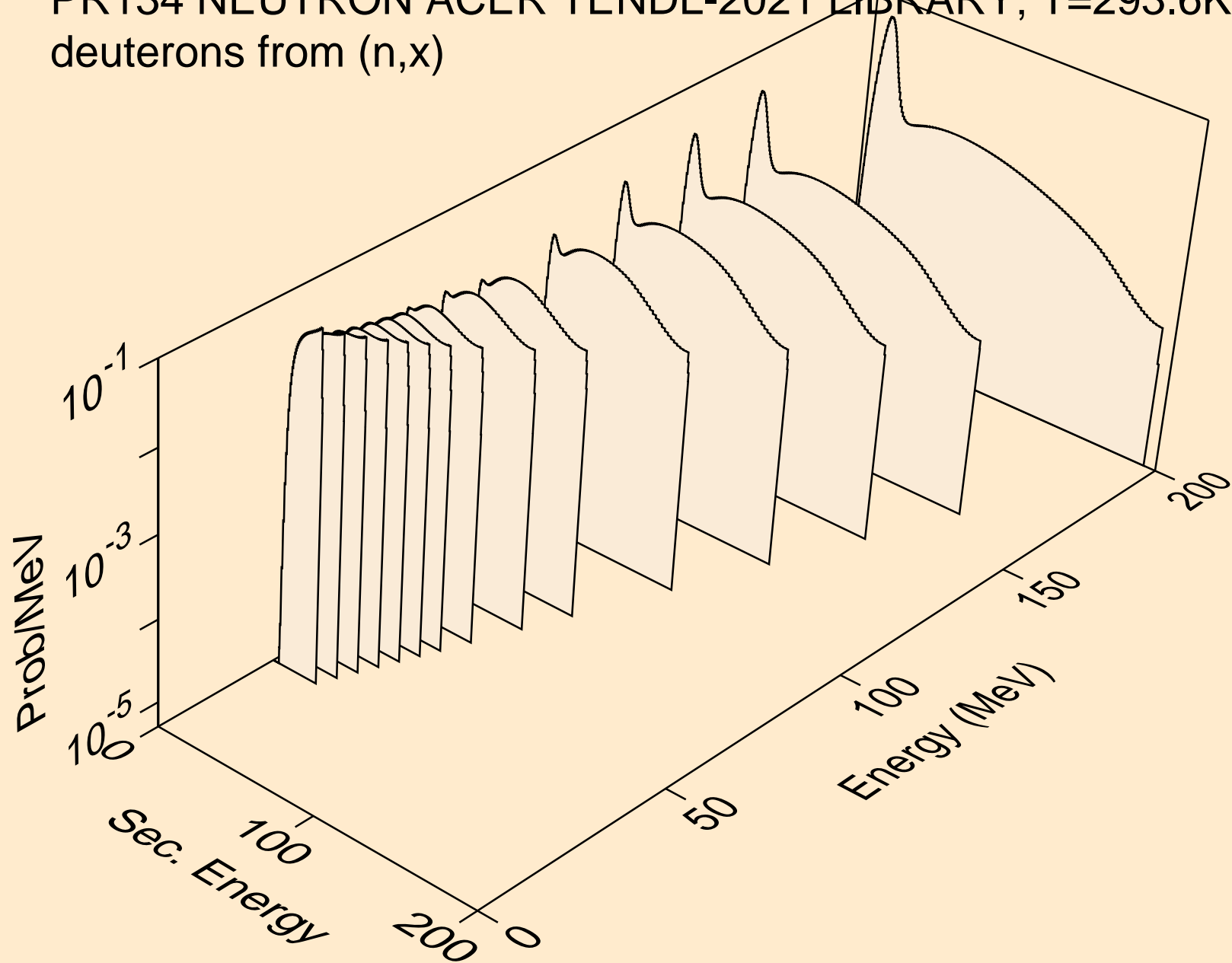

PR134 NEUTRON ACER TENDL-2021 LIBRARY; T=293.6K
deuterons from (n,2nd)

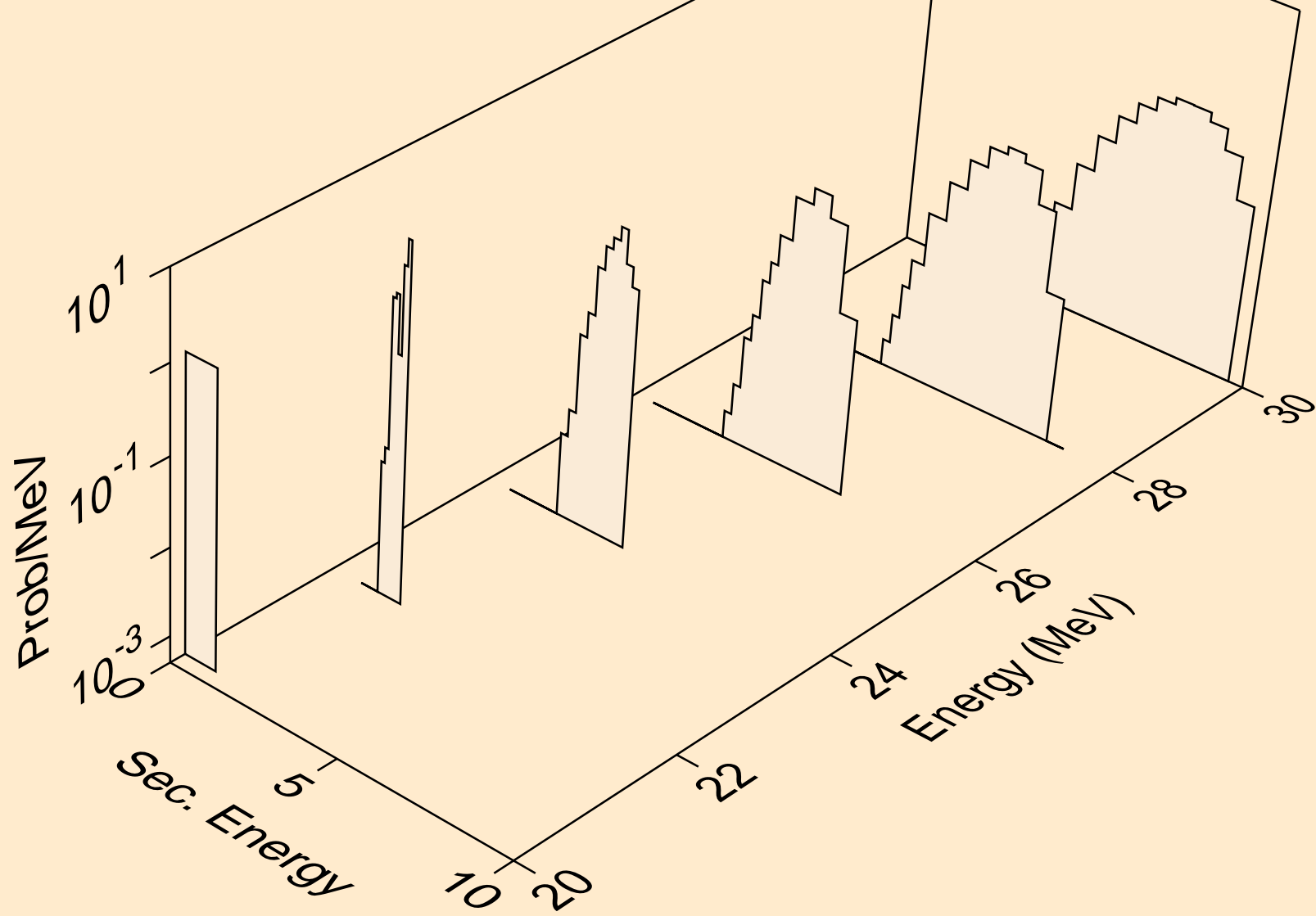

PR134 NEUTRON ACER TENDL-2021 LIBRARY; T=293.6K
deuterons from (n,n*)d

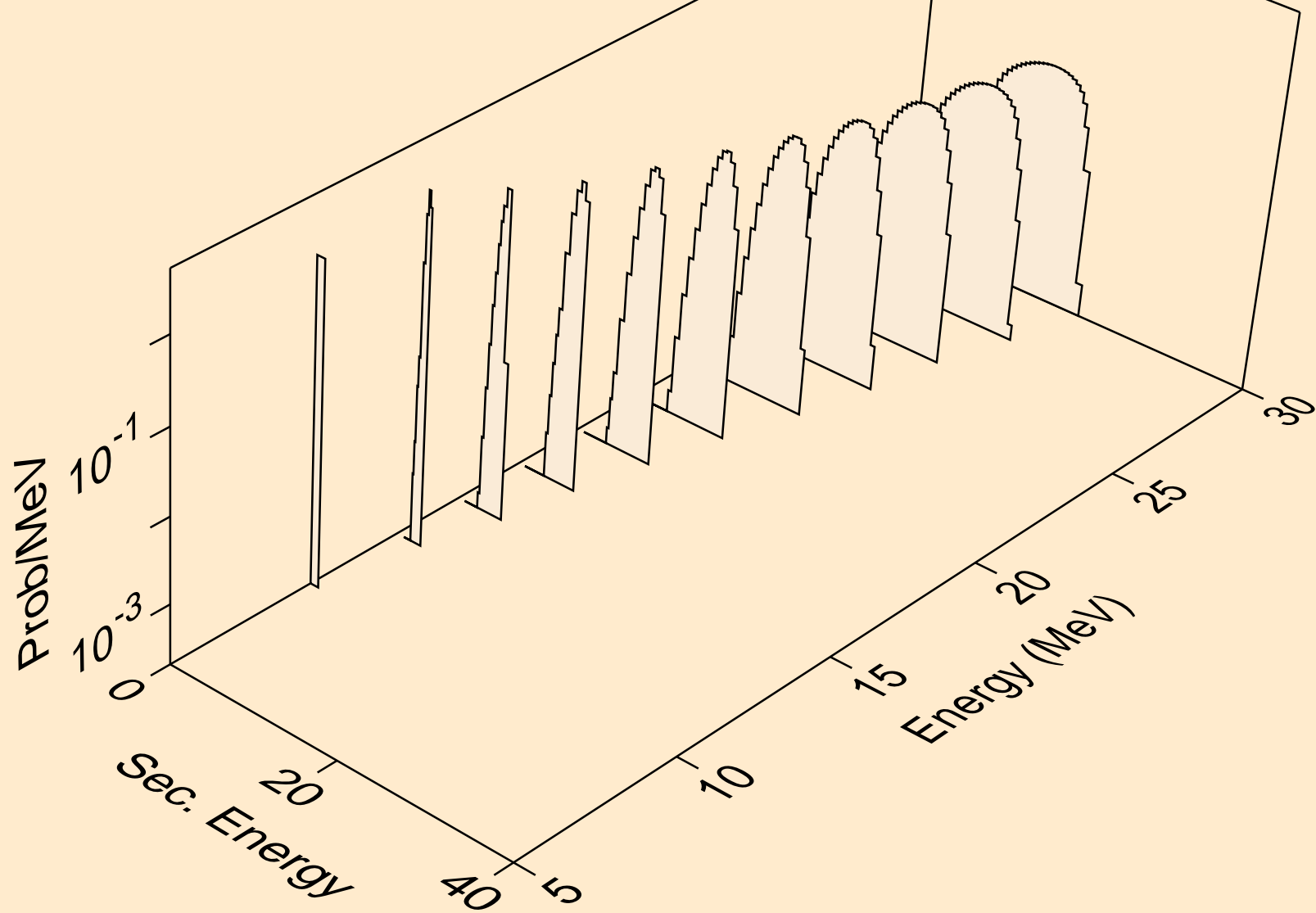

PR134 NEUTRON ACER TENDL-2021 LIBRARY; T=293.6K
deuterons from (n,d)

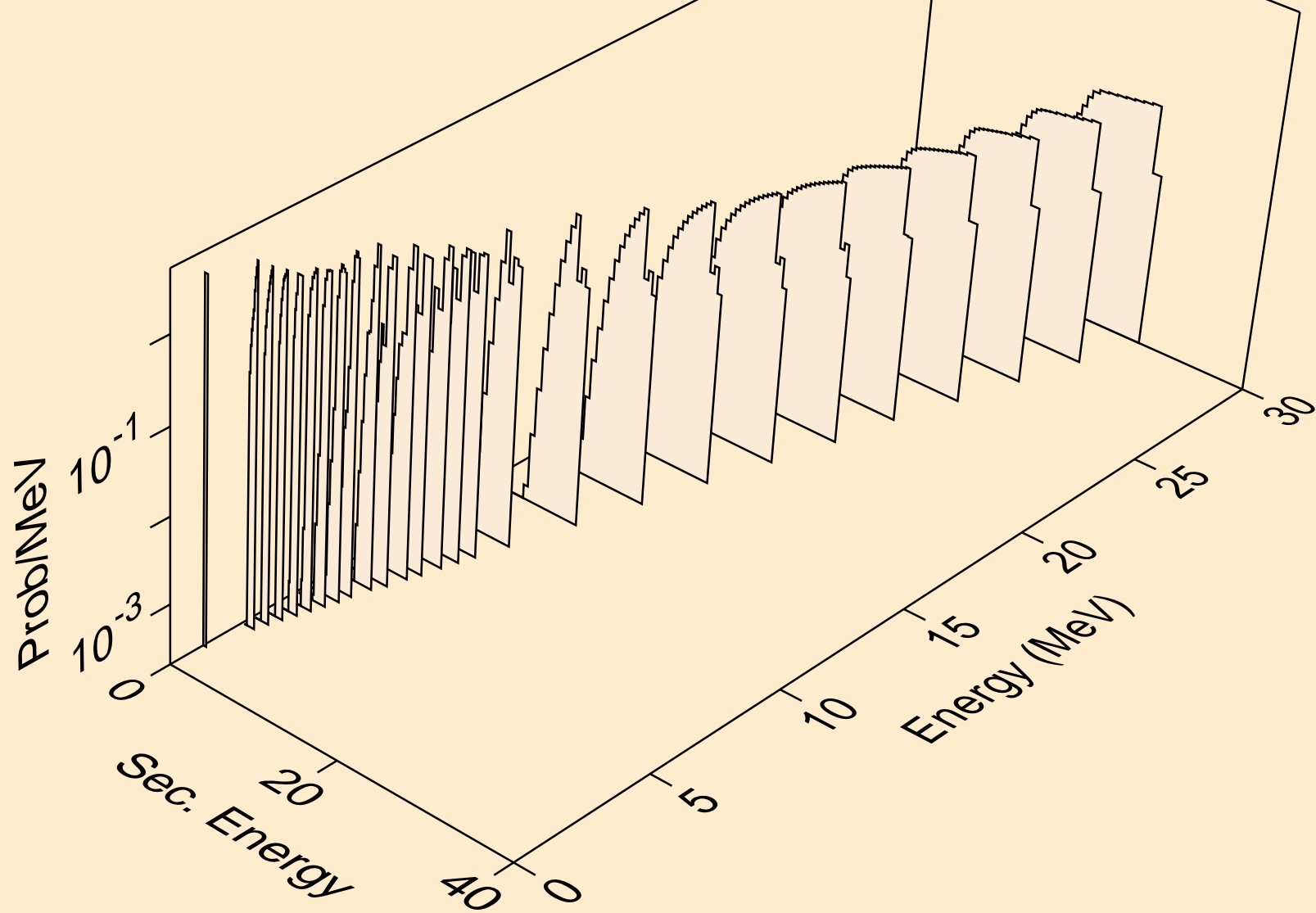

PR134 NEUTRON ACER TENDL-2021 LIBRARY; T=293.6K
deuterons from (n,pd)

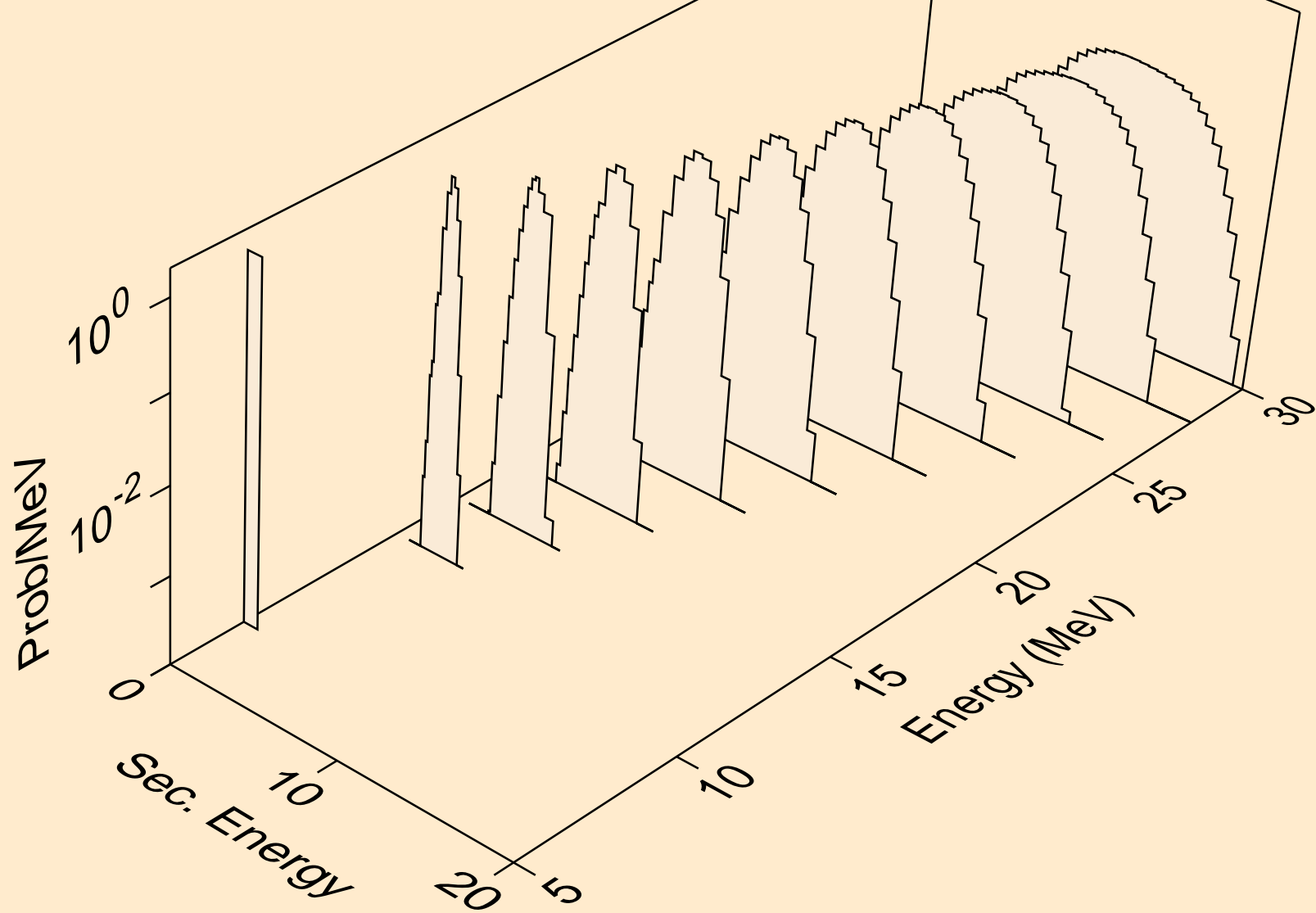

PR134 NEUTRON ACER TENDL-2021 LIBRARY; T=293.6K
deuterons from (n,da)

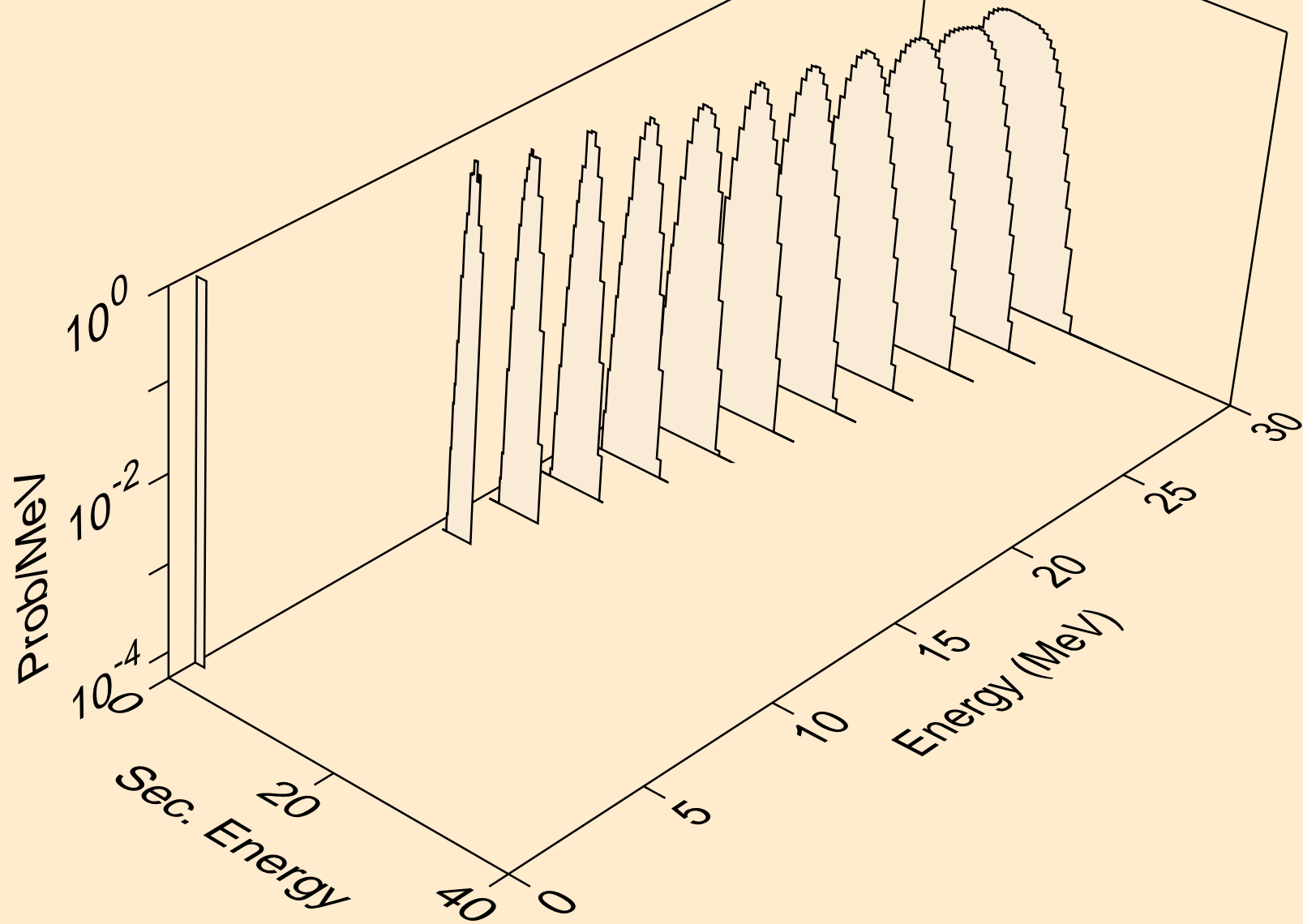

PR134 NEUTRON ACER TENDL-2021 LIBRARY; T=293.6K
tritons from (n,x)

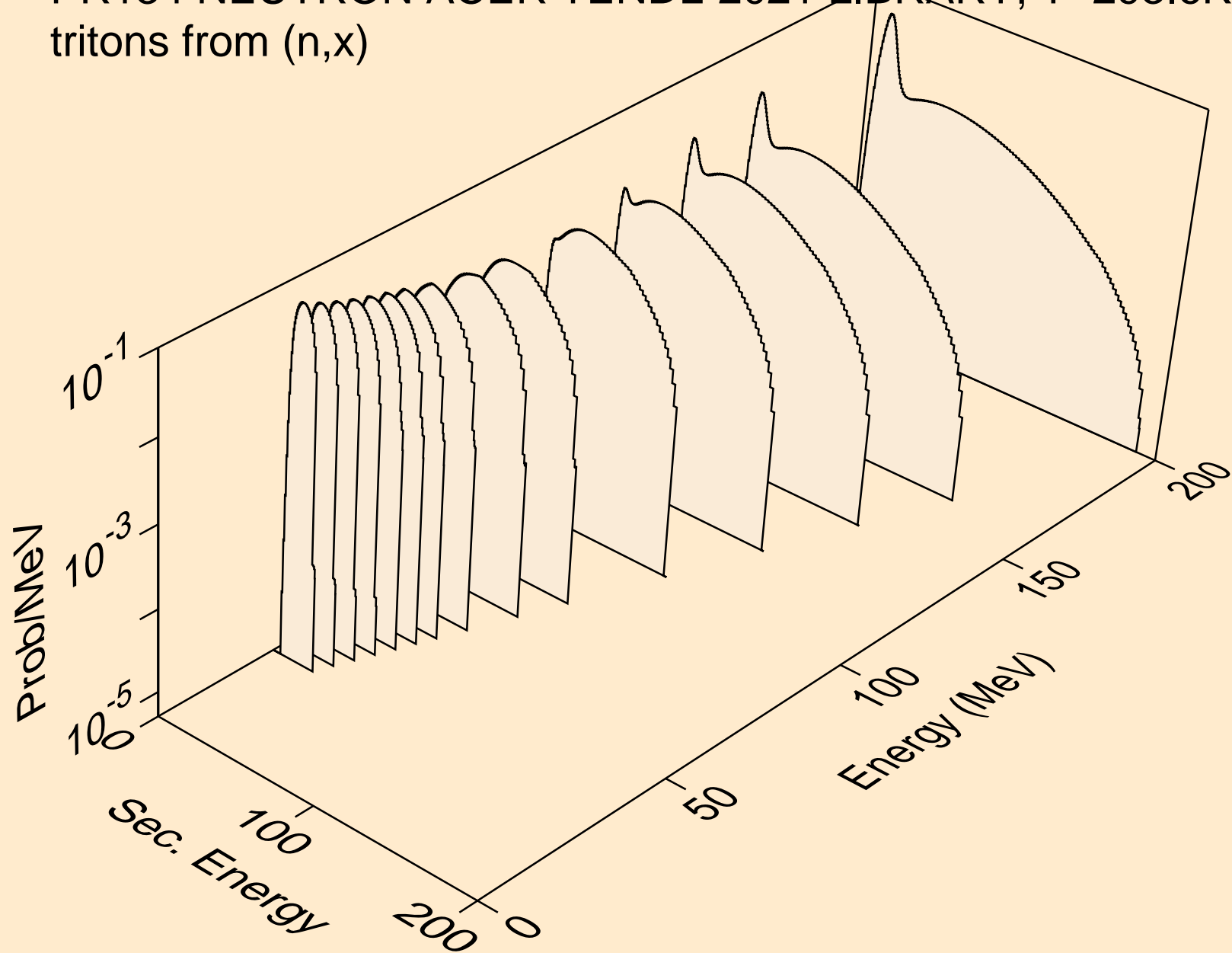

PR134 NEUTRON ACER TENDL-2021 LIBRARY; T=293.6K
tritons from (n,n*)t

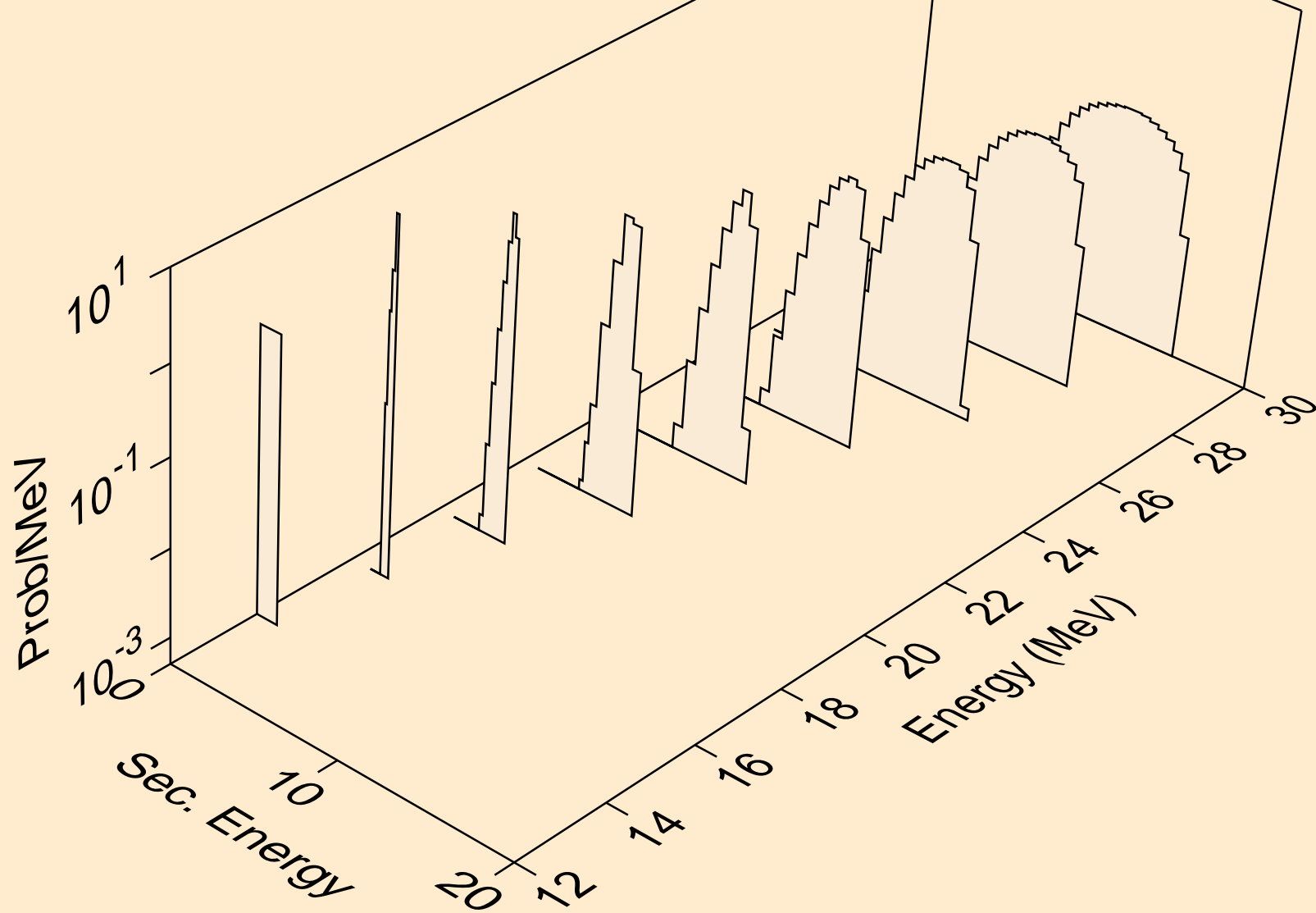

PR134 NEUTRON ACER TENDL-2021 LIBRARY; T=293.6K
tritons from (n,t)

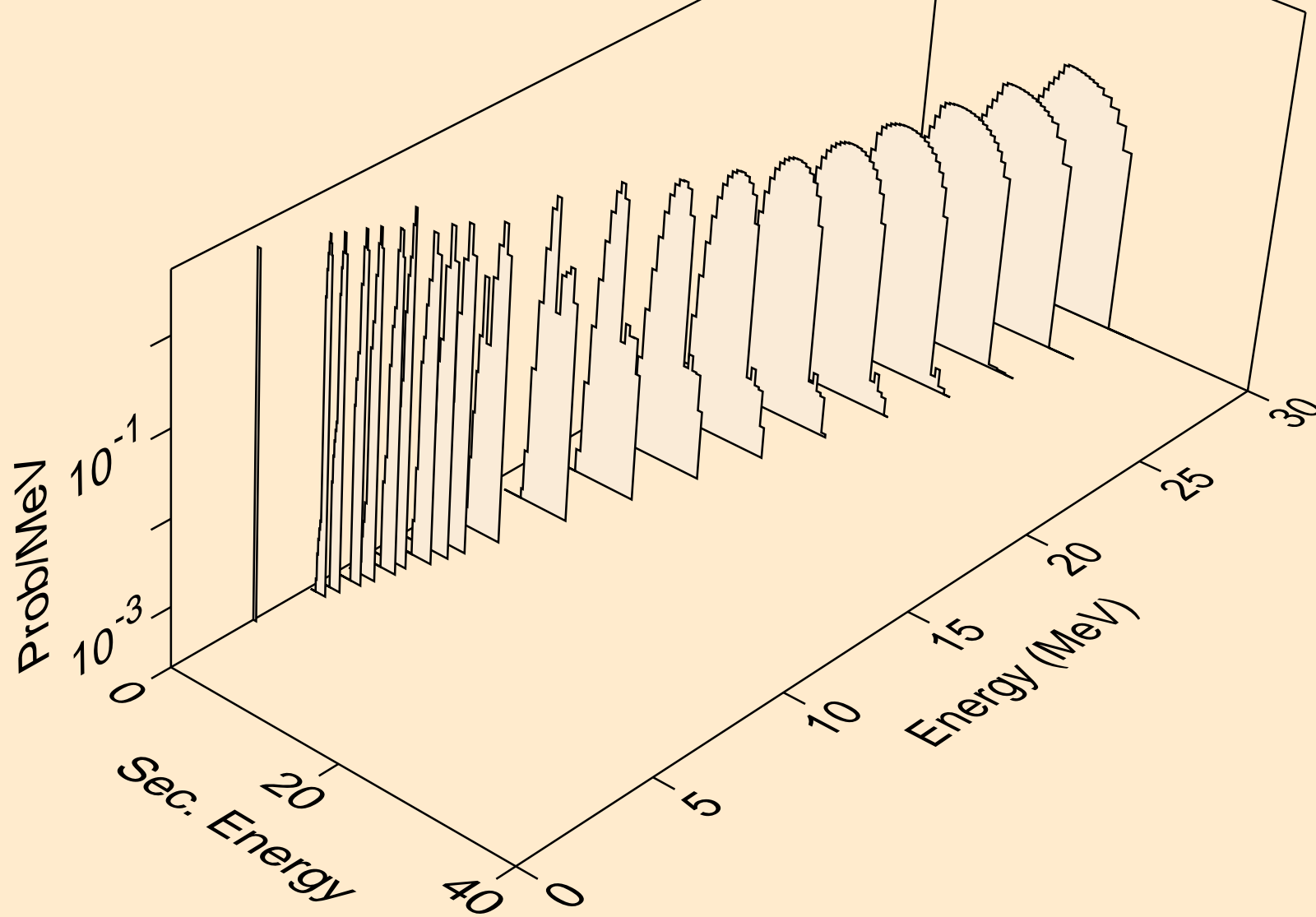

PR134 NEUTRON ACER TENDL-2021 LIBRARY; T=293.6K
tritons from (n,pt)

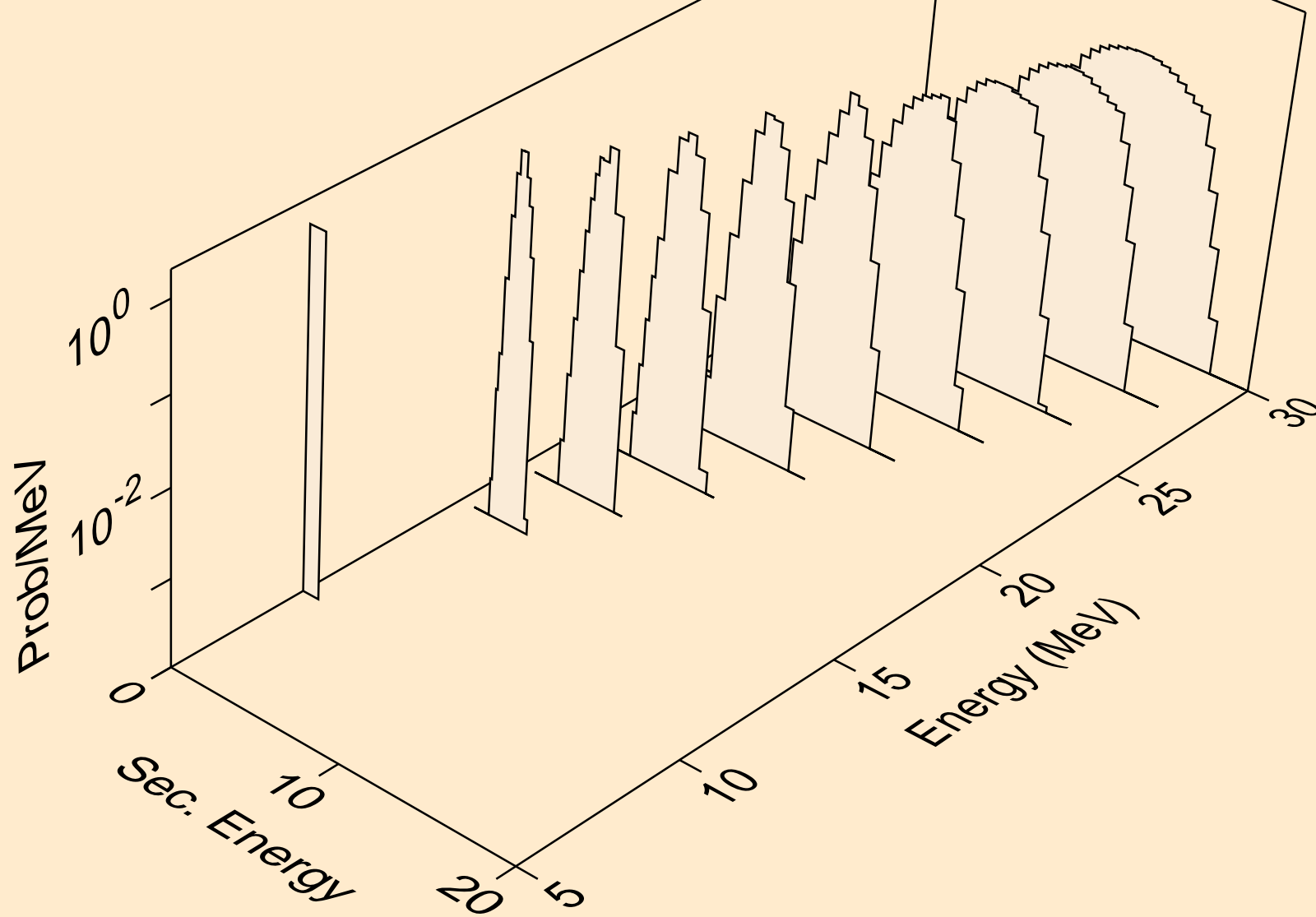

PR134 NEUTRON ACER TENDL-2021 LIBRARY; T=293.6K
he3s from (n,x)

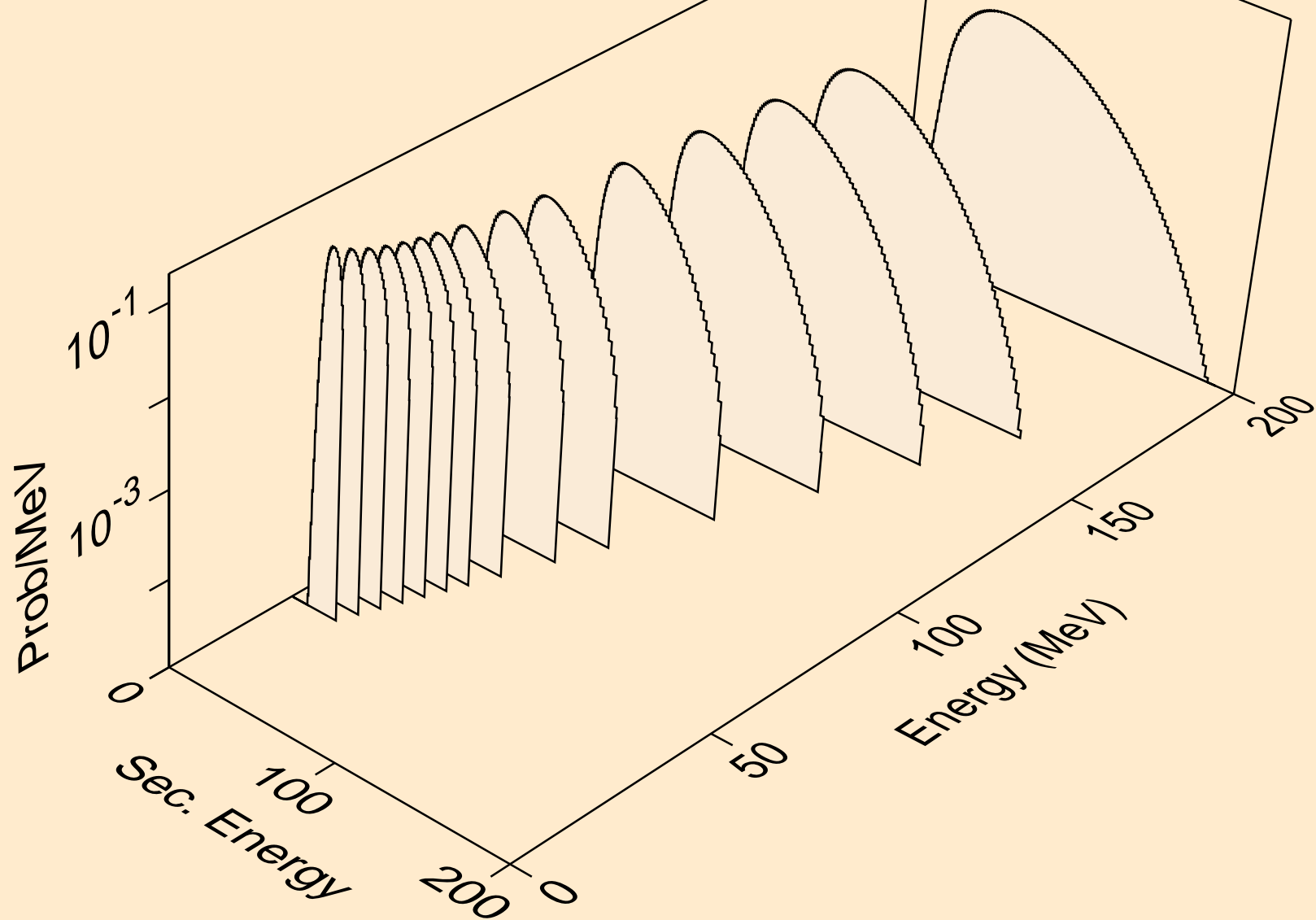

PR134 NEUTRON ACER TENDL-2021 LIBRARY; T=293.6K
he3s from (n,n*)he3

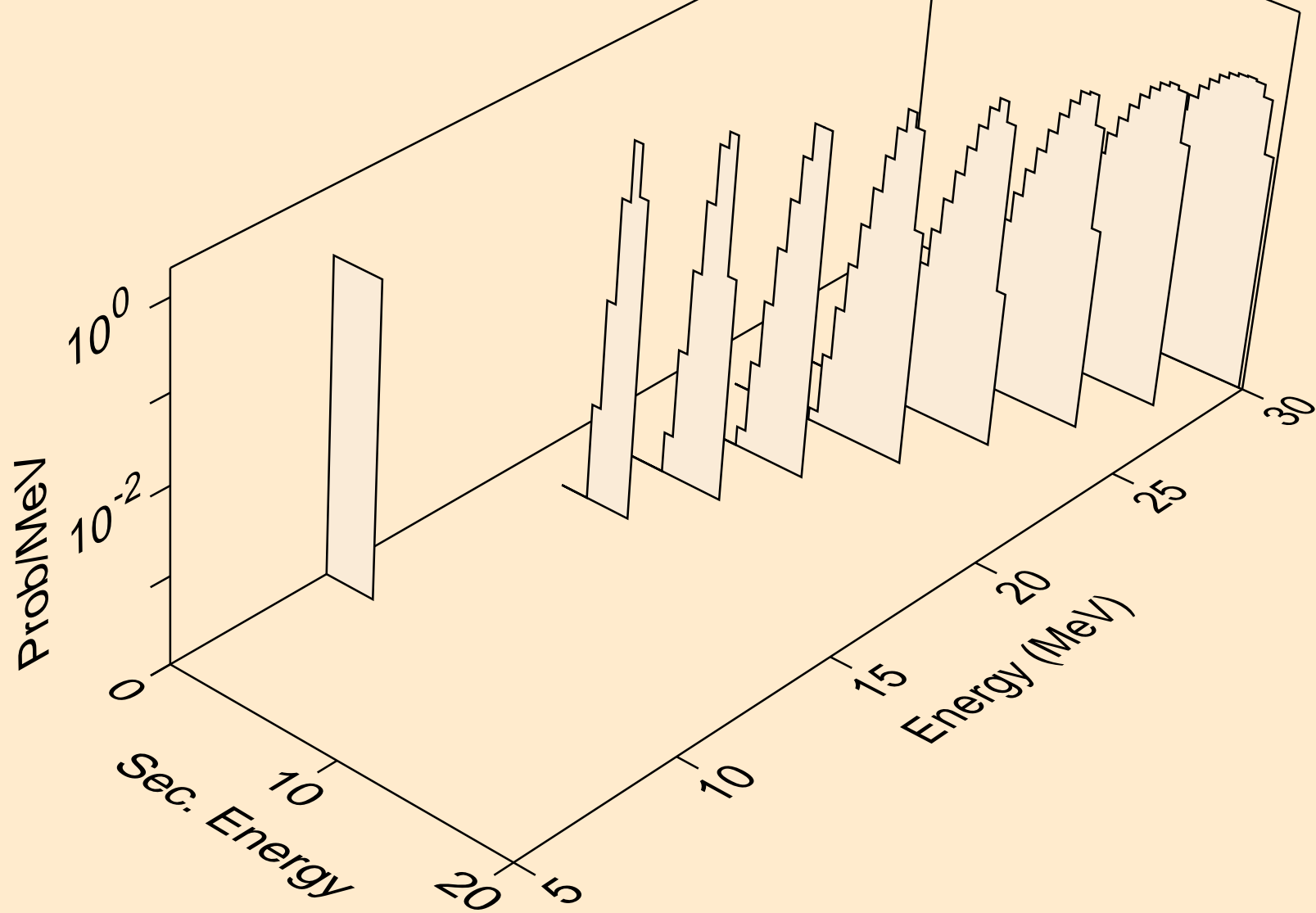

PR134 NEUTRON ACER TENDL-2021 LIBRARY; T=293.6K
he3s from (n,he3)

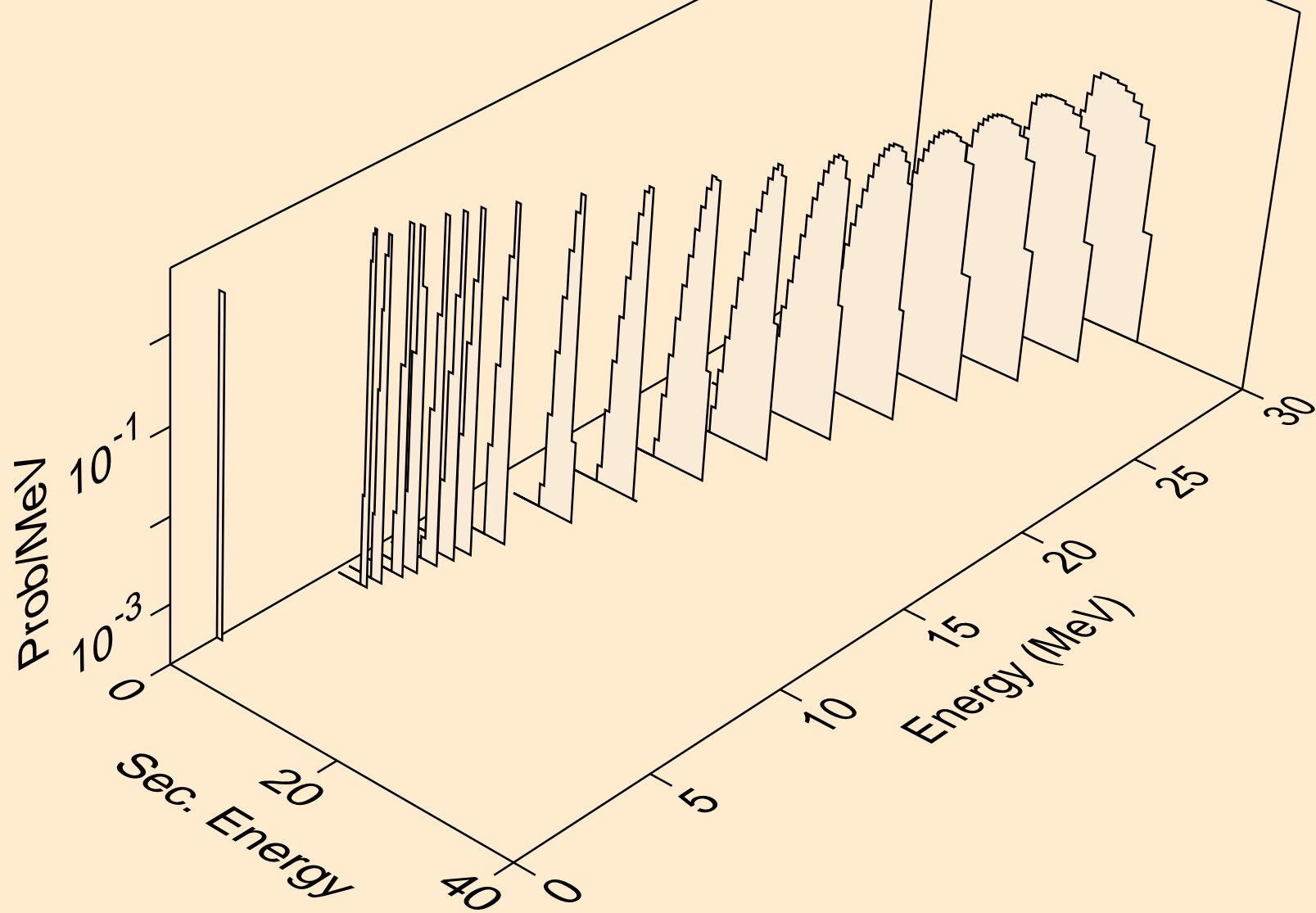

PR134 NEUTRON ACER TENDL-2021 LIBRARY; T=293.6K
alphas from (n,x)

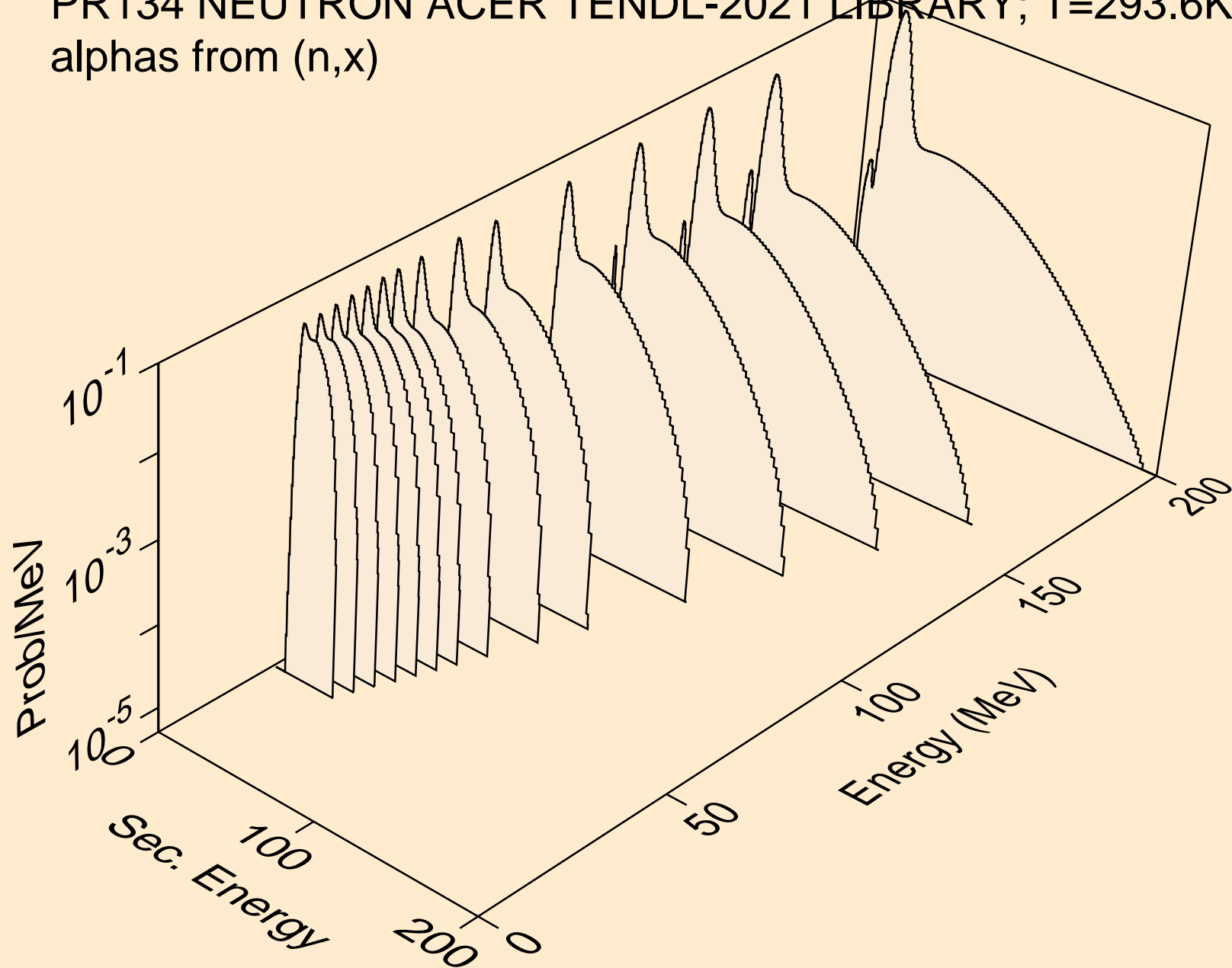

PR134 NEUTRON ACER TENDL-2021 LIBRARY; T=293.6K
alphas from (n,n*)a

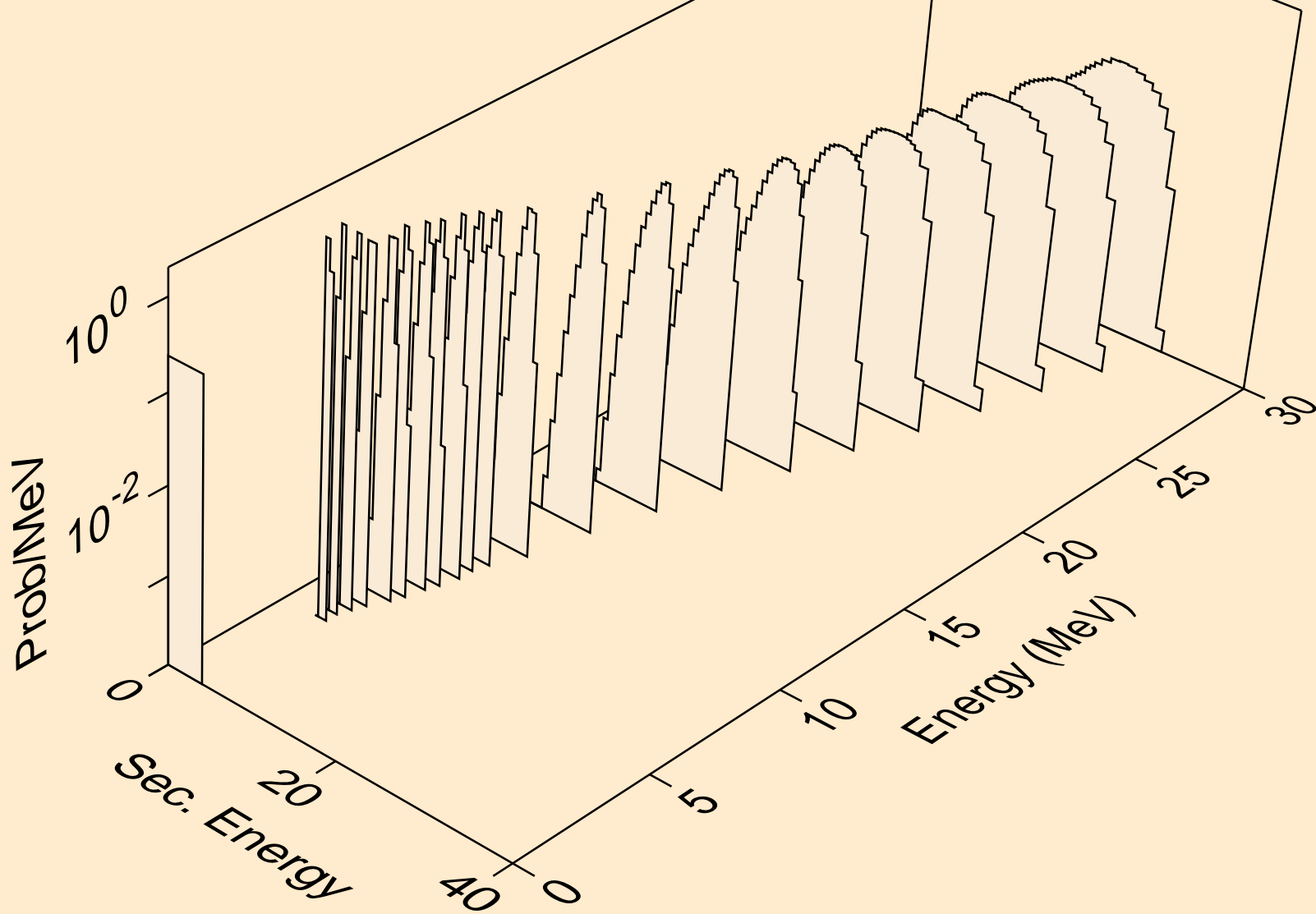

PR134 NEUTRON ACER TENDL-2021 LIBRARY; T=293.6K
alphas from (n,2n)a

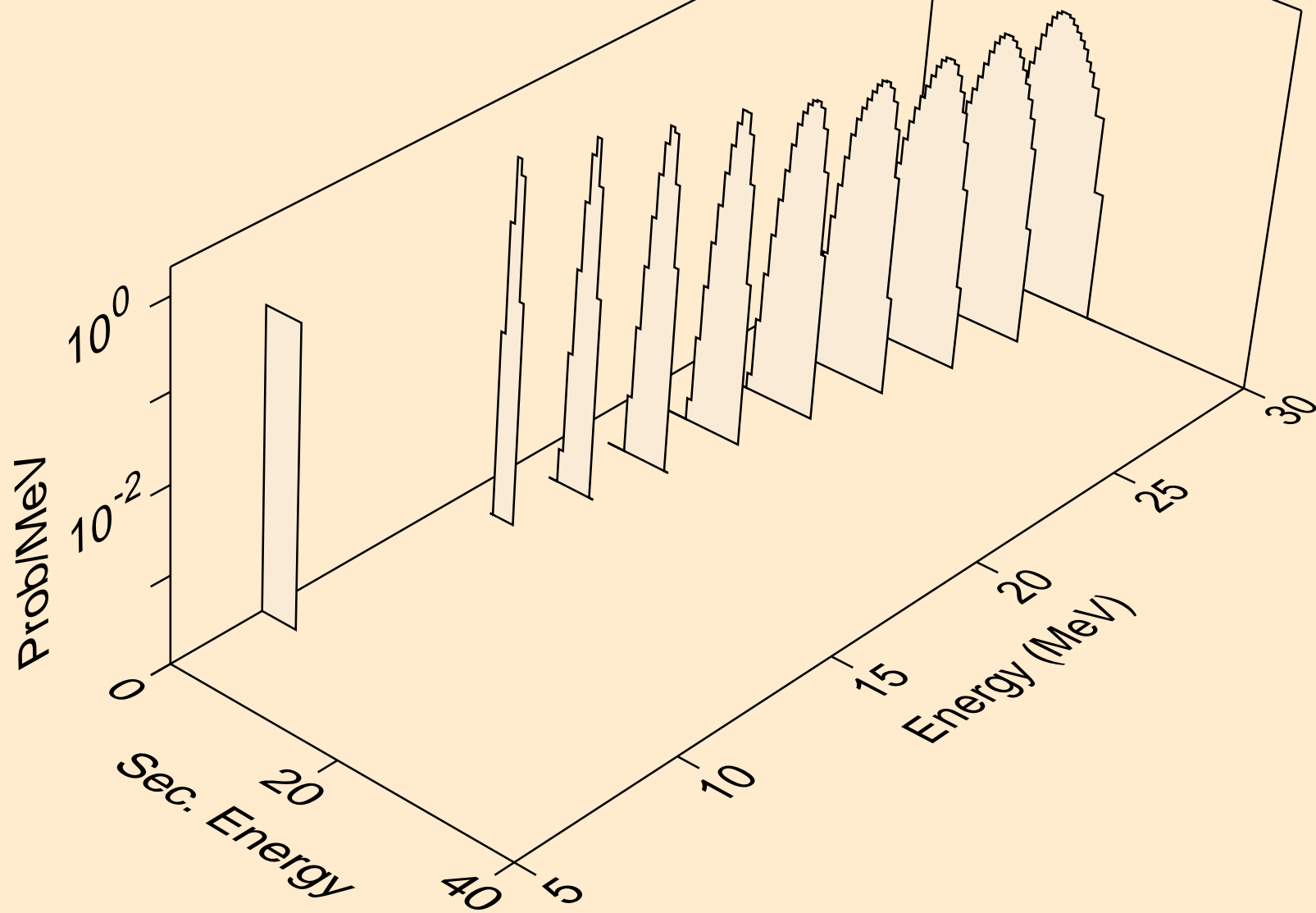

PR134 NEUTRON ACER TENDL-2021 LIBRARY; T=293.6K
alphas from (n,3n)a

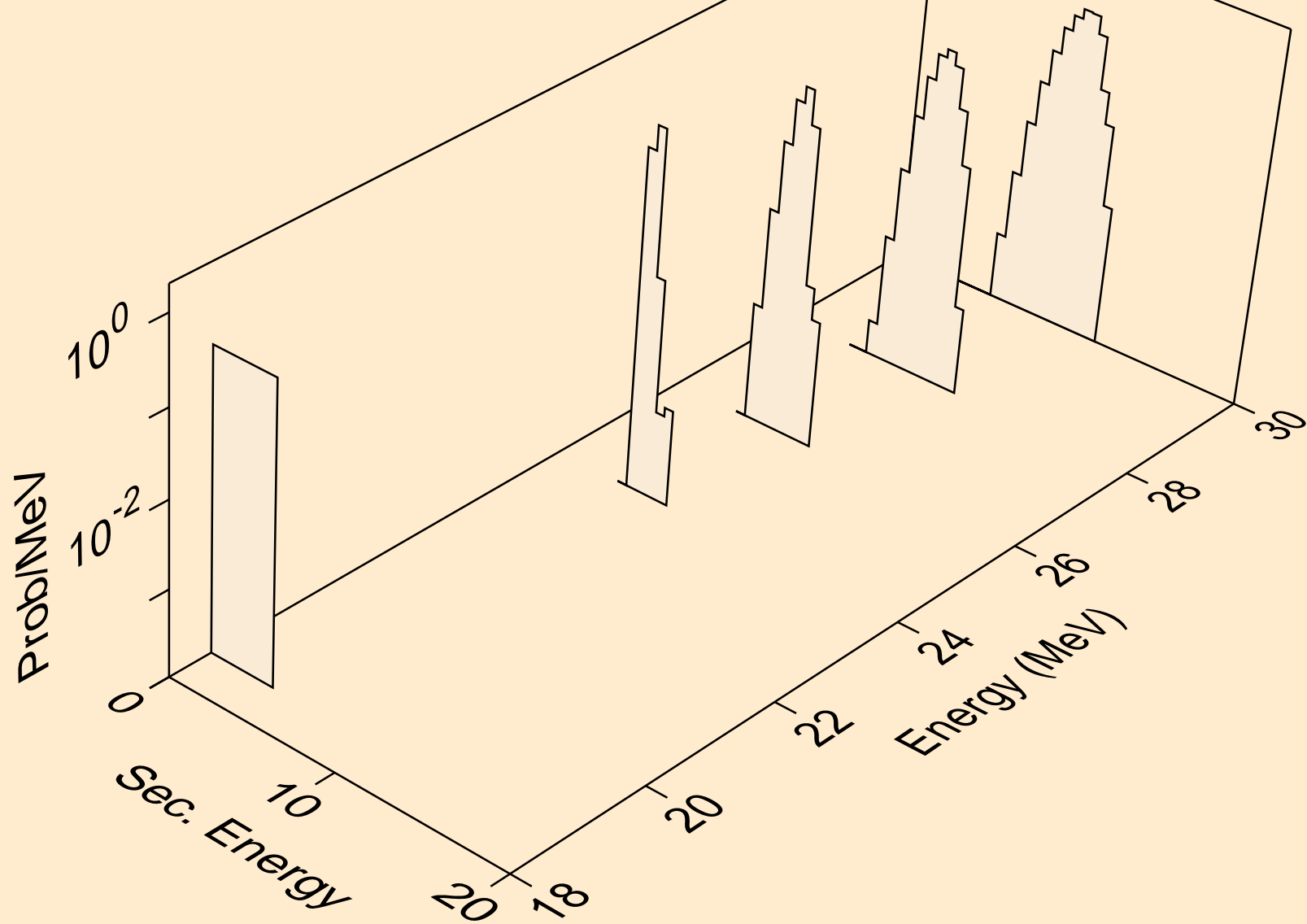

PR134 NEUTRON ACER TENDL-2021 LIBRARY; T=293.6K
alphas from (n,n*)2a

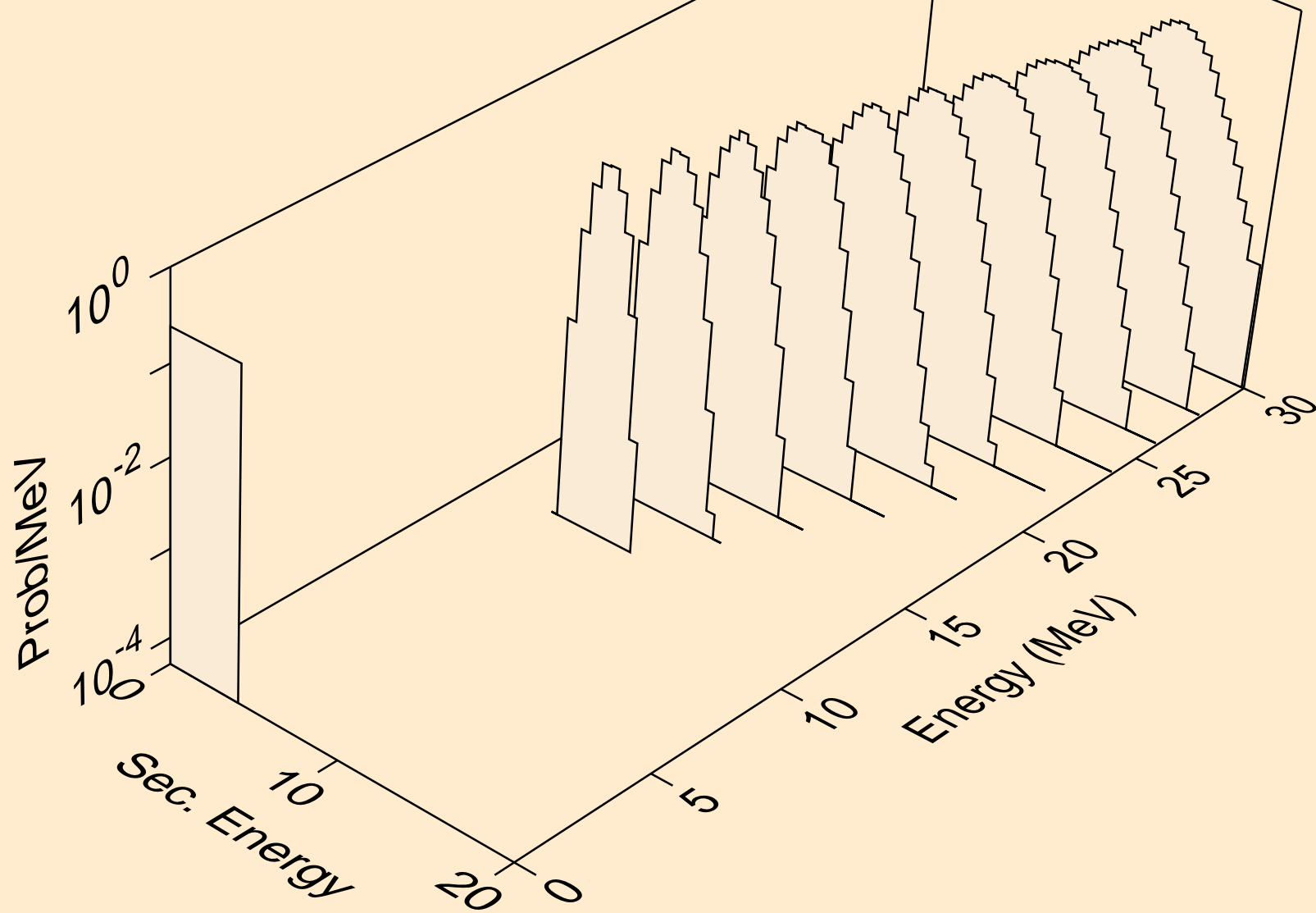

PR134 NEUTRON ACER TENDL-2021 LIBRARY; T=293.6K
alphas from (n,2n)2a

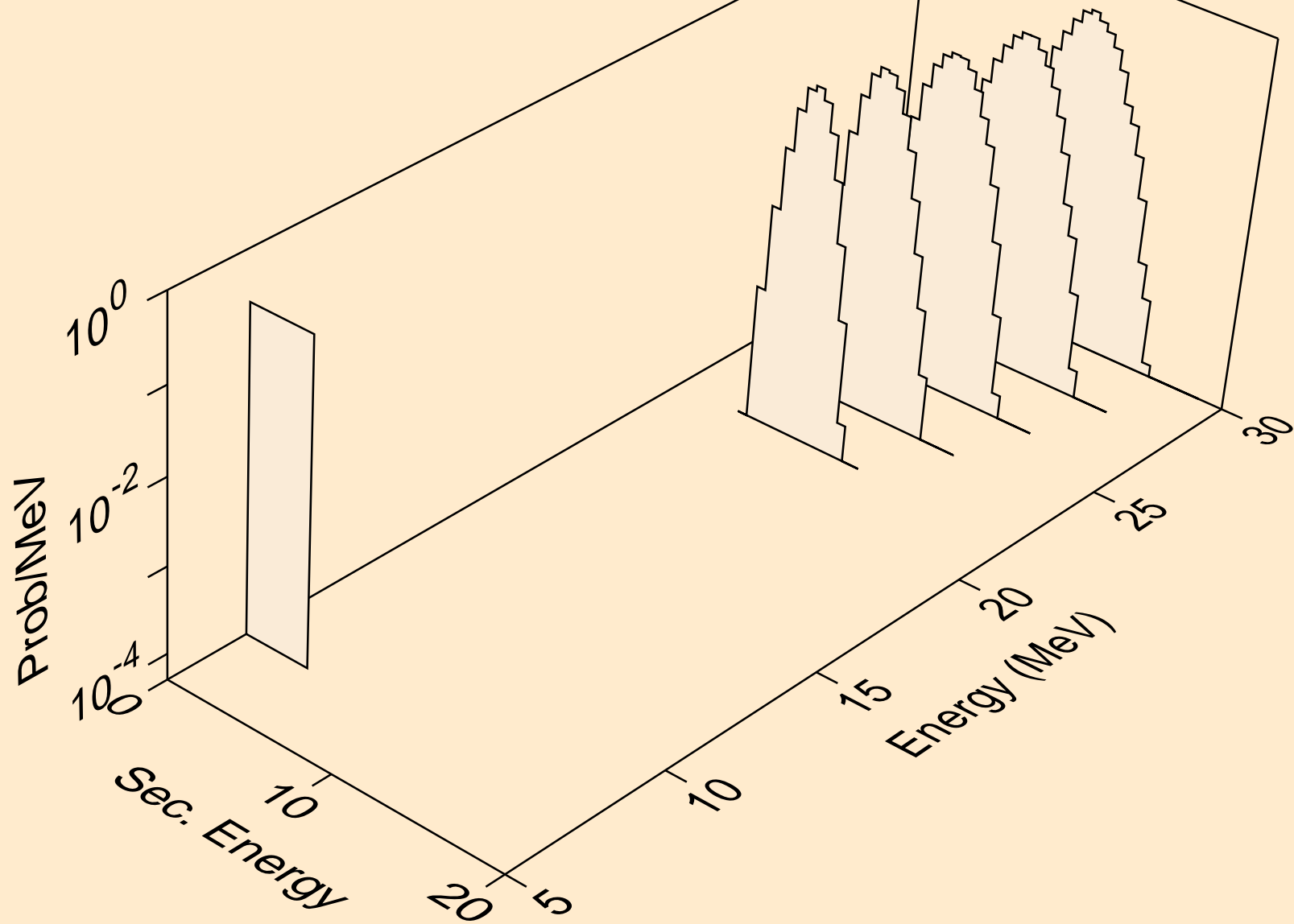

PR134 NEUTRON ACER TENDL-2021 LIBRARY; T=293.6K
alphas from (n,npa)

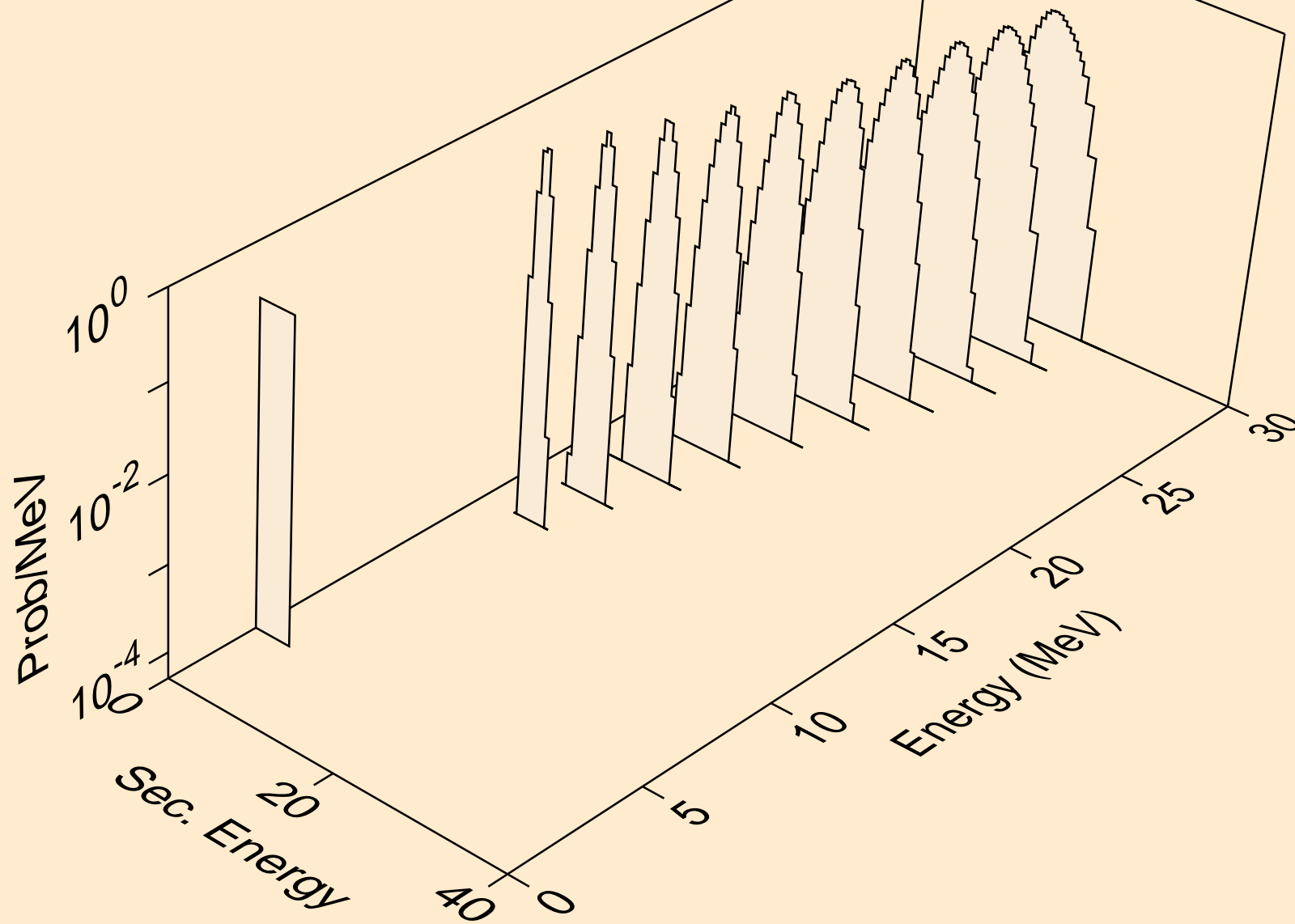

PR134 NEUTRON ACER TENDL-2021 LIBRARY; T=293.6K
alphas from (n,a)

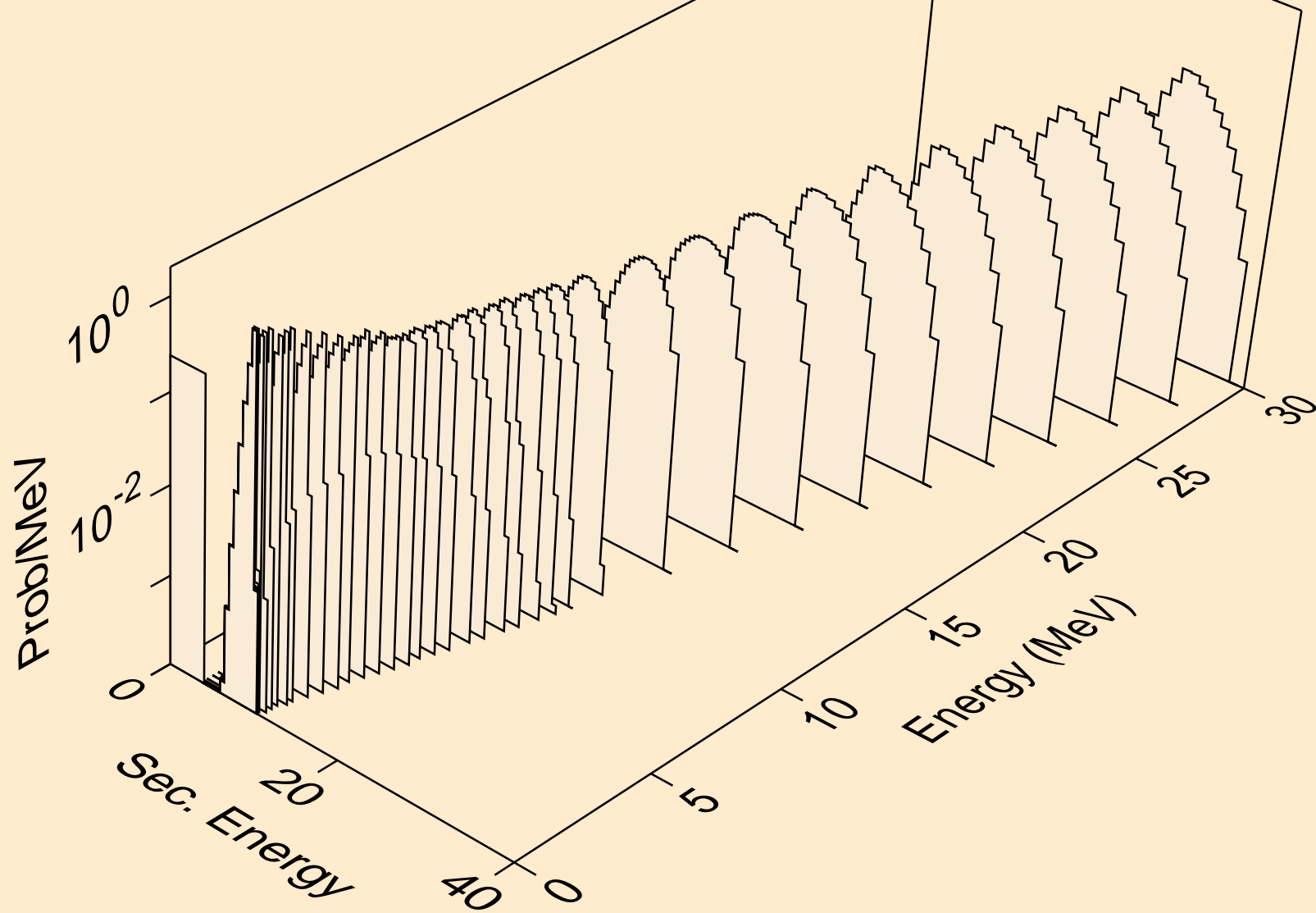

PR134 NEUTRON ACER TENDL-2021 LIBRARY; T=293.6K
alphas from (n,2a)

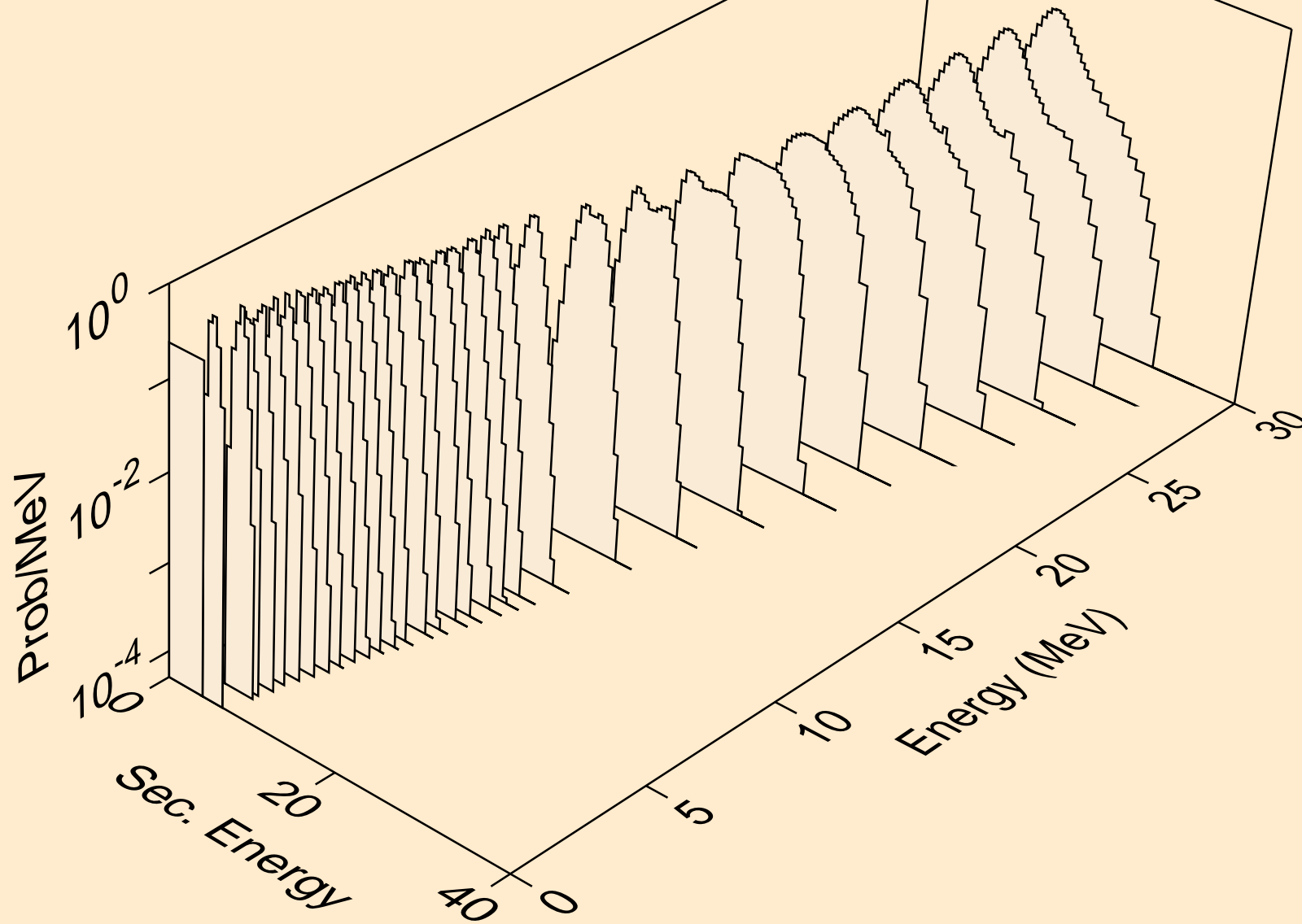

PR134 NEUTRON ACER TENDL-2021 LIBRARY; T=293.6K
alphas from (n,pa)

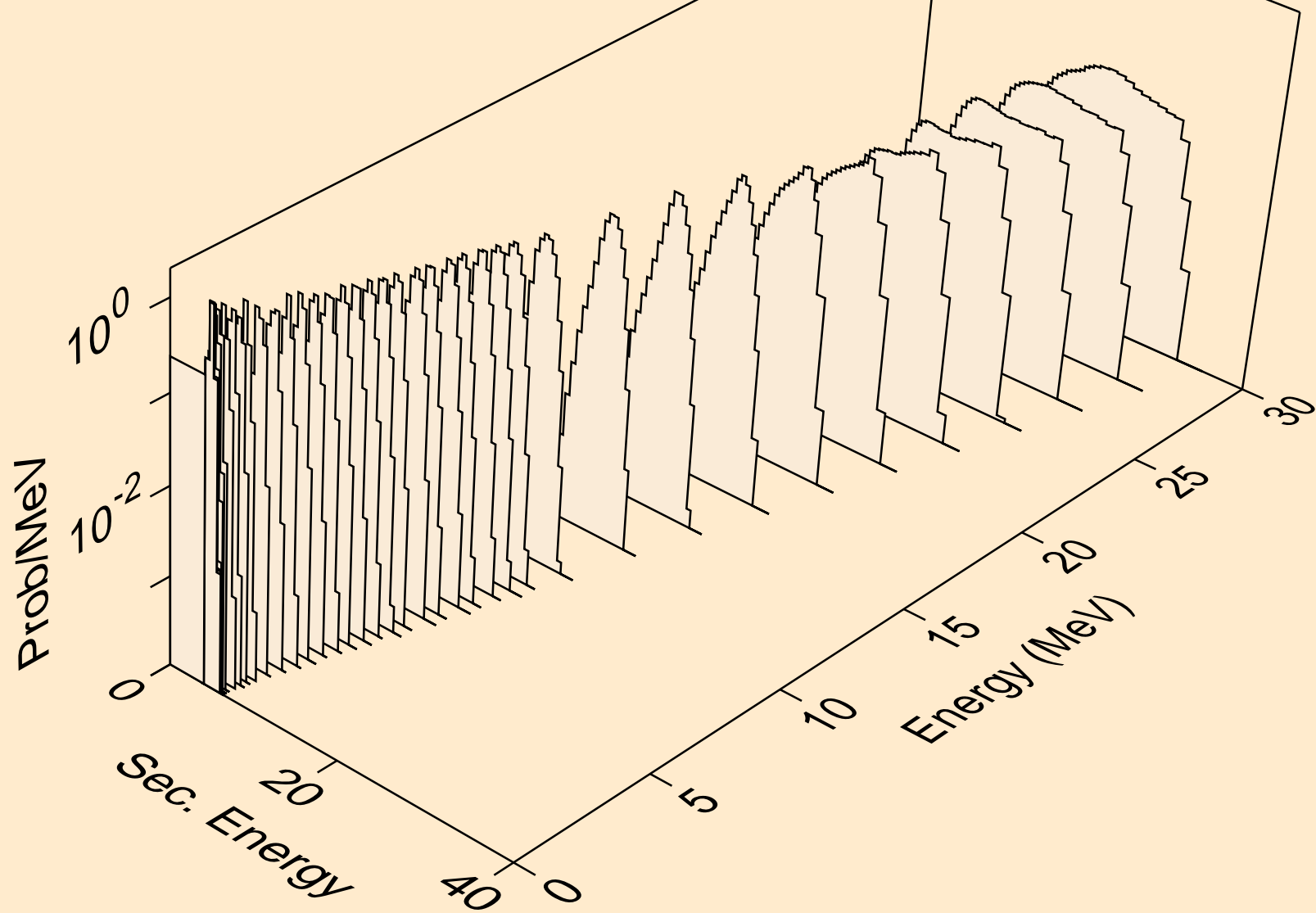

PR134 NEUTRON ACER TENDL-2021 LIBRARY; T=293.6K
alphas from (n,da)

