

PR144M NEUTRON ACER TENDL-2021 LIBRARY; T=293.6K  
Principal cross sections

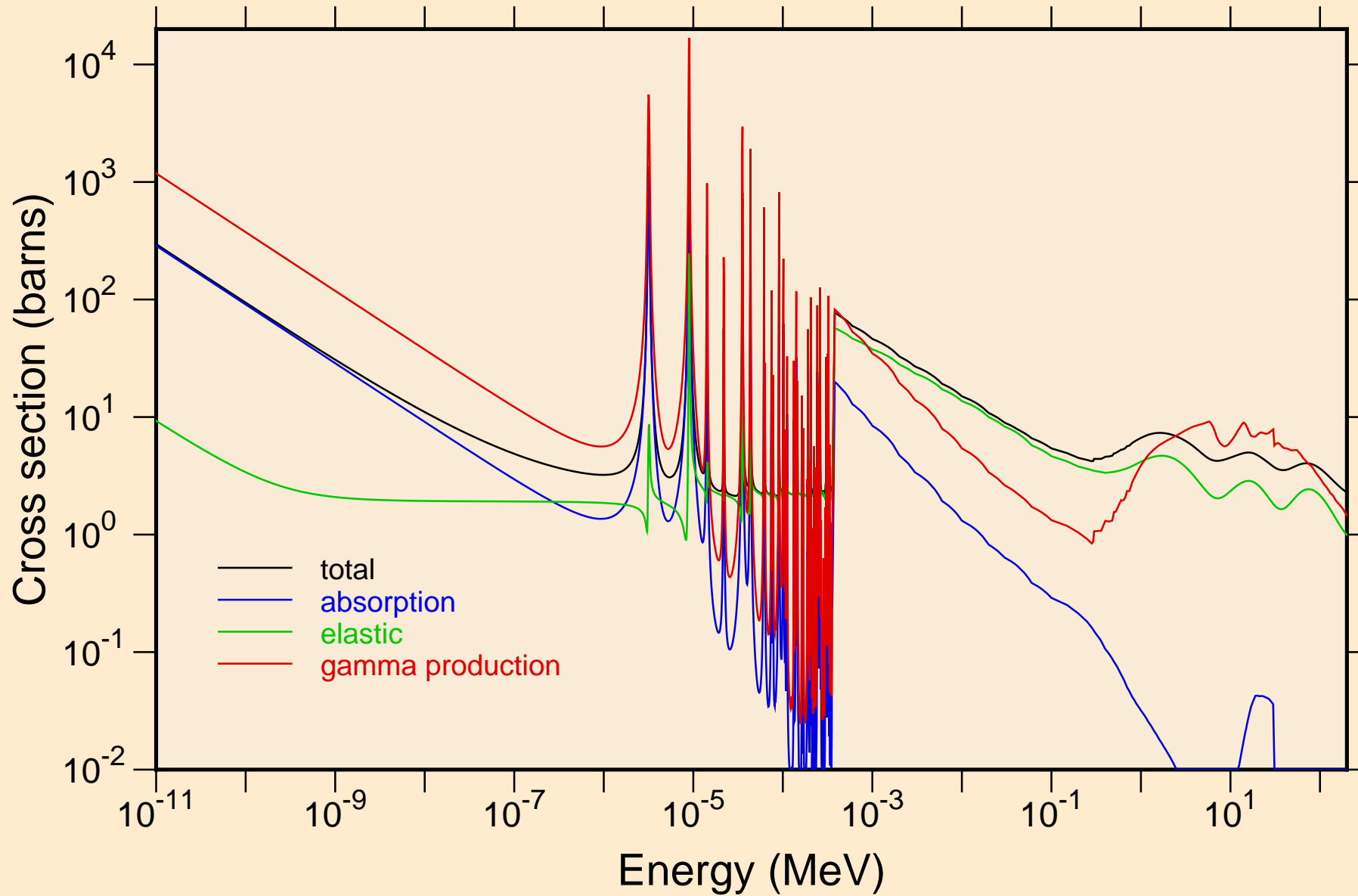

PR144M NEUTRON ACER TENDL-2021 LIBRARY; T=293.6K  
resonance total cross section

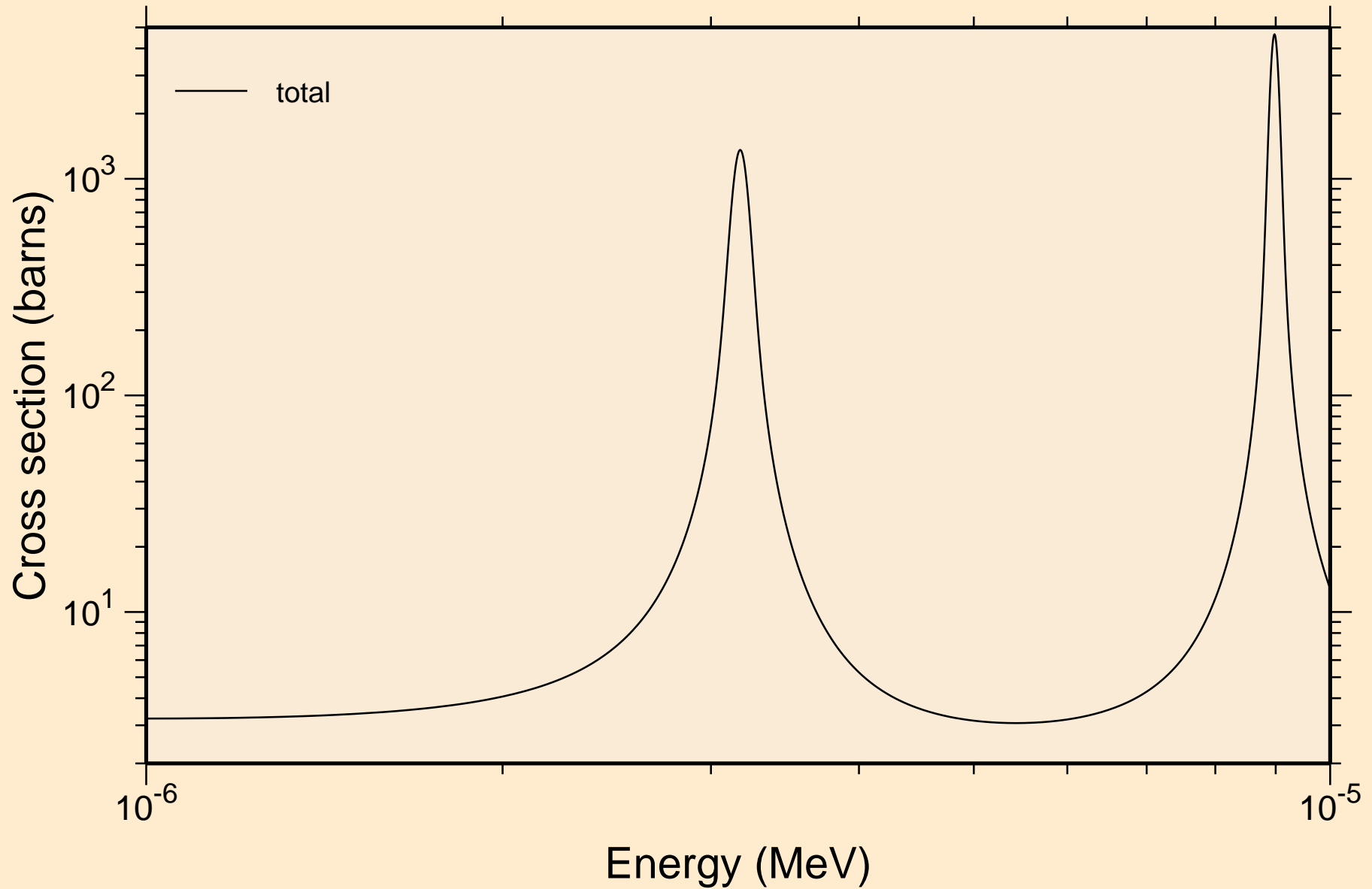

PR144M NEUTRON ACER TENDL-2021 LIBRARY; T=293.6K  
resonance total cross section

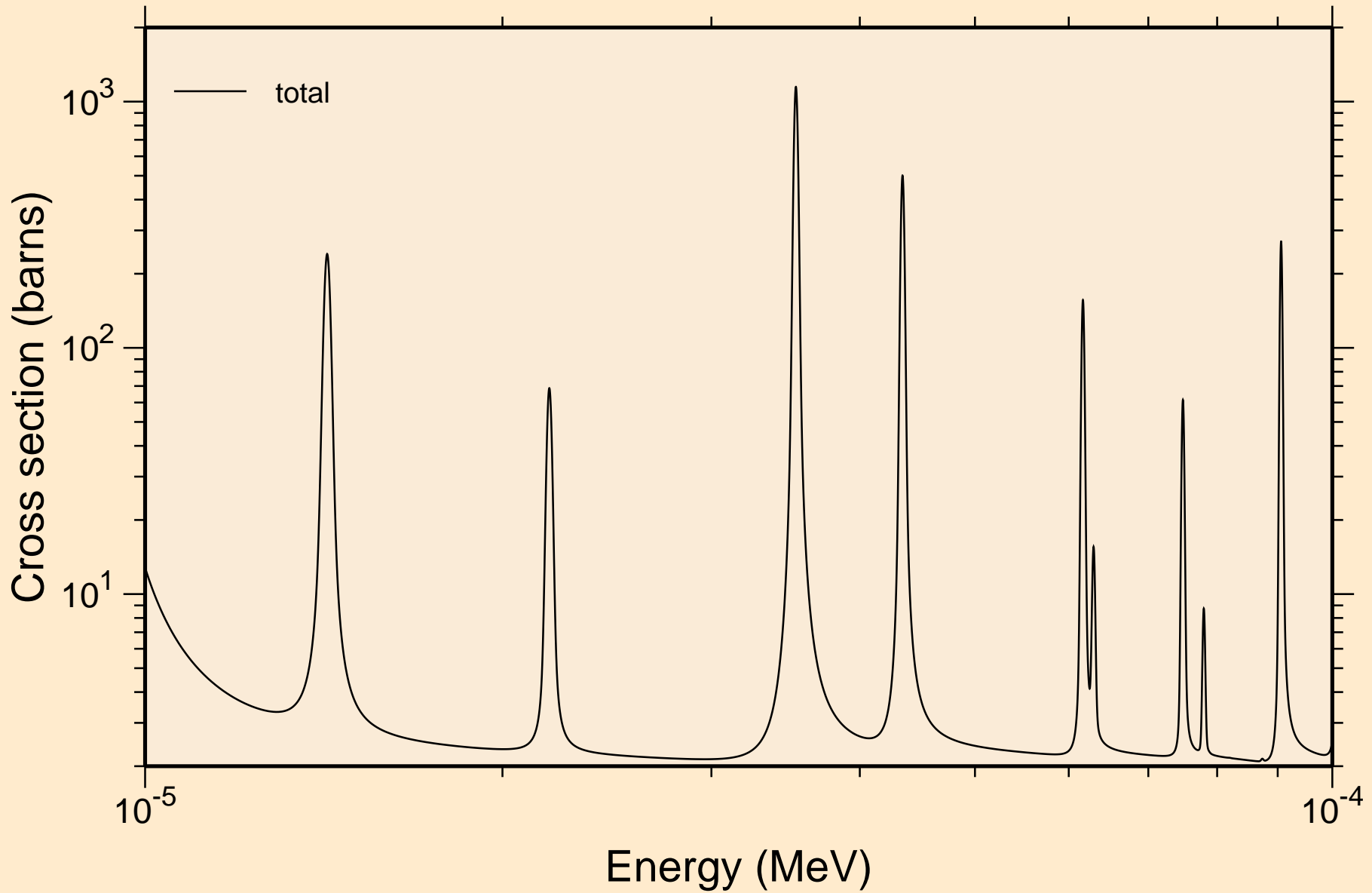

PR144M NEUTRON ACER TENDL-2021 LIBRARY; T=293.6K  
resonance total cross section

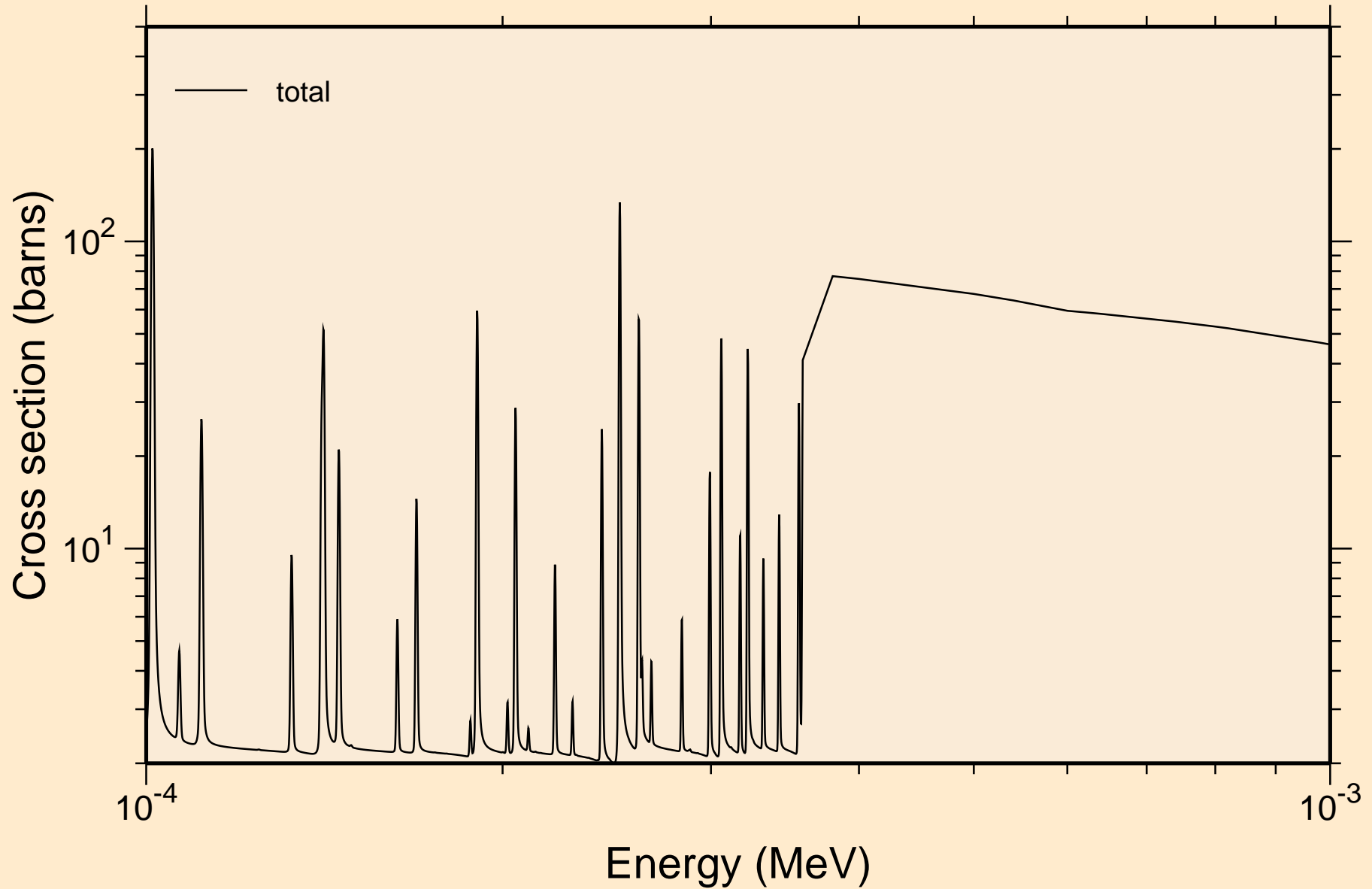

PR144M NEUTRON ACER TENDL-2021 LIBRARY; T=293.6K  
resonance total cross section

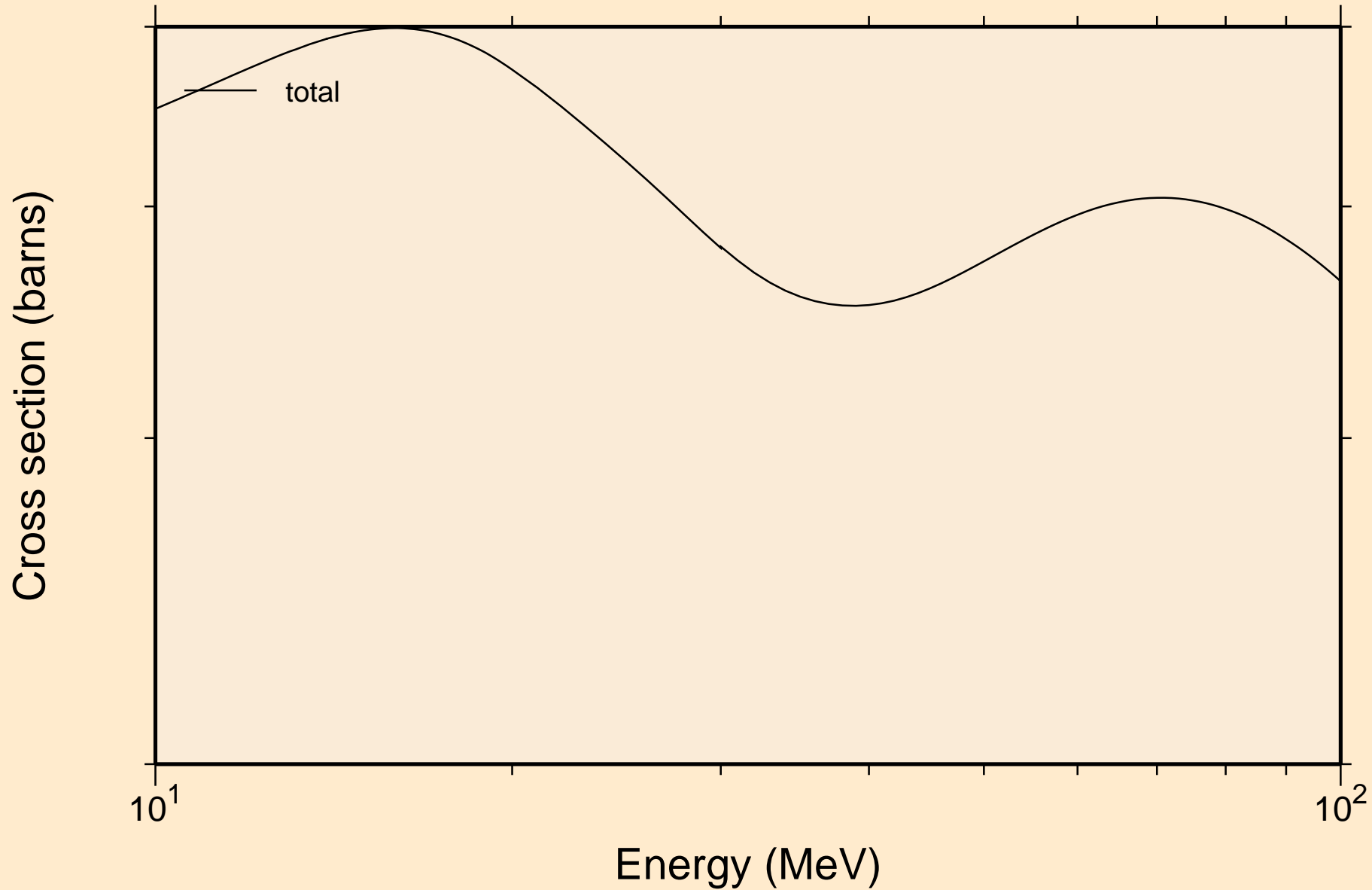

PR144M NEUTRON ACER TENDL-2021 LIBRARY; T=293.6K  
resonance absorption cross sections

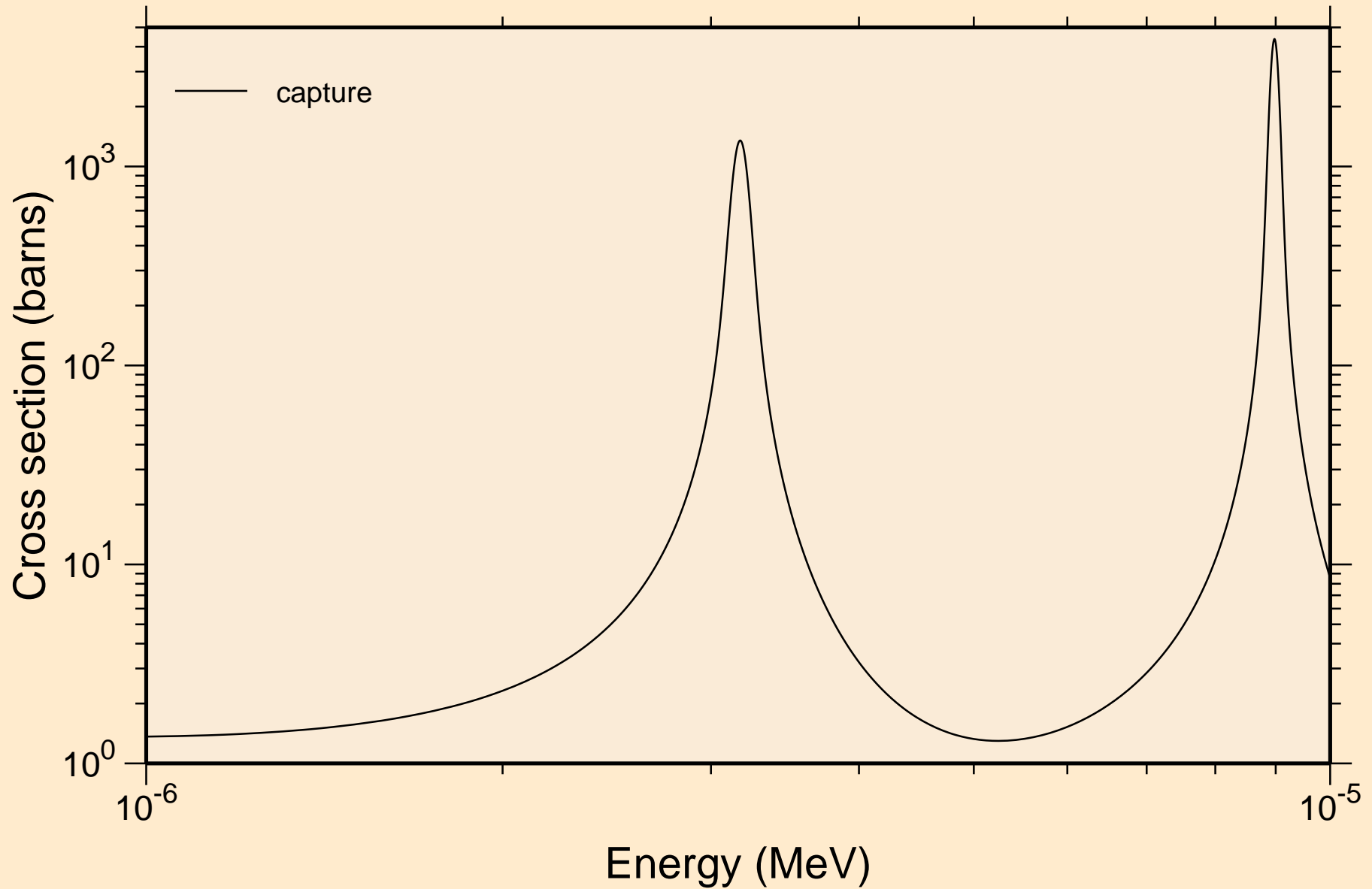

PR144M NEUTRON ACER TENDL-2021 LIBRARY; T=293.6K  
resonance absorption cross sections

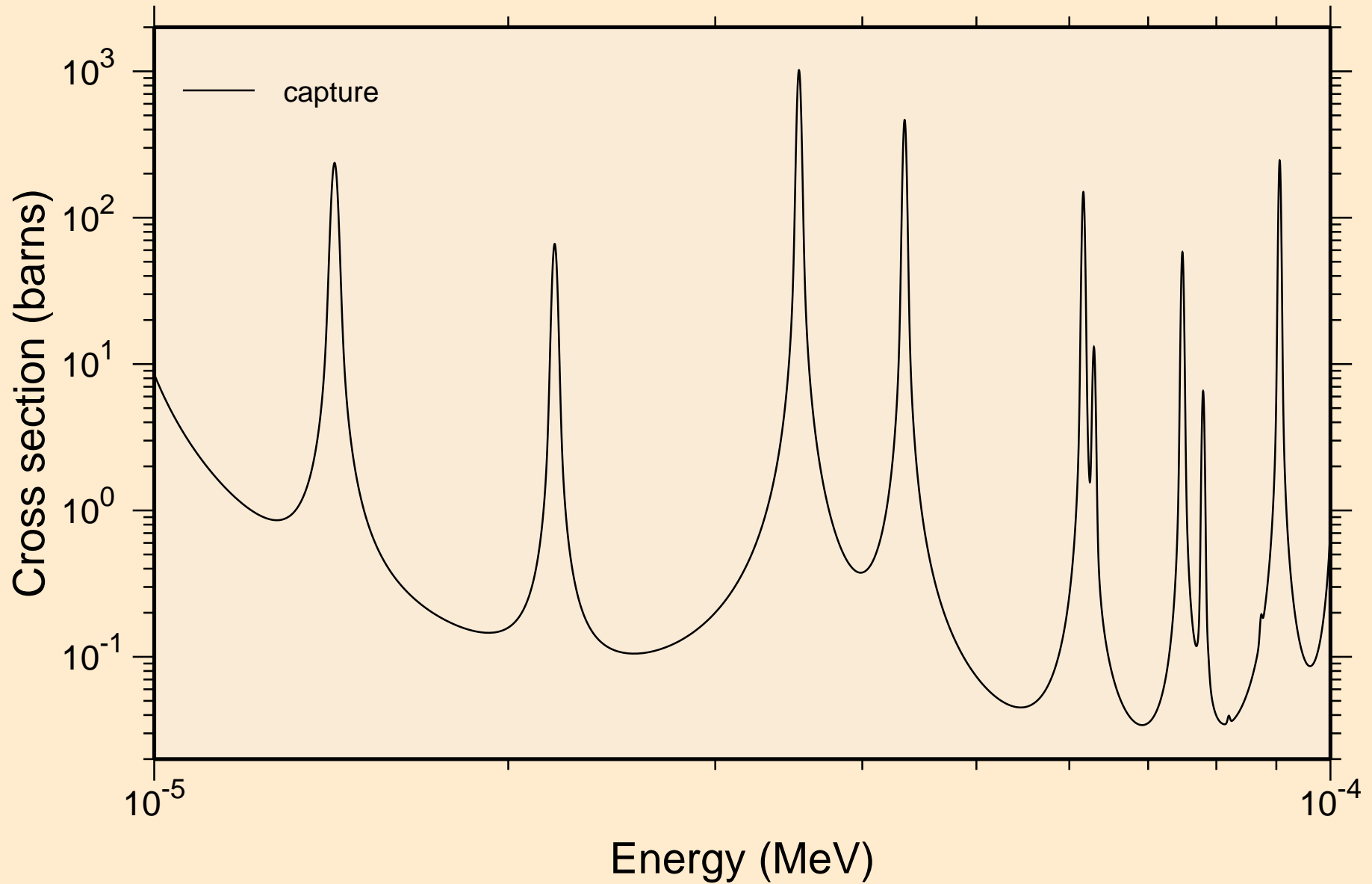

PR144M NEUTRON ACER TENDL-2021 LIBRARY; T=293.6K  
resonance absorption cross sections

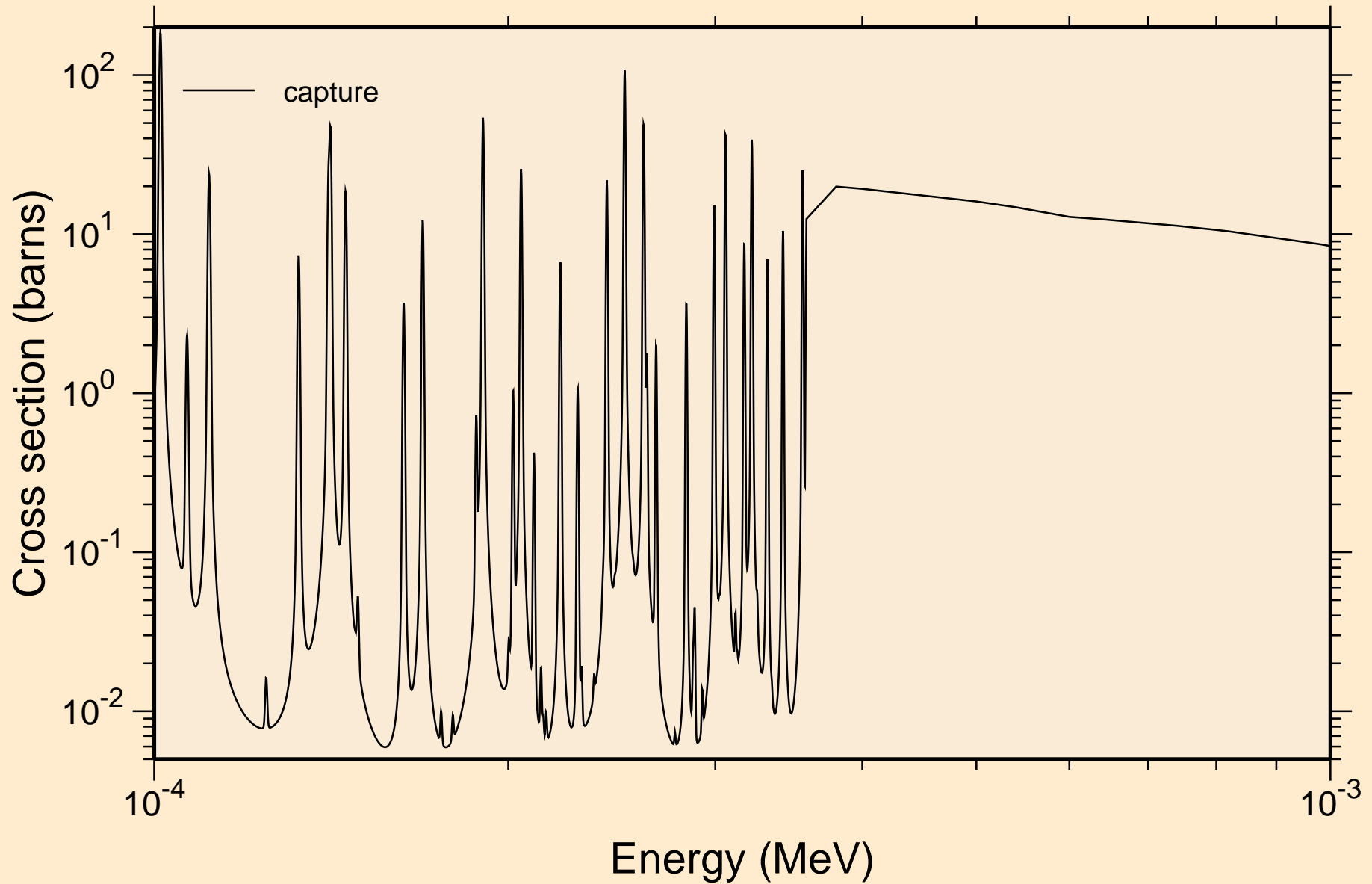



PR144M NEUTRON ACER TENDL-2021 LIBRARY; T=293.6K  
resonance absorption cross sections

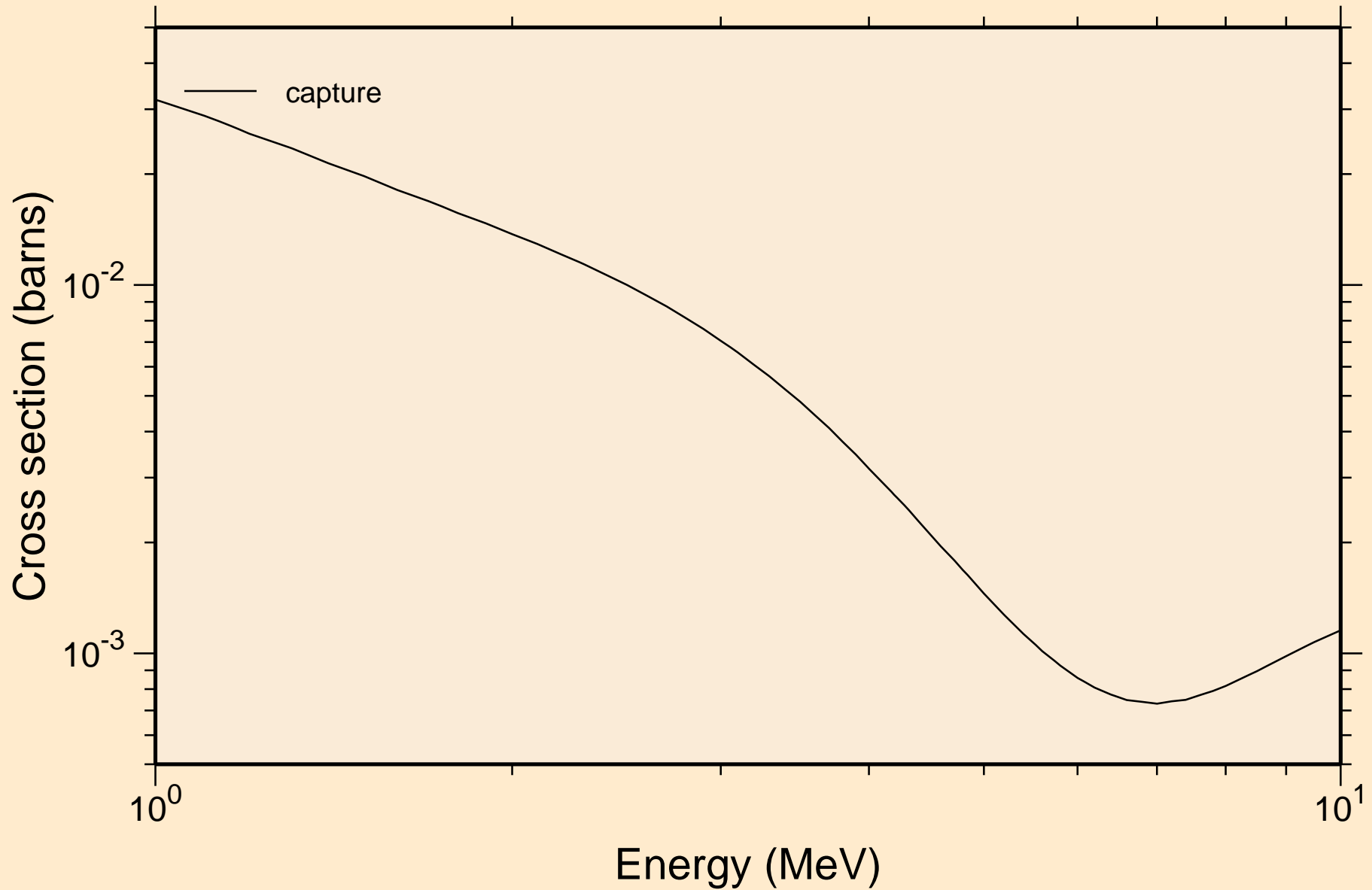

PR144M NEUTRON ACER TENDL-2021 LIBRARY; T=293.6K  
Heating

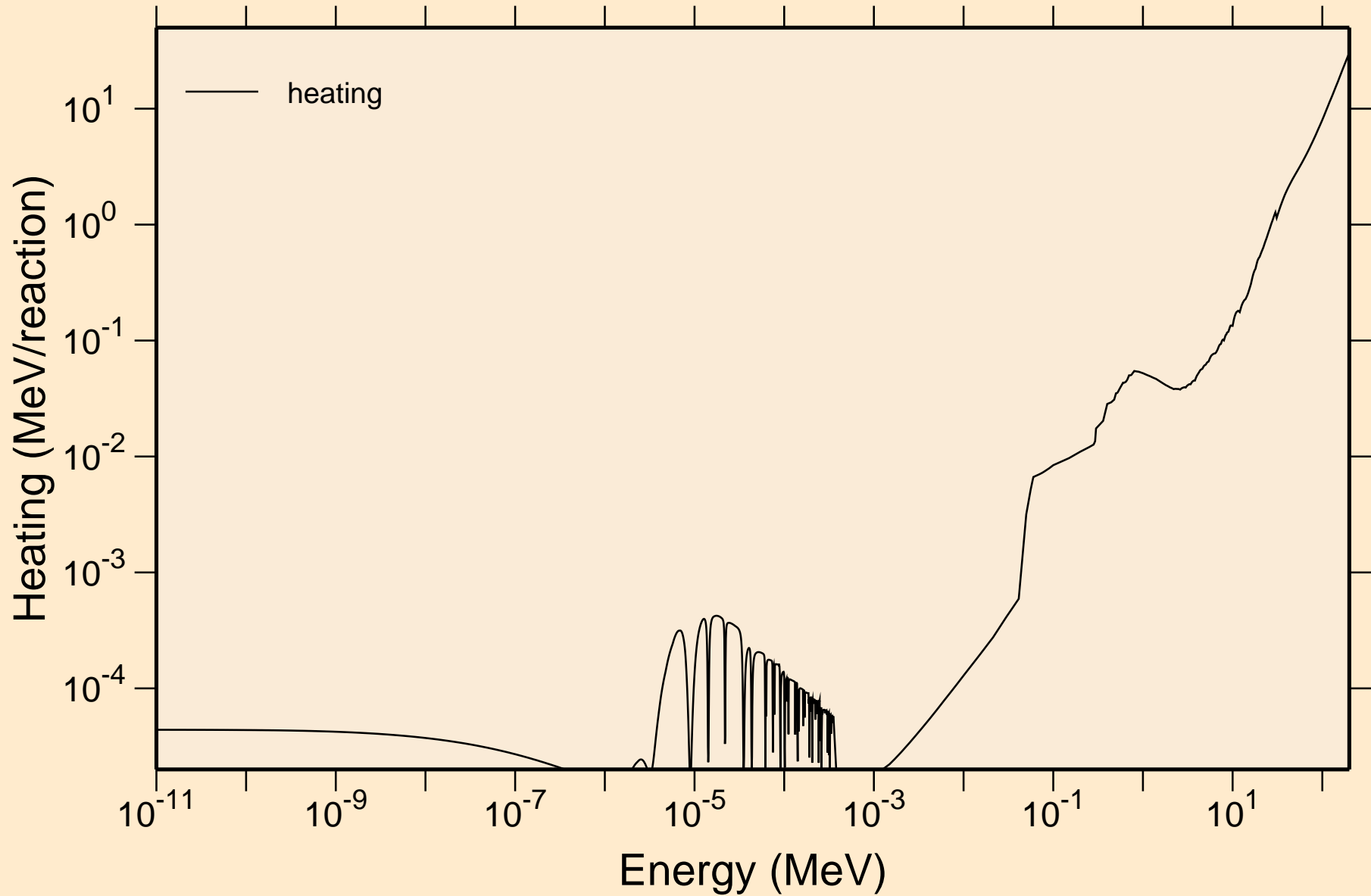

PR144M NEUTRON ACER TENDL-2021 LIBRARY; T=293.6K  
Damage

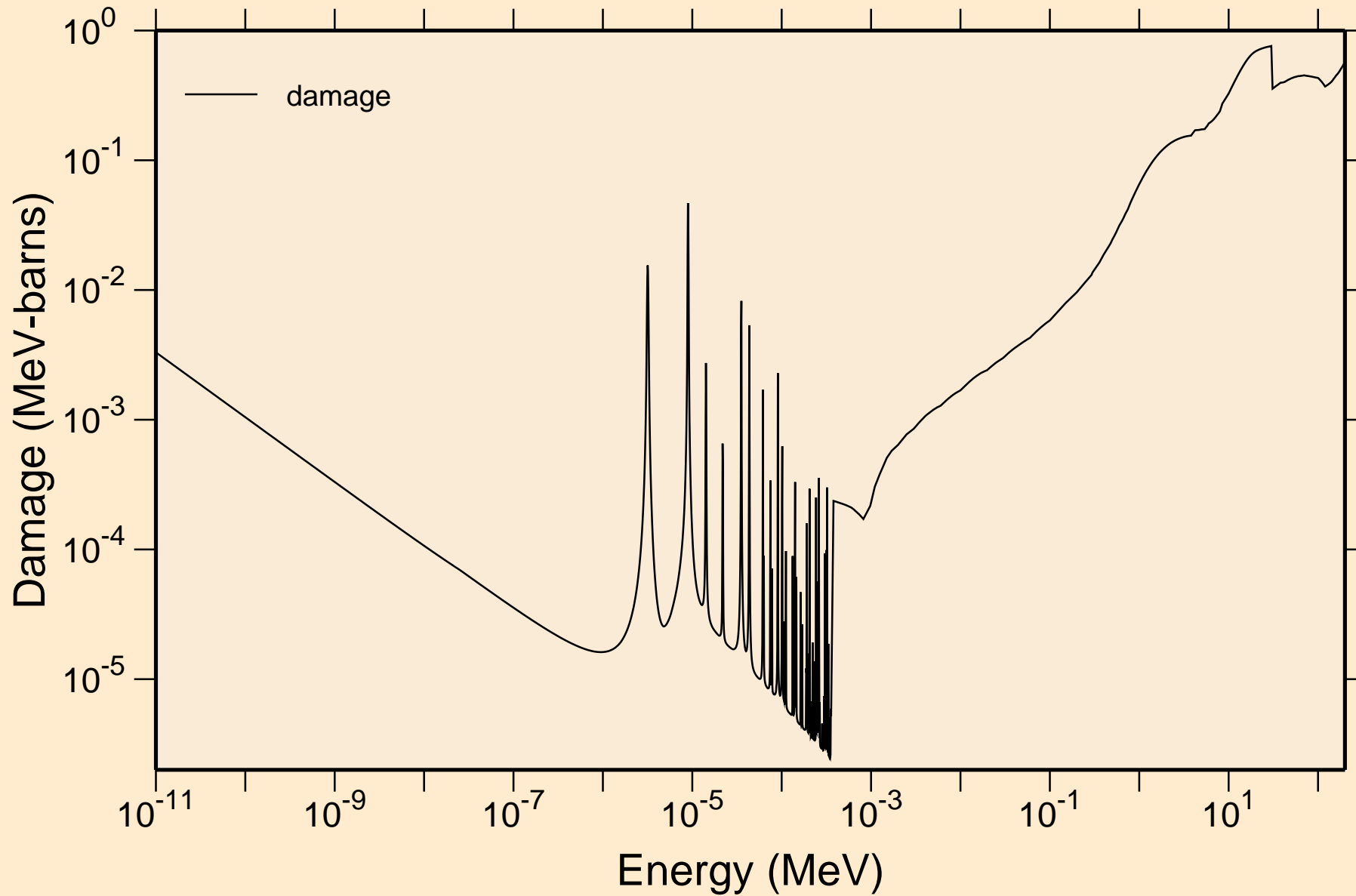

PR144M NEUTRON ACER TENDL-2021 LIBRARY; T=293.6K  
Non-threshold reactions

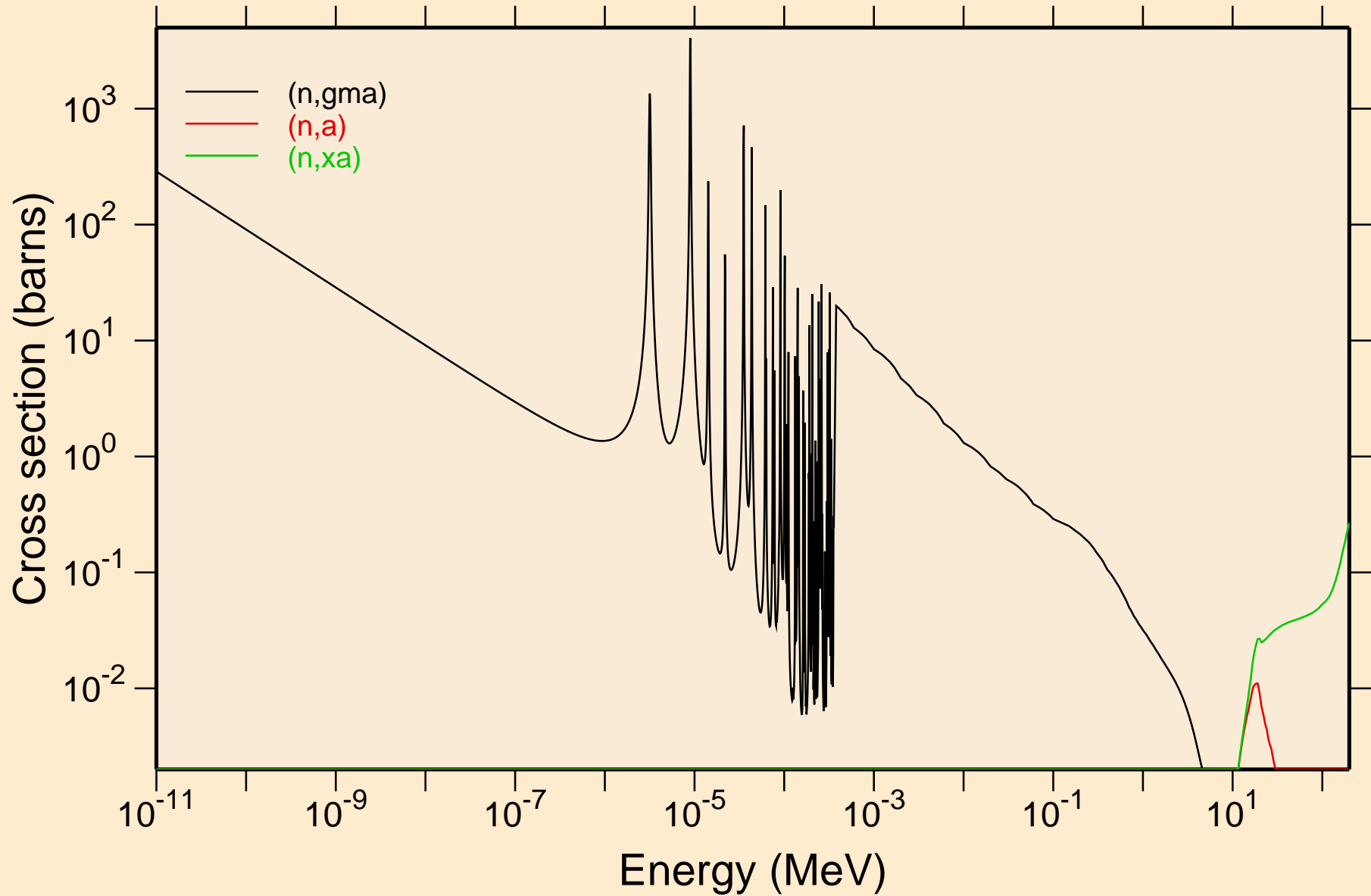

PR144M NEUTRON ACER TENDL-2021 LIBRARY; T=293.6K  
Principal cross sections

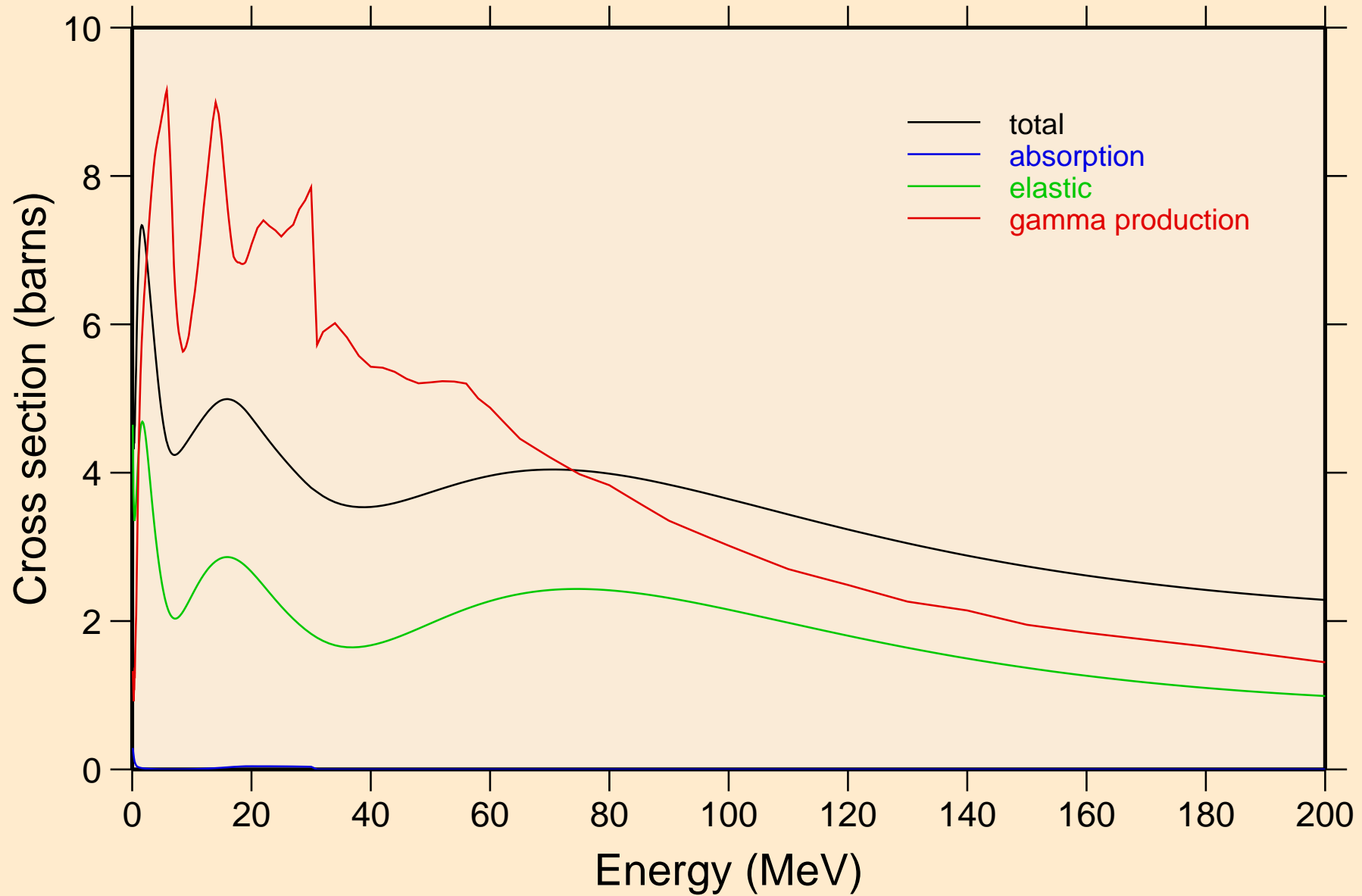

PR144M NEUTRON ACER TENDL-2021 LIBRARY; T=293.6K  
Heating

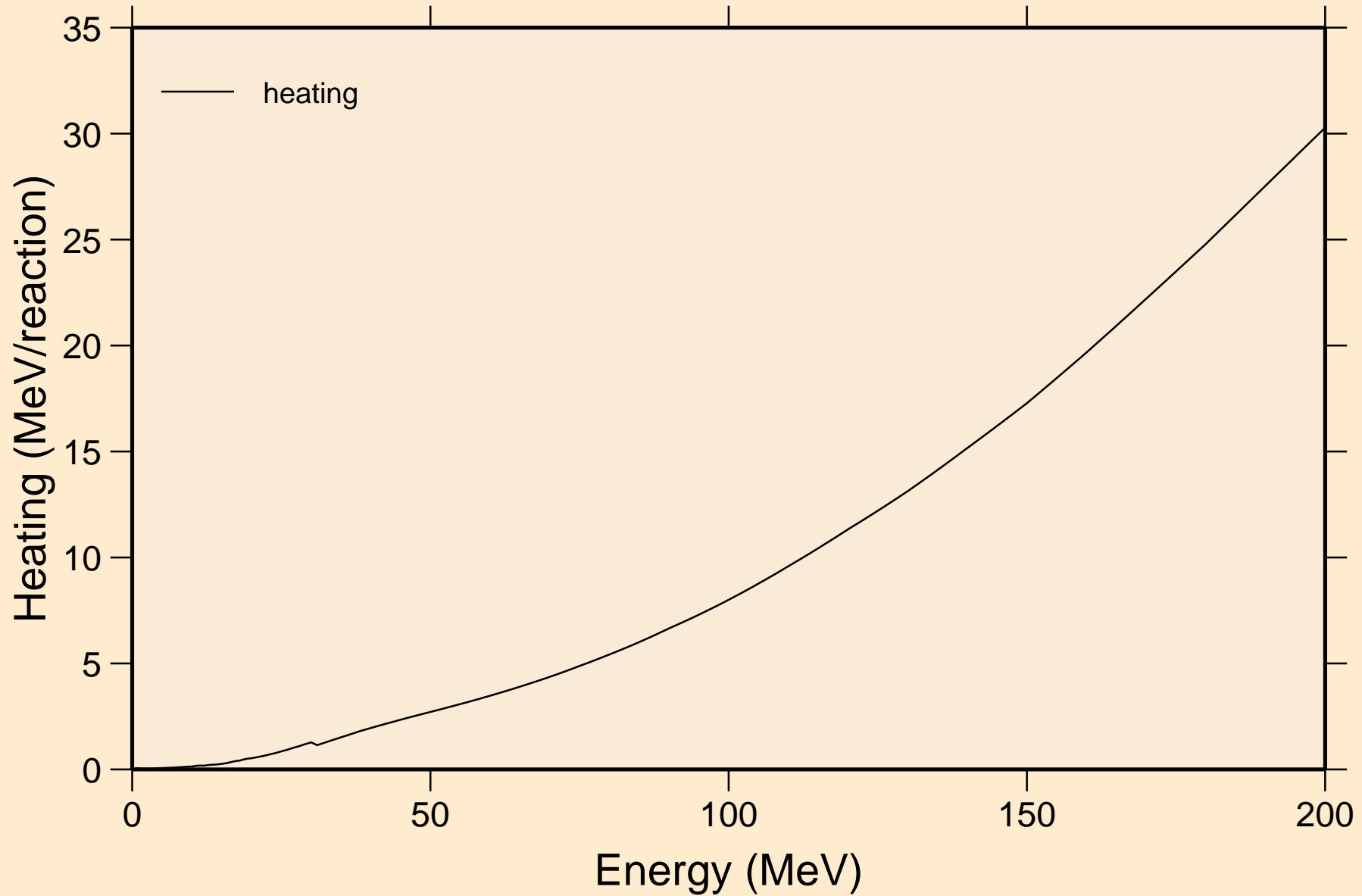

PR144M NEUTRON ACER TENDL-2021 LIBRARY; T=293.6K  
Damage

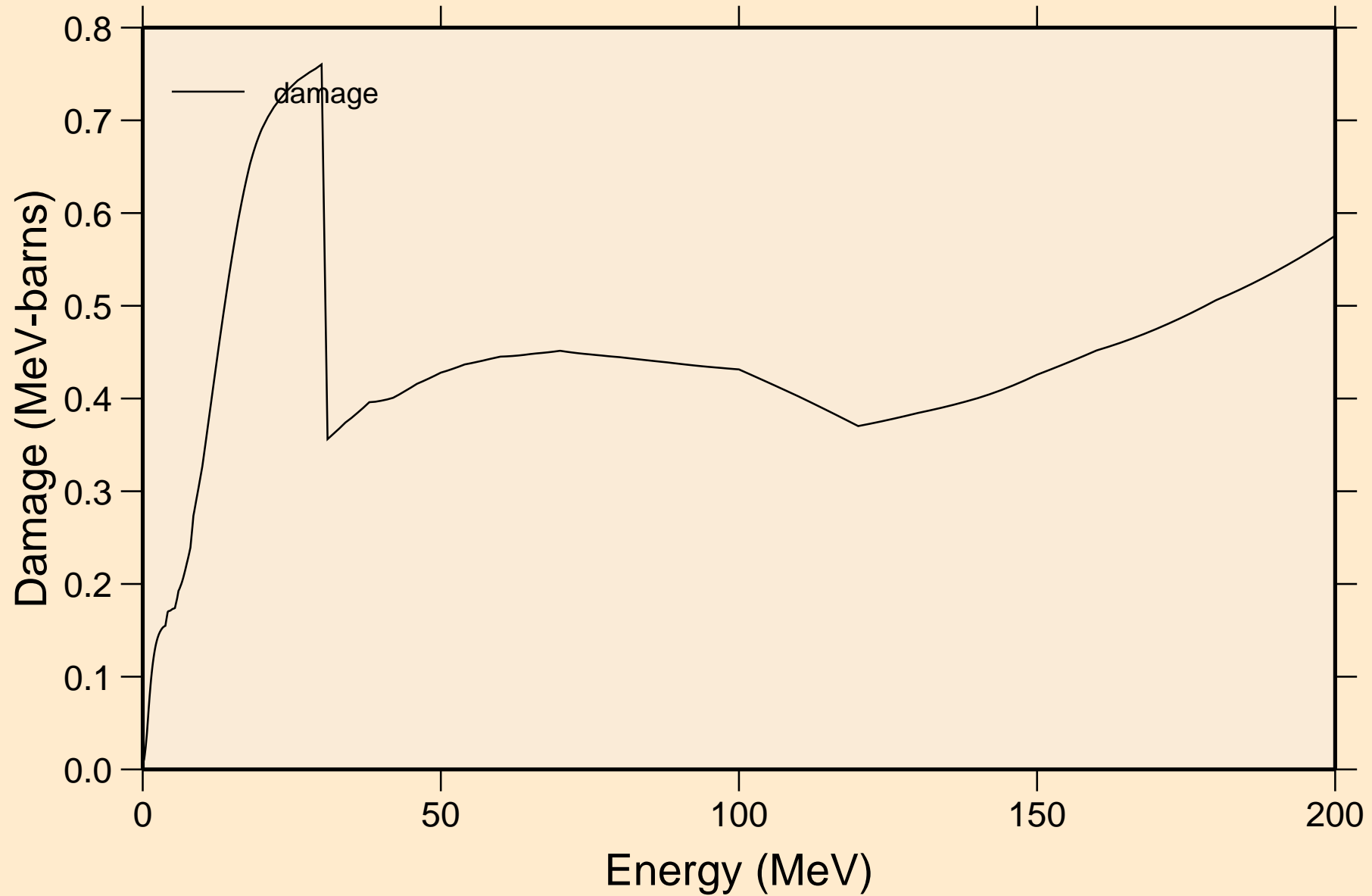

PR144M NEUTRON ACER TENDL-2021 LIBRARY; T=293.6K  
Non-threshold reactions

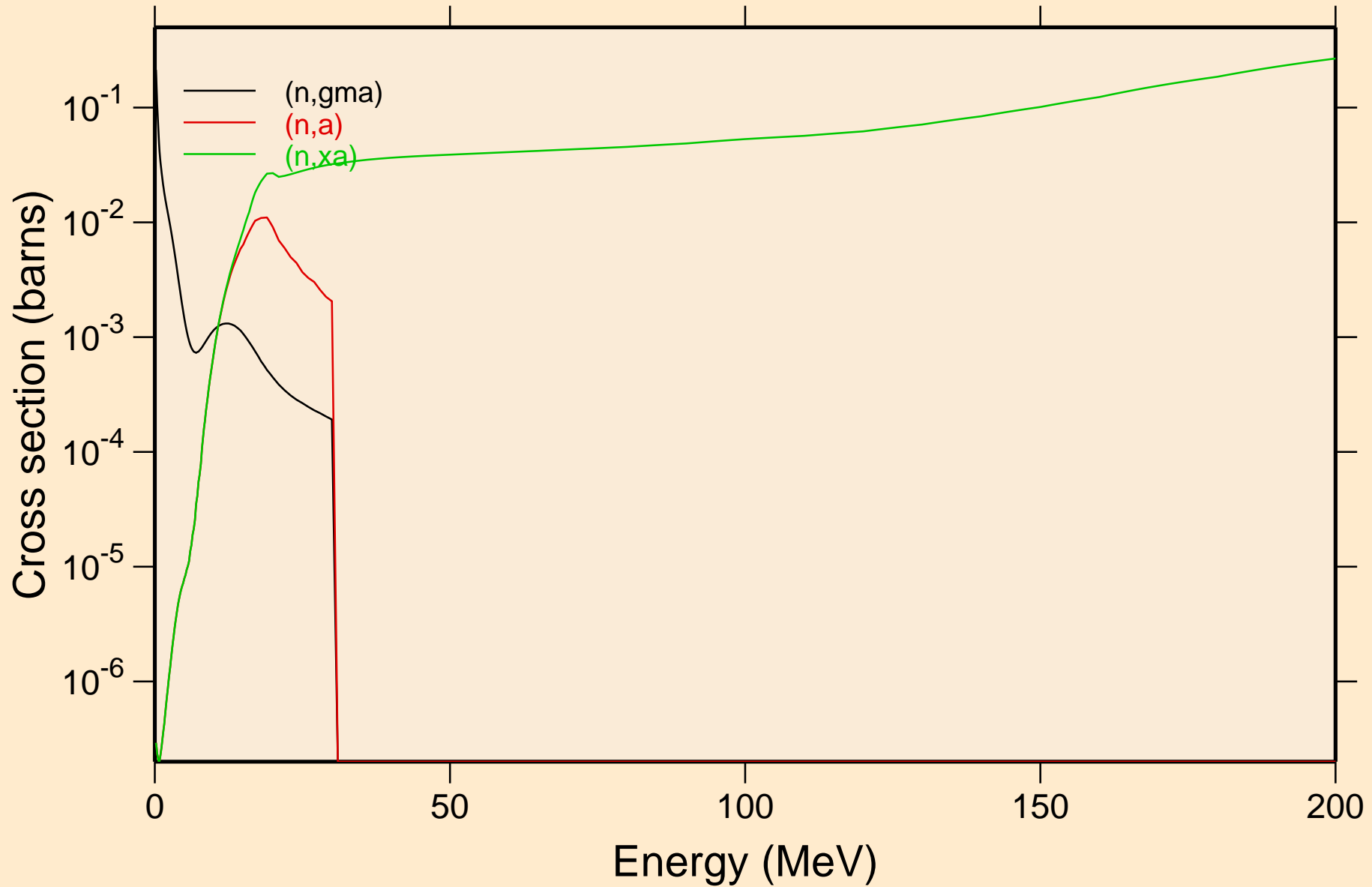



PR144M NEUTRON ACER TENDL-2021 LIBRARY; T=293.6K  
Inelastic levels

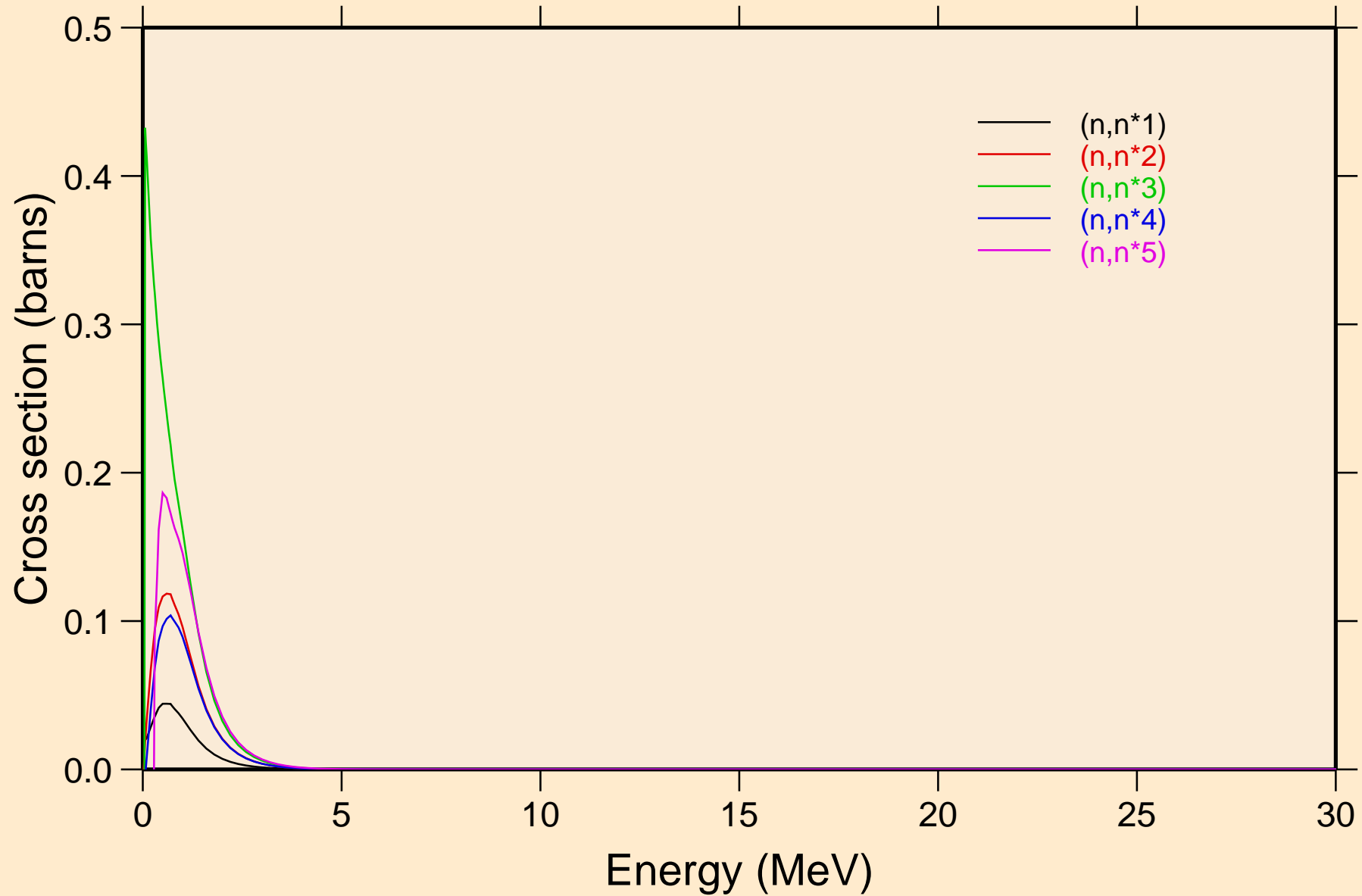

PR144M NEUTRON ACER TENDL-2021 LIBRARY; T=293.6K  
Inelastic levels

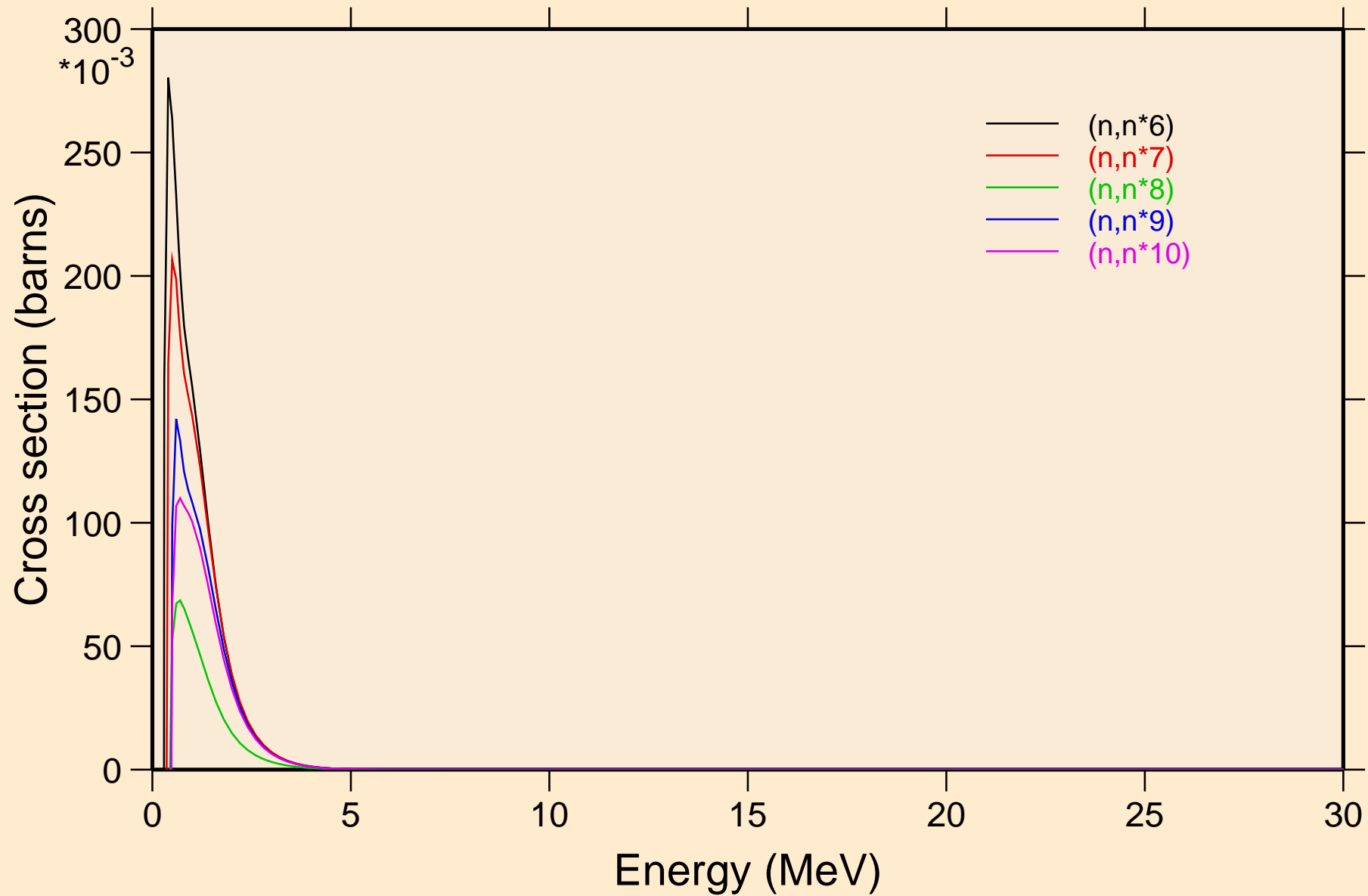

PR144M NEUTRON ACER TENDL-2021 LIBRARY; T=293.6K  
Inelastic levels

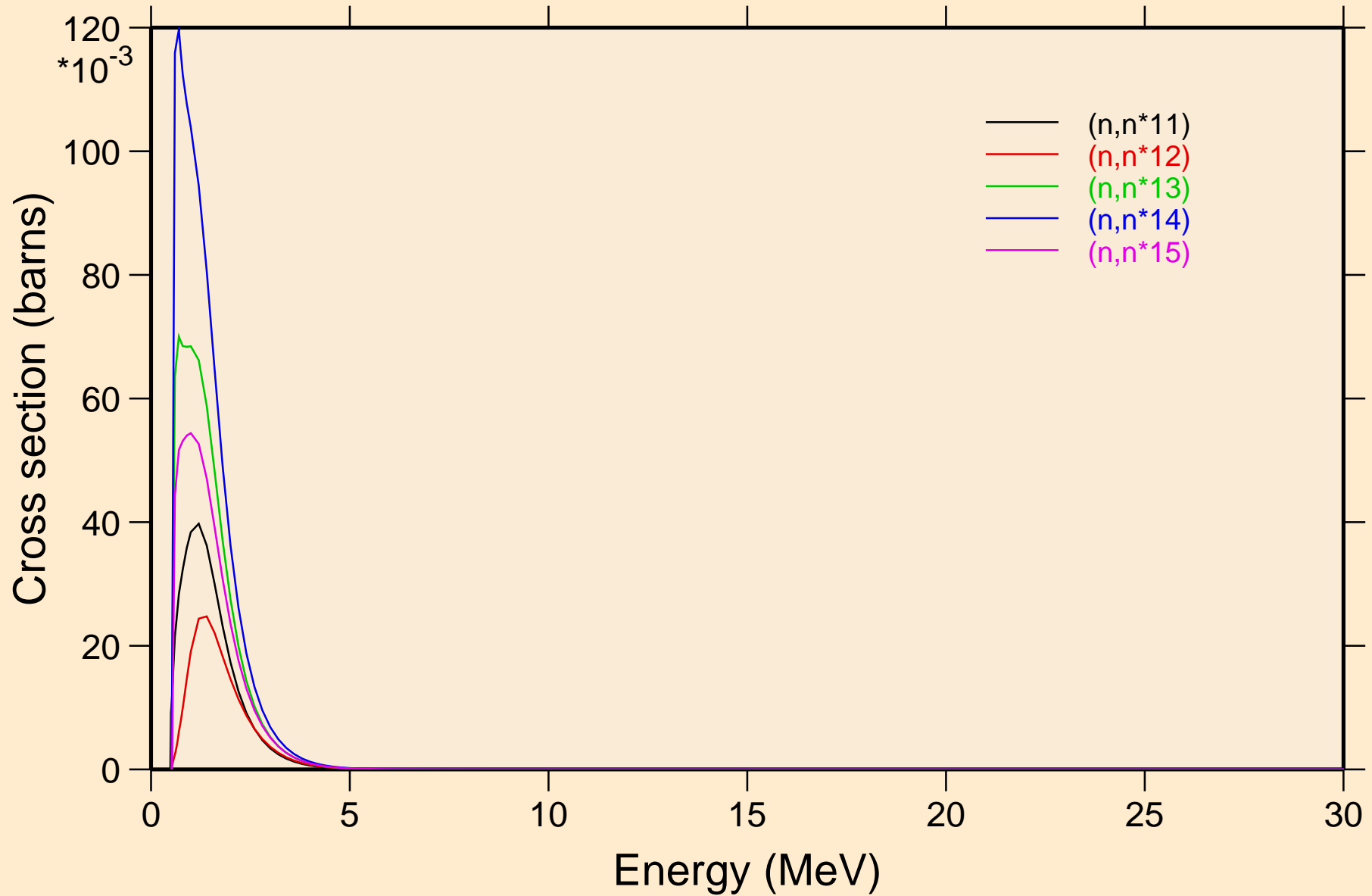

PR144M NEUTRON ACER TENDL-2021 LIBRARY; T=293.6K  
Inelastic levels

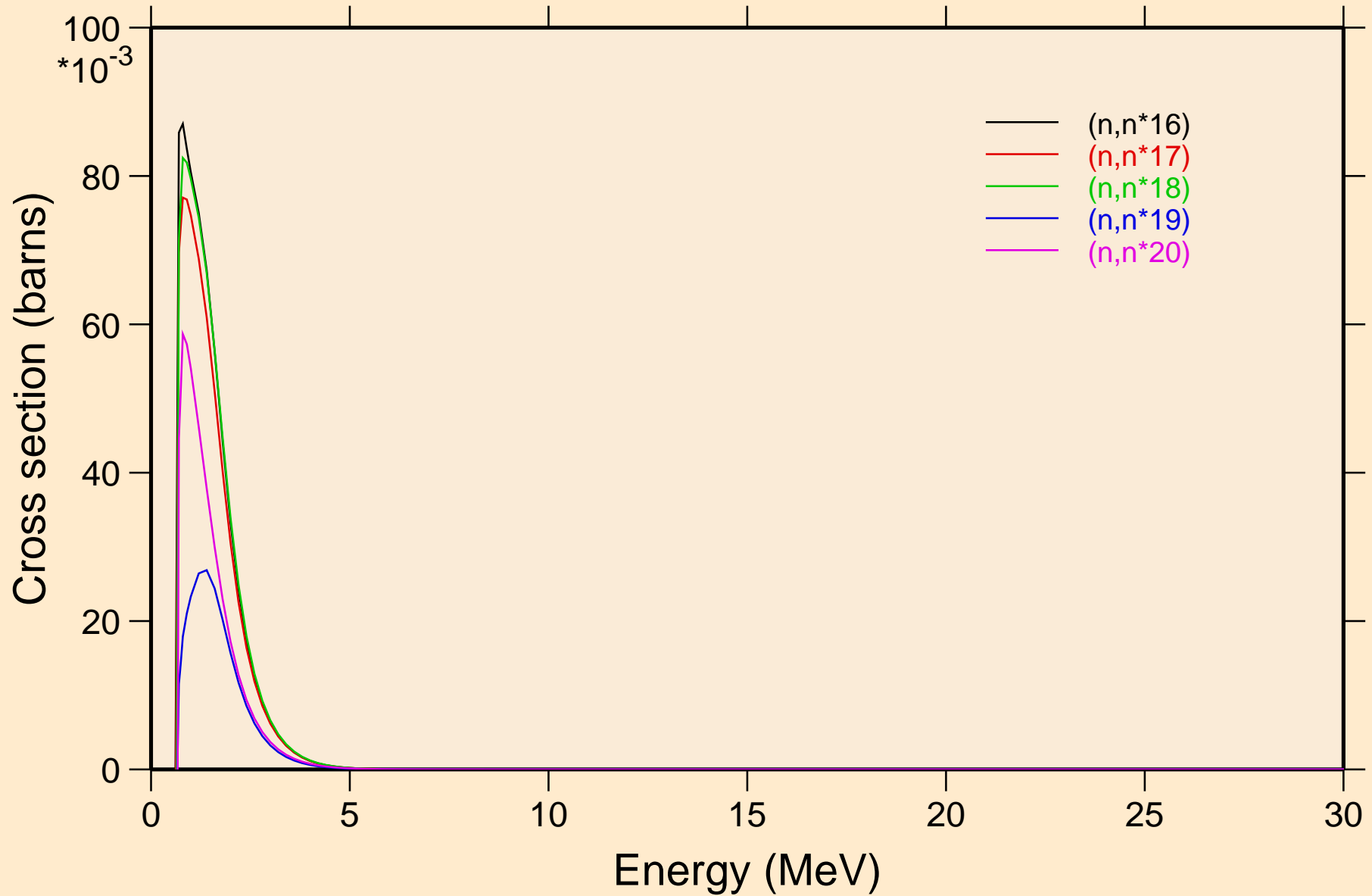

PR144M NEUTRON ACER TENDL-2021 LIBRARY; T=293.6K  
Inelastic levels

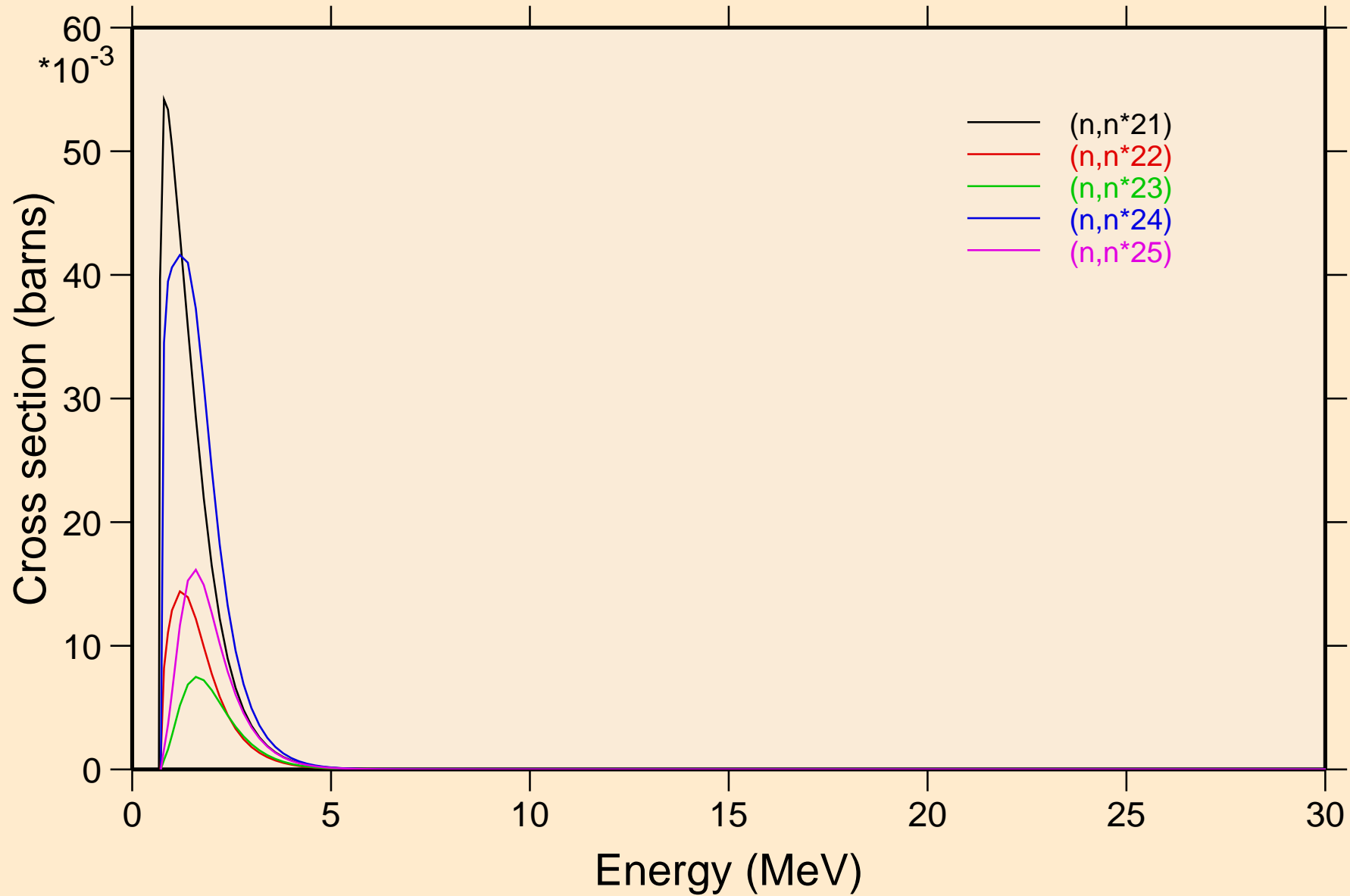

PR144M NEUTRON ACER TENDL-2021 LIBRARY; T=293.6K  
Inelastic levels

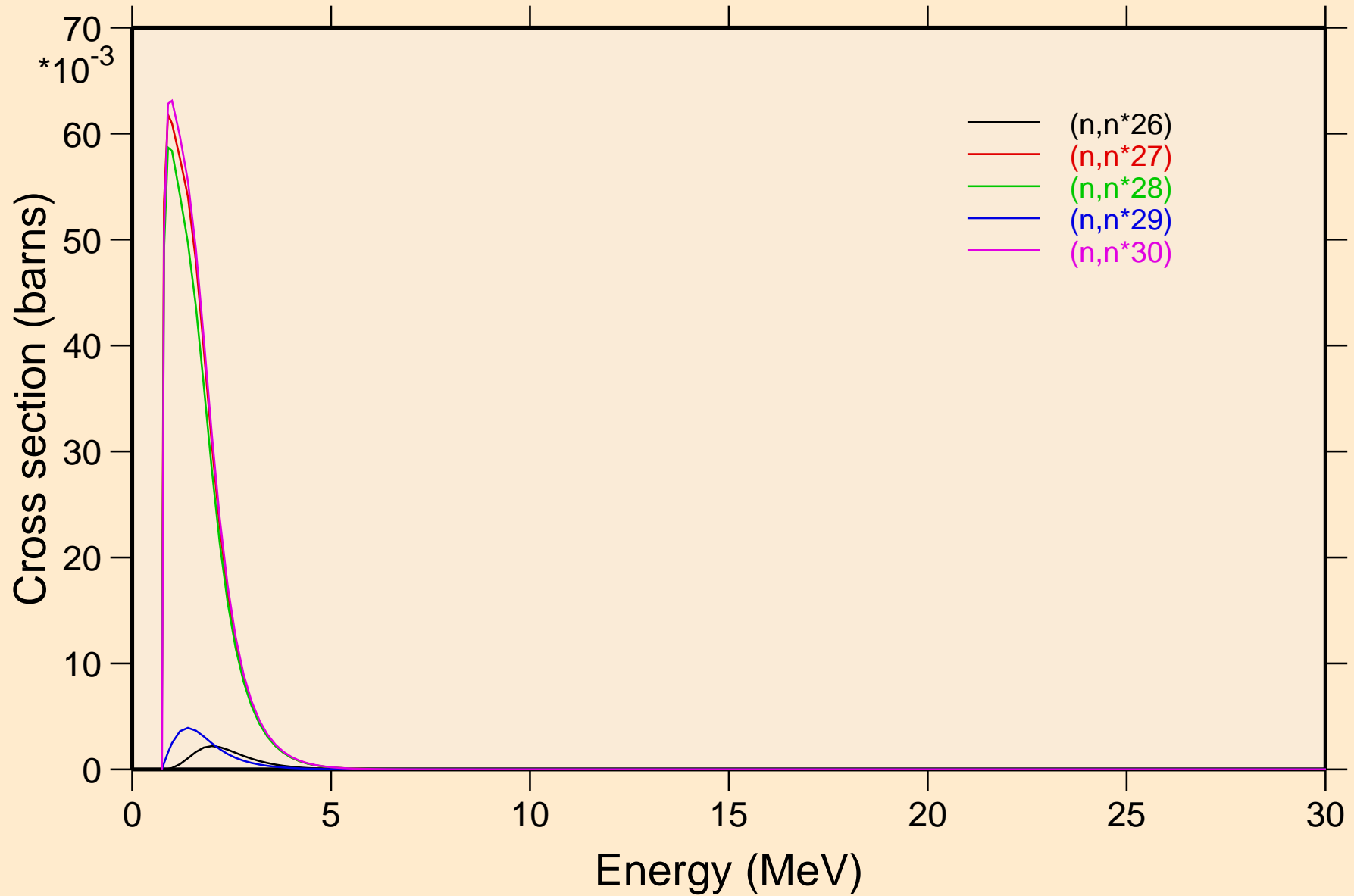

PR144M NEUTRON ACER TENDL-2021 LIBRARY; T=293.6K  
Threshold reactions

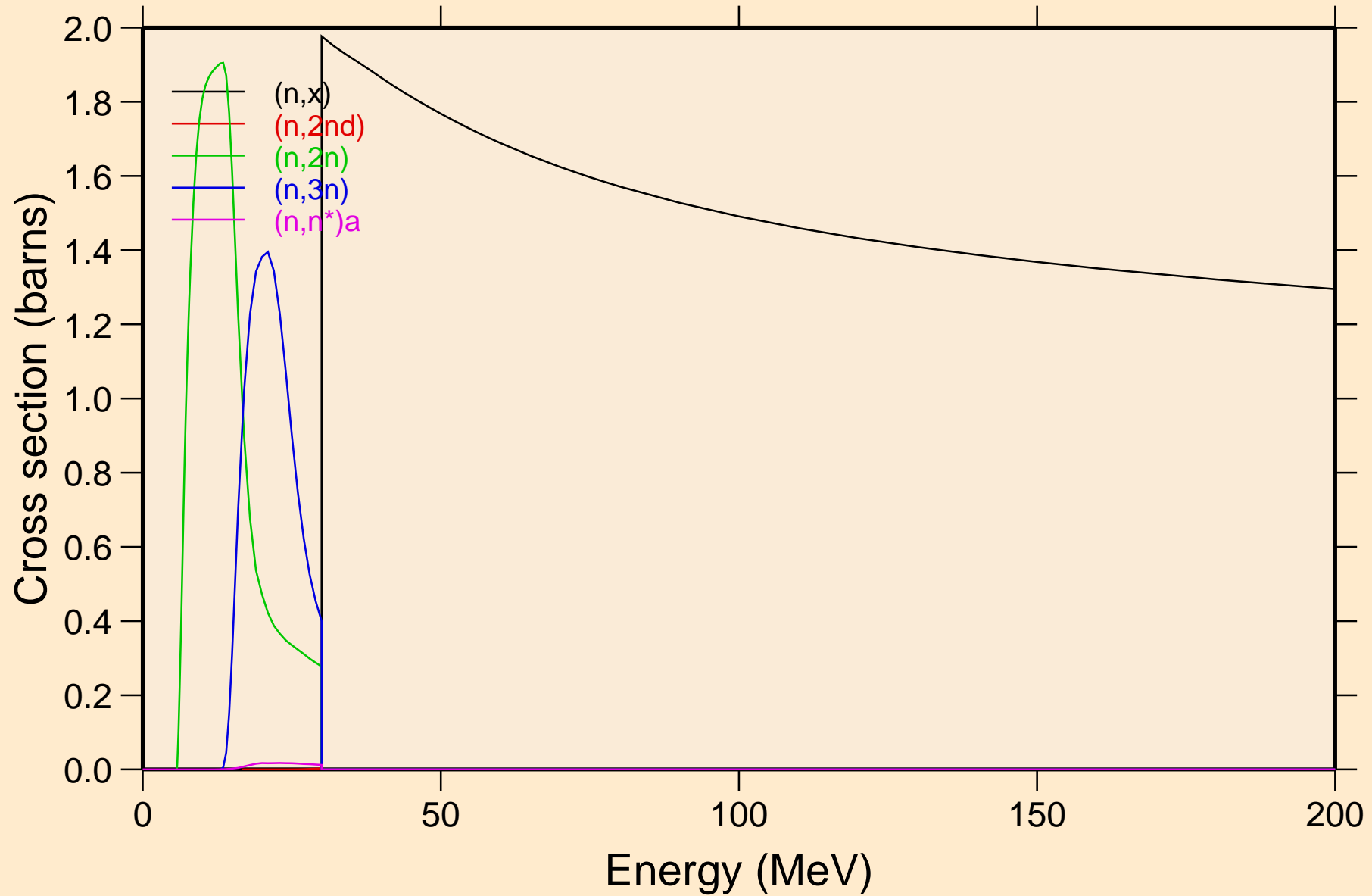

PR144M NEUTRON ACER TENDL-2021 LIBRARY; T=293.6K  
Threshold reactions

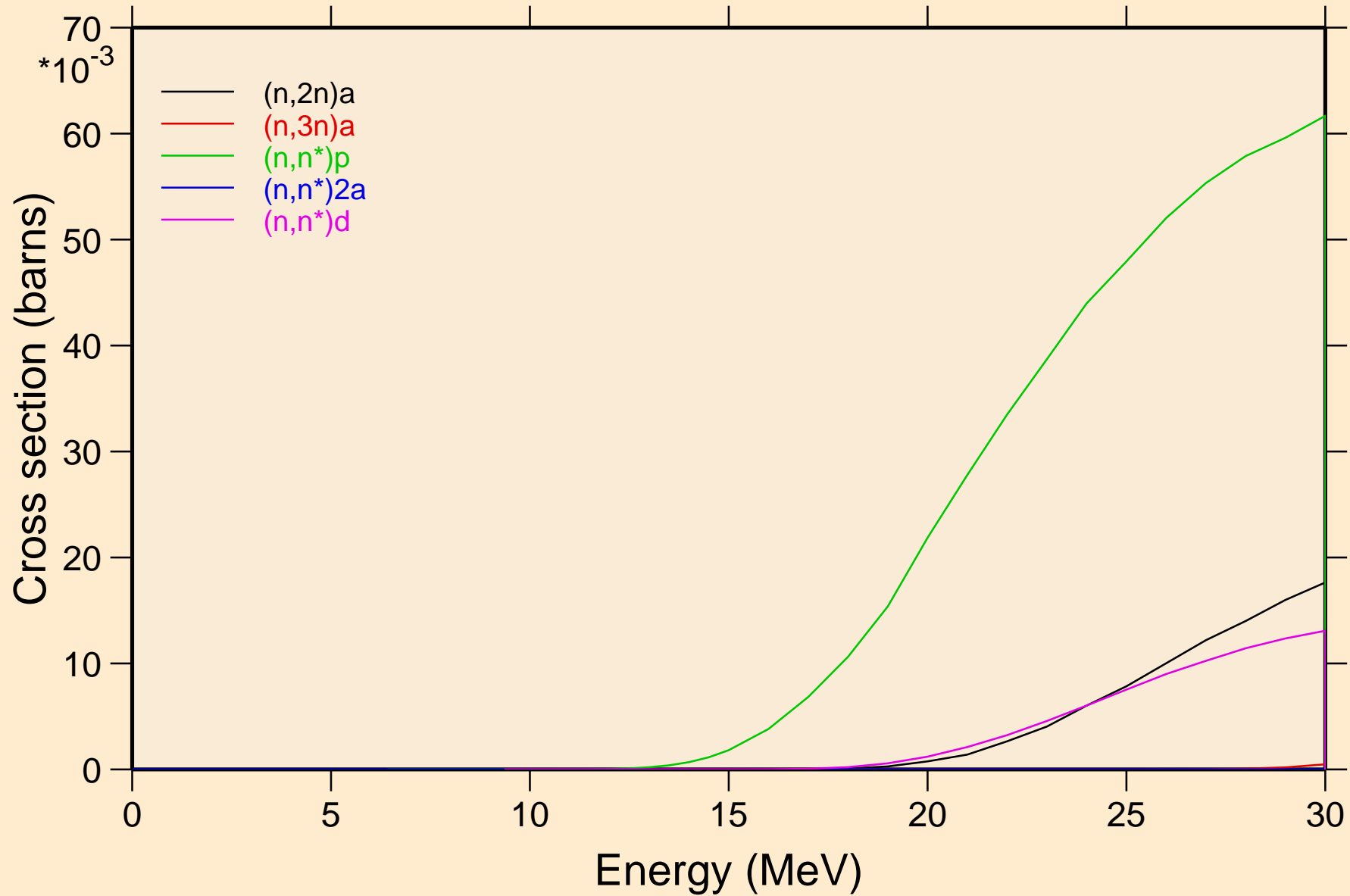



PR144M NEUTRON ACER TENDL-2021 LIBRARY; T=293.6K  
Threshold reactions

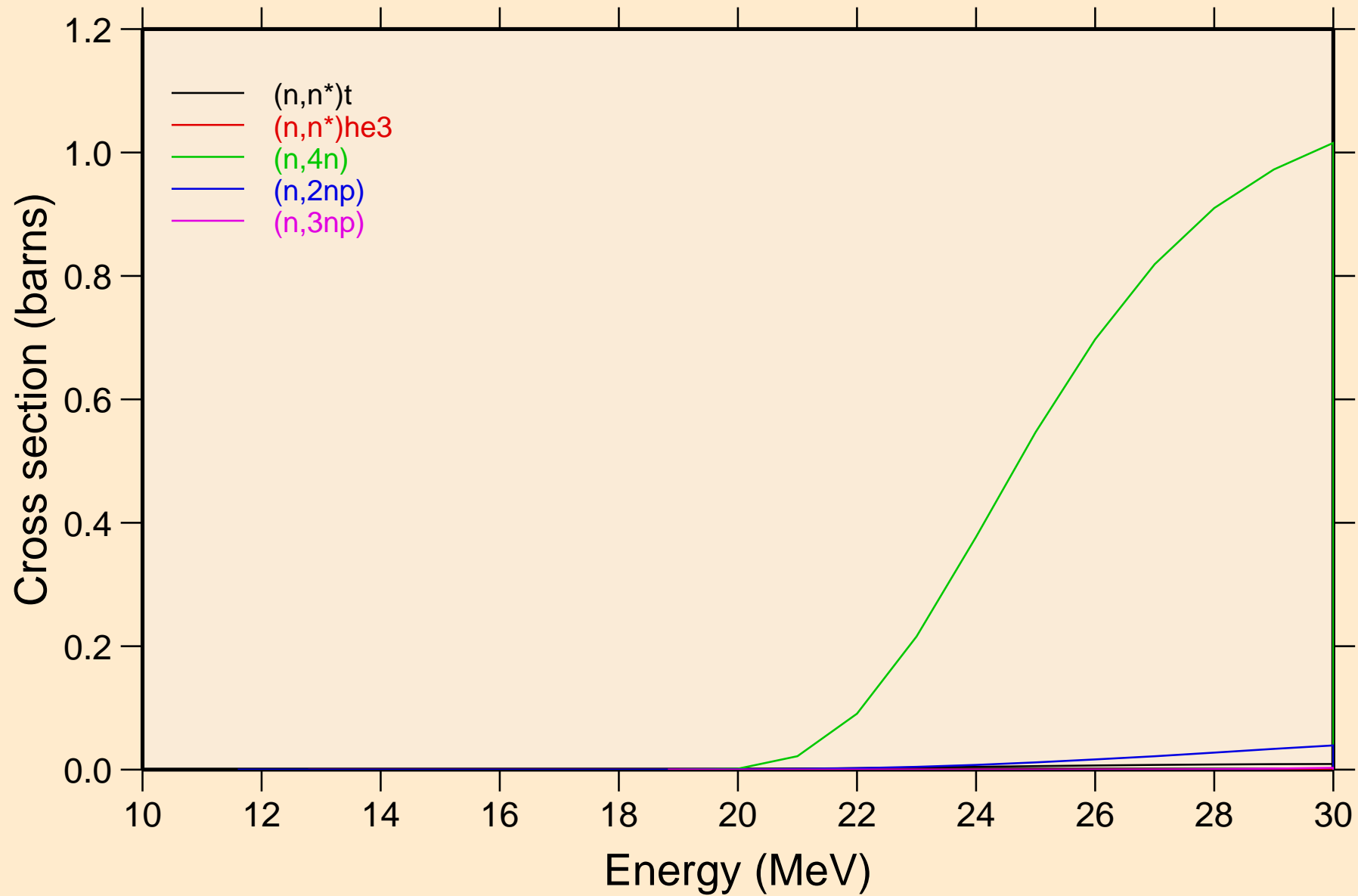

PR144M NEUTRON ACER TENDL-2021 LIBRARY; T=293.6K  
Threshold reactions

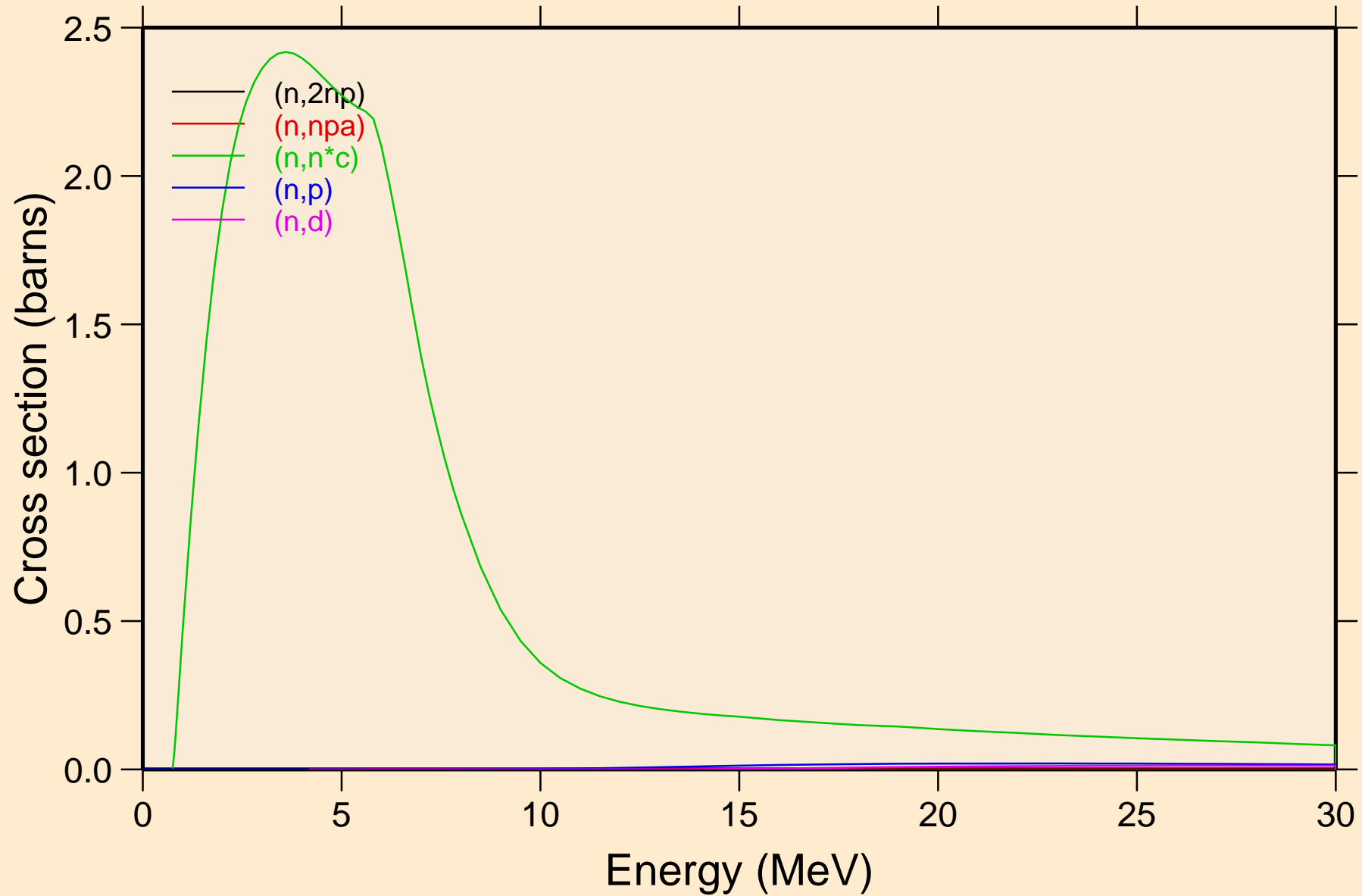

PR144M NEUTRON ACER TENDL-2021 LIBRARY; T=293.6K  
Threshold reactions

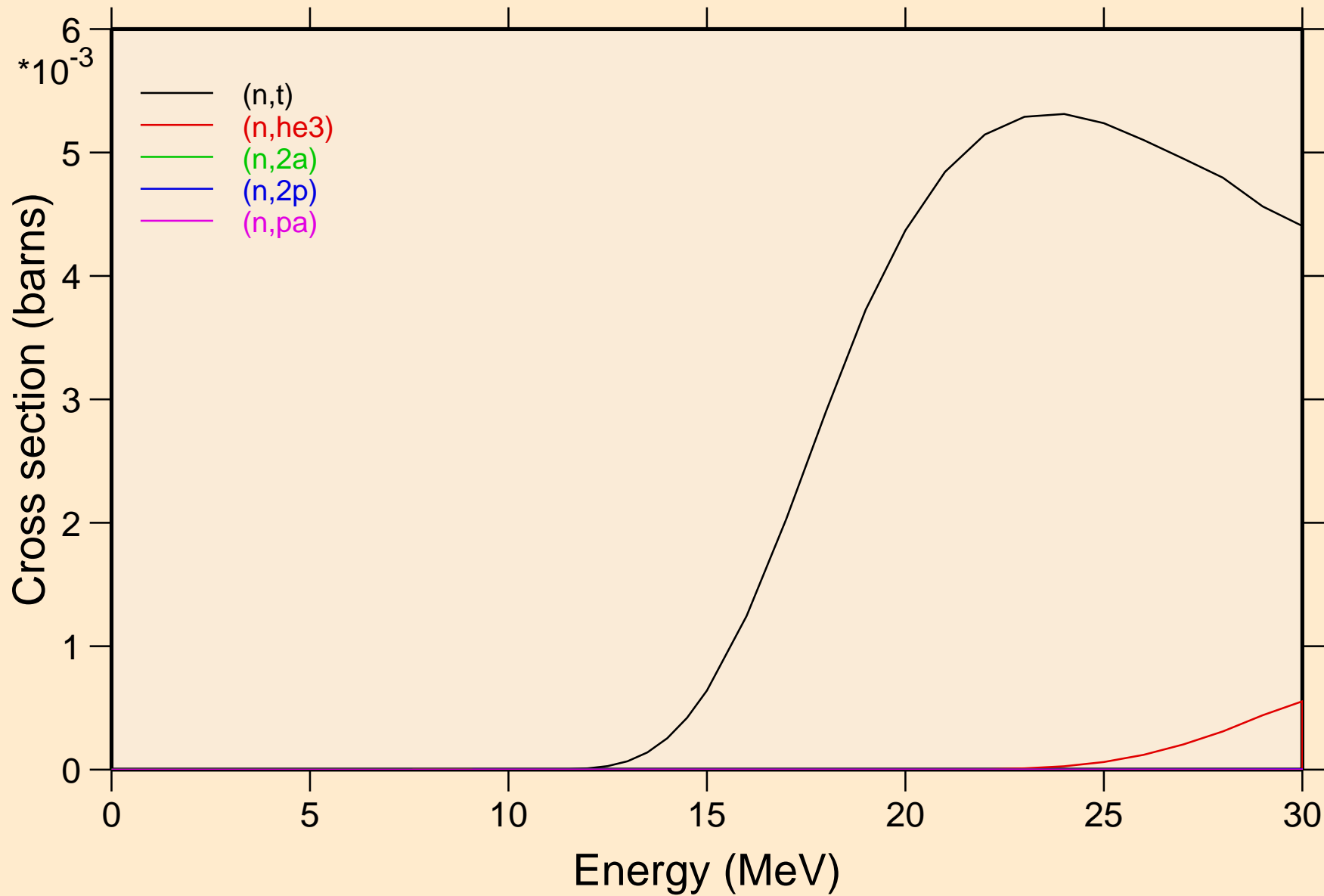

PR144M NEUTRON ACER TENDL-2021 LIBRARY; T=293.6K  
Threshold reactions

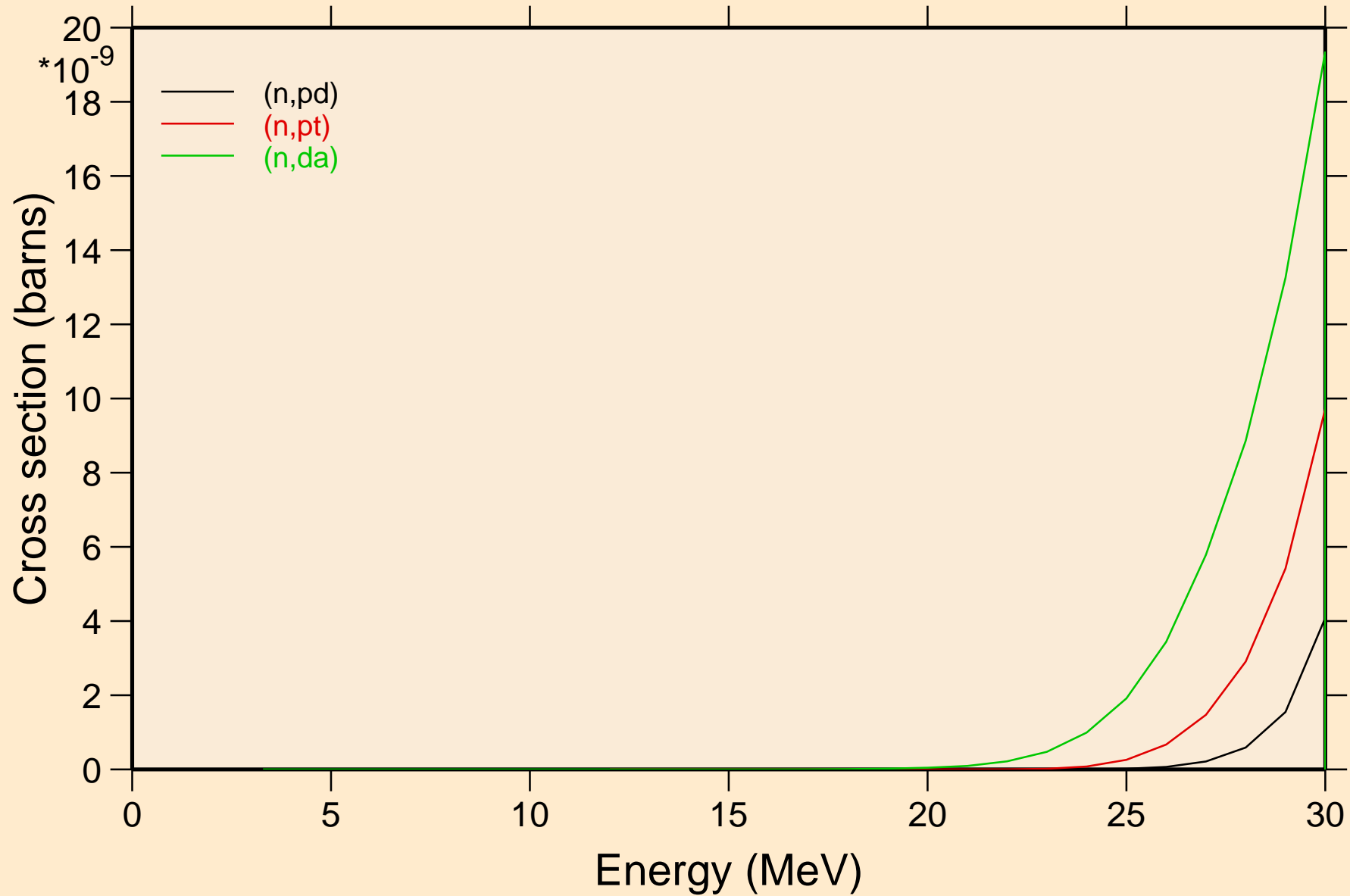

PR144M NEUTRON ACER TENDL-2021 LIBRARY; T=293.6K  
Threshold reactions

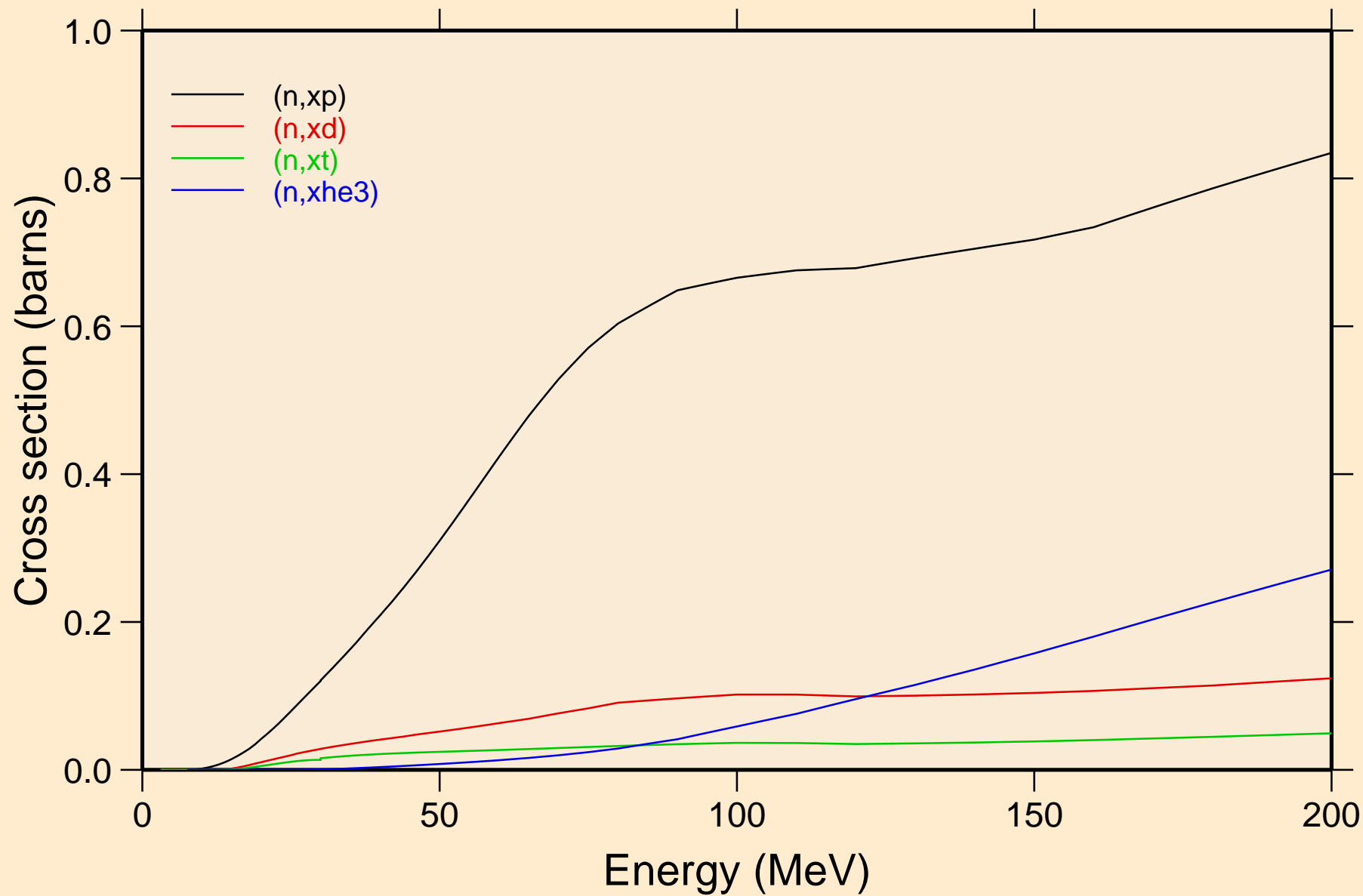

PR144M NEUTRON ACER TENDL-2021 LIBRARY; T=293.6K  
angular distribution for elastic

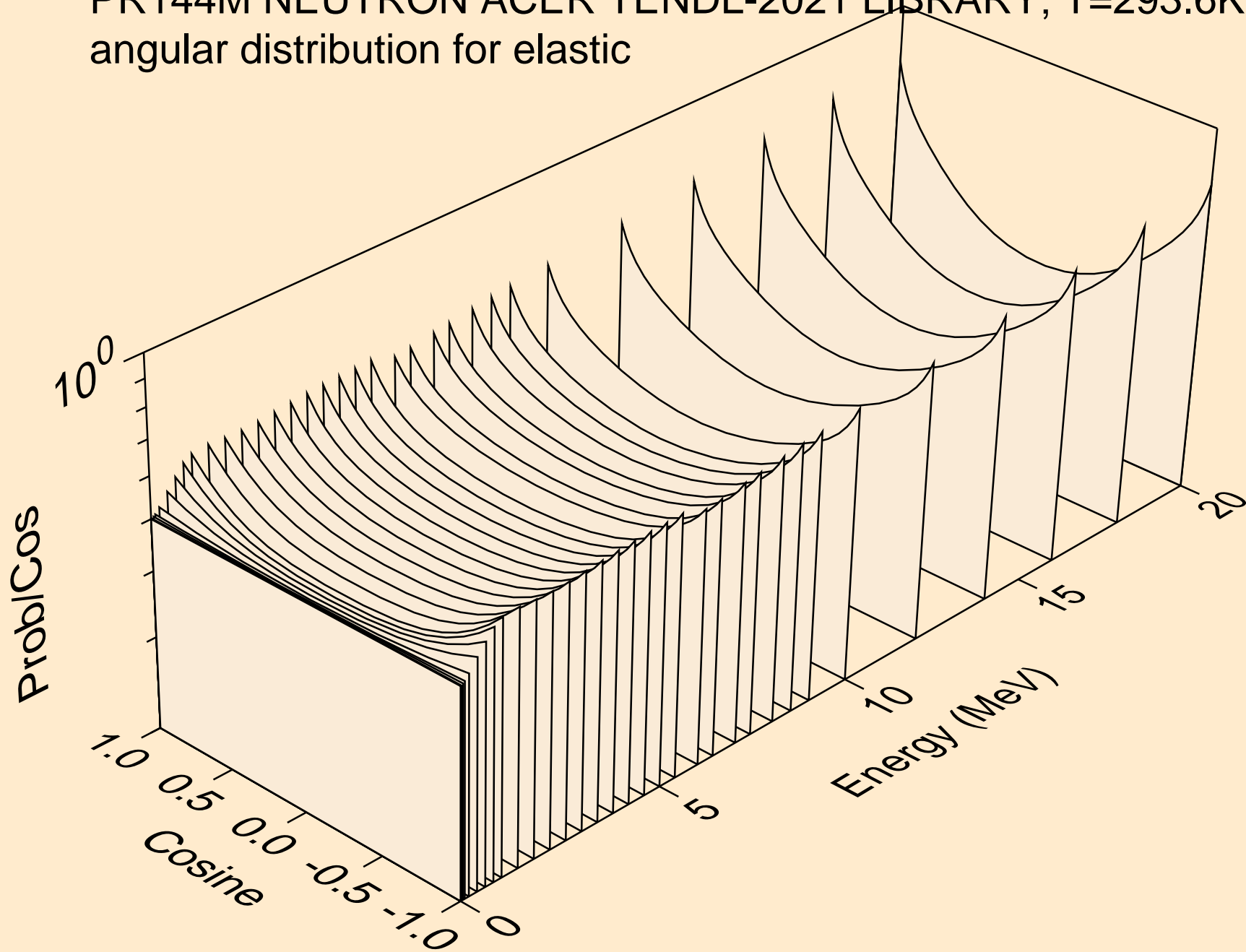

PR144M NEUTRON ACER TENDL-2021 LIBRARY; T=293.6K  
angular distribution for elastic

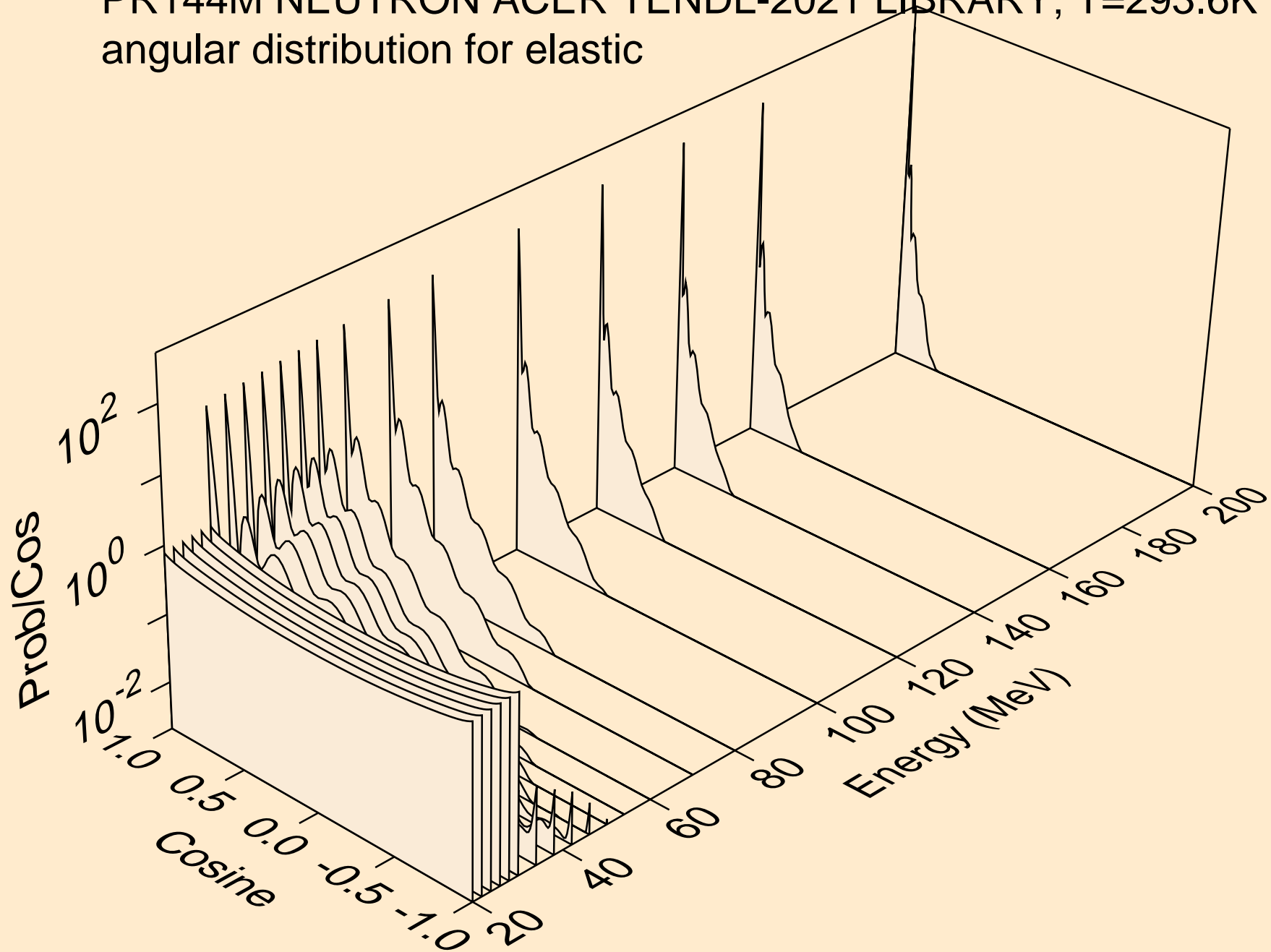

PR144M NEUTRON ACER TENDL-2021 LIBRARY; T=293.6K  
angular distribution for (n,n\*1)

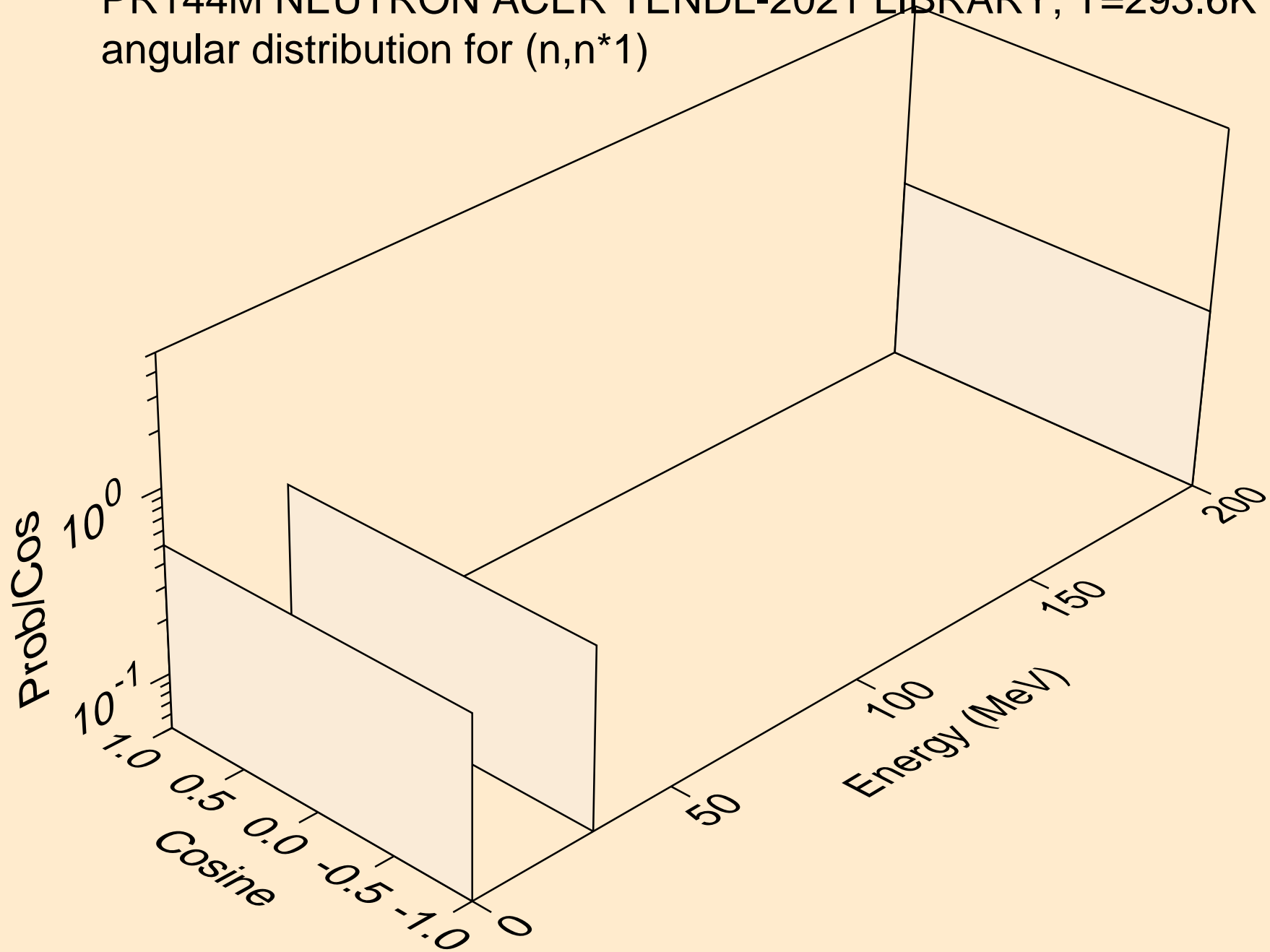



PR144M NEUTRON ACER TENDL-2021 LIBRARY; T=293.6K  
angular distribution for (n,n\*2)

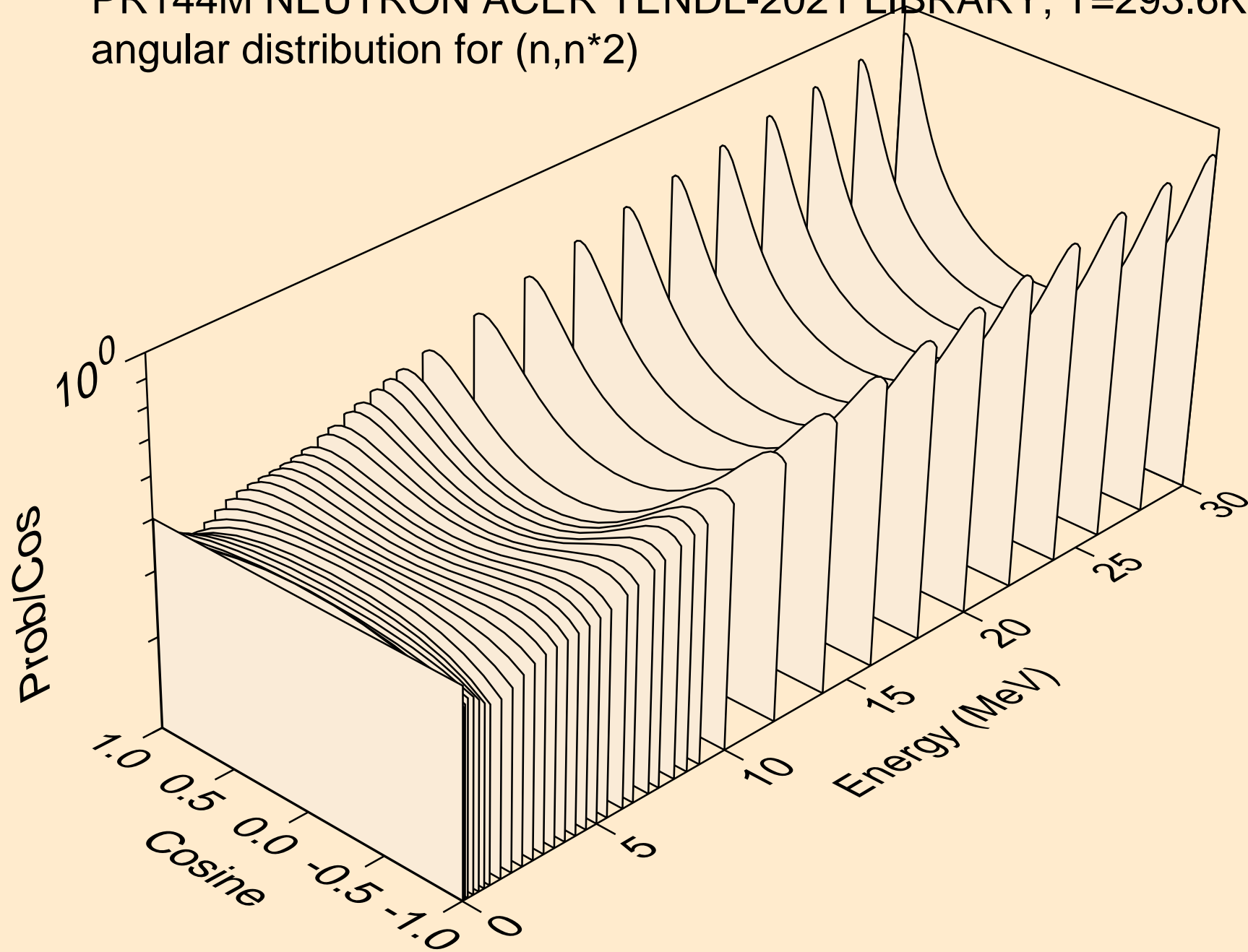

PR144M NEUTRON ACER TENDL-2021 LIBRARY; T=293.6K  
angular distribution for (n,n\*3)

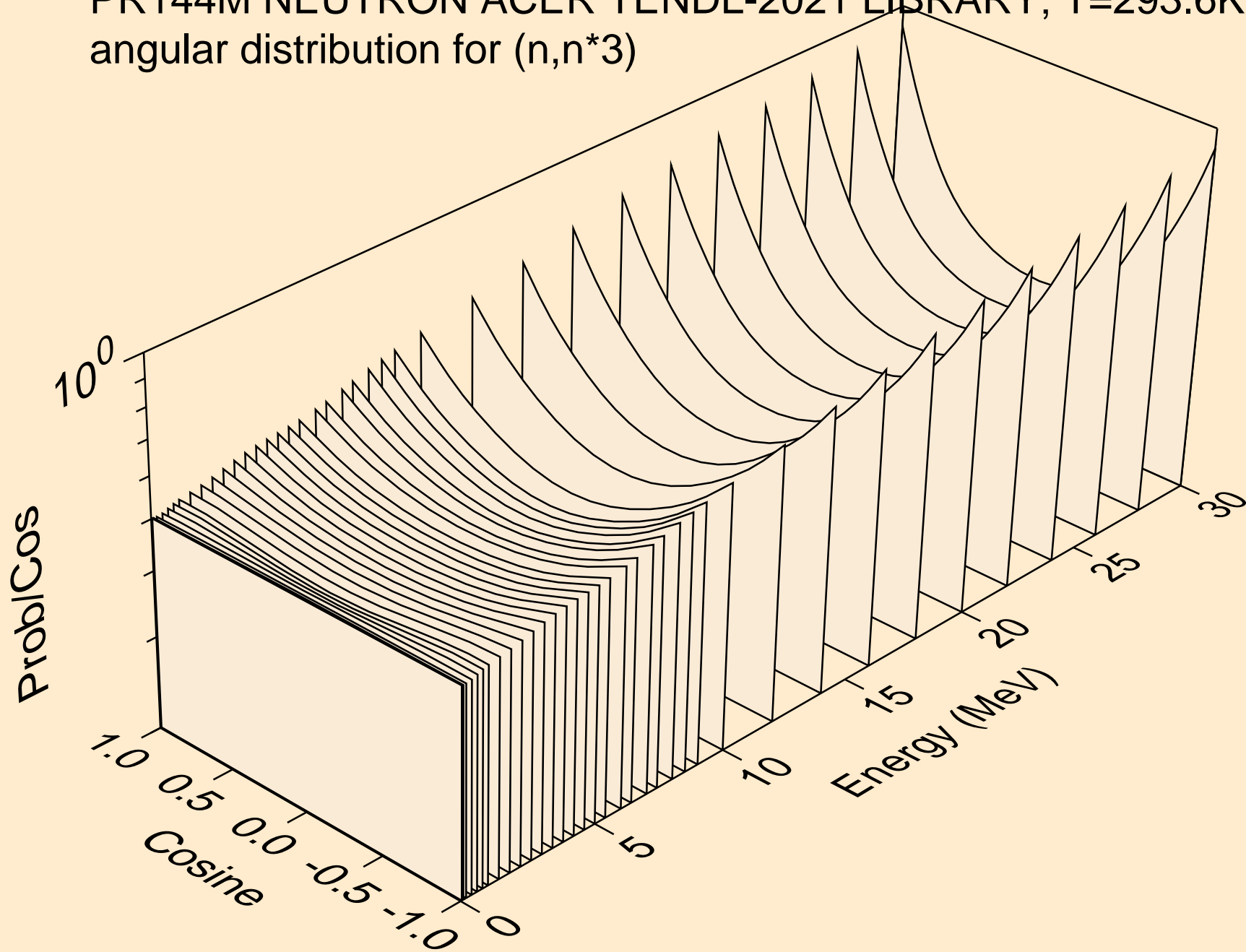

PR144M NEUTRON ACER TENDL-2021 LIBRARY; T=293.6K  
angular distribution for (n,n\*4)

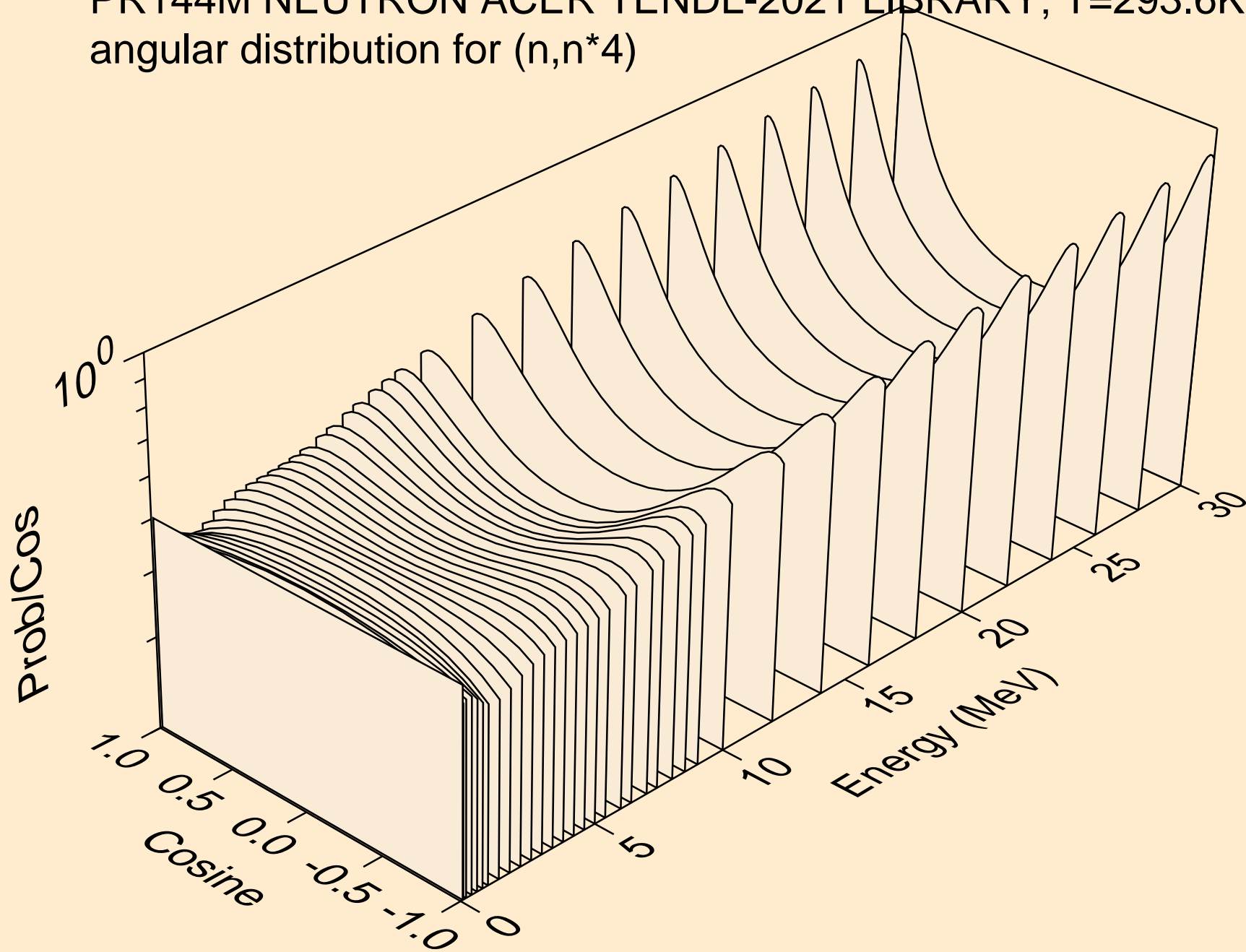

PR144M NEUTRON ACER TENDL-2021 LIBRARY; T=293.6K  
angular distribution for (n,n\*5)

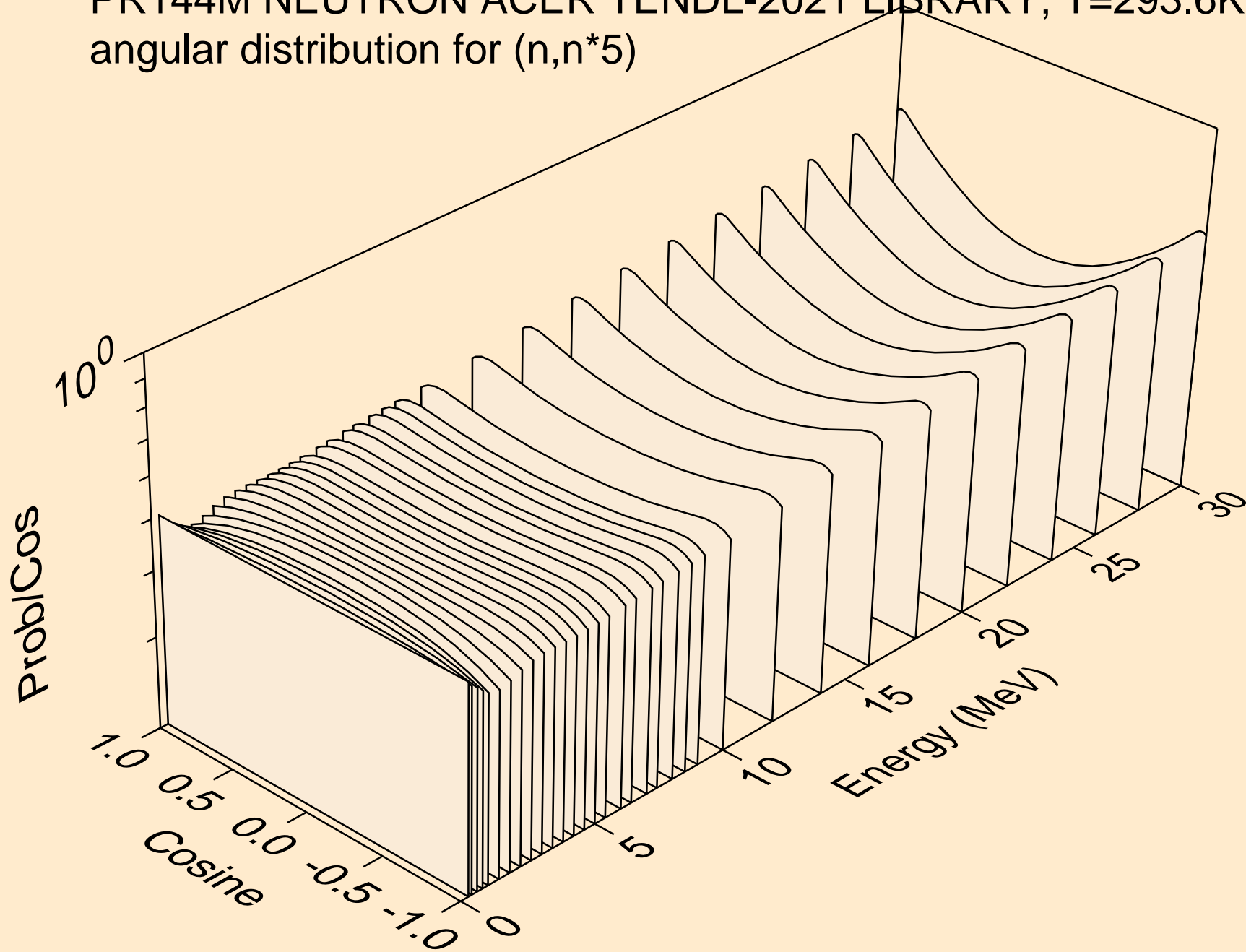

PR144M NEUTRON ACER TENDL-2021 LIBRARY; T=293.6K  
angular distribution for (n,n\*6)

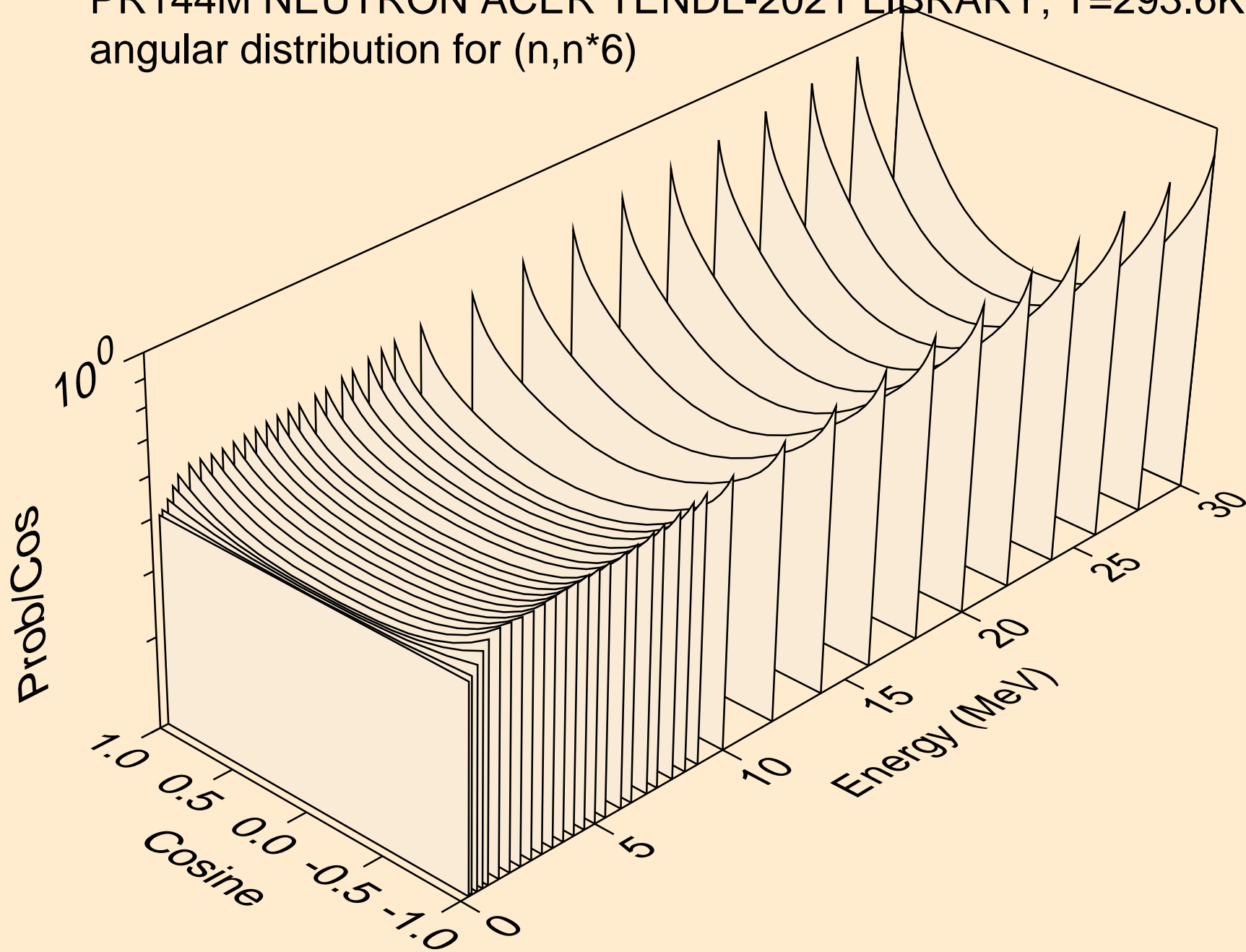

PR144M NEUTRON ACER TENDL-2021 LIBRARY; T=293.6K  
angular distribution for (n,n\*7)

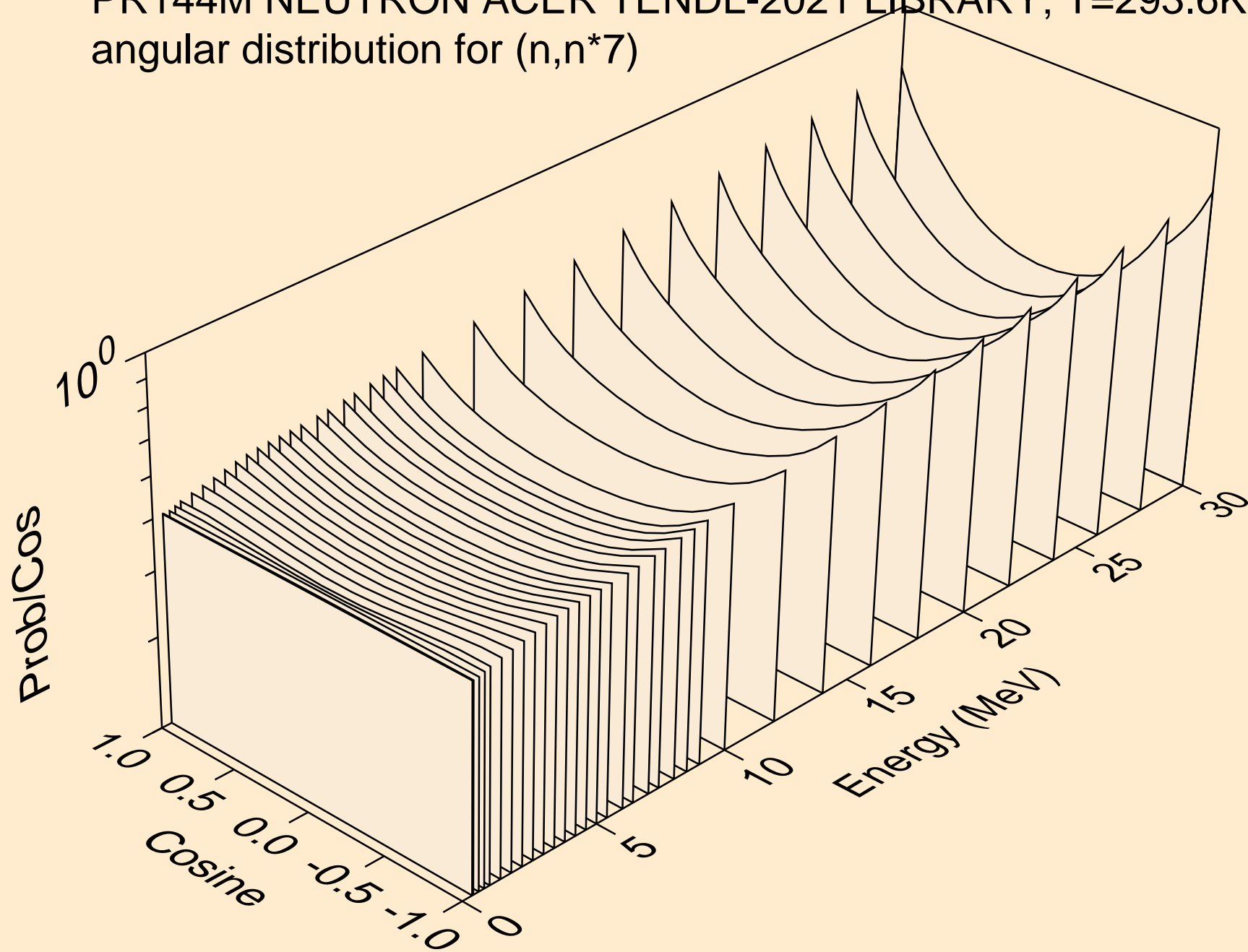

PR144M NEUTRON ACER TENDL-2021 LIBRARY; T=293.6K  
angular distribution for (n,n\*8)

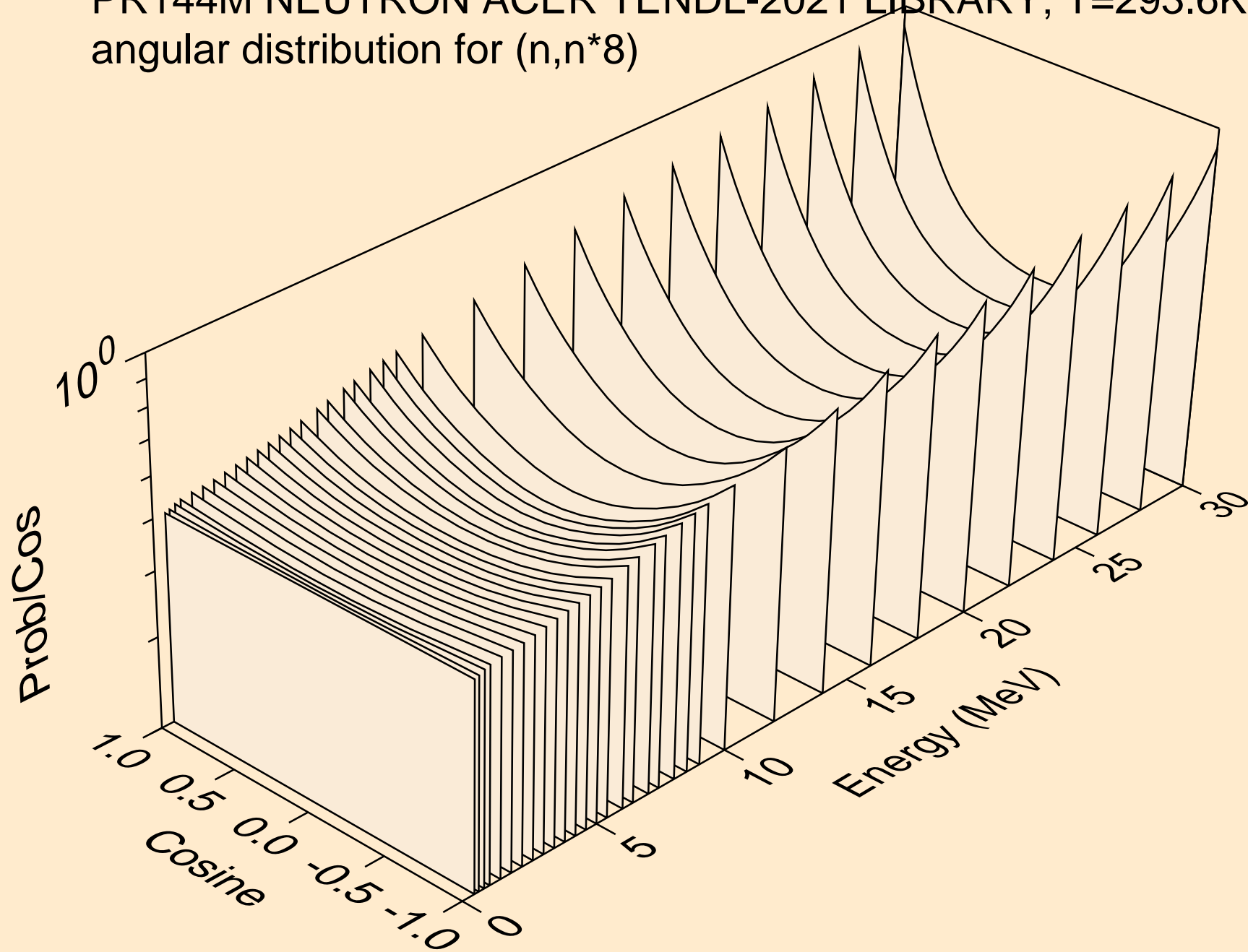

PR144M NEUTRON ACER TENDL-2021 LIBRARY; T=293.6K  
angular distribution for (n,n\*9)

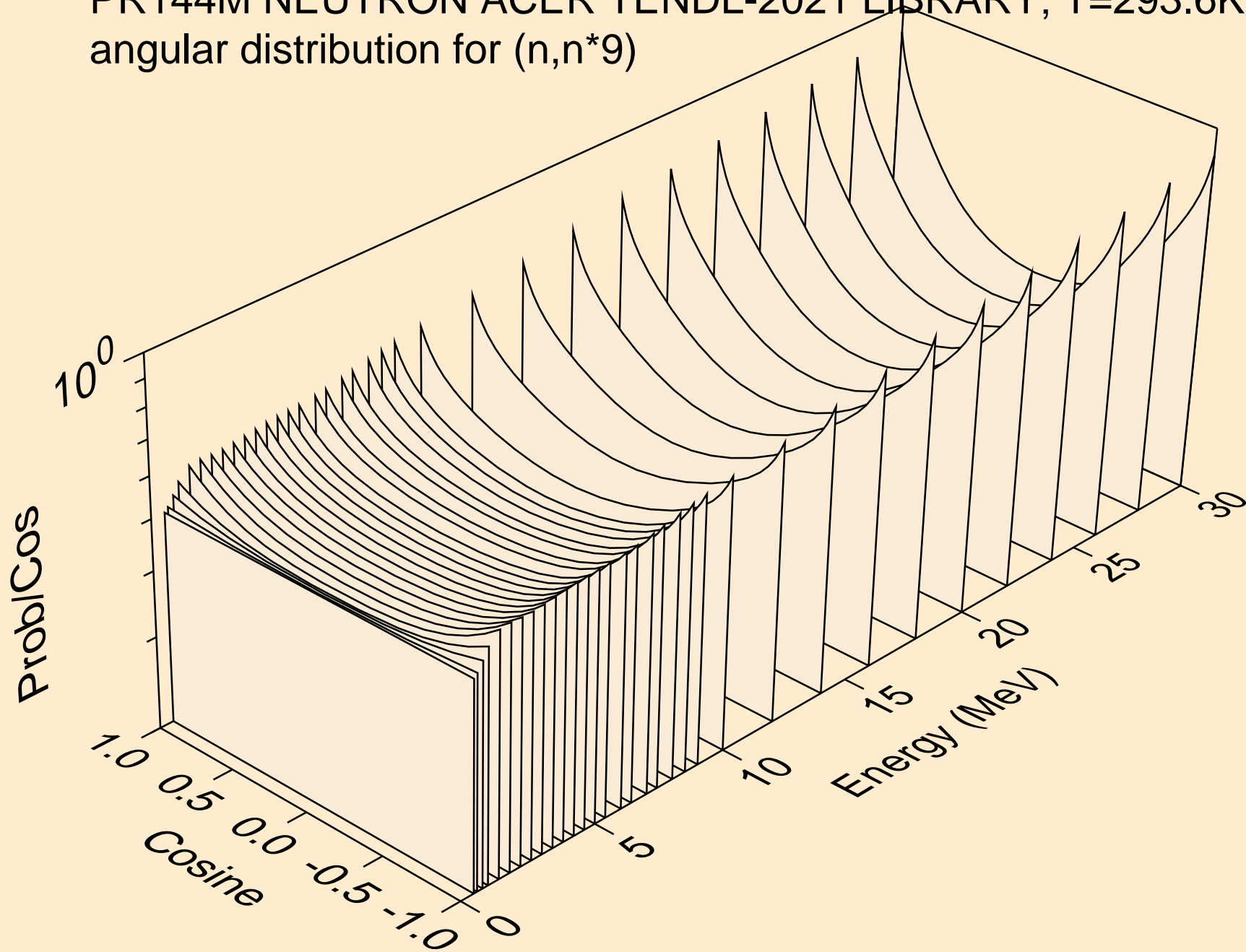



PR144M NEUTRON ACER TENDL-2021 LIBRARY; T=293.6K  
angular distribution for (n,n\*10)

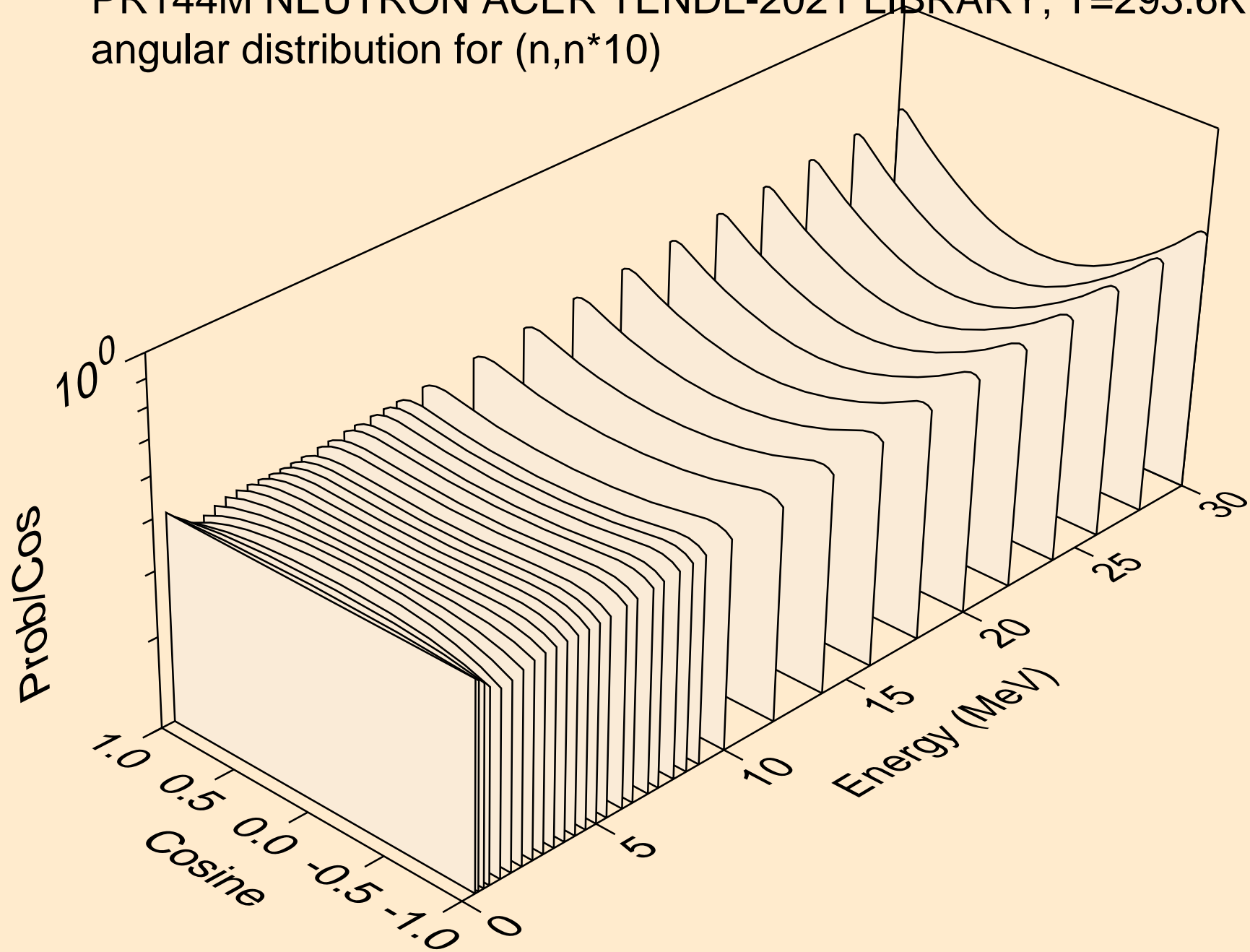

PR144M NEUTRON ACER TENDL-2021 LIBRARY; T=293.6K  
angular distribution for (n,n\*11)

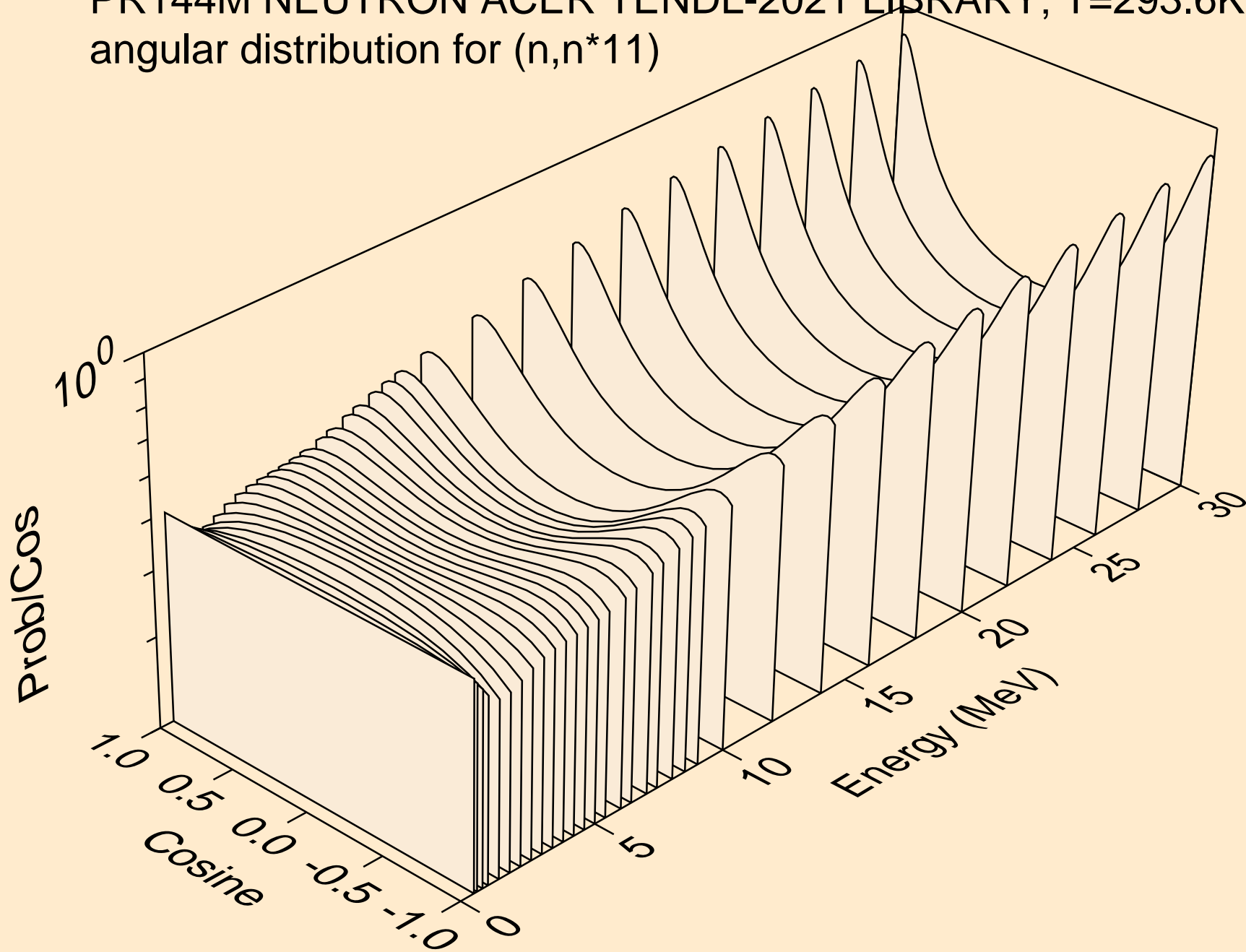

PR144M NEUTRON ACER TENDL-2021 LIBRARY; T=293.6K  
angular distribution for (n,n\*12)

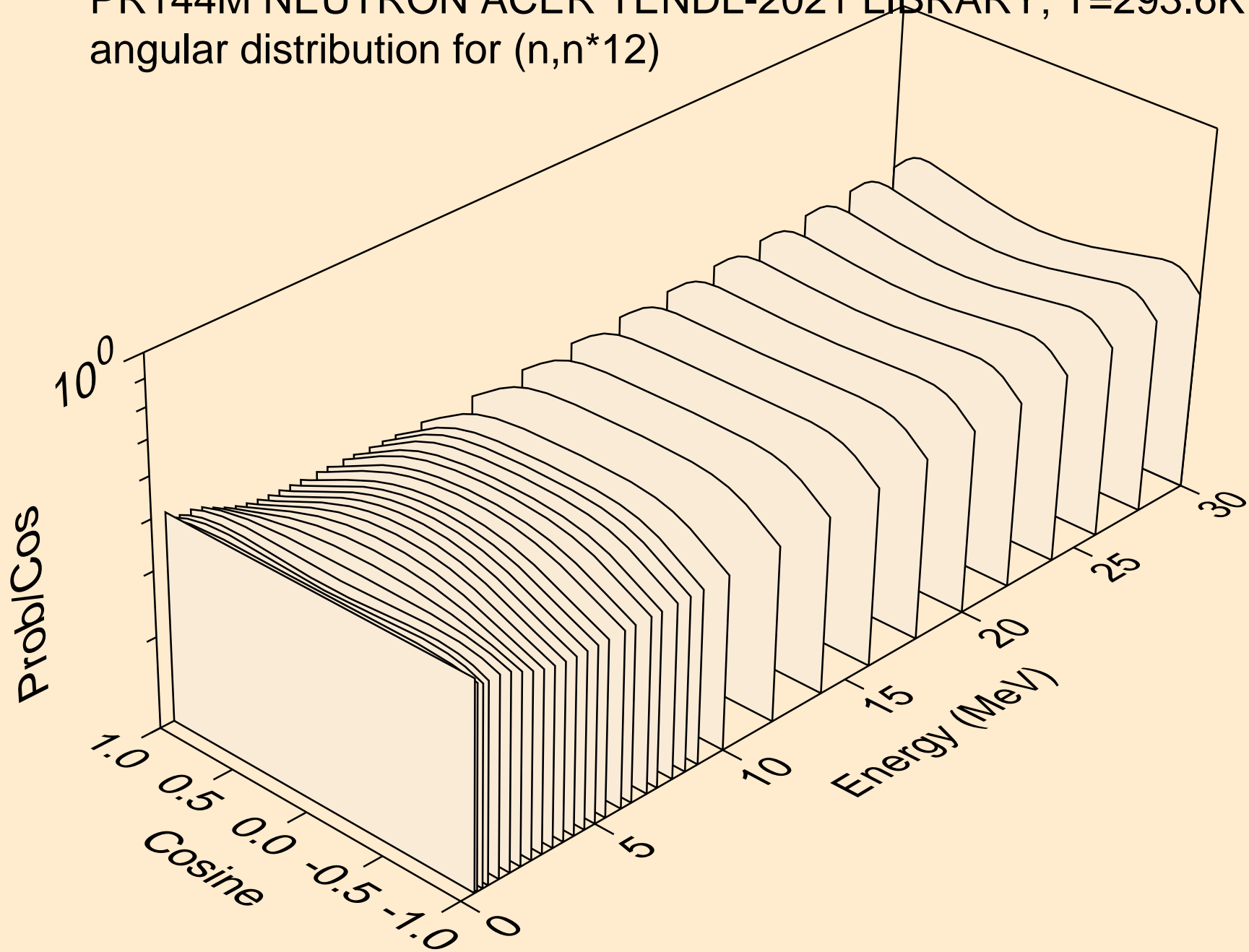

PR144M NEUTRON ACER TENDL-2021 LIBRARY; T=293.6K  
angular distribution for (n,n\*13)

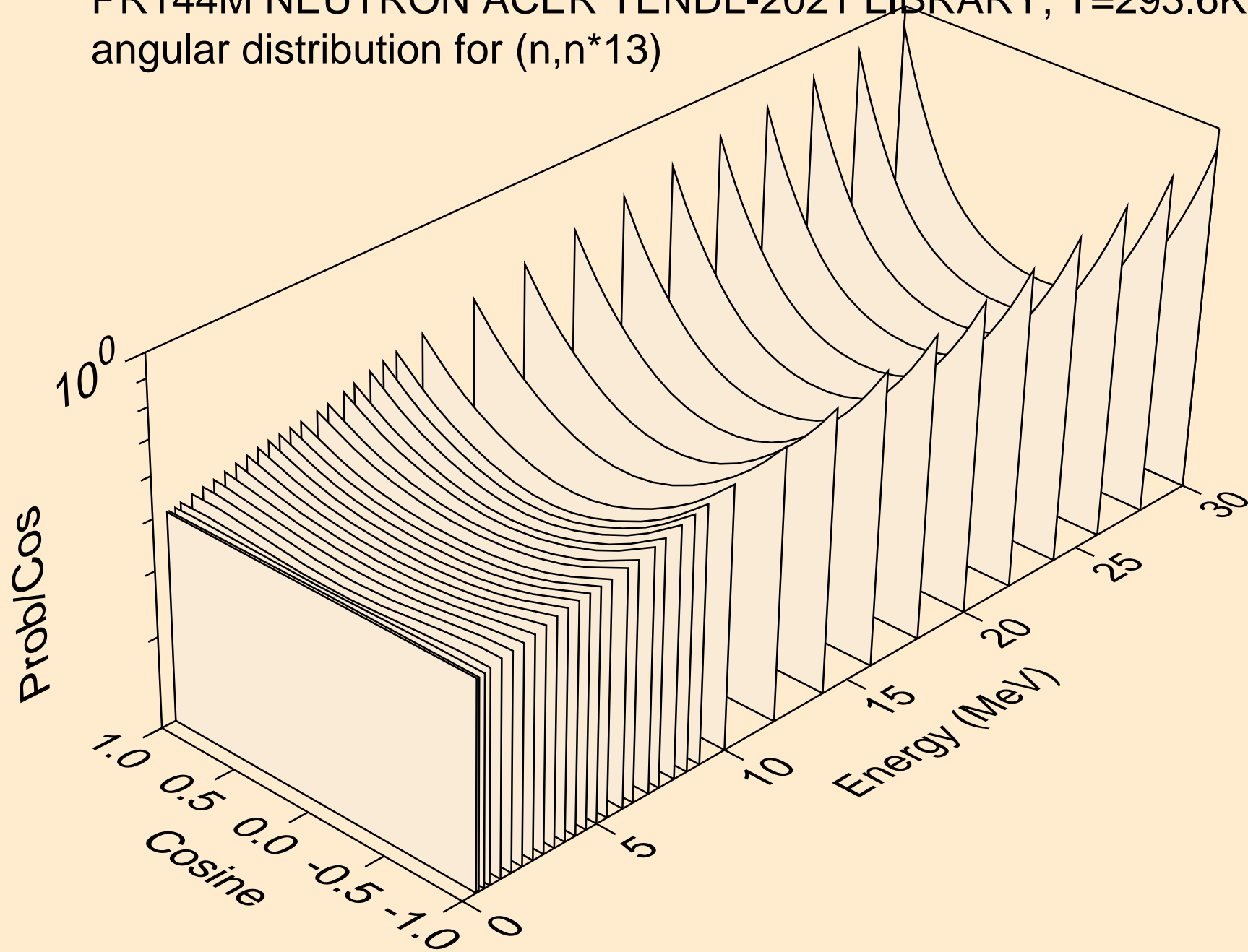

PR144M NEUTRON ACER TENDL-2021 LIBRARY; T=293.6K  
angular distribution for (n,n\*14)

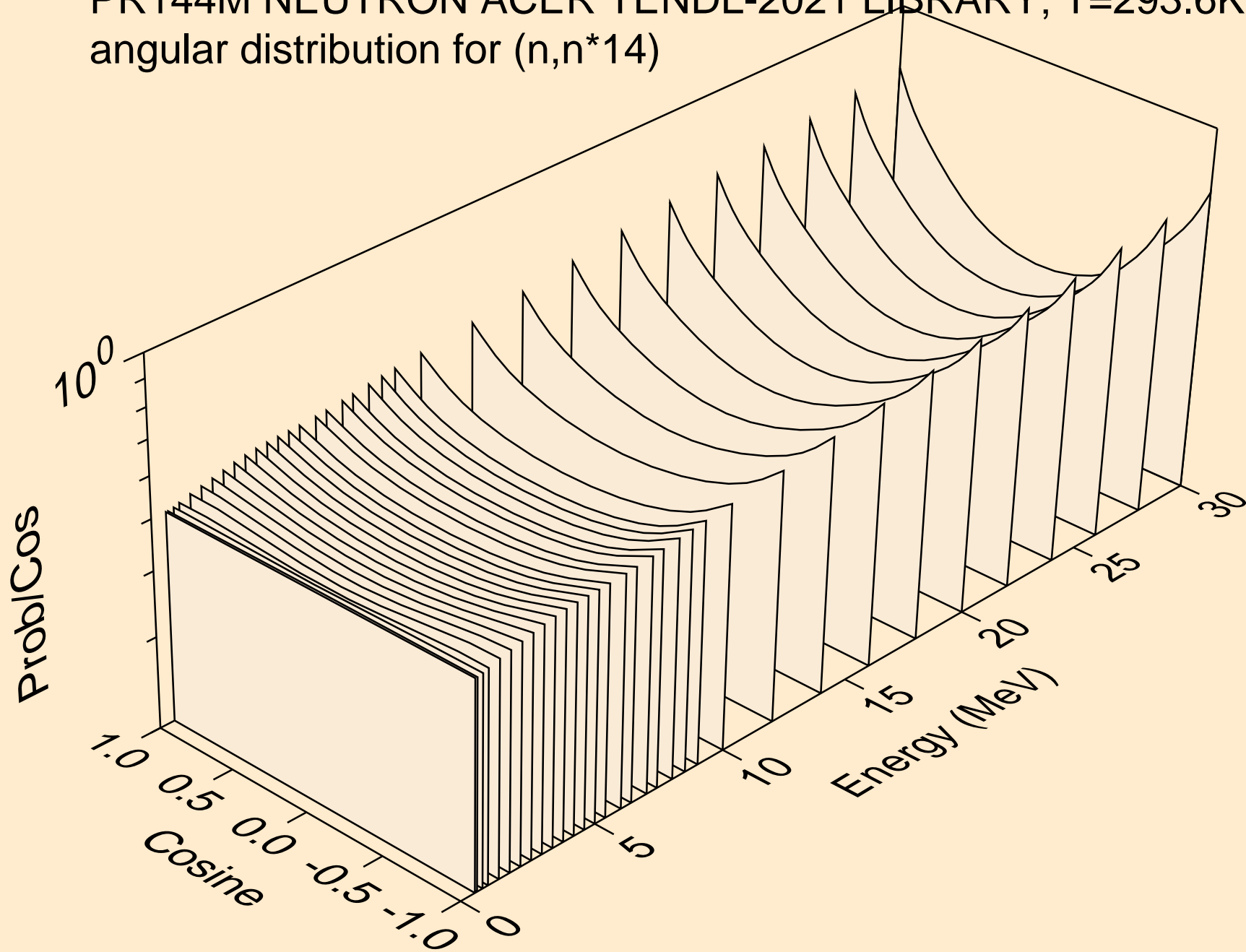

PR144M NEUTRON ACER TENDL-2021 LIBRARY; T=293.6K  
angular distribution for (n,n\*15)

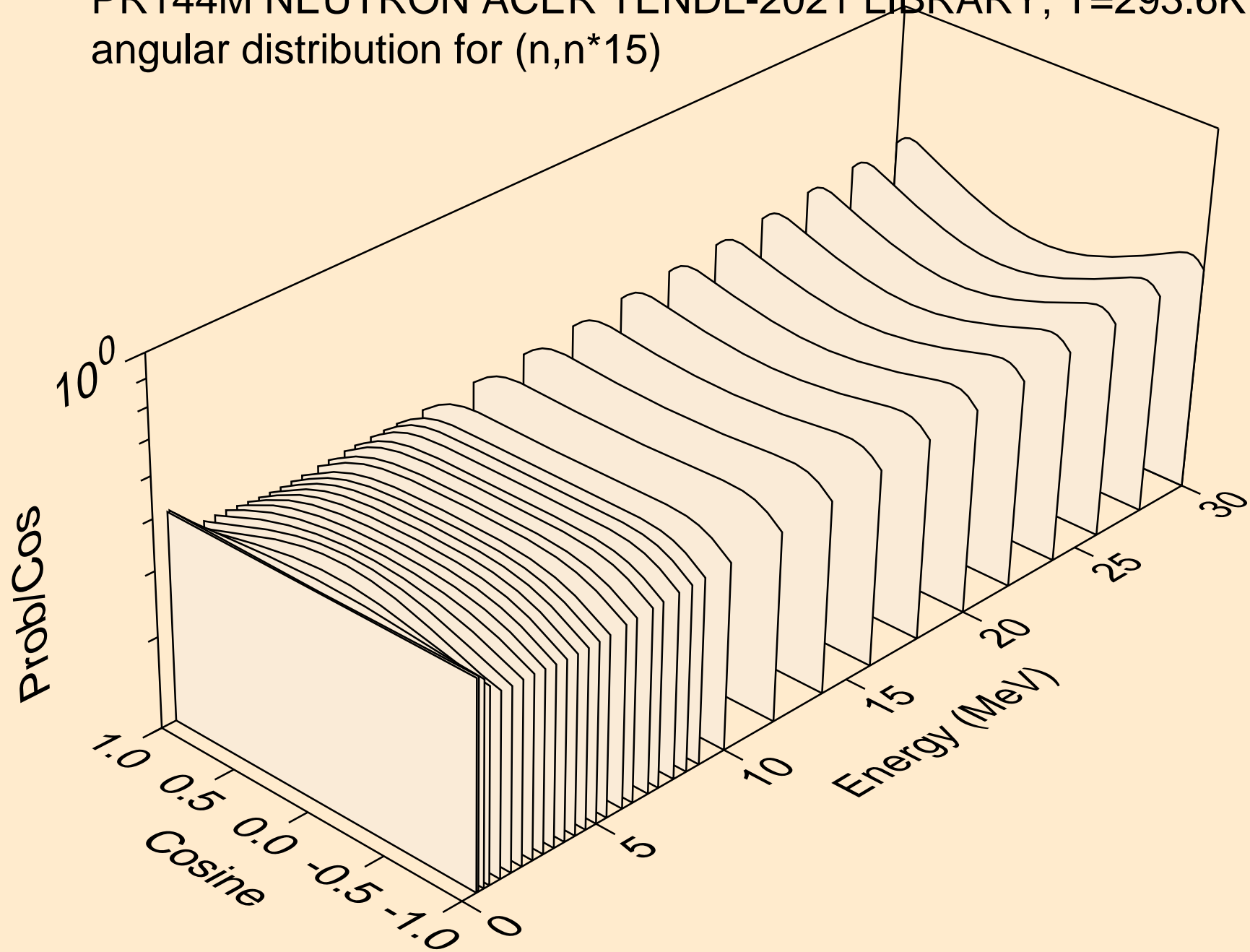

PR144M NEUTRON ACER TENDL-2021 LIBRARY; T=293.6K  
angular distribution for (n,n\*16)

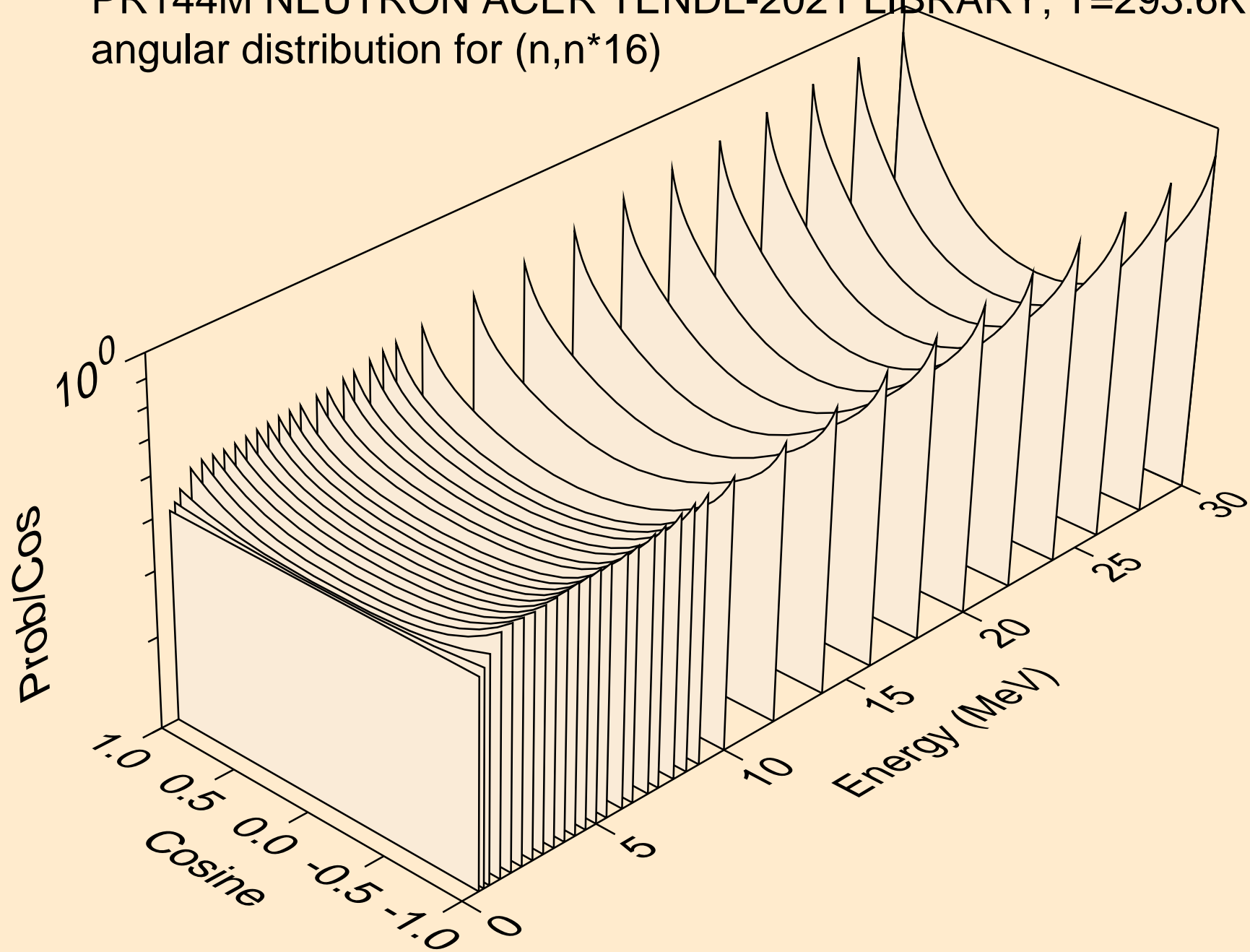

PR144M NEUTRON ACER TENDL-2021 LIBRARY; T=293.6K  
angular distribution for (n,n\*17)

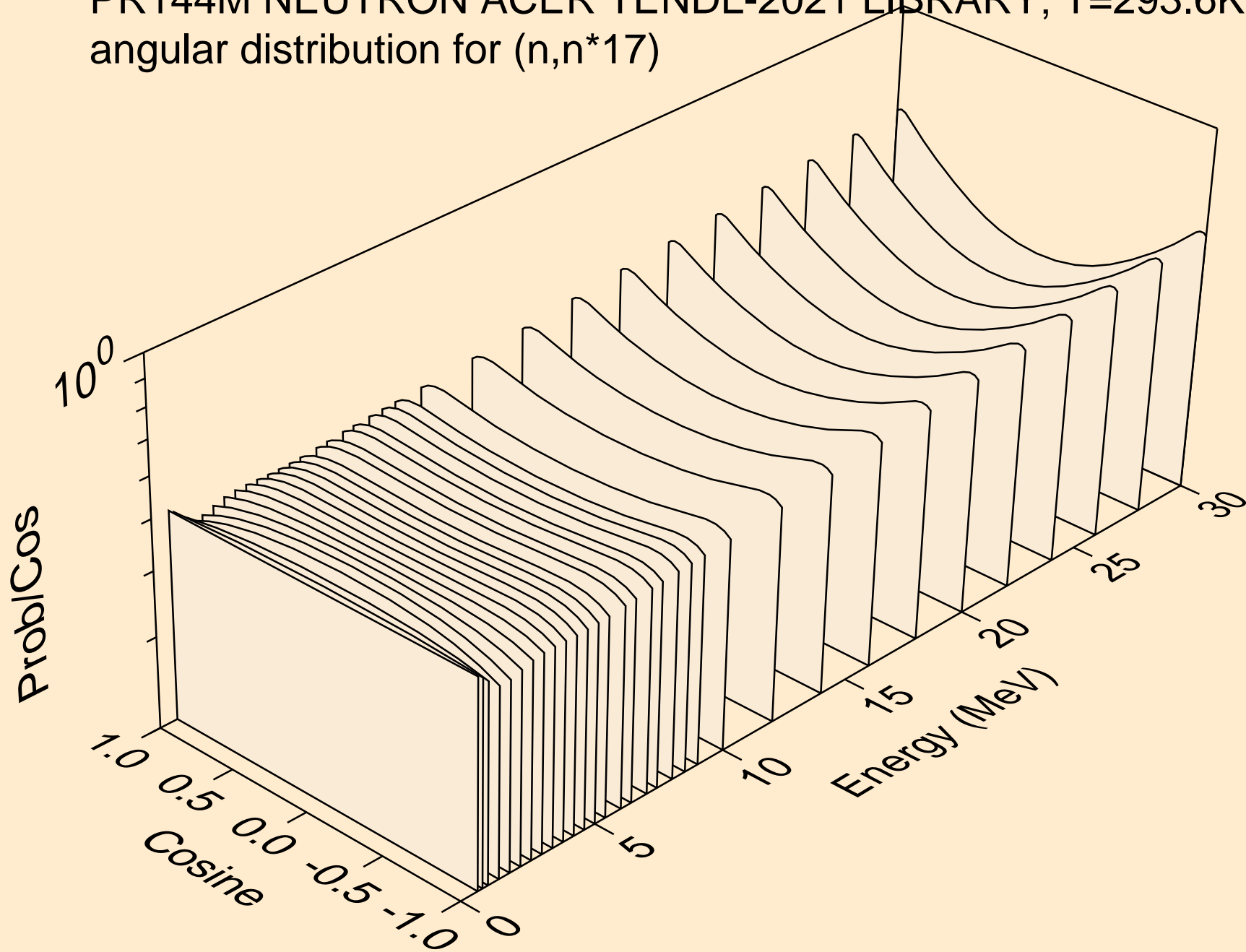



PR144M NEUTRON ACER TENDL-2021 LIBRARY; T=293.6K  
angular distribution for (n,n\*18)

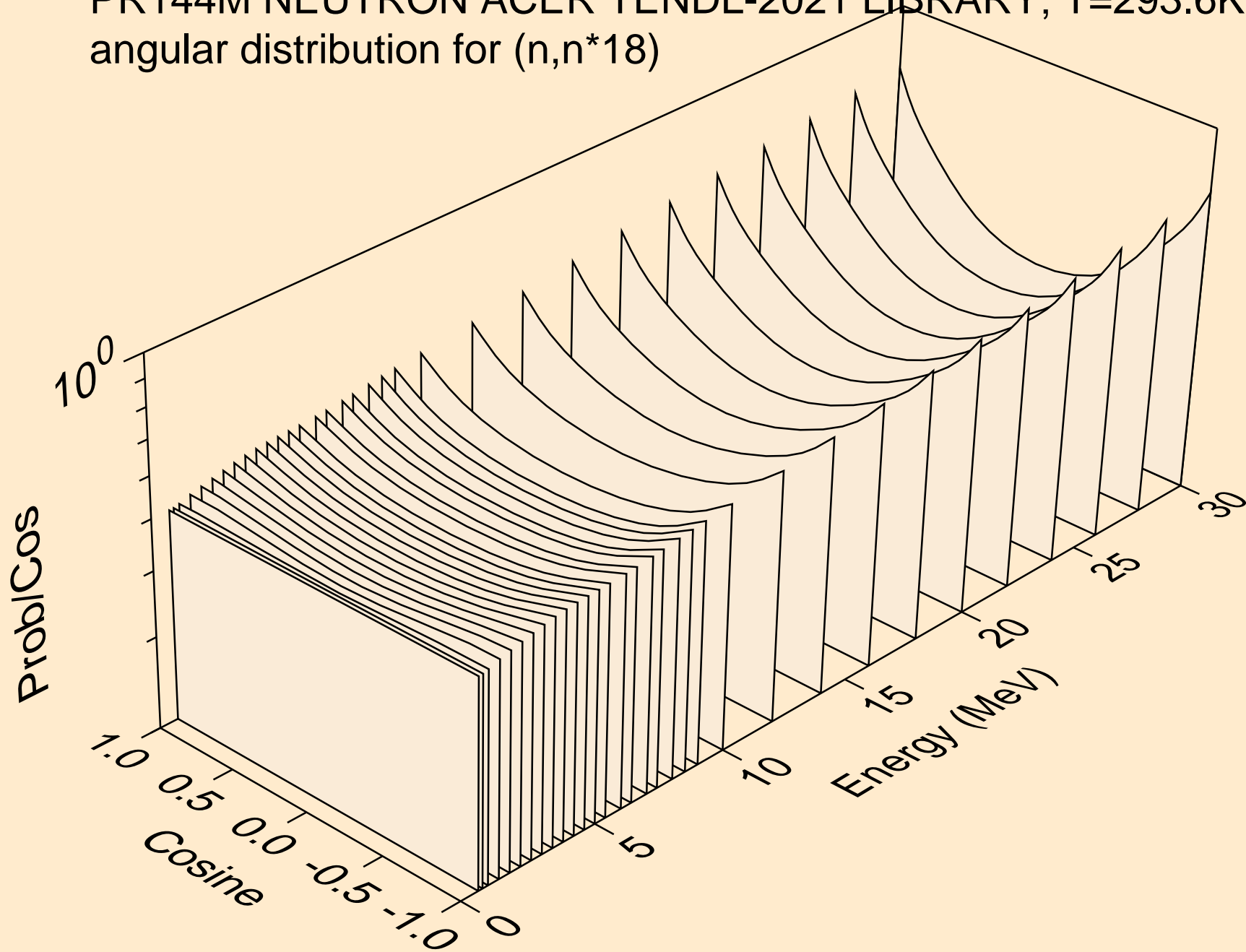

PR144M NEUTRON ACER TENDL-2021 LIBRARY; T=293.6K  
angular distribution for (n,n\*19)

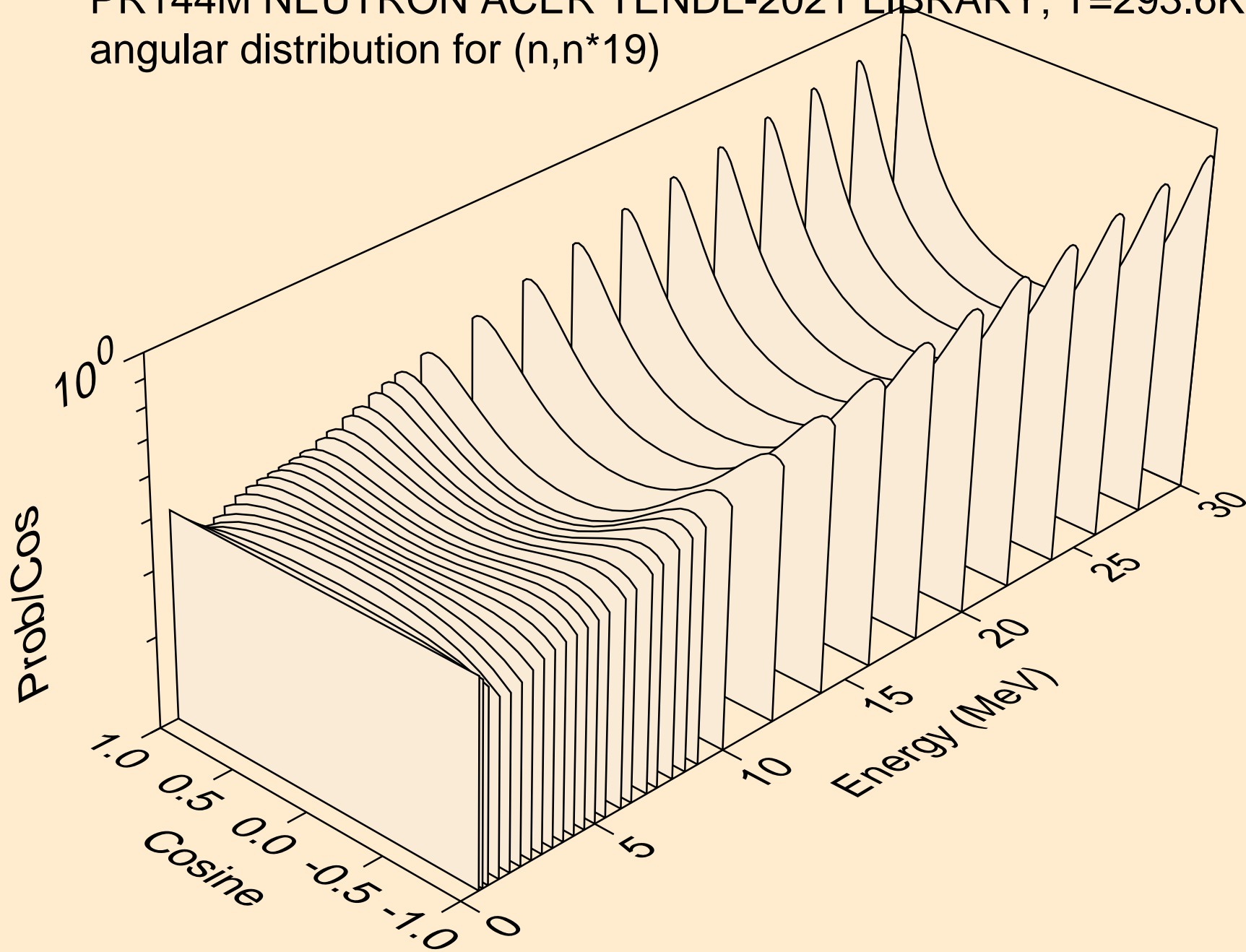

PR144M NEUTRON ACER TENDL-2021 LIBRARY; T=293.6K  
angular distribution for (n,n\*20)

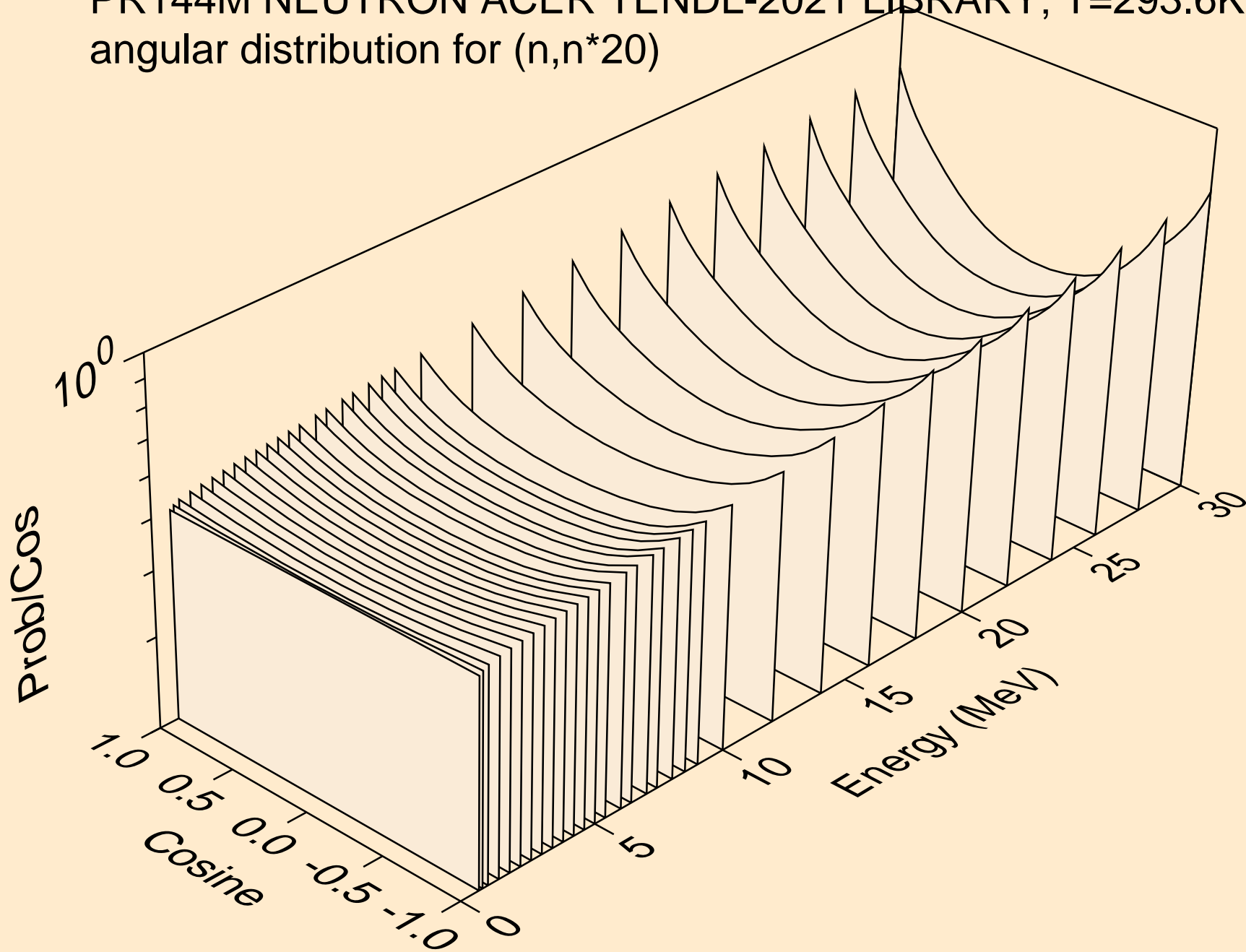

PR144M NEUTRON ACER TENDL-2021 LIBRARY; T=293.6K  
angular distribution for (n,n\*21)

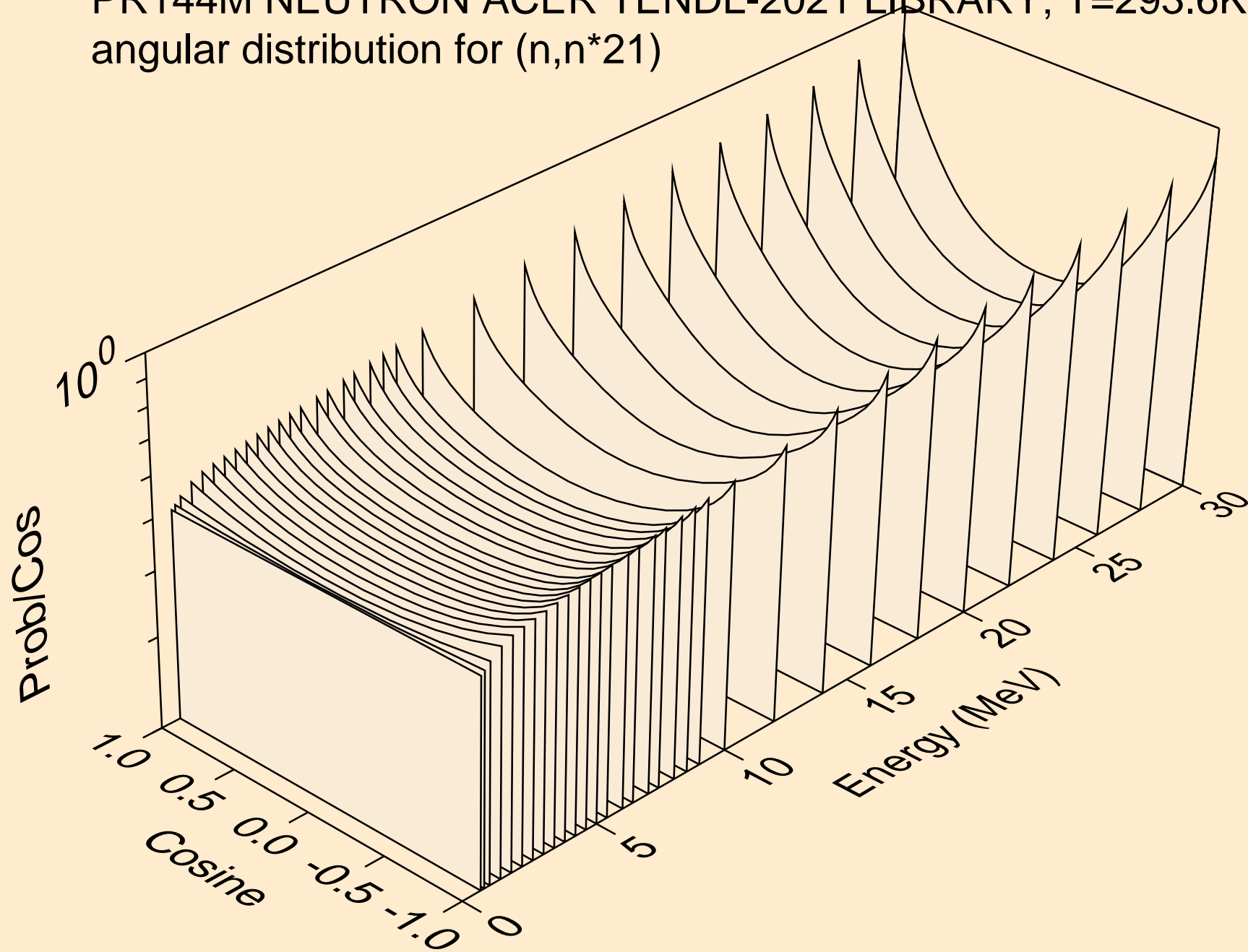

PR144M NEUTRON ACER TENDL-2021 LIBRARY; T=293.6K  
angular distribution for (n,n\*22)

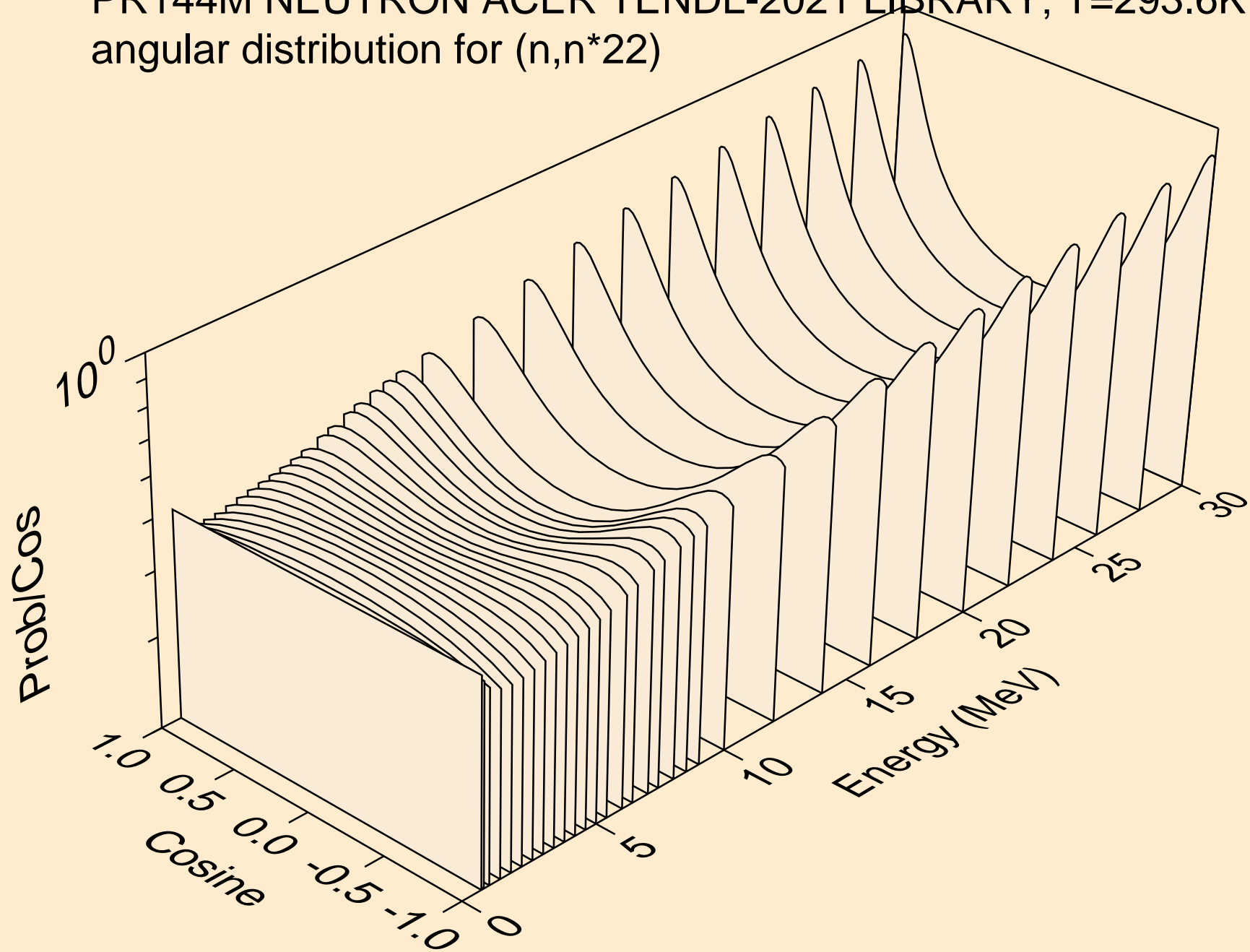

PR144M NEUTRON ACER TENDL-2021 LIBRARY; T=293.6K  
angular distribution for (n,n\*23)

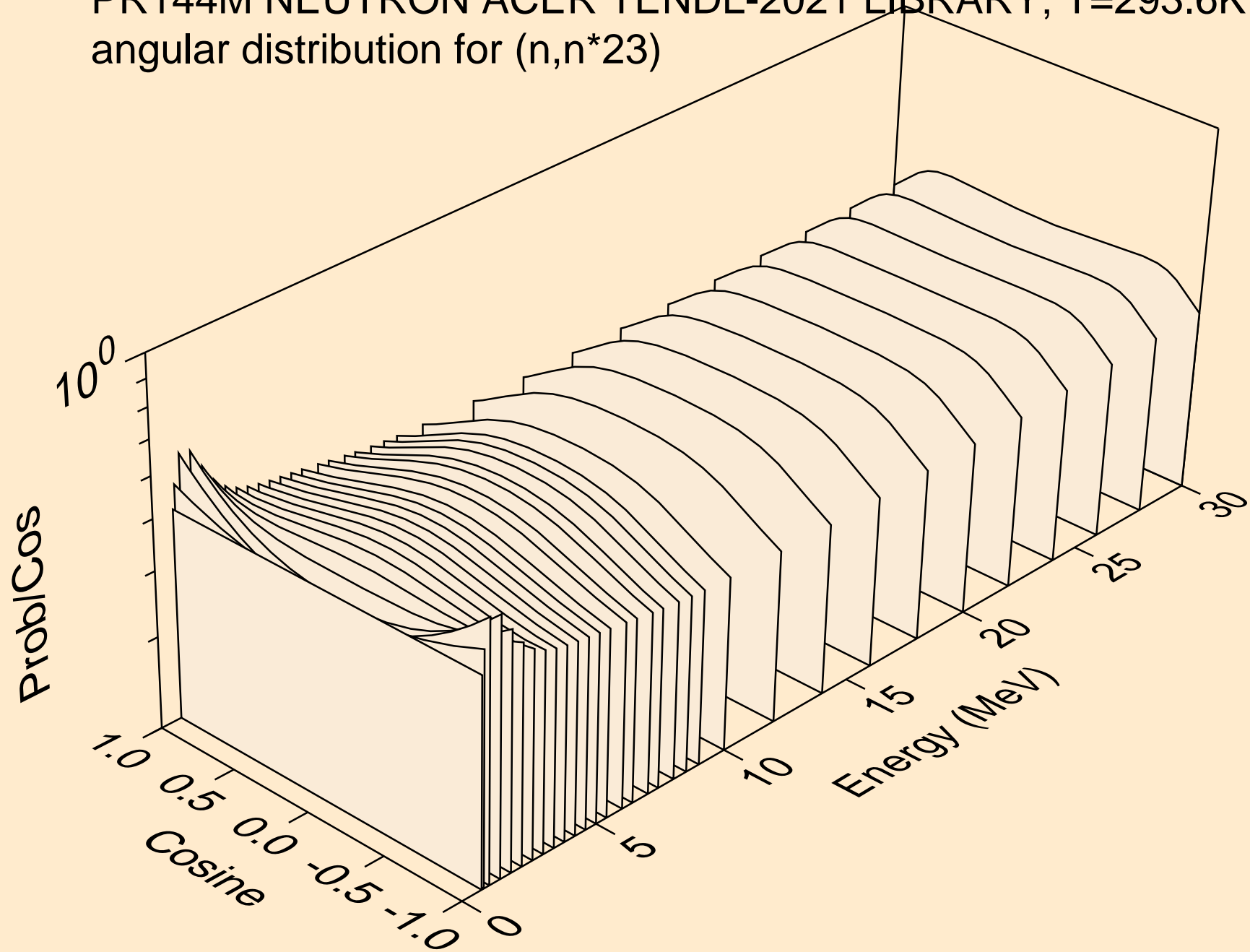

PR144M NEUTRON ACER TENDL-2021 LIBRARY; T=293.6K  
angular distribution for (n,n\*24)

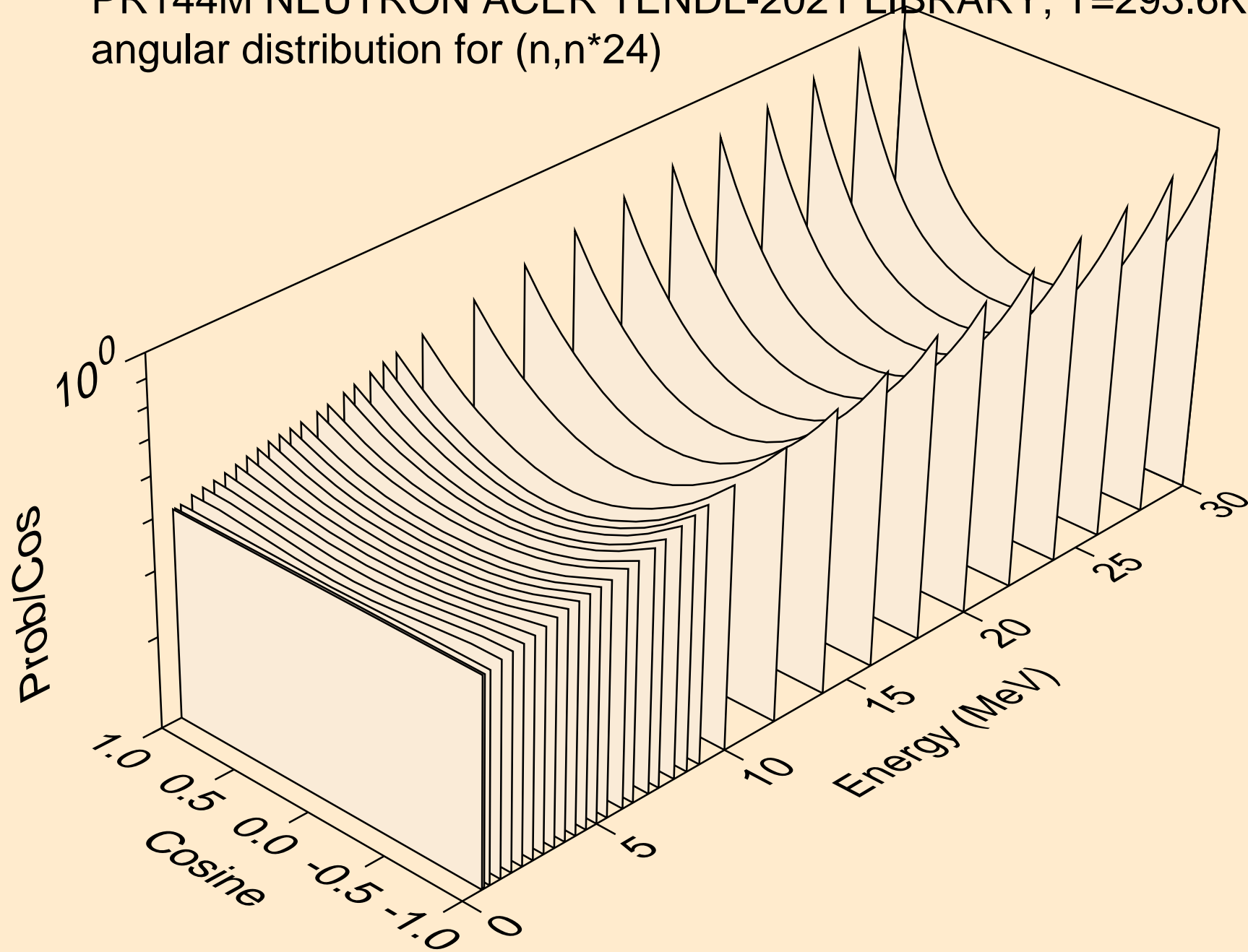

PR144M NEUTRON ACER TENDL-2021 LIBRARY; T=293.6K  
angular distribution for (n,n\*25)

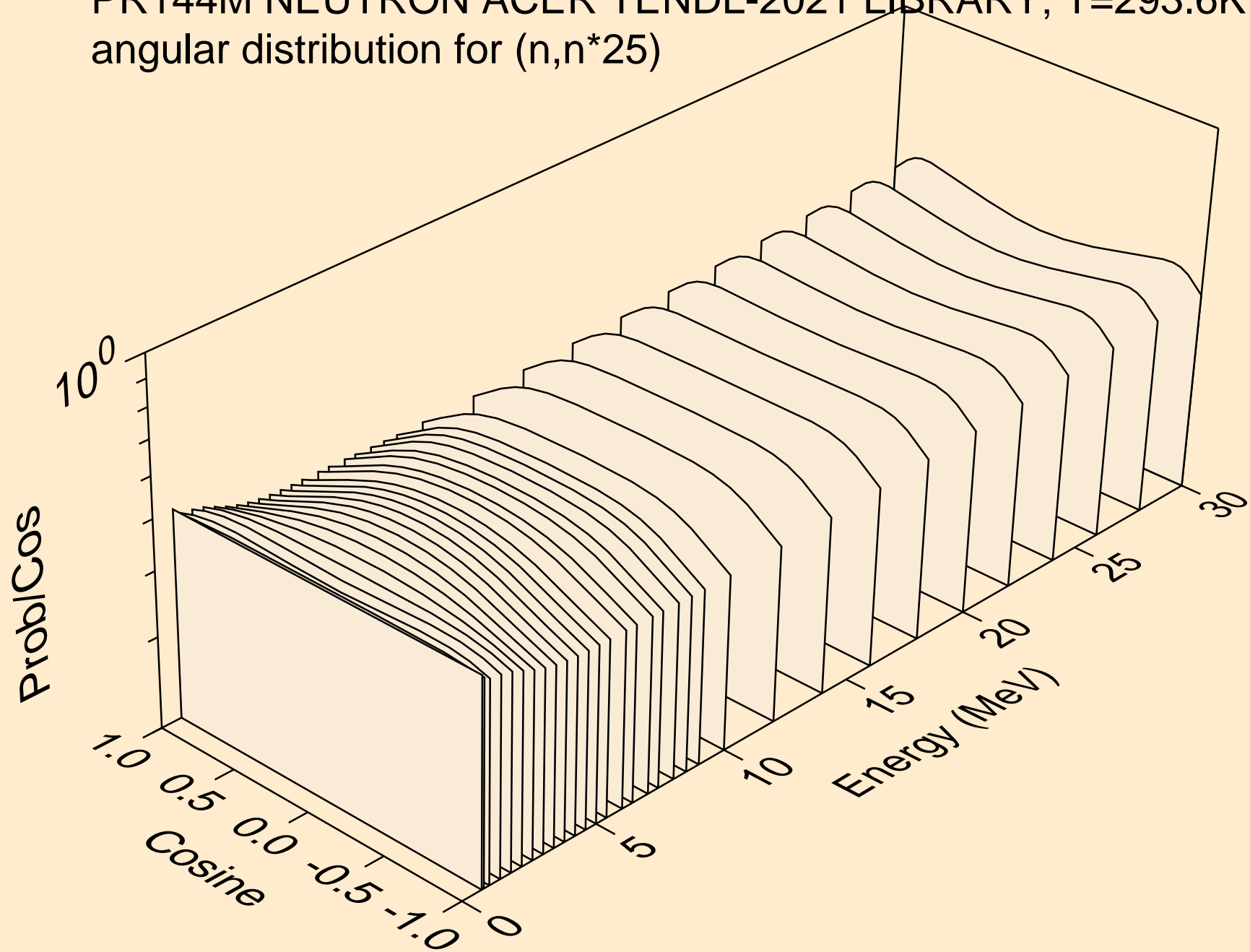



PR144M NEUTRON ACER TENDL-2021 LIBRARY; T=293.6K  
angular distribution for (n,n\*26)

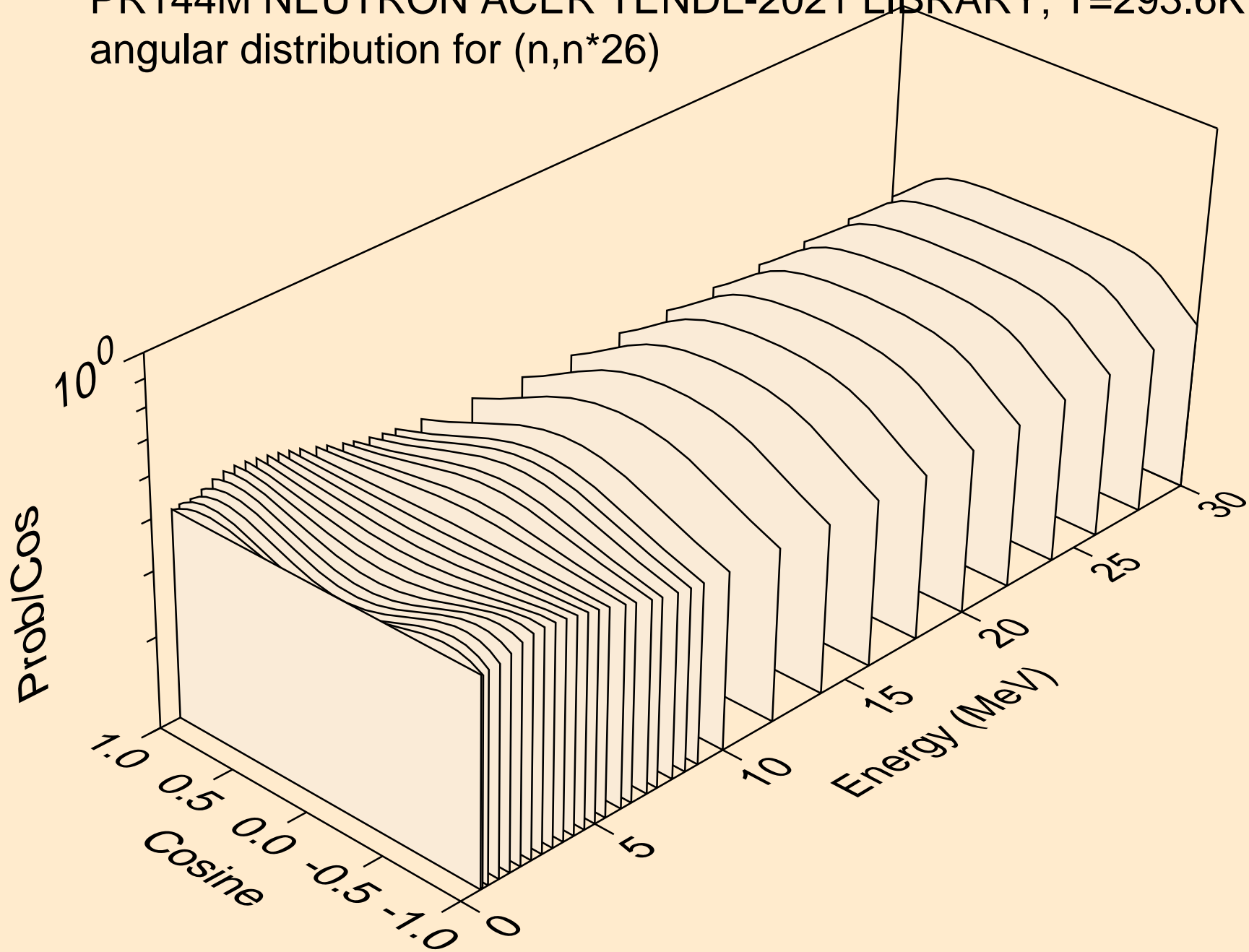

PR144M NEUTRON ACER TENDL-2021 LIBRARY; T=293.6K  
angular distribution for (n,n\*27)

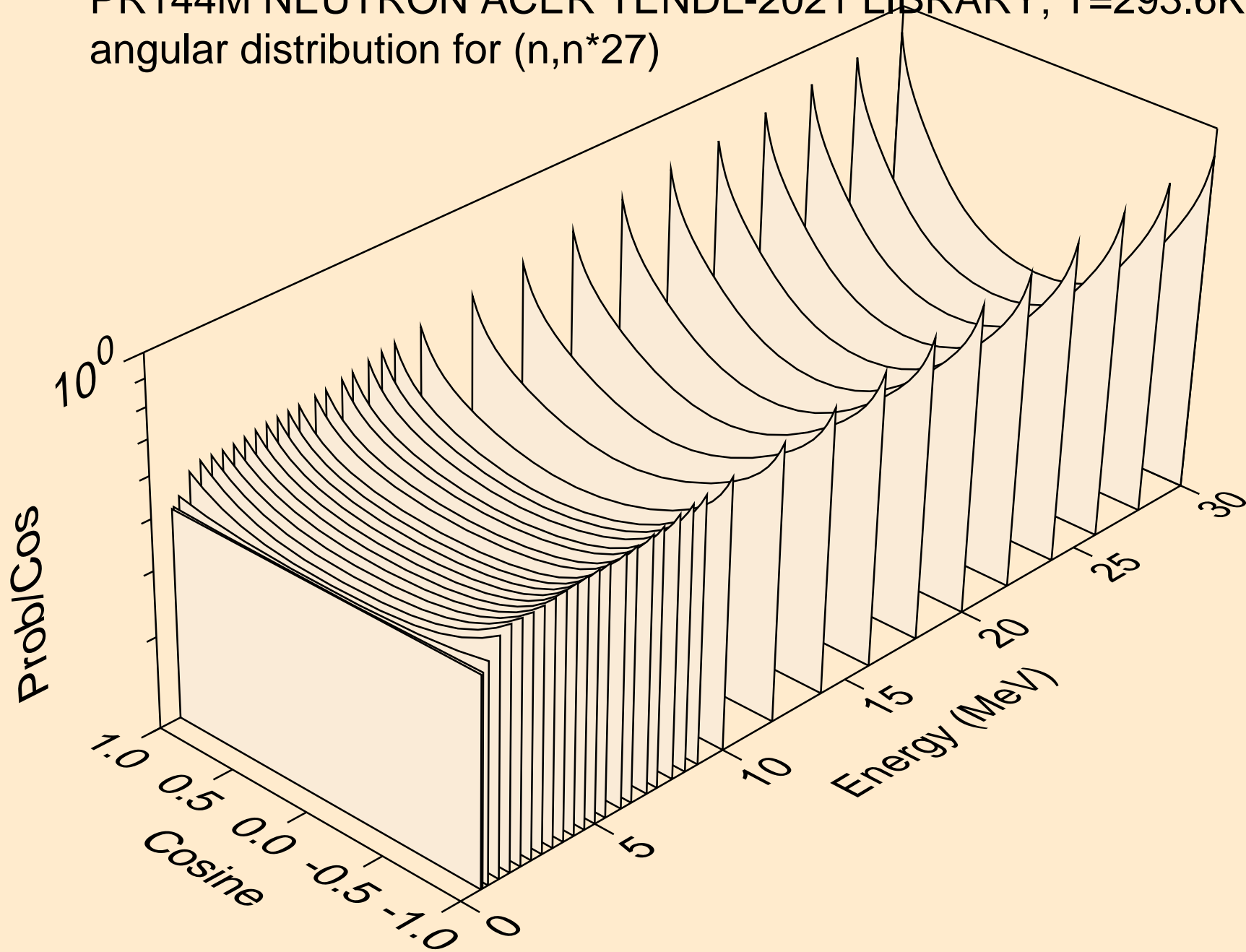

PR144M NEUTRON ACER TENDL-2021 LIBRARY; T=293.6K  
angular distribution for (n,n\*28)

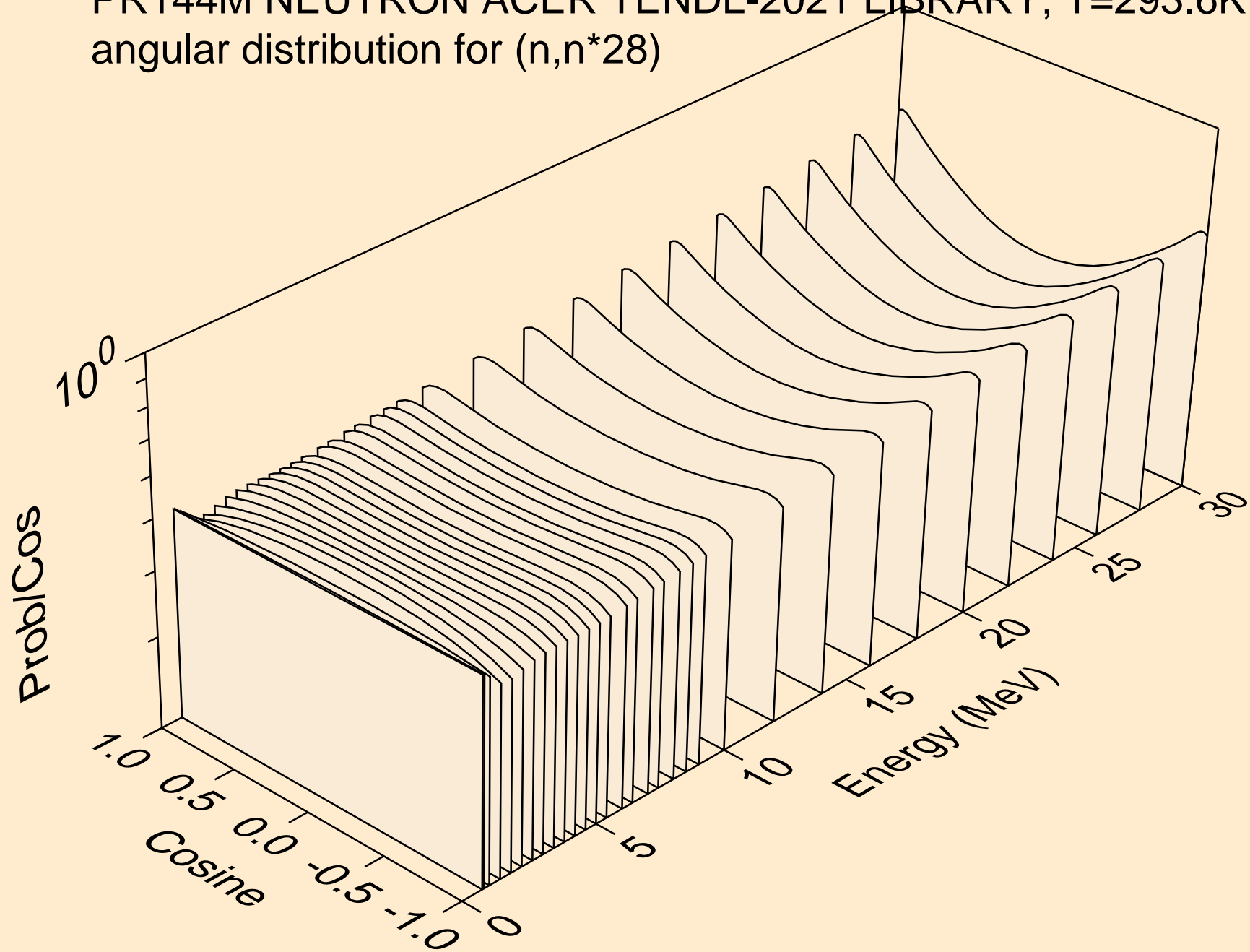

PR144M NEUTRON ACER TENDL-2021 LIBRARY; T=293.6K  
angular distribution for (n,n\*29)

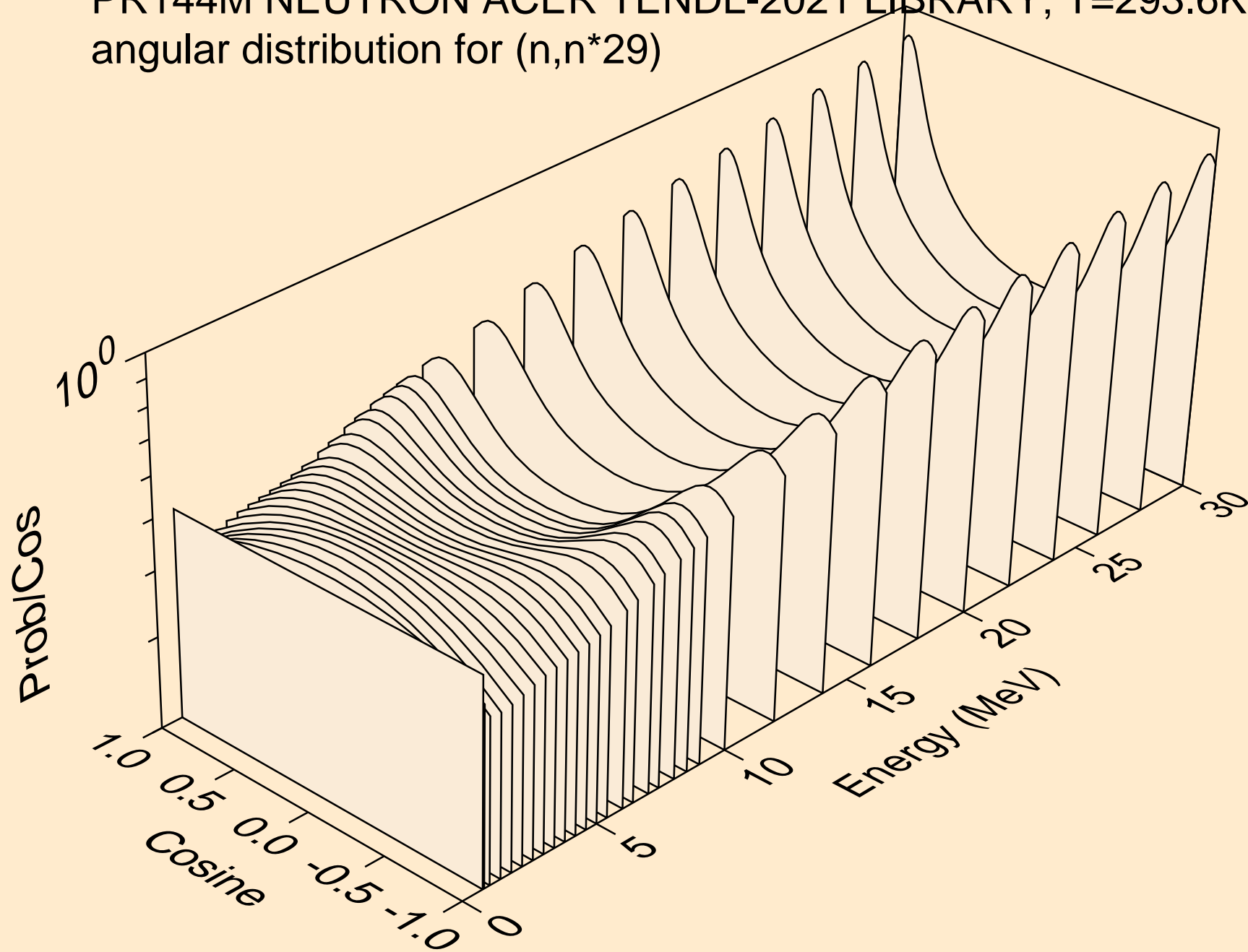

PR144M NEUTRON ACER TENDL-2021 LIBRARY; T=293.6K  
angular distribution for (n,n\*30)

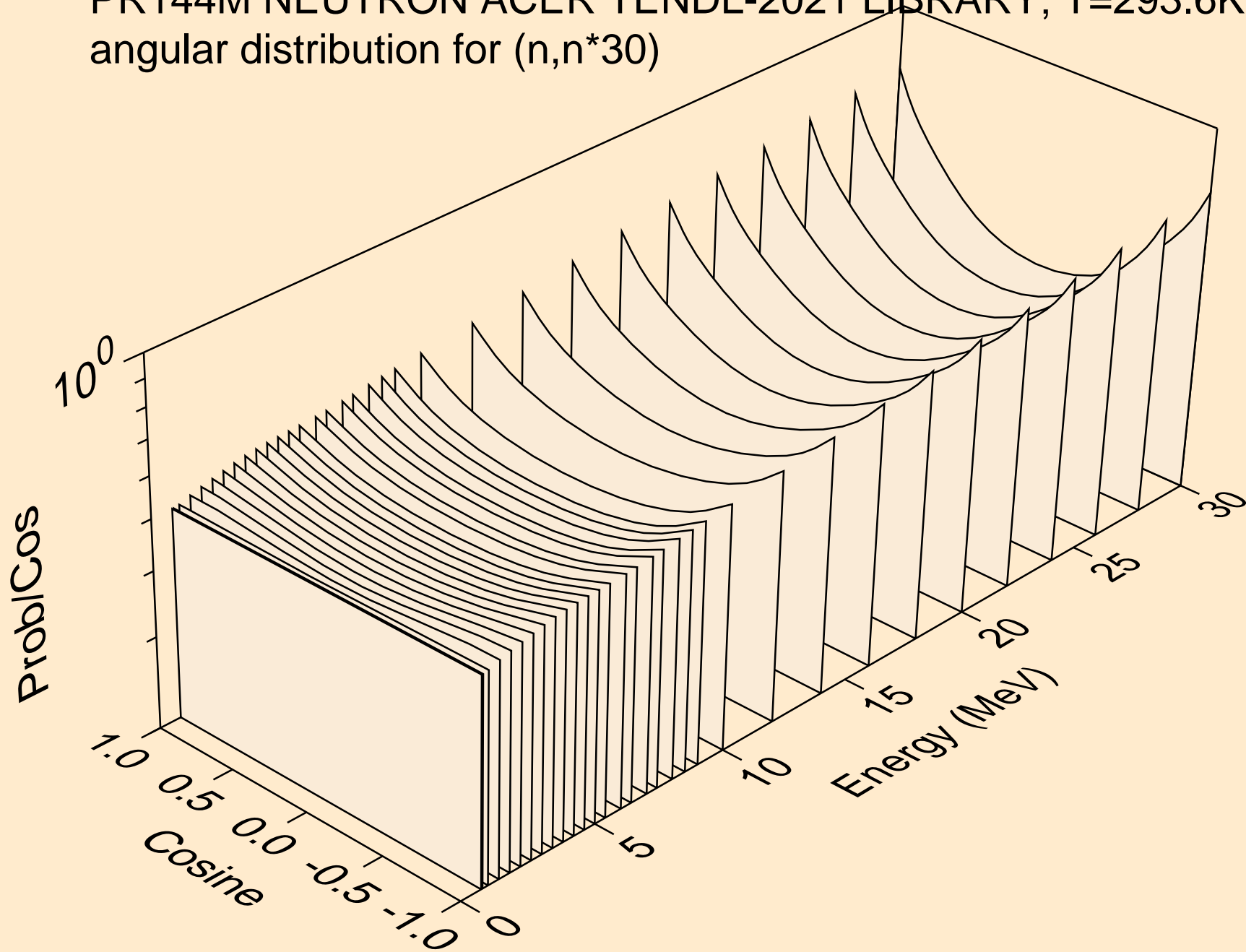

PR144M NEUTRON ACER TENDL-2021 LIBRARY; T=293.6K  
Neutron emission for (n,x)

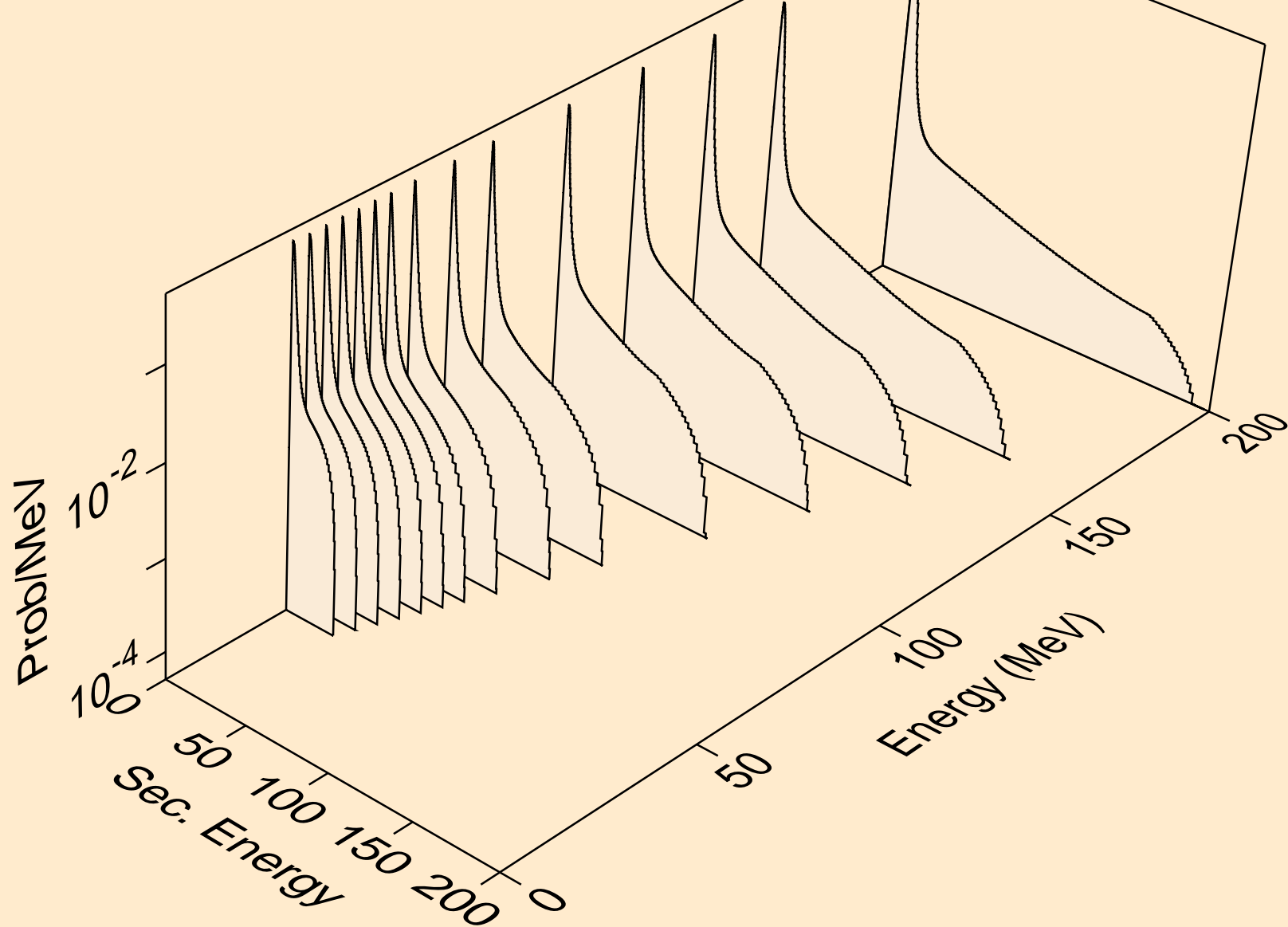

PR144M NEUTRON ACER TENDL-2021 LIBRARY; T=293.6K  
Neutron emission for (n,2nd)

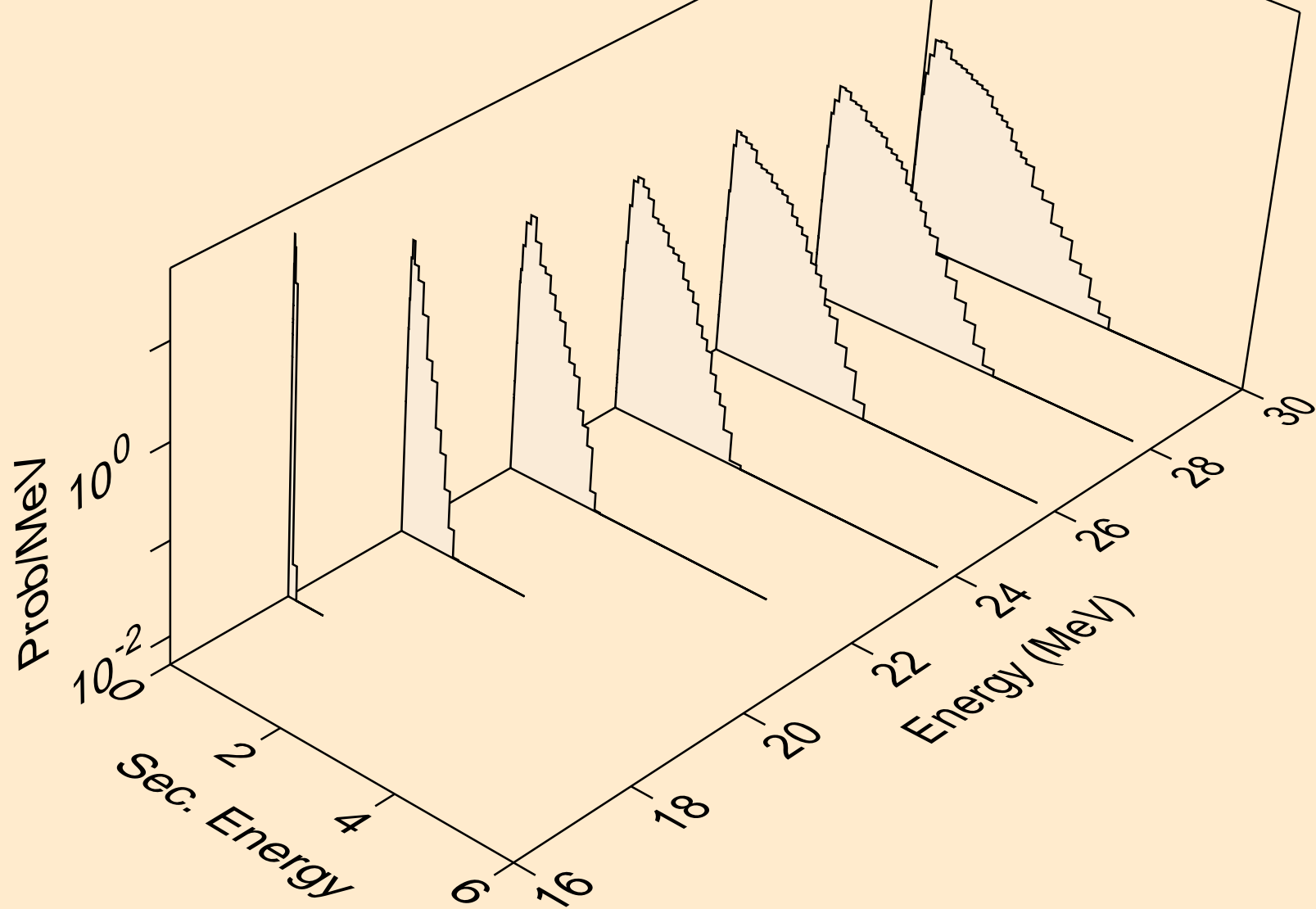

PR144M NEUTRON ACER TENDL-2021 LIBRARY; T=293.6K  
Neutron emission for (n,2n)

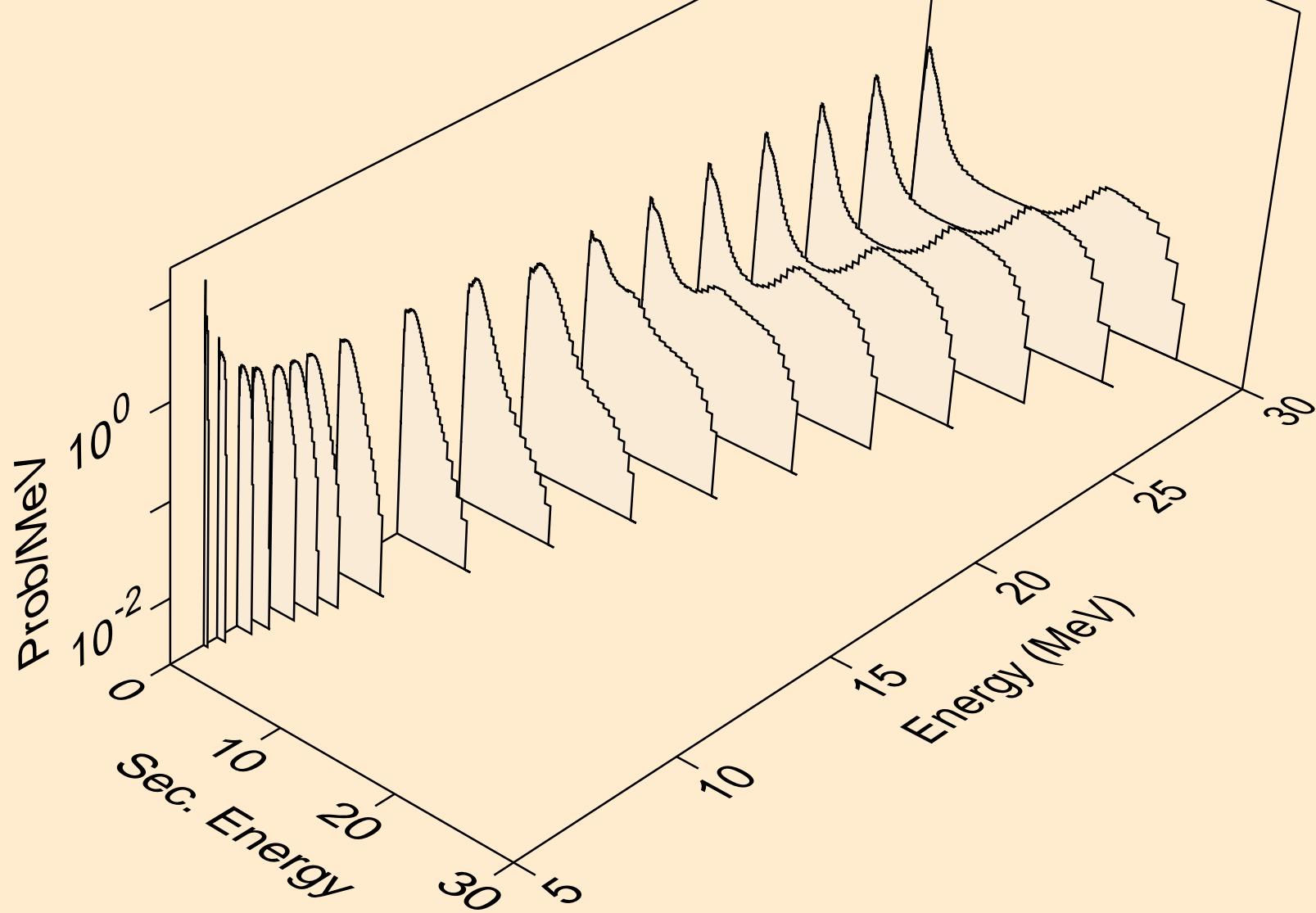



PR144M NEUTRON ACER TENDL-2021 LIBRARY; T=293.6K  
Neutron emission for (n,3n)

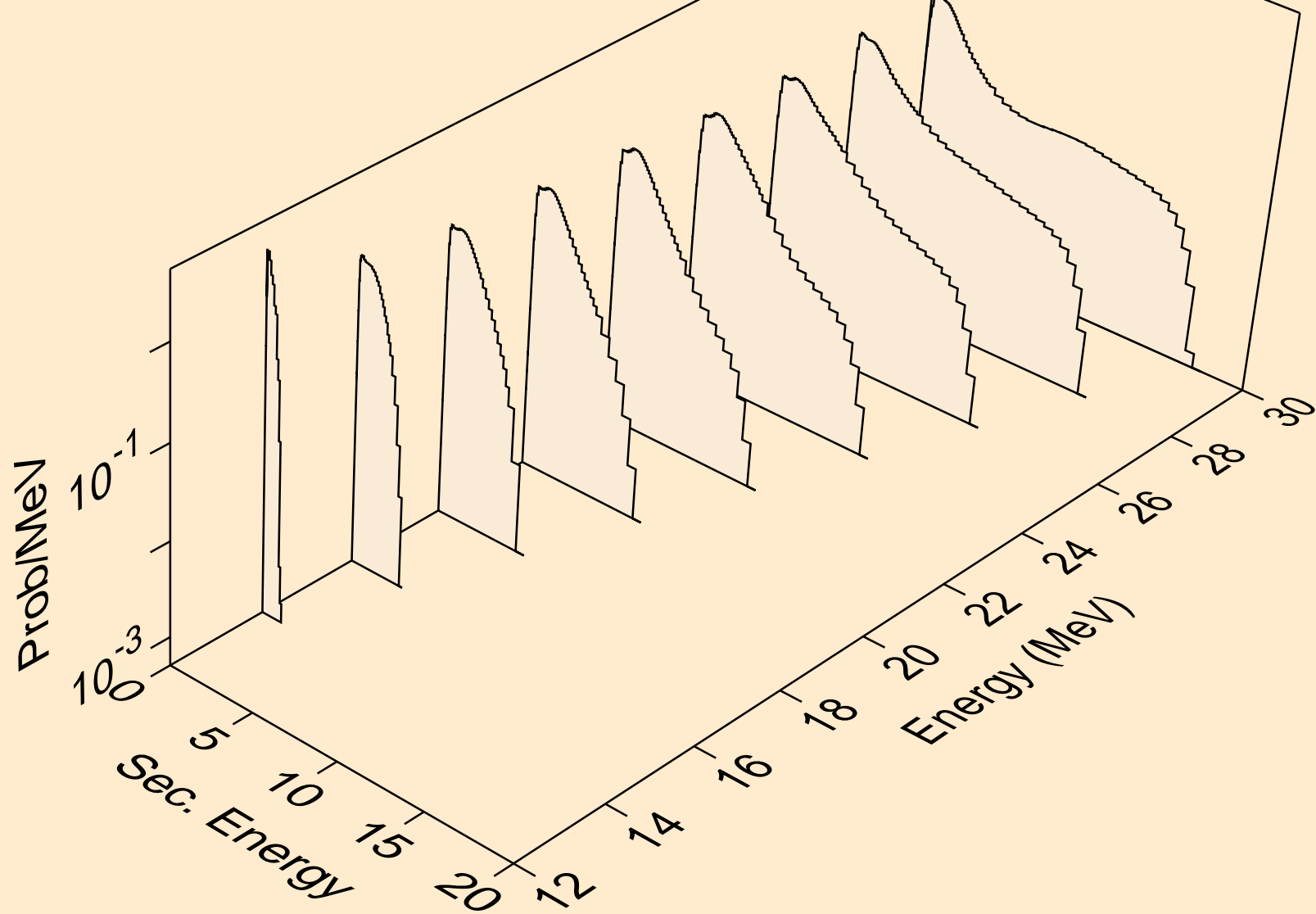

PR144M NEUTRON ACER TENDL-2021 LIBRARY; T=293.6K  
Neutron emission for (n,n\*)a

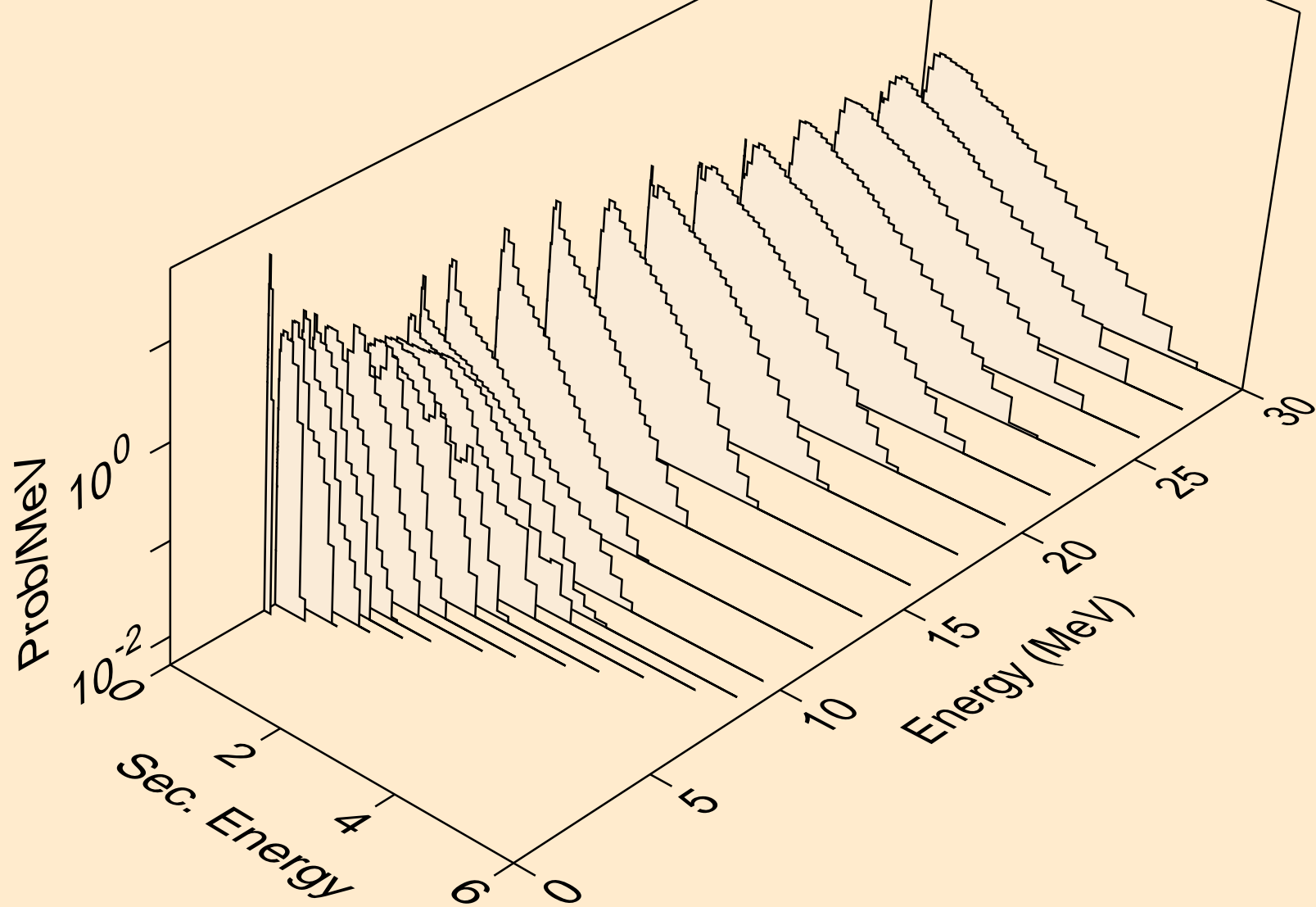

PR144M NEUTRON ACER TENDL-2021 LIBRARY; T=293.6K  
Neutron emission for (n,2n)a

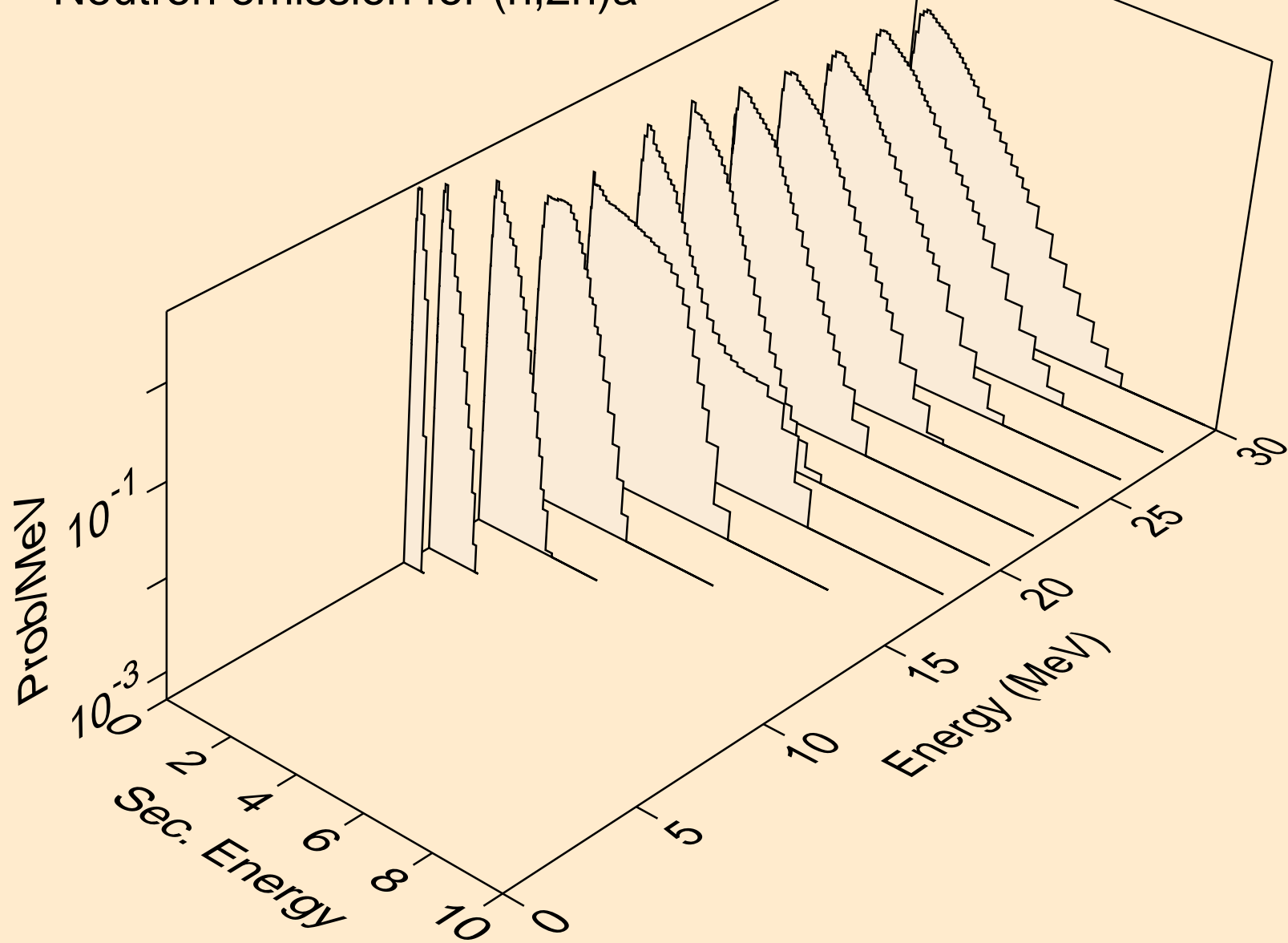

PR144M NEUTRON ACER TENDL-2021 LIBRARY; T=293.6K  
Neutron emission for (n,3n)a

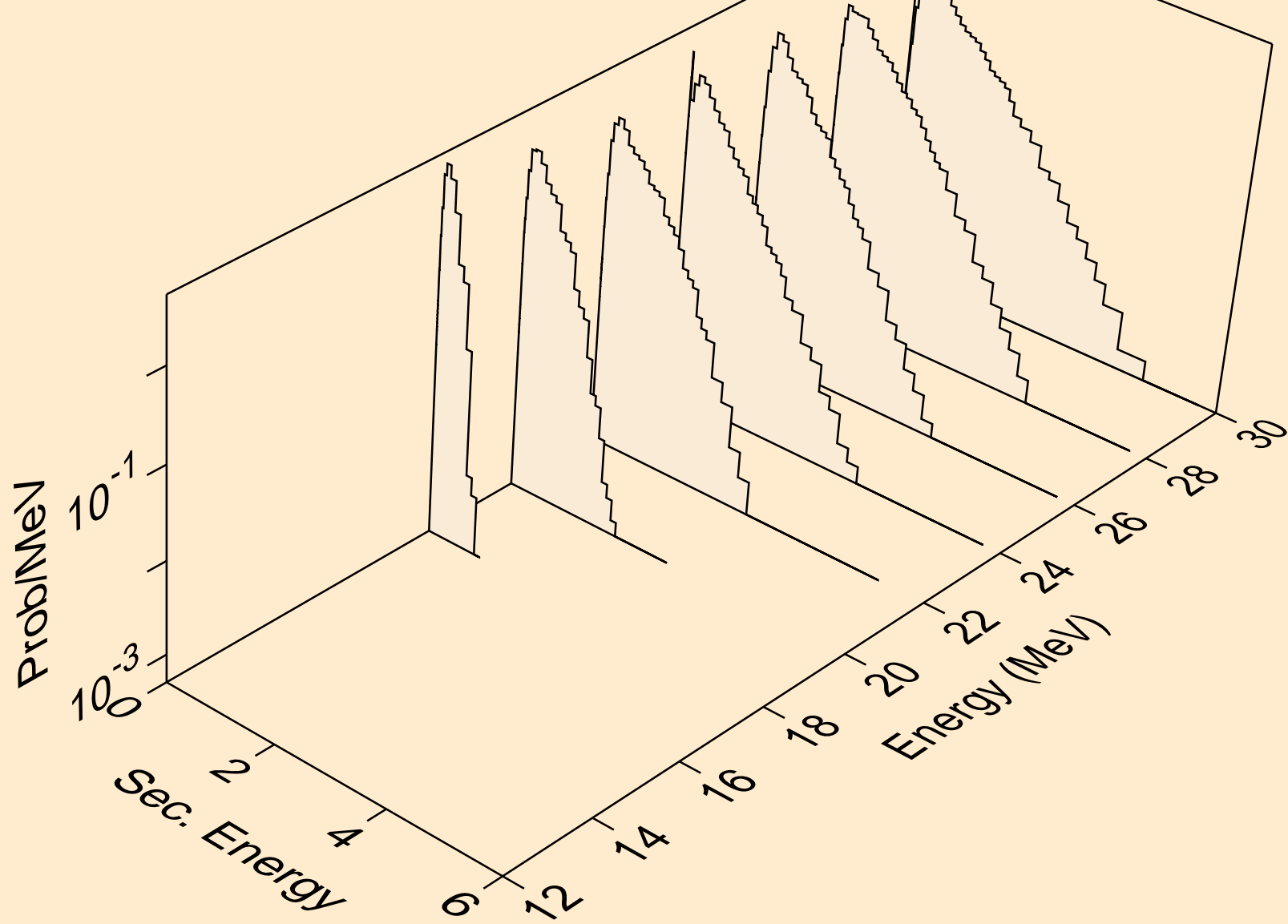

PR144M NEUTRON ACER TENDL-2021 LIBRARY; T=293.6K  
Neutron emission for (n,n\*)p

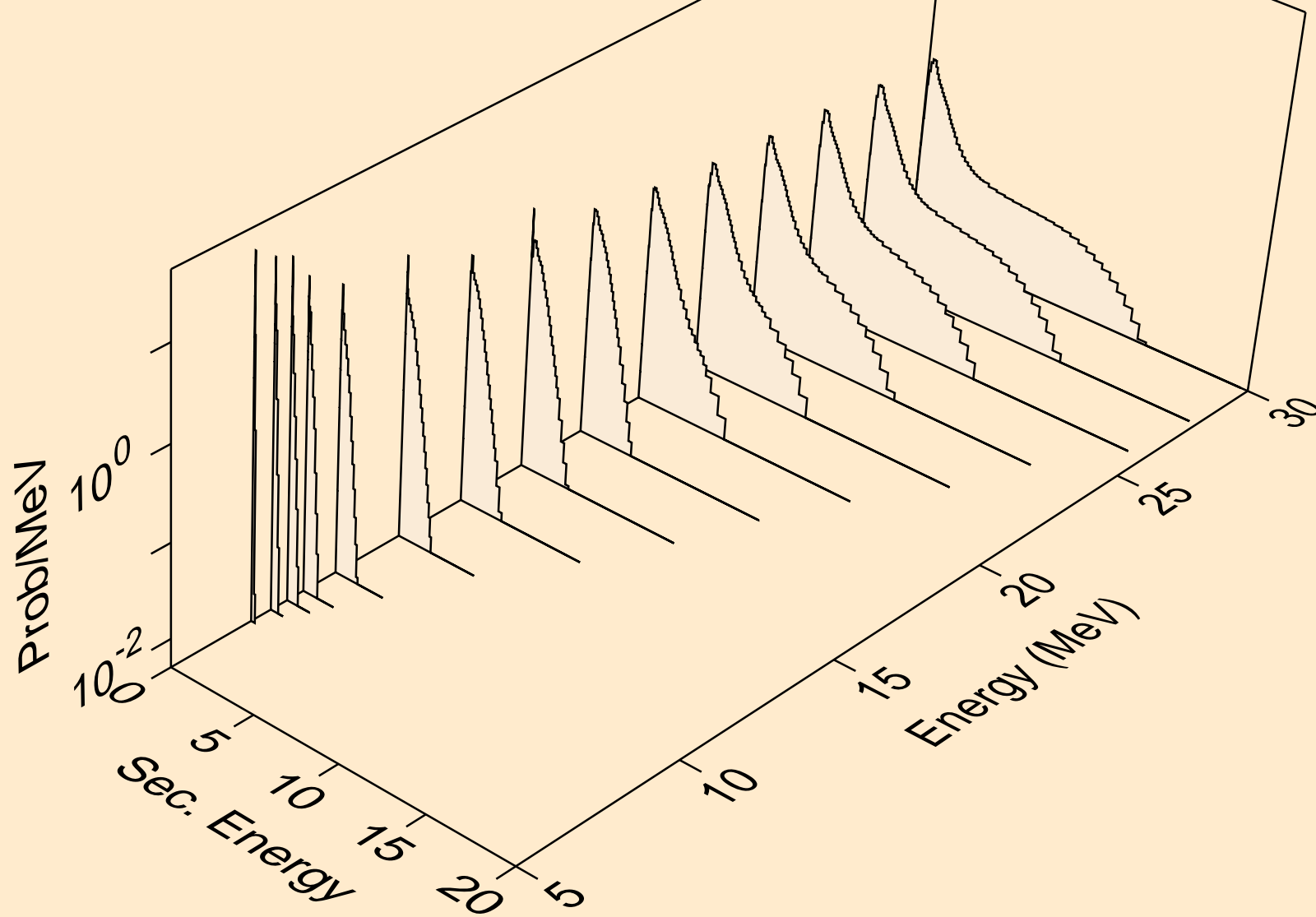

PR144M NEUTRON ACER TENDL-2021 LIBRARY; T=293.6K  
Neutron emission for (n,n\*)2a

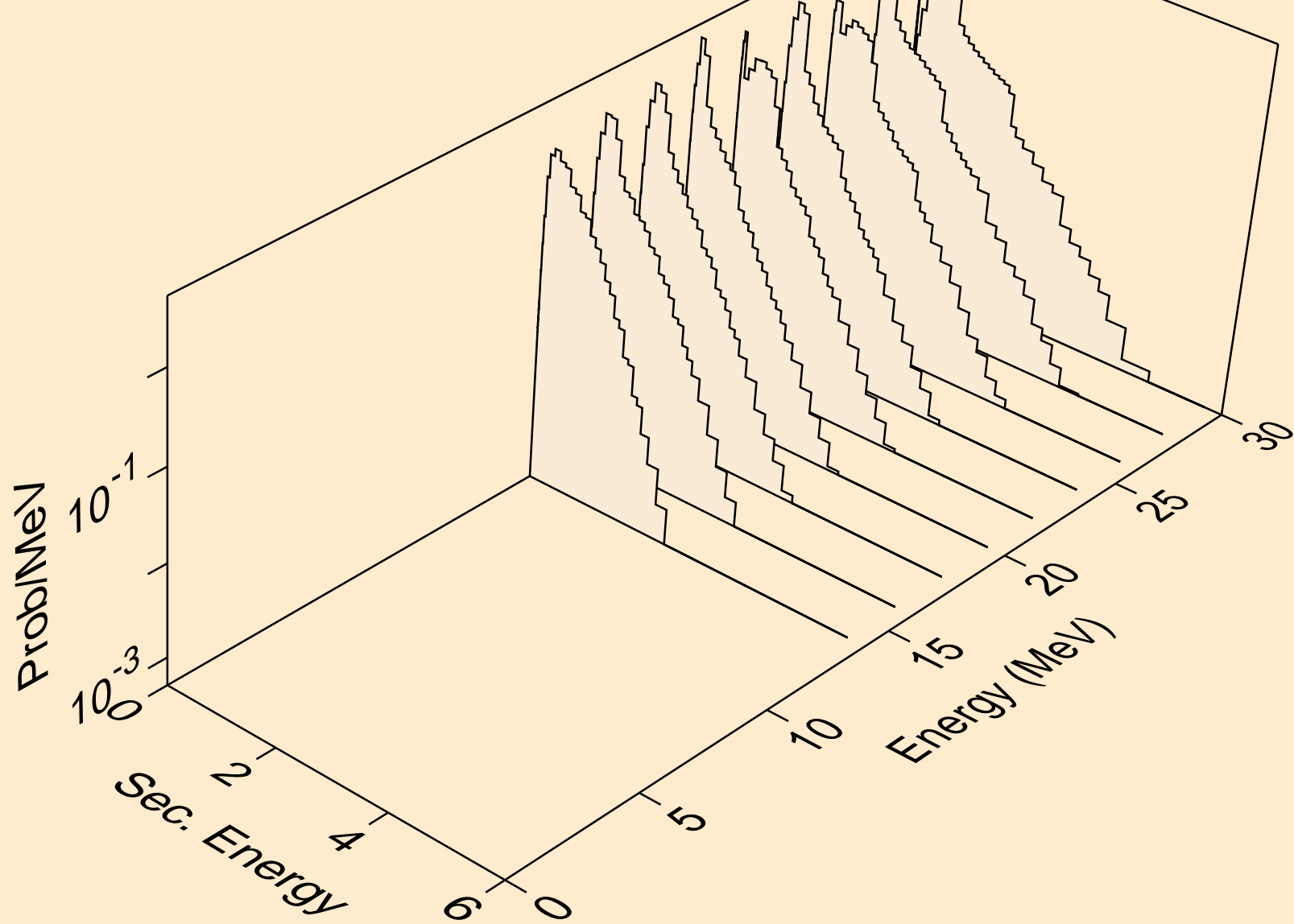

PR144M NEUTRON ACER TENDL-2021 LIBRARY; T=293.6K  
Neutron emission for (n,n\*)d

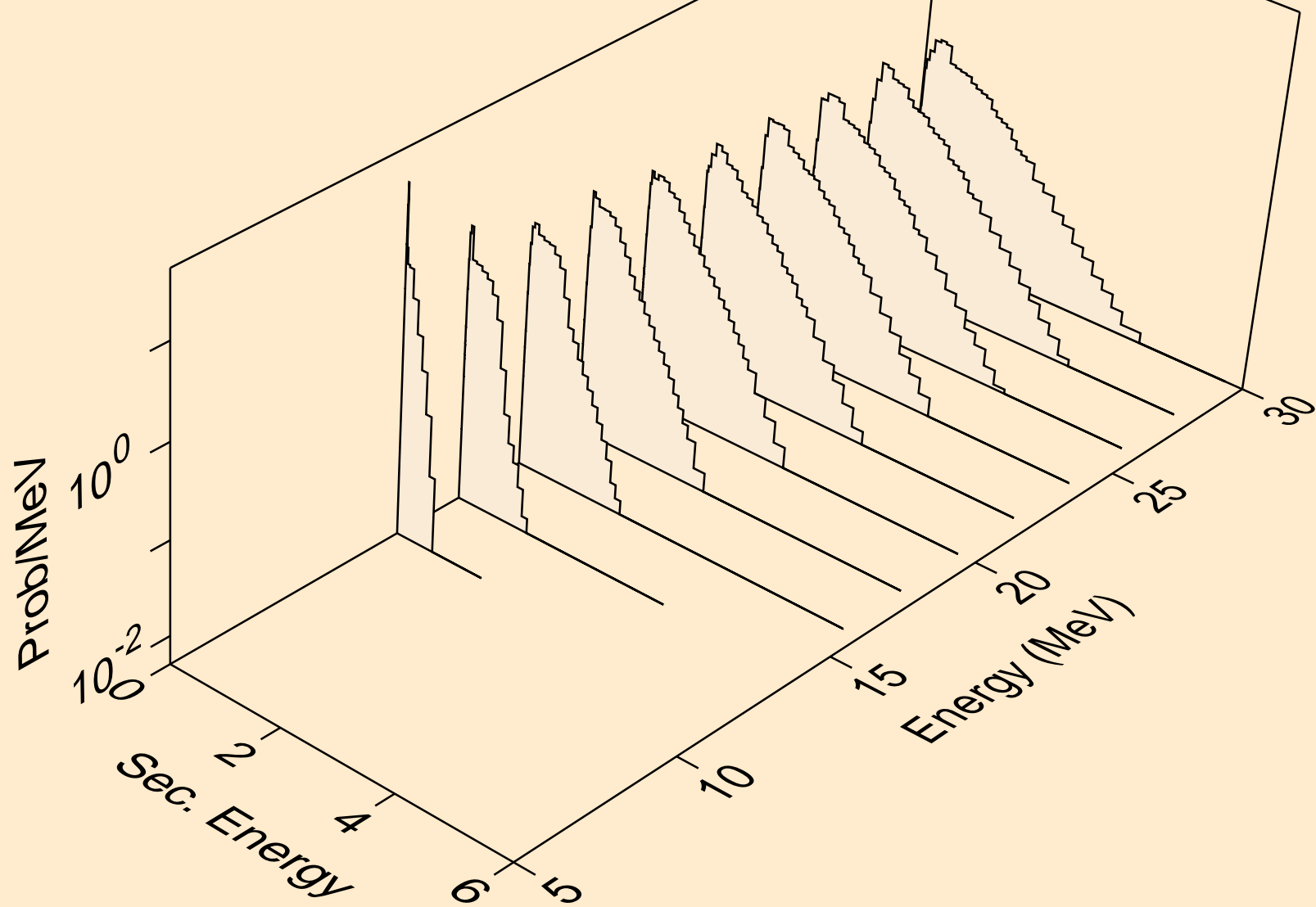

PR144M NEUTRON ACER TENDL-2021 LIBRARY; T=293.6K  
Neutron emission for (n,n\*)t

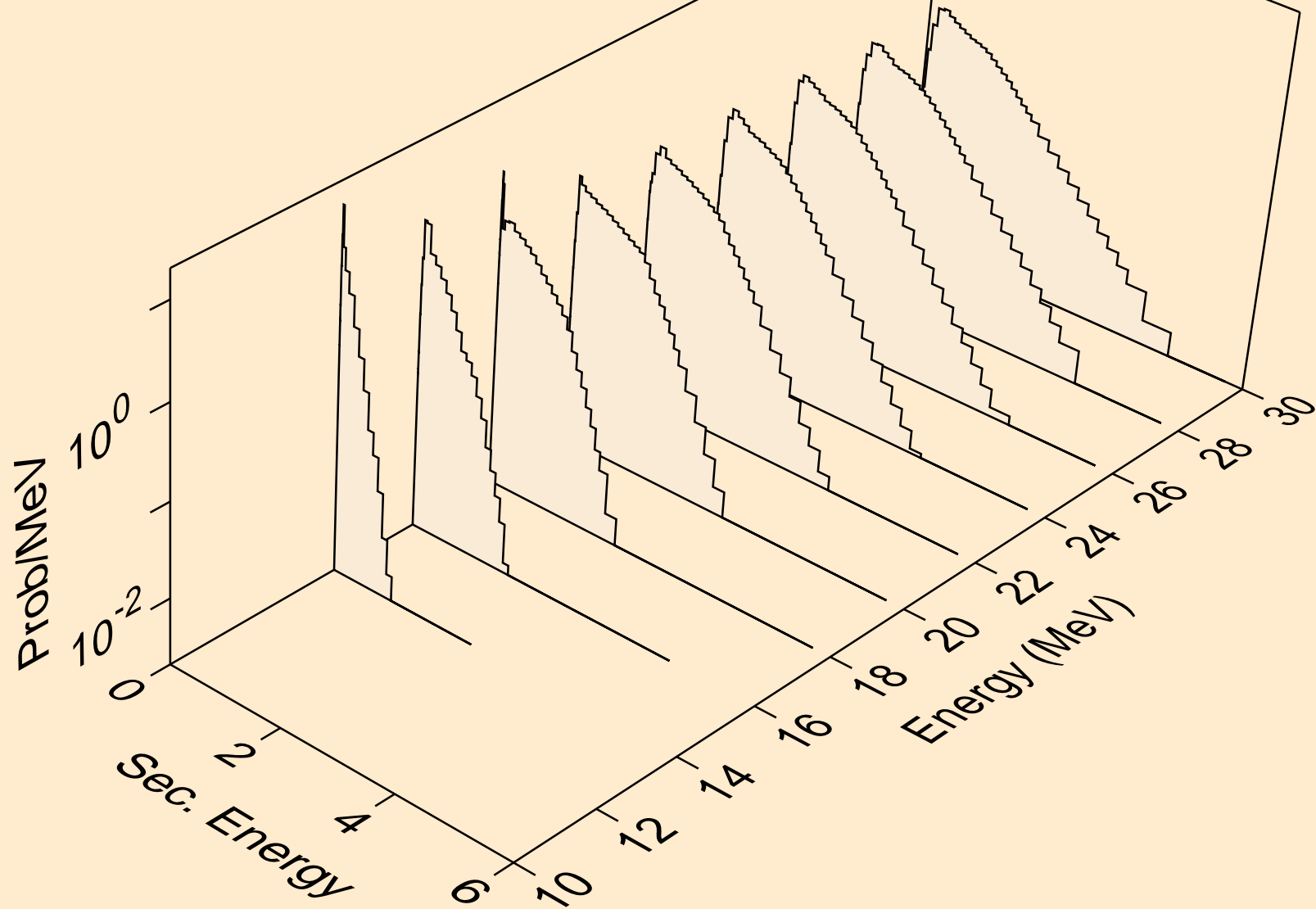



PR144M NEUTRON ACER TENDL-2021 LIBRARY; T=293.6K  
Neutron emission for (n,n\*)he3

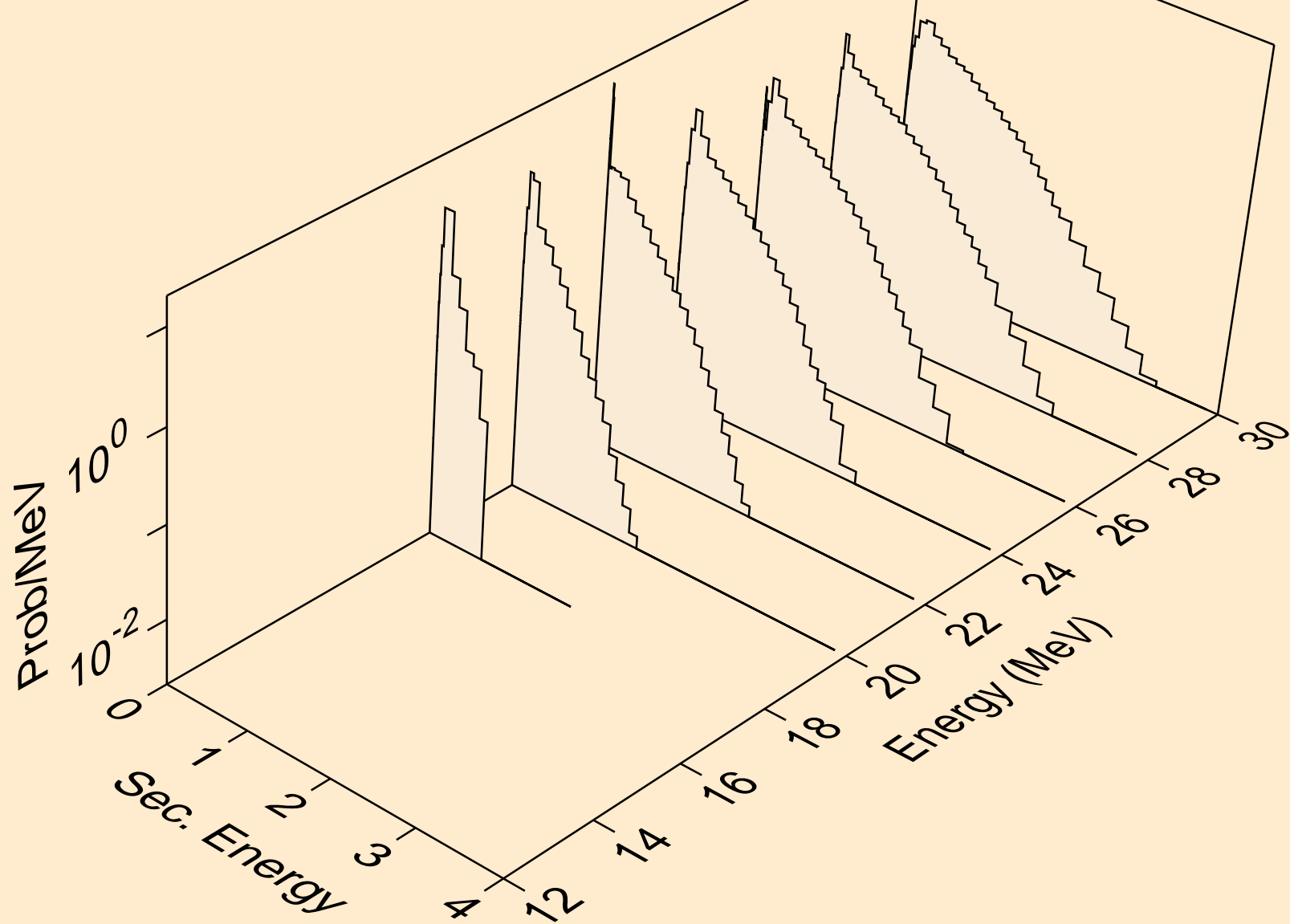

PR144M NEUTRON ACER TENDL-2021 LIBRARY; T=293.6K  
Neutron emission for (n,4n)

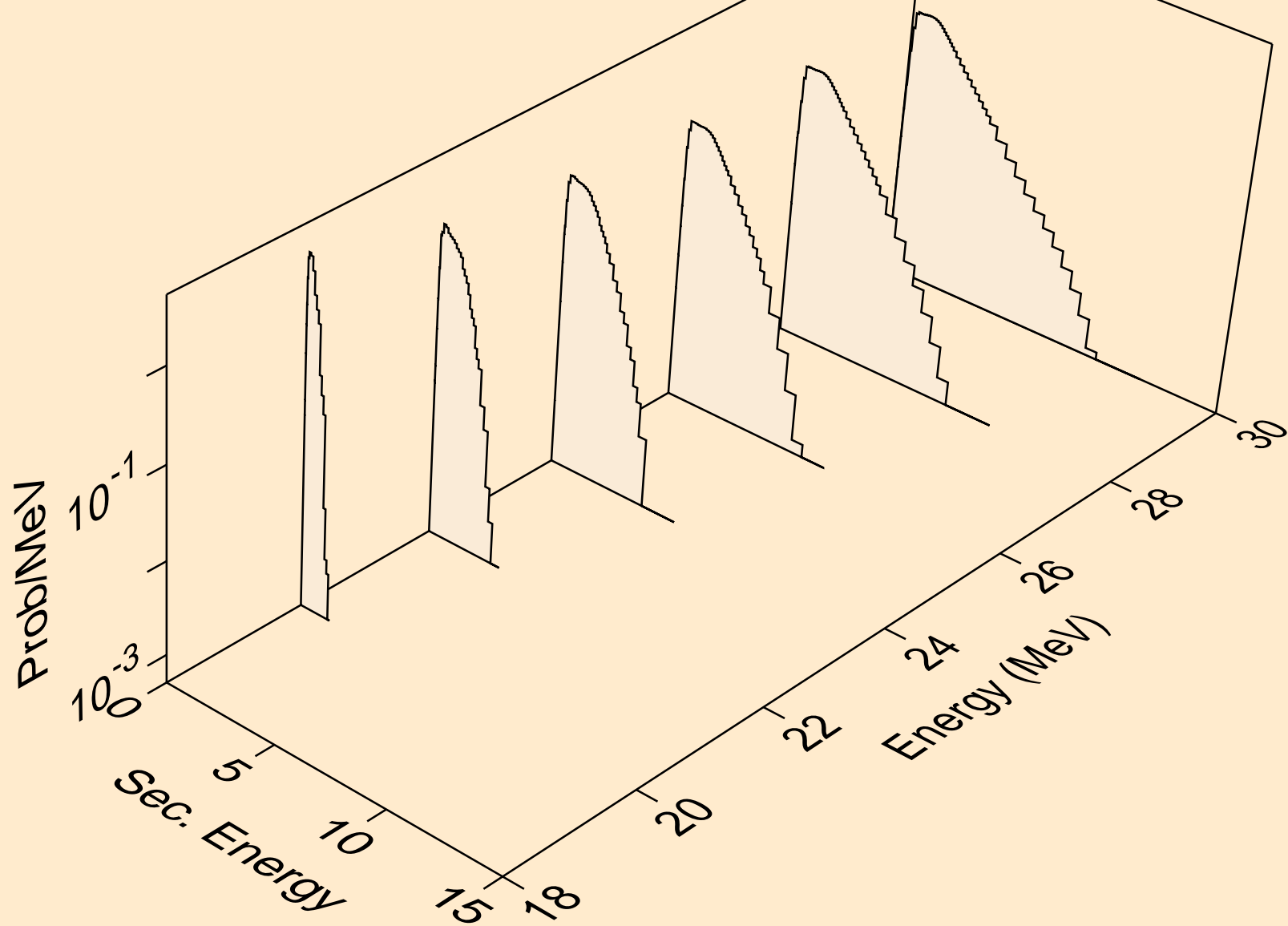

PR144M NEUTRON ACER TENDL-2021 LIBRARY; T=293.6K  
Neutron emission for (n,2np)

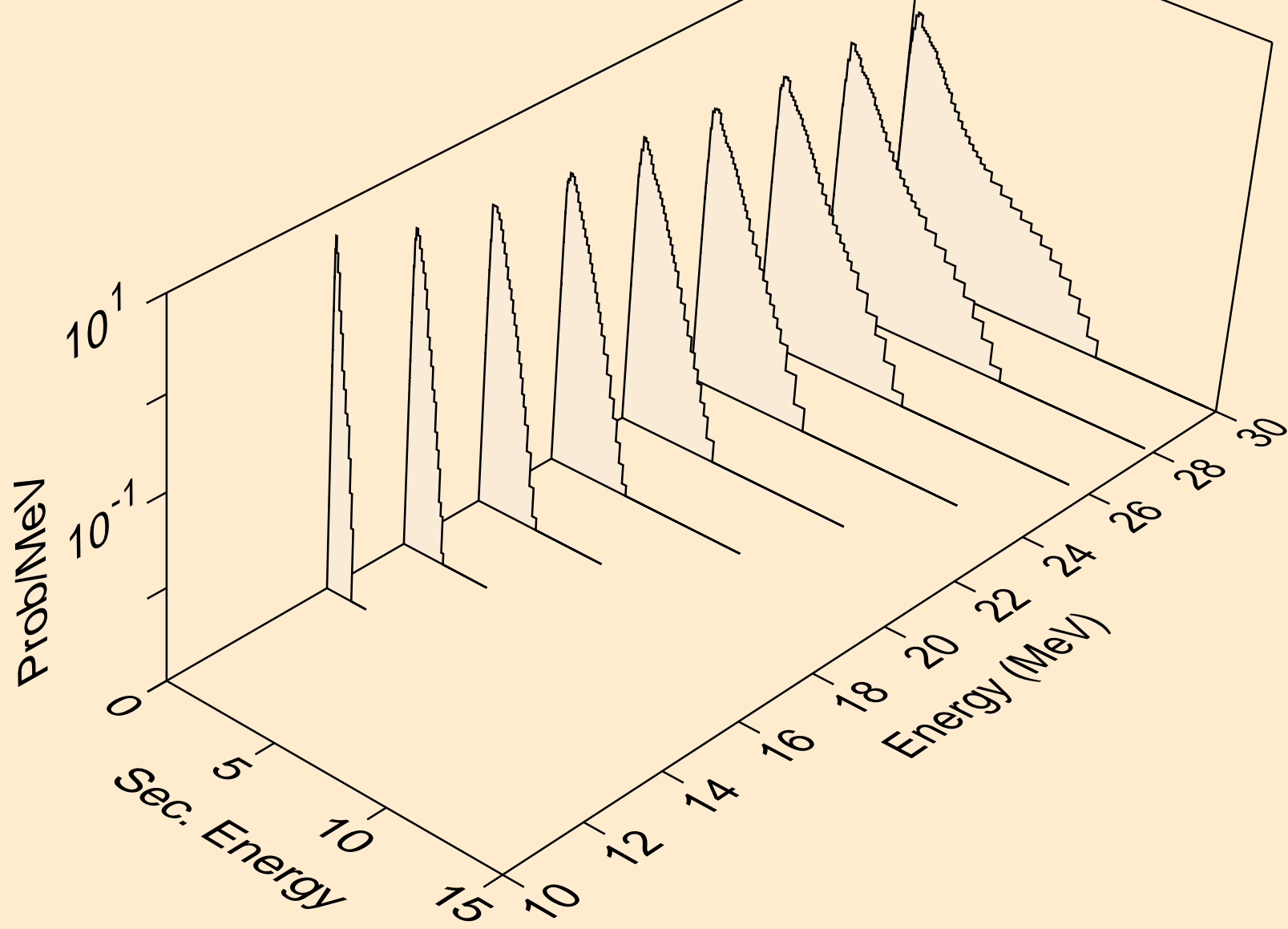

PR144M NEUTRON ACER TENDL-2021 LIBRARY; T=293.6K  
Neutron emission for (n,3np)

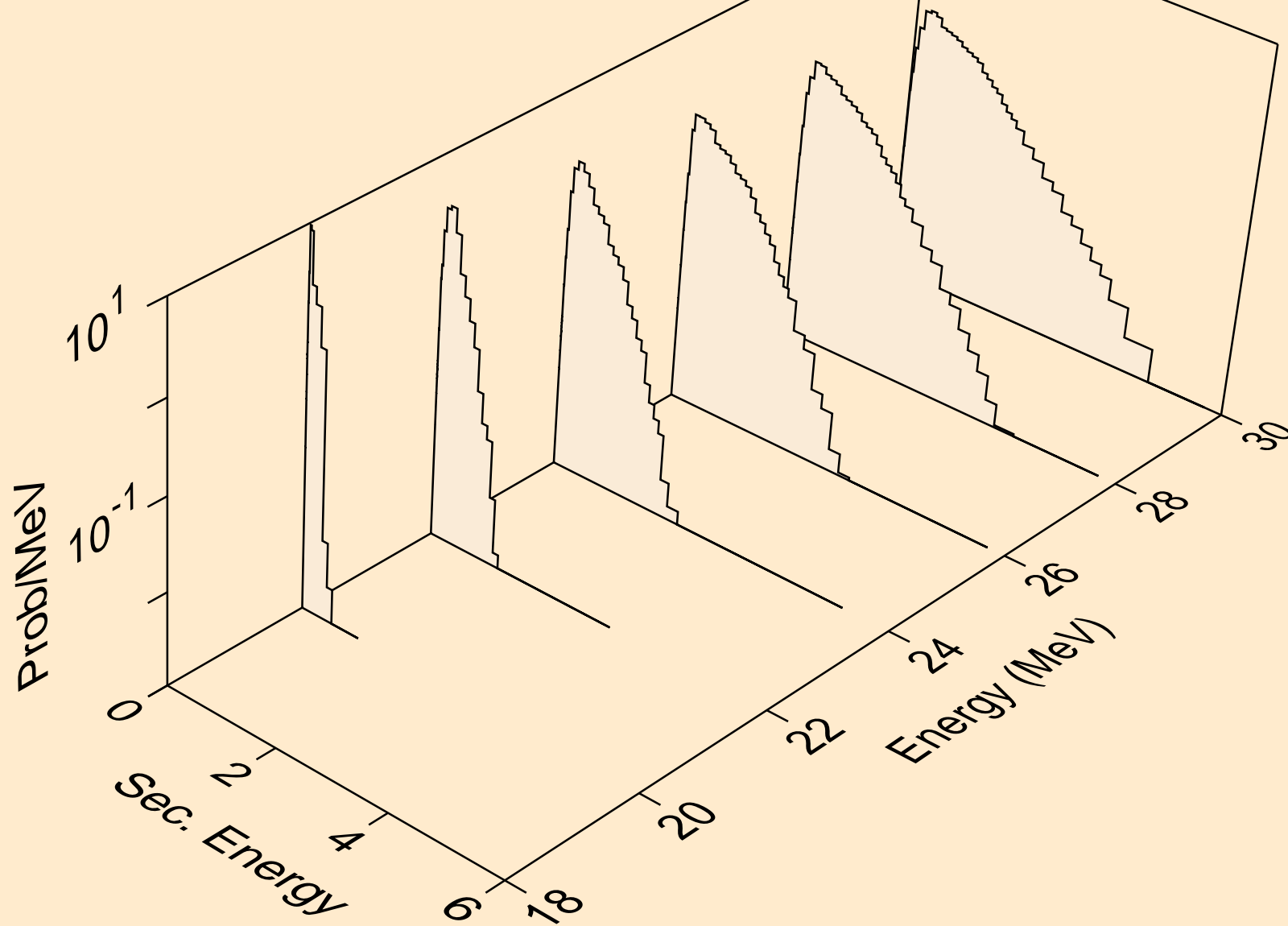

PR144M NEUTRON ACER TENDL-2021 LIBRARY; T=293.6K  
Neutron emission for (n,2np)

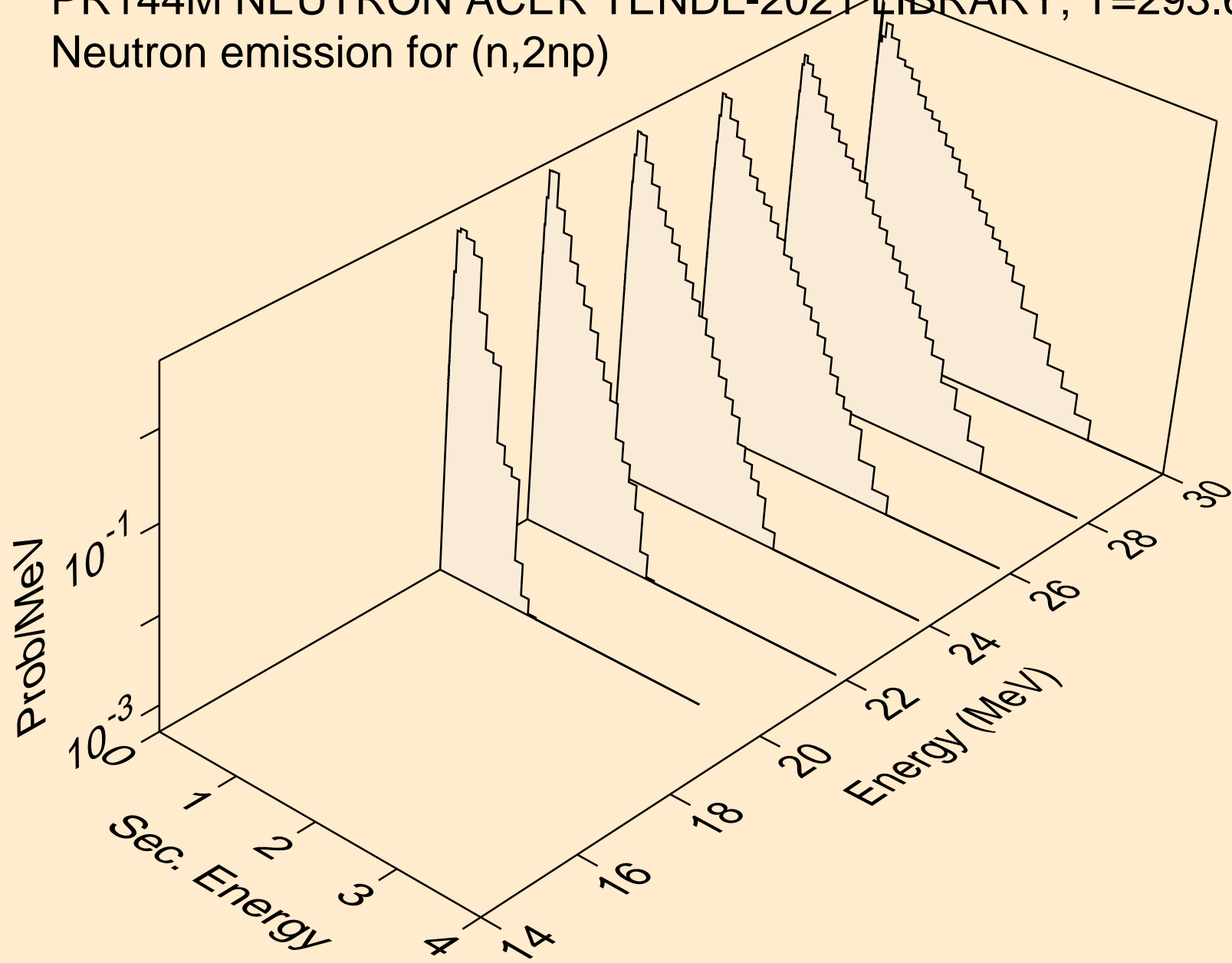

PR144M NEUTRON ACER TENDL-2021 LIBRARY; T=293.6K  
Neutron emission for (n,npa)

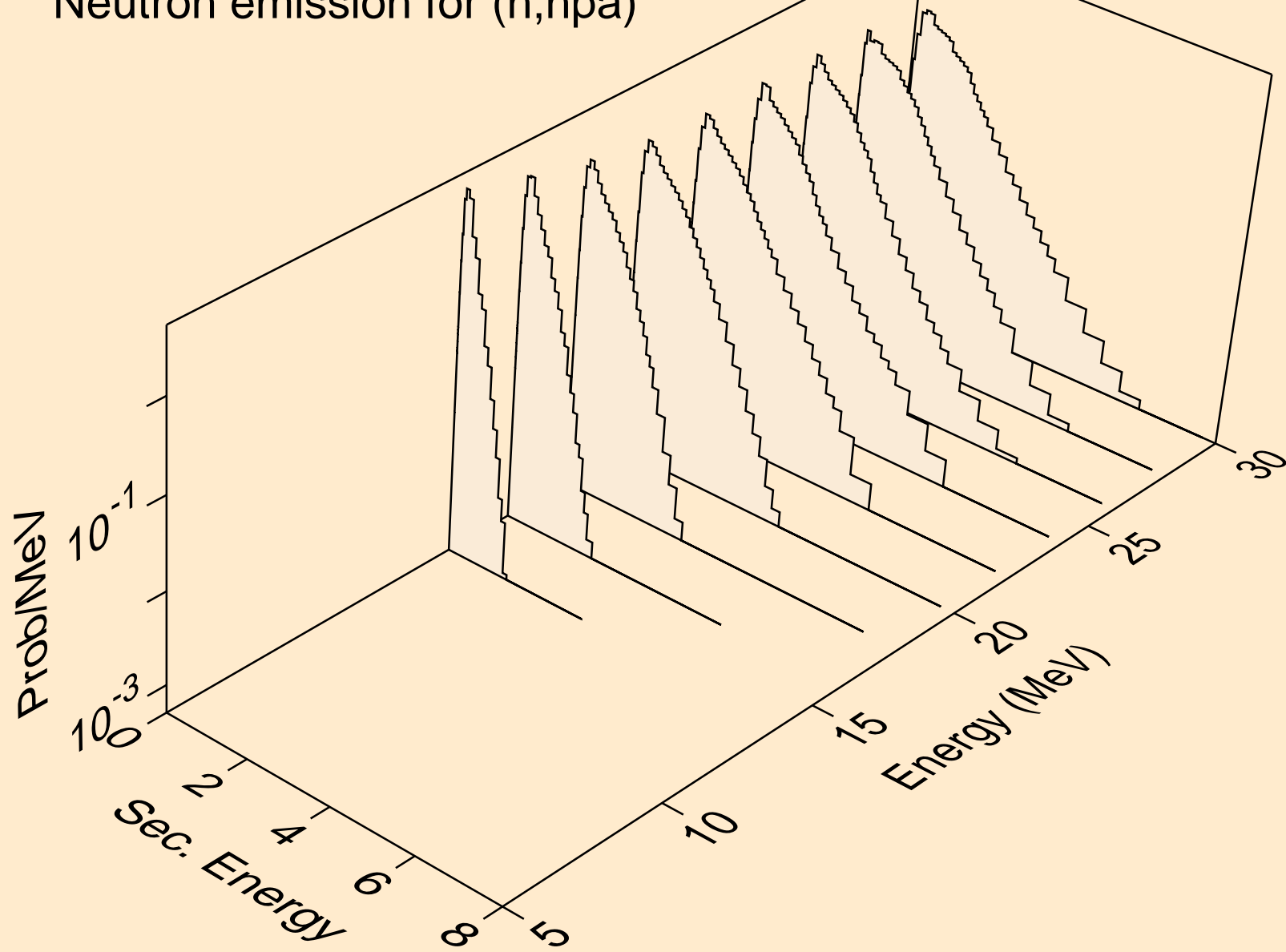

PR144M NEUTRON ACER TENDL-2021 LIBRARY; T=293.6K  
Neutron emission for (n,n\*c)

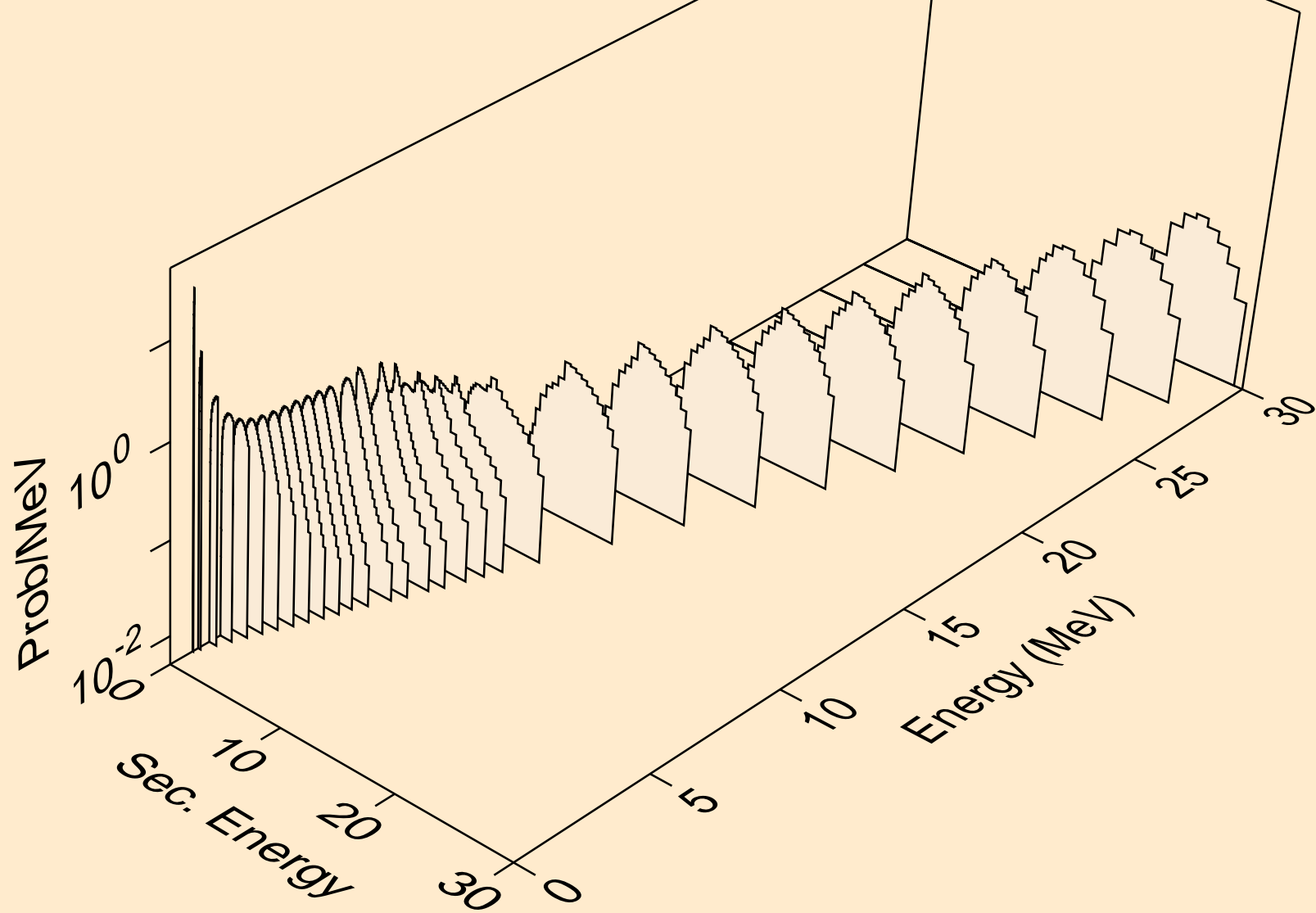

PR144M NEUTRON ACER TENDL-2021 LIBRARY; T=293.6K  
Photon emission for (n,x)

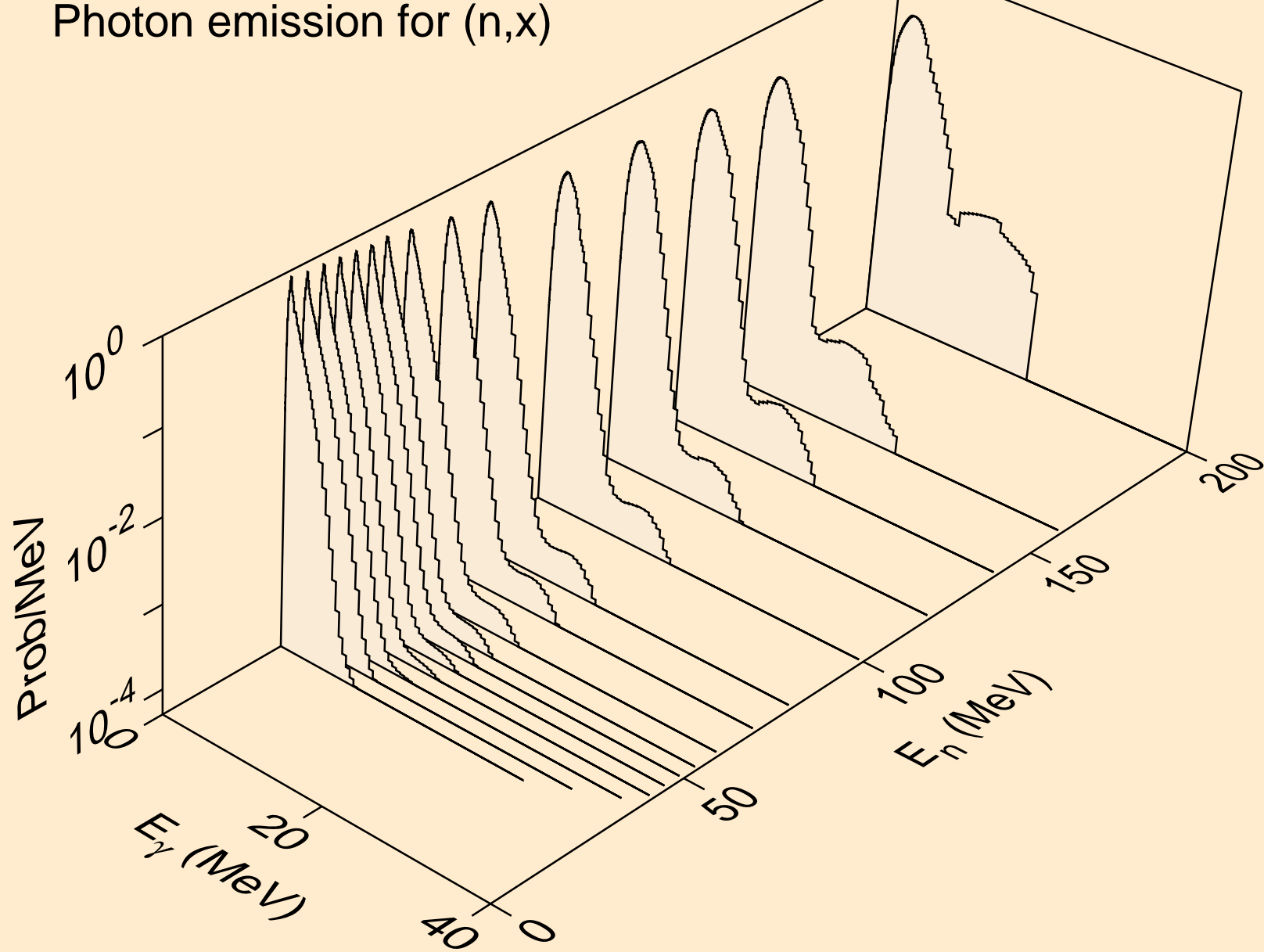



PR144M NEUTRON ACER TENDL-2021 LIBRARY; T=293.6K  
Photon emission for (n,2nd)

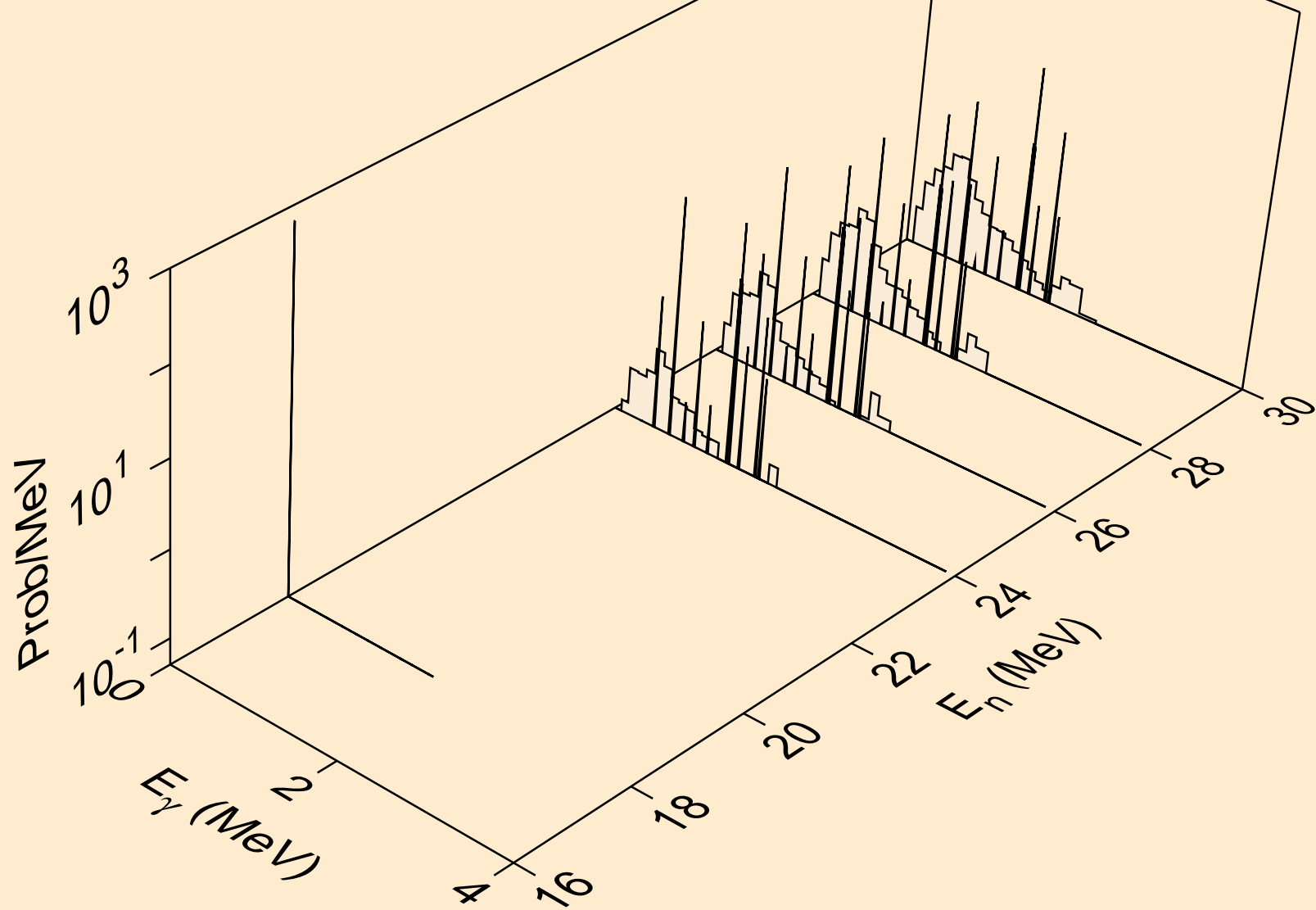

PR144M NEUTRON ACER TENDL-2021 LIBRARY; T=293.6K  
Photon emission for (n,2n)

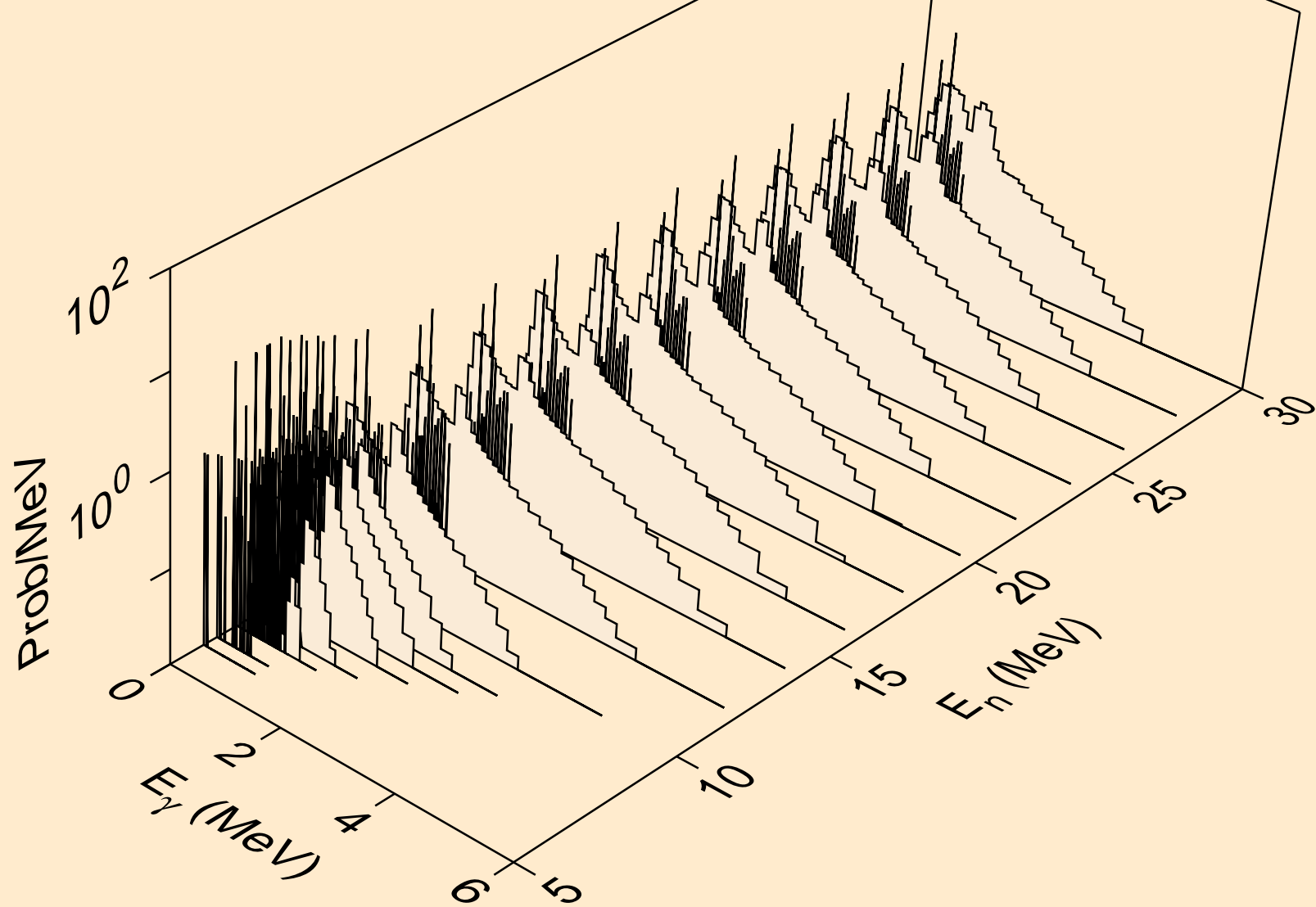

PR144M NEUTRON ACER TENDL-2021 LIBRARY; T=293.6K  
Photon emission for (n,3n)

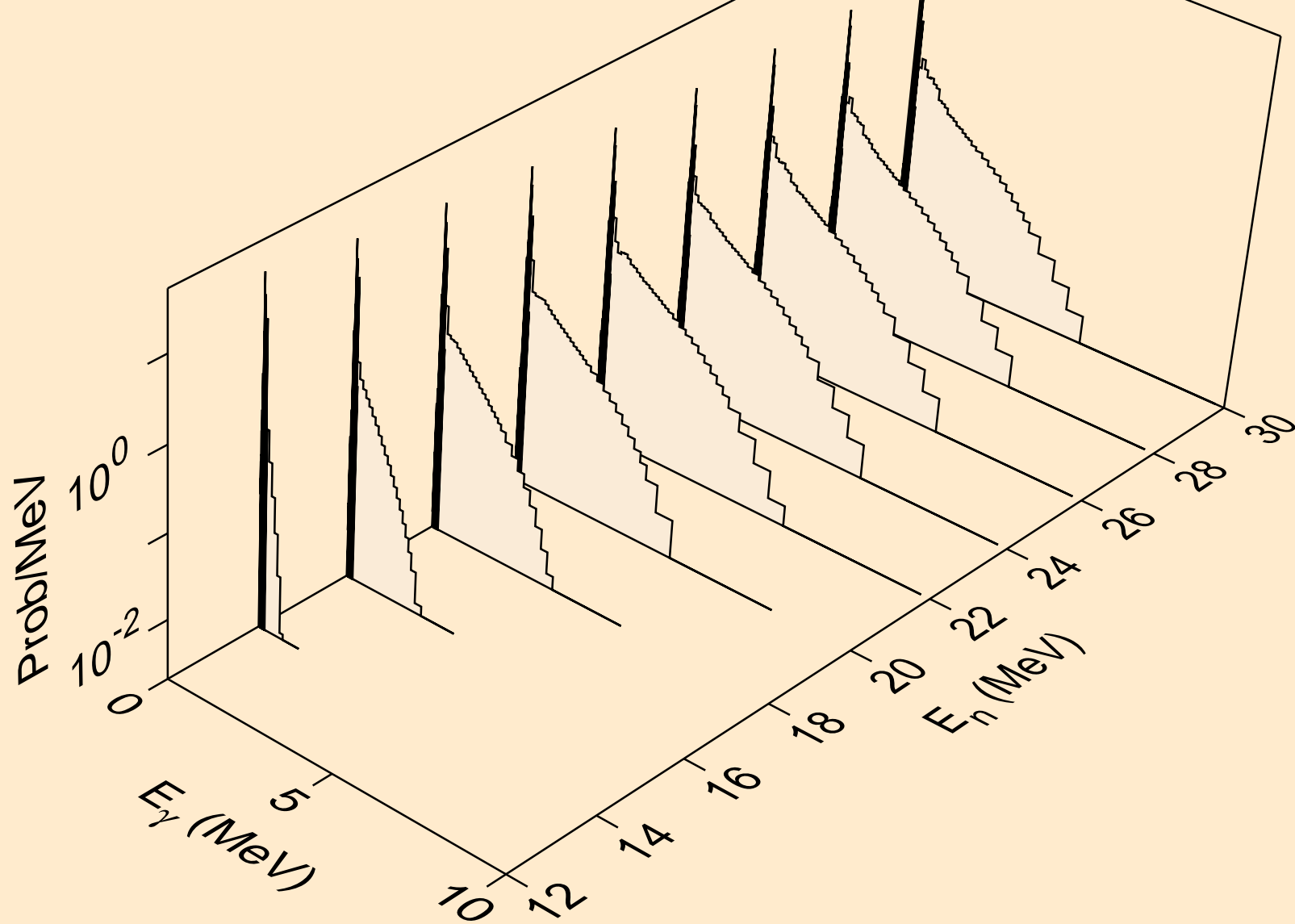

PR144M NEUTRON ACER TENDL-2021 LIBRARY; T=293.6K  
Photon emission for (n,n\*)a

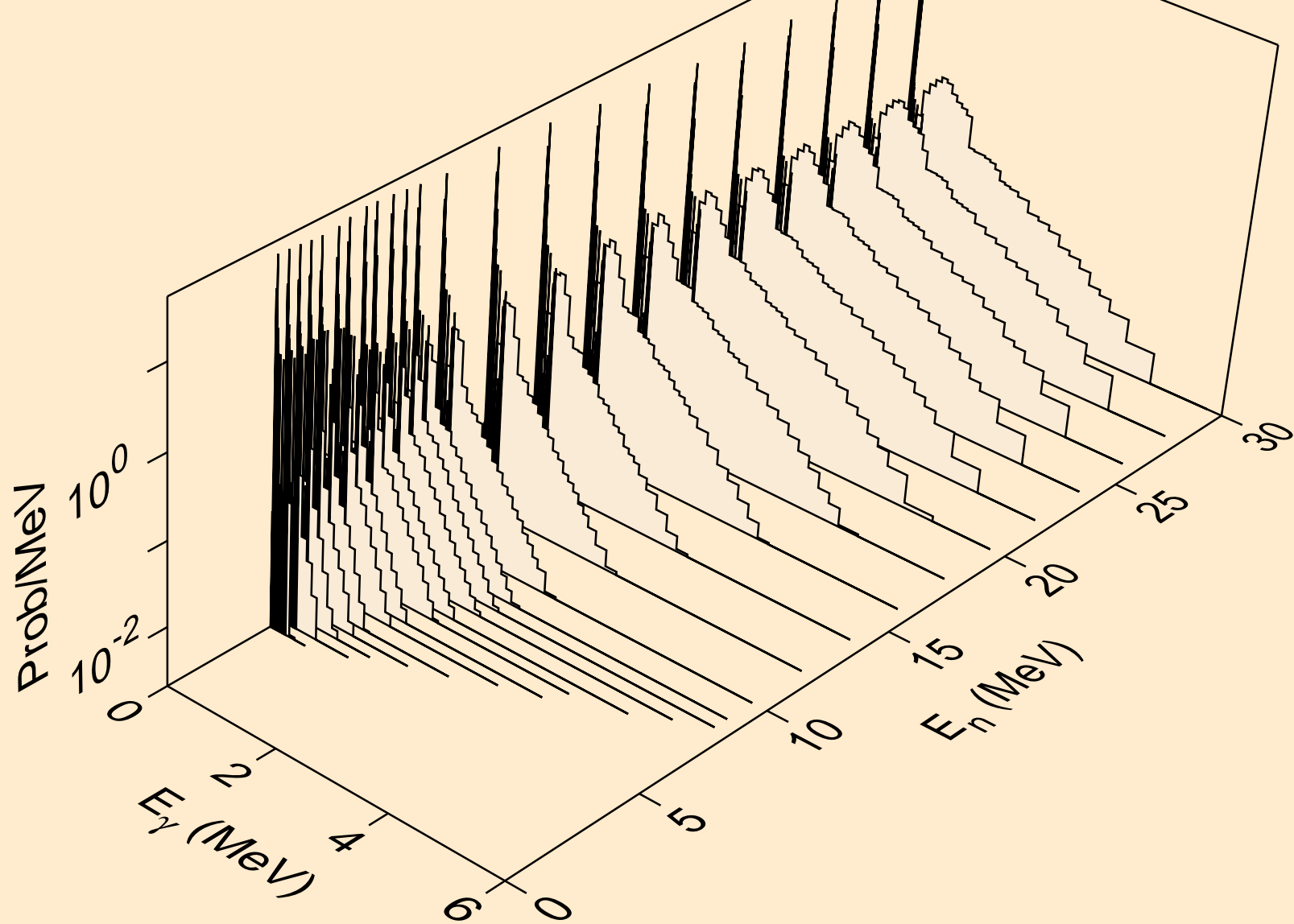

PR144M NEUTRON ACER TENDL-2021 LIBRARY; T=293.6K  
Photon emission for (n,2n)a

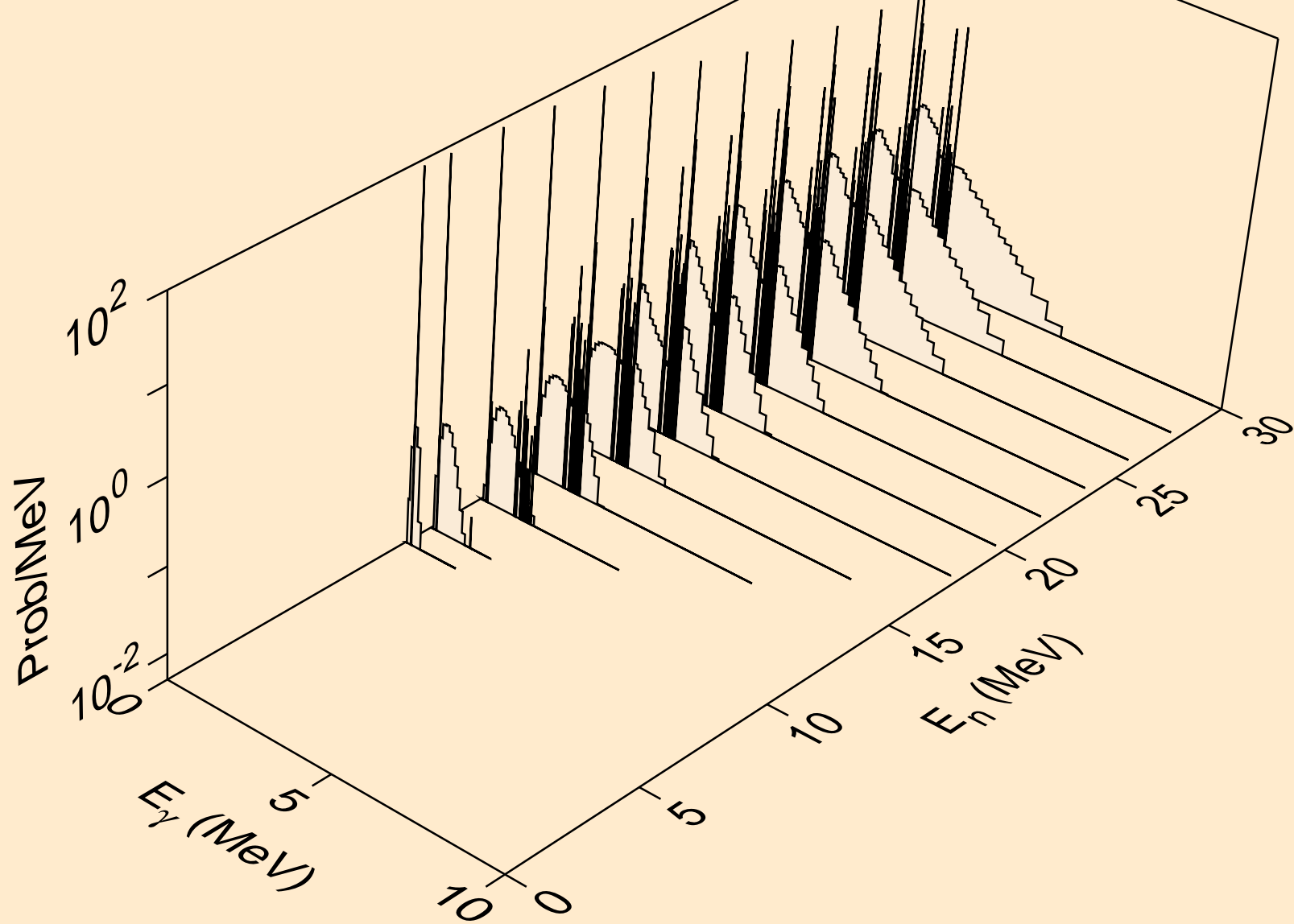

PR144M NEUTRON ACER TENDL-2021 LIBRARY; T=293.6K  
Photon emission for (n,3n)a

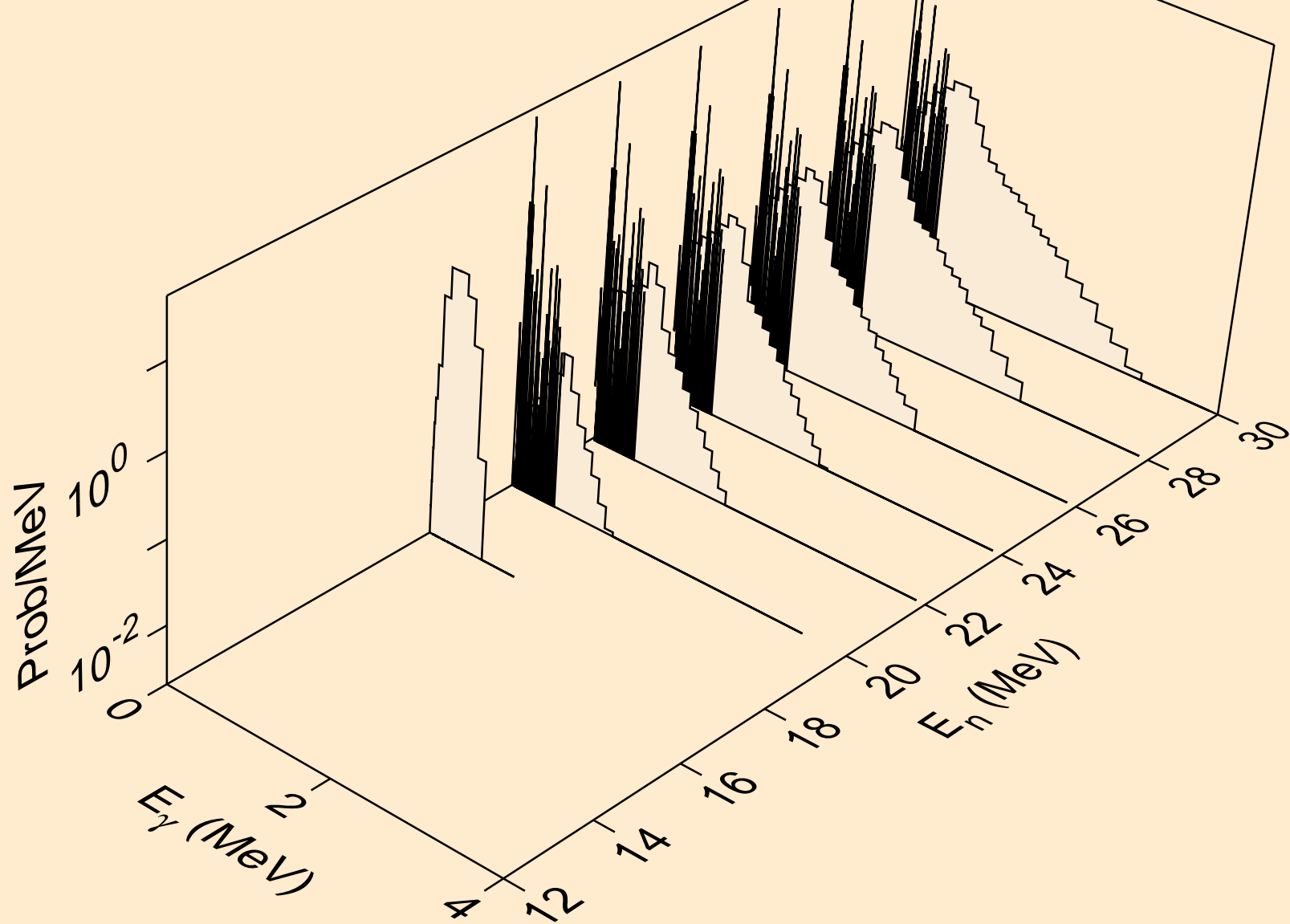

PR144M NEUTRON ACER TENDL-2021 LIBRARY; T=293.6K  
Photon emission for (n,n\*)p

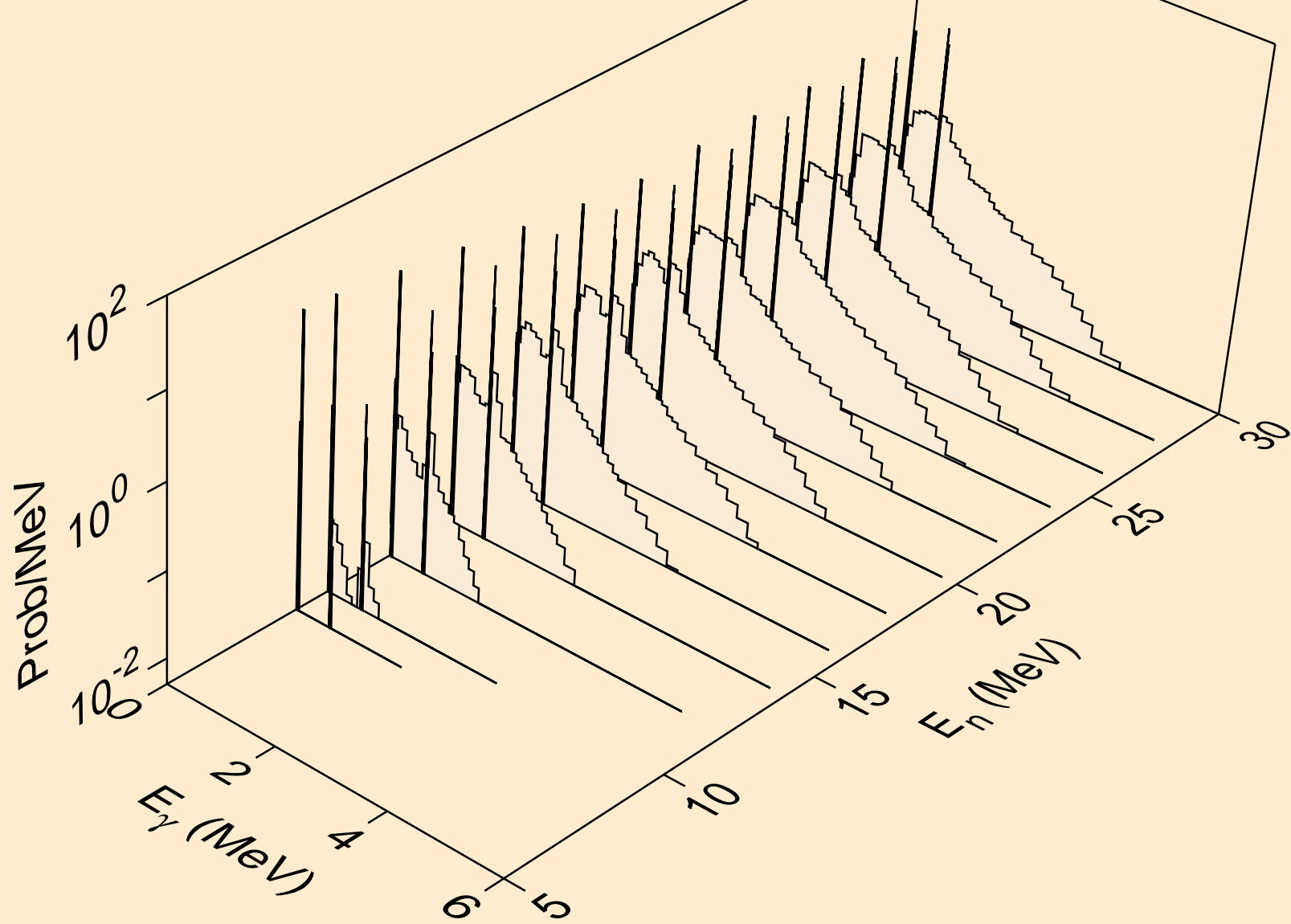

PR144M NEUTRON ACER TENDL-2021 LIBRARY; T=293.6K  
Photon emission for (n,n\*)2a

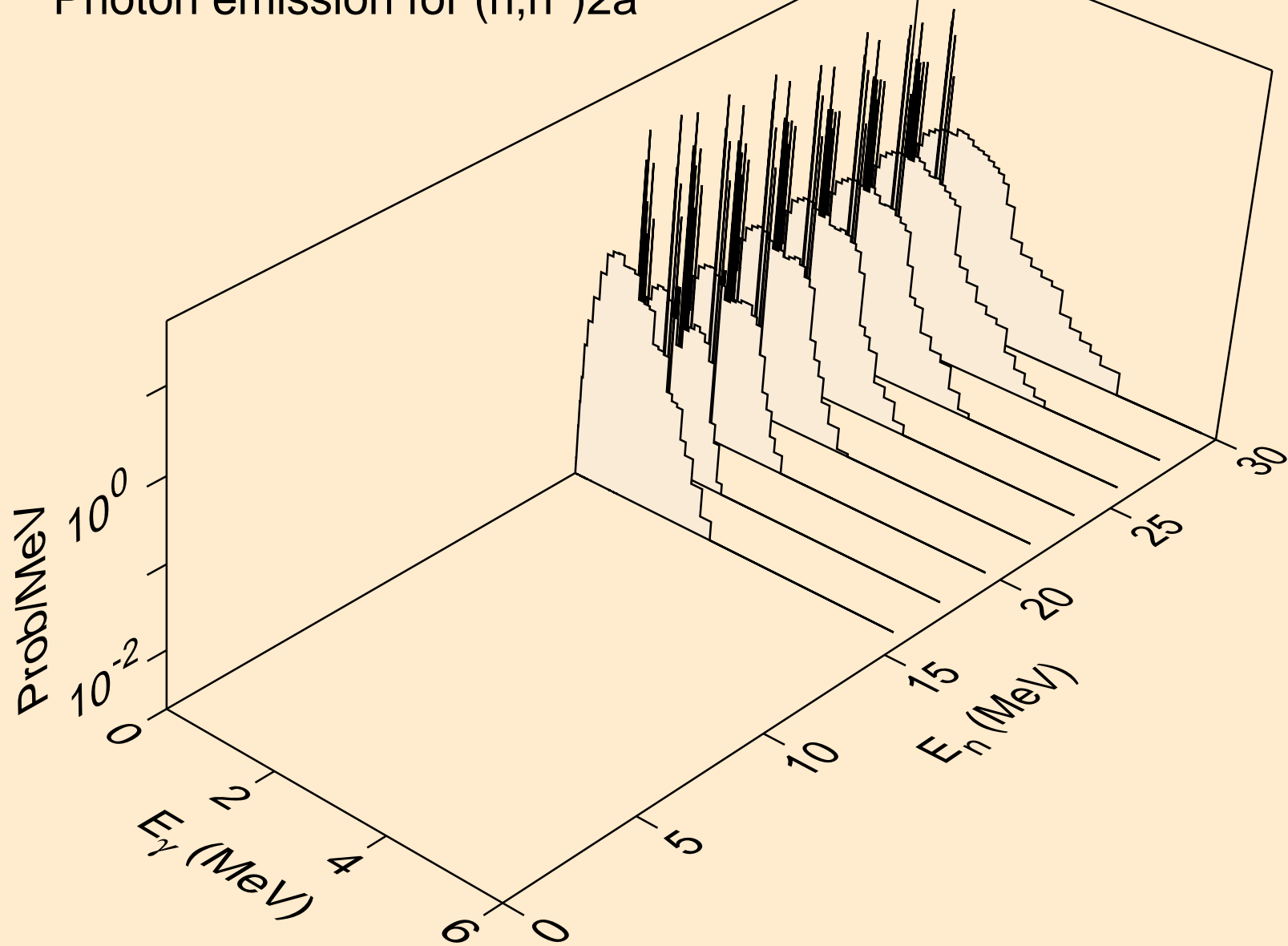



PR144M NEUTRON ACER TENDL-2021 LIBRARY; T=293.6K  
Photon emission for (n,n\*)d

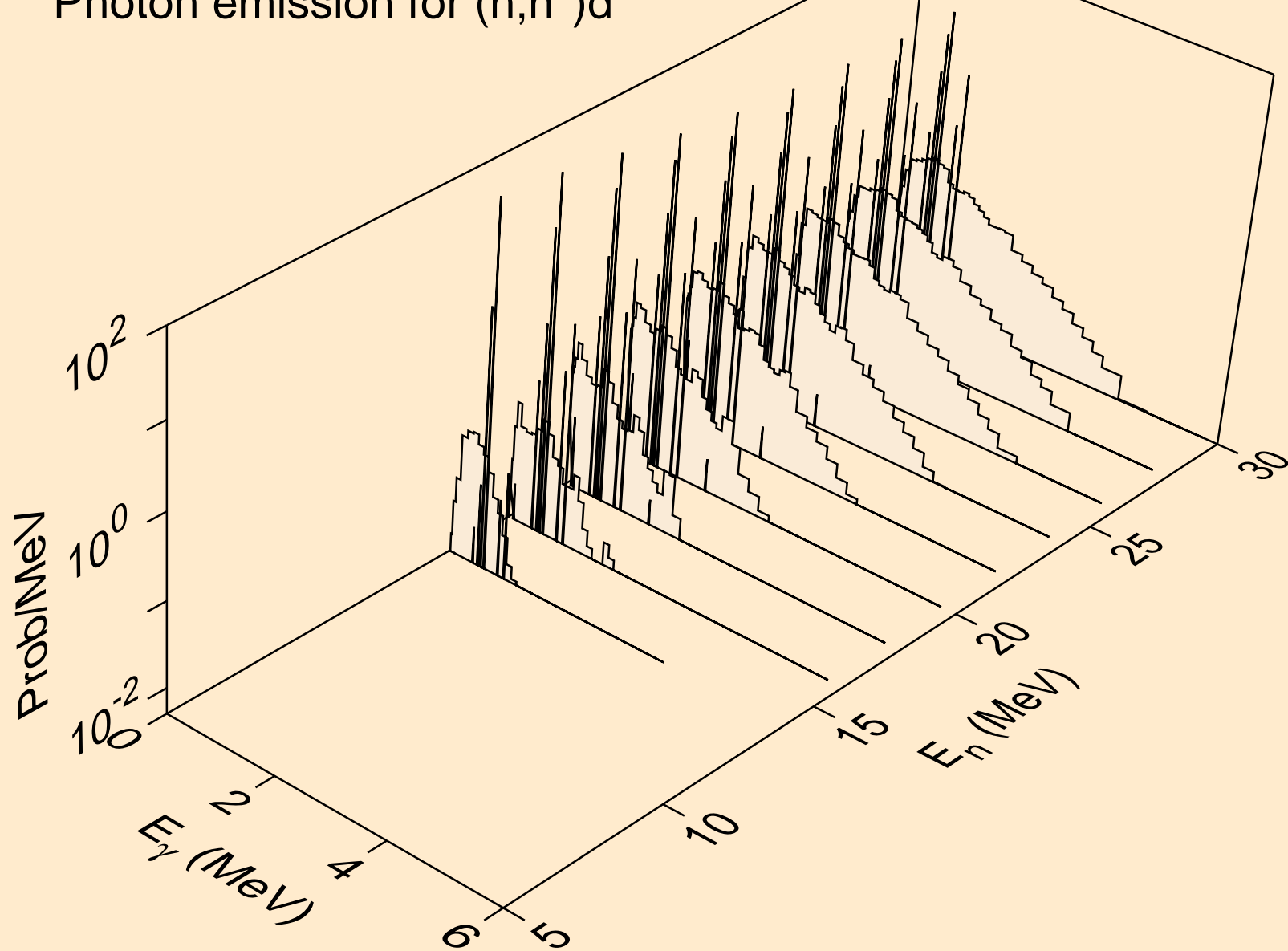

PR144M NEUTRON ACER TENDL-2021 LIBRARY; T=293.6K  
Photon emission for (n,n\*)t

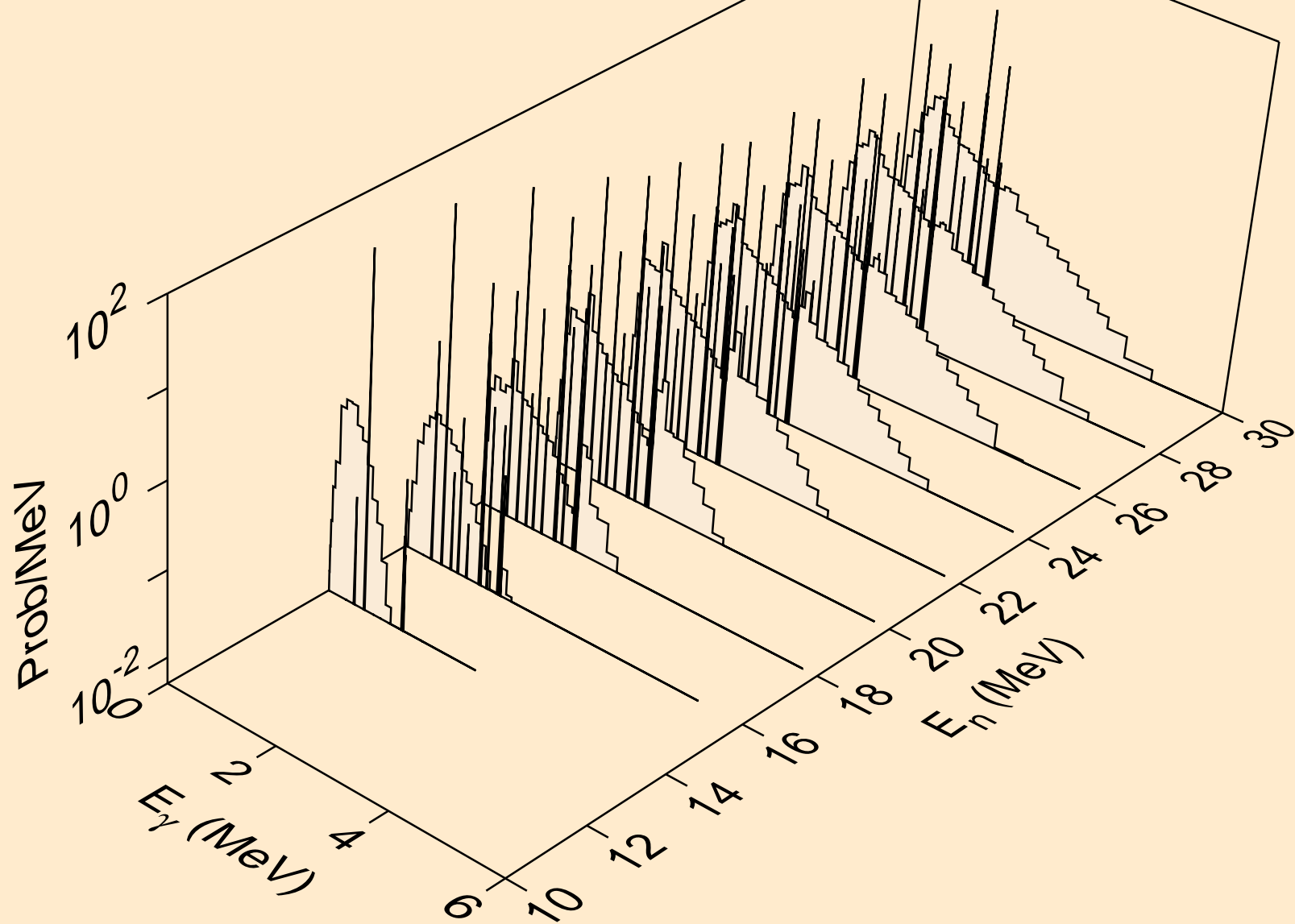

PR144M NEUTRON ACER TENDL-2021 LIBRARY; T=293.6K  
Photon emission for (n,n\*)he3

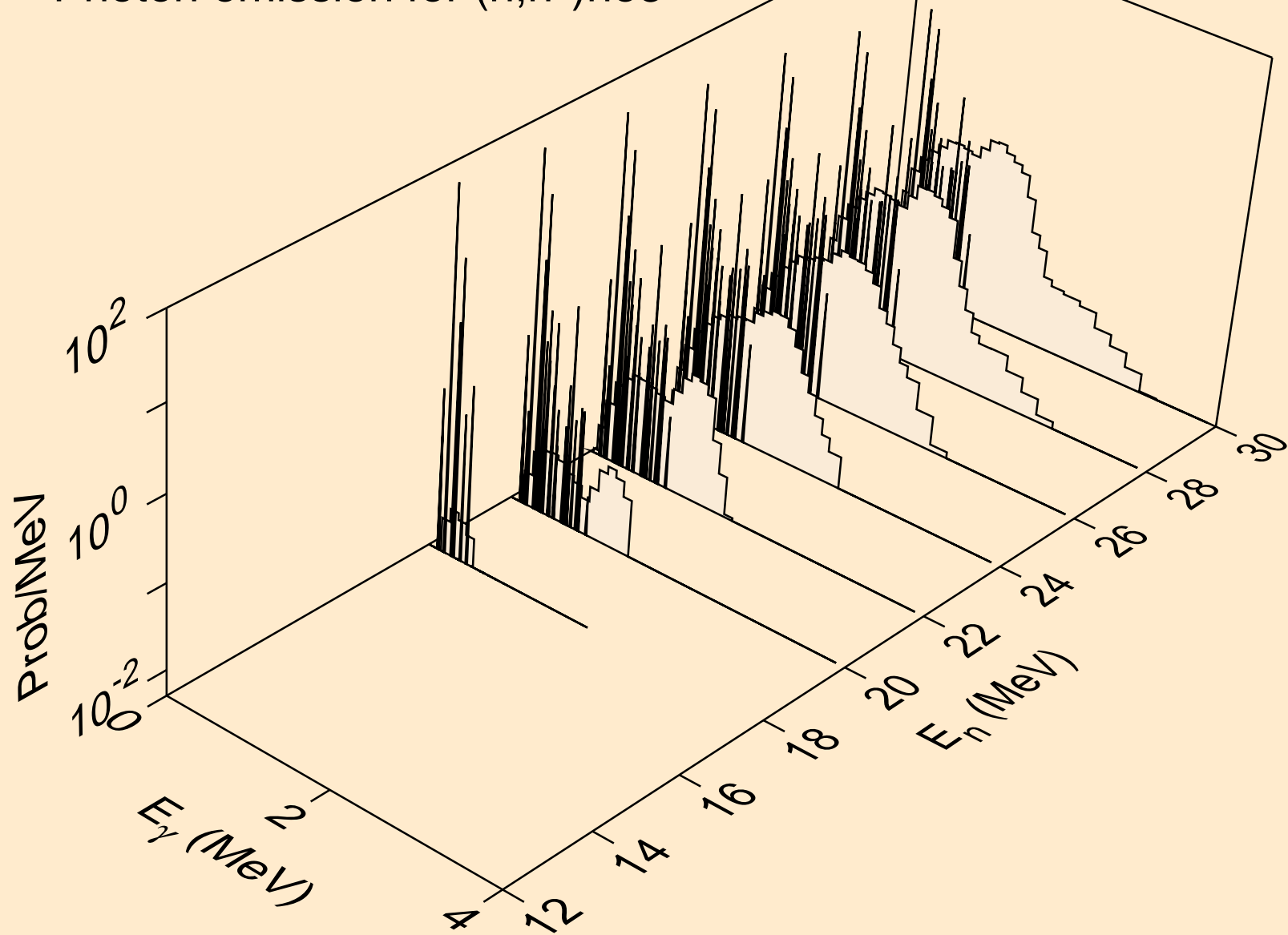

PR144M NEUTRON ACER TENDL-2021 LIBRARY; T=293.6K  
Photon emission for (n,4n)

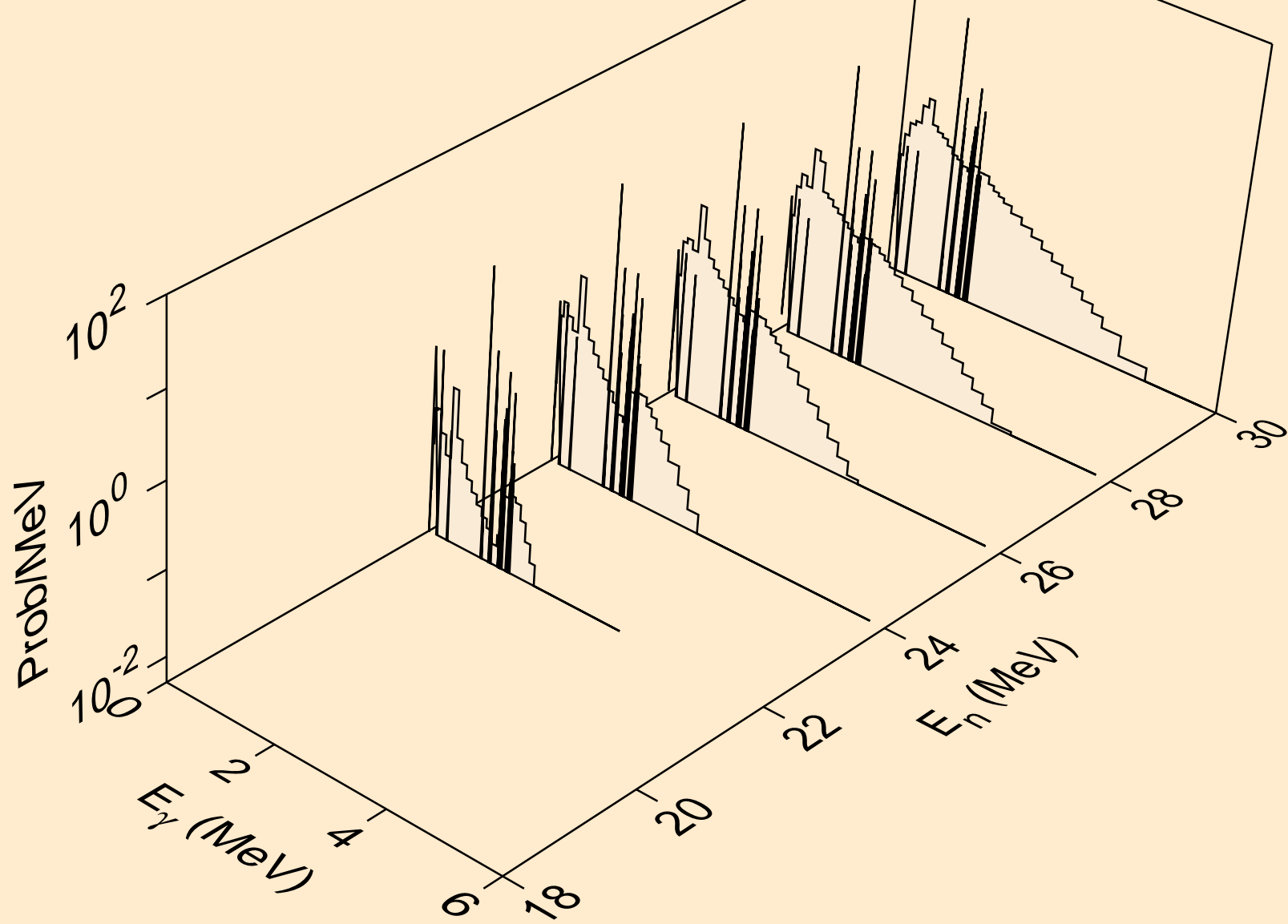

PR144M NEUTRON ACER TENDL-2021 LIBRARY; T=293.6K  
Photon emission for (n,2np)

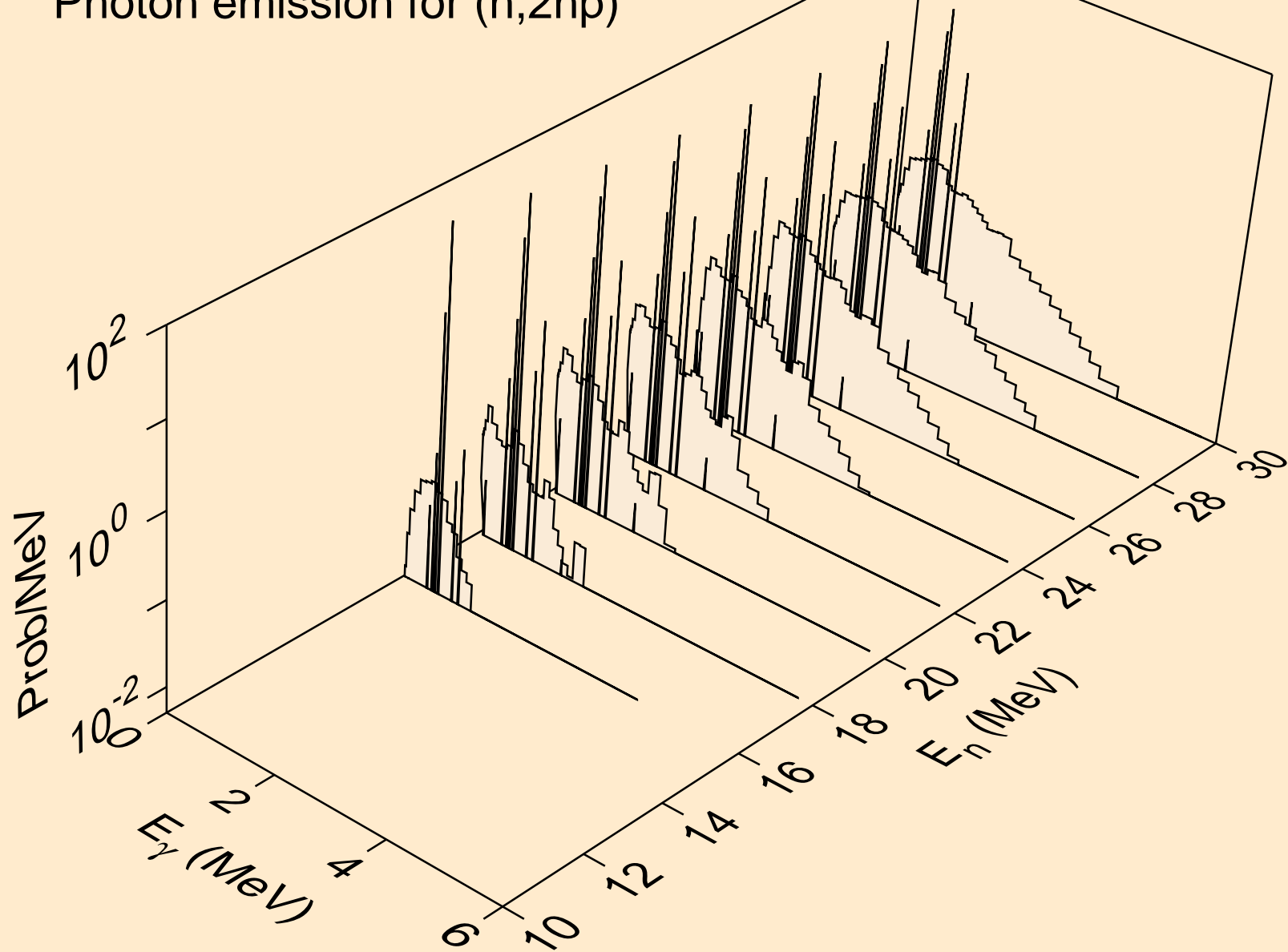

PR144M NEUTRON ACER TENDL-2021 LIBRARY; T=293.6K  
Photon emission for (n,3np)

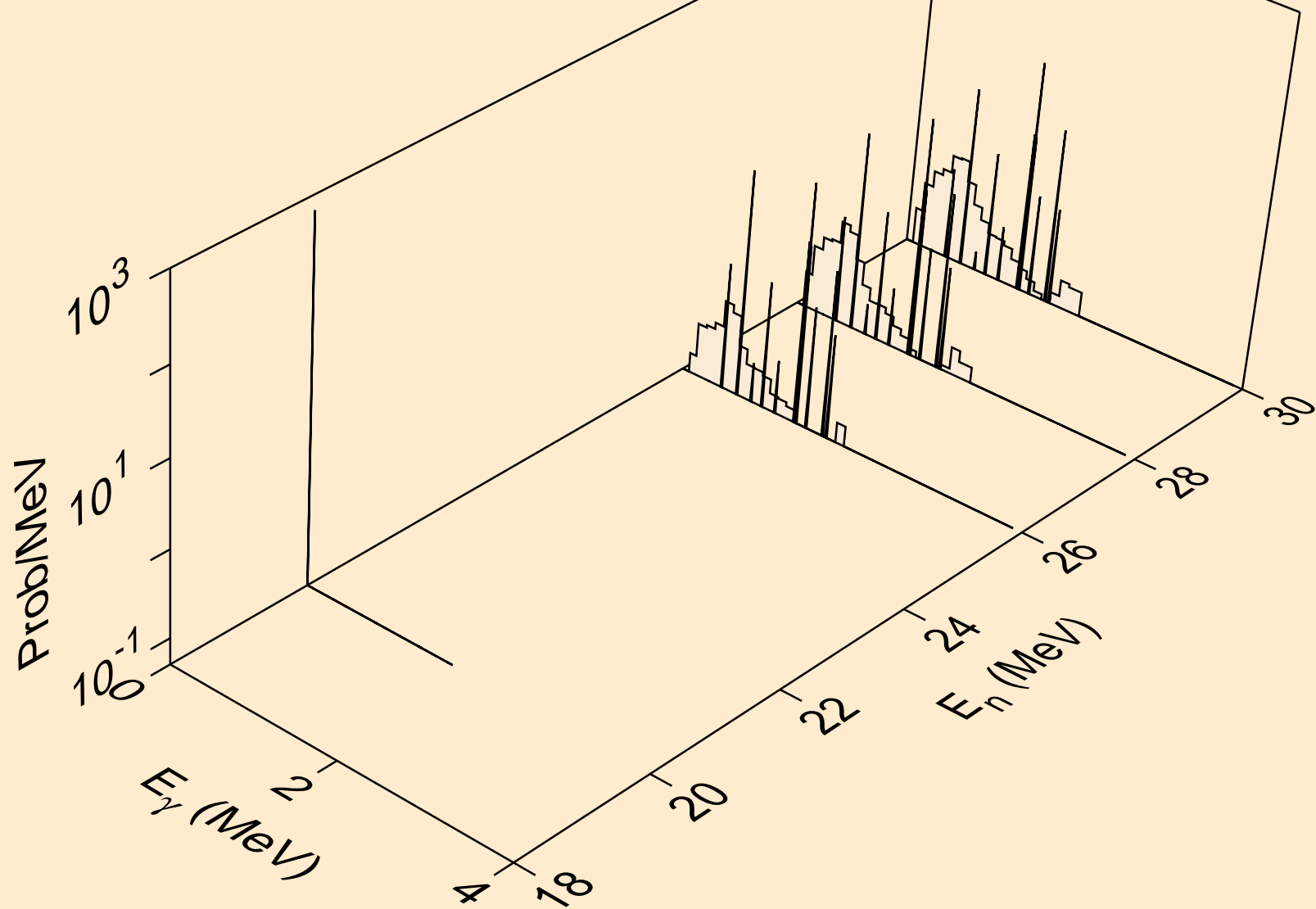

PR144M NEUTRON ACER TENDL-2021 LIBRARY; T=293.6K  
Photon emission for (n,2np)

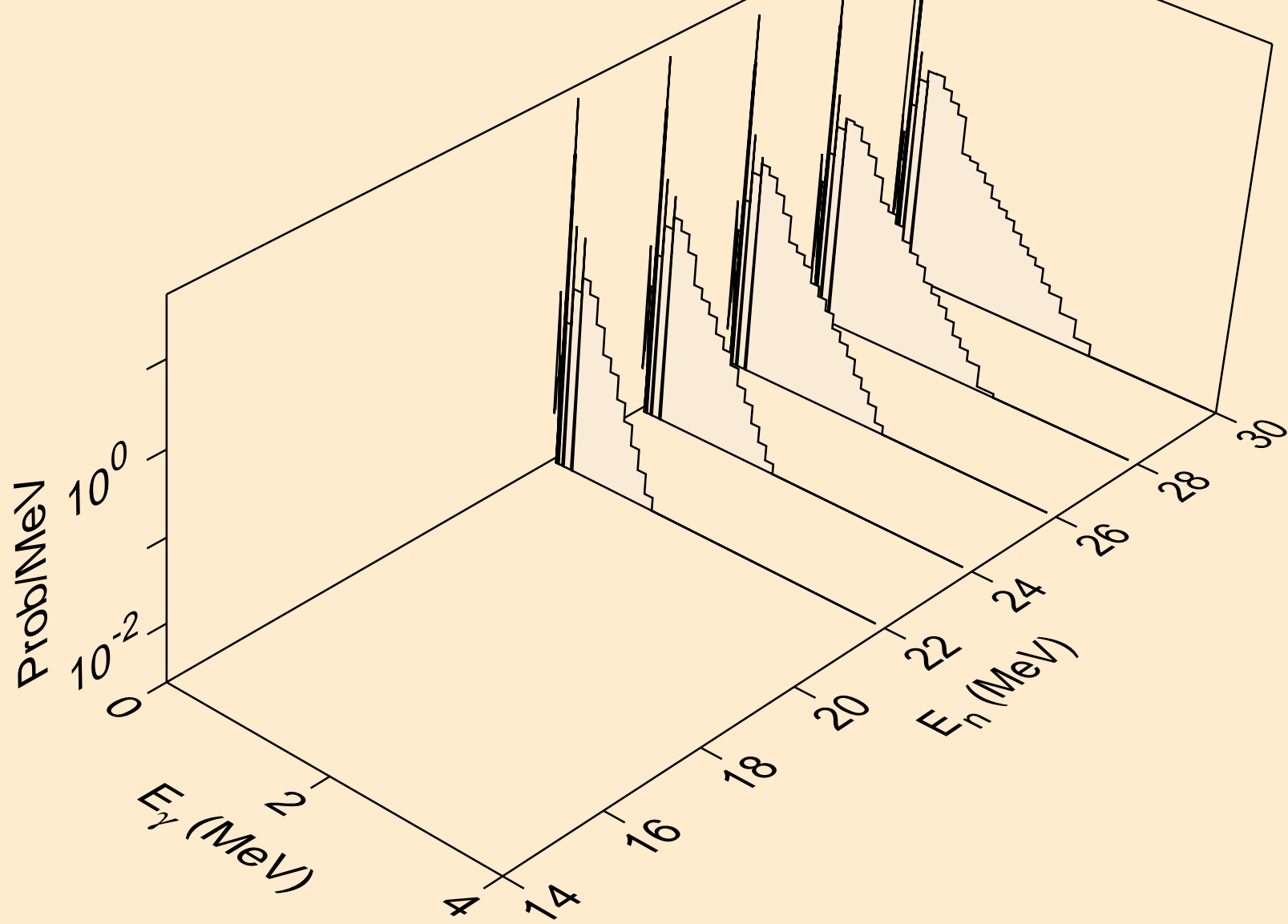

PR144M NEUTRON ACER TENDL-2021 LIBRARY; T=293.6K  
Photon emission for (n,npa)

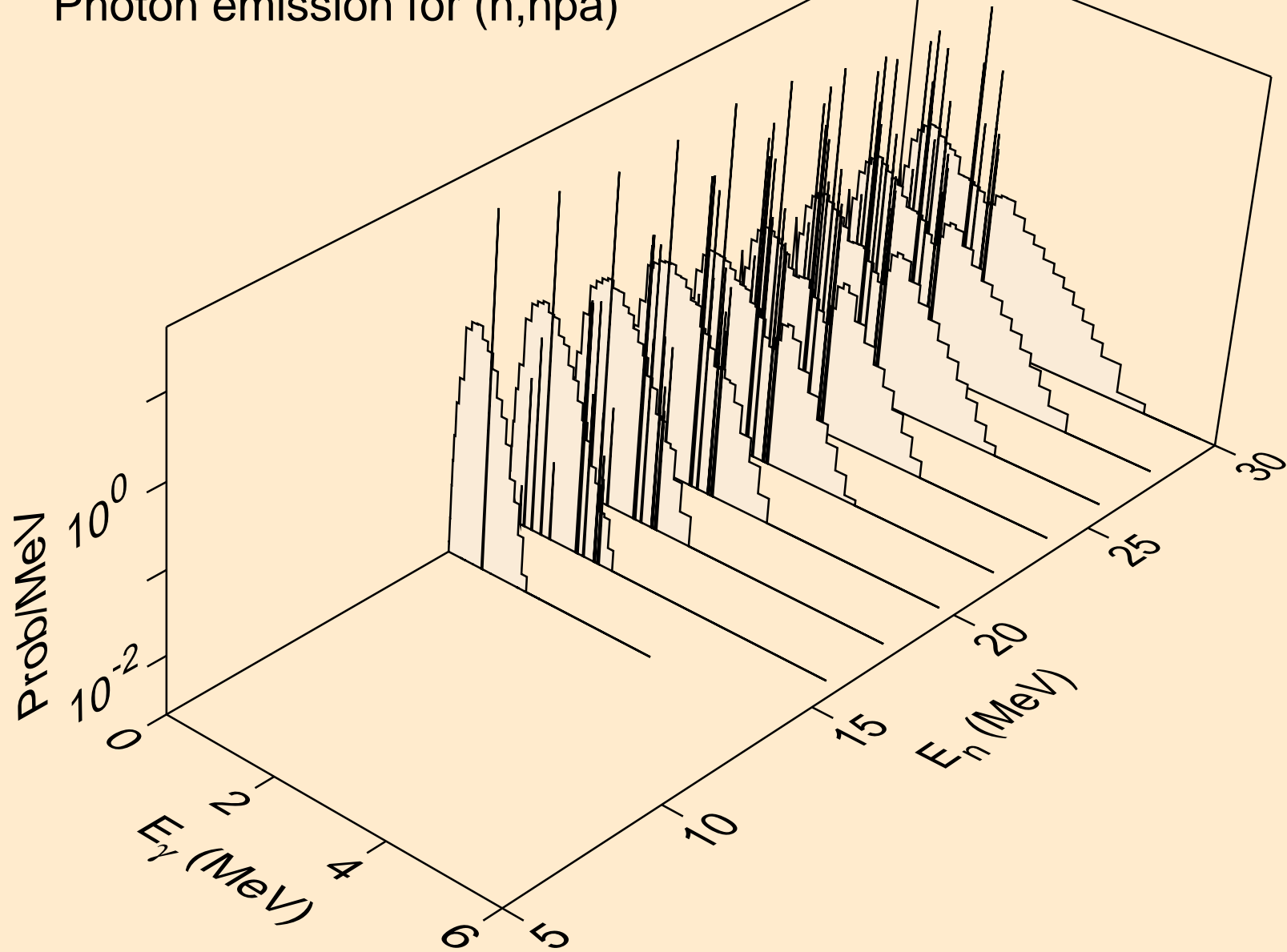



PR144M NEUTRON ACER TENDL-2021 LIBRARY; T=293.6K  
Photon emission for (n,n\*2)

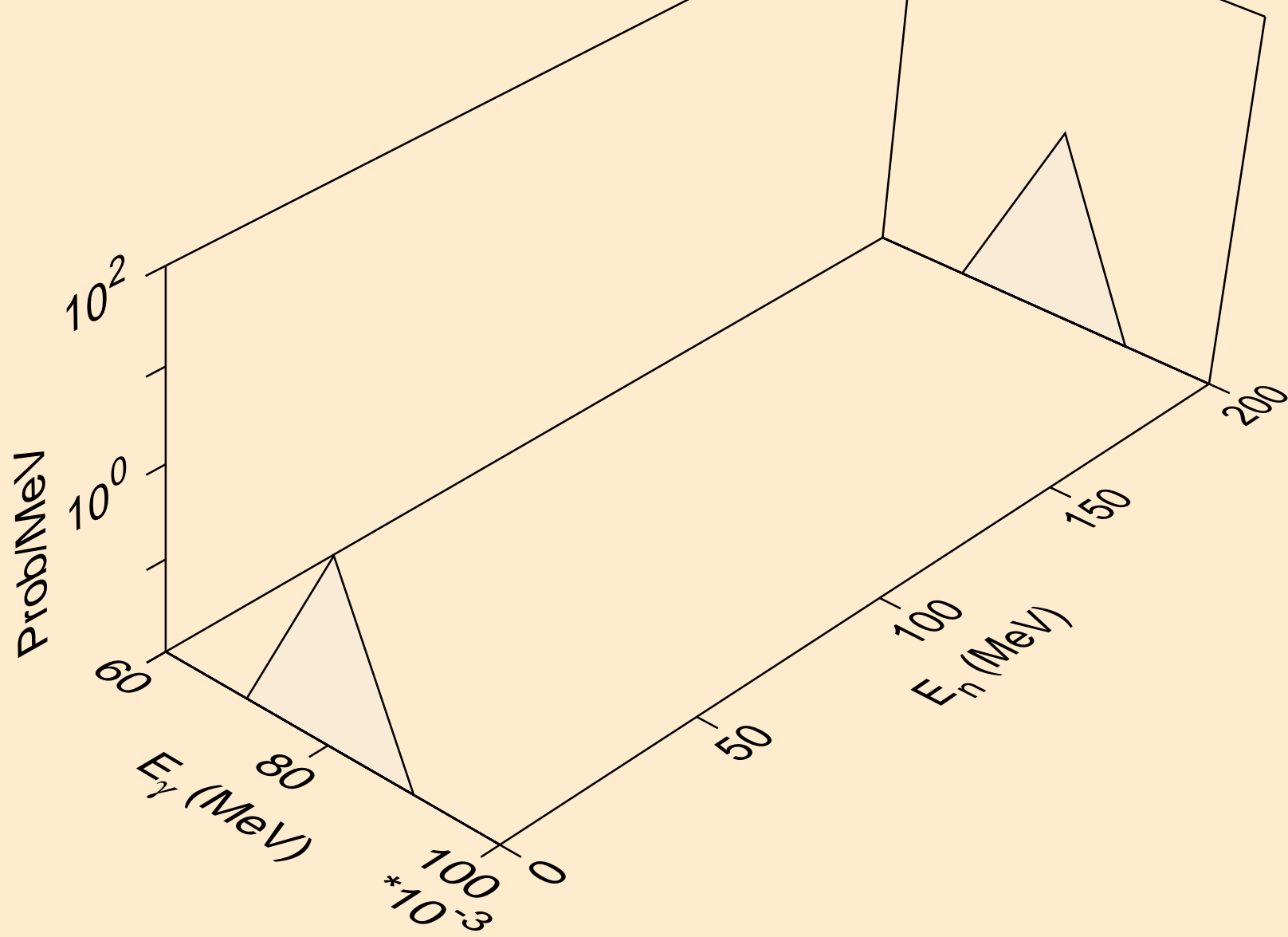

PR144M NEUTRON ACER TENDL-2021 LIBRARY; T=293.6K  
Photon emission for (n,n\*3)

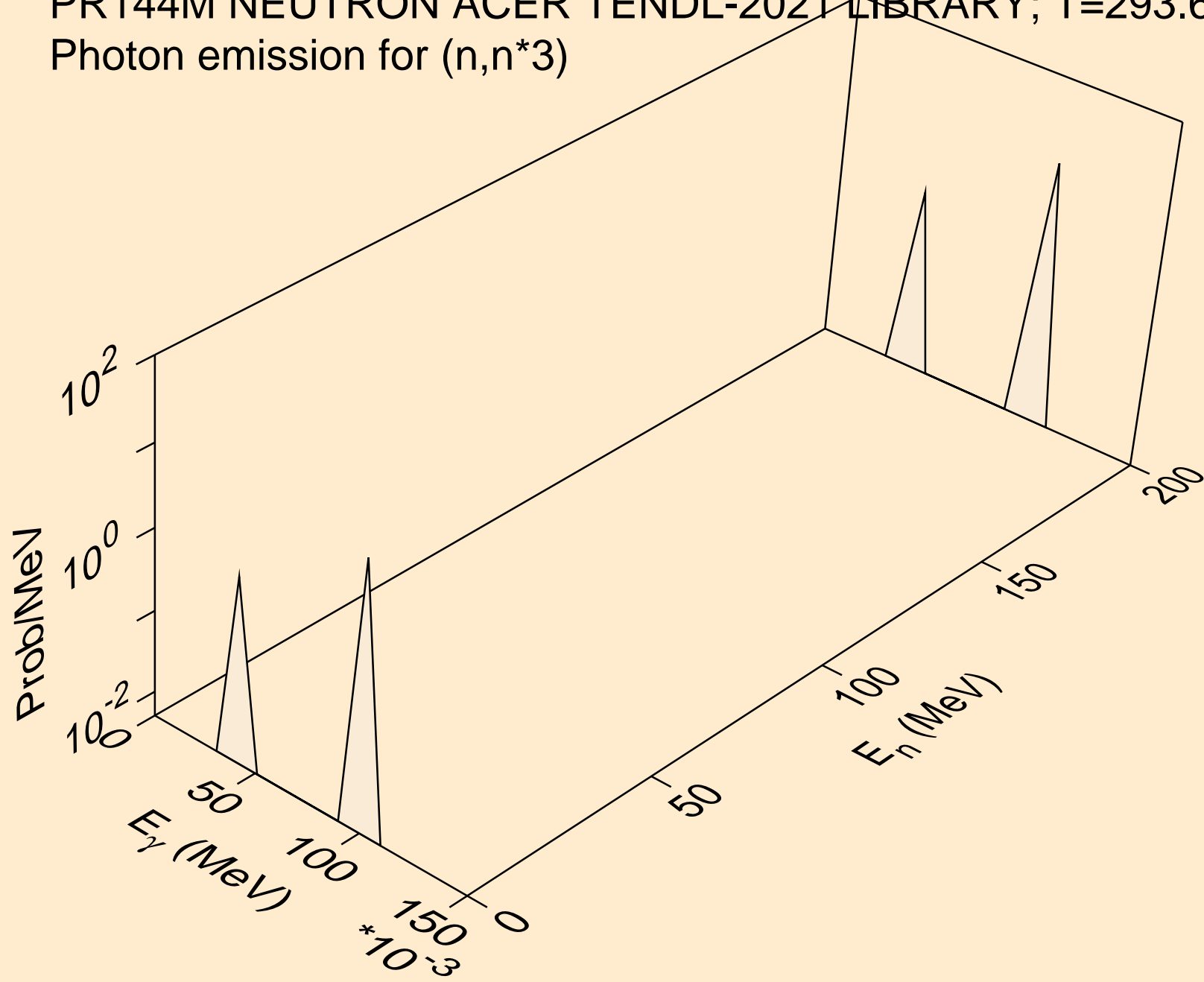

PR144M NEUTRON ACER TENDL-2021 LIBRARY; T=293.6K  
Photon emission for (n,n\*4)

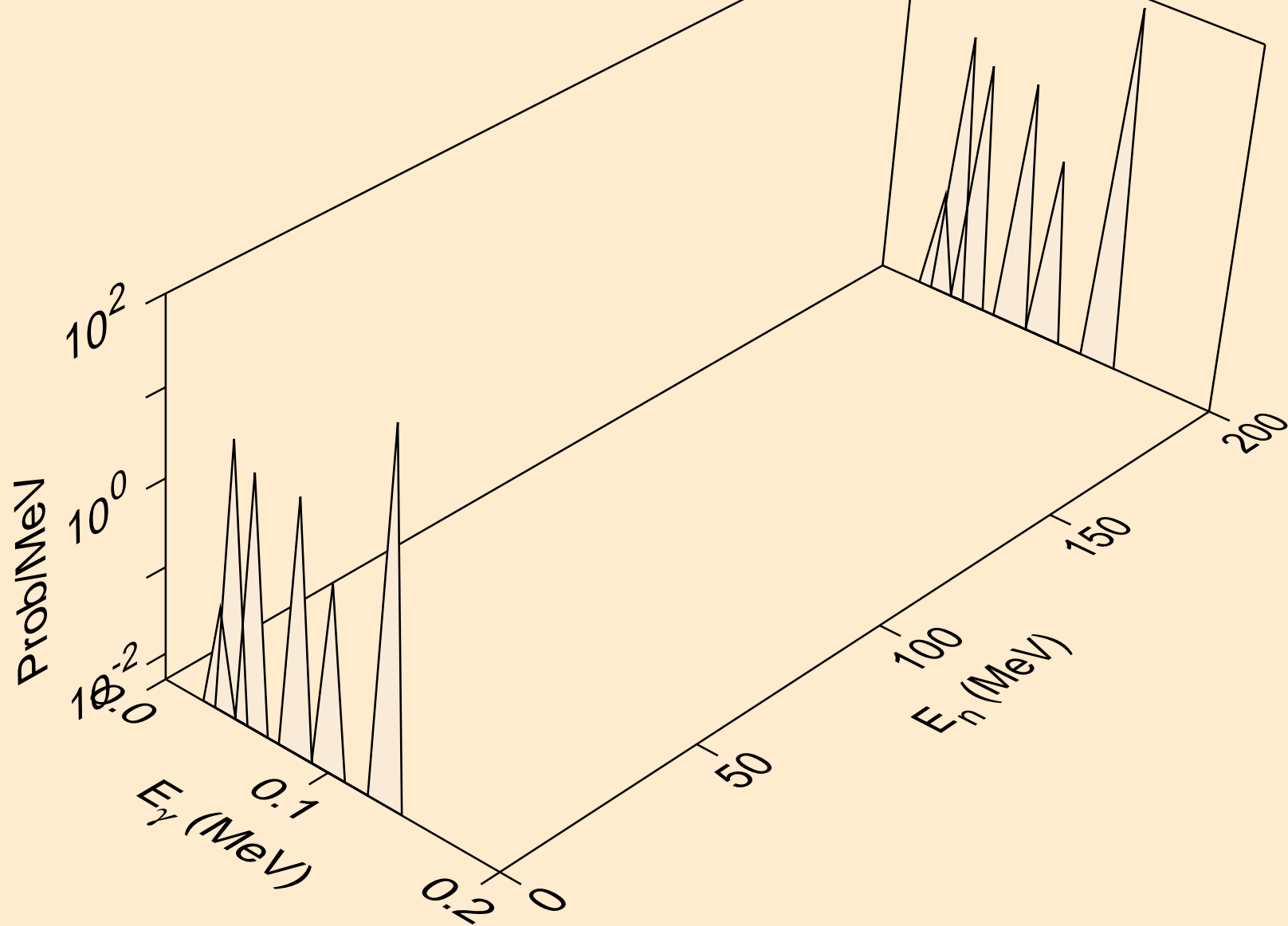

PR144M NEUTRON ACER TENDL-2021 LIBRARY; T=293.6K  
Photon emission for (n,n\*5)

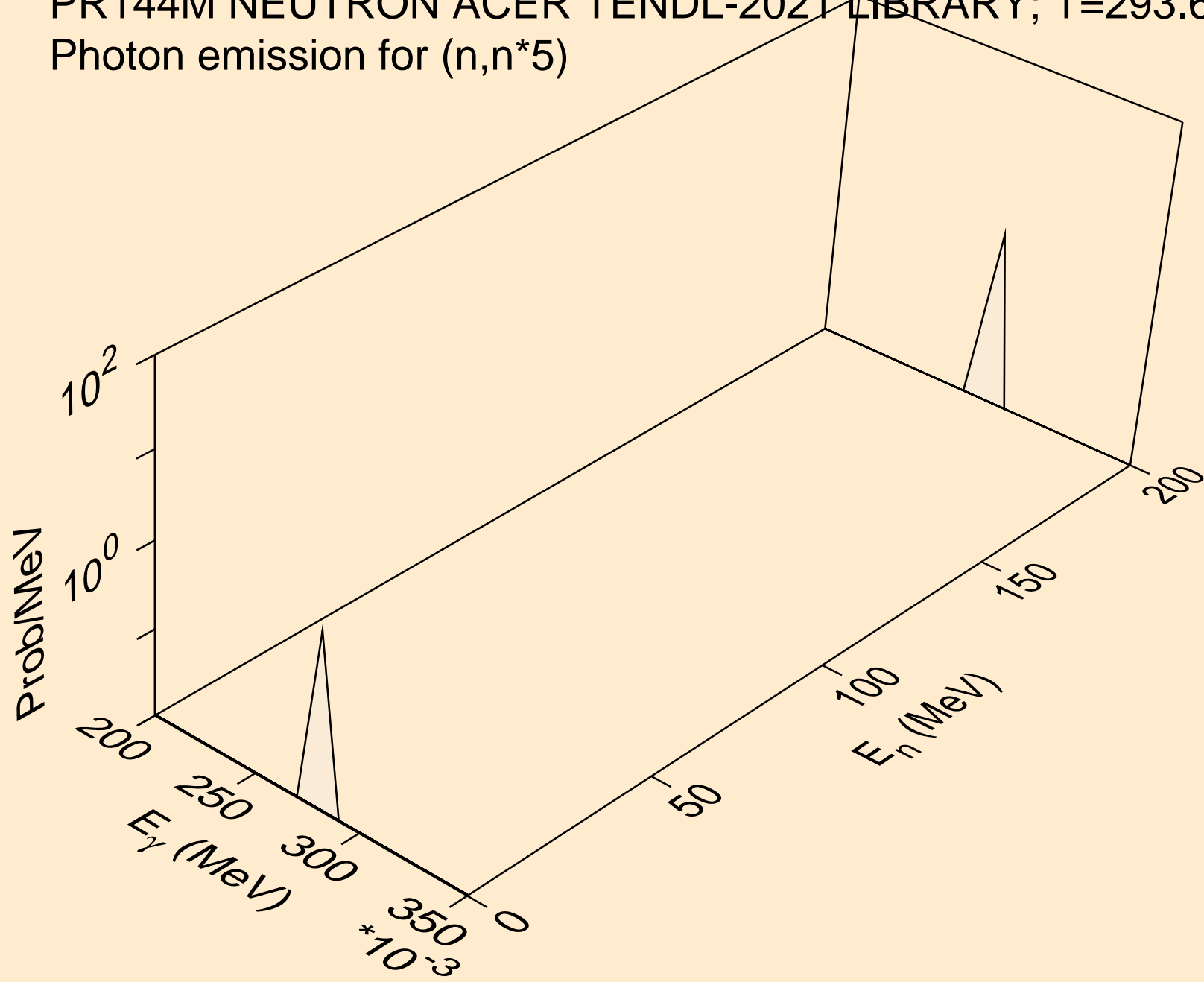

PR144M NEUTRON ACER TENDL-2021 LIBRARY; T=293.6K  
Photon emission for (n,n\*6)

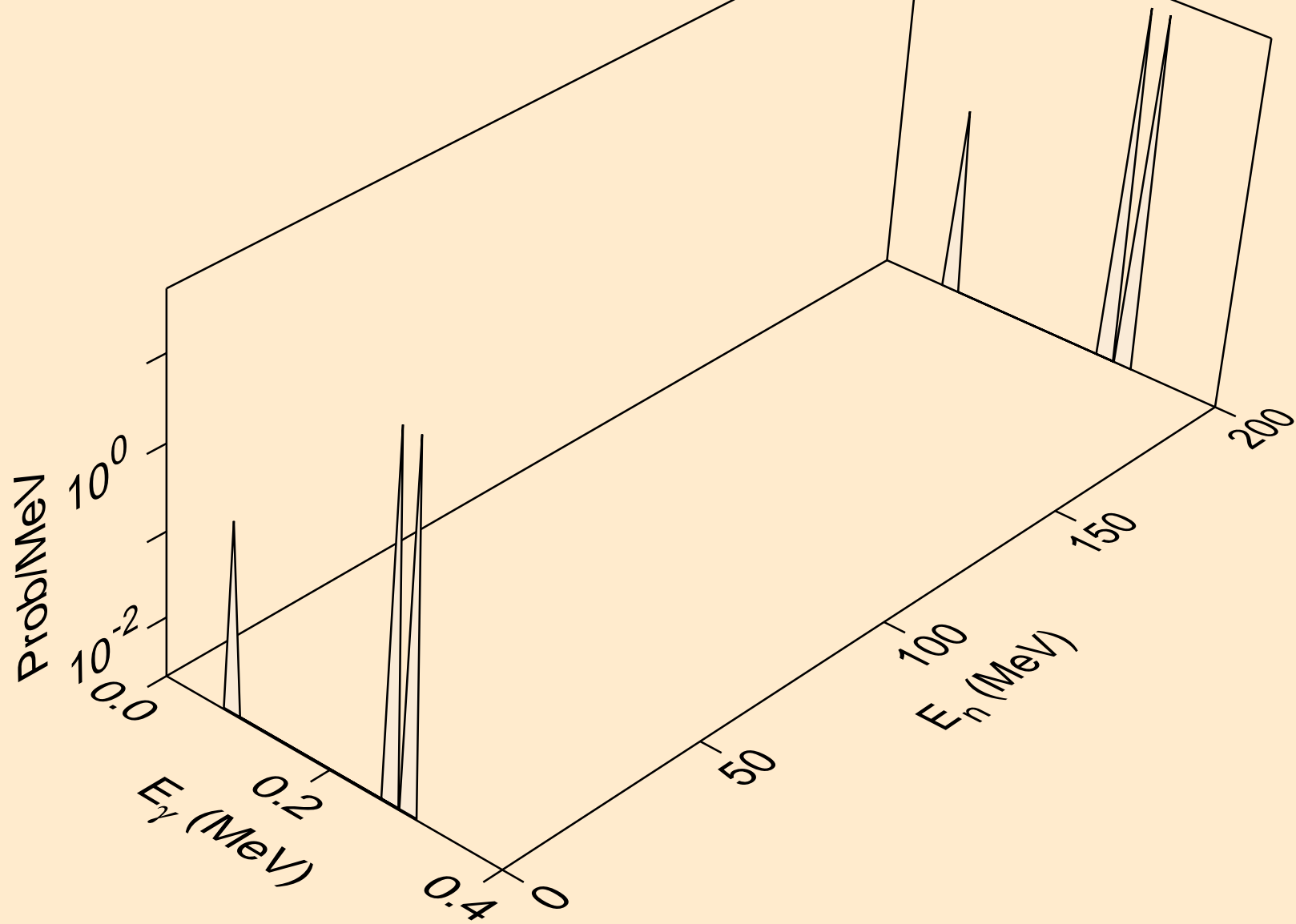

PR144M NEUTRON ACER TENDL-2021 LIBRARY; T=293.6K  
Photon emission for (n,n\*7)

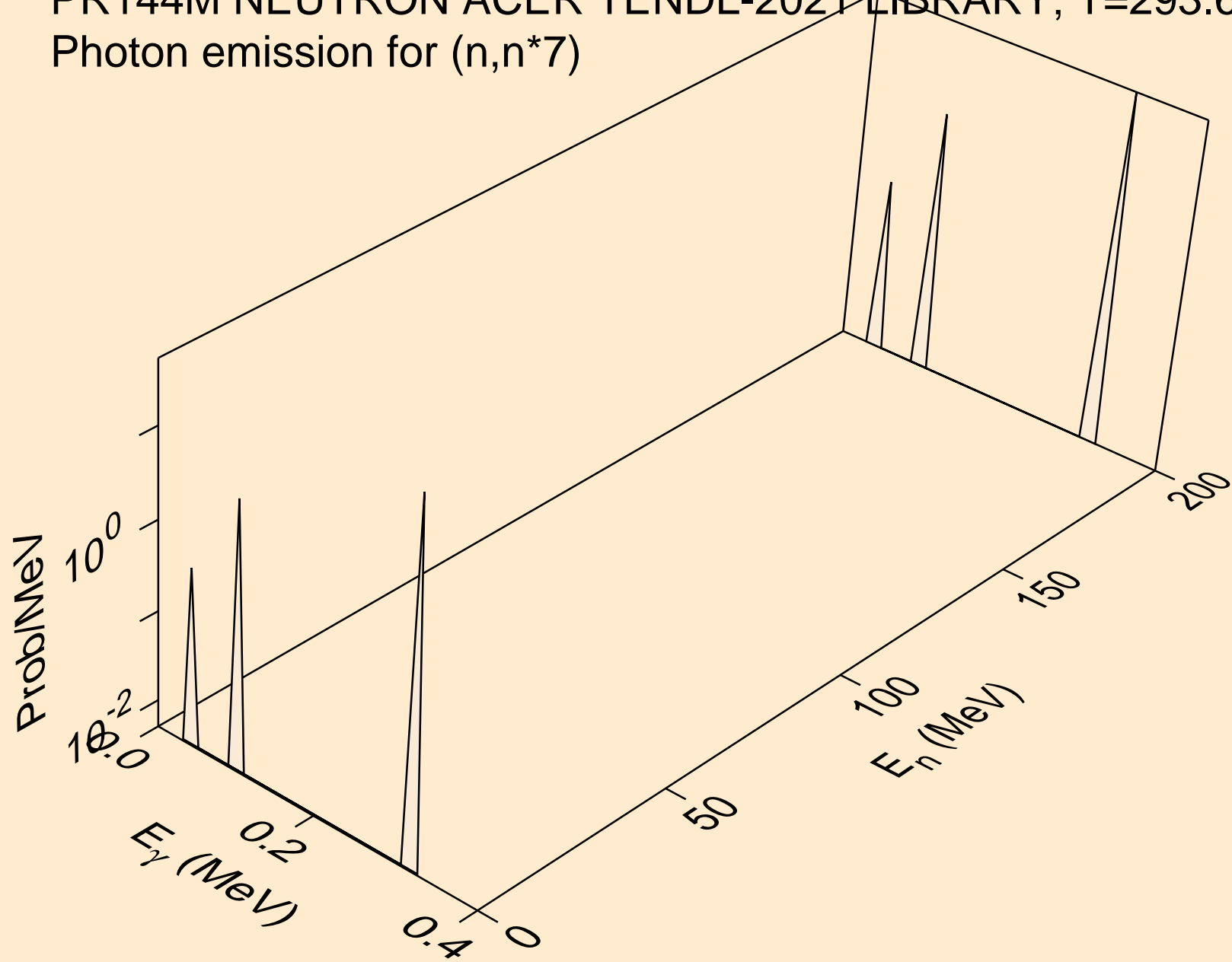

PR144M NEUTRON ACER TENDL-2021 LIBRARY; T=293.6K  
Photon emission for (n,n\*8)

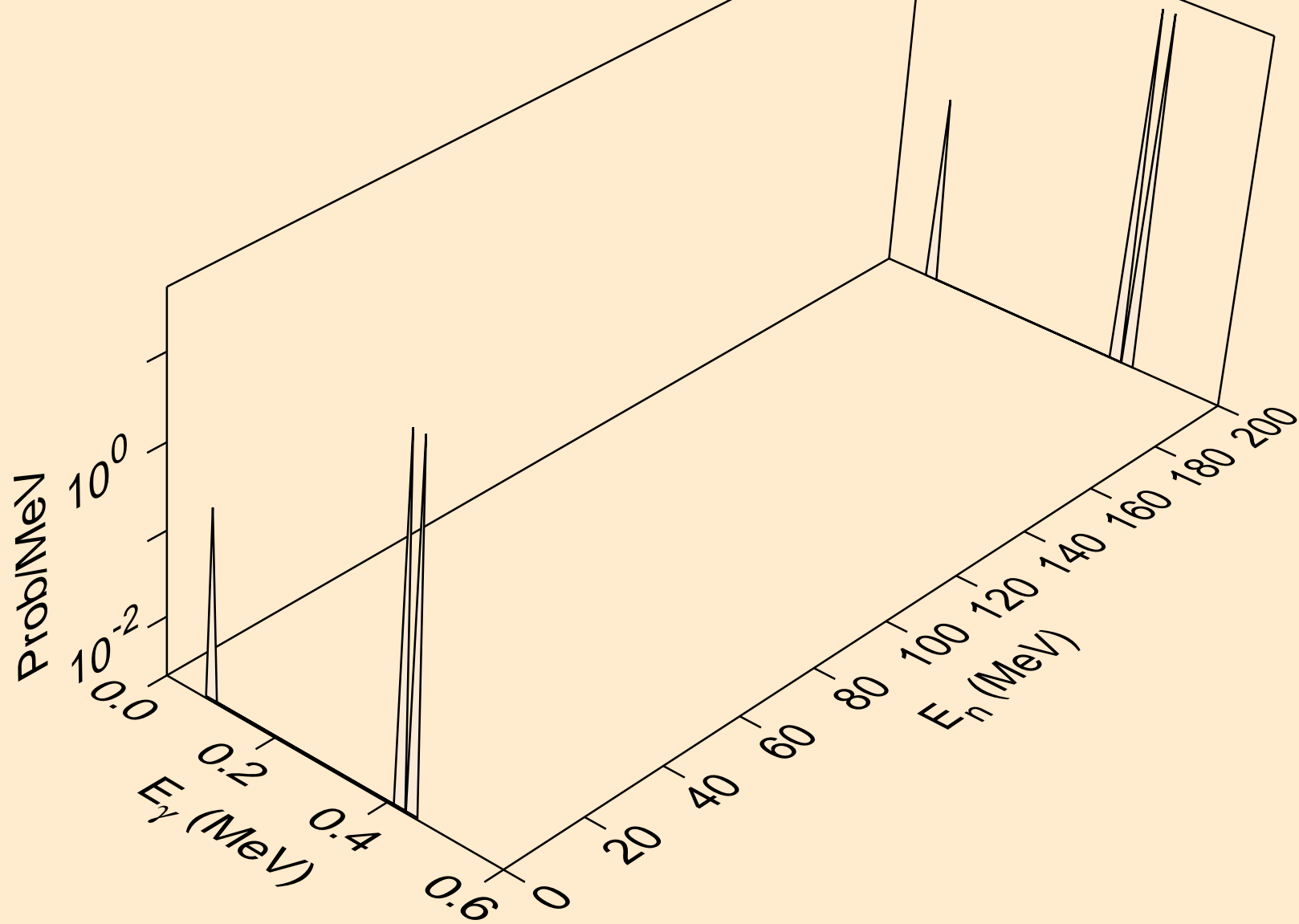

PR144M NEUTRON ACER TENDL-2021 LIBRARY; T=293.6K  
Photon emission for (n,n\*9)

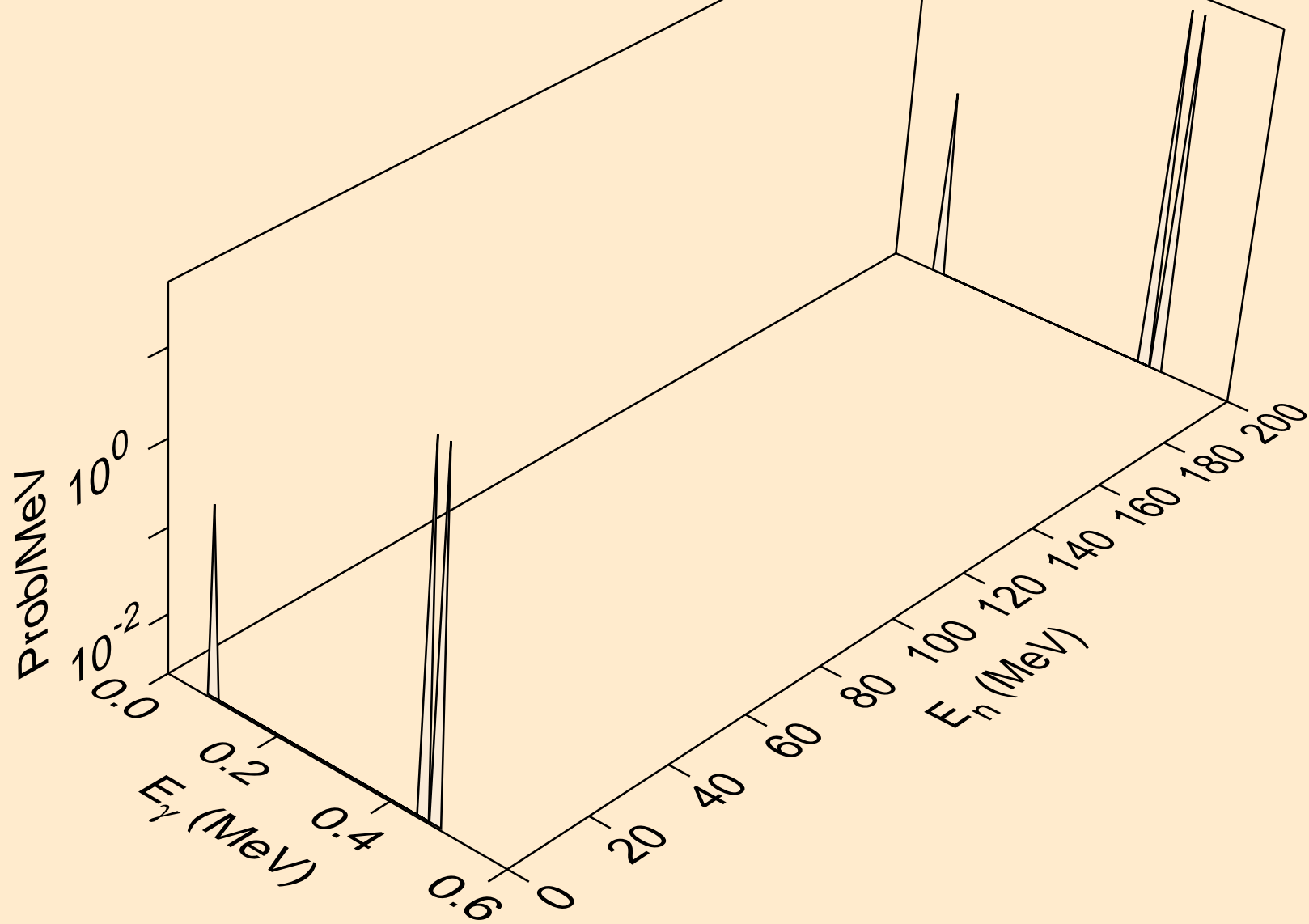



PR144M NEUTRON ACER TENDL-2021 LIBRARY; T=293.6K  
Photon emission for (n,n\*10)

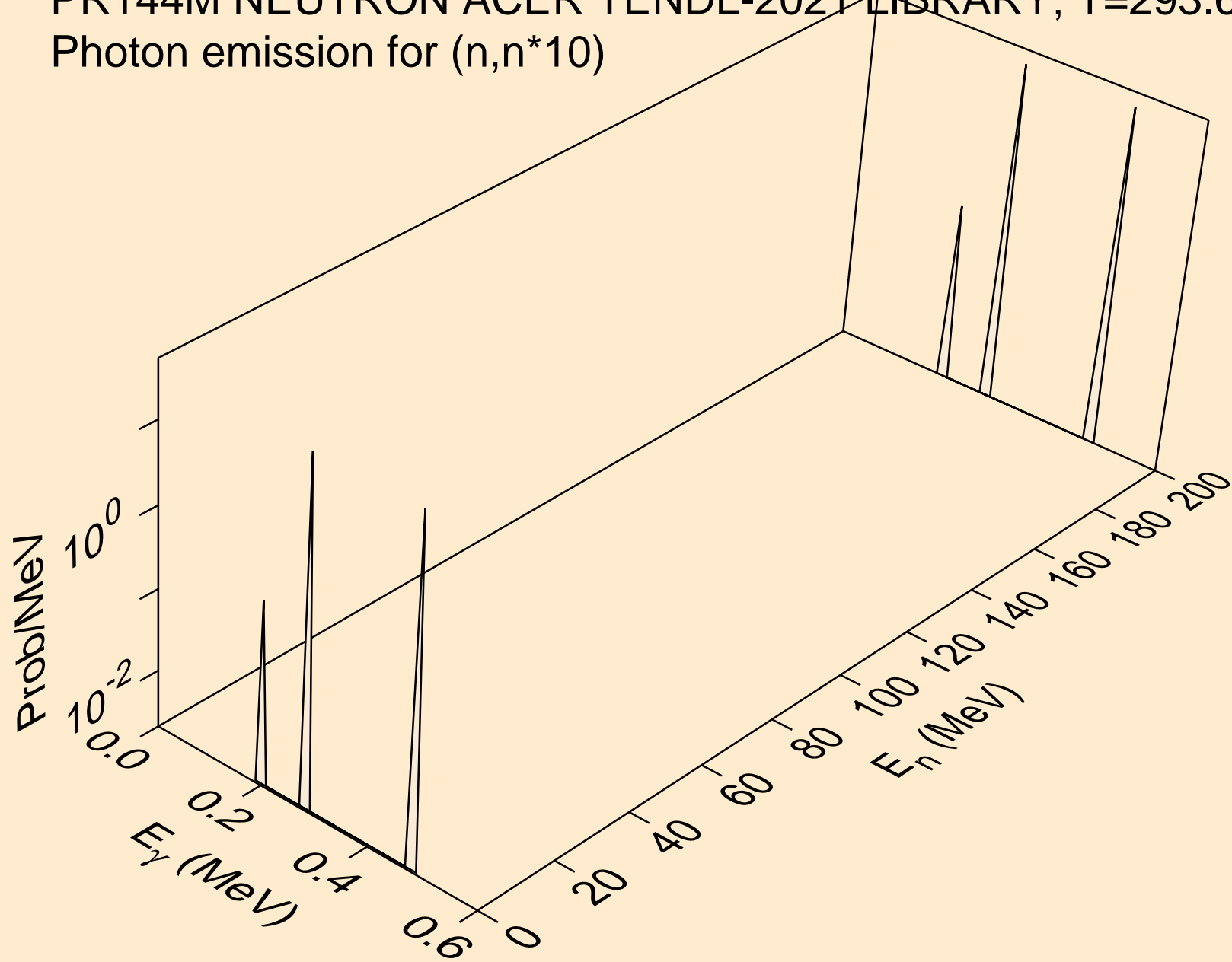

PR144M NEUTRON ACER TENDL-2021 LIBRARY; T=293.6K  
Photon emission for (n,n\*11)

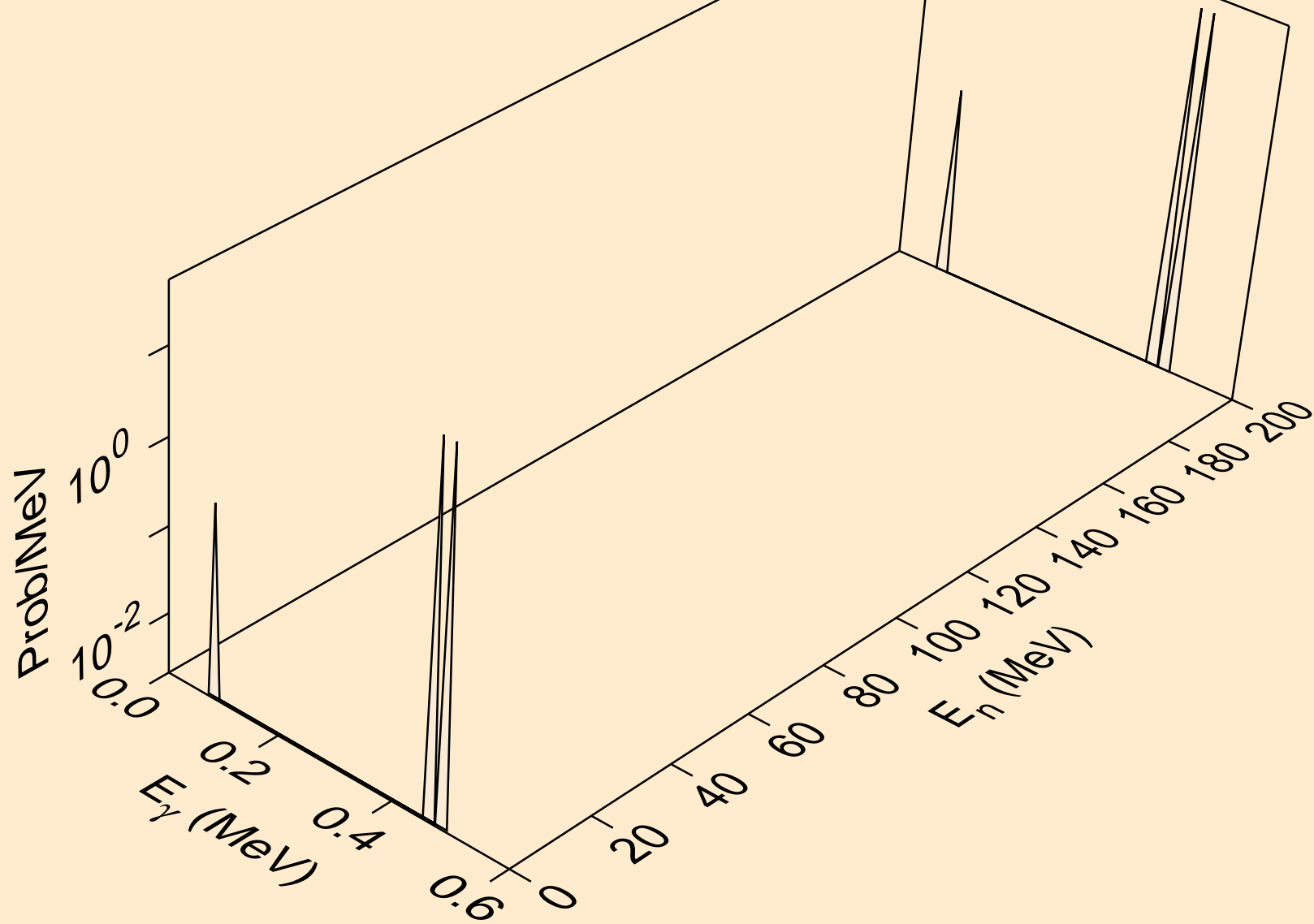

PR144M NEUTRON ACER TENDL-2021 LIBRARY; T=293.6K  
Photon emission for (n,n\*12)

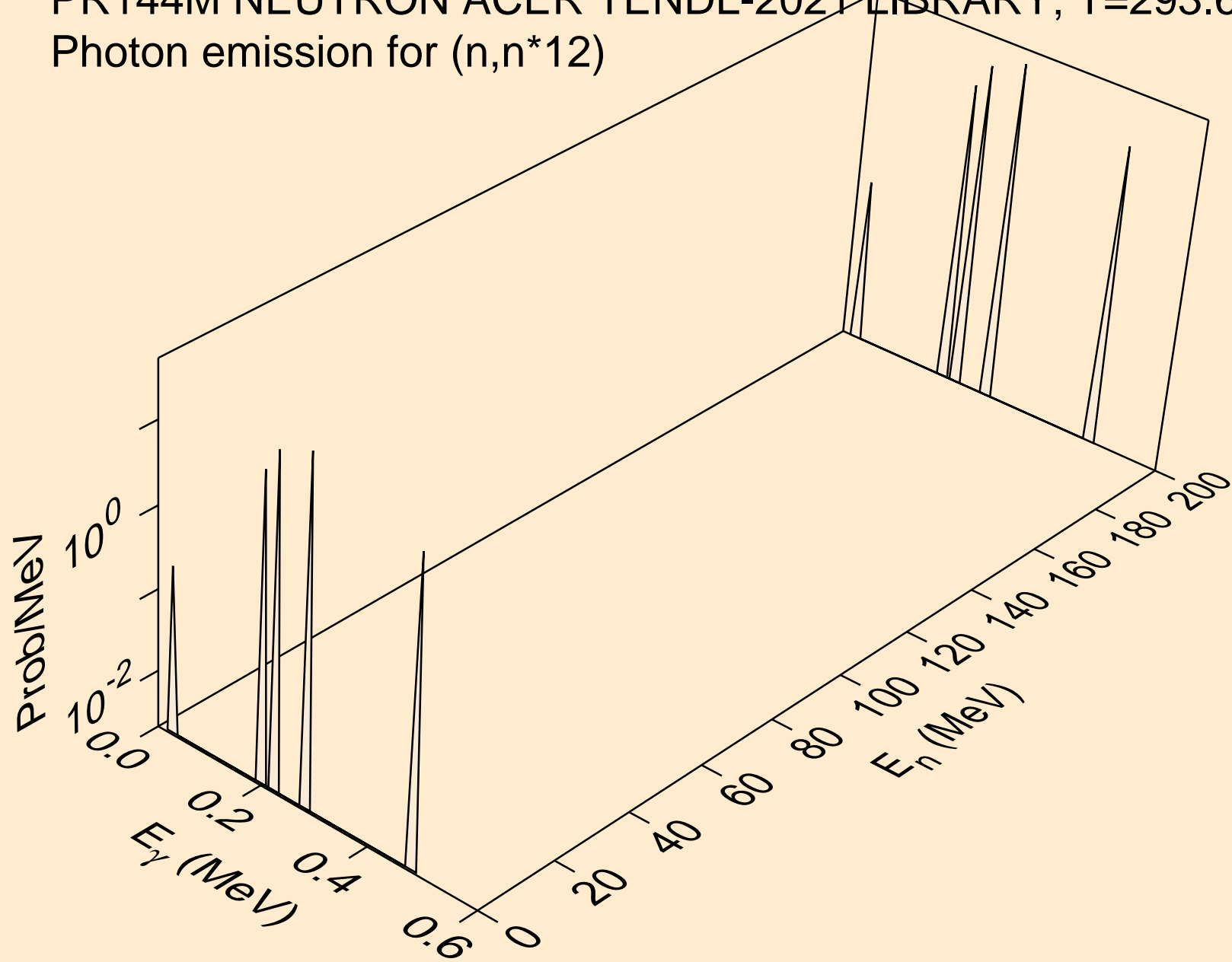

PR144M NEUTRON ACER TENDL-2021 LIBRARY; T=293.6K  
Photon emission for (n,n\*13)

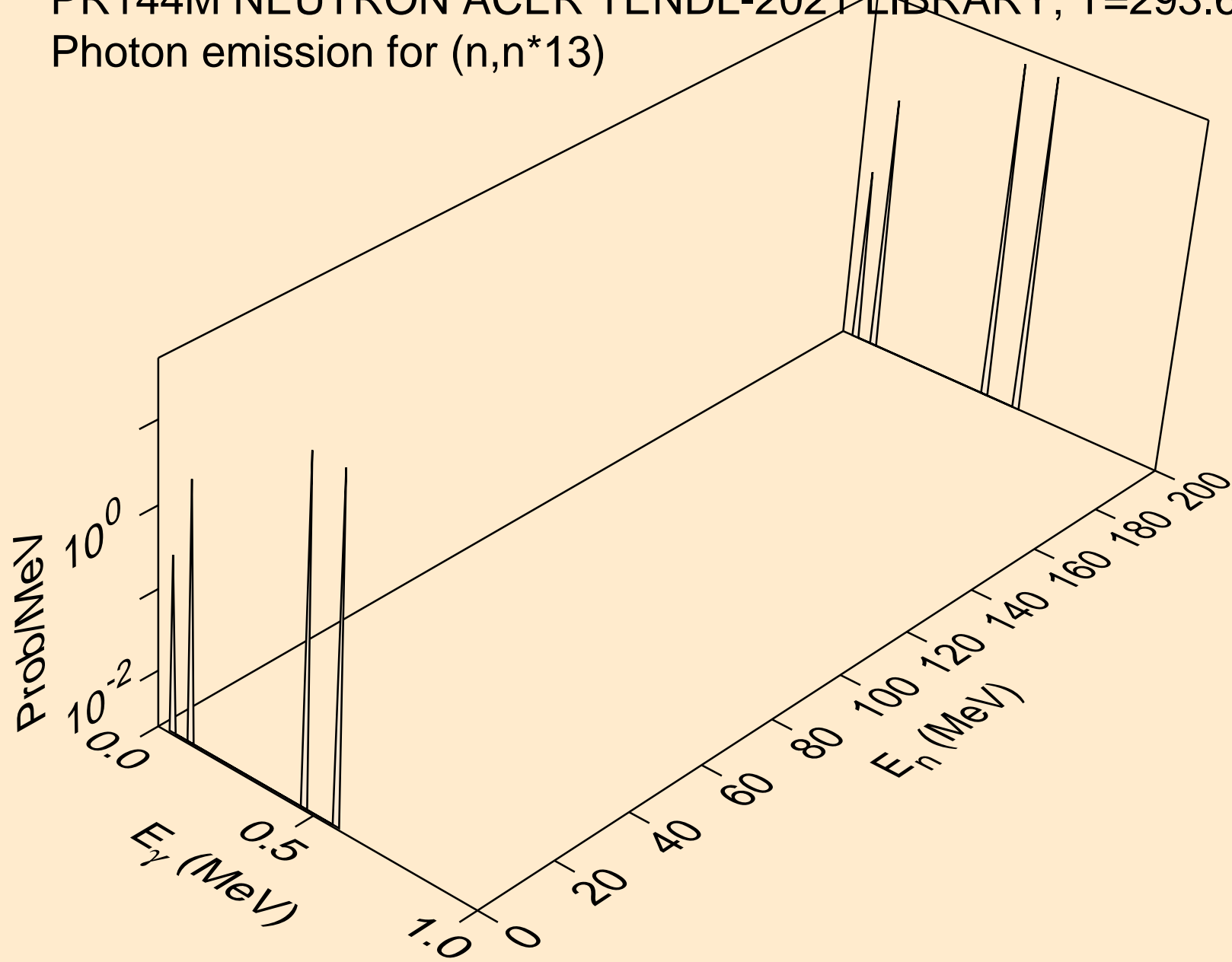

PR144M NEUTRON ACER TENDL-2021 LIBRARY; T=293.6K  
Photon emission for (n,n\*14)

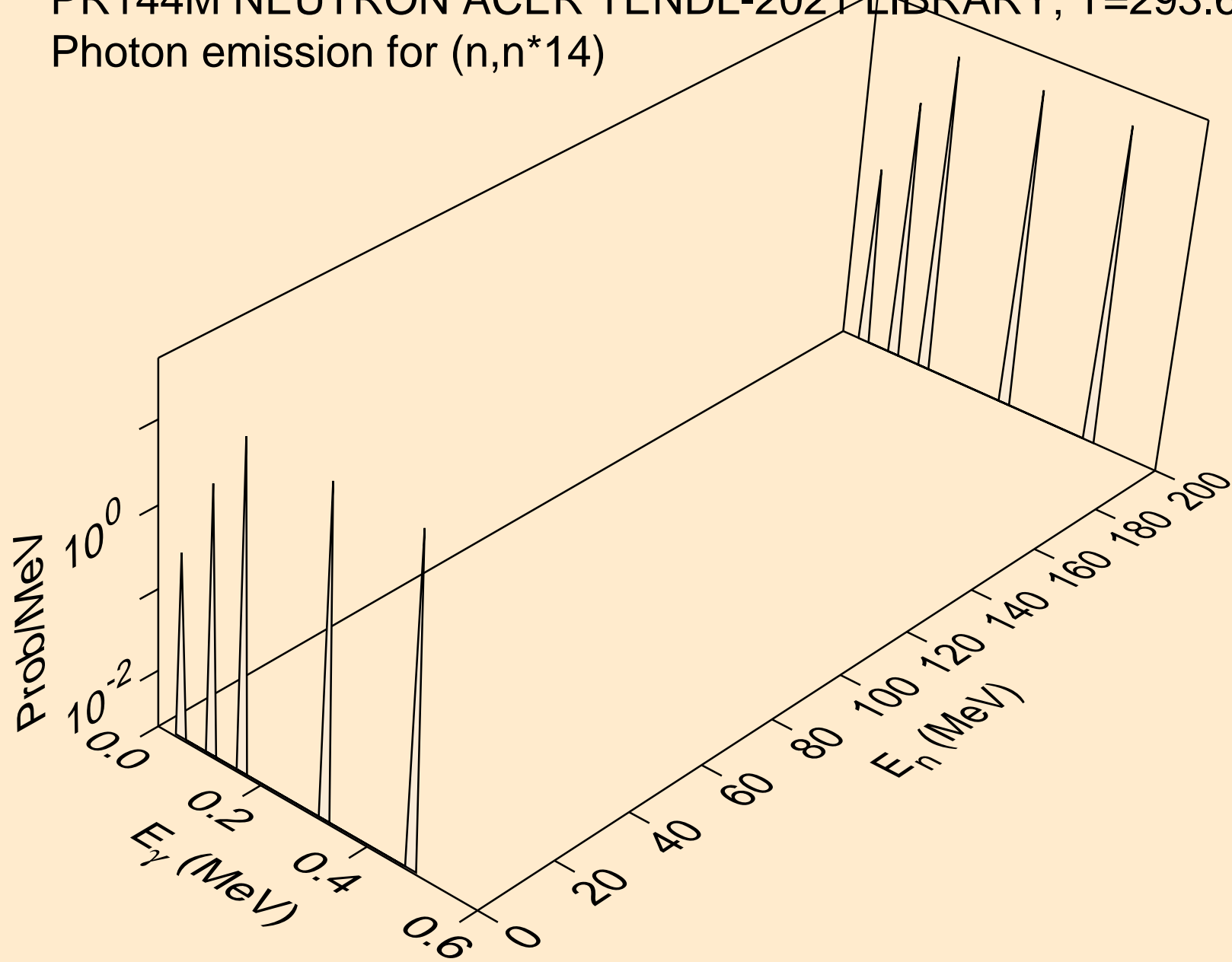

PR144M NEUTRON ACER TENDL-2021 LIBRARY; T=293.6K  
Photon emission for (n,n\*15)

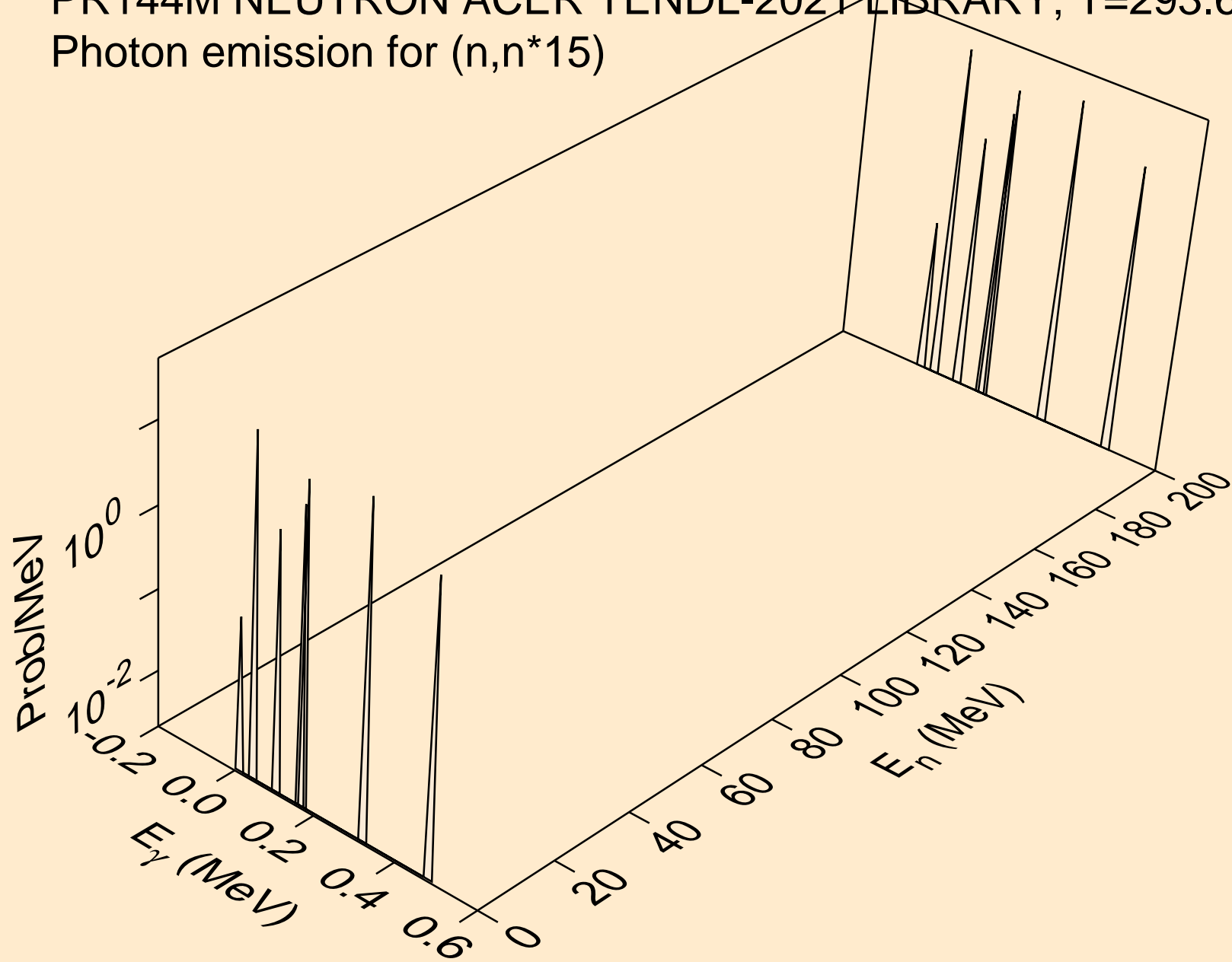

PR144M NEUTRON ACER TENDL-2021 LIBRARY; T=293.6K  
Photon emission for (n,n\*16)

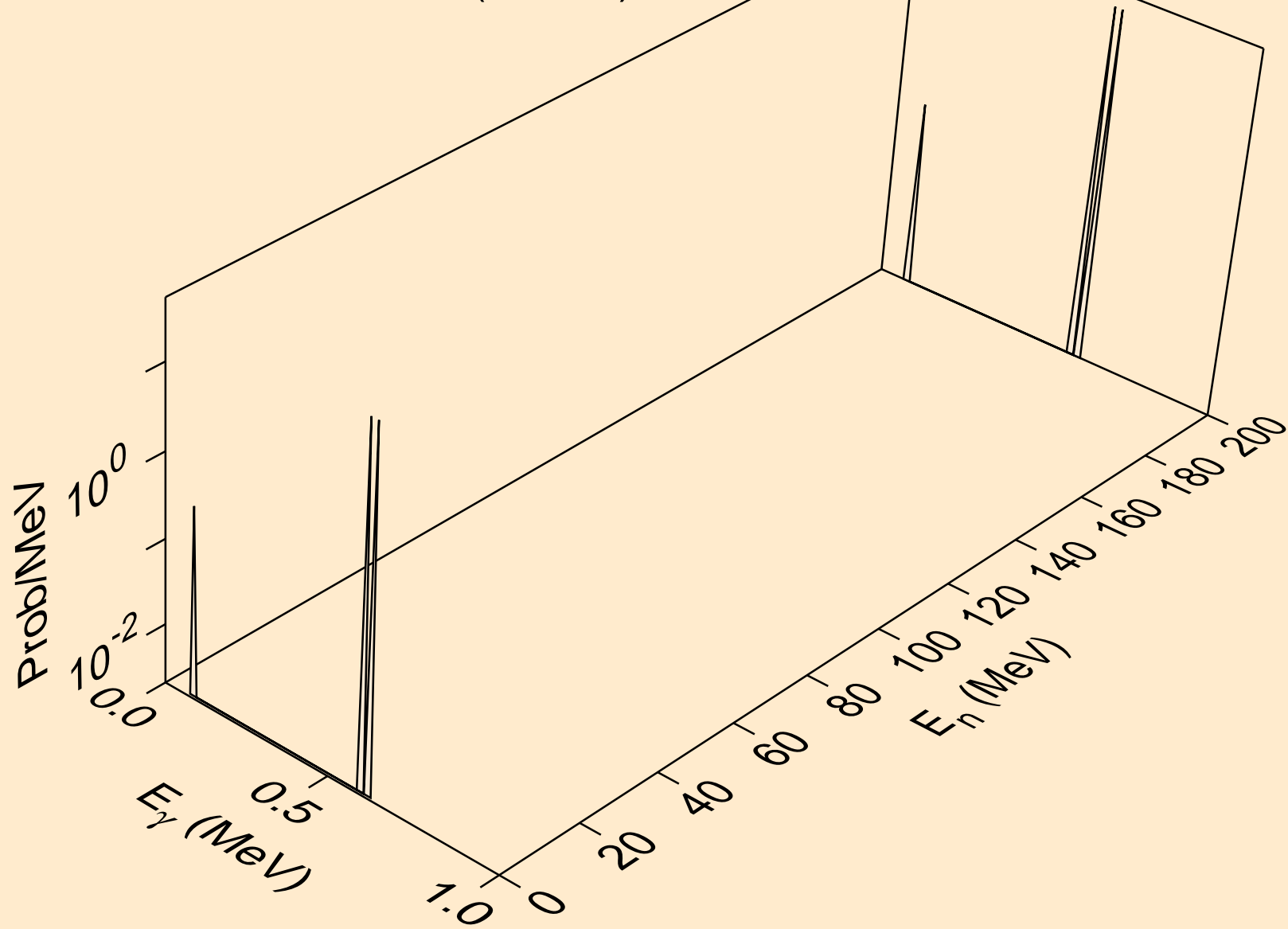

PR144M NEUTRON ACER TENDL-2021 LIBRARY; T=293.6K  
Photon emission for (n,n\*17)

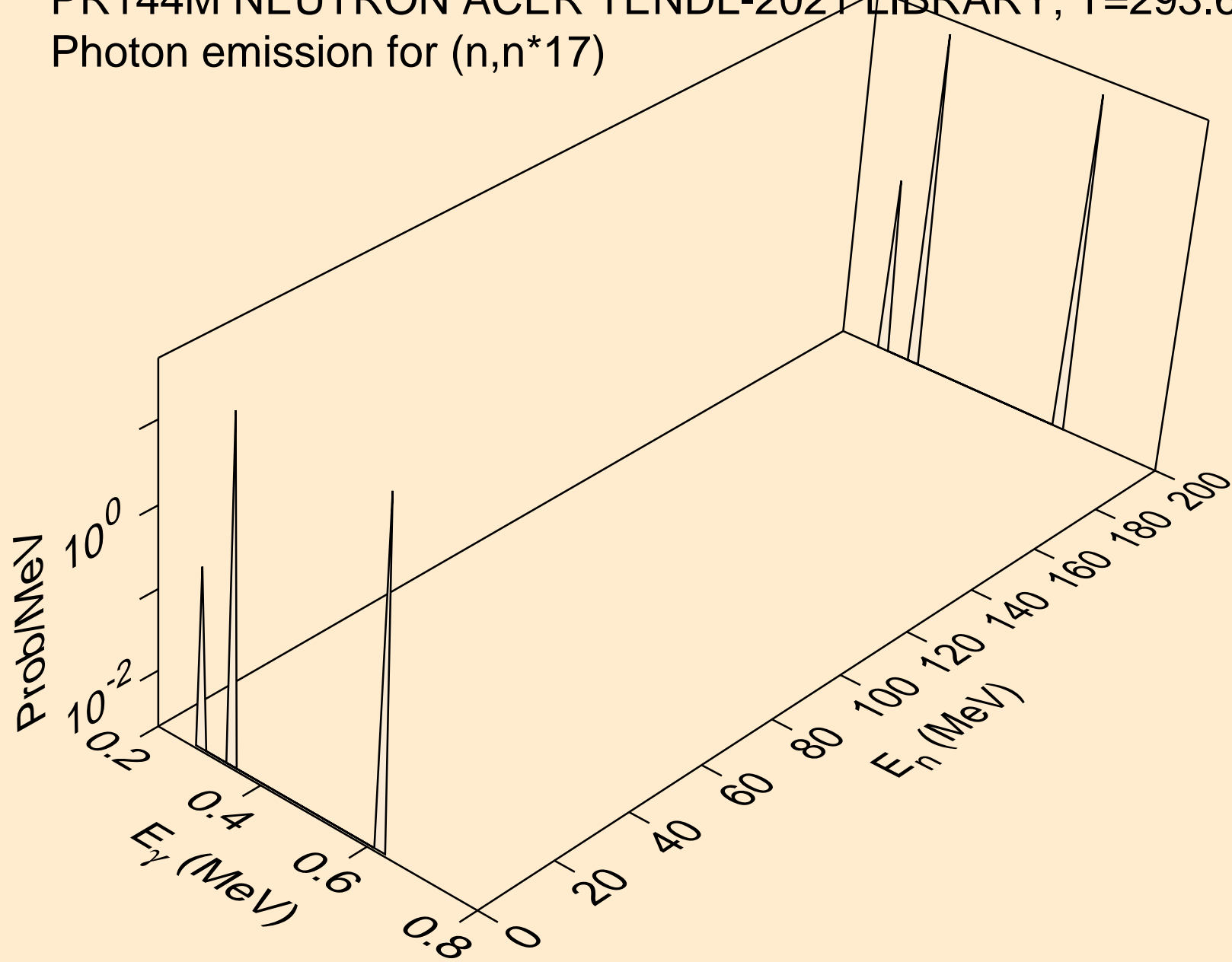



PR144M NEUTRON ACER TENDL-2021 LIBRARY; T=293.6K  
Photon emission for (n,n\*18)

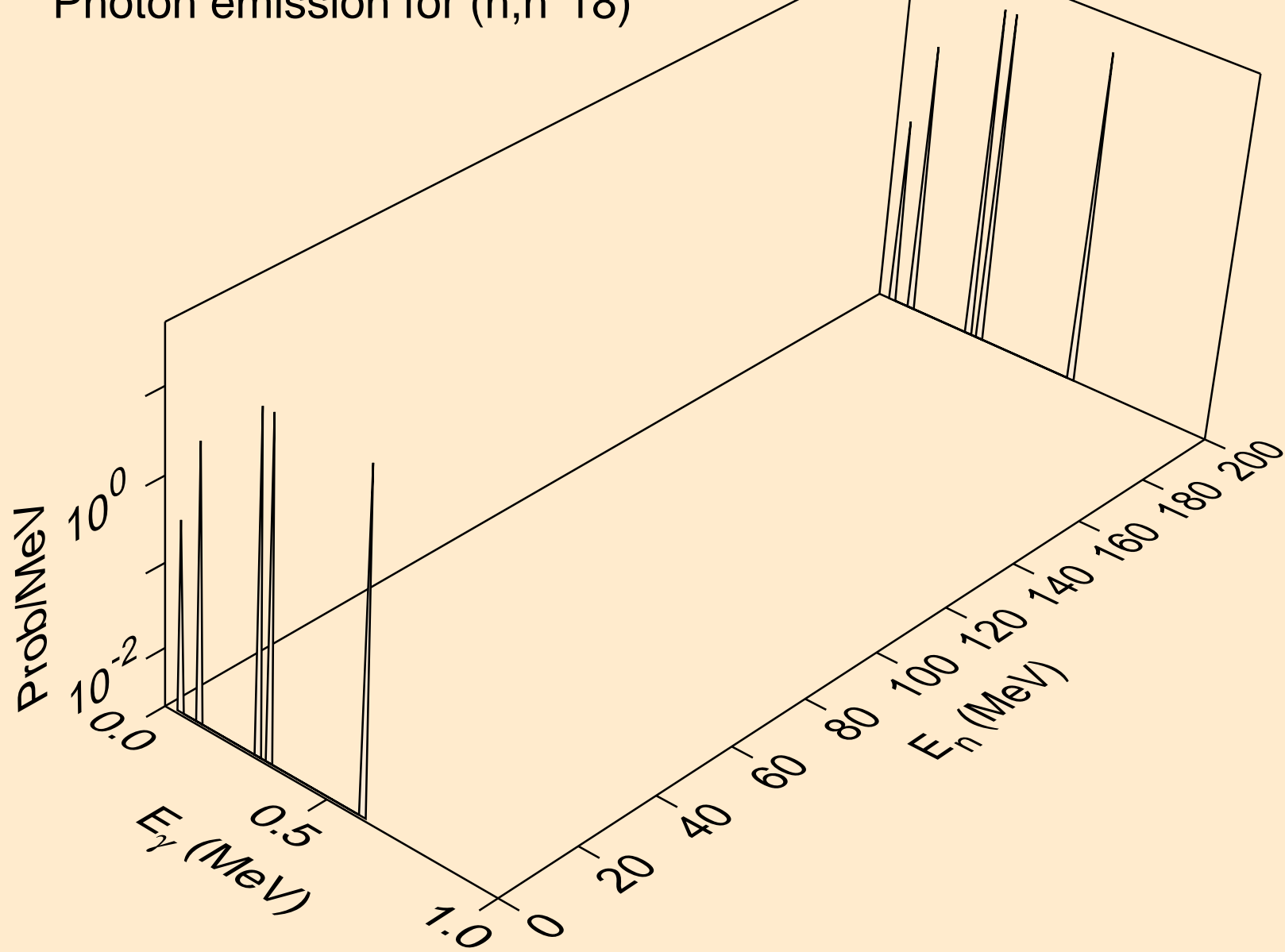

PR144M NEUTRON ACER TENDL-2021 LIBRARY; T=293.6K  
Photon emission for (n,n\*19)

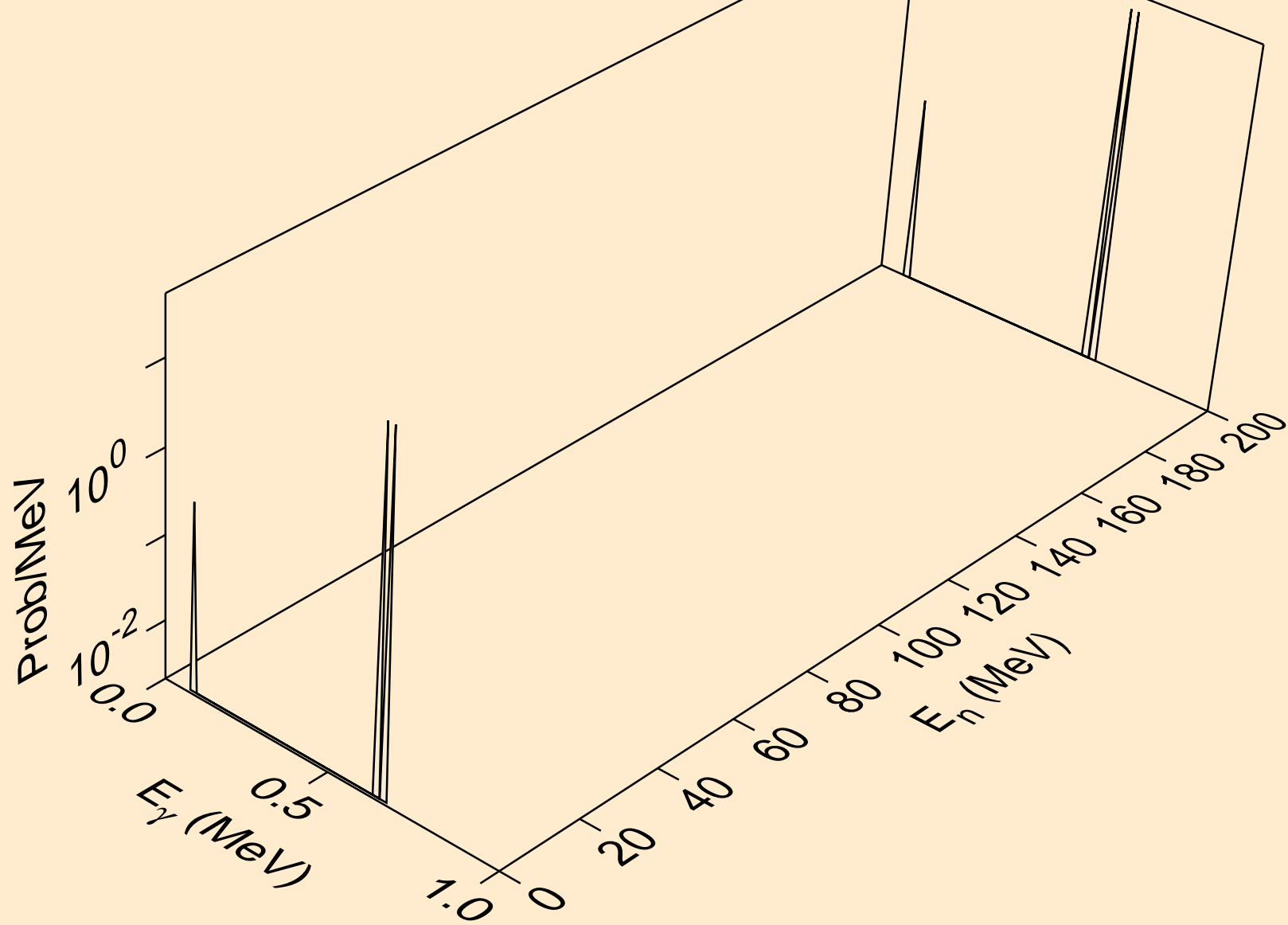

PR144M NEUTRON ACER TENDL-2021 LIBRARY; T=293.6K  
Photon emission for (n,n\*20)

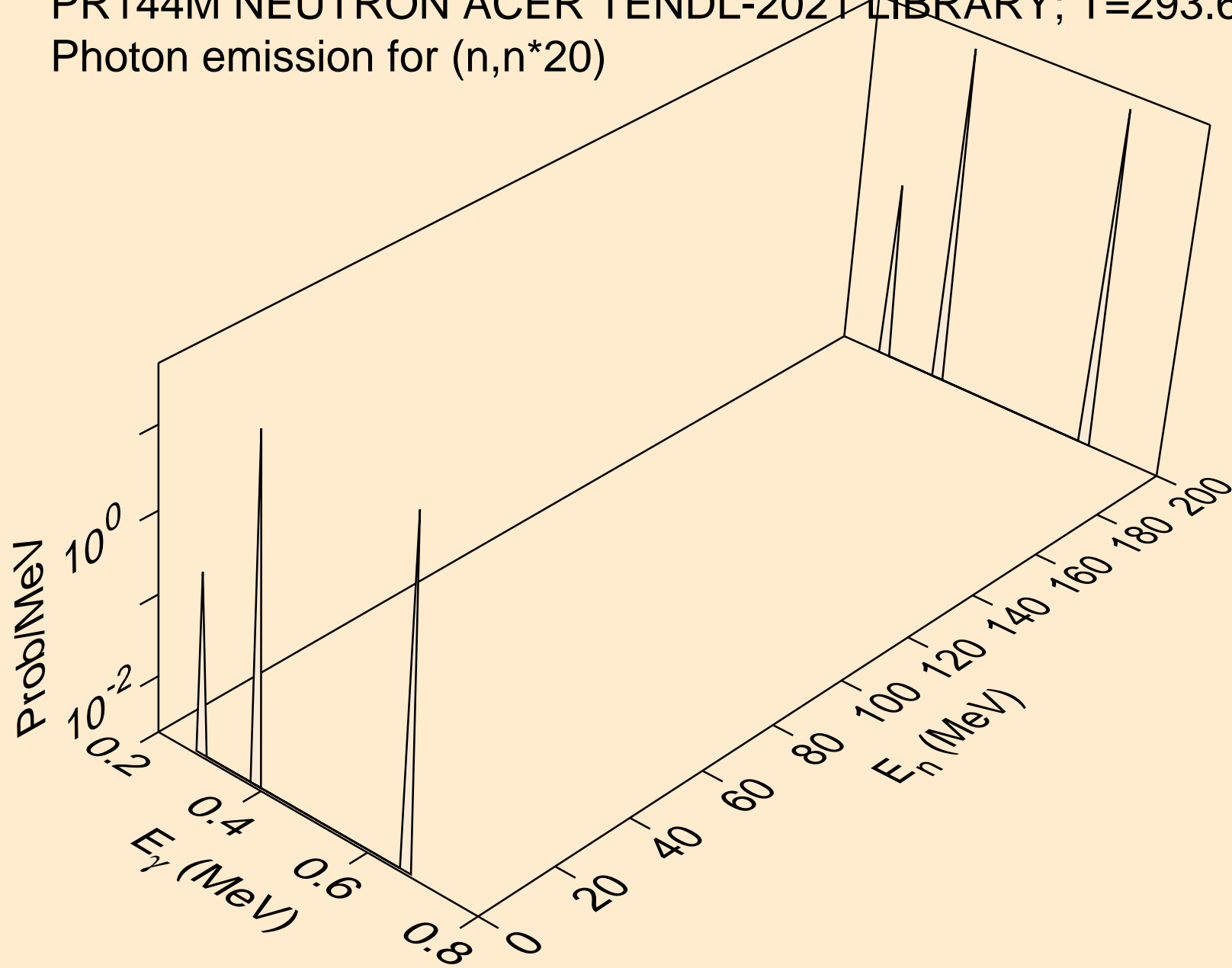

PR144M NEUTRON ACER TENDL-2021 LIBRARY; T=293.6K  
Photon emission for (n,n\*21)

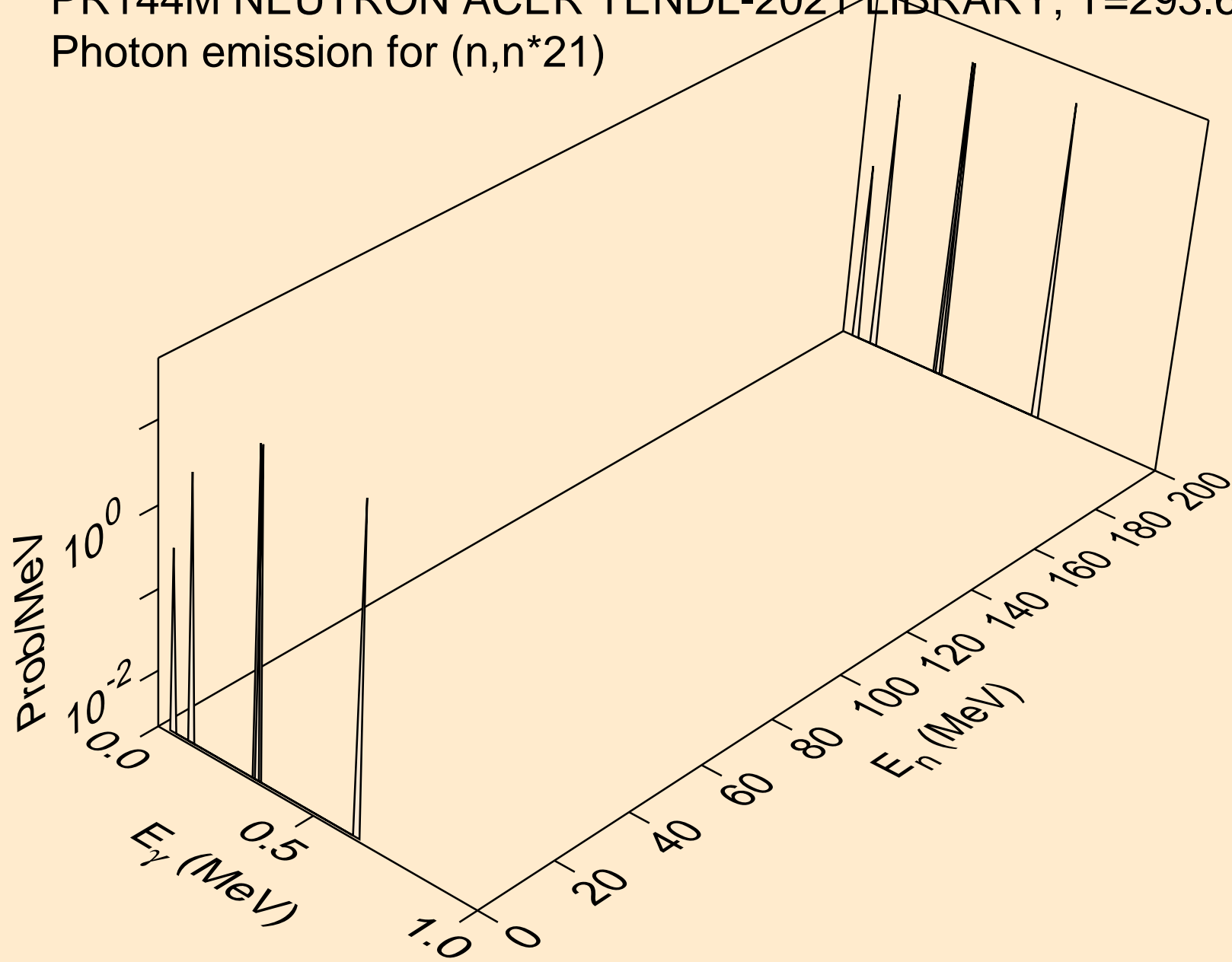

PR144M NEUTRON ACER TENDL-2021 LIBRARY; T=293.6K  
Photon emission for (n,n\*22)

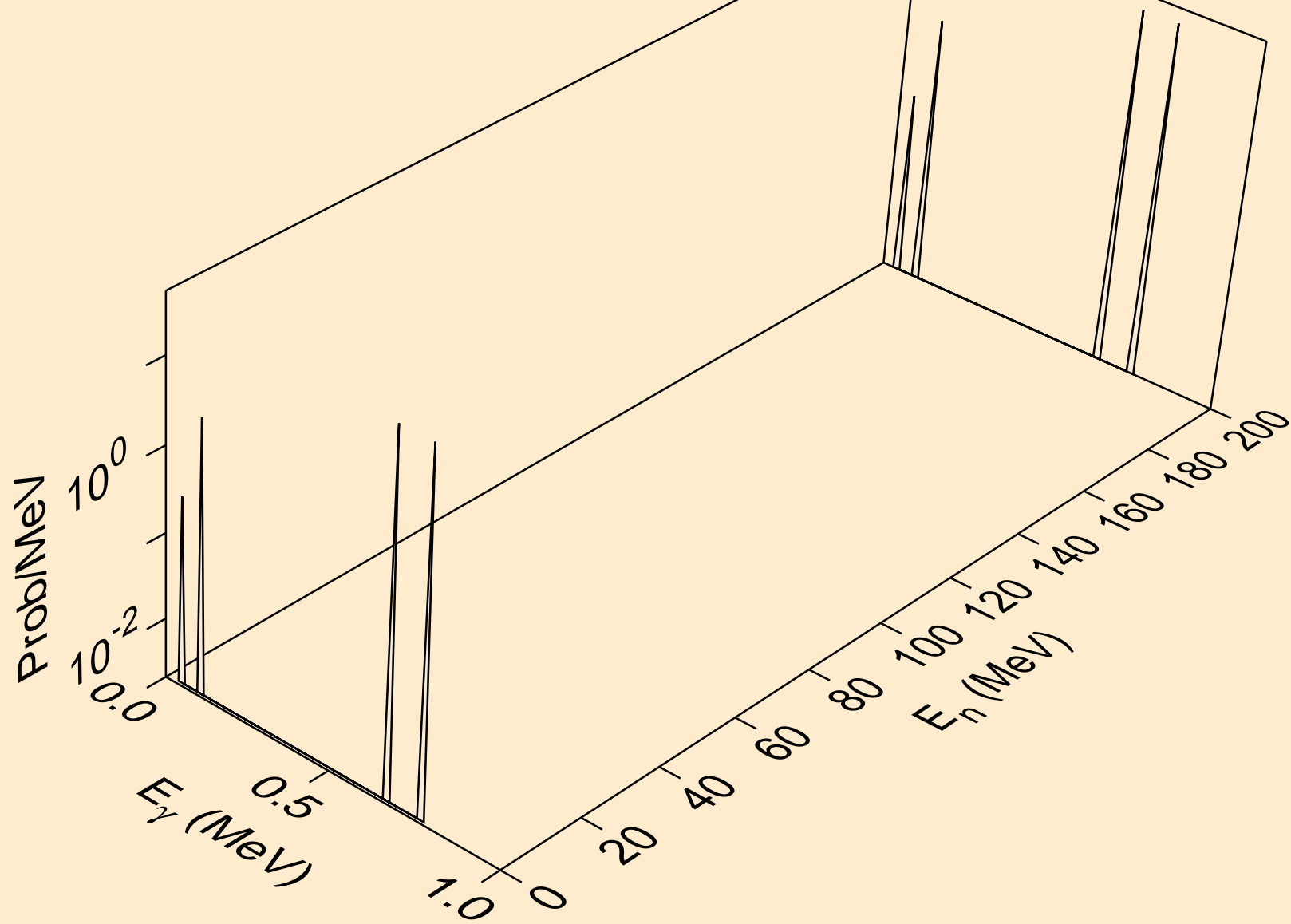

PR144M NEUTRON ACER TENDL-2021 LIBRARY; T=293.6K  
Photon emission for (n,n\*23)

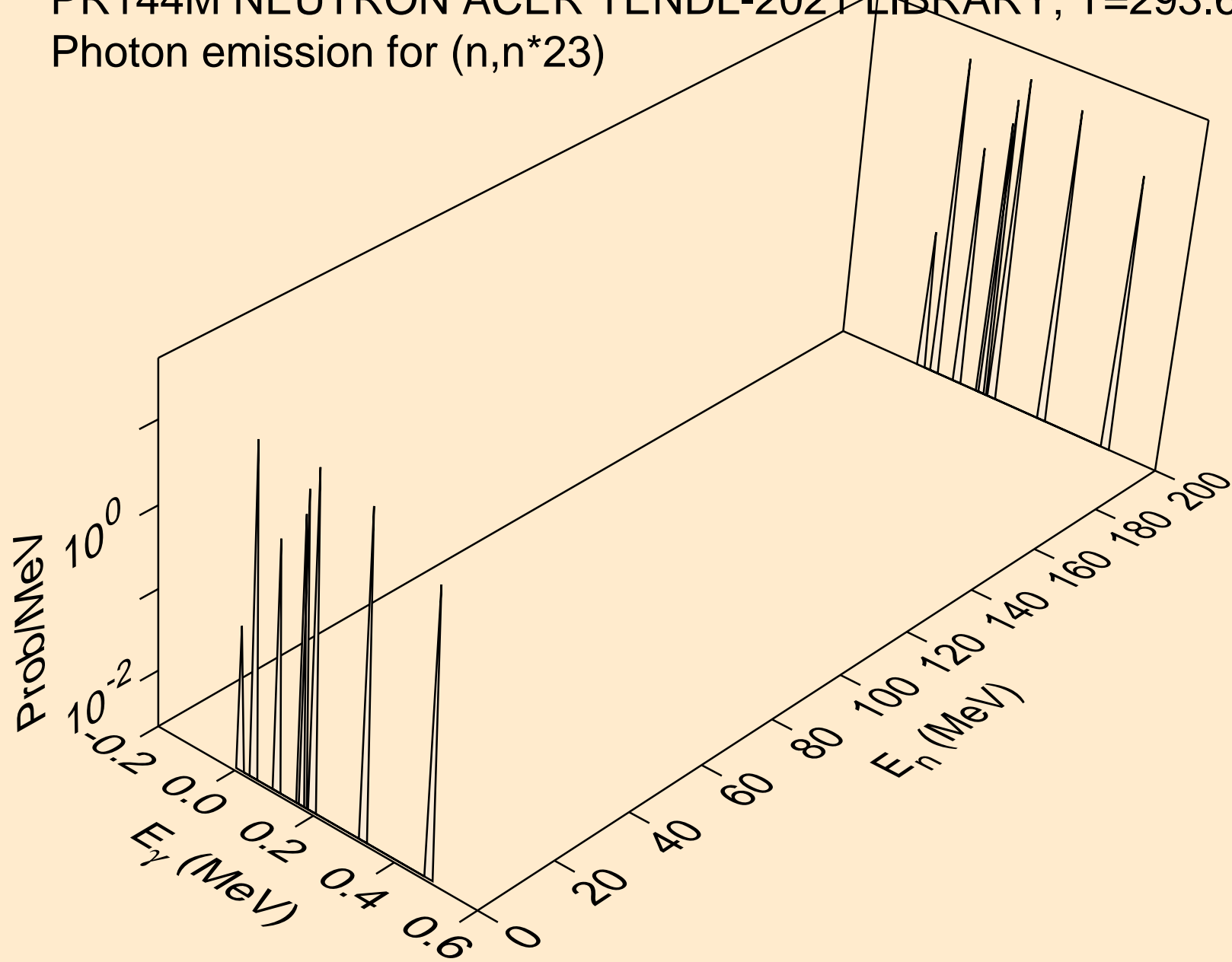

PR144M NEUTRON ACER TENDL-2021 LIBRARY; T=293.6K  
Photon emission for (n,n\*24)

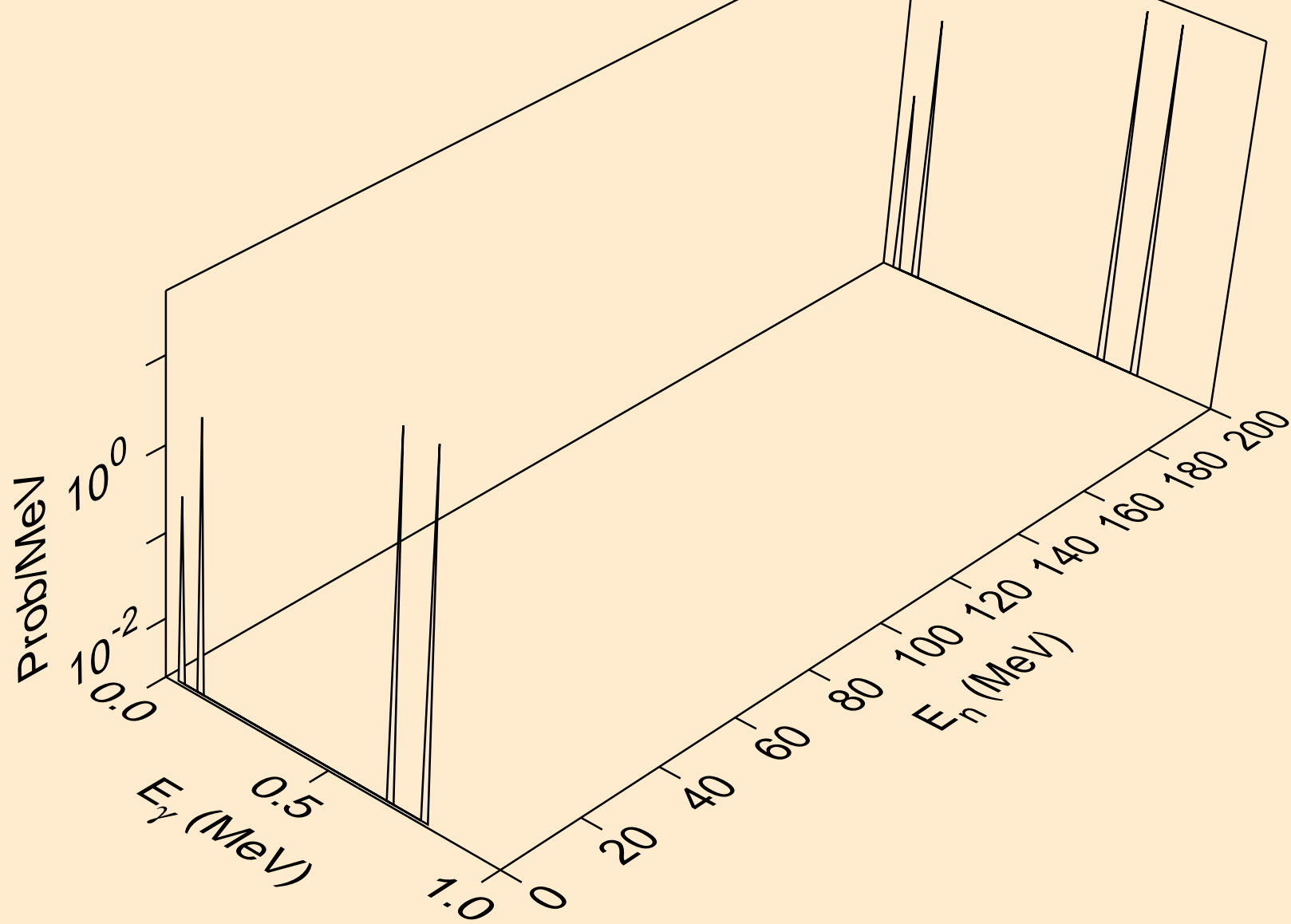

PR144M NEUTRON ACER TENDL-2021 LIBRARY; T=293.6K  
Photon emission for (n,n\*25)

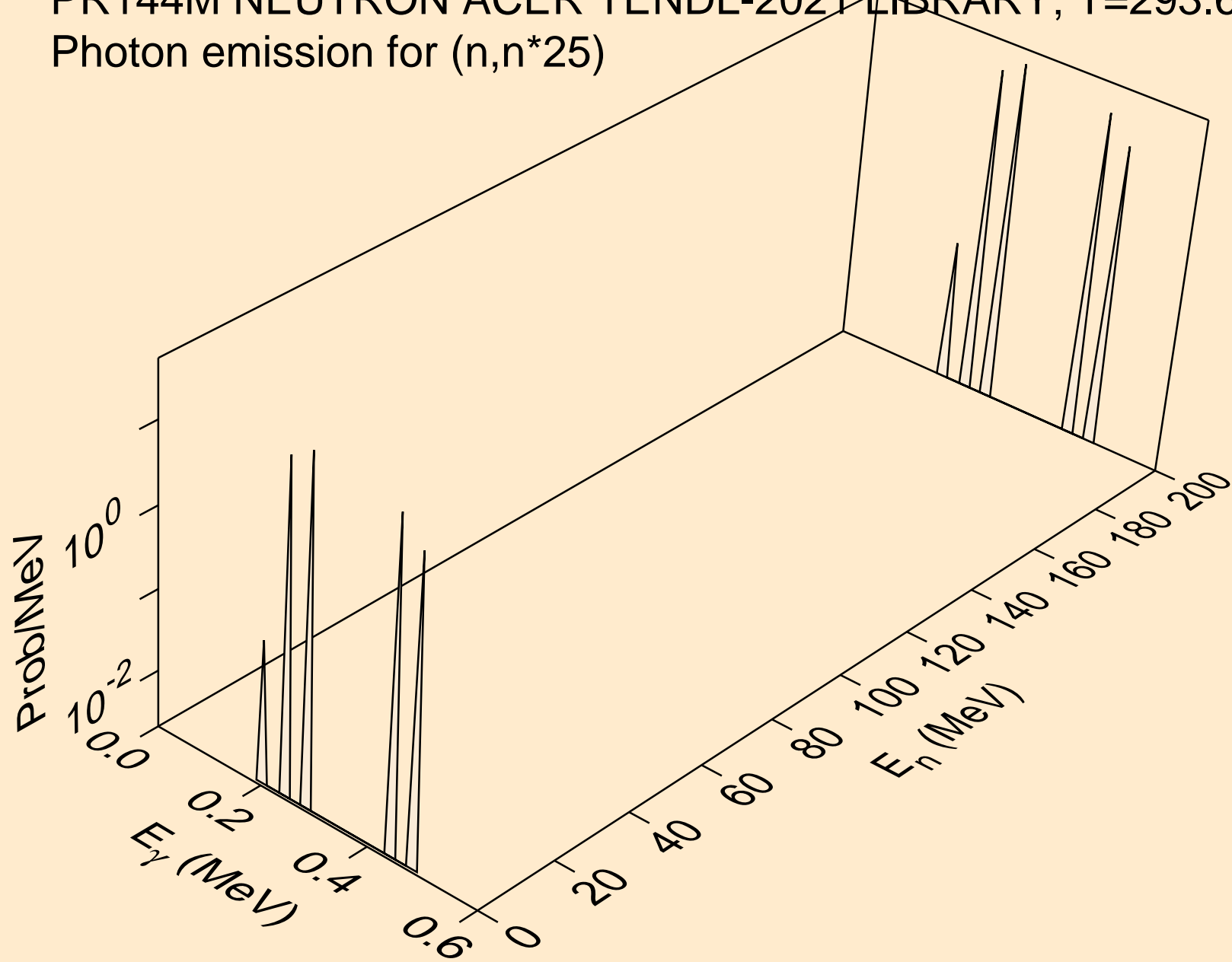



PR144M NEUTRON ACER TENDL-2021 LIBRARY; T=293.6K  
Photon emission for (n,n\*26)

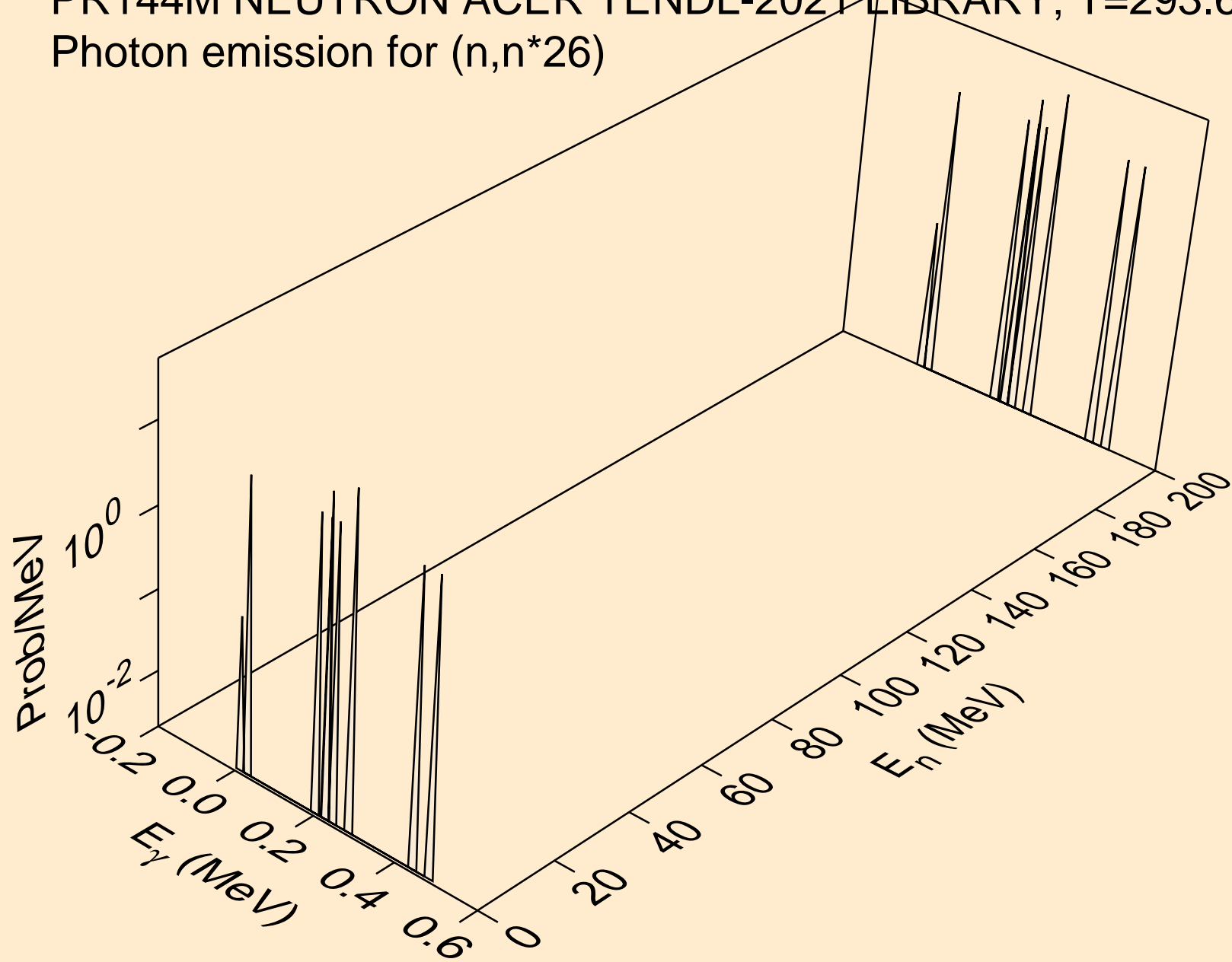

PR144M NEUTRON ACER TENDL-2021 LIBRARY; T=293.6K  
Photon emission for (n,n\*27)

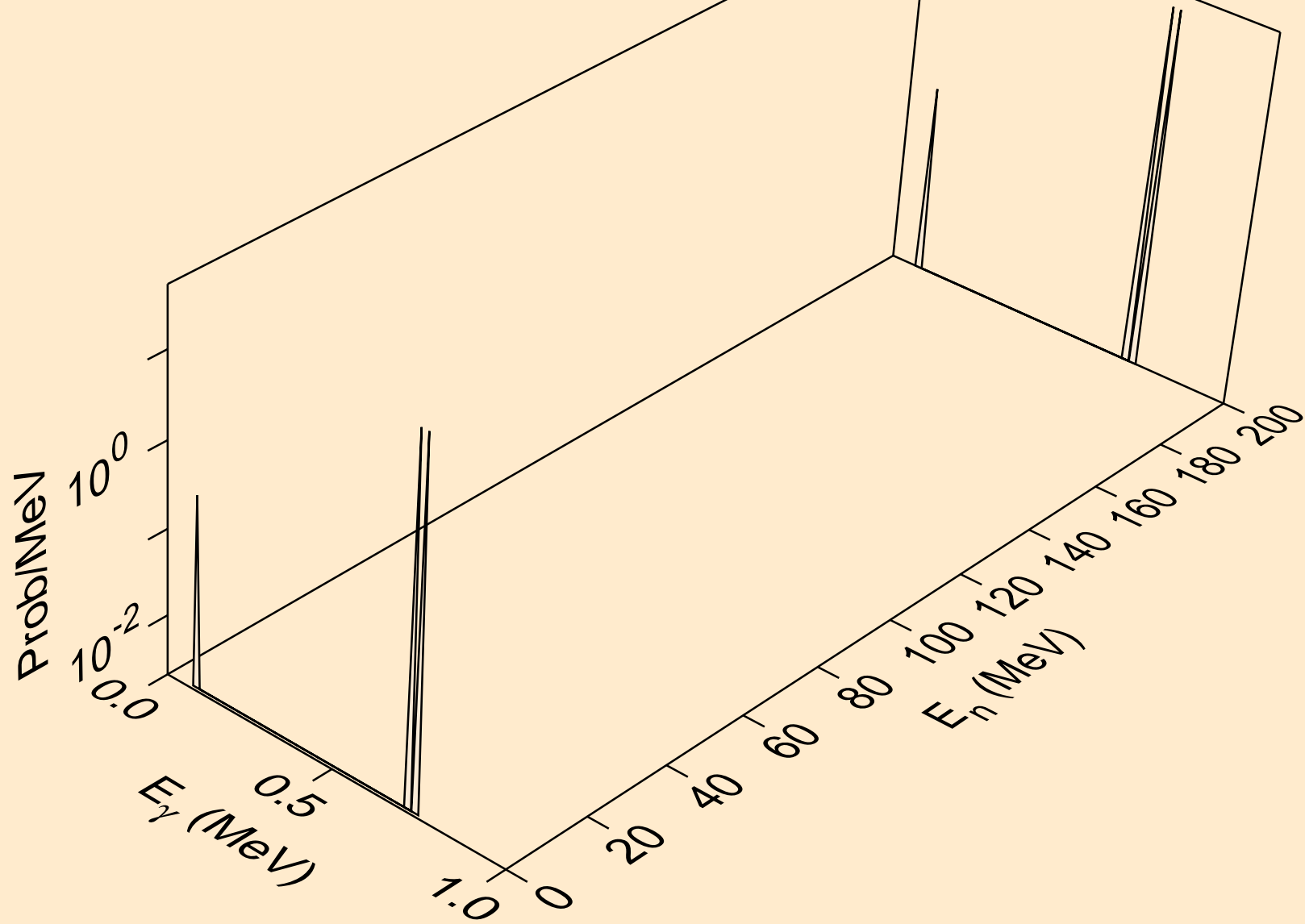

PR144M NEUTRON ACER TENDL-2021 LIBRARY; T=293.6K  
Photon emission for (n,n\*28)

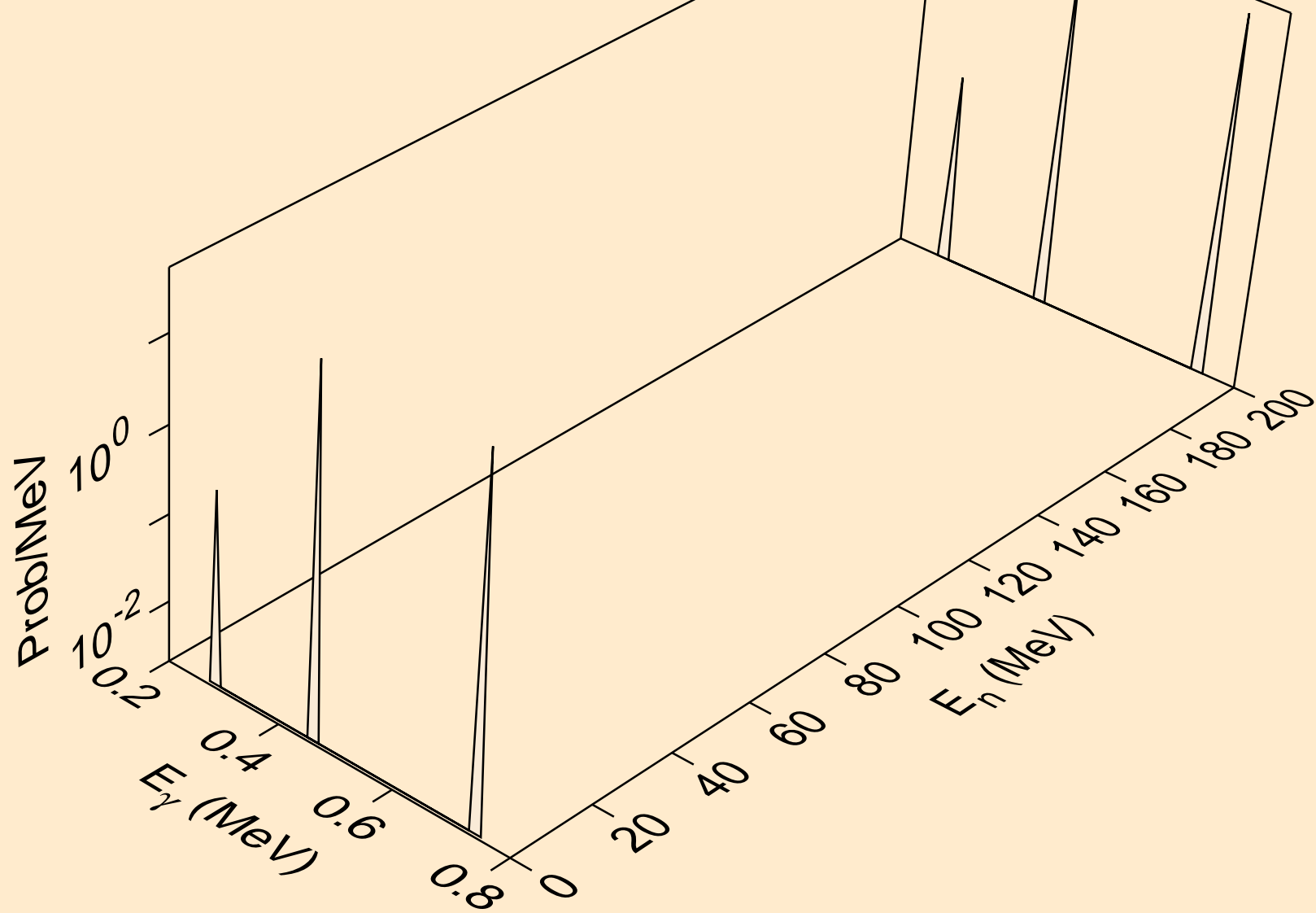

PR144M NEUTRON ACER TENDL-2021 LIBRARY; T=293.6K  
Photon emission for (n,n\*29)

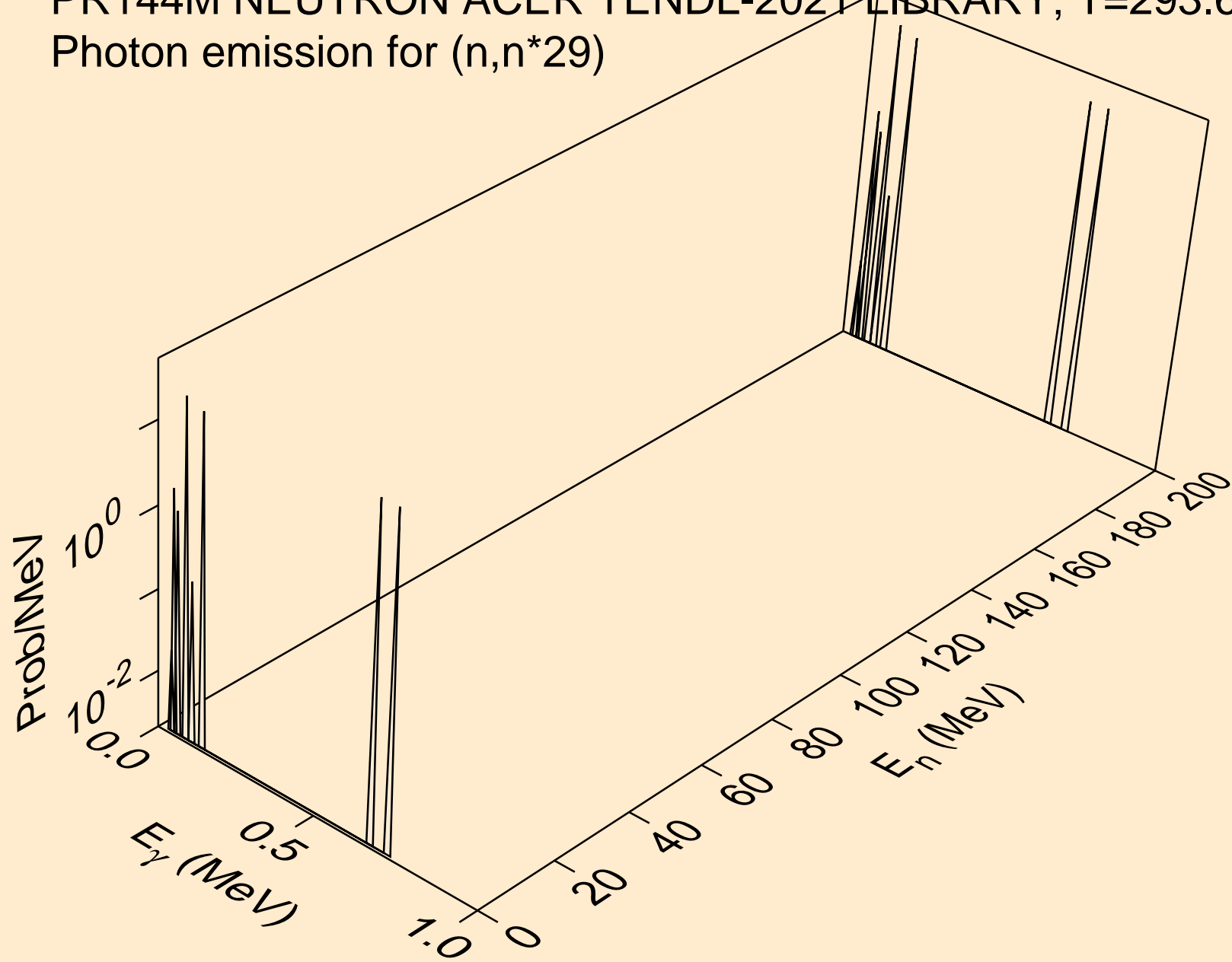

PR144M NEUTRON ACER TENDL-2021 LIBRARY; T=293.6K  
Photon emission for (n,n\*30)

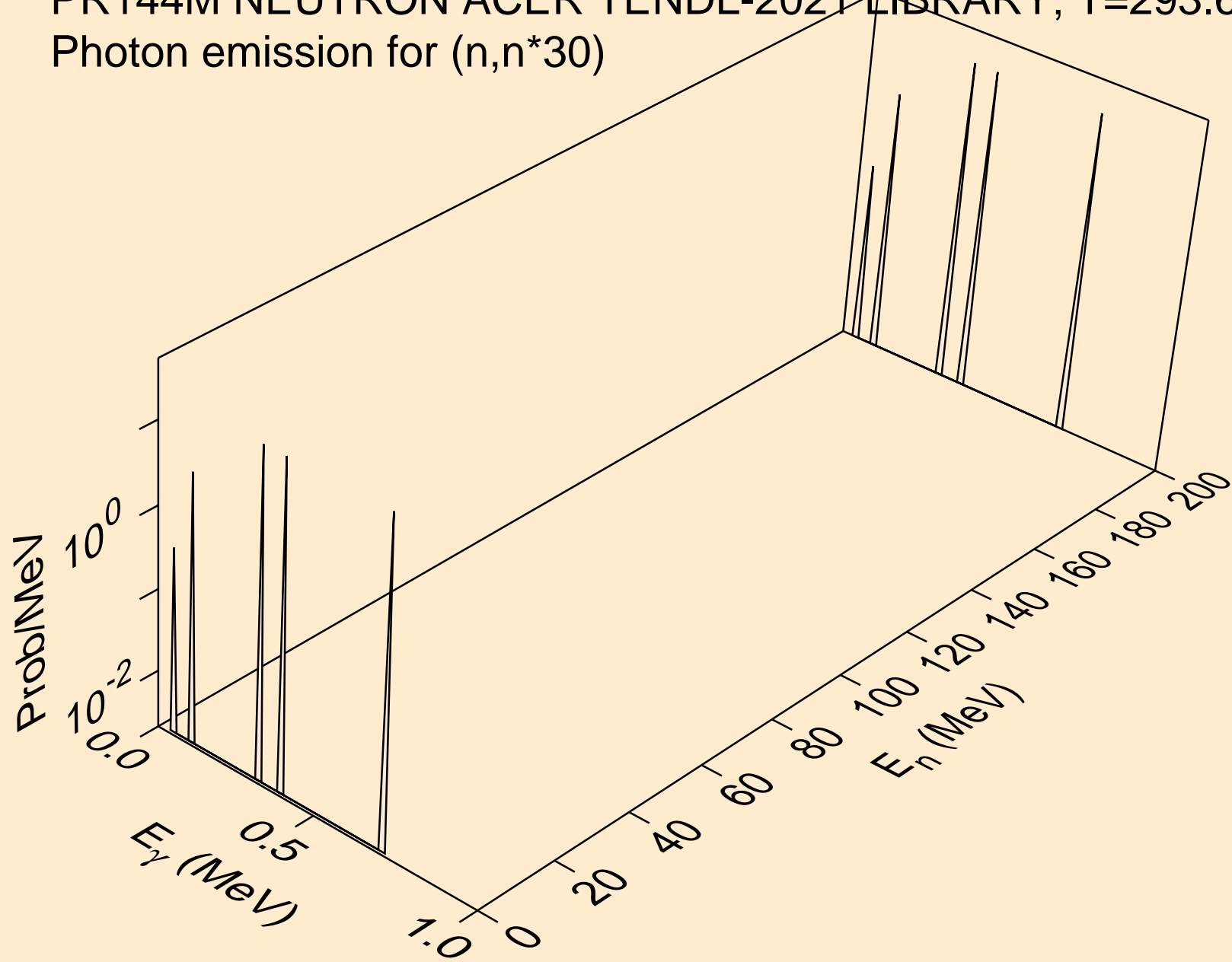

PR144M NEUTRON ACER TENDL-2021 LIBRARY; T=293.6K  
Photon emission for (n,n\*c)

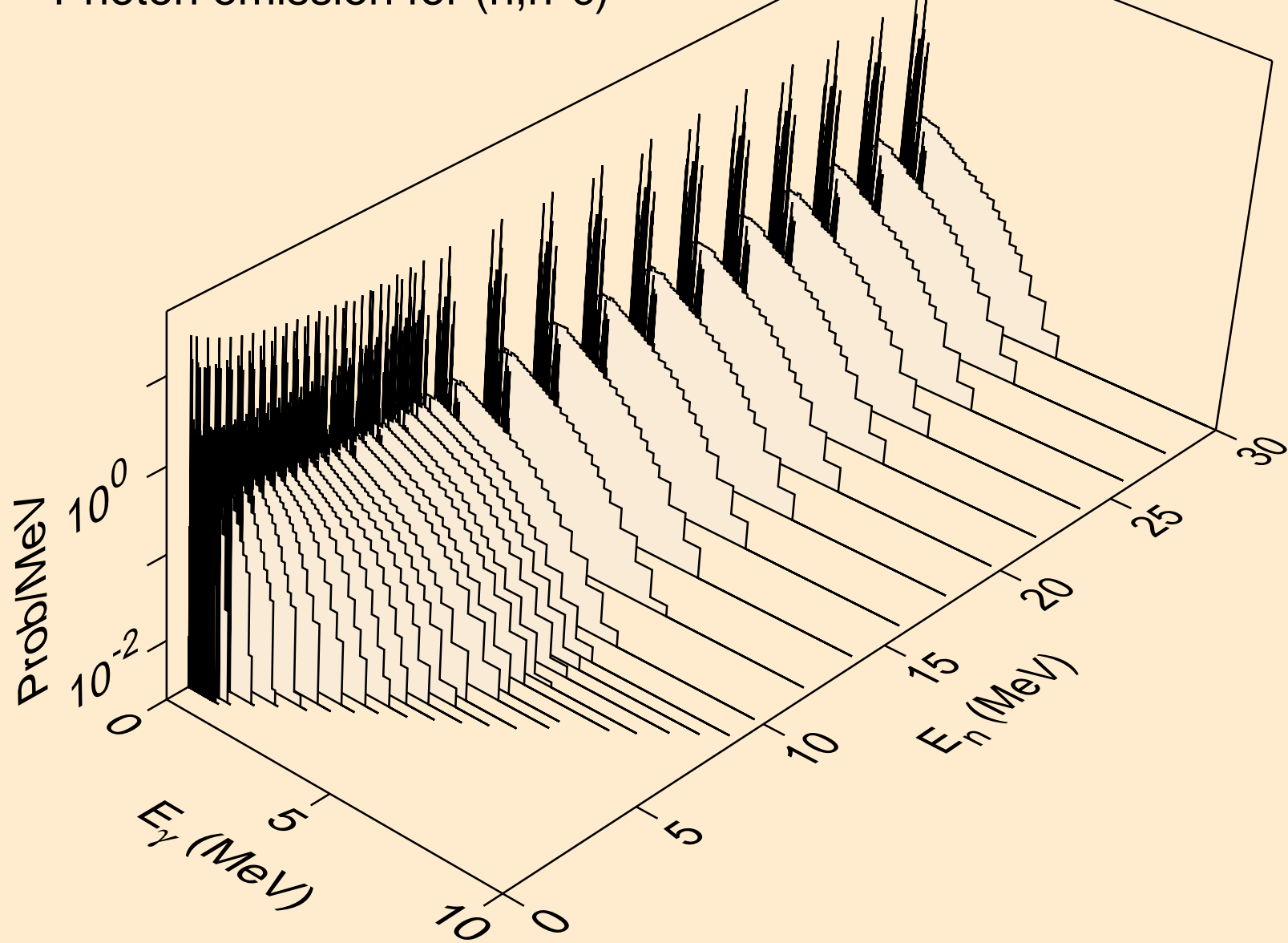

PR144M NEUTRON ACER TENDL-2021 LIBRARY; T=293.6K  
Photon emission for (n,gma)

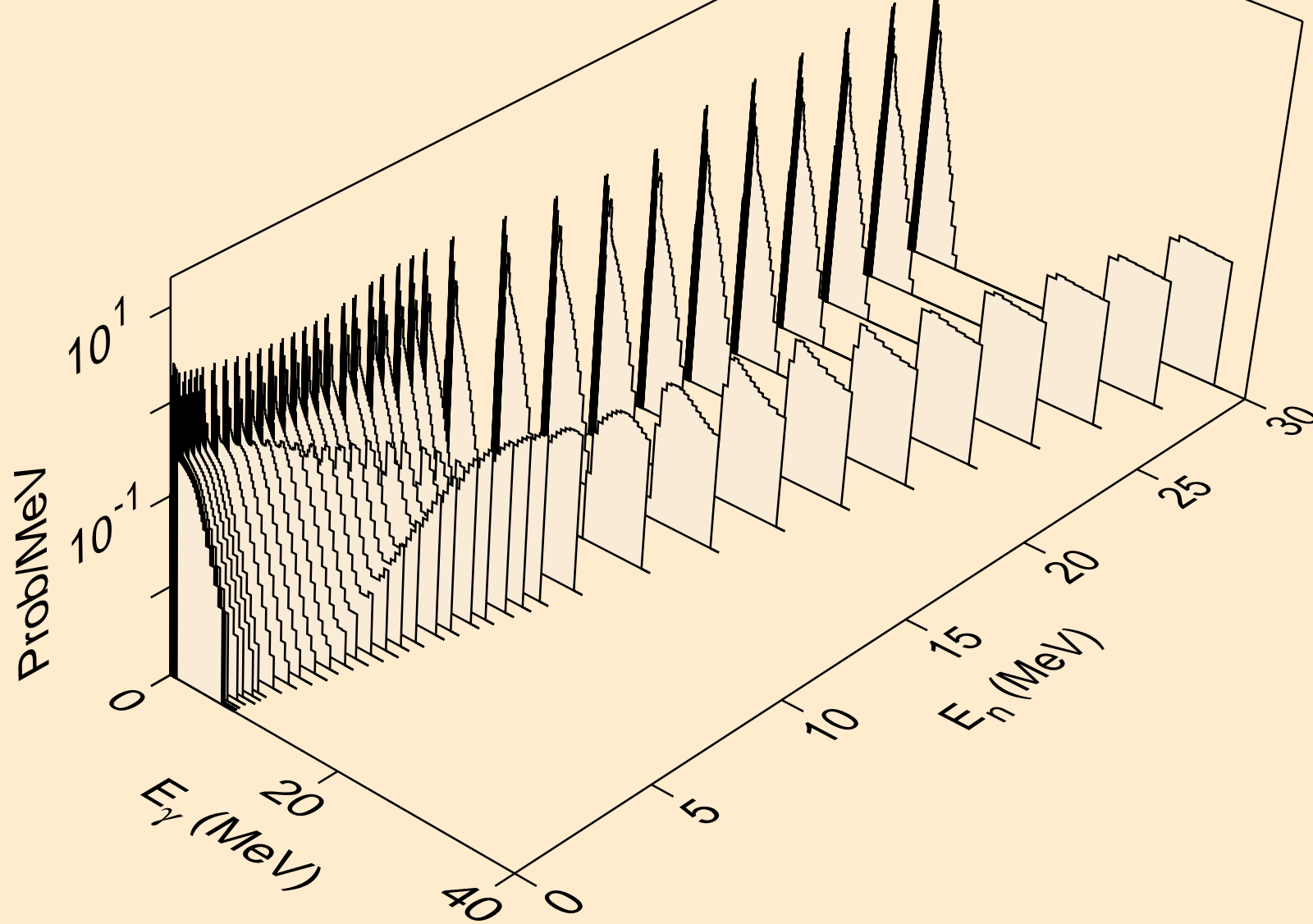

PR144M NEUTRON ACER TENDL-2021 LIBRARY; T=293.6K  
Photon emission for (n,p)

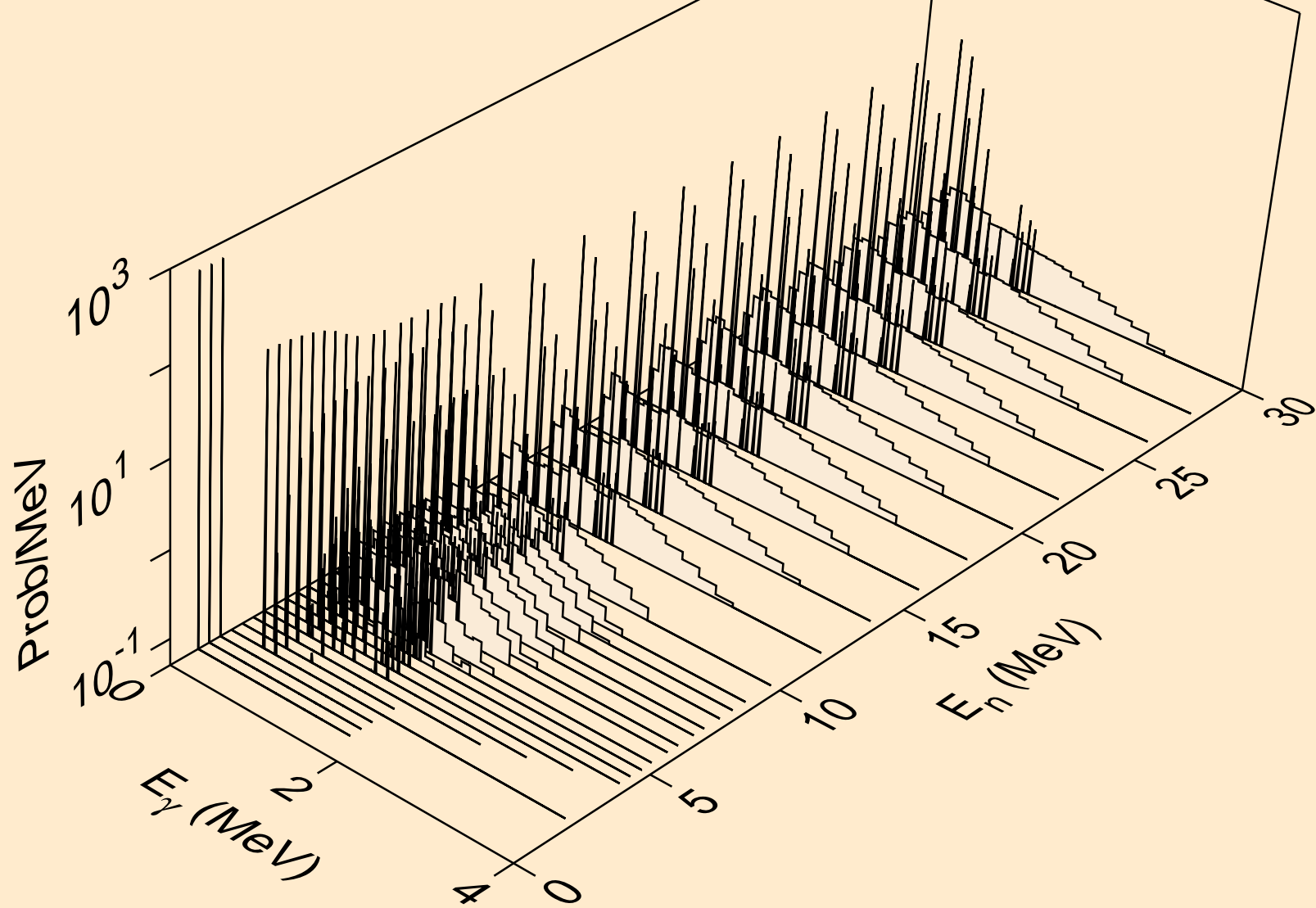



PR144M NEUTRON ACER TENDL-2021 LIBRARY; T=293.6K  
Photon emission for (n,d)

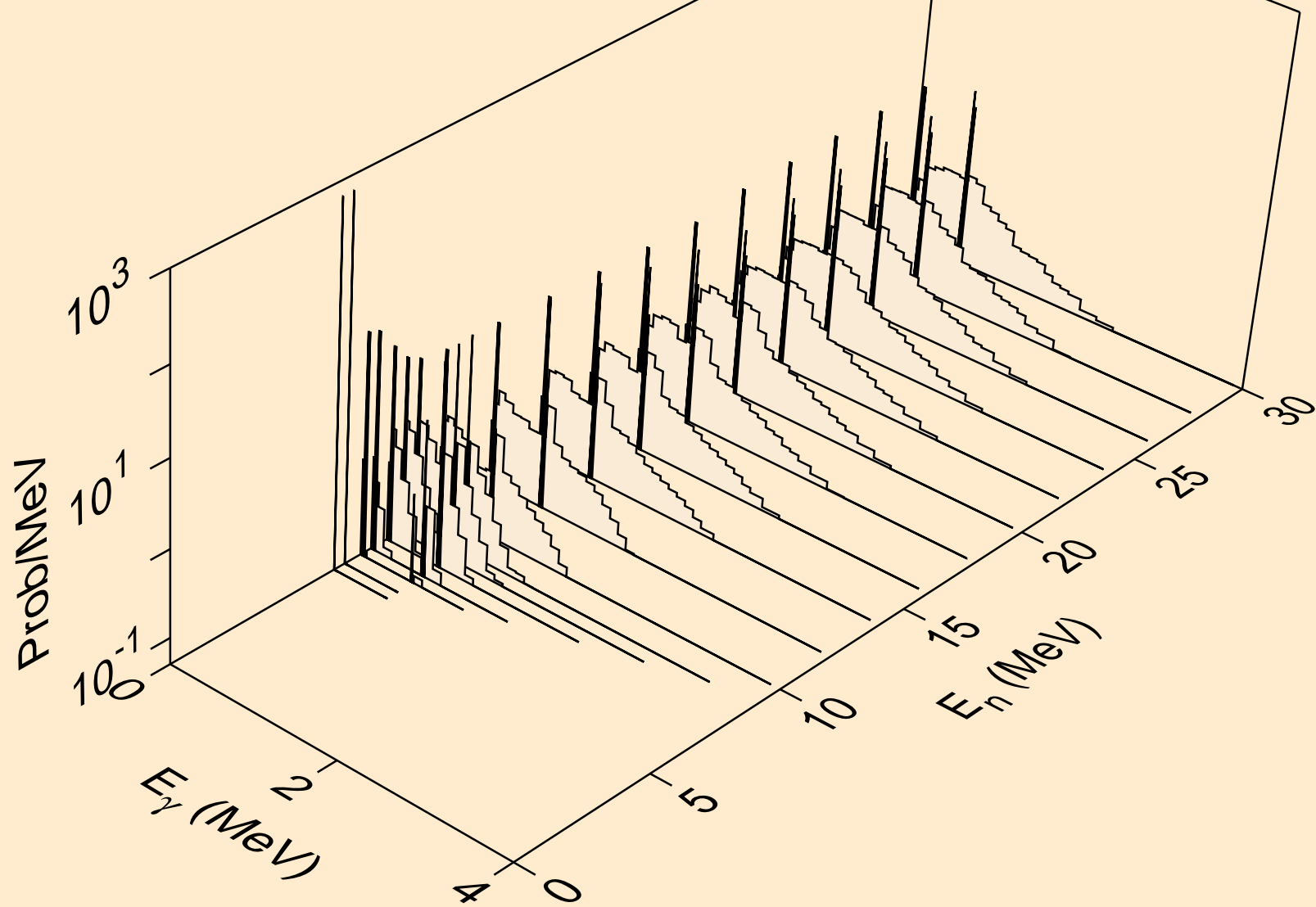

PR144M NEUTRON ACER TENDL-2021 LIBRARY; T=293.6K  
Photon emission for (n,t)

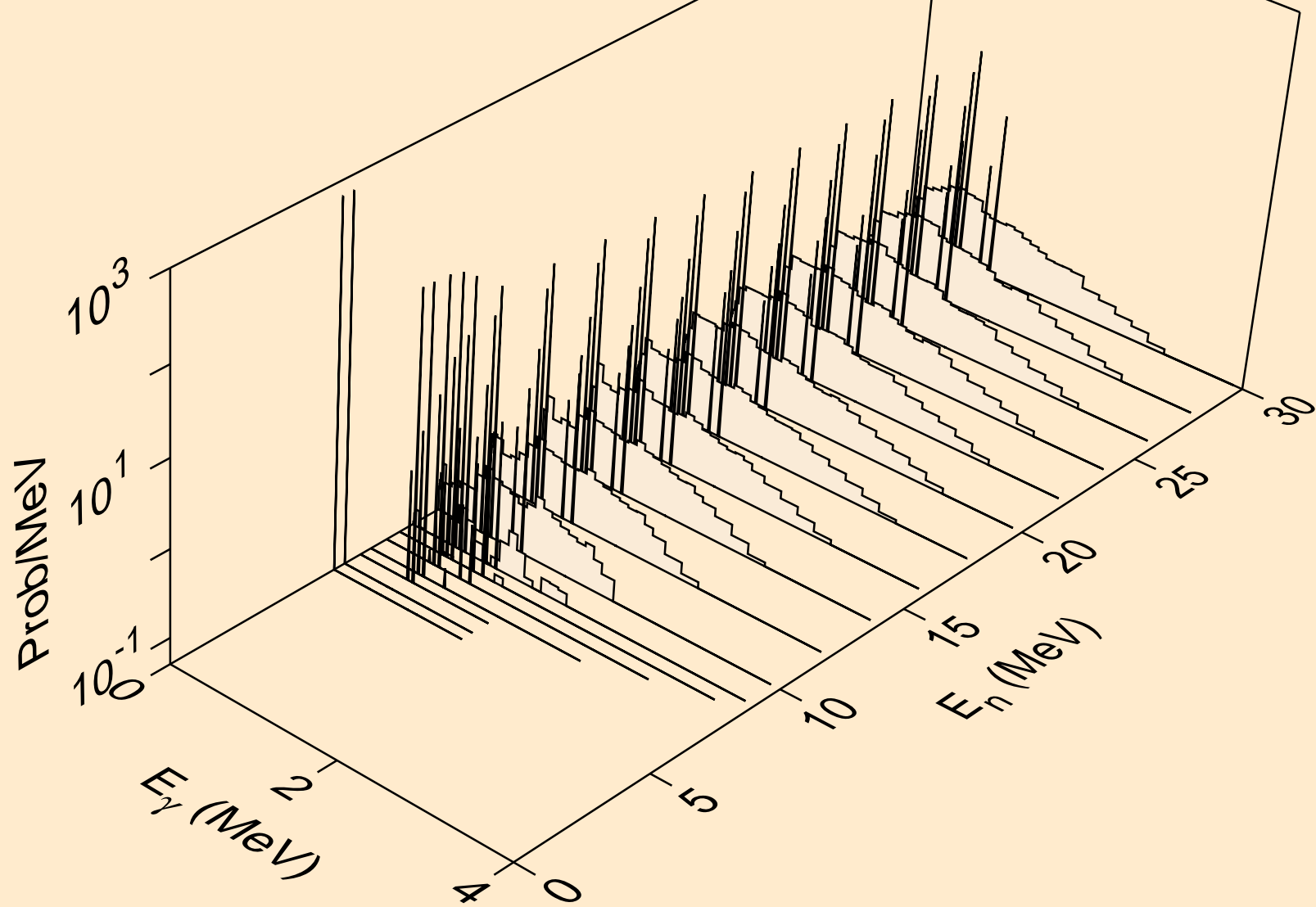

PR144M NEUTRON ACER TENDL-2021 LIBRARY; T=293.6K  
Photon emission for (n,he3)

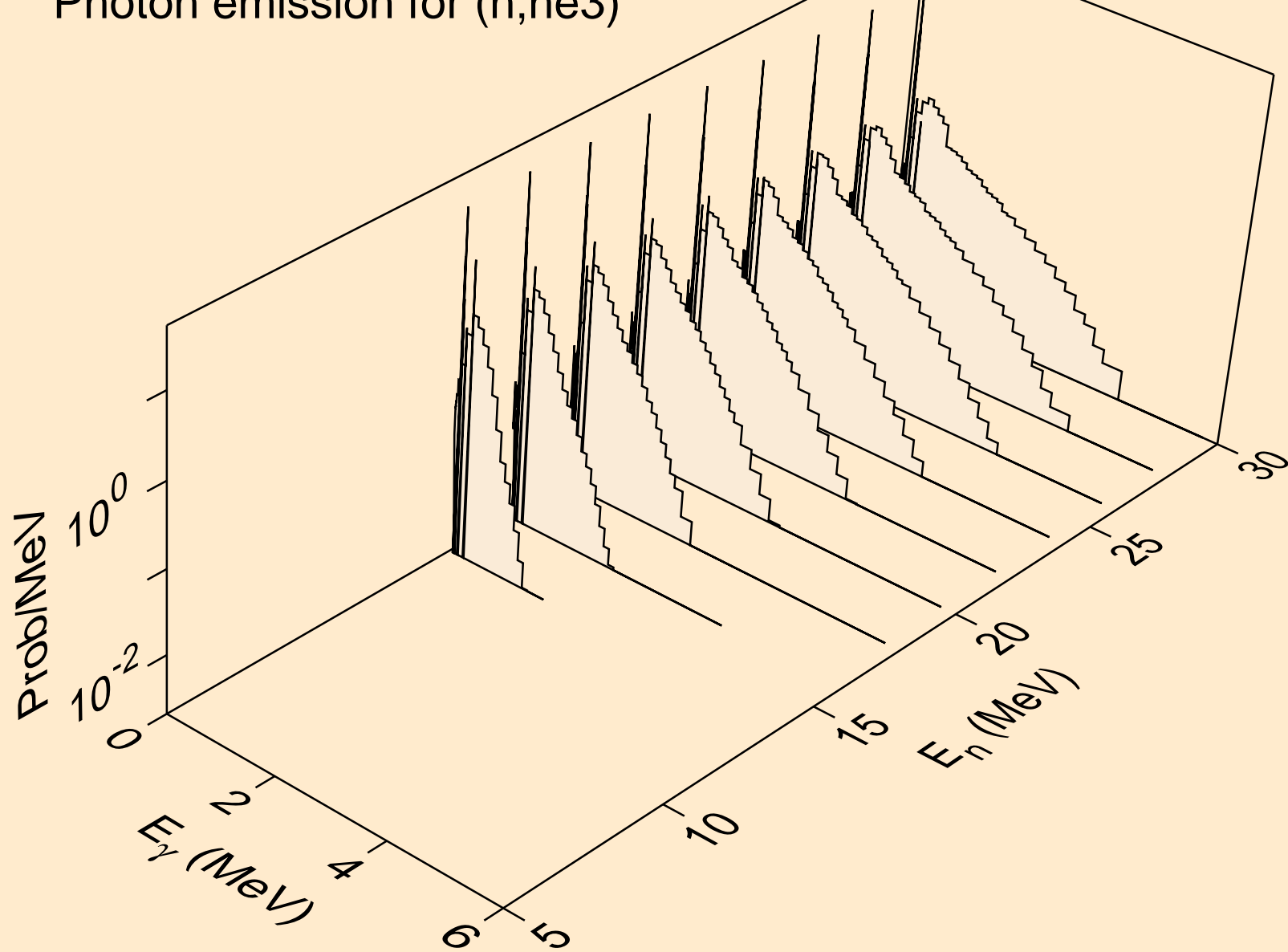

PR144M NEUTRON ACER TENDL-2021 LIBRARY; T=293.6K  
Photon emission for (n,a)

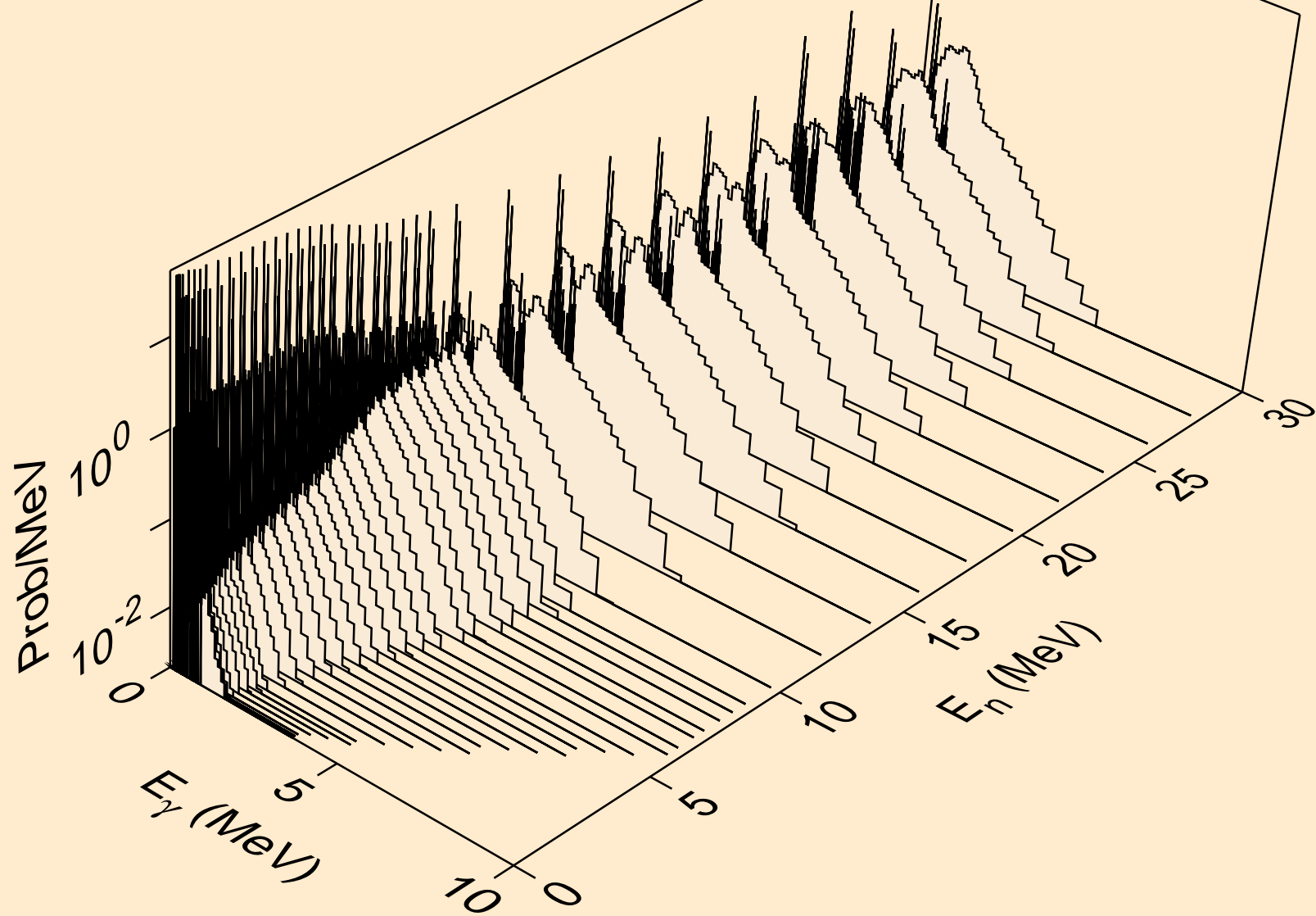

PR144M NEUTRON ACER TENDL-2021 LIBRARY; T=293.6K  
Photon emission for (n,2a)

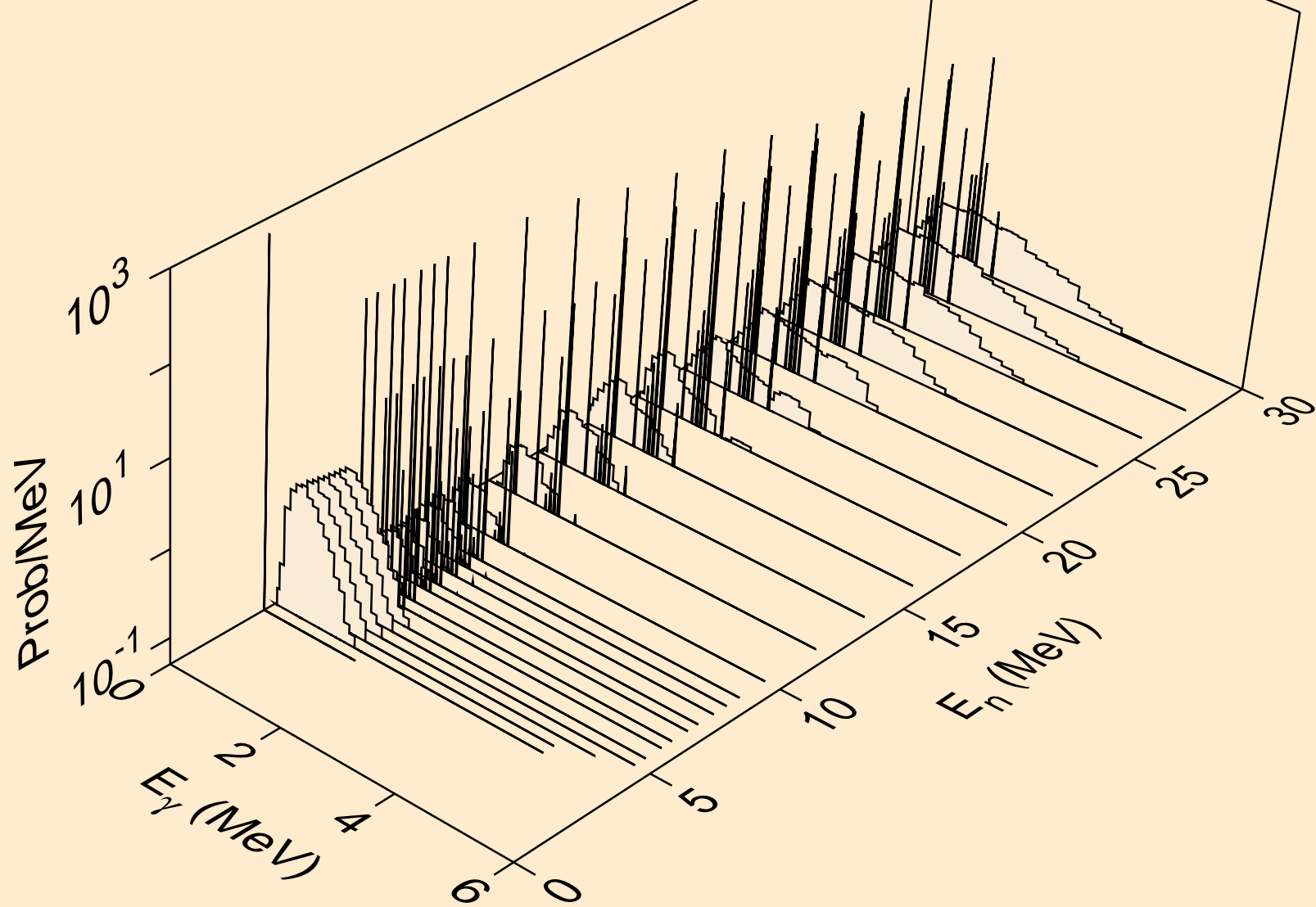

PR144M NEUTRON ACER TENDL-2021 LIBRARY; T=293.6K  
Photon emission for (n,2p)

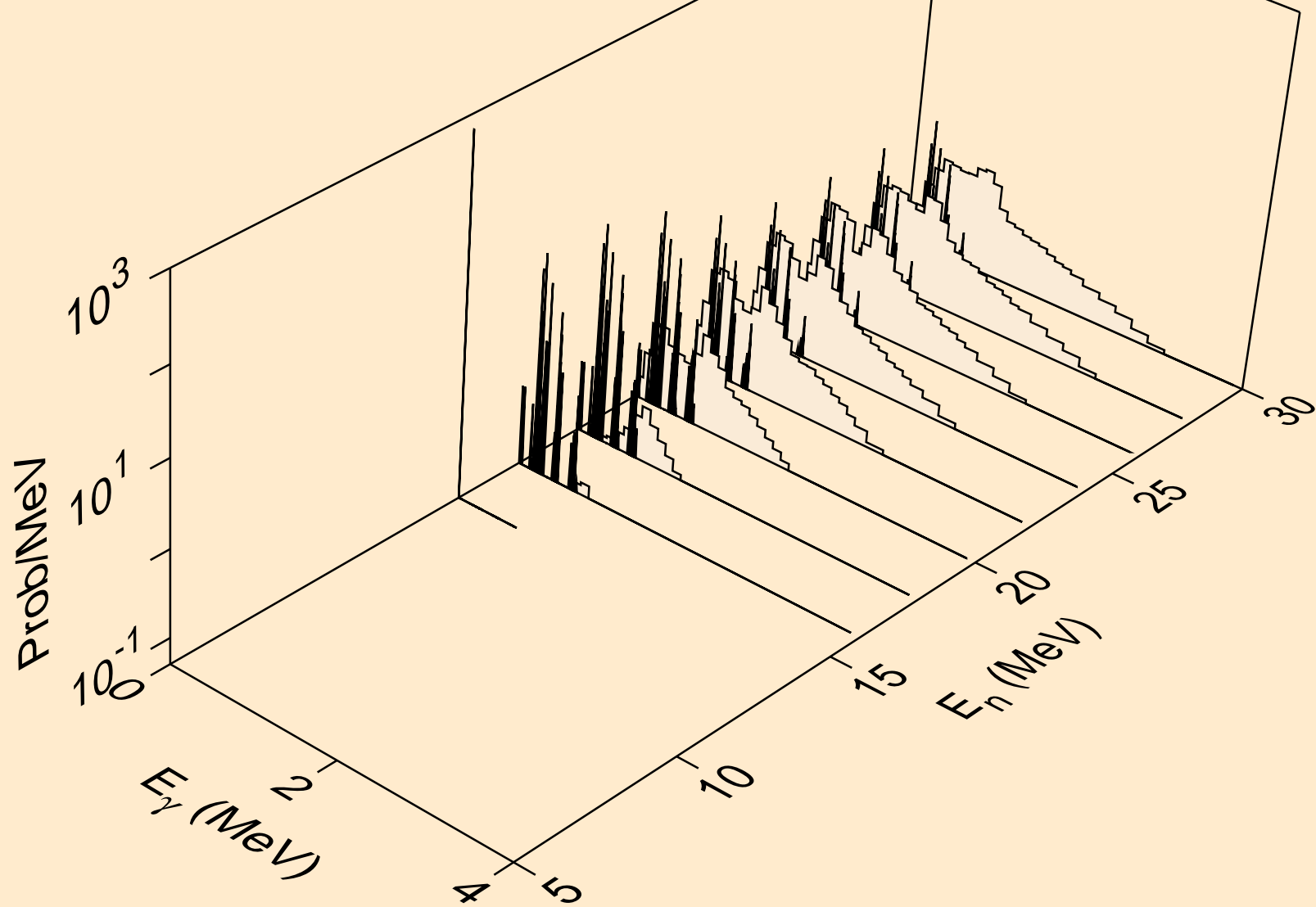

PR144M NEUTRON ACER TENDL-2021 LIBRARY; T=293.6K  
Photon emission for (n,p)

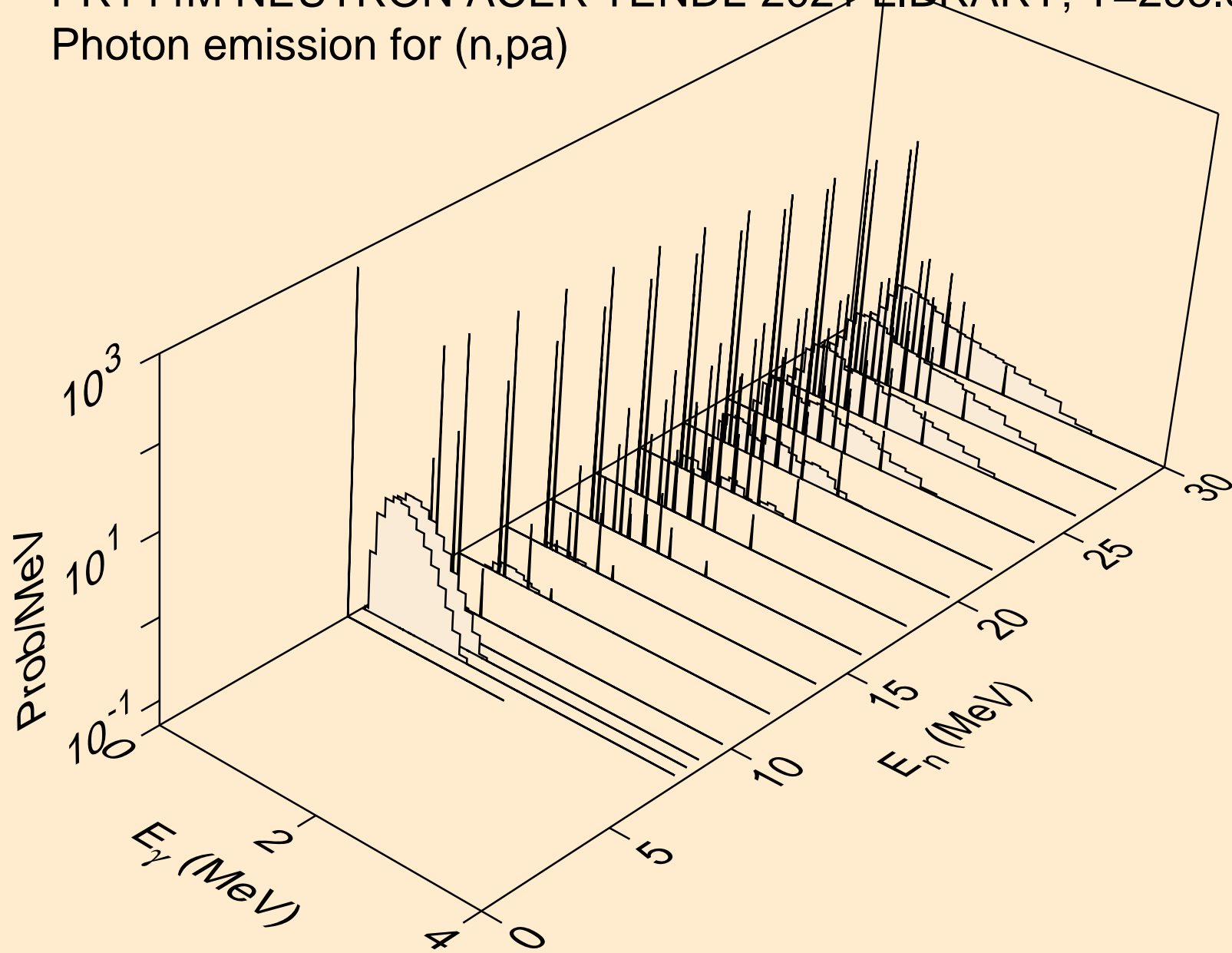

PR144M NEUTRON ACER TENDL-2021 LIBRARY; T=293.6K  
Photon emission for (n,pd)

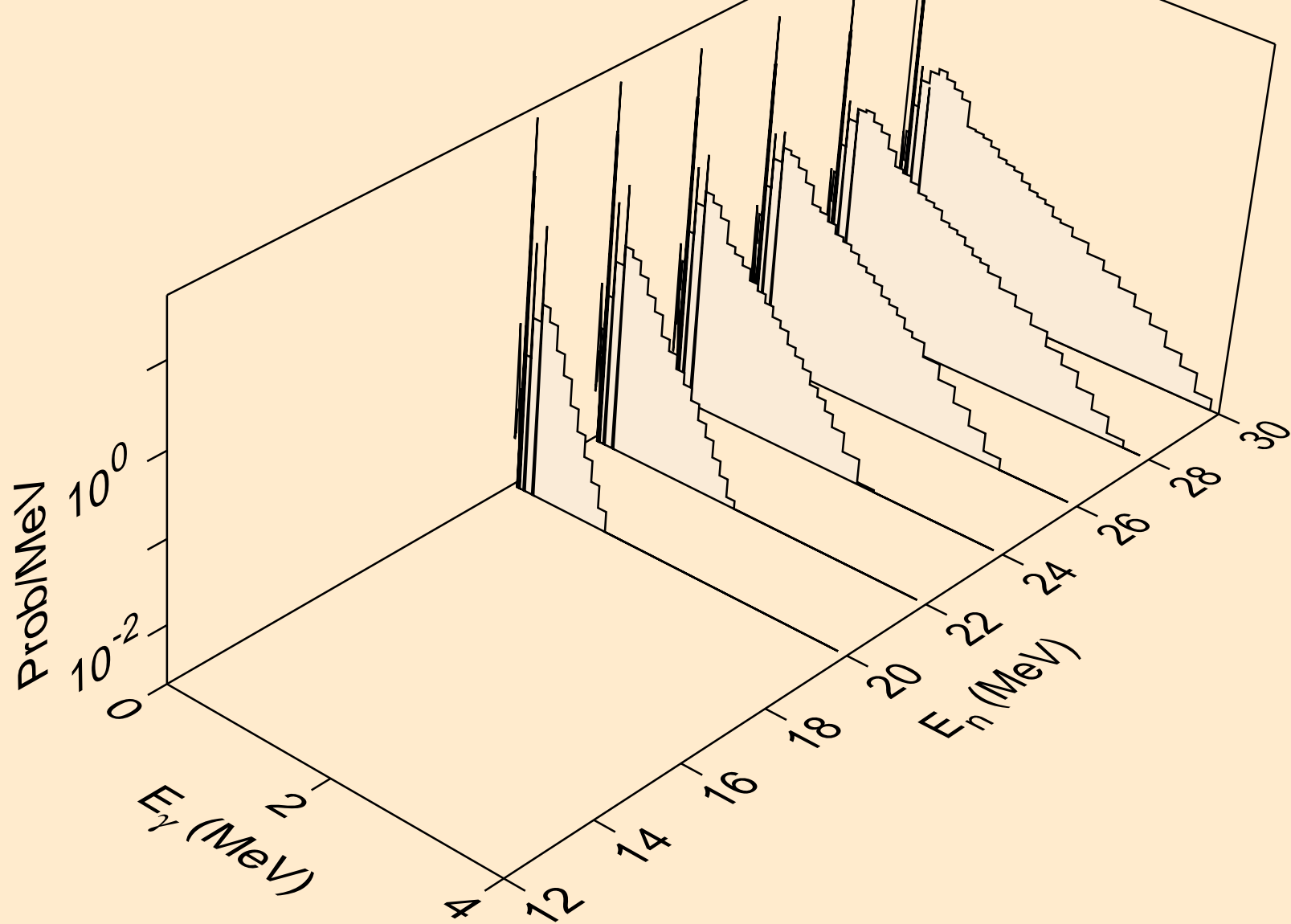



PR144M NEUTRON ACER TENDL-2021 LIBRARY; T=293.6K  
Photon emission for (n,pt)

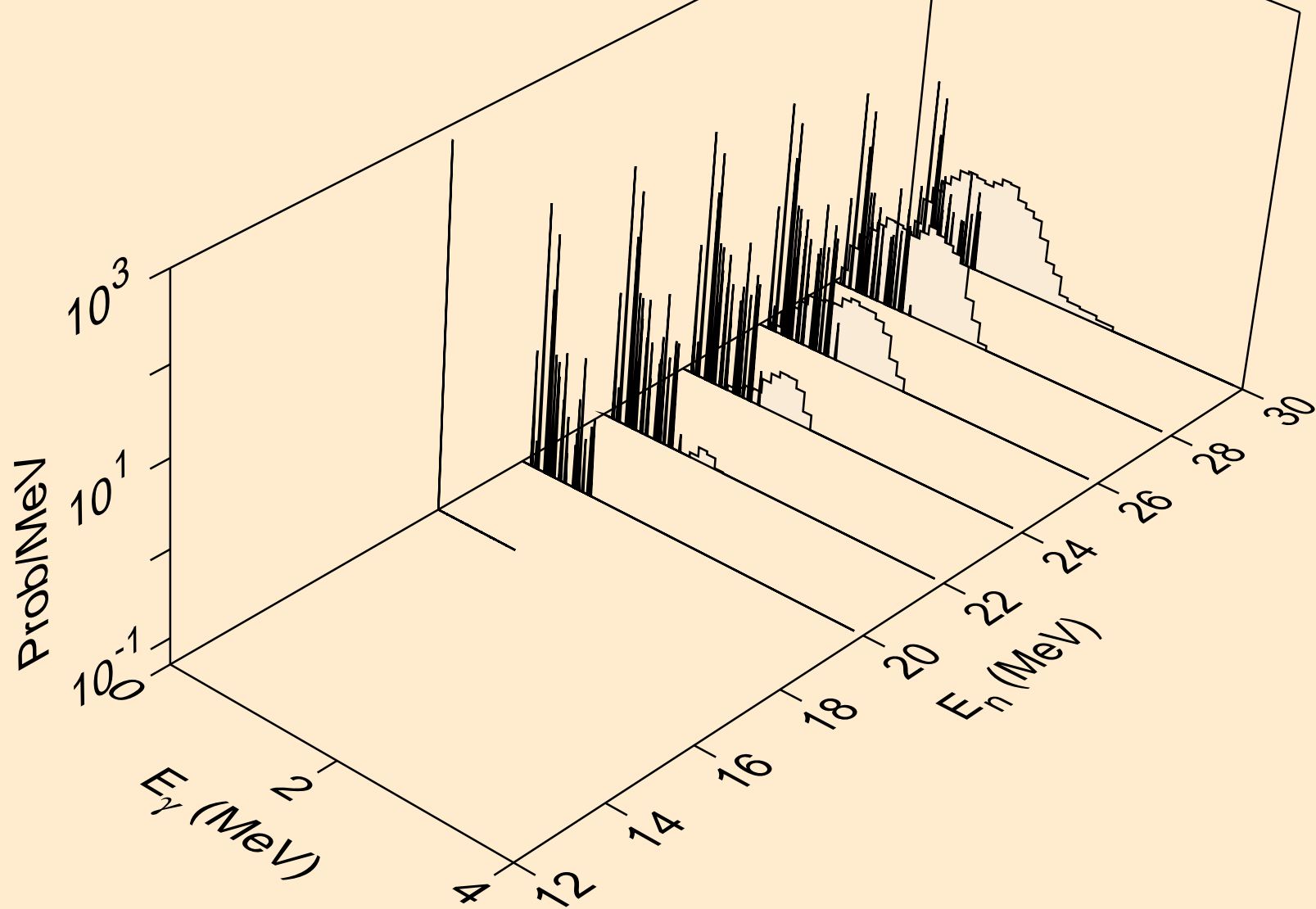

PR144M NEUTRON ACER TENDL-2021 LIBRARY; T=293.6K  
Photon emission for (n,da)

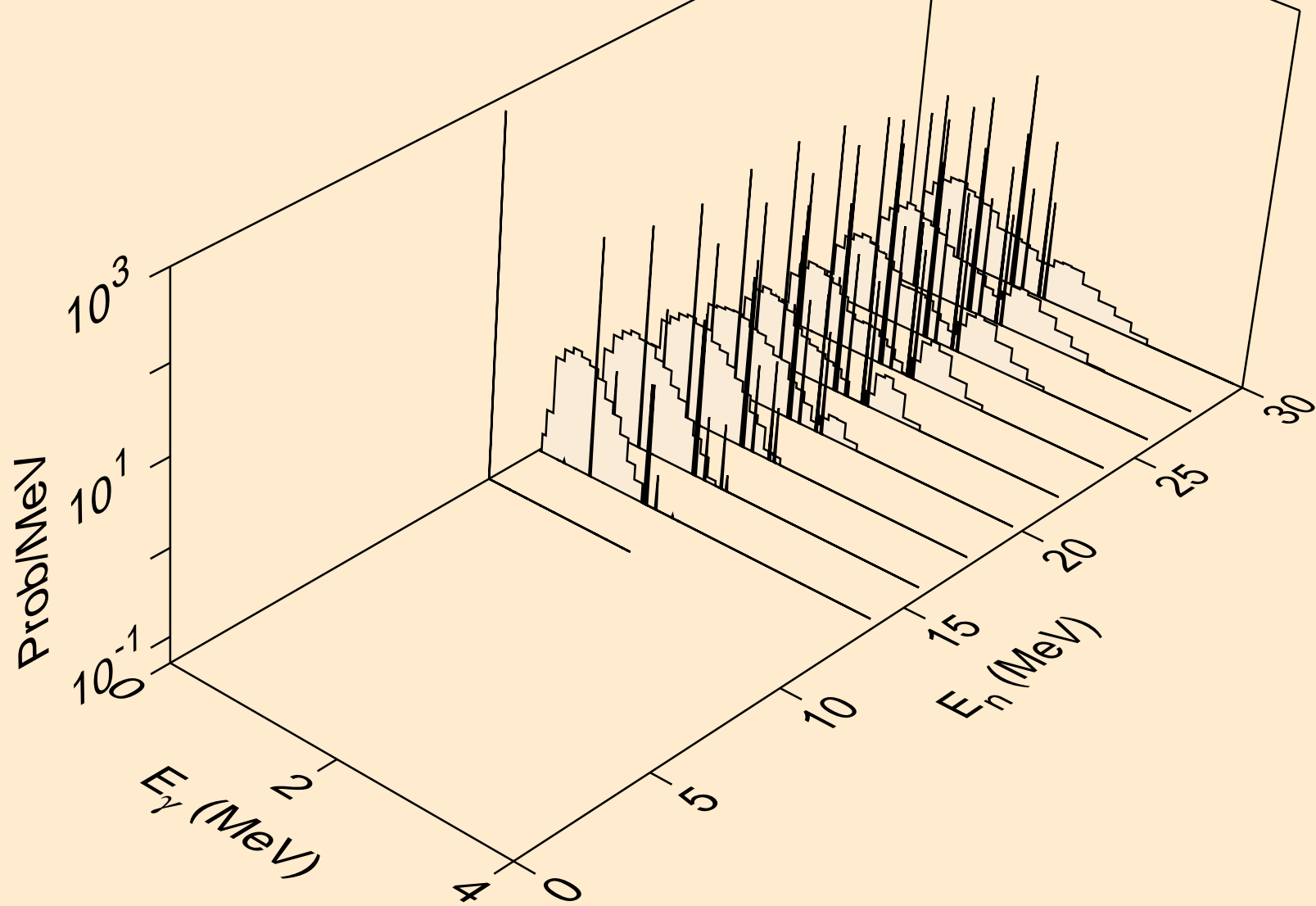

PR144M NEUTRON ACER TENDL-2021 LIBRARY; T=293.6K  
thermal capture photon spectrum

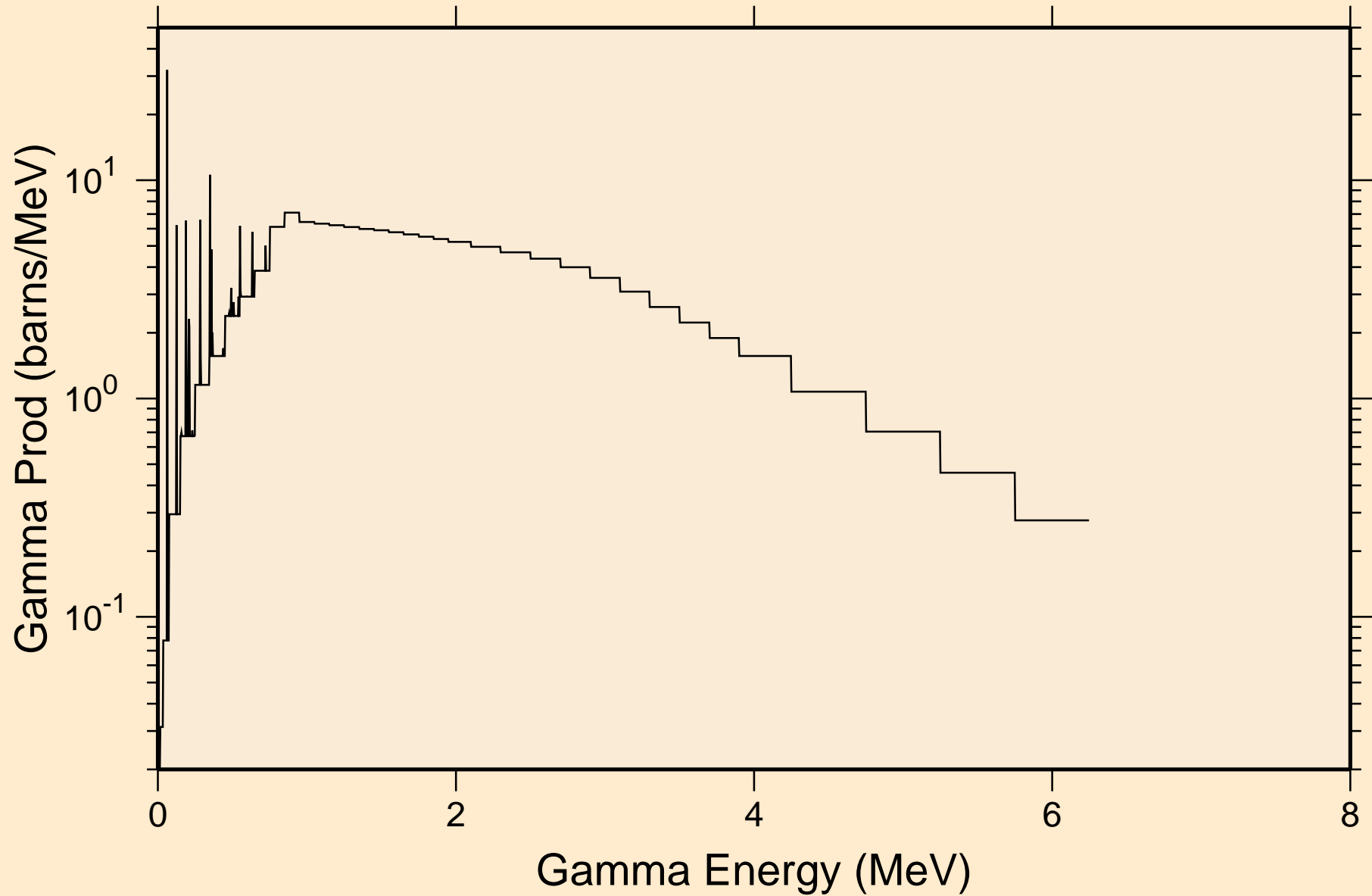

PR144M NEUTRON ACER TENDL-2021 LIBRARY; T=293.6K  
14 MeV photon spectrum

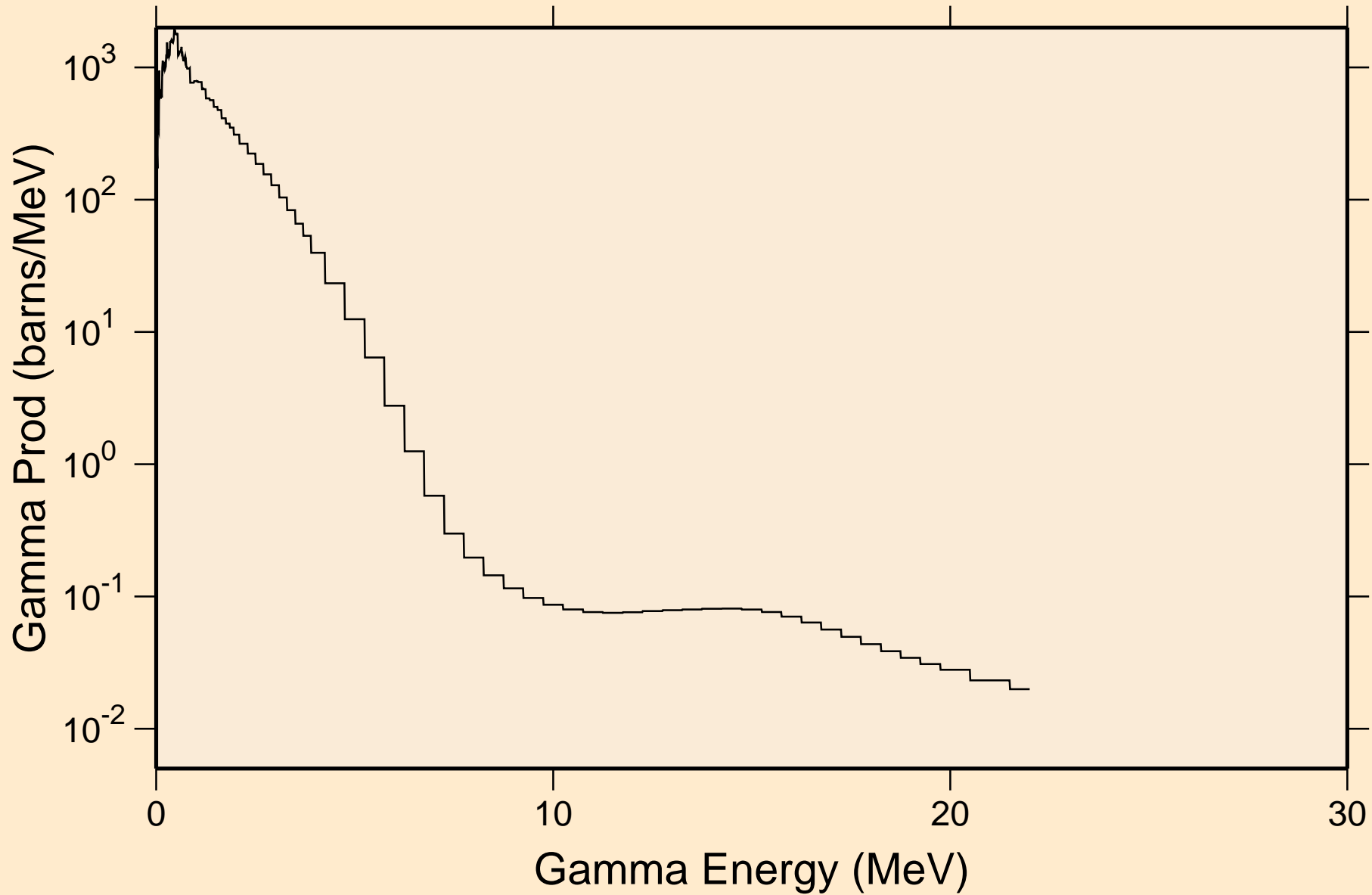

PR144M NEUTRON ACER TENDL-2021 LIBRARY; T=293.6K  
Particle heating contributions

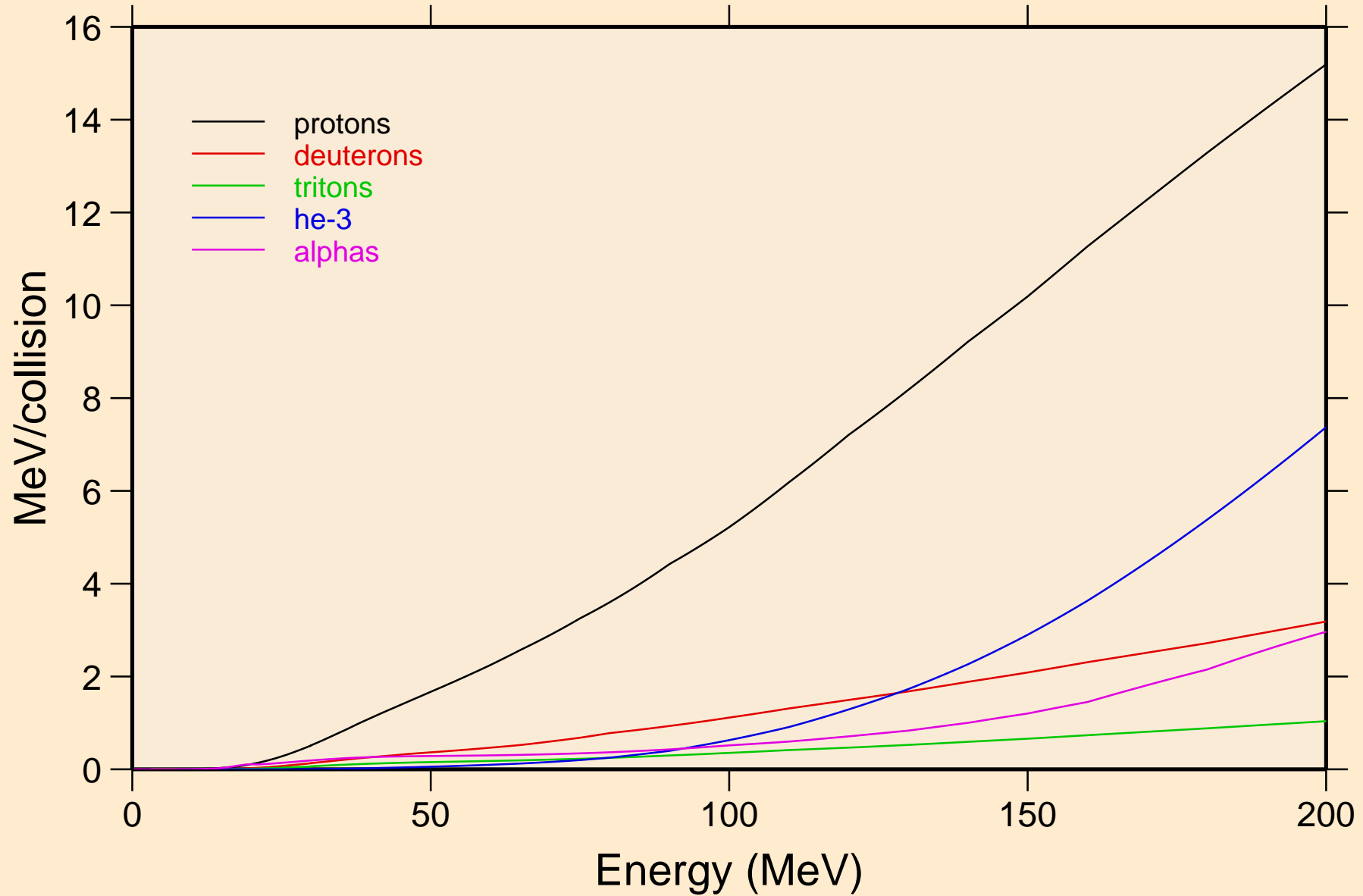

PR144M NEUTRON ACER TENDL-2021 LIBRARY; T=293.6K  
Recoil Heating

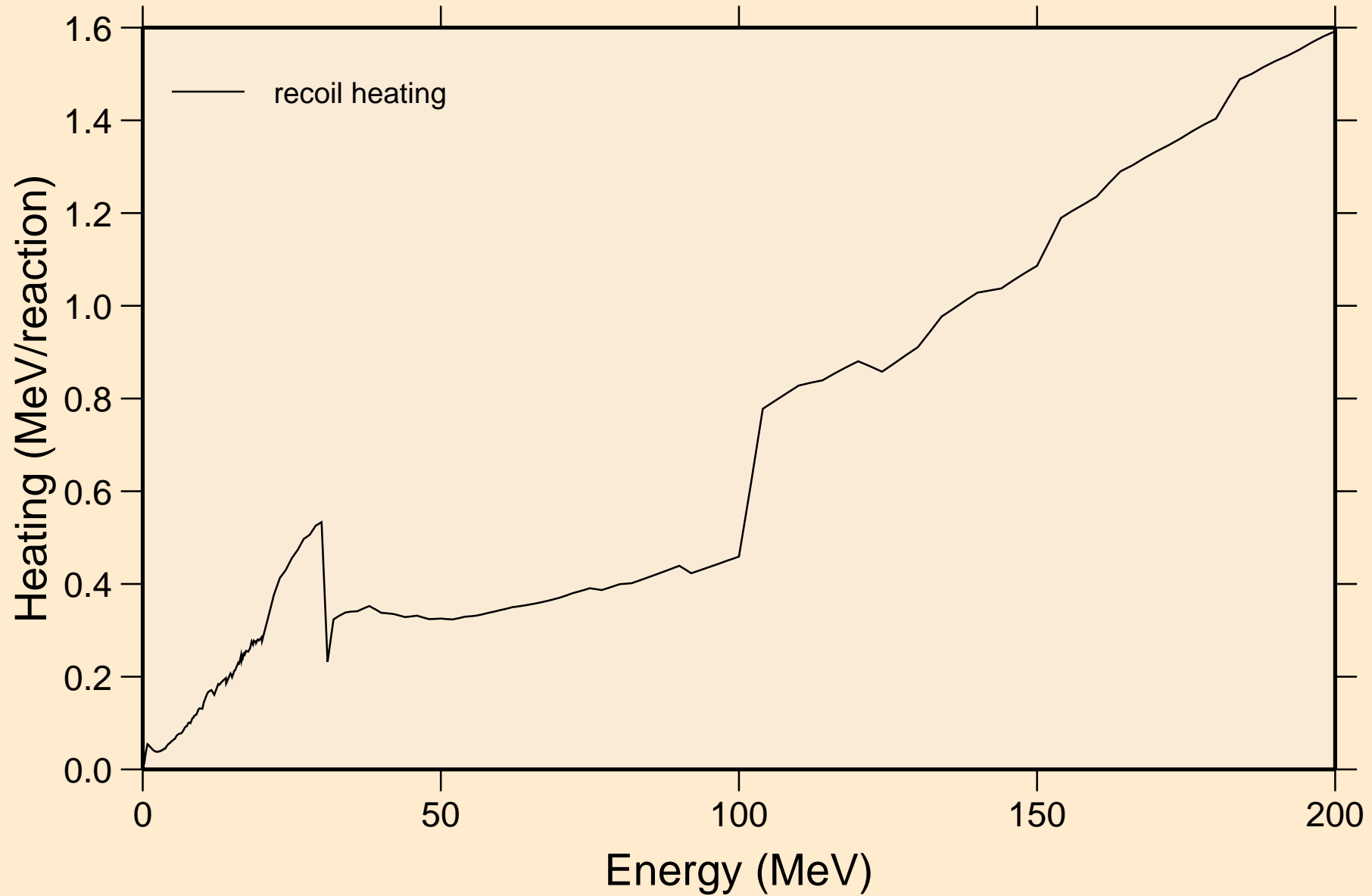

PR144M NEUTRON ACER TENDL-2021 LIBRARY; T=293.6K  
Particle production cross sections

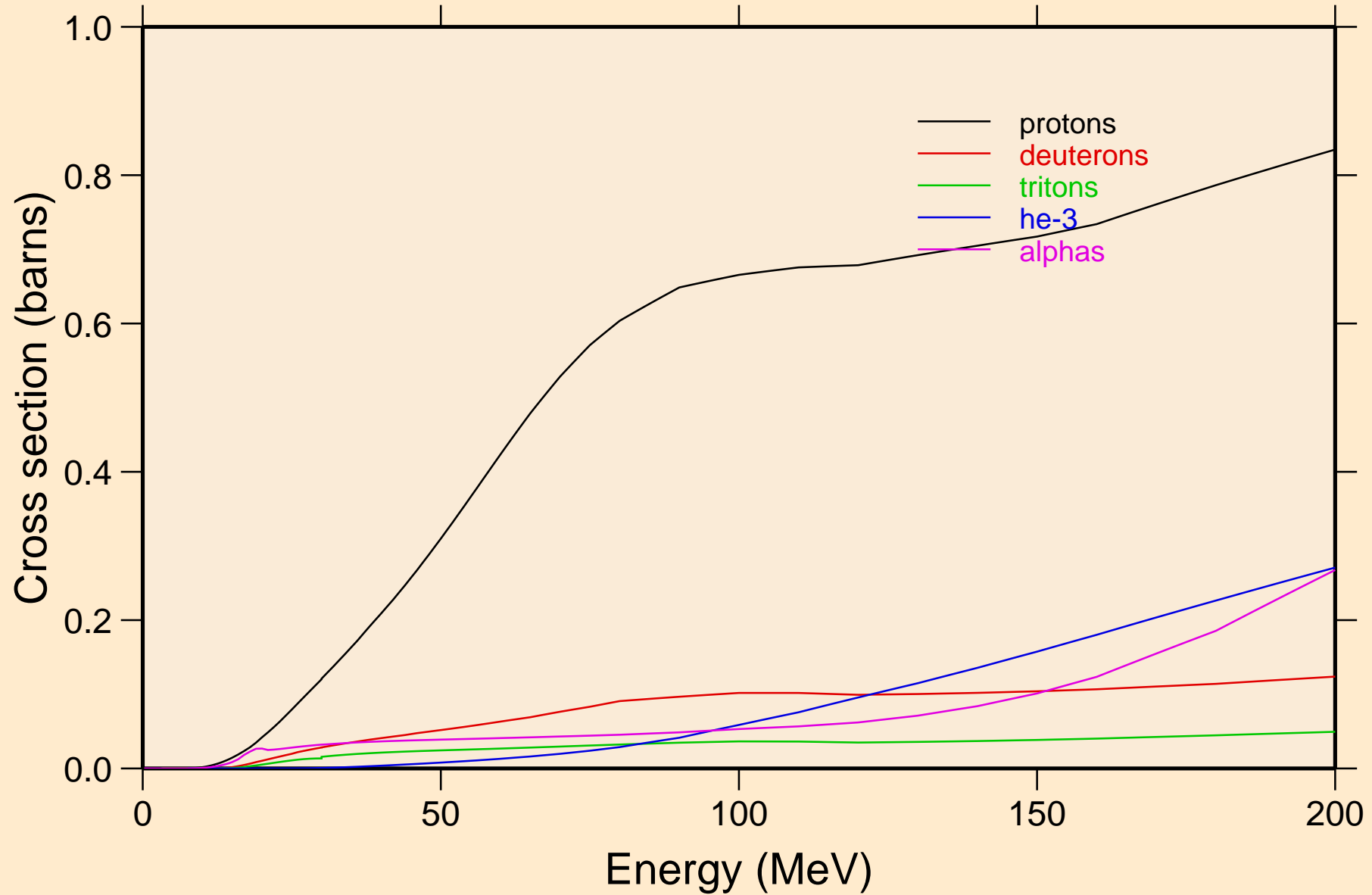

PR144M NEUTRON ACER TENDL-2021 LIBRARY; T=293.6K  
protons from (n,x)

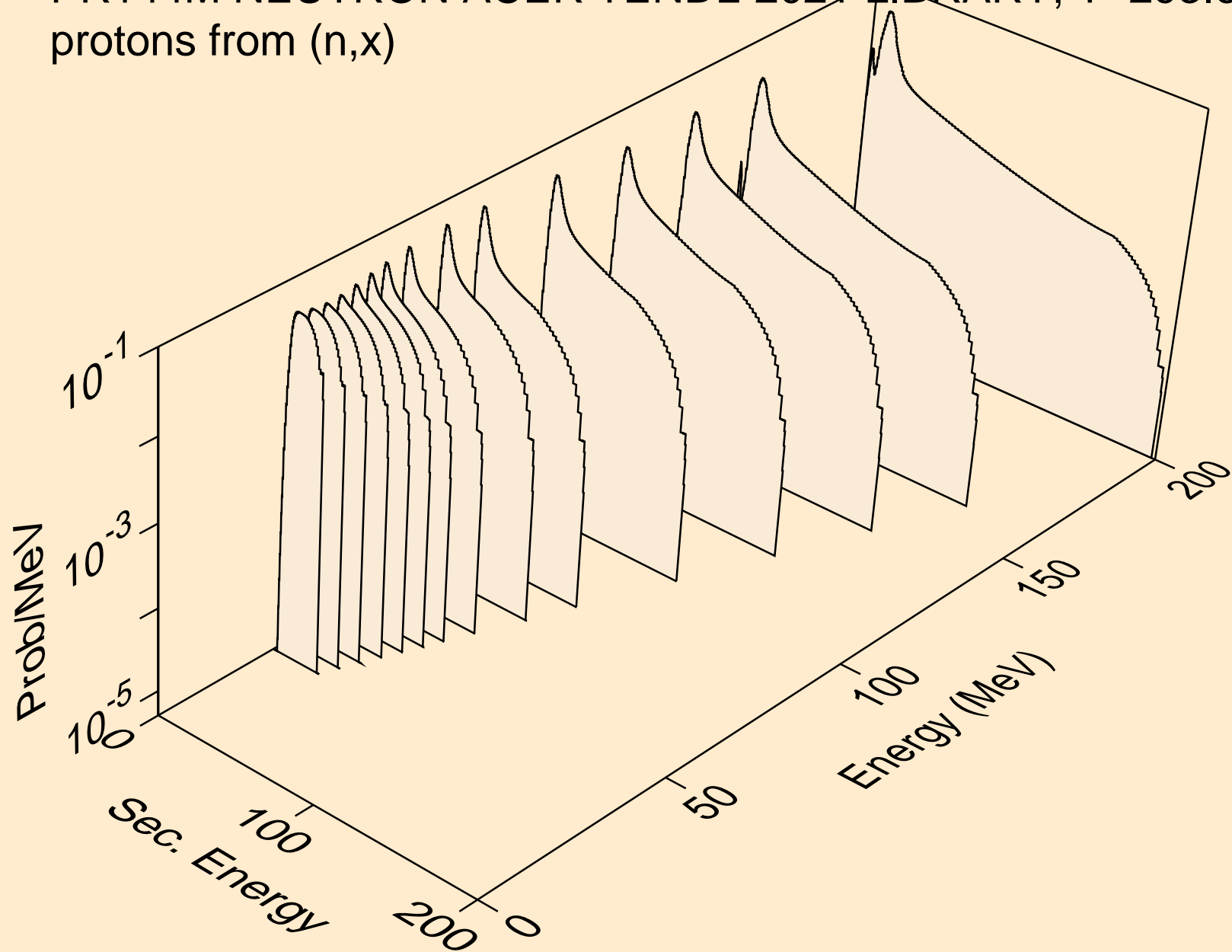



PR144M NEUTRON ACER TENDL-2021 LIBRARY; T=293.6K  
protons from (n,n\*)p

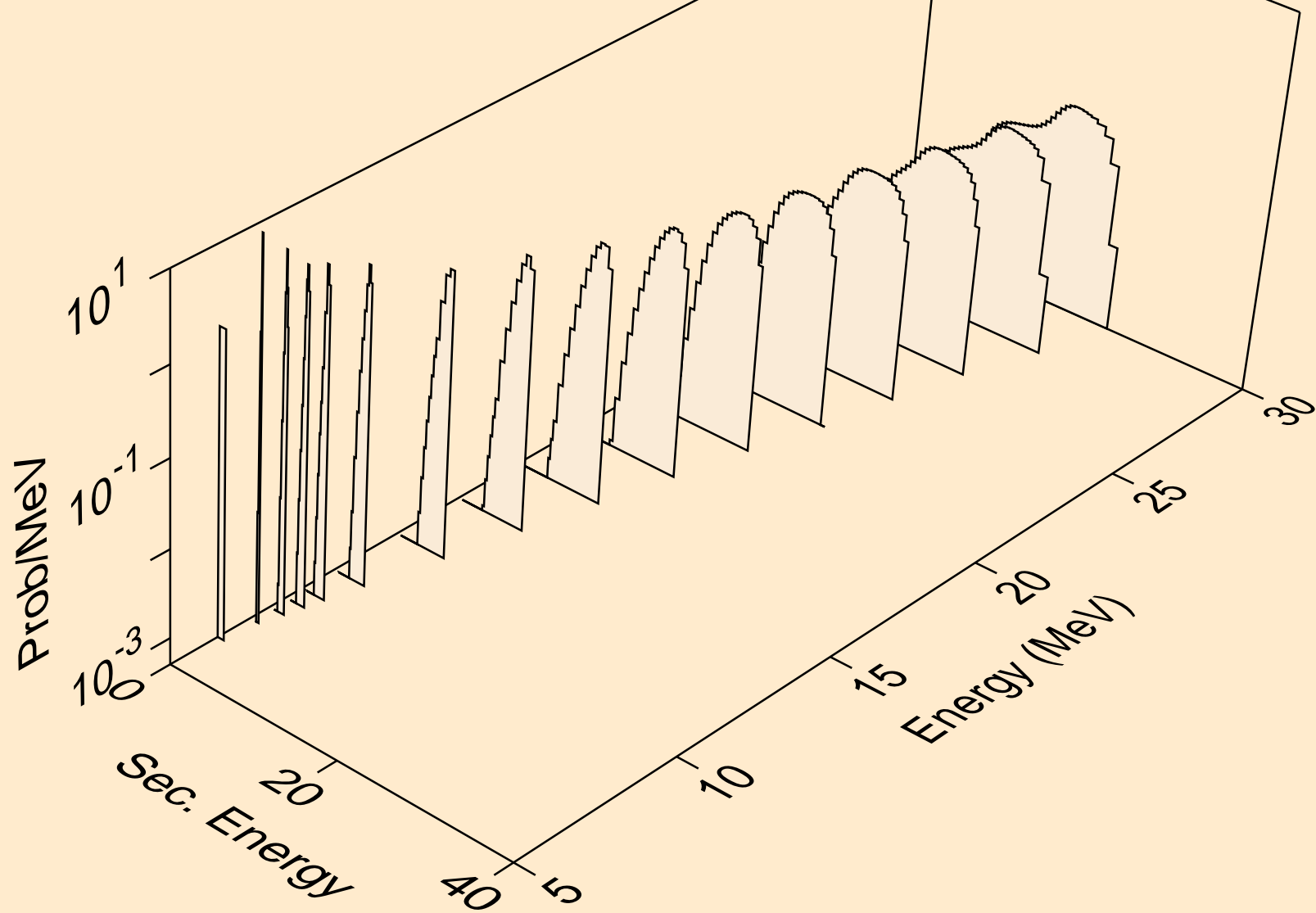

PR144M NEUTRON ACER TENDL-2021 LIBRARY; T=293.6K  
protons from (n,2np)

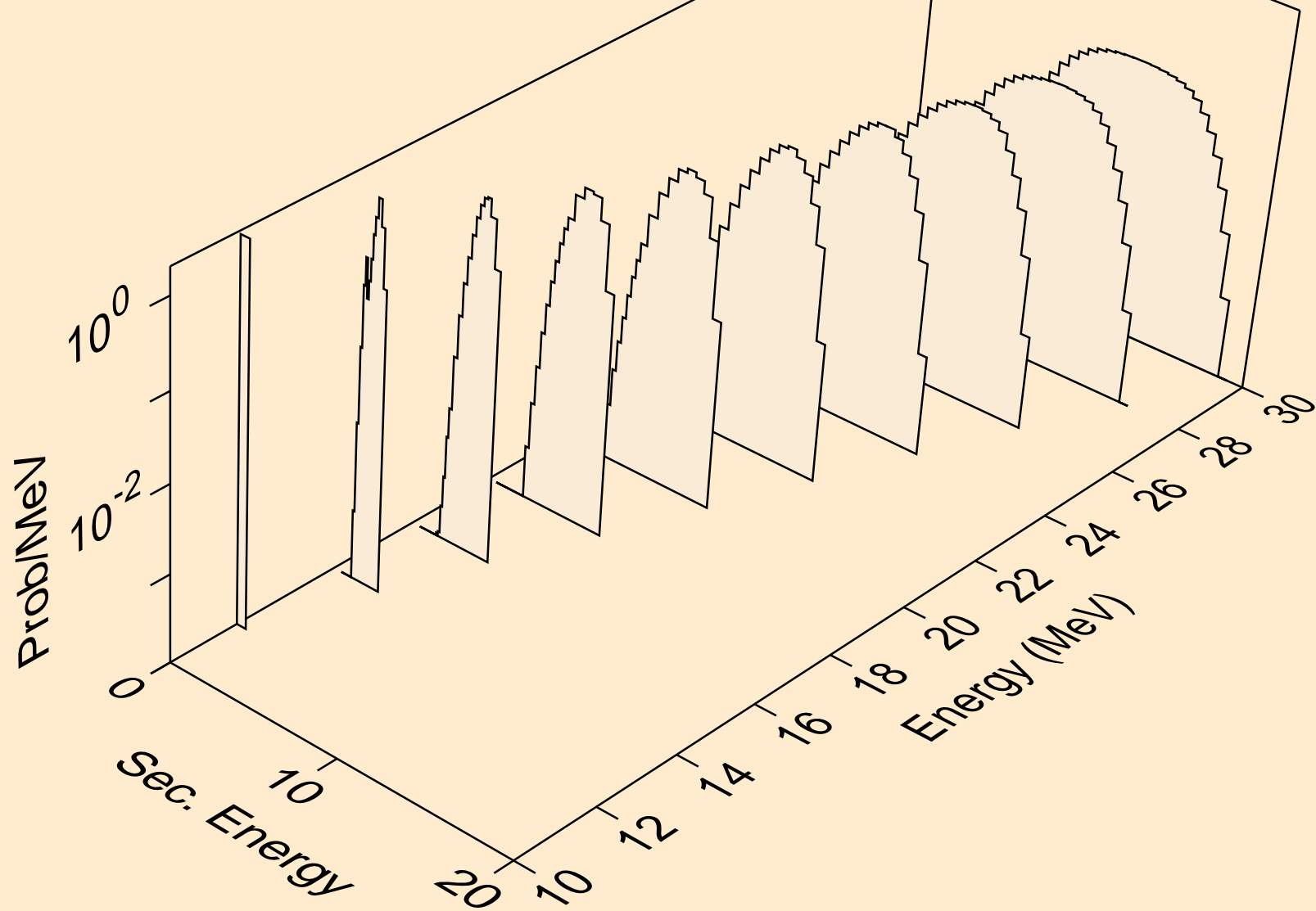

PR144M NEUTRON ACER TENDL-2021 LIBRARY; T=293.6K  
protons from (n,3np)

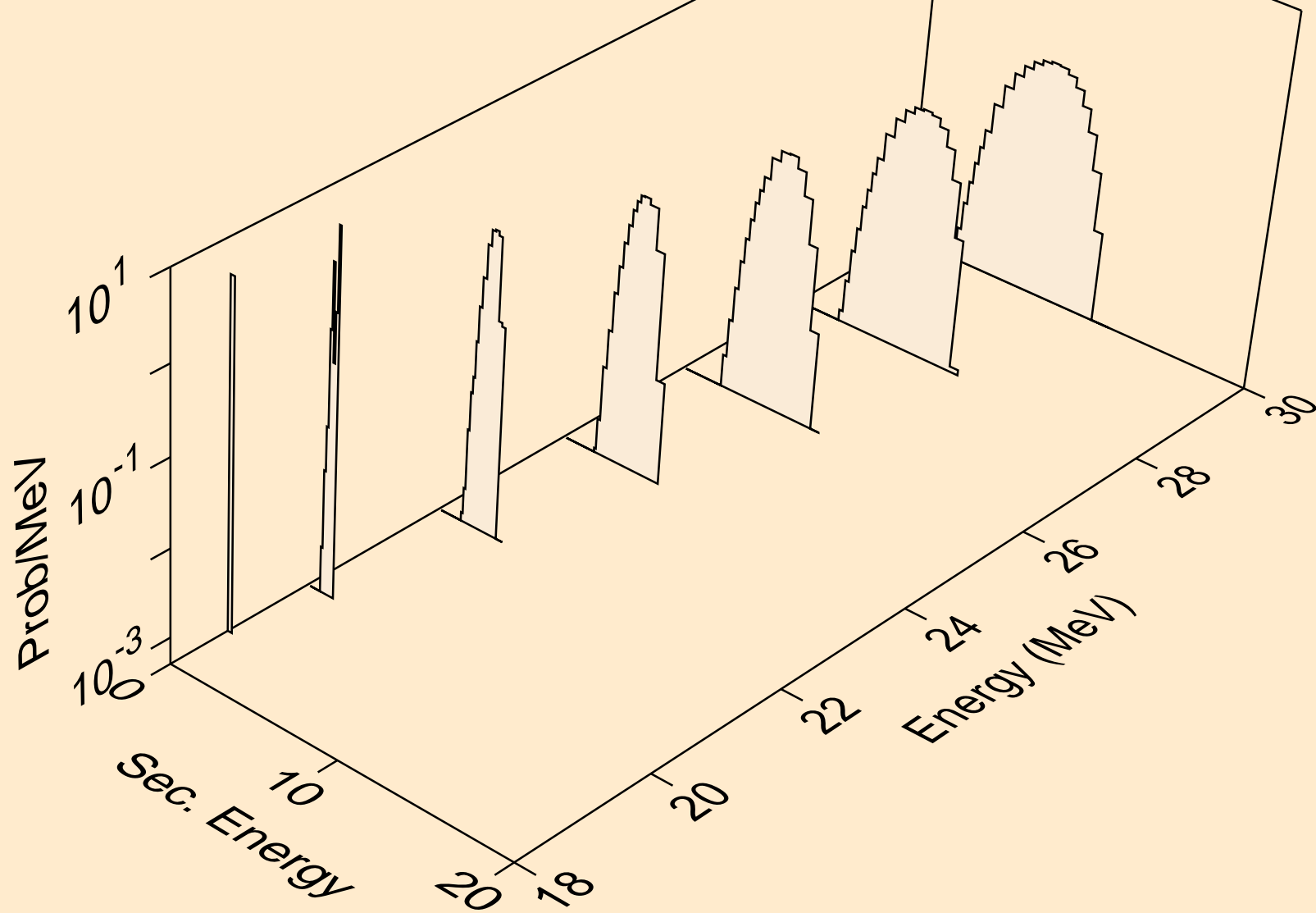

PR144M NEUTRON ACER TENDL-2021 LIBRARY; T=293.6K  
protons from (n,2np)

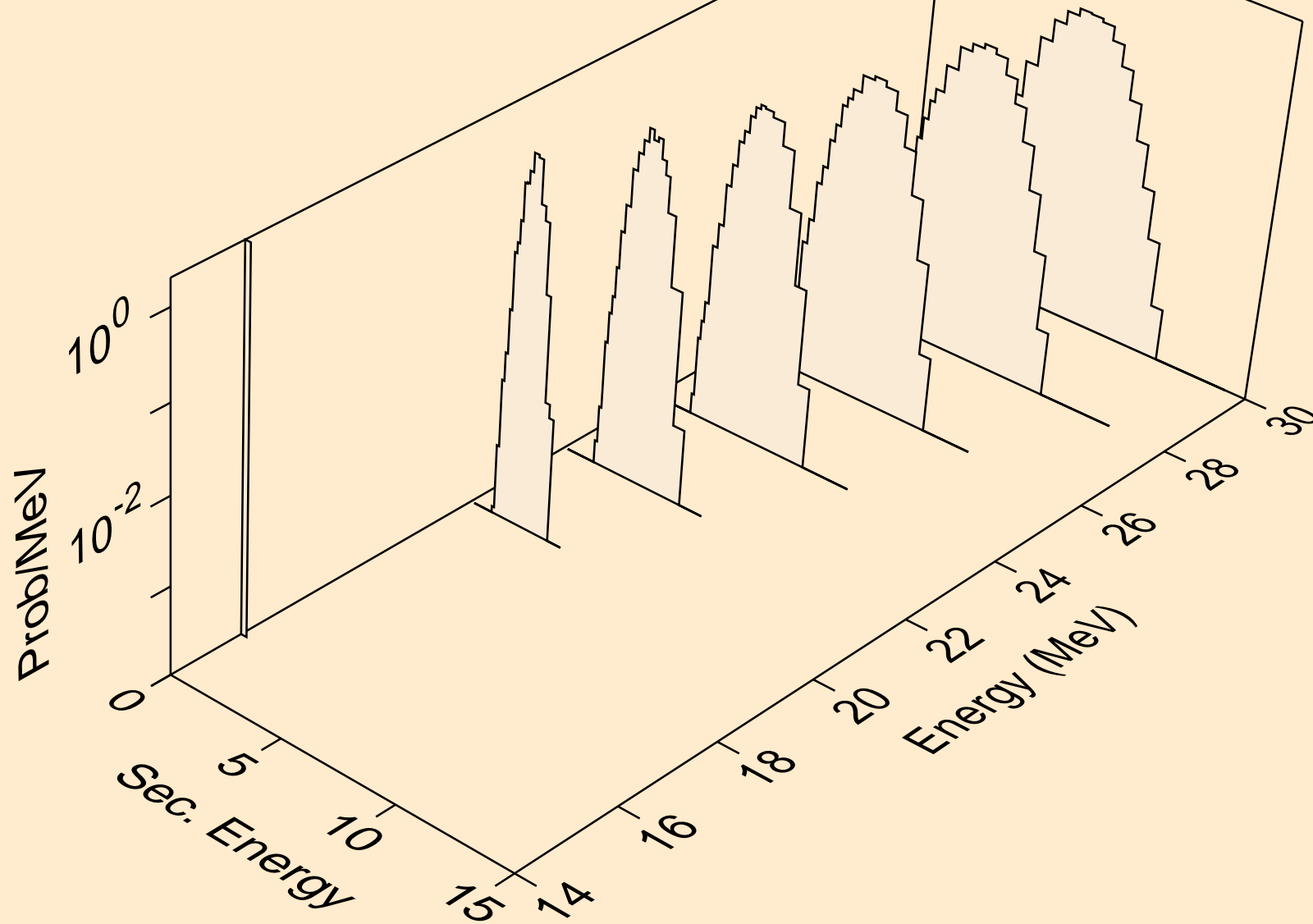

PR144M NEUTRON ACER TENDL-2021 LIBRARY; T=293.6K  
protons from (n,npa)

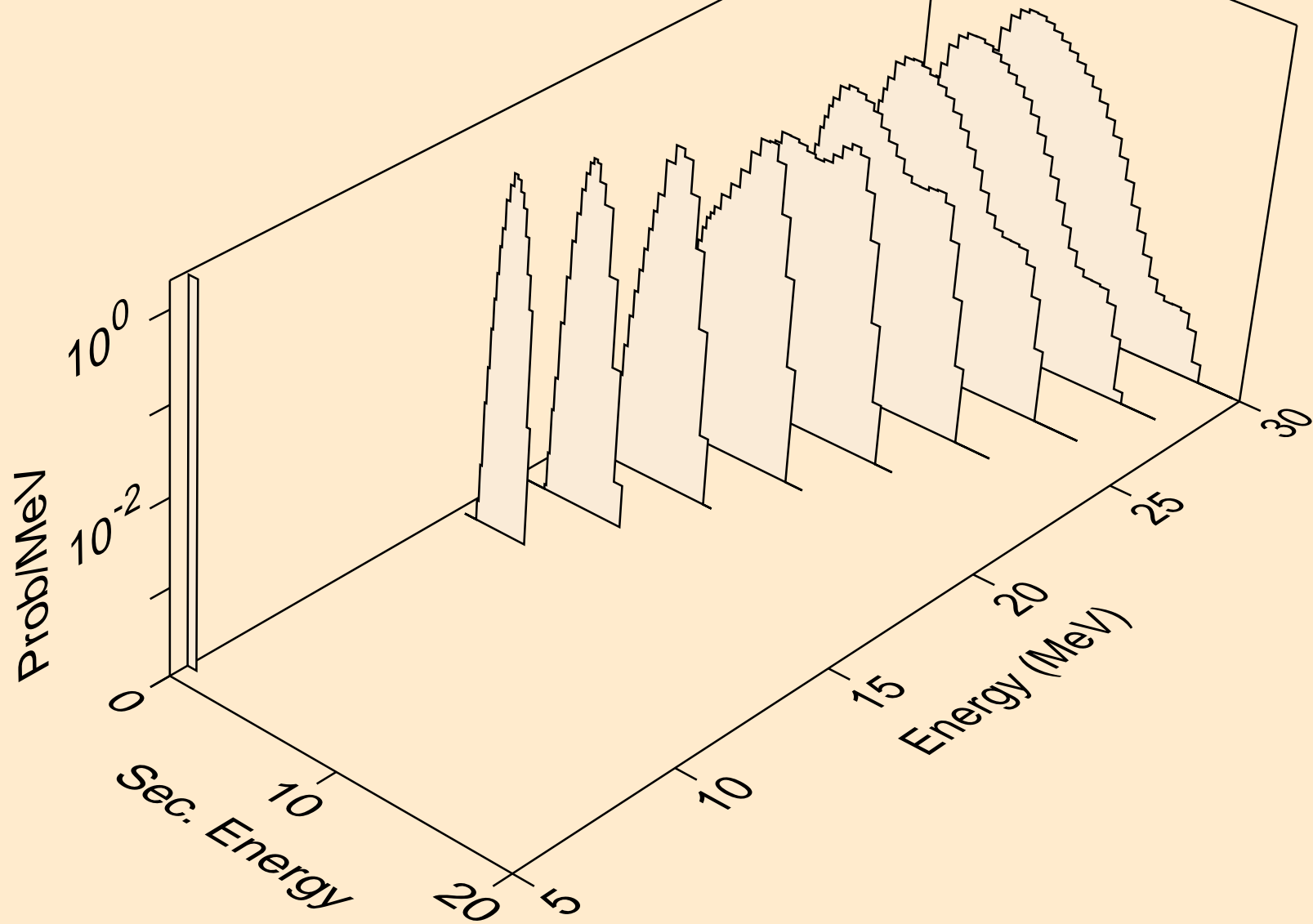

PR144M NEUTRON ACER TENDL-2021 LIBRARY; T=293.6K  
protons from (n,p)

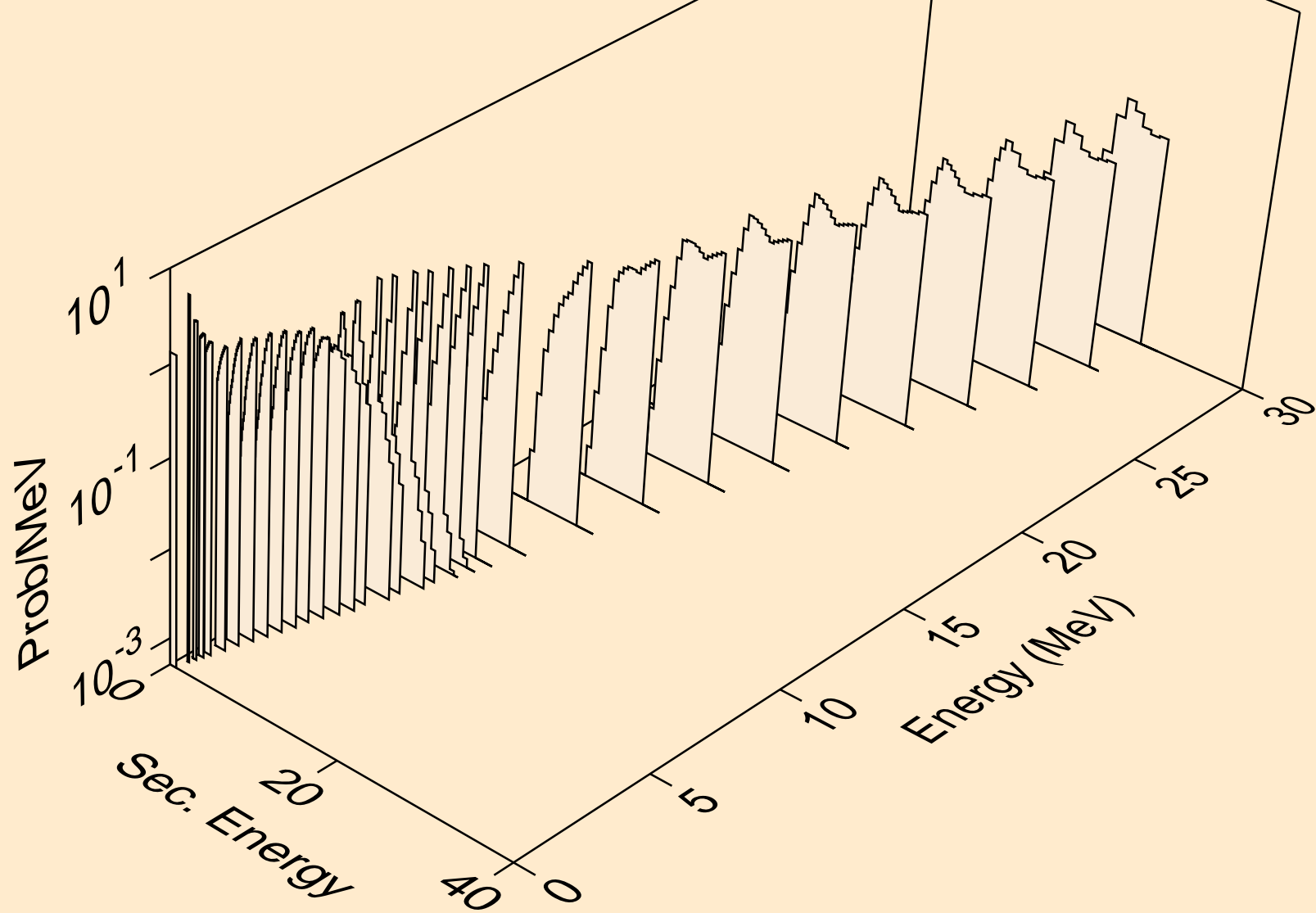

PR144M NEUTRON ACER TENDL-2021 LIBRARY; T=293.6K  
protons from (n,2p)

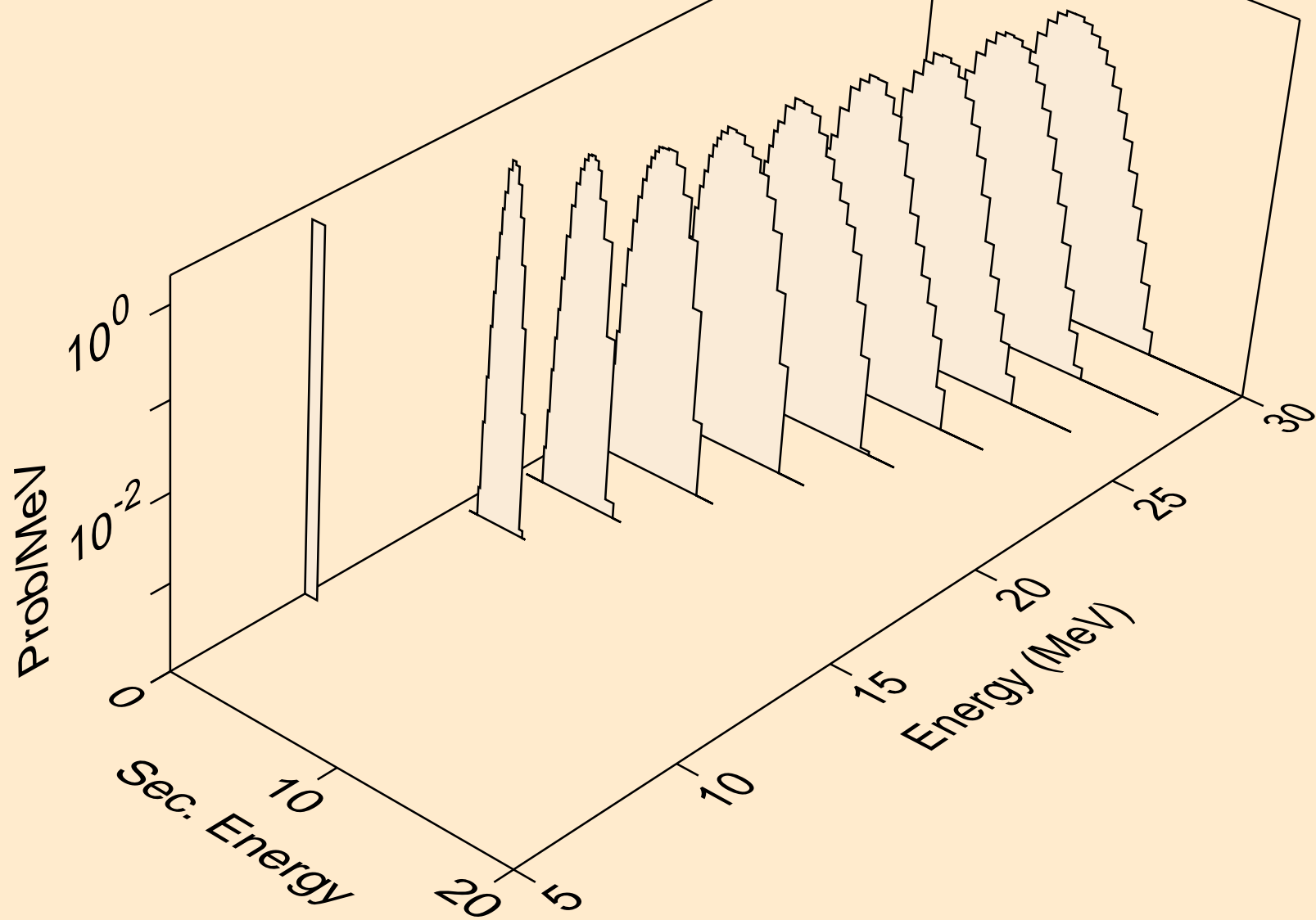

PR144M NEUTRON ACER TENDL-2021 LIBRARY; T=293.6K  
protons from (n,p)

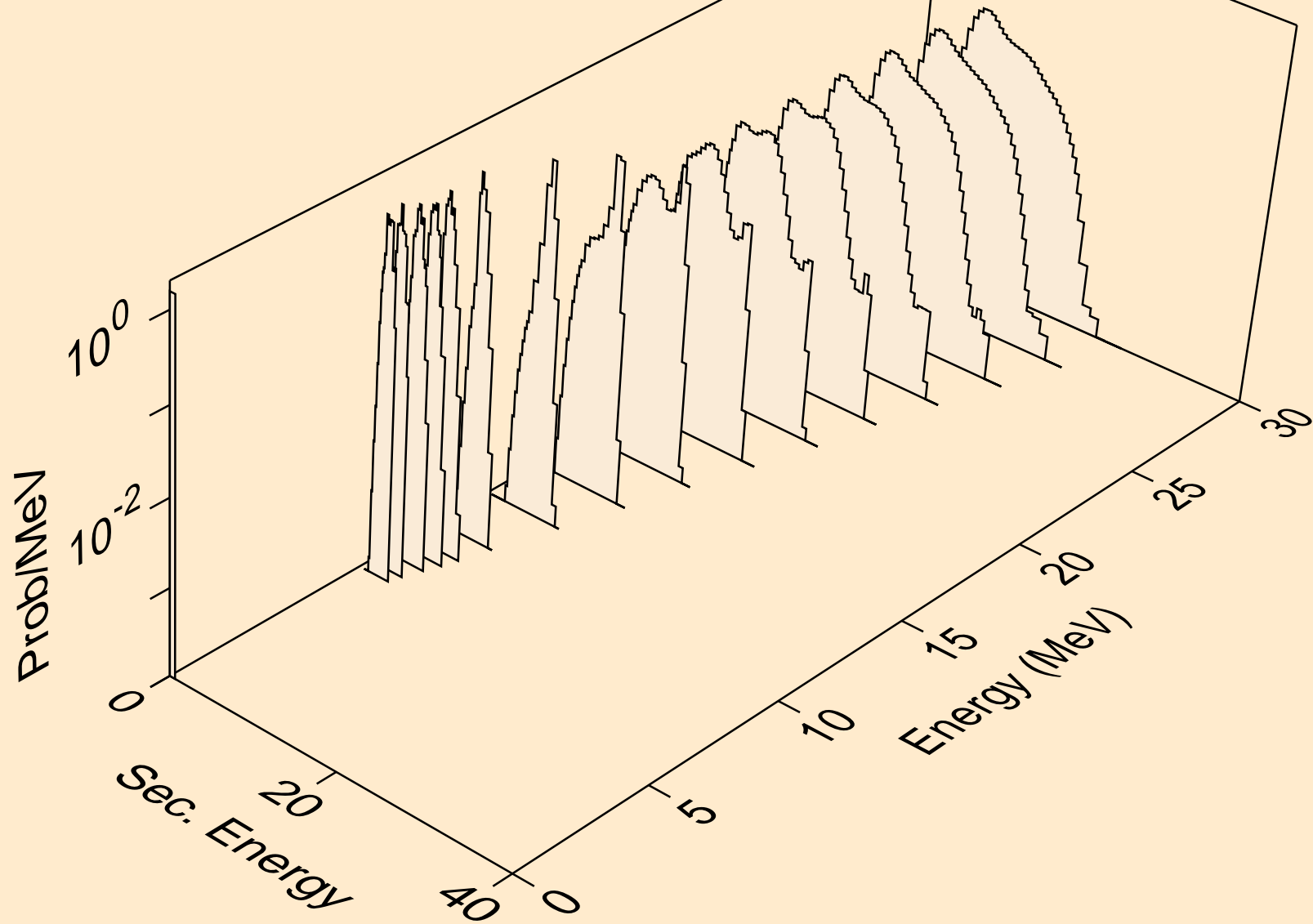



PR144M NEUTRON ACER TENDL-2021 LIBRARY; T=293.6K  
protons from (n,pd)

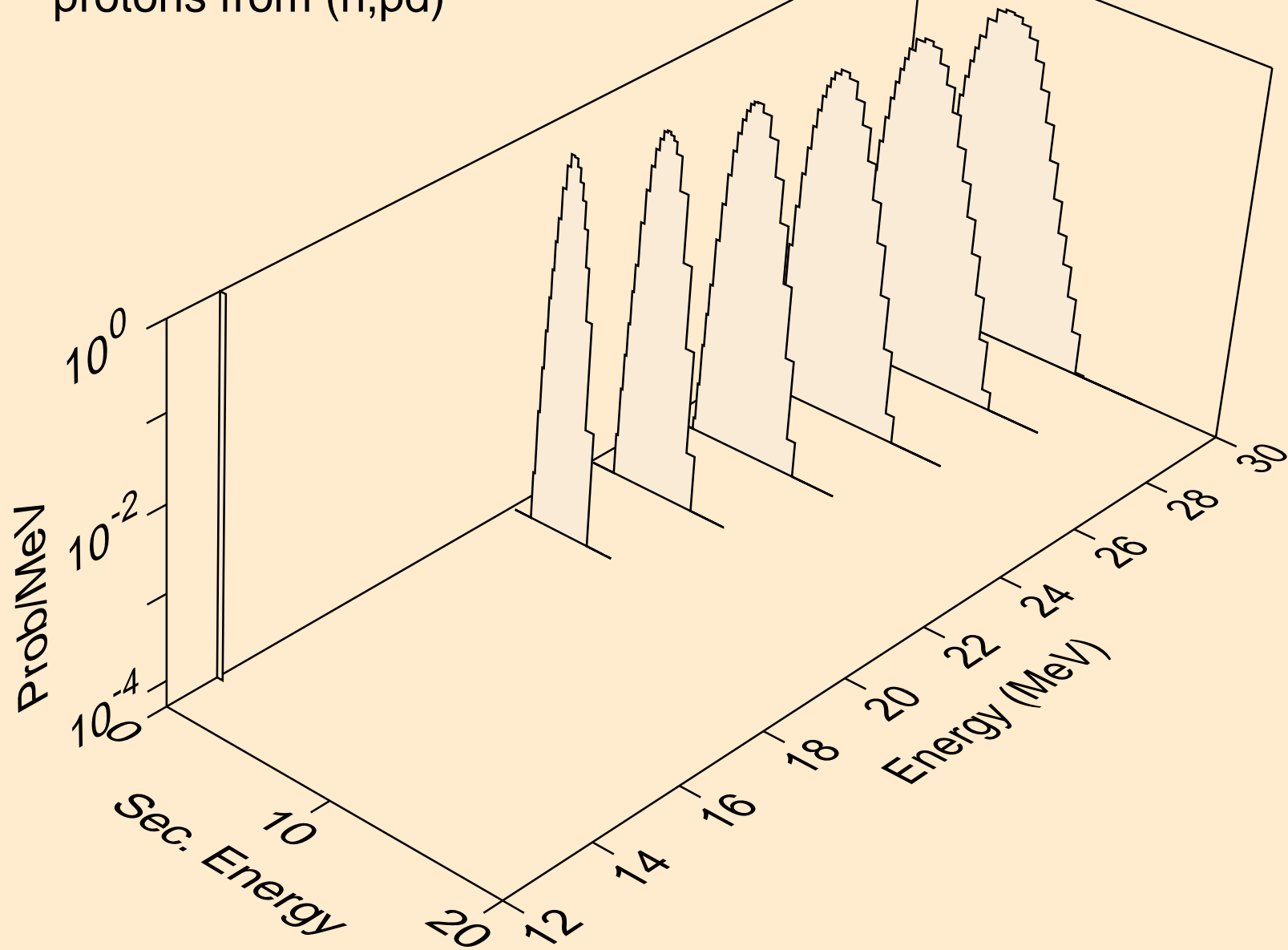

PR144M NEUTRON ACER TENDL-2021 LIBRARY; T=293.6K  
protons from (n,pt)

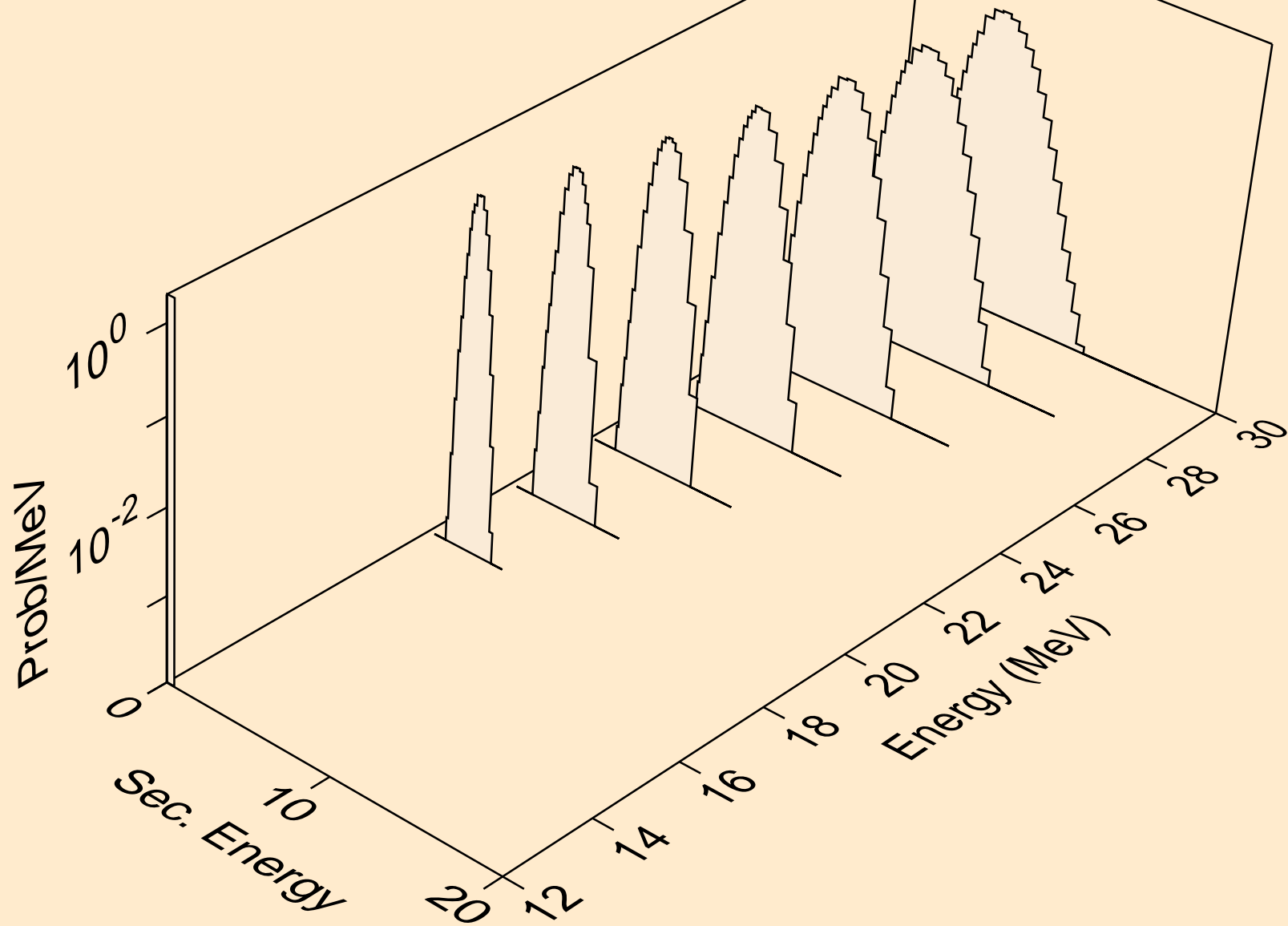

PR144M NEUTRON ACER TENDL-2021 LIBRARY; T=293.6K  
deuterons from (n,x)

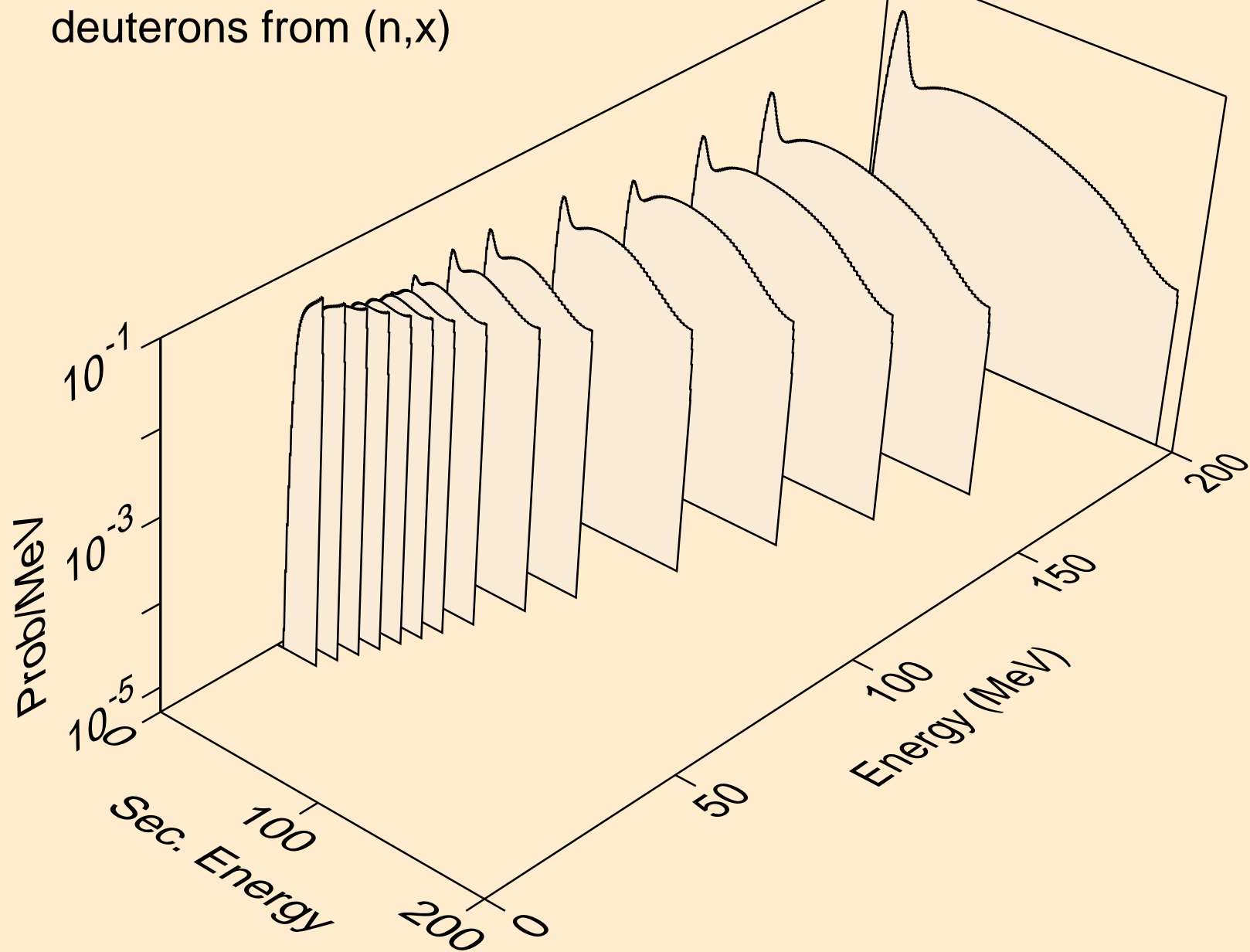

PR144M NEUTRON ACER TENDL-2021 LIBRARY; T=293.6K  
deuterons from (n,2nd)

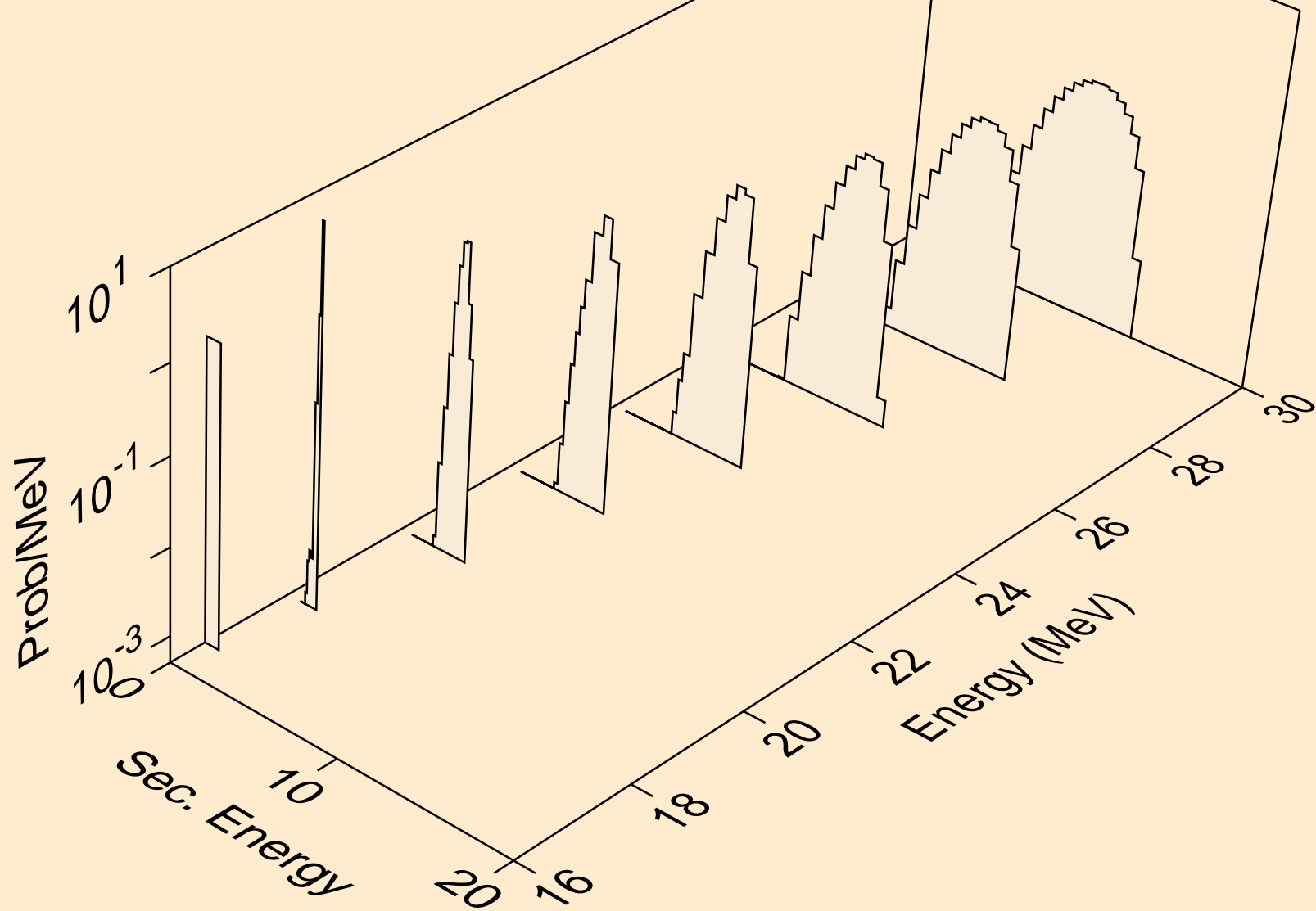

PR144M NEUTRON ACER TENDL-2021 LIBRARY; T=293.6K  
deuterons from (n,n\*)d

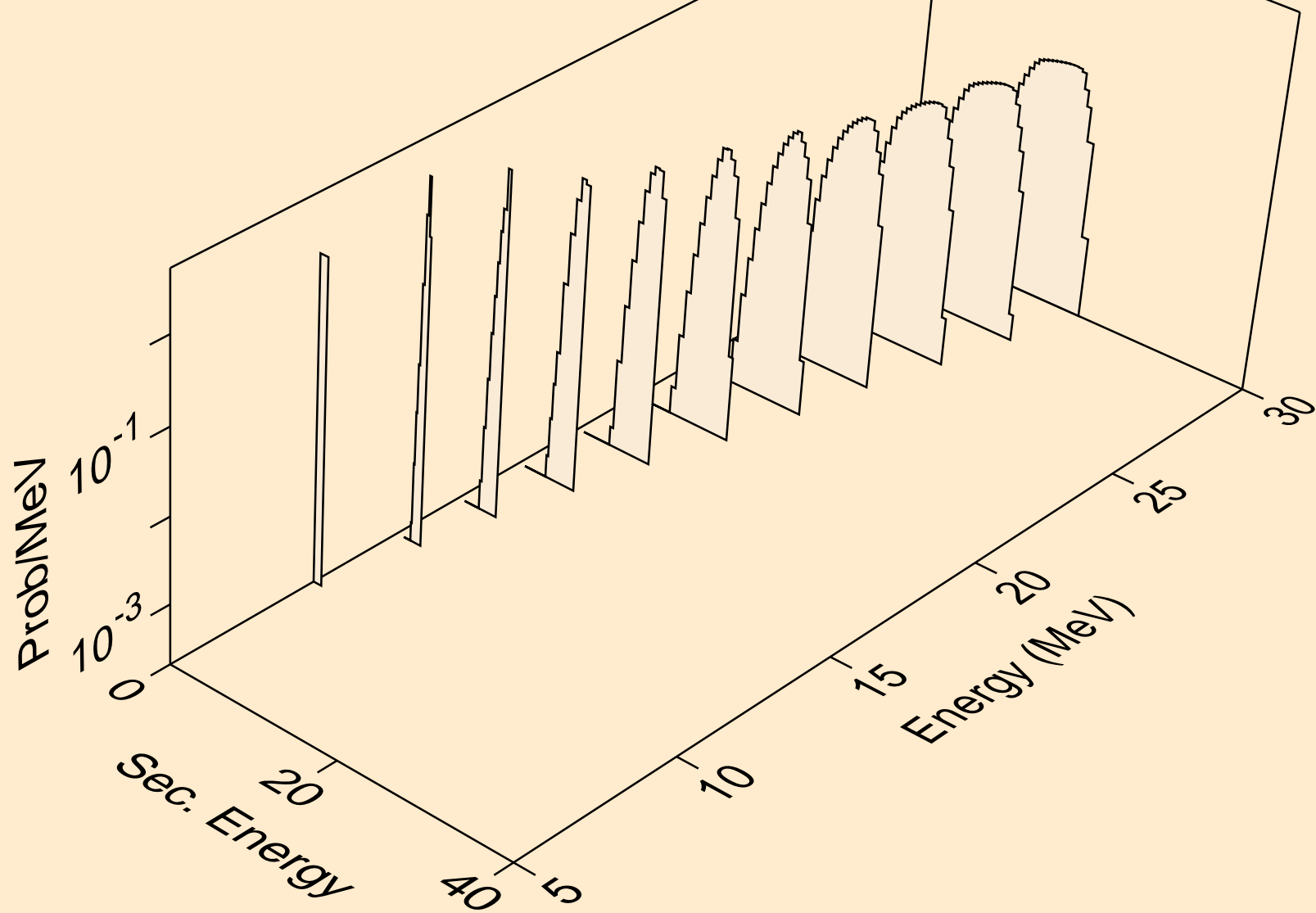

PR144M NEUTRON ACER TENDL-2021 LIBRARY; T=293.6K  
deuterons from (n,d)

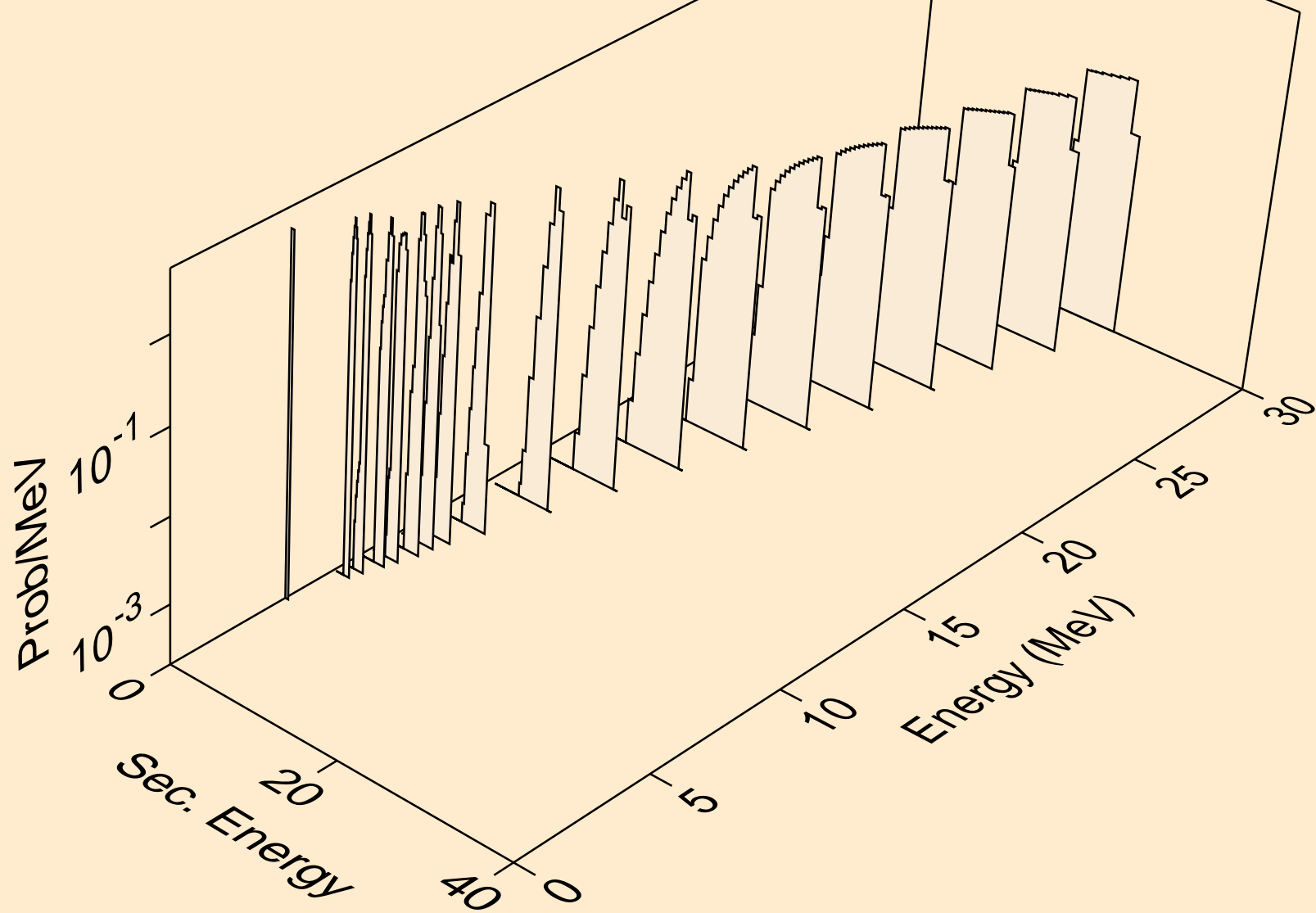

PR144M NEUTRON ACER TENDL-2021 LIBRARY; T=293.6K  
deuterons from (n,pd)

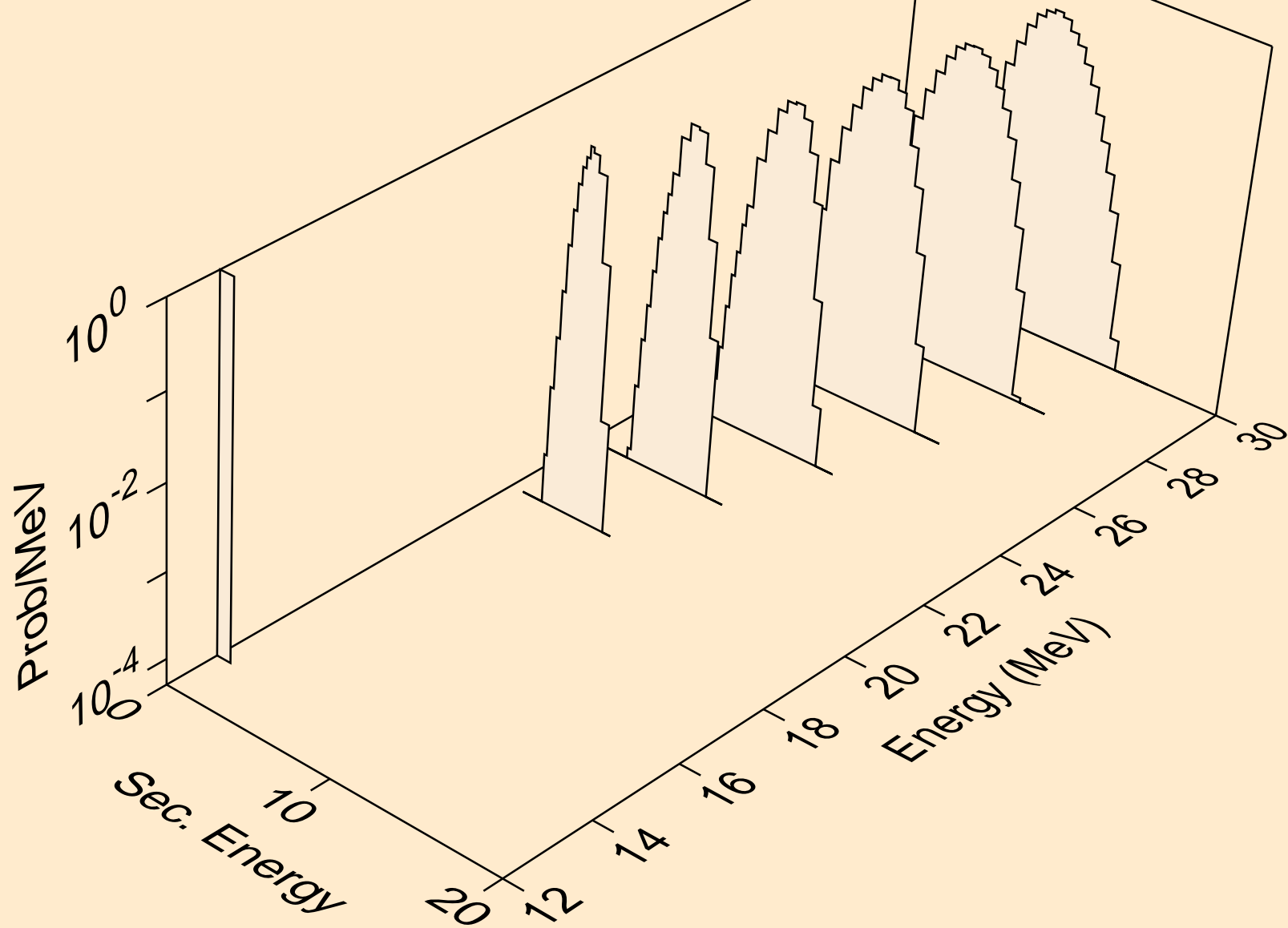

PR144M NEUTRON ACER TENDL-2021 LIBRARY; T=293.6K  
deuterons from (n,da)

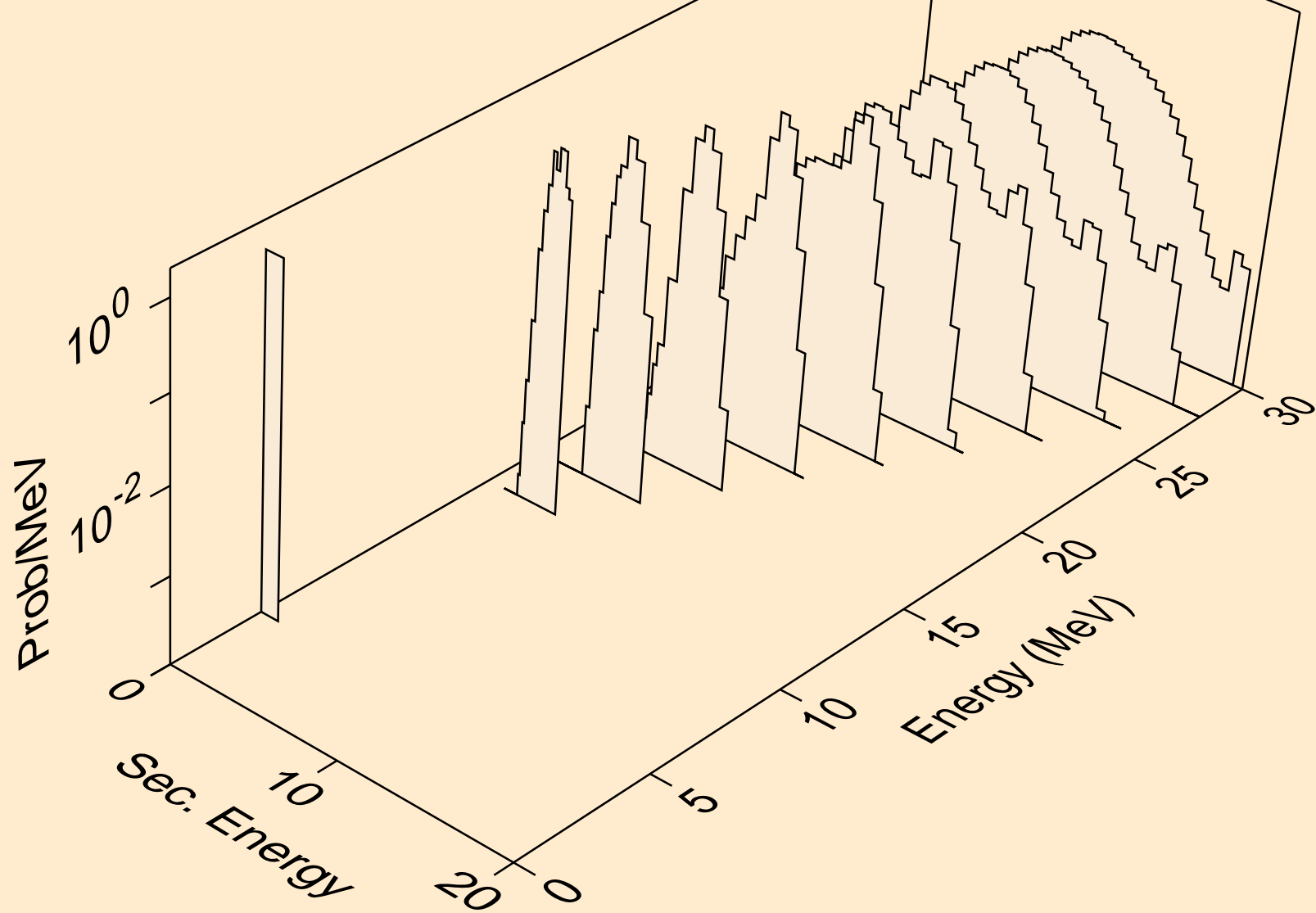



PR144M NEUTRON ACER TENDL-2021 LIBRARY; T=293.6K  
tritons from (n,x)

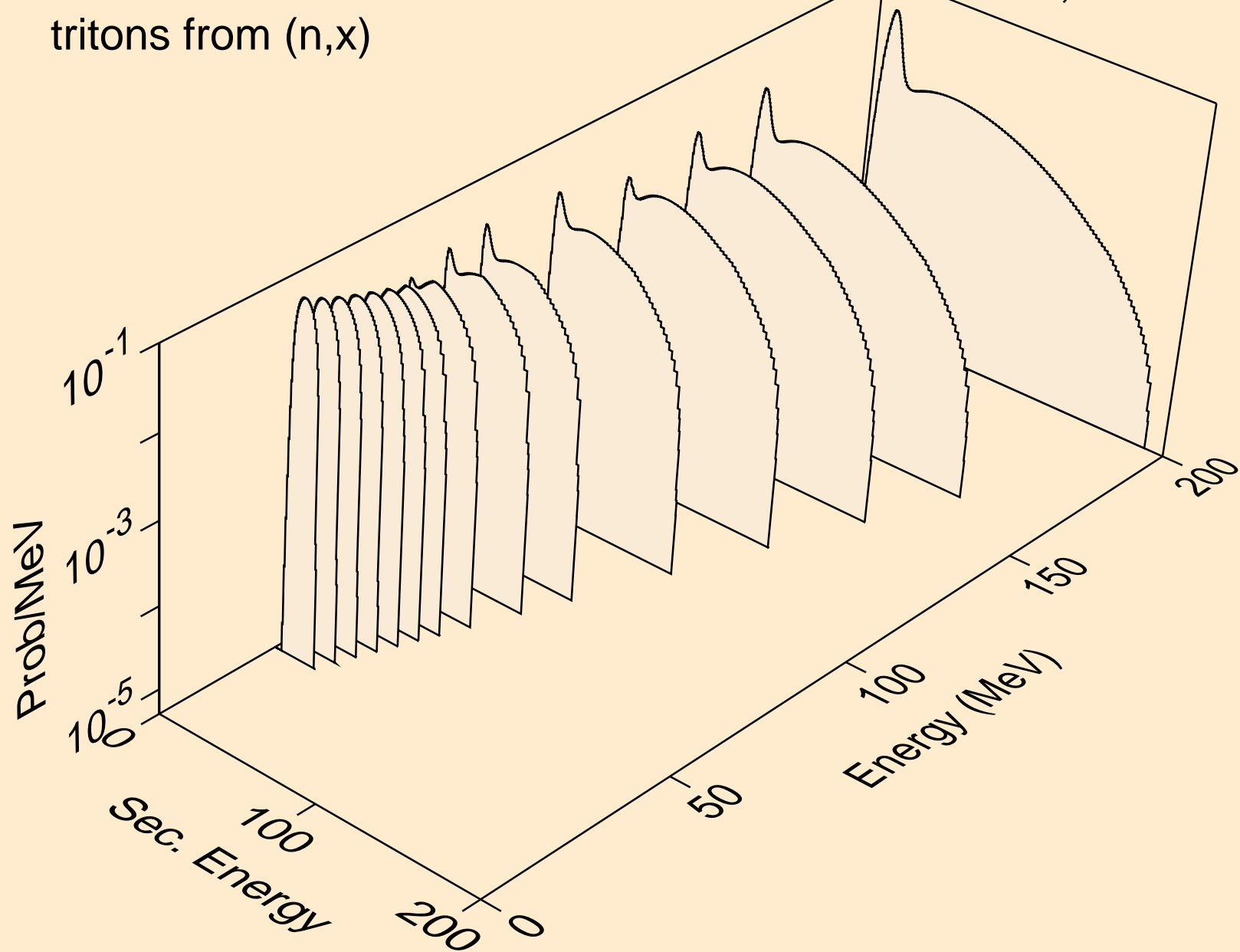

PR144M NEUTRON ACER TENDL-2021 LIBRARY; T=293.6K  
tritons from (n,n\*)t

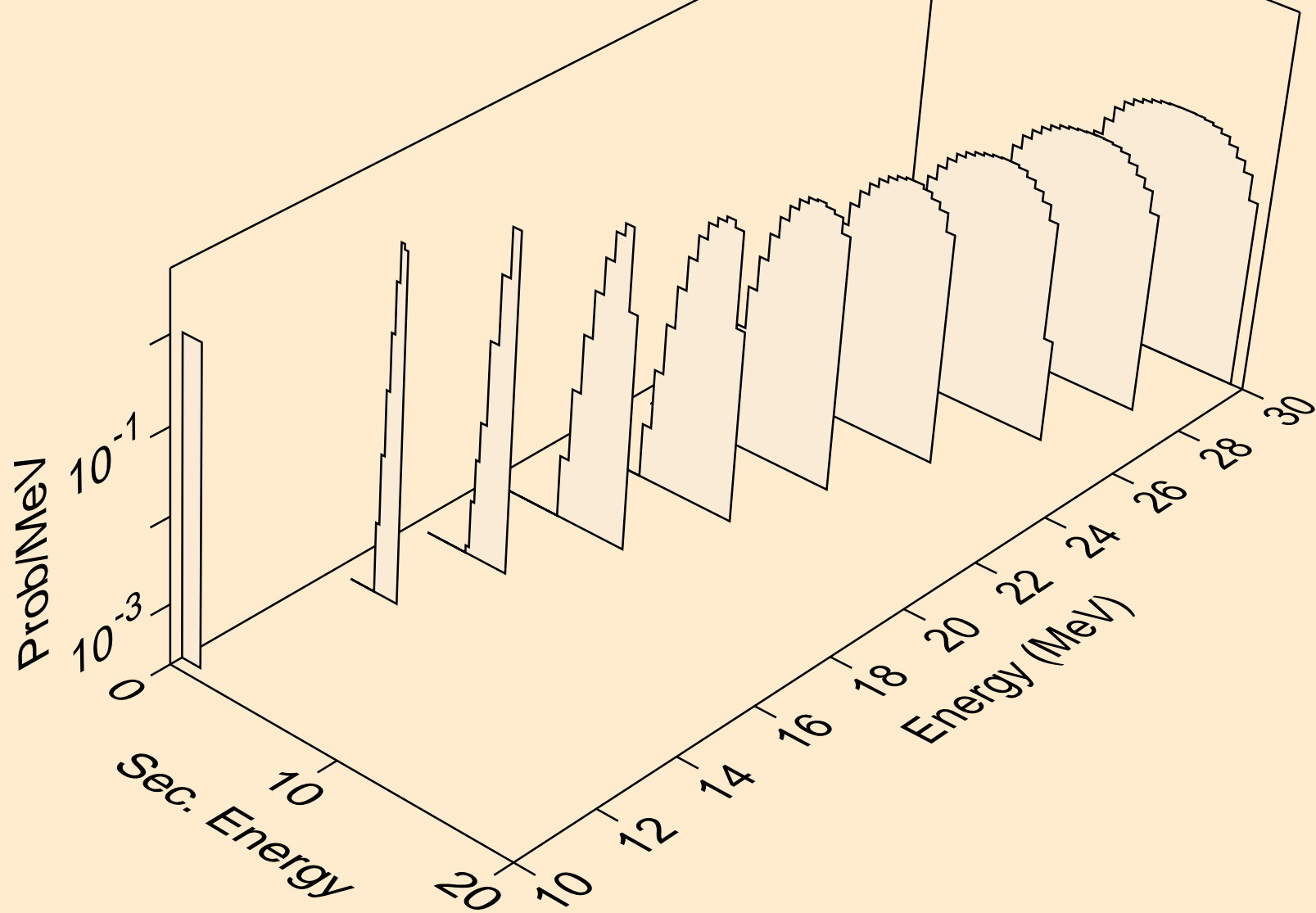

PR144M NEUTRON ACER TENDL-2021 LIBRARY; T=293.6K  
tritons from (n,t)

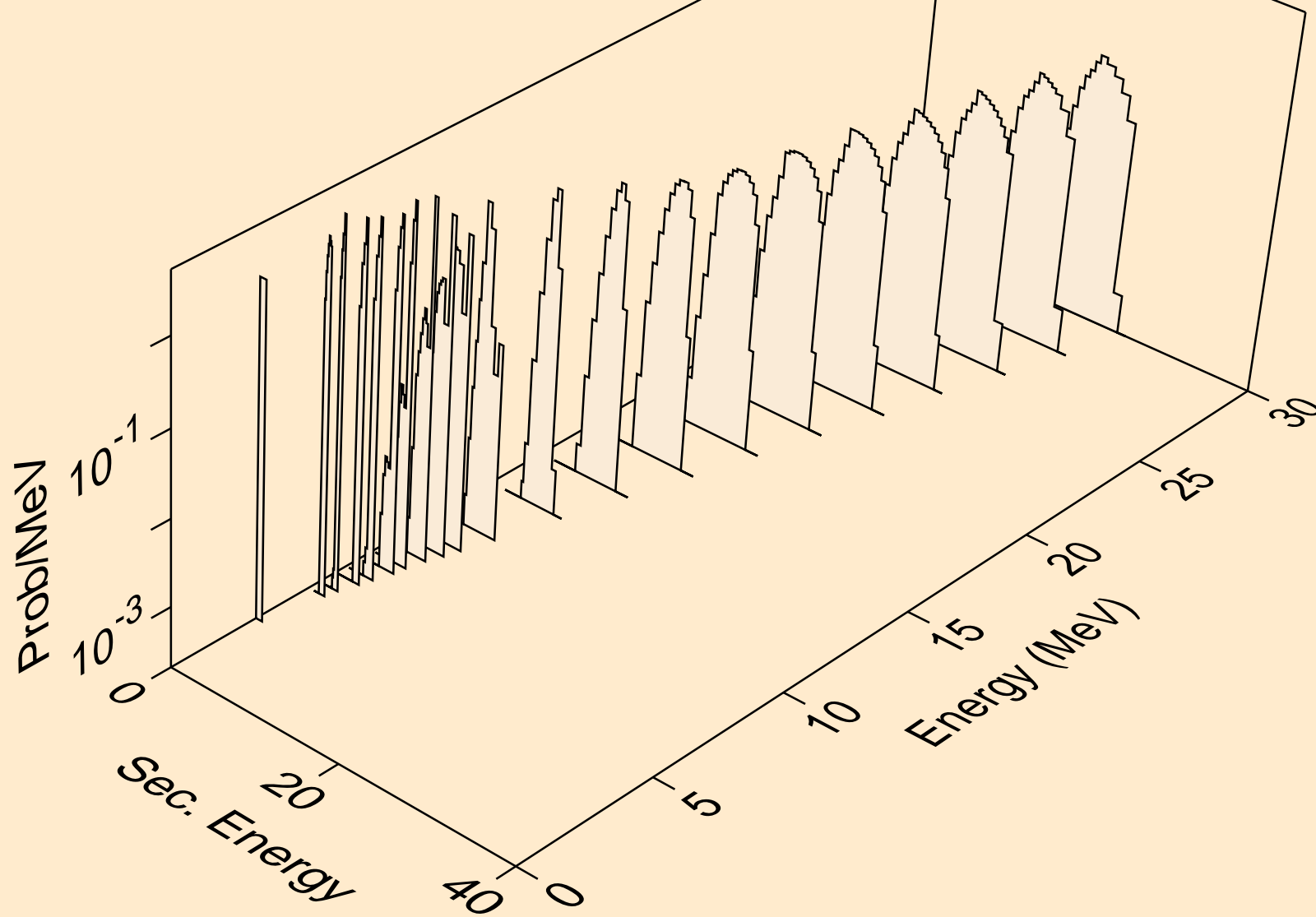

PR144M NEUTRON ACER TENDL-2021 LIBRARY; T=293.6K  
tritons from (n,pt)

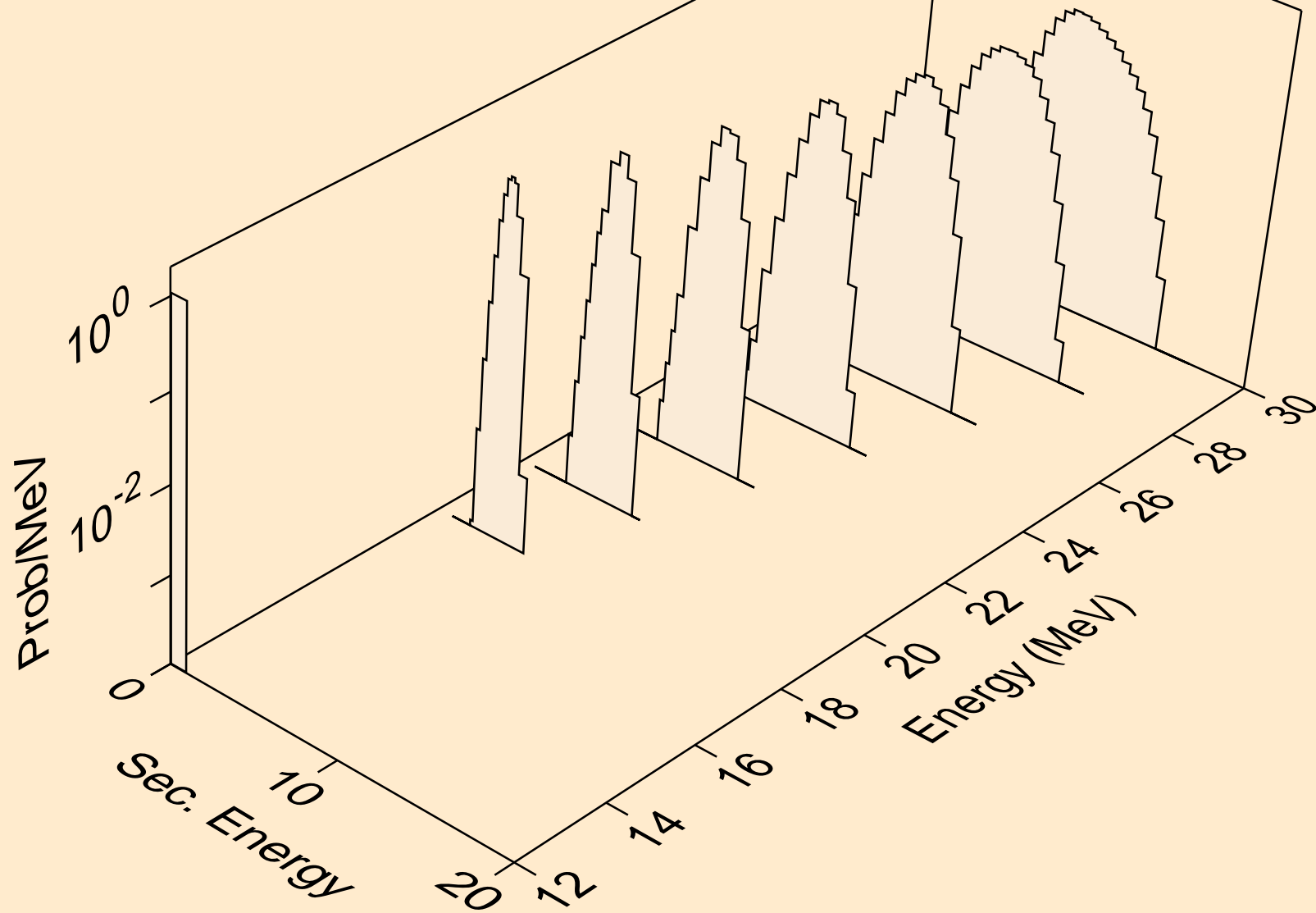

PR144M NEUTRON ACER TENDL-2021 LIBRARY; T=293.6K  
he3s from (n,x)

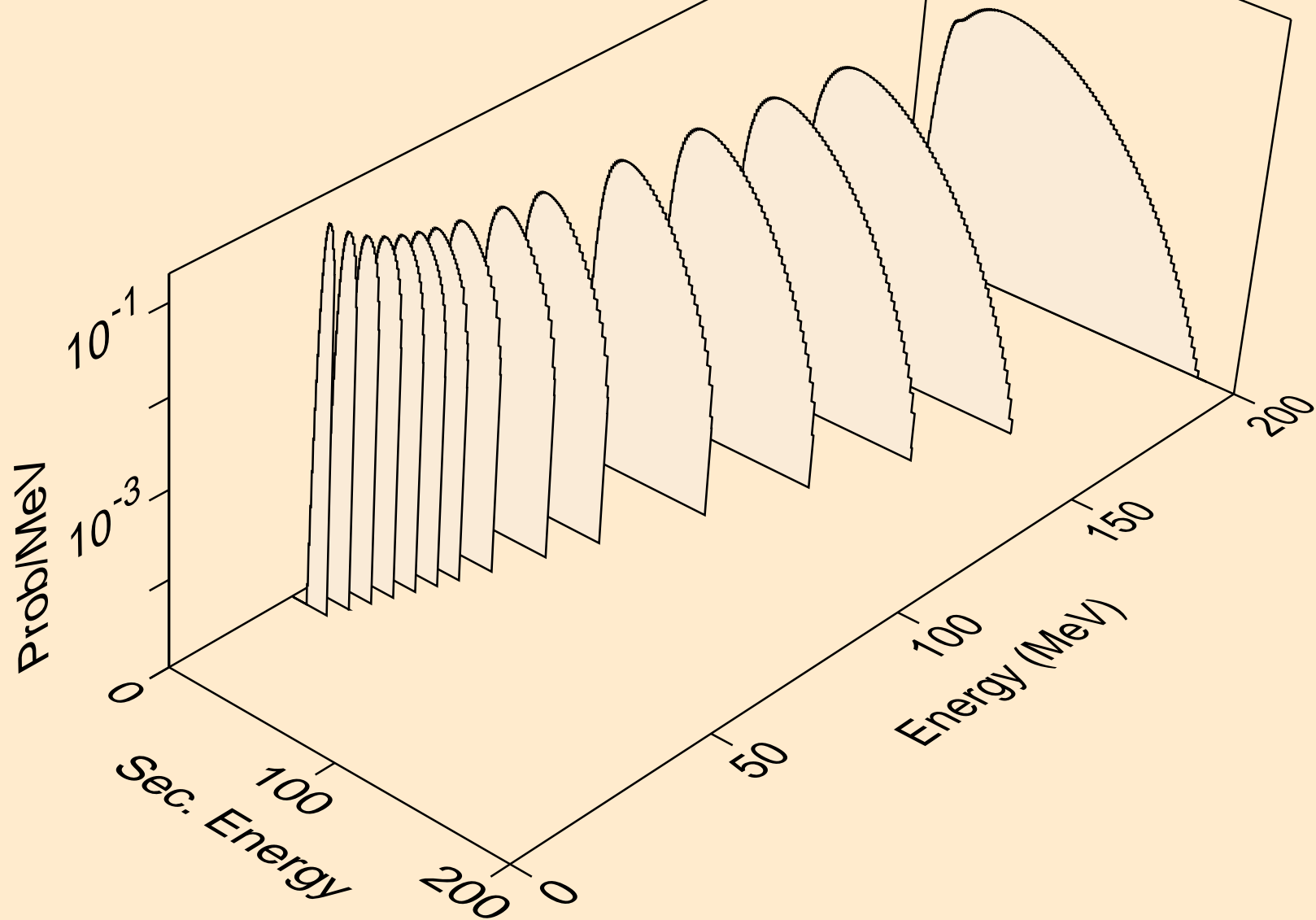

PR144M NEUTRON ACER TENDL-2021 LIBRARY; T=293.6K  
he3s from (n,n\*)he3

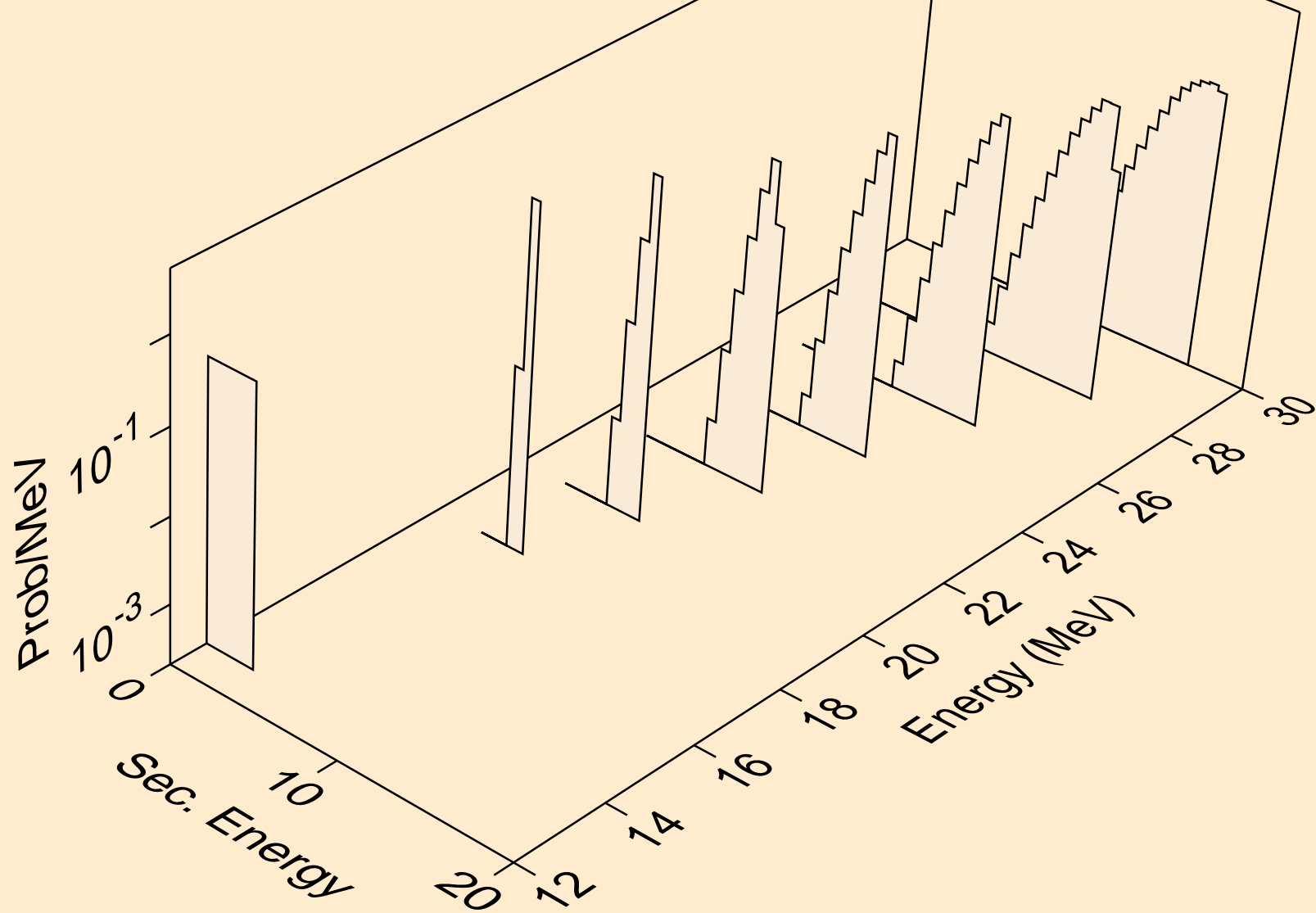

PR144M NEUTRON ACER TENDL-2021 LIBRARY; T=293.6K  
he3s from (n,he3)

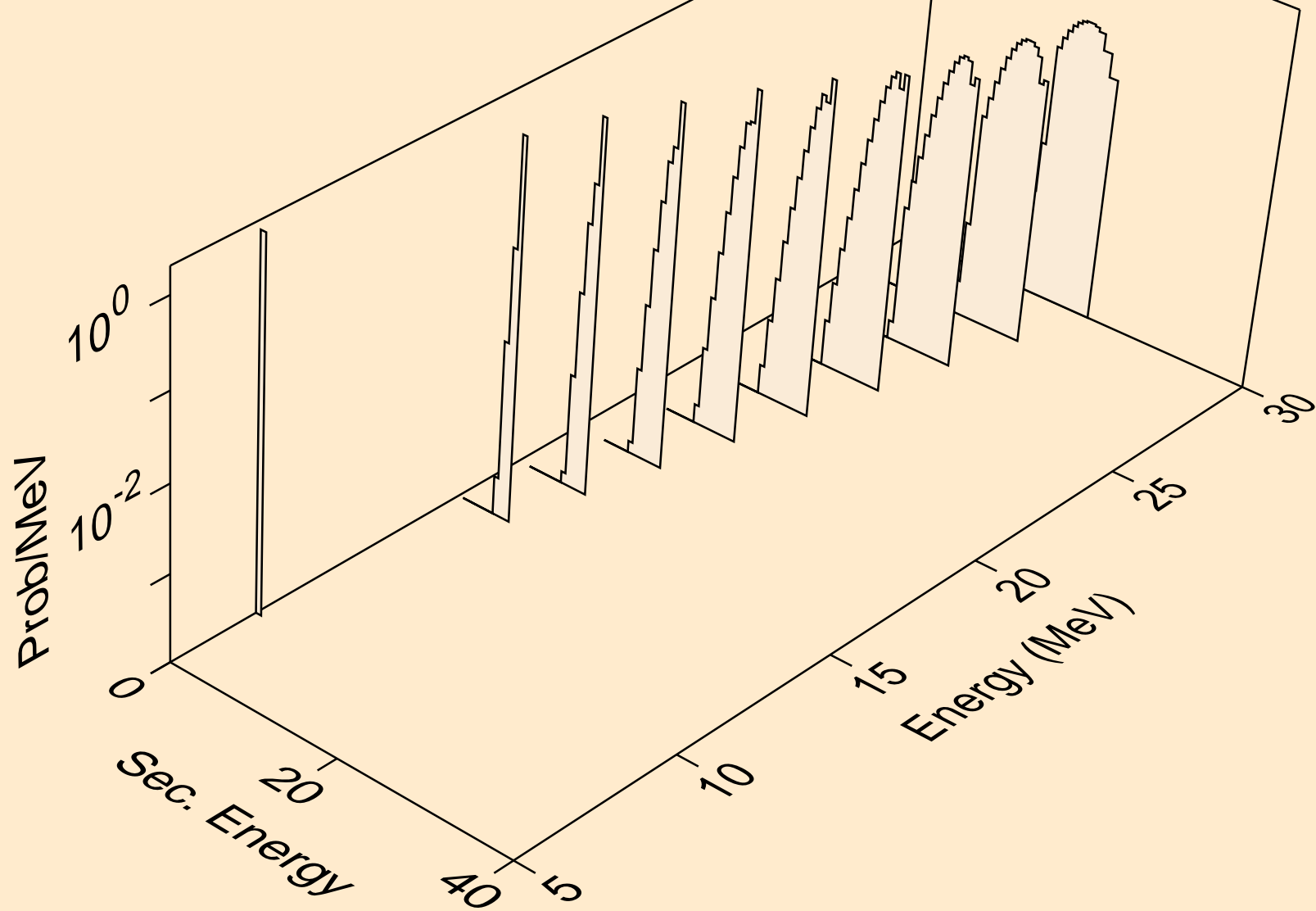

PR144M NEUTRON ACER TENDL-2021 LIBRARY; T=293.6K  
alphas from (n,x)

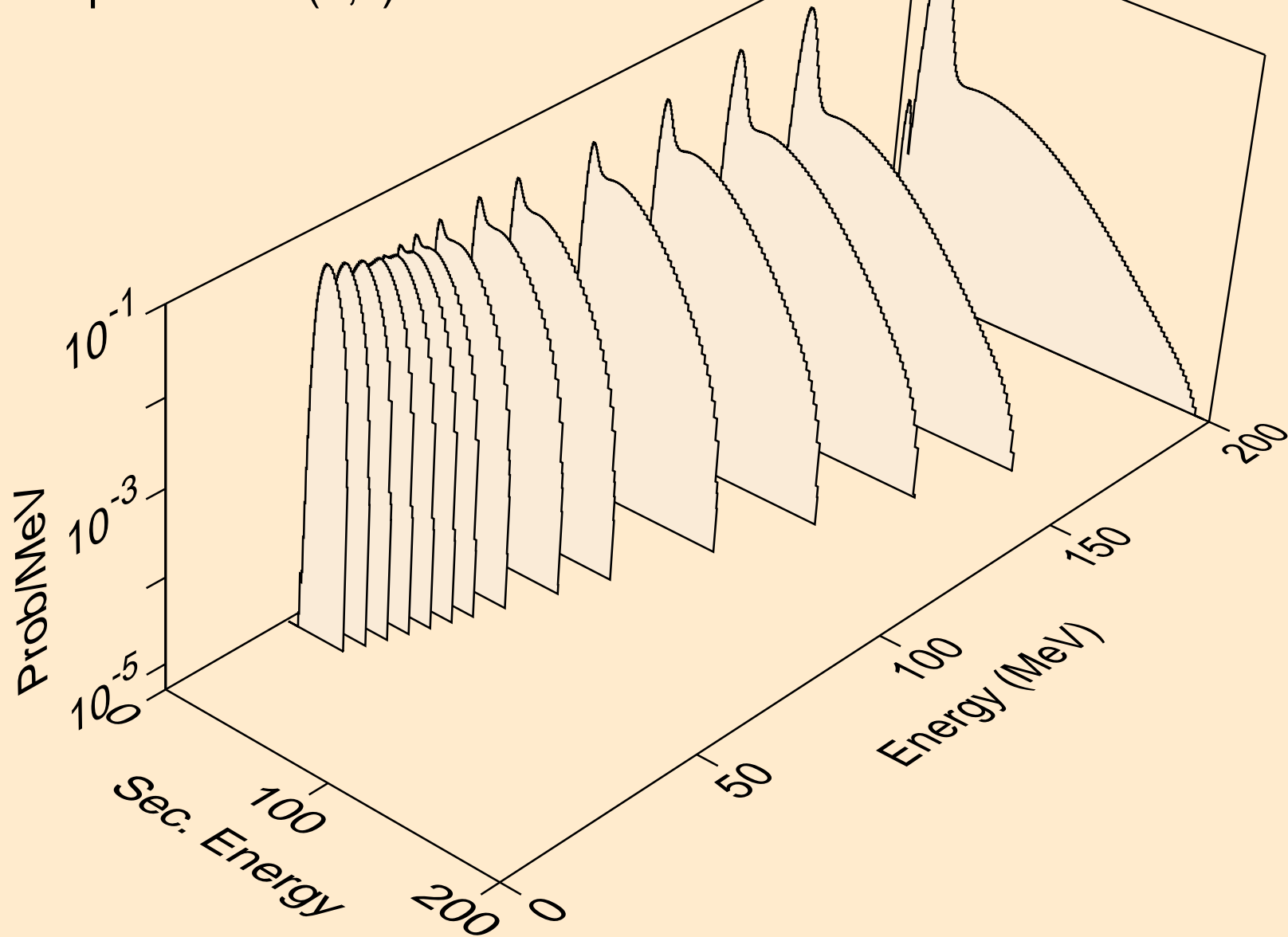



PR144M NEUTRON ACER TENDL-2021 LIBRARY; T=293.6K  
alphas from (n,n\*)a

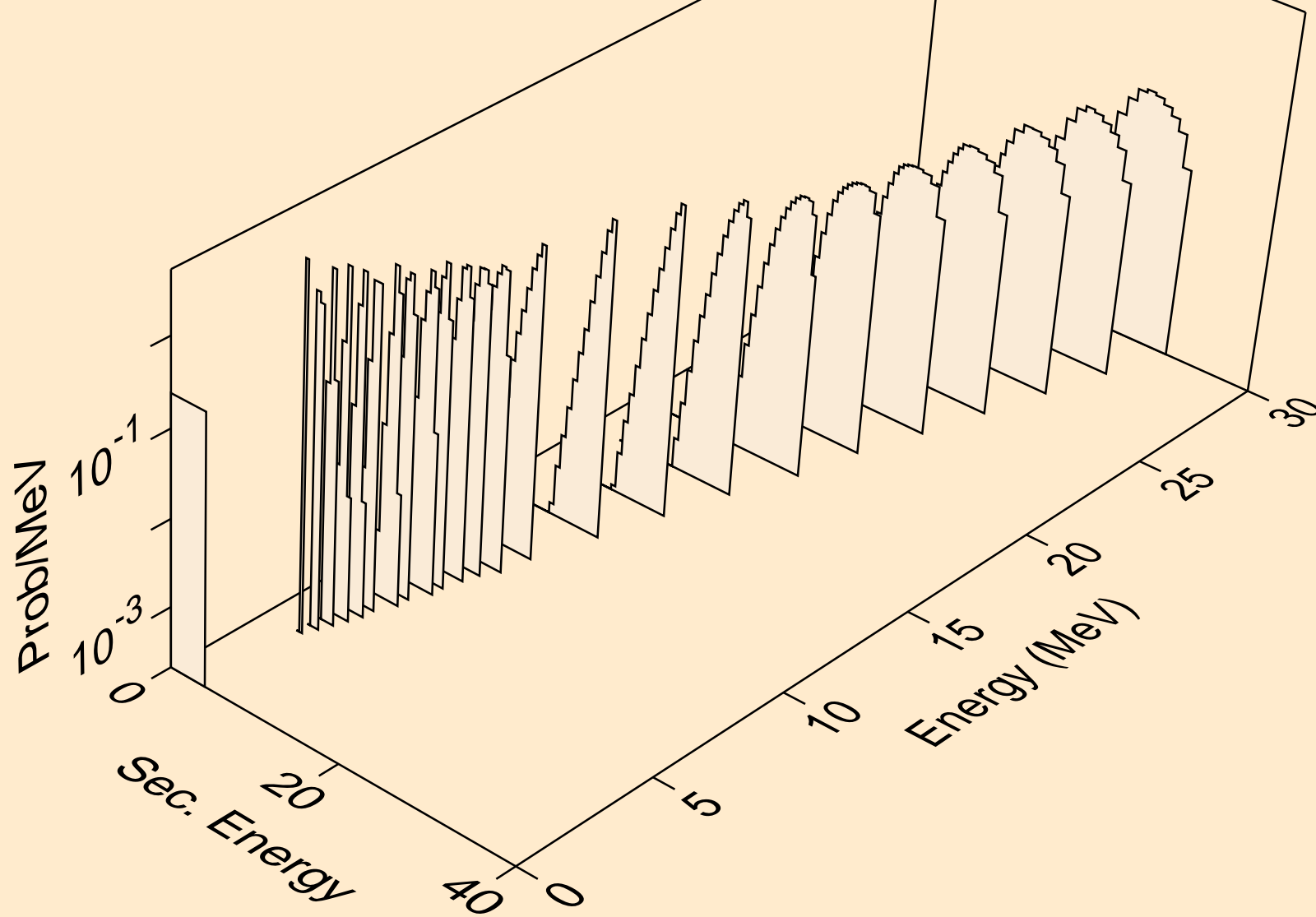

PR144M NEUTRON ACER TENDL-2021 LIBRARY; T=293.6K  
alphas from (n,2n)a

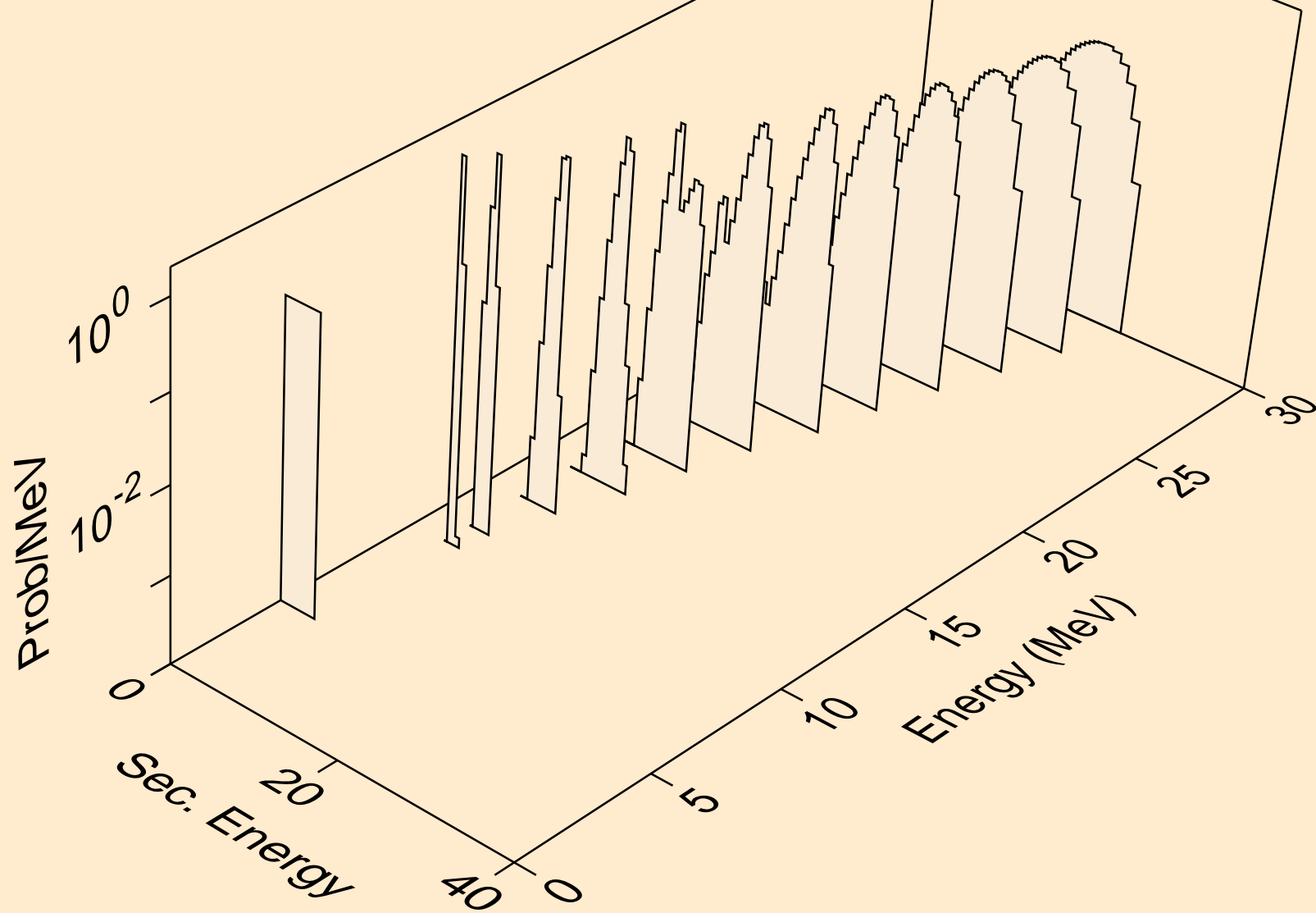

PR144M NEUTRON ACER TENDL-2021 LIBRARY; T=293.6K  
alphas from (n,3n)a

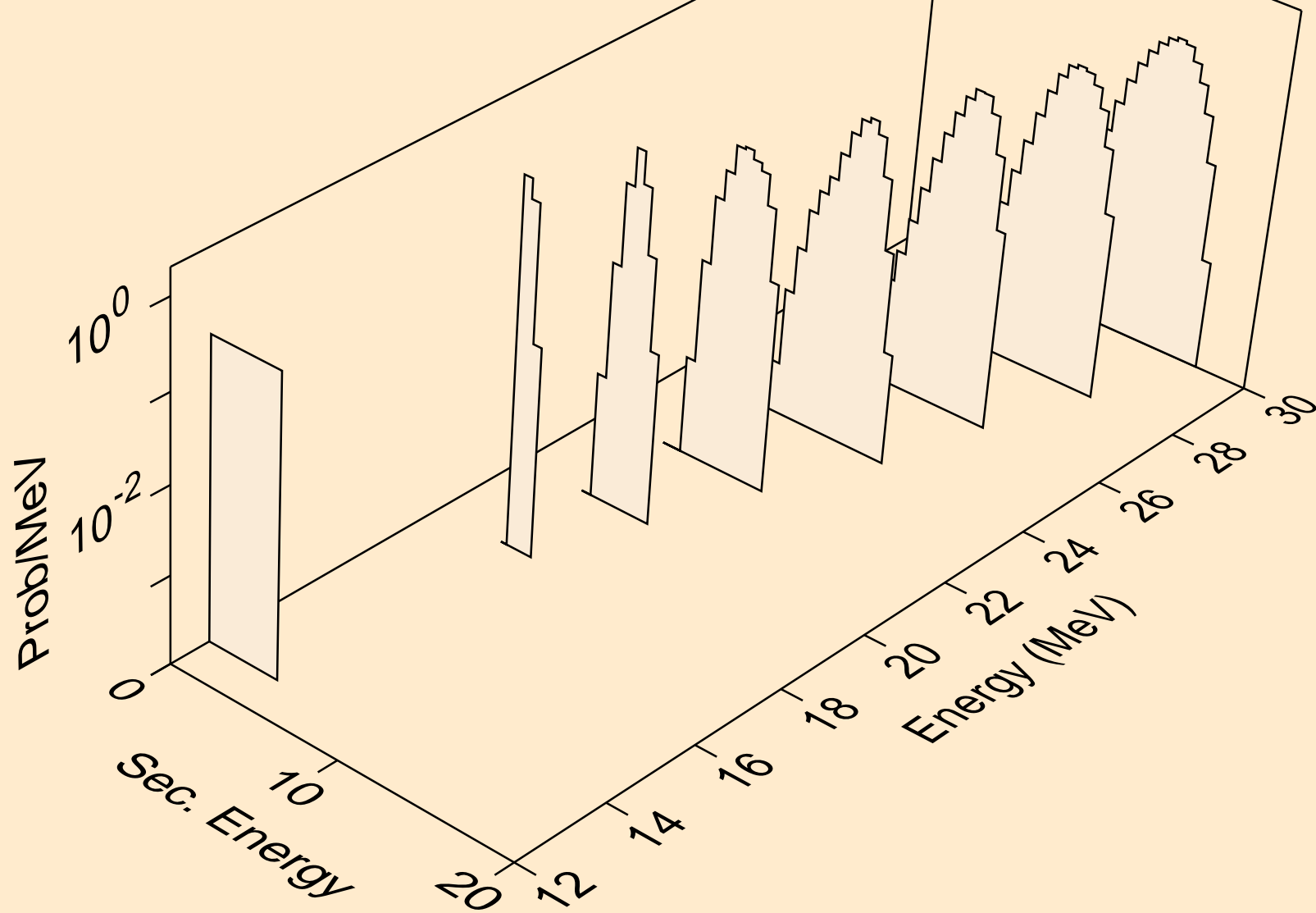

PR144M NEUTRON ACER TENDL-2021 LIBRARY; T=293.6K  
alphas from (n,n\*)2a

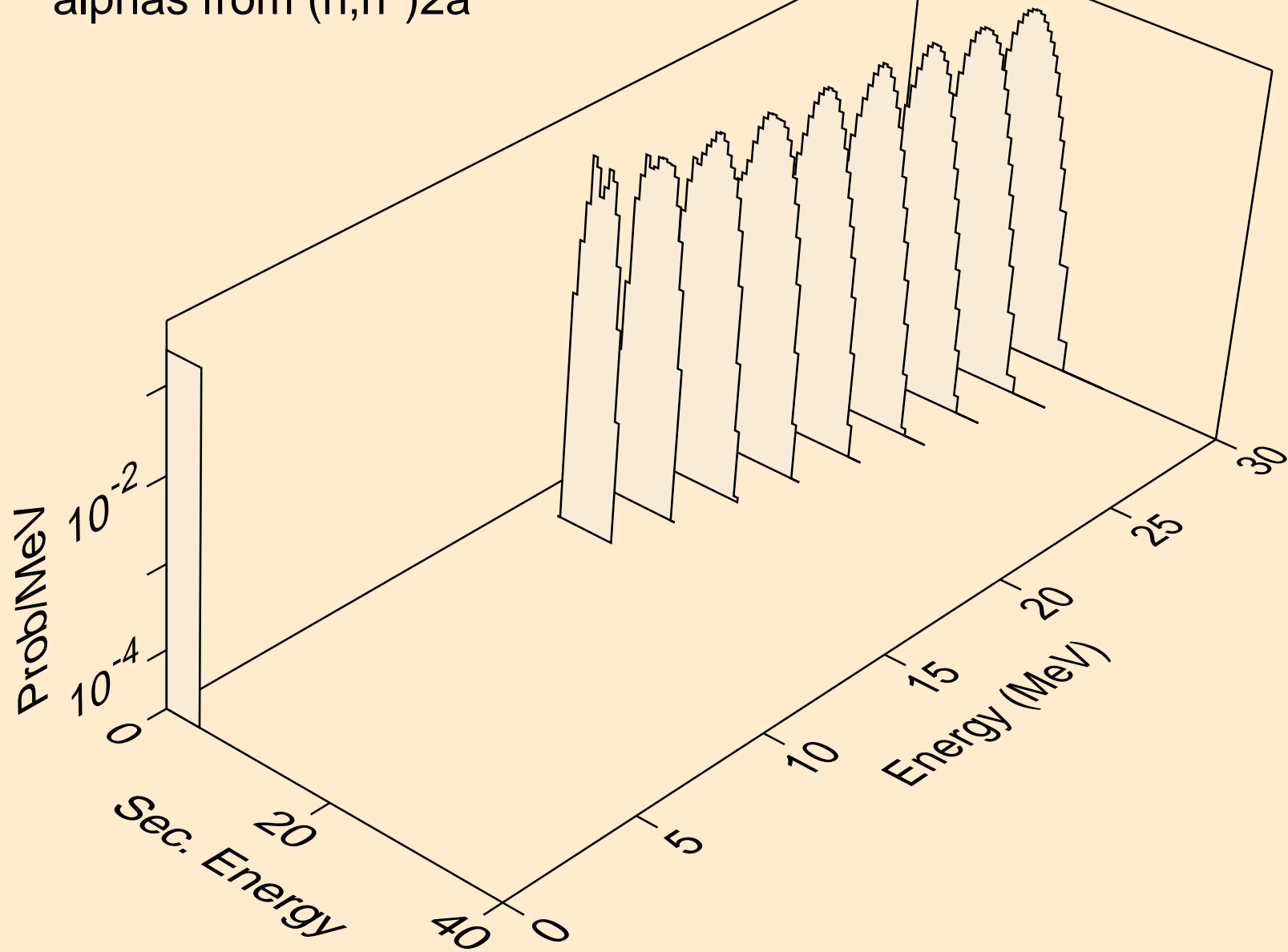

PR144M NEUTRON ACER TENDL-2021 LIBRARY; T=293.6K  
alphas from (n,npa)

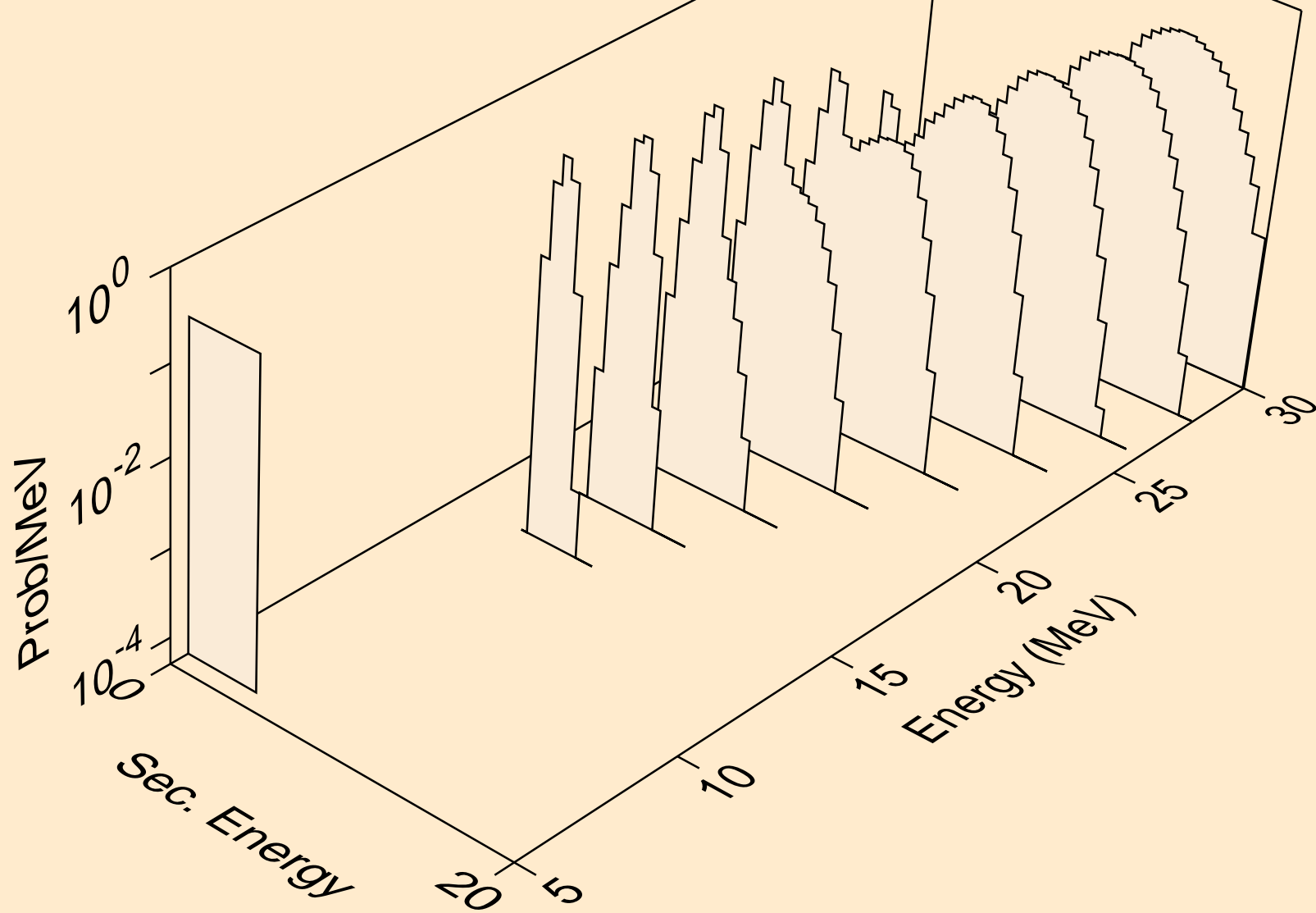

PR144M NEUTRON ACER TENDL-2021 LIBRARY; T=293.6K  
alphas from (n,a)

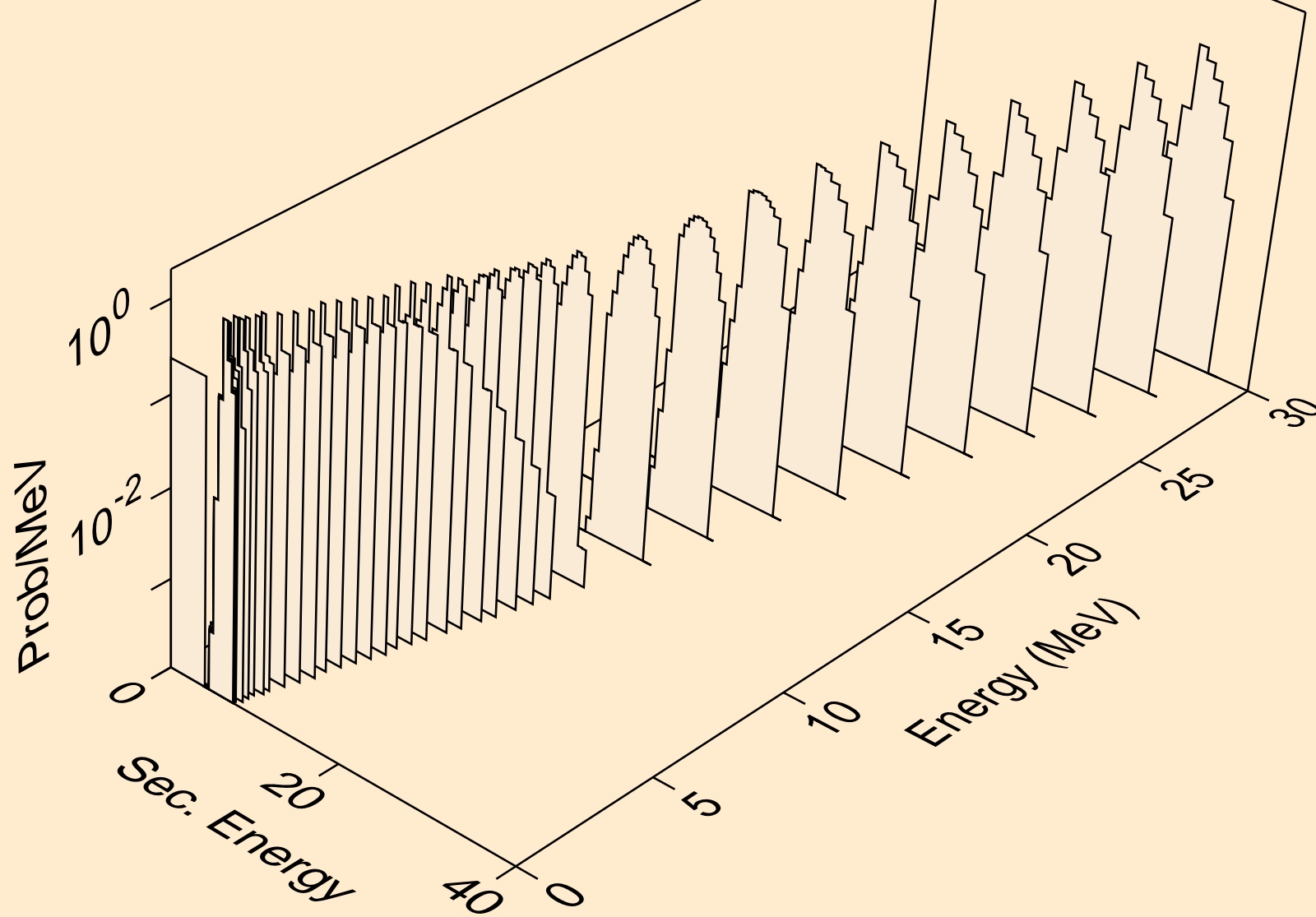

PR144M NEUTRON ACER TENDL-2021 LIBRARY; T=293.6K  
alphas from (n,2a)

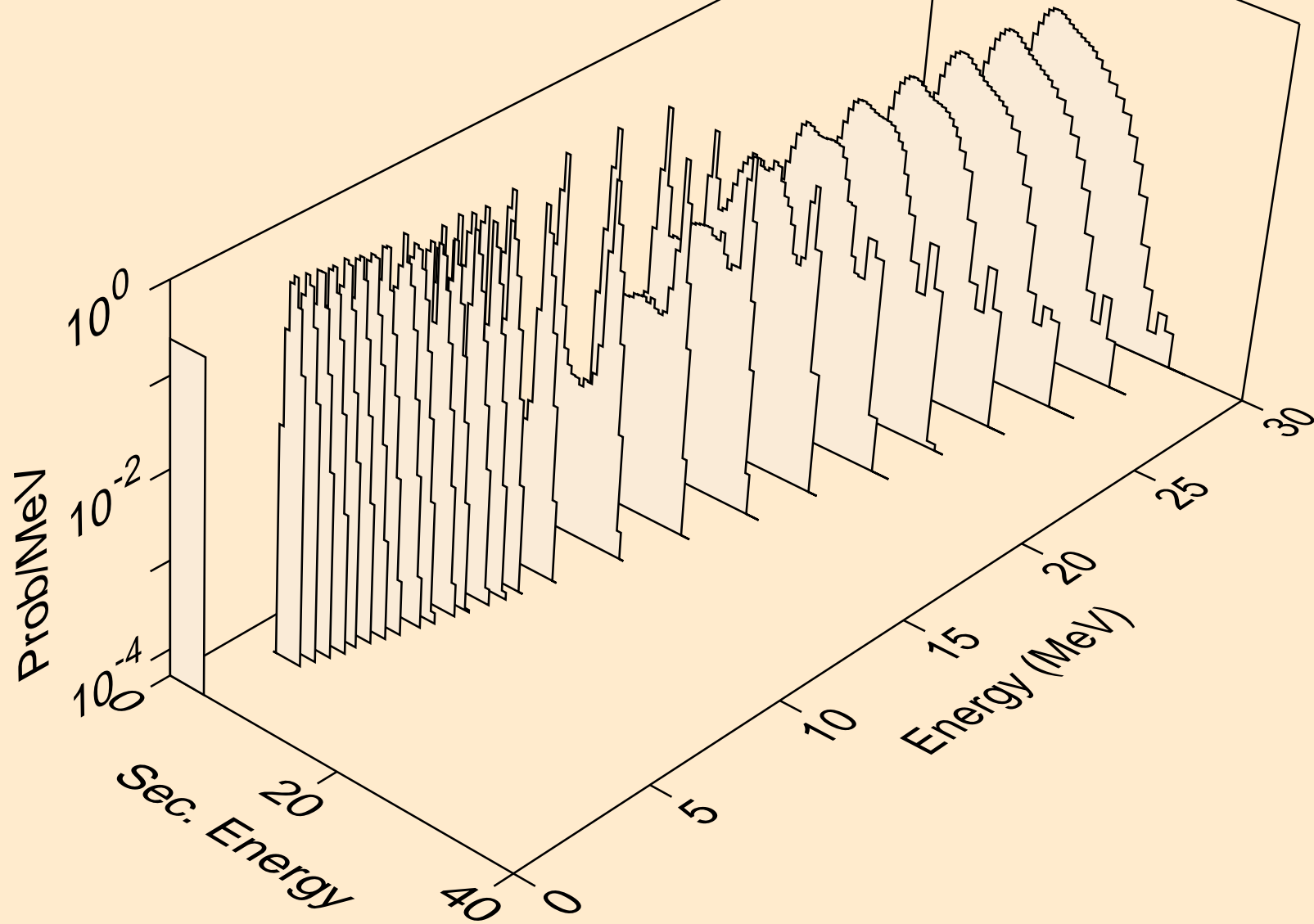

PR144M NEUTRON ACER TENDL-2021 LIBRARY; T=293.6K  
alphas from (n,pa)

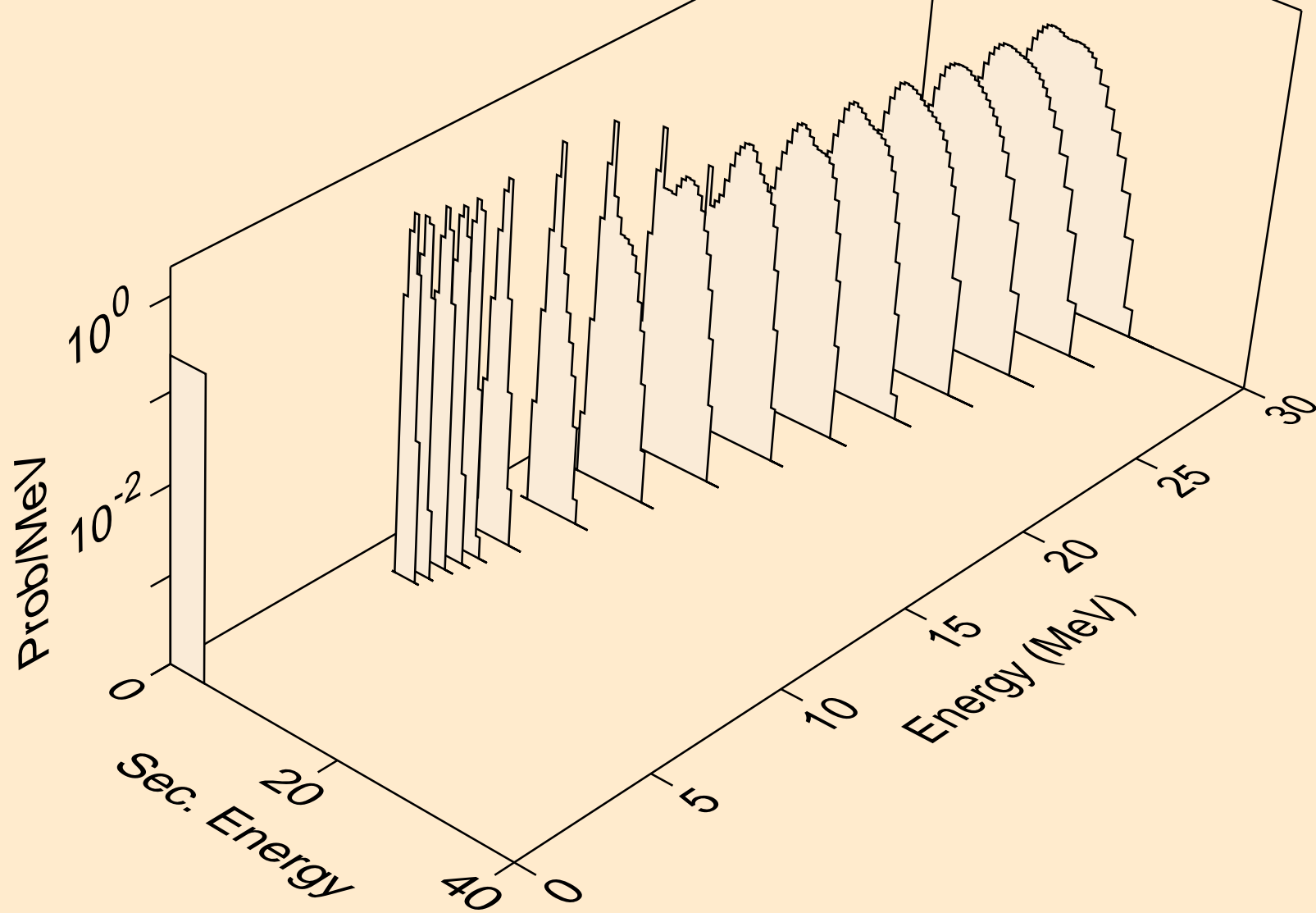



PR144M NEUTRON ACER TENDL-2021 LIBRARY; T=293.6K  
alphas from (n,da)

