

PT179 NEUTRON ACER TENDL-2021 LIBRARY; T=293.6K  
Principal cross sections

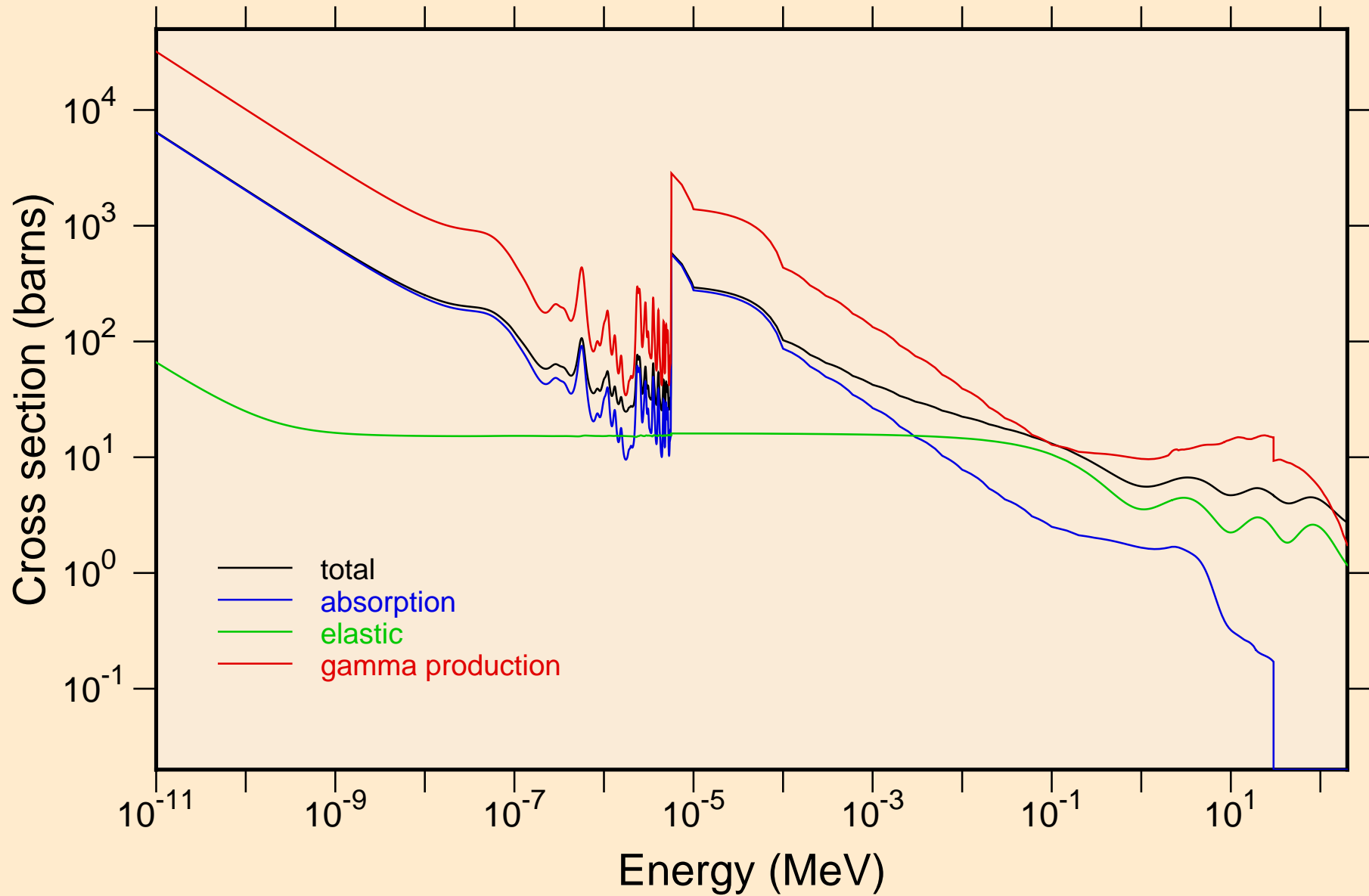

PT179 NEUTRON ACER TENDL-2021 LIBRARY; T=293.6K  
resonance total cross section

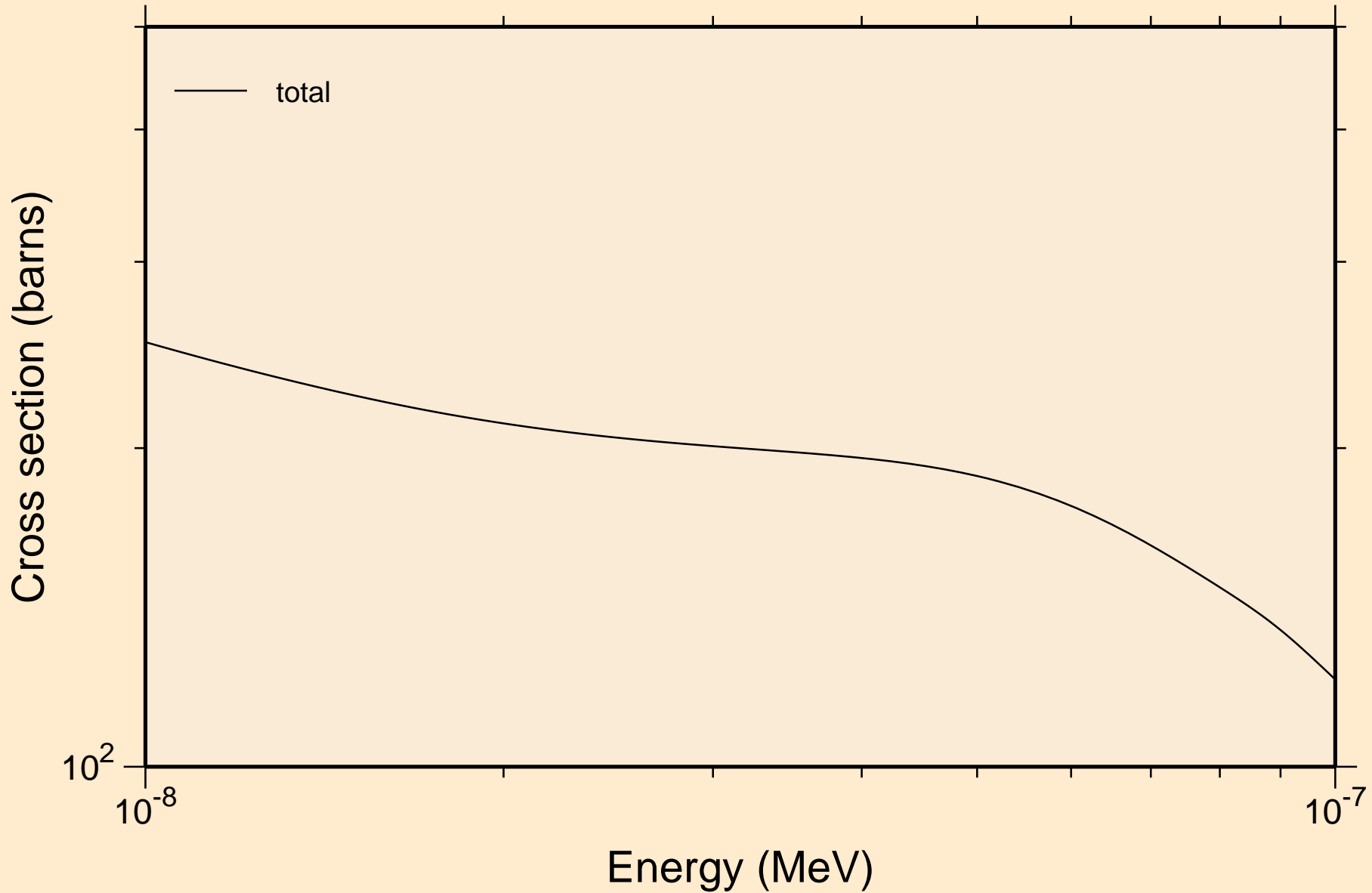

PT179 NEUTRON ACER TENDL-2021 LIBRARY; T=293.6K  
resonance total cross section

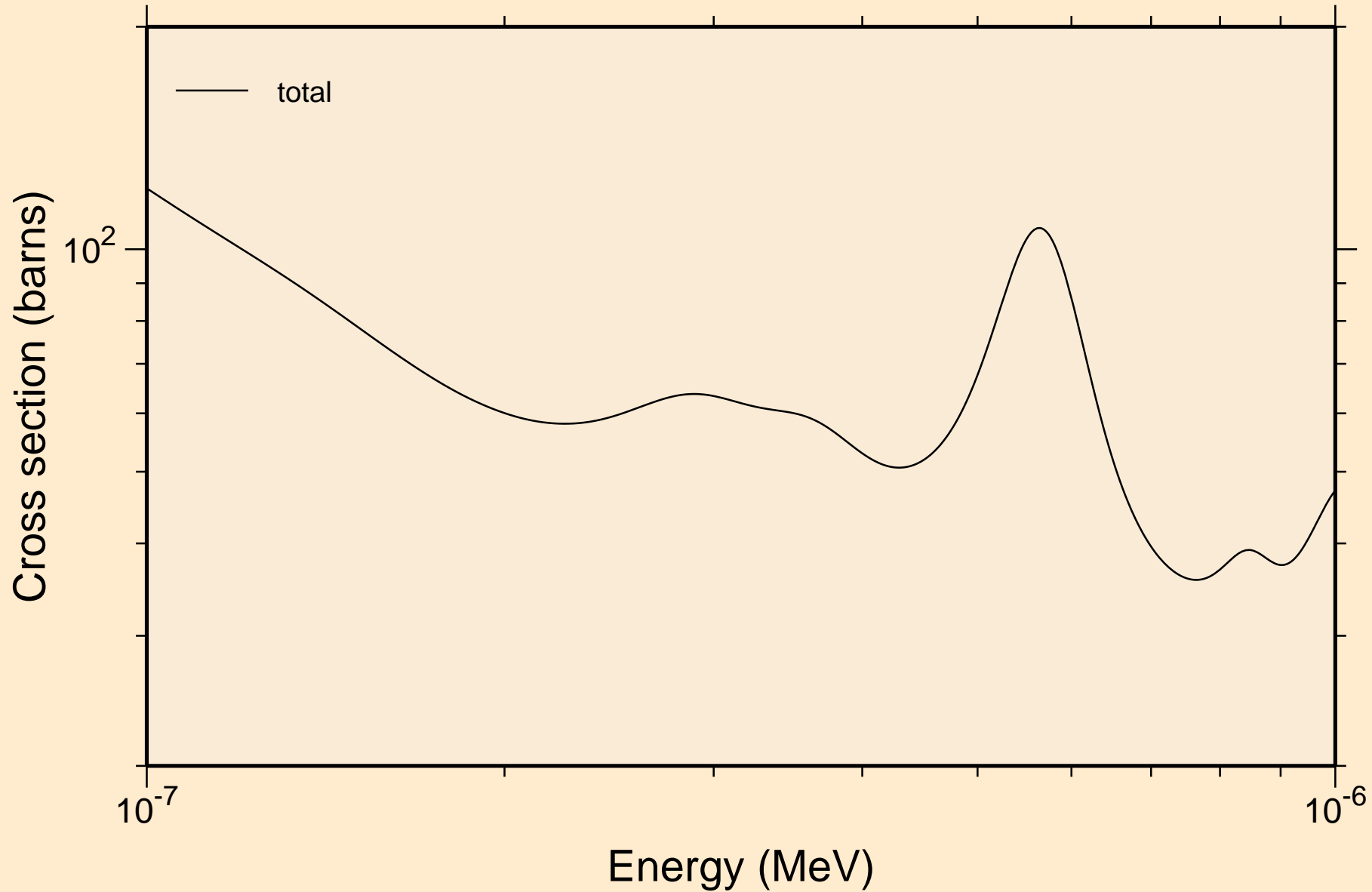

PT179 NEUTRON ACER TENDL-2021 LIBRARY; T=293.6K  
resonance total cross section

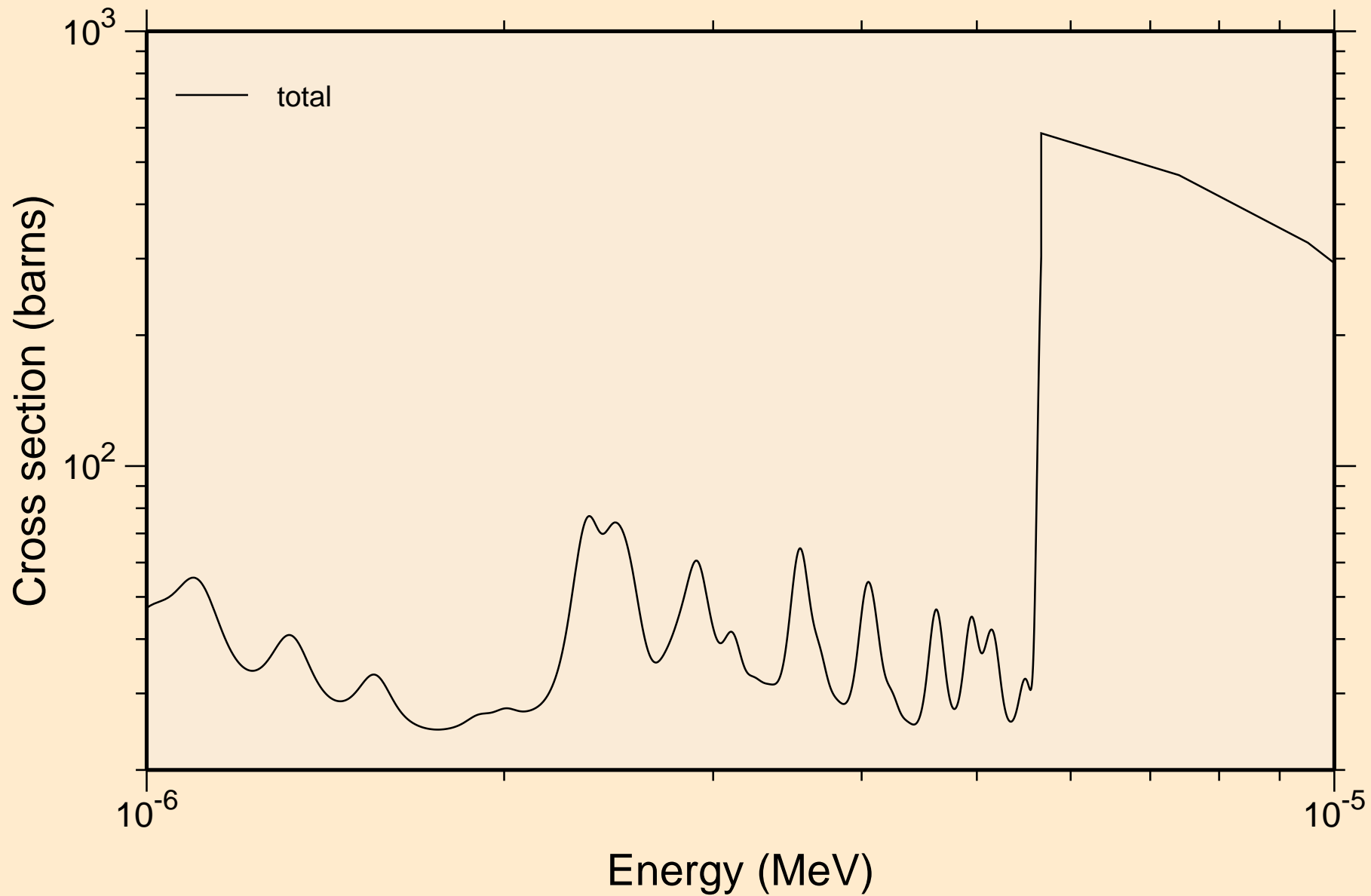

PT179 NEUTRON ACER TENDL-2021 LIBRARY; T=293.6K  
resonance total cross section

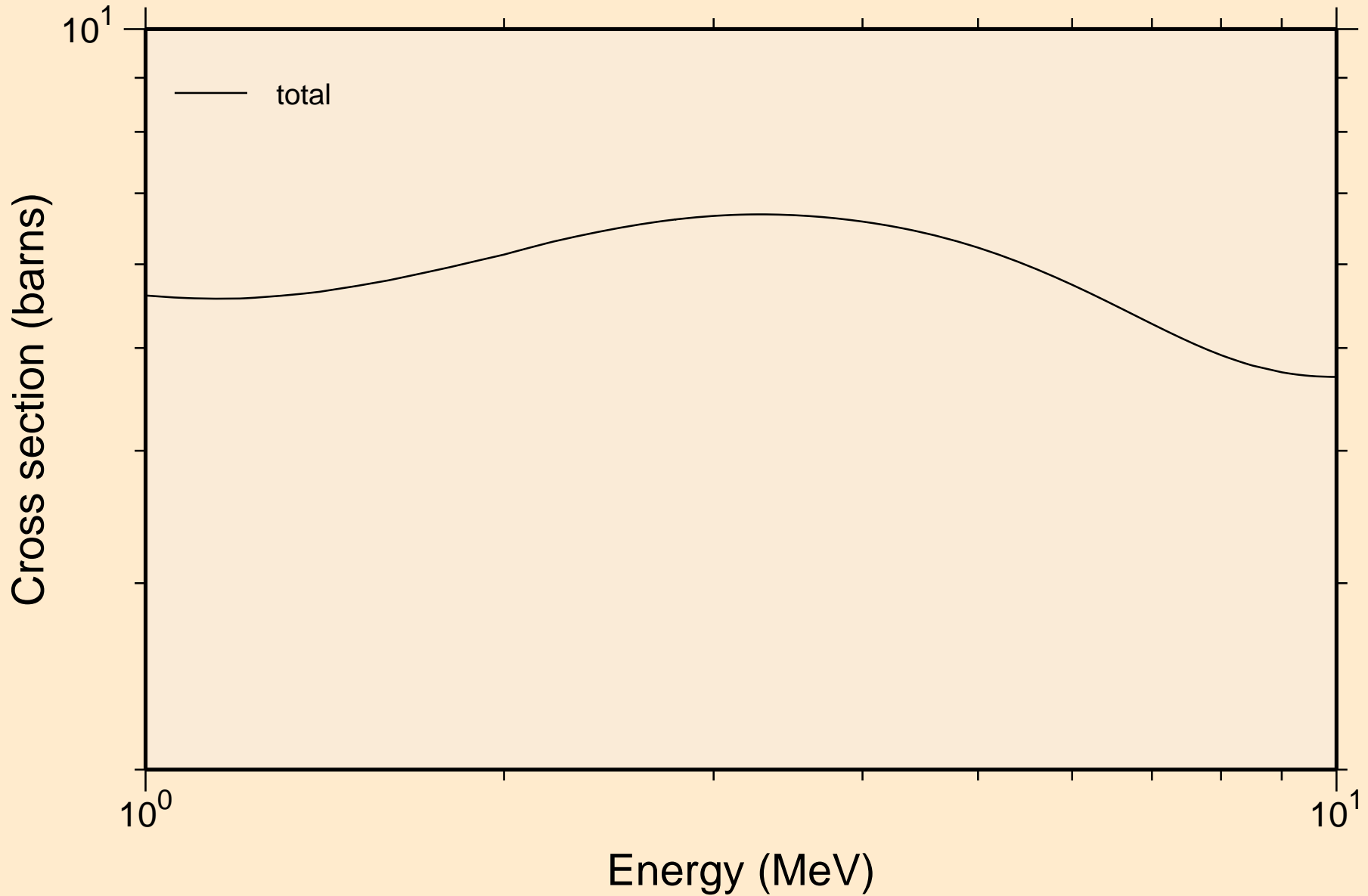

PT179 NEUTRON ACER TENDL-2021 LIBRARY; T=293.6K  
resonance absorption cross sections

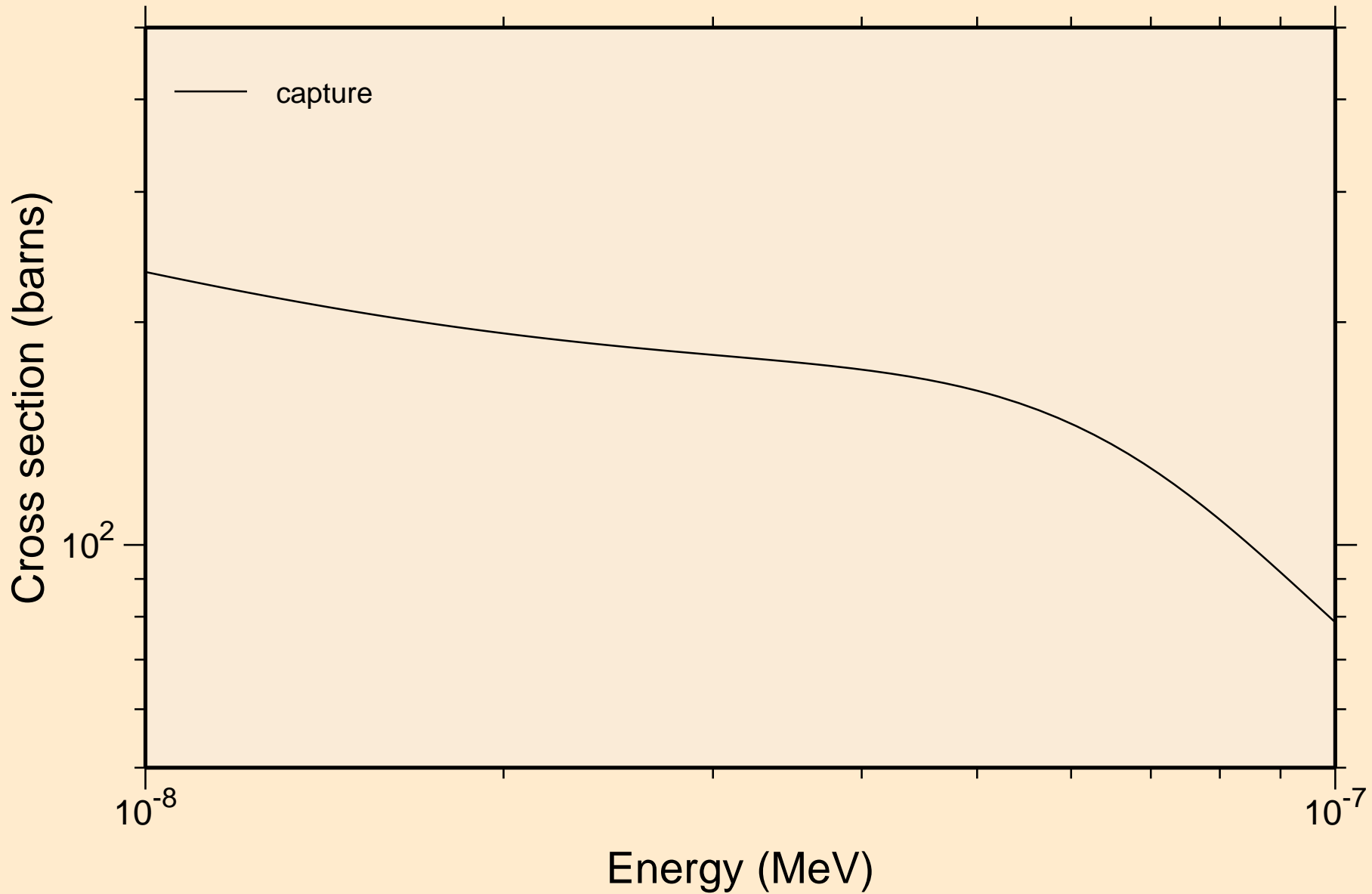

PT179 NEUTRON ACER TENDL-2021 LIBRARY; T=293.6K  
resonance absorption cross sections

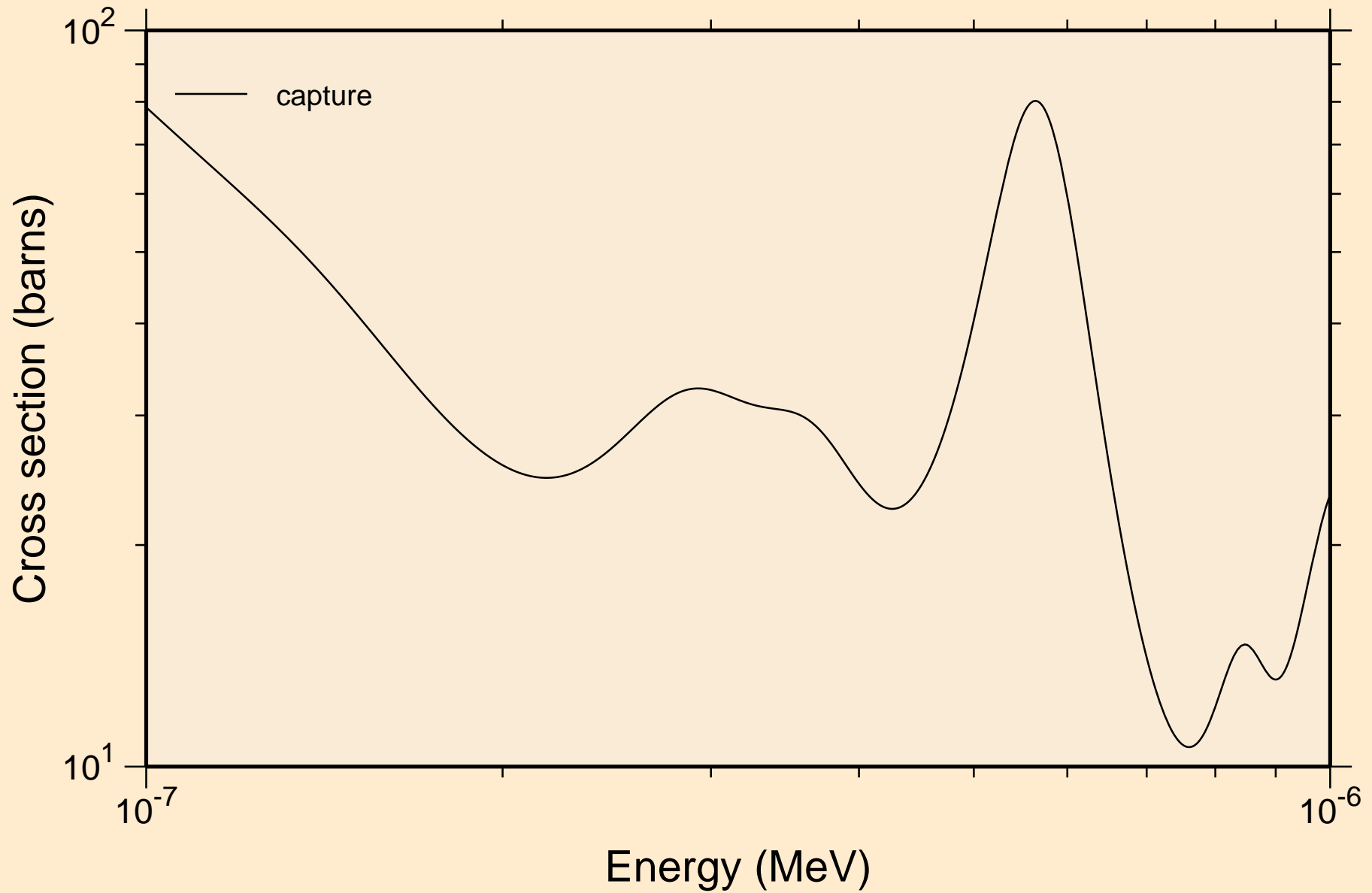

PT179 NEUTRON ACER TENDL-2021 LIBRARY; T=293.6K  
resonance absorption cross sections

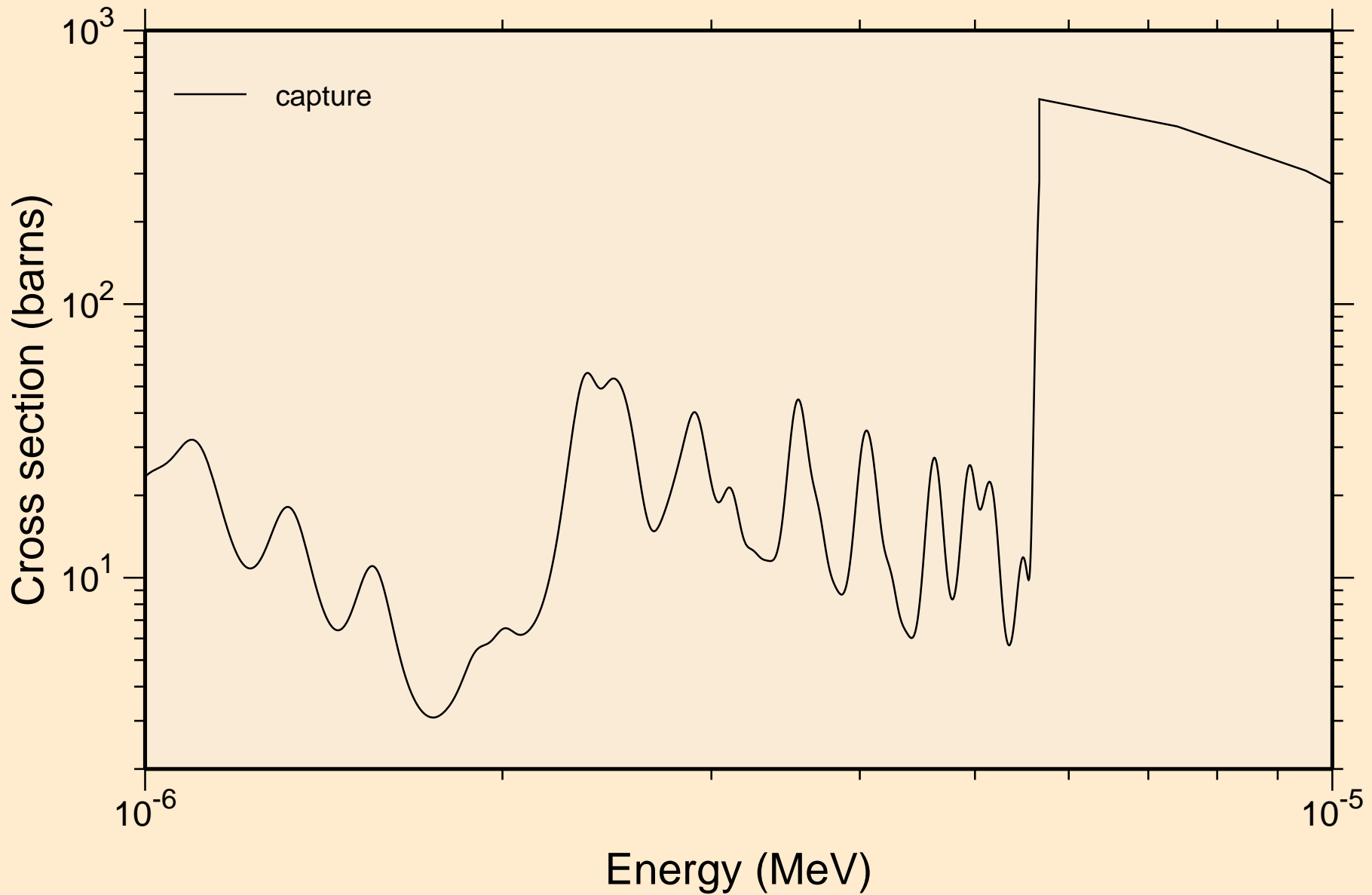



PT179 NEUTRON ACER TENDL-2021 LIBRARY; T=293.6K  
resonance absorption cross sections

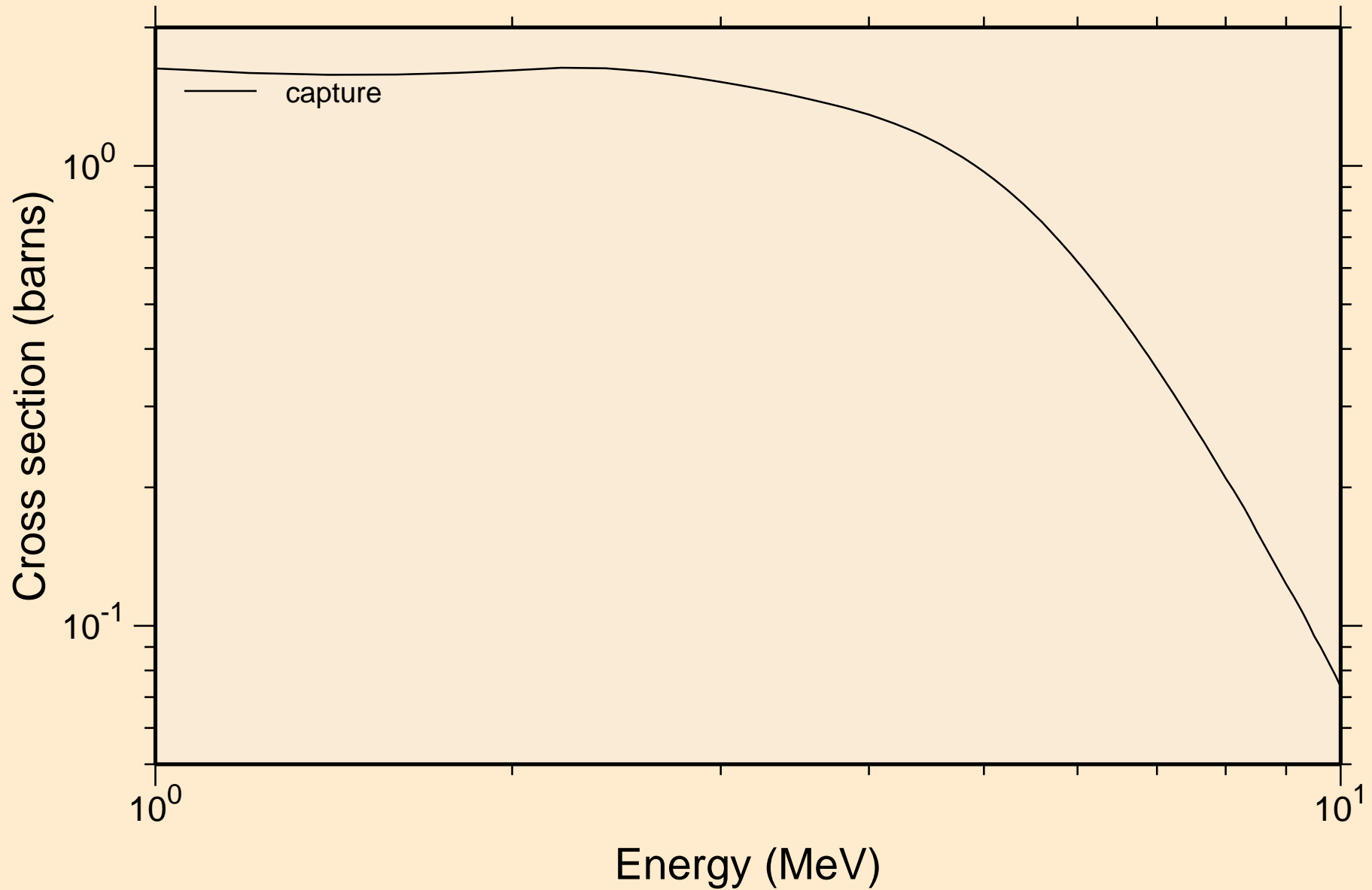

PT179 NEUTRON ACER TENDL-2021 LIBRARY; T=293.6K  
Heating

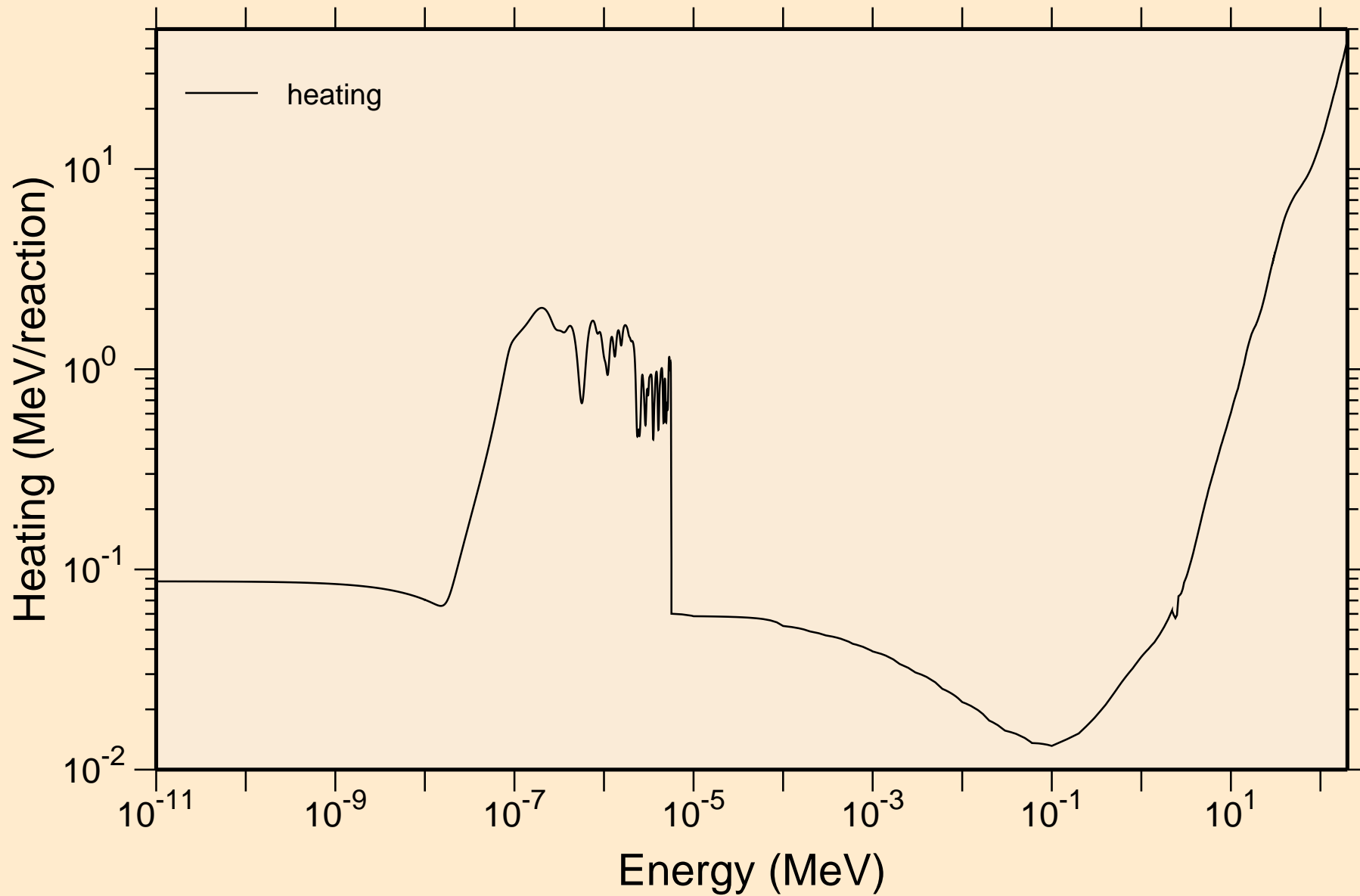

PT179 NEUTRON ACER TENDL-2021 LIBRARY; T=293.6K  
Damage

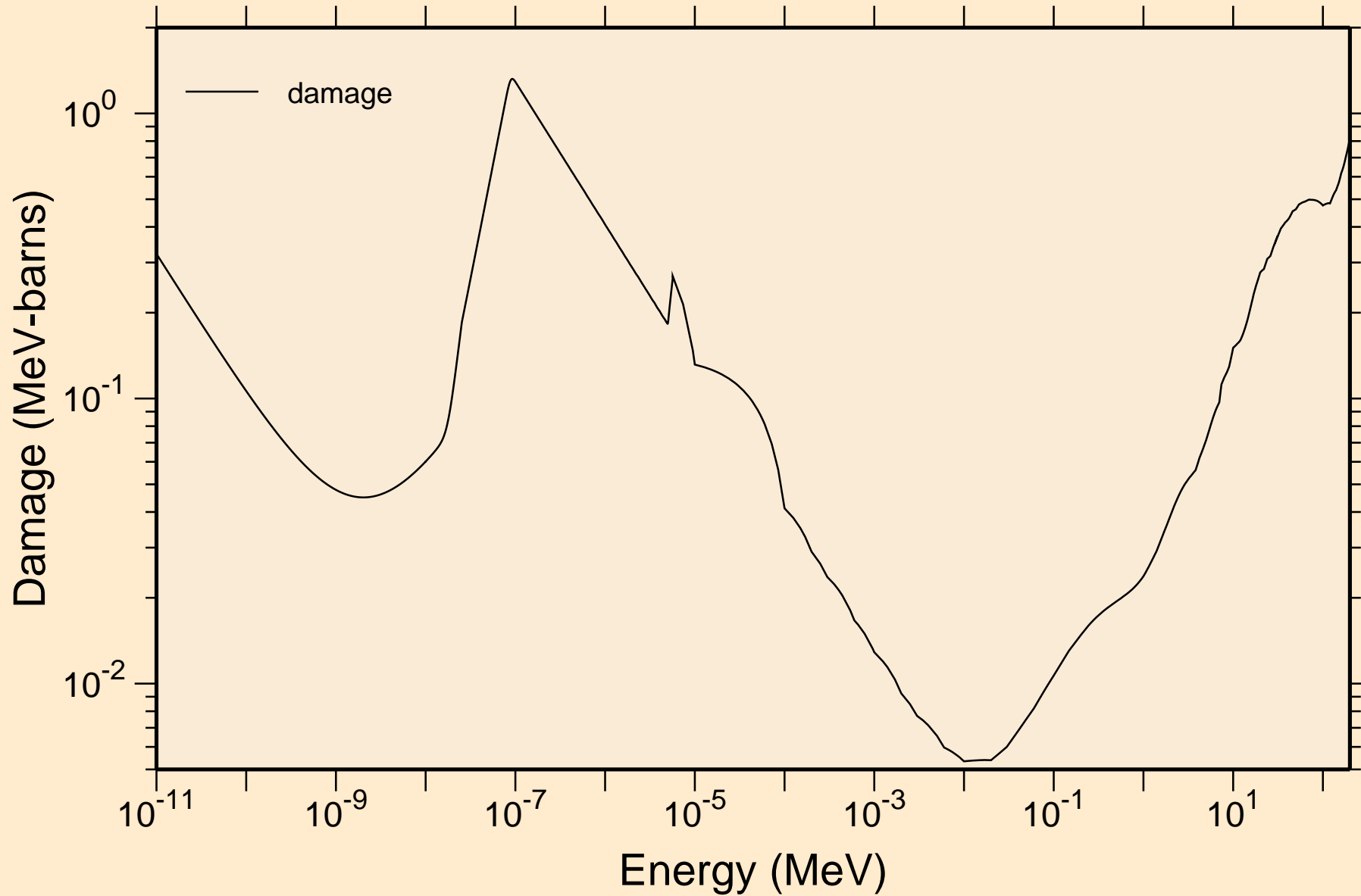

PT179 NEUTRON ACER TENDL-2021 LIBRARY; T=293.6K  
Non-threshold reactions

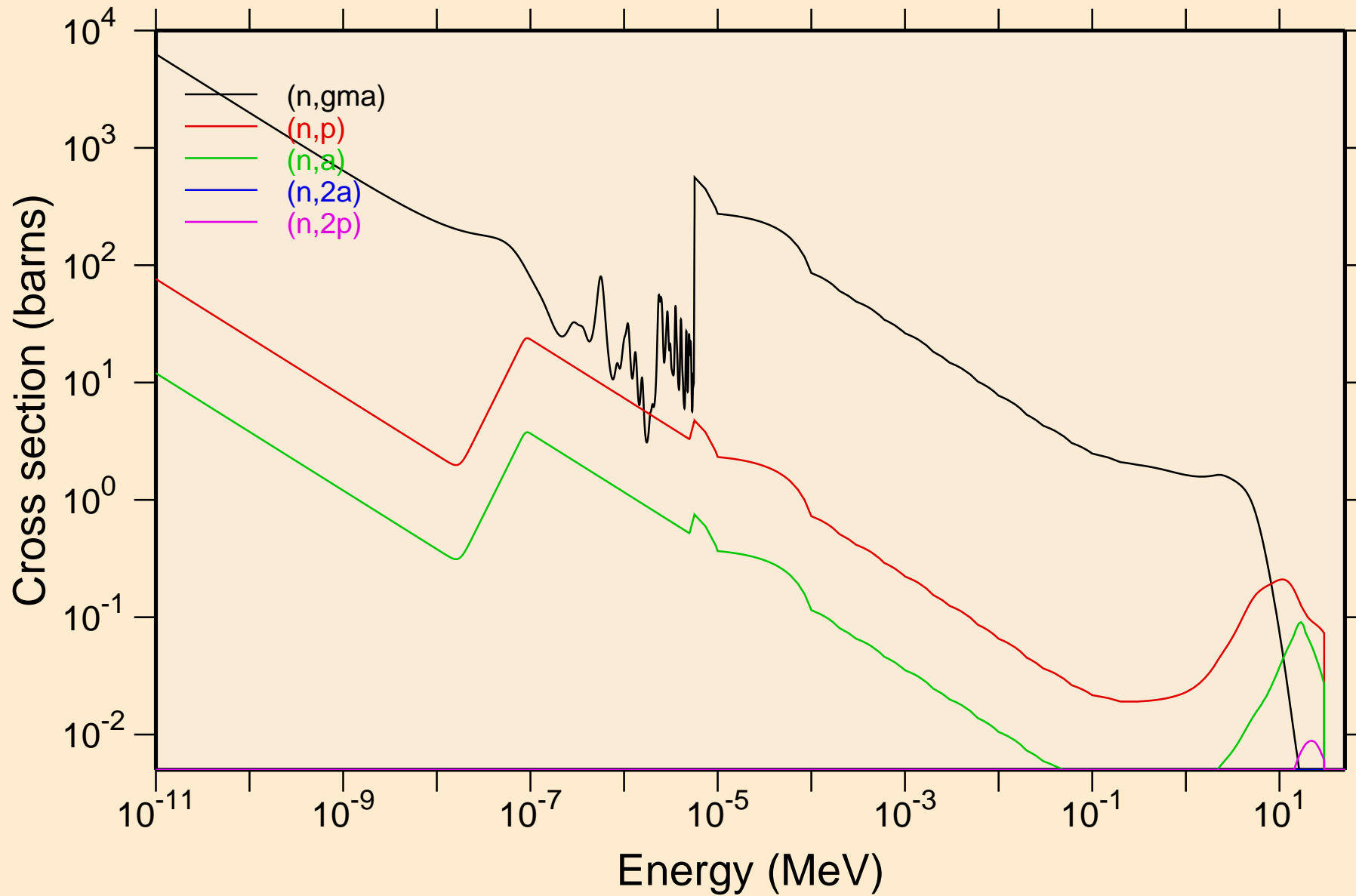

PT179 NEUTRON ACER TENDL-2021 LIBRARY; T=293.6K  
Non-threshold reactions

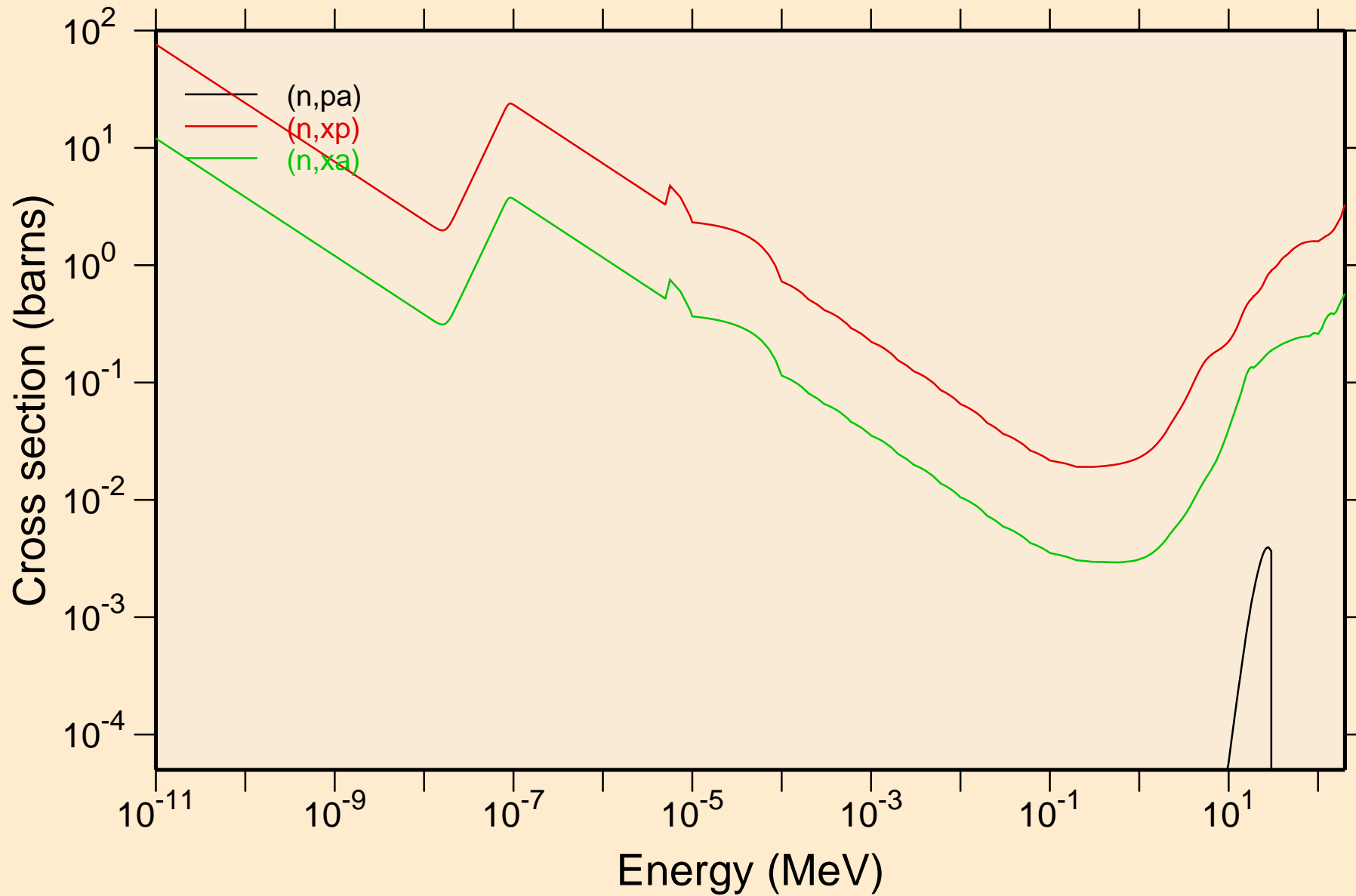

PT179 NEUTRON ACER TENDL-2021 LIBRARY; T=293.6K  
Principal cross sections

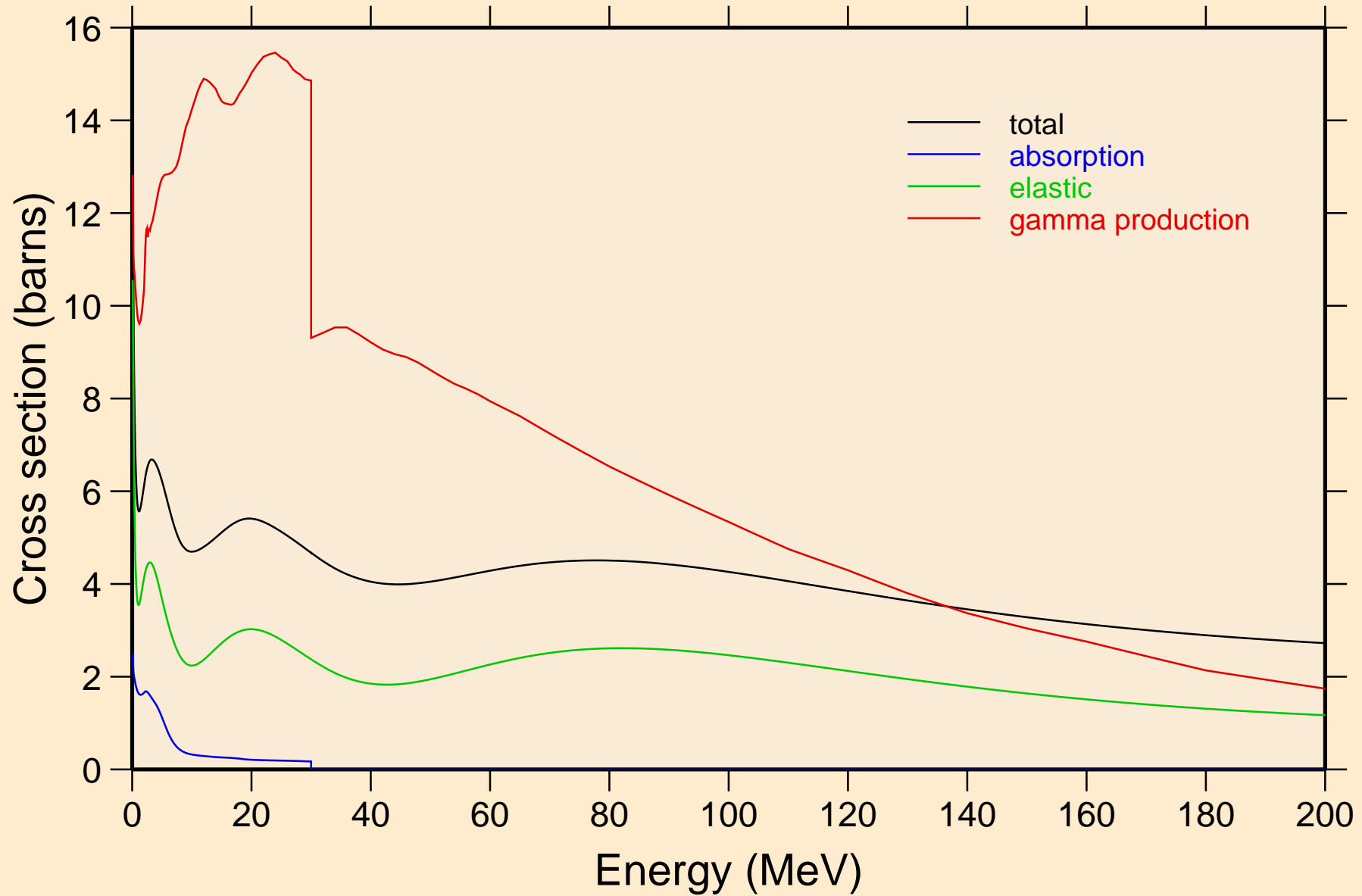

PT179 NEUTRON ACER TENDL-2021 LIBRARY; T=293.6K

Heating

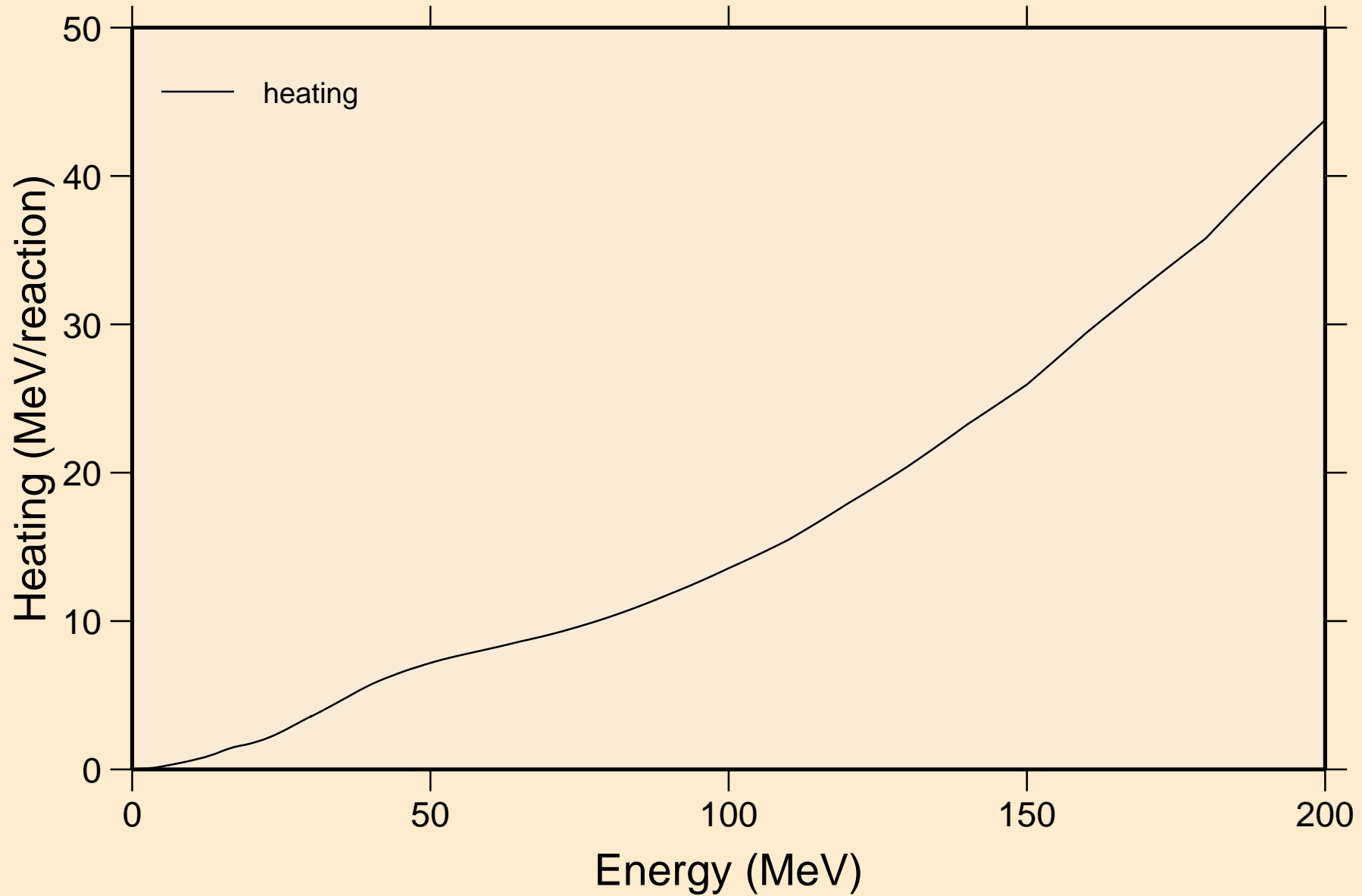

PT179 NEUTRON ACER TENDL-2021 LIBRARY; T=293.6K  
Damage

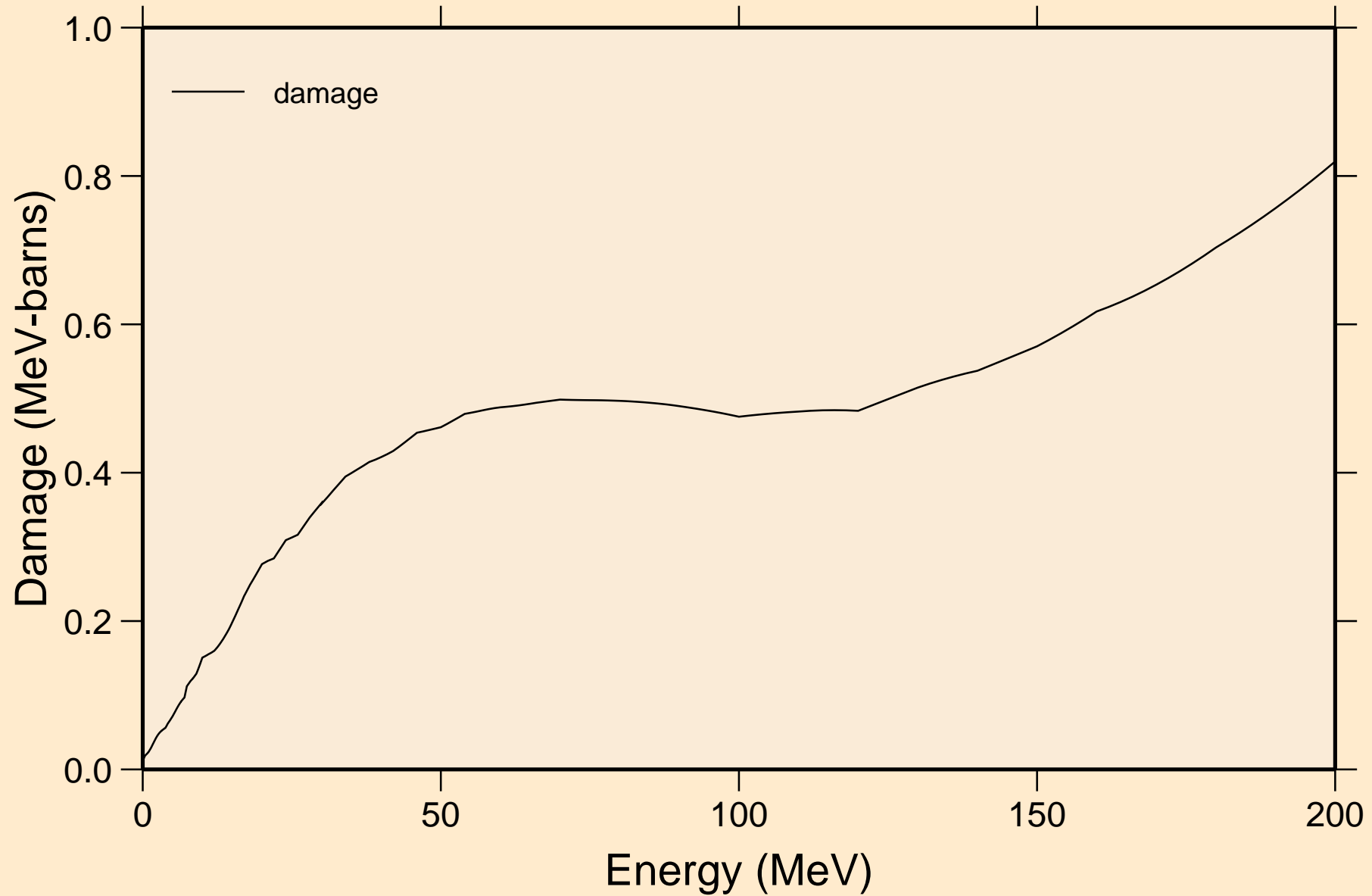



PT179 NEUTRON ACER TENDL-2021 LIBRARY; T=293.6K  
Non-threshold reactions

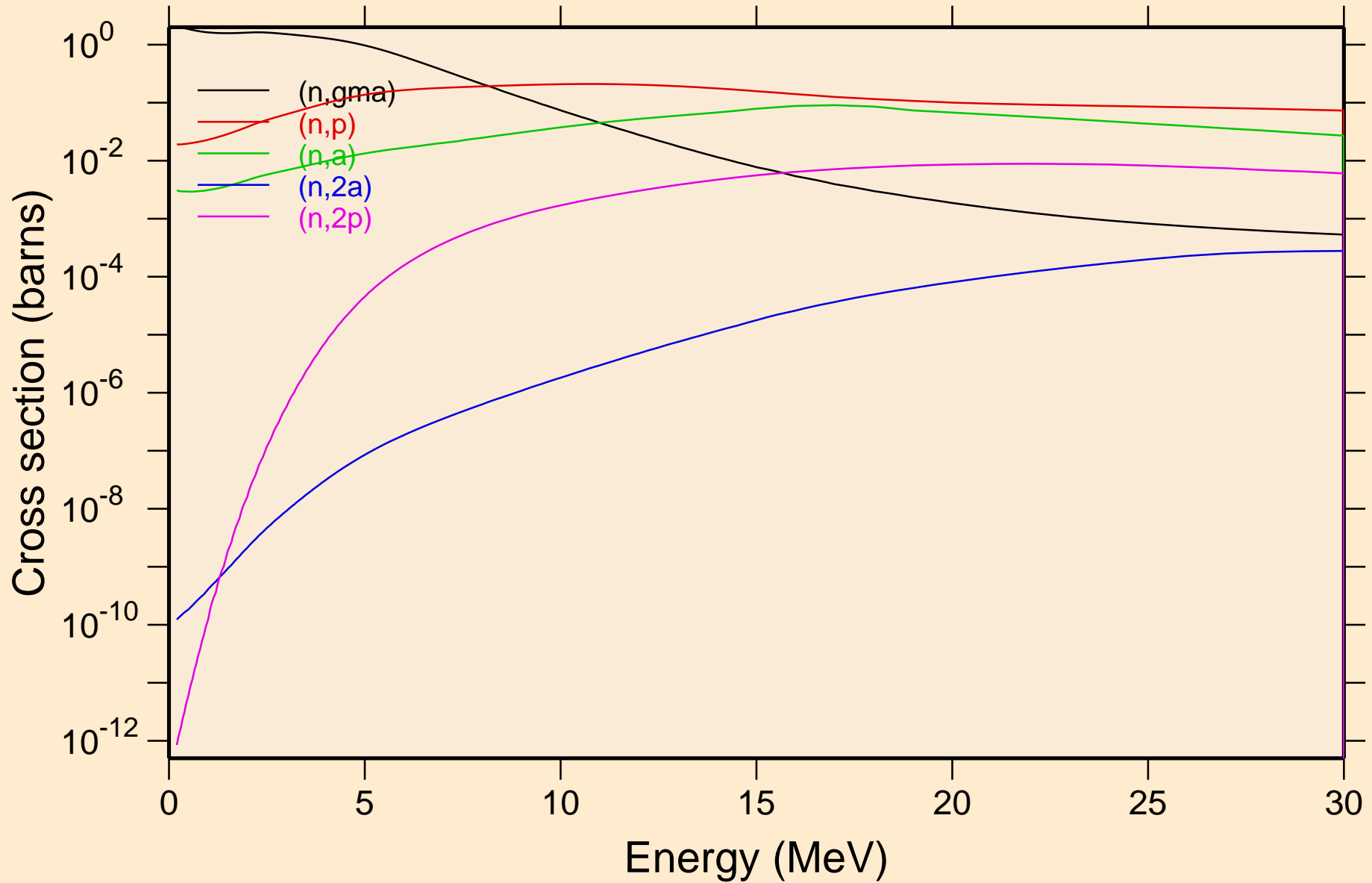

PT179 NEUTRON ACER TENDL-2021 LIBRARY; T=293.6K  
Non-threshold reactions

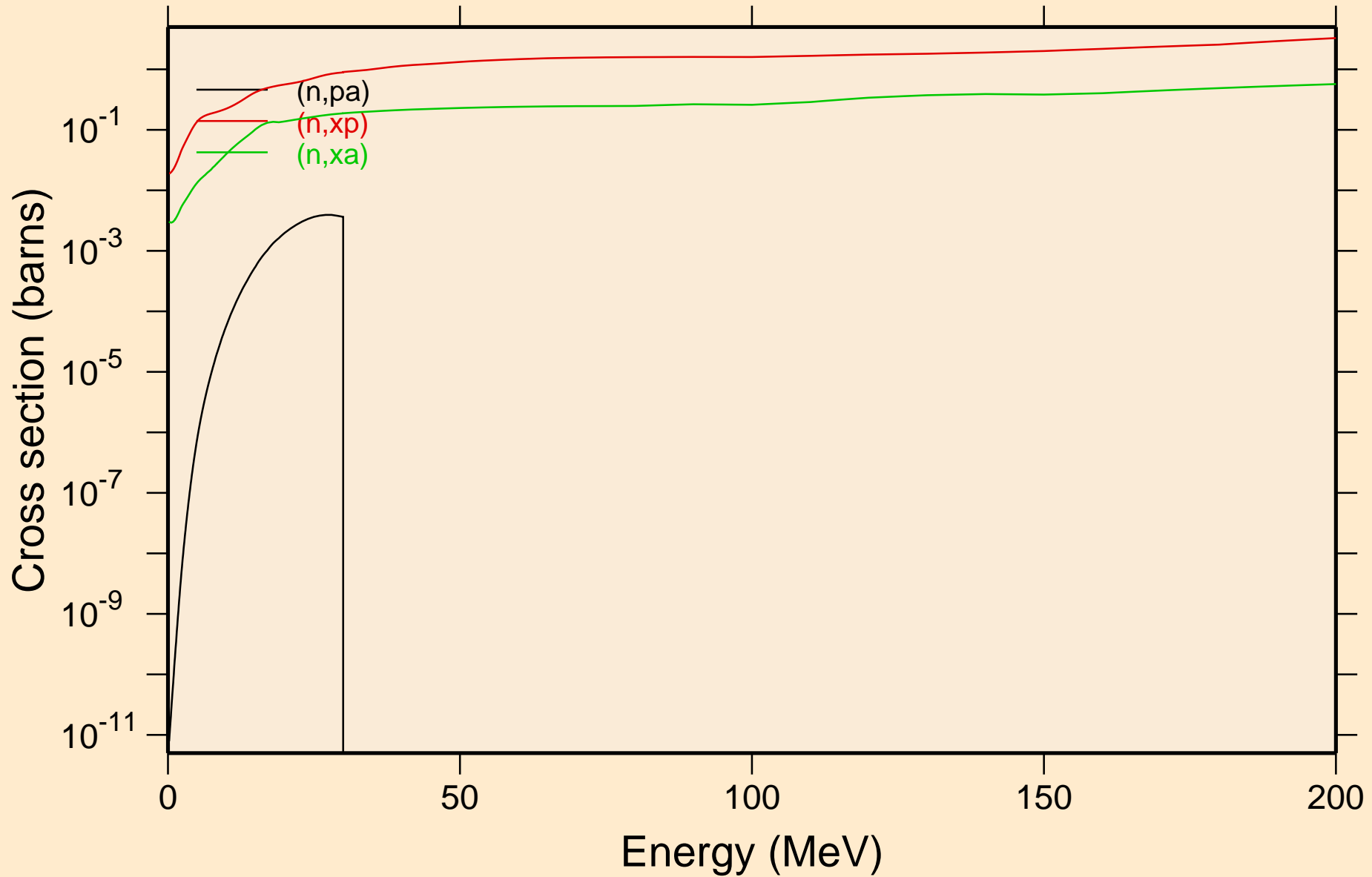

PT179 NEUTRON ACER TENDL-2021 LIBRARY; T=293.6K  
Inelastic levels

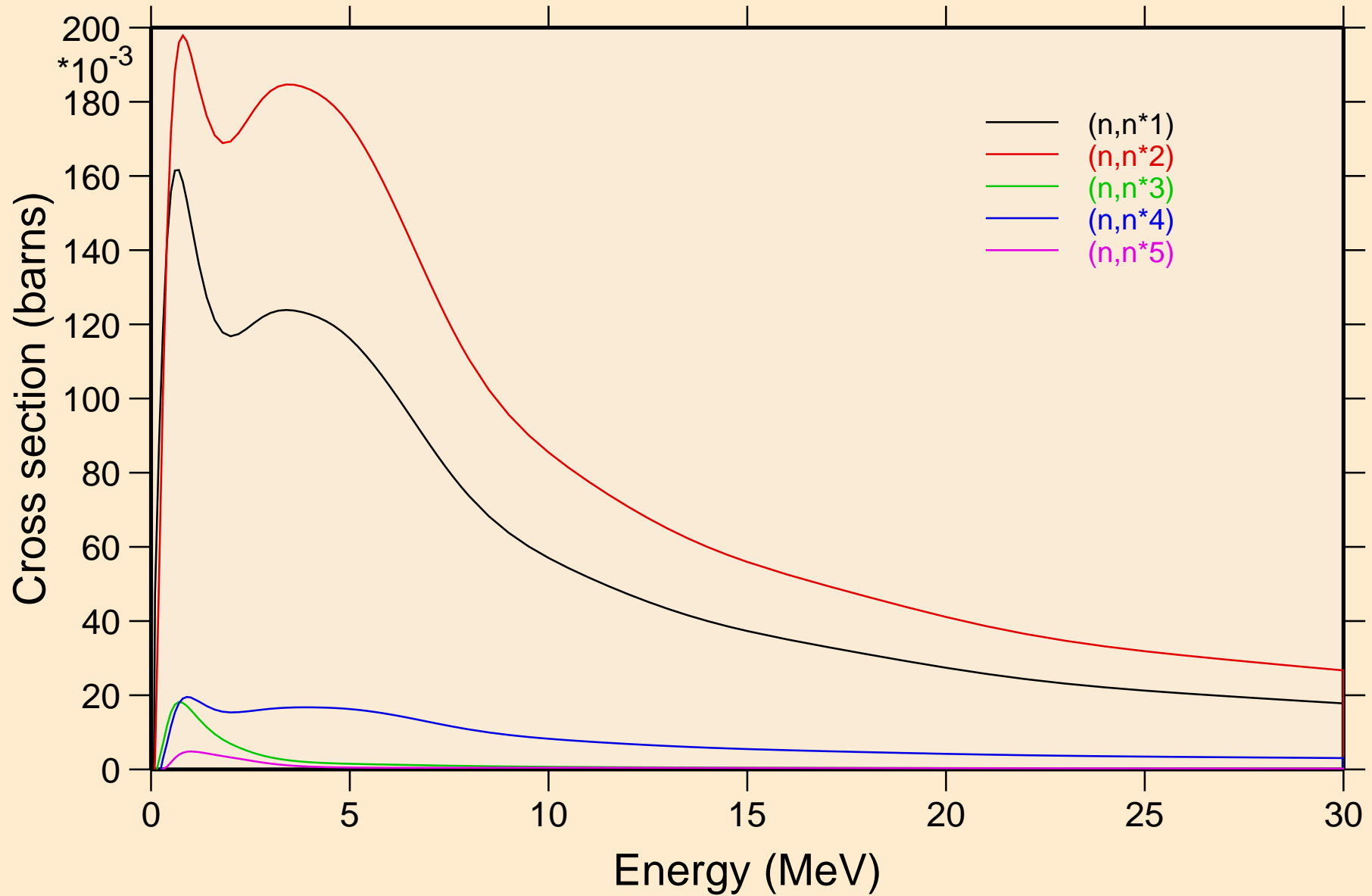

PT179 NEUTRON ACER TENDL-2021 LIBRARY; T=293.6K  
Inelastic levels

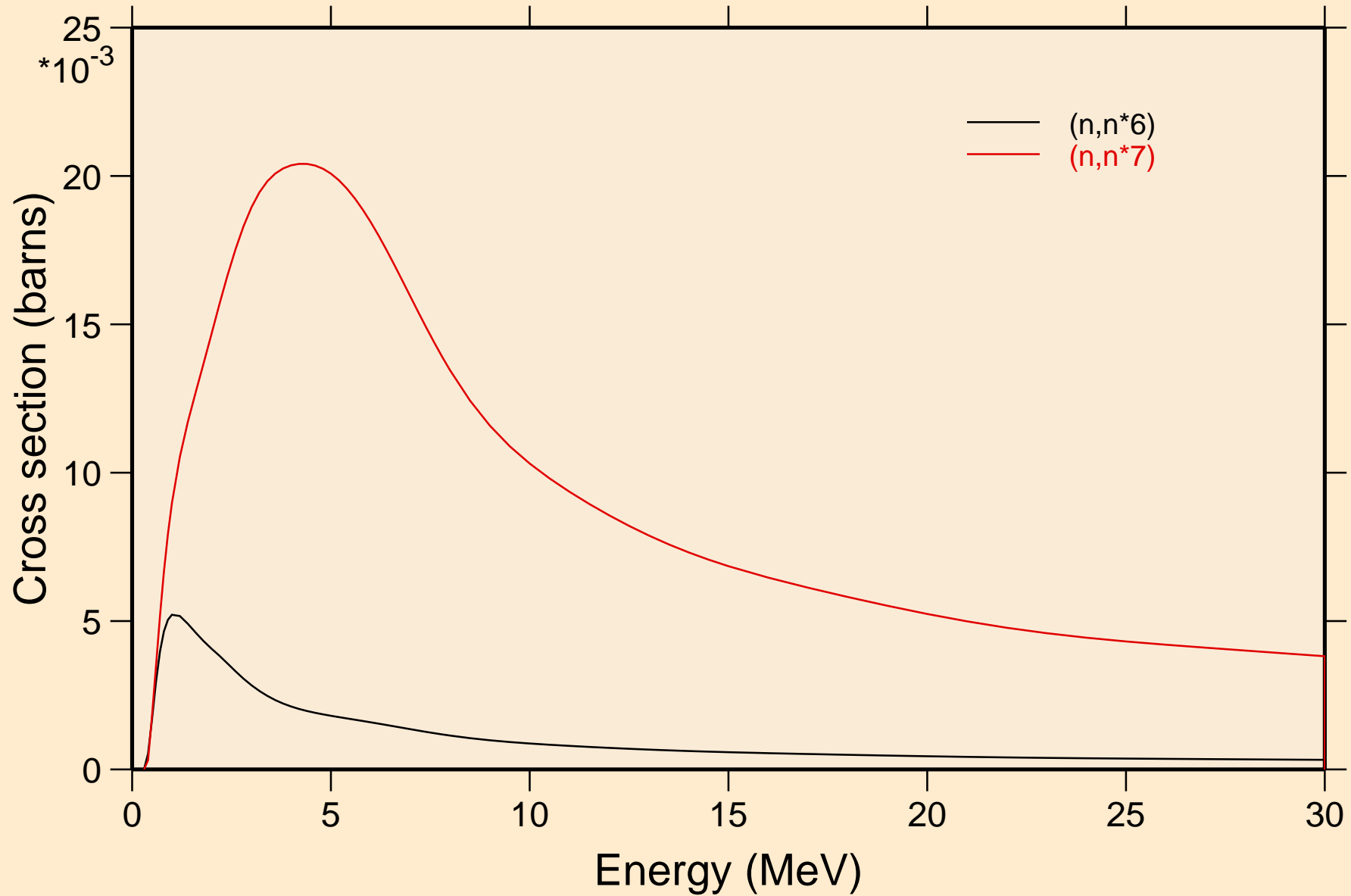

PT179 NEUTRON ACER TENDL-2021 LIBRARY; T=293.6K  
Threshold reactions

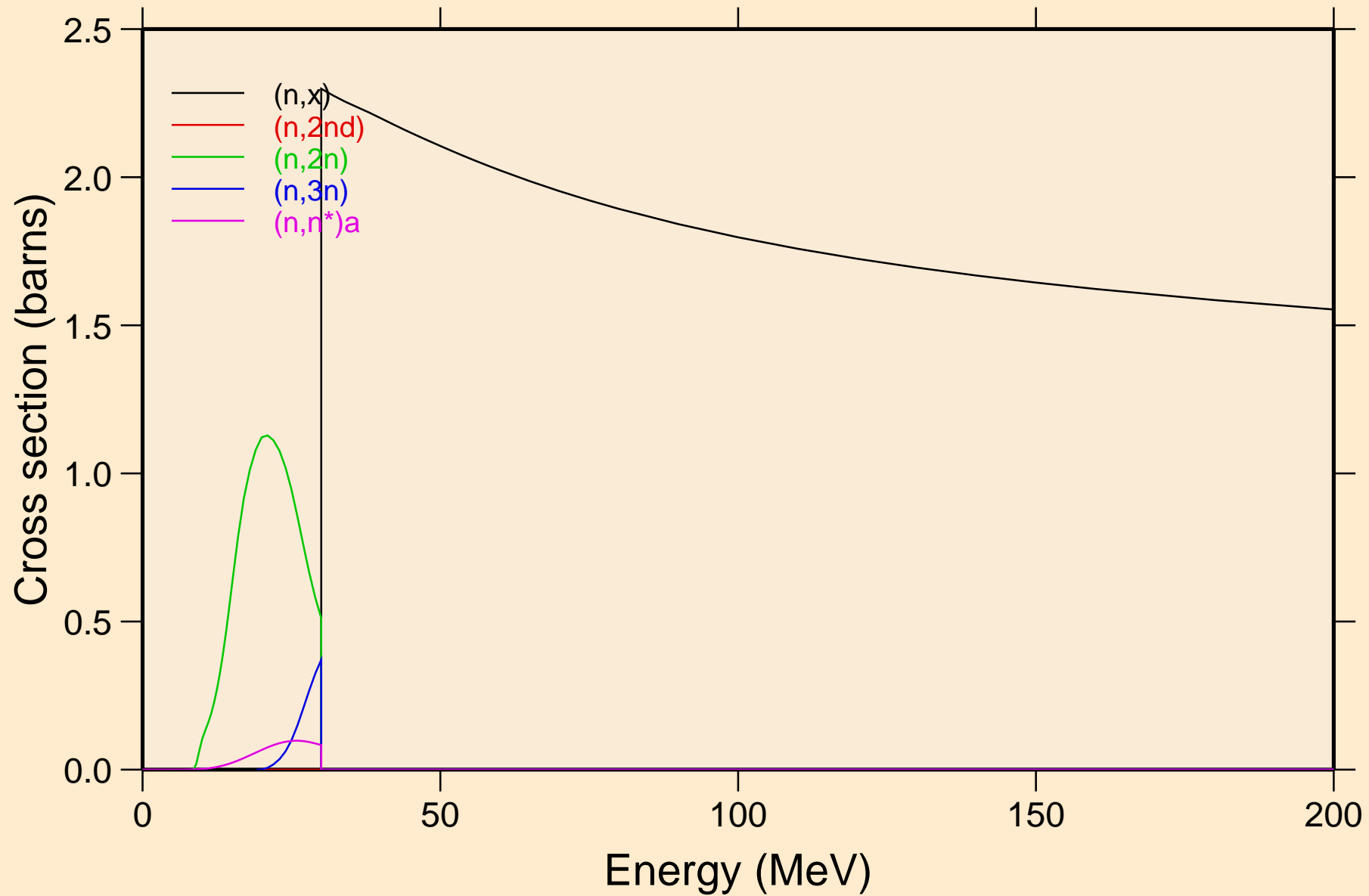

PT179 NEUTRON ACER TENDL-2021 LIBRARY; T=293.6K  
Threshold reactions

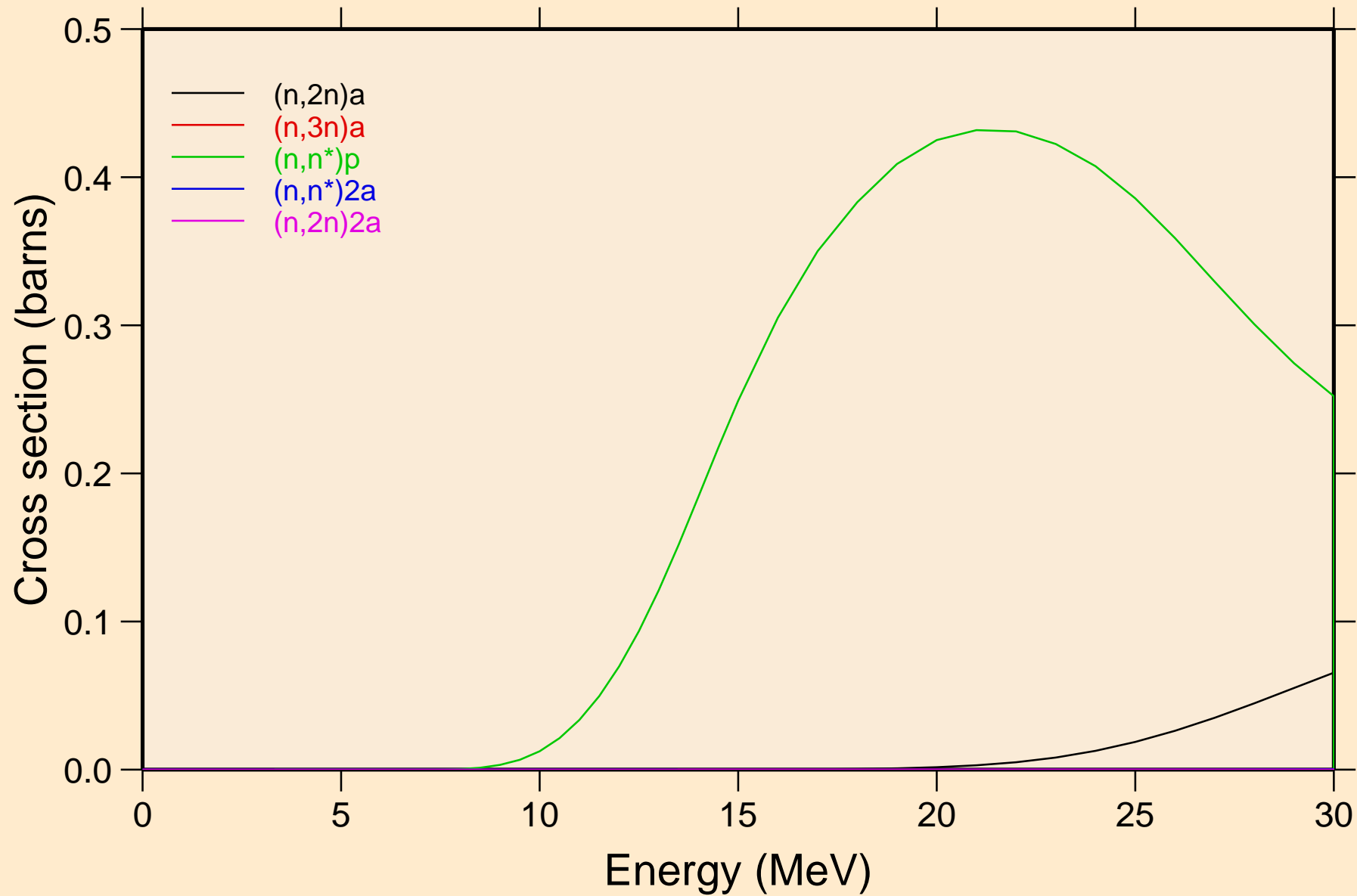

PT179 NEUTRON ACER TENDL-2021 LIBRARY; T=293.6K  
Threshold reactions

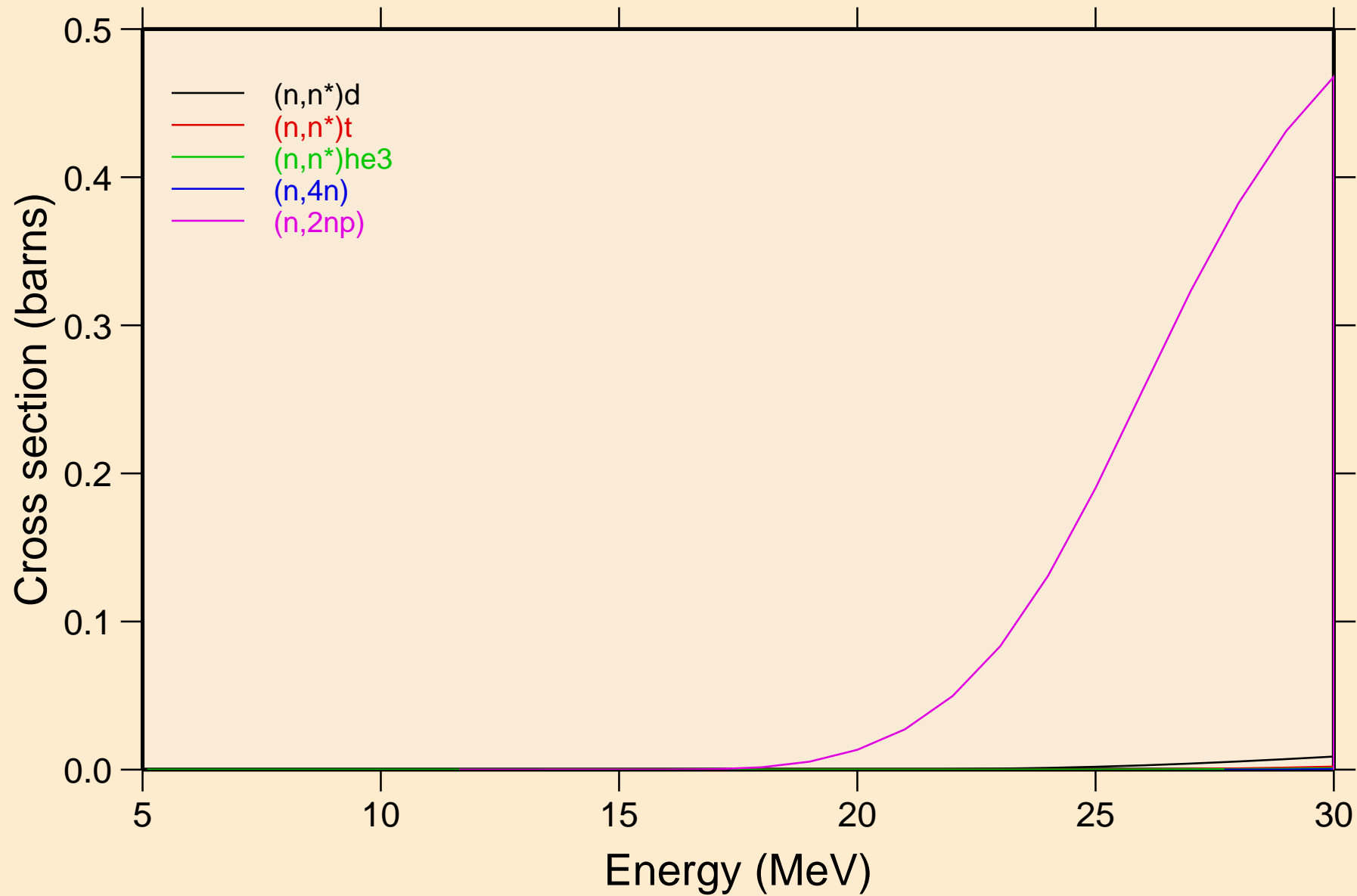

PT179 NEUTRON ACER TENDL-2021 LIBRARY; T=293.6K  
Threshold reactions

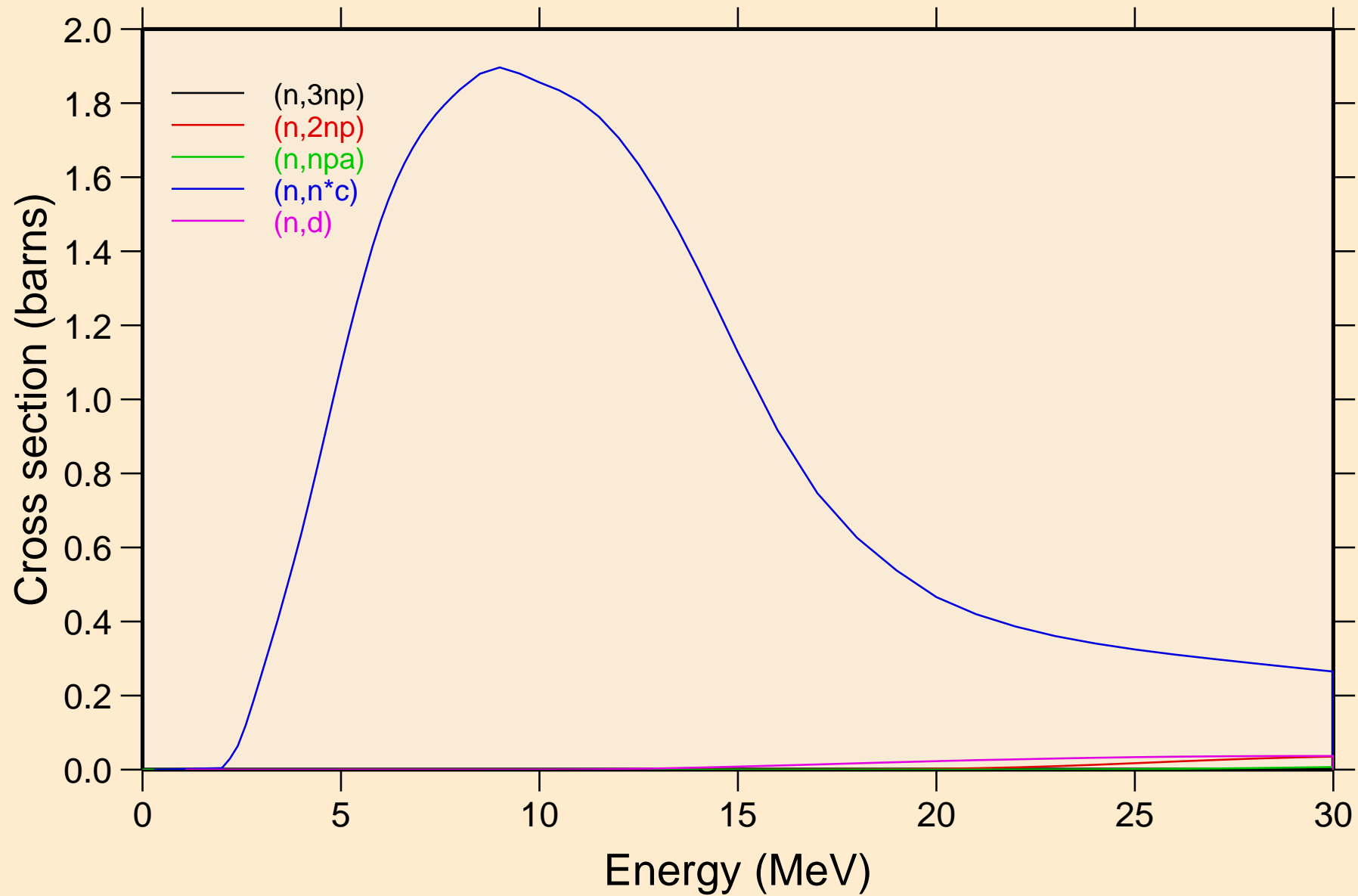



PT179 NEUTRON ACER TENDL-2021 LIBRARY; T=293.6K  
Threshold reactions

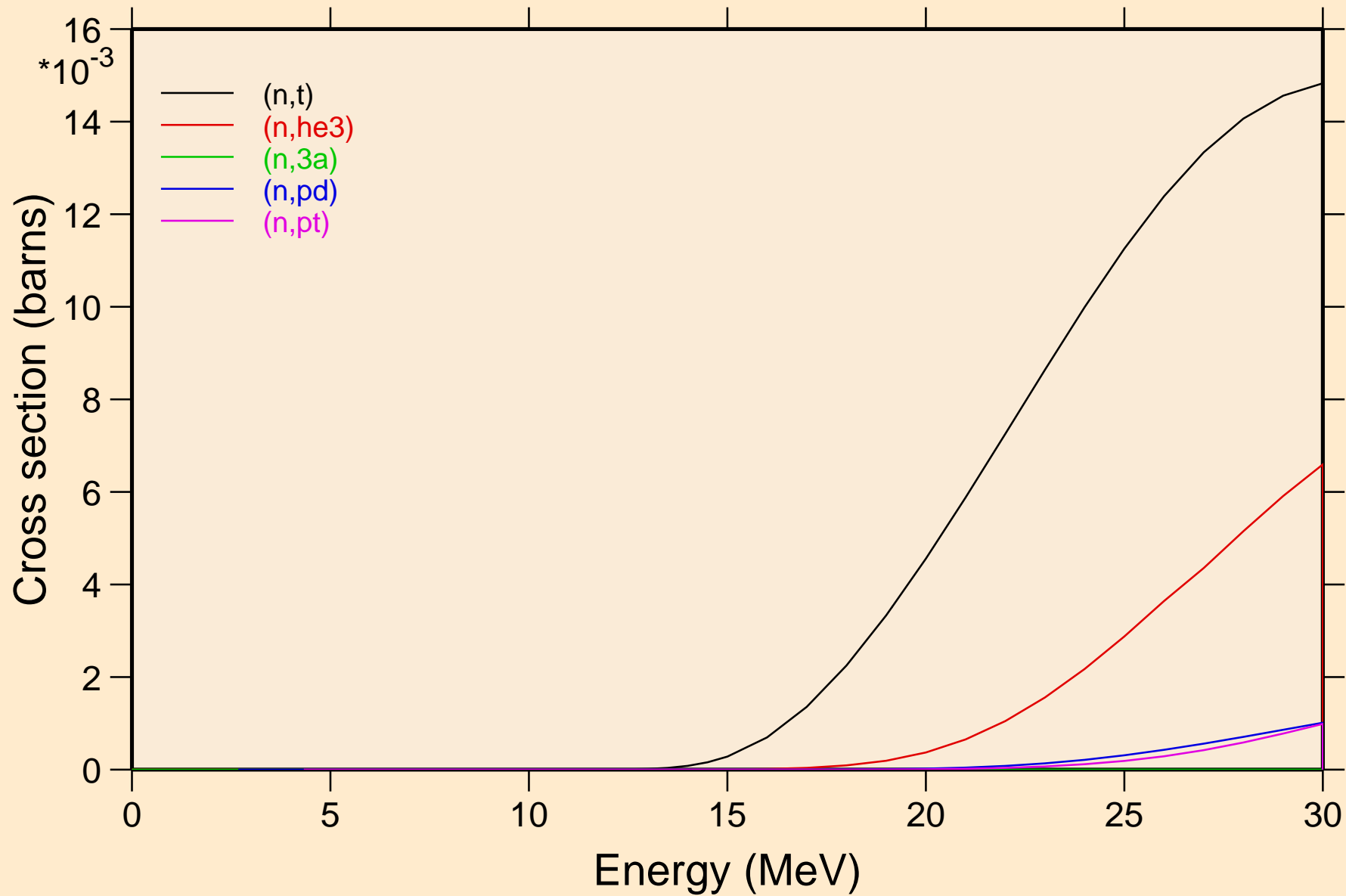

PT179 NEUTRON ACER TENDL-2021 LIBRARY; T=293.6K  
Threshold reactions

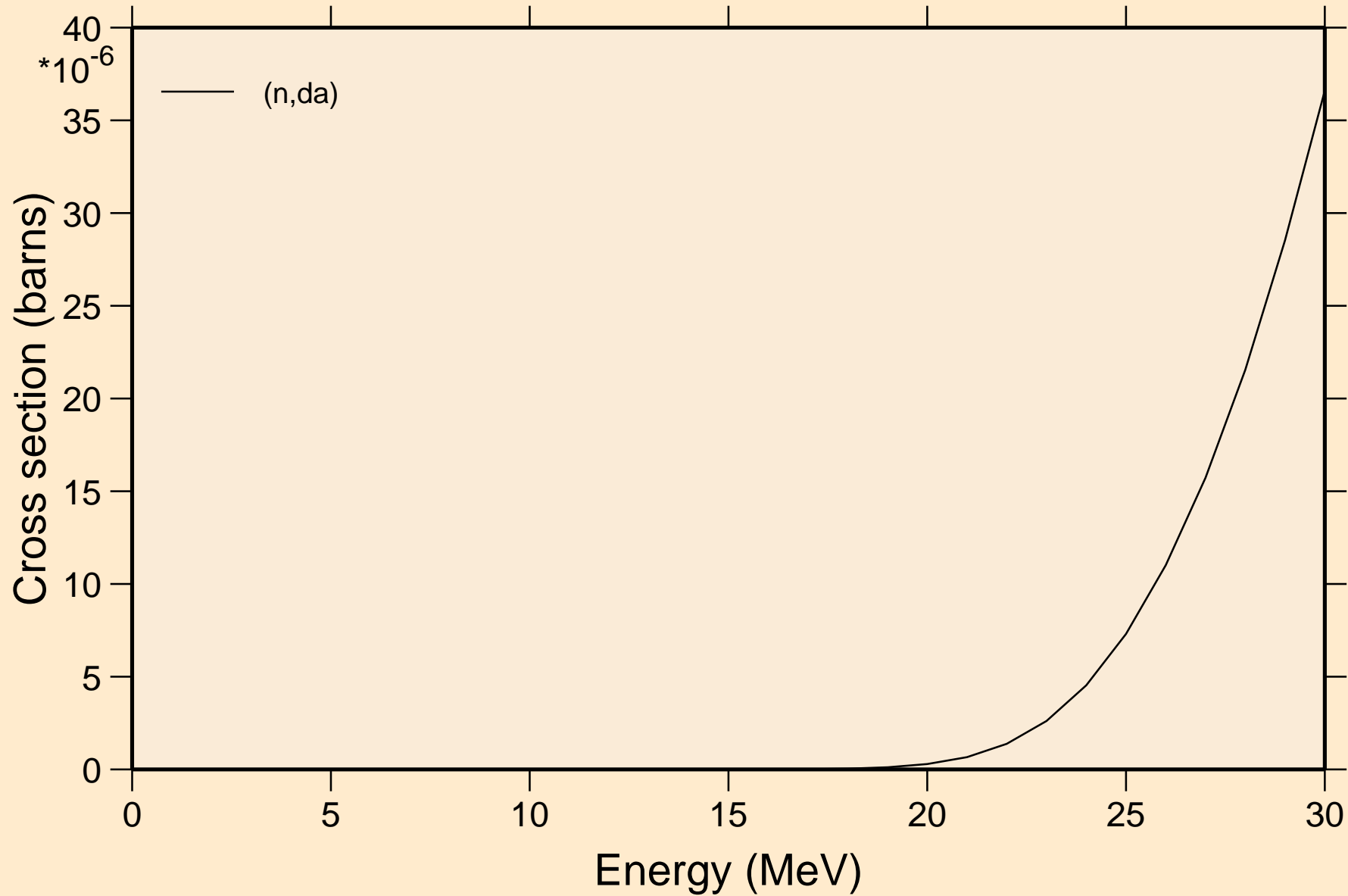

PT179 NEUTRON ACER TENDL-2021 LIBRARY; T=293.6K  
Threshold reactions

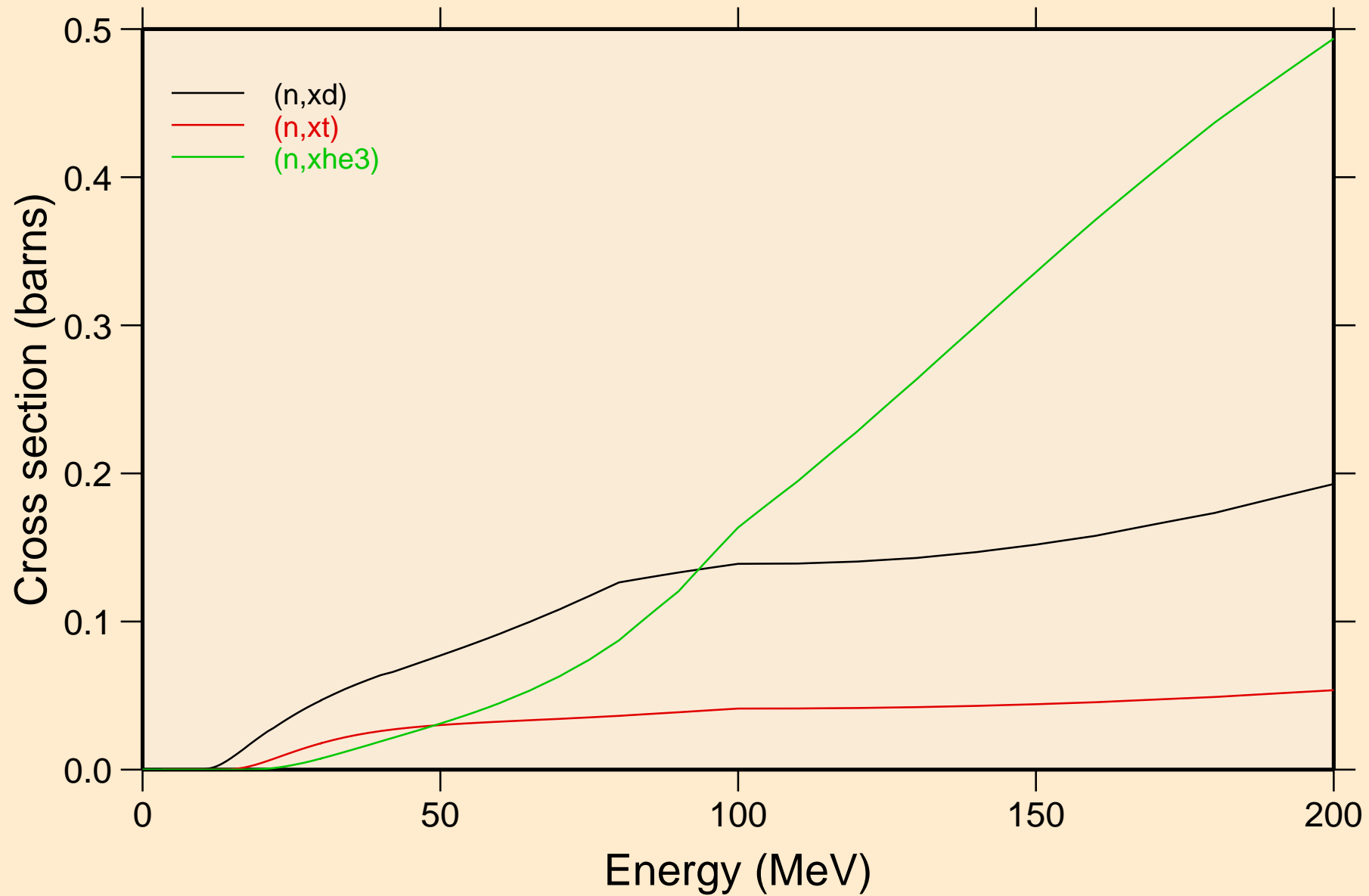

PT179 NEUTRON ACER TENDL-2021 LIBRARY; T=293.6K  
angular distribution for elastic

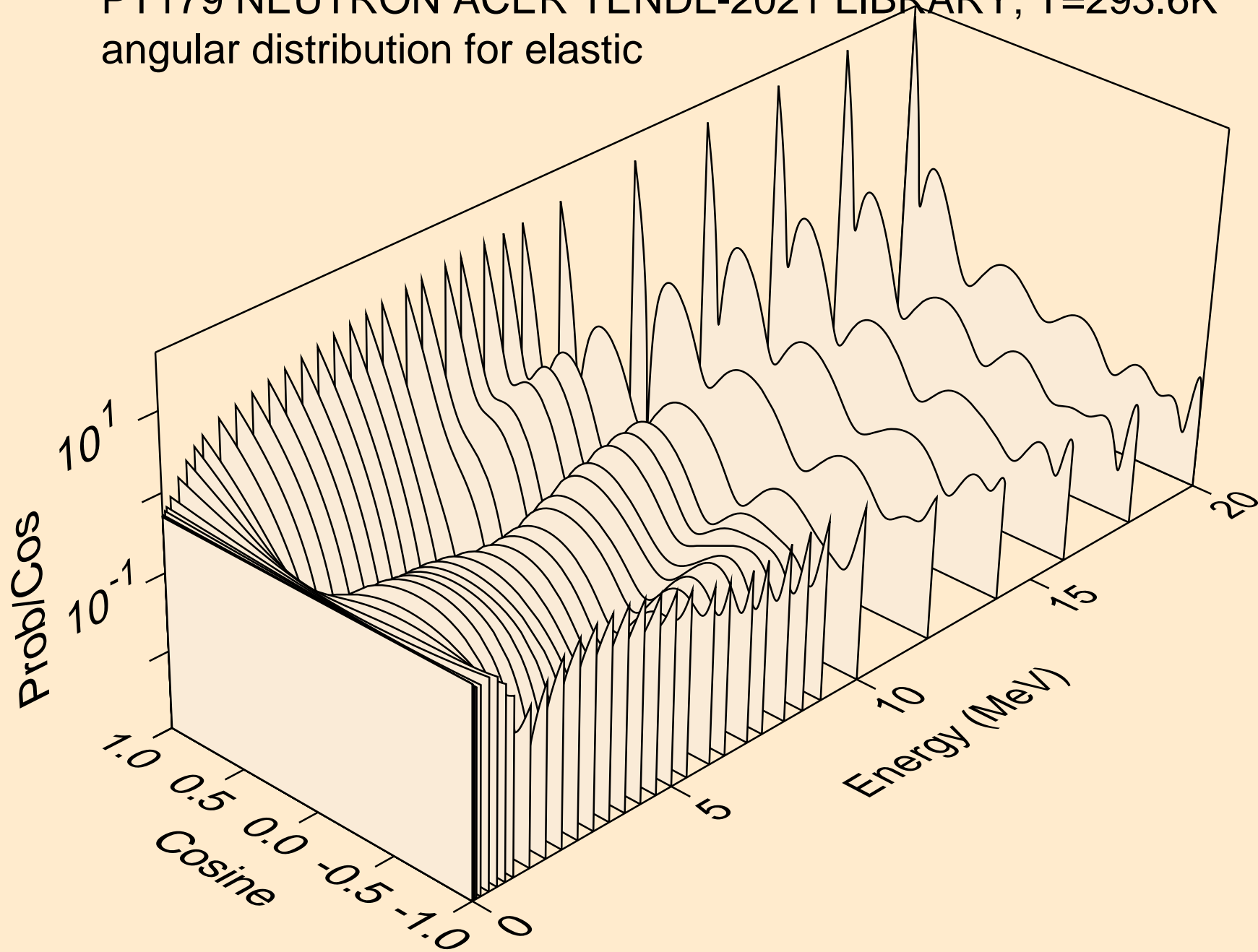

PT179 NEUTRON ACER TENDL-2021 LIBRARY; T=293.6K  
angular distribution for elastic

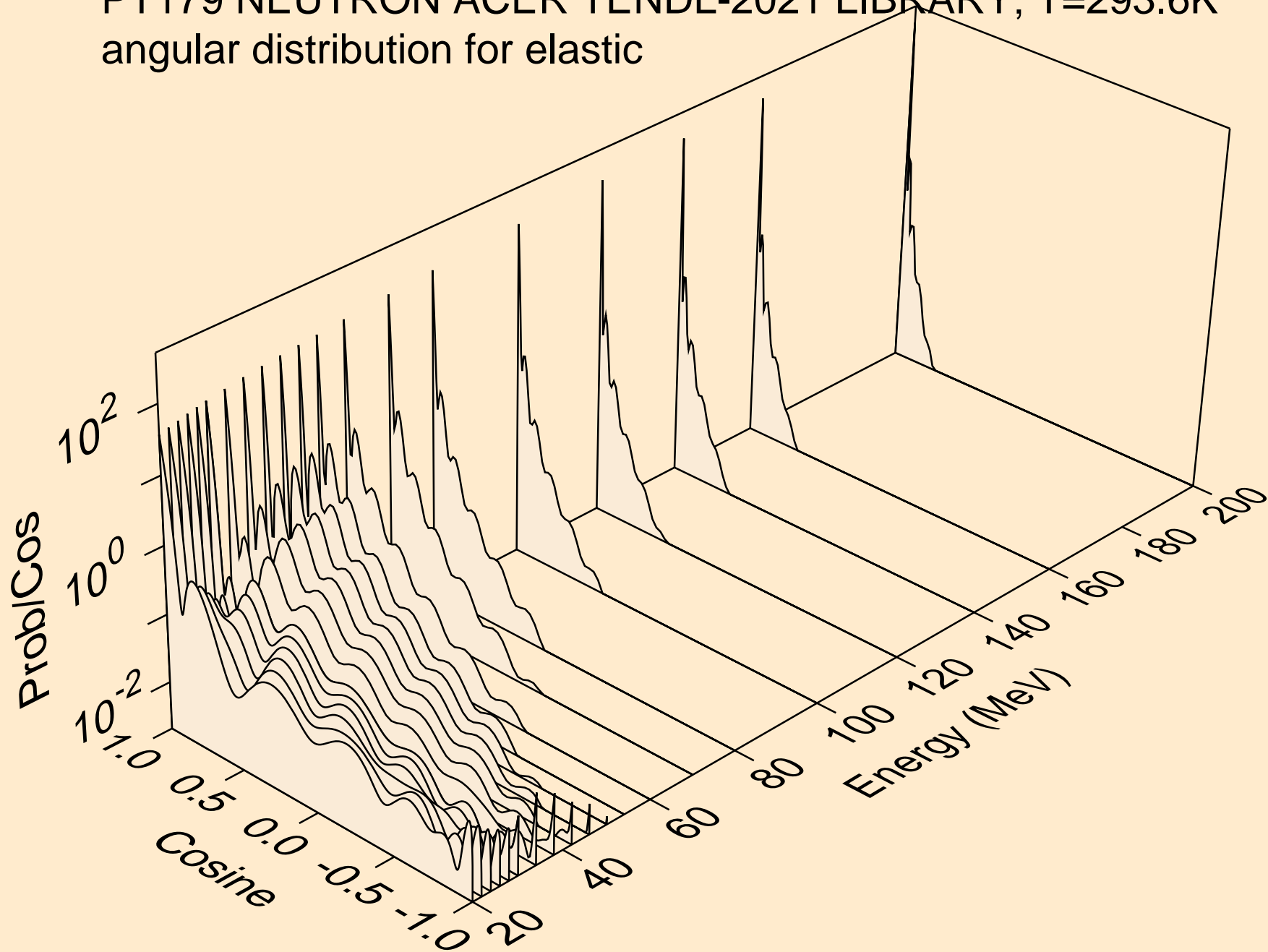

PT179 NEUTRON ACER TENDL-2021 LIBRARY; T=293.6K  
angular distribution for (n,n\*1)

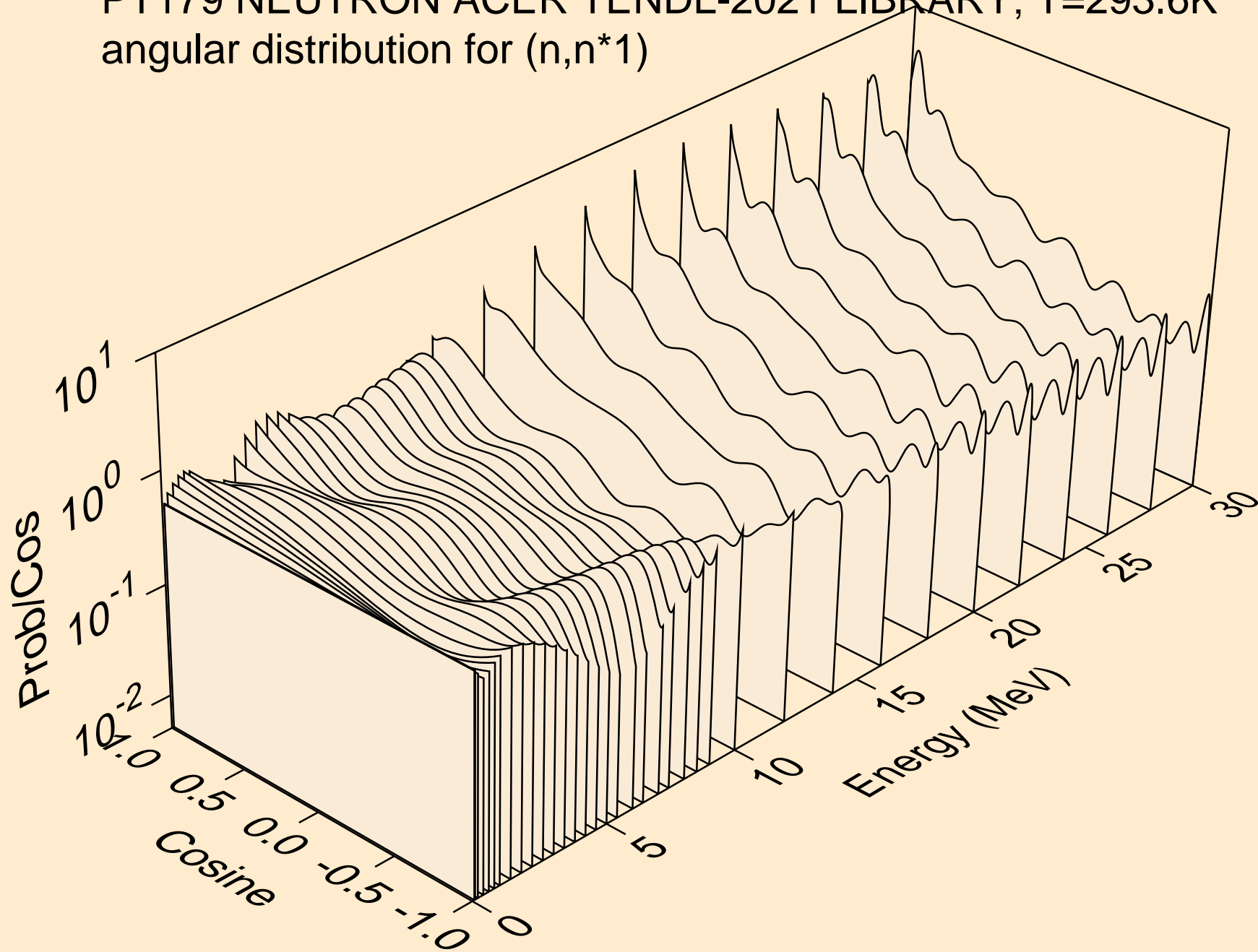

PT179 NEUTRON ACER TENDL-2021 LIBRARY; T=293.6K  
angular distribution for (n,n\*2)

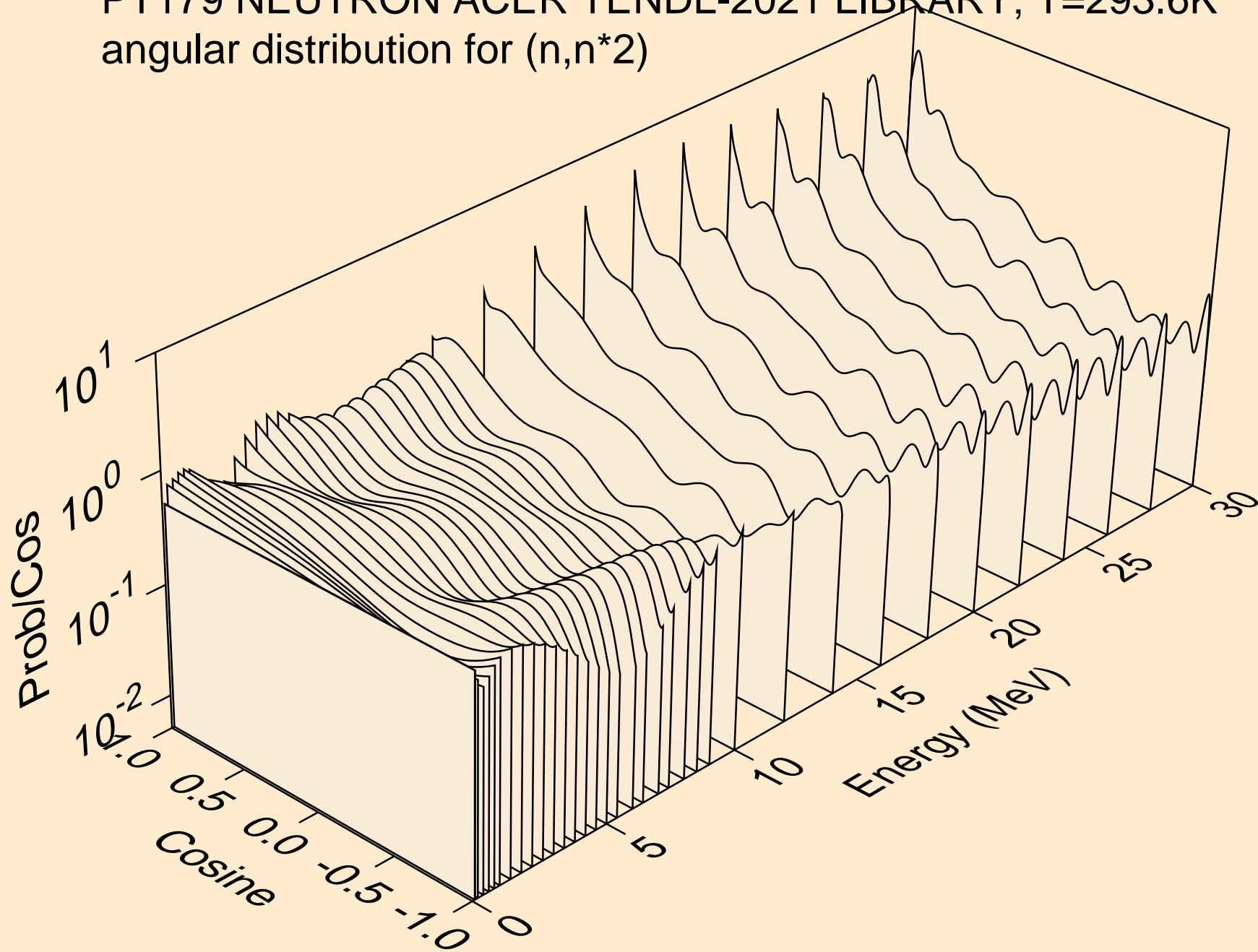

PT179 NEUTRON ACER TENDL-2021 LIBRARY; T=293.6K  
angular distribution for (n,n\*3)

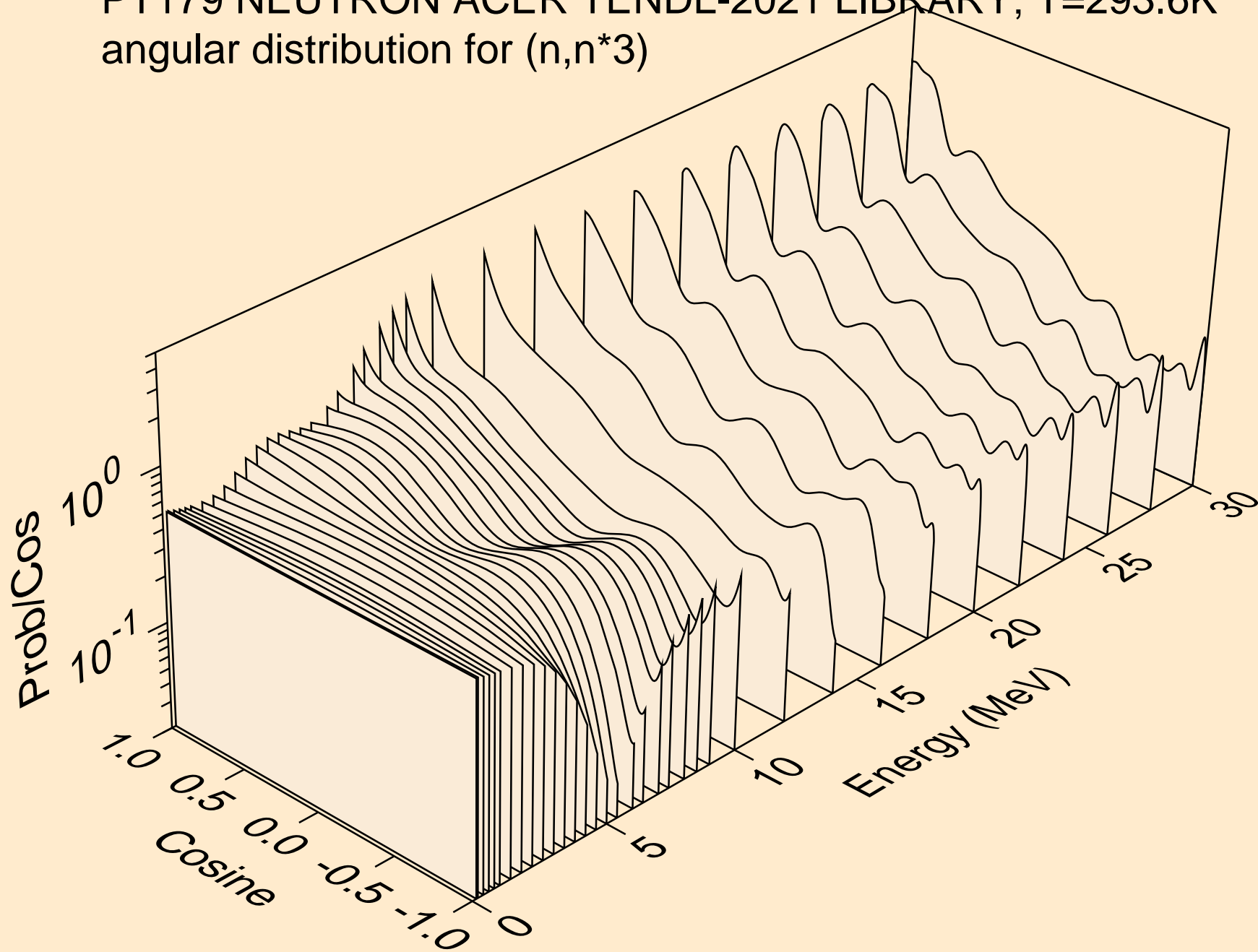



PT179 NEUTRON ACER TENDL-2021 LIBRARY; T=293.6K  
angular distribution for (n,n\*4)

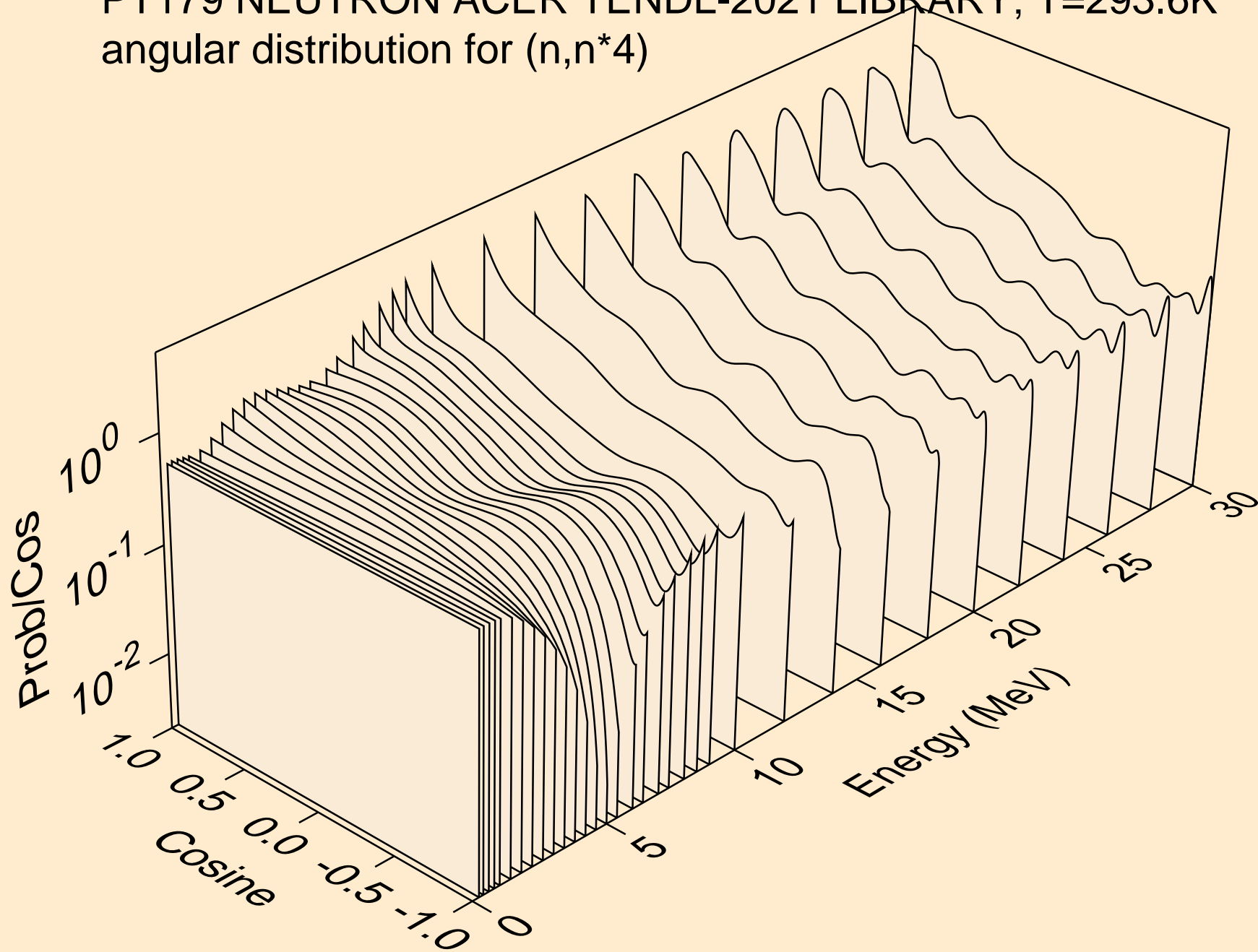

PT179 NEUTRON ACER TENDL-2021 LIBRARY; T=293.6K  
angular distribution for (n,n\*5)

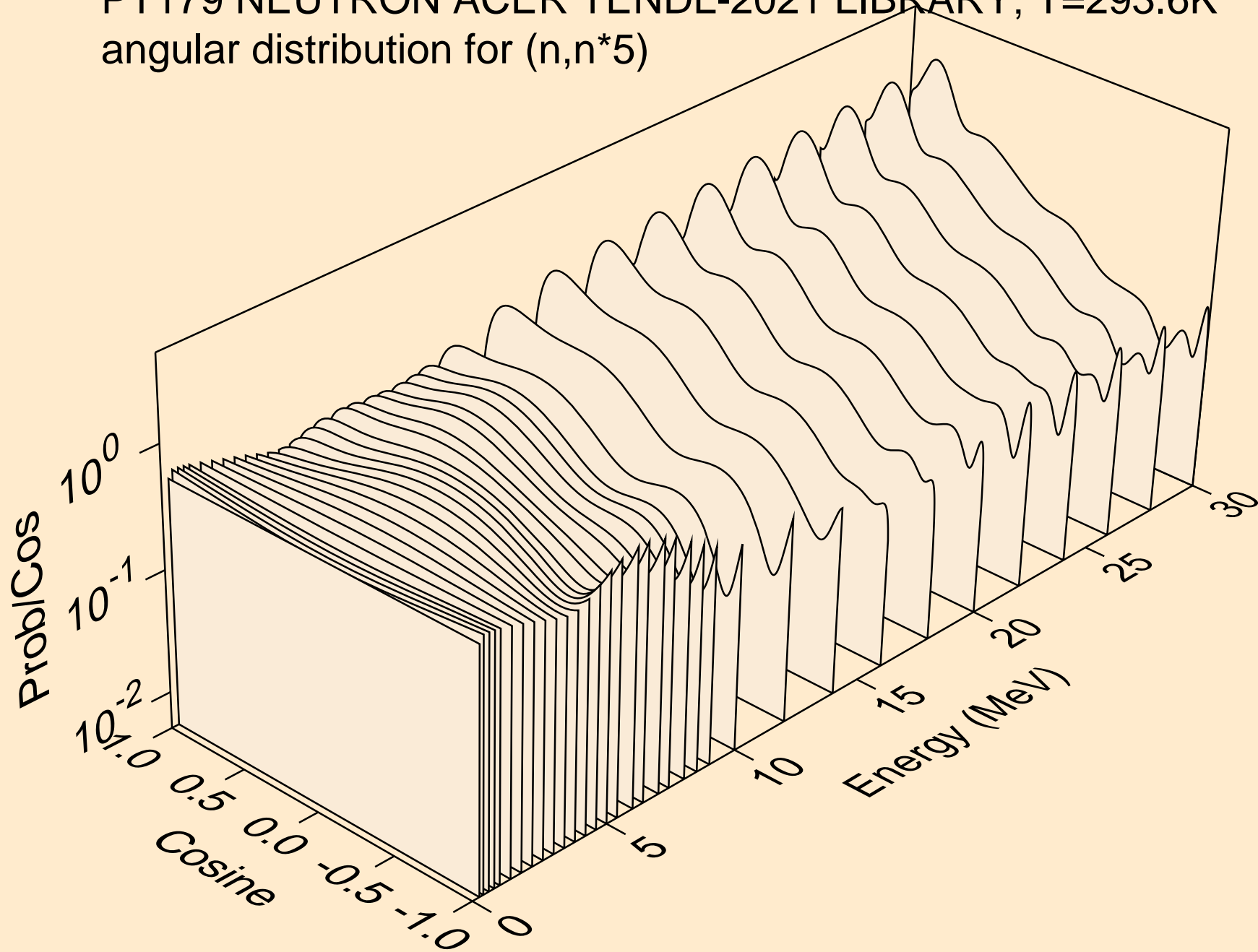

PT179 NEUTRON ACER TENDL-2021 LIBRARY; T=293.6K  
angular distribution for (n,n\*6)

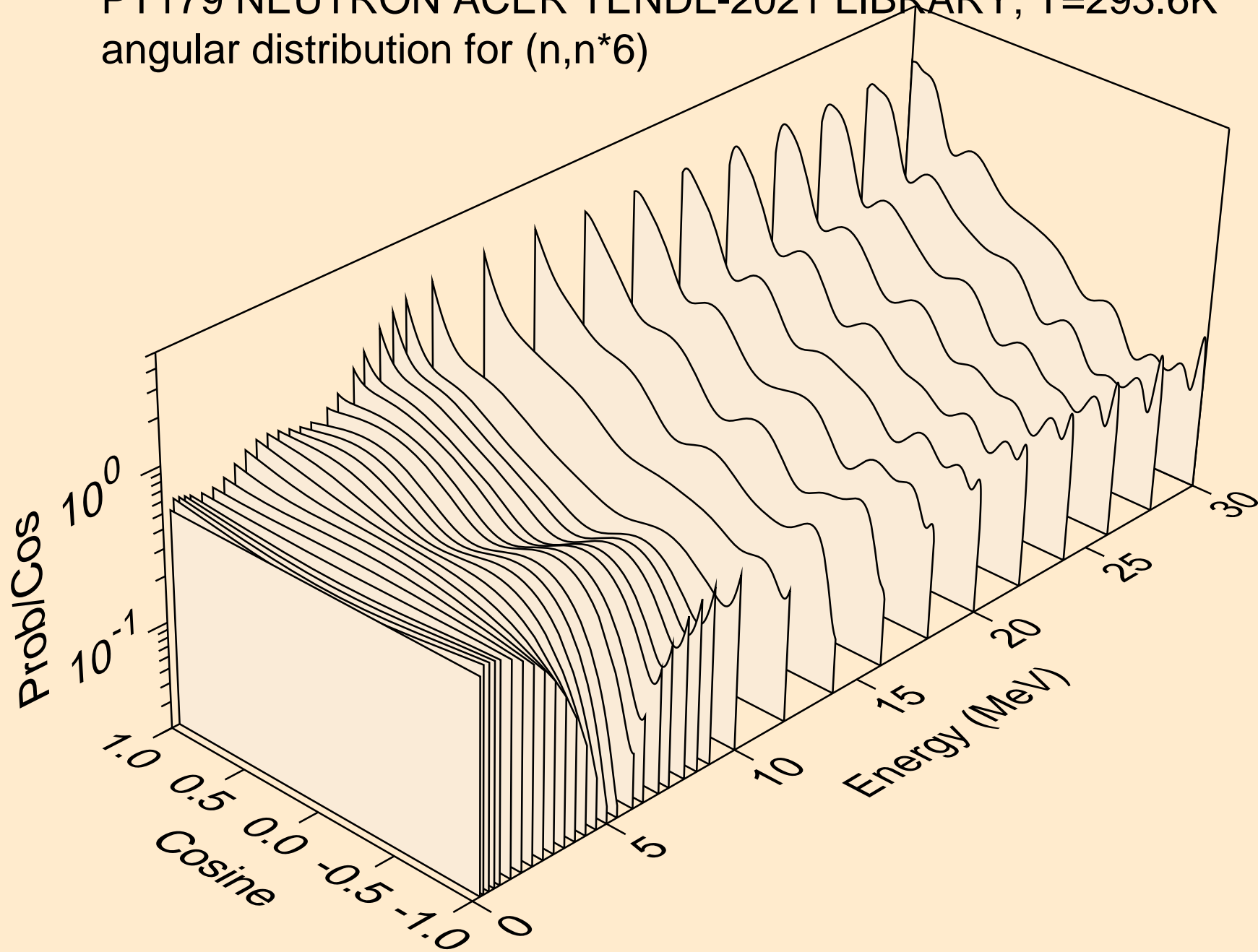

PT179 NEUTRON ACER TENDL-2021 LIBRARY; T=293.6K  
angular distribution for (n,n\*7)

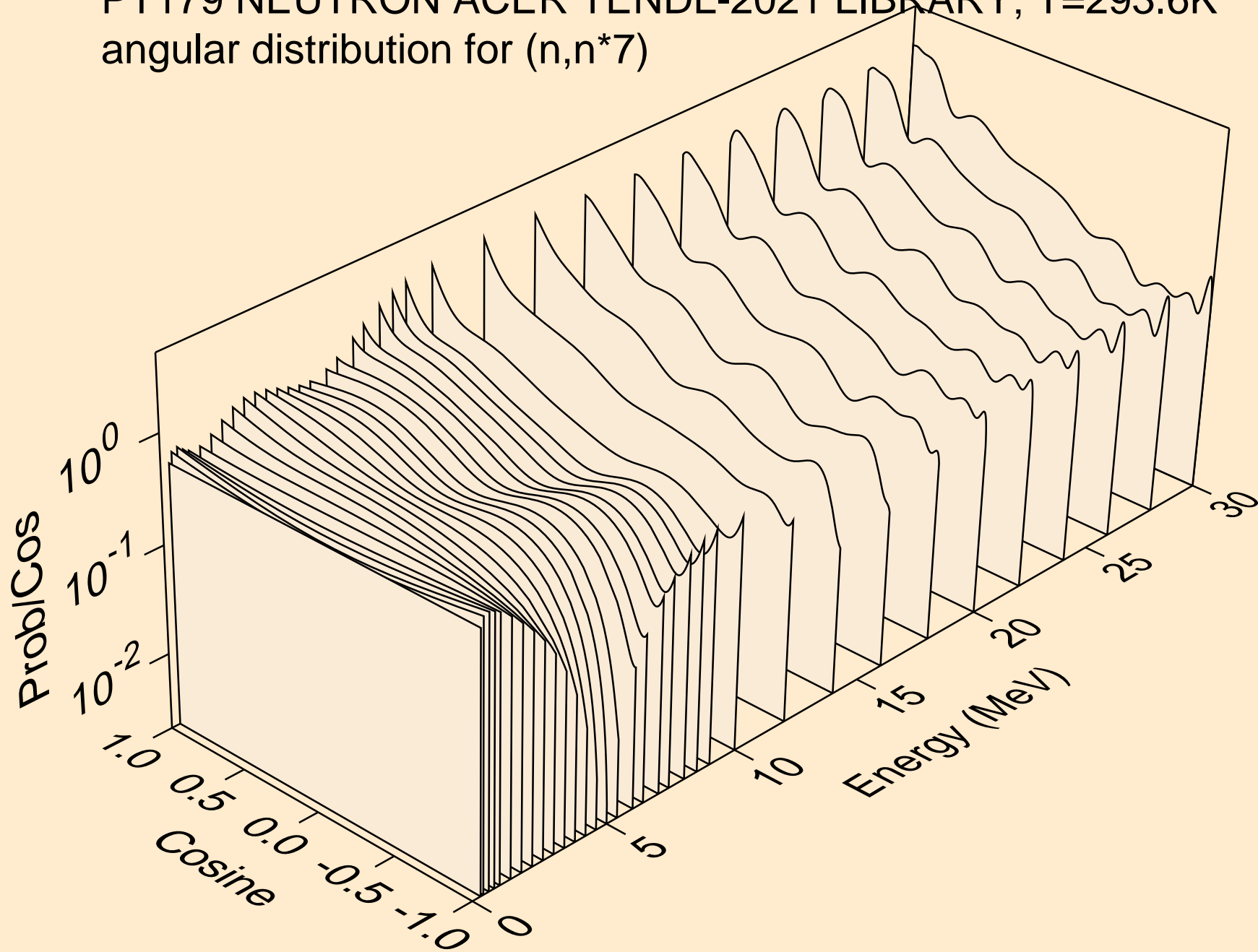

PT179 NEUTRON ACER TENDL-2021 LIBRARY; T=293.6K  
Neutron emission for (n,x)

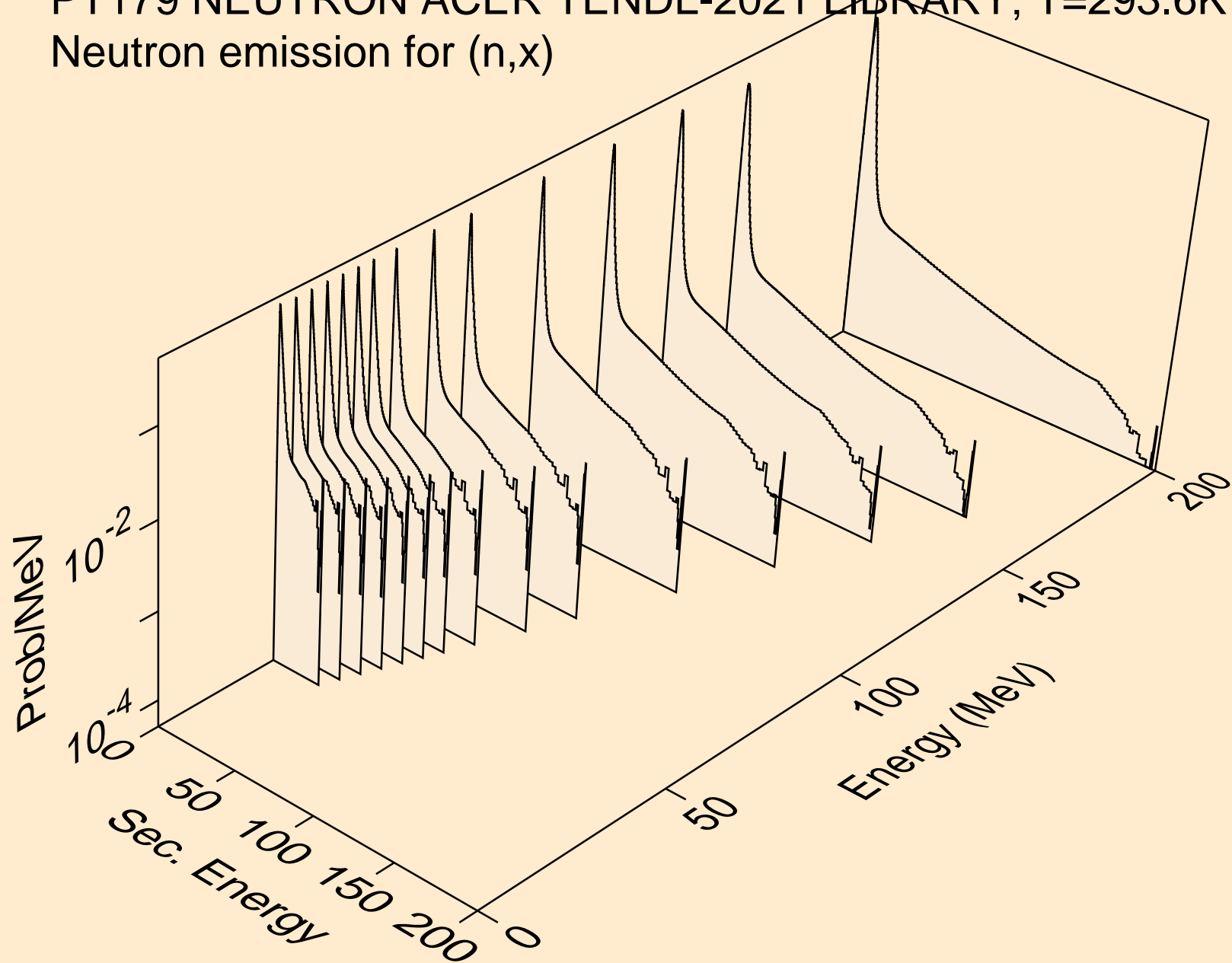

PT179 NEUTRON ACER TENDL-2021 LIBRARY; T=293.6K  
Neutron emission for (n,2nd)

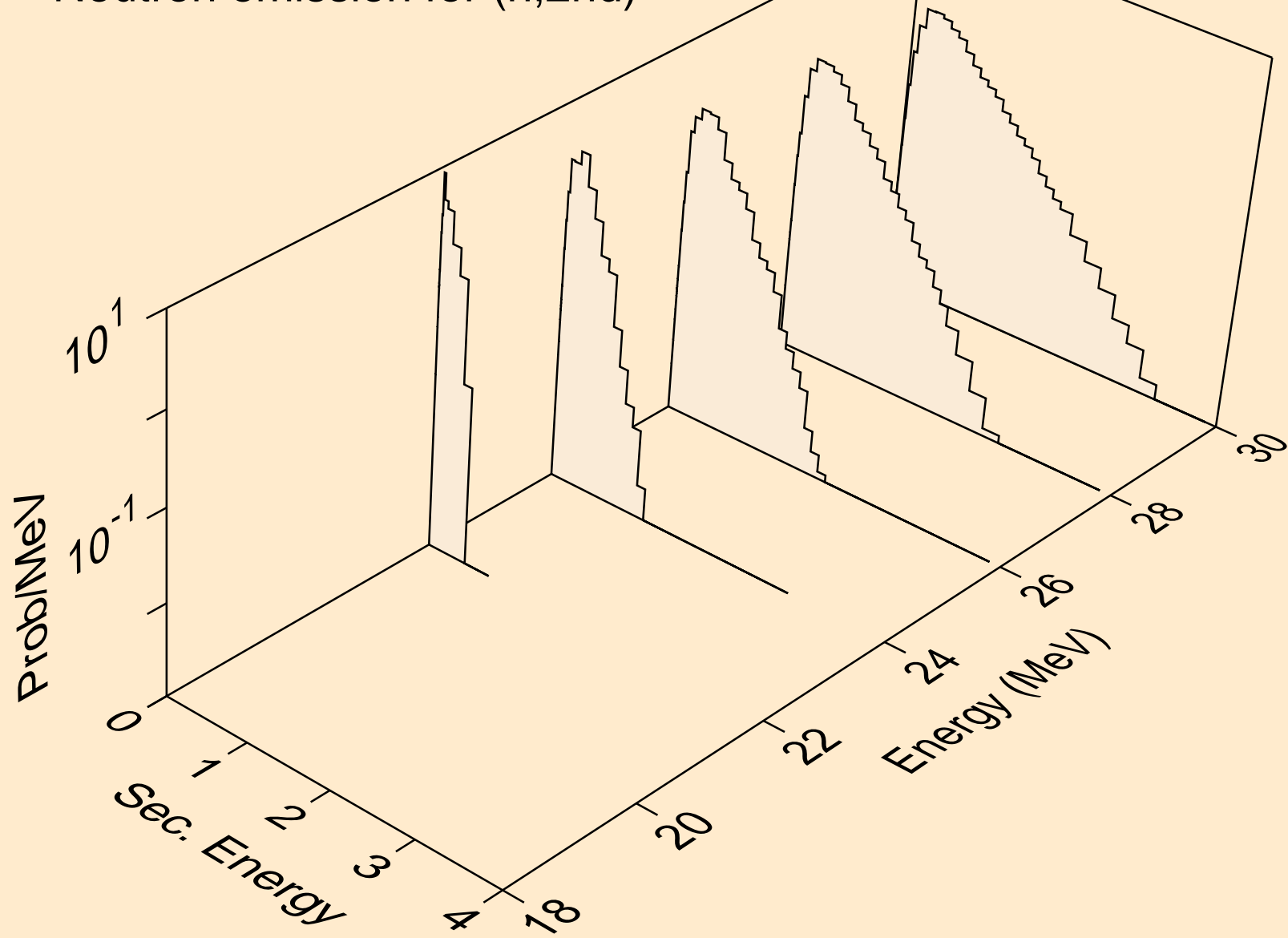

PT179 NEUTRON ACER TENDL-2021 LIBRARY; T=293.6K  
Neutron emission for (n,2n)

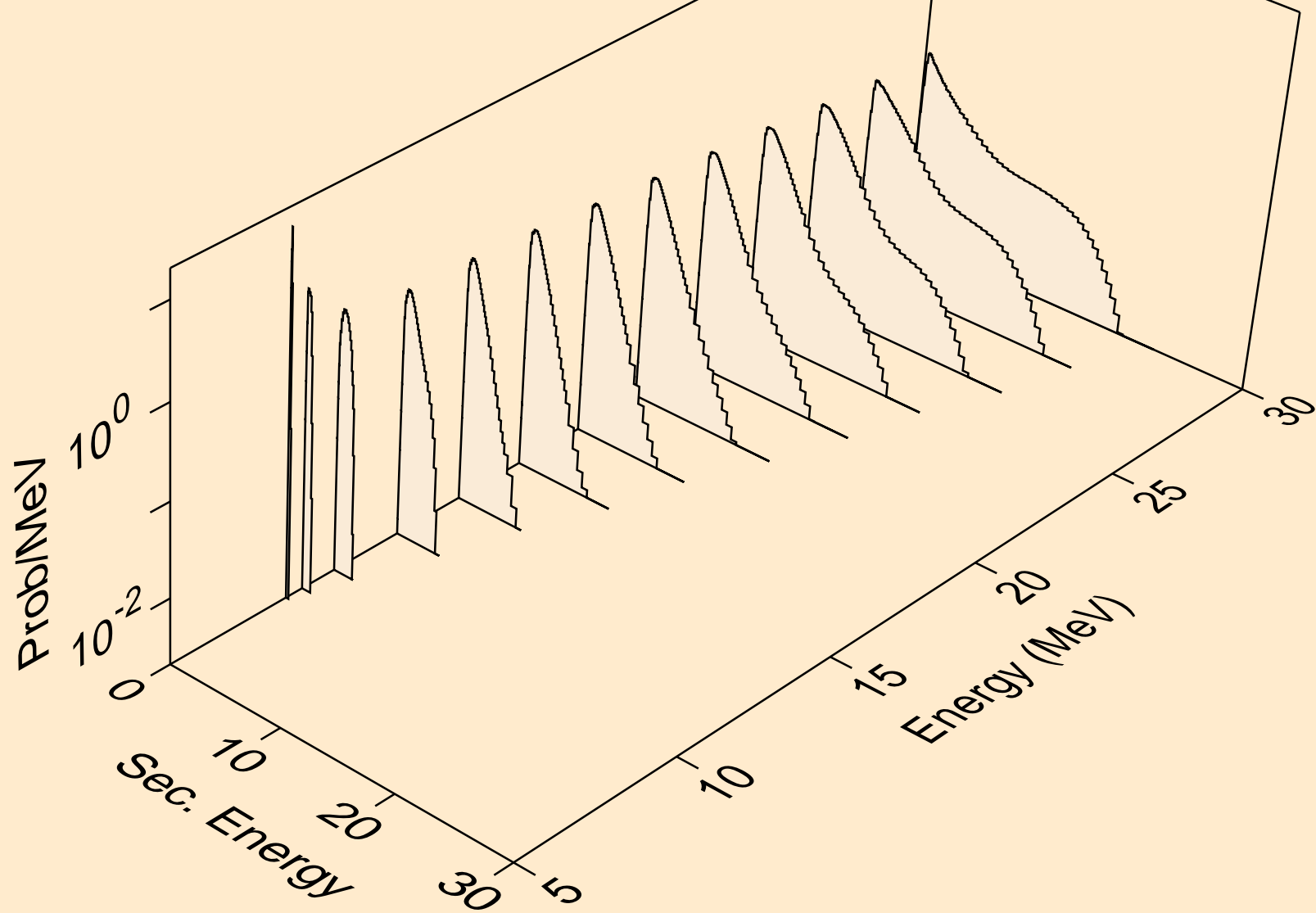

PT179 NEUTRON ACER TENDL-2021 LIBRARY; T=293.6K  
Neutron emission for (n,3n)

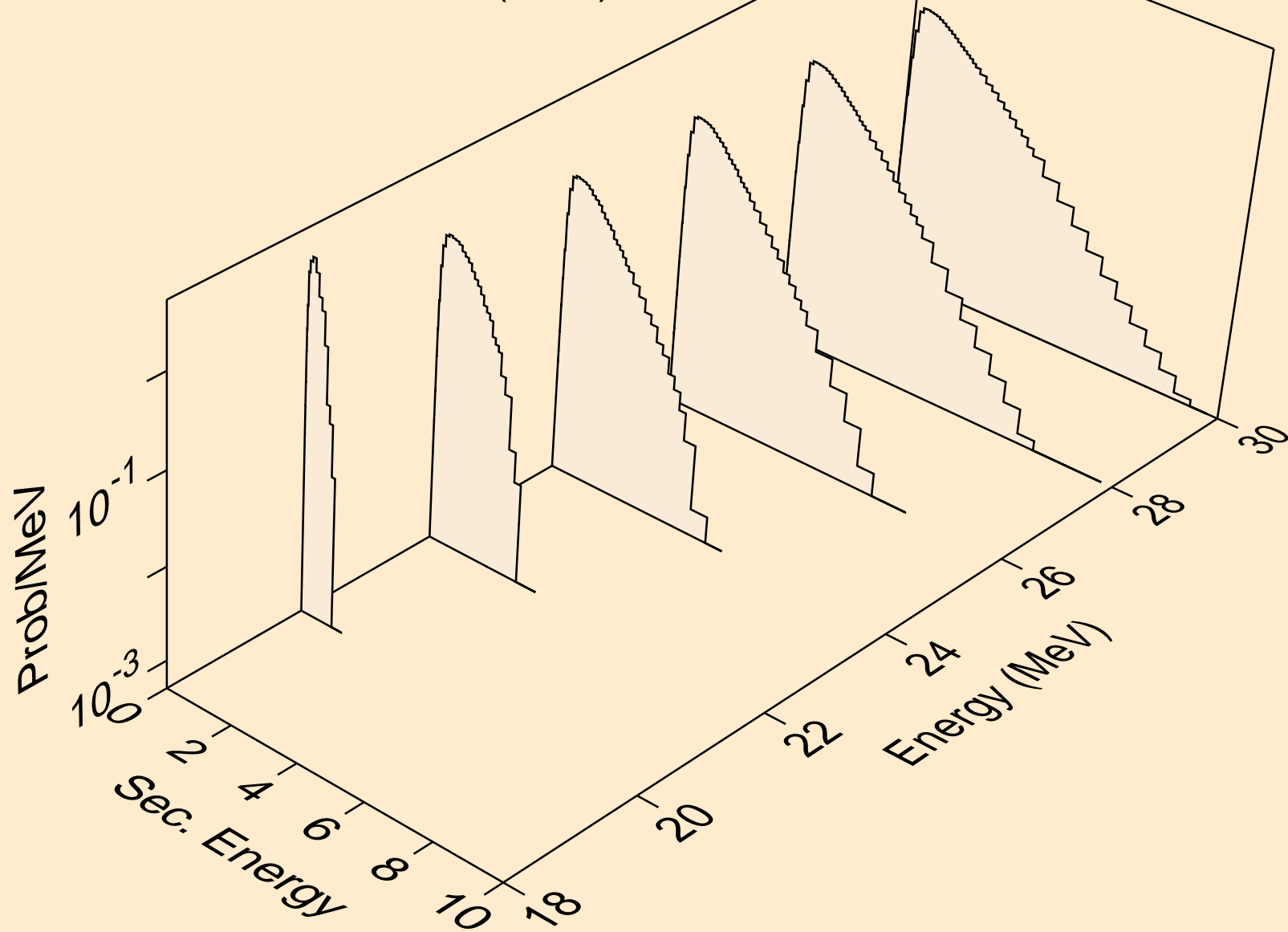



PT179 NEUTRON ACER TENDL-2021 LIBRARY; T=293.6K  
Neutron emission for (n,n\*)a

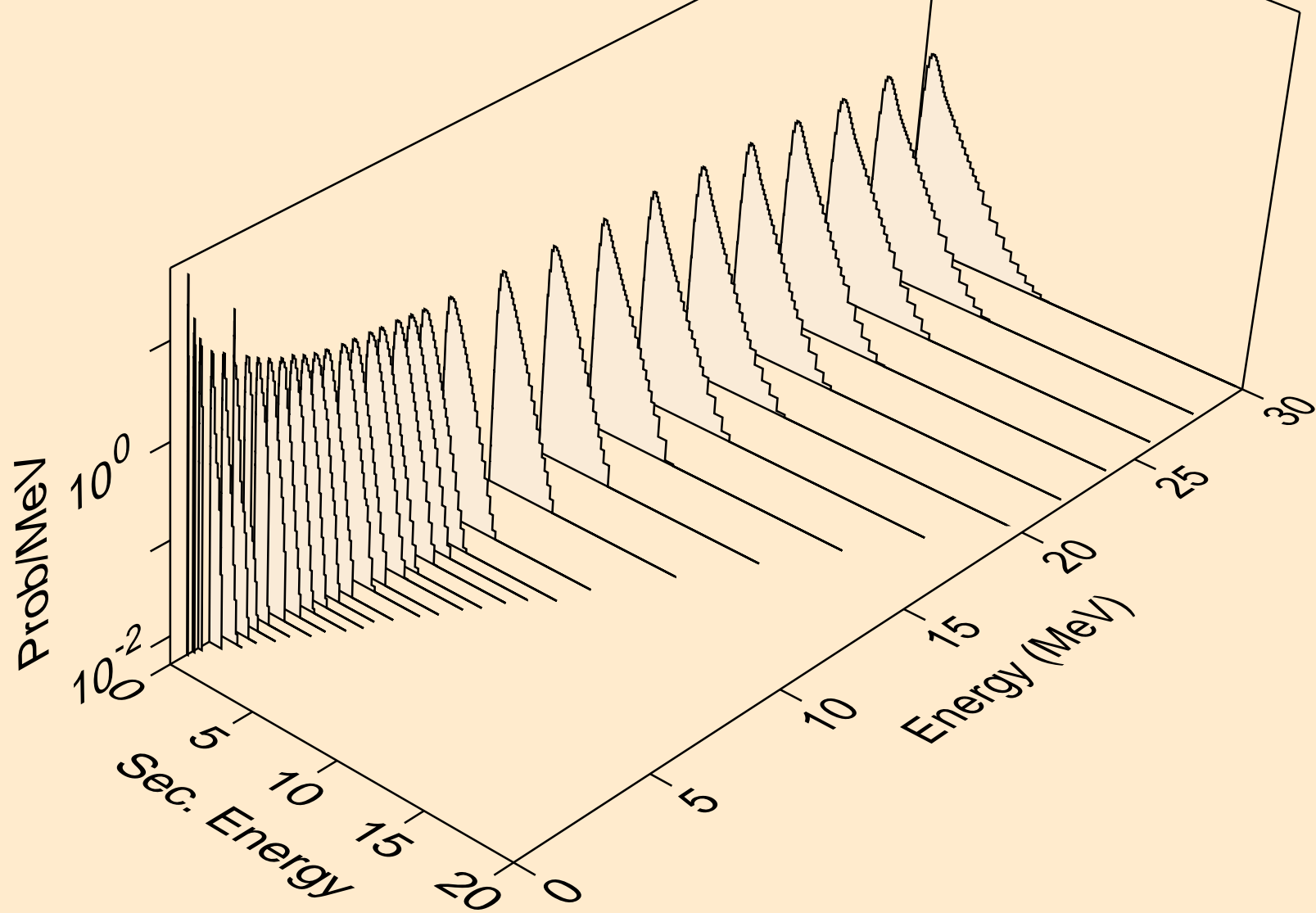

PT179 NEUTRON ACER TENDL-2021 LIBRARY; T=293.6K  
Neutron emission for (n,2n)<sub>a</sub>

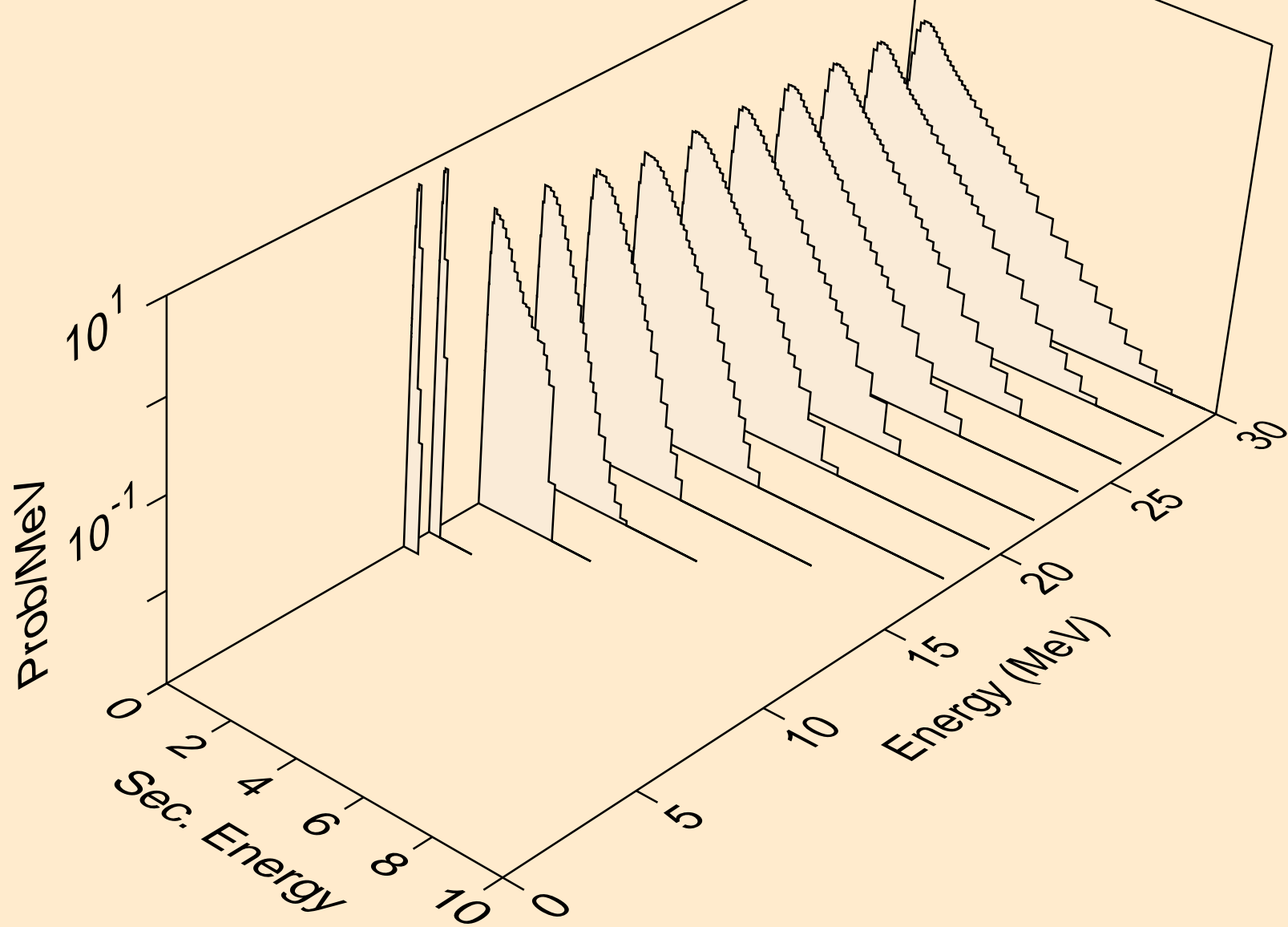

PT179 NEUTRON ACER TENDL-2021 LIBRARY; T=293.6K  
Neutron emission for (n,3n)a

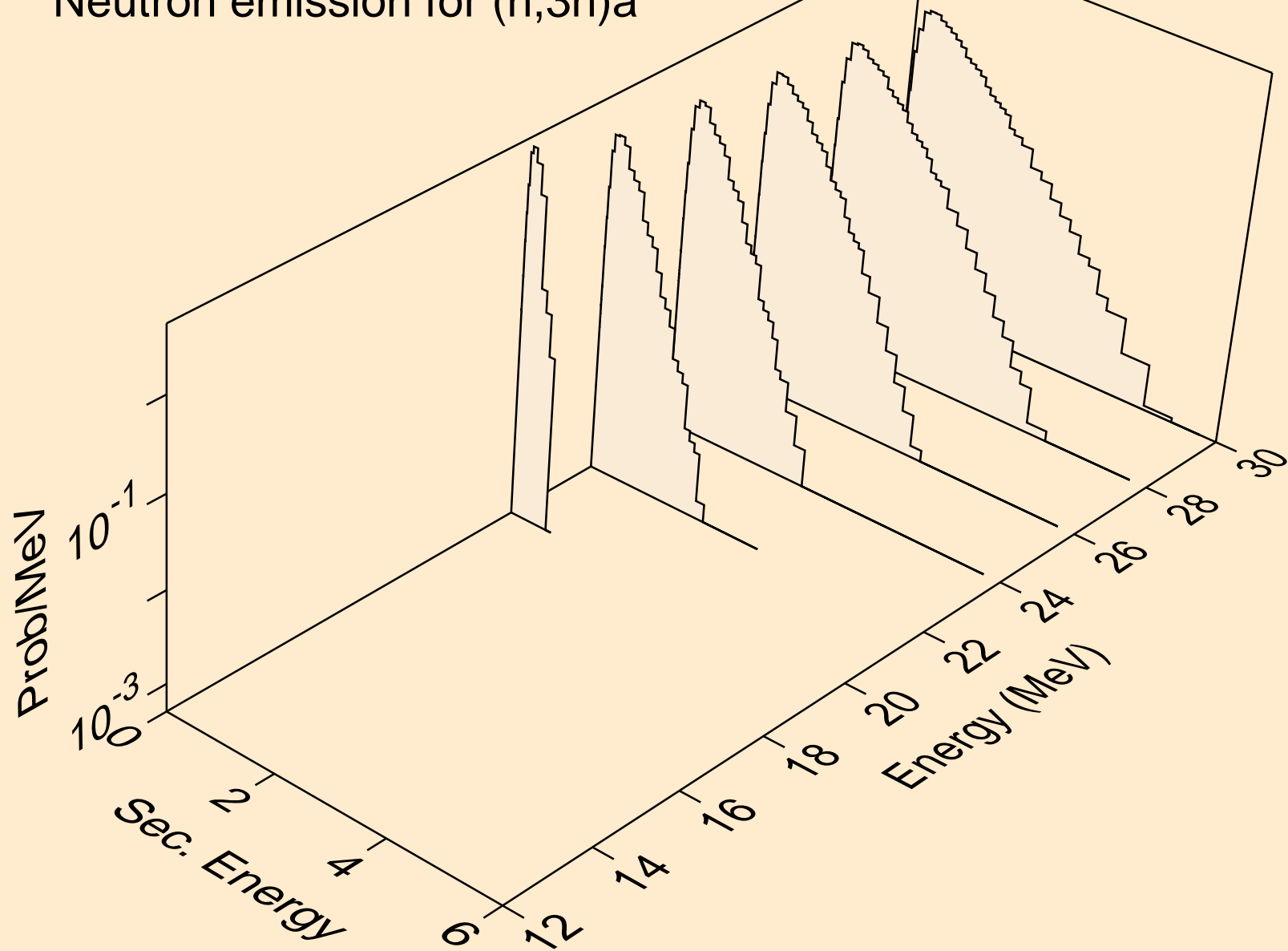

PT179 NEUTRON ACER TENDL-2021 LIBRARY; T=293.6K  
Neutron emission for (n,n\*)p

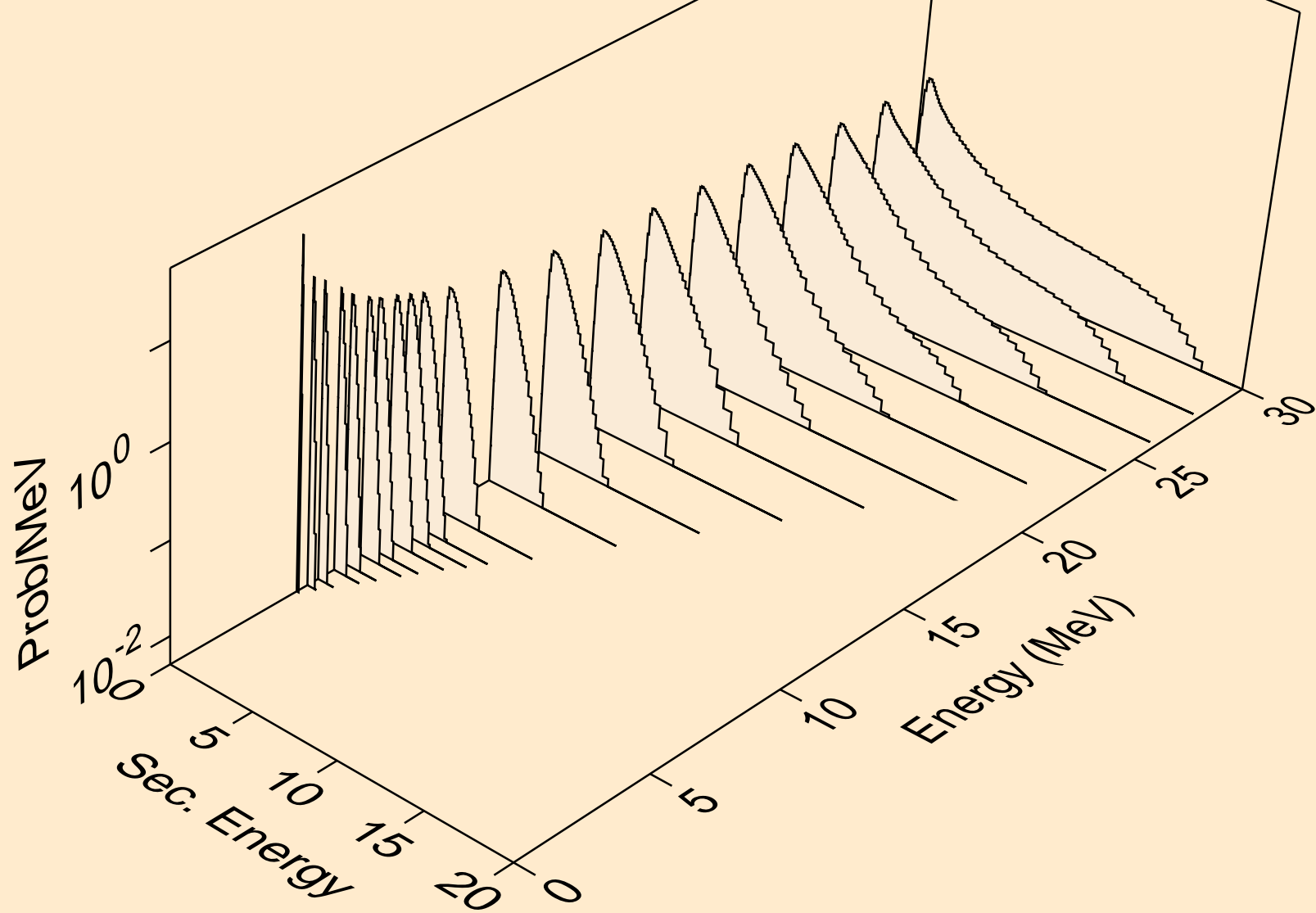

PT179 NEUTRON ACER TENDL-2021 LIBRARY; T=293.6K  
Neutron emission for (n,n\*)2a

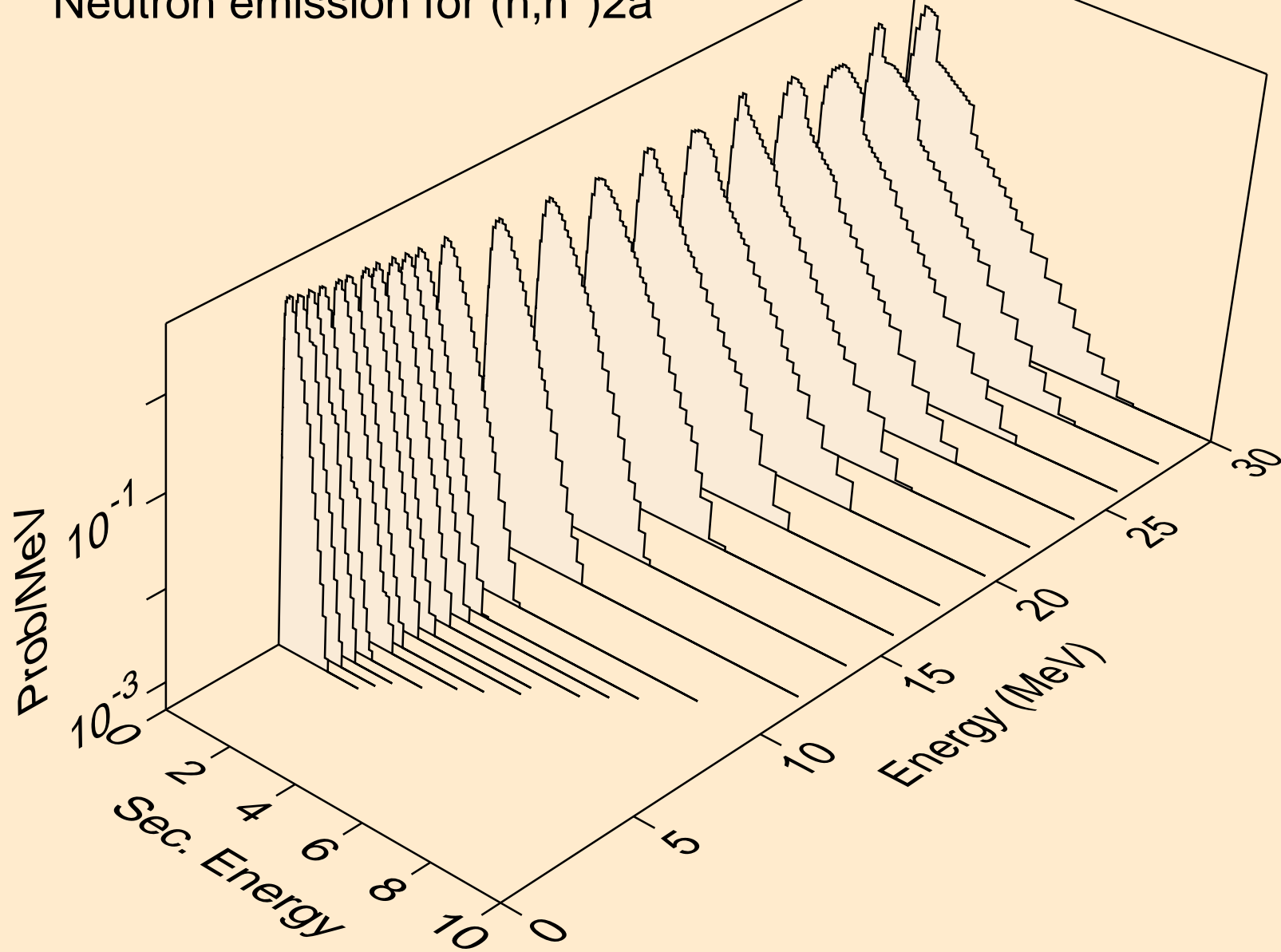

PT179 NEUTRON ACER TENDL-2021 LIBRARY; T=293.6K  
Neutron emission for (n,2n)2a

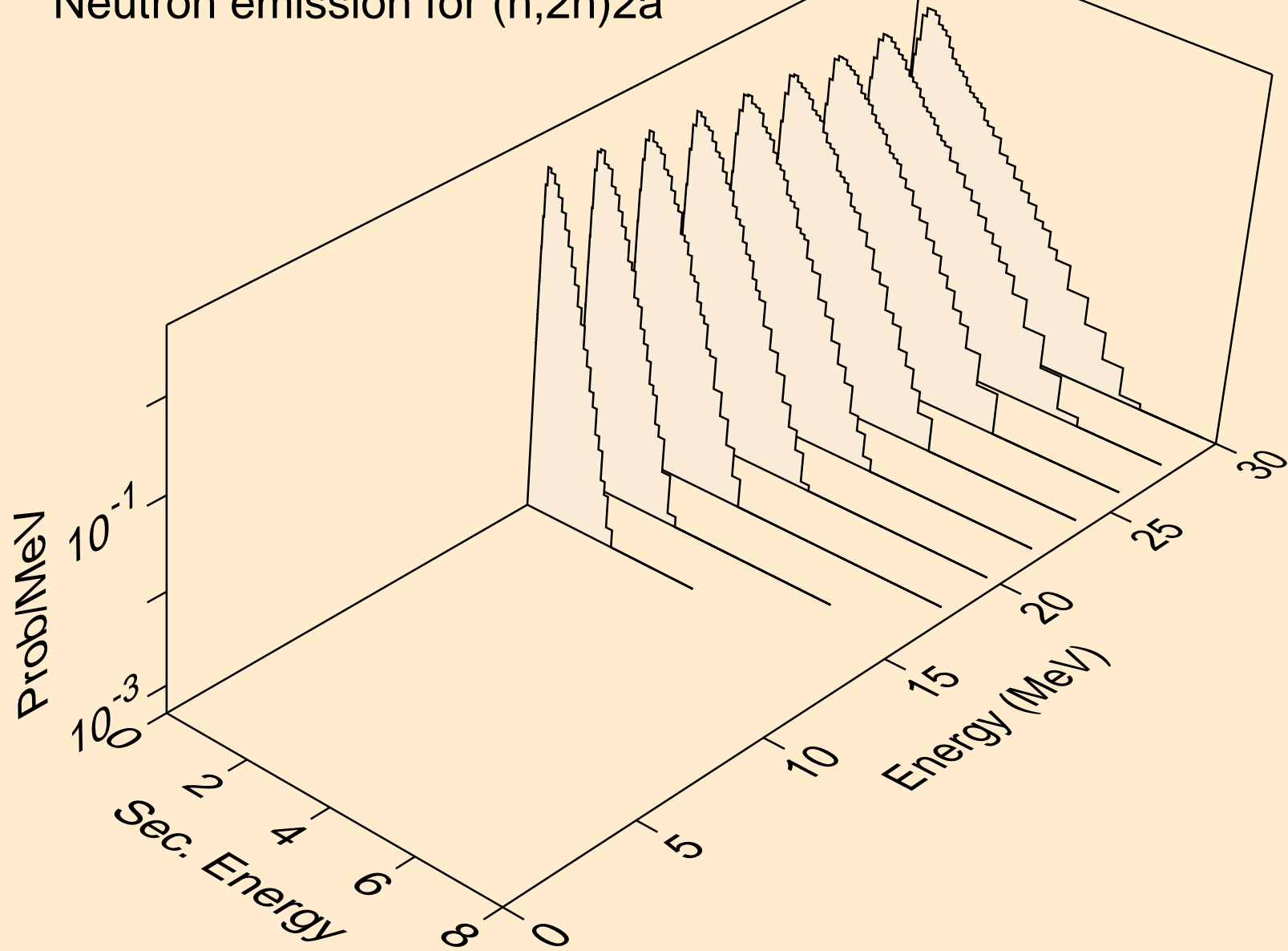

PT179 NEUTRON ACER TENDL-2021 LIBRARY; T=293.6K  
Neutron emission for (n,n\*)d

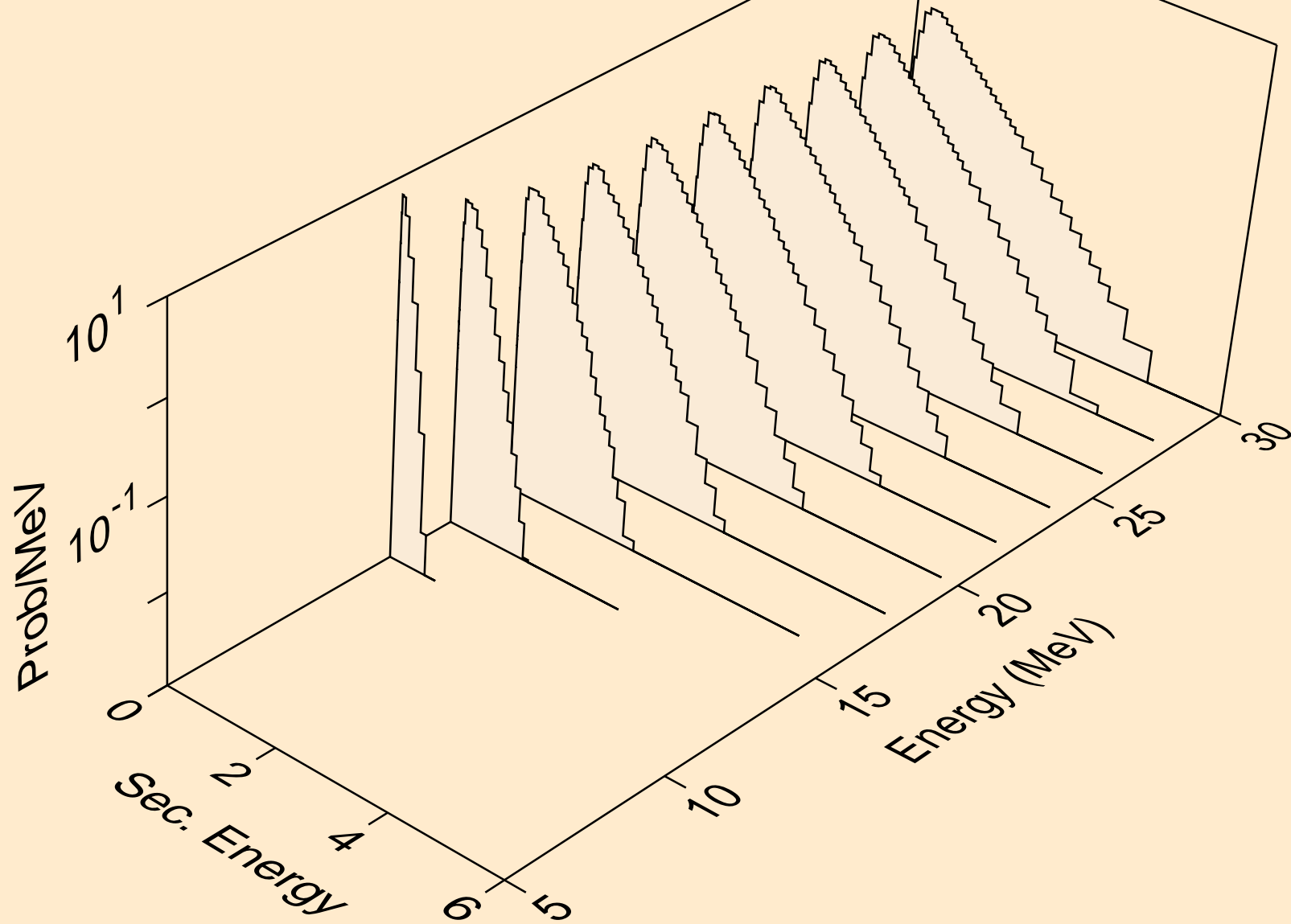

PT179 NEUTRON ACER TENDL-2021 LIBRARY; T=293.6K  
Neutron emission for (n,n\*)t

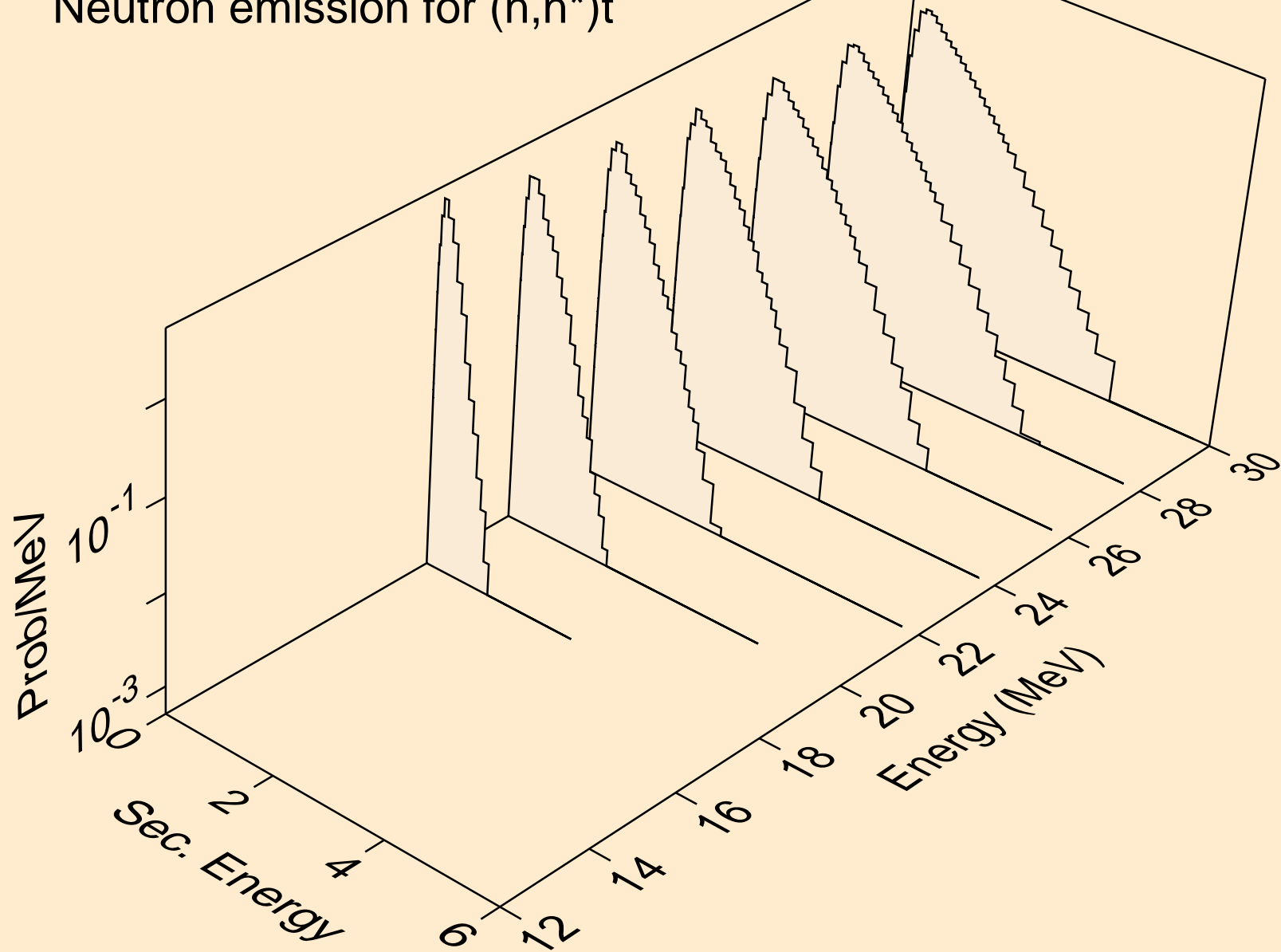



PT179 NEUTRON ACER TENDL-2021 LIBRARY; T=293.6K  
Neutron emission for (n,n\*)he3

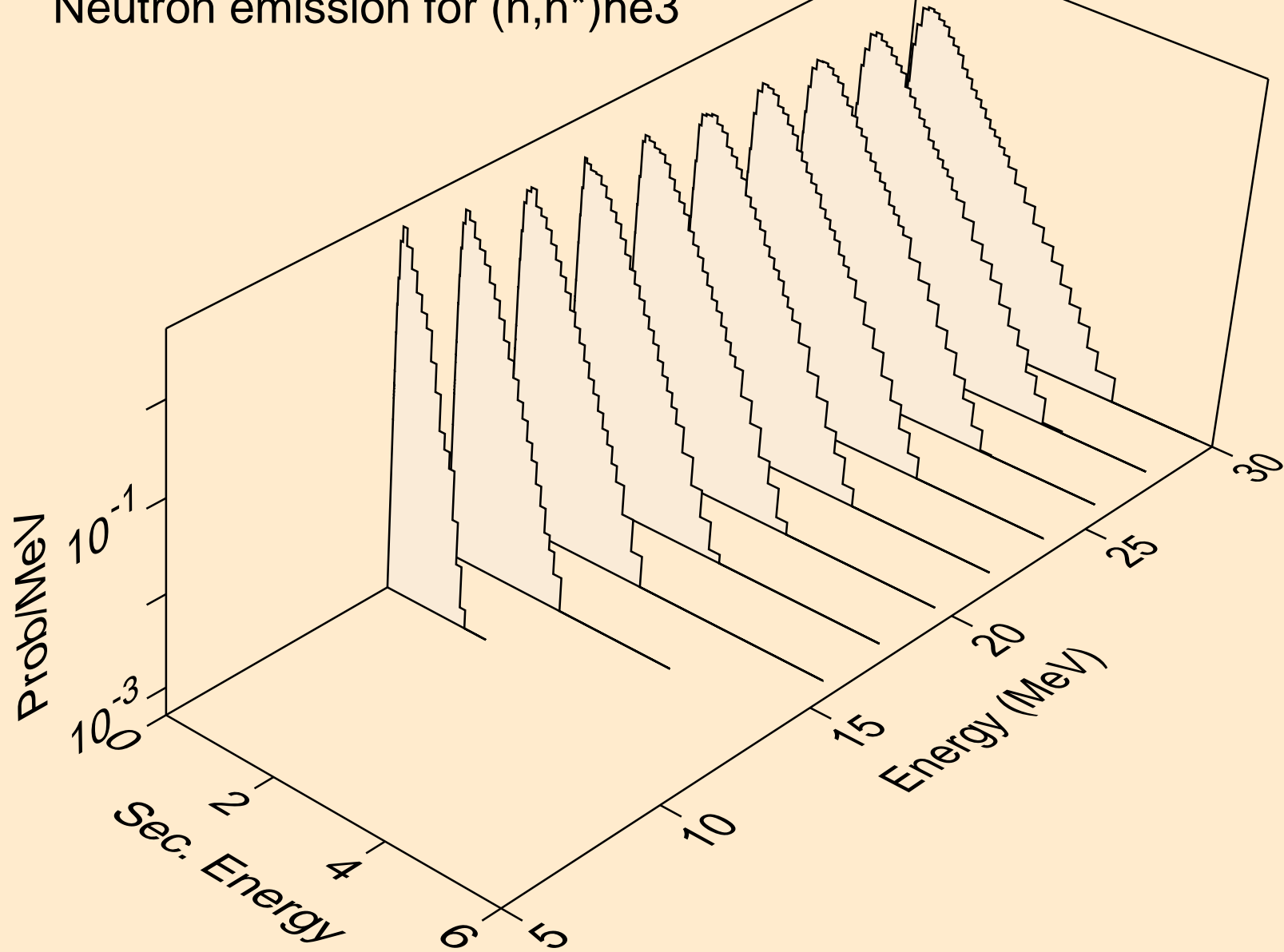

PT179 NEUTRON ACER TENDL-2021 LIBRARY; T=293.6K  
Neutron emission for (n,4n)

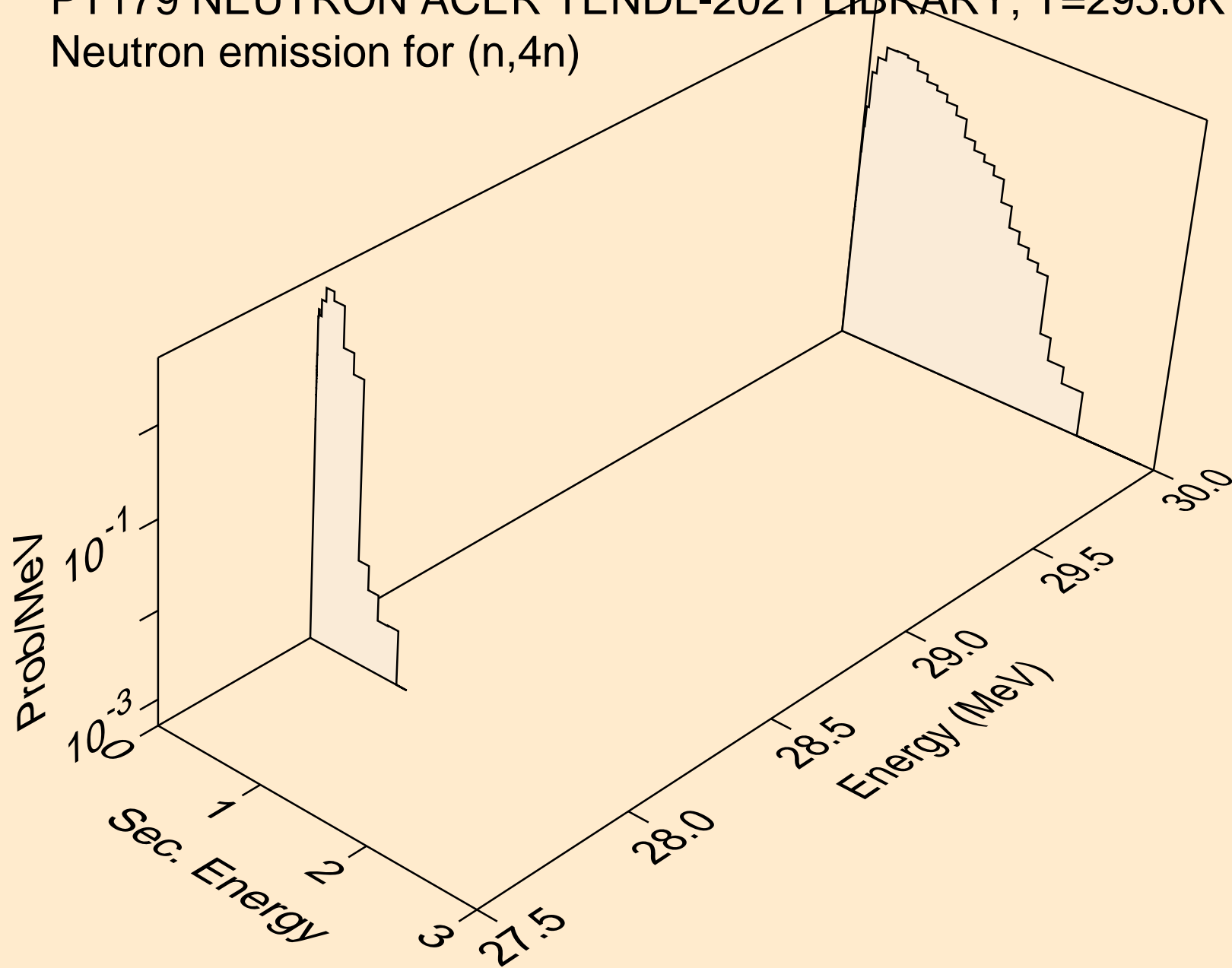

PT179 NEUTRON ACER TENDL-2021 LIBRARY; T=293.6K  
Neutron emission for (n,2np)

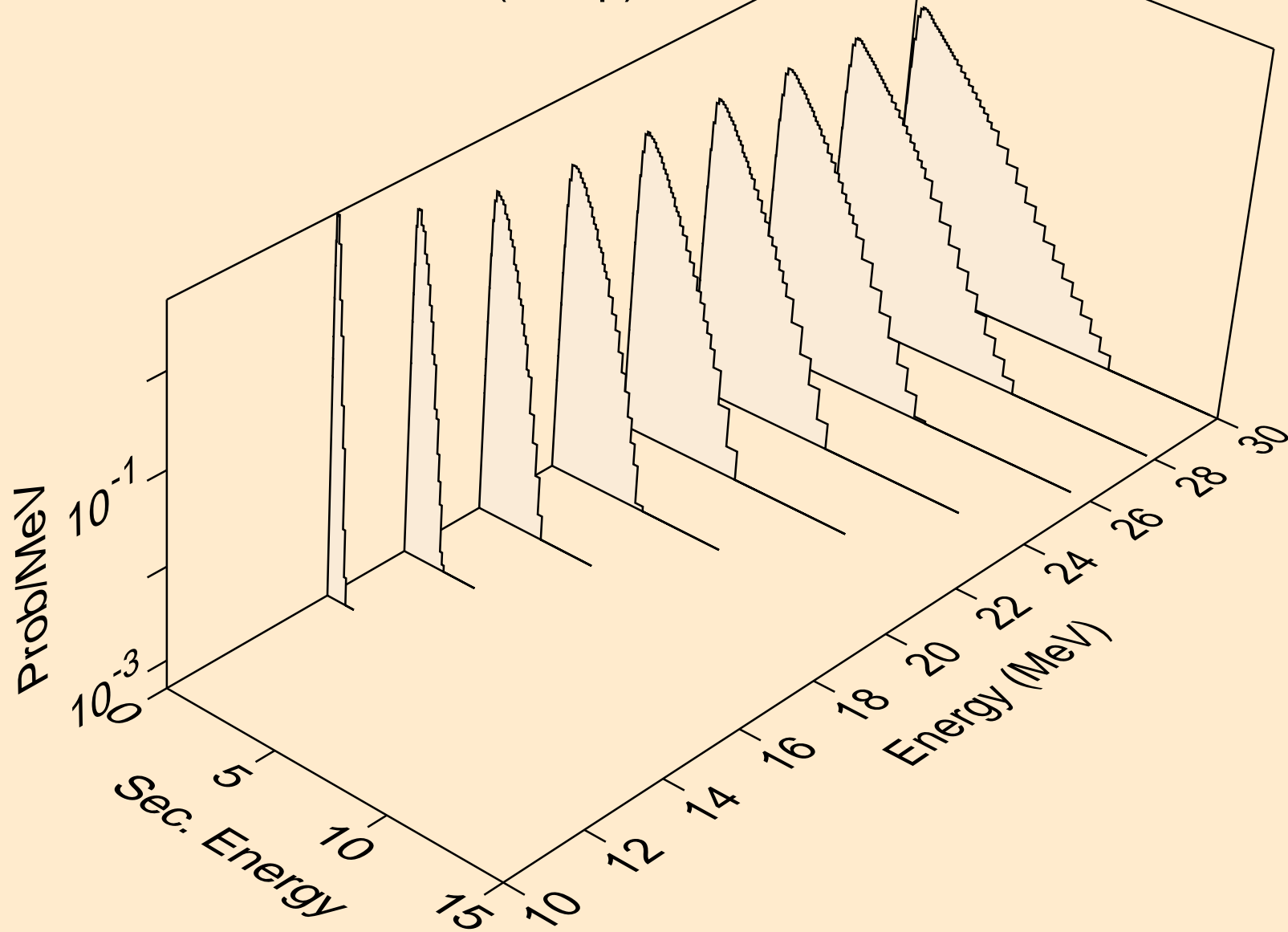

PT179 NEUTRON ACER TENDL-2021 LIBRARY; T=293.6K  
Neutron emission for (n,3np)

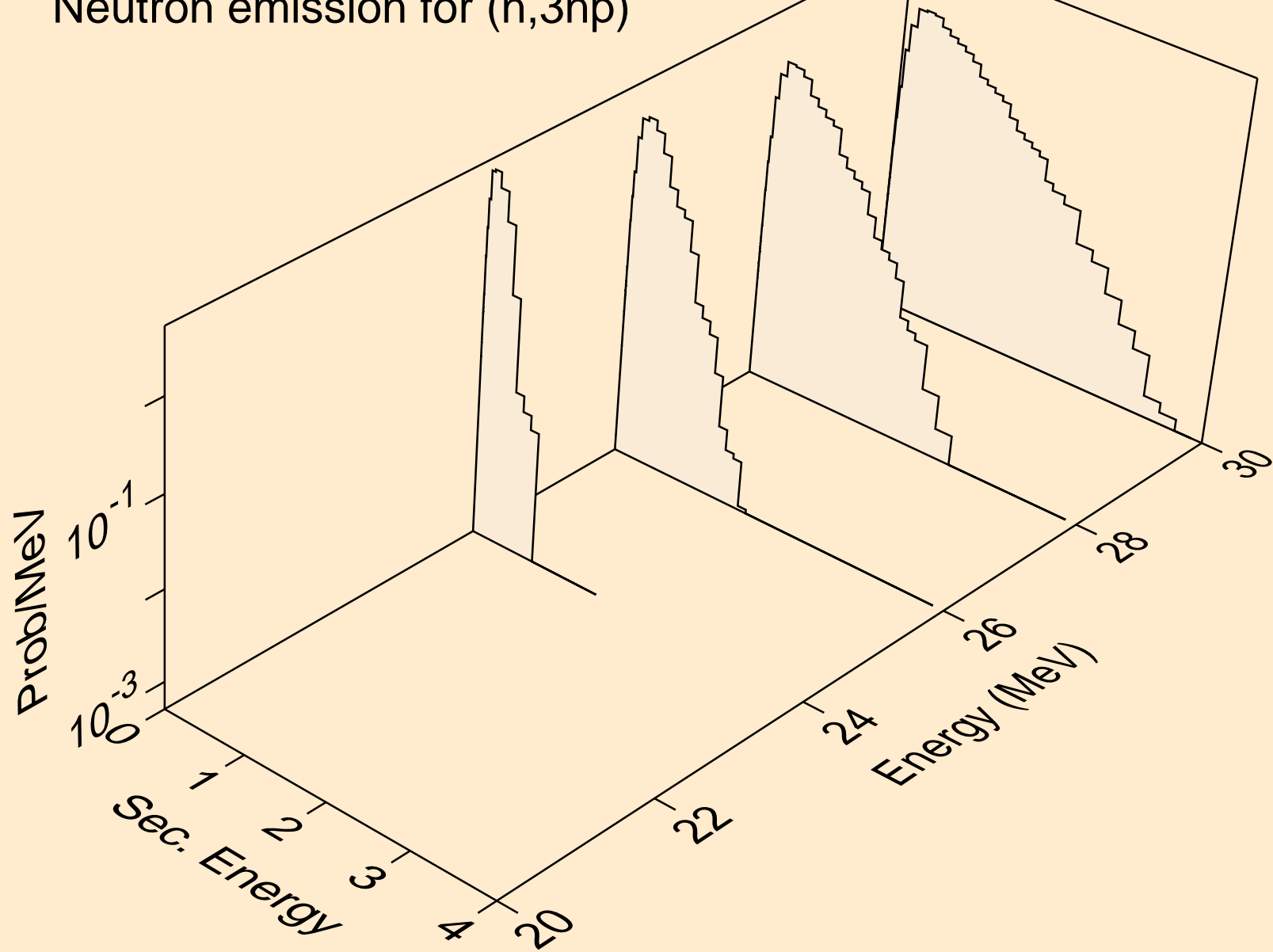

PT179 NEUTRON ACER TENDL-2021 LIBRARY; T=293.6K  
Neutron emission for (n,2np)

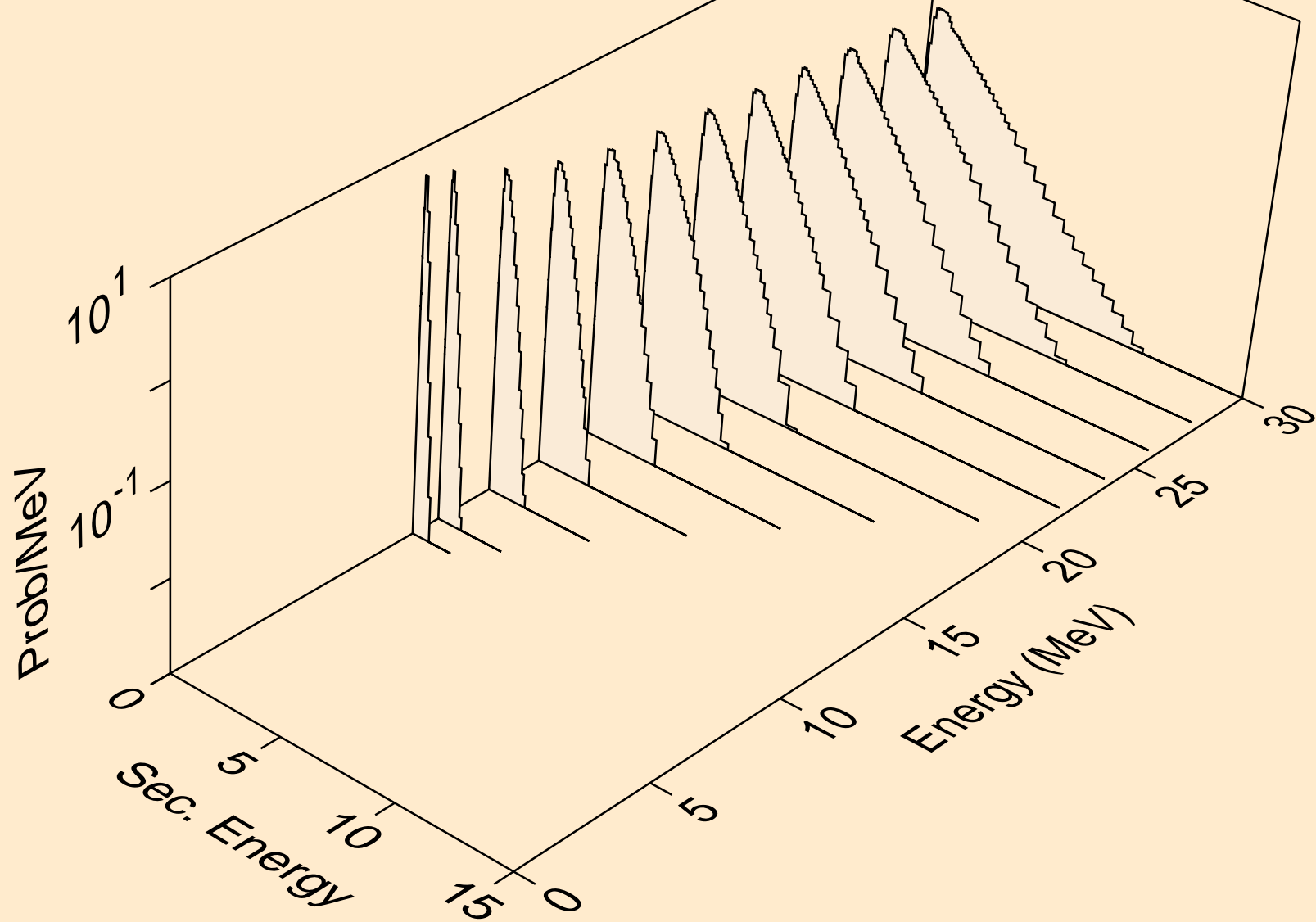

PT179 NEUTRON ACER TENDL-2021 LIBRARY; T=293.6K  
Neutron emission for (n,npa)

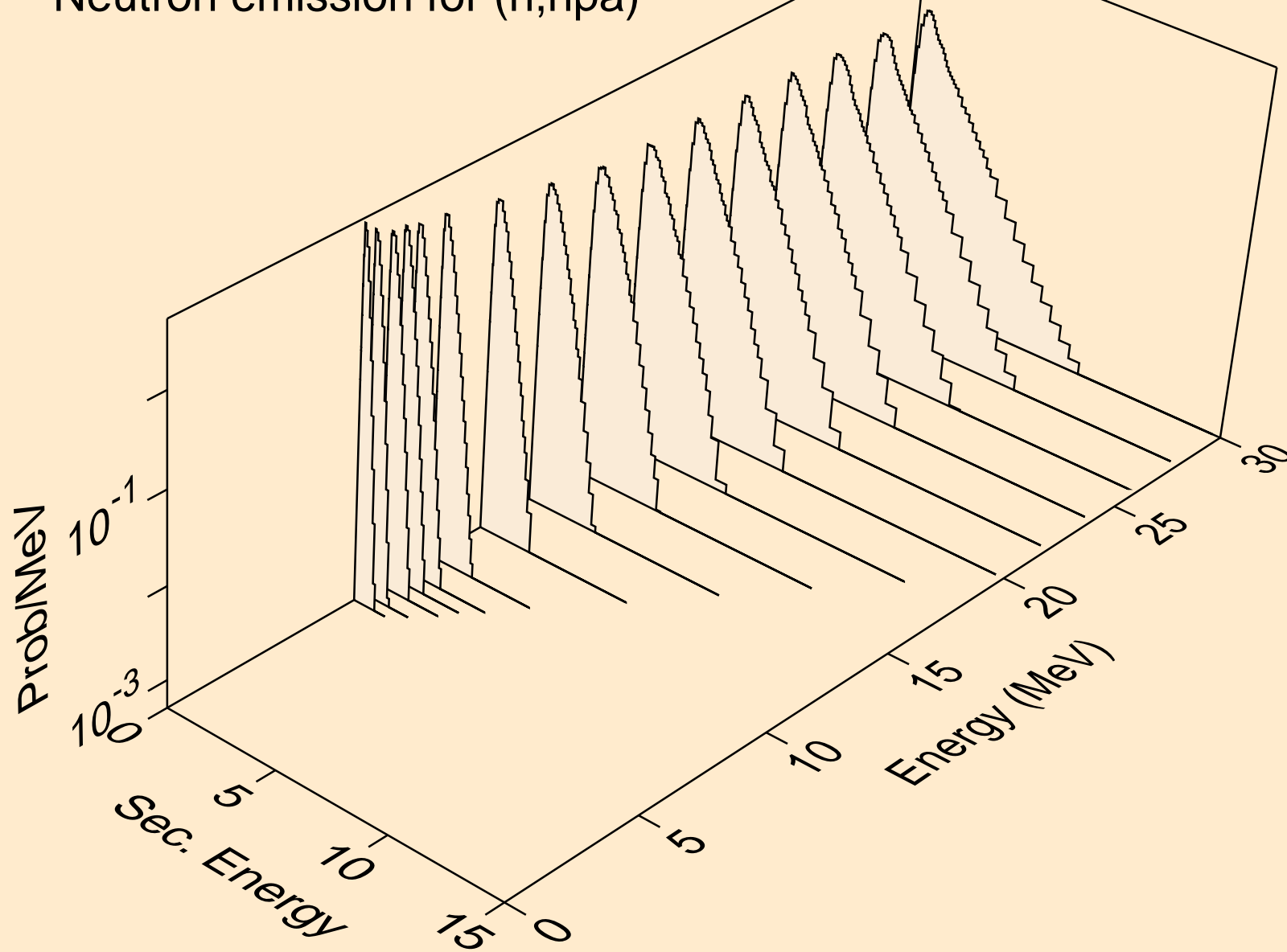

PT179 NEUTRON ACER TENDL-2021 LIBRARY; T=293.6K  
Neutron emission for (n,n\*c)

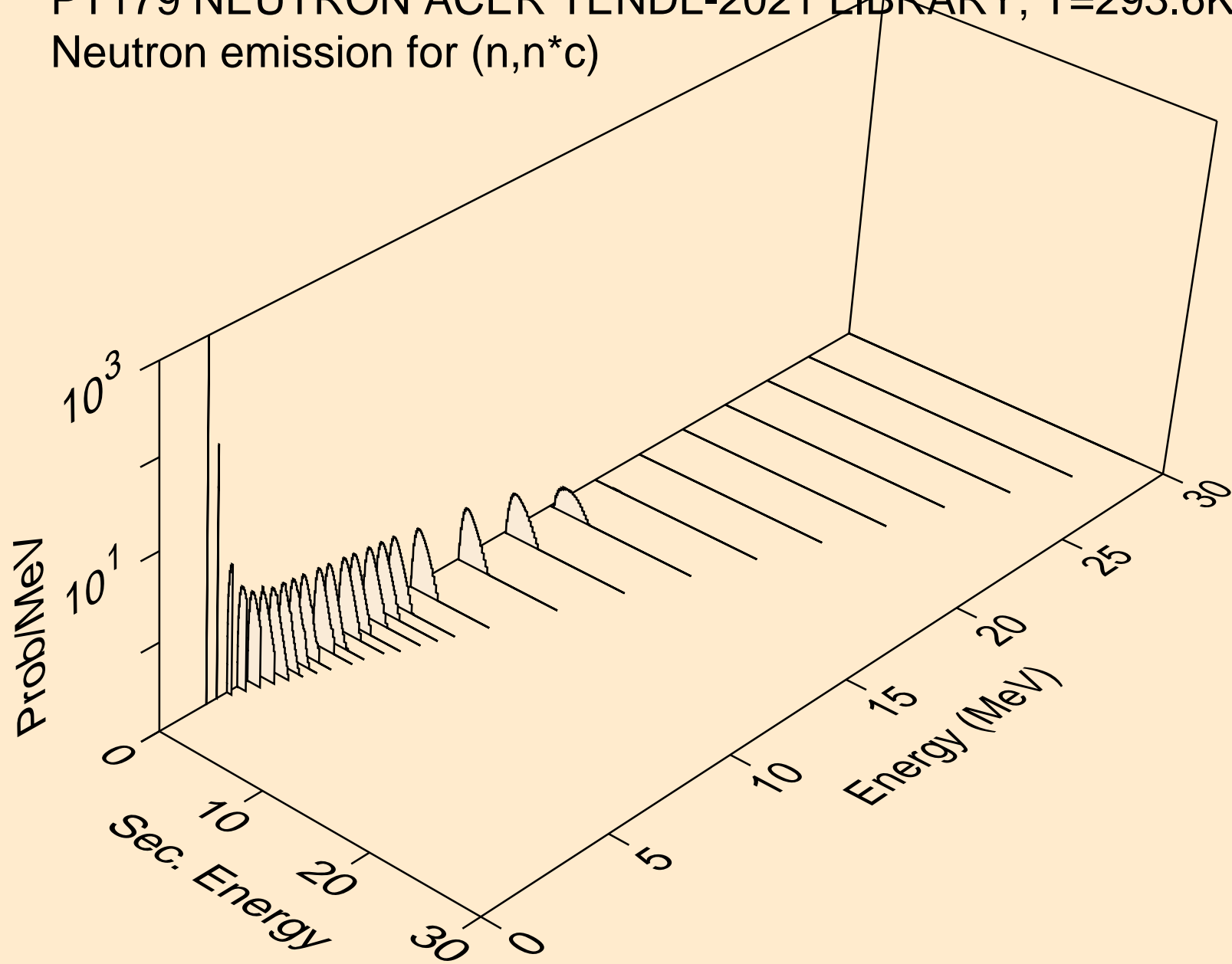

PT179 NEUTRON ACER TENDL-2021 LIBRARY; T=293.6K  
Photon emission for (n,x)

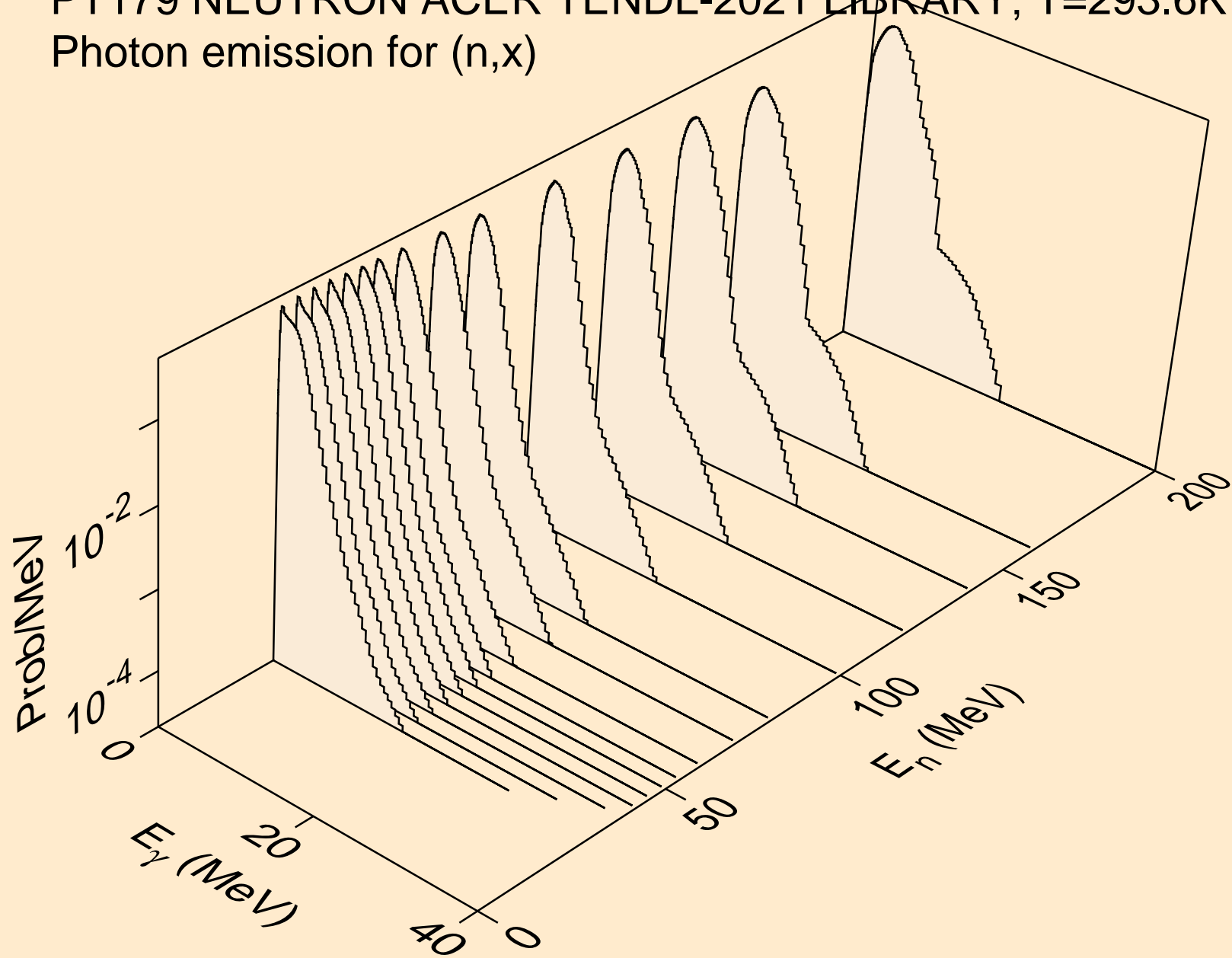



PT179 NEUTRON ACER TENDL-2021 LIBRARY; T=293.6K  
Photon emission for (n,2nd)

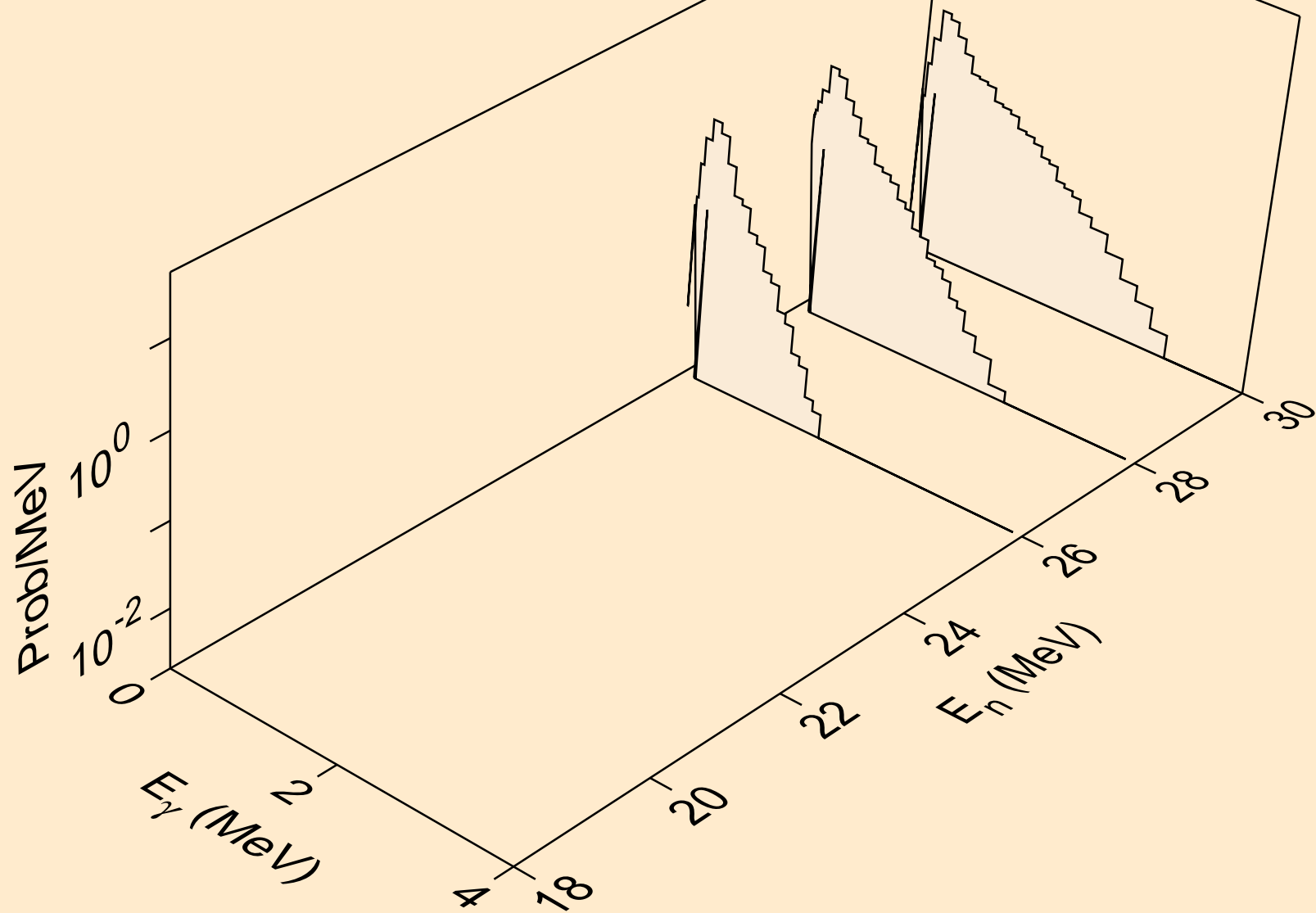

PT179 NEUTRON ACER TENDL-2021 LIBRARY; T=293.6K  
Photon emission for (n,2n)

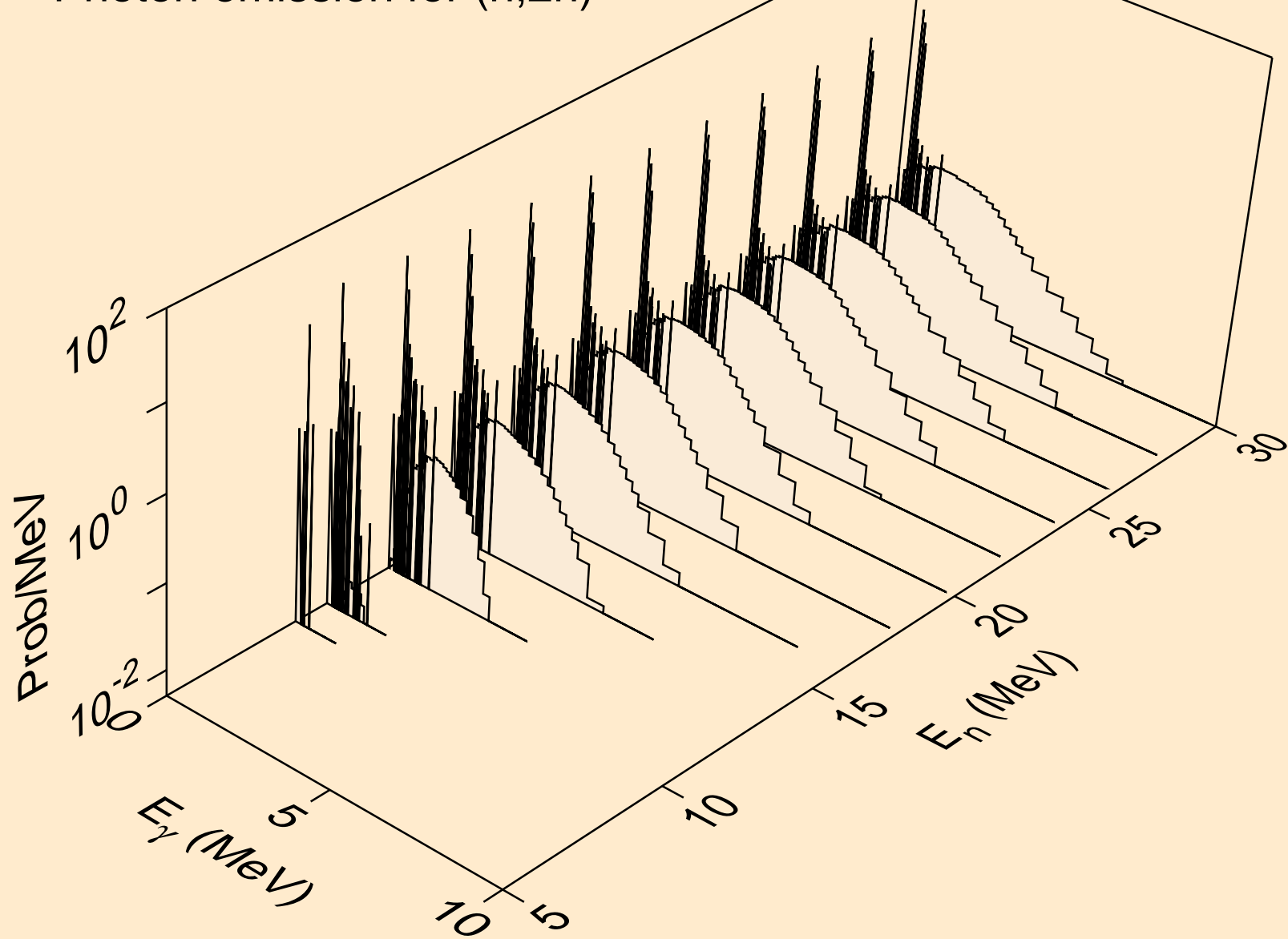

PT179 NEUTRON ACER TENDL-2021 LIBRARY; T=293.6K  
Photon emission for (n,3n)

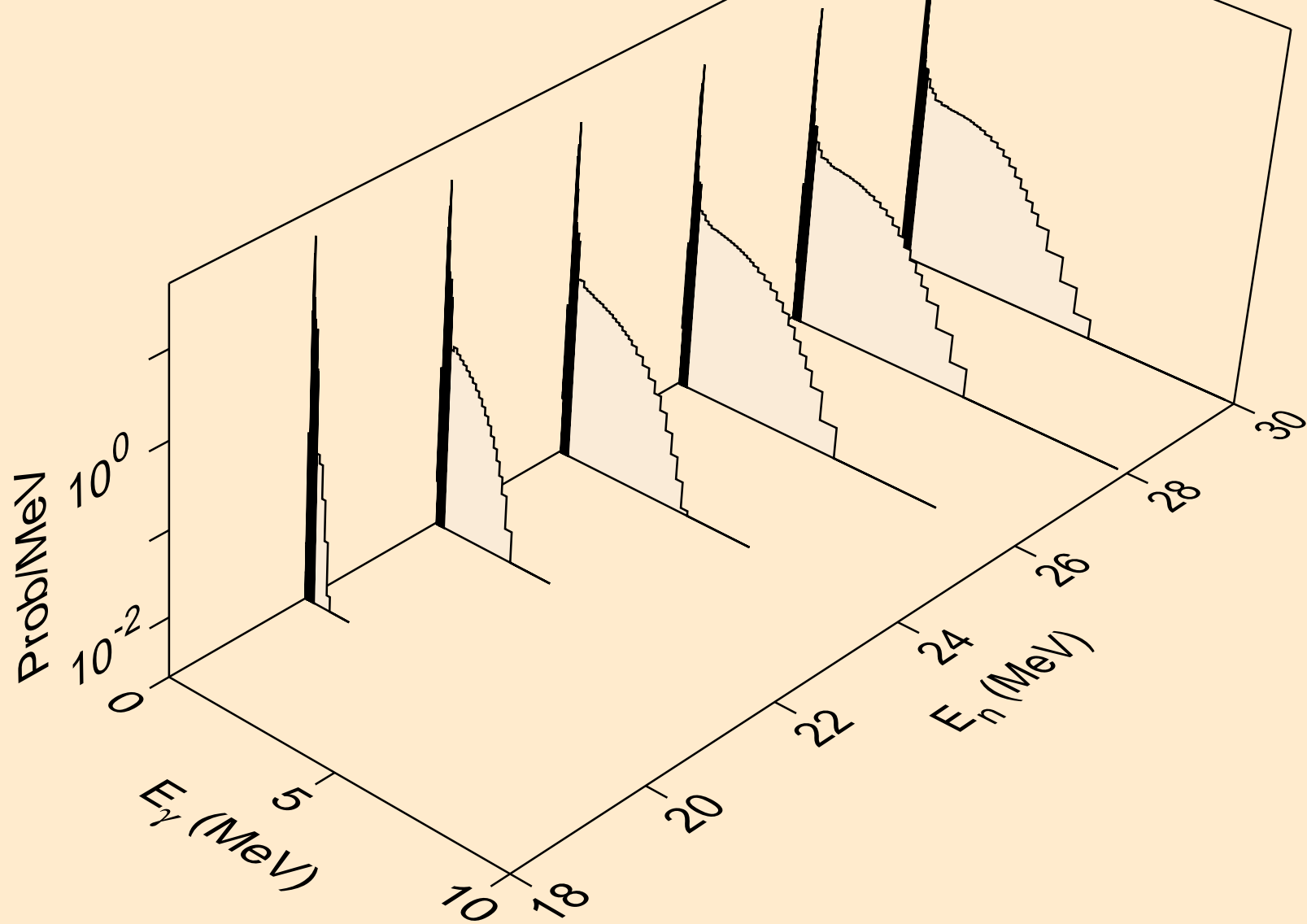

PT179 NEUTRON ACER TENDL-2021 LIBRARY; T=293.6K  
Photon emission for (n,n\*)a

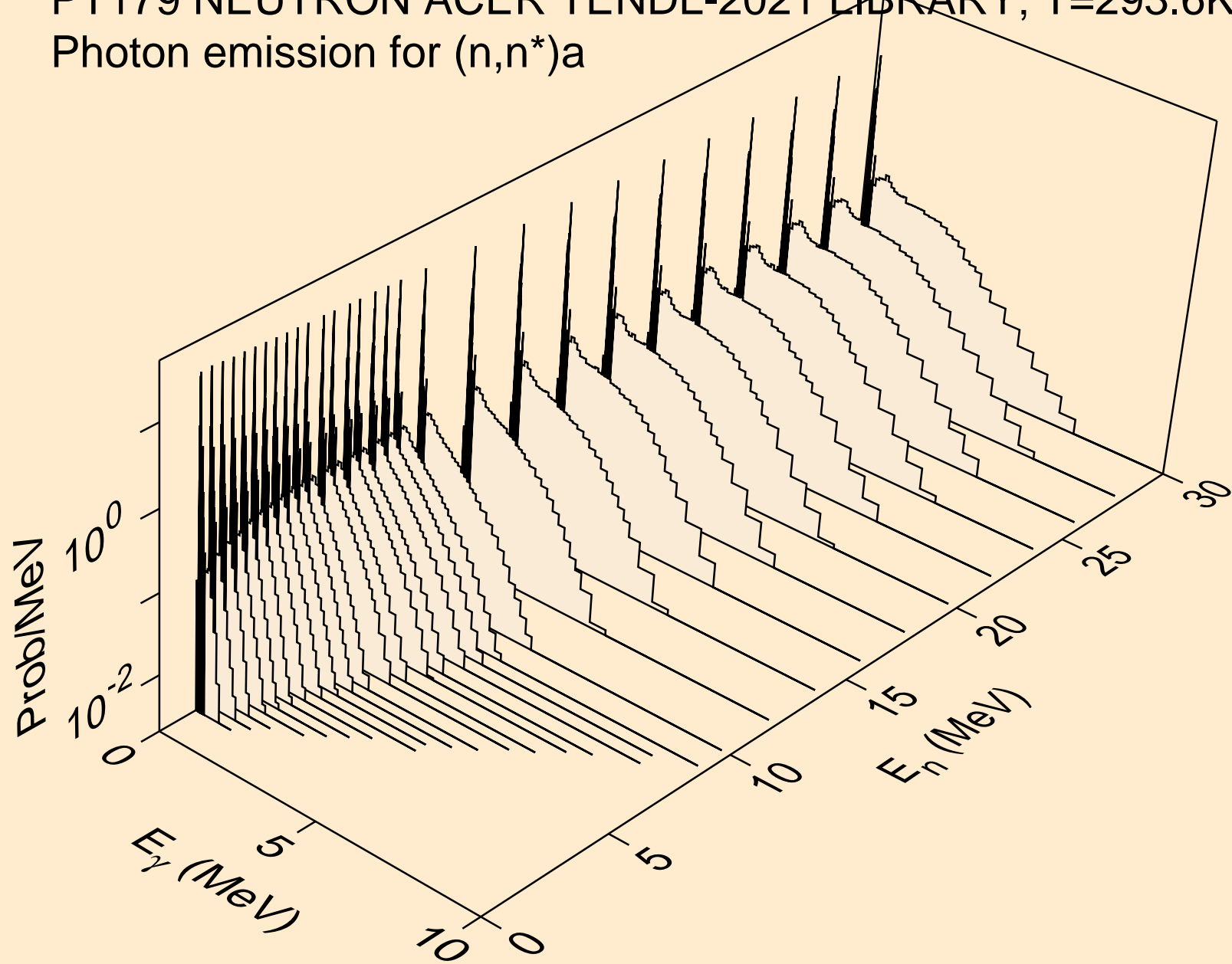

PT179 NEUTRON ACER TENDL-2021 LIBRARY; T=293.6K  
Photon emission for (n,2n)a

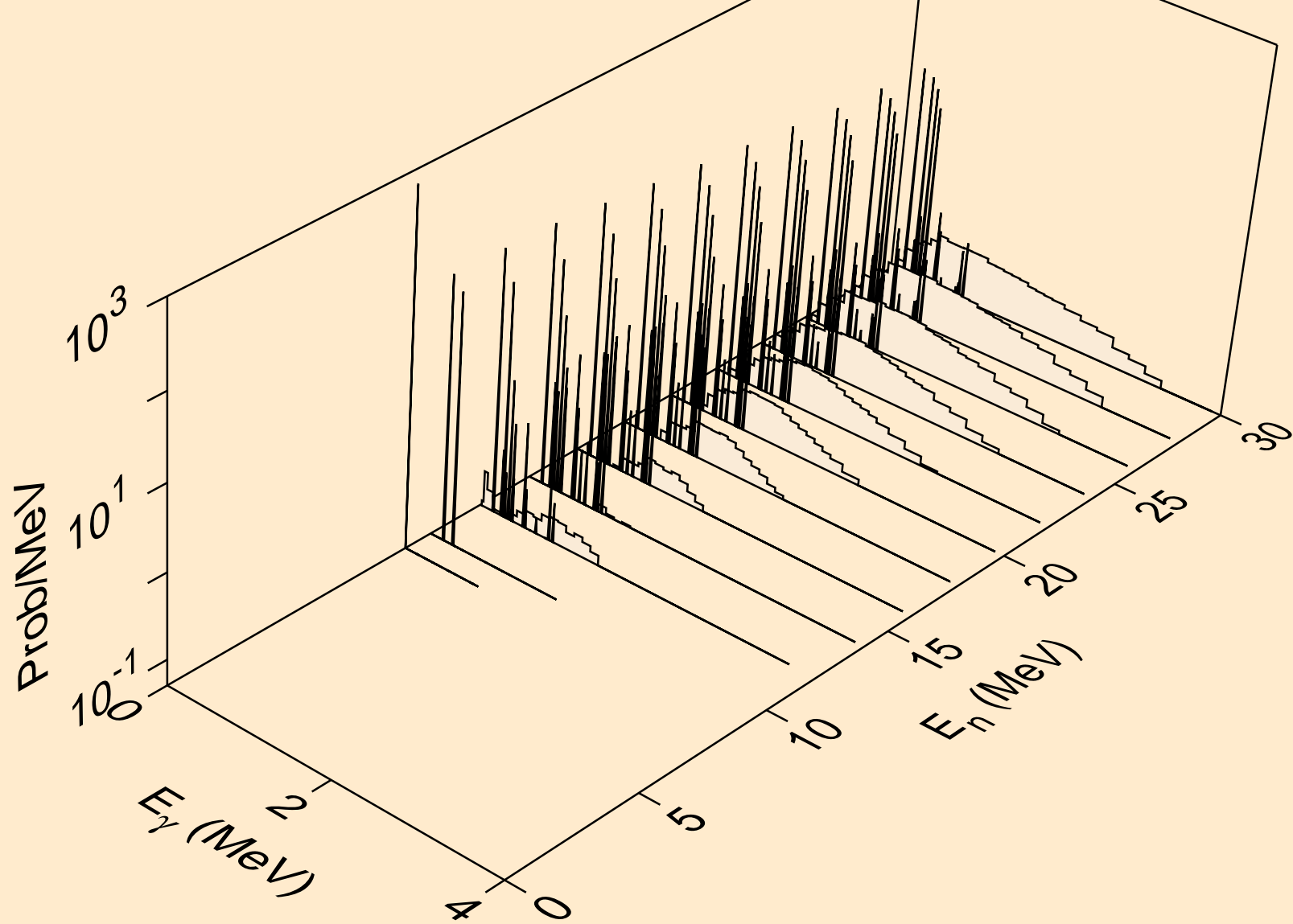

PT179 NEUTRON ACER TENDL-2021 LIBRARY; T=293.6K  
Photon emission for (n,3n)a

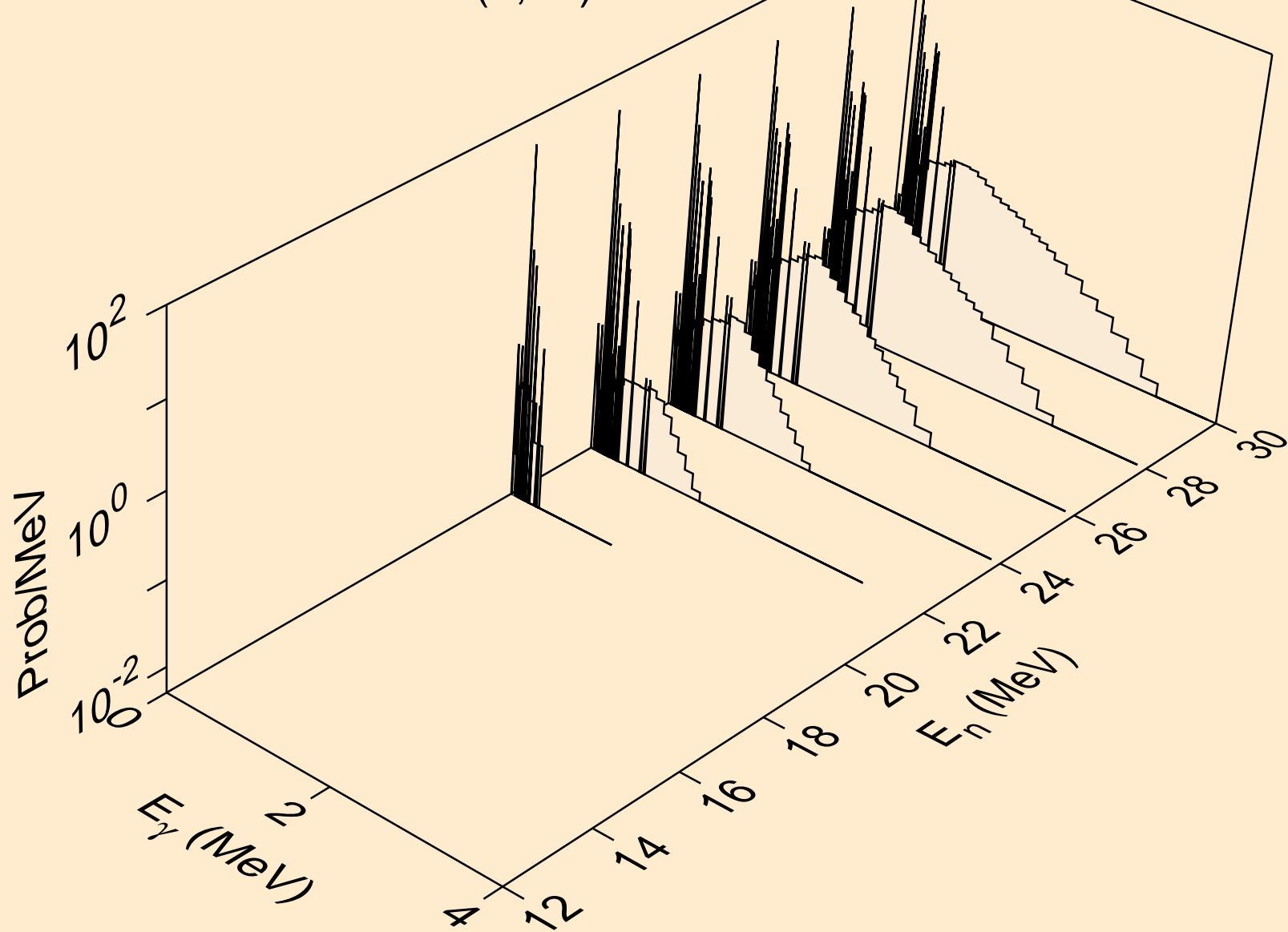

PT179 NEUTRON ACER TENDL-2021 LIBRARY; T=293.6K  
Photon emission for (n,n\*)p

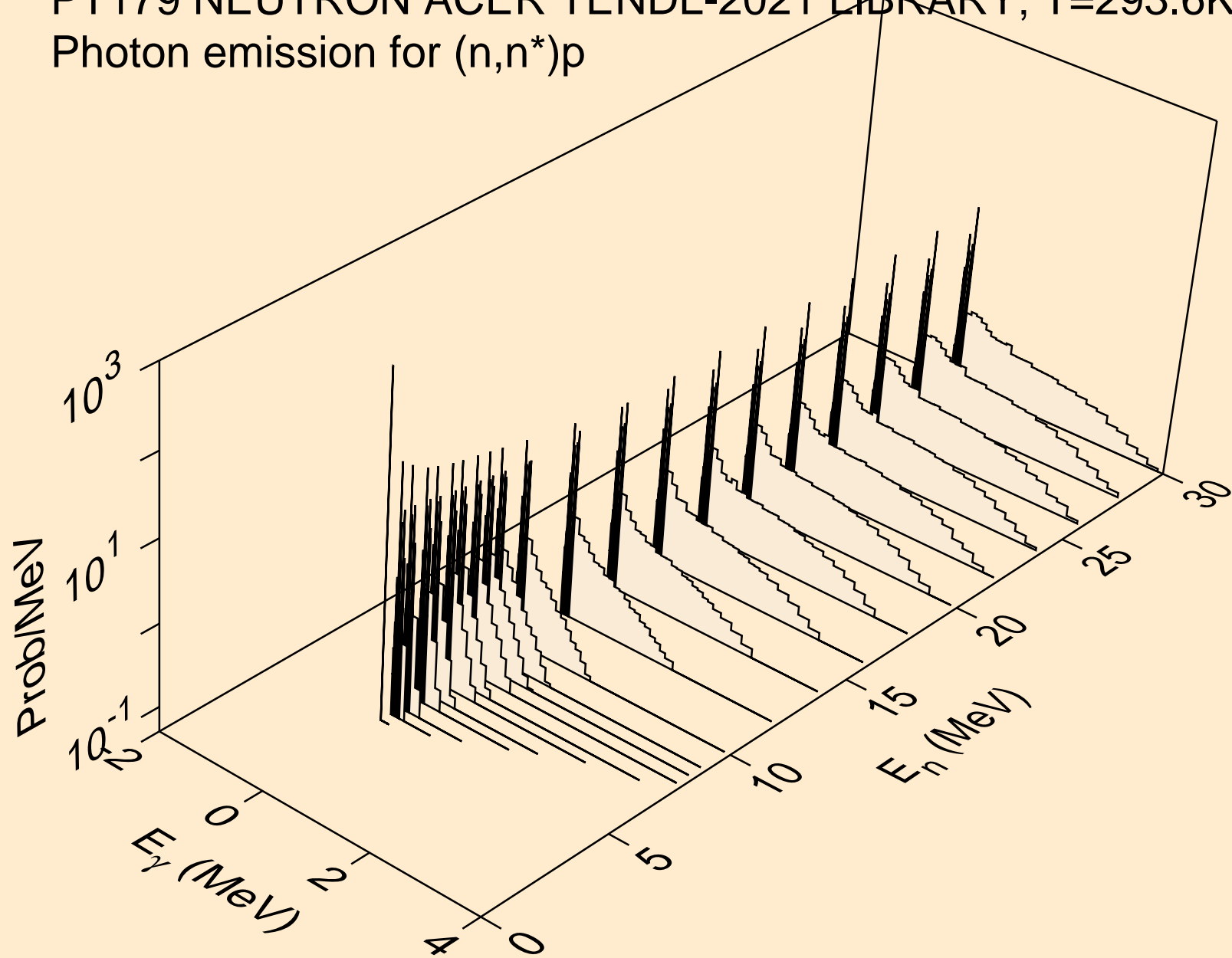

PT179 NEUTRON ACER TENDL-2021 LIBRARY; T=293.6K  
Photon emission for (n,n\*)2a

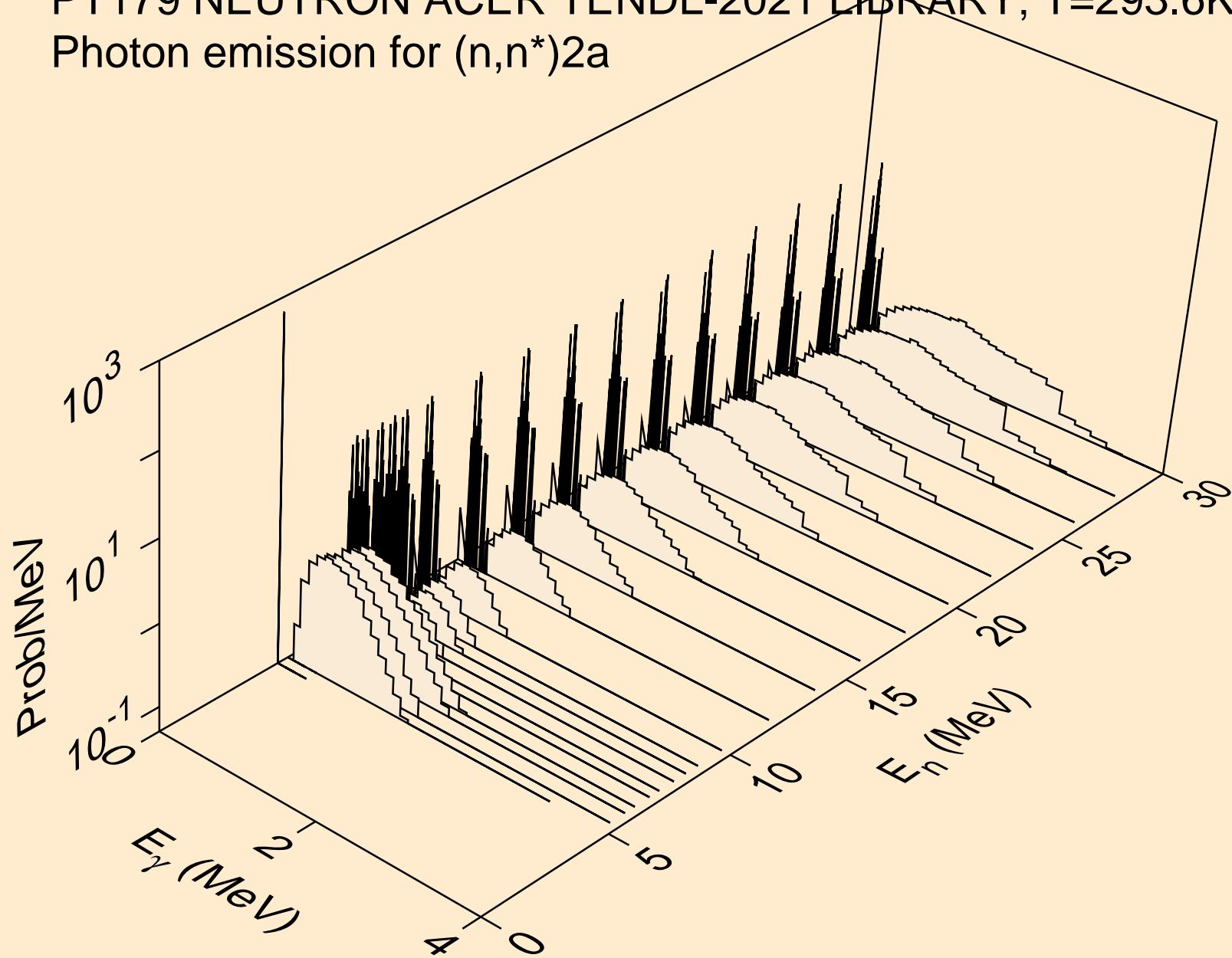



PT179 NEUTRON ACER TENDL-2021 LIBRARY; T=293.6K  
Photon emission for (n,2n)2a

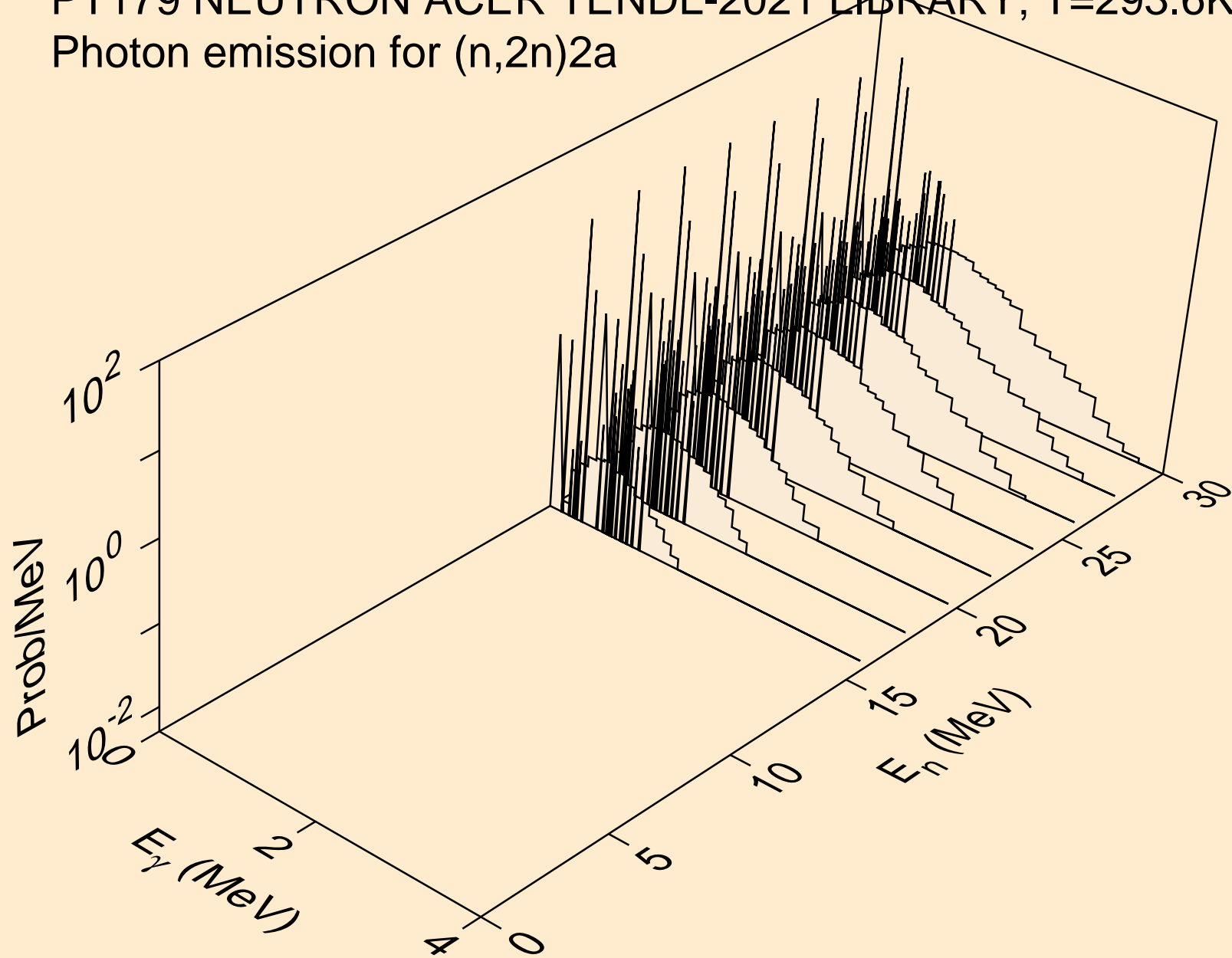

PT179 NEUTRON ACER TENDL-2021 LIBRARY; T=293.6K  
Photon emission for (n,n\*)d

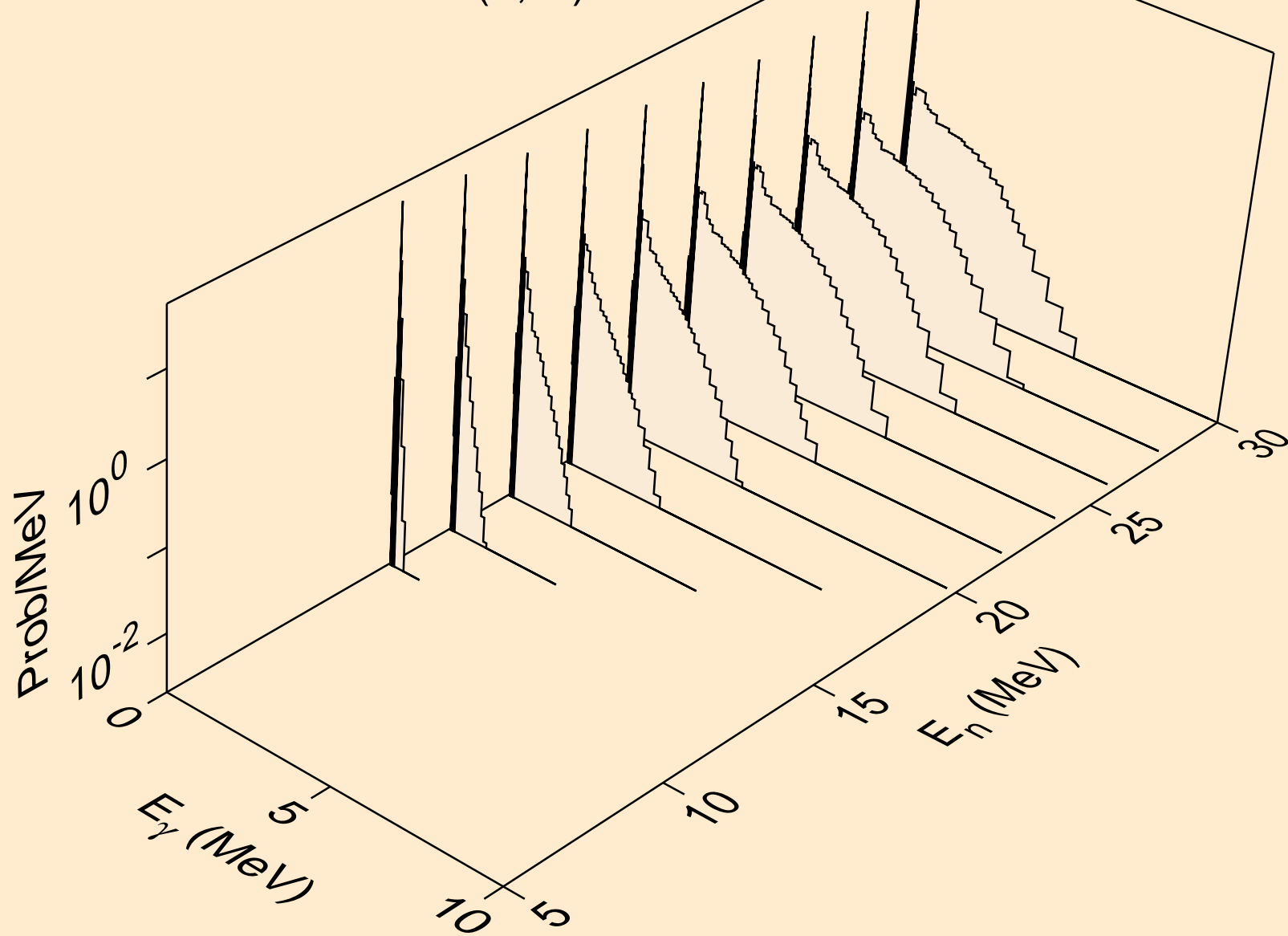

PT179 NEUTRON ACER TENDL-2021 LIBRARY; T=293.6K  
Photon emission for (n,n\*)t

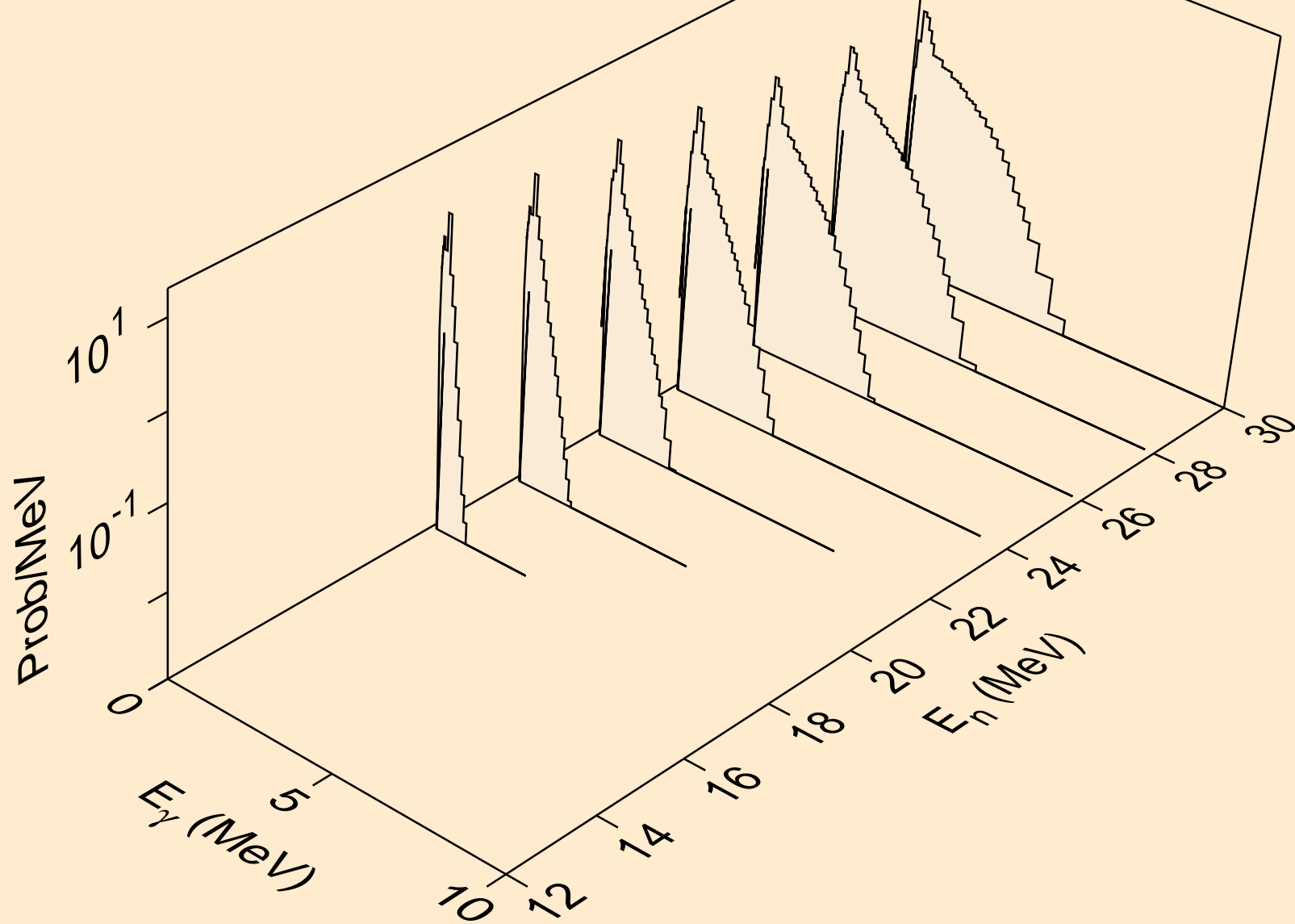

PT179 NEUTRON ACER TENDL-2021 LIBRARY; T=293.6K  
Photon emission for (n,n\*)he3

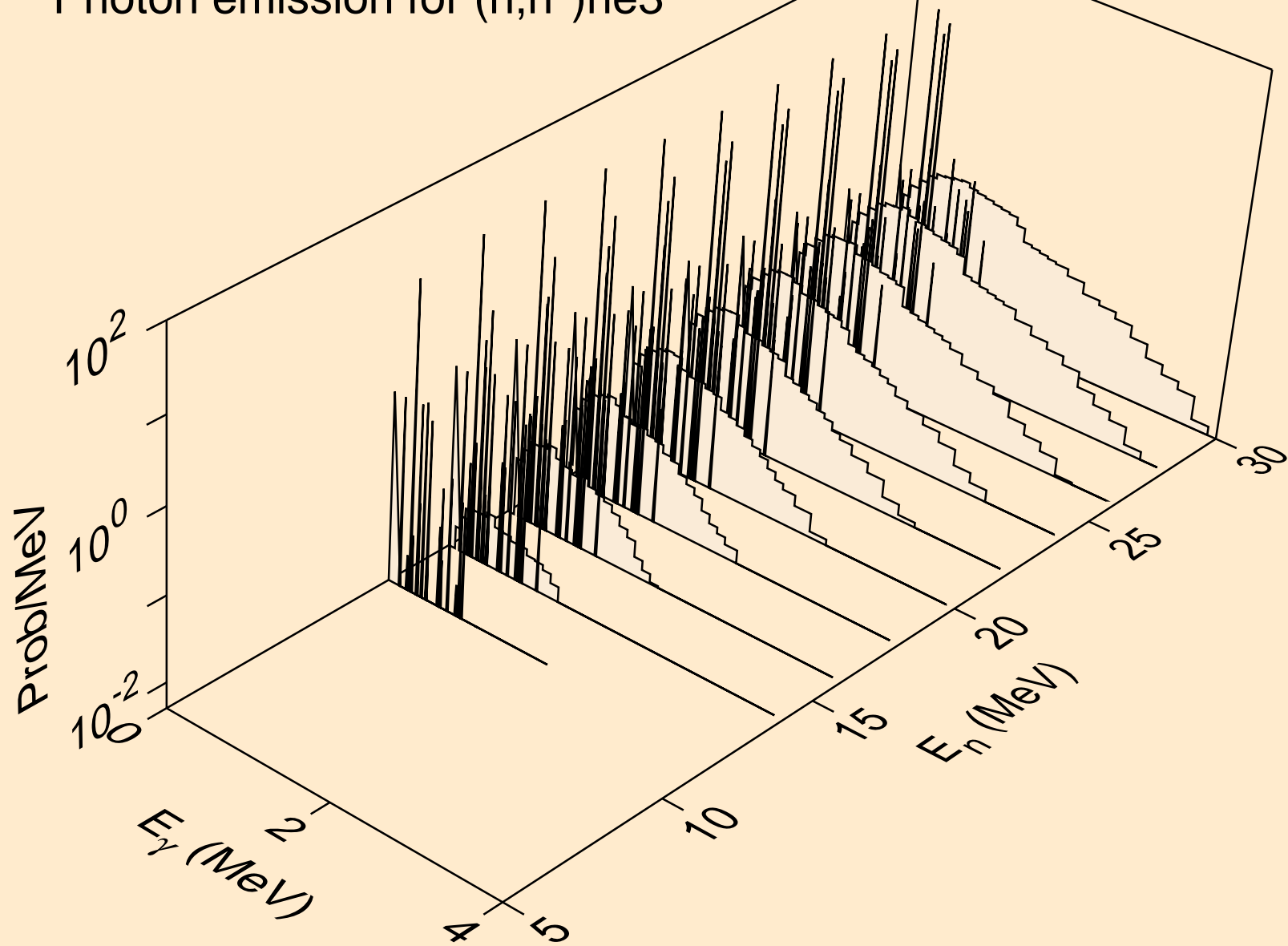

PT179 NEUTRON ACER TENDL-2021 LIBRARY; T=293.6K  
Photon emission for (n,4n)

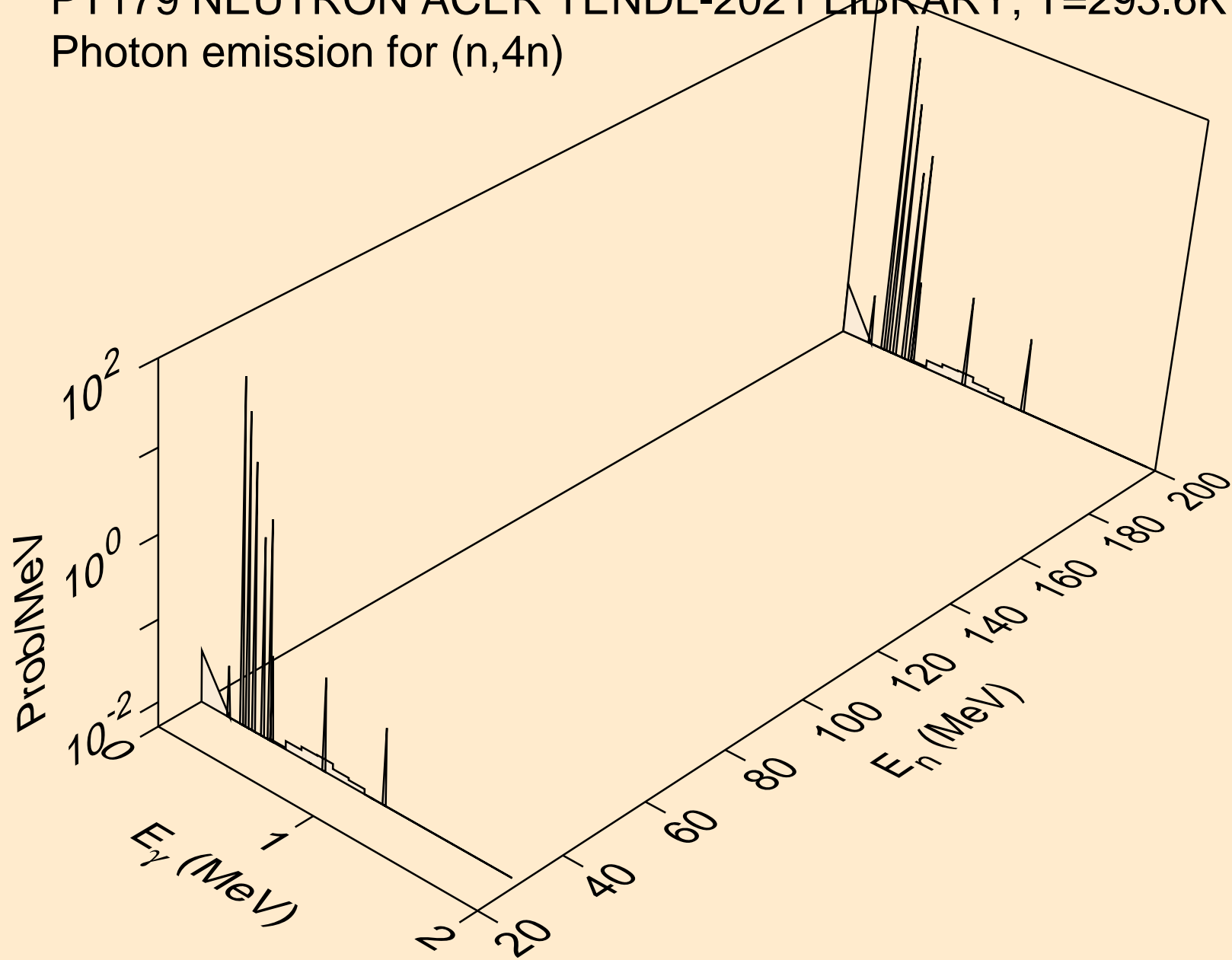

PT179 NEUTRON ACER TENDL-2021 LIBRARY; T=293.6K  
Photon emission for (n,2np)

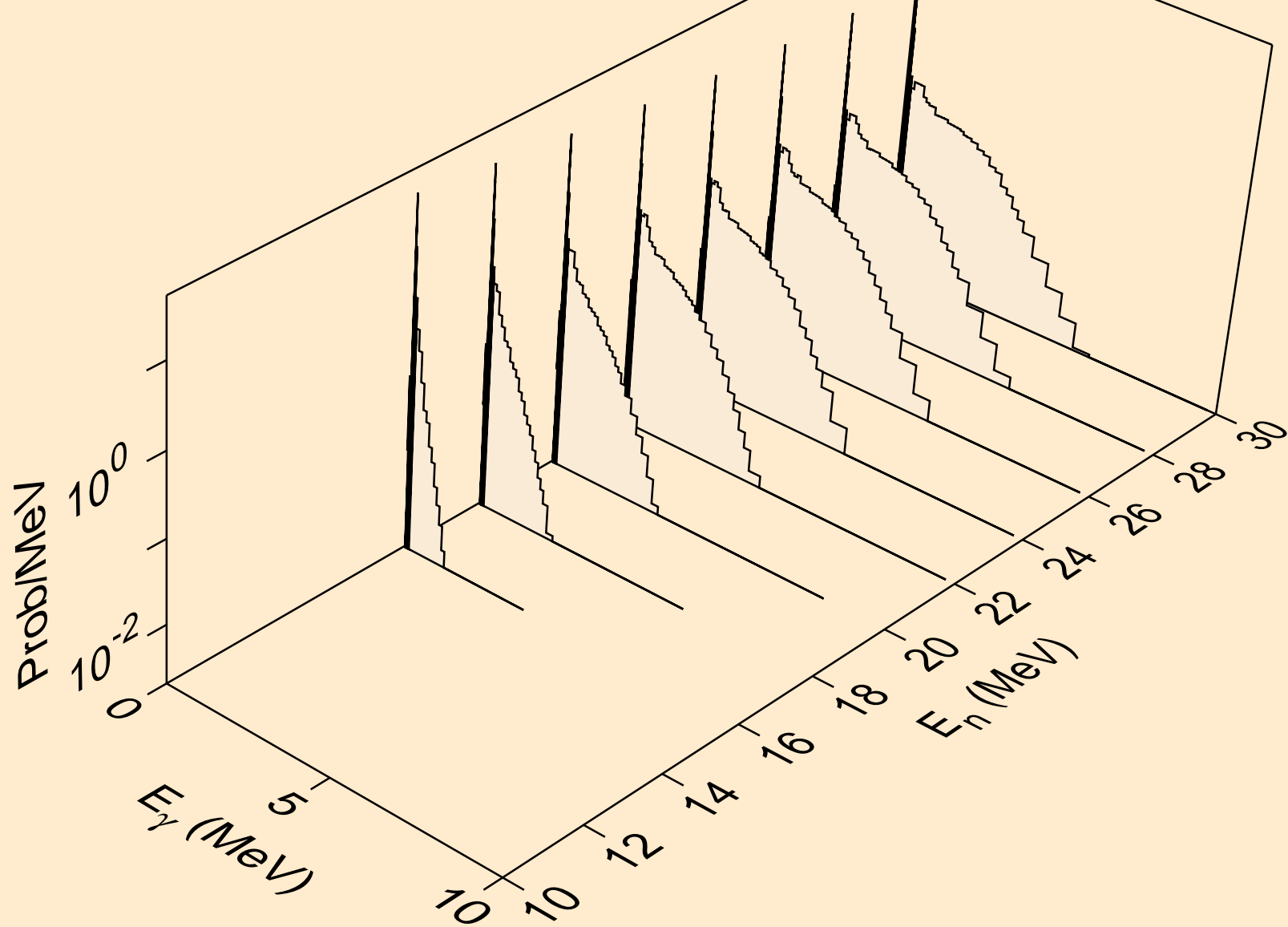

PT179 NEUTRON ACER TENDL-2021 LIBRARY; T=293.6K  
Photon emission for (n,3np)

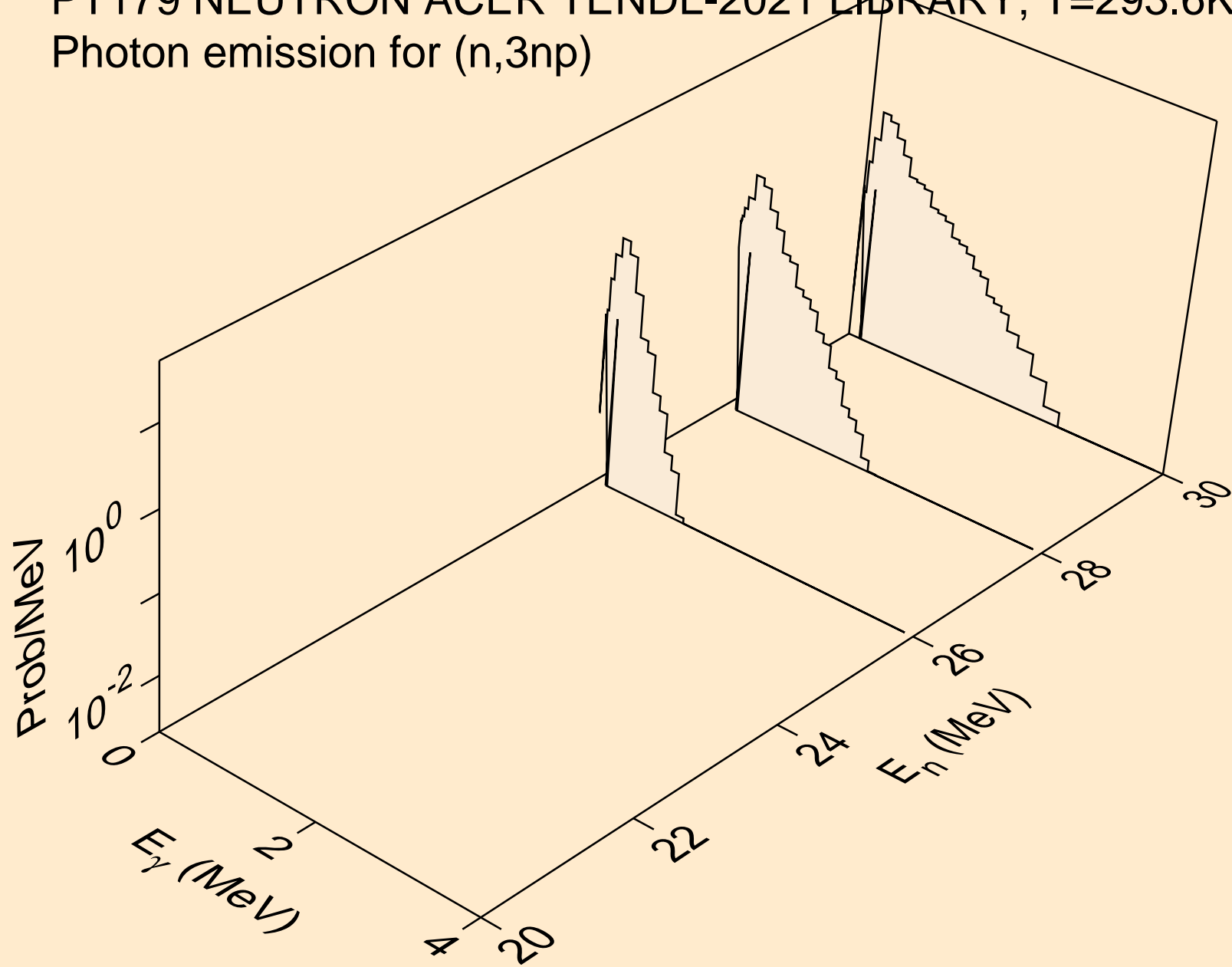

PT179 NEUTRON ACER TENDL-2021 LIBRARY; T=293.6K  
Photon emission for (n,2np)

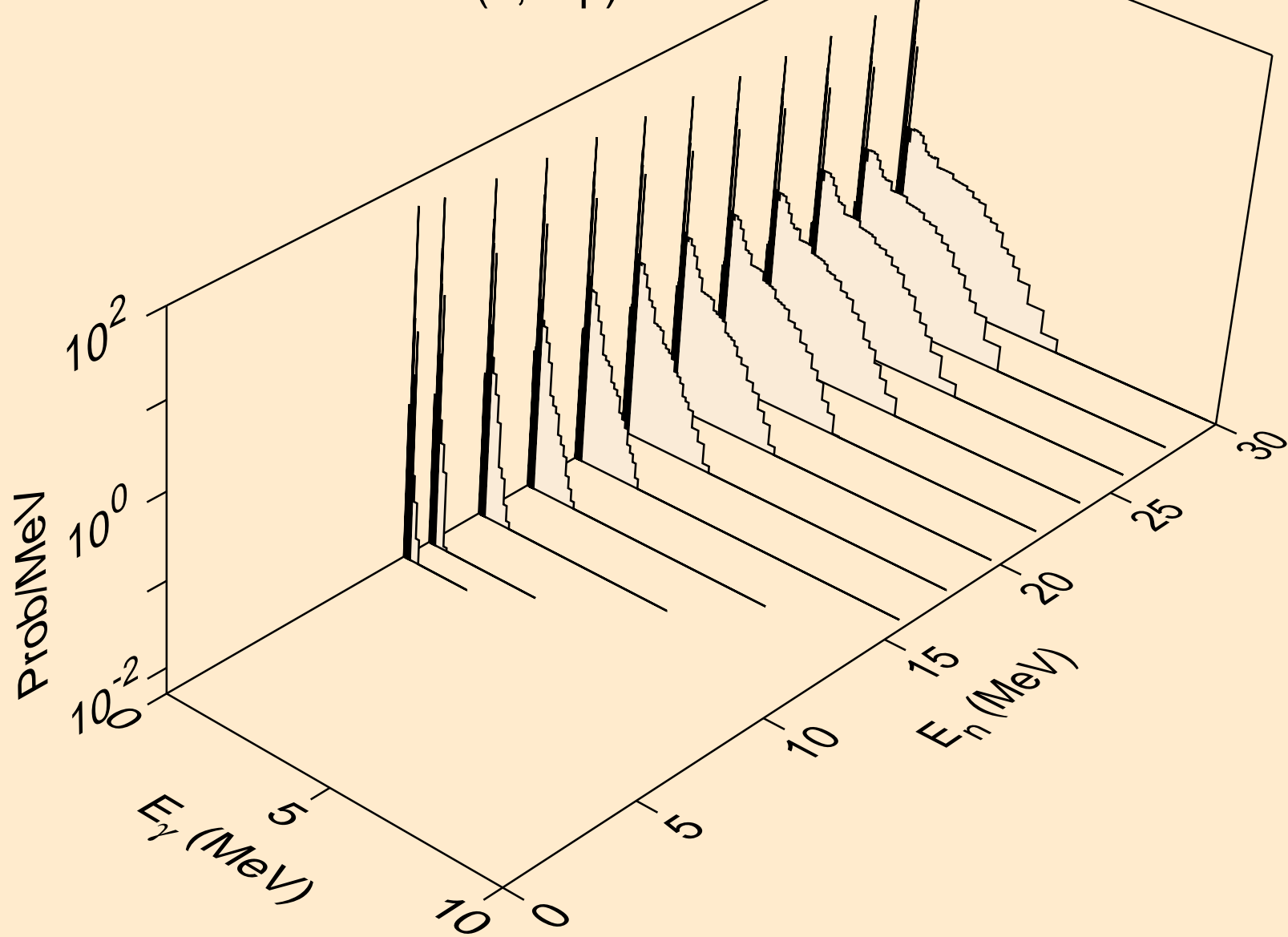



PT179 NEUTRON ACER TENDL-2021 LIBRARY; T=293.6K  
Photon emission for (n,npa)

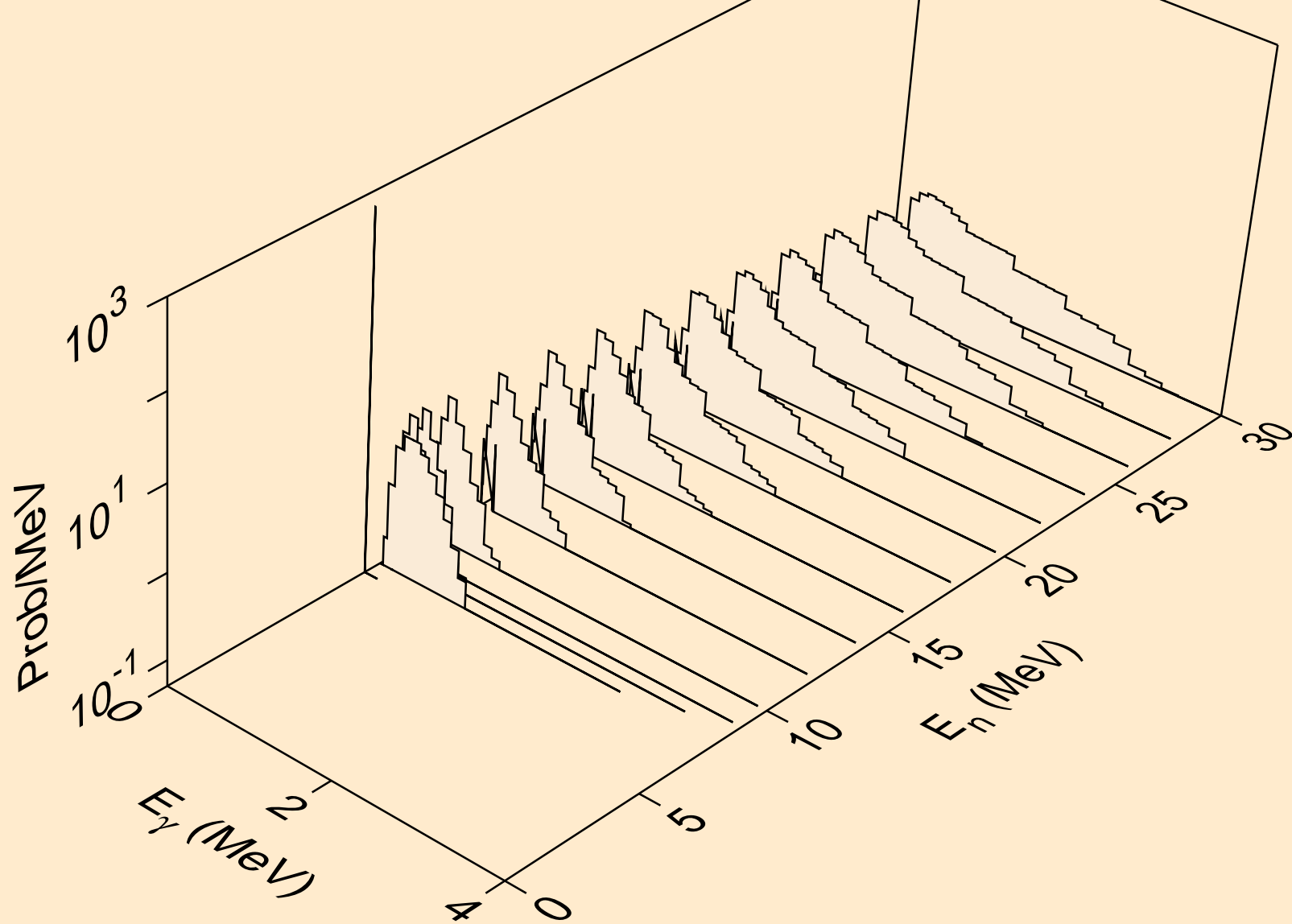

PT179 NEUTRON ACER TENDL-2021 LIBRARY; T=293.6K  
Photon emission for (n,n\*c)

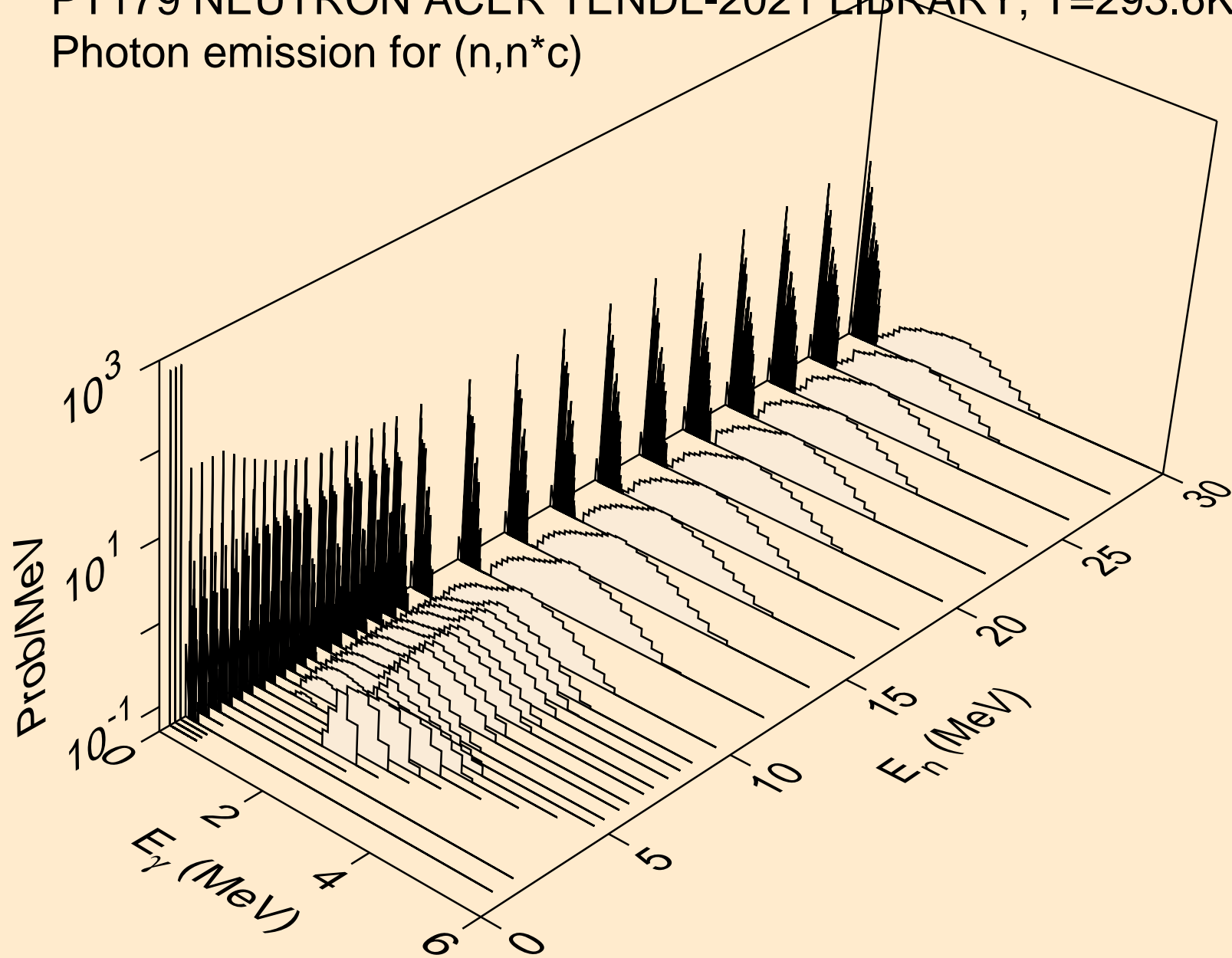

PT179 NEUTRON ACER TENDL-2021 LIBRARY; T=293.6K  
Photon emission for (n,gma)

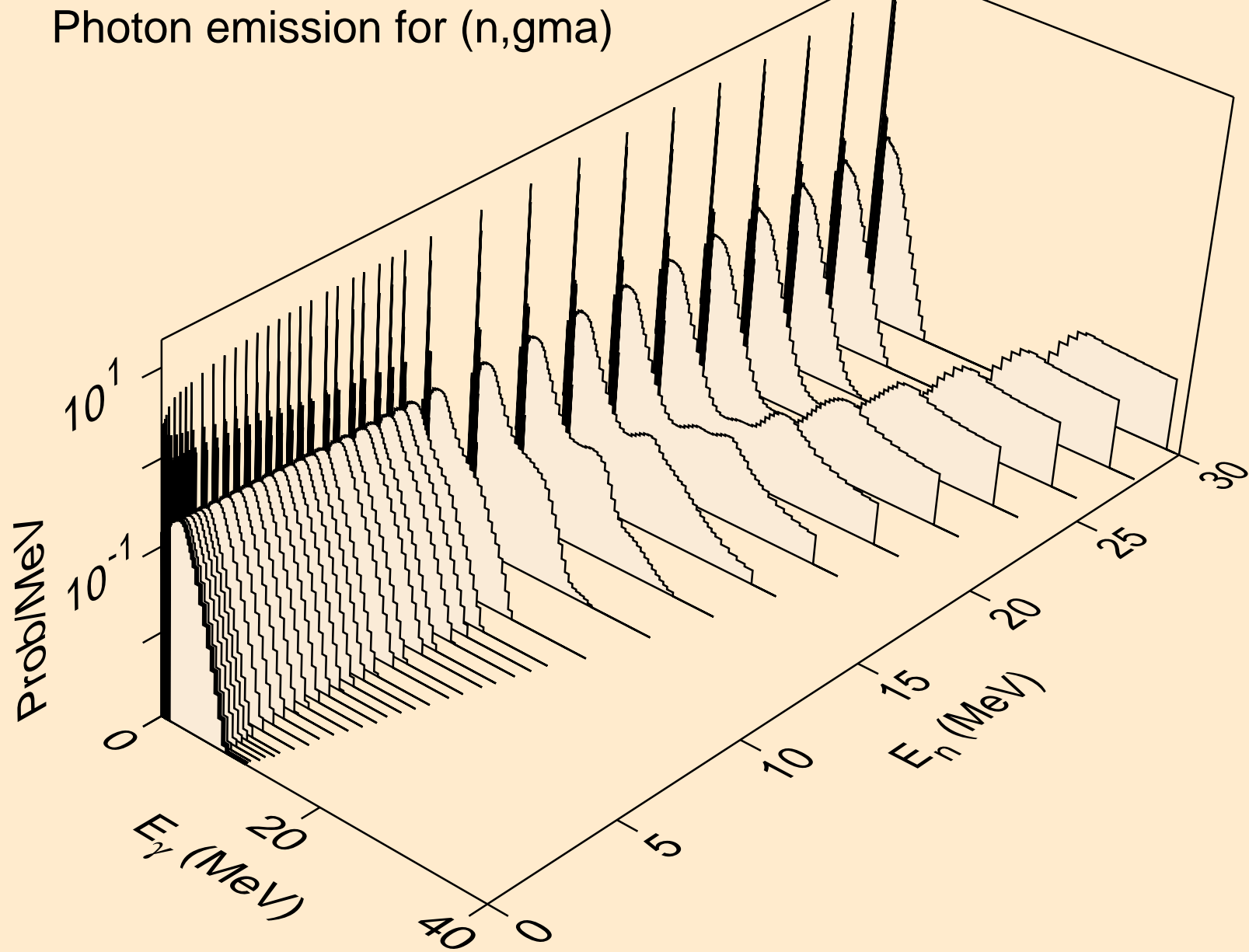

PT179 NEUTRON ACER TENDL-2021 LIBRARY; T=293.6K  
Photon emission for (n,p)

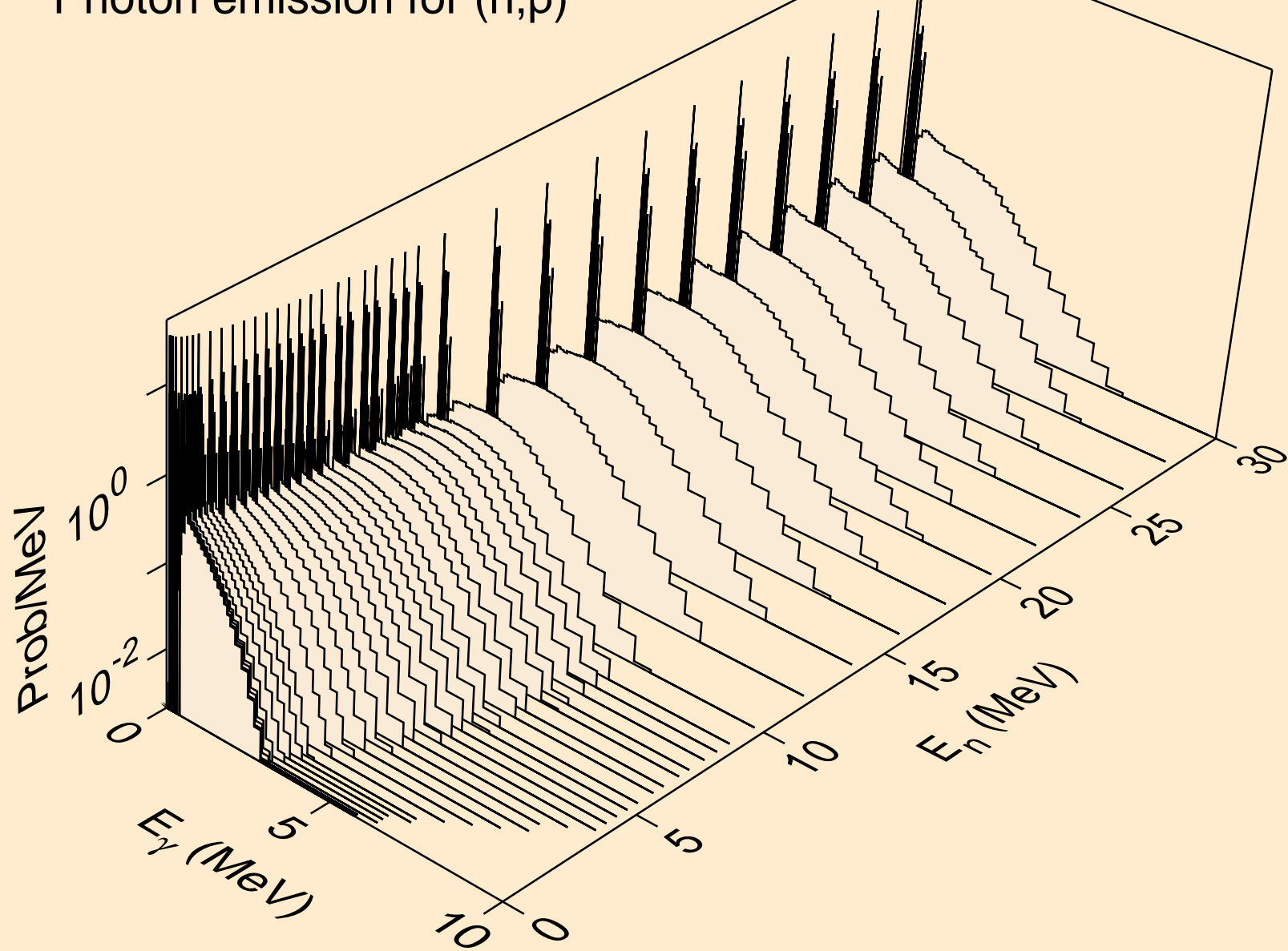

PT179 NEUTRON ACER TENDL-2021 LIBRARY; T=293.6K  
Photon emission for (n,d)

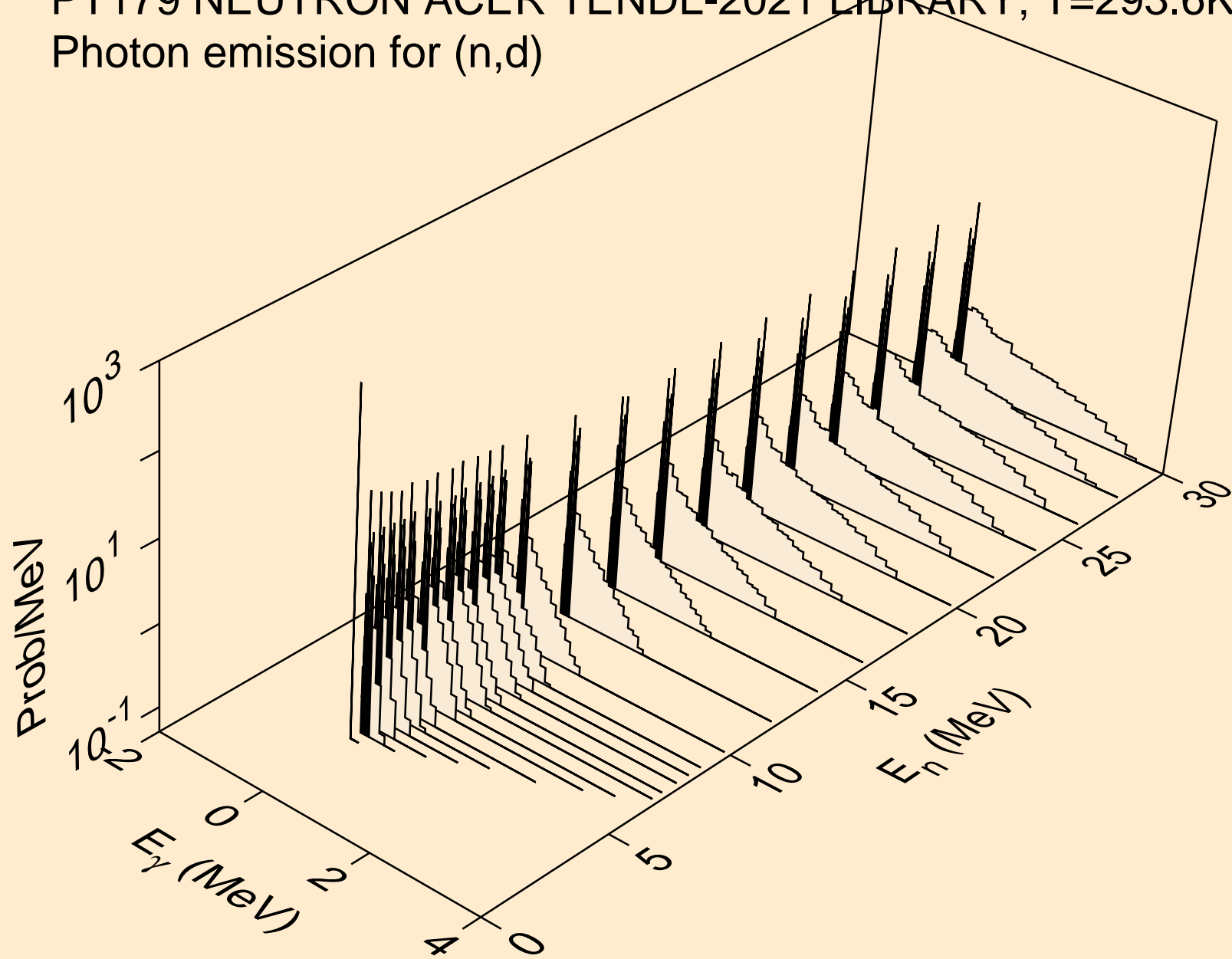

PT179 NEUTRON ACER TENDL-2021 LIBRARY; T=293.6K  
Photon emission for (n,t)

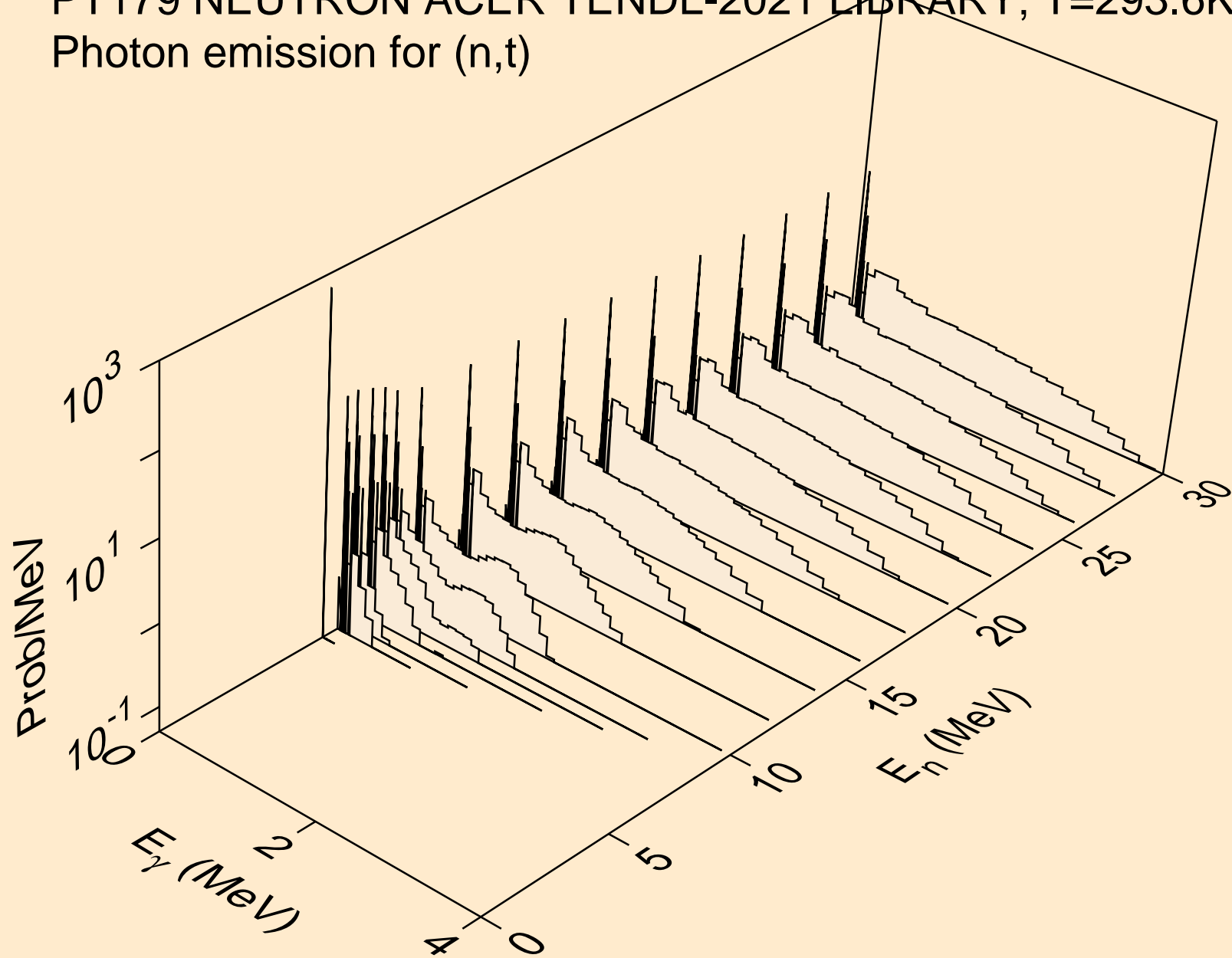

PT179 NEUTRON ACER TENDL-2021 LIBRARY; T=293.6K  
Photon emission for (n,he3)

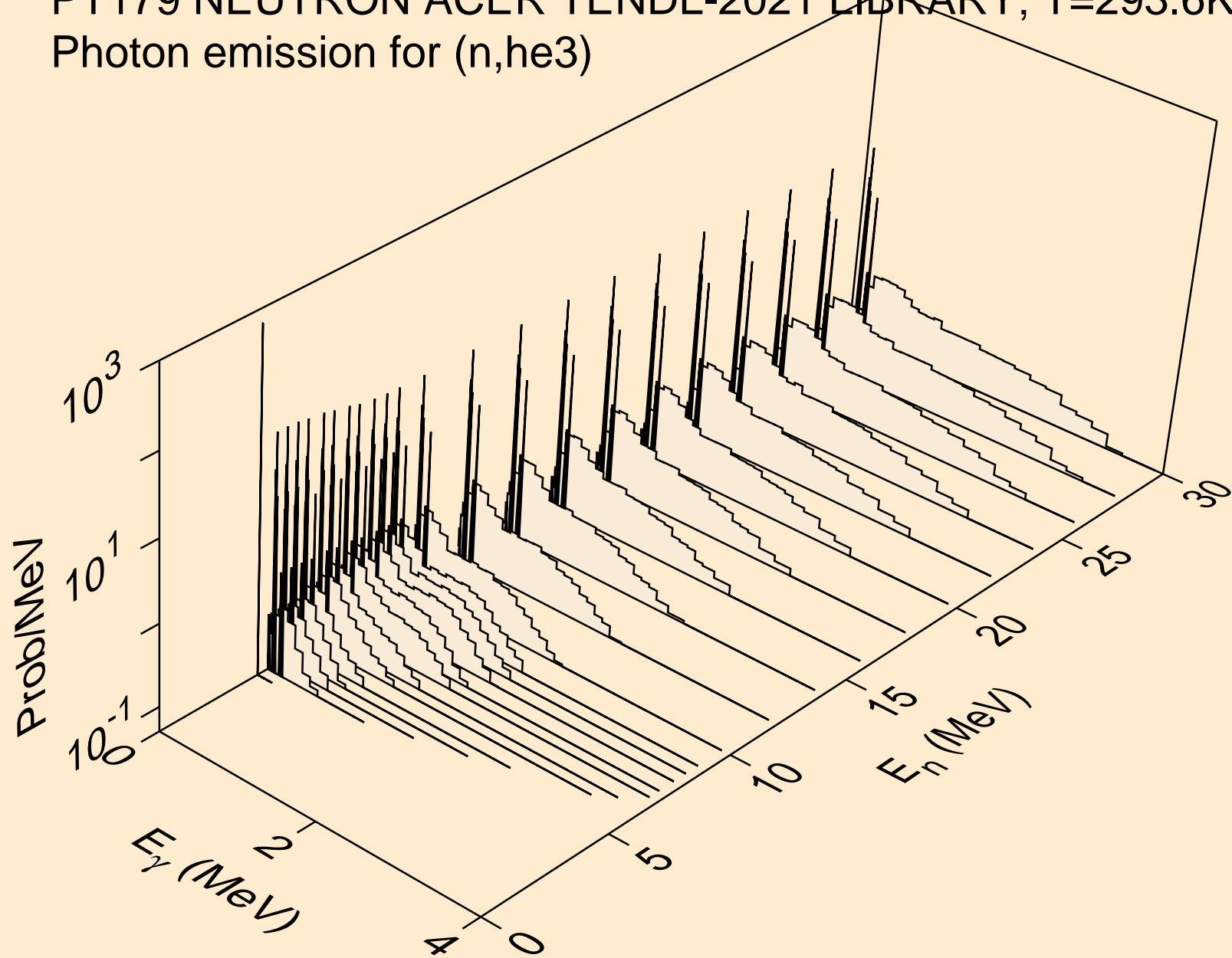

PT179 NEUTRON ACER TENDL-2021 LIBRARY; T=293.6K  
Photon emission for (n,a)

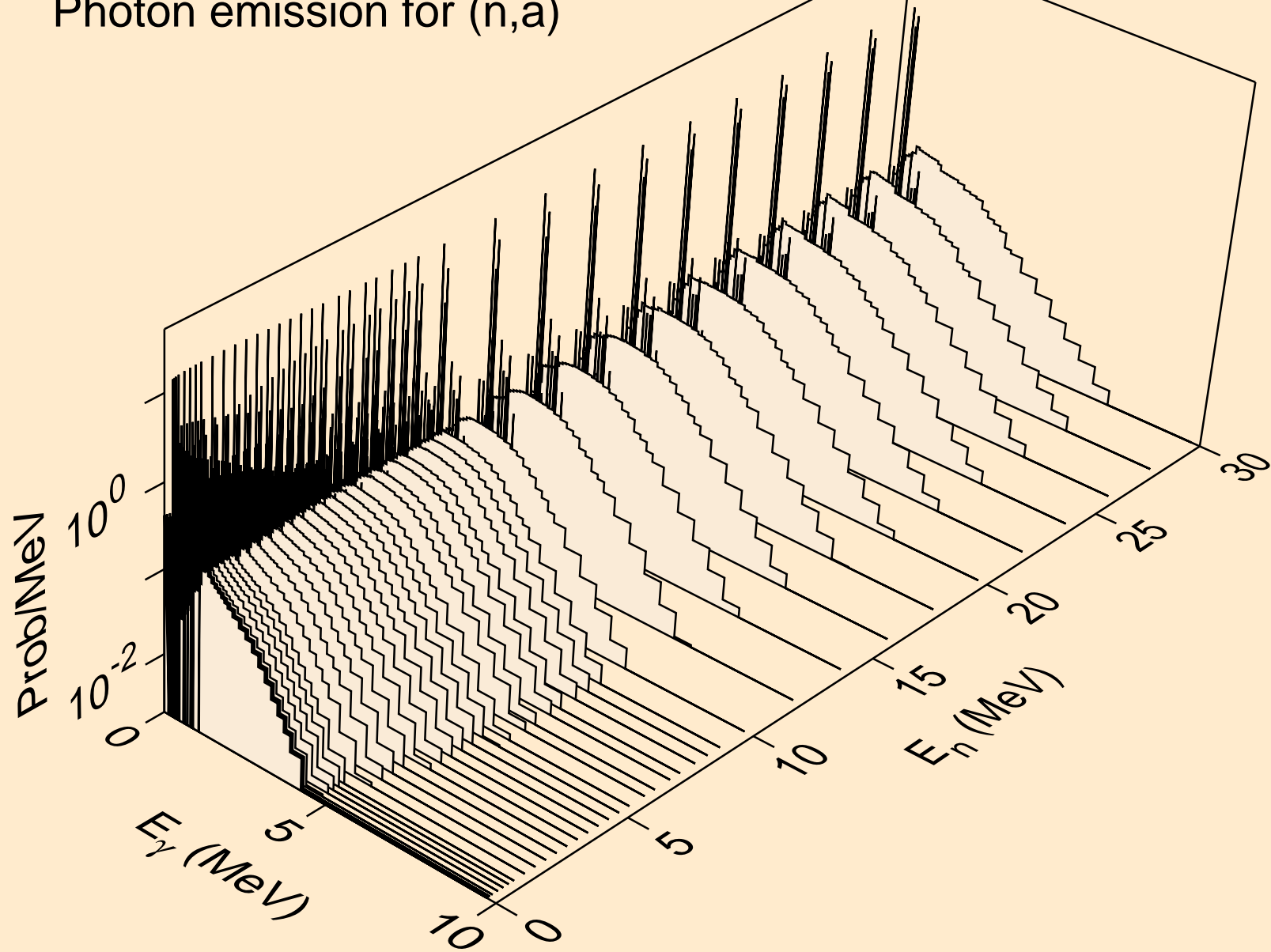



PT179 NEUTRON ACER TENDL-2021 LIBRARY; T=293.6K  
Photon emission for (n,2a)

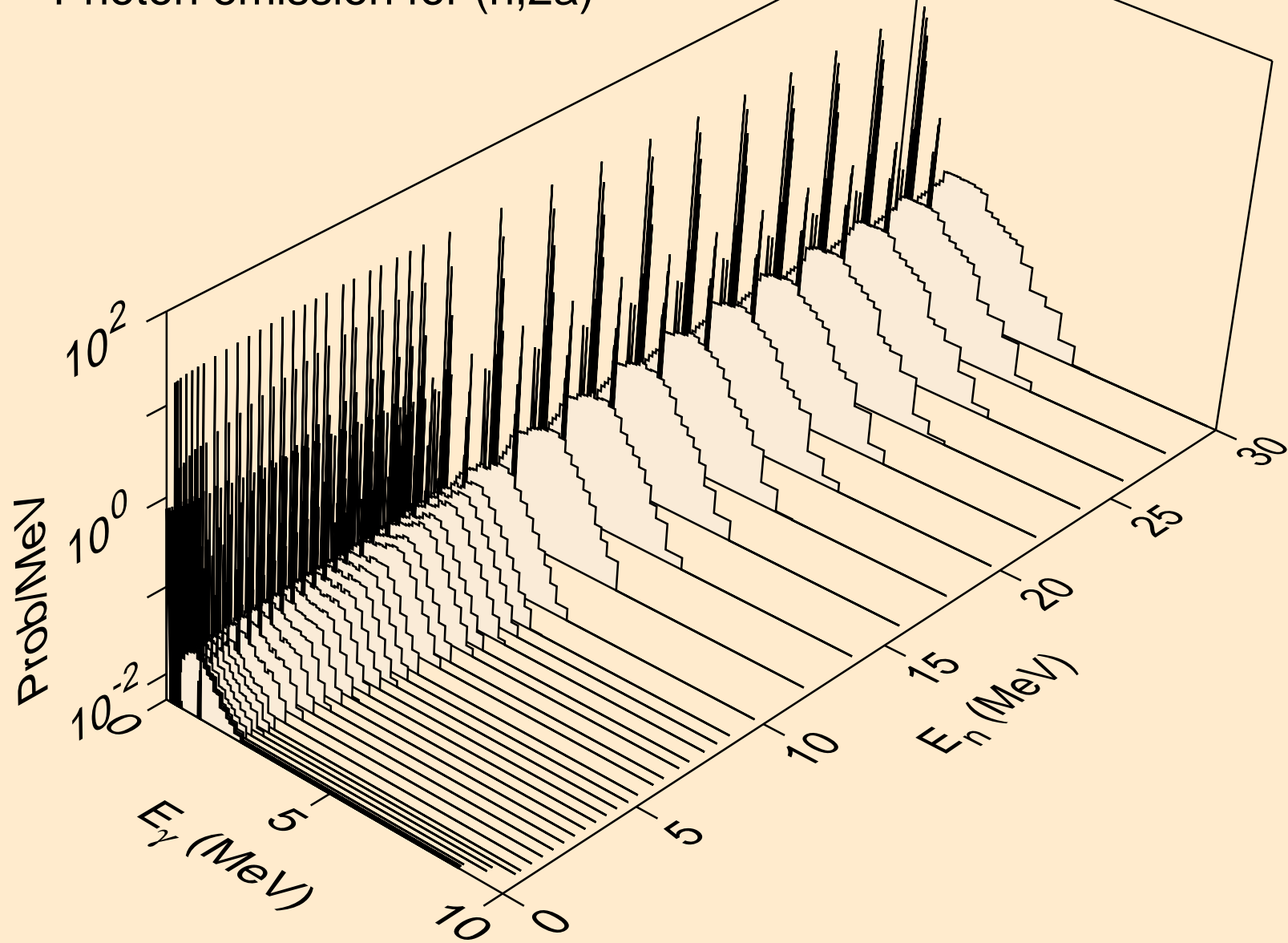

PT179 NEUTRON ACER TENDL-2021 LIBRARY; T=293.6K  
Photon emission for (n,3a)

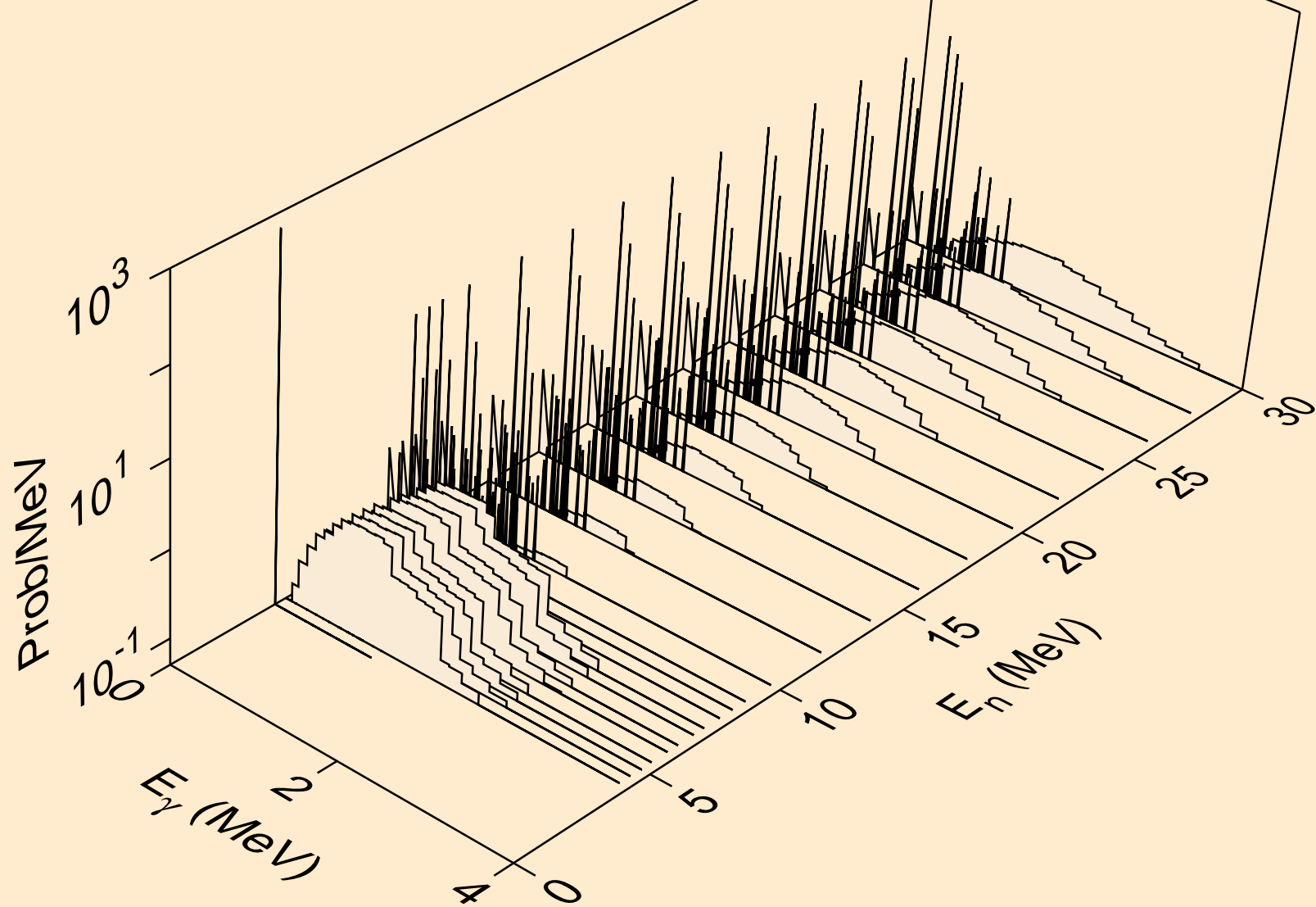

PT179 NEUTRON ACER TENDL-2021 LIBRARY; T=293.6K  
Photon emission for (n,2p)

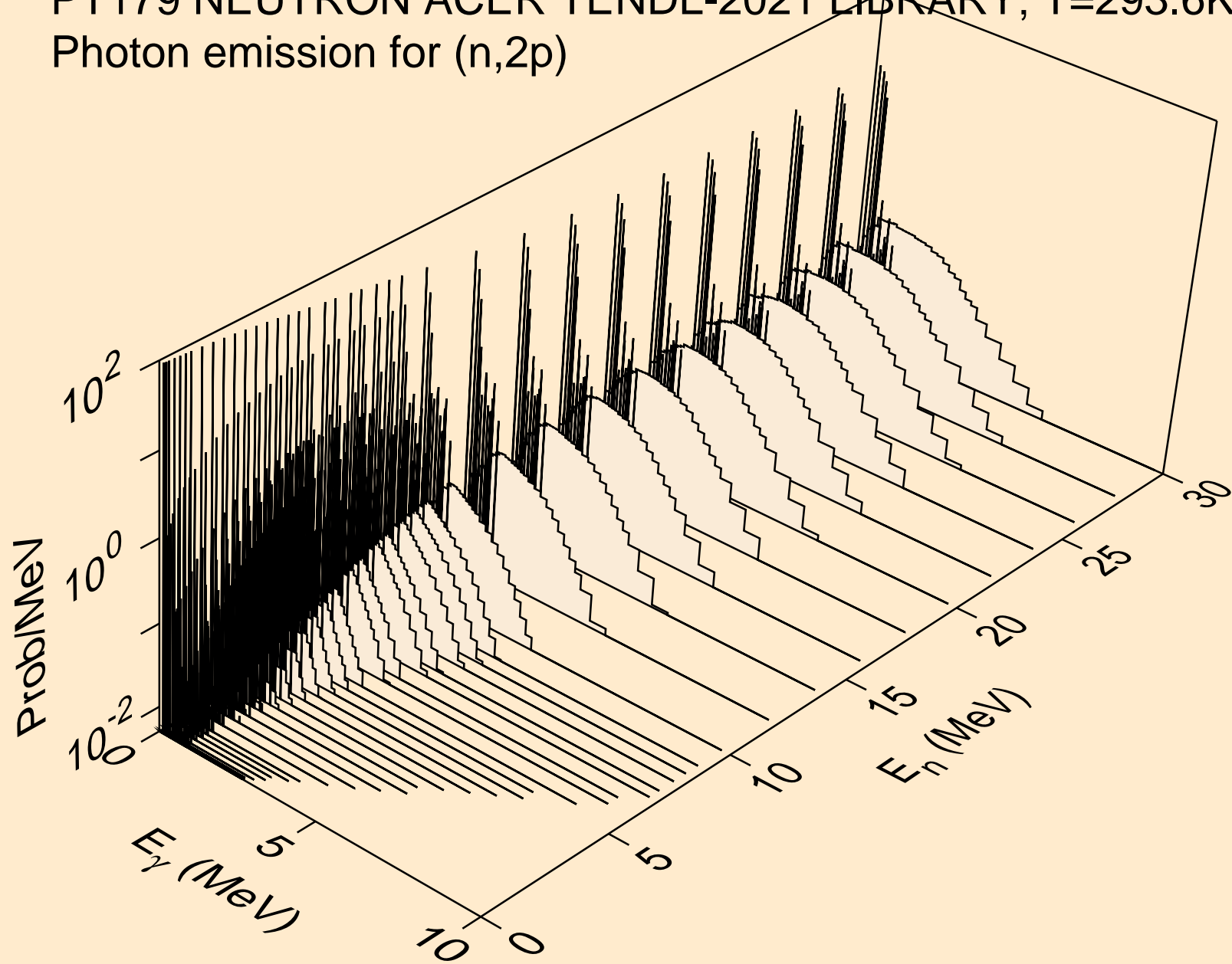

PT179 NEUTRON ACER TENDL-2021 LIBRARY; T=293.6K  
Photon emission for (n,p $\alpha$ )

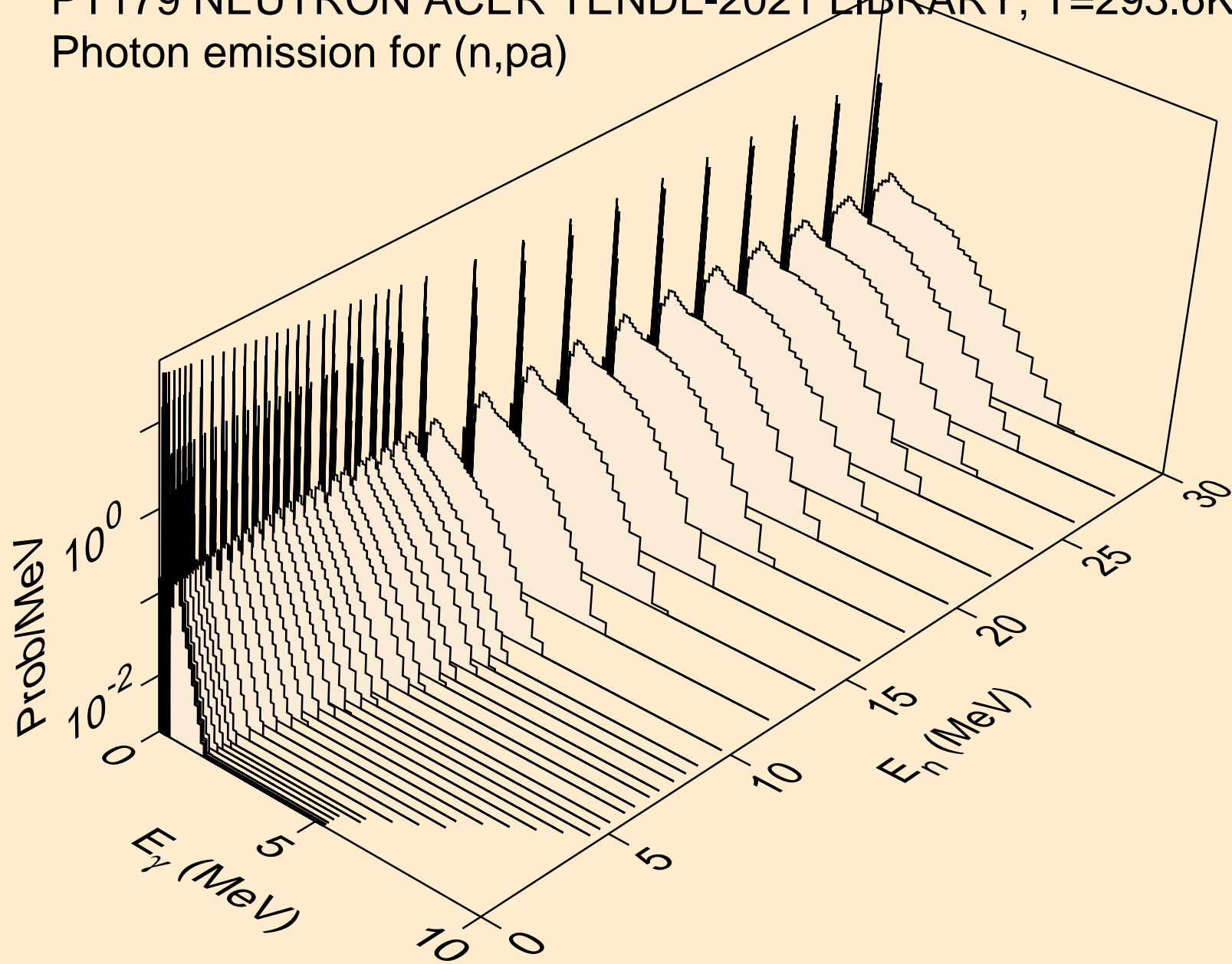

PT179 NEUTRON ACER TENDL-2021 LIBRARY; T=293.6K  
Photon emission for (n,pd)

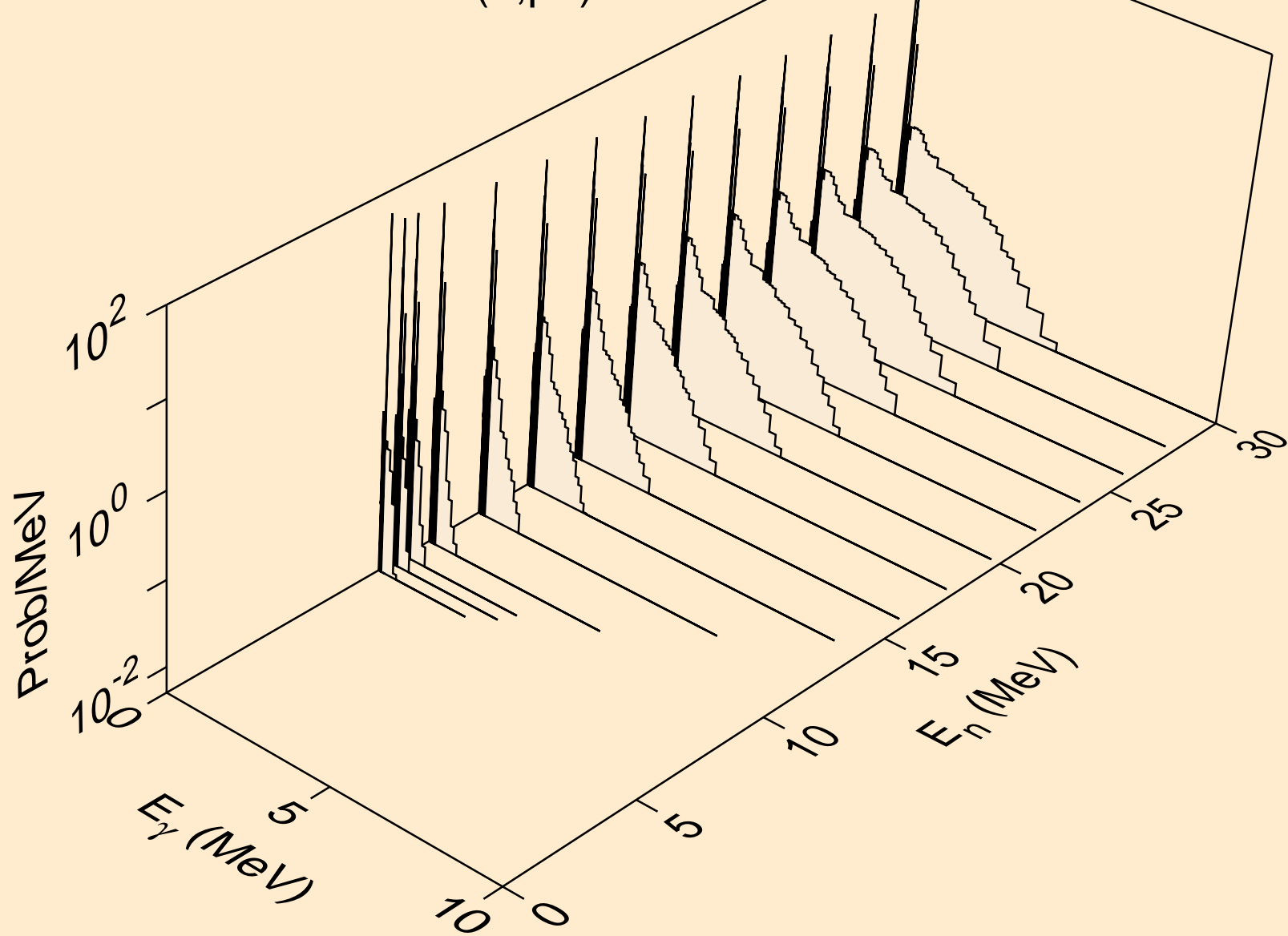

PT179 NEUTRON ACER TENDL-2021 LIBRARY; T=293.6K  
Photon emission for (n,pt)

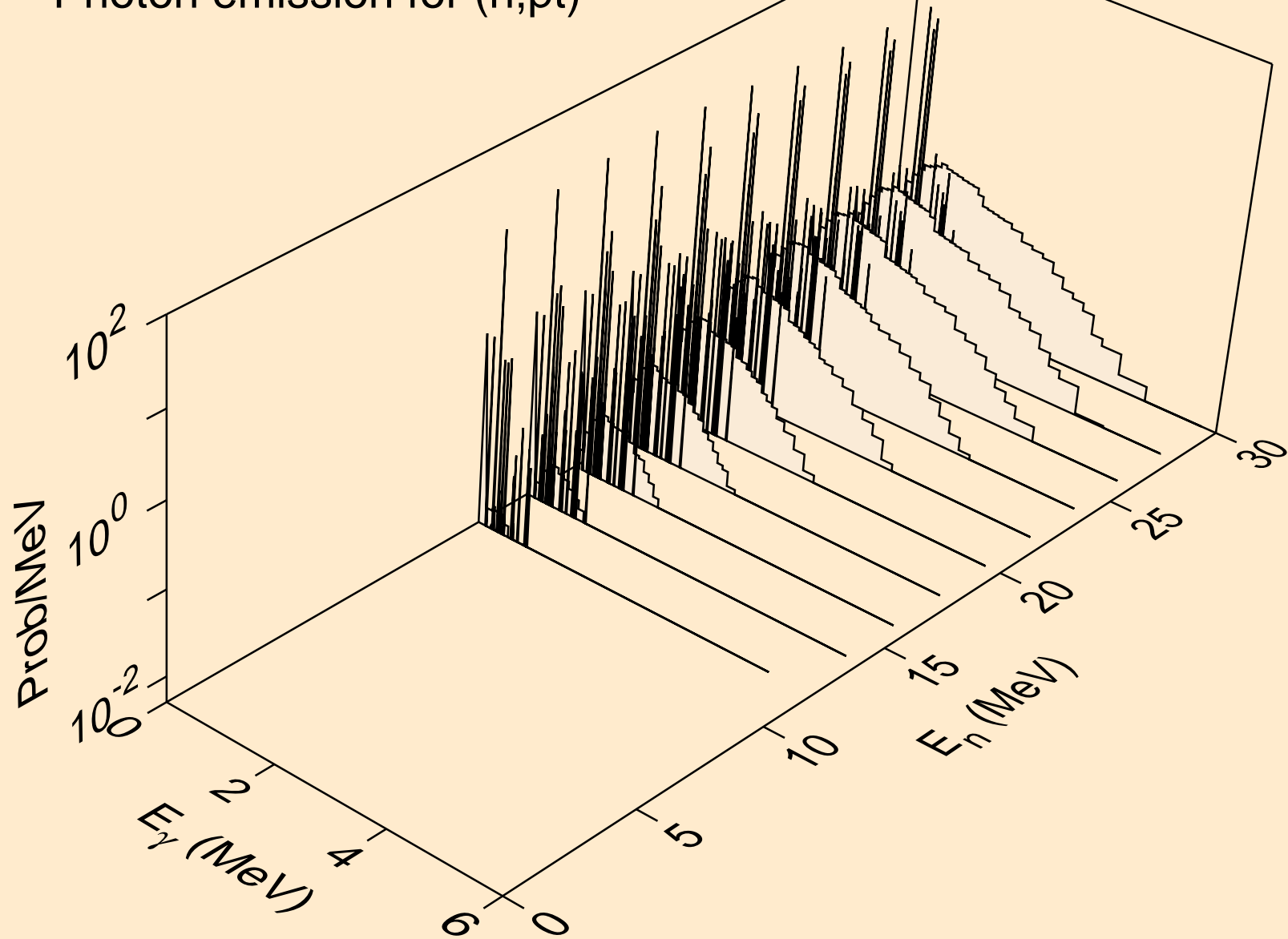

PT179 NEUTRON ACER TENDL-2021 LIBRARY; T=293.6K  
Photon emission for (n,da)

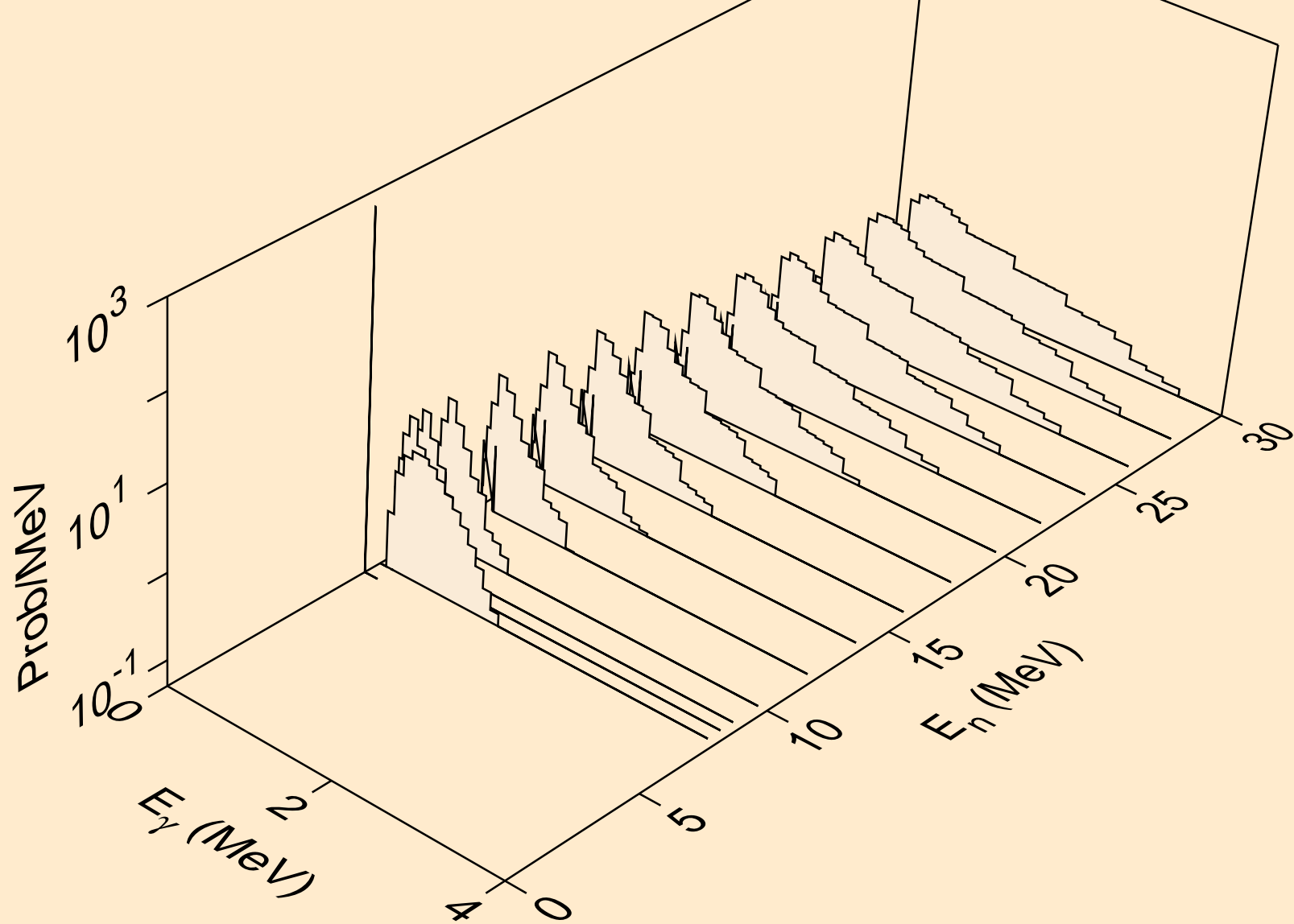

PT179 NEUTRON ACER TENDL-2021 LIBRARY; T=293.6K  
thermal capture photon spectrum

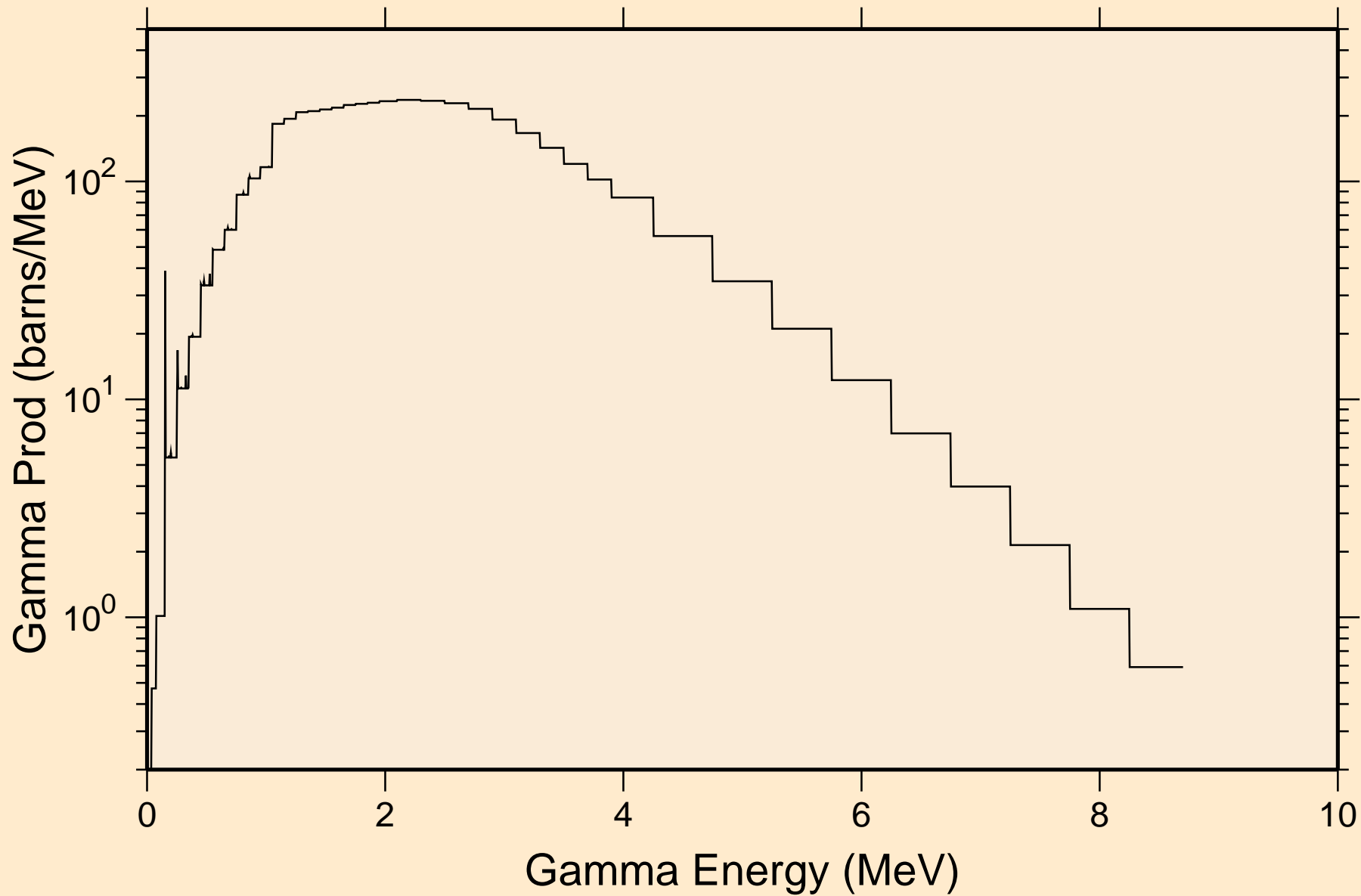



PT179 NEUTRON ACER TENDL-2021 LIBRARY; T=293.6K  
14 MeV photon spectrum

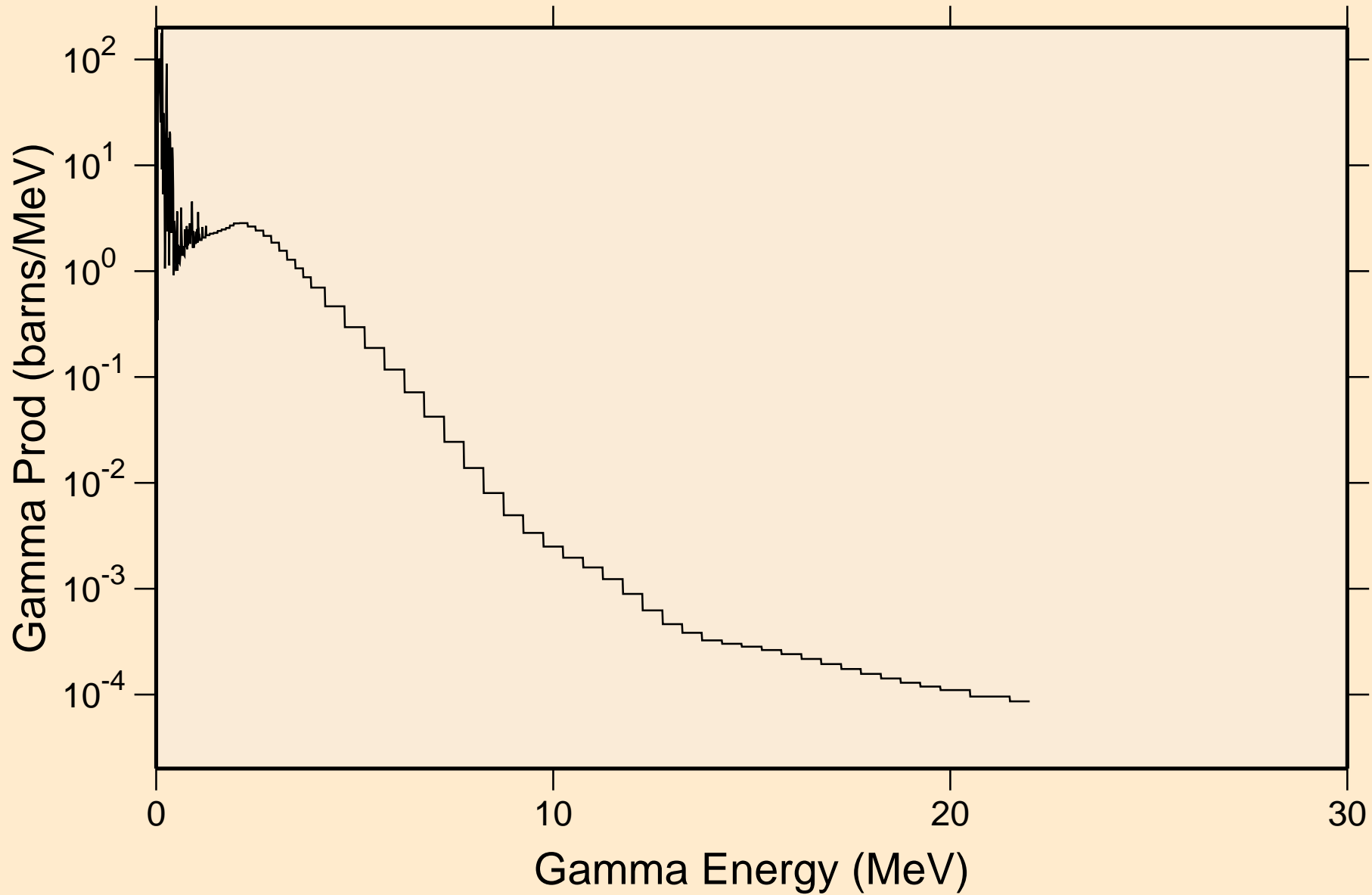

PT179 NEUTRON ACER TENDL-2021 LIBRARY; T=293.6K  
Particle heating contributions

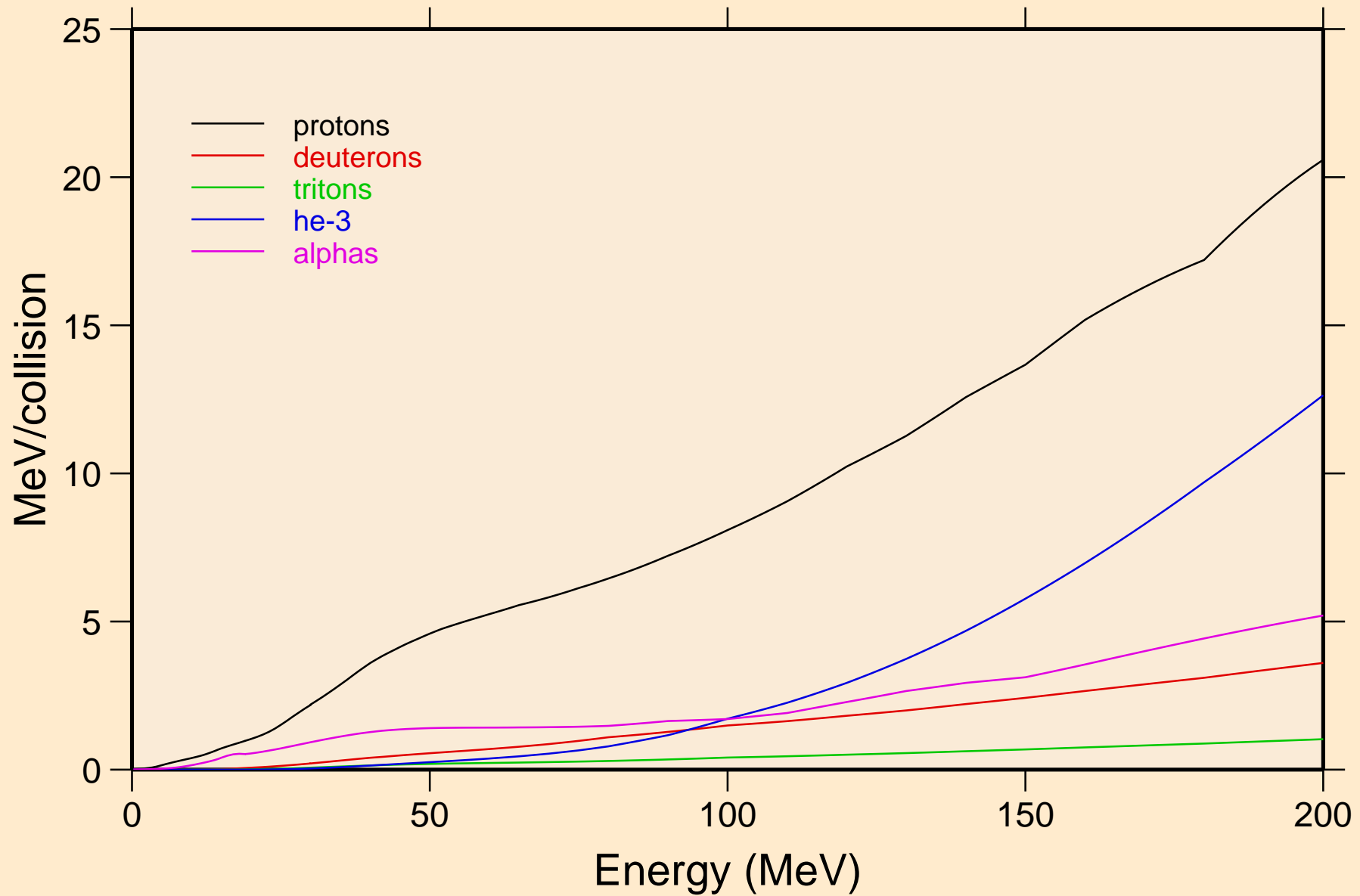

PT179 NEUTRON ACER TENDL-2021 LIBRARY; T=293.6K  
Recoil Heating

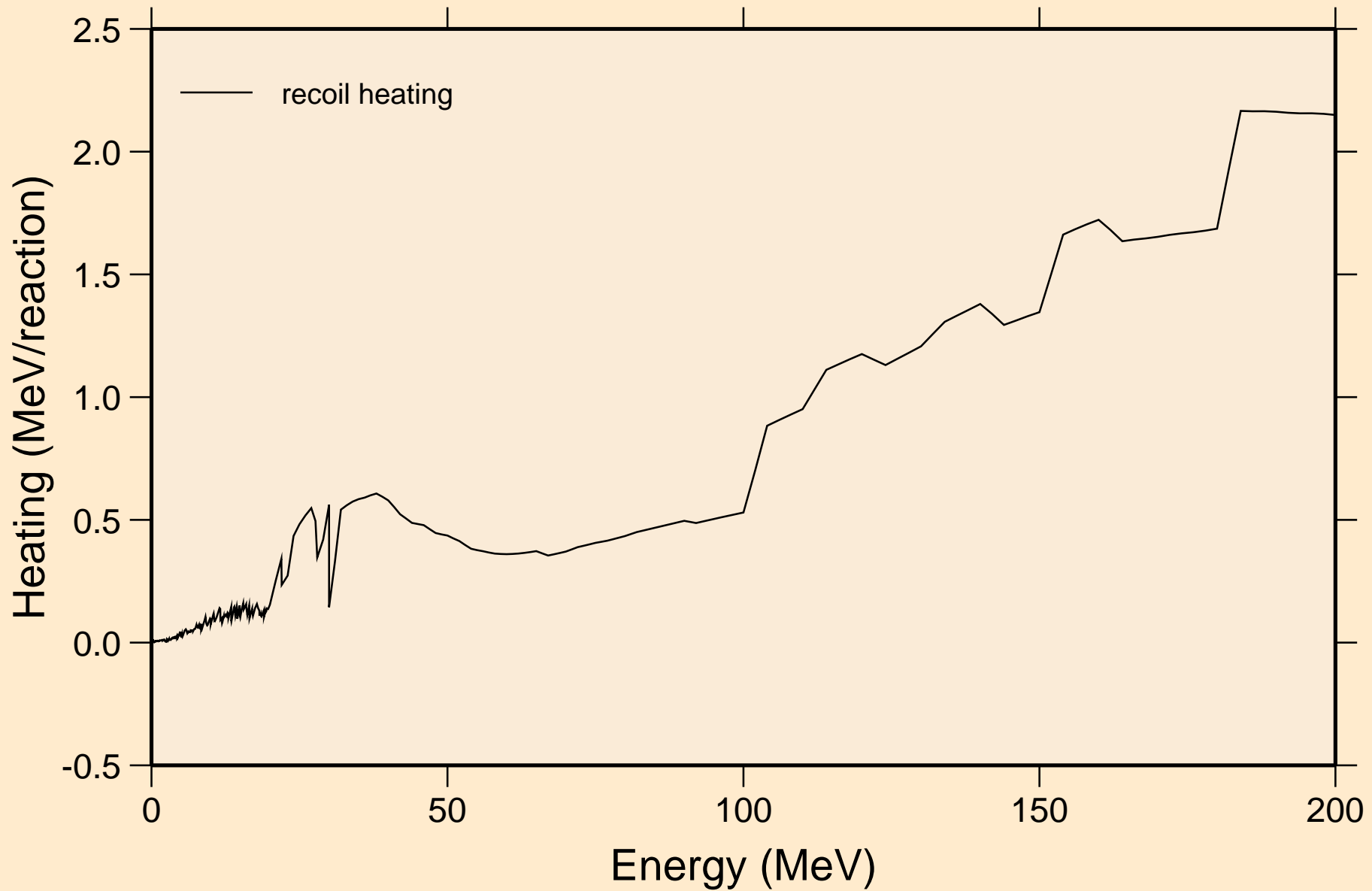

PT179 NEUTRON ACER TENDL-2021 LIBRARY; T=293.6K  
Particle production cross sections

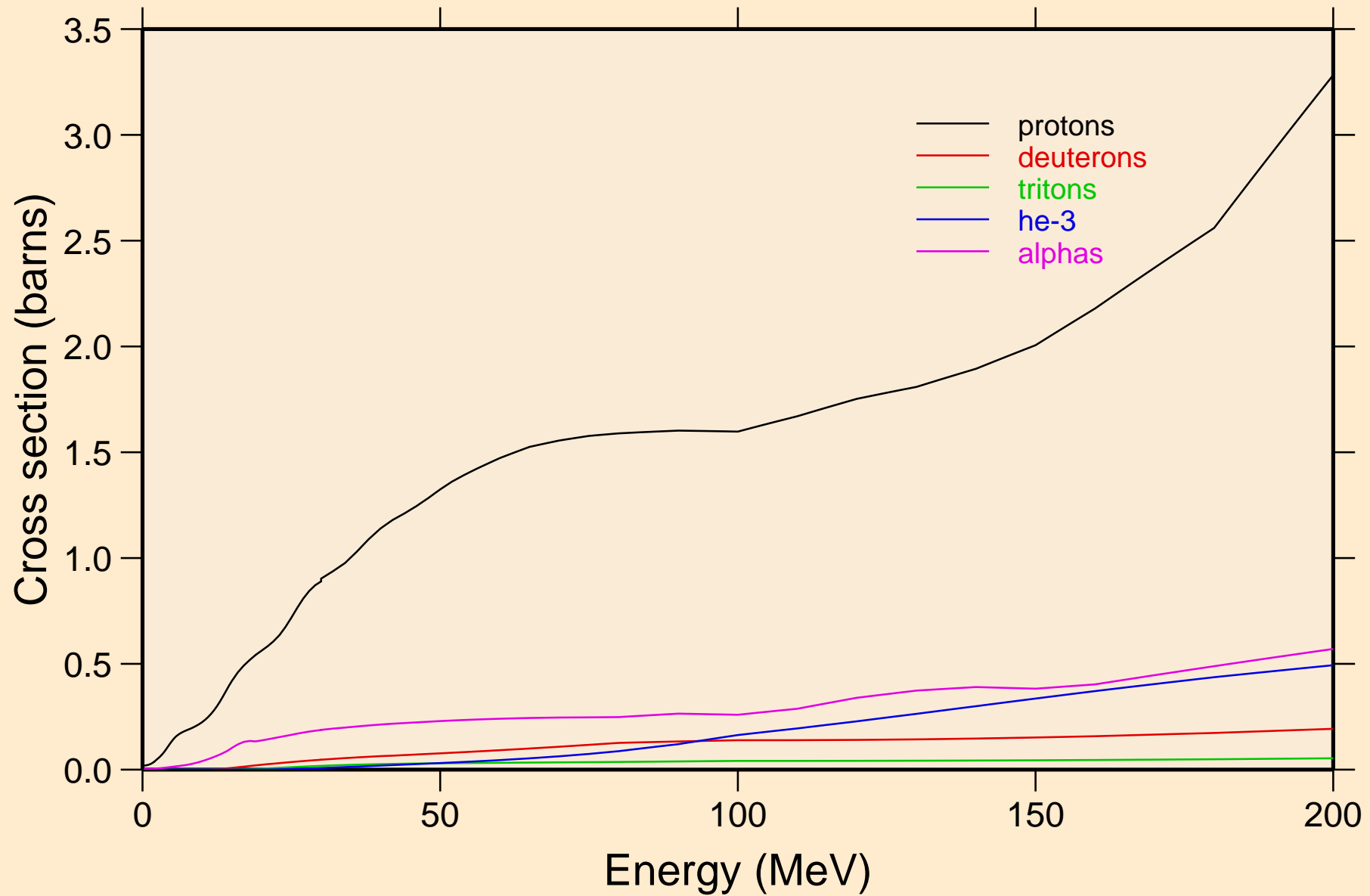

PT179 NEUTRON ACER TENDL-2021 LIBRARY; T=293.6K  
protons from (n,x)

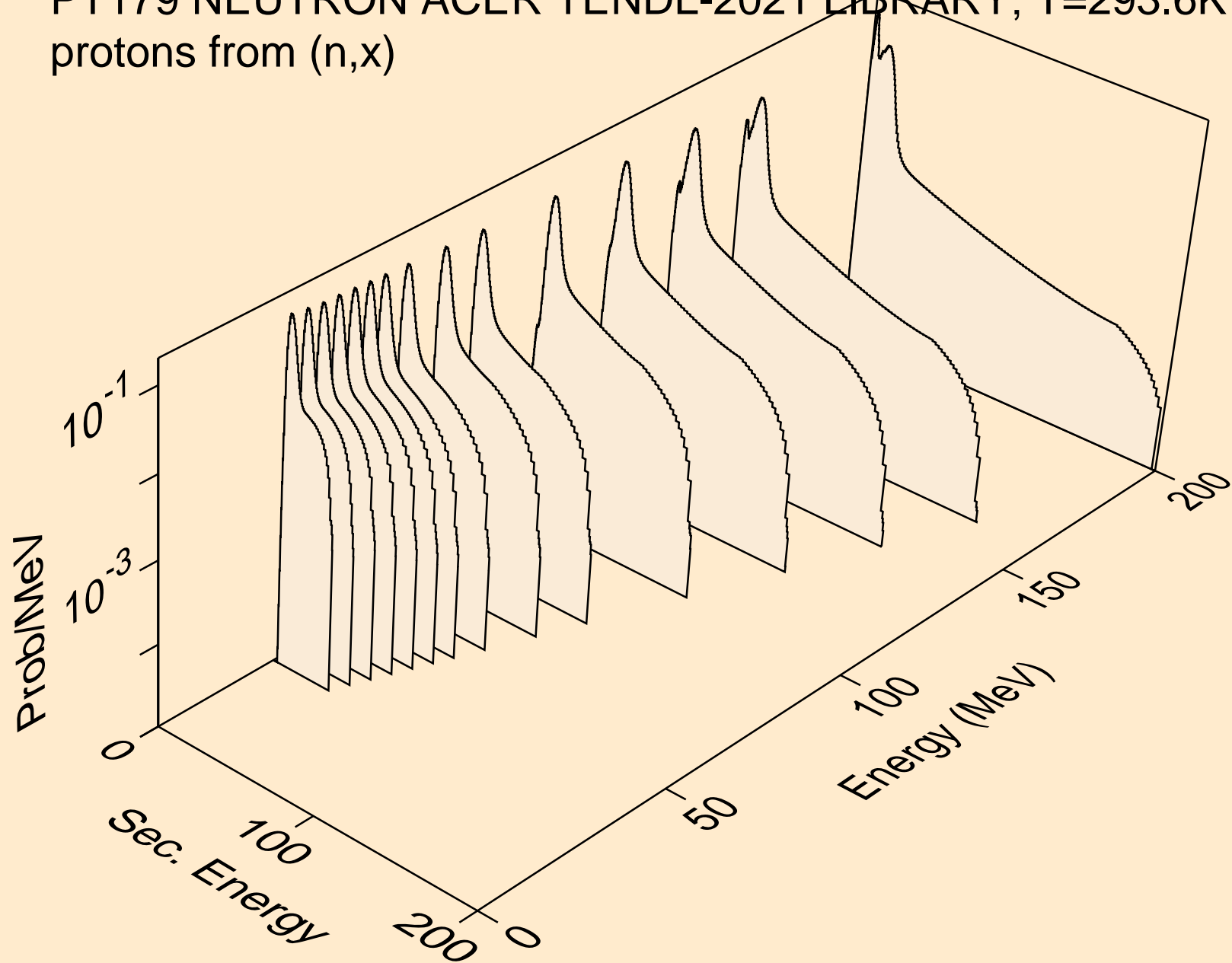

PT179 NEUTRON ACER TENDL-2021 LIBRARY; T=293.6K  
protons from (n,n\*)p

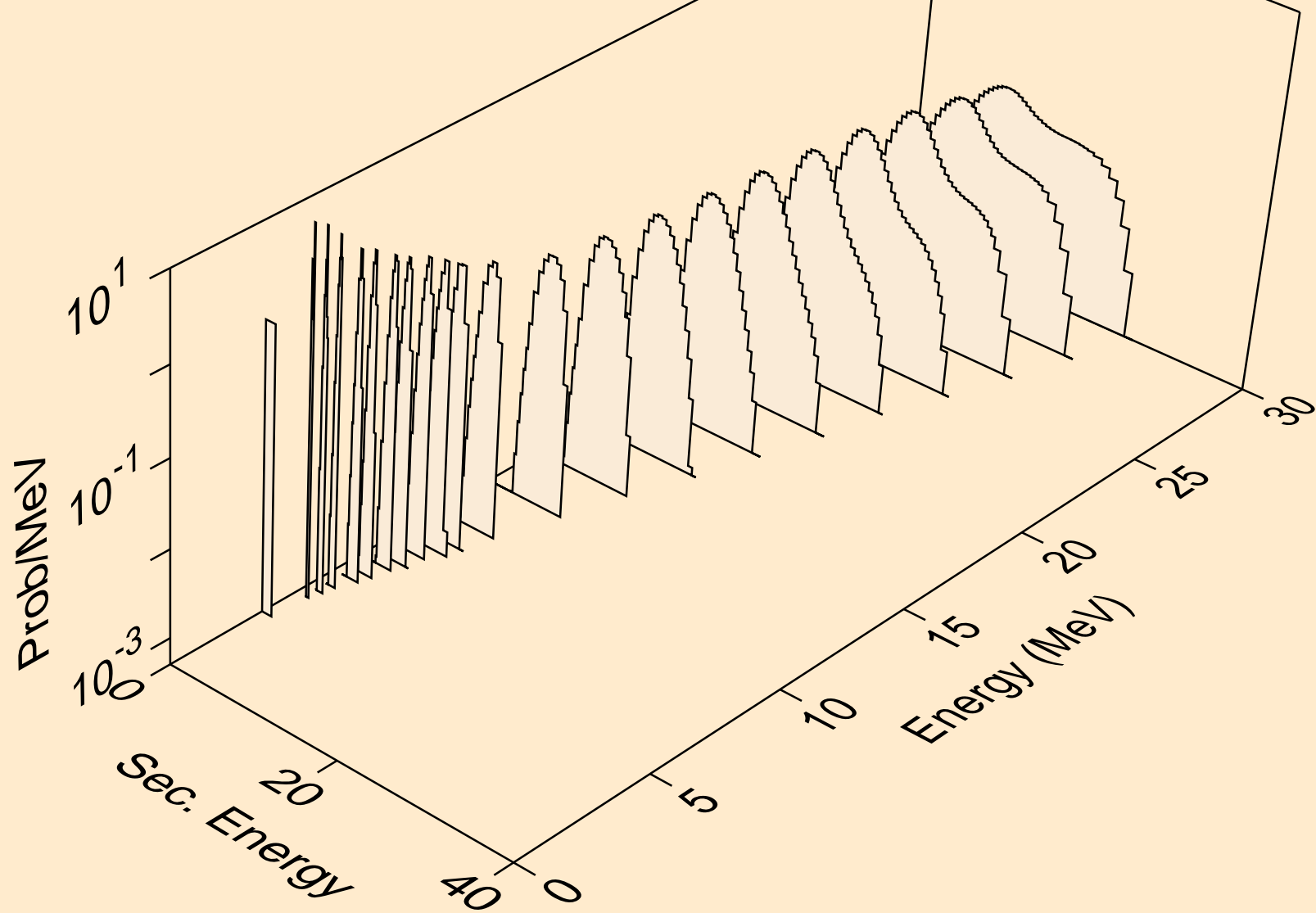

PT179 NEUTRON ACER TENDL-2021 LIBRARY; T=293.6K  
protons from (n,2np)

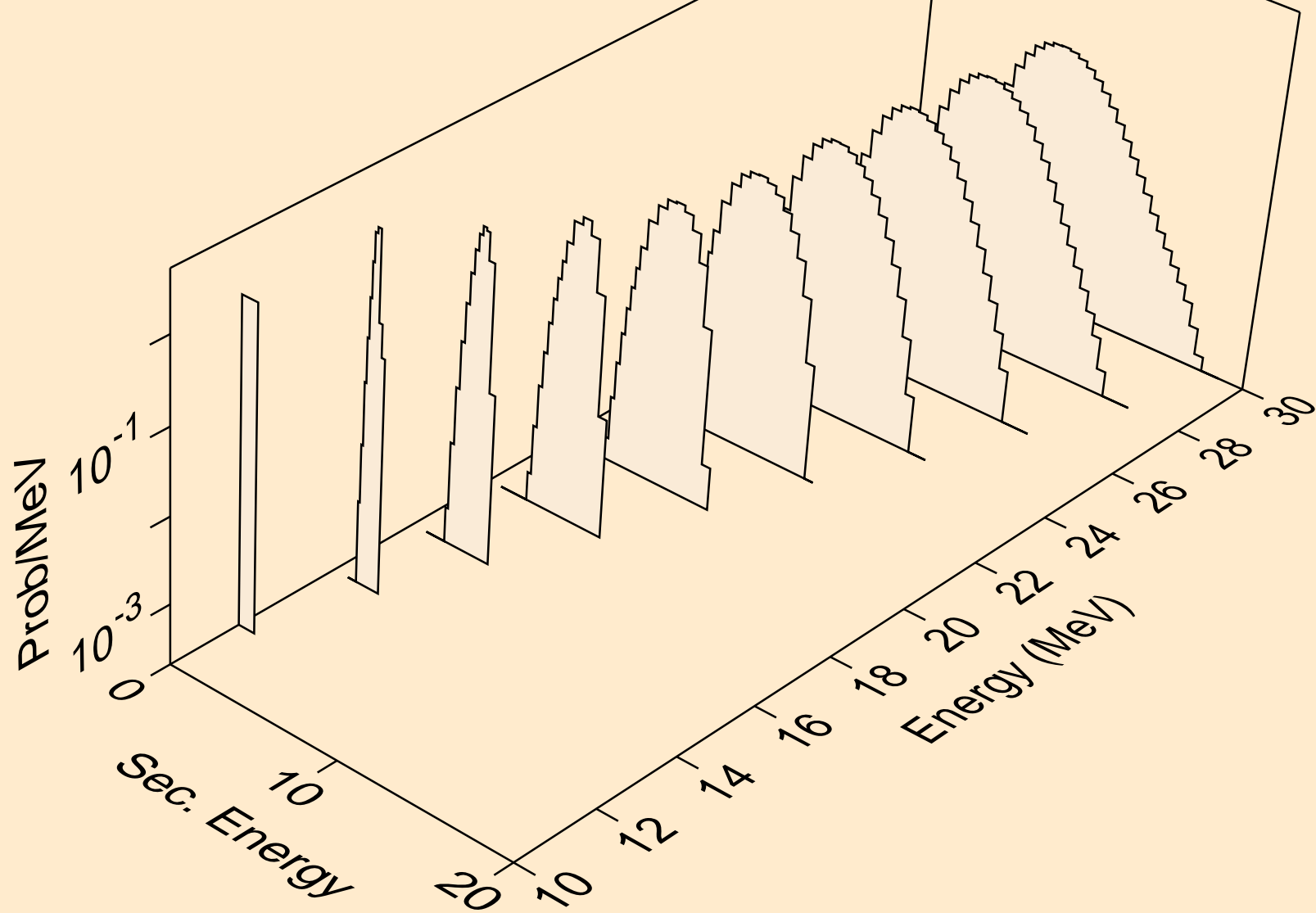

PT179 NEUTRON ACER TENDL-2021 LIBRARY; T=293.6K  
protons from (n,3np)

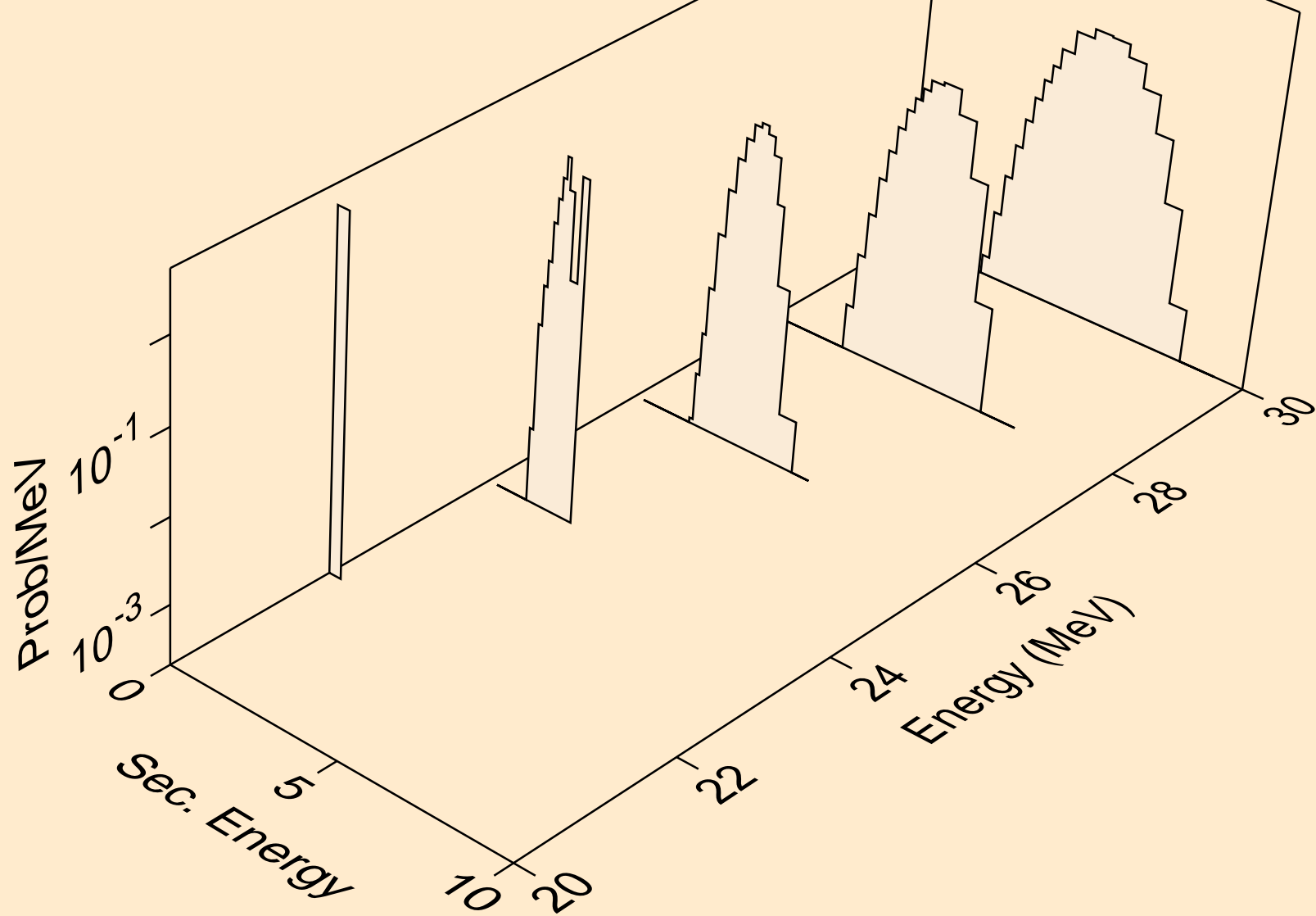



PT179 NEUTRON ACER TENDL-2021 LIBRARY; T=293.6K  
protons from (n,2np)

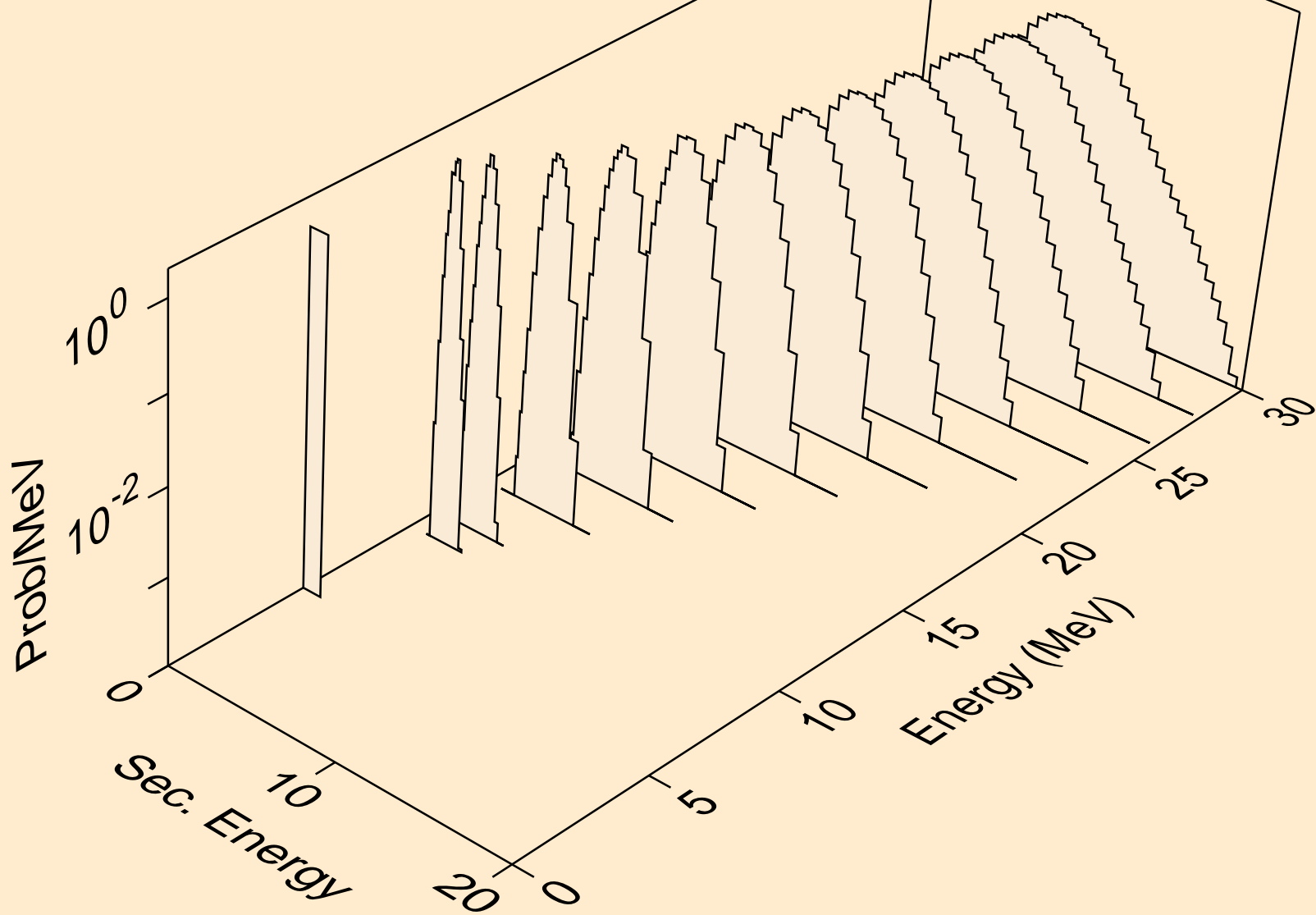

PT179 NEUTRON ACER TENDL-2021 LIBRARY; T=293.6K  
protons from (n,npa)

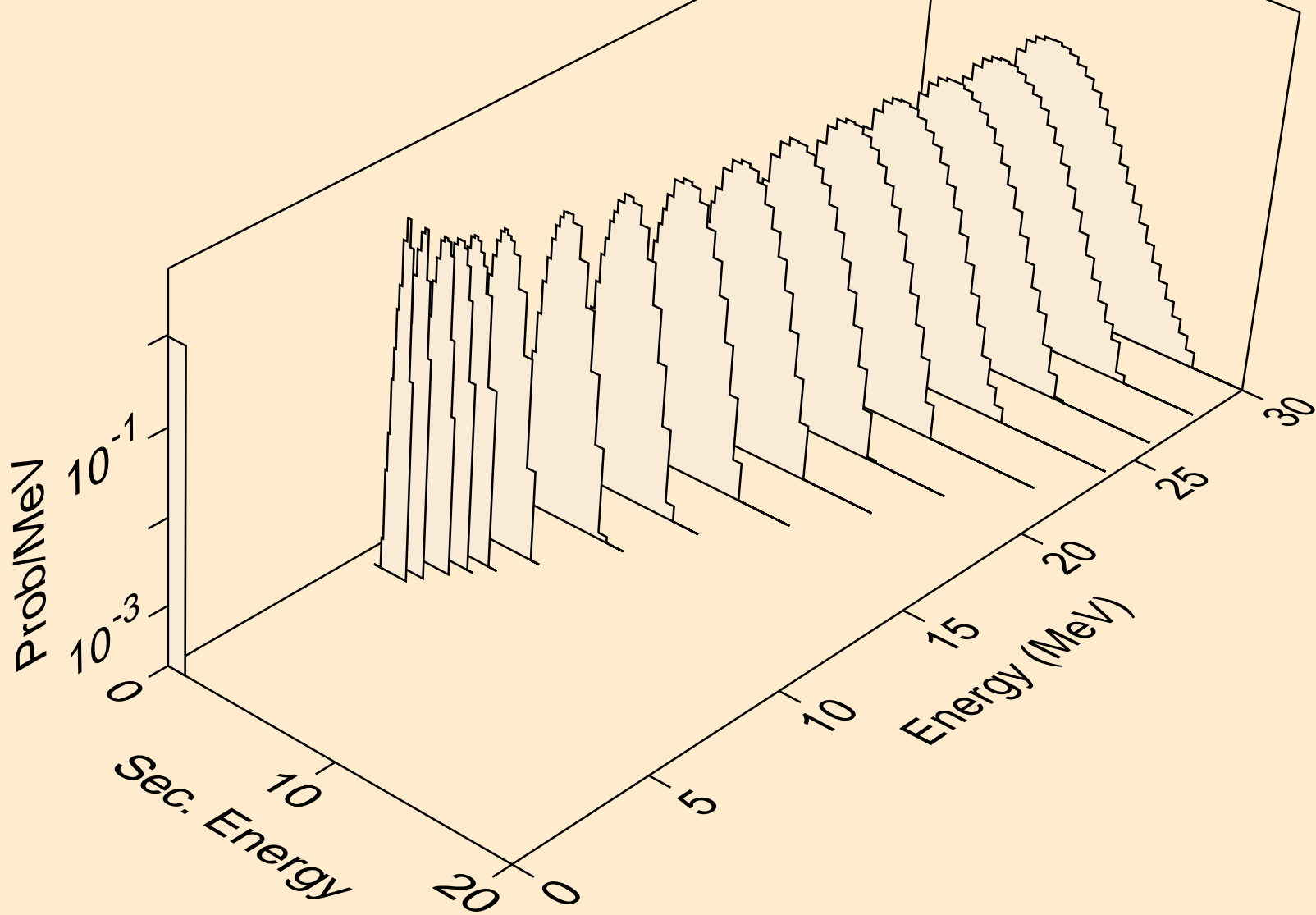

PT179 NEUTRON ACER TENDL-2021 LIBRARY; T=293.6K  
protons from (n,p)

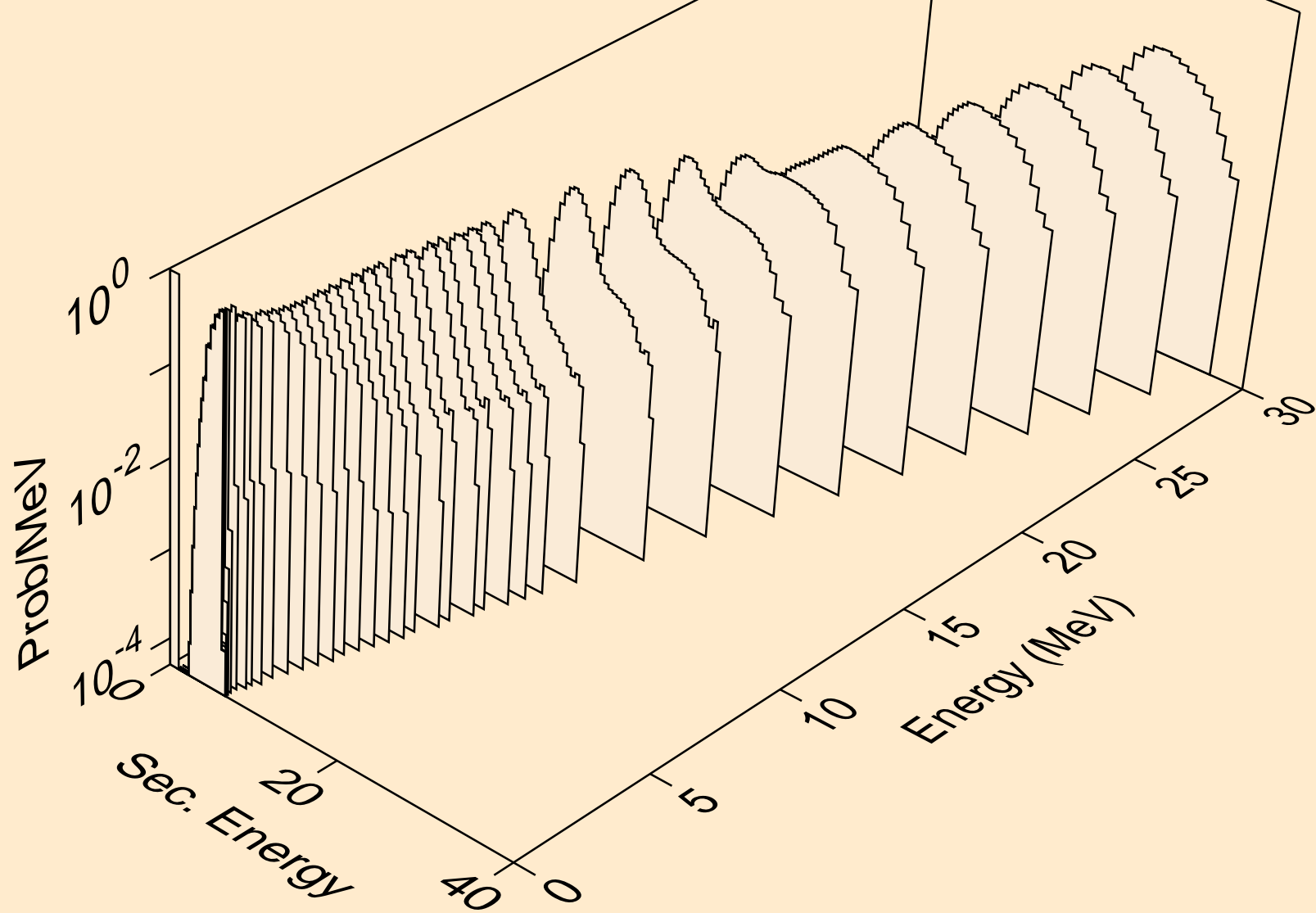

PT179 NEUTRON ACER TENDL-2021 LIBRARY; T=293.6K  
protons from (n,2p)

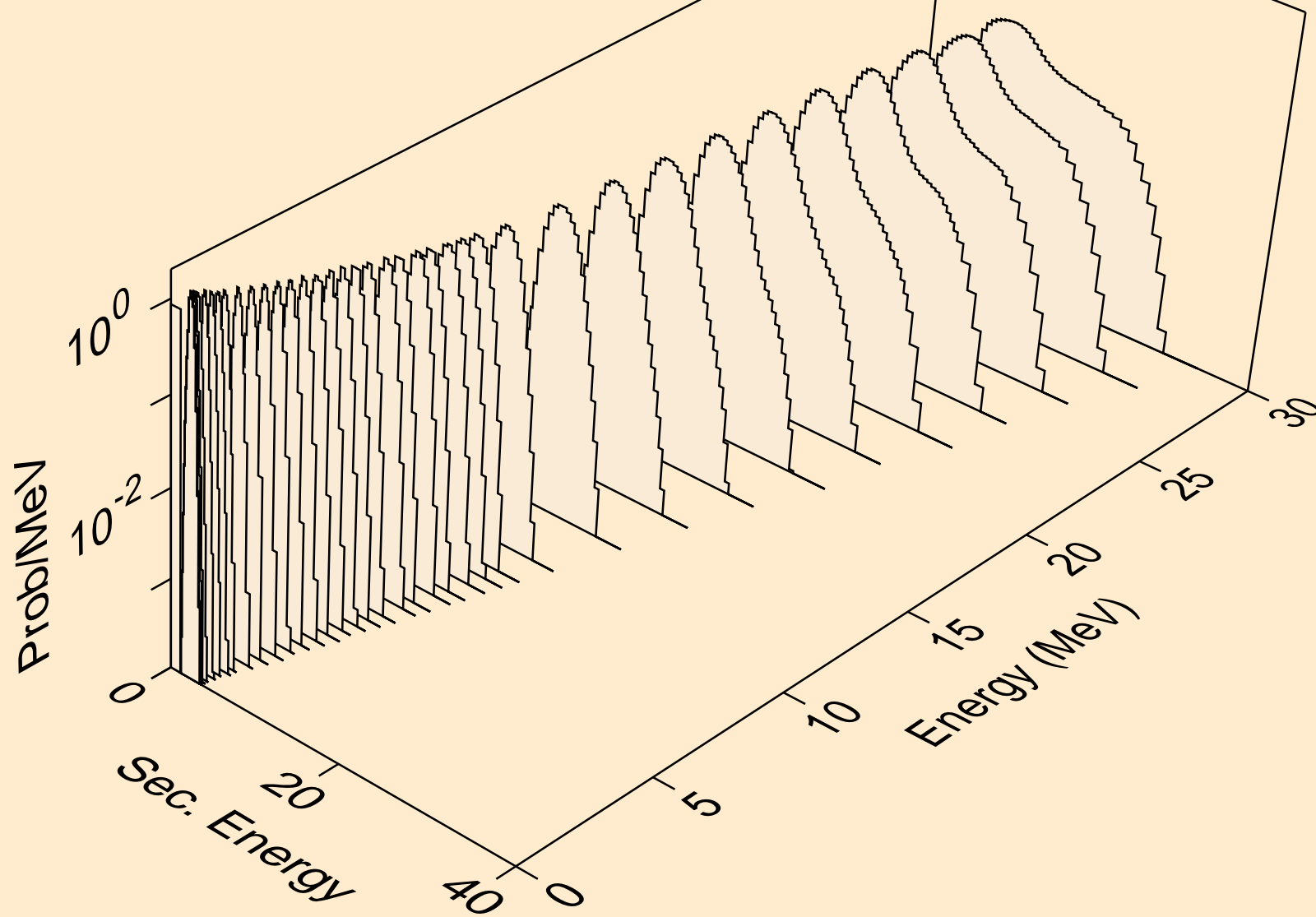

PT179 NEUTRON ACER TENDL-2021 LIBRARY; T=293.6K  
protons from (n,p)

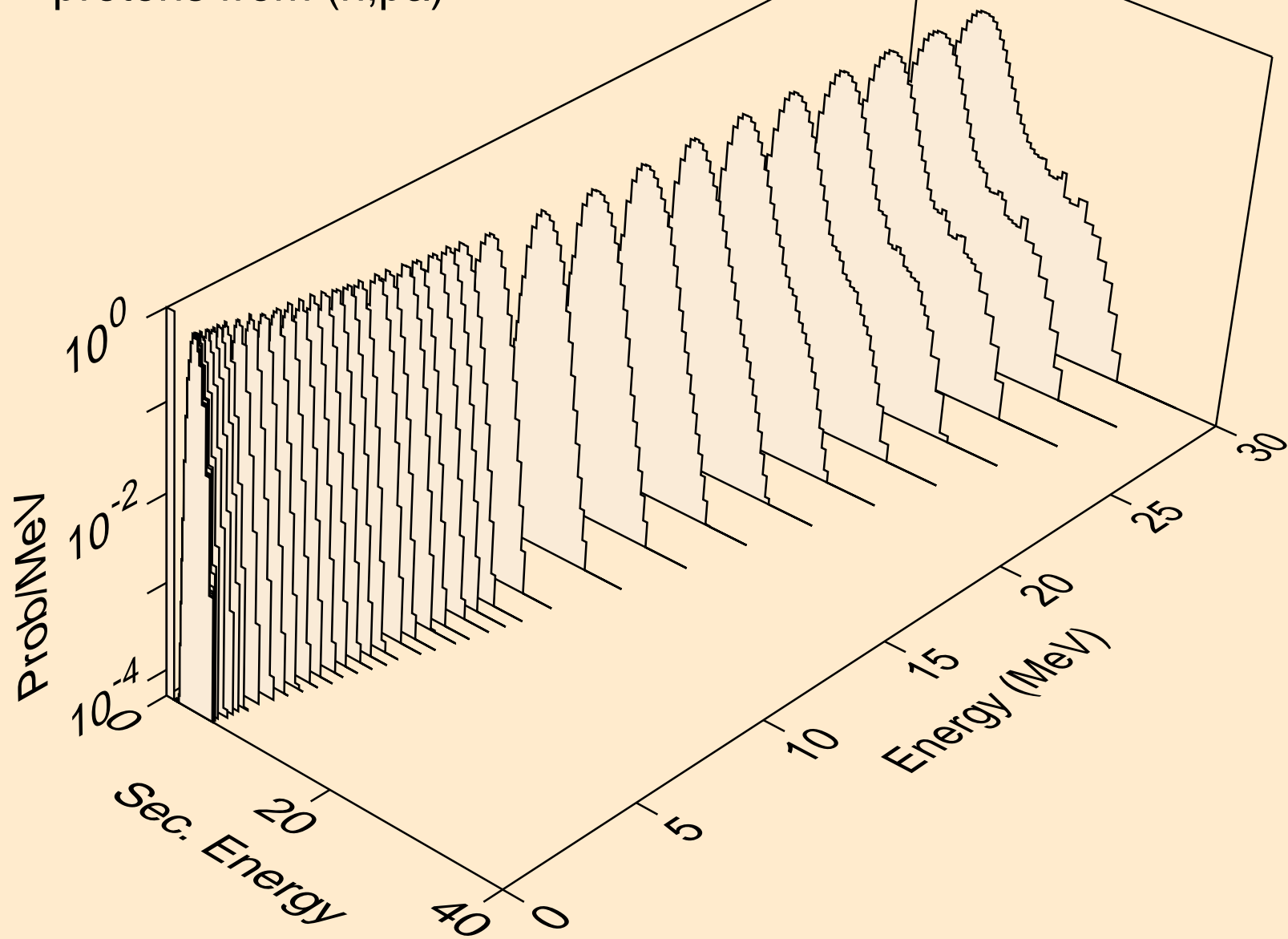

PT179 NEUTRON ACER TENDL-2021 LIBRARY; T=293.6K  
protons from (n,pd)

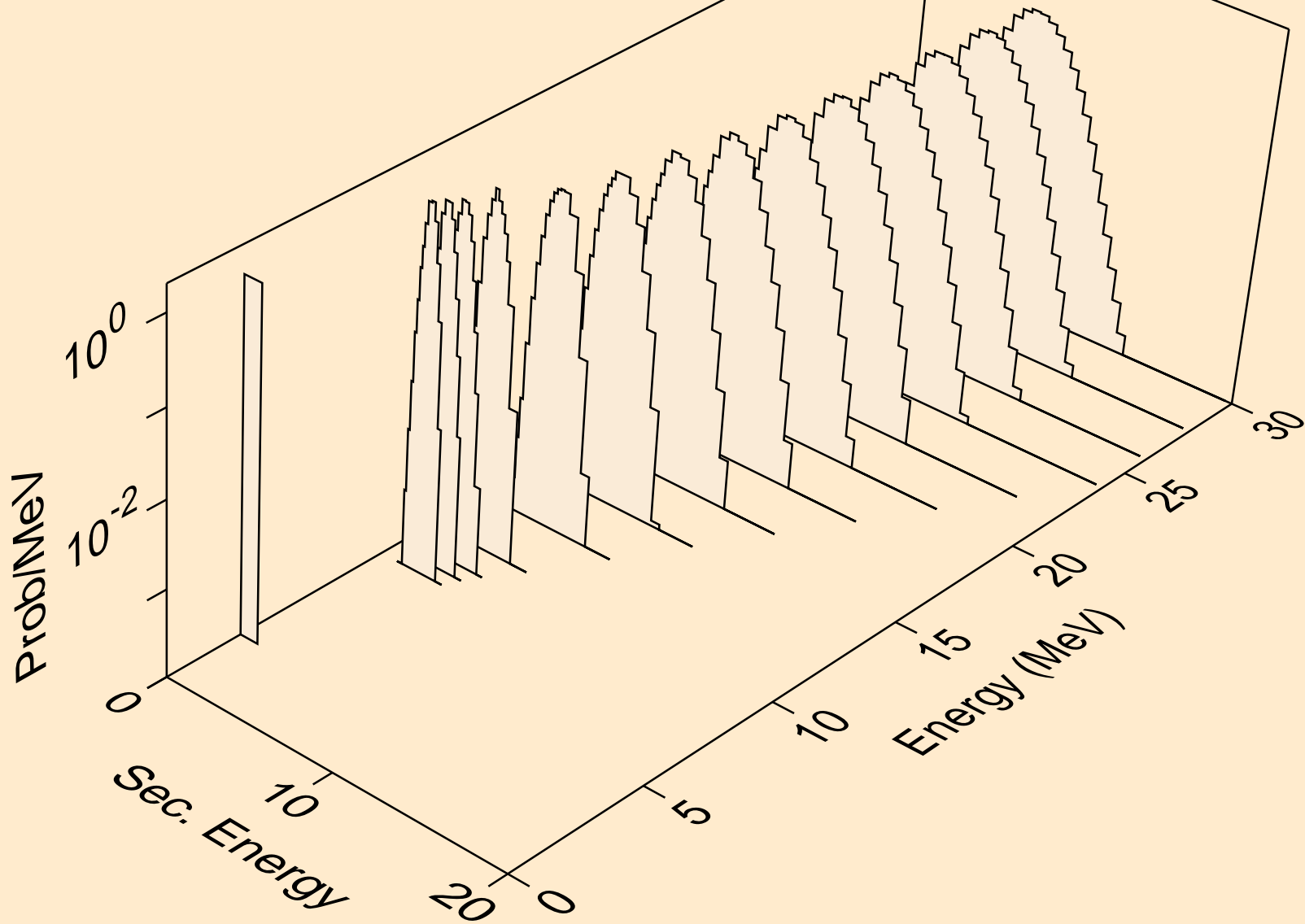

PT179 NEUTRON ACER TENDL-2021 LIBRARY; T=293.6K  
protons from (n,pt)

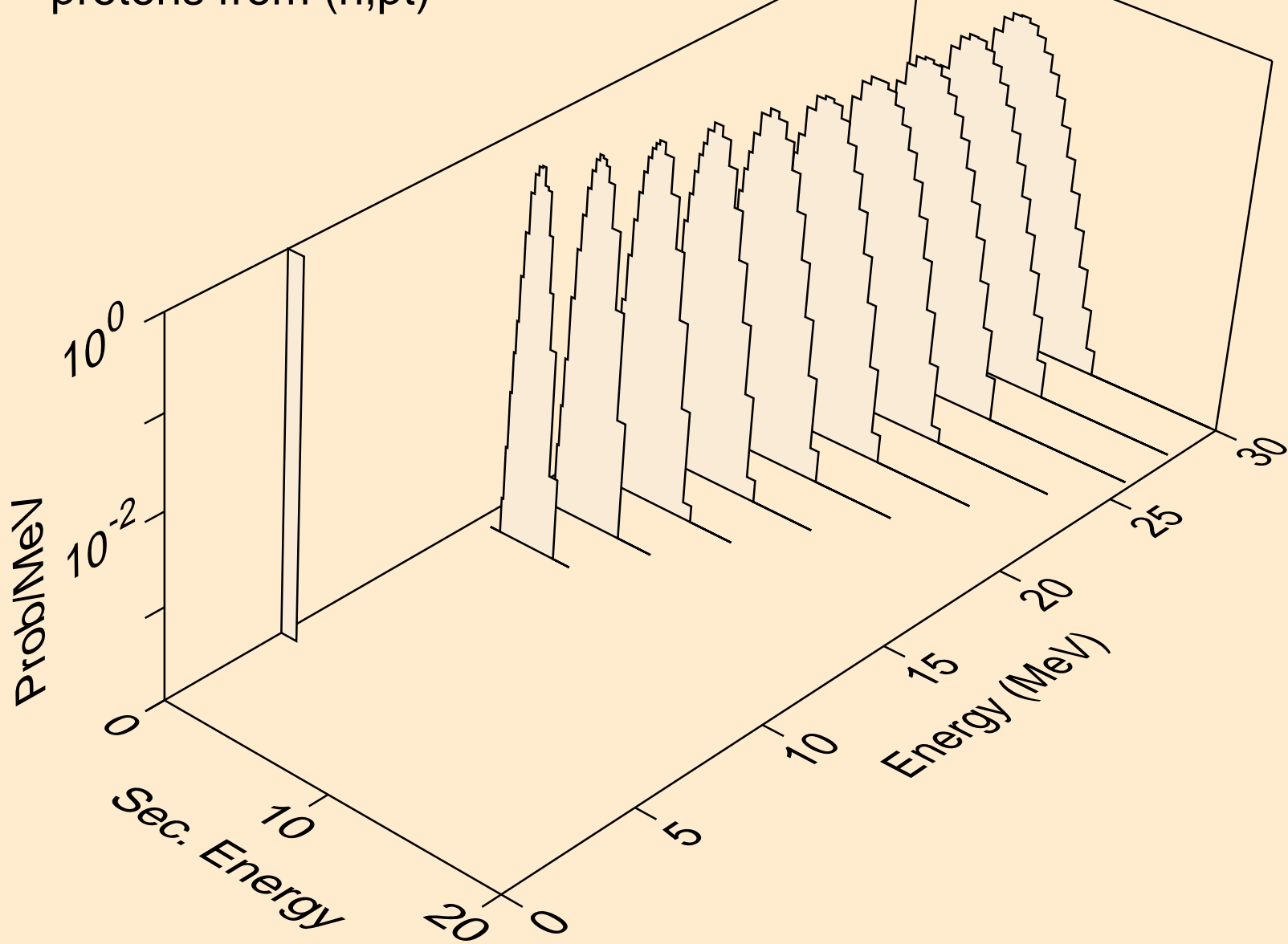

PT179 NEUTRON ACER TENDL-2021 LIBRARY; T=293.6K  
deuterons from (n,x)

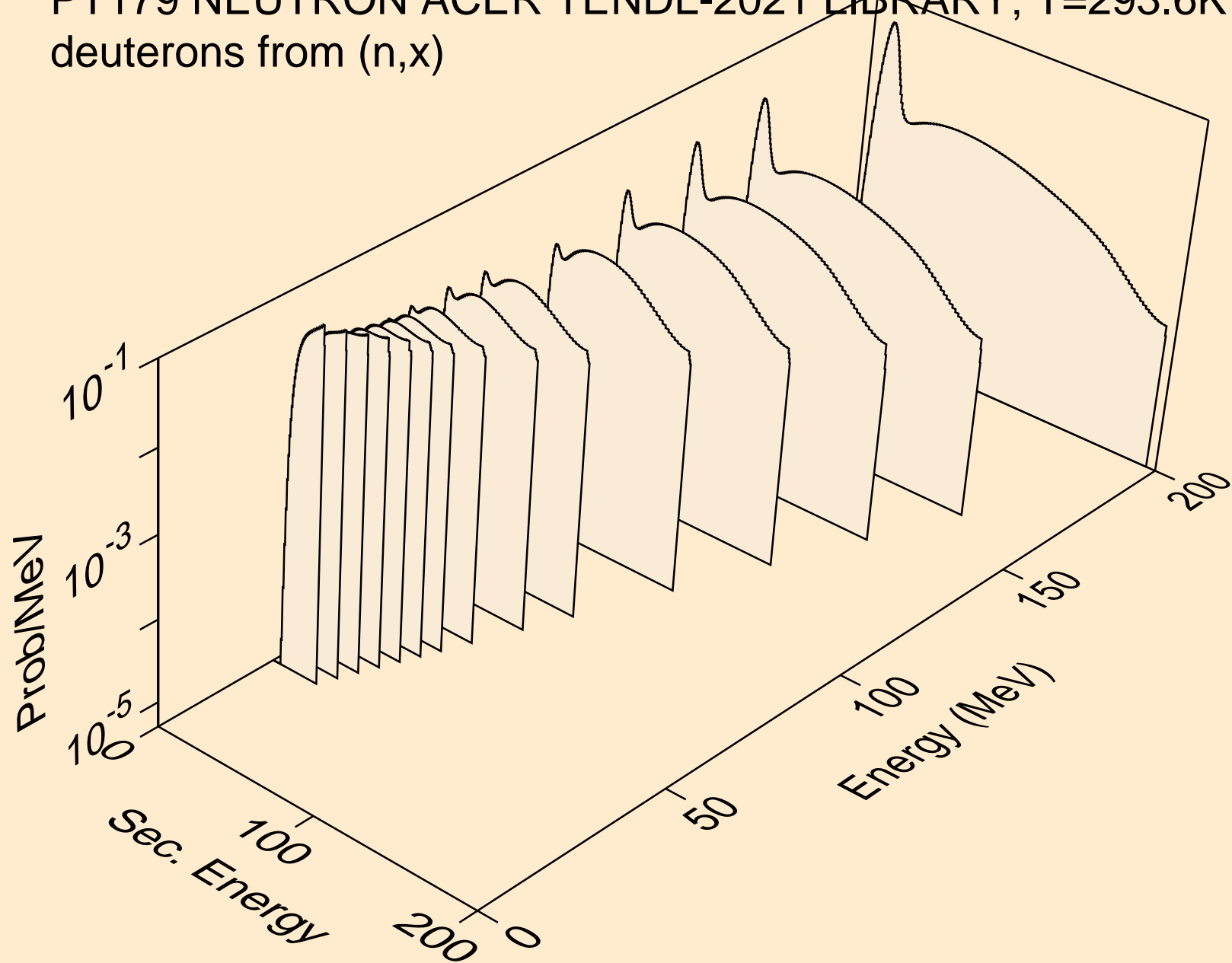



PT179 NEUTRON ACER TENDL-2021 LIBRARY; T=293.6K  
deuterons from (n,2nd)

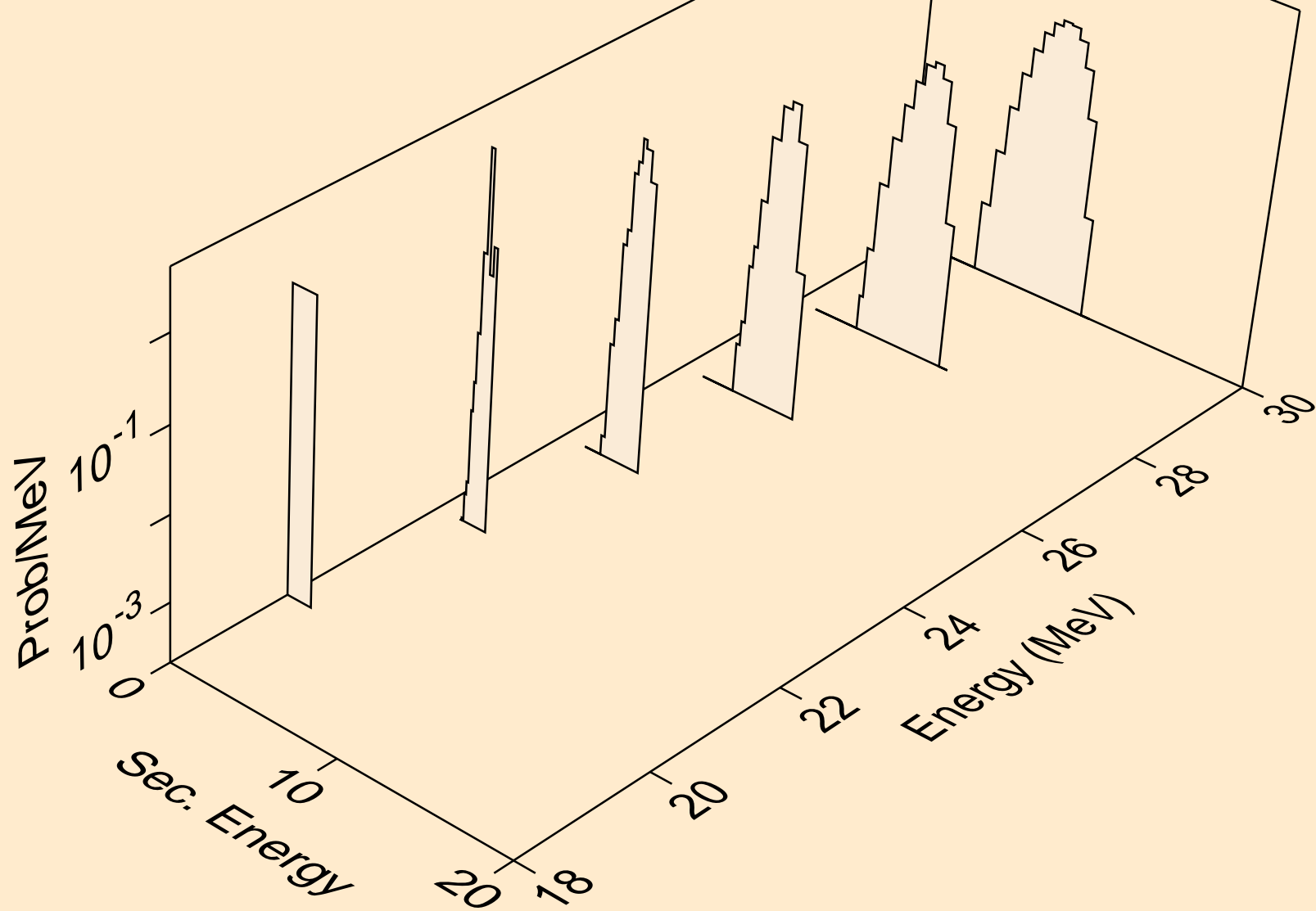

PT179 NEUTRON ACER TENDL-2021 LIBRARY; T=293.6K  
deuterons from (n,n\*)d

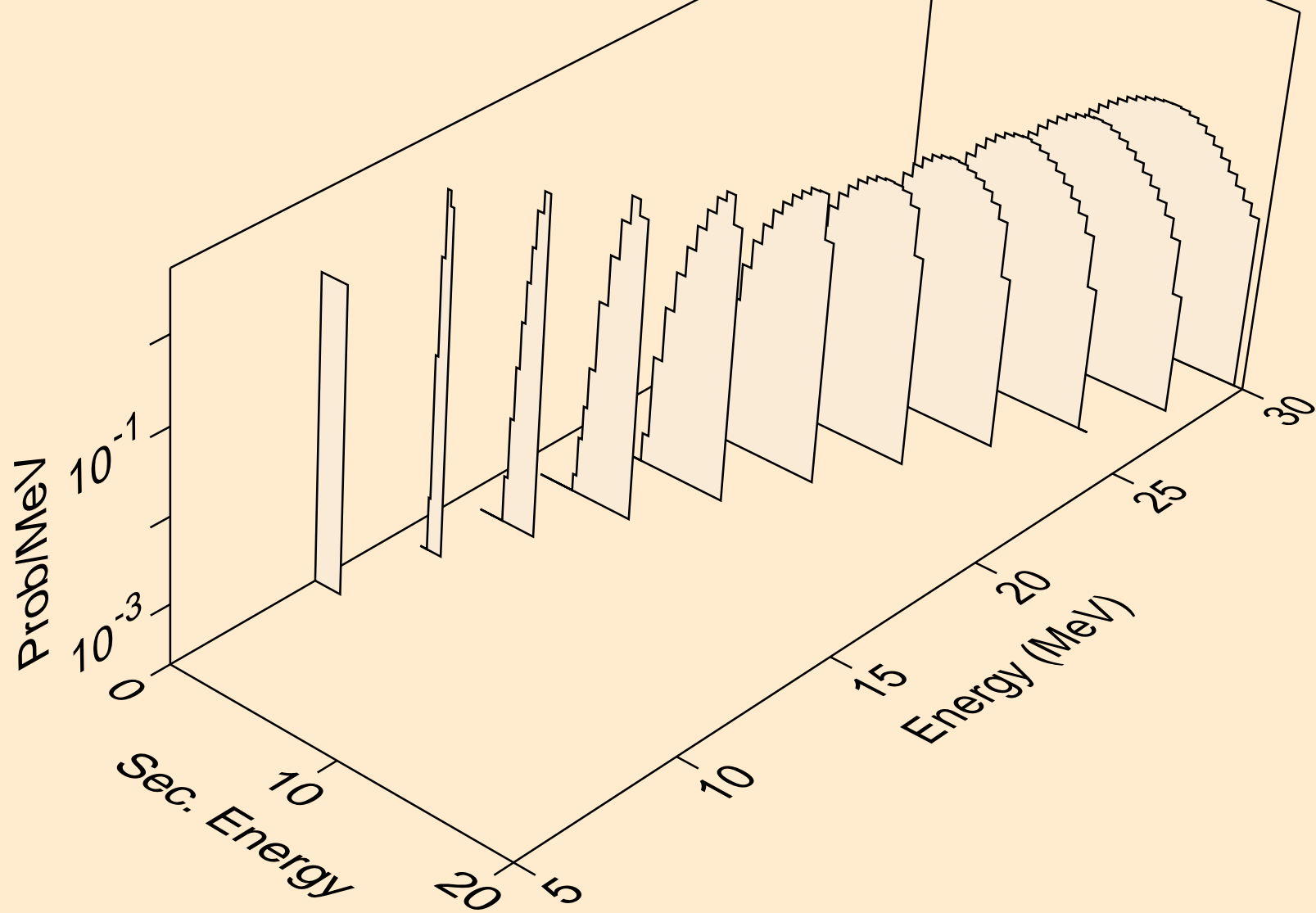

PT179 NEUTRON ACER TENDL-2021 LIBRARY; T=293.6K  
deuterons from (n,d)

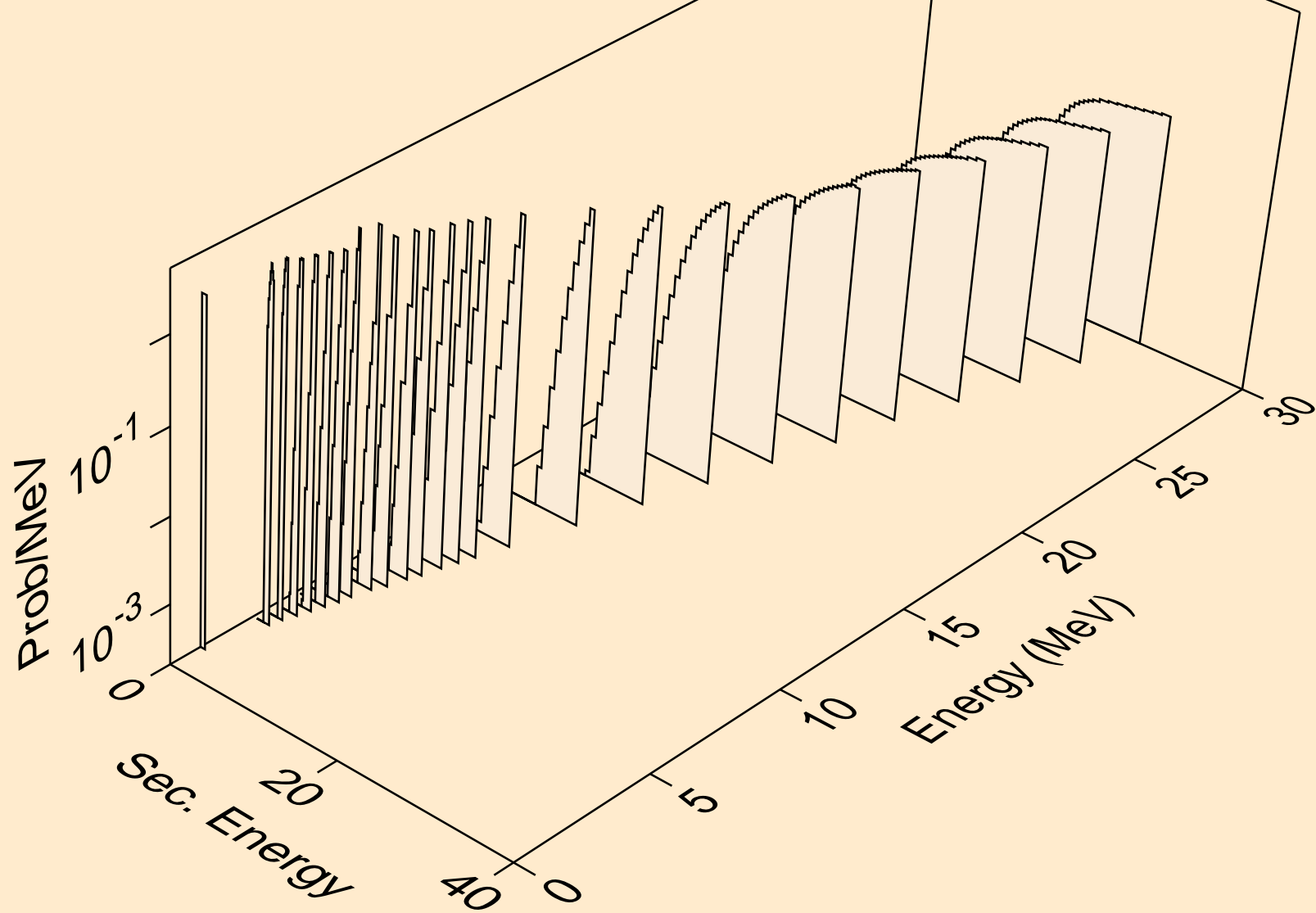

PT179 NEUTRON ACER TENDL-2021 LIBRARY; T=293.6K  
deuterons from (n,pd)

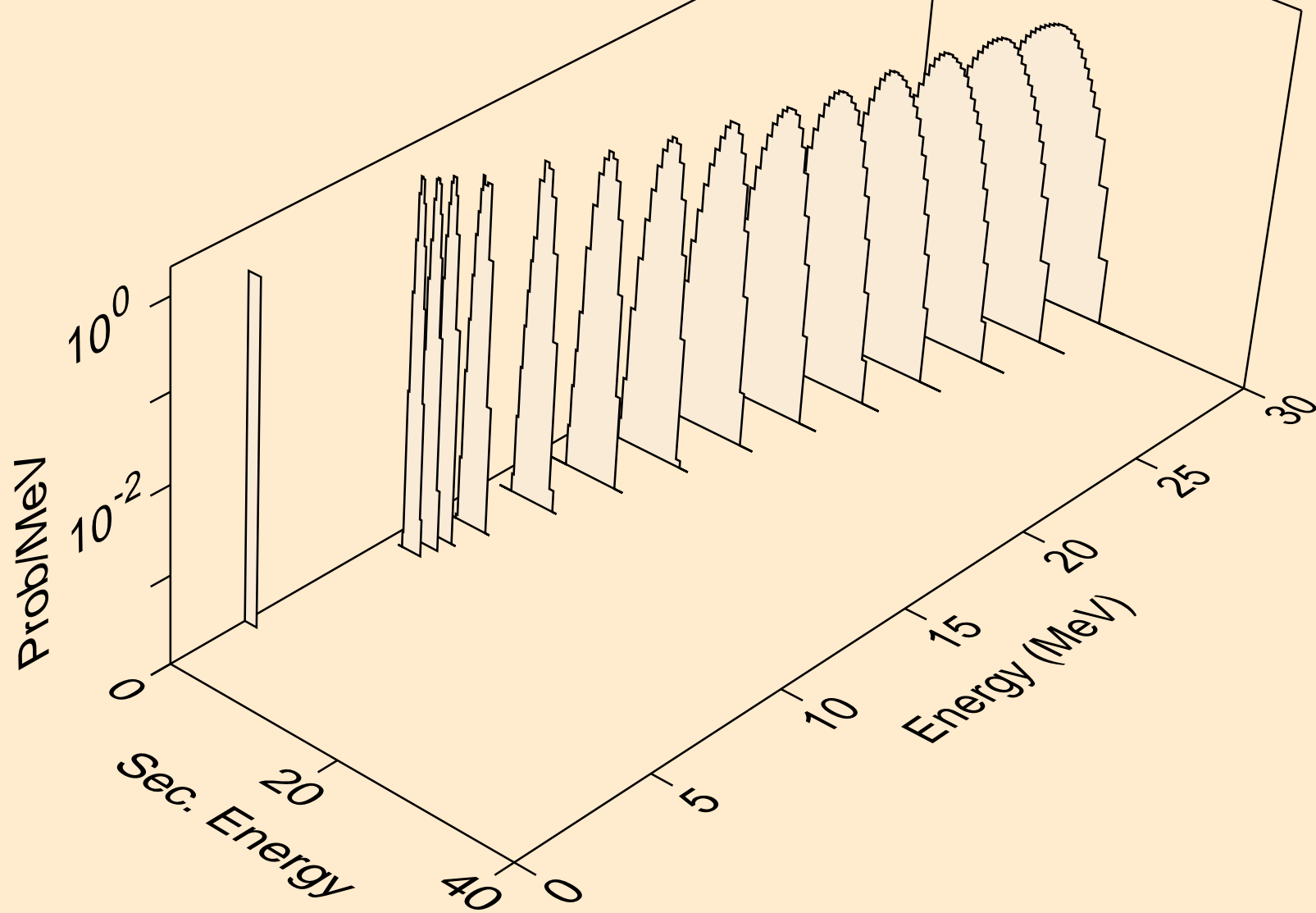

PT179 NEUTRON ACER TENDL-2021 LIBRARY; T=293.6K  
deuterons from (n,da)

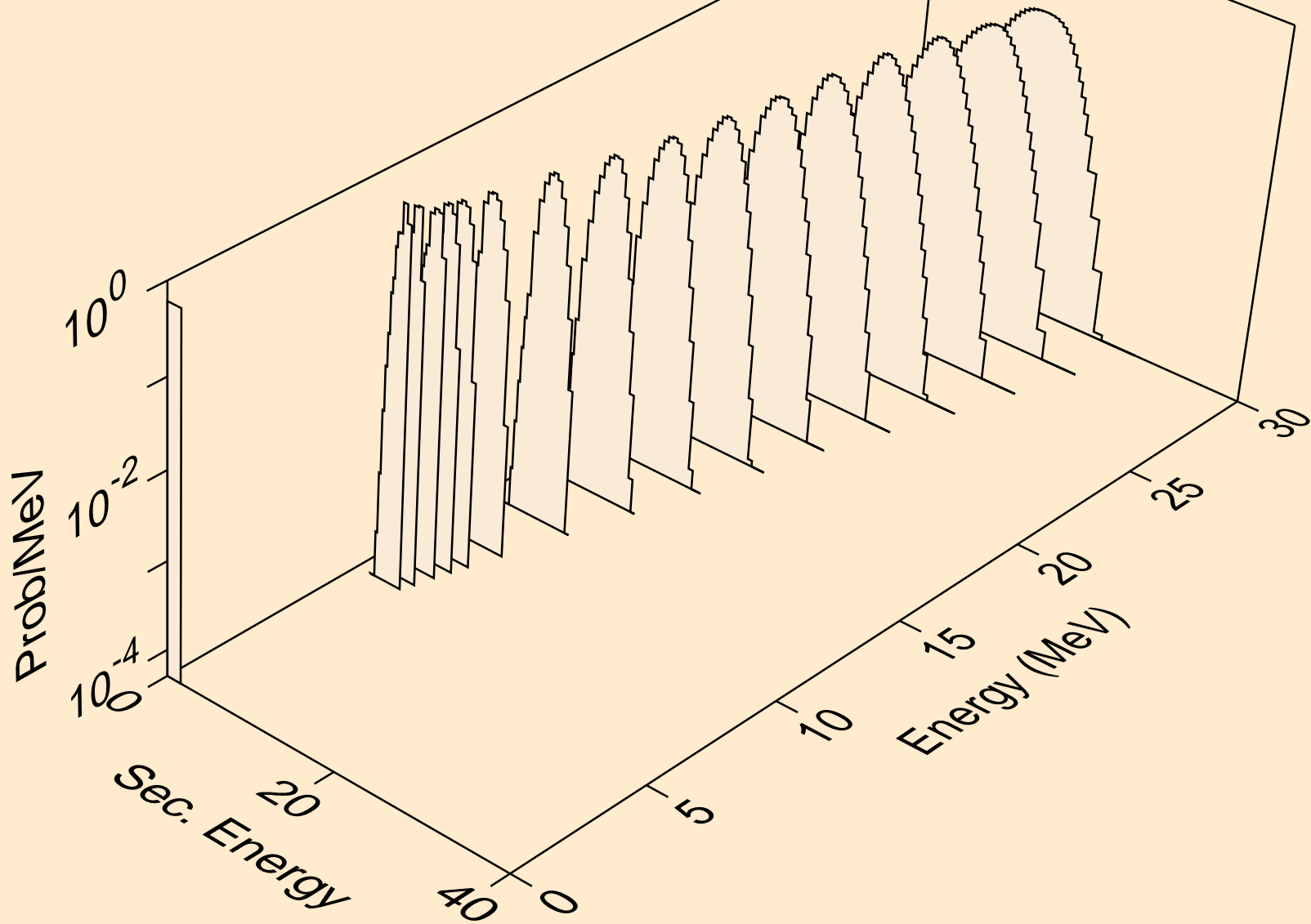

PT179 NEUTRON ACER TENDL-2021 LIBRARY; T=293.6K  
tritons from (n,x)

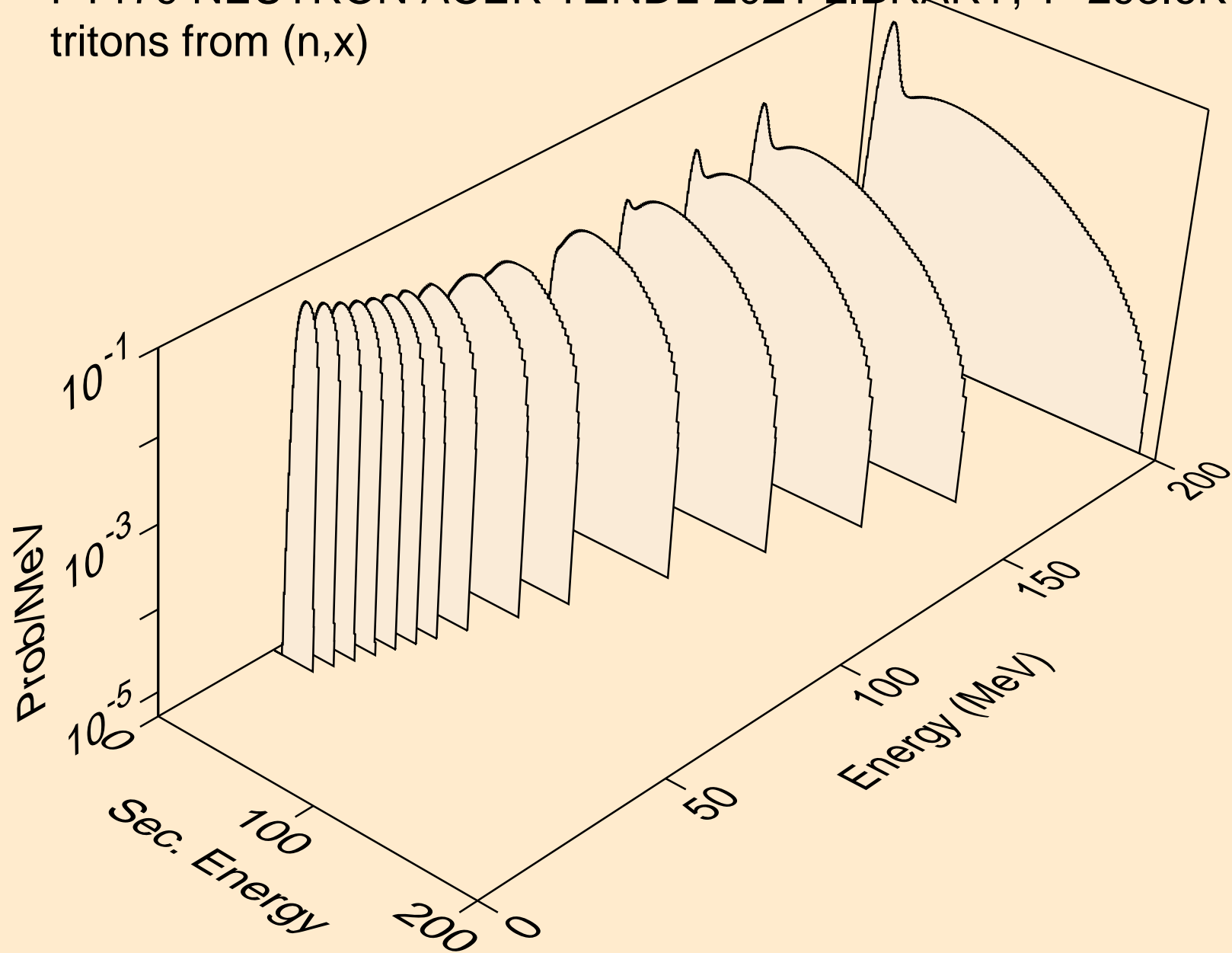

PT179 NEUTRON ACER TENDL-2021 LIBRARY; T=293.6K  
tritons from (n,n\*)t

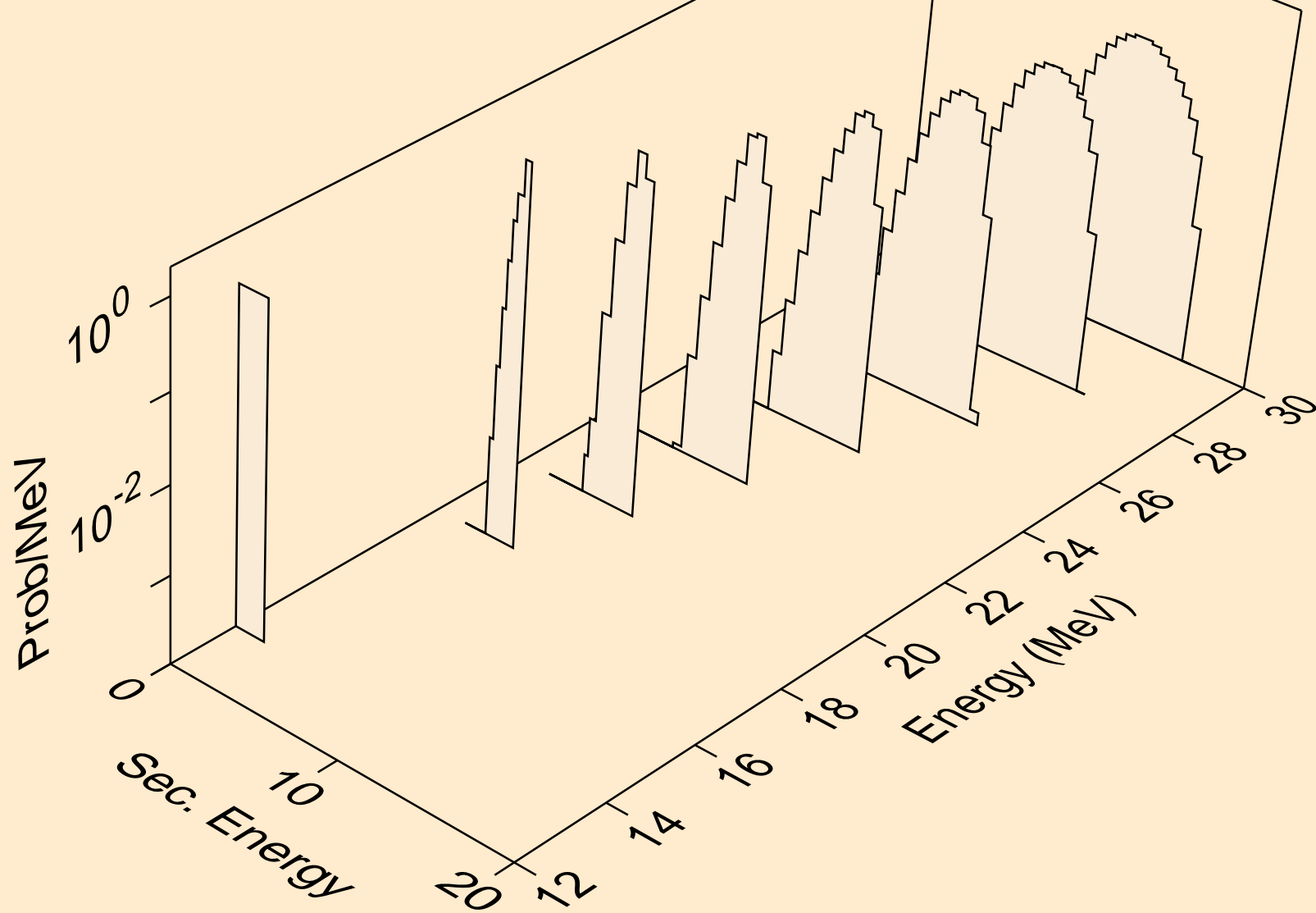

PT179 NEUTRON ACER TENDL-2021 LIBRARY; T=293.6K  
tritons from (n,t)

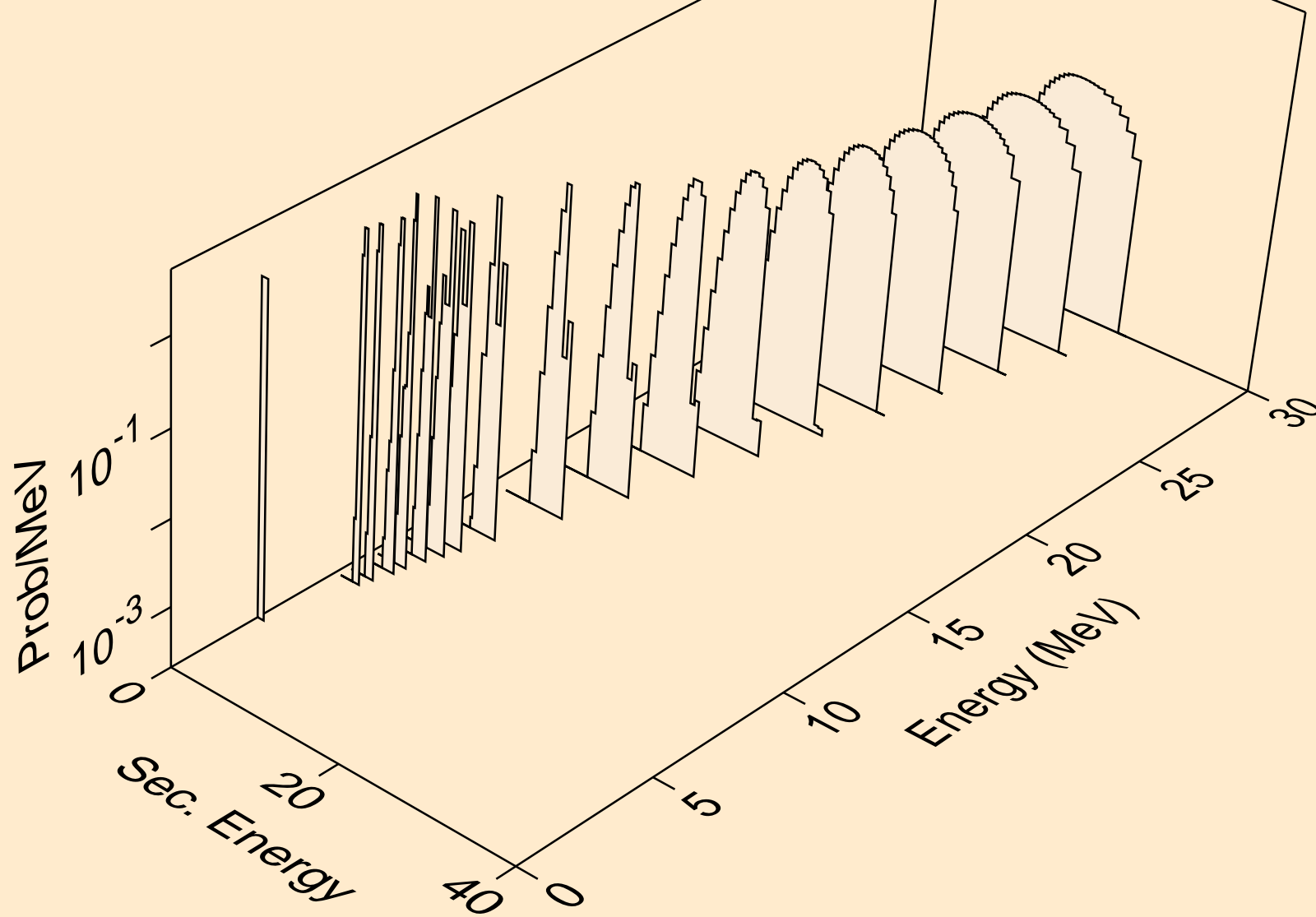



PT179 NEUTRON ACER TENDL-2021 LIBRARY; T=293.6K  
tritons from (n,pt)

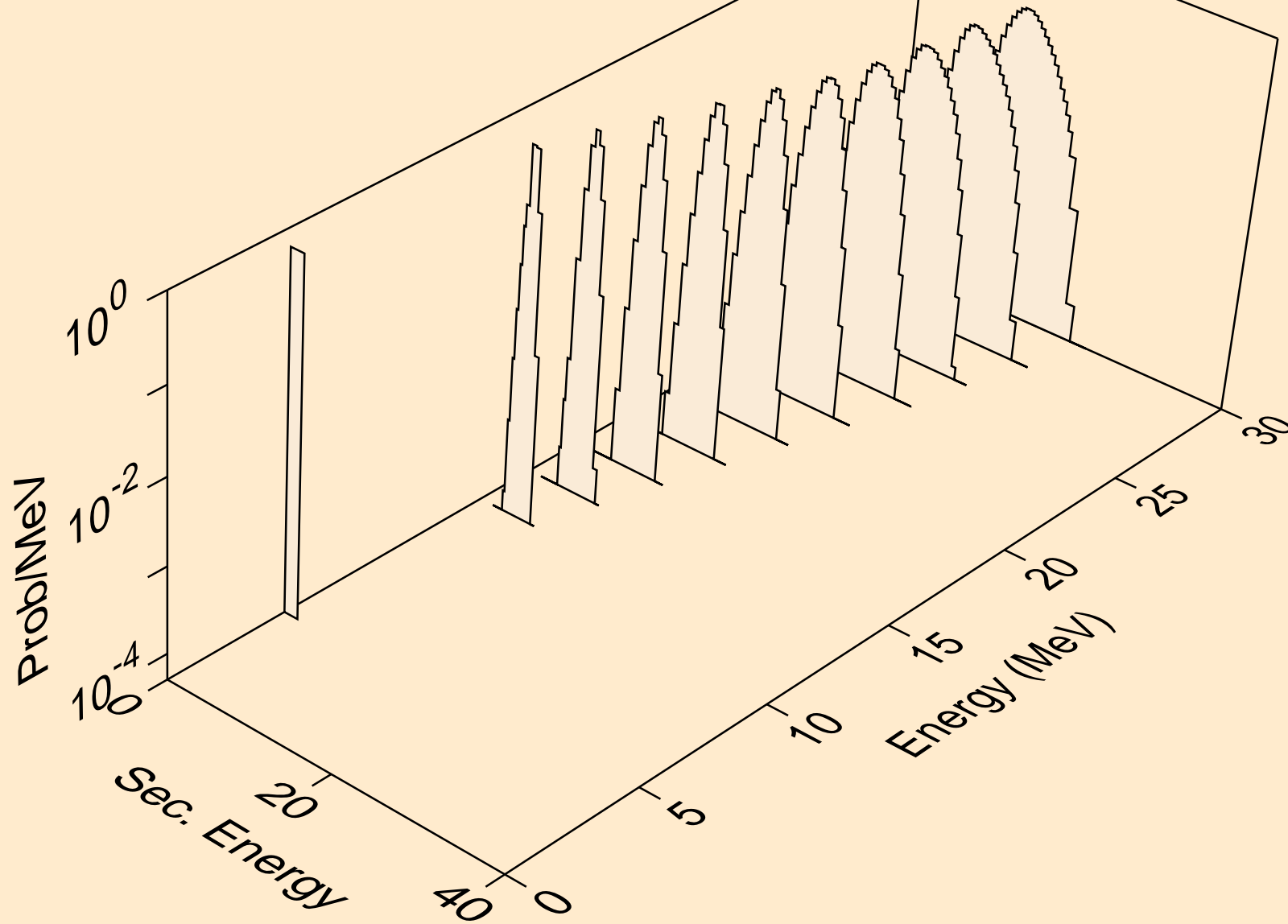

PT179 NEUTRON ACER TENDL-2021 LIBRARY; T=293.6K  
he3s from (n,x)

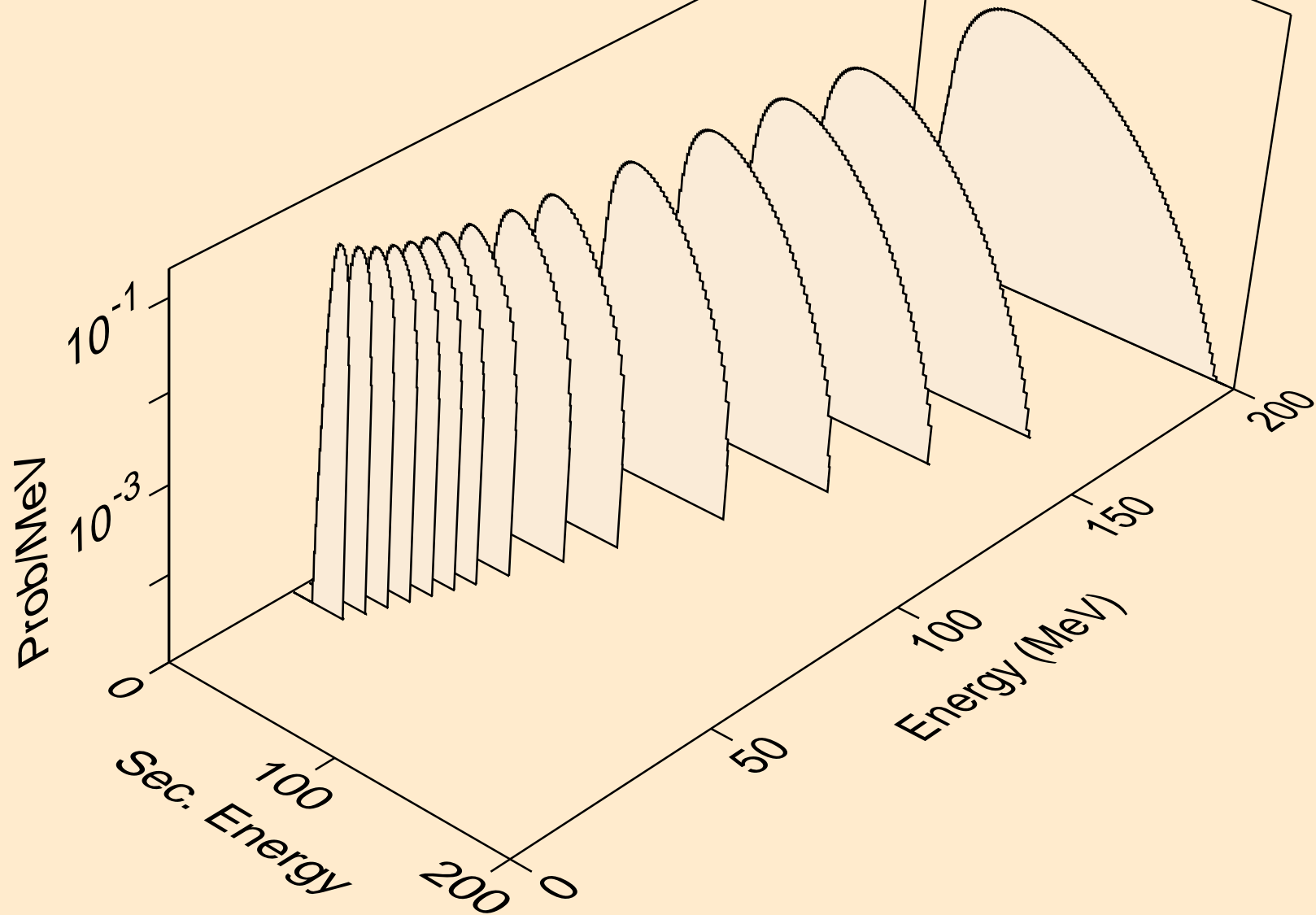

PT179 NEUTRON ACER TENDL-2021 LIBRARY; T=293.6K  
he3s from (n,n\*)he3

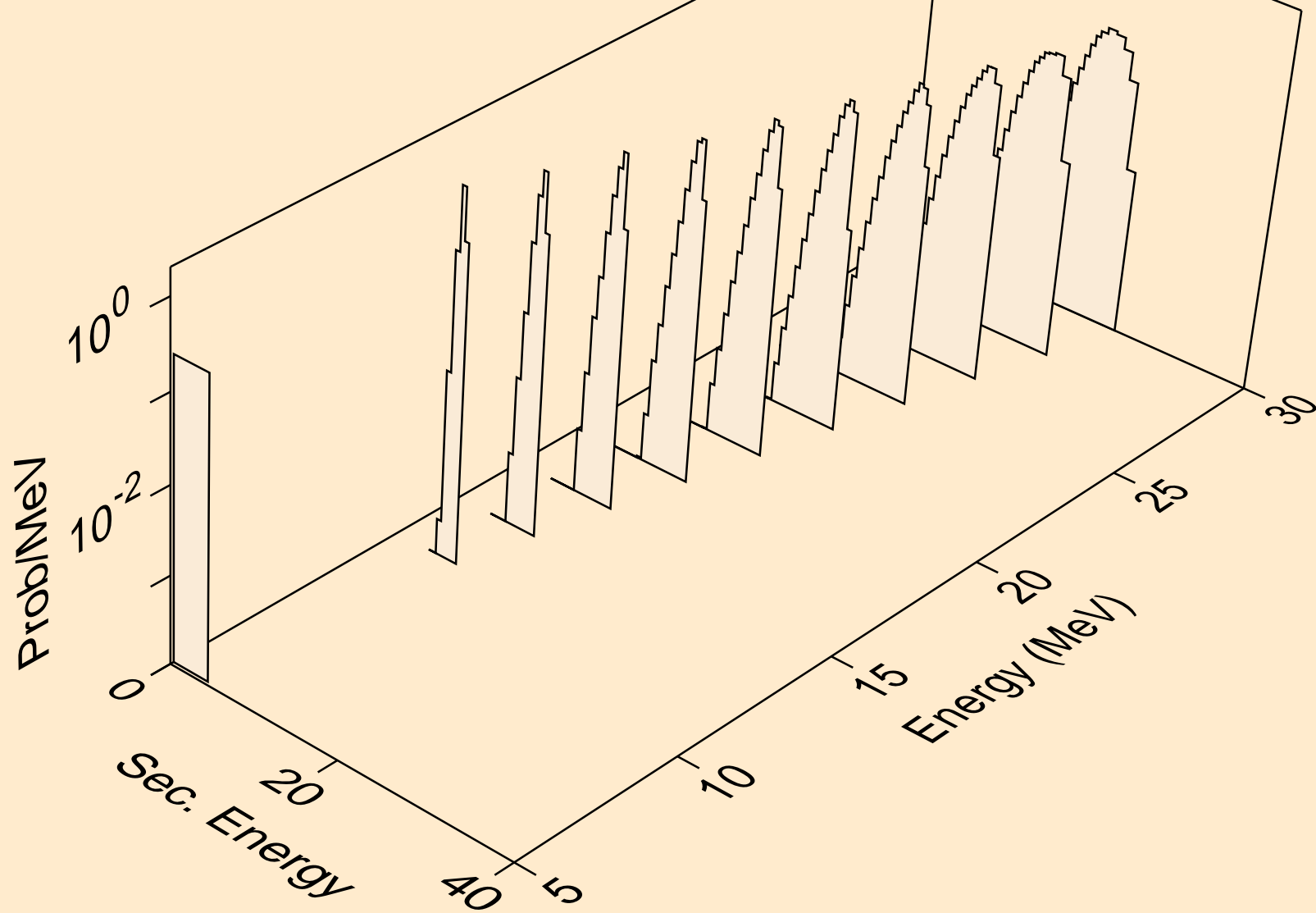

PT179 NEUTRON ACER TENDL-2021 LIBRARY; T=293.6K  
he3s from (n,he3)

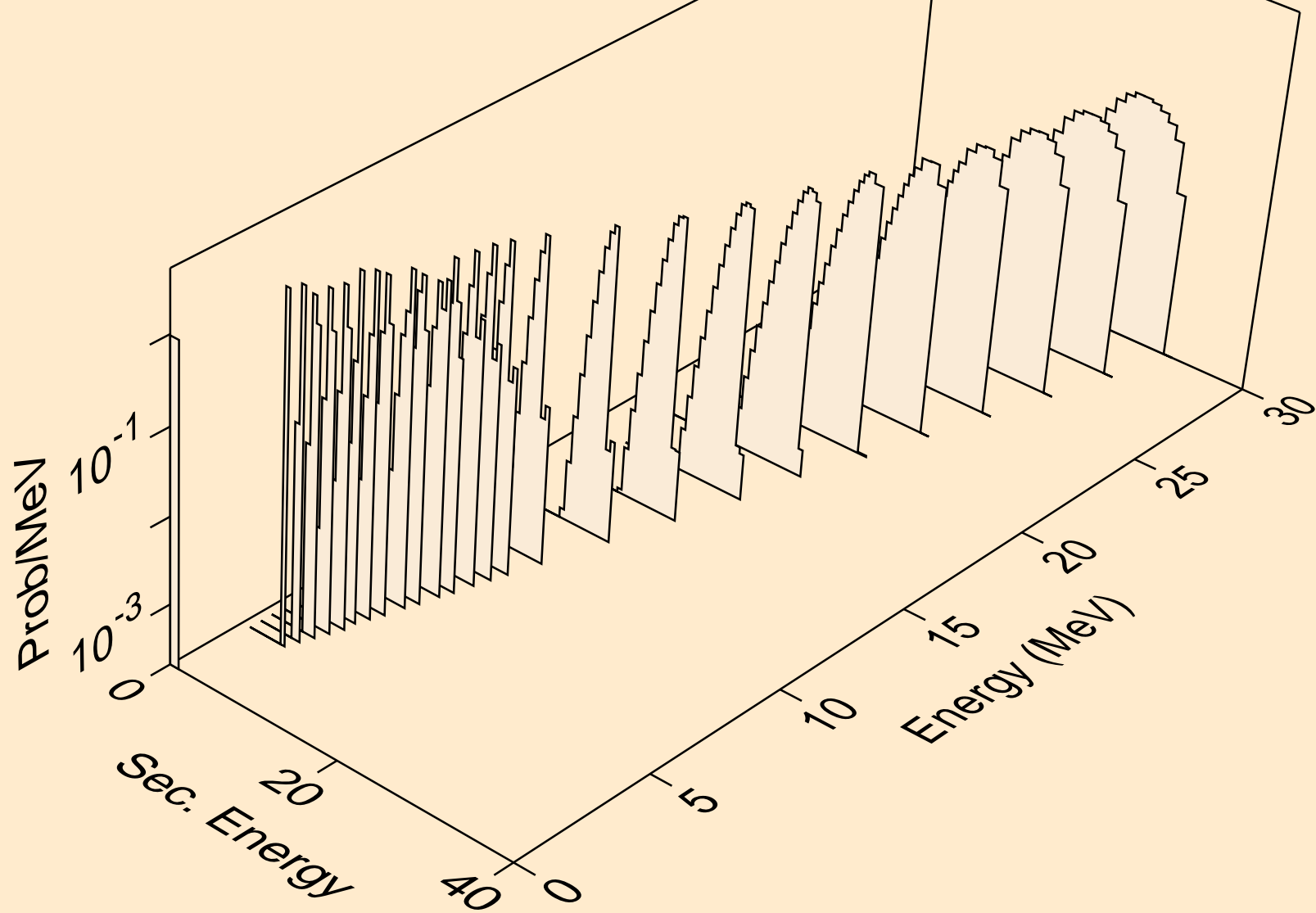

PT179 NEUTRON ACER TENDL-2021 LIBRARY; T=293.6K  
alphas from (n,x)

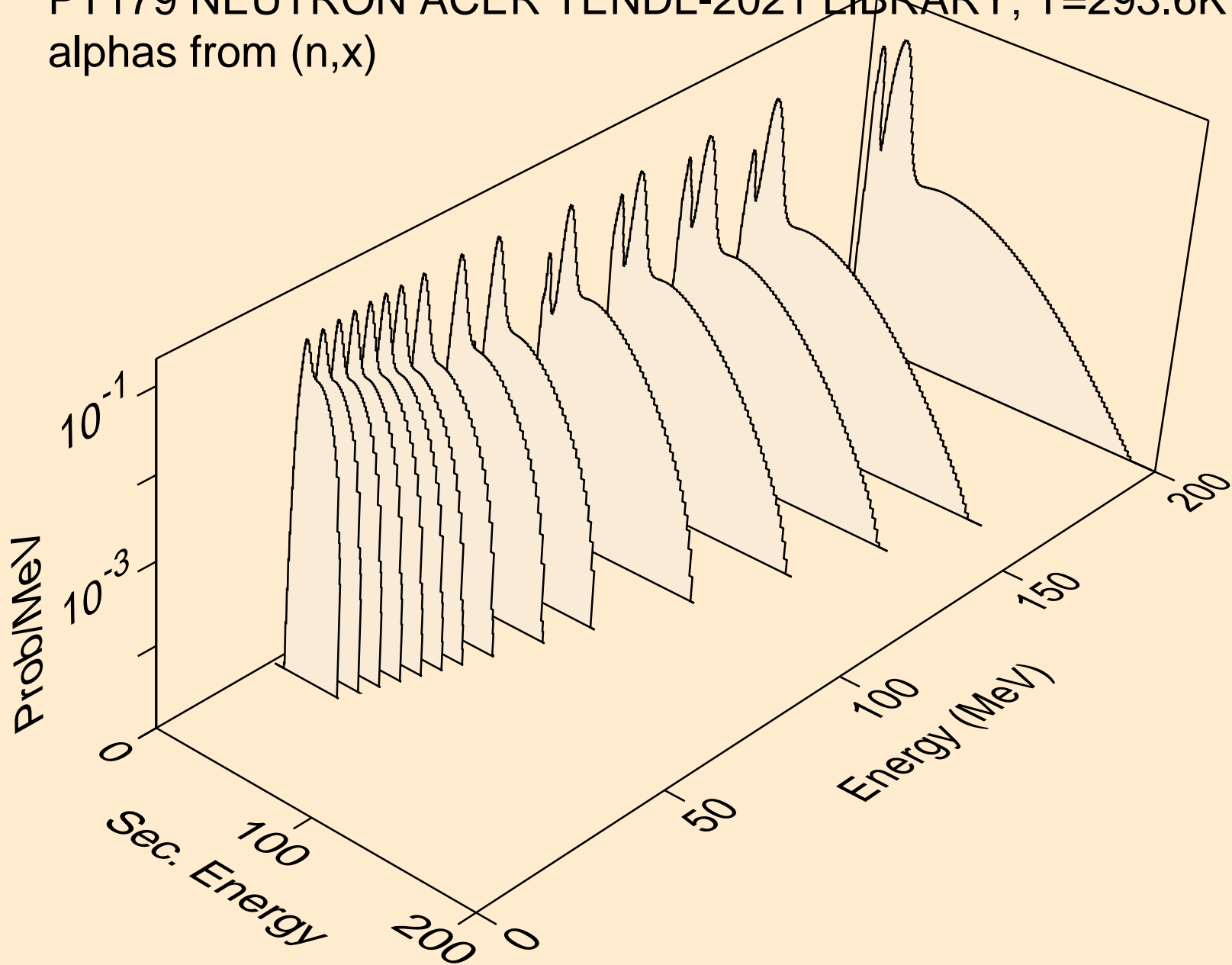

PT179 NEUTRON ACER TENDL-2021 LIBRARY; T=293.6K  
alphas from (n,n\*)a

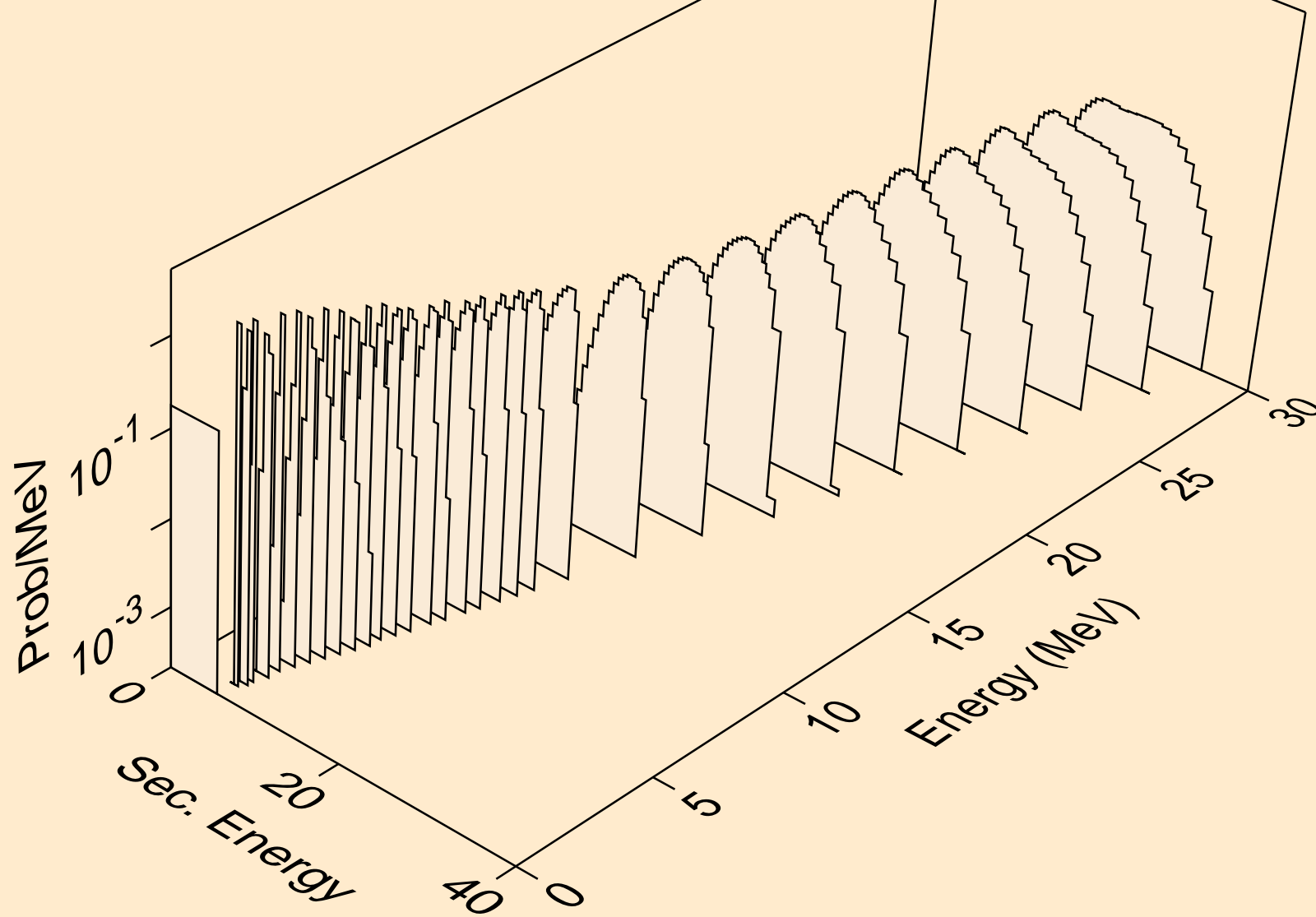

PT179 NEUTRON ACER TENDL-2021 LIBRARY; T=293.6K  
alphas from (n,2n)a

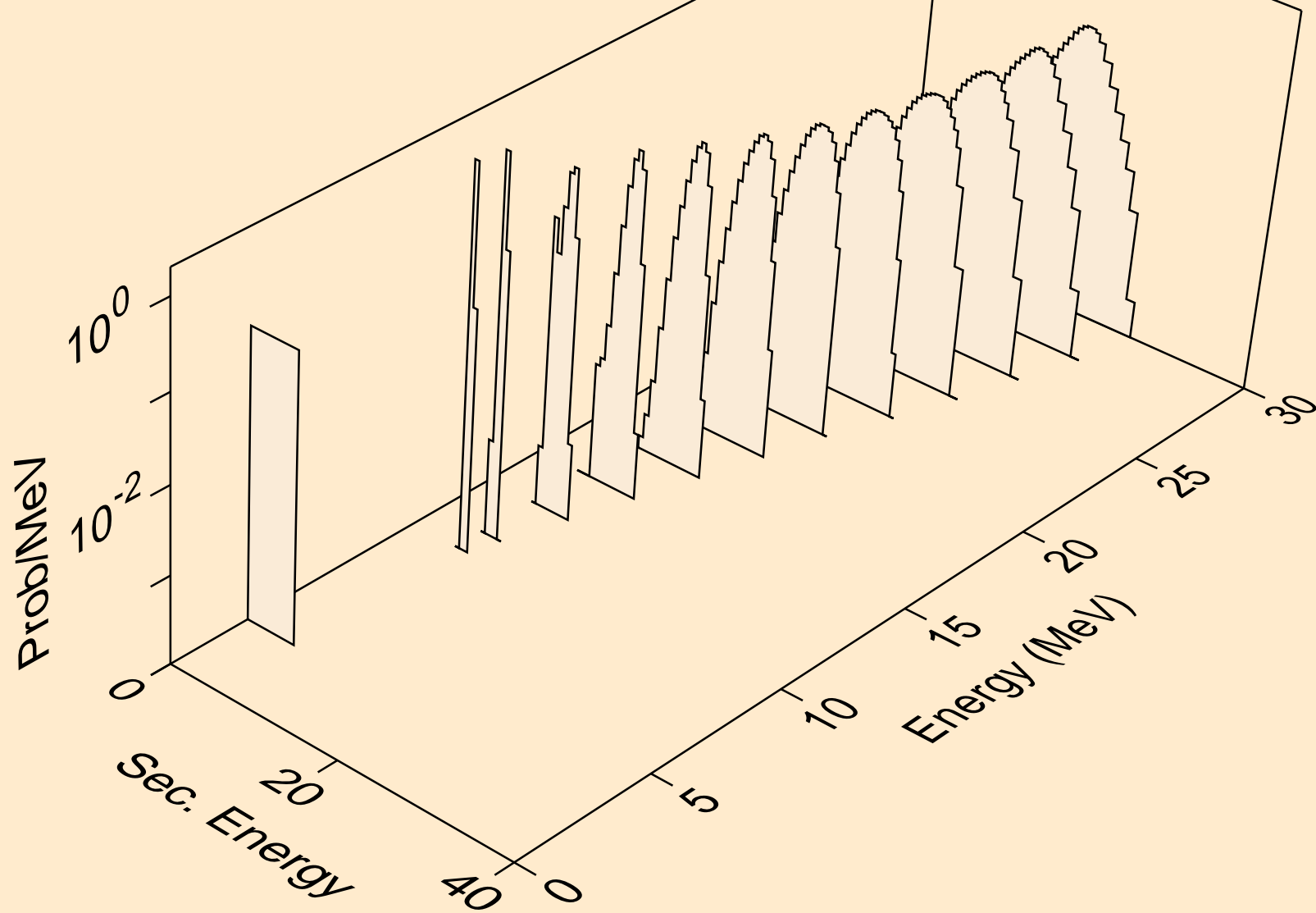

PT179 NEUTRON ACER TENDL-2021 LIBRARY; T=293.6K  
alphas from (n,3n)a

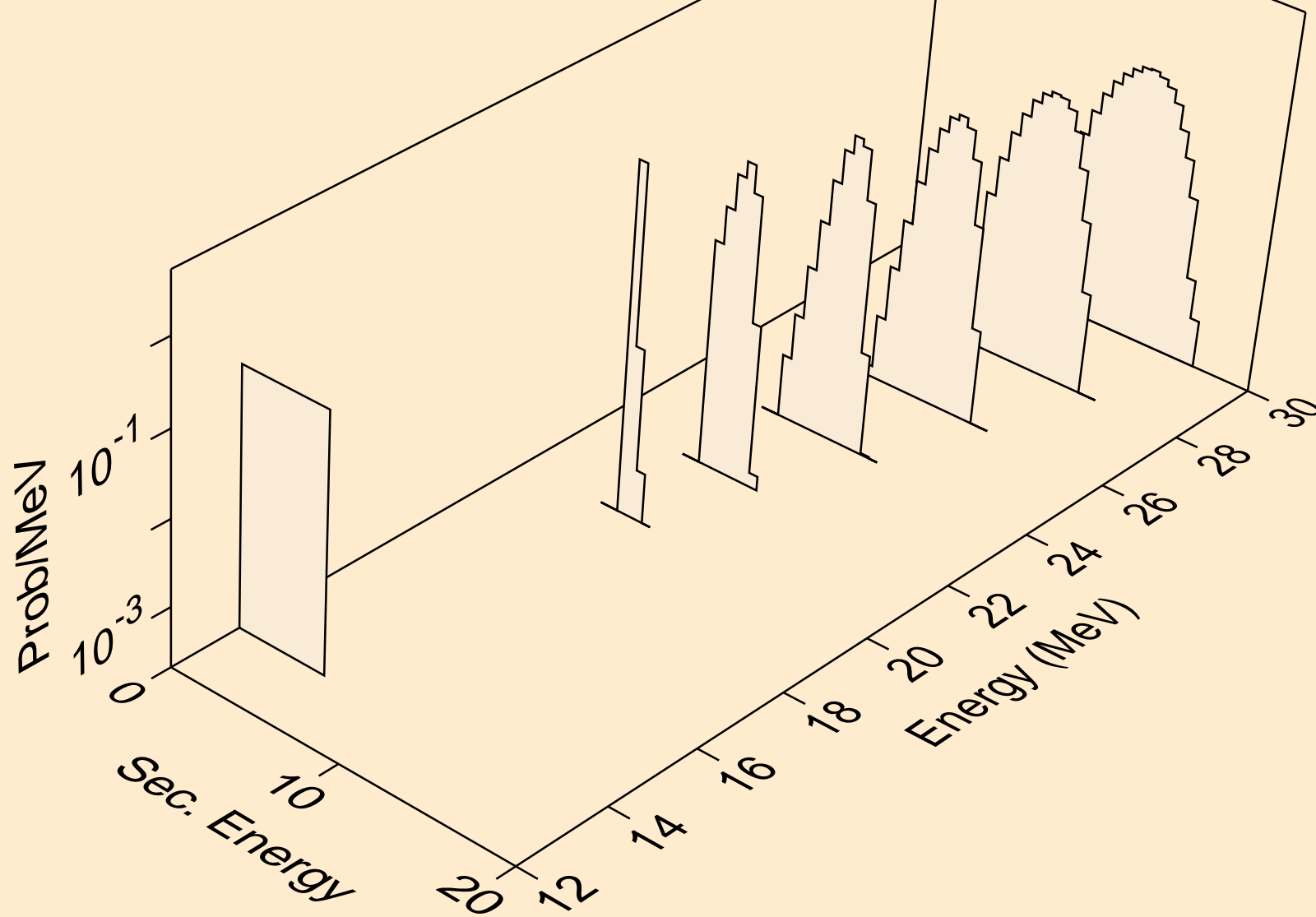



PT179 NEUTRON ACER TENDL-2021 LIBRARY; T=293.6K  
alphas from (n,n\*)2a

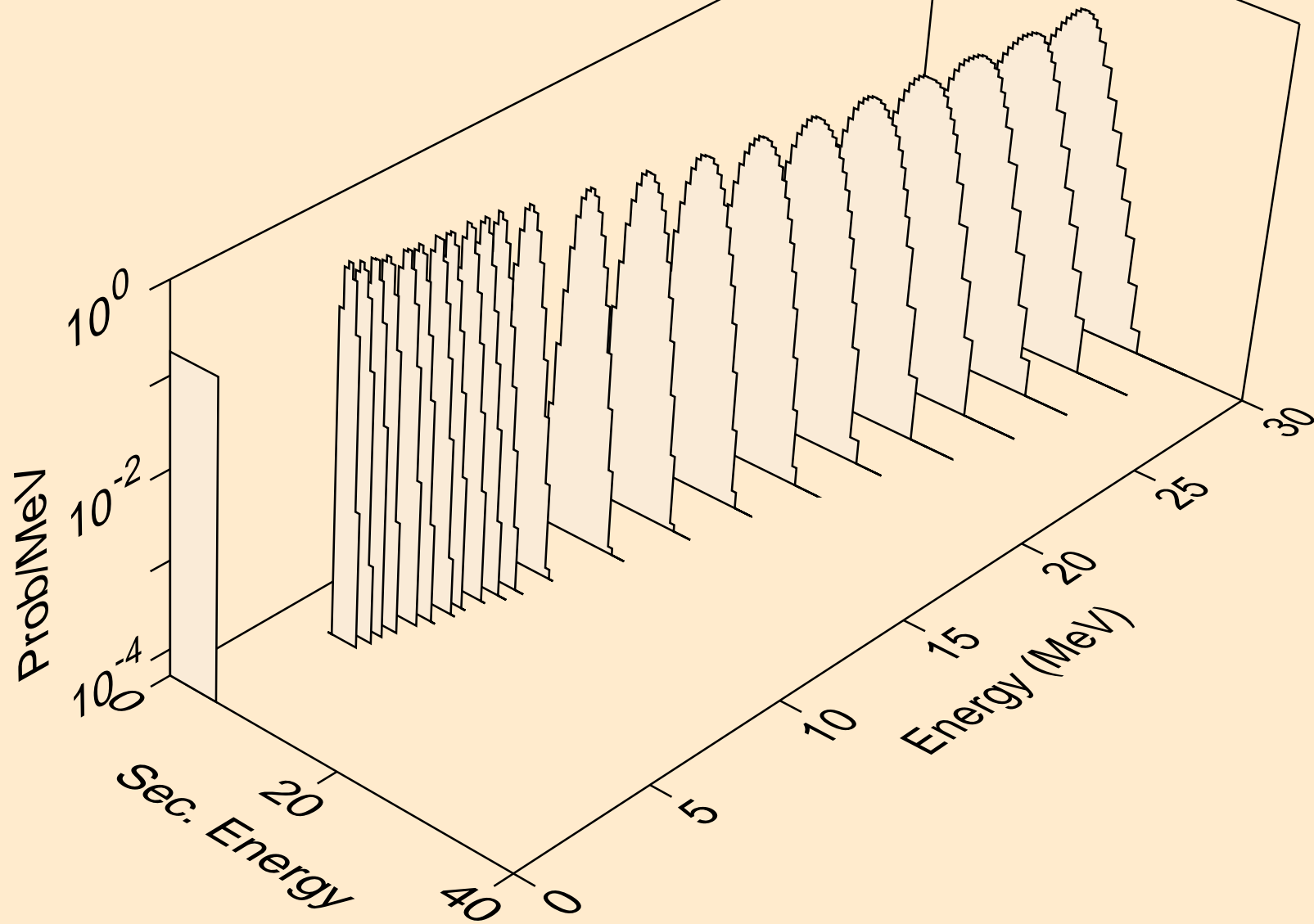

PT179 NEUTRON ACER TENDL-2021 LIBRARY; T=293.6K  
alphas from (n,2n)2a

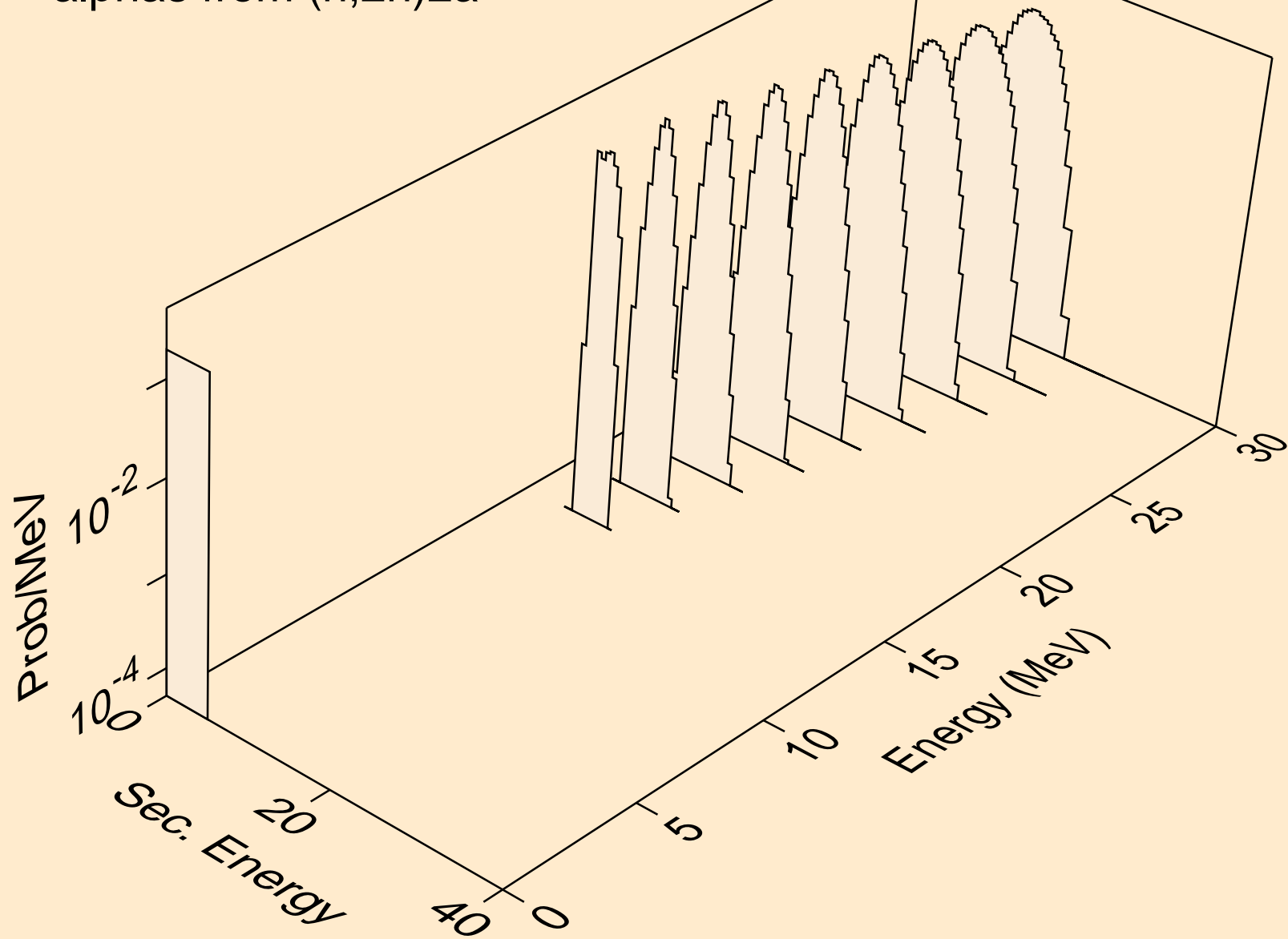

PT179 NEUTRON ACER TENDL-2021 LIBRARY; T=293.6K  
alphas from (n,npa)

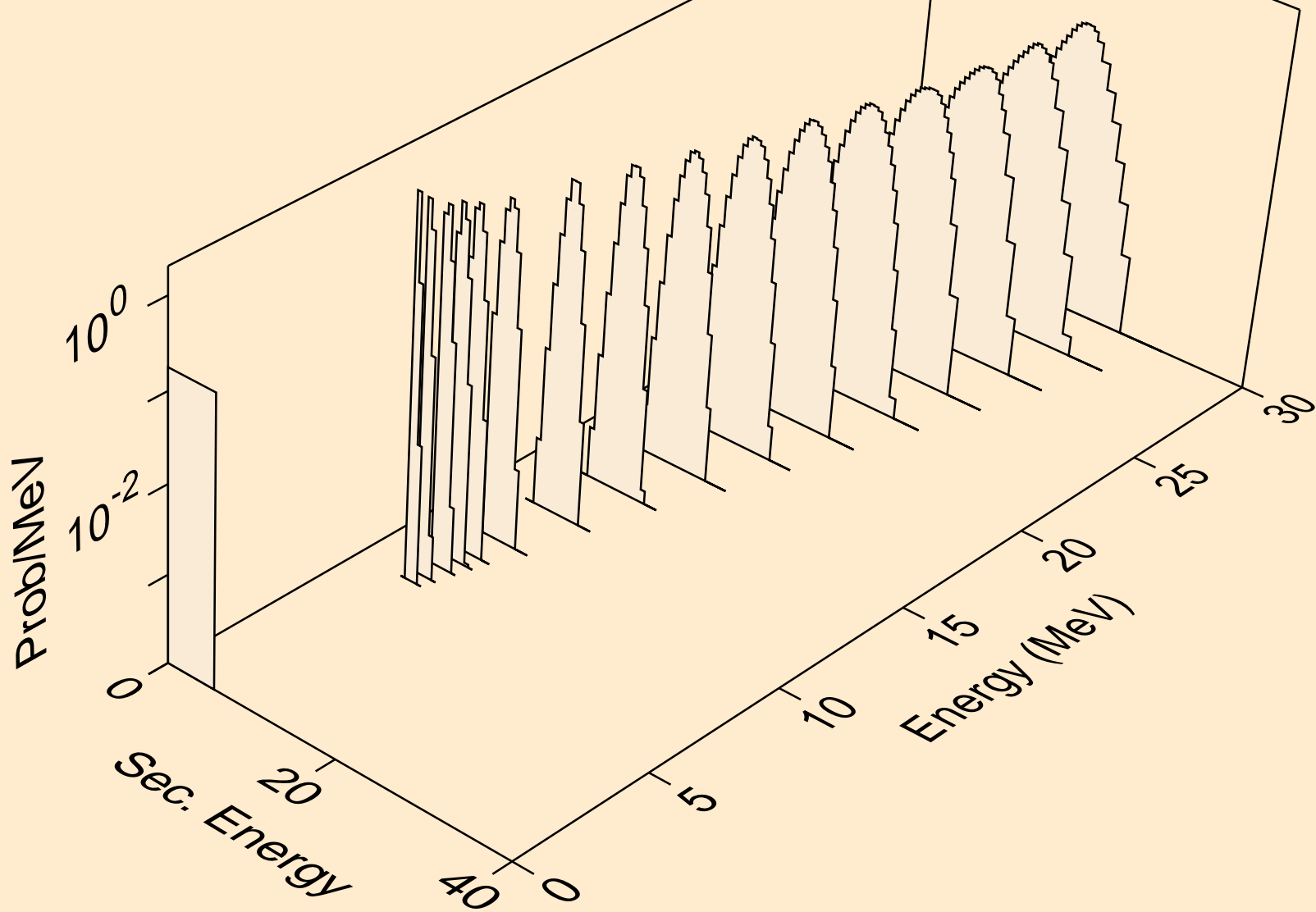

PT179 NEUTRON ACER TENDL-2021 LIBRARY; T=293.6K  
alphas from (n,a)

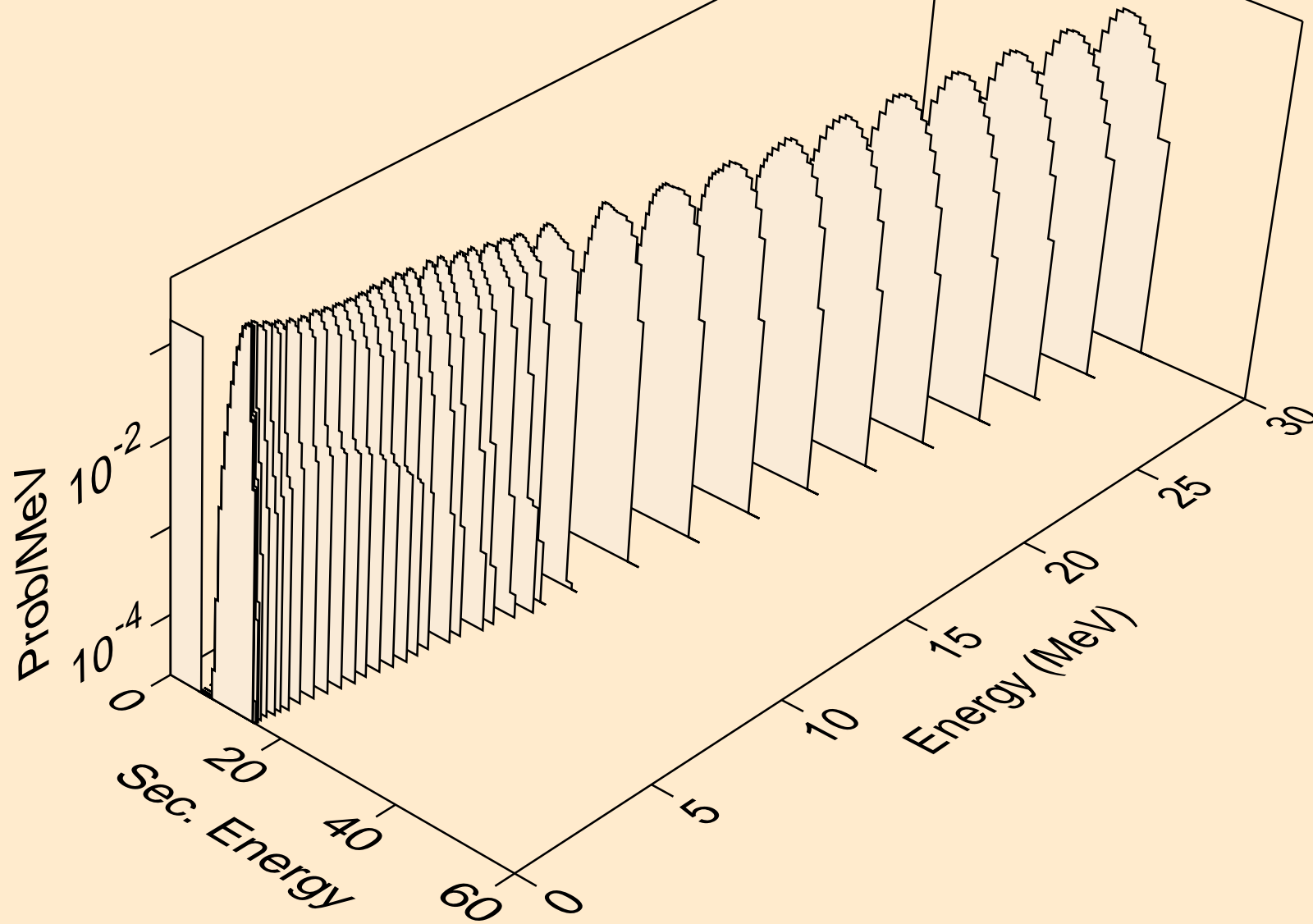

PT179 NEUTRON ACER TENDL-2021 LIBRARY; T=293.6K  
alphas from (n,2a)

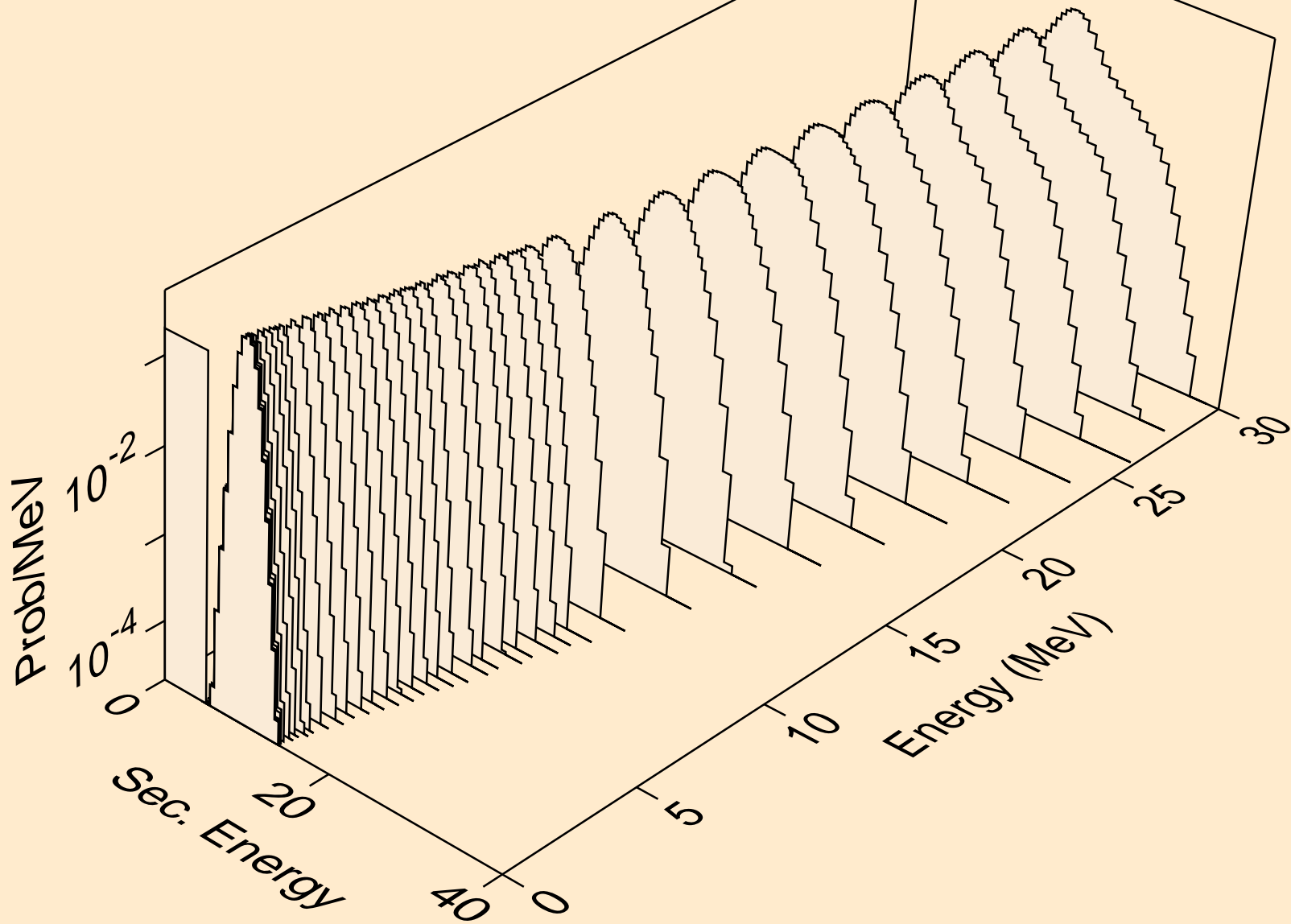

PT179 NEUTRON ACER TENDL-2021 LIBRARY; T=293.6K  
alphas from (n,3a)

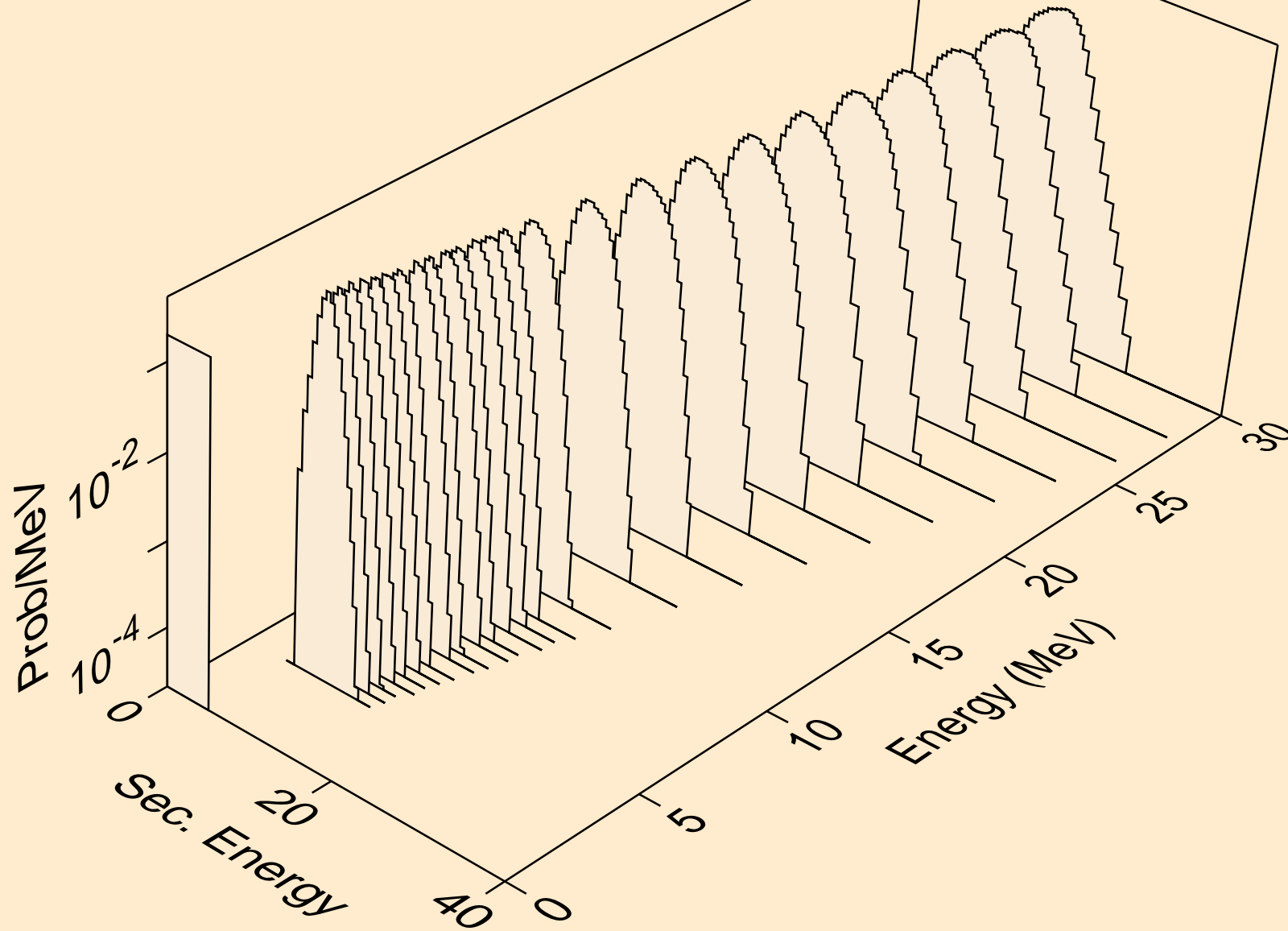

PT179 NEUTRON ACER TENDL-2021 LIBRARY; T=293.6K  
alphas from (n,pa)

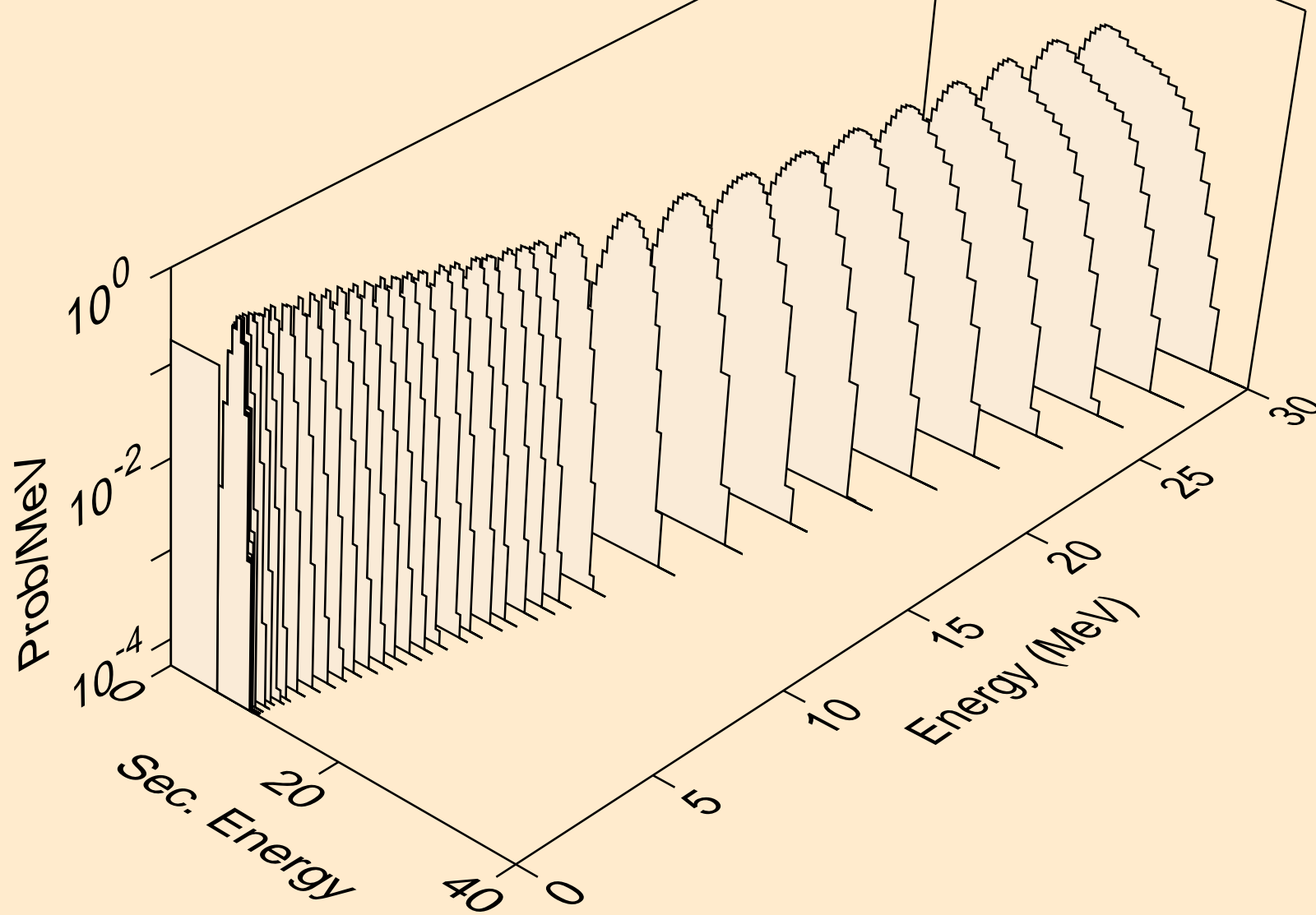

PT179 NEUTRON ACER TENDL-2021 LIBRARY; T=293.6K  
alphas from (n,da)

