

PT180 NEUTRON ACER TENDL-2021 LIBRARY; T=293.6K
Principal cross sections

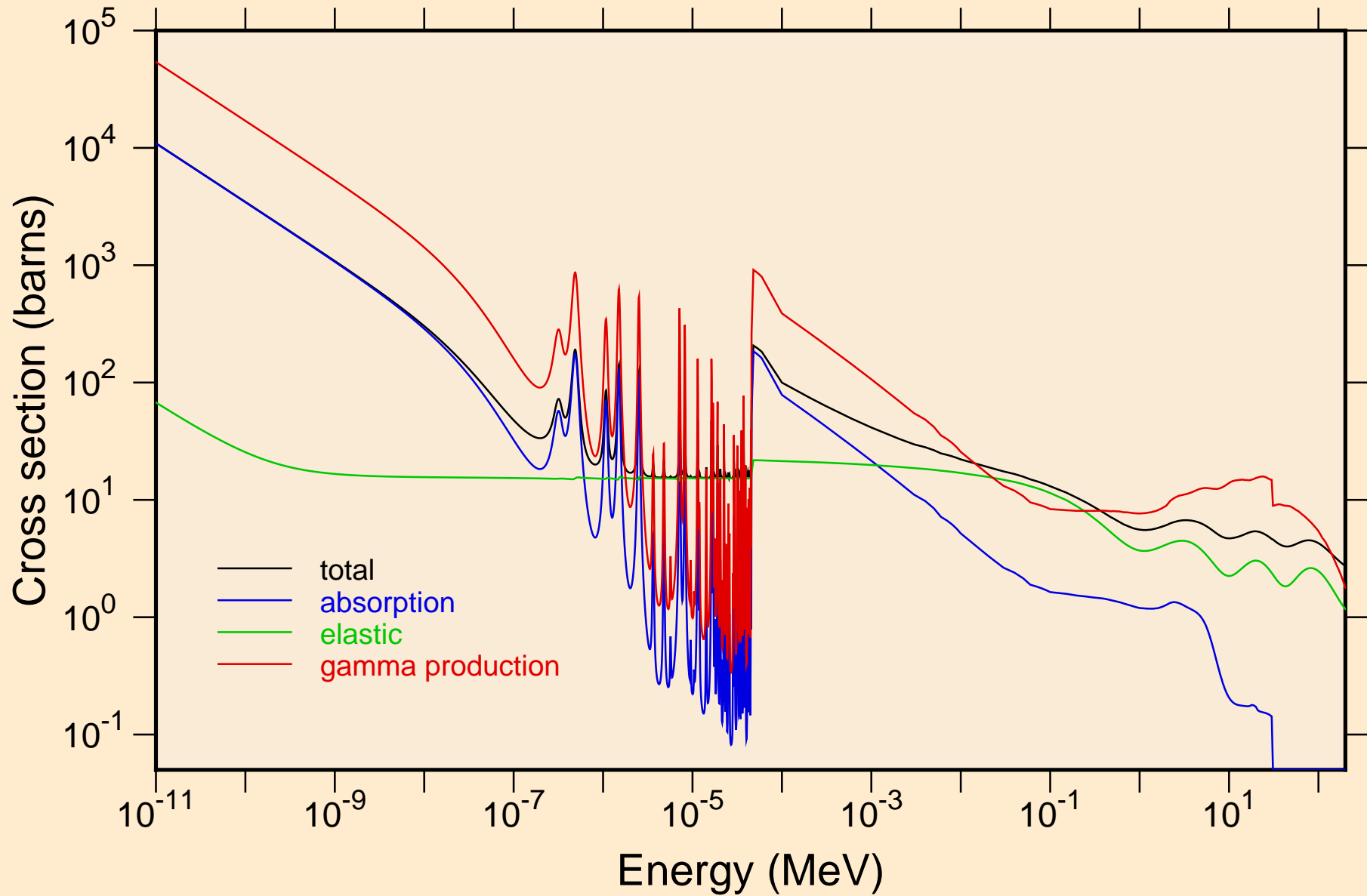

PT180 NEUTRON ACER TENDL-2021 LIBRARY; T=293.6K
resonance total cross section

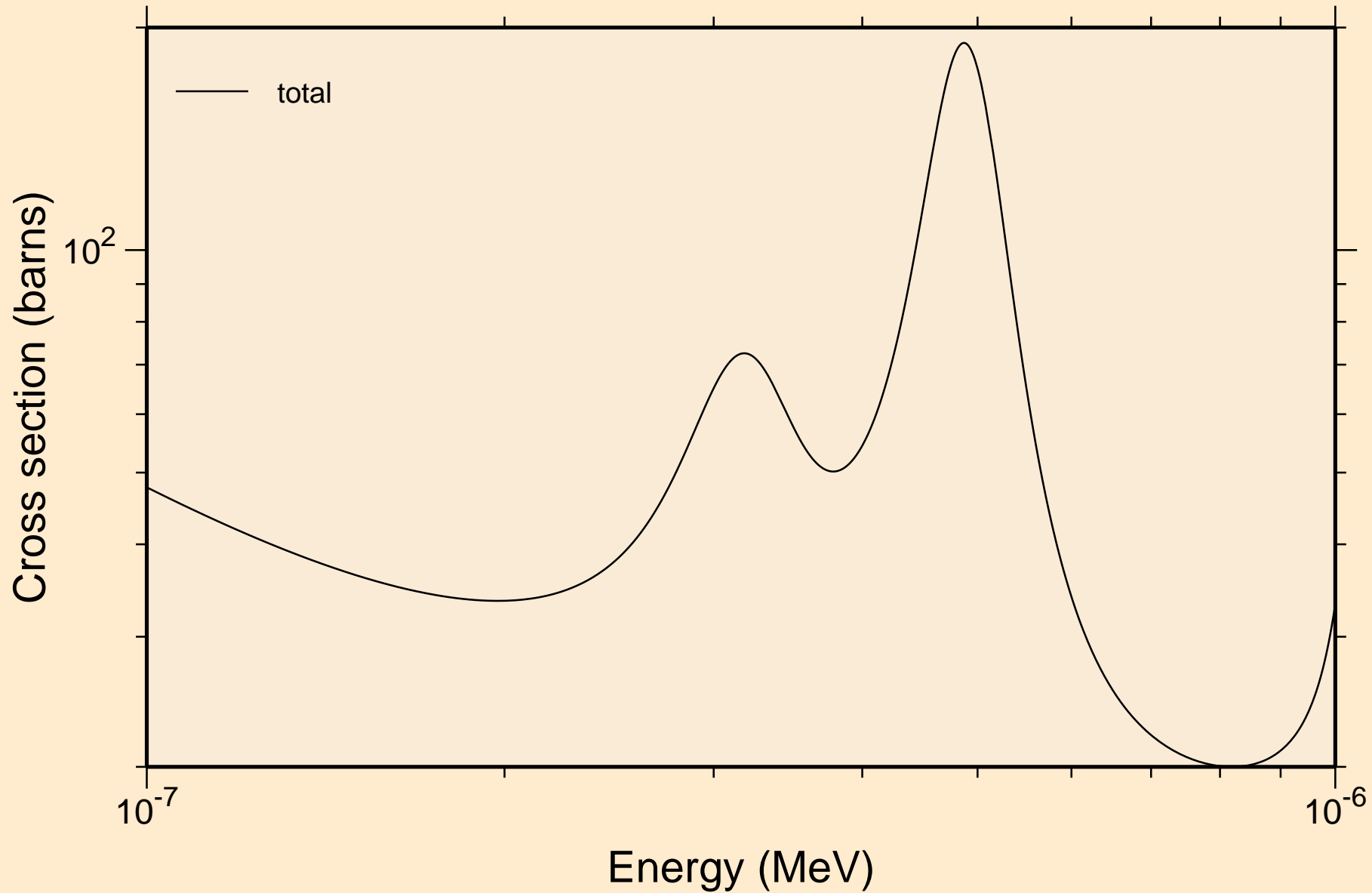

PT180 NEUTRON ACER TENDL-2021 LIBRARY; T=293.6K
resonance total cross section

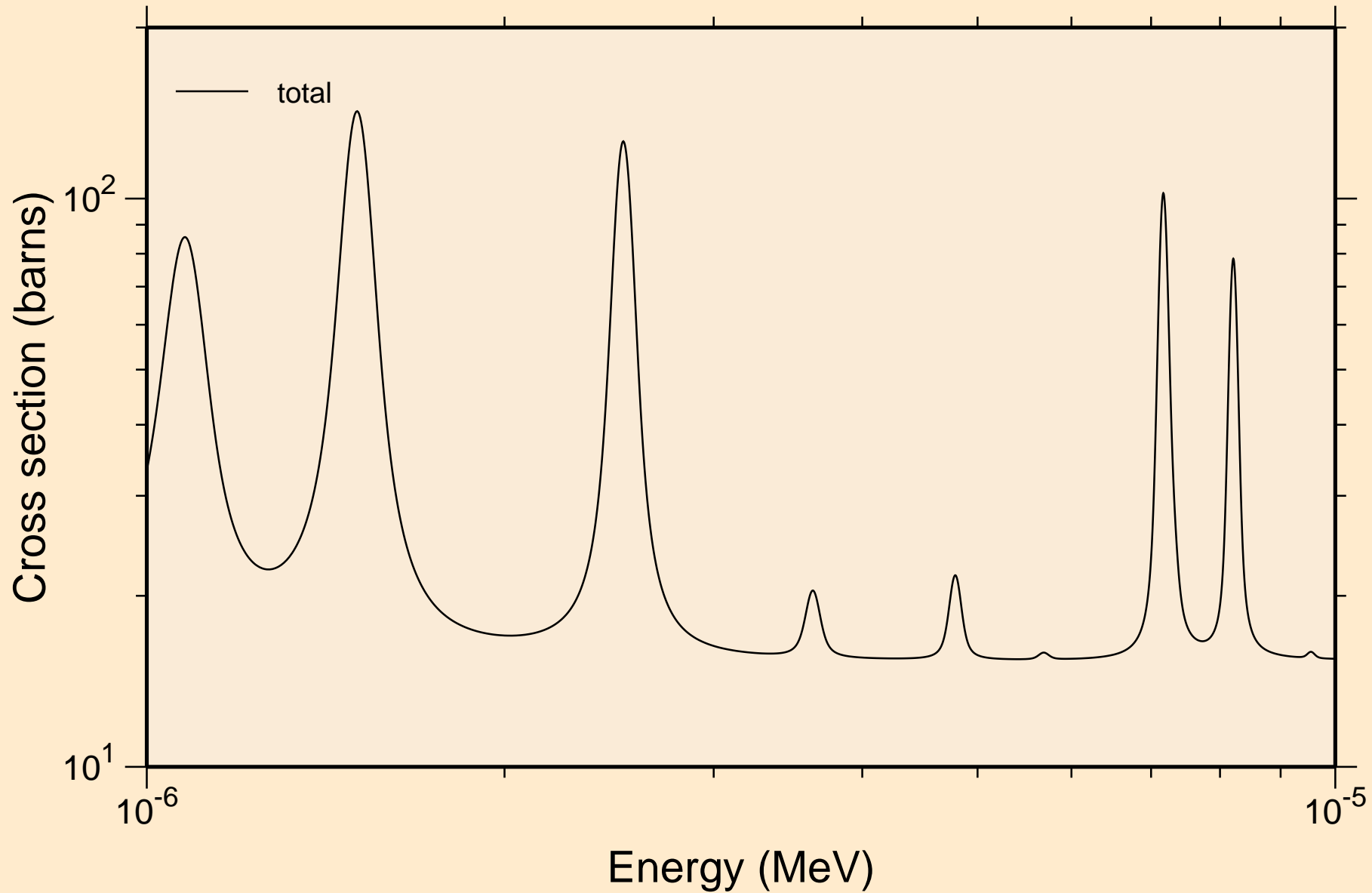

PT180 NEUTRON ACER TENDL-2021 LIBRARY; T=293.6K
resonance total cross section

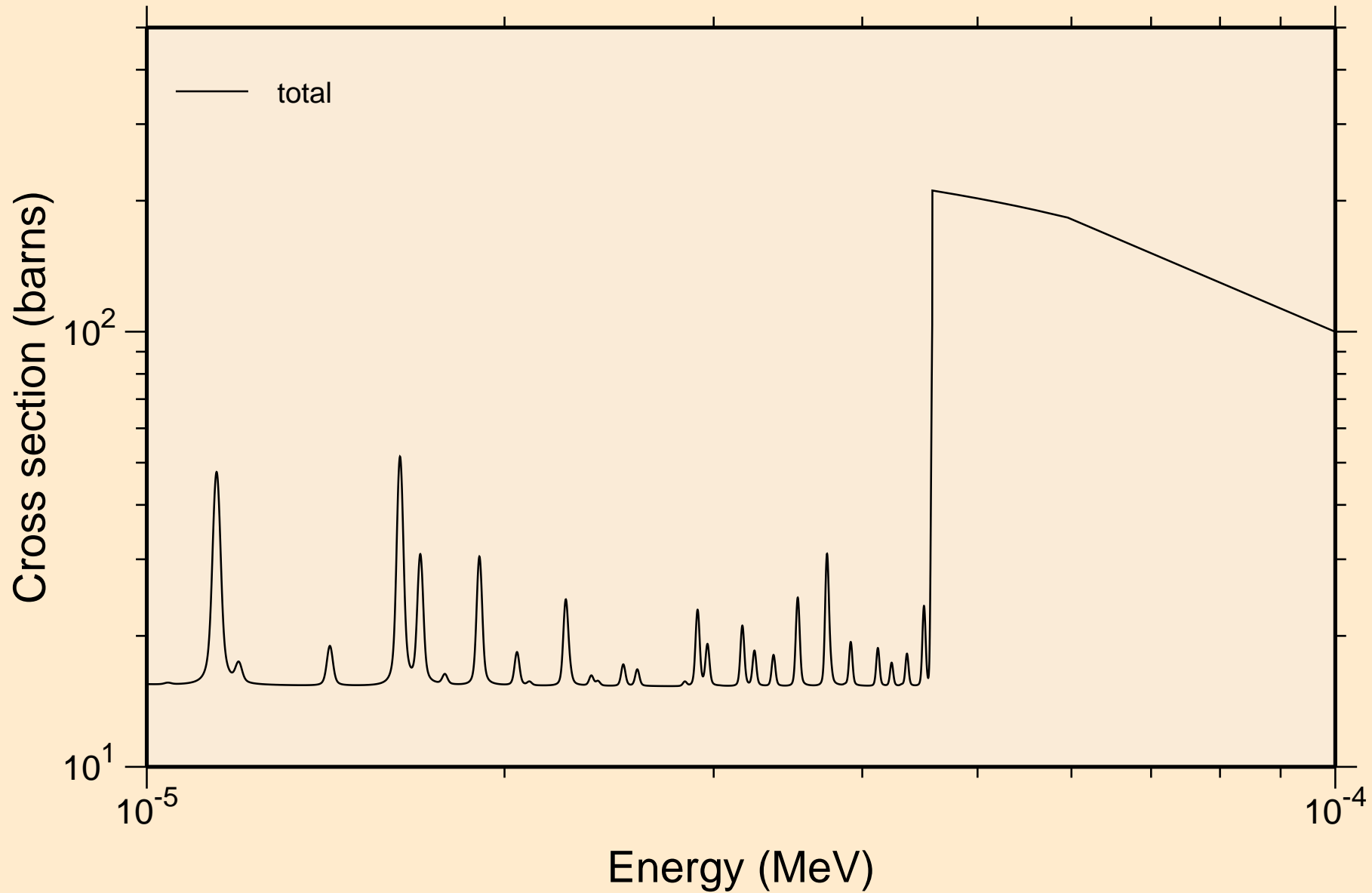

PT180 NEUTRON ACER TENDL-2021 LIBRARY; T=293.6K
resonance total cross section

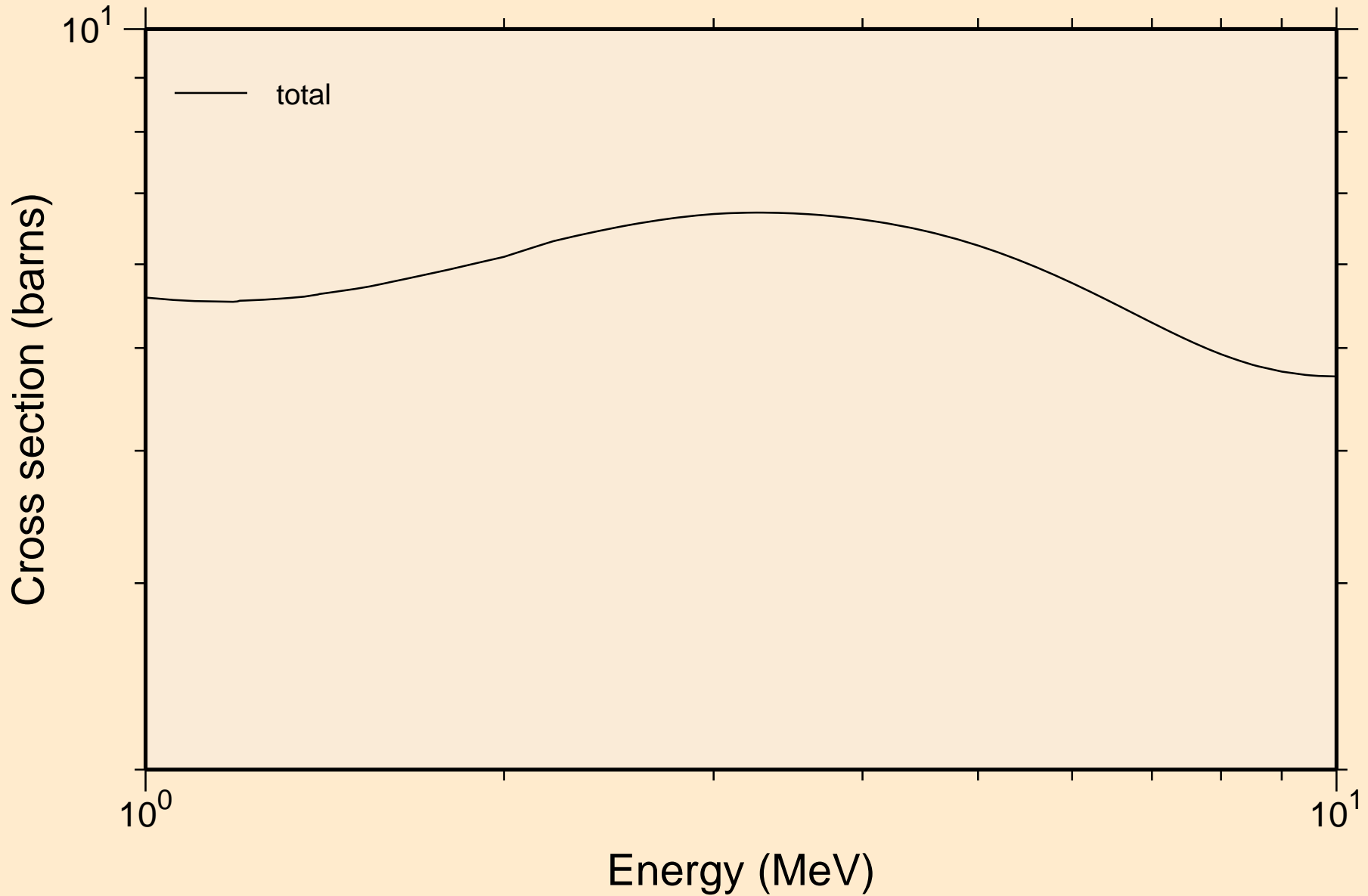

PT180 NEUTRON ACER TENDL-2021 LIBRARY; T=293.6K
resonance absorption cross sections

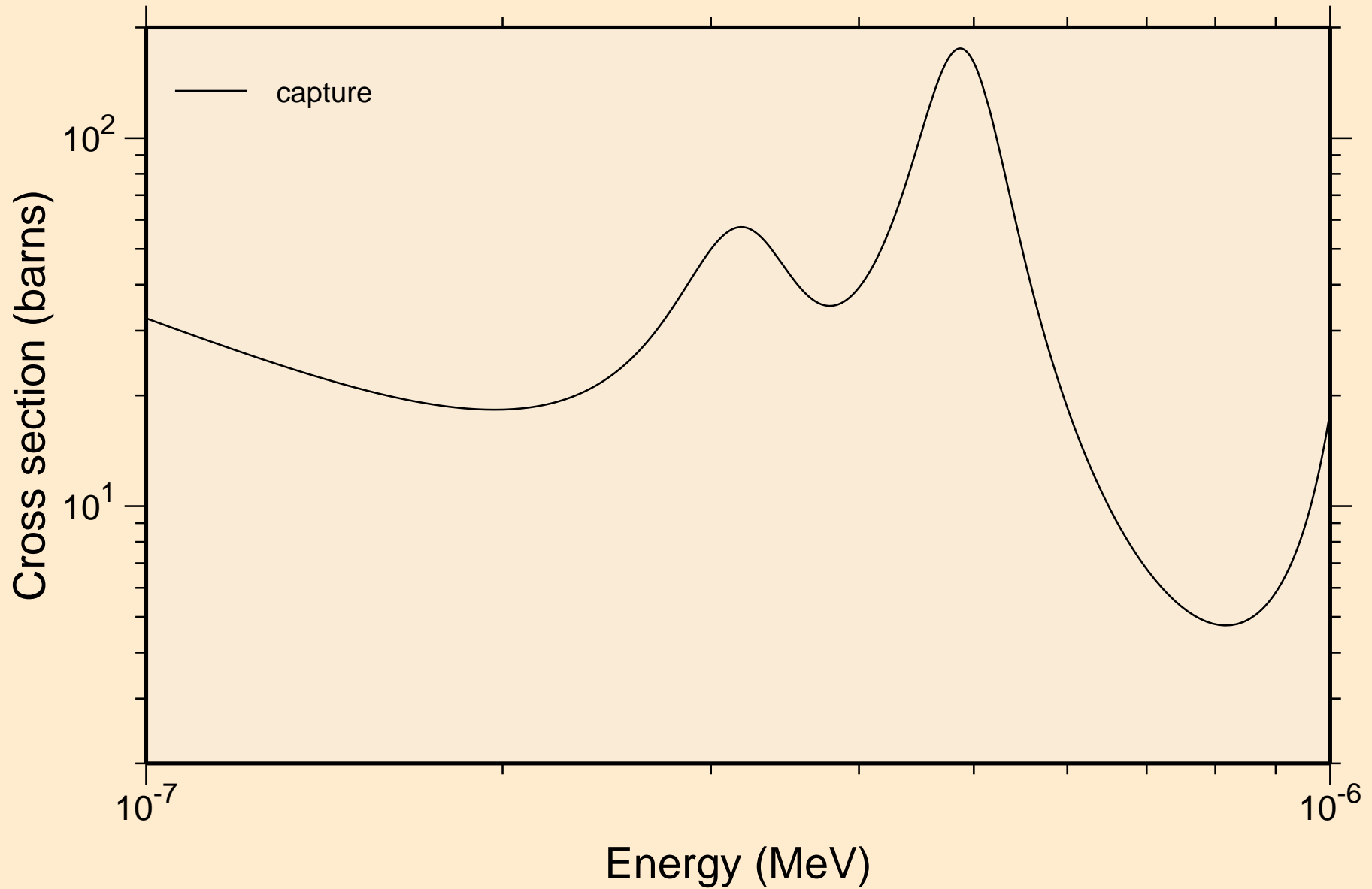

PT180 NEUTRON ACER TENDL-2021 LIBRARY; T=293.6K
resonance absorption cross sections

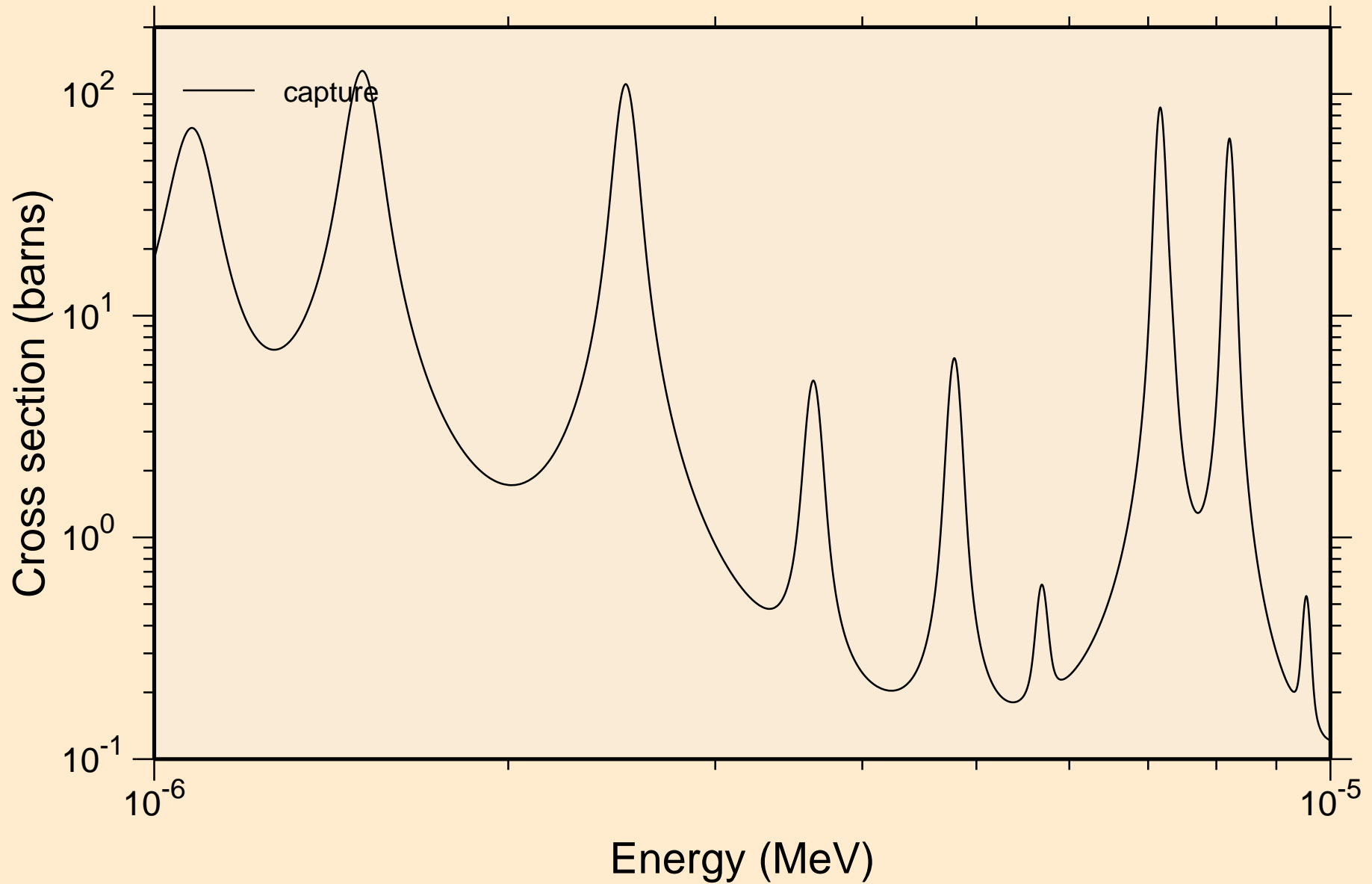

PT180 NEUTRON ACER TENDL-2021 LIBRARY; T=293.6K
resonance absorption cross sections

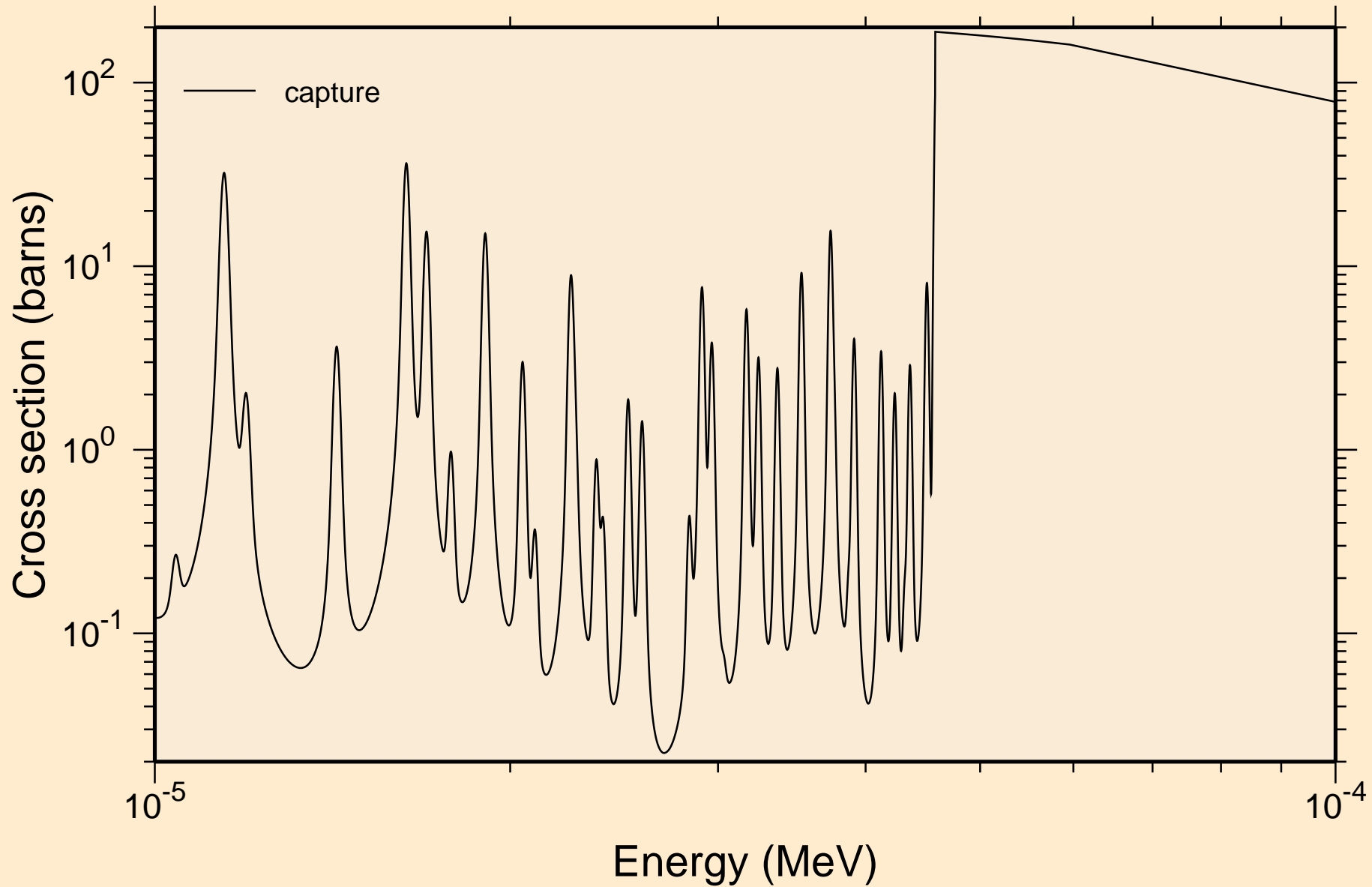

PT180 NEUTRON ACER TENDL-2021 LIBRARY; T=293.6K
resonance absorption cross sections

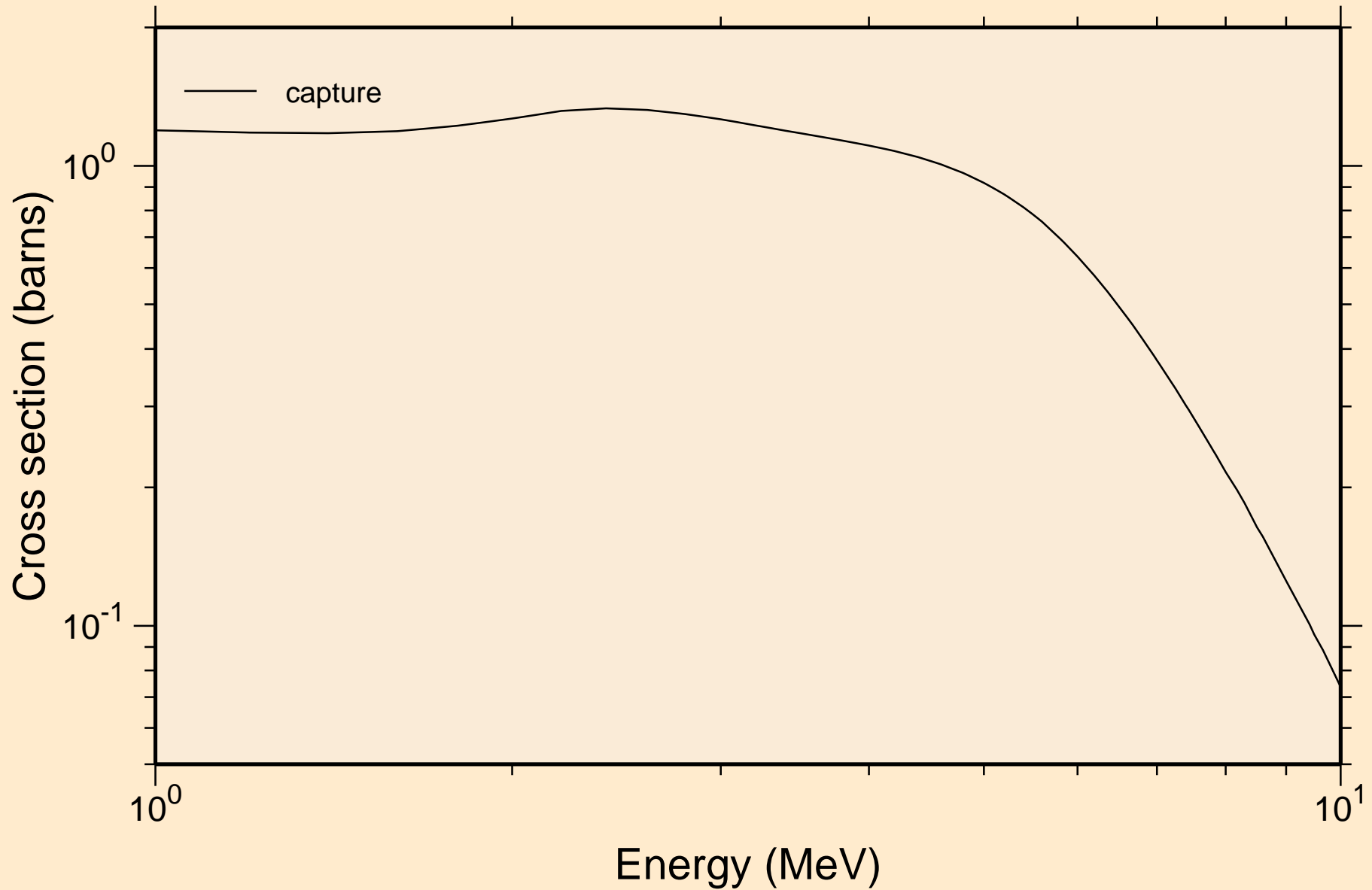

PT180 NEUTRON ACER TENDL-2021 LIBRARY; T=293.6K
Heating

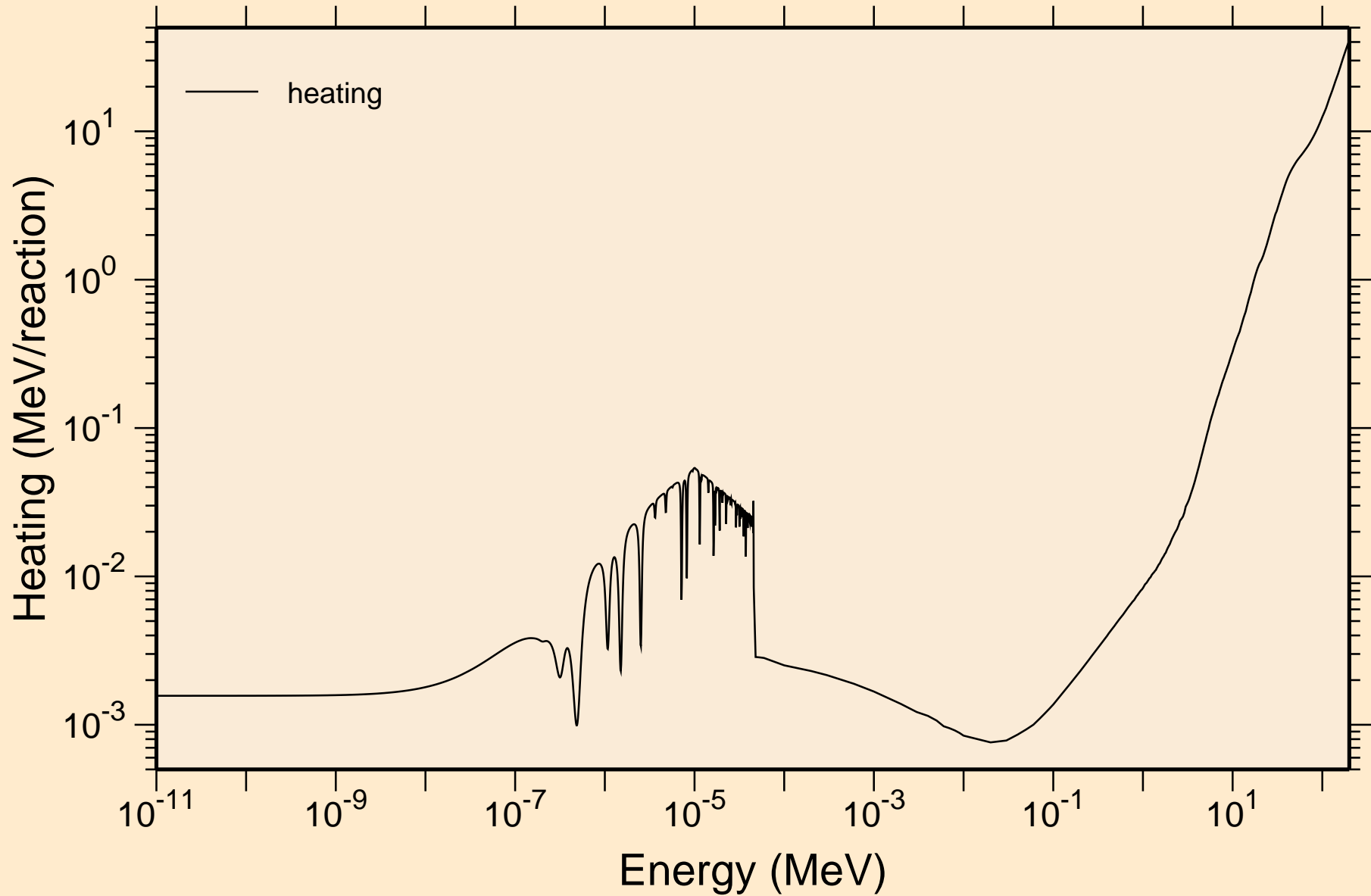

PT180 NEUTRON ACER TENDL-2021 LIBRARY; T=293.6K
Damage

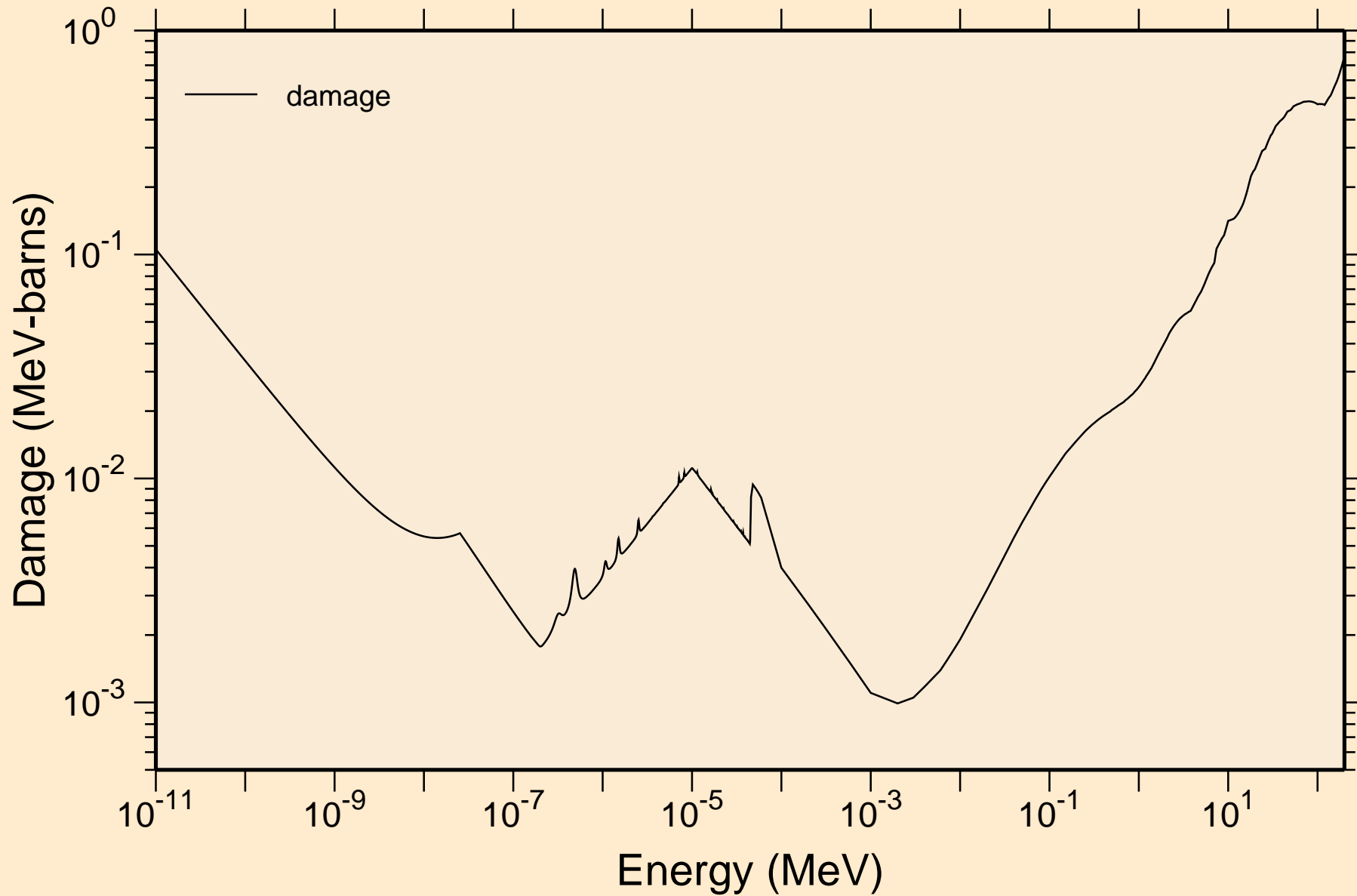

PT180 NEUTRON ACER TENDL-2021 LIBRARY; T=293.6K
Non-threshold reactions

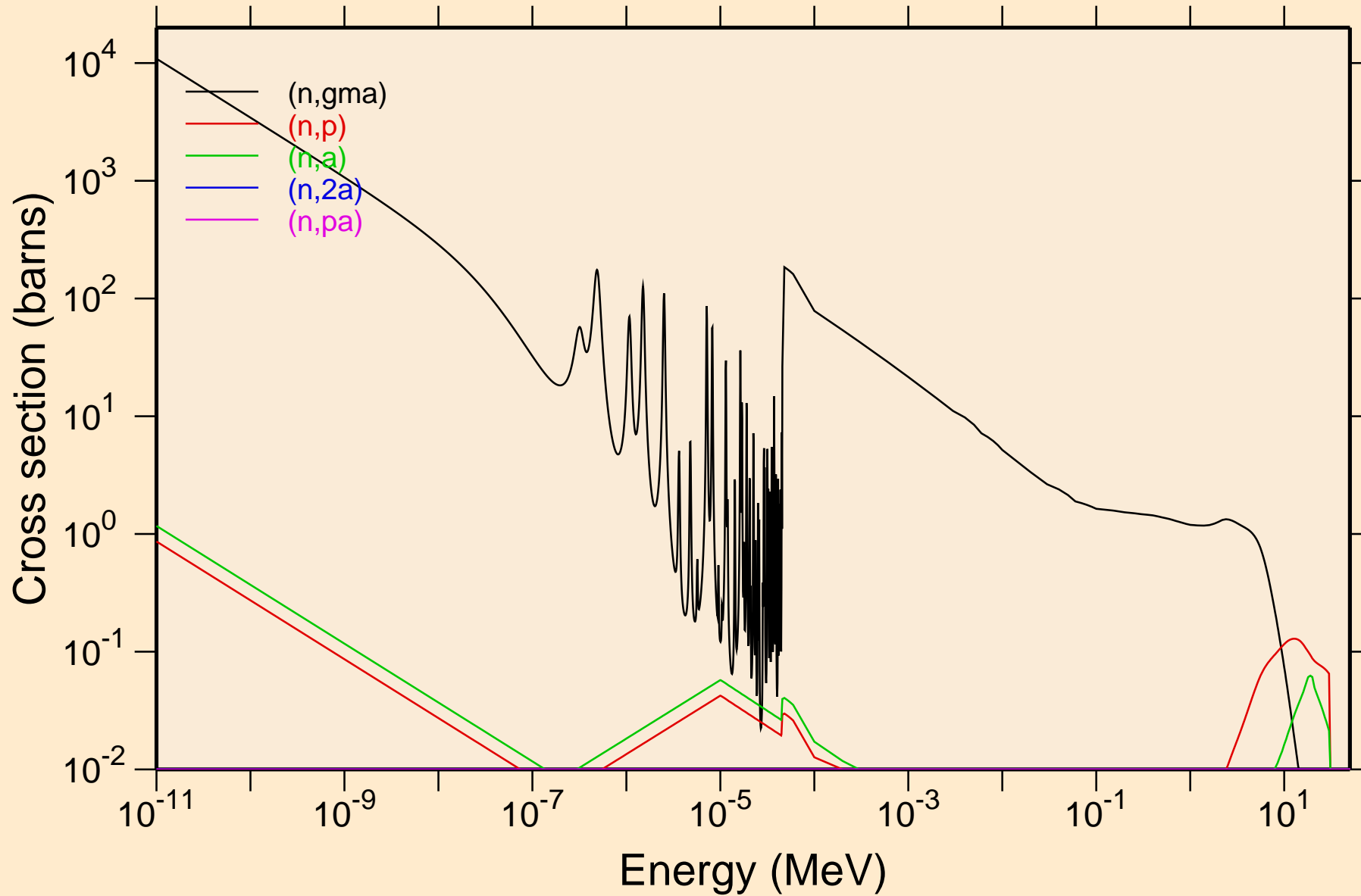

PT180 NEUTRON ACER TENDL-2021 LIBRARY; T=293.6K
Non-threshold reactions

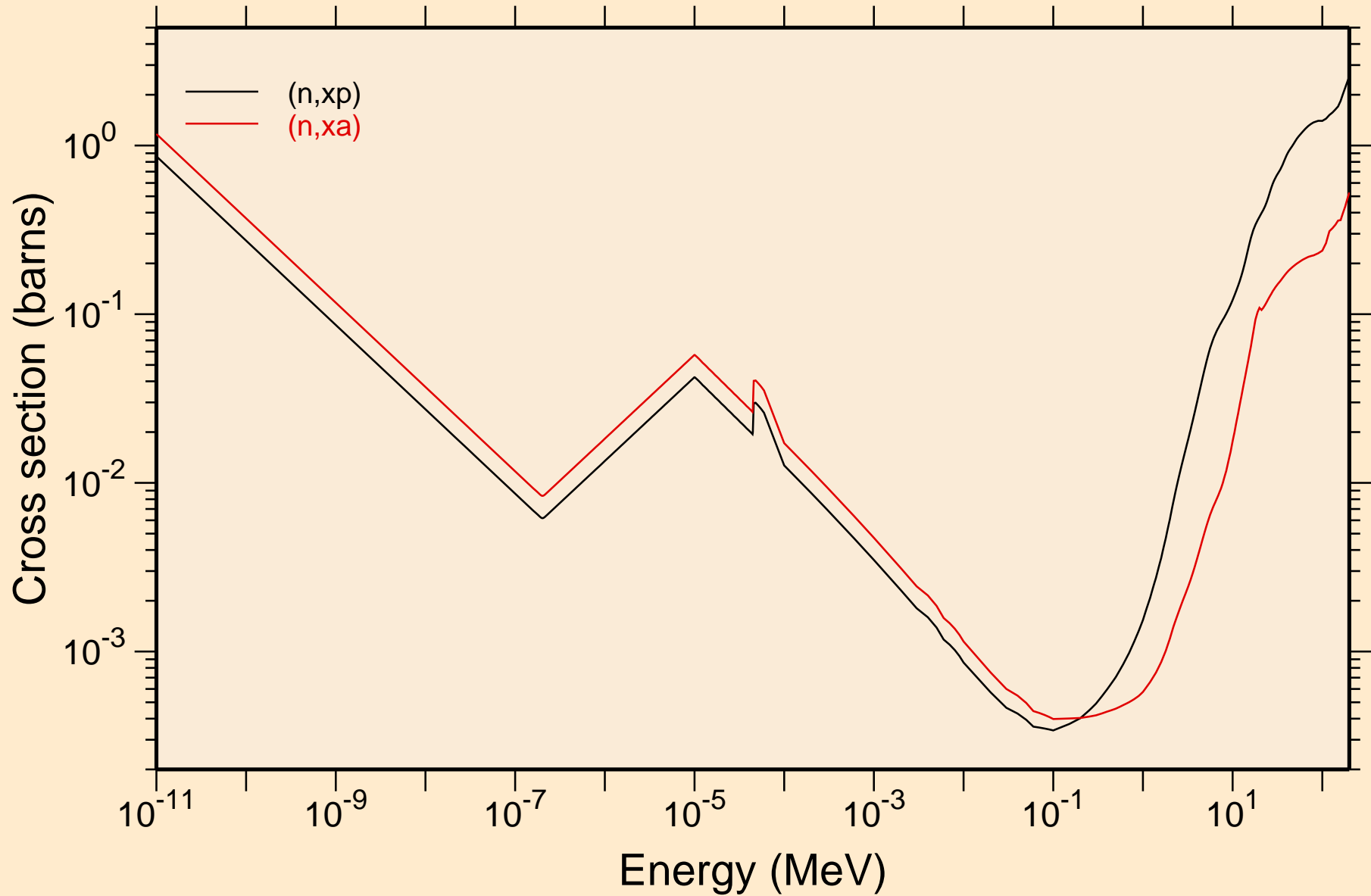

PT180 NEUTRON ACER TENDL-2021 LIBRARY; T=293.6K
Principal cross sections

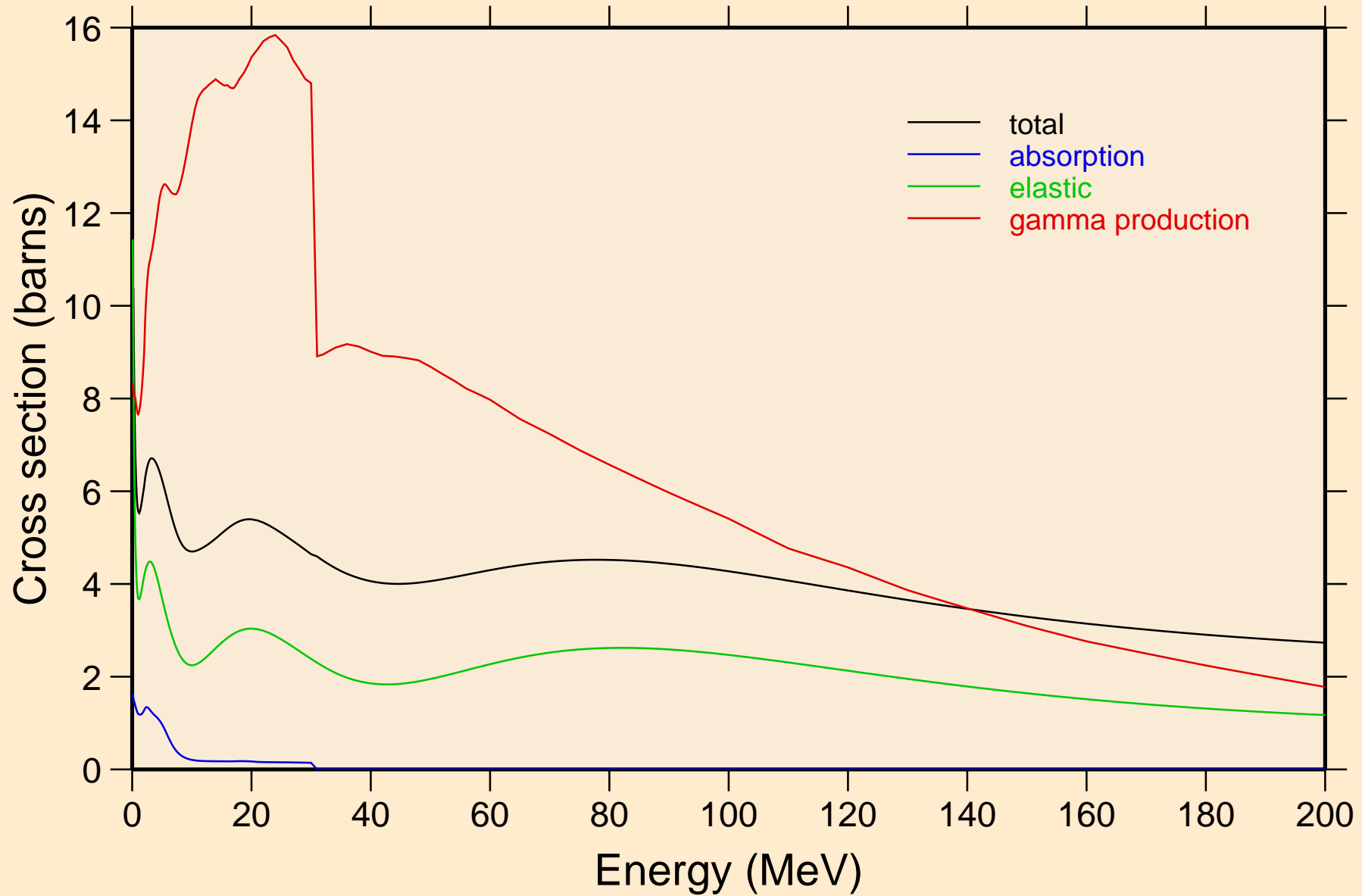

PT180 NEUTRON ACER TENDL-2021 LIBRARY; T=293.6K

Heating

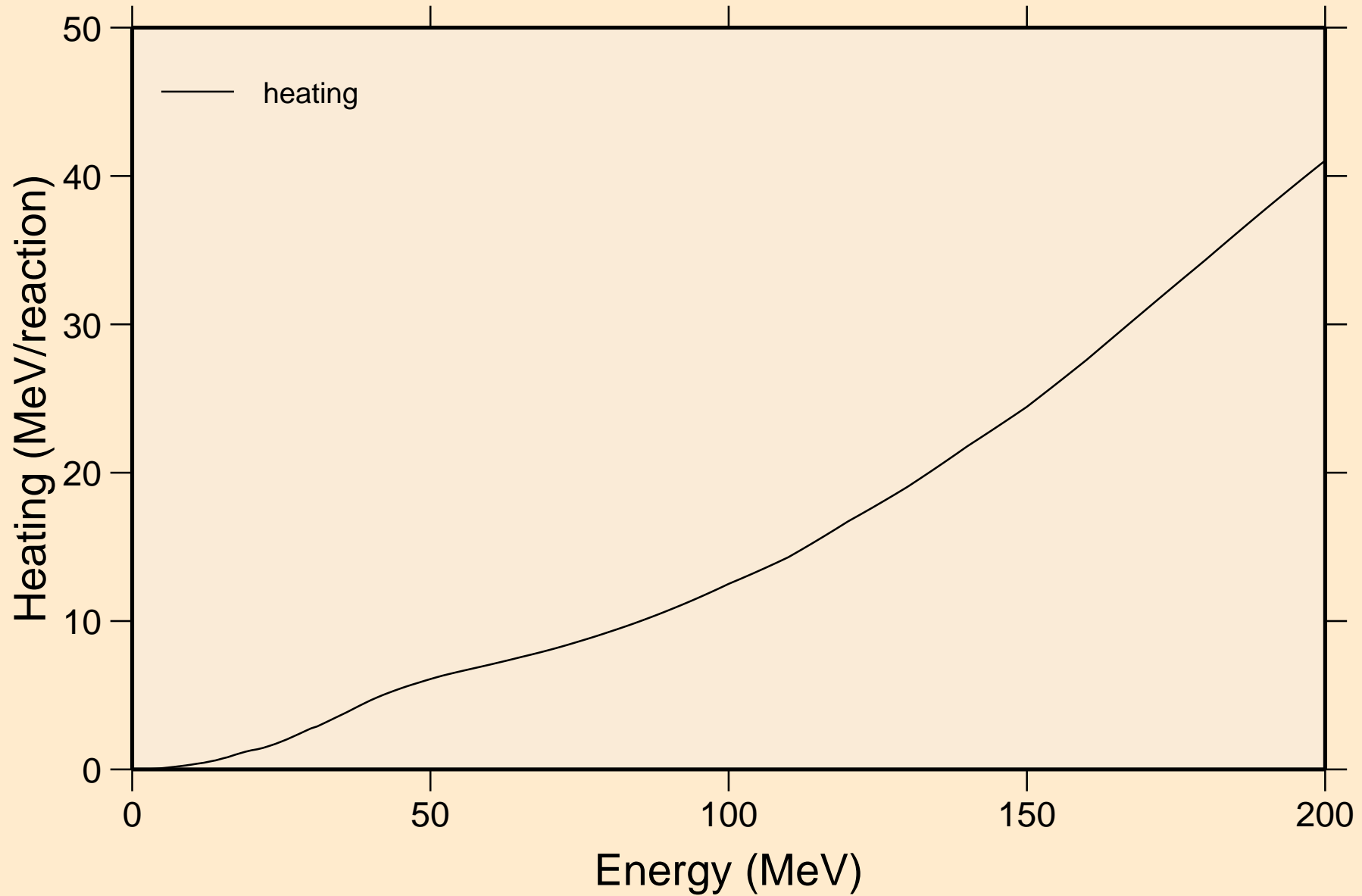

PT180 NEUTRON ACER TENDL-2021 LIBRARY; T=293.6K
Damage

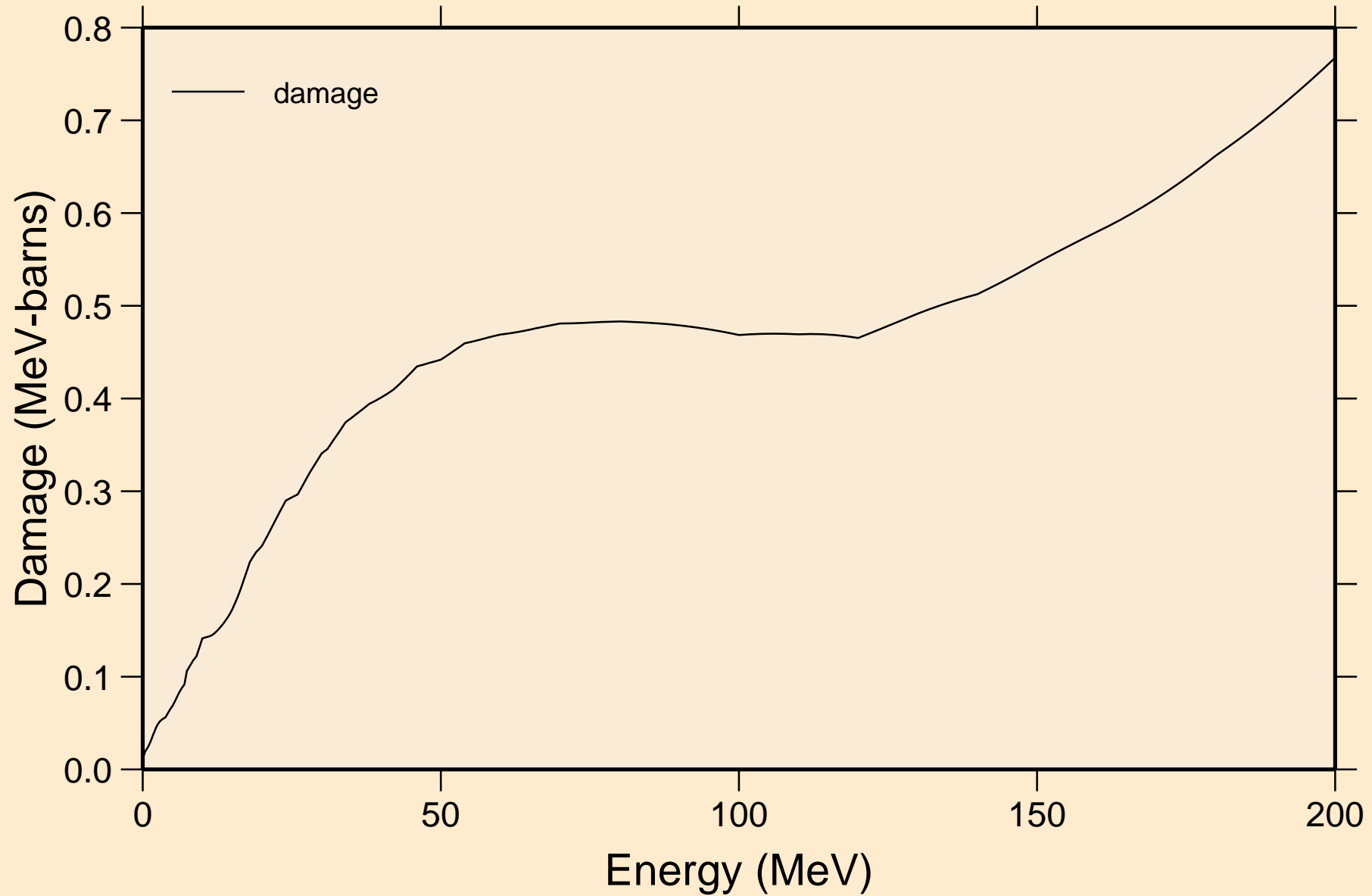

PT180 NEUTRON ACER TENDL-2021 LIBRARY; T=293.6K
Non-threshold reactions

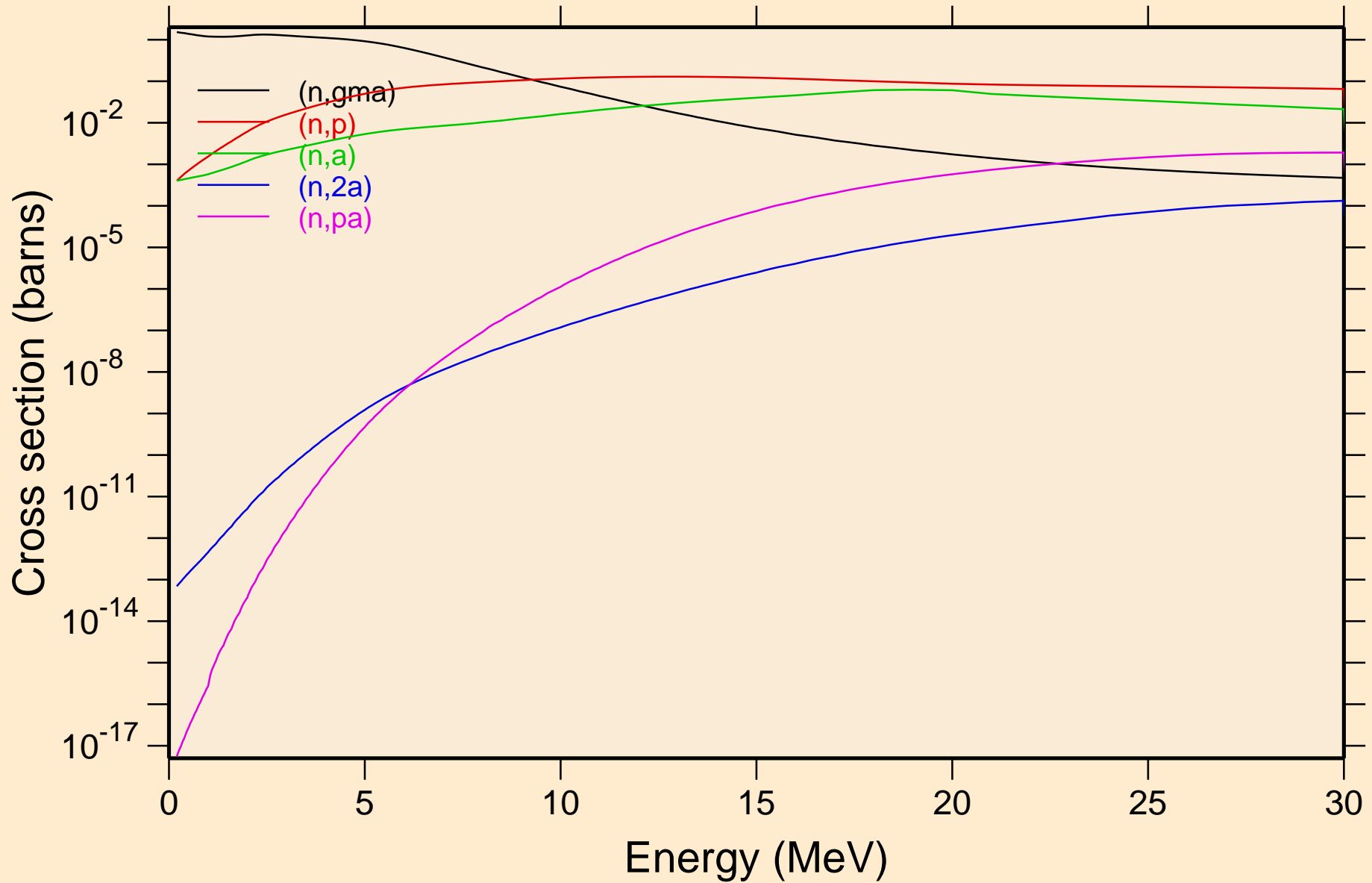

PT180 NEUTRON ACER TENDL-2021 LIBRARY; T=293.6K
Non-threshold reactions

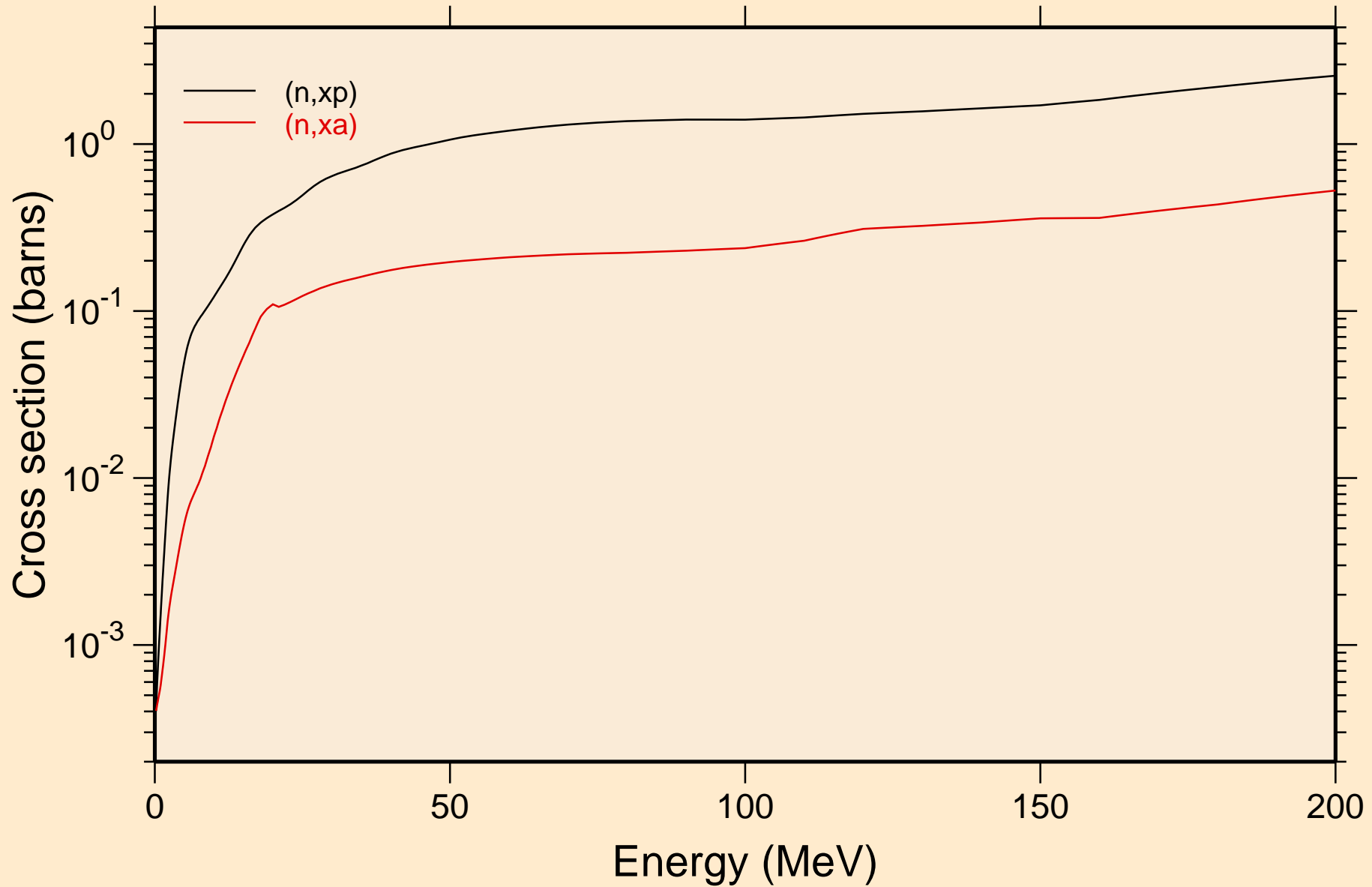

PT180 NEUTRON ACER TENDL-2021 LIBRARY; T=293.6K
Inelastic levels

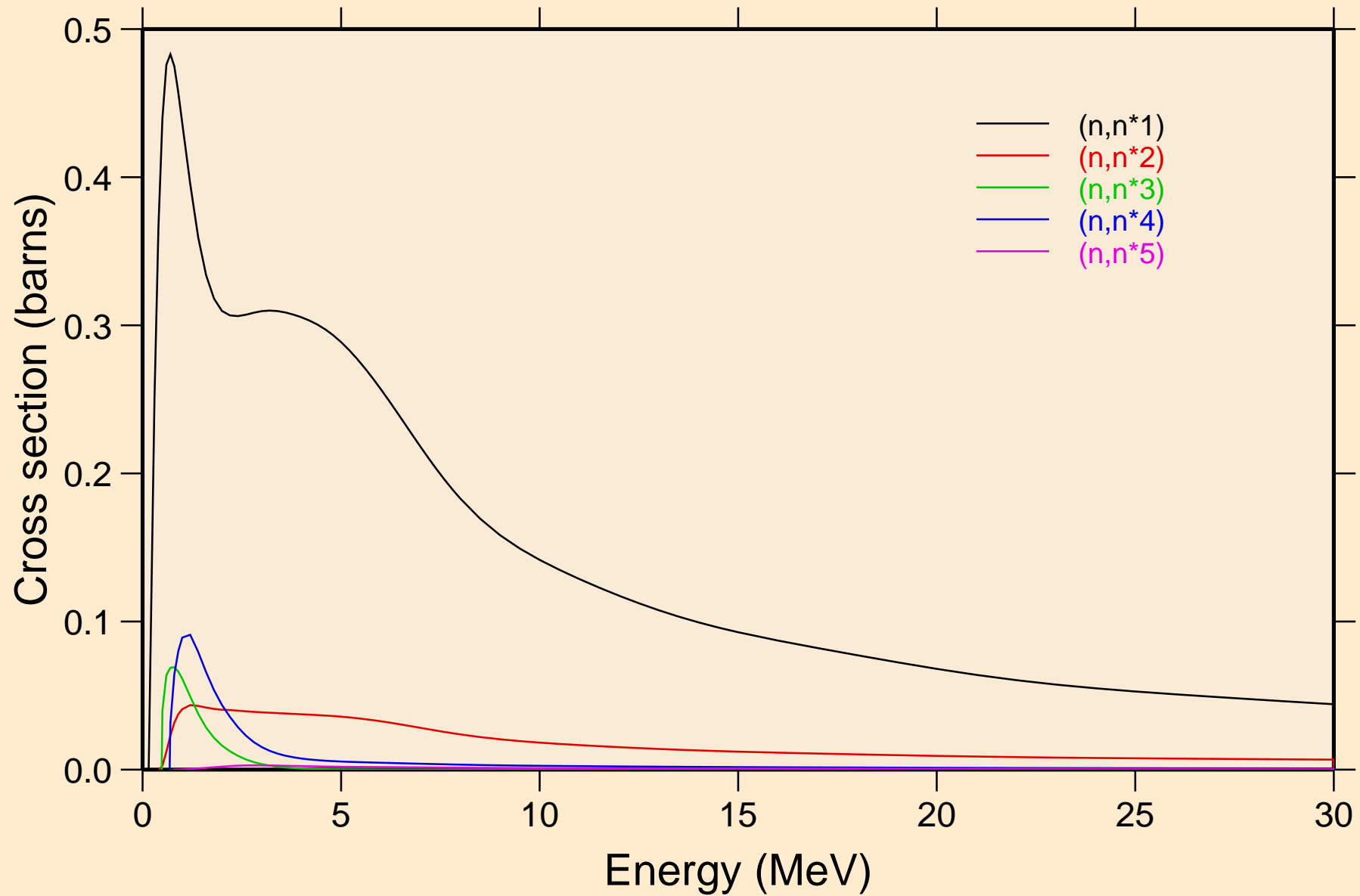

PT180 NEUTRON ACER TENDL-2021 LIBRARY; T=293.6K
Inelastic levels

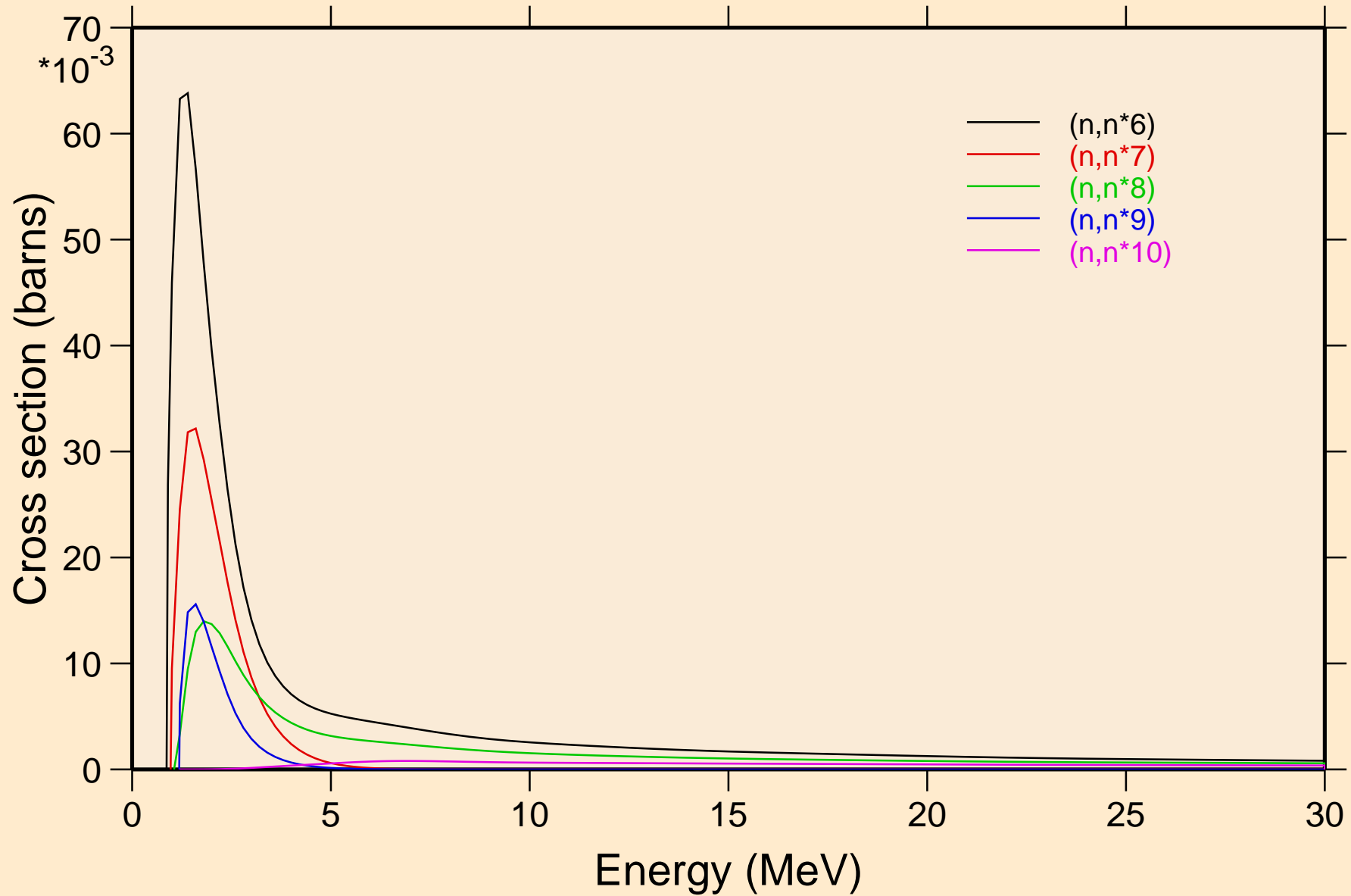

PT180 NEUTRON ACER TENDL-2021 LIBRARY; T=293.6K
Inelastic levels

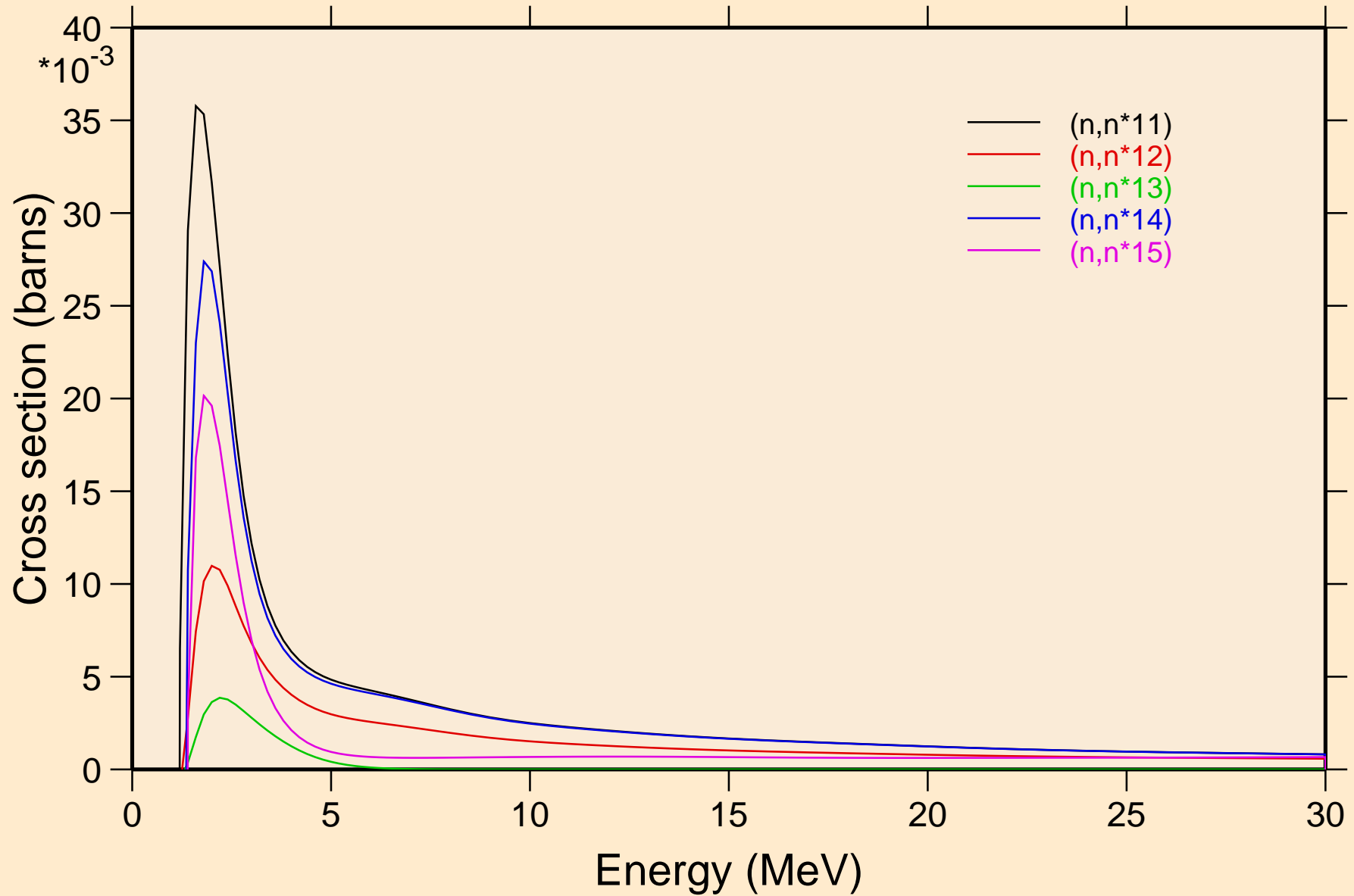

PT180 NEUTRON ACER TENDL-2021 LIBRARY; T=293.6K
Inelastic levels

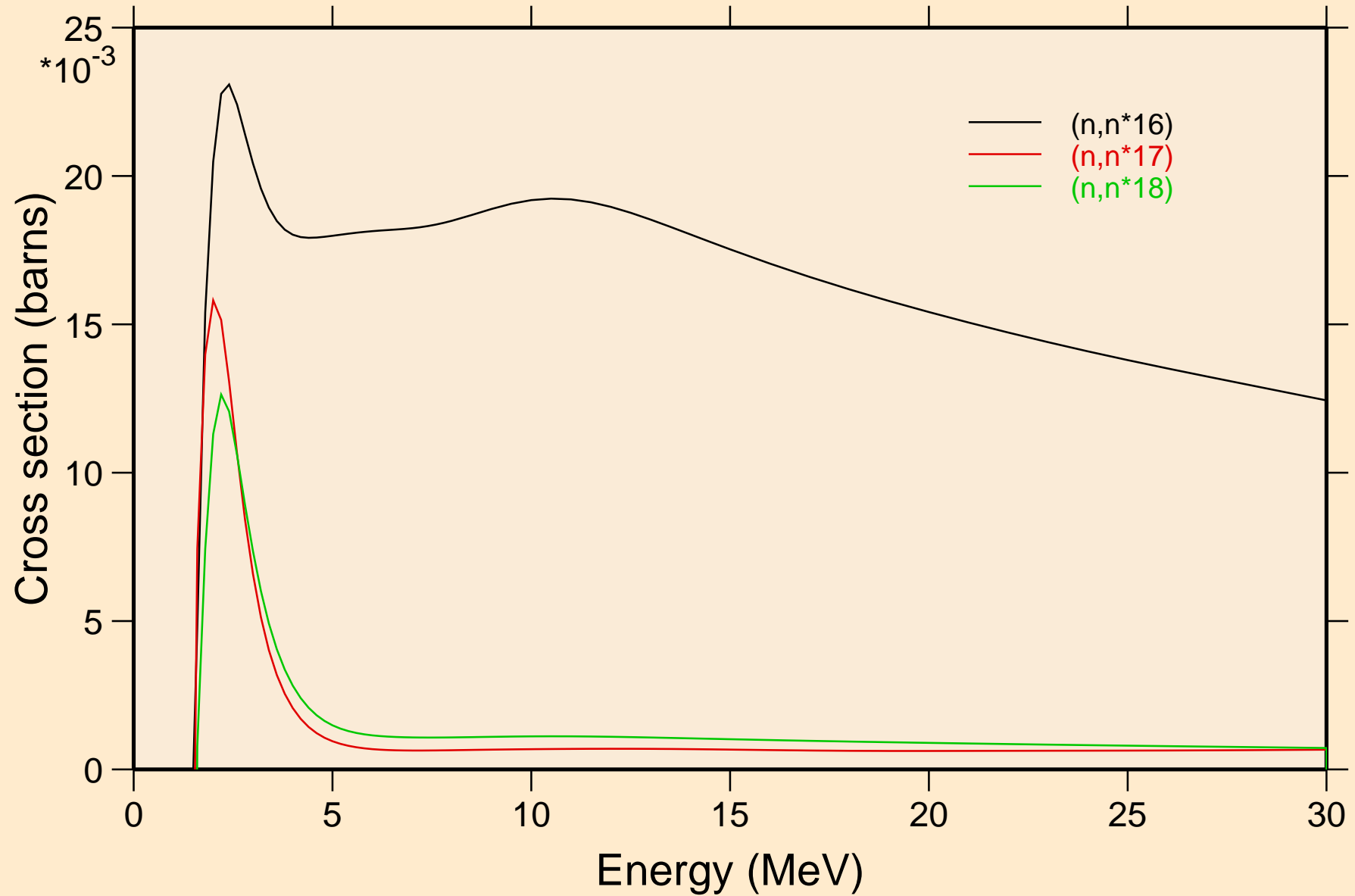

PT180 NEUTRON ACER TENDL-2021 LIBRARY; T=293.6K
Threshold reactions

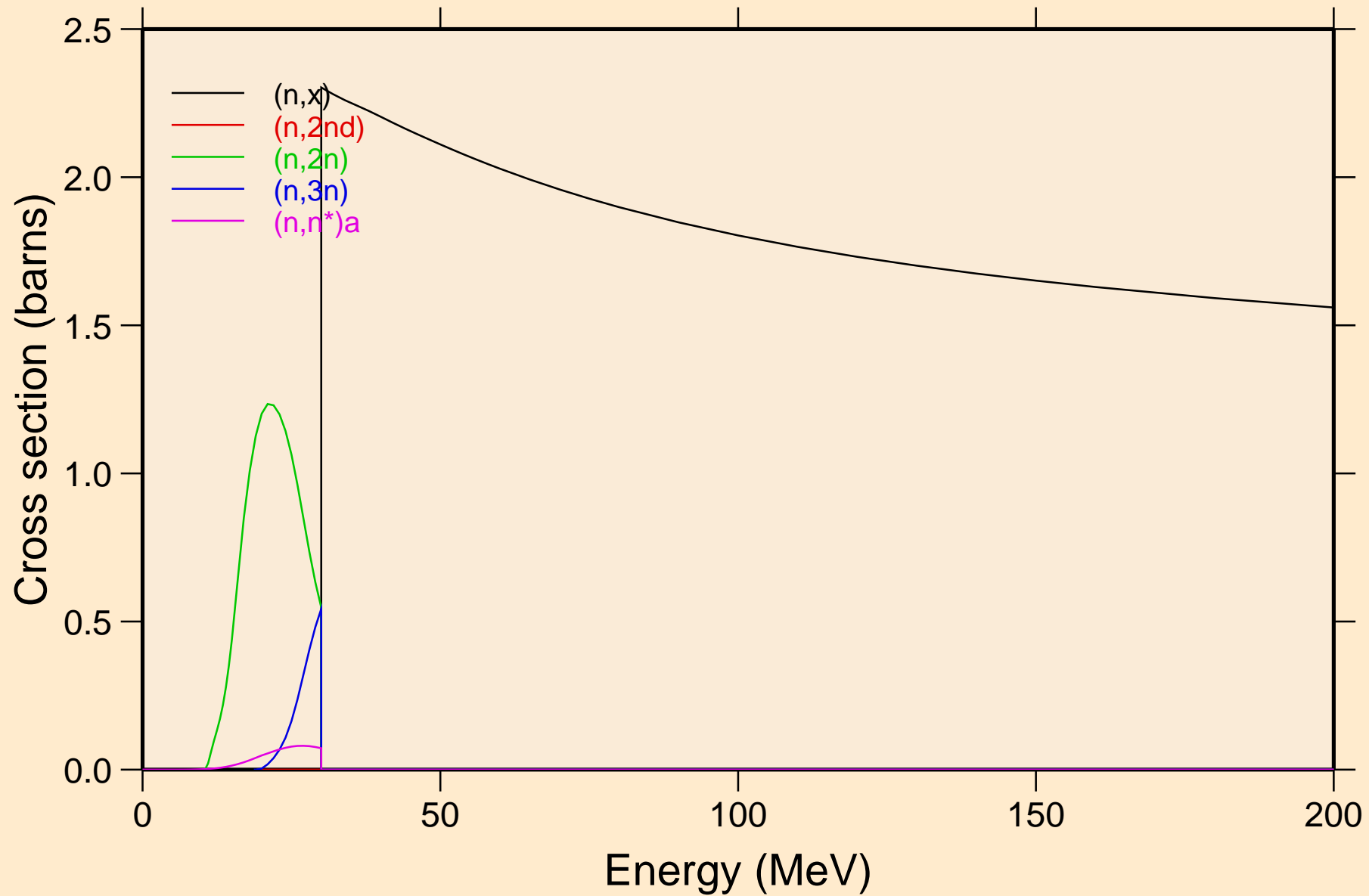

PT180 NEUTRON ACER TENDL-2021 LIBRARY; T=293.6K
Threshold reactions

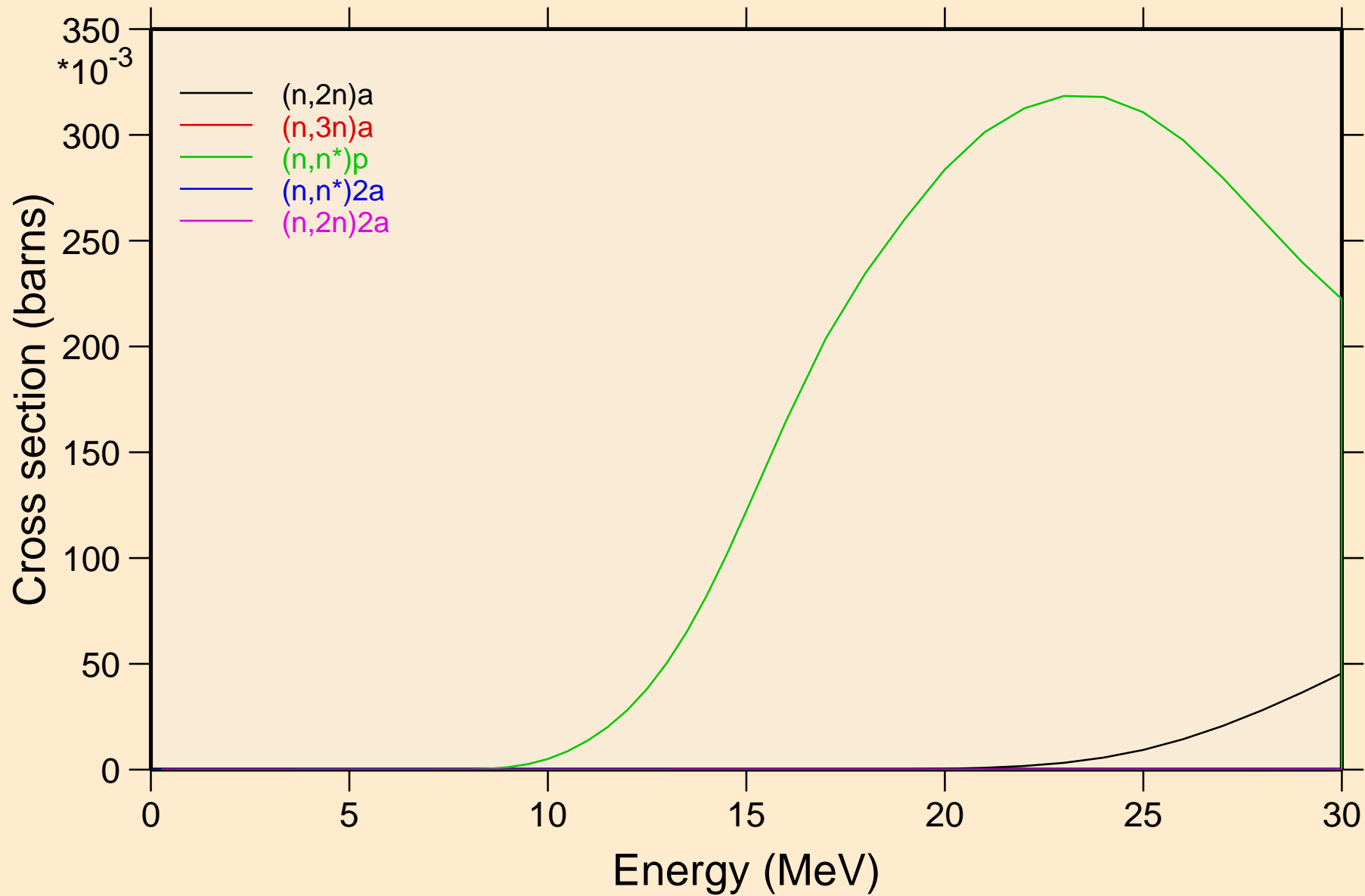

PT180 NEUTRON ACER TENDL-2021 LIBRARY; T=293.6K
Threshold reactions

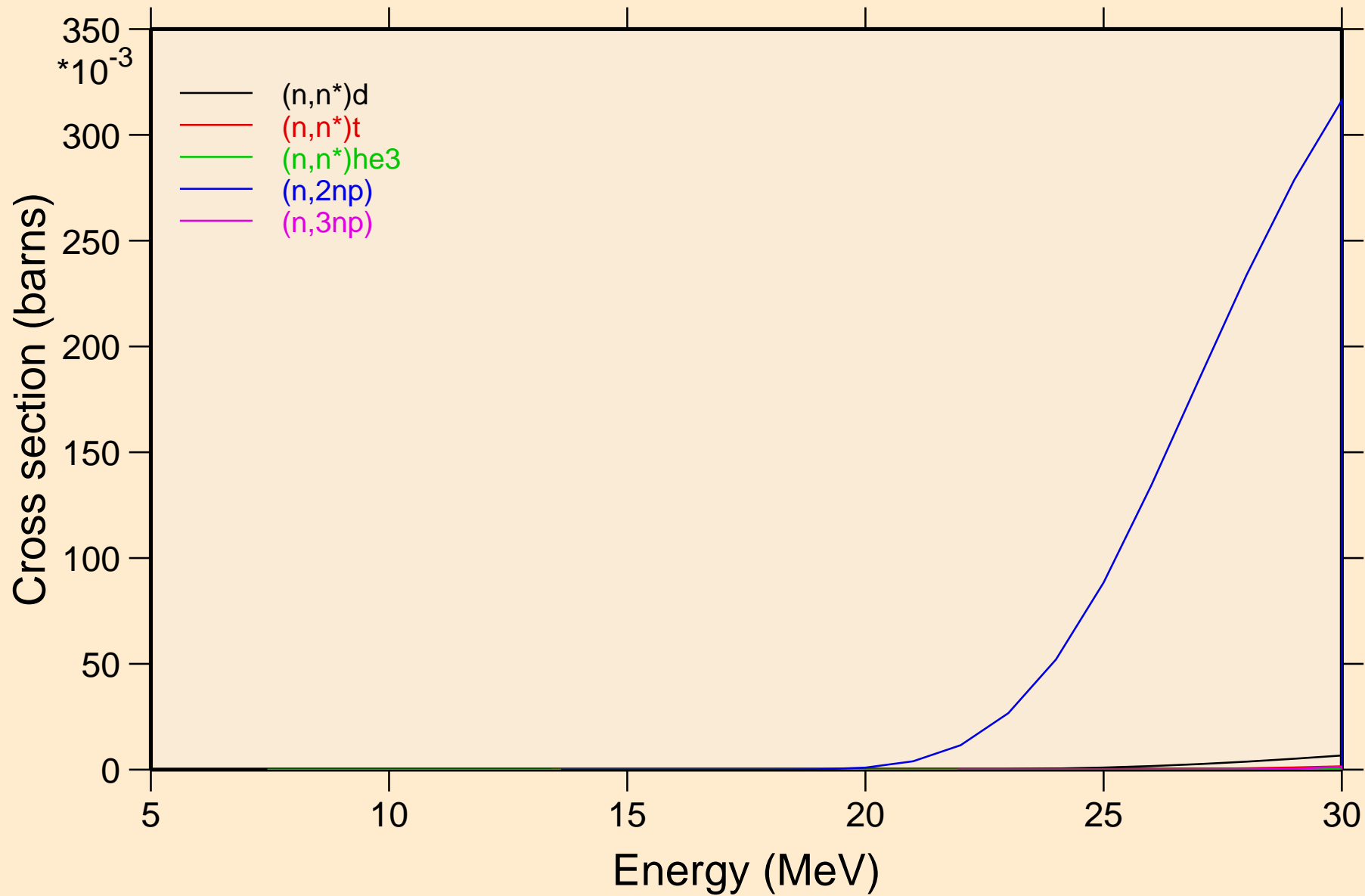

PT180 NEUTRON ACER TENDL-2021 LIBRARY; T=293.6K
Threshold reactions

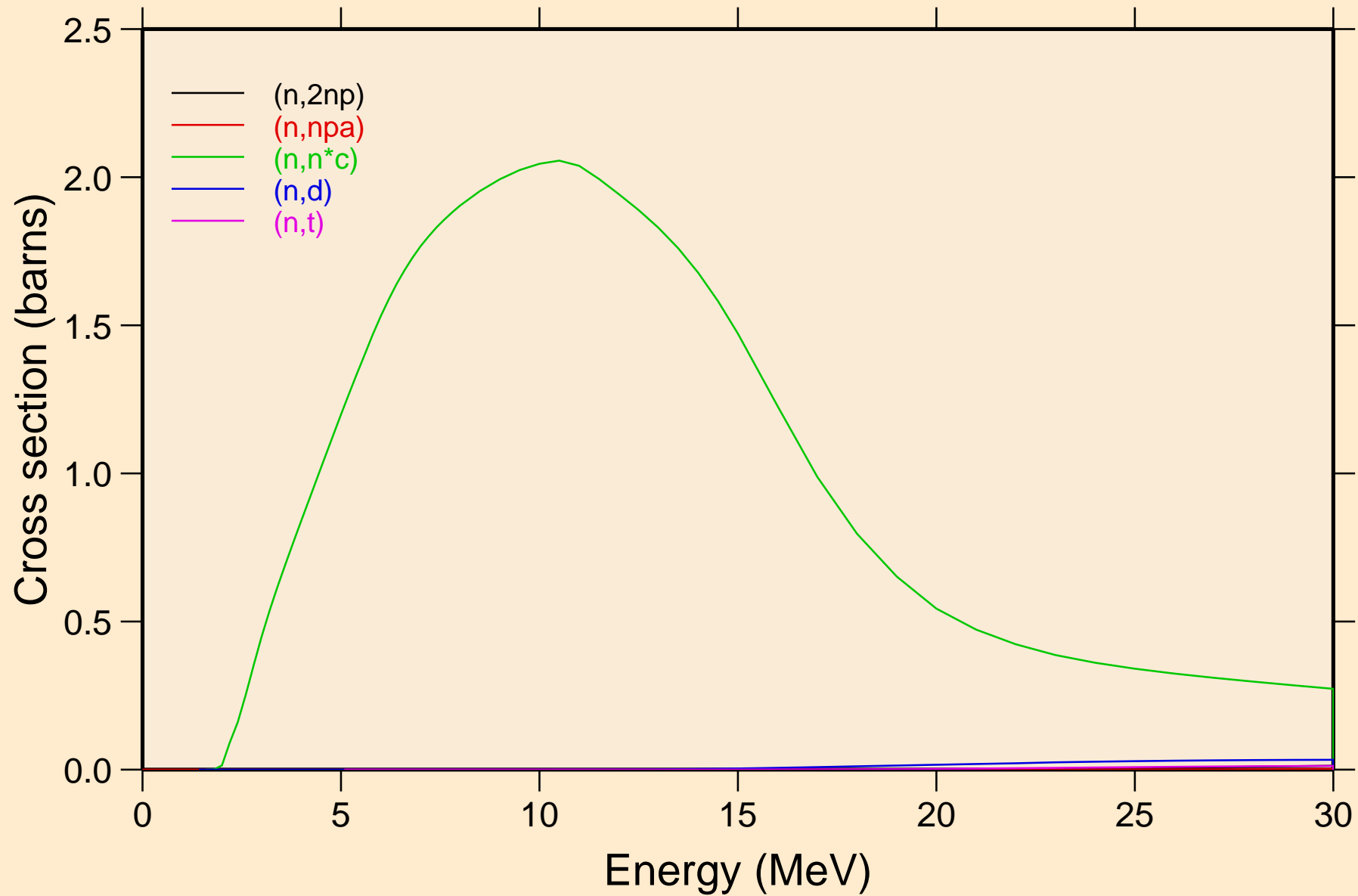

PT180 NEUTRON ACER TENDL-2021 LIBRARY; T=293.6K
Threshold reactions

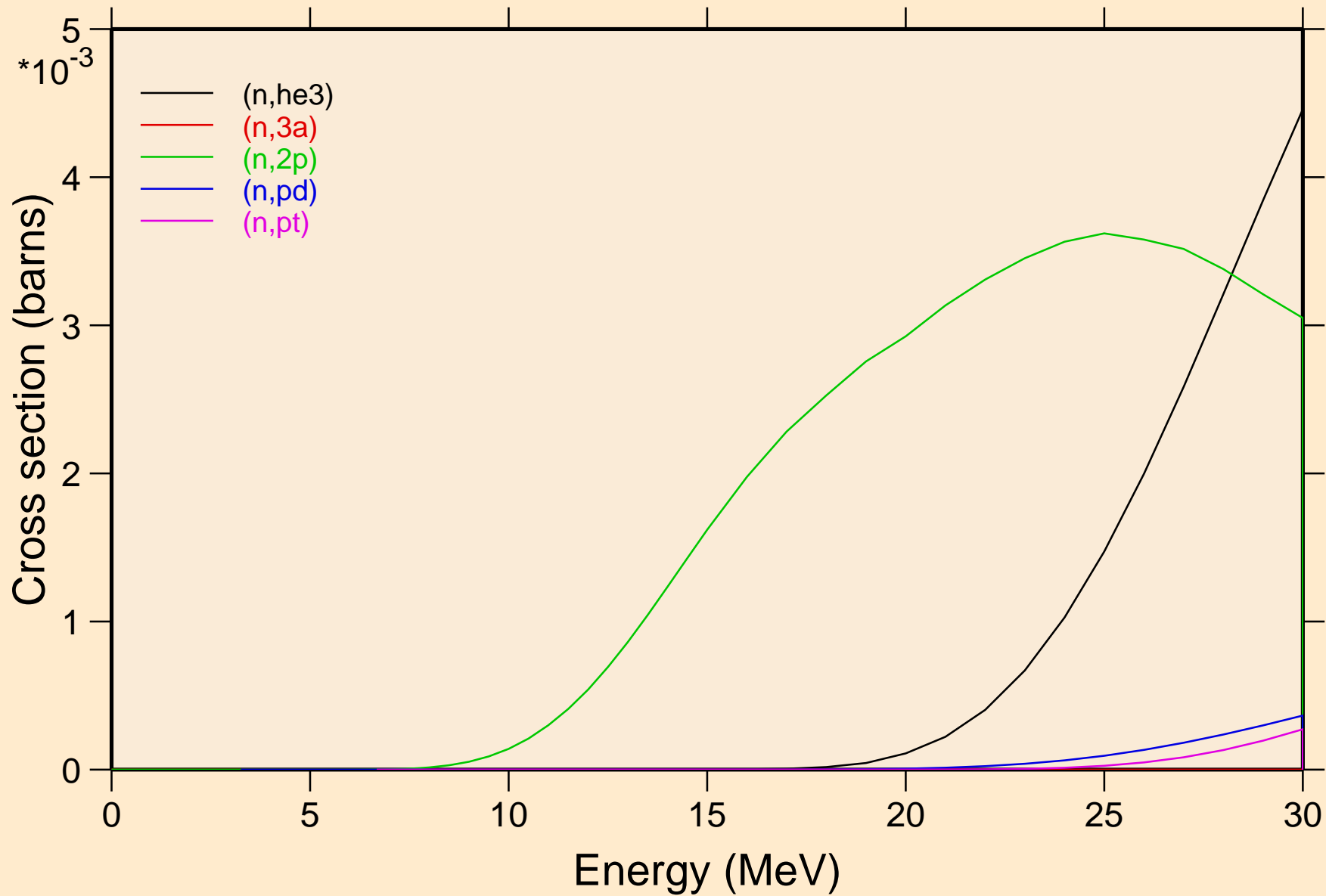

PT180 NEUTRON ACER TENDL-2021 LIBRARY; T=293.6K
Threshold reactions

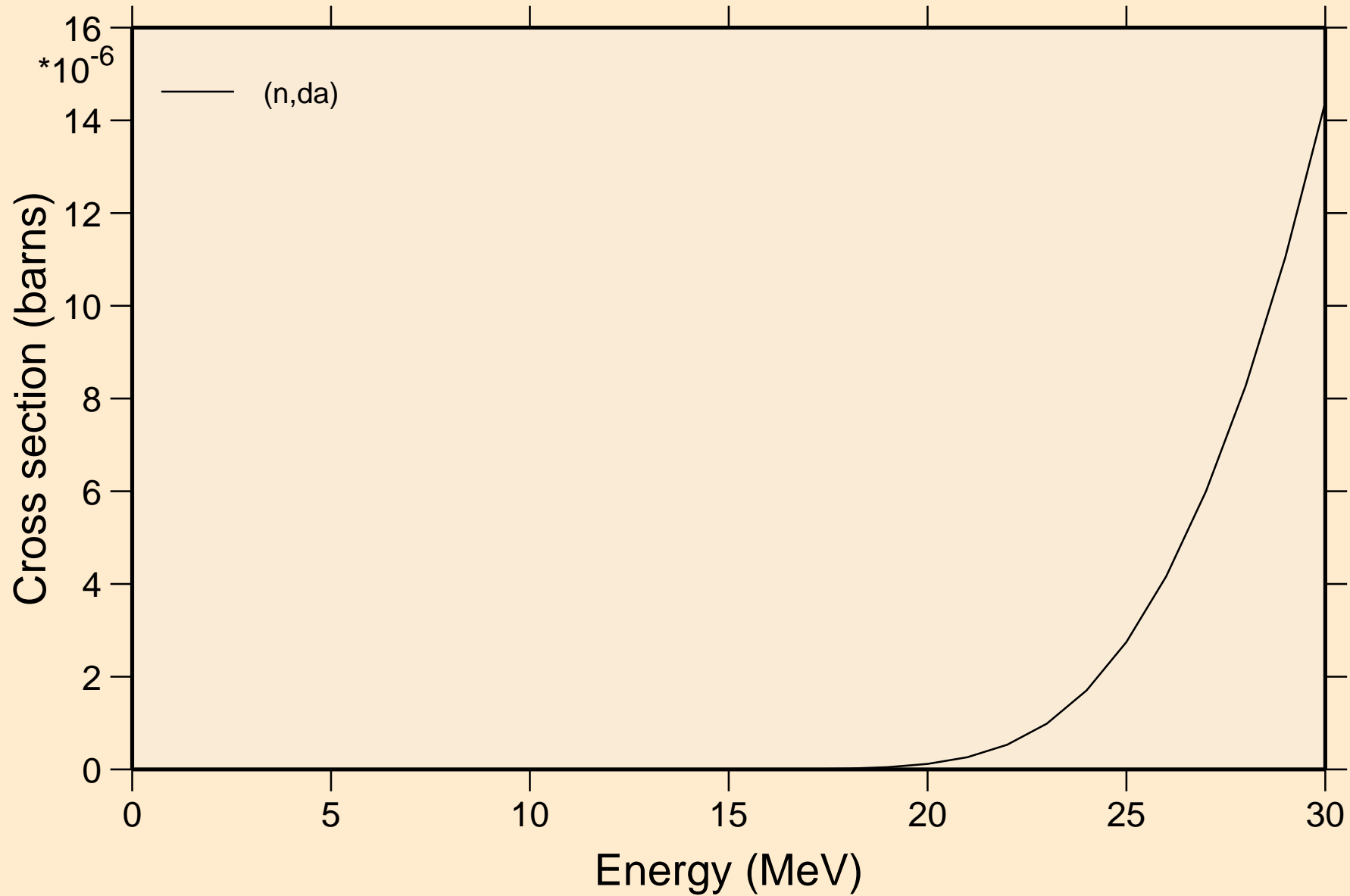

PT180 NEUTRON ACER TENDL-2021 LIBRARY; T=293.6K
Threshold reactions

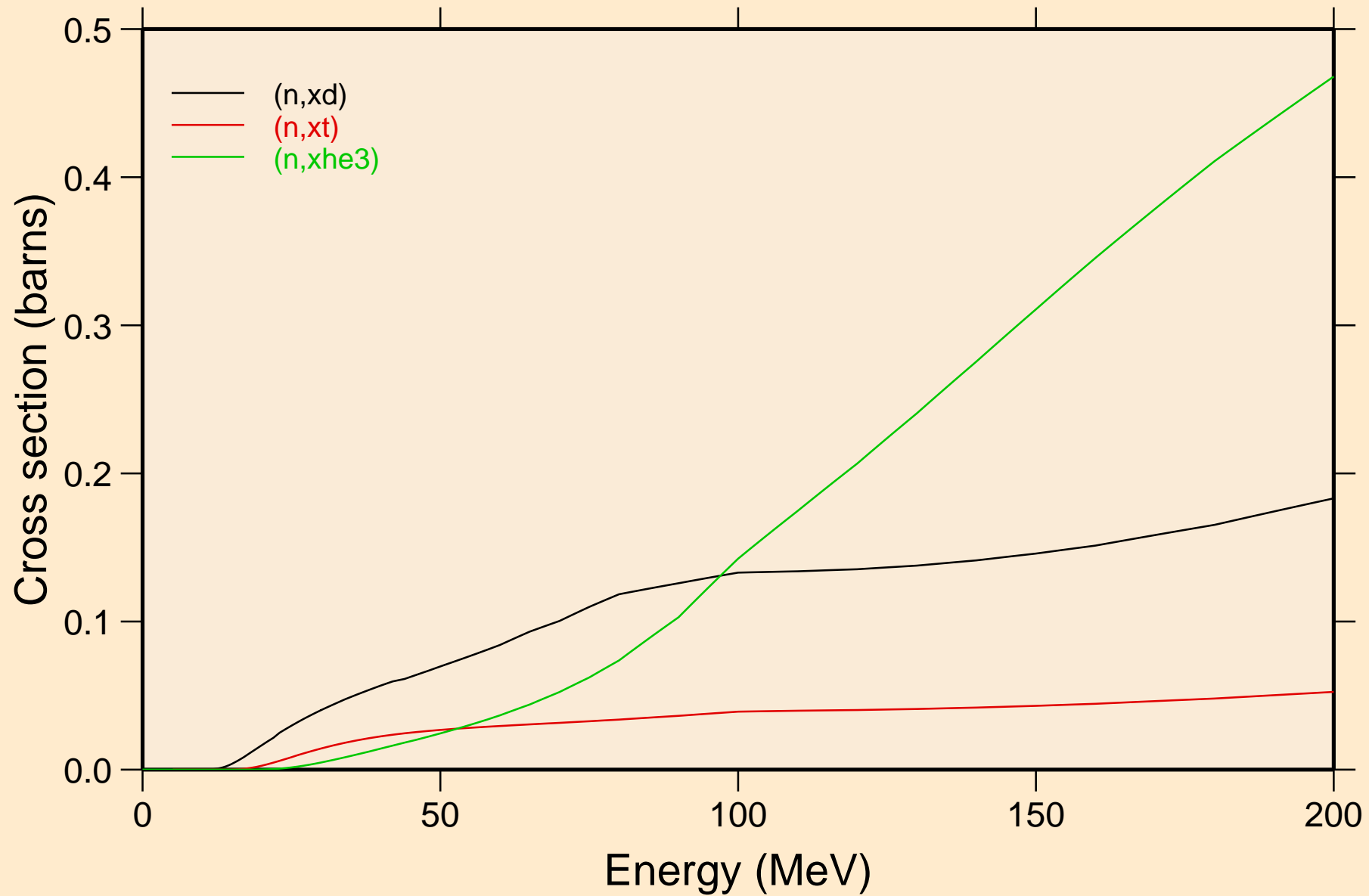

PT180 NEUTRON ACER TENDL-2021 LIBRARY; T=293.6K
angular distribution for elastic

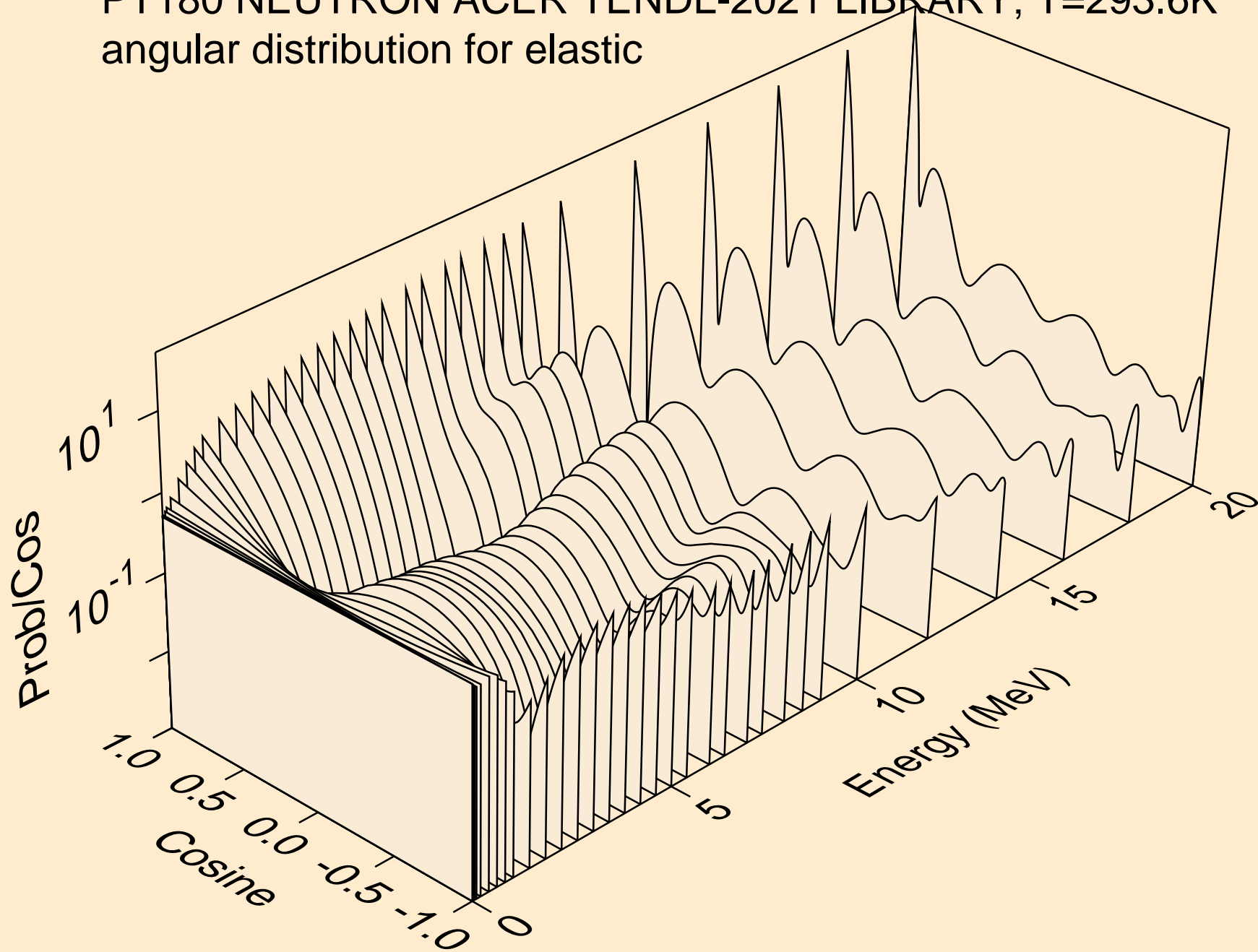

PT180 NEUTRON ACER TENDL-2021 LIBRARY; T=293.6K
angular distribution for elastic

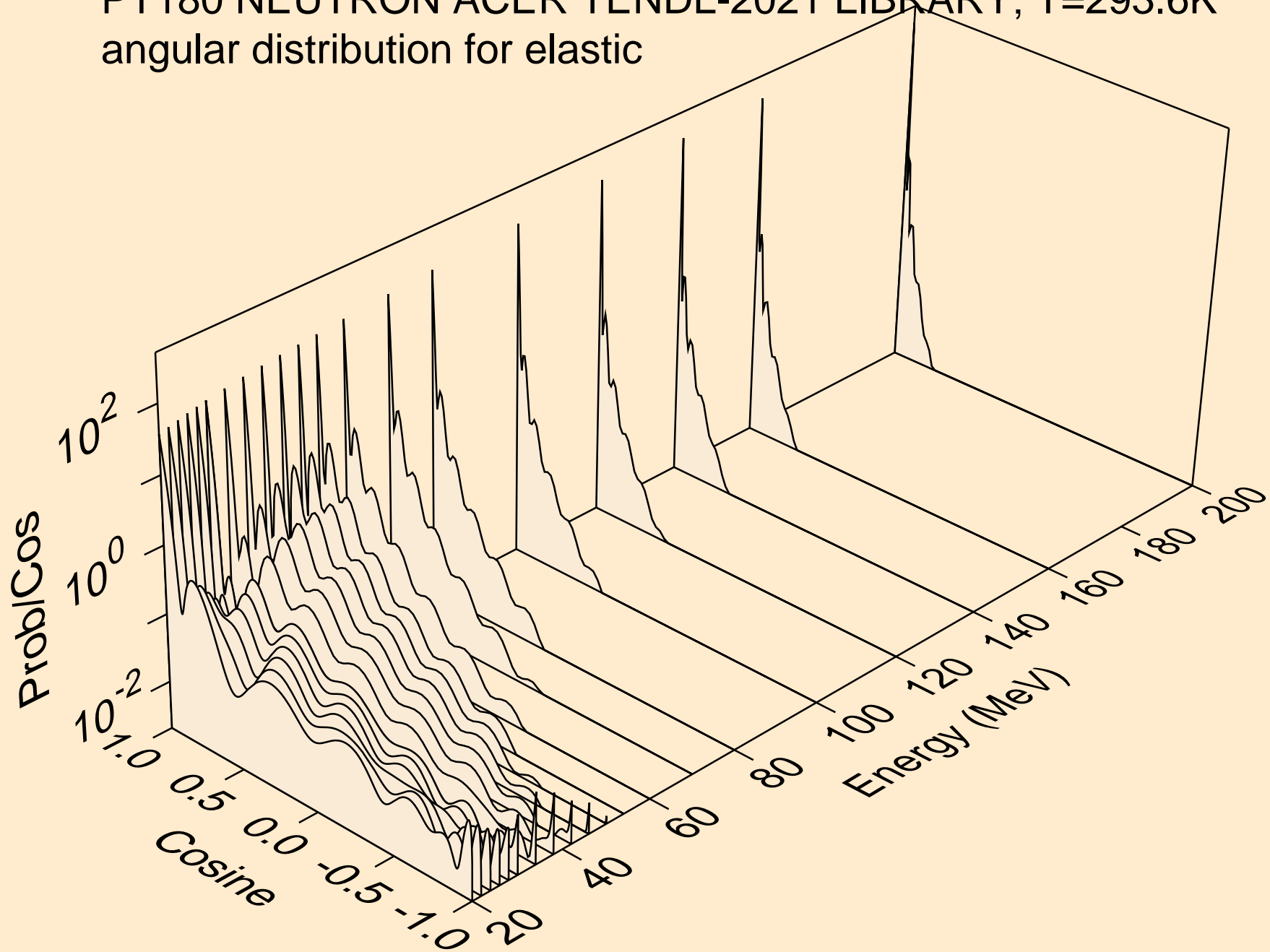

PT180 NEUTRON ACER TENDL-2021 LIBRARY; T=293.6K
angular distribution for (n,n*1)

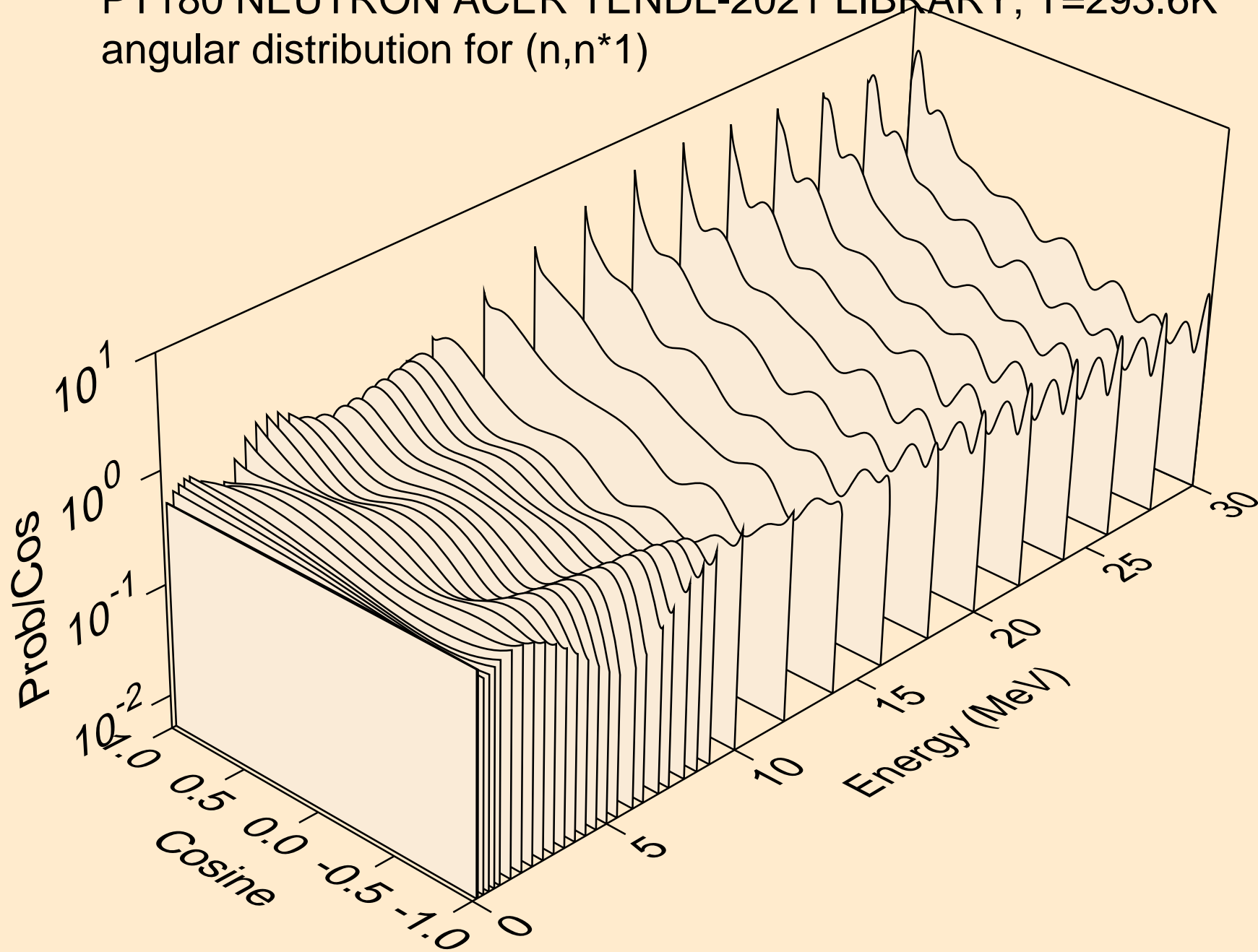

PT180 NEUTRON ACER TENDL-2021 LIBRARY; T=293.6K
angular distribution for (n,n*2)

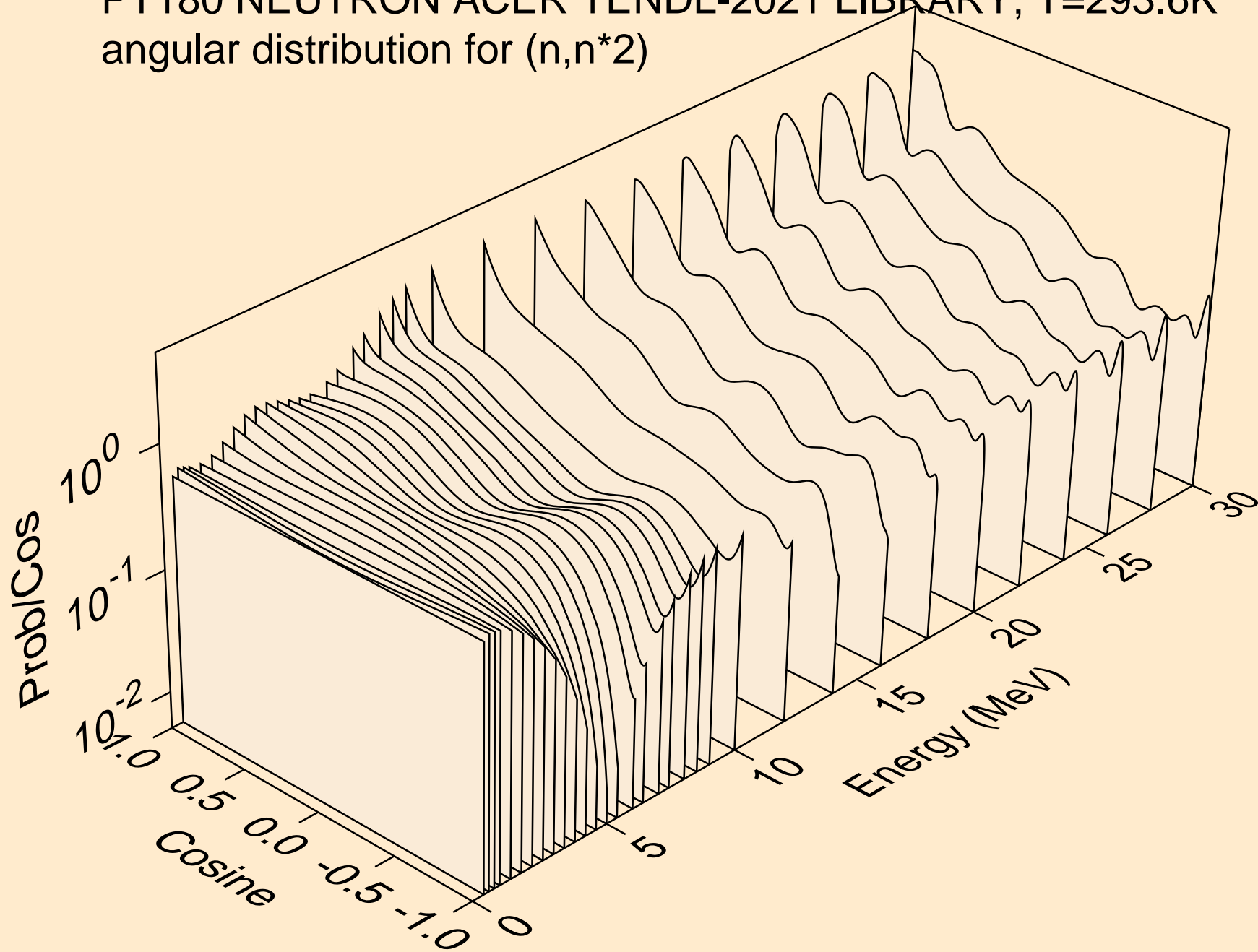

PT180 NEUTRON ACER TENDL-2021 LIBRARY; T=293.6K
angular distribution for (n,n*3)

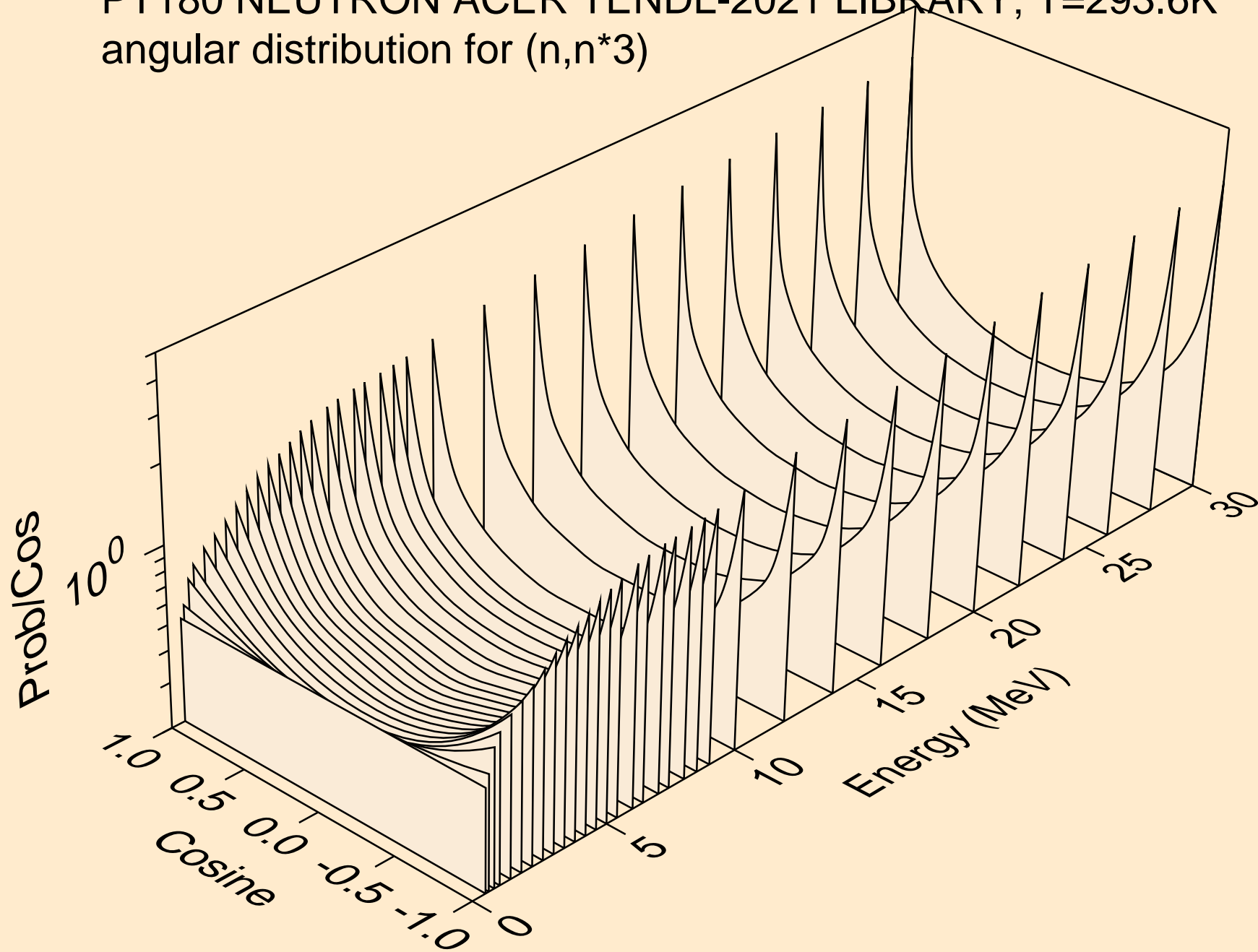

PT180 NEUTRON ACER TENDL-2021 LIBRARY; T=293.6K
angular distribution for (n,n*4)

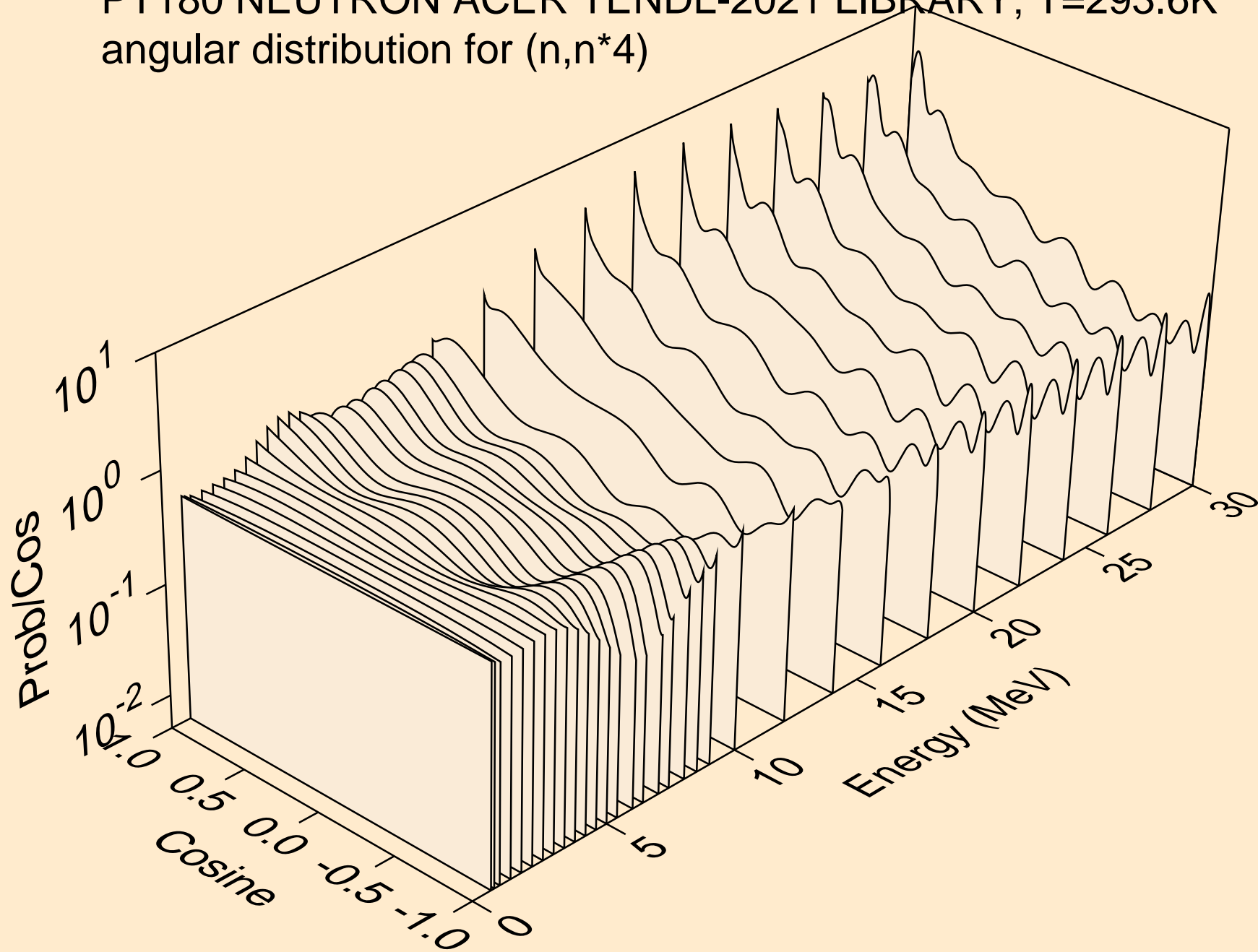

PT180 NEUTRON ACER TENDL-2021 LIBRARY; T=293.6K
angular distribution for (n,n*5)

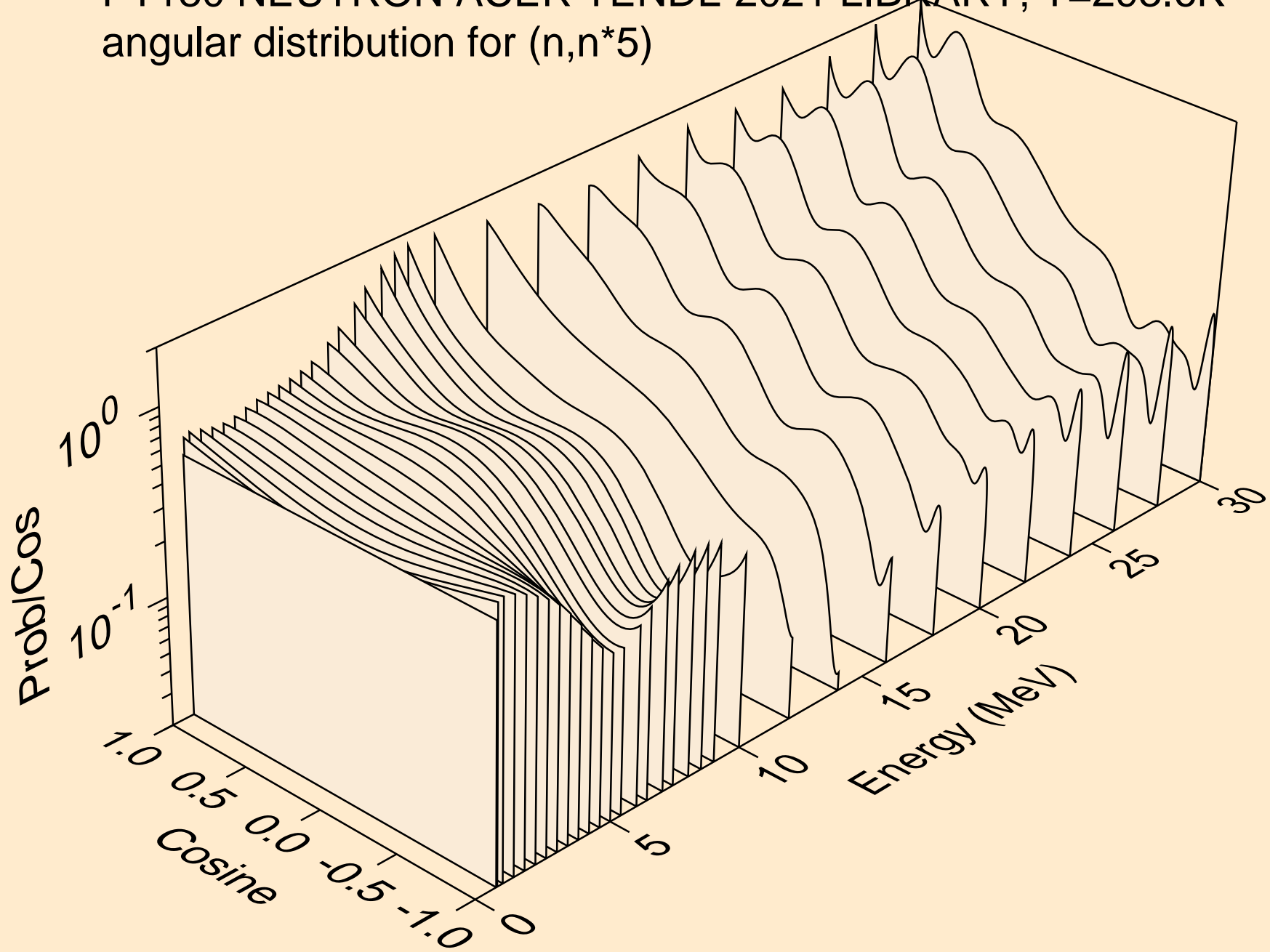

PT180 NEUTRON ACER TENDL-2021 LIBRARY; T=293.6K
angular distribution for (n,n*6)

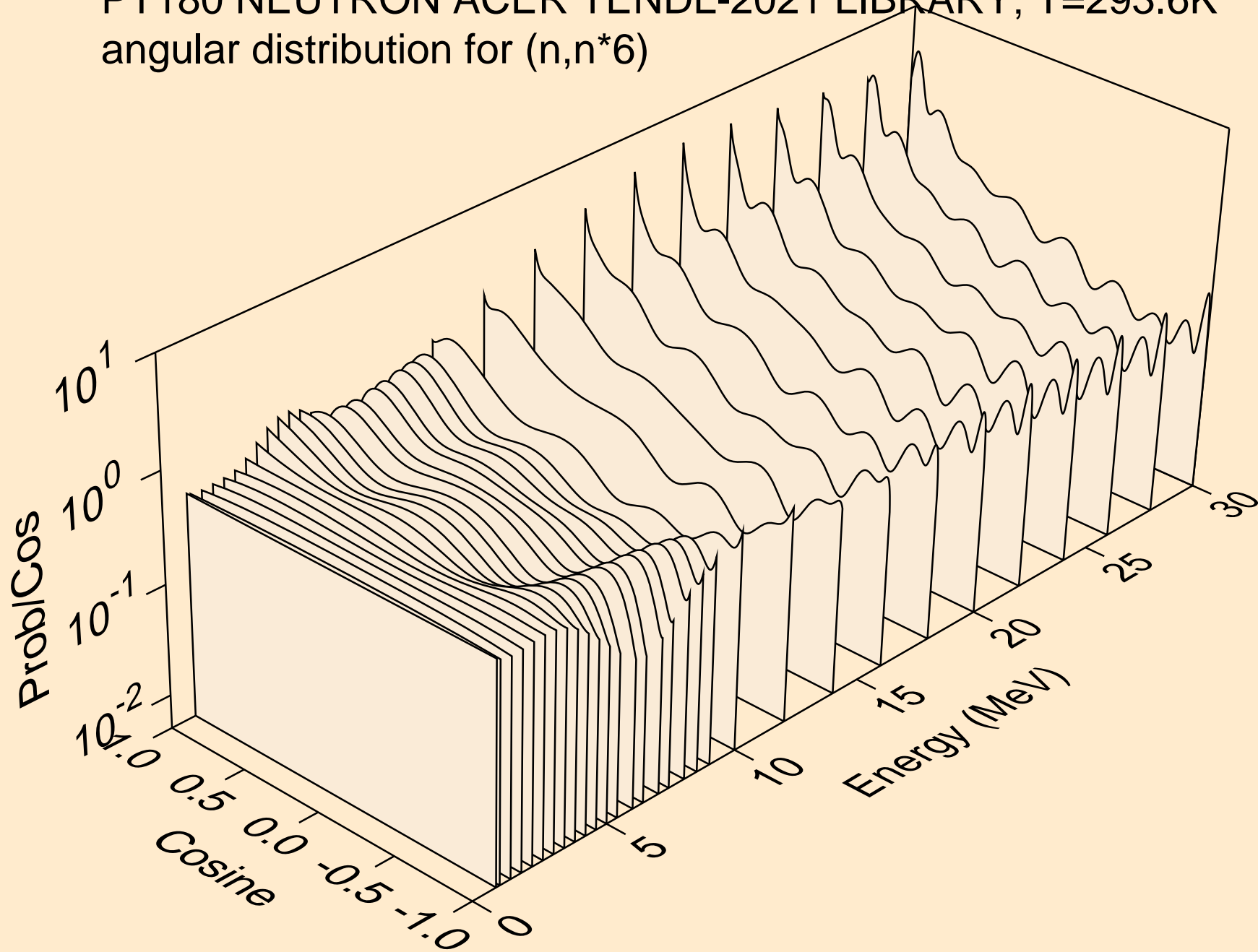

PT180 NEUTRON ACER TENDL-2021 LIBRARY; T=293.6K
angular distribution for (n,n*7)

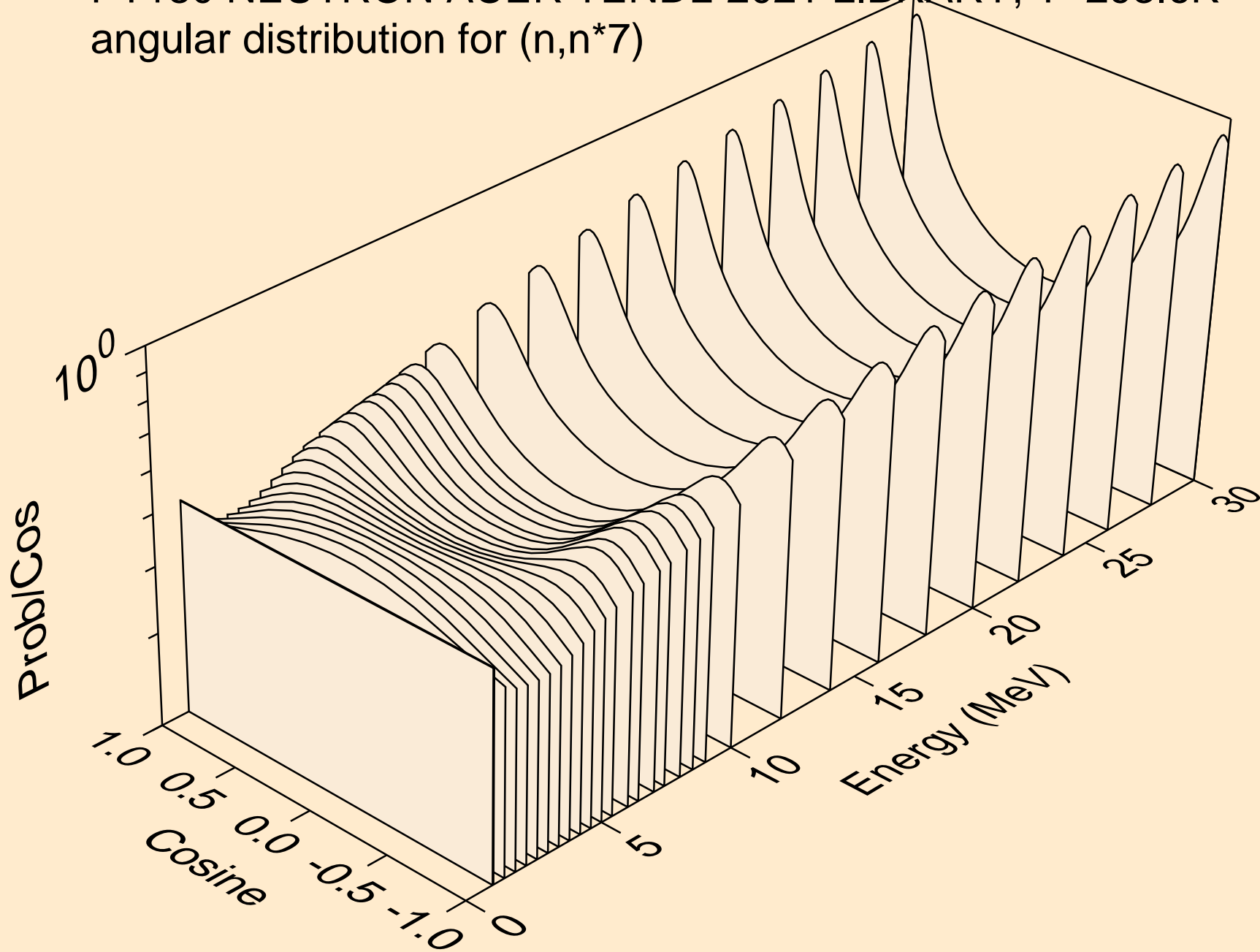

PT180 NEUTRON ACER TENDL-2021 LIBRARY; T=293.6K
angular distribution for (n,n*8)

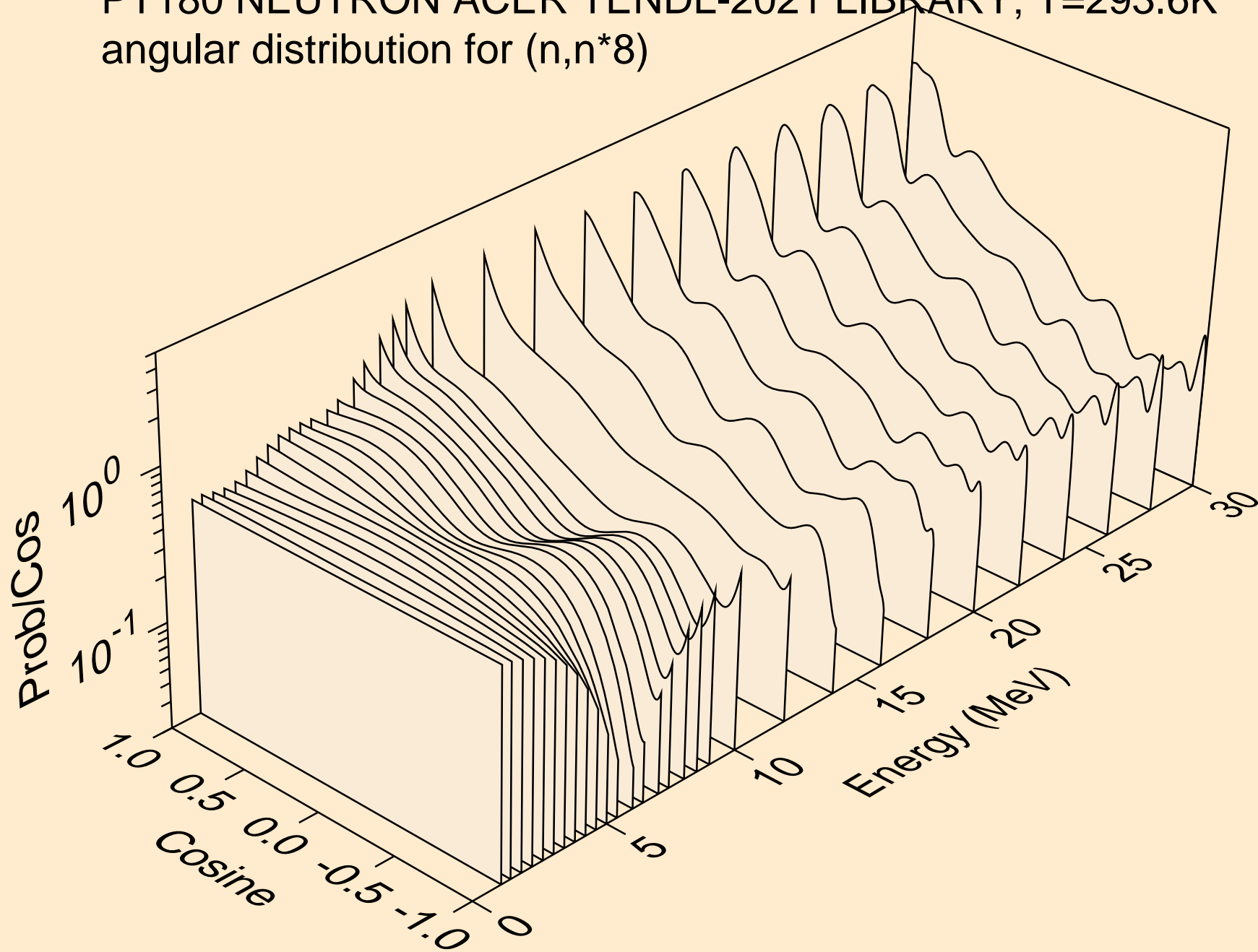

PT180 NEUTRON ACER TENDL-2021 LIBRARY; T=293.6K
angular distribution for (n,n*9)

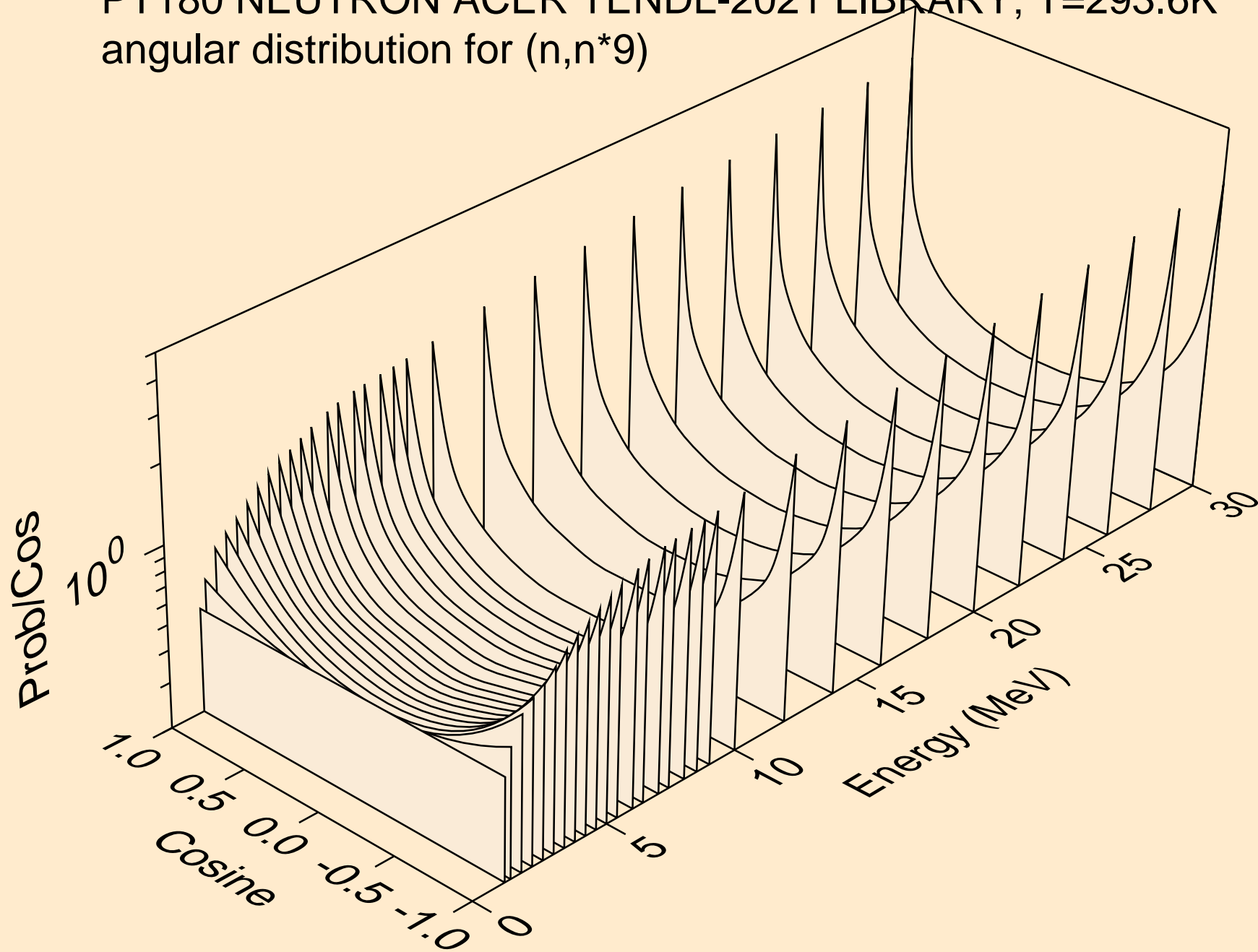

PT180 NEUTRON ACER TENDL-2021 LIBRARY; T=293.6K
angular distribution for (n,n*10)

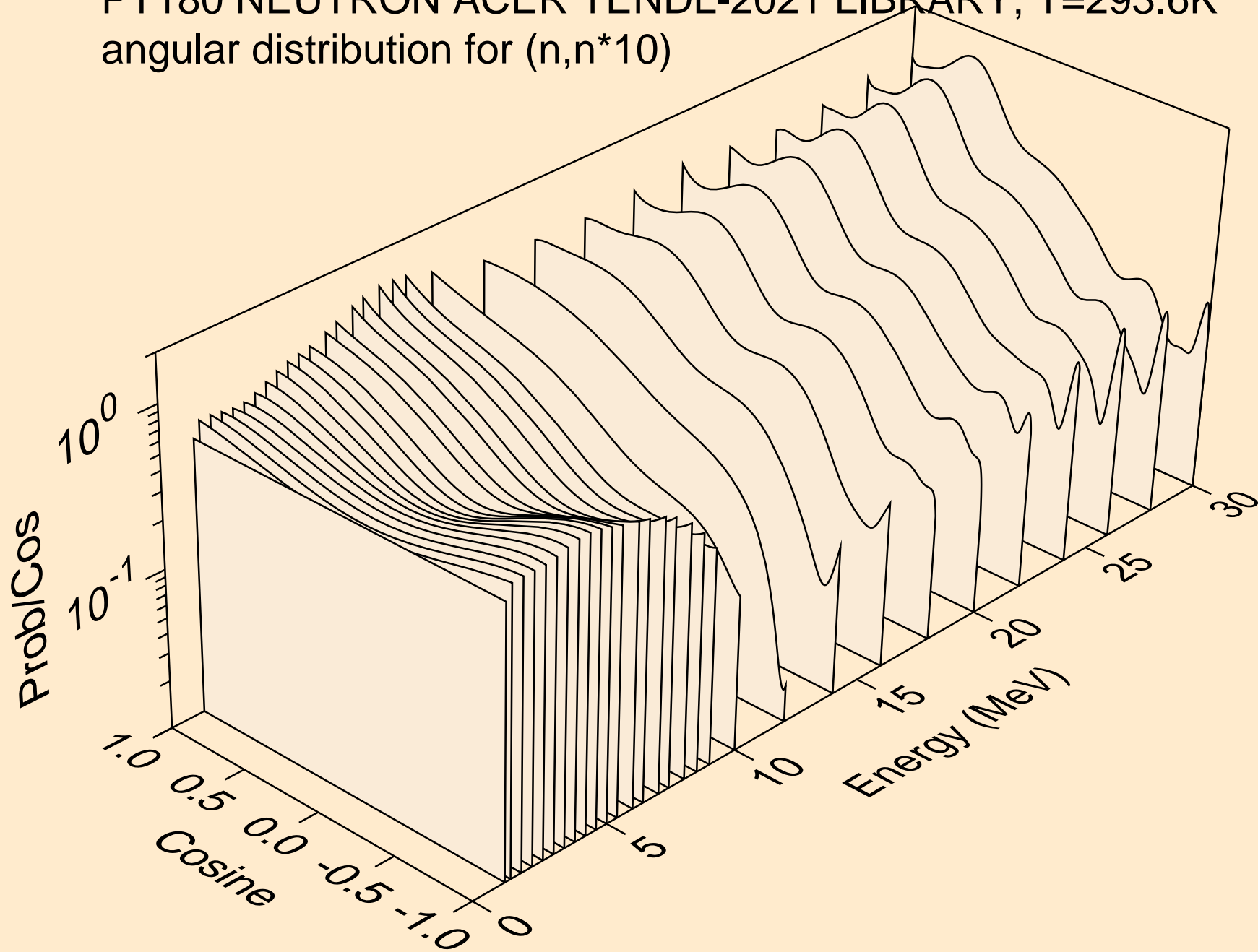

PT180 NEUTRON ACER TENDL-2021 LIBRARY; T=293.6K
angular distribution for (n,n*11)

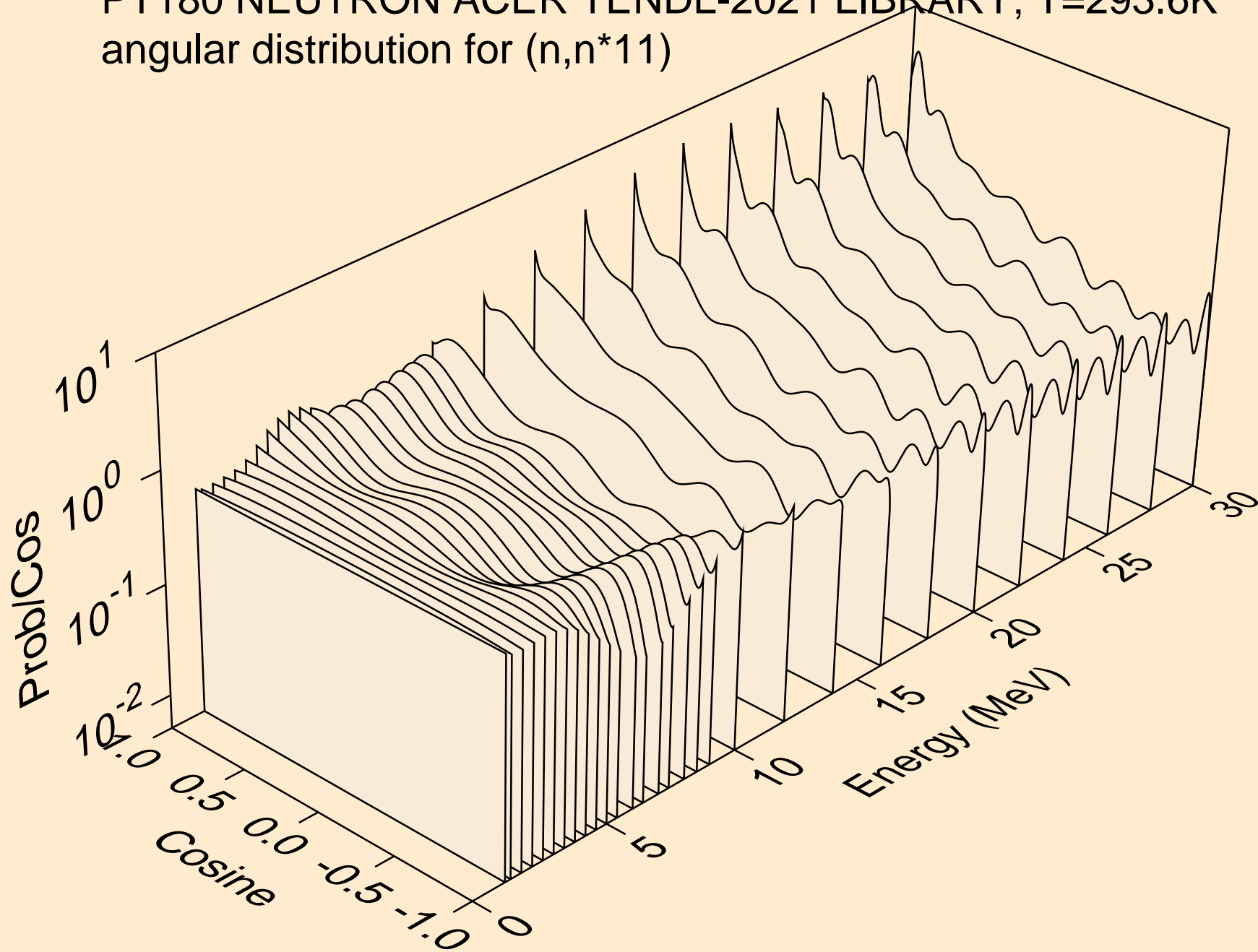

PT180 NEUTRON ACER TENDL-2021 LIBRARY; T=293.6K
angular distribution for (n,n*12)

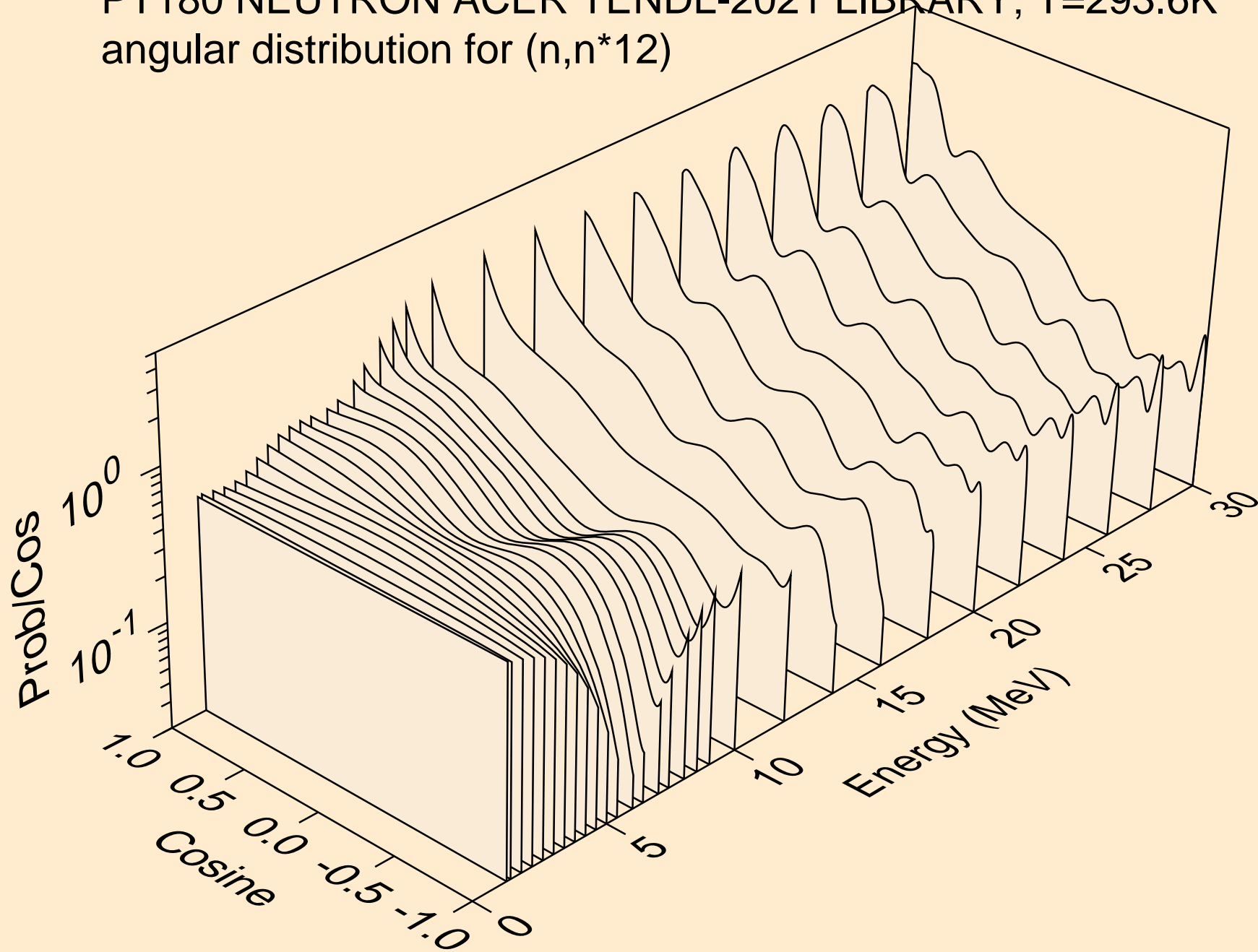

PT180 NEUTRON ACER TENDL-2021 LIBRARY; T=293.6K
angular distribution for (n,n*13)

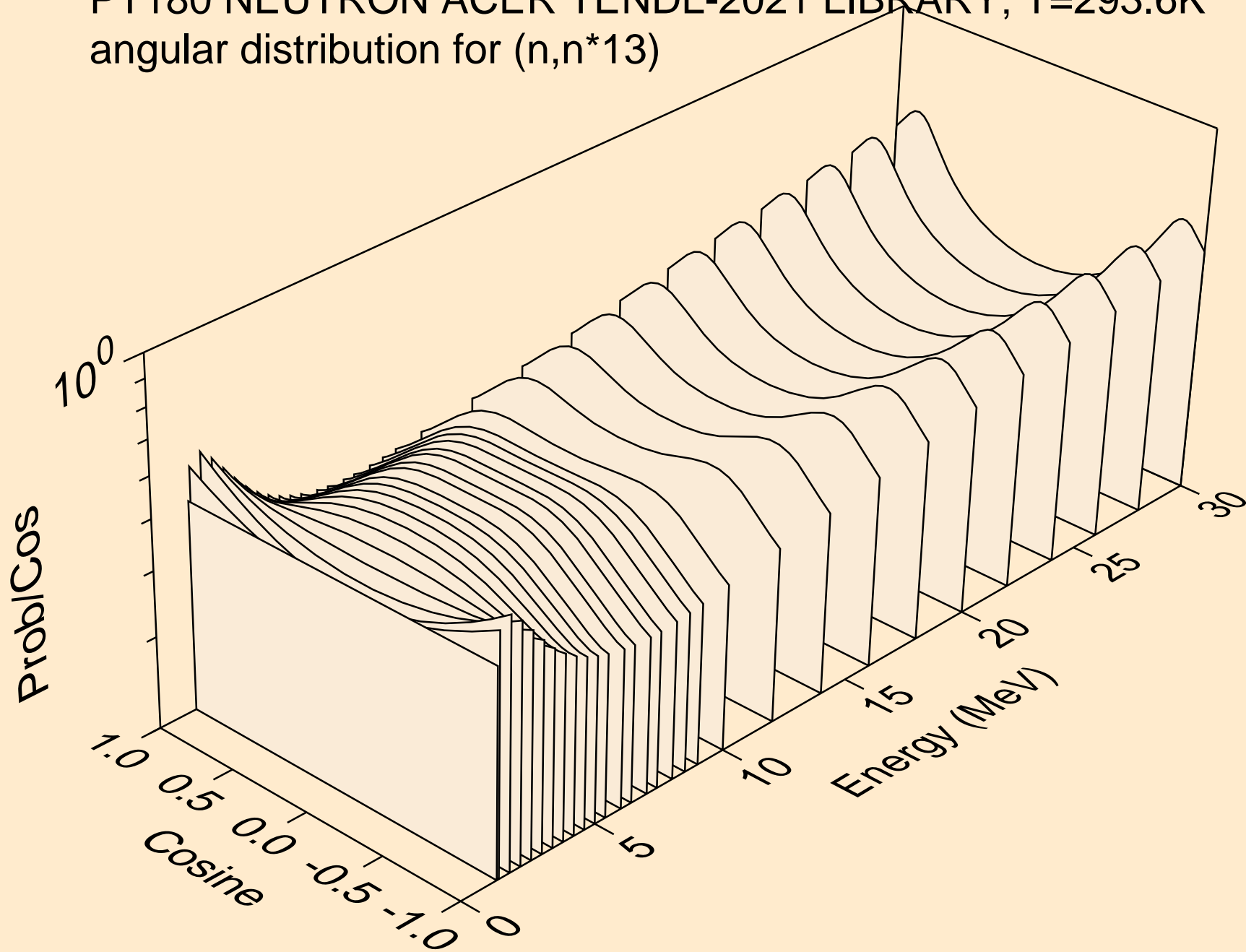

PT180 NEUTRON ACER TENDL-2021 LIBRARY; T=293.6K
angular distribution for (n,n*14)

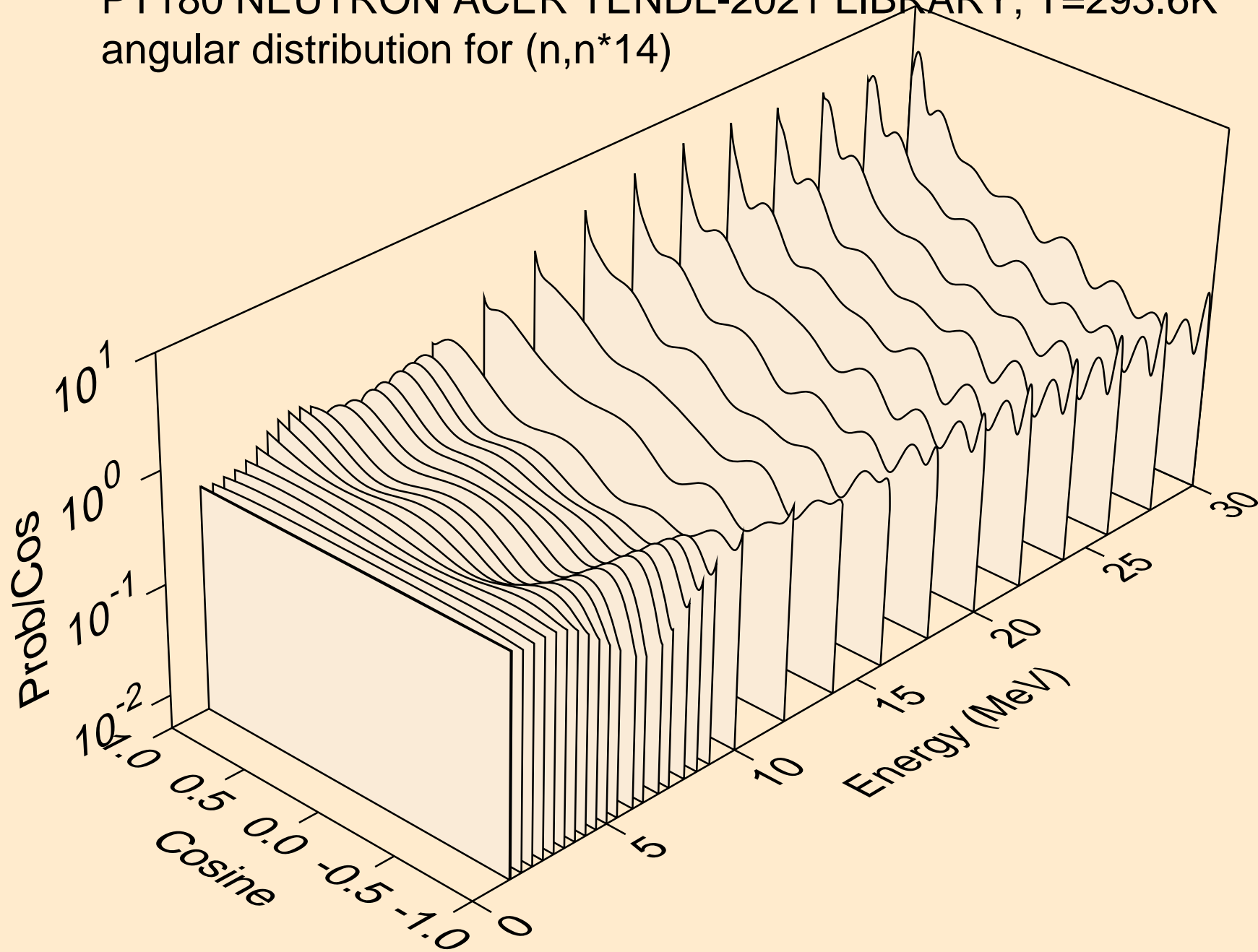

PT180 NEUTRON ACER TENDL-2021 LIBRARY; T=293.6K
angular distribution for (n,n*15)

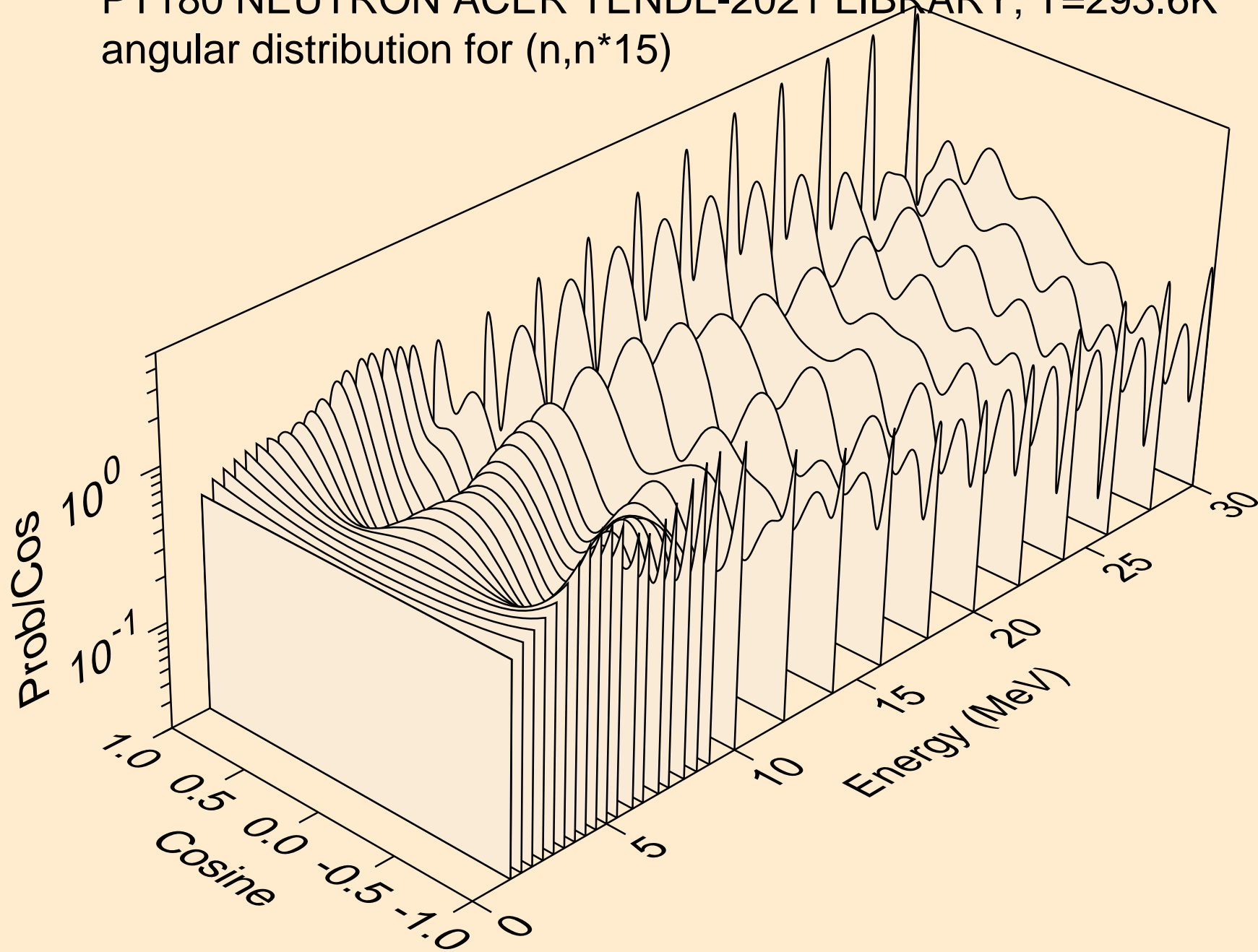

PT180 NEUTRON ACER TENDL-2021 LIBRARY; T=293.6K
angular distribution for (n,n*16)

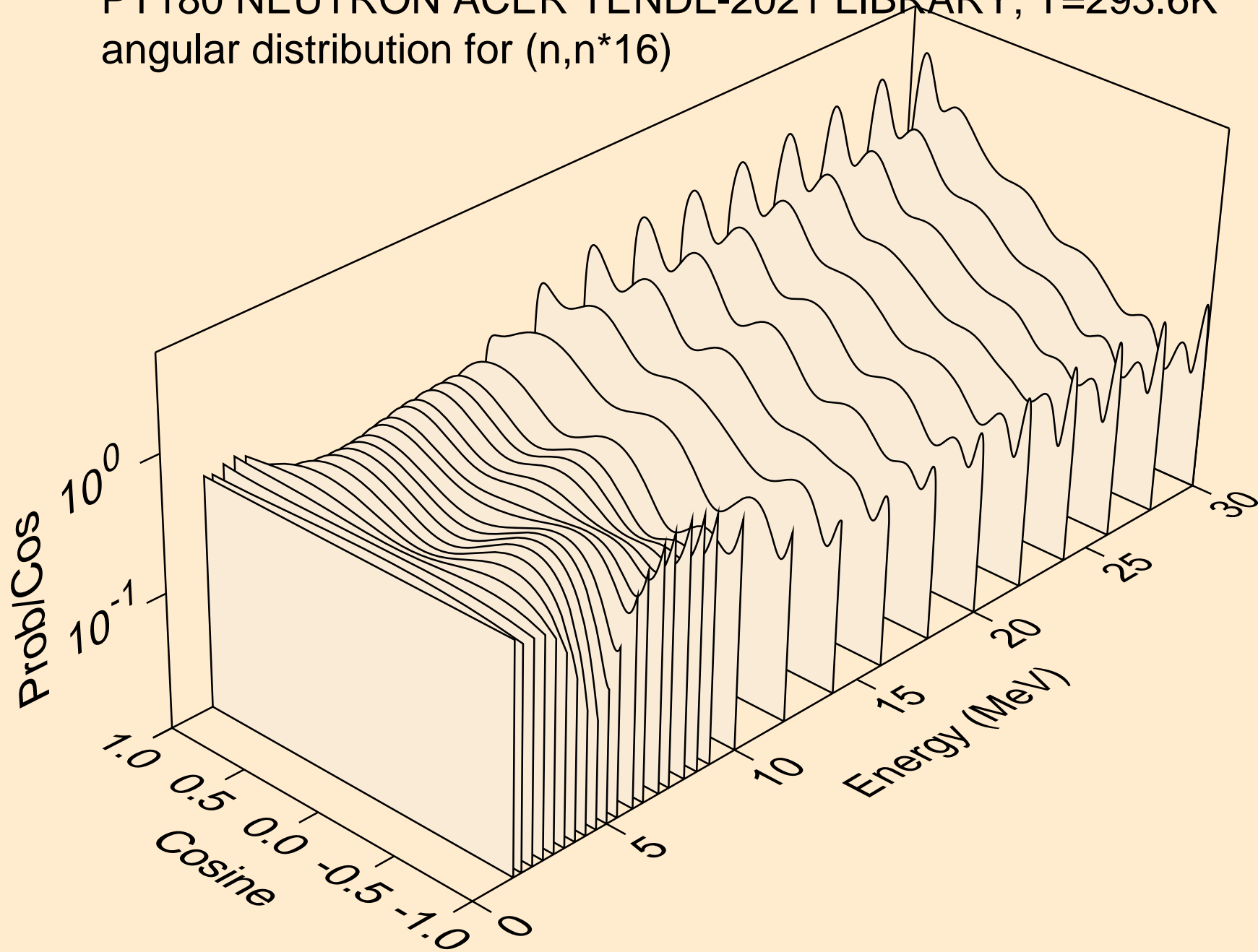

PT180 NEUTRON ACER TENDL-2021 LIBRARY; T=293.6K
angular distribution for (n,n*17)

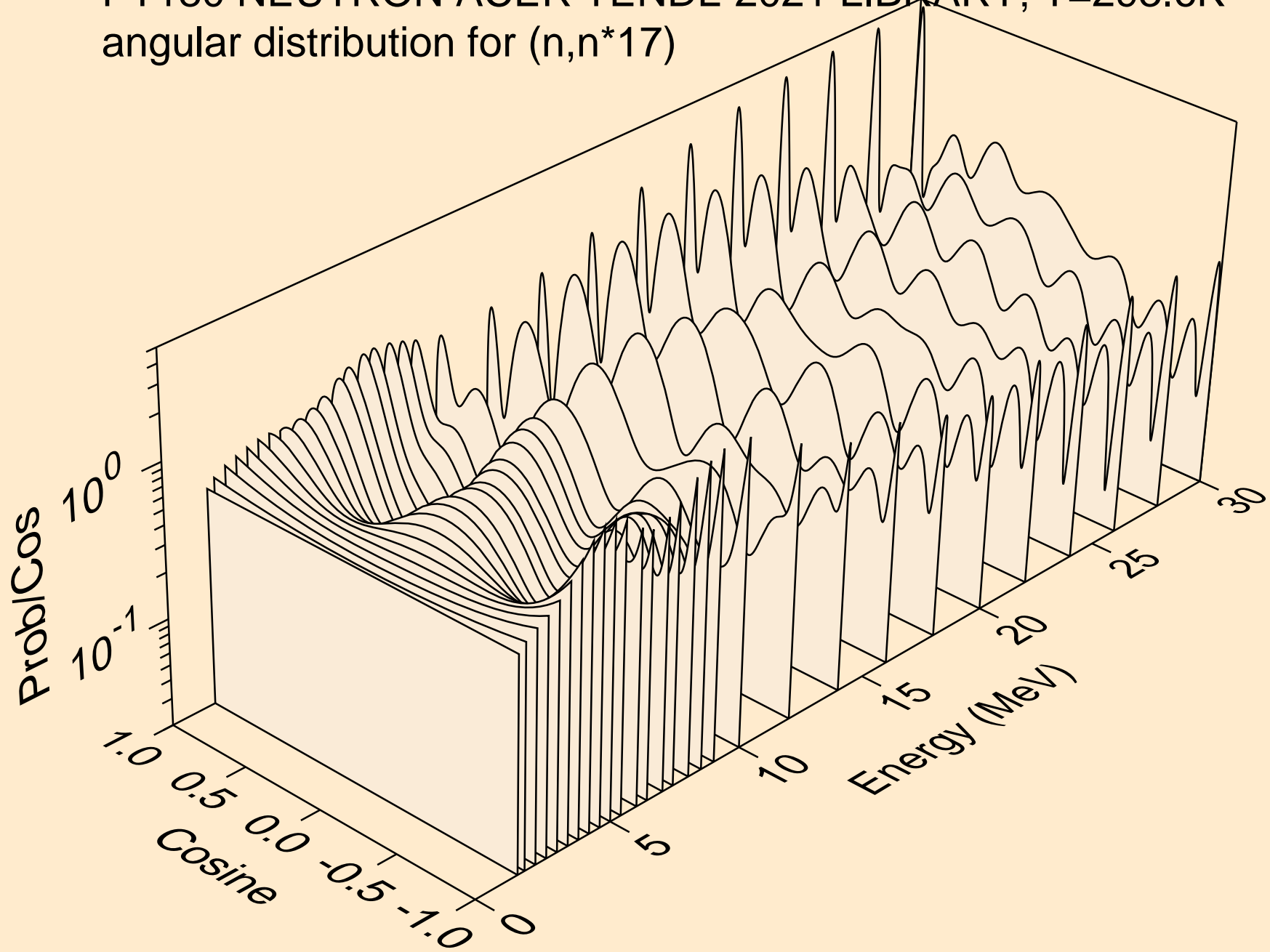

PT180 NEUTRON ACER TENDL-2021 LIBRARY; T=293.6K
angular distribution for (n,n*18)

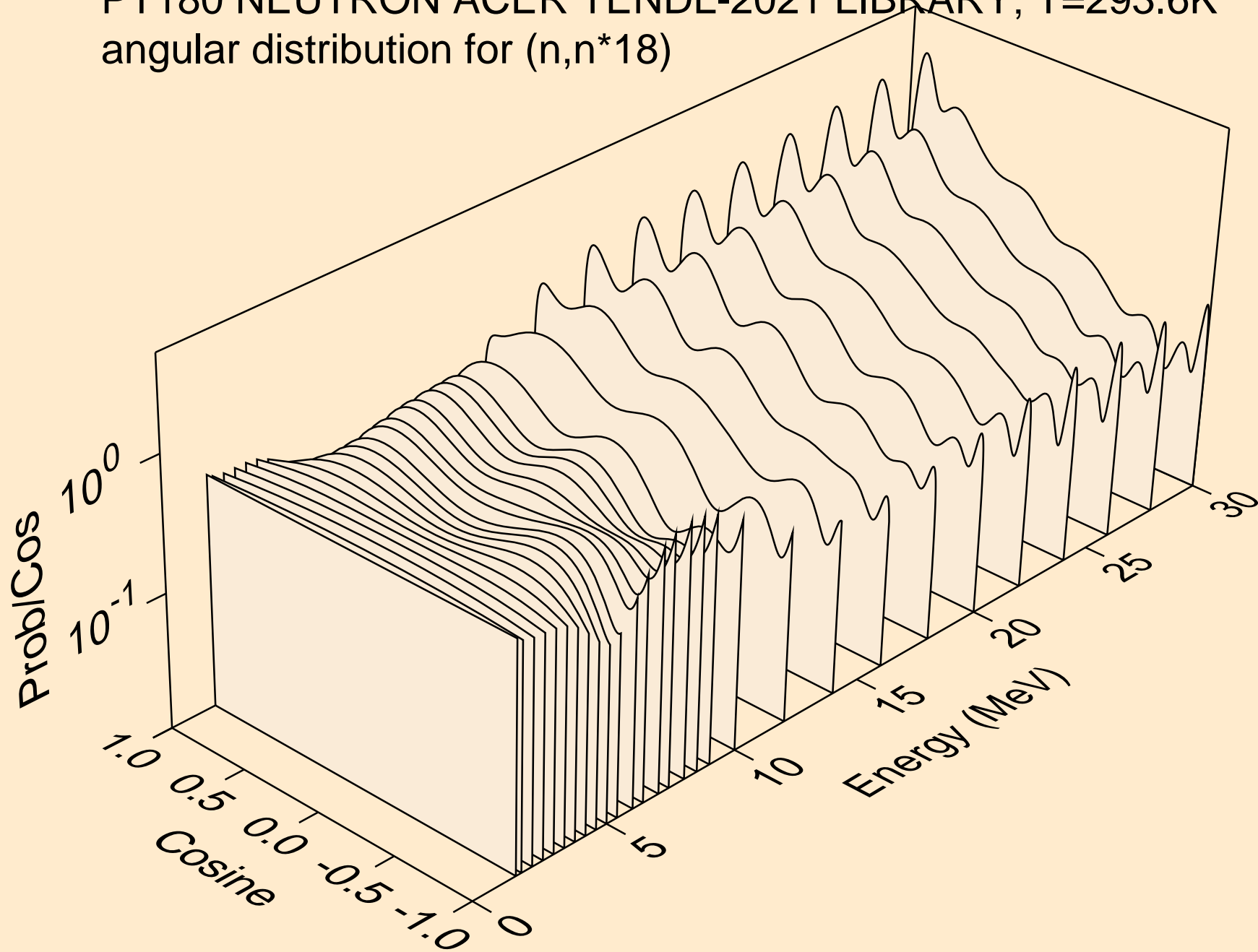

PT180 NEUTRON ACER TENDL-2021 LIBRARY; T=293.6K
Neutron emission for (n,x)

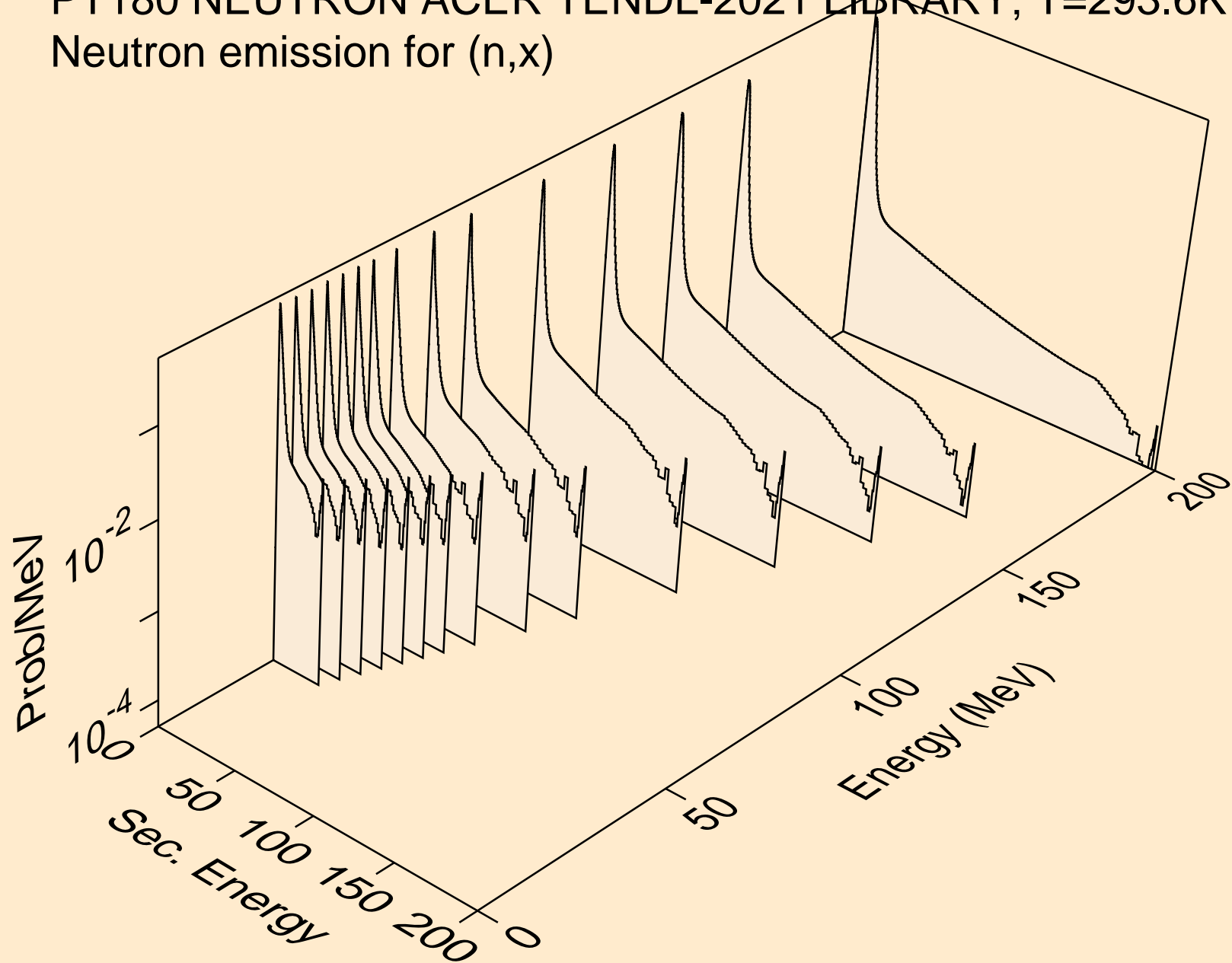

PT180 NEUTRON ACER TENDL-2021 LIBRARY; T=293.6K
Neutron emission for (n,2nd)

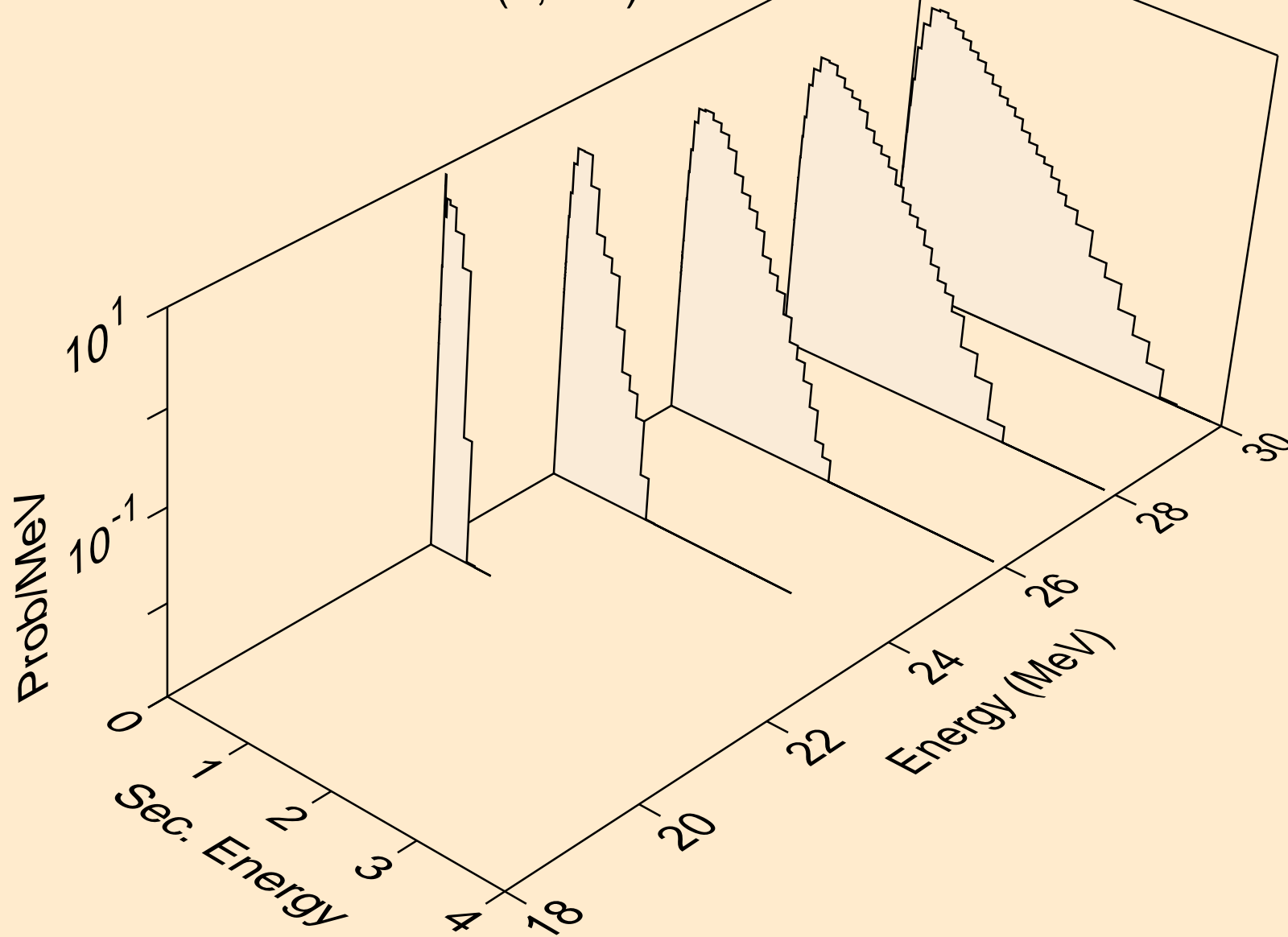

PT180 NEUTRON ACER TENDL-2021 LIBRARY; T=293.6K
Neutron emission for (n,2n)

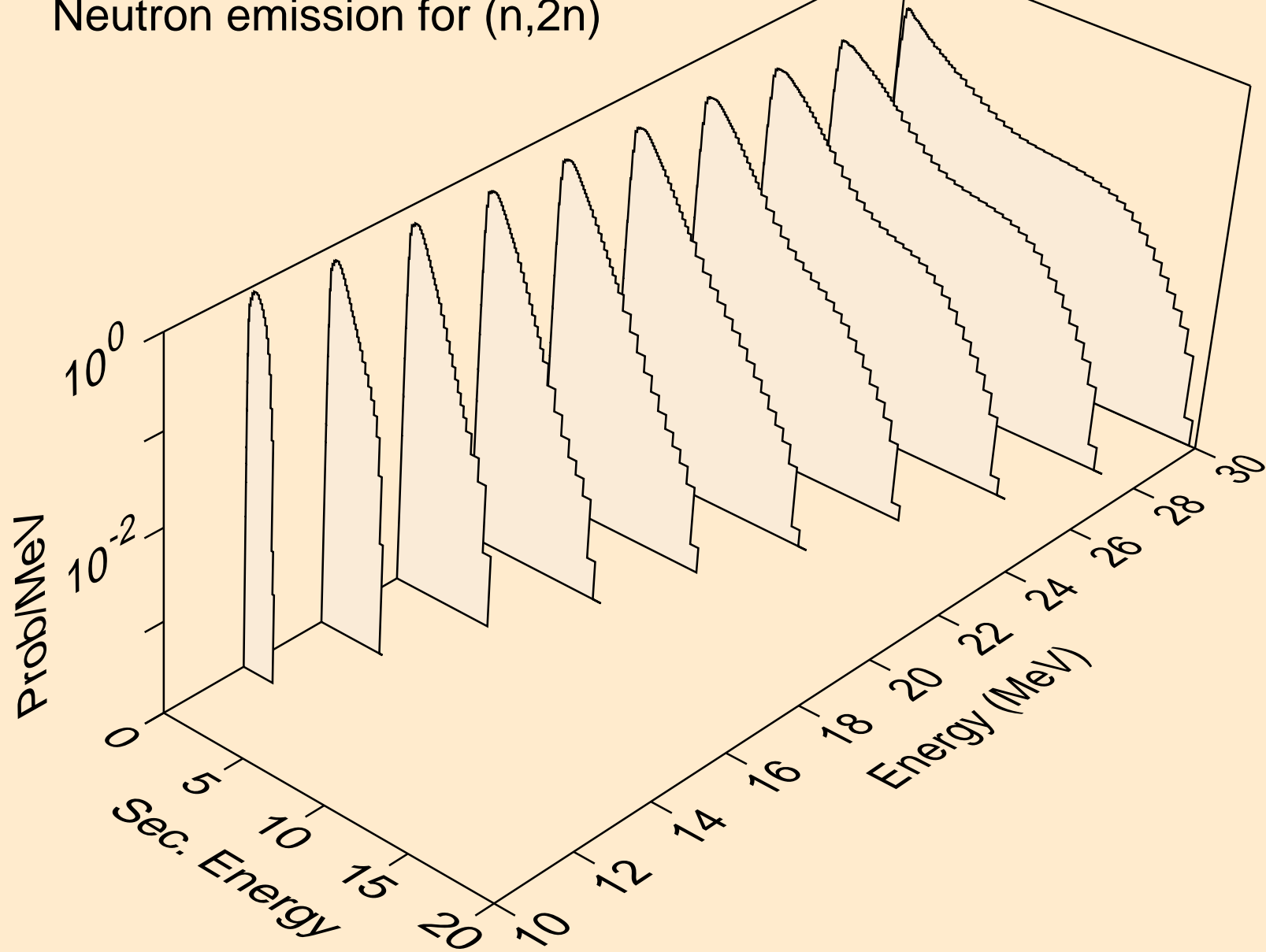

PT180 NEUTRON ACER TENDL-2021 LIBRARY; T=293.6K
Neutron emission for (n,3n)

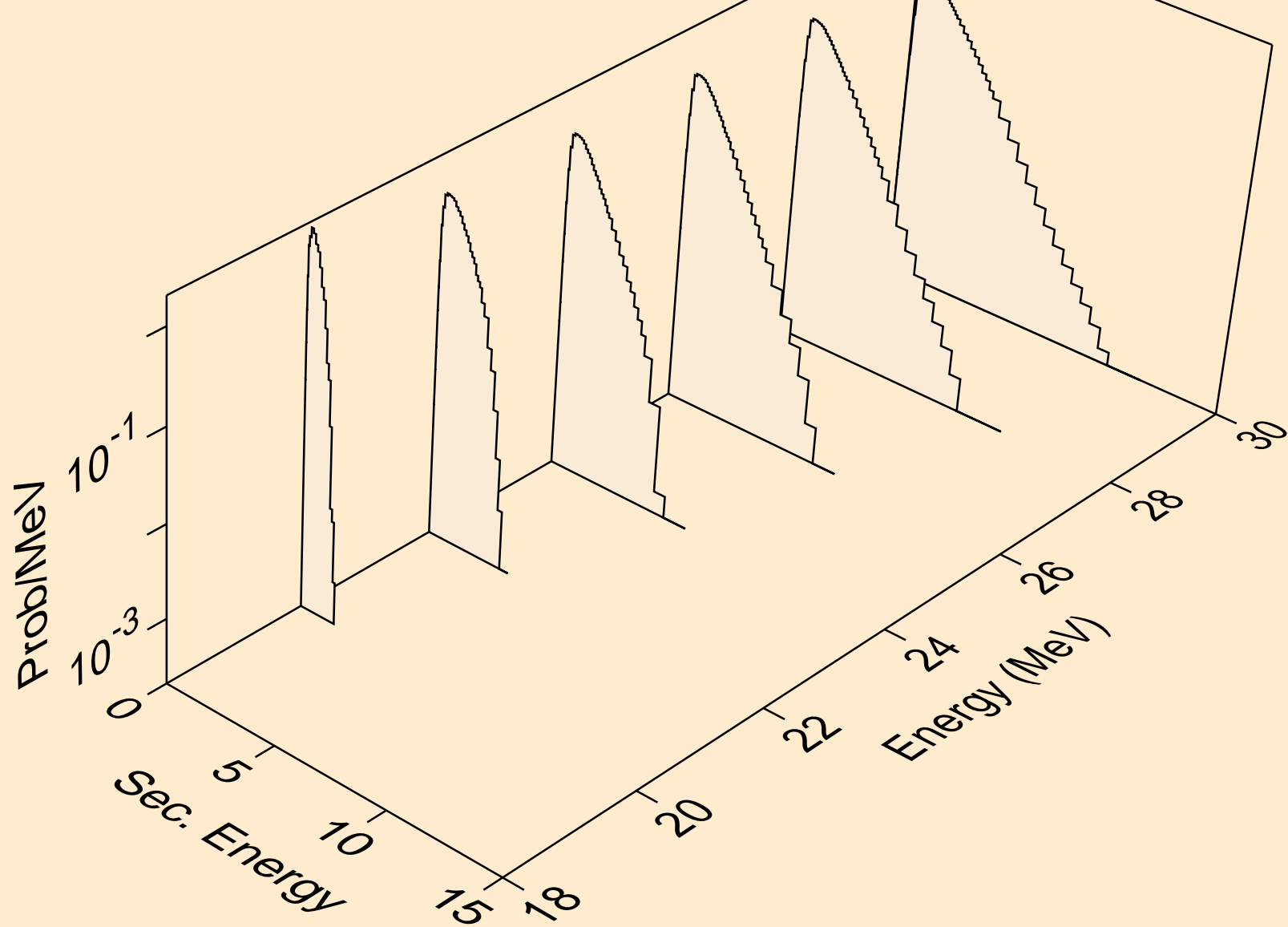

PT180 NEUTRON ACER TENDL-2021 LIBRARY; T=293.6K
Neutron emission for (n,n*)a

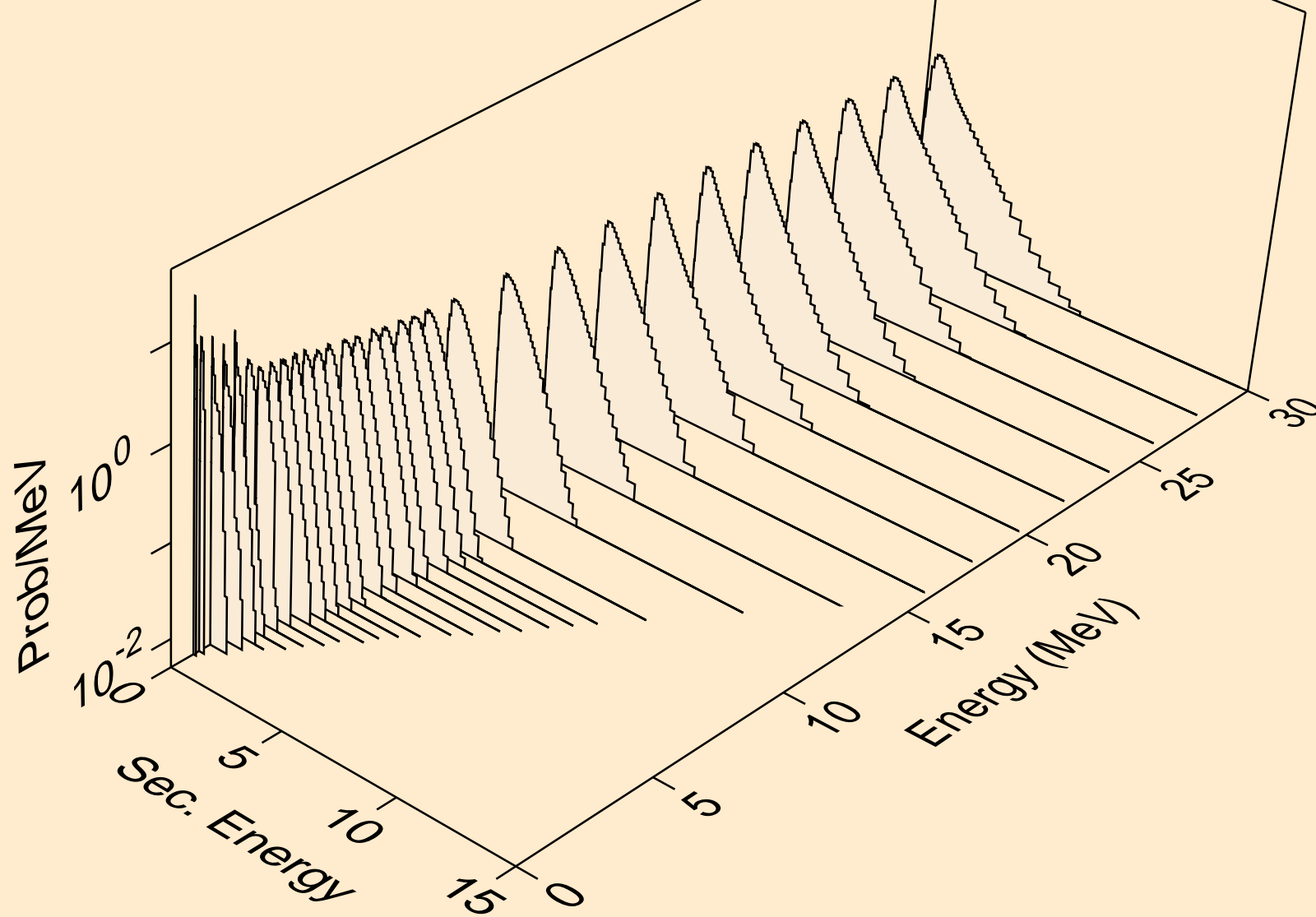

PT180 NEUTRON ACER TENDL-2021 LIBRARY; T=293.6K
Neutron emission for (n,2n)_a

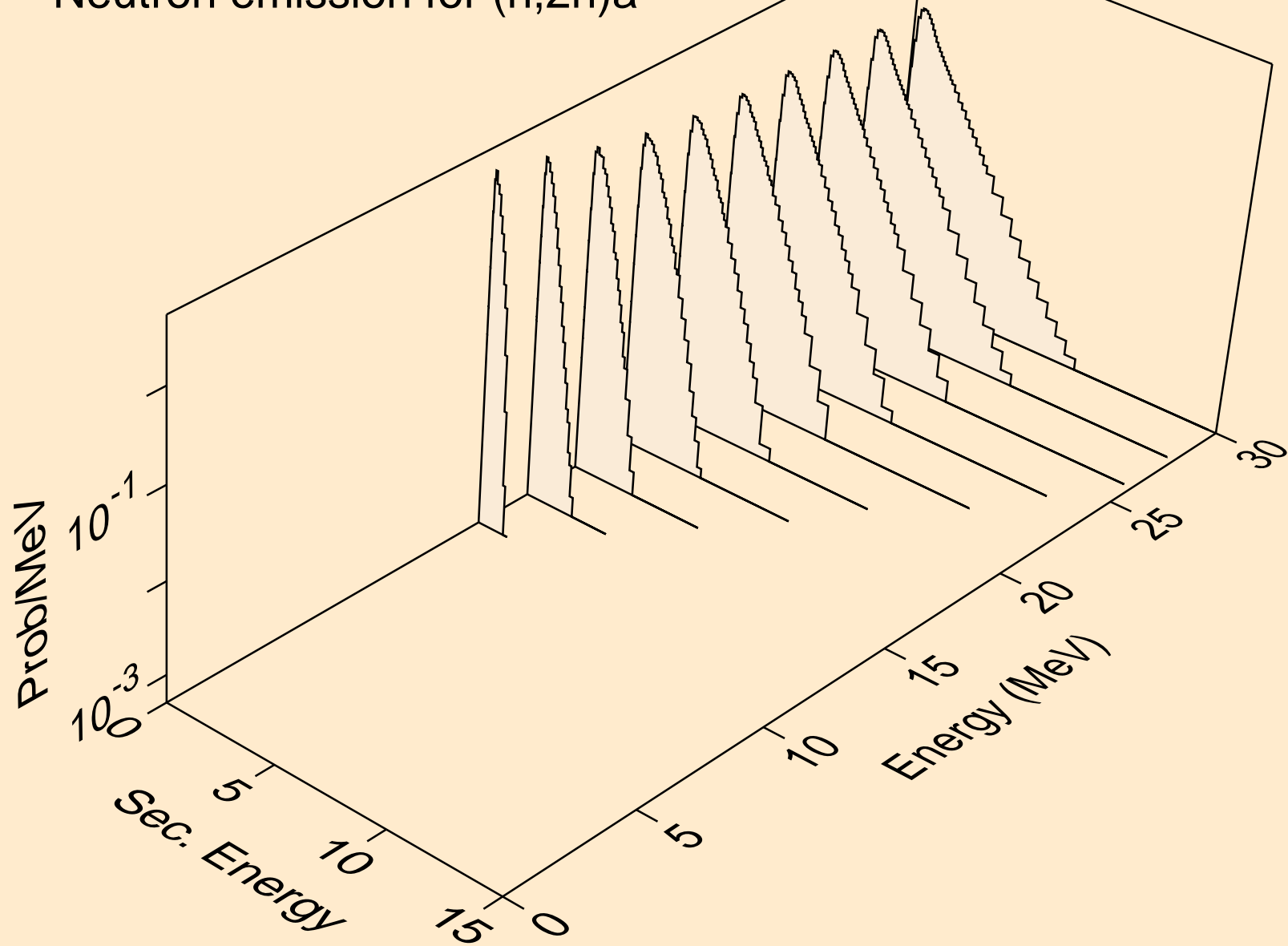

PT180 NEUTRON ACER TENDL-2021 LIBRARY; T=293.6K
Neutron emission for (n,3n)a

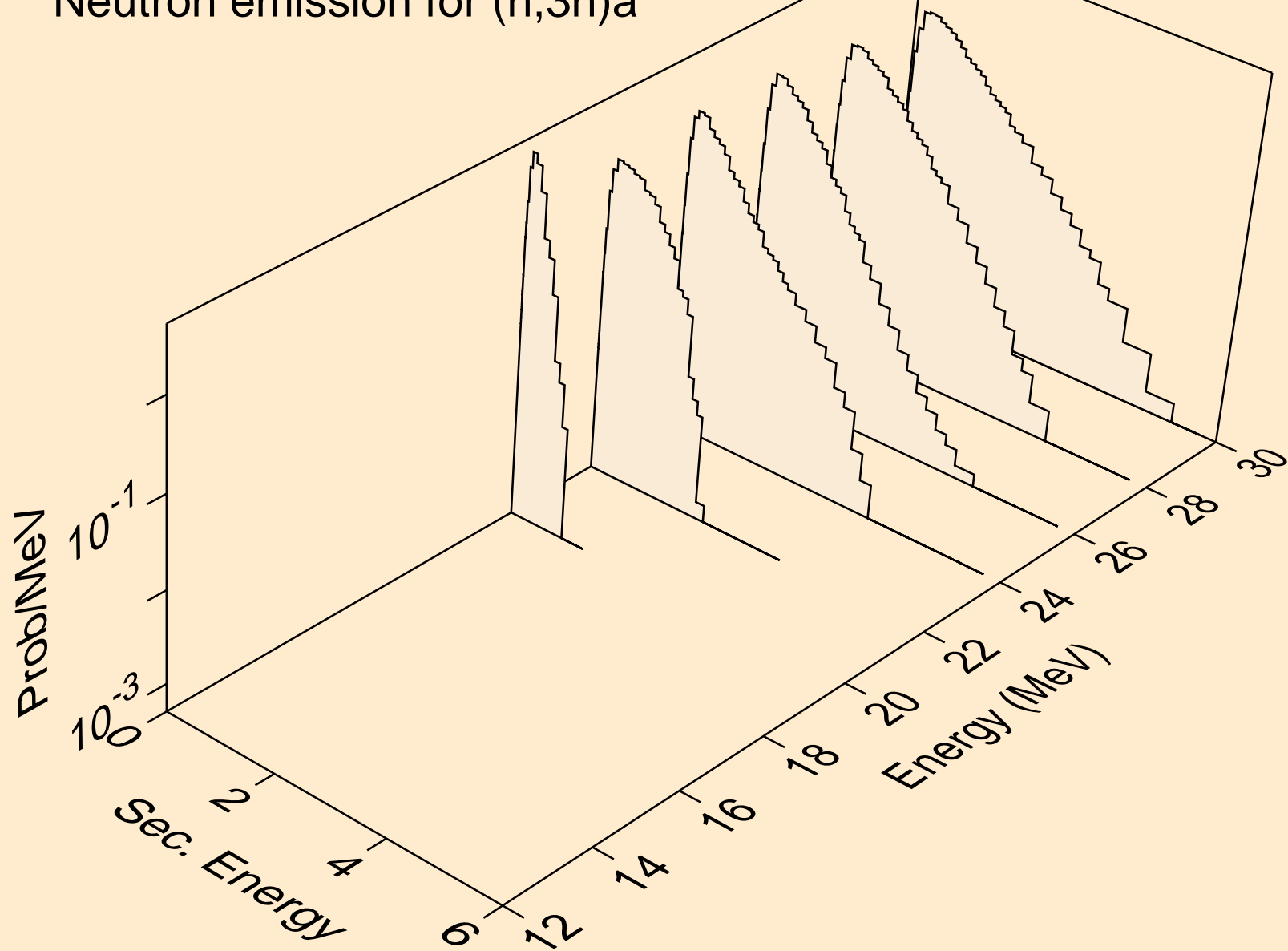

PT180 NEUTRON ACER TENDL-2021 LIBRARY; T=293.6K
Neutron emission for (n,n*)p

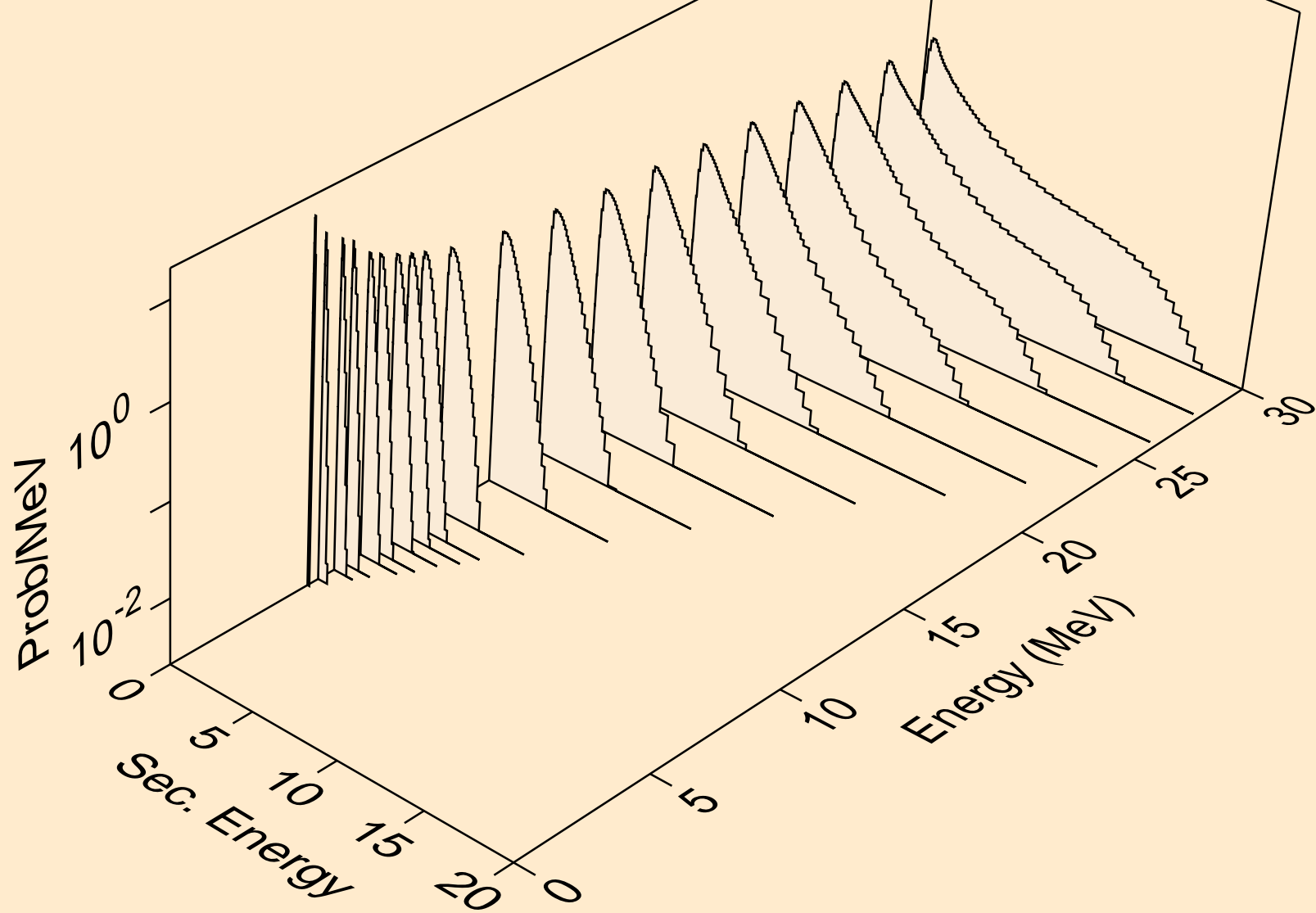

PT180 NEUTRON ACER TENDL-2021 LIBRARY; T=293.6K
Neutron emission for (n,n*)2a

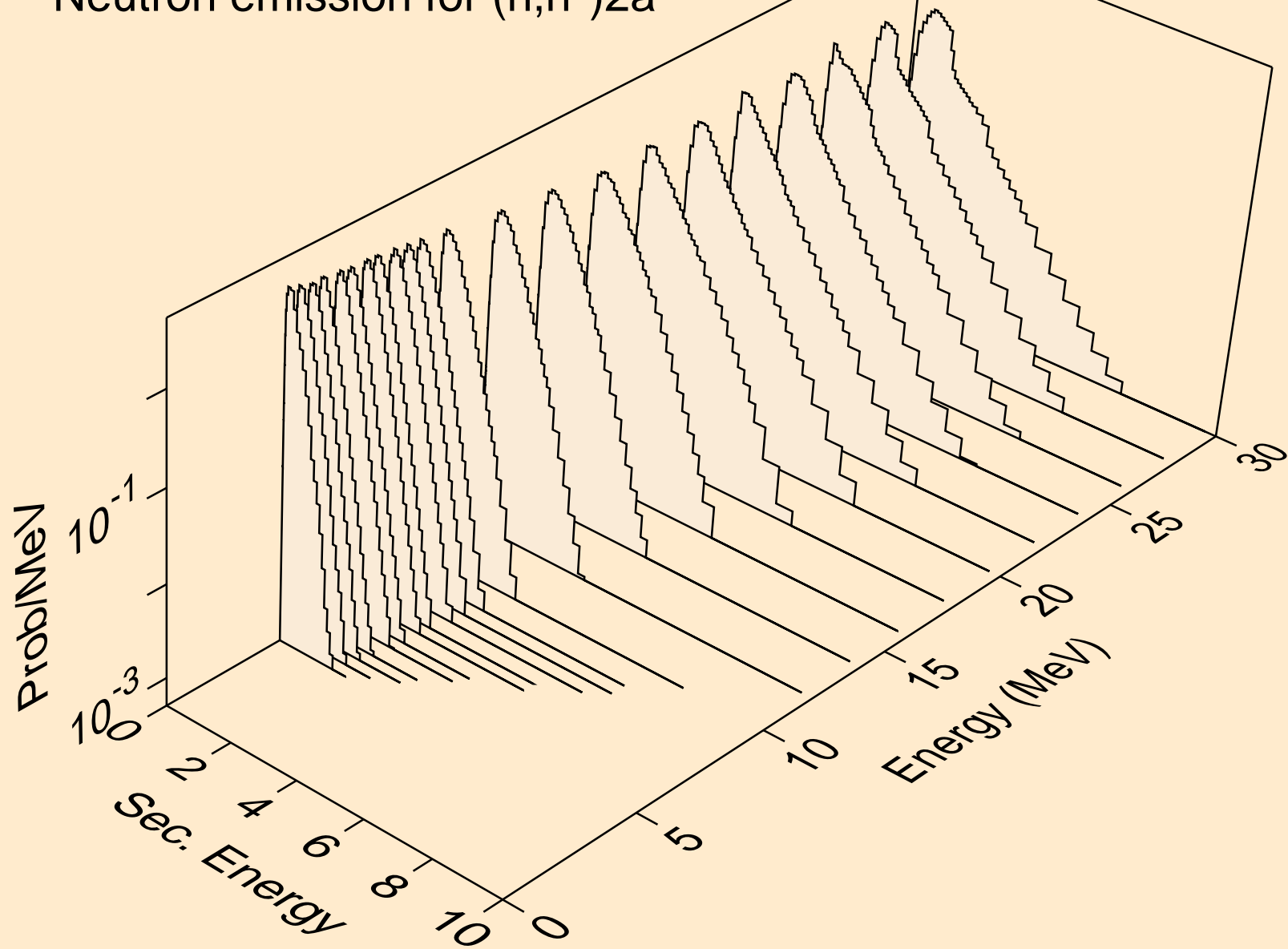

PT180 NEUTRON ACER TENDL-2021 LIBRARY; T=293.6K
Neutron emission for (n,2n)2a

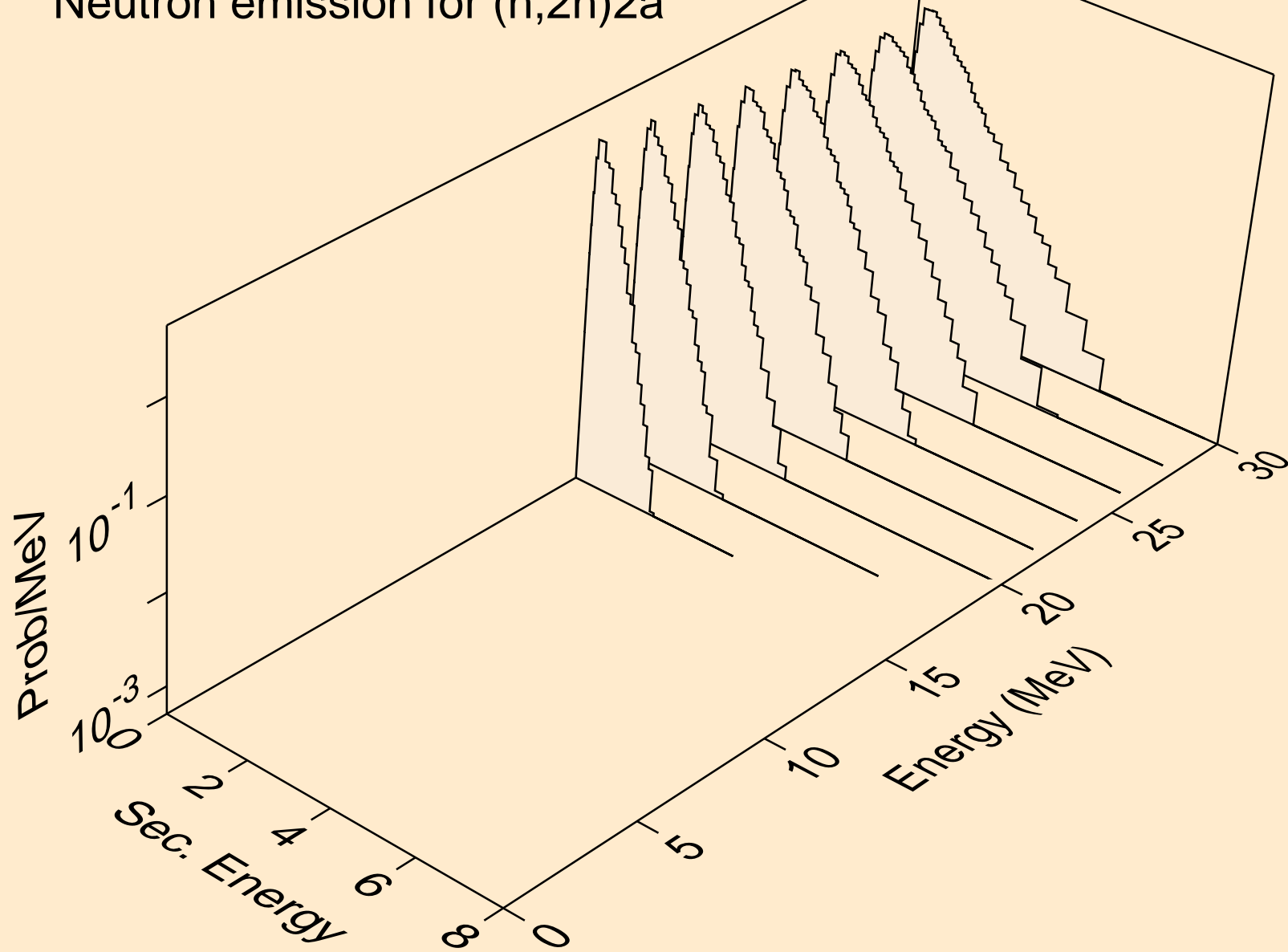

PT180 NEUTRON ACER TENDL-2021 LIBRARY; T=293.6K
Neutron emission for (n,n*)d

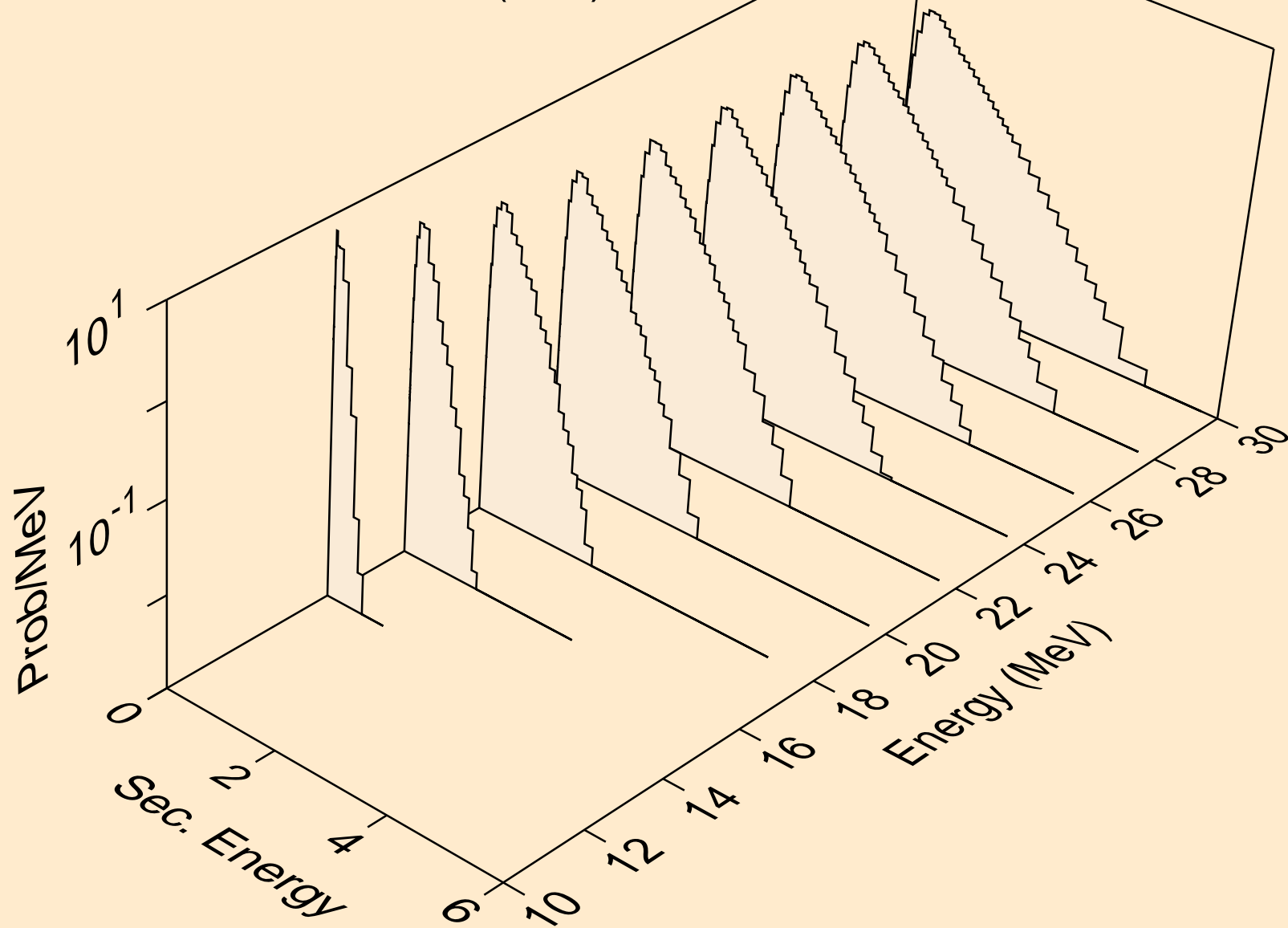

PT180 NEUTRON ACER TENDL-2021 LIBRARY; T=293.6K
Neutron emission for (n,n*)t

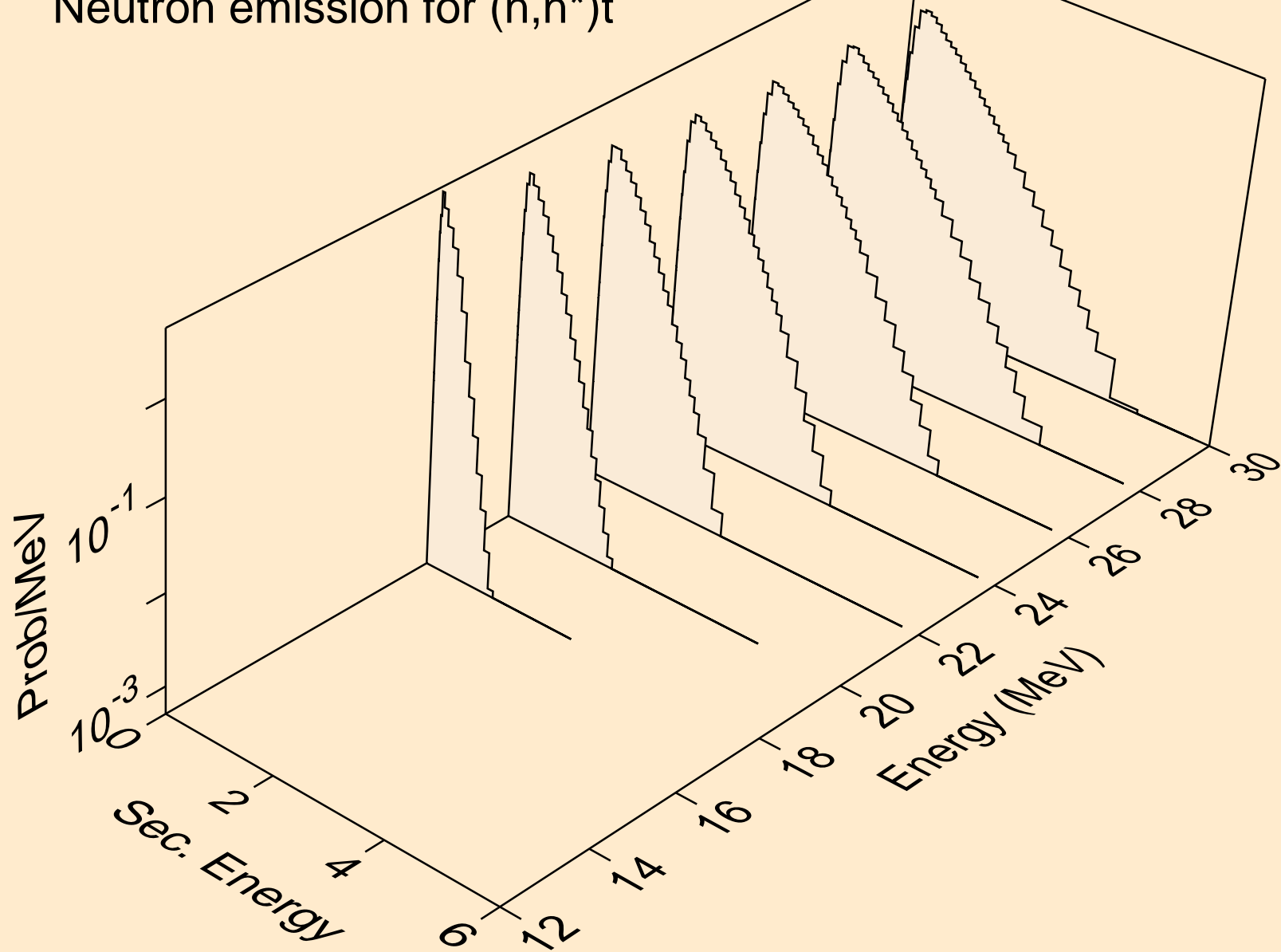

PT180 NEUTRON ACER TENDL-2021 LIBRARY; T=293.6K
Neutron emission for (n,n*)he3

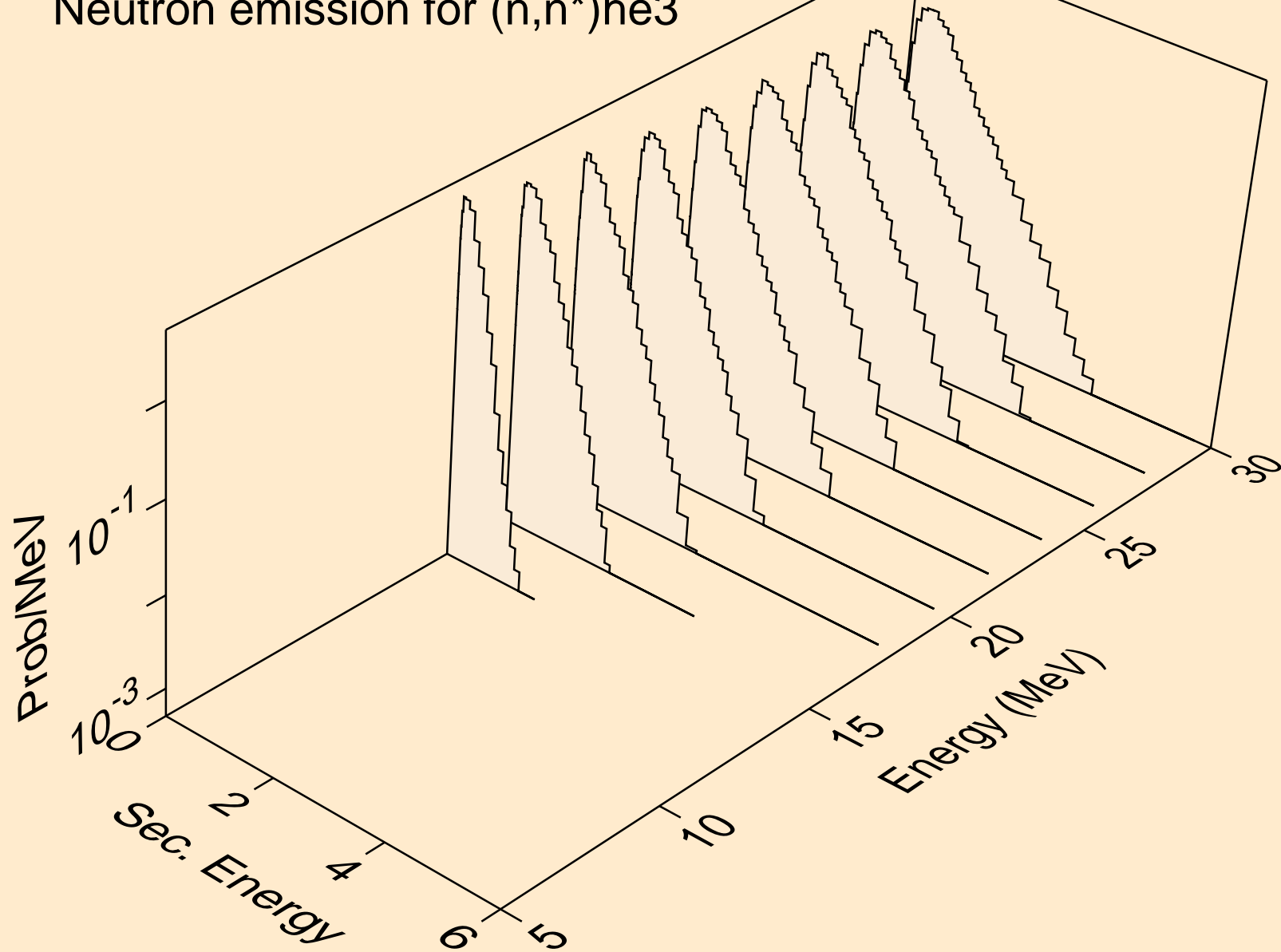

PT180 NEUTRON ACER TENDL-2021 LIBRARY; T=293.6K
Neutron emission for (n,2np)

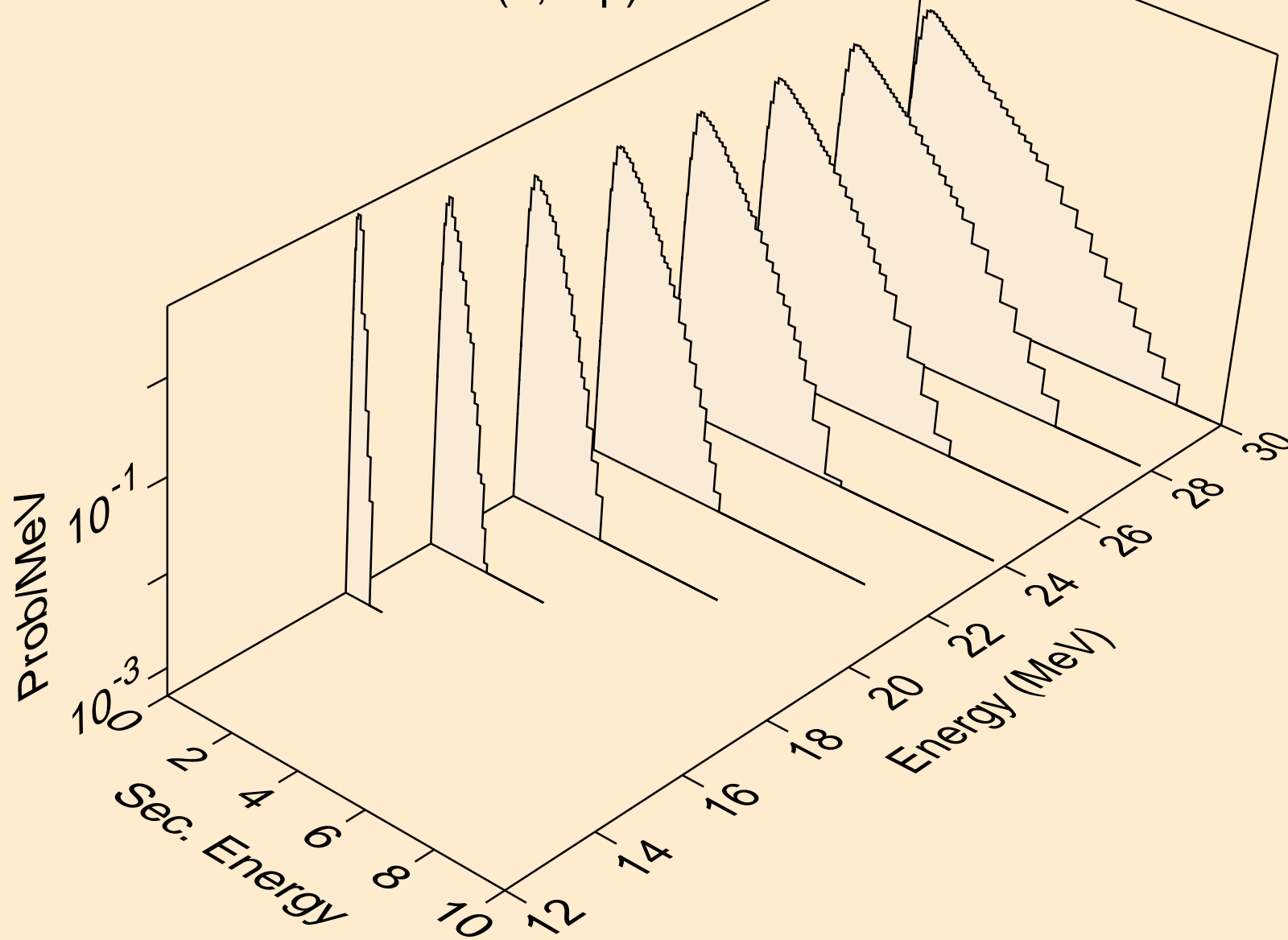

PT180 NEUTRON ACER TENDL-2021 LIBRARY; T=293.6K
Neutron emission for (n,3np)

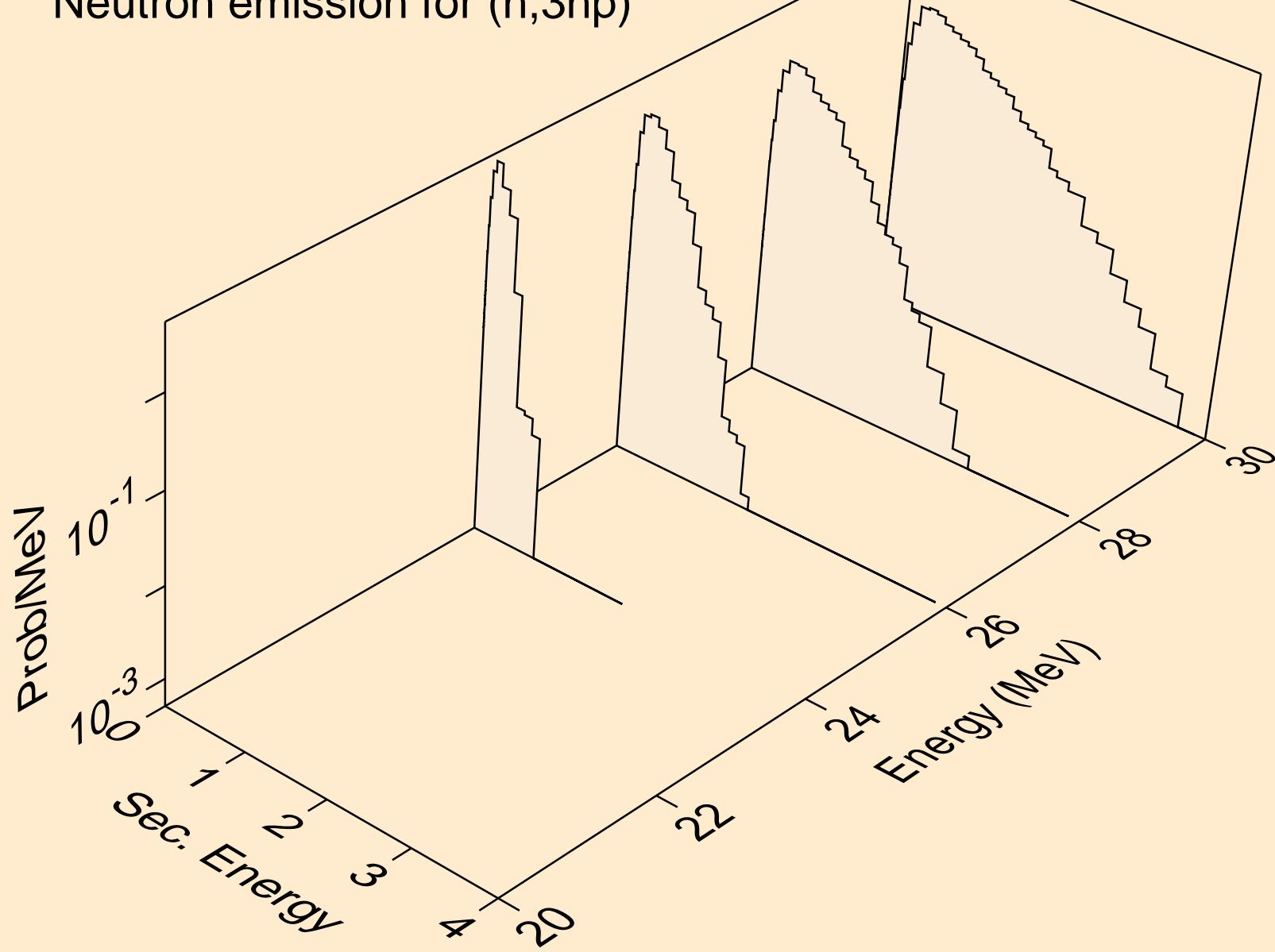

PT180 NEUTRON ACER TENDL-2021 LIBRARY; T=293.6K
Neutron emission for (n,2np)

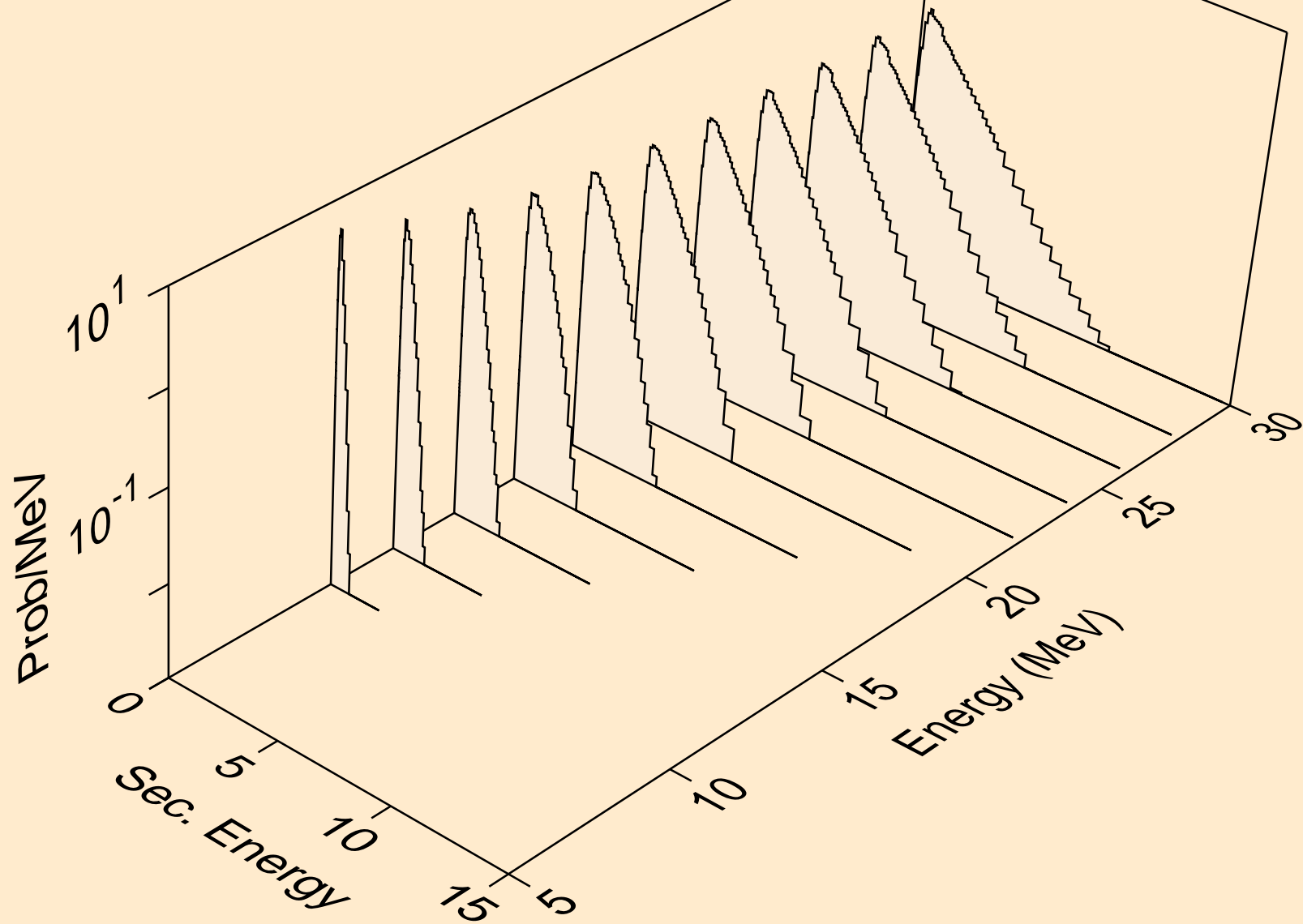

PT180 NEUTRON ACER TENDL-2021 LIBRARY; T=293.6K
Neutron emission for (n,npa)

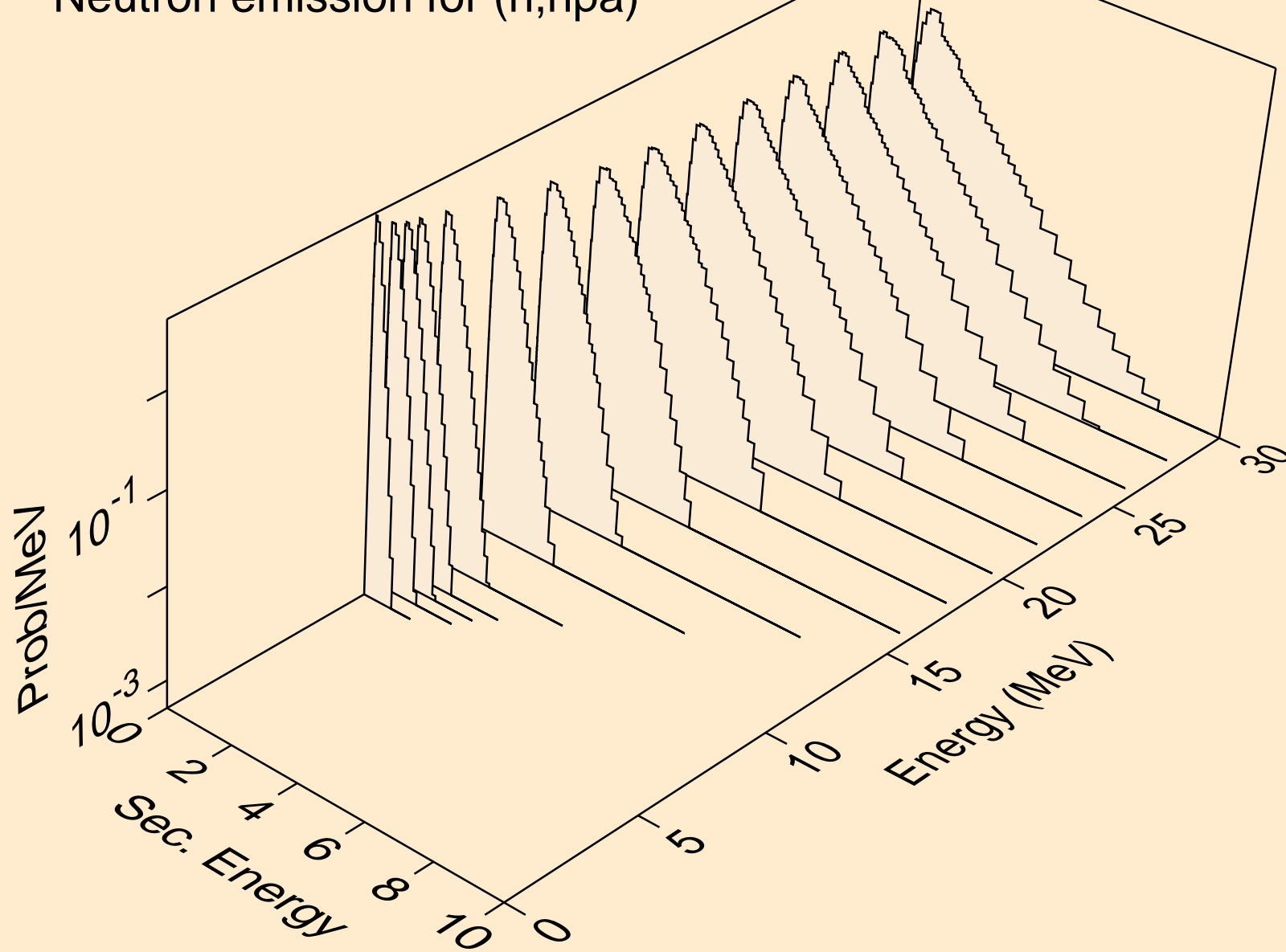

PT180 NEUTRON ACER TENDL-2021 LIBRARY; T=293.6K
Neutron emission for (n,n*c)

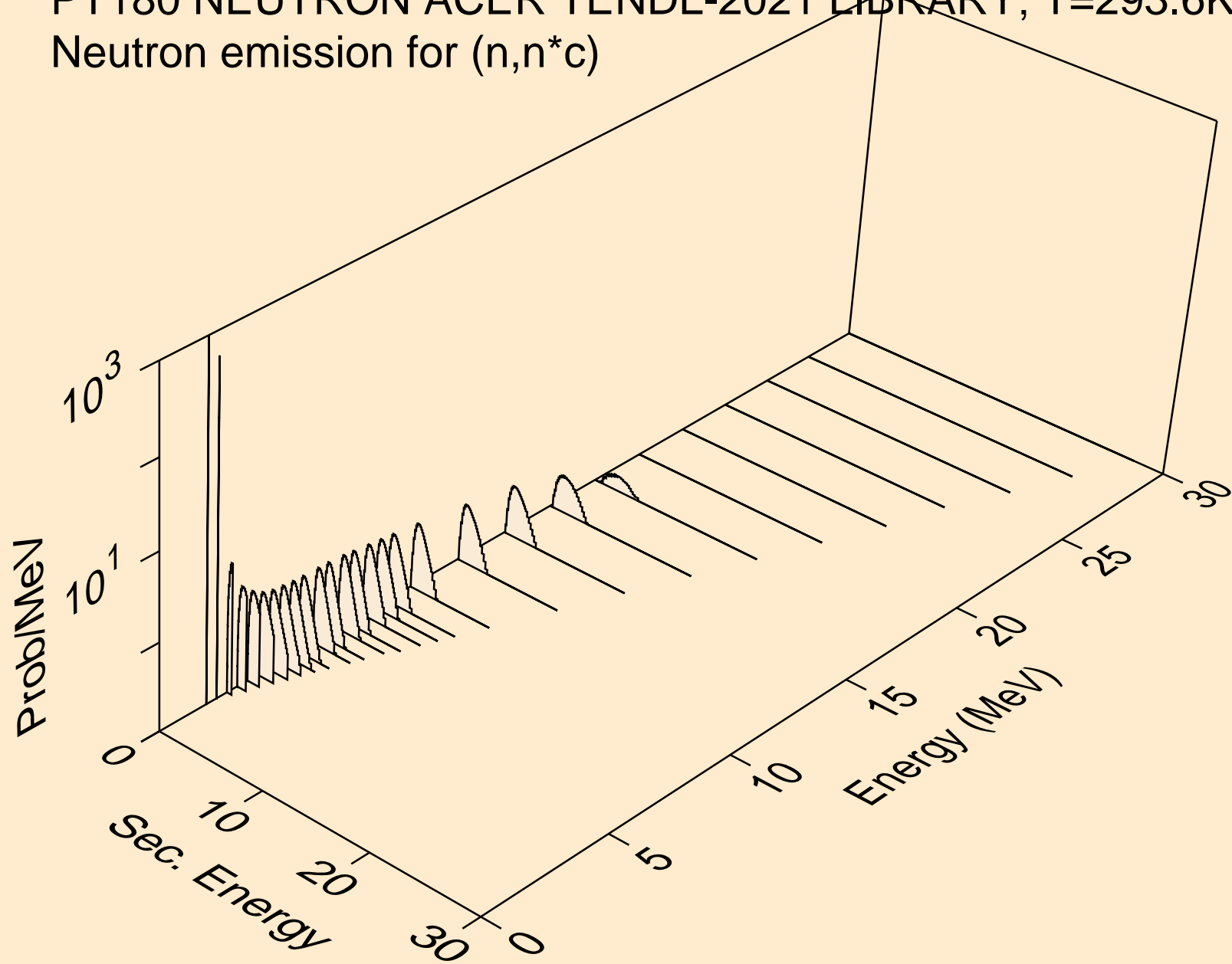

PT180 NEUTRON ACER TENDL-2021 LIBRARY; T=293.6K
Photon emission for (n,x)

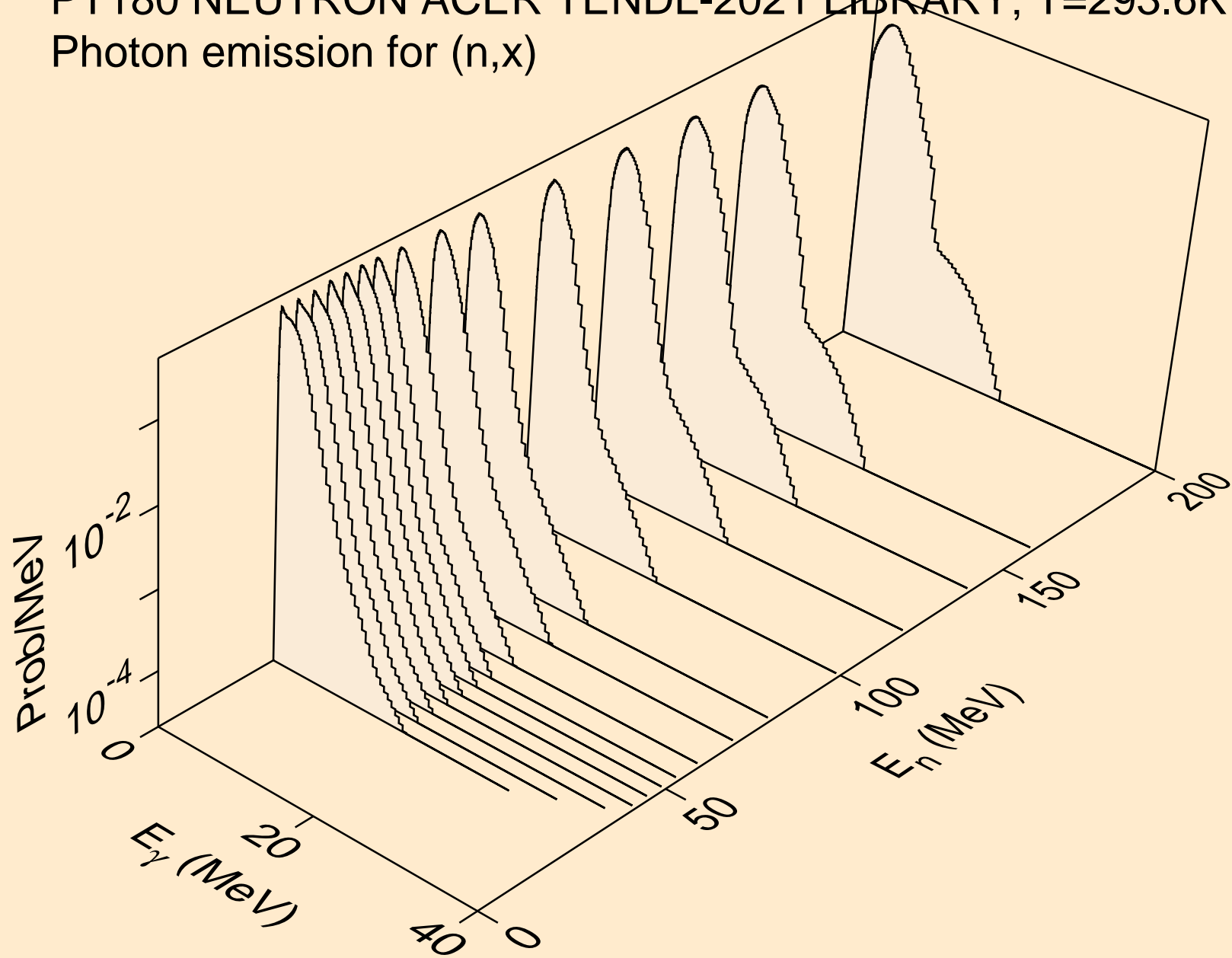

PT180 NEUTRON ACER TENDL-2021 LIBRARY; T=293.6K
Photon emission for (n,2nd)

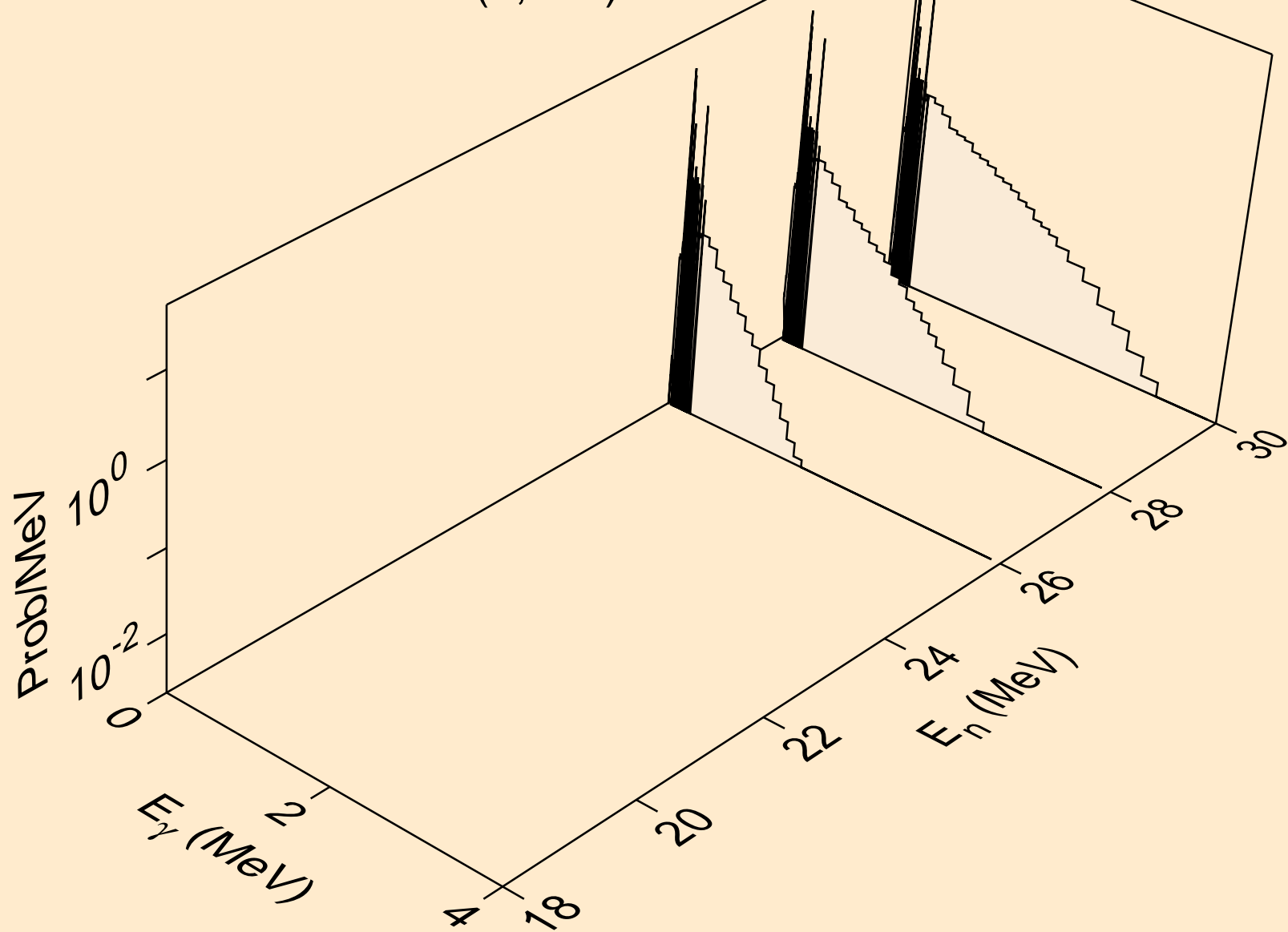

PT180 NEUTRON ACER TENDL-2021 LIBRARY; T=293.6K
Photon emission for (n,2n)

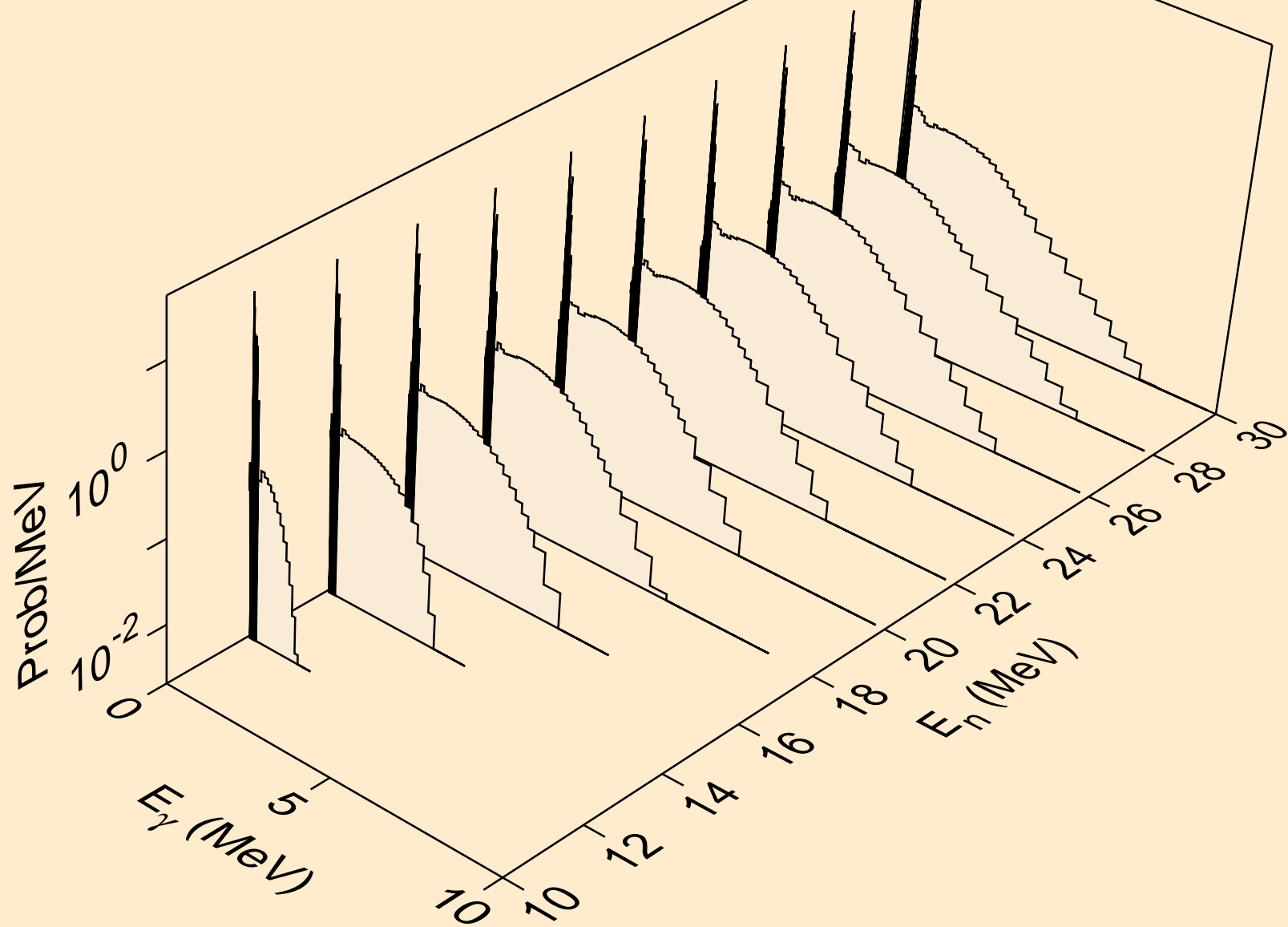

PT180 NEUTRON ACER TENDL-2021 LIBRARY; T=293.6K
Photon emission for (n,3n)

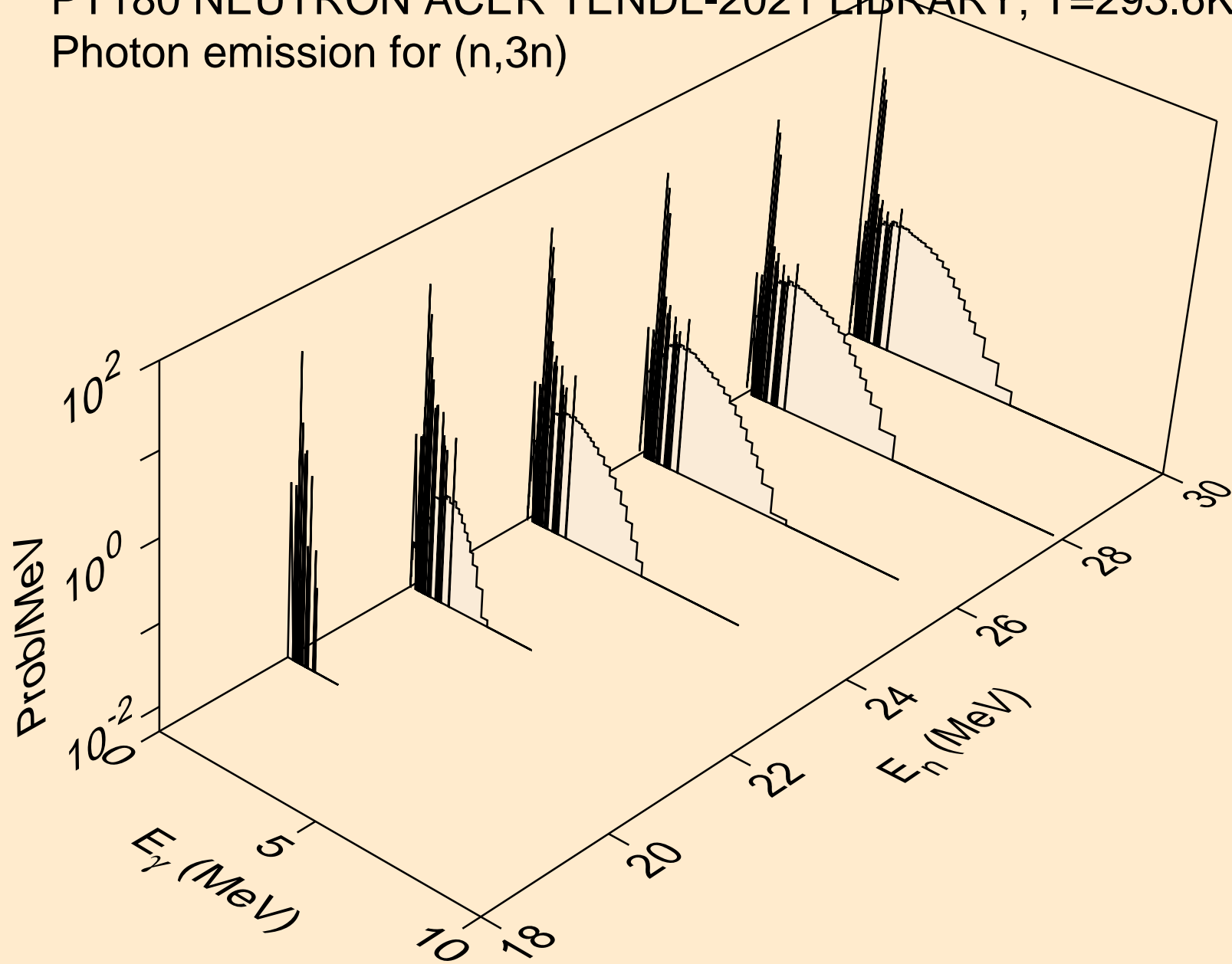

PT180 NEUTRON ACER TENDL-2021 LIBRARY; T=293.6K
Photon emission for (n,n*)a

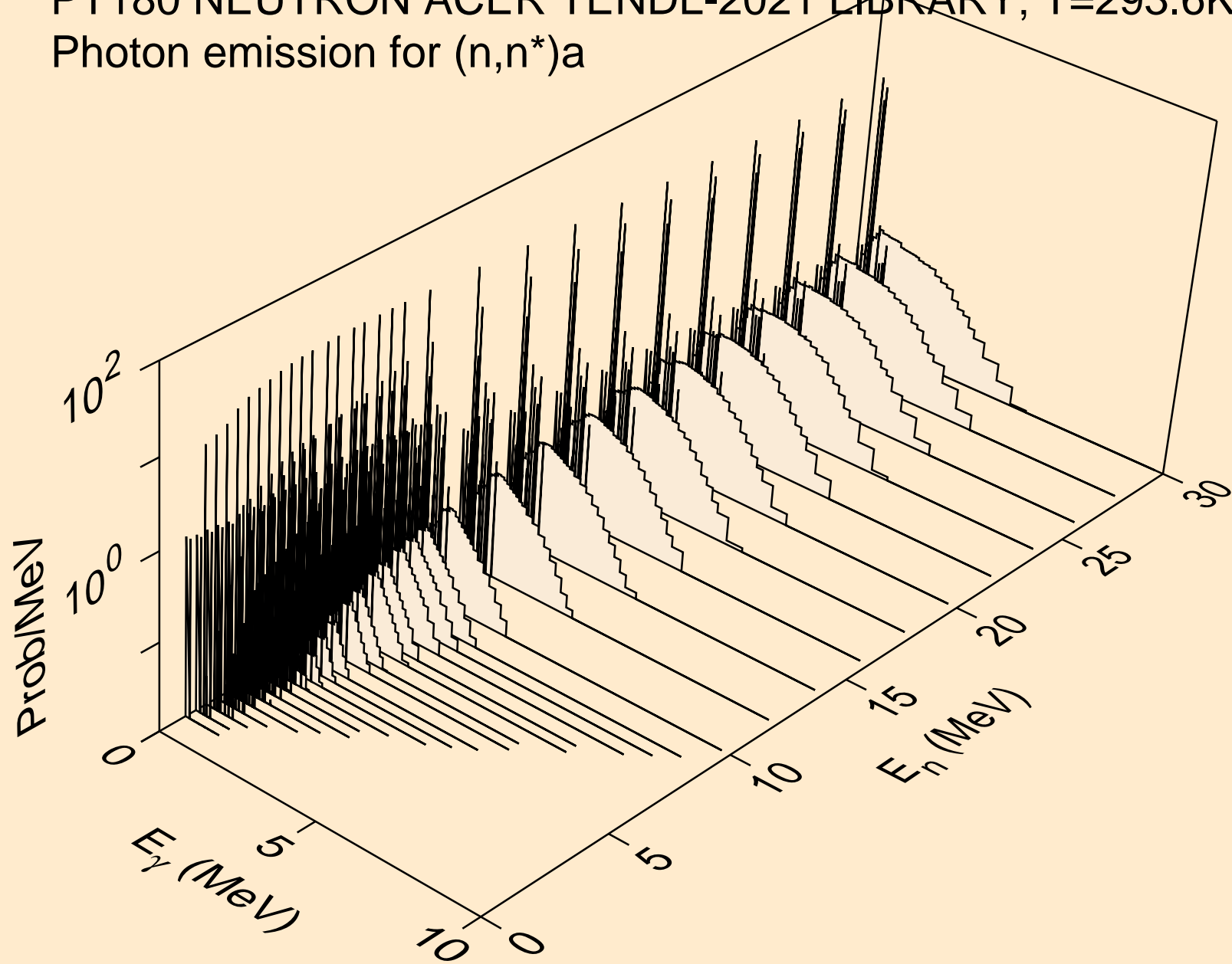

PT180 NEUTRON ACER TENDL-2021 LIBRARY; T=293.6K
Photon emission for (n,2n)a

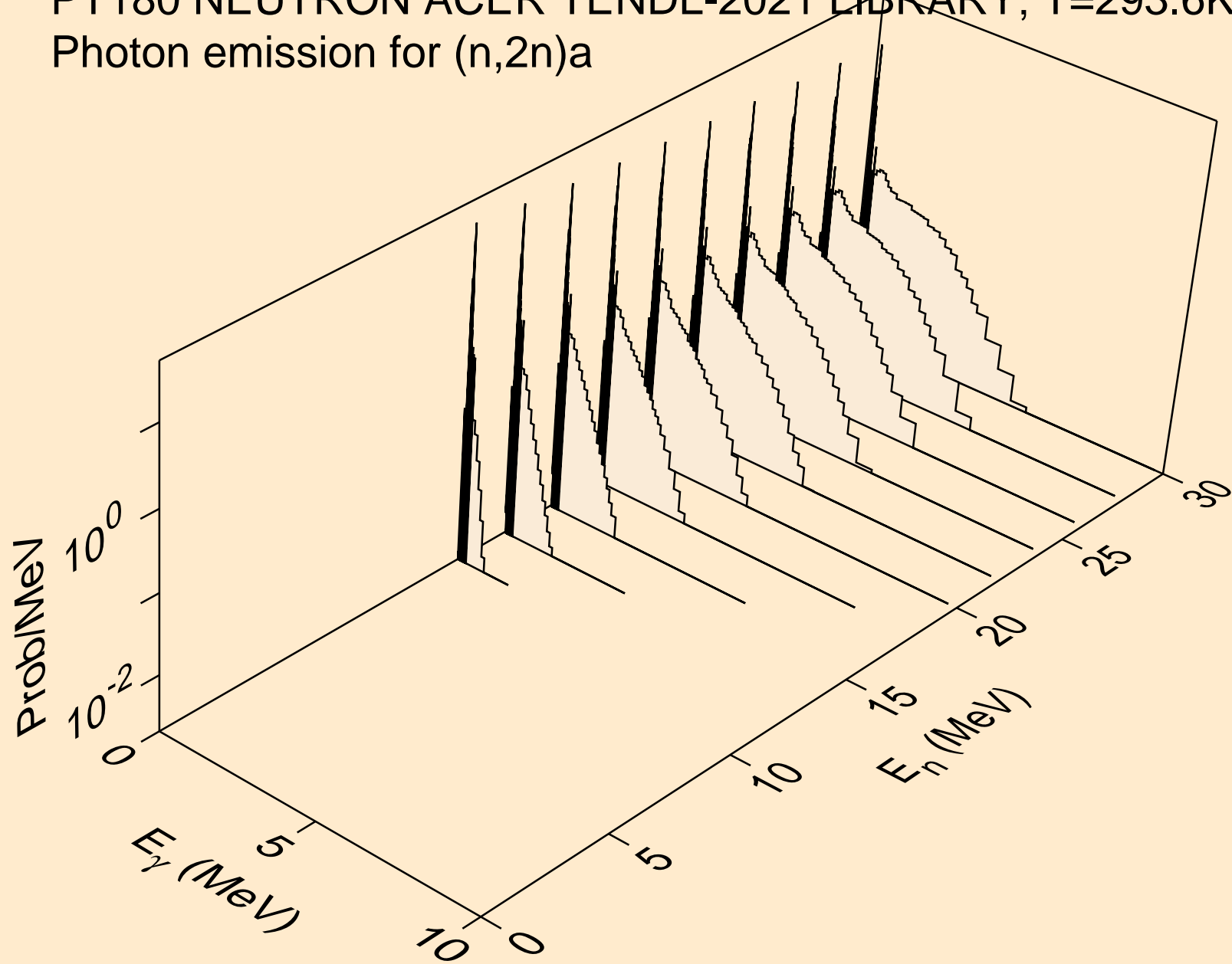

PT180 NEUTRON ACER TENDL-2021 LIBRARY; T=293.6K
Photon emission for (n,3n)a

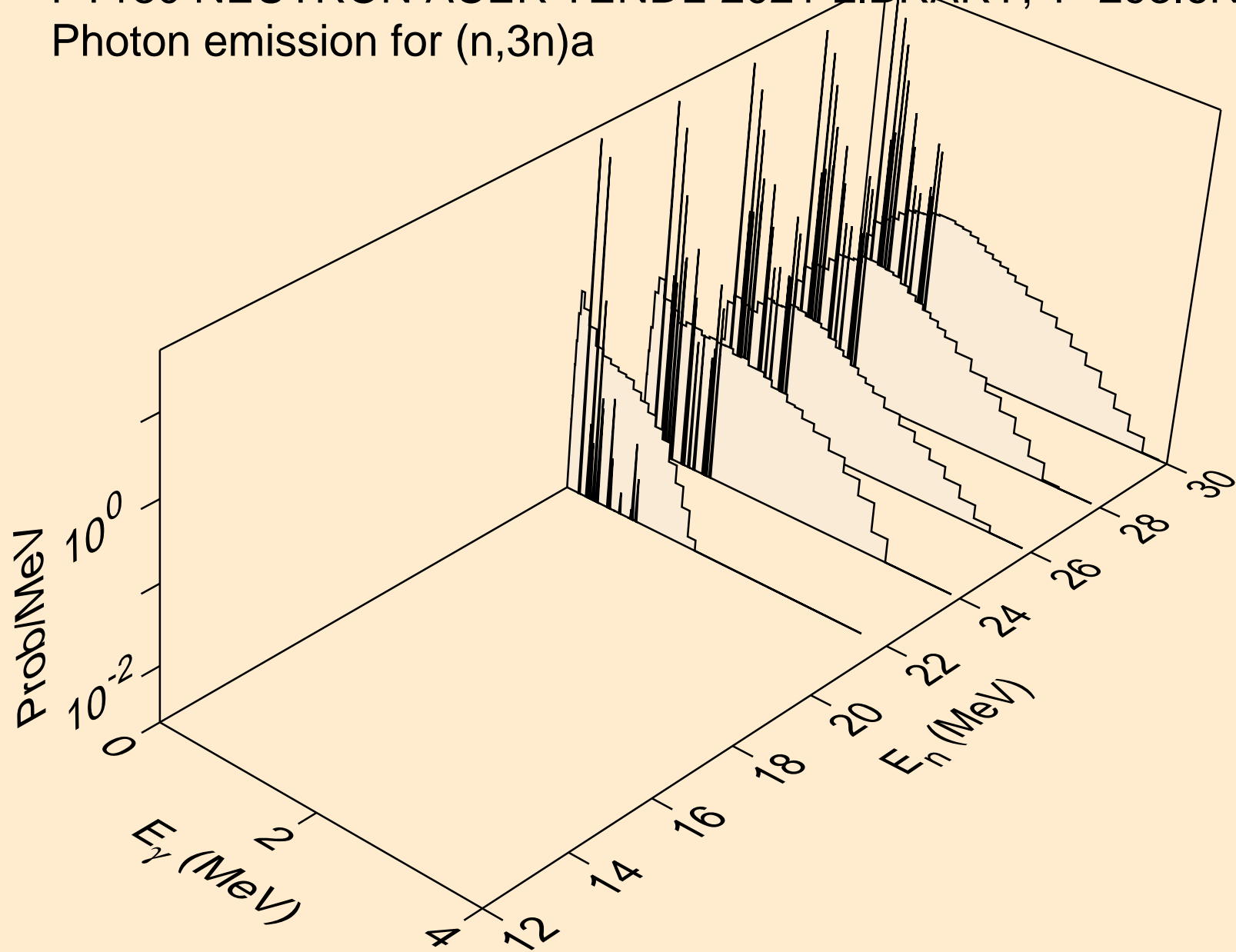

PT180 NEUTRON ACER TENDL-2021 LIBRARY; T=293.6K
Photon emission for (n,n*)p

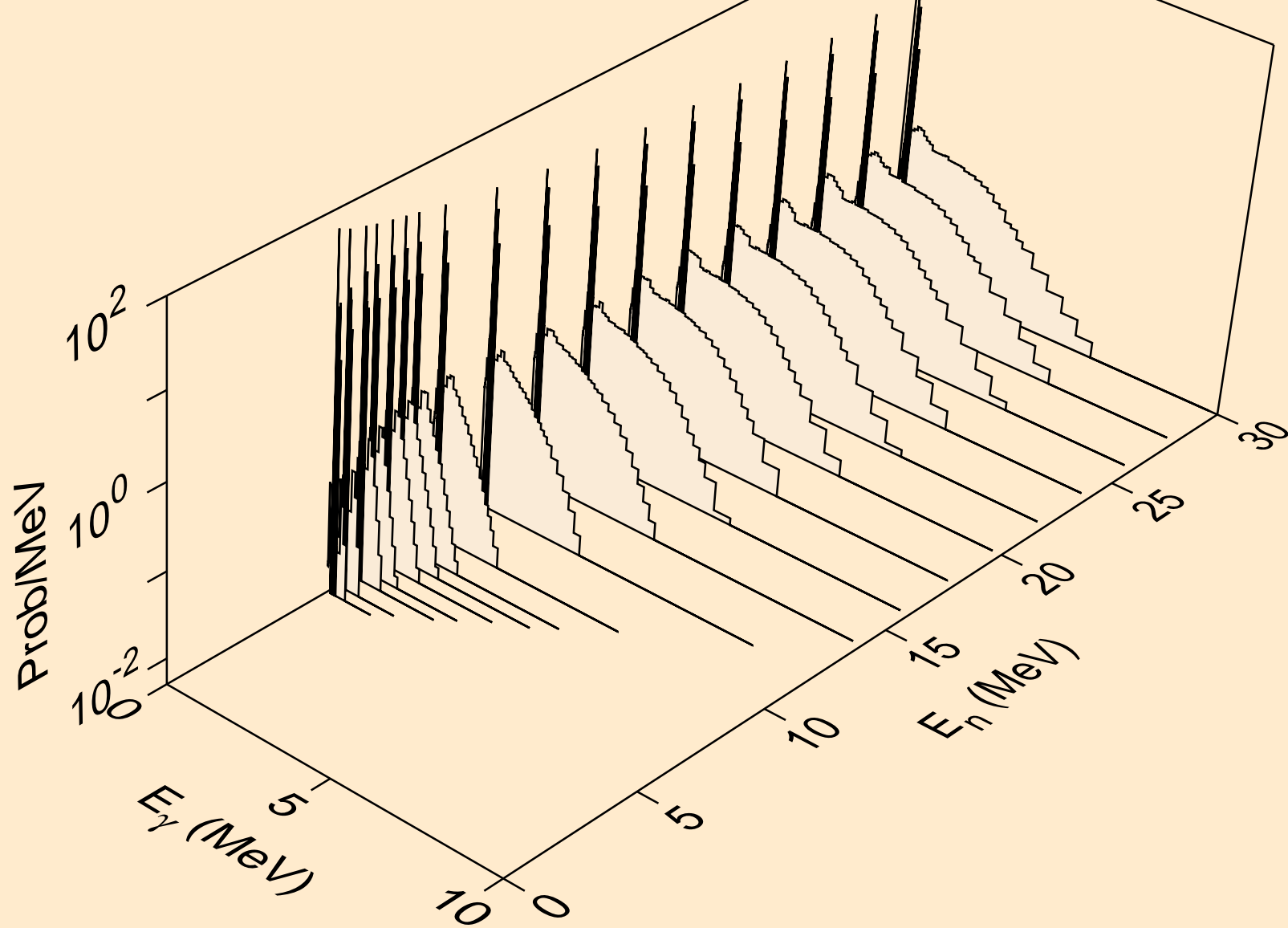

PT180 NEUTRON ACER TENDL-2021 LIBRARY; T=293.6K
Photon emission for (n,n*)2a

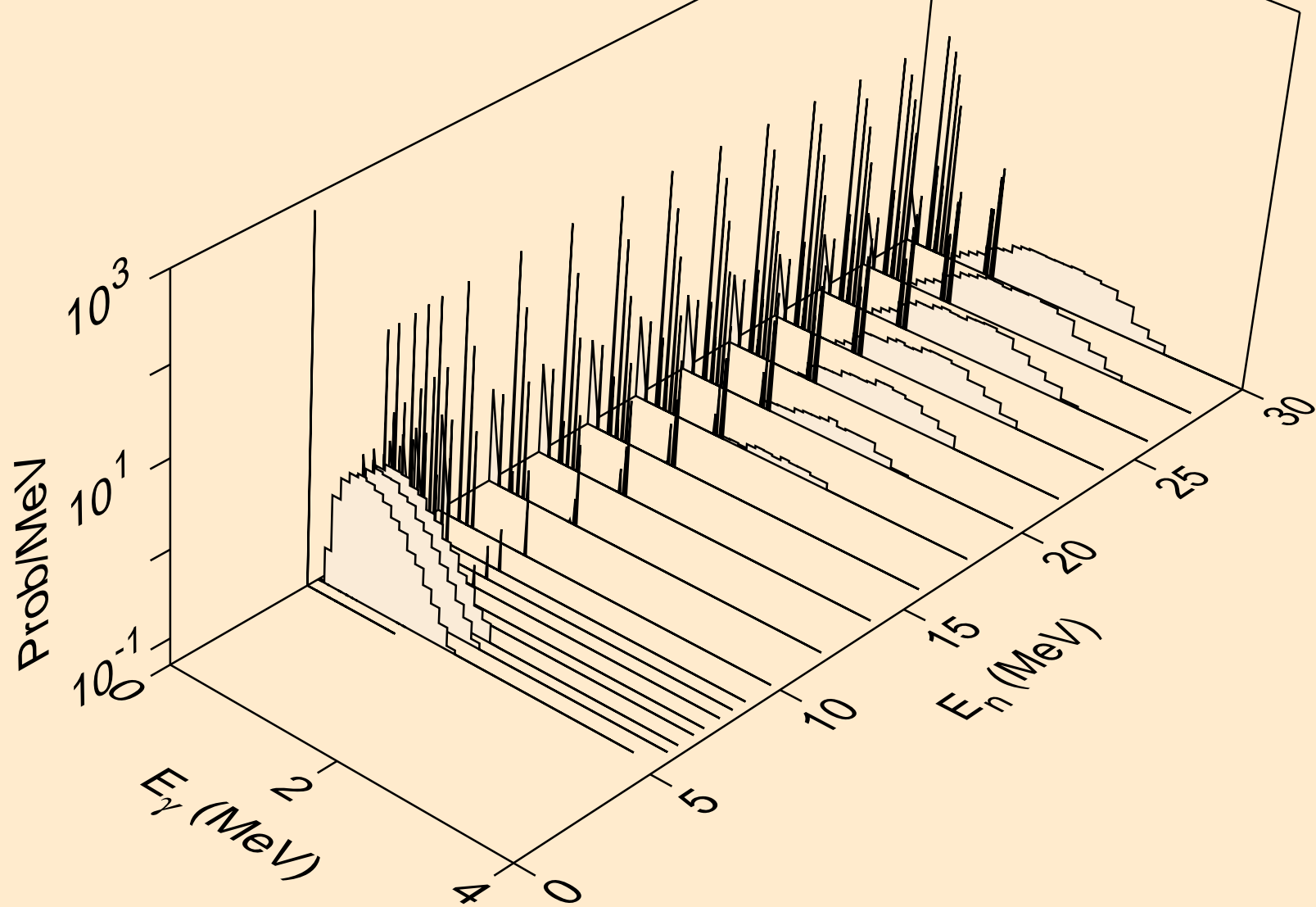

PT180 NEUTRON ACER TENDL-2021 LIBRARY; T=293.6K
Photon emission for (n,2n)2a

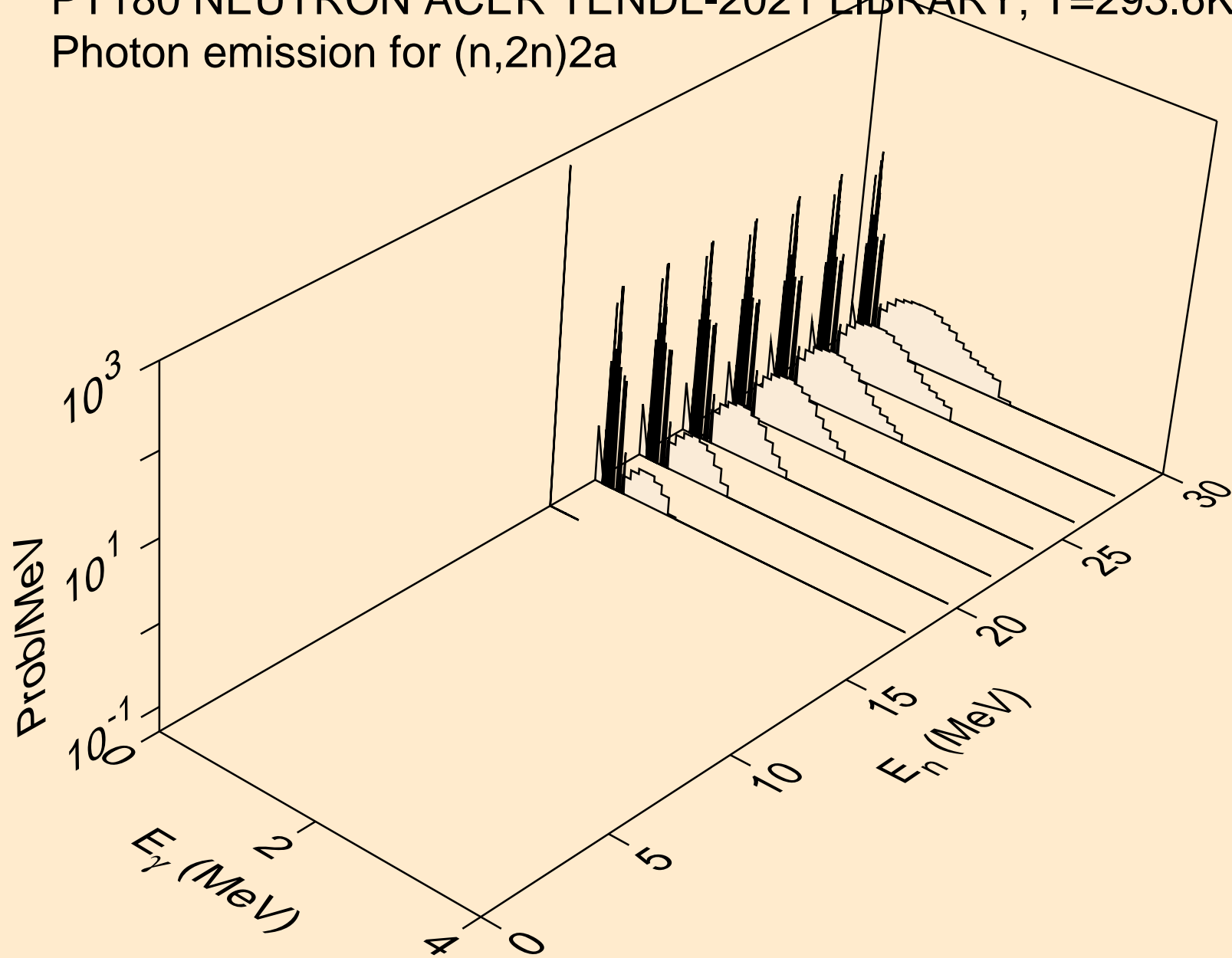

PT180 NEUTRON ACER TENDL-2021 LIBRARY; T=293.6K
Photon emission for (n,n*)d

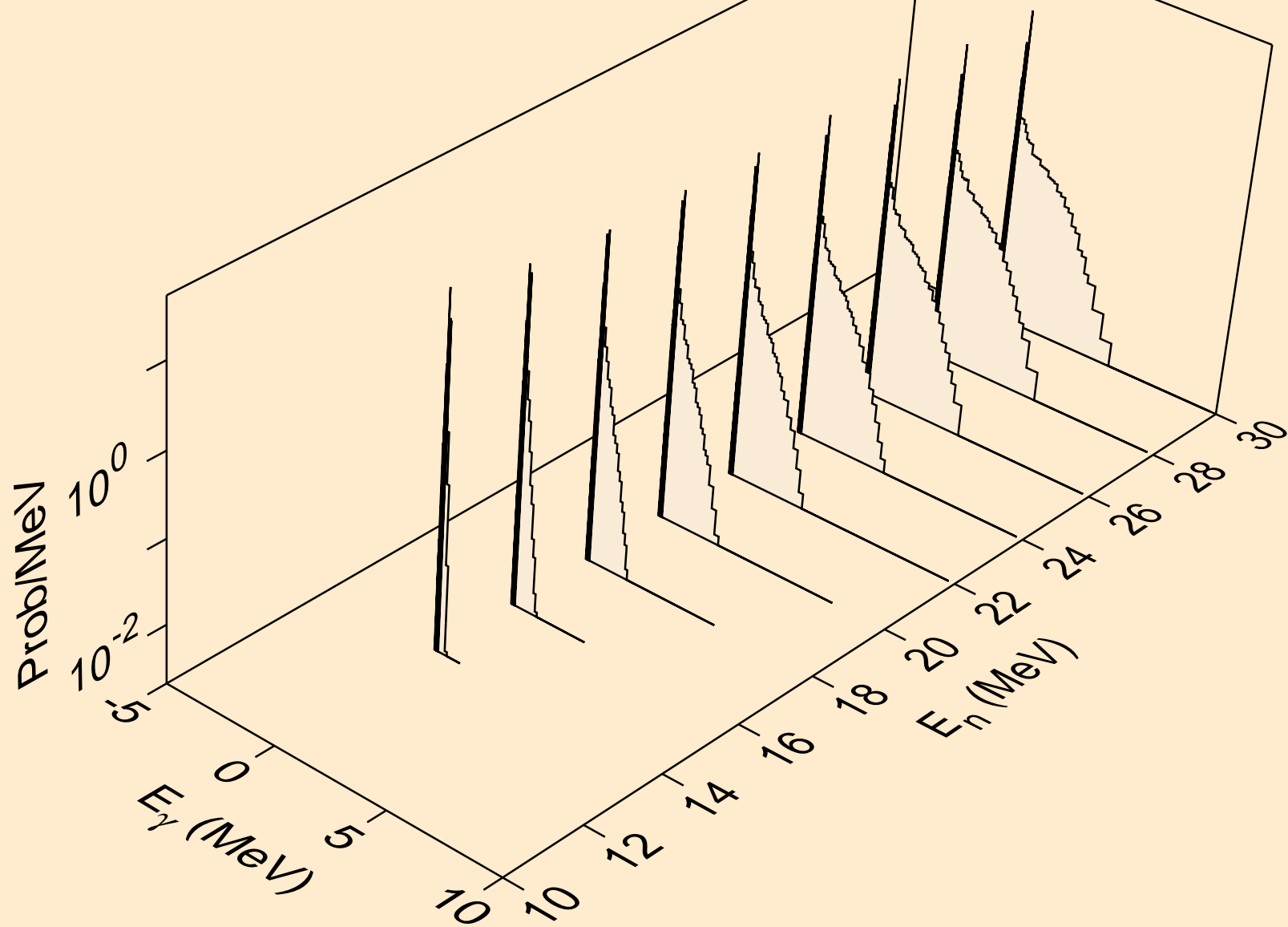

PT180 NEUTRON ACER TENDL-2021 LIBRARY; T=293.6K
Photon emission for (n,n*)t

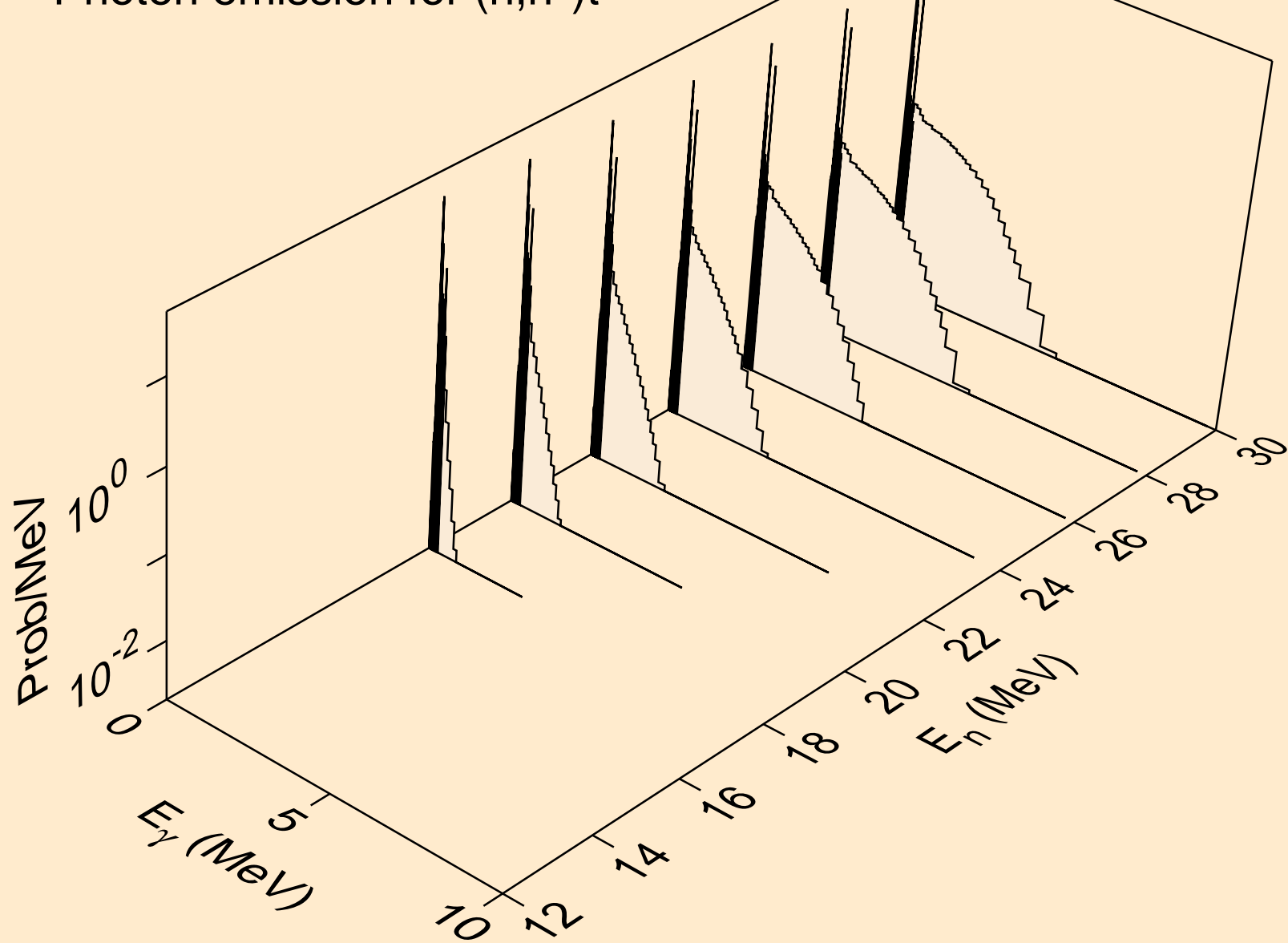

PT180 NEUTRON ACER TENDL-2021 LIBRARY; T=293.6K
Photon emission for (n,n*)he3

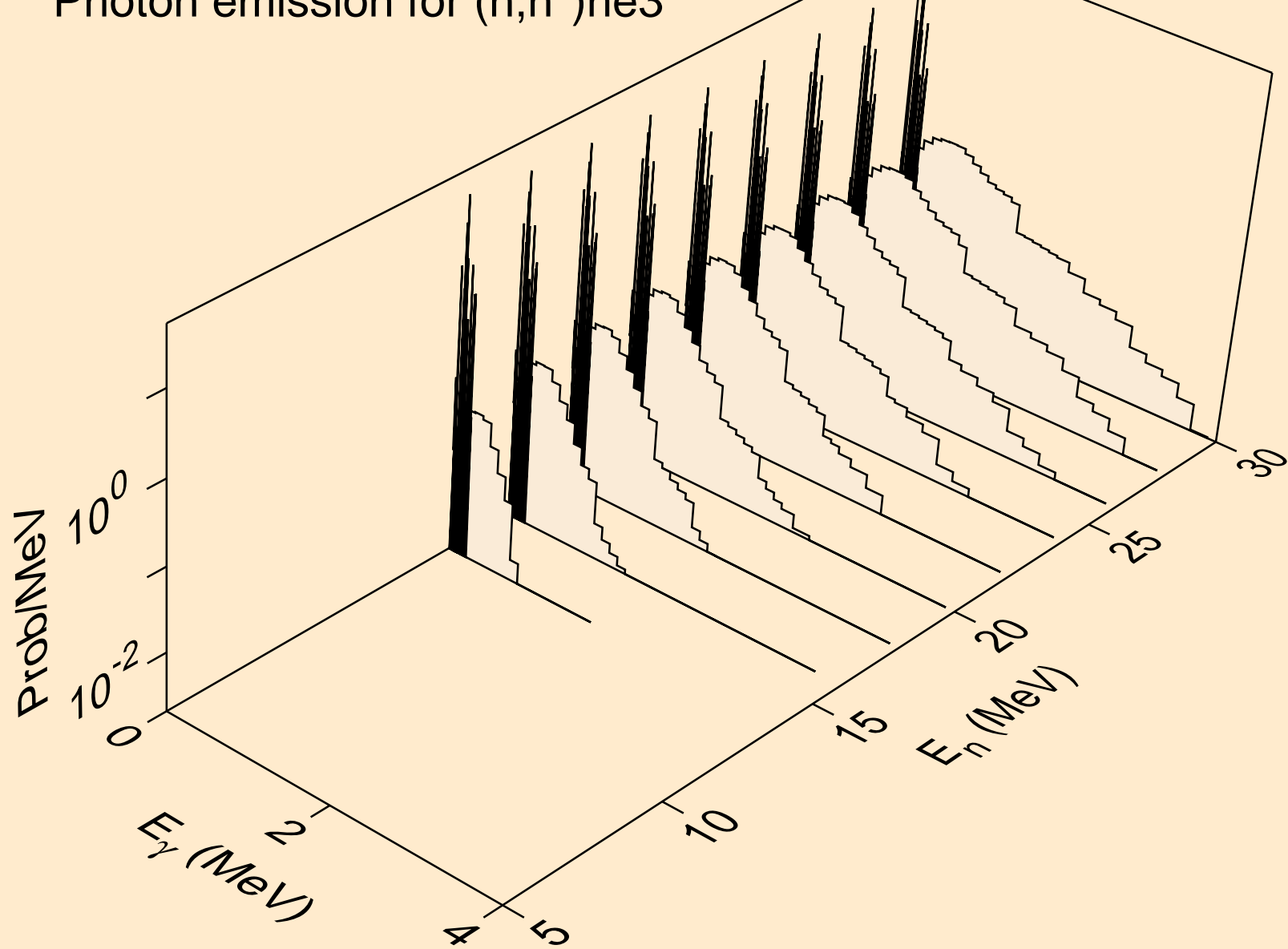

PT180 NEUTRON ACER TENDL-2021 LIBRARY; T=293.6K
Photon emission for (n,2np)

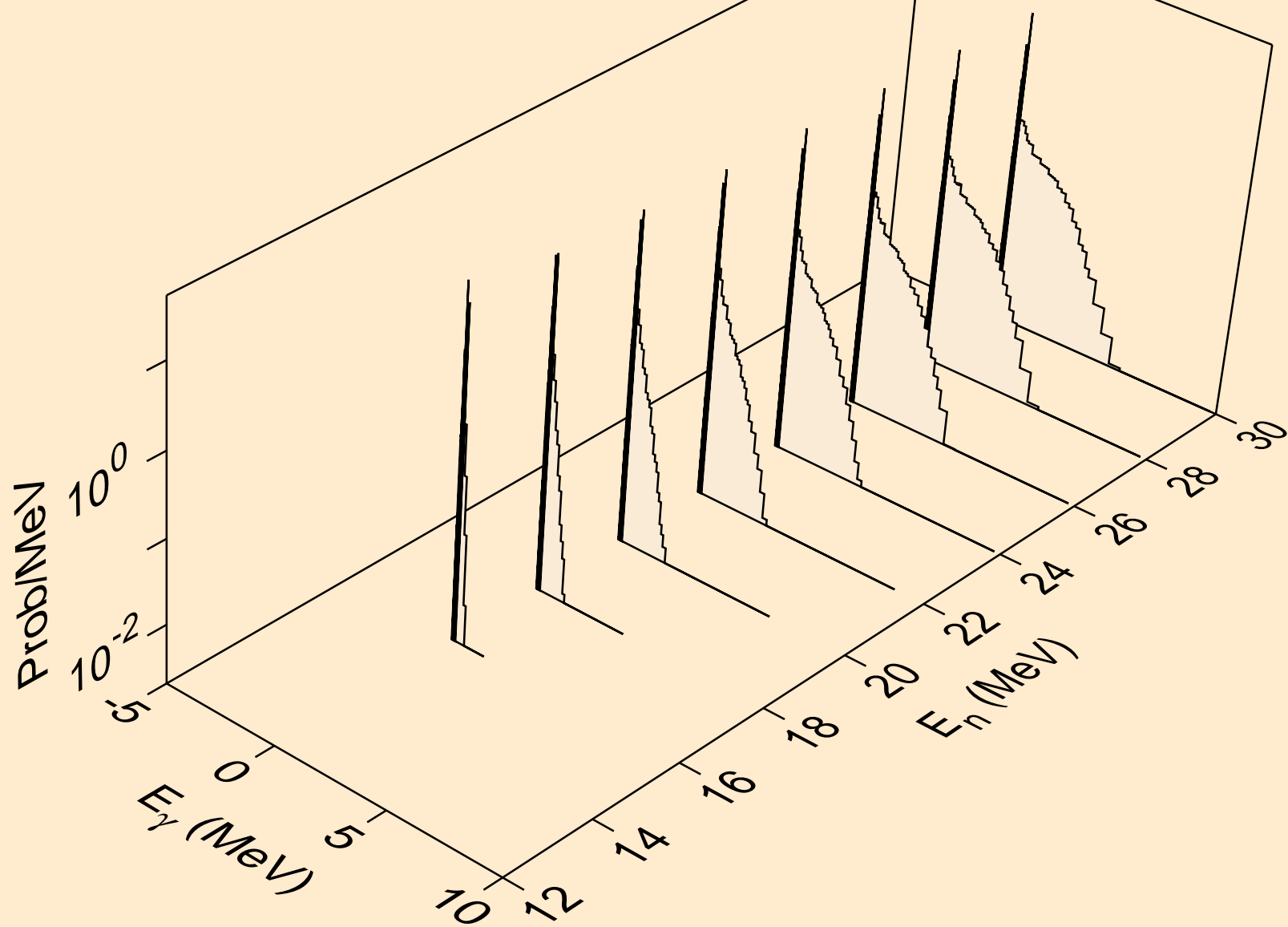

PT180 NEUTRON ACER TENDL-2021 LIBRARY; T=293.6K
Photon emission for (n,3np)

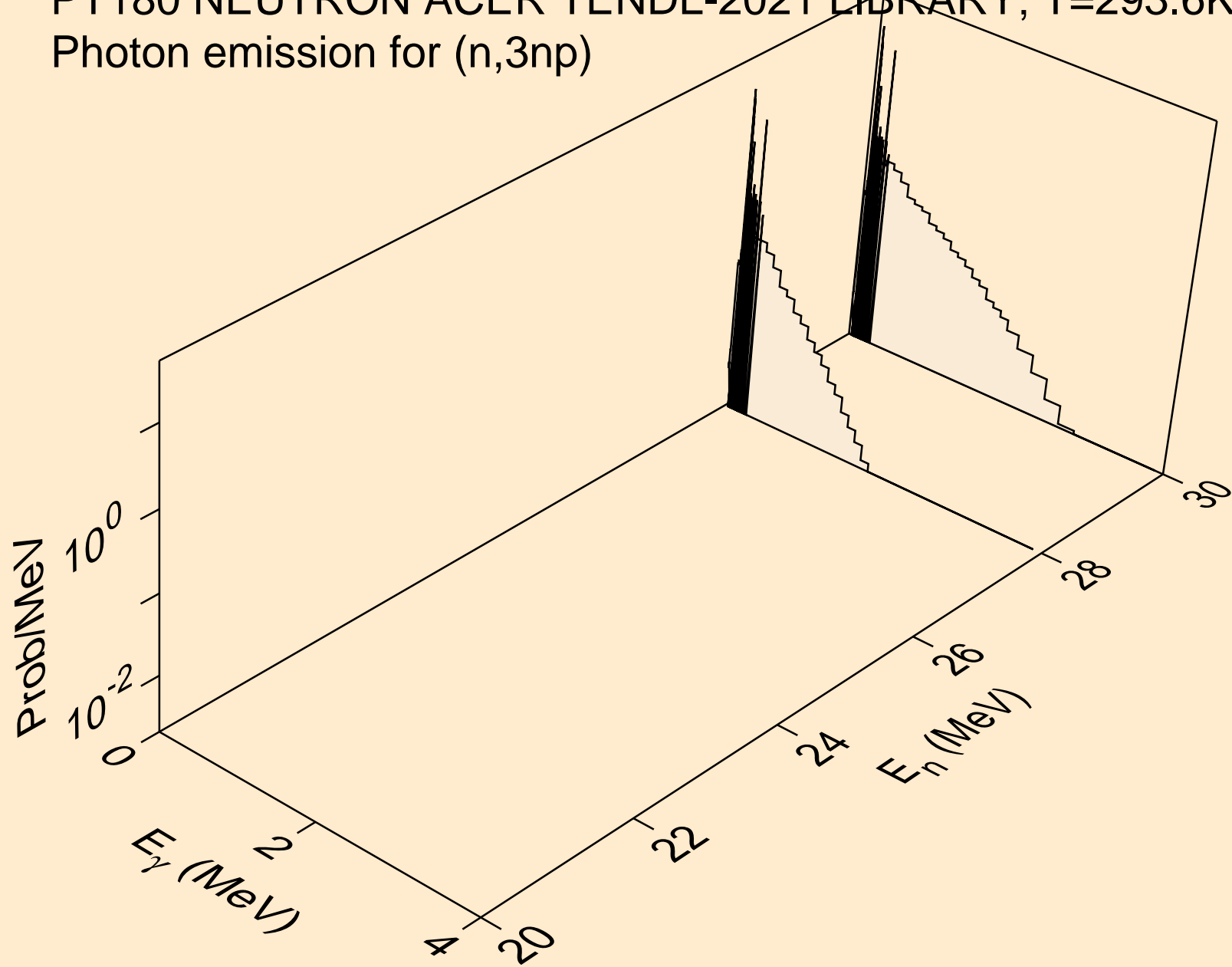

PT180 NEUTRON ACER TENDL-2021 LIBRARY; T=293.6K
Photon emission for (n,2np)

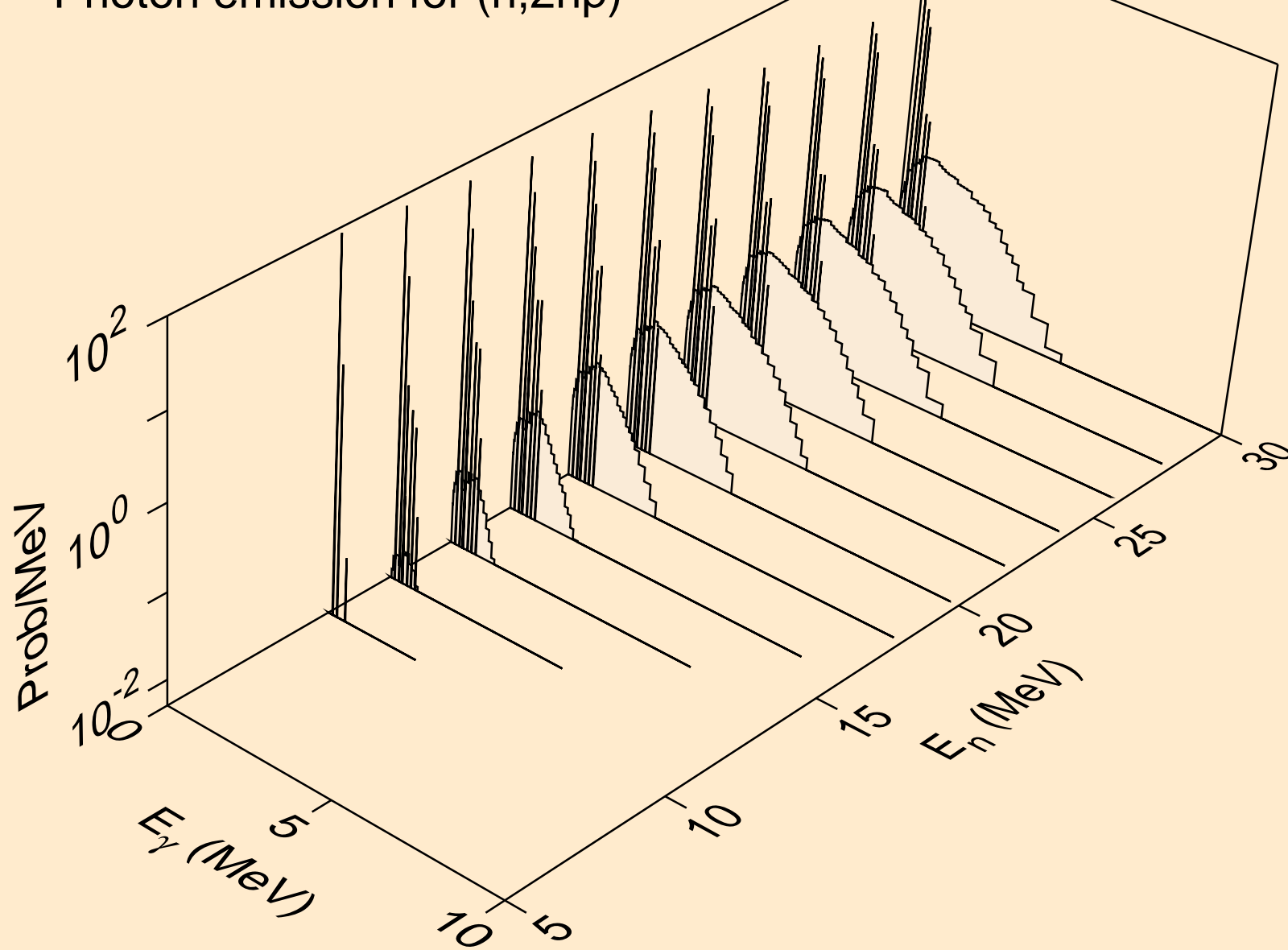

PT180 NEUTRON ACER TENDL-2021 LIBRARY; T=293.6K
Photon emission for (n,npa)

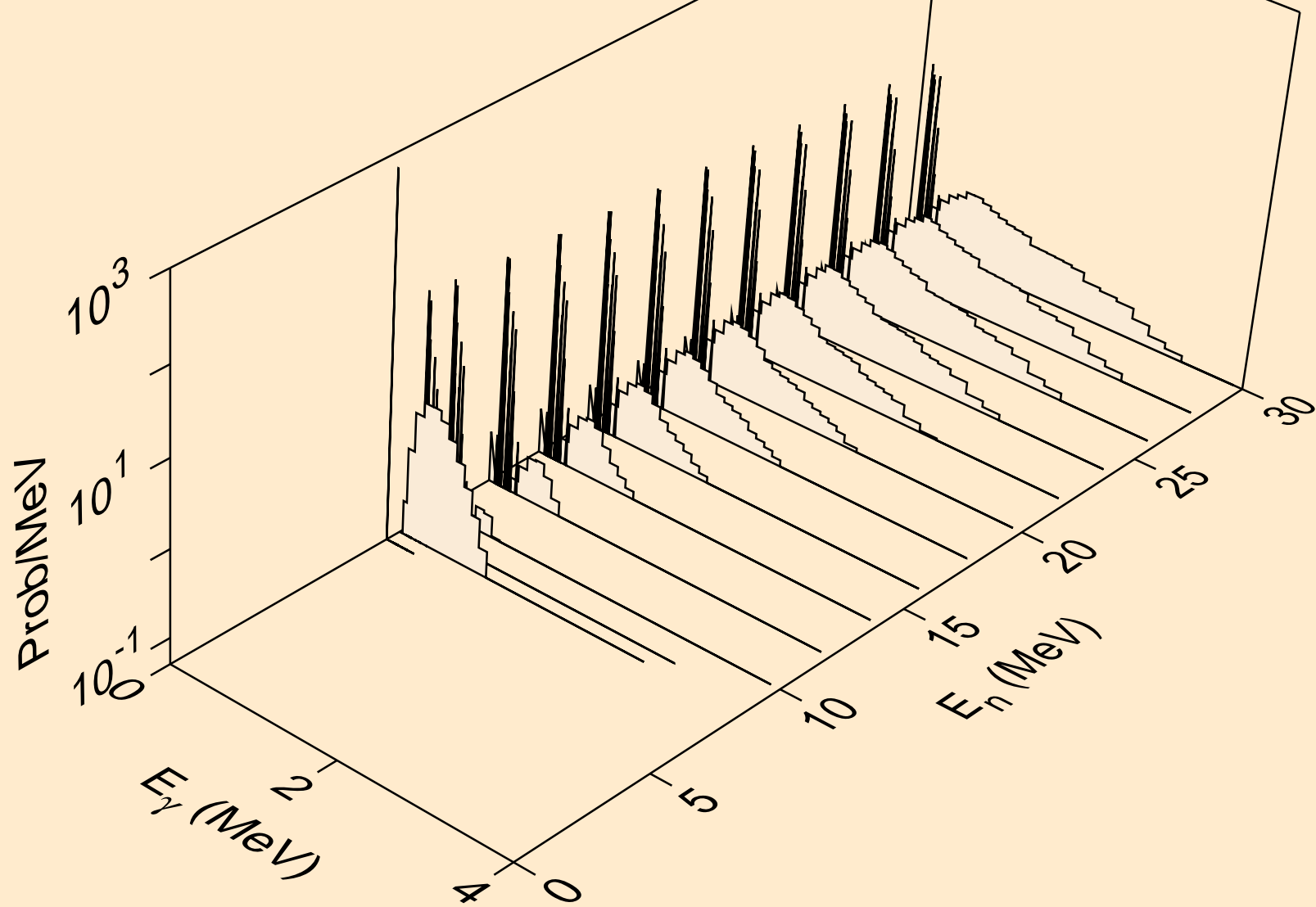

PT180 NEUTRON ACER TENDL-2021 LIBRARY; T=293.6K
Photon emission for (n,n*c)

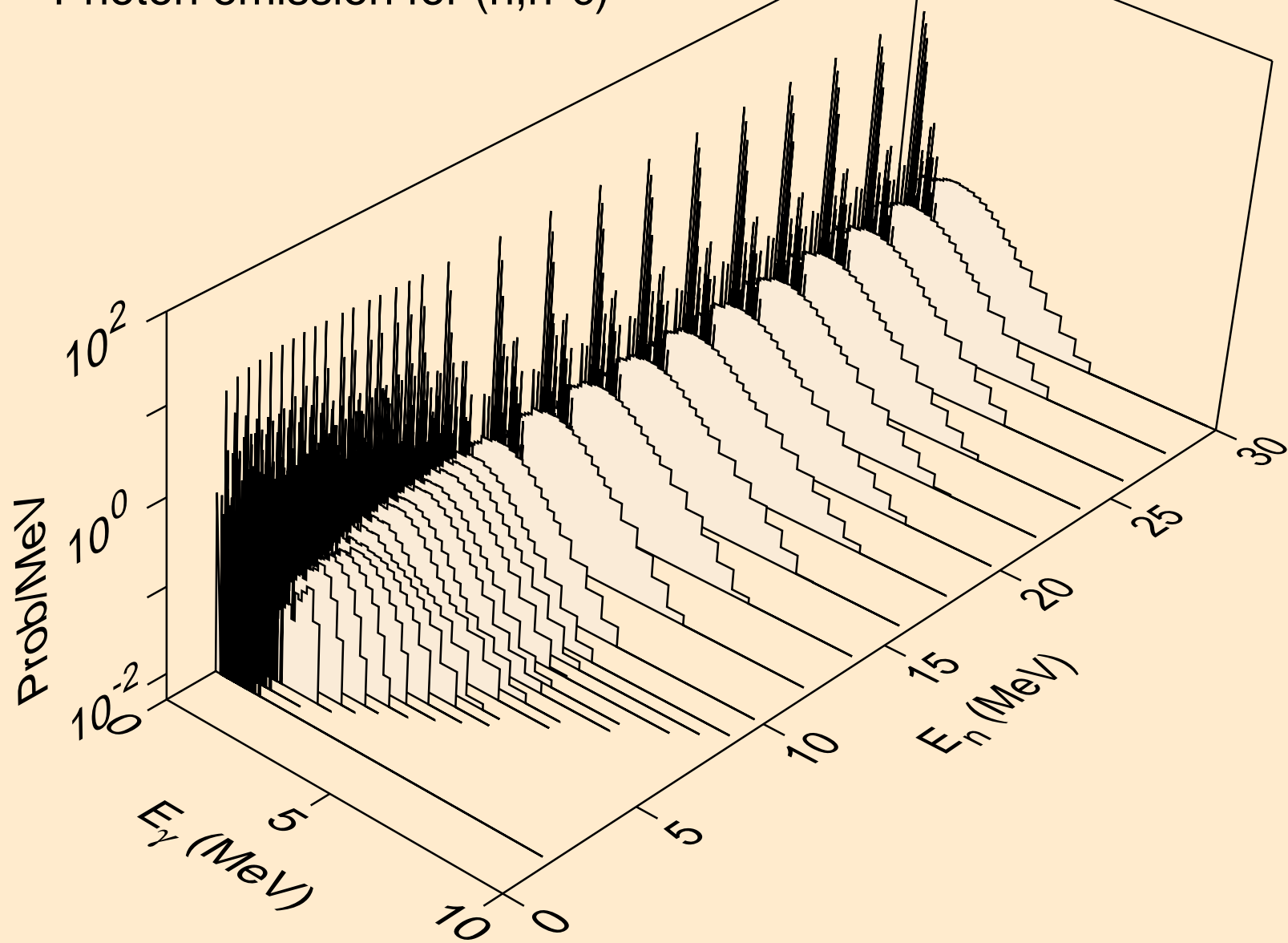

PT180 NEUTRON ACER TENDL-2021 LIBRARY; T=293.6K
Photon emission for (n,gma)

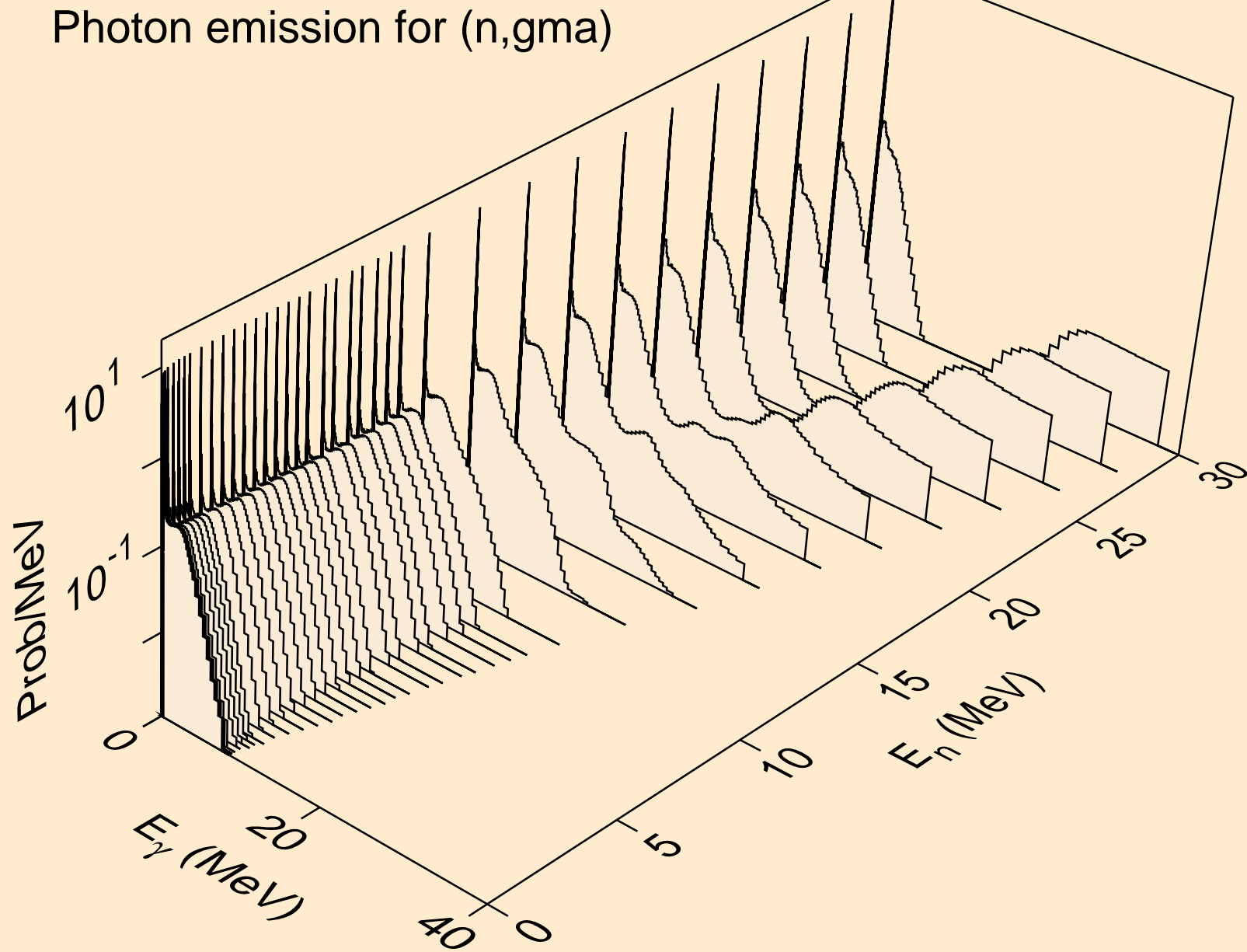

PT180 NEUTRON ACER TENDL-2021 LIBRARY; T=293.6K
Photon emission for (n,p)

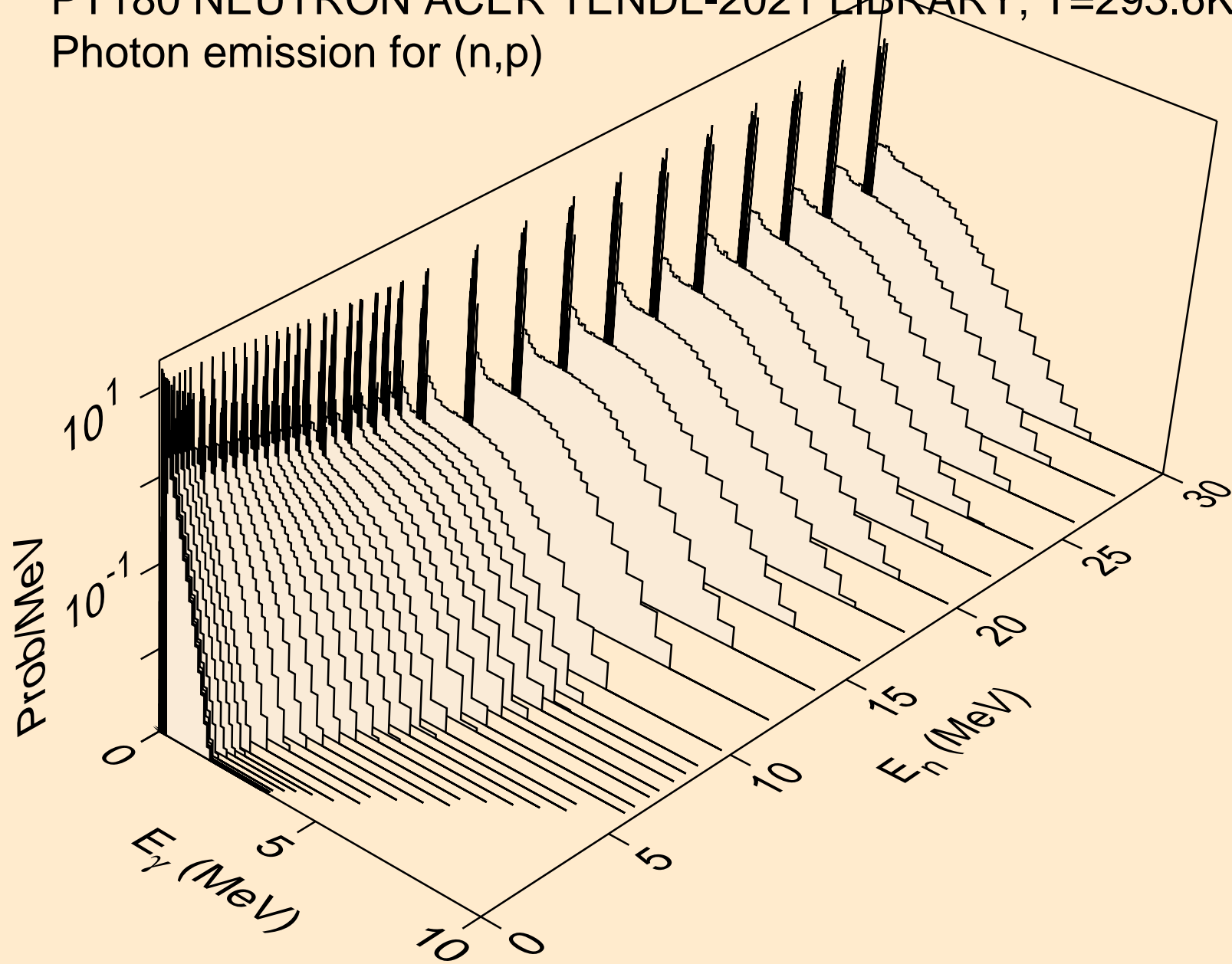

PT180 NEUTRON ACER TENDL-2021 LIBRARY; T=293.6K
Photon emission for (n,d)

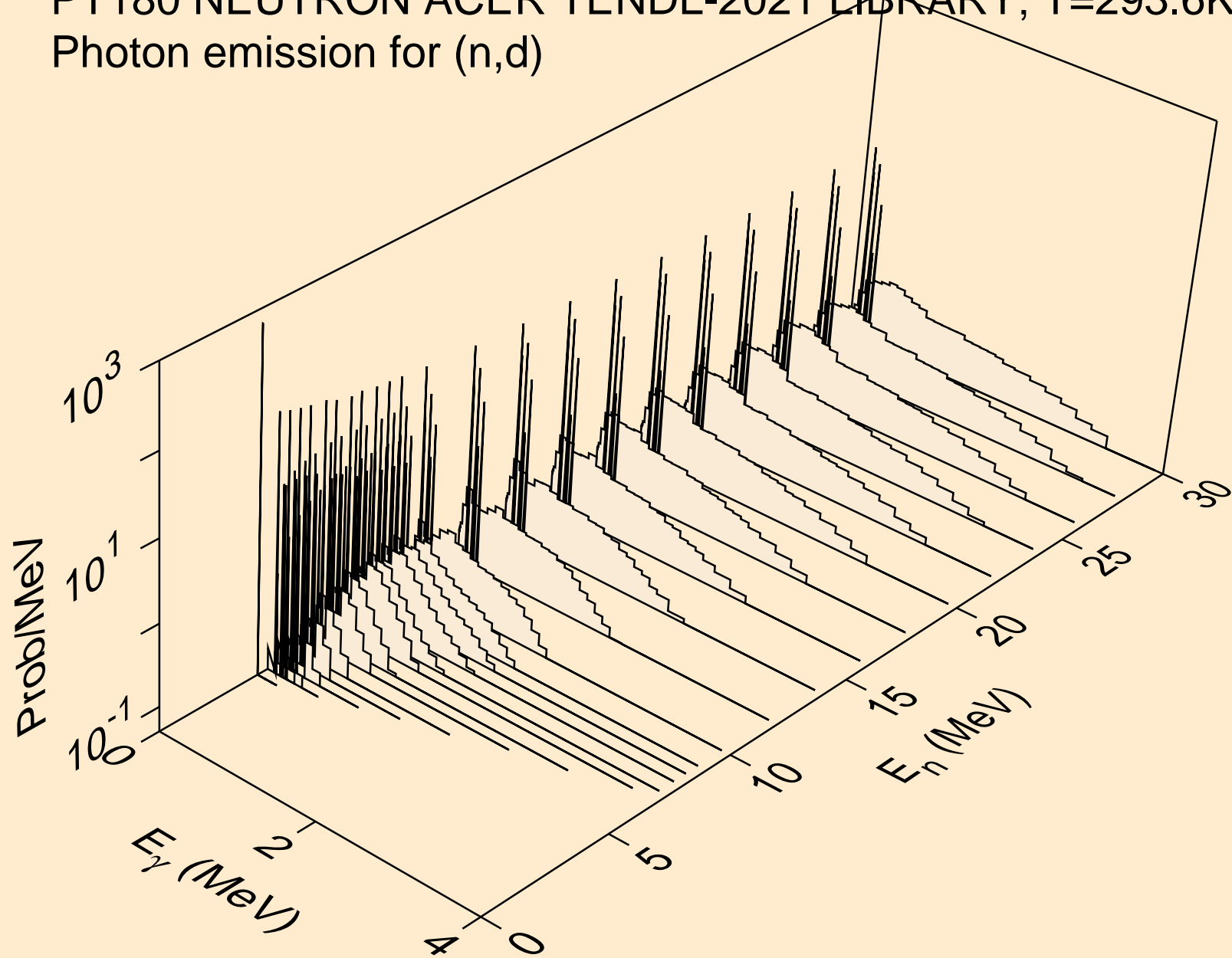

PT180 NEUTRON ACER TENDL-2021 LIBRARY; T=293.6K
Photon emission for (n,t)

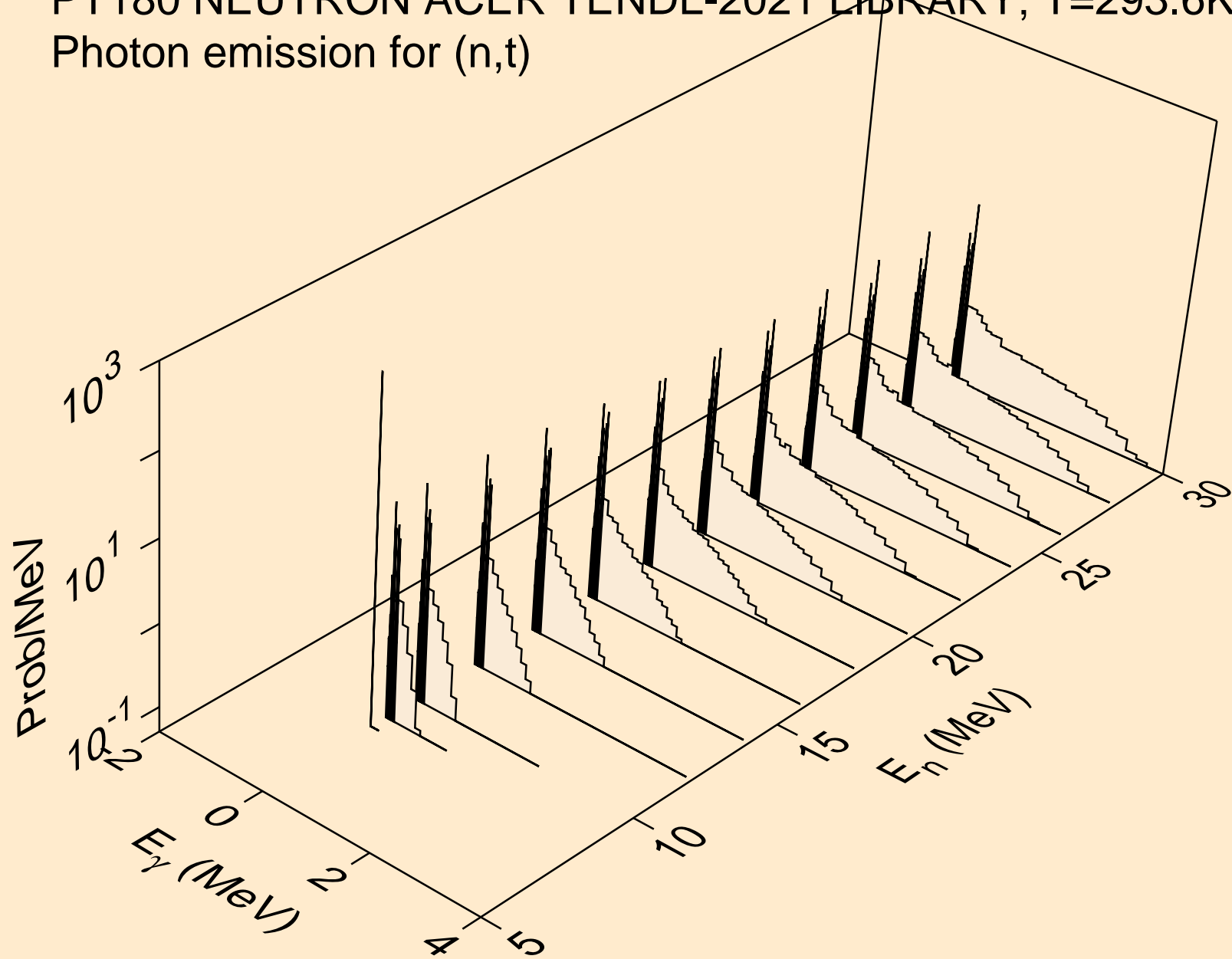

PT180 NEUTRON ACER TENDL-2021 LIBRARY; T=293.6K
Photon emission for (n,he3)

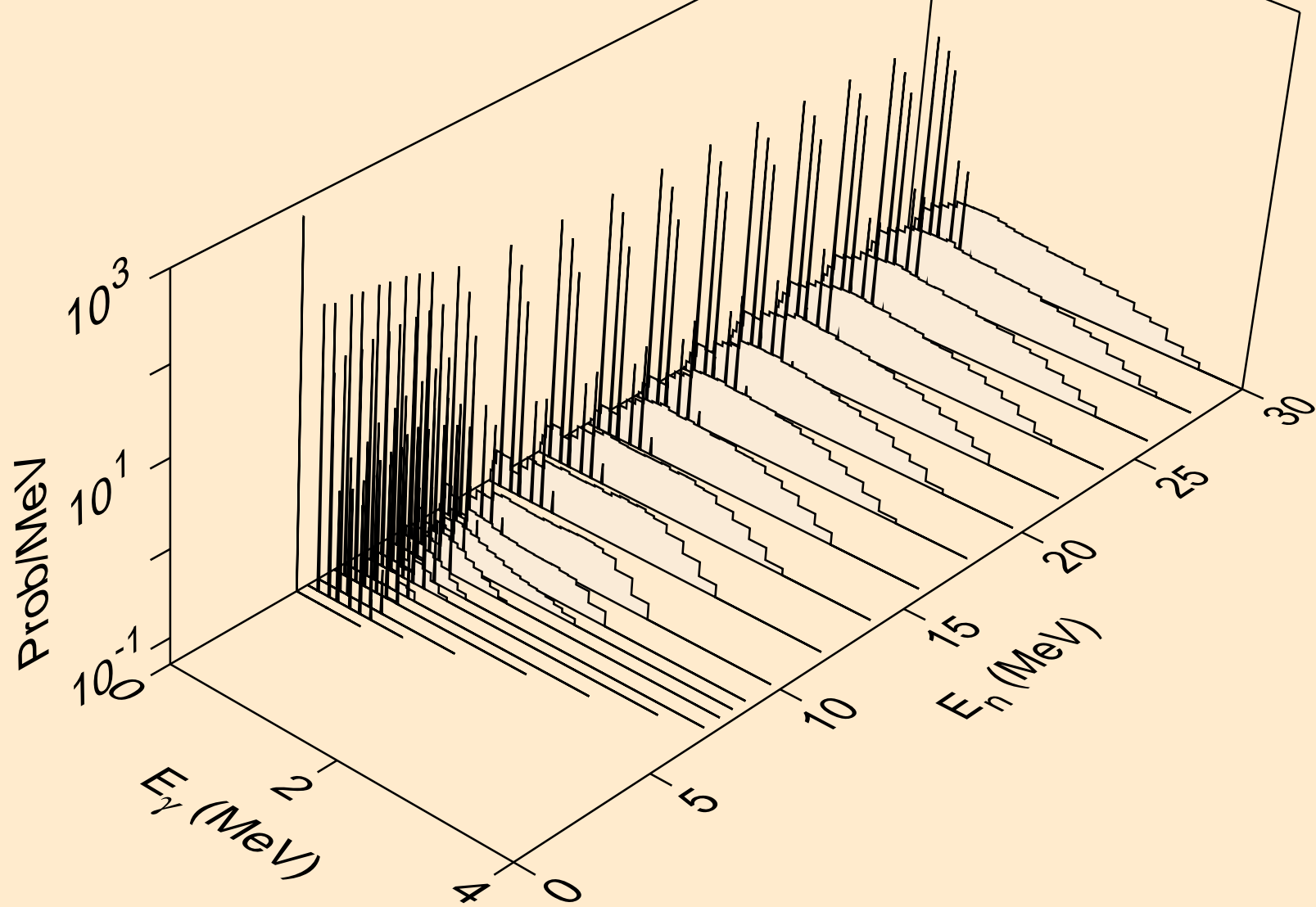

PT180 NEUTRON ACER TENDL-2021 LIBRARY; T=293.6K
Photon emission for (n,a)

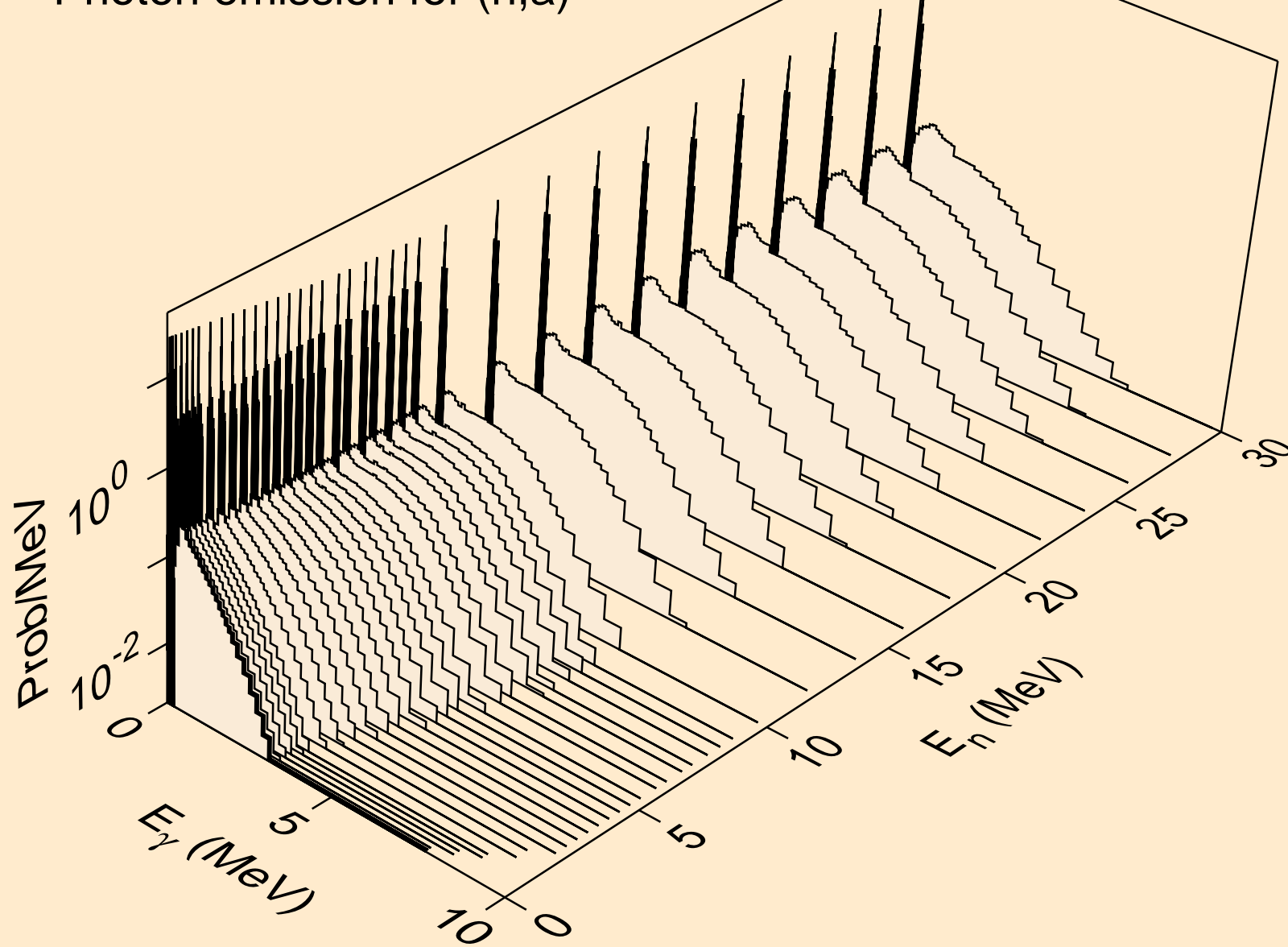

PT180 NEUTRON ACER TENDL-2021 LIBRARY; T=293.6K
Photon emission for (n,2a)

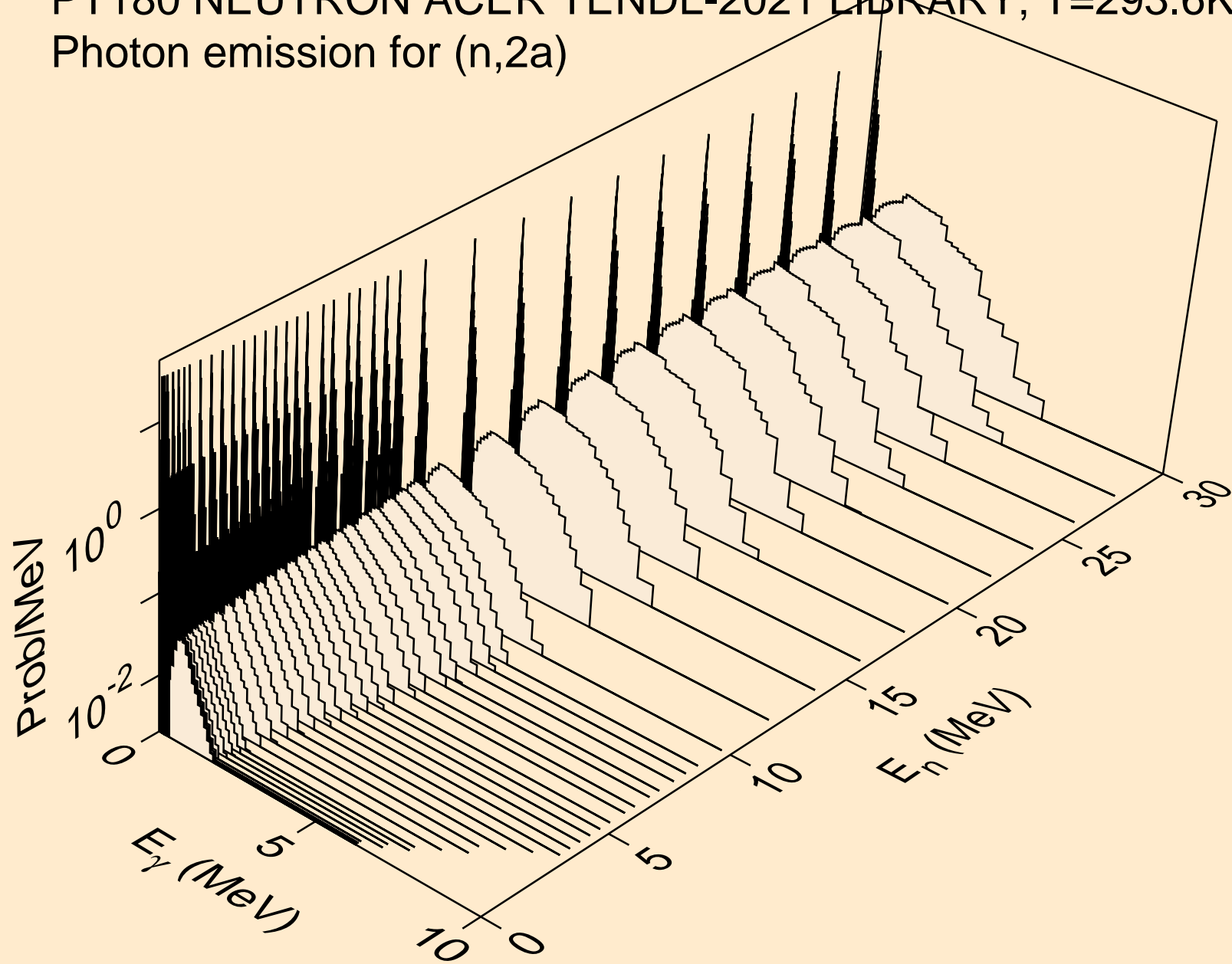

PT180 NEUTRON ACER TENDL-2021 LIBRARY; T=293.6K
Photon emission for (n,3a)

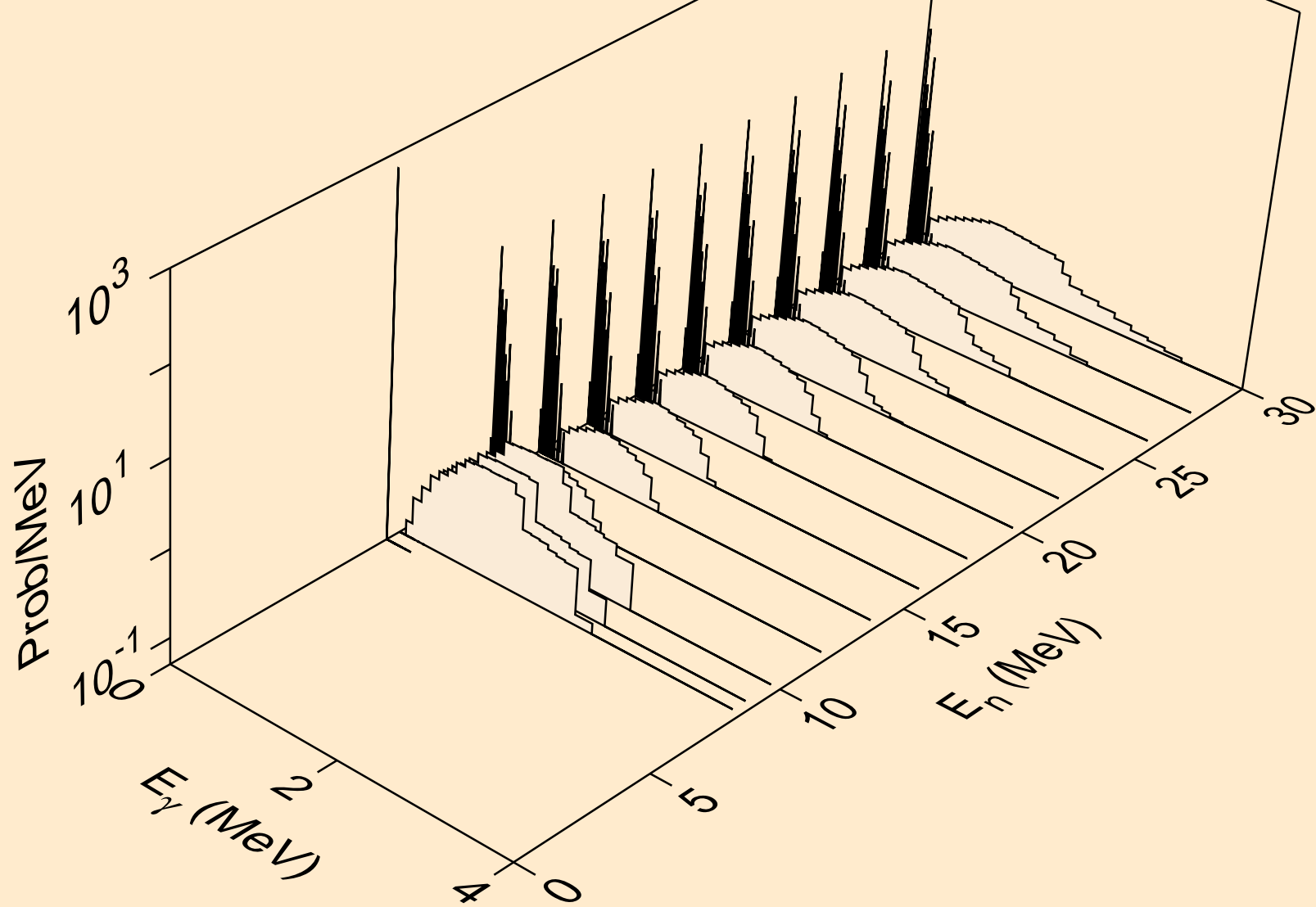

PT180 NEUTRON ACER TENDL-2021 LIBRARY; T=293.6K
Photon emission for (n,2p)

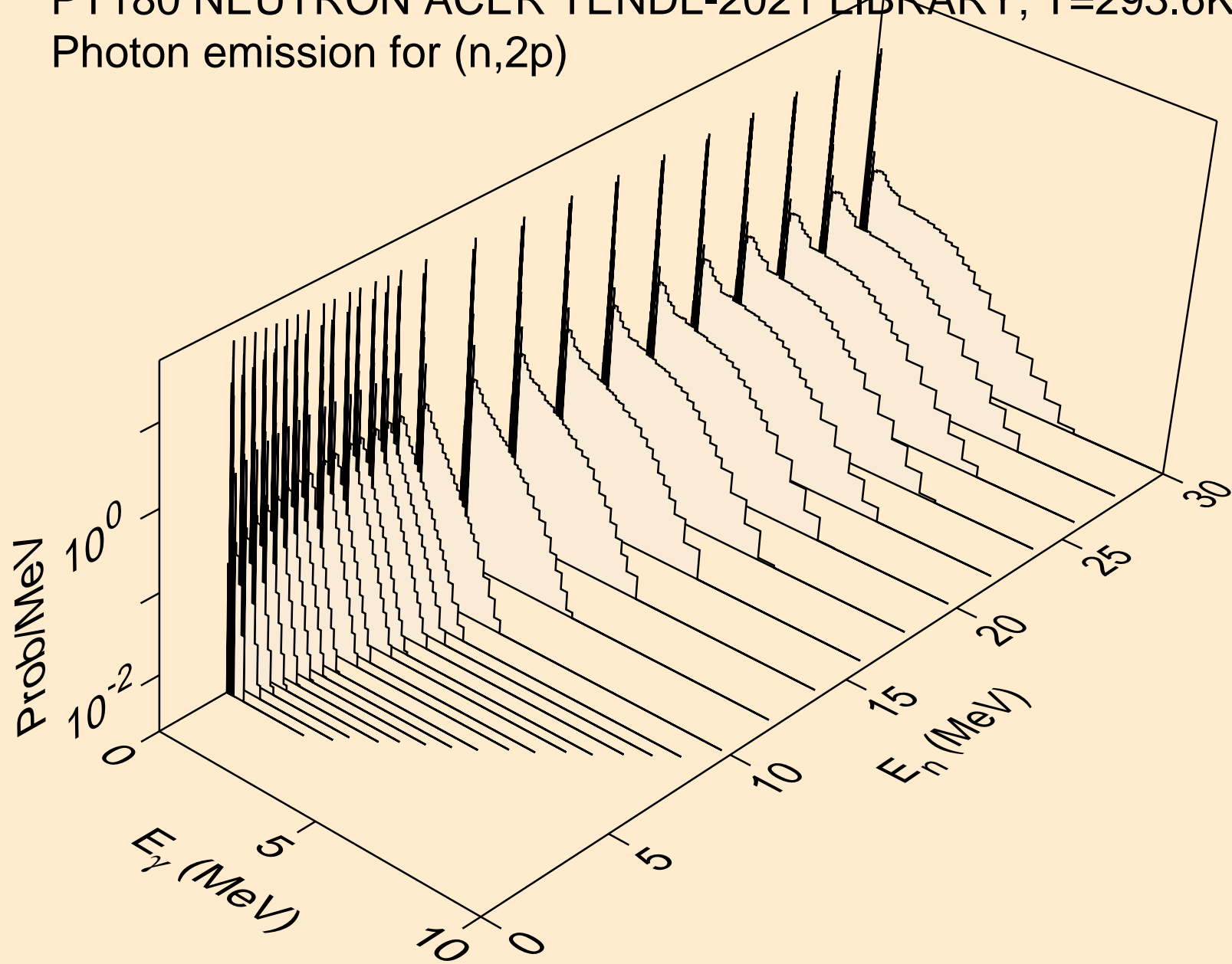

PT180 NEUTRON ACER TENDL-2021 LIBRARY; T=293.6K
Photon emission for (n,p)

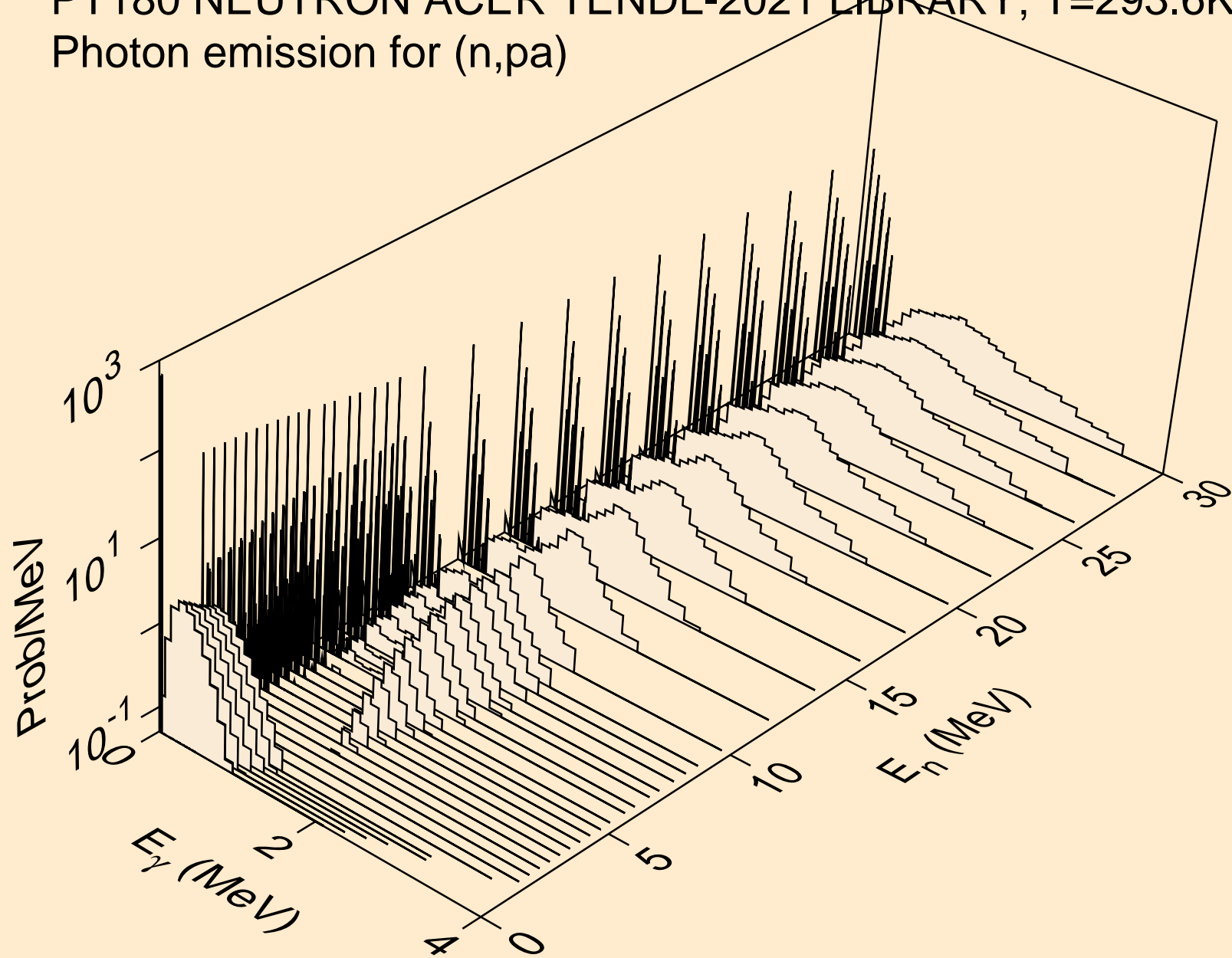

PT180 NEUTRON ACER TENDL-2021 LIBRARY; T=293.6K
Photon emission for (n,pd)

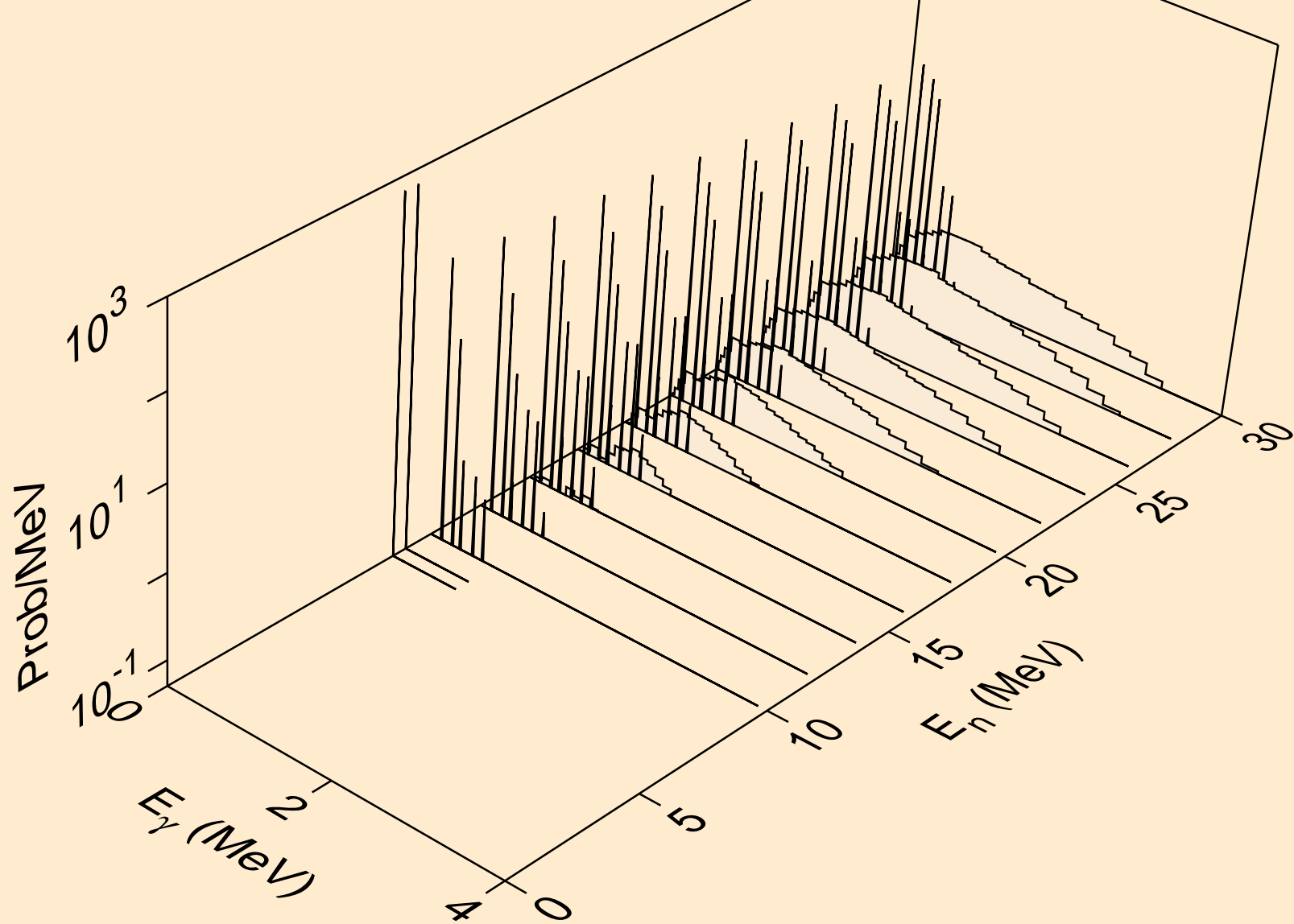

PT180 NEUTRON ACER TENDL-2021 LIBRARY; T=293.6K
Photon emission for (n,pt)

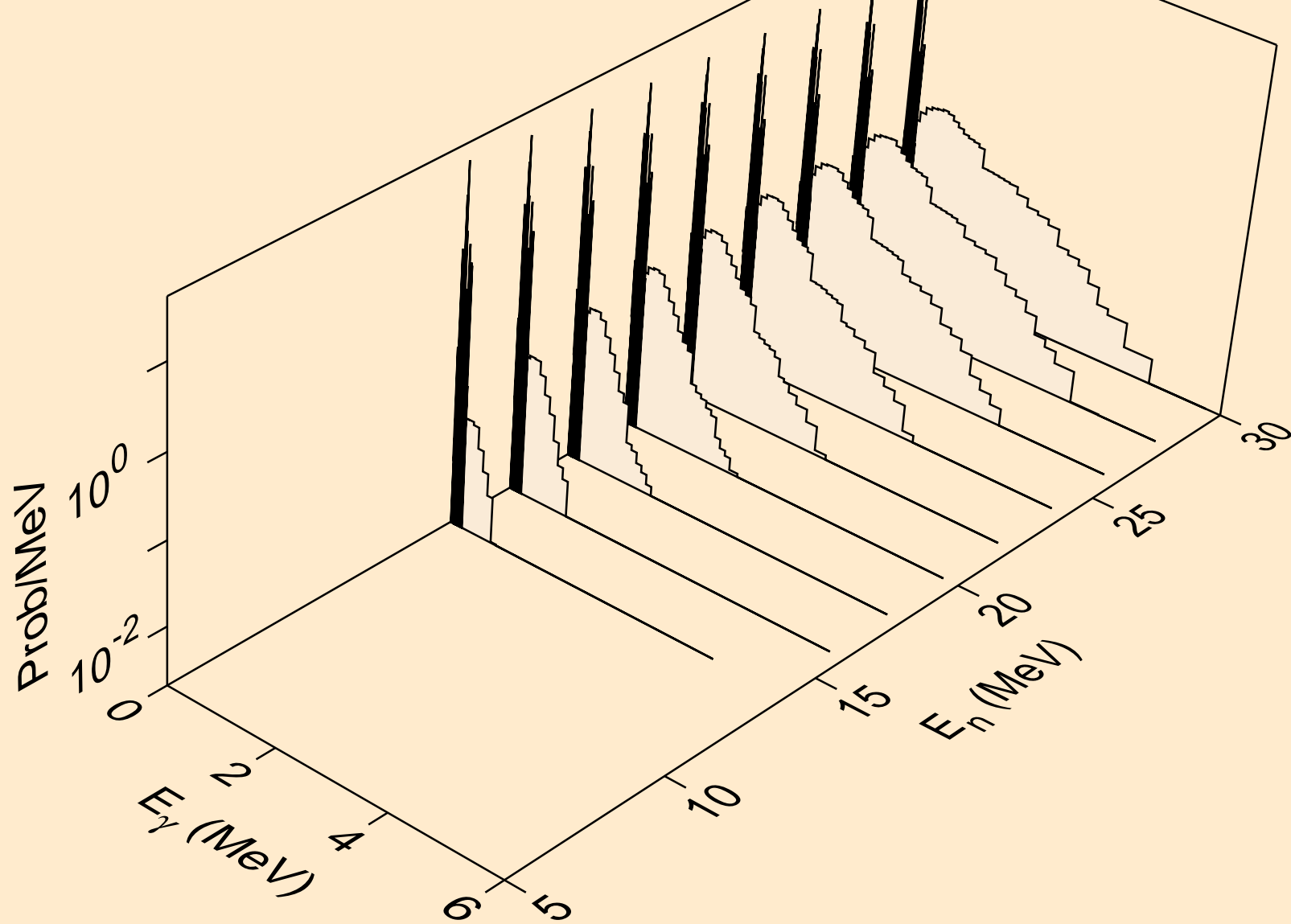

PT180 NEUTRON ACER TENDL-2021 LIBRARY; T=293.6K
Photon emission for (n,da)

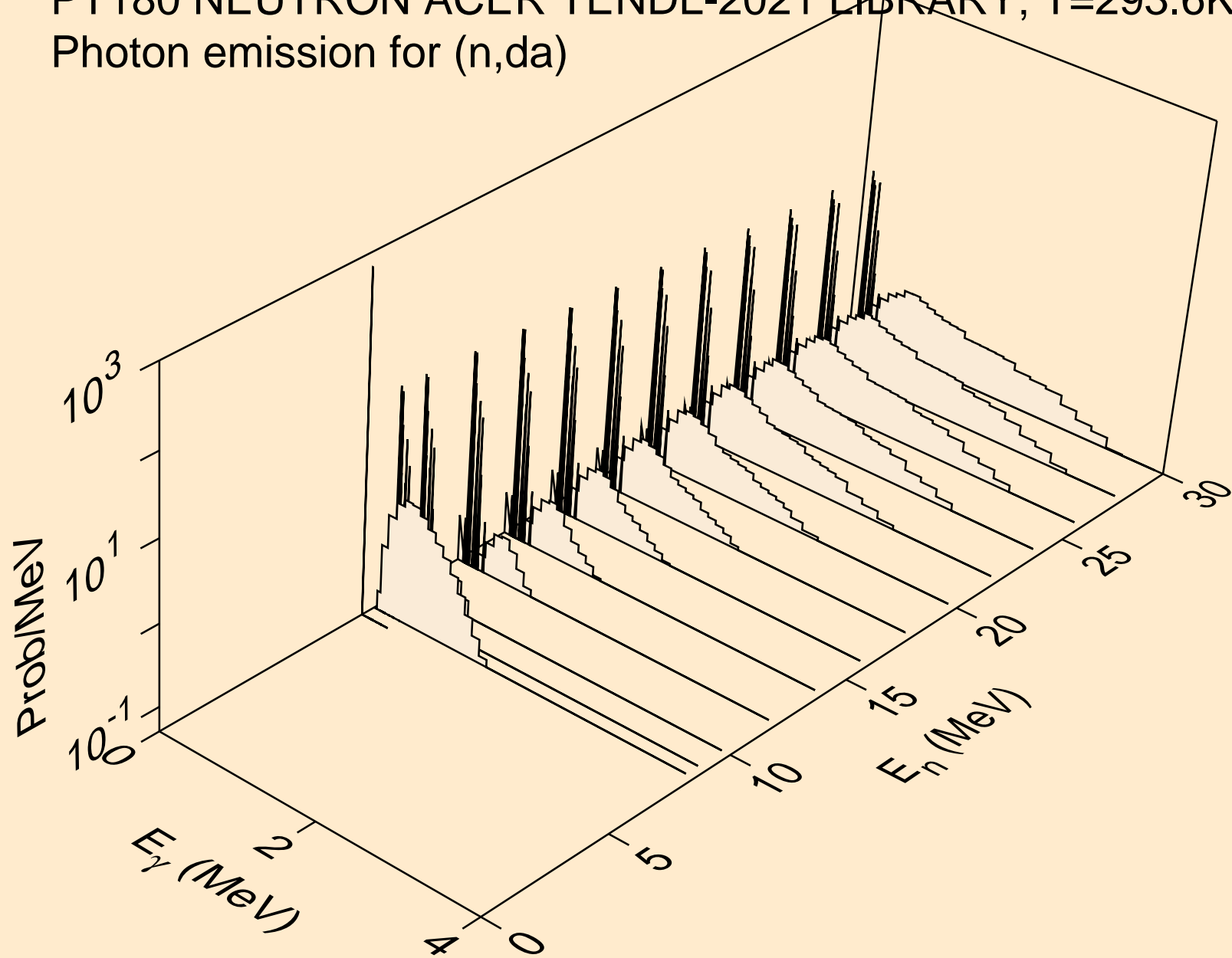

PT180 NEUTRON ACER TENDL-2021 LIBRARY; T=293.6K
thermal capture photon spectrum

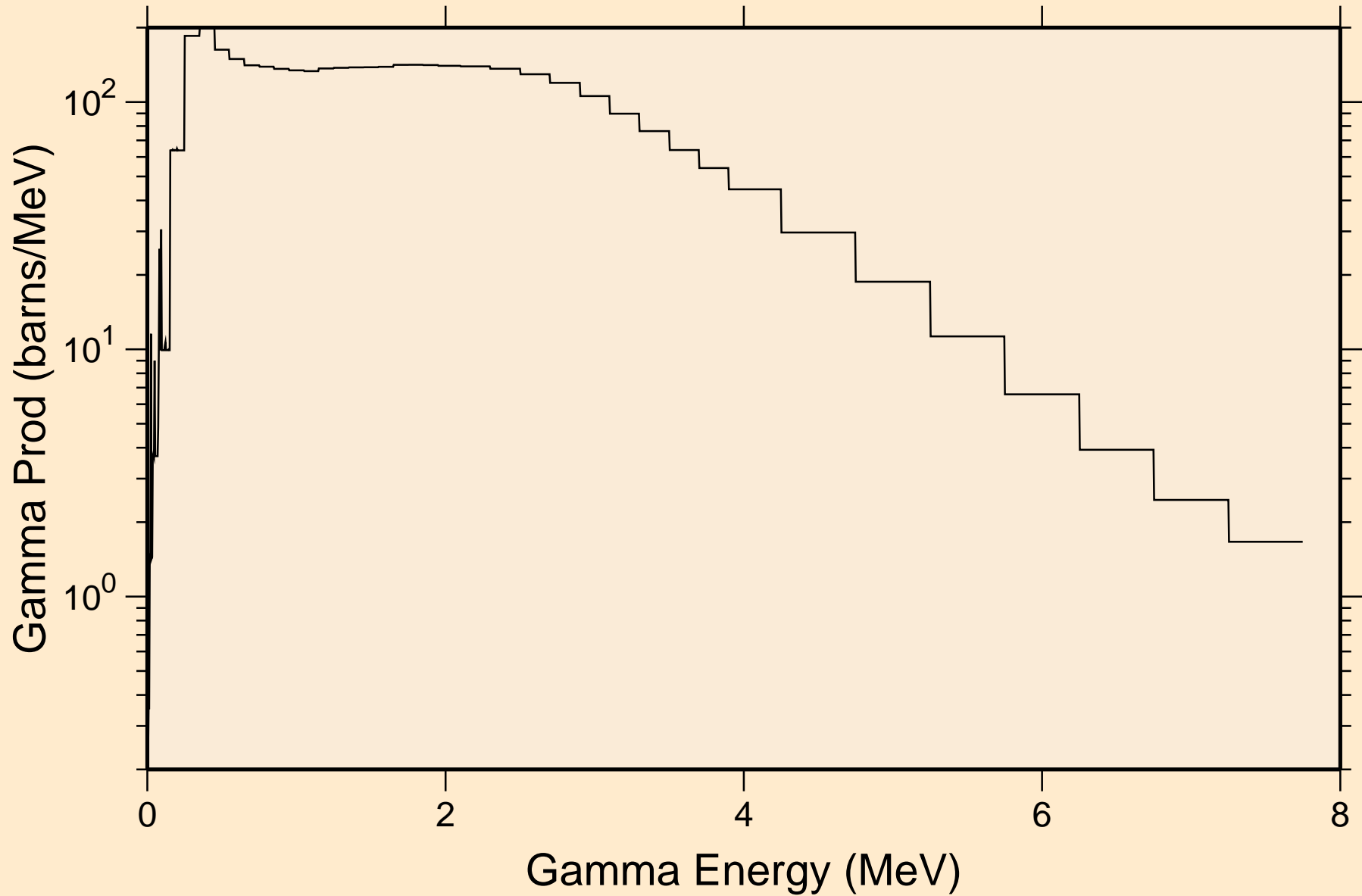

PT180 NEUTRON ACER TENDL-2021 LIBRARY; T=293.6K
14 MeV photon spectrum

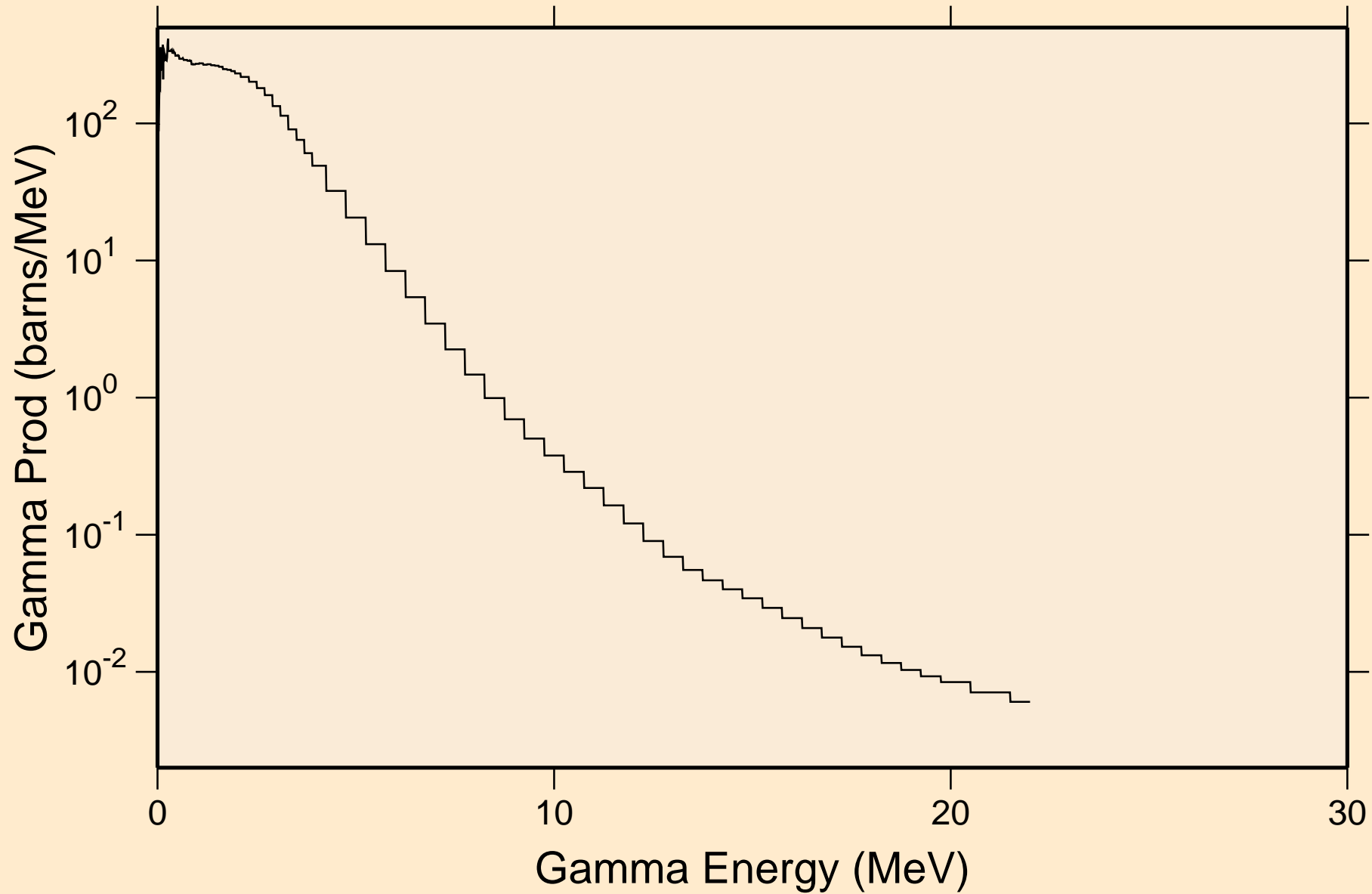

PT180 NEUTRON ACER TENDL-2021 LIBRARY; T=293.6K
Particle heating contributions

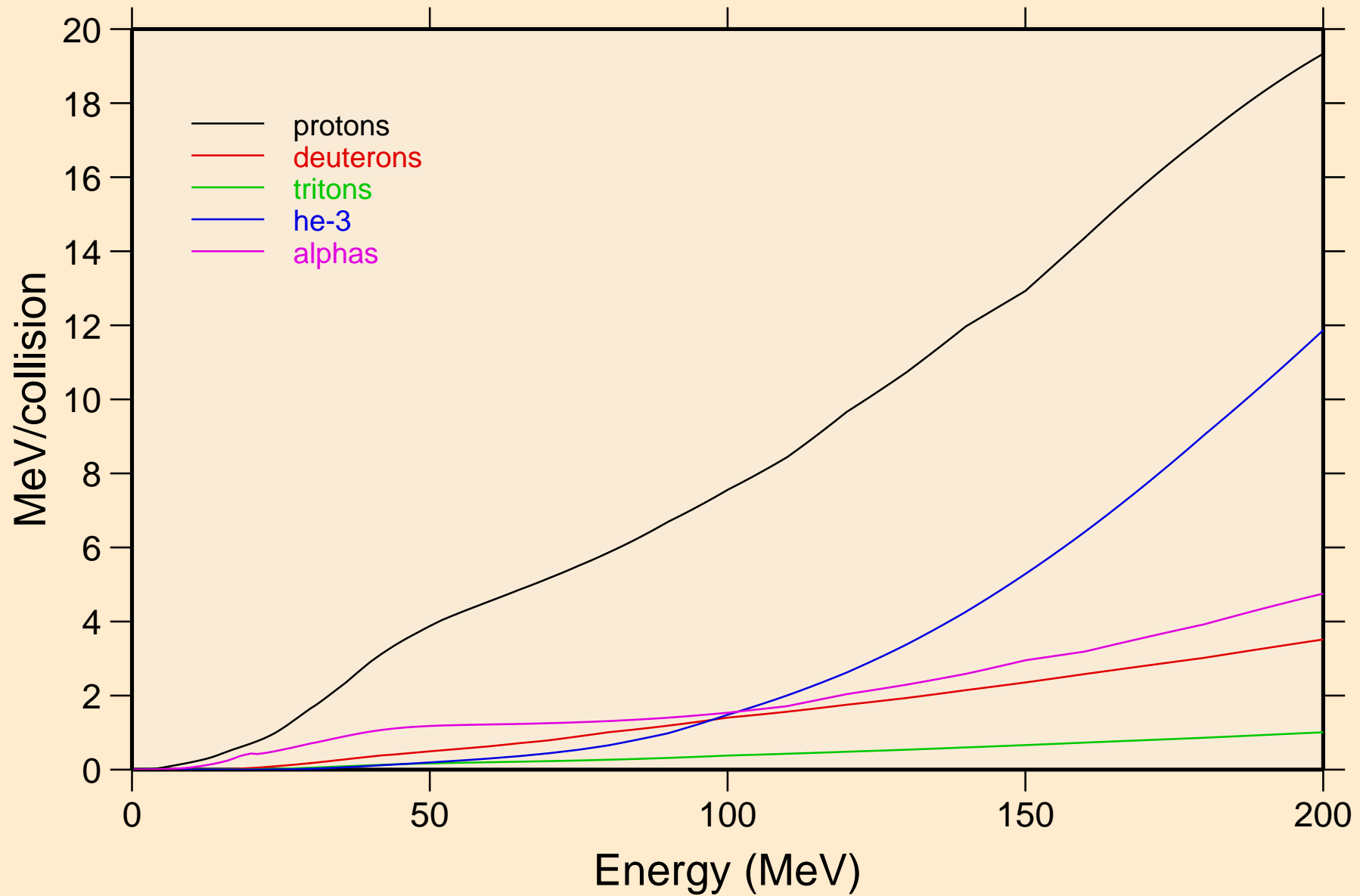

PT180 NEUTRON ACER TENDL-2021 LIBRARY; T=293.6K
Recoil Heating

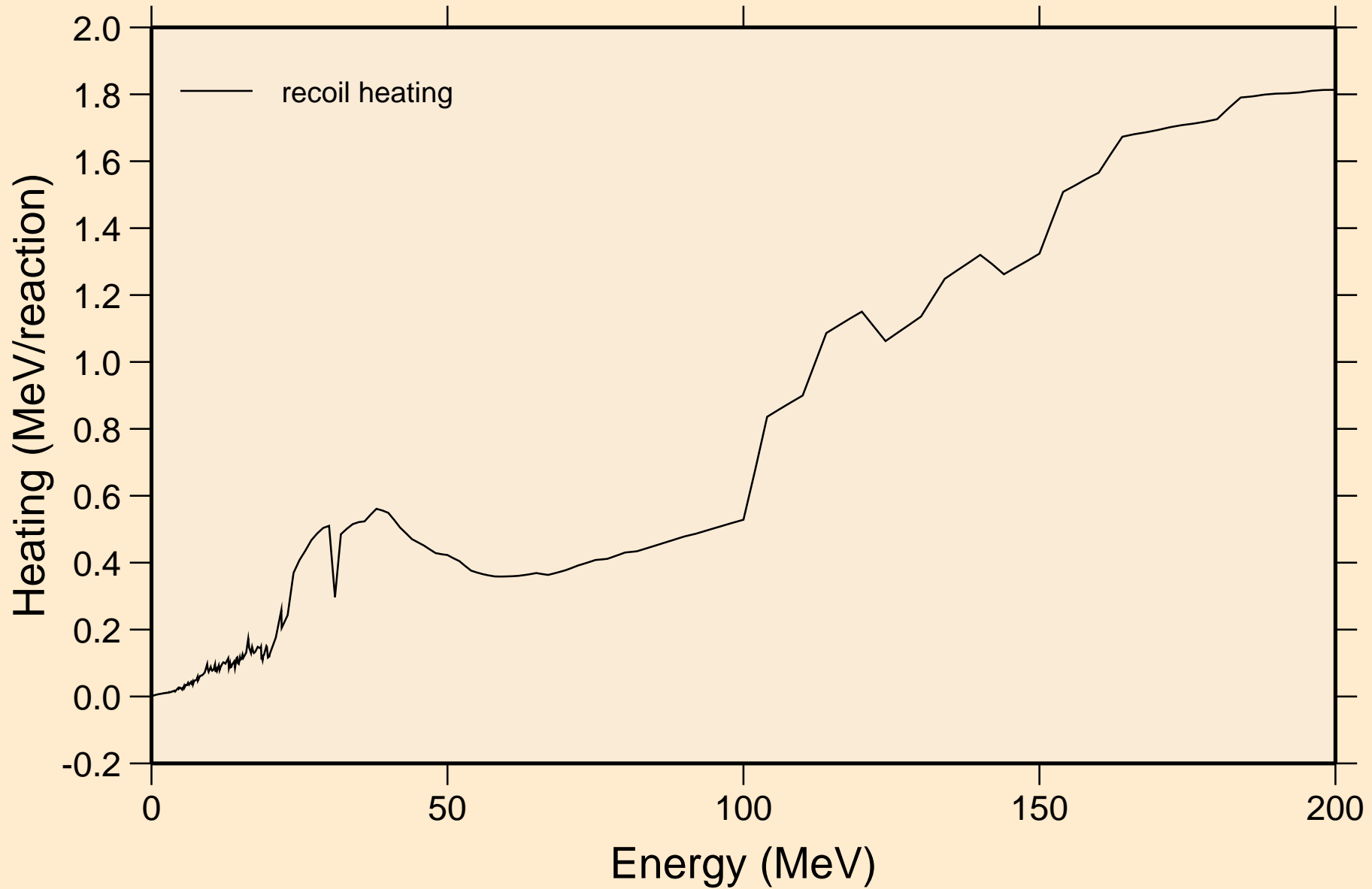

PT180 NEUTRON ACER TENDL-2021 LIBRARY; T=293.6K
Particle production cross sections

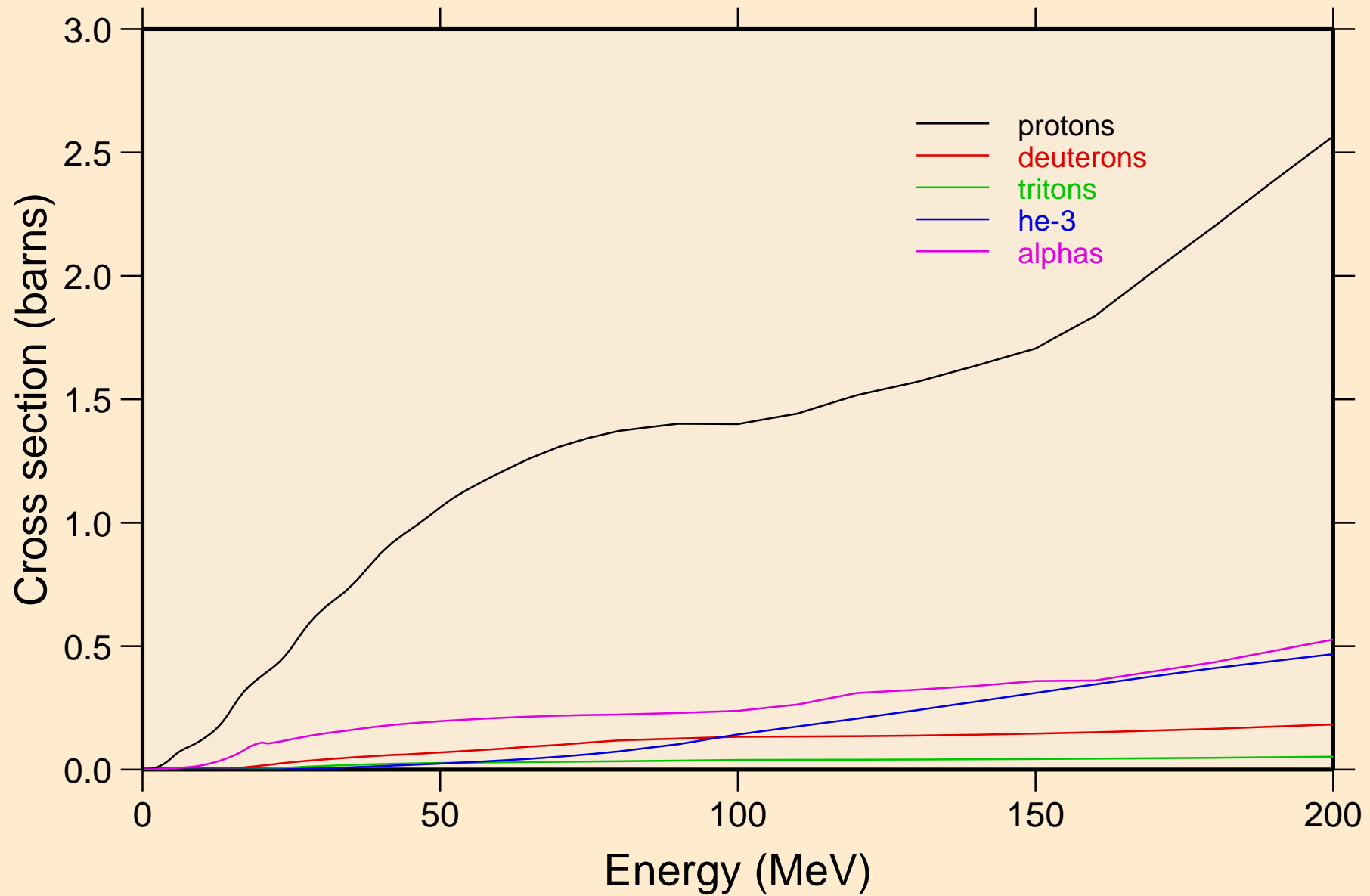

PT180 NEUTRON ACER TENDL-2021 LIBRARY; T=293.6K
protons from (n,x)

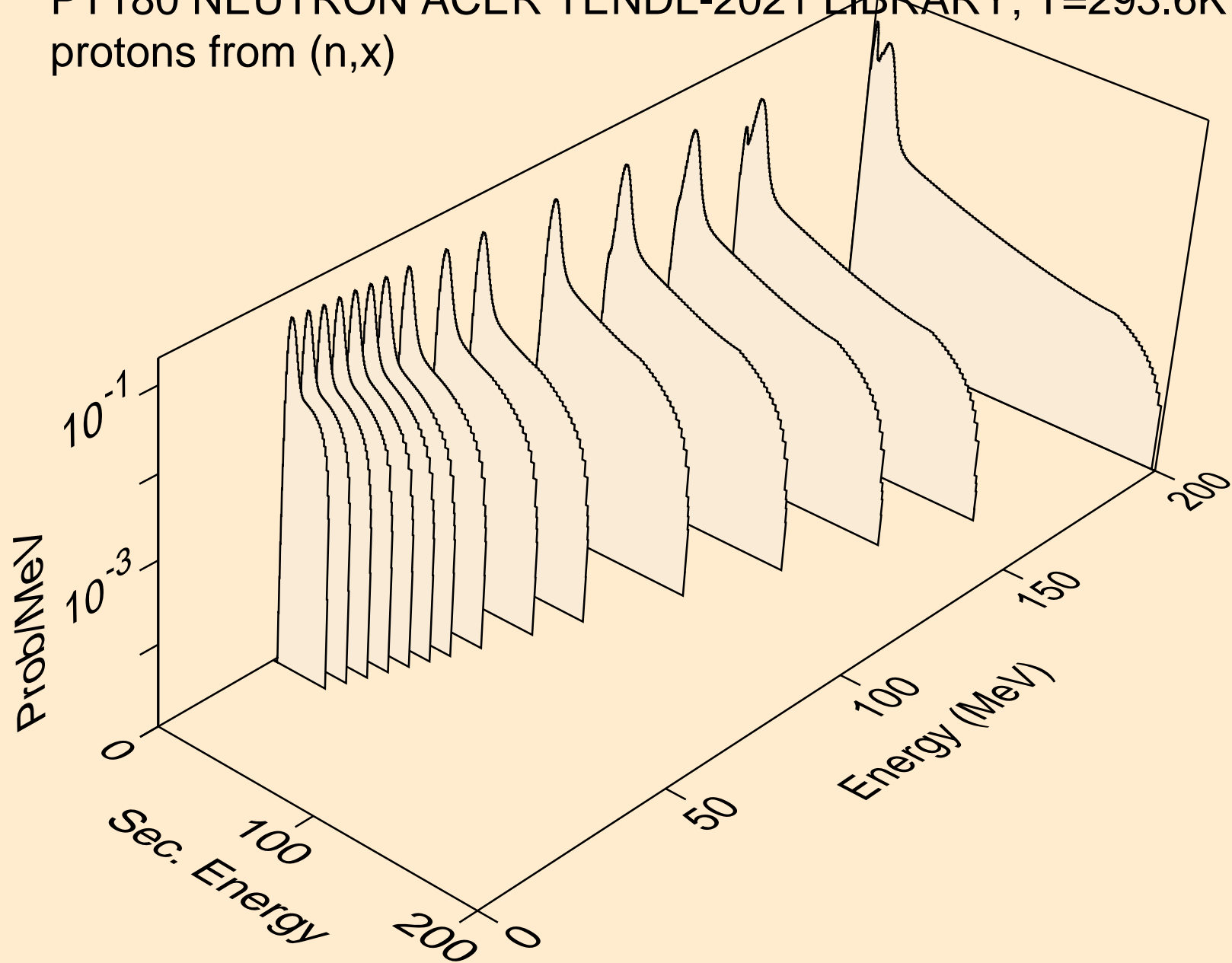

PT180 NEUTRON ACER TENDL-2021 LIBRARY; T=293.6K
protons from (n,n*)p

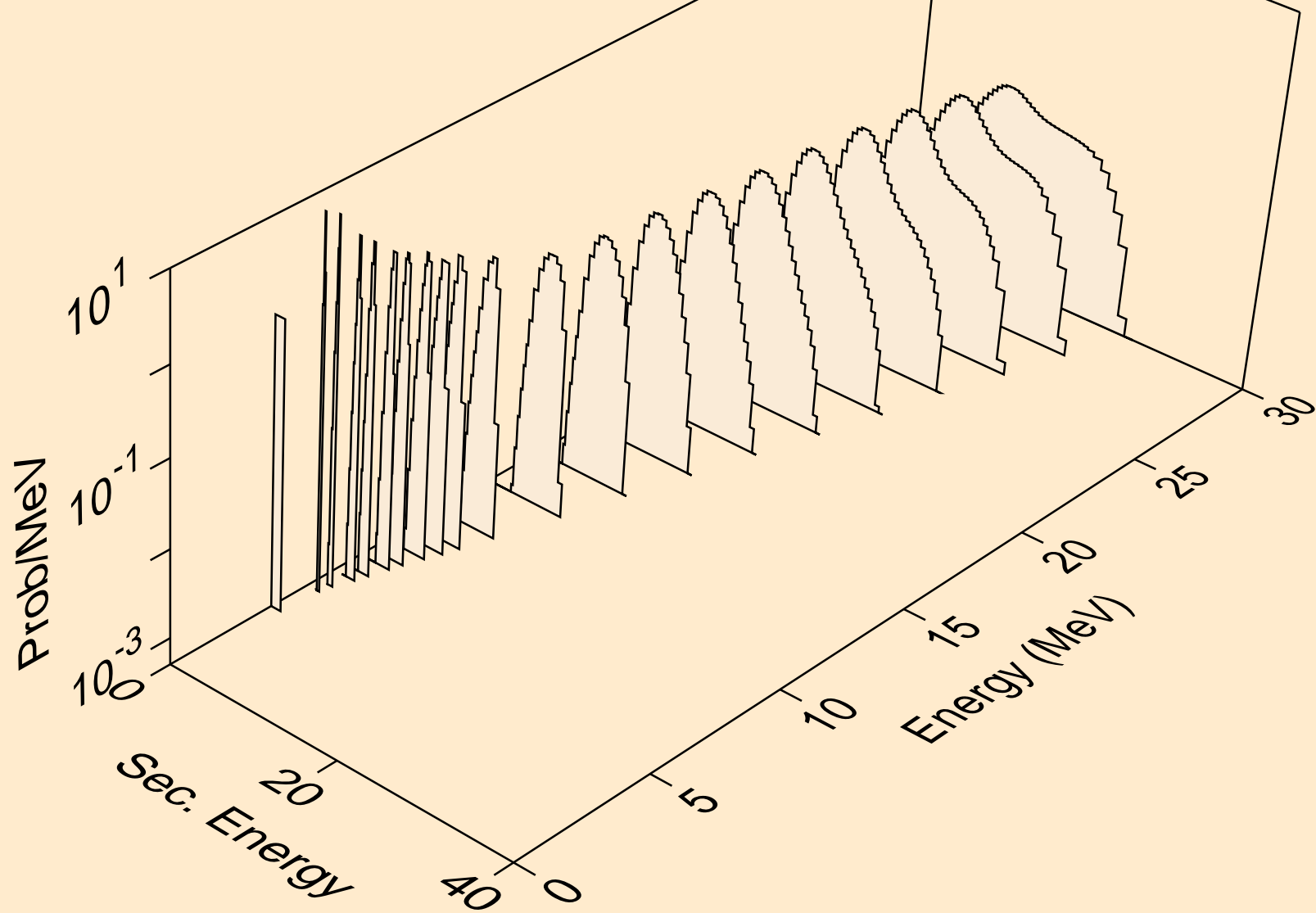

PT180 NEUTRON ACER TENDL-2021 LIBRARY; T=293.6K
protons from (n,2np)

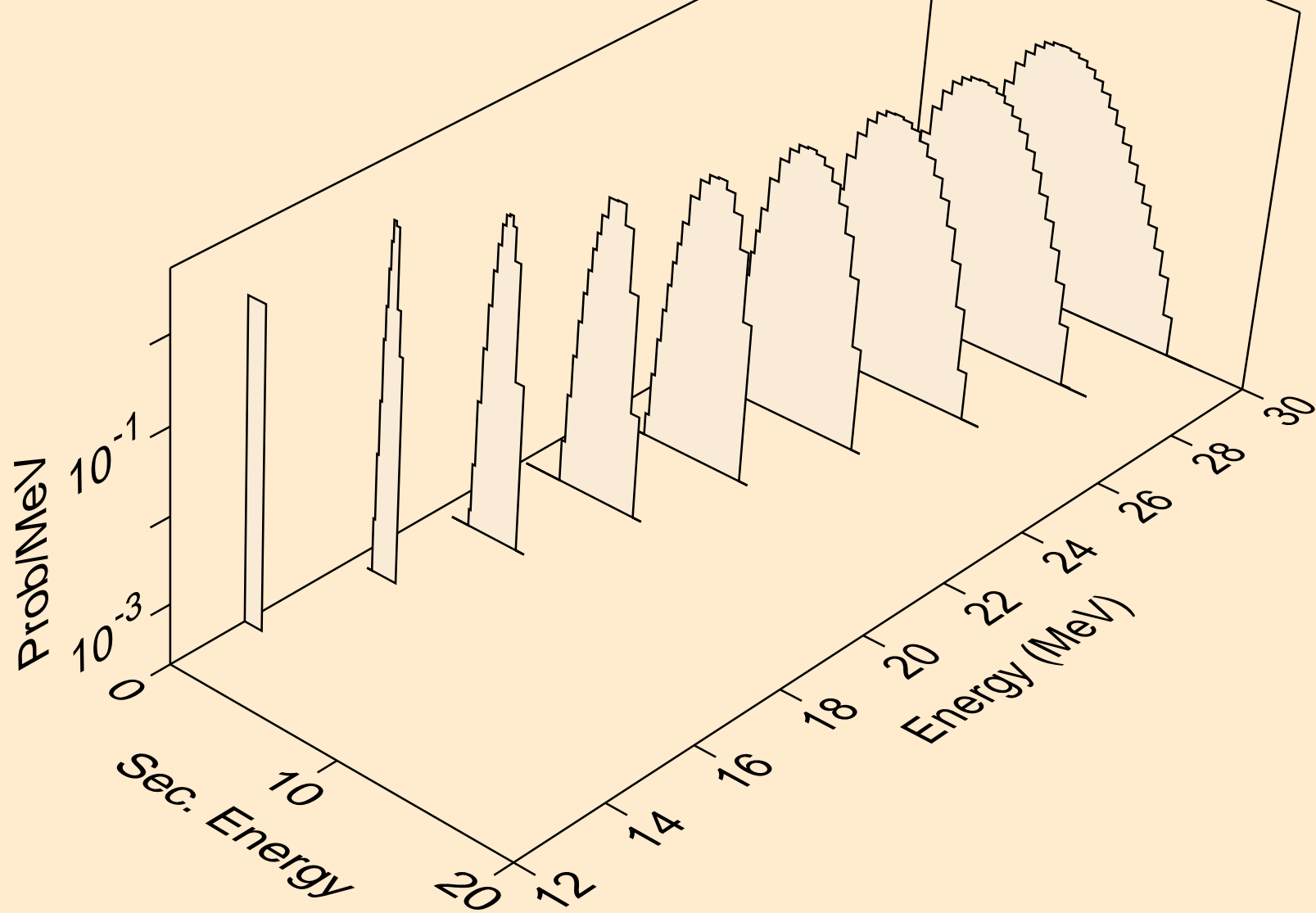

PT180 NEUTRON ACER TENDL-2021 LIBRARY; T=293.6K
protons from (n,3np)

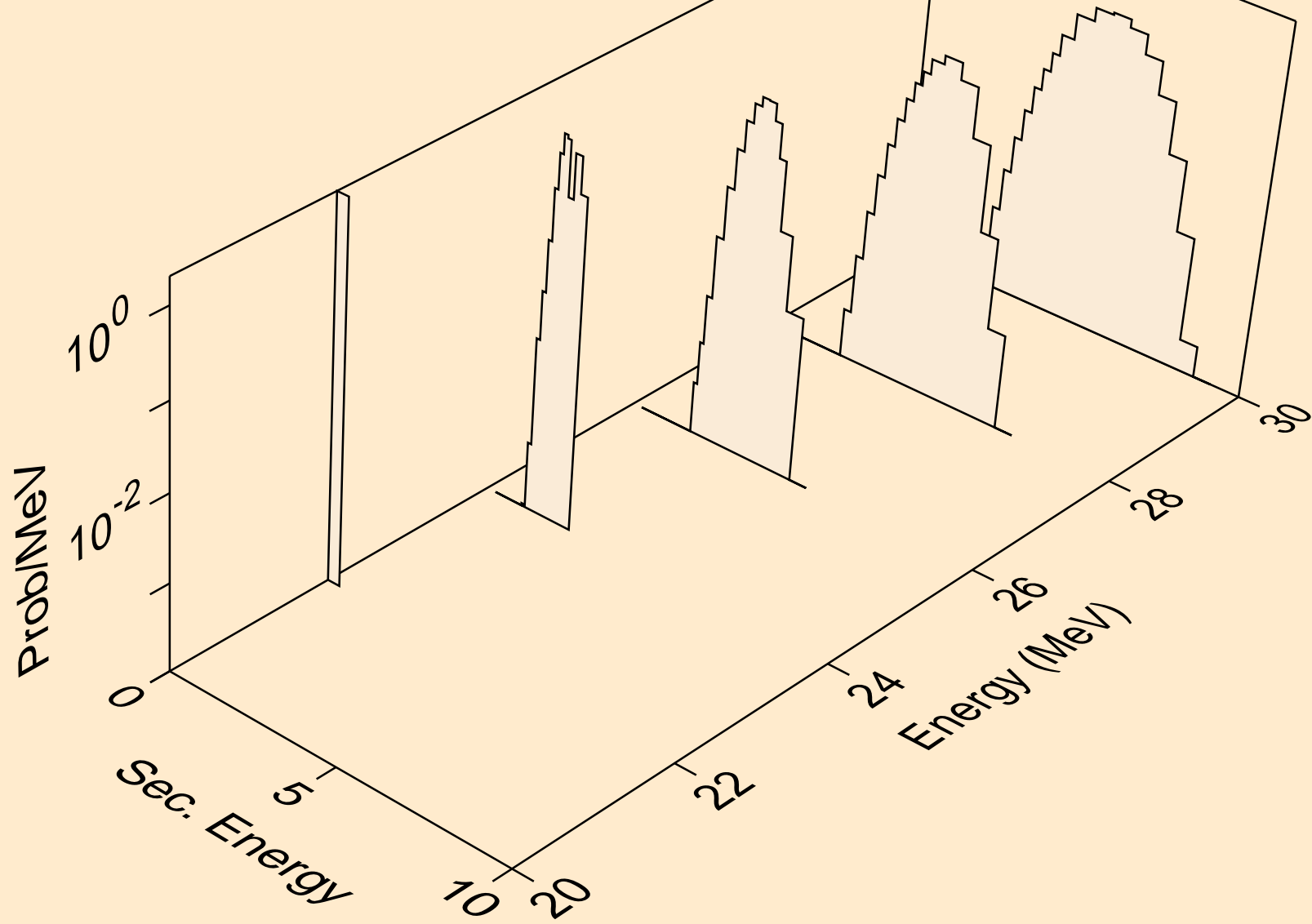

PT180 NEUTRON ACER TENDL-2021 LIBRARY; T=293.6K
protons from (n,2np)

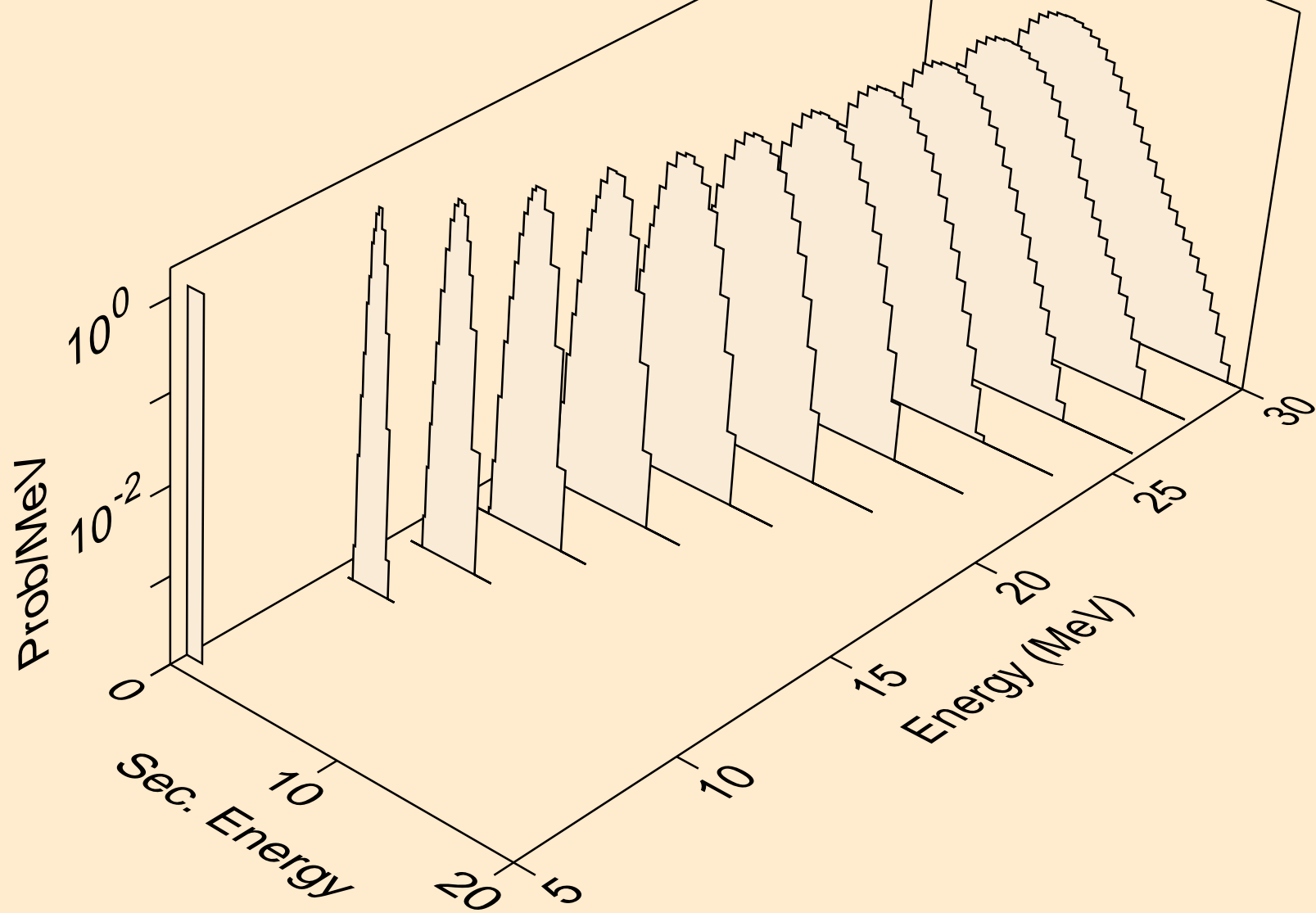

PT180 NEUTRON ACER TENDL-2021 LIBRARY; T=293.6K
protons from (n,npa)

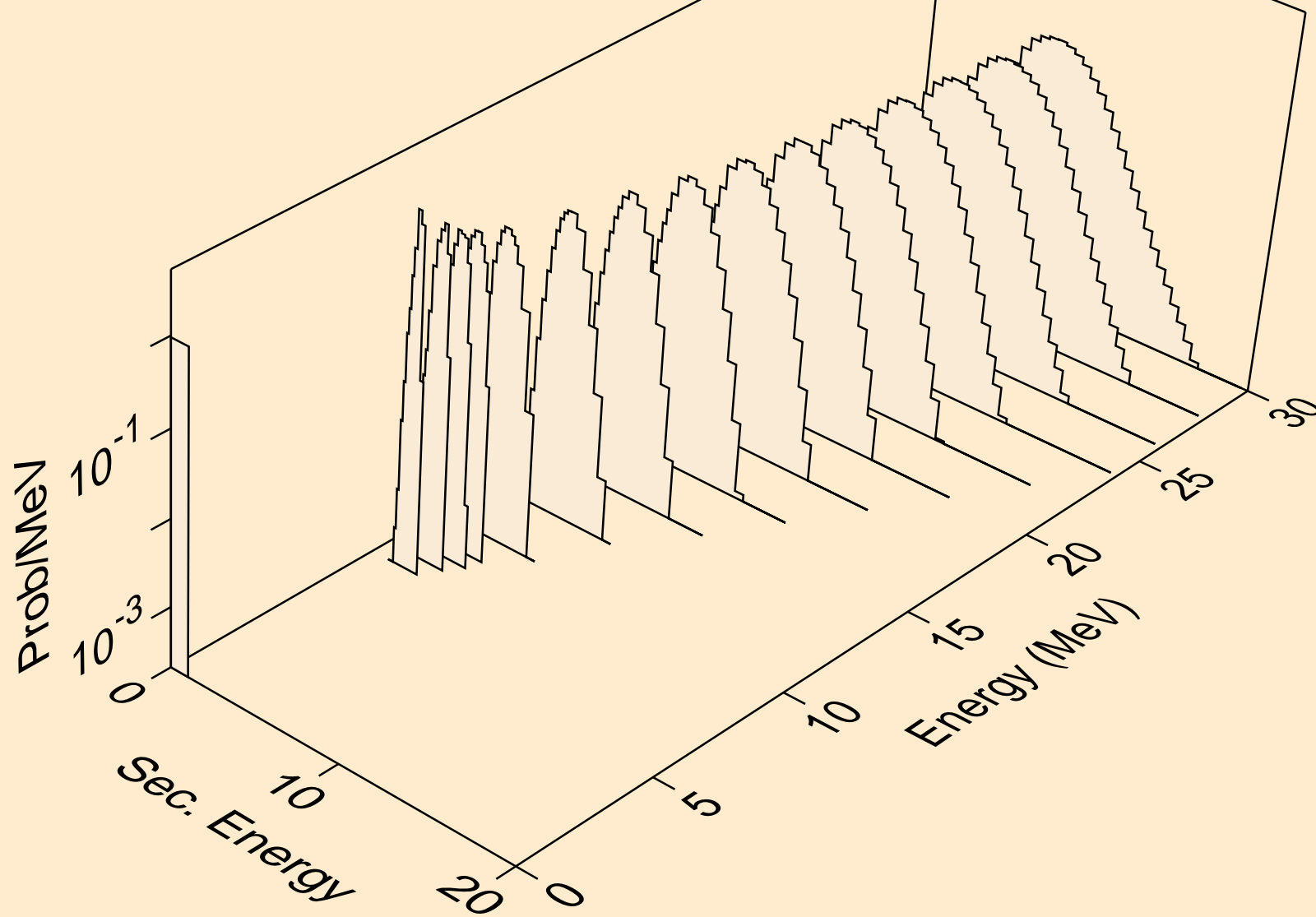

PT180 NEUTRON ACER TENDL-2021 LIBRARY; T=293.6K
protons from (n,p)

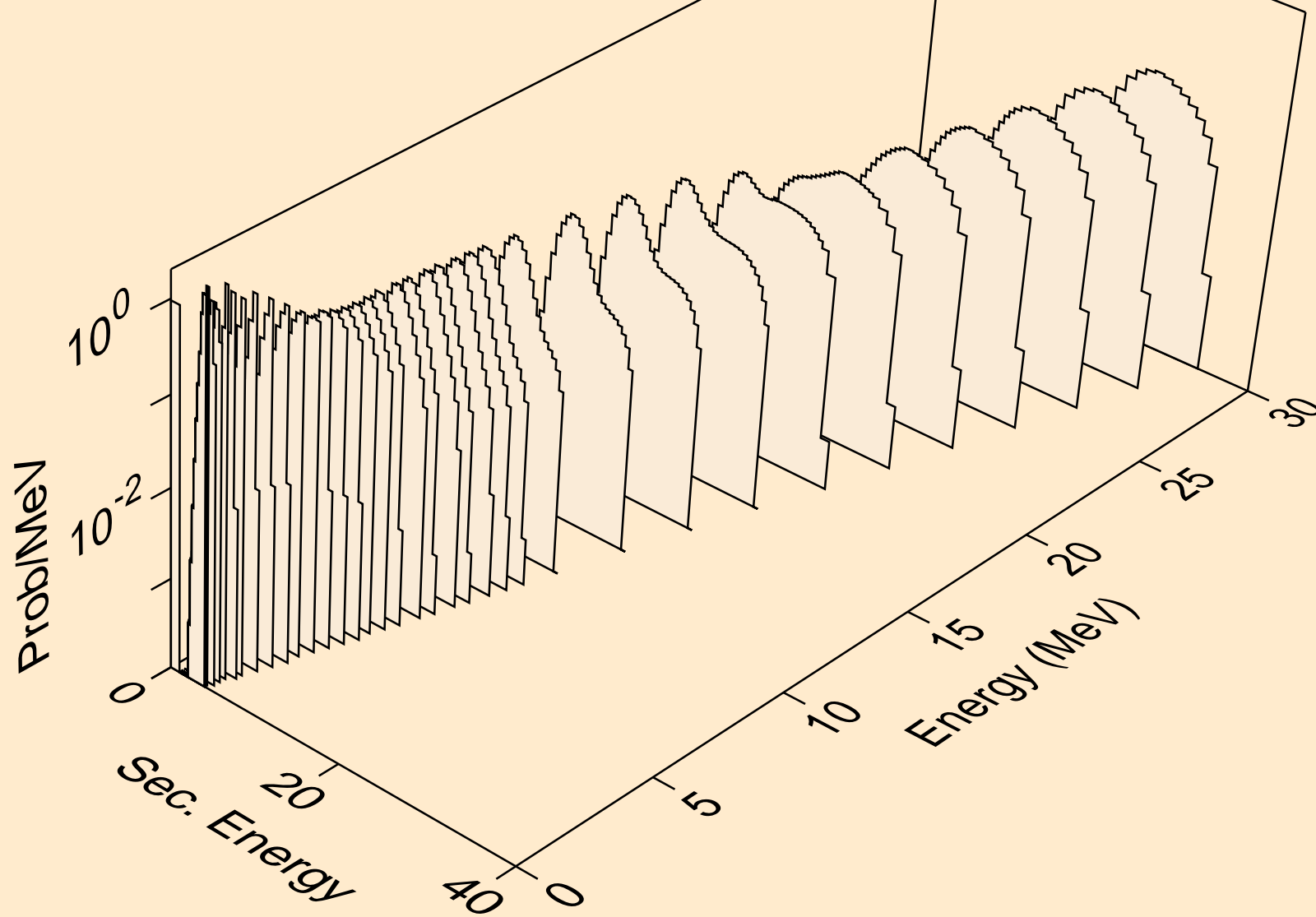

PT180 NEUTRON ACER TENDL-2021 LIBRARY; T=293.6K
protons from (n,2p)

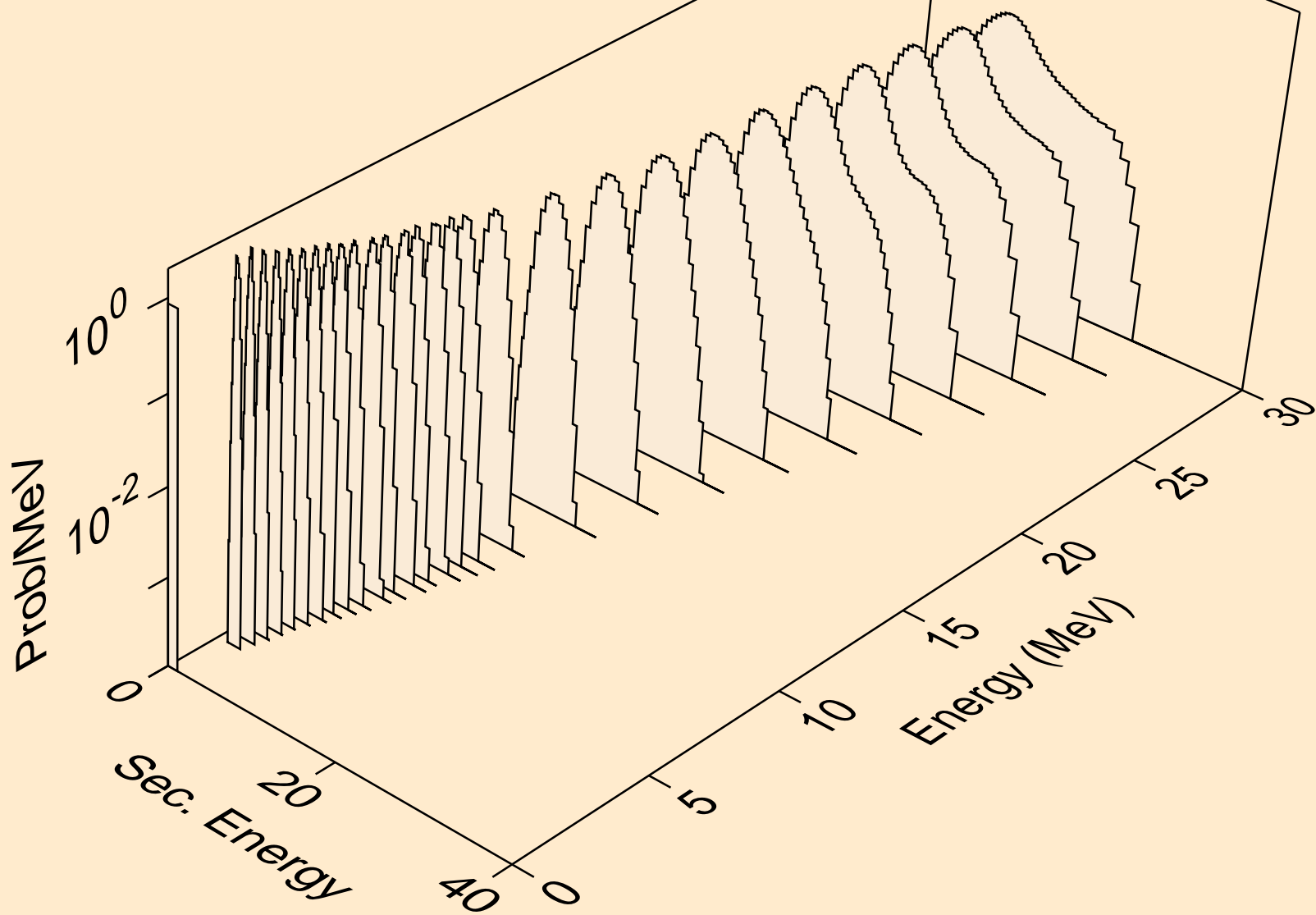

PT180 NEUTRON ACER TENDL-2021 LIBRARY; T=293.6K
protons from (n,p)

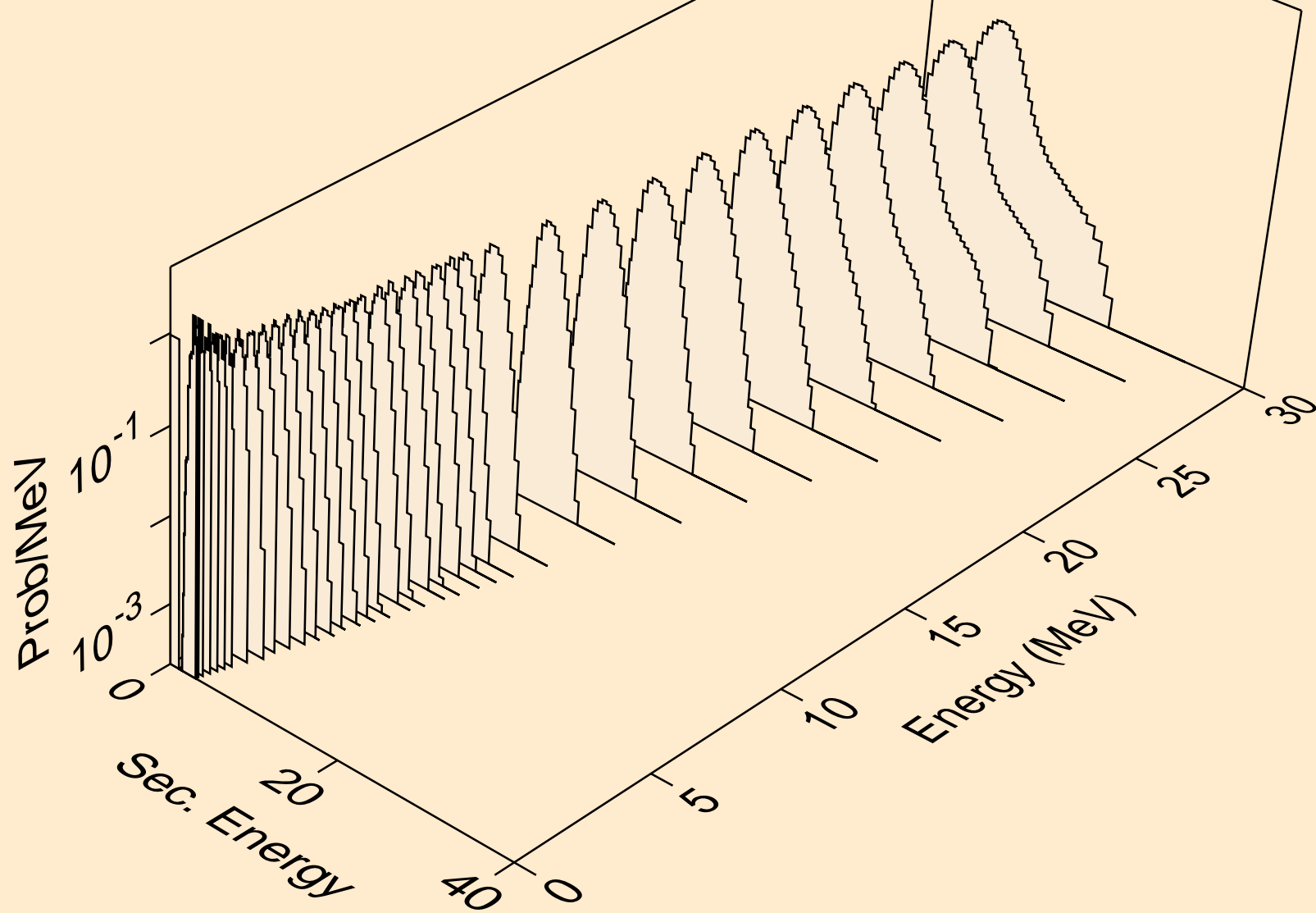

PT180 NEUTRON ACER TENDL-2021 LIBRARY; T=293.6K
protons from (n,pd)

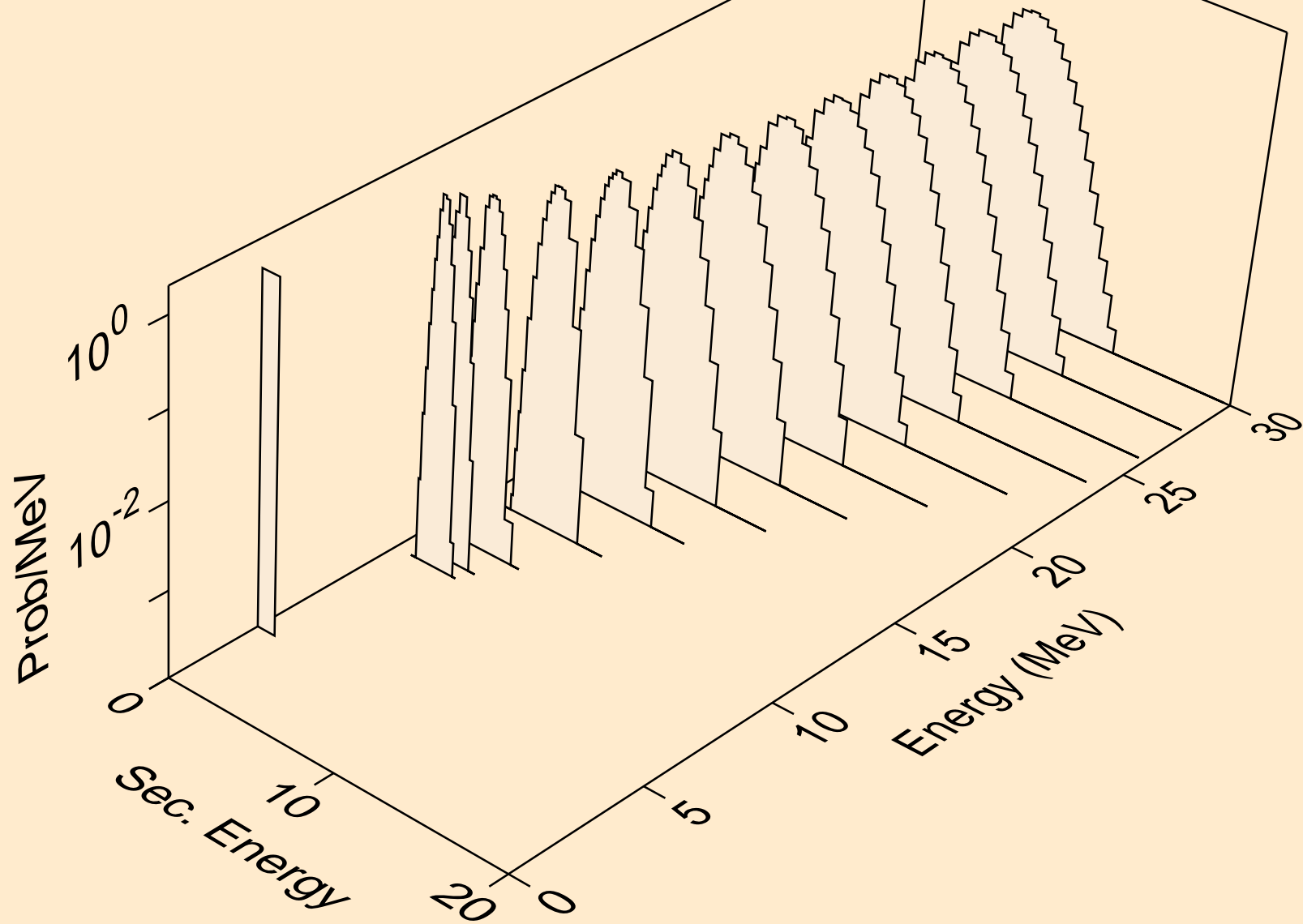

PT180 NEUTRON ACER TENDL-2021 LIBRARY; T=293.6K
protons from (n,pt)

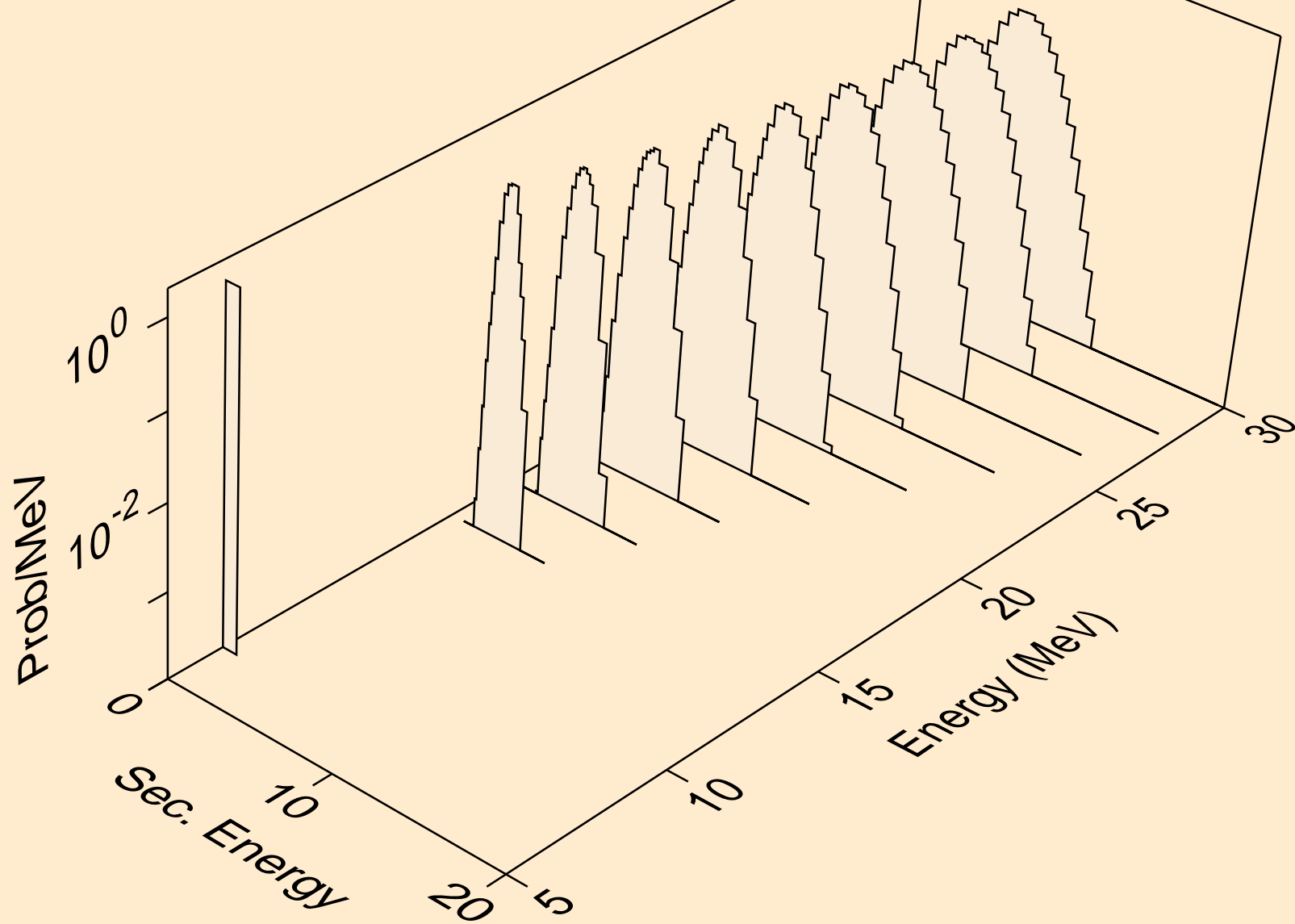

PT180 NEUTRON ACER TENDL-2021 LIBRARY; T=293.6K
deuterons from (n,x)

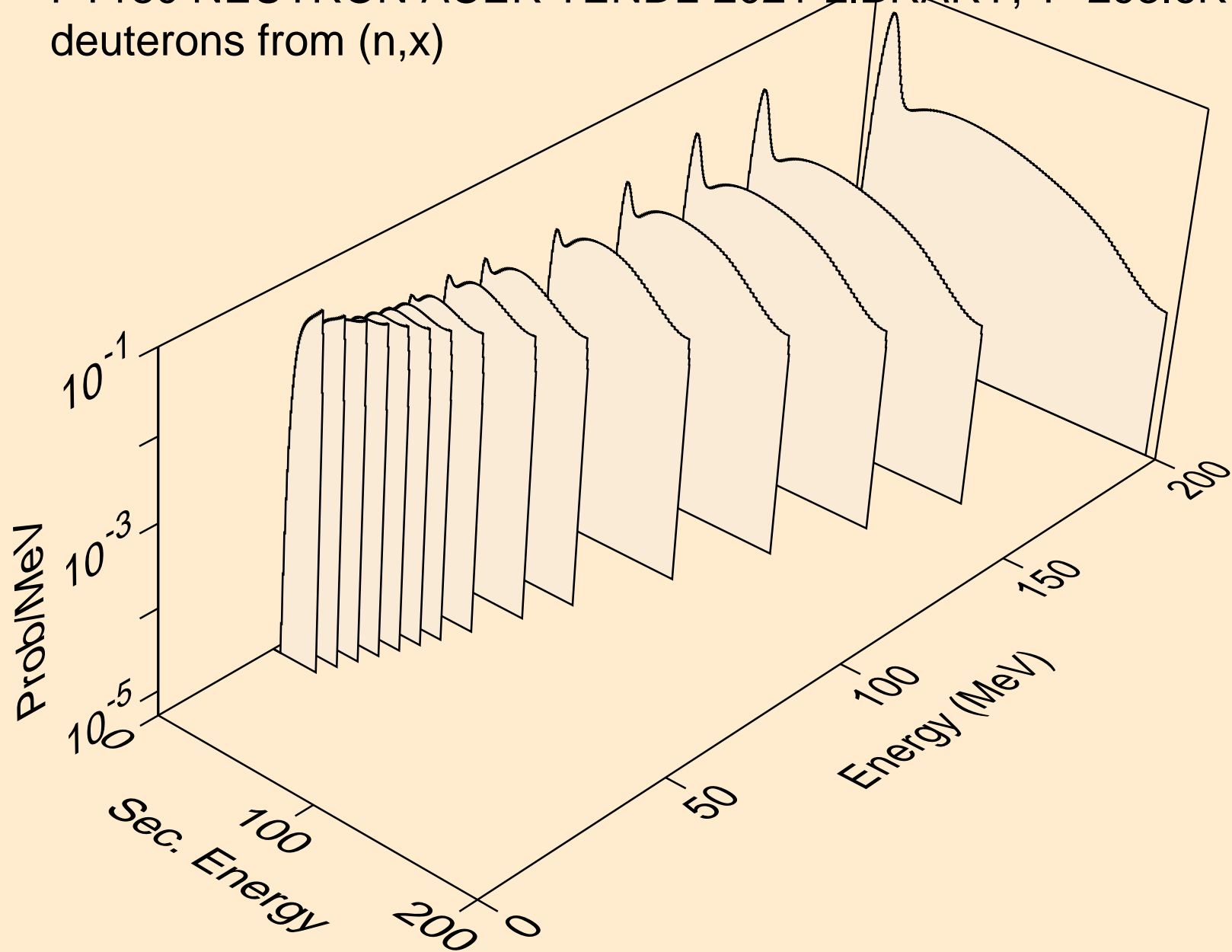

PT180 NEUTRON ACER TENDL-2021 LIBRARY; T=293.6K
deuterons from (n,2nd)

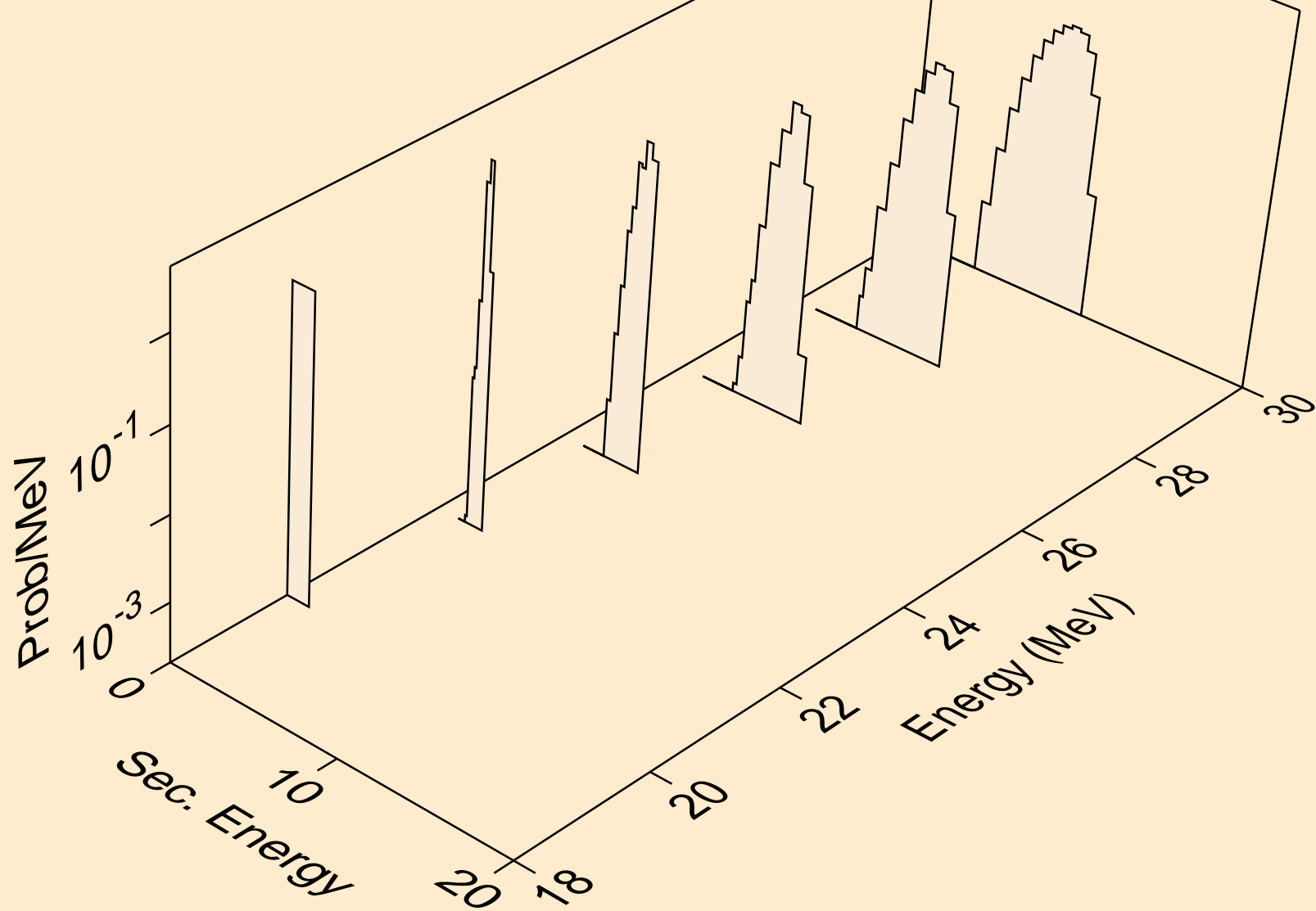

PT180 NEUTRON ACER TENDL-2021 LIBRARY; T=293.6K
deuterons from (n,n*)d

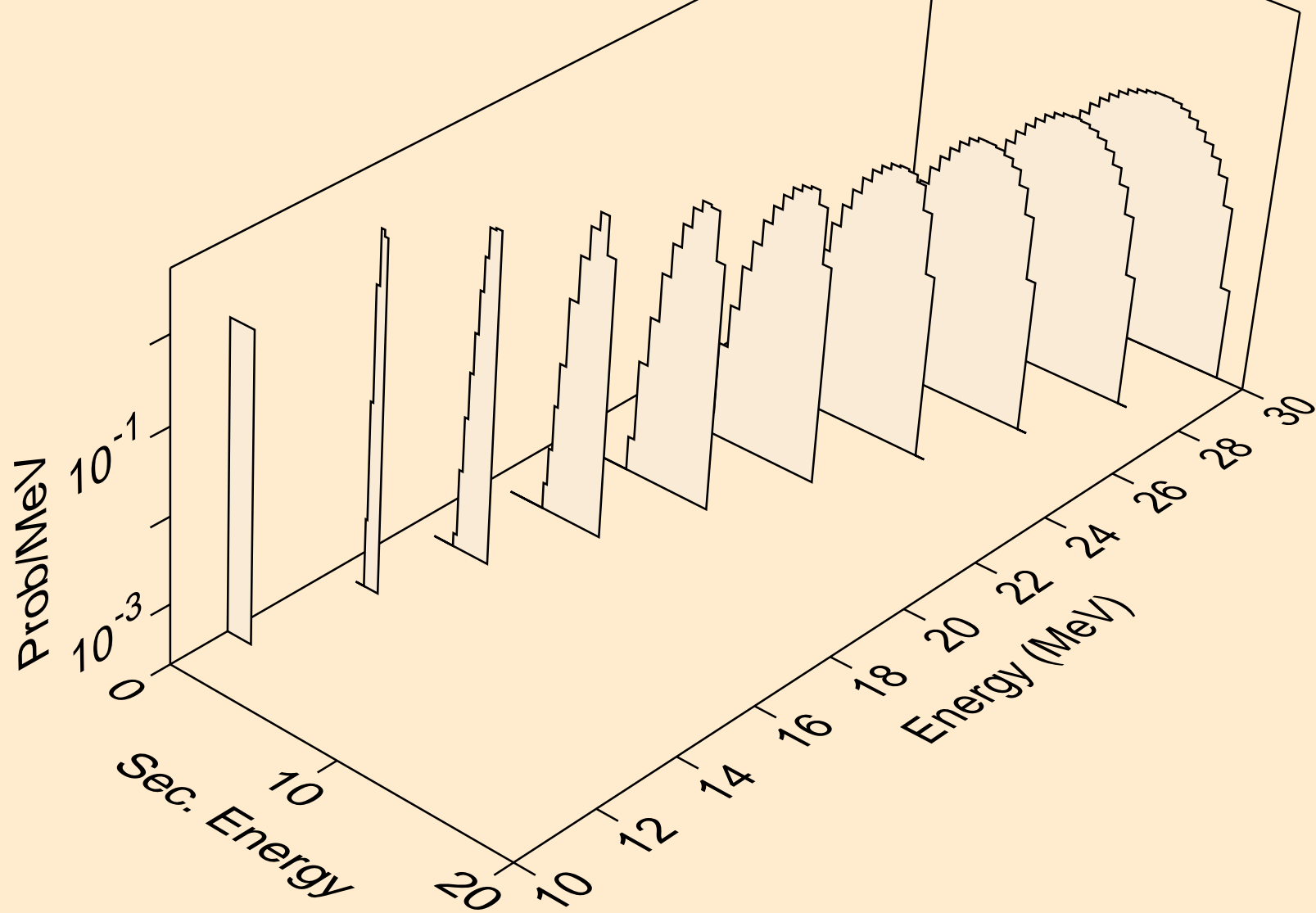

PT180 NEUTRON ACER TENDL-2021 LIBRARY; T=293.6K
deuterons from (n,d)

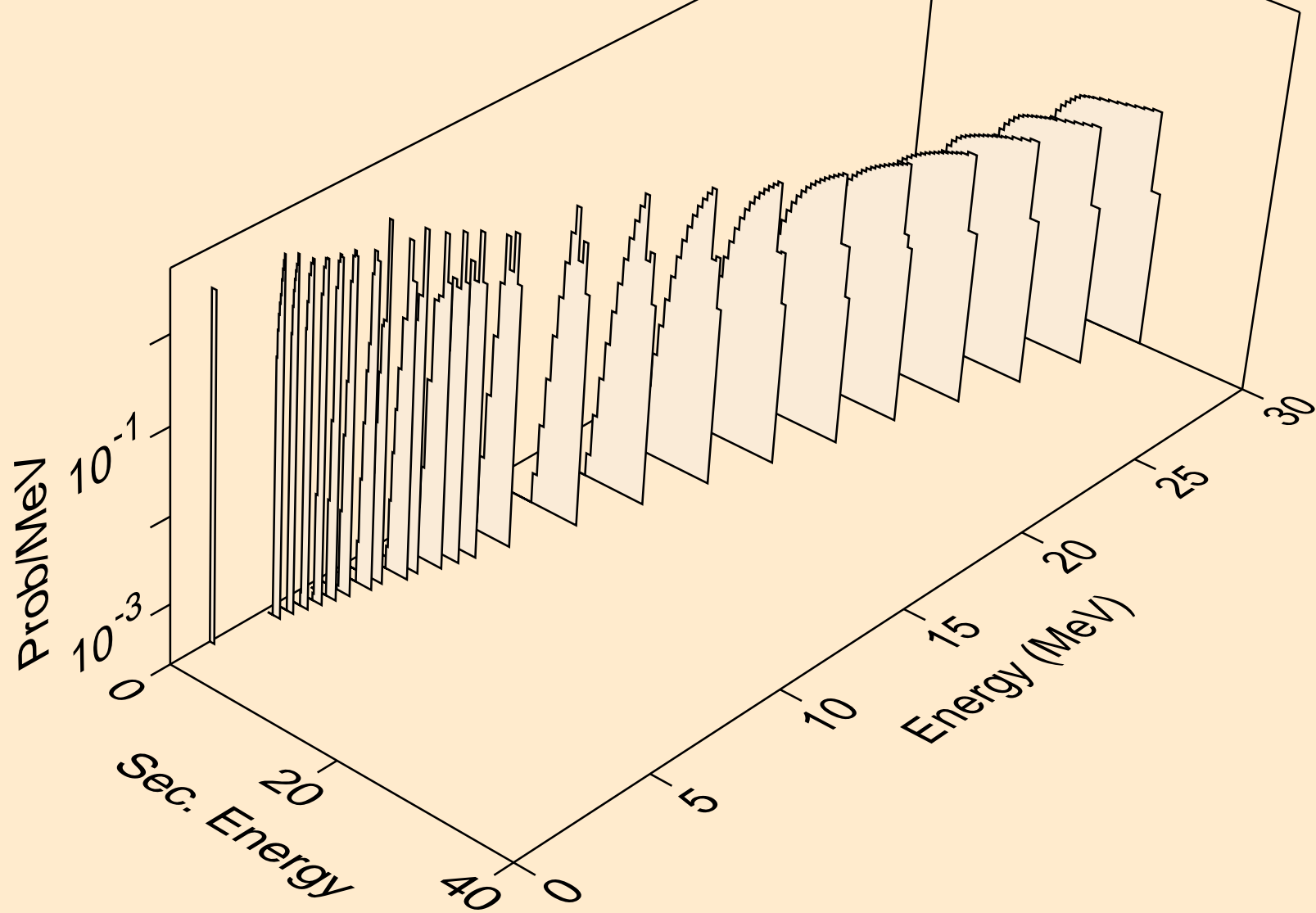

PT180 NEUTRON ACER TENDL-2021 LIBRARY; T=293.6K
deuterons from (n,pd)

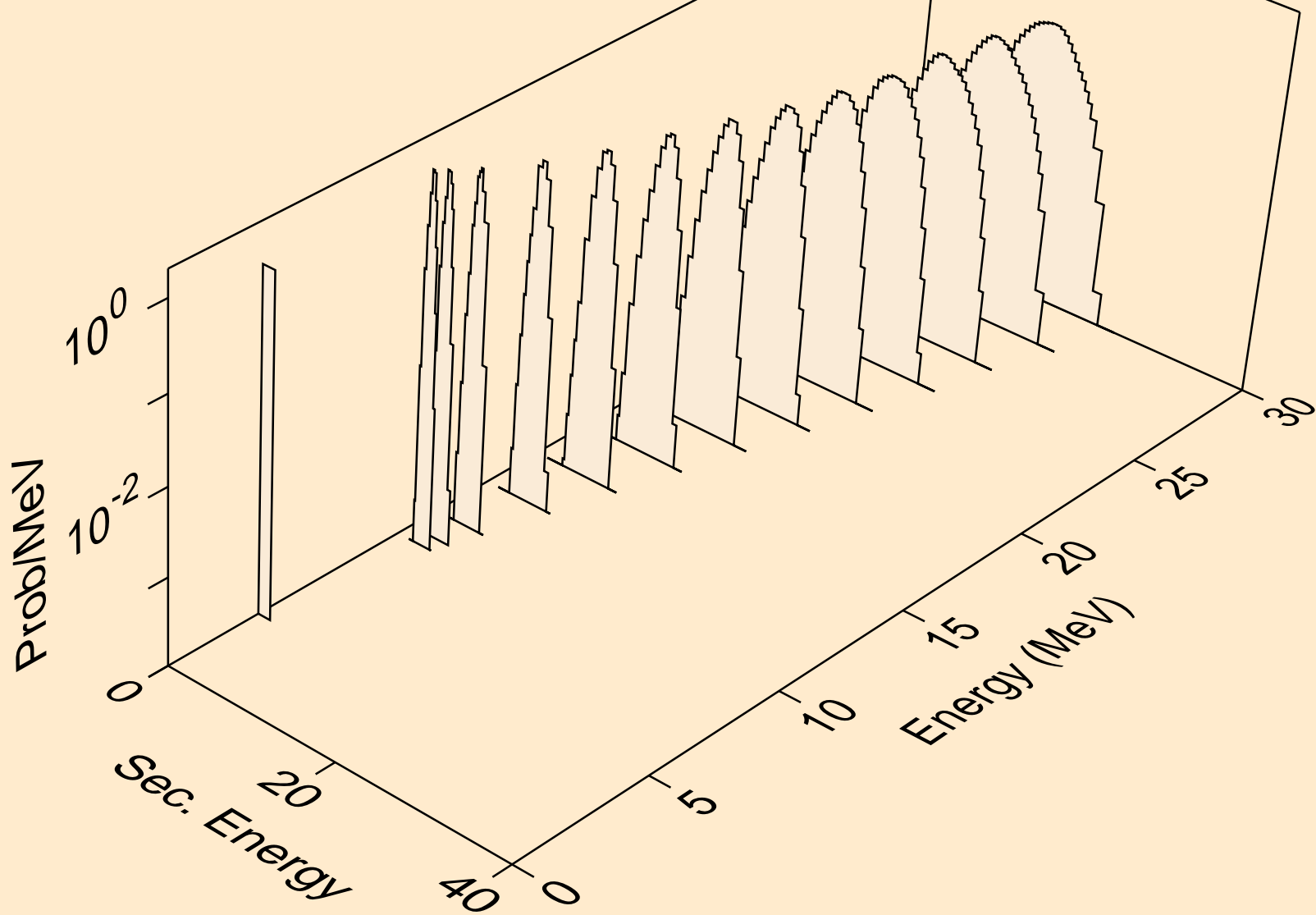

PT180 NEUTRON ACER TENDL-2021 LIBRARY; T=293.6K
deuterons from (n,da)

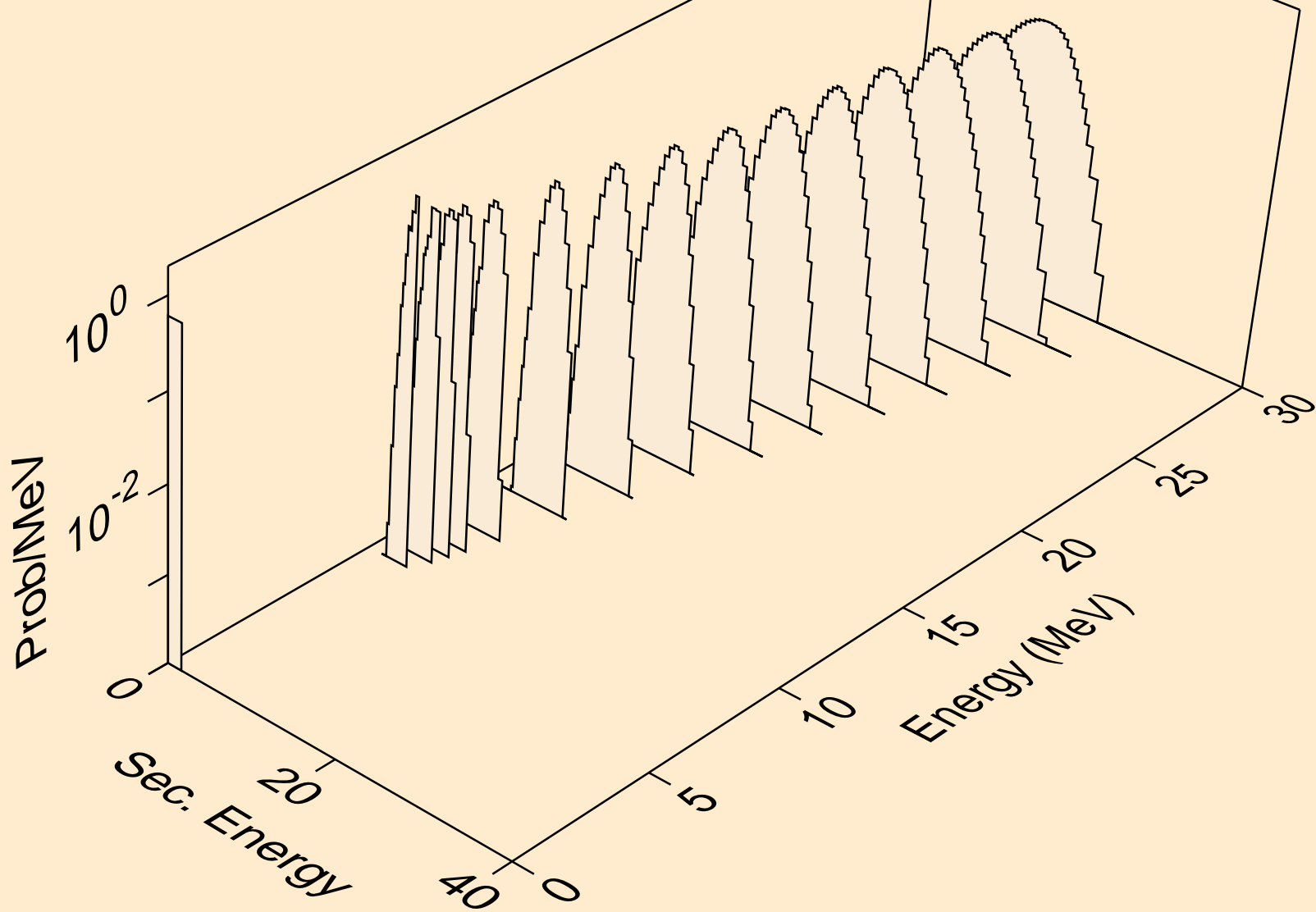

PT180 NEUTRON ACER TENDL-2021 LIBRARY; T=293.6K
tritons from (n,x)

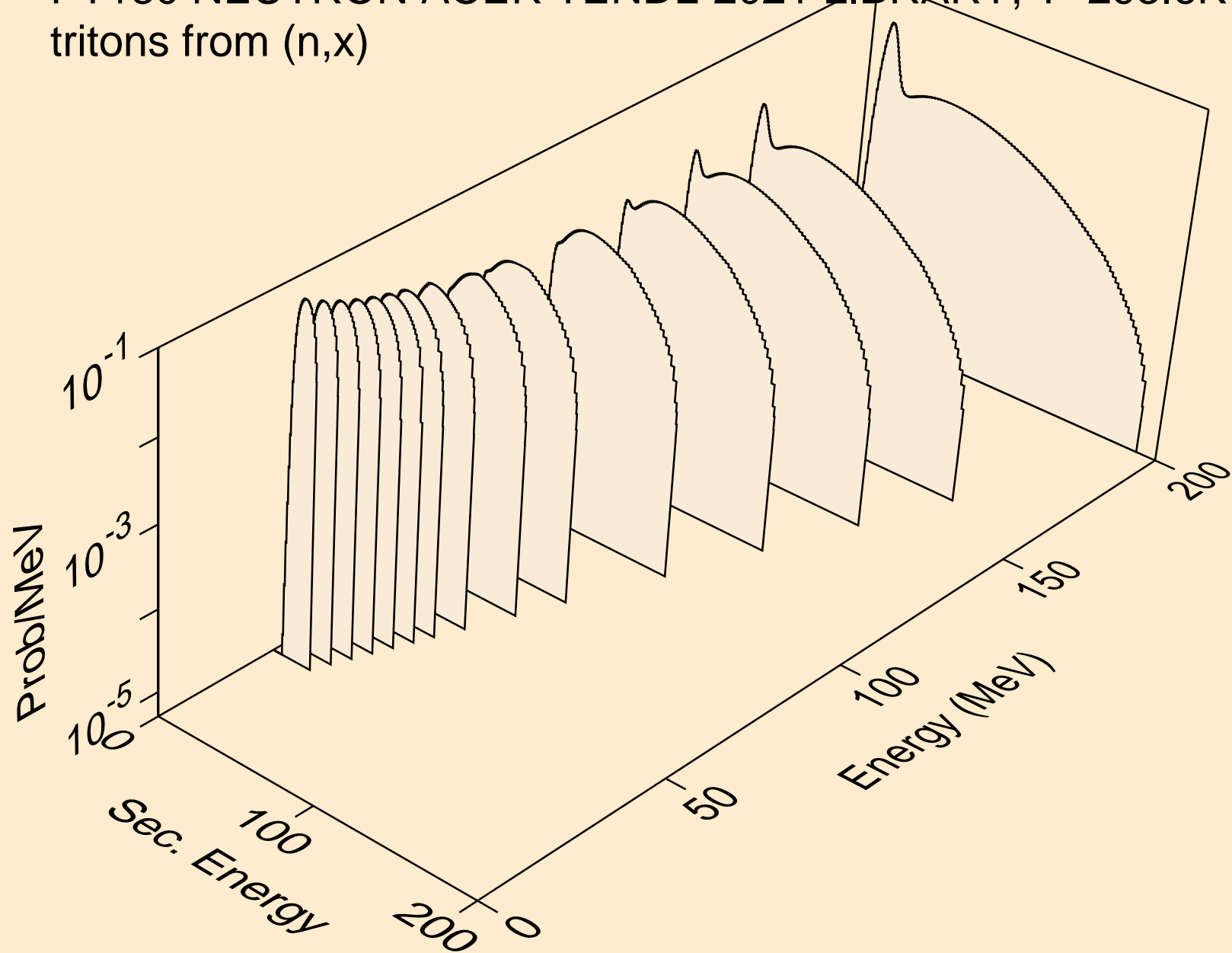

PT180 NEUTRON ACER TENDL-2021 LIBRARY; T=293.6K
tritons from (n,n*)t

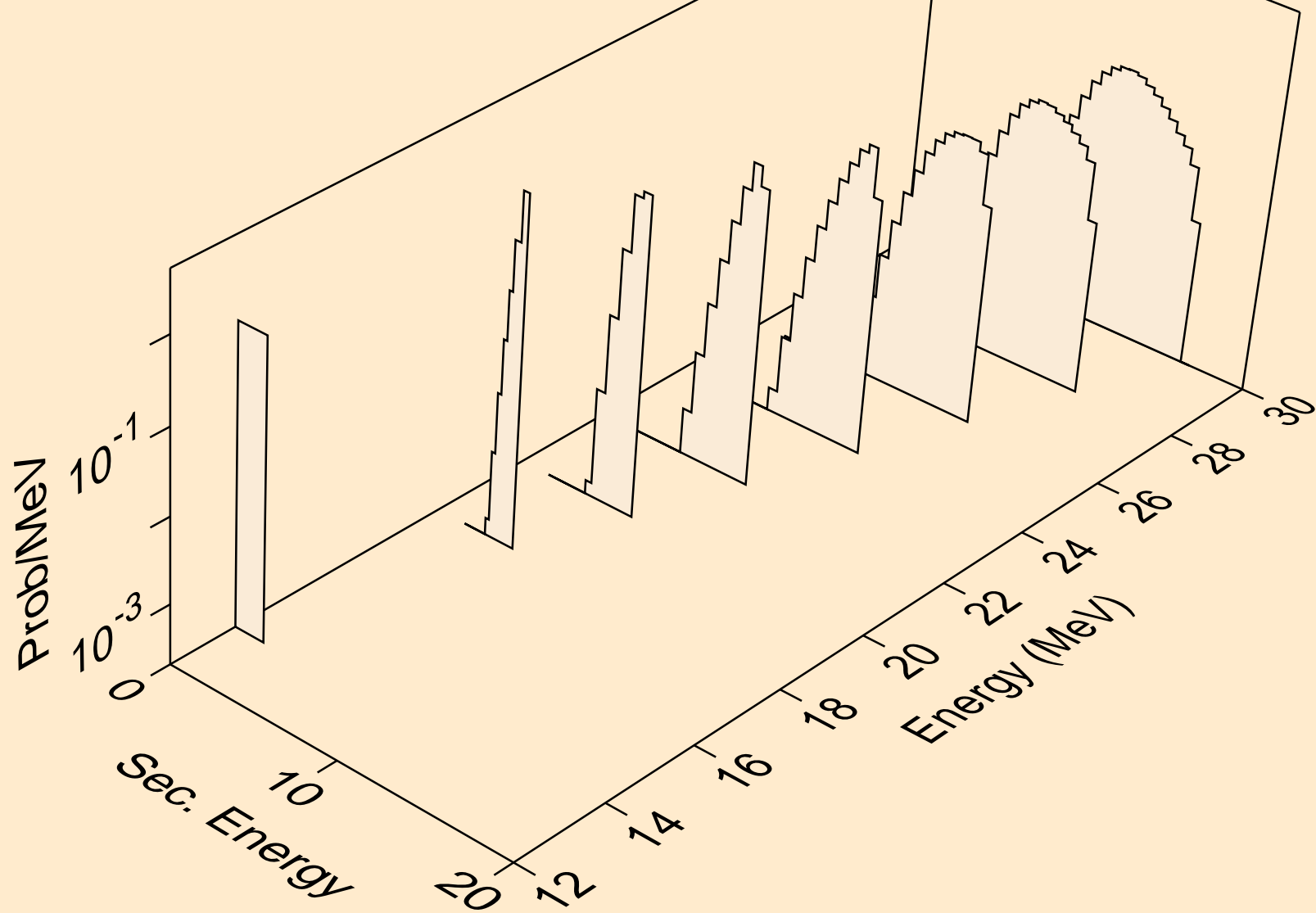

PT180 NEUTRON ACER TENDL-2021 LIBRARY; T=293.6K
tritons from (n,t)

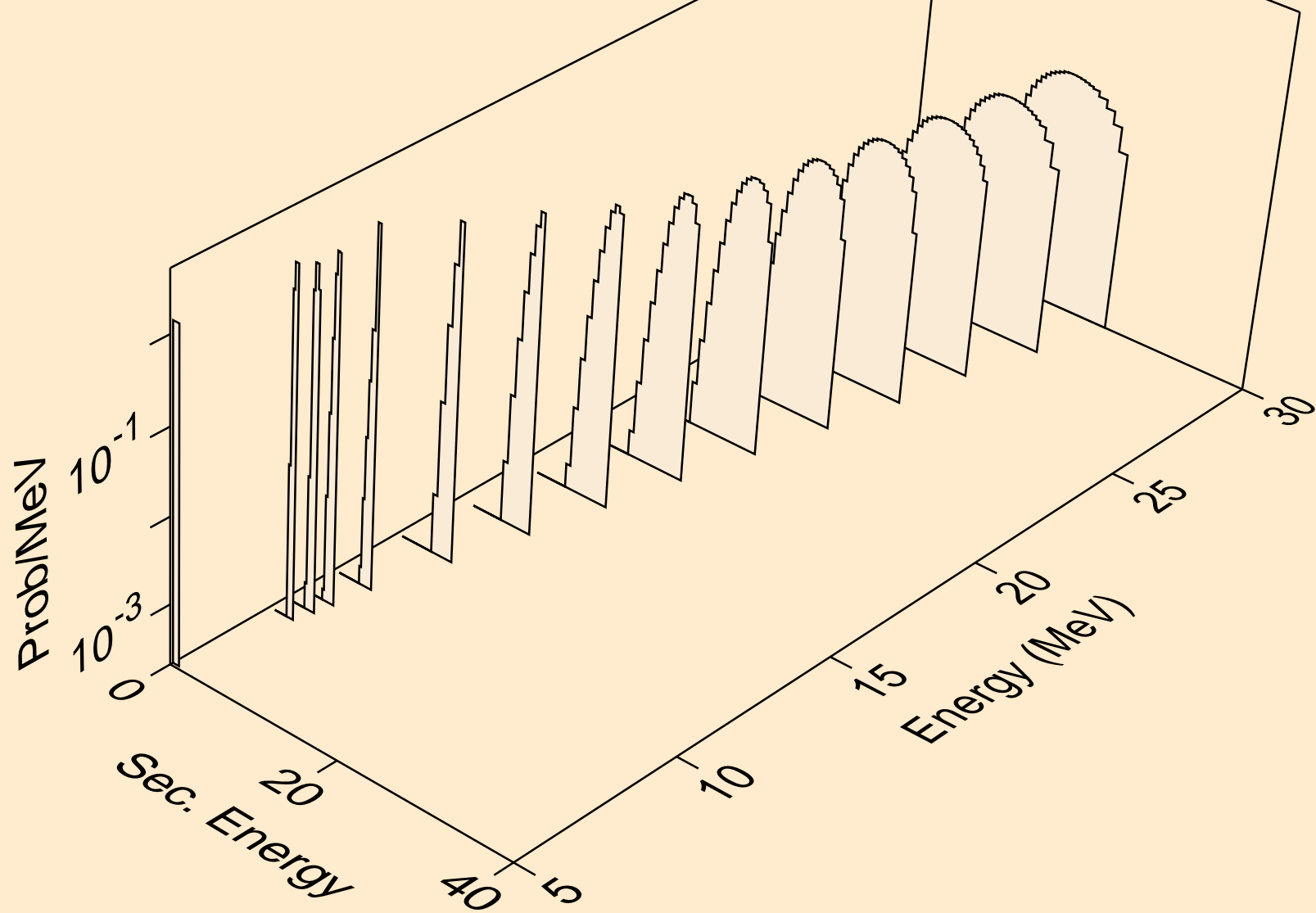

PT180 NEUTRON ACER TENDL-2021 LIBRARY; T=293.6K
tritons from (n,pt)

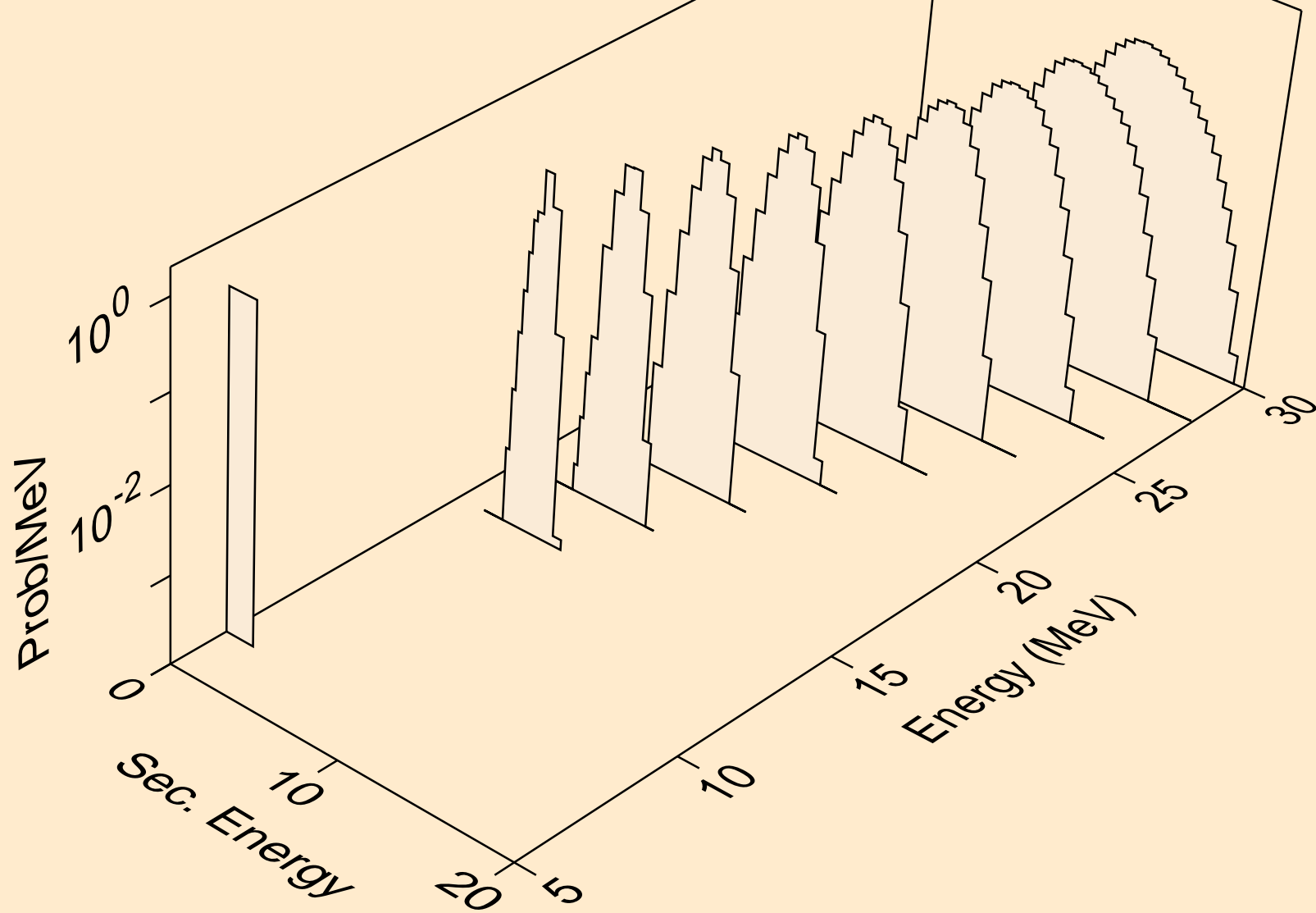

PT180 NEUTRON ACER TENDL-2021 LIBRARY; T=293.6K
he3s from (n,x)

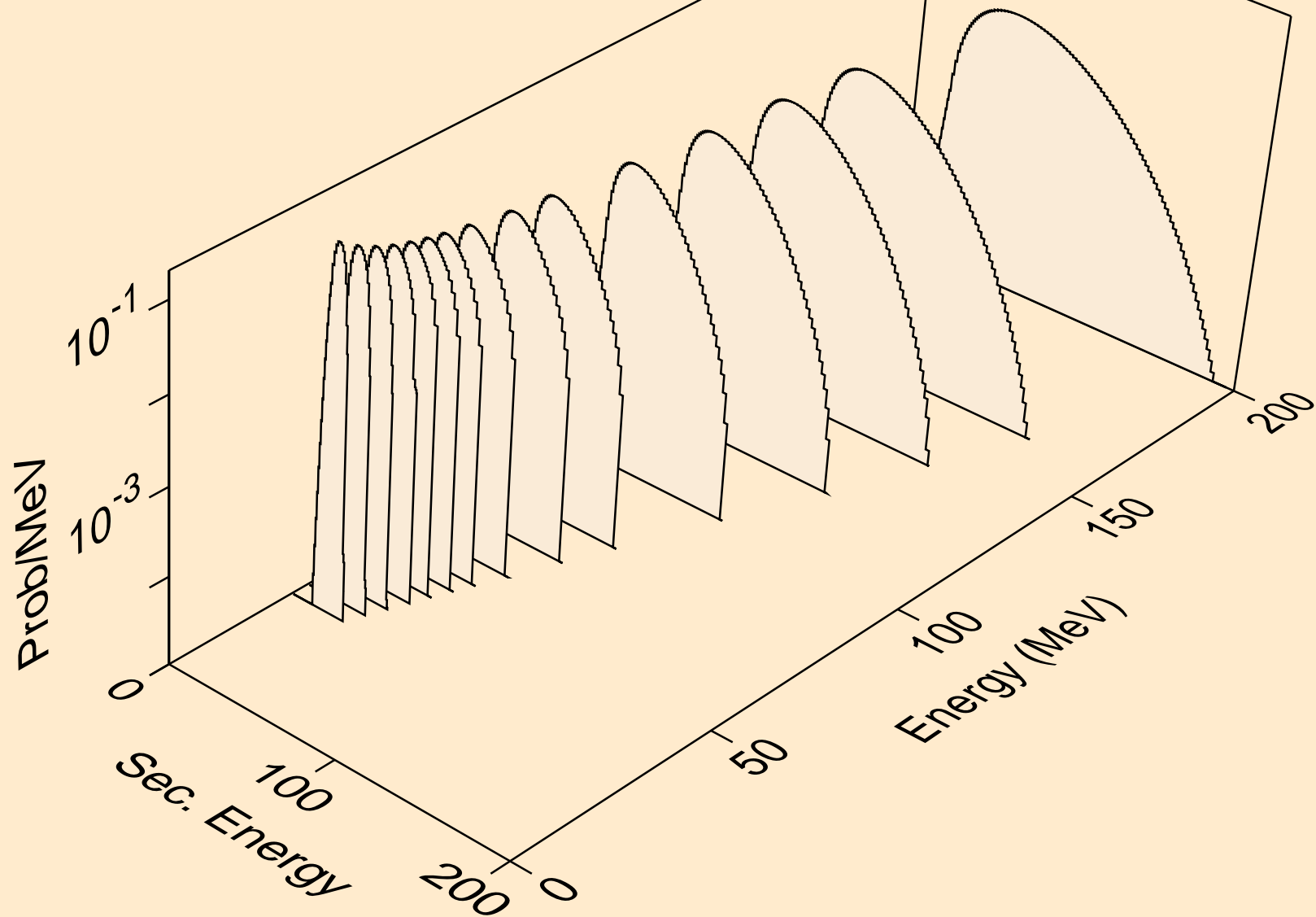

PT180 NEUTRON ACER TENDL-2021 LIBRARY; T=293.6K
he3s from (n,n*)he3

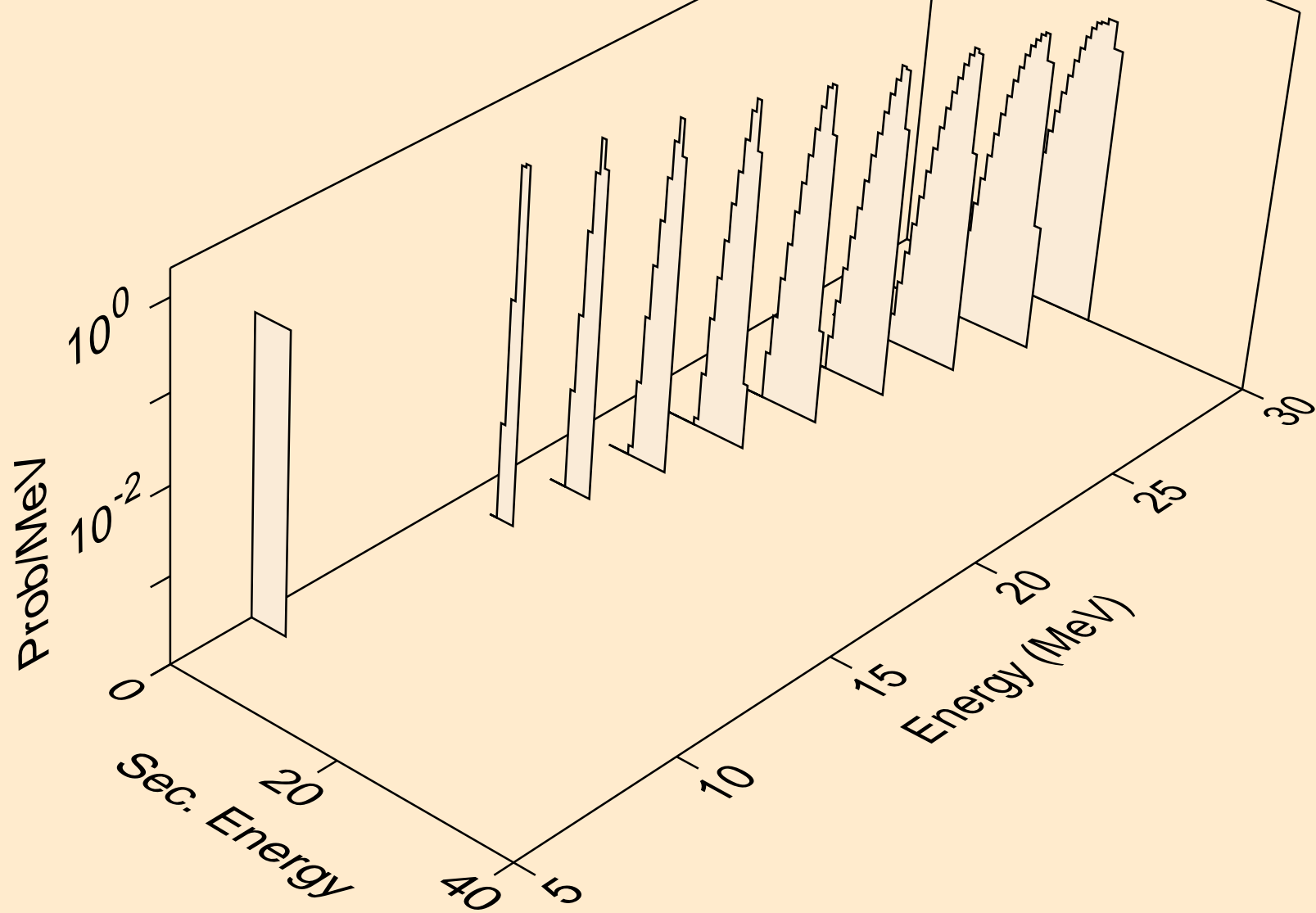

PT180 NEUTRON ACER TENDL-2021 LIBRARY; T=293.6K
he3s from (n,he3)

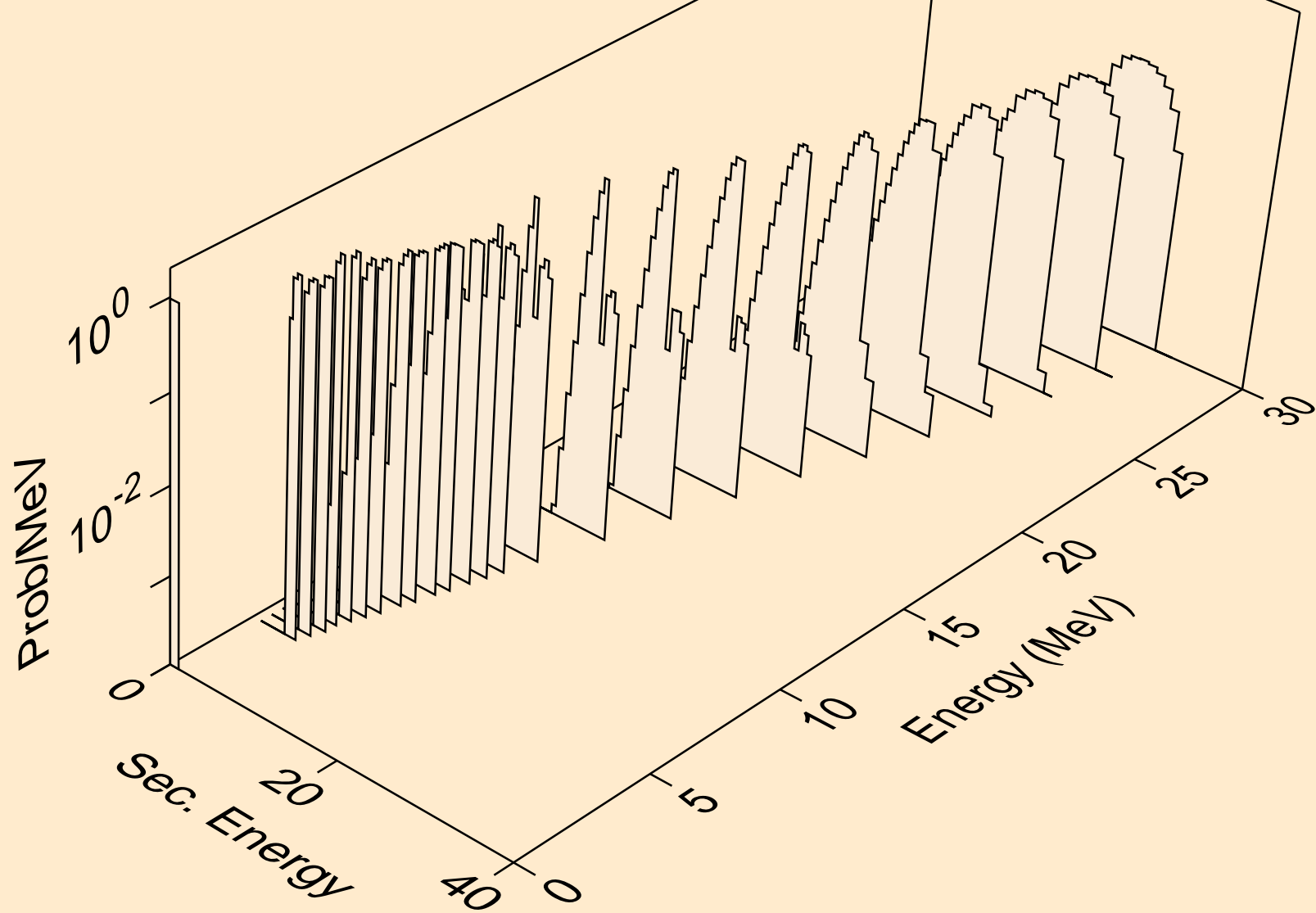

PT180 NEUTRON ACER TENDL-2021 LIBRARY; T=293.6K
alphas from (n,x)

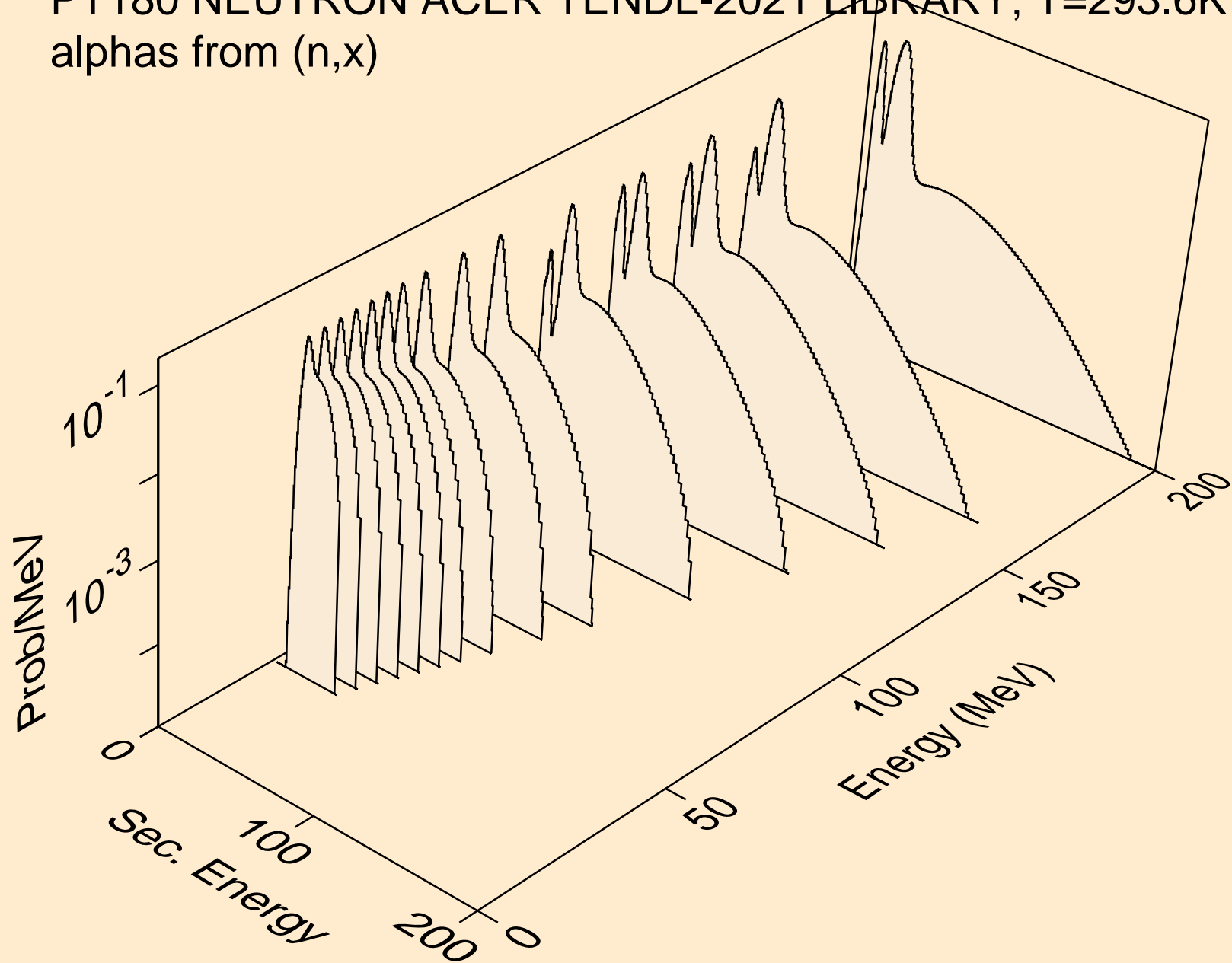

PT180 NEUTRON ACER TENDL-2021 LIBRARY; T=293.6K
alphas from (n,n*)a

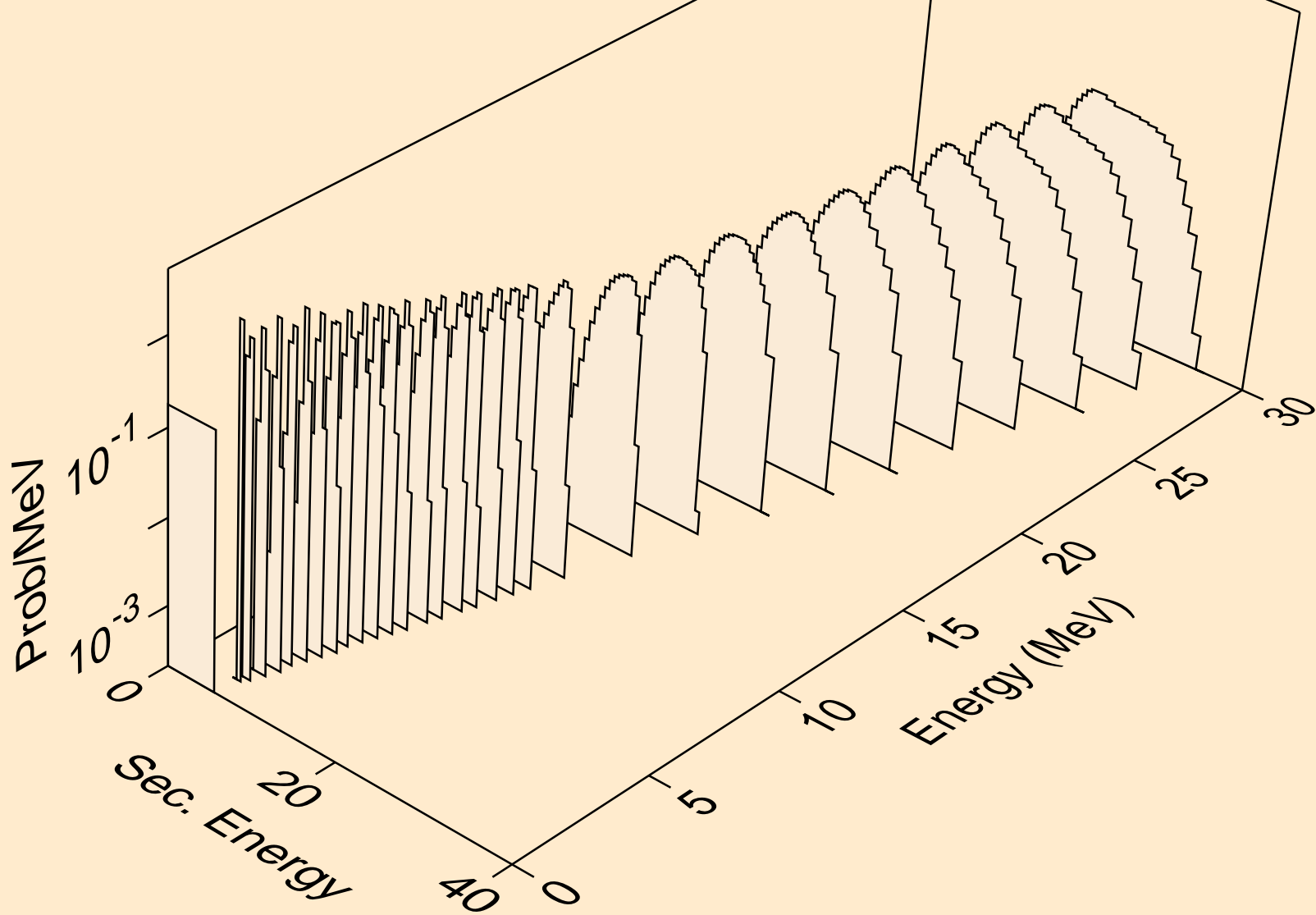

PT180 NEUTRON ACER TENDL-2021 LIBRARY; T=293.6K
alphas from (n,2n)a

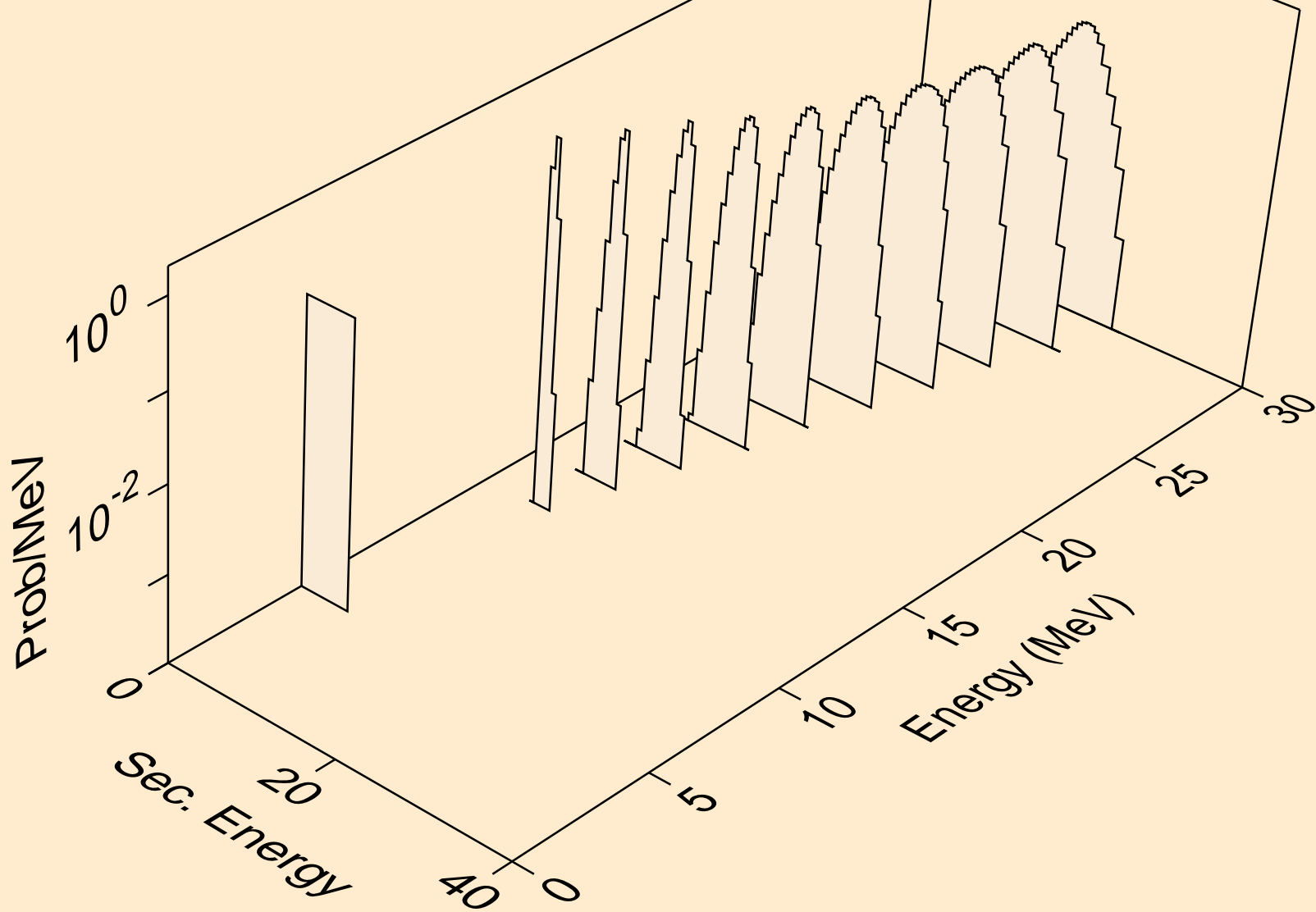

PT180 NEUTRON ACER TENDL-2021 LIBRARY; T=293.6K
alphas from (n,3n)a

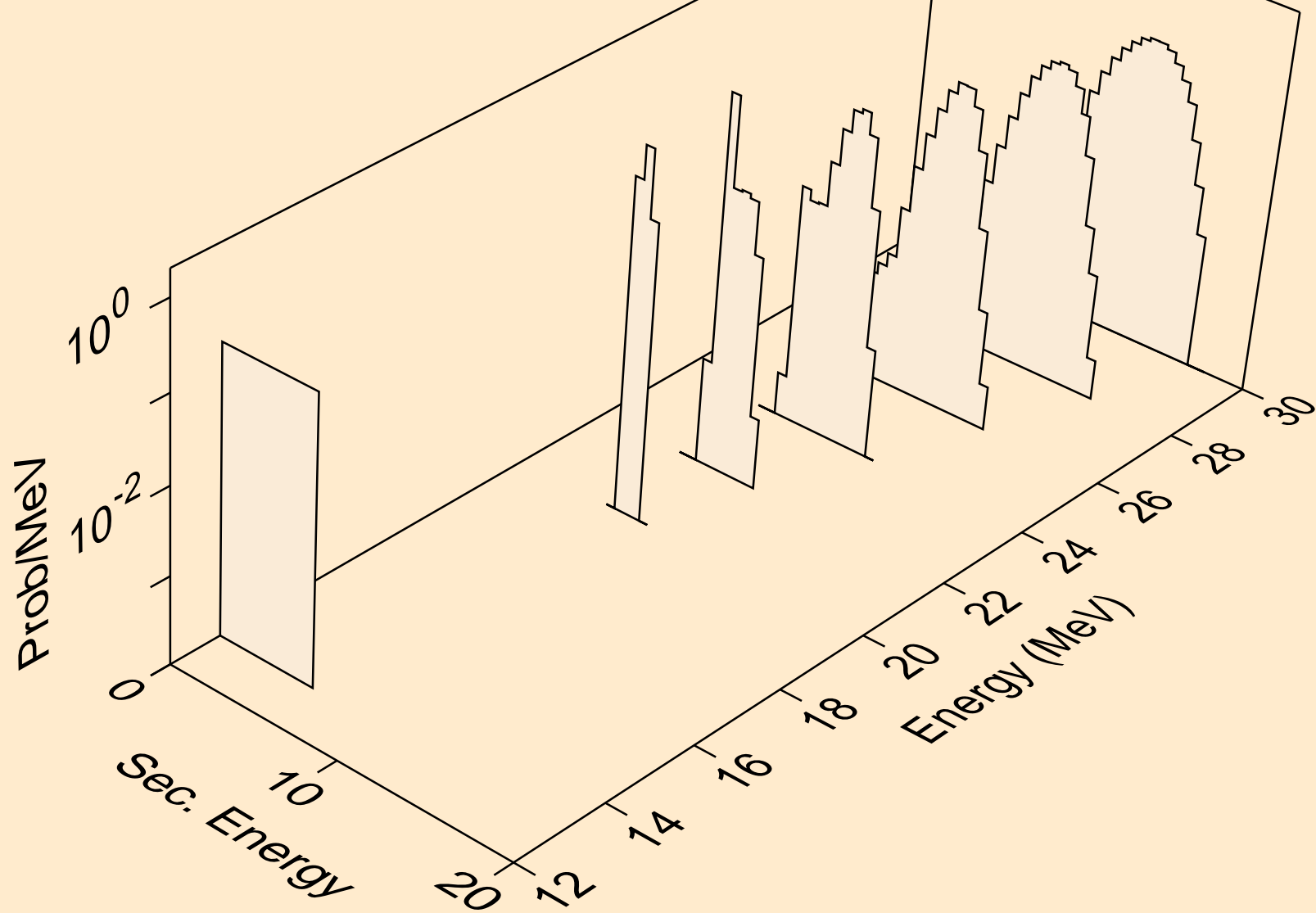

PT180 NEUTRON ACER TENDL-2021 LIBRARY; T=293.6K
alphas from (n,n*)2a

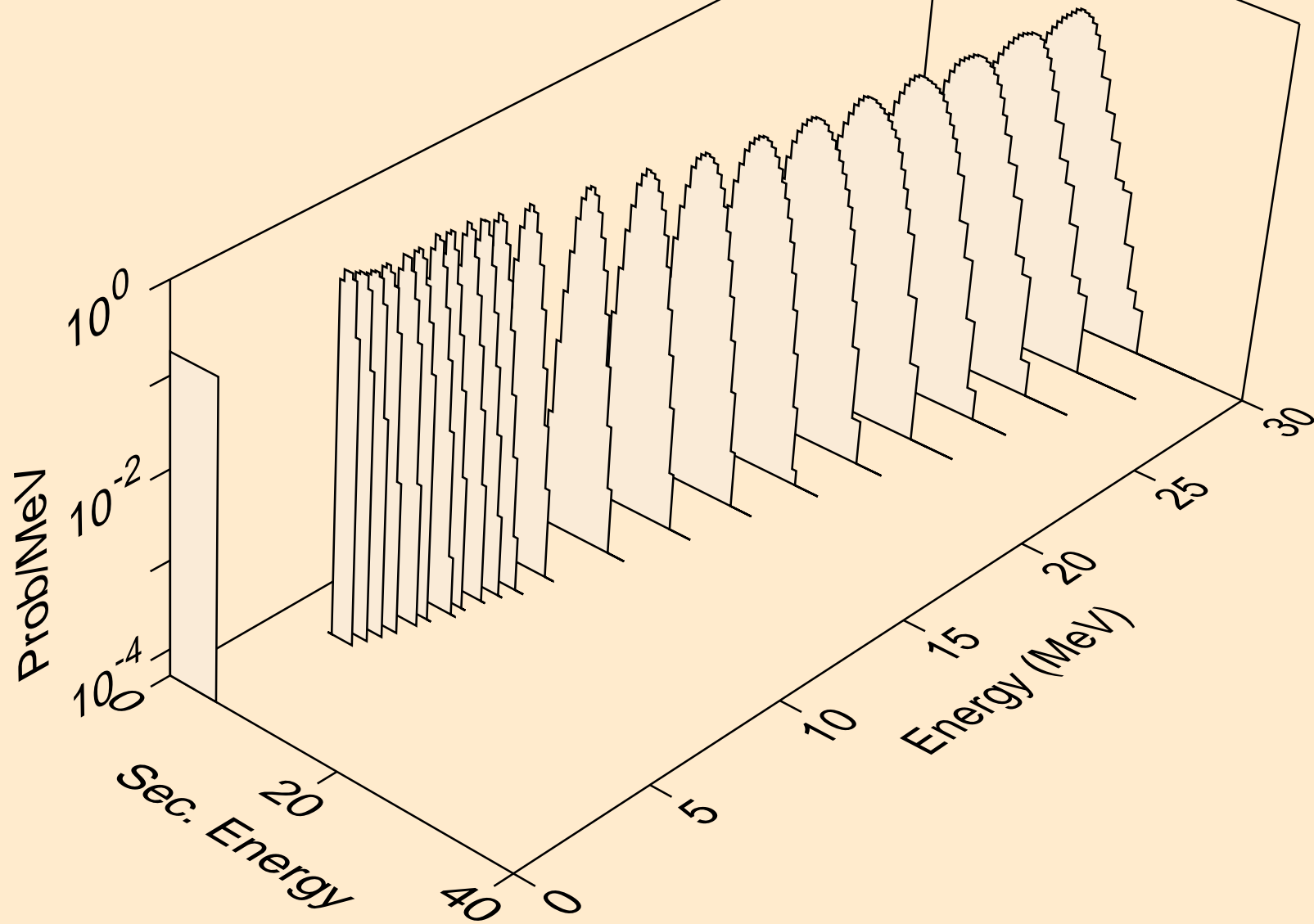

PT180 NEUTRON ACER TENDL-2021 LIBRARY; T=293.6K
alphas from (n,2n)2a

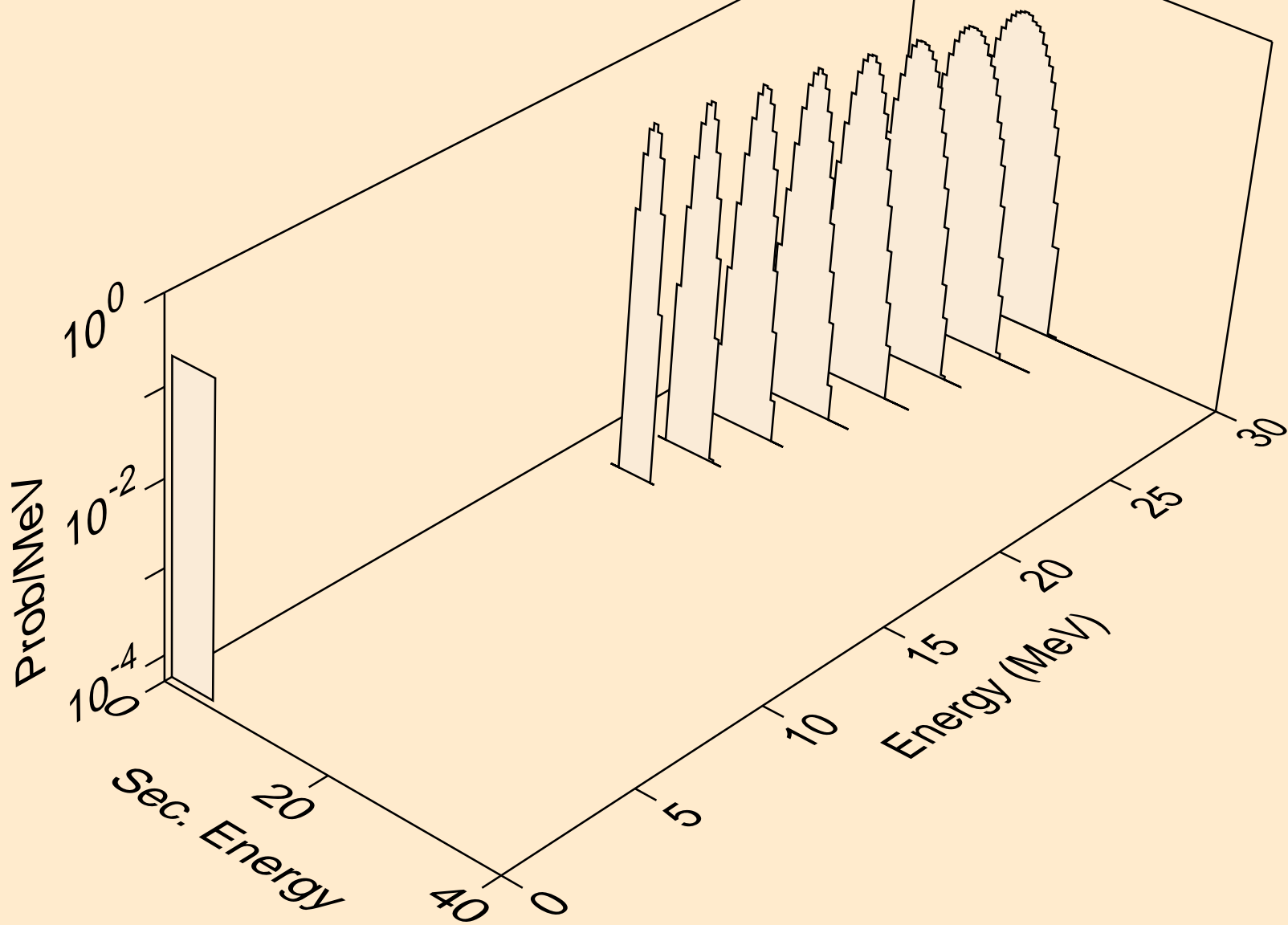

PT180 NEUTRON ACER TENDL-2021 LIBRARY; T=293.6K
alphas from (n,npa)

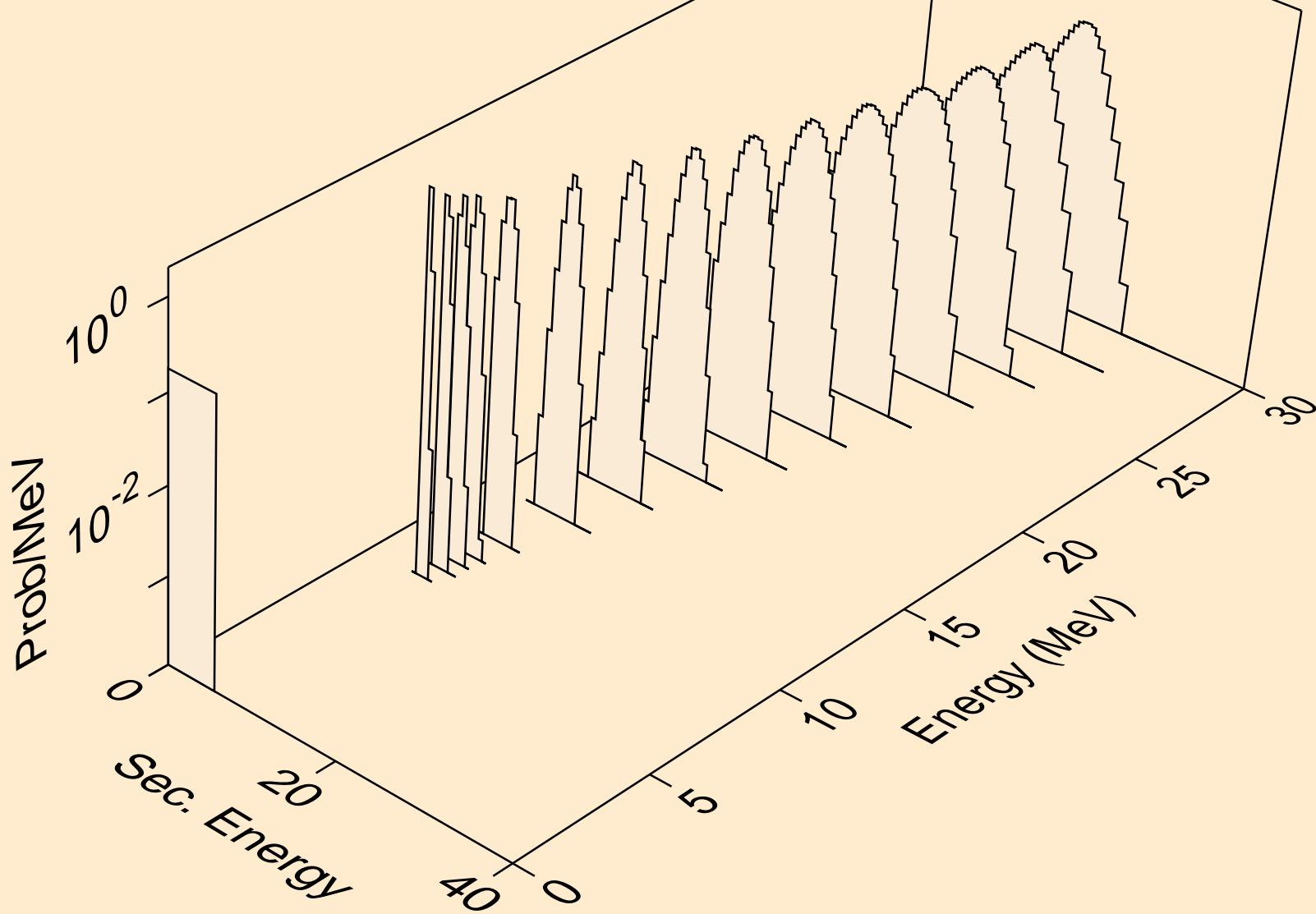

PT180 NEUTRON ACER TENDL-2021 LIBRARY; T=293.6K
alphas from (n,a)

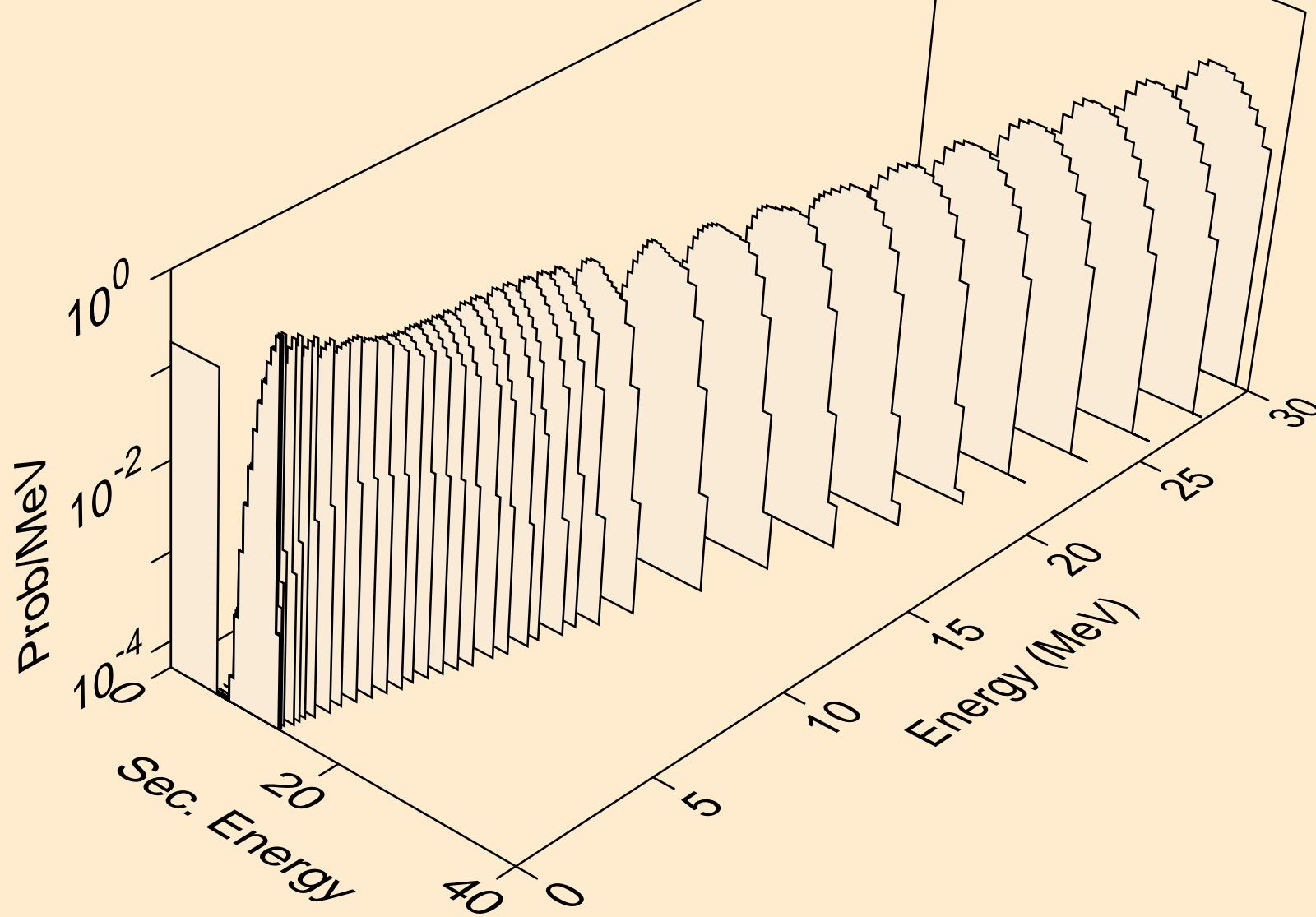

PT180 NEUTRON ACER TENDL-2021 LIBRARY; T=293.6K
alphas from (n,2a)

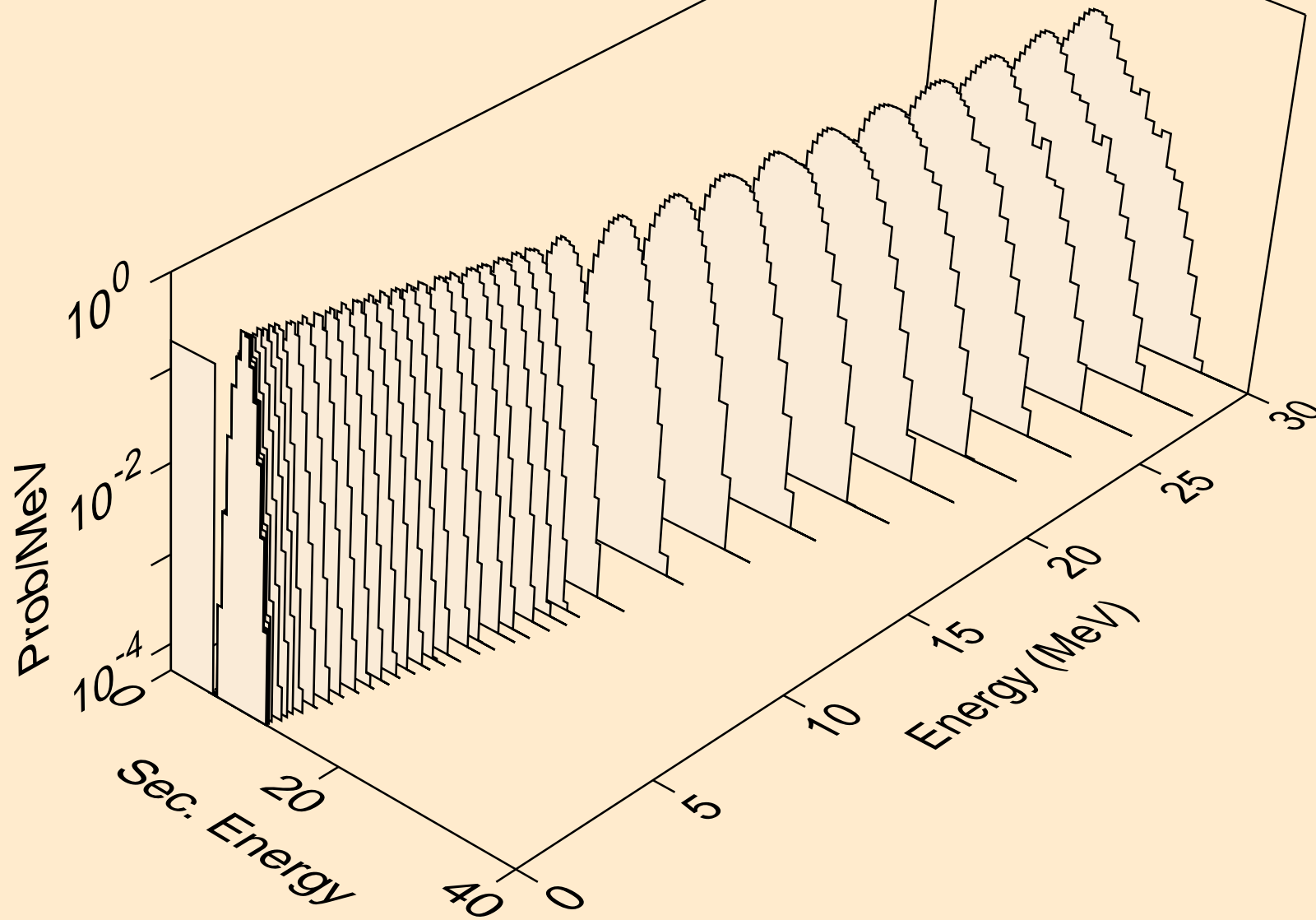

PT180 NEUTRON ACER TENDL-2021 LIBRARY; T=293.6K
alphas from (n,3a)

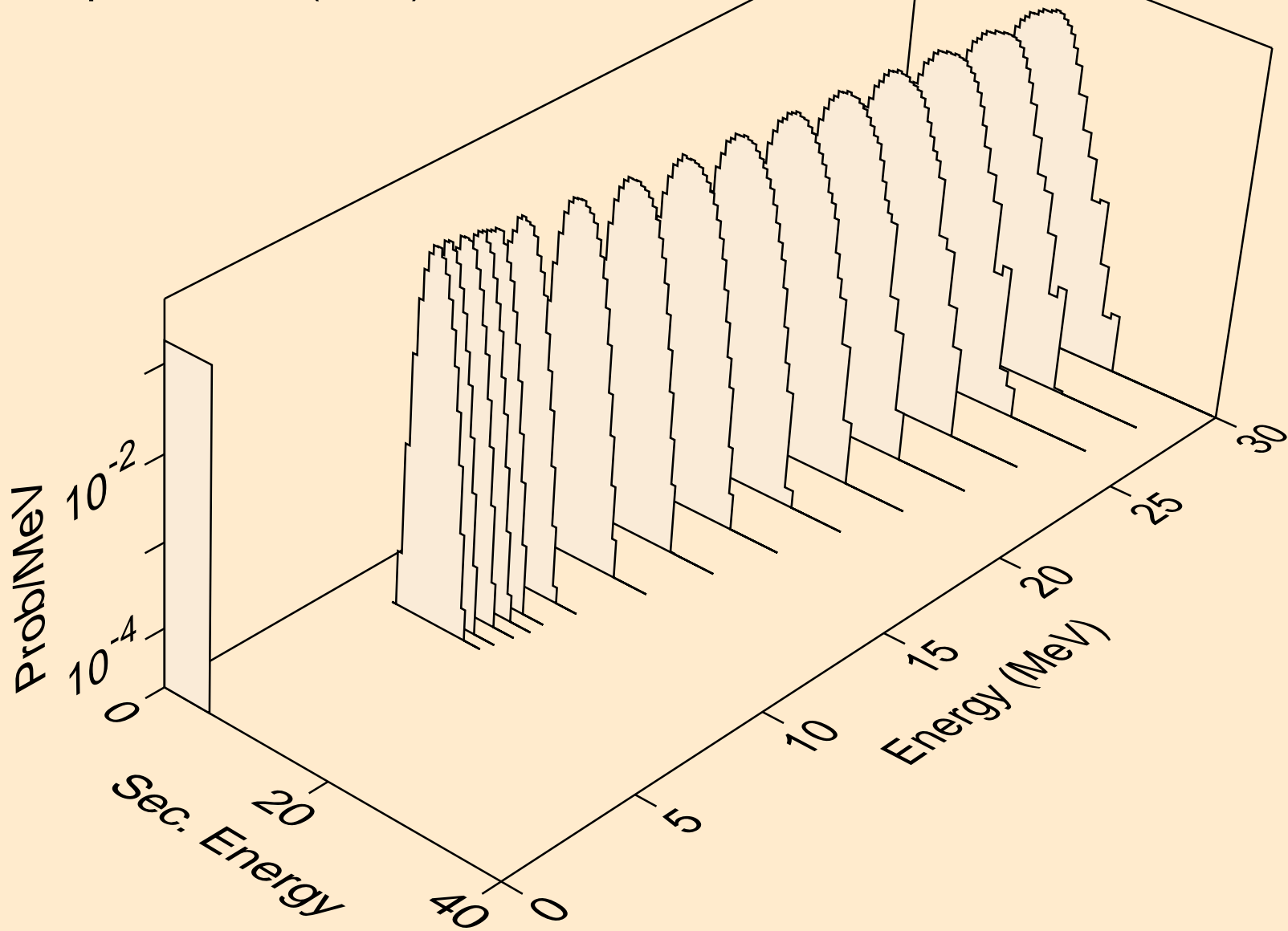

PT180 NEUTRON ACER TENDL-2021 LIBRARY; T=293.6K
alphas from (n,pa)

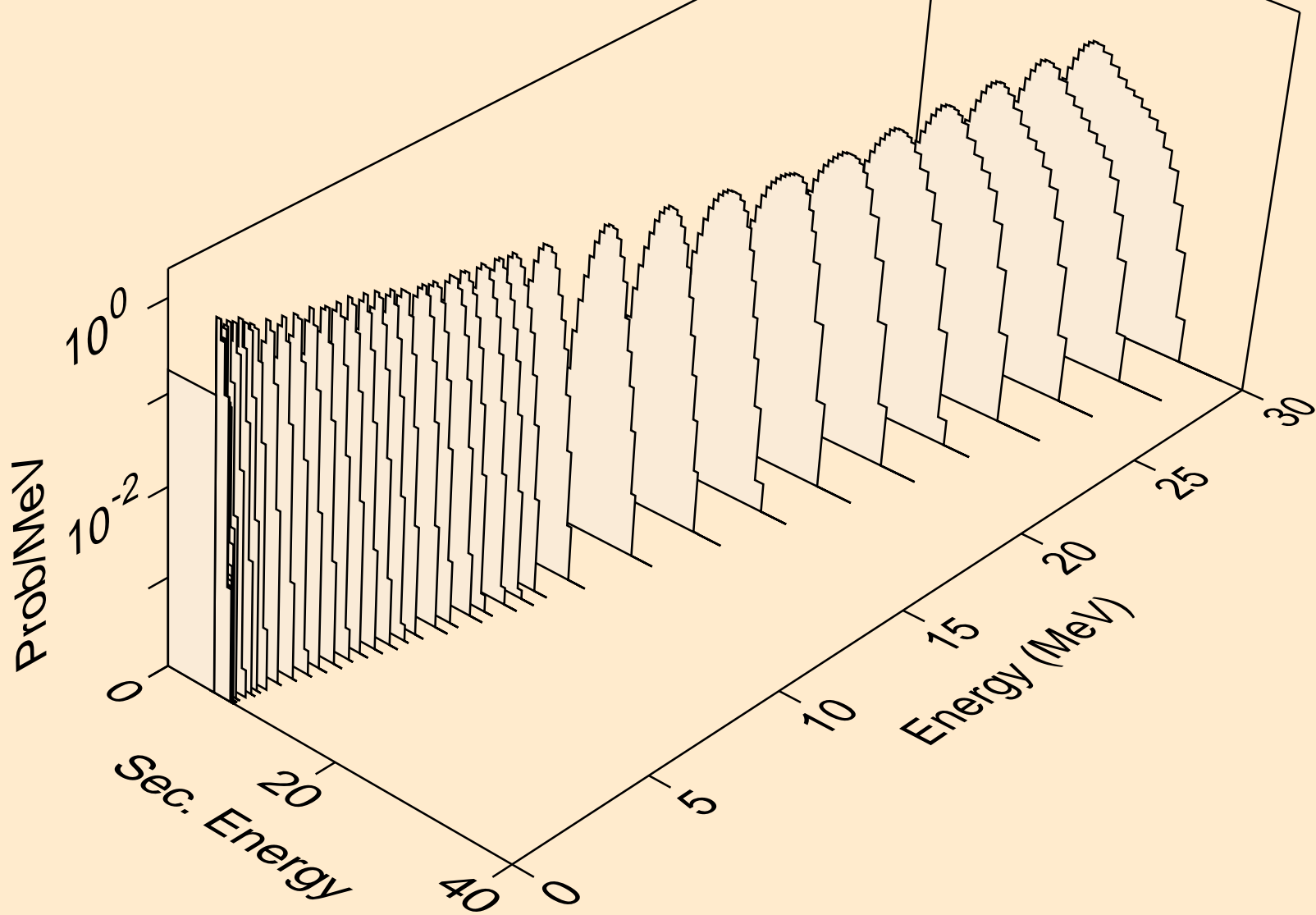

PT180 NEUTRON ACER TENDL-2021 LIBRARY; T=293.6K
alphas from (n,da)

