

PT191 NEUTRON ACER TENDL-2021 LIBRARY; T=293.6K  
Principal cross sections

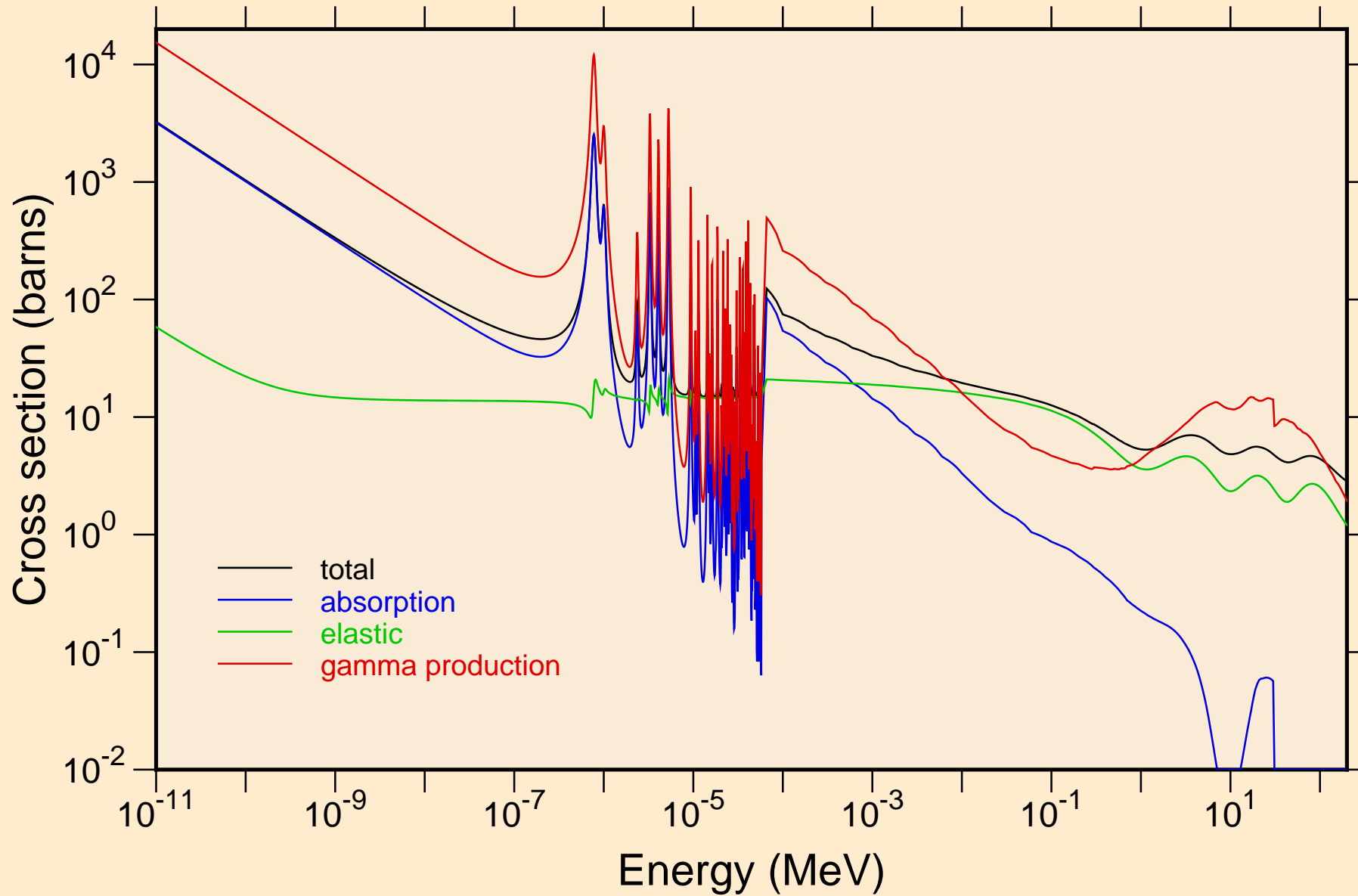

PT191 NEUTRON ACER TENDL-2021 LIBRARY; T=293.6K  
resonance total cross section

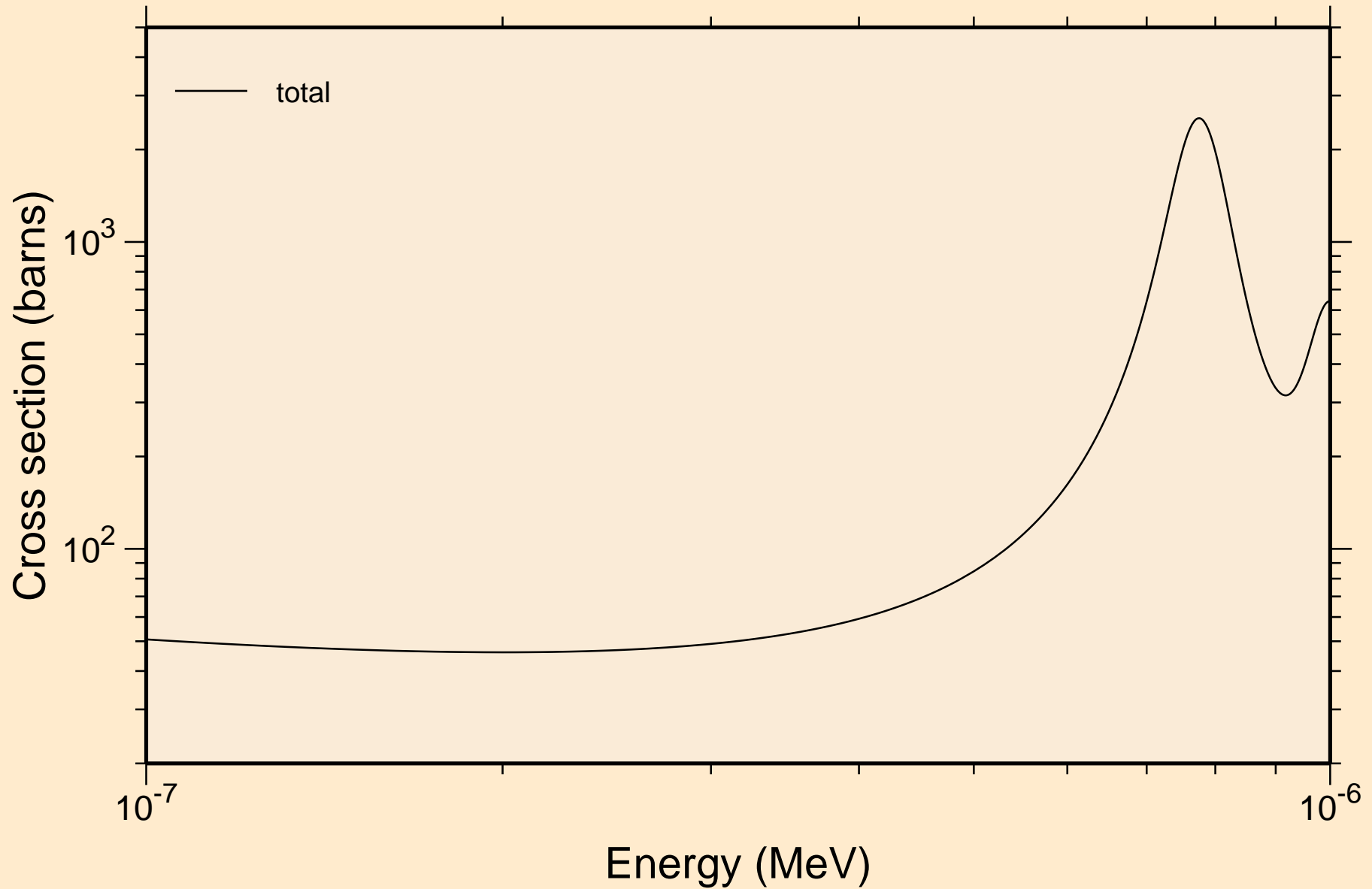

PT191 NEUTRON ACER TENDL-2021 LIBRARY; T=293.6K  
resonance total cross section

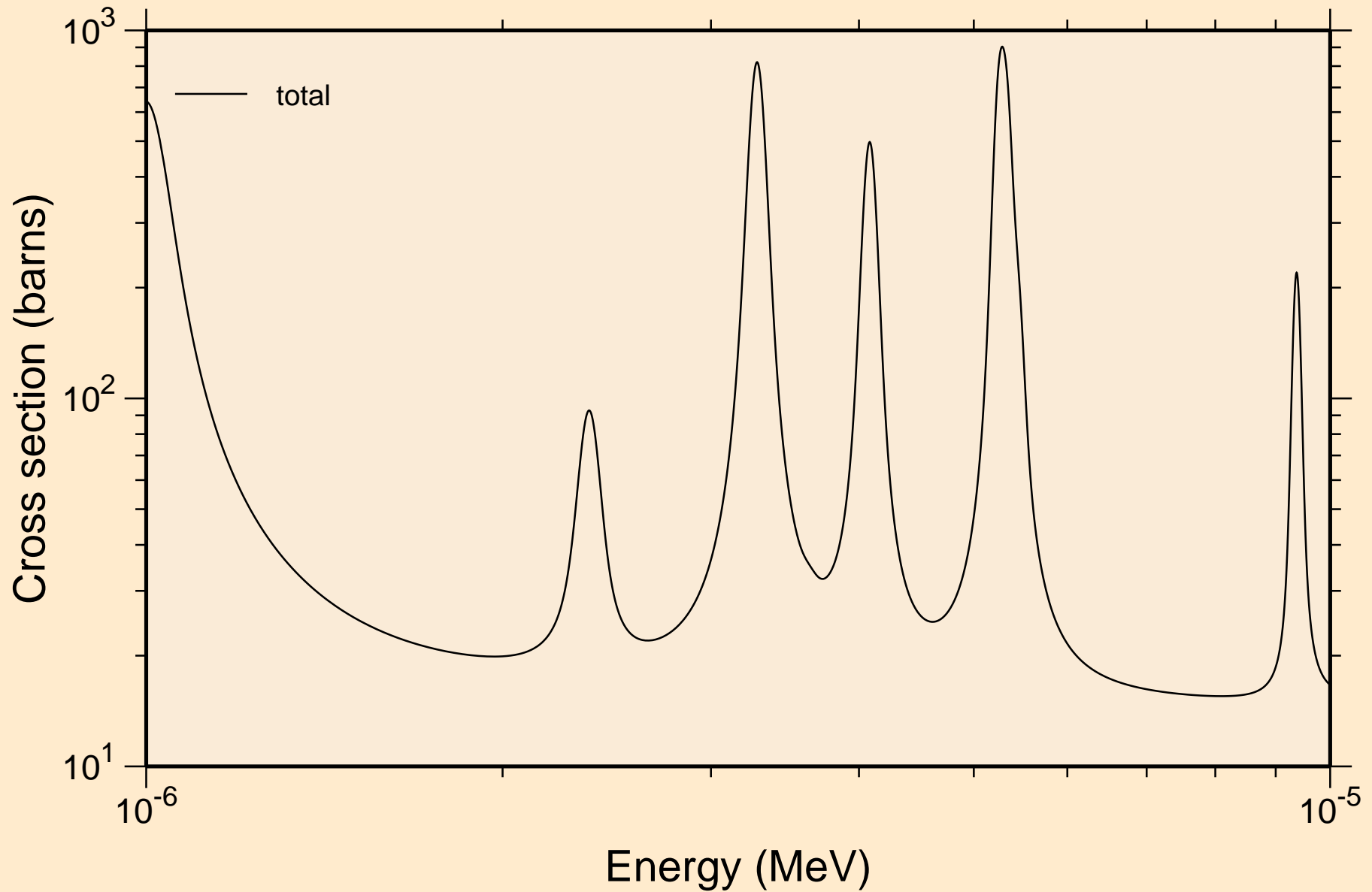

PT191 NEUTRON ACER TENDL-2021 LIBRARY; T=293.6K  
resonance total cross section

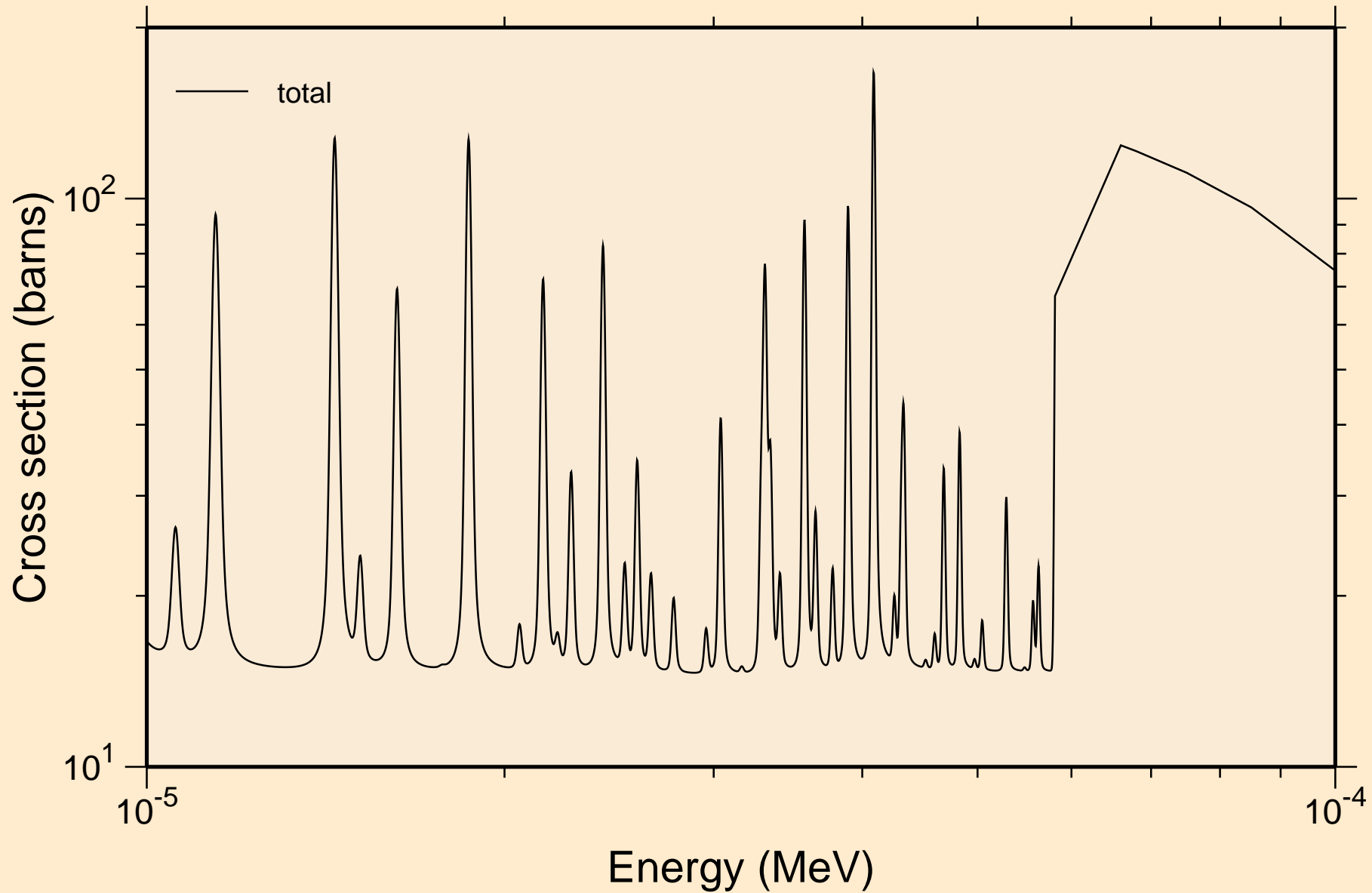

PT191 NEUTRON ACER TENDL-2021 LIBRARY; T=293.6K  
resonance total cross section

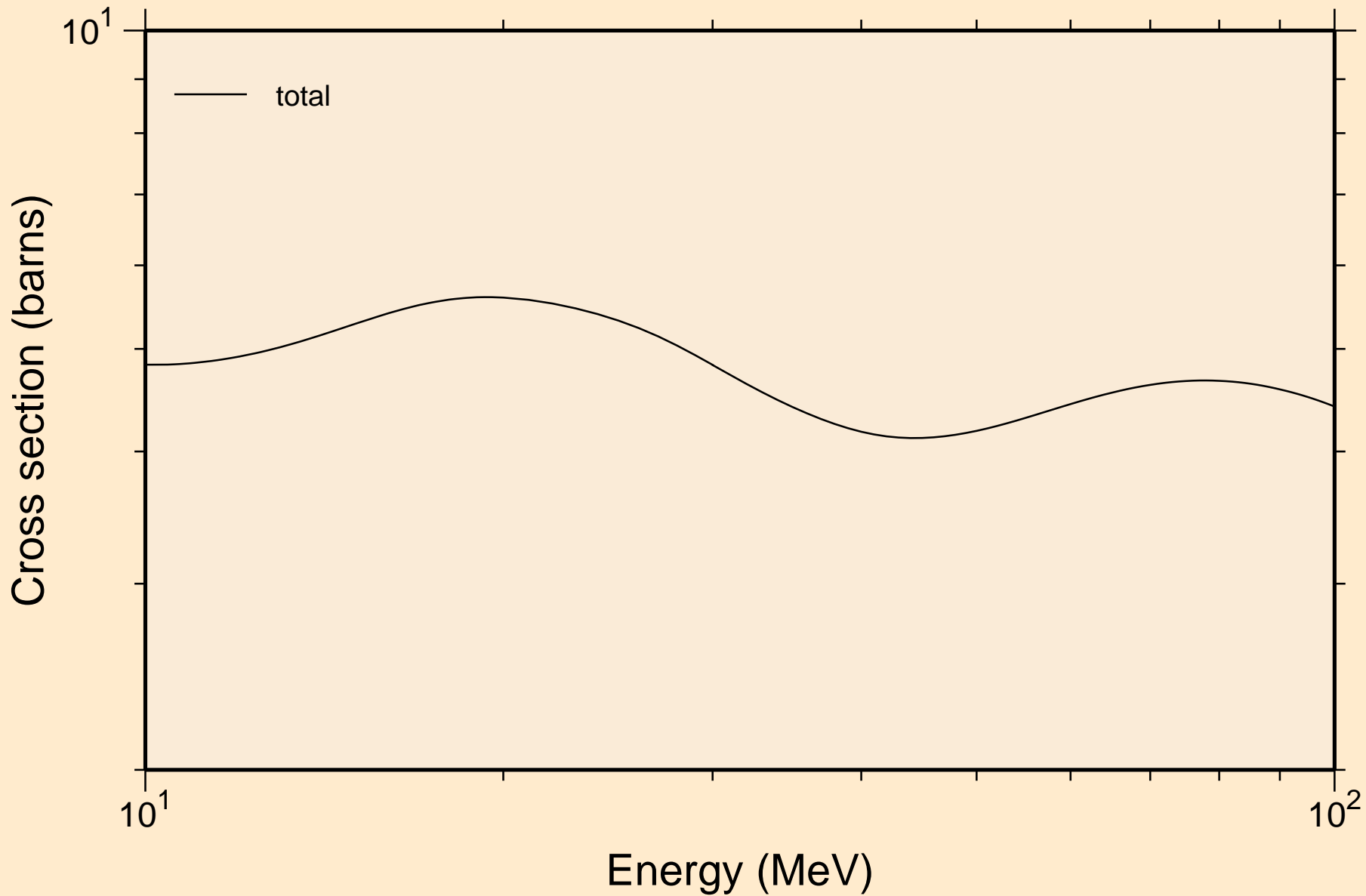

PT191 NEUTRON ACER TENDL-2021 LIBRARY; T=293.6K  
resonance absorption cross sections

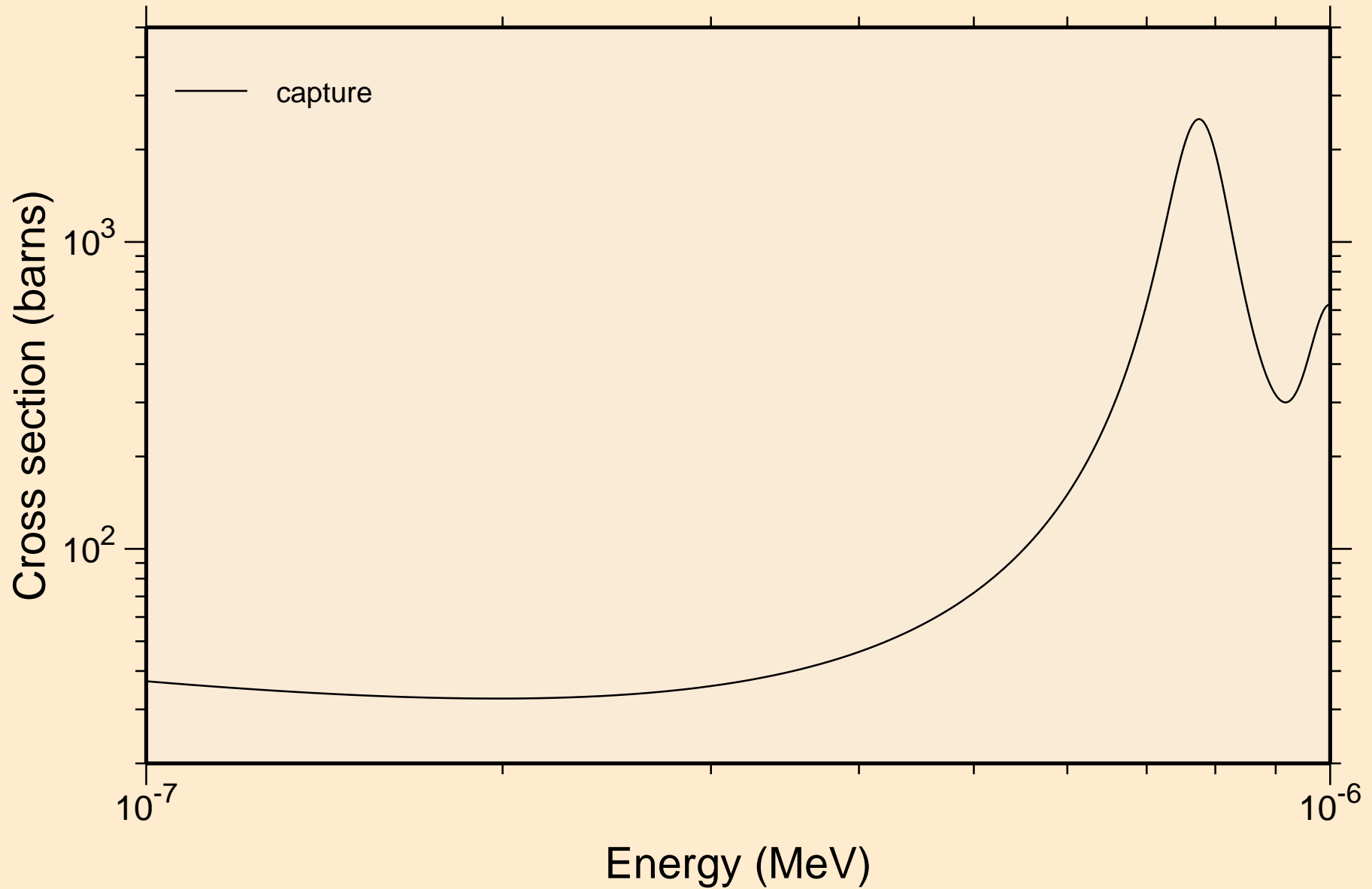

PT191 NEUTRON ACER TENDL-2021 LIBRARY; T=293.6K  
resonance absorption cross sections

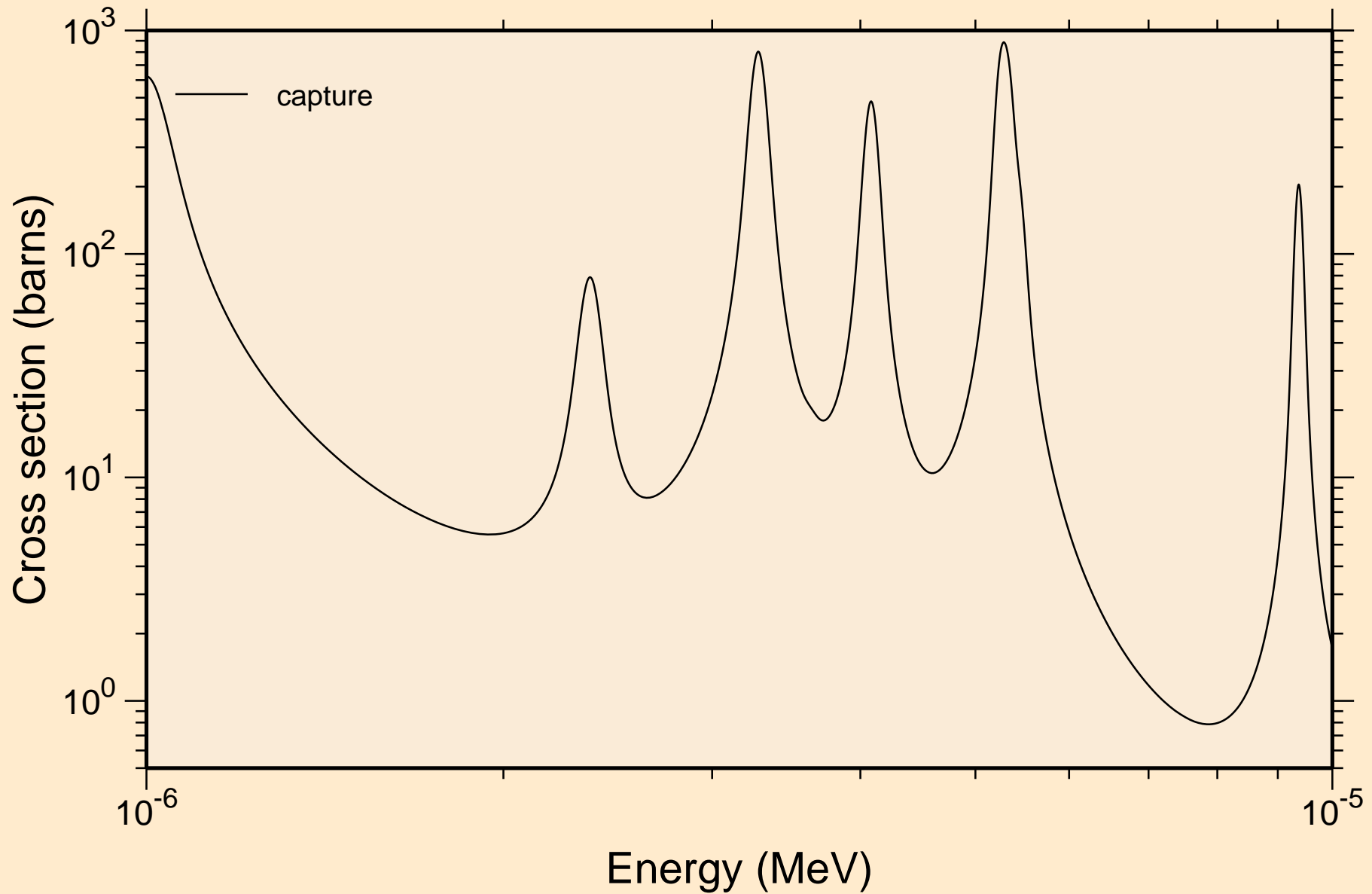

PT191 NEUTRON ACER TENDL-2021 LIBRARY; T=293.6K  
resonance absorption cross sections

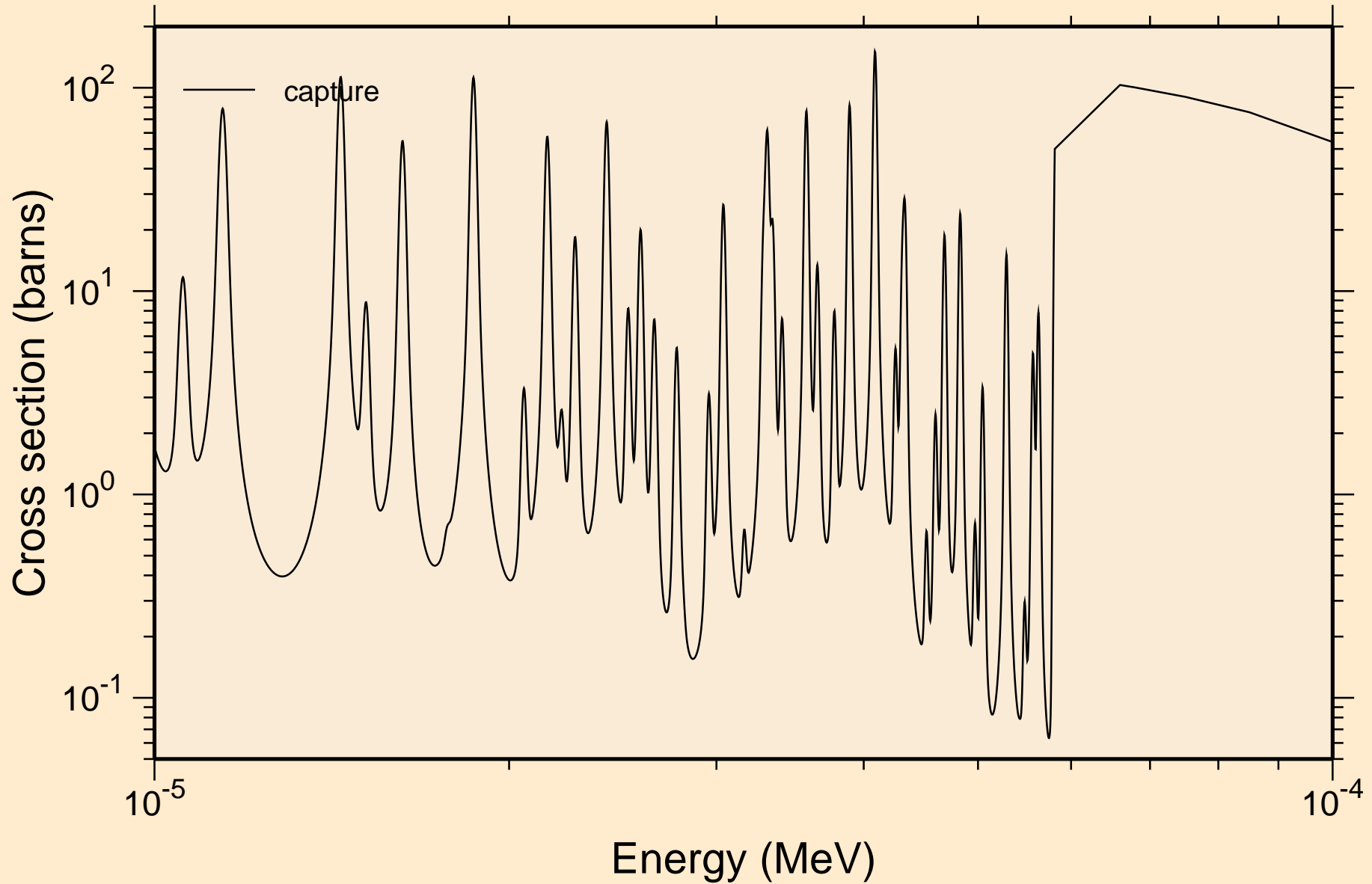



PT191 NEUTRON ACER TENDL-2021 LIBRARY; T=293.6K  
resonance absorption cross sections

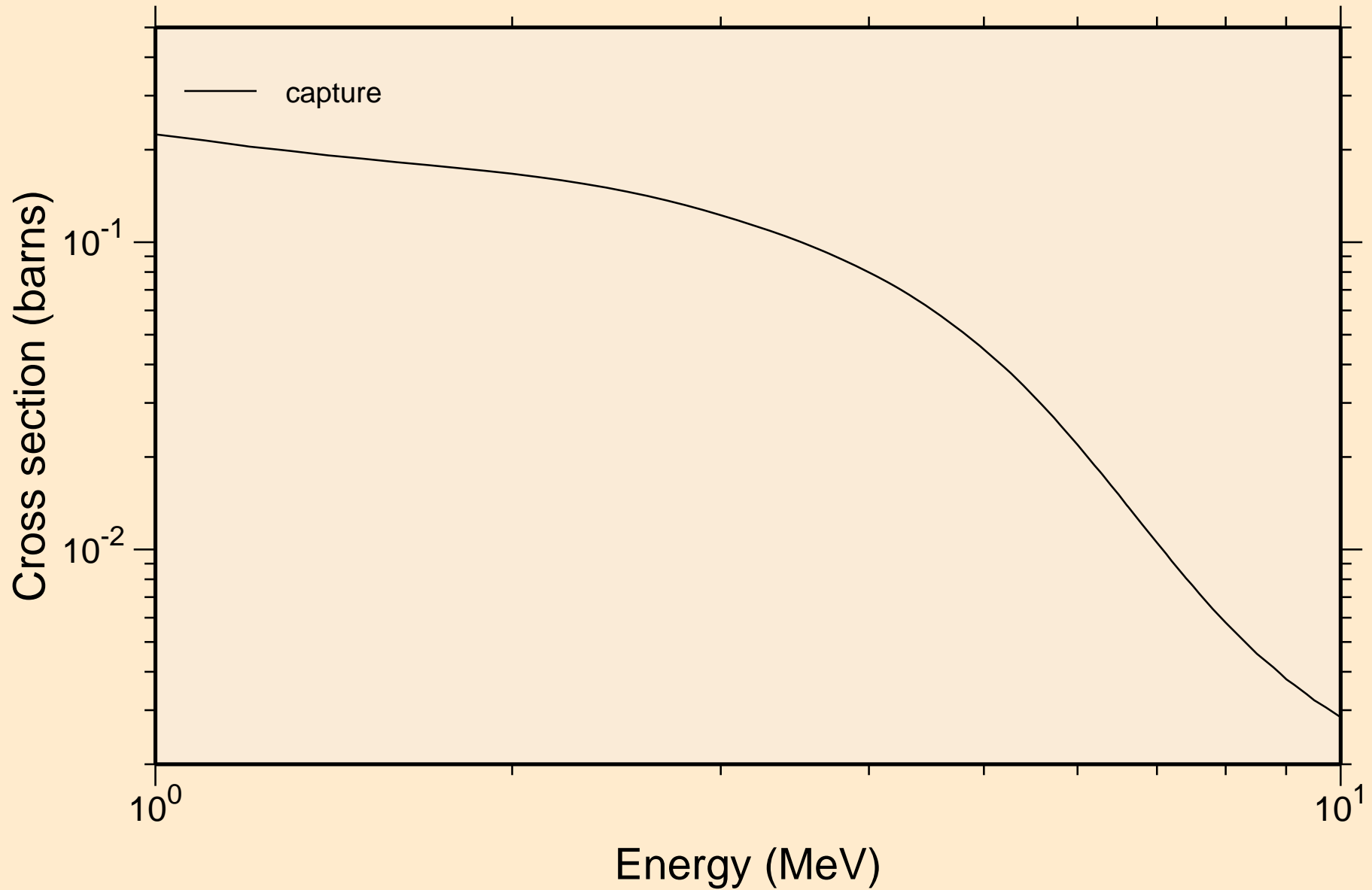

PT191 NEUTRON ACER TENDL-2021 LIBRARY; T=293.6K  
Heating

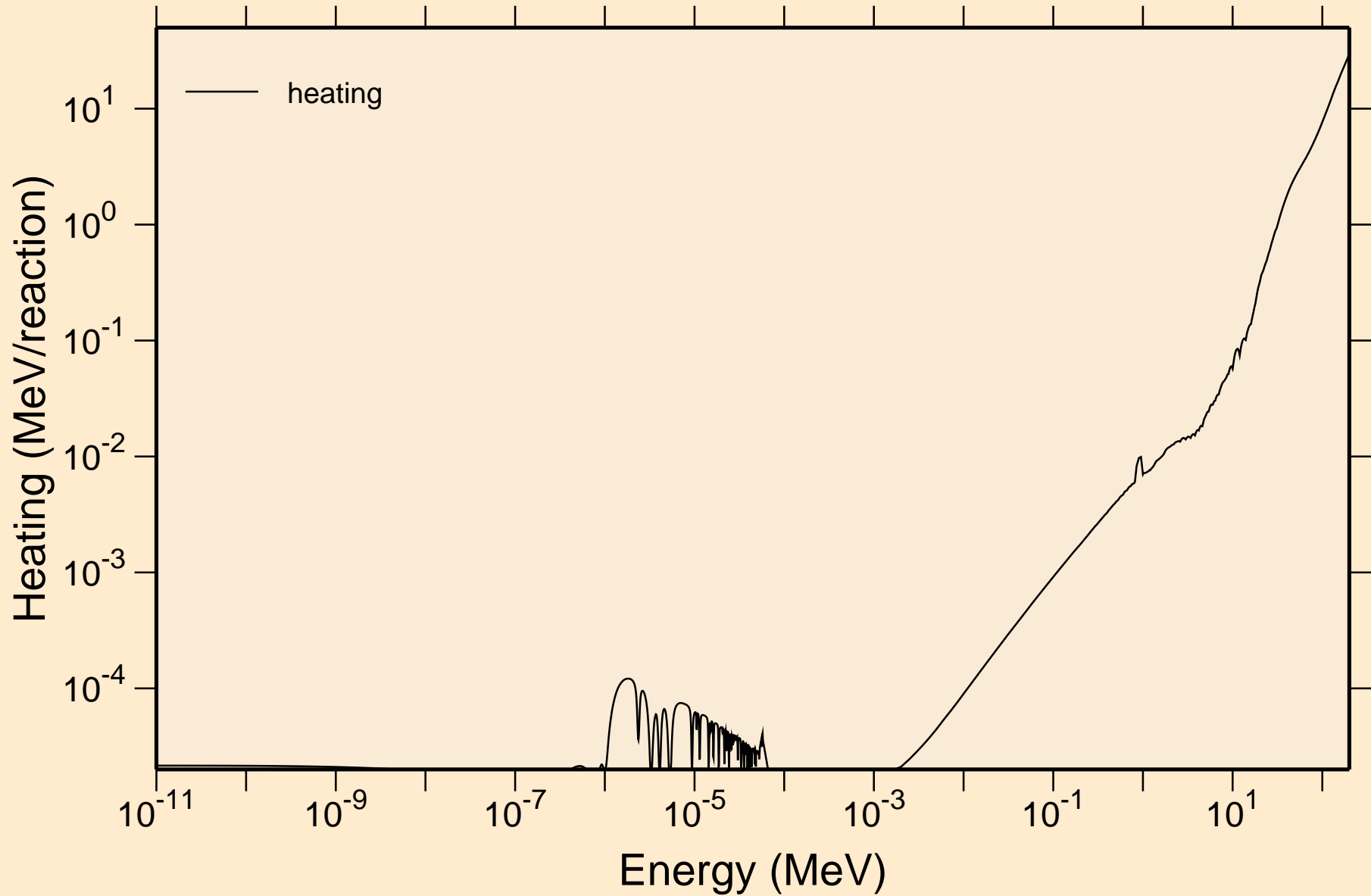

PT191 NEUTRON ACER TENDL-2021 LIBRARY; T=293.6K  
Damage

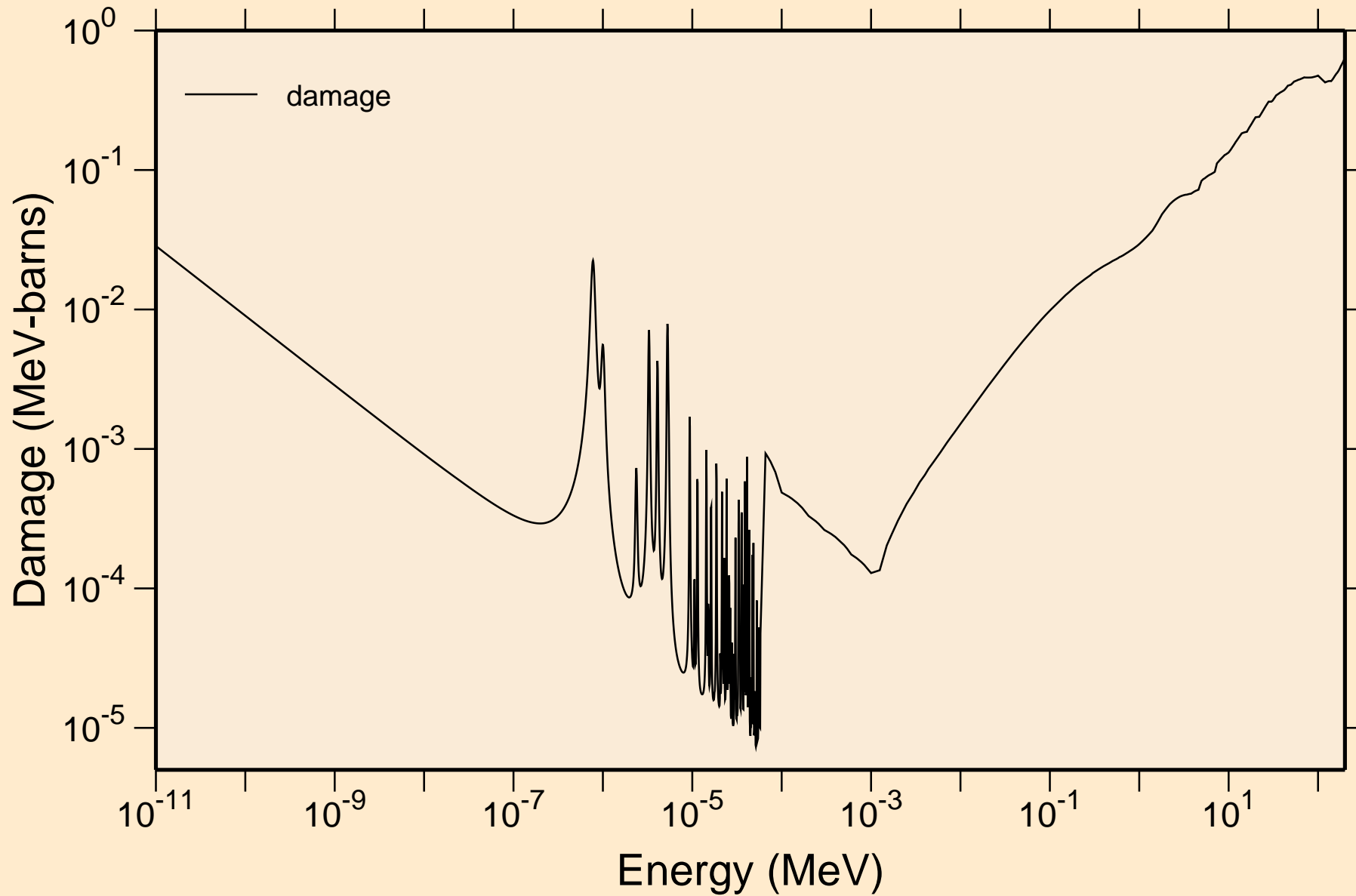

PT191 NEUTRON ACER TENDL-2021 LIBRARY; T=293.6K  
Non-threshold reactions

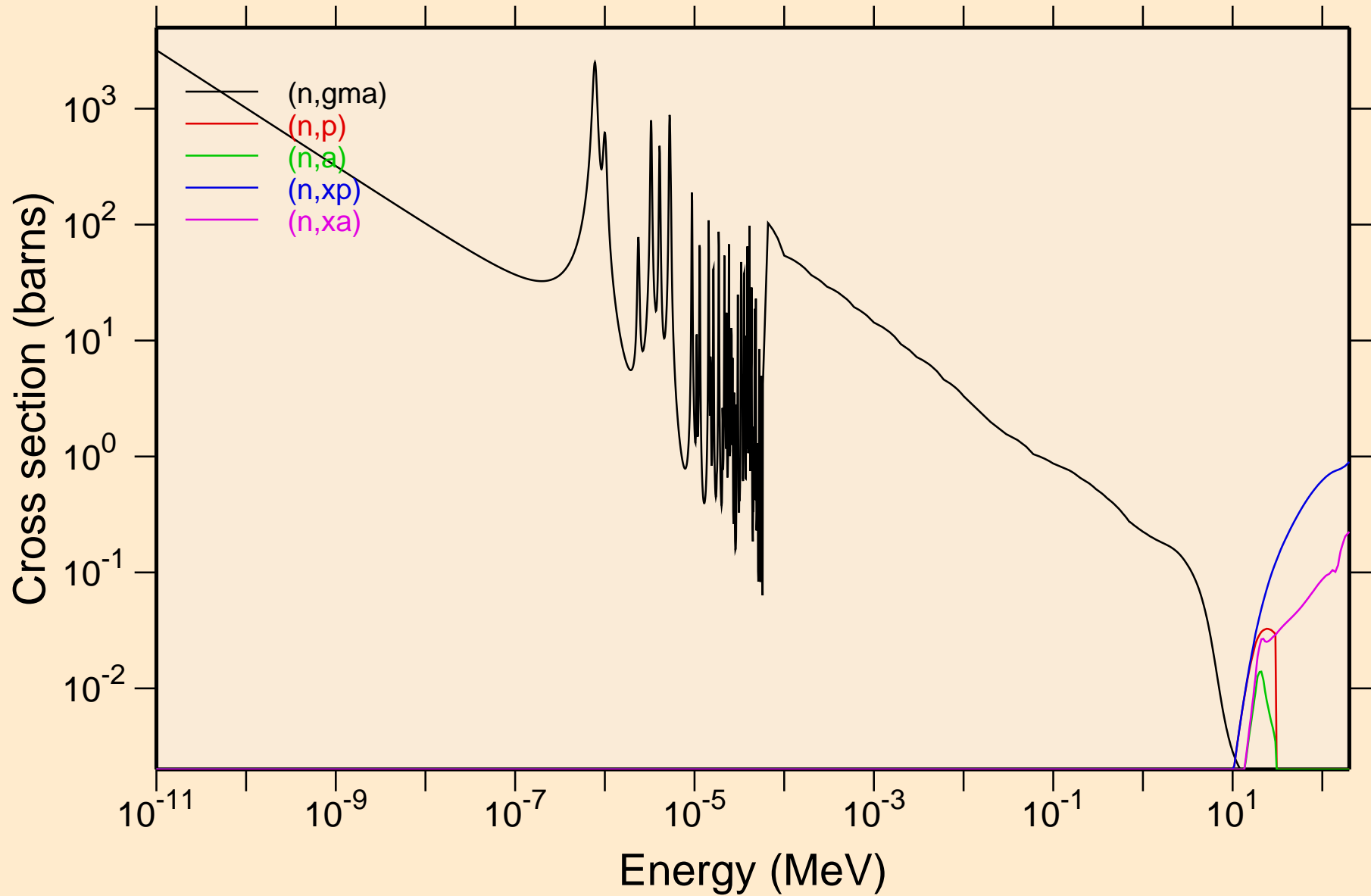

PT191 NEUTRON ACER TENDL-2021 LIBRARY; T=293.6K  
Principal cross sections

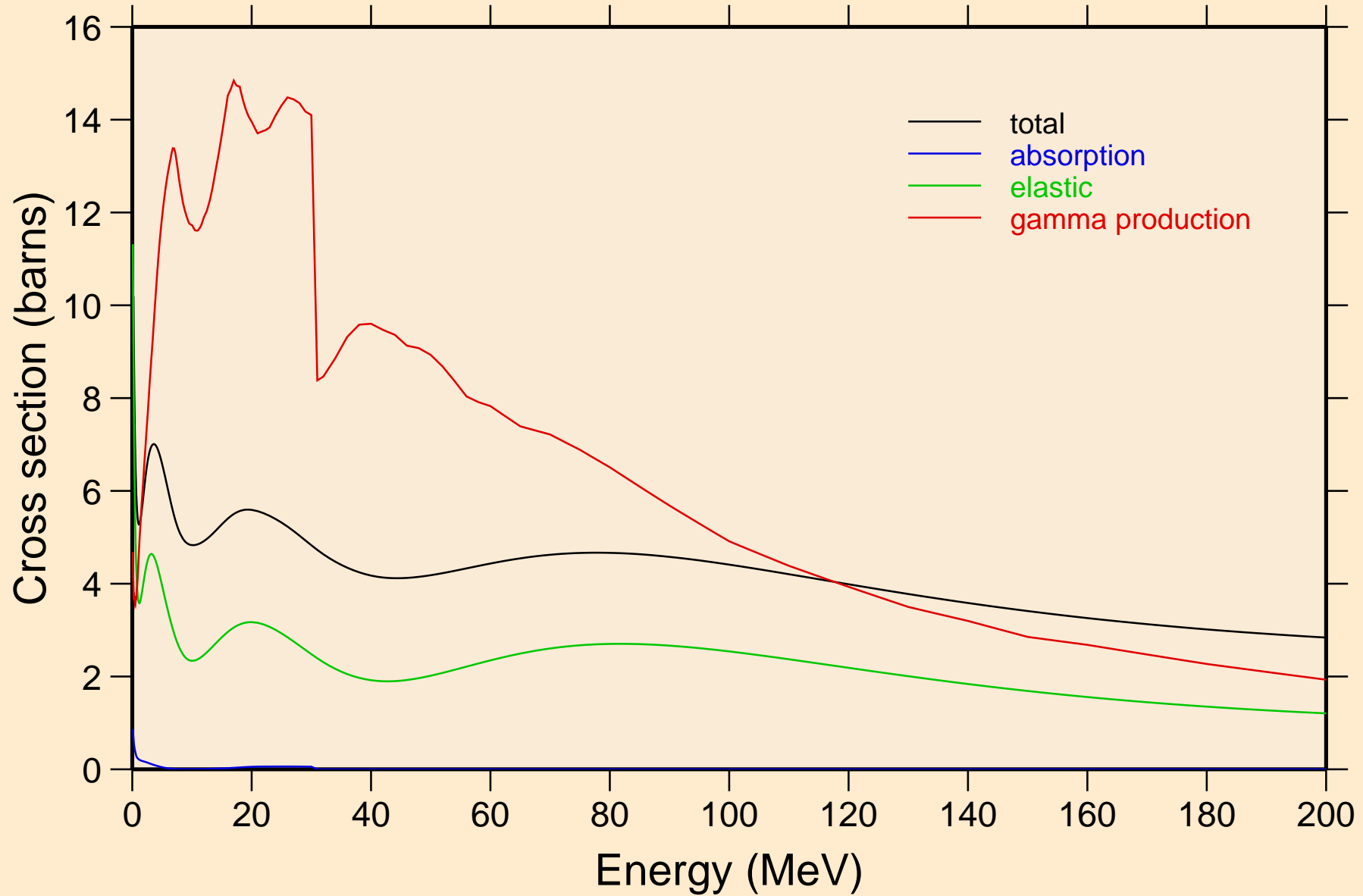

PT191 NEUTRON ACER TENDL-2021 LIBRARY; T=293.6K  
Heating

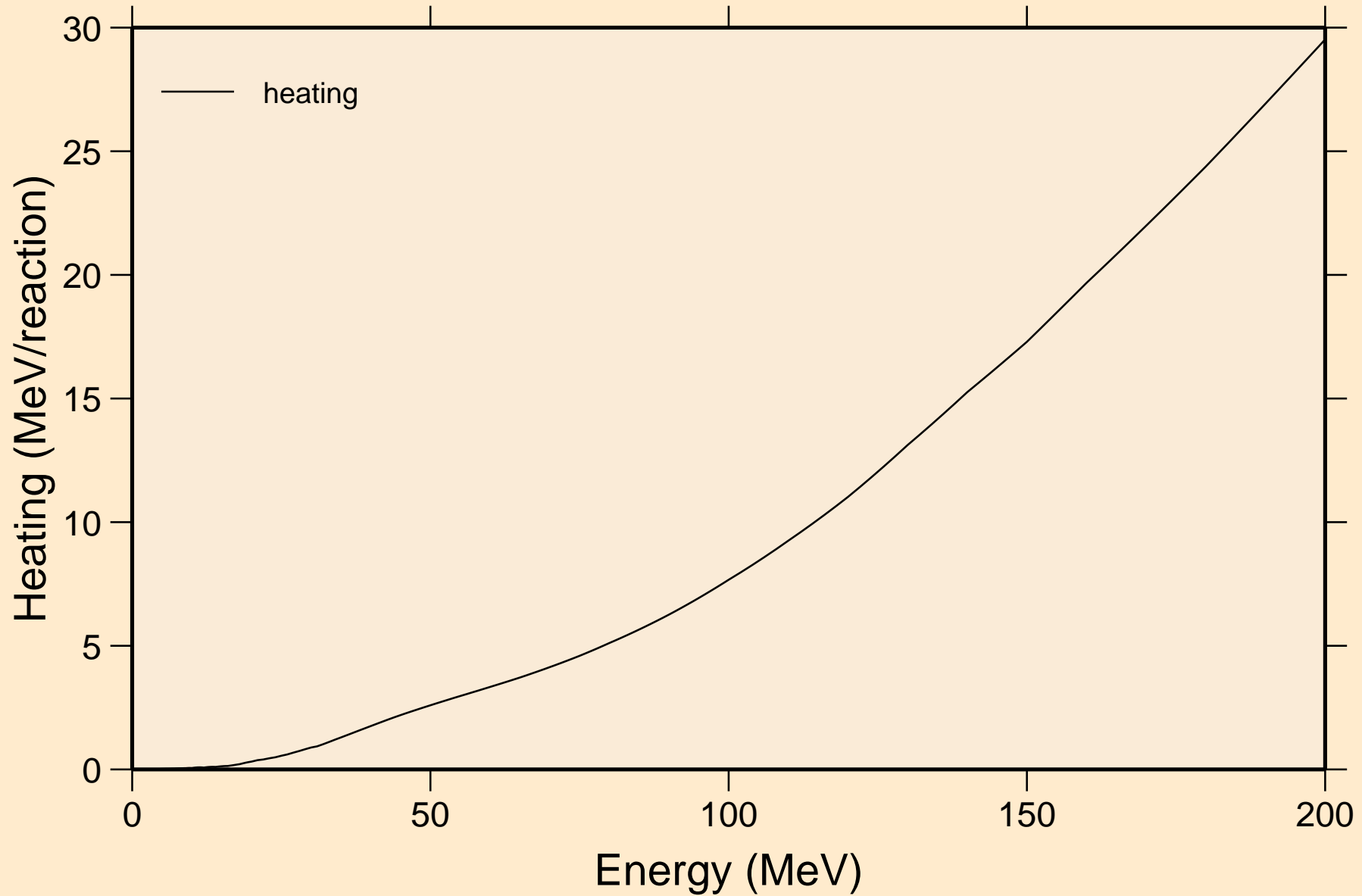

PT191 NEUTRON ACER TENDL-2021 LIBRARY; T=293.6K  
Damage

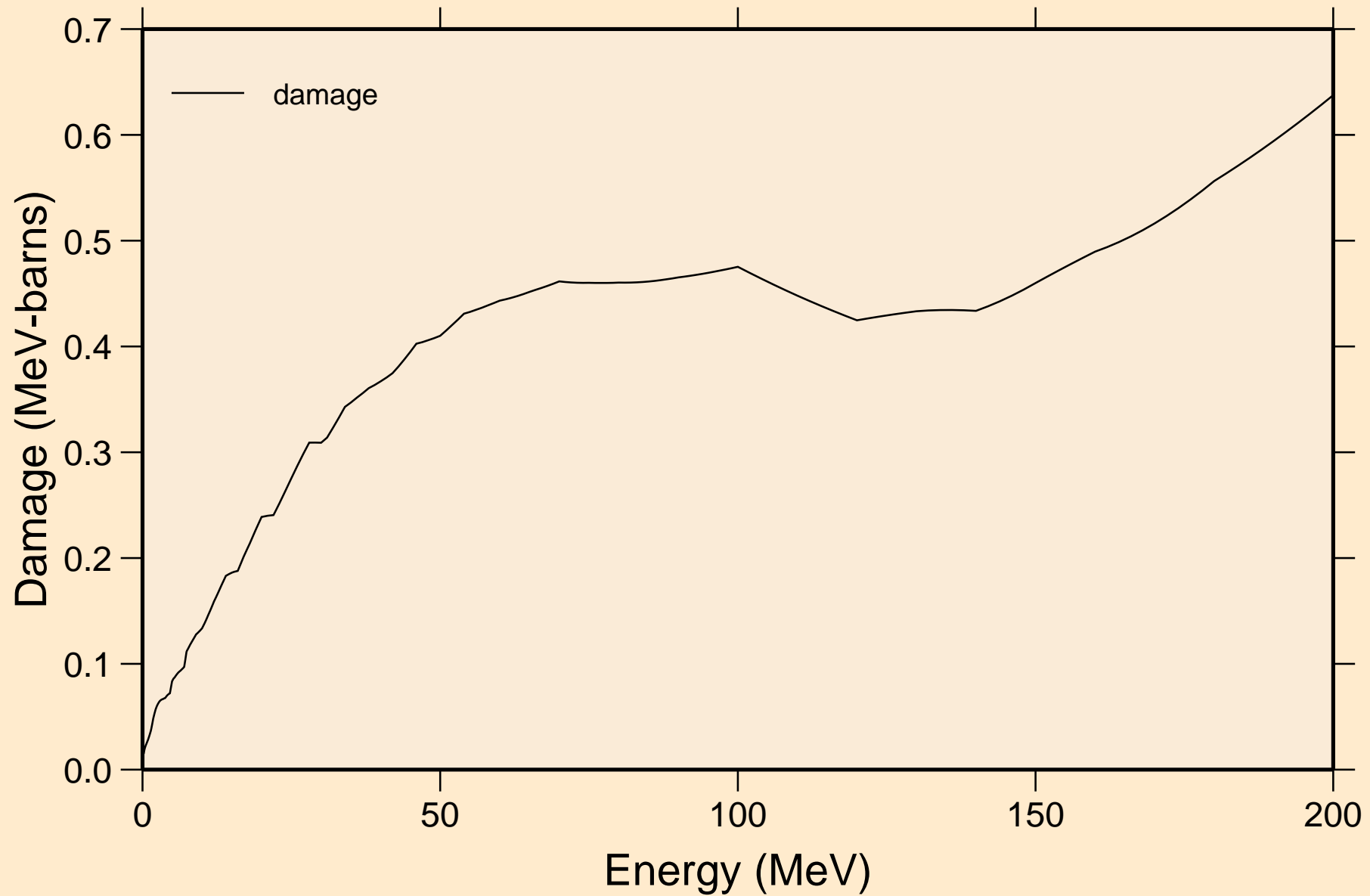

PT191 NEUTRON ACER TENDL-2021 LIBRARY; T=293.6K  
Non-threshold reactions

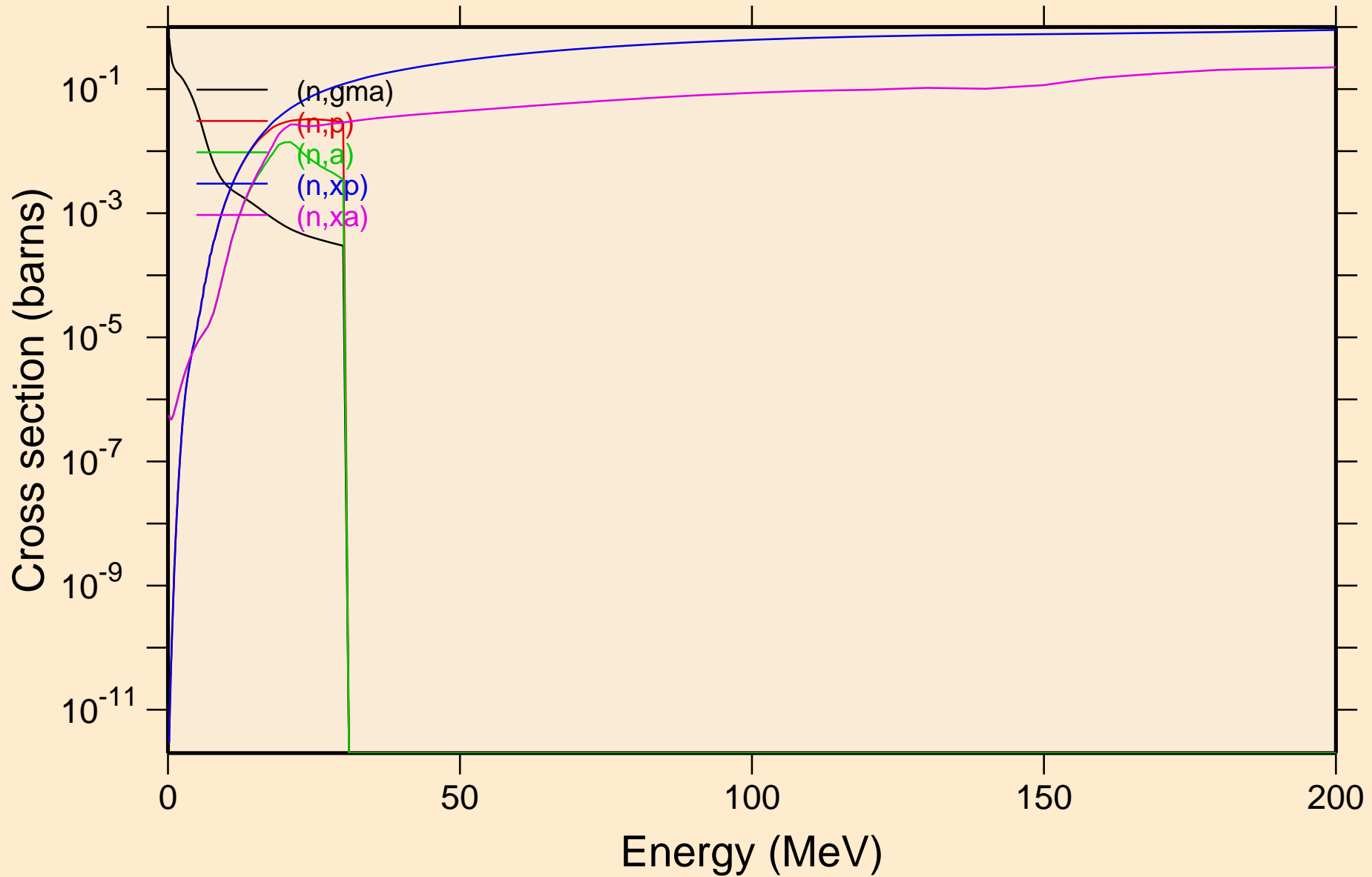



PT191 NEUTRON ACER TENDL-2021 LIBRARY; T=293.6K  
Inelastic levels

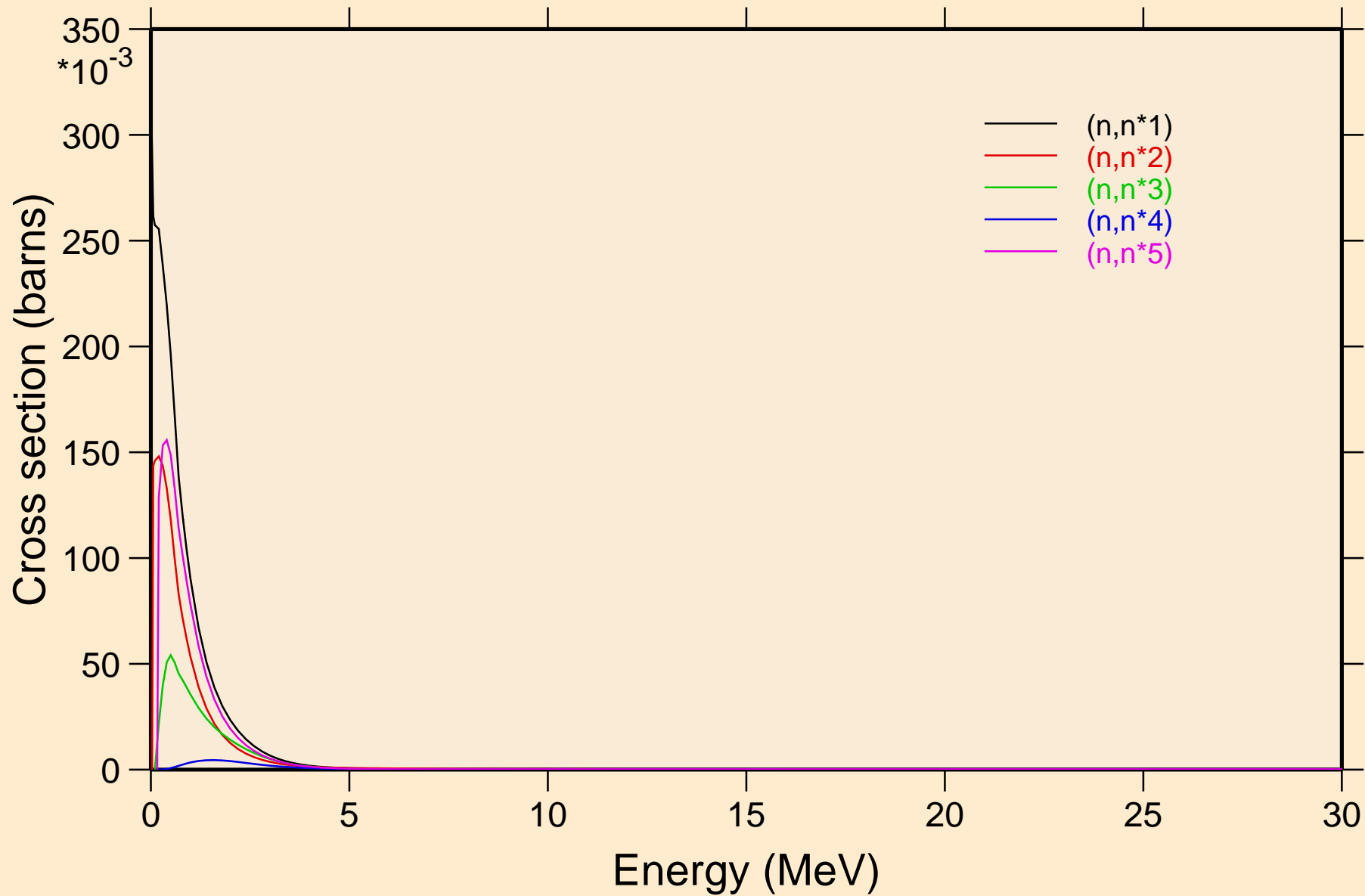

PT191 NEUTRON ACER TENDL-2021 LIBRARY; T=293.6K  
Inelastic levels

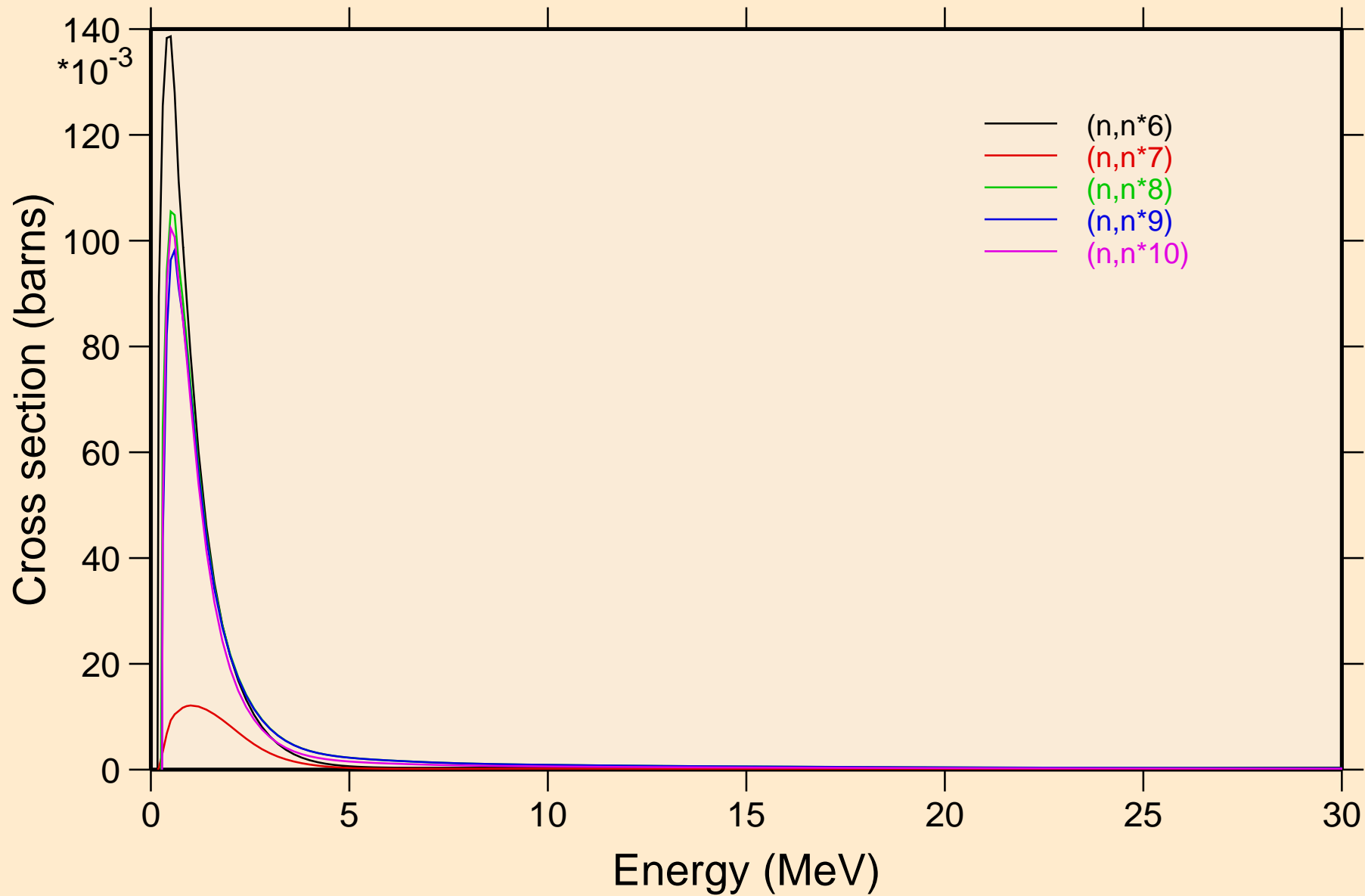

PT191 NEUTRON ACER TENDL-2021 LIBRARY; T=293.6K  
Inelastic levels

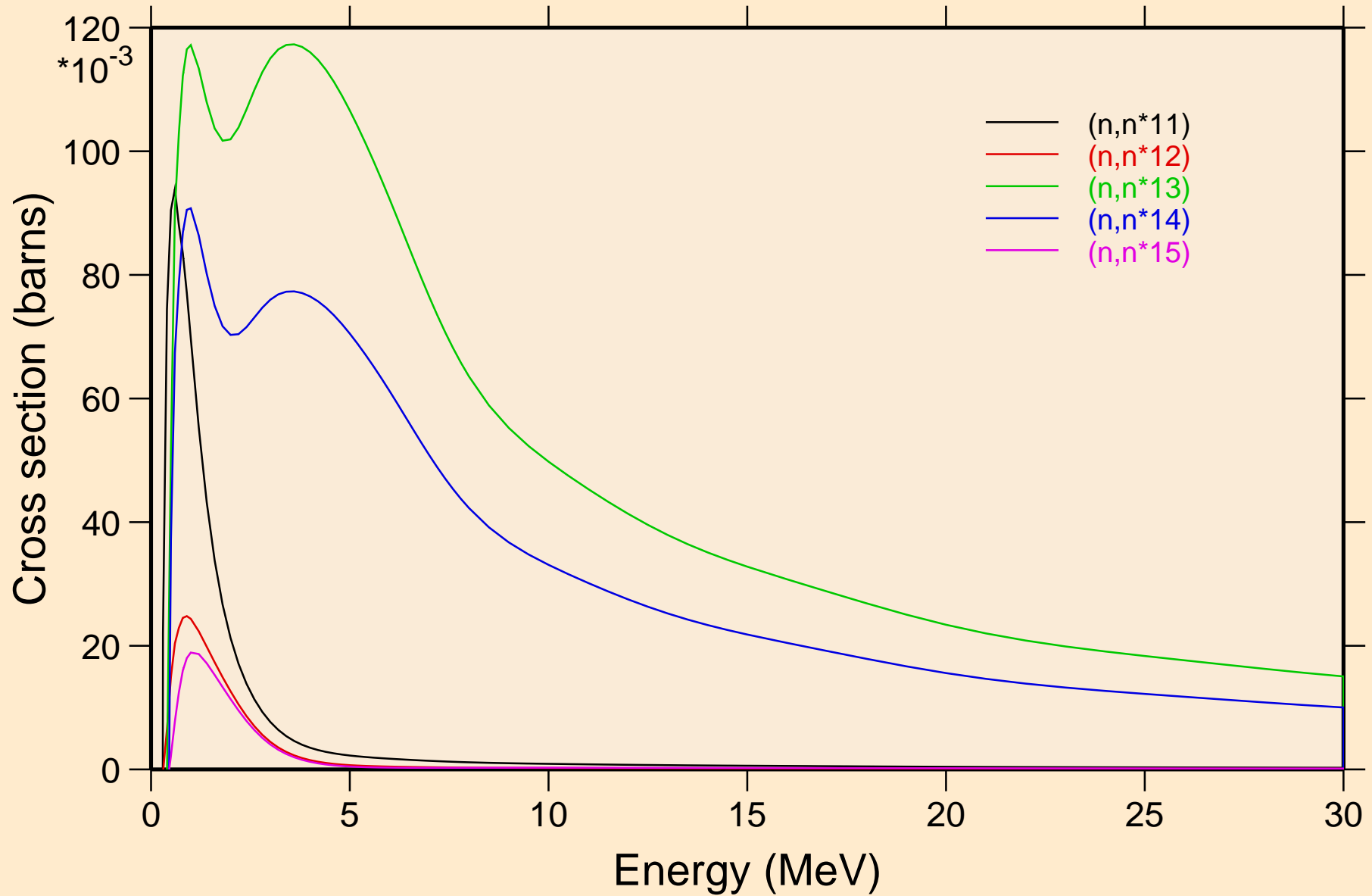

PT191 NEUTRON ACER TENDL-2021 LIBRARY; T=293.6K  
Inelastic levels

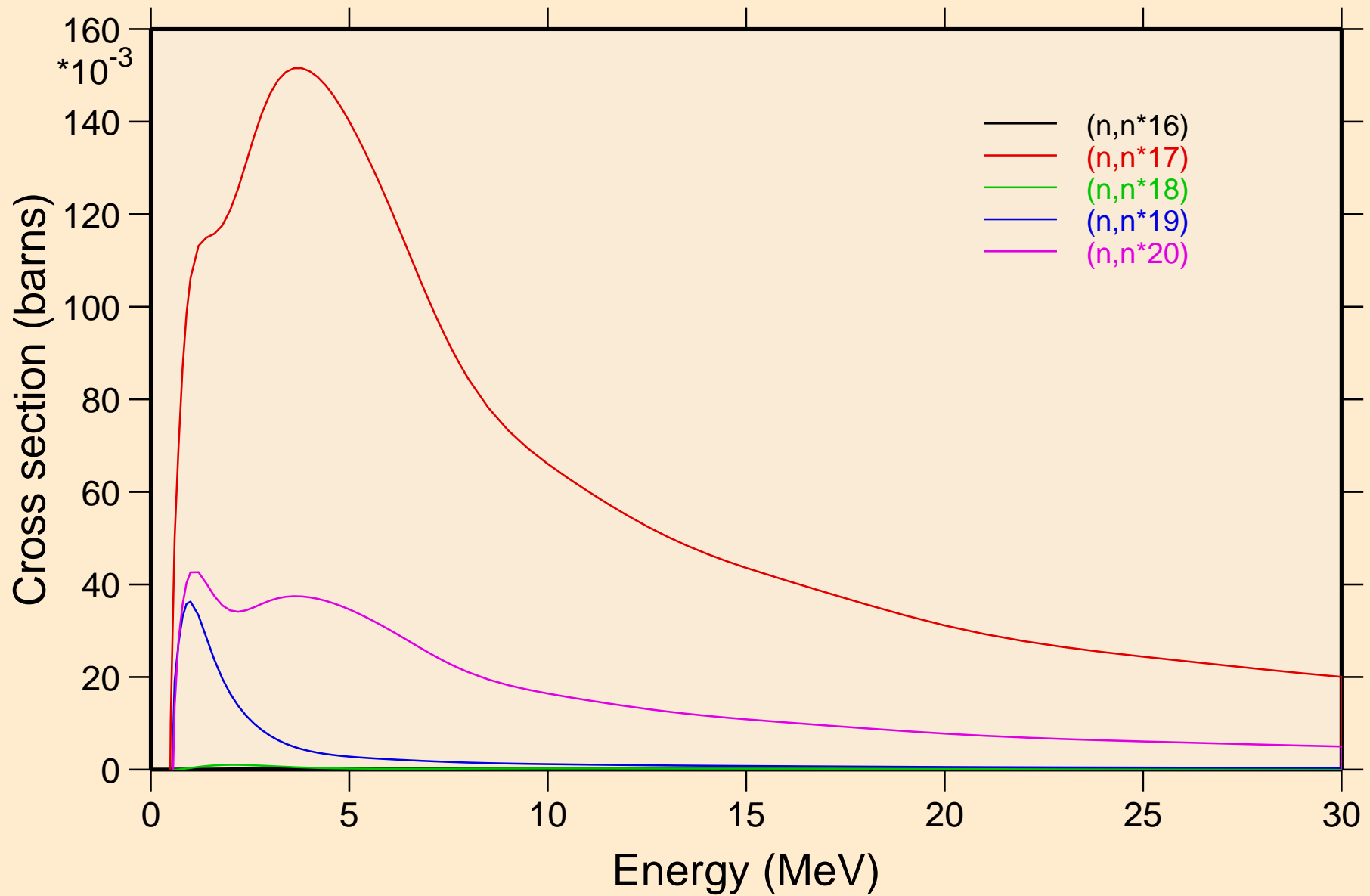

PT191 NEUTRON ACER TENDL-2021 LIBRARY; T=293.6K  
Inelastic levels

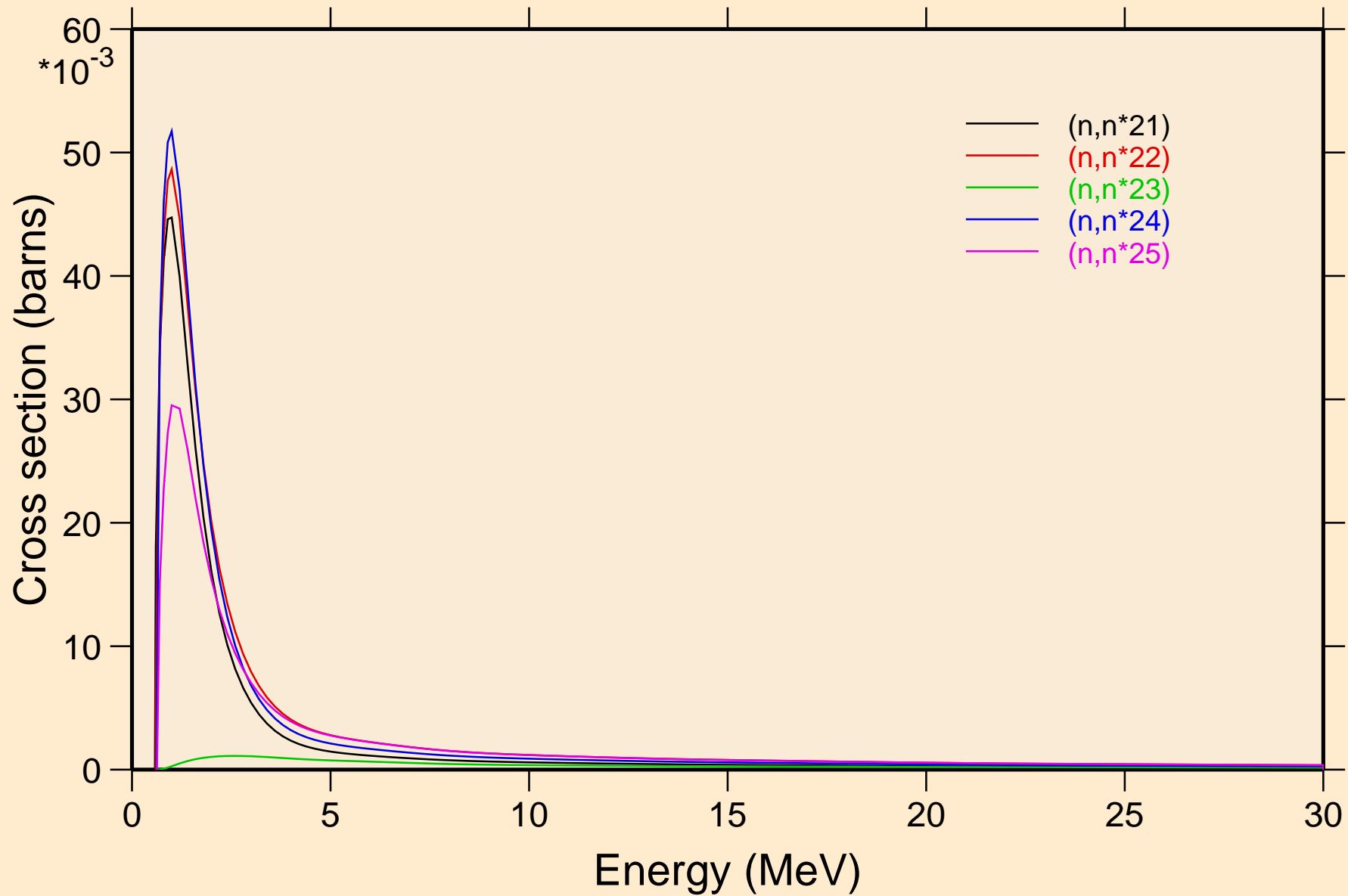

PT191 NEUTRON ACER TENDL-2021 LIBRARY; T=293.6K  
Inelastic levels

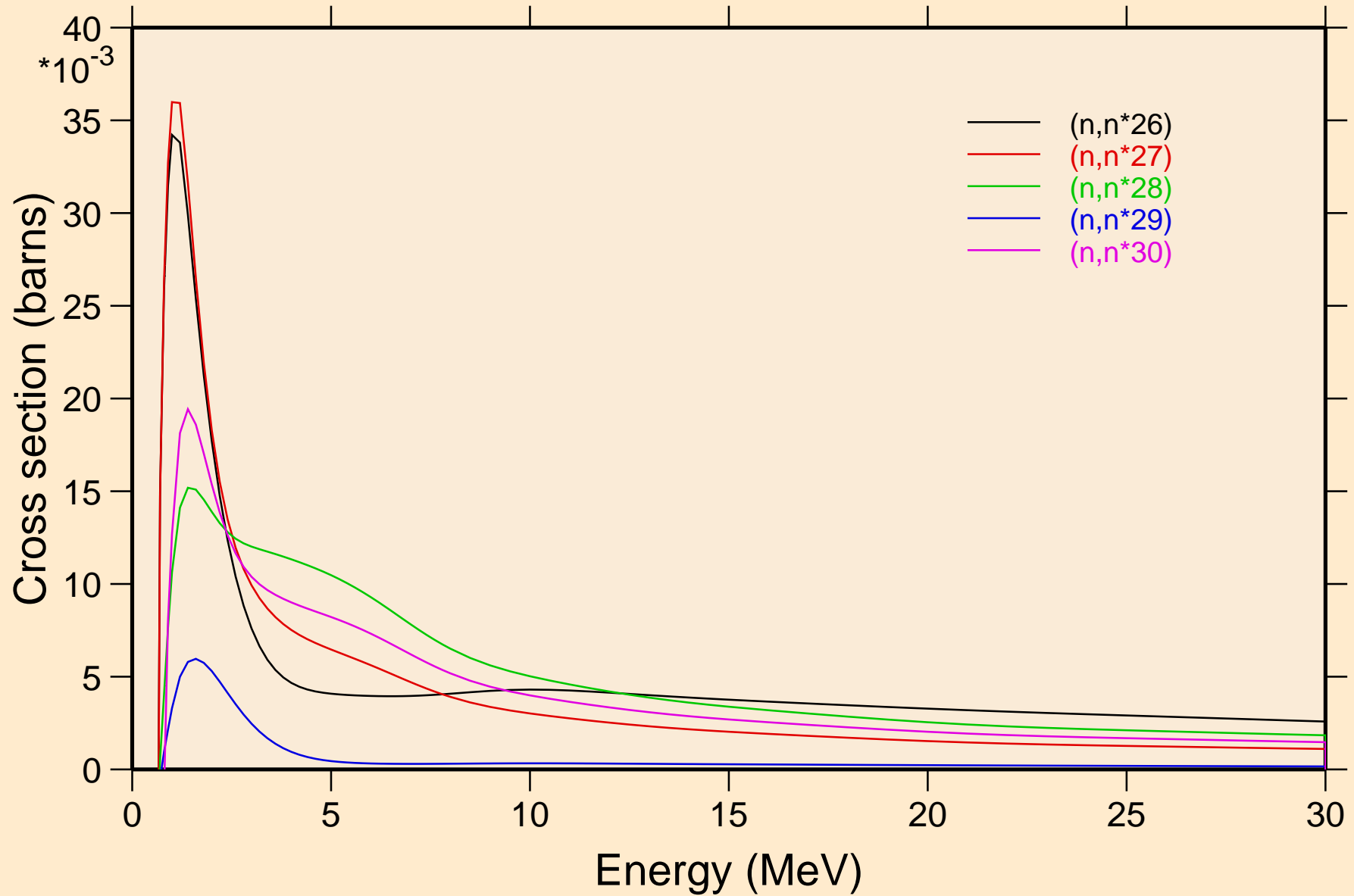

PT191 NEUTRON ACER TENDL-2021 LIBRARY; T=293.6K  
Threshold reactions

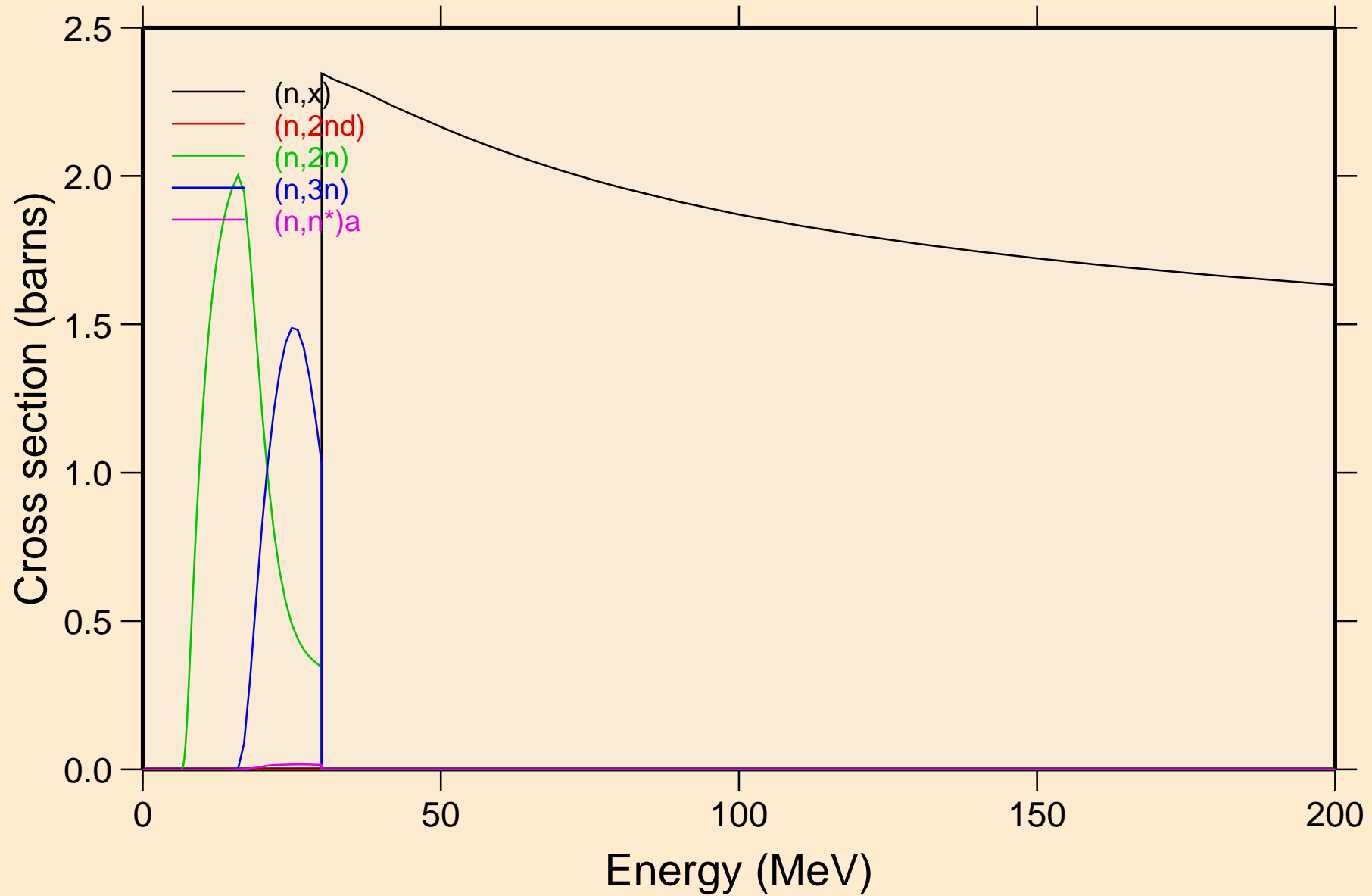

PT191 NEUTRON ACER TENDL-2021 LIBRARY; T=293.6K  
Threshold reactions

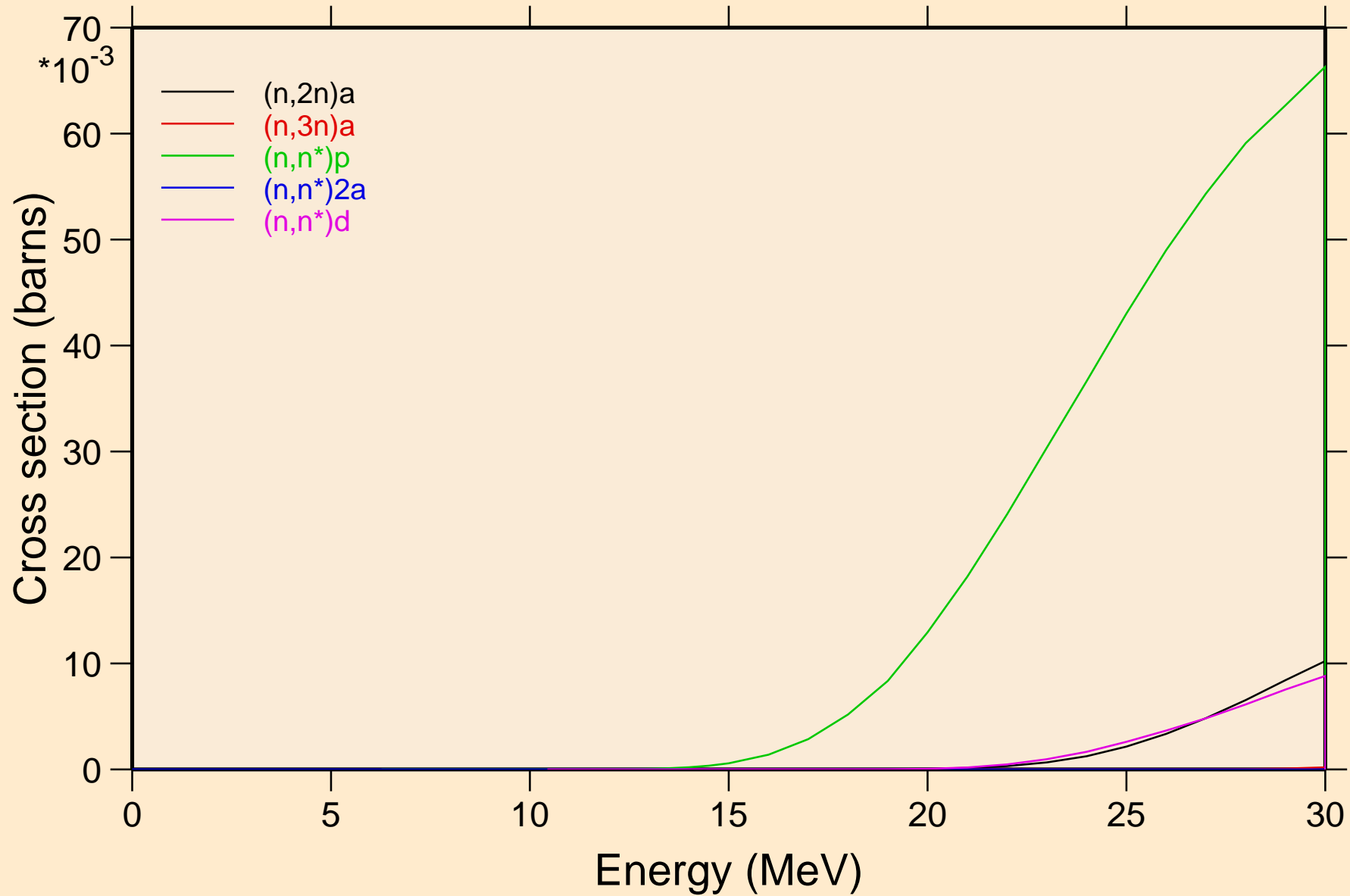



PT191 NEUTRON ACER TENDL-2021 LIBRARY; T=293.6K  
Threshold reactions

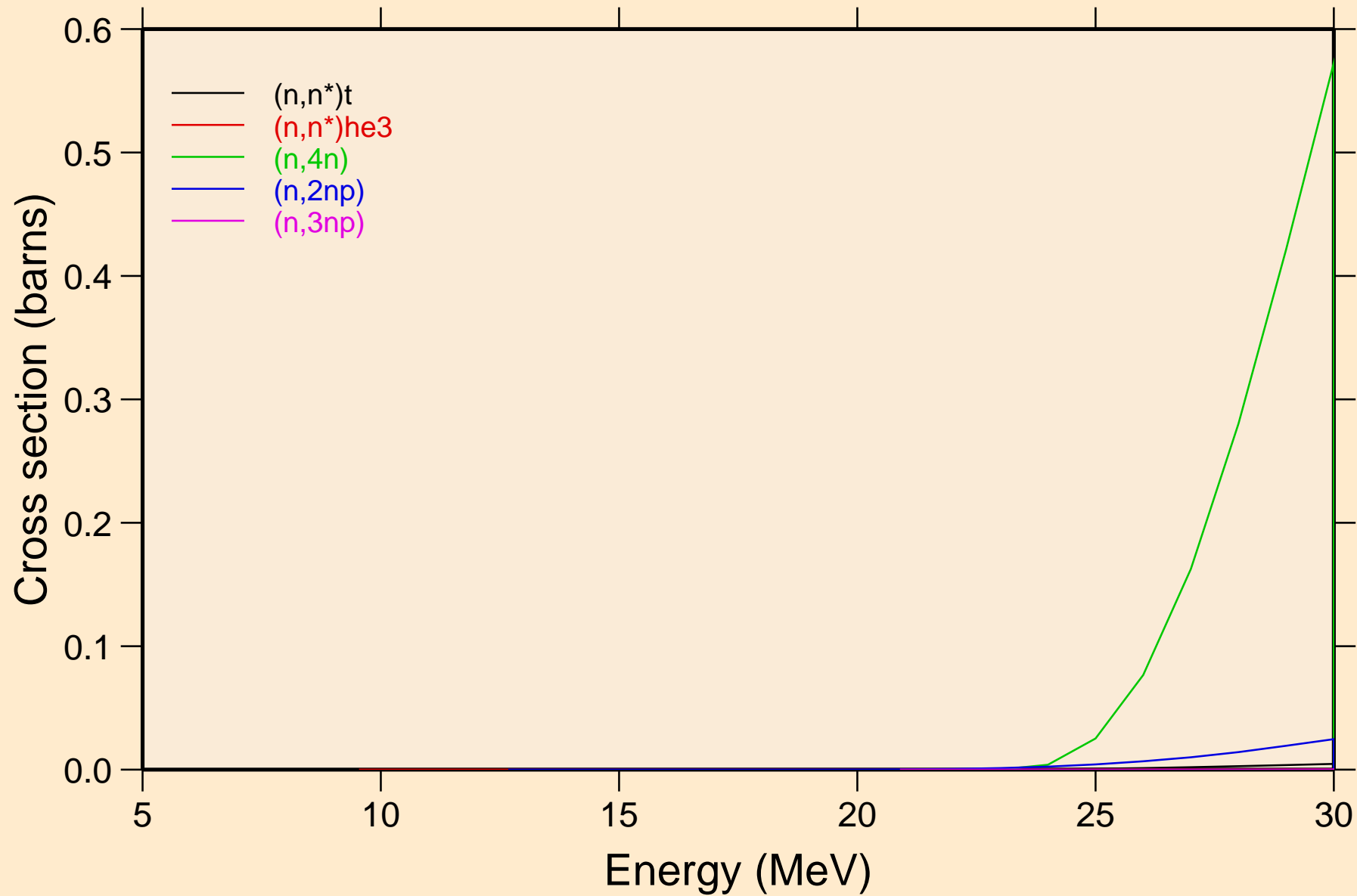

PT191 NEUTRON ACER TENDL-2021 LIBRARY; T=293.6K  
Threshold reactions

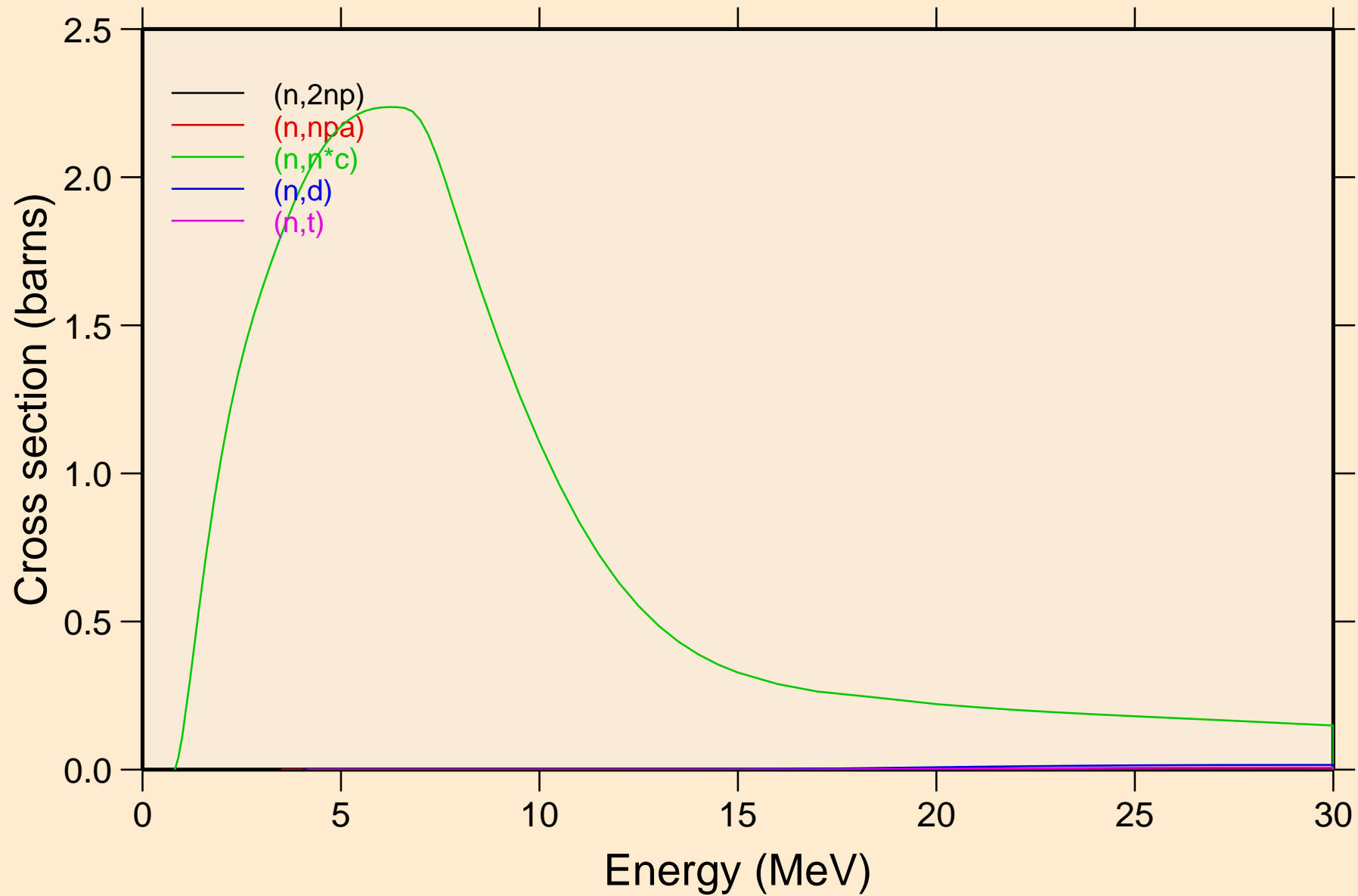

PT191 NEUTRON ACER TENDL-2021 LIBRARY; T=293.6K  
Threshold reactions

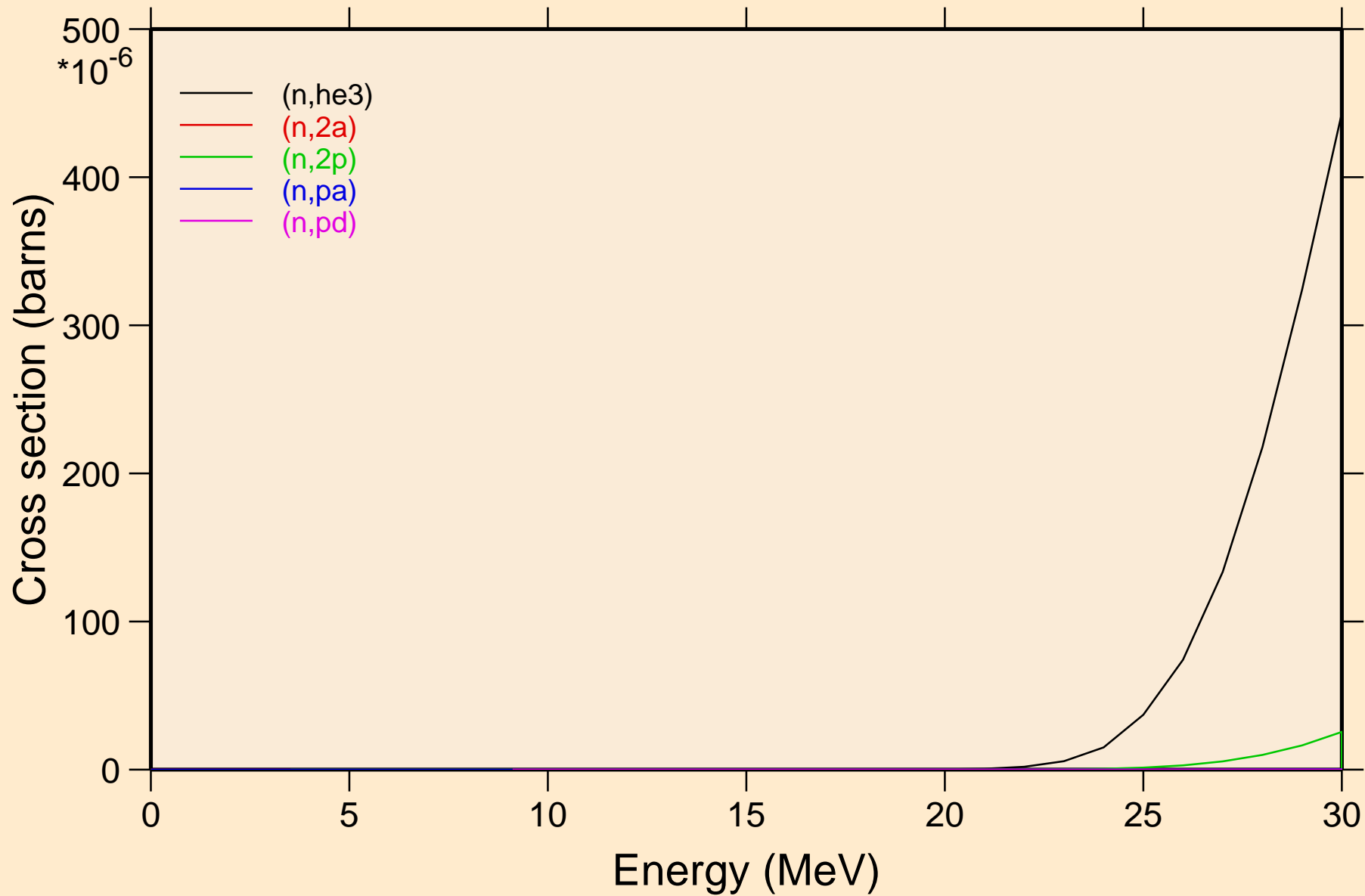

PT191 NEUTRON ACER TENDL-2021 LIBRARY; T=293.6K  
Threshold reactions

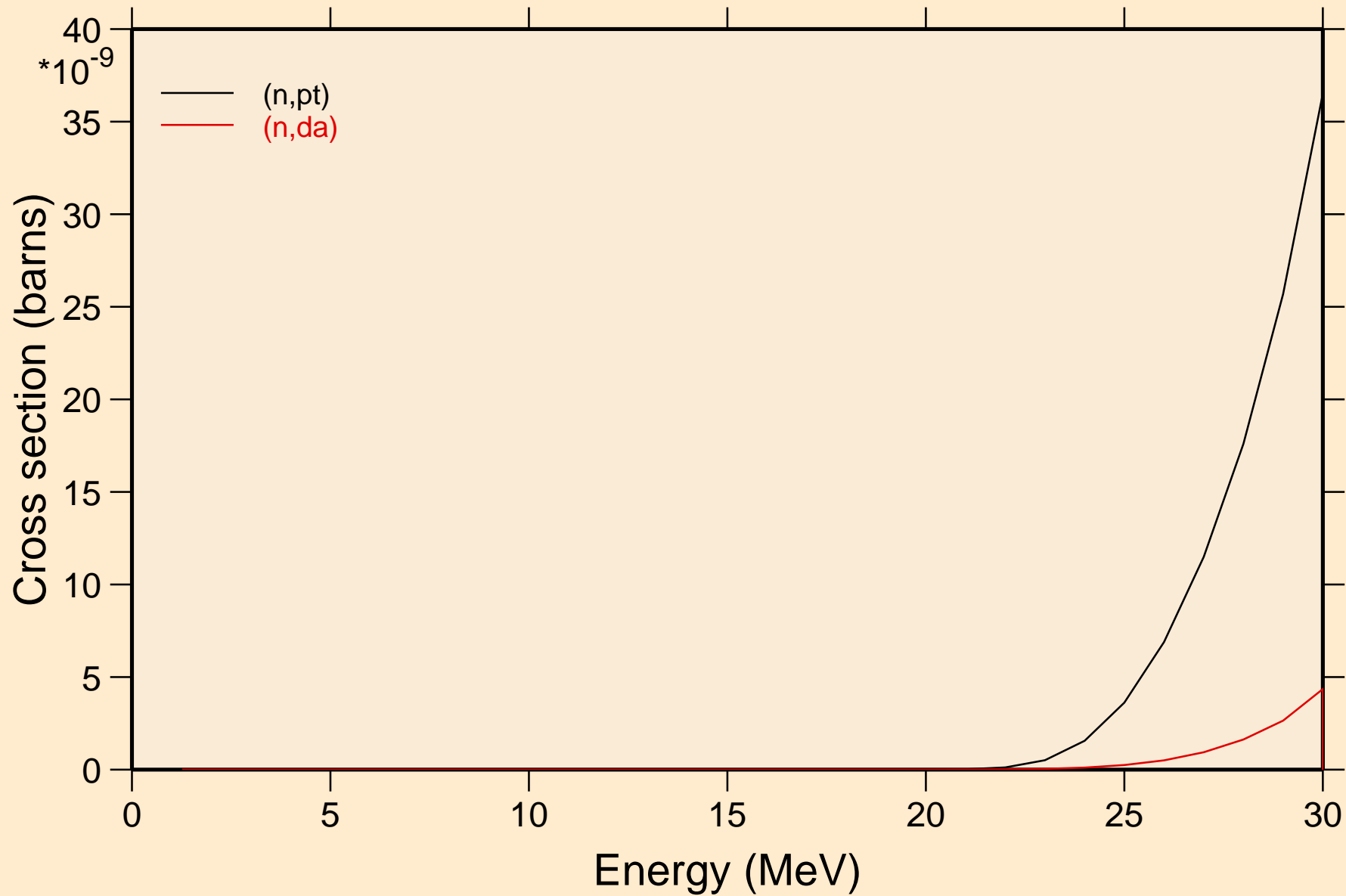

PT191 NEUTRON ACER TENDL-2021 LIBRARY; T=293.6K  
Threshold reactions

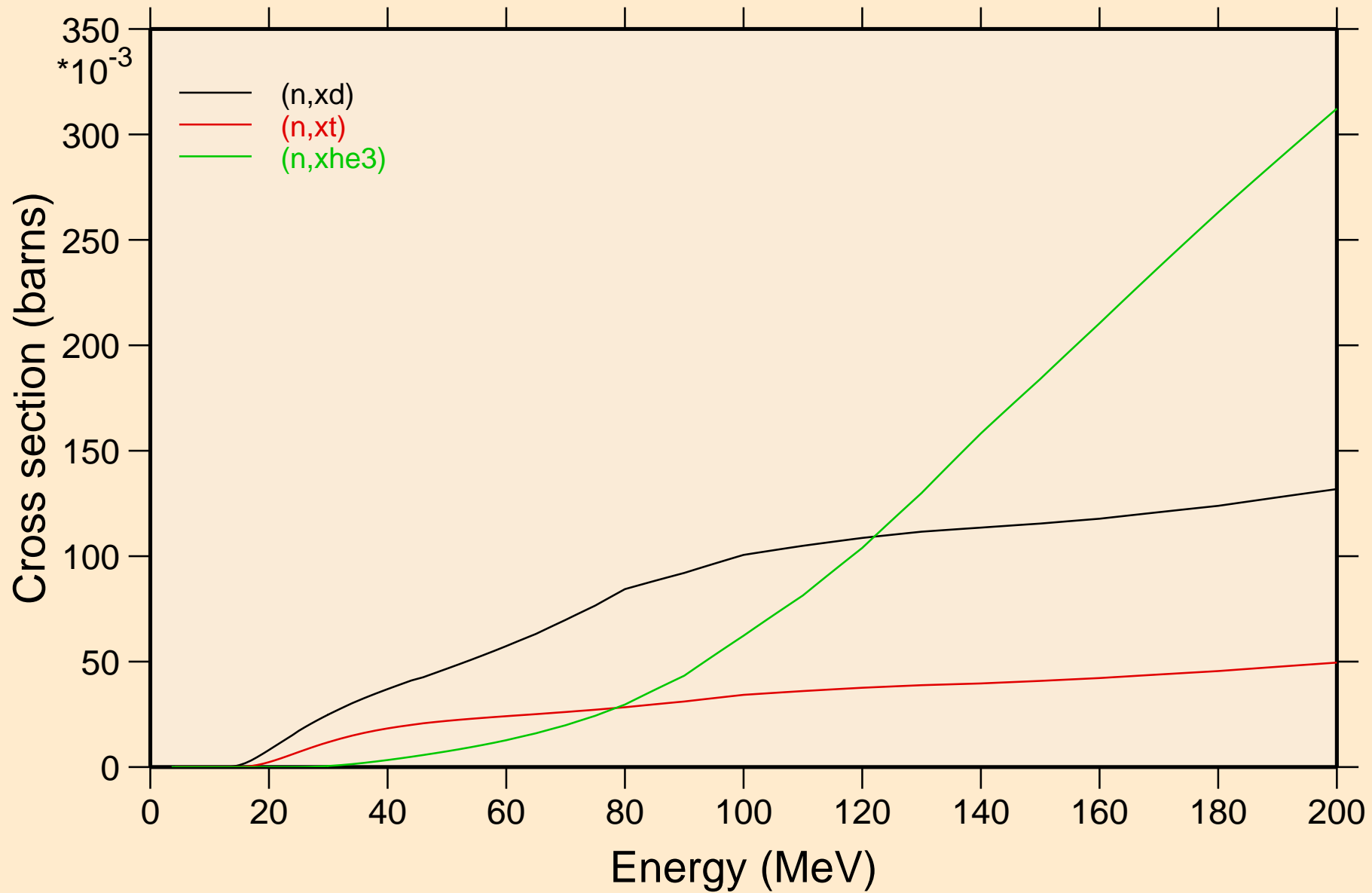

PT191 NEUTRON ACER TENDL-2021 LIBRARY; T=293.6K  
angular distribution for elastic

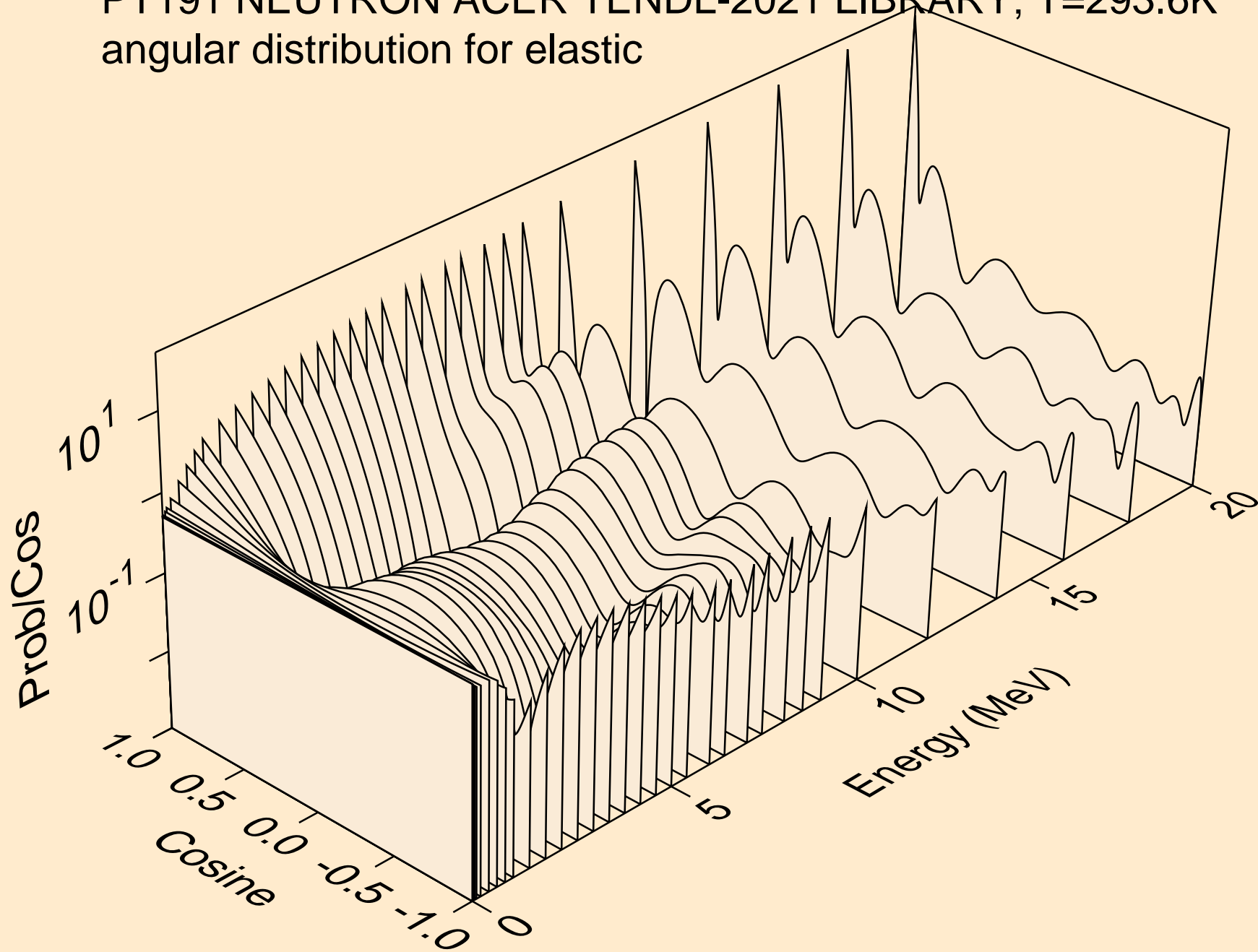

PT191 NEUTRON ACER TENDL-2021 LIBRARY; T=293.6K  
angular distribution for elastic

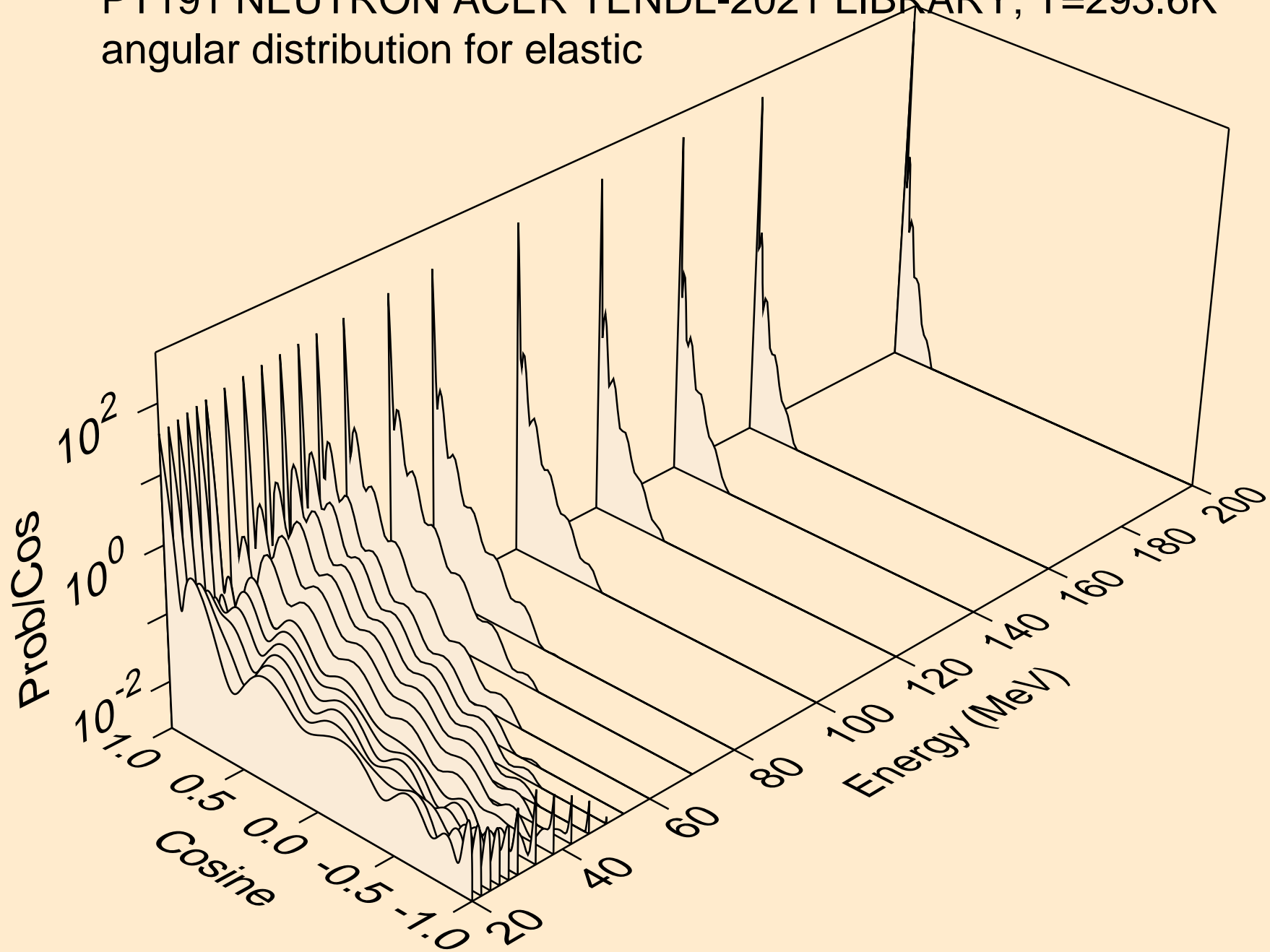

PT191 NEUTRON ACER TENDL-2021 LIBRARY; T=293.6K  
angular distribution for (n,n\*1)

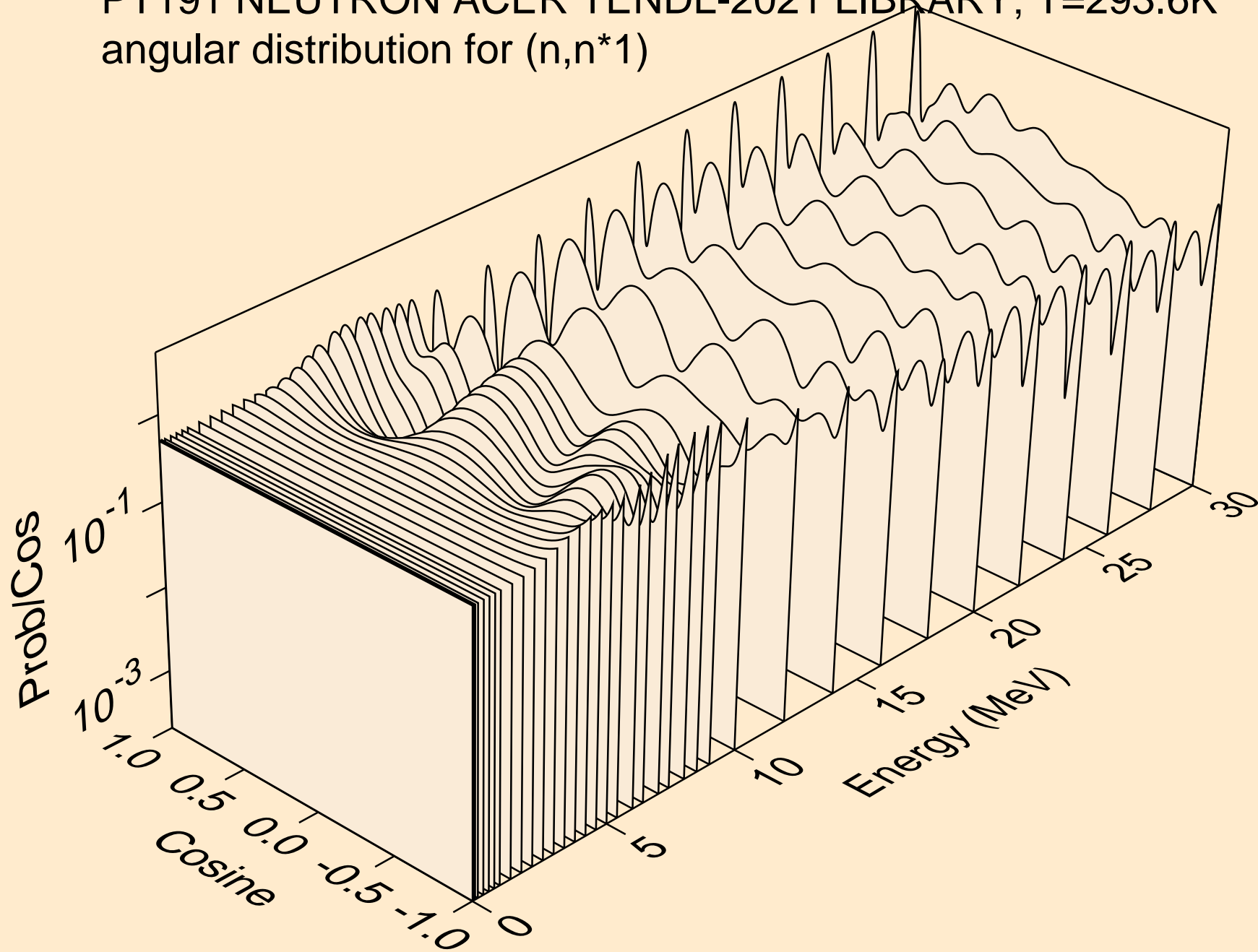



PT191 NEUTRON ACER TENDL-2021 LIBRARY; T=293.6K  
angular distribution for (n,n\*2)

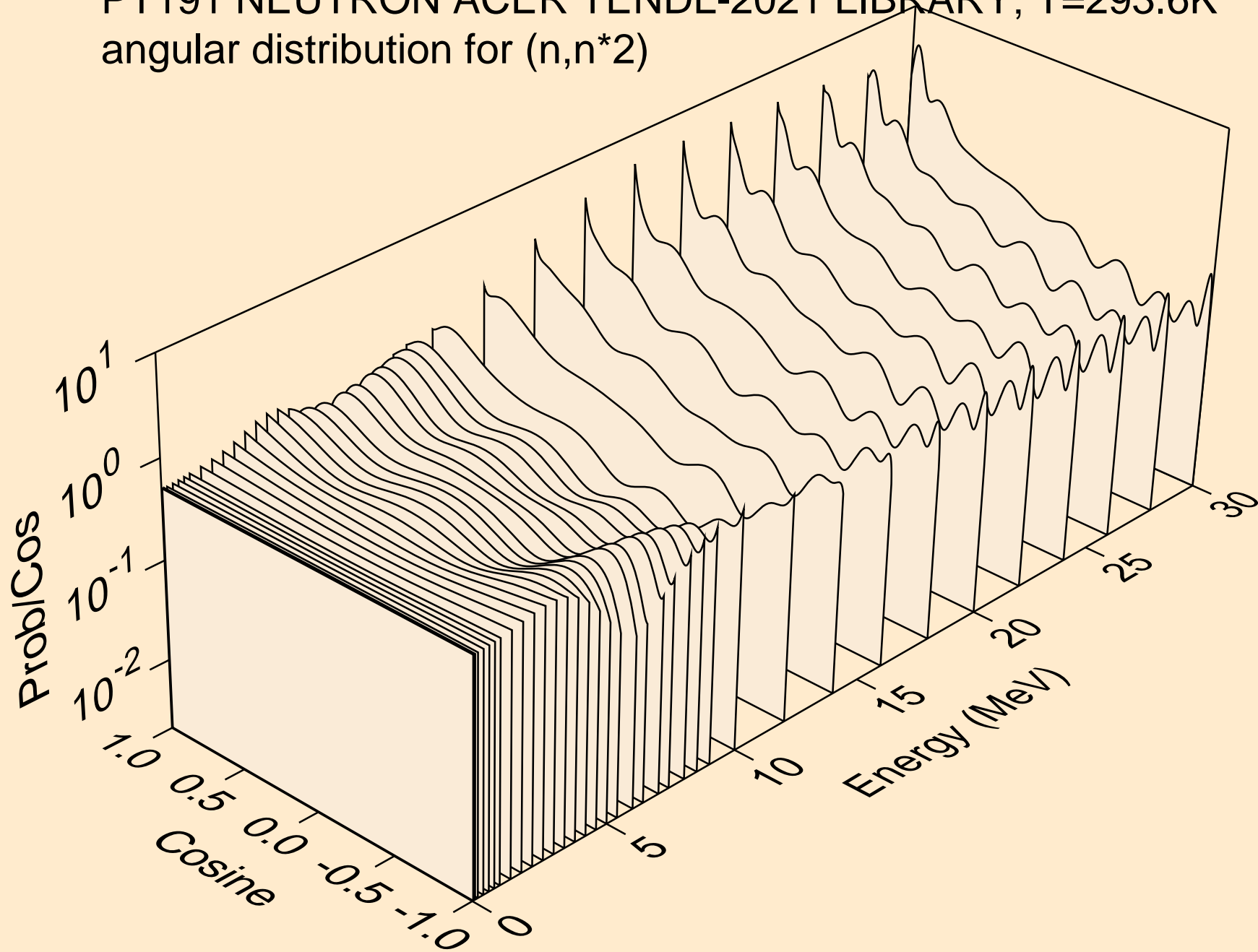

PT191 NEUTRON ACER TENDL-2021 LIBRARY; T=293.6K  
angular distribution for (n,n\*3)

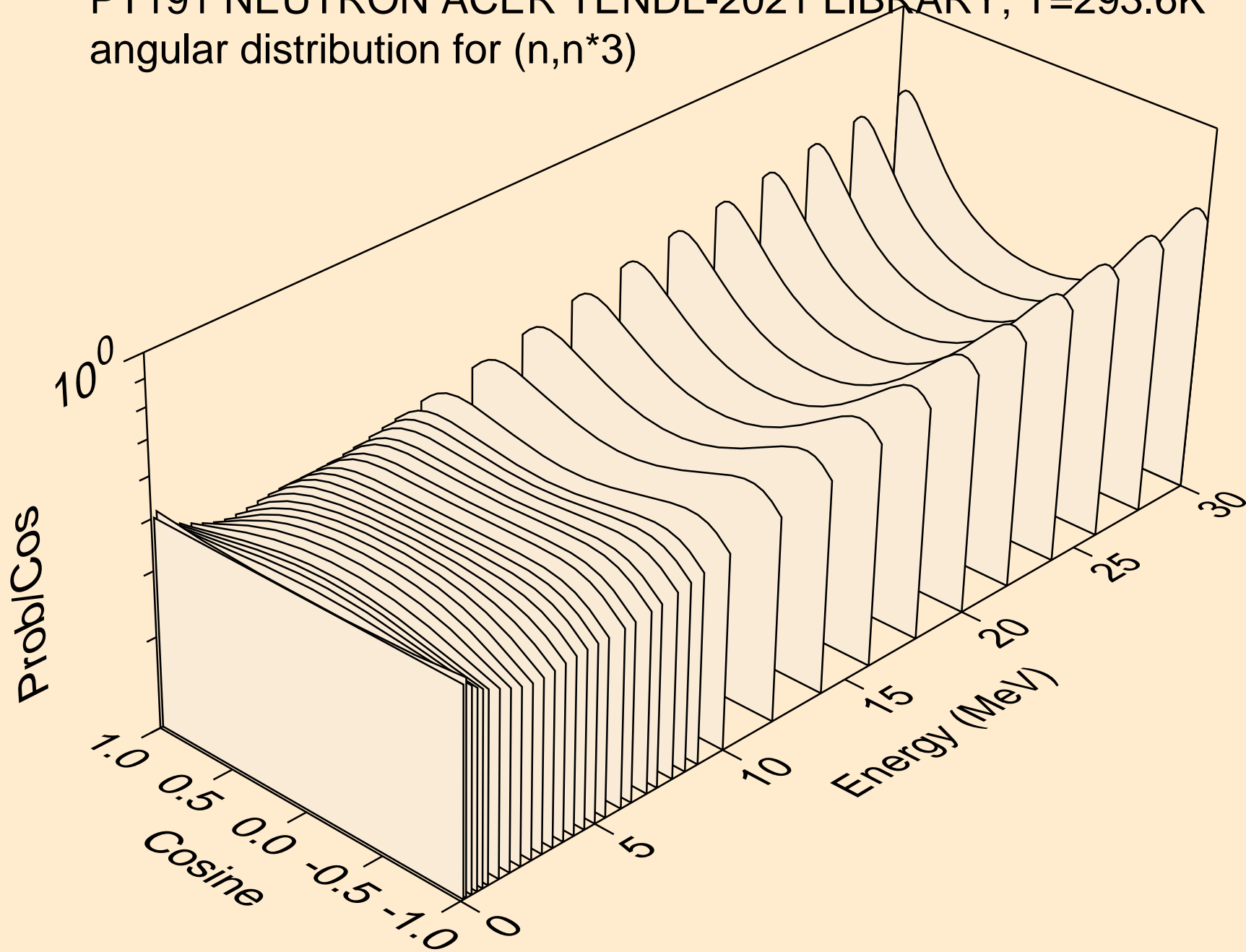

PT191 NEUTRON ACER TENDL-2021 LIBRARY; T=293.6K  
angular distribution for (n,n\*4)

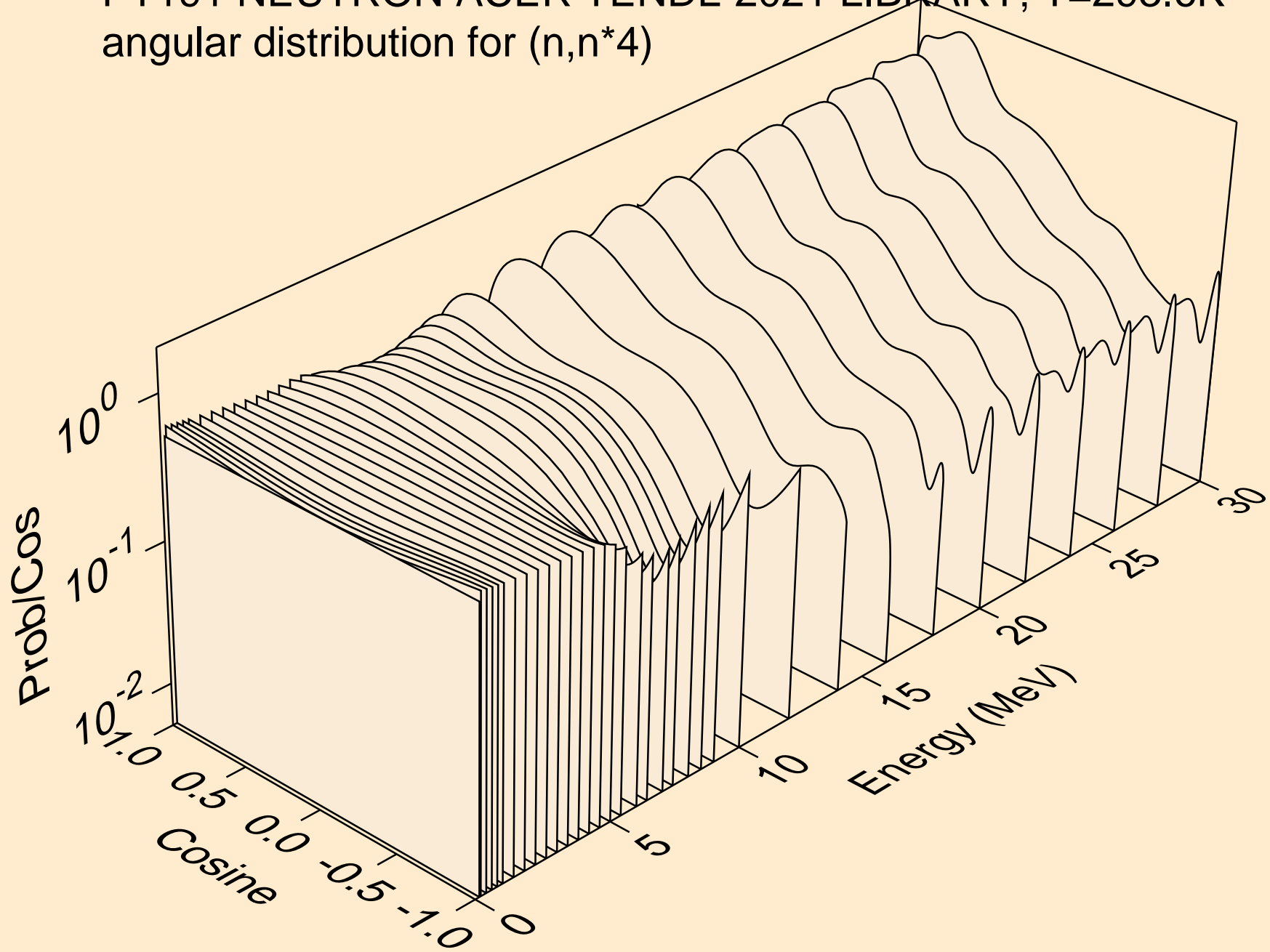

PT191 NEUTRON ACER TENDL-2021 LIBRARY; T=293.6K  
angular distribution for (n,n\*5)

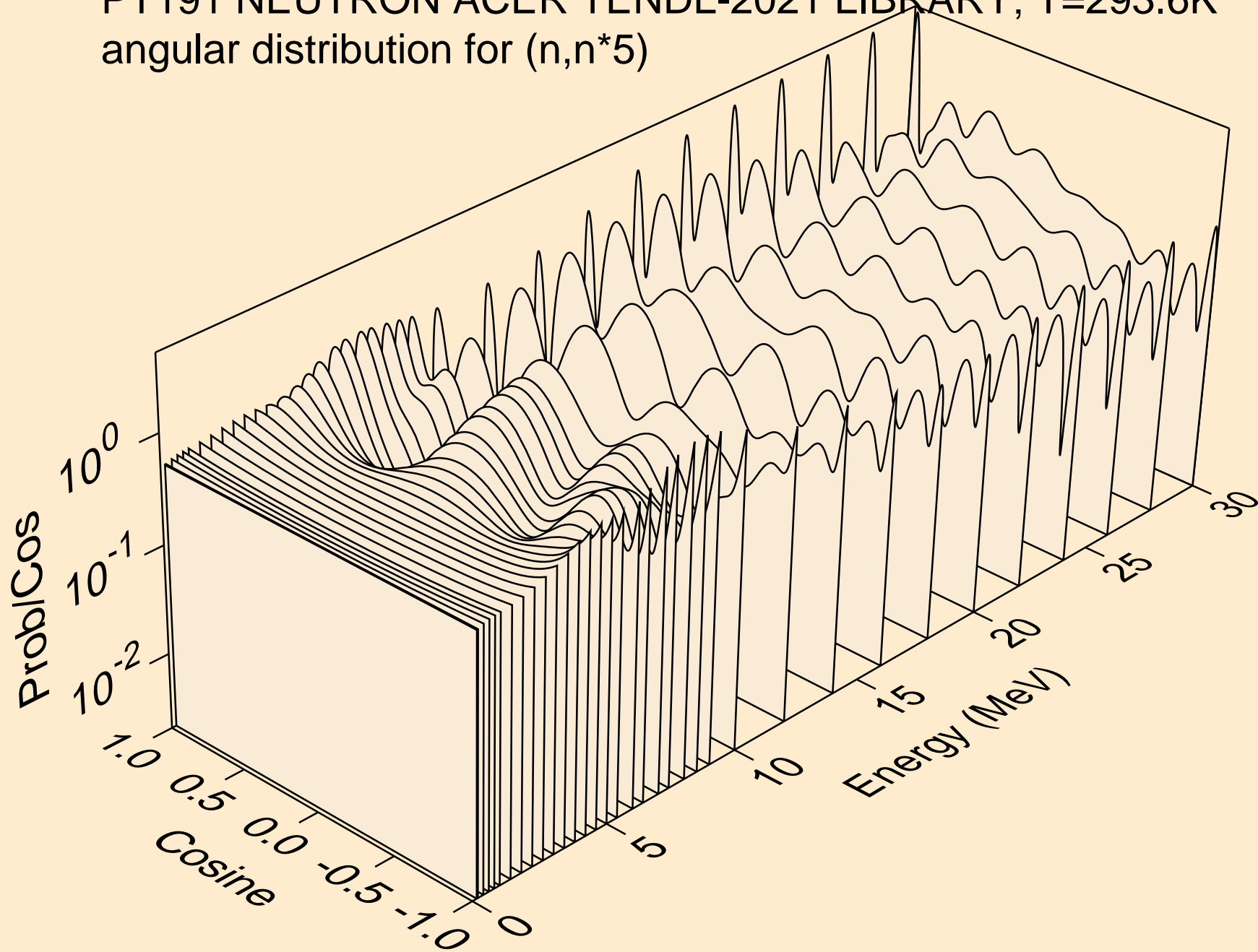

PT191 NEUTRON ACER TENDL-2021 LIBRARY; T=293.6K  
angular distribution for (n,n\*6)

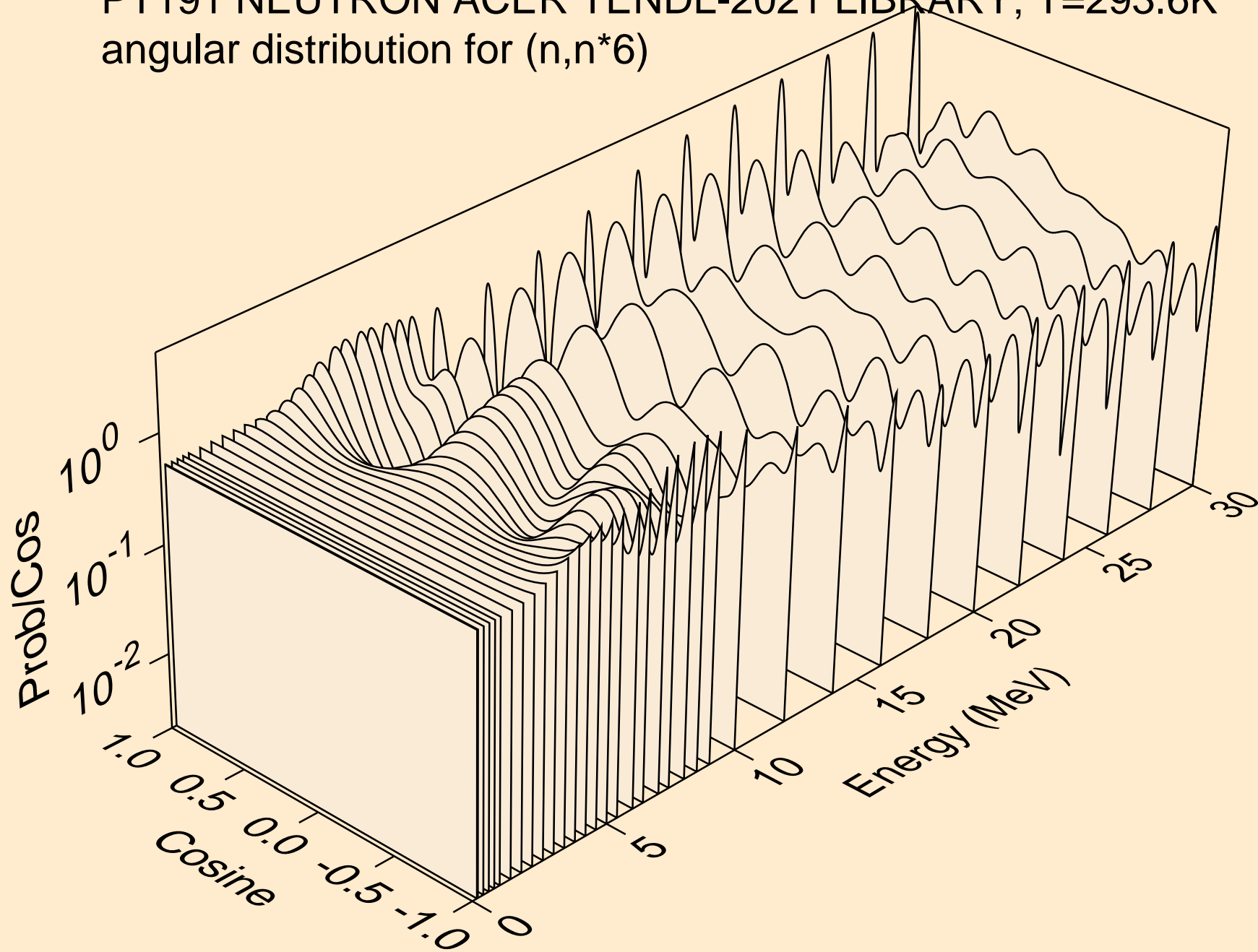

PT191 NEUTRON ACER TENDL-2021 LIBRARY; T=293.6K  
angular distribution for (n,n\*7)

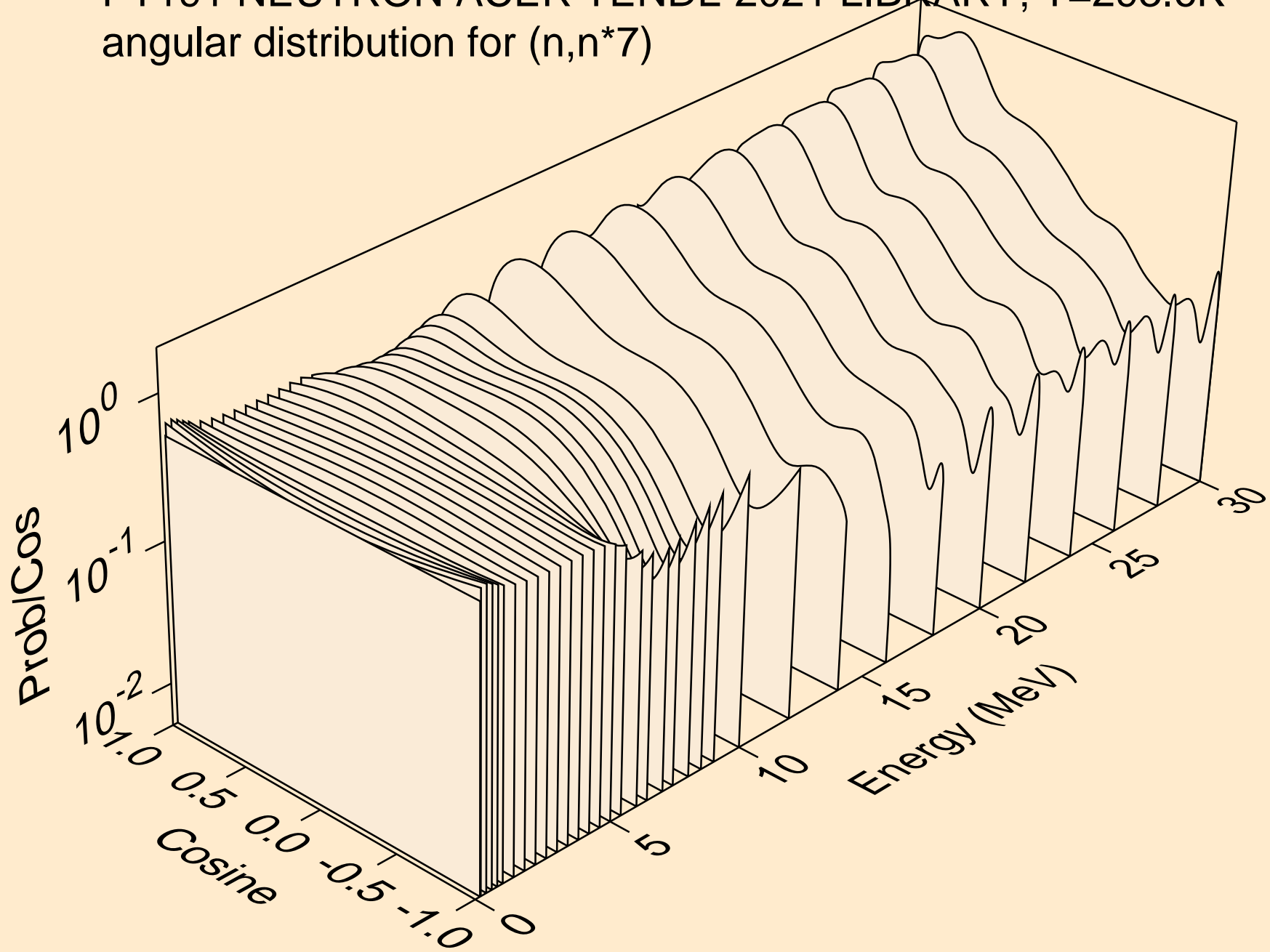

PT191 NEUTRON ACER TENDL-2021 LIBRARY; T=293.6K  
angular distribution for (n,n\*8)

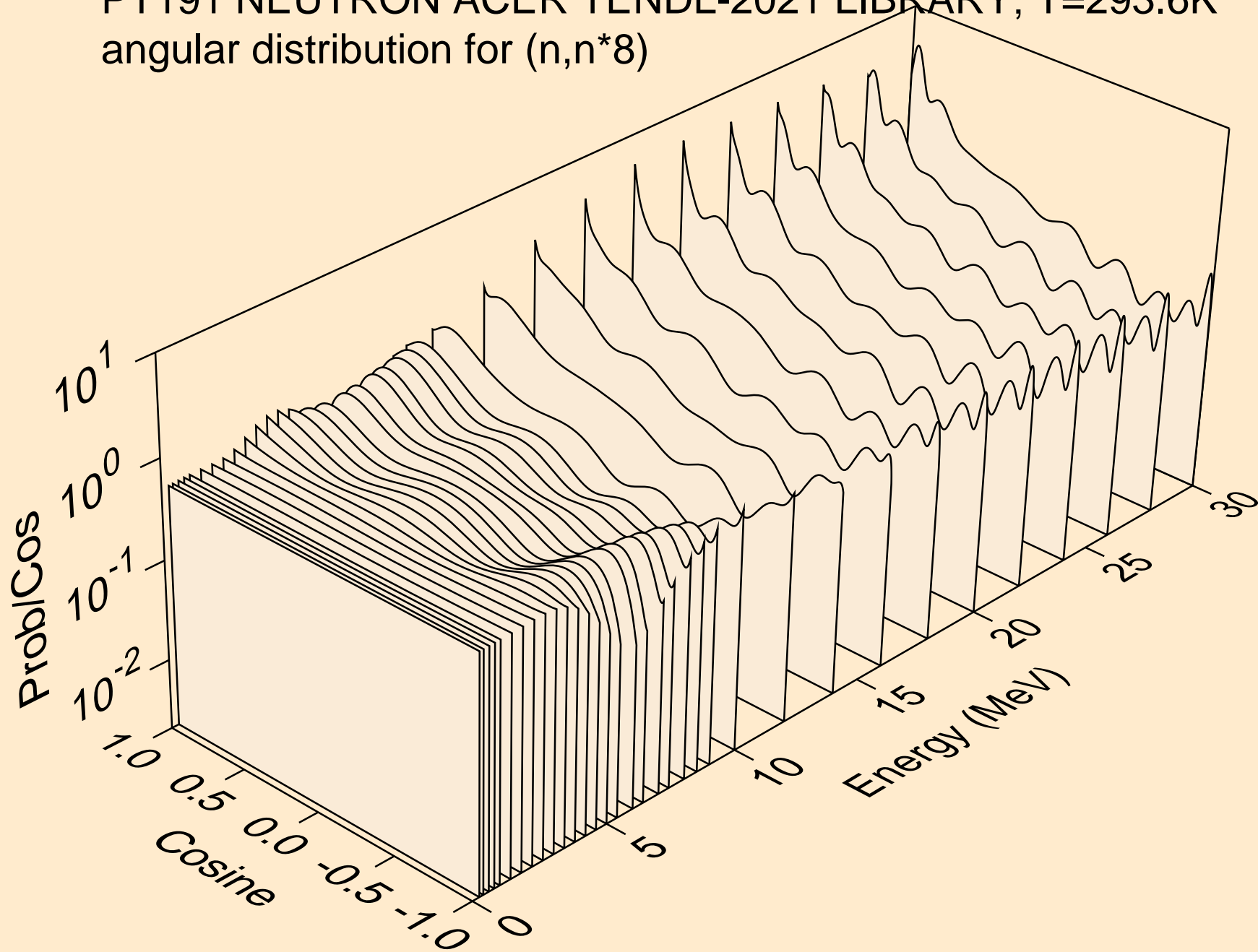

PT191 NEUTRON ACER TENDL-2021 LIBRARY; T=293.6K  
angular distribution for (n,n\*9)

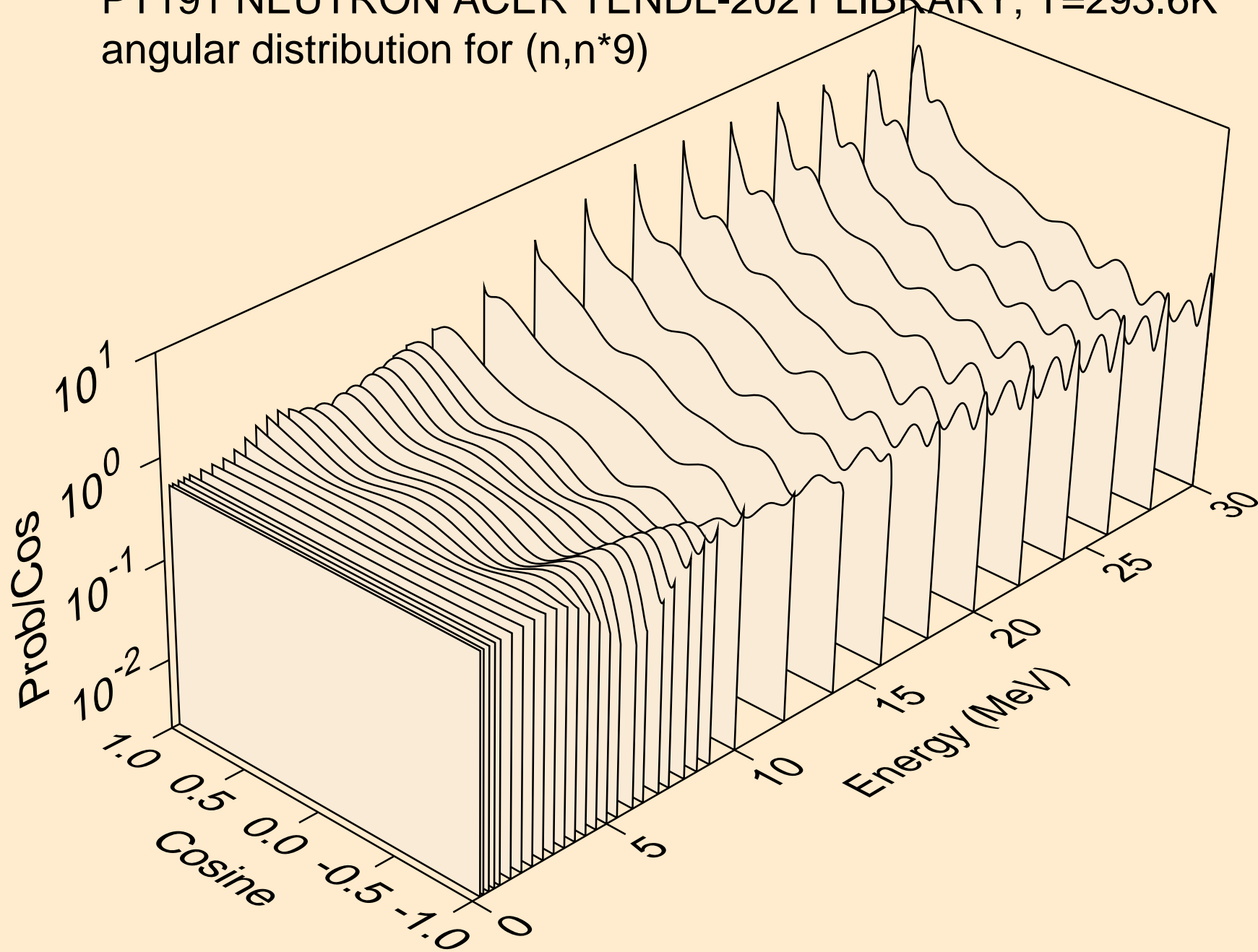



PT191 NEUTRON ACER TENDL-2021 LIBRARY; T=293.6K  
angular distribution for (n,n\*10)

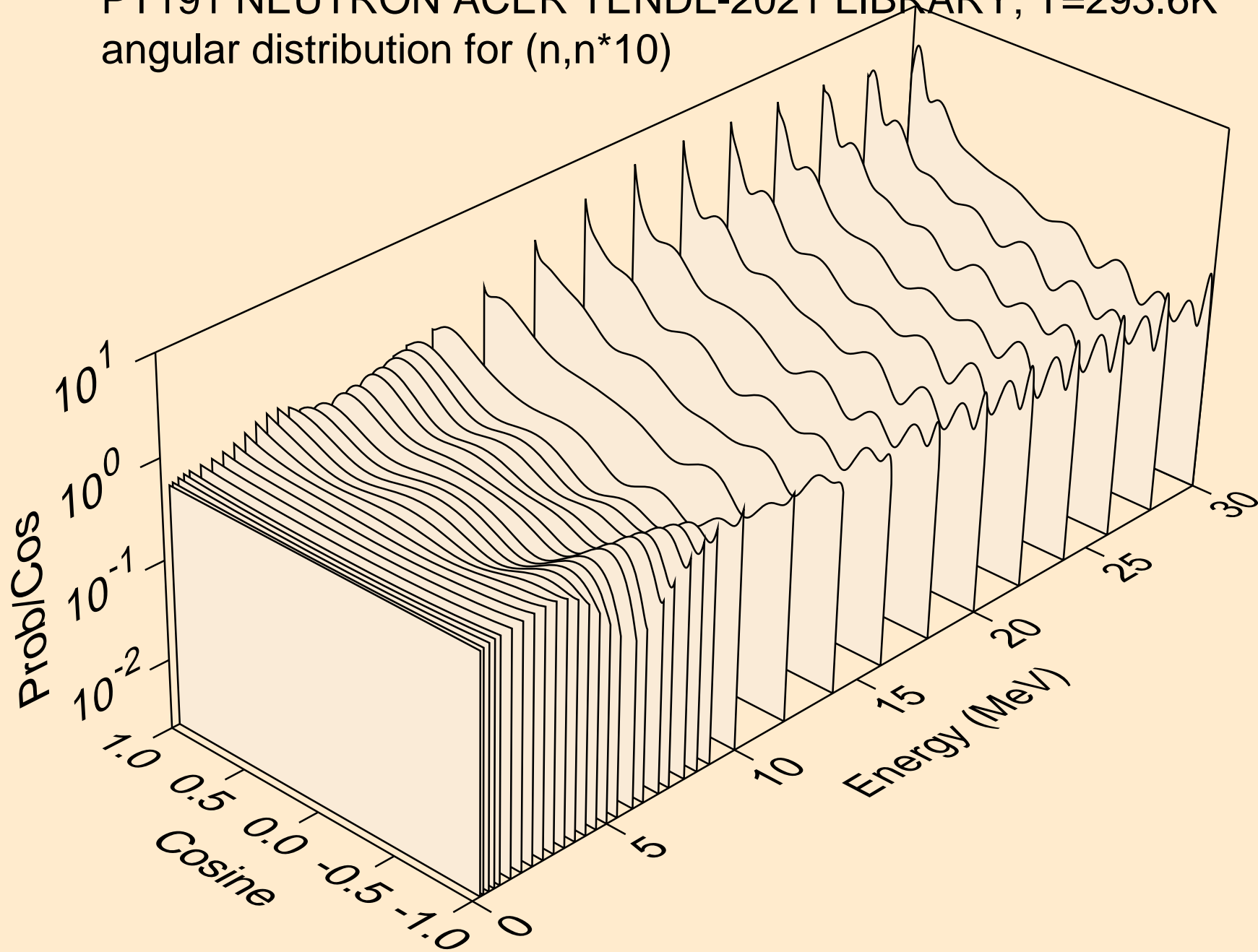

PT191 NEUTRON ACER TENDL-2021 LIBRARY; T=293.6K  
angular distribution for (n,n\*11)

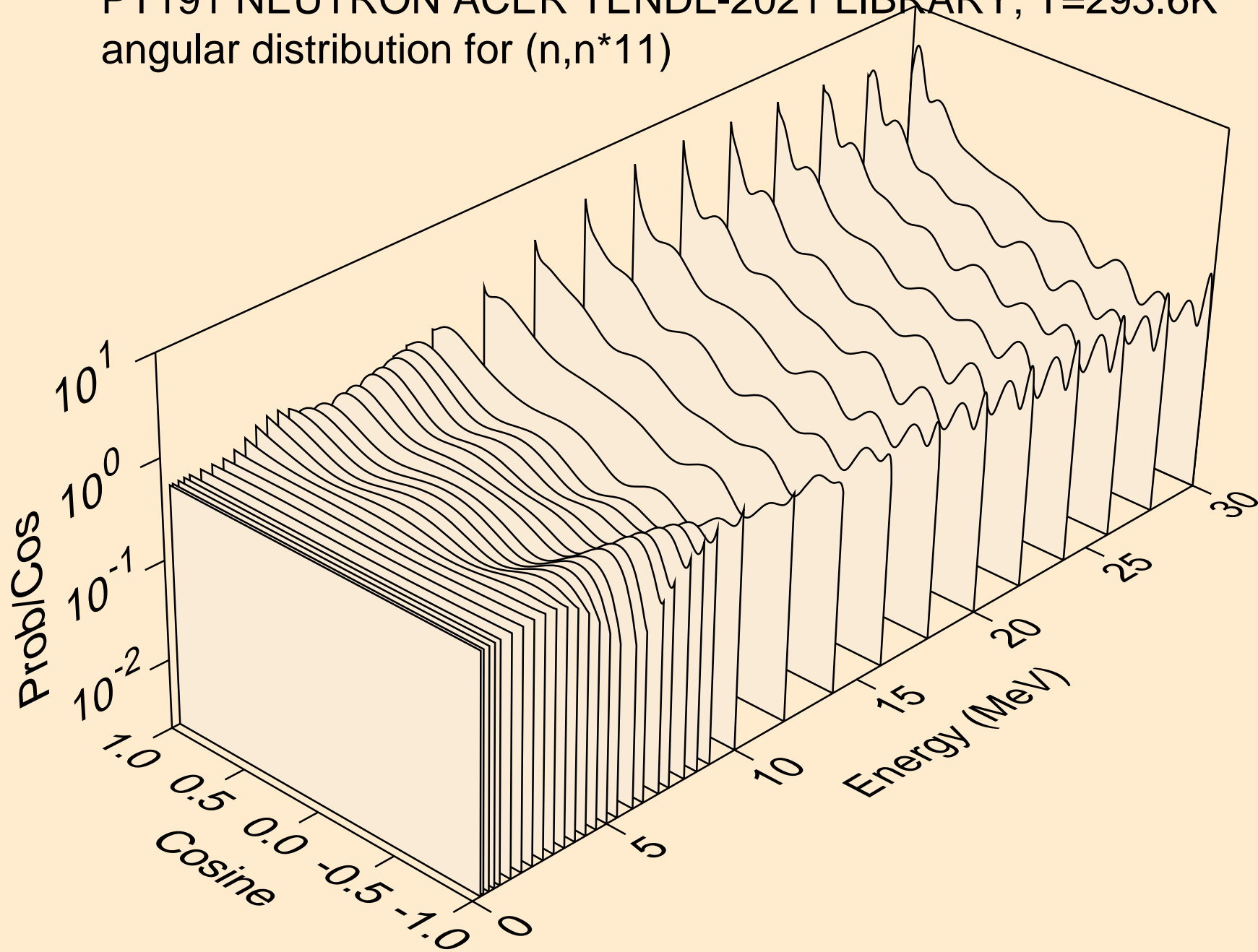

PT191 NEUTRON ACER TENDL-2021 LIBRARY; T=293.6K  
angular distribution for (n,n\*12)

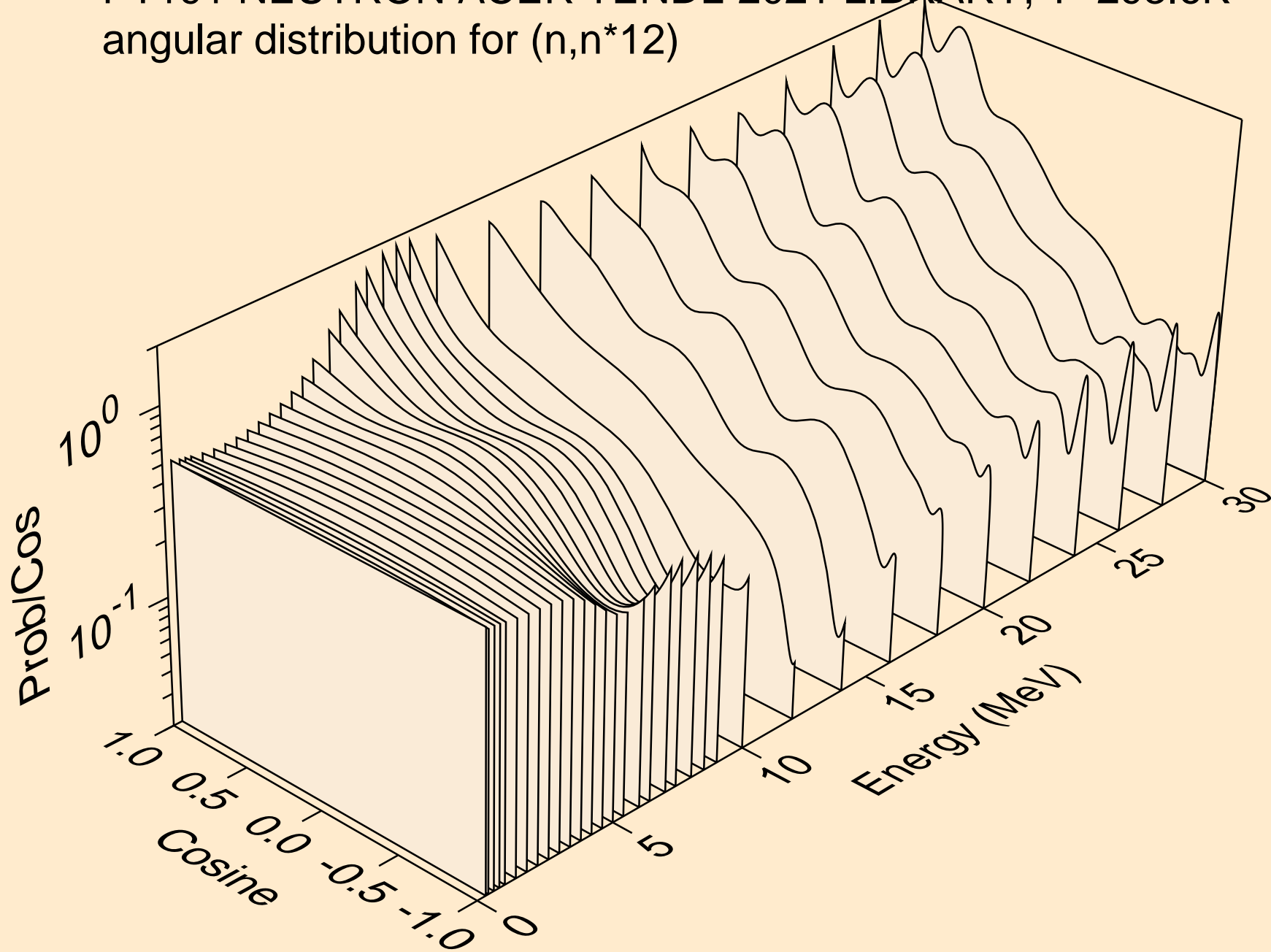

PT191 NEUTRON ACER TENDL-2021 LIBRARY; T=293.6K  
angular distribution for (n,n\*13)

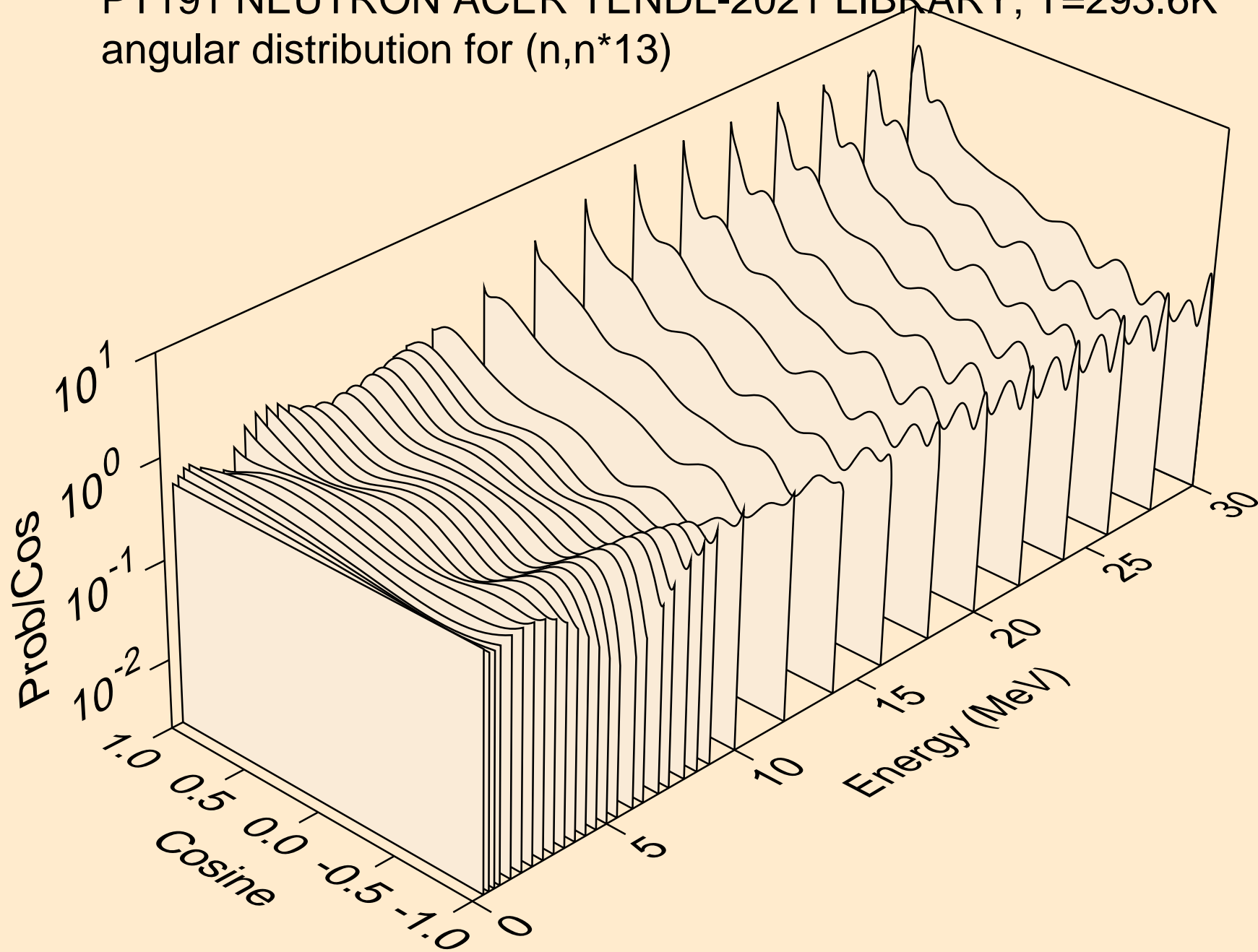

PT191 NEUTRON ACER TENDL-2021 LIBRARY; T=293.6K  
angular distribution for (n,n\*14)

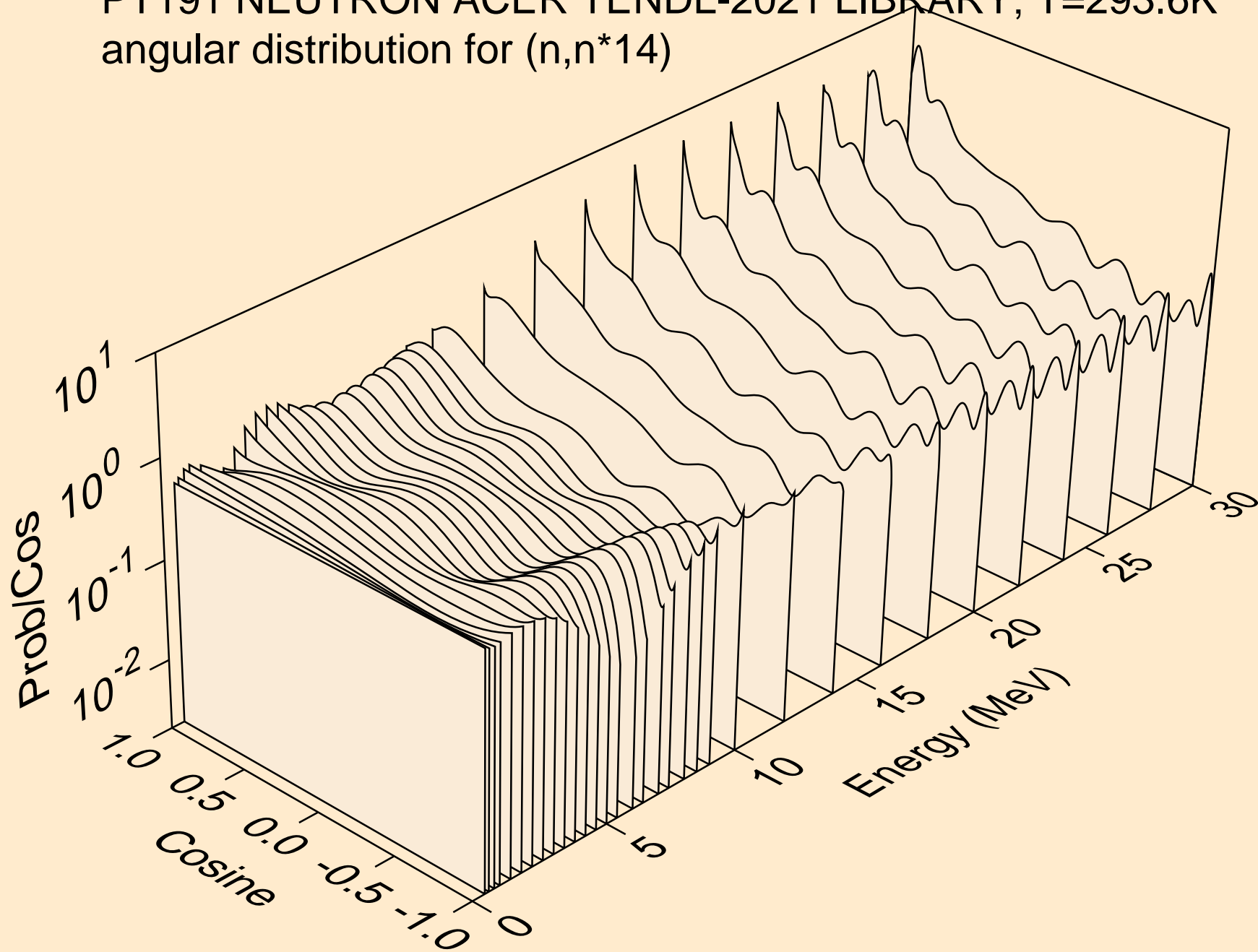

PT191 NEUTRON ACER TENDL-2021 LIBRARY; T=293.6K  
angular distribution for (n,n\*15)

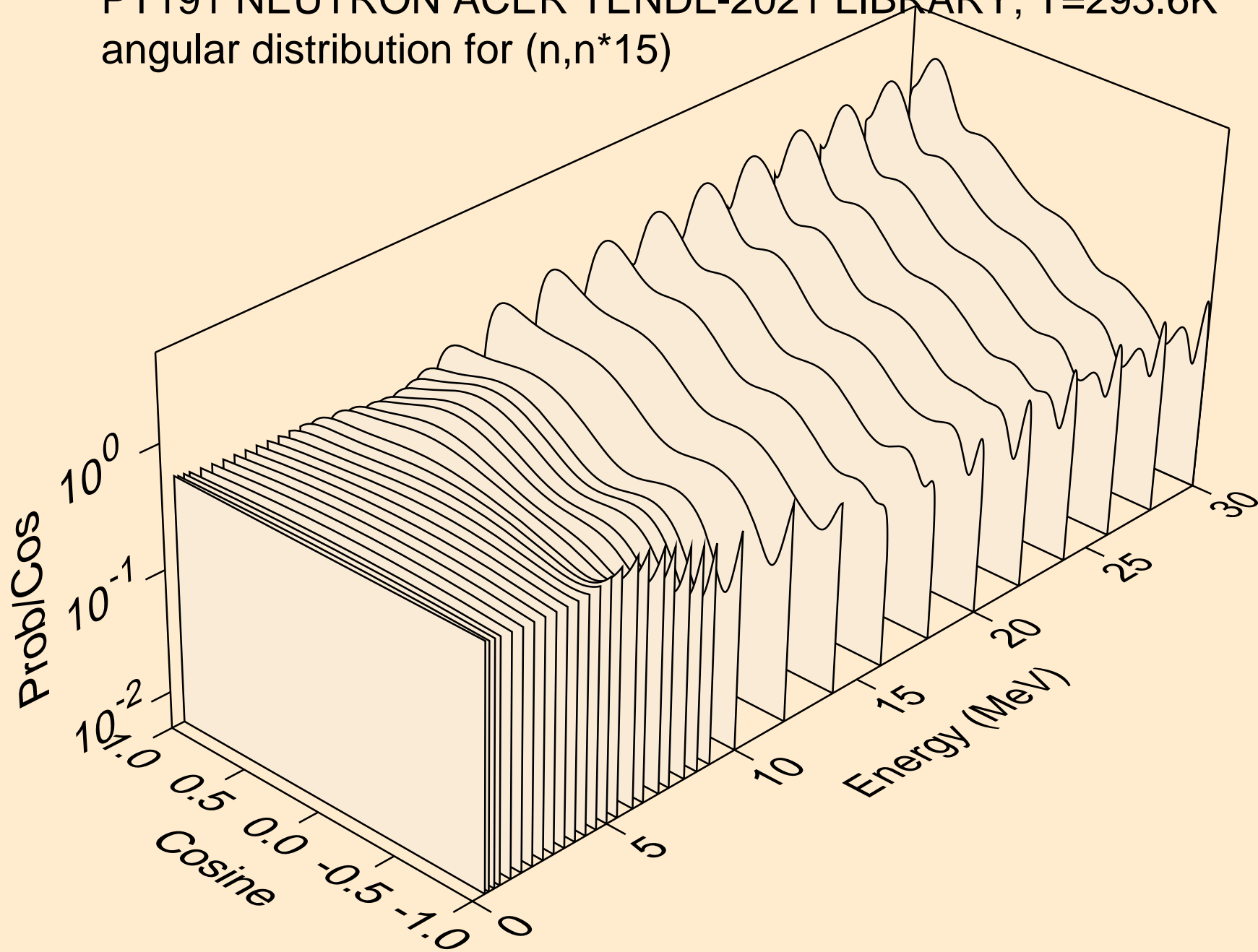

PT191 NEUTRON ACER TENDL-2021 LIBRARY; T=293.6K  
angular distribution for (n,n\*16)

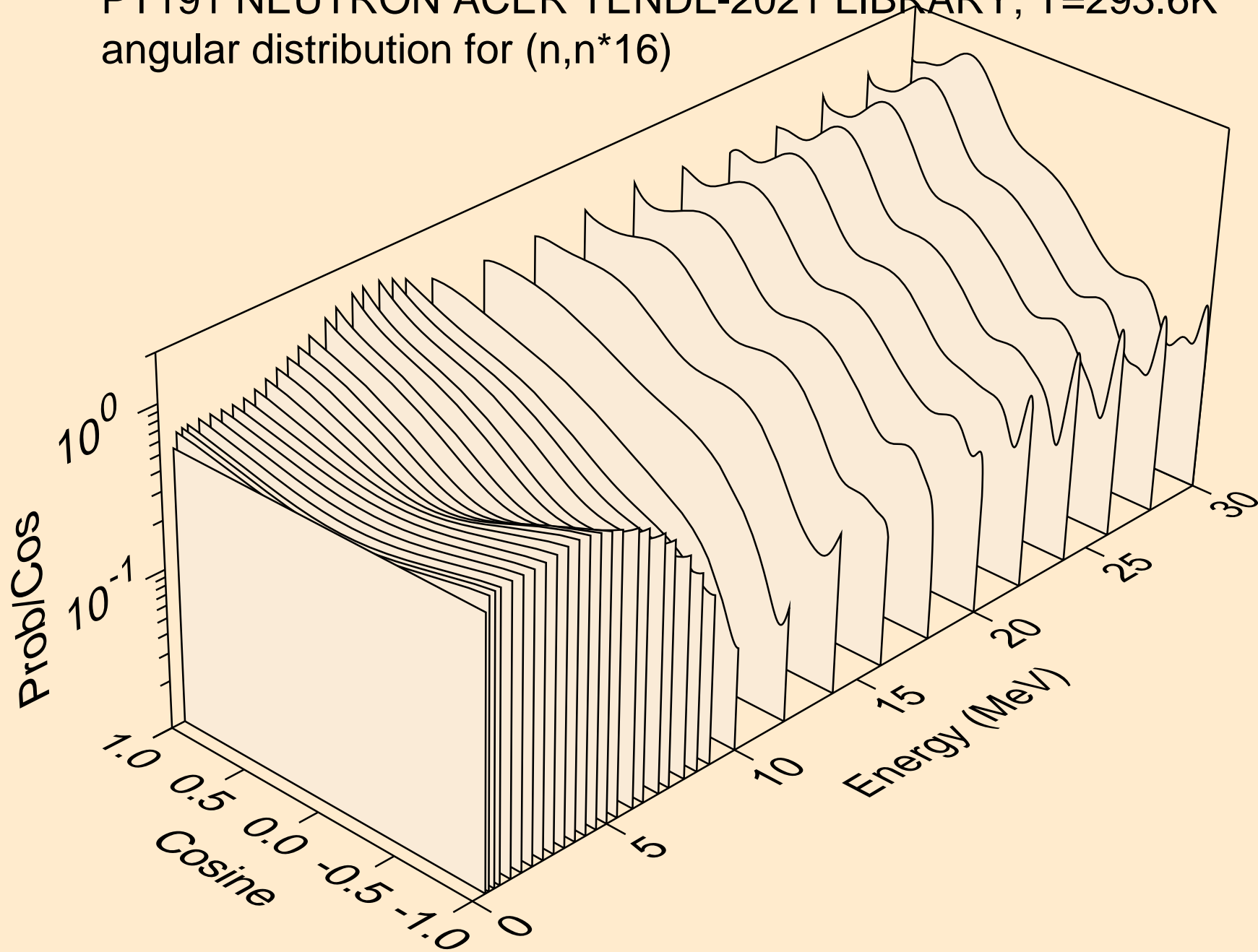

PT191 NEUTRON ACER TENDL-2021 LIBRARY; T=293.6K  
angular distribution for (n,n\*17)

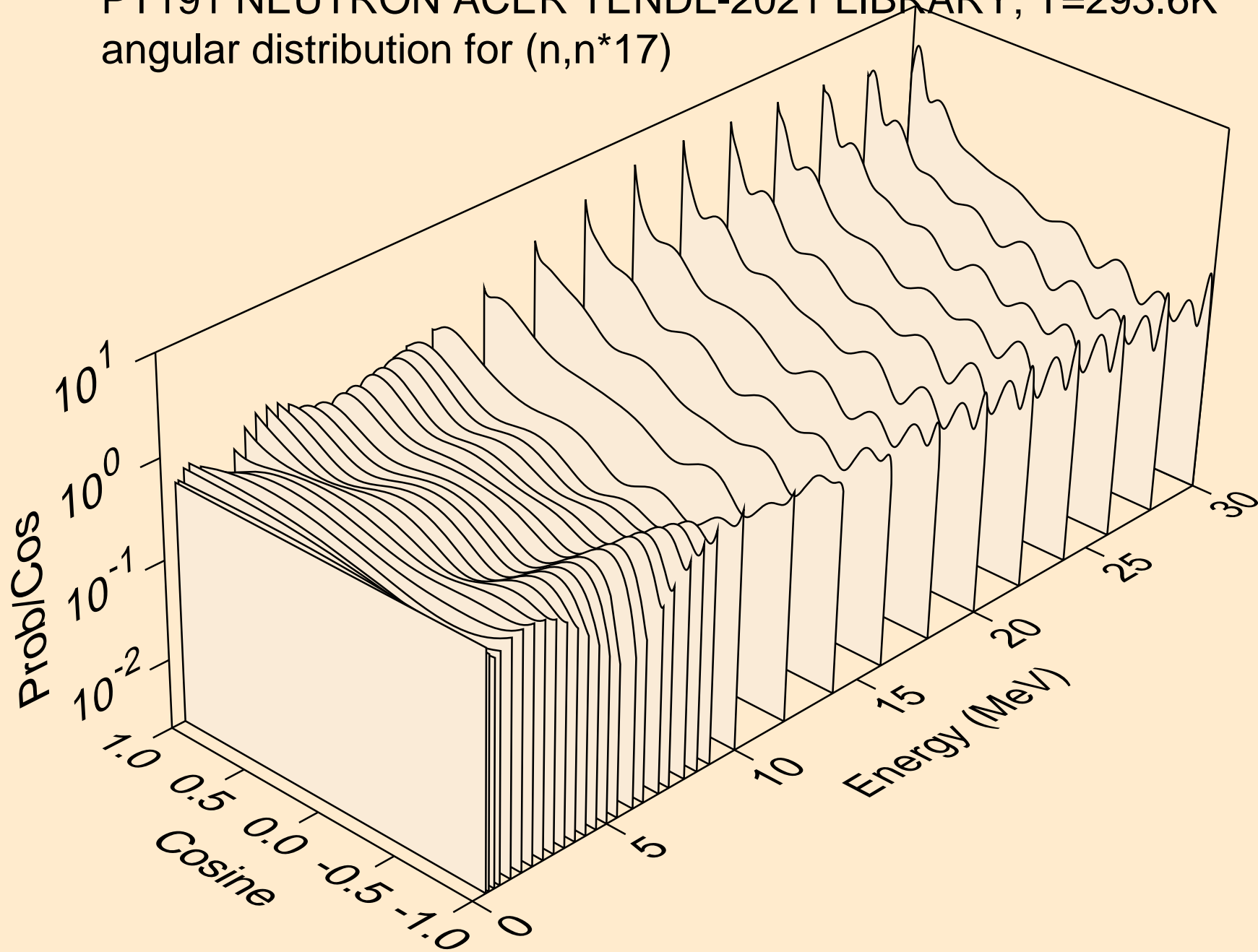



PT191 NEUTRON ACER TENDL-2021 LIBRARY; T=293.6K  
angular distribution for (n,n\*18)

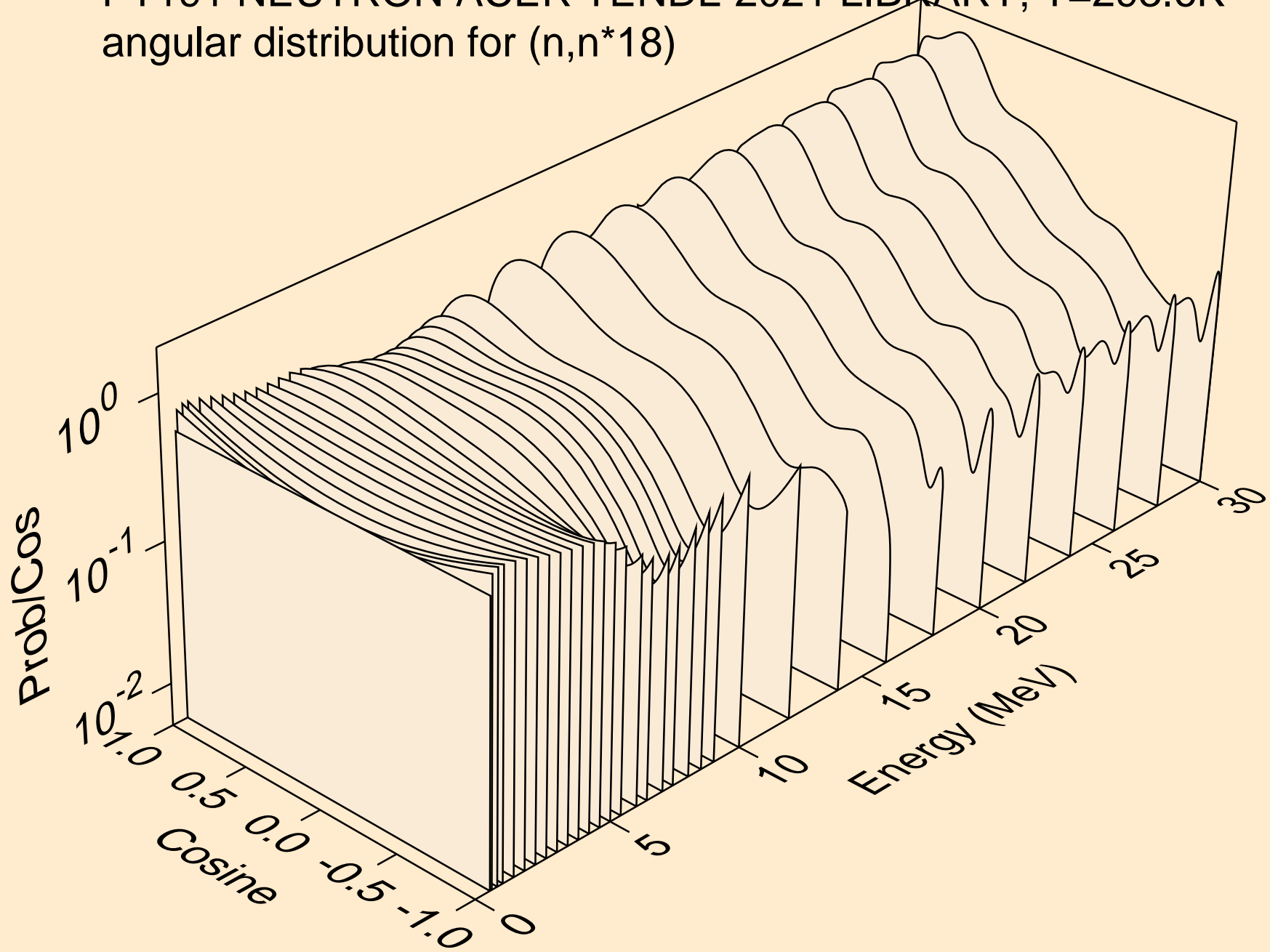

PT191 NEUTRON ACER TENDL-2021 LIBRARY; T=293.6K  
angular distribution for (n,n\*19)

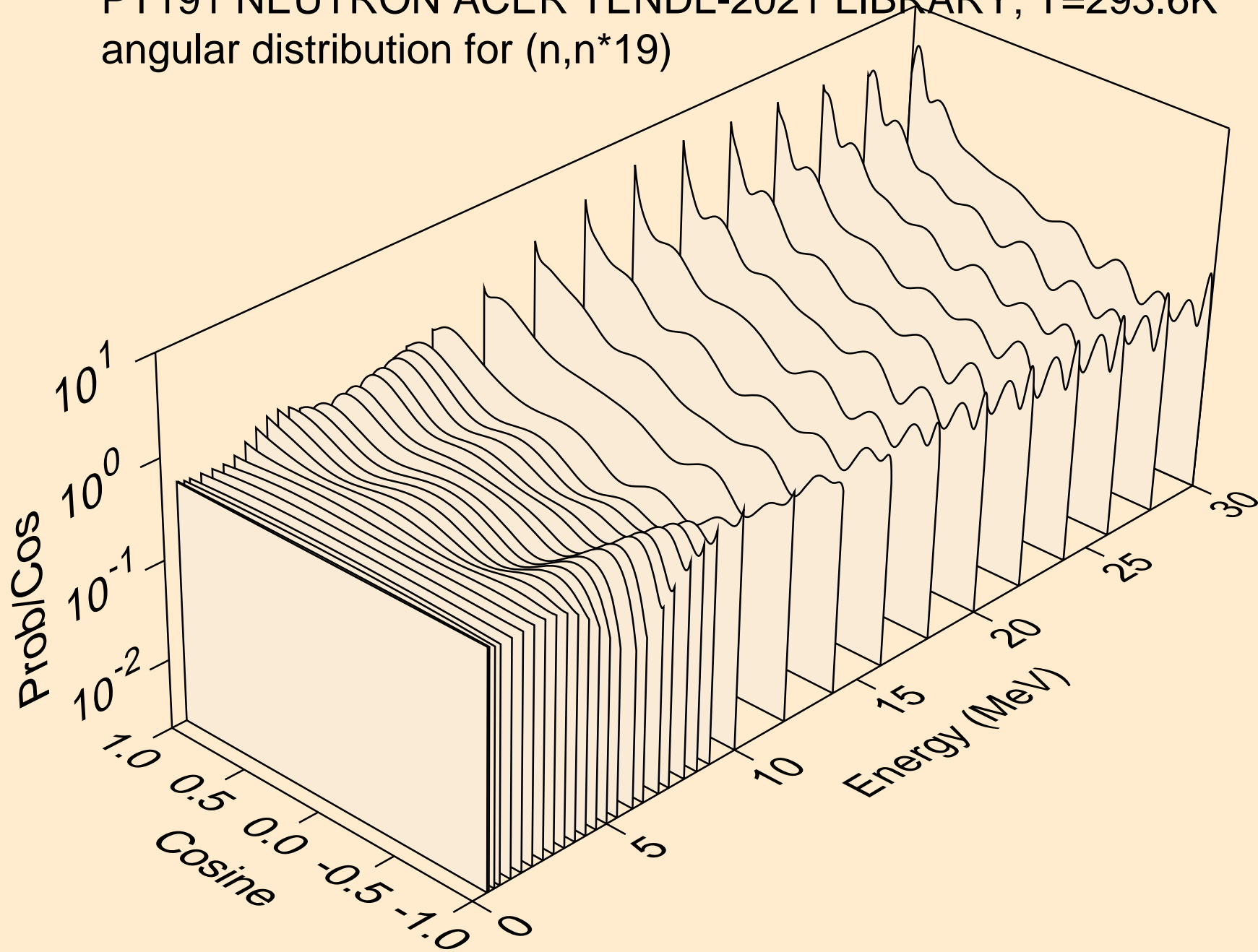

PT191 NEUTRON ACER TENDL-2021 LIBRARY; T=293.6K  
angular distribution for (n,n\*20)

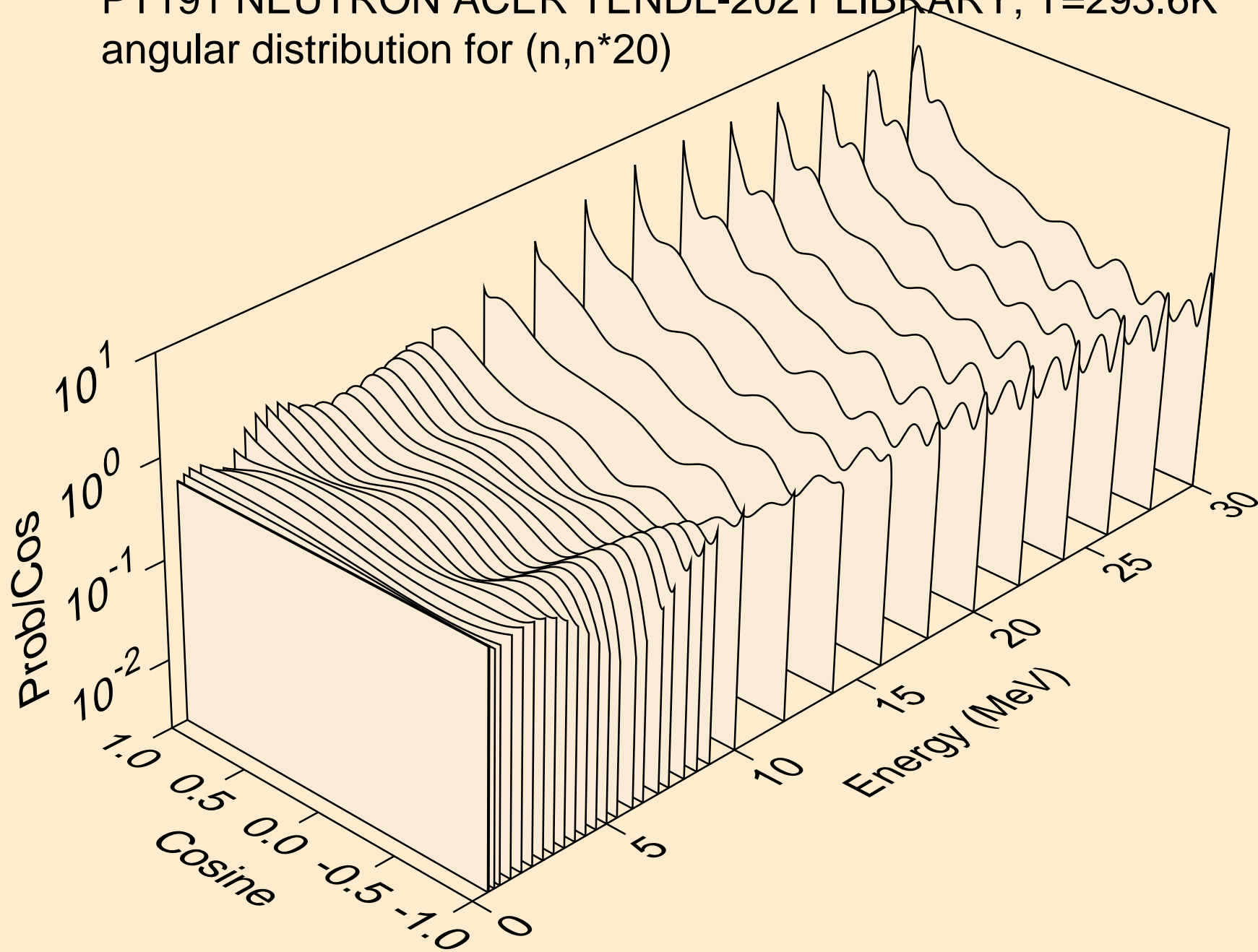

PT191 NEUTRON ACER TENDL-2021 LIBRARY; T=293.6K  
angular distribution for (n,n\*21)

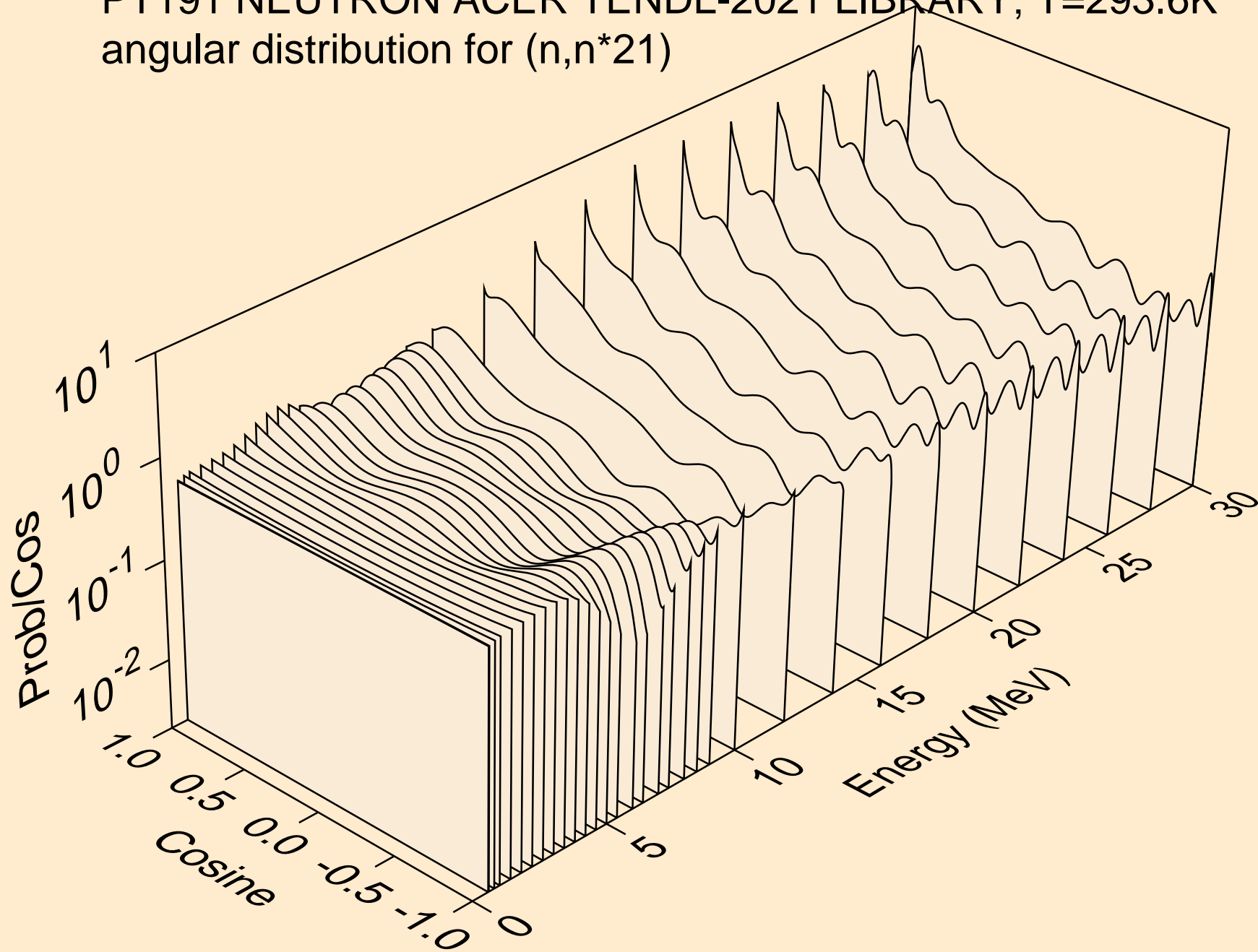

PT191 NEUTRON ACER TENDL-2021 LIBRARY; T=293.6K  
angular distribution for (n,n\*22)

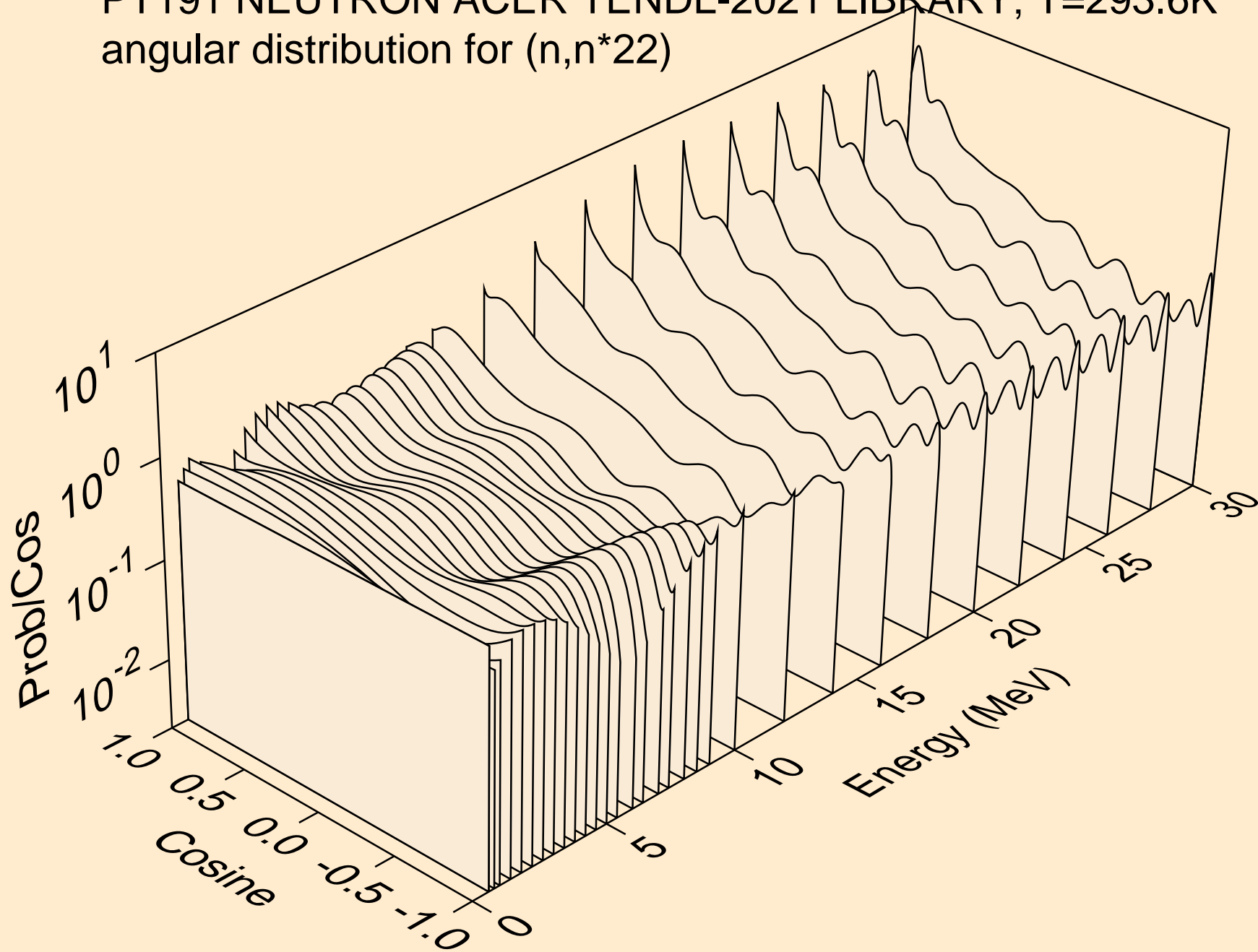

PT191 NEUTRON ACER TENDL-2021 LIBRARY; T=293.6K  
angular distribution for (n,n\*23)

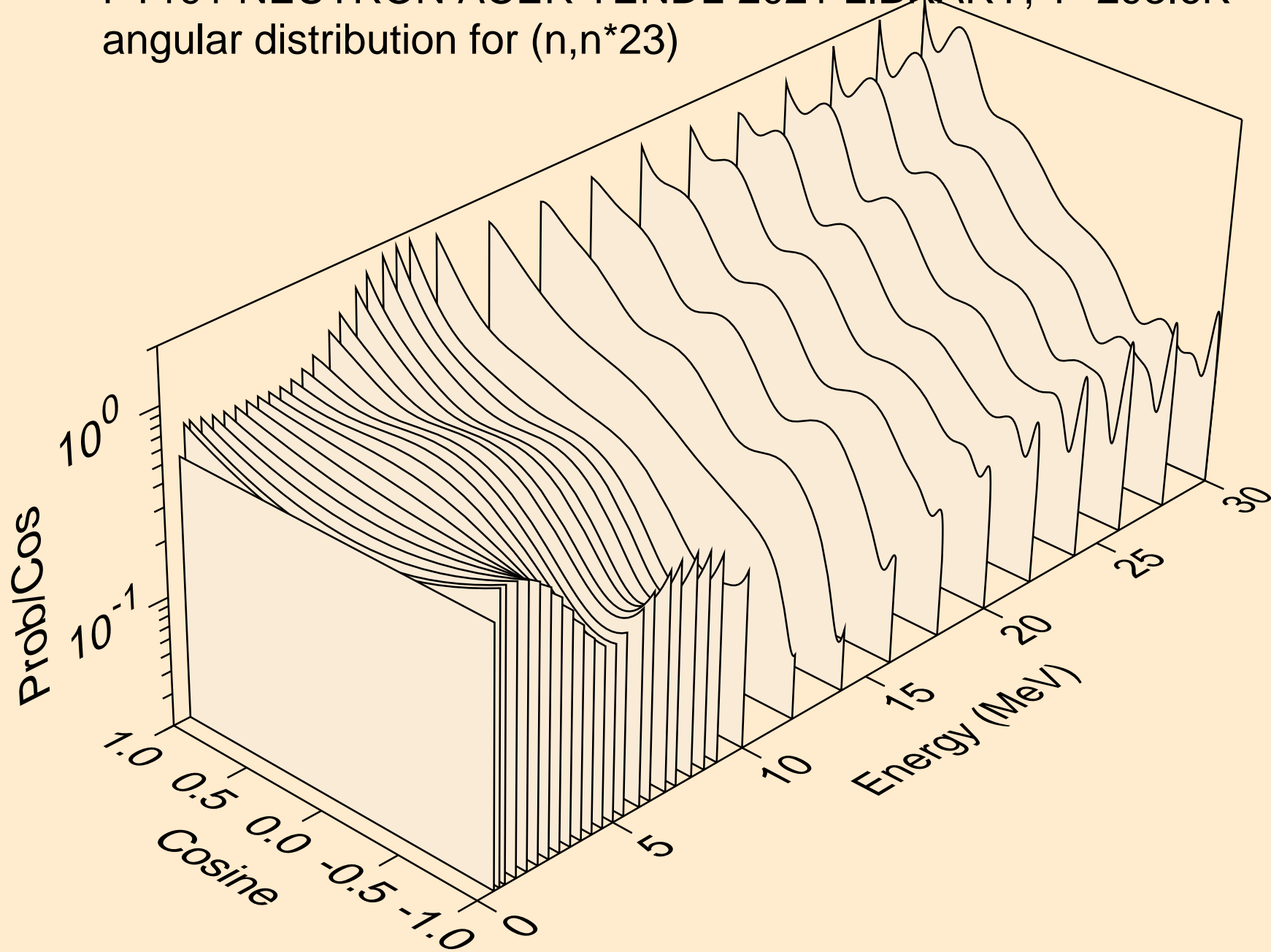

PT191 NEUTRON ACER TENDL-2021 LIBRARY; T=293.6K  
angular distribution for (n,n\*24)

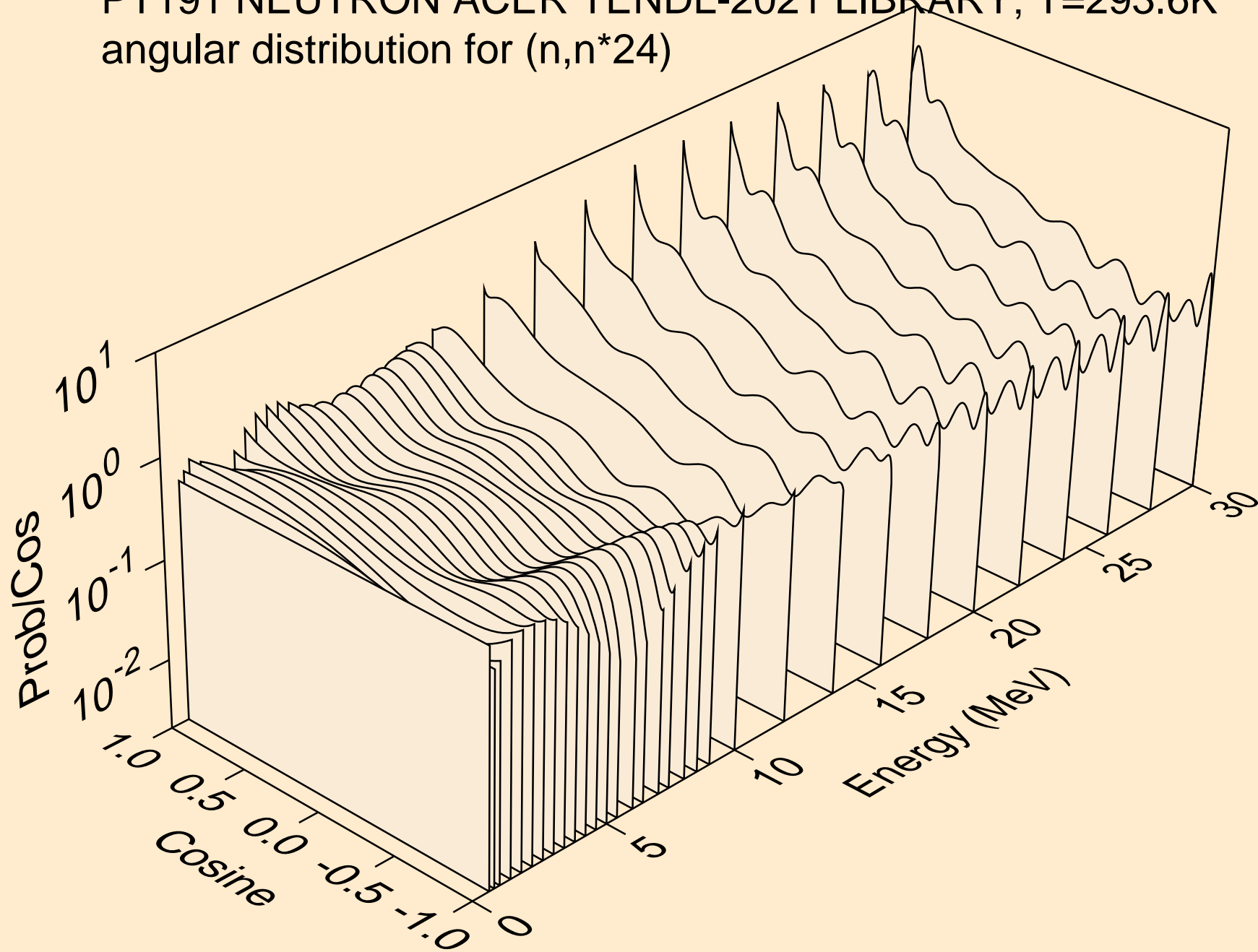

PT191 NEUTRON ACER TENDL-2021 LIBRARY; T=293.6K  
angular distribution for (n,n\*25)

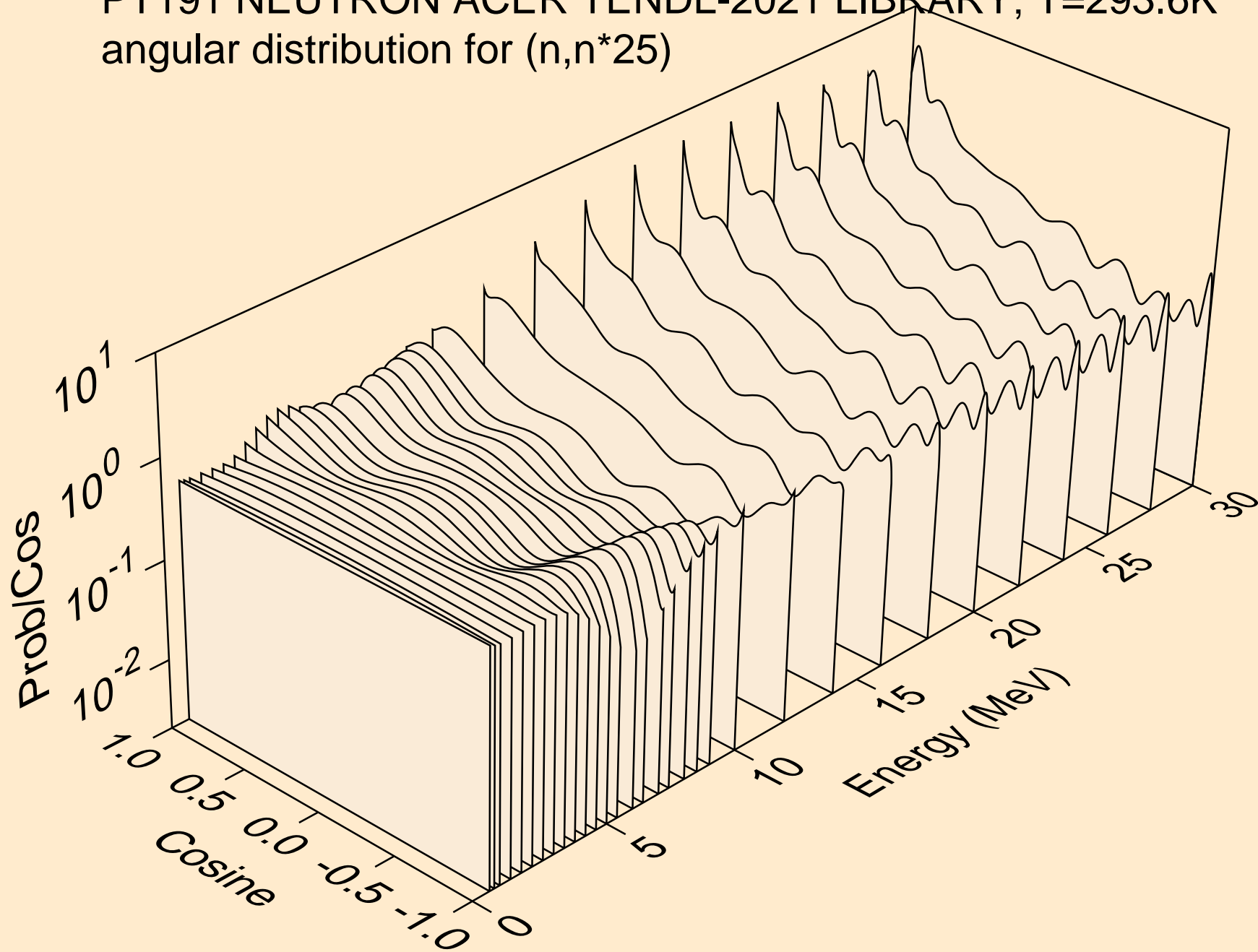



PT191 NEUTRON ACER TENDL-2021 LIBRARY; T=293.6K  
angular distribution for (n,n\*26)

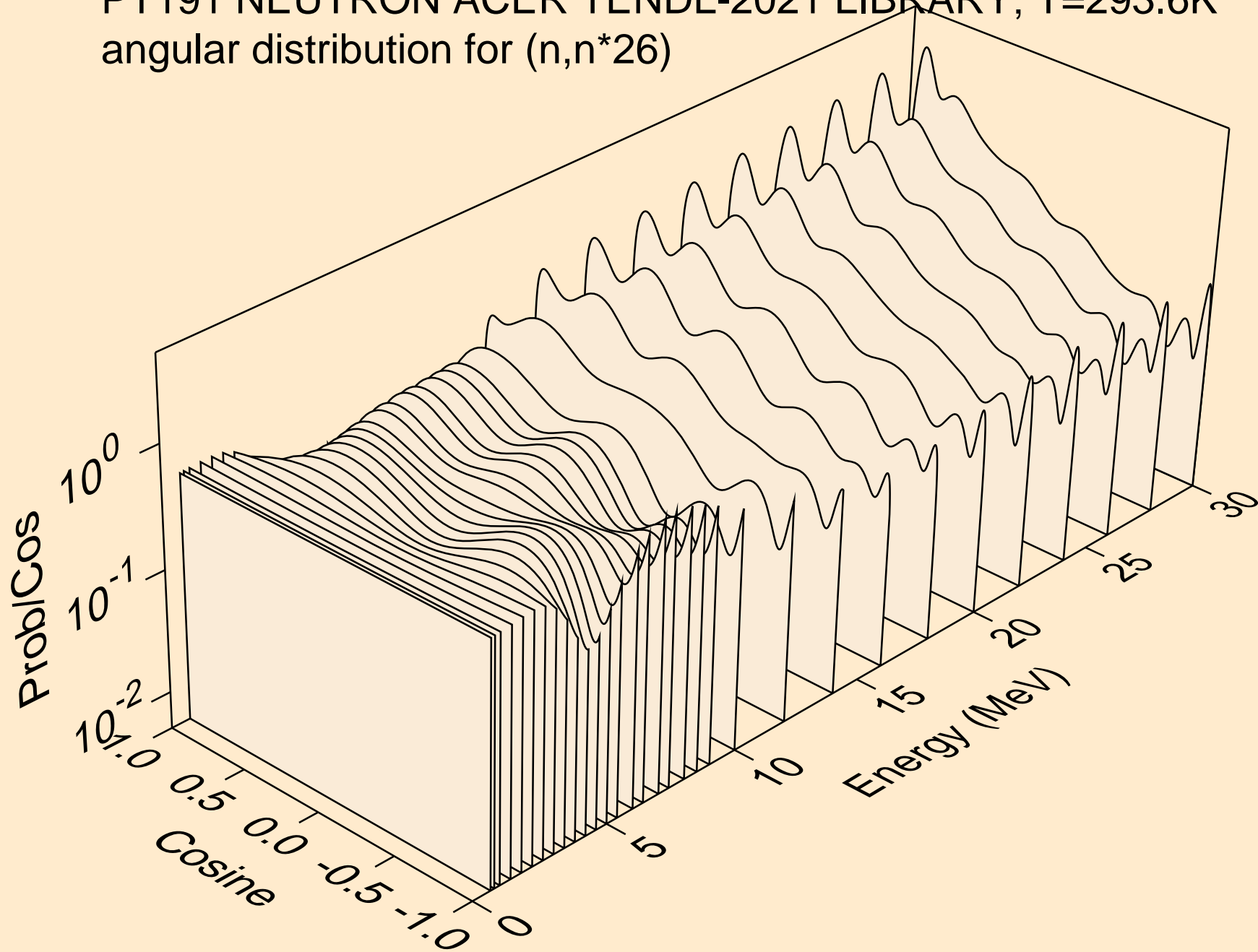

PT191 NEUTRON ACER TENDL-2021 LIBRARY; T=293.6K  
angular distribution for (n,n\*27)

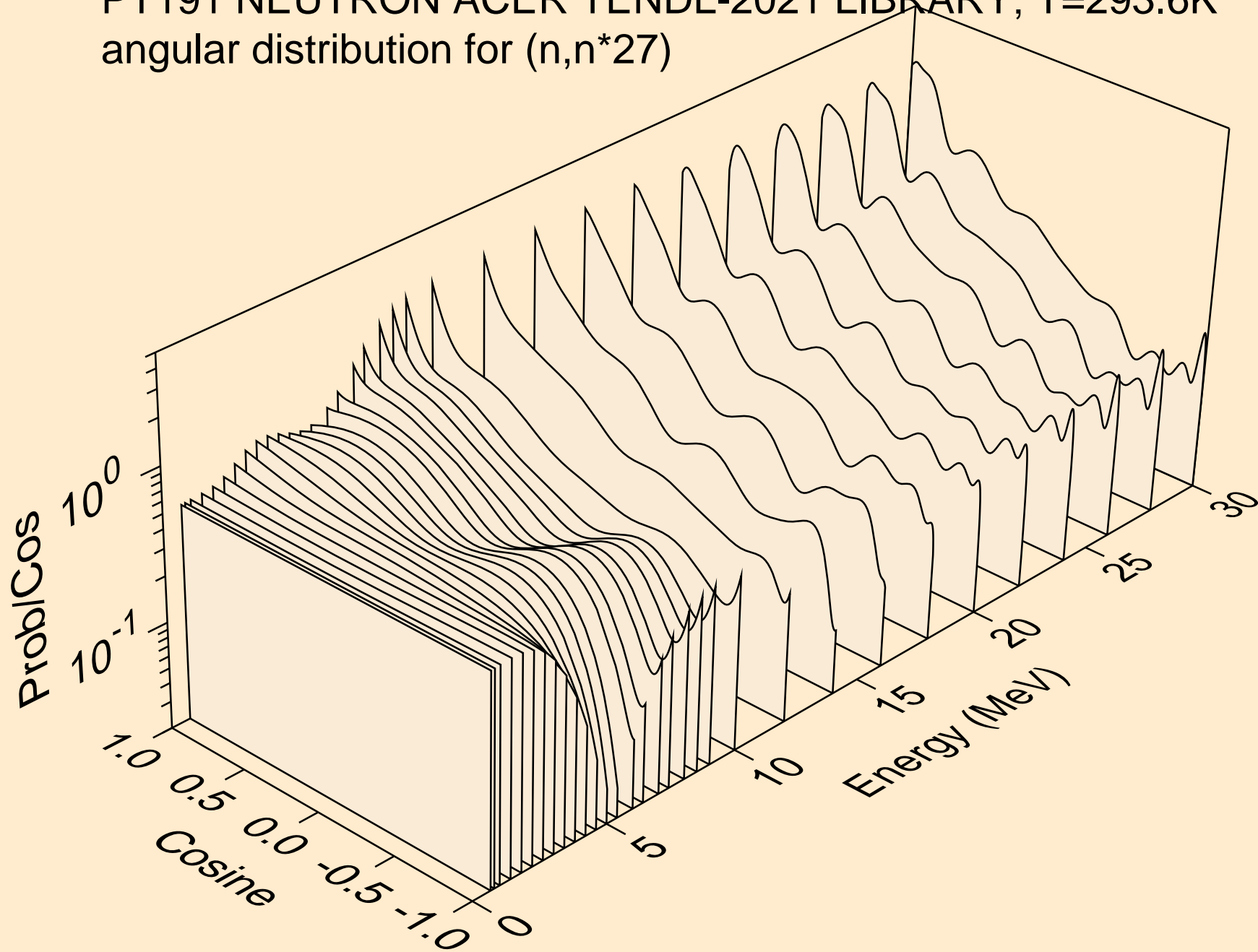

PT191 NEUTRON ACER TENDL-2021 LIBRARY; T=293.6K  
angular distribution for (n,n\*28)

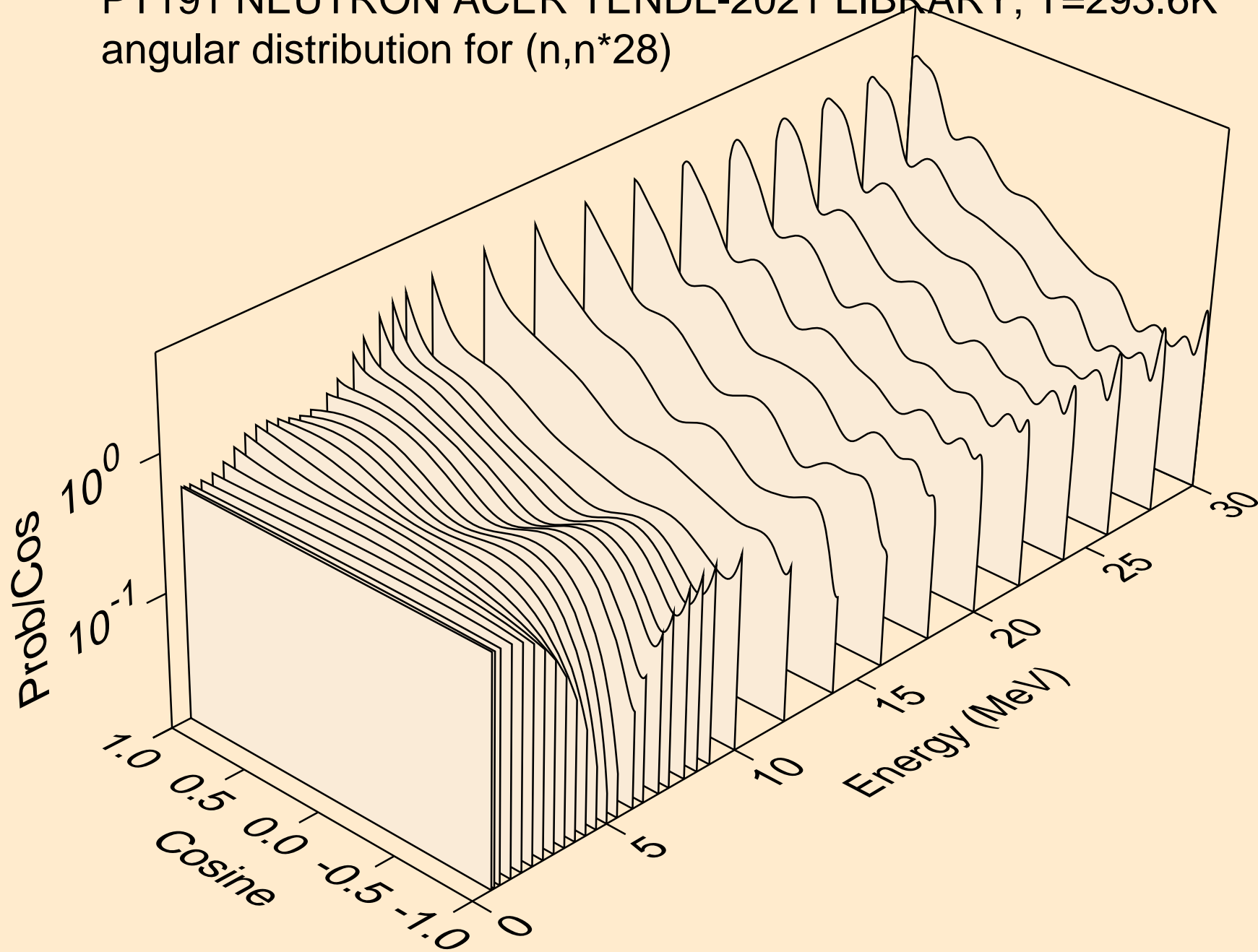

PT191 NEUTRON ACER TENDL-2021 LIBRARY; T=293.6K  
angular distribution for (n,n\*29)

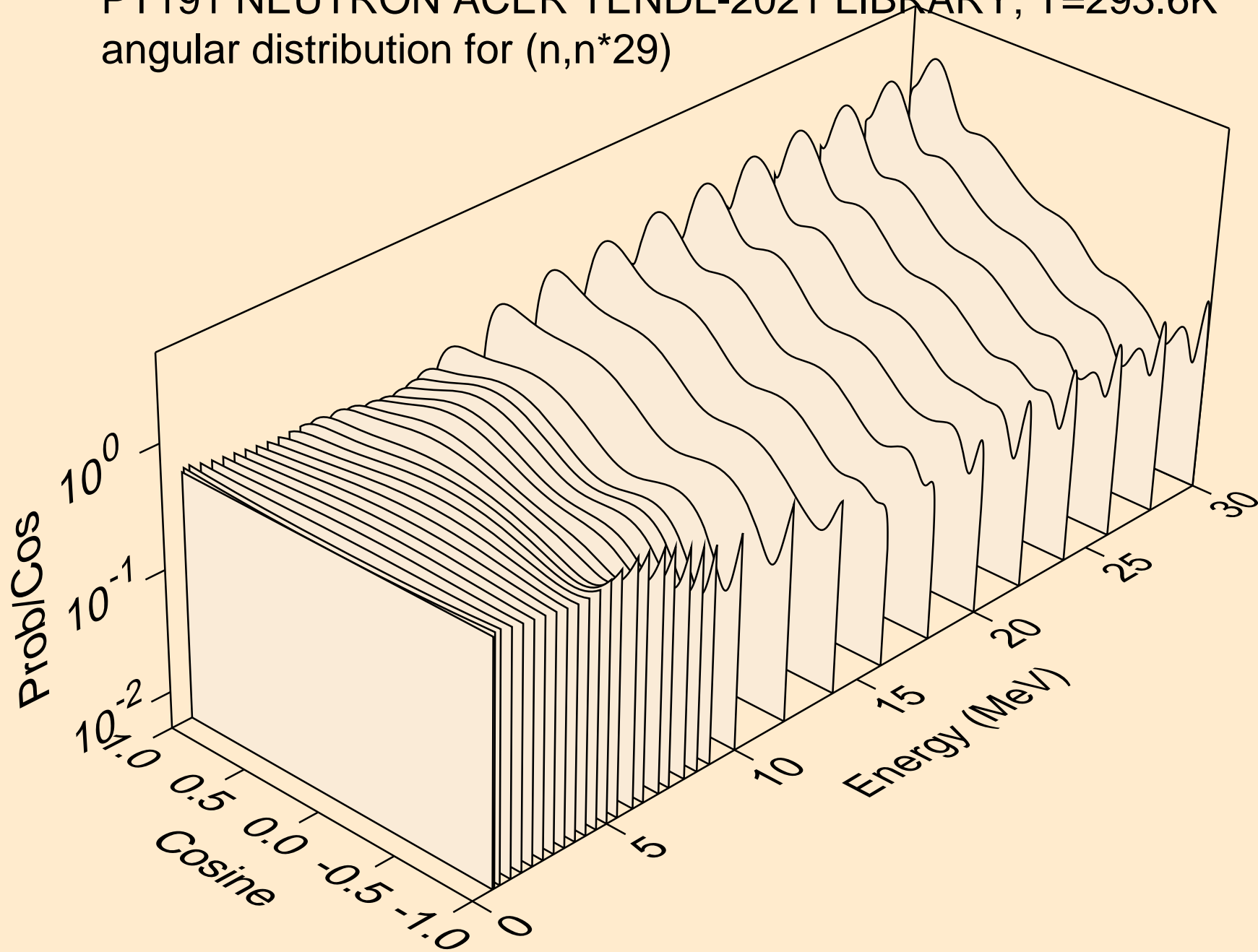

PT191 NEUTRON ACER TENDL-2021 LIBRARY; T=293.6K  
angular distribution for (n,n\*30)

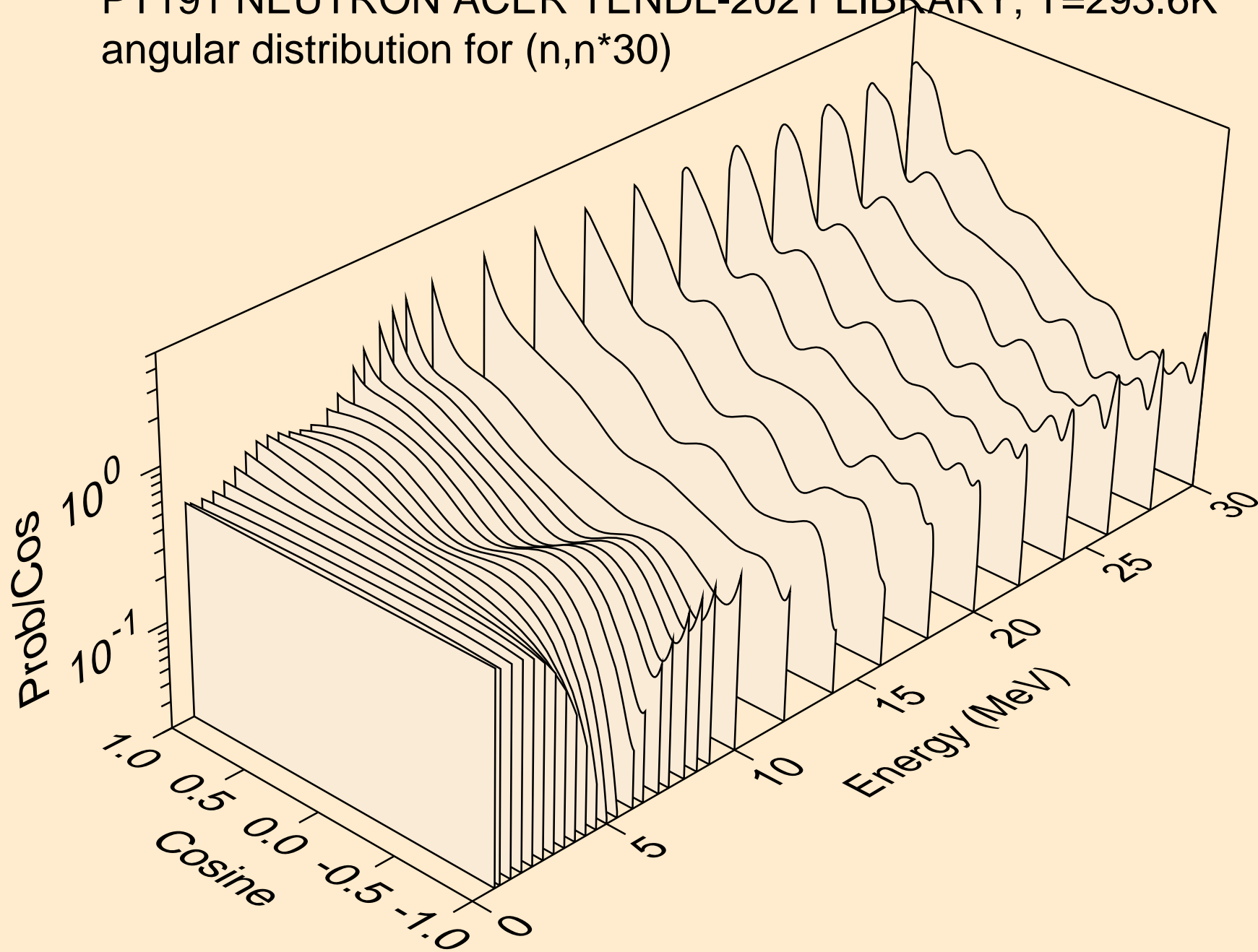

PT191 NEUTRON ACER TENDL-2021 LIBRARY; T=293.6K  
Neutron emission for (n,x)

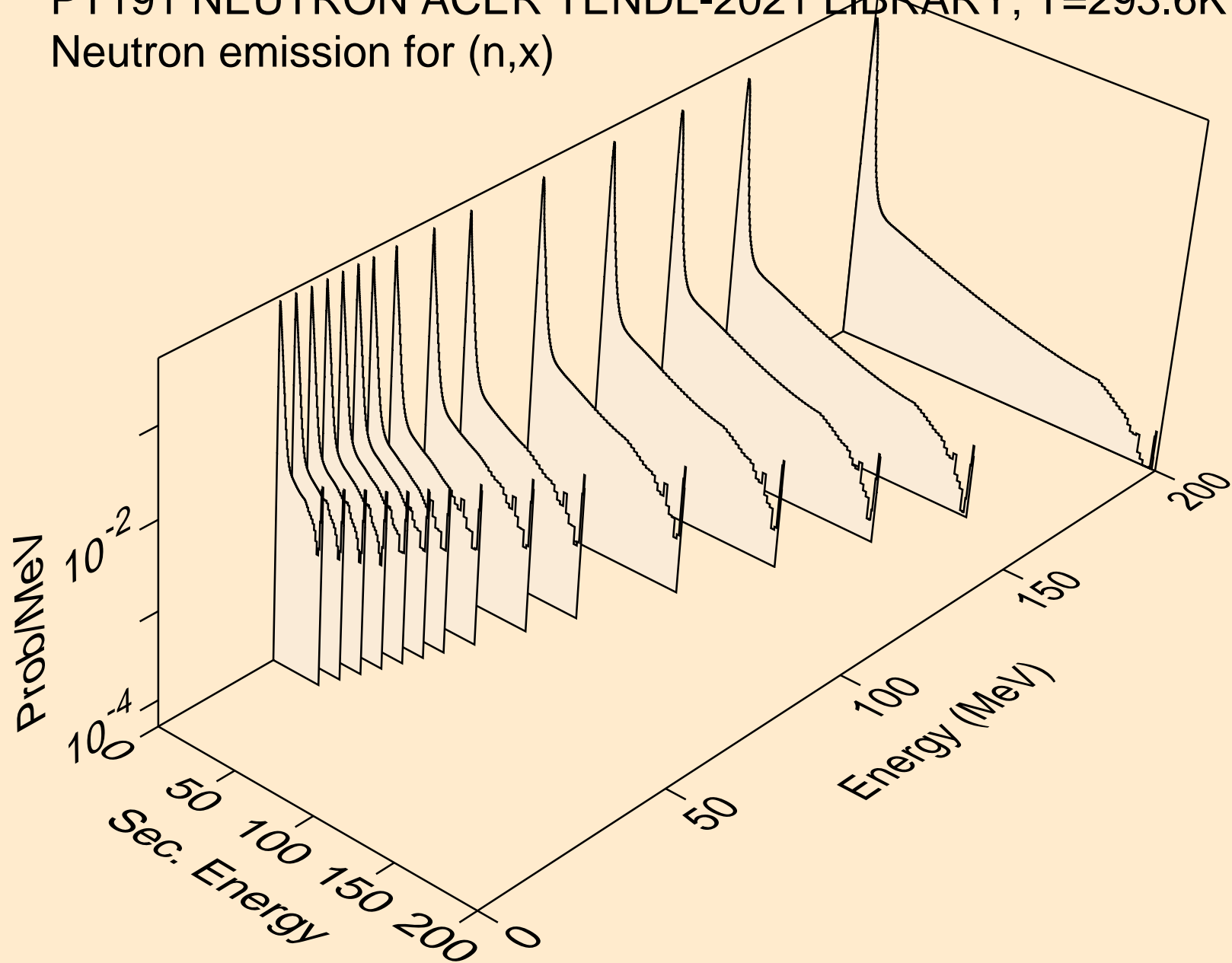

PT191 NEUTRON ACER TENDL-2021 LIBRARY; T=293.6K  
Neutron emission for (n,2nd)

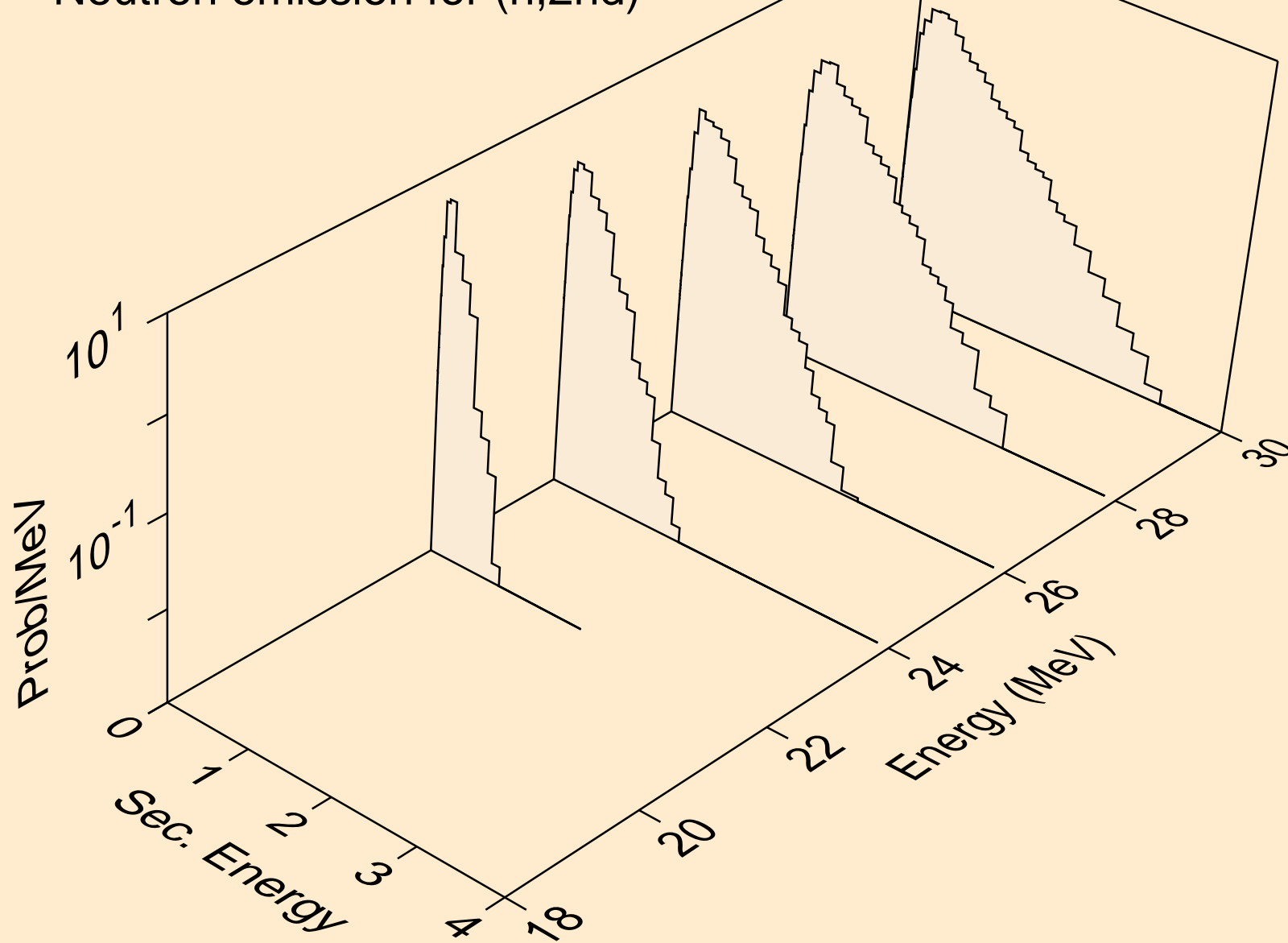

PT191 NEUTRON ACER TENDL-2021 LIBRARY; T=293.6K  
Neutron emission for (n,2n)

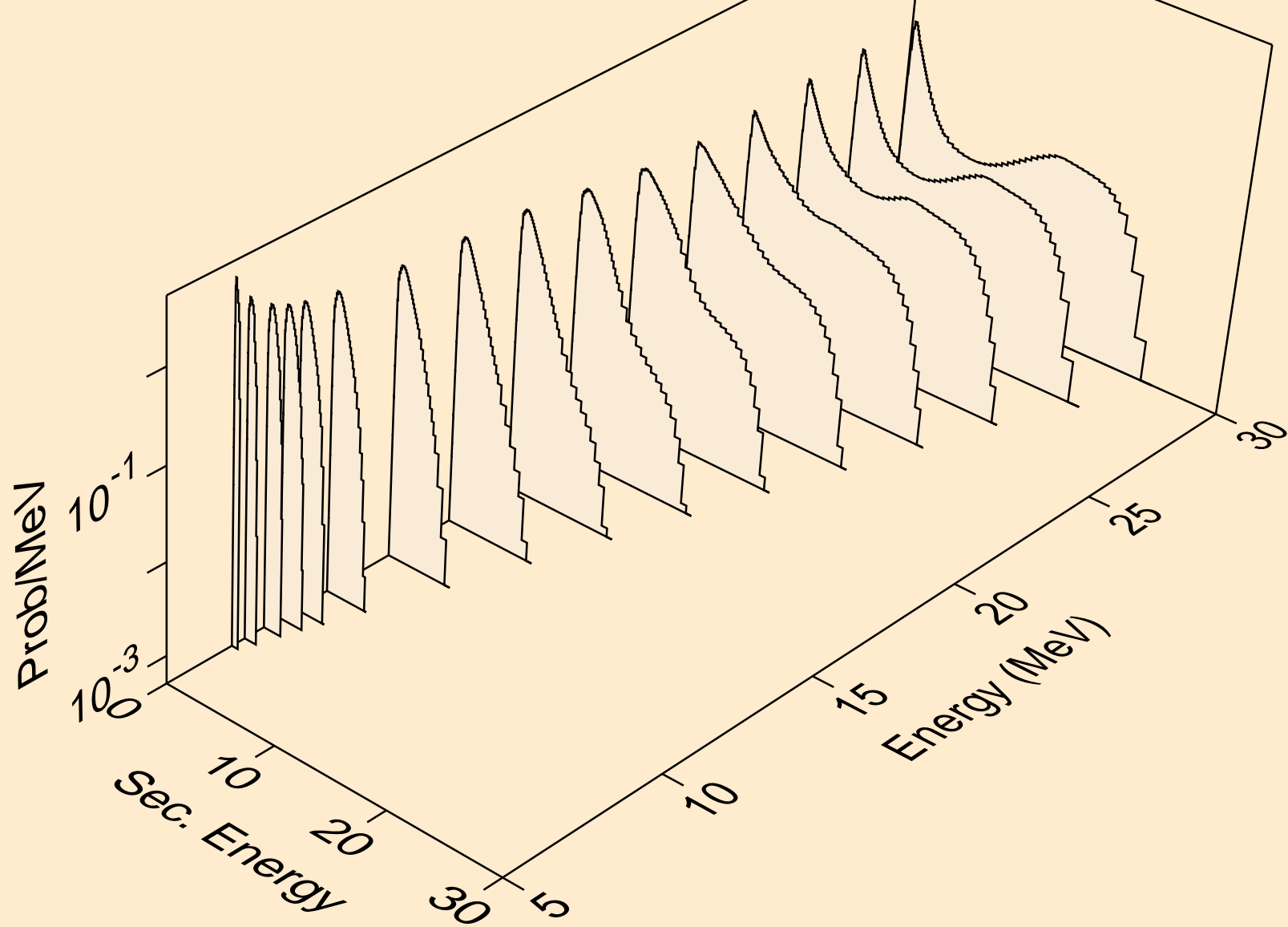



PT191 NEUTRON ACER TENDL-2021 LIBRARY; T=293.6K  
Neutron emission for (n,3n)

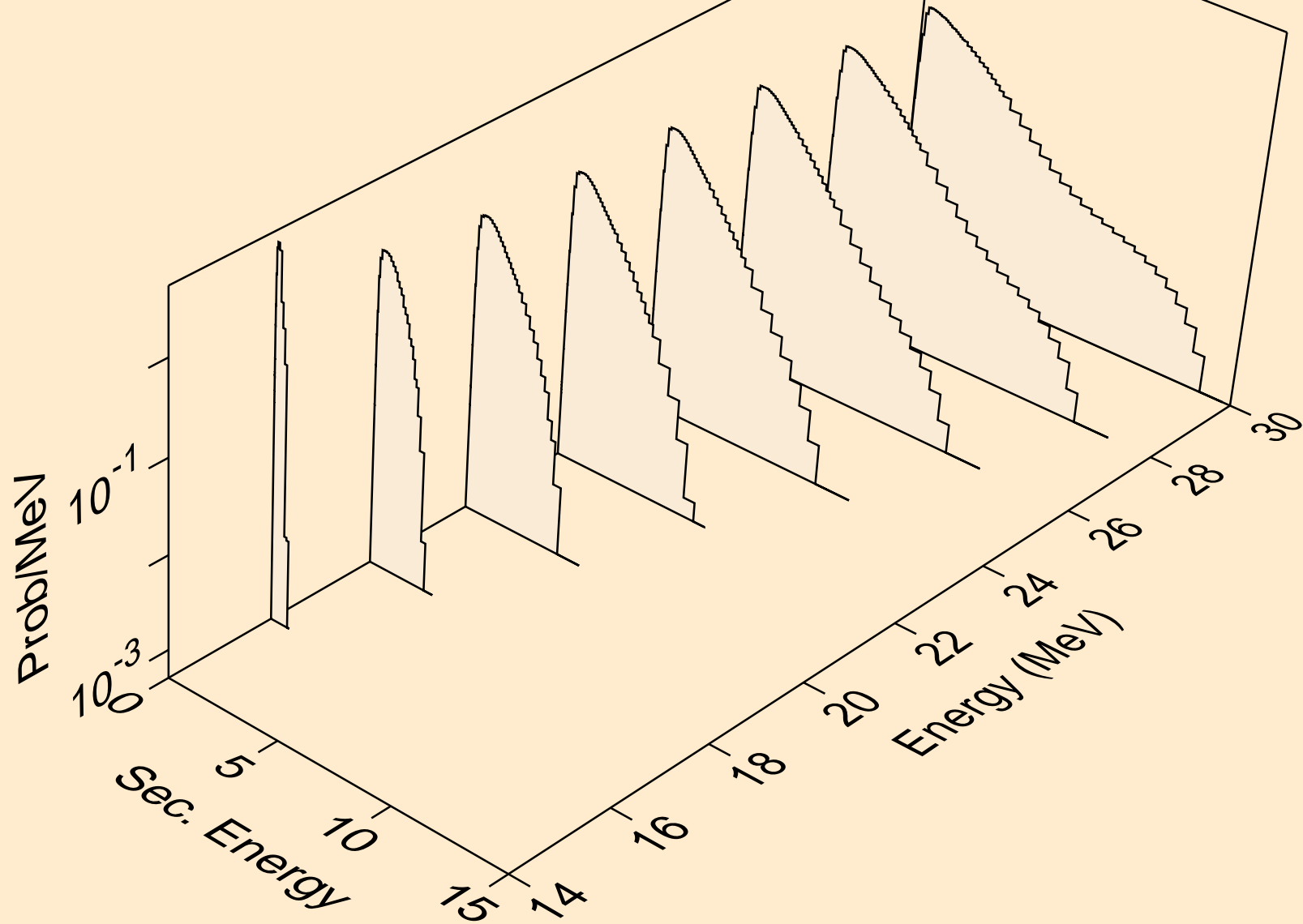

PT191 NEUTRON ACER TENDL-2021 LIBRARY; T=293.6K  
Neutron emission for (n,n\*)a

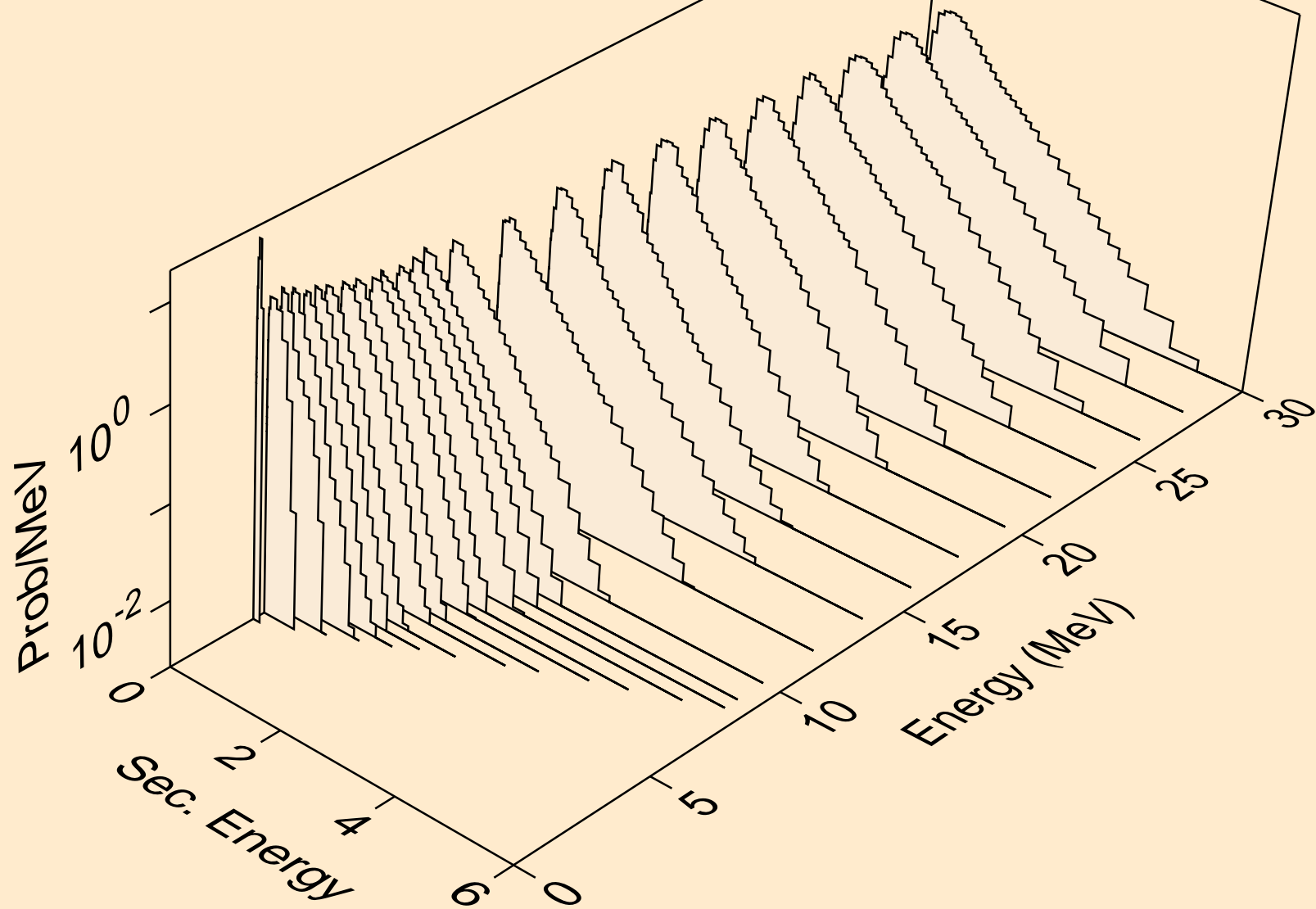

PT191 NEUTRON ACER TENDL-2021 LIBRARY; T=293.6K  
Neutron emission for (n,2n)<sub>a</sub>

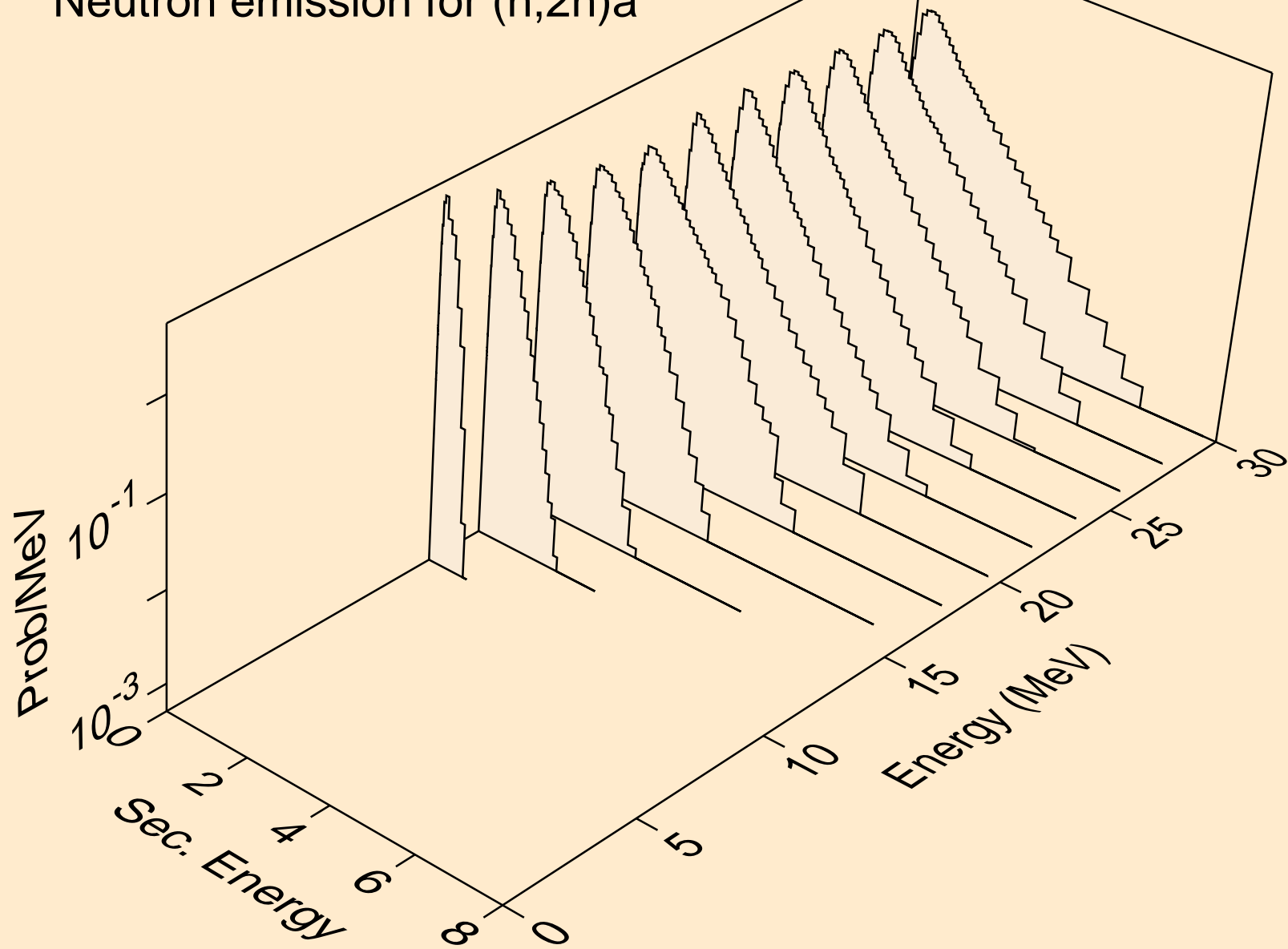

PT191 NEUTRON ACER TENDL-2021 LIBRARY; T=293.6K  
Neutron emission for (n,3n)a

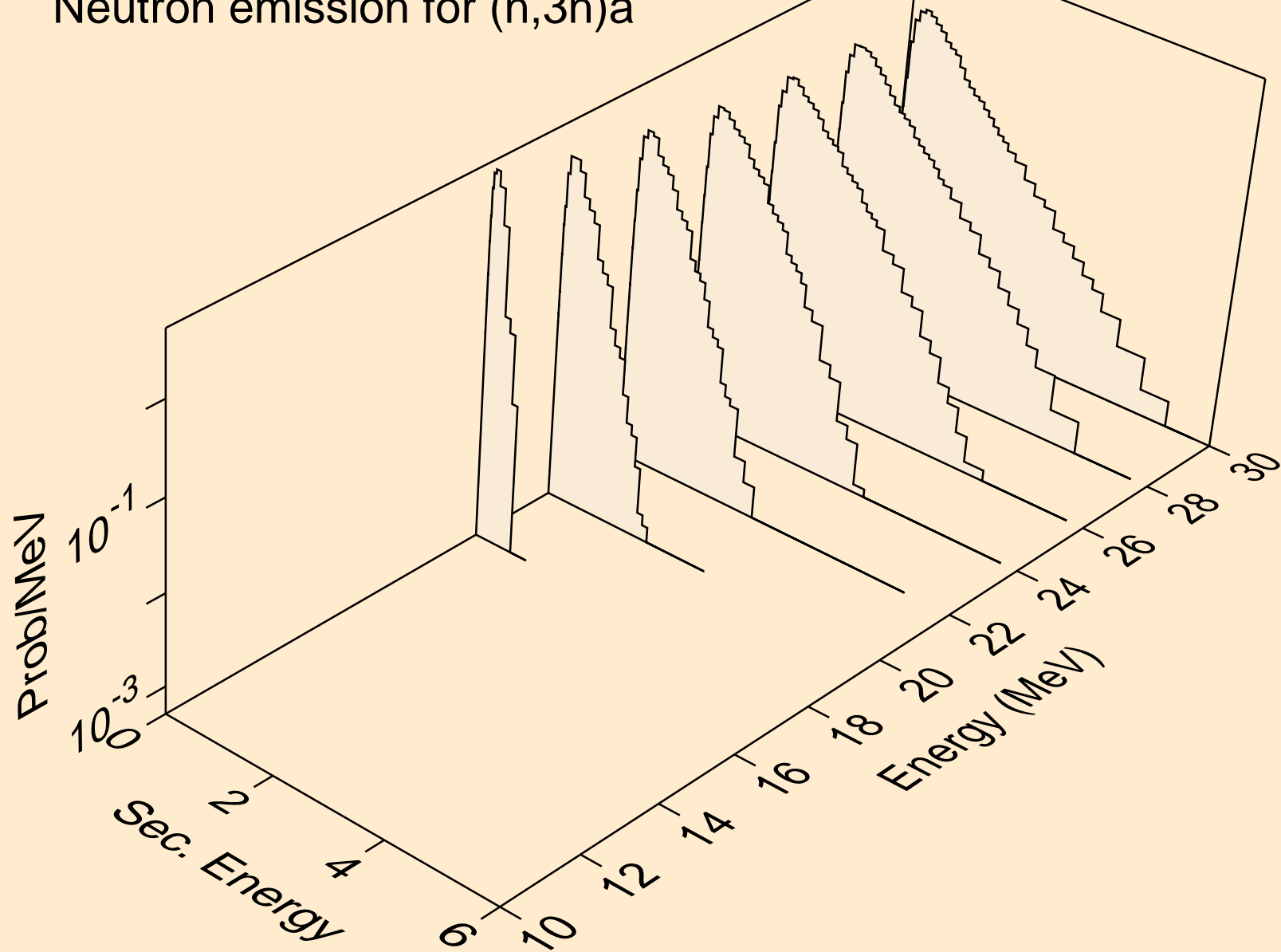

PT191 NEUTRON ACER TENDL-2021 LIBRARY; T=293.6K  
Neutron emission for (n,n\*)p

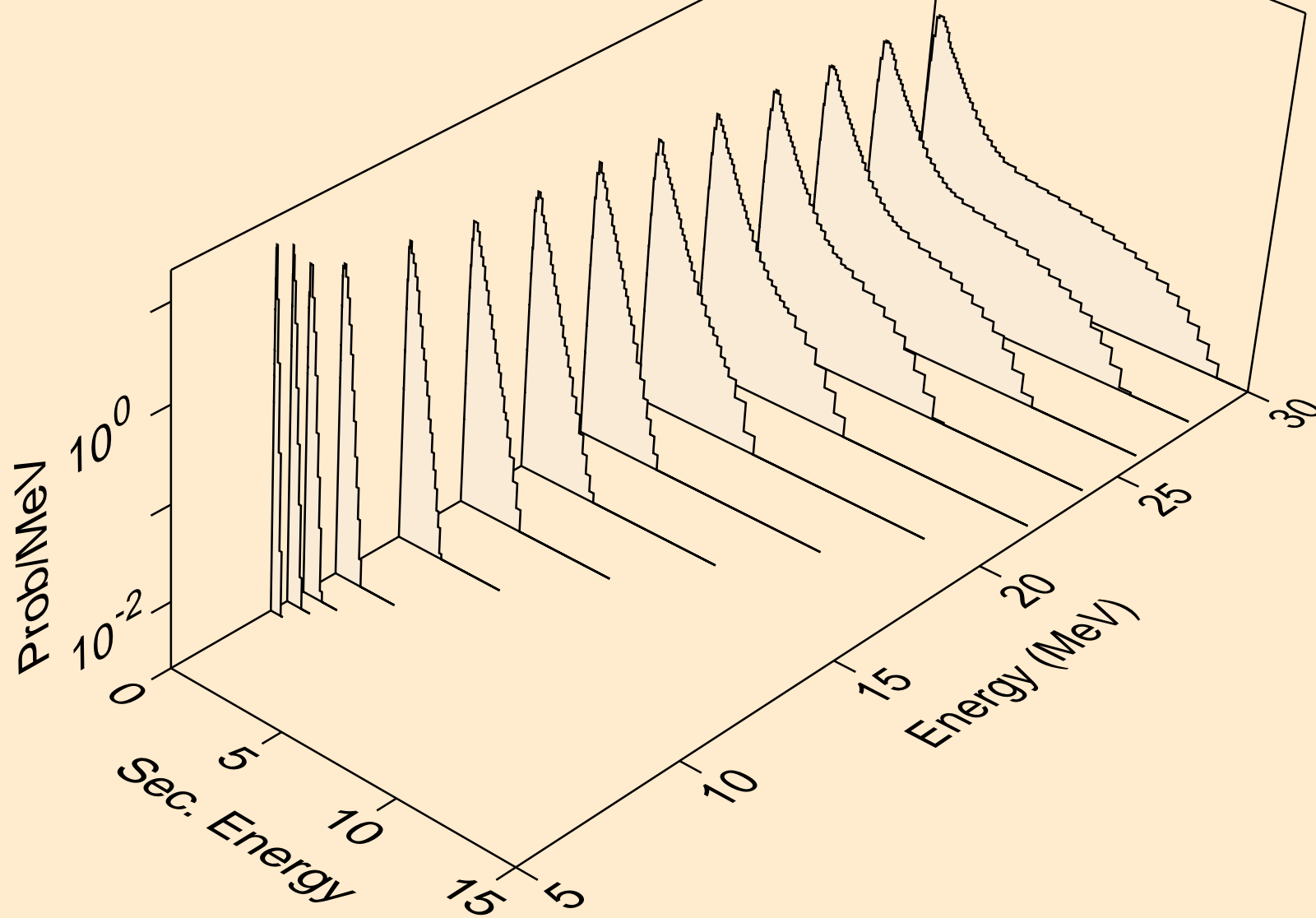

PT191 NEUTRON ACER TENDL-2021 LIBRARY; T=293.6K  
Neutron emission for (n,n\*)2a

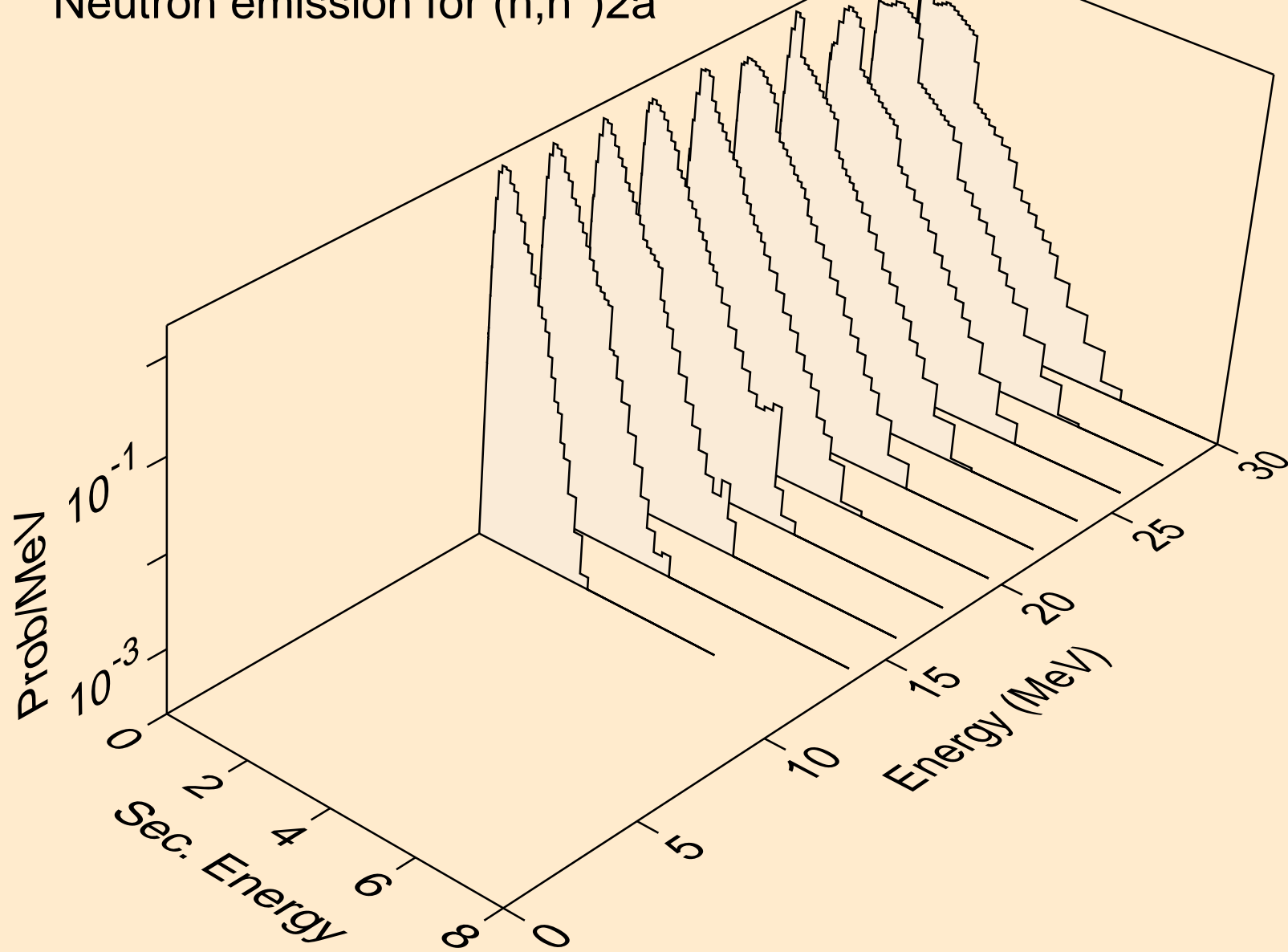

PT191 NEUTRON ACER TENDL-2021 LIBRARY; T=293.6K  
Neutron emission for (n,n\*)d

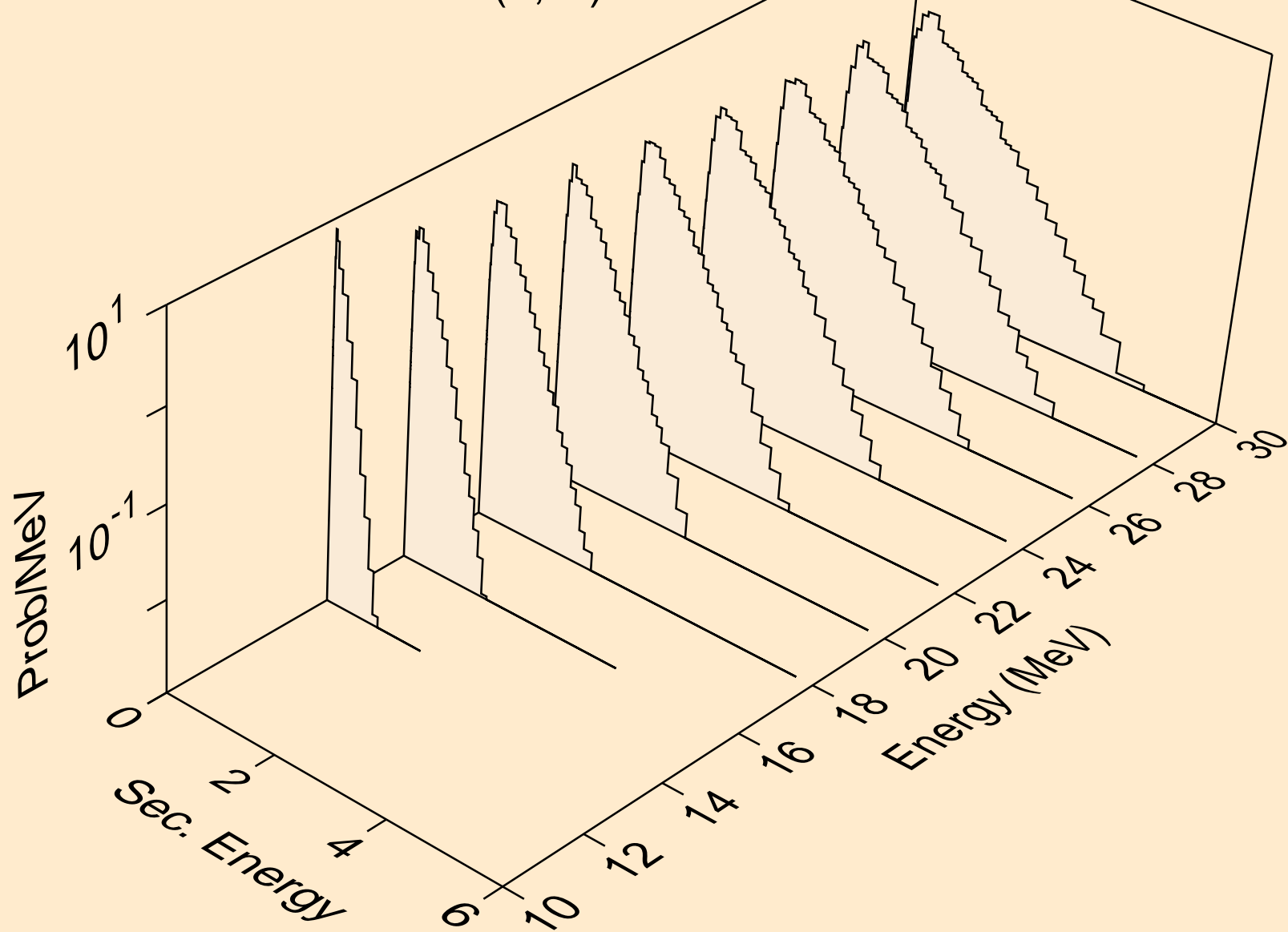

PT191 NEUTRON ACER TENDL-2021 LIBRARY; T=293.6K  
Neutron emission for (n,n\*)t

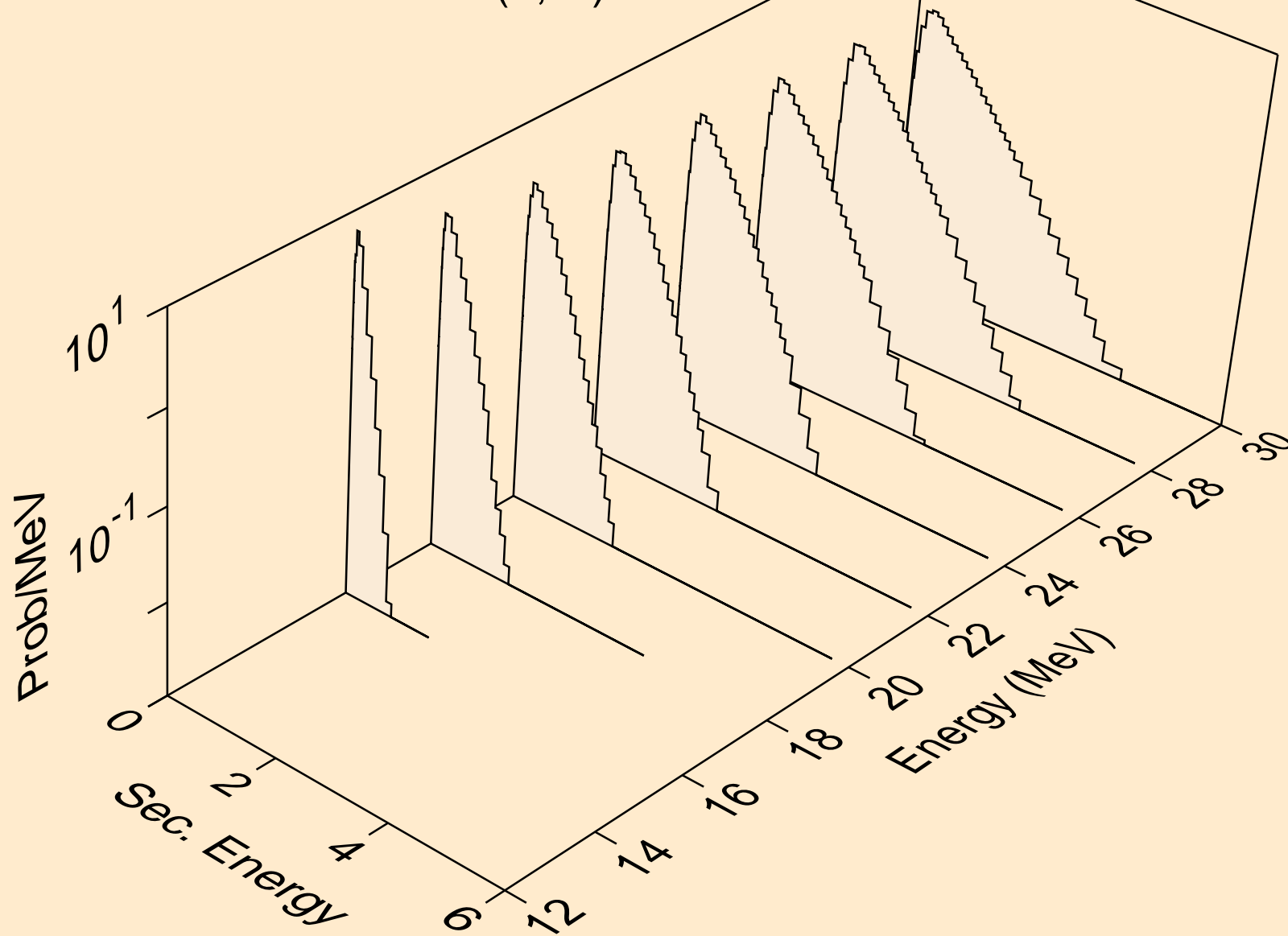



PT191 NEUTRON ACER TENDL-2021 LIBRARY; T=293.6K  
Neutron emission for (n,n\*)he3

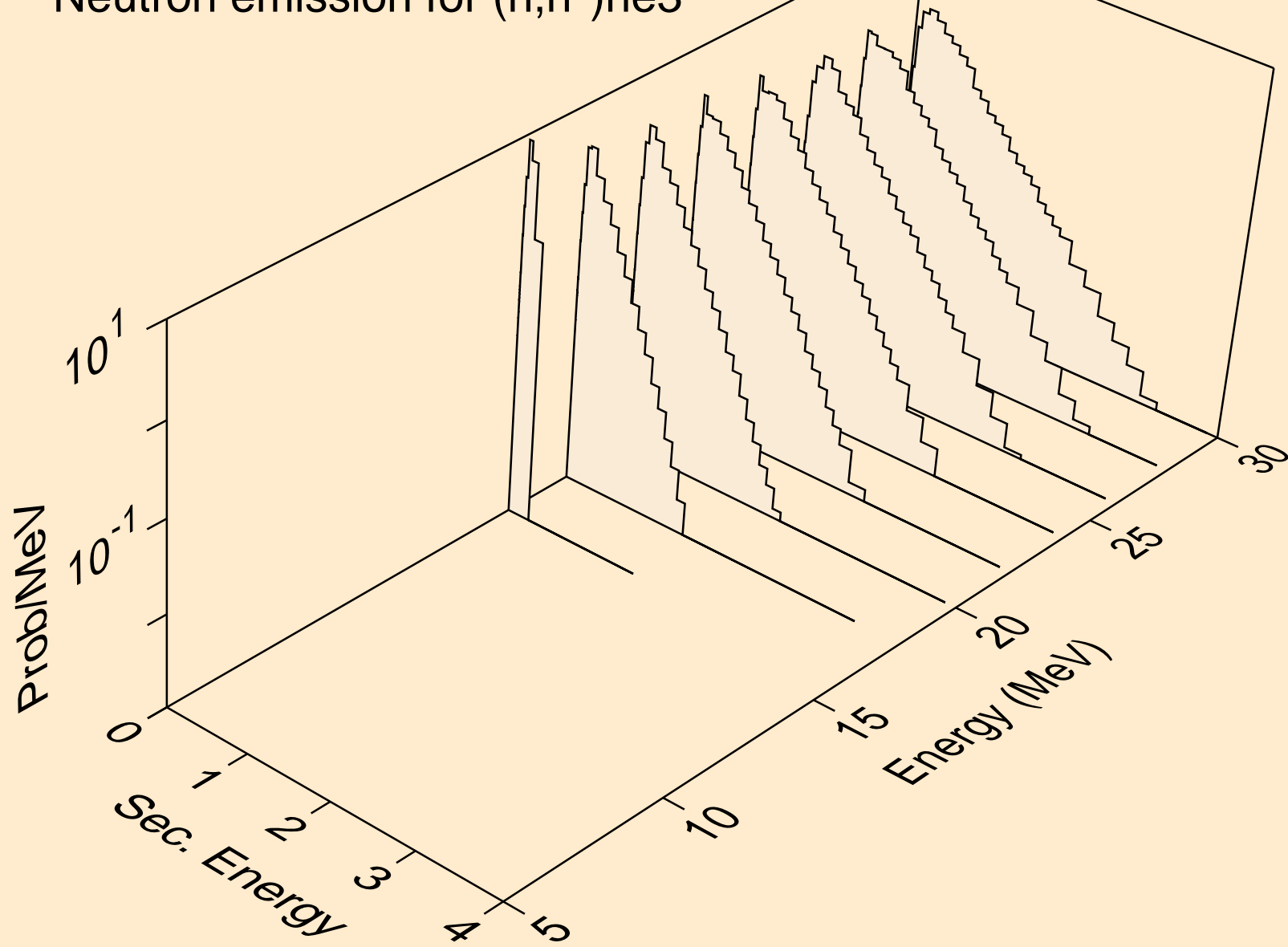

PT191 NEUTRON ACER TENDL-2021 LIBRARY; T=293.6K  
Neutron emission for (n,4n)

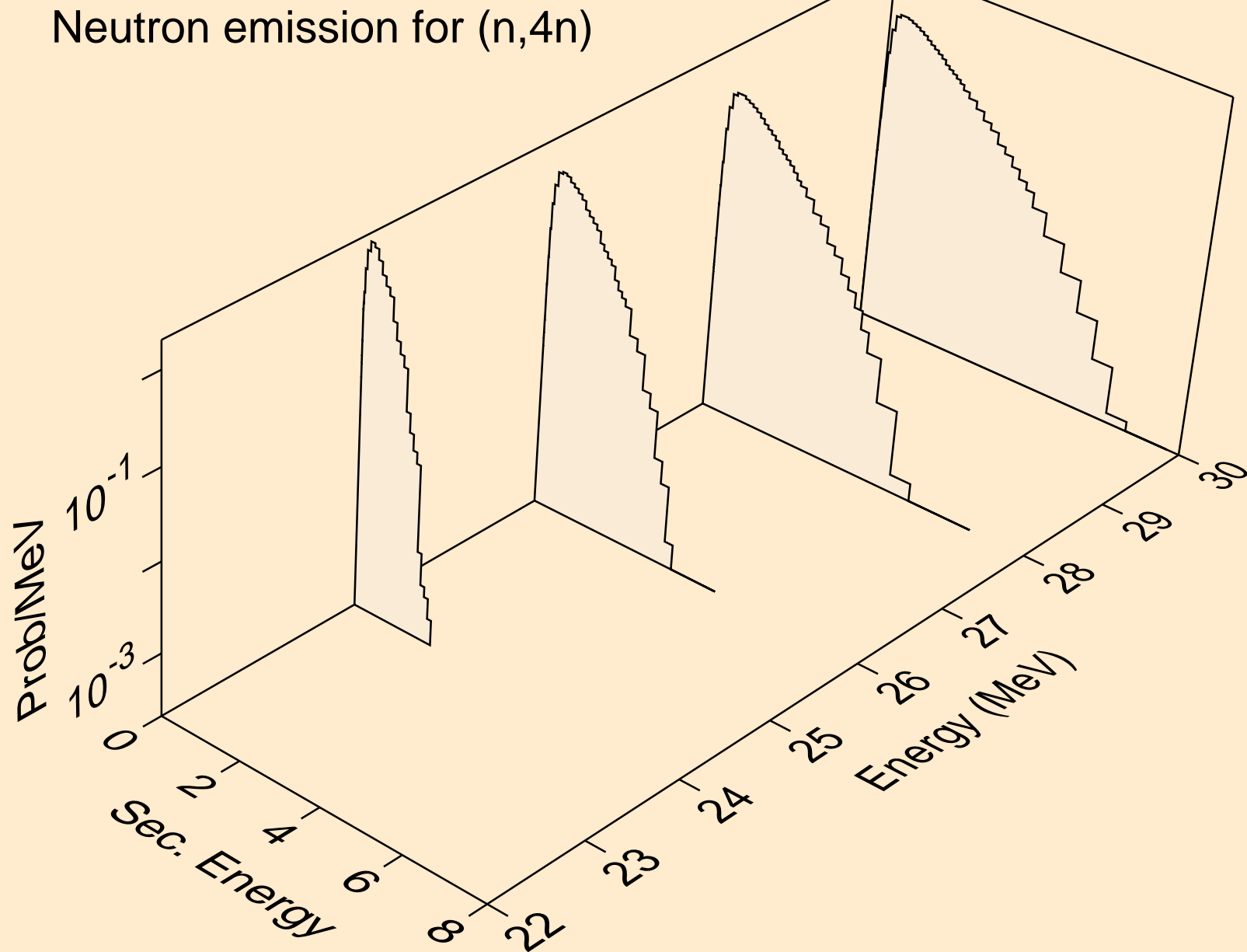

PT191 NEUTRON ACER TENDL-2021 LIBRARY; T=293.6K  
Neutron emission for (n,2np)

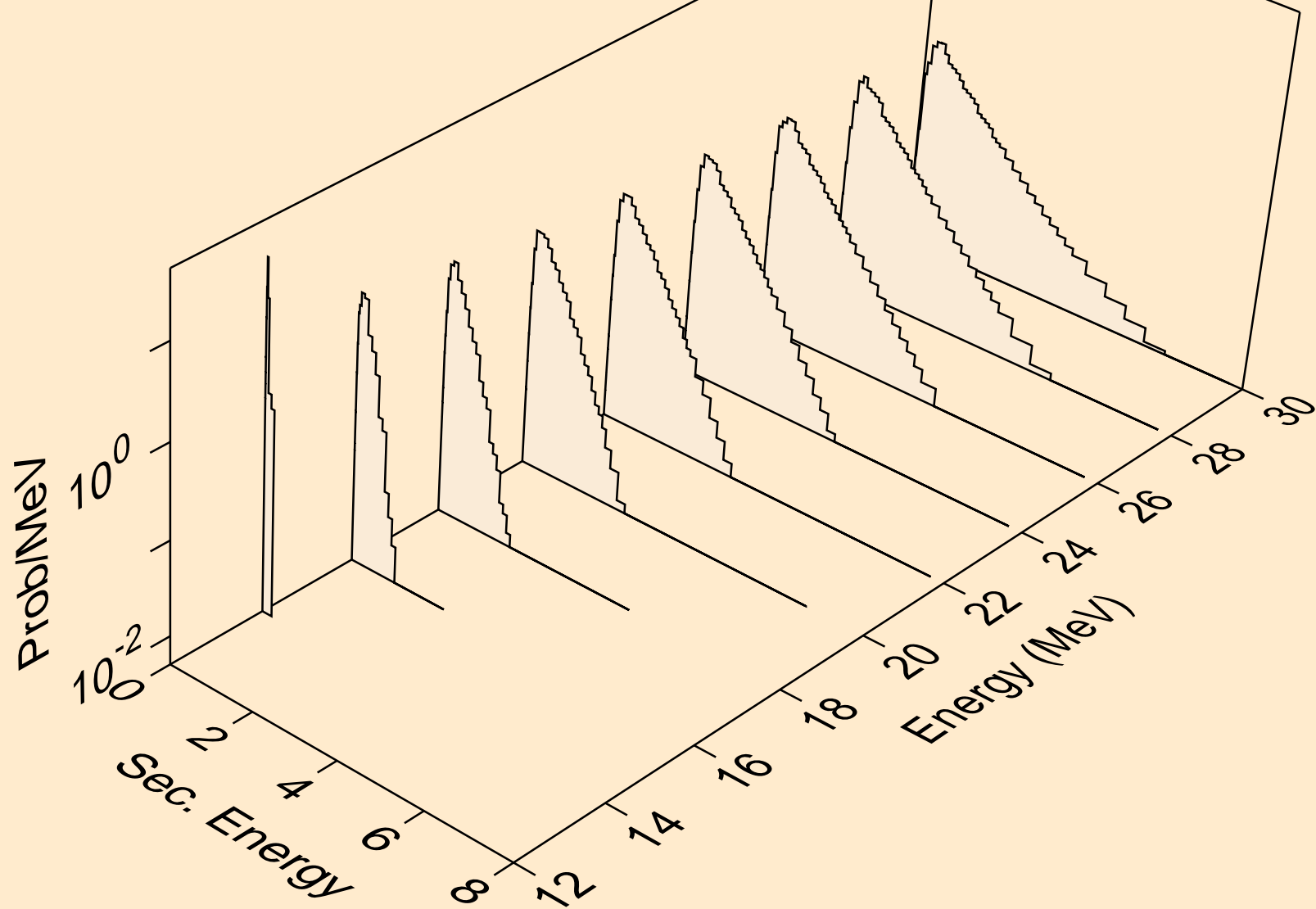

PT191 NEUTRON ACER TENDL-2021 LIBRARY; T=293.6K  
Neutron emission for (n,3np)

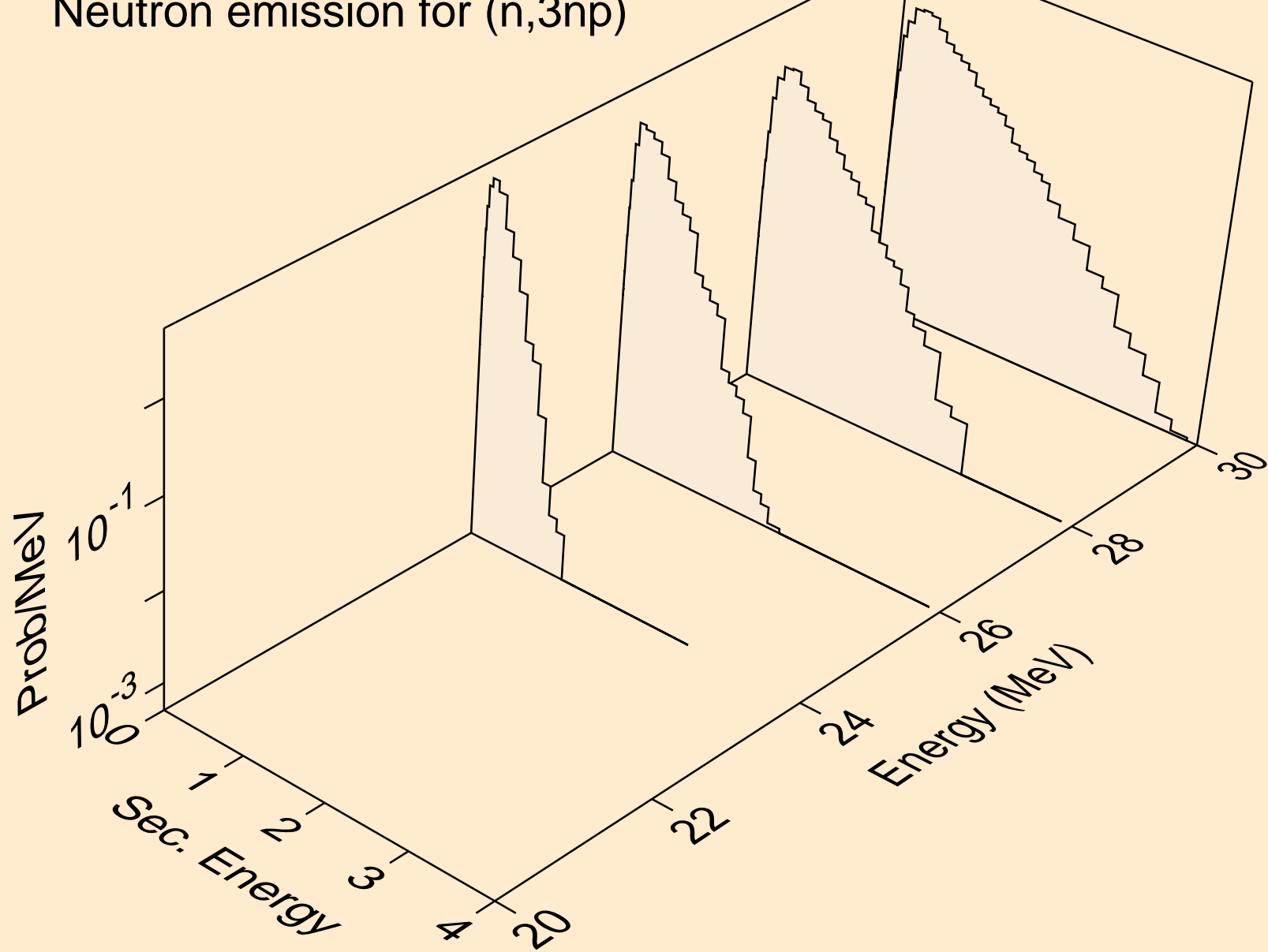

PT191 NEUTRON ACER TENDL-2021 LIBRARY; T=293.6K  
Neutron emission for (n,2np)

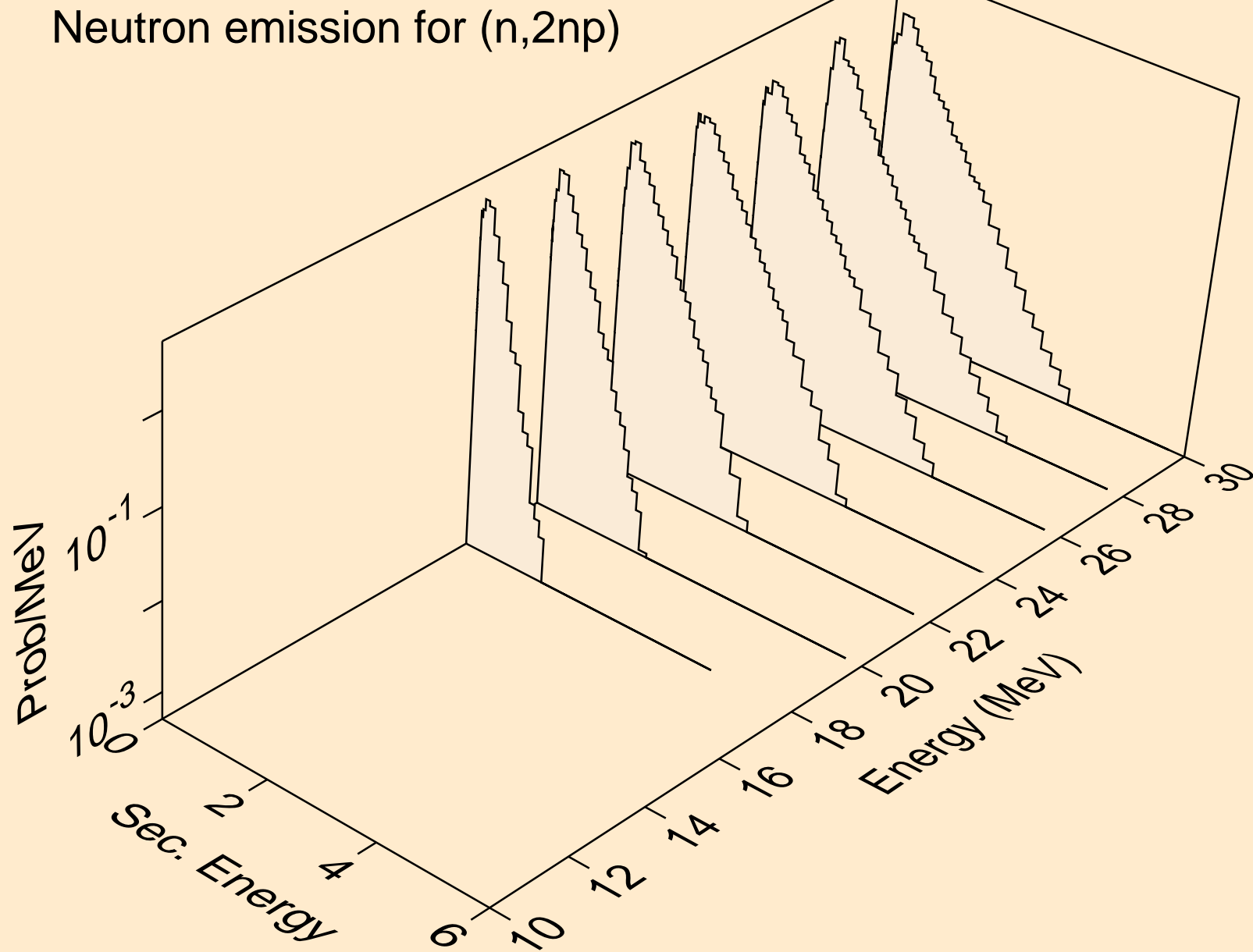

PT191 NEUTRON ACER TENDL-2021 LIBRARY; T=293.6K  
Neutron emission for (n,npa)

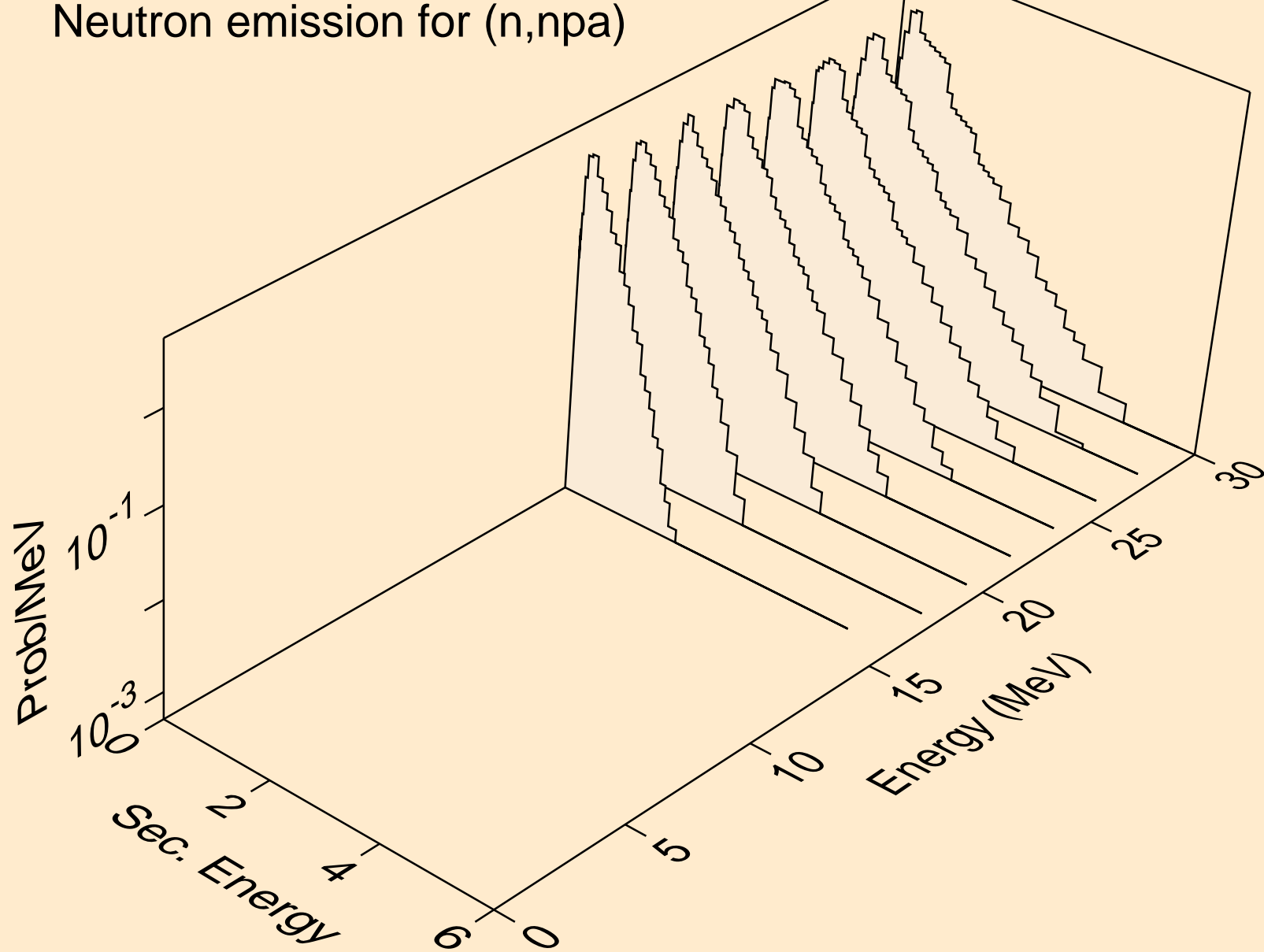

PT191 NEUTRON ACER TENDL-2021 LIBRARY; T=293.6K  
Neutron emission for (n,n\*c)

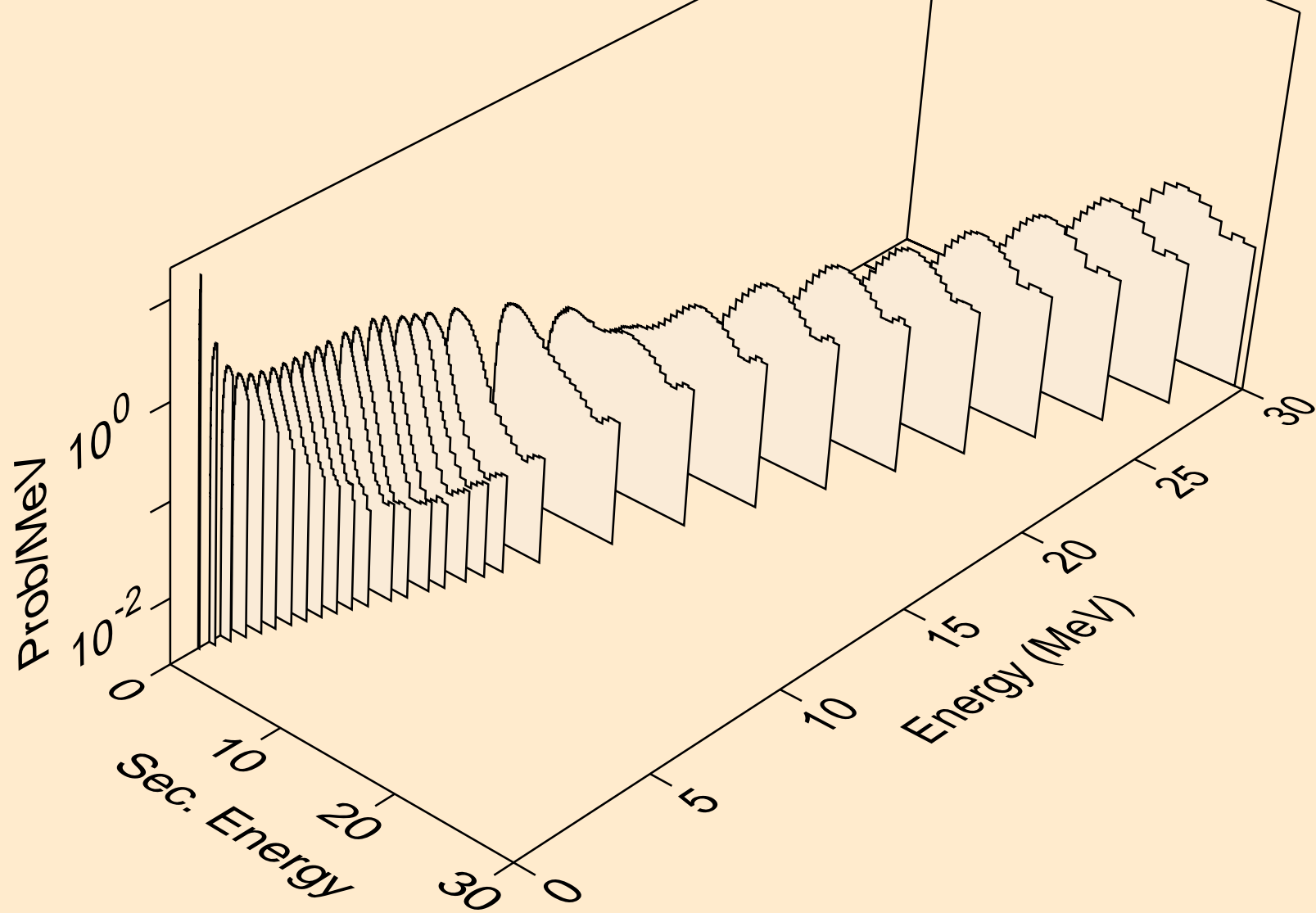

PT191 NEUTRON ACER TENDL-2021 LIBRARY; T=293.6K  
Photon emission for (n,x)

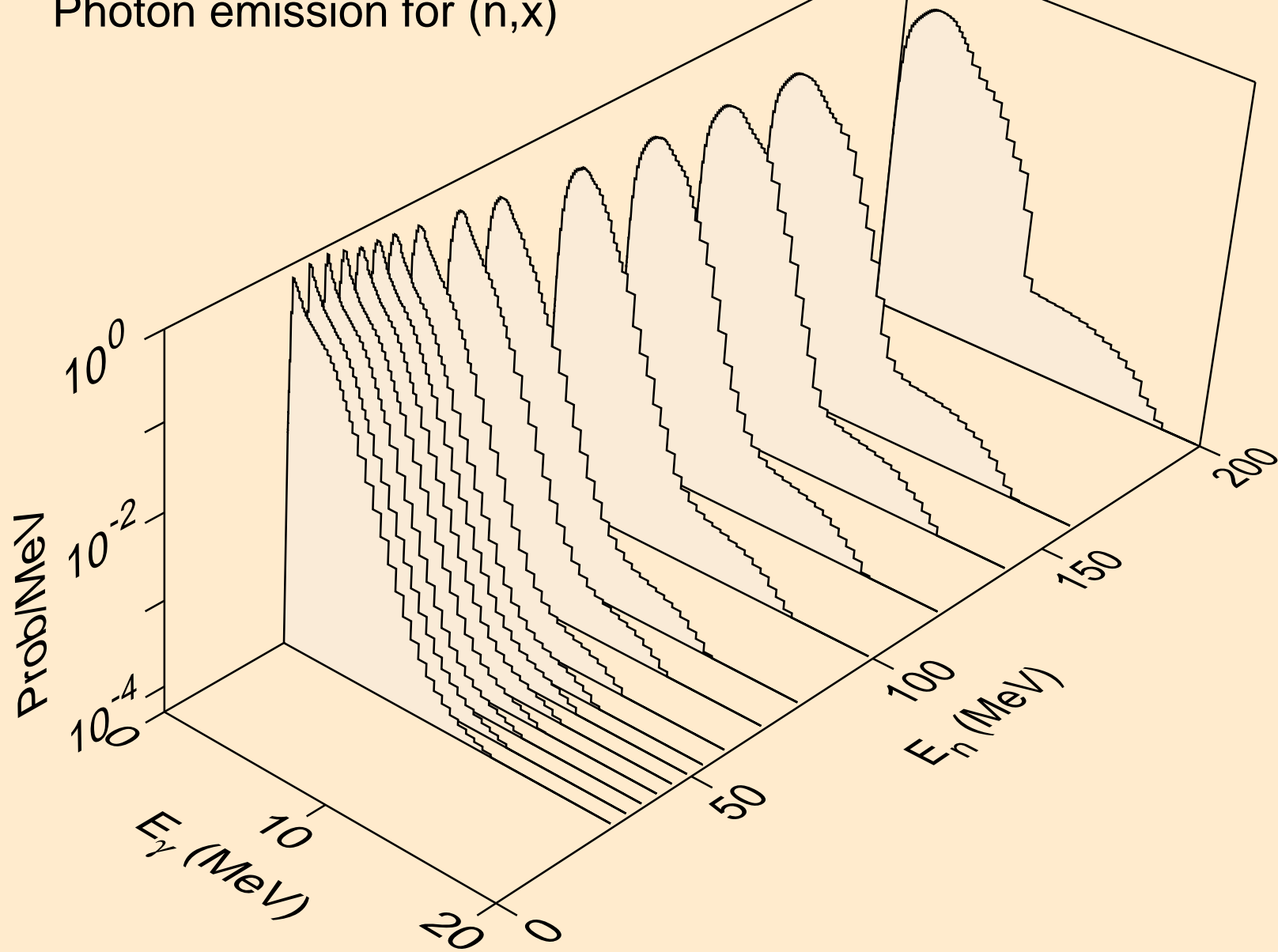



PT191 NEUTRON ACER TENDL-2021 LIBRARY; T=293.6K  
Photon emission for (n,2nd)

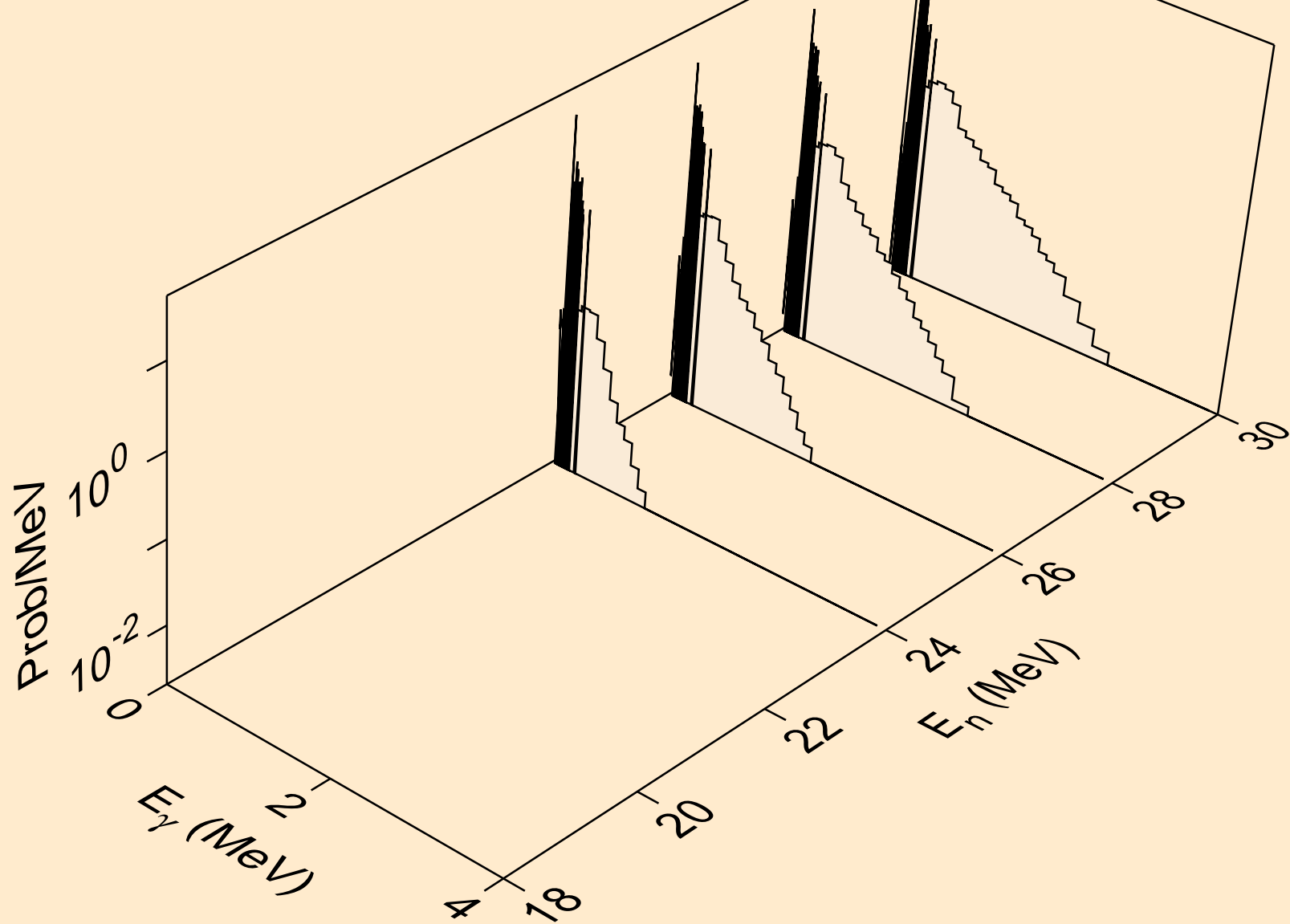

PT191 NEUTRON ACER TENDL-2021 LIBRARY; T=293.6K  
Photon emission for (n,2n)

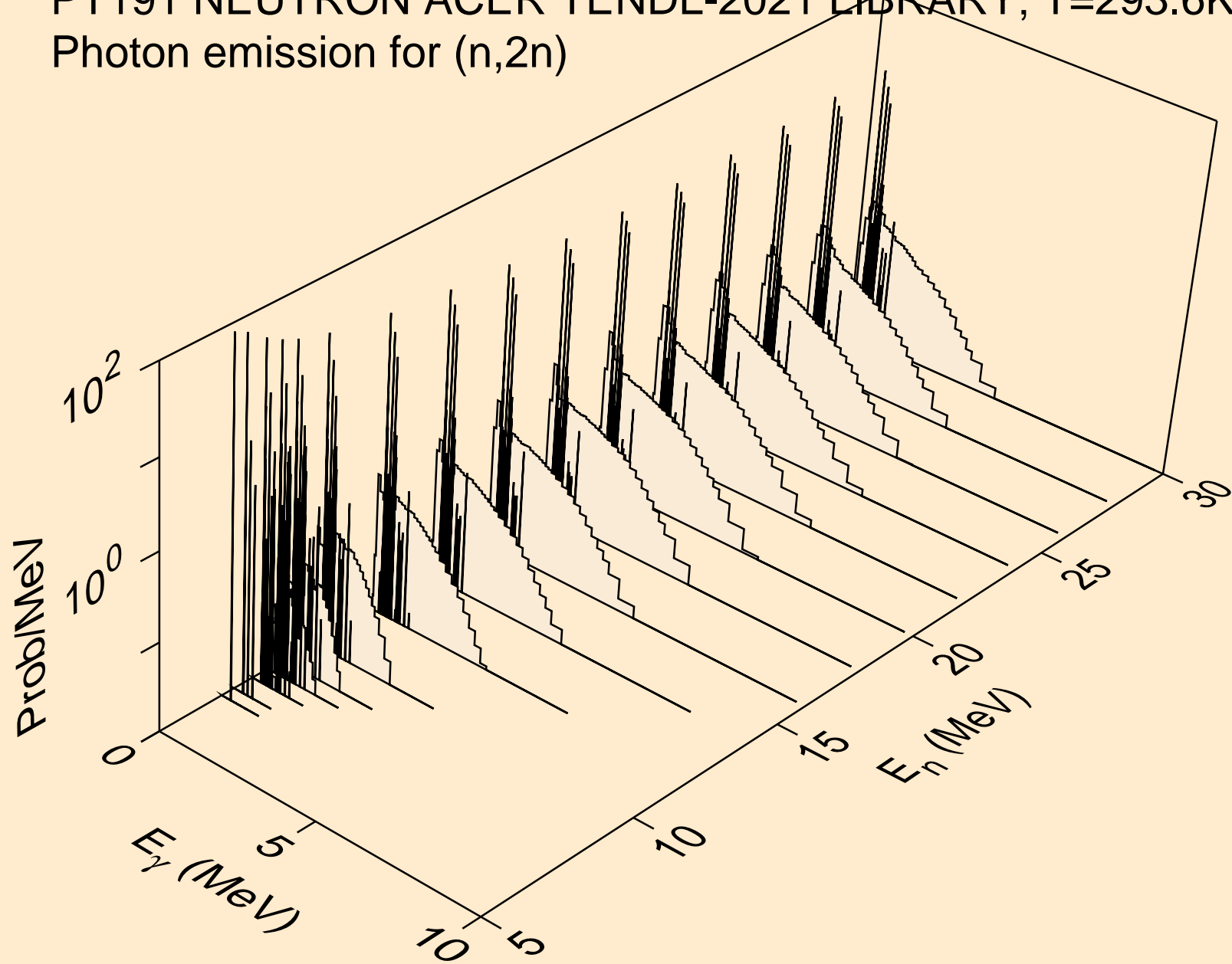

PT191 NEUTRON ACER TENDL-2021 LIBRARY; T=293.6K  
Photon emission for (n,3n)

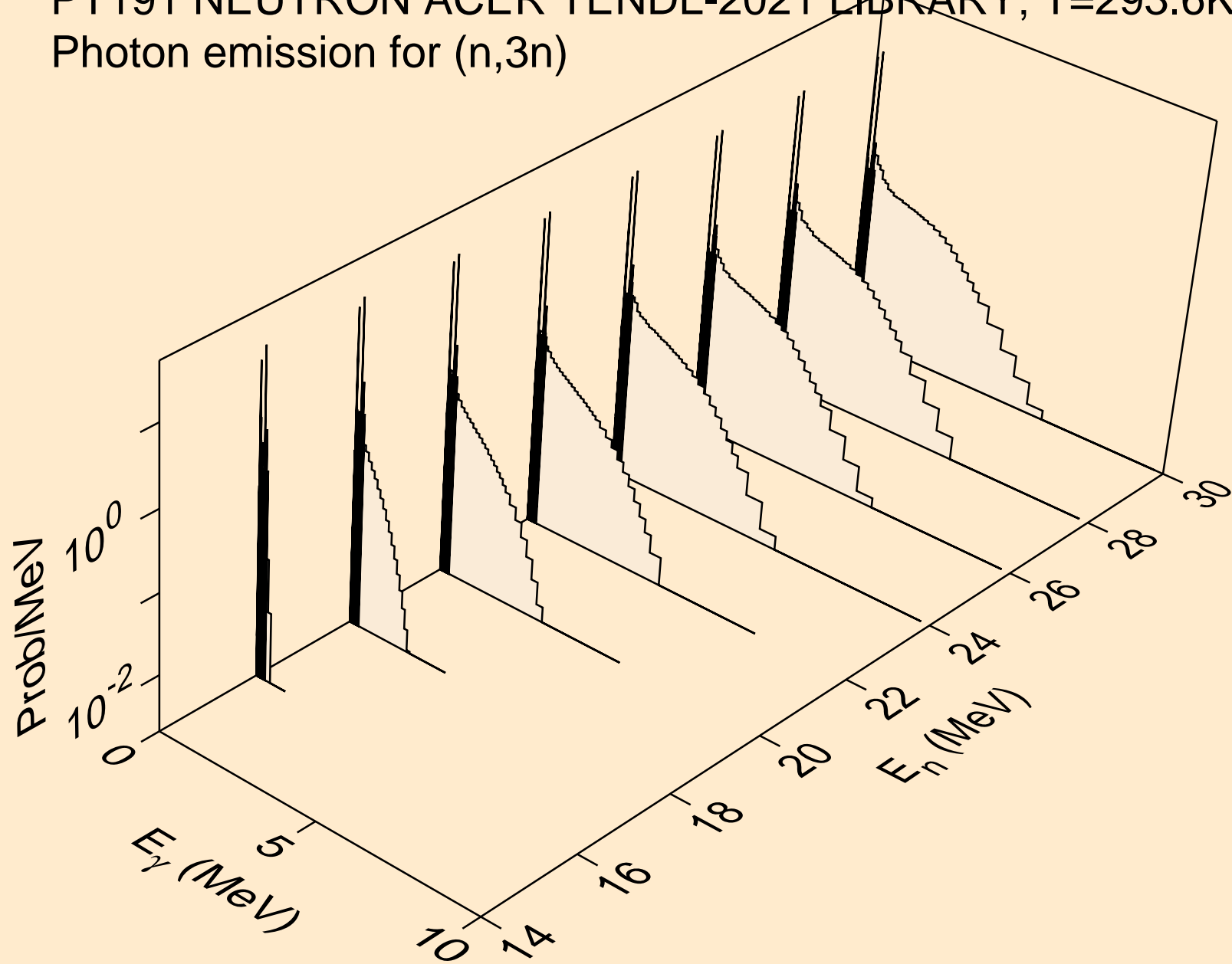

PT191 NEUTRON ACER TENDL-2021 LIBRARY; T=293.6K  
Photon emission for (n,n\*)a

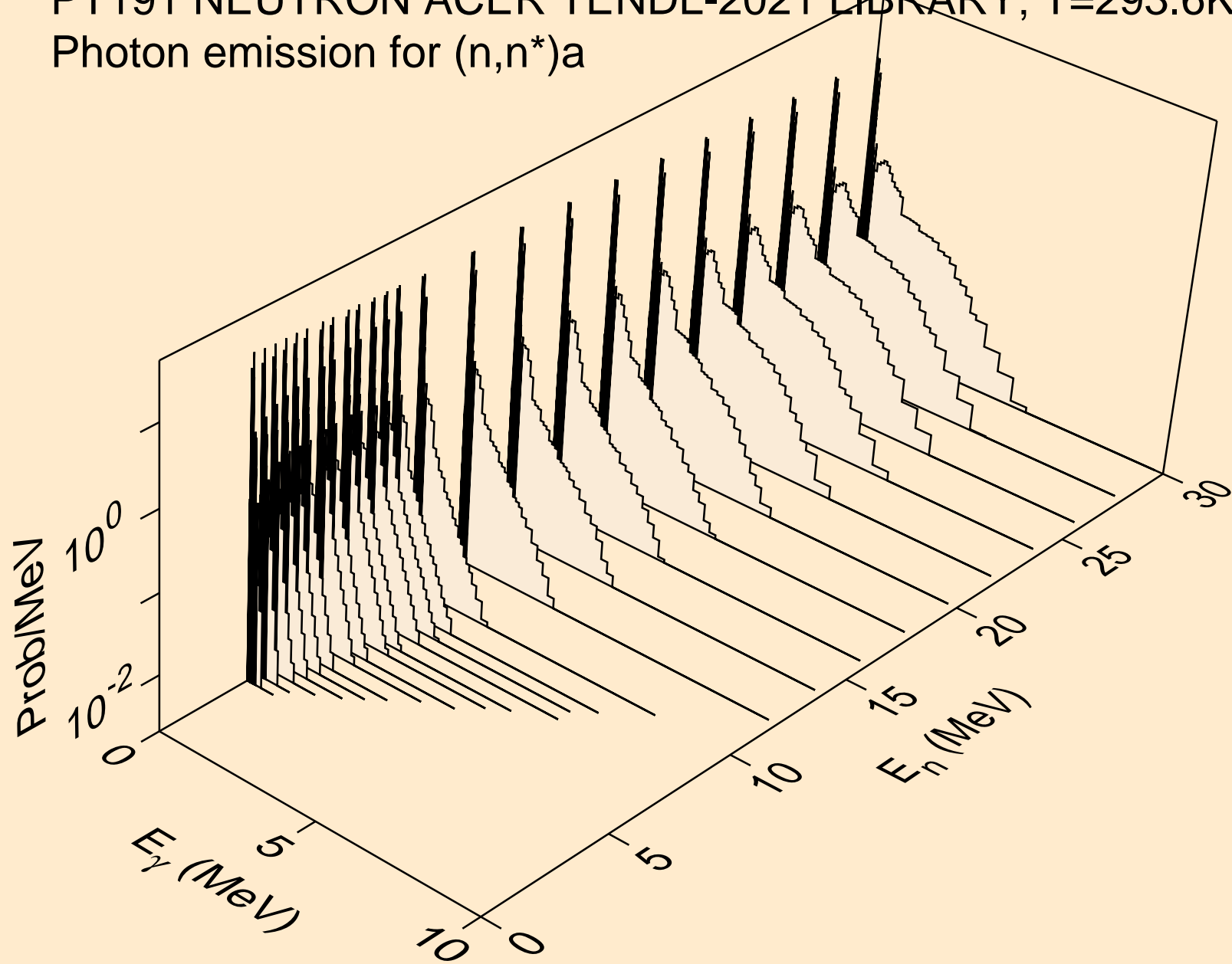

PT191 NEUTRON ACER TENDL-2021 LIBRARY; T=293.6K  
Photon emission for (n,2n)a

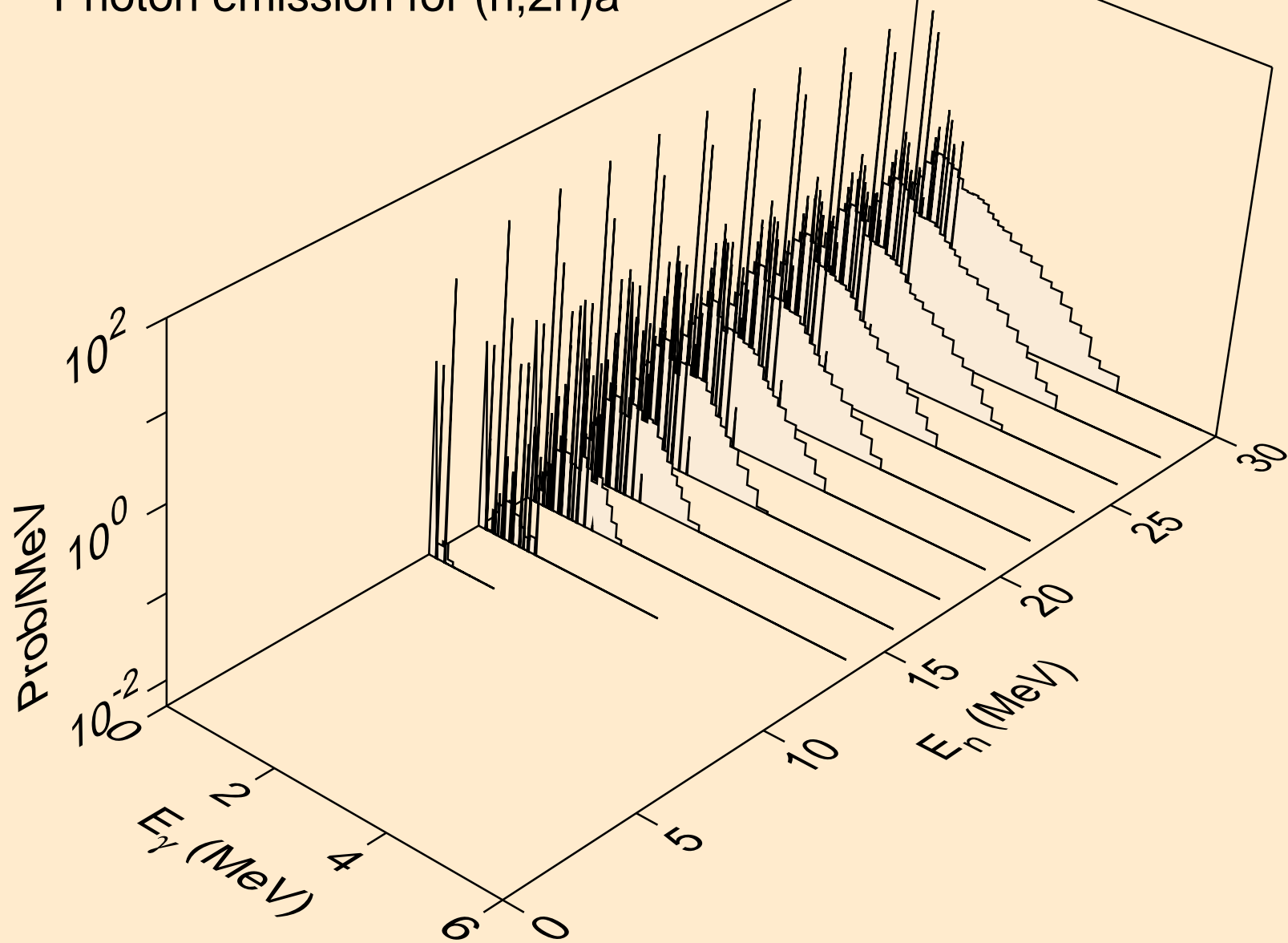

PT191 NEUTRON ACER TENDL-2021 LIBRARY; T=293.6K  
Photon emission for (n,3n)a

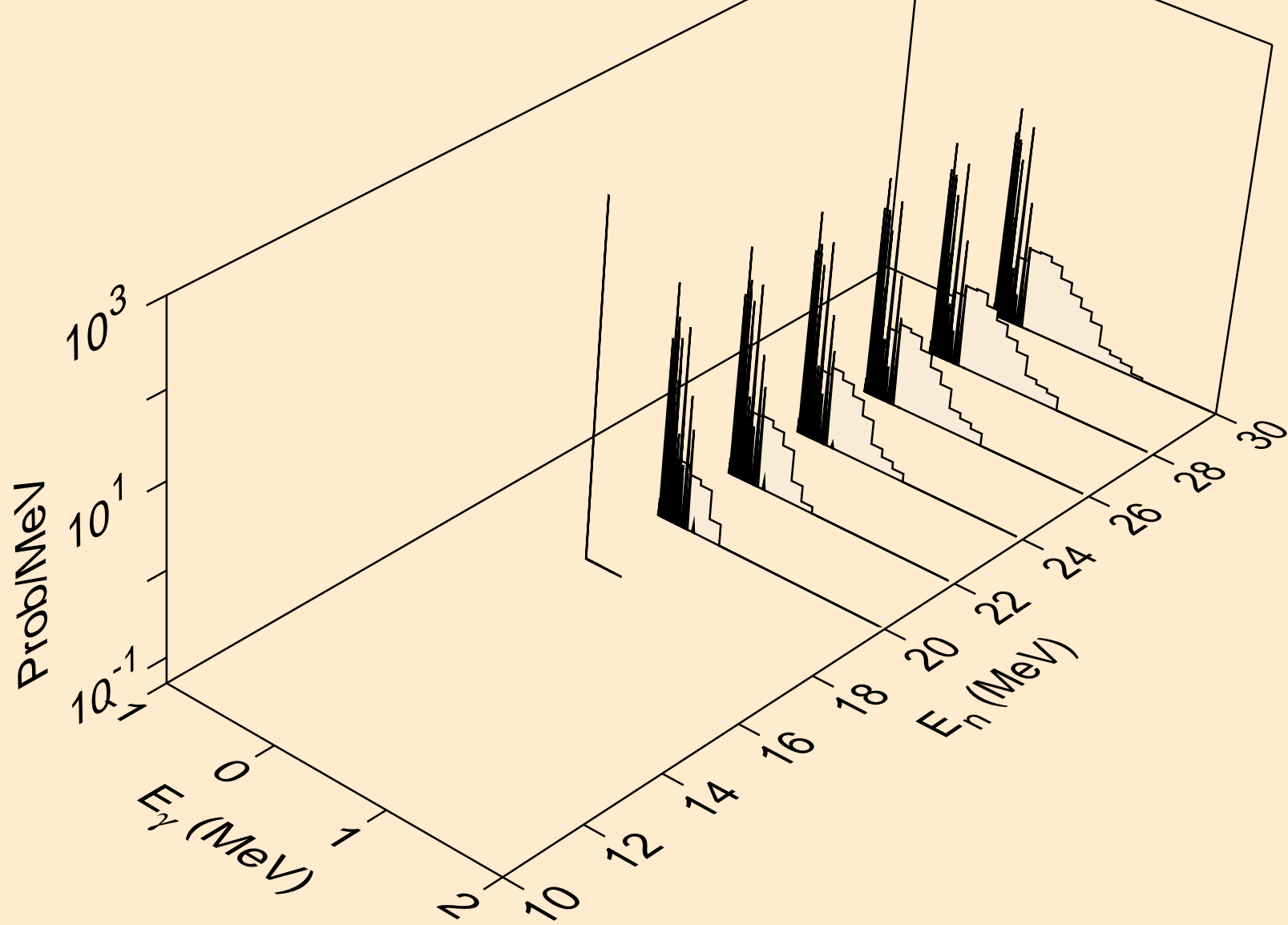

PT191 NEUTRON ACER TENDL-2021 LIBRARY; T=293.6K  
Photon emission for (n,n\*)p

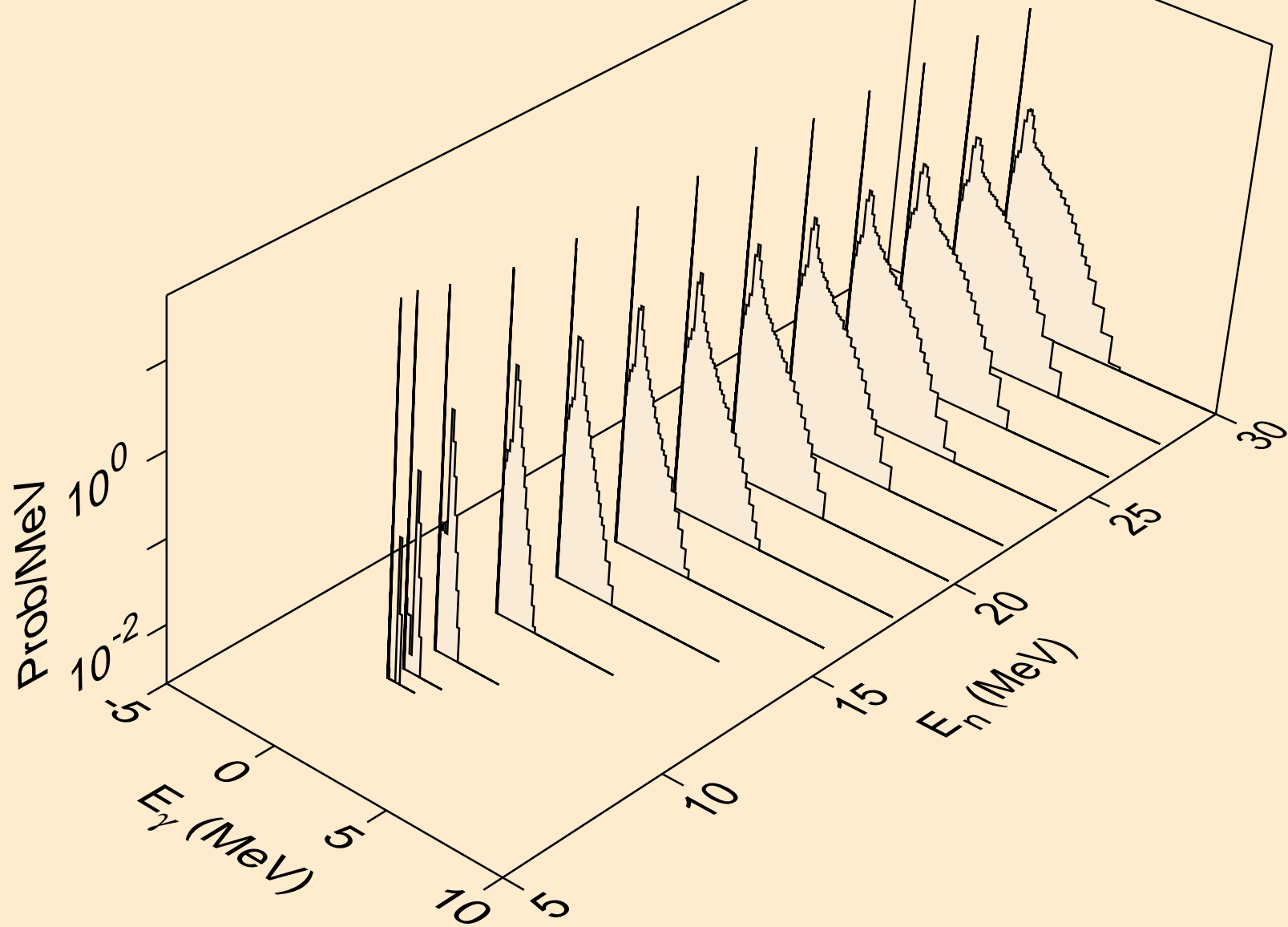

PT191 NEUTRON ACER TENDL-2021 LIBRARY; T=293.6K  
Photon emission for (n,n\*)2a

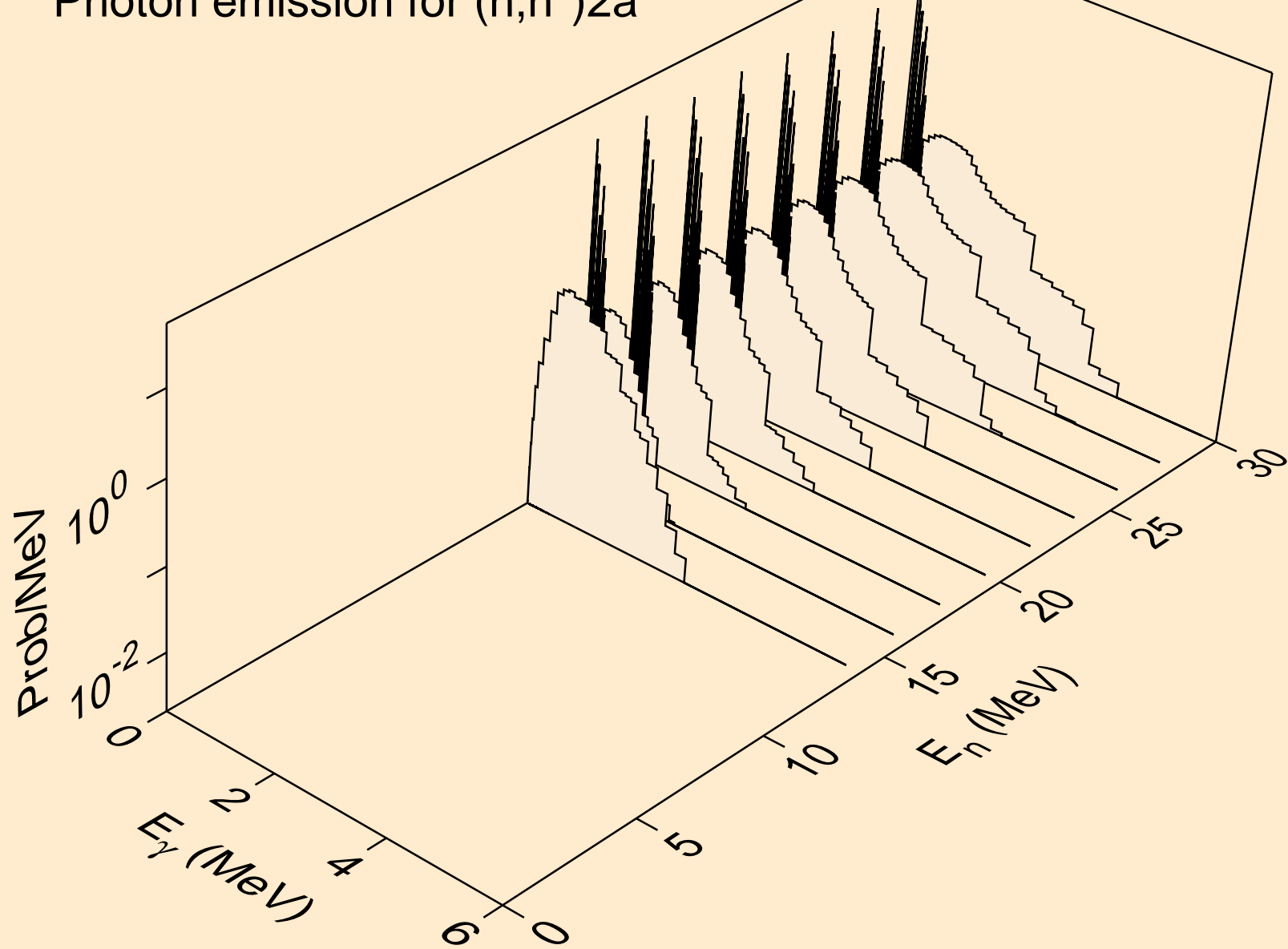



PT191 NEUTRON ACER TENDL-2021 LIBRARY; T=293.6K  
Photon emission for (n,n\*)d

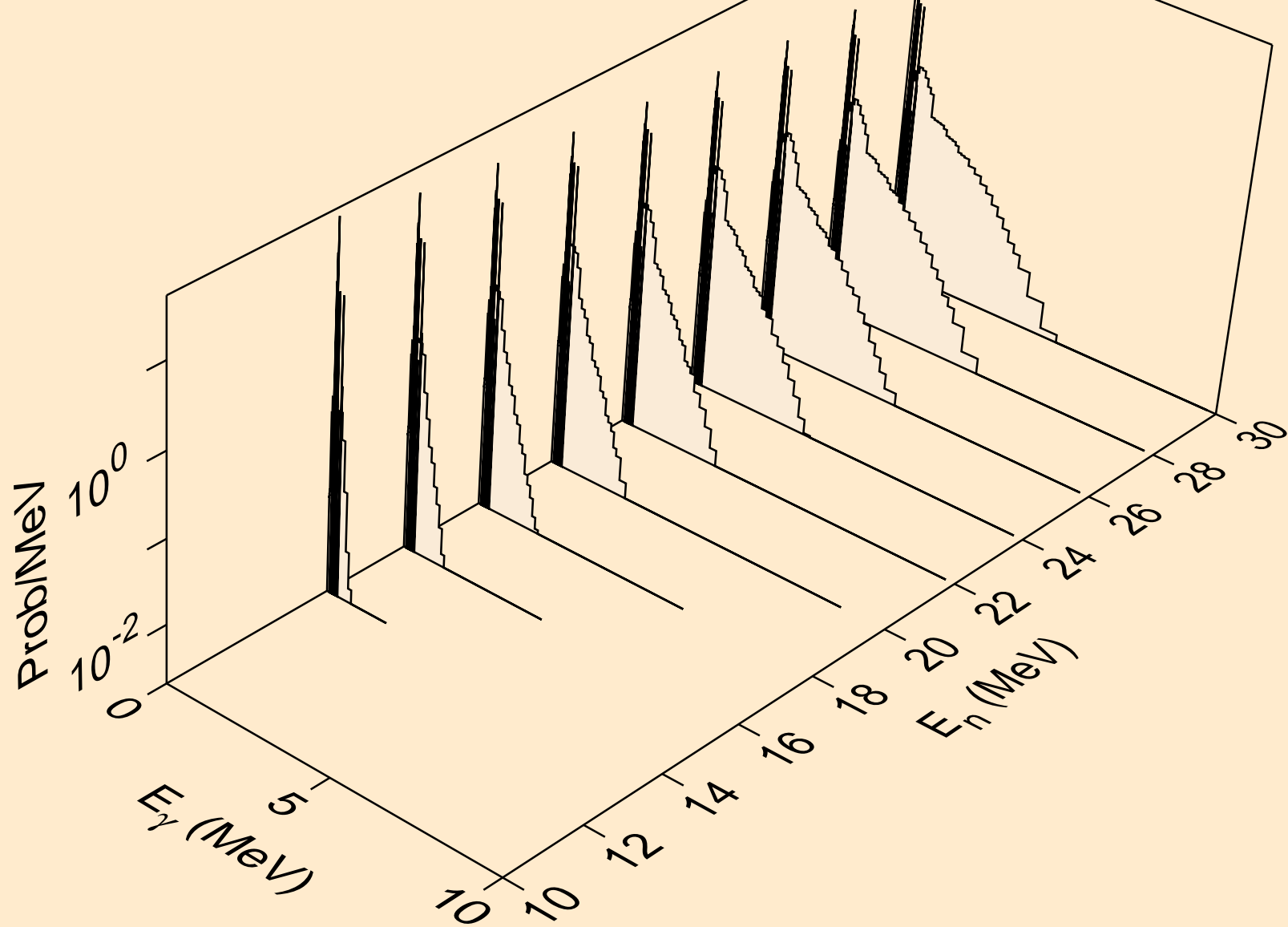

PT191 NEUTRON ACER TENDL-2021 LIBRARY; T=293.6K  
Photon emission for (n,n\*)t

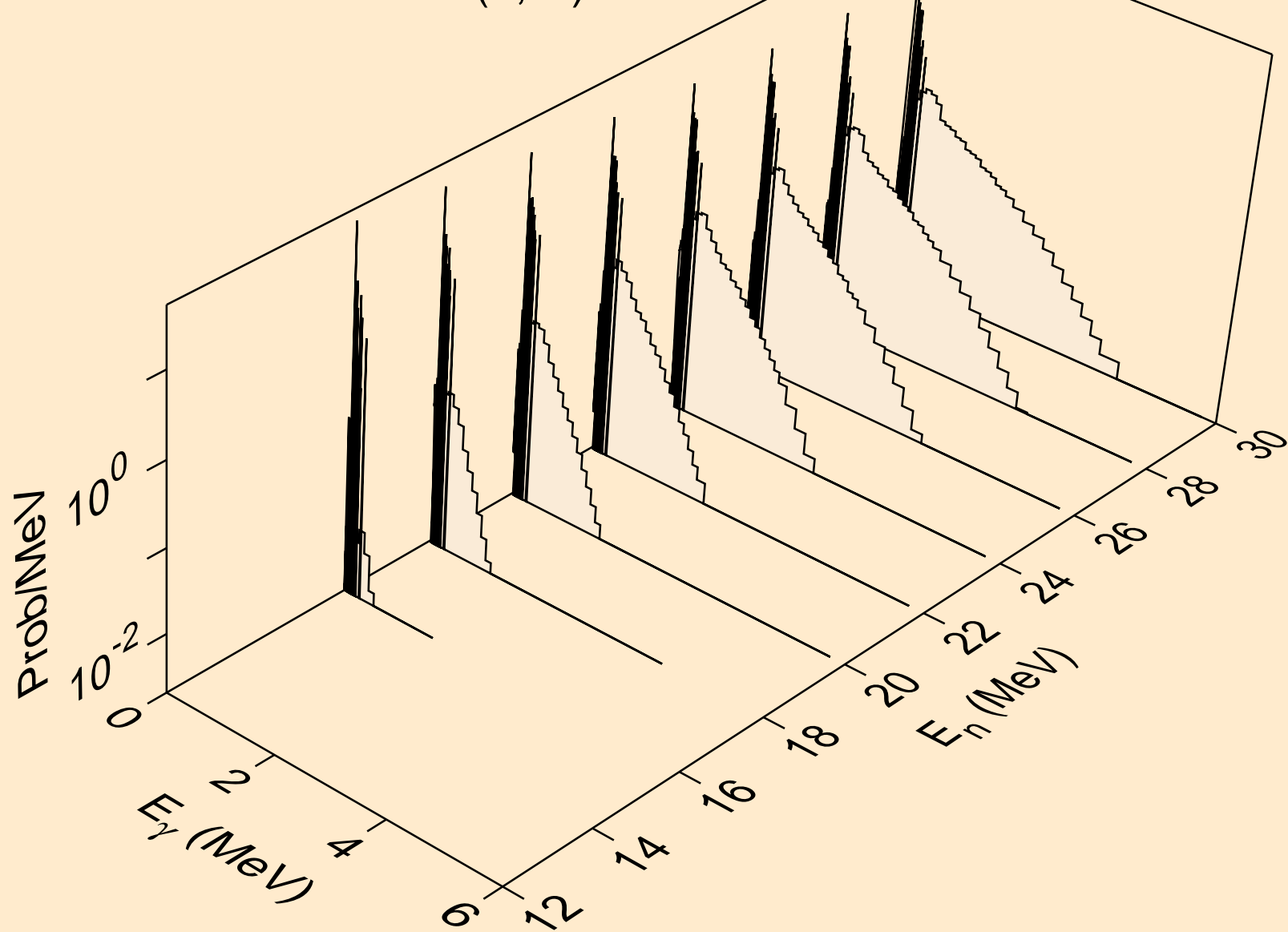

PT191 NEUTRON ACER TENDL-2021 LIBRARY; T=293.6K  
Photon emission for (n,n\*)he3

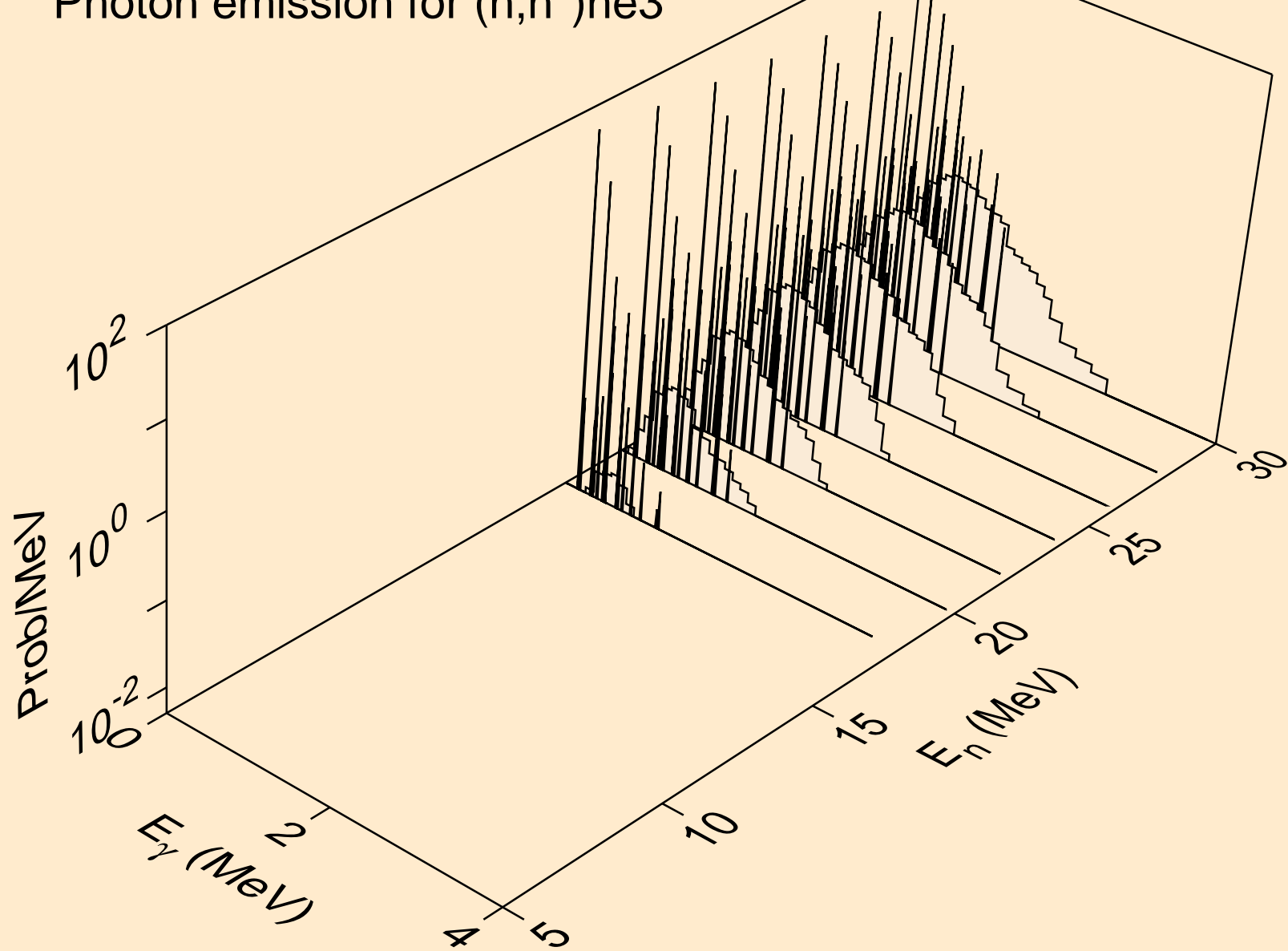

PT191 NEUTRON ACER TENDL-2021 LIBRARY; T=293.6K  
Photon emission for (n,4n)

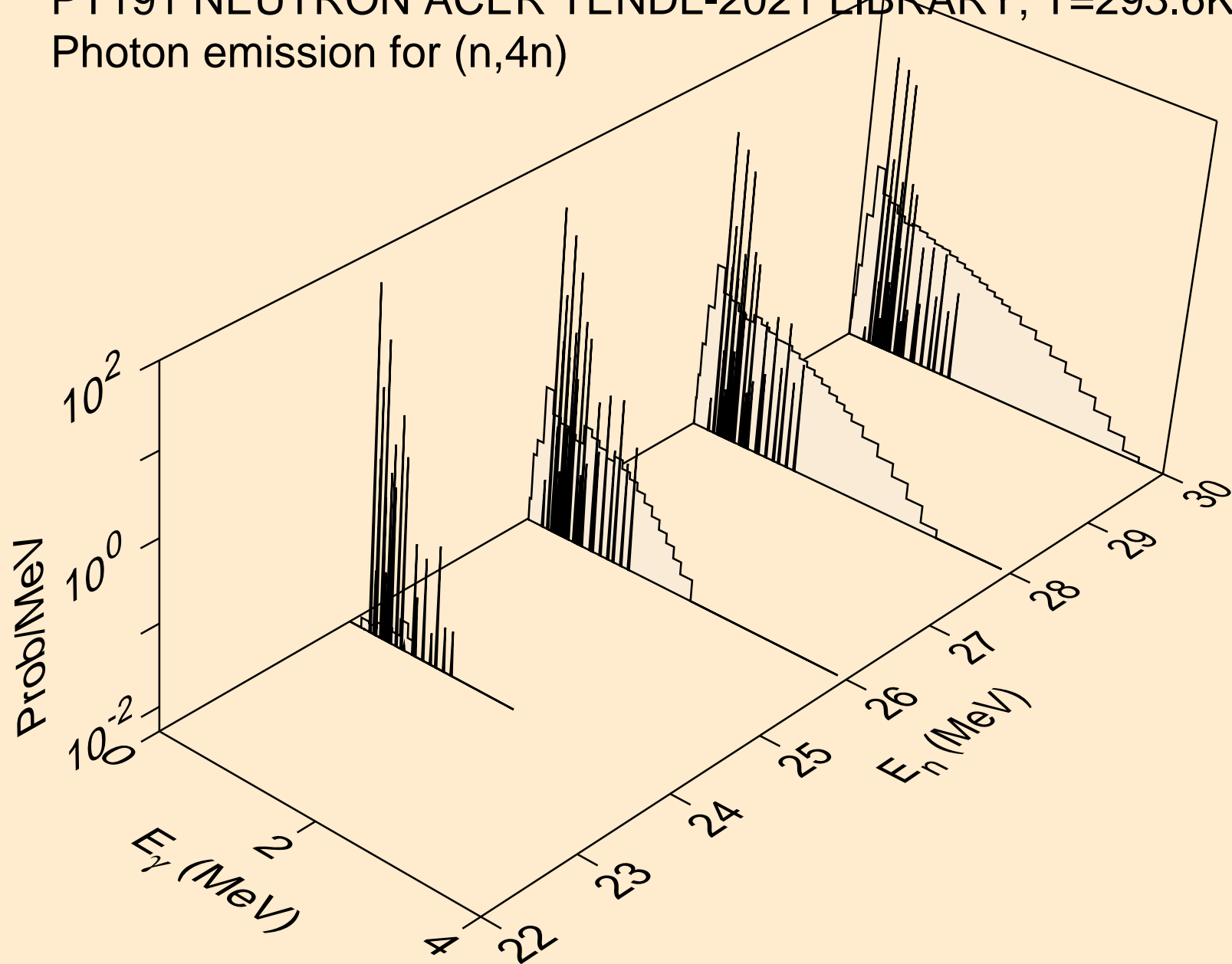

PT191 NEUTRON ACER TENDL-2021 LIBRARY; T=293.6K  
Photon emission for (n,2np)

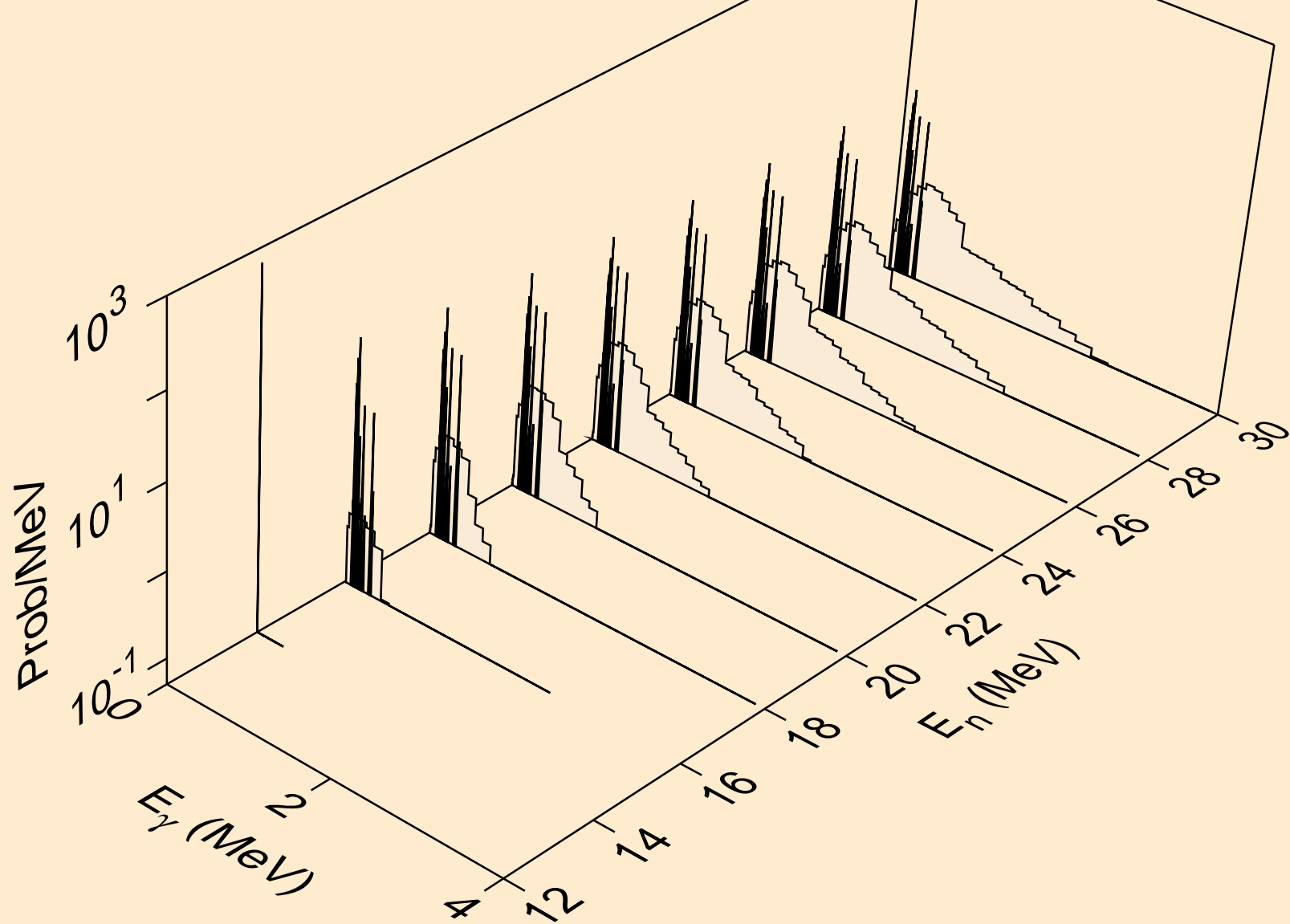

PT191 NEUTRON ACER TENDL-2021 LIBRARY; T=293.6K  
Photon emission for (n,3np)

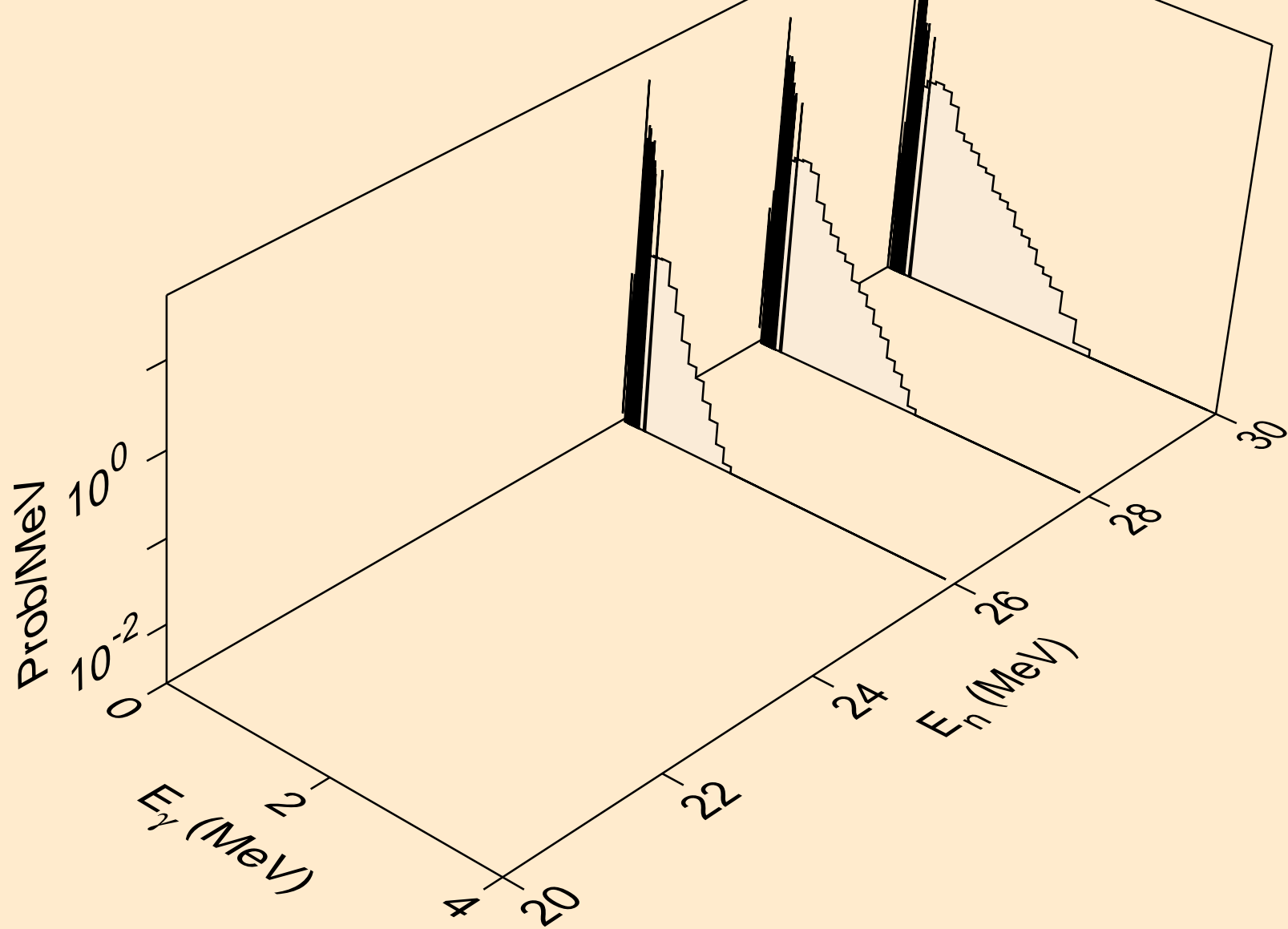

PT191 NEUTRON ACER TENDL-2021 LIBRARY; T=293.6K  
Photon emission for (n,2np)

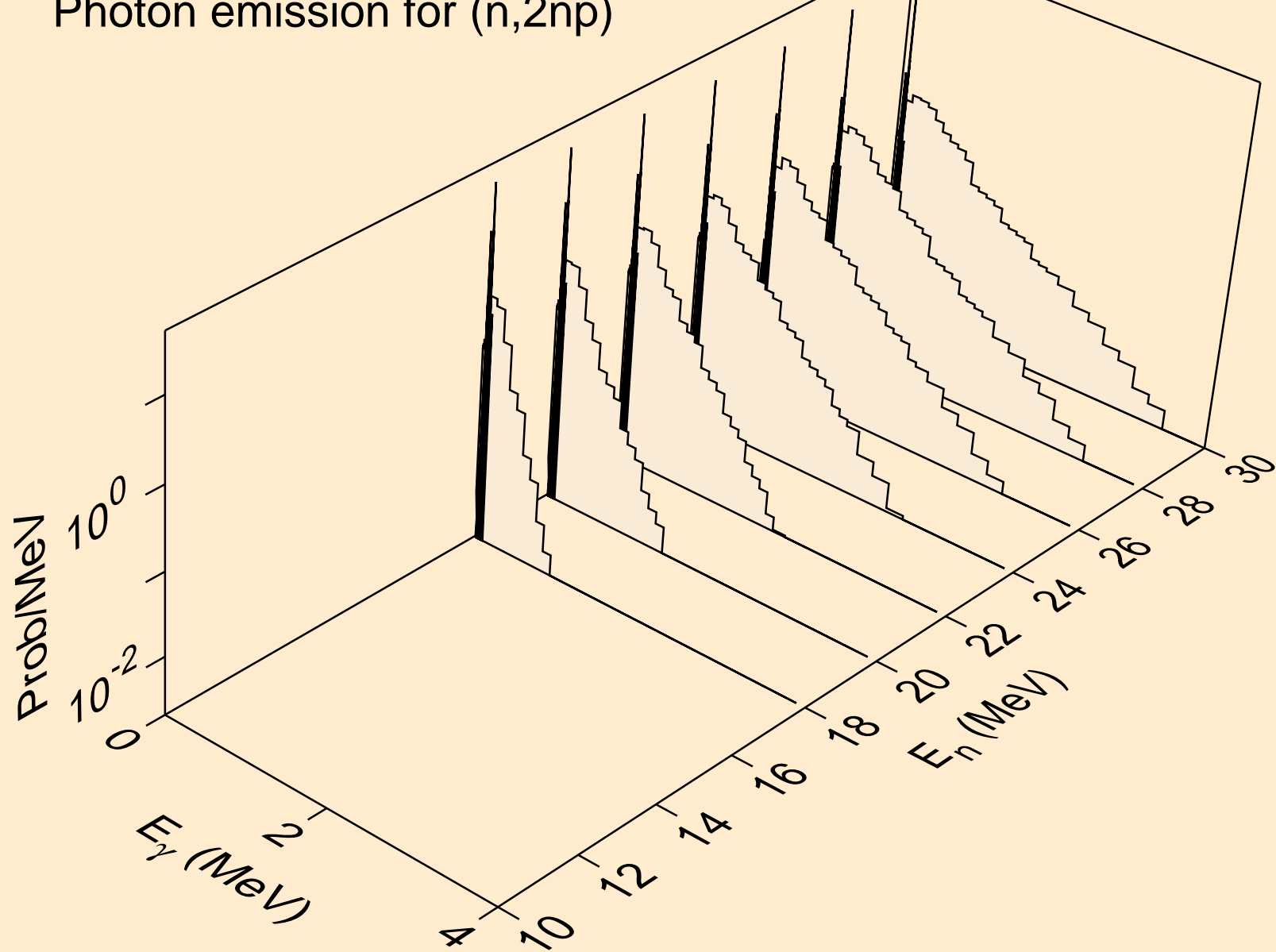

PT191 NEUTRON ACER TENDL-2021 LIBRARY; T=293.6K  
Photon emission for (n,npa)

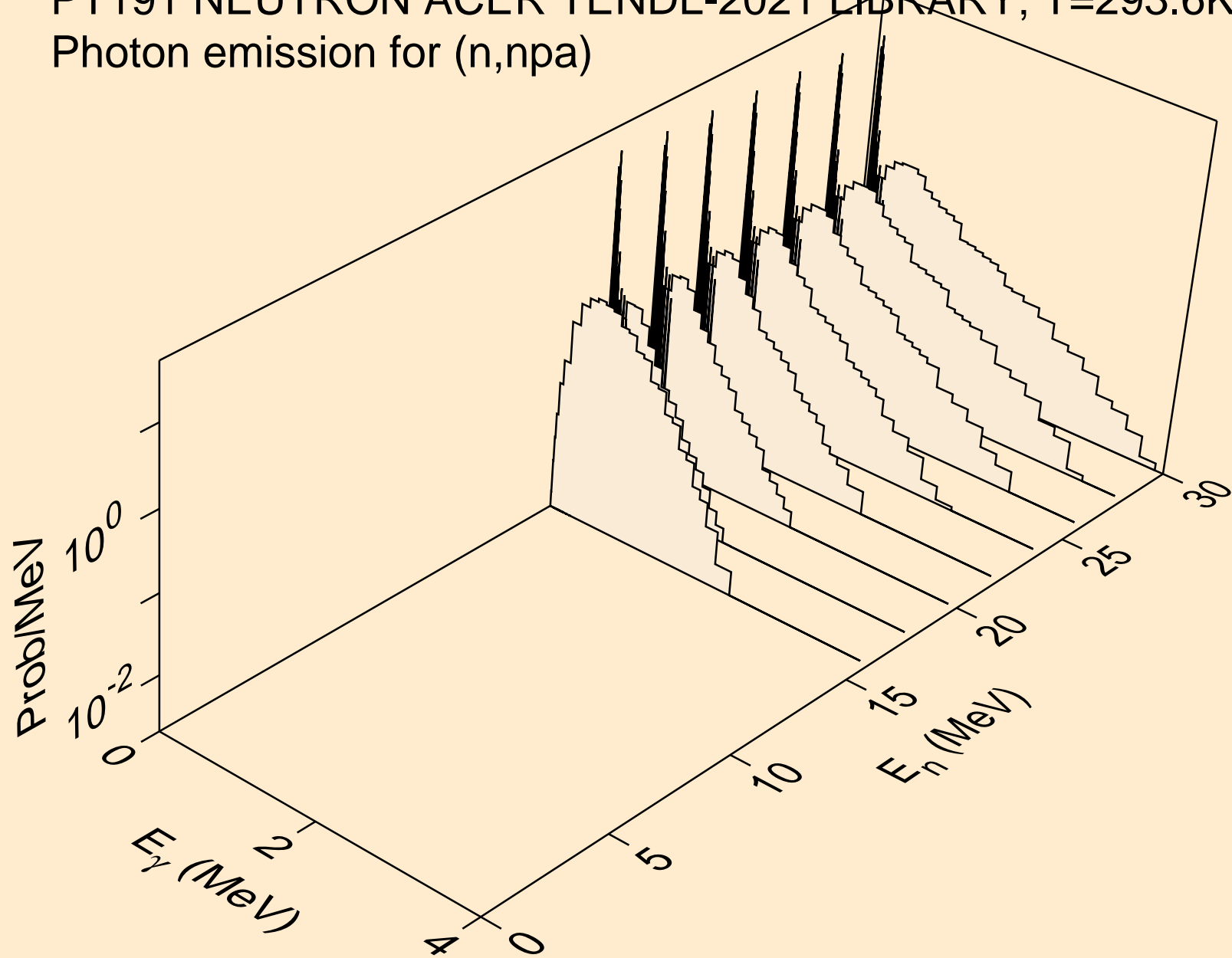



PT191 NEUTRON ACER TENDL-2021 LIBRARY; T=293.6K  
Photon emission for (n,n\*c)

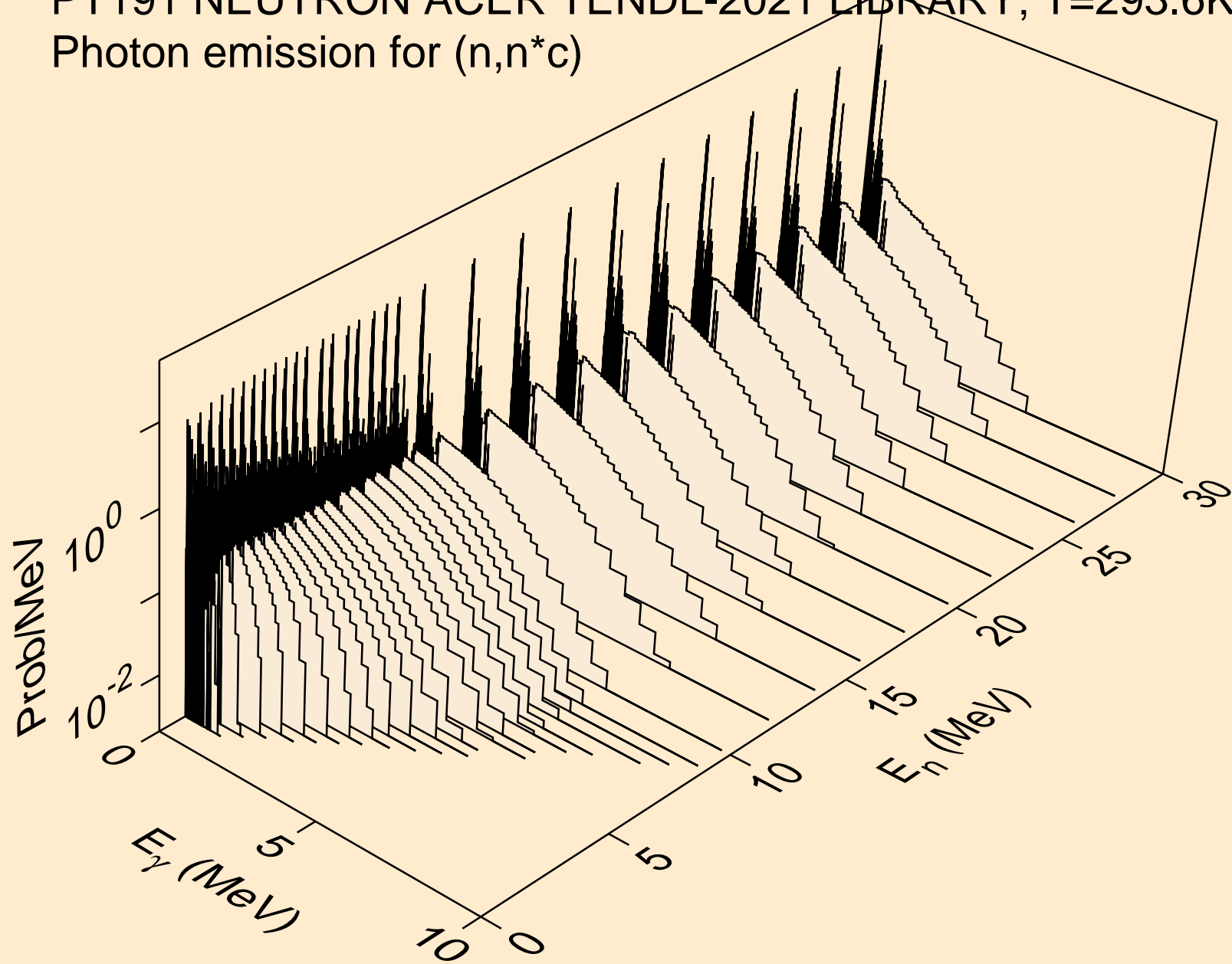

PT191 NEUTRON ACER TENDL-2021 LIBRARY; T=293.6K  
Photon emission for (n,gma)

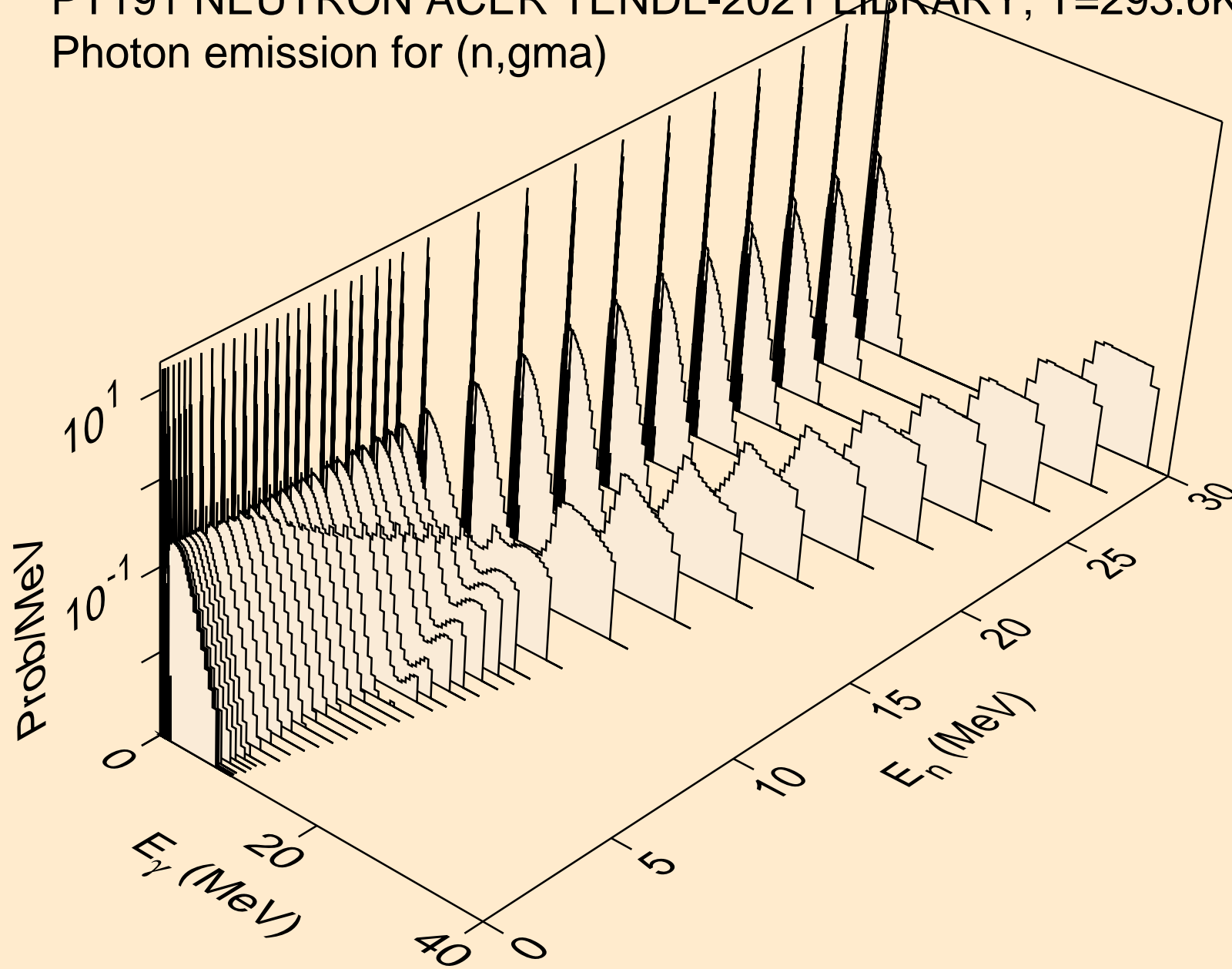

PT191 NEUTRON ACER TENDL-2021 LIBRARY; T=293.6K  
Photon emission for (n,p)

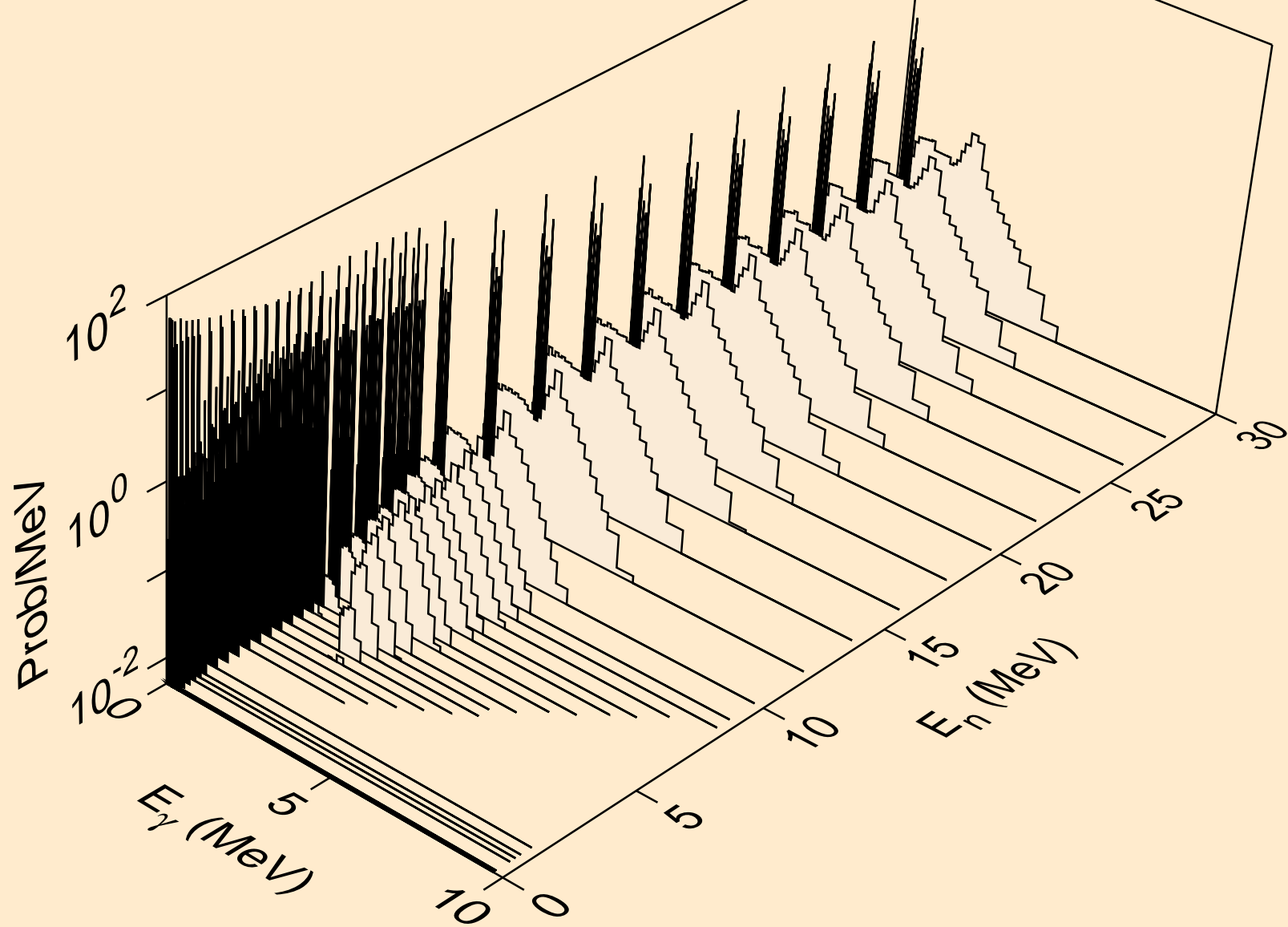

PT191 NEUTRON ACER TENDL-2021 LIBRARY; T=293.6K  
Photon emission for (n,d)

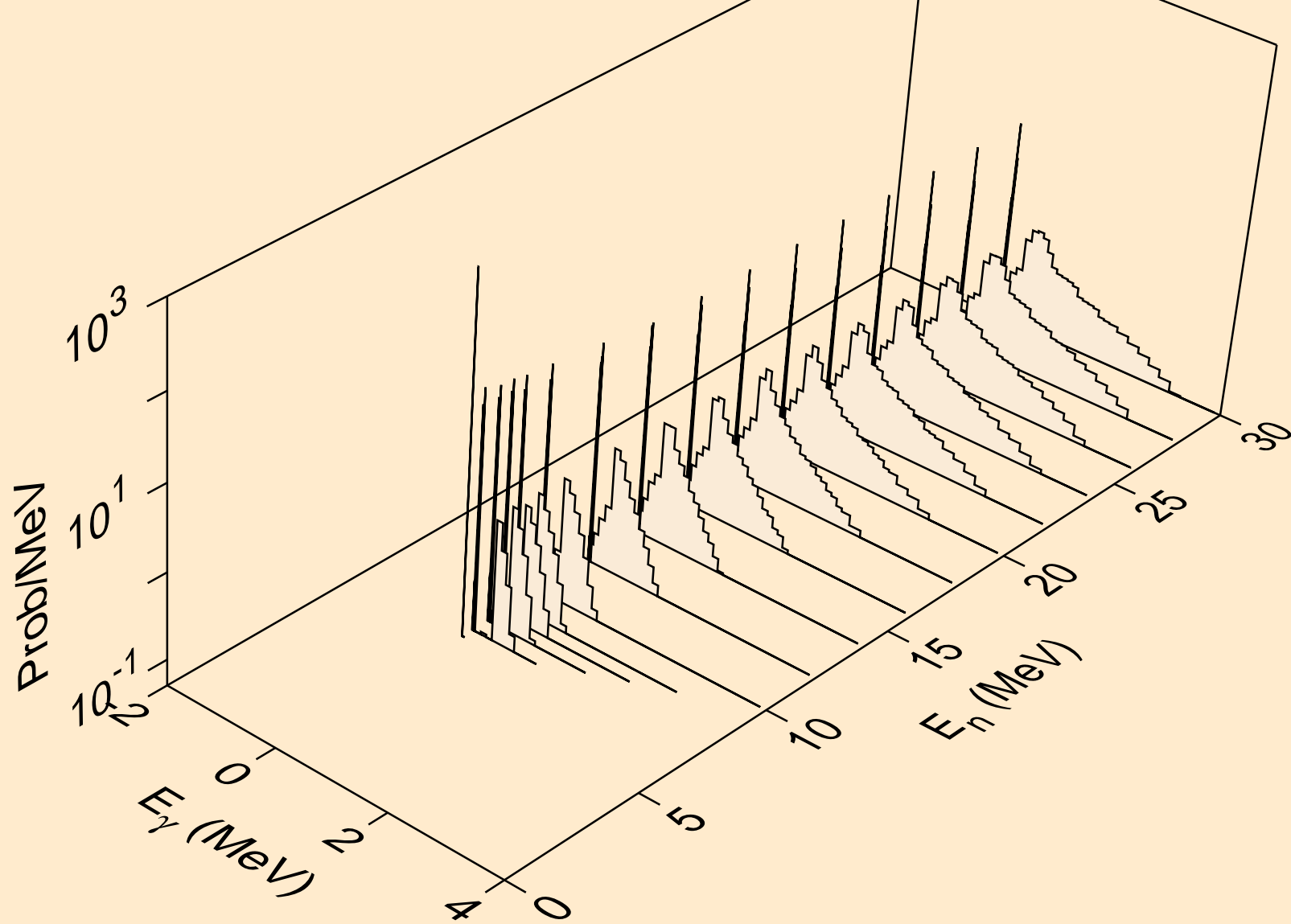

PT191 NEUTRON ACER TENDL-2021 LIBRARY; T=293.6K  
Photon emission for (n,t)

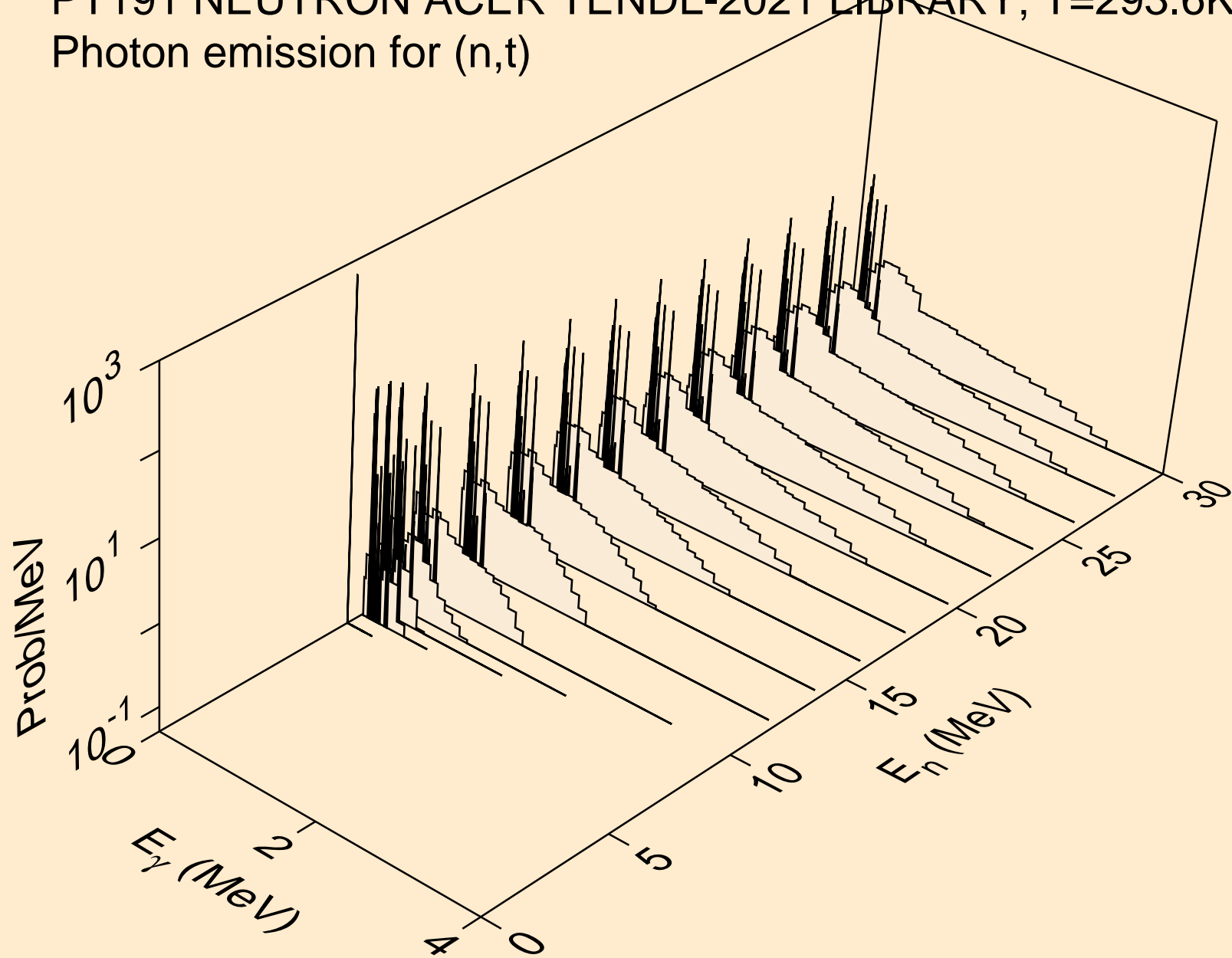

PT191 NEUTRON ACER TENDL-2021 LIBRARY; T=293.6K  
Photon emission for (n,he3)

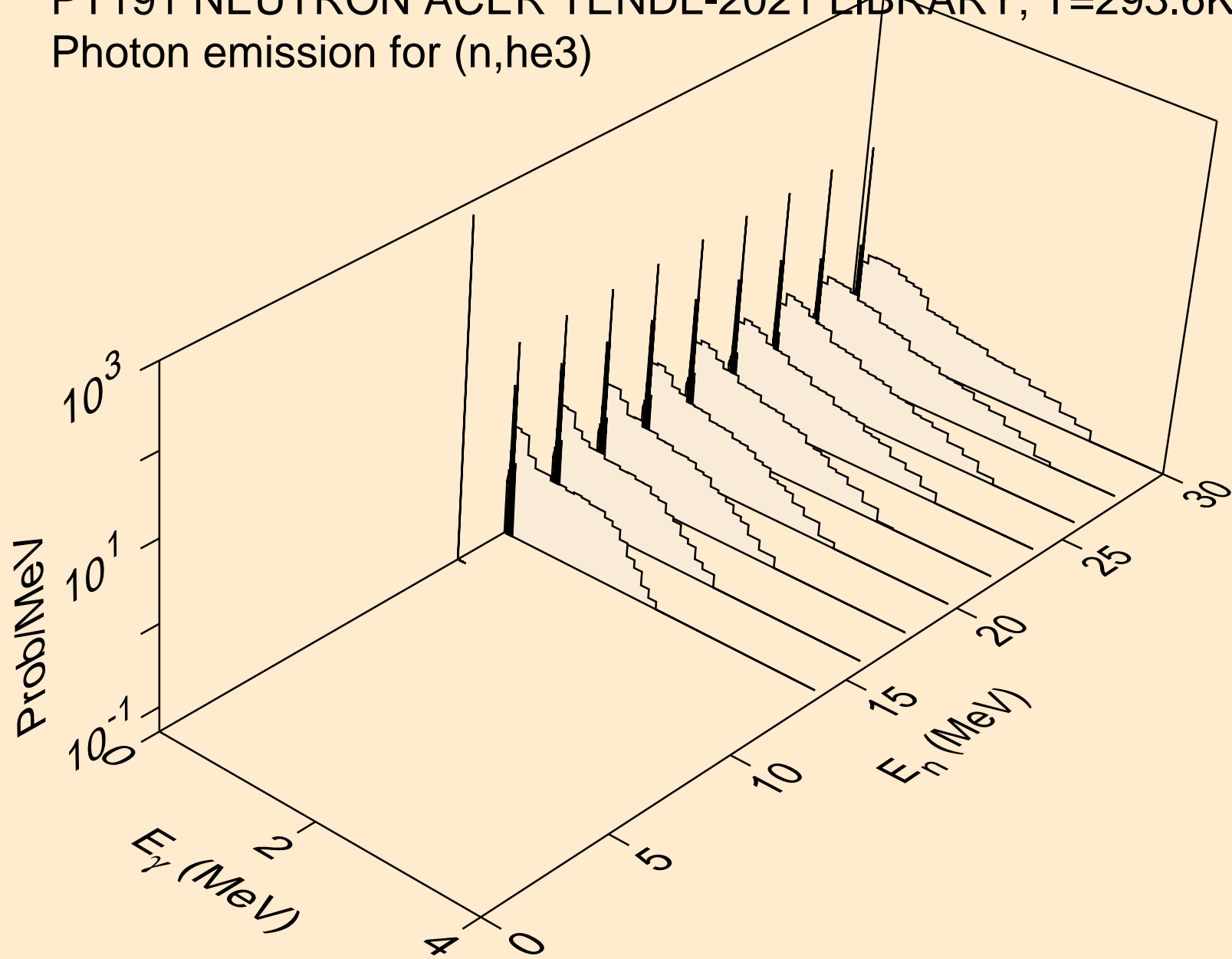

PT191 NEUTRON ACER TENDL-2021 LIBRARY; T=293.6K  
Photon emission for (n,a)

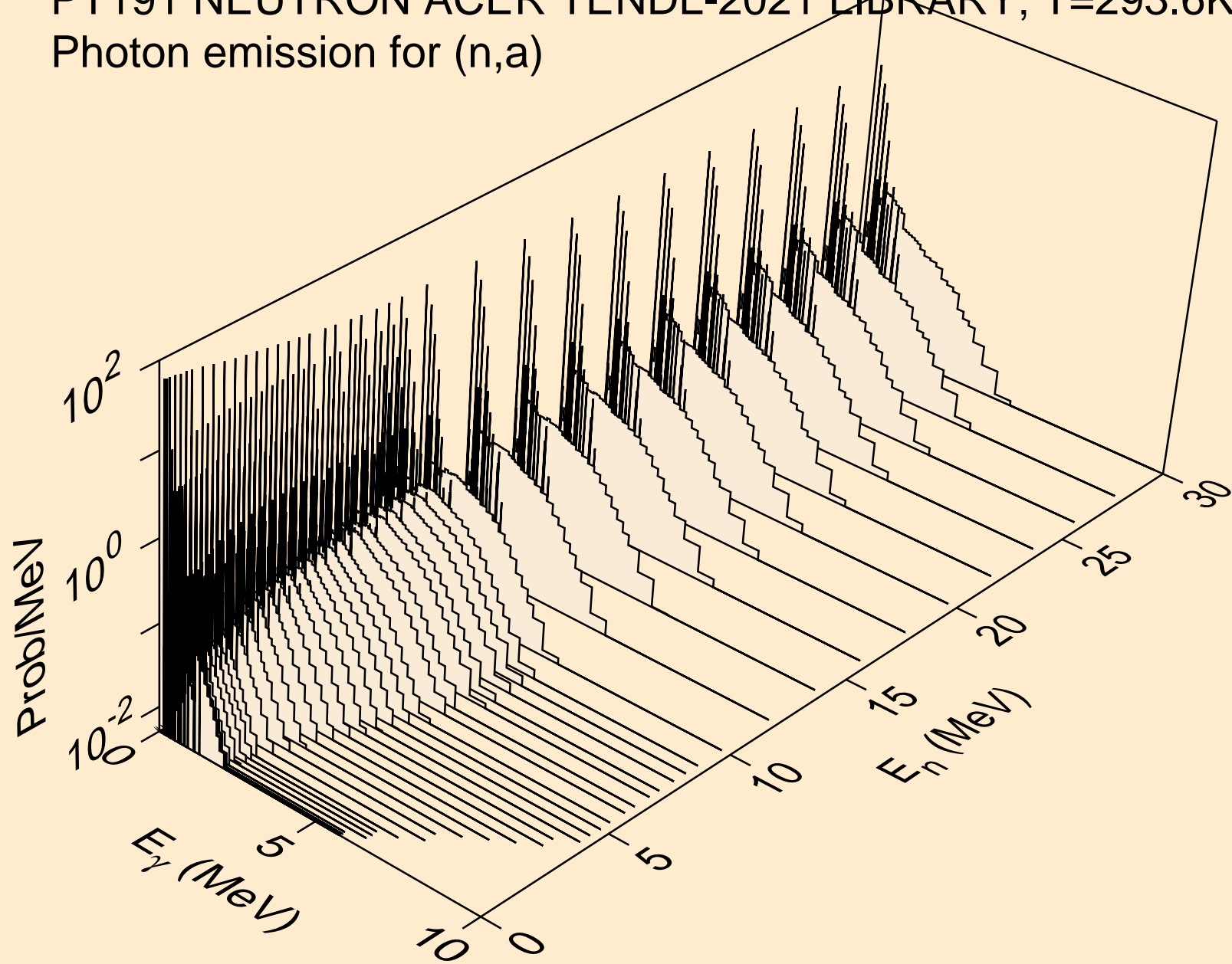

PT191 NEUTRON ACER TENDL-2021 LIBRARY; T=293.6K  
Photon emission for (n,2a)

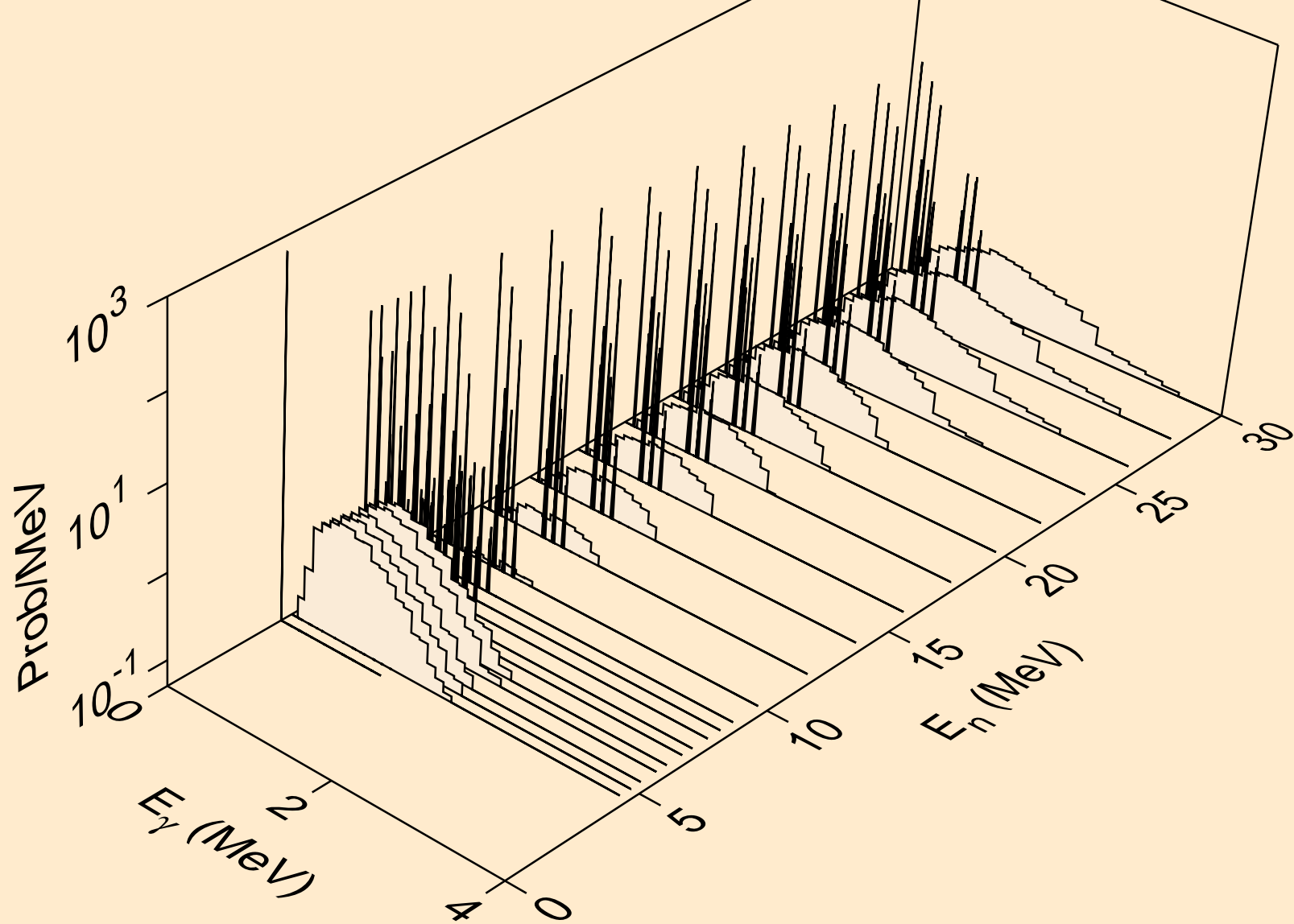



PT191 NEUTRON ACER TENDL-2021 LIBRARY; T=293.6K  
Photon emission for (n,2p)

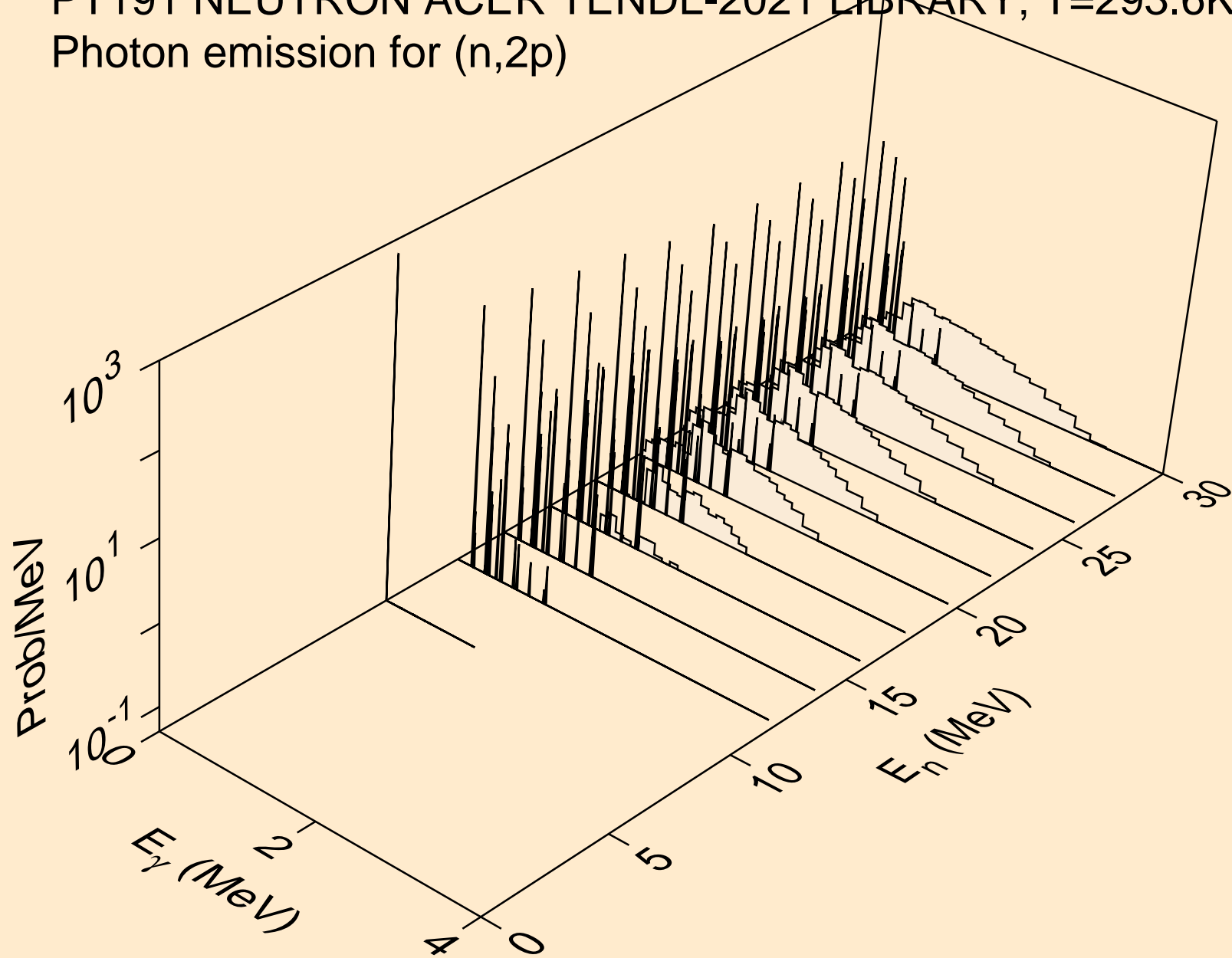

PT191 NEUTRON ACER TENDL-2021 LIBRARY; T=293.6K  
Photon emission for (n,p)

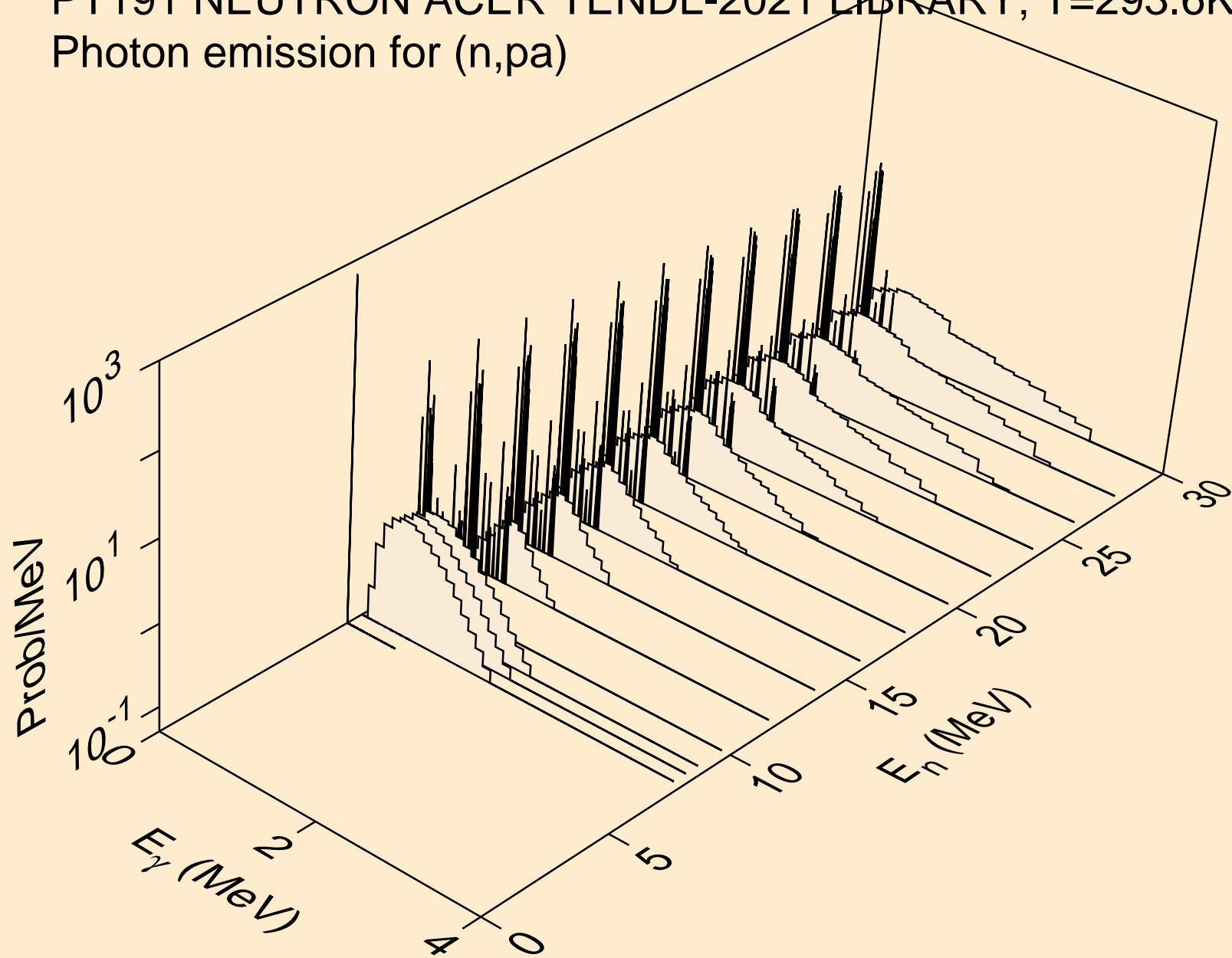

PT191 NEUTRON ACER TENDL-2021 LIBRARY; T=293.6K  
Photon emission for (n,pd)

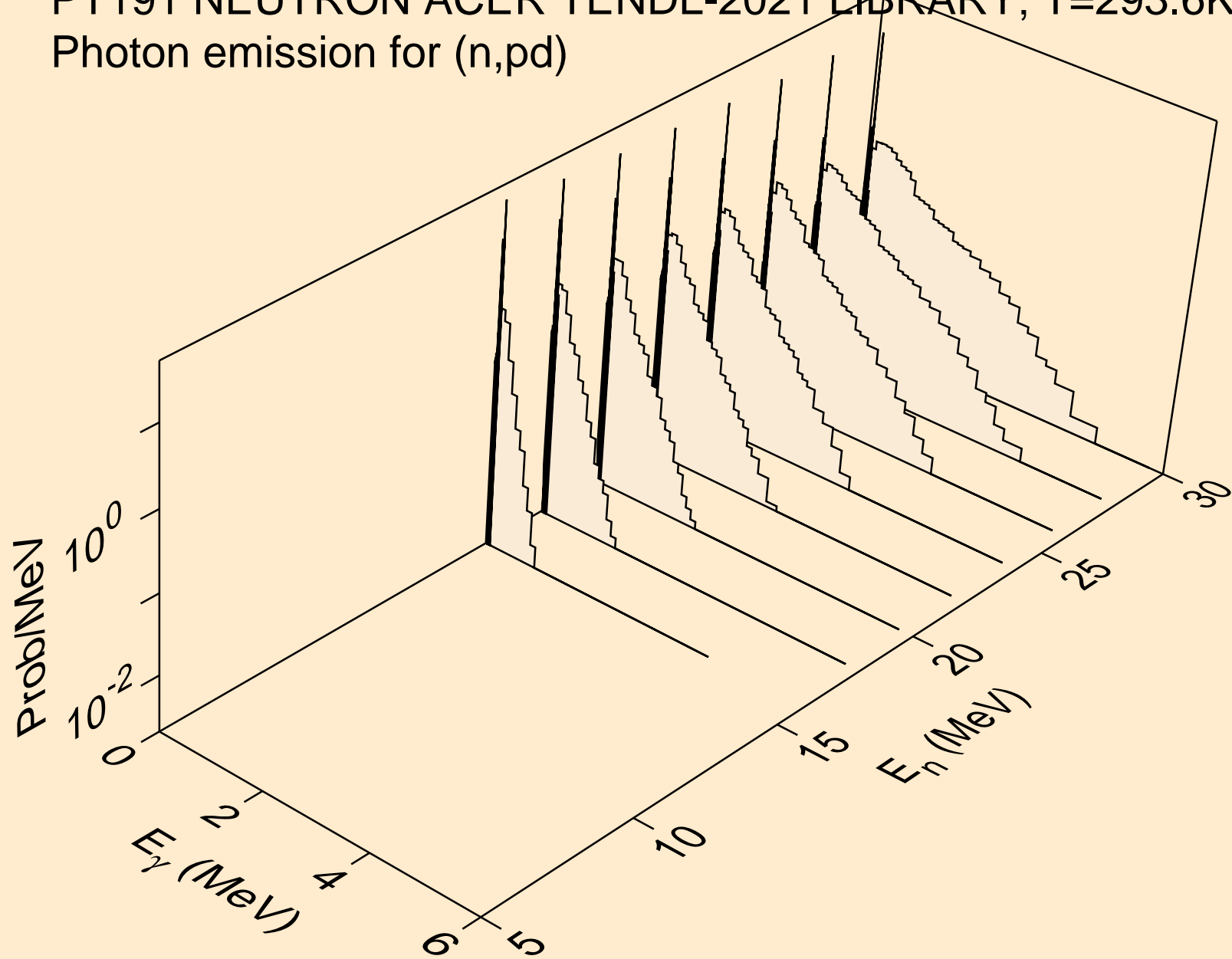

PT191 NEUTRON ACER TENDL-2021 LIBRARY; T=293.6K  
Photon emission for (n,pt)

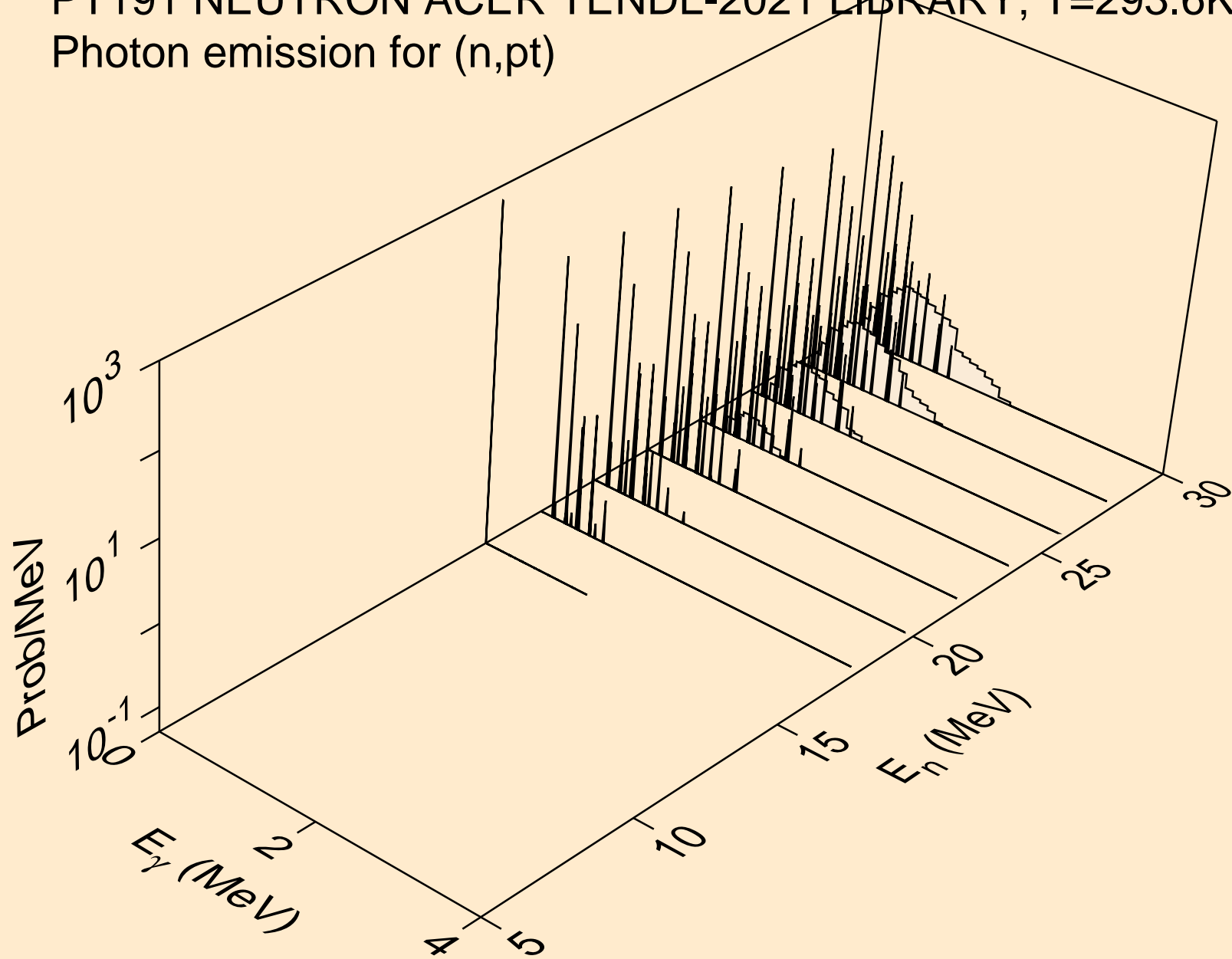

PT191 NEUTRON ACER TENDL-2021 LIBRARY; T=293.6K  
Photon emission for (n,da)

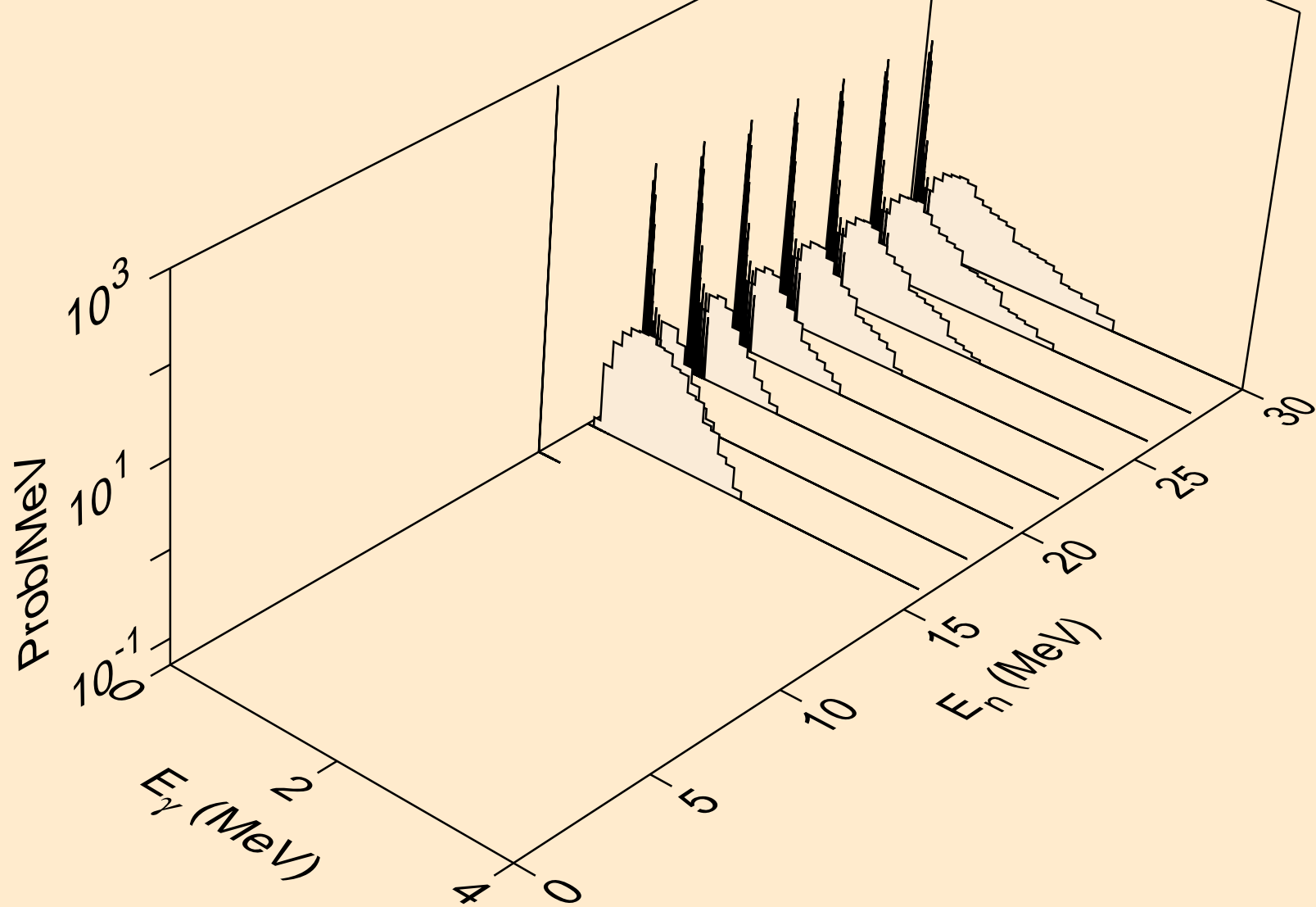

PT191 NEUTRON ACER TENDL-2021 LIBRARY; T=293.6K  
thermal capture photon spectrum

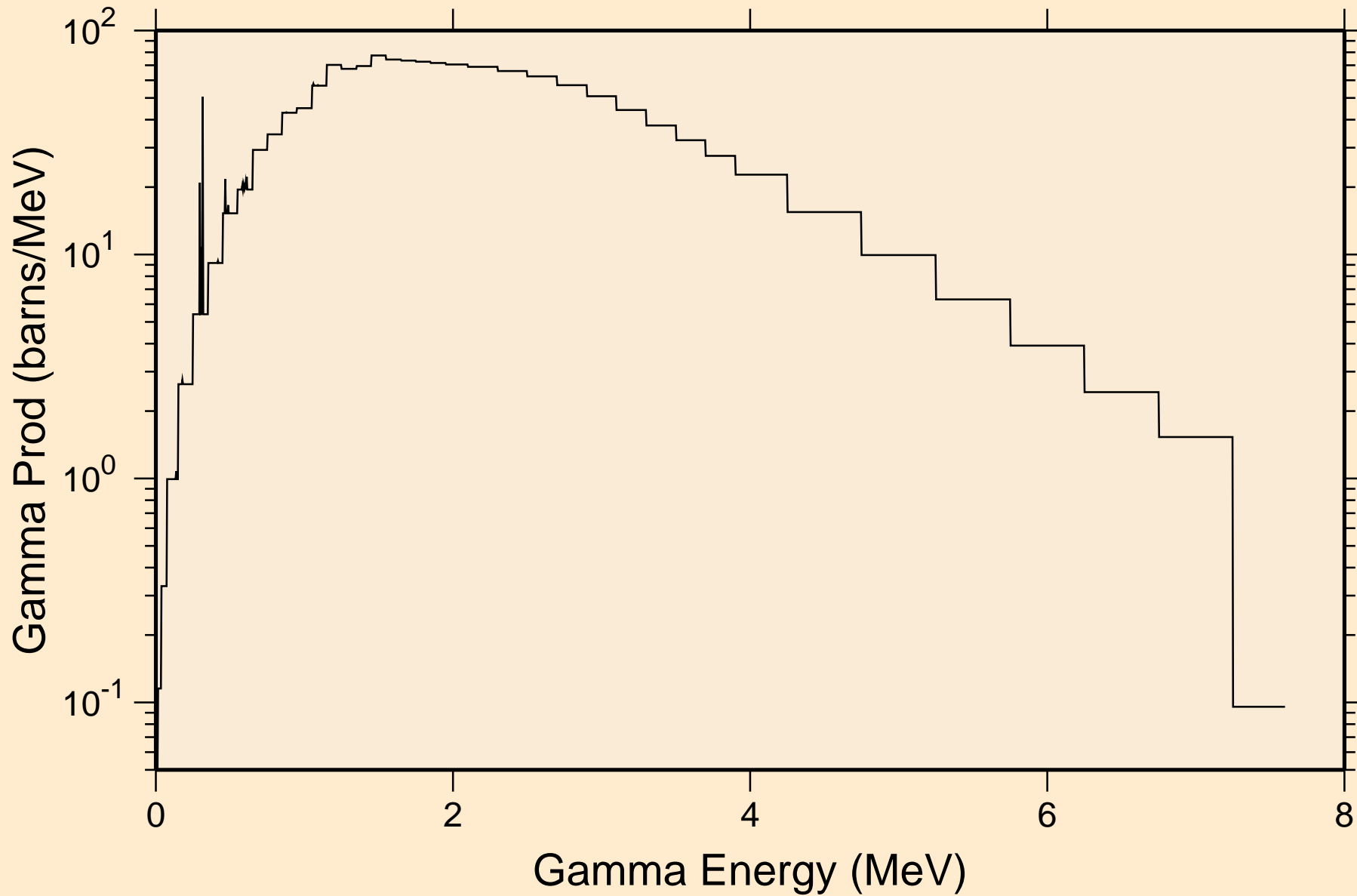

PT191 NEUTRON ACER TENDL-2021 LIBRARY; T=293.6K  
14 MeV photon spectrum

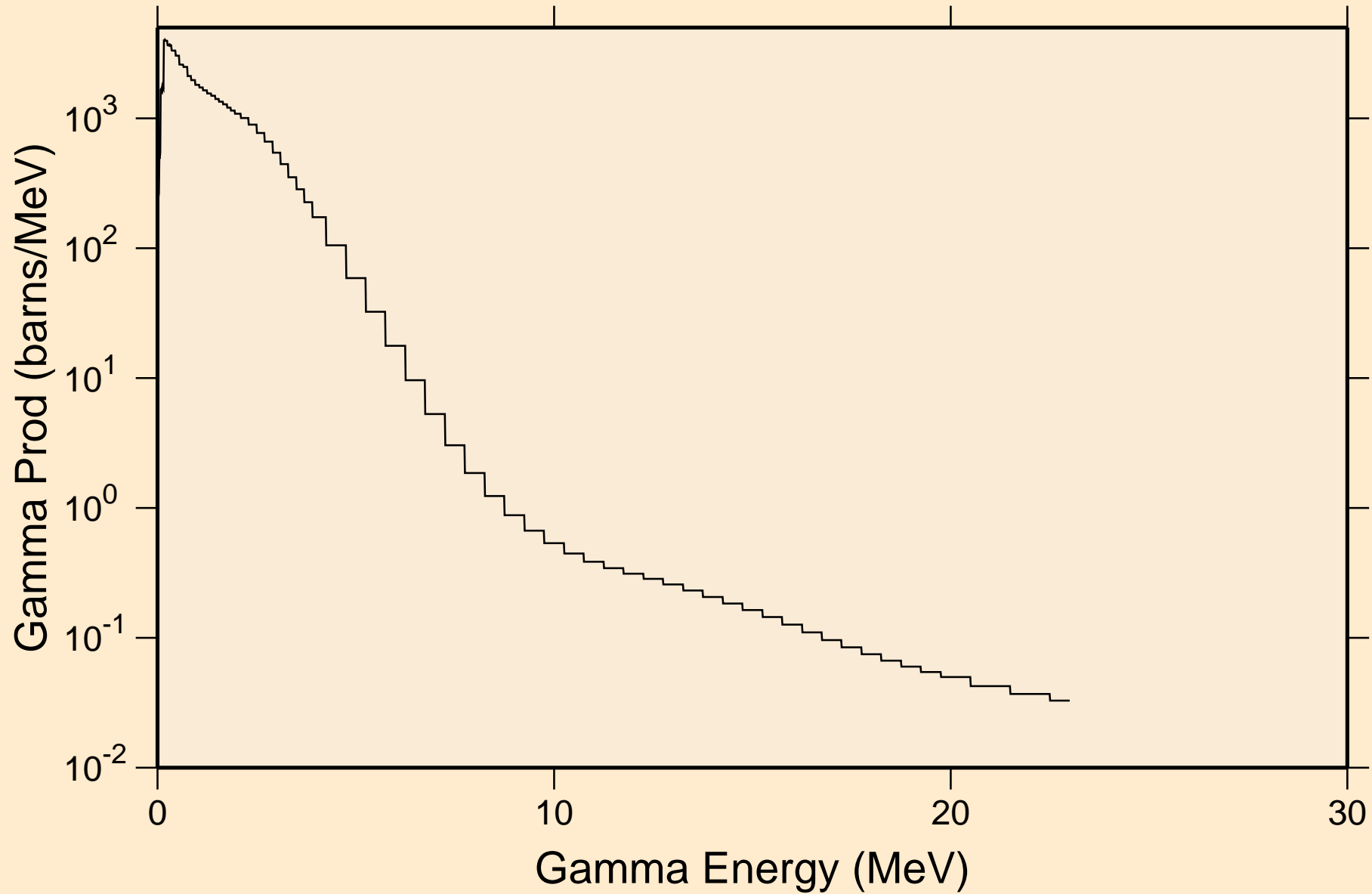

PT191 NEUTRON ACER TENDL-2021 LIBRARY; T=293.6K  
Particle heating contributions

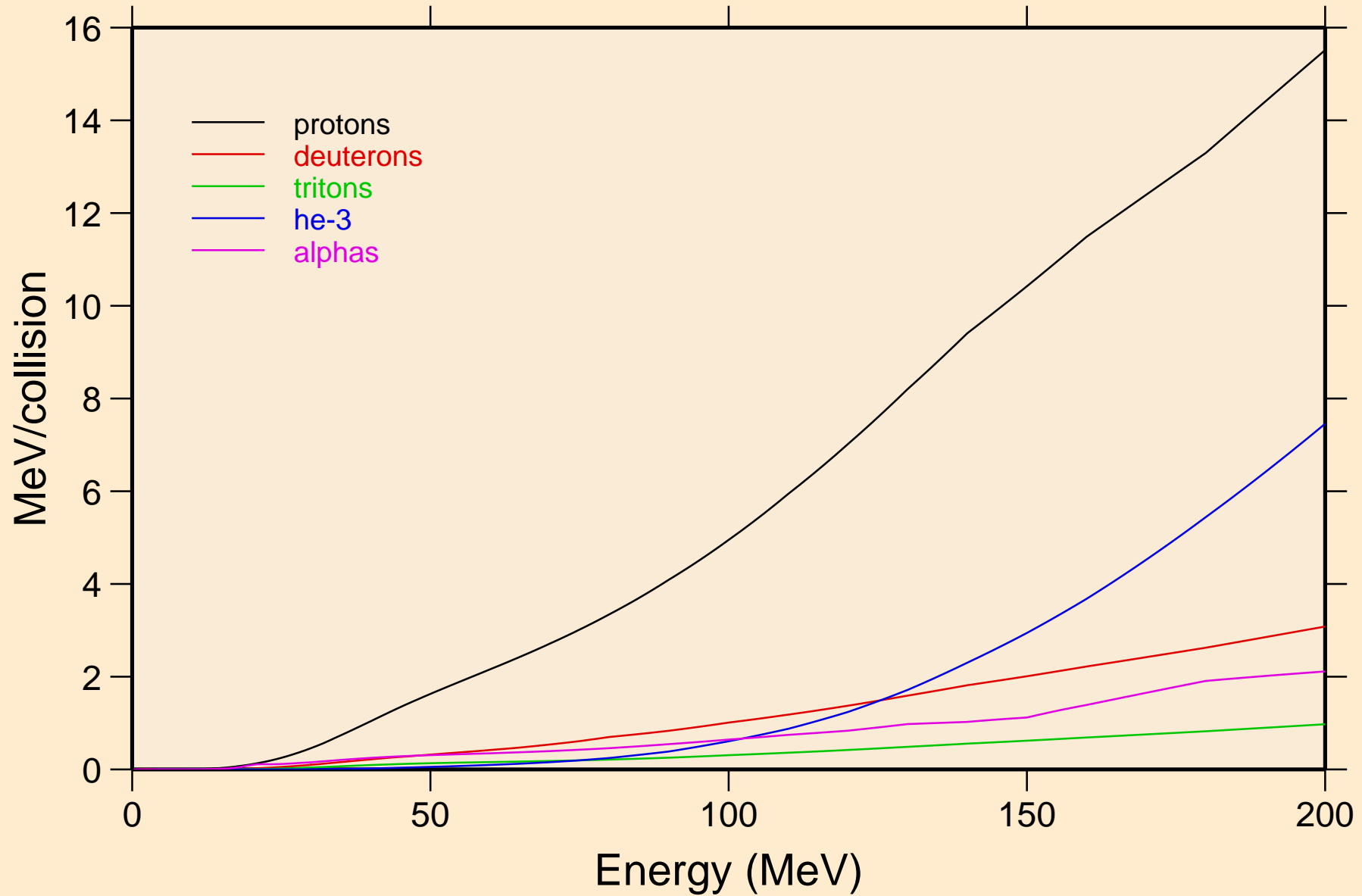



PT191 NEUTRON ACER TENDL-2021 LIBRARY; T=293.6K  
Recoil Heating

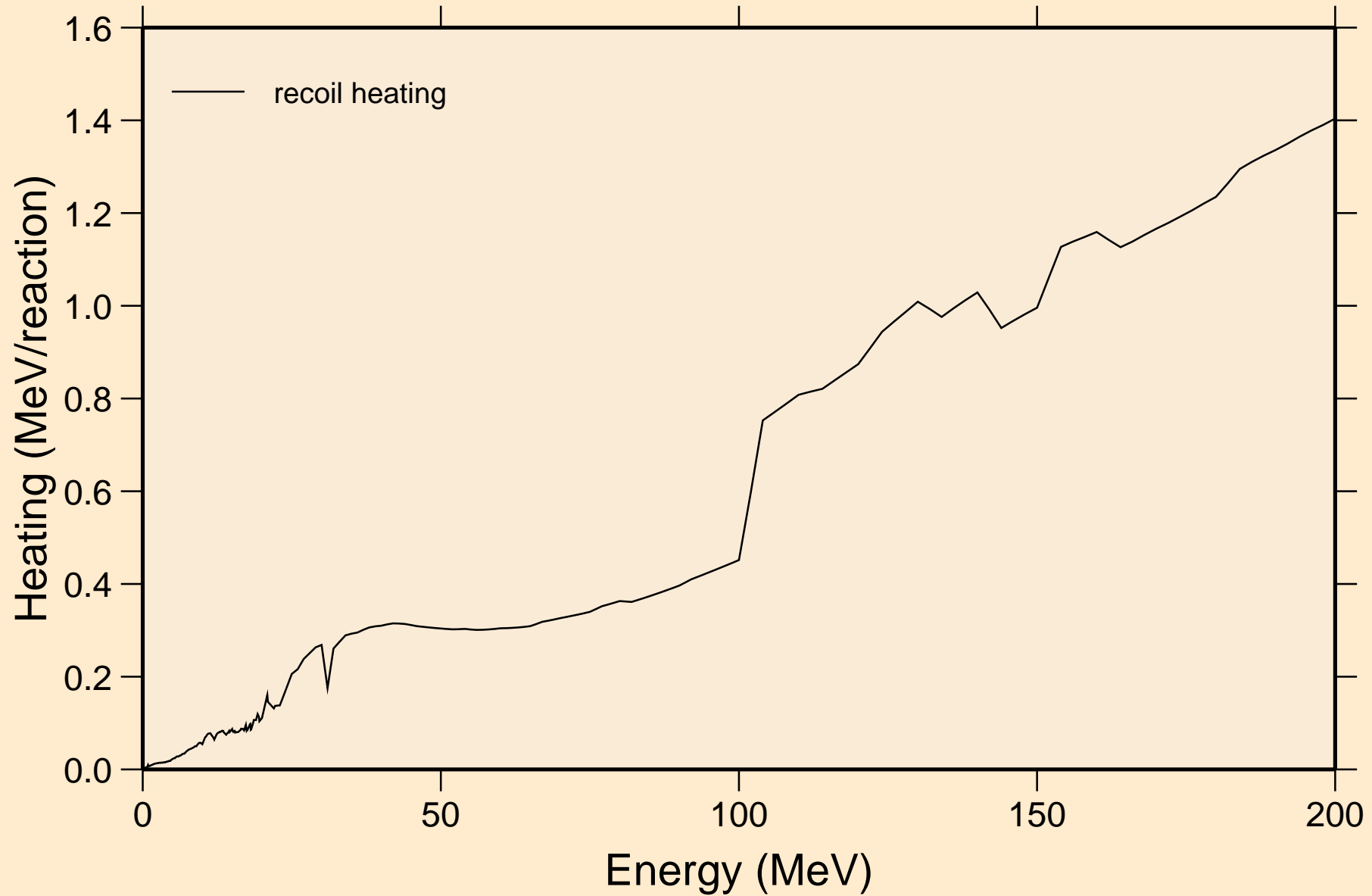

PT191 NEUTRON ACER TENDL-2021 LIBRARY; T=293.6K  
Particle production cross sections

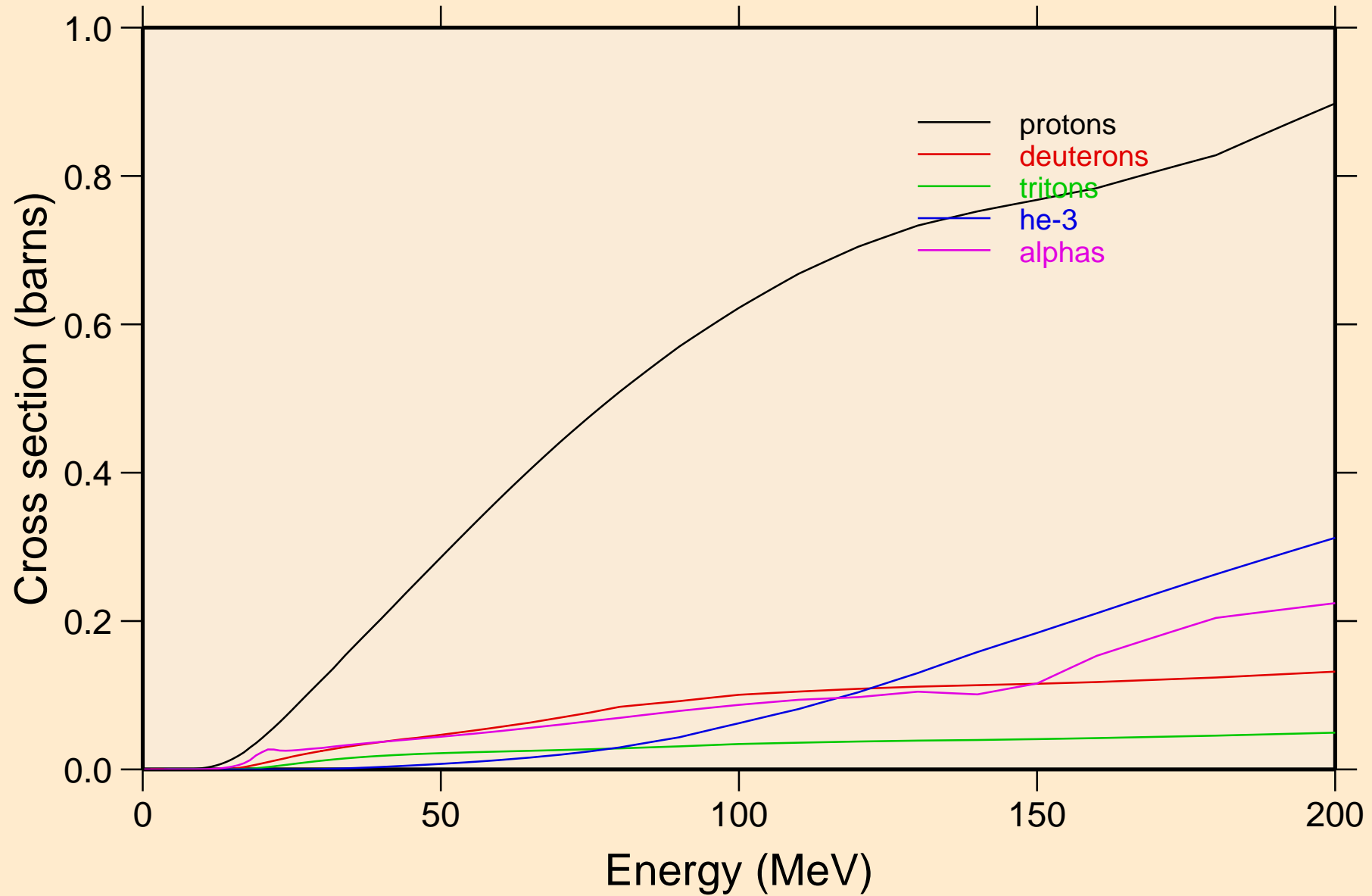

PT191 NEUTRON ACER TENDL-2021 LIBRARY; T=293.6K  
protons from (n,x)

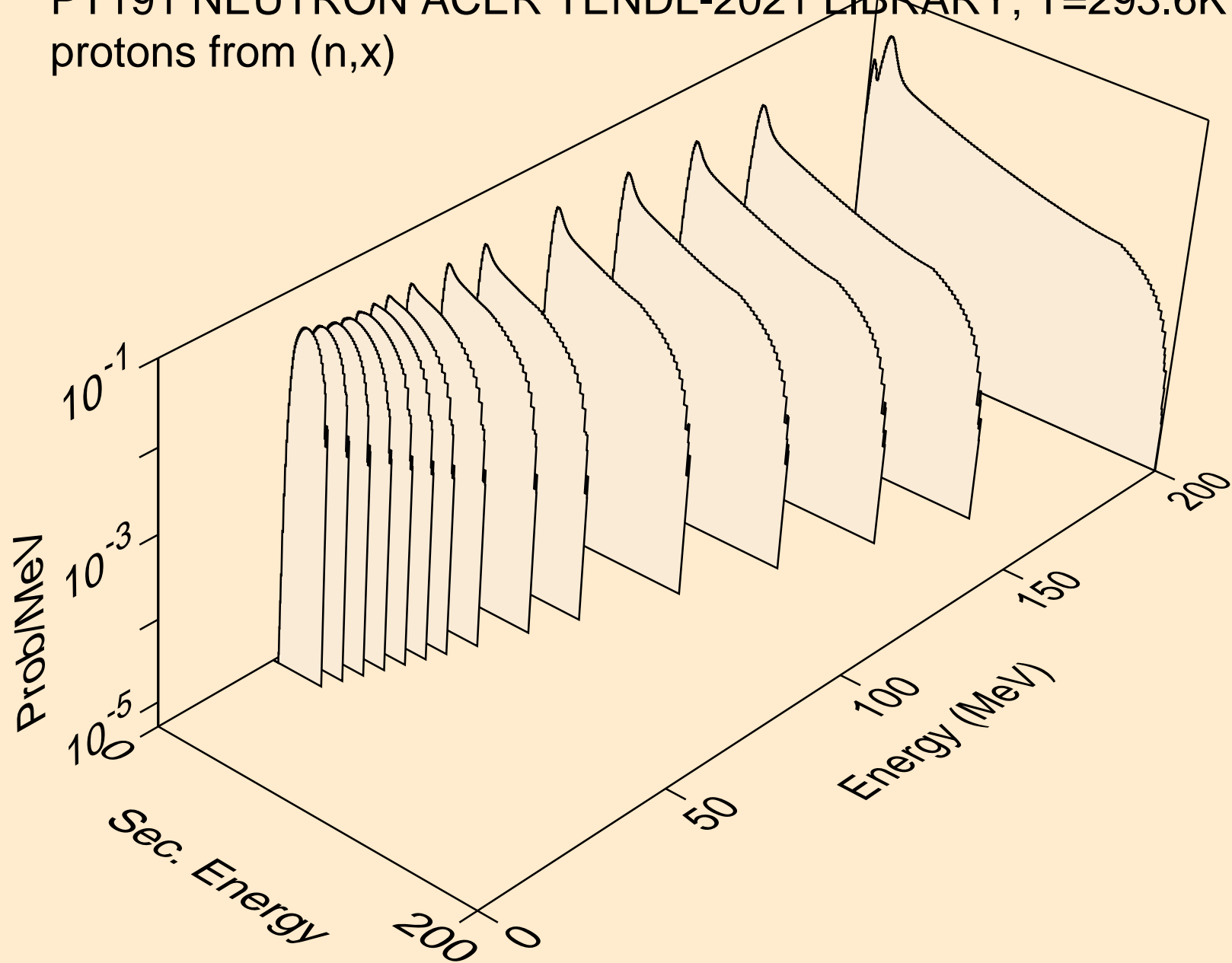

PT191 NEUTRON ACER TENDL-2021 LIBRARY; T=293.6K  
protons from (n,n\*)p

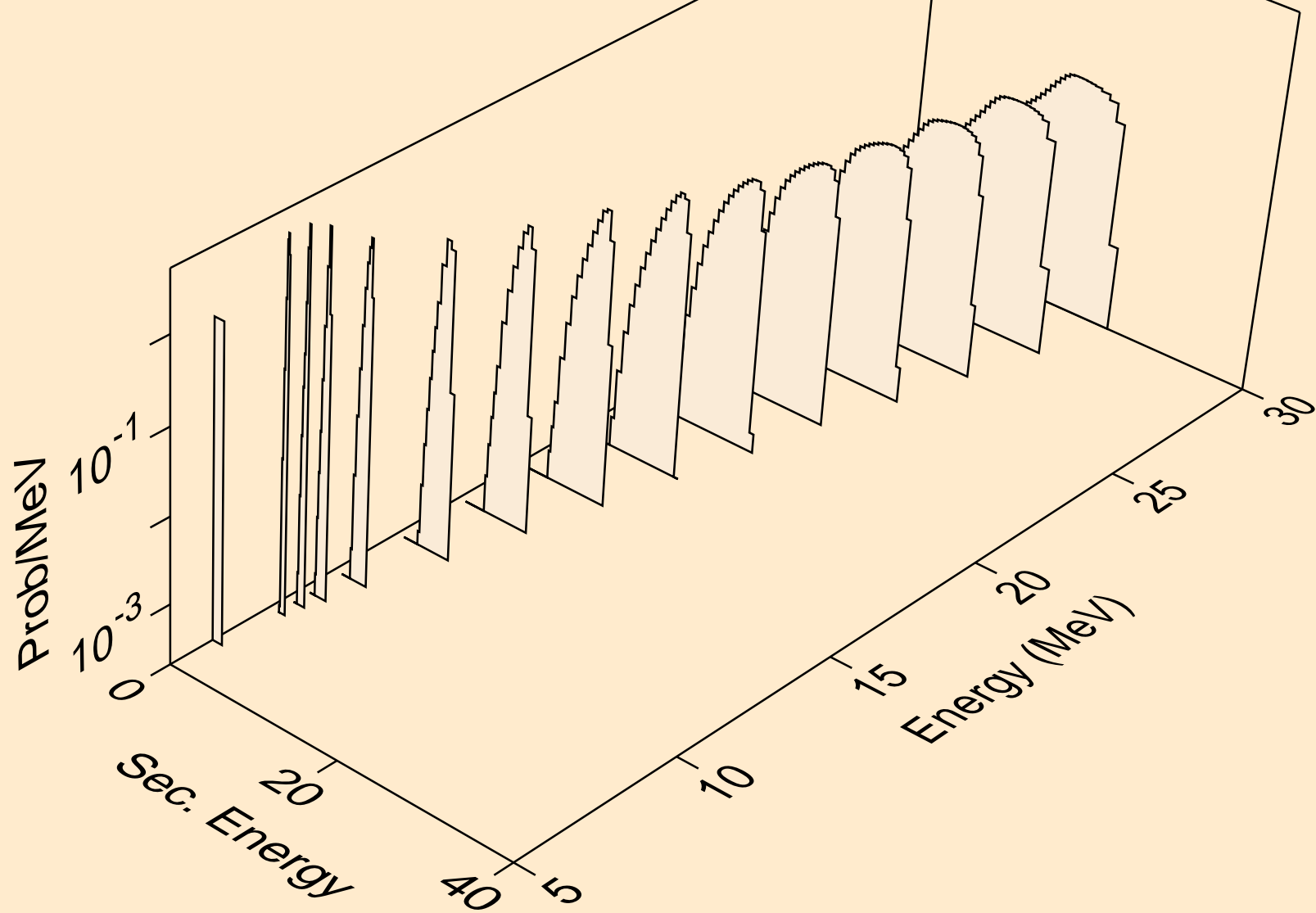

PT191 NEUTRON ACER TENDL-2021 LIBRARY; T=293.6K  
protons from (n,2np)

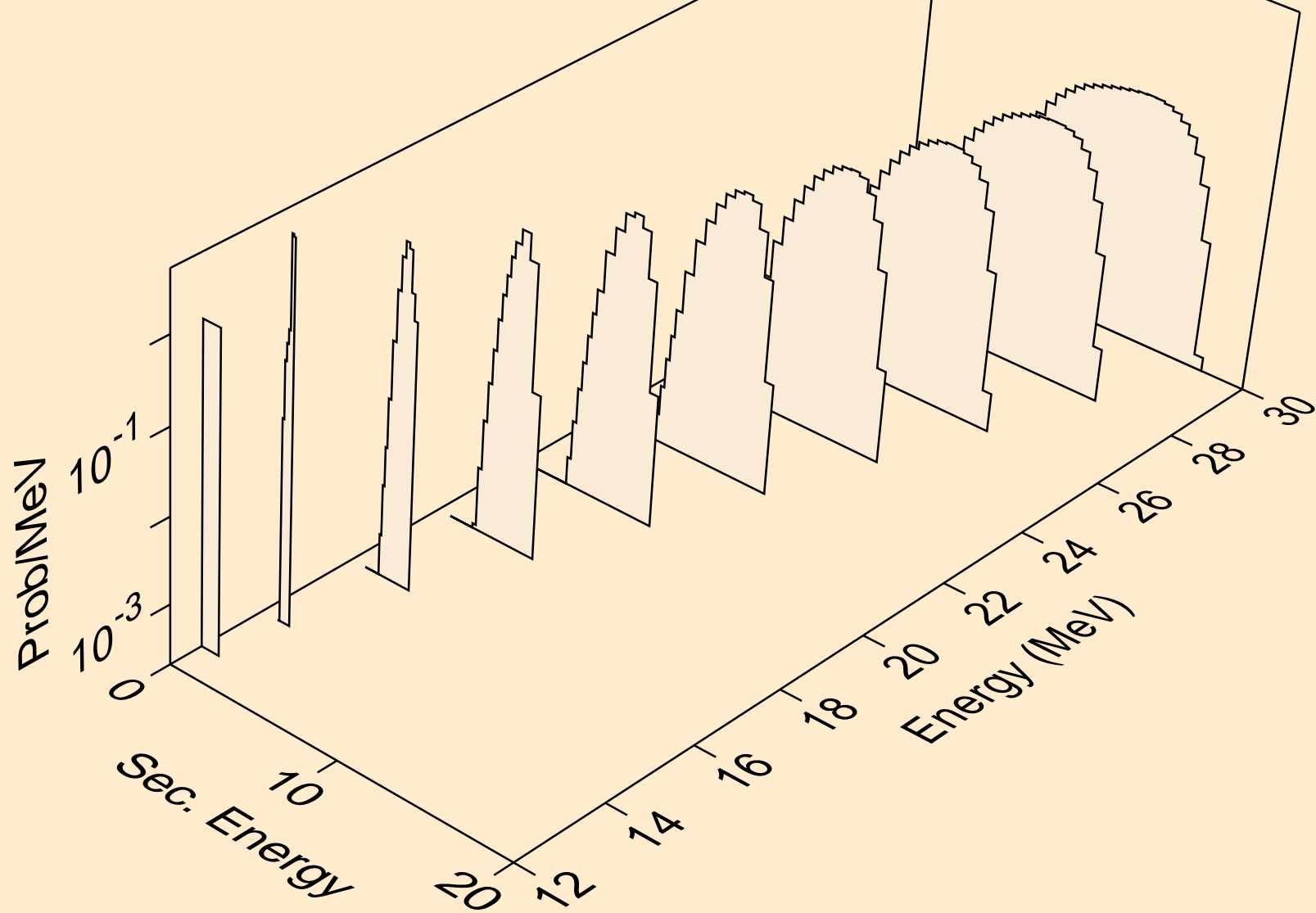

PT191 NEUTRON ACER TENDL-2021 LIBRARY; T=293.6K  
protons from (n,3np)

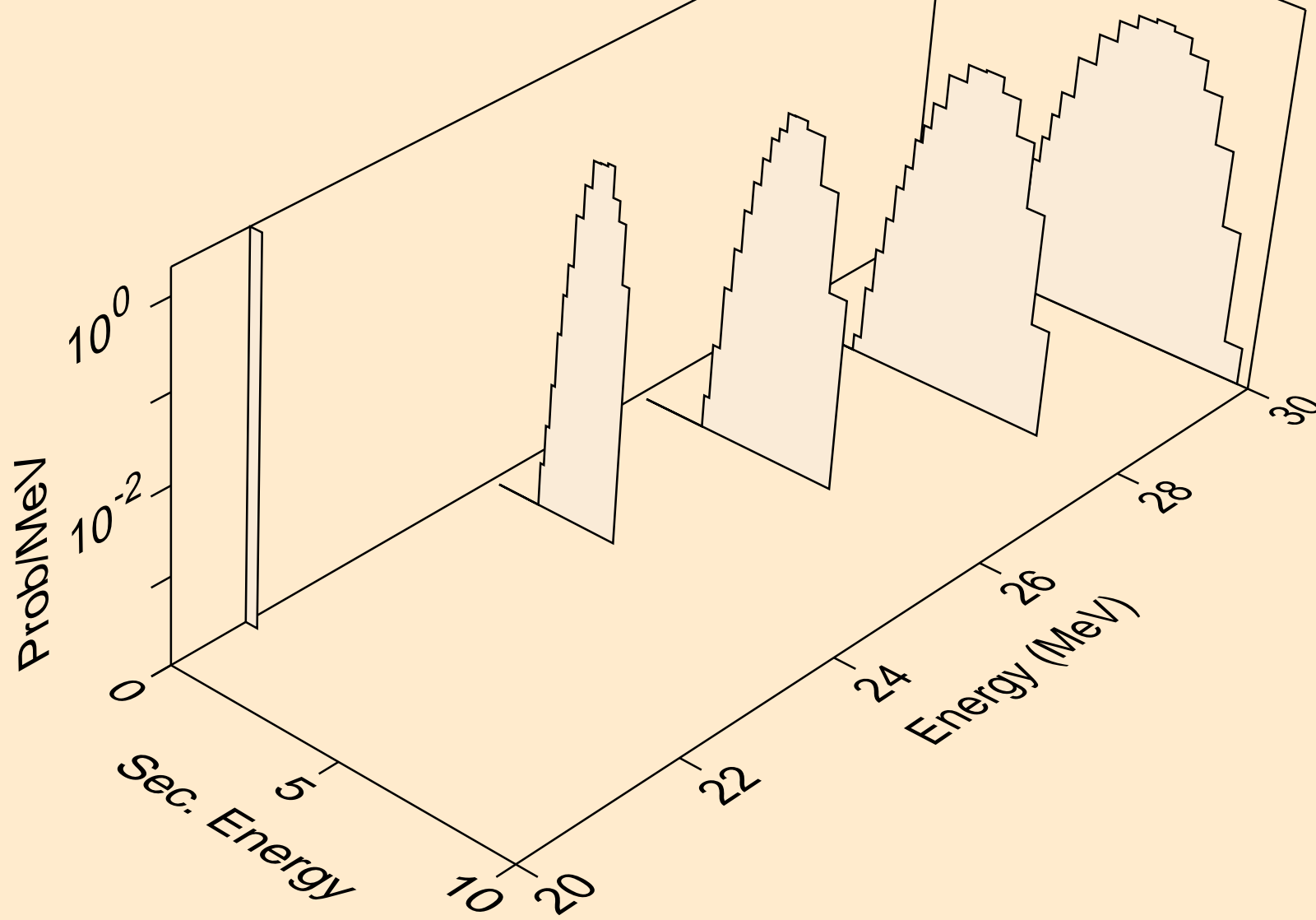

PT191 NEUTRON ACER TENDL-2021 LIBRARY; T=293.6K  
protons from (n,2np)

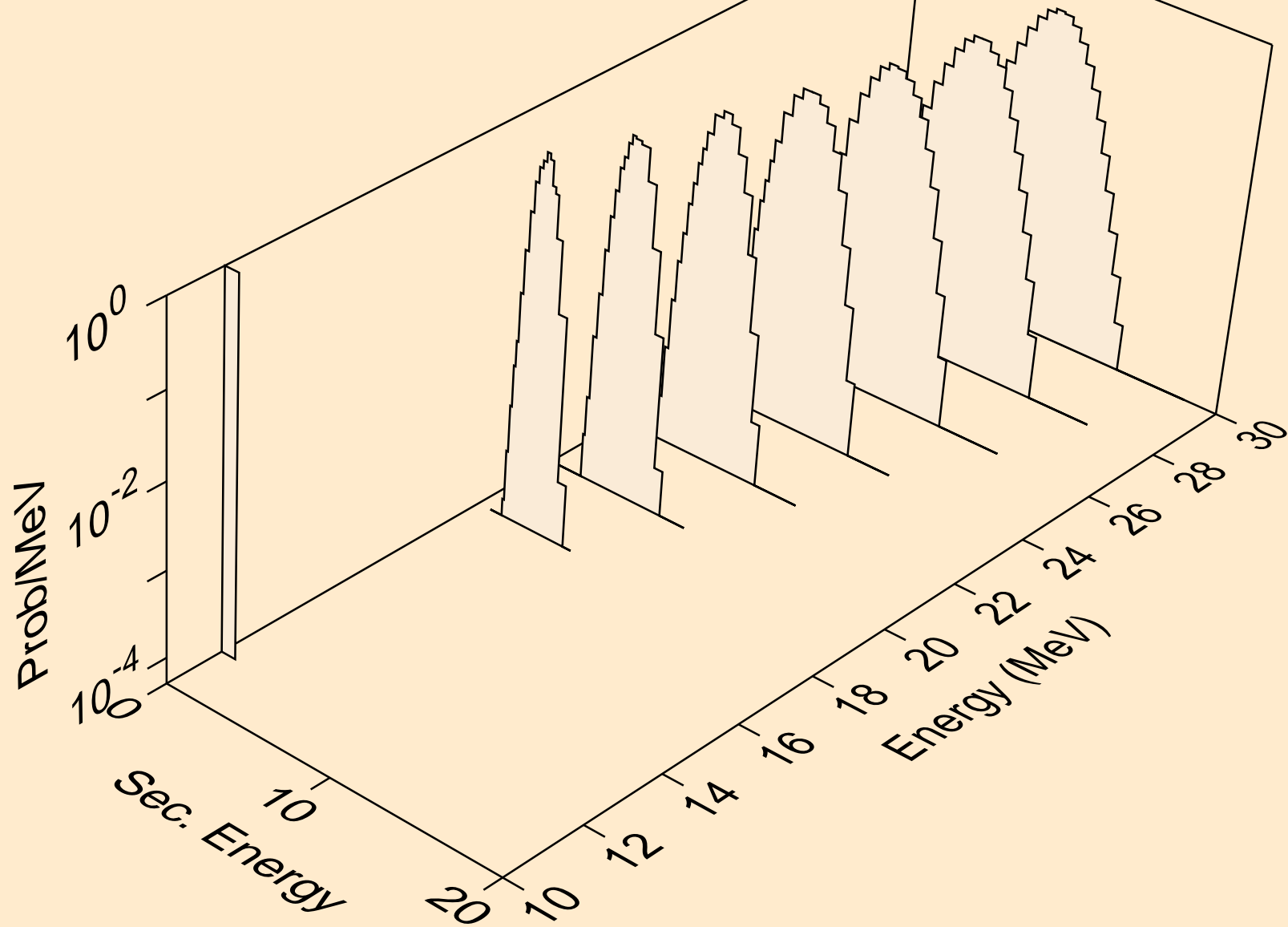

PT191 NEUTRON ACER TENDL-2021 LIBRARY; T=293.6K  
protons from (n,npa)

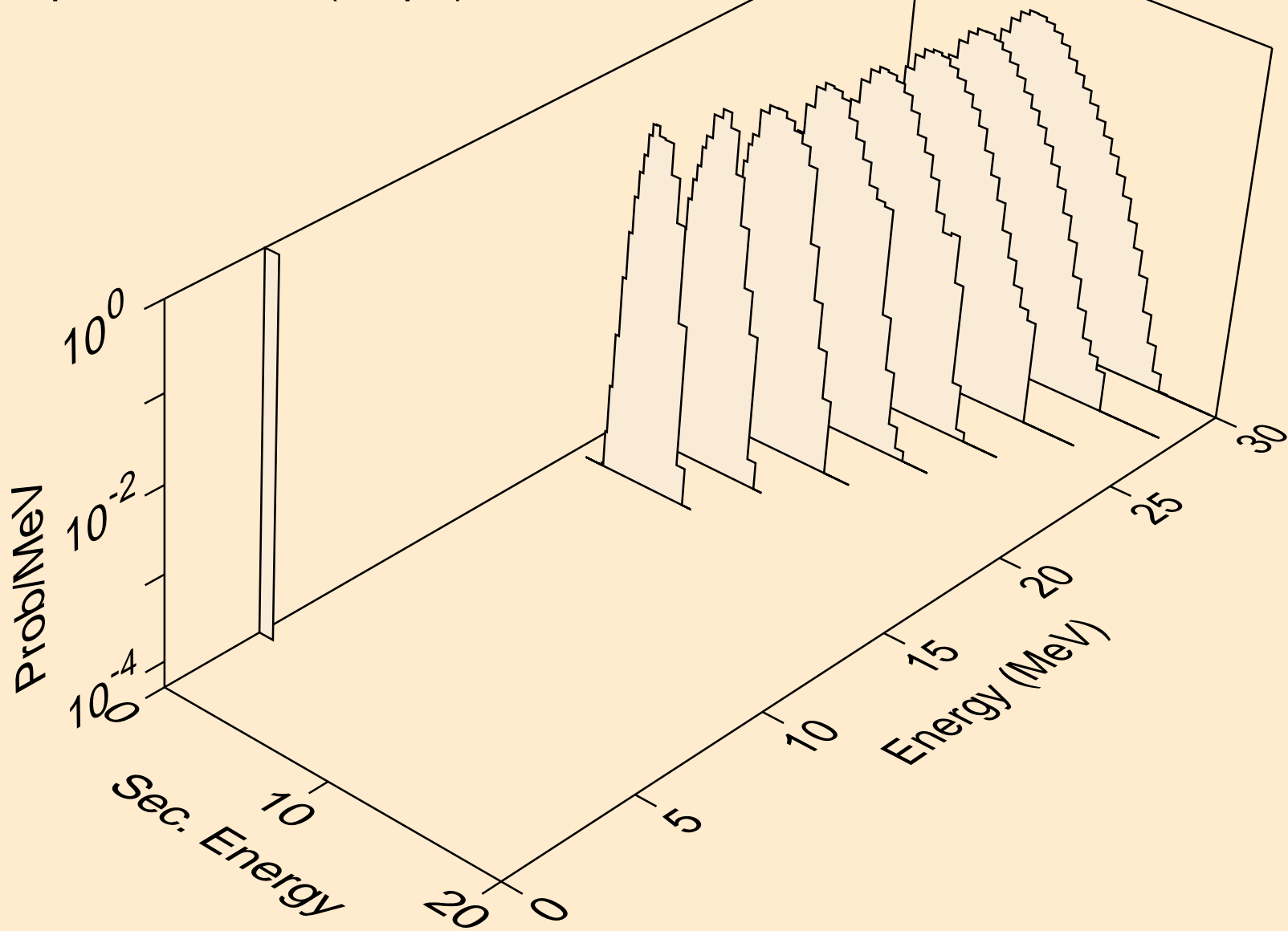



PT191 NEUTRON ACER TENDL-2021 LIBRARY; T=293.6K  
protons from (n,p)

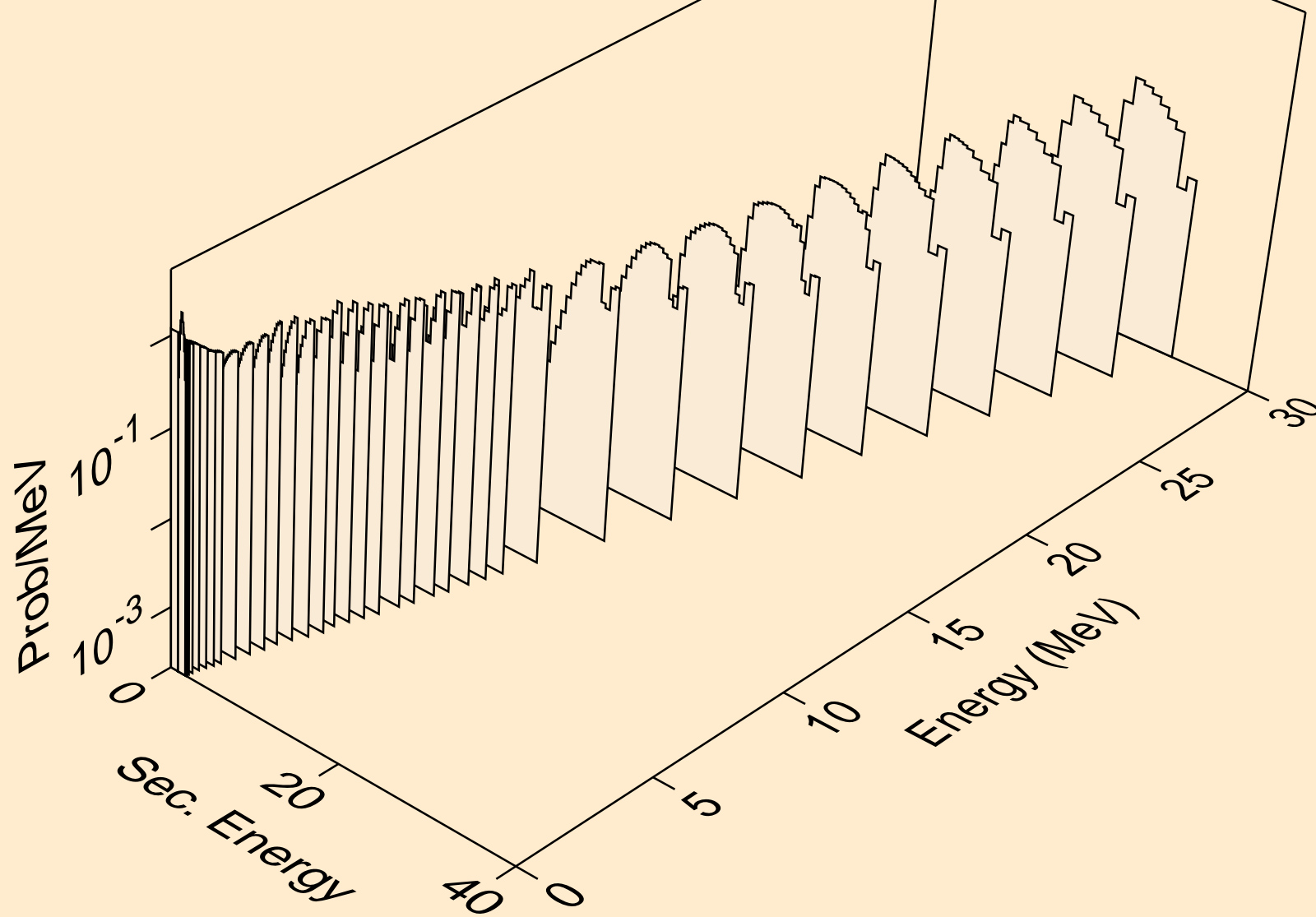

PT191 NEUTRON ACER TENDL-2021 LIBRARY; T=293.6K  
protons from (n,2p)

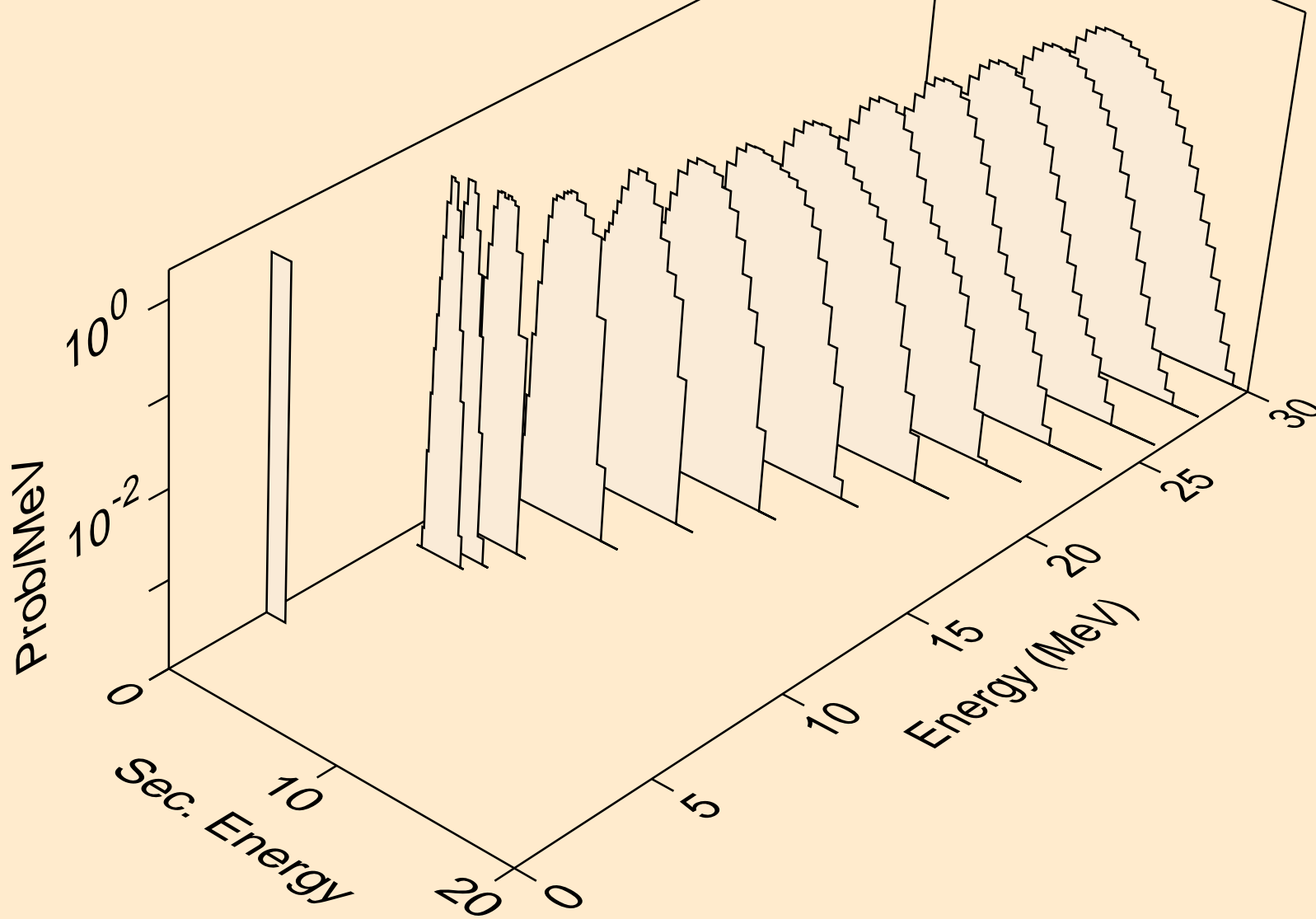

PT191 NEUTRON ACER TENDL-2021 LIBRARY; T=293.6K  
protons from (n,p)

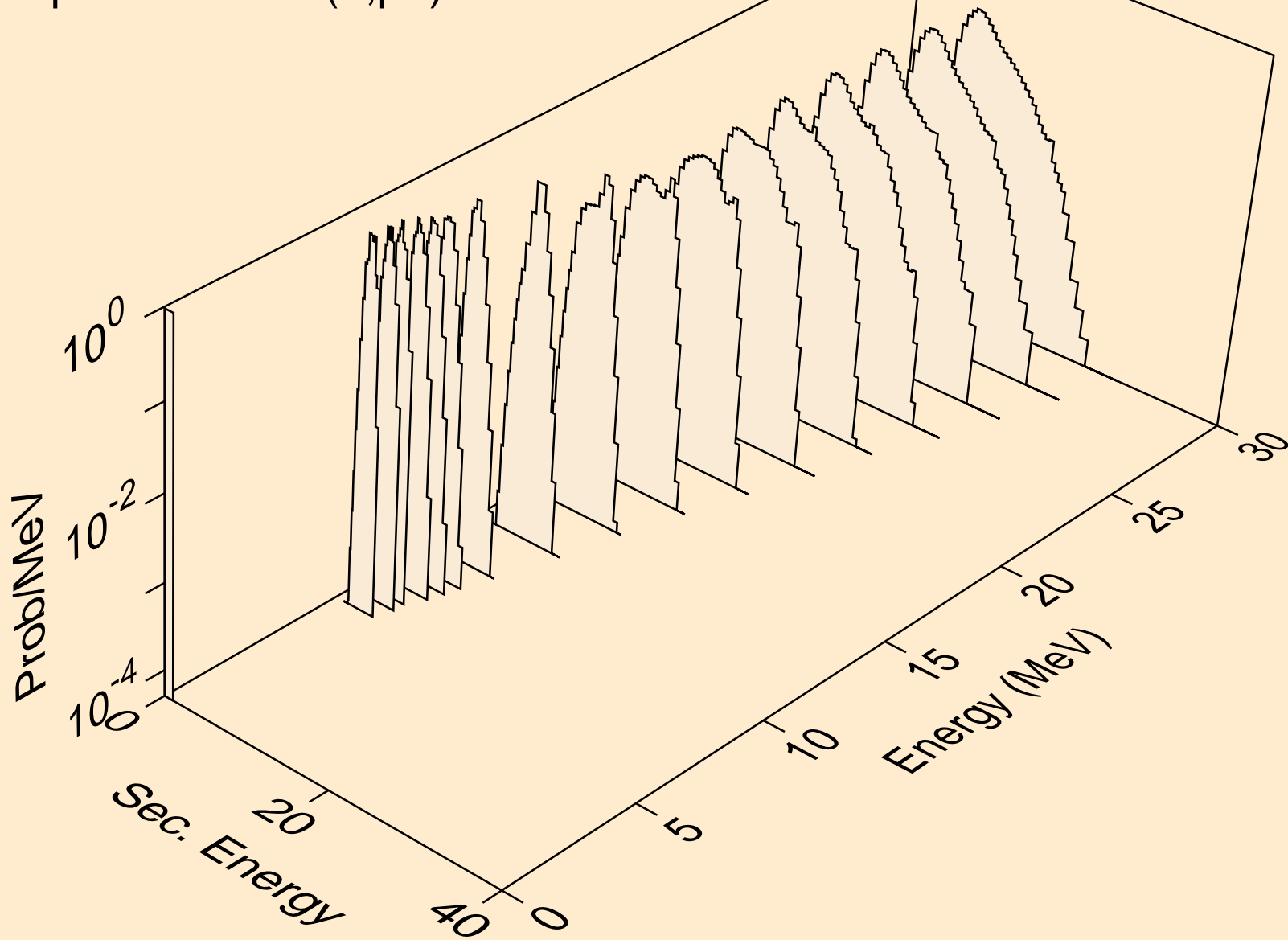

PT191 NEUTRON ACER TENDL-2021 LIBRARY; T=293.6K  
protons from (n,pd)

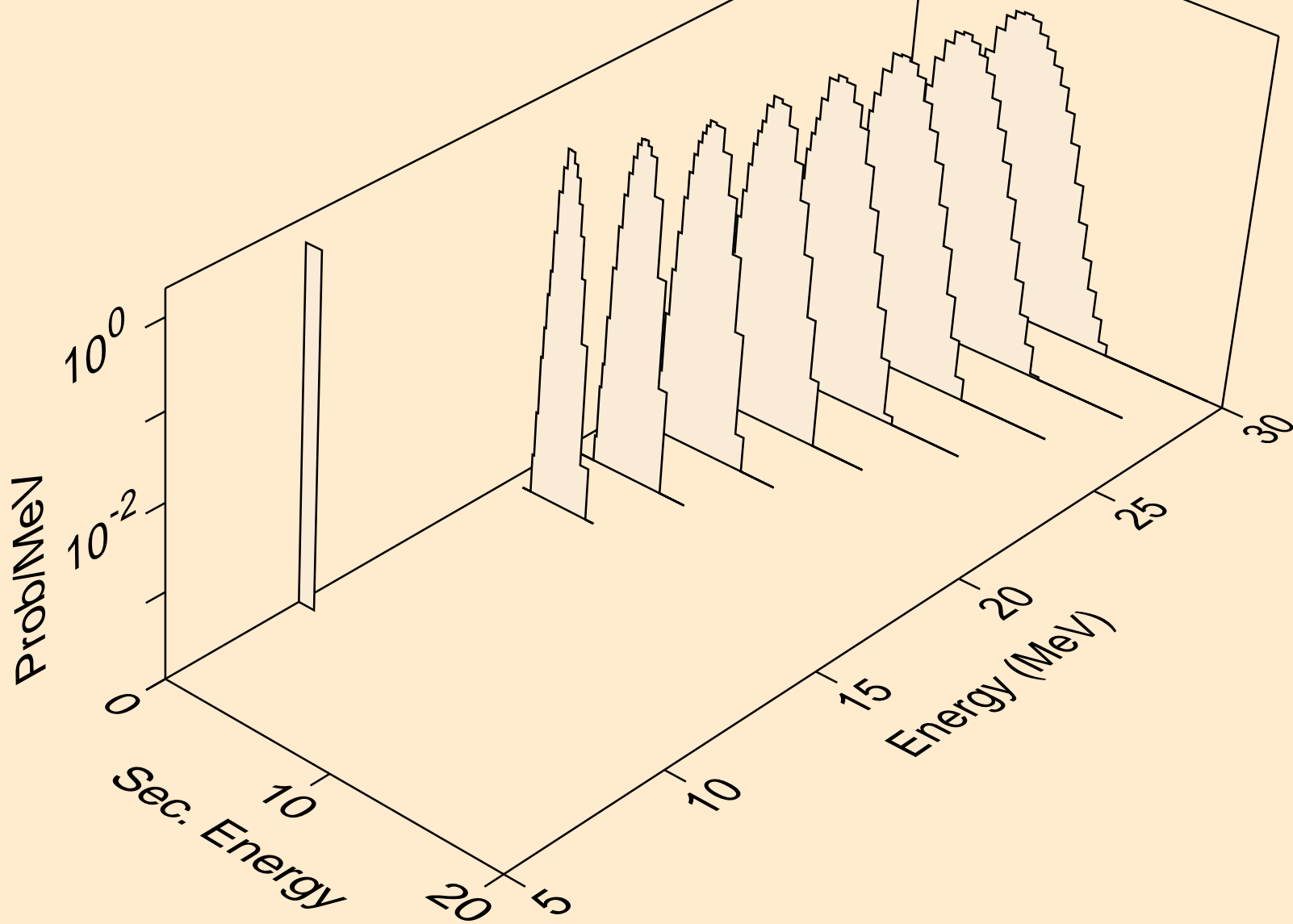

PT191 NEUTRON ACER TENDL-2021 LIBRARY; T=293.6K  
protons from (n,pt)

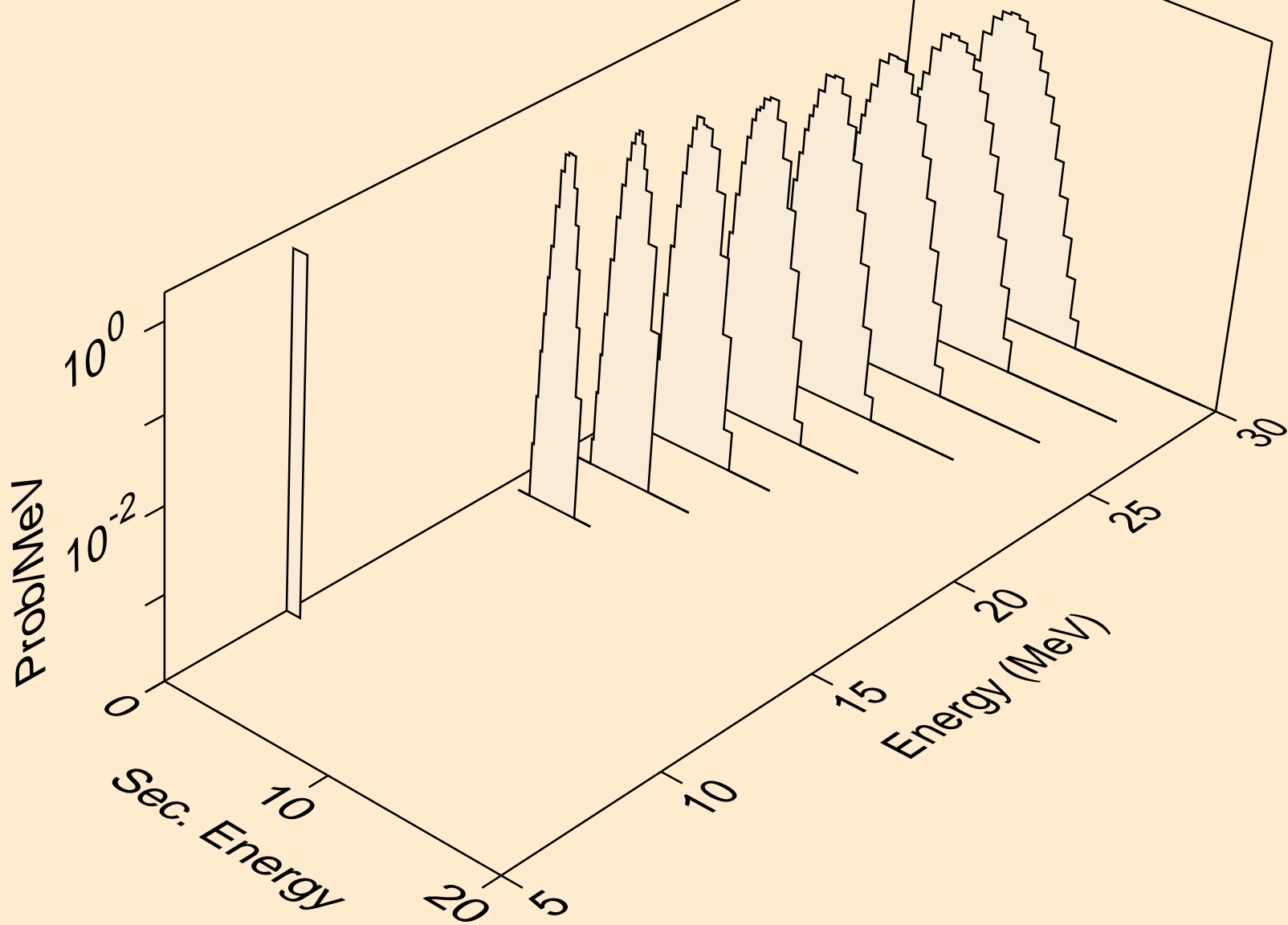

PT191 NEUTRON ACER TENDL-2021 LIBRARY; T=293.6K  
deuterons from (n,x)

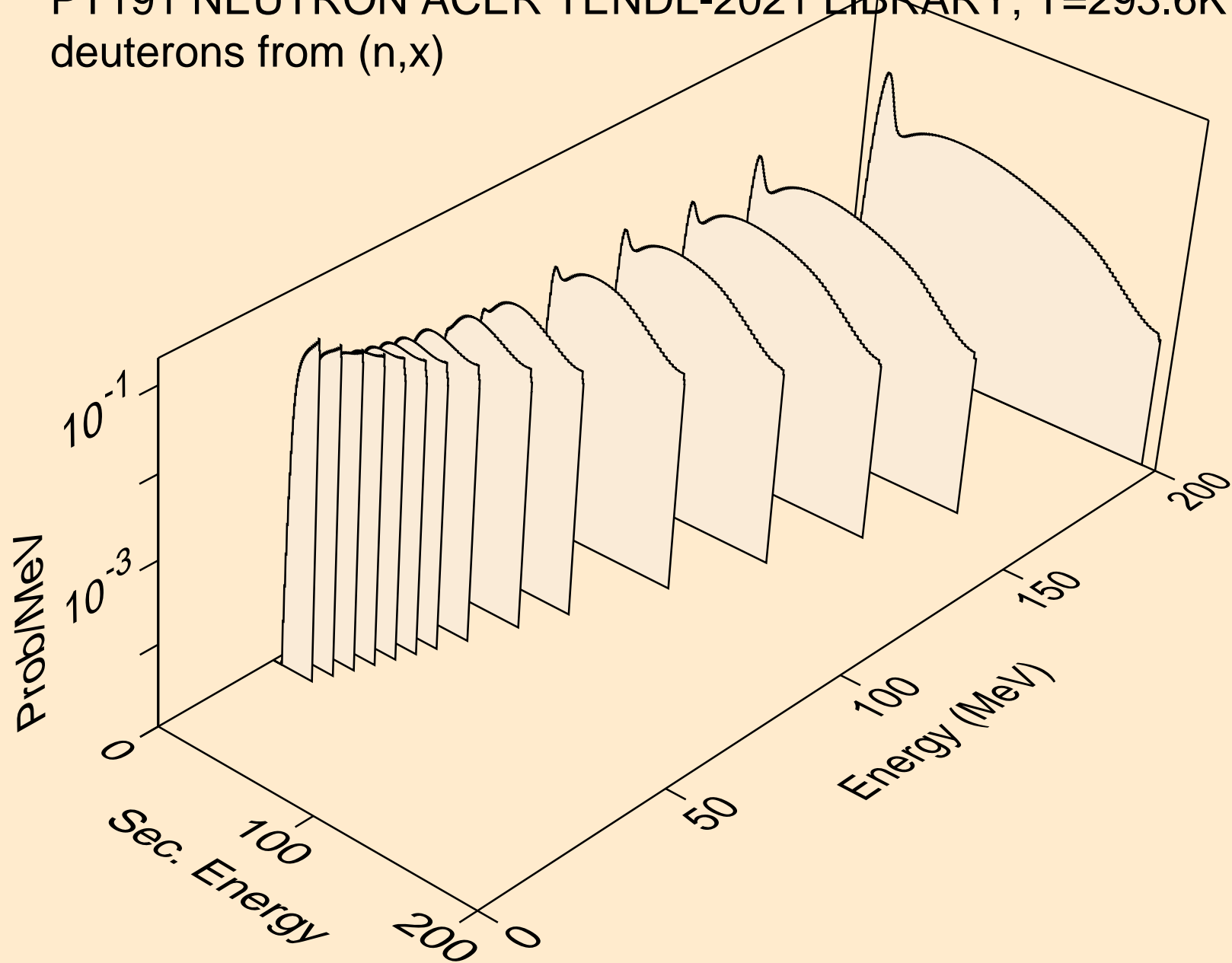

PT191 NEUTRON ACER TENDL-2021 LIBRARY; T=293.6K  
deuterons from (n,2nd)

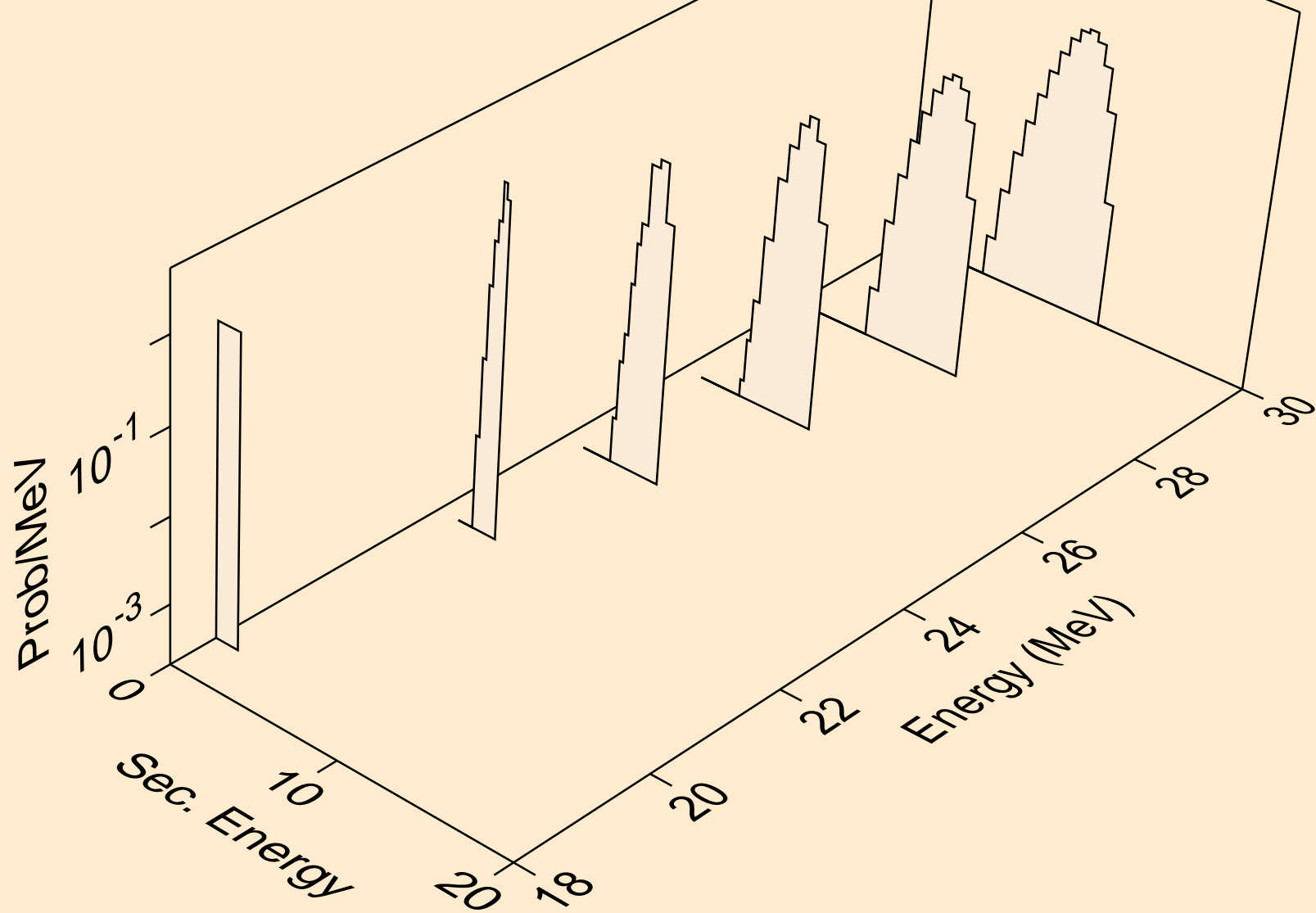

PT191 NEUTRON ACER TENDL-2021 LIBRARY; T=293.6K  
deuterons from (n,n\*)d

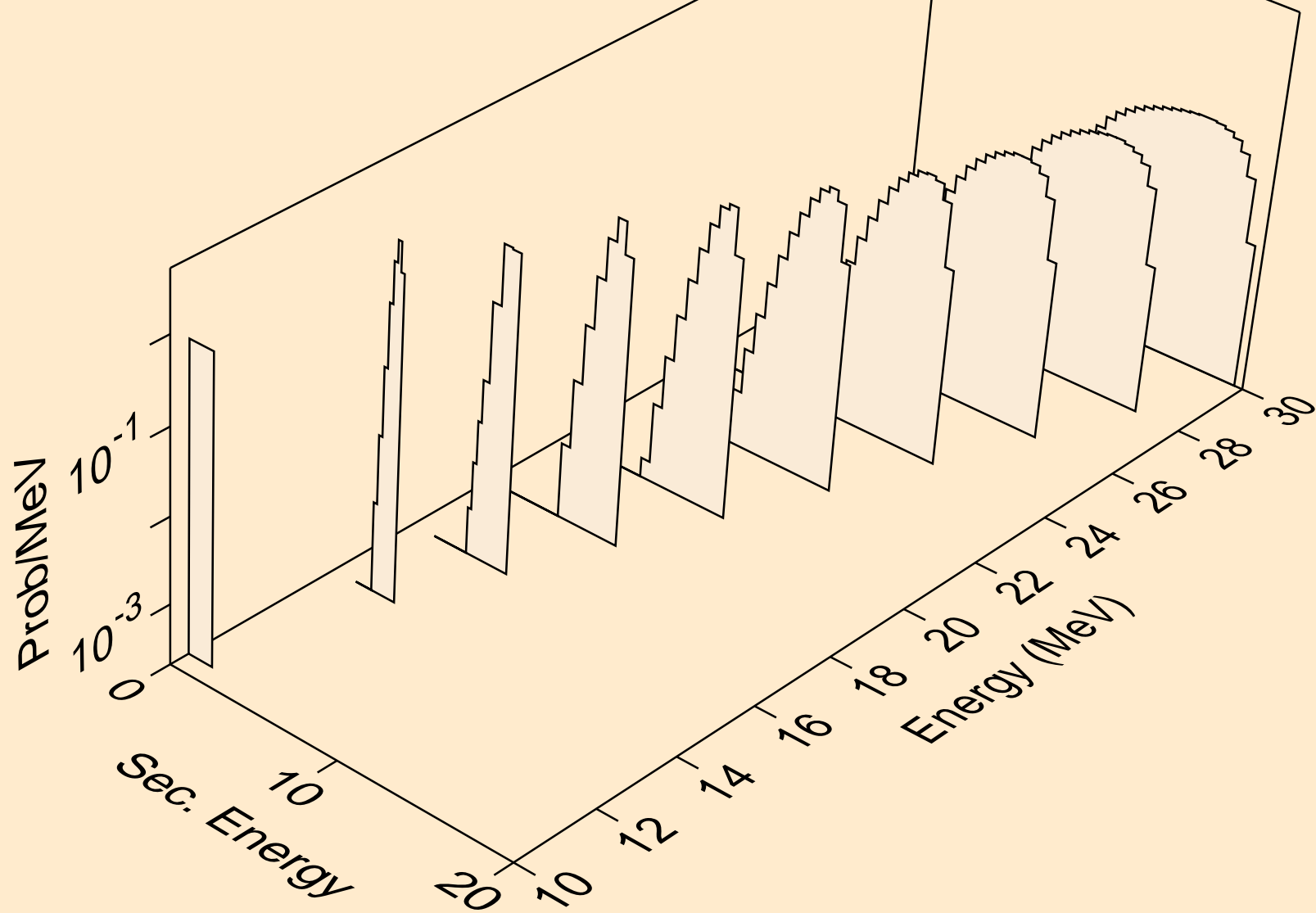



PT191 NEUTRON ACER TENDL-2021 LIBRARY; T=293.6K  
deuterons from (n,d)

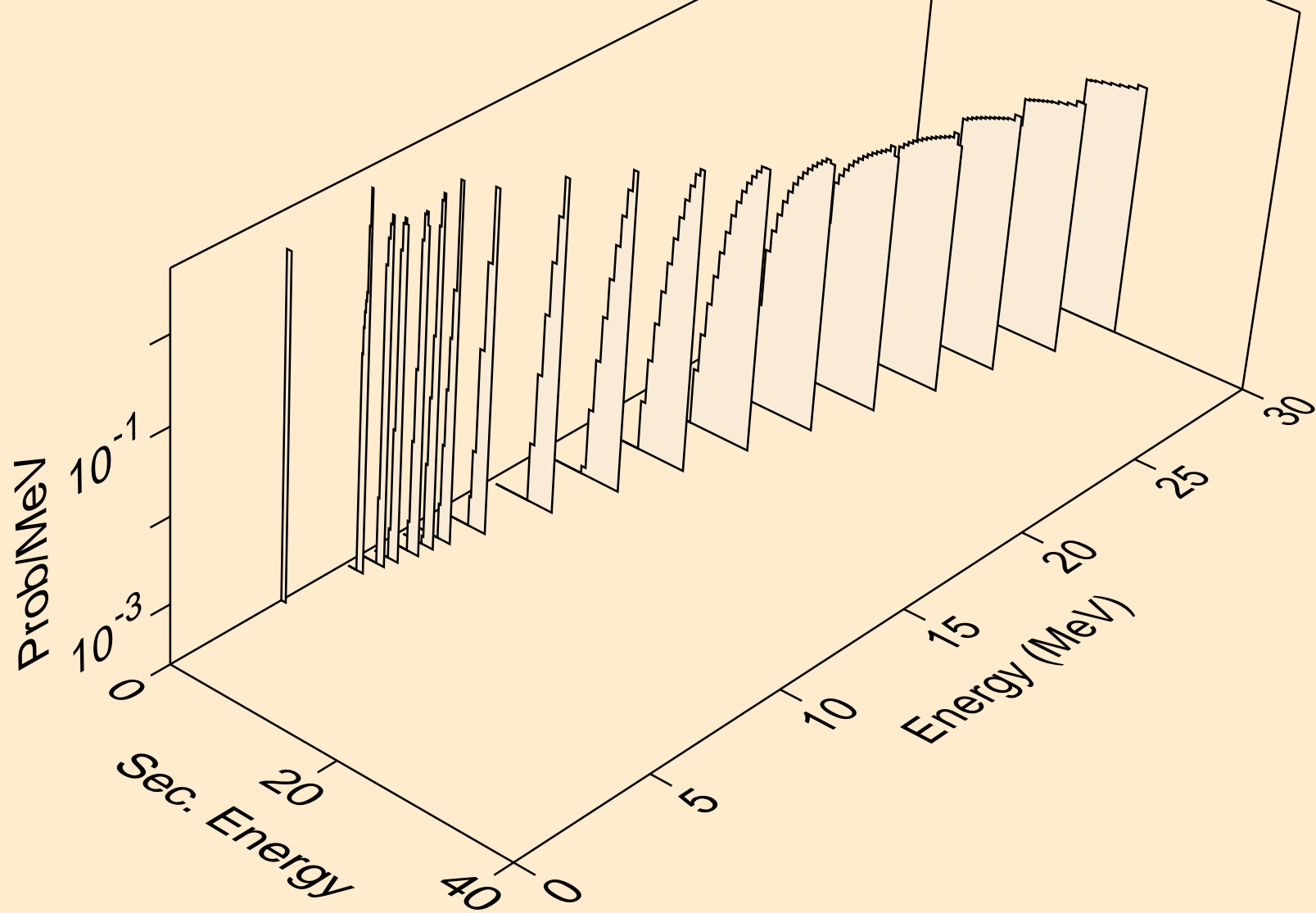

PT191 NEUTRON ACER TENDL-2021 LIBRARY; T=293.6K  
deuterons from (n,pd)

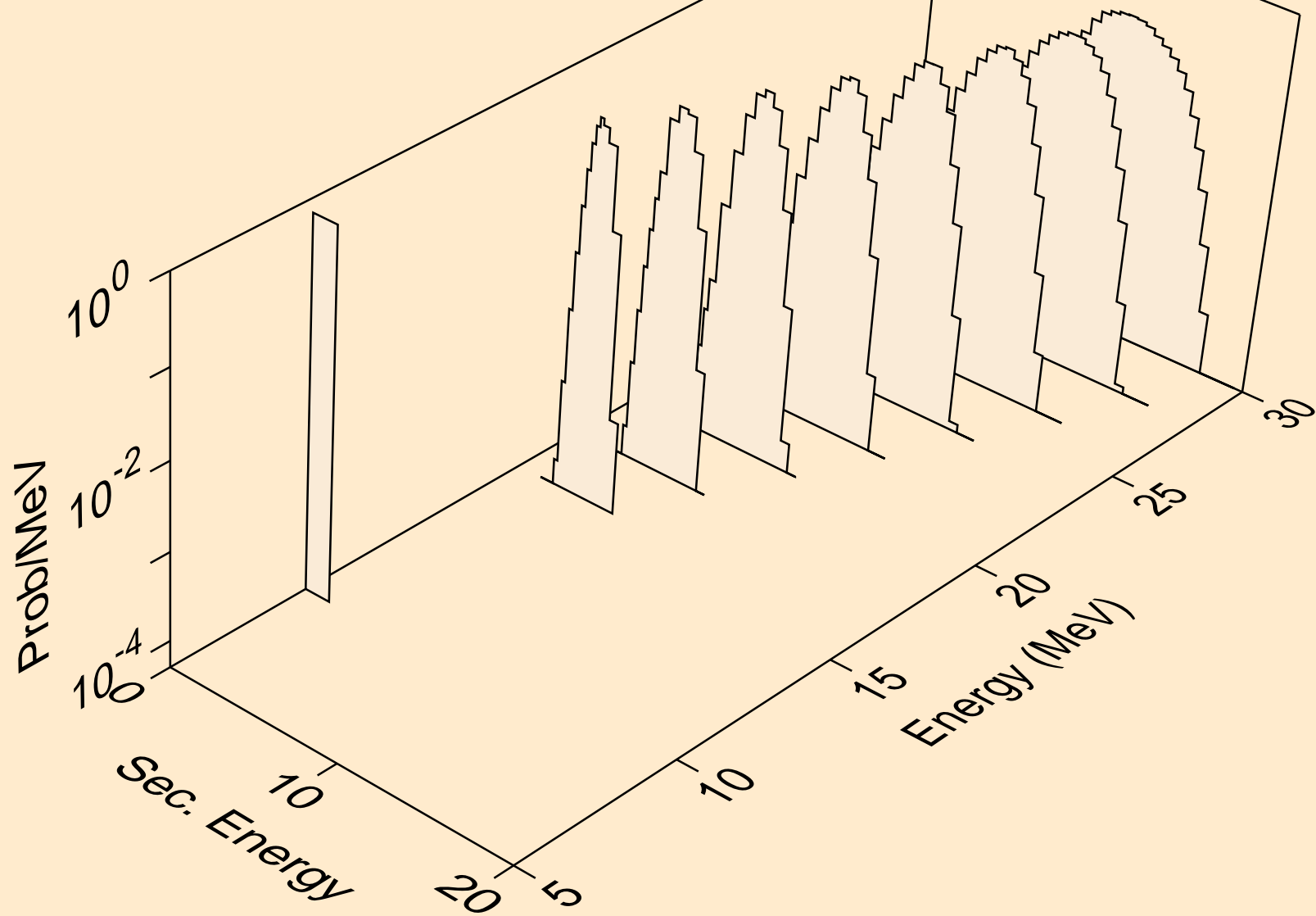

PT191 NEUTRON ACER TENDL-2021 LIBRARY; T=293.6K  
deuterons from (n,da)

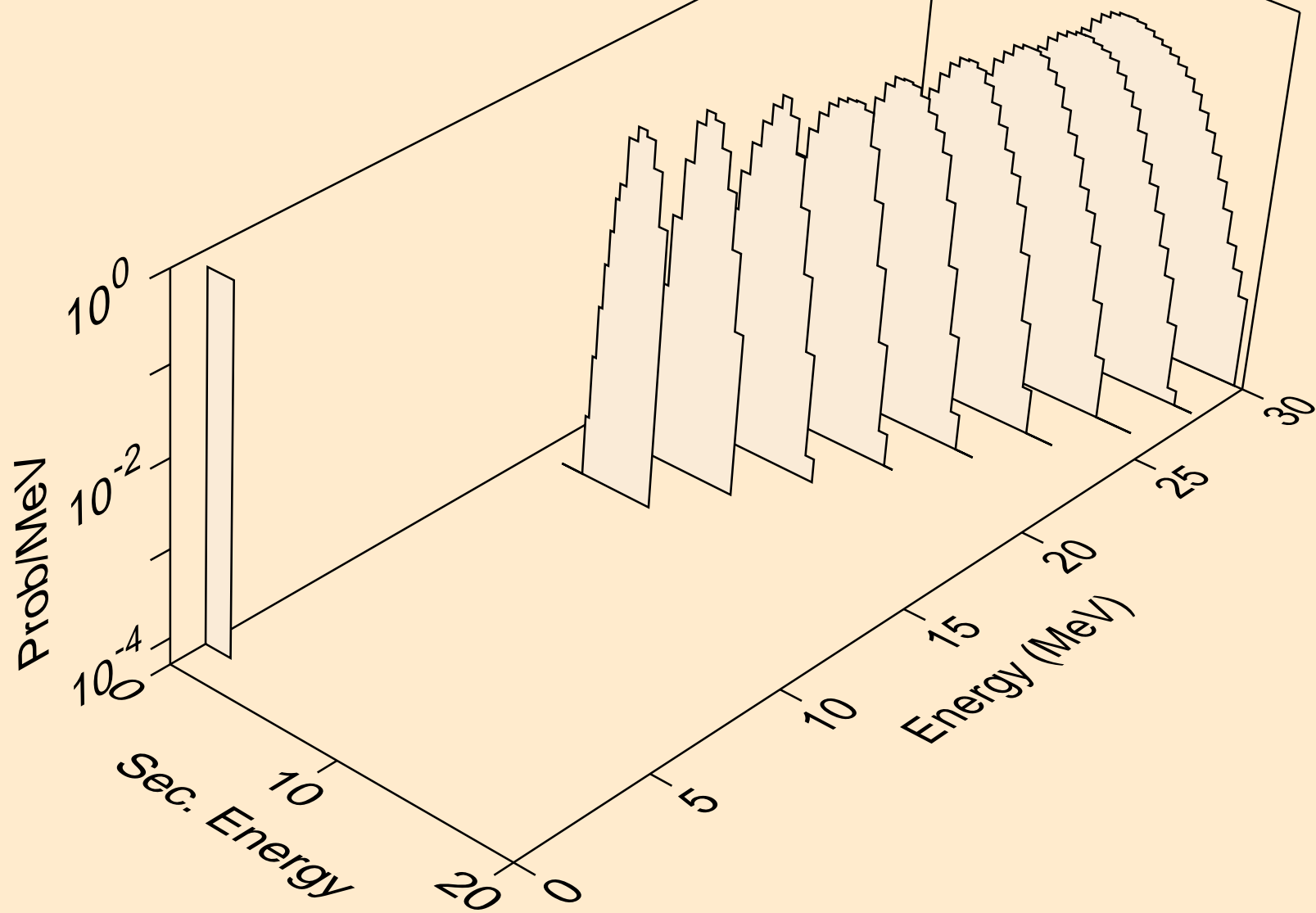

PT191 NEUTRON ACER TENDL-2021 LIBRARY; T=293.6K  
tritons from (n,x)

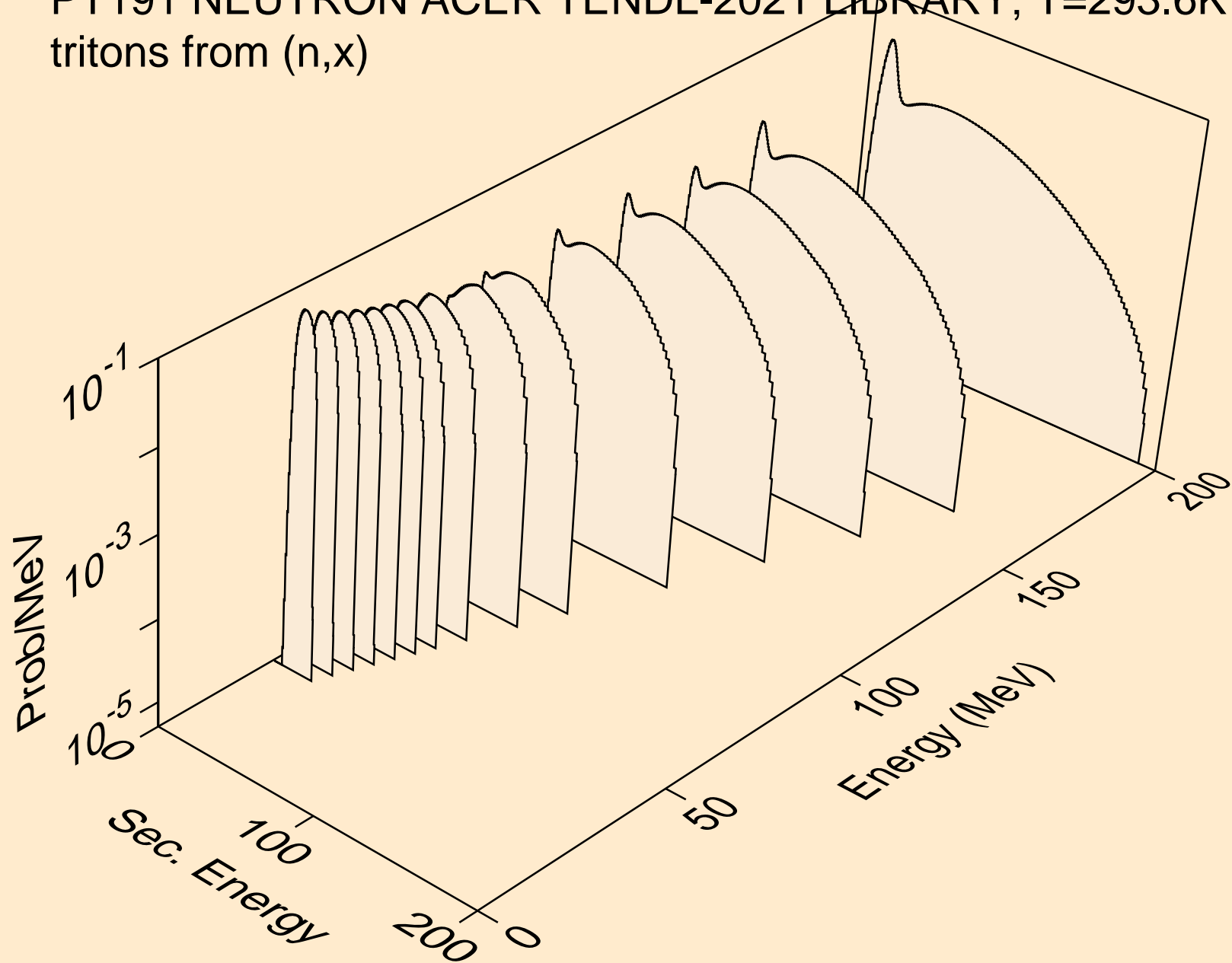

PT191 NEUTRON ACER TENDL-2021 LIBRARY; T=293.6K  
tritons from (n,n\*)t

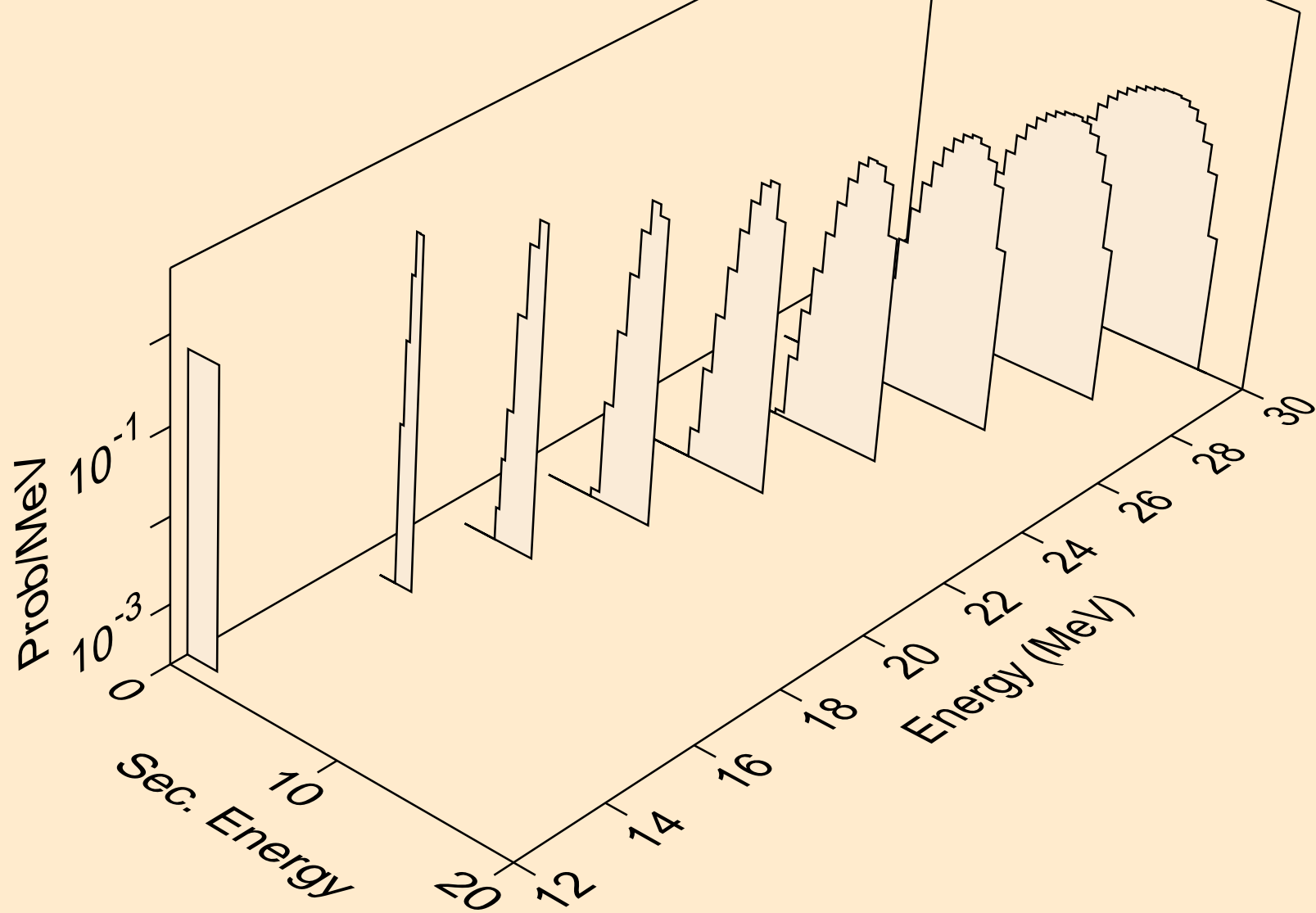

PT191 NEUTRON ACER TENDL-2021 LIBRARY; T=293.6K  
tritons from (n,t)

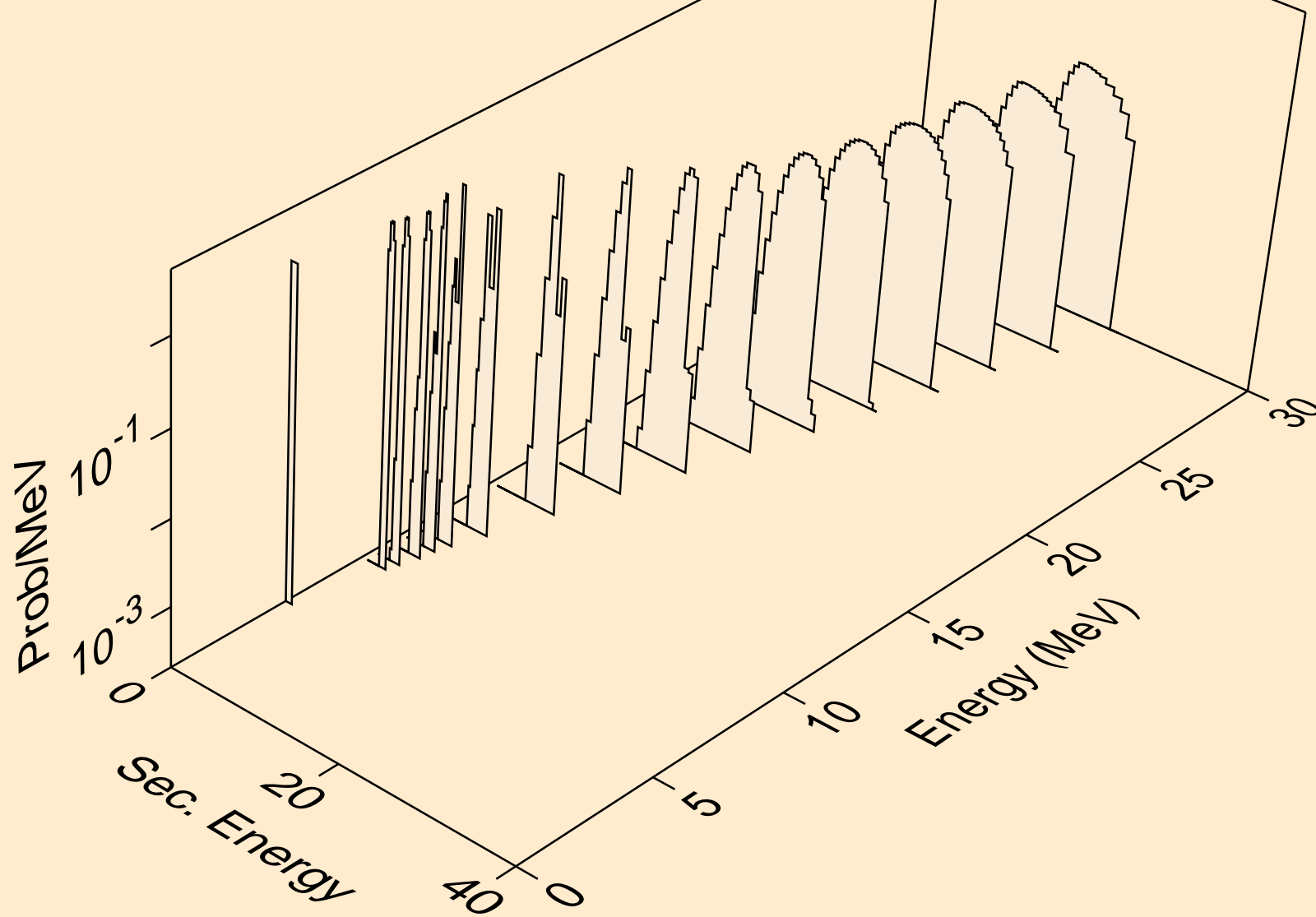

PT191 NEUTRON ACER TENDL-2021 LIBRARY; T=293.6K  
tritons from (n,pt)

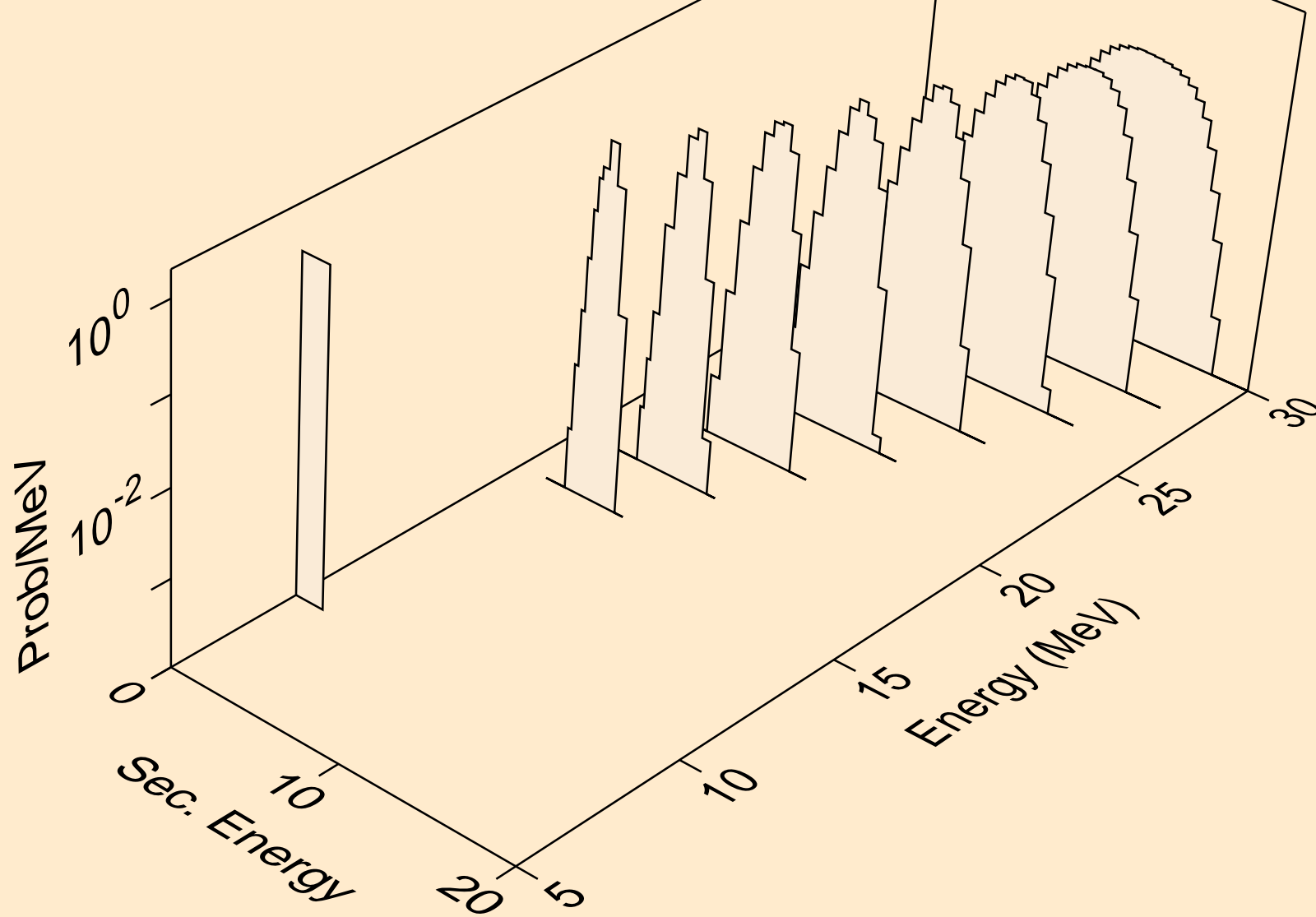

PT191 NEUTRON ACER TENDL-2021 LIBRARY; T=293.6K  
he3s from (n,x)

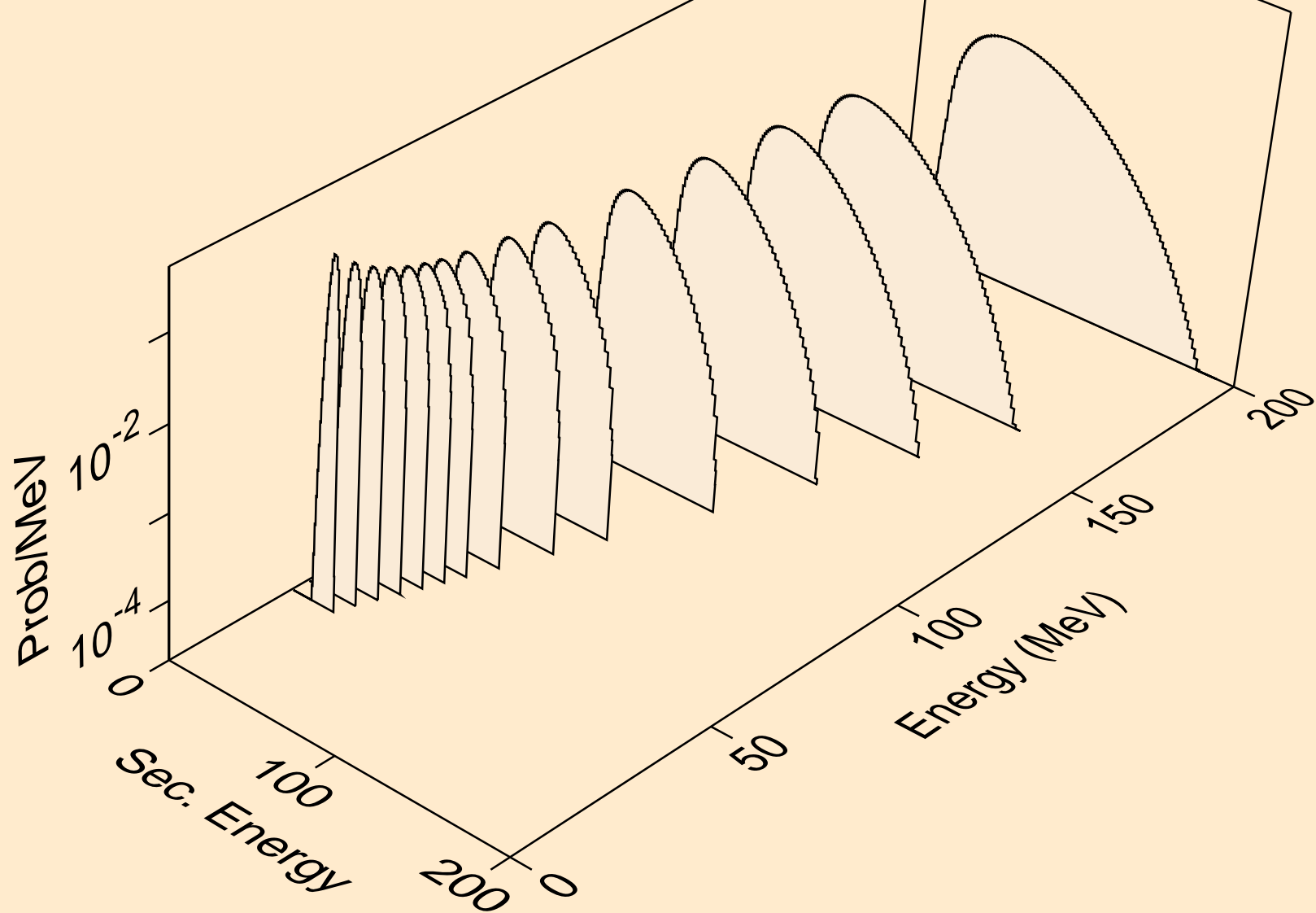



PT191 NEUTRON ACER TENDL-2021 LIBRARY; T=293.6K  
he3s from (n,n\*)he3

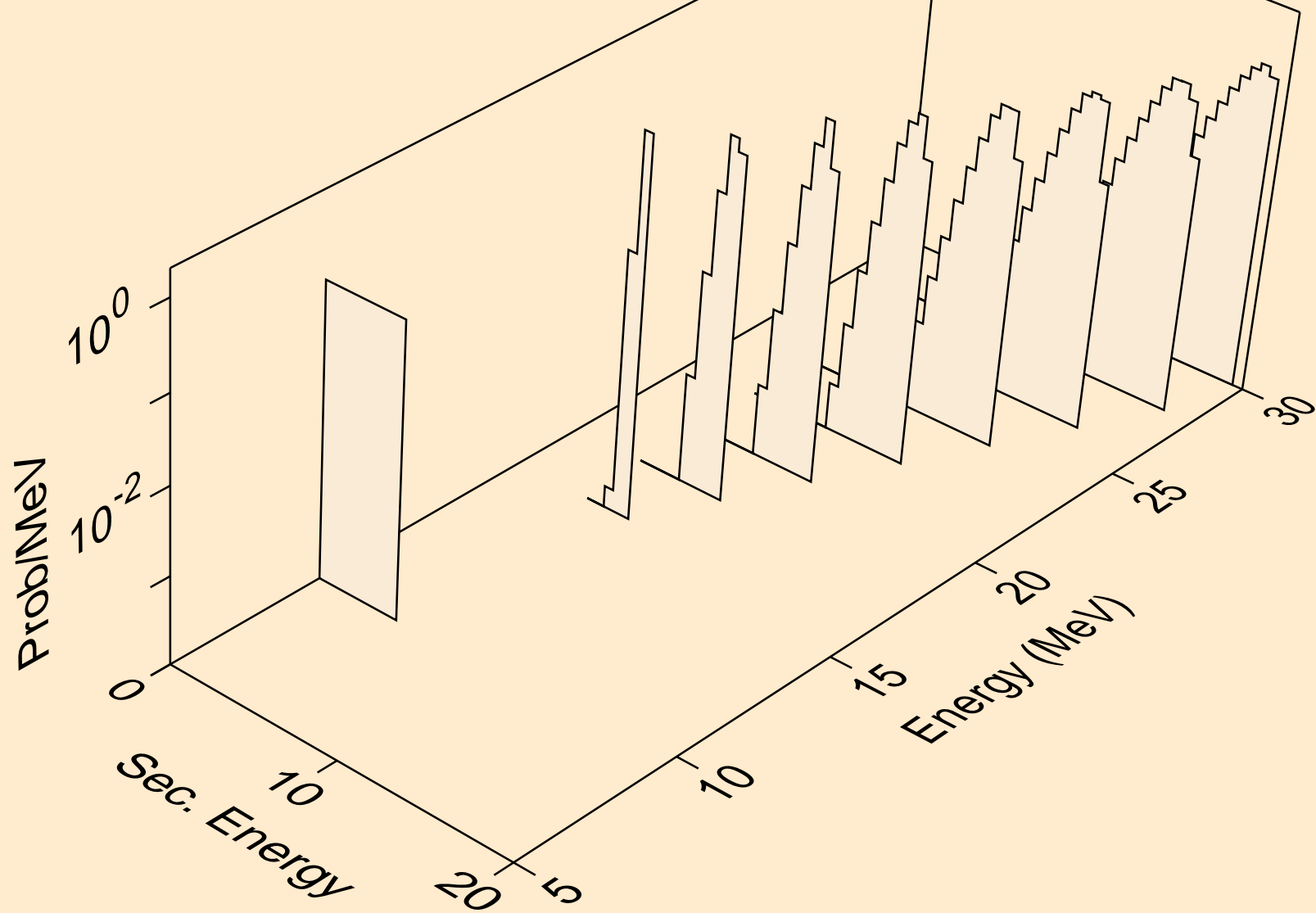

PT191 NEUTRON ACER TENDL-2021 LIBRARY; T=293.6K  
he3s from (n,he3)

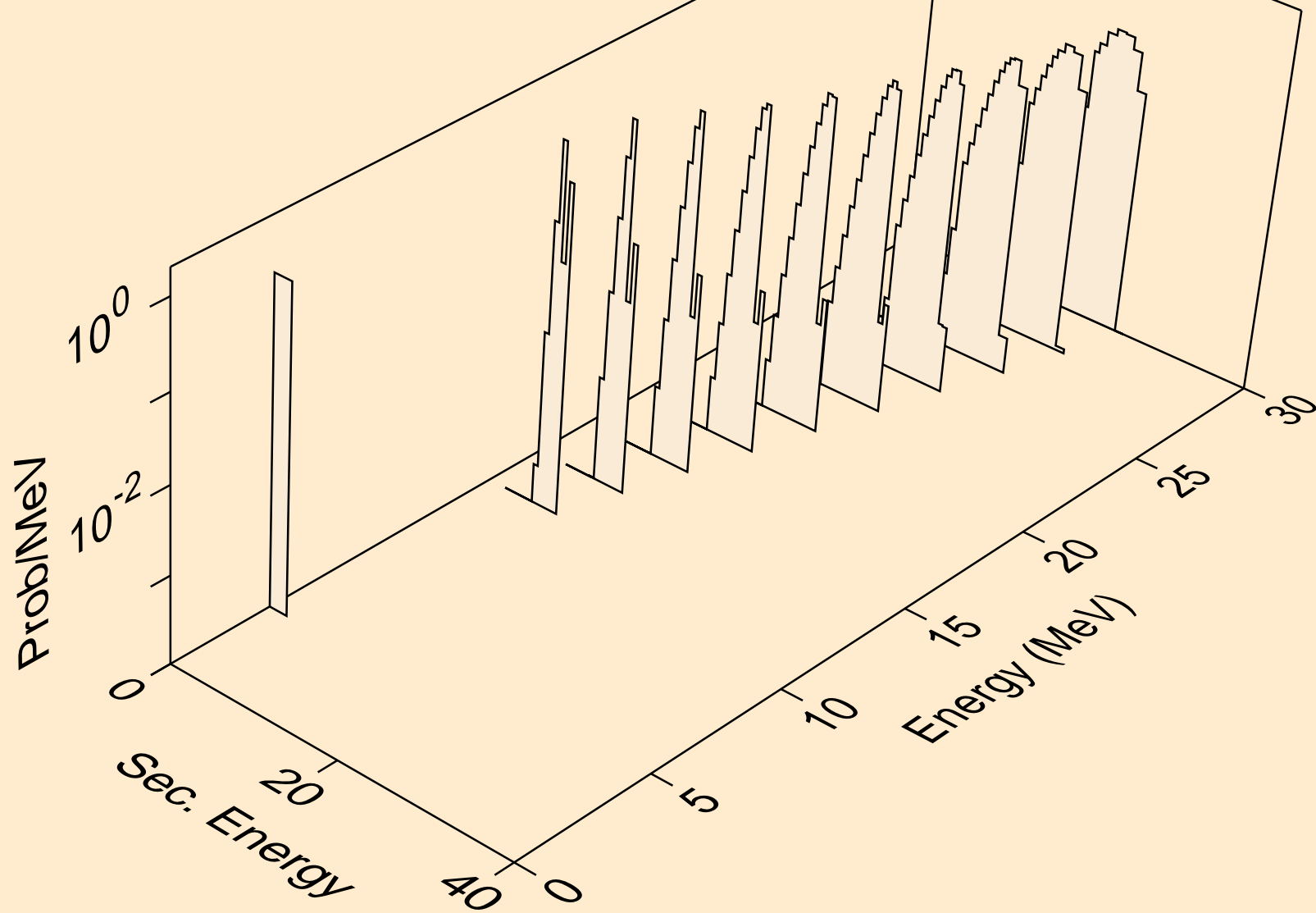

PT191 NEUTRON ACER TENDL-2021 LIBRARY; T=293.6K  
alphas from (n,x)

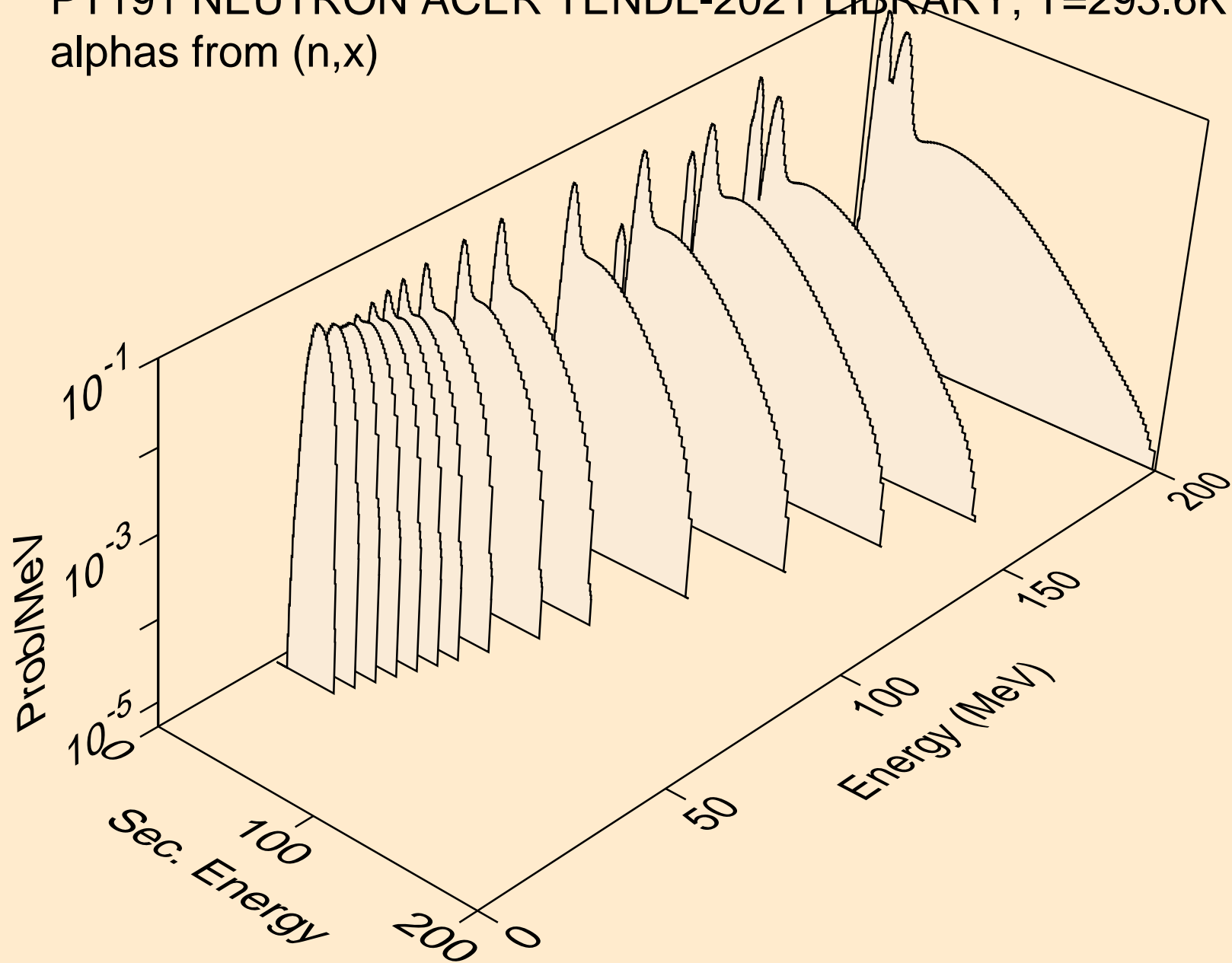

PT191 NEUTRON ACER TENDL-2021 LIBRARY; T=293.6K  
alphas from (n,n\*)a

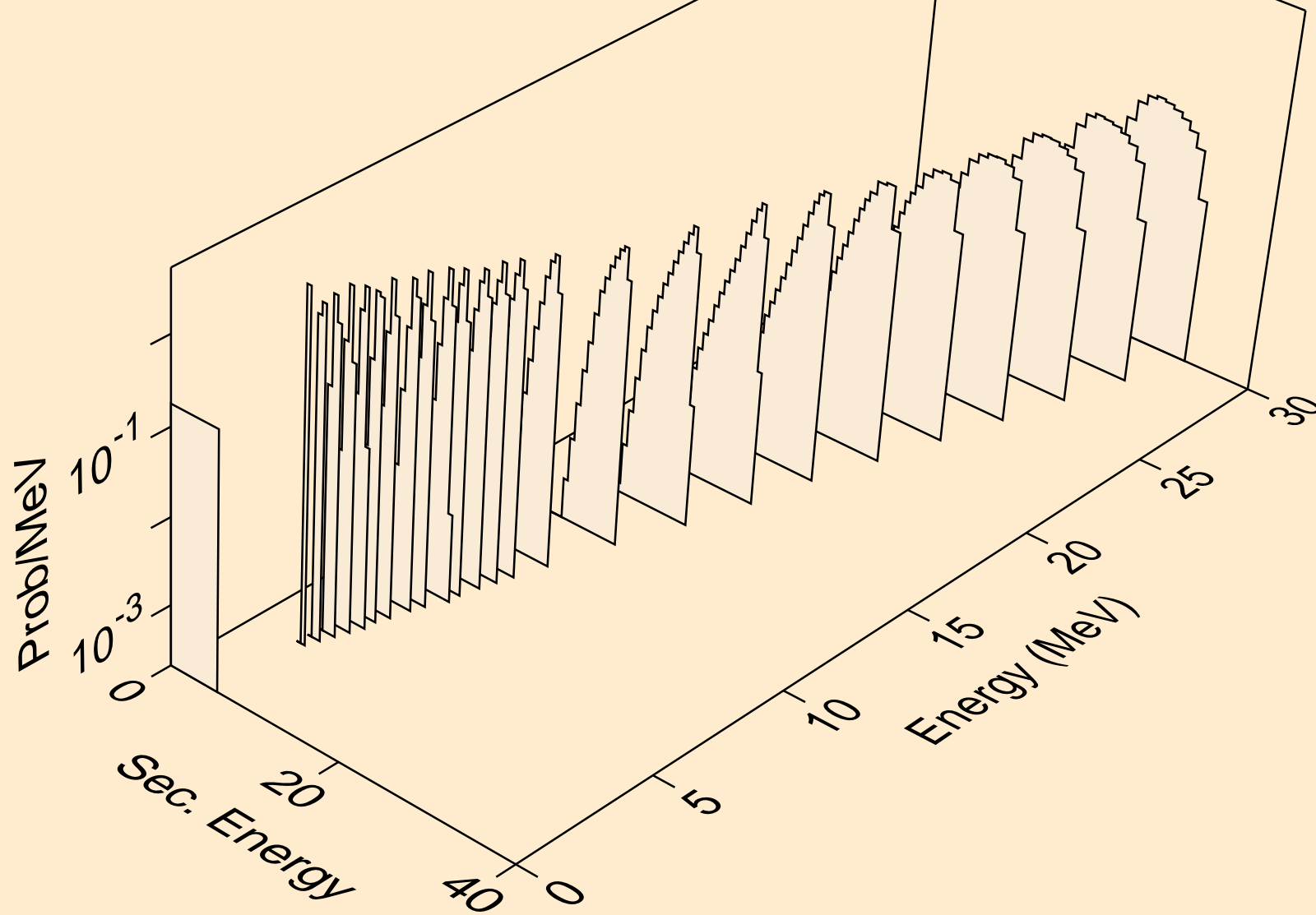

PT191 NEUTRON ACER TENDL-2021 LIBRARY; T=293.6K  
alphas from (n,2n)a

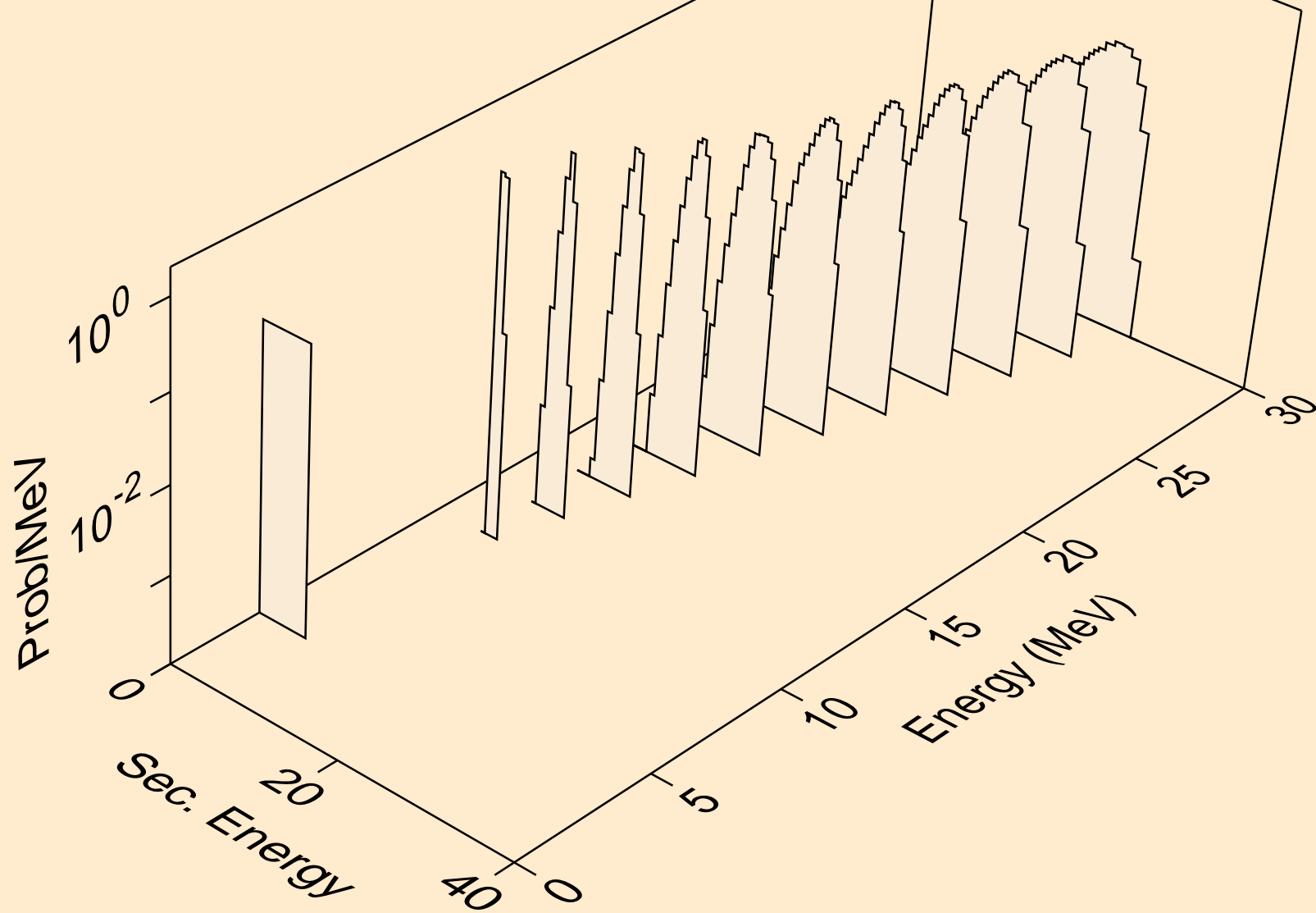

PT191 NEUTRON ACER TENDL-2021 LIBRARY; T=293.6K  
alphas from (n,3n)a

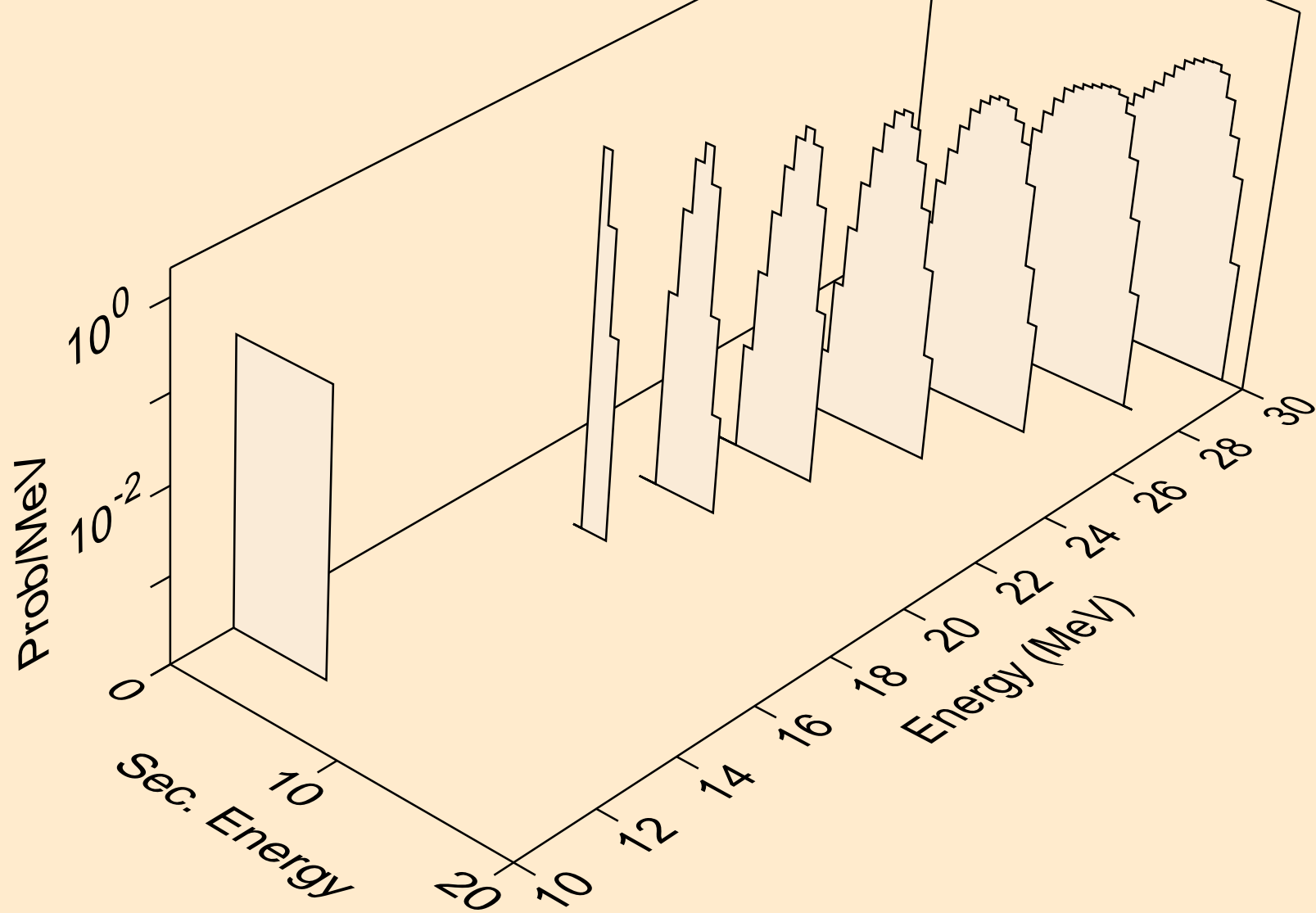

PT191 NEUTRON ACER TENDL-2021 LIBRARY; T=293.6K  
alphas from (n,n\*)2a

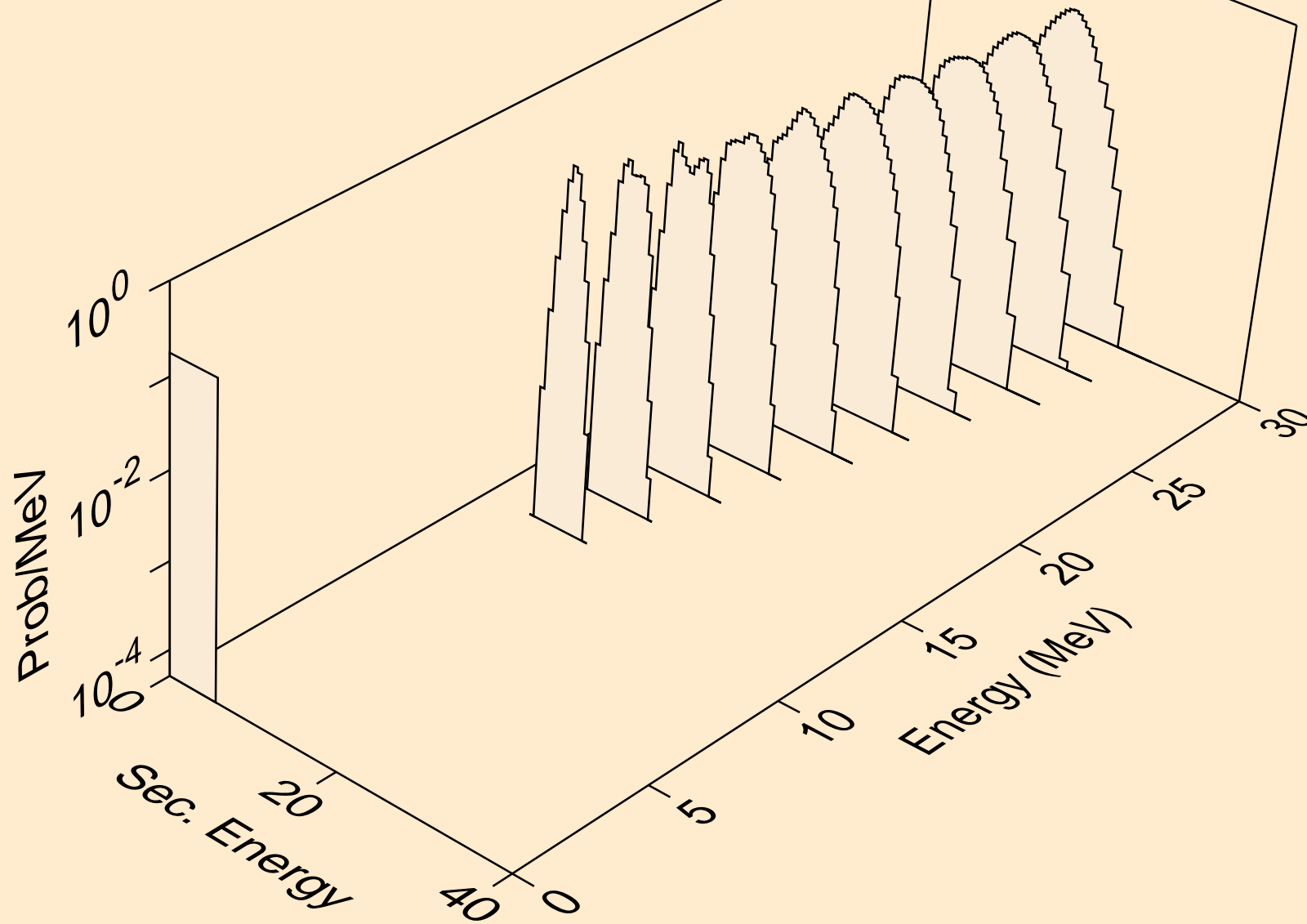

PT191 NEUTRON ACER TENDL-2021 LIBRARY; T=293.6K  
alphas from (n,npa)

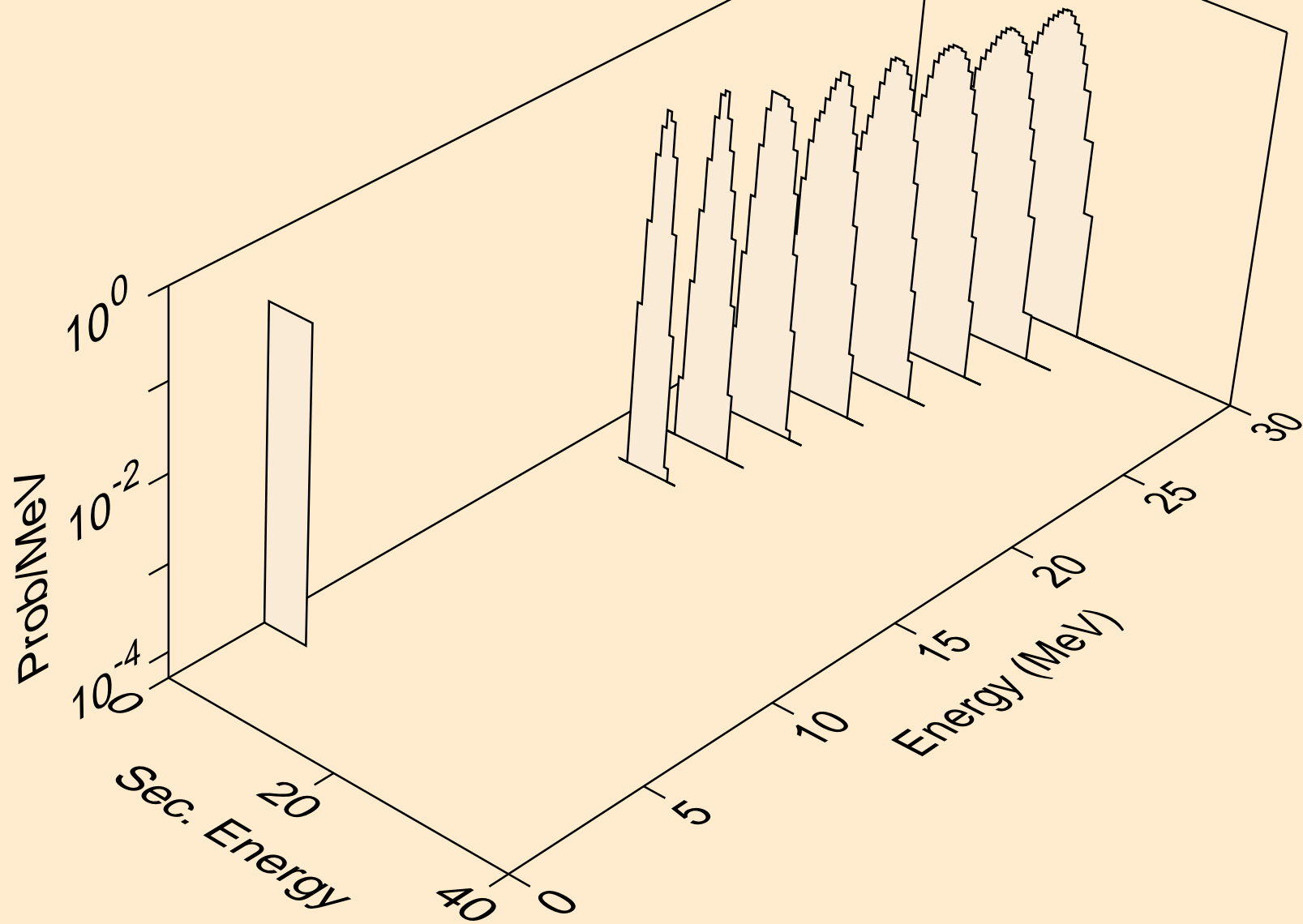



PT191 NEUTRON ACER TENDL-2021 LIBRARY; T=293.6K  
alphas from (n,a)

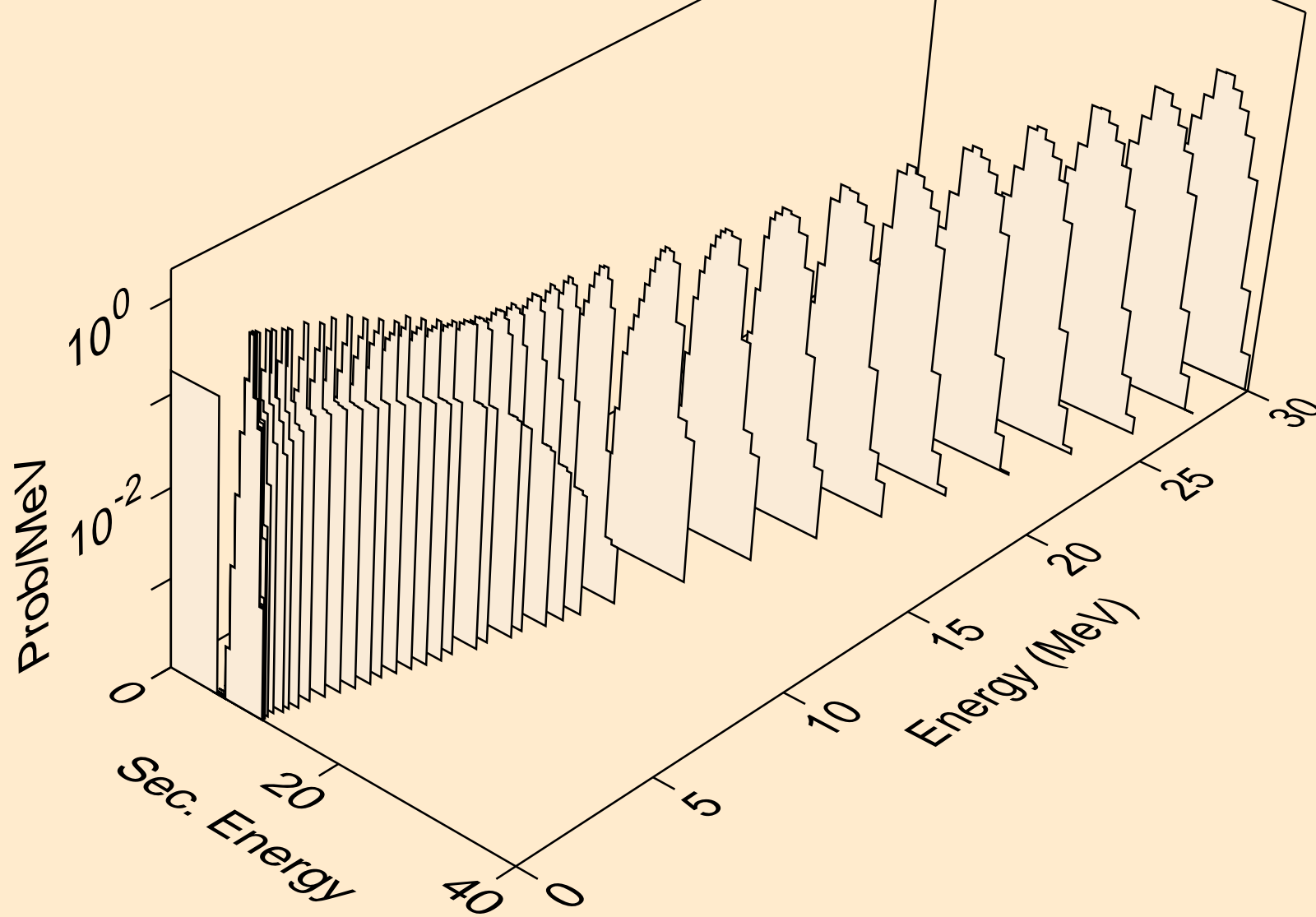

PT191 NEUTRON ACER TENDL-2021 LIBRARY; T=293.6K  
alphas from (n,2a)

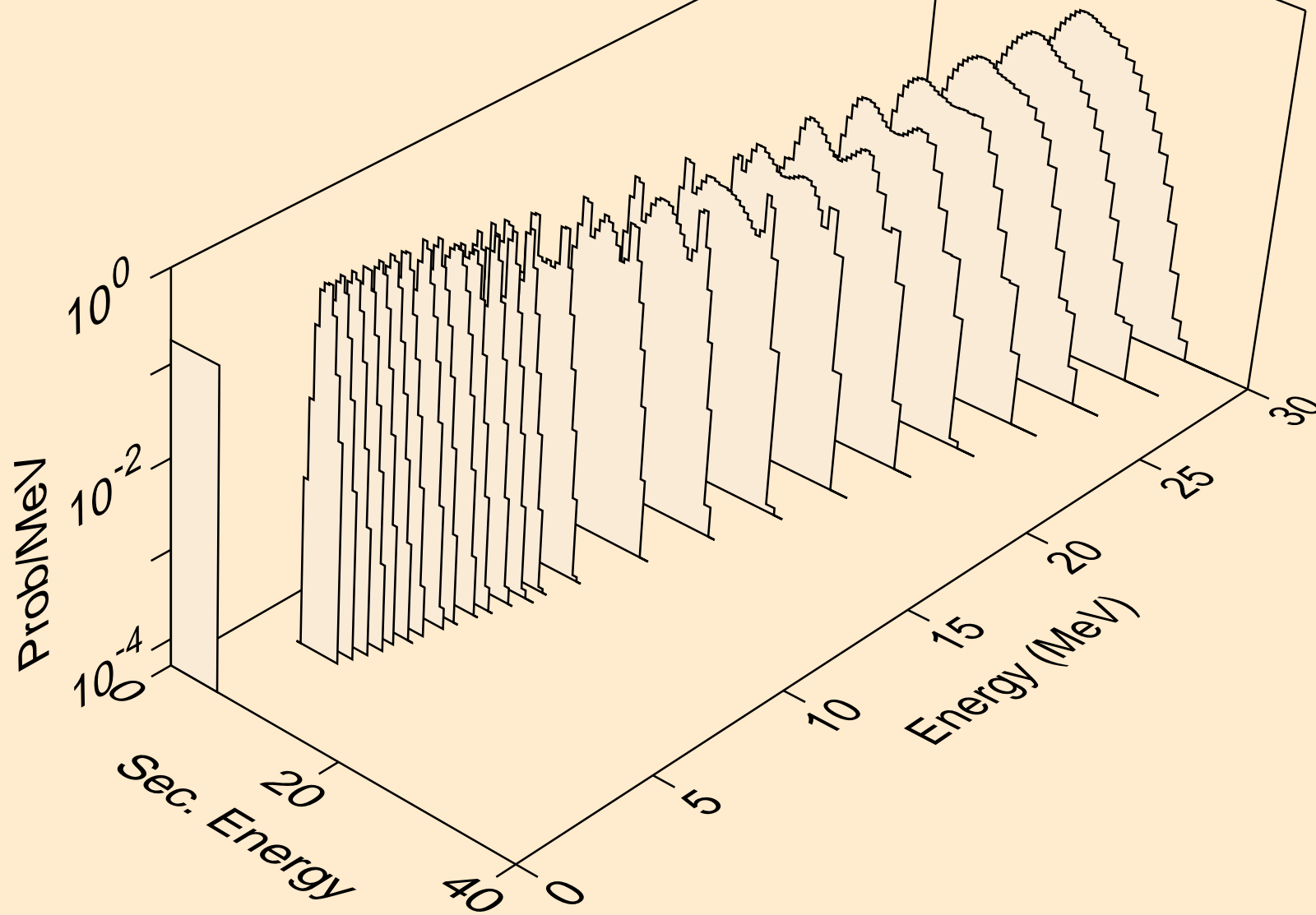

PT191 NEUTRON ACER TENDL-2021 LIBRARY; T=293.6K  
alphas from (n,pa)

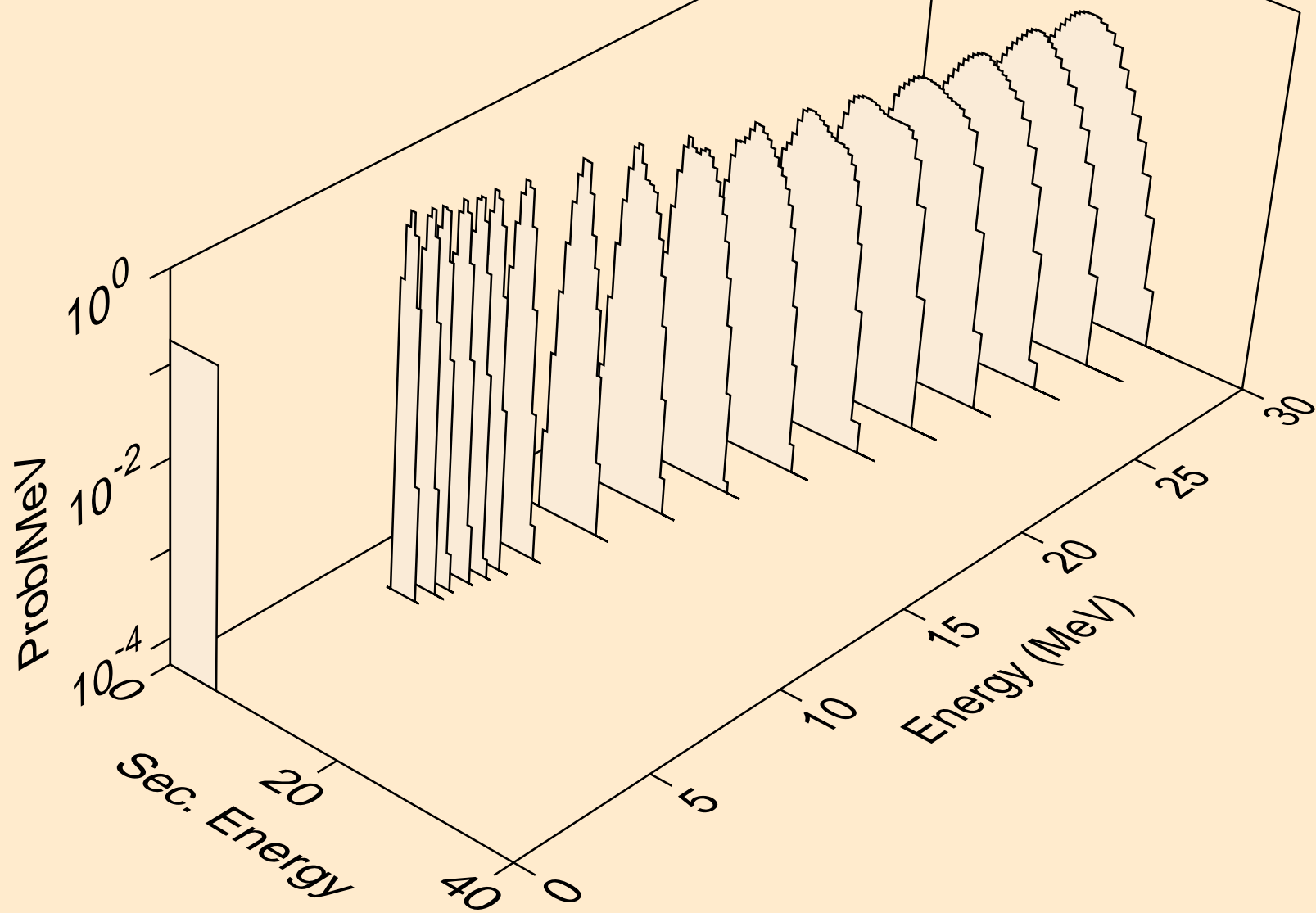

PT191 NEUTRON ACER TENDL-2021 LIBRARY; T=293.6K  
alphas from (n,da)

