

PT198 NEUTRON ACER TENDL-2021 LIBRARY; T=293.6K
Principal cross sections

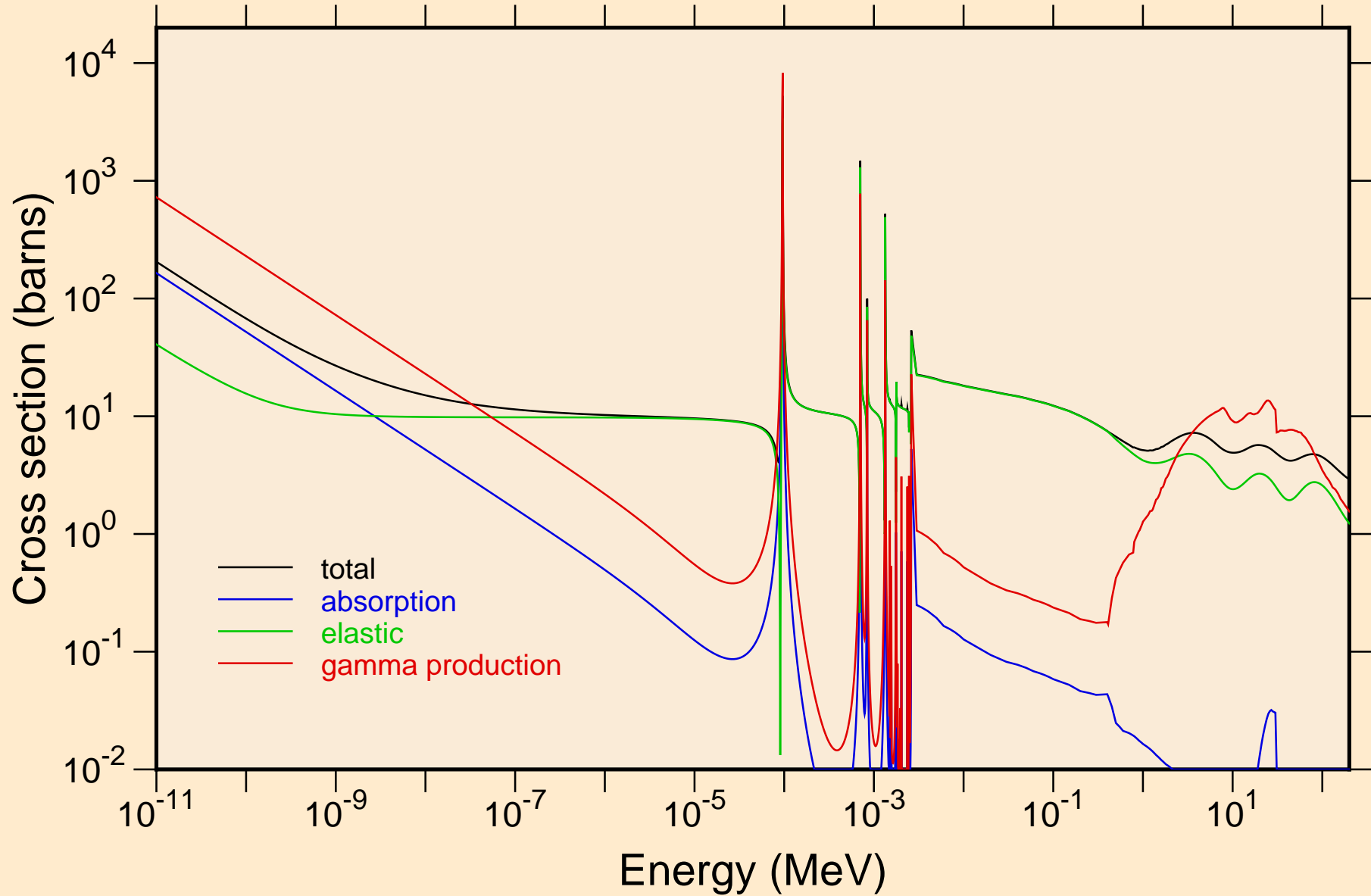

PT198 NEUTRON ACER TENDL-2021 LIBRARY; T=293.6K
resonance total cross section

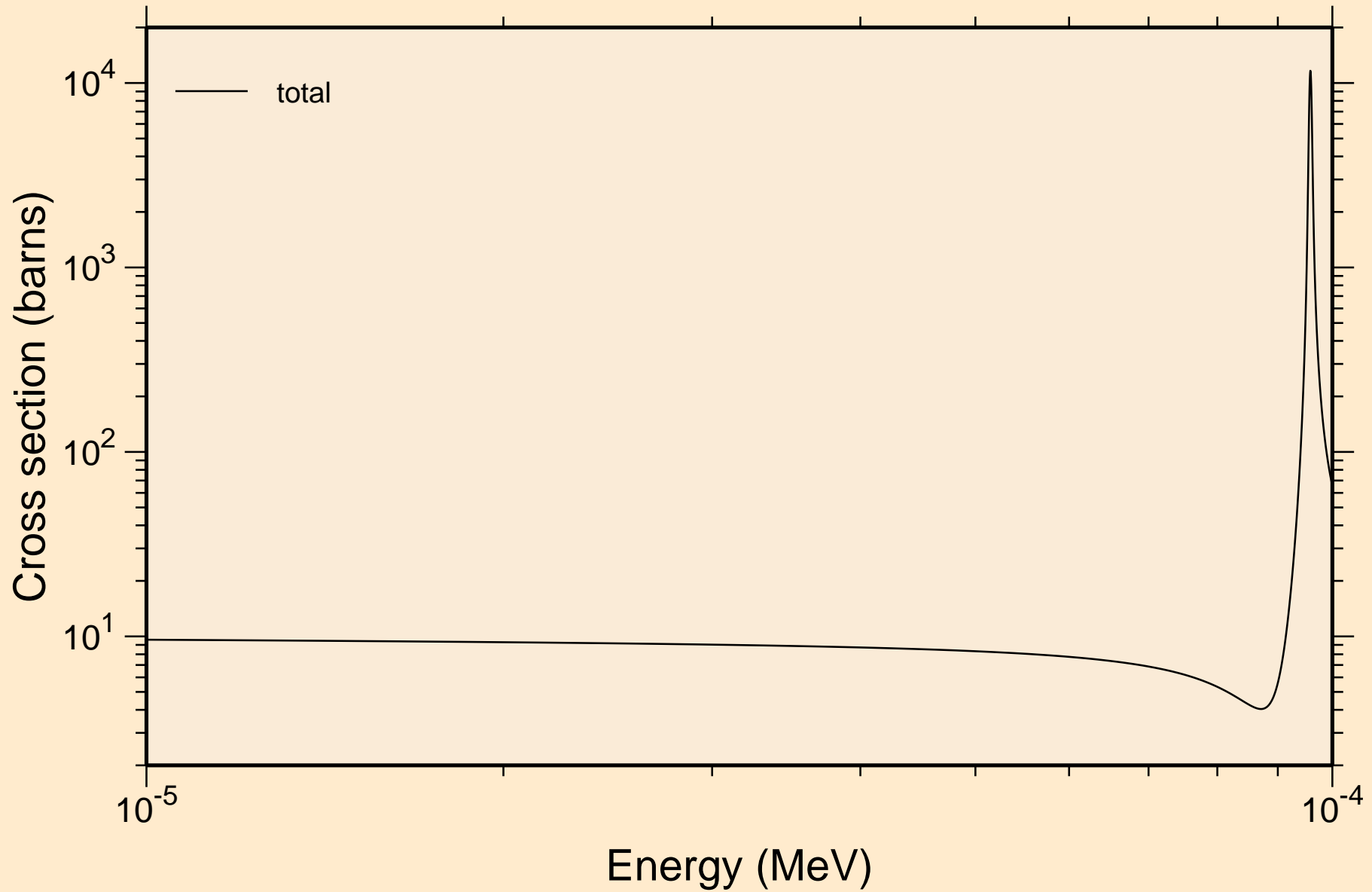

PT198 NEUTRON ACER TENDL-2021 LIBRARY; T=293.6K
resonance total cross section

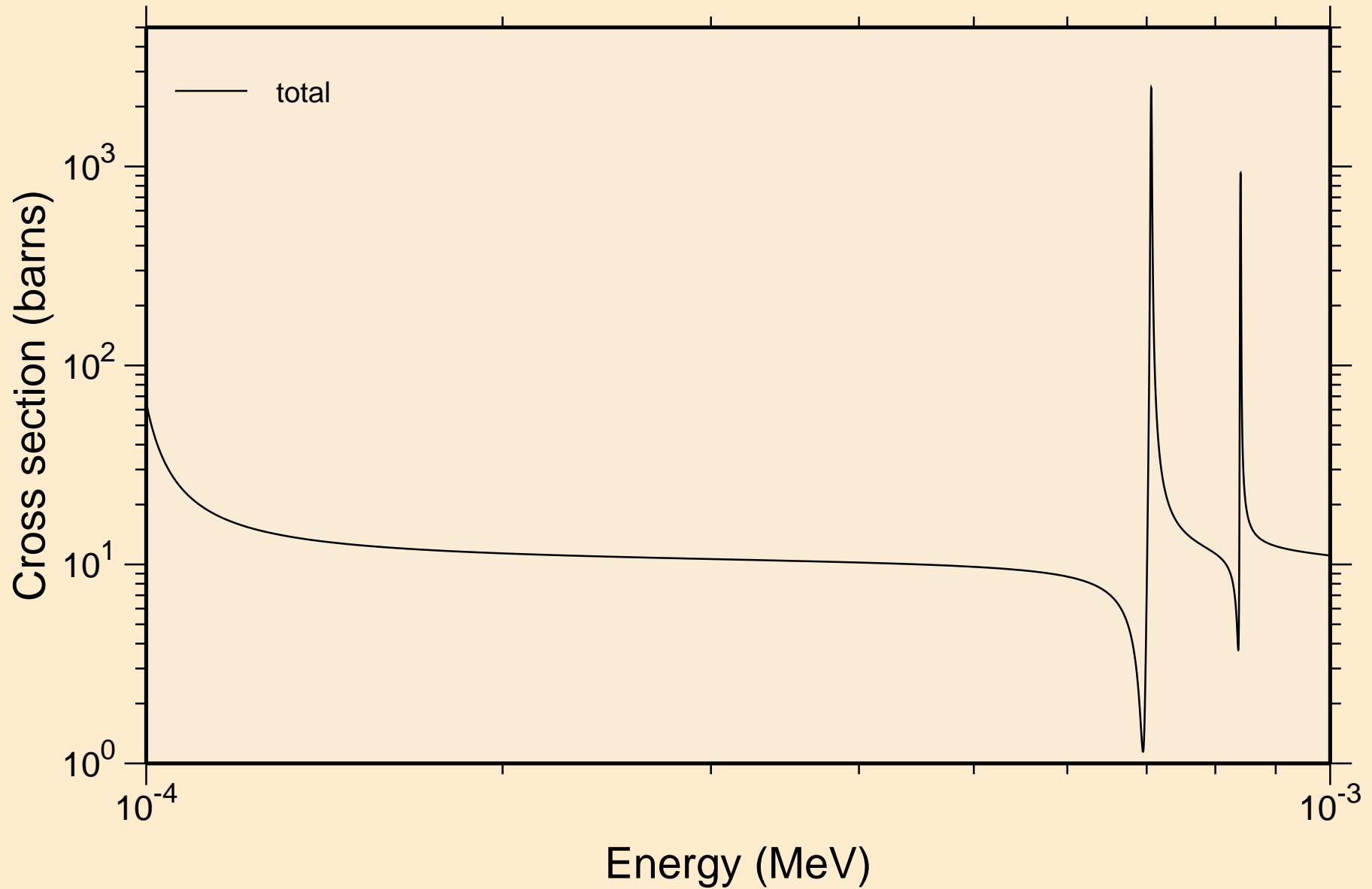

PT198 NEUTRON ACER TENDL-2021 LIBRARY; T=293.6K
resonance total cross section

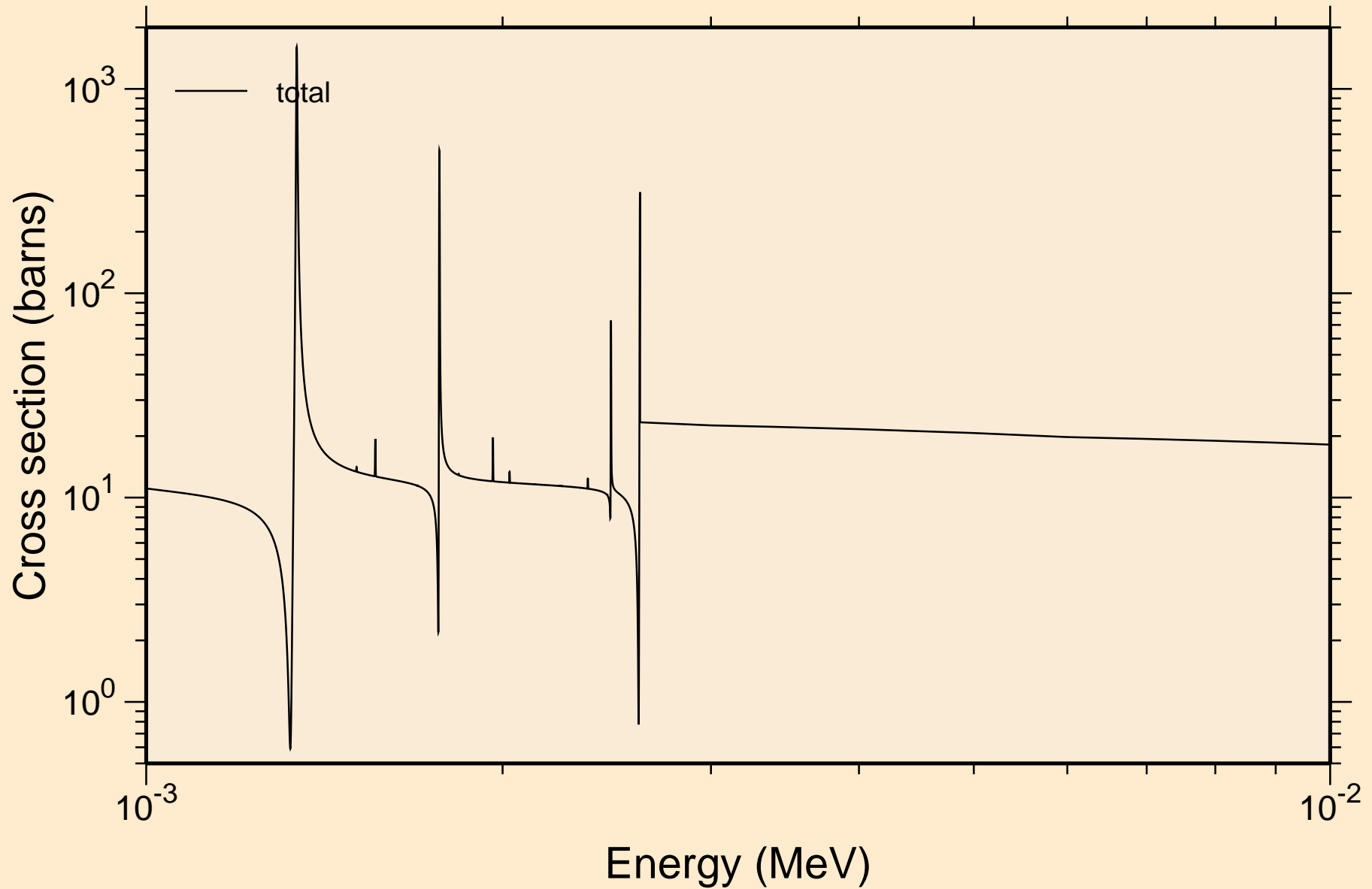

PT198 NEUTRON ACER TENDL-2021 LIBRARY; T=293.6K
resonance total cross section

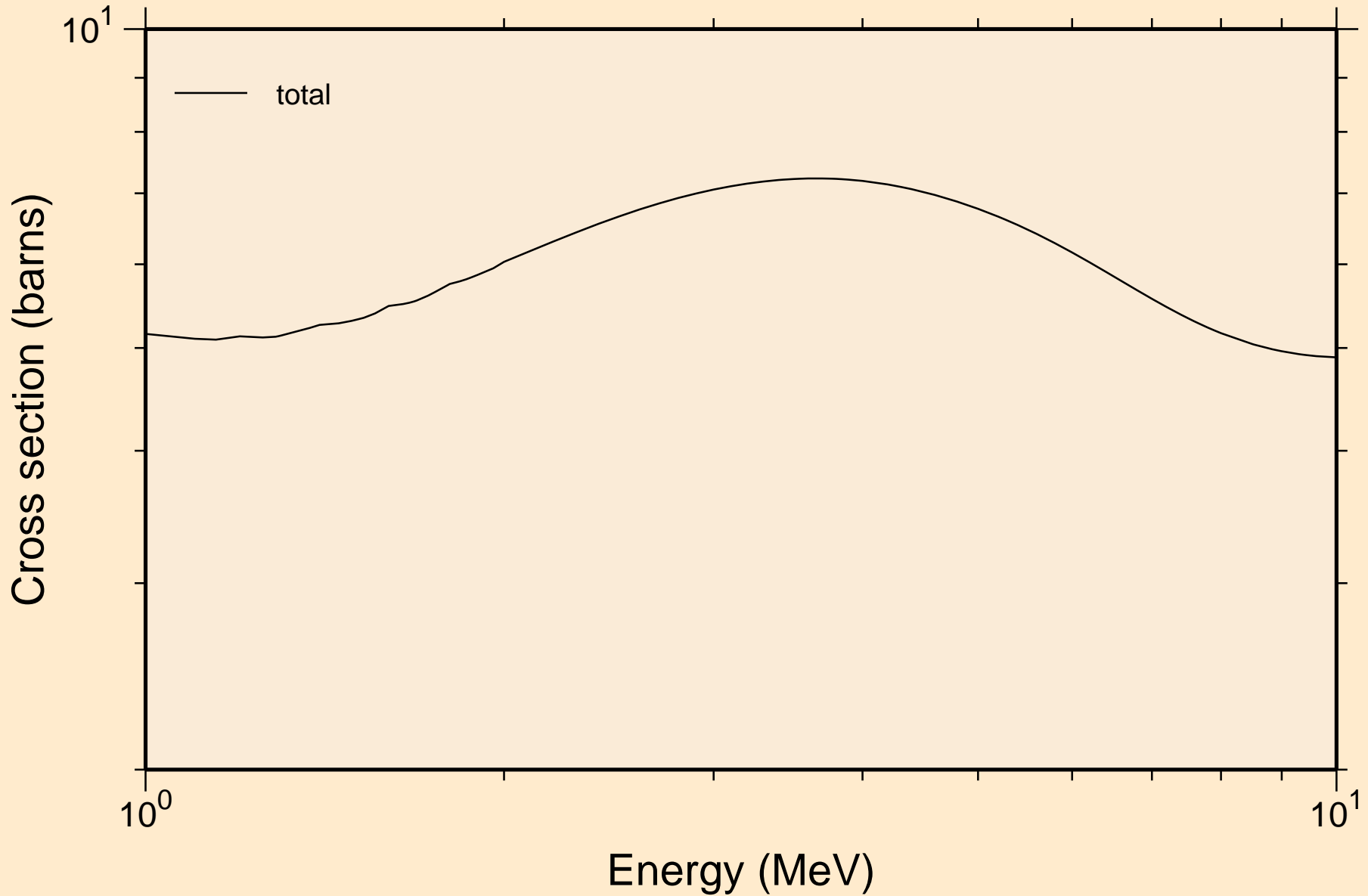

PT198 NEUTRON ACER TENDL-2021 LIBRARY; T=293.6K
resonance absorption cross sections

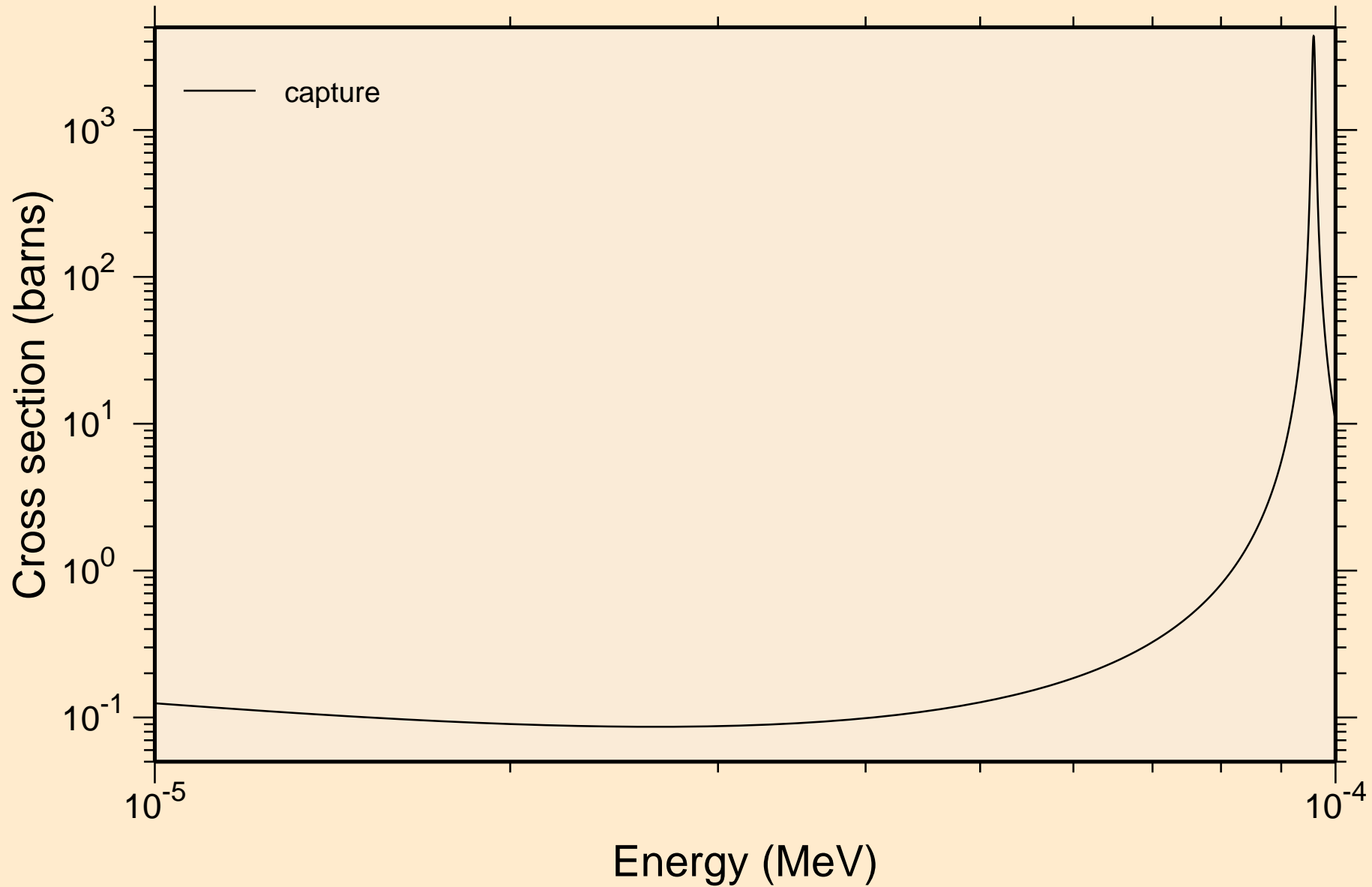

PT198 NEUTRON ACER TENDL-2021 LIBRARY; T=293.6K
resonance absorption cross sections

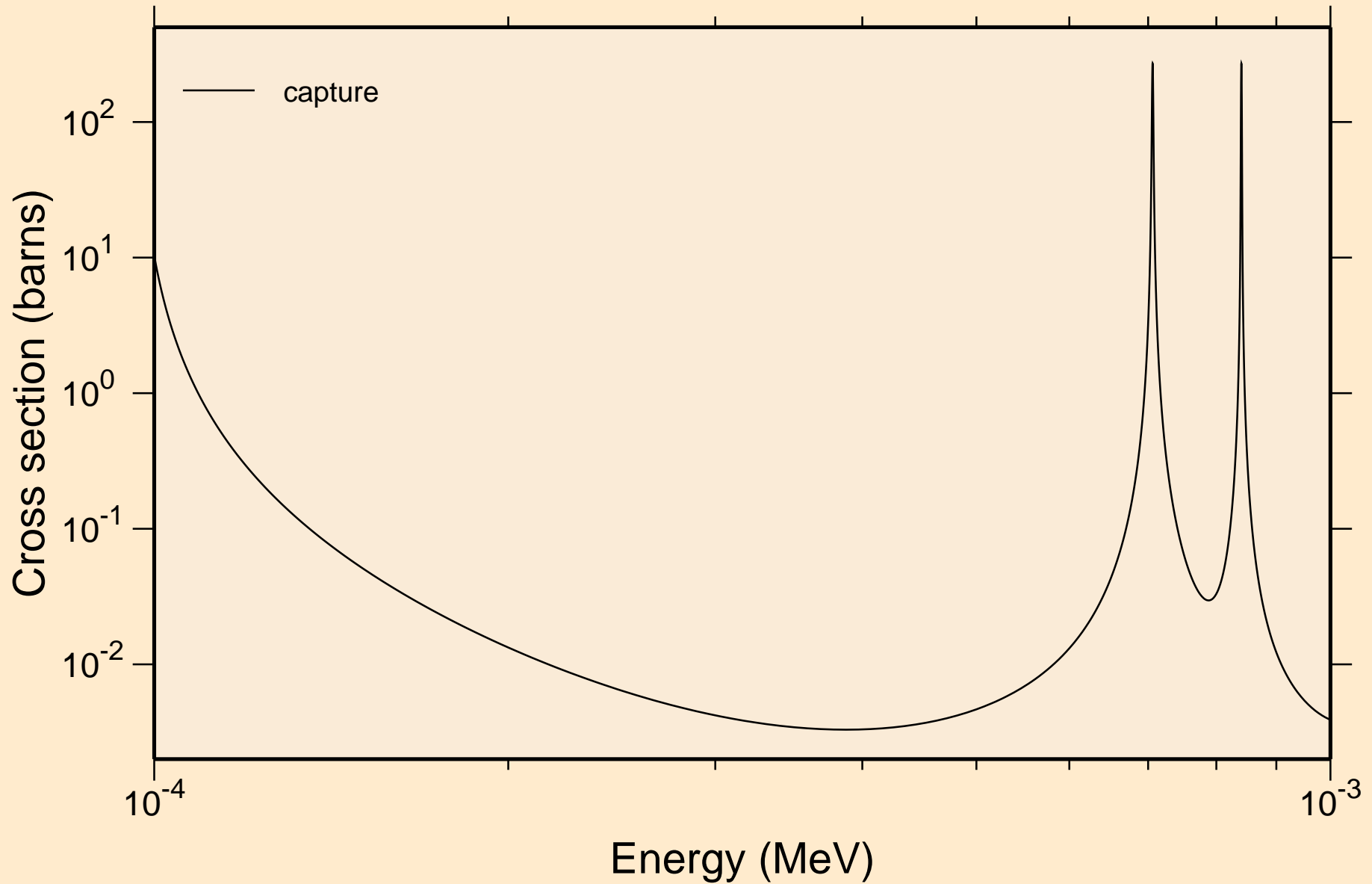

PT198 NEUTRON ACER TENDL-2021 LIBRARY; T=293.6K
resonance absorption cross sections

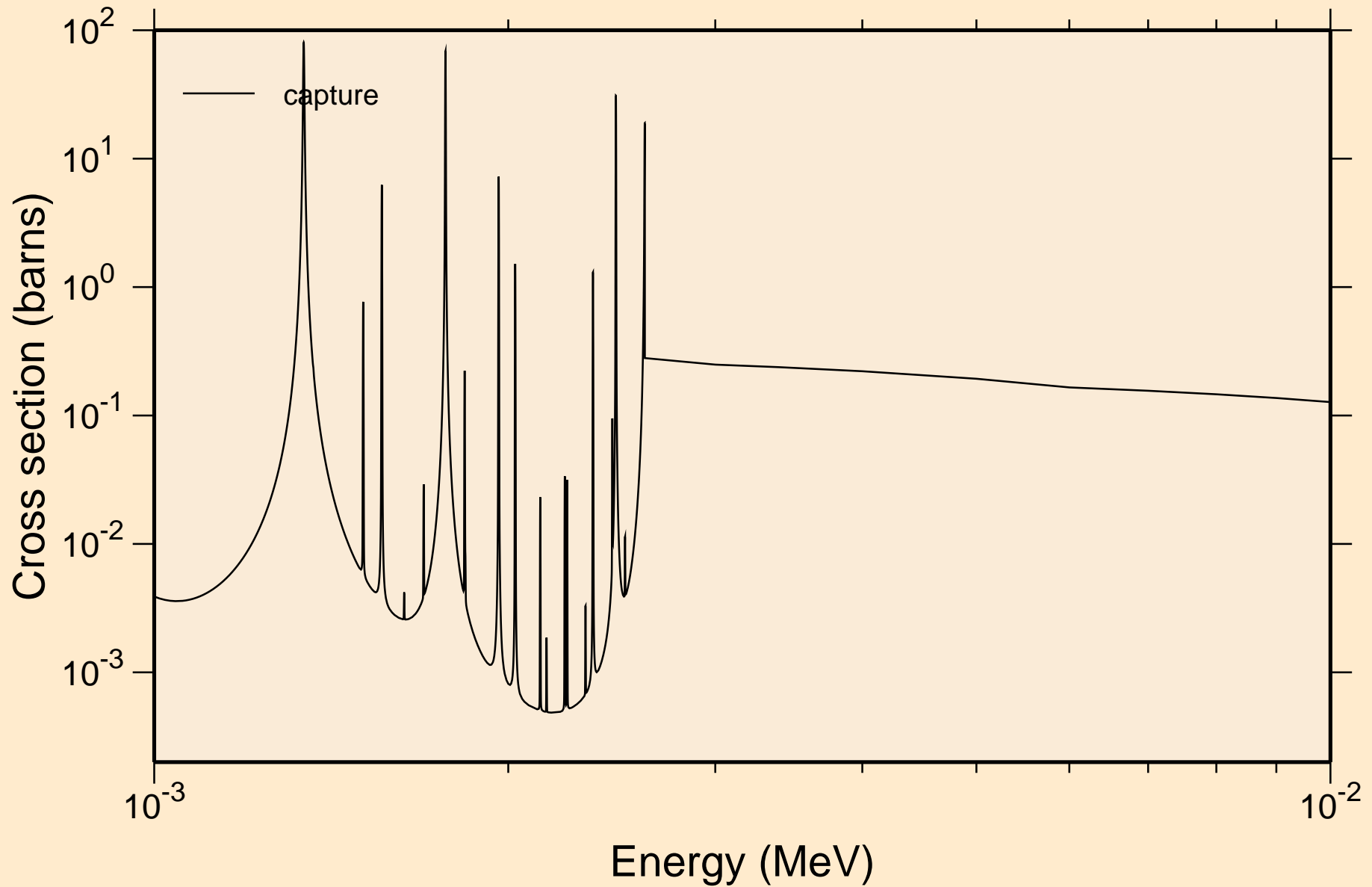

PT198 NEUTRON ACER TENDL-2021 LIBRARY; T=293.6K
resonance absorption cross sections

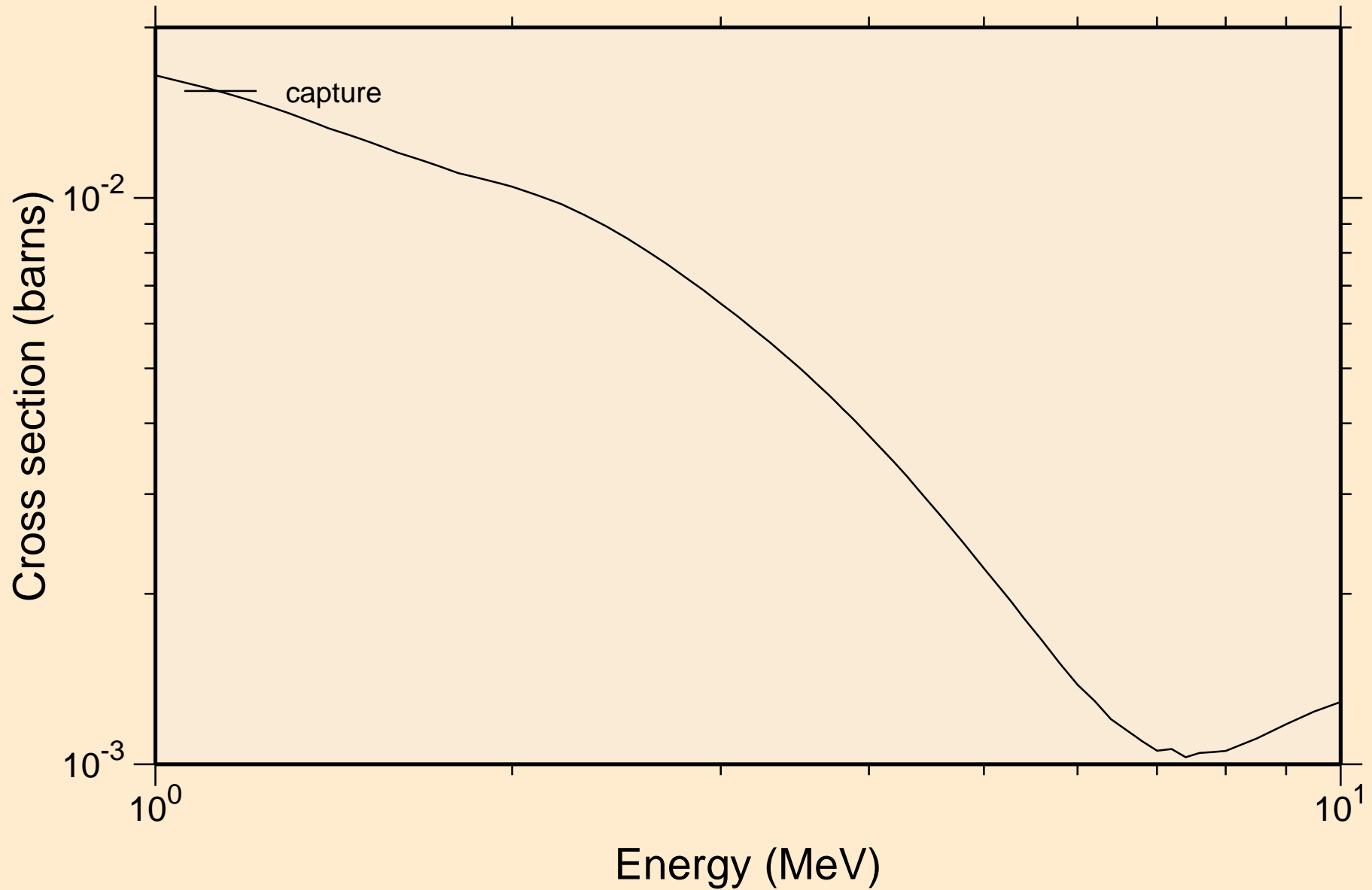

PT198 NEUTRON ACER TENDL-2021 LIBRARY; T=293.6K
Heating

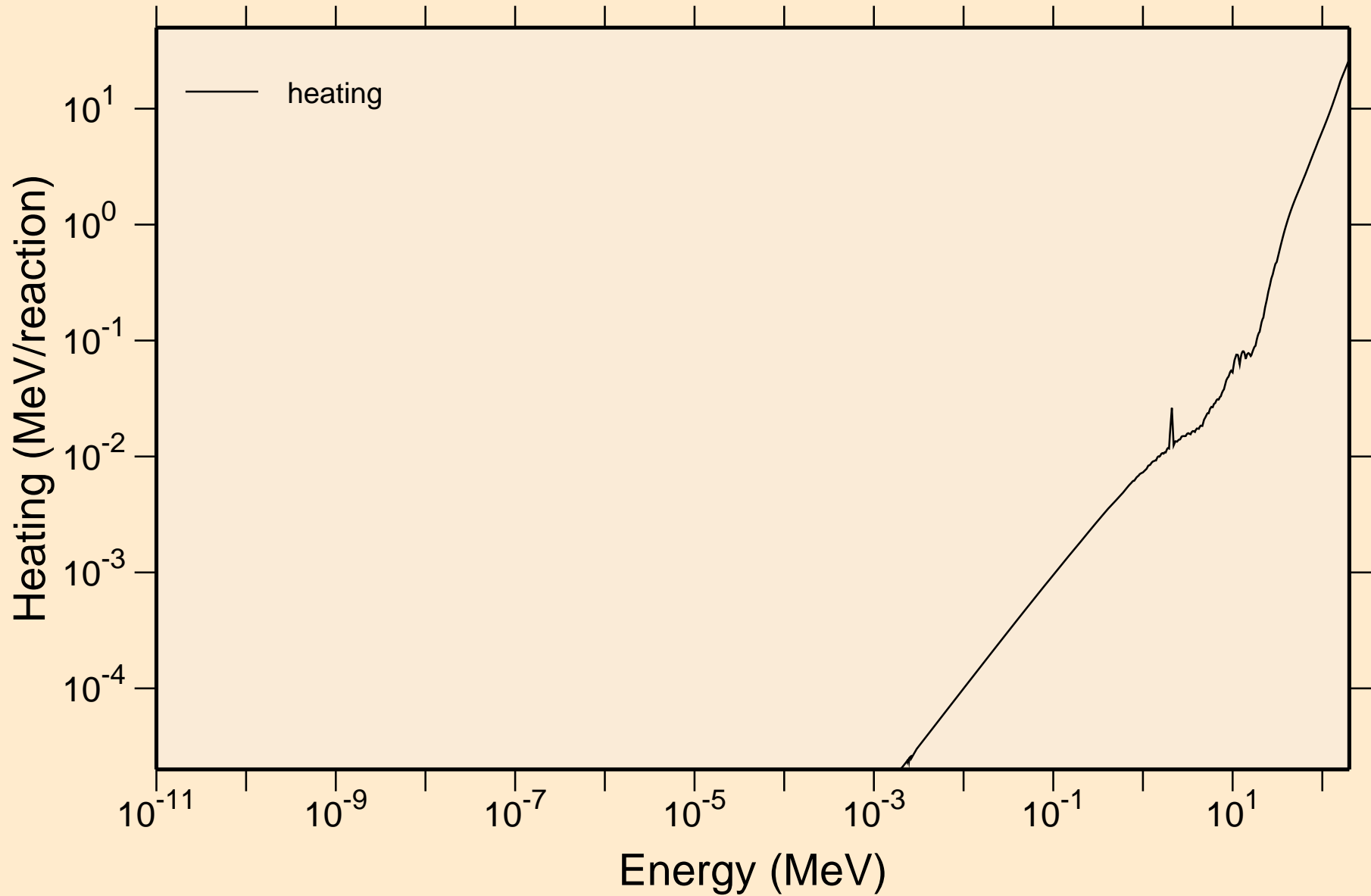

PT198 NEUTRON ACER TENDL-2021 LIBRARY; T=293.6K
Damage

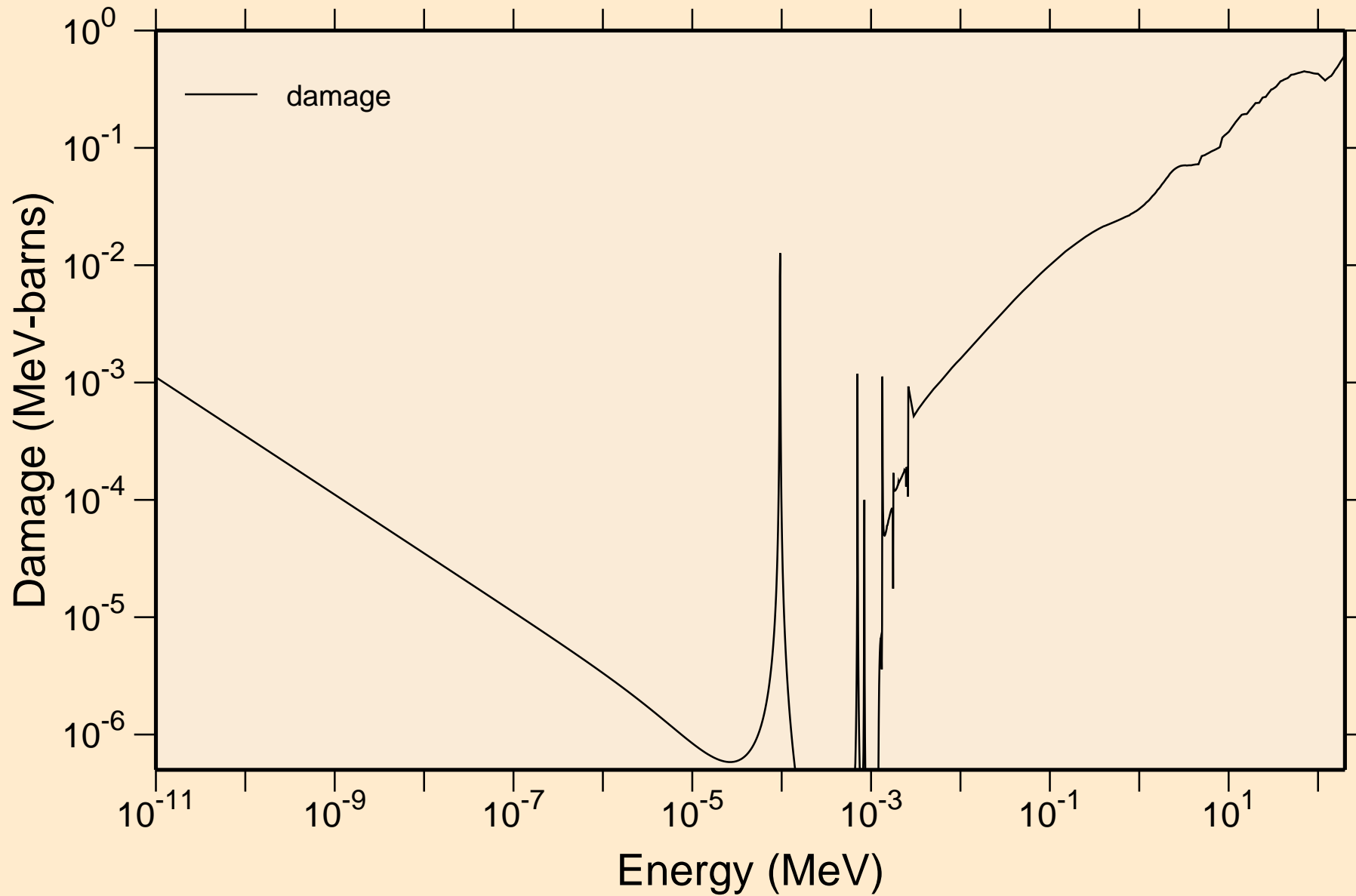

PT198 NEUTRON ACER TENDL-2021 LIBRARY; T=293.6K
Non-threshold reactions

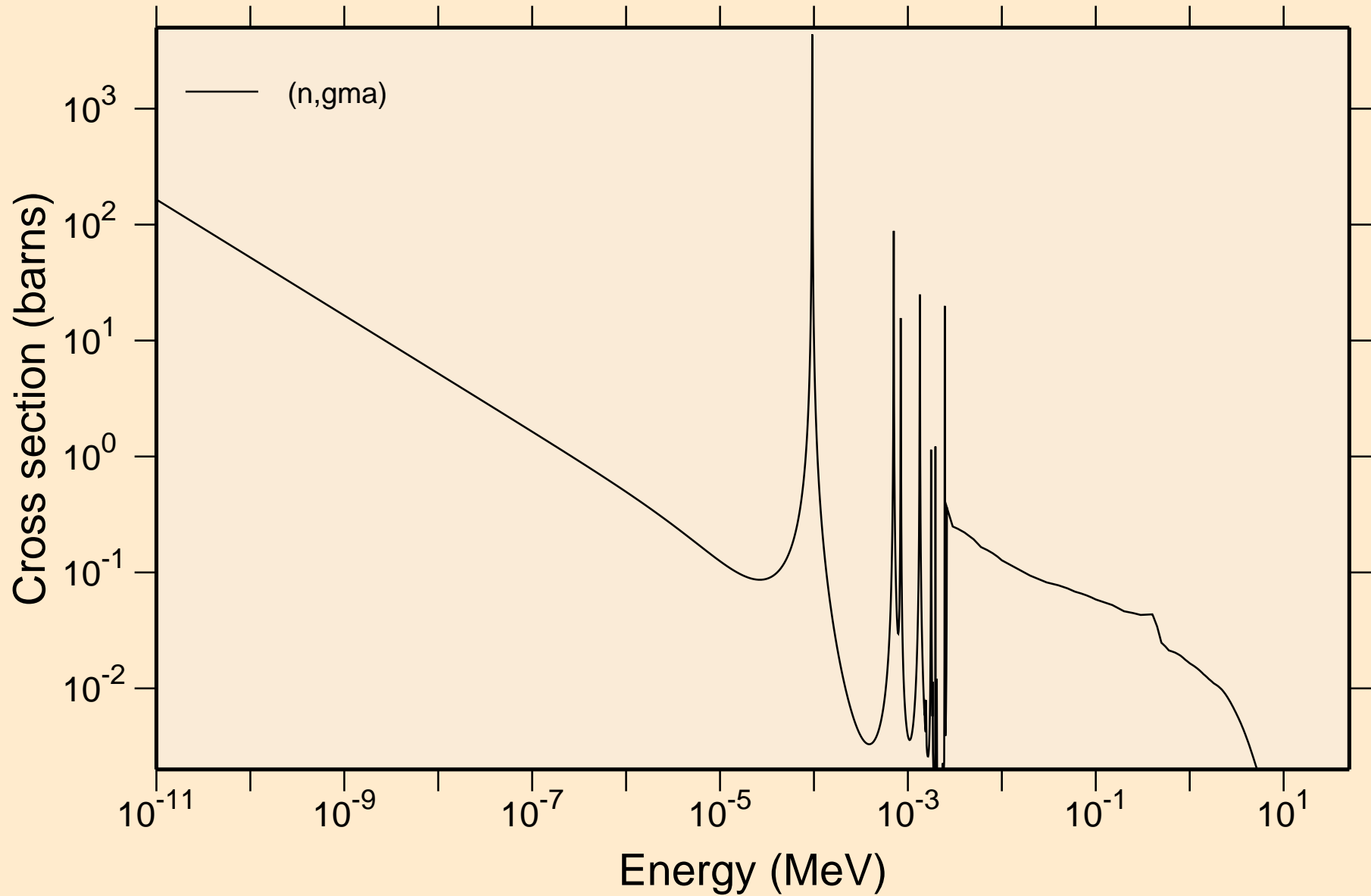

PT198 NEUTRON ACER TENDL-2021 LIBRARY; T=293.6K
Principal cross sections

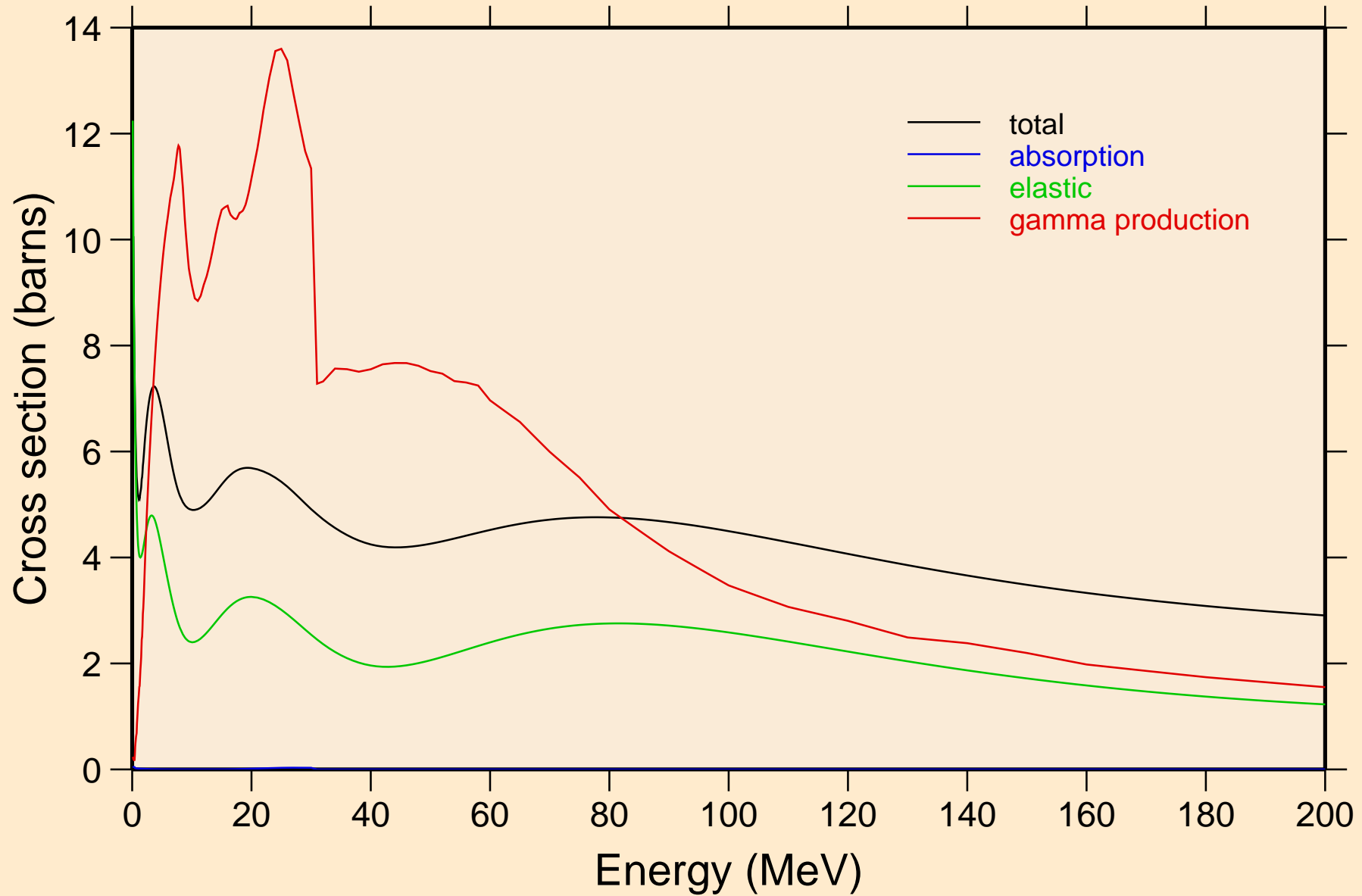

PT198 NEUTRON ACER TENDL-2021 LIBRARY; T=293.6K
Heating

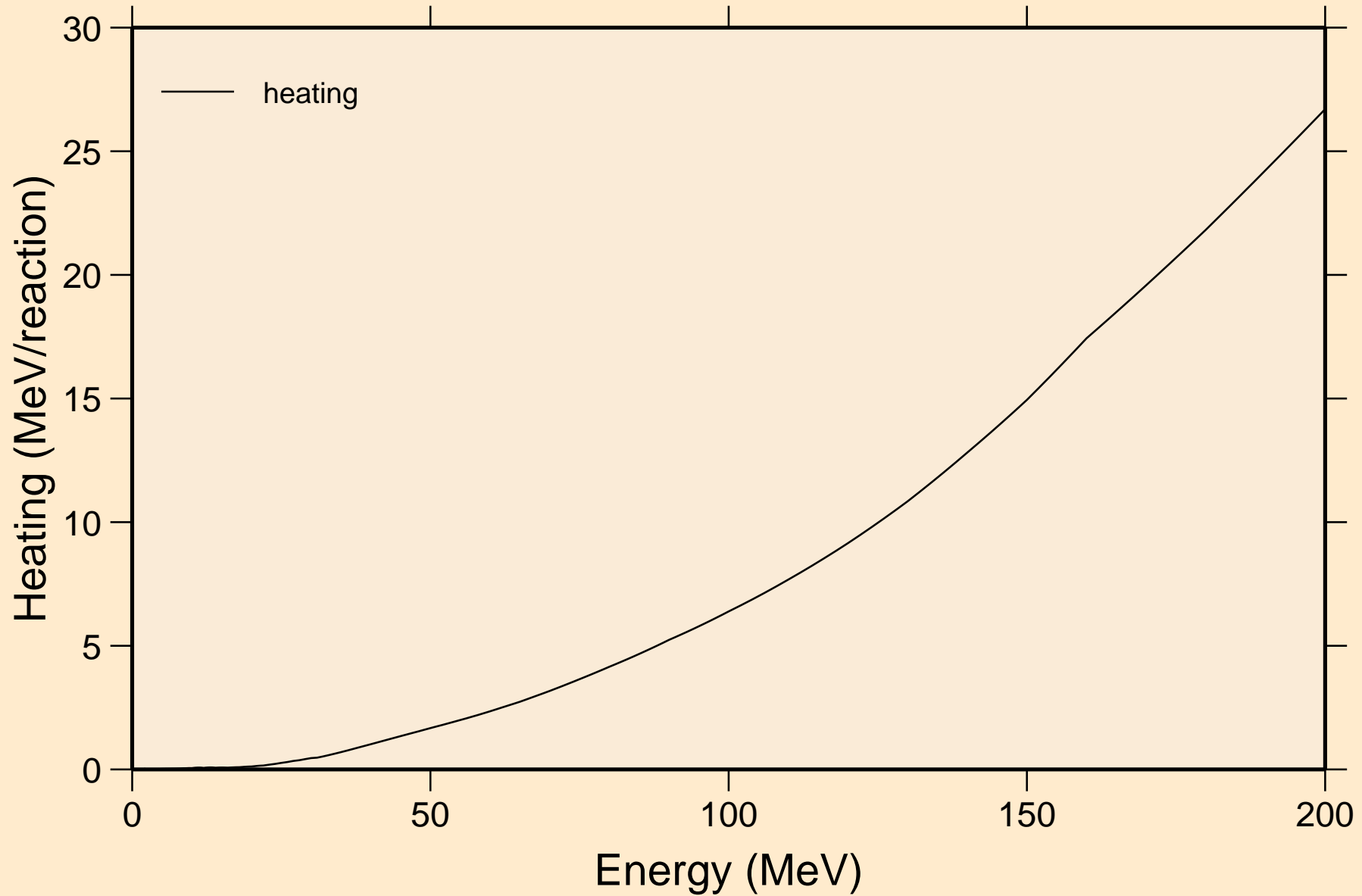

PT198 NEUTRON ACER TENDL-2021 LIBRARY; T=293.6K
Damage

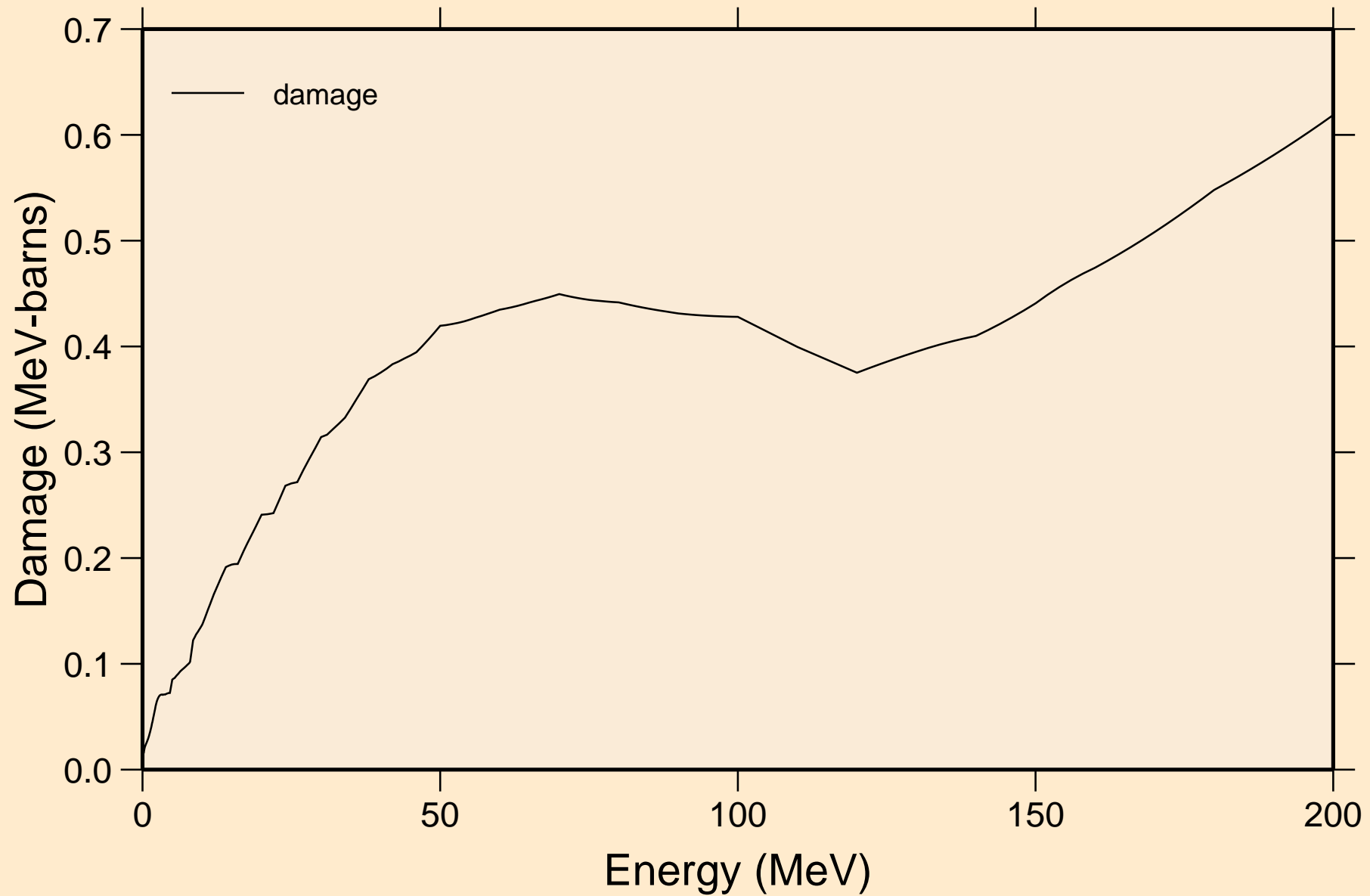

PT198 NEUTRON ACER TENDL-2021 LIBRARY; T=293.6K
Non-threshold reactions

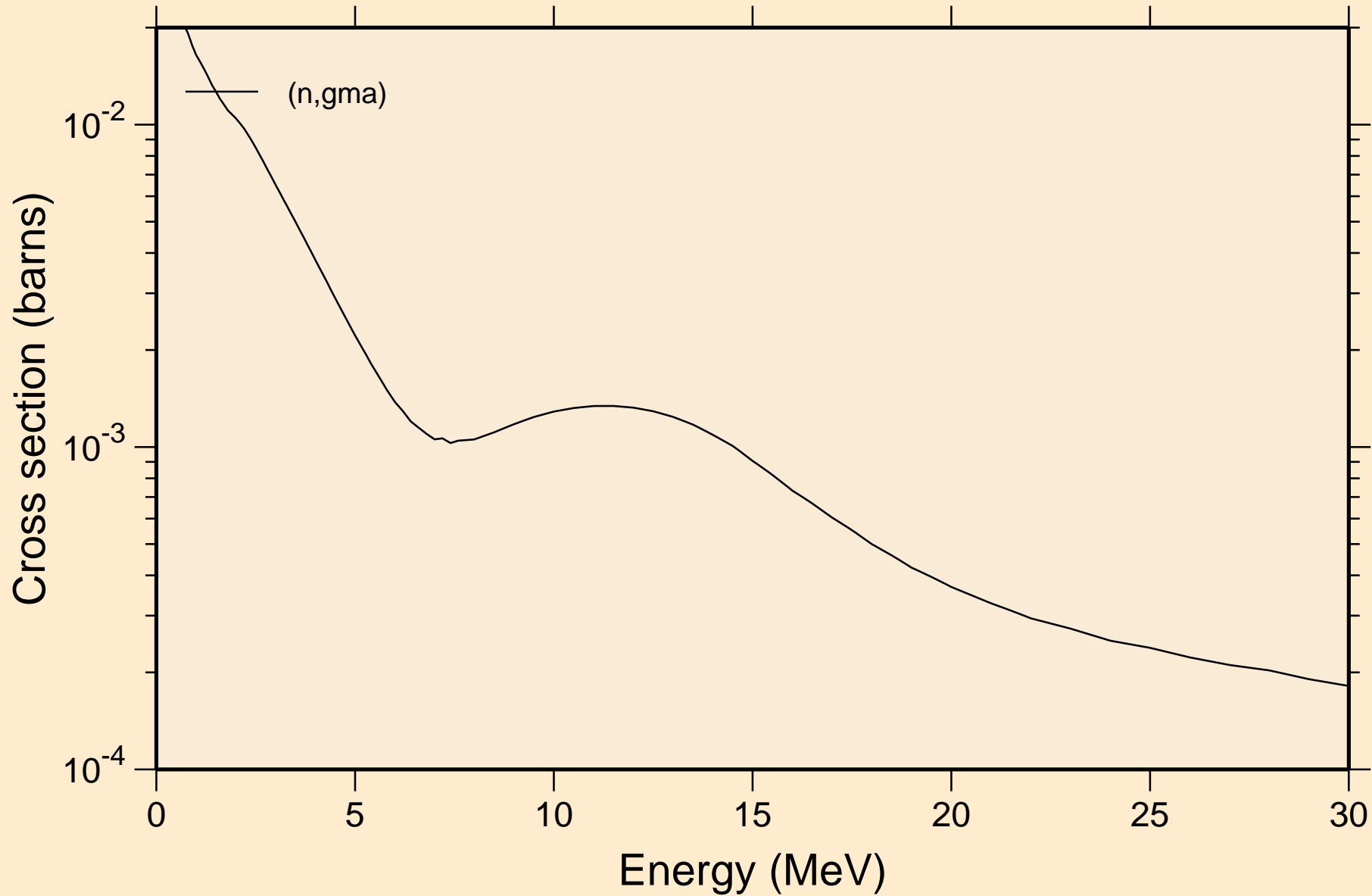

PT198 NEUTRON ACER TENDL-2021 LIBRARY; T=293.6K
Inelastic levels

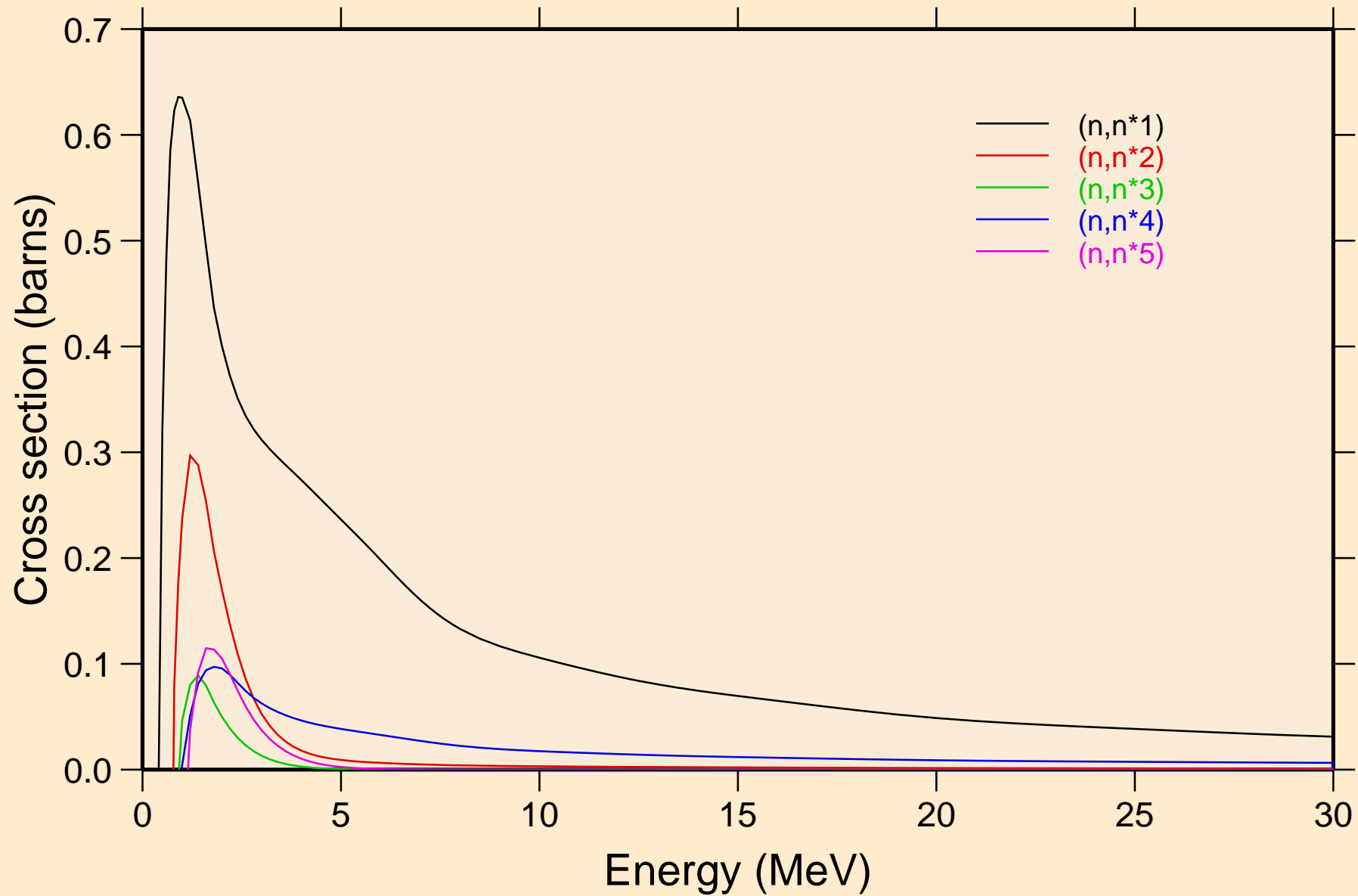

PT198 NEUTRON ACER TENDL-2021 LIBRARY; T=293.6K
Inelastic levels

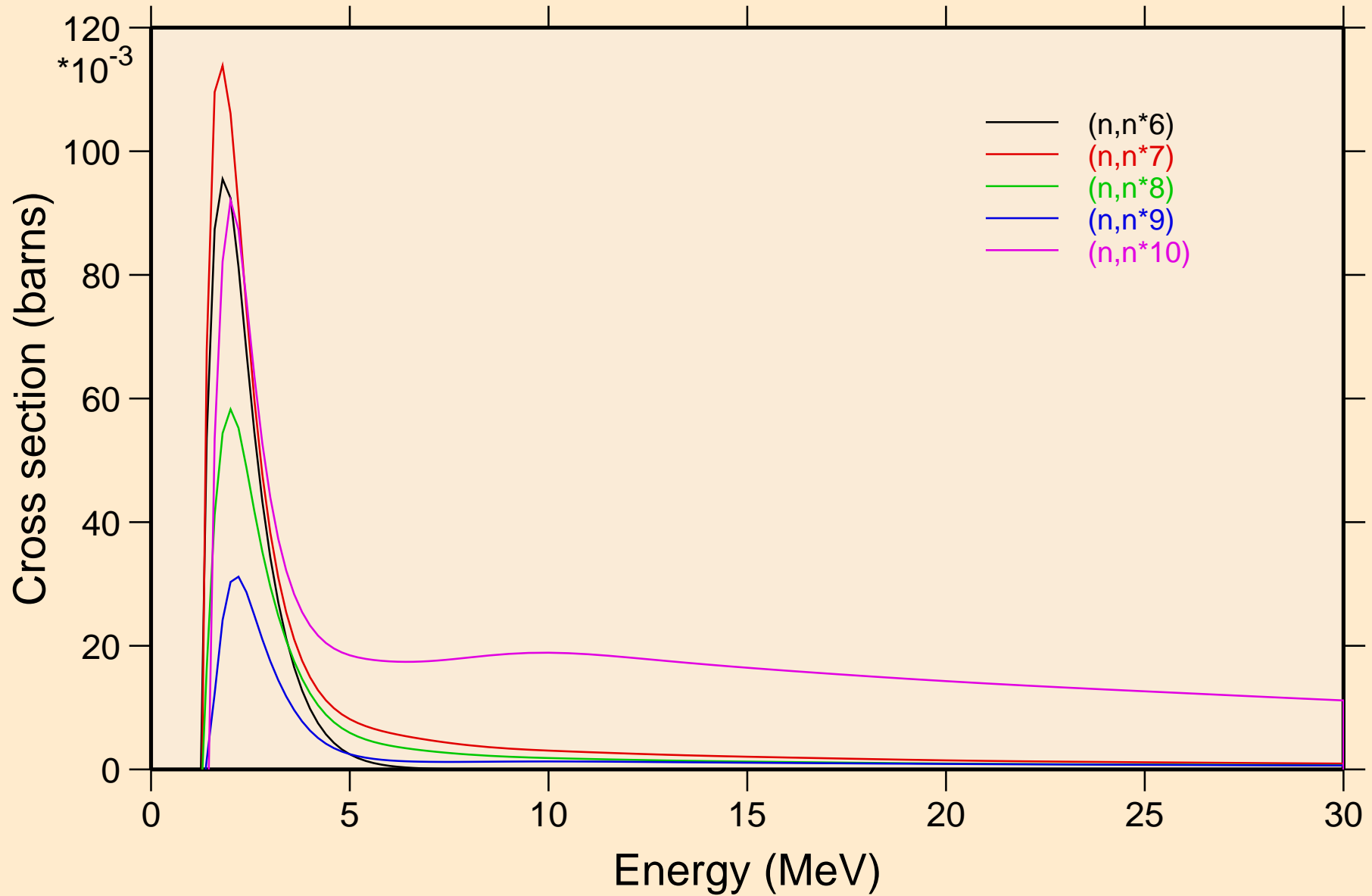

PT198 NEUTRON ACER TENDL-2021 LIBRARY; T=293.6K
Inelastic levels

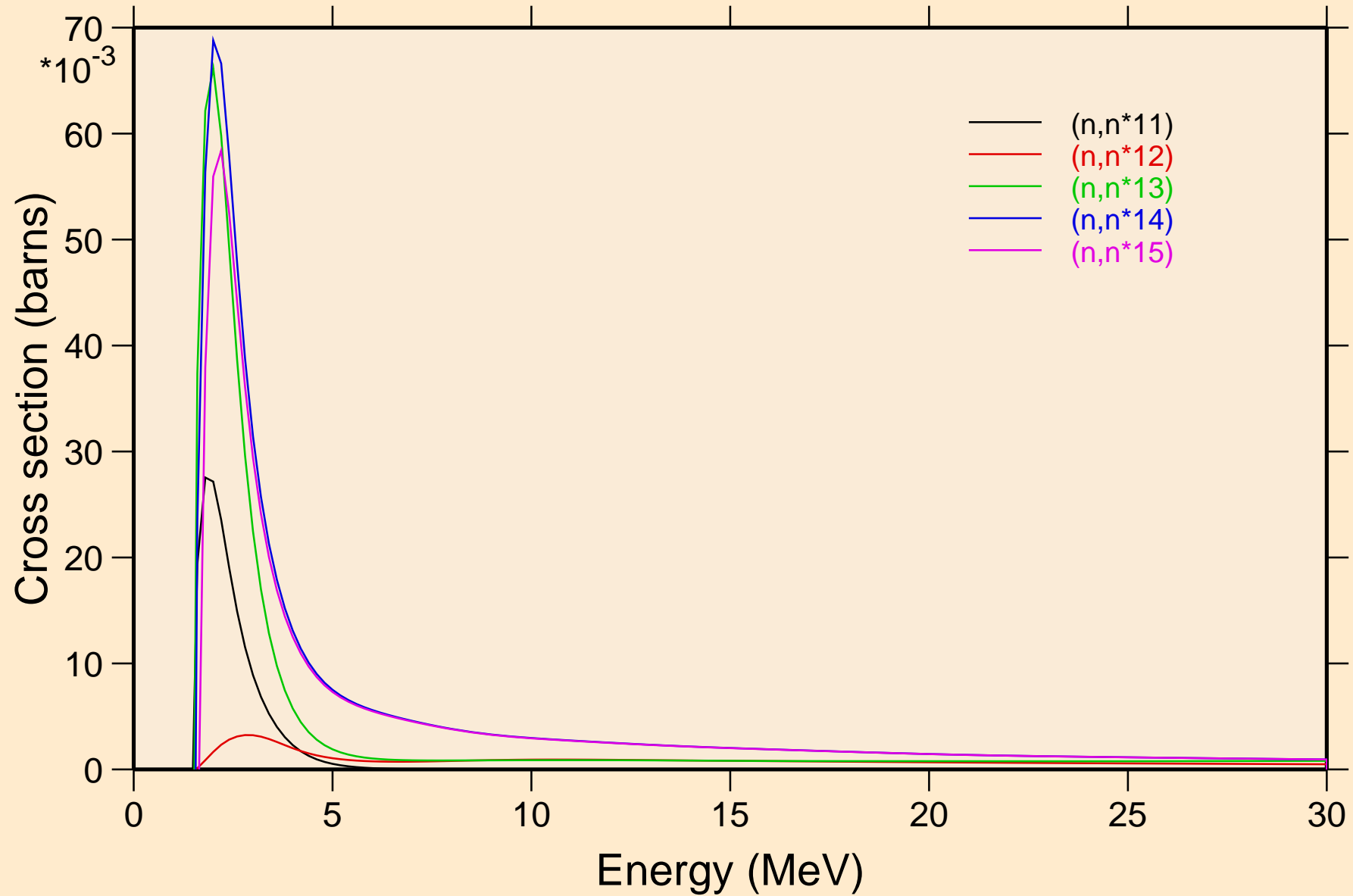

PT198 NEUTRON ACER TENDL-2021 LIBRARY; T=293.6K
Inelastic levels

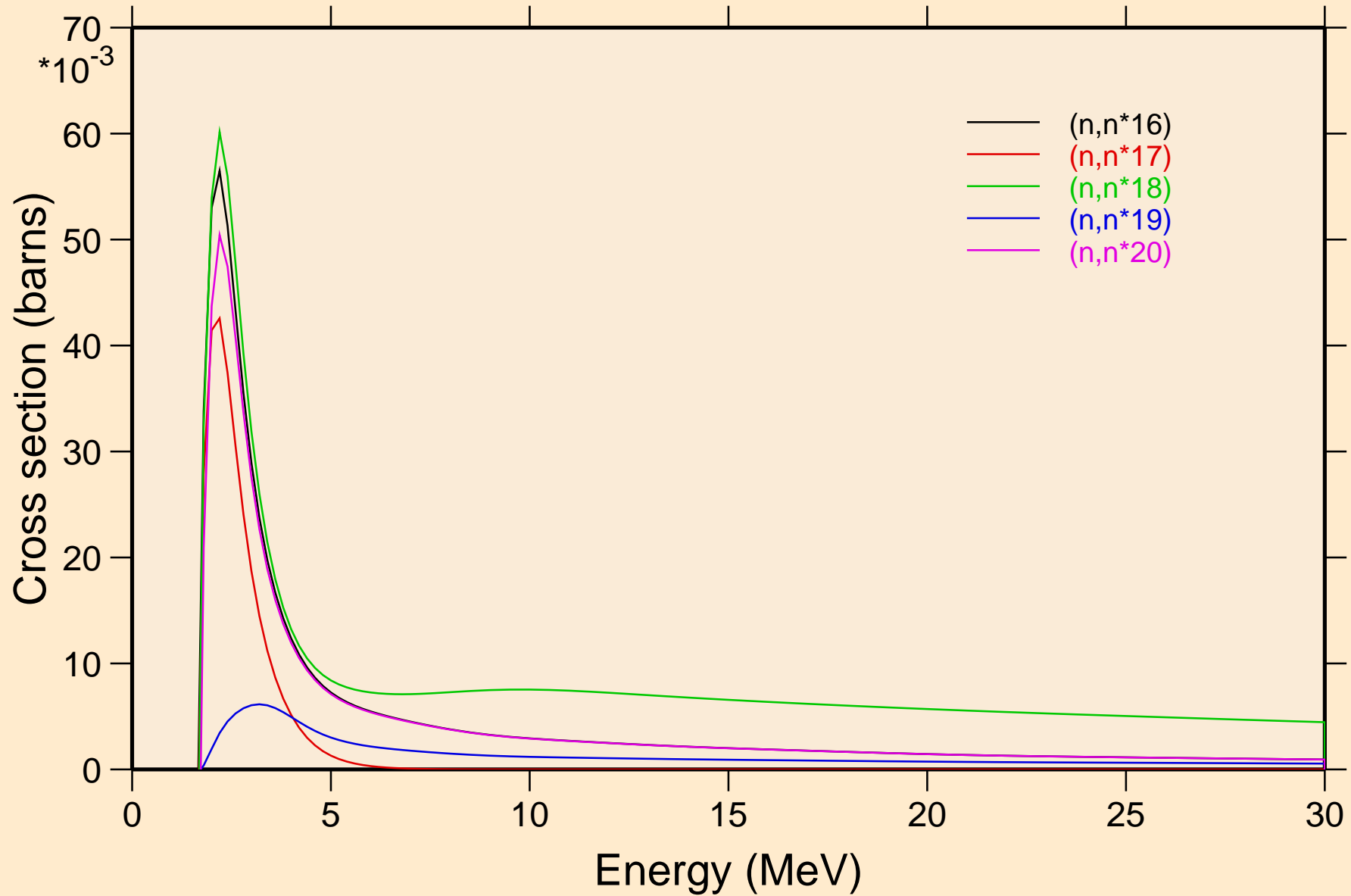

PT198 NEUTRON ACER TENDL-2021 LIBRARY; T=293.6K
Inelastic levels

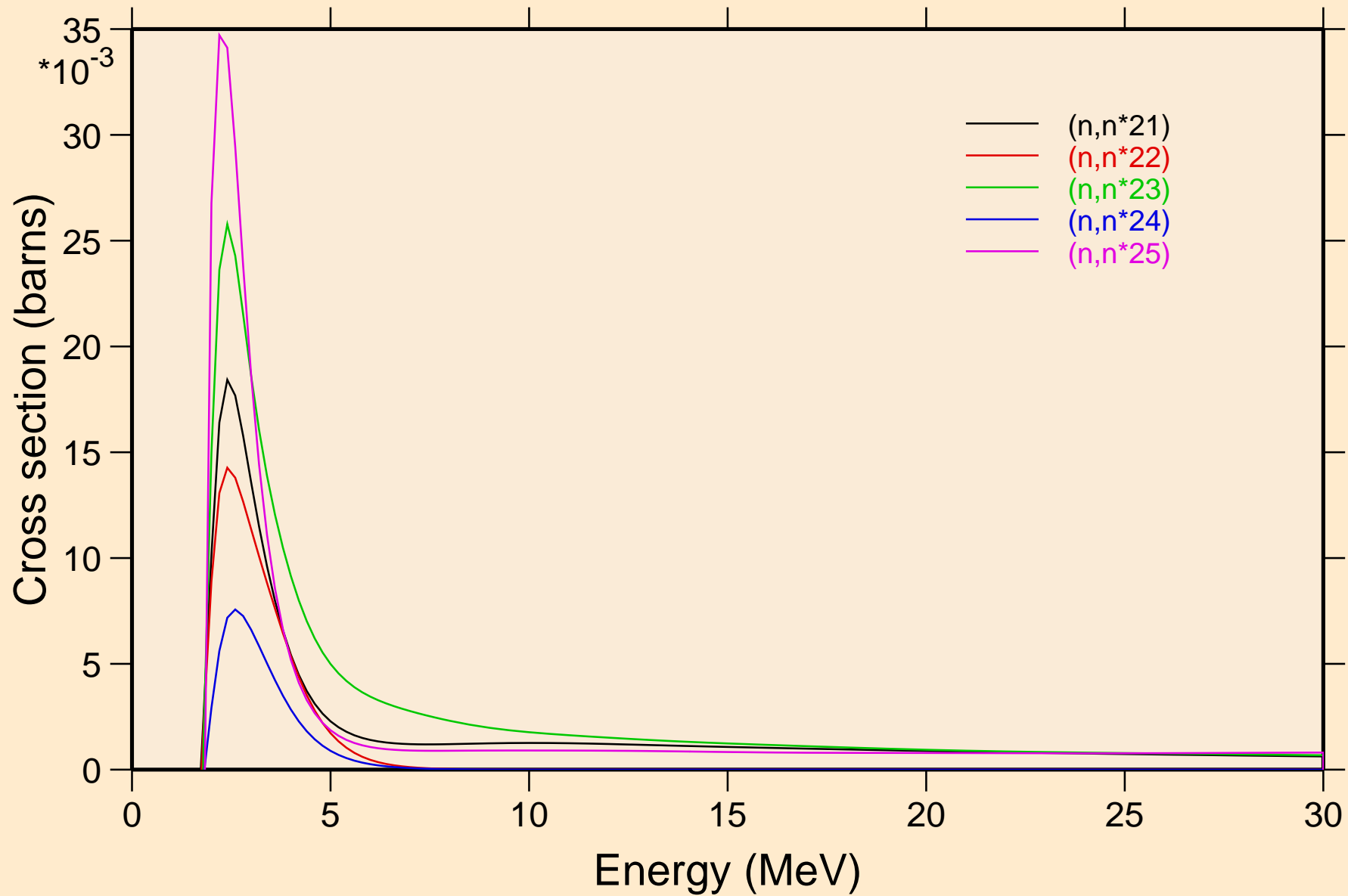

PT198 NEUTRON ACER TENDL-2021 LIBRARY; T=293.6K
Inelastic levels

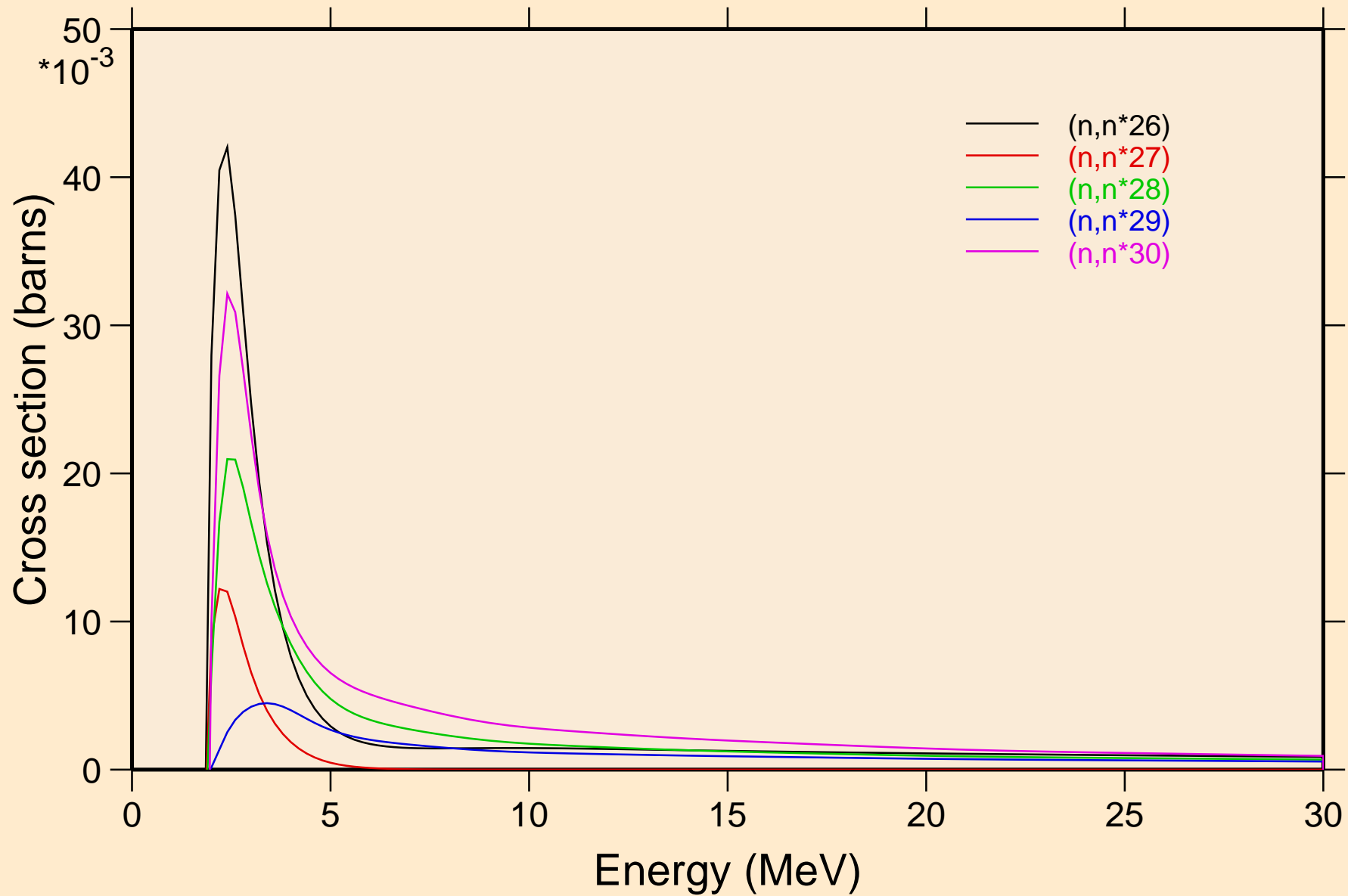

PT198 NEUTRON ACER TENDL-2021 LIBRARY; T=293.6K
Threshold reactions

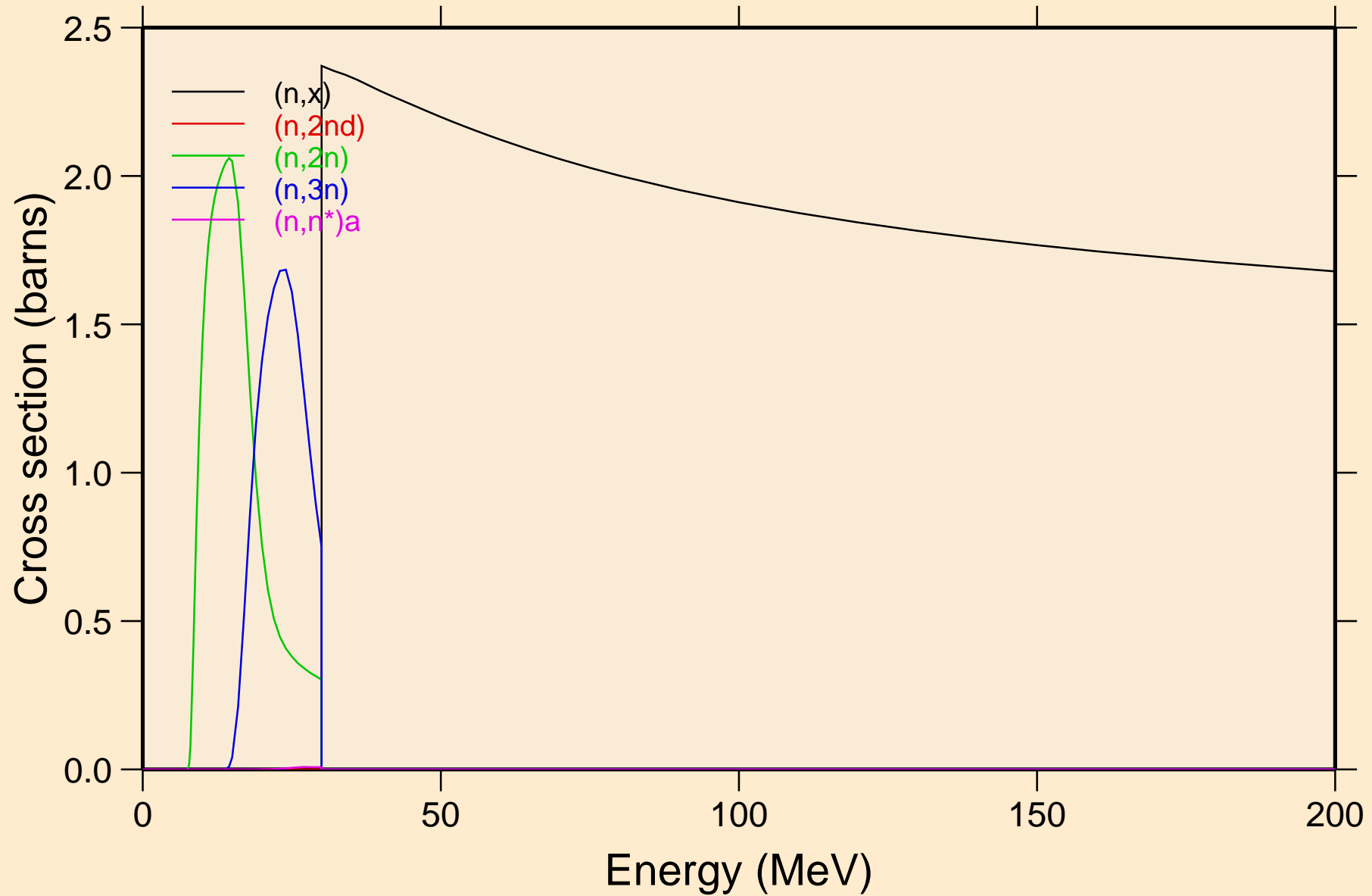

PT198 NEUTRON ACER TENDL-2021 LIBRARY; T=293.6K
Threshold reactions

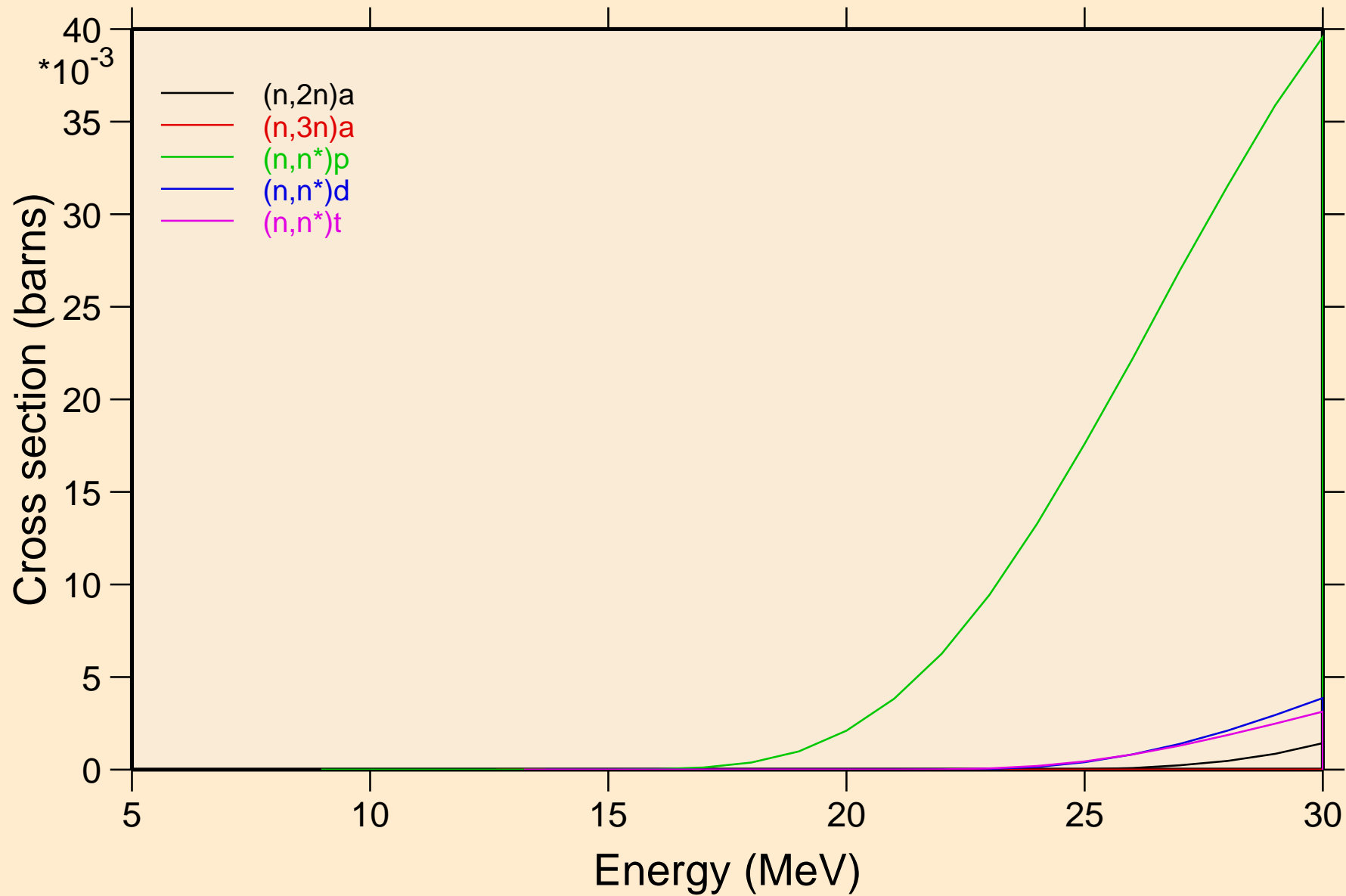

PT198 NEUTRON ACER TENDL-2021 LIBRARY; T=293.6K
Threshold reactions

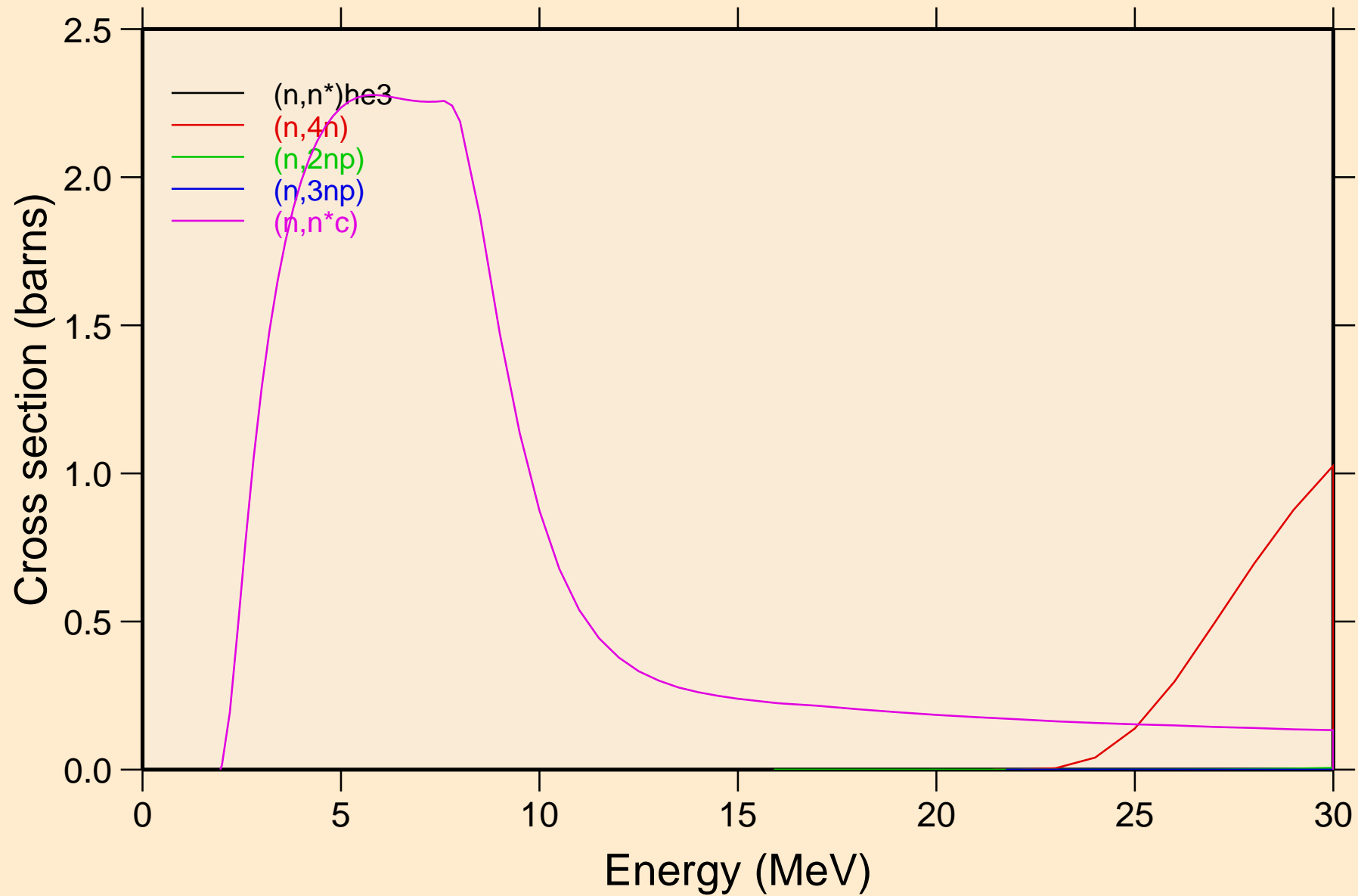

PT198 NEUTRON ACER TENDL-2021 LIBRARY; T=293.6K
Threshold reactions

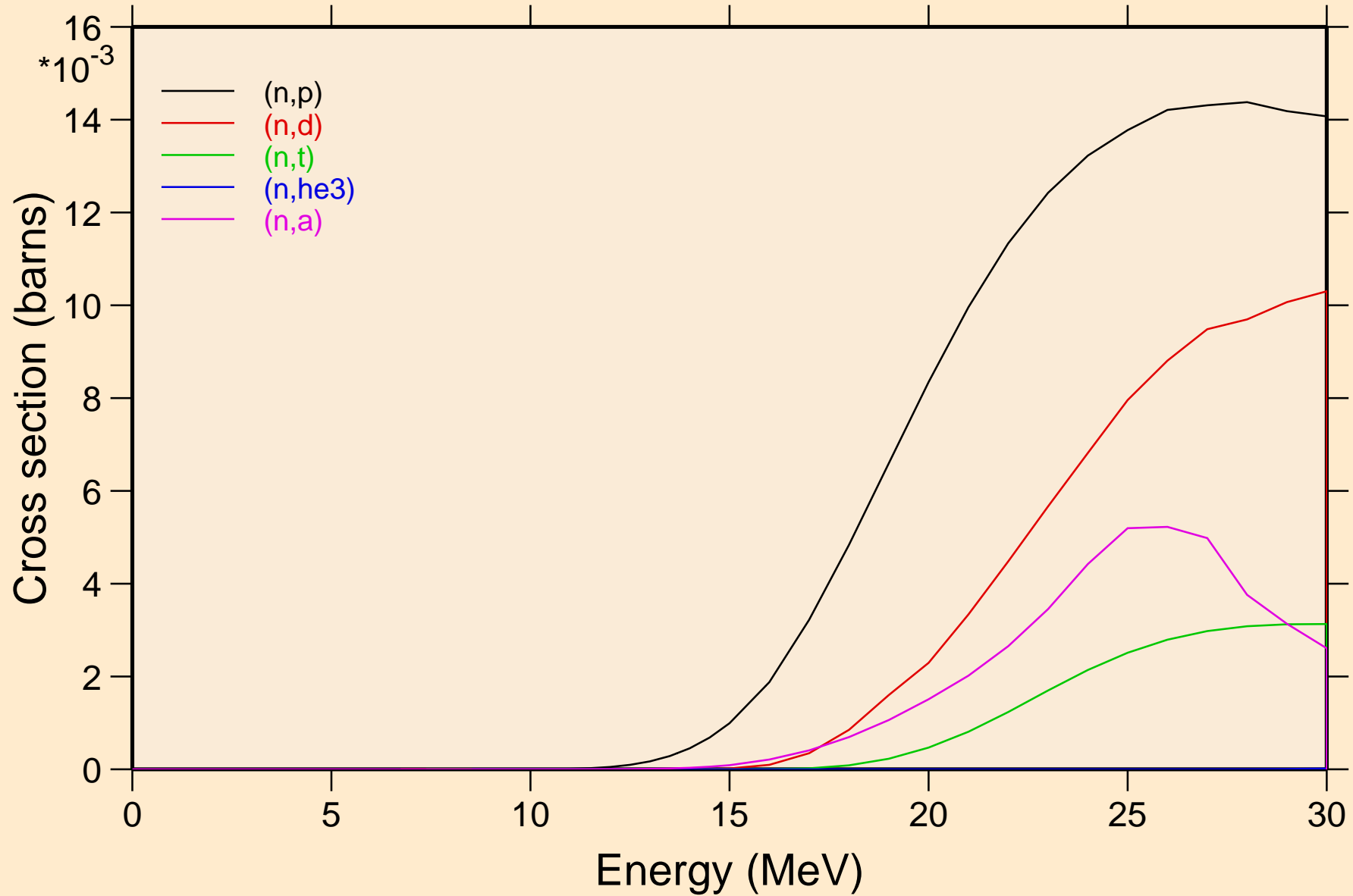

PT198 NEUTRON ACER TENDL-2021 LIBRARY; T=293.6K
Threshold reactions

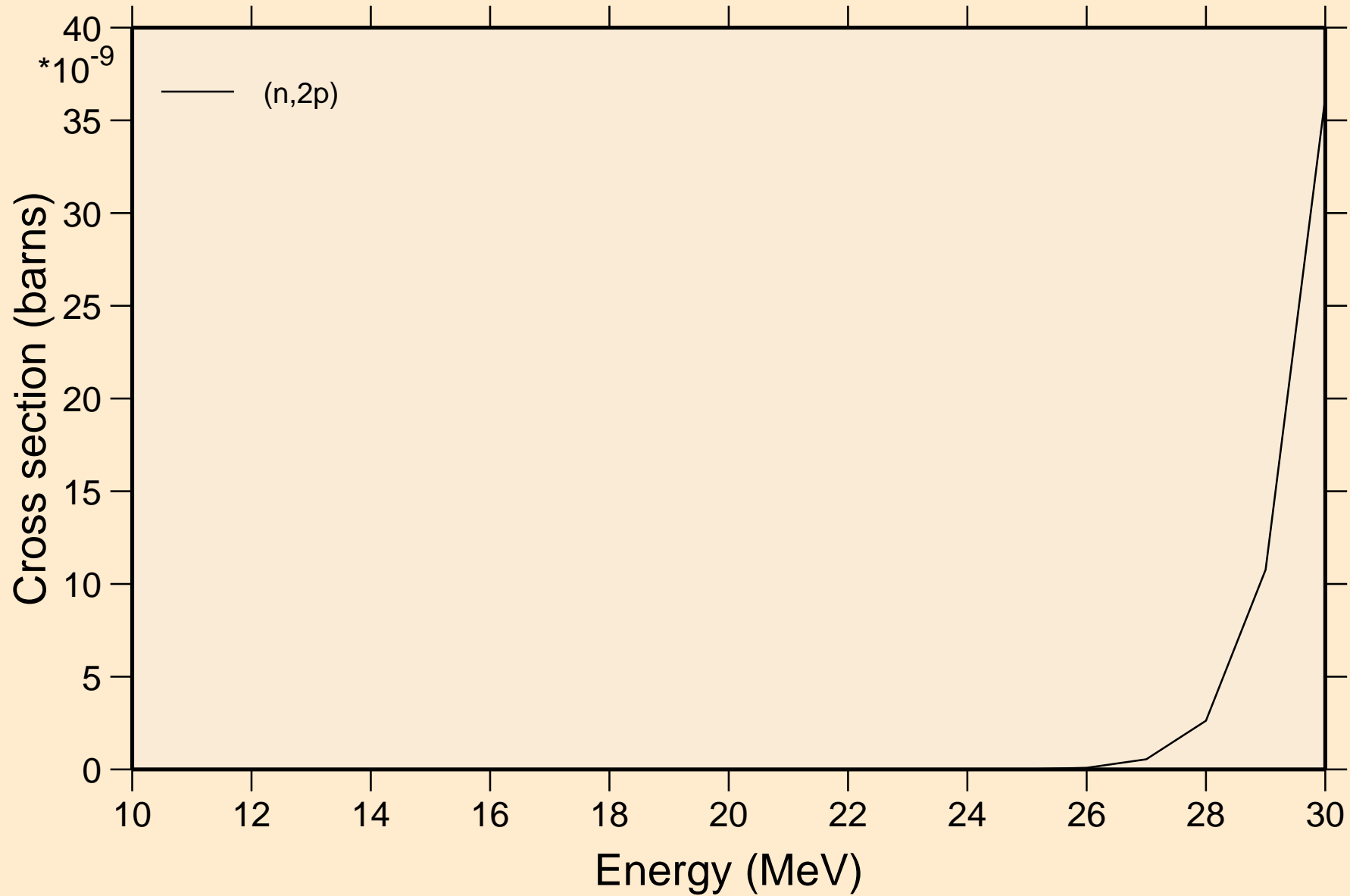

PT198 NEUTRON ACER TENDL-2021 LIBRARY; T=293.6K
Threshold reactions

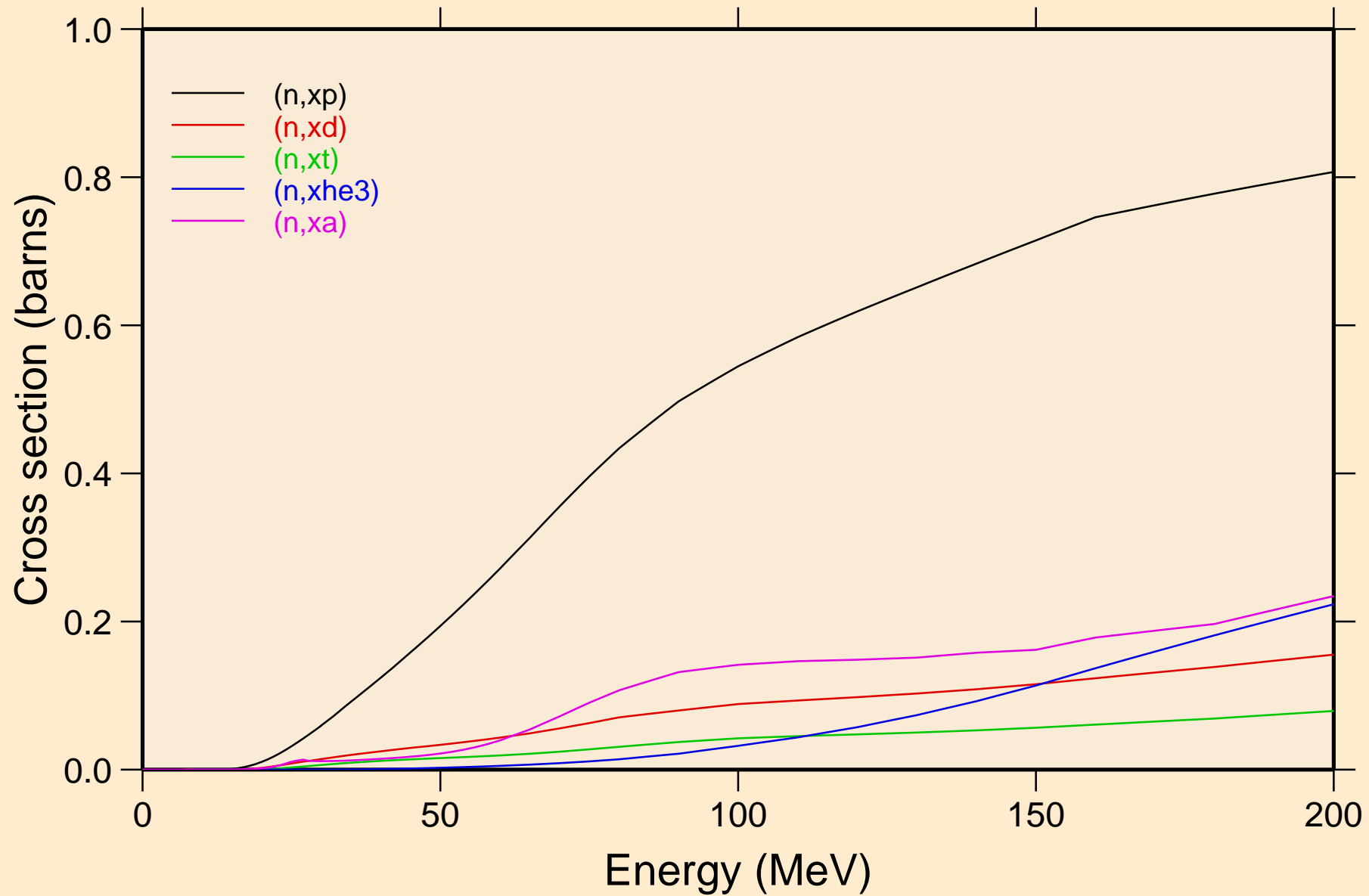

PT198 NEUTRON ACER TENDL-2021 LIBRARY; T=293.6K
angular distribution for elastic

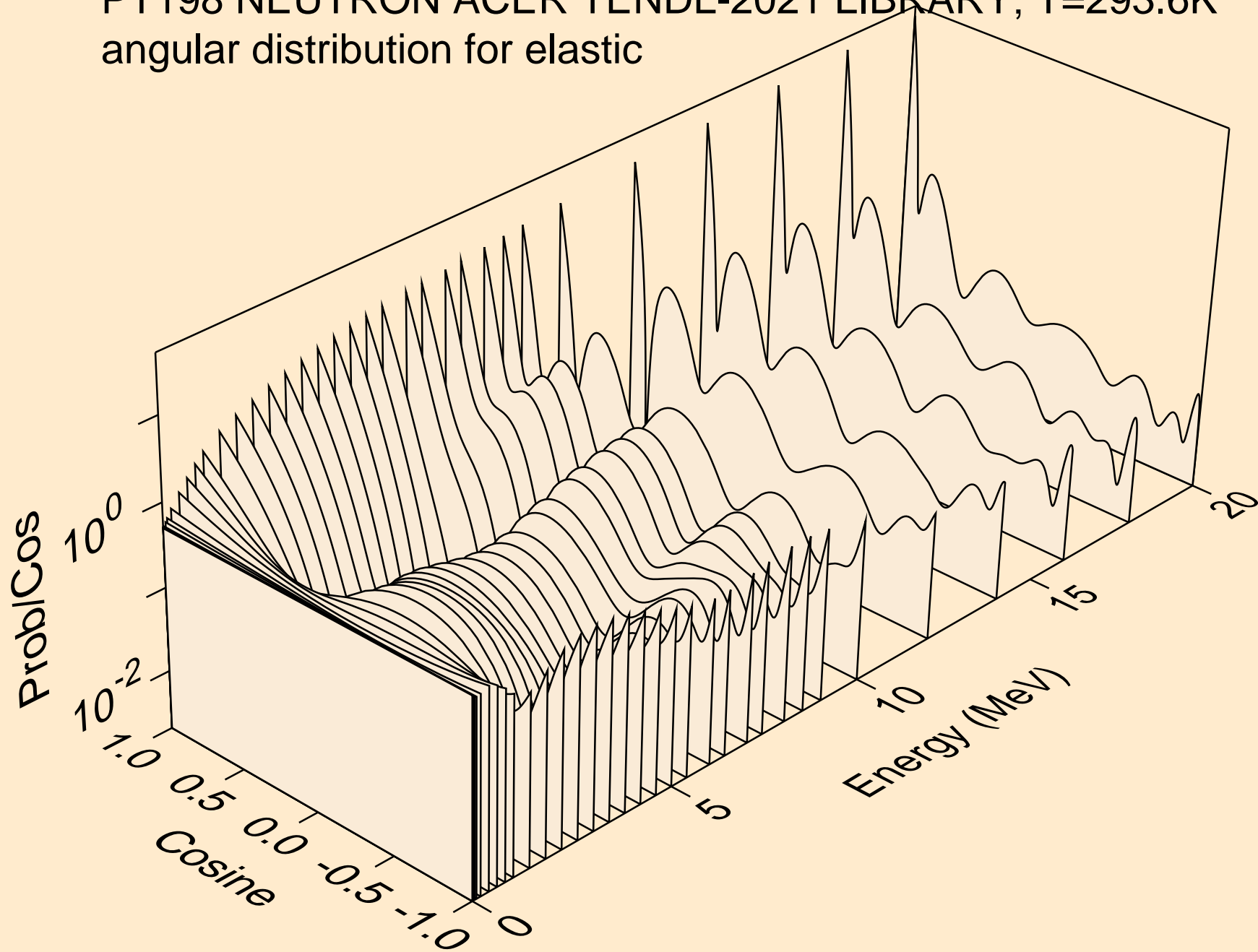

PT198 NEUTRON ACER TENDL-2021 LIBRARY; T=293.6K
angular distribution for elastic

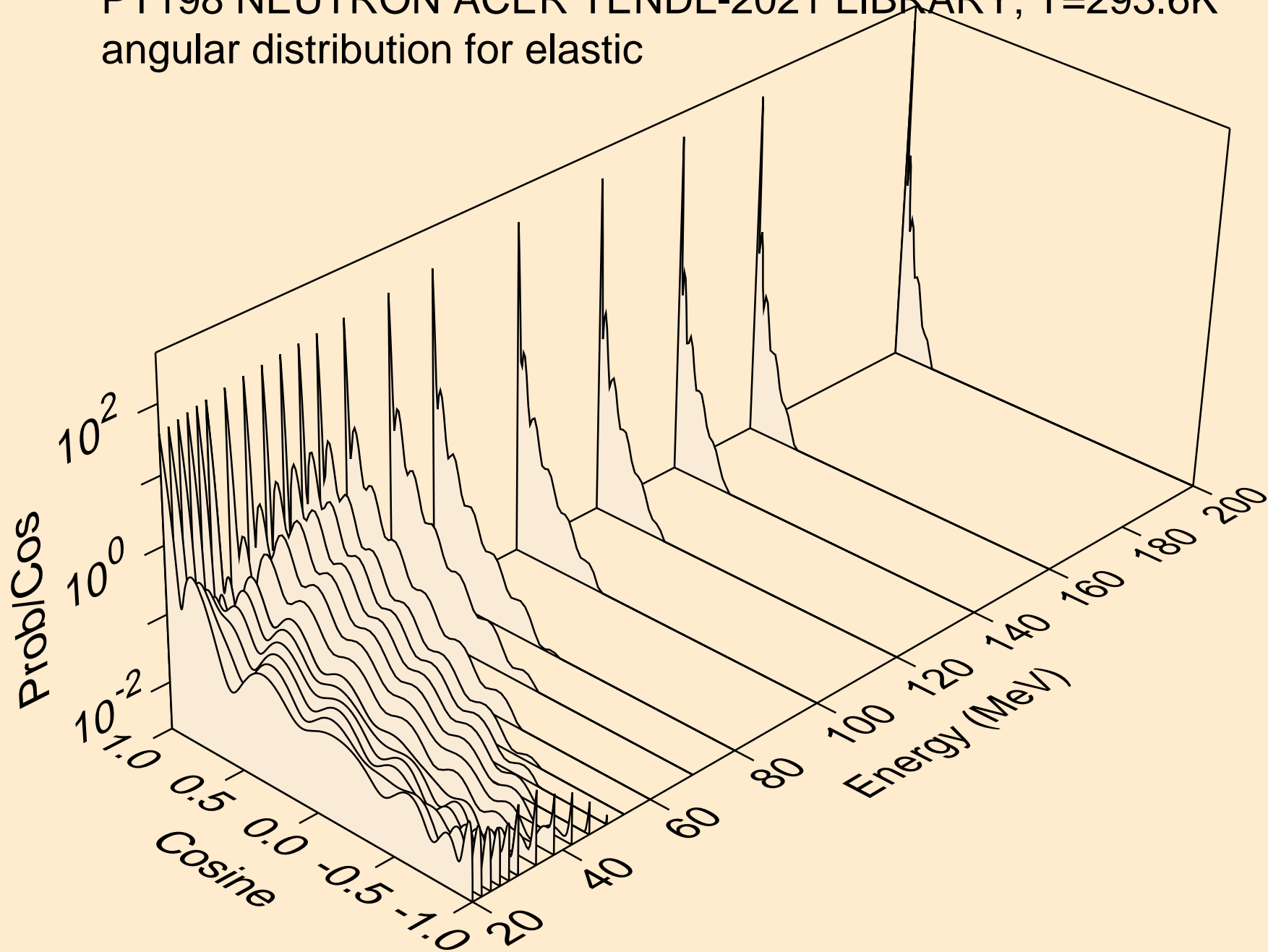

PT198 NEUTRON ACER TENDL-2021 LIBRARY; T=293.6K
angular distribution for (n,n*1)

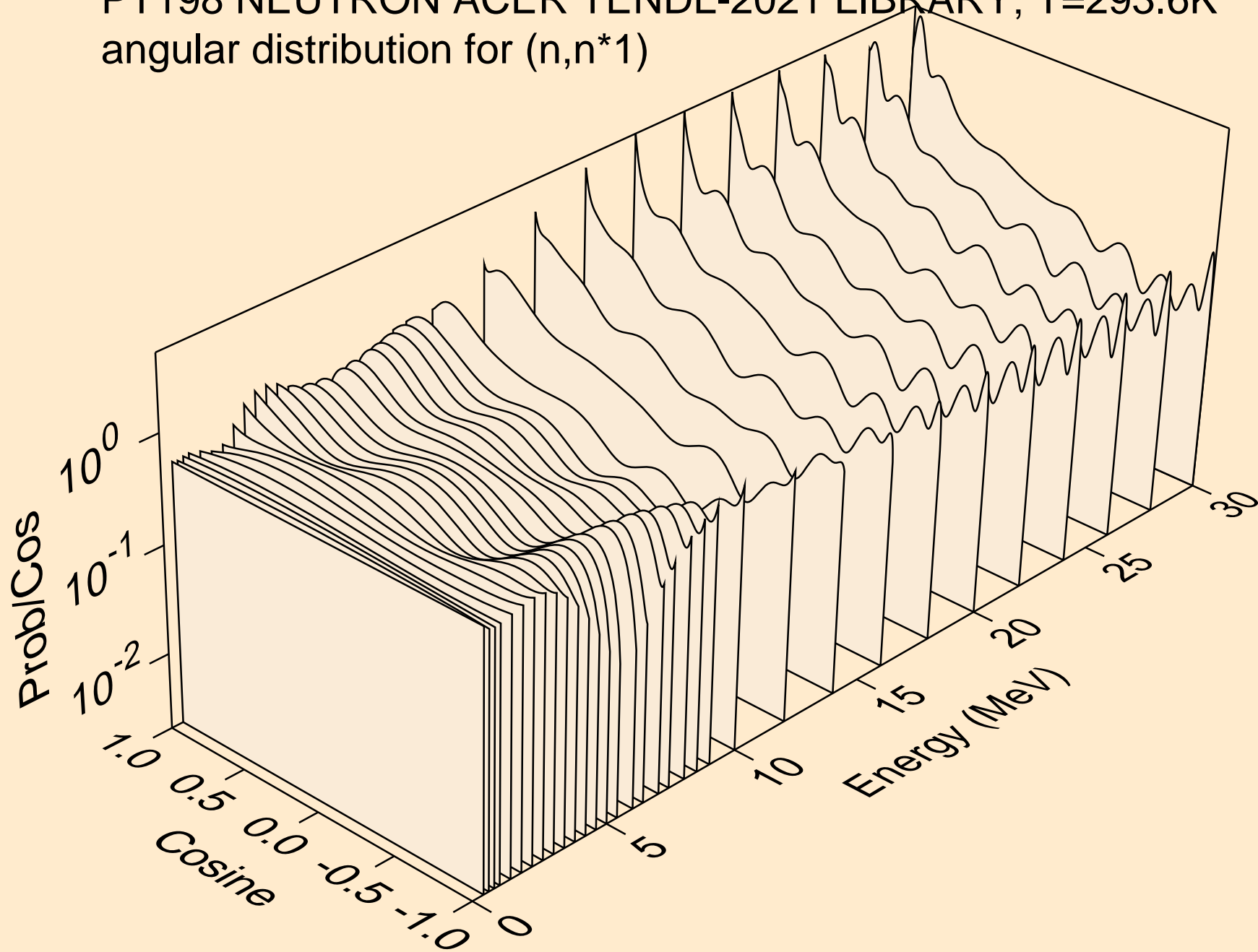

PT198 NEUTRON ACER TENDL-2021 LIBRARY; T=293.6K
angular distribution for (n,n*2)

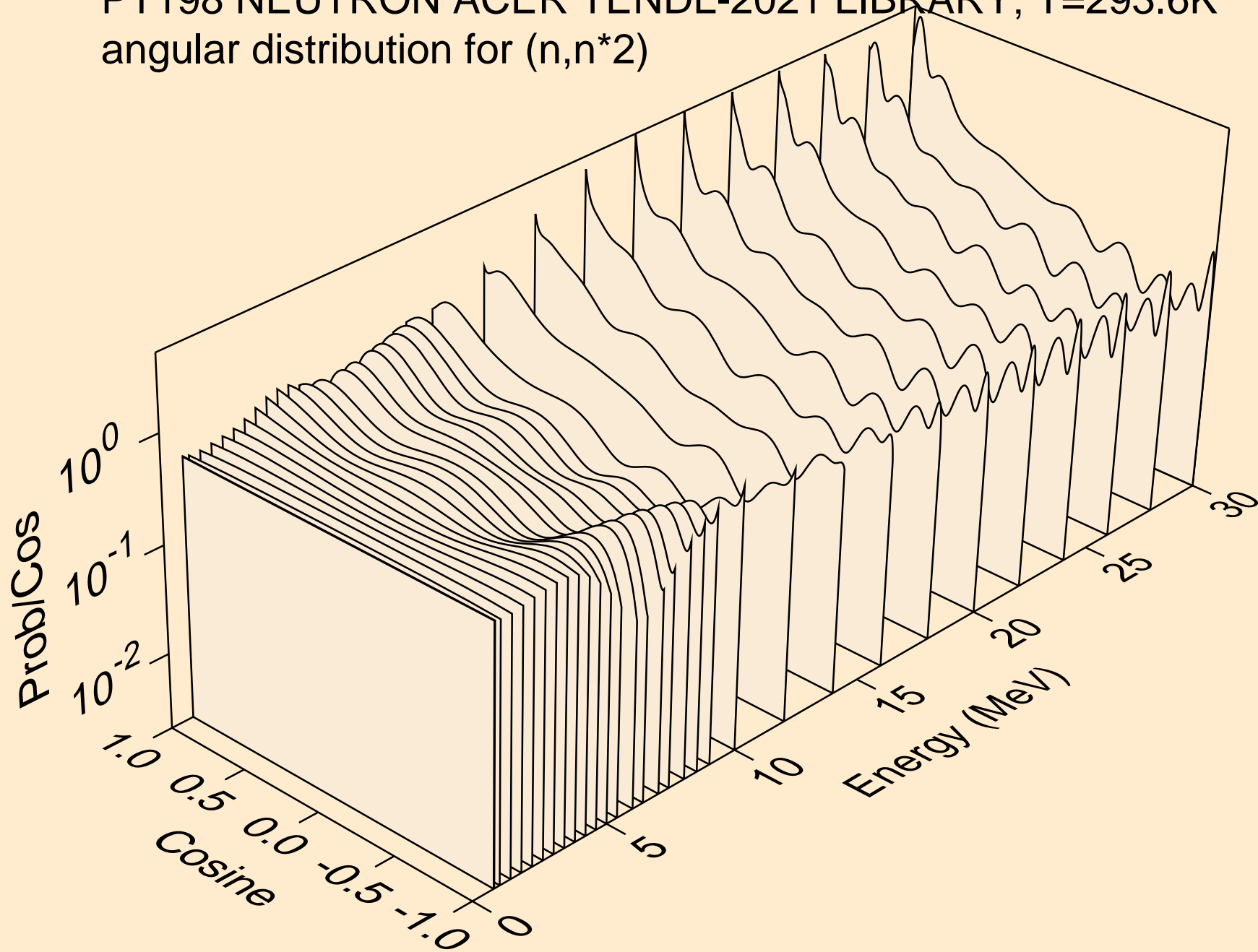

PT198 NEUTRON ACER TENDL-2021 LIBRARY; T=293.6K
angular distribution for (n,n*3)

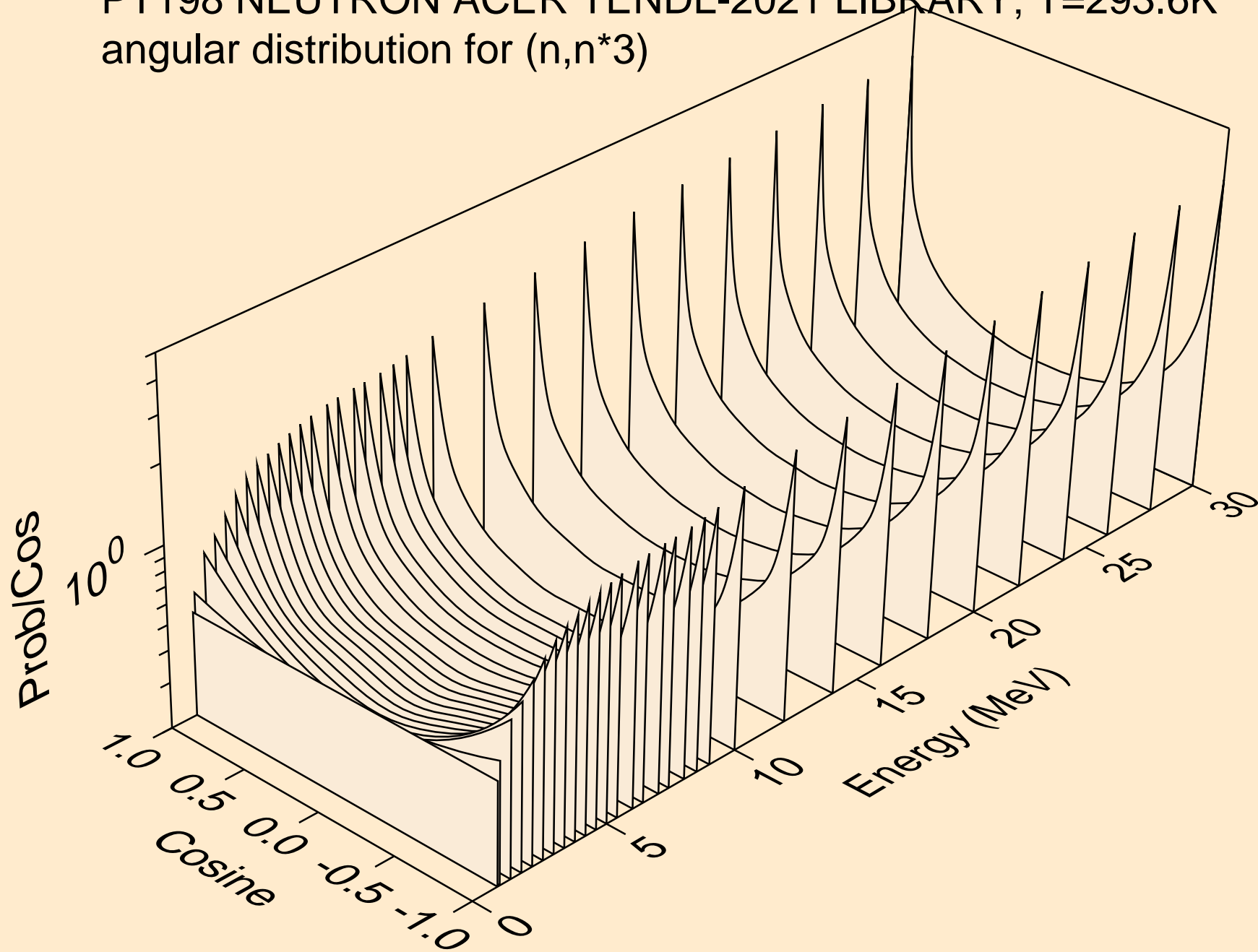

PT198 NEUTRON ACER TENDL-2021 LIBRARY; T=293.6K
angular distribution for (n,n*4)

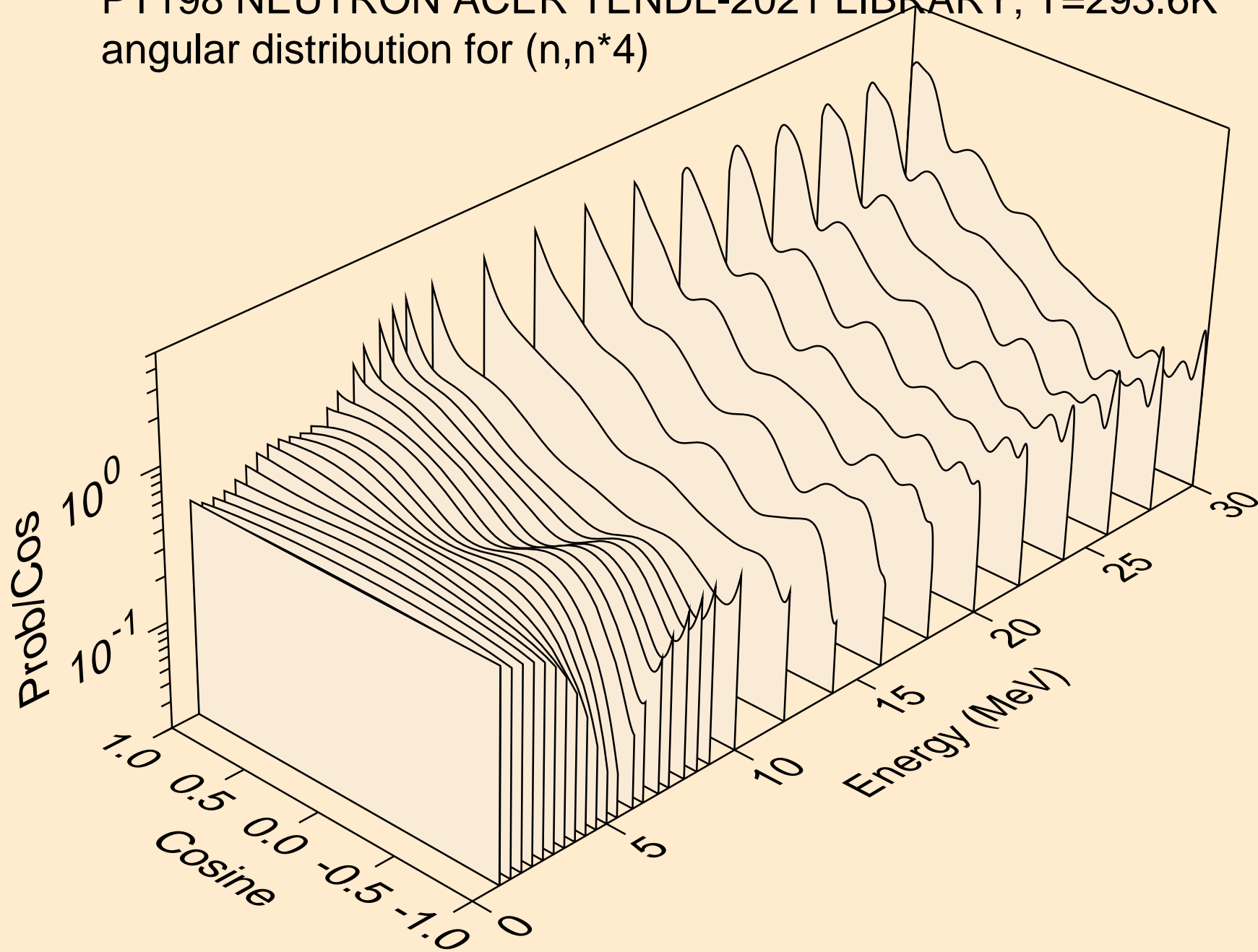

PT198 NEUTRON ACER TENDL-2021 LIBRARY; T=293.6K
angular distribution for (n,n*5)

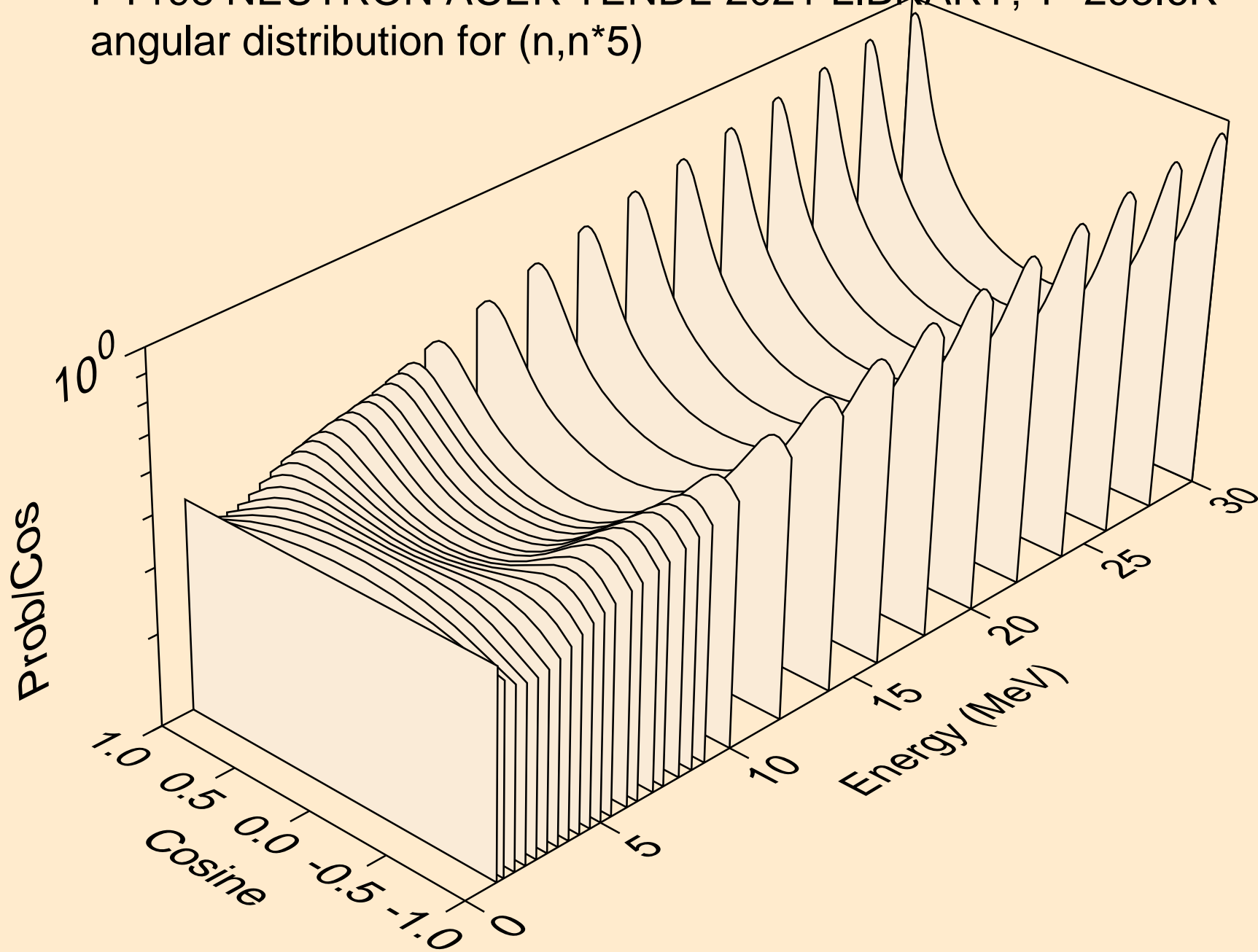

PT198 NEUTRON ACER TENDL-2021 LIBRARY; T=293.6K
angular distribution for (n,n*6)

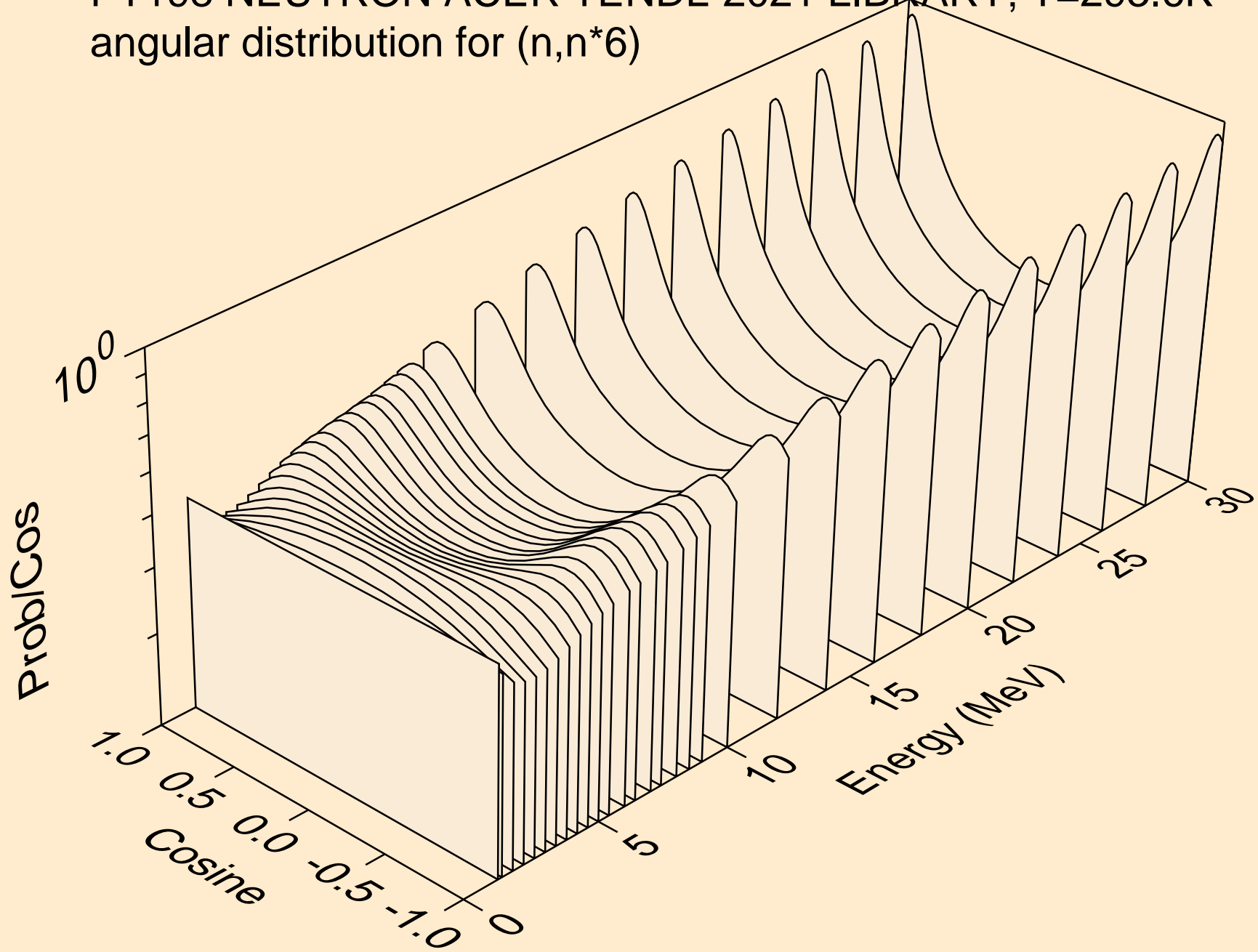

PT198 NEUTRON ACER TENDL-2021 LIBRARY; T=293.6K
angular distribution for (n,n*7)

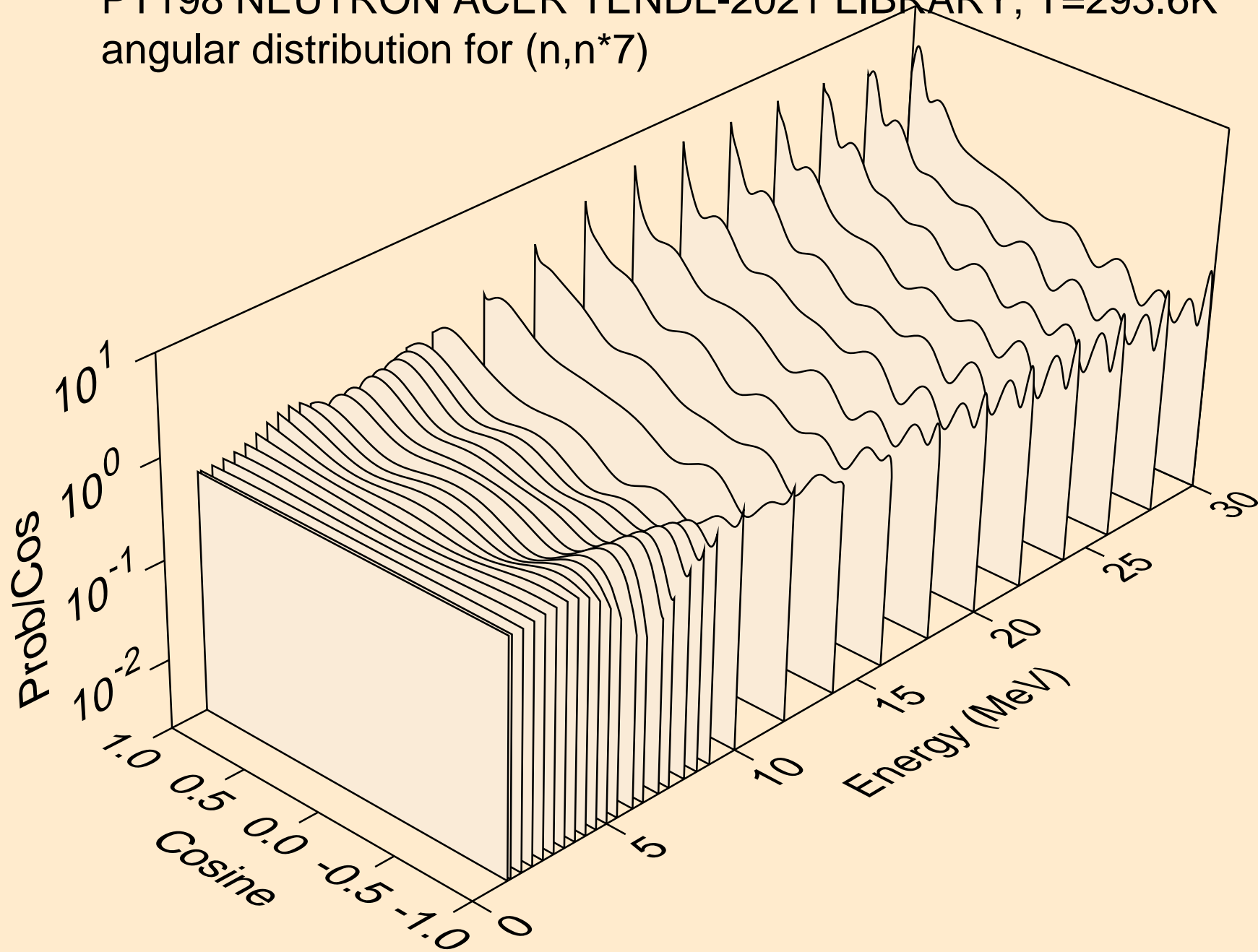

PT198 NEUTRON ACER TENDL-2021 LIBRARY; T=293.6K
angular distribution for (n,n*8)

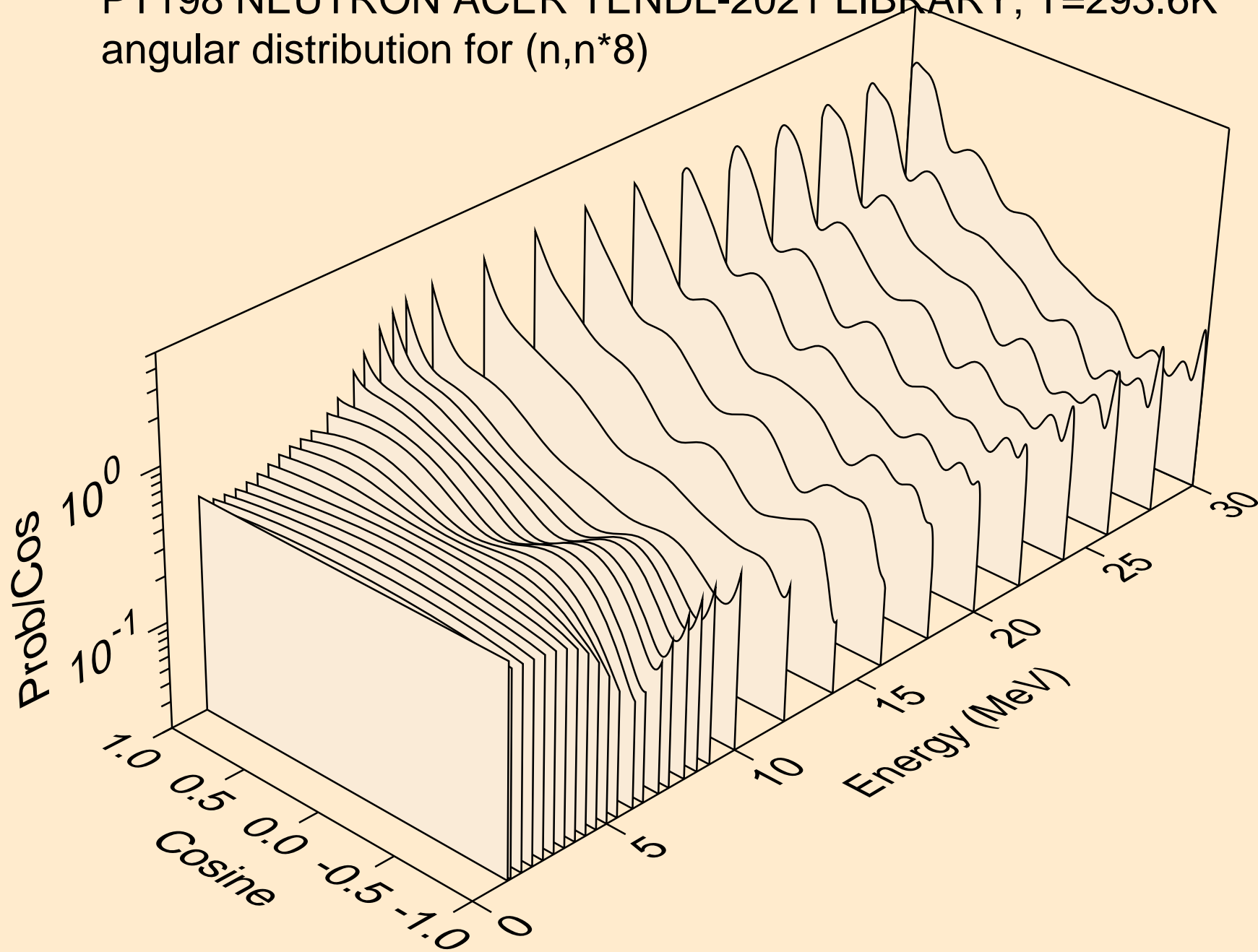

PT198 NEUTRON ACER TENDL-2021 LIBRARY; T=293.6K
angular distribution for (n,n*9)

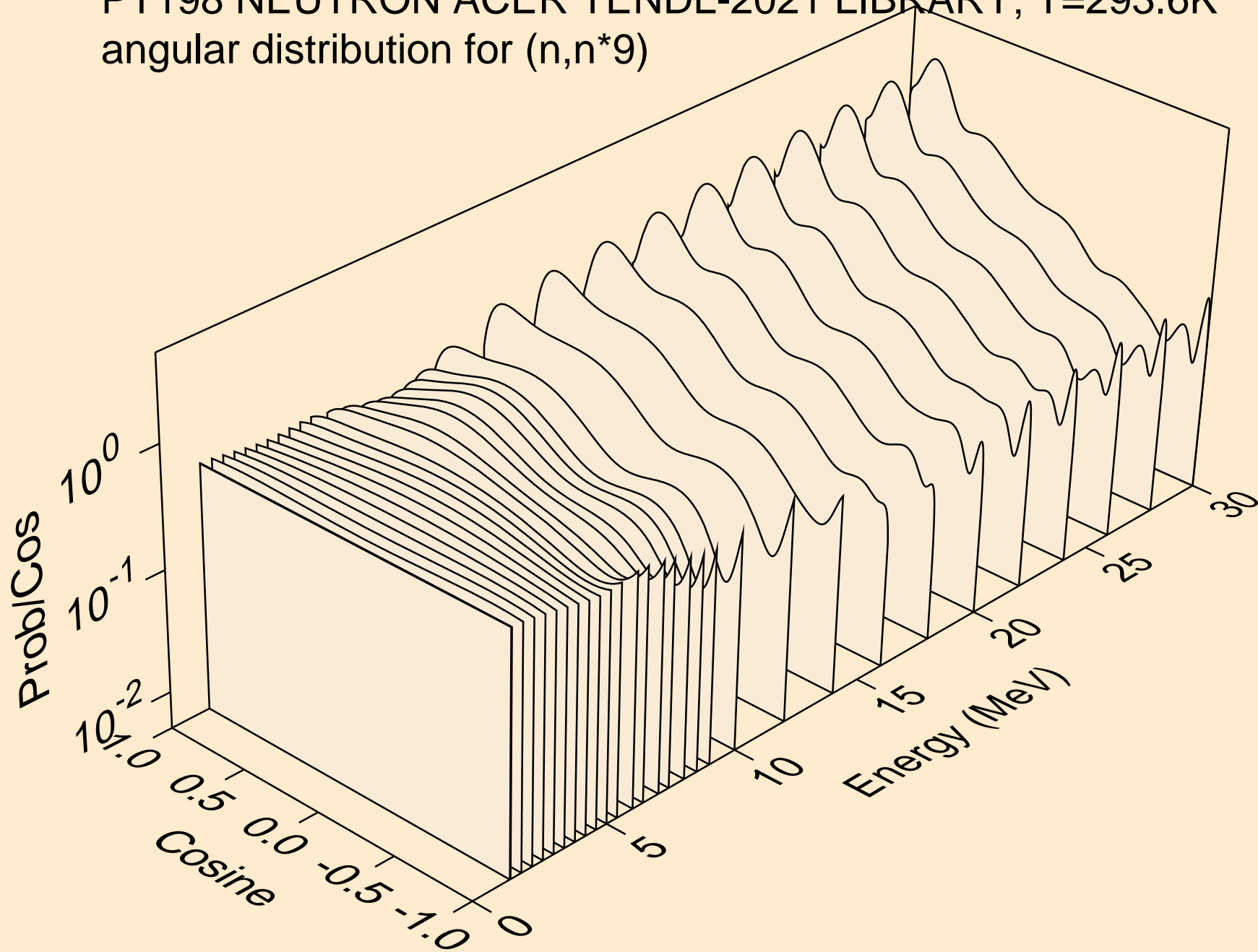

PT198 NEUTRON ACER TENDL-2021 LIBRARY; T=293.6K
angular distribution for (n,n*10)

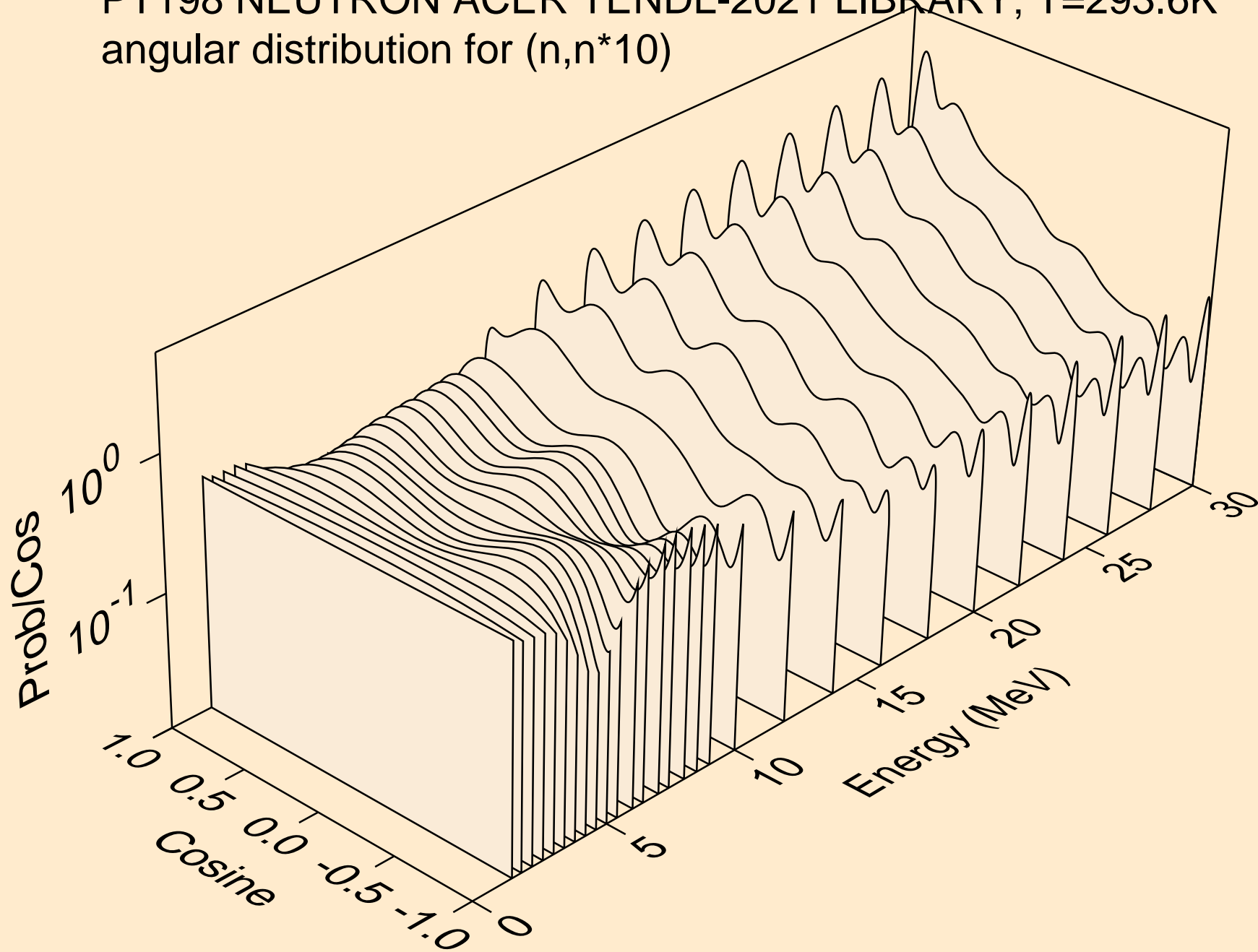

PT198 NEUTRON ACER TENDL-2021 LIBRARY; T=293.6K
angular distribution for (n,n*11)

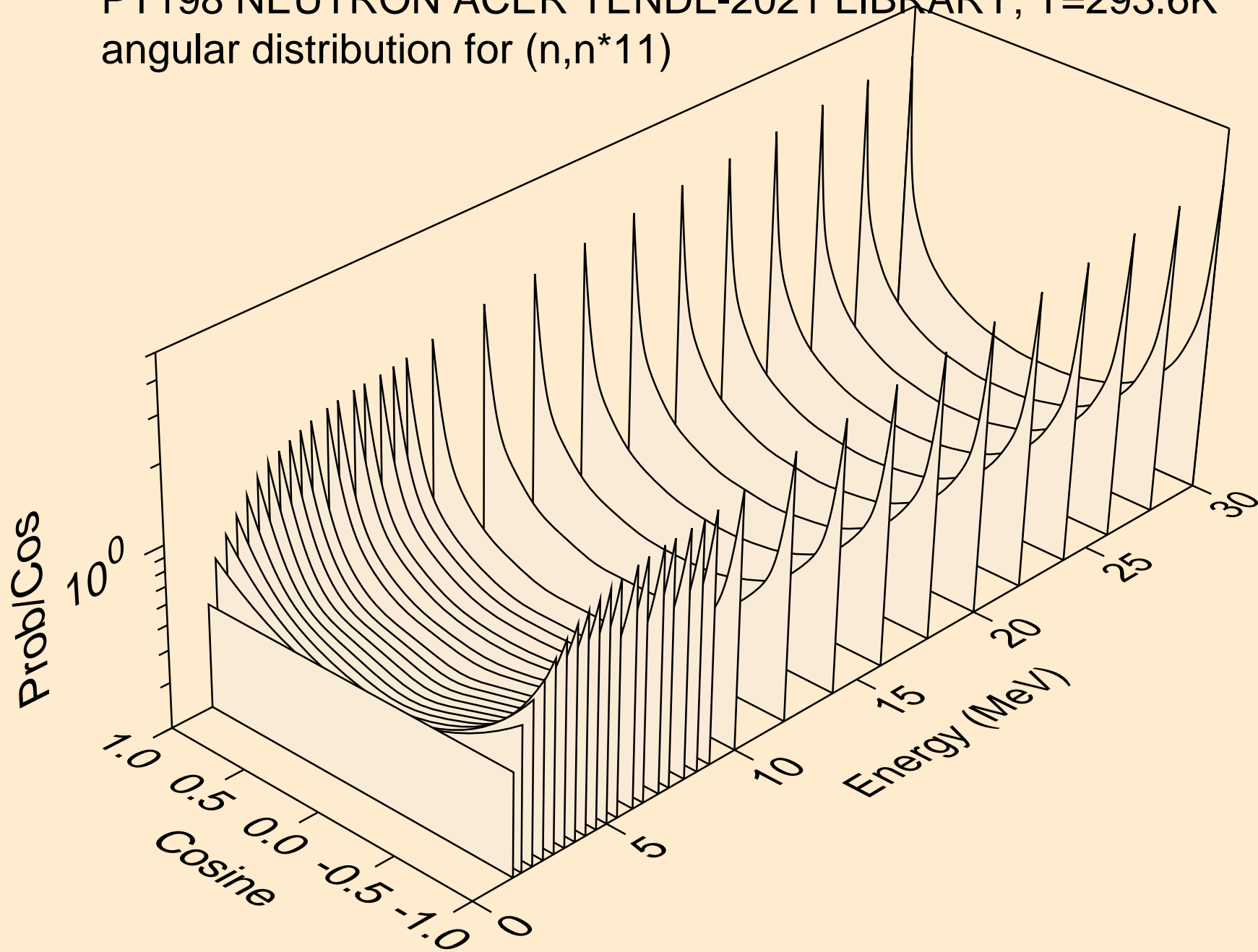

PT198 NEUTRON ACER TENDL-2021 LIBRARY; T=293.6K
angular distribution for (n,n*12)

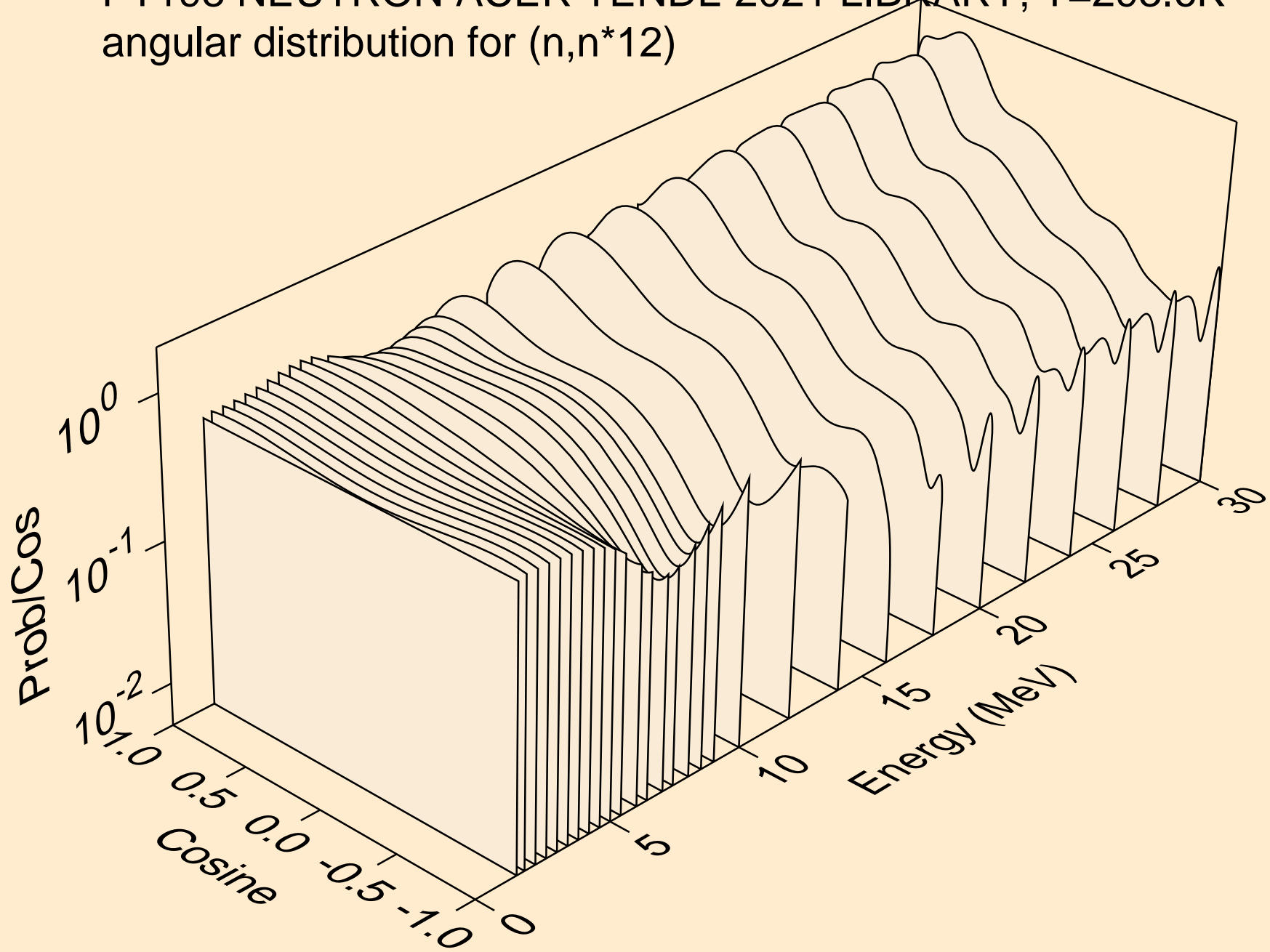

PT198 NEUTRON ACER TENDL-2021 LIBRARY; T=293.6K
angular distribution for (n,n*13)

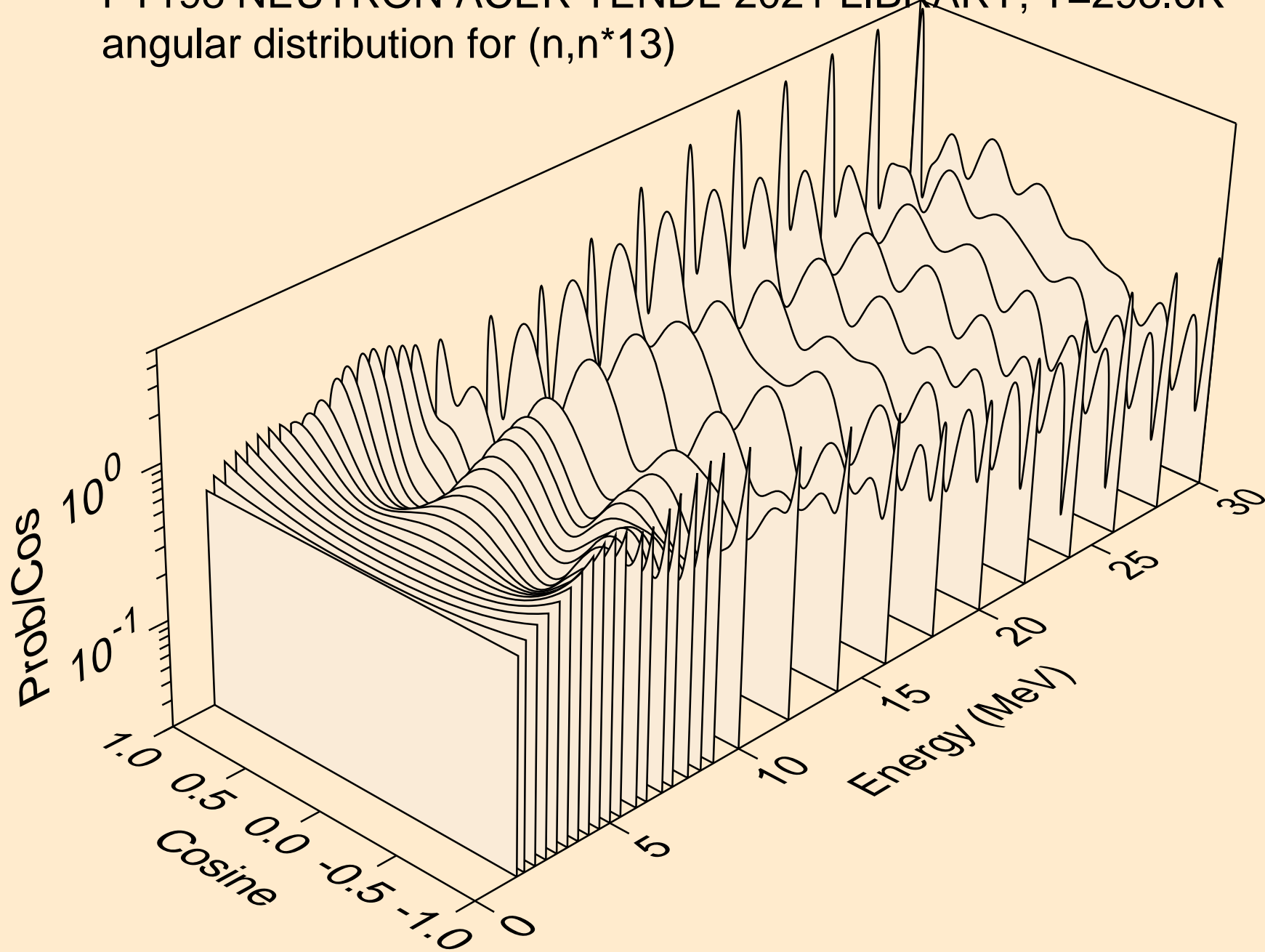

PT198 NEUTRON ACER TENDL-2021 LIBRARY; T=293.6K
angular distribution for (n,n*14)

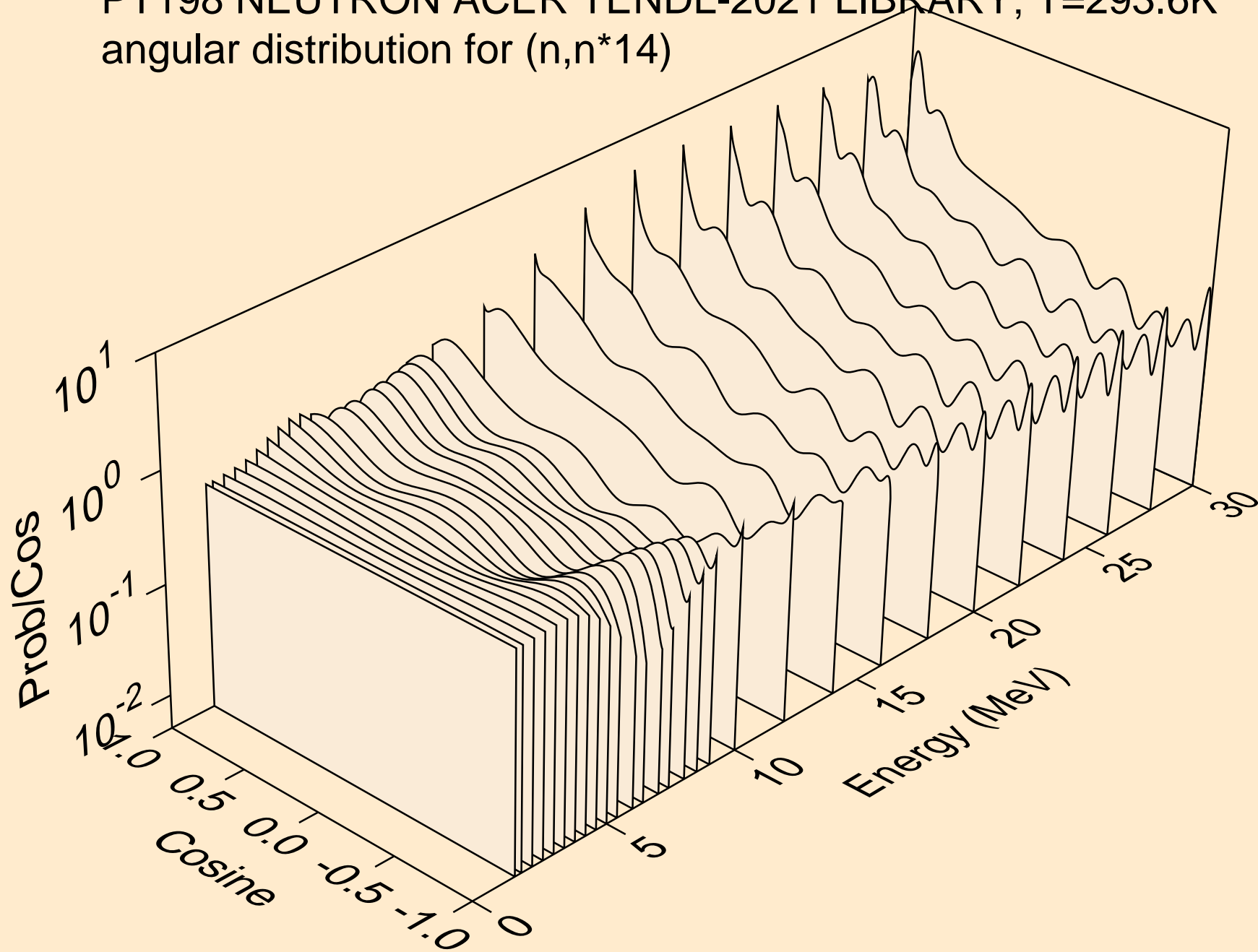

PT198 NEUTRON ACER TENDL-2021 LIBRARY; T=293.6K
angular distribution for (n,n*15)

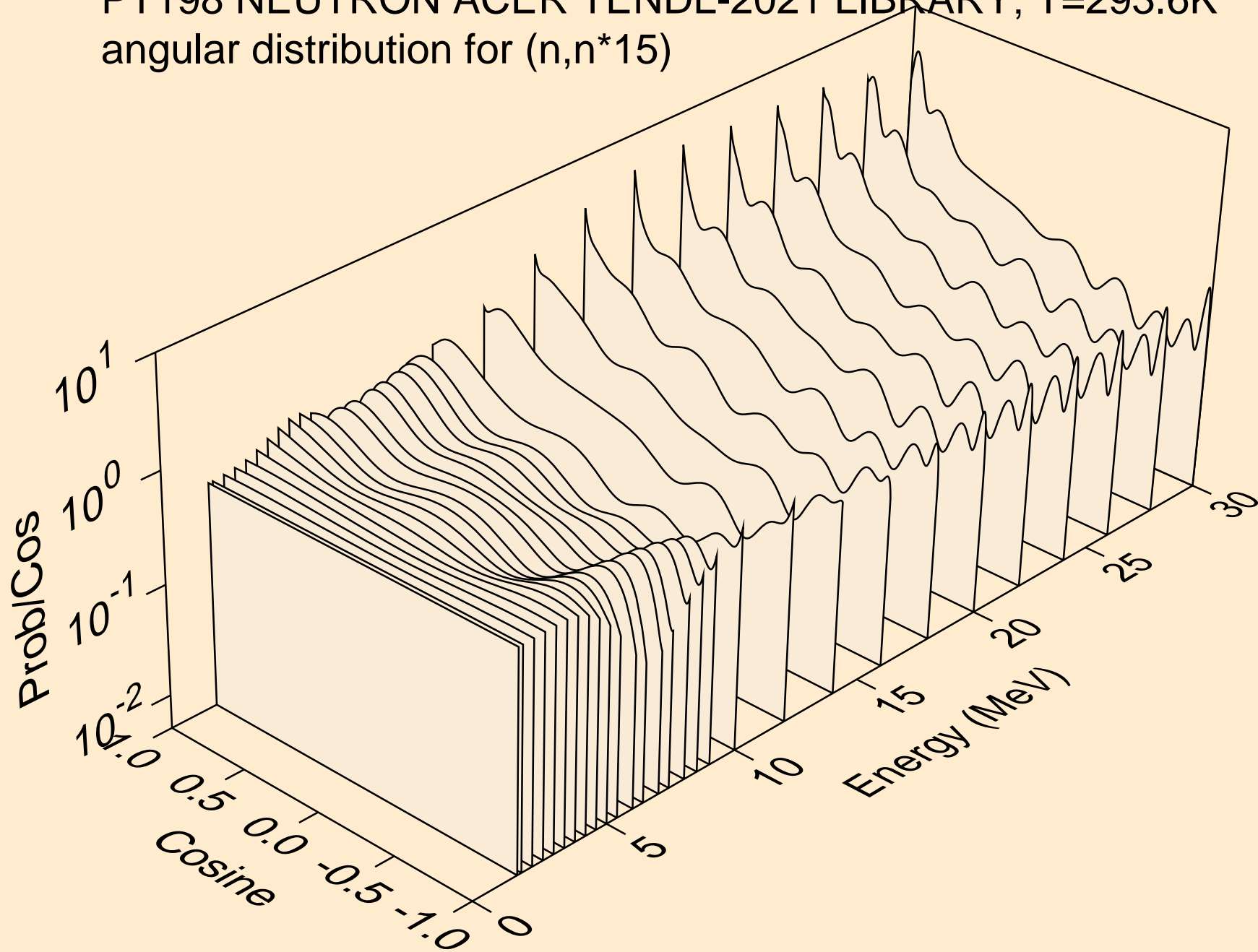

PT198 NEUTRON ACER TENDL-2021 LIBRARY; T=293.6K
angular distribution for (n,n*16)

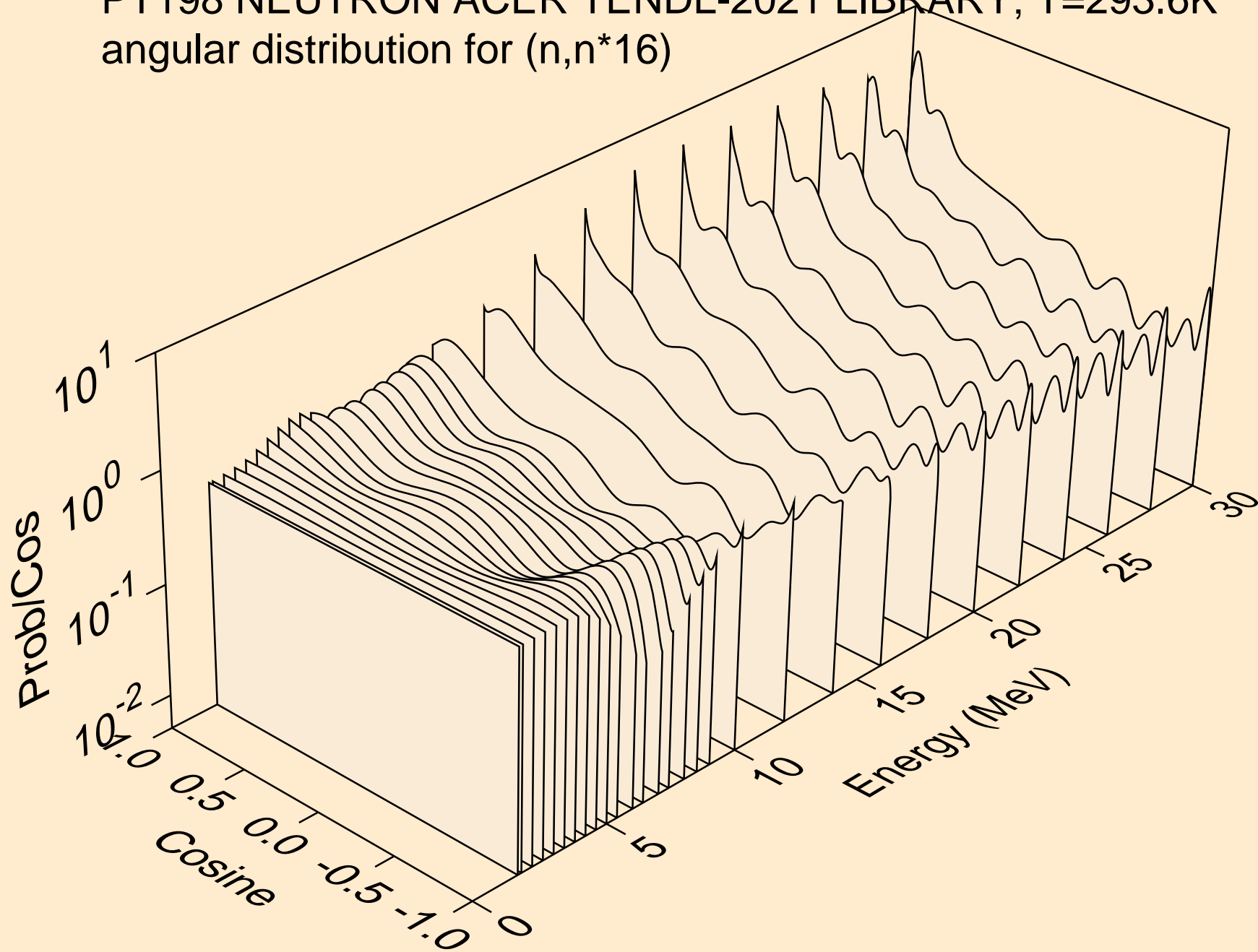

PT198 NEUTRON ACER TENDL-2021 LIBRARY; T=293.6K
angular distribution for (n,n*17)

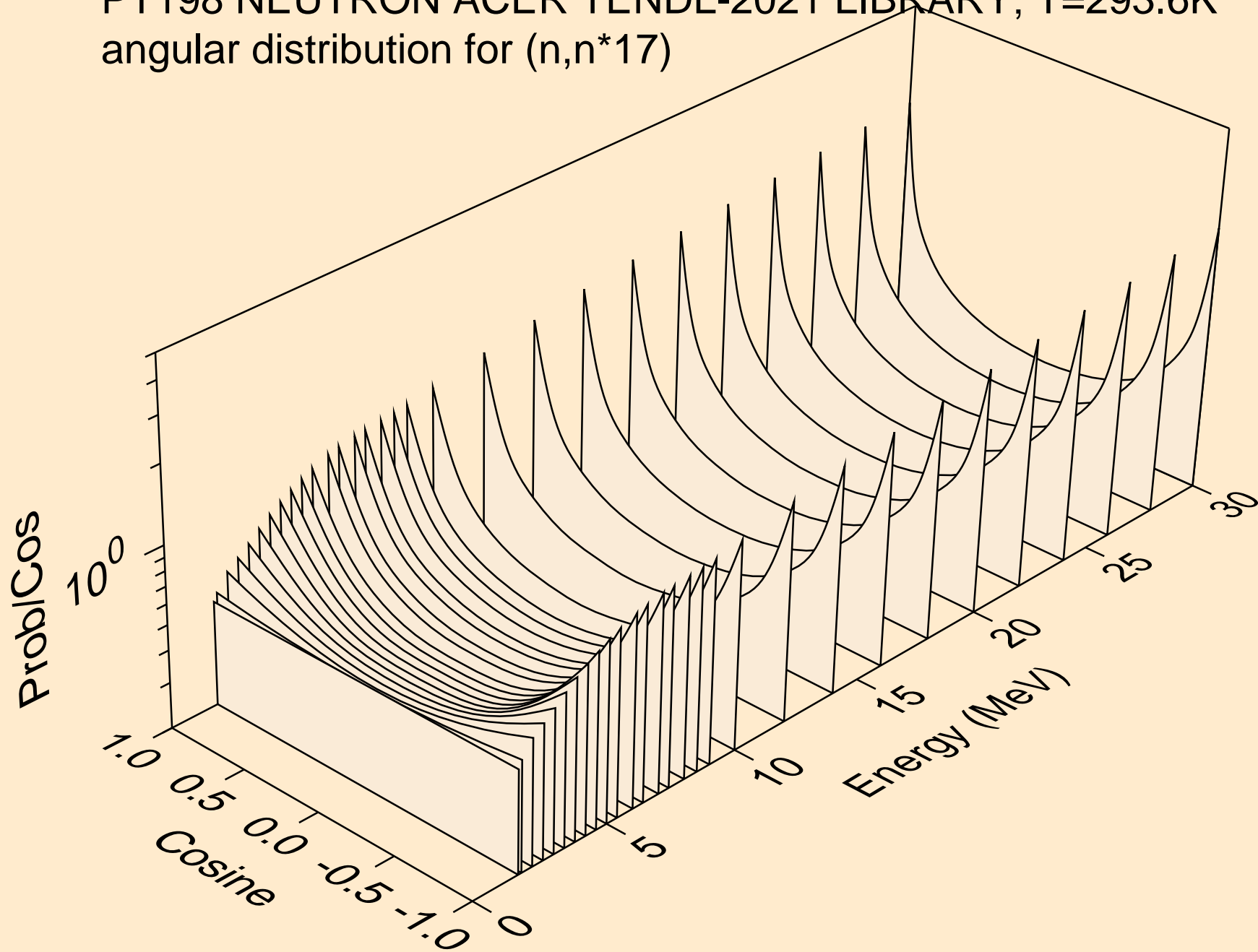

PT198 NEUTRON ACER TENDL-2021 LIBRARY; T=293.6K
angular distribution for (n,n*18)

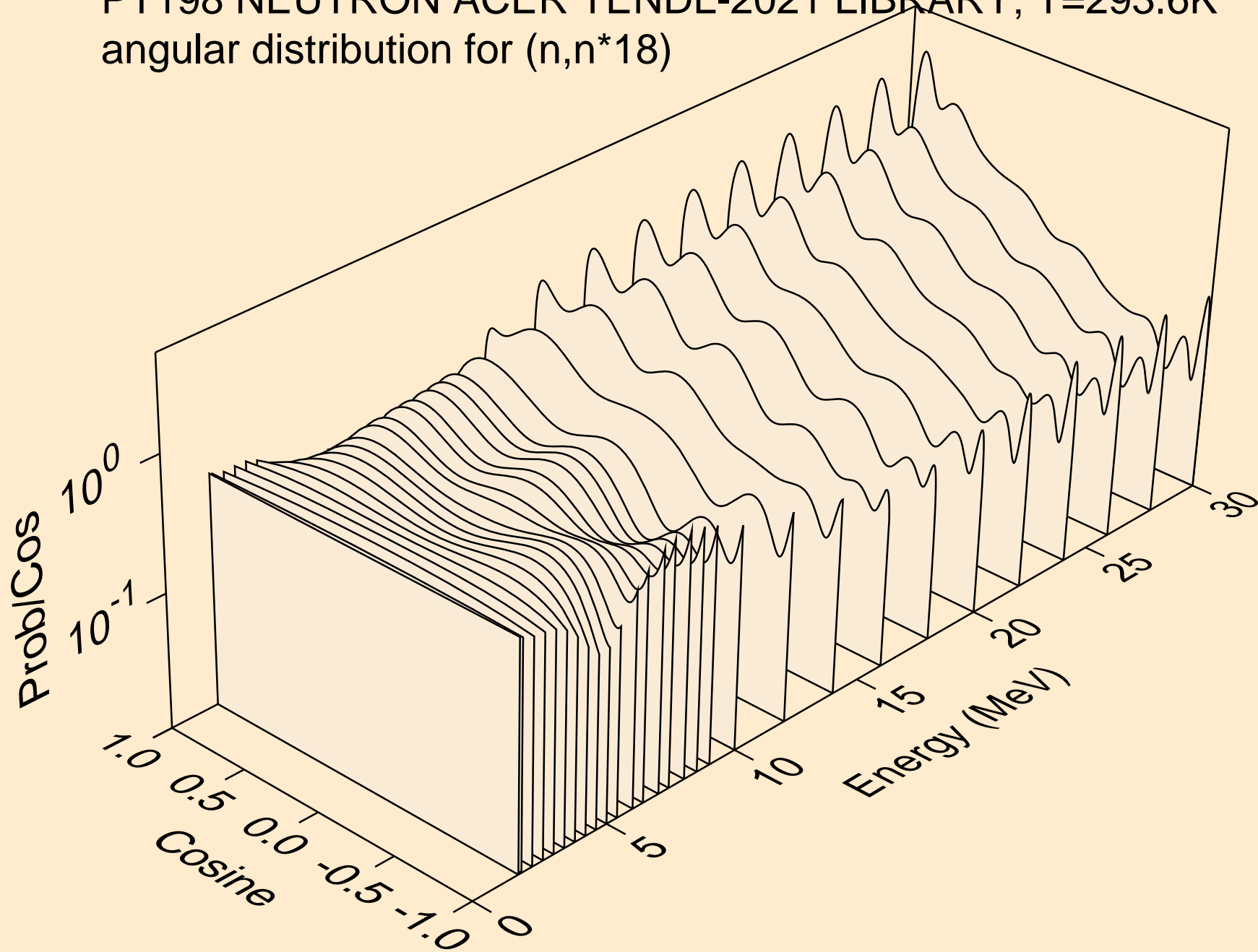

PT198 NEUTRON ACER TENDL-2021 LIBRARY; T=293.6K
angular distribution for (n,n*19)

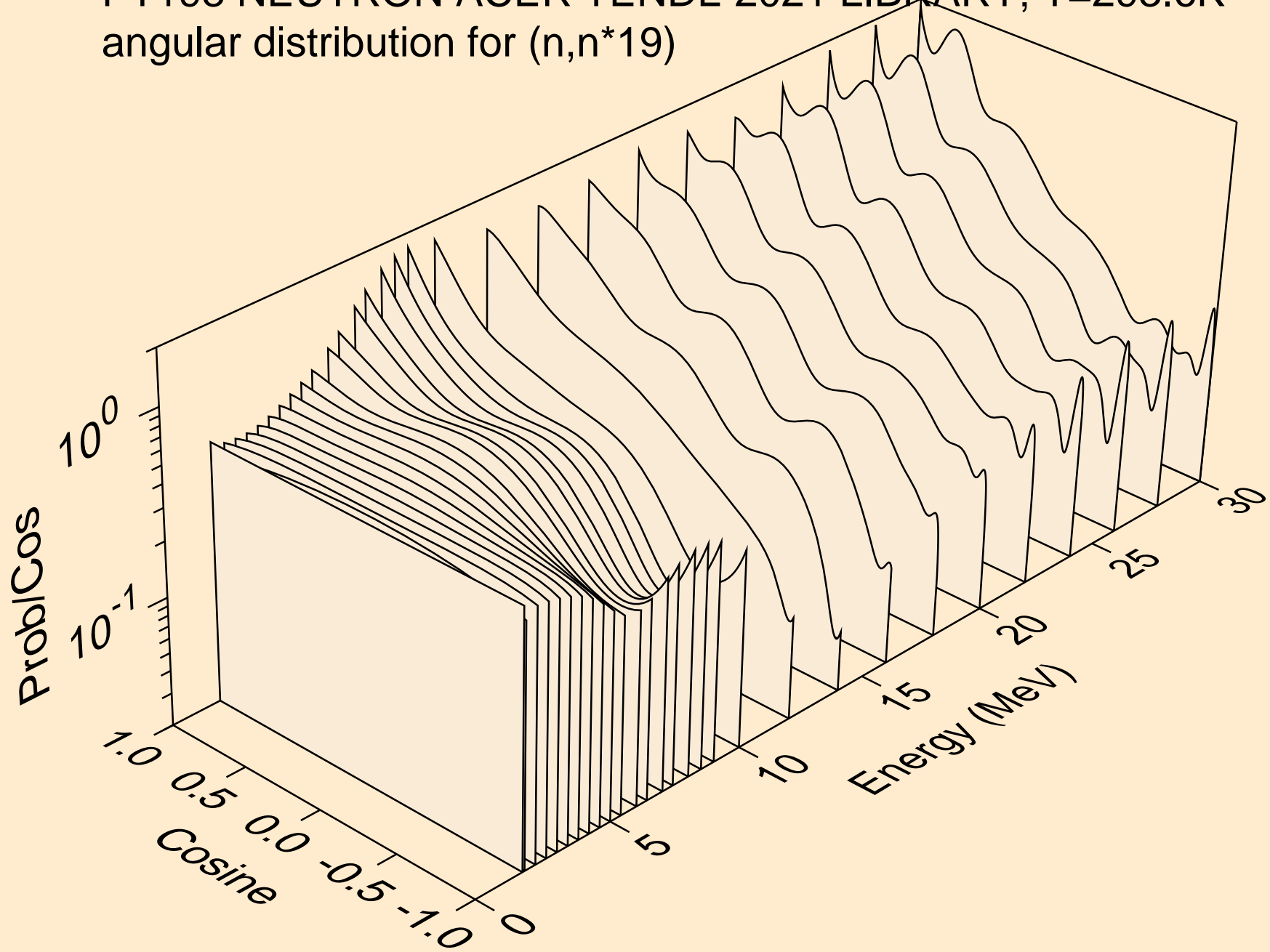

PT198 NEUTRON ACER TENDL-2021 LIBRARY; T=293.6K
angular distribution for (n,n*20)

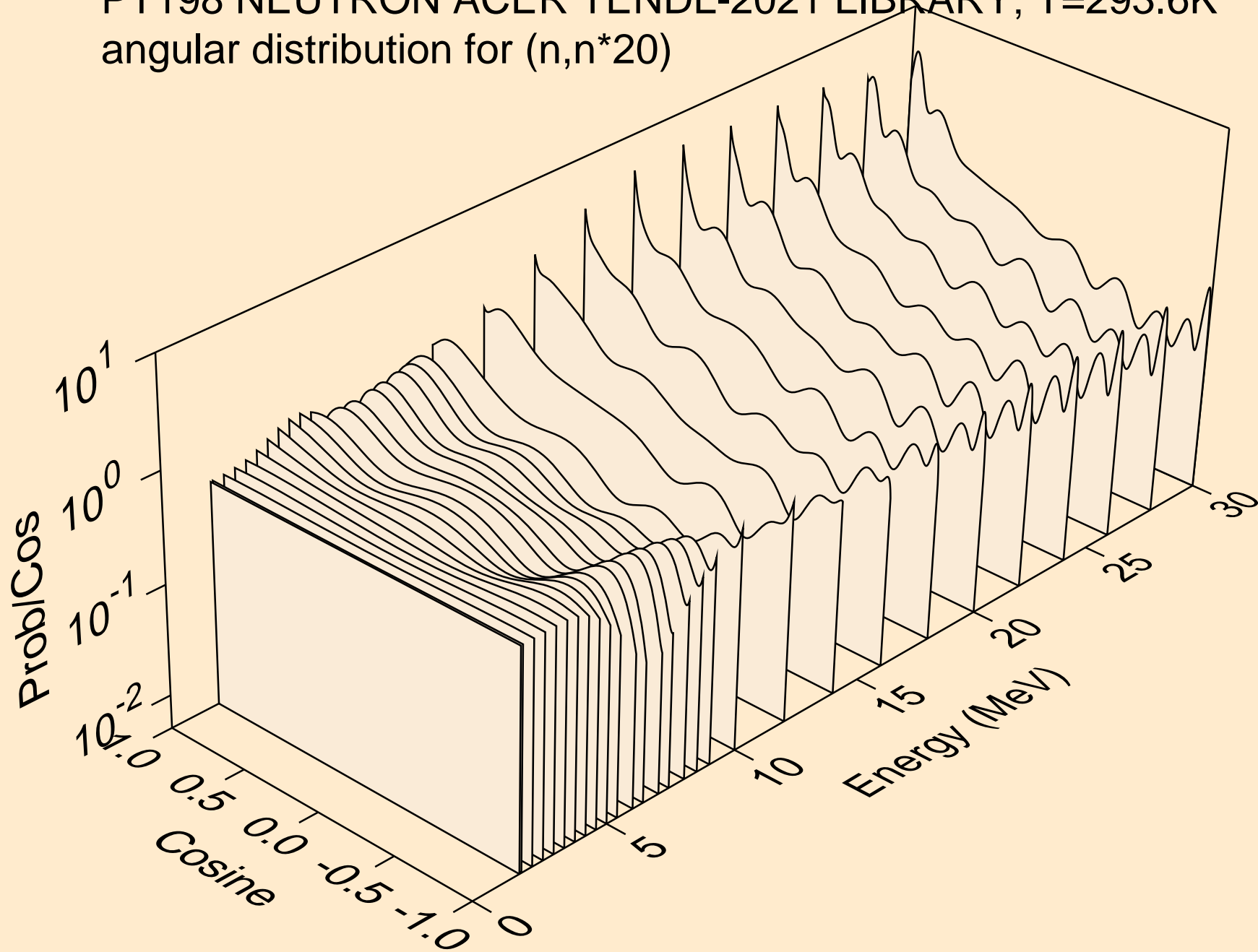

PT198 NEUTRON ACER TENDL-2021 LIBRARY; T=293.6K
angular distribution for (n,n*21)

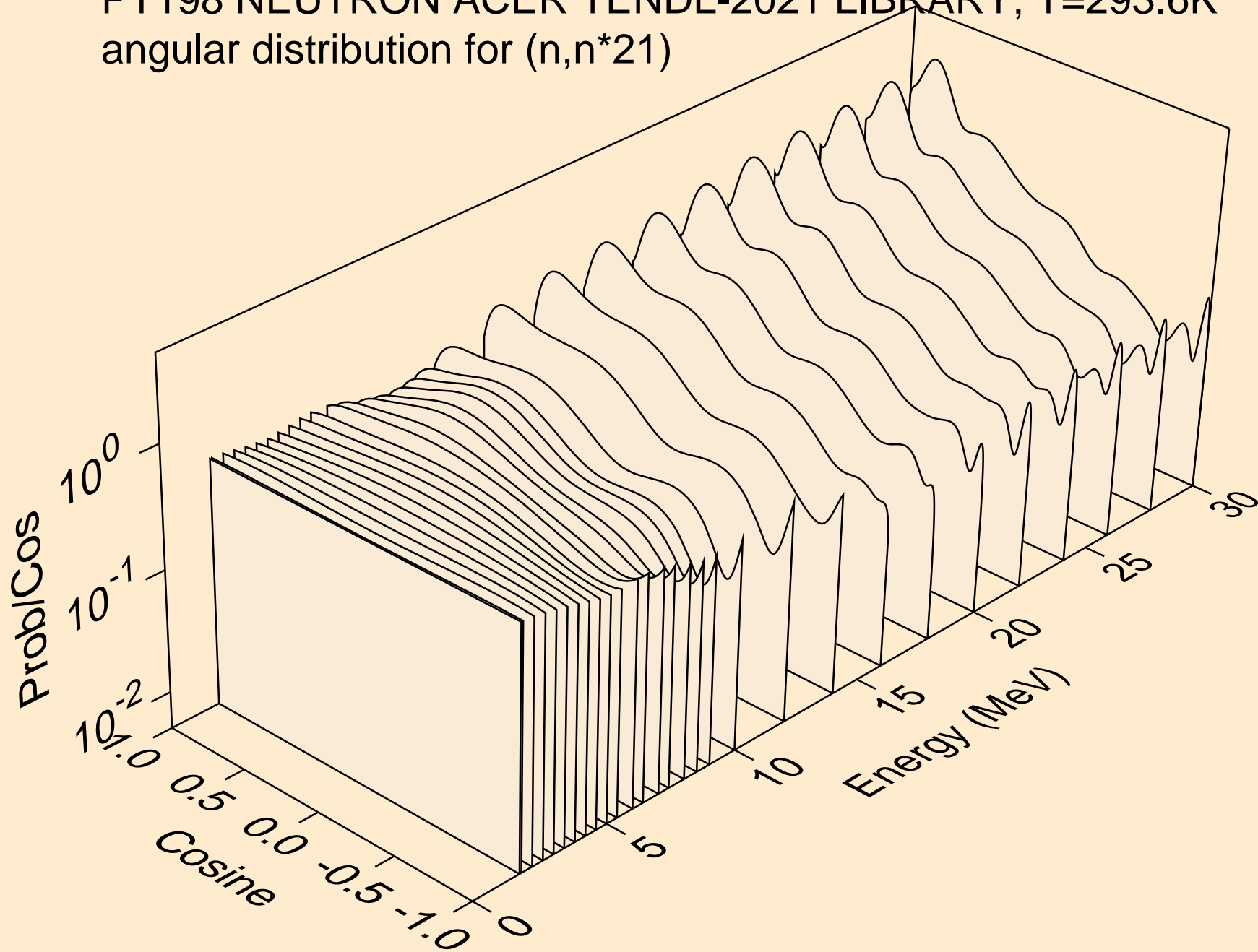

PT198 NEUTRON ACER TENDL-2021 LIBRARY; T=293.6K
angular distribution for (n,n*22)

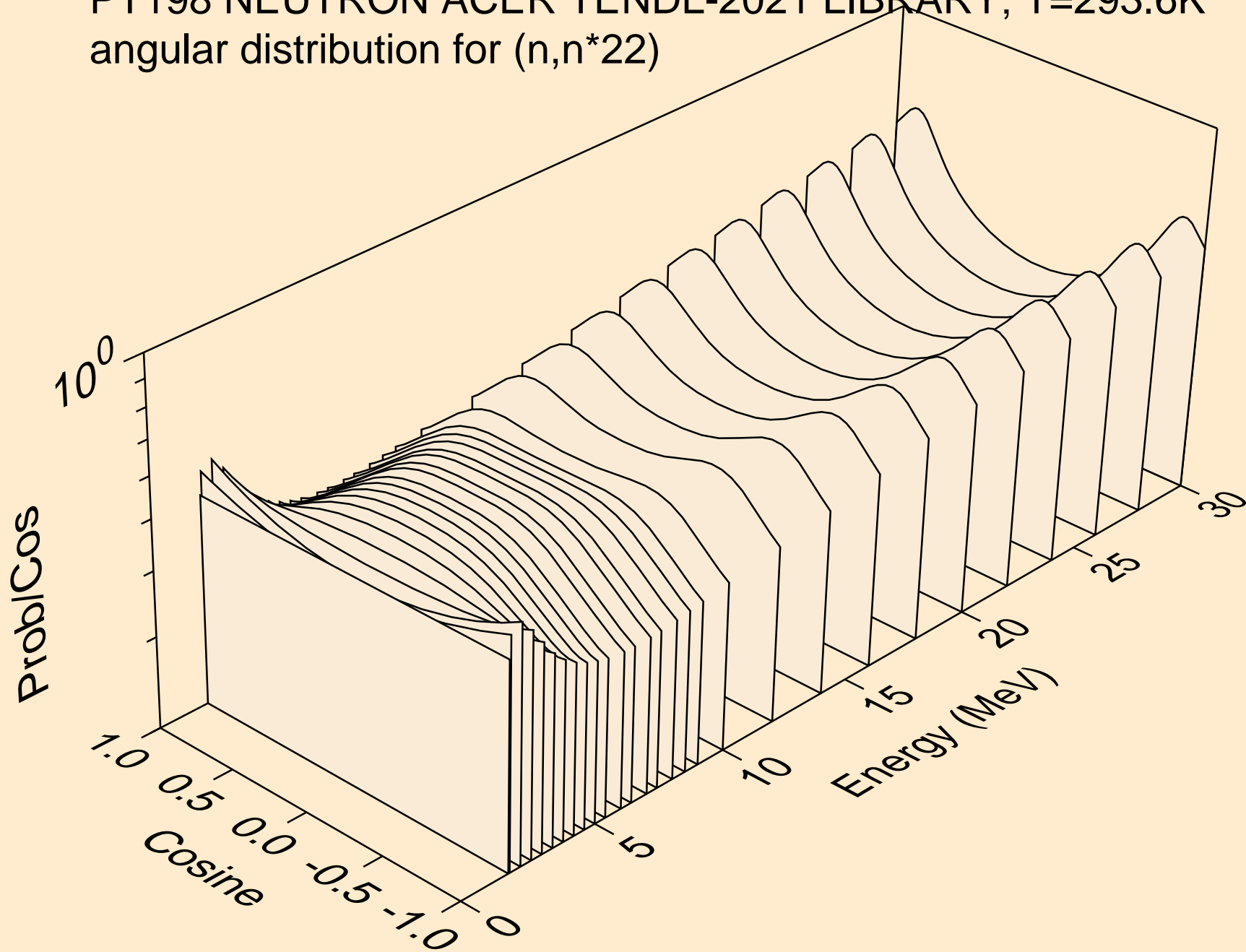

PT198 NEUTRON ACER TENDL-2021 LIBRARY; T=293.6K
angular distribution for (n,n*23)

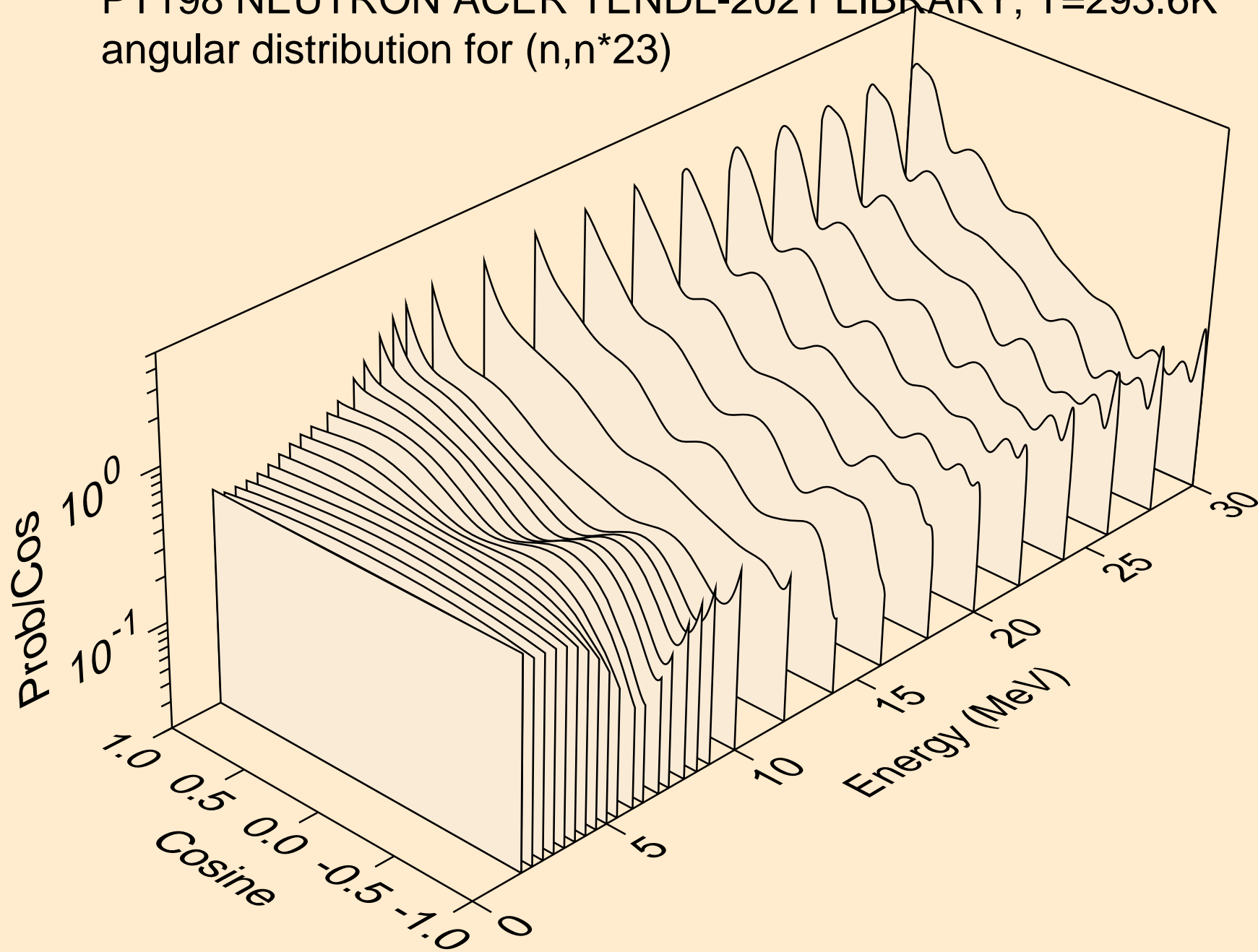

PT198 NEUTRON ACER TENDL-2021 LIBRARY; T=293.6K
angular distribution for (n,n*24)

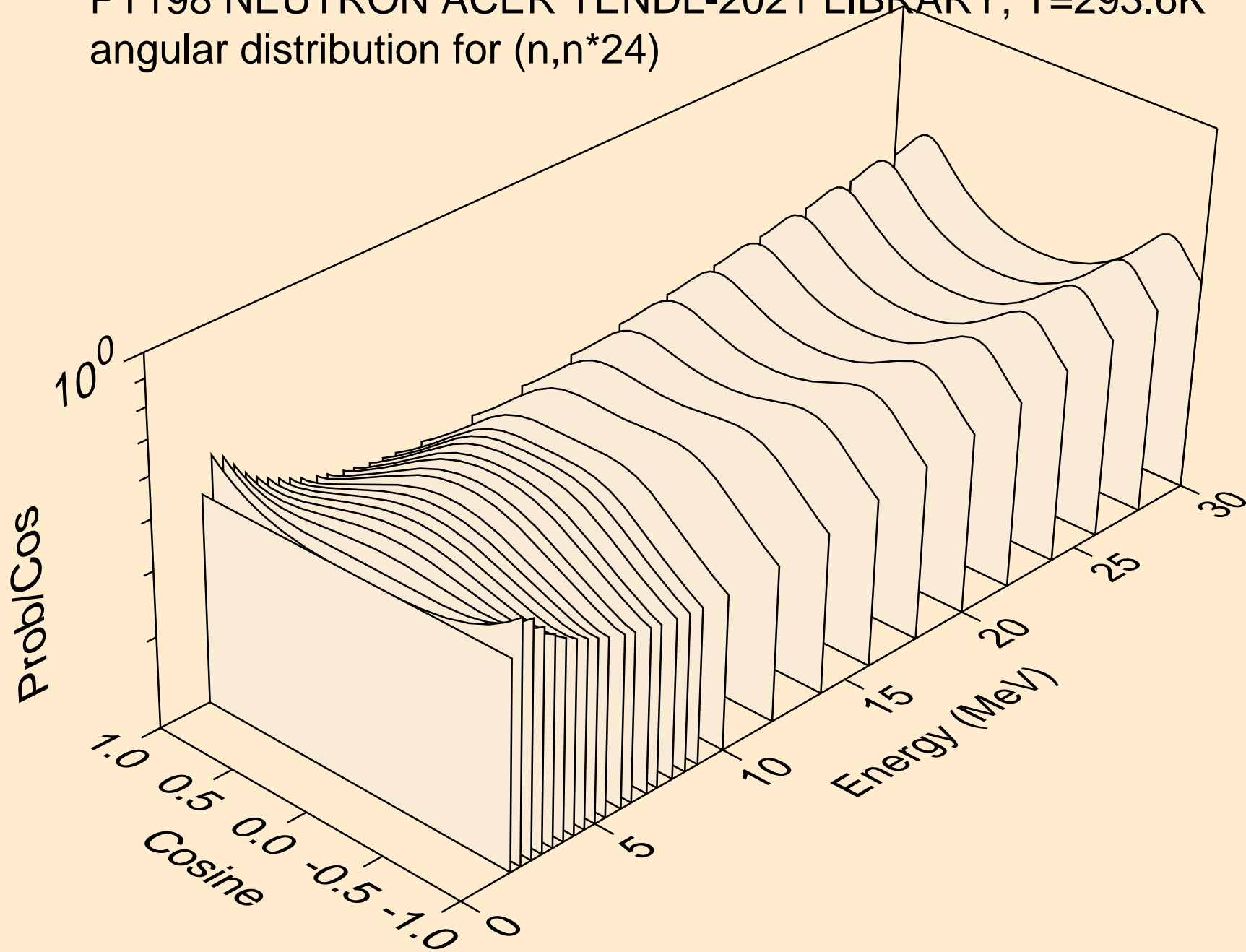

PT198 NEUTRON ACER TENDL-2021 LIBRARY; T=293.6K
angular distribution for (n,n*25)

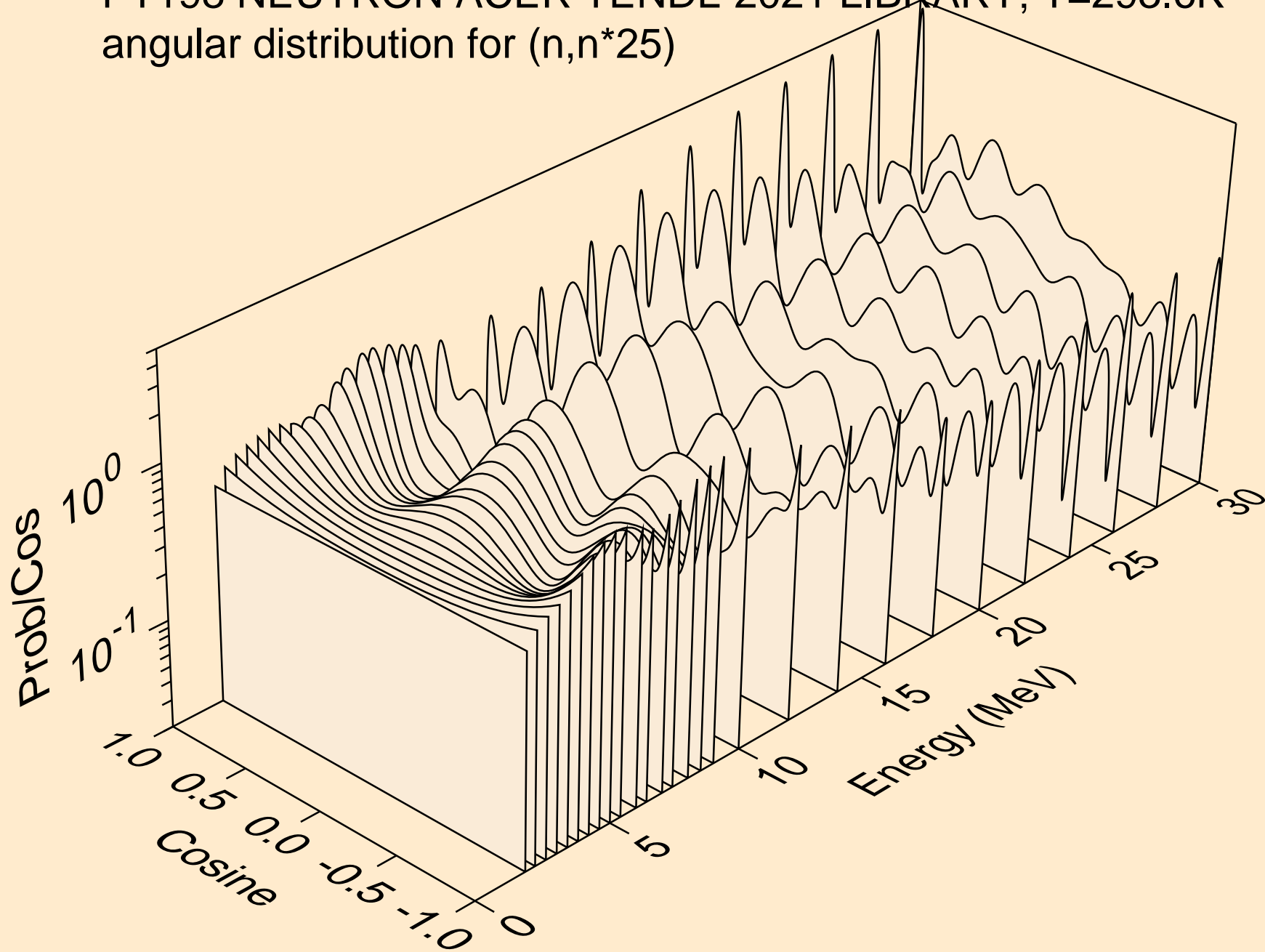

PT198 NEUTRON ACER TENDL-2021 LIBRARY; T=293.6K
angular distribution for (n,n*26)

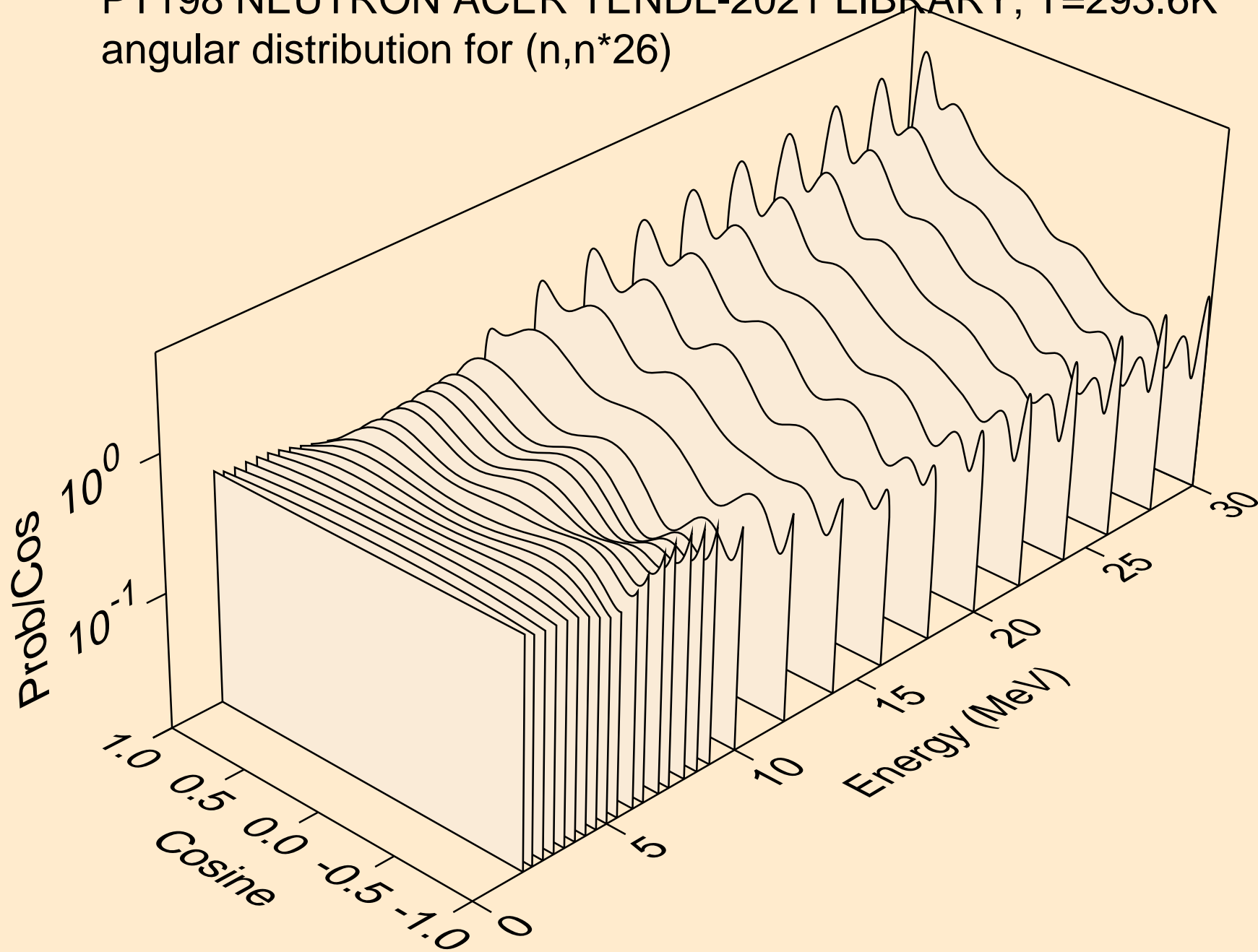

PT198 NEUTRON ACER TENDL-2021 LIBRARY; T=293.6K
angular distribution for (n,n*27)

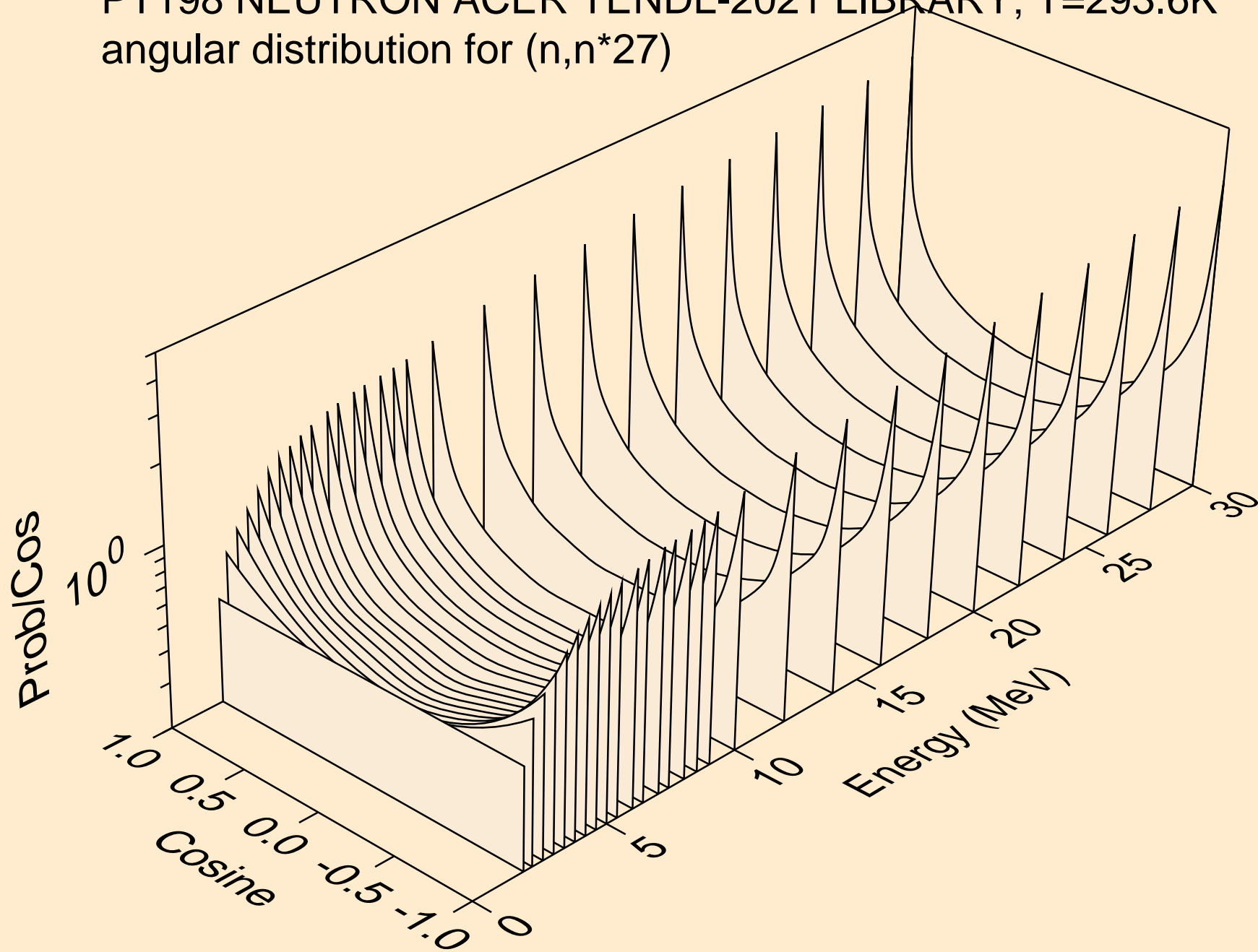

PT198 NEUTRON ACER TENDL-2021 LIBRARY; T=293.6K
angular distribution for (n,n*28)

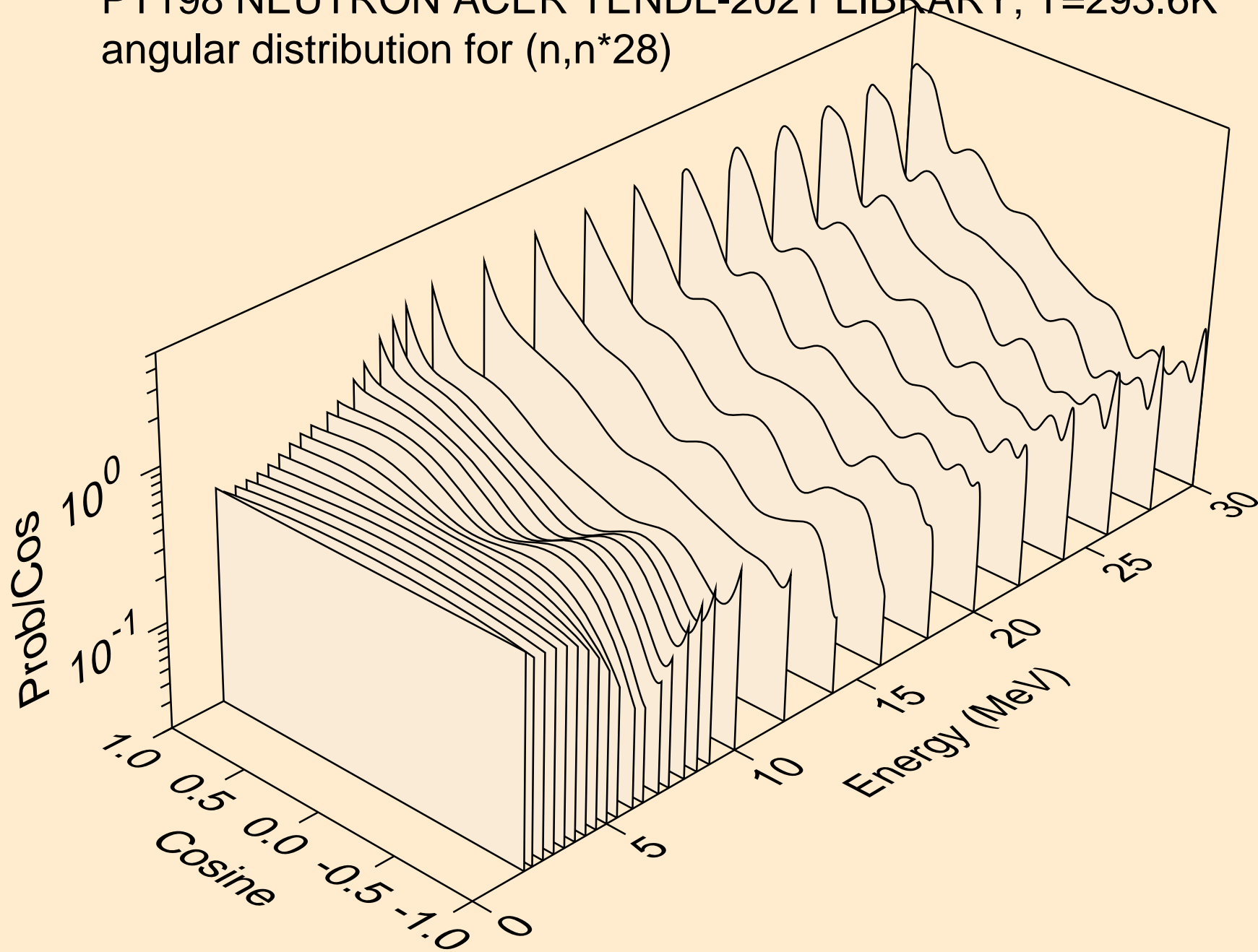

PT198 NEUTRON ACER TENDL-2021 LIBRARY; T=293.6K
angular distribution for (n,n*29)

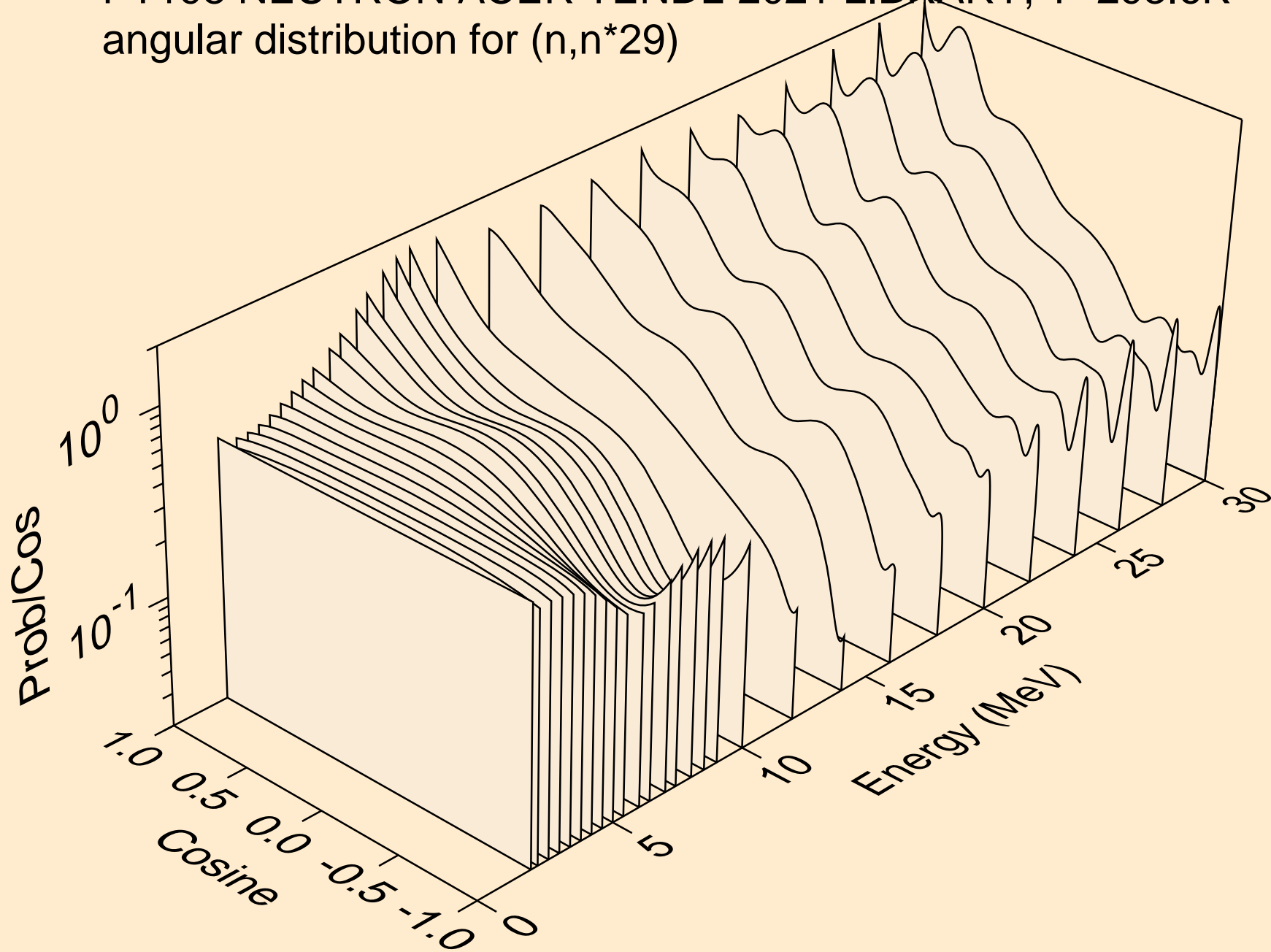

PT198 NEUTRON ACER TENDL-2021 LIBRARY; T=293.6K
angular distribution for (n,n*30)

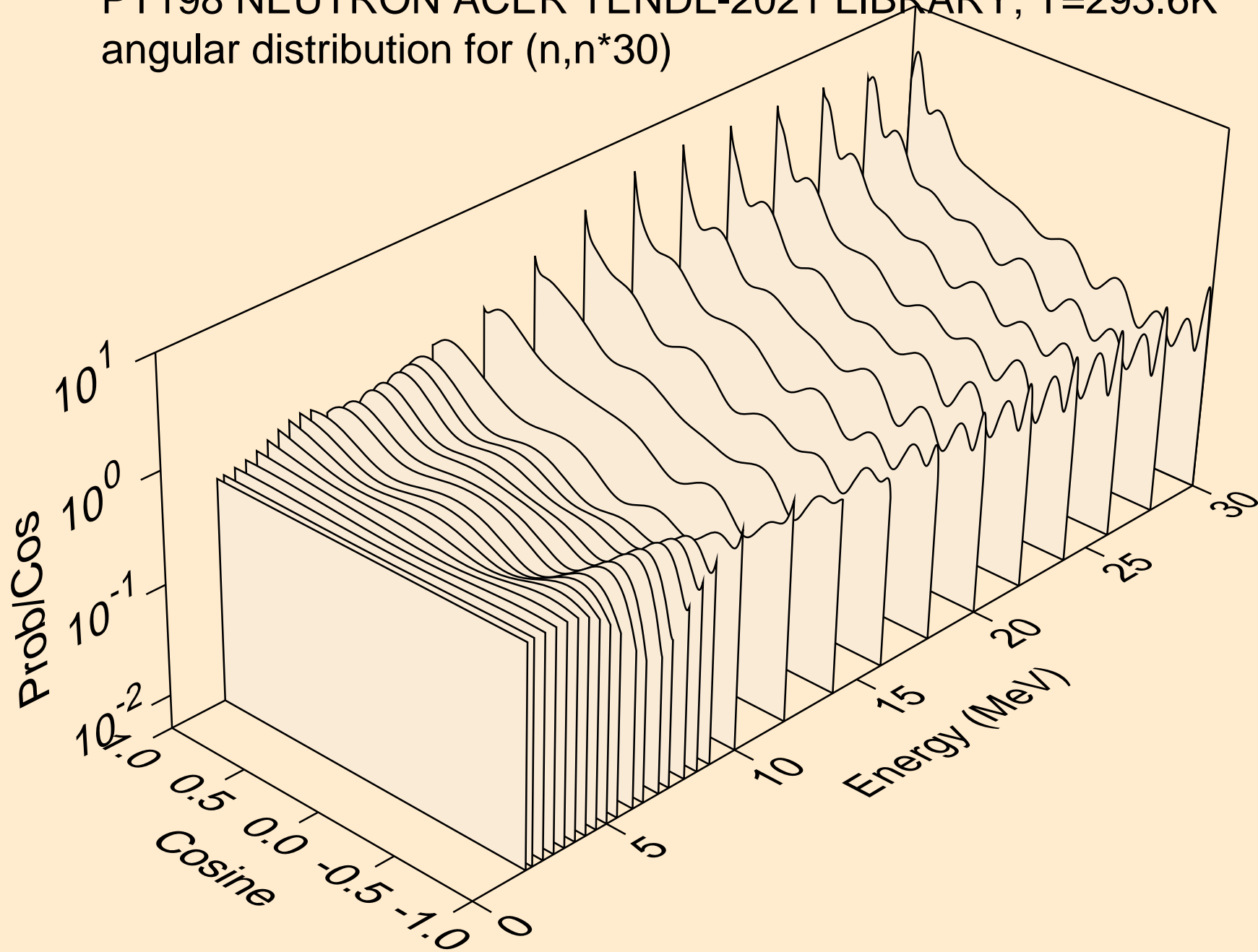

PT198 NEUTRON ACER TENDL-2021 LIBRARY; T=293.6K
Neutron emission for (n,x)

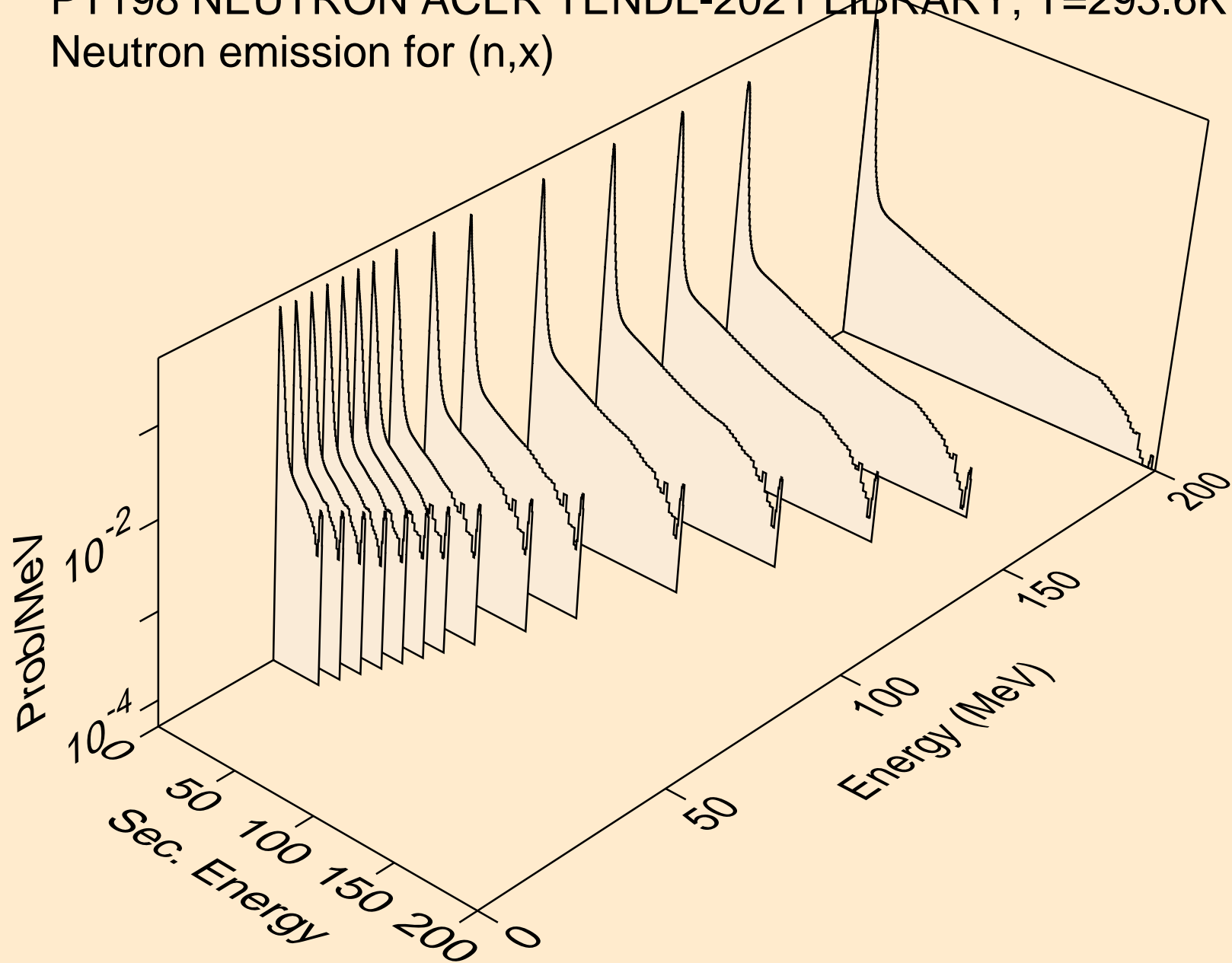

PT198 NEUTRON ACER TENDL-2021 LIBRARY; T=293.6K
Neutron emission for (n,2nd)

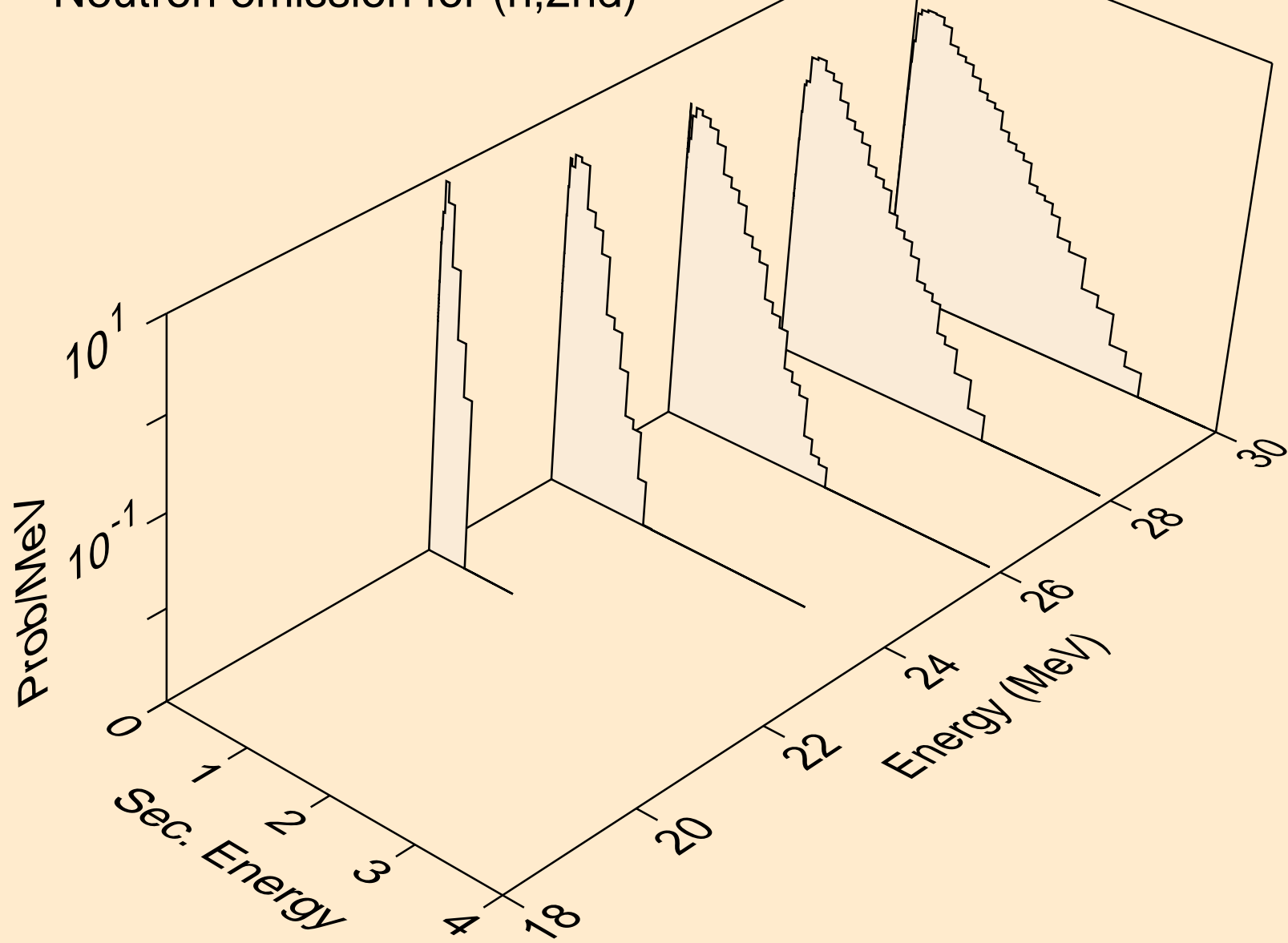

PT198 NEUTRON ACER TENDL-2021 LIBRARY; T=293.6K
Neutron emission for (n,2n)

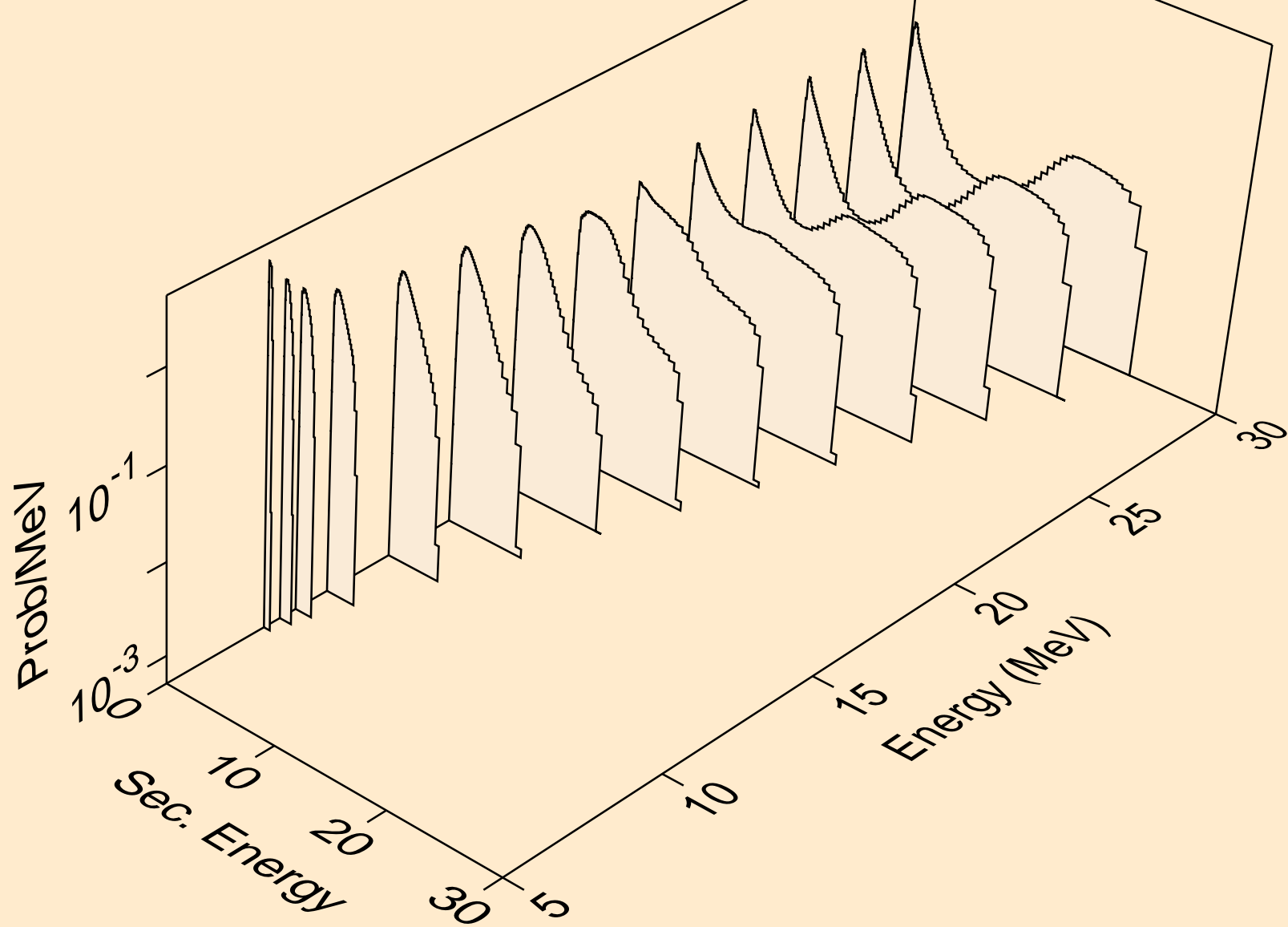

PT198 NEUTRON ACER TENDL-2021 LIBRARY; T=293.6K
Neutron emission for (n,3n)

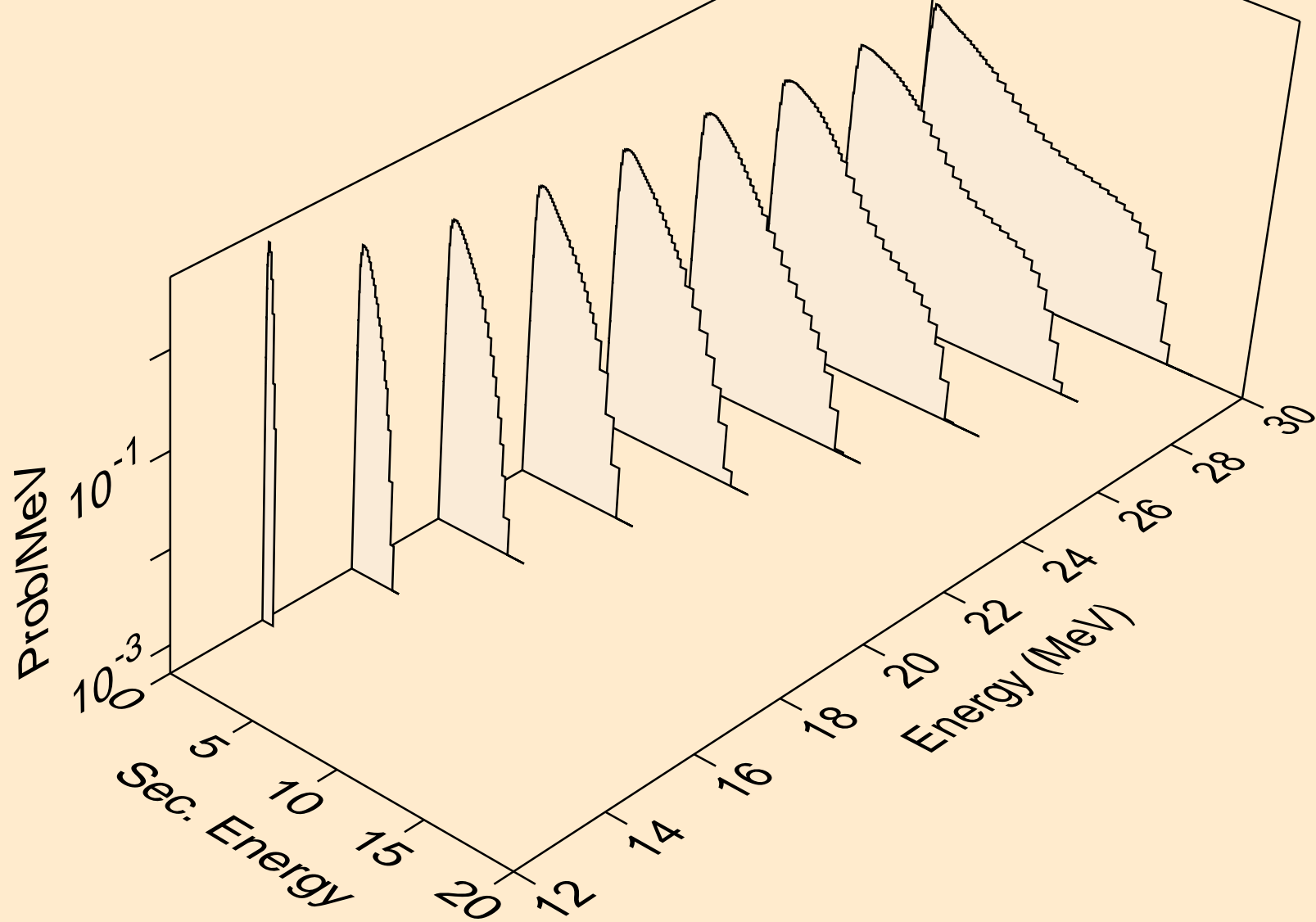

PT198 NEUTRON ACER TENDL-2021 LIBRARY; T=293.6K
Neutron emission for (n,n*)a

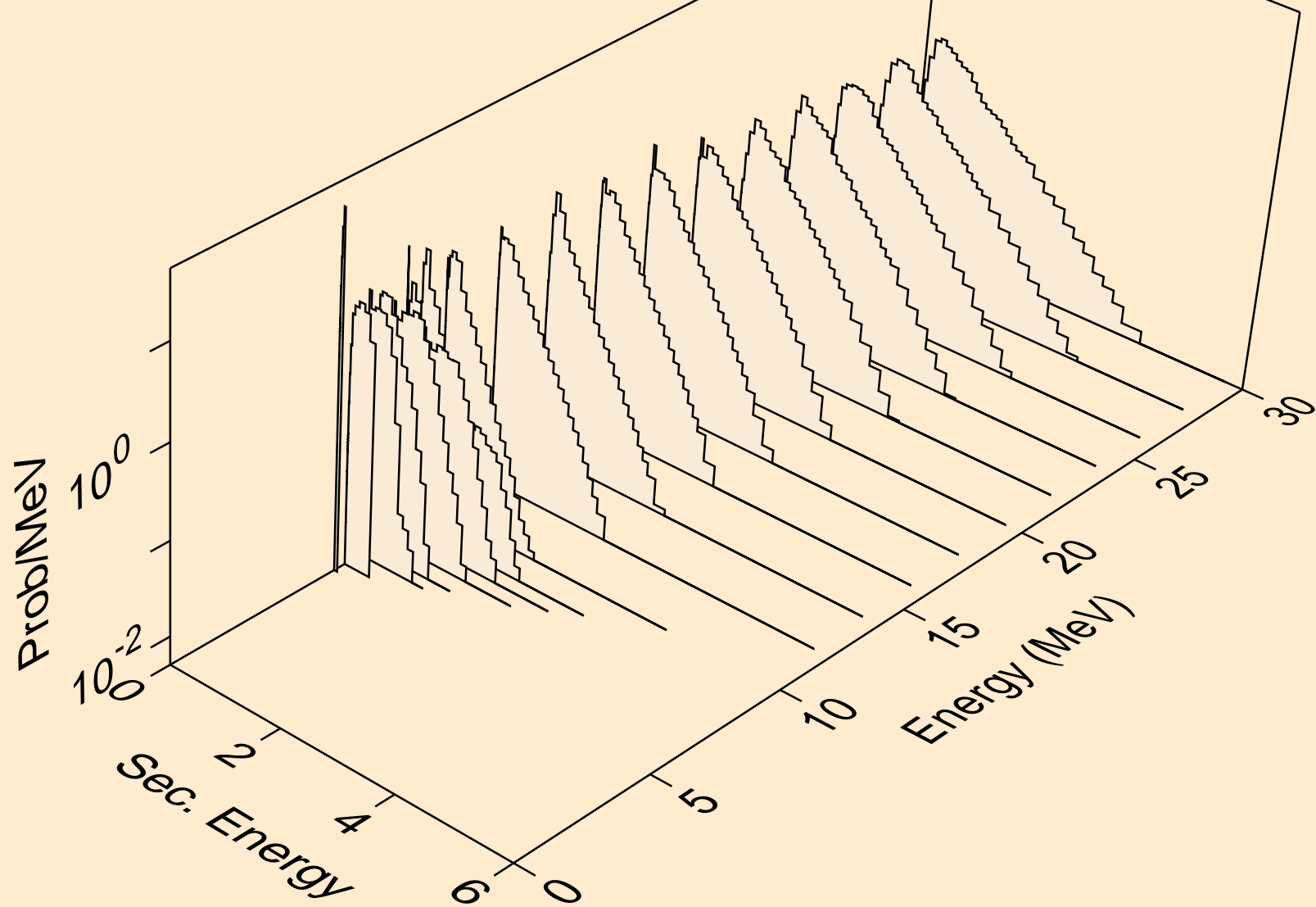

PT198 NEUTRON ACER TENDL-2021 LIBRARY; T=293.6K
Neutron emission for (n,2n)_a

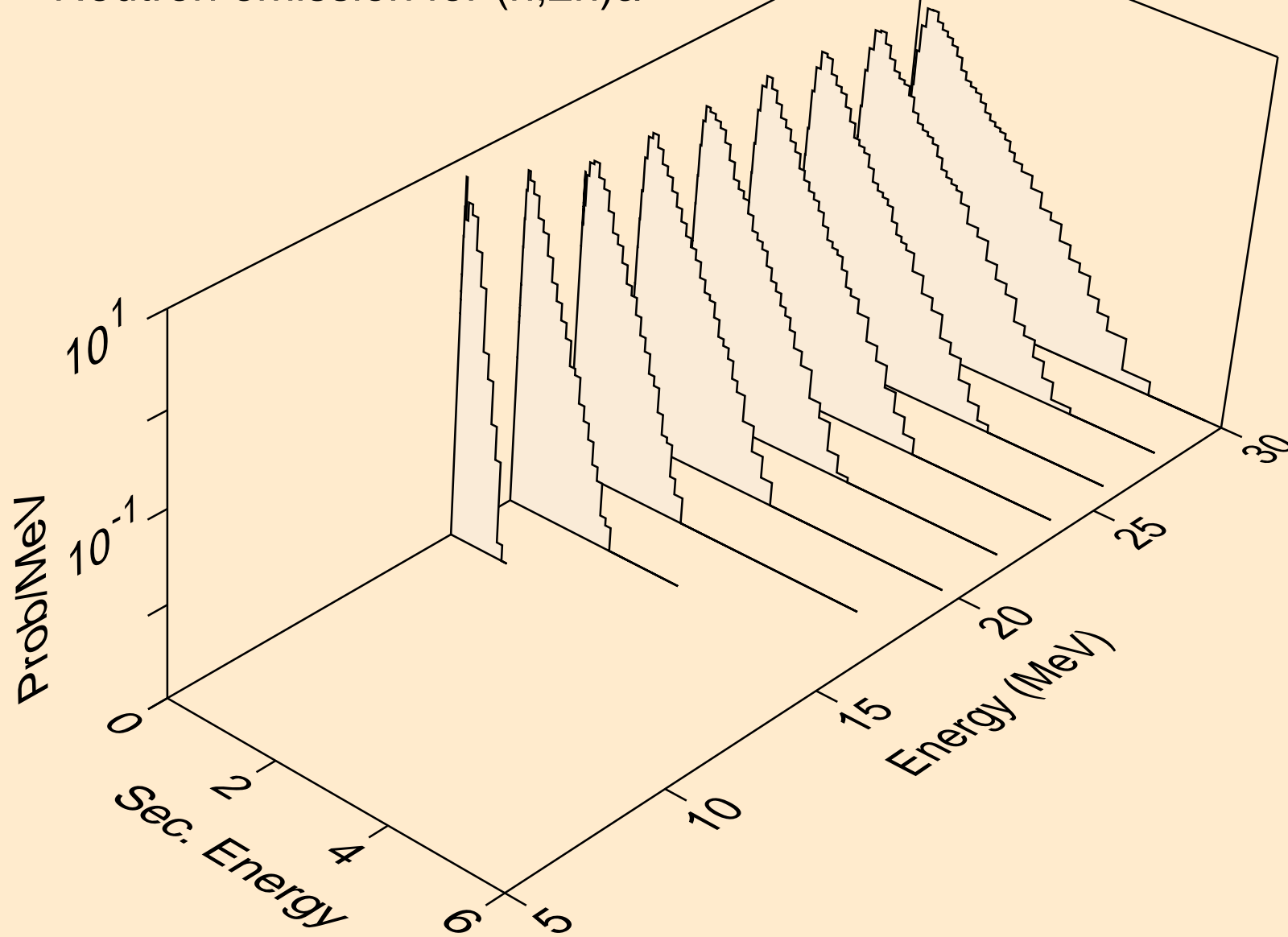

PT198 NEUTRON ACER TENDL-2021 LIBRARY; T=293.6K
Neutron emission for (n,3n)a

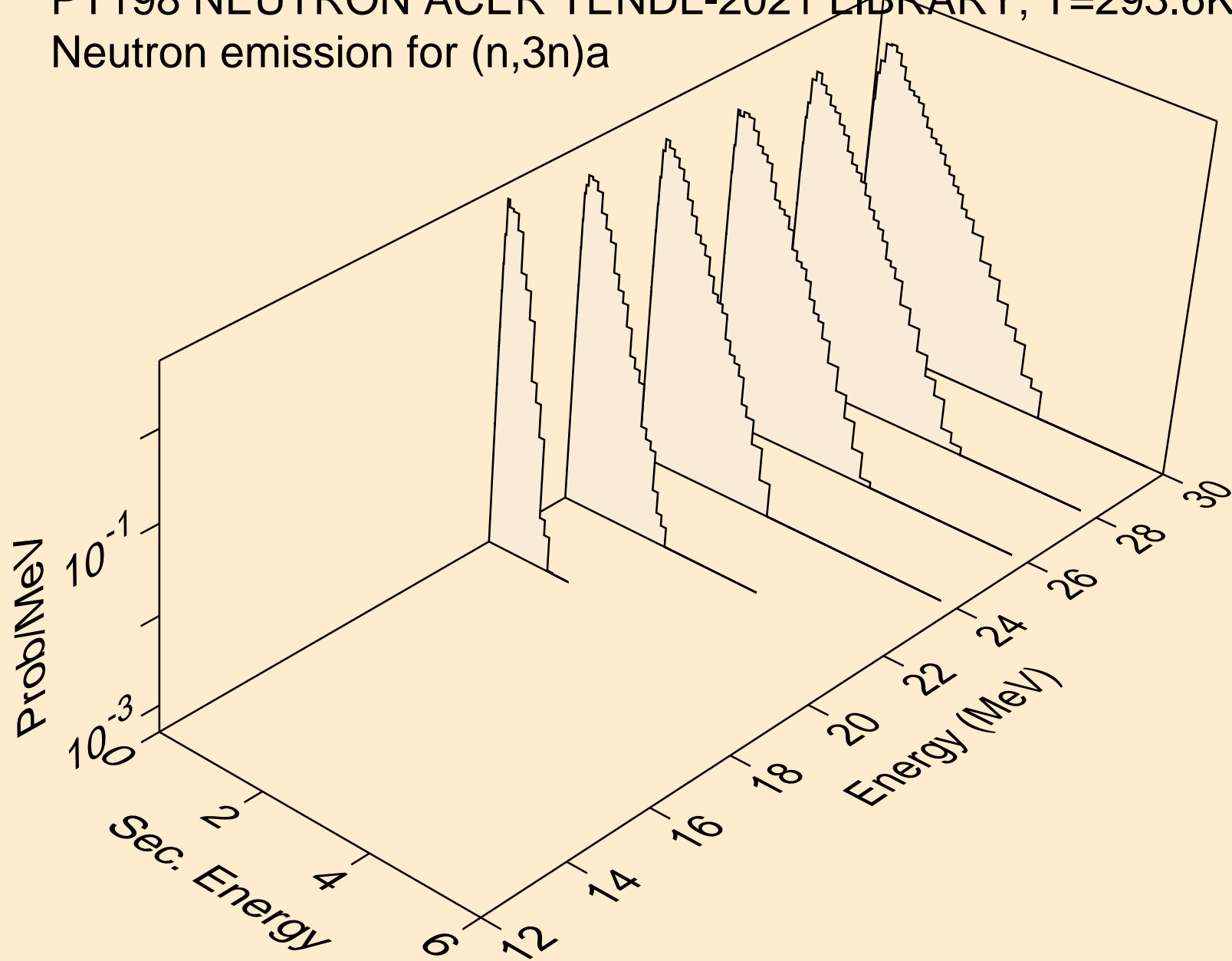

PT198 NEUTRON ACER TENDL-2021 LIBRARY; T=293.6K
Neutron emission for (n,n*)p

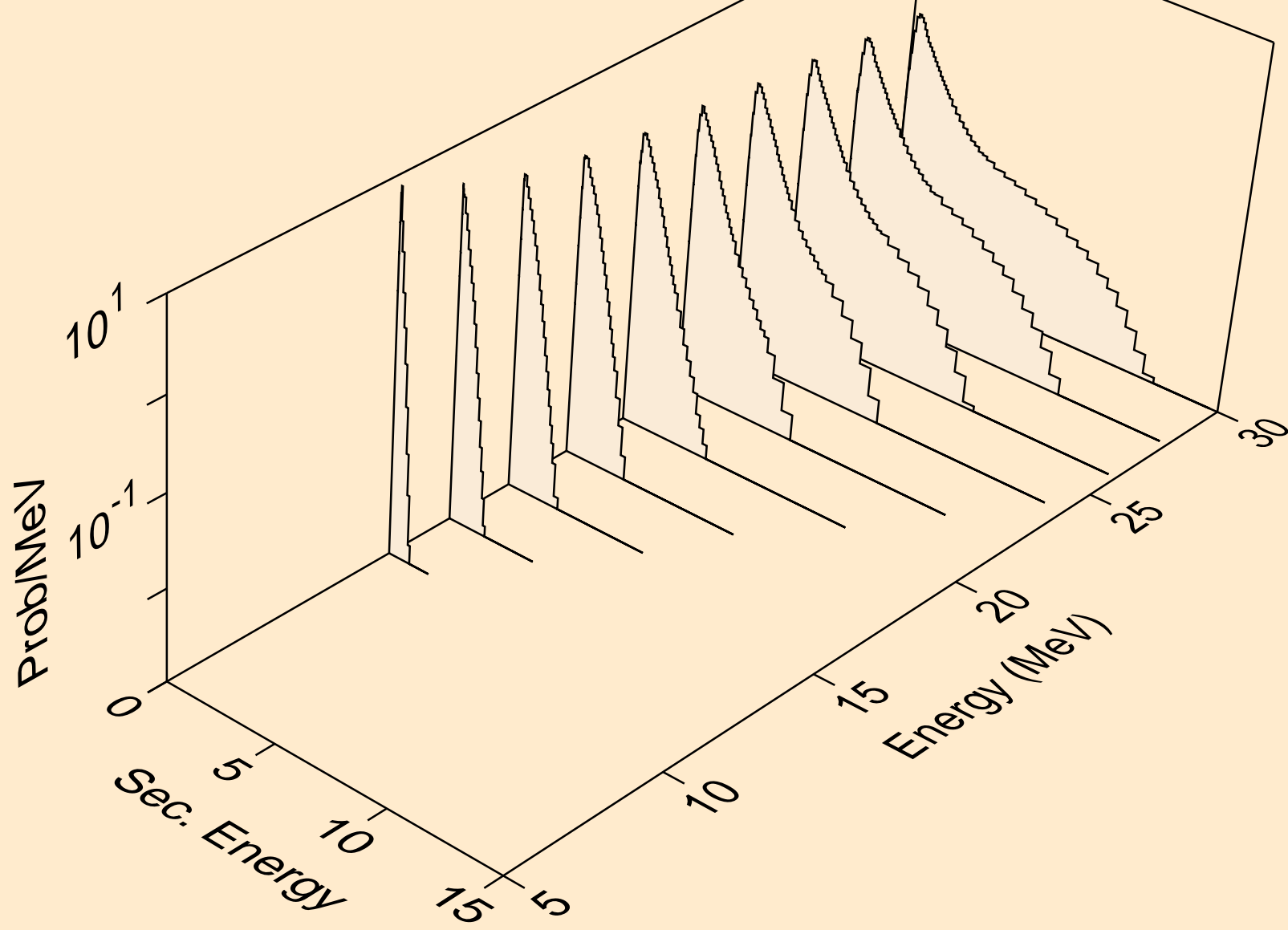

PT198 NEUTRON ACER TENDL-2021 LIBRARY; T=293.6K
Neutron emission for (n,n*)d

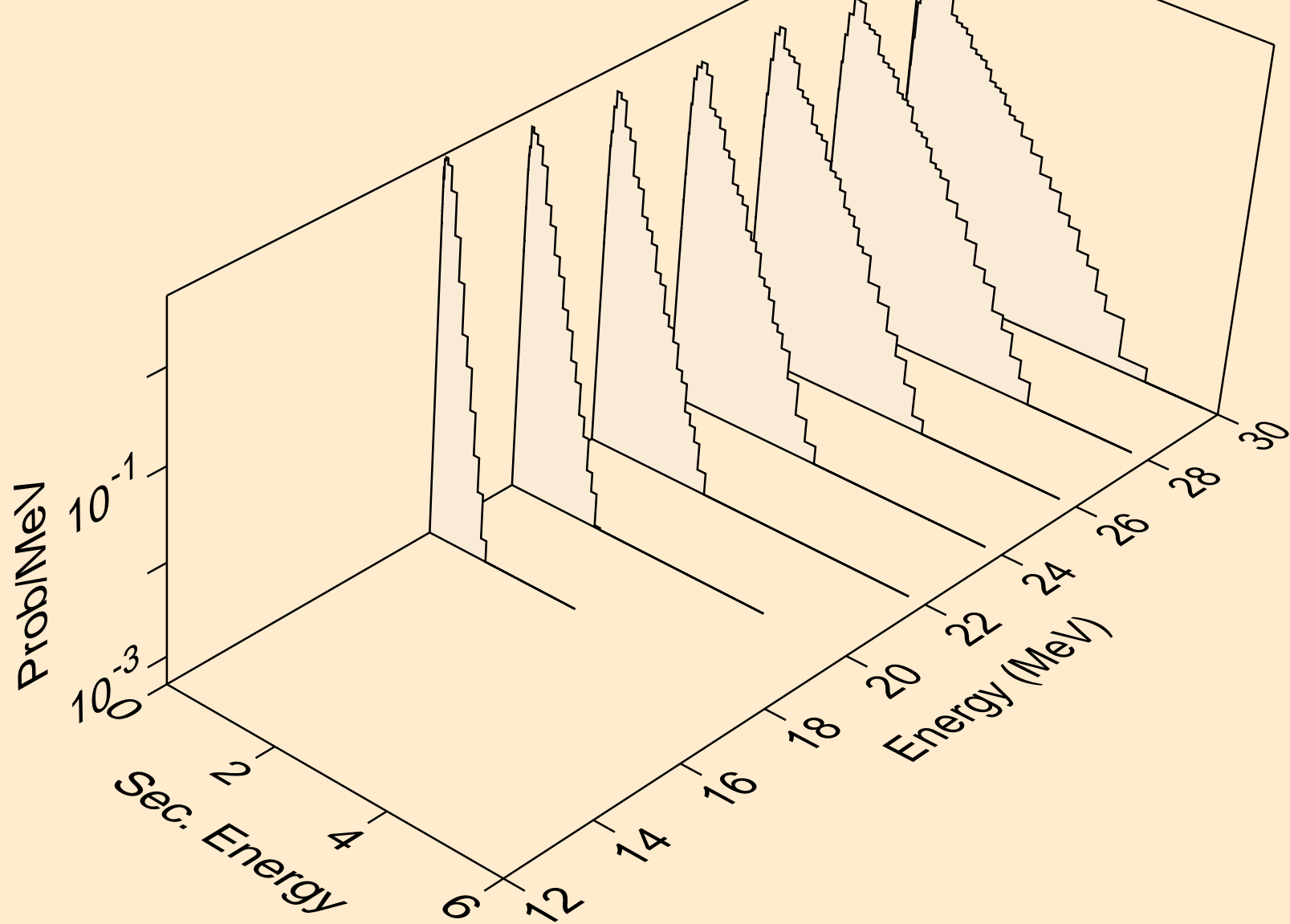

PT198 NEUTRON ACER TENDL-2021 LIBRARY; T=293.6K
Neutron emission for (n,n*)t

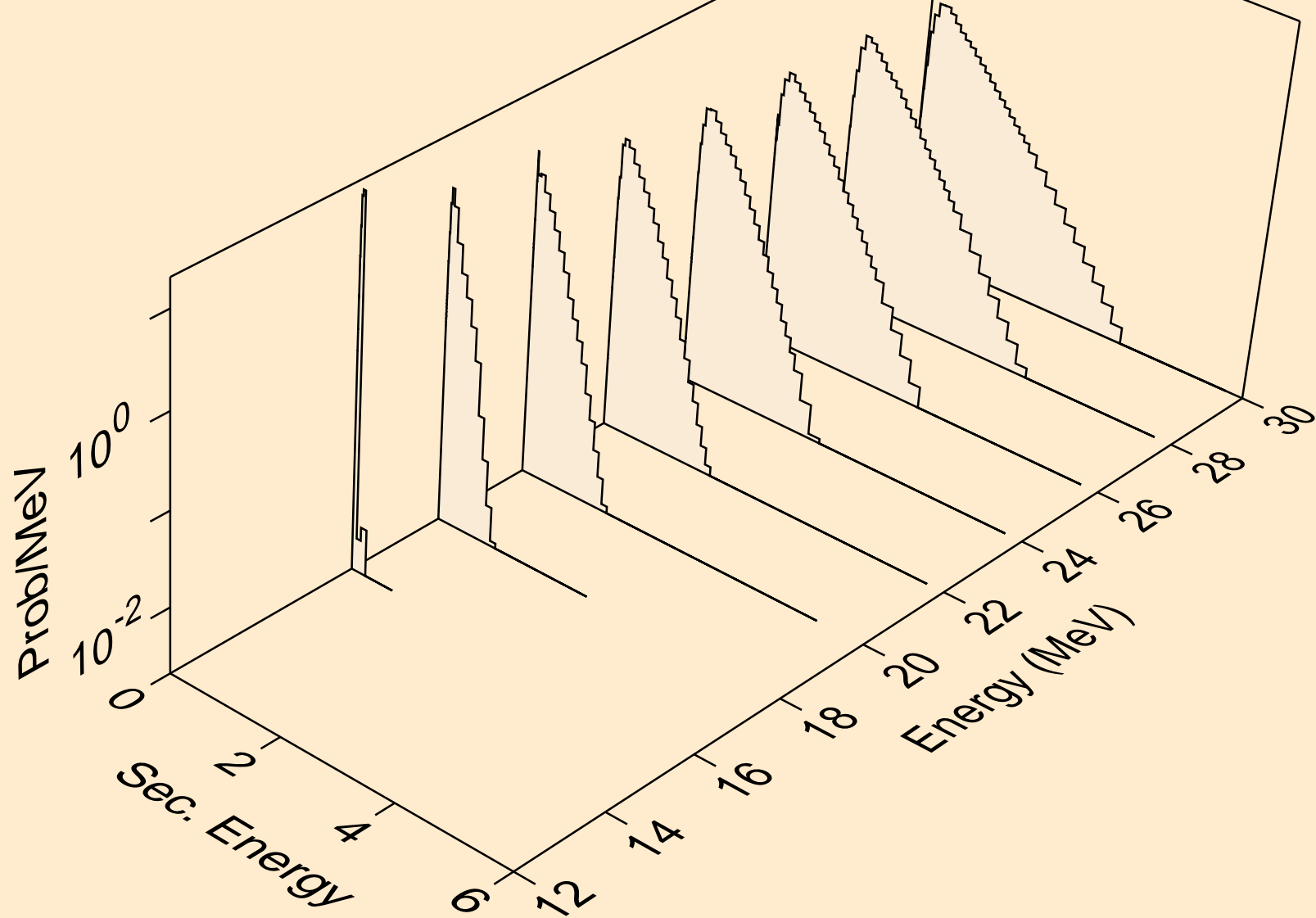

PT198 NEUTRON ACER TENDL-2021 LIBRARY; T=293.6K
Neutron emission for (n,n*)he3

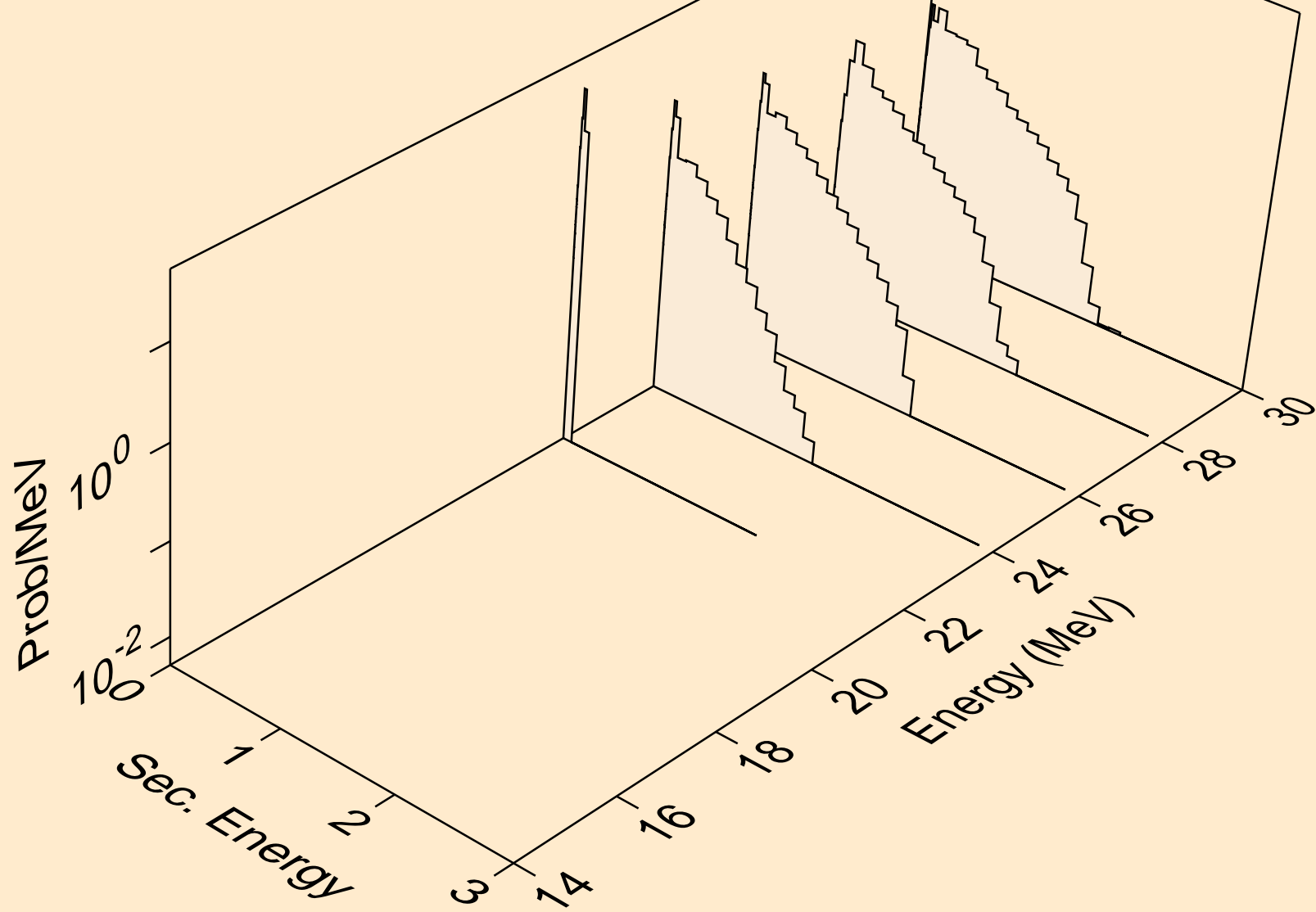

PT198 NEUTRON ACER TENDL-2021 LIBRARY; T=293.6K
Neutron emission for (n,4n)

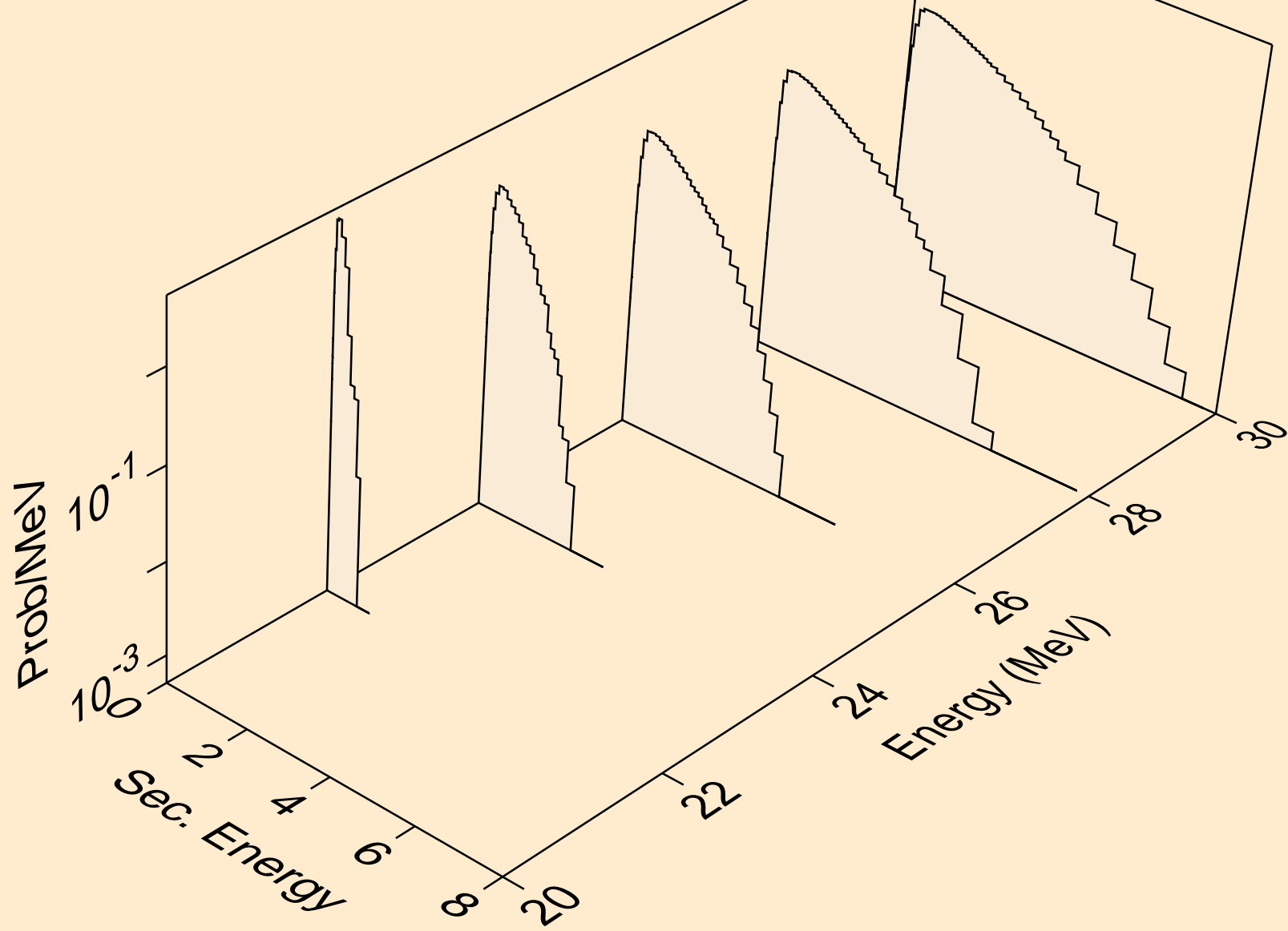

PT198 NEUTRON ACER TENDL-2021 LIBRARY; T=293.6K
Neutron emission for (n,2np)

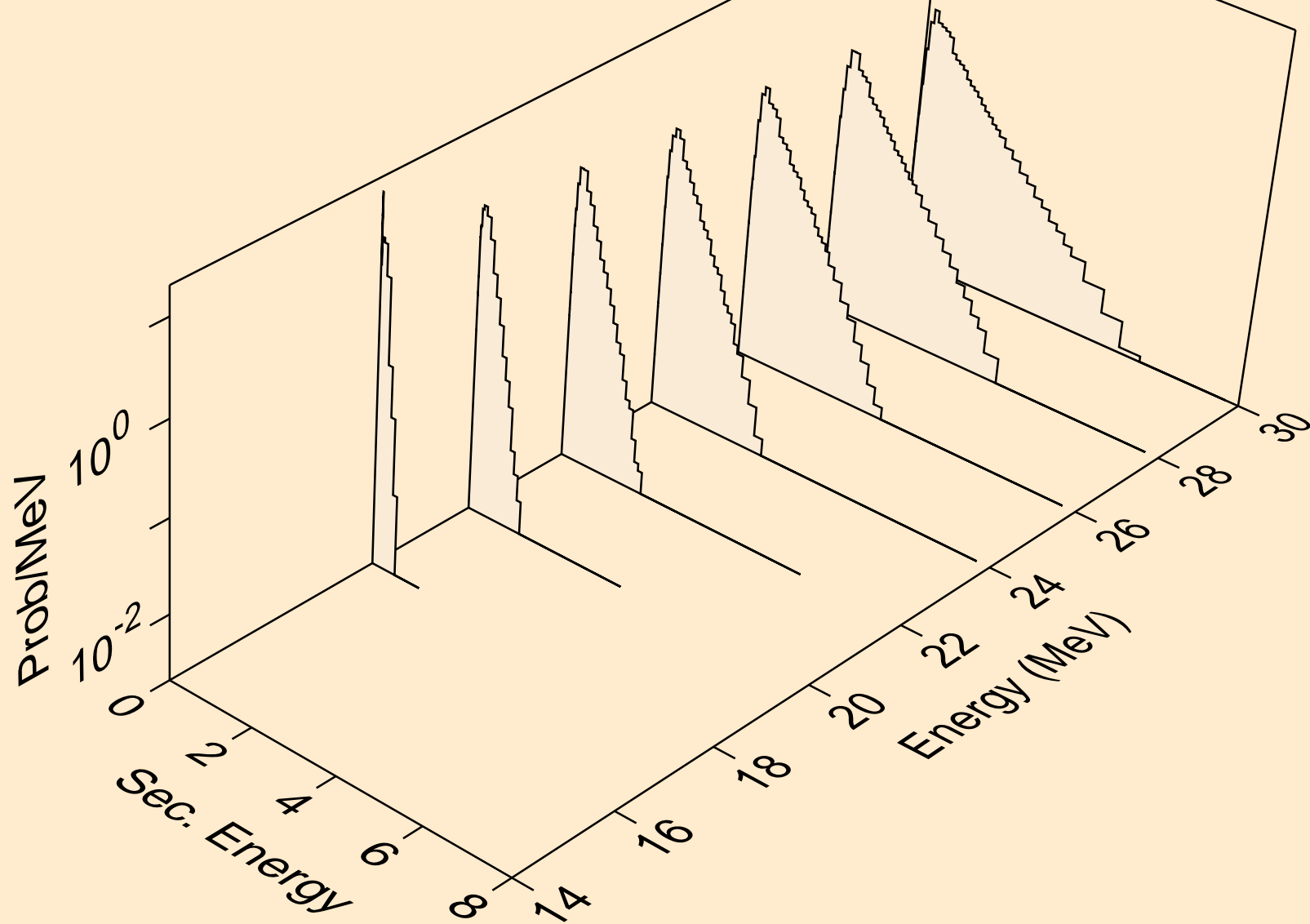

PT198 NEUTRON ACER TENDL-2021 LIBRARY; T=293.6K
Neutron emission for (n,3np)

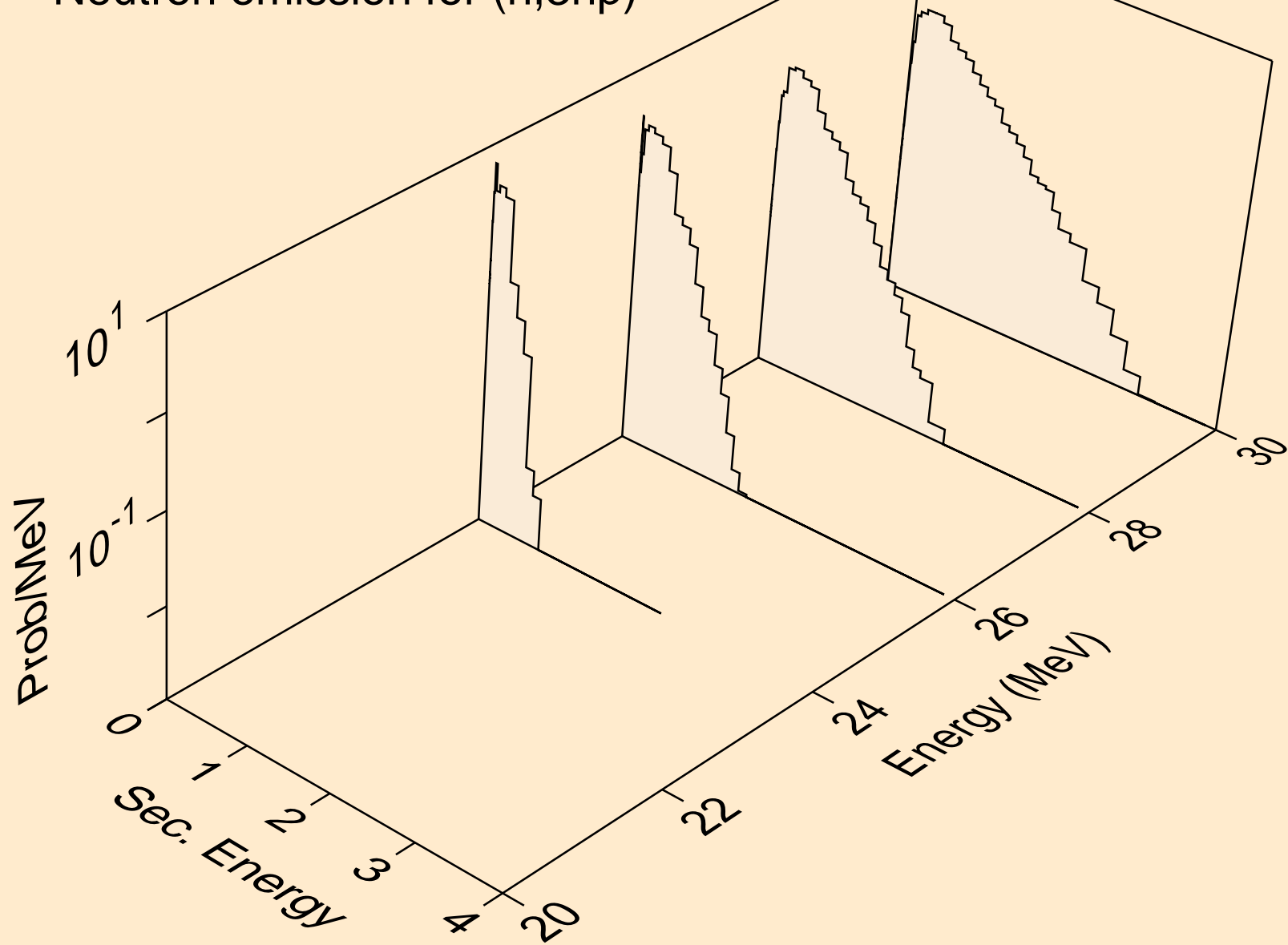

PT198 NEUTRON ACER TENDL-2021 LIBRARY; T=293.6K
Neutron emission for (n,n*c)

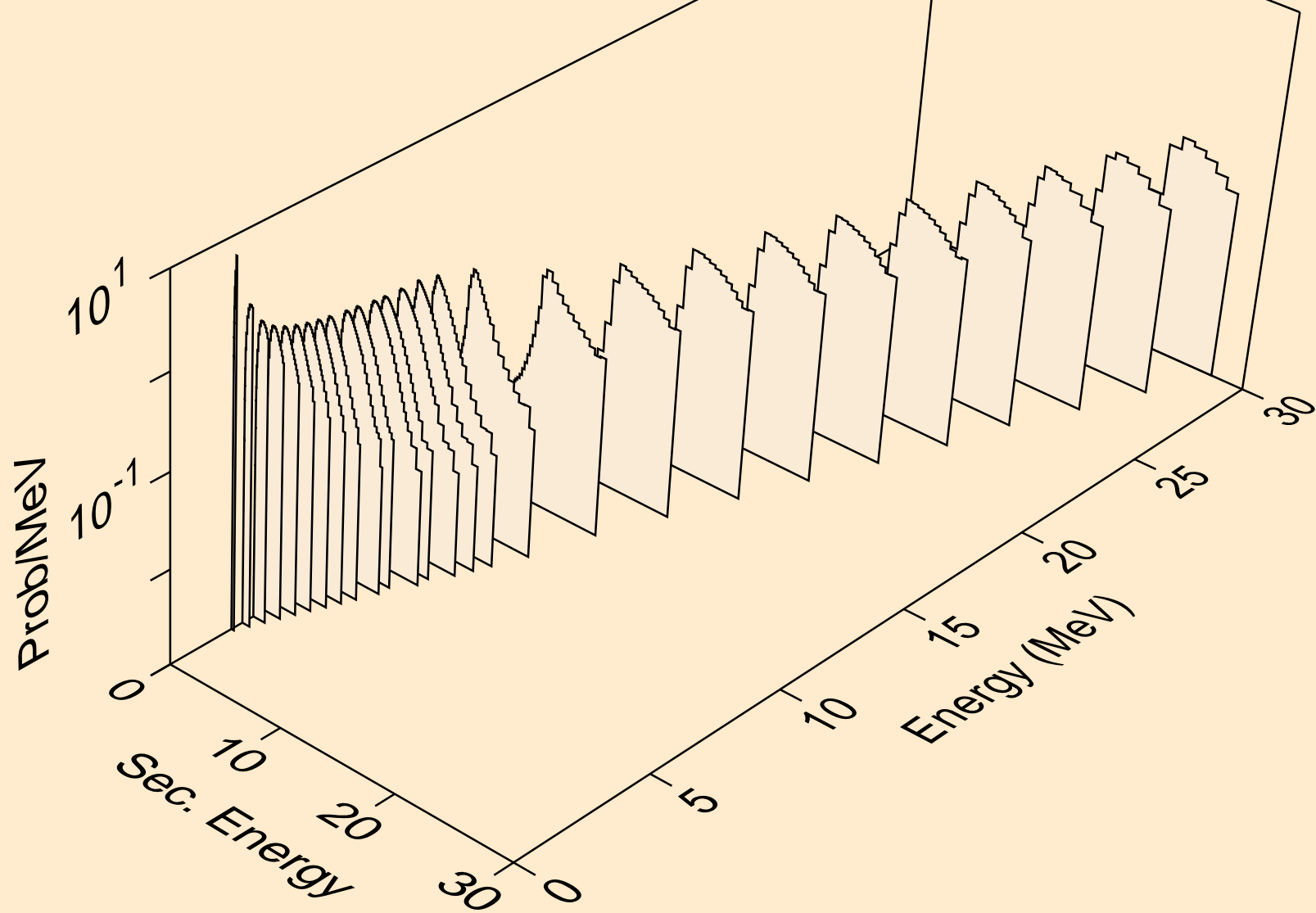

PT198 NEUTRON ACER TENDL-2021 LIBRARY; T=293.6K
Photon emission for (n,x)

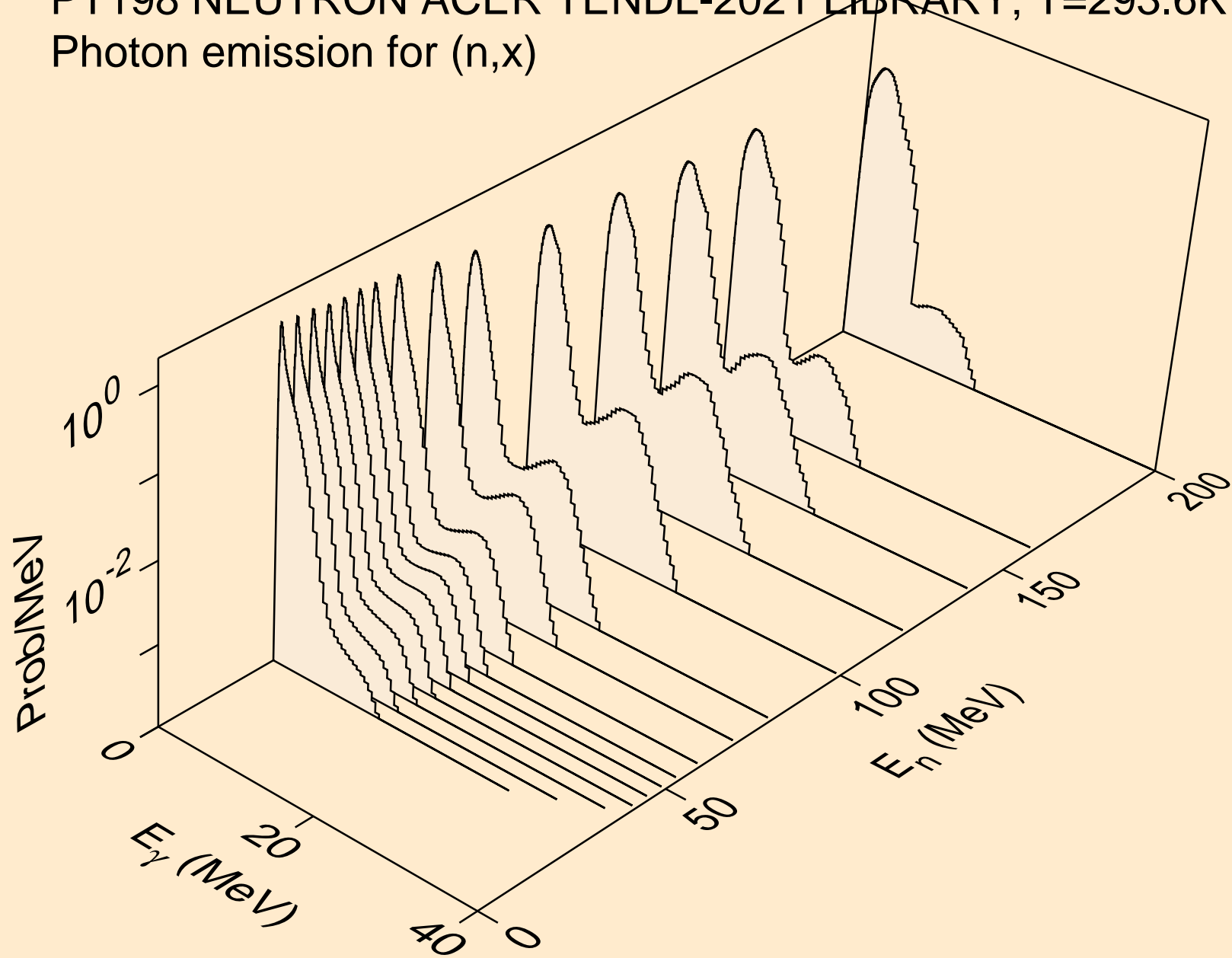

PT198 NEUTRON ACER TENDL-2021 LIBRARY; T=293.6K
Photon emission for (n,2nd)

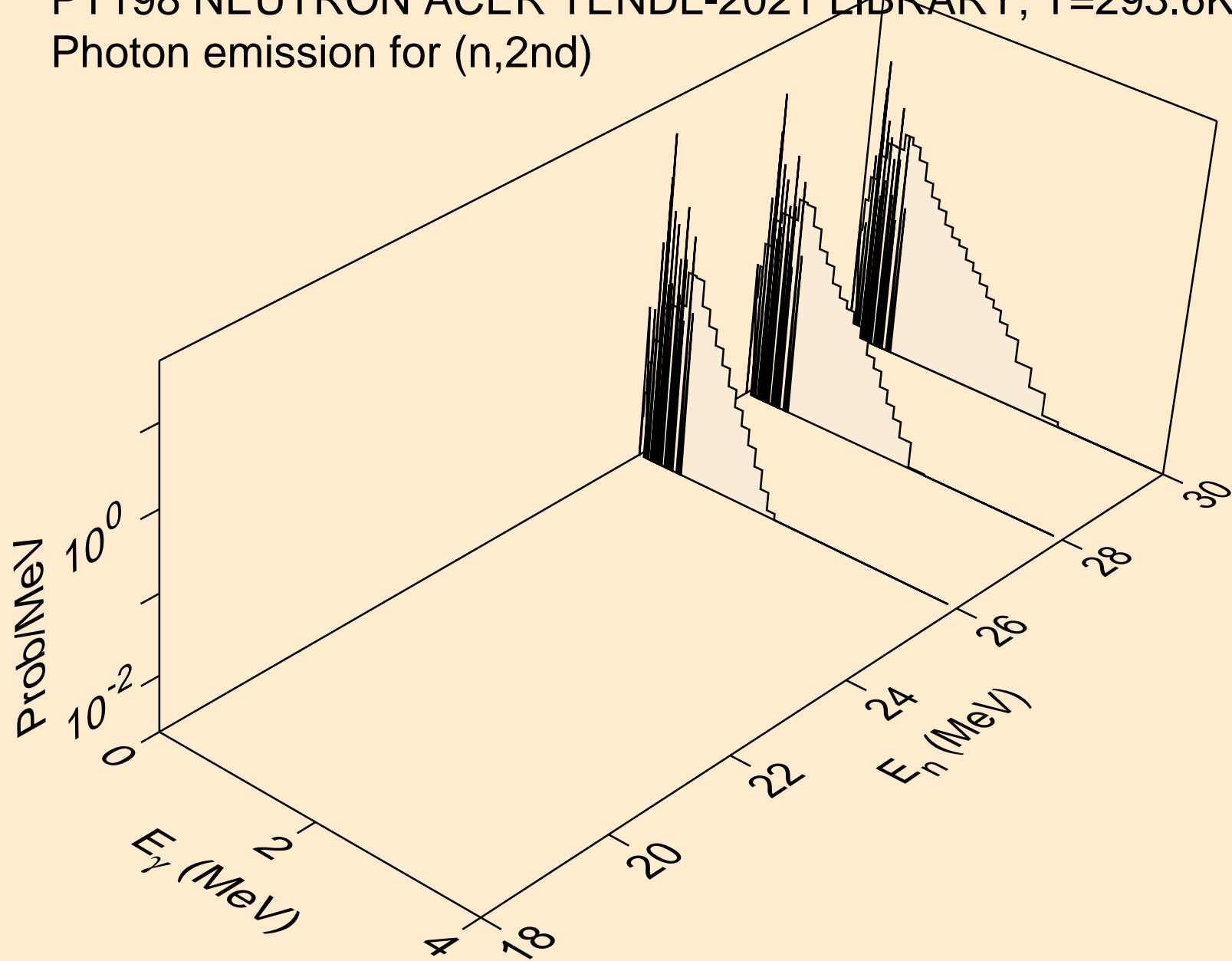

PT198 NEUTRON ACER TENDL-2021 LIBRARY; T=293.6K
Photon emission for (n,2n)

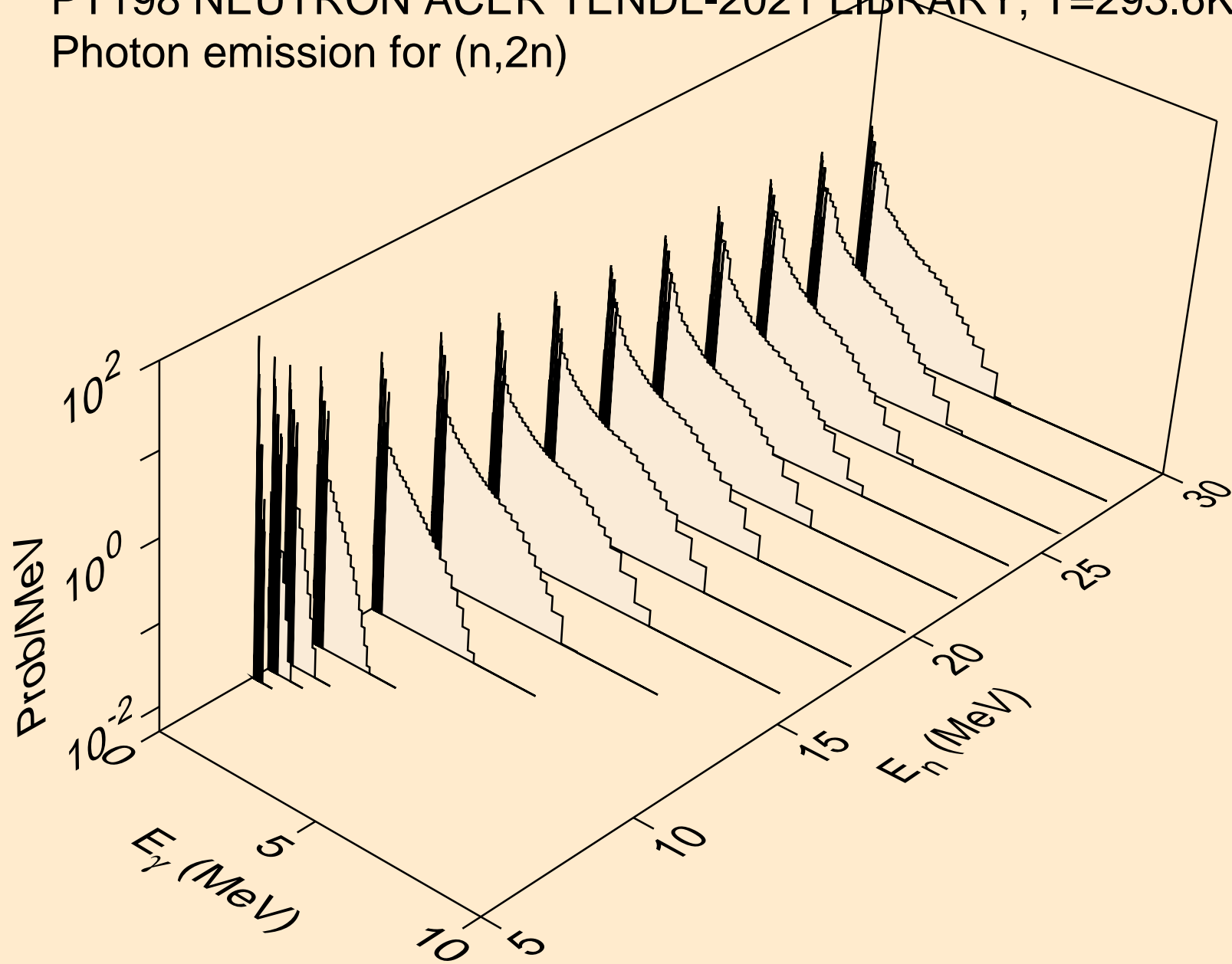

PT198 NEUTRON ACER TENDL-2021 LIBRARY; T=293.6K
Photon emission for (n,3n)

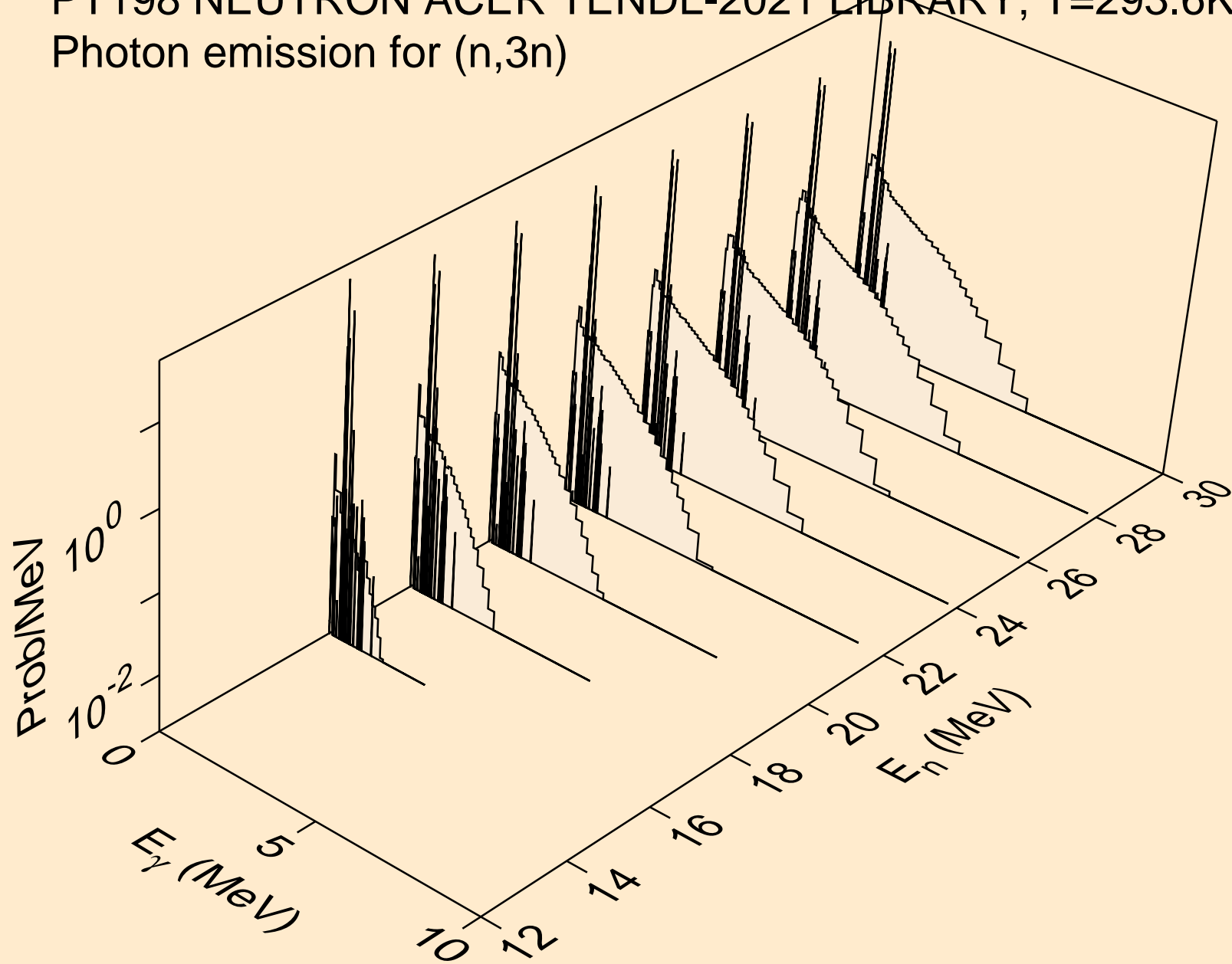

PT198 NEUTRON ACER TENDL-2021 LIBRARY; T=293.6K
Photon emission for (n,n*)a

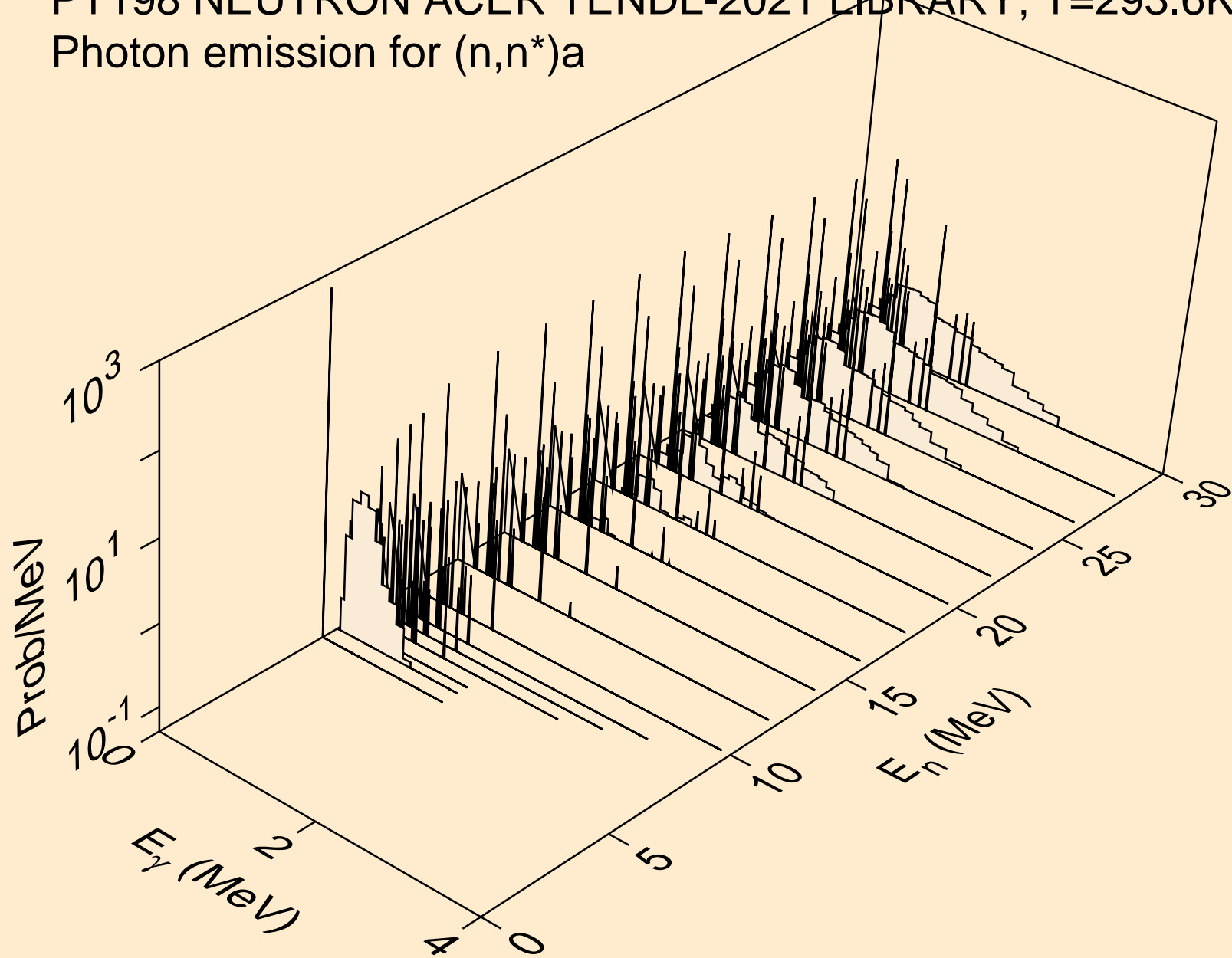

PT198 NEUTRON ACER TENDL-2021 LIBRARY; T=293.6K
Photon emission for (n,2n)a

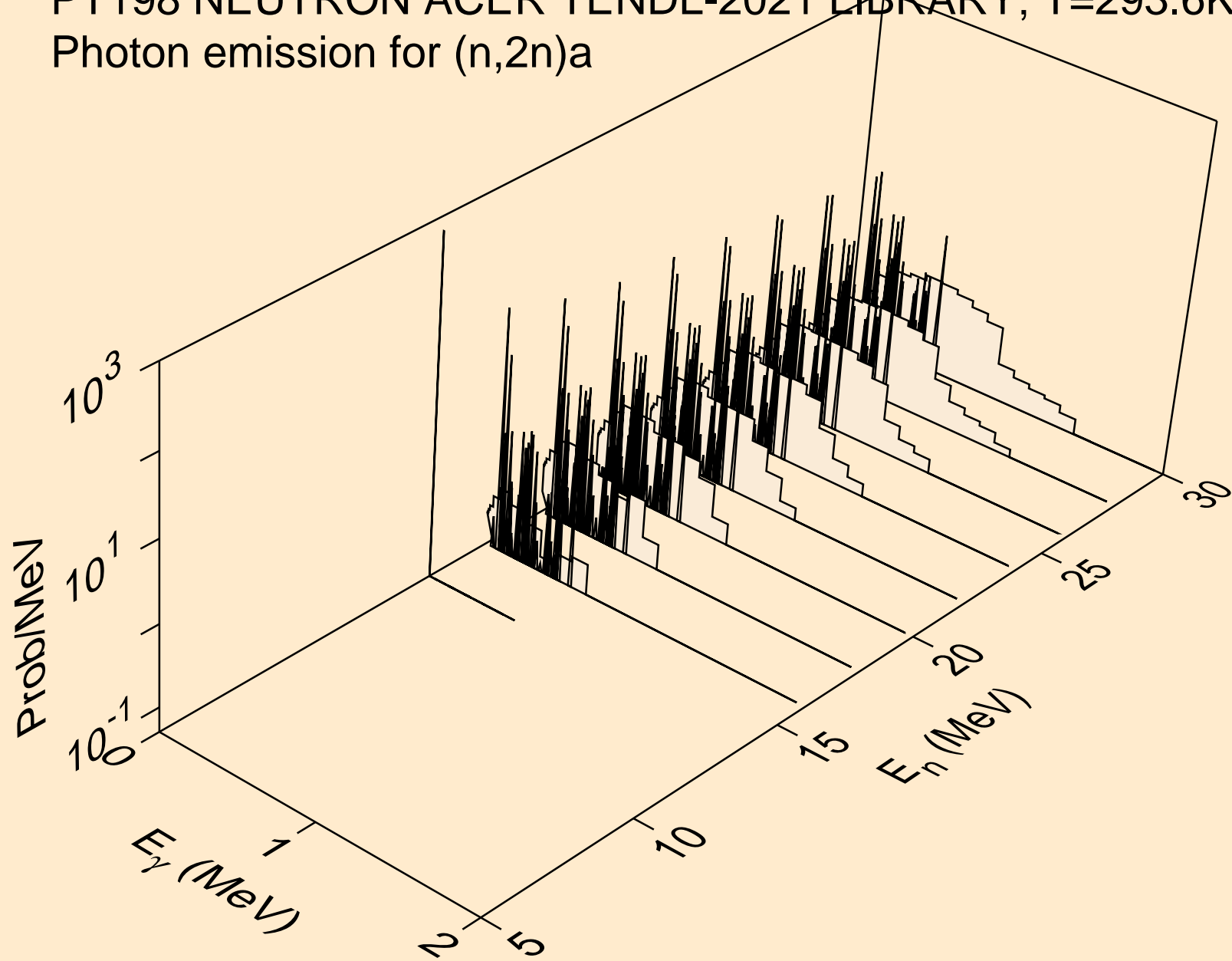

PT198 NEUTRON ACER TENDL-2021 LIBRARY; T=293.6K
Photon emission for (n,3n)a

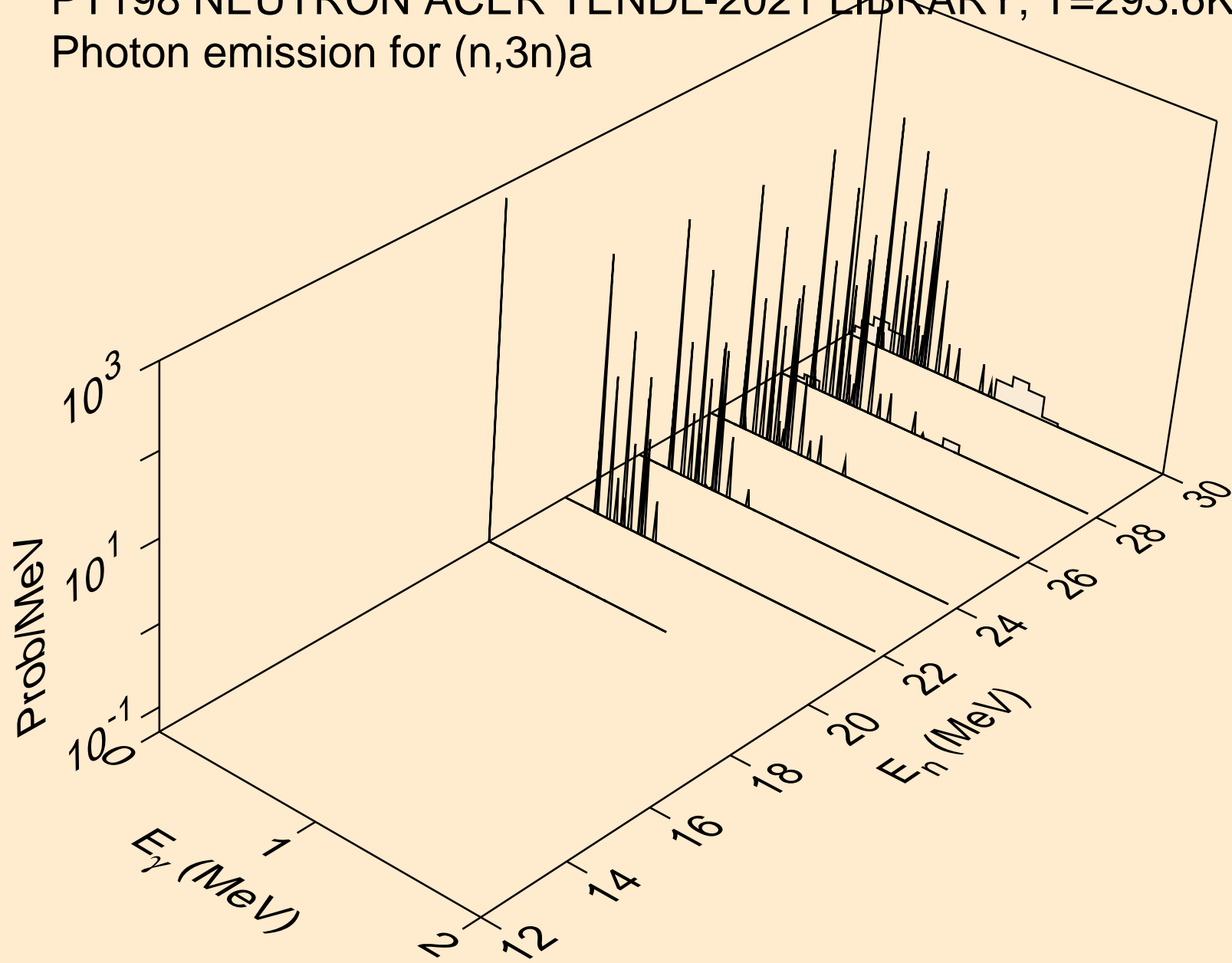

PT198 NEUTRON ACER TENDL-2021 LIBRARY; T=293.6K
Photon emission for (n,n*)p

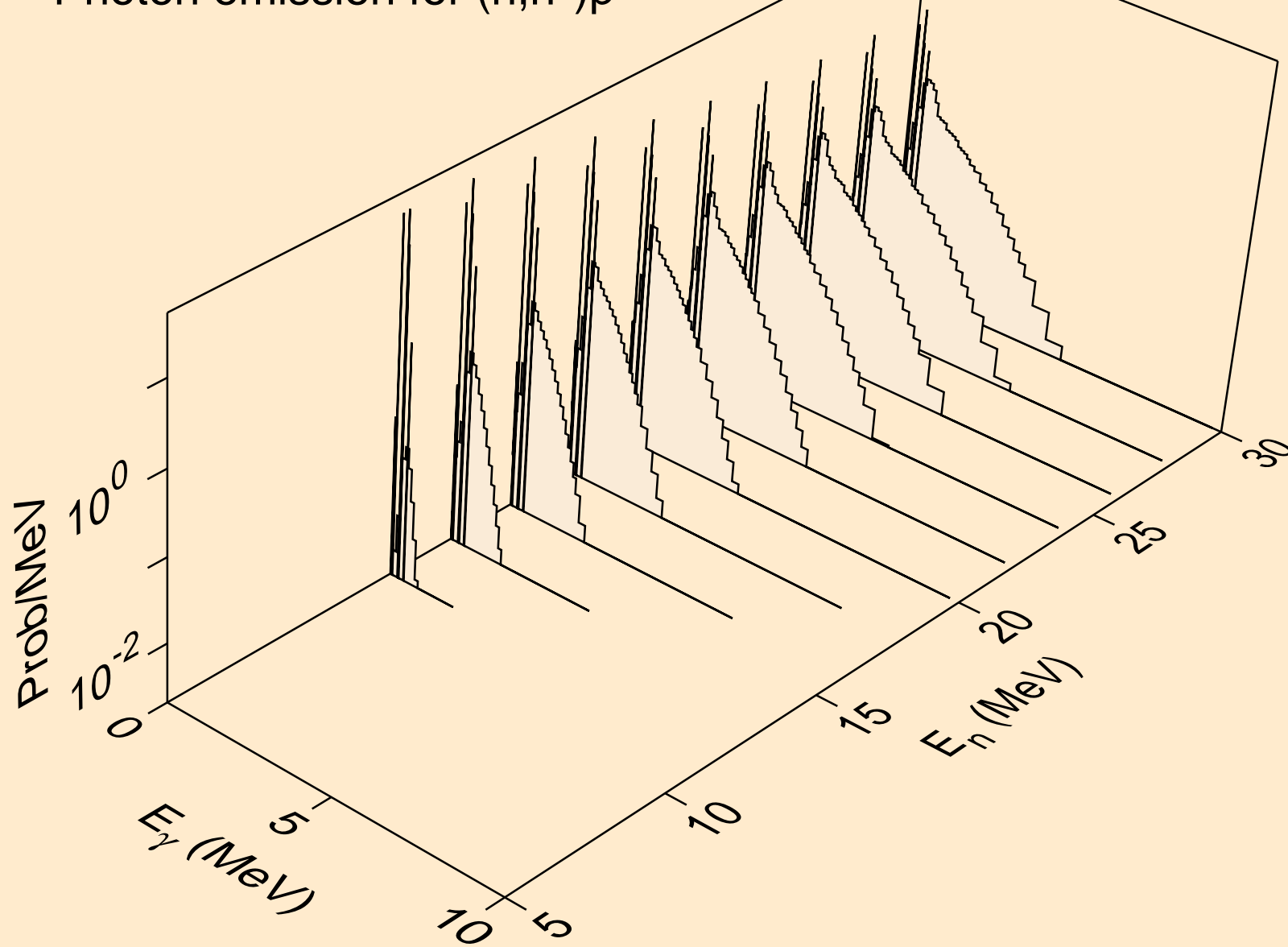

PT198 NEUTRON ACER TENDL-2021 LIBRARY; T=293.6K
Photon emission for (n,n*)d

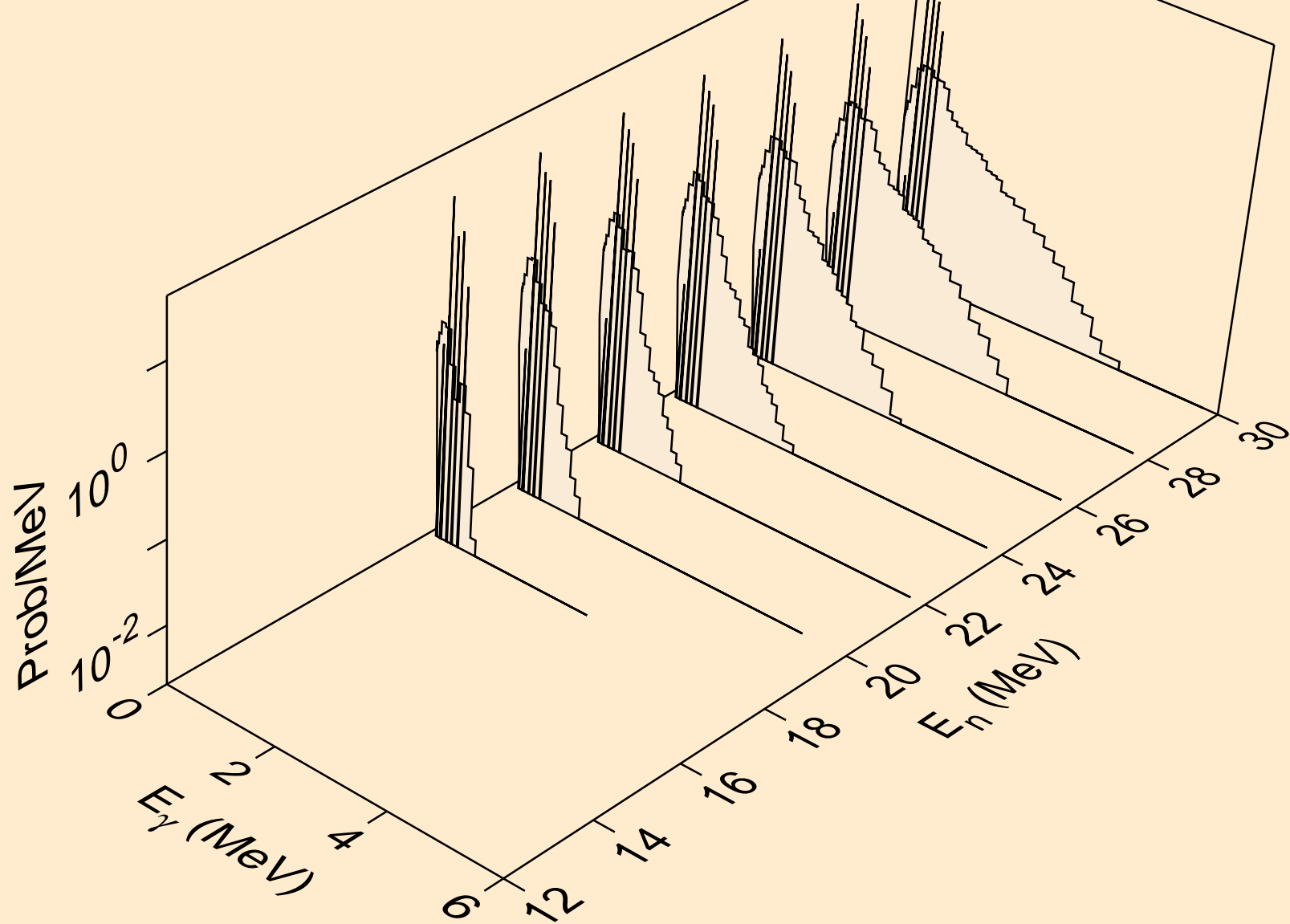

PT198 NEUTRON ACER TENDL-2021 LIBRARY; T=293.6K
Photon emission for (n,n*)t

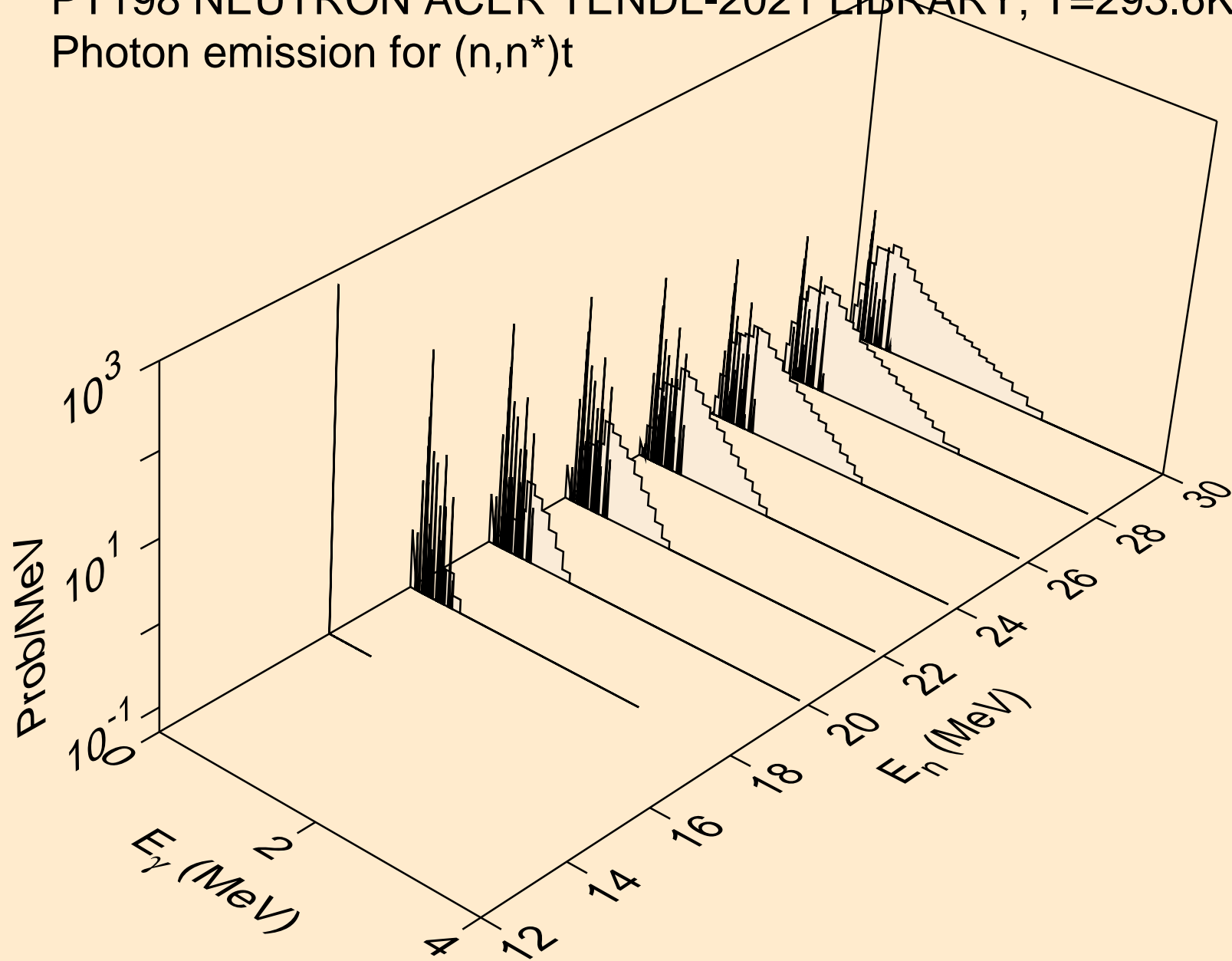

PT198 NEUTRON ACER TENDL-2021 LIBRARY; T=293.6K
Photon emission for (n,n*)he3

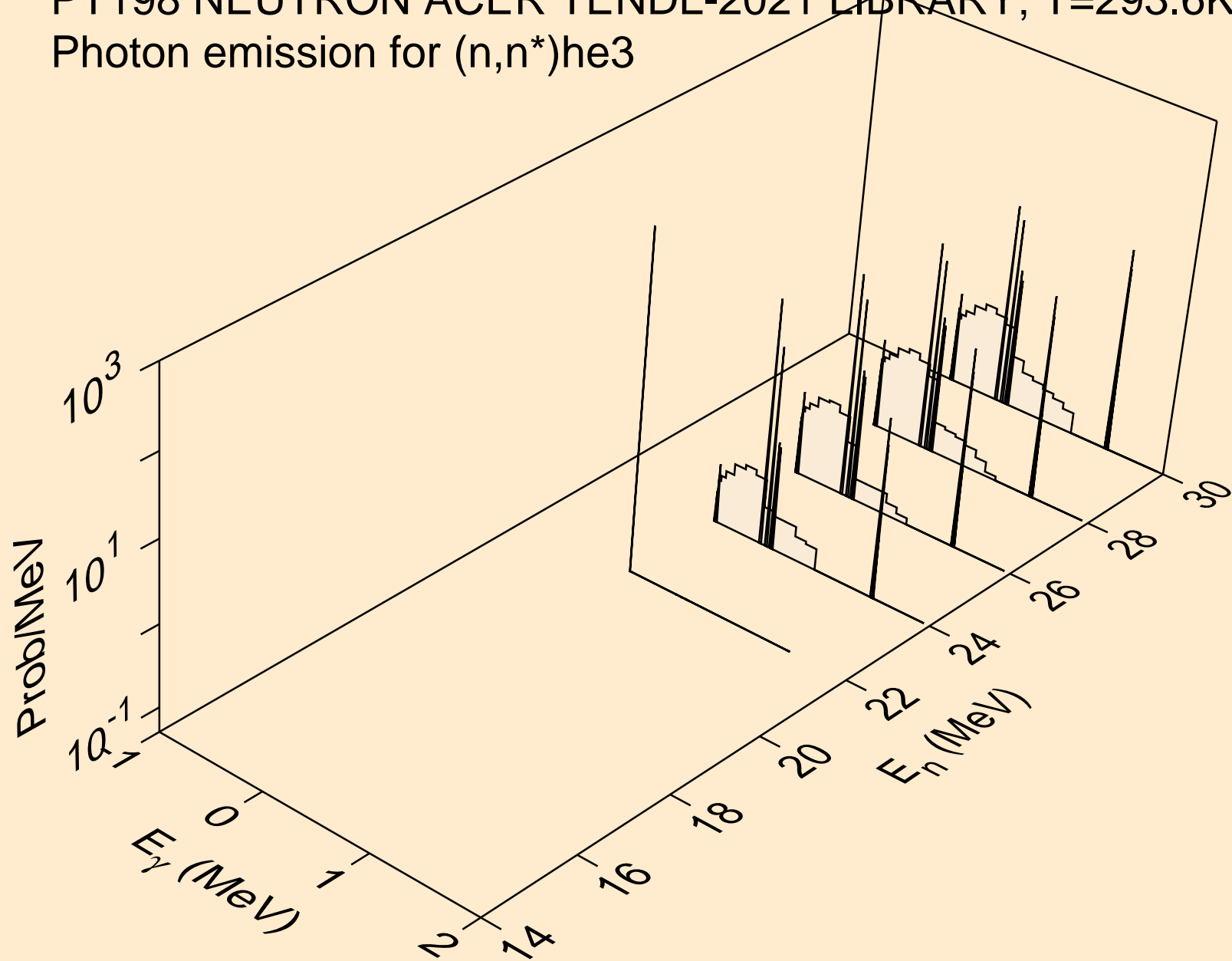

PT198 NEUTRON ACER TENDL-2021 LIBRARY; T=293.6K
Photon emission for (n,4n)

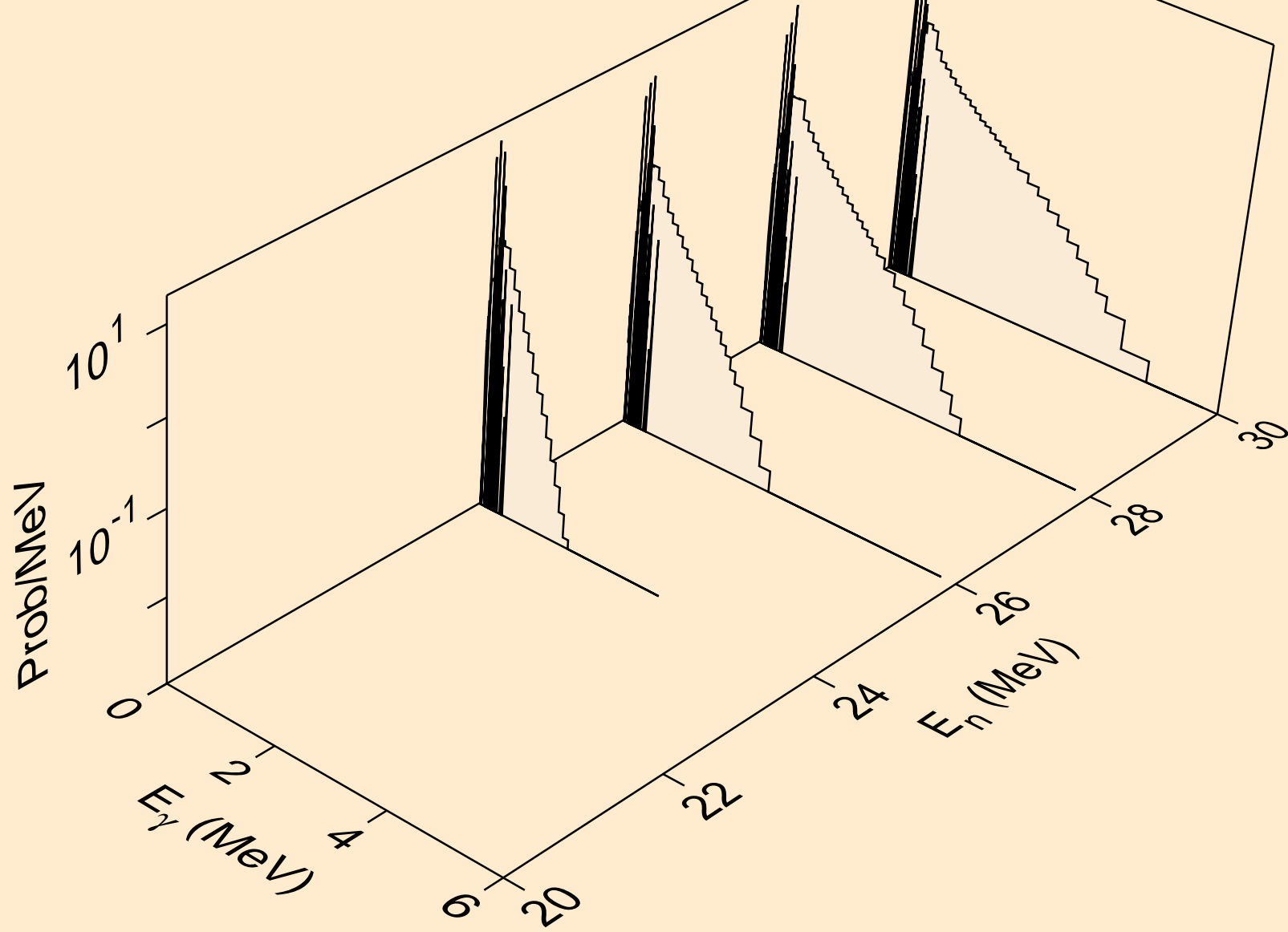

PT198 NEUTRON ACER TENDL-2021 LIBRARY; T=293.6K
Photon emission for (n,2np)

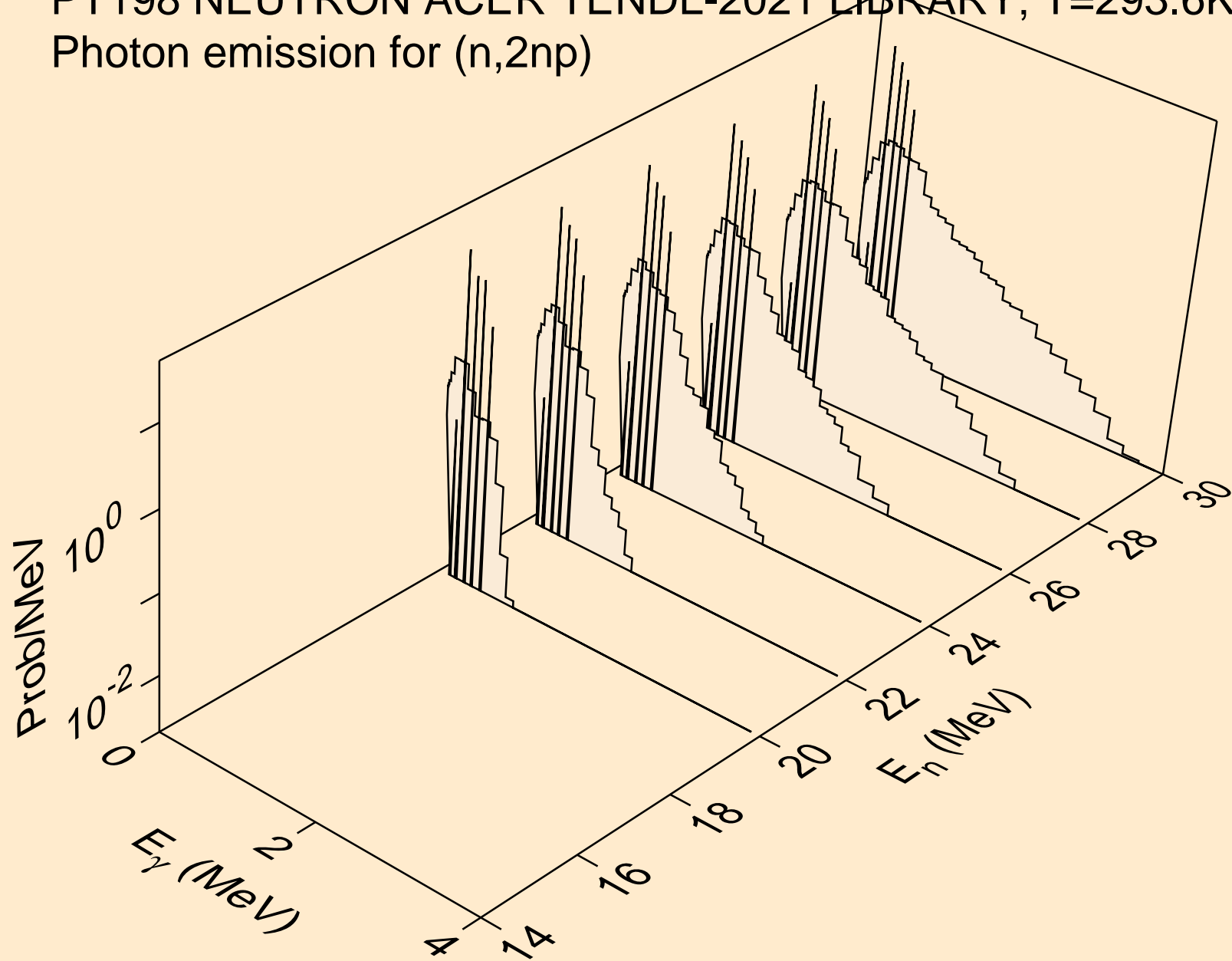

PT198 NEUTRON ACER TENDL-2021 LIBRARY; T=293.6K
Photon emission for (n,3np)

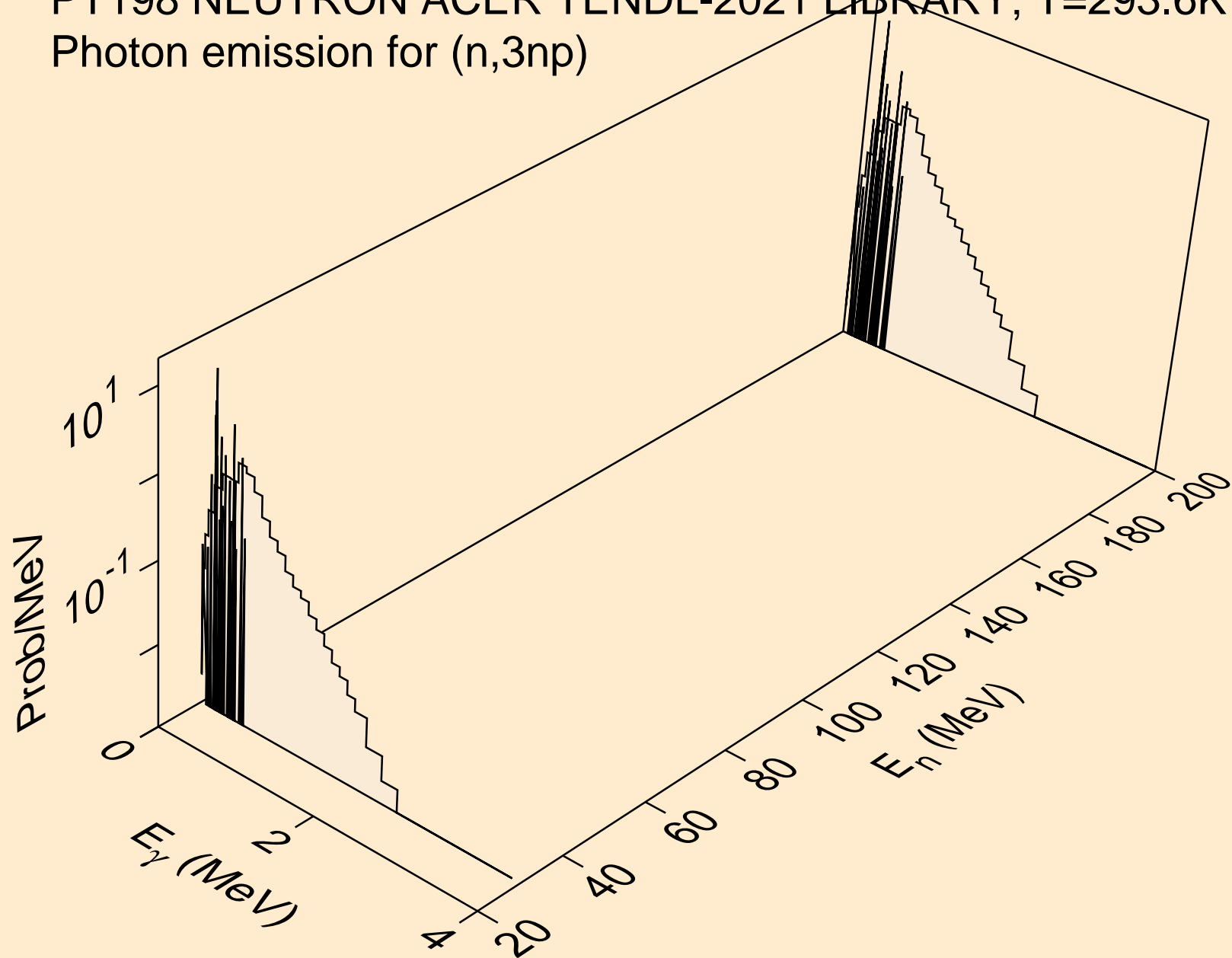

PT198 NEUTRON ACER TENDL-2021 LIBRARY; T=293.6K
Photon emission for (n,n*c)

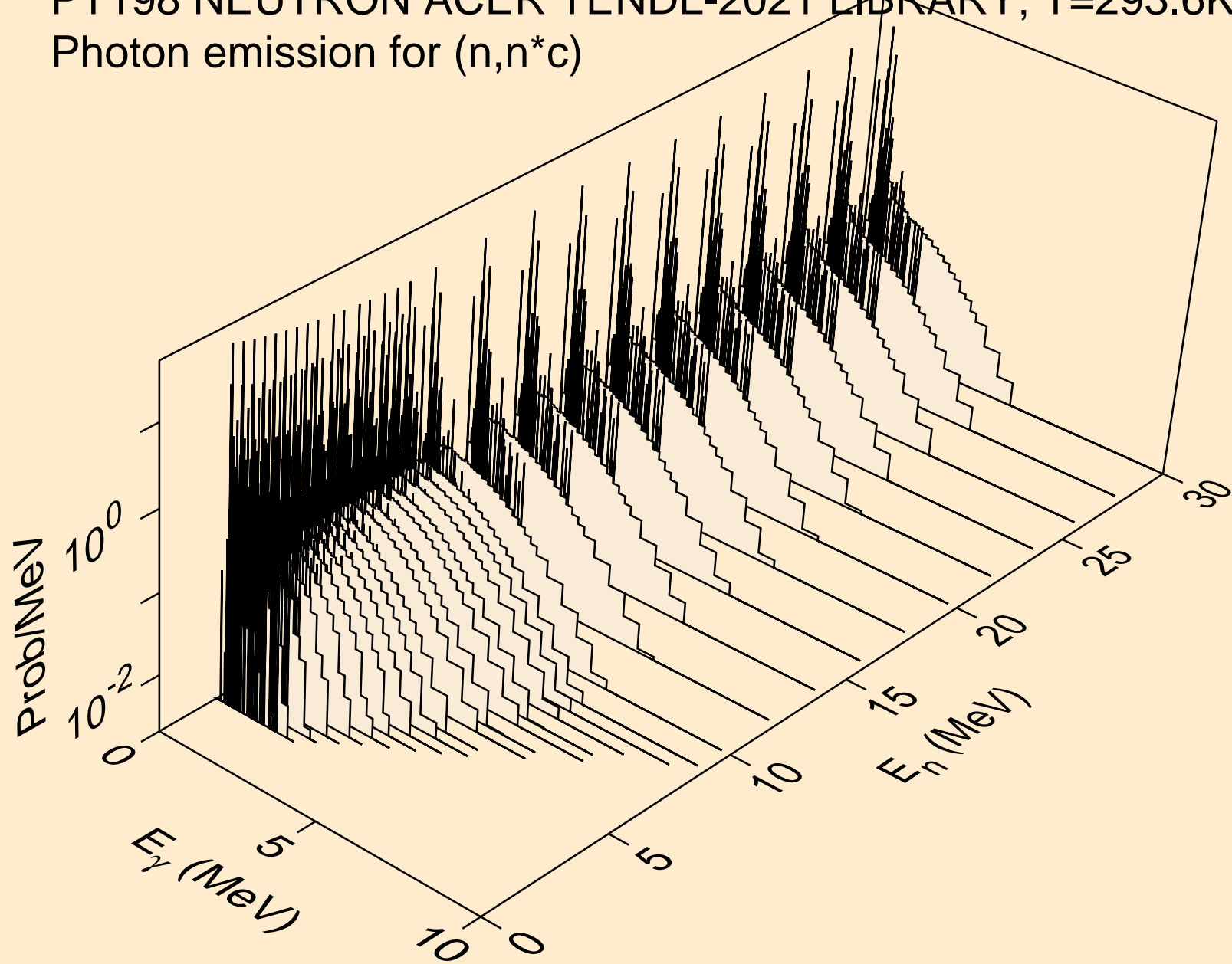

PT198 NEUTRON ACER TENDL-2021 LIBRARY; T=293.6K
Photon emission for (n,gma)

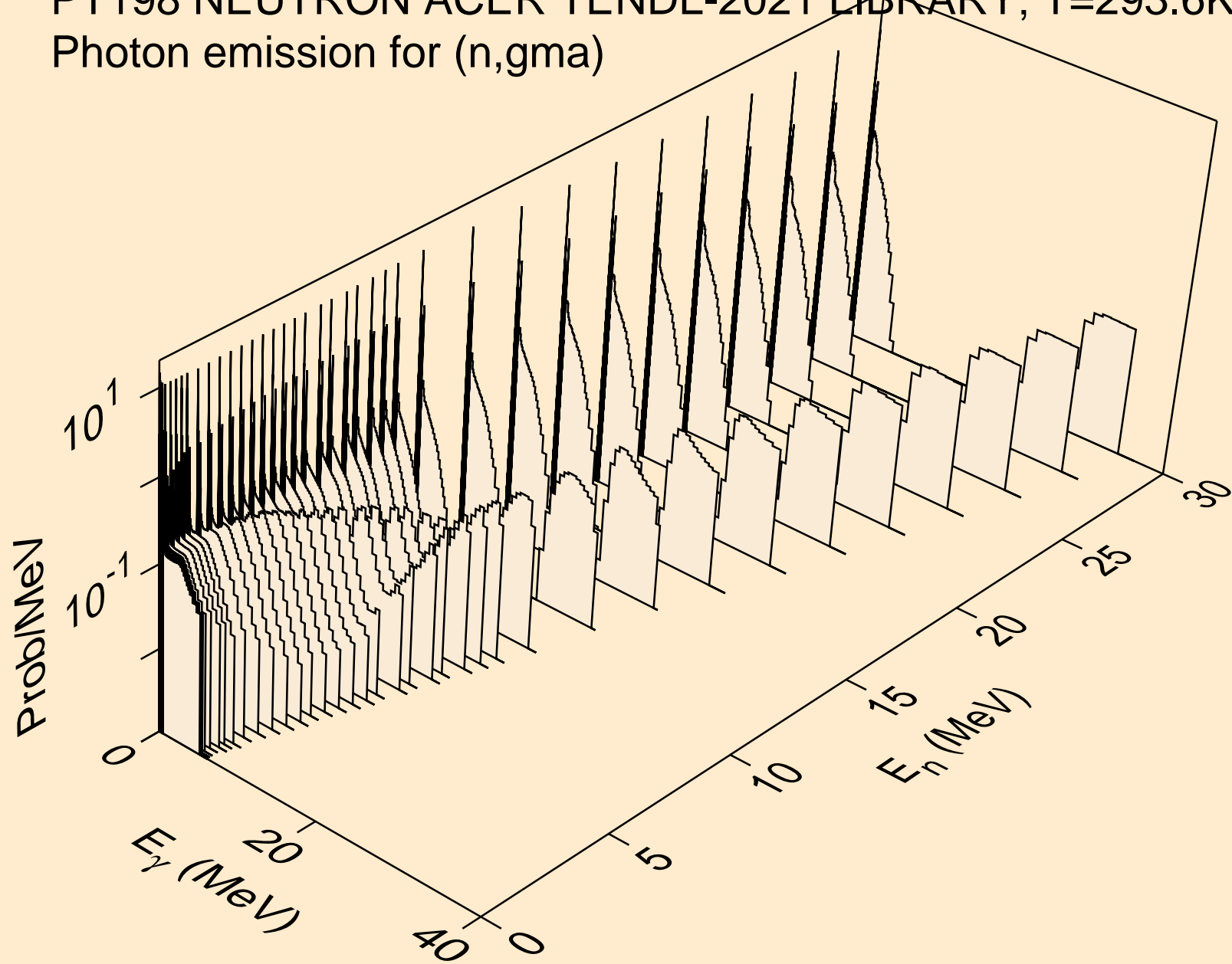

PT198 NEUTRON ACER TENDL-2021 LIBRARY; T=293.6K
Photon emission for (n,p)

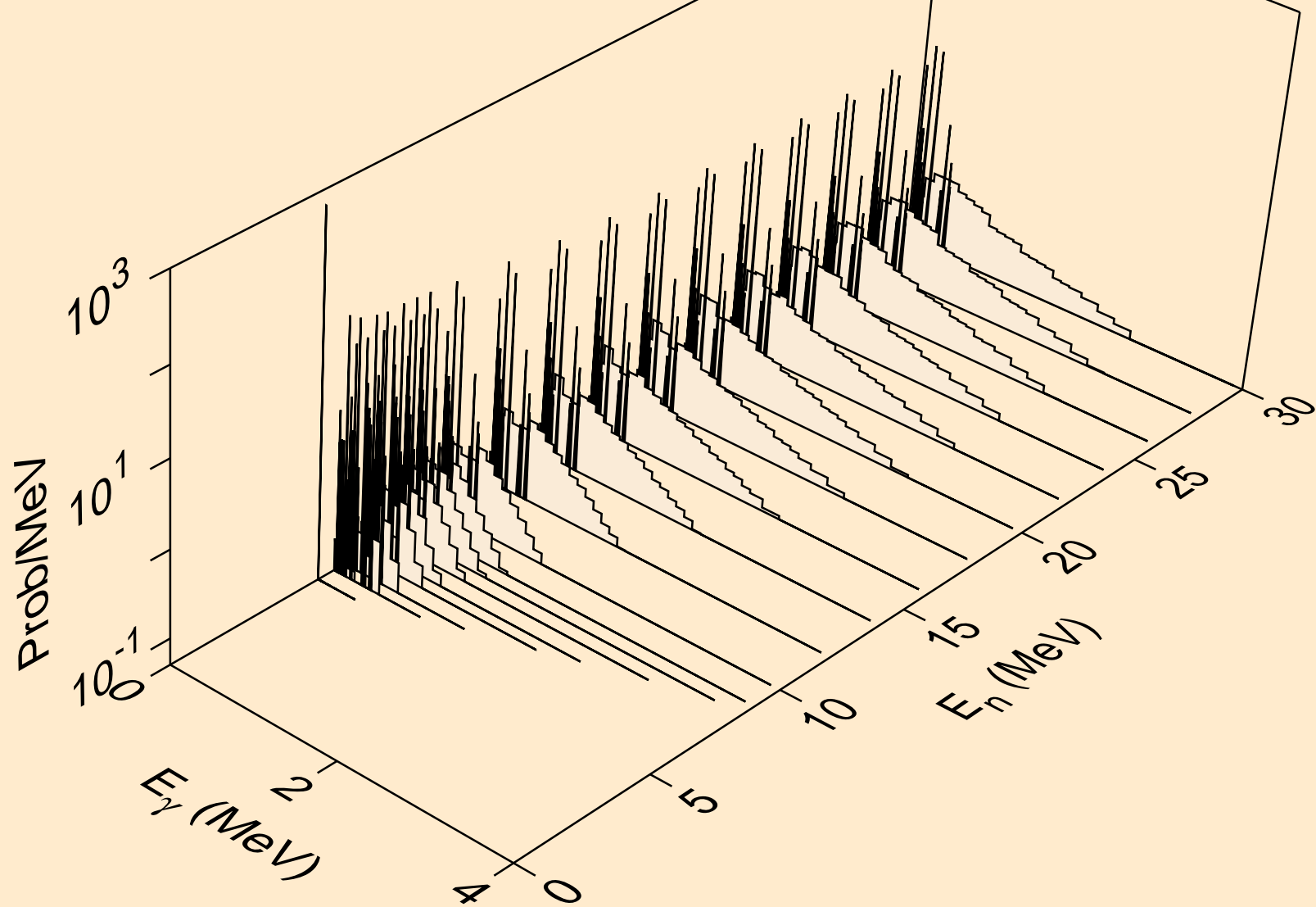

PT198 NEUTRON ACER TENDL-2021 LIBRARY; T=293.6K
Photon emission for (n,d)

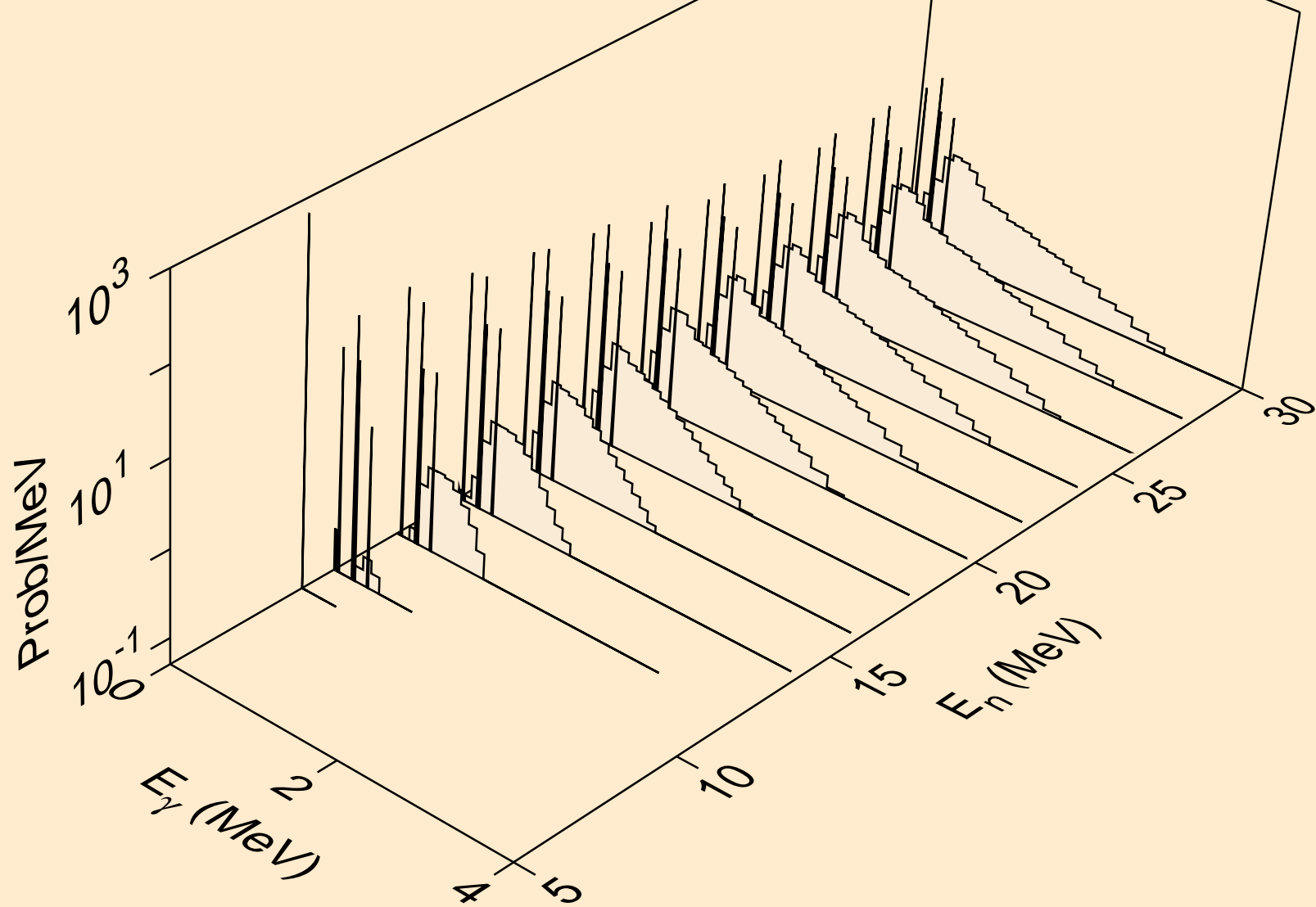

PT198 NEUTRON ACER TENDL-2021 LIBRARY; T=293.6K
Photon emission for (n,t)

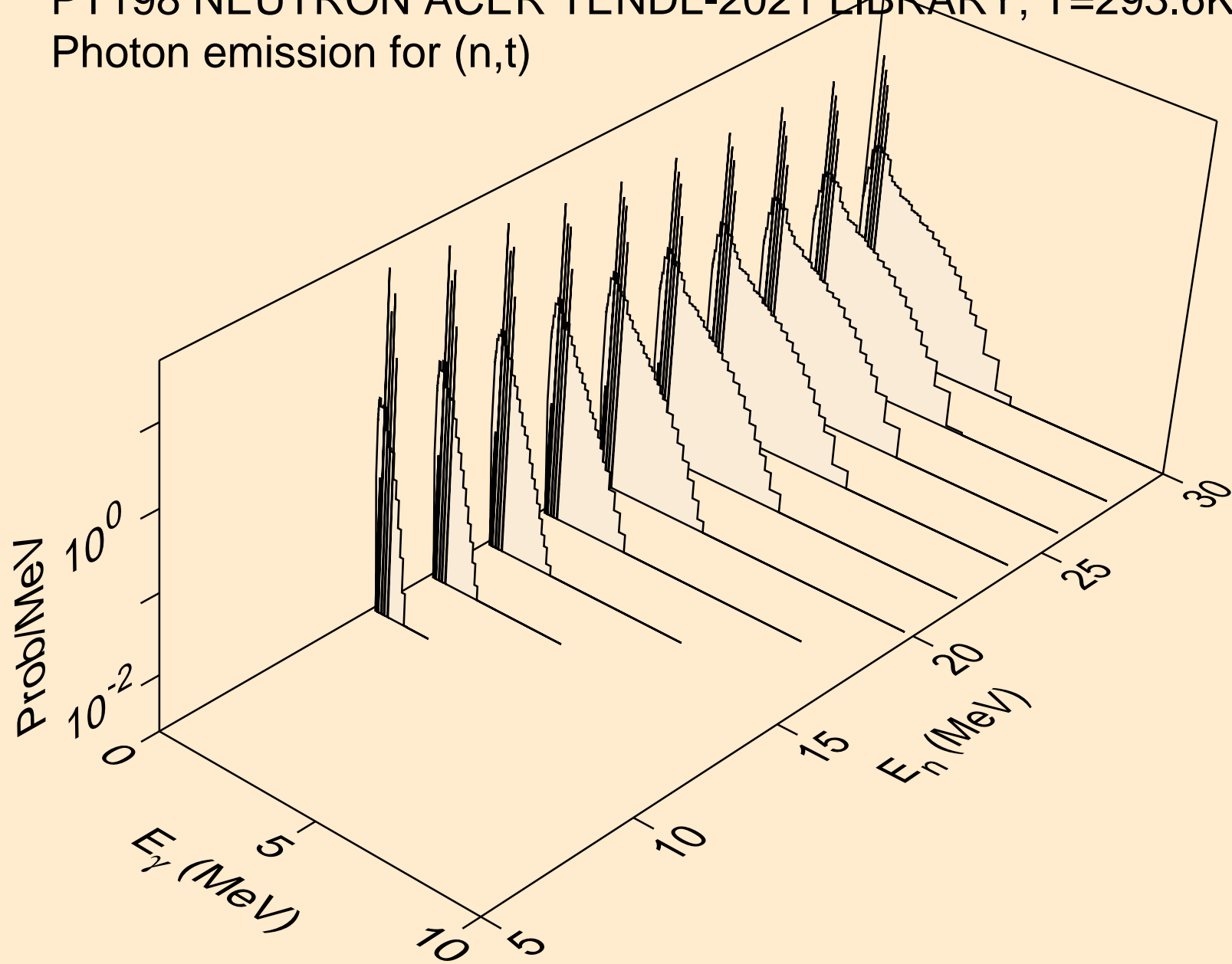

PT198 NEUTRON ACER TENDL-2021 LIBRARY; T=293.6K
Photon emission for (n,he3)

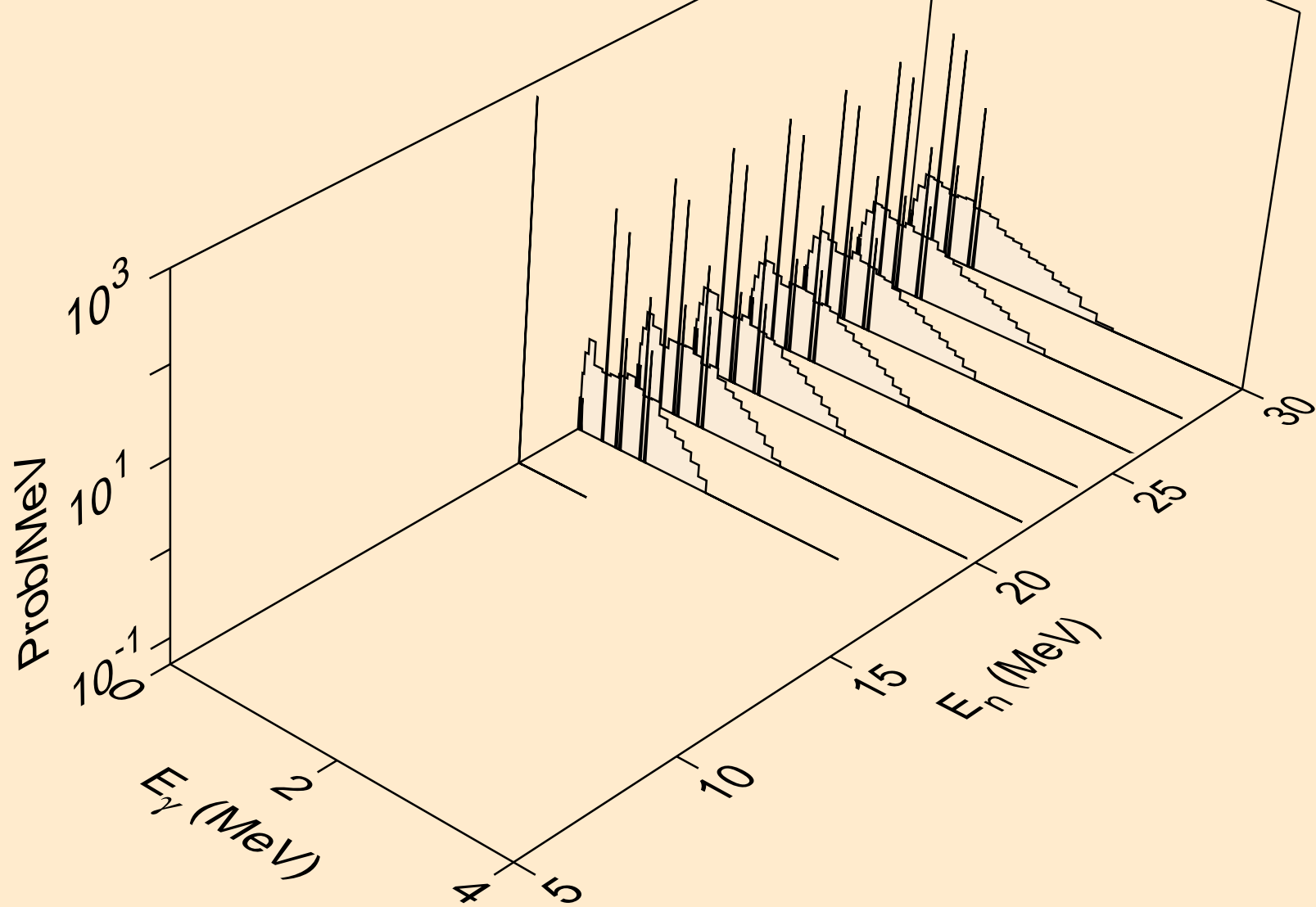

PT198 NEUTRON ACER TENDL-2021 LIBRARY; T=293.6K
Photon emission for (n,a)

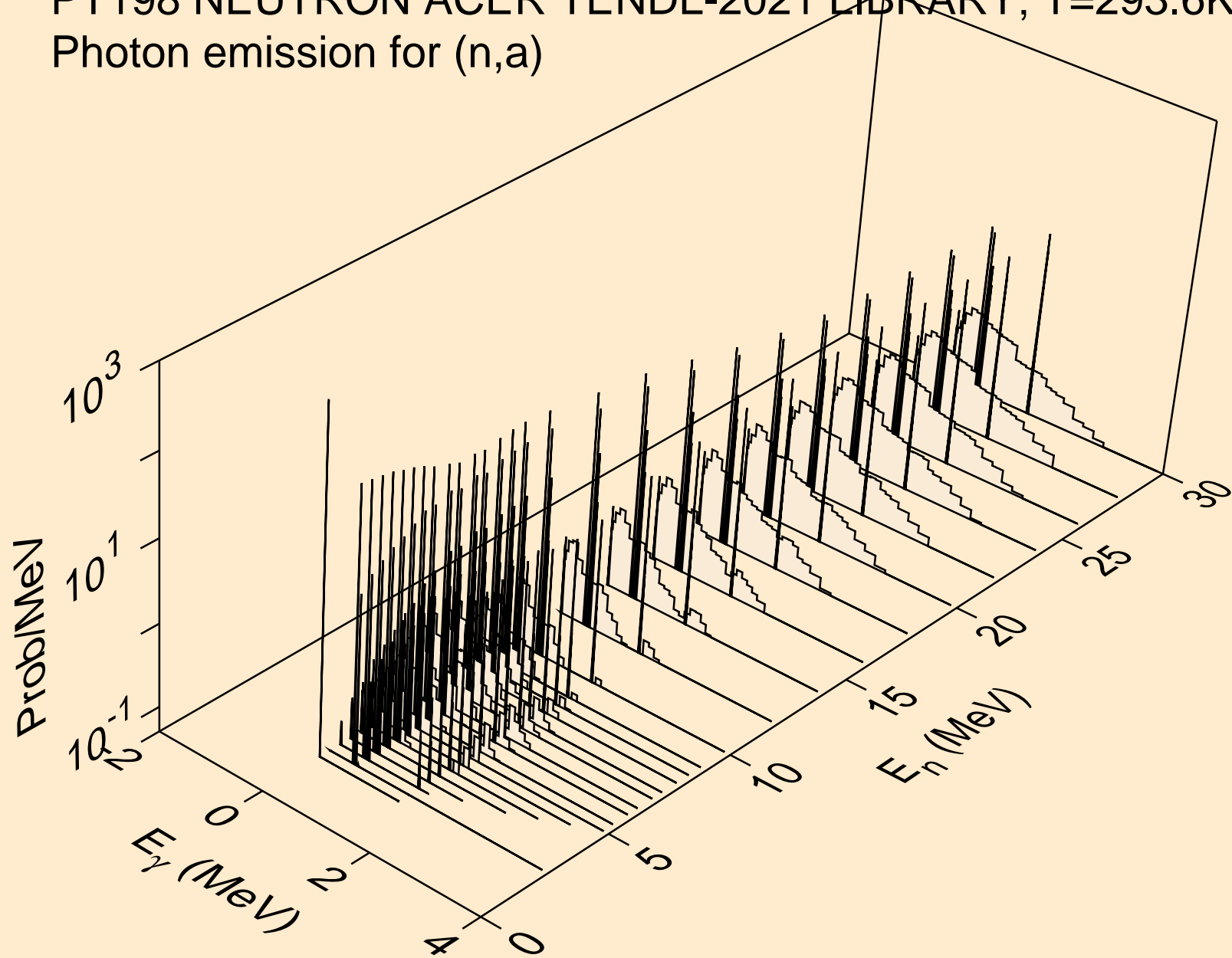

PT198 NEUTRON ACER TENDL-2021 LIBRARY; T=293.6K
Photon emission for (n,2p)

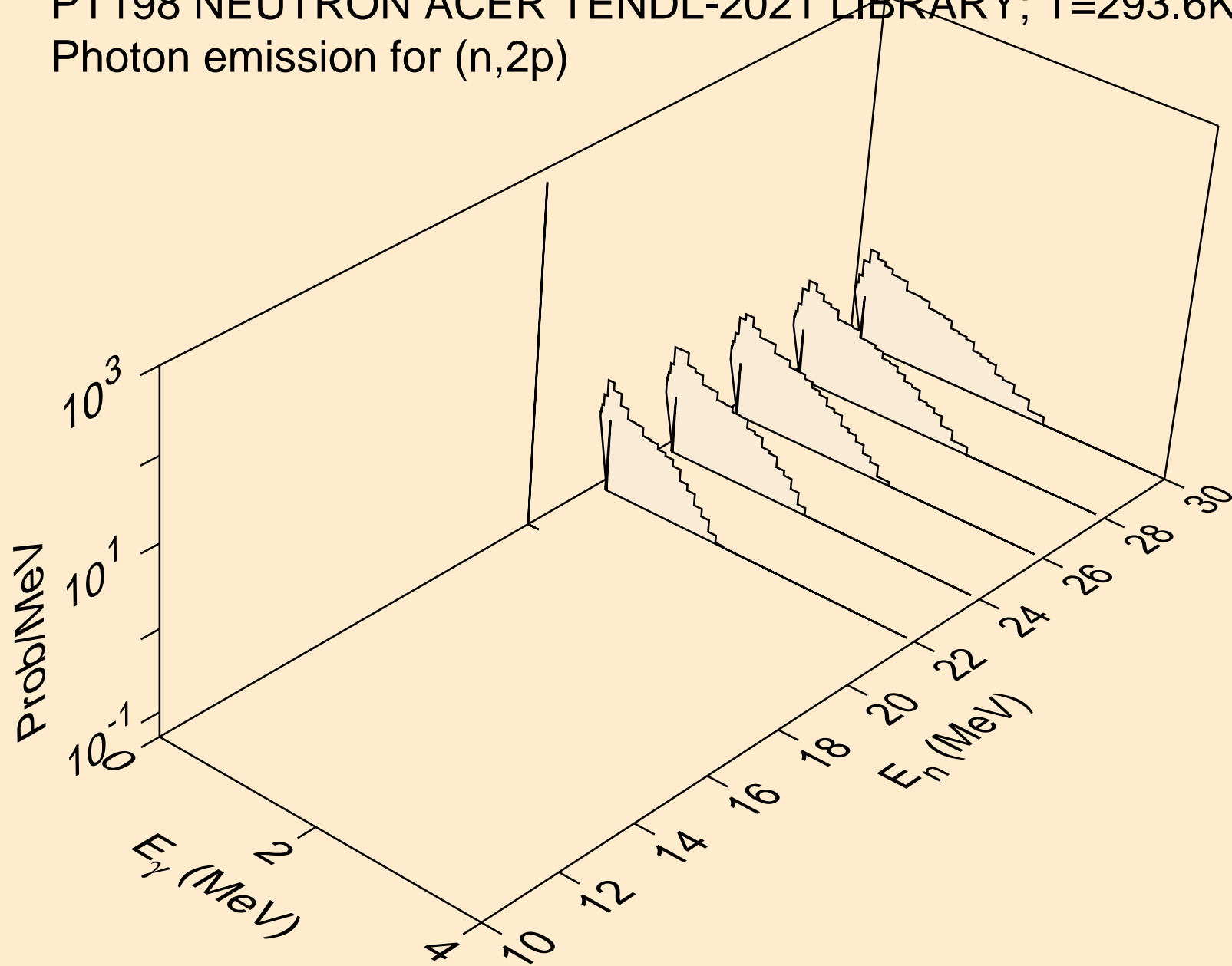

PT198 NEUTRON ACER TENDL-2021 LIBRARY; T=293.6K
thermal capture photon spectrum

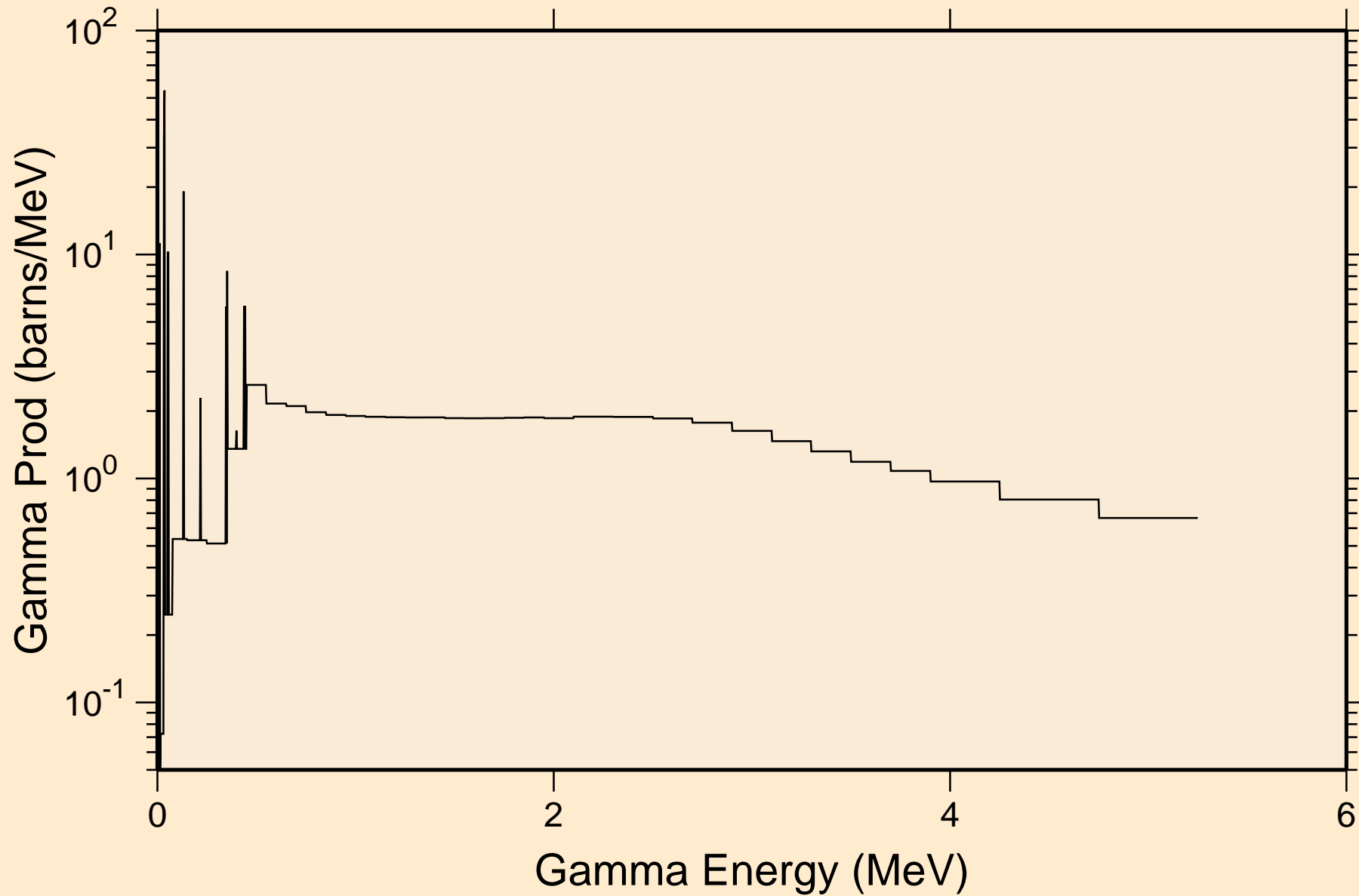

PT198 NEUTRON ACER TENDL-2021 LIBRARY; T=293.6K
14 MeV photon spectrum

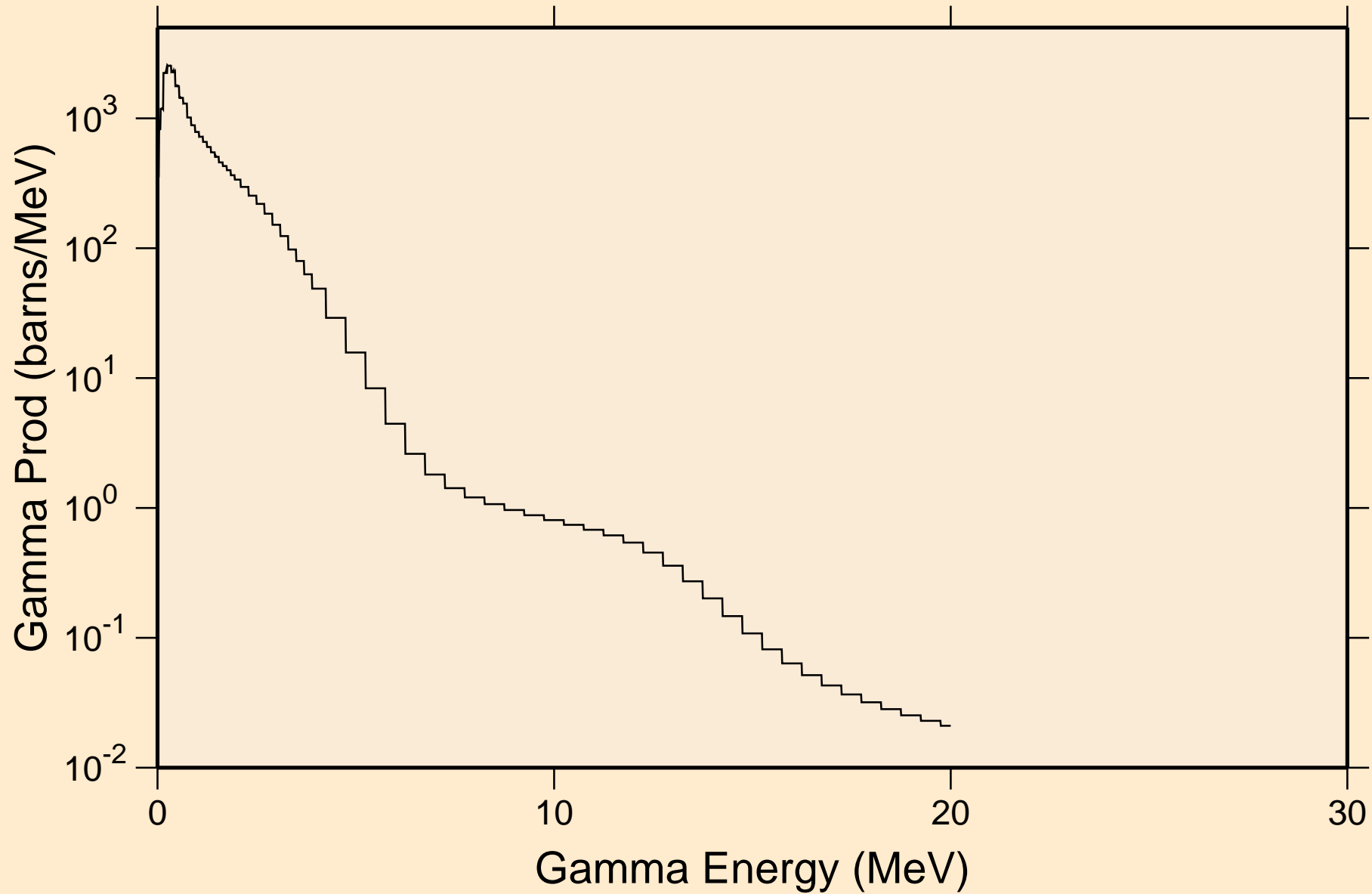

PT198 NEUTRON ACER TENDL-2021 LIBRARY; T=293.6K
Particle heating contributions

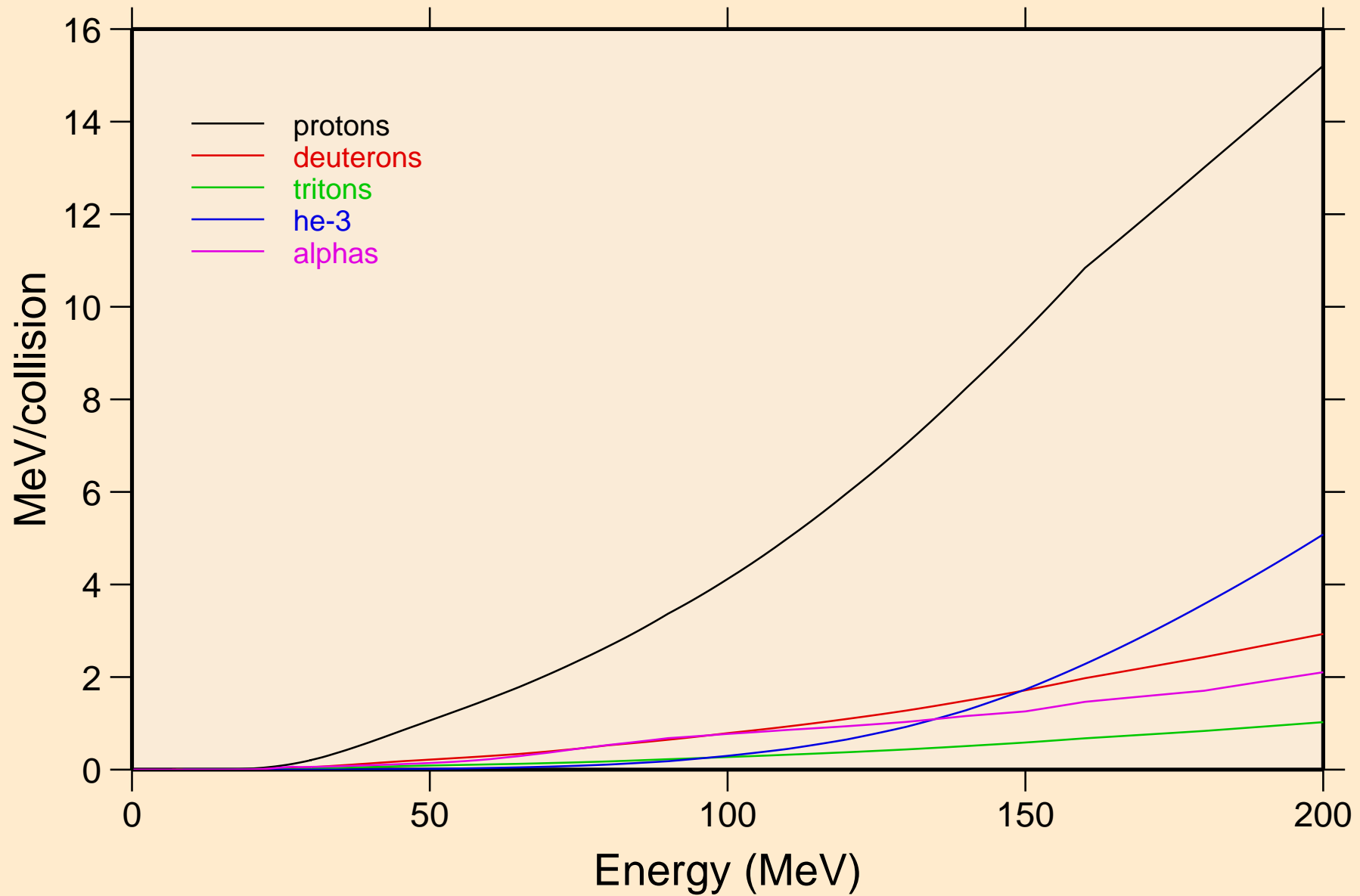

PT198 NEUTRON ACER TENDL-2021 LIBRARY; T=293.6K
Recoil Heating

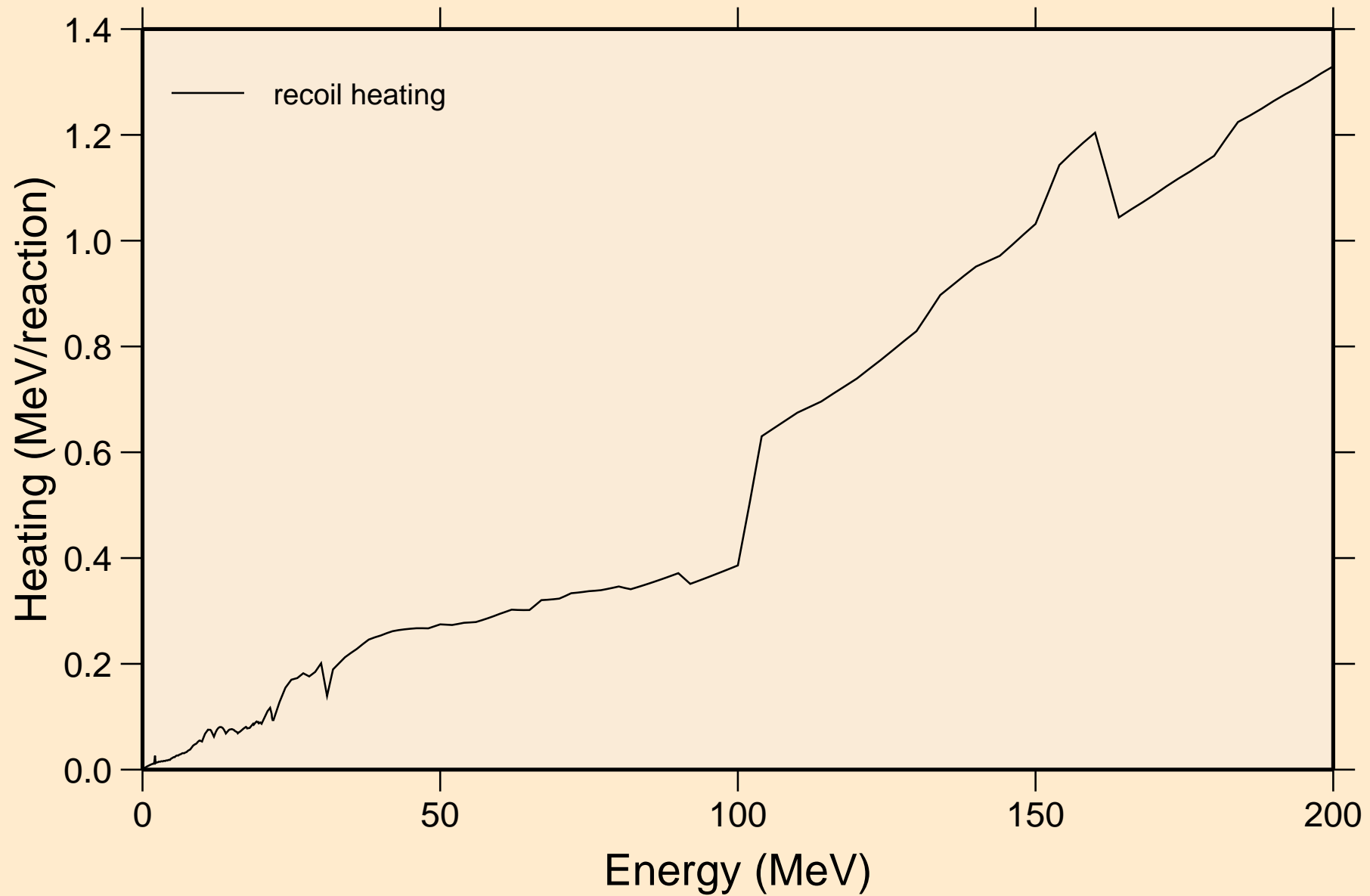

PT198 NEUTRON ACER TENDL-2021 LIBRARY; T=293.6K
Particle production cross sections

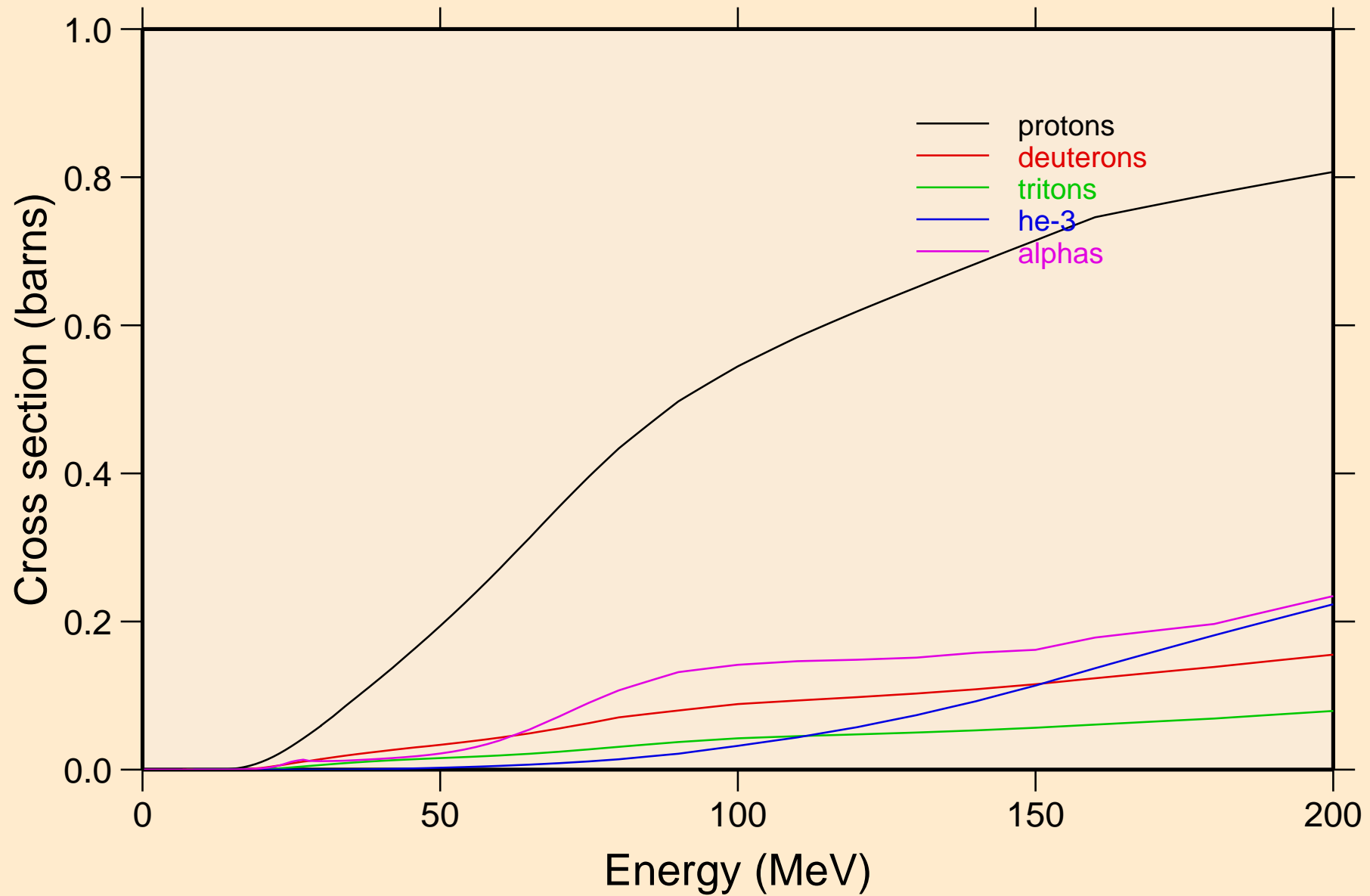

PT198 NEUTRON ACER TENDL-2021 LIBRARY; T=293.6K
protons from (n,x)

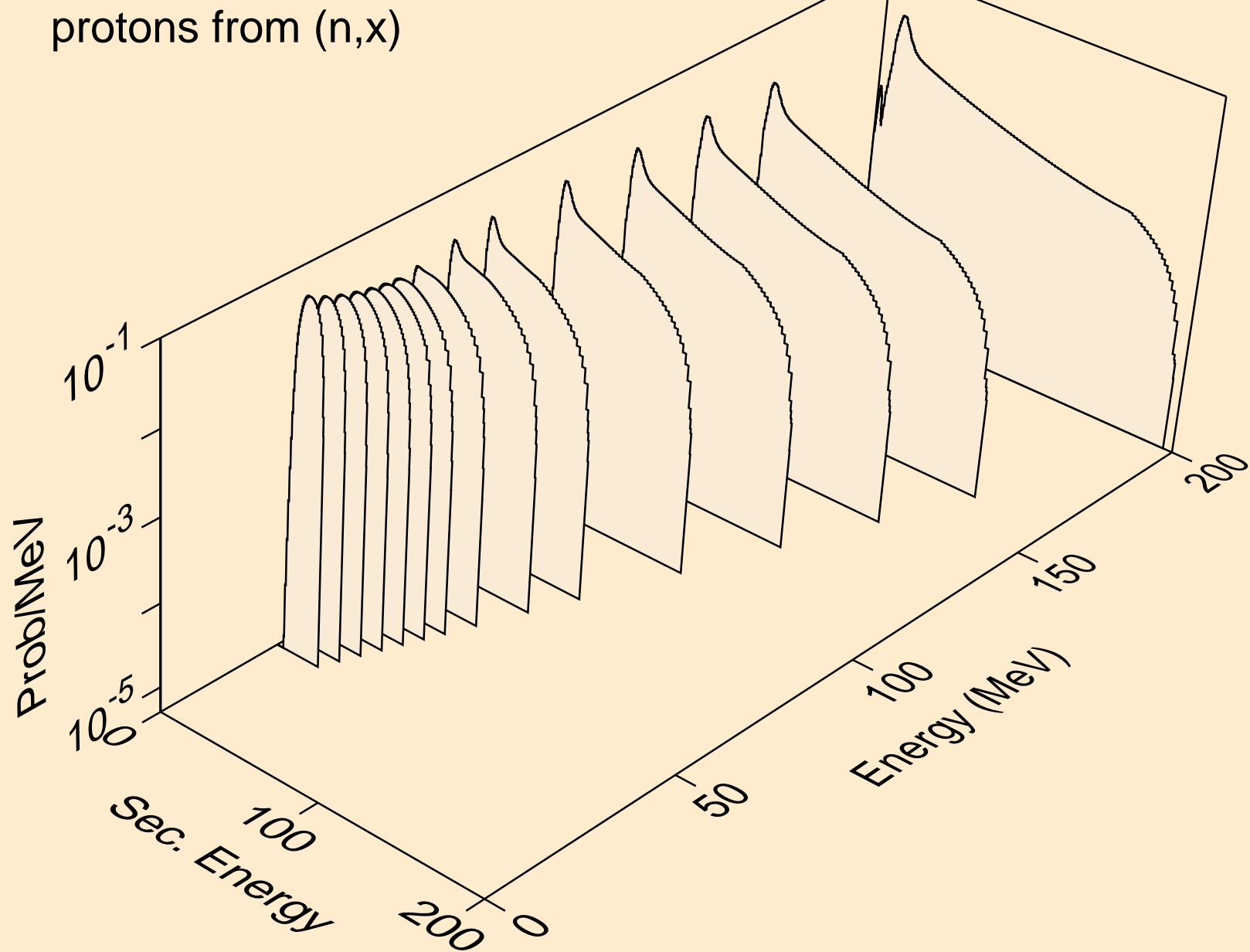

PT198 NEUTRON ACER TENDL-2021 LIBRARY; T=293.6K
protons from (n,n*)p

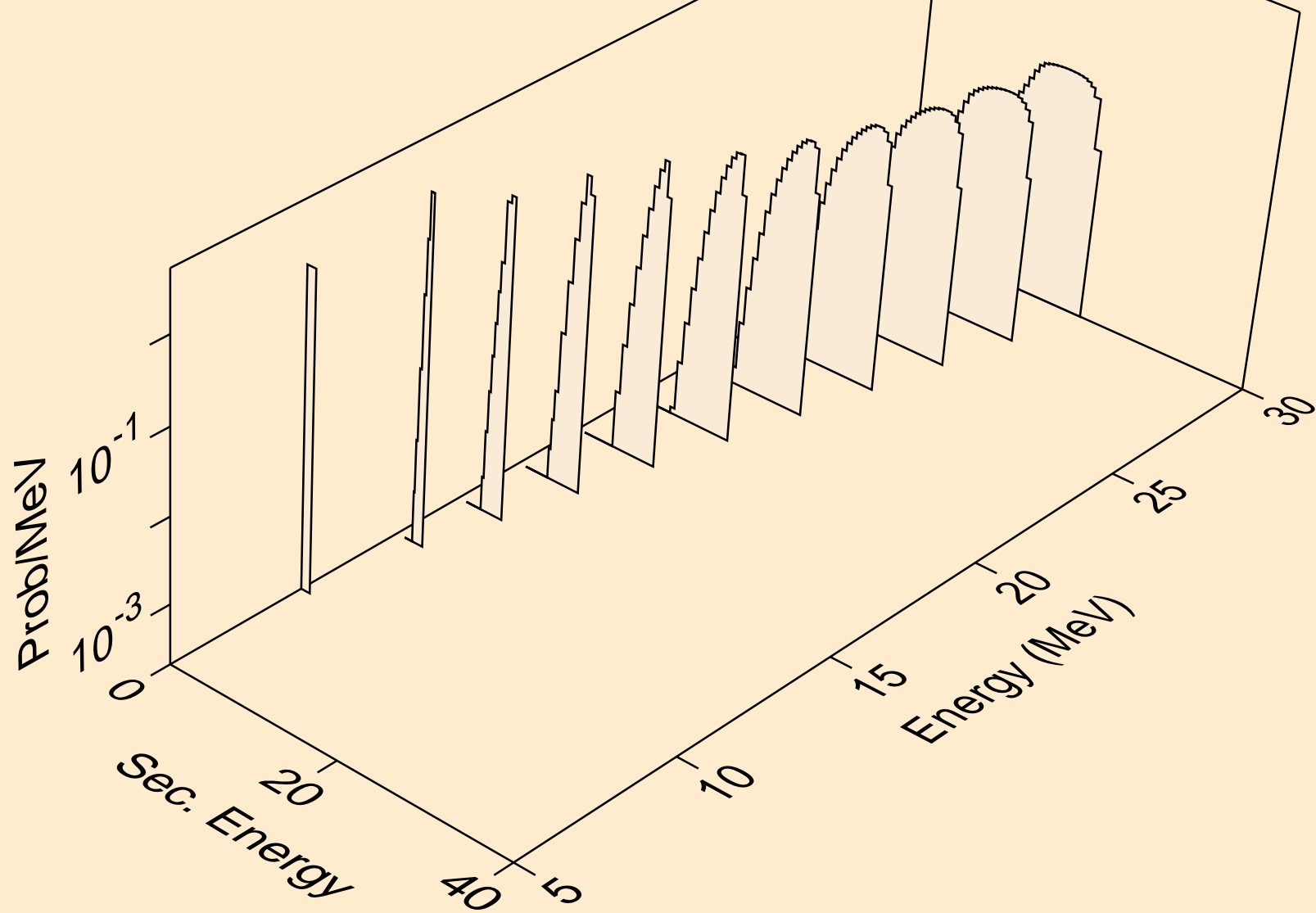

PT198 NEUTRON ACER TENDL-2021 LIBRARY; T=293.6K
protons from (n,2np)

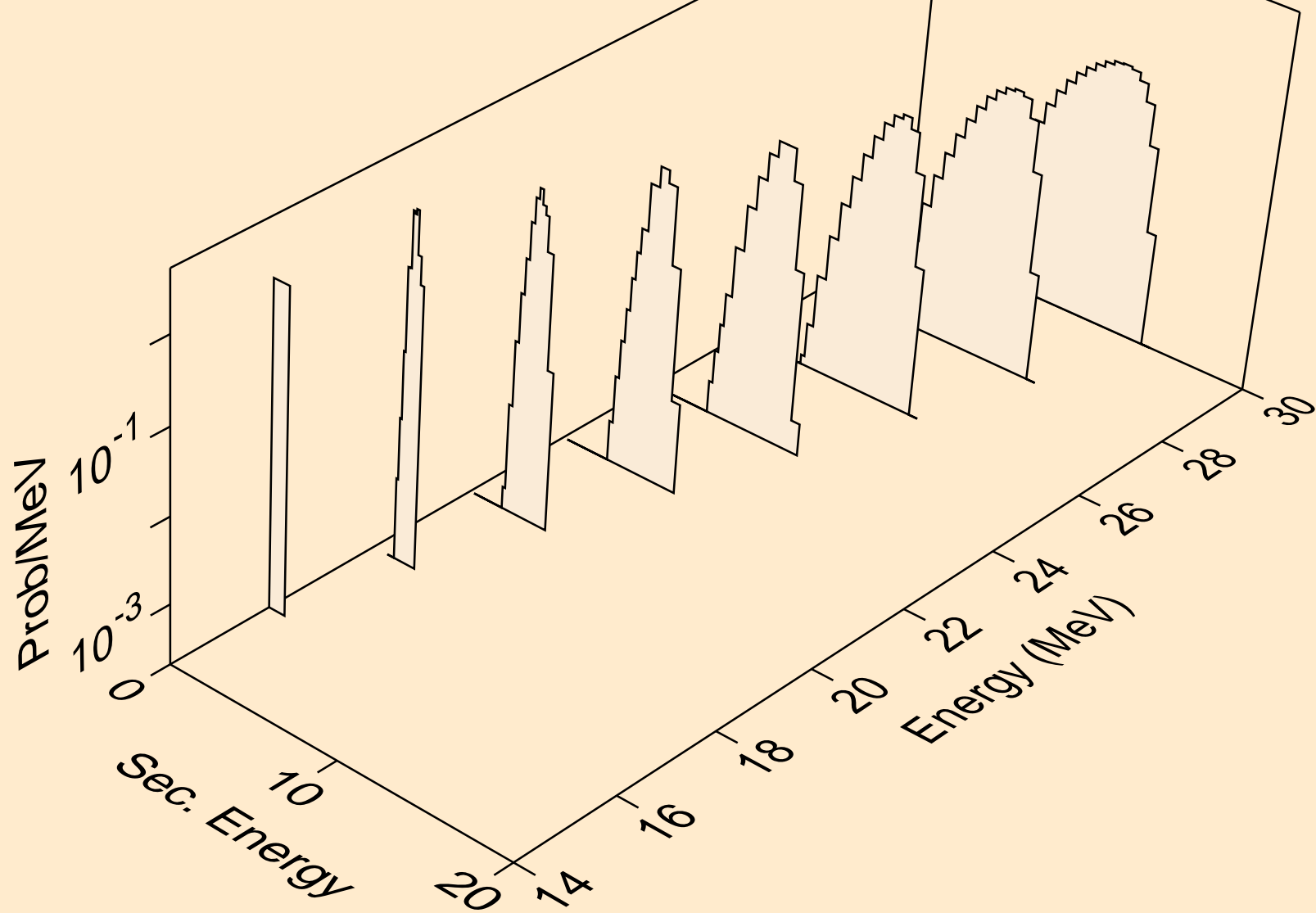

PT198 NEUTRON ACER TENDL-2021 LIBRARY; T=293.6K
protons from (n,3np)

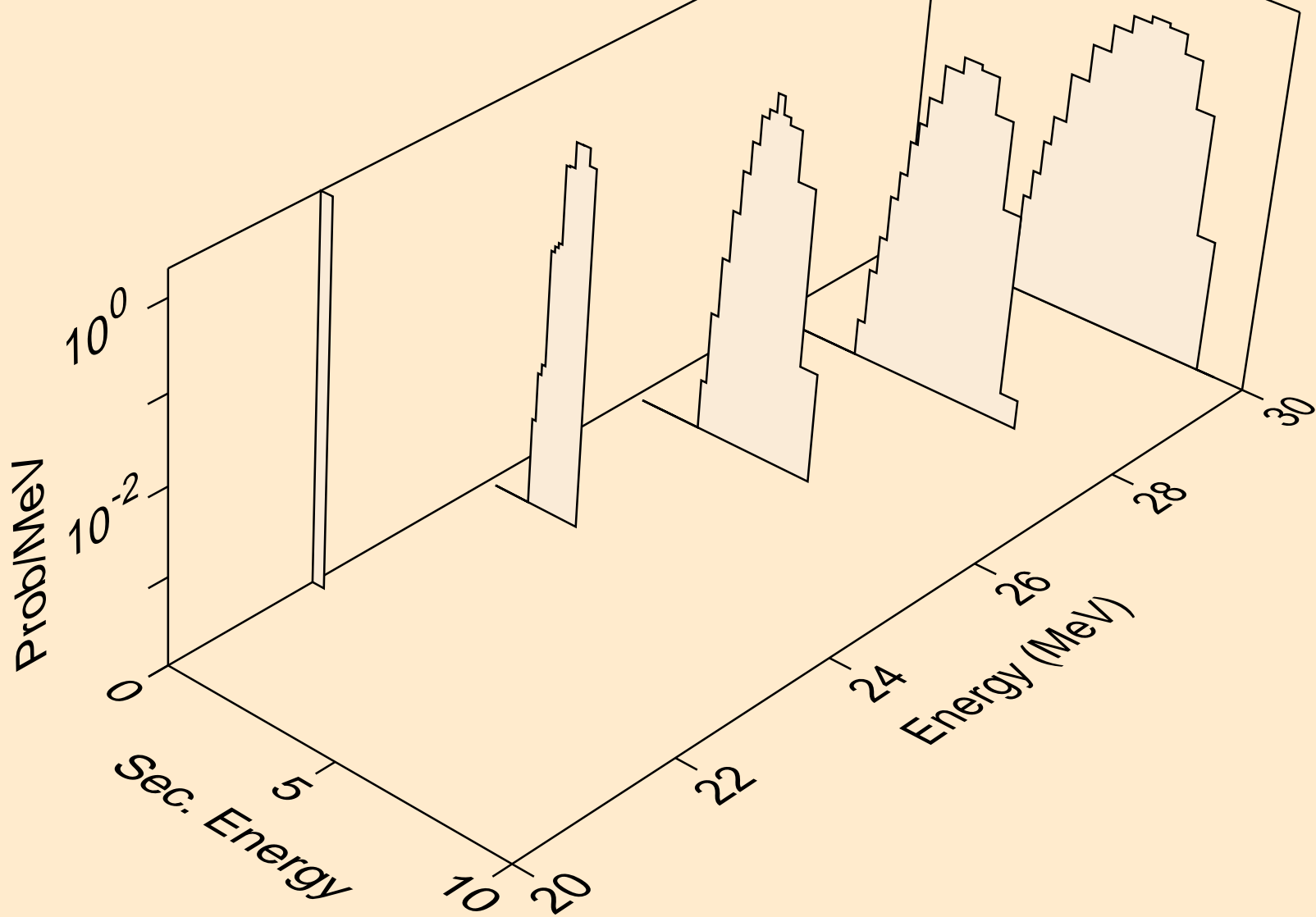

PT198 NEUTRON ACER TENDL-2021 LIBRARY; T=293.6K
protons from (n,p)

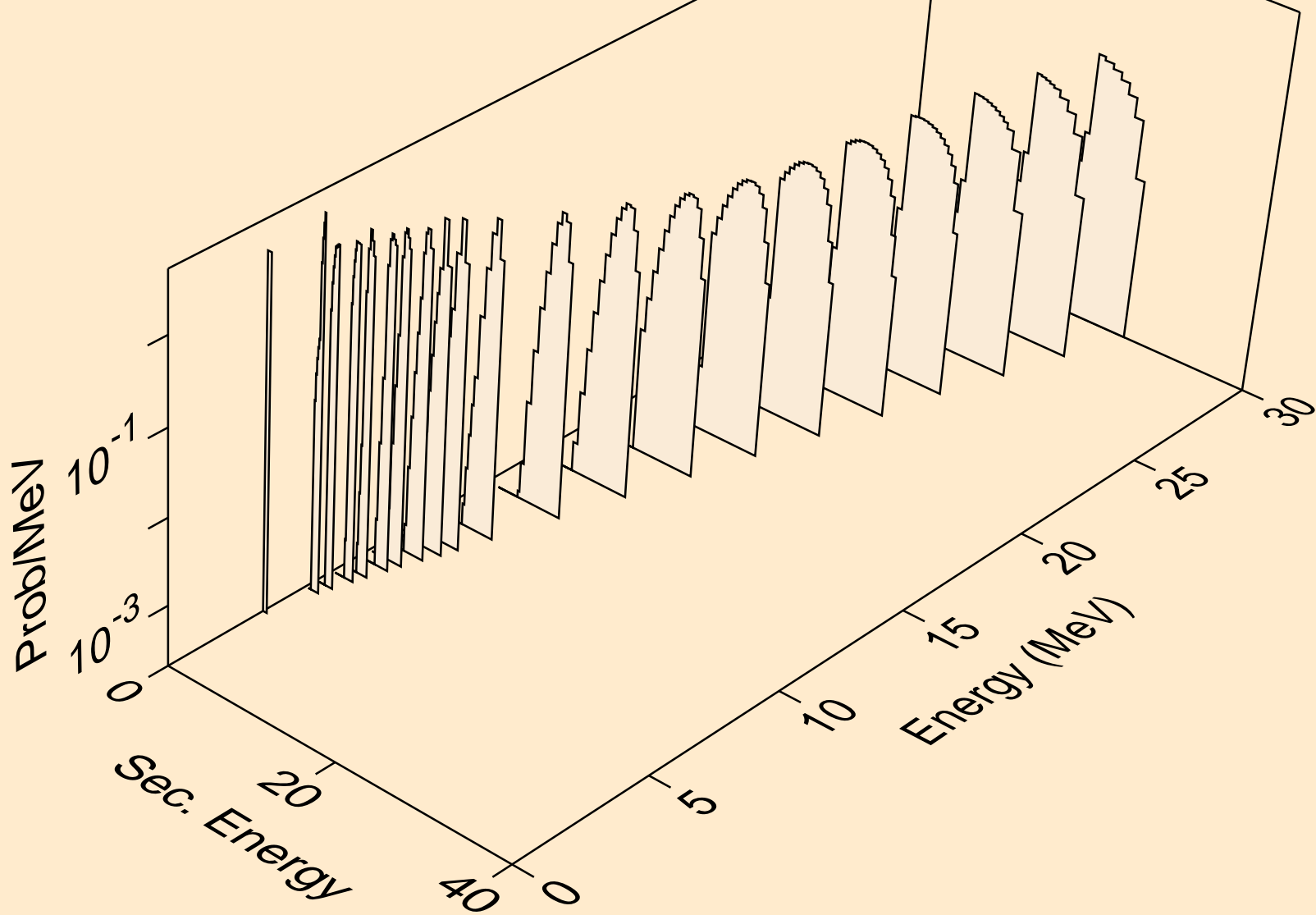

PT198 NEUTRON ACER TENDL-2021 LIBRARY; T=293.6K
protons from (n,2p)

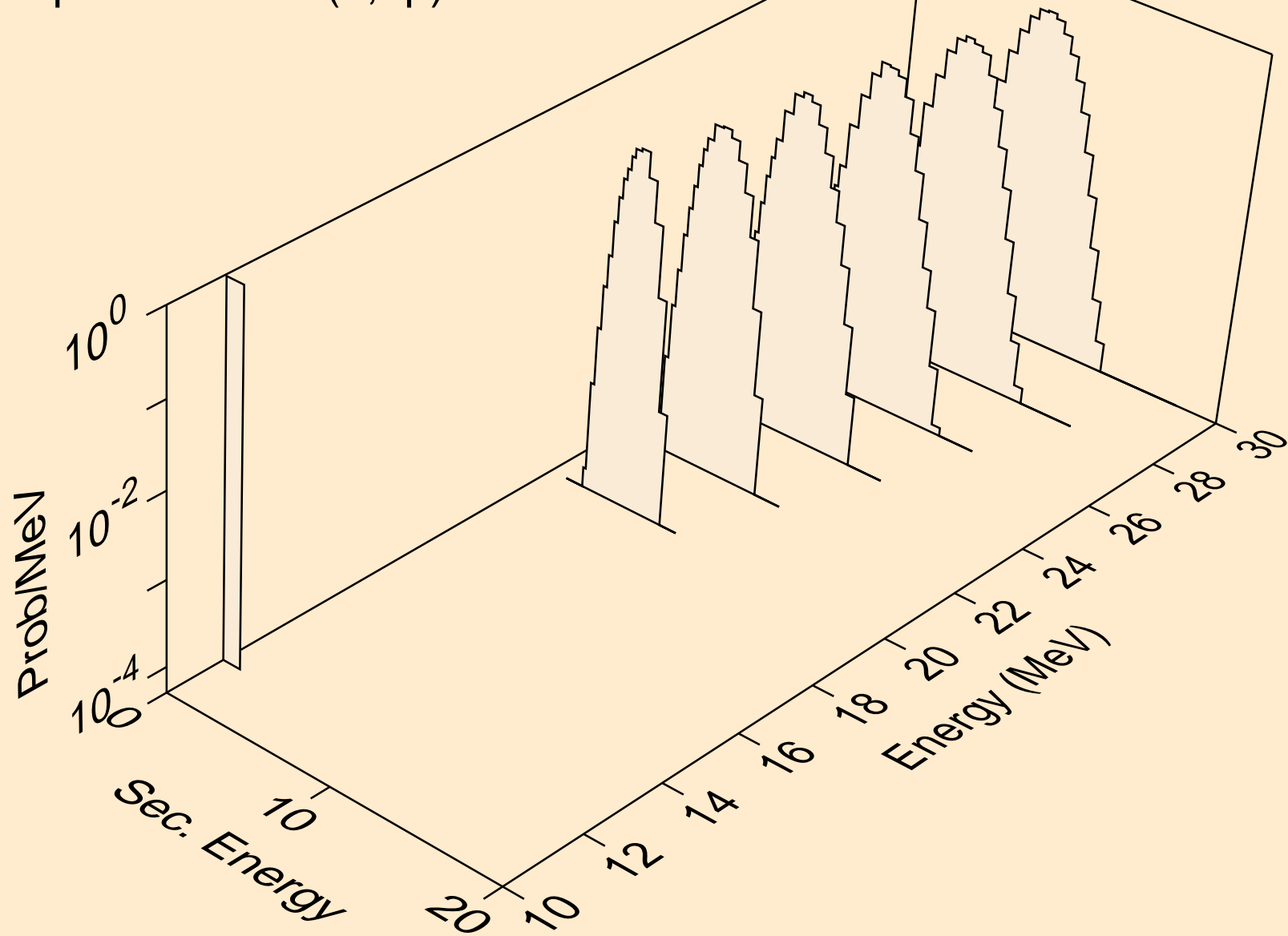

PT198 NEUTRON ACER TENDL-2021 LIBRARY; T=293.6K
deuterons from (n,x)

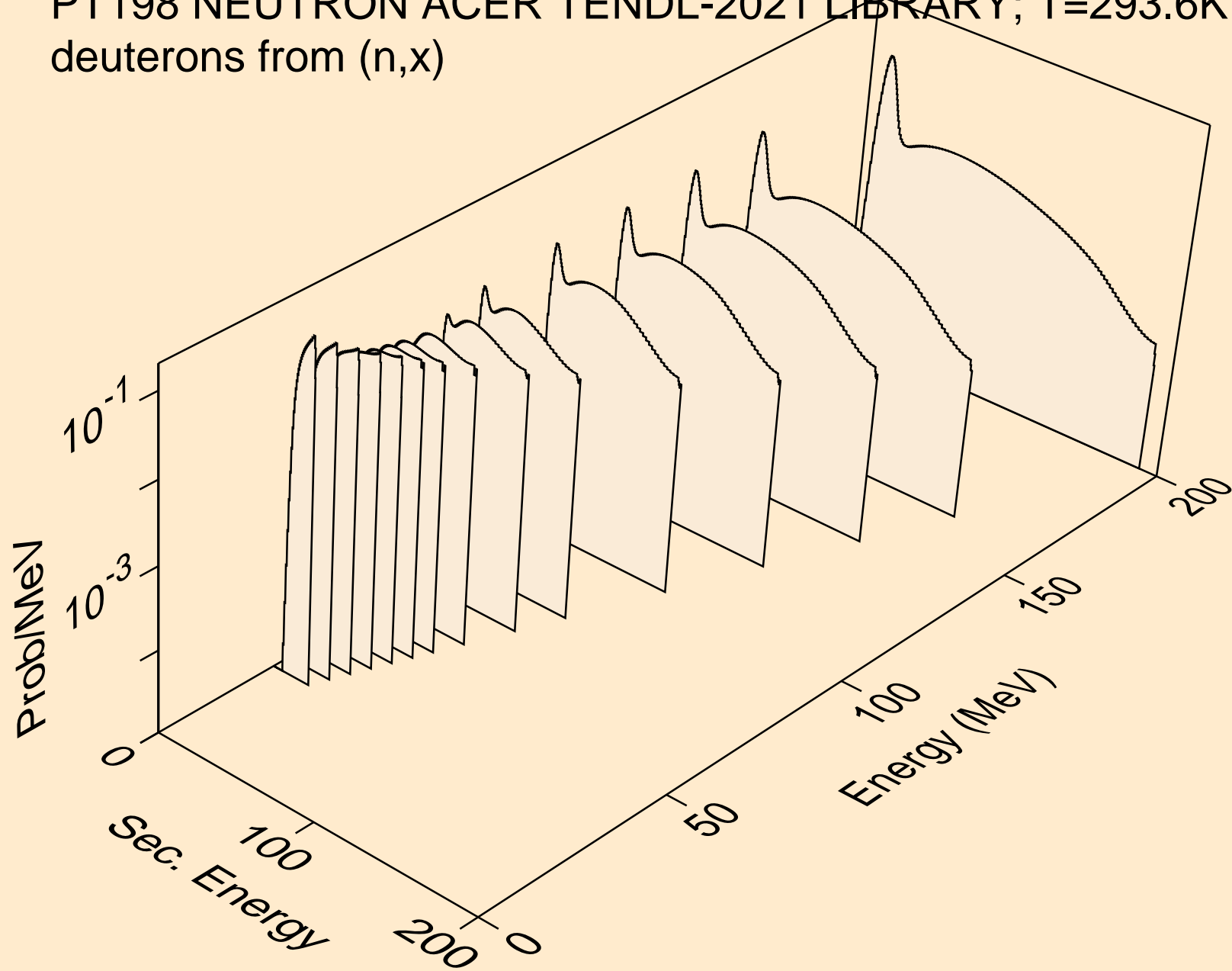

PT198 NEUTRON ACER TENDL-2021 LIBRARY; T=293.6K
deuterons from (n,2nd)

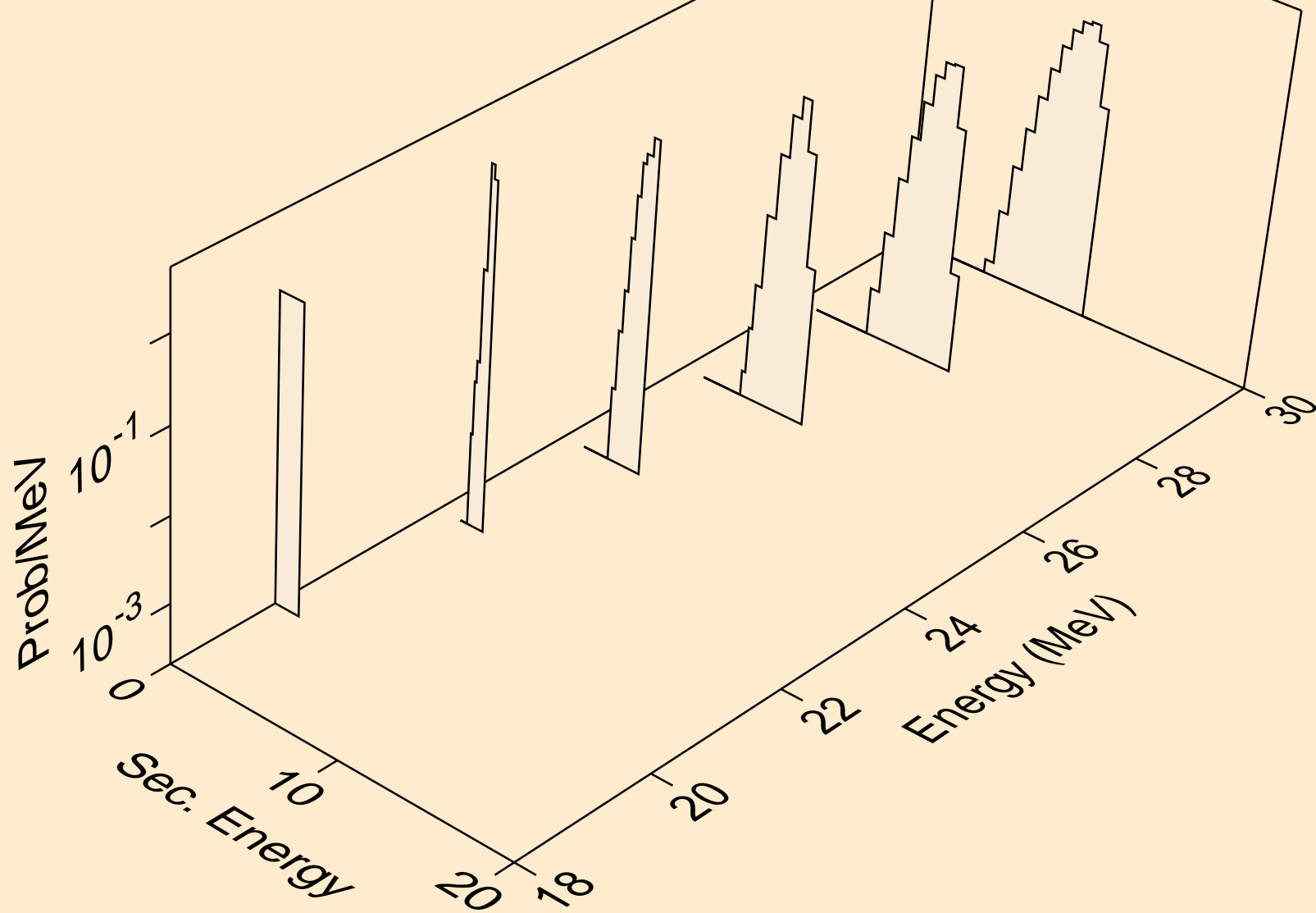

PT198 NEUTRON ACER TENDL-2021 LIBRARY; T=293.6K
deuterons from (n,n*)d

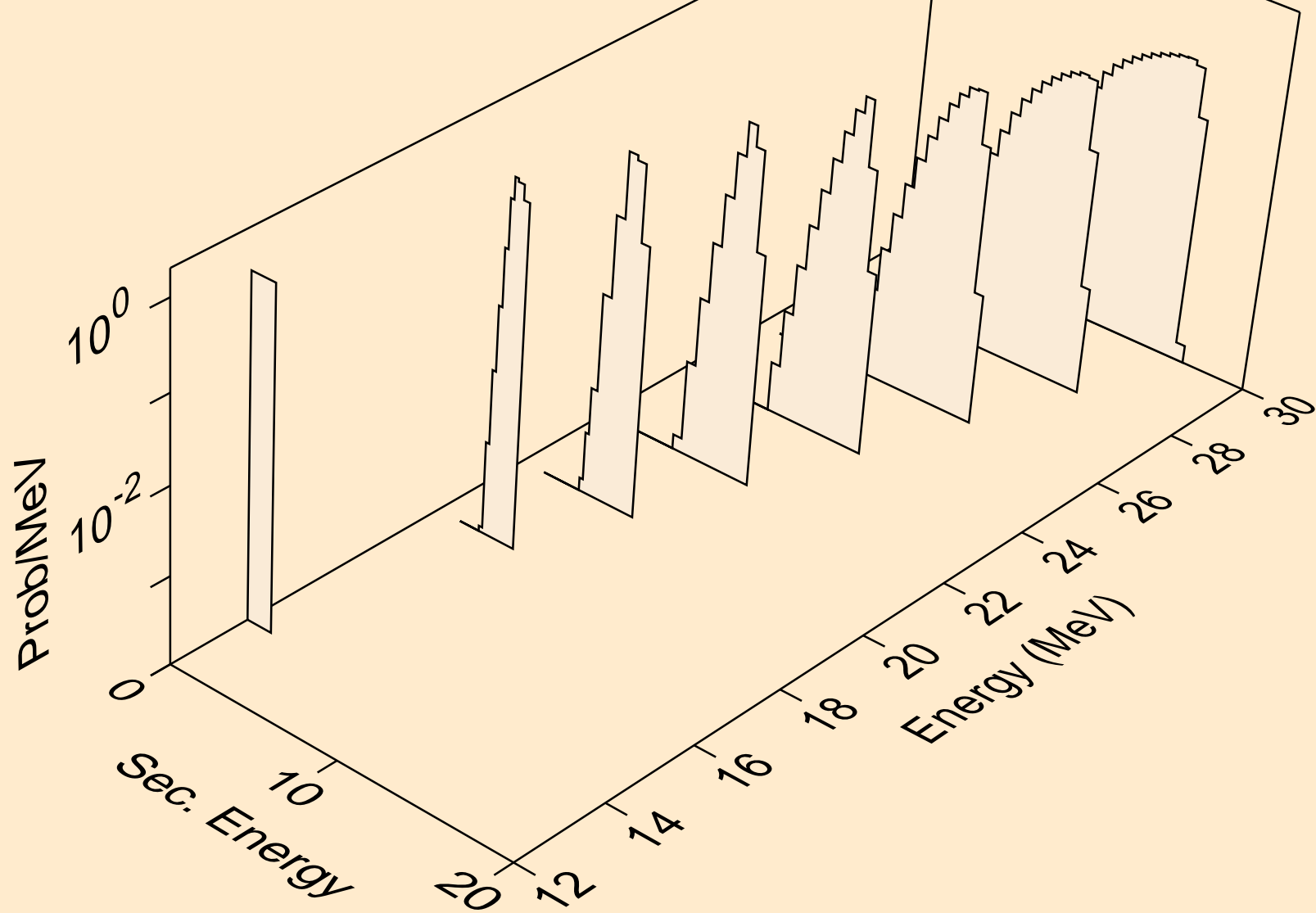

PT198 NEUTRON ACER TENDL-2021 LIBRARY; T=293.6K
deuterons from (n,d)

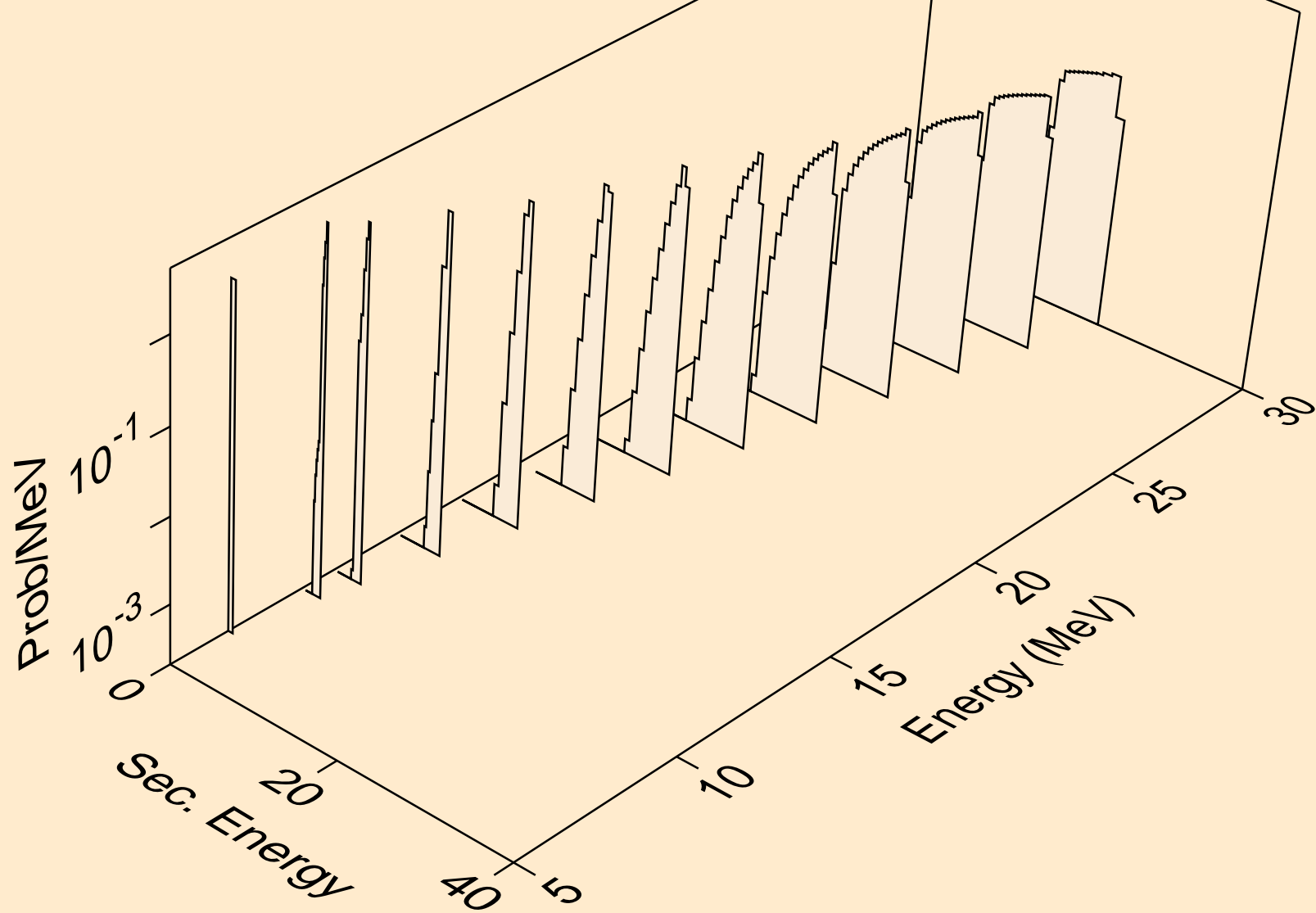

PT198 NEUTRON ACER TENDL-2021 LIBRARY; T=293.6K
tritons from (n,x)

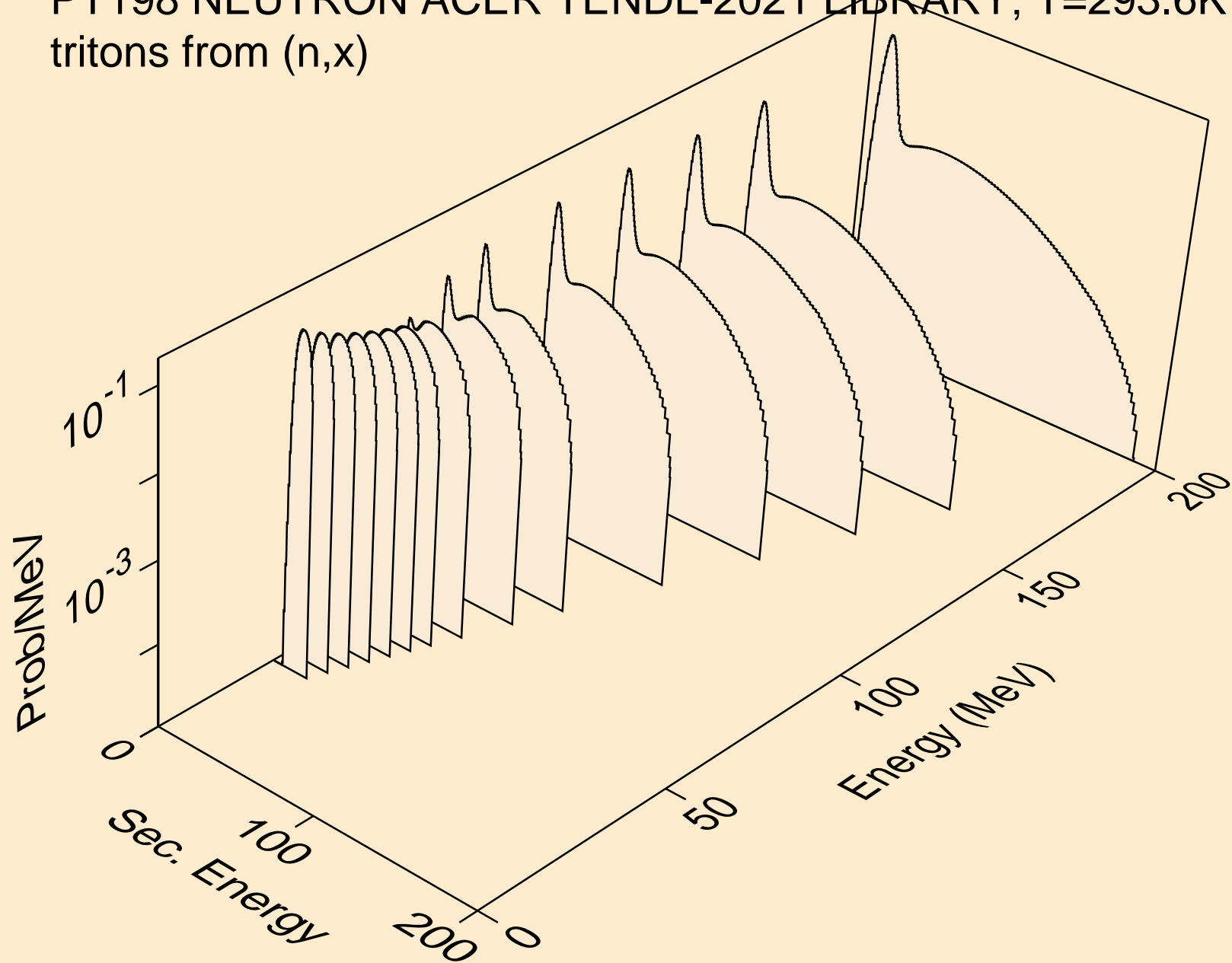

PT198 NEUTRON ACER TENDL-2021 LIBRARY; T=293.6K
tritons from (n,n*)t

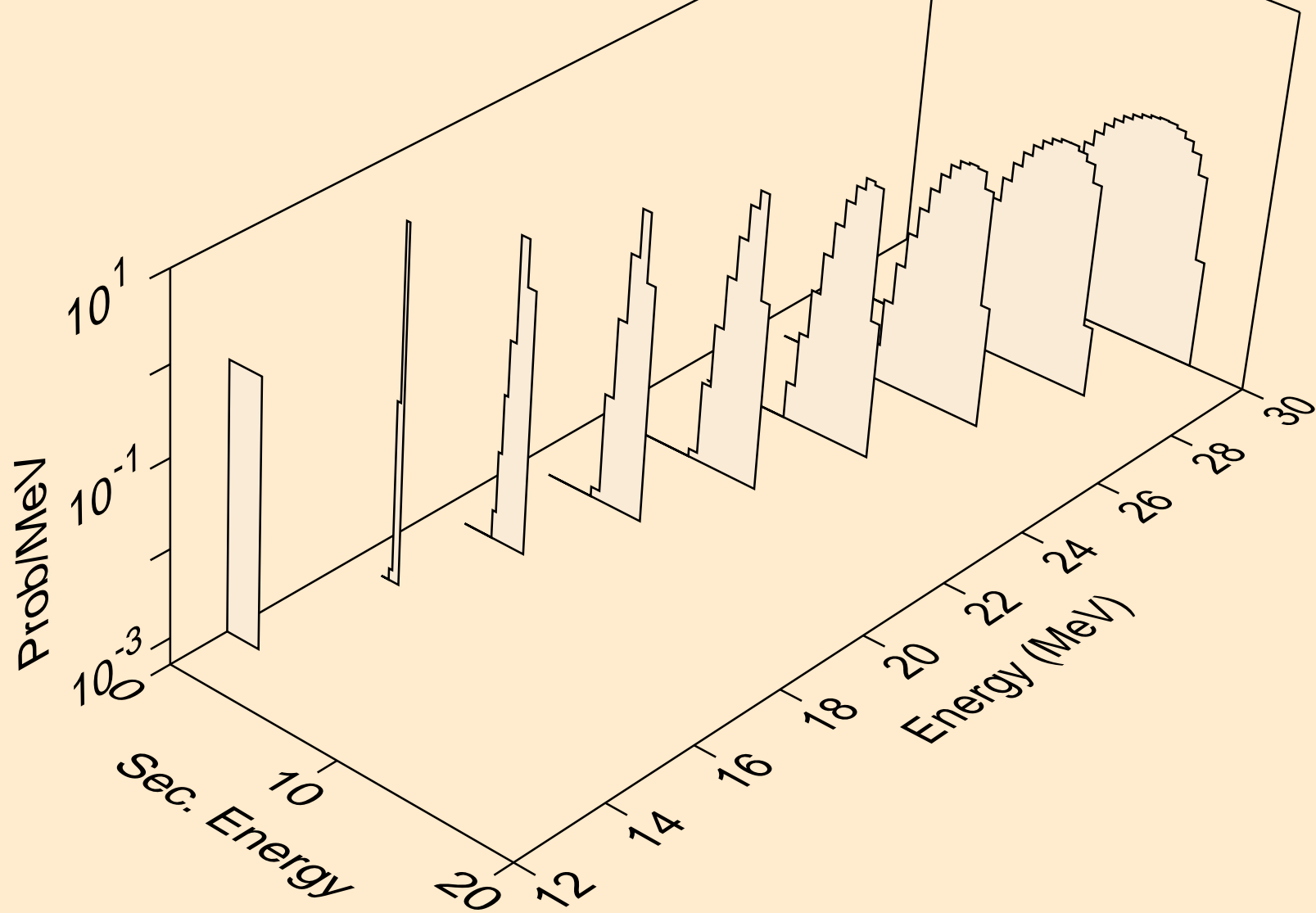

PT198 NEUTRON ACER TENDL-2021 LIBRARY; T=293.6K
tritons from (n,t)

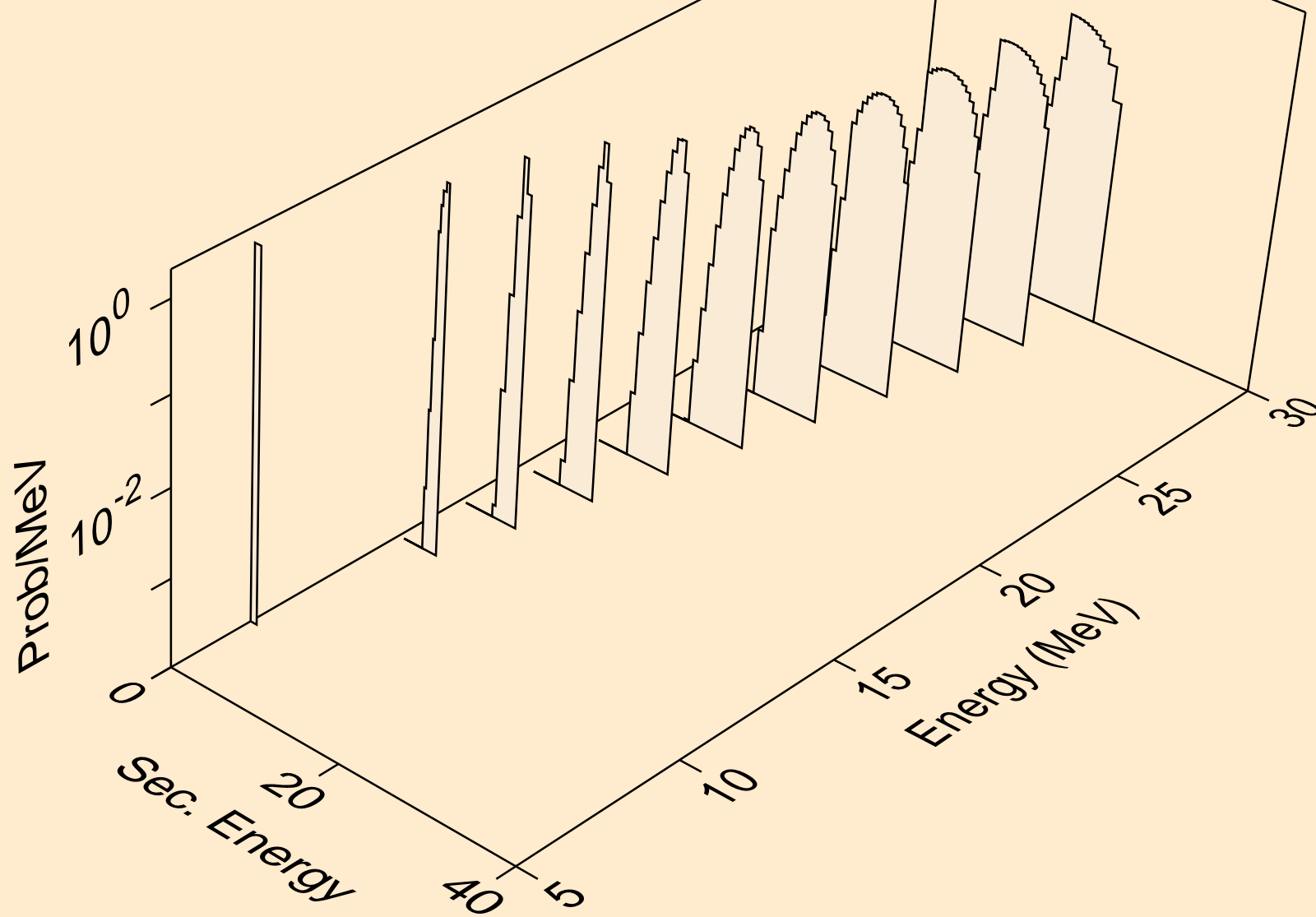

PT198 NEUTRON ACER TENDL-2021 LIBRARY; T=293.6K
he3s from (n,x)

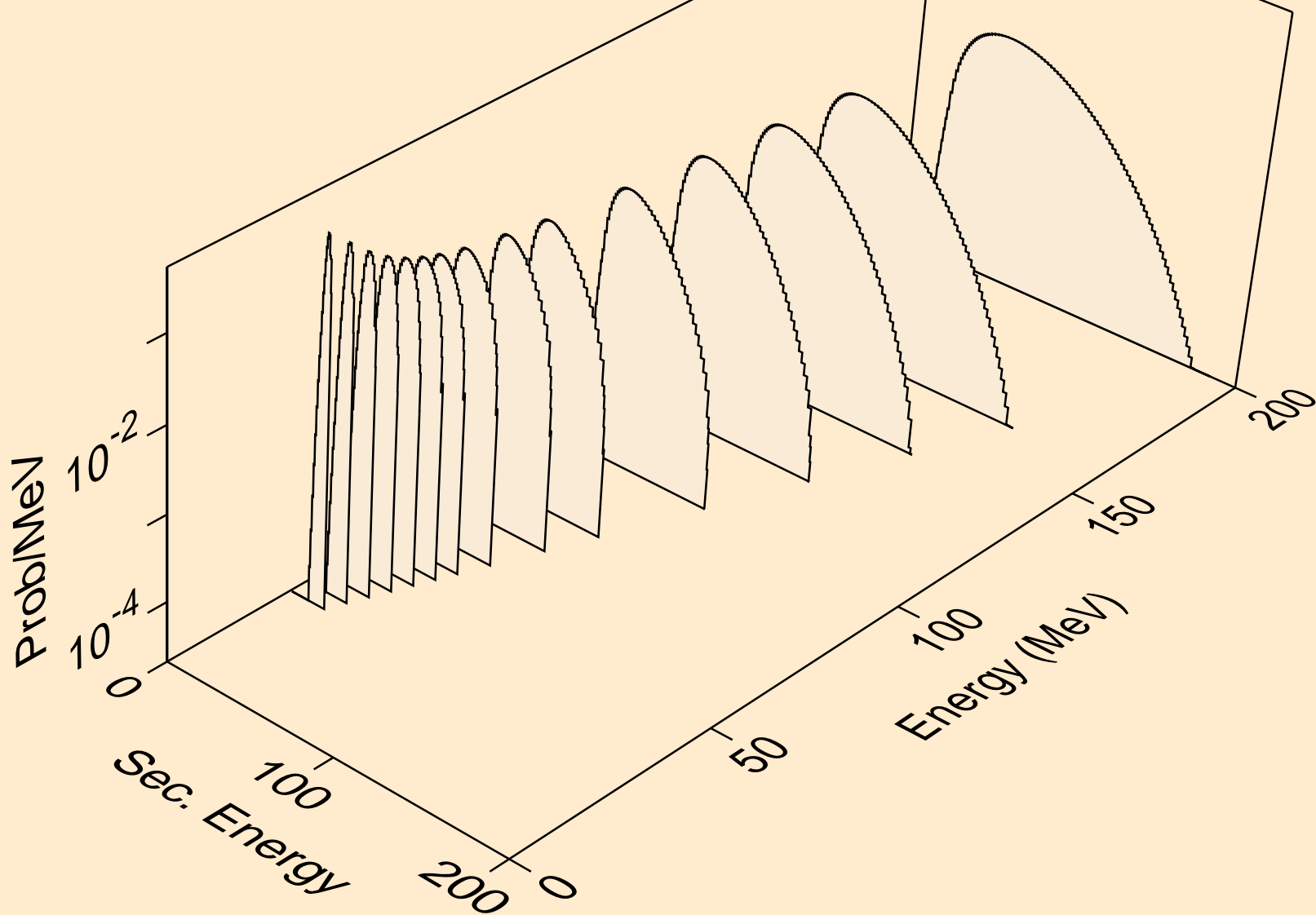

PT198 NEUTRON ACER TENDL-2021 LIBRARY; T=293.6K
he3s from (n,n*)he3

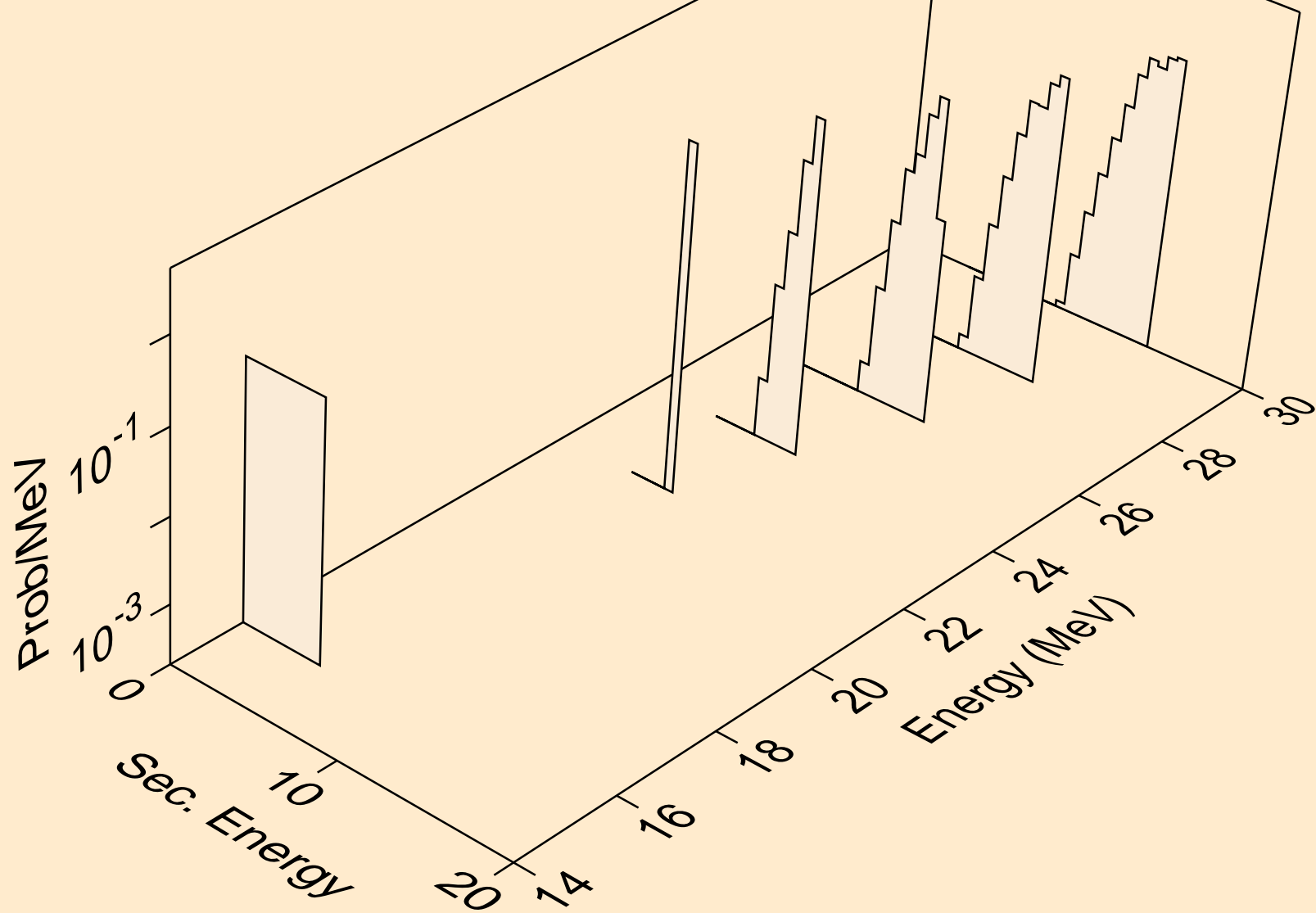

PT198 NEUTRON ACER TENDL-2021 LIBRARY; T=293.6K
he3s from (n,he3)

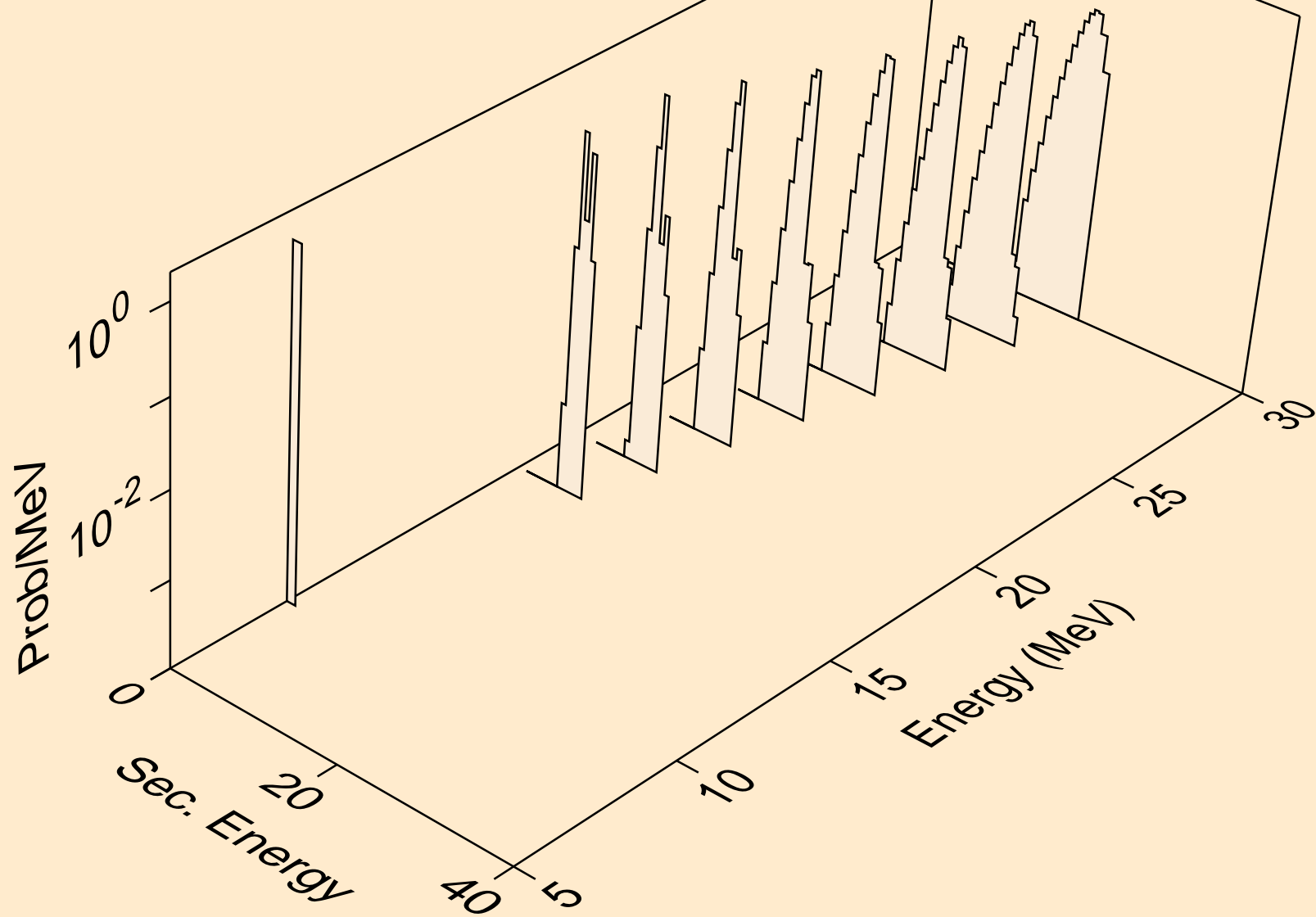

PT198 NEUTRON ACER TENDL-2021 LIBRARY; T=293.6K
alphas from (n,x)

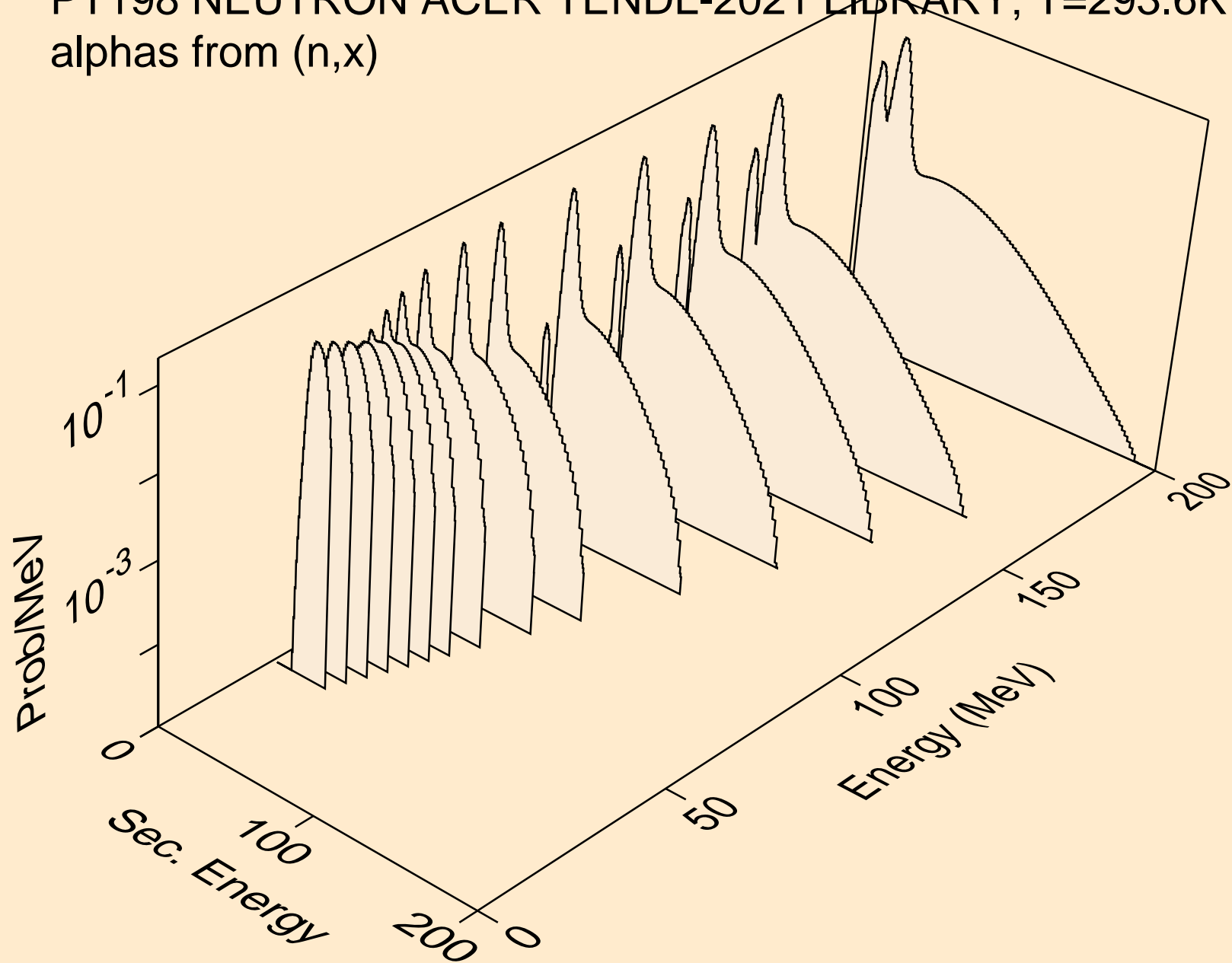

PT198 NEUTRON ACER TENDL-2021 LIBRARY; T=293.6K
alphas from (n,n*)a

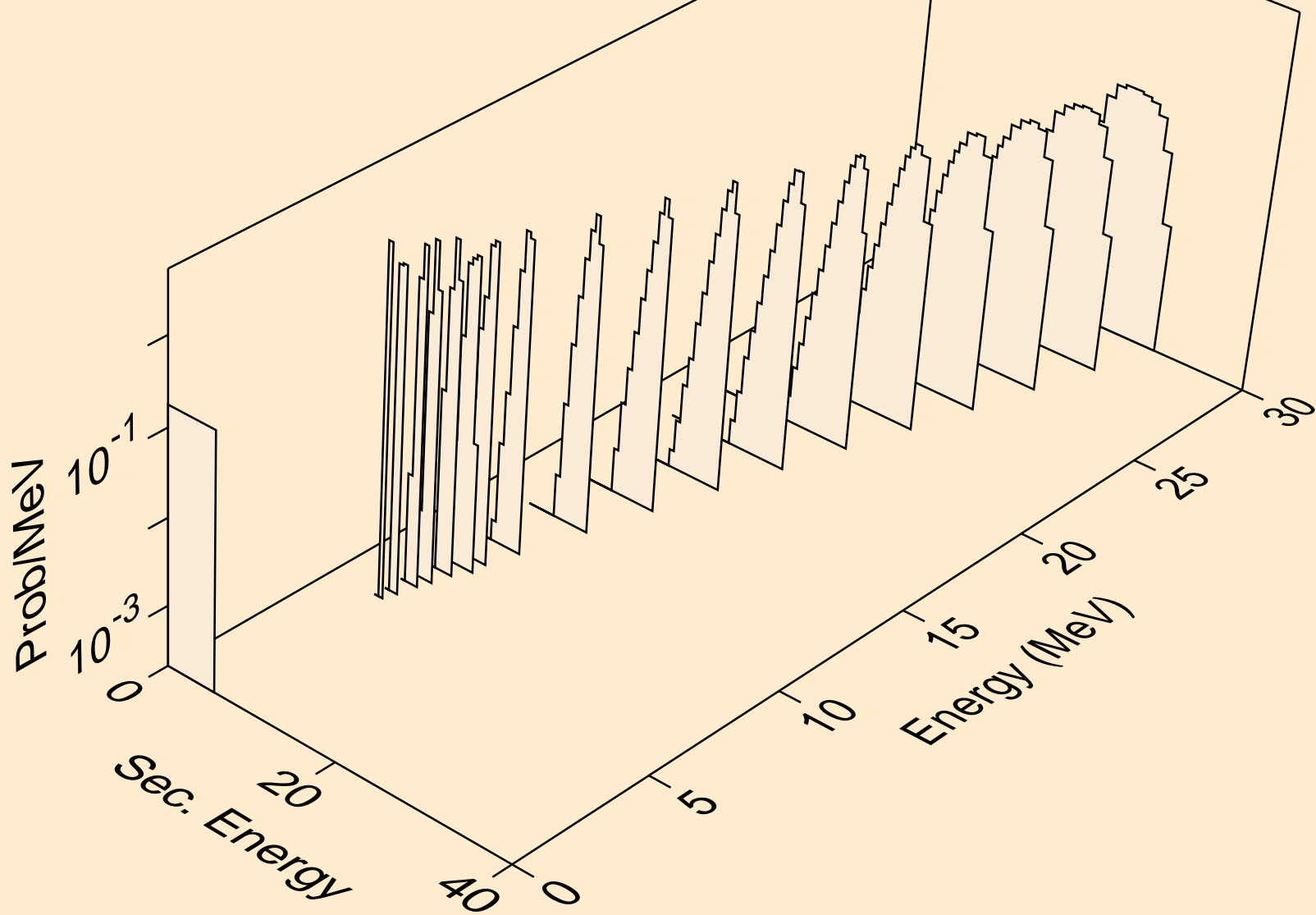

PT198 NEUTRON ACER TENDL-2021 LIBRARY; T=293.6K
alphas from (n,2n)a

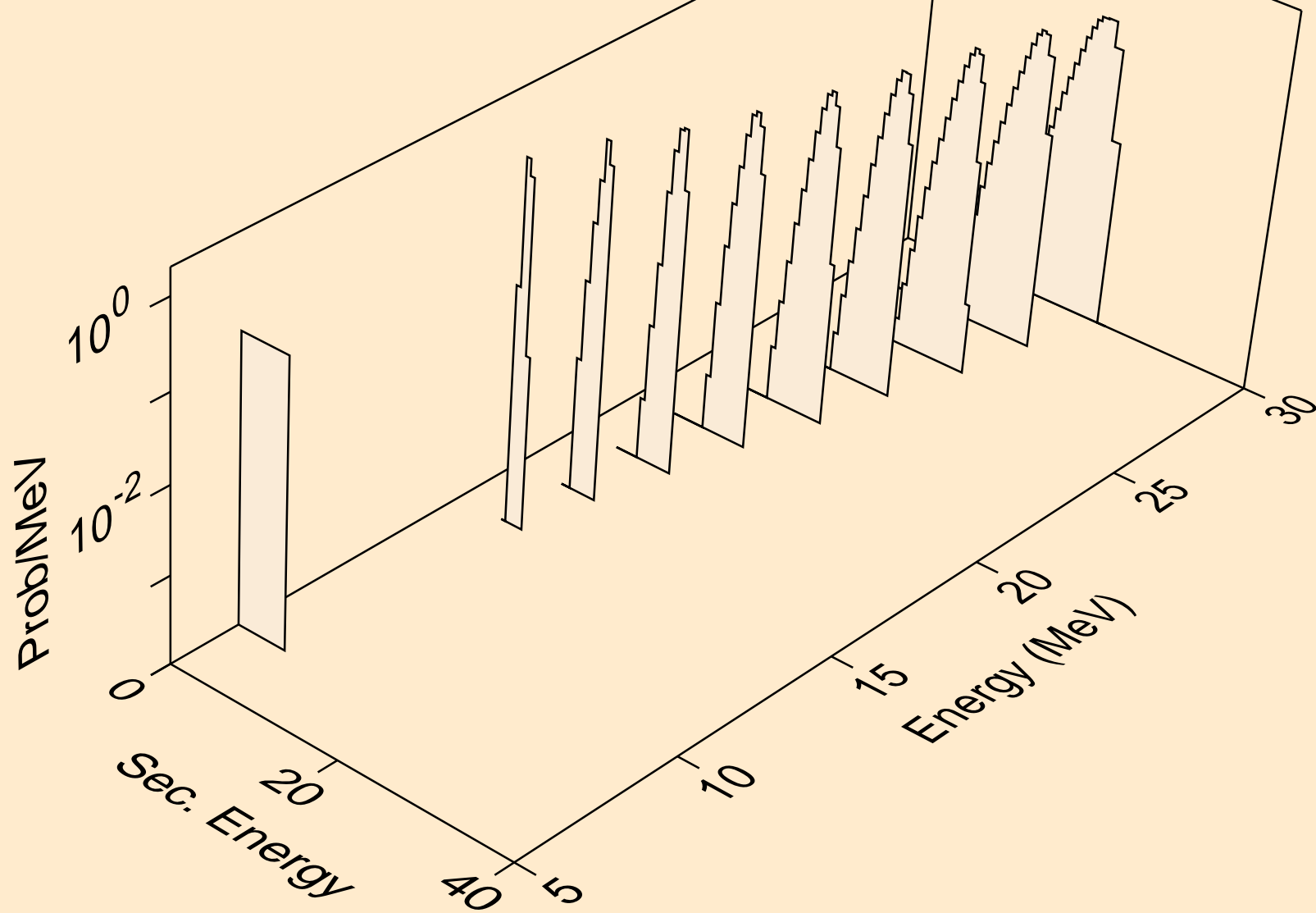

PT198 NEUTRON ACER TENDL-2021 LIBRARY; T=293.6K
alphas from (n,3n)a

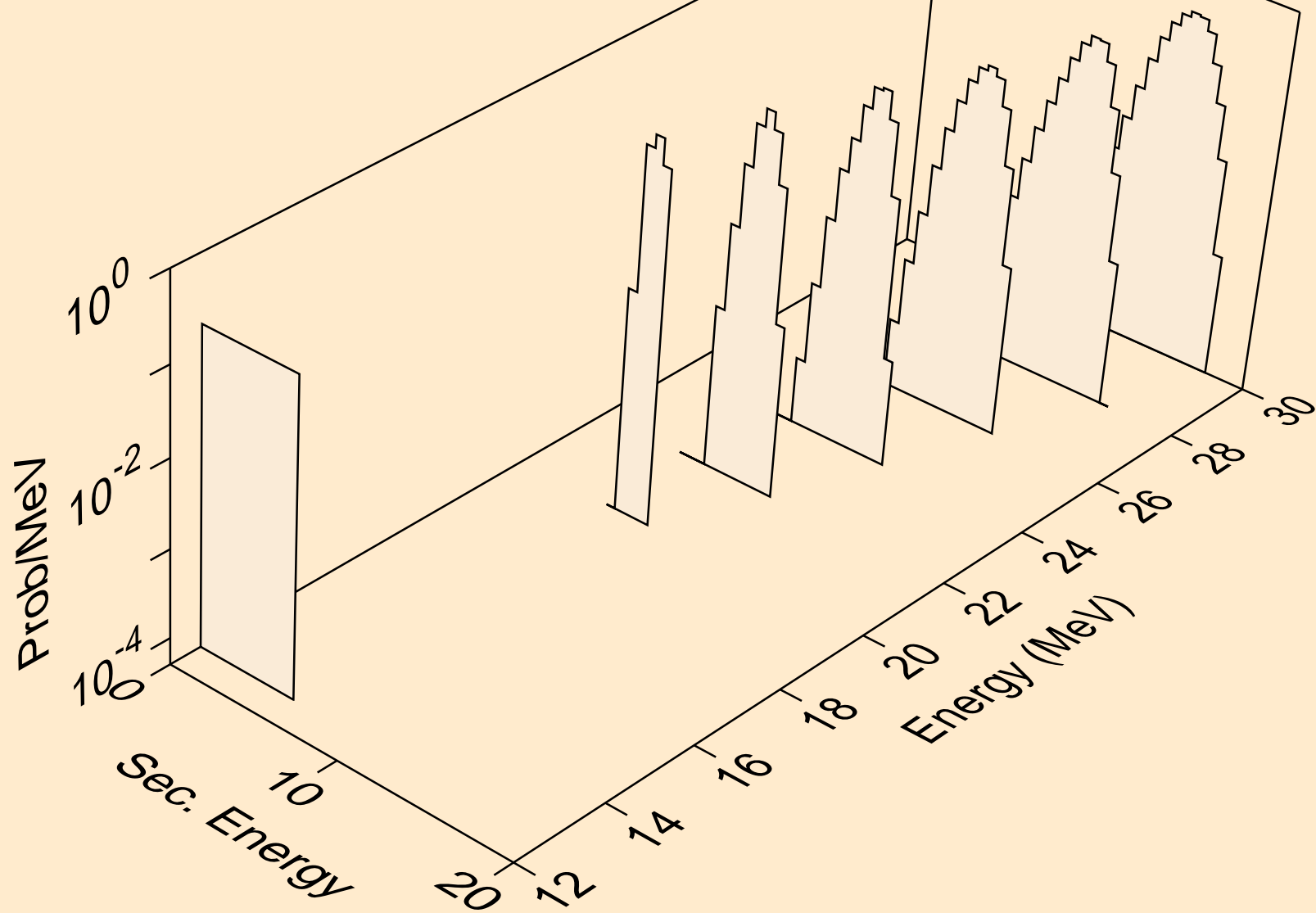

PT198 NEUTRON ACER TENDL-2021 LIBRARY; T=293.6K
alphas from (n,a)

