

PU229 NEUTRON ACER TENDL-2021 LIBRARY; T=293.6K
Principal cross sections

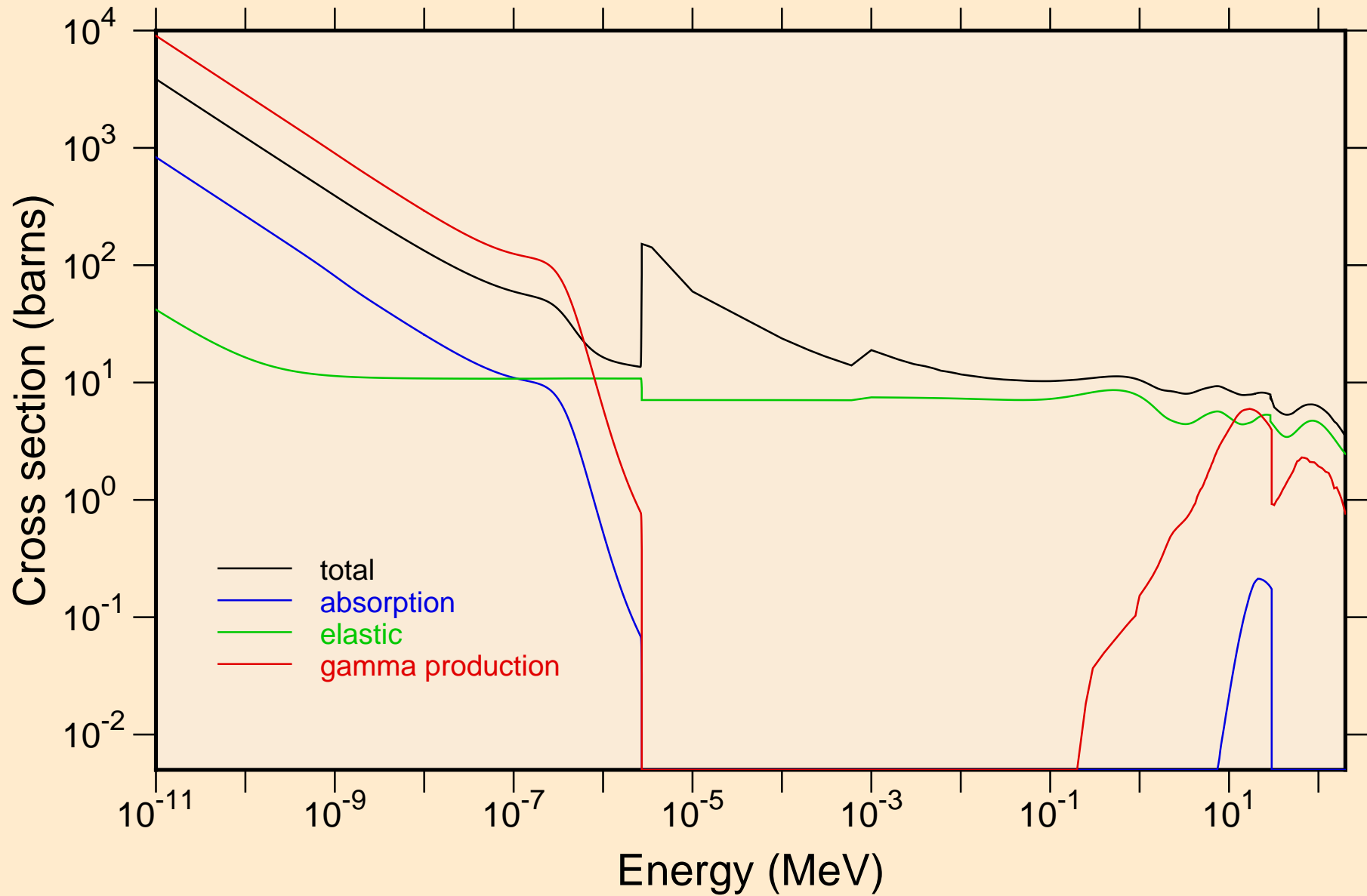

PU229 NEUTRON ACER TENDL-2021 LIBRARY; T=293.6K
Heating

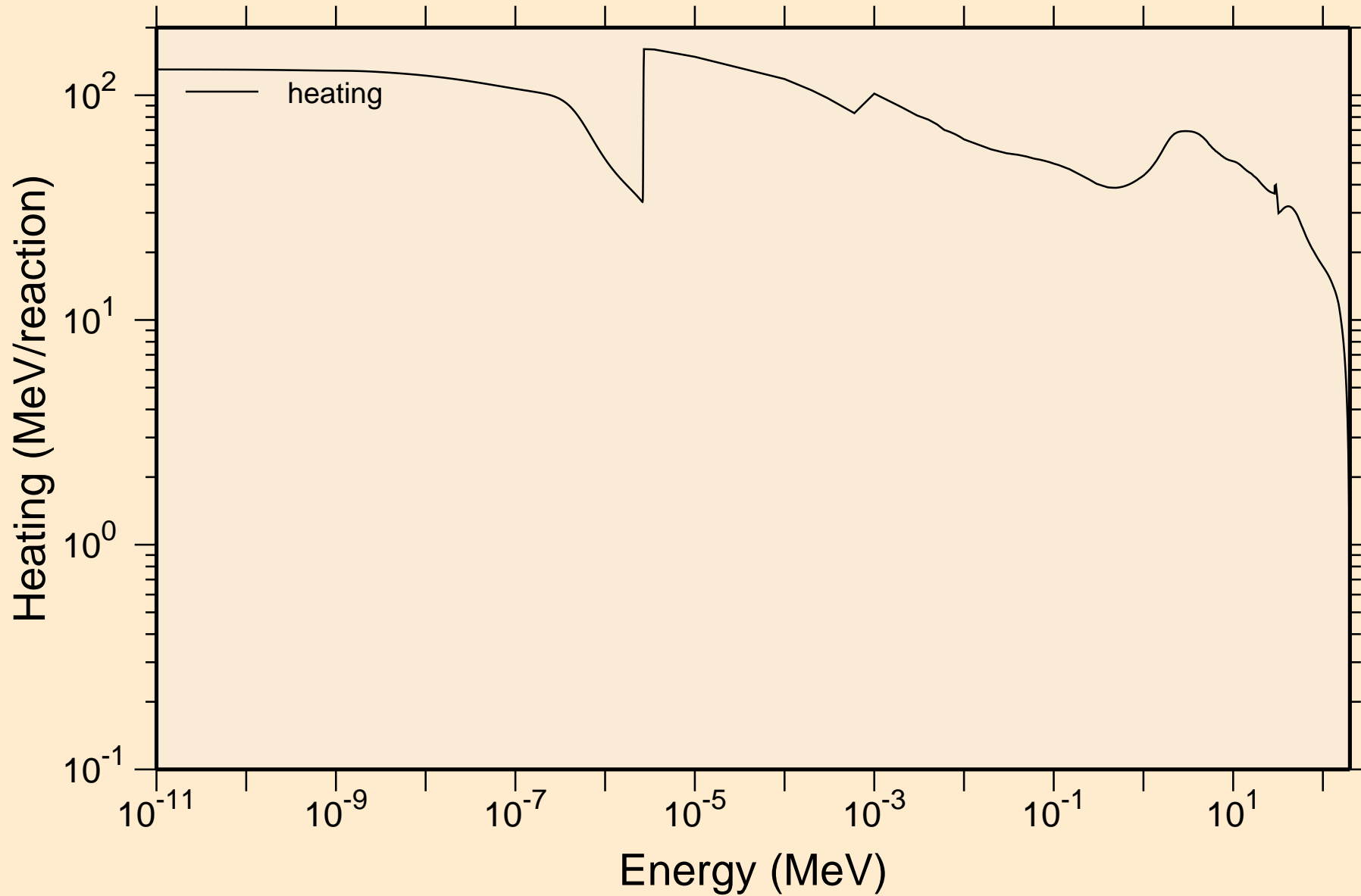

PU229 NEUTRON ACER TENDL-2021 LIBRARY; T=293.6K
Damage

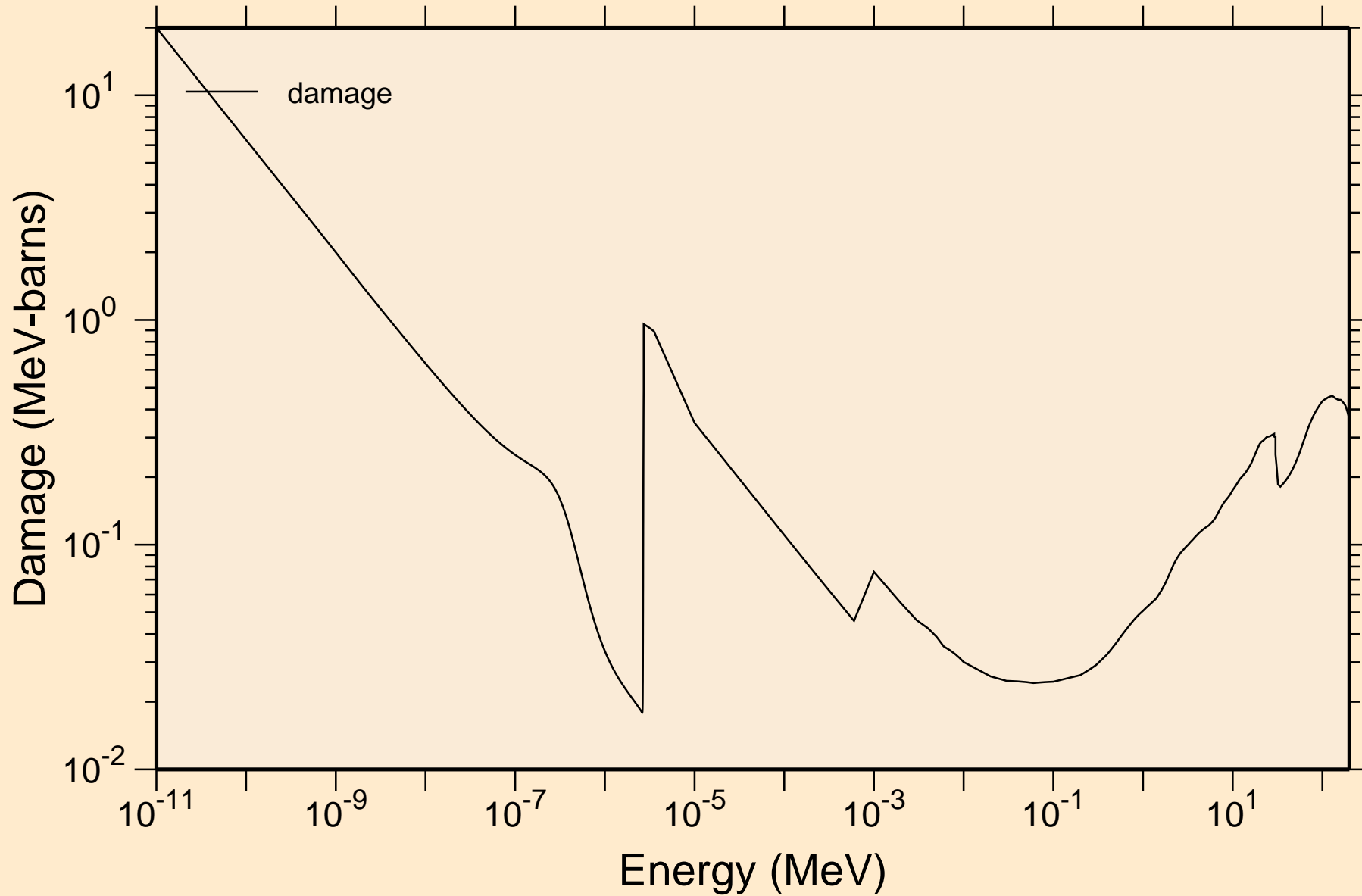

PU229 NEUTRON ACER TENDL-2021 LIBRARY; T=293.6K
Non-threshold reactions

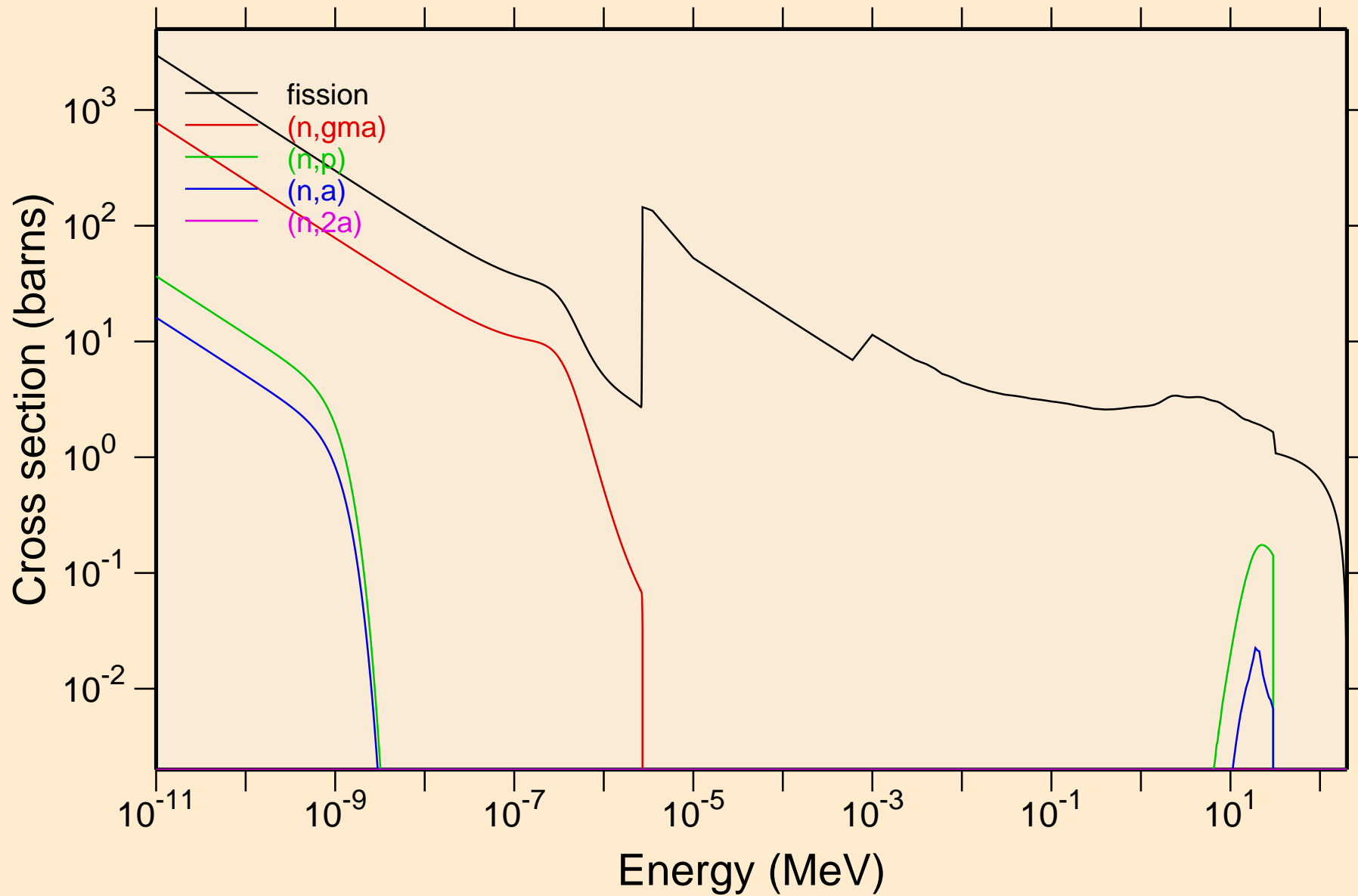

PU229 NEUTRON ACER TENDL-2021 LIBRARY; T=293.6K
Non-threshold reactions

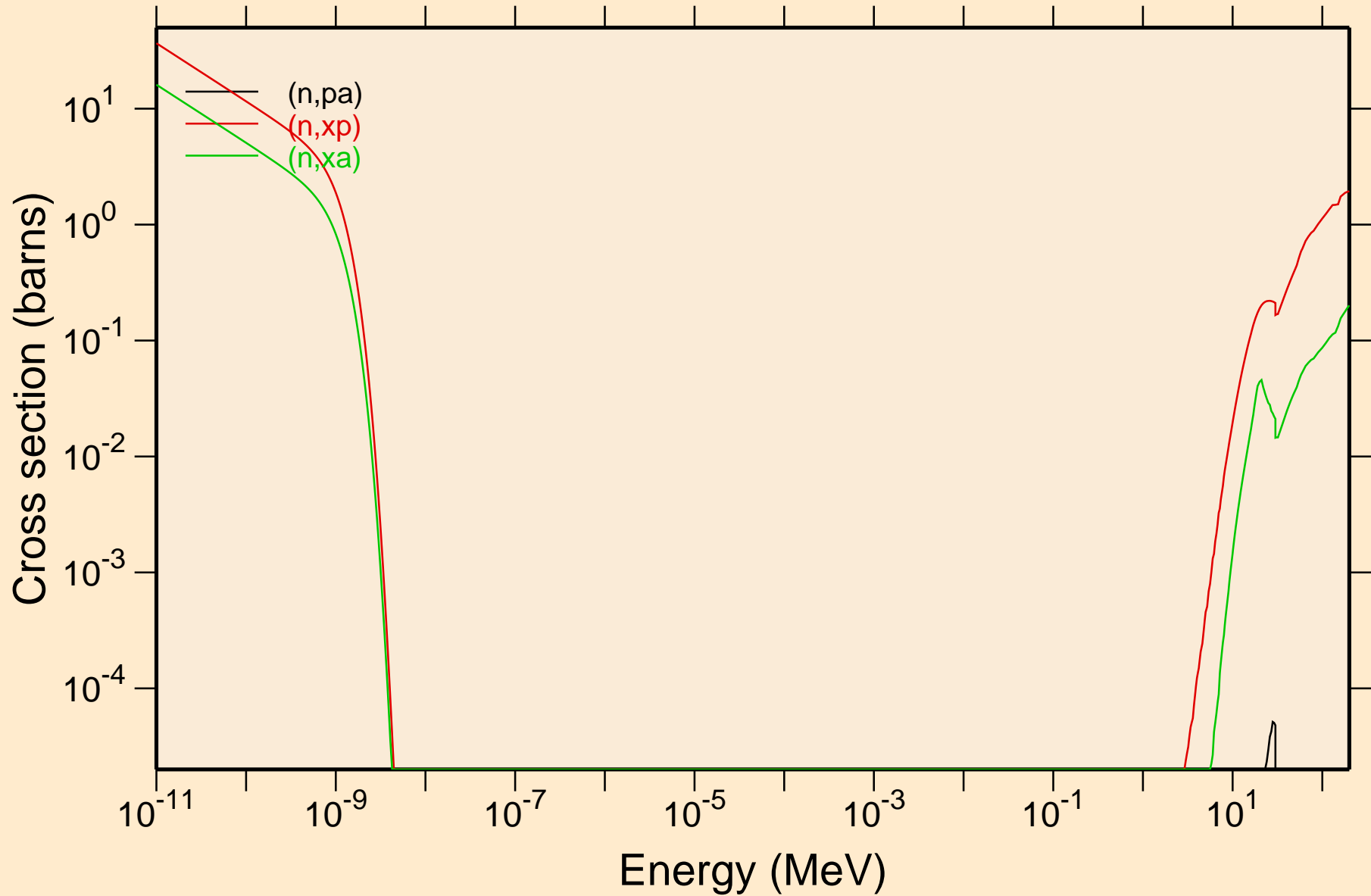

PU229 NEUTRON ACER TENDL-2021 LIBRARY; T=293.6K
Principal cross sections

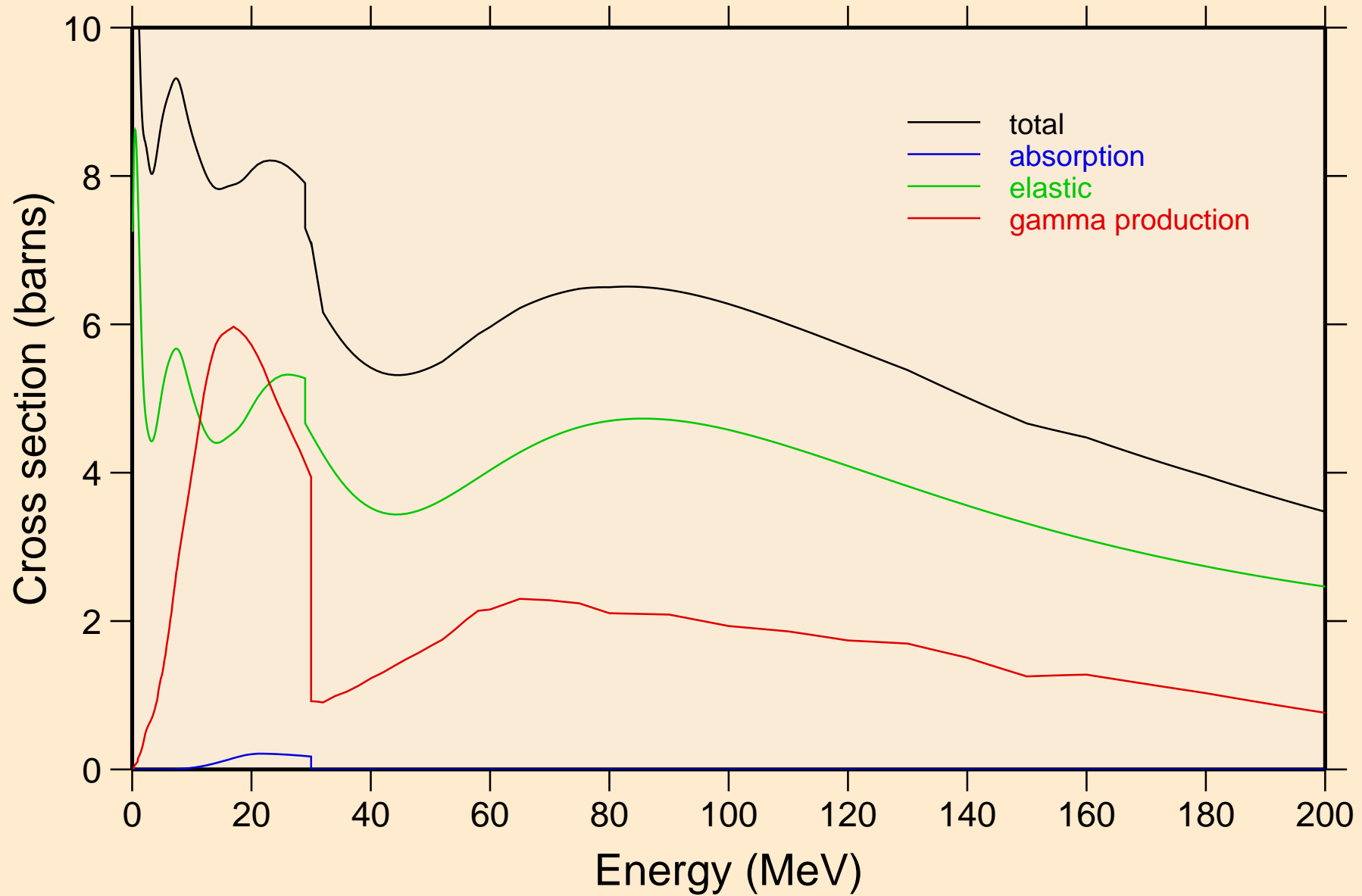

PU229 NEUTRON ACER TENDL-2021 LIBRARY; T=293.6K
Heating

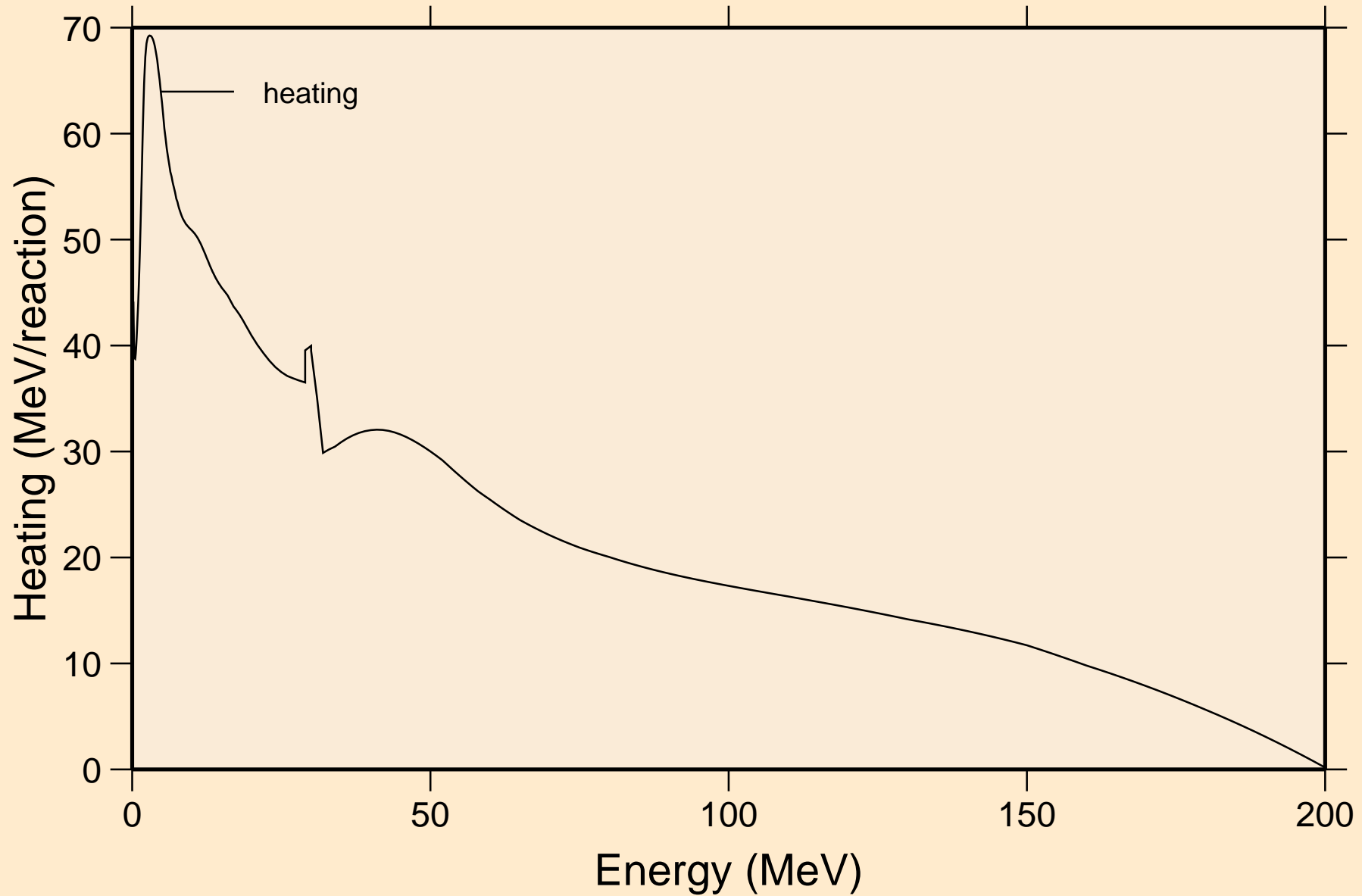

PU229 NEUTRON ACER TENDL-2021 LIBRARY; T=293.6K
Damage

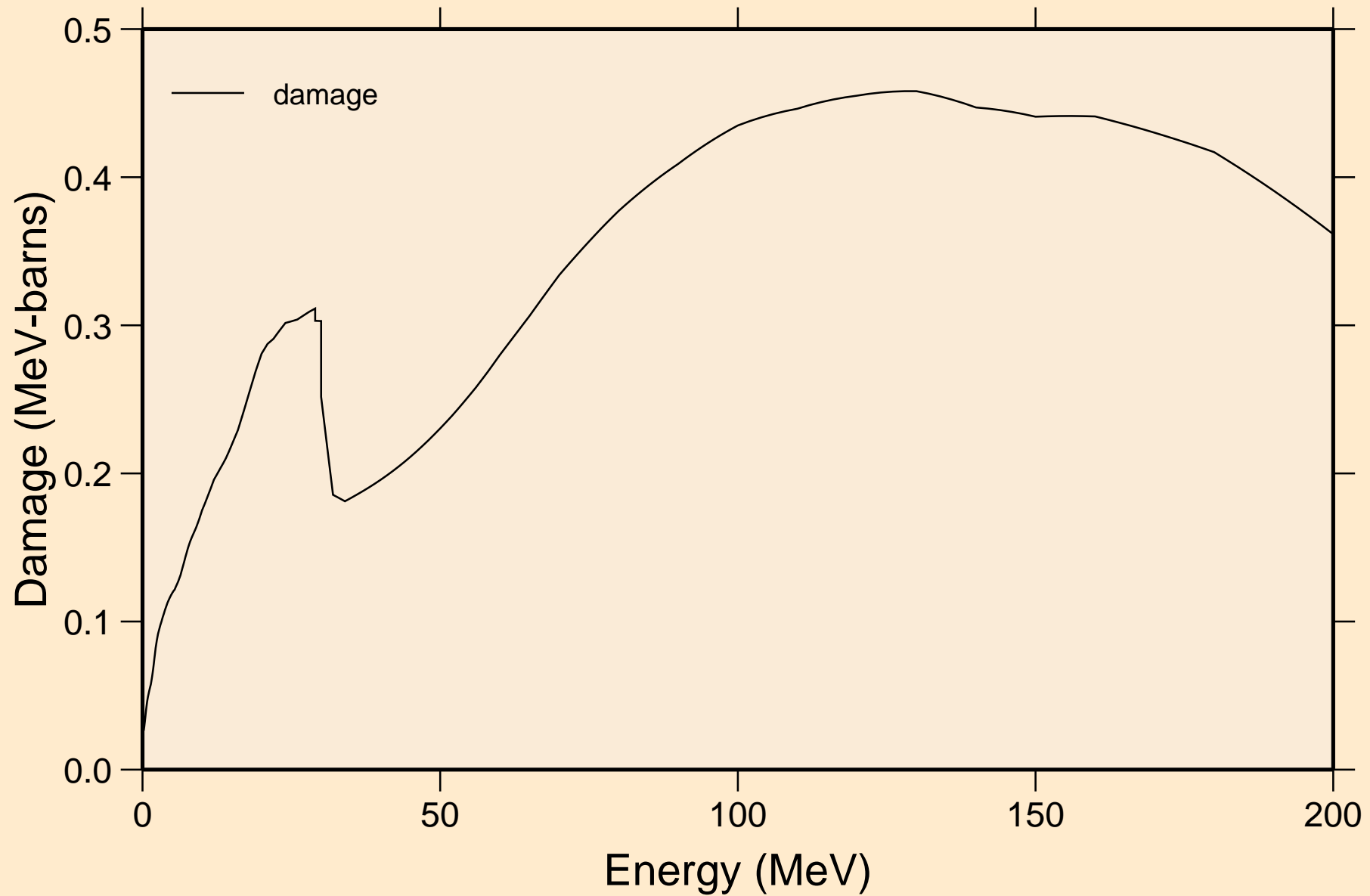

PU229 NEUTRON ACER TENDL-2021 LIBRARY; T=293.6K
Non-threshold reactions

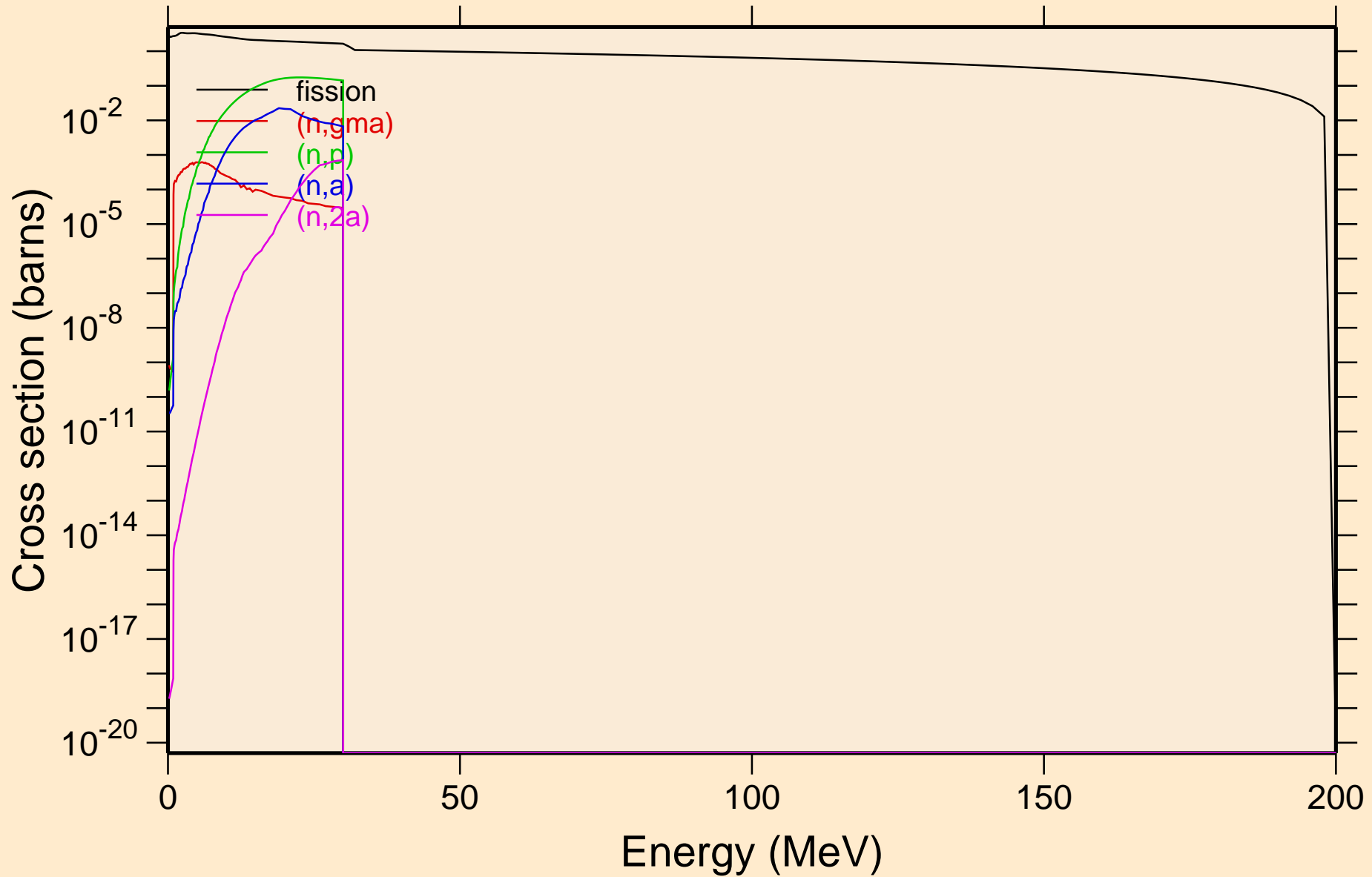

PU229 NEUTRON ACER TENDL-2021 LIBRARY; T=293.6K
Non-threshold reactions

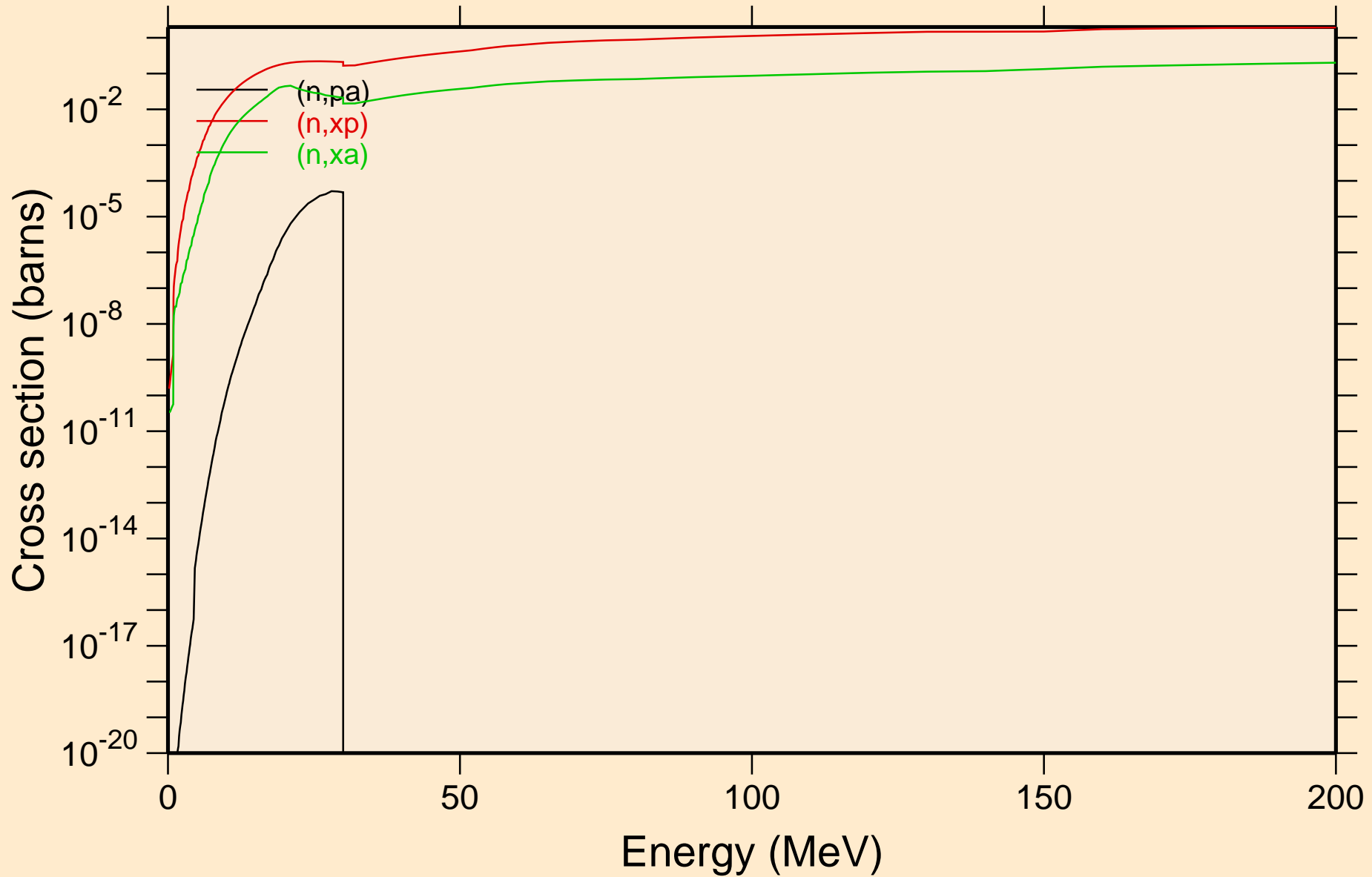

PU229 NEUTRON ACER TENDL-2021 LIBRARY; T=293.6K
Inelastic levels

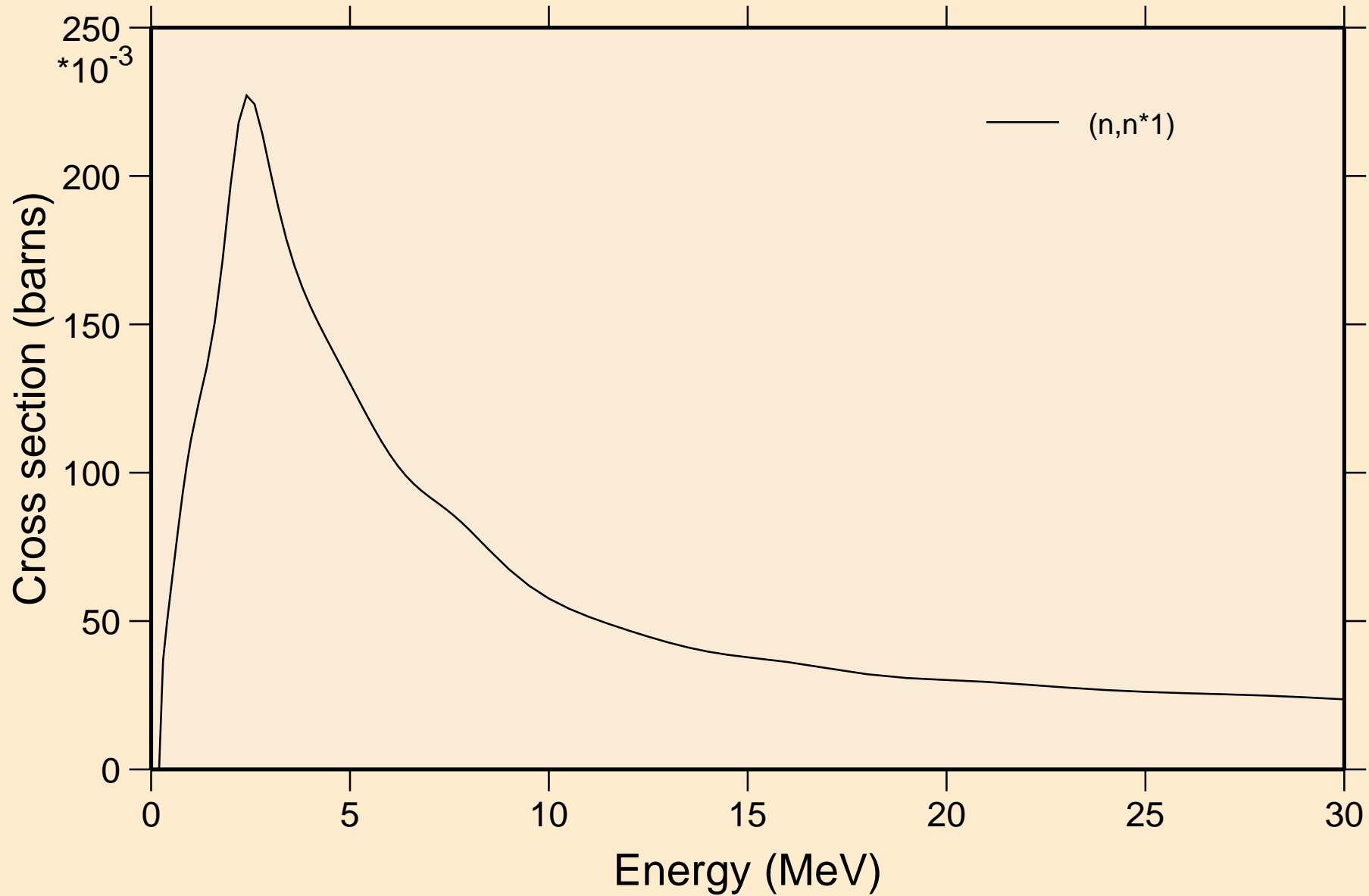

PU229 NEUTRON ACER TENDL-2021 LIBRARY; T=293.6K
Threshold reactions

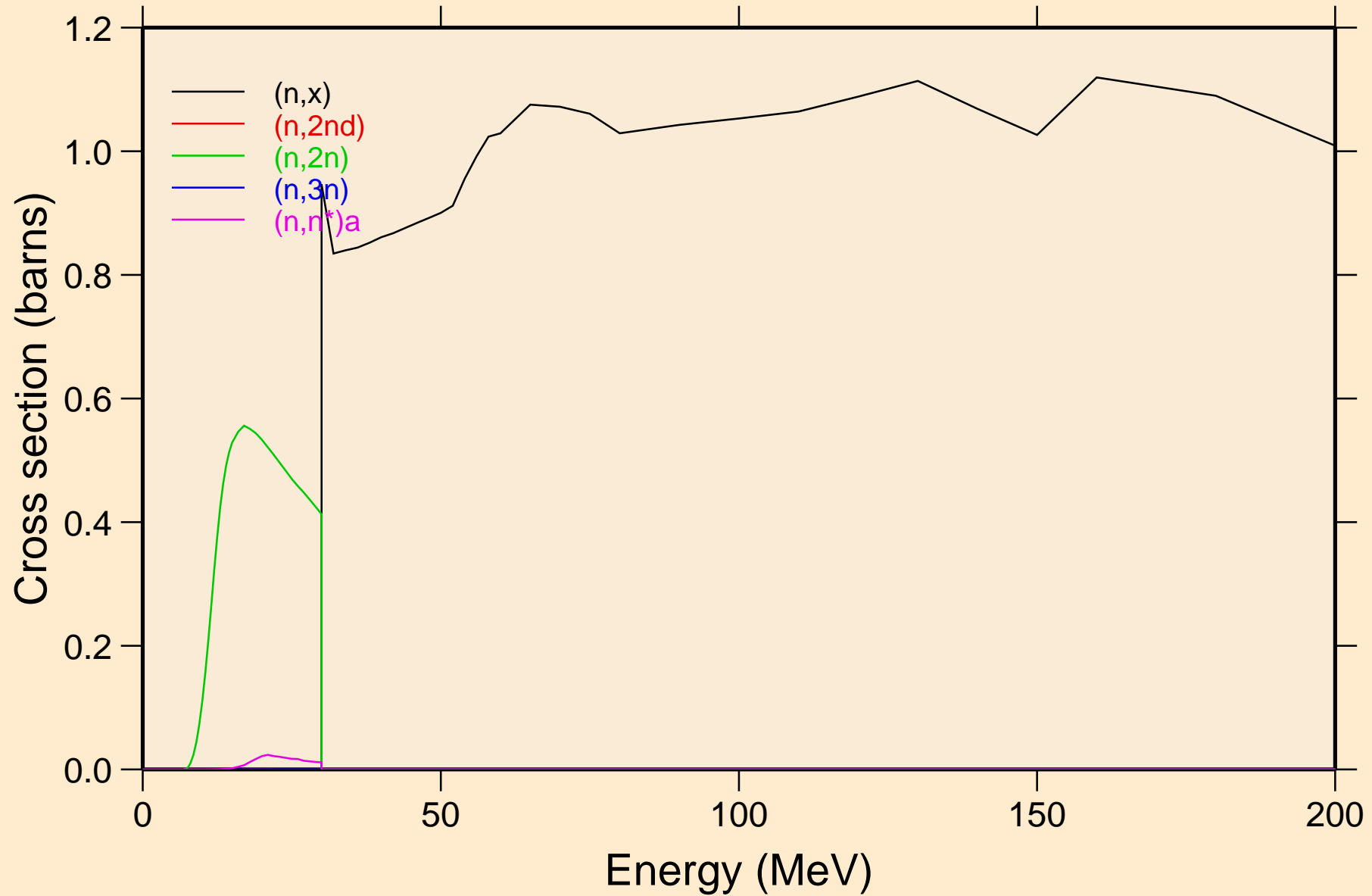

PU229 NEUTRON ACER TENDL-2021 LIBRARY; T=293.6K
Threshold reactions

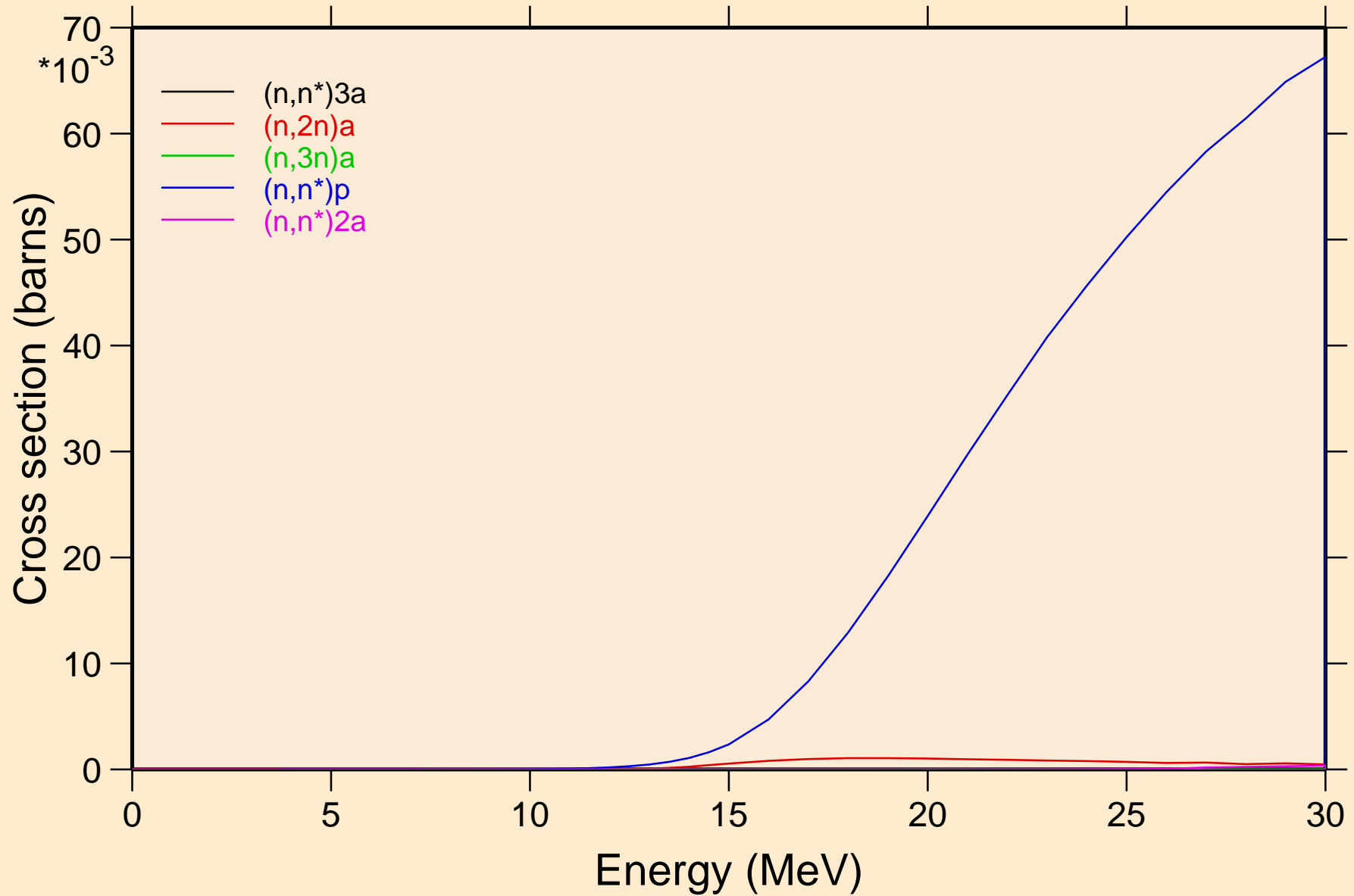

PU229 NEUTRON ACER TENDL-2021 LIBRARY; T=293.6K
Threshold reactions

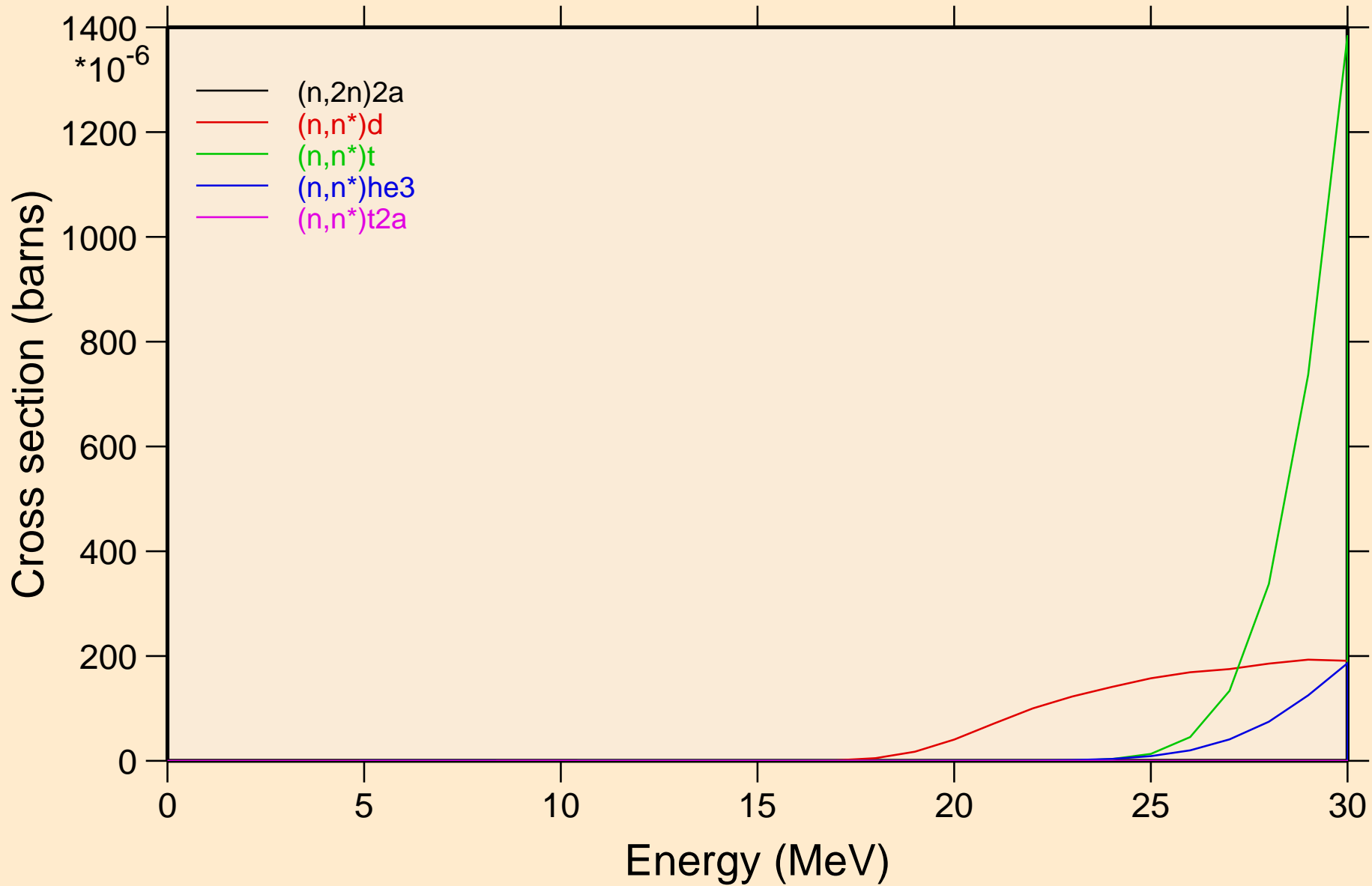

PU229 NEUTRON ACER TENDL-2021 LIBRARY; T=293.6K
Threshold reactions

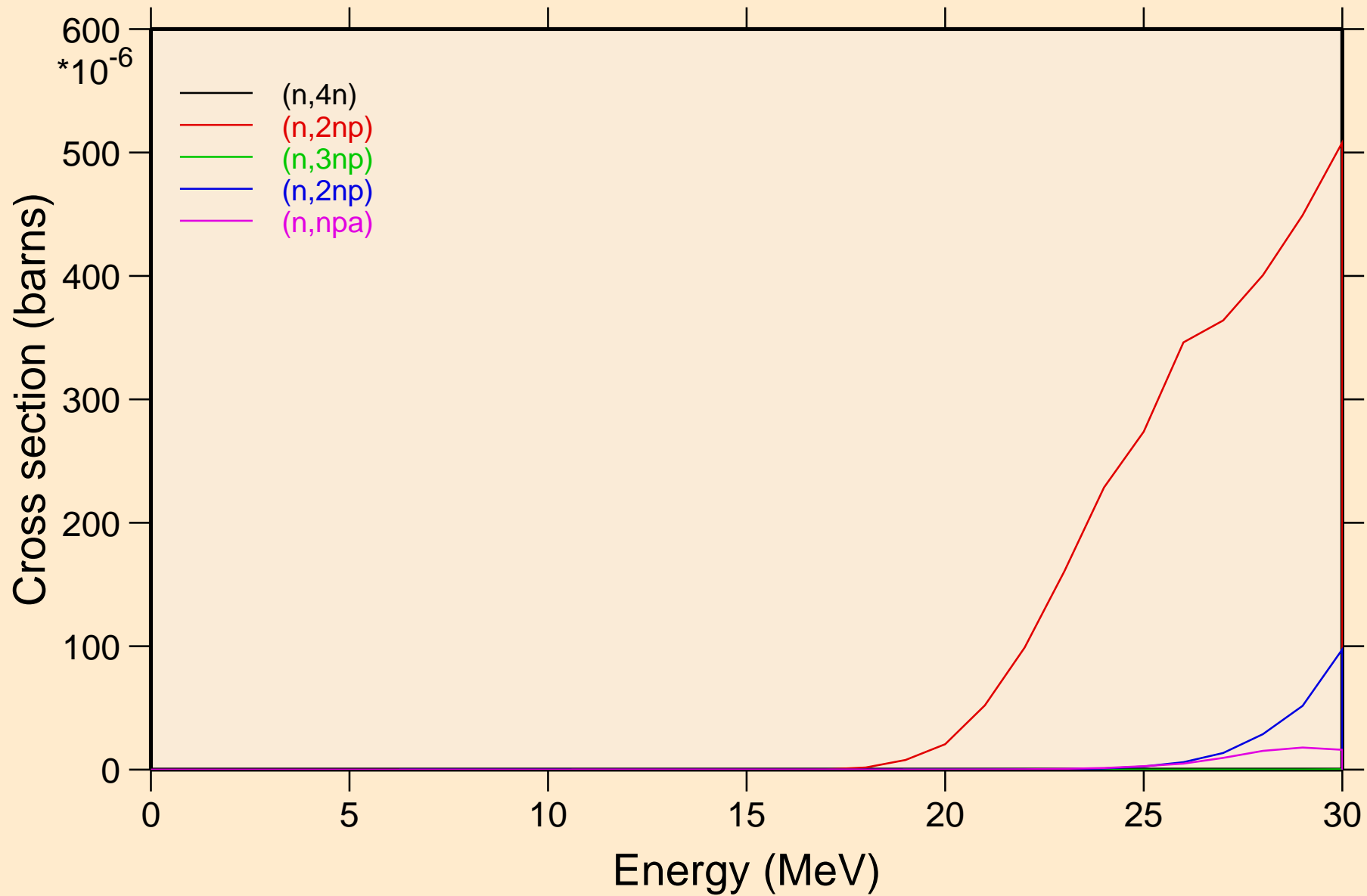

PU229 NEUTRON ACER TENDL-2021 LIBRARY; T=293.6K
Threshold reactions

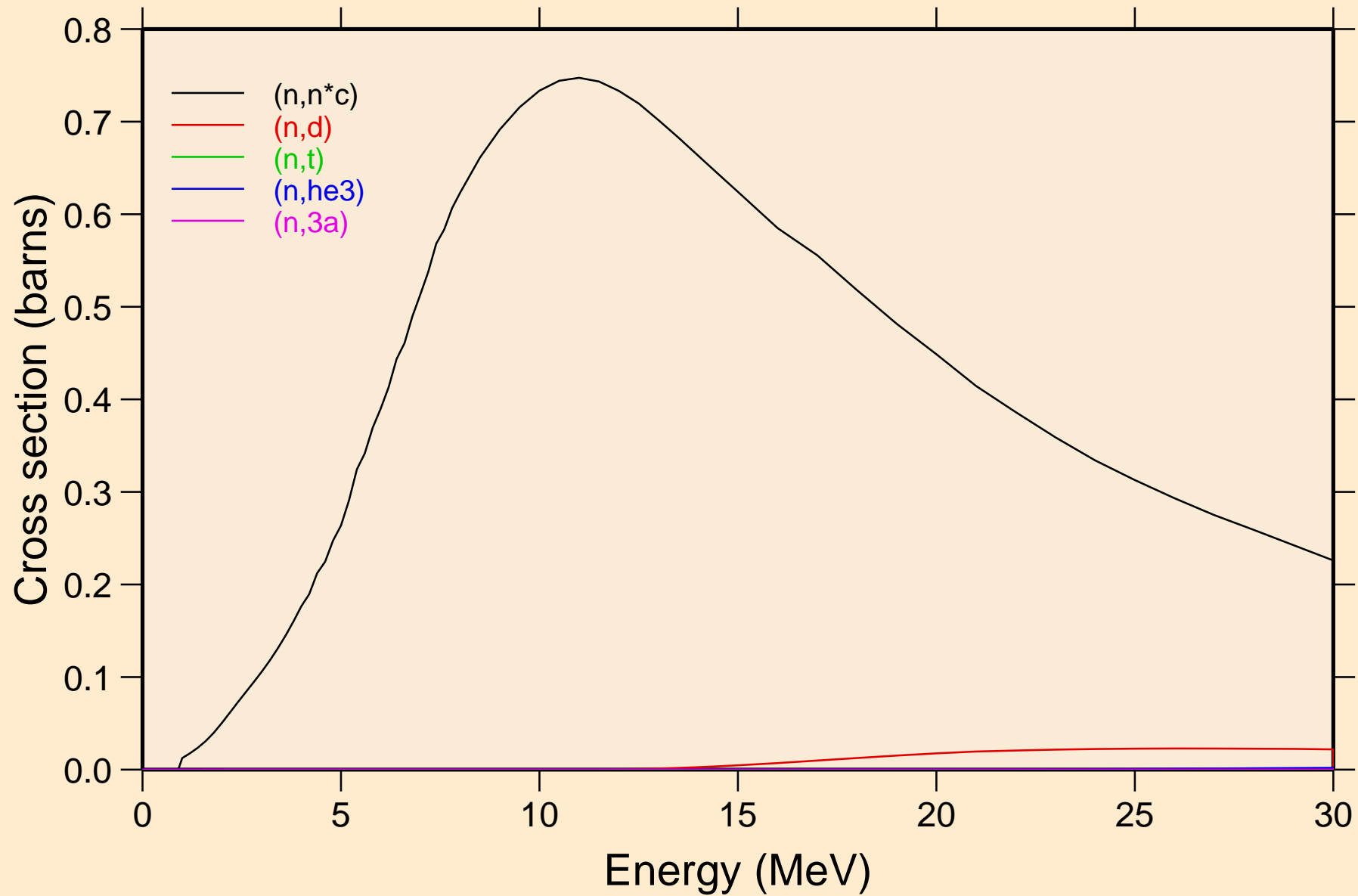

PU229 NEUTRON ACER TENDL-2021 LIBRARY; T=293.6K
Threshold reactions

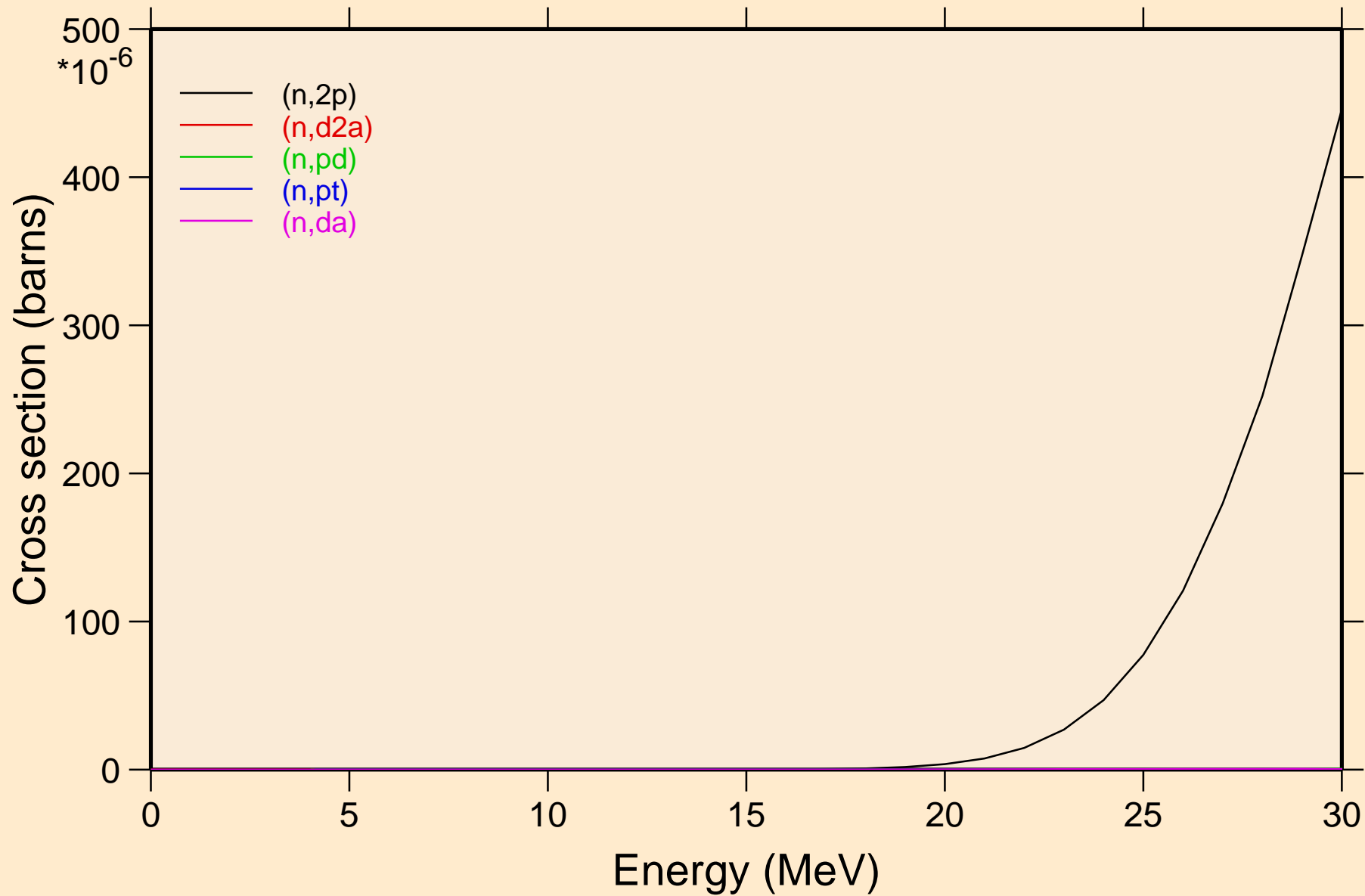

PU229 NEUTRON ACER TENDL-2021 LIBRARY; T=293.6K
Threshold reactions

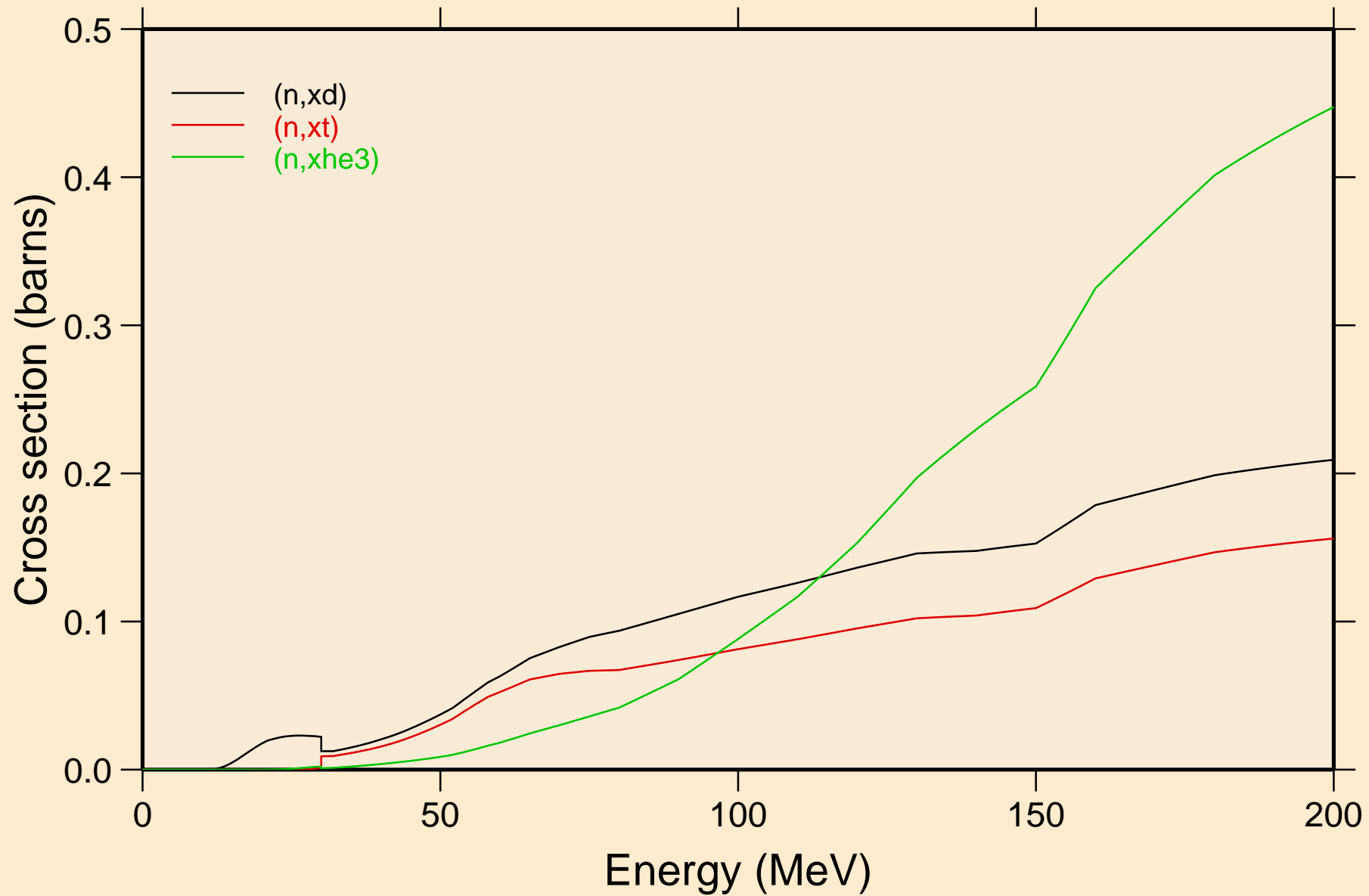

PU229 NEUTRON ACER TENDL-2021 LIBRARY; T=293.6K
angular distribution for elastic

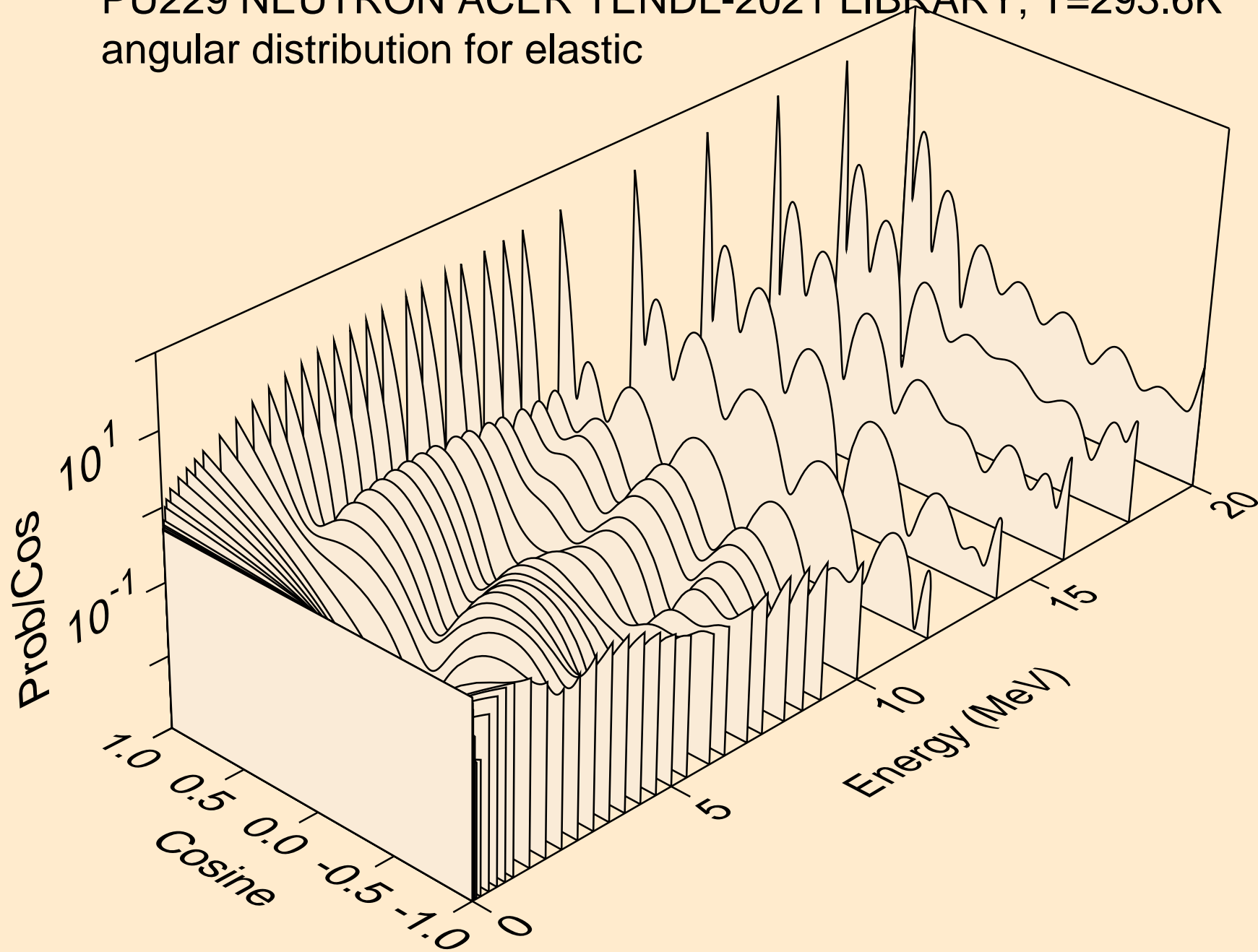

PU229 NEUTRON ACER TENDL-2021 LIBRARY; T=293.6K
angular distribution for elastic

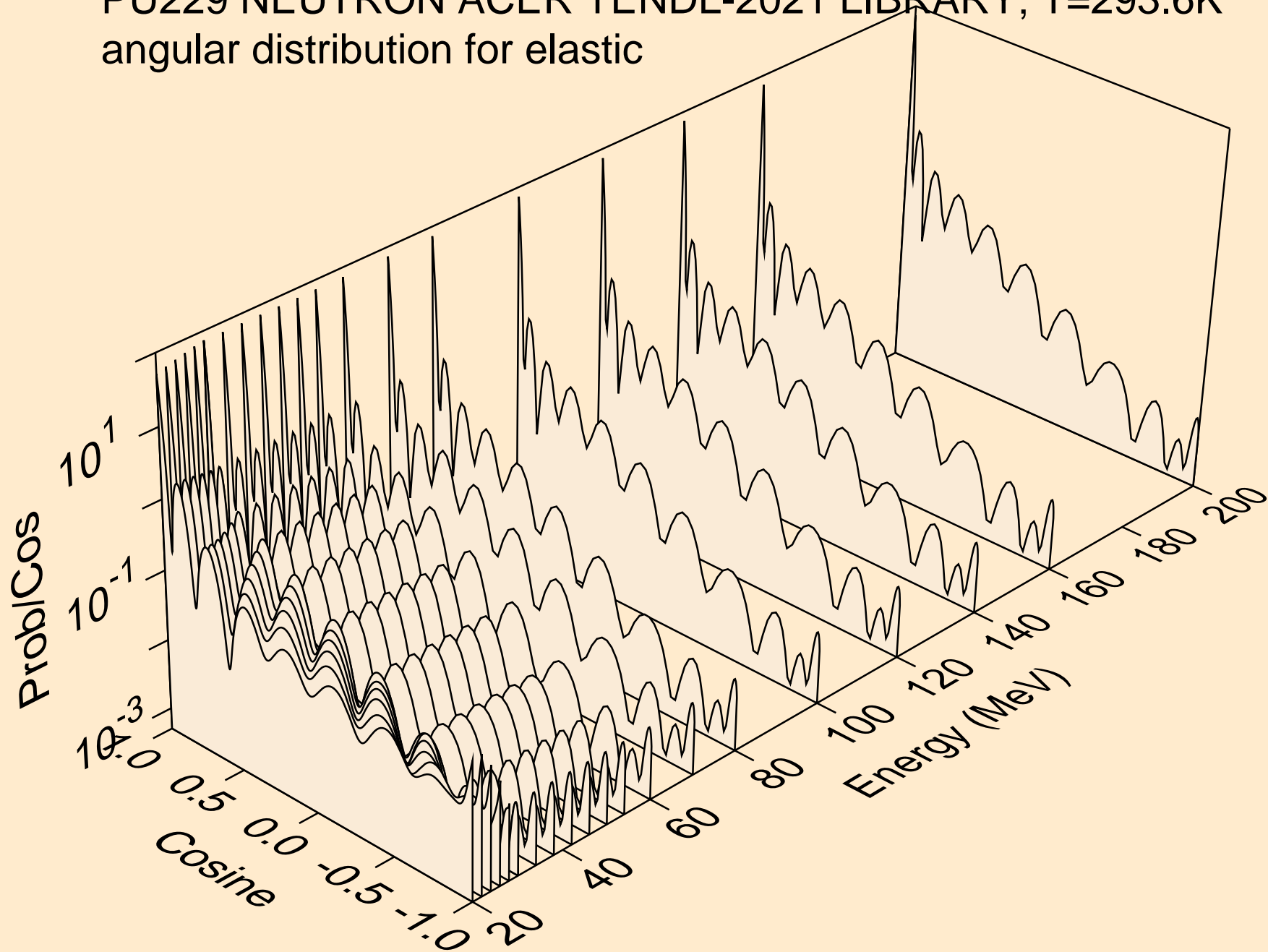

PU229 NEUTRON ACER TENDL-2021 LIBRARY; T=293.6K
angular distribution for (n,n*1)

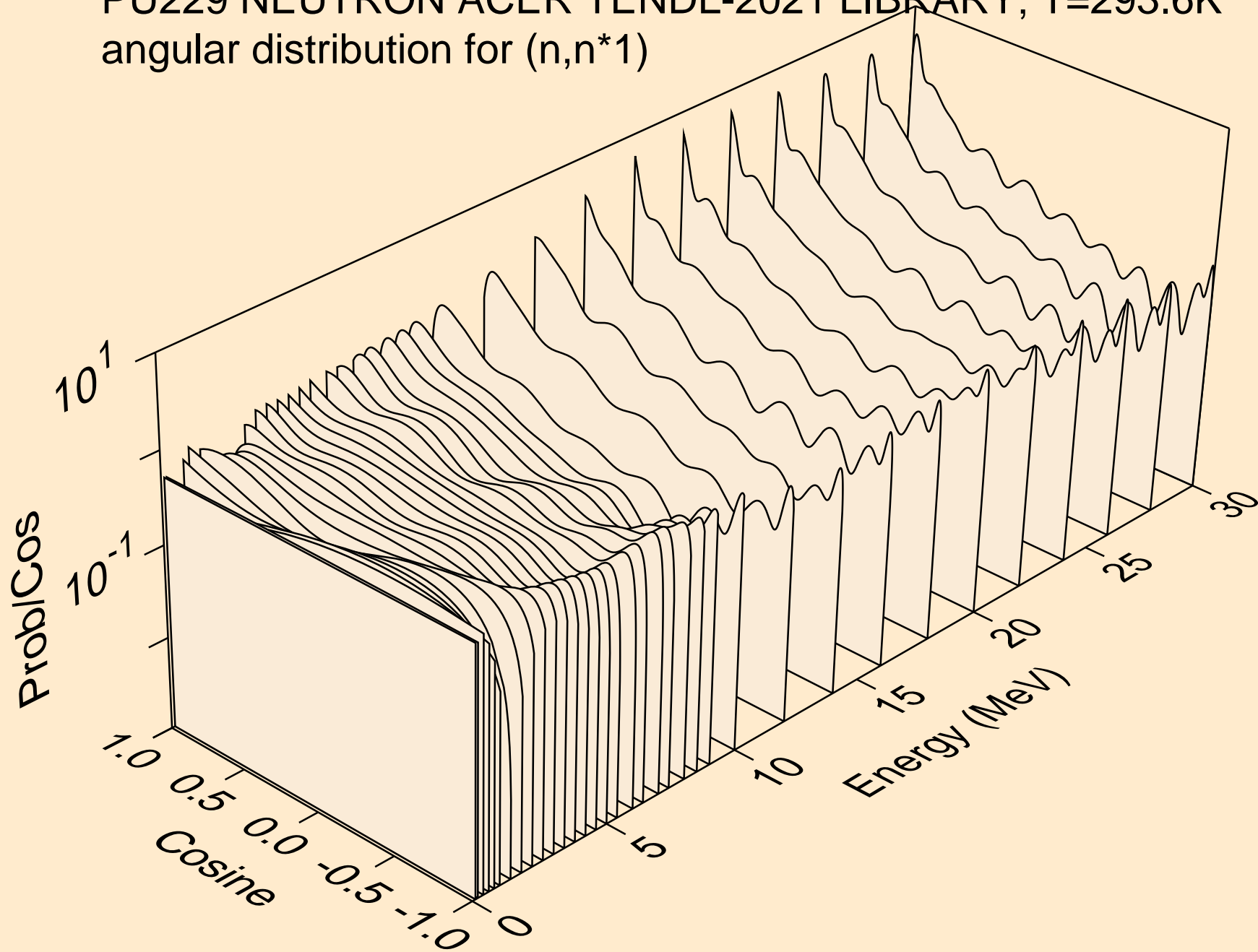

PU229 NEUTRON ACER TENDL-2021 LIBRARY; T=293.6K
Total fission nubar

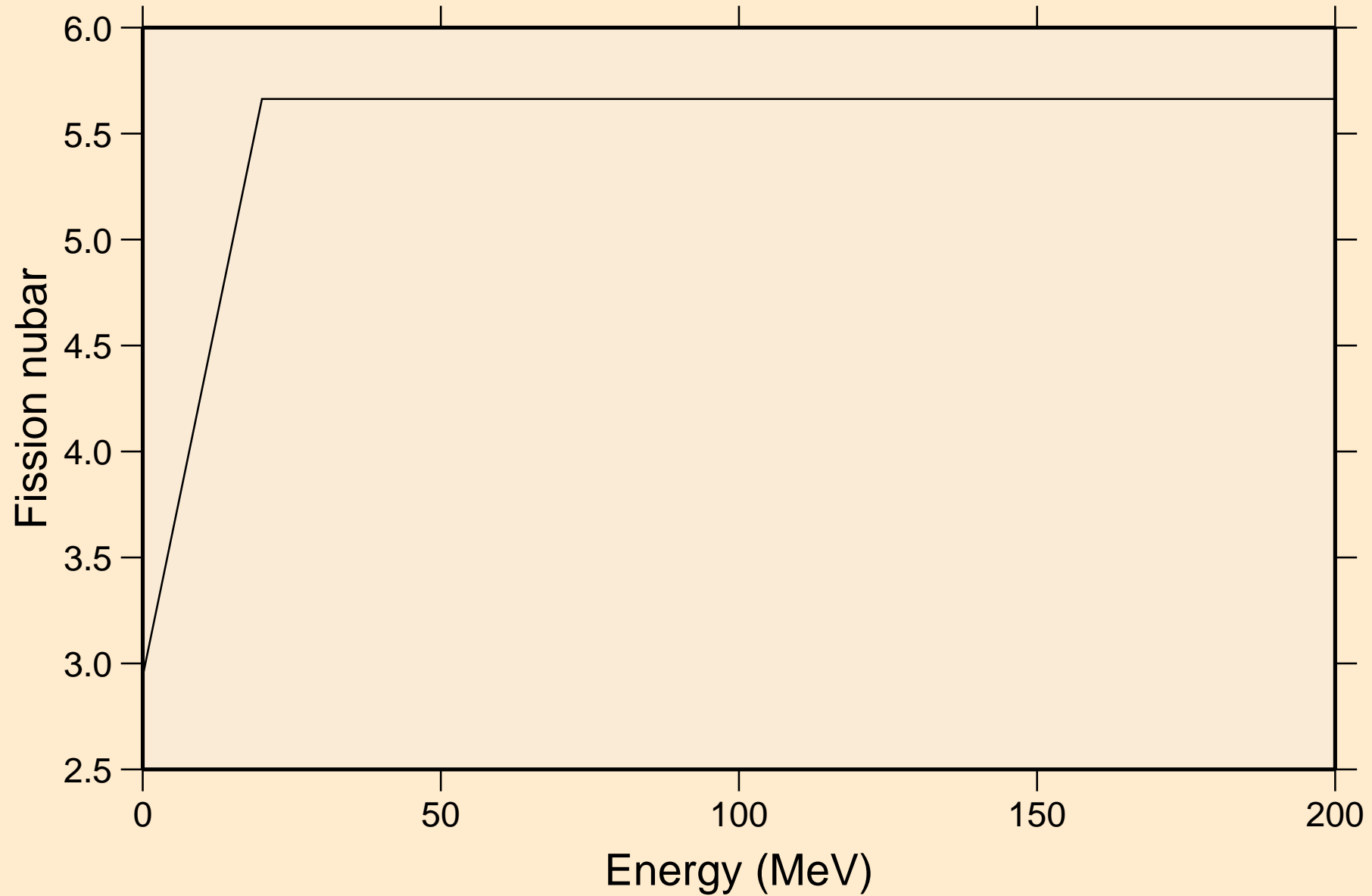

PU229 NEUTRON ACER TENDL-2021 LIBRARY; T=293.6K
Neutron emission for (n,x)

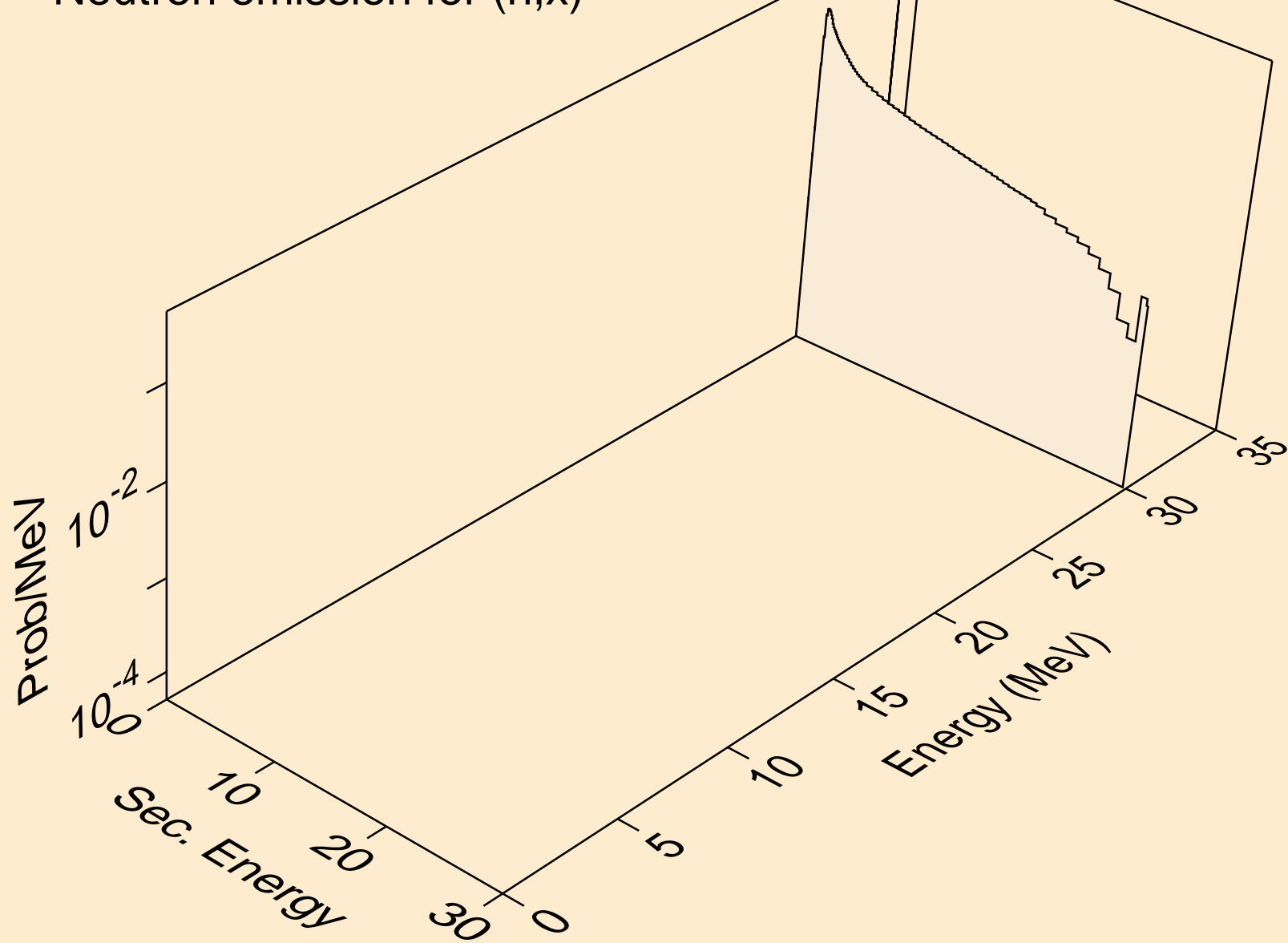

PU229 NEUTRON ACER TENDL-2021 LIBRARY; T=293.6K
Neutron emission for (n,2nd)

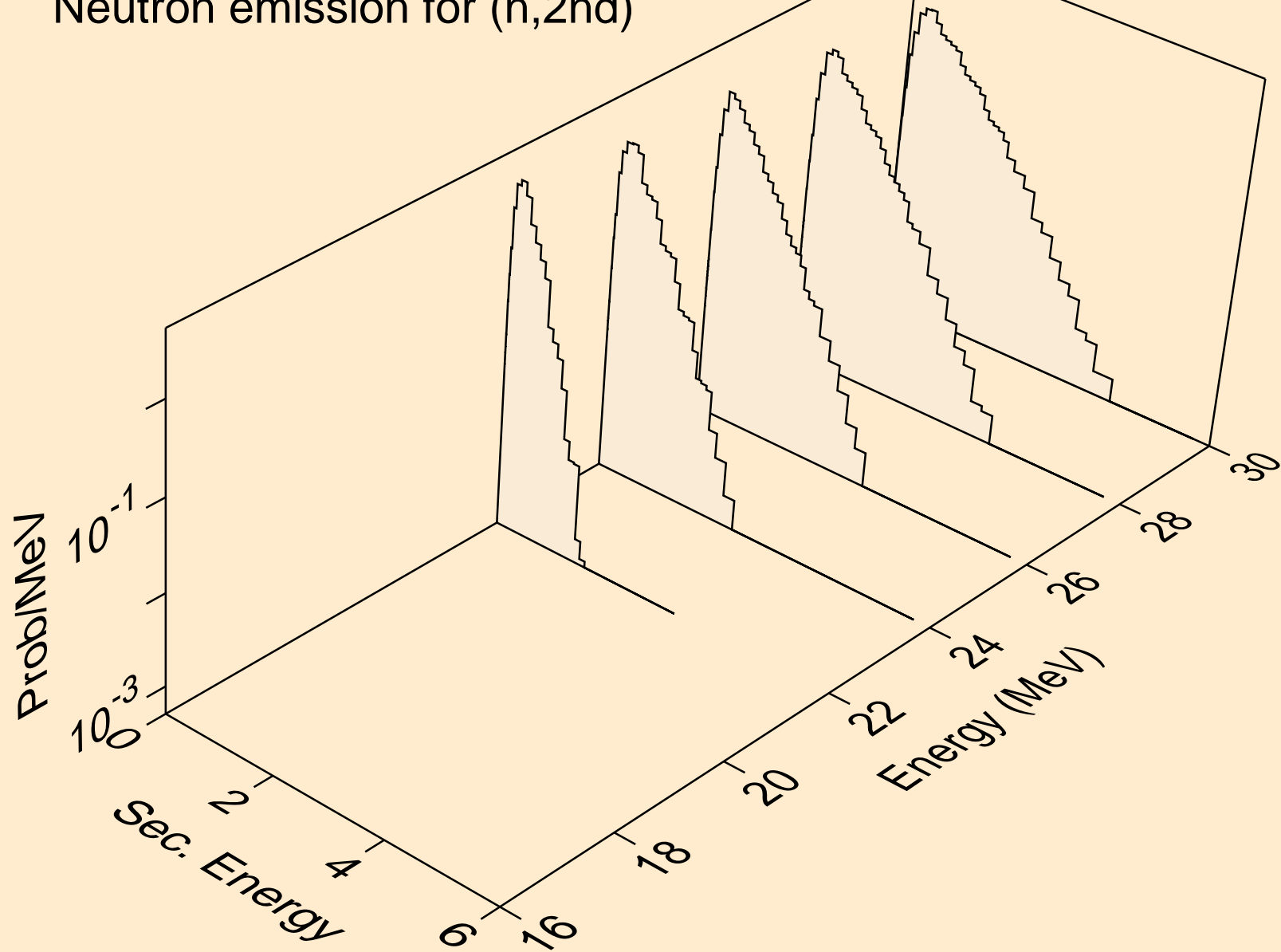

PU229 NEUTRON ACER TENDL-2021 LIBRARY; T=293.6K
Neutron emission for (n,2n)

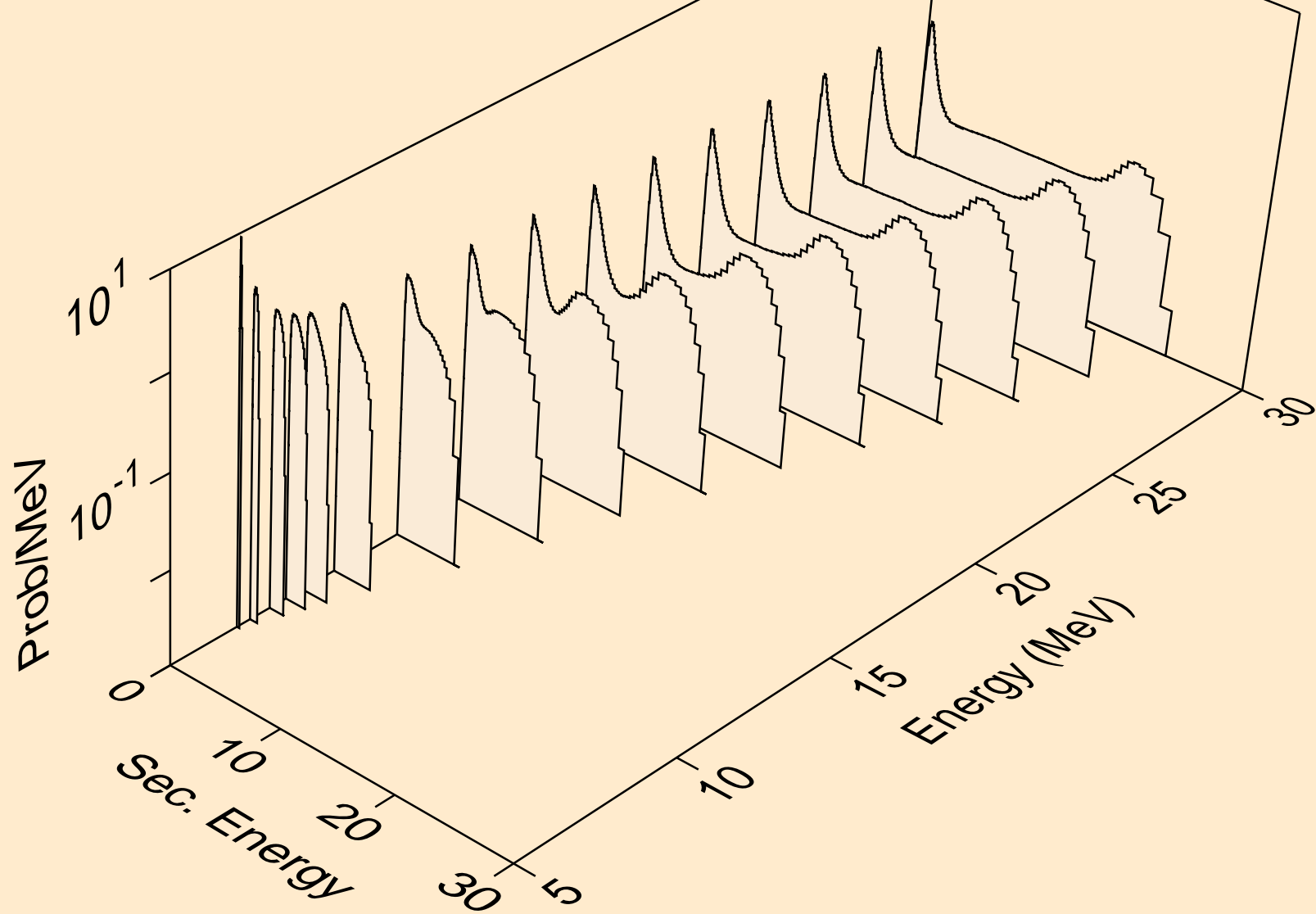

PU229 NEUTRON ACER TENDL-2021 LIBRARY; T=293.6K
Neutron emission for (n,3n)

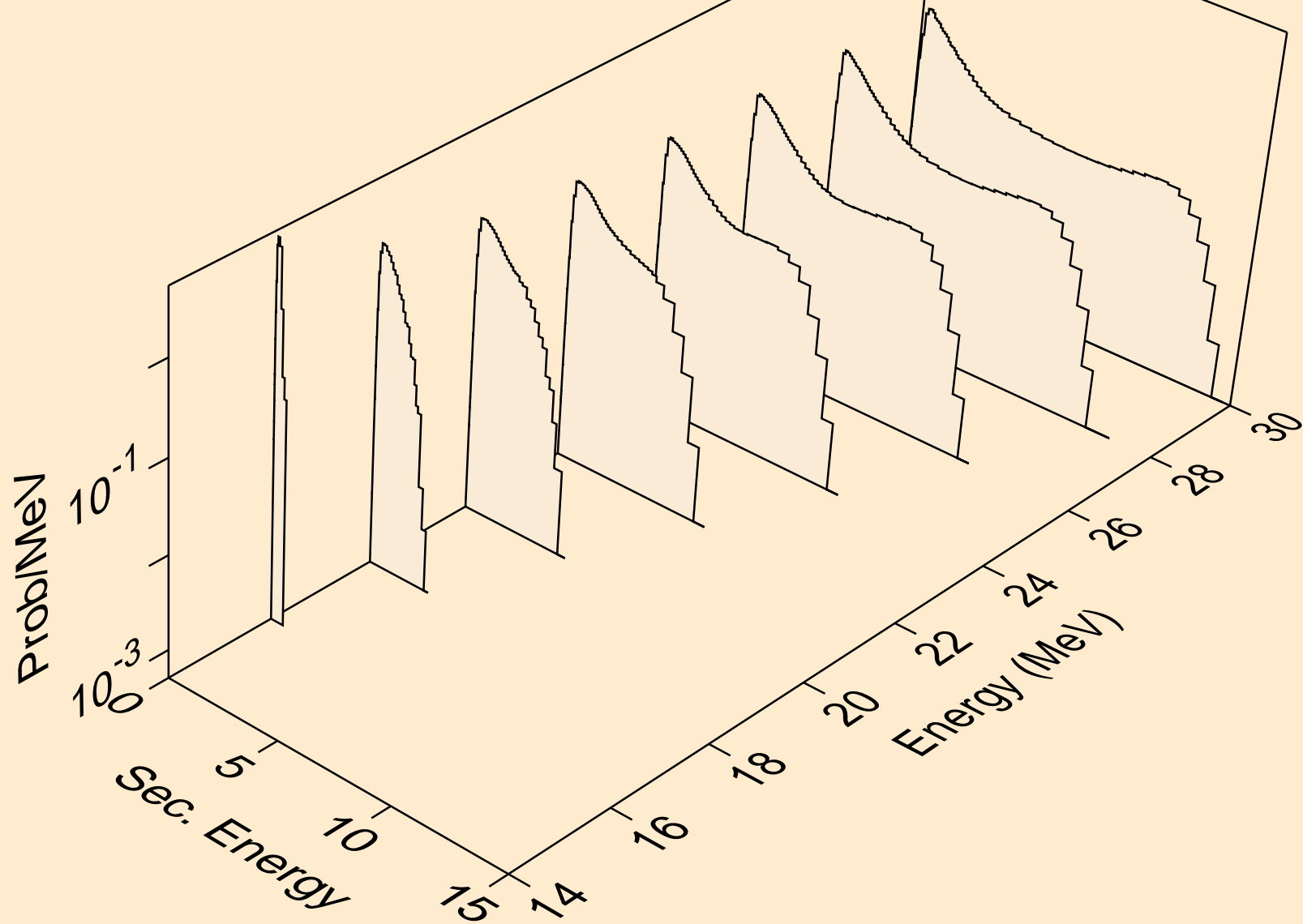

PU229 NEUTRON ACER TENDL-2021 LIBRARY; T=293.6K
Neutron emission for fission

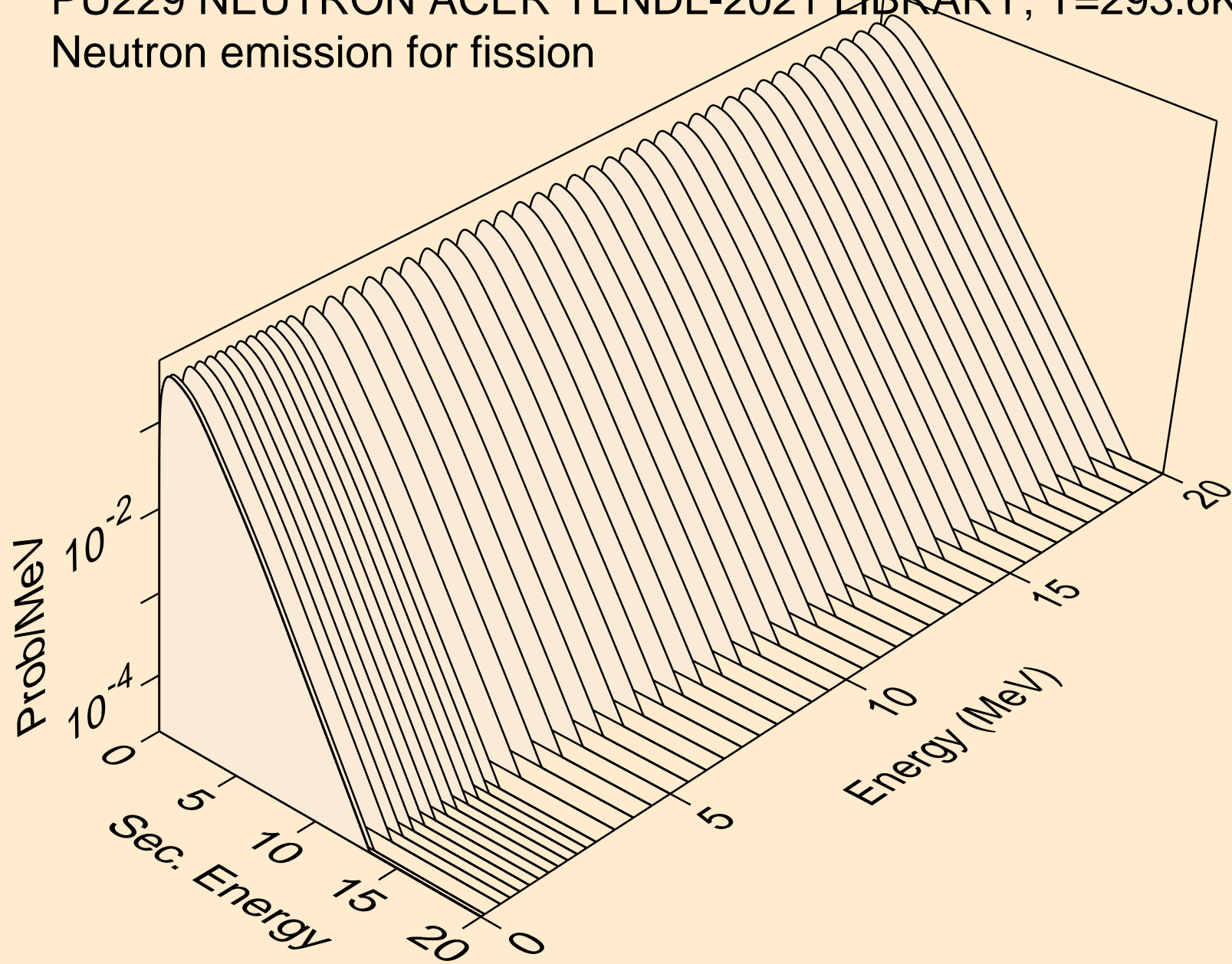

PU229 NEUTRON ACER TENDL-2021 LIBRARY; T=293.6K
Neutron emission for (n,n*)a

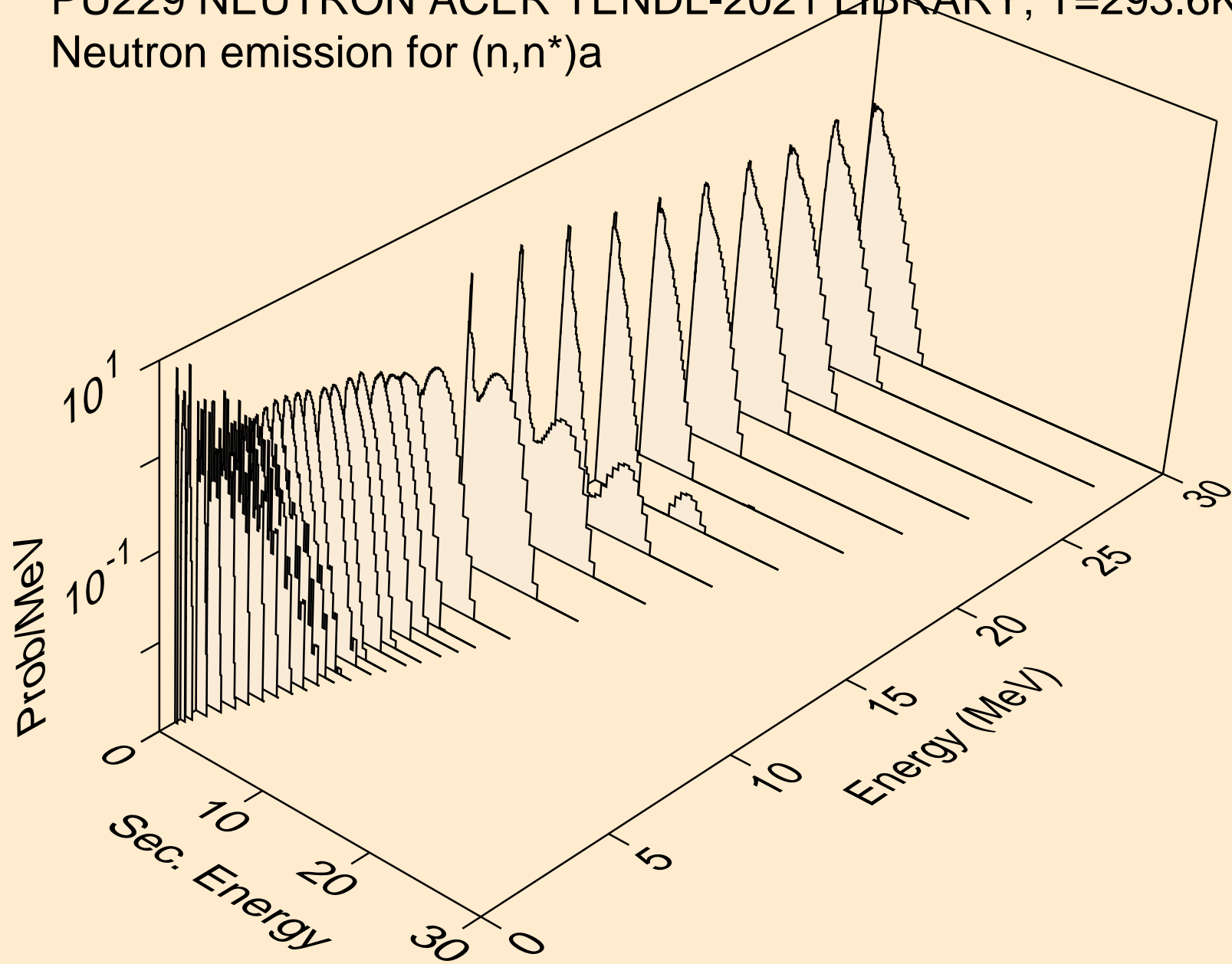

PU229 NEUTRON ACER TENDL-2021 LIBRARY; T=293.6K
Neutron emission for (n,n*)3a

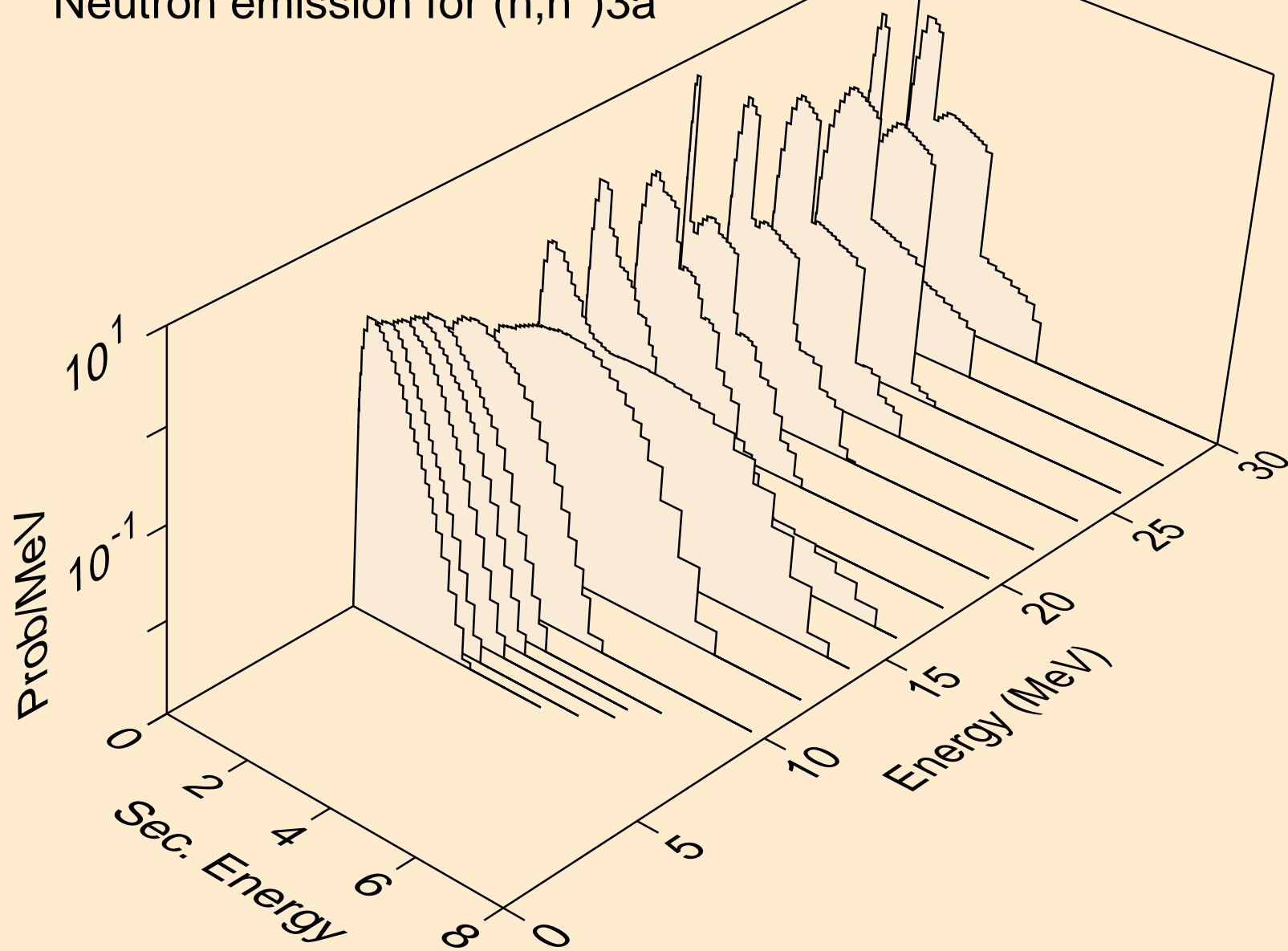

PU229 NEUTRON ACER TENDL-2021 LIBRARY; T=293.6K
Neutron emission for (n,2n)a

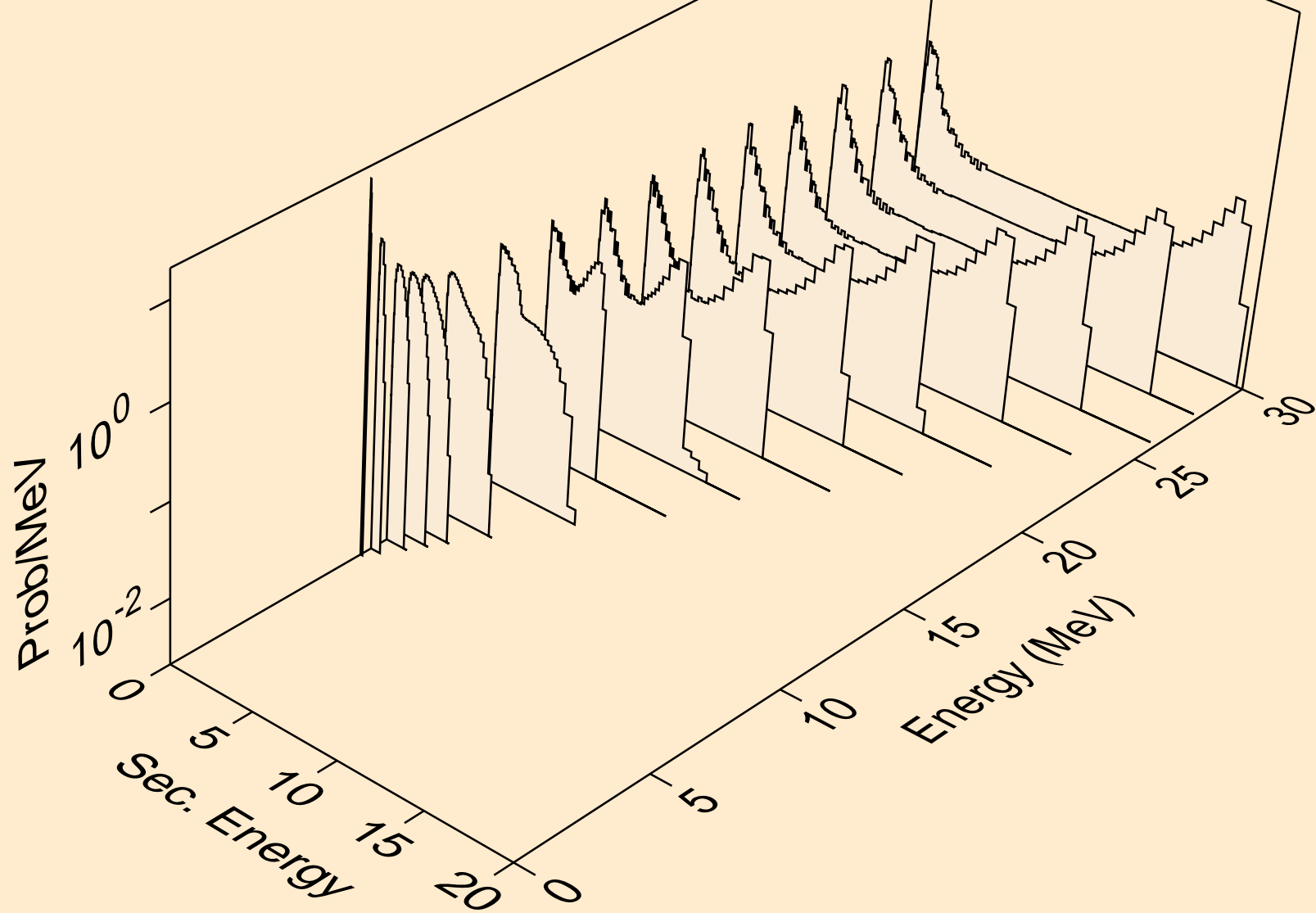

PU229 NEUTRON ACER TENDL-2021 LIBRARY; T=293.6K
Neutron emission for (n,3n)a

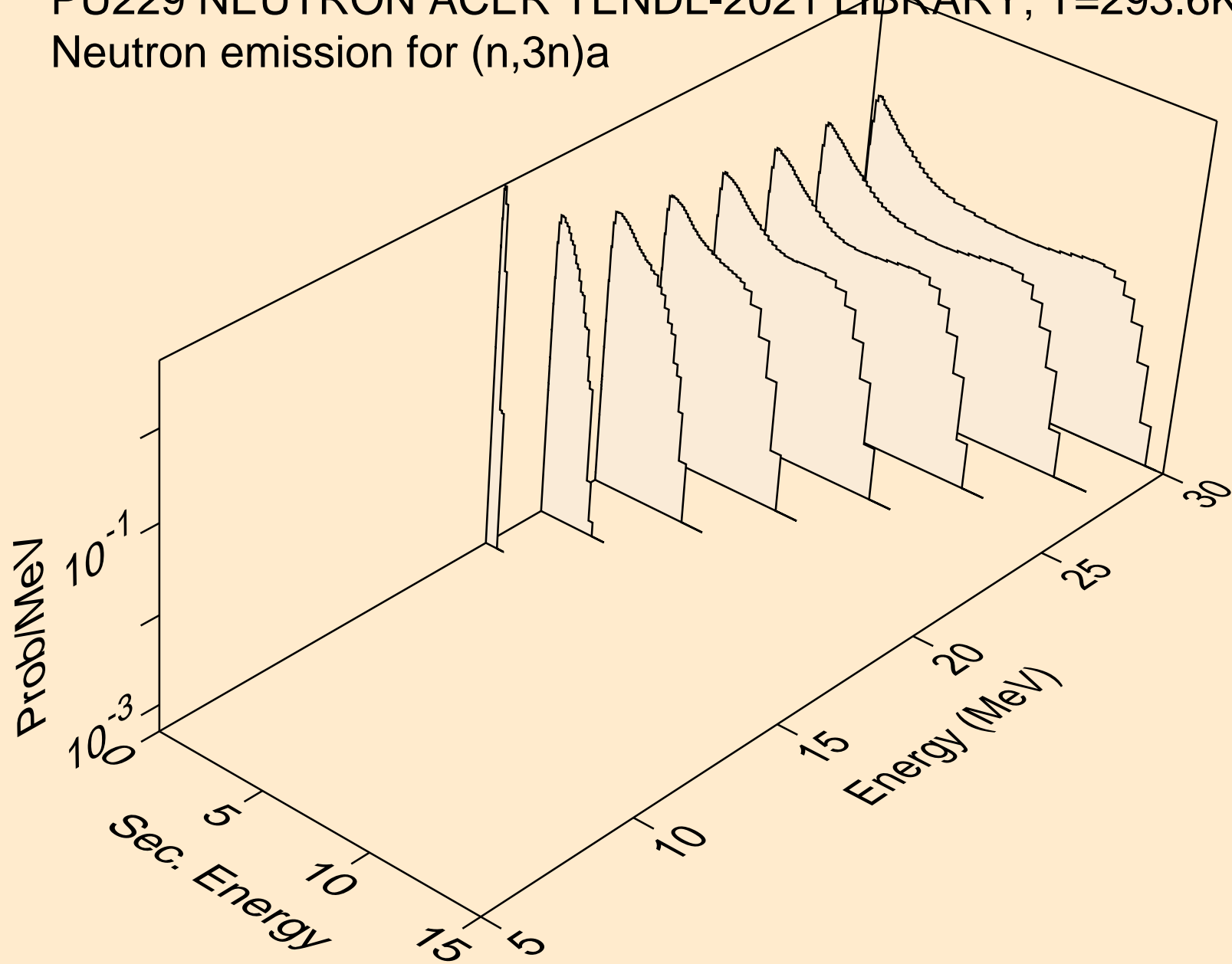

PU229 NEUTRON ACER TENDL-2021 LIBRARY; T=293.6K
Neutron emission for (n,n*)p

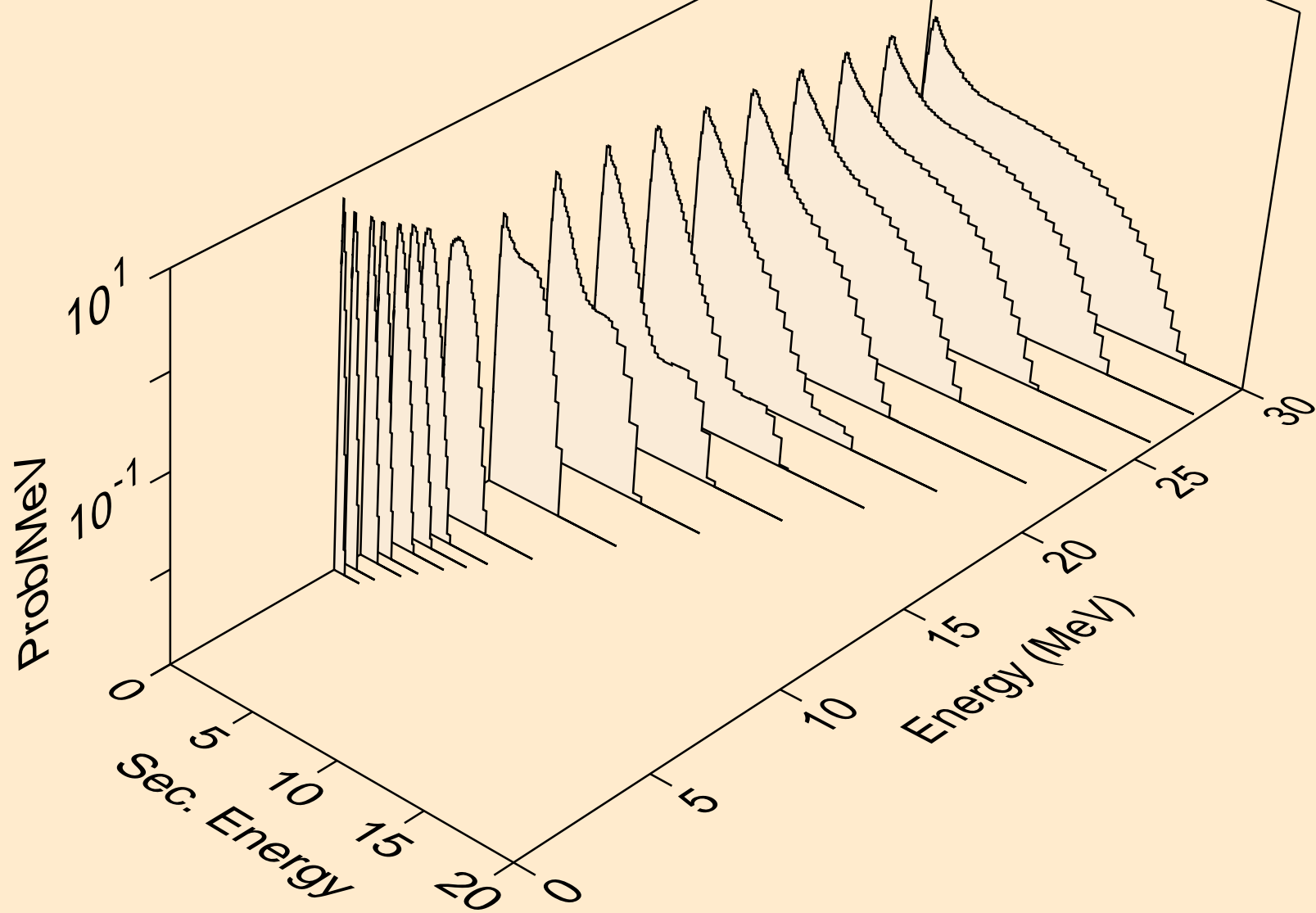

PU229 NEUTRON ACER TENDL-2021 LIBRARY; T=293.6K
Neutron emission for (n,n*)2a

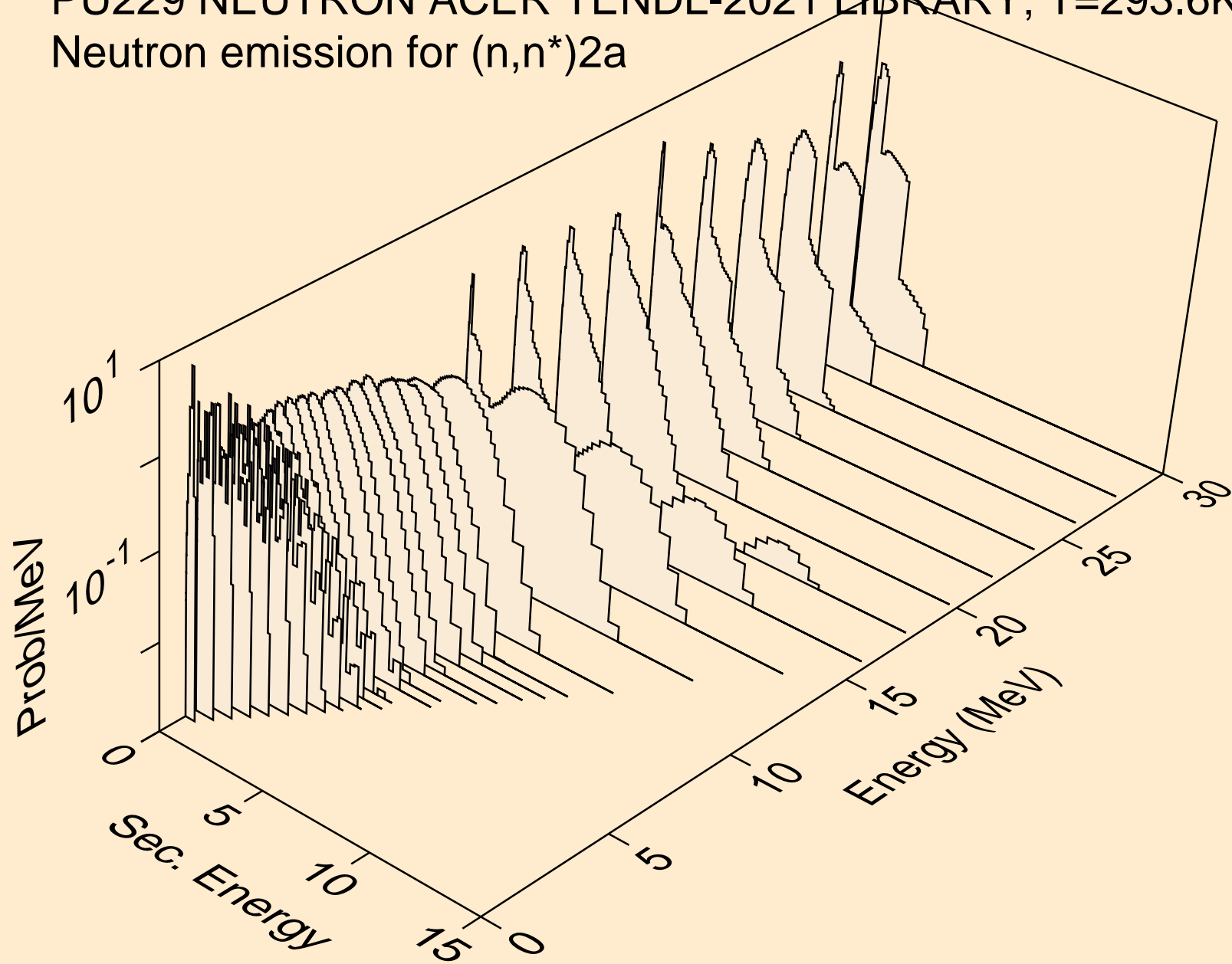

PU229 NEUTRON ACER TENDL-2021 LIBRARY; T=293.6K
Neutron emission for (n,2n)2a

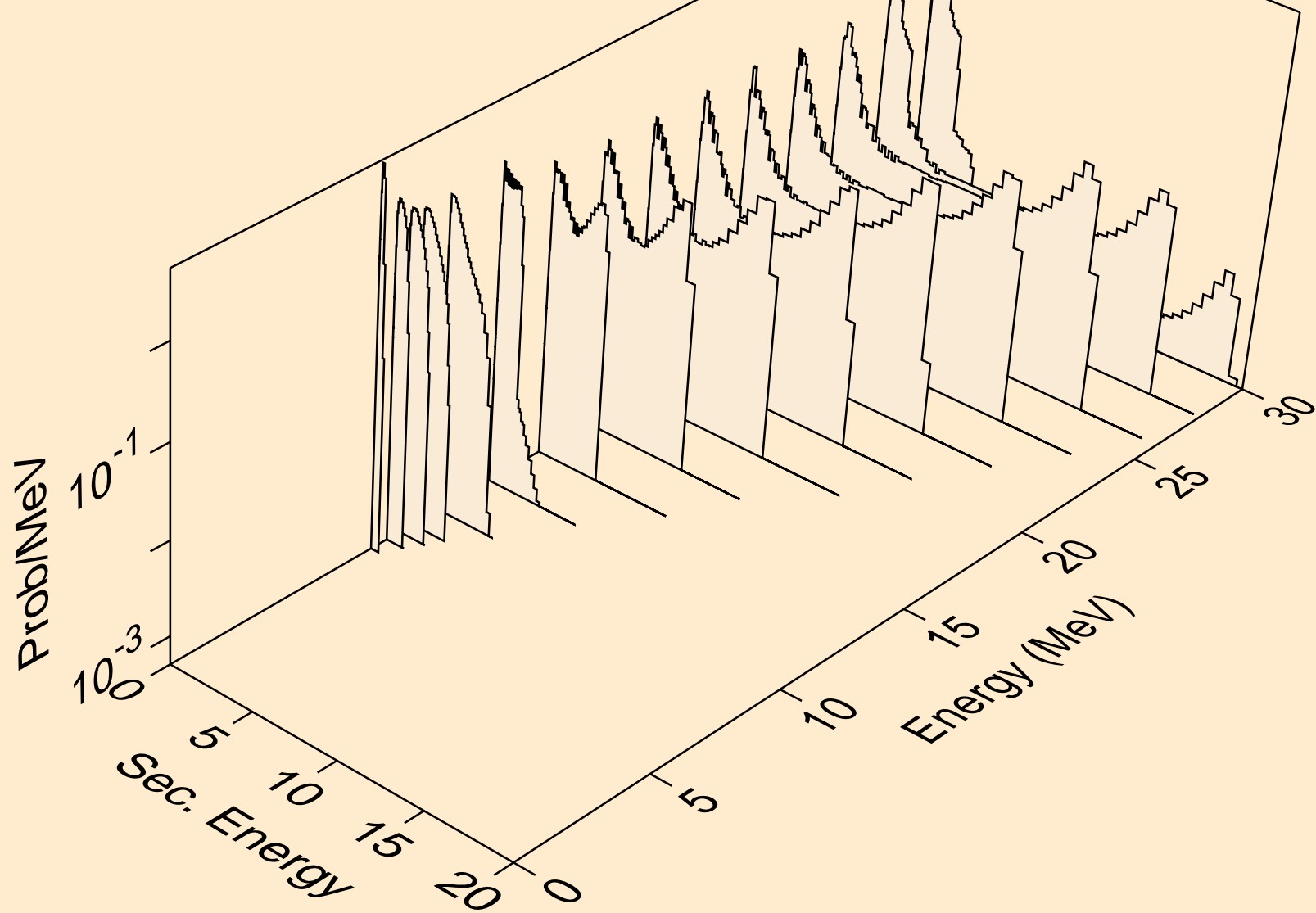

PU229 NEUTRON ACER TENDL-2021 LIBRARY; T=293.6K
Neutron emission for (n,n*)d

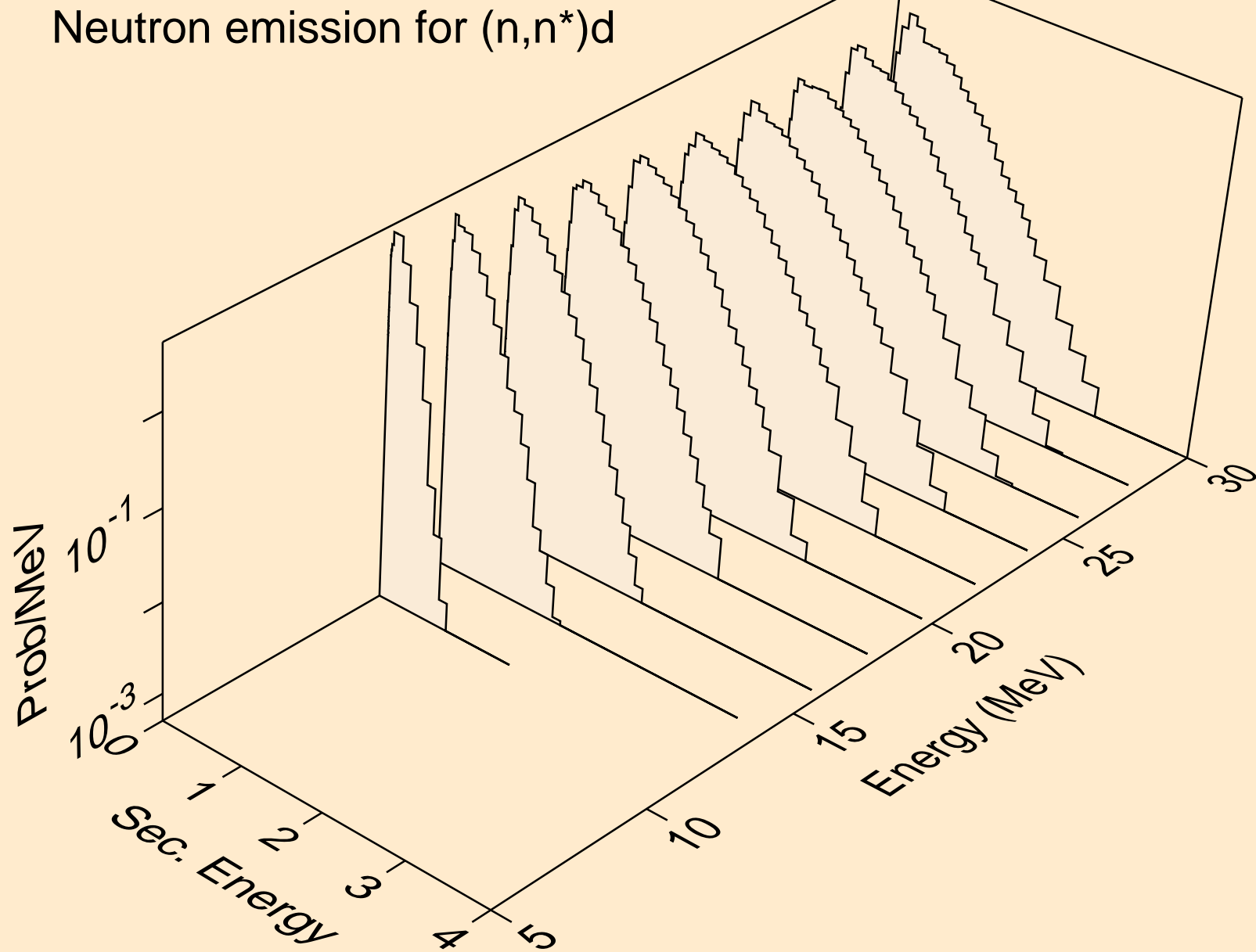

PU229 NEUTRON ACER TENDL-2021 LIBRARY; T=293.6K
Neutron emission for (n,n*)t

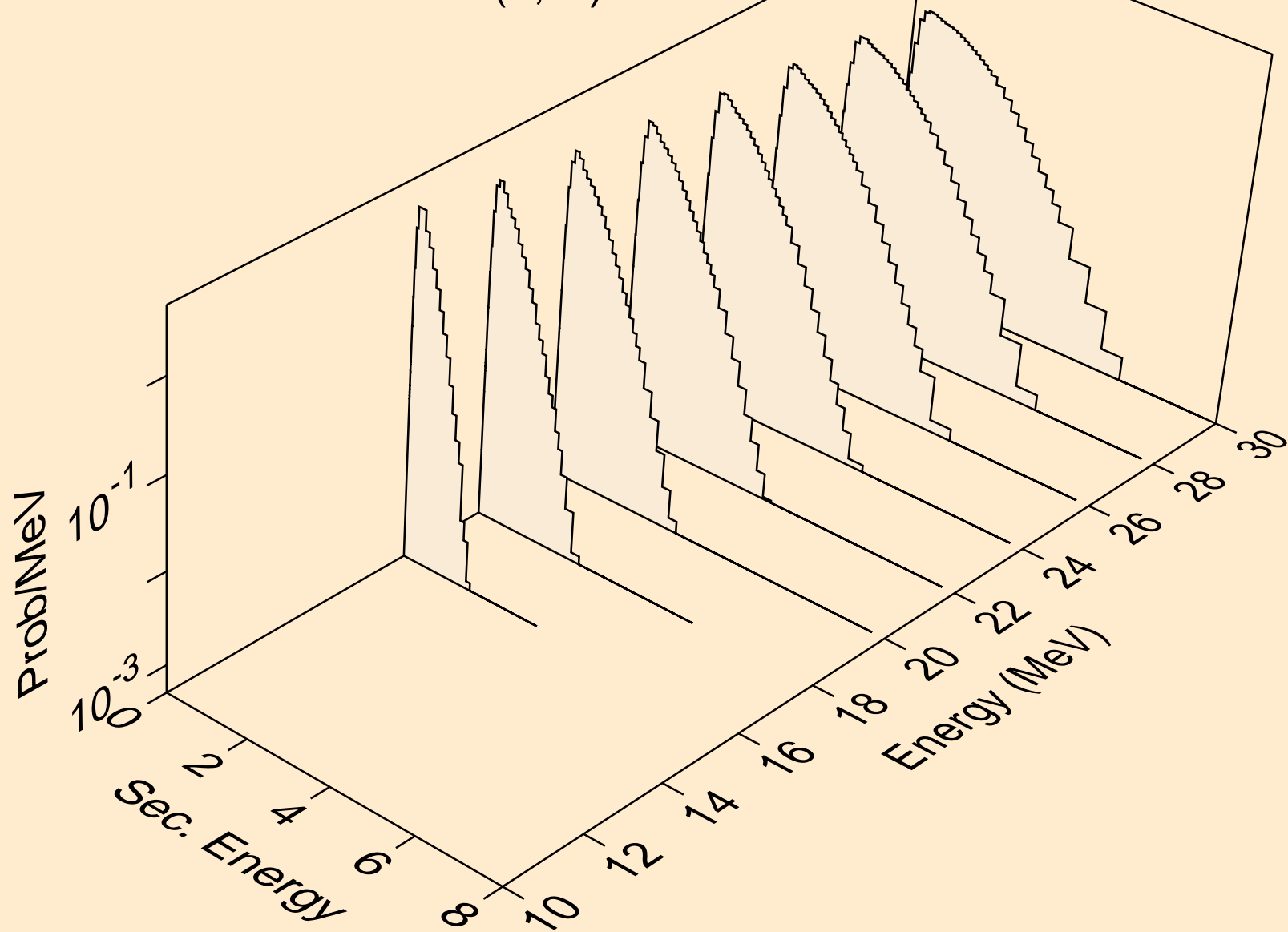

PU229 NEUTRON ACER TENDL-2021 LIBRARY; T=293.6K
Neutron emission for (n,n*)he3

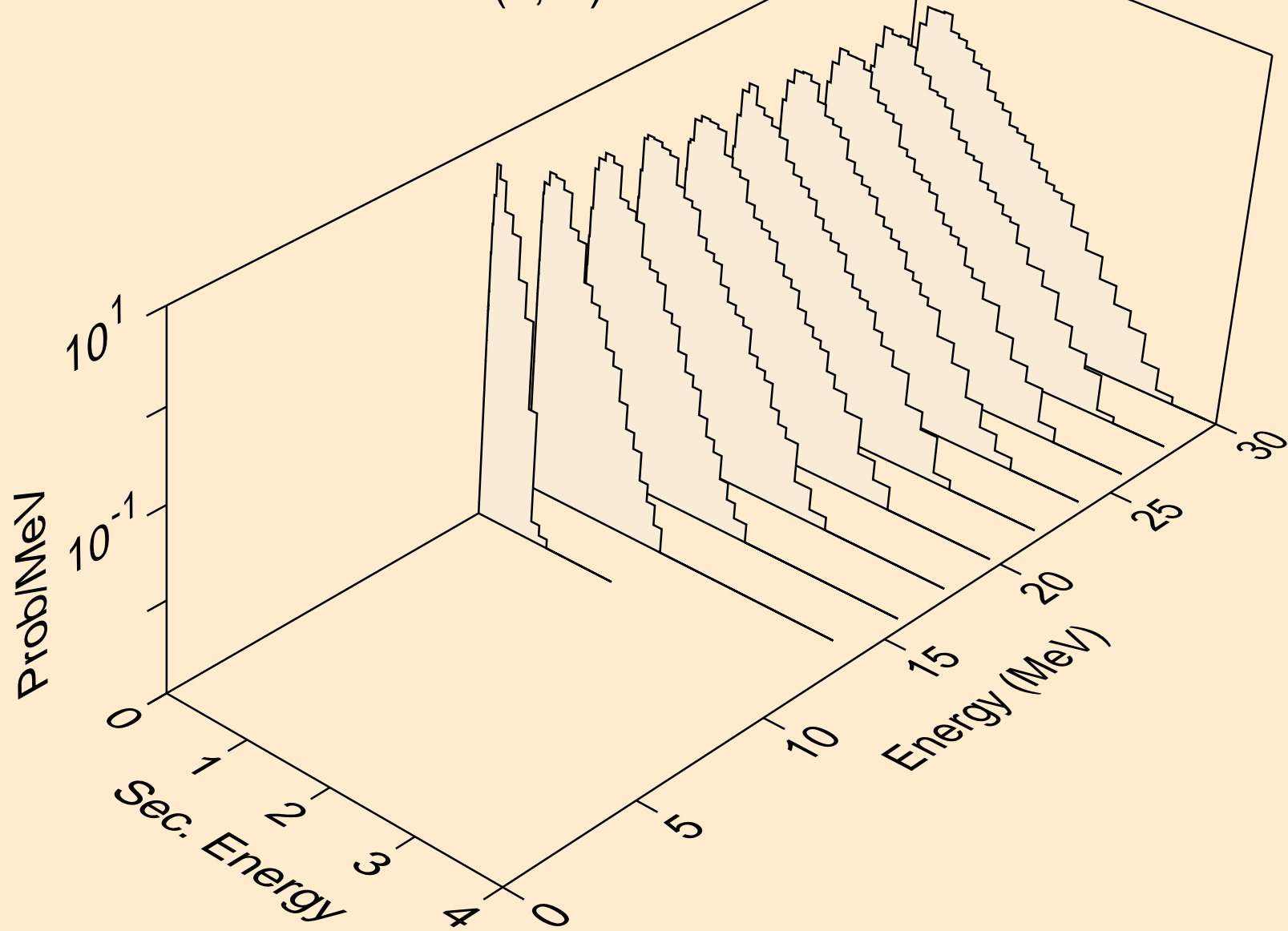

PU229 NEUTRON ACER TENDL-2021 LIBRARY; T=293.6K
Neutron emission for (n,n*)t2a

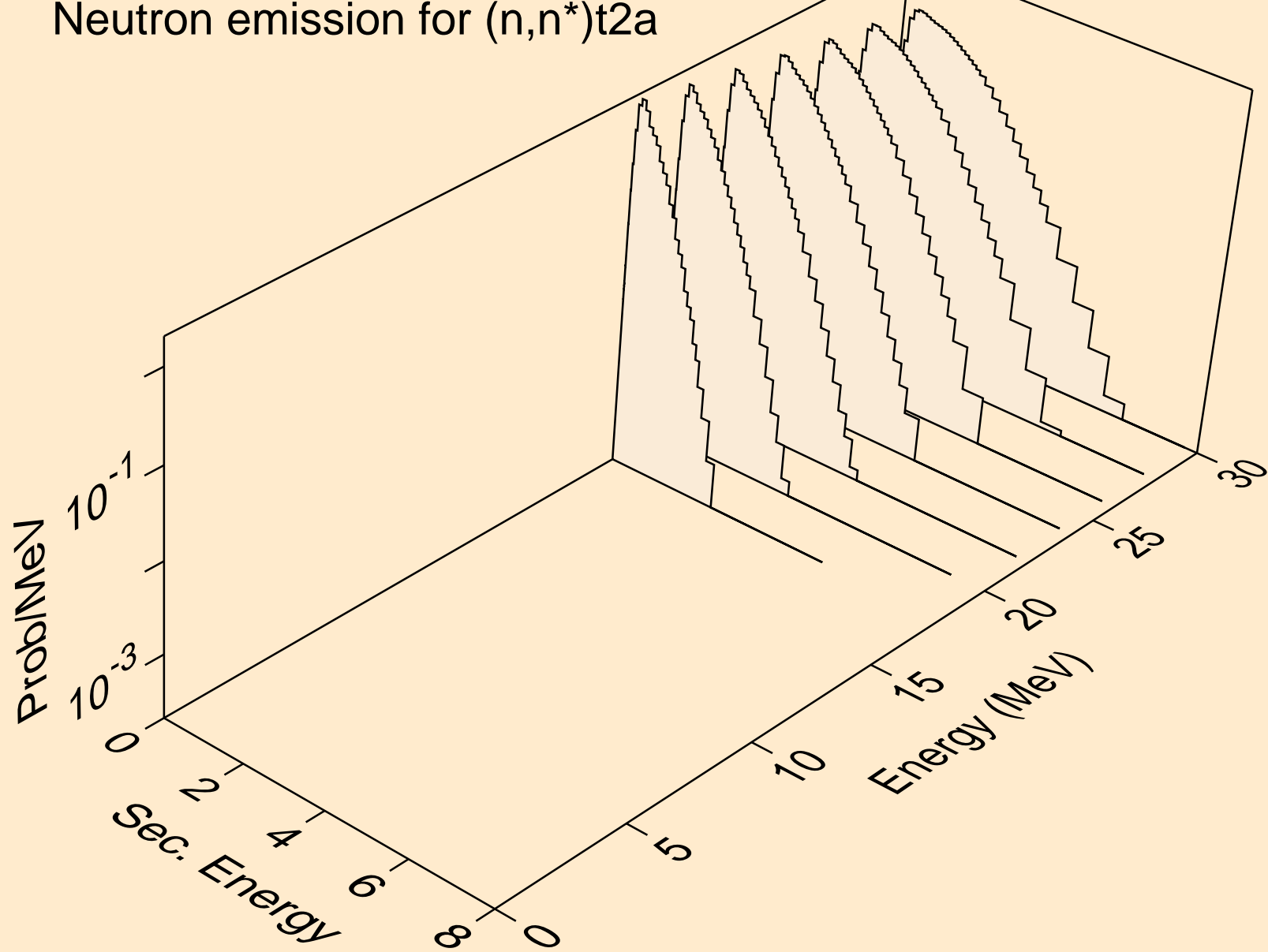

PU229 NEUTRON ACER TENDL-2021 LIBRARY; T=293.6K
Neutron emission for (n,4n)

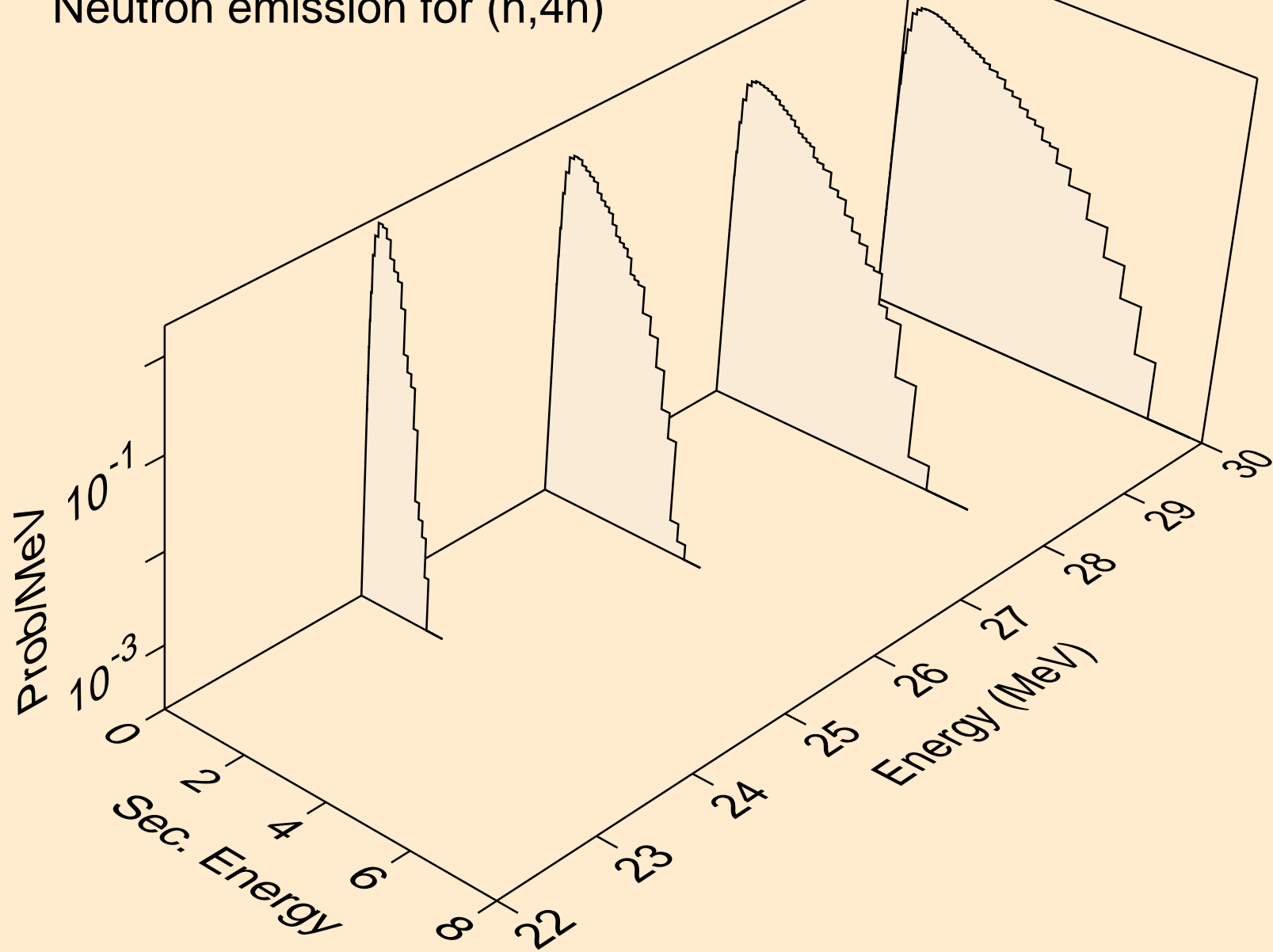

PU229 NEUTRON ACER TENDL-2021 LIBRARY; T=293.6K
Neutron emission for (n,2np)

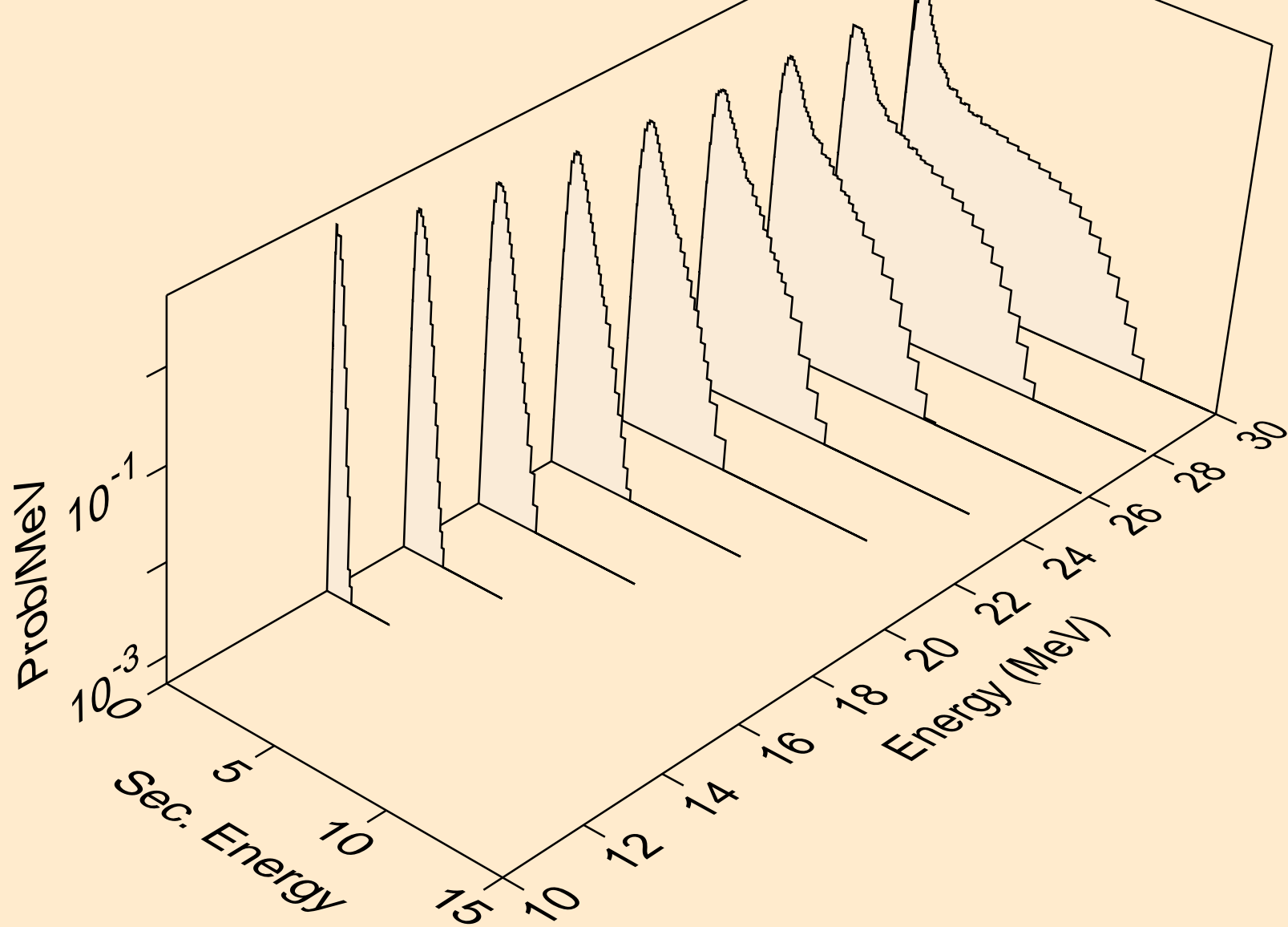

PU229 NEUTRON ACER TENDL-2021 LIBRARY; T=293.6K
Neutron emission for (n,3np)

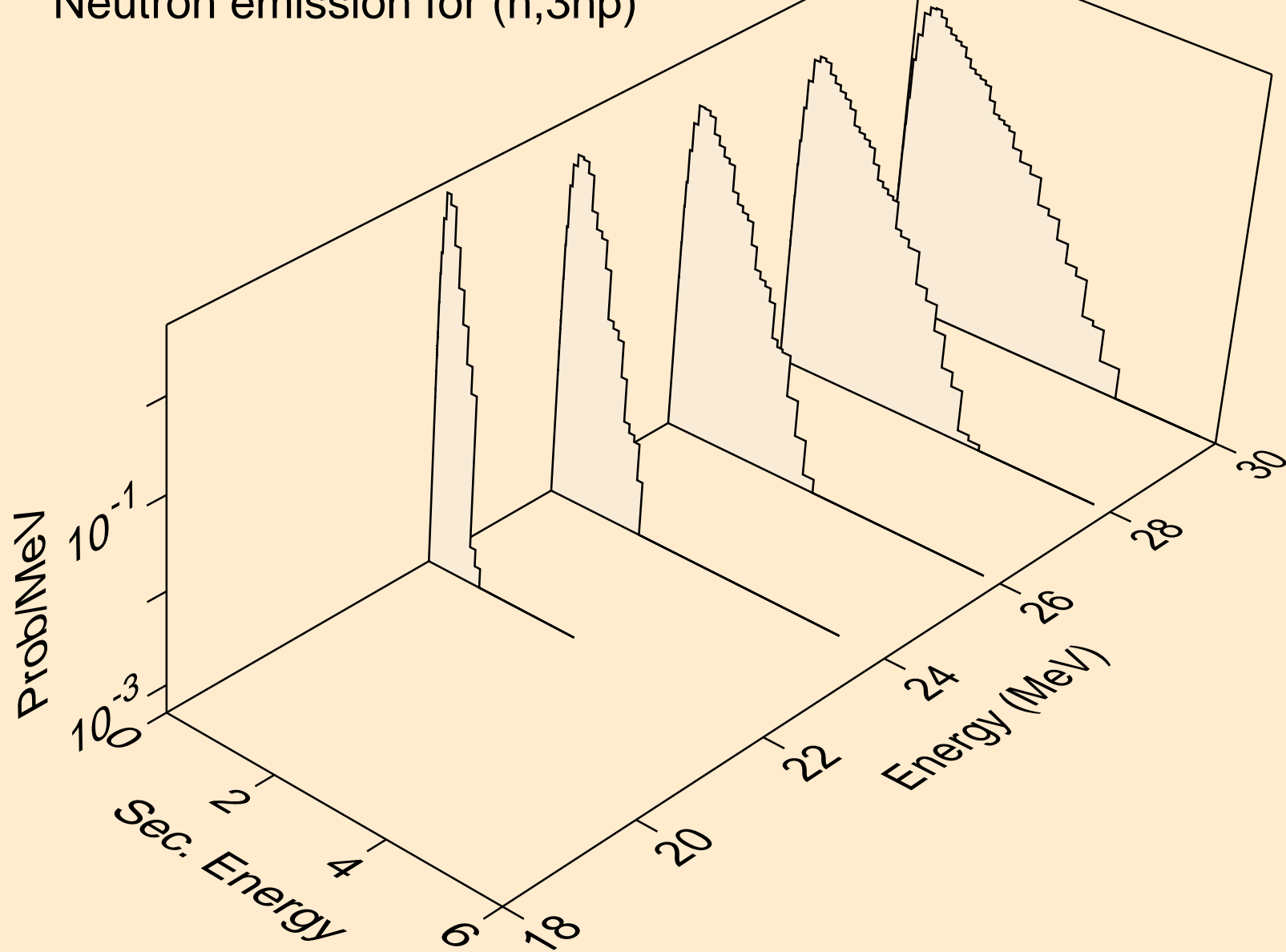

PU229 NEUTRON ACER TENDL-2021 LIBRARY; T=293.6K
Neutron emission for (n,2np)

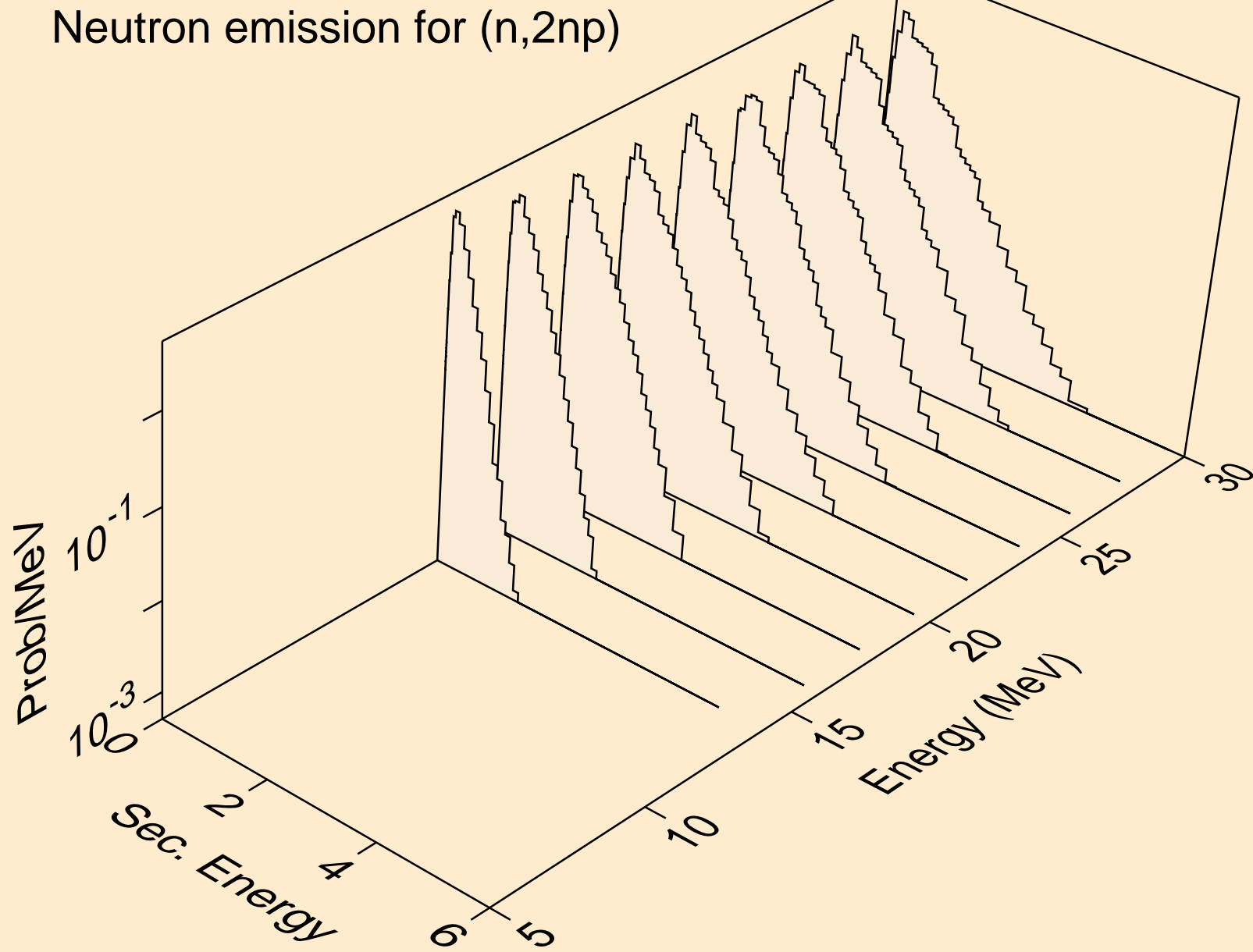

PU229 NEUTRON ACER TENDL-2021 LIBRARY; T=293.6K
Neutron emission for (n,npa)

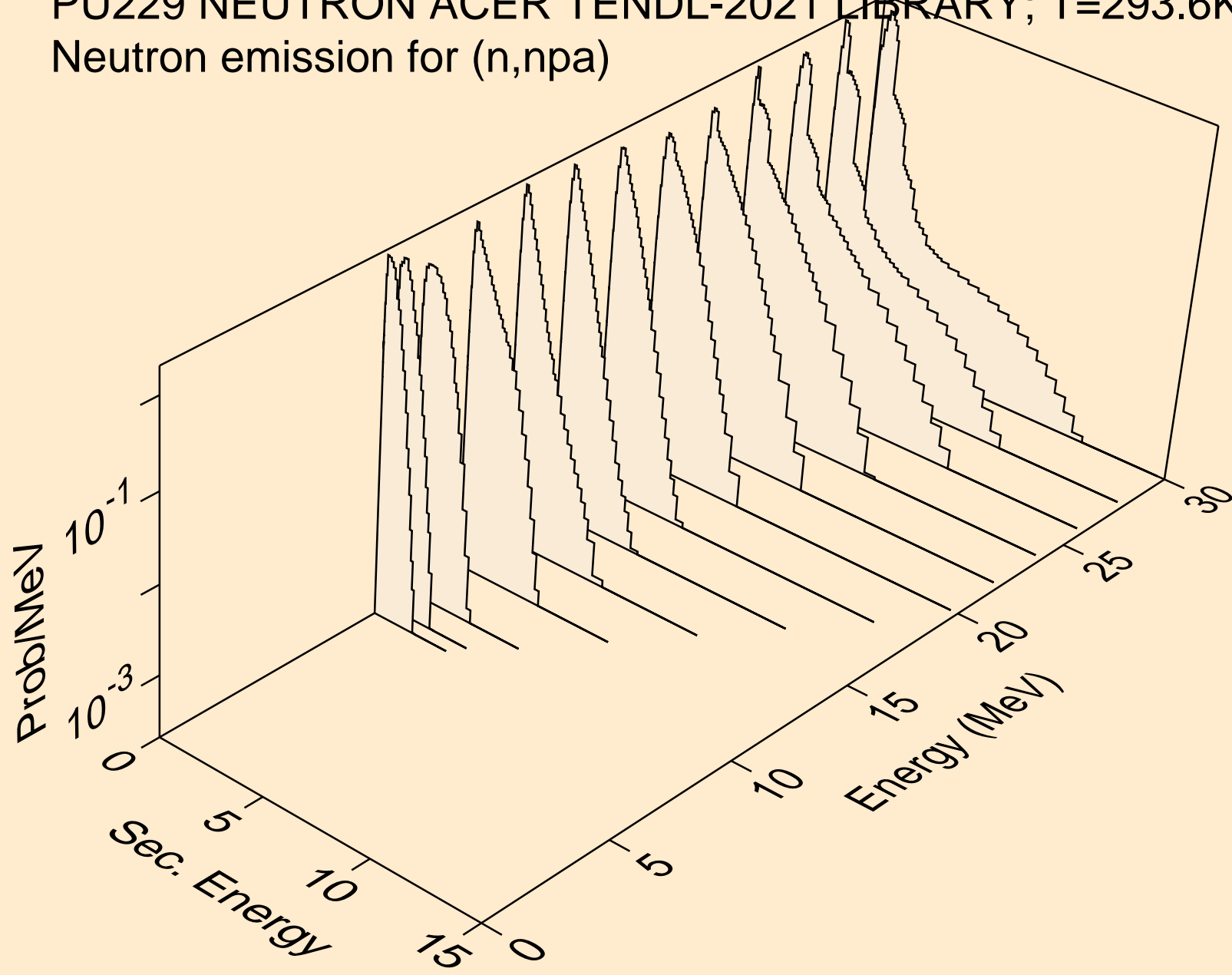

PU229 NEUTRON ACER TENDL-2021 LIBRARY; T=293.6K
Neutron emission for (n,n*c)

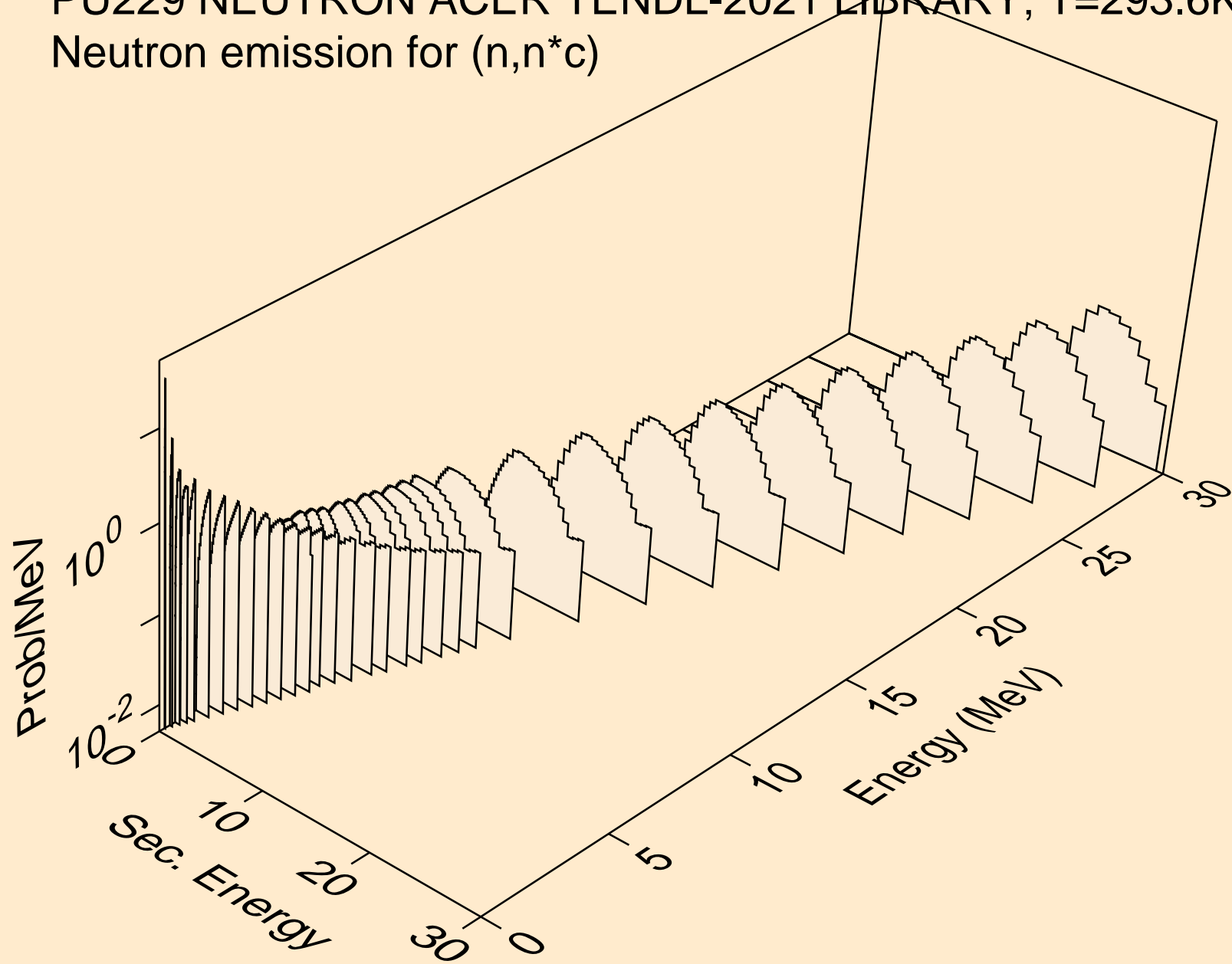

PU229 NEUTRON ACER TENDL-2021 LIBRARY; T=293.6K
Delayed nubar

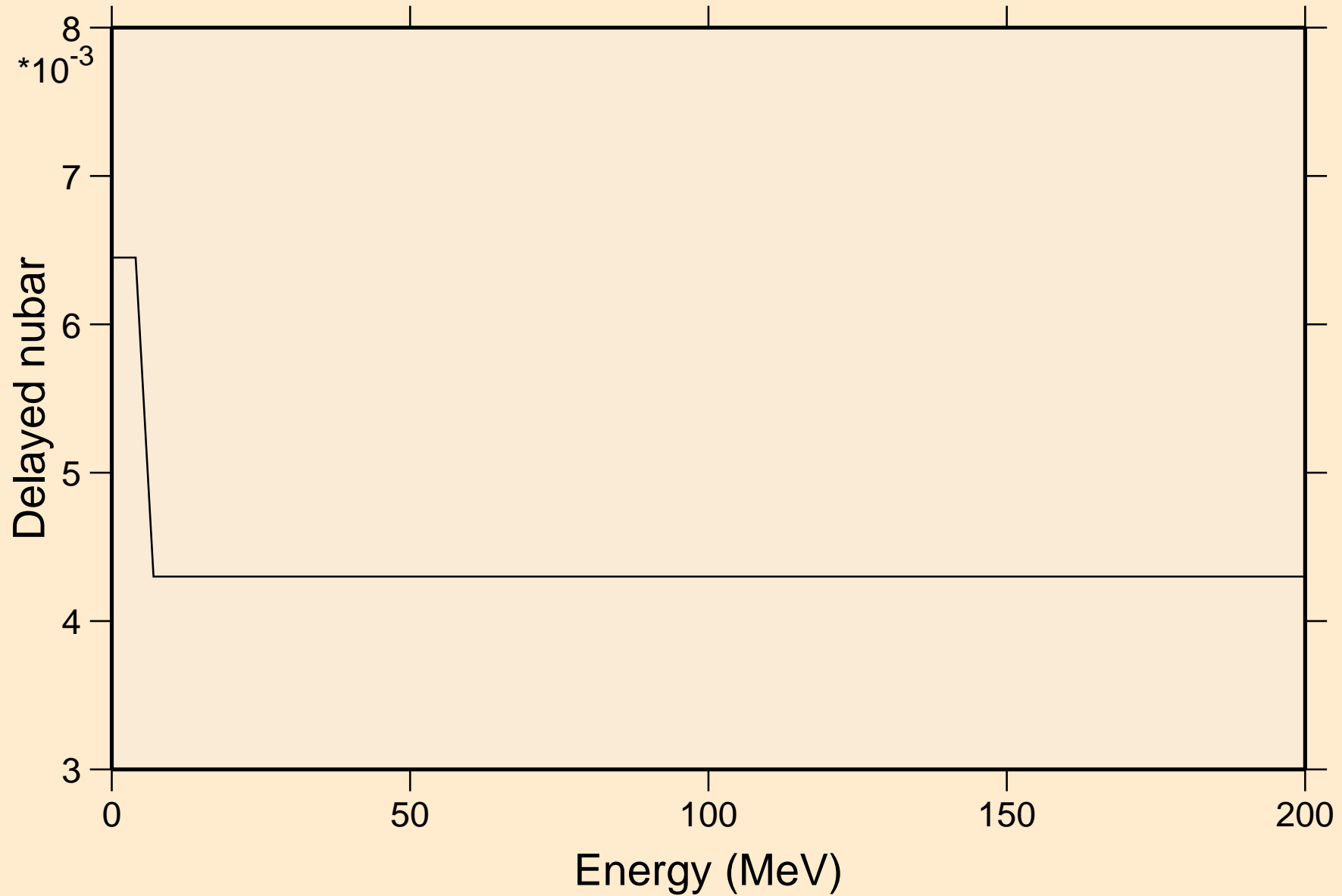

PU229 NEUTRON ACER TENDL-2021 LIBRARY; T=293.6K
Delayed neutron spectra

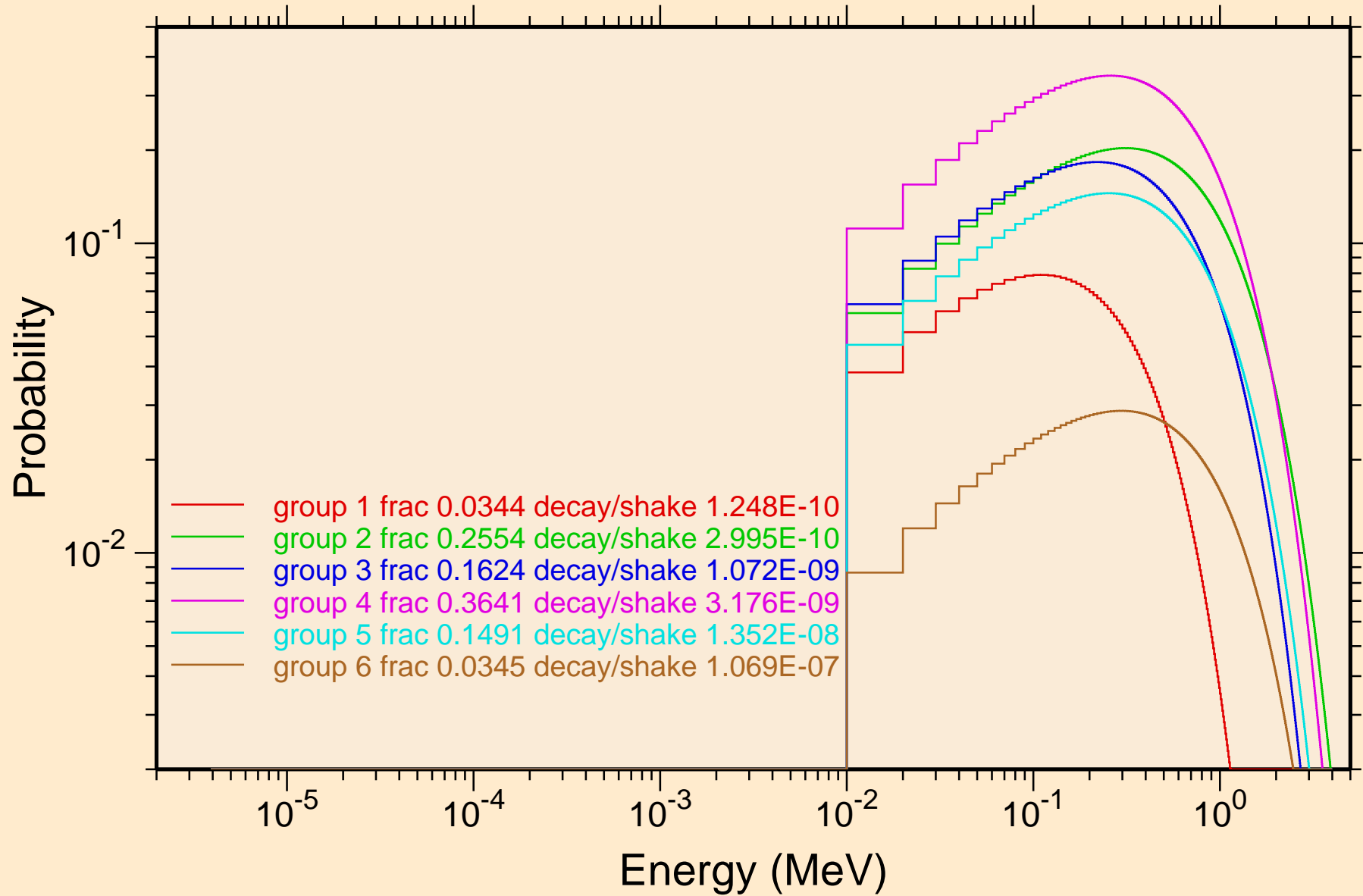

PU229 NEUTRON ACER TENDL-2021 LIBRARY; T=293.6K
Photon emission for (n,x)

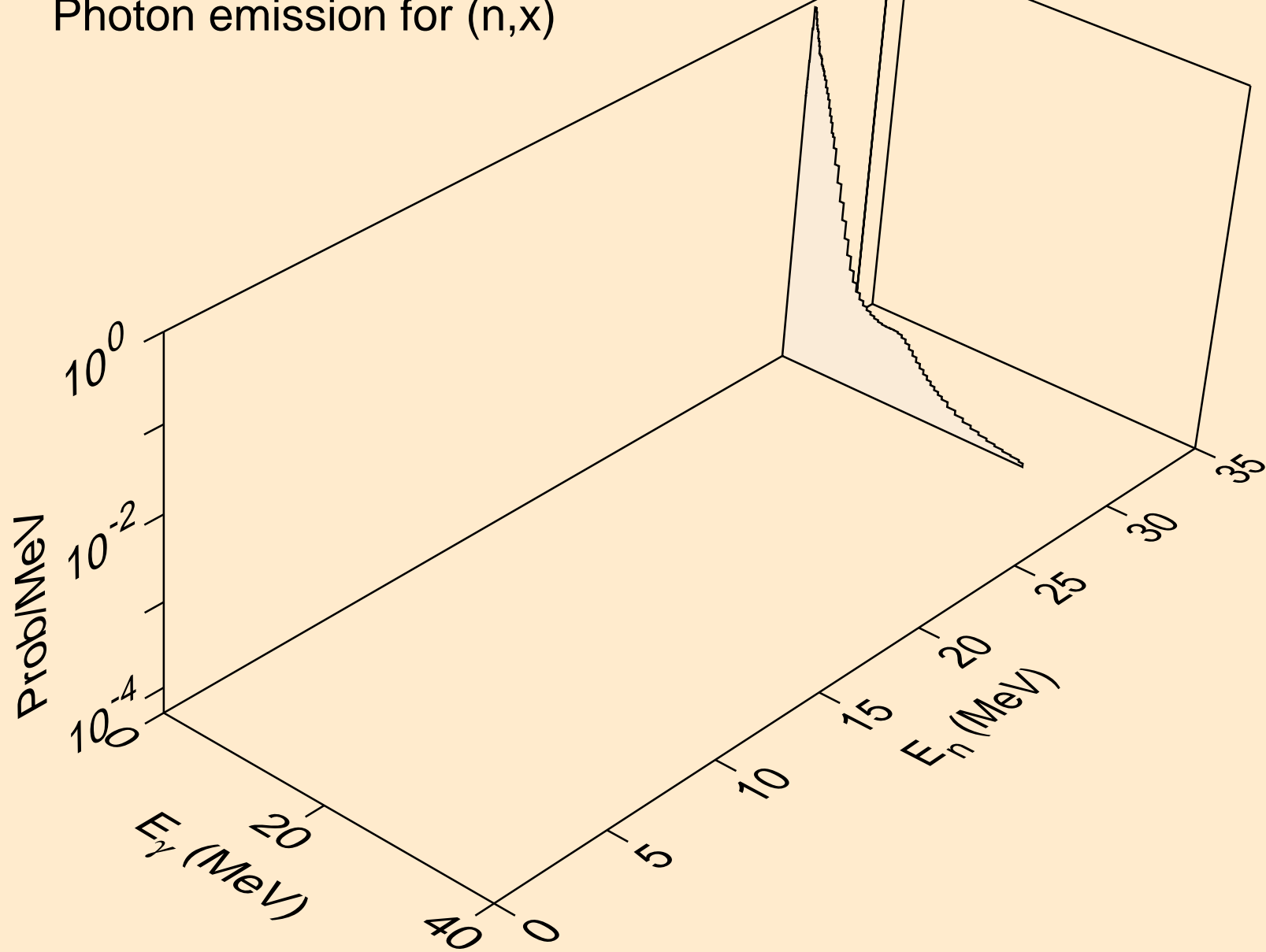

PU229 NEUTRON ACER TENDL-2021 LIBRARY; T=293.6K
Photon emission for (n,2nd)

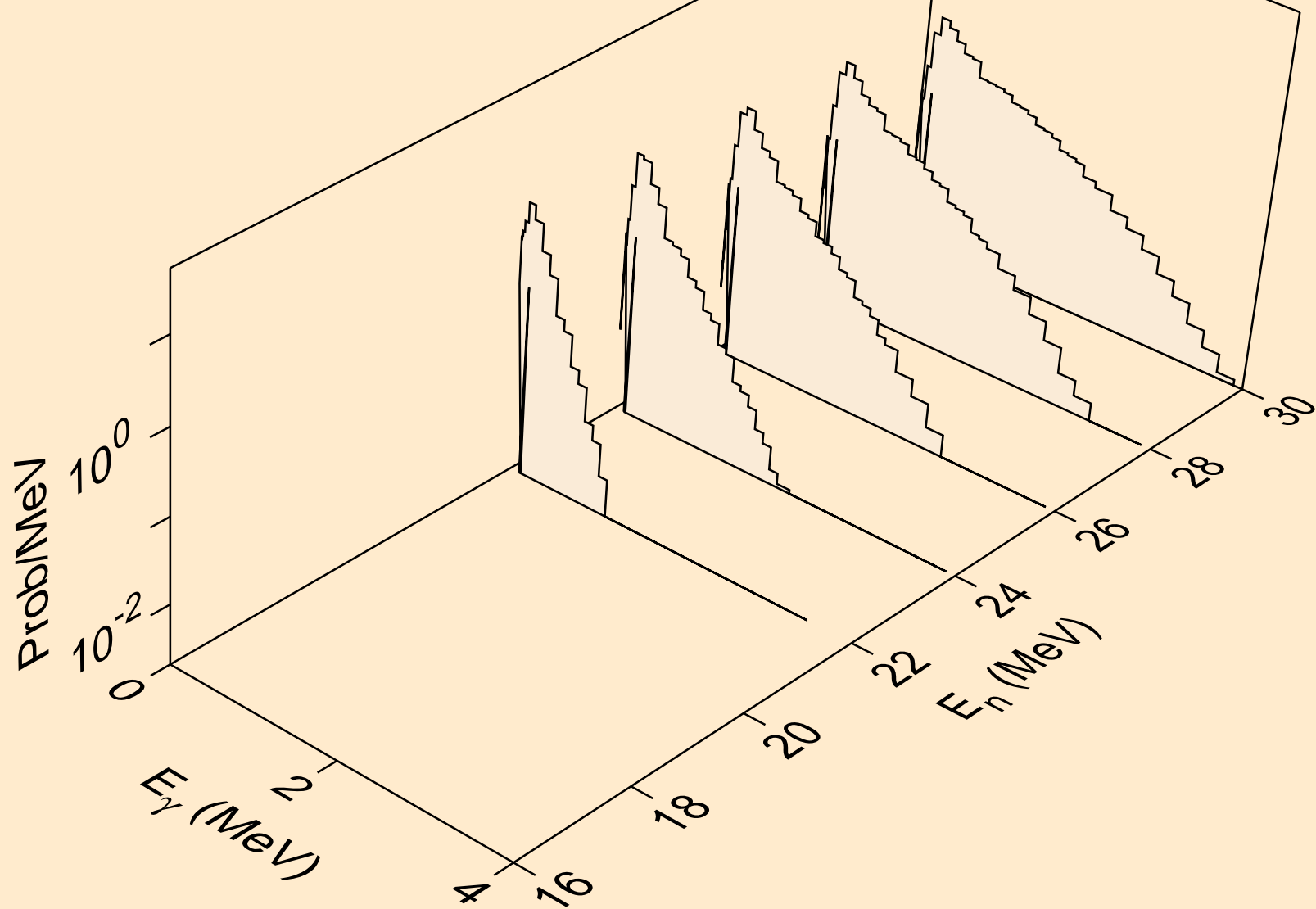

PU229 NEUTRON ACER TENDL-2021 LIBRARY; T=293.6K
Photon emission for (n,2n)

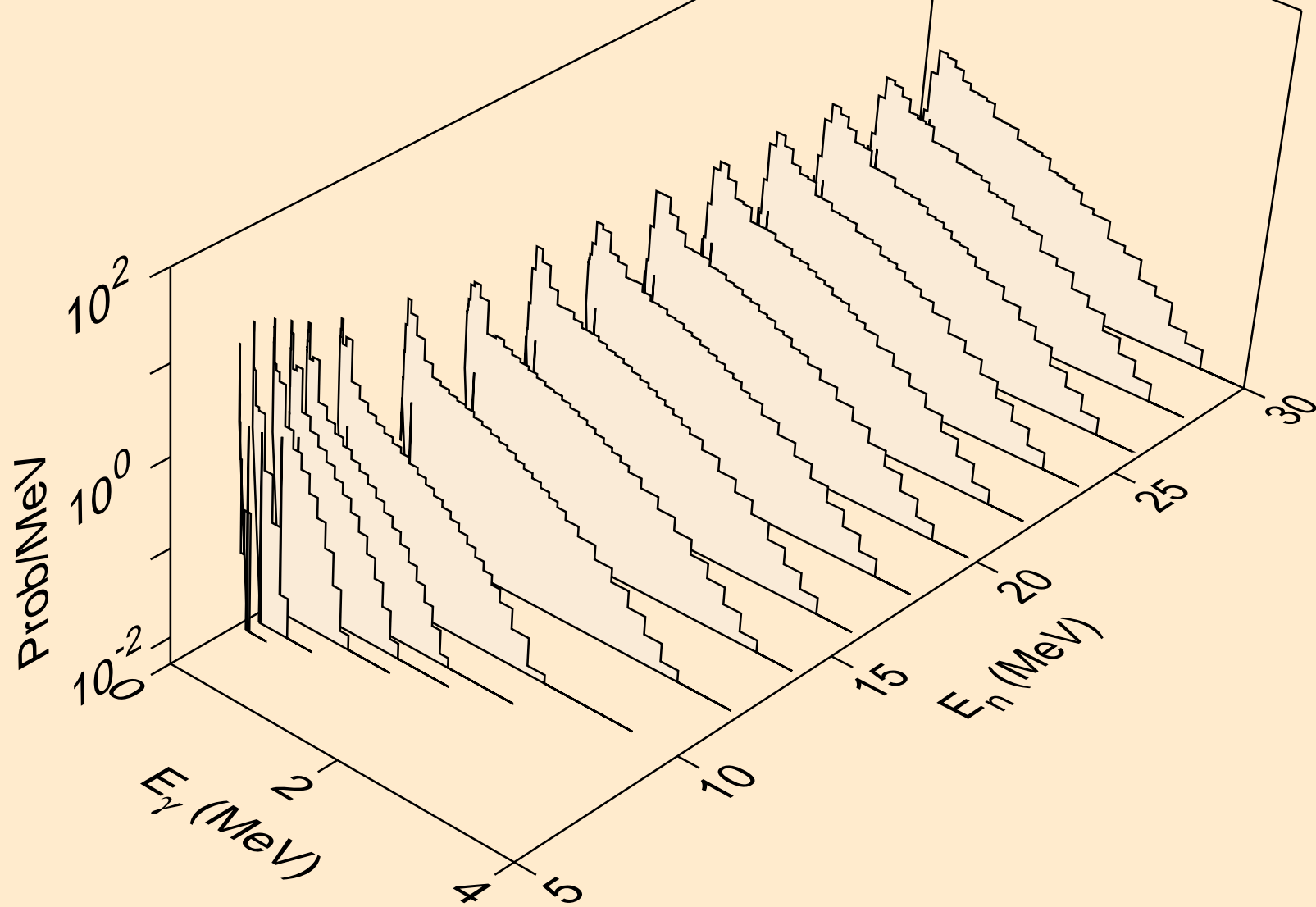

PU229 NEUTRON ACER TENDL-2021 LIBRARY; T=293.6K
Photon emission for (n,3n)

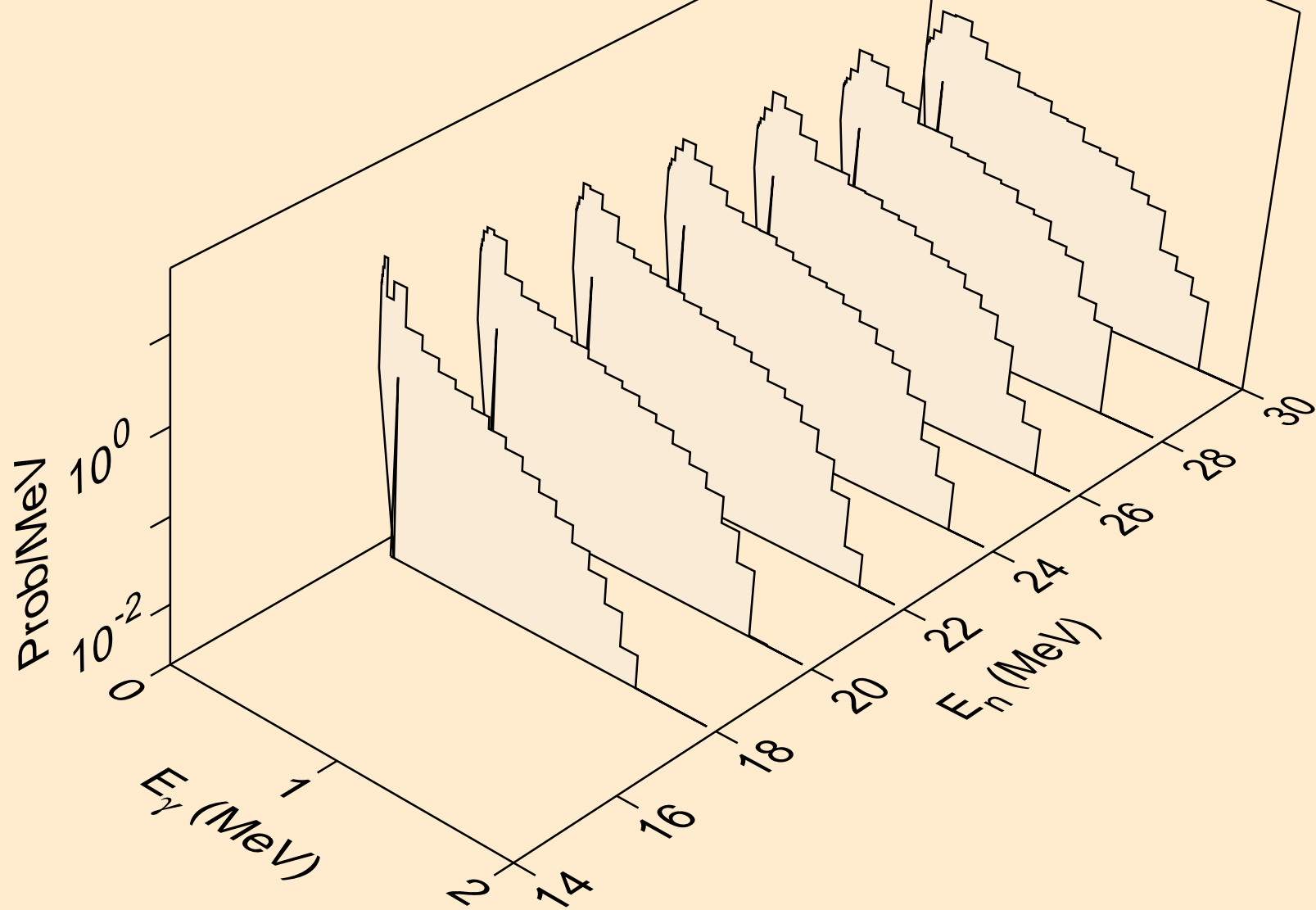

PU229 NEUTRON ACER TENDL-2021 LIBRARY; T=293.6K
Photon emission for (n,n*)a

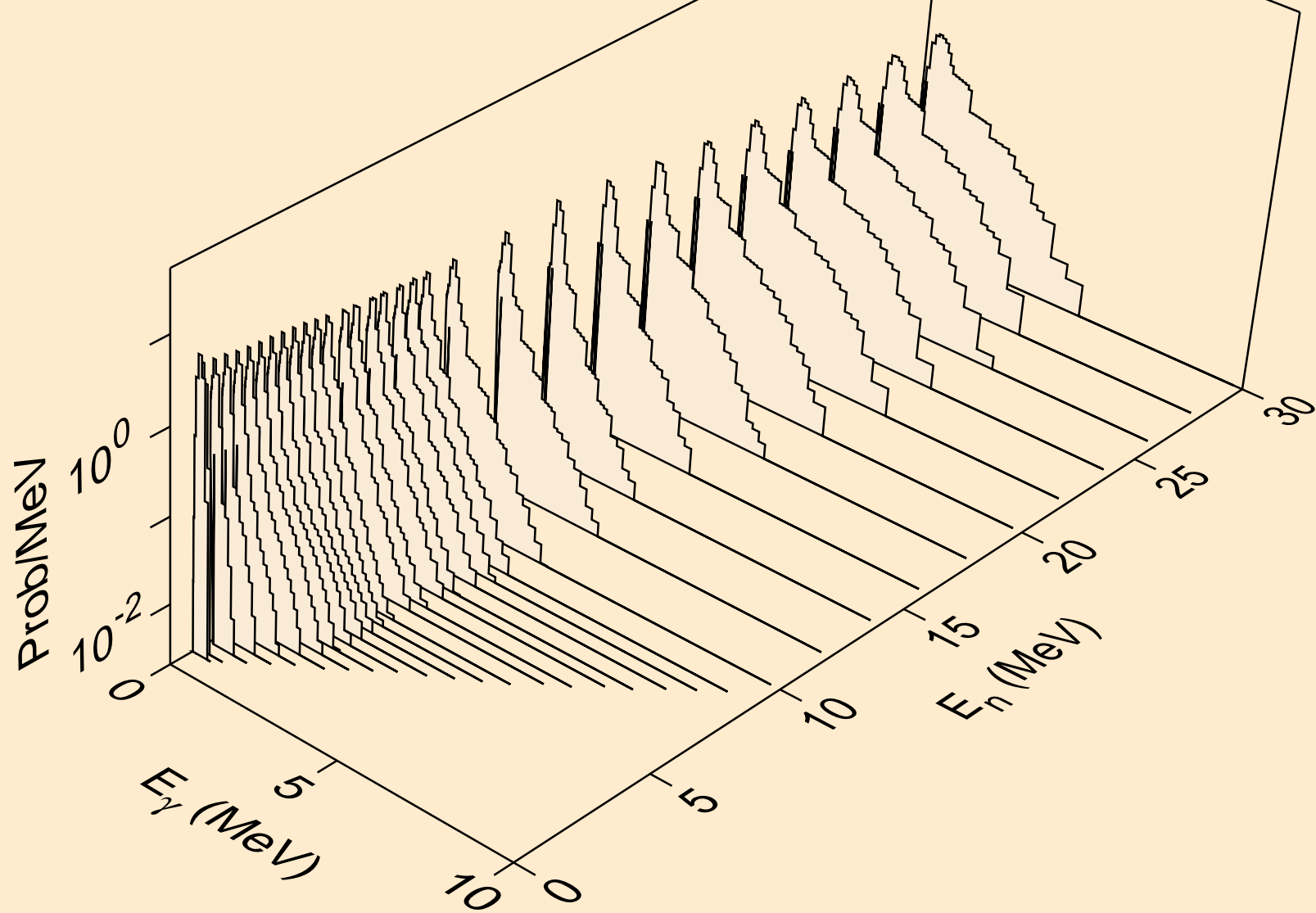

PU229 NEUTRON ACER TENDL-2021 LIBRARY; T=293.6K
Photon emission for (n,n*)3a

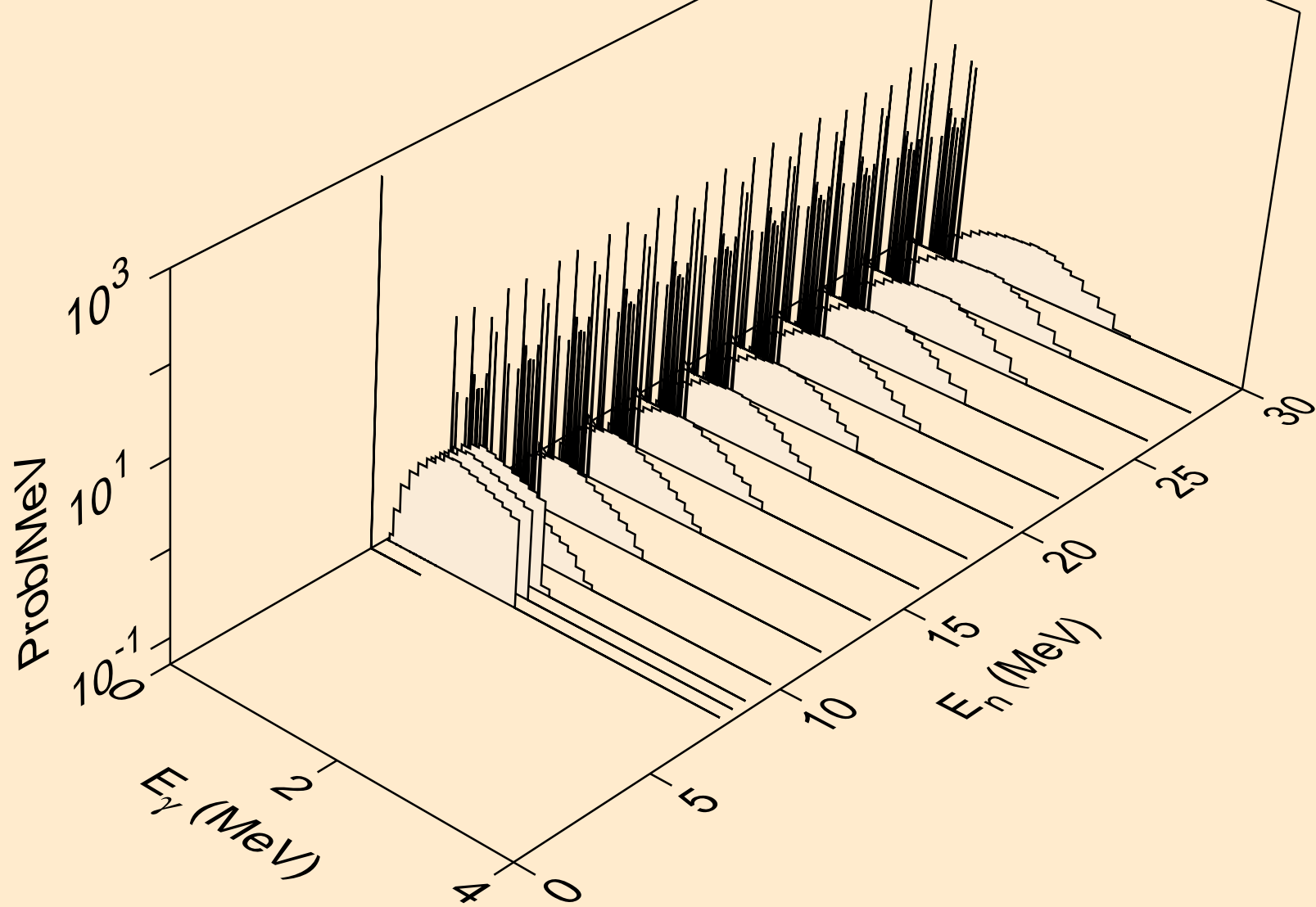

PU229 NEUTRON ACER TENDL-2021 LIBRARY; T=293.6K
Photon emission for (n,2n) α

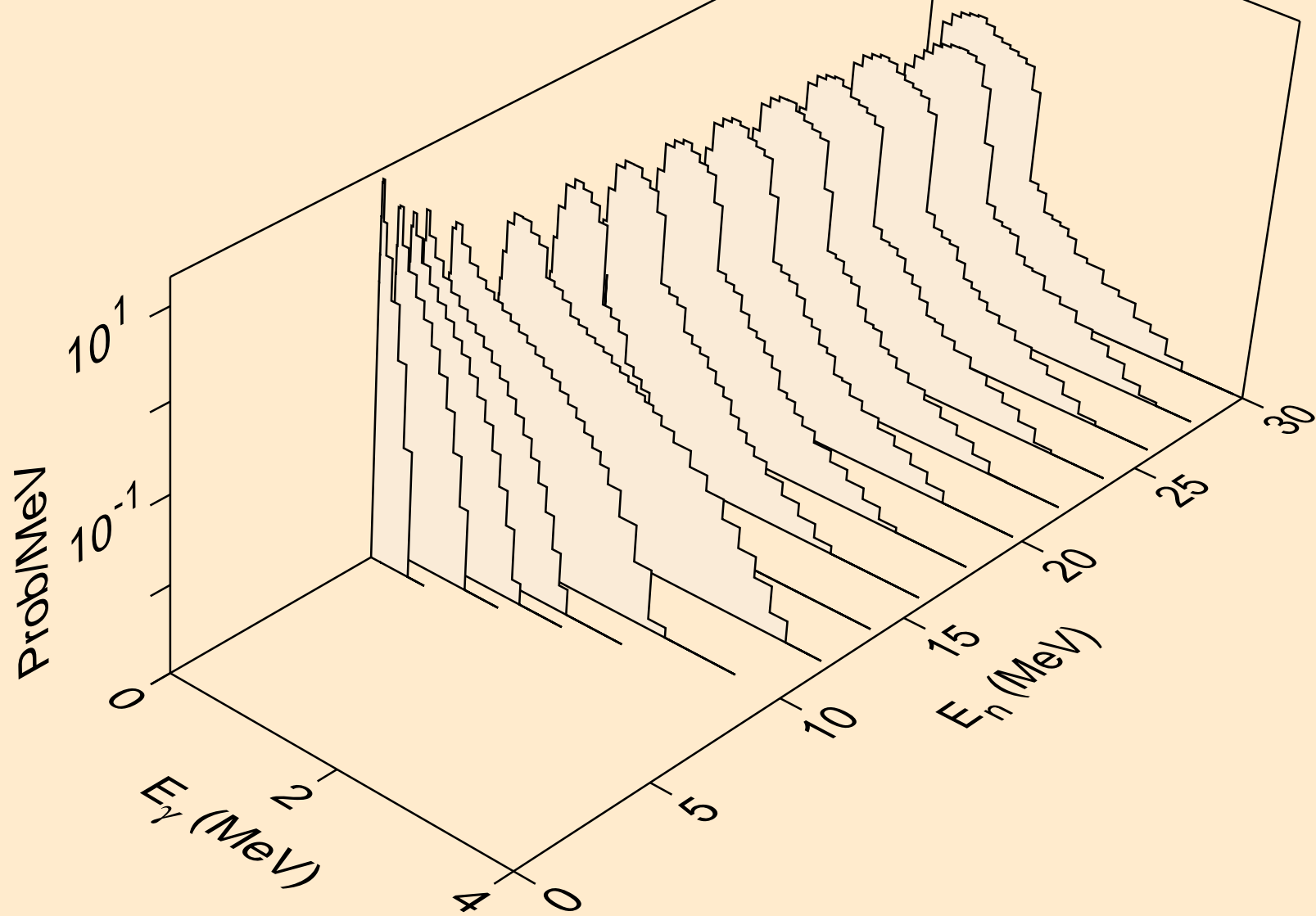

PU229 NEUTRON ACER TENDL-2021 LIBRARY; T=293.6K
Photon emission for (n,3n)a

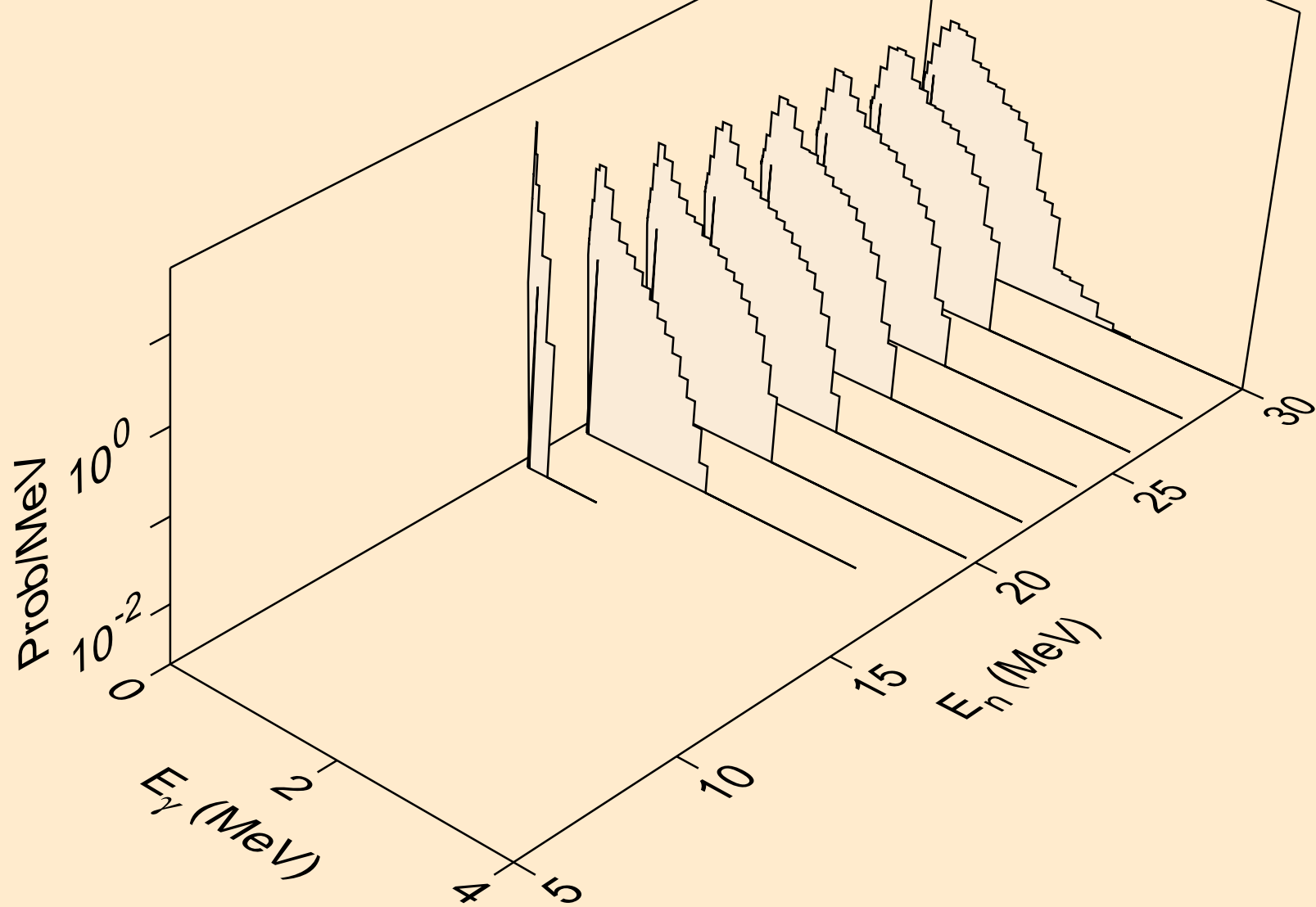

PU229 NEUTRON ACER TENDL-2021 LIBRARY; T=293.6K
Photon emission for (n,n*)p

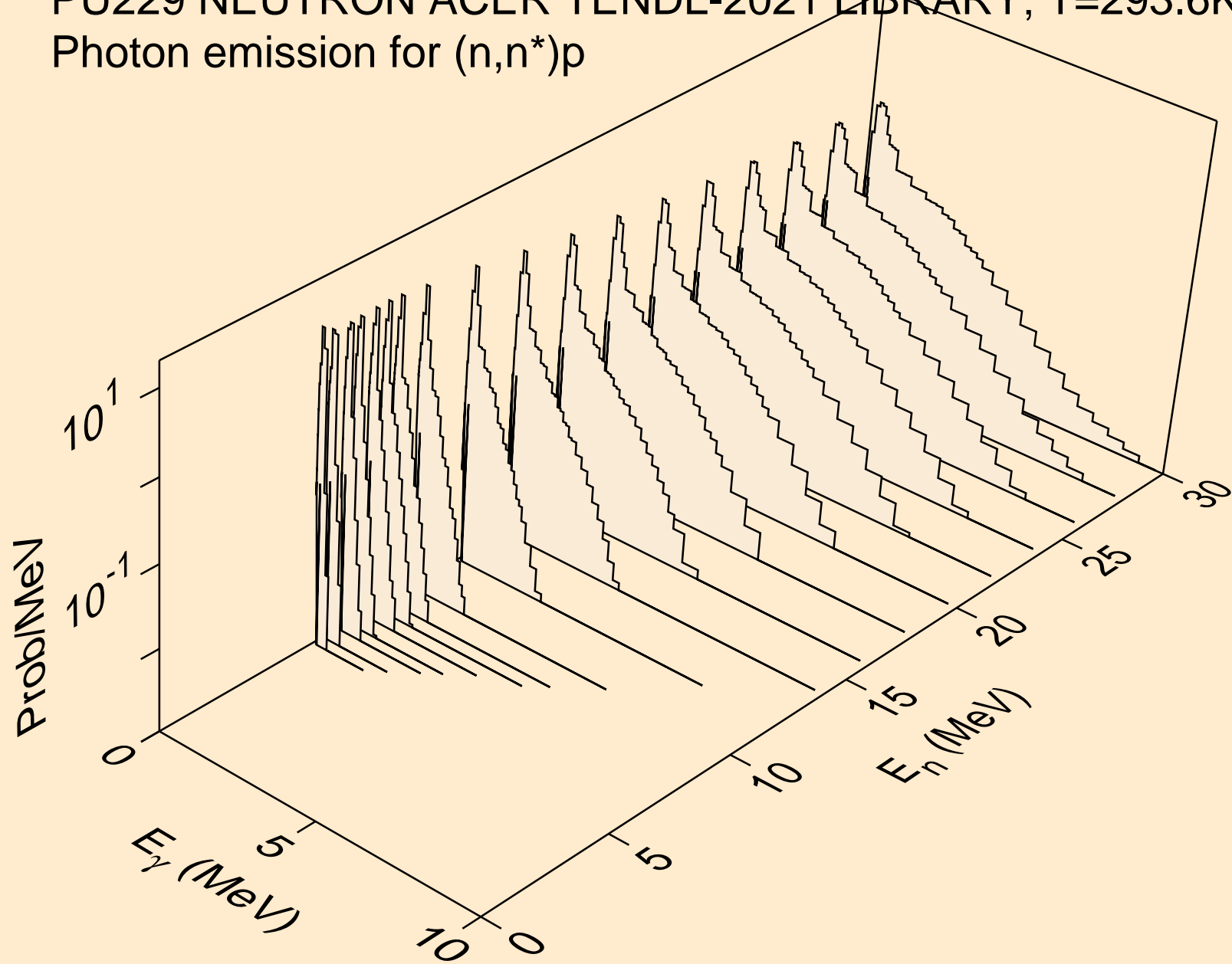

PU229 NEUTRON ACER TENDL-2021 LIBRARY; T=293.6K
Photon emission for (n,n*)2a

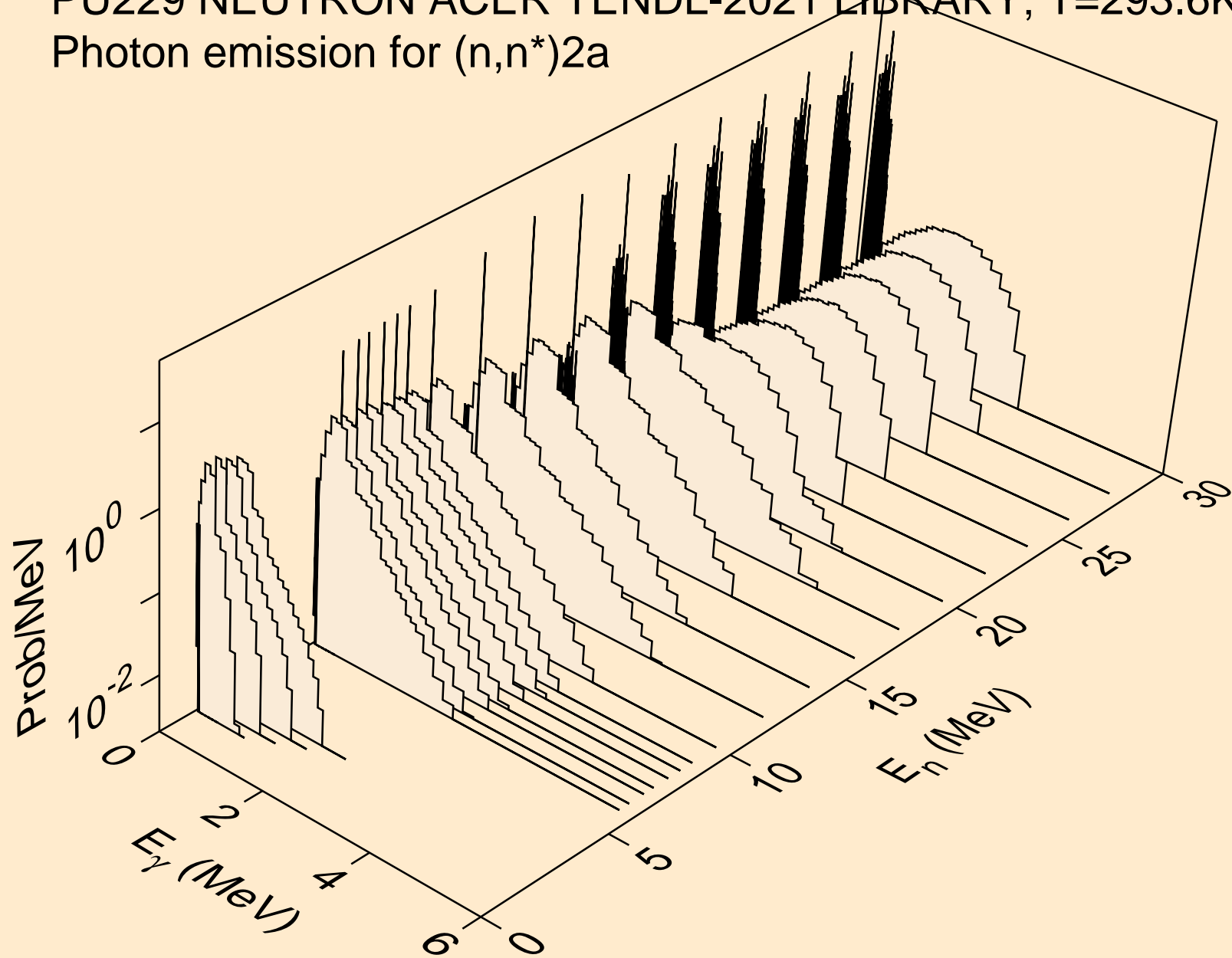

PU229 NEUTRON ACER TENDL-2021 LIBRARY; T=293.6K
Photon emission for (n,2n)2a

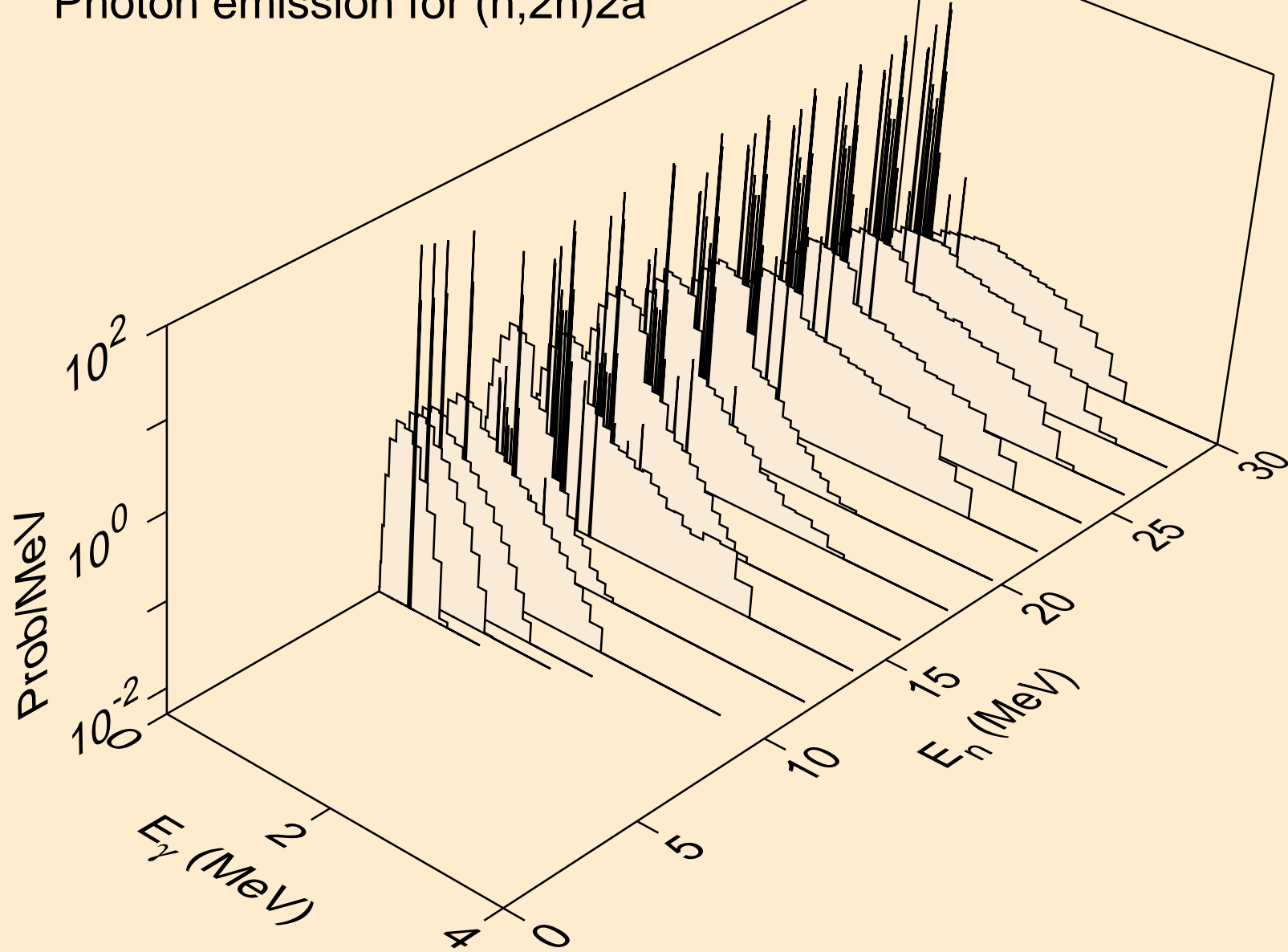

PU229 NEUTRON ACER TENDL-2021 LIBRARY; T=293.6K
Photon emission for (n,n*)d

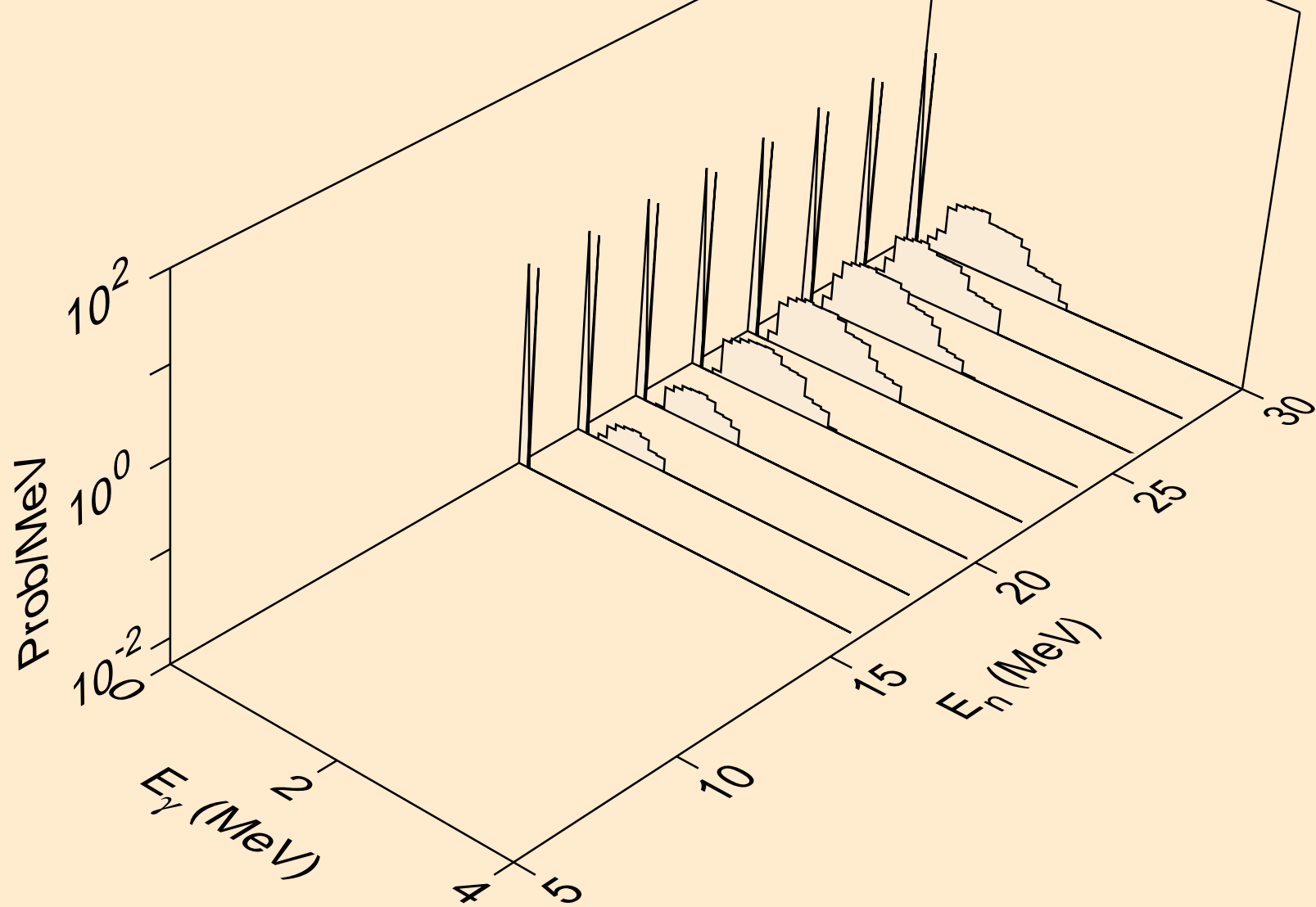

PU229 NEUTRON ACER TENDL-2021 LIBRARY; T=293.6K
Photon emission for (n,n*)t

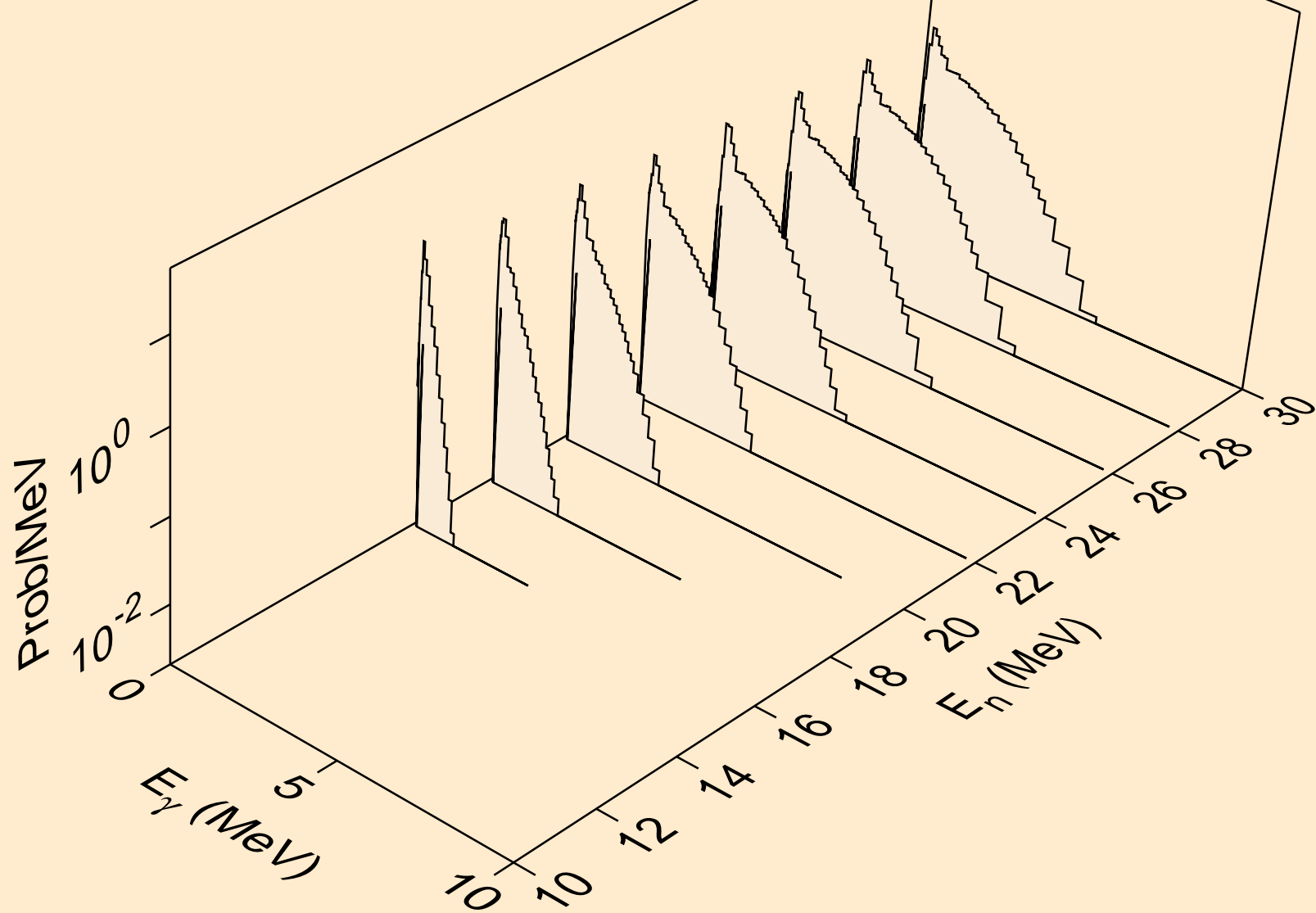

PU229 NEUTRON ACER TENDL-2021 LIBRARY; T=293.6K
Photon emission for (n,n*)he3

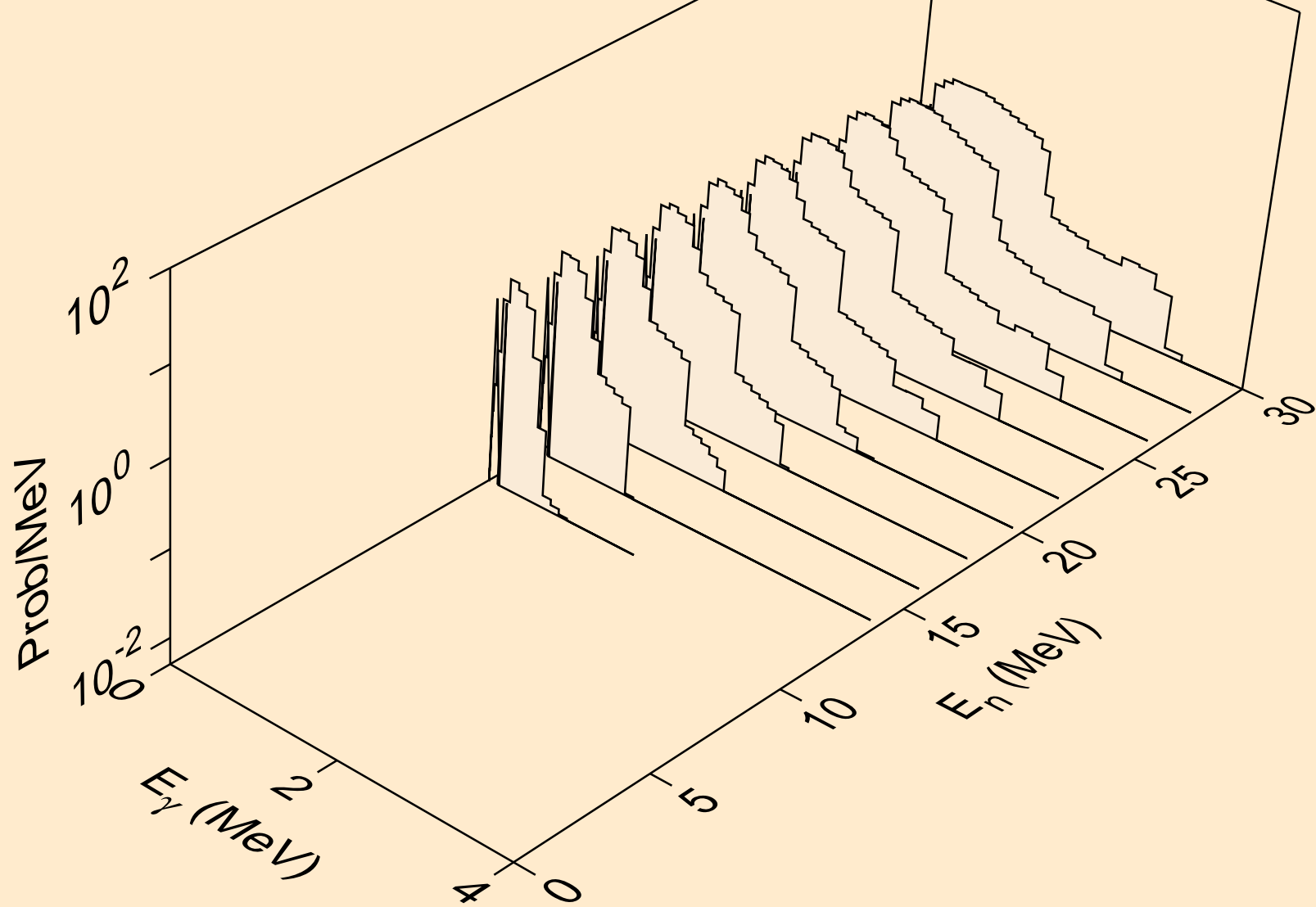

PU229 NEUTRON ACER TENDL-2021 LIBRARY; T=293.6K
Photon emission for (n,n*)t2a

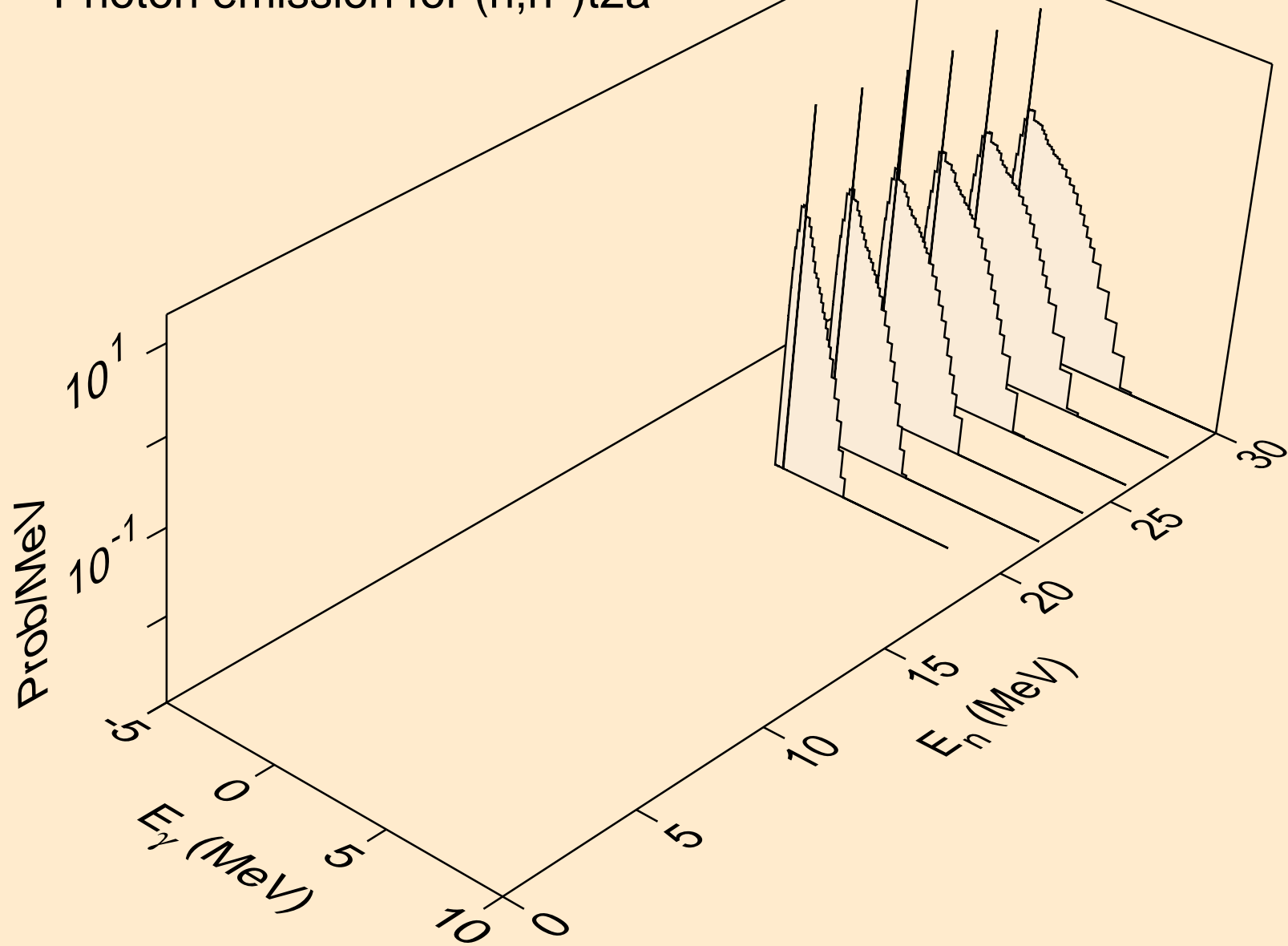

PU229 NEUTRON ACER TENDL-2021 LIBRARY; T=293.6K
Photon emission for (n,4n)

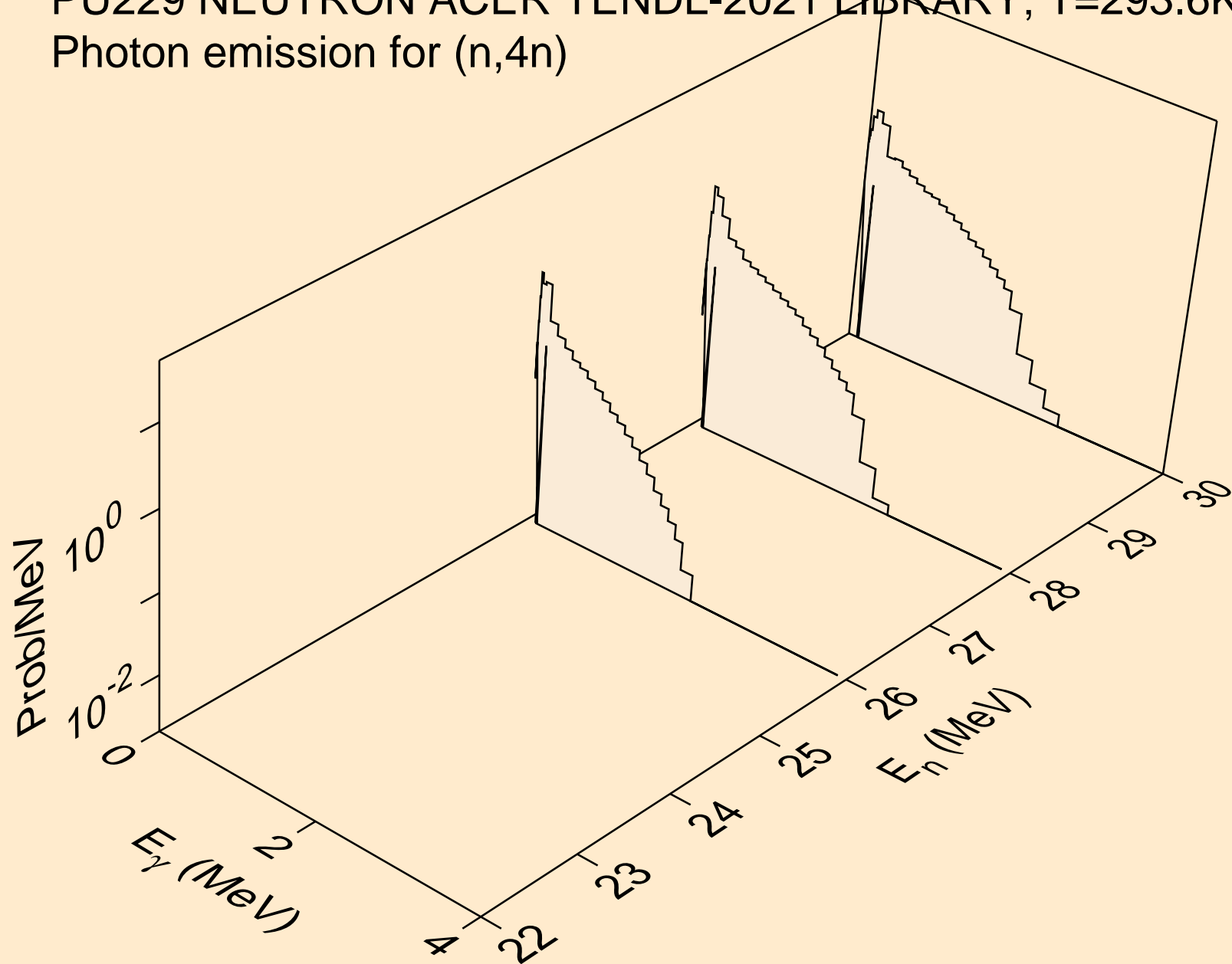

PU229 NEUTRON ACER TENDL-2021 LIBRARY; T=293.6K
Photon emission for (n,2np)

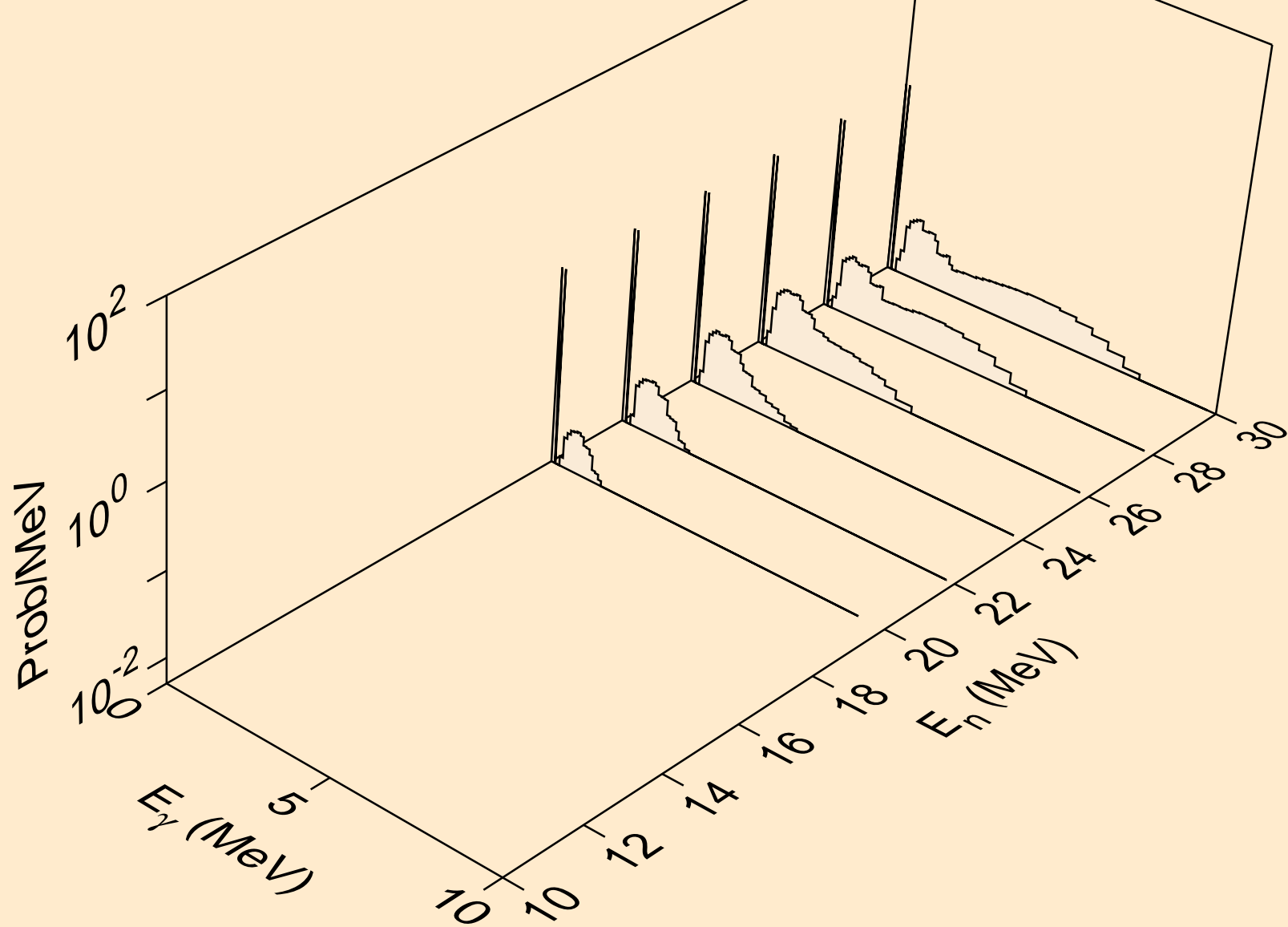

PU229 NEUTRON ACER TENDL-2021 LIBRARY; T=293.6K
Photon emission for (n,3np)

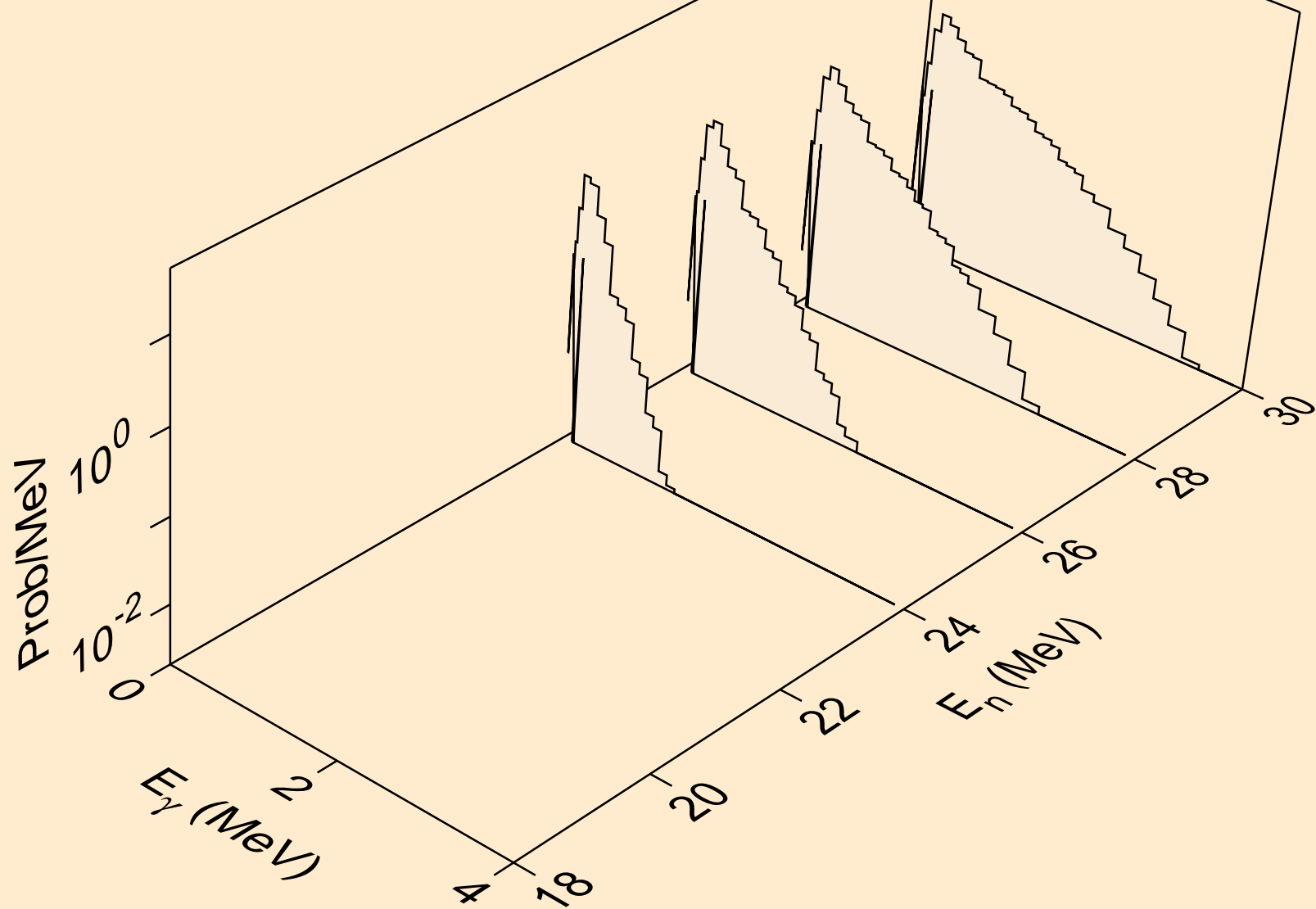

PU229 NEUTRON ACER TENDL-2021 LIBRARY; T=293.6K
Photon emission for (n,2np)

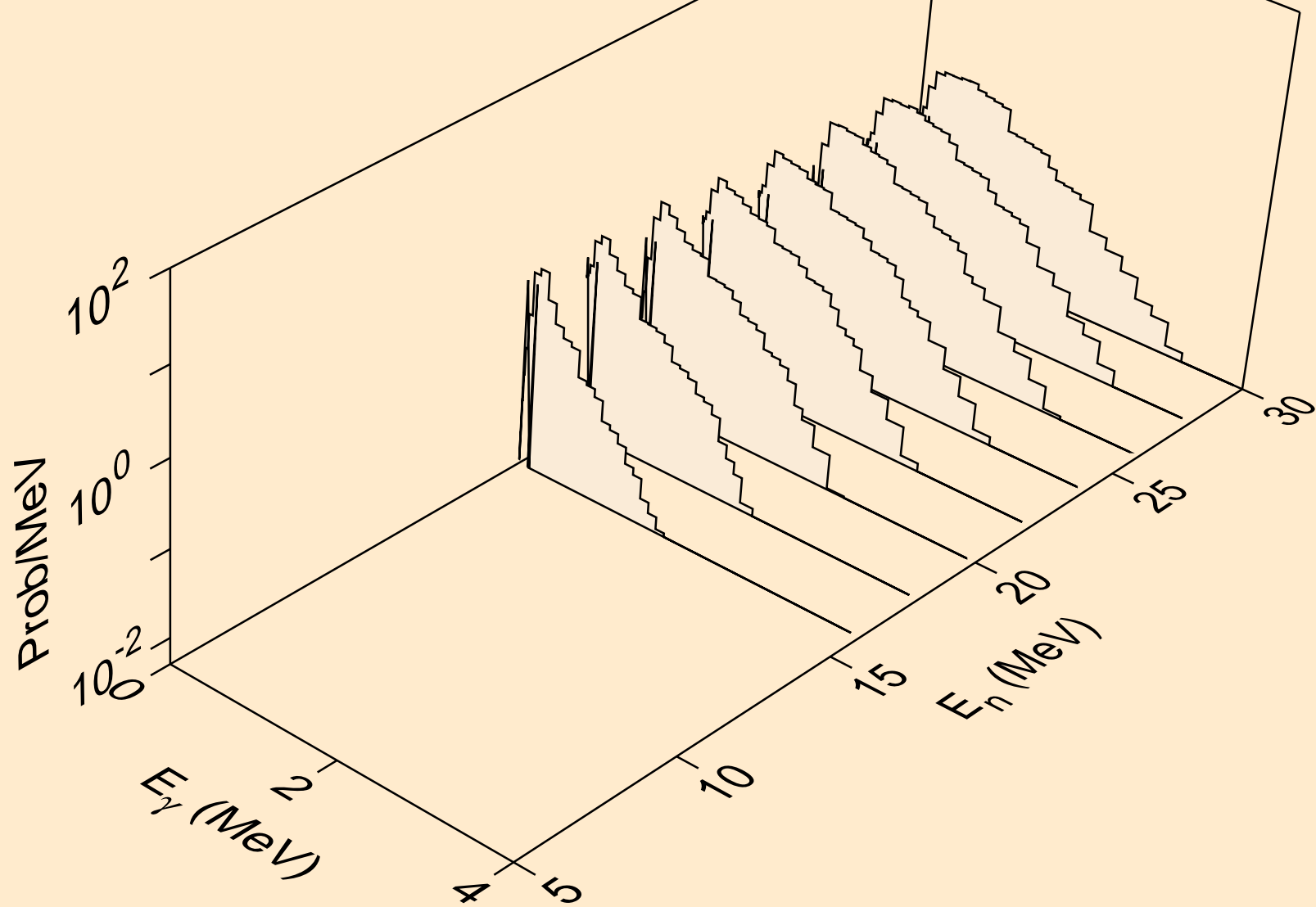

PU229 NEUTRON ACER TENDL-2021 LIBRARY; T=293.6K
Photon emission for (n,npa)

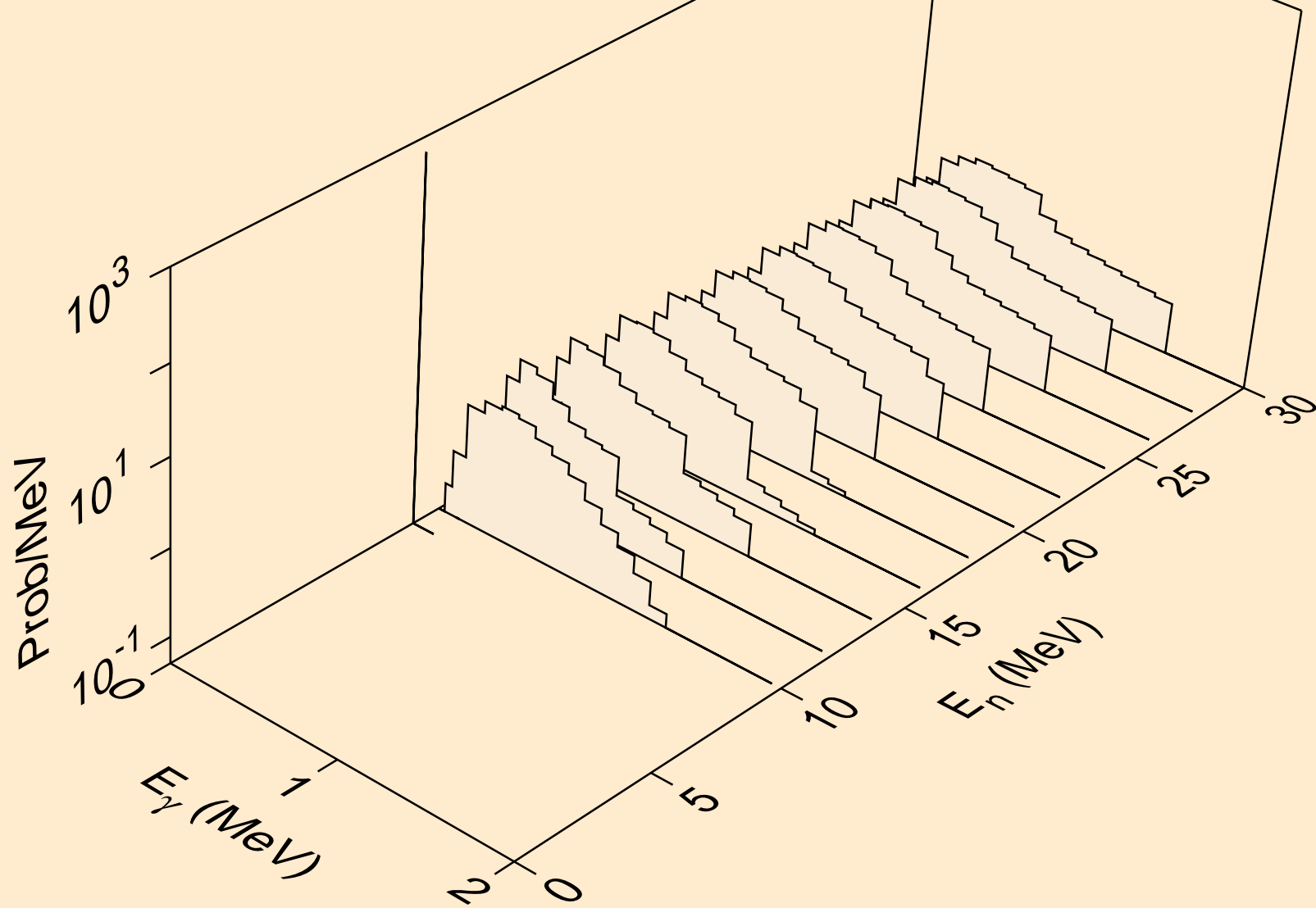

PU229 NEUTRON ACER TENDL-2021 LIBRARY; T=293.6K
Photon emission for (n,n*c)

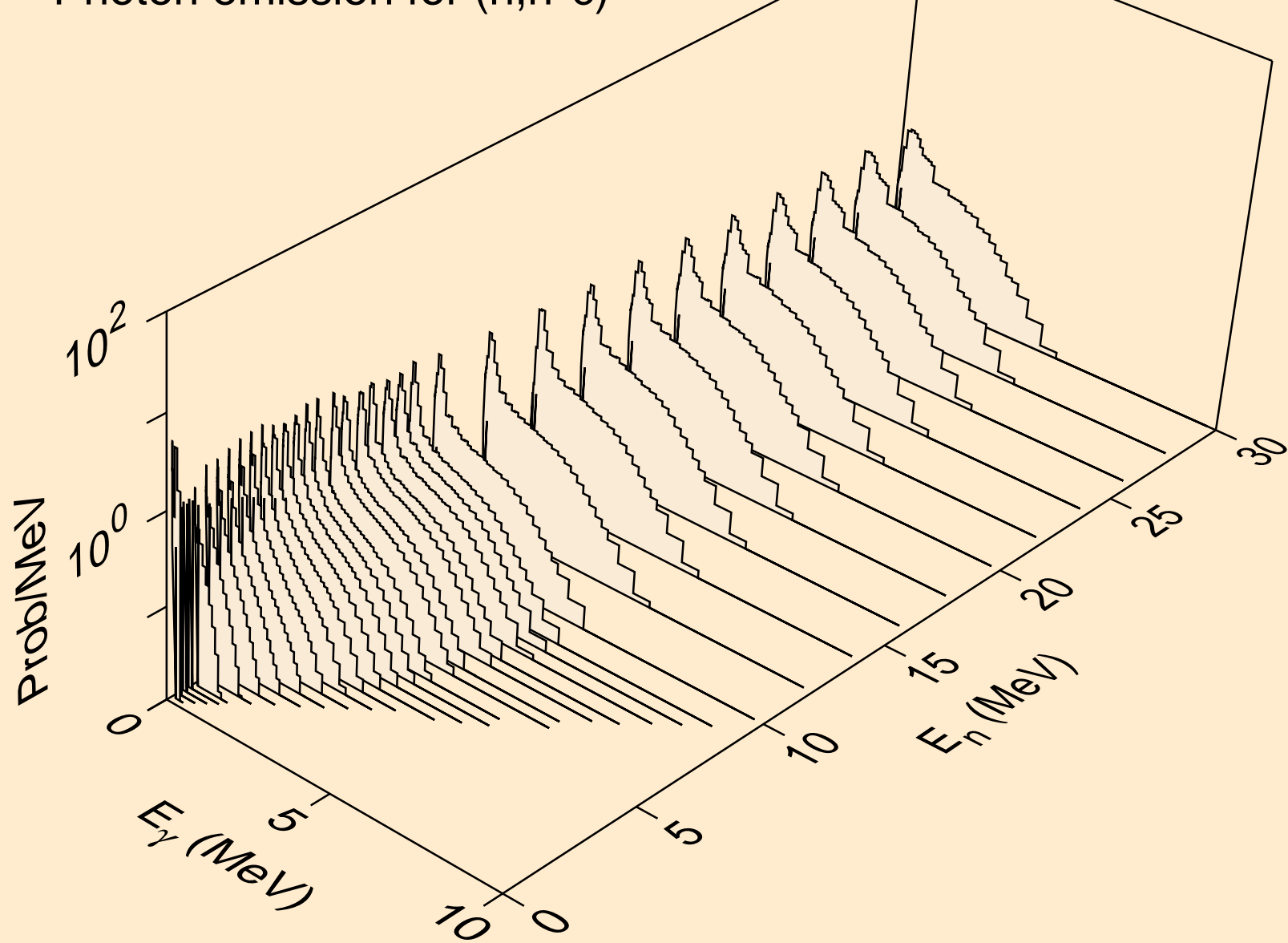

PU229 NEUTRON ACER TENDL-2021 LIBRARY; T=293.6K
Photon emission for (n,gma)

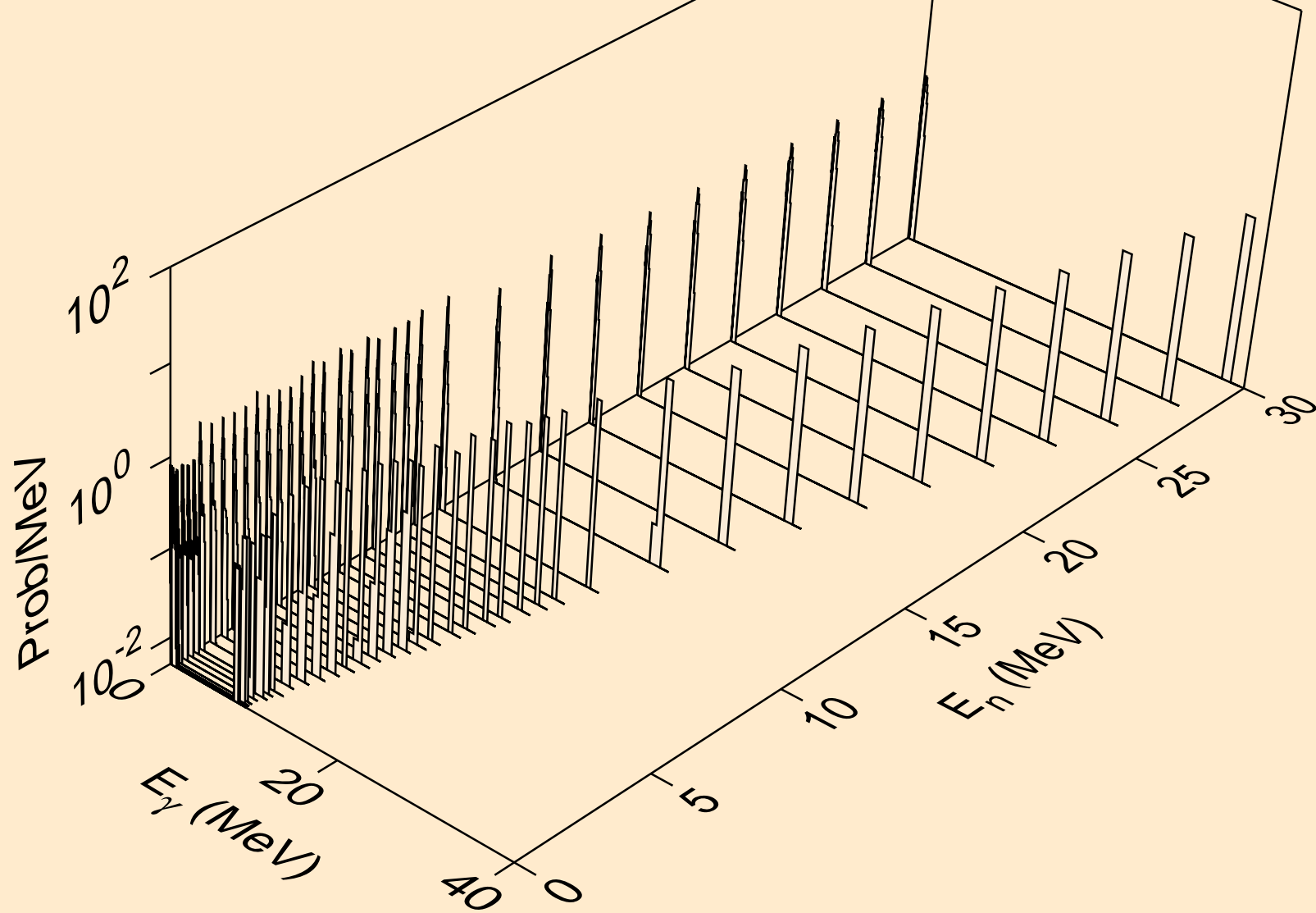

PU229 NEUTRON ACER TENDL-2021 LIBRARY; T=293.6K
Photon emission for (n,p)

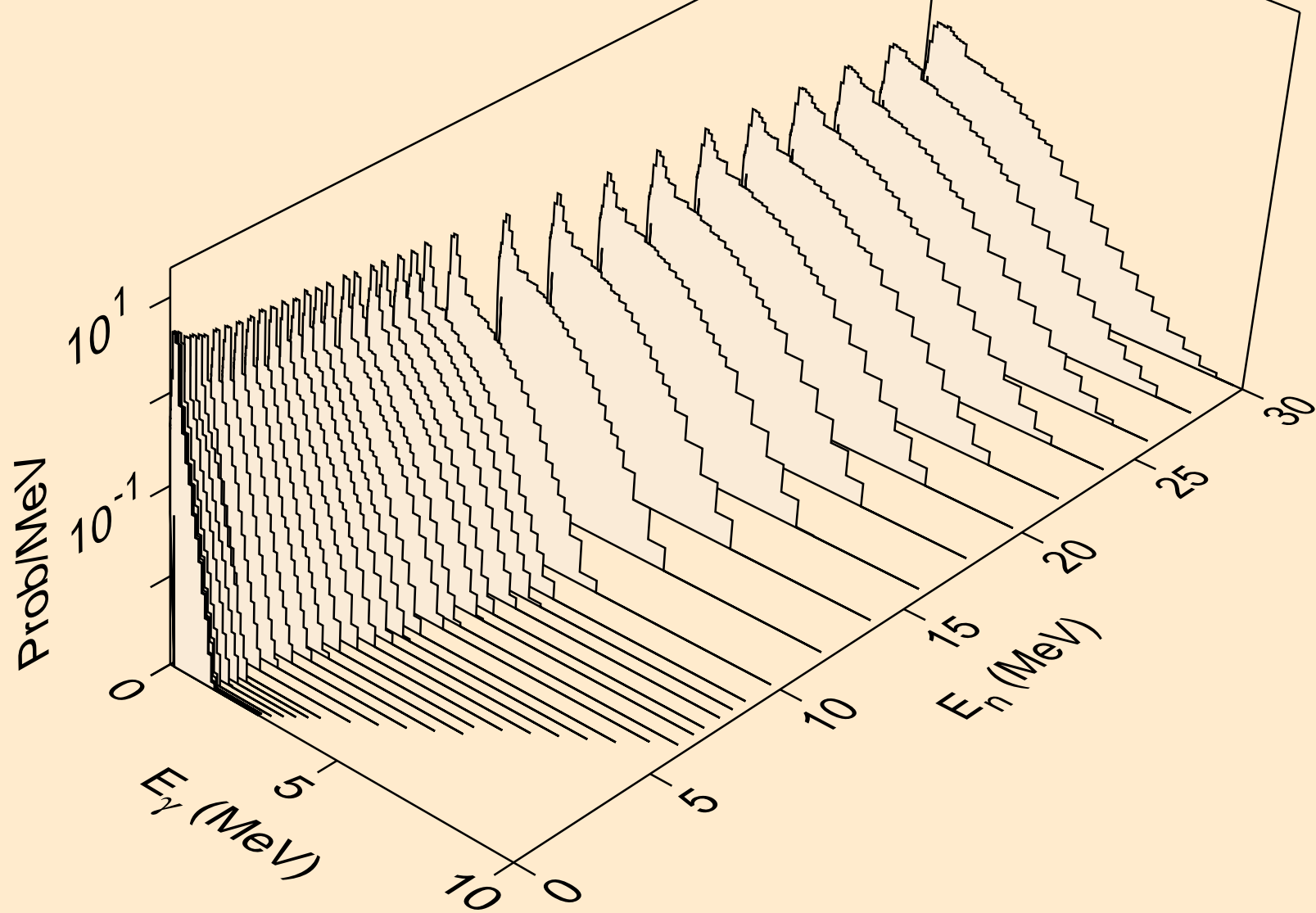

PU229 NEUTRON ACER TENDL-2021 LIBRARY; T=293.6K
Photon emission for (n,d)

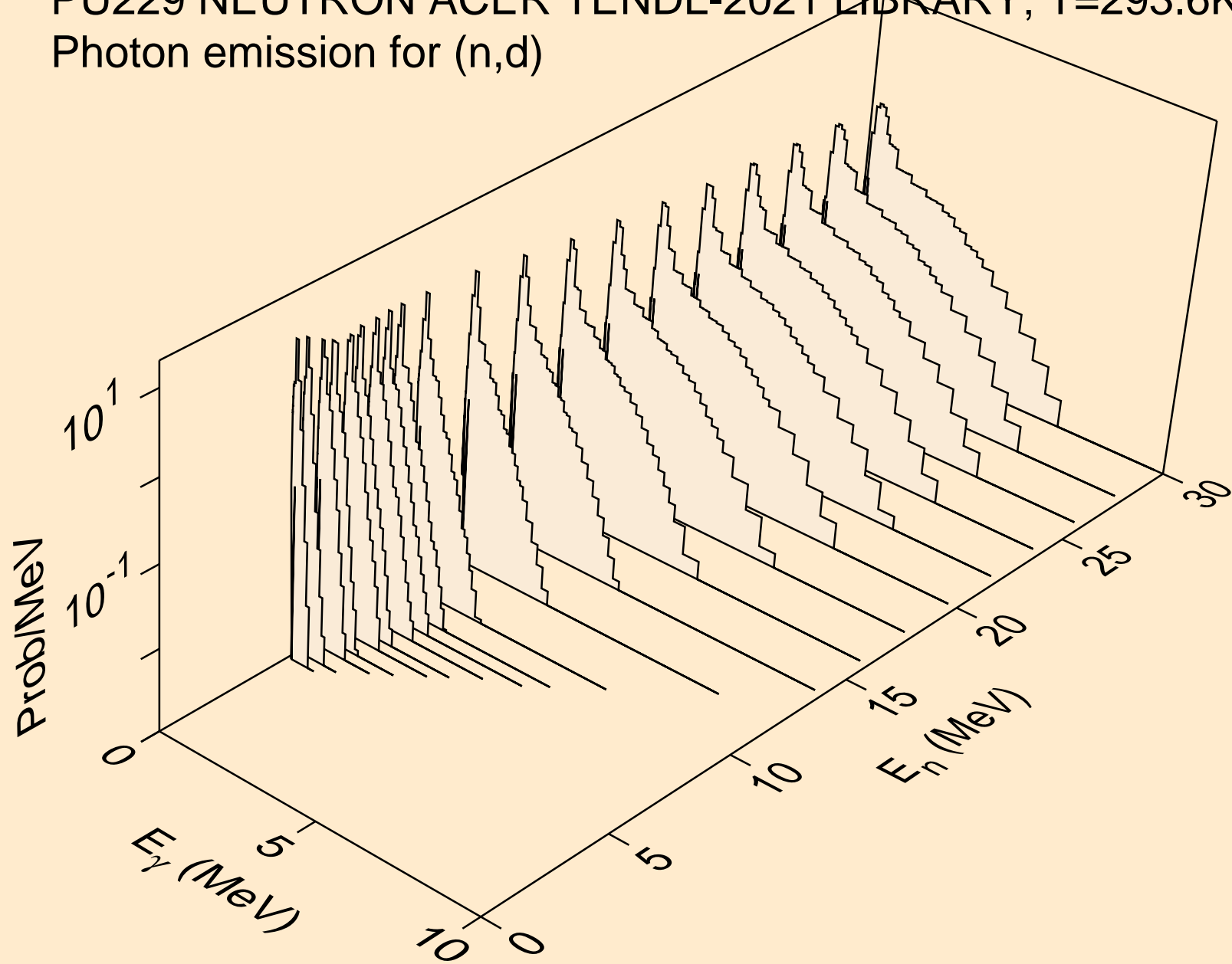

PU229 NEUTRON ACER TENDL-2021 LIBRARY; T=293.6K
Photon emission for (n,t)

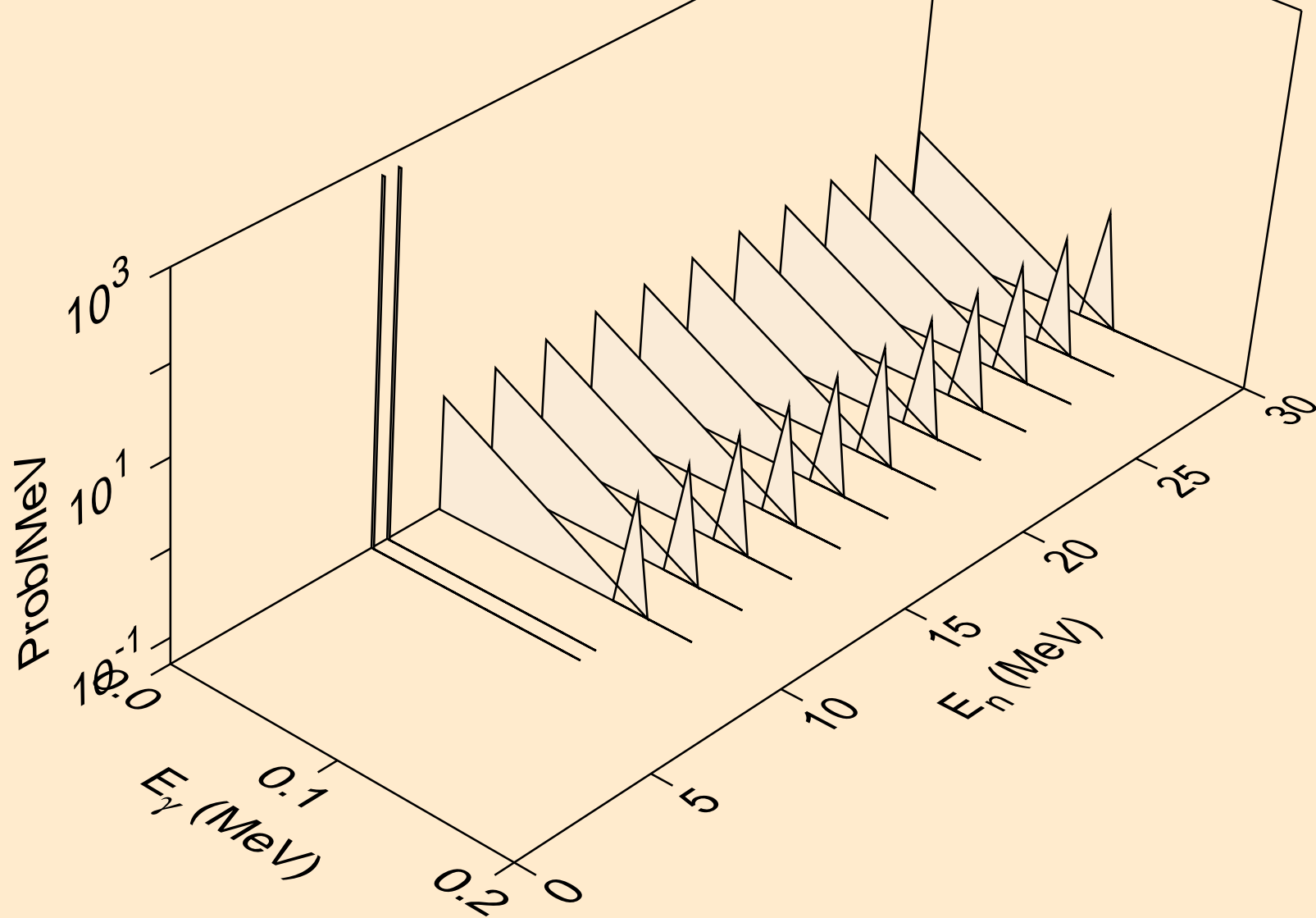

PU229 NEUTRON ACER TENDL-2021 LIBRARY; T=293.6K
Photon emission for (n,he3)

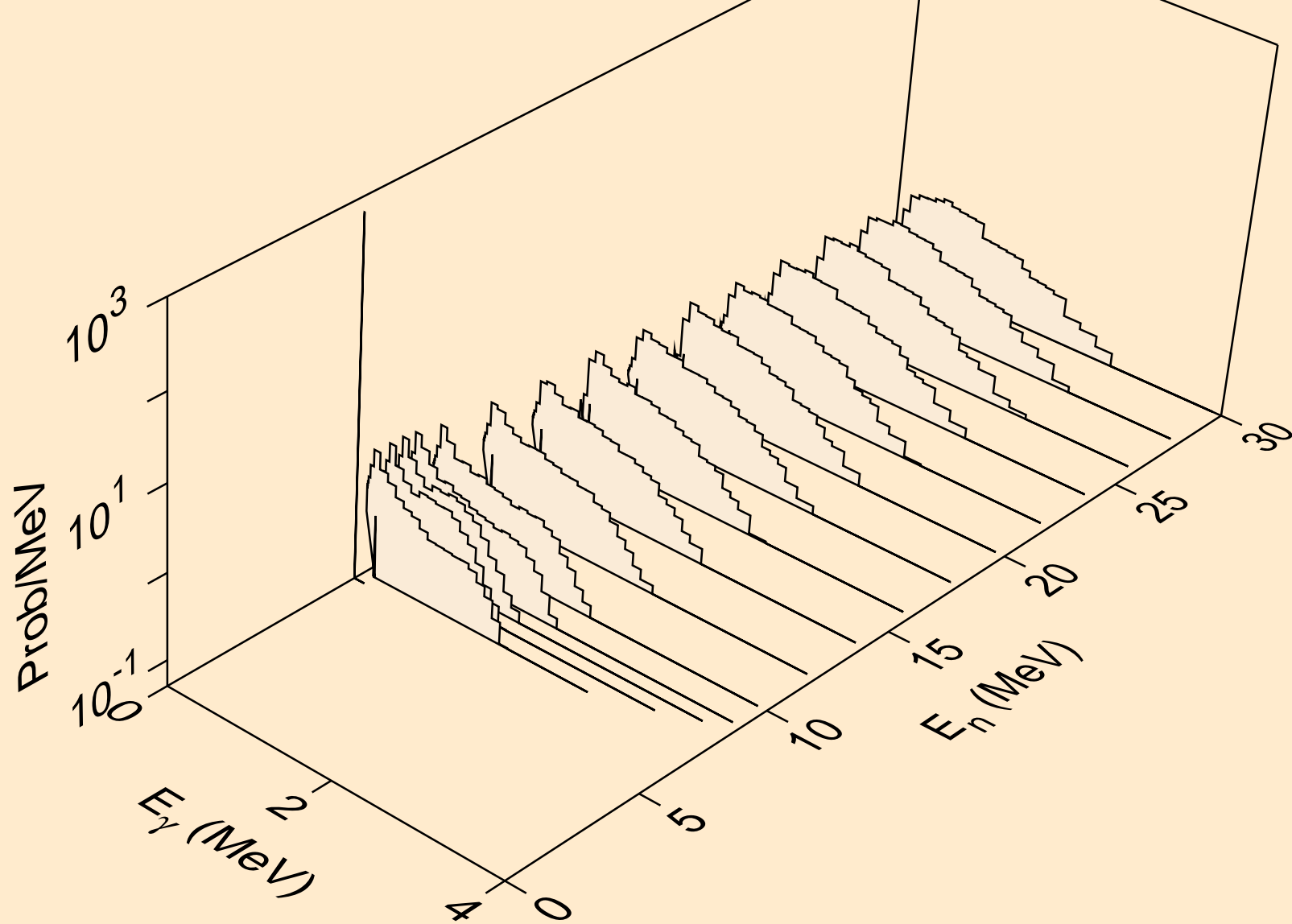

PU229 NEUTRON ACER TENDL-2021 LIBRARY; T=293.6K
Photon emission for (n,a)

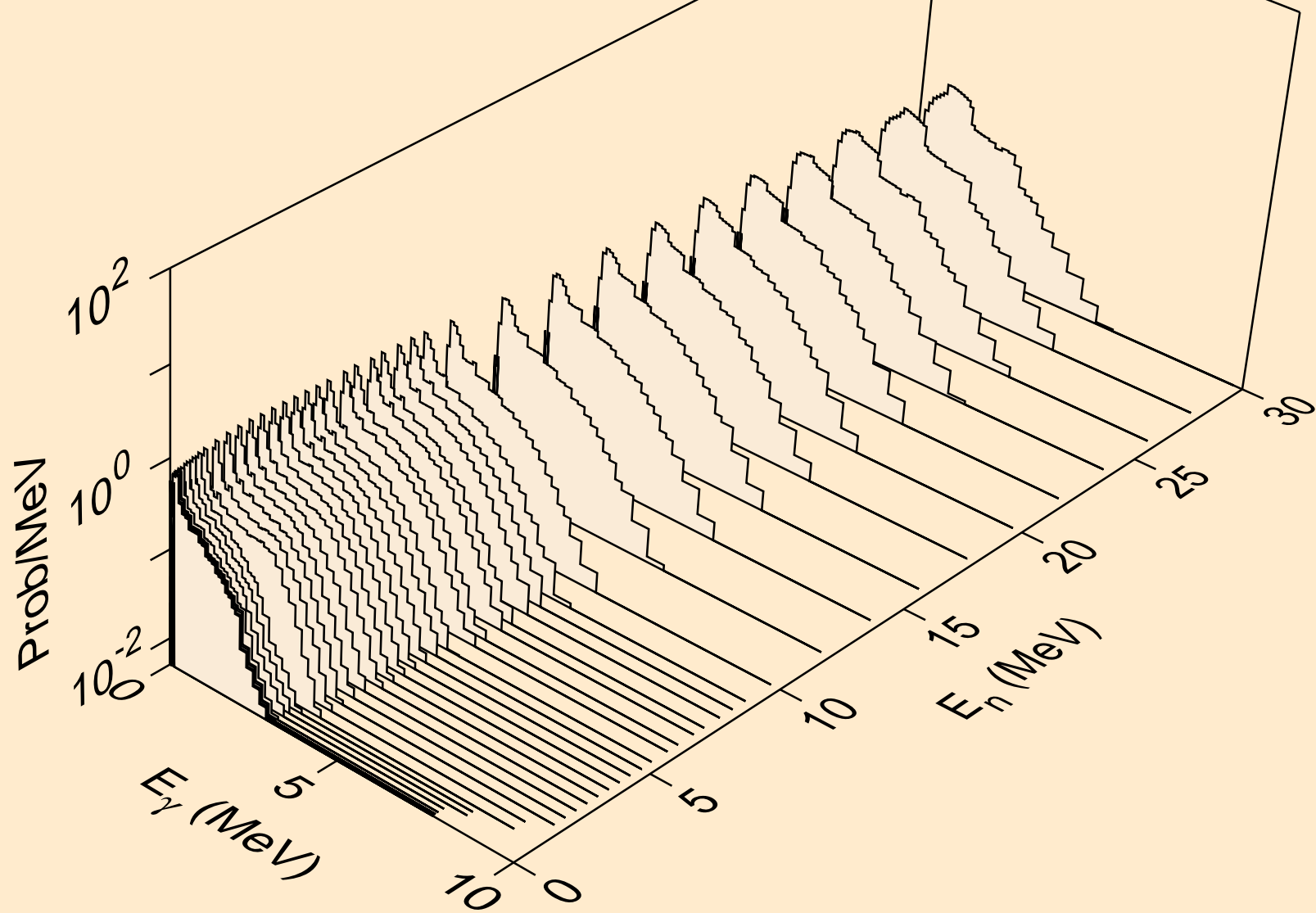

PU229 NEUTRON ACER TENDL-2021 LIBRARY; T=293.6K
Photon emission for (n,2a)

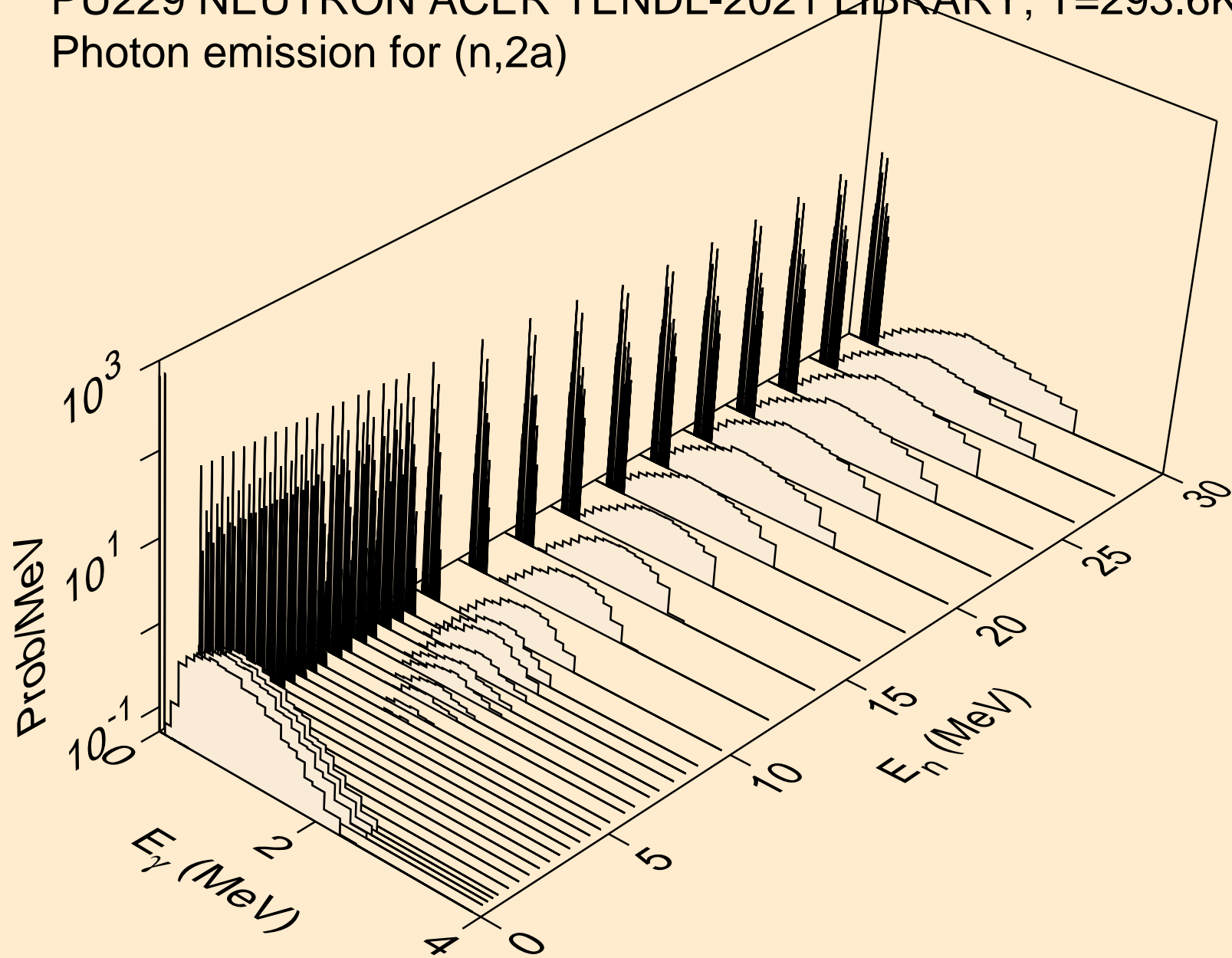

PU229 NEUTRON ACER TENDL-2021 LIBRARY; T=293.6K
Photon emission for (n,3a)

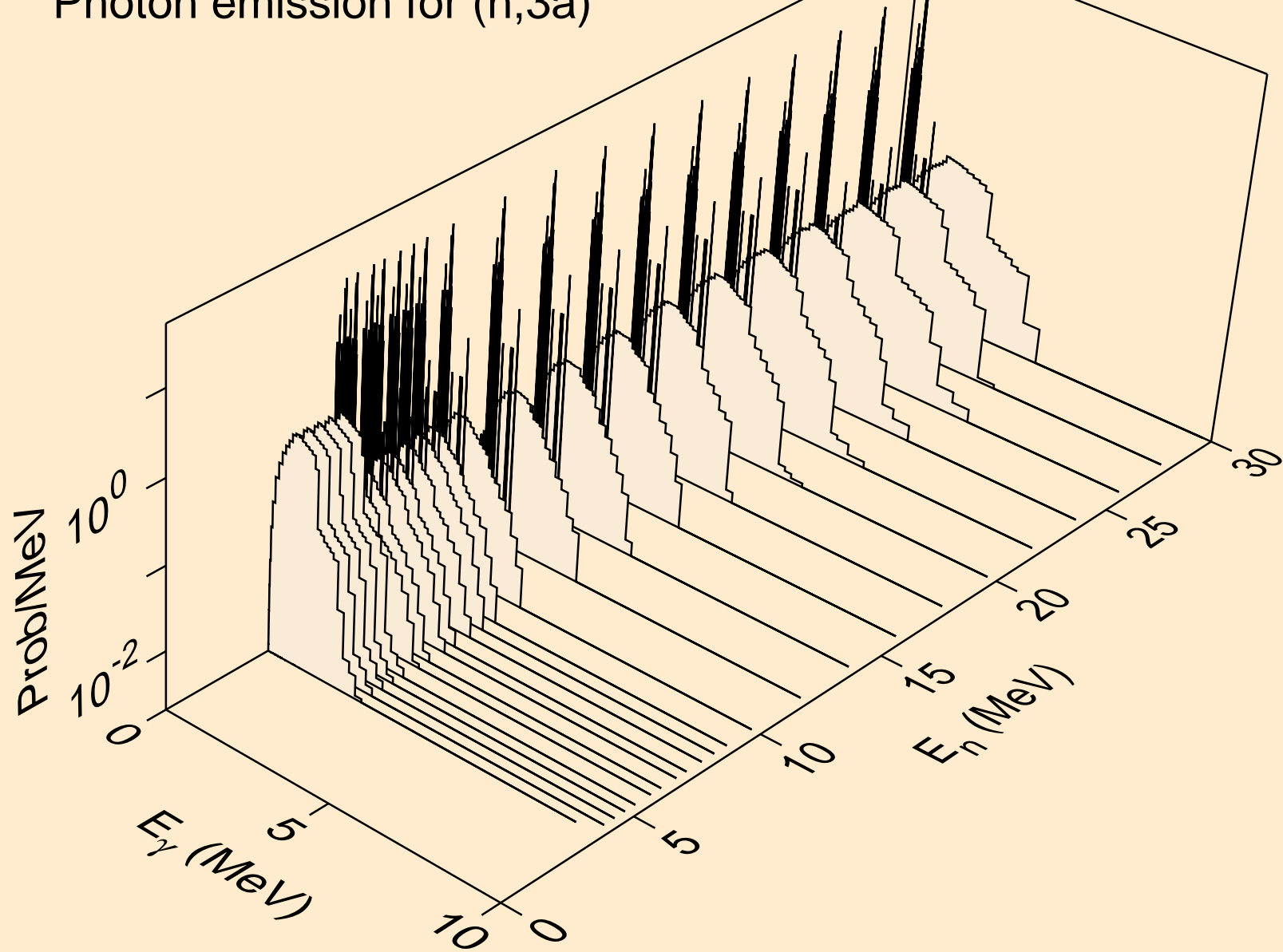

PU229 NEUTRON ACER TENDL-2021 LIBRARY; T=293.6K
Photon emission for (n,2p)

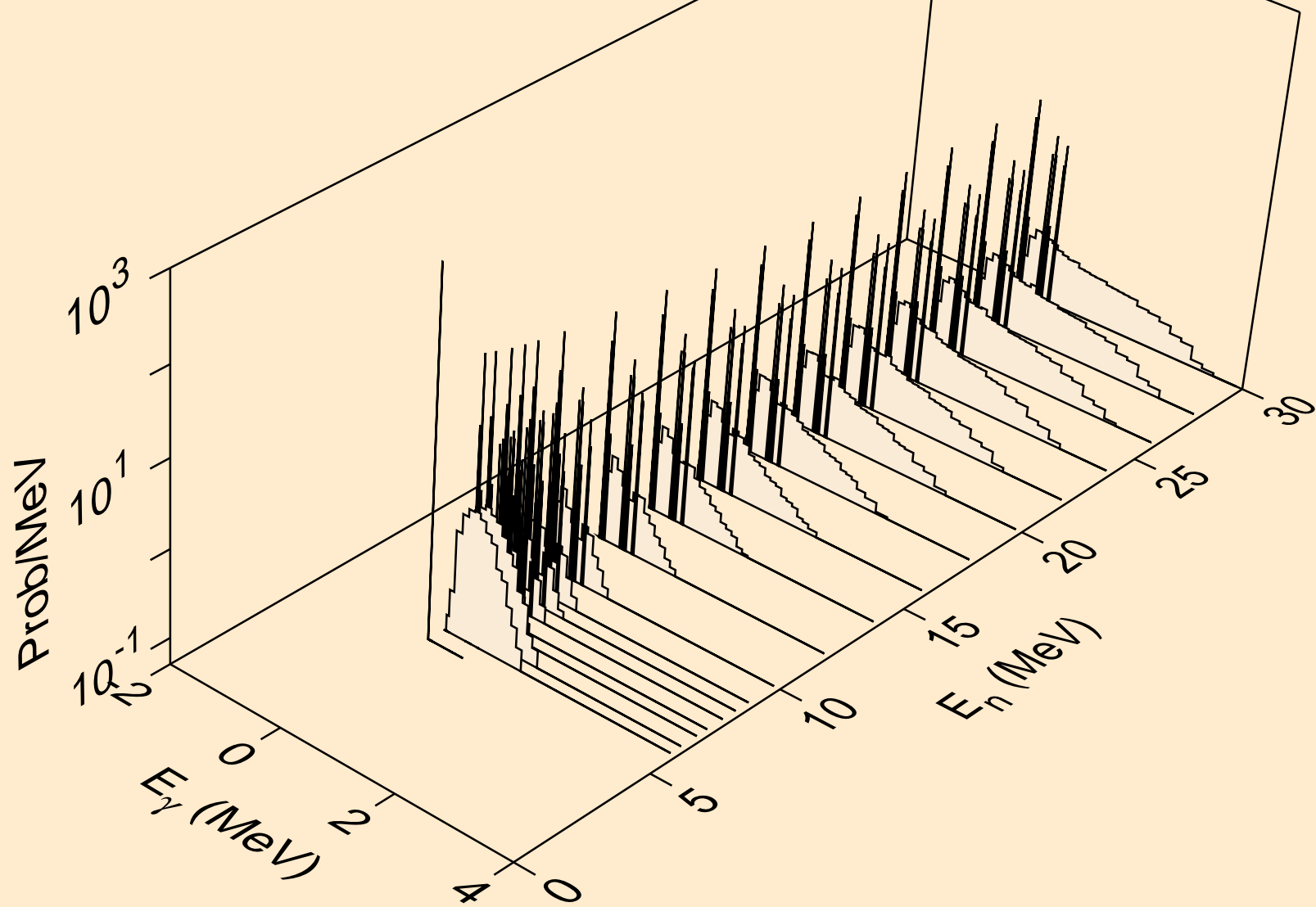

PU229 NEUTRON ACER TENDL-2021 LIBRARY; T=293.6K
Photon emission for (n,p α)

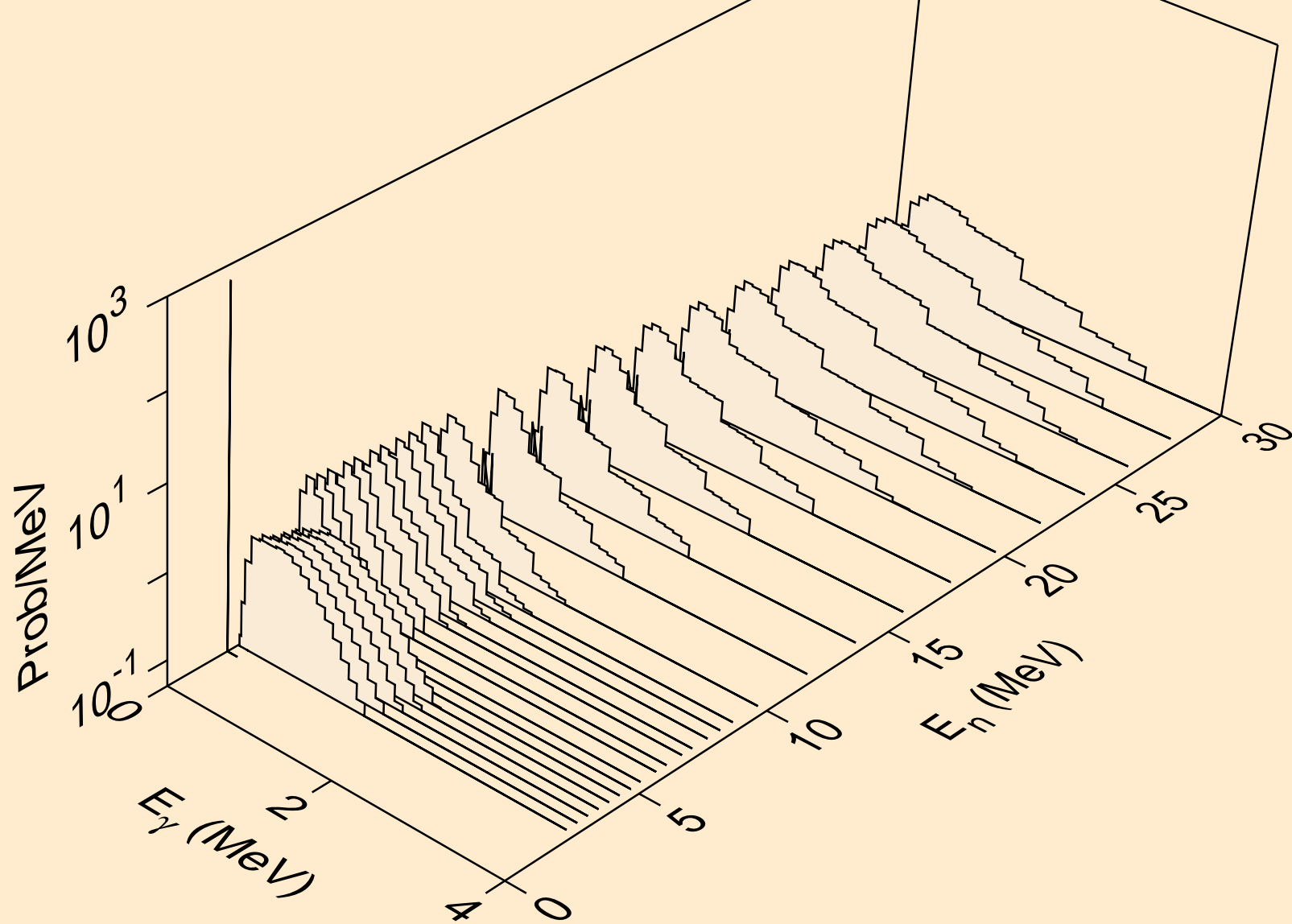

PU229 NEUTRON ACER TENDL-2021 LIBRARY; T=293.6K
Photon emission for (n,d2a)

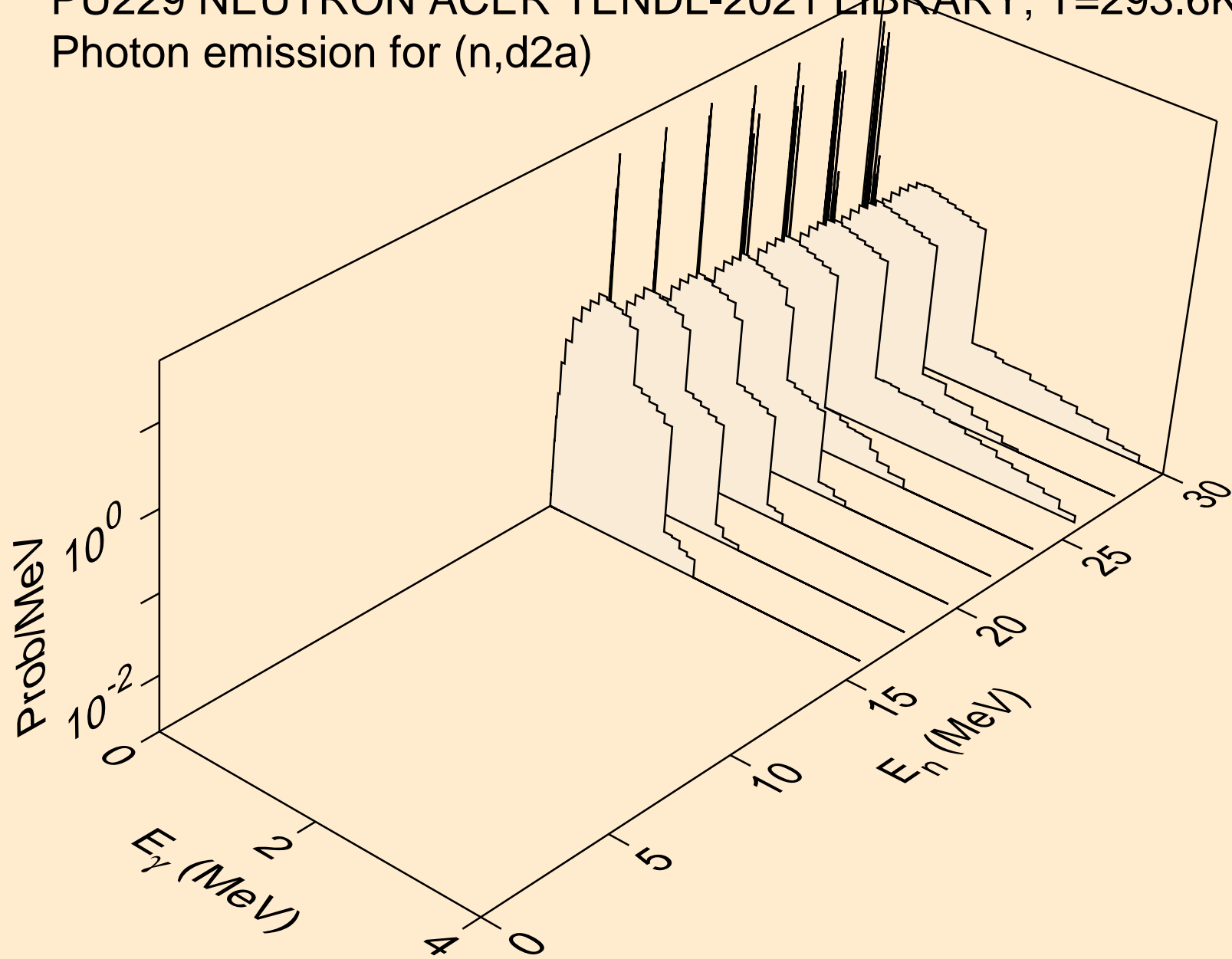

PU229 NEUTRON ACER TENDL-2021 LIBRARY; T=293.6K
Photon emission for (n,pd)

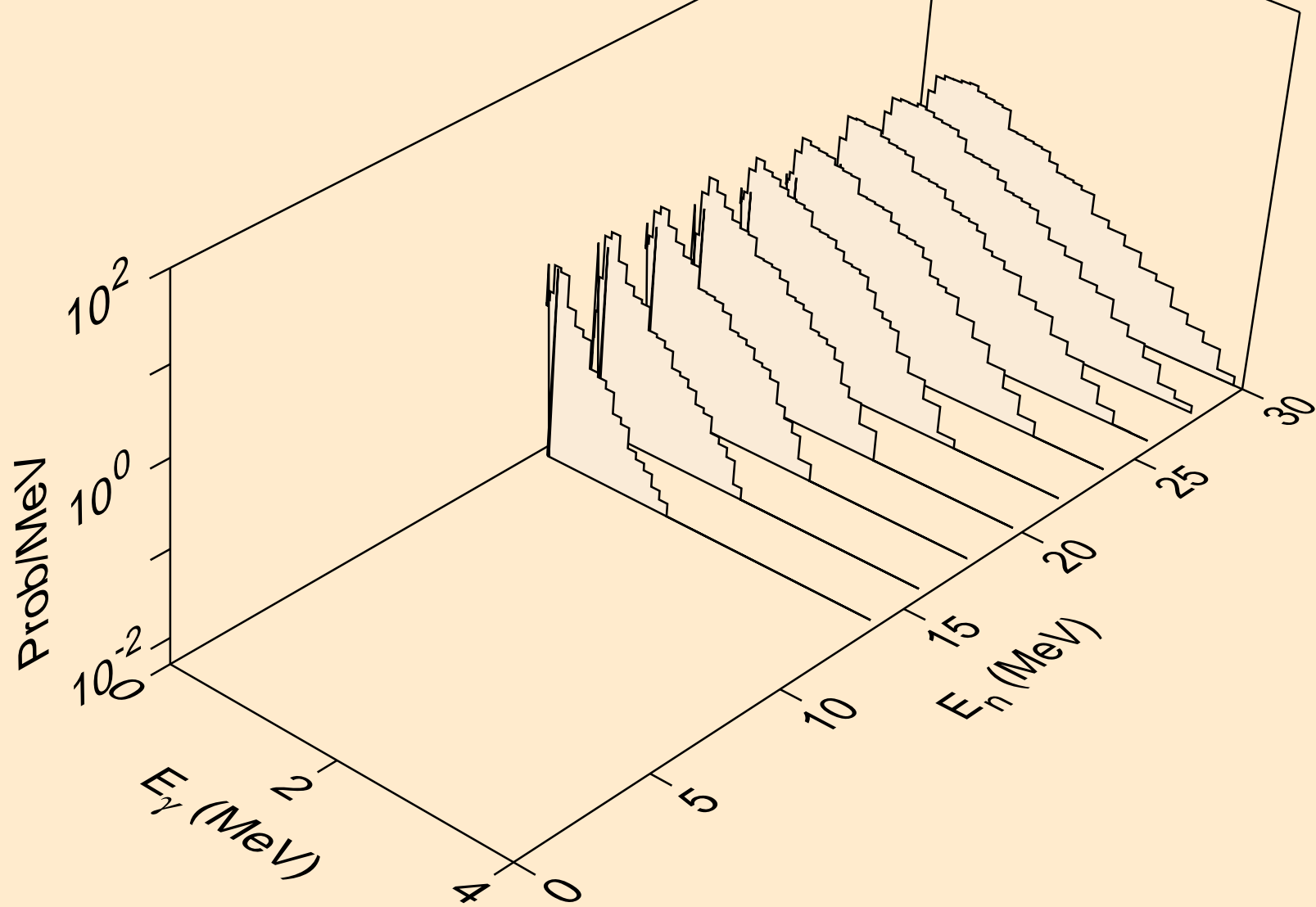

PU229 NEUTRON ACER TENDL-2021 LIBRARY; T=293.6K
Photon emission for (n,pt)

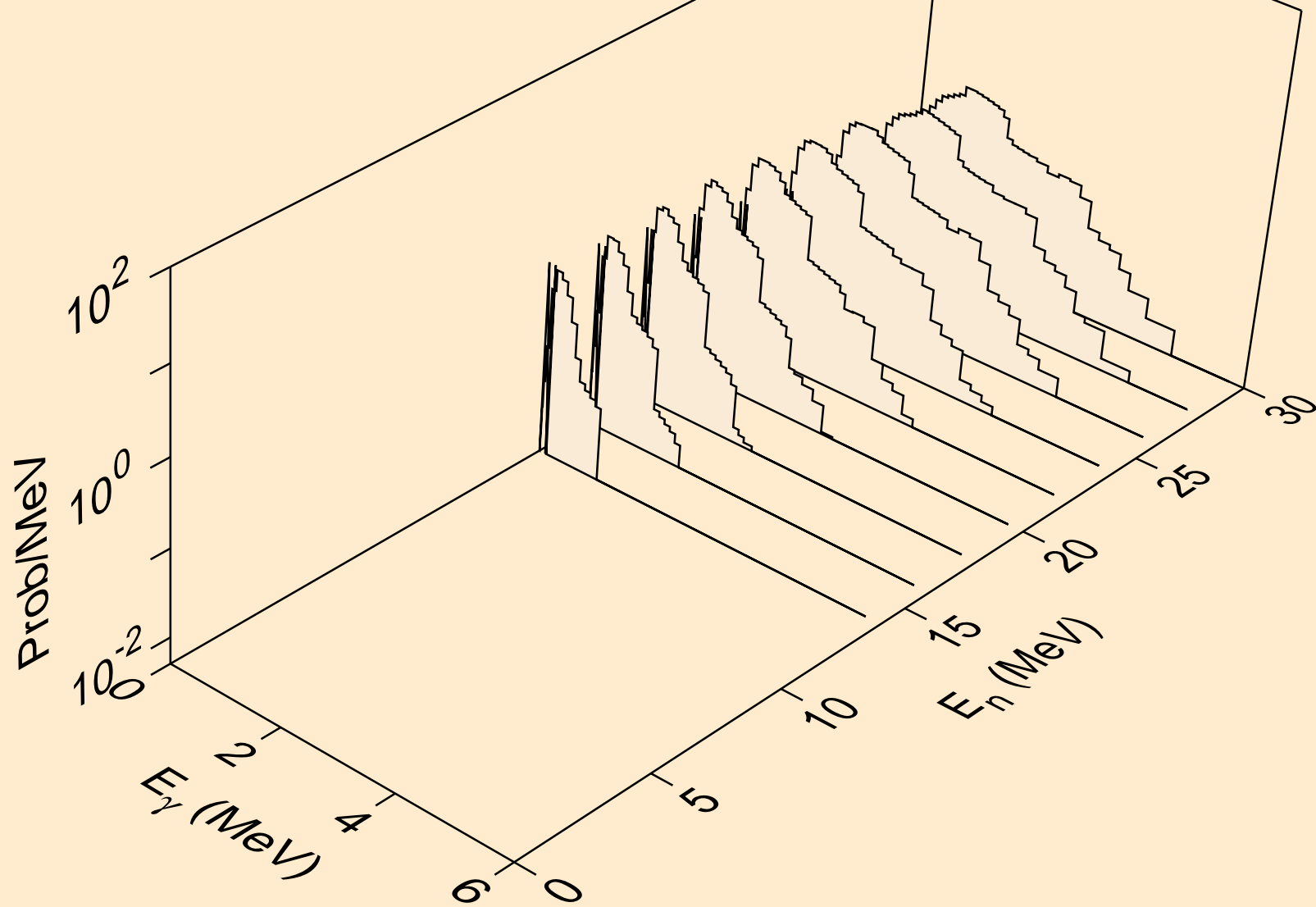

PU229 NEUTRON ACER TENDL-2021 LIBRARY; T=293.6K
Photon emission for (n,da)

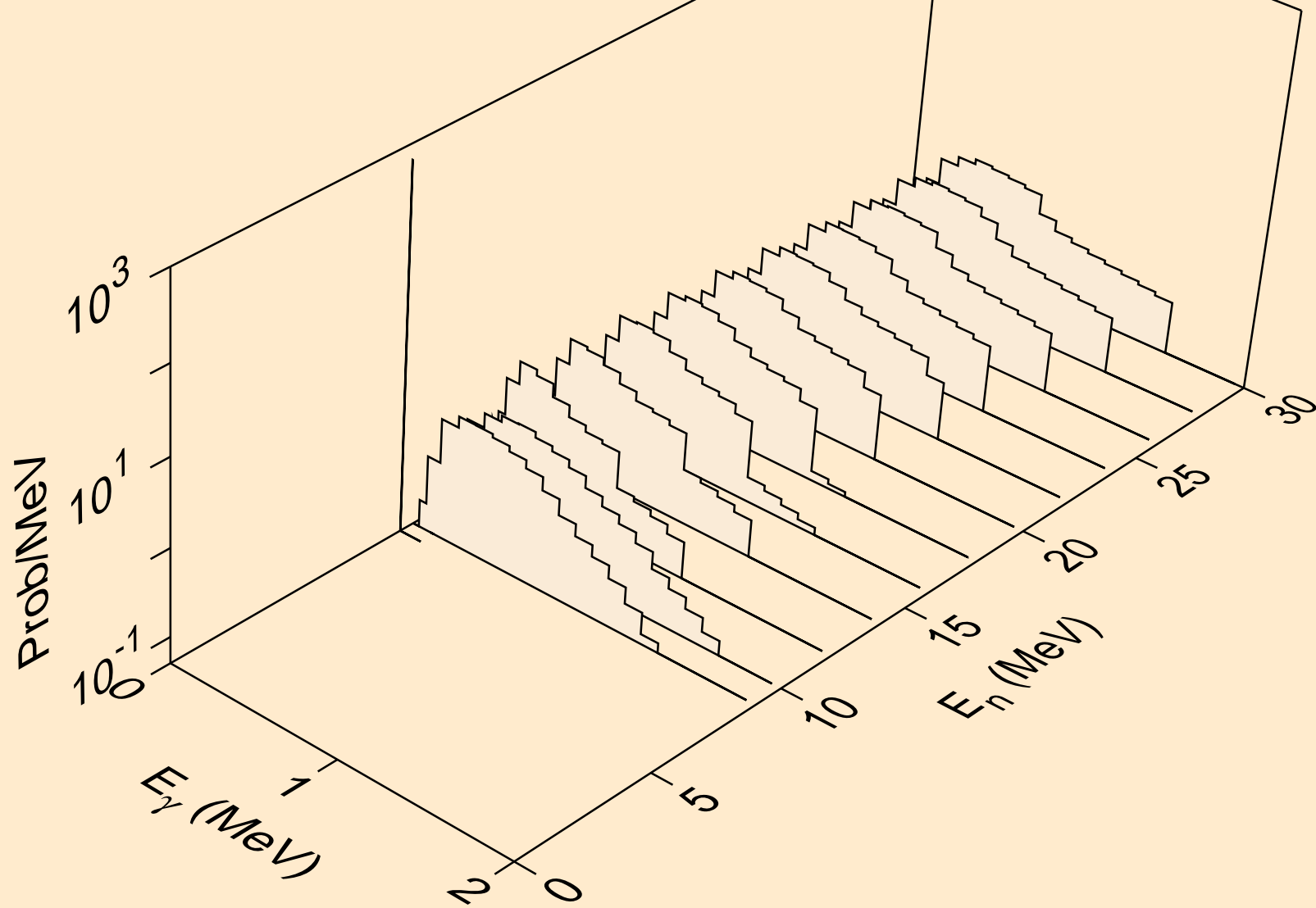

PU229 NEUTRON ACER TENDL-2021 LIBRARY; T=293.6K
thermal capture photon spectrum

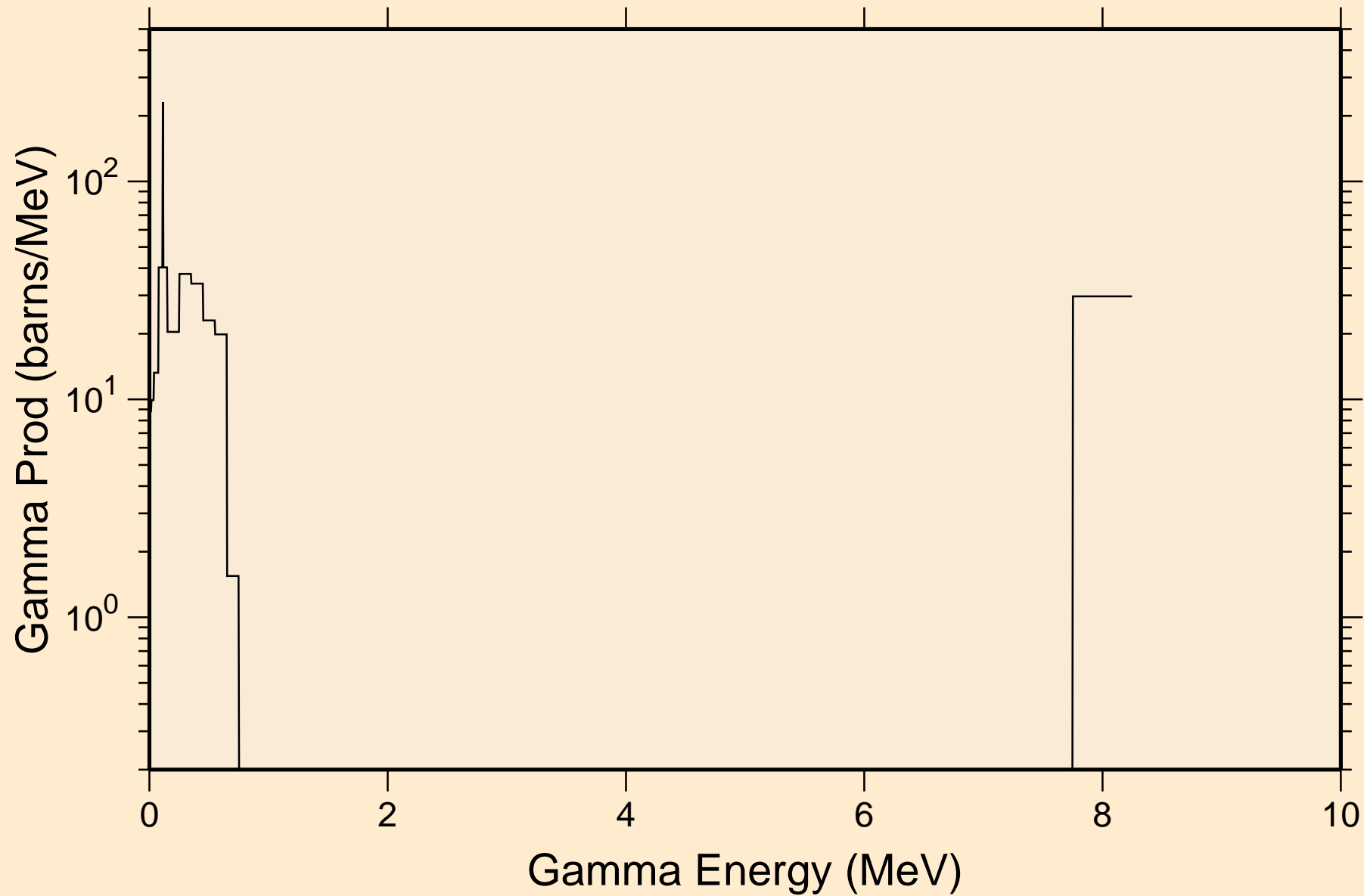

PU229 NEUTRON ACER TENDL-2021 LIBRARY; T=293.6K
14 MeV photon spectrum

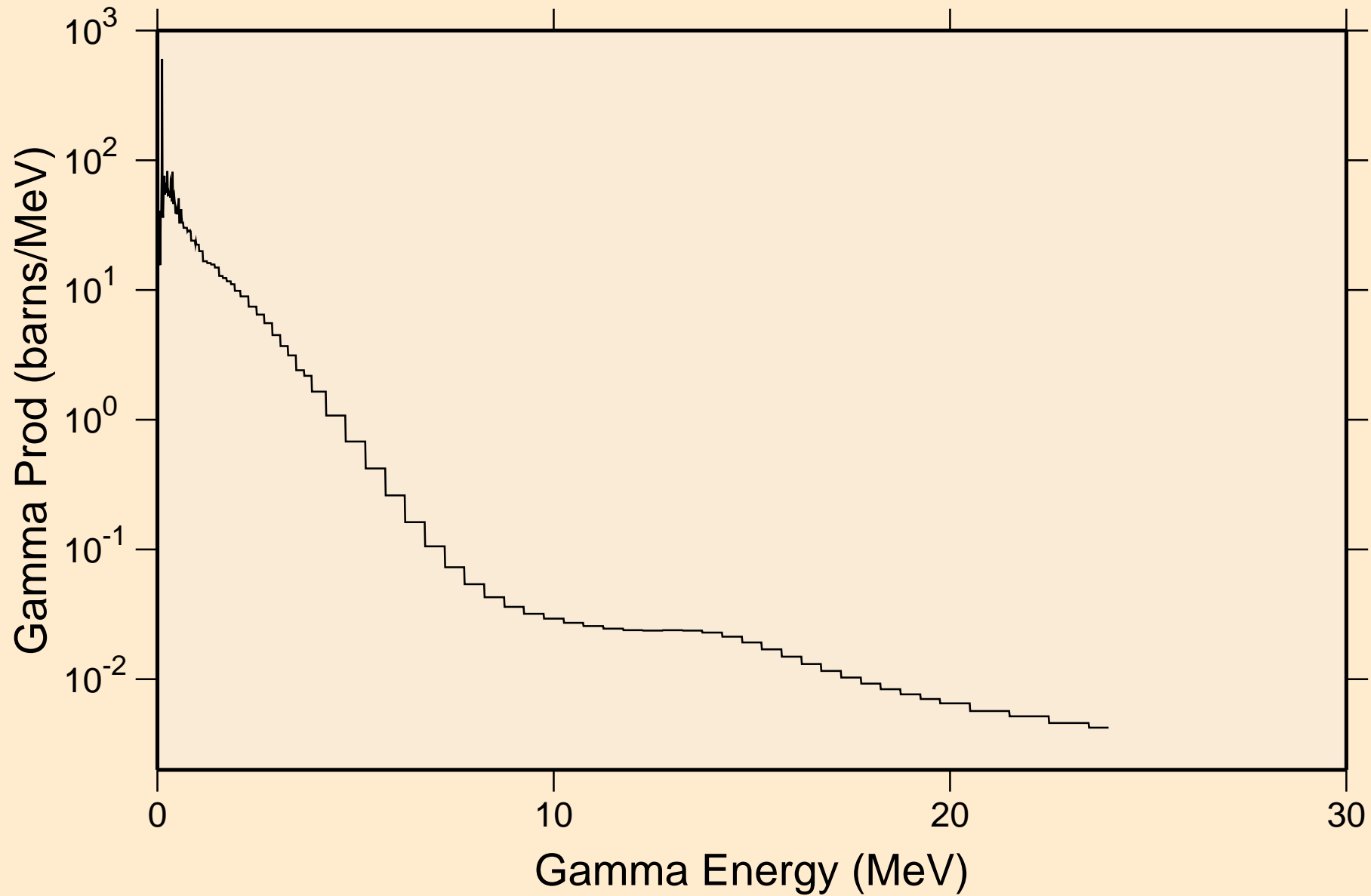

PU229 NEUTRON ACER TENDL-2021 LIBRARY; T=293.6K
Particle heating contributions

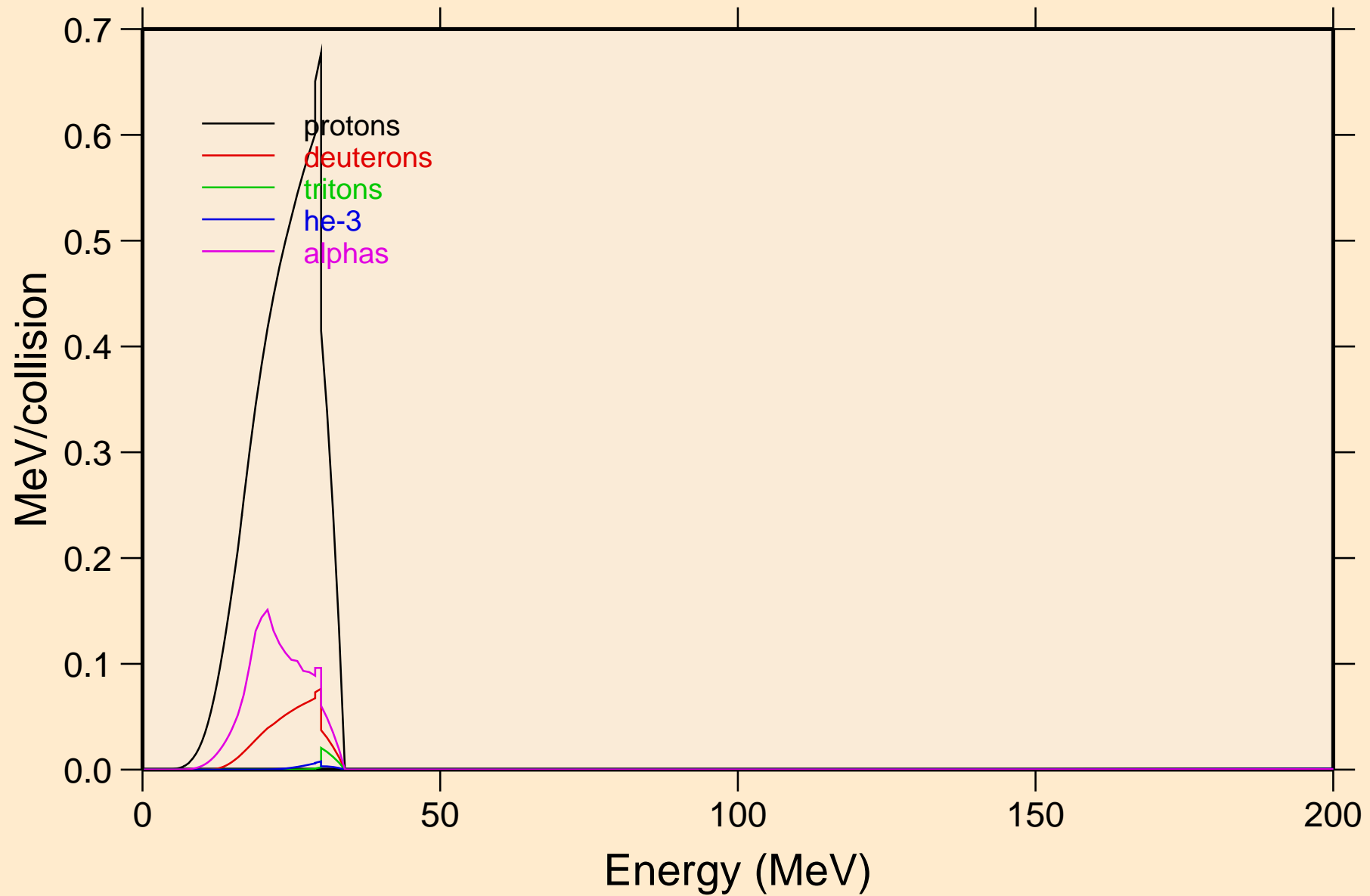

PU229 NEUTRON ACER TENDL-2021 LIBRARY; T=293.6K
Recoil Heating

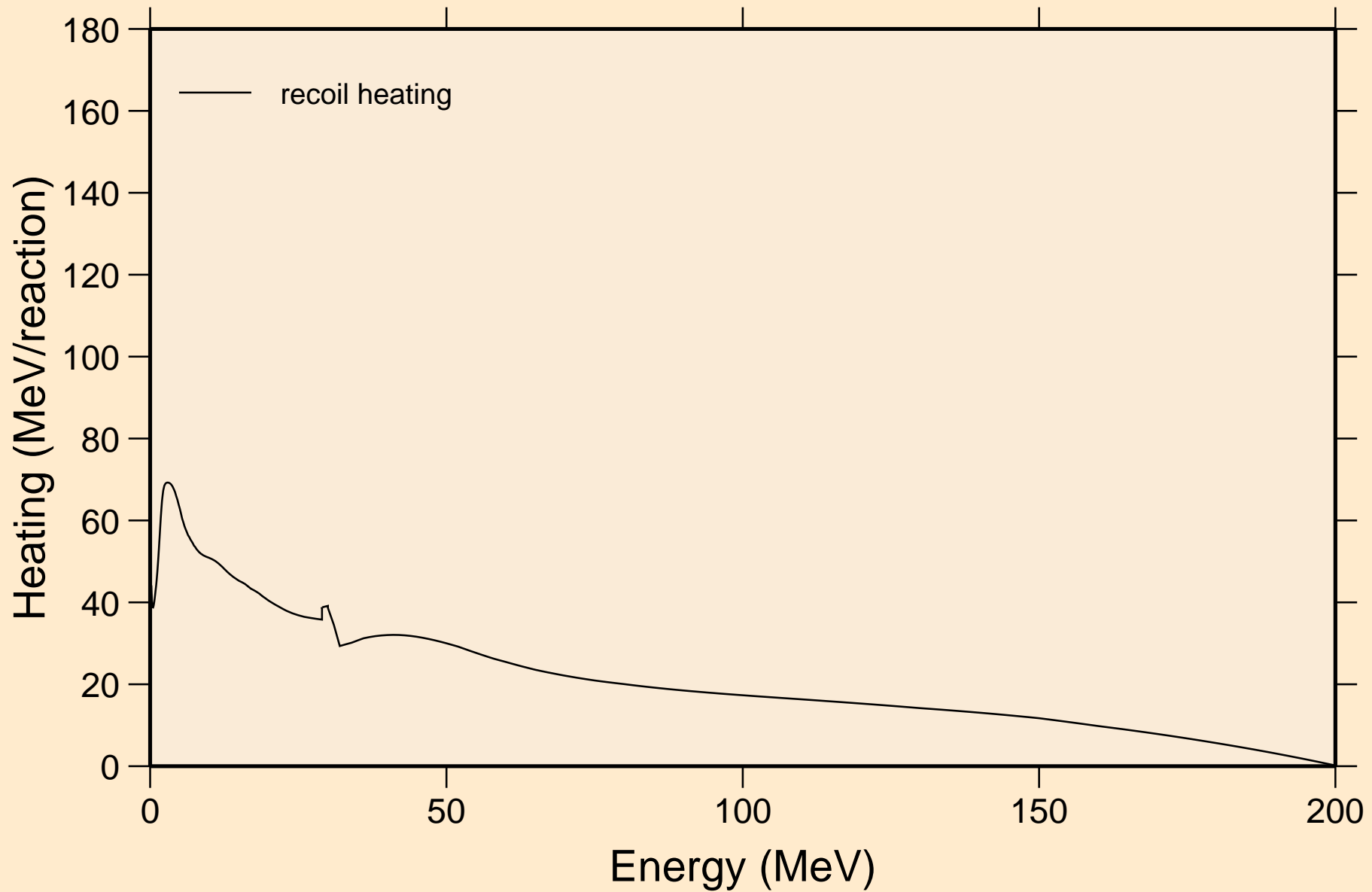

PU229 NEUTRON ACER TENDL-2021 LIBRARY; T=293.6K
Particle production cross sections

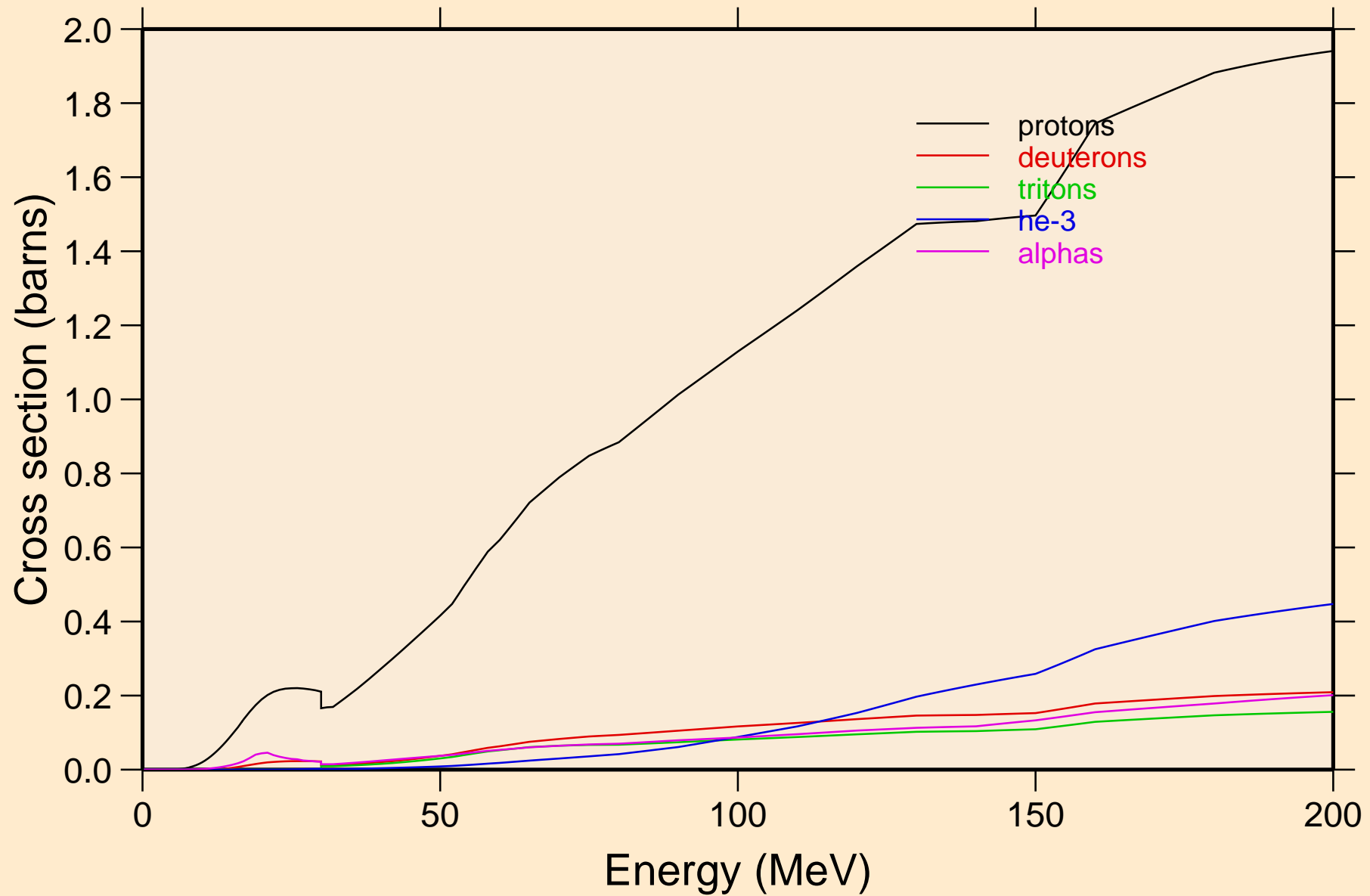

PU229 NEUTRON ACER TENDL-2021 LIBRARY; T=293.6K
protons from (n,x)

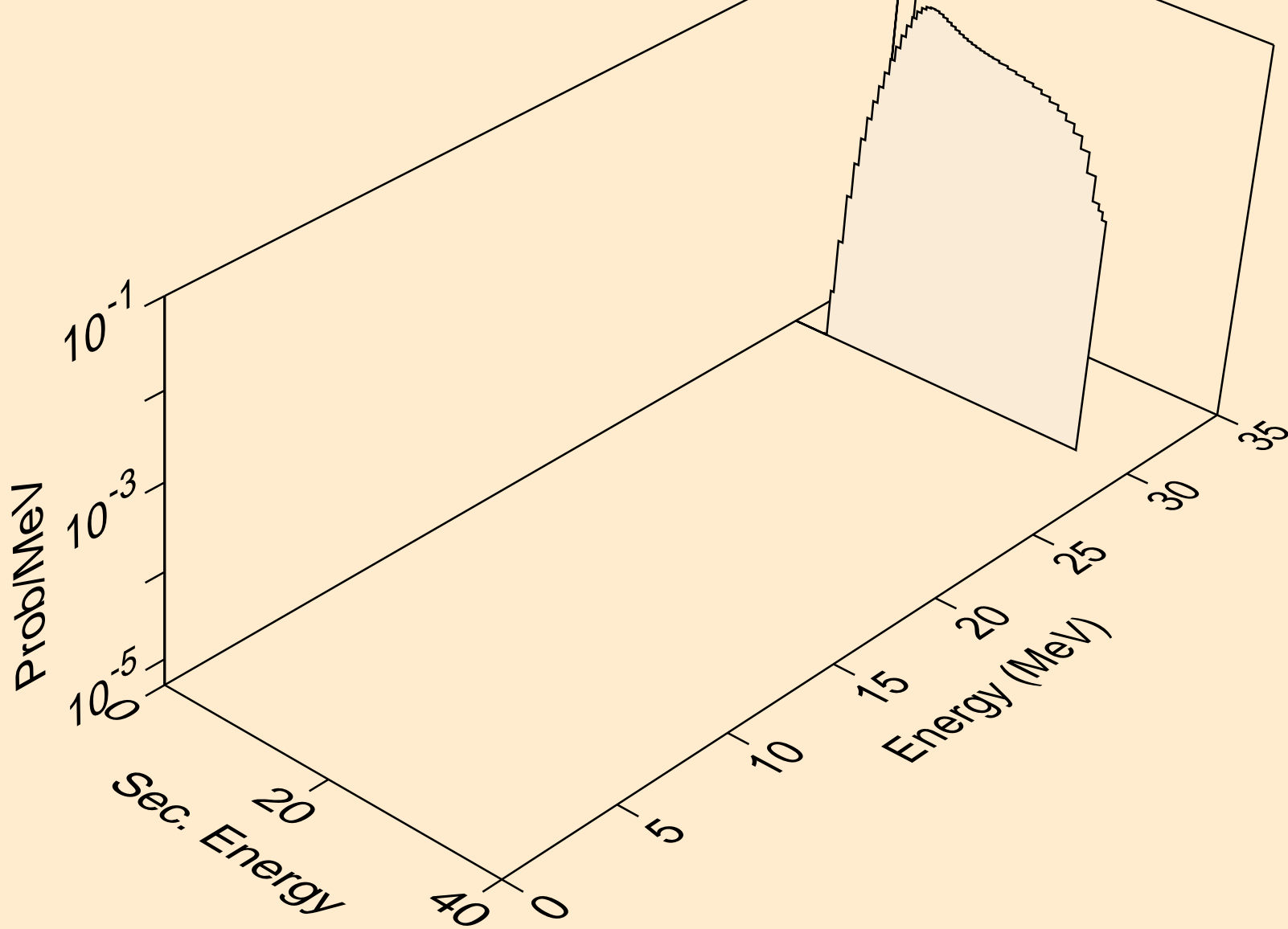

PU229 NEUTRON ACER TENDL-2021 LIBRARY; T=293.6K
protons from (n,n*)p

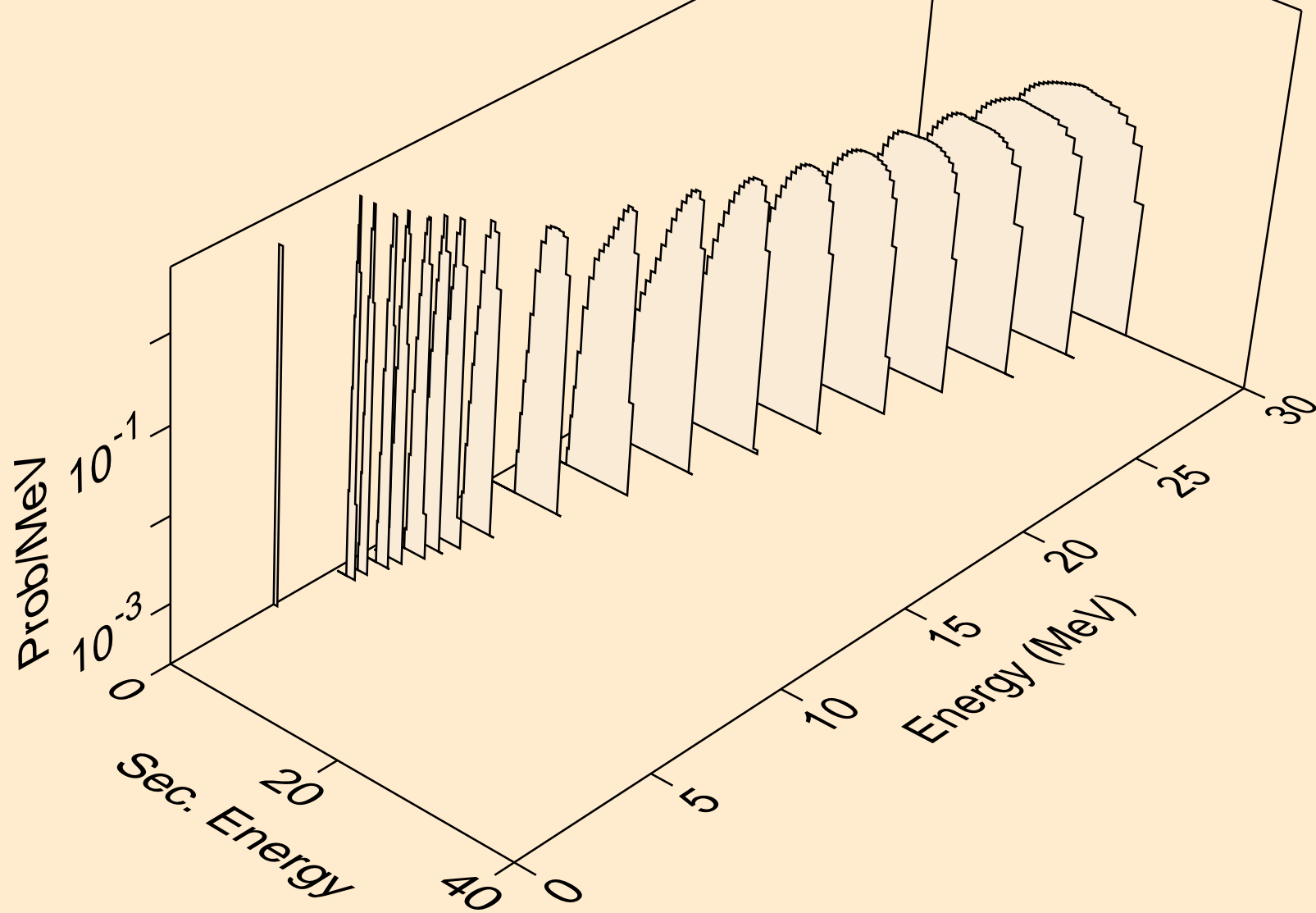

PU229 NEUTRON ACER TENDL-2021 LIBRARY; T=293.6K
protons from (n,2np)

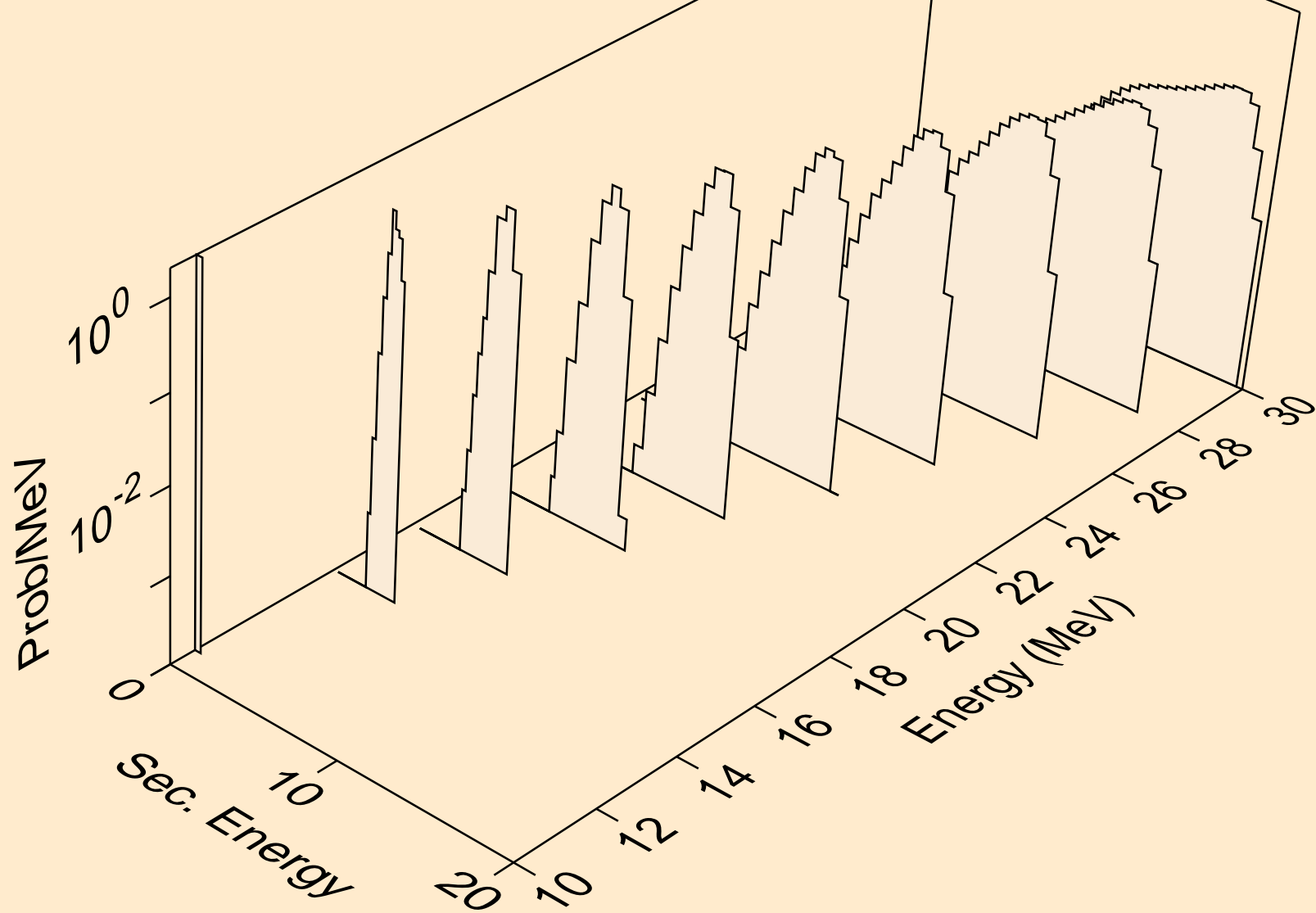

PU229 NEUTRON ACER TENDL-2021 LIBRARY; T=293.6K
protons from (n,3np)

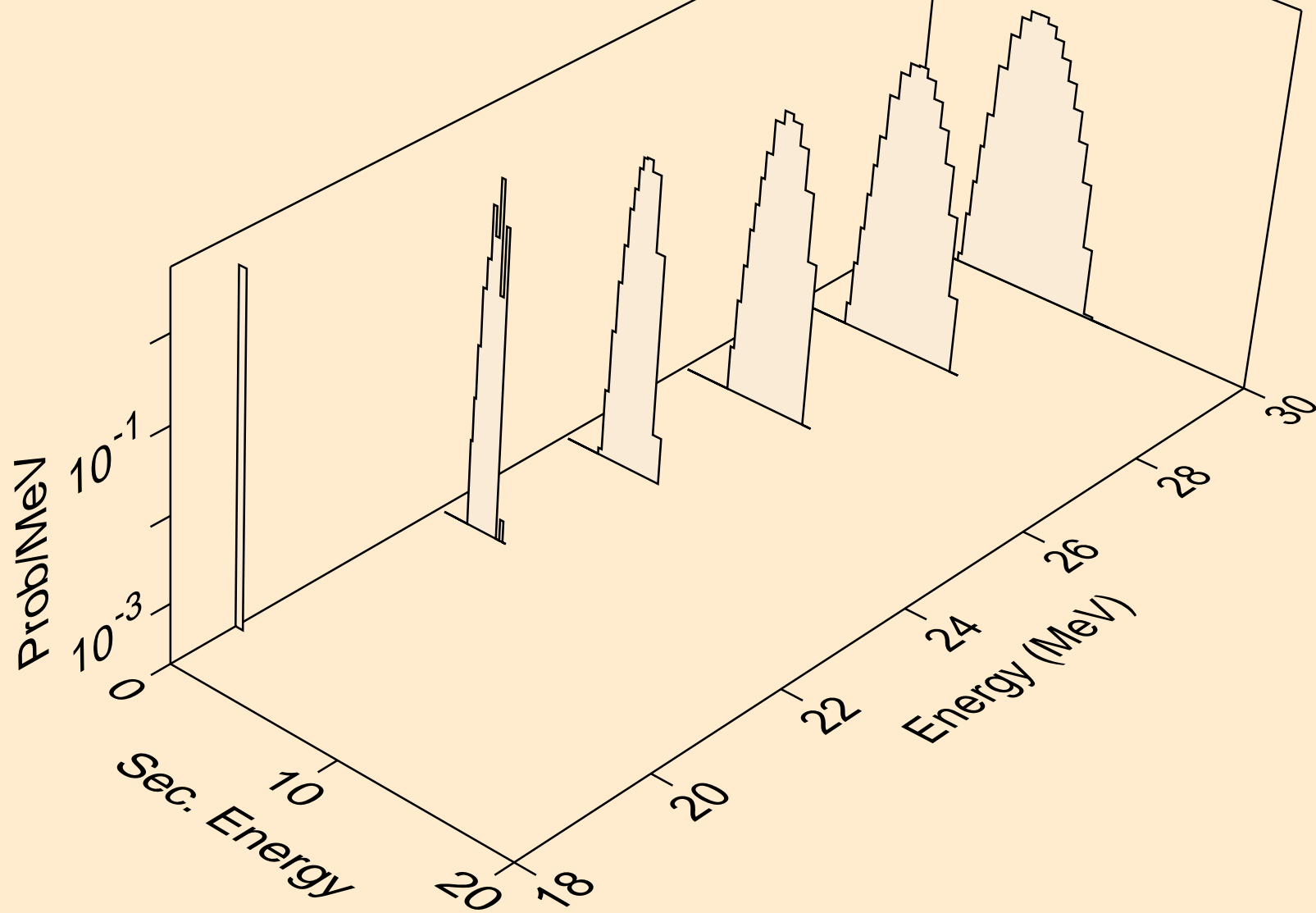

PU229 NEUTRON ACER TENDL-2021 LIBRARY; T=293.6K
protons from (n,2np)

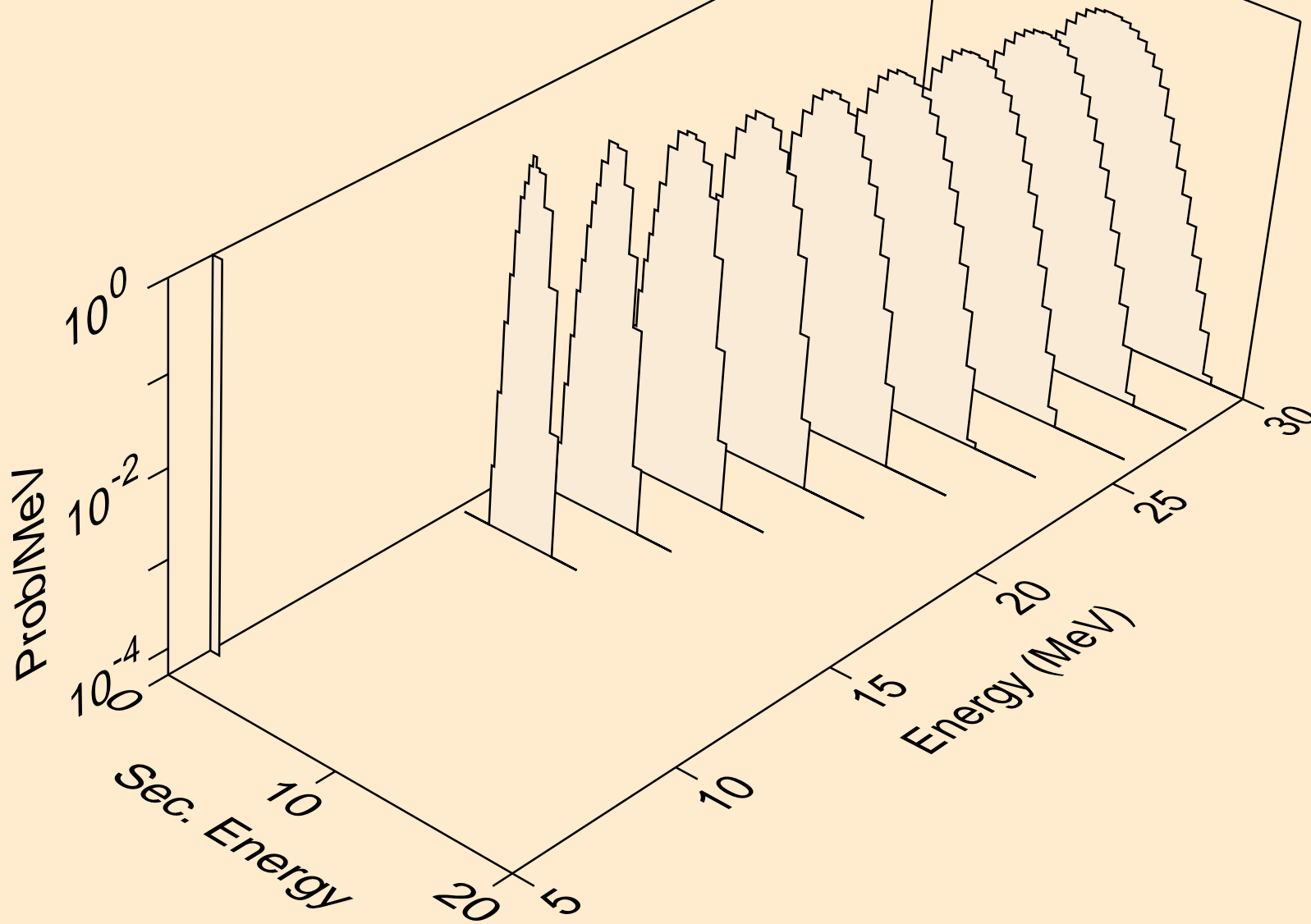

PU229 NEUTRON ACER TENDL-2021 LIBRARY; T=293.6K
protons from (n,npa)

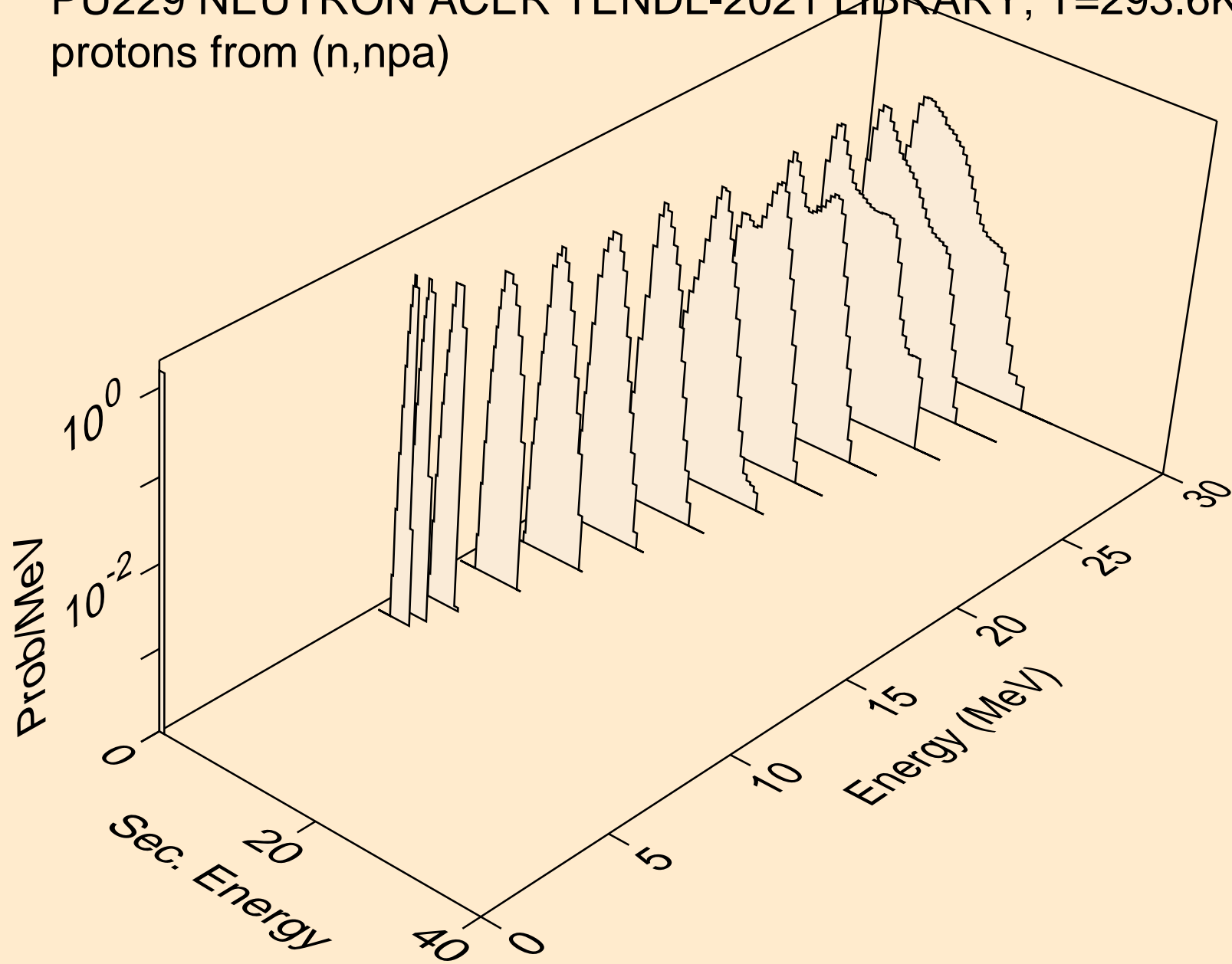

PU229 NEUTRON ACER TENDL-2021 LIBRARY; T=293.6K
protons from (n,p)

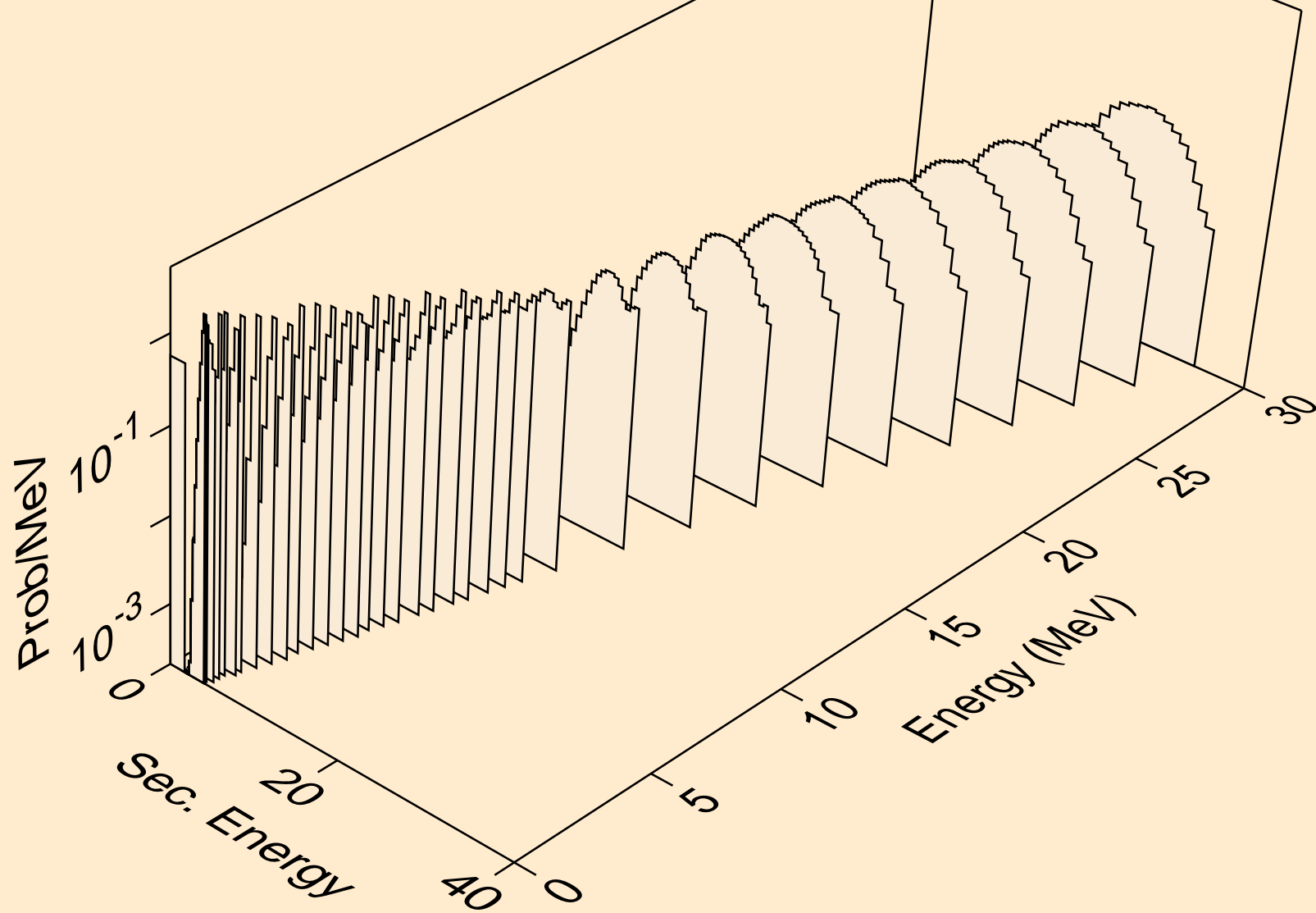

PU229 NEUTRON ACER TENDL-2021 LIBRARY; T=293.6K
protons from (n,2p)

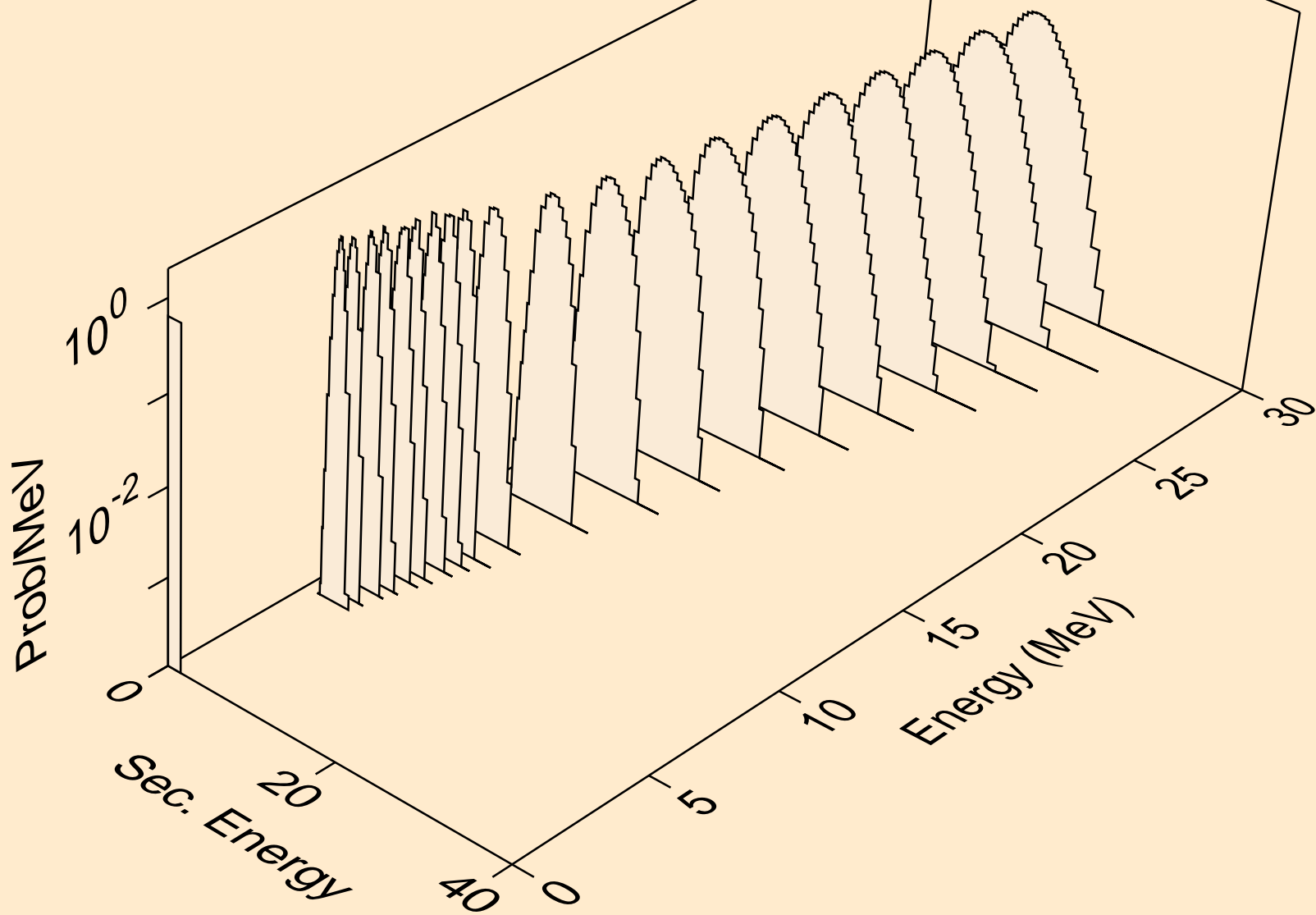

PU229 NEUTRON ACER TENDL-2021 LIBRARY; T=293.6K
protons from (n,p)

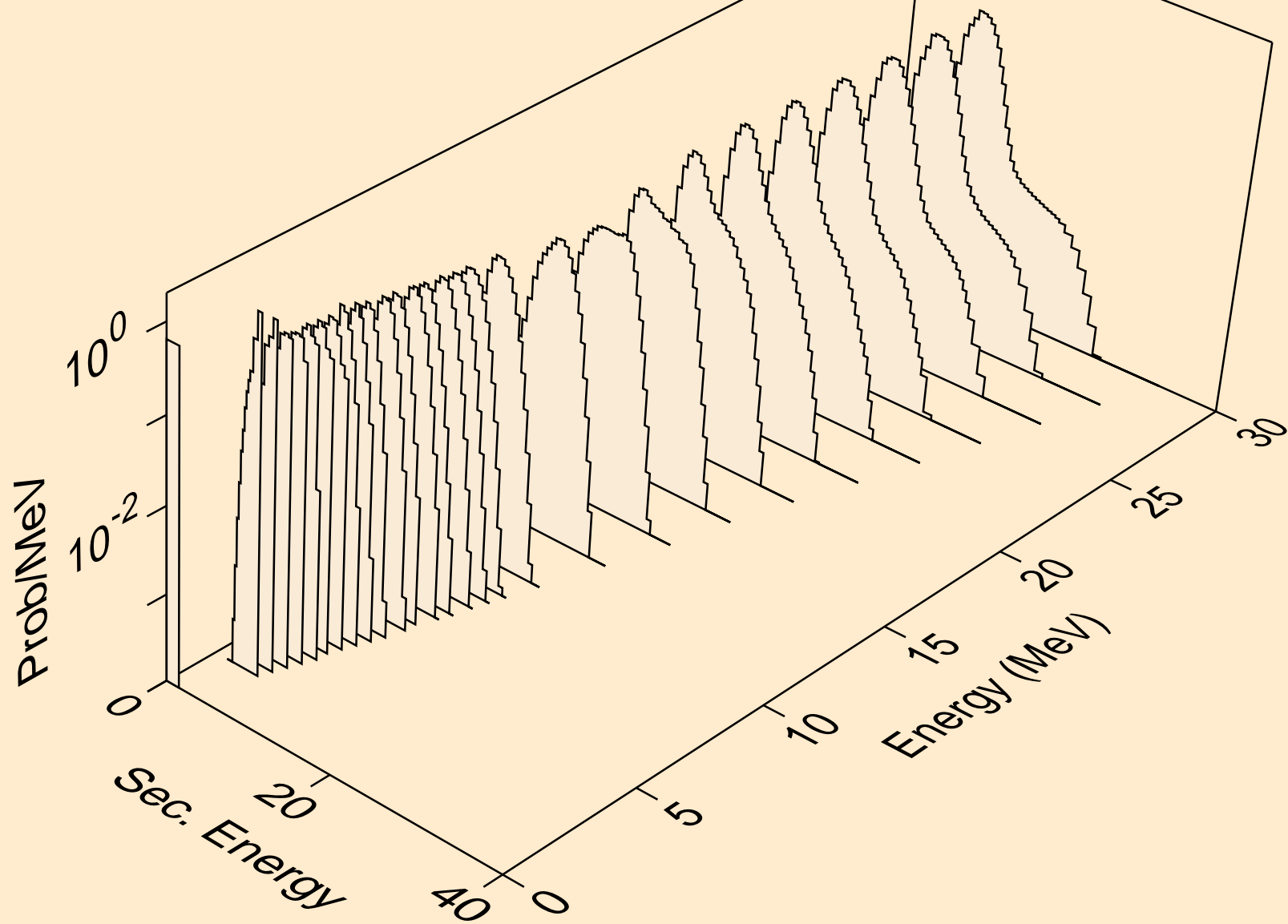

PU229 NEUTRON ACER TENDL-2021 LIBRARY; T=293.6K
protons from (n,pd)

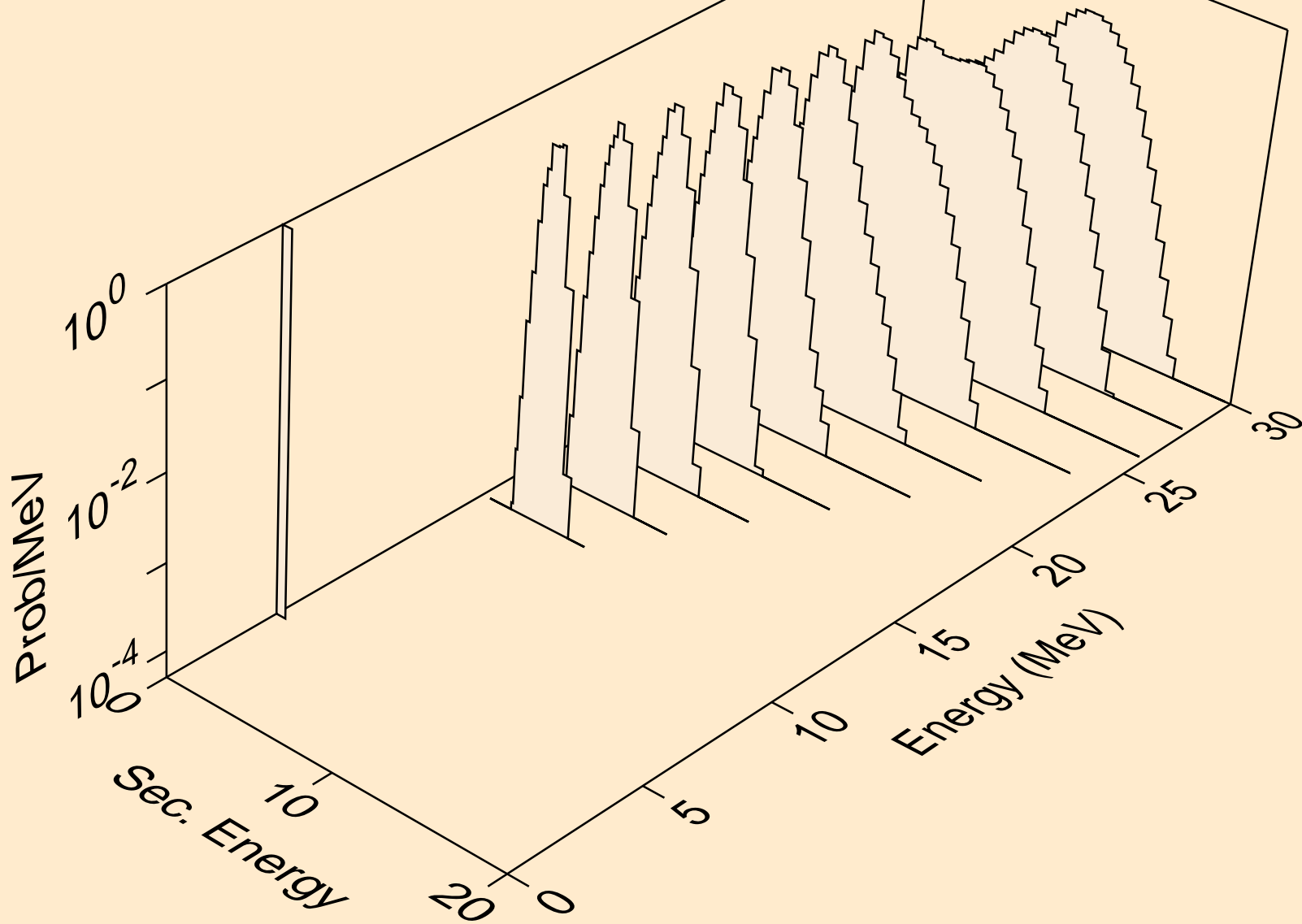

PU229 NEUTRON ACER TENDL-2021 LIBRARY; T=293.6K
protons from (n,pt)

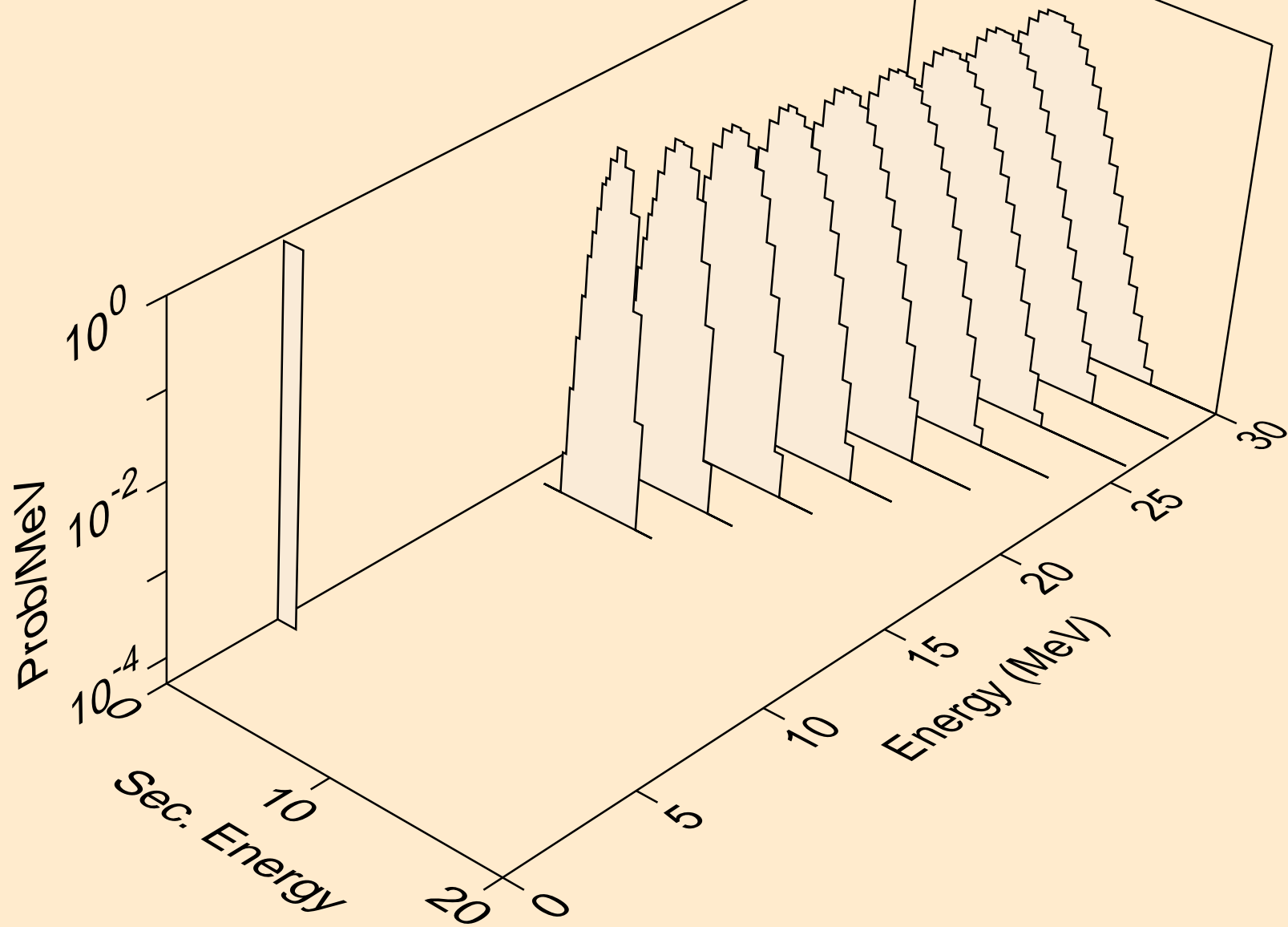

PU229 NEUTRON ACER TENDL-2021 LIBRARY; T=293.6K
deuterons from (n,x)

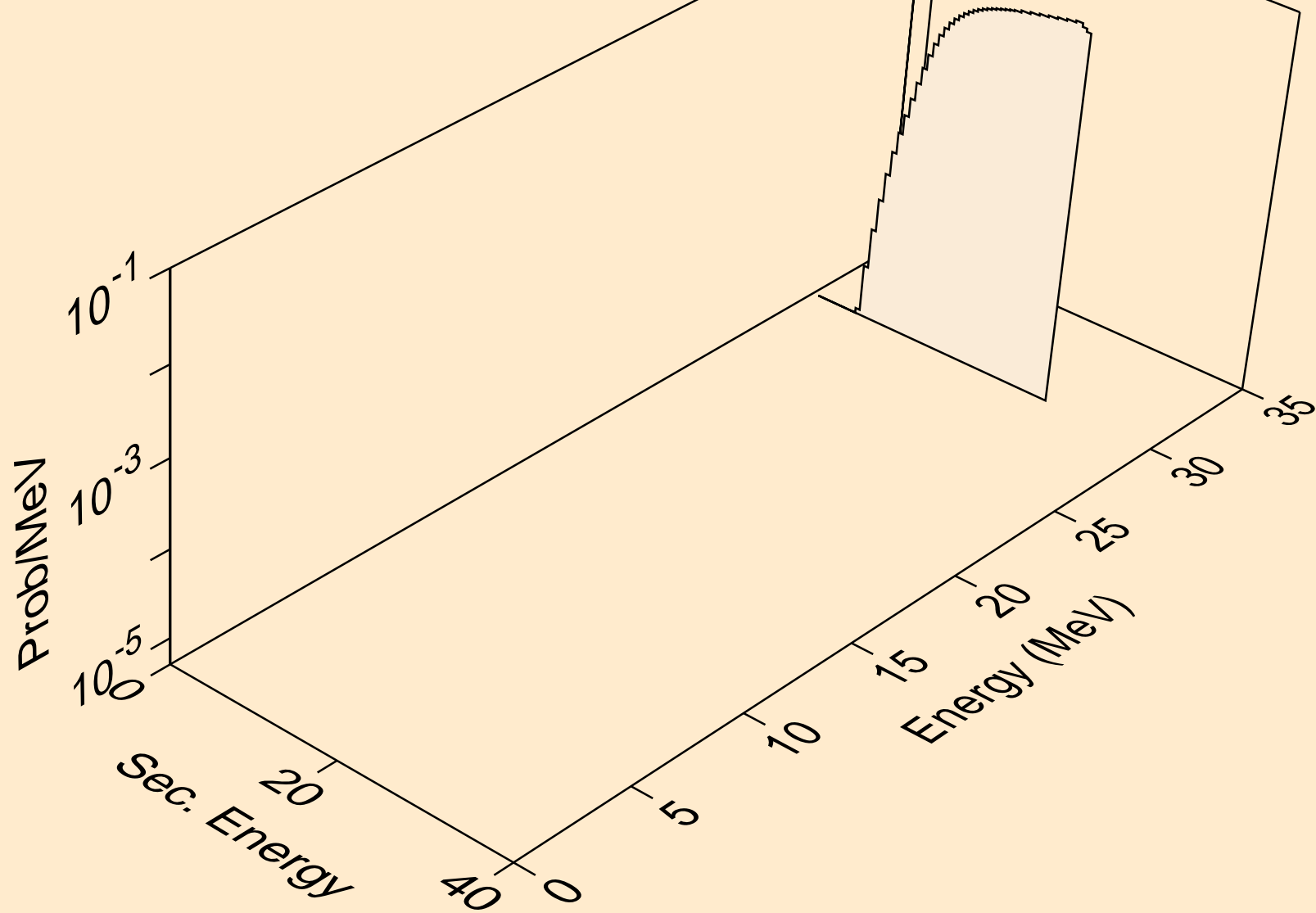

PU229 NEUTRON ACER TENDL-2021 LIBRARY; T=293.6K
deuterons from (n,2nd)

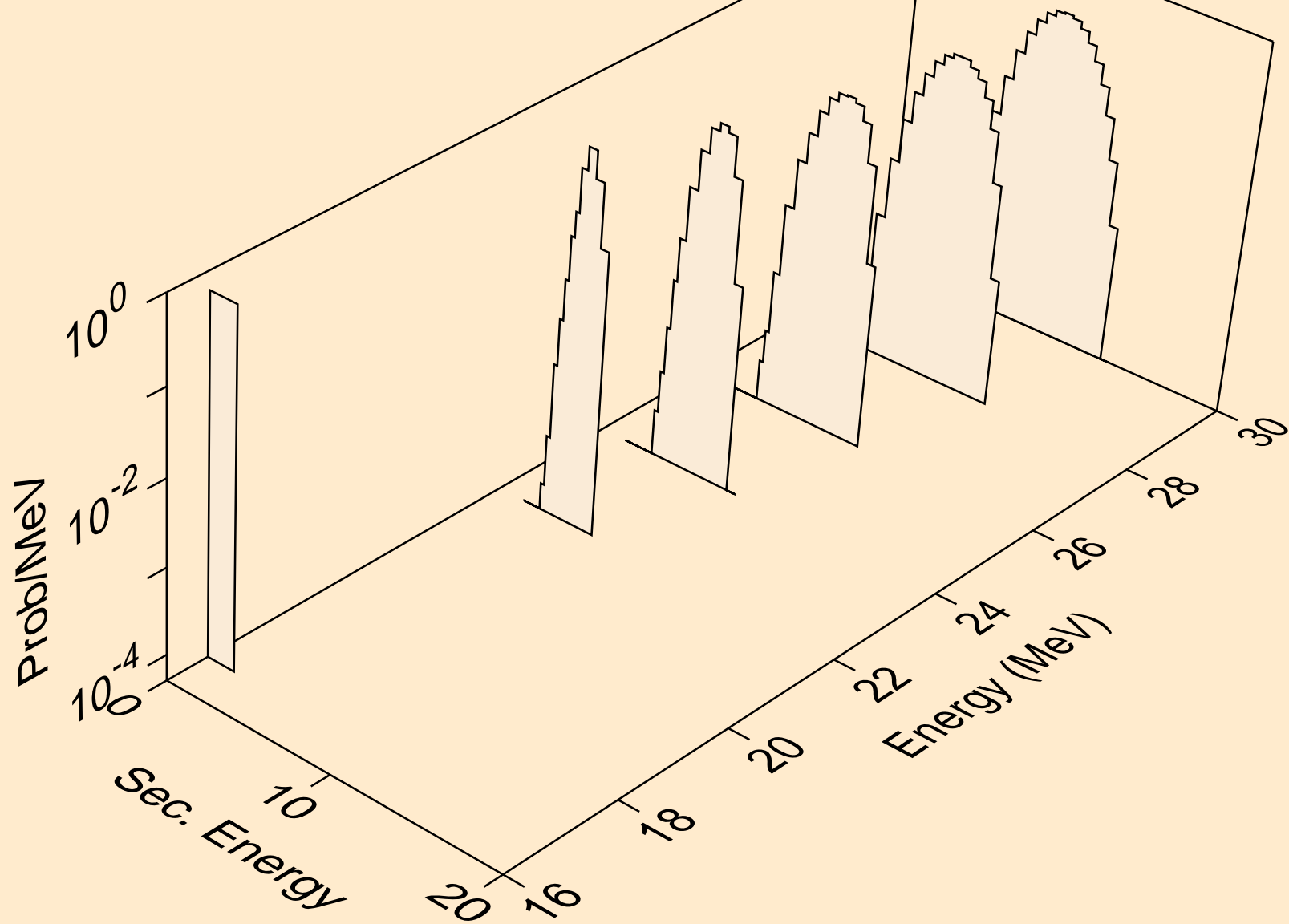

PU229 NEUTRON ACER TENDL-2021 LIBRARY; T=293.6K
deuterons from (n,n*)d

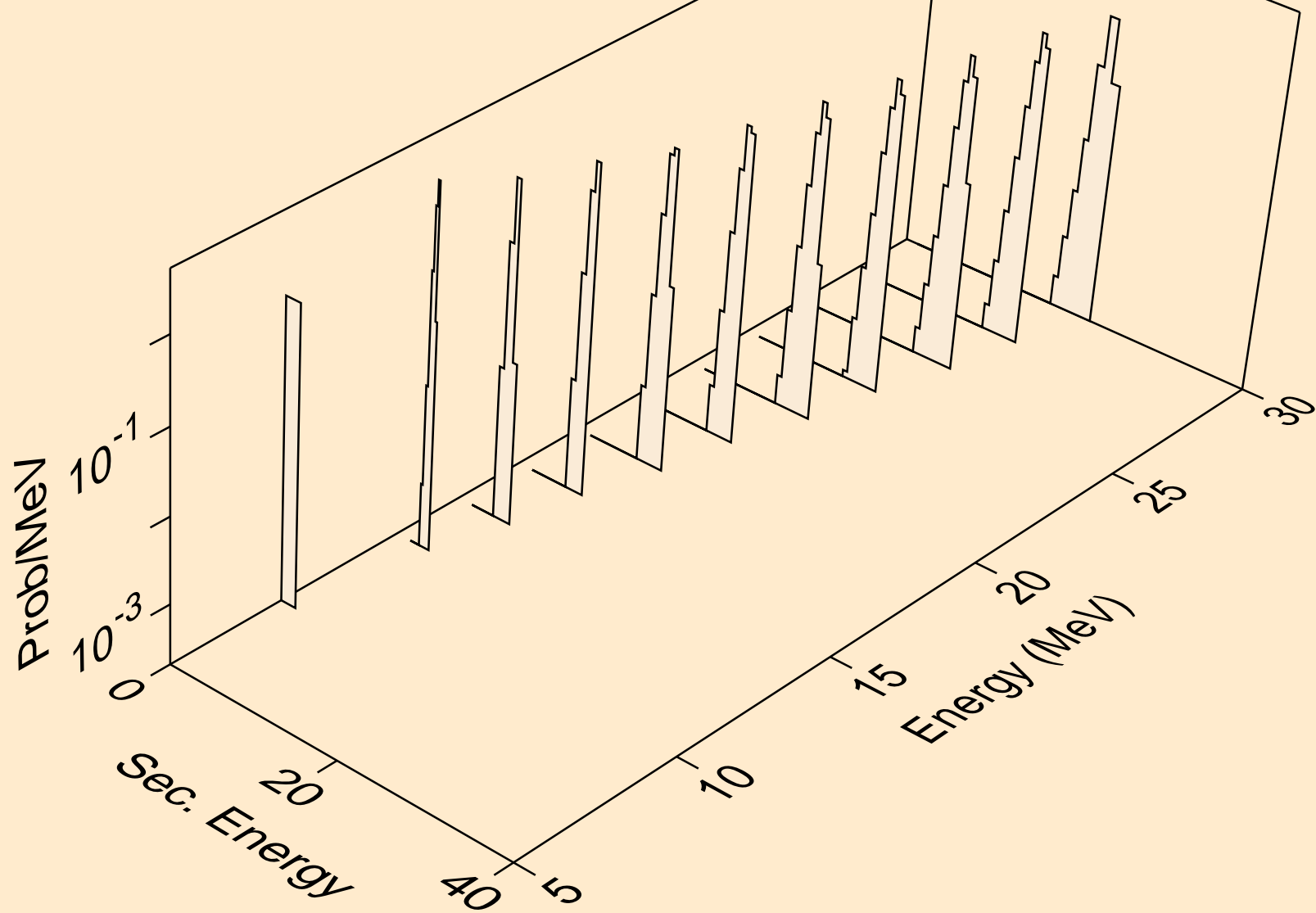

PU229 NEUTRON ACER TENDL-2021 LIBRARY; T=293.6K
deuterons from (n,d)

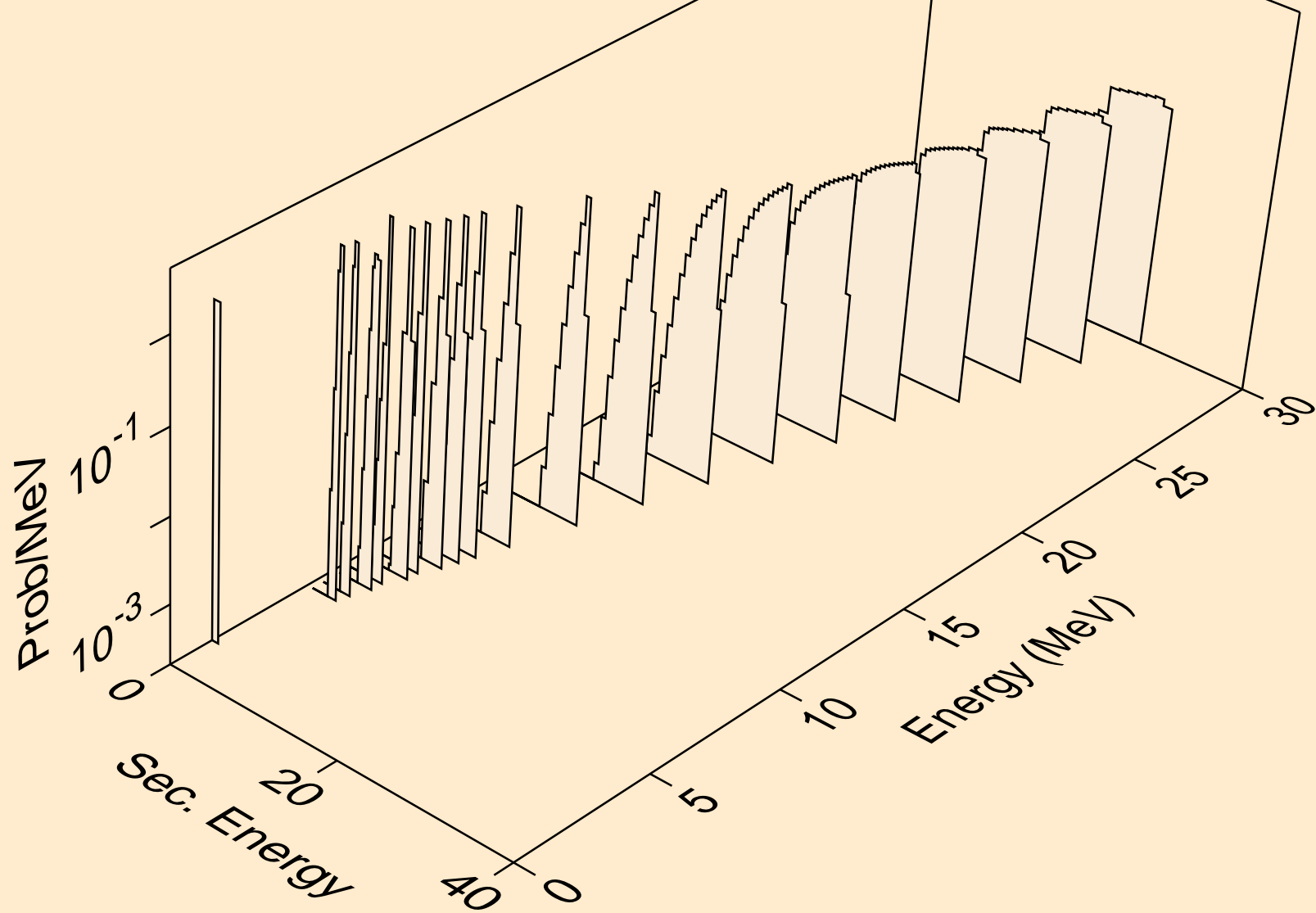

PU229 NEUTRON ACER TENDL-2021 LIBRARY; T=293.6K
deuterons from (n,d2a)

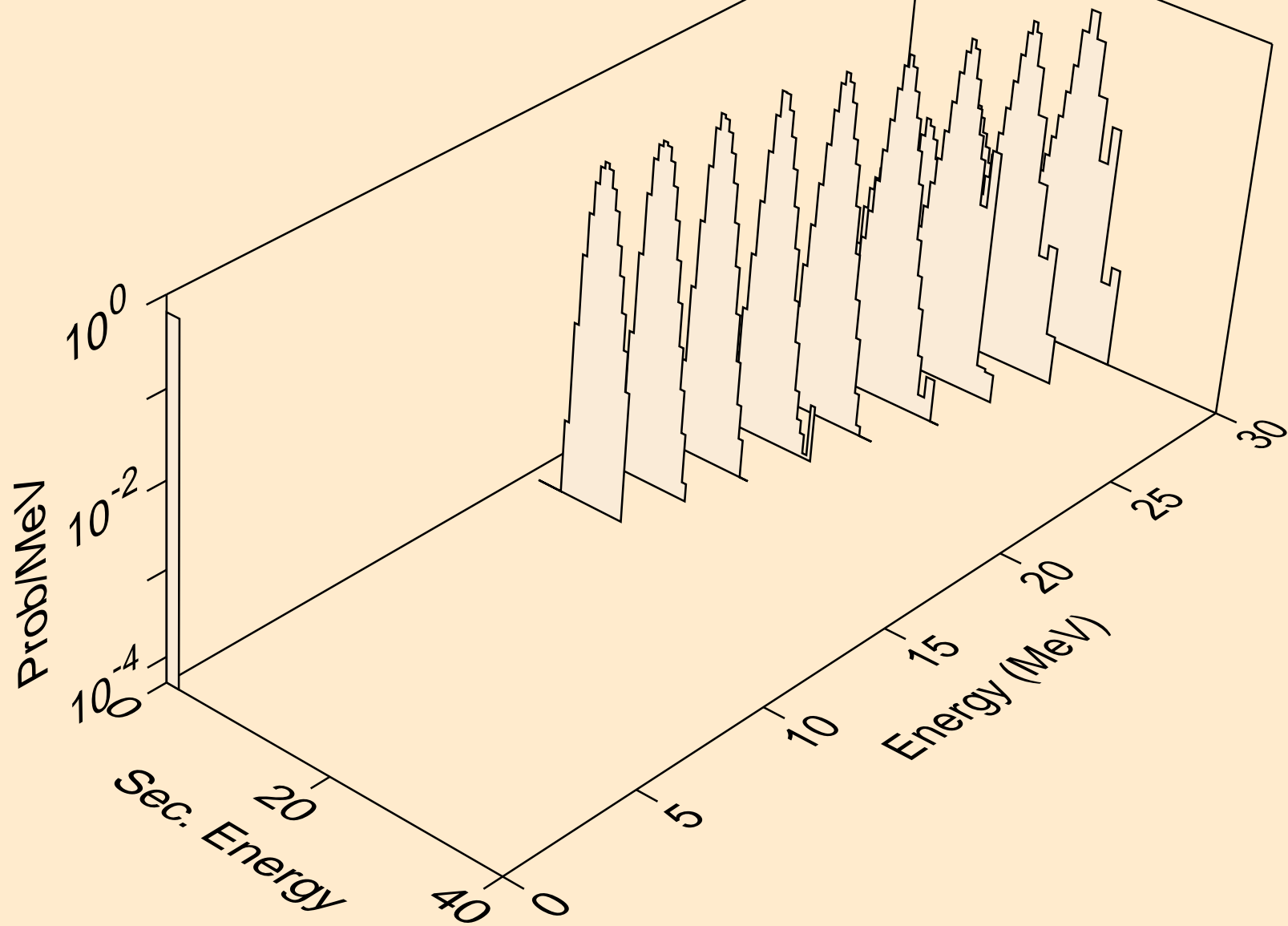

PU229 NEUTRON ACER TENDL-2021 LIBRARY; T=293.6K
deuterons from (n,pd)

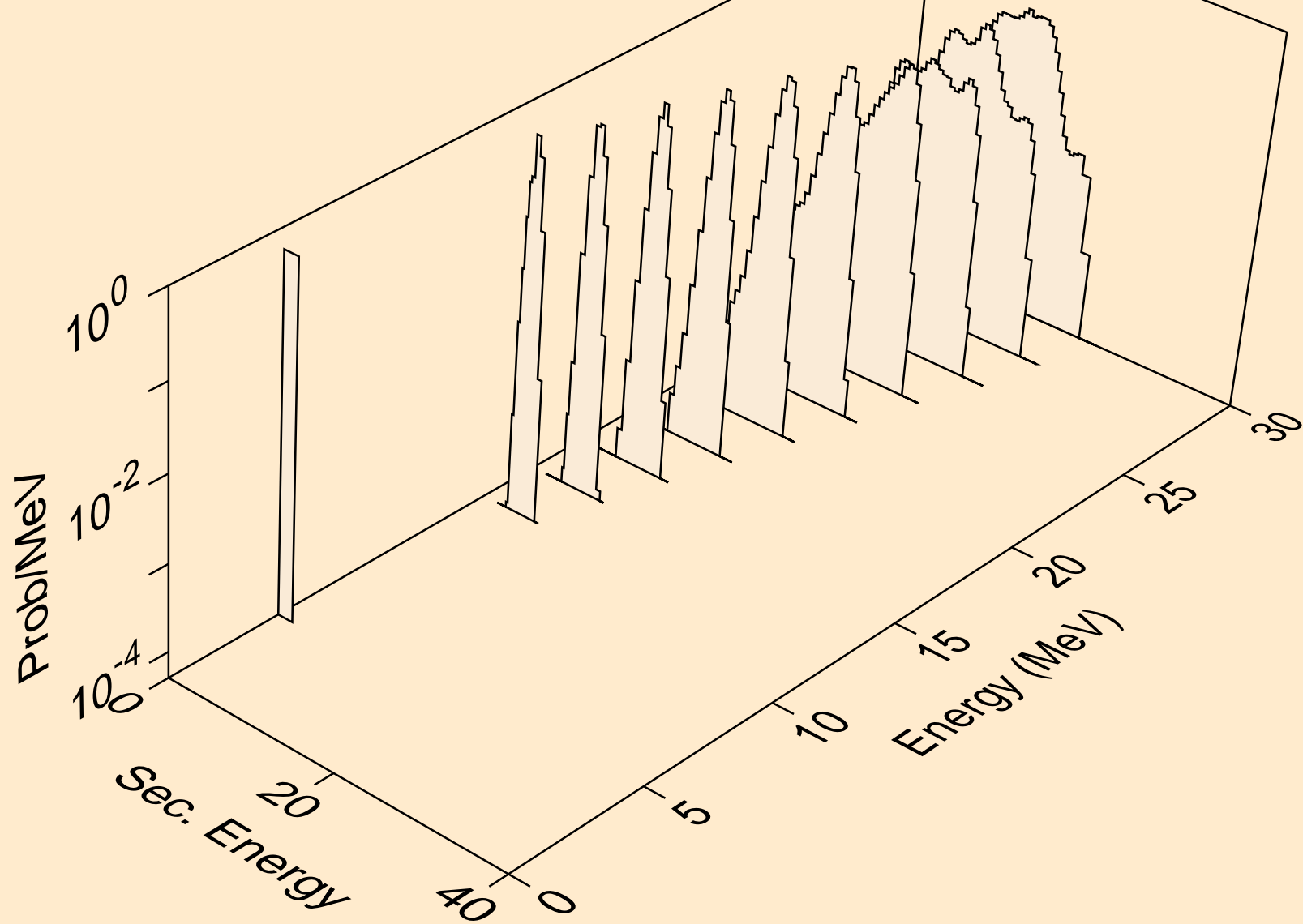

PU229 NEUTRON ACER TENDL-2021 LIBRARY; T=293.6K
deuterons from (n,da)

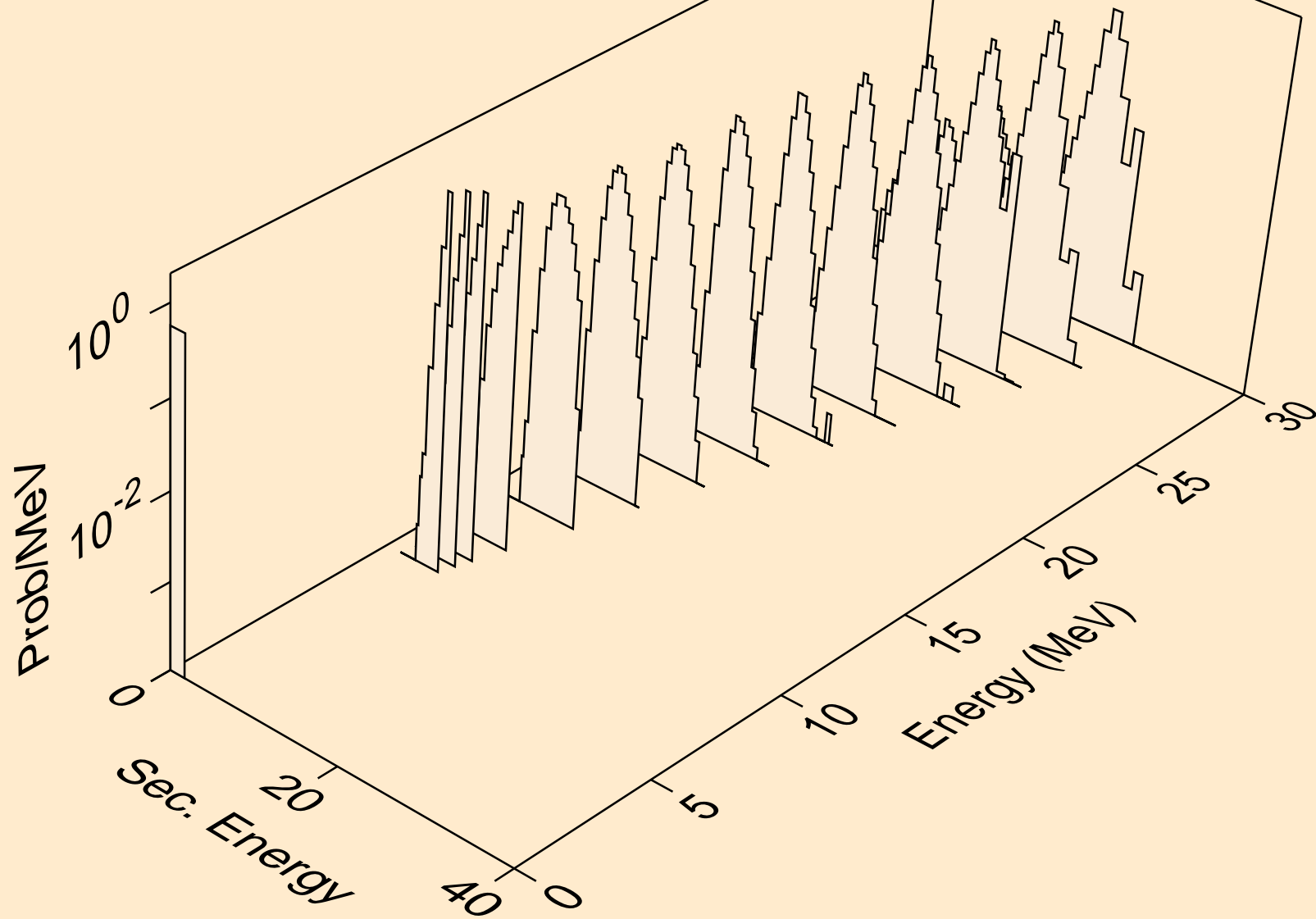

PU229 NEUTRON ACER TENDL-2021 LIBRARY; T=293.6K
tritons from (n,x)

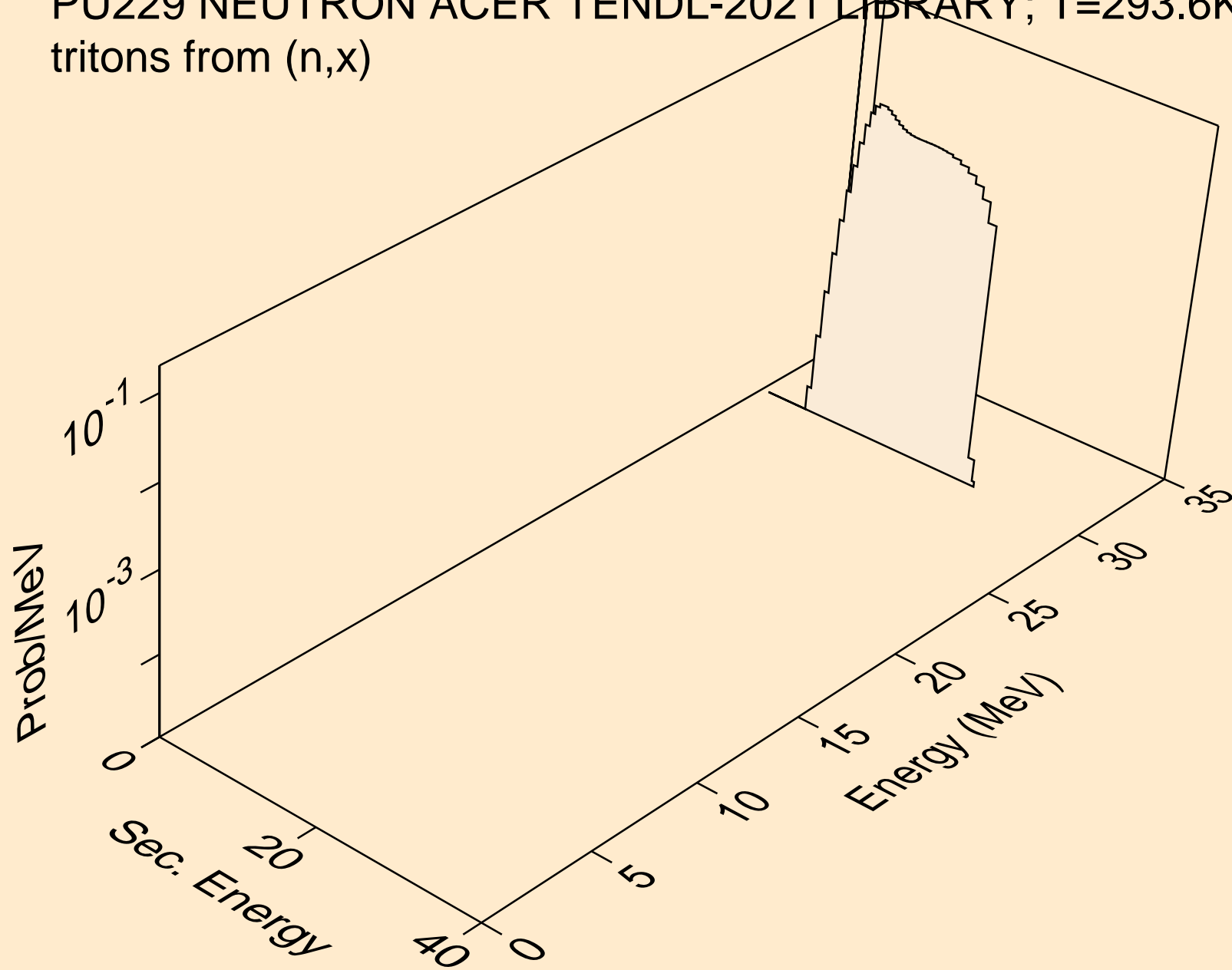

PU229 NEUTRON ACER TENDL-2021 LIBRARY; T=293.6K
tritons from (n,n*)t

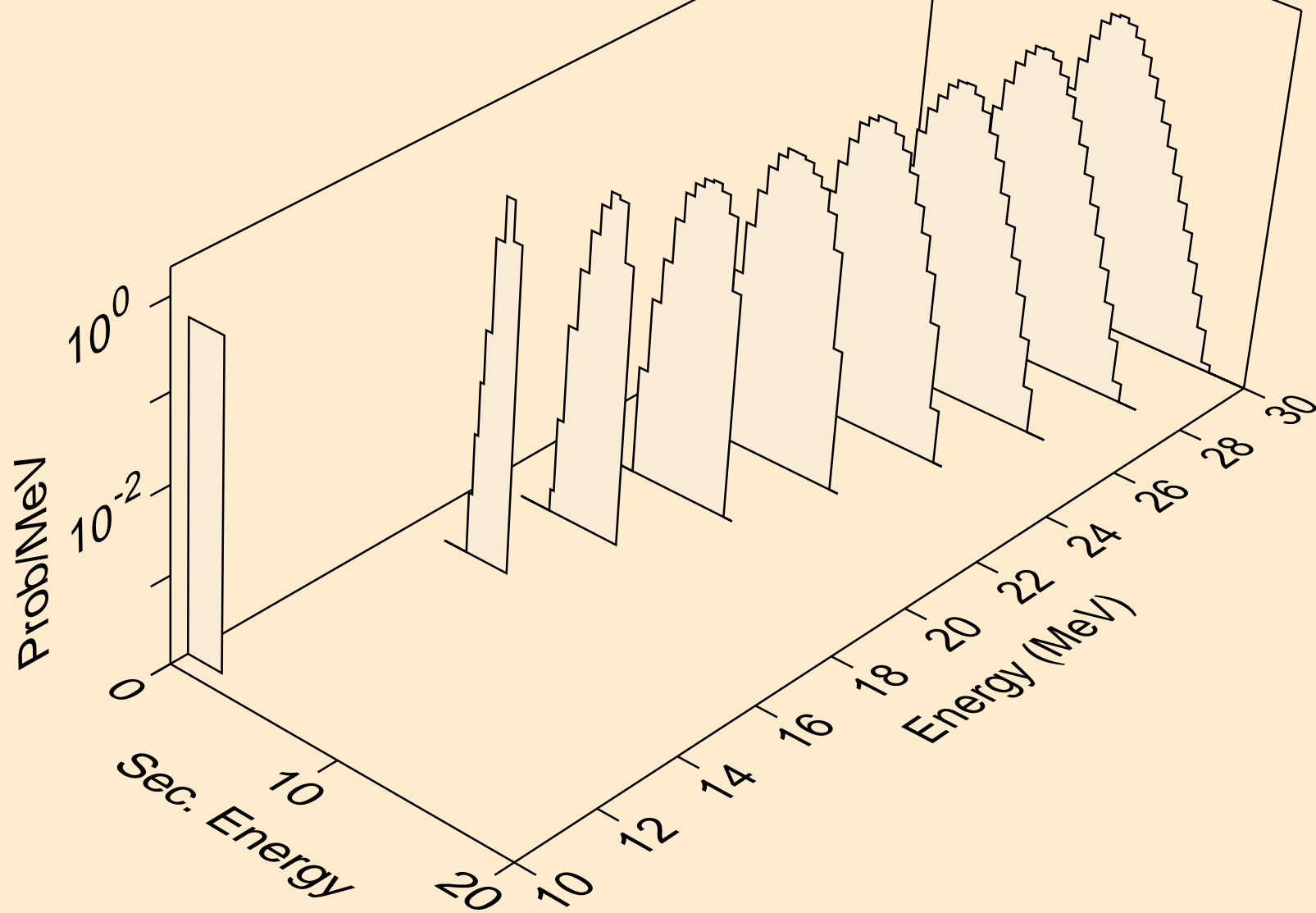

PU229 NEUTRON ACER TENDL-2021 LIBRARY; T=293.6K
tritons from (n,n*)t2a

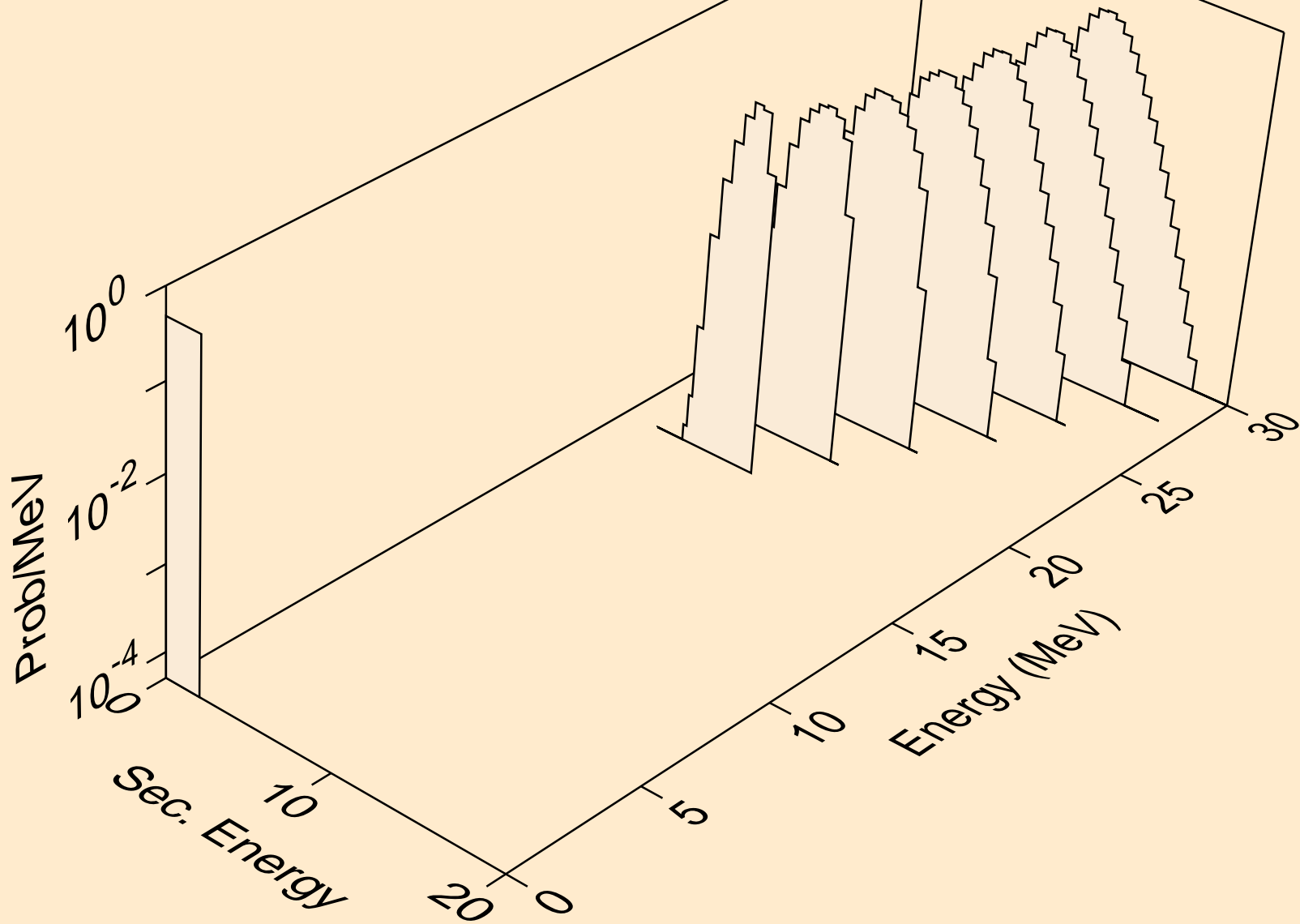

PU229 NEUTRON ACER TENDL-2021 LIBRARY; T=293.6K
tritons from (n,t)

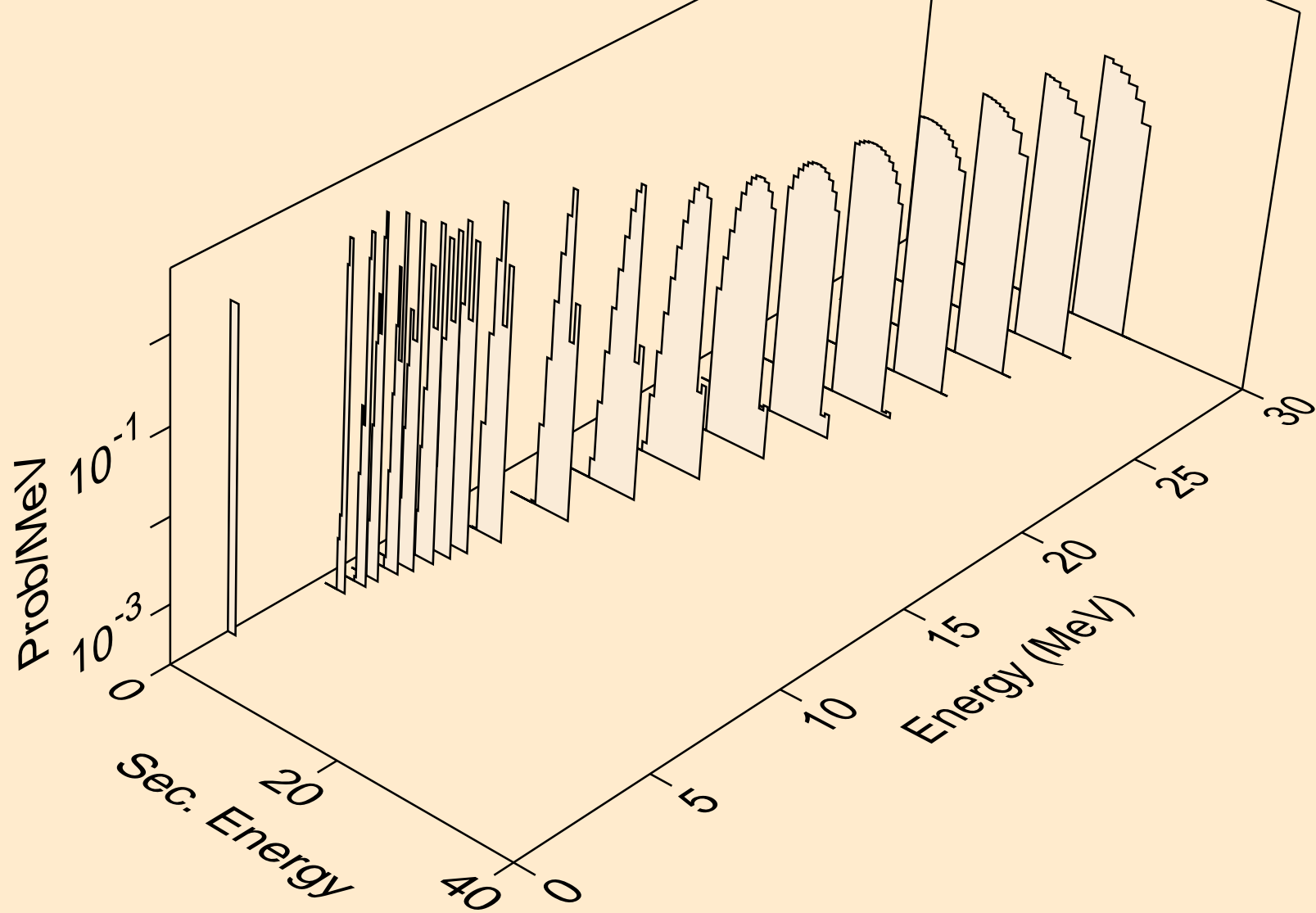

PU229 NEUTRON ACER TENDL-2021 LIBRARY; T=293.6K
tritons from (n,pt)

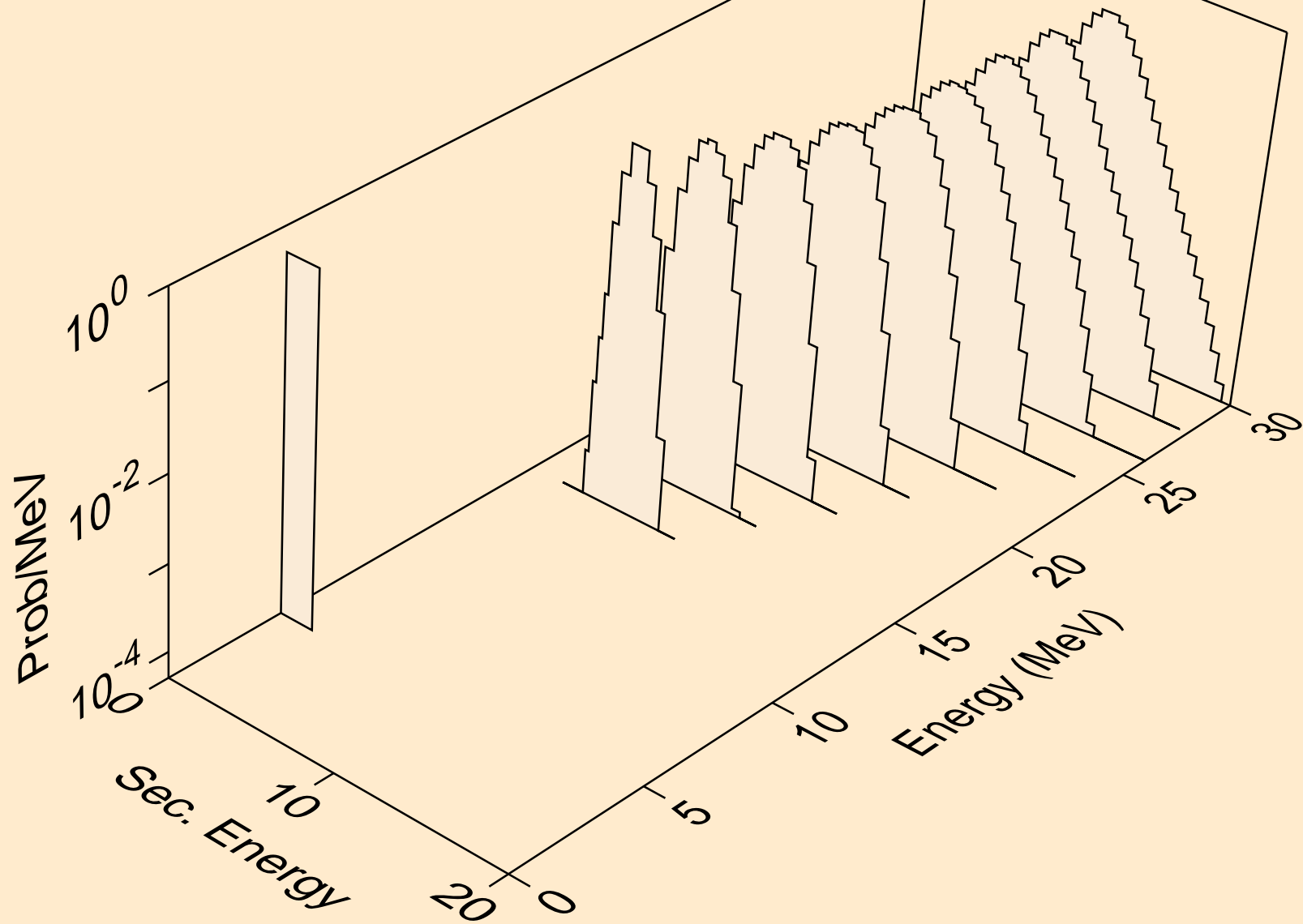

PU229 NEUTRON ACER TENDL-2021 LIBRARY; T=293.6K
he3s from (n,x)

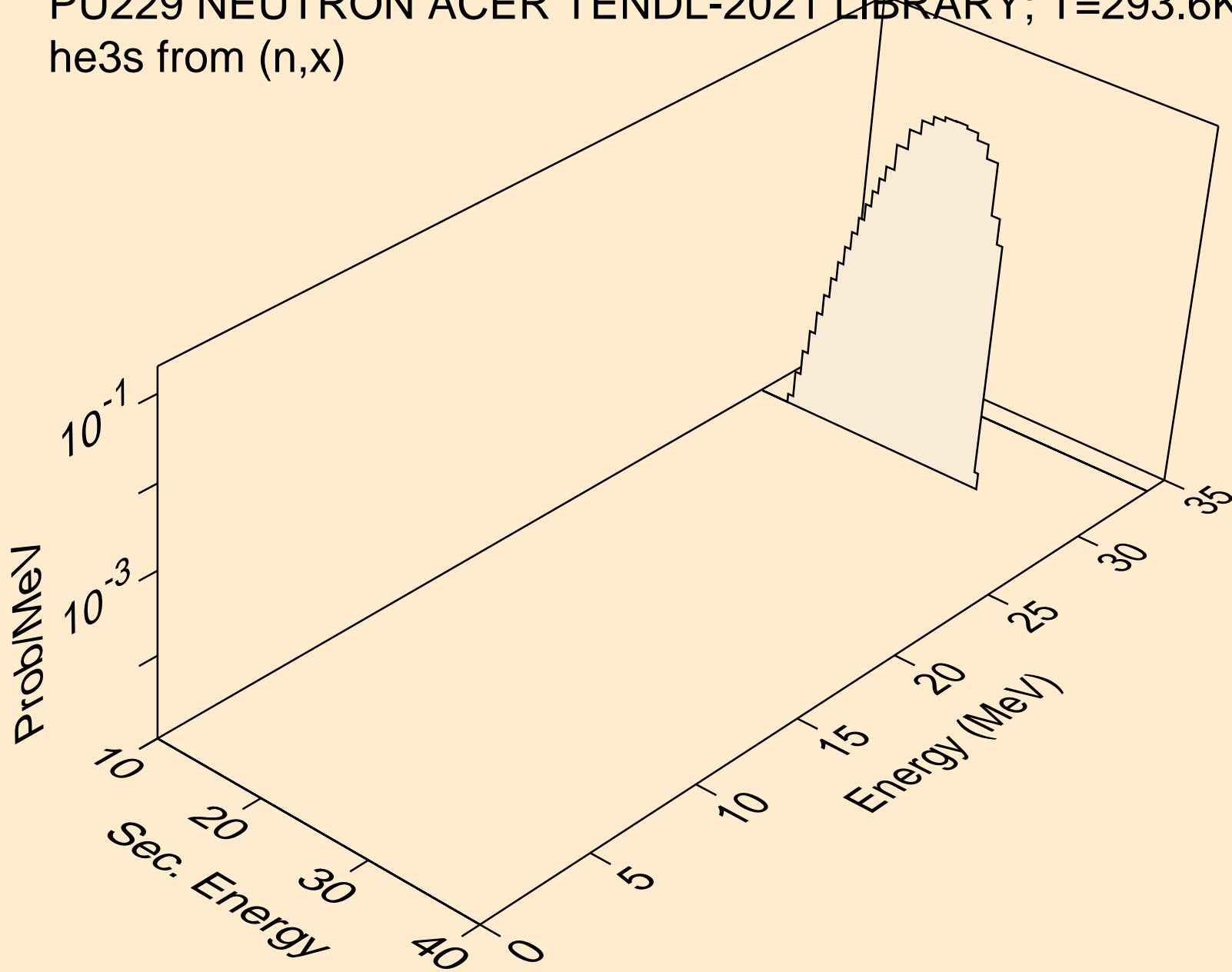

PU229 NEUTRON ACER TENDL-2021 LIBRARY; T=293.6K
he3s from (n,n*)he3

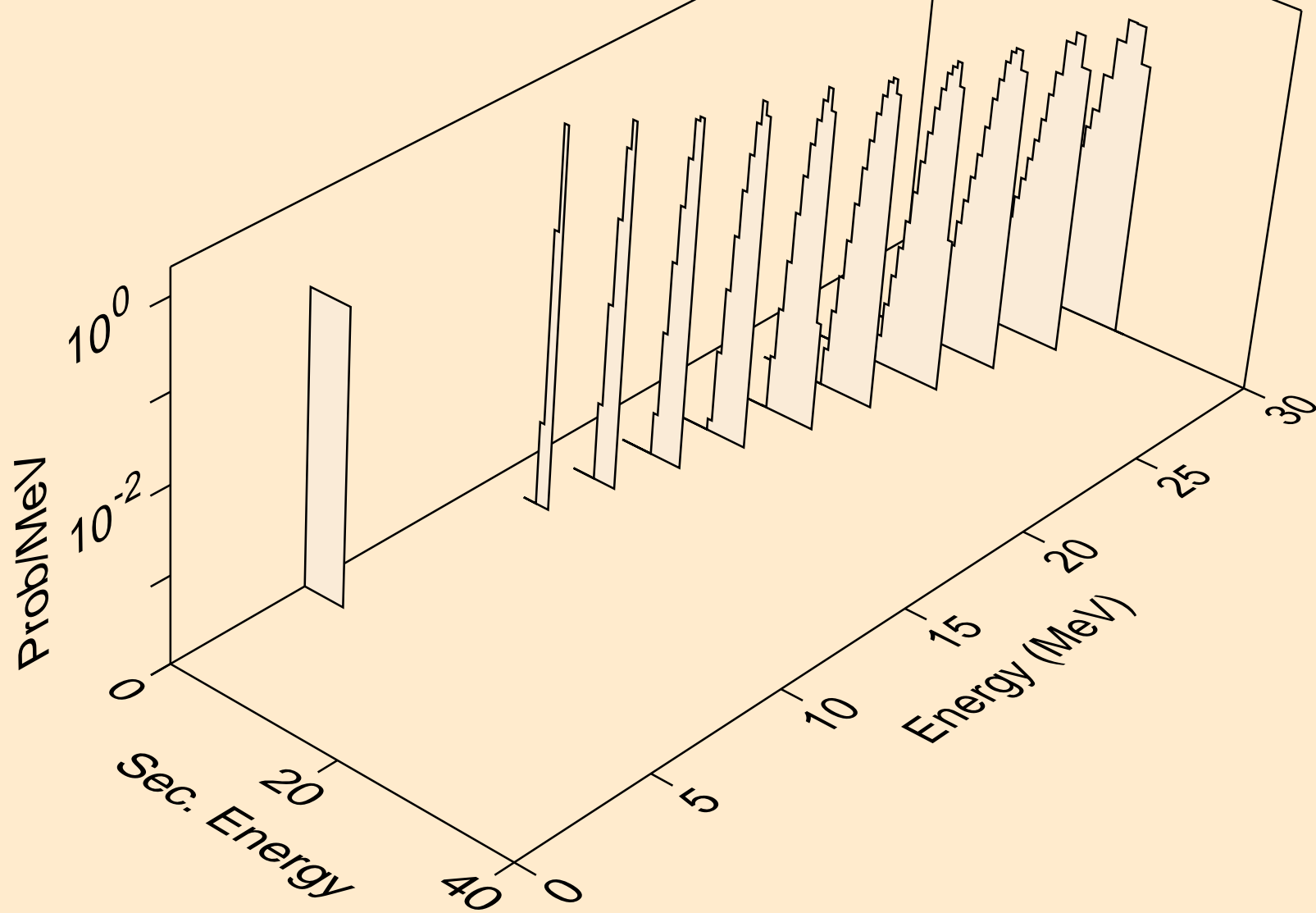

PU229 NEUTRON ACER TENDL-2021 LIBRARY; T=293.6K
he3s from (n,he3)

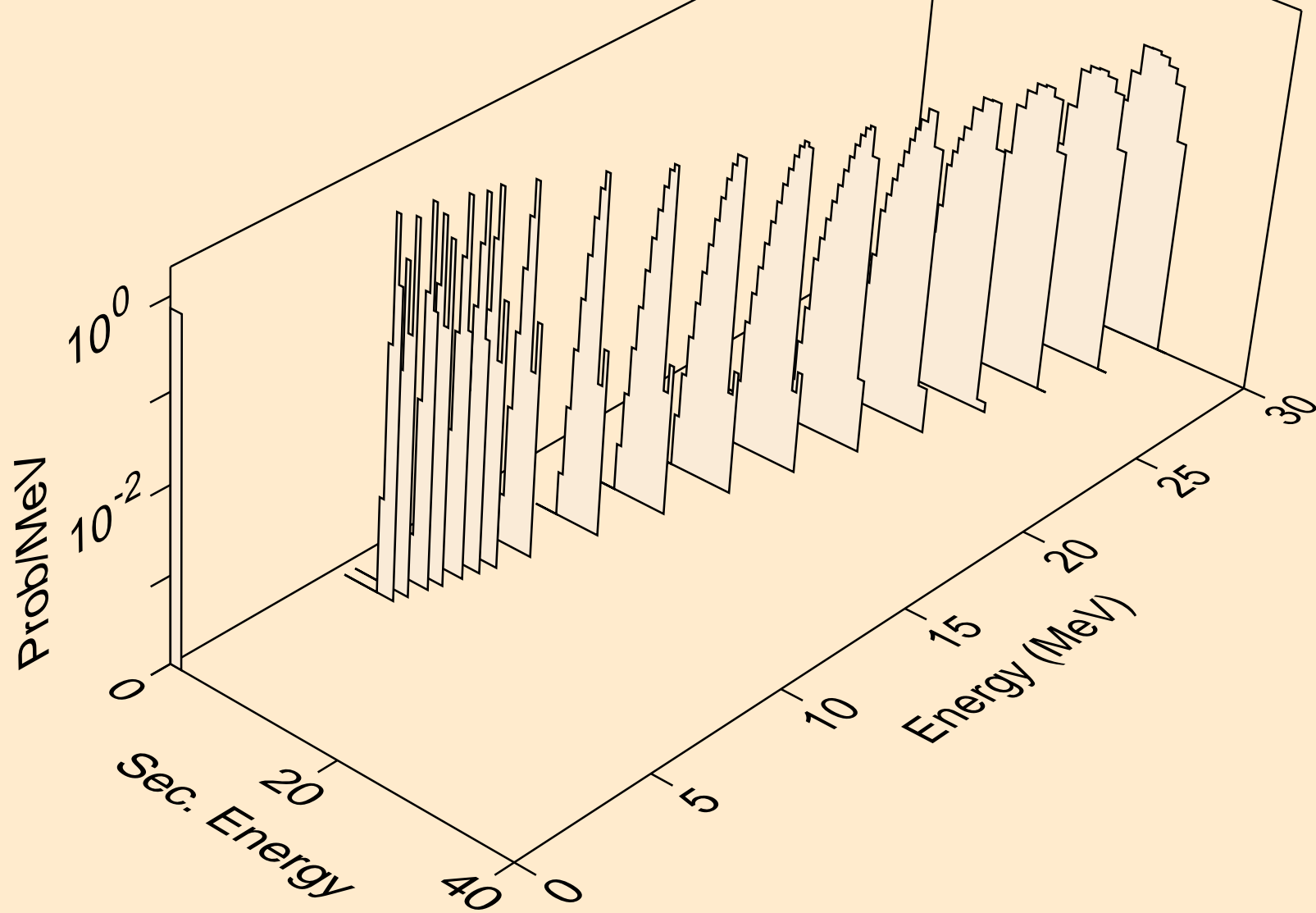

PU229 NEUTRON ACER TENDL-2021 LIBRARY; T=293.6K
alphas from (n,x)

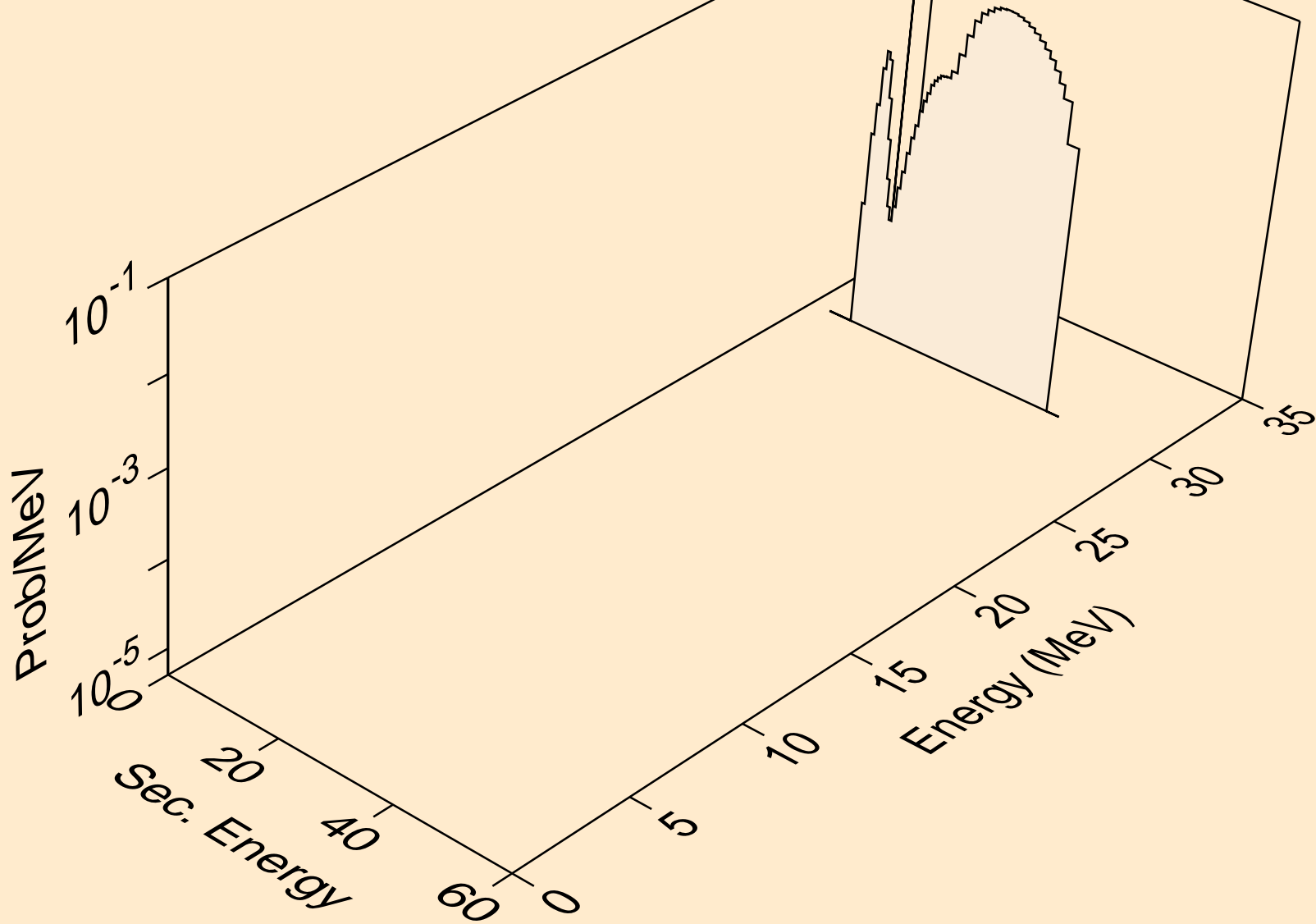

PU229 NEUTRON ACER TENDL-2021 LIBRARY; T=293.6K
alphas from (n,n*)a

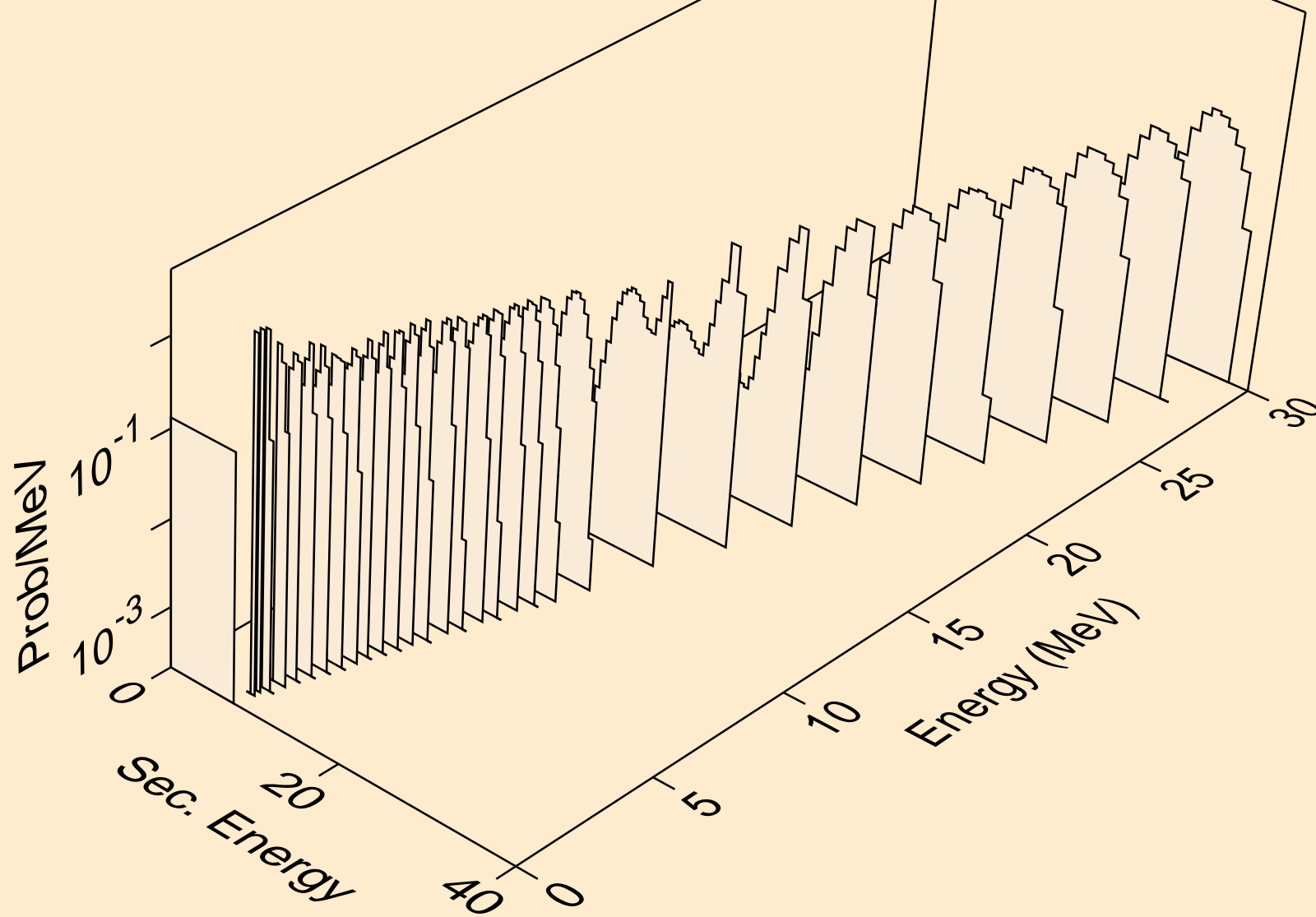

PU229 NEUTRON ACER TENDL-2021 LIBRARY; T=293.6K
alphas from (n,n*)3a

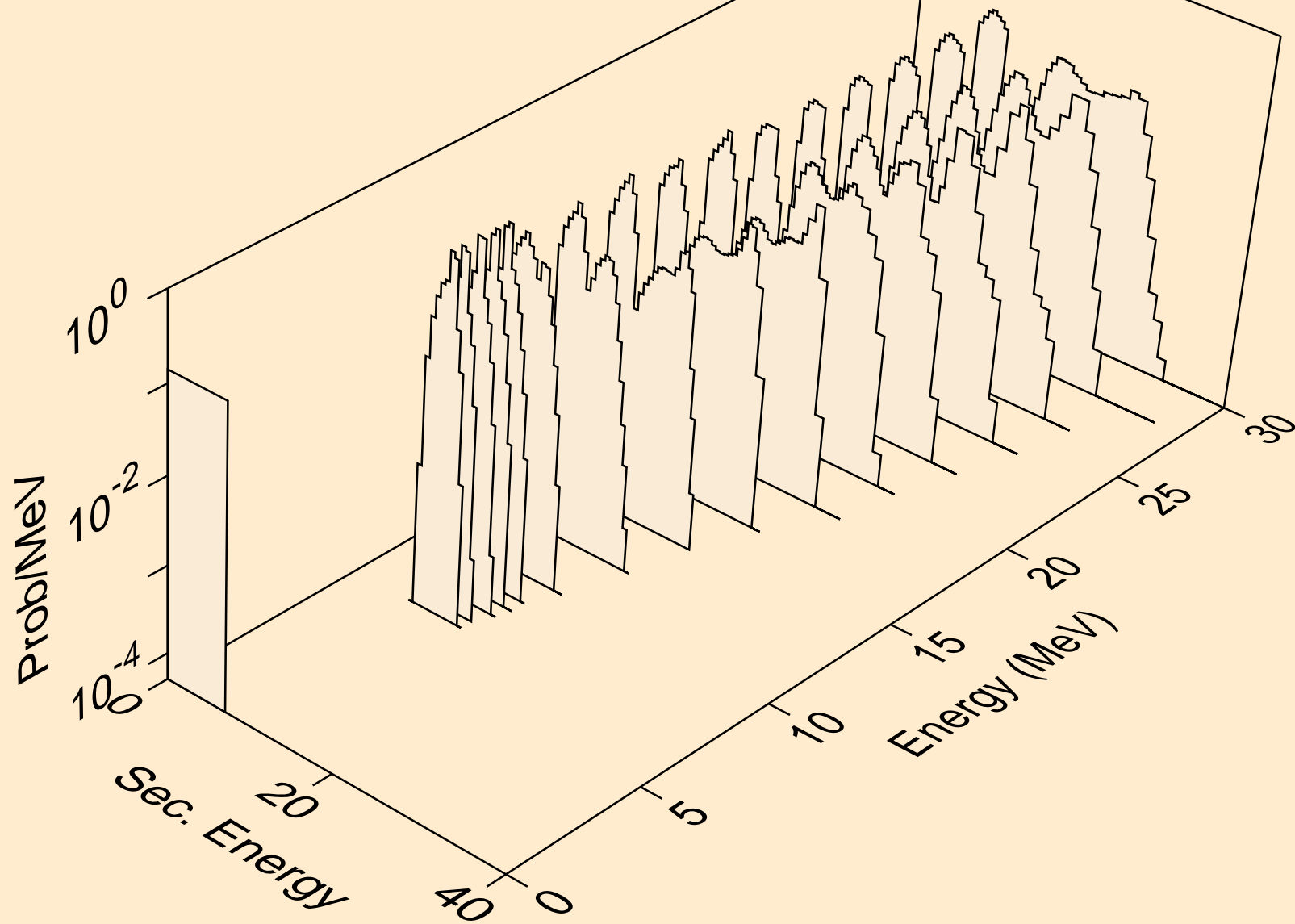

PU229 NEUTRON ACER TENDL-2021 LIBRARY; T=293.6K
alphas from (n,2n)a

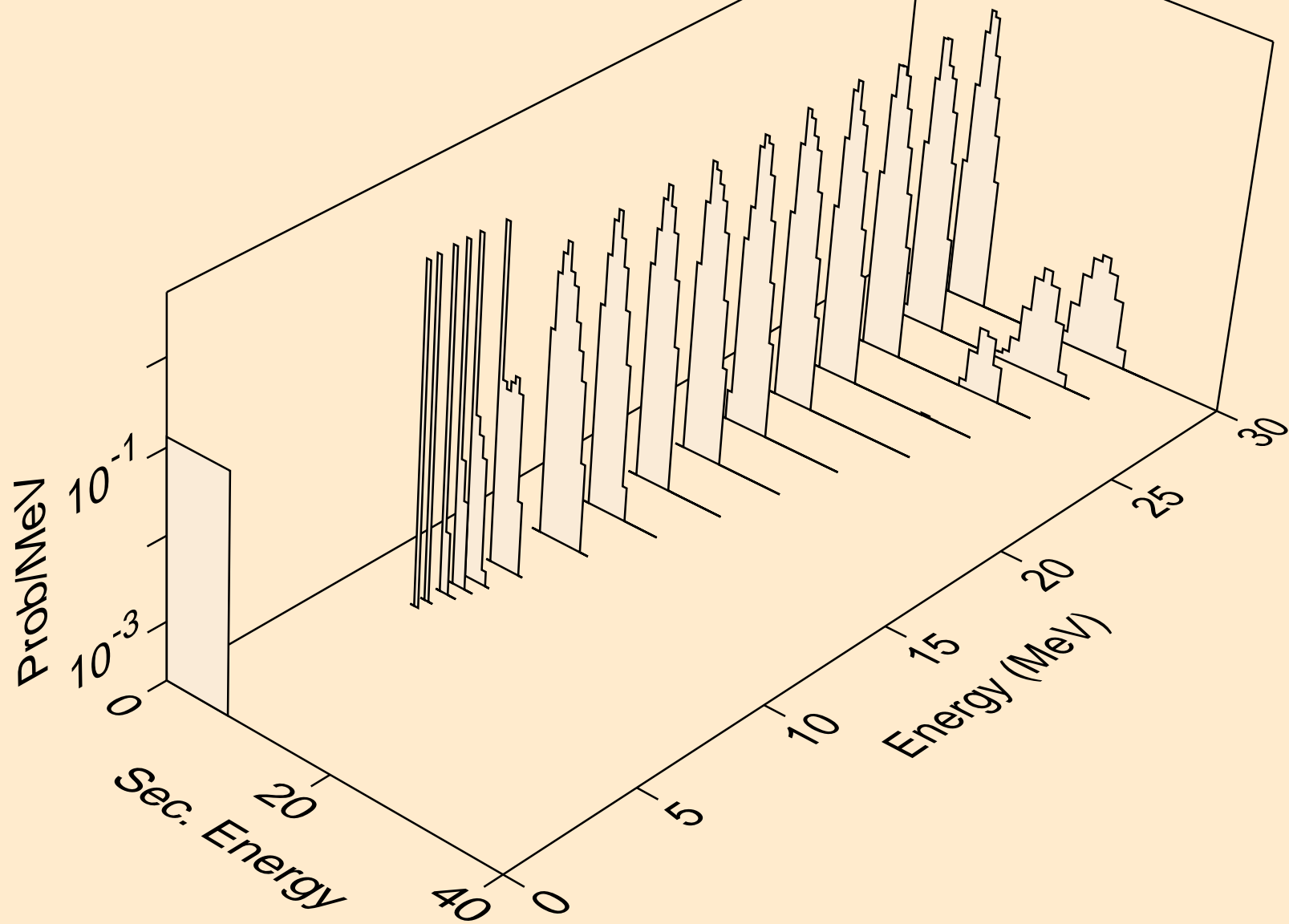

PU229 NEUTRON ACER TENDL-2021 LIBRARY; T=293.6K
alphas from (n,3n)a

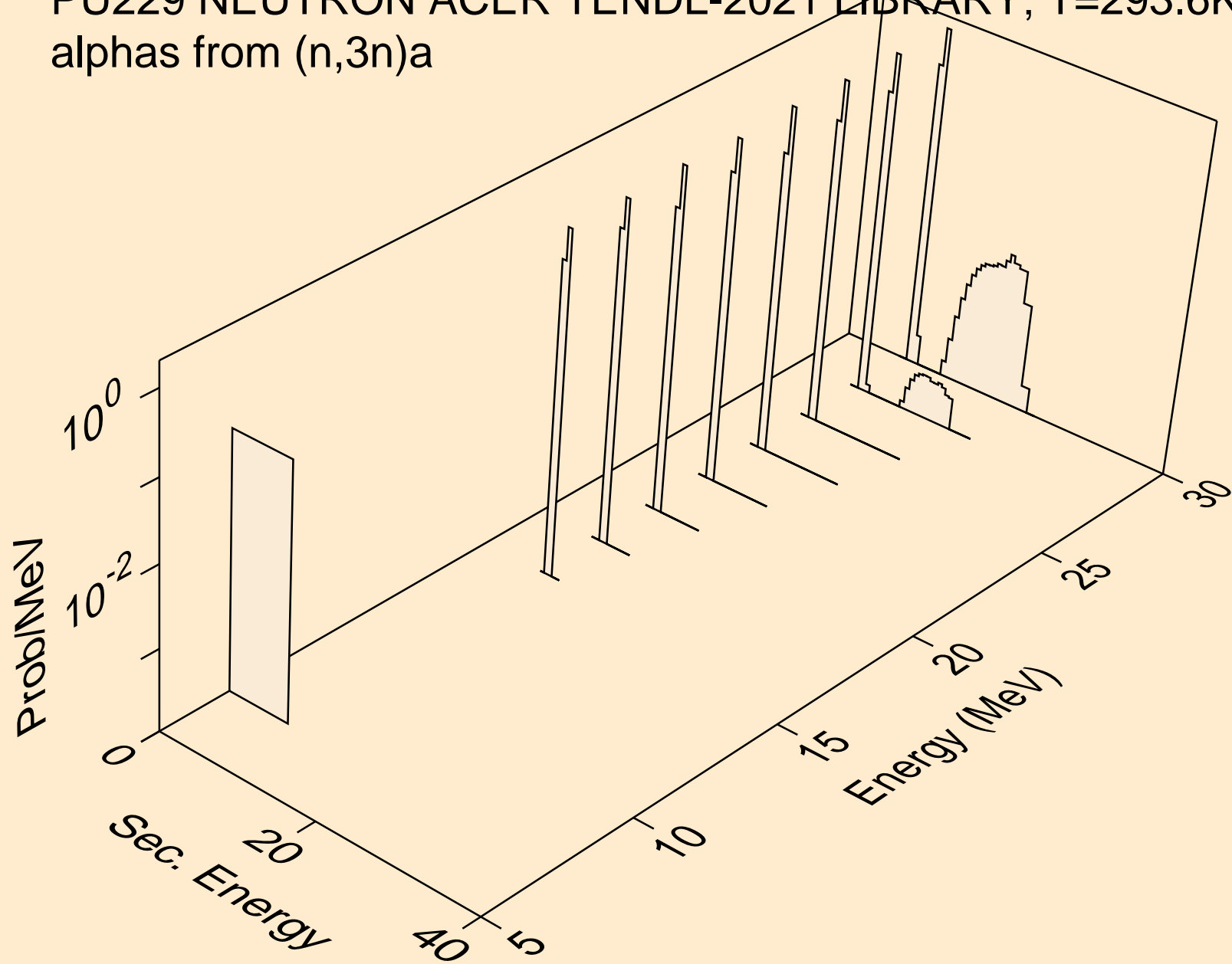

PU229 NEUTRON ACER TENDL-2021 LIBRARY; T=293.6K
alphas from (n,n*)2a

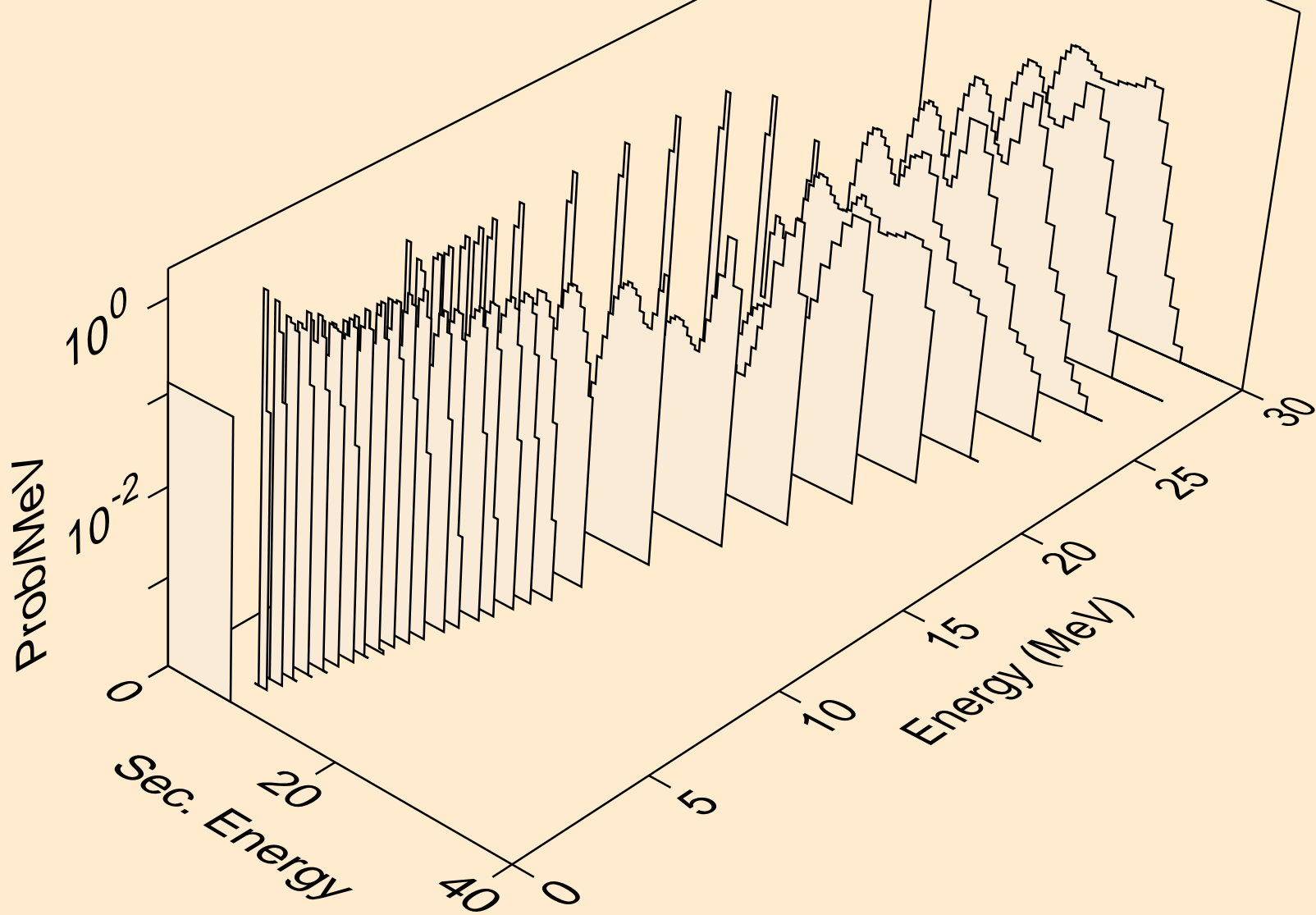

PU229 NEUTRON ACER TENDL-2021 LIBRARY; T=293.6K
alphas from (n,2n)2a

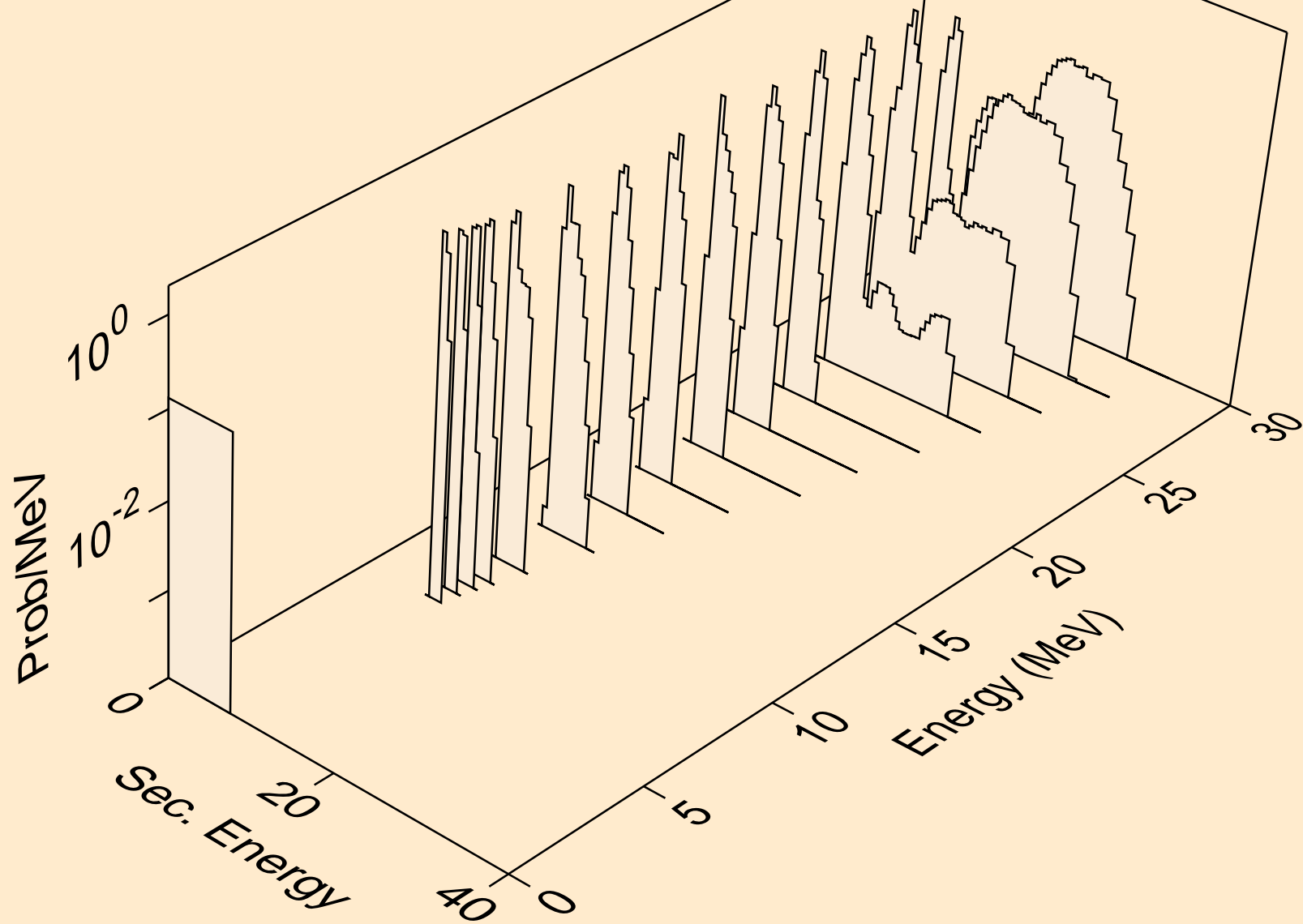

PU229 NEUTRON ACER TENDL-2021 LIBRARY; T=293.6K
alphas from (n,n*)t2a

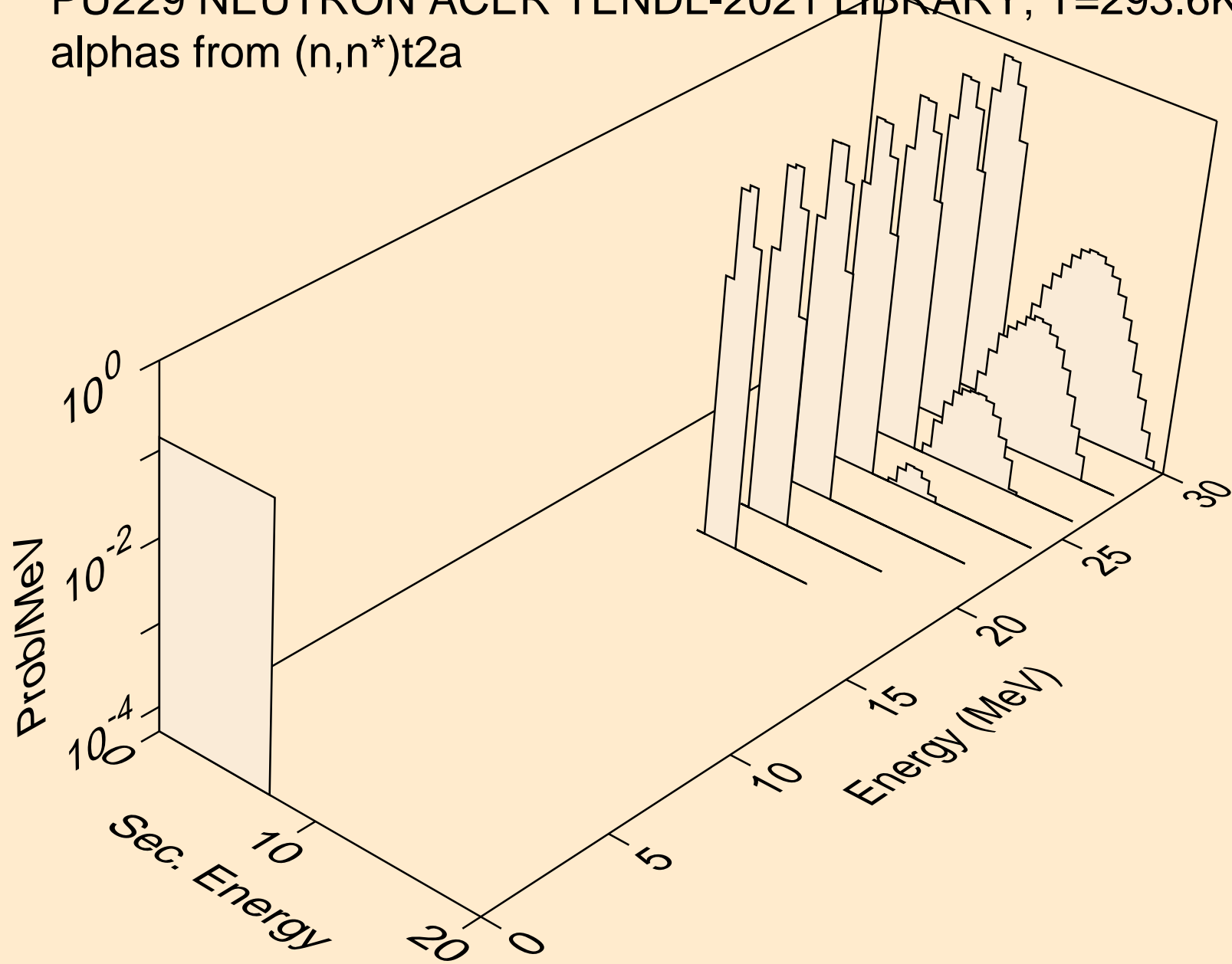

PU229 NEUTRON ACER TENDL-2021 LIBRARY; T=293.6K
alphas from (n,npa)

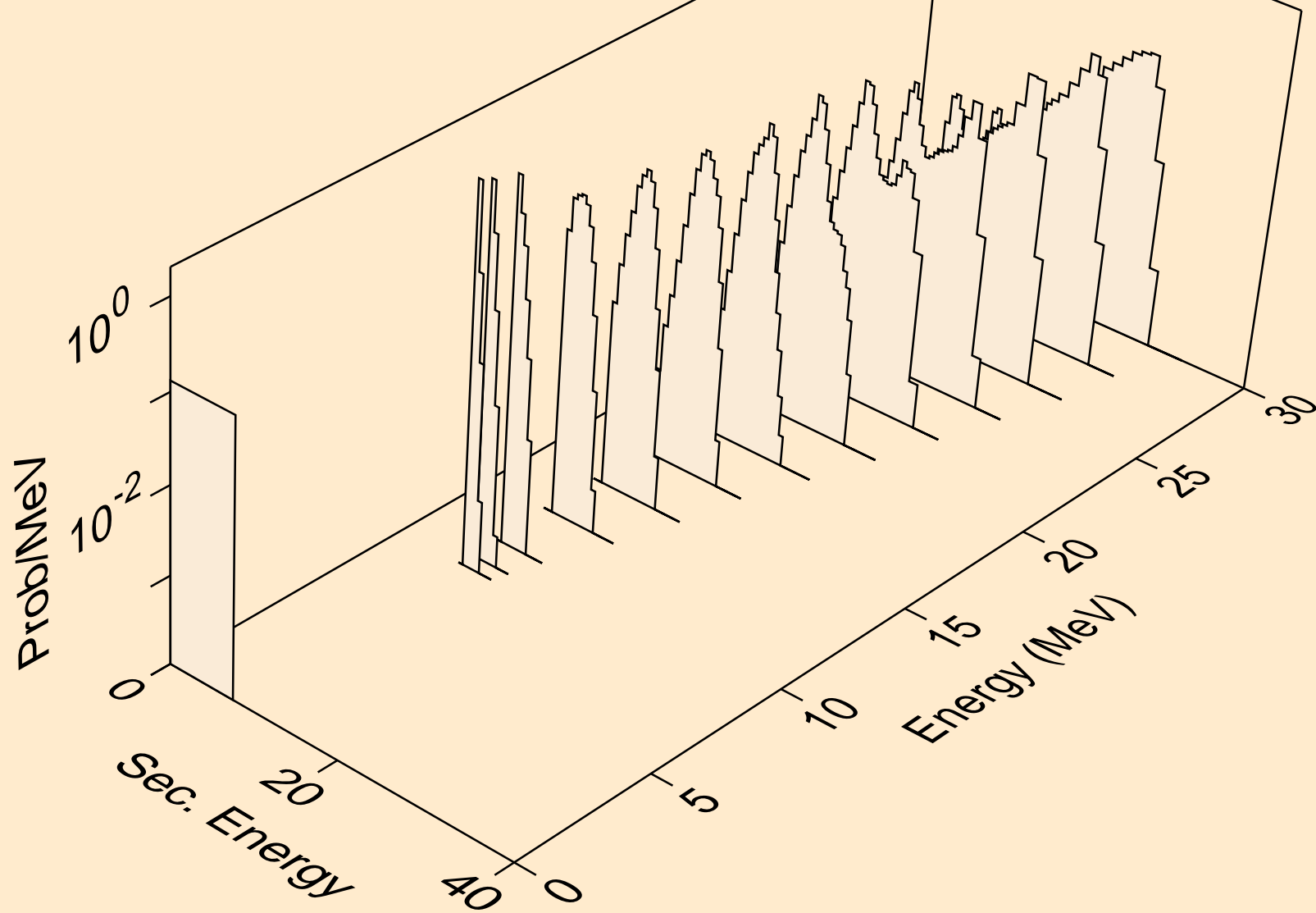

PU229 NEUTRON ACER TENDL-2021 LIBRARY; T=293.6K
alphas from (n,a)

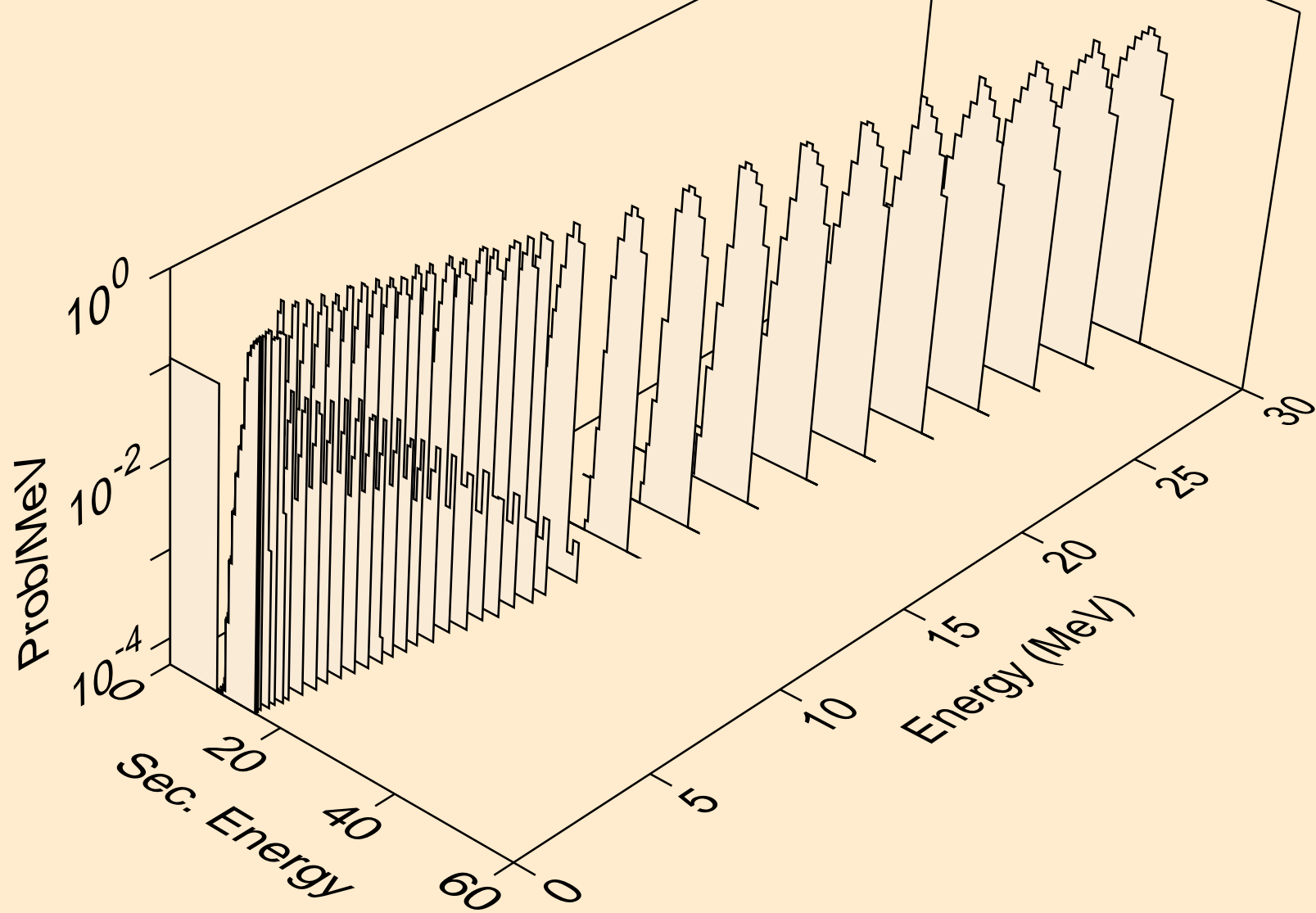

PU229 NEUTRON ACER TENDL-2021 LIBRARY; T=293.6K
alphas from (n,2a)

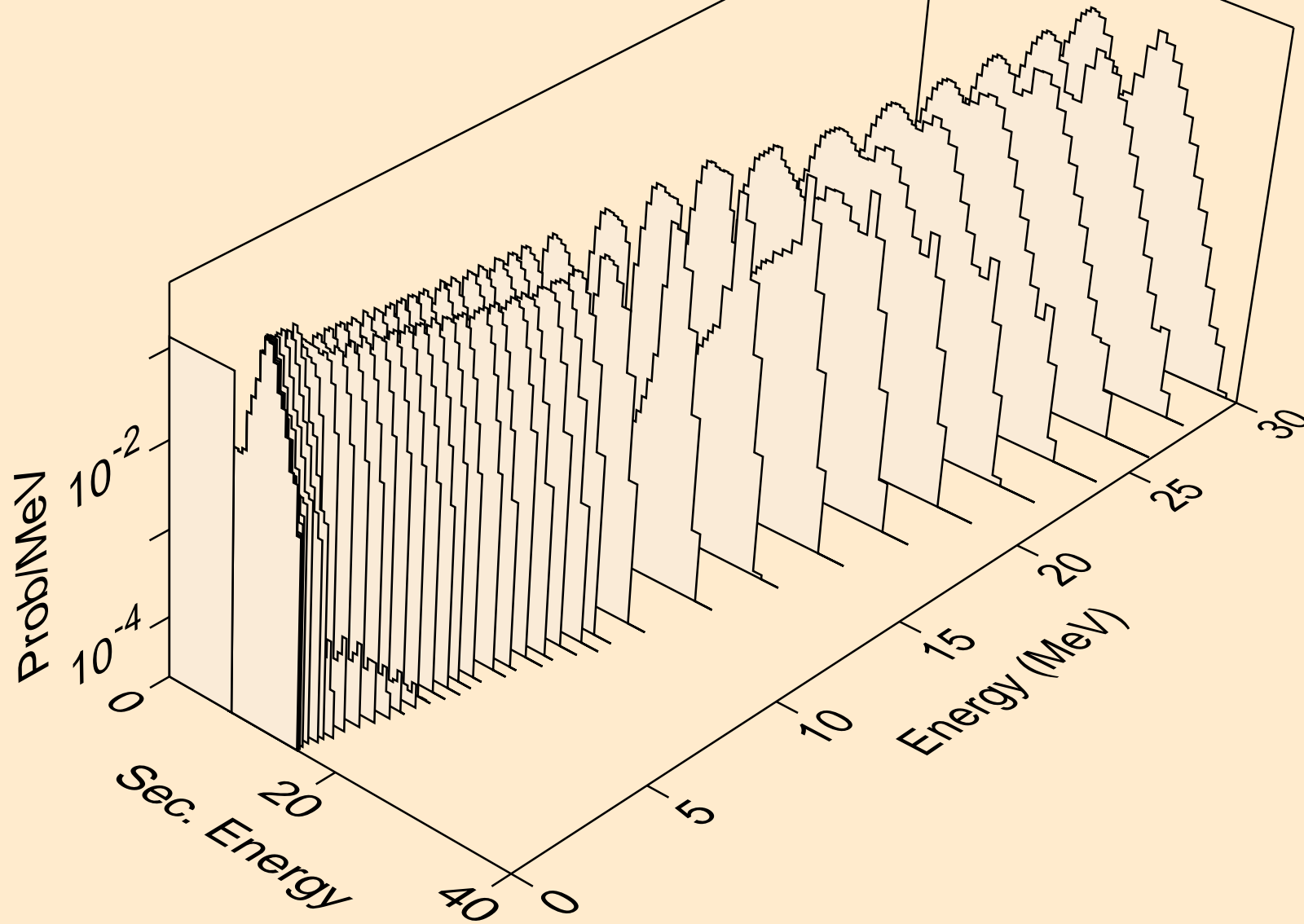

PU229 NEUTRON ACER TENDL-2021 LIBRARY; T=293.6K
alphas from (n,3a)

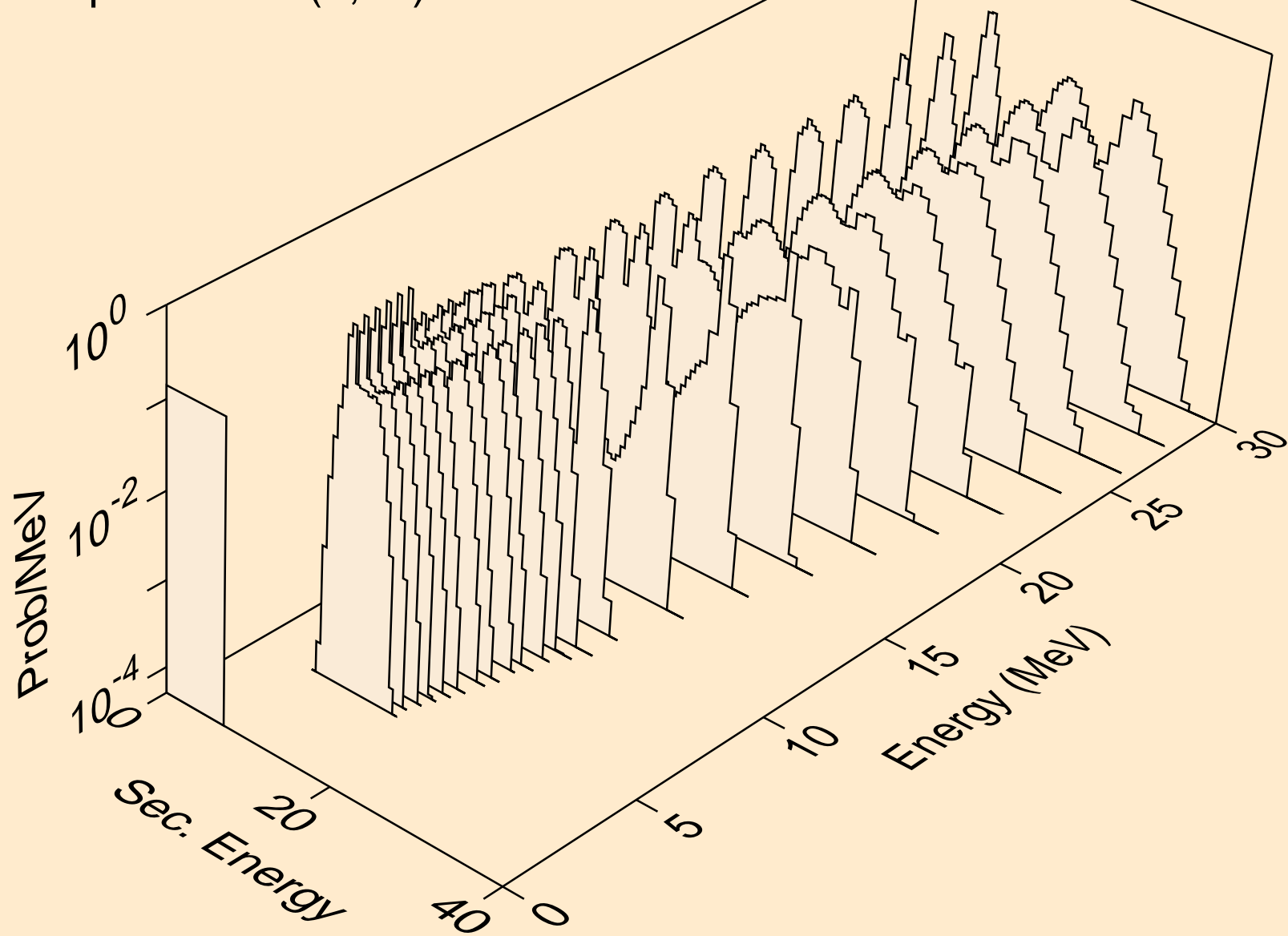

PU229 NEUTRON ACER TENDL-2021 LIBRARY; T=293.6K
alphas from (n,pa)

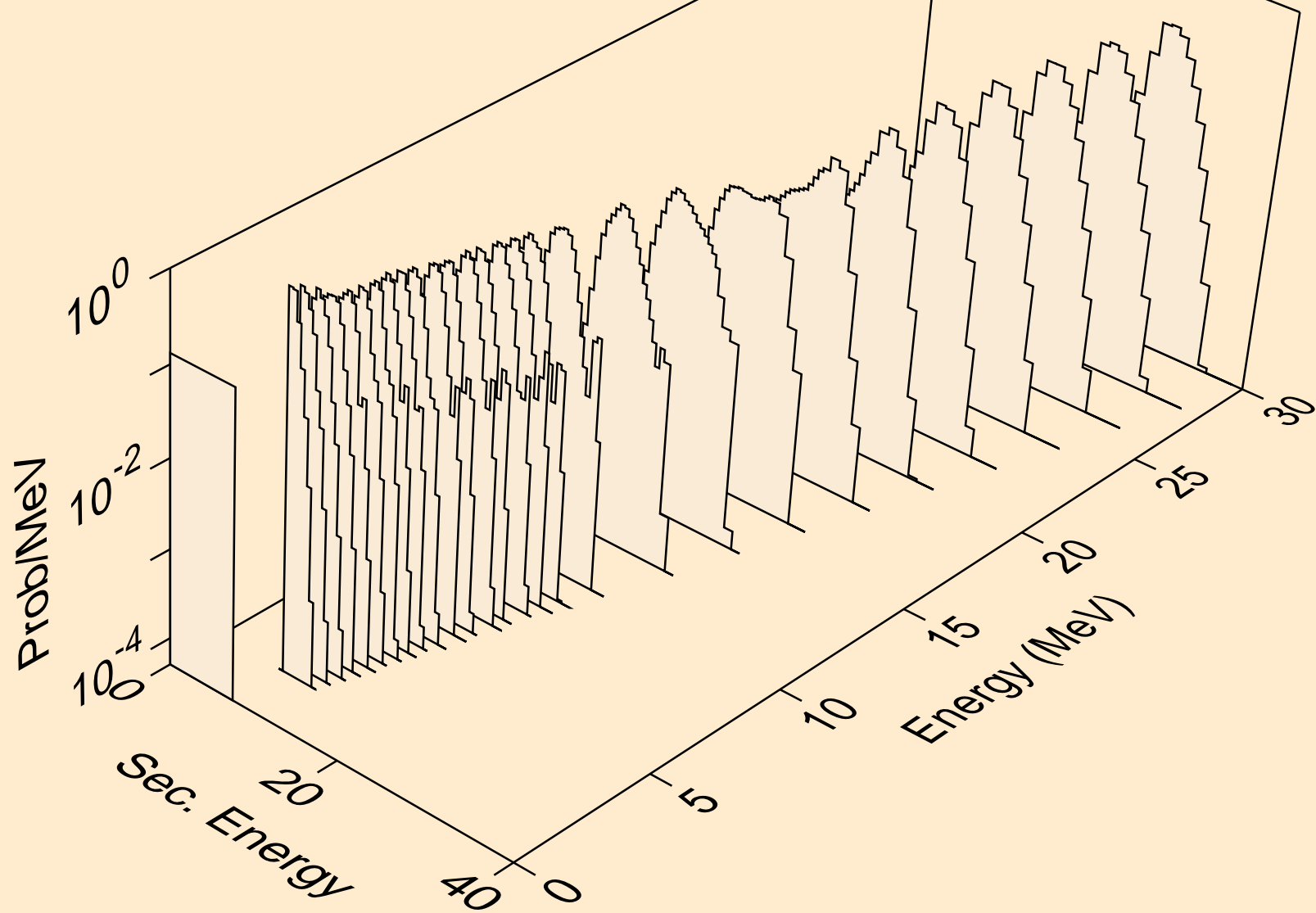

PU229 NEUTRON ACER TENDL-2021 LIBRARY; T=293.6K
alphas from (n,d2a)

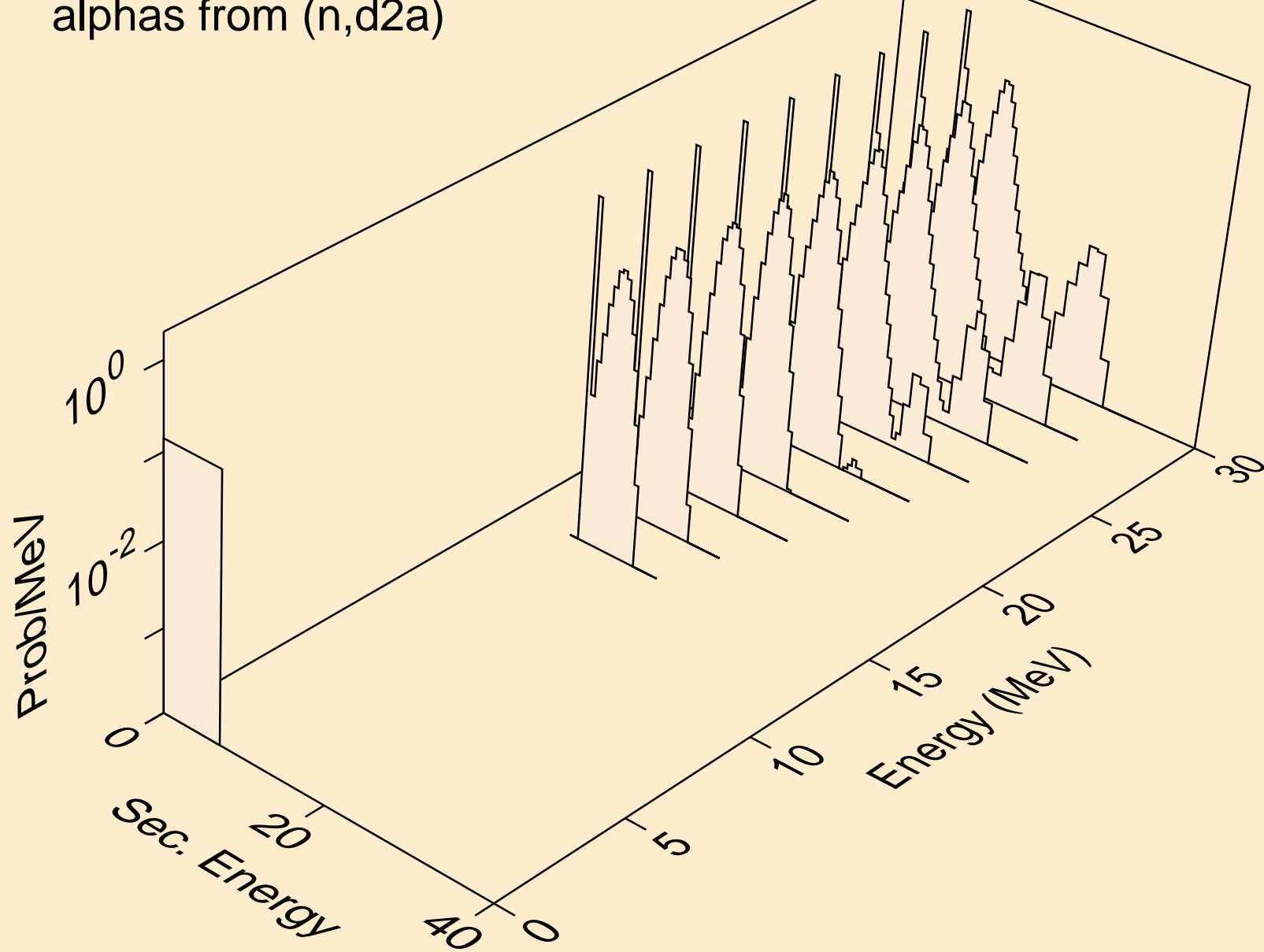

PU229 NEUTRON ACER TENDL-2021 LIBRARY; T=293.6K
alphas from (n,da)

