

PU242 NEUTRON ACER TENDL-2021 LIBRARY; T=293.6K
Principal cross sections

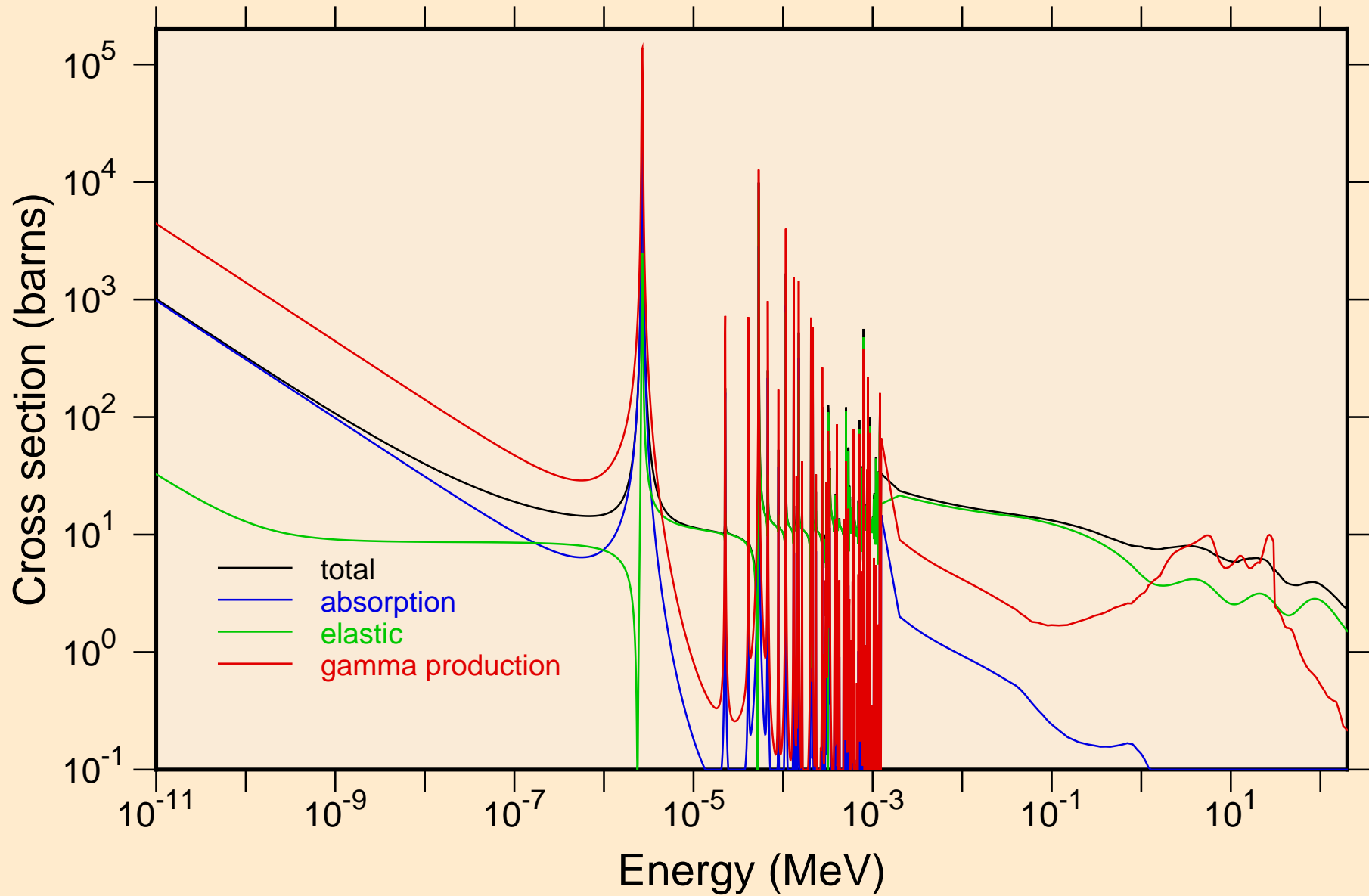

PU242 NEUTRON ACER TENDL-2021 LIBRARY; T=293.6K
resonance total cross section

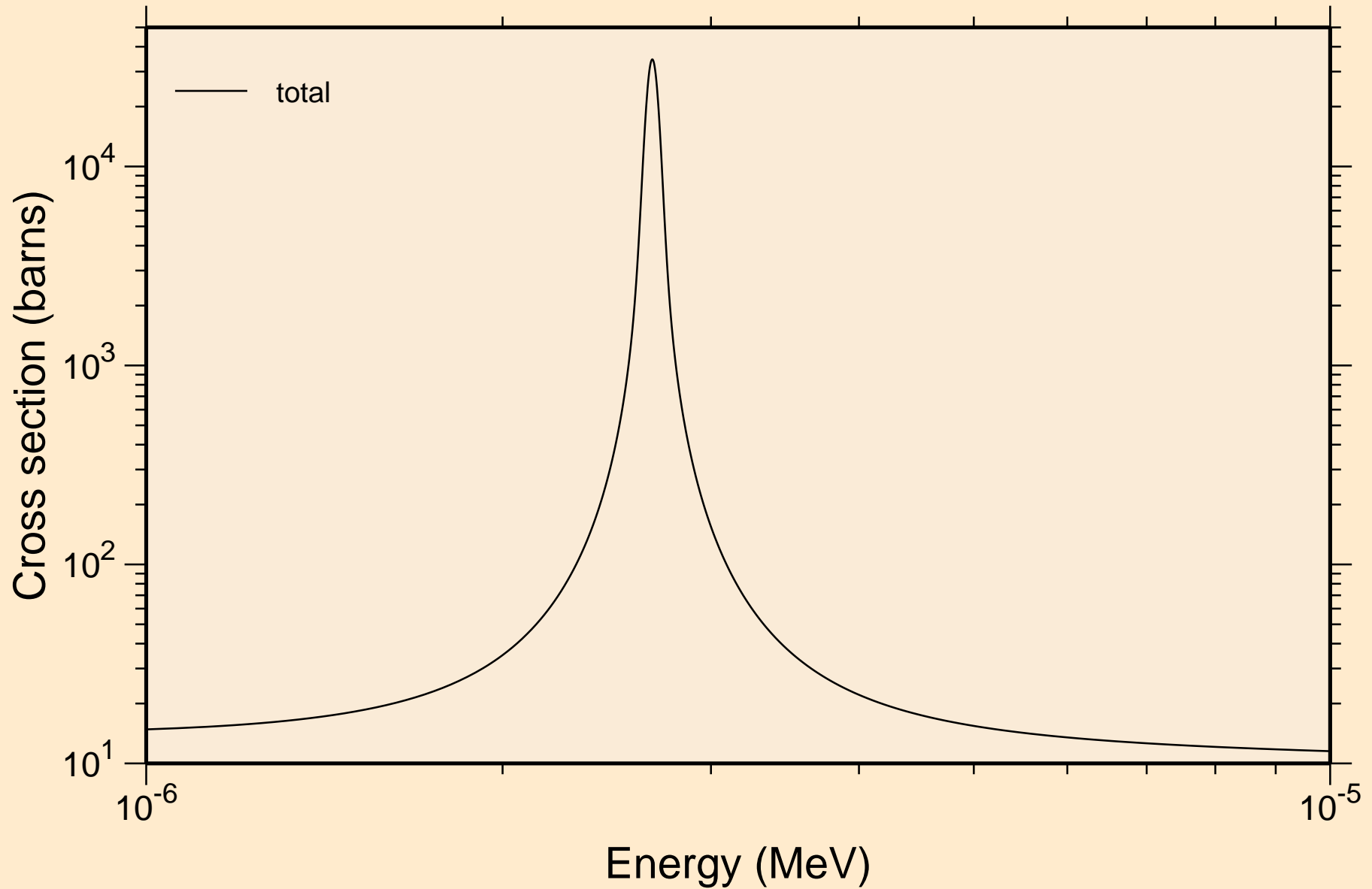

PU242 NEUTRON ACER TENDL-2021 LIBRARY; T=293.6K
resonance total cross section

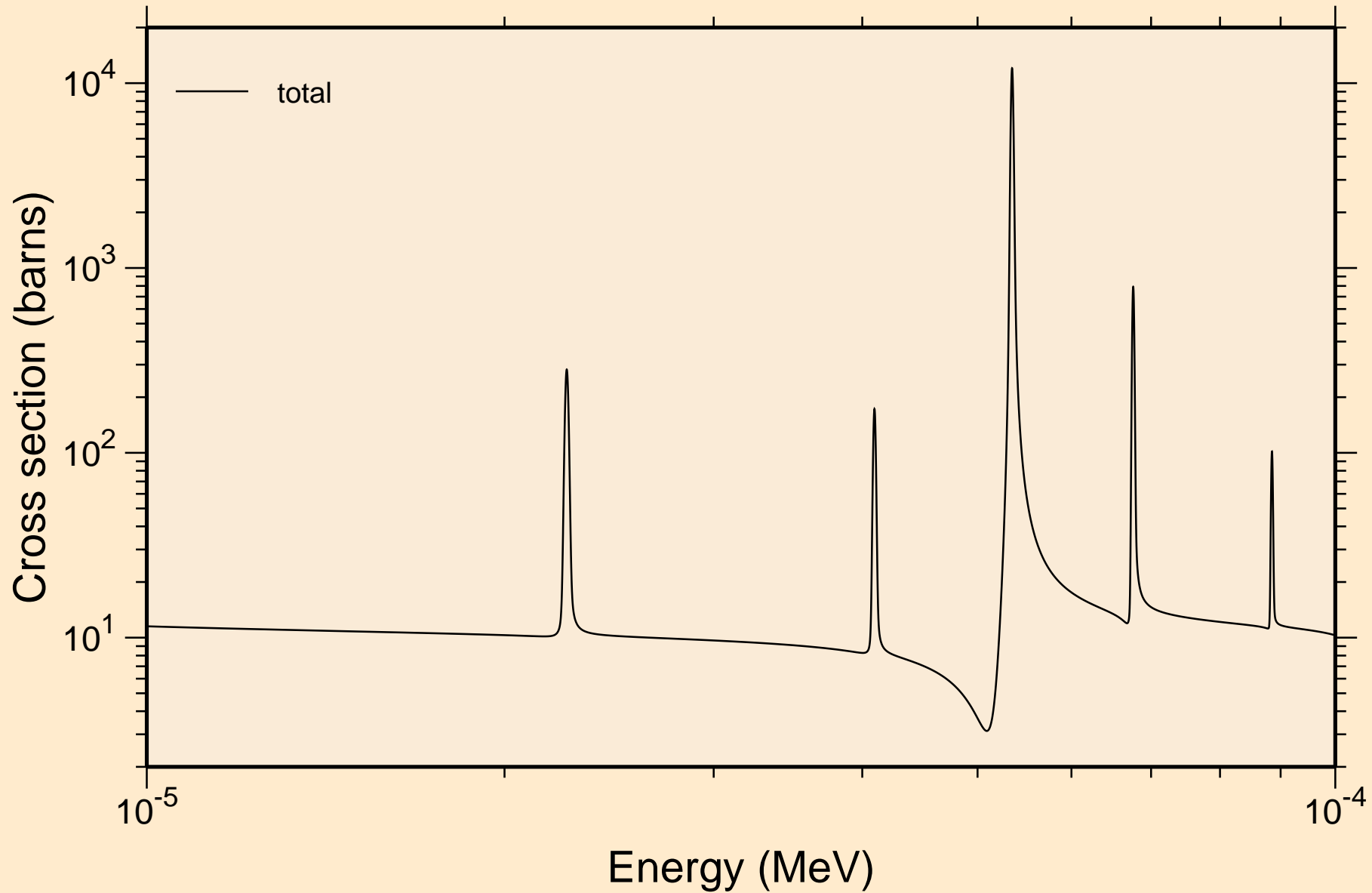

PU242 NEUTRON ACER TENDL-2021 LIBRARY; T=293.6K
resonance total cross section

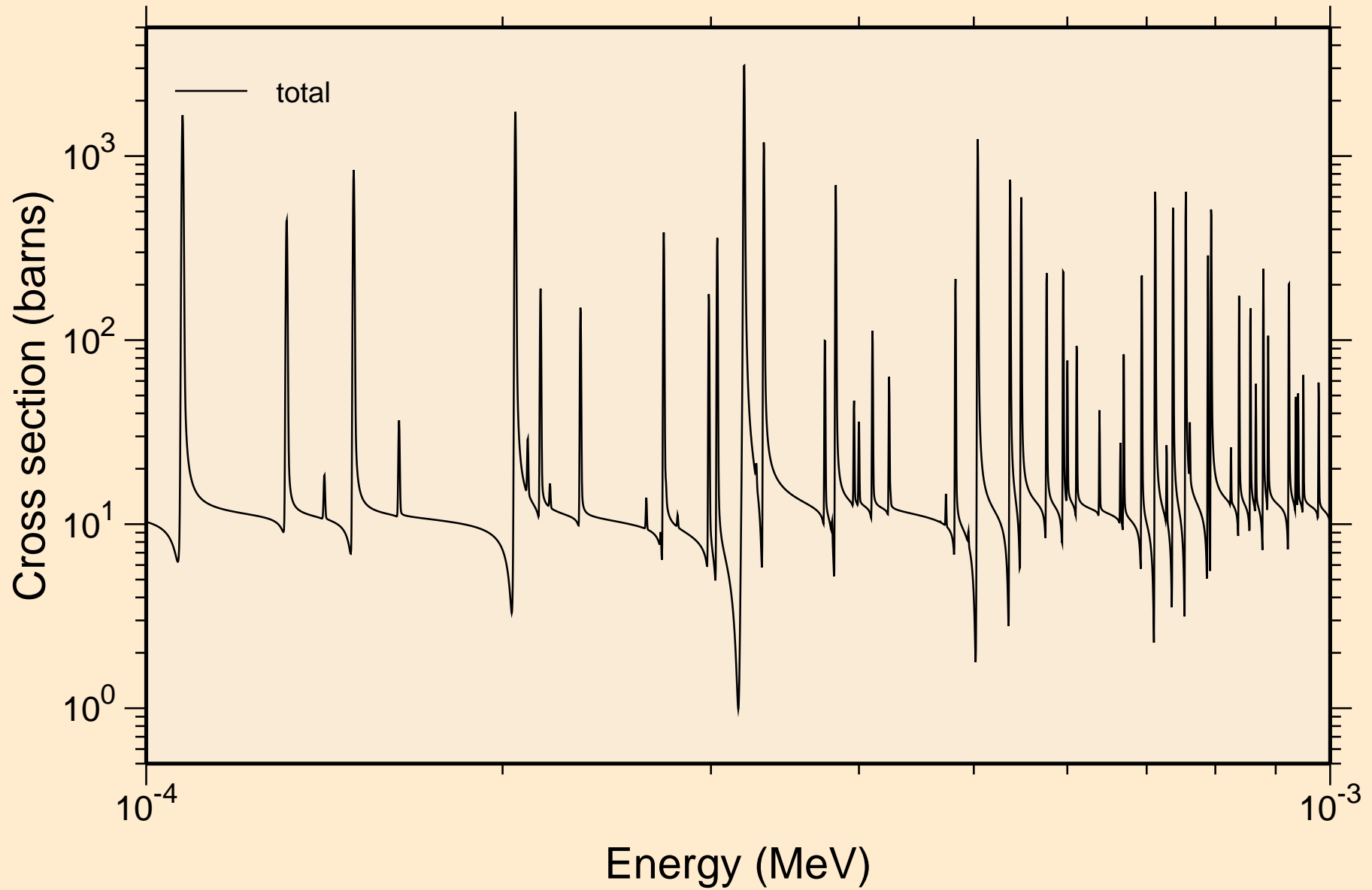

PU242 NEUTRON ACER TENDL-2021 LIBRARY; T=293.6K
resonance total cross section

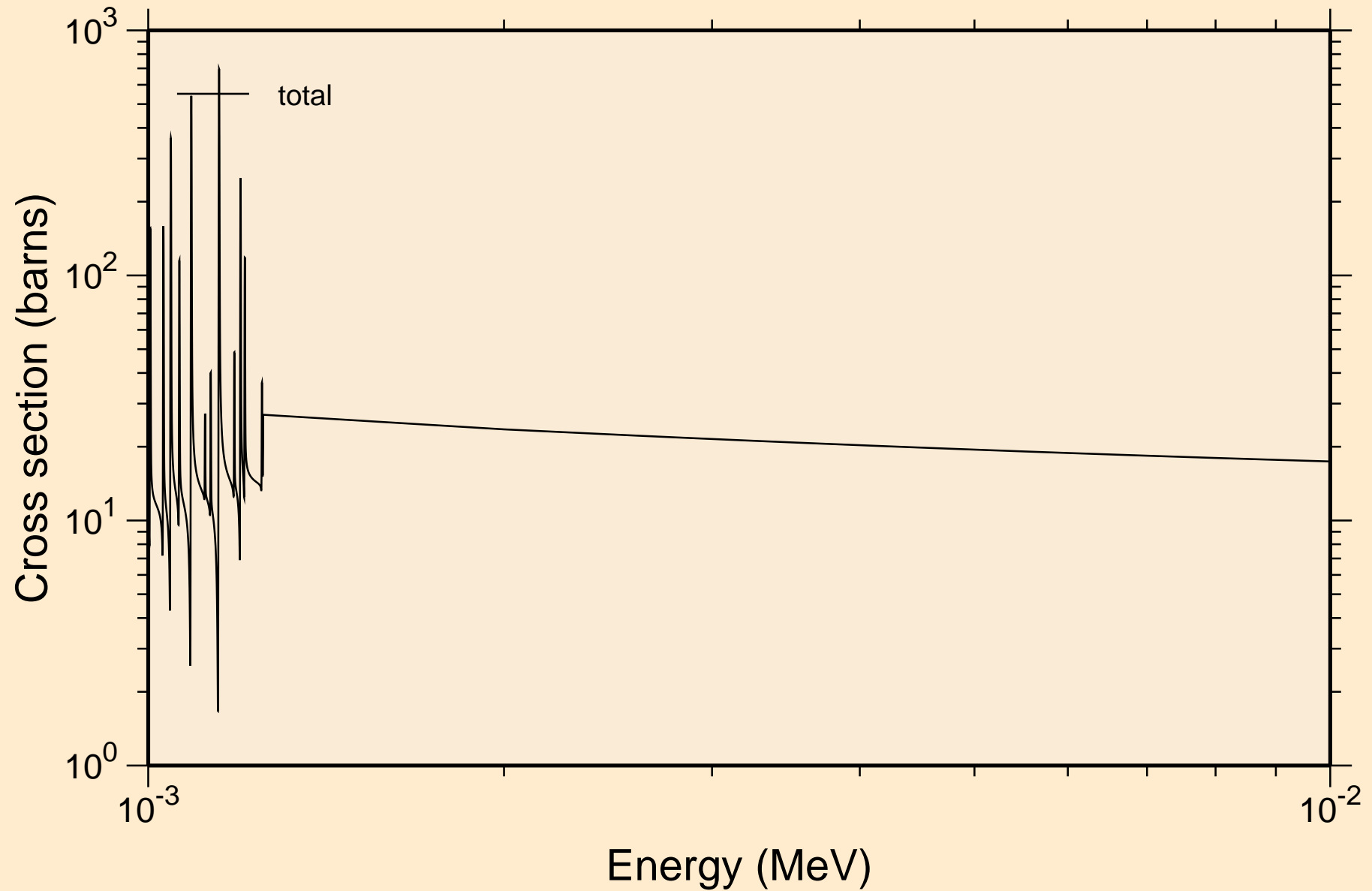

PU242 NEUTRON ACER TENDL-2021 LIBRARY; T=293.6K
resonance total cross section

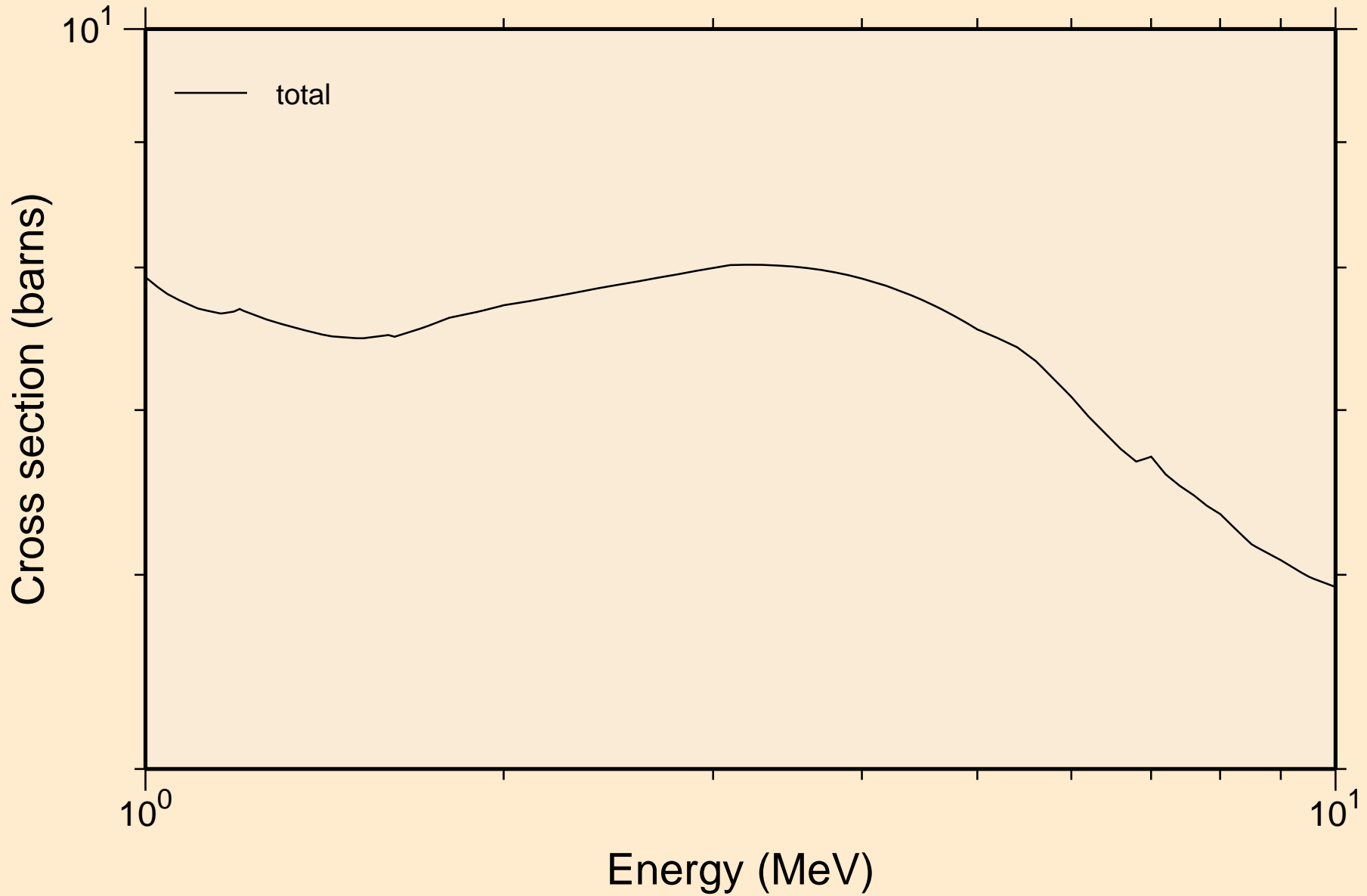

PU242 NEUTRON ACER TENDL-2021 LIBRARY; T=293.6K
resonance absorption cross sections

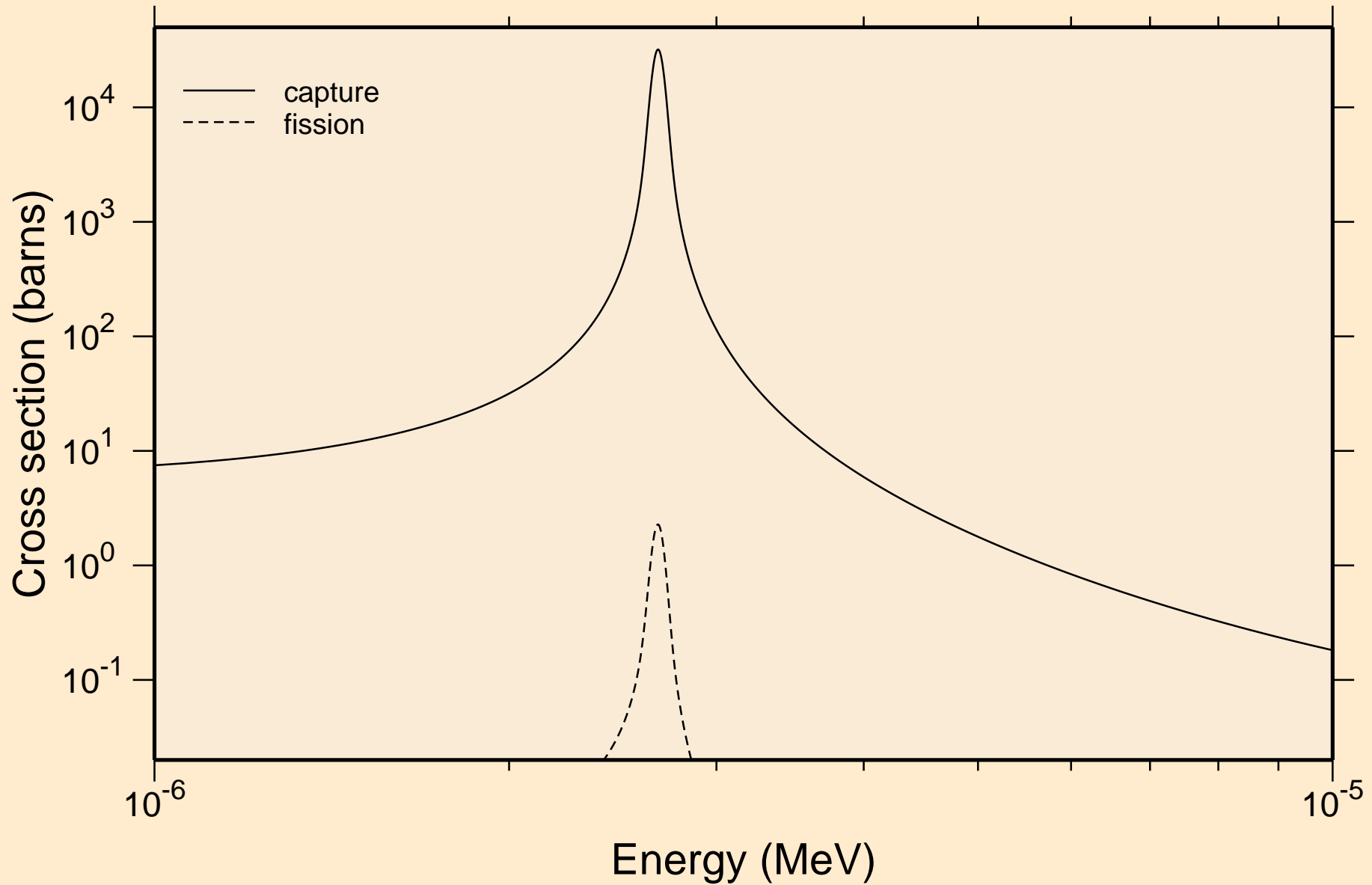

PU242 NEUTRON ACER TENDL-2021 LIBRARY; T=293.6K
resonance absorption cross sections

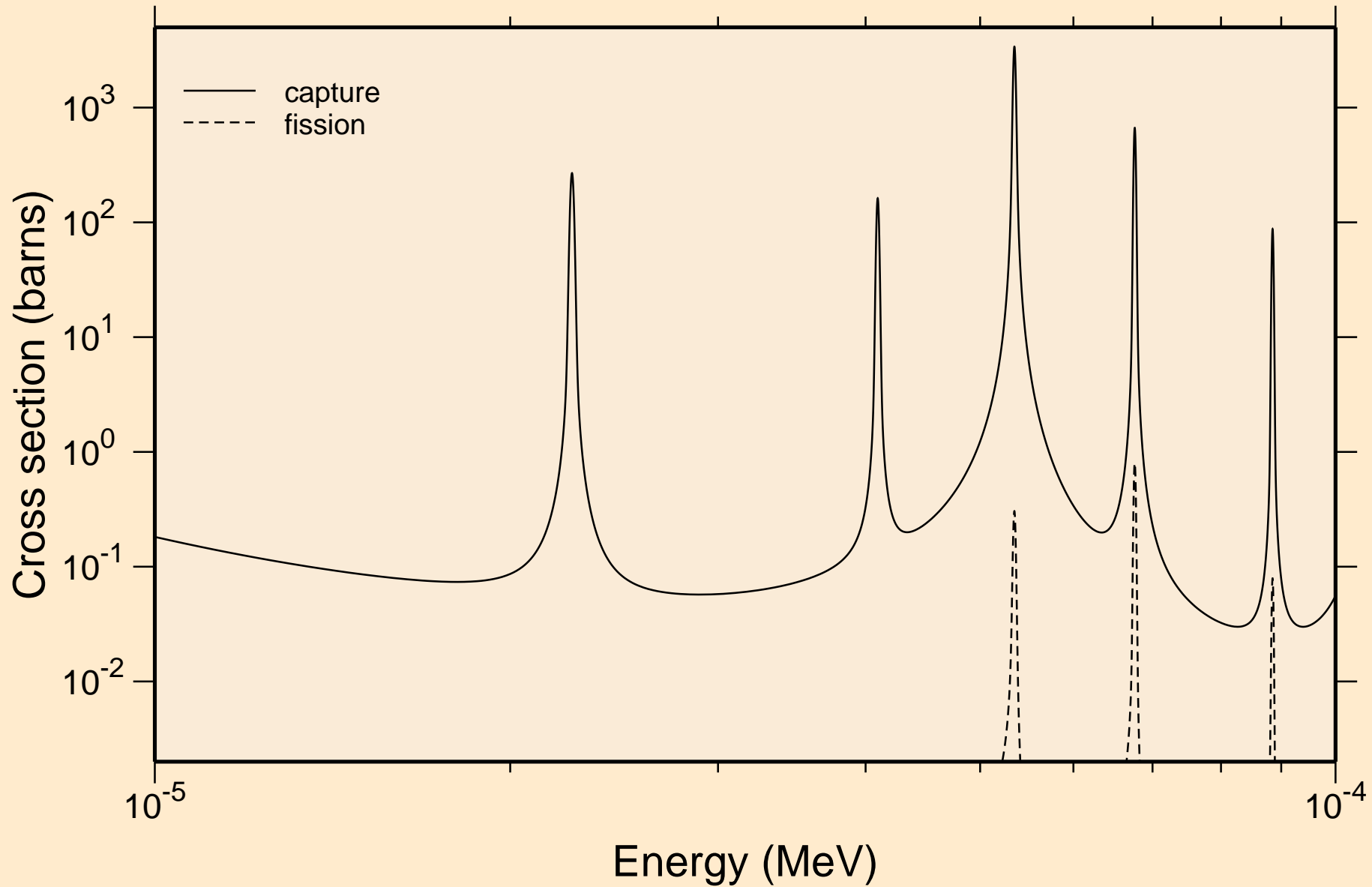

PU242 NEUTRON ACER TENDL-2021 LIBRARY; T=293.6K
resonance absorption cross sections

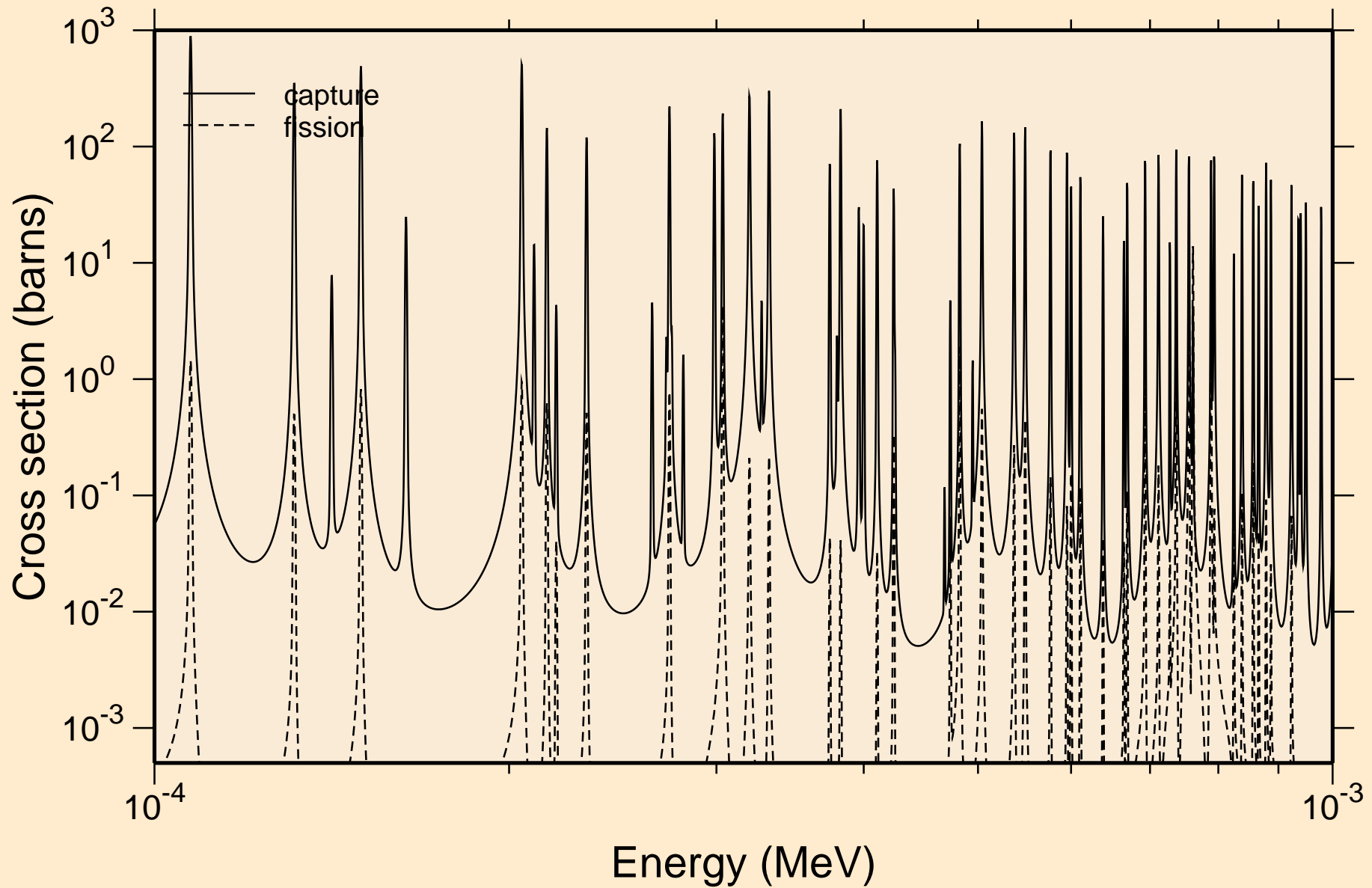

PU242 NEUTRON ACER TENDL-2021 LIBRARY; T=293.6K
resonance absorption cross sections

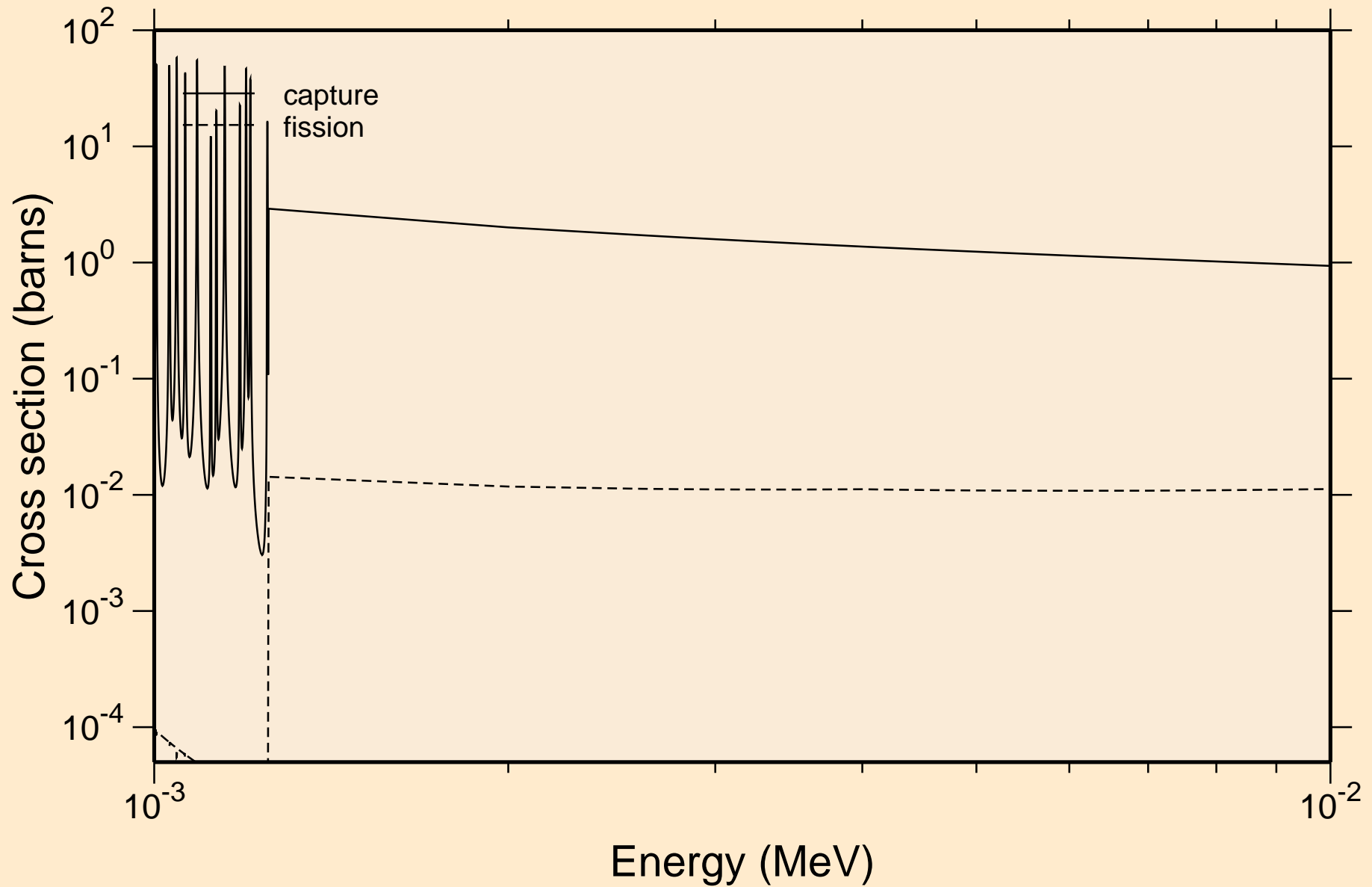

PU242 NEUTRON ACER TENDL-2021 LIBRARY; T=293.6K
resonance absorption cross sections

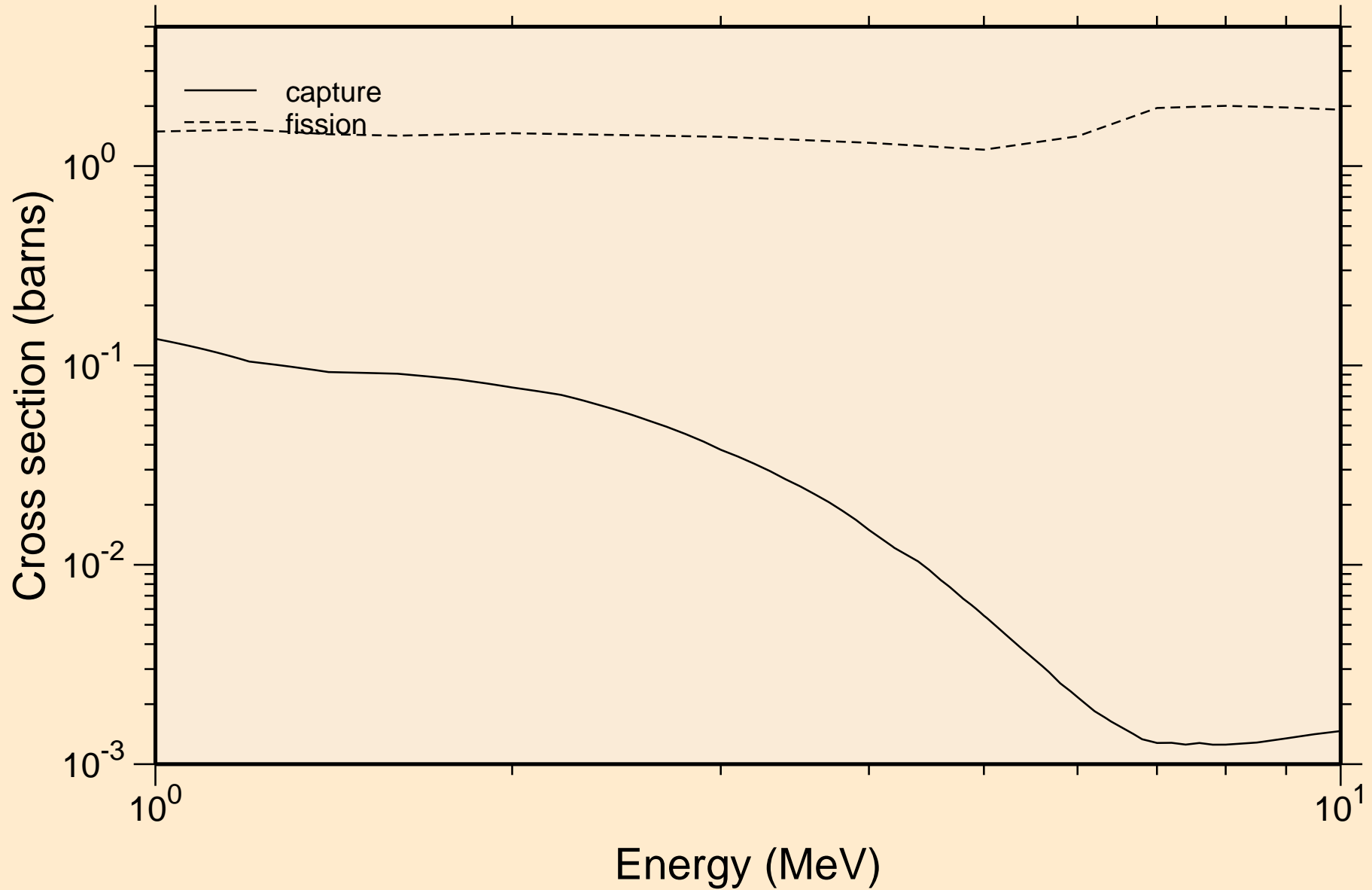

PU242 NEUTRON ACER TENDL-2021 LIBRARY; T=293.6K
Heating

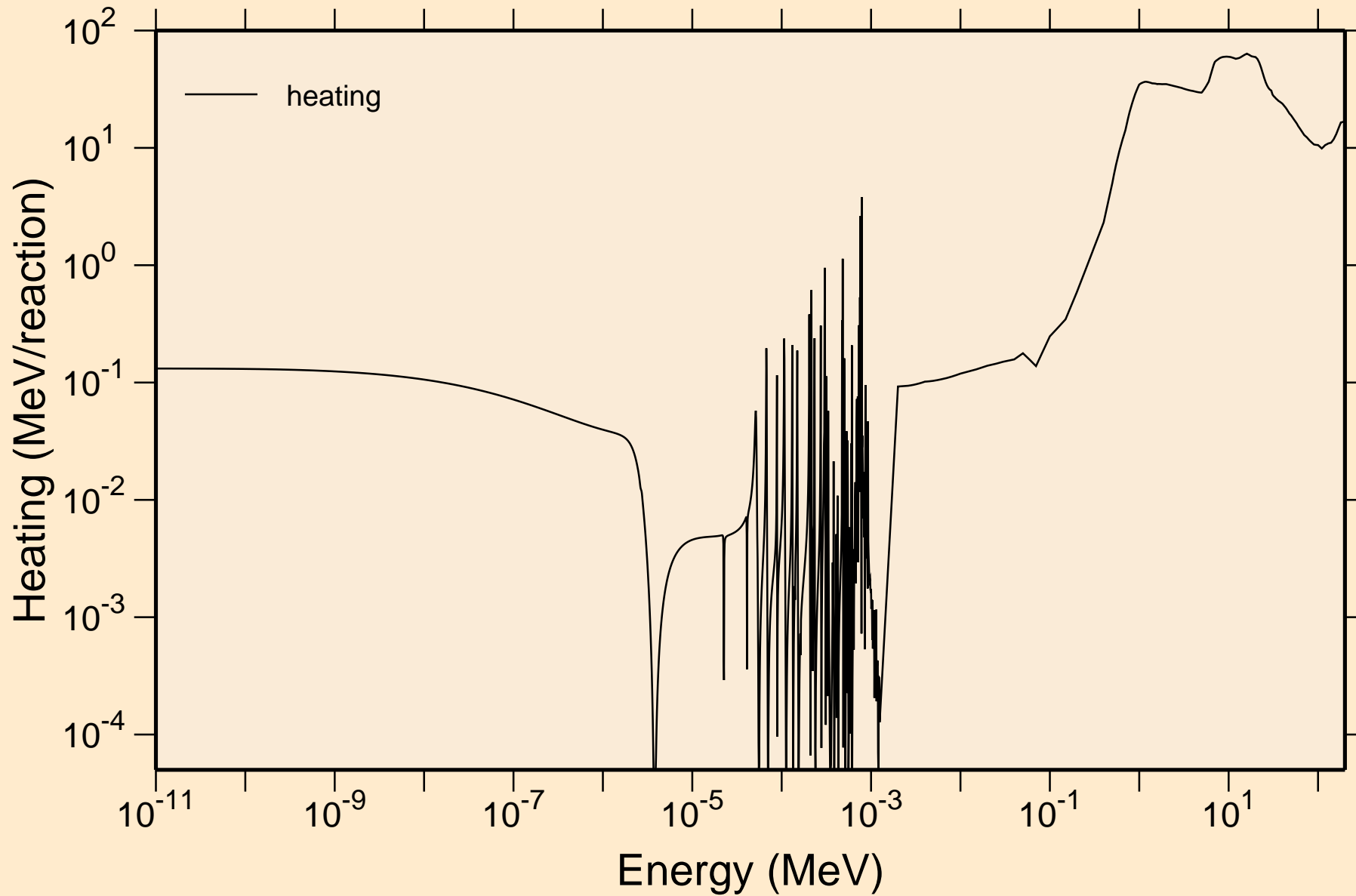

PU242 NEUTRON ACER TENDL-2021 LIBRARY; T=293.6K
Damage

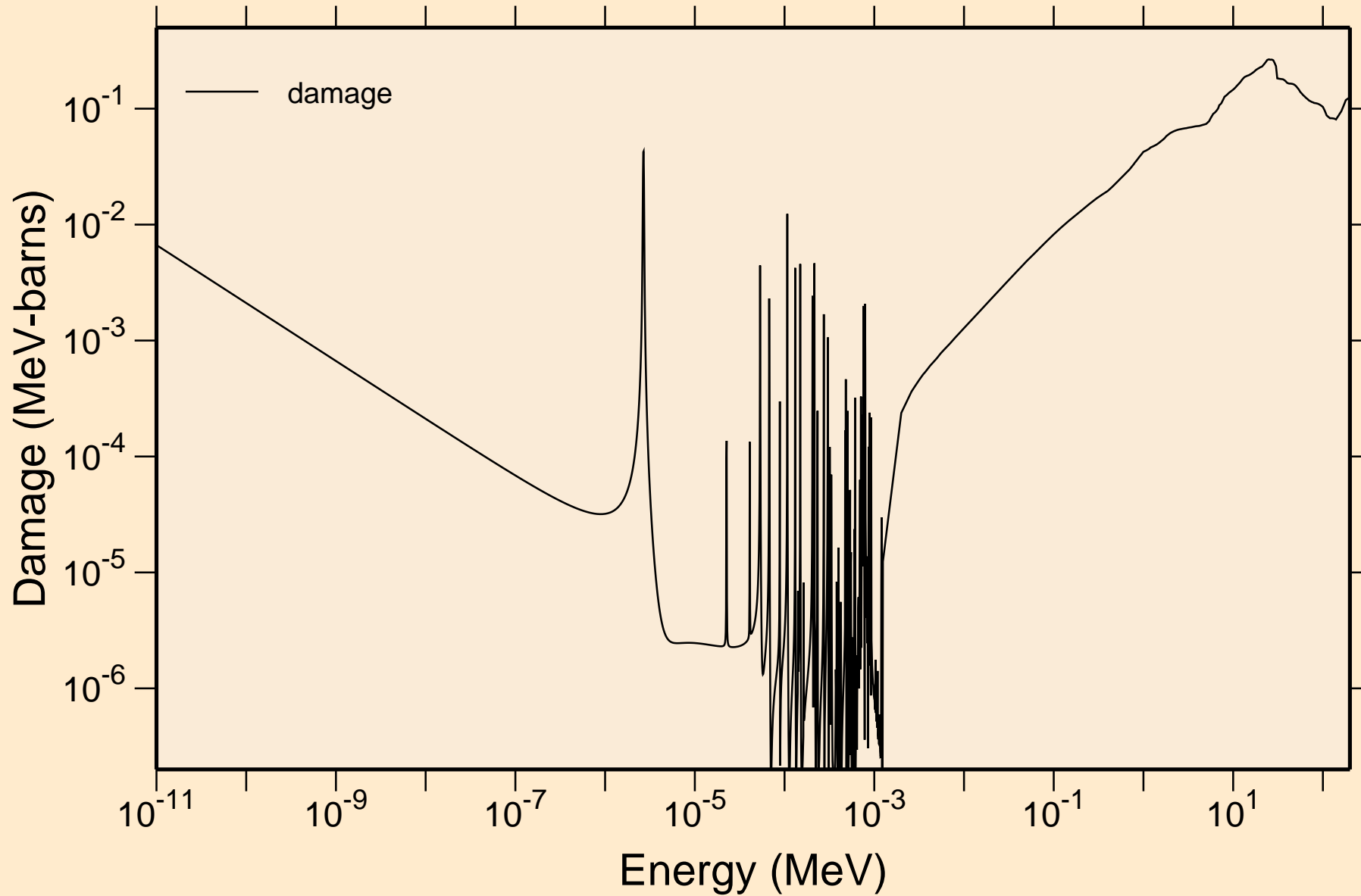

PU242 NEUTRON ACER TENDL-2021 LIBRARY; T=293.6K
Non-threshold reactions

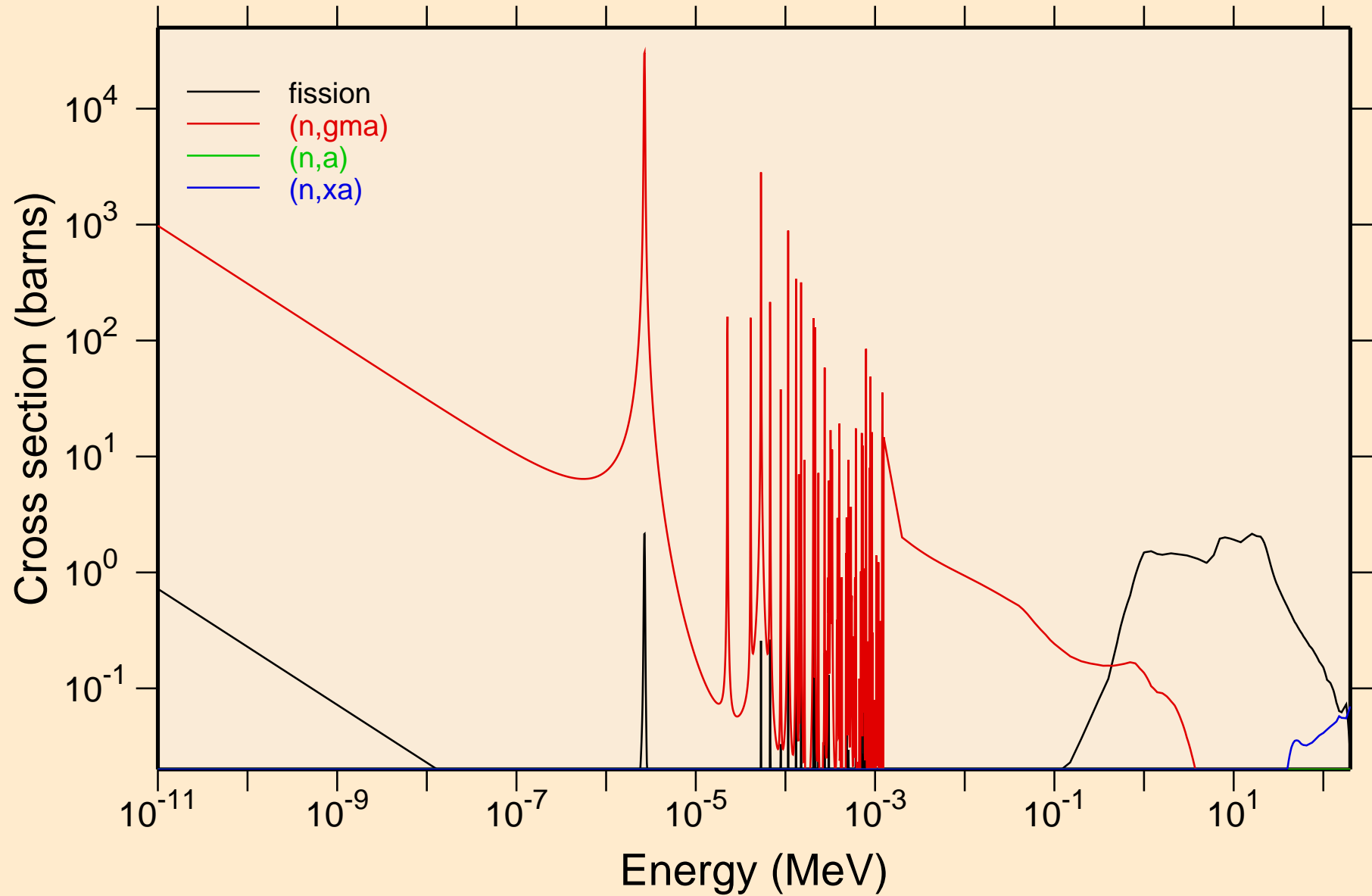

PU242 NEUTRON ACER TENDL-2021 LIBRARY; T=293.6K
Principal cross sections

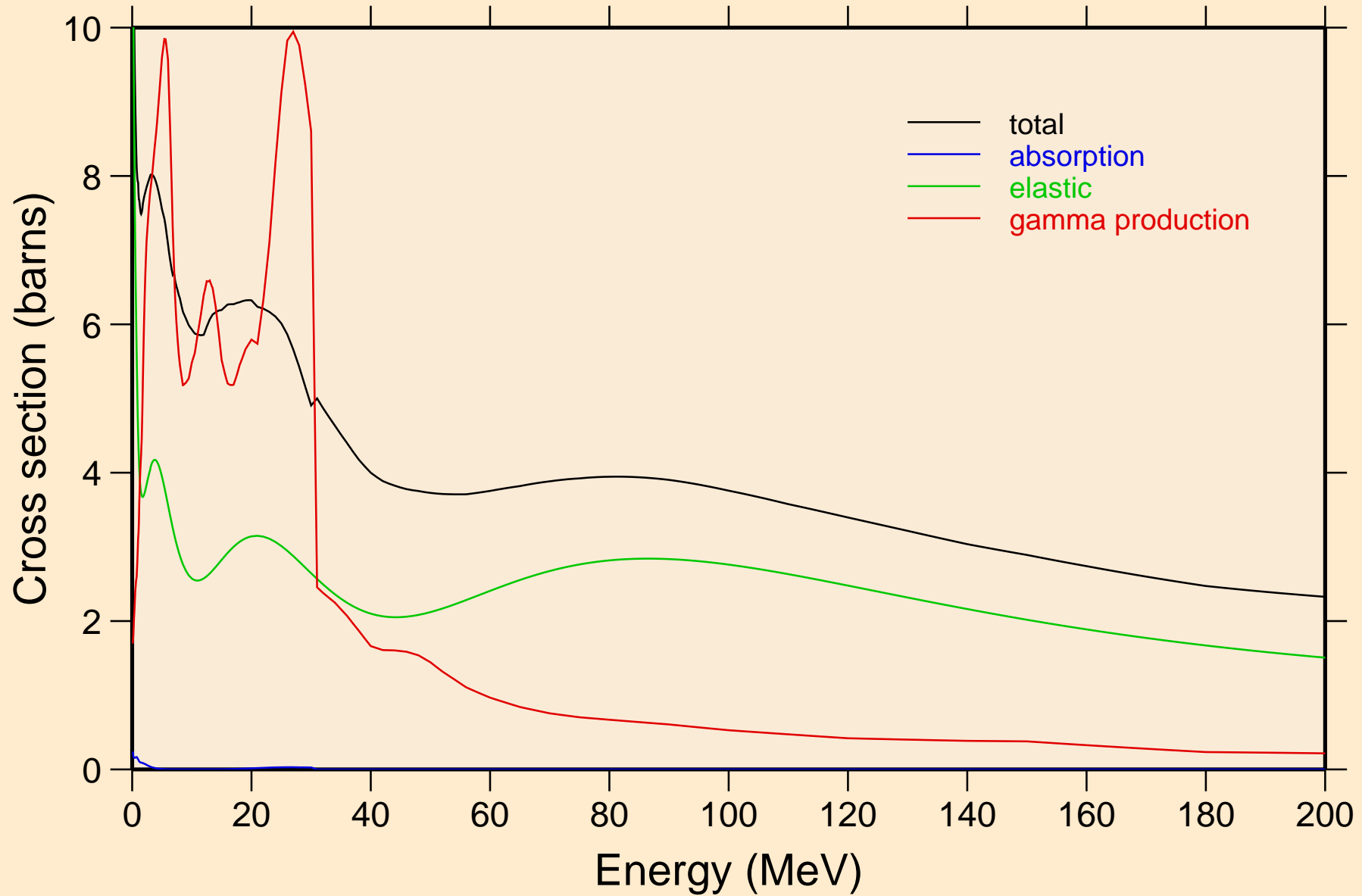

PU242 NEUTRON ACER TENDL-2021 LIBRARY; T=293.6K
Heating

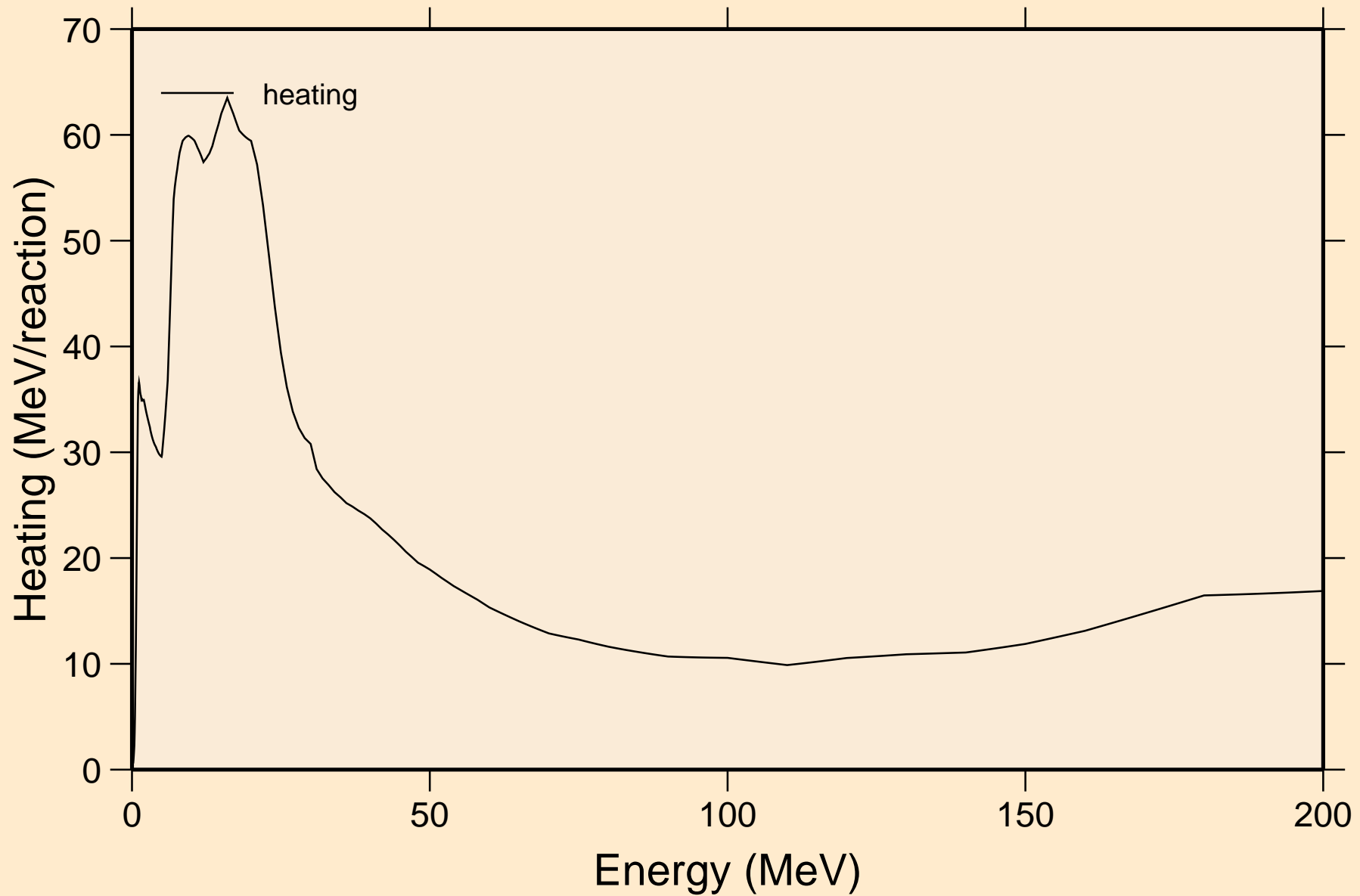

PU242 NEUTRON ACER TENDL-2021 LIBRARY; T=293.6K
Damage

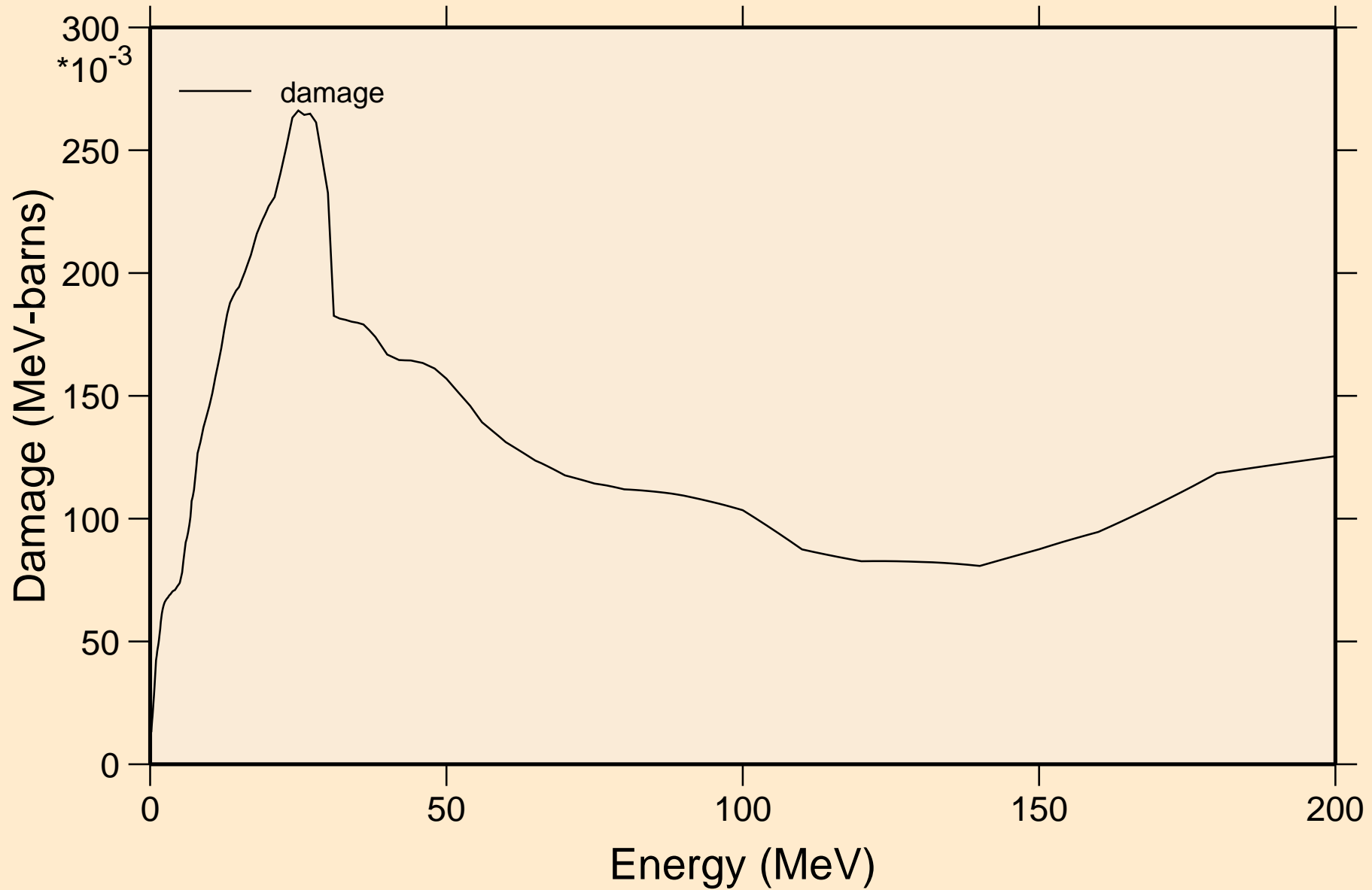

PU242 NEUTRON ACER TENDL-2021 LIBRARY; T=293.6K
Non-threshold reactions

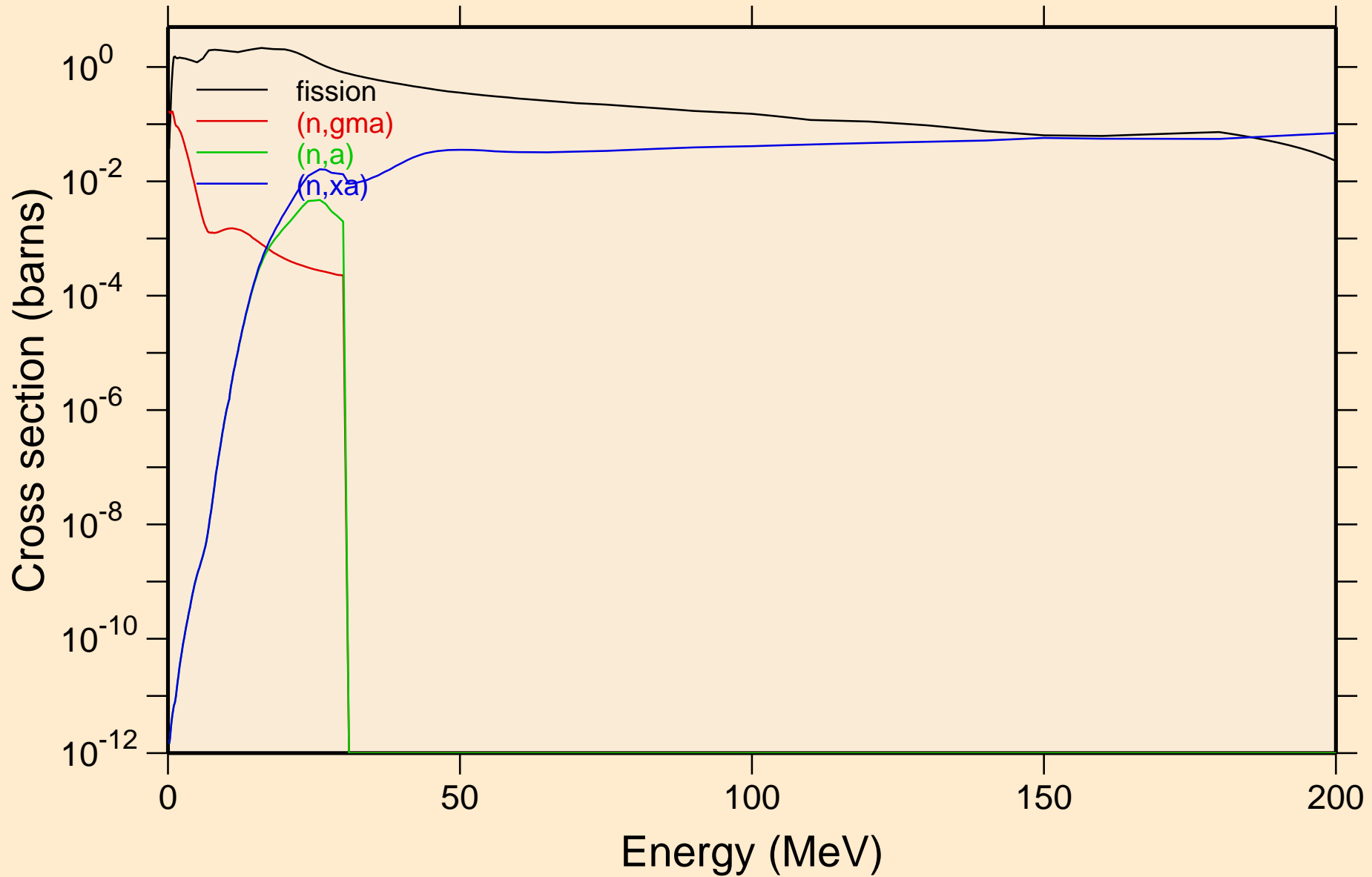

PU242 NEUTRON ACER TENDL-2021 LIBRARY; T=293.6K
Inelastic levels

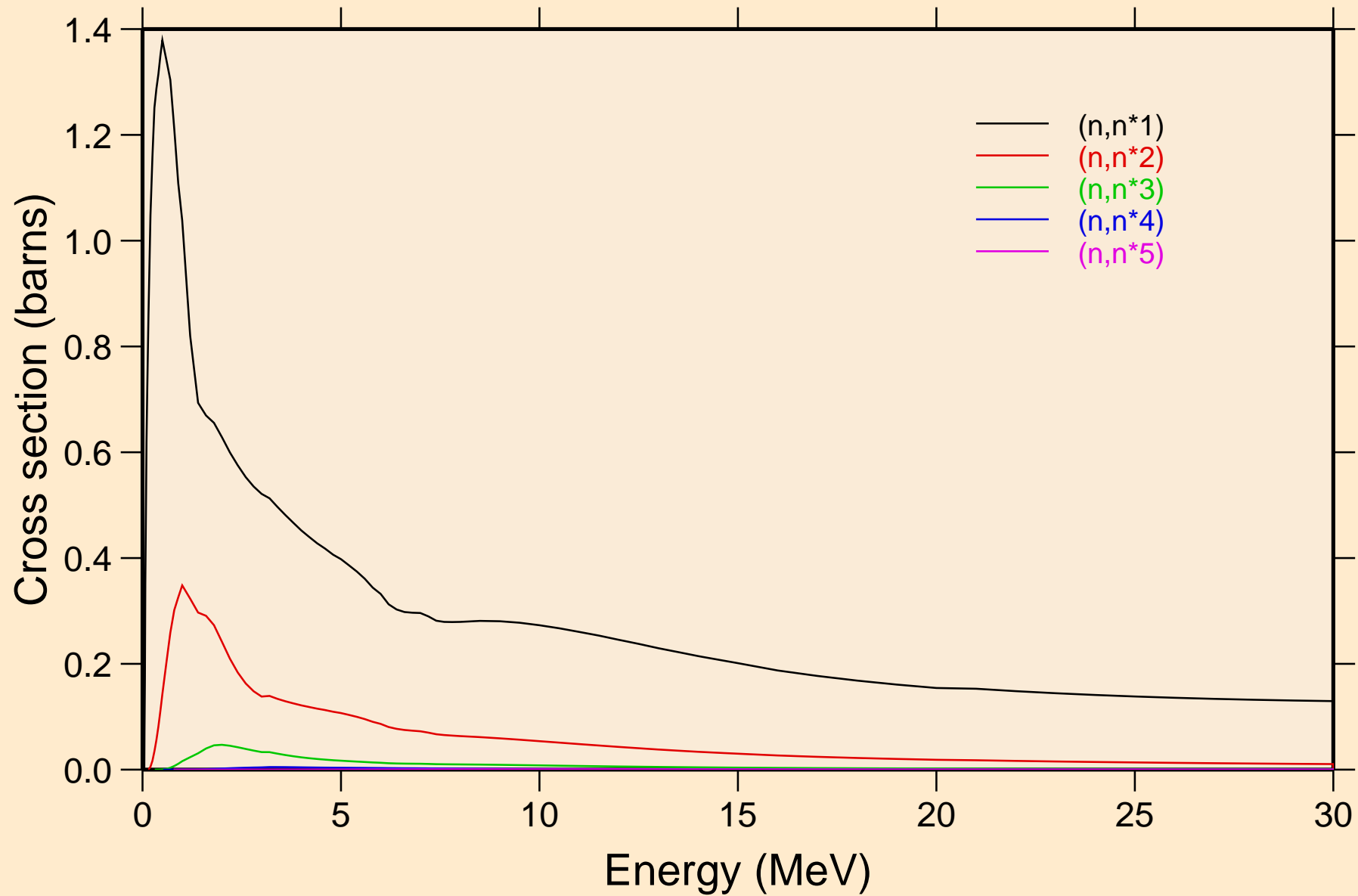

PU242 NEUTRON ACER TENDL-2021 LIBRARY; T=293.6K
Inelastic levels

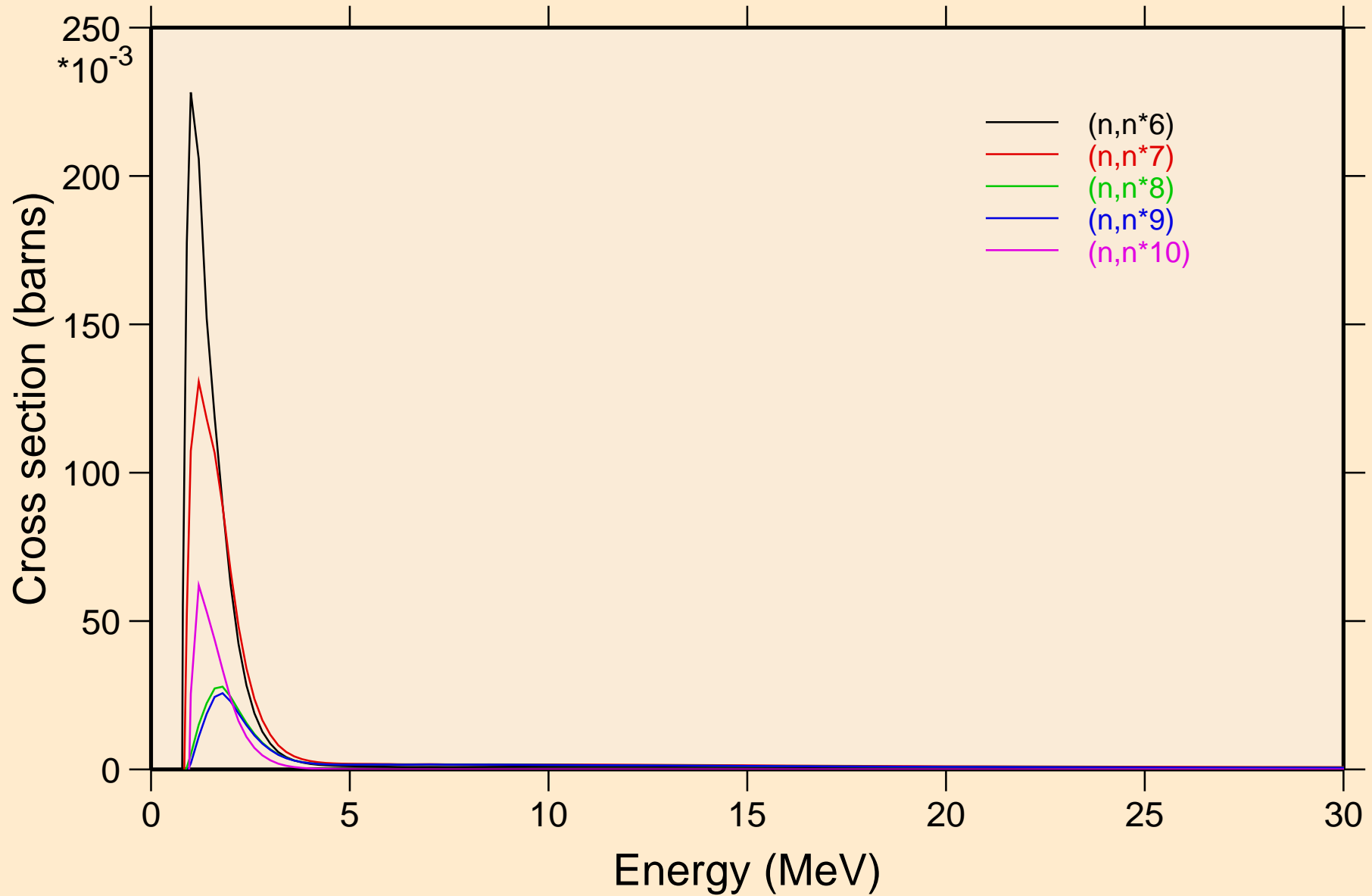

PU242 NEUTRON ACER TENDL-2021 LIBRARY; T=293.6K
Inelastic levels

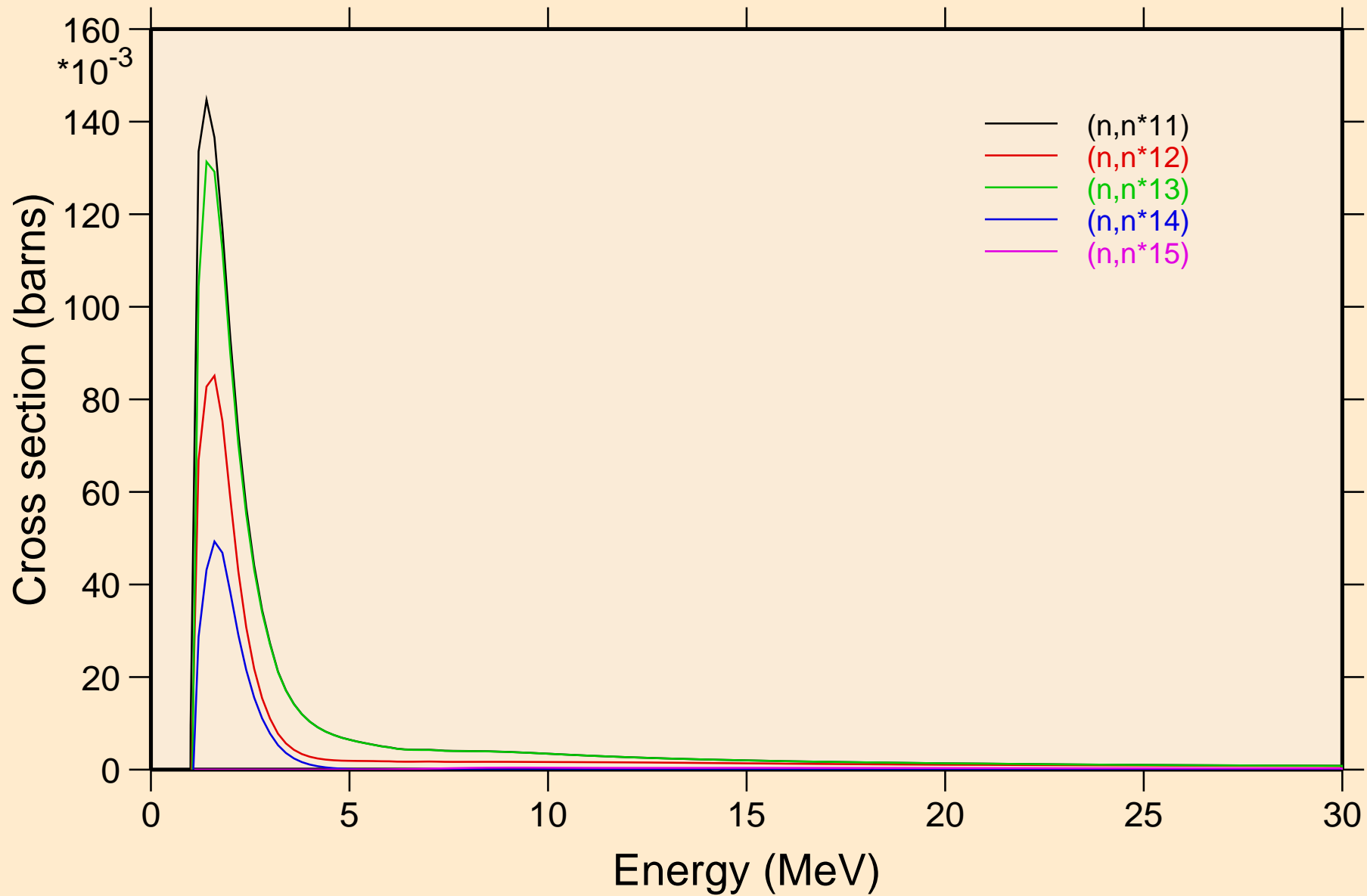

PU242 NEUTRON ACER TENDL-2021 LIBRARY; T=293.6K
Inelastic levels

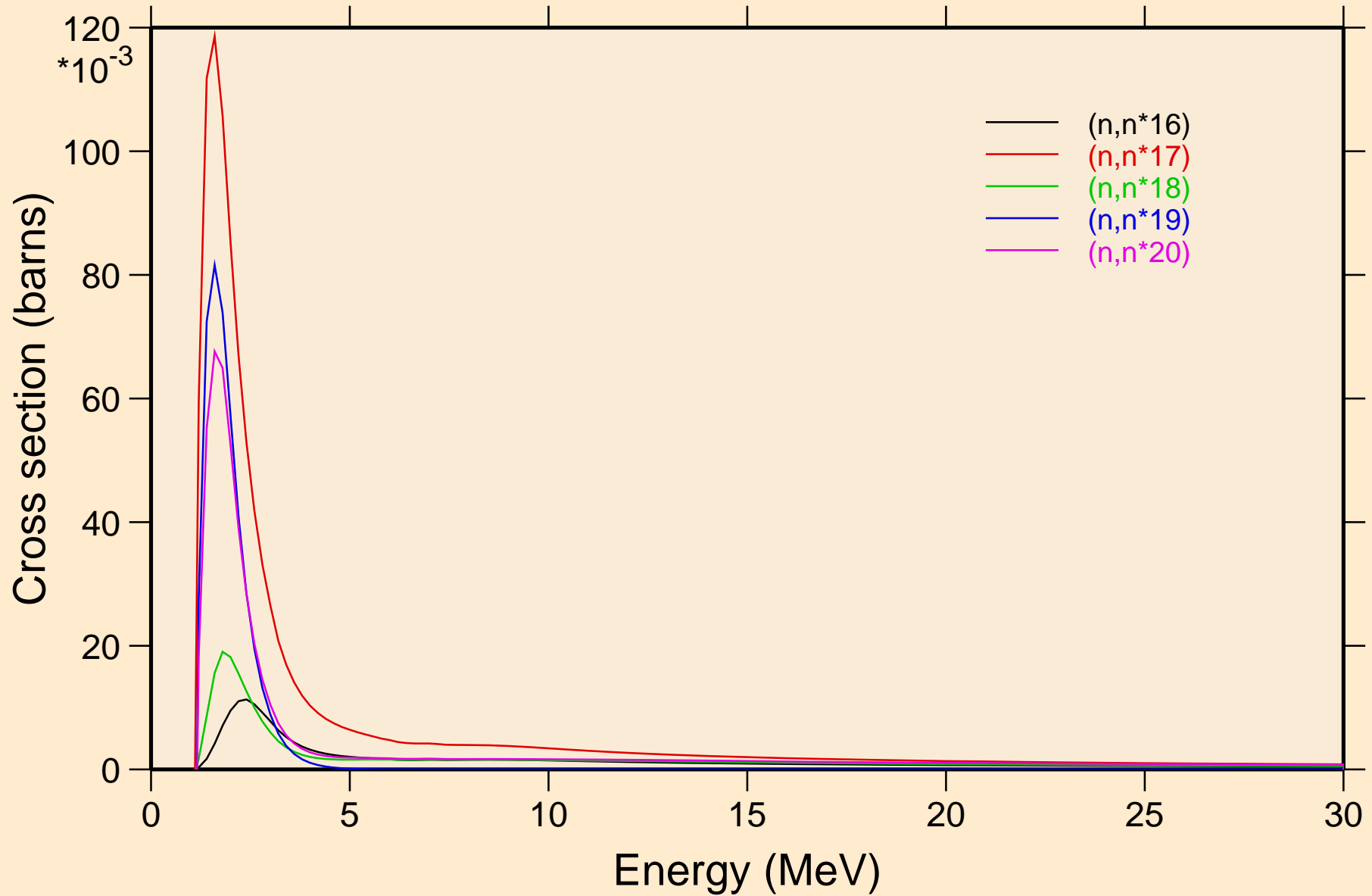

PU242 NEUTRON ACER TENDL-2021 LIBRARY; T=293.6K
Inelastic levels

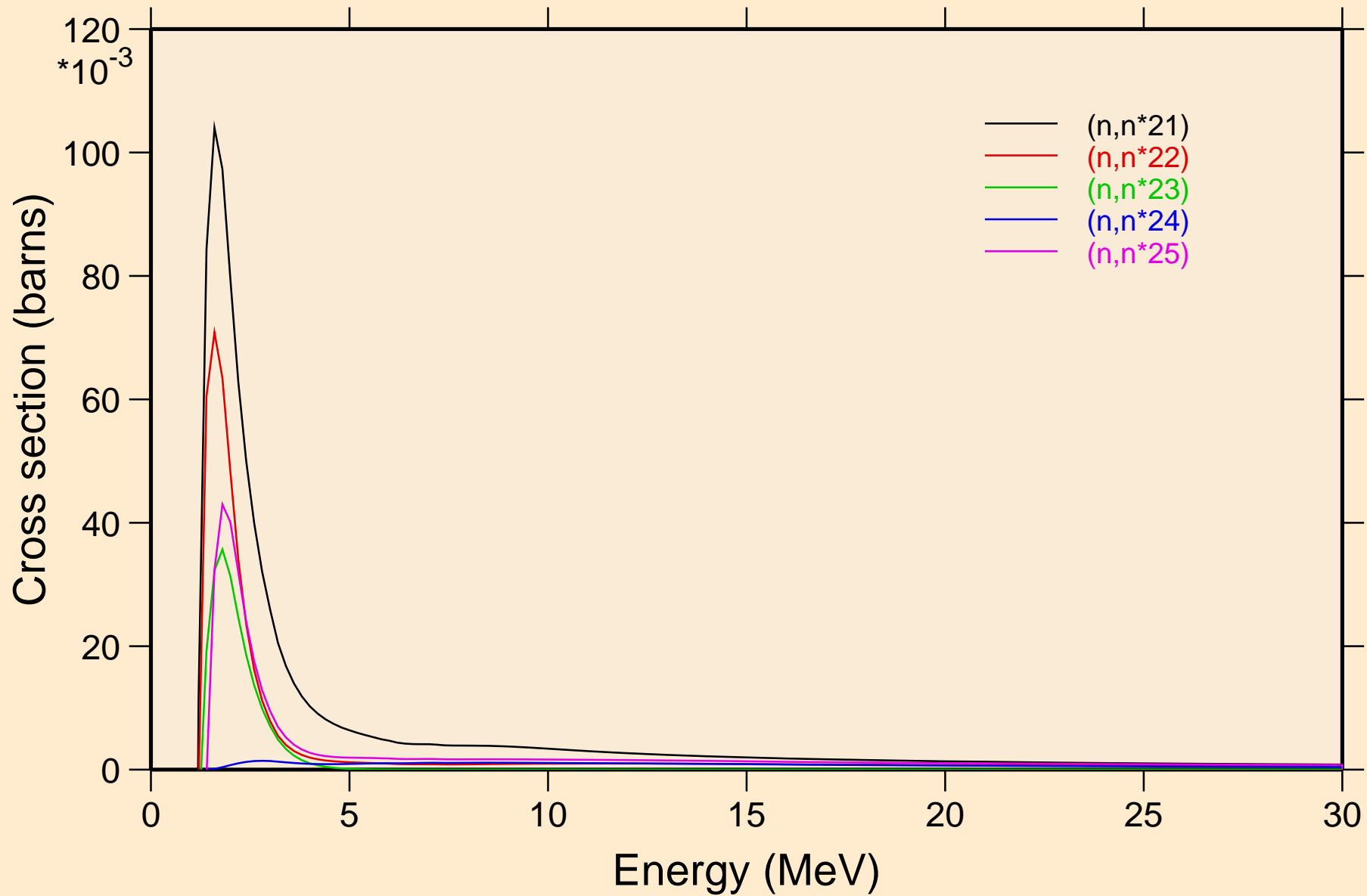

PU242 NEUTRON ACER TENDL-2021 LIBRARY; T=293.6K
Inelastic levels

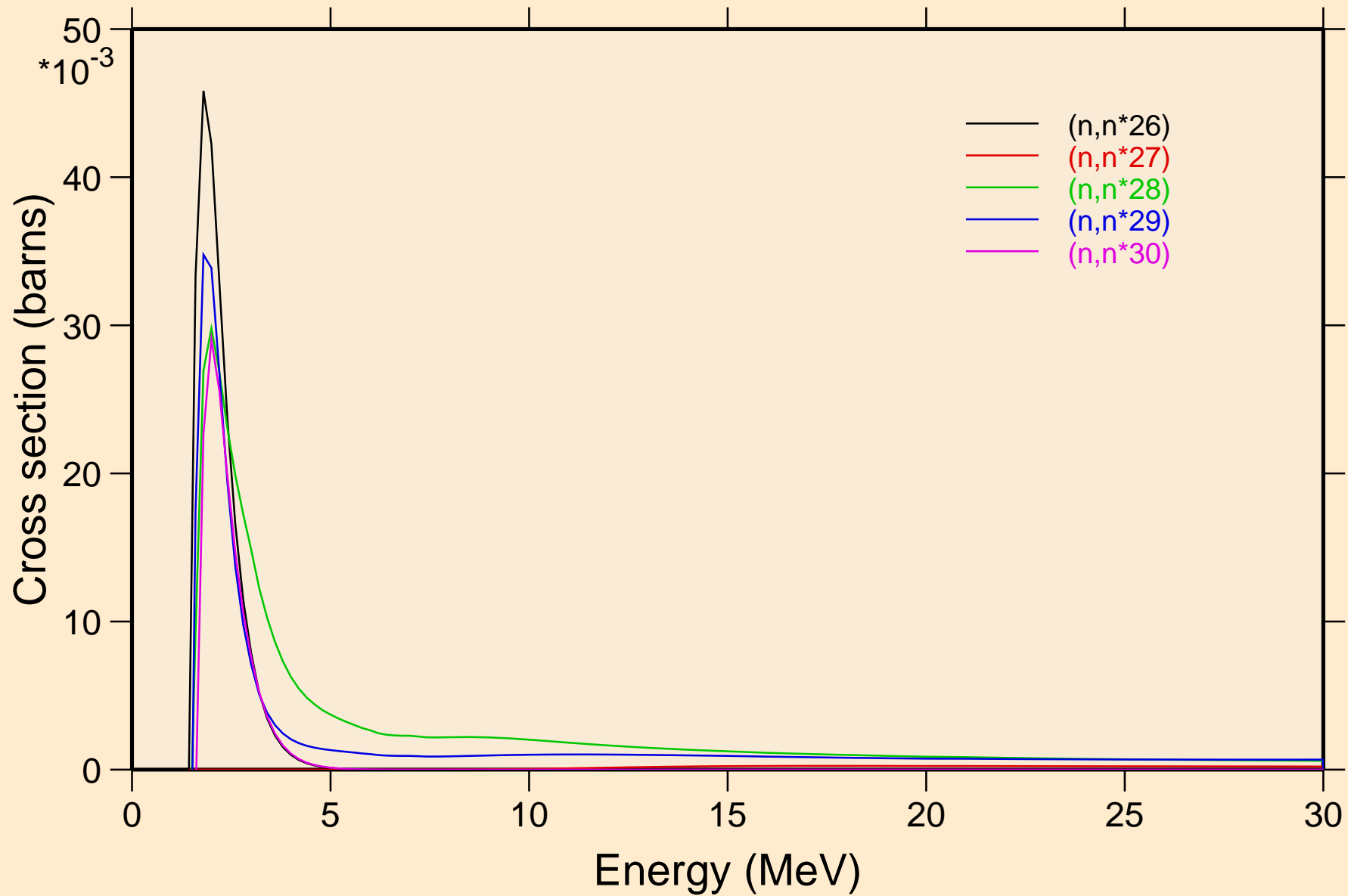

PU242 NEUTRON ACER TENDL-2021 LIBRARY; T=293.6K
Threshold reactions

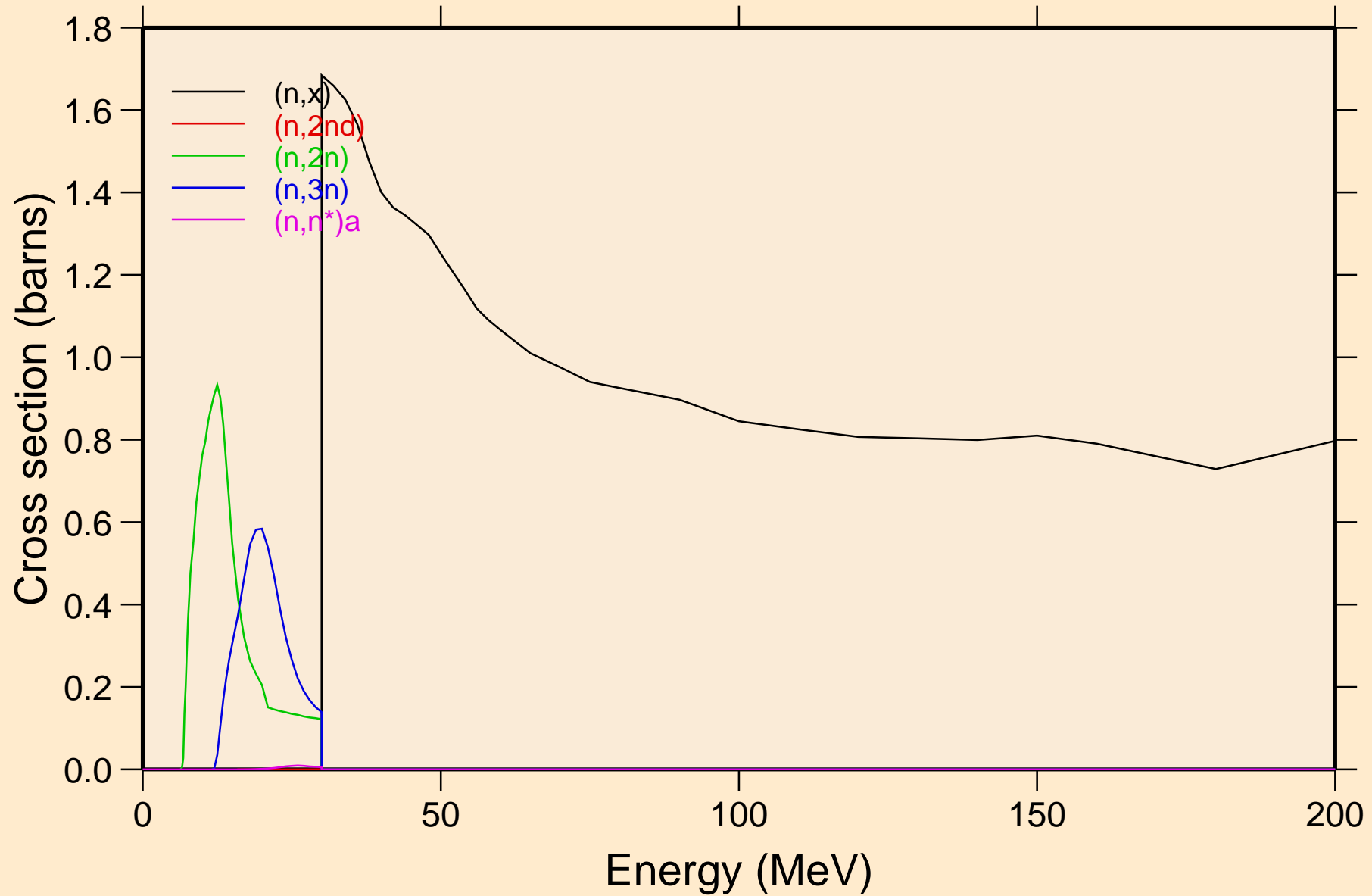

PU242 NEUTRON ACER TENDL-2021 LIBRARY; T=293.6K
Threshold reactions

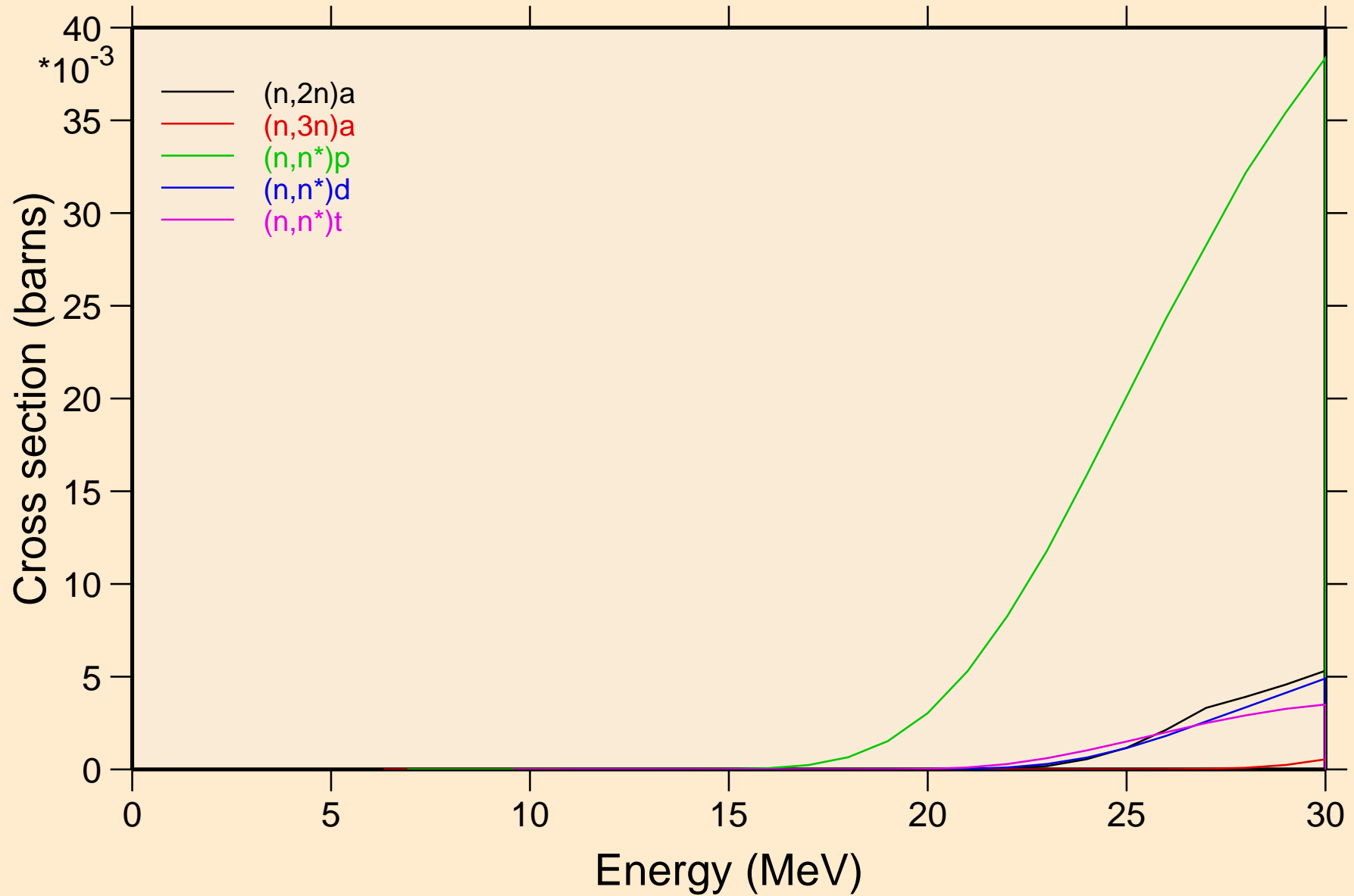

PU242 NEUTRON ACER TENDL-2021 LIBRARY; T=293.6K
Threshold reactions

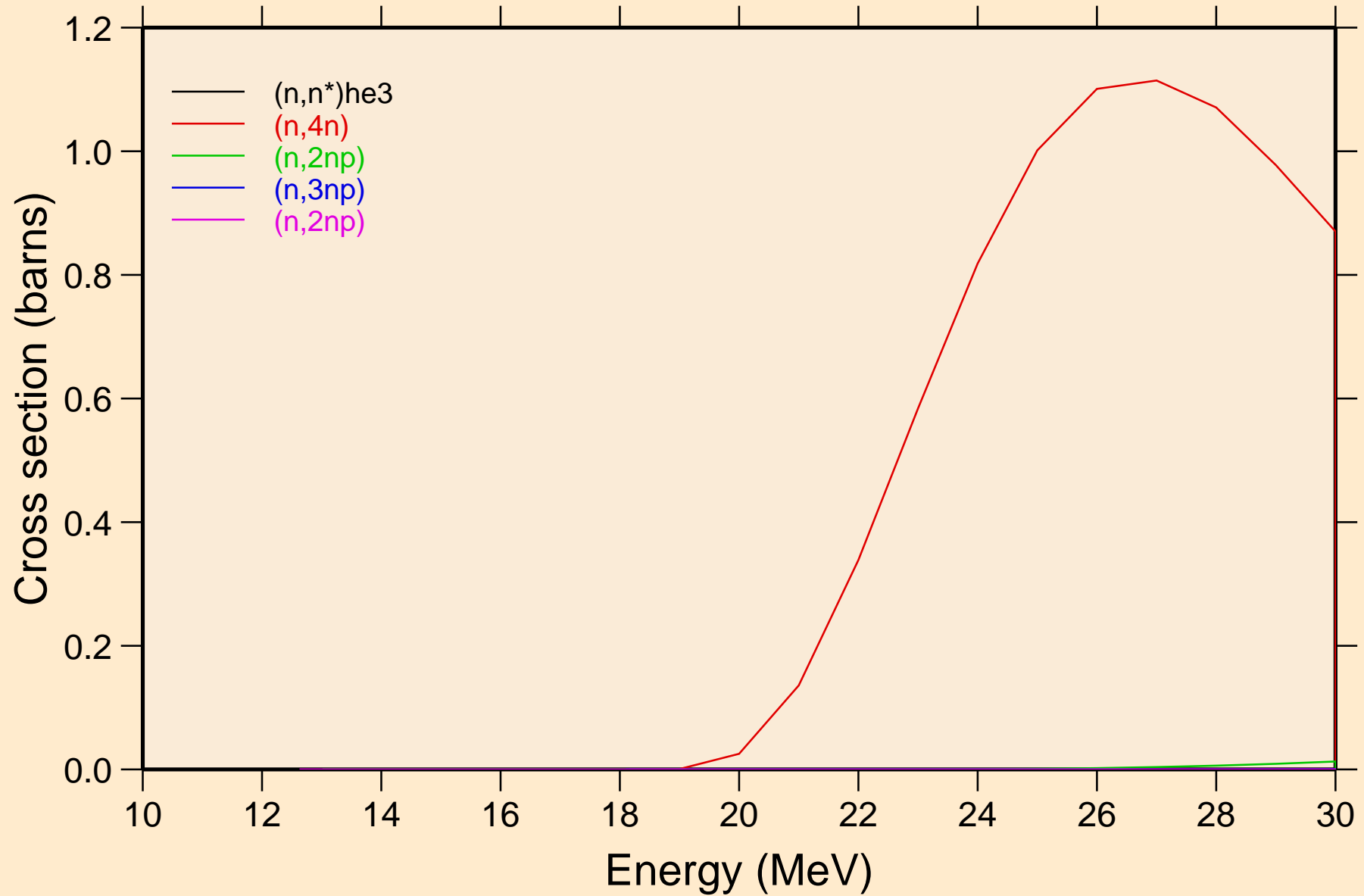

PU242 NEUTRON ACER TENDL-2021 LIBRARY; T=293.6K
Threshold reactions

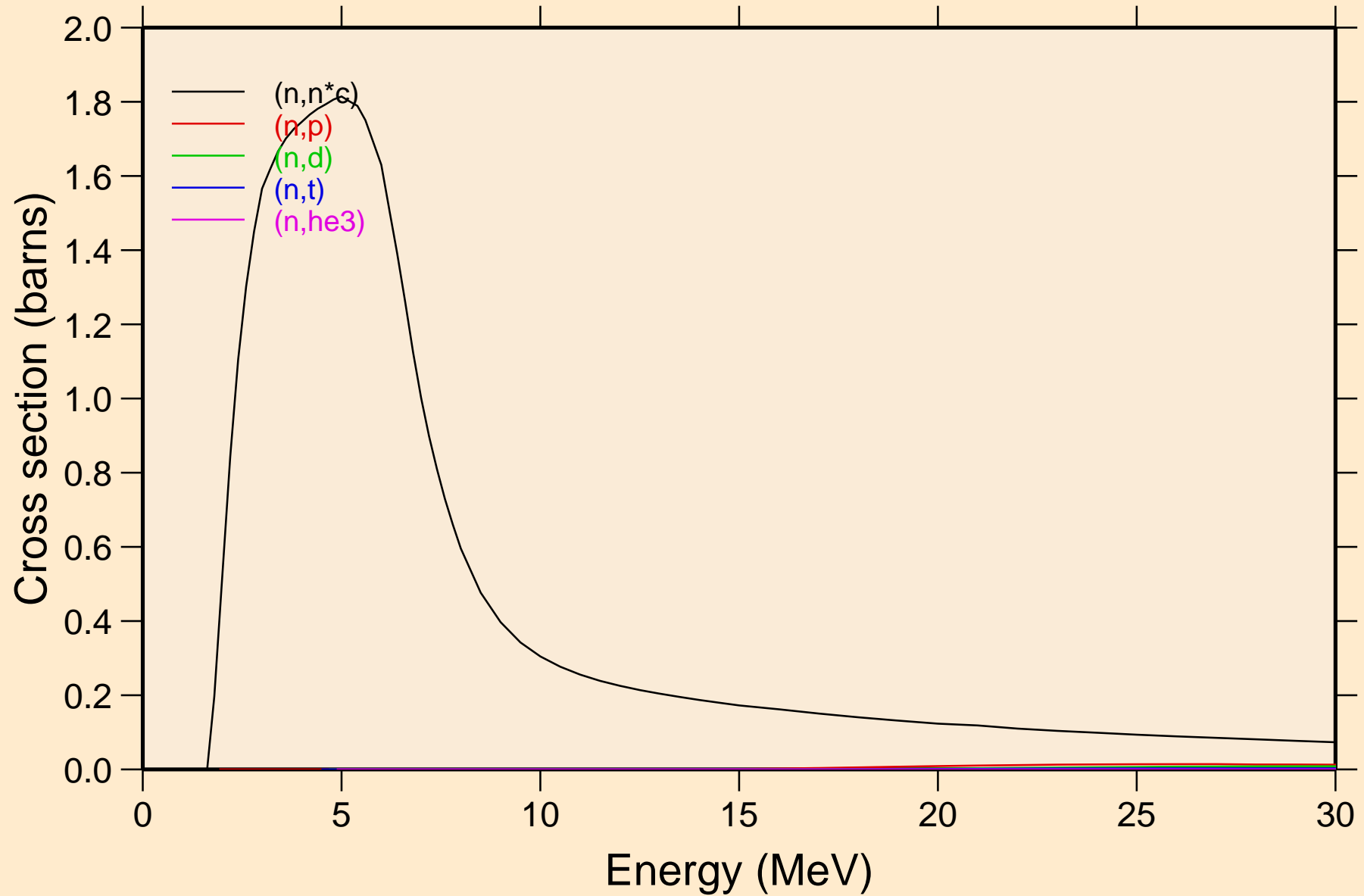

PU242 NEUTRON ACER TENDL-2021 LIBRARY; T=293.6K
Threshold reactions

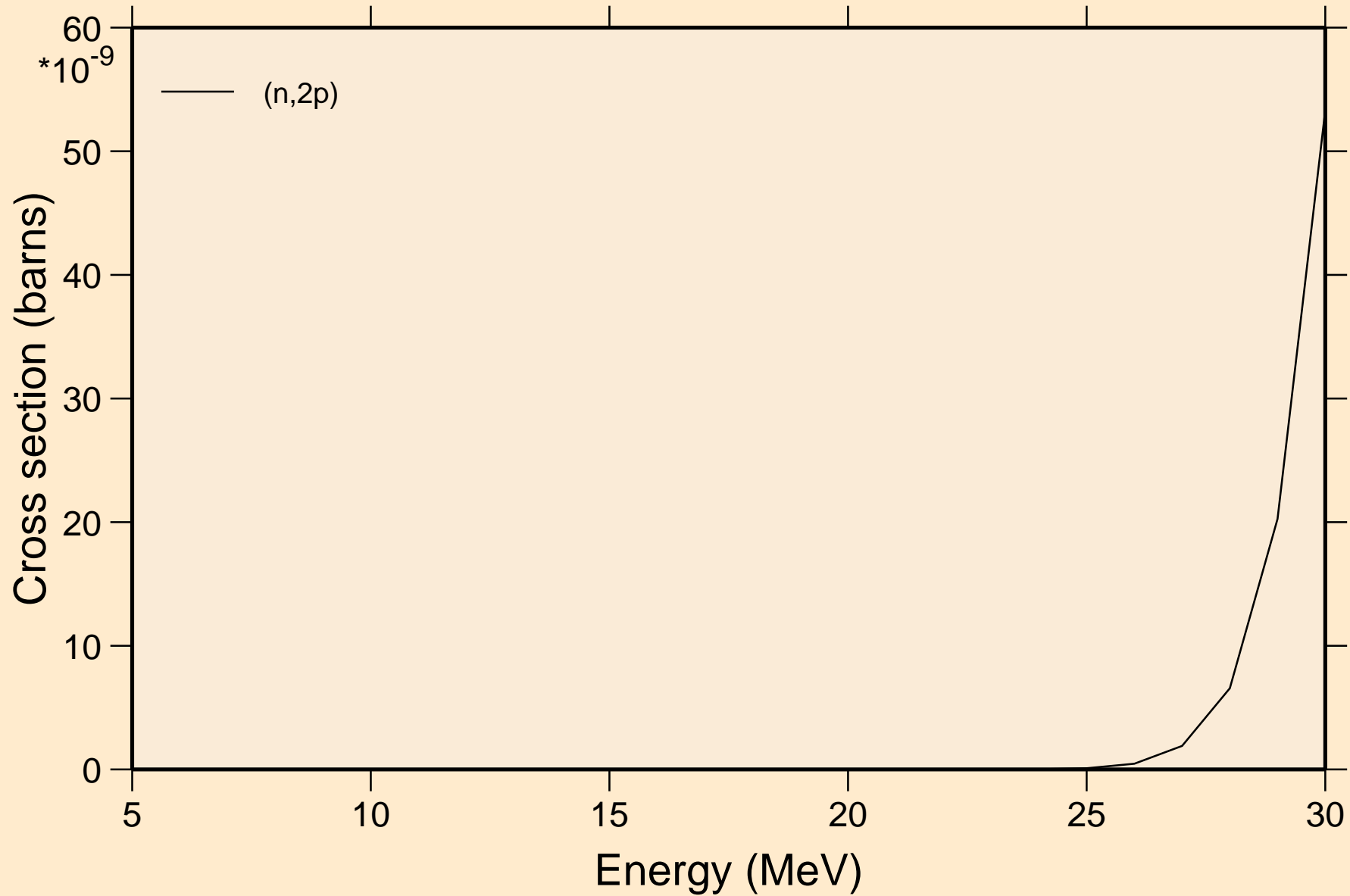

PU242 NEUTRON ACER TENDL-2021 LIBRARY; T=293.6K
Threshold reactions

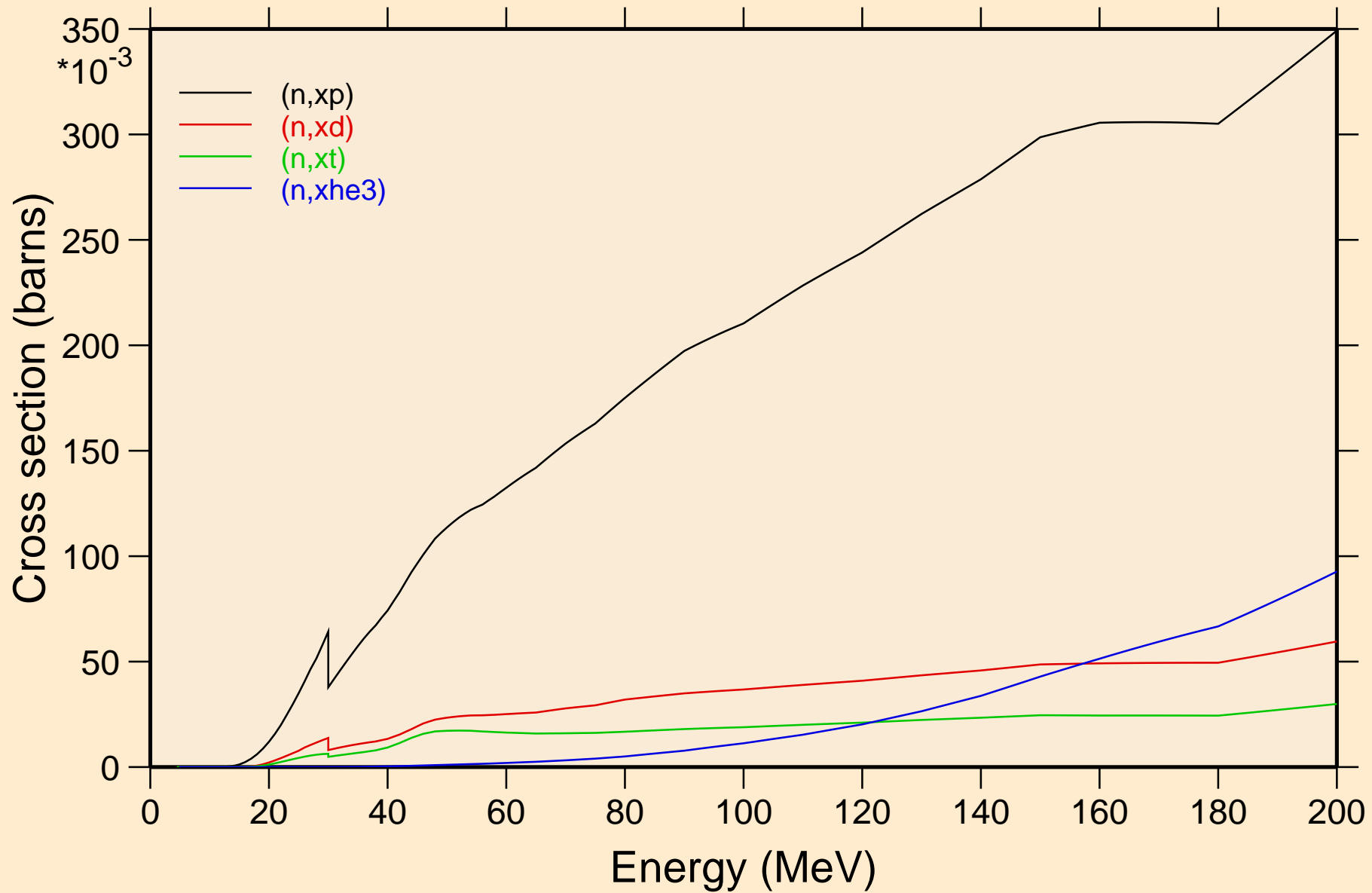

PU242 NEUTRON ACER TENDL-2021 LIBRARY; T=293.6K
angular distribution for elastic

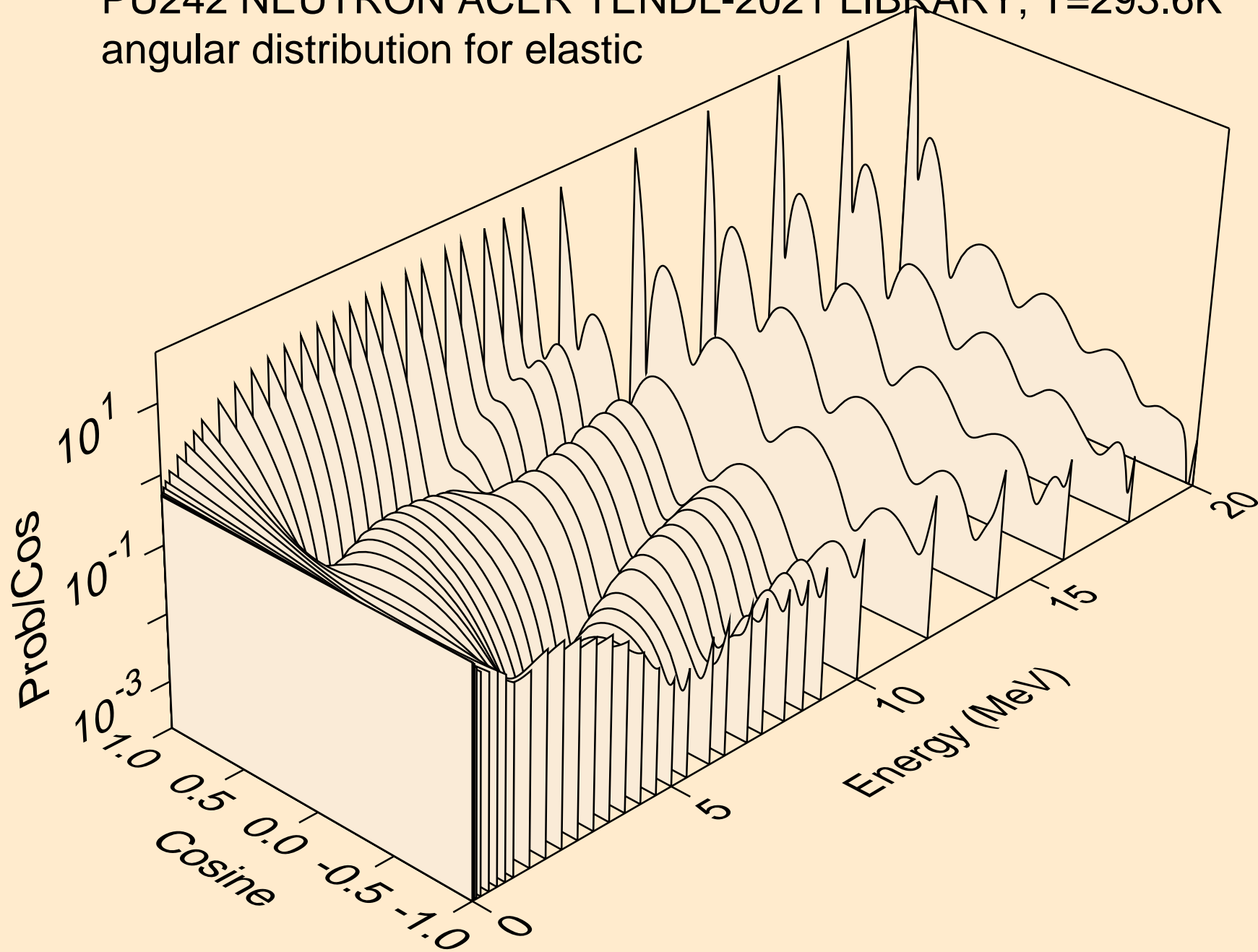

PU242 NEUTRON ACER TENDL-2021 LIBRARY; T=293.6K
angular distribution for elastic

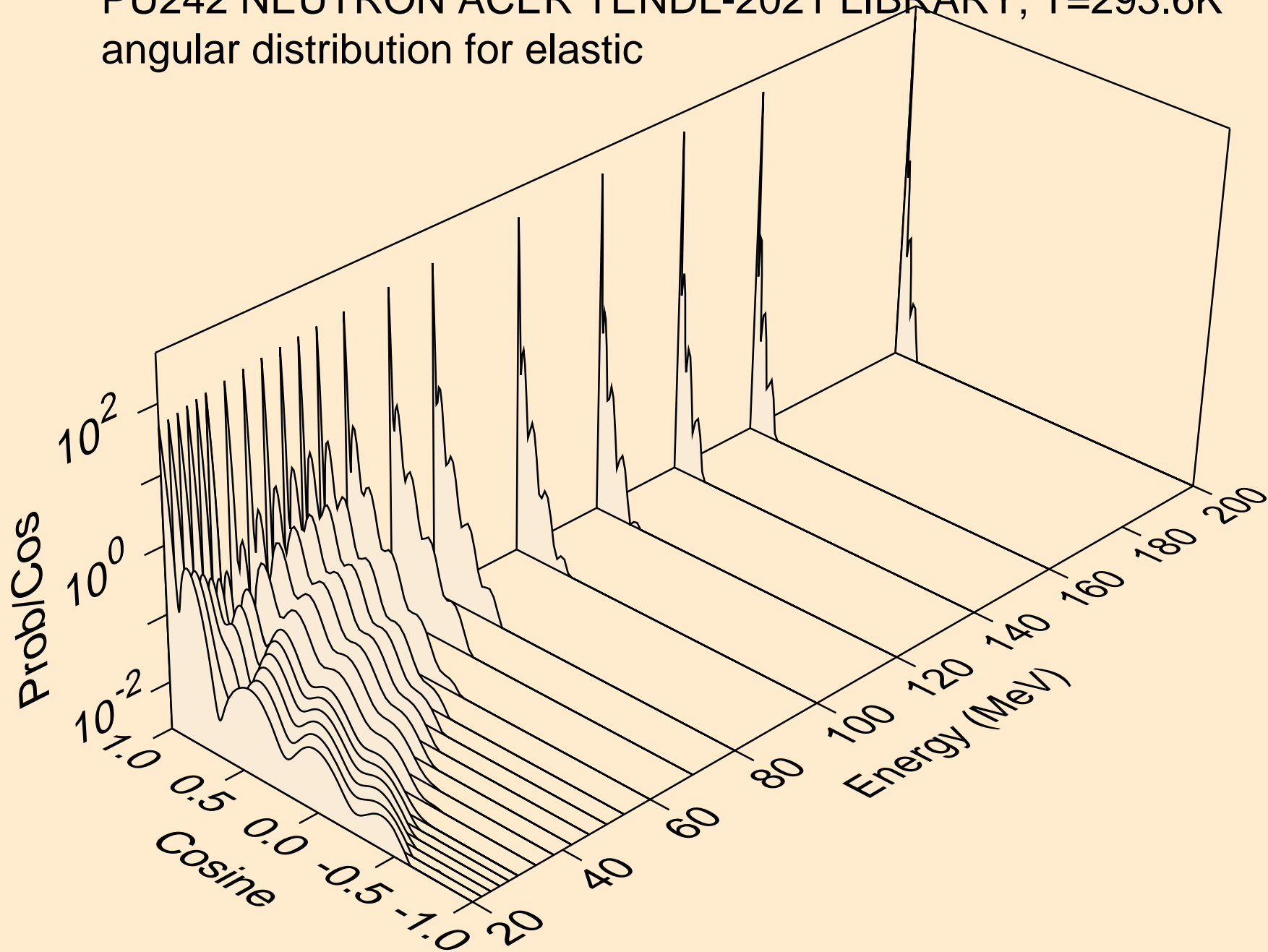

PU242 NEUTRON ACER TENDL-2021 LIBRARY; T=293.6K
angular distribution for (n,n*1)

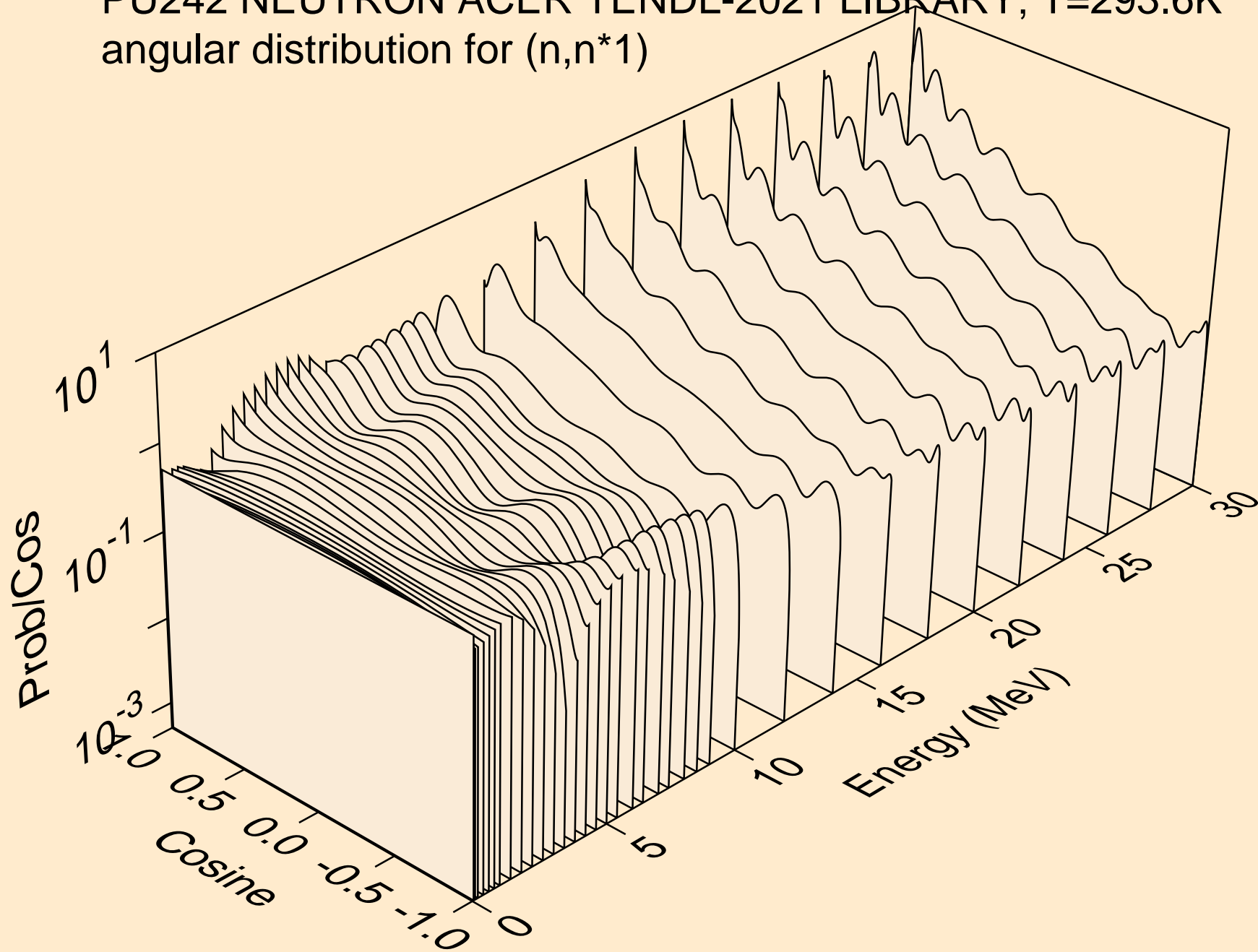

PU242 NEUTRON ACER TENDL-2021 LIBRARY; T=293.6K
angular distribution for (n,n*2)

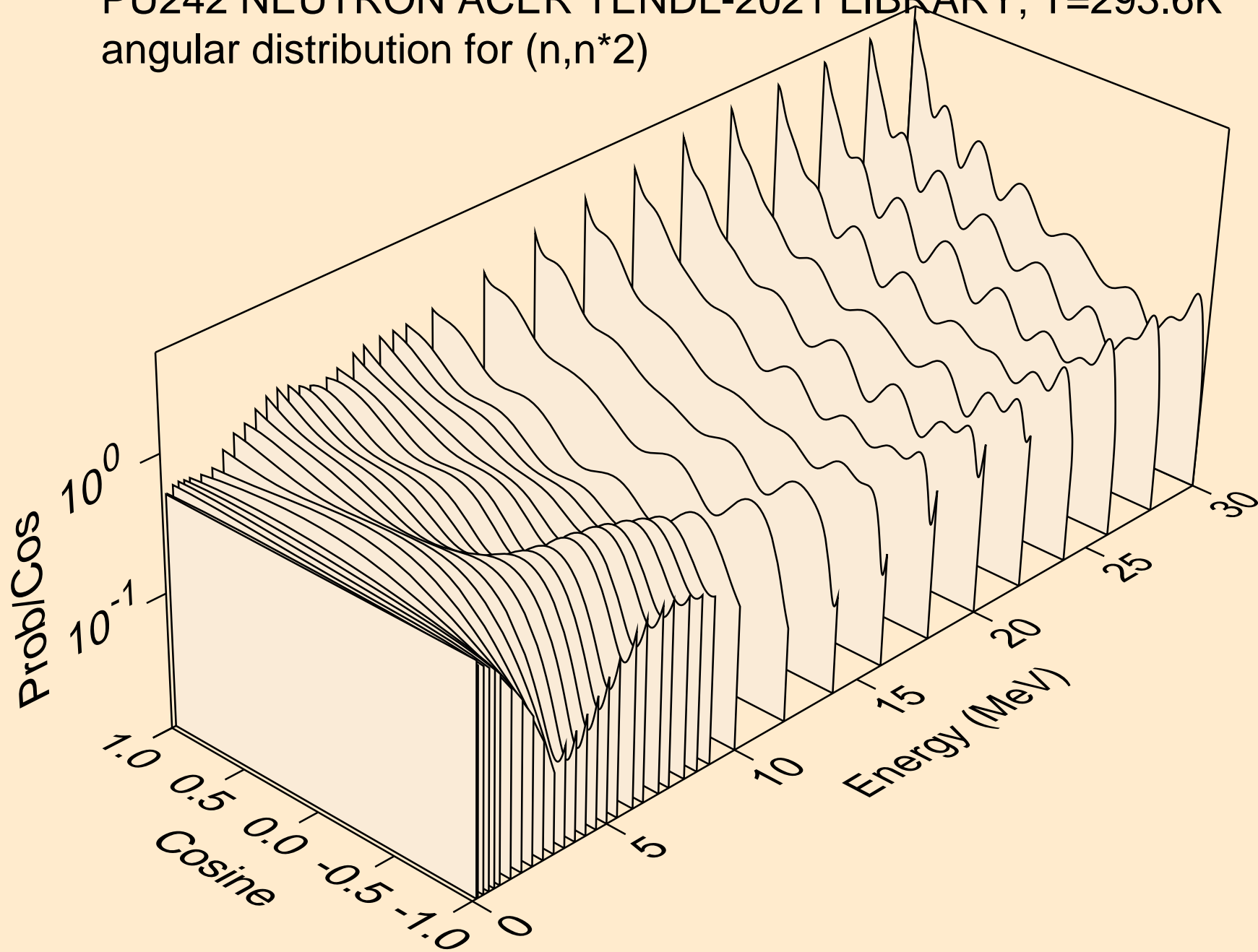

PU242 NEUTRON ACER TENDL-2021 LIBRARY; T=293.6K
angular distribution for (n,n*3)

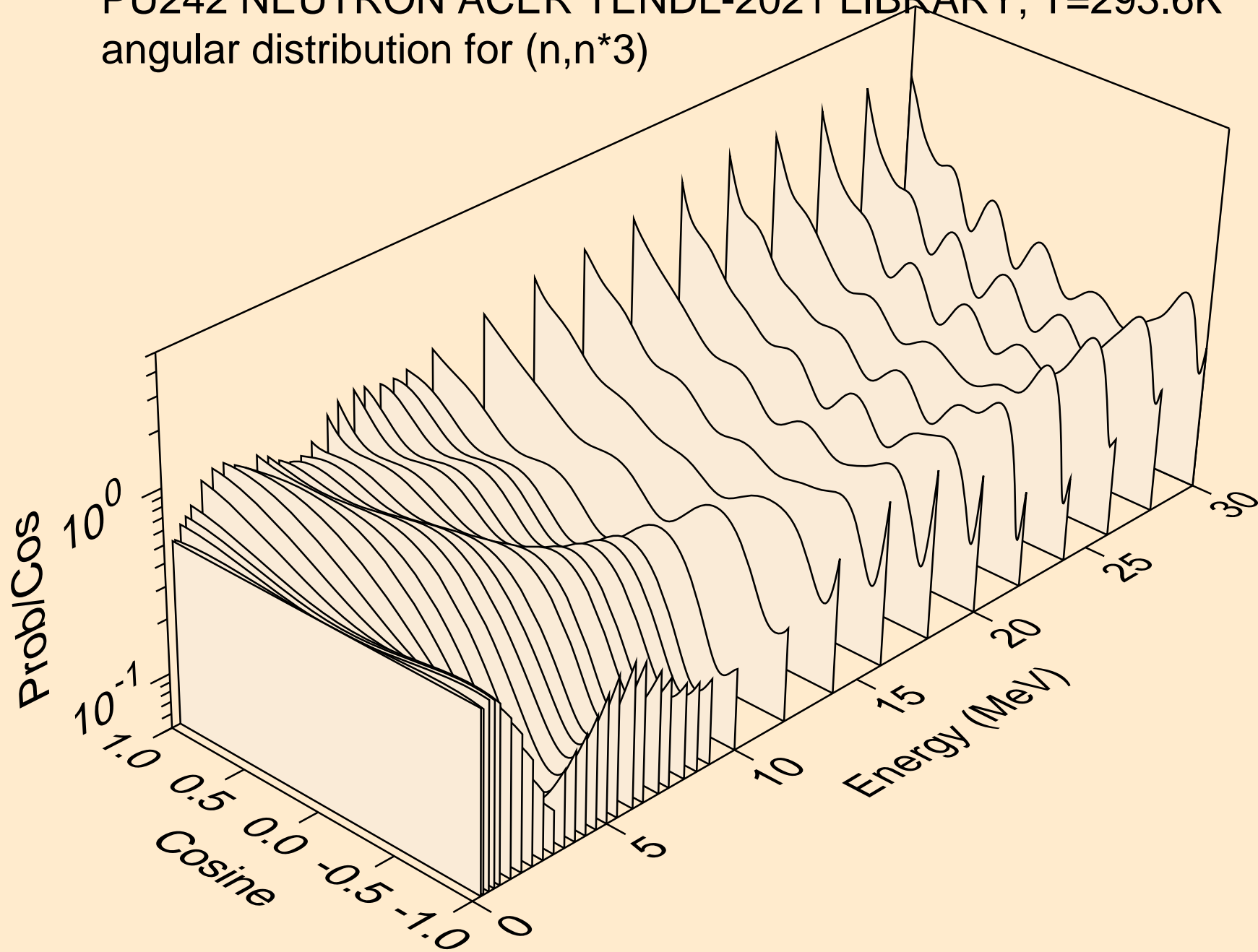

PU242 NEUTRON ACER TENDL-2021 LIBRARY; T=293.6K
angular distribution for (n,n*4)

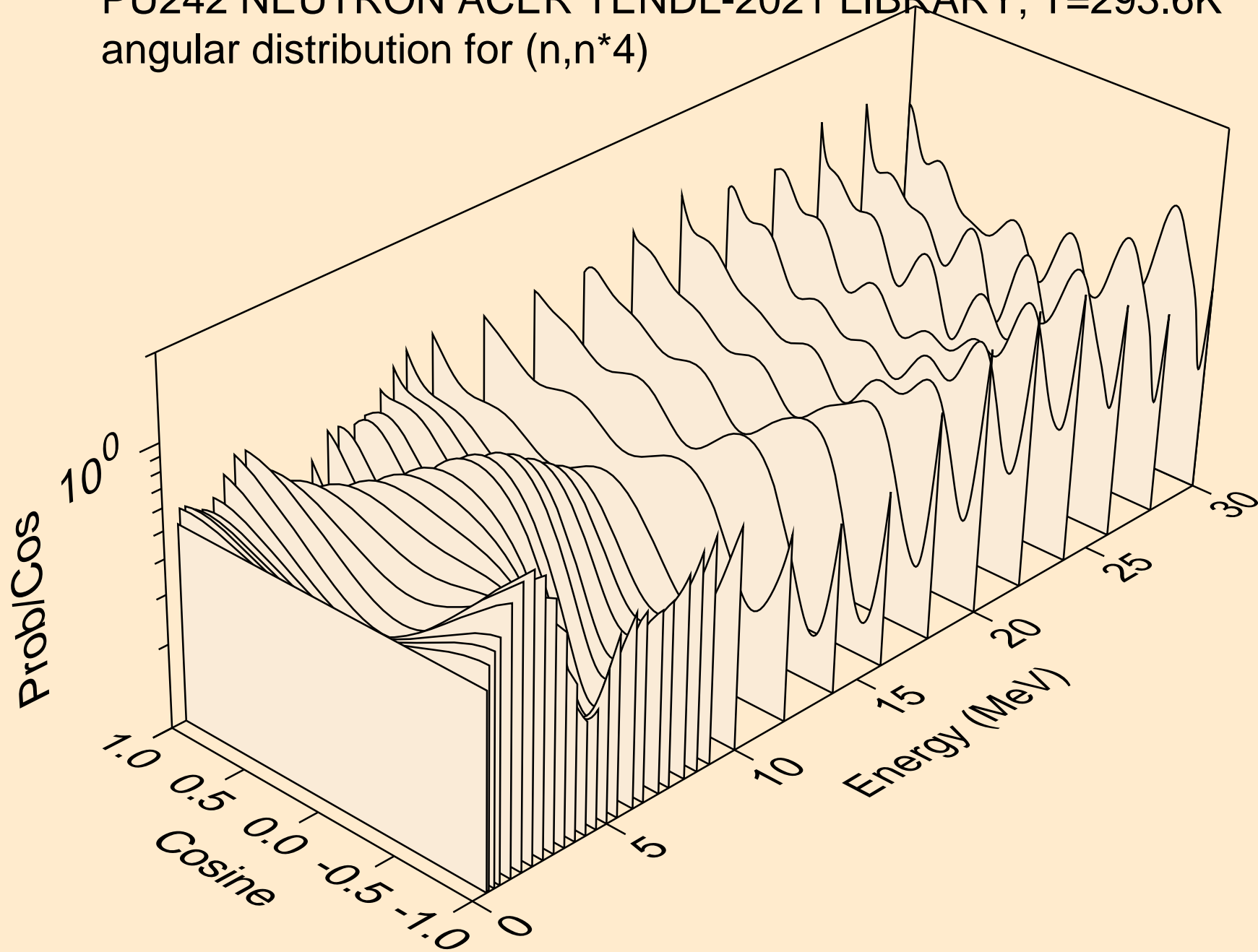

PU242 NEUTRON ACER TENDL-2021 LIBRARY; T=293.6K
angular distribution for (n,n*5)

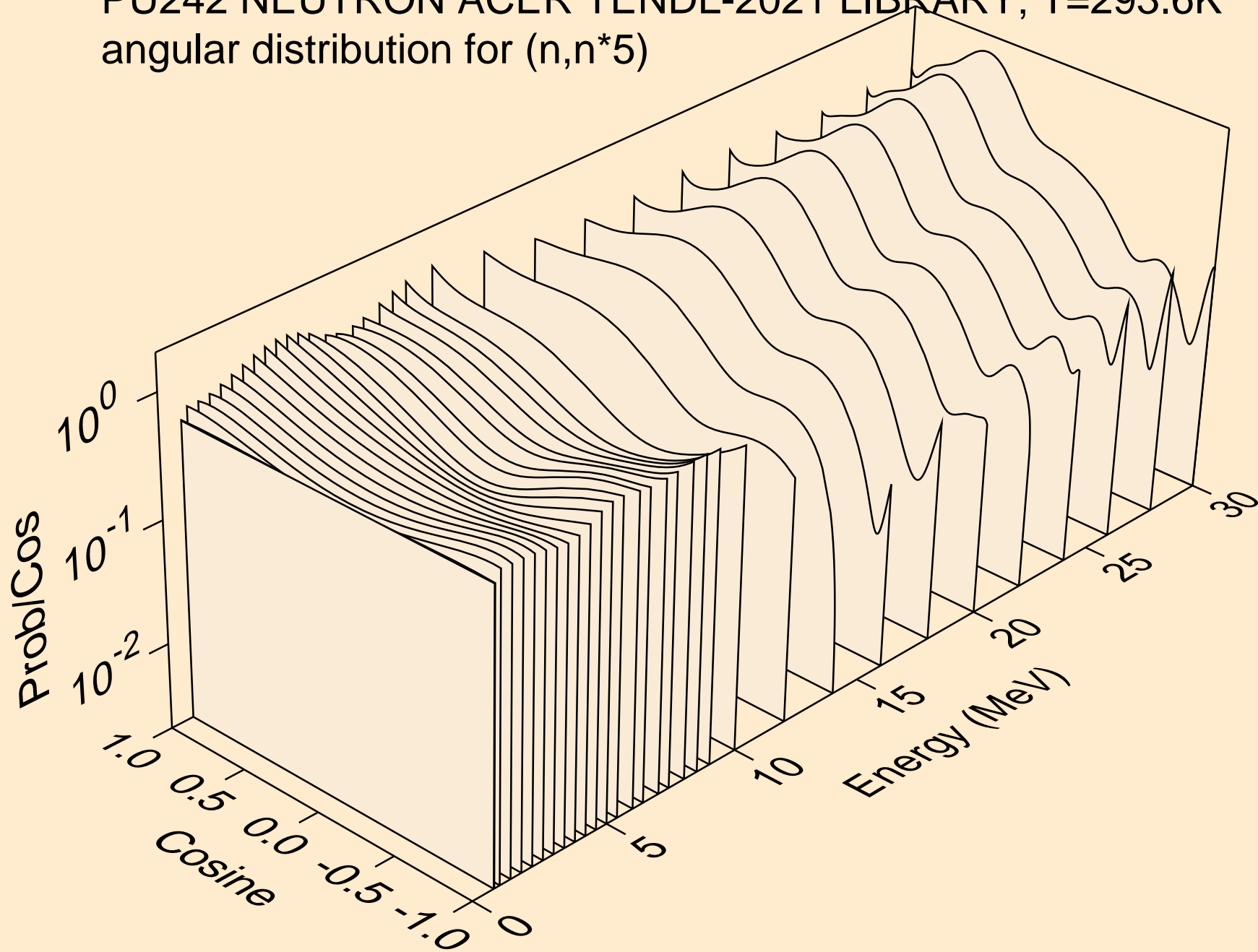

PU242 NEUTRON ACER TENDL-2021 LIBRARY; T=293.6K
angular distribution for (n,n*6)

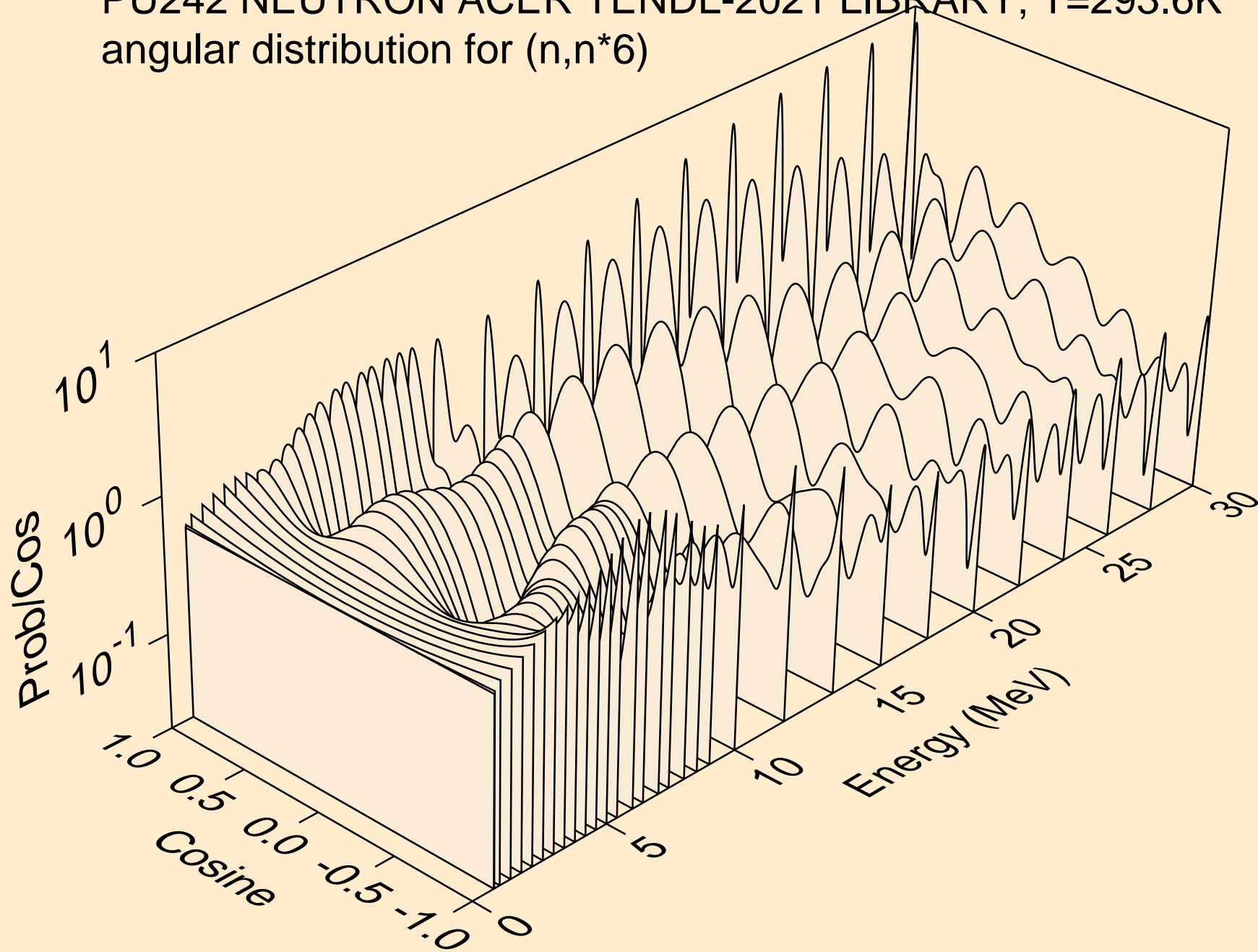

PU242 NEUTRON ACER TENDL-2021 LIBRARY; T=293.6K
angular distribution for (n,n*7)

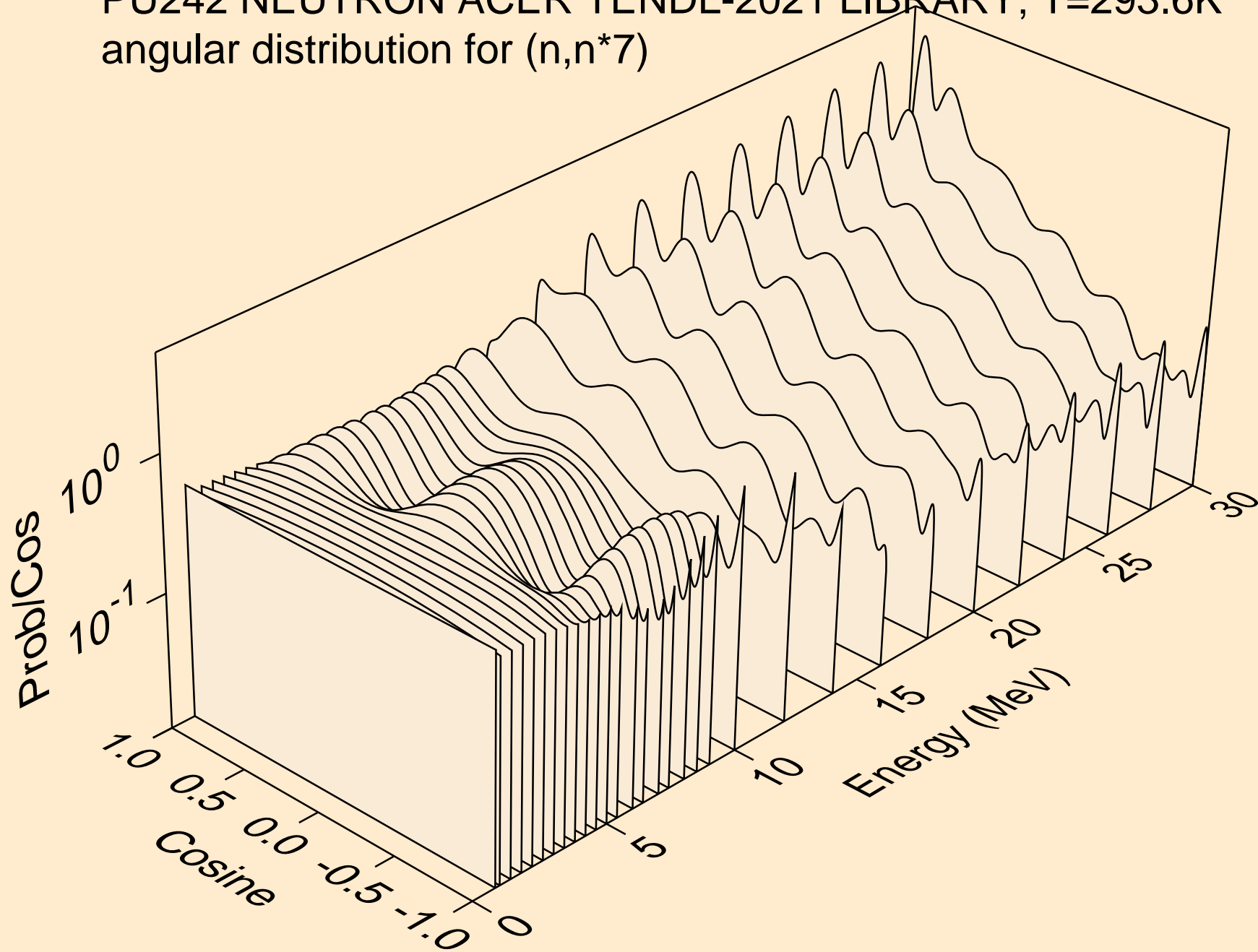

PU242 NEUTRON ACER TENDL-2021 LIBRARY; T=293.6K
angular distribution for (n,n*8)

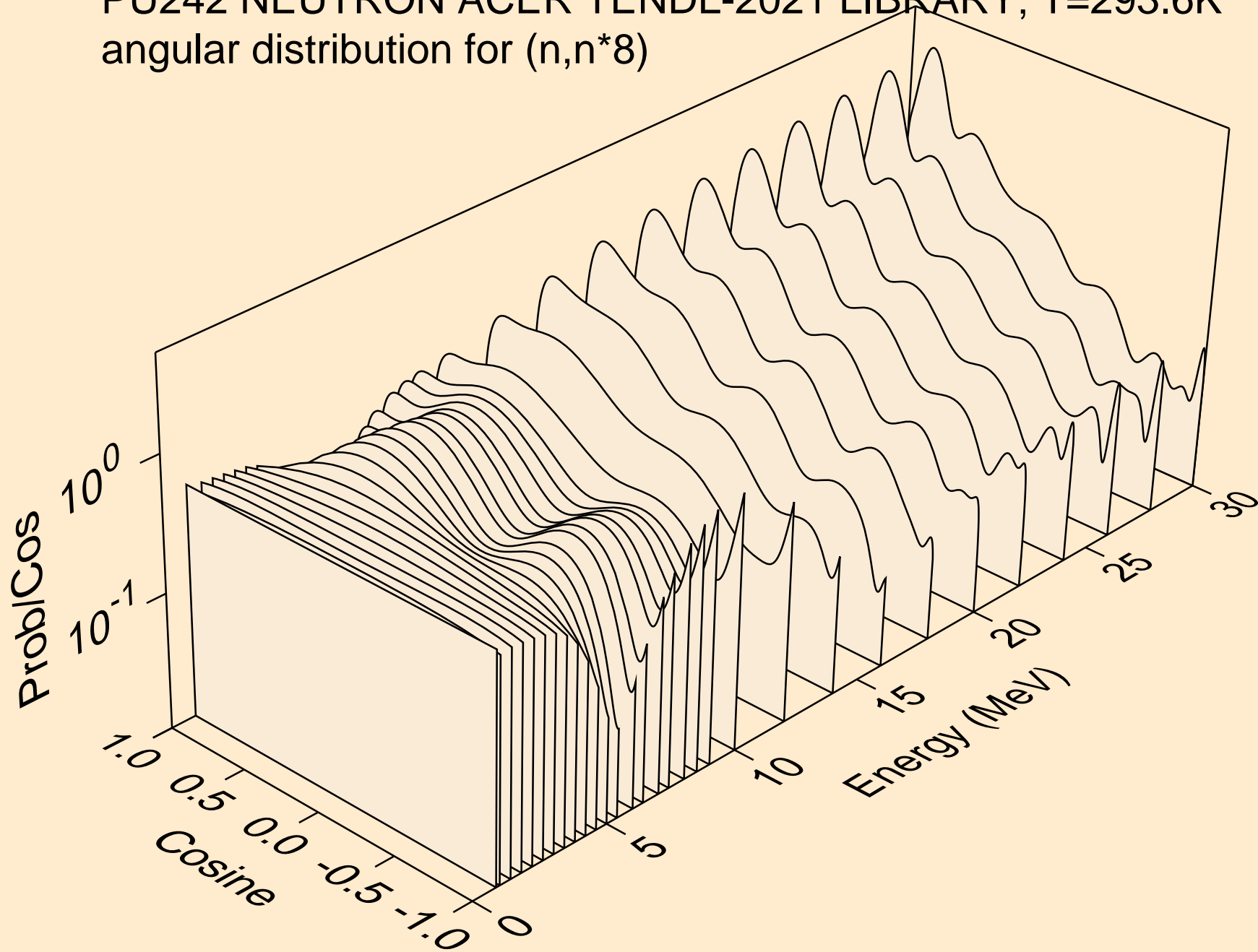

PU242 NEUTRON ACER TENDL-2021 LIBRARY; T=293.6K
angular distribution for (n,n*9)

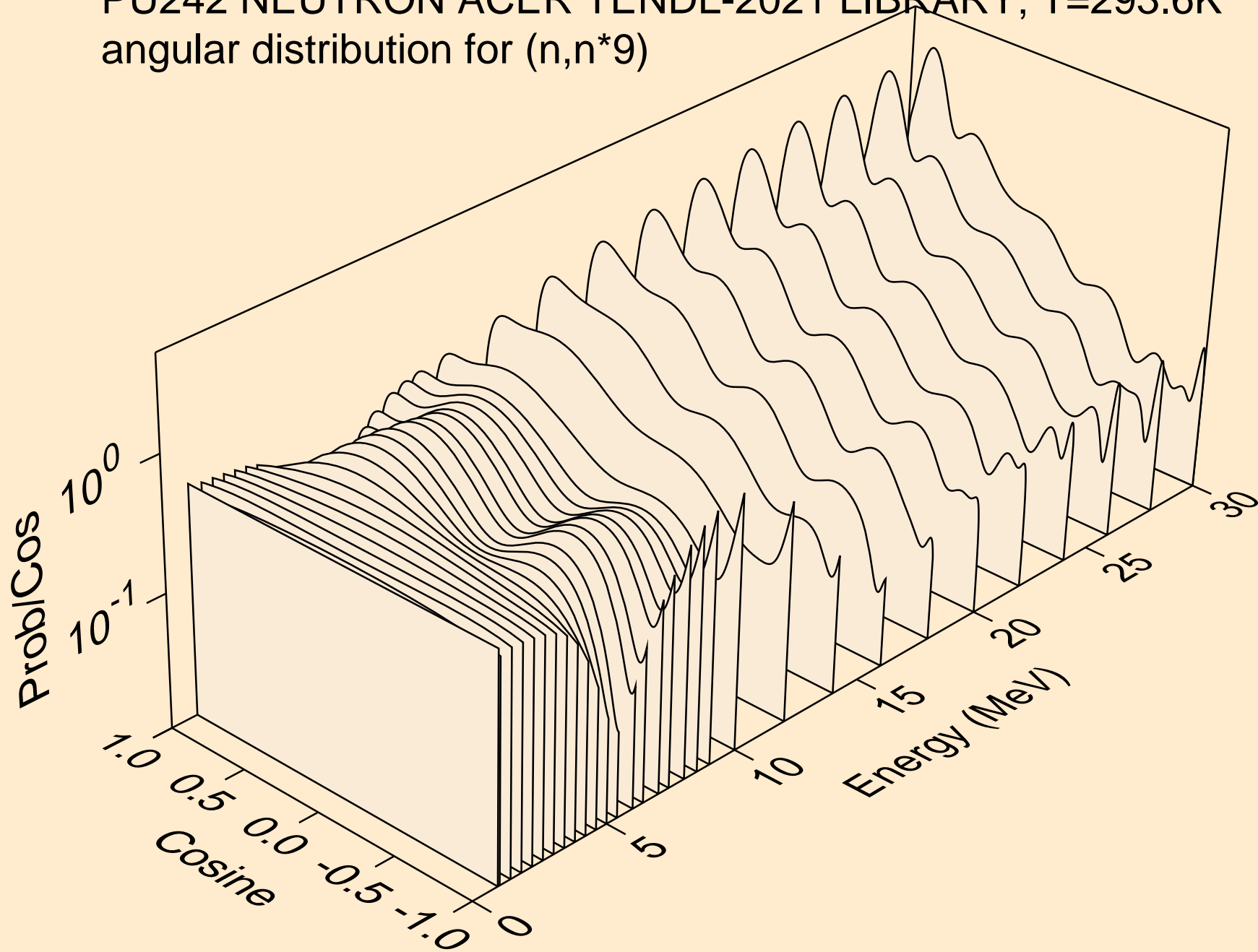

PU242 NEUTRON ACER TENDL-2021 LIBRARY; T=293.6K
angular distribution for (n,n*10)

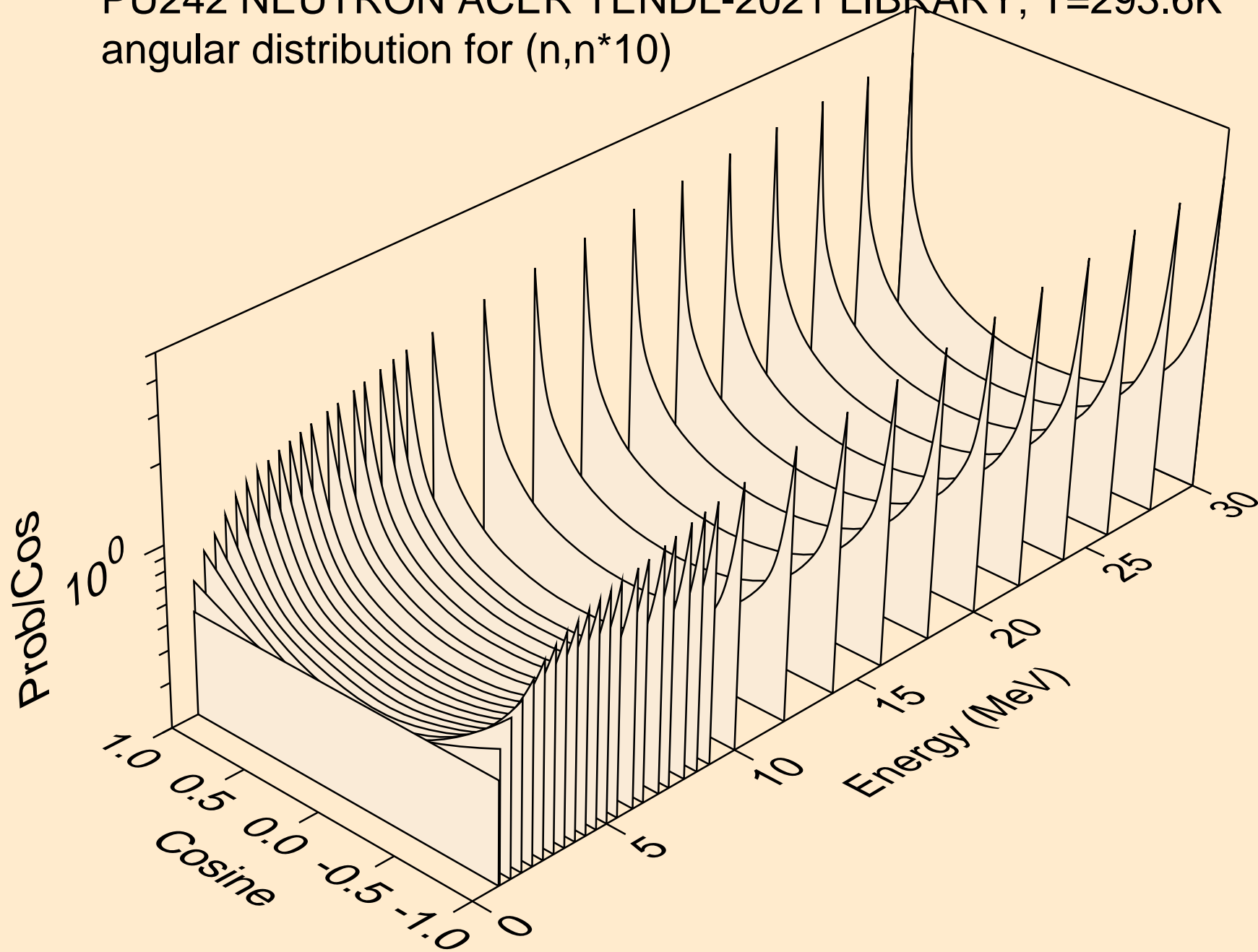

PU242 NEUTRON ACER TENDL-2021 LIBRARY; T=293.6K
angular distribution for (n,n*11)

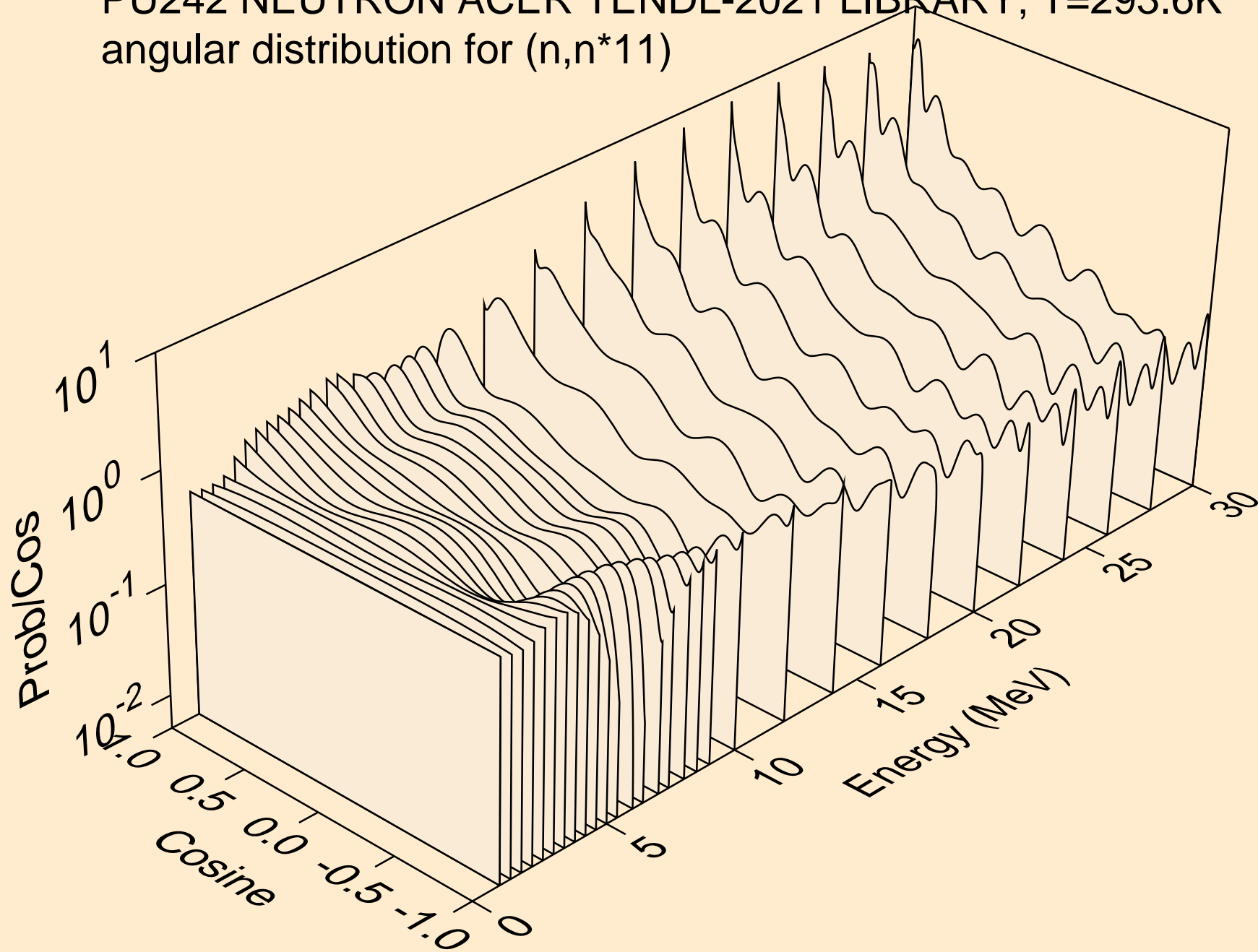

PU242 NEUTRON ACER TENDL-2021 LIBRARY; T=293.6K
angular distribution for (n,n*12)

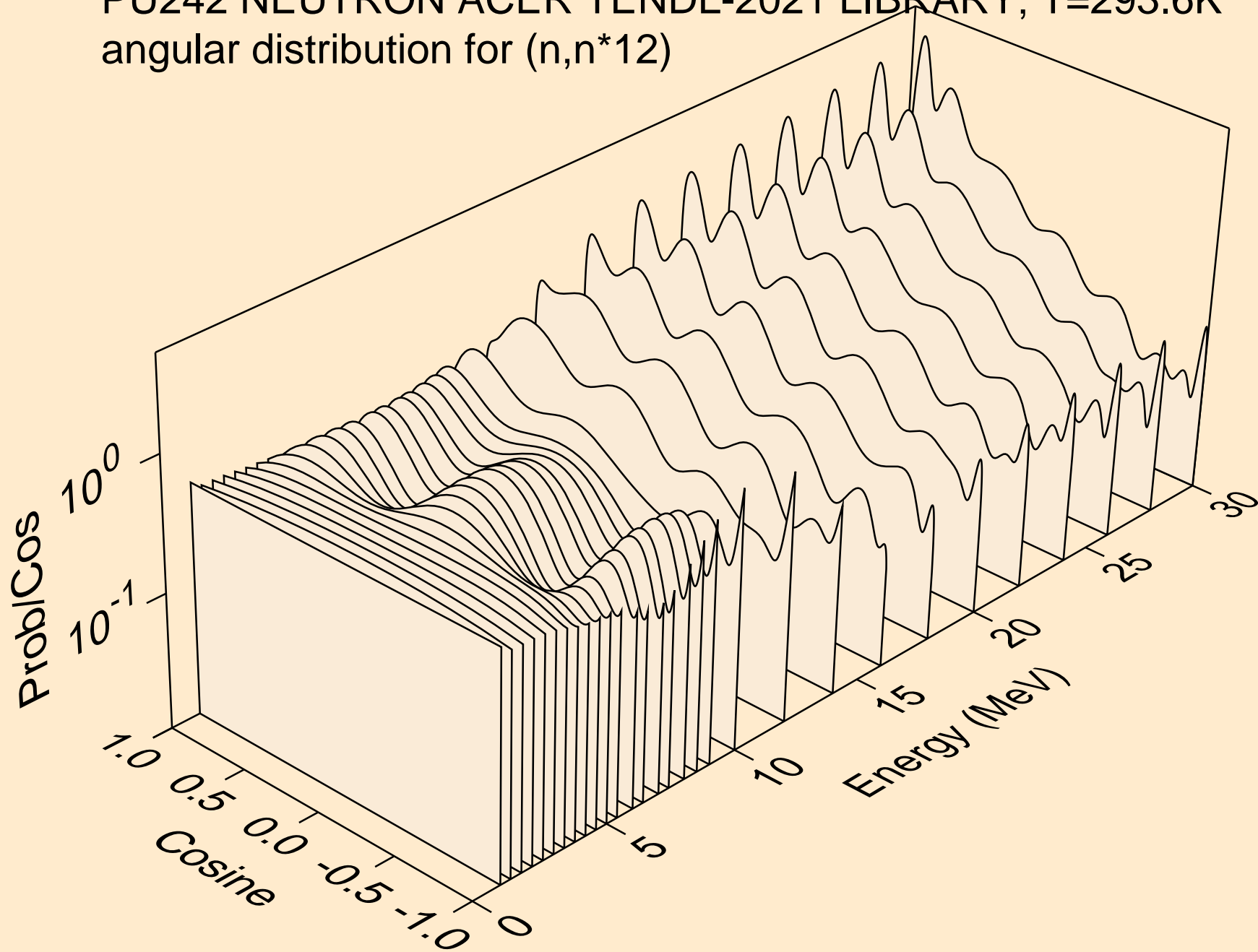

PU242 NEUTRON ACER TENDL-2021 LIBRARY; T=293.6K
angular distribution for (n,n*13)

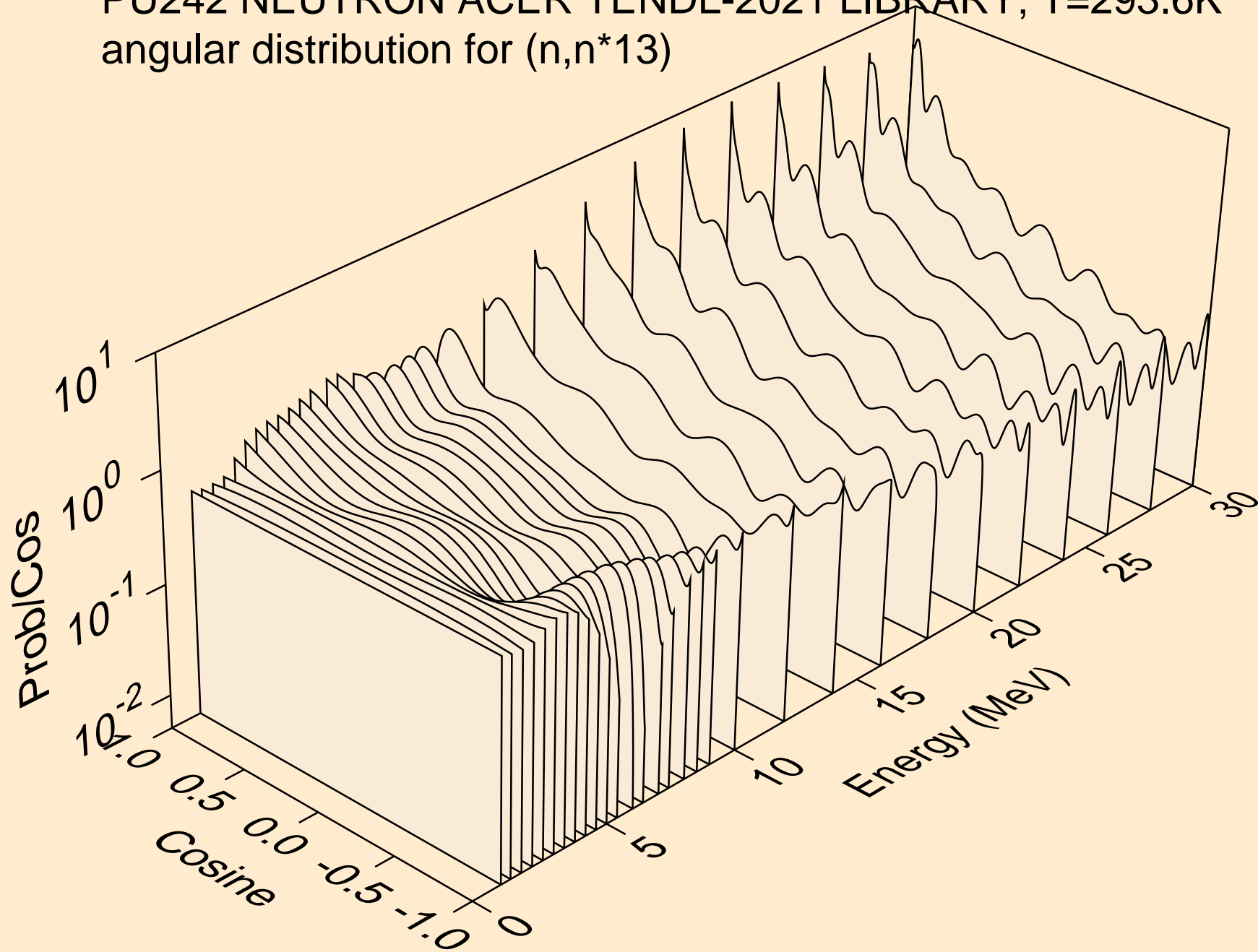

PU242 NEUTRON ACER TENDL-2021 LIBRARY; T=293.6K
angular distribution for (n,n*14)

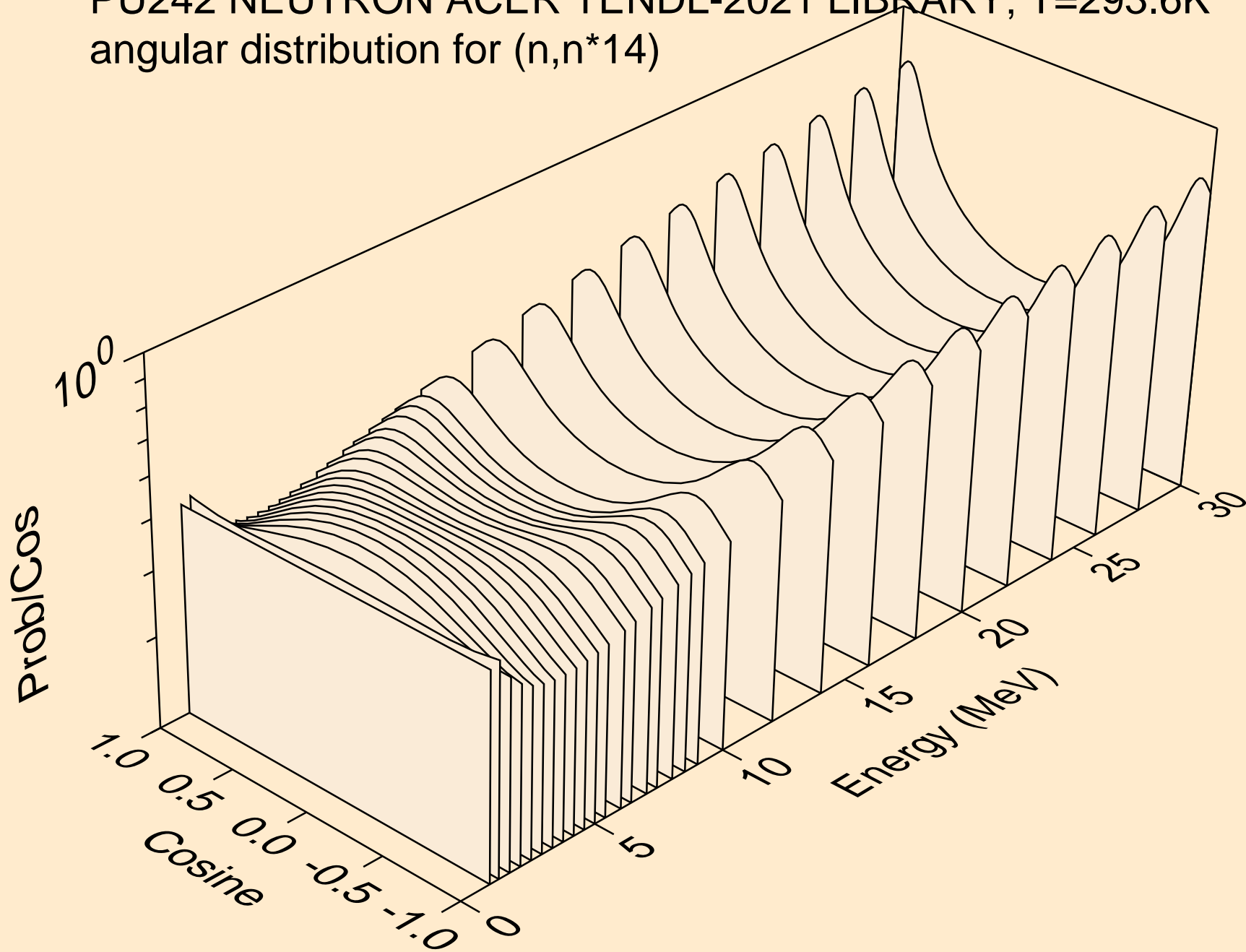

PU242 NEUTRON ACER TENDL-2021 LIBRARY; T=293.6K
angular distribution for (n,n*15)

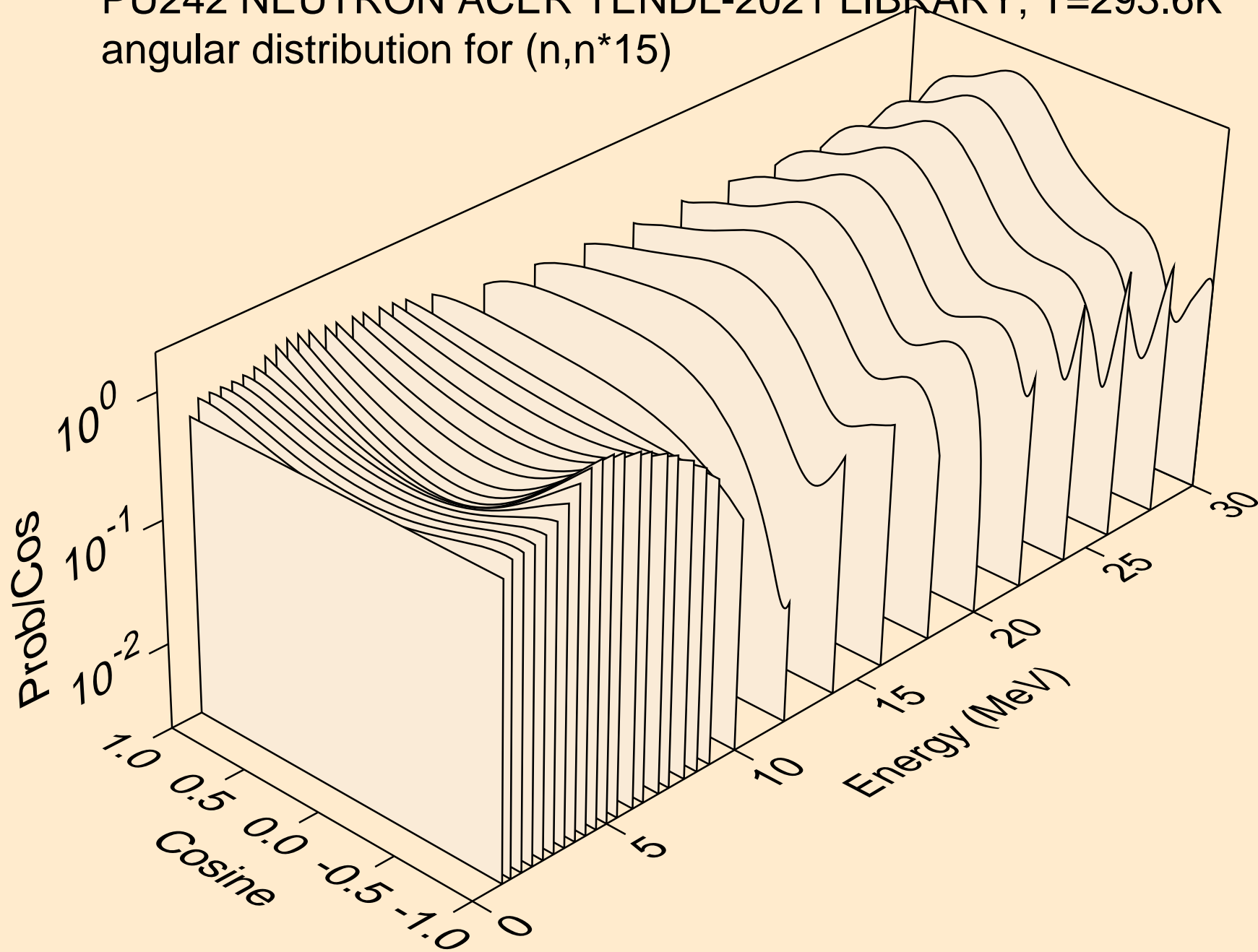

PU242 NEUTRON ACER TENDL-2021 LIBRARY; T=293.6K
angular distribution for (n,n*16)

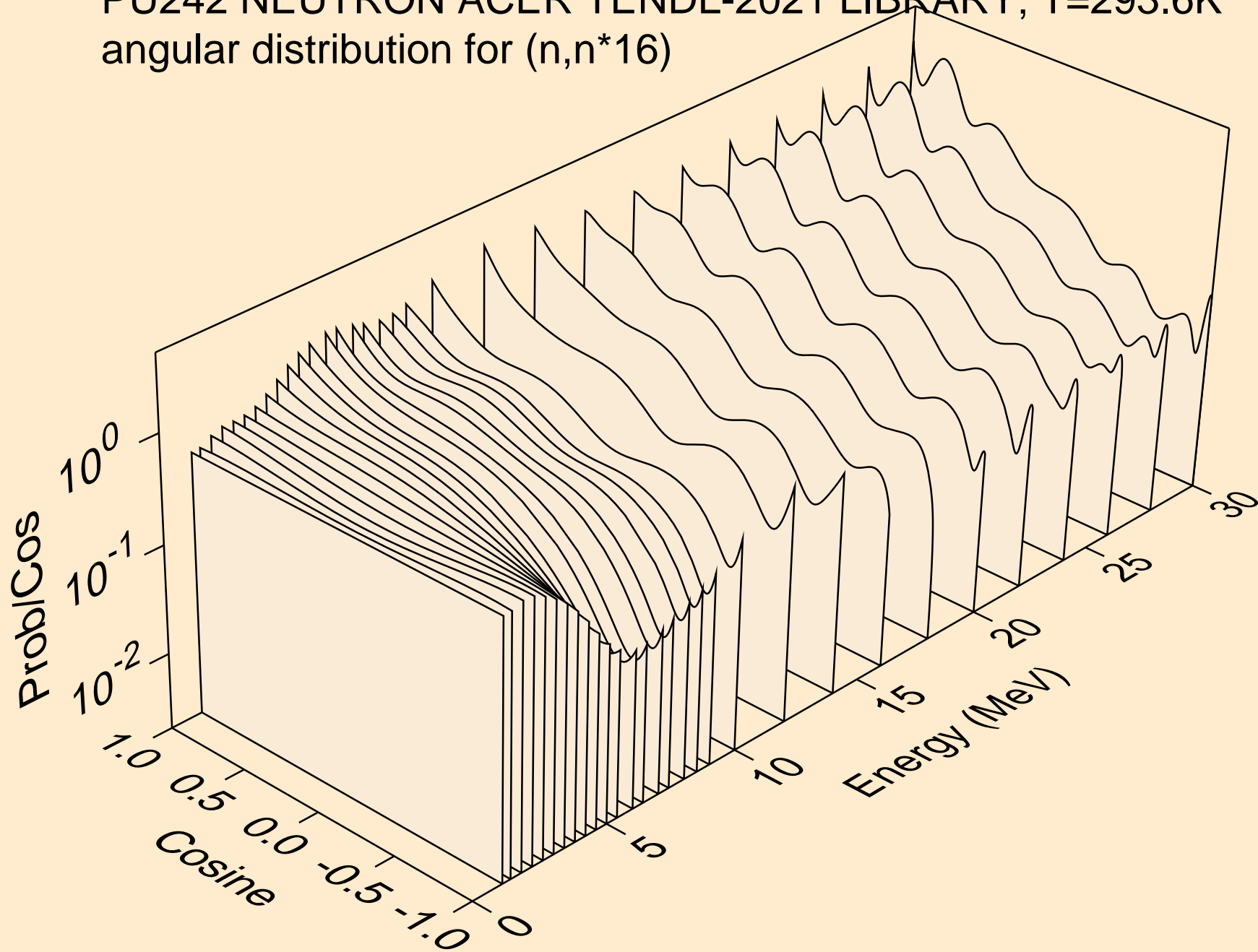

PU242 NEUTRON ACER TENDL-2021 LIBRARY; T=293.6K
angular distribution for (n,n*17)

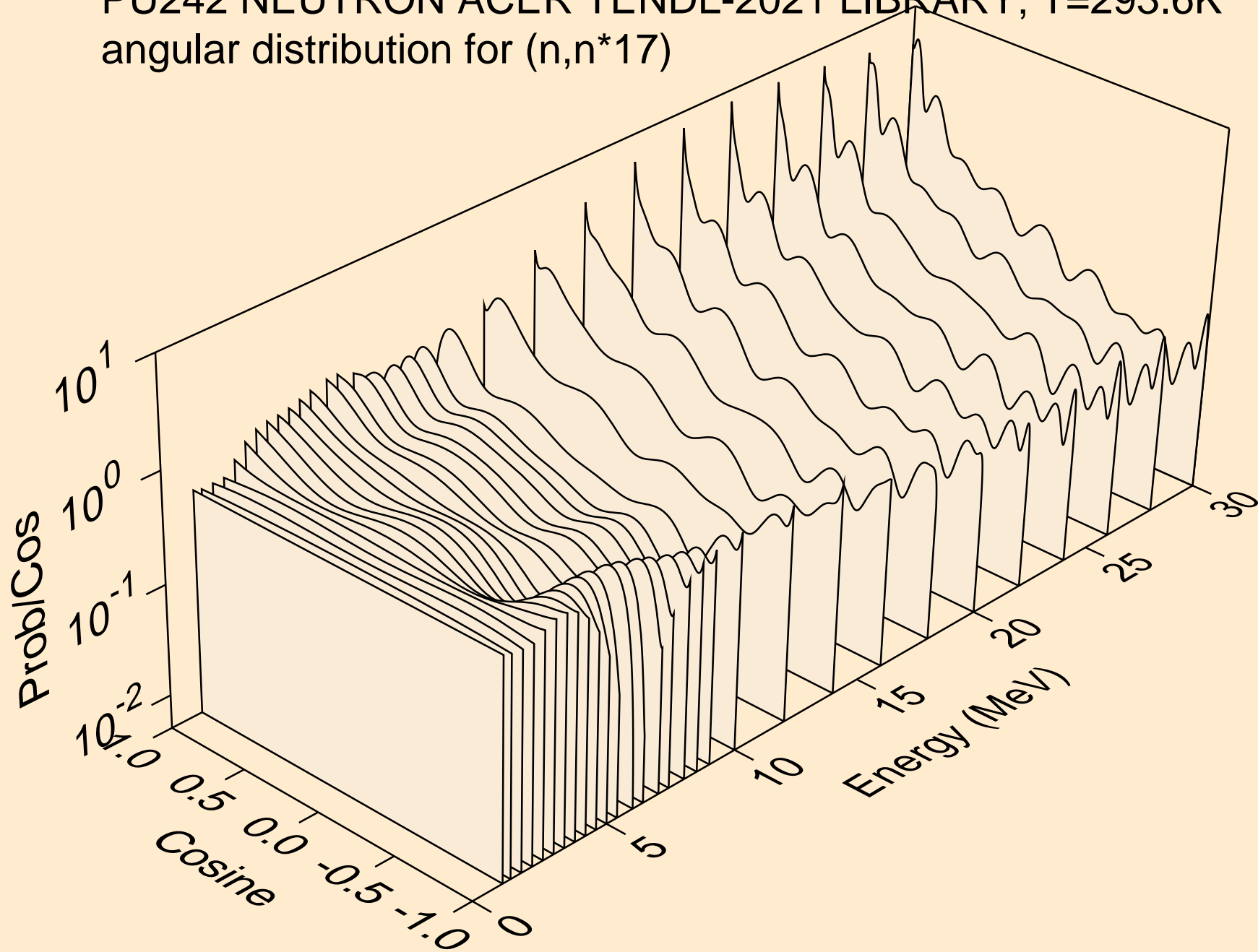

PU242 NEUTRON ACER TENDL-2021 LIBRARY; T=293.6K
angular distribution for (n,n*18)

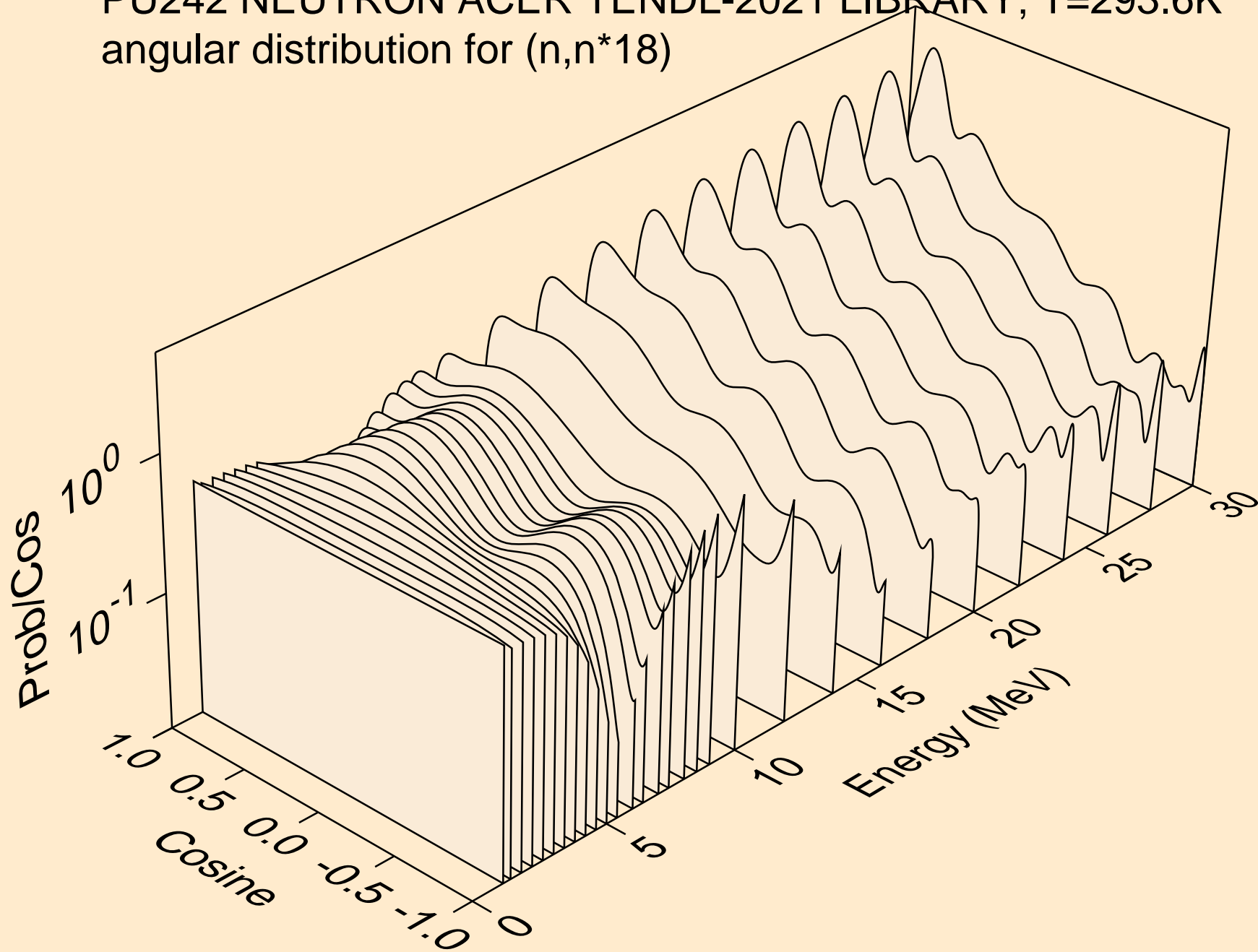

PU242 NEUTRON ACER TENDL-2021 LIBRARY; T=293.6K
angular distribution for (n,n*19)

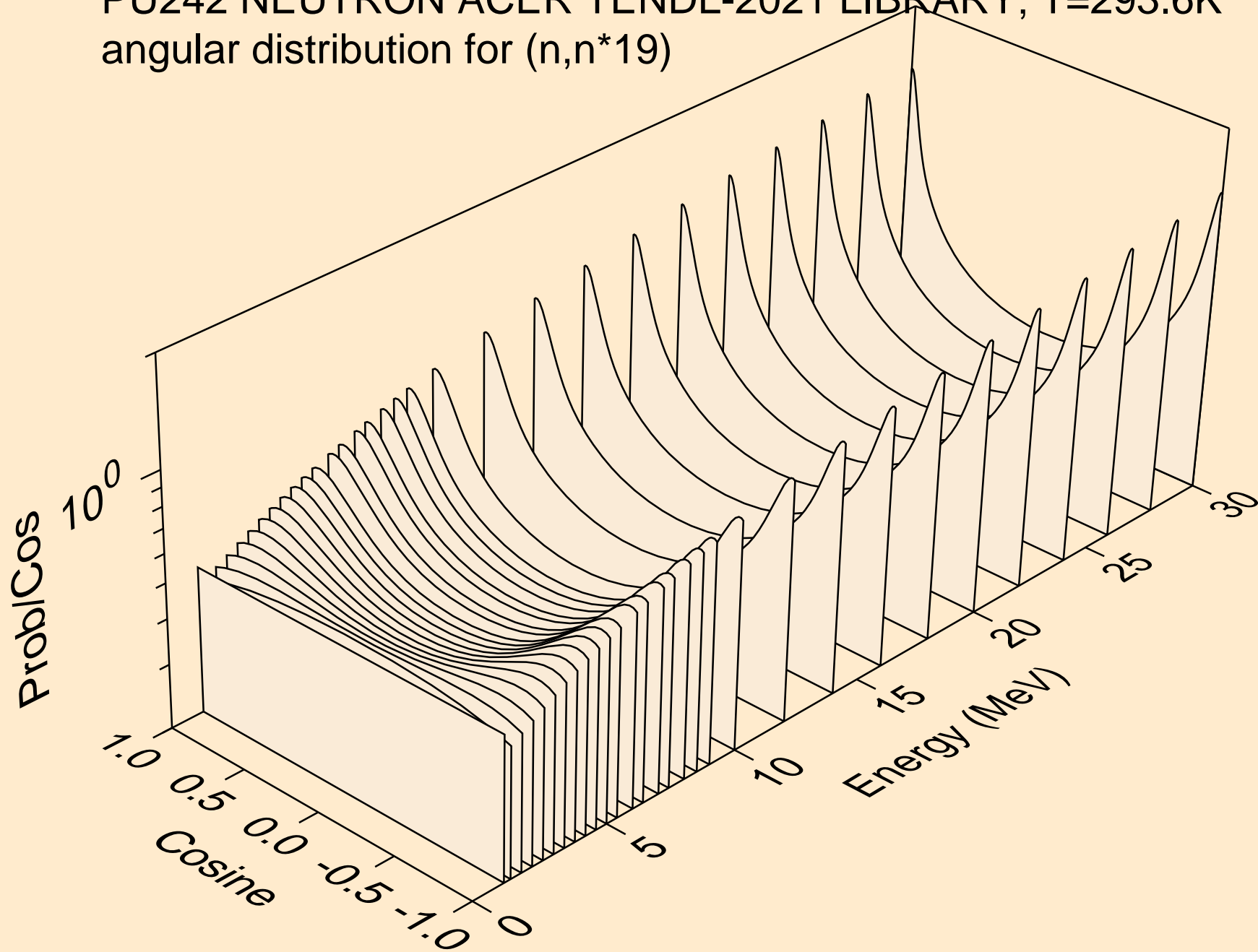

PU242 NEUTRON ACER TENDL-2021 LIBRARY; T=293.6K
angular distribution for (n,n*20)

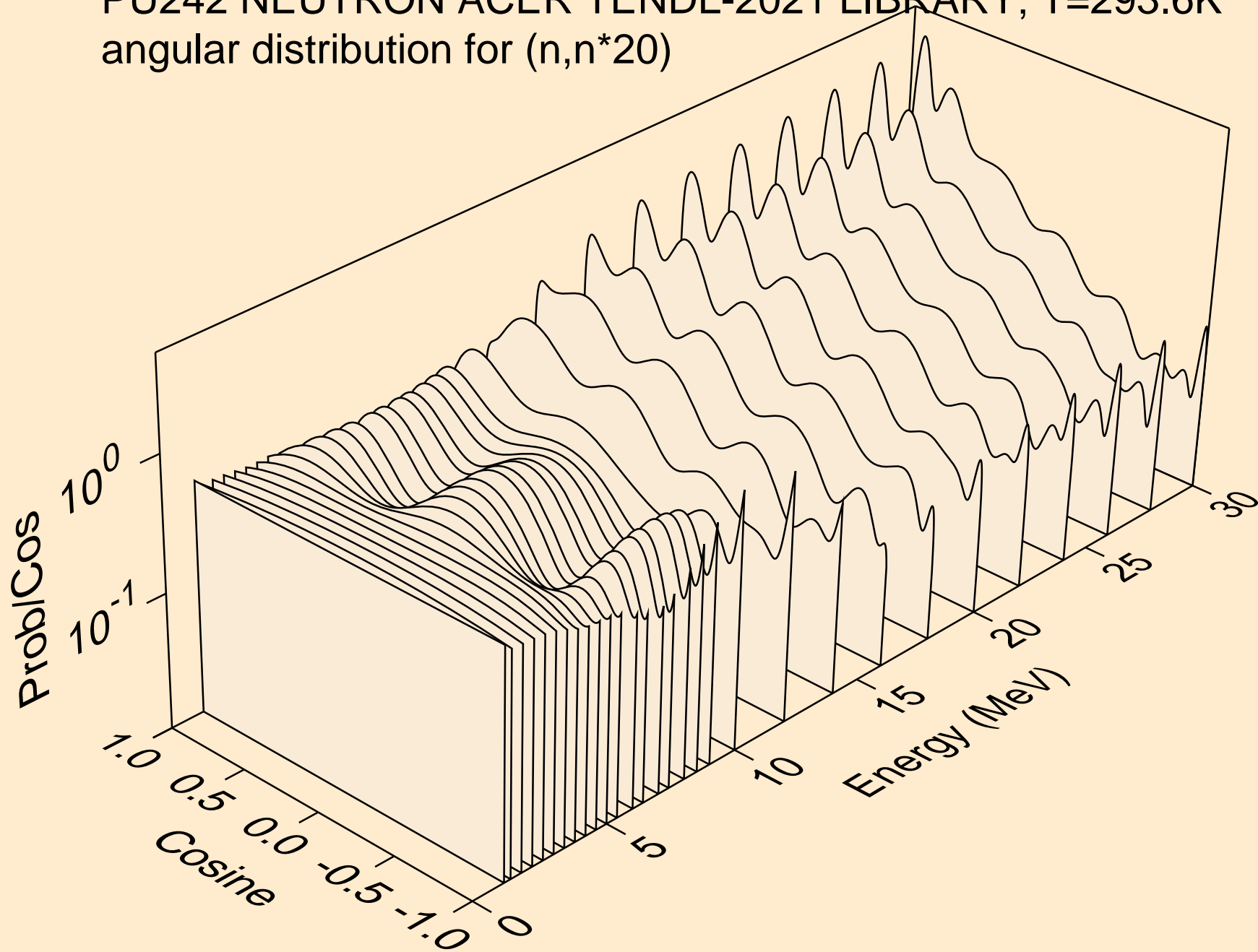

PU242 NEUTRON ACER TENDL-2021 LIBRARY; T=293.6K
angular distribution for (n,n*21)

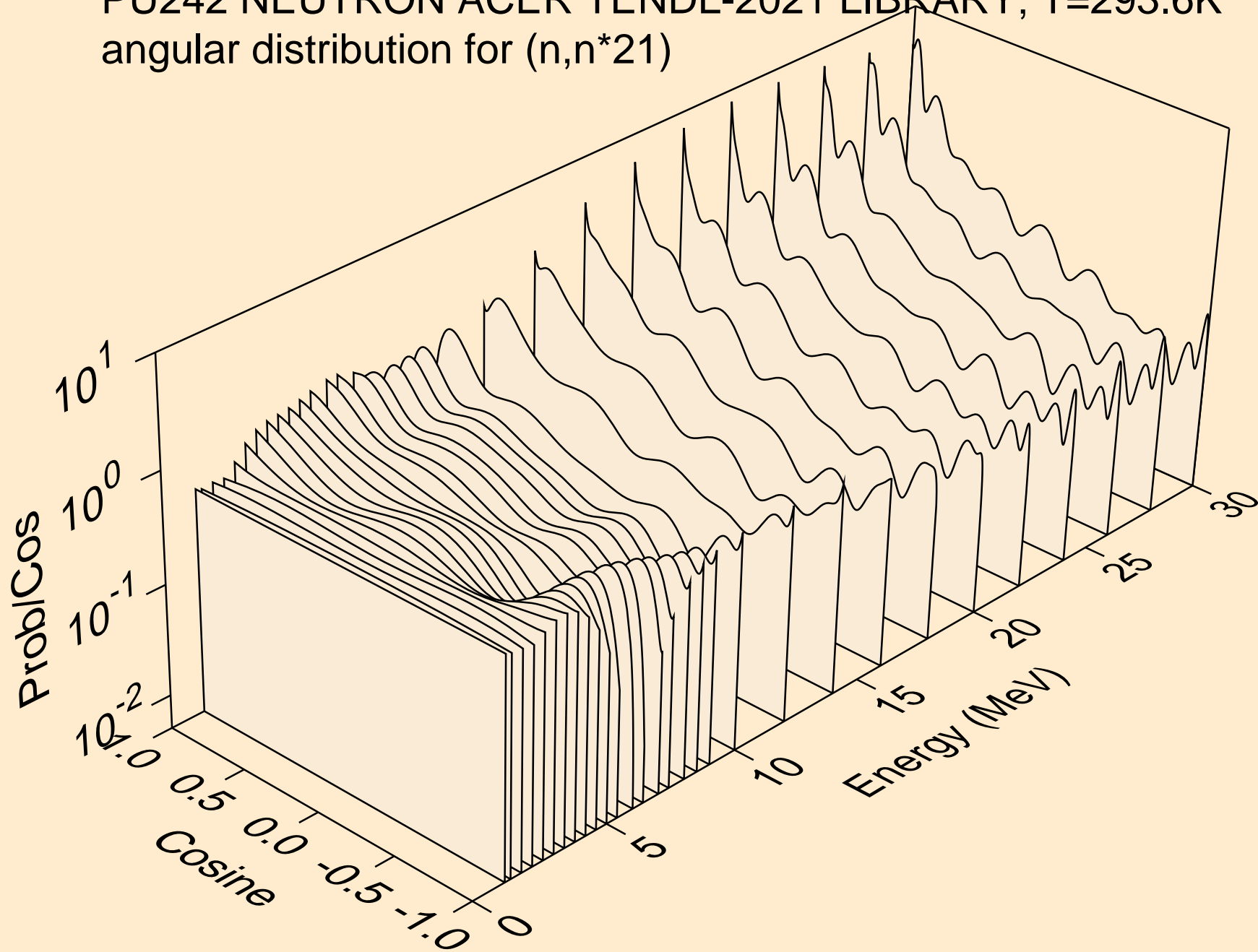

PU242 NEUTRON ACER TENDL-2021 LIBRARY; T=293.6K
angular distribution for (n,n*22)

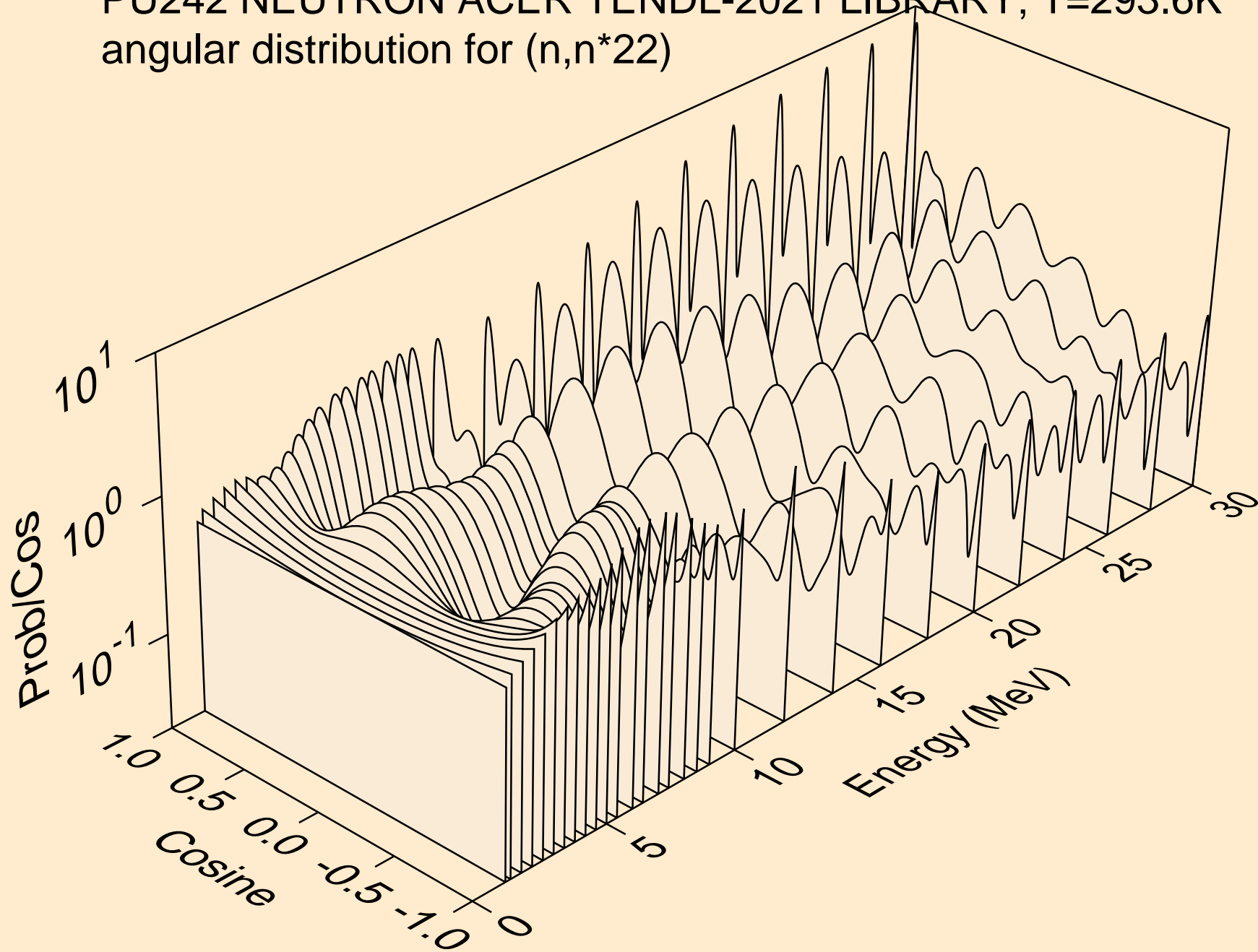

PU242 NEUTRON ACER TENDL-2021 LIBRARY; T=293.6K
angular distribution for (n,n*23)

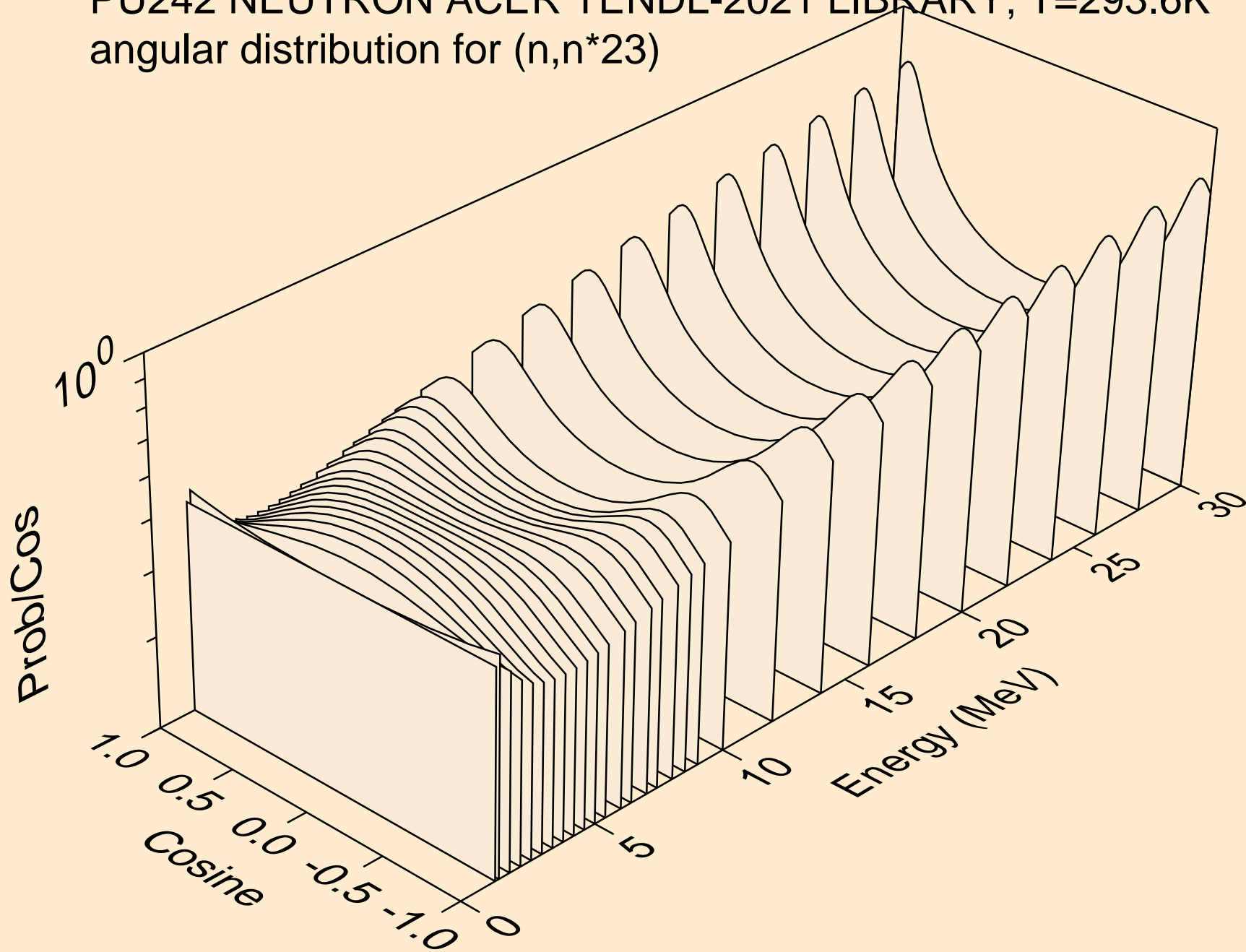

PU242 NEUTRON ACER TENDL-2021 LIBRARY; T=293.6K
angular distribution for (n,n*24)

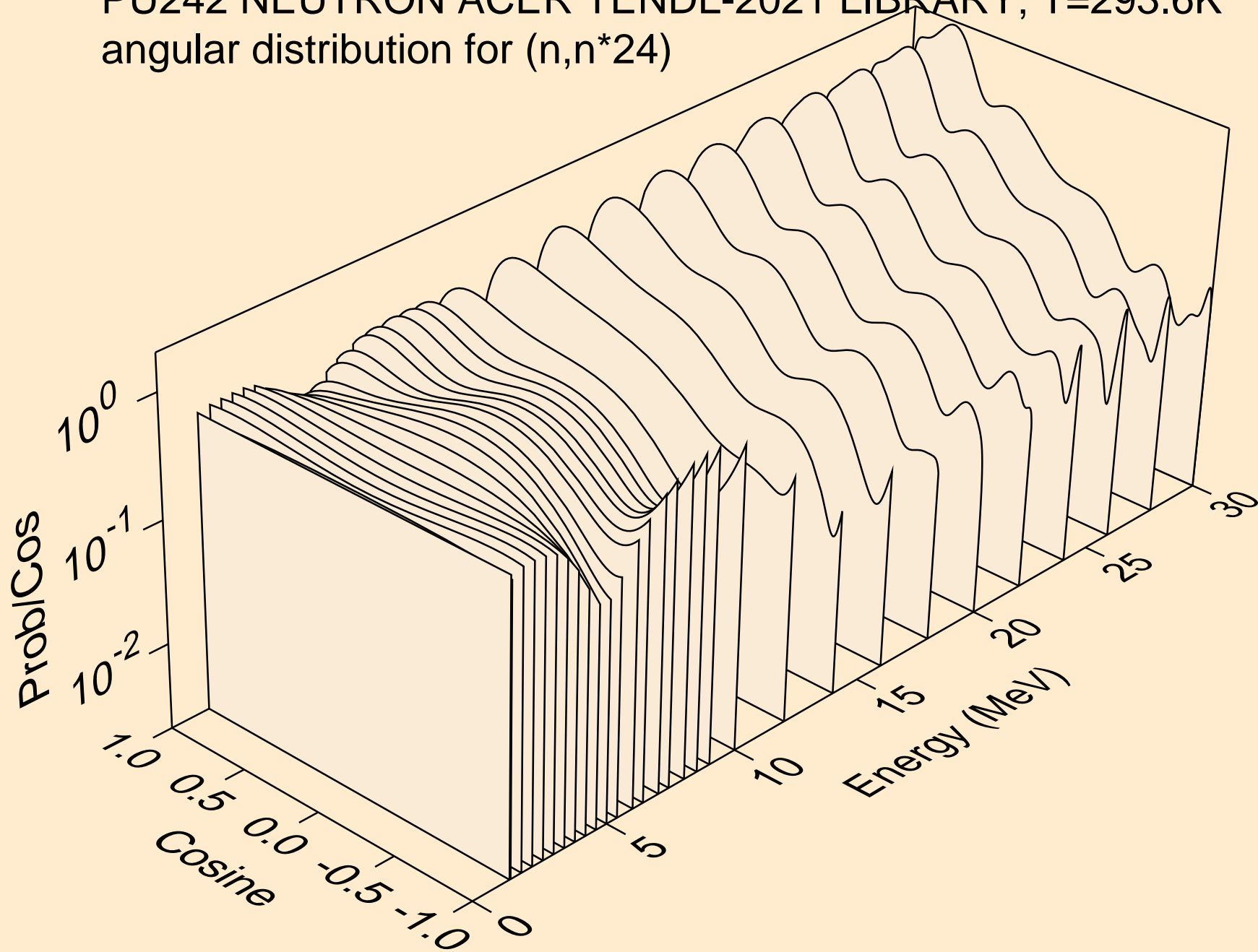

PU242 NEUTRON ACER TENDL-2021 LIBRARY; T=293.6K
angular distribution for (n,n*25)

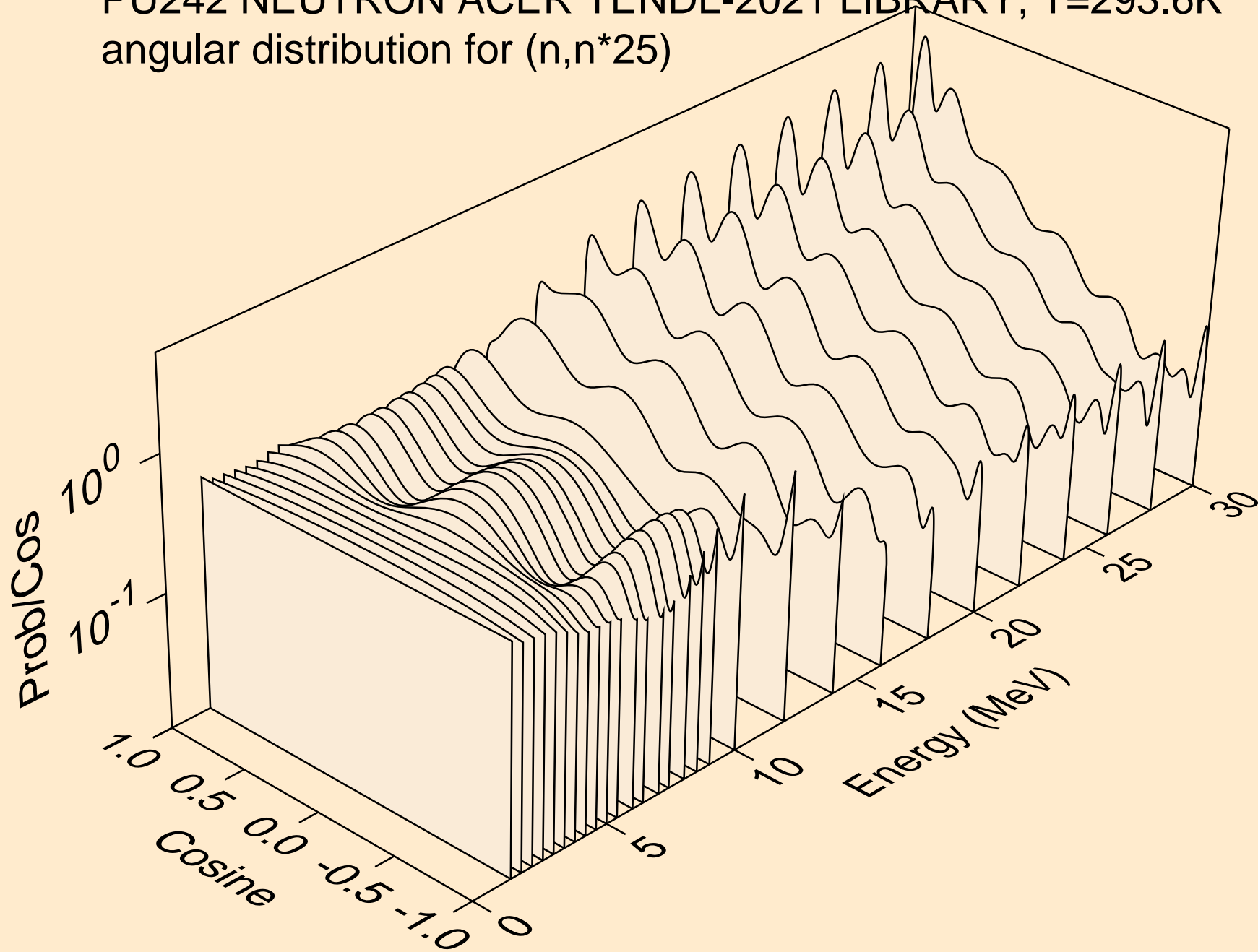

PU242 NEUTRON ACER TENDL-2021 LIBRARY; T=293.6K
angular distribution for (n,n*26)

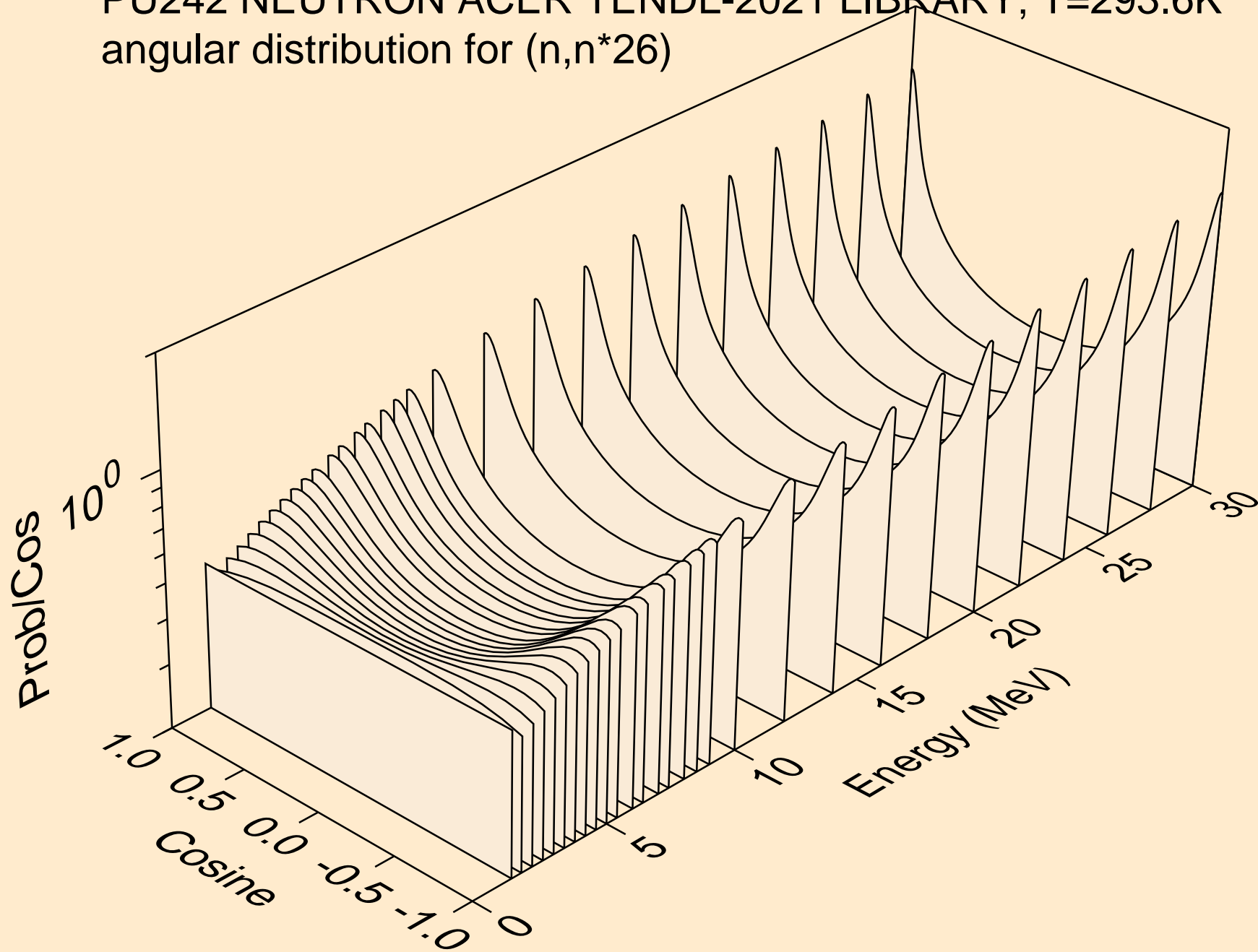

PU242 NEUTRON ACER TENDL-2021 LIBRARY; T=293.6K
angular distribution for (n,n*27)

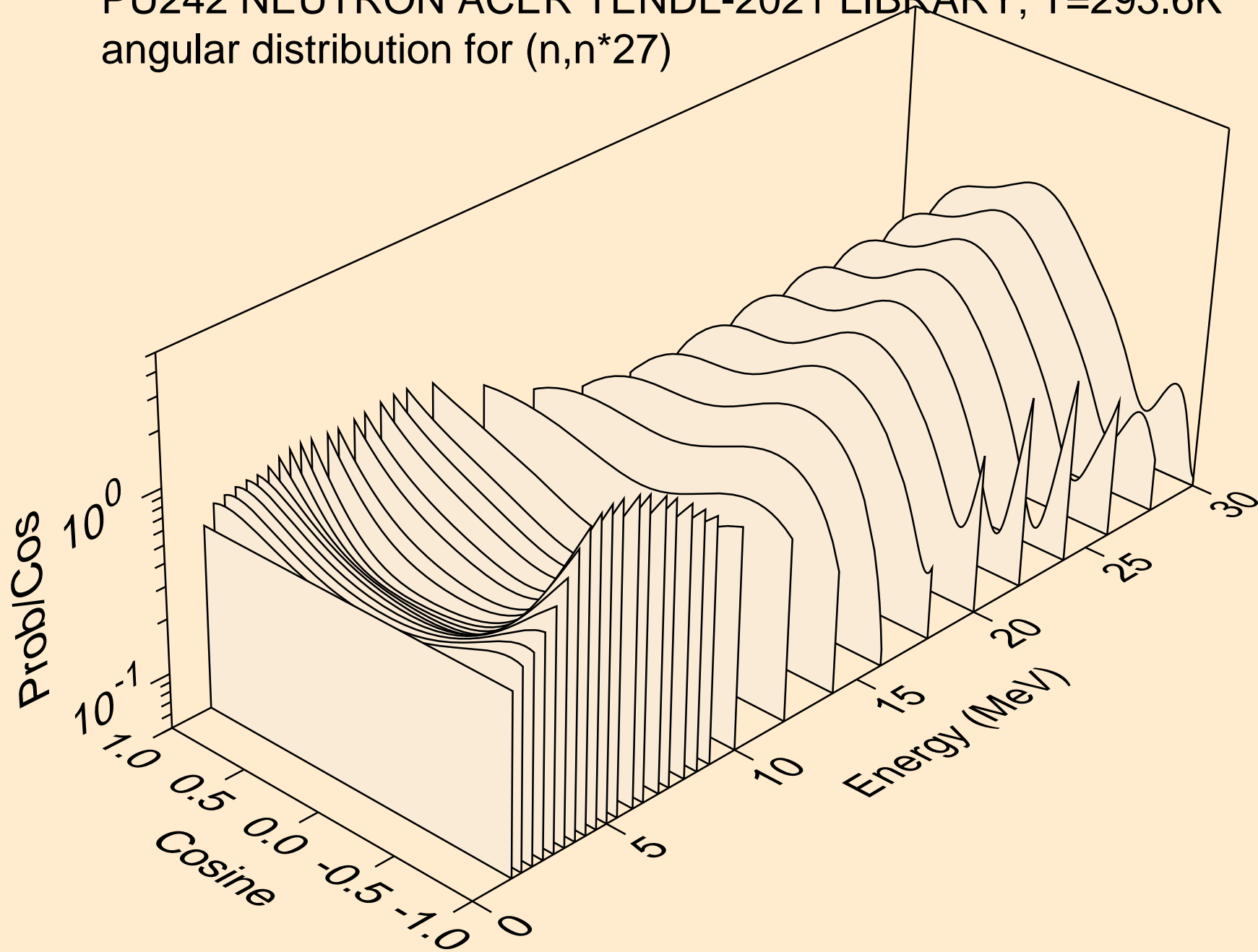

PU242 NEUTRON ACER TENDL-2021 LIBRARY; T=293.6K
angular distribution for (n,n*28)

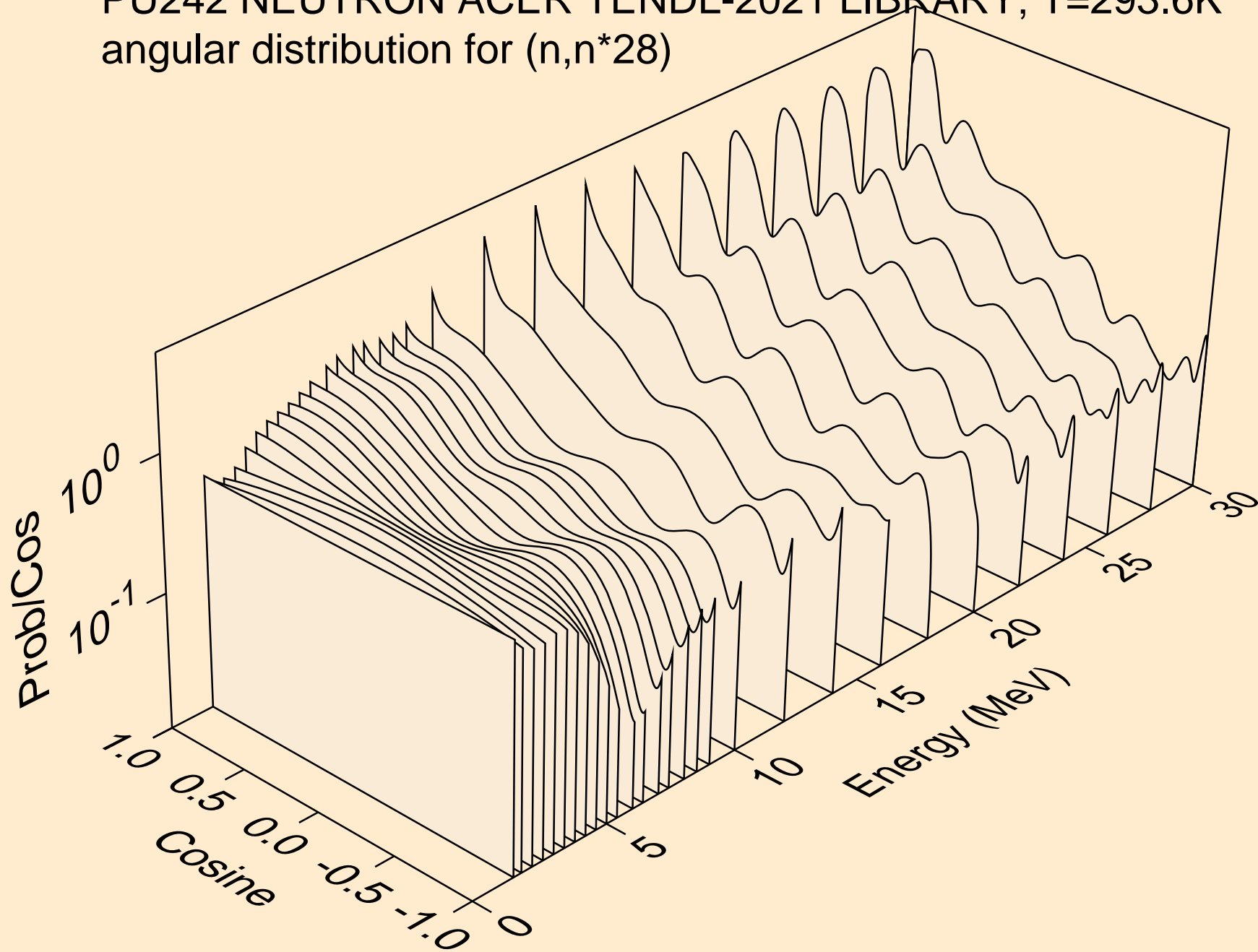

PU242 NEUTRON ACER TENDL-2021 LIBRARY; T=293.6K
angular distribution for (n,n*29)

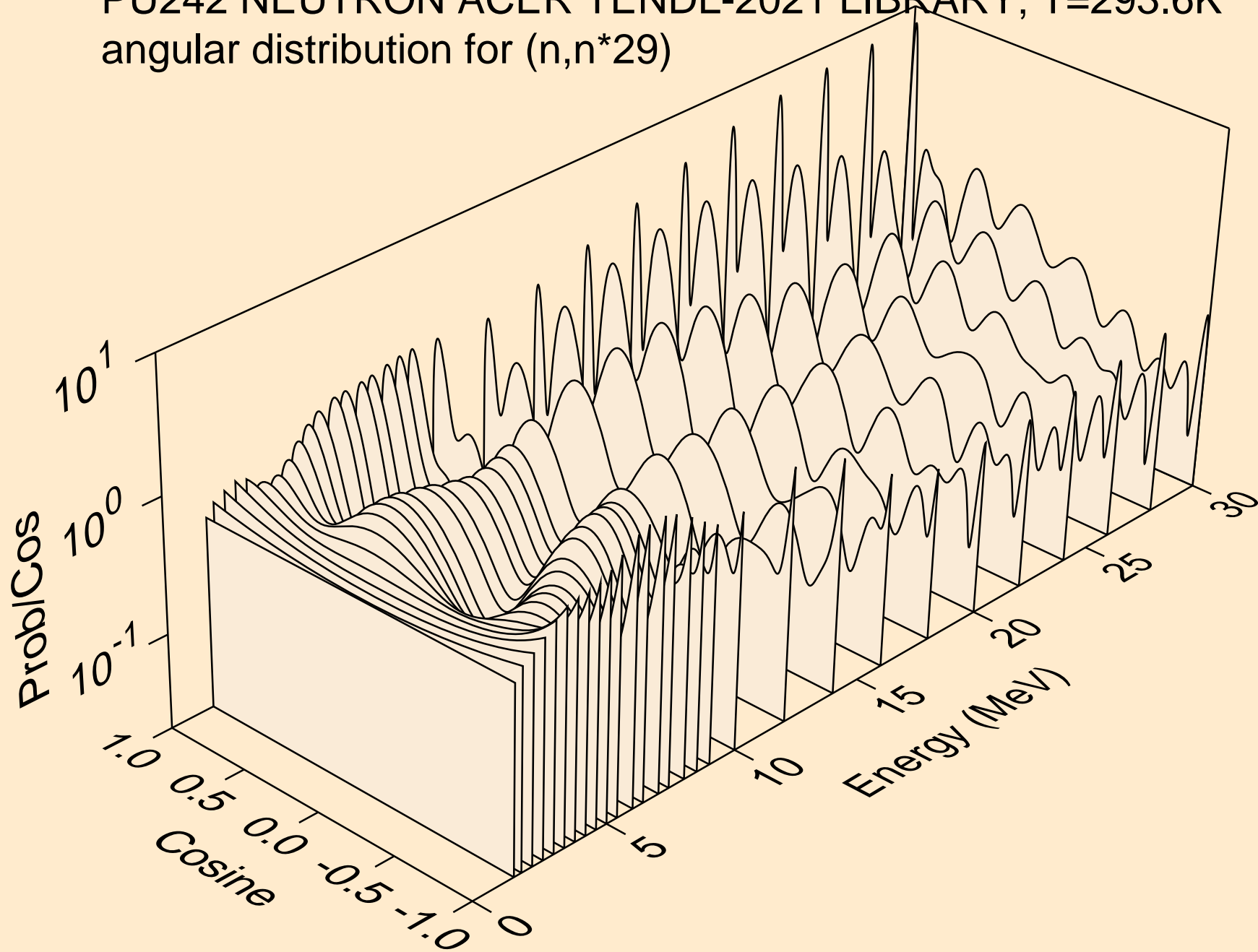

PU242 NEUTRON ACER TENDL-2021 LIBRARY; T=293.6K
angular distribution for (n,n*30)

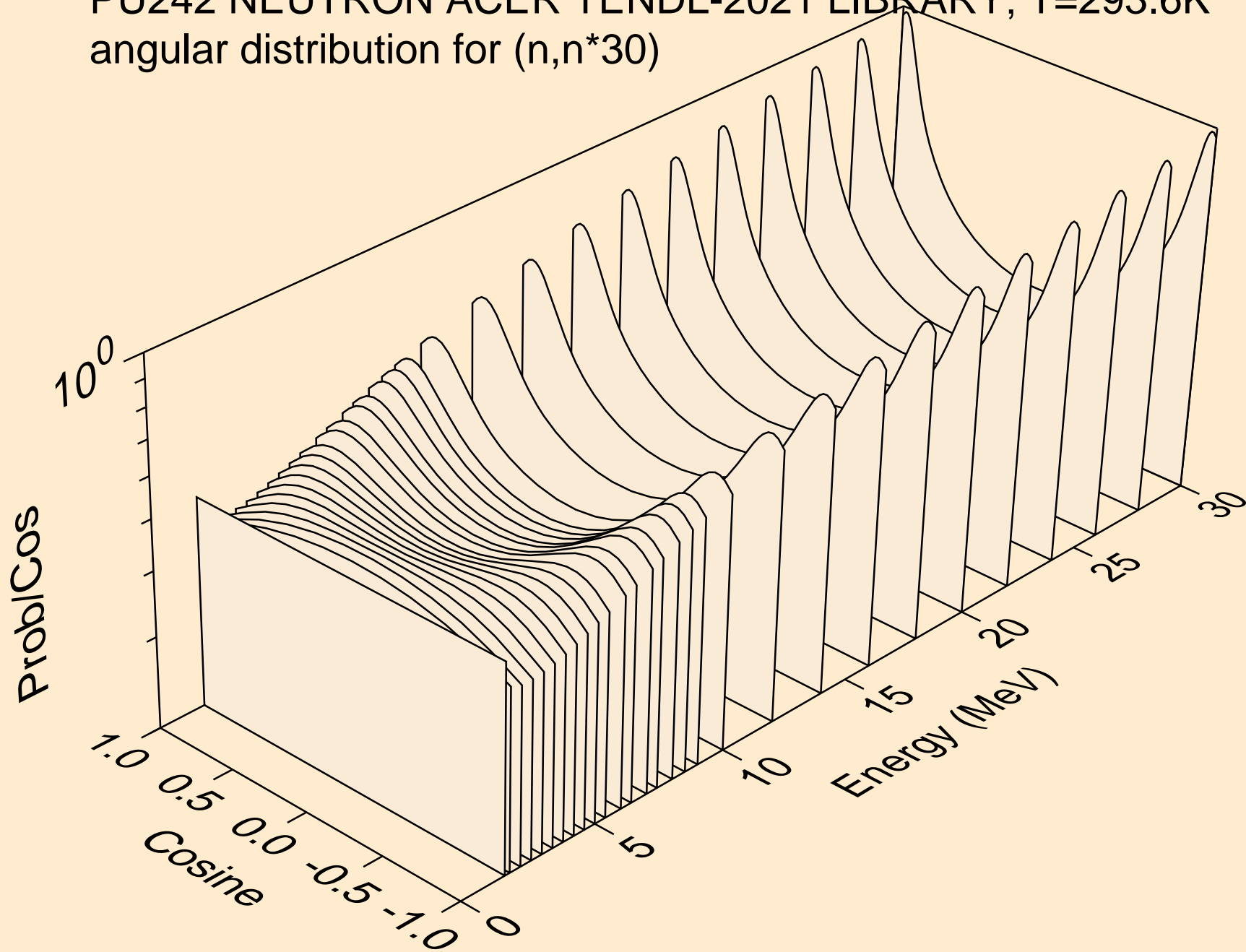

PU242 NEUTRON ACER TENDL-2021 LIBRARY; T=293.6K
Total fission nubar

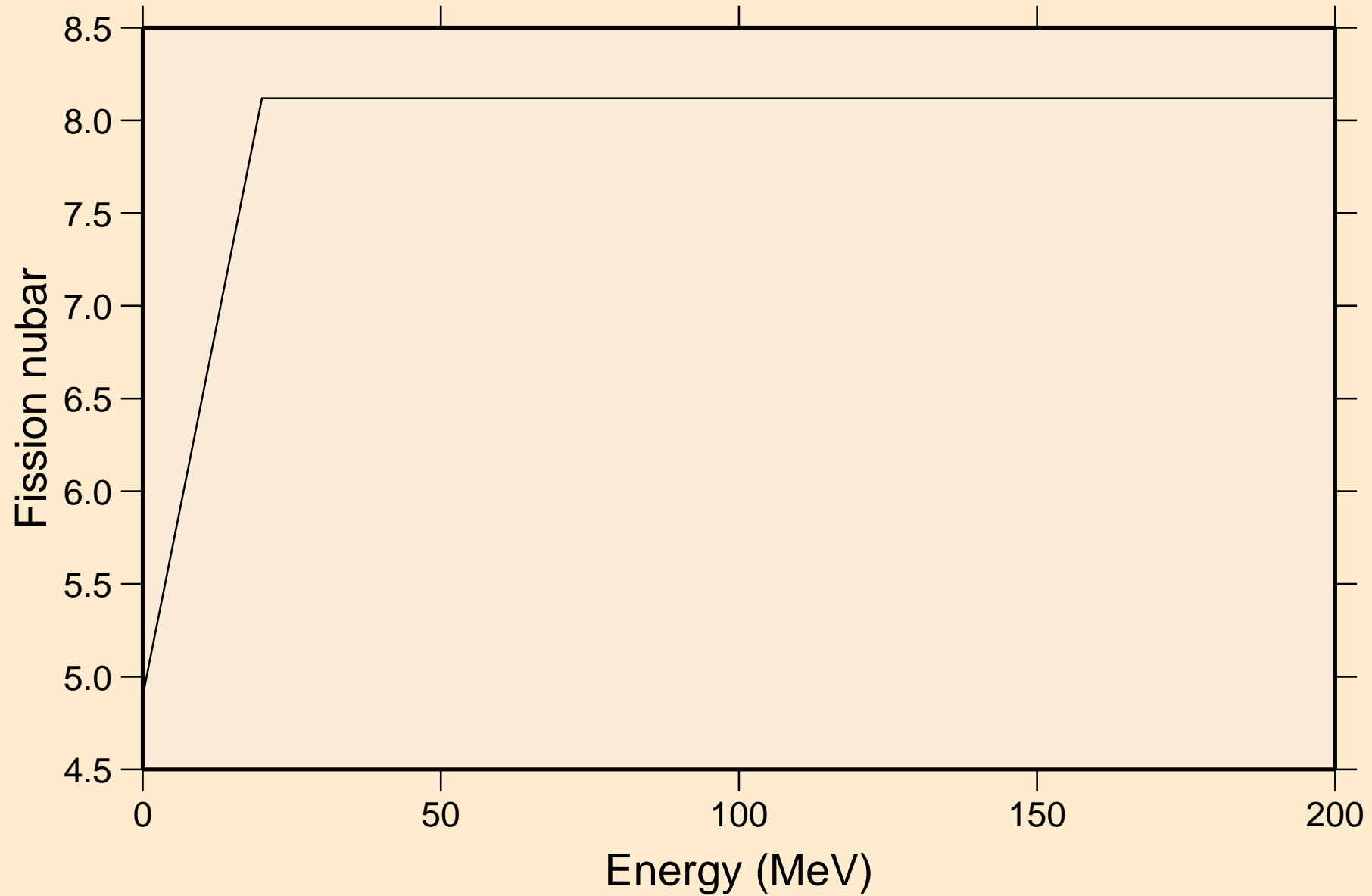

PU242 NEUTRON ACER TENDL-2021 LIBRARY; T=293.6K
Neutron emission for (n,x)

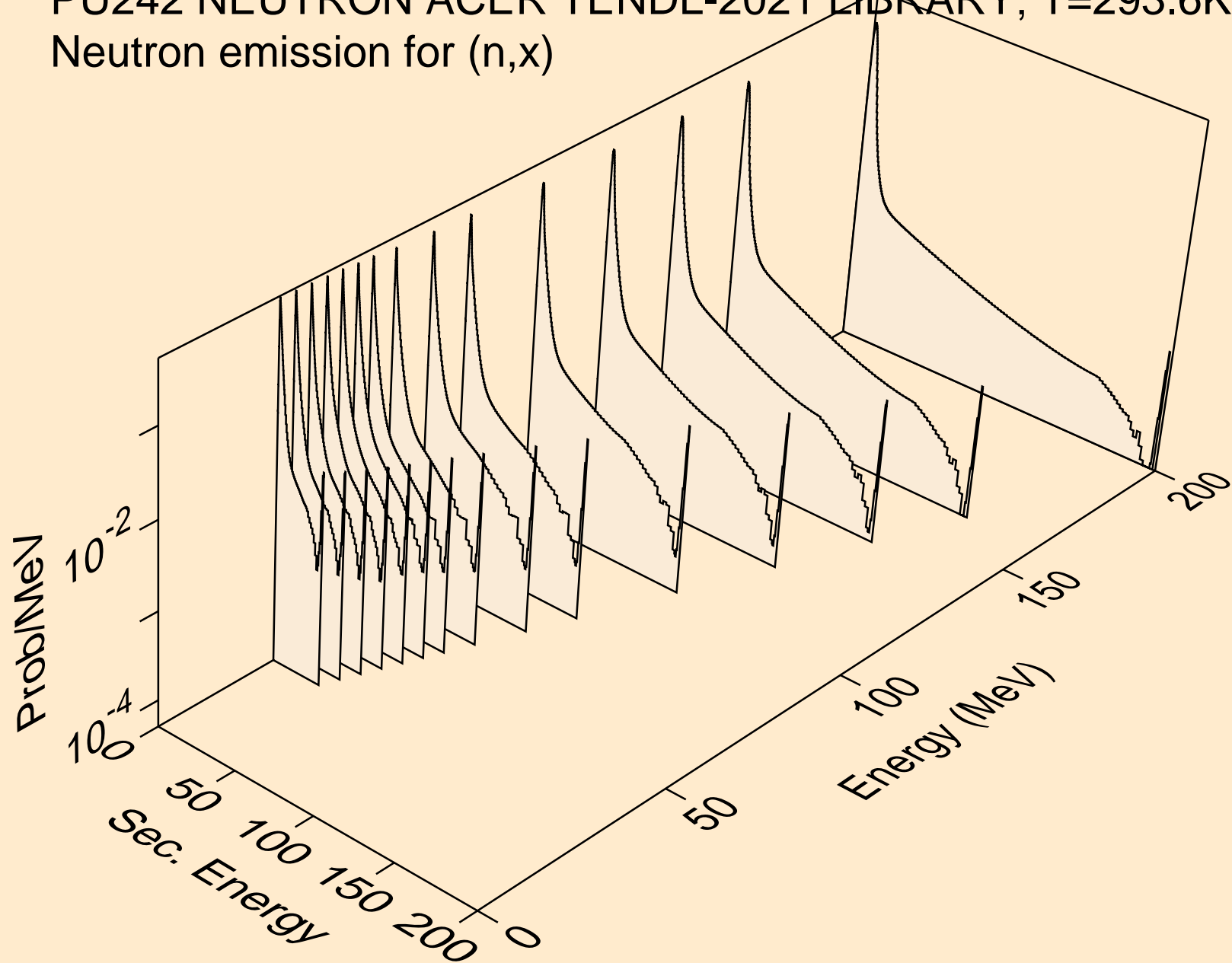

PU242 NEUTRON ACER TENDL-2021 LIBRARY; T=293.6K
Neutron emission for (n,2nd)

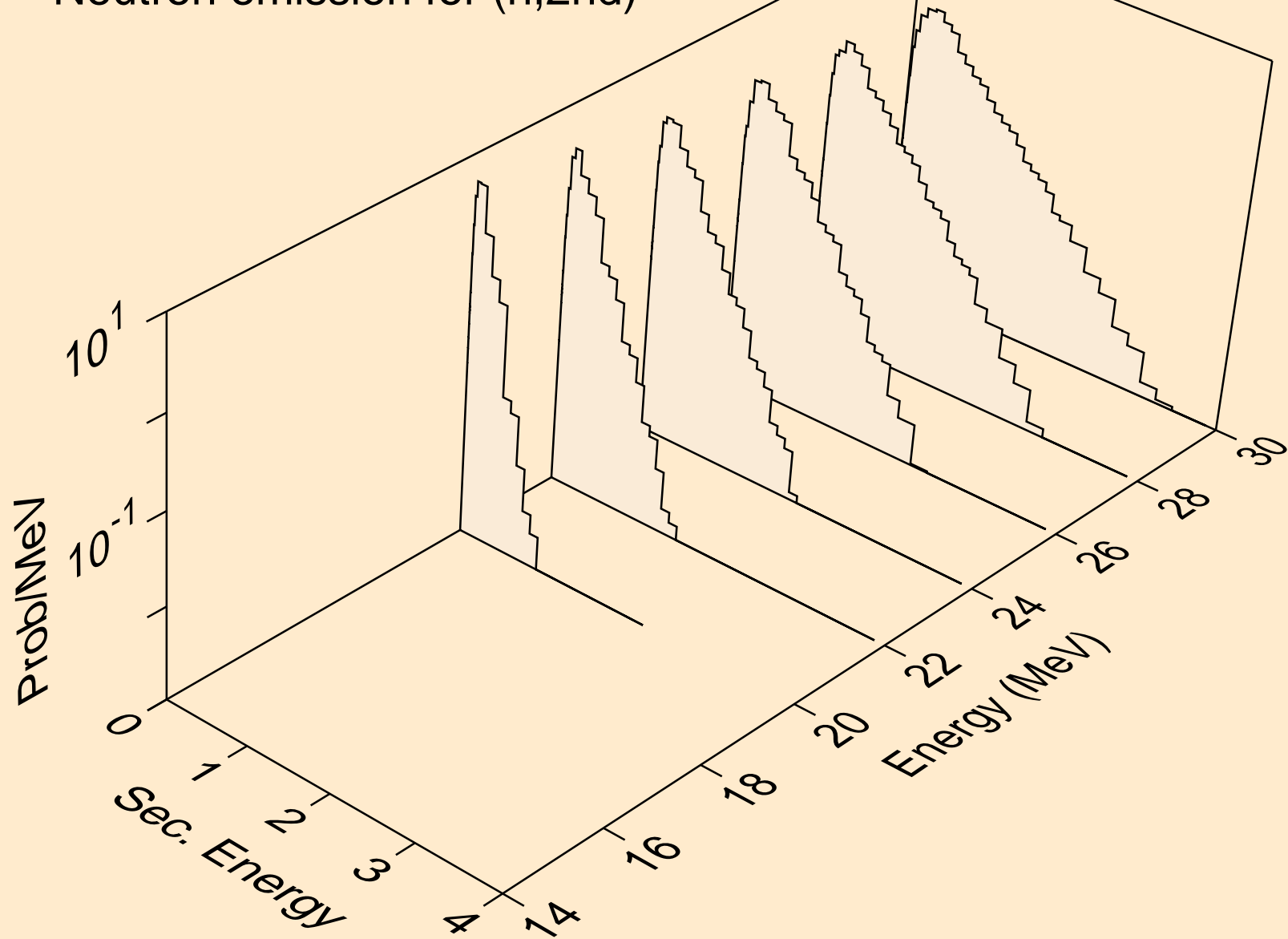

PU242 NEUTRON ACER TENDL-2021 LIBRARY; T=293.6K
Neutron emission for (n,2n)

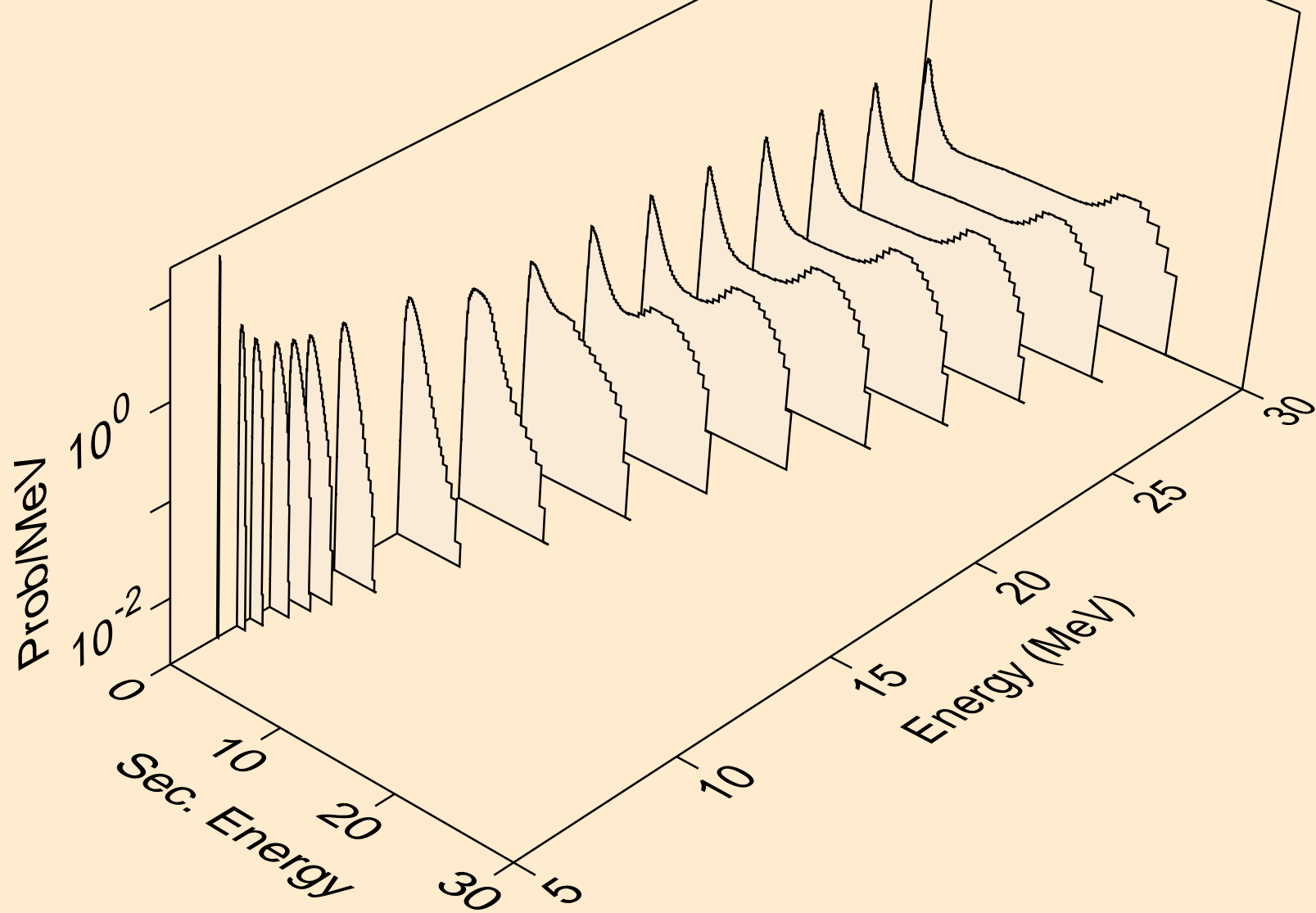

PU242 NEUTRON ACER TENDL-2021 LIBRARY; T=293.6K
Neutron emission for (n,3n)

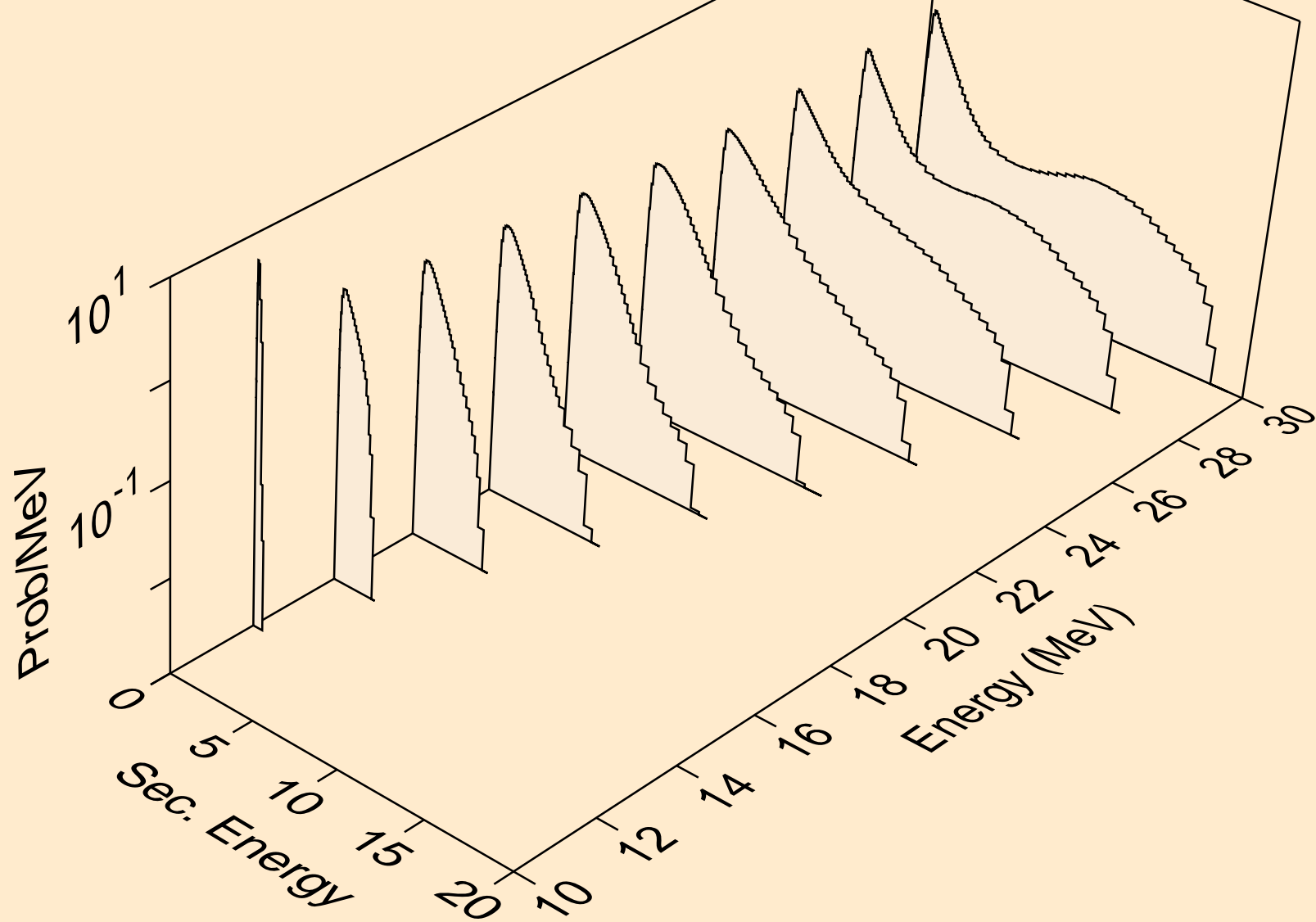

PU242 NEUTRON ACER TENDL-2021 LIBRARY; T=293.6K
Neutron emission for fission

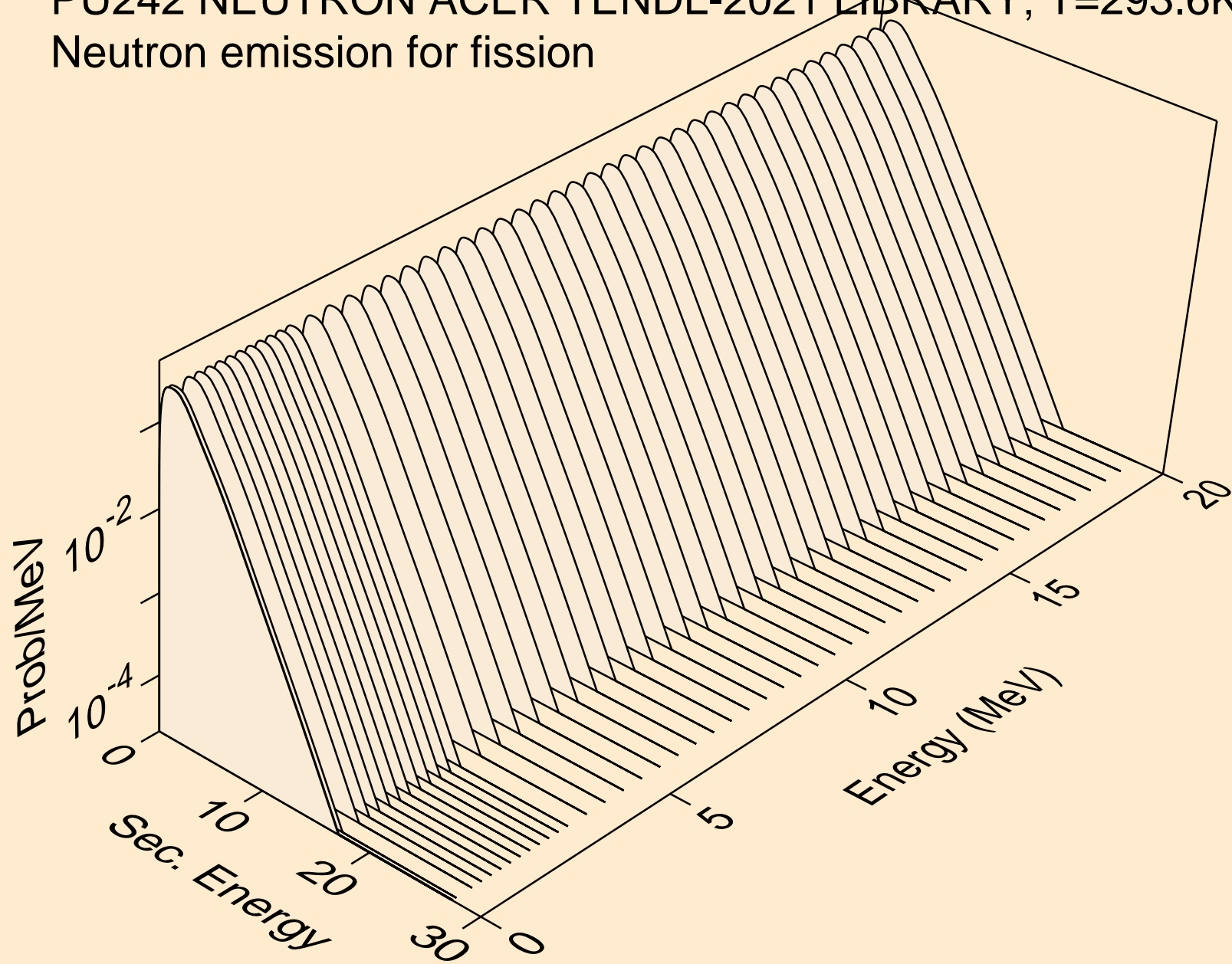

PU242 NEUTRON ACER TENDL-2021 LIBRARY; T=293.6K
Neutron emission for (n,n*)a

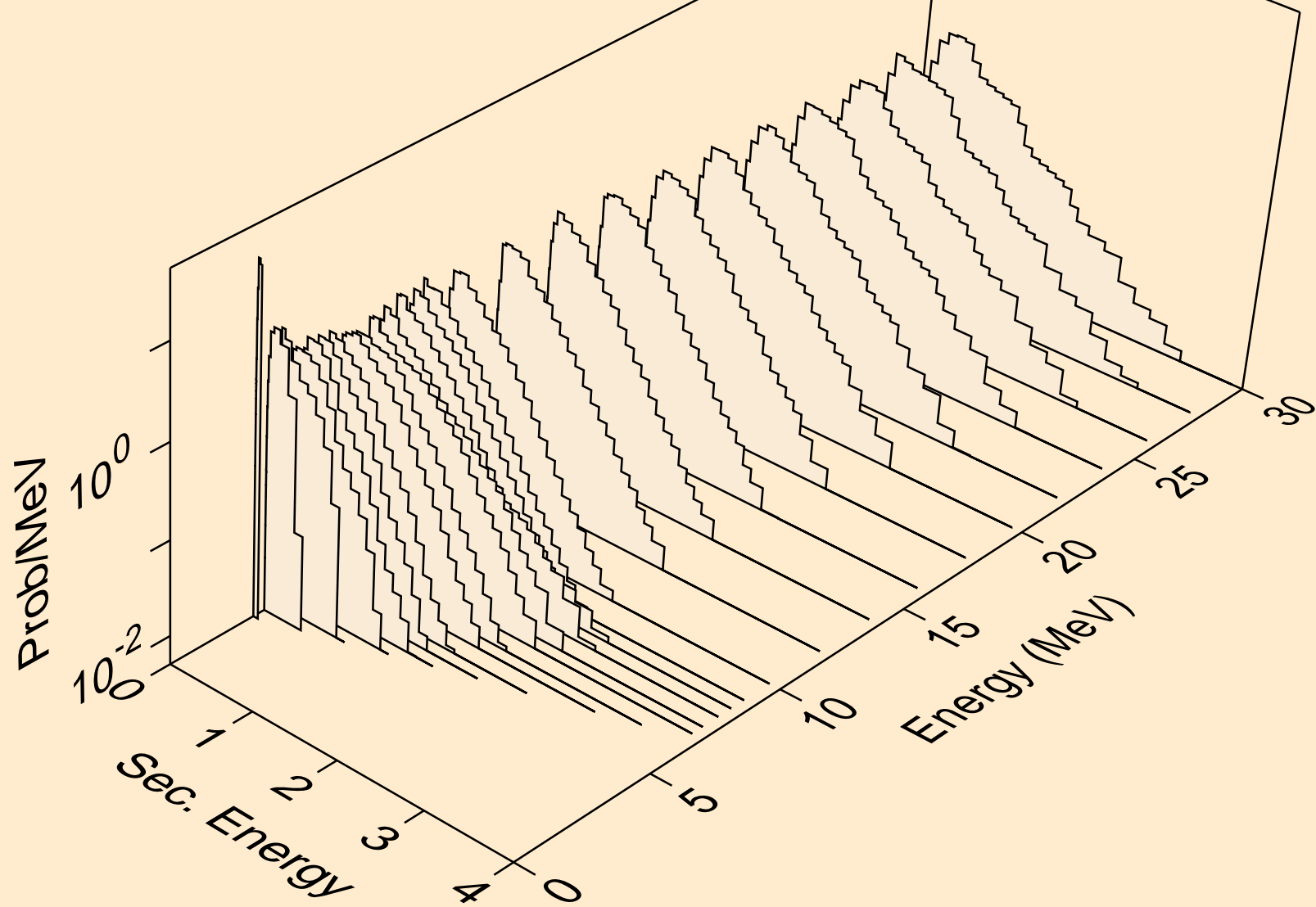

PU242 NEUTRON ACER TENDL-2021 LIBRARY; T=293.6K
Neutron emission for (n,2n)a

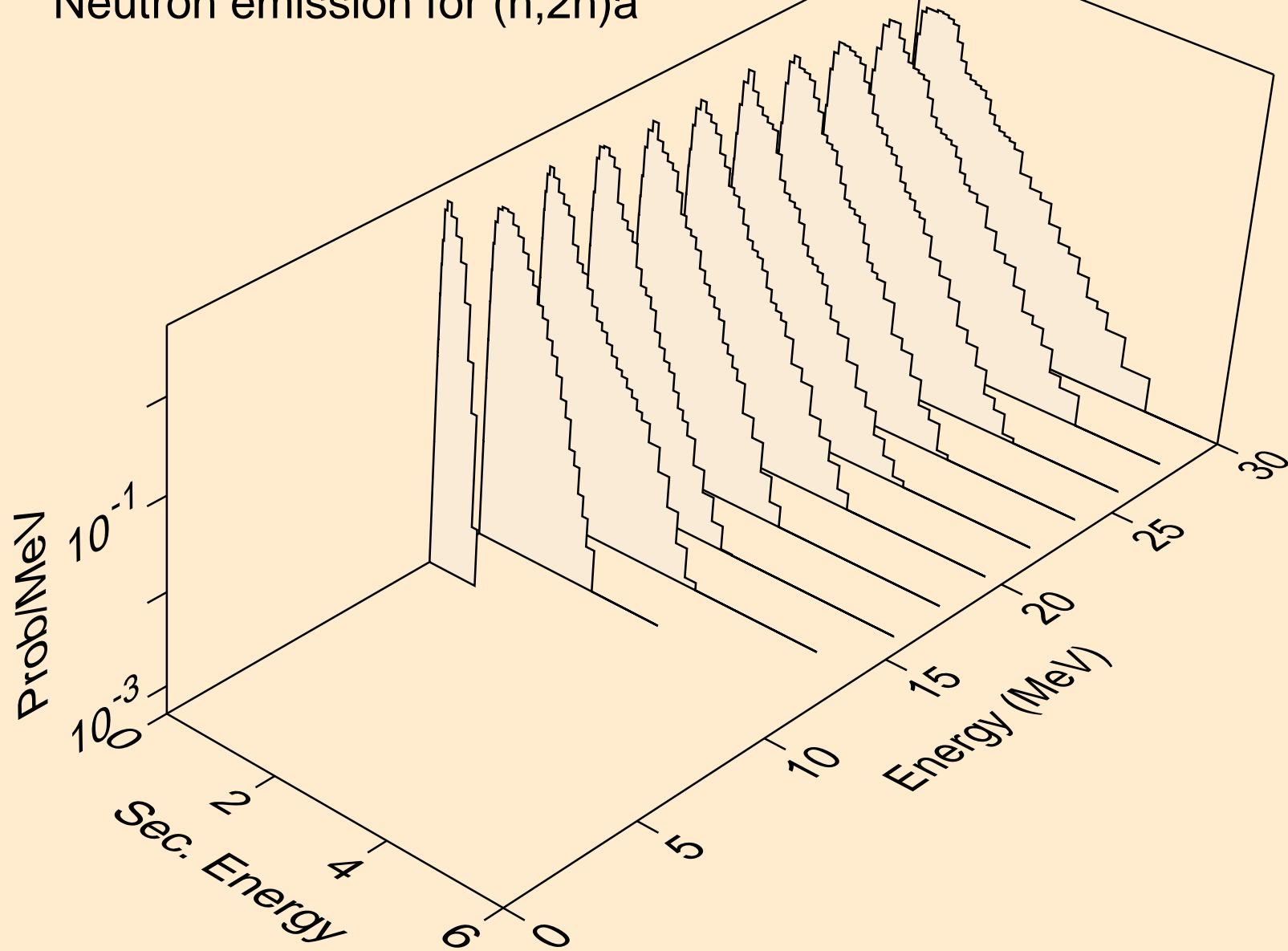

PU242 NEUTRON ACER TENDL-2021 LIBRARY; T=293.6K
Neutron emission for (n,3n)a

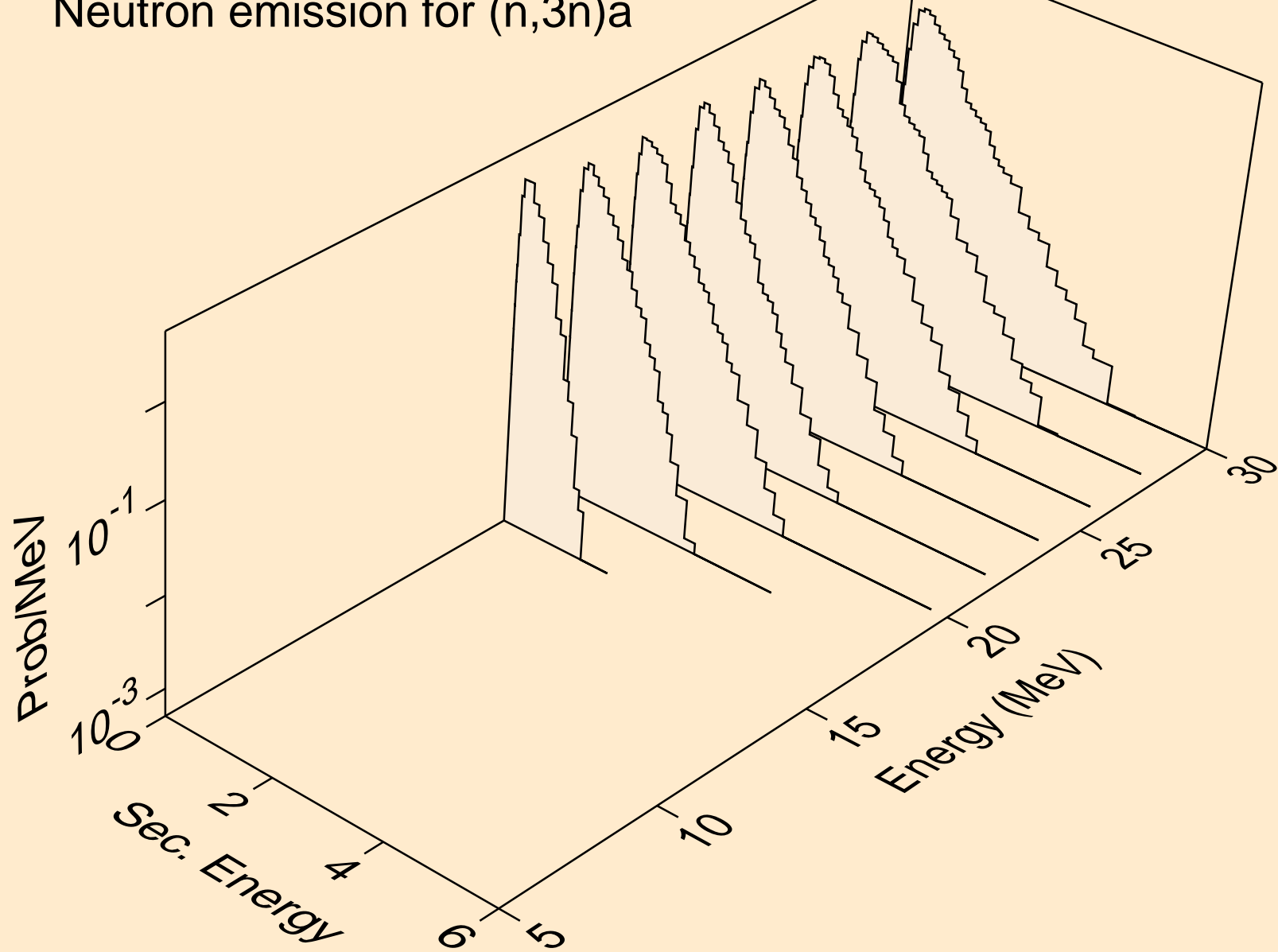

PU242 NEUTRON ACER TENDL-2021 LIBRARY; T=293.6K
Neutron emission for (n,n*)p

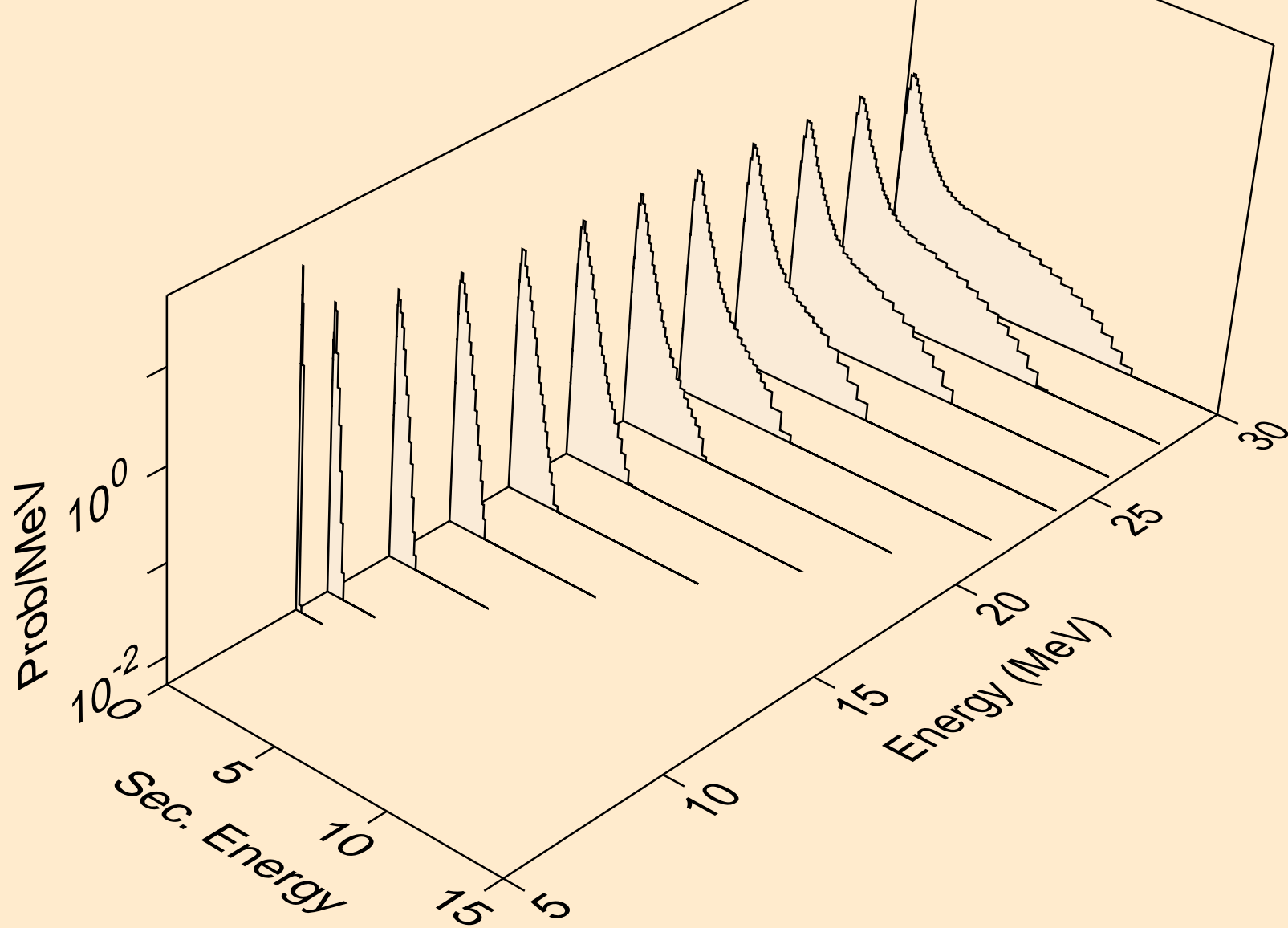

PU242 NEUTRON ACER TENDL-2021 LIBRARY; T=293.6K
Neutron emission for (n,n*)d

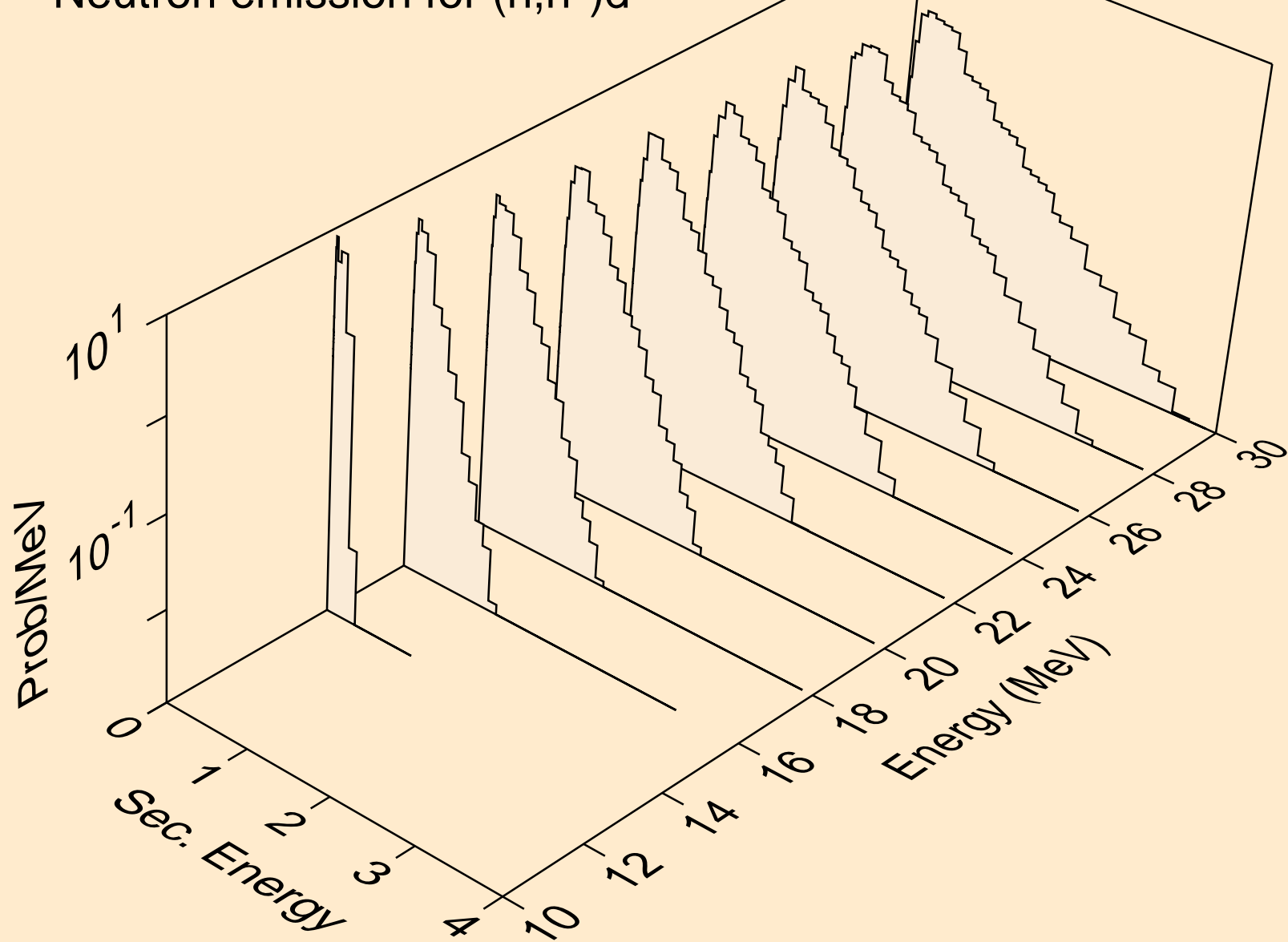

PU242 NEUTRON ACER TENDL-2021 LIBRARY; T=293.6K
Neutron emission for (n,n*)t

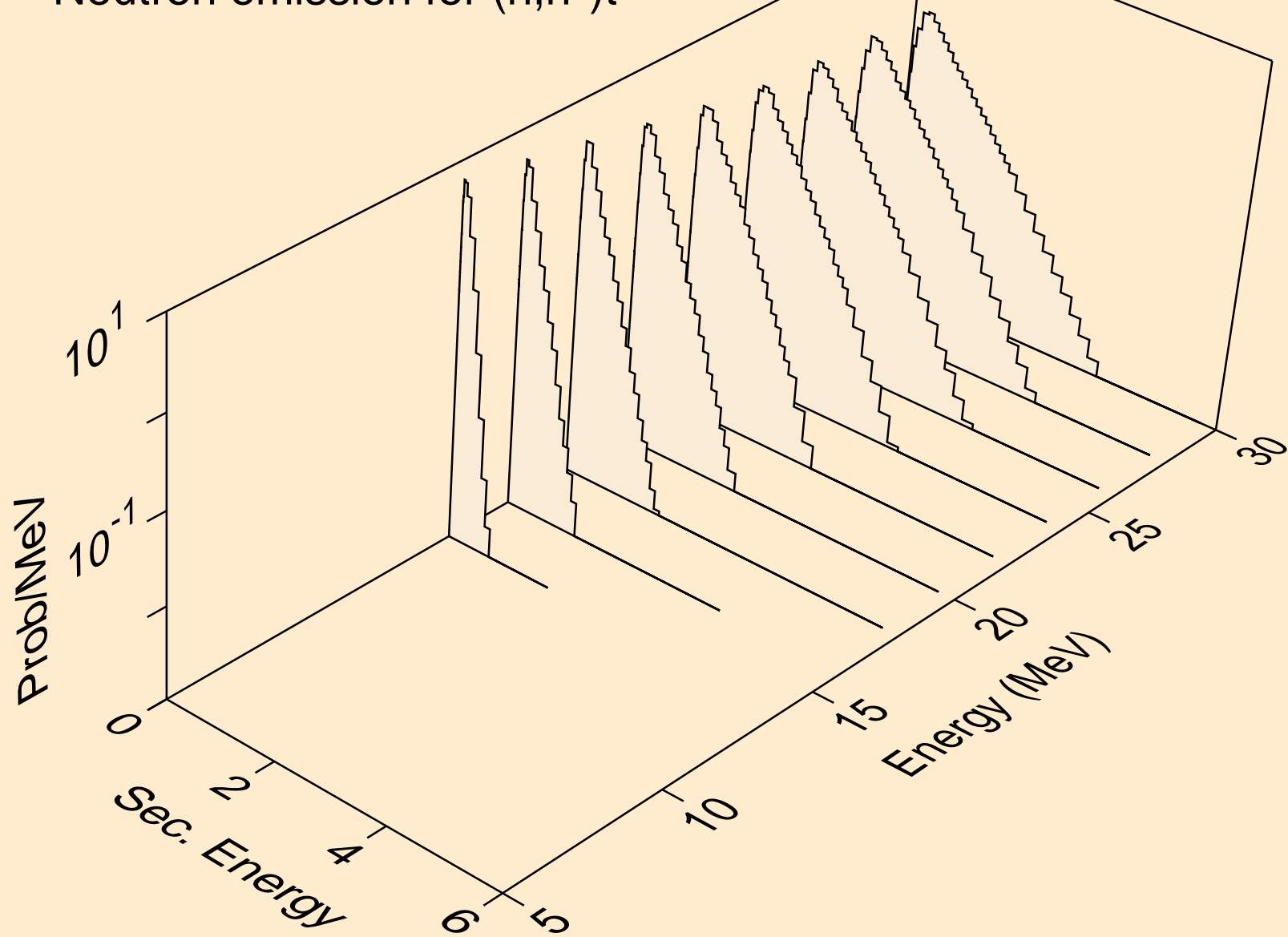

PU242 NEUTRON ACER TENDL-2021 LIBRARY; T=293.6K
Neutron emission for (n,n*)he3

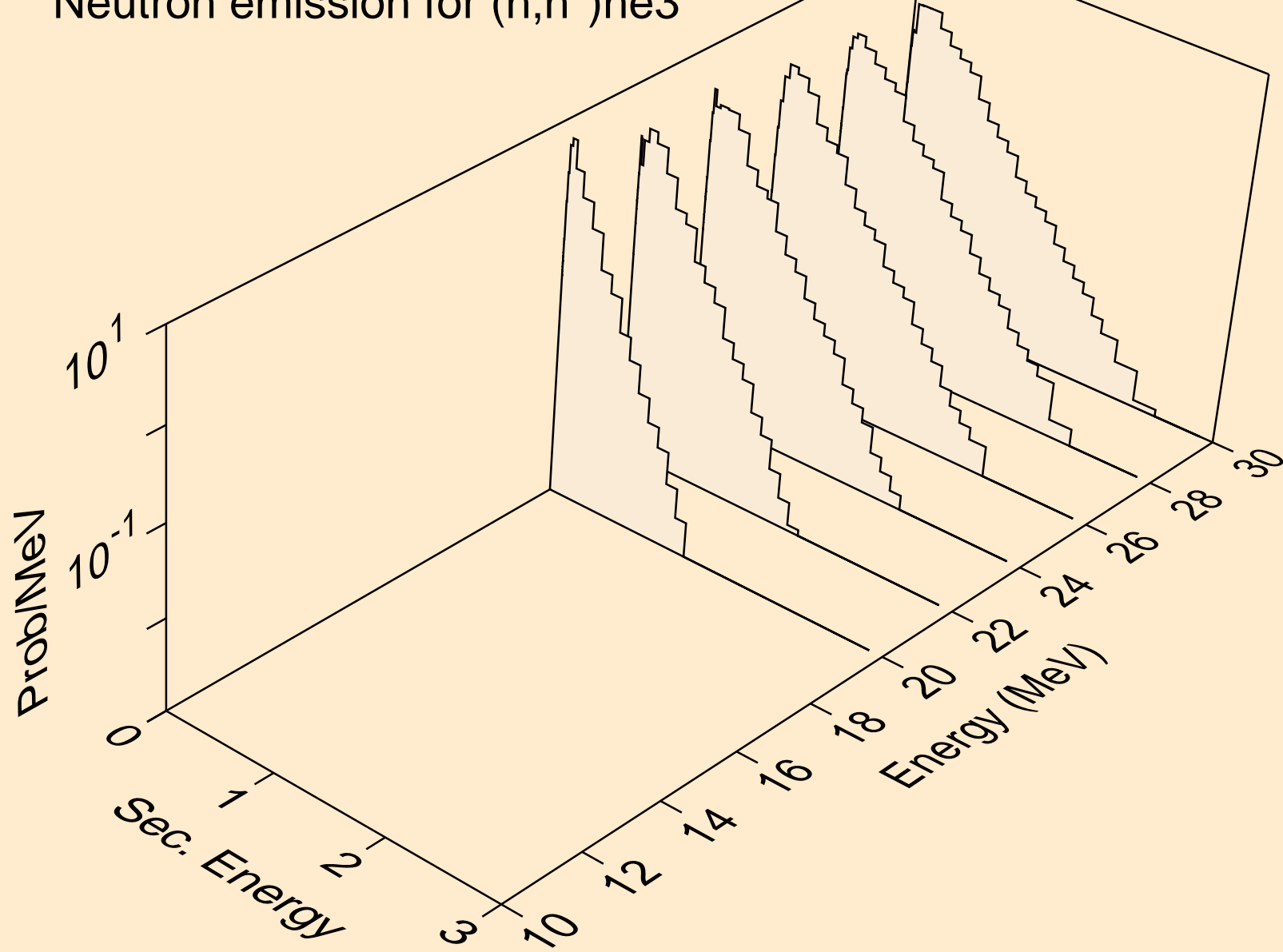

PU242 NEUTRON ACER TENDL-2021 LIBRARY; T=293.6K
Neutron emission for (n,4n)

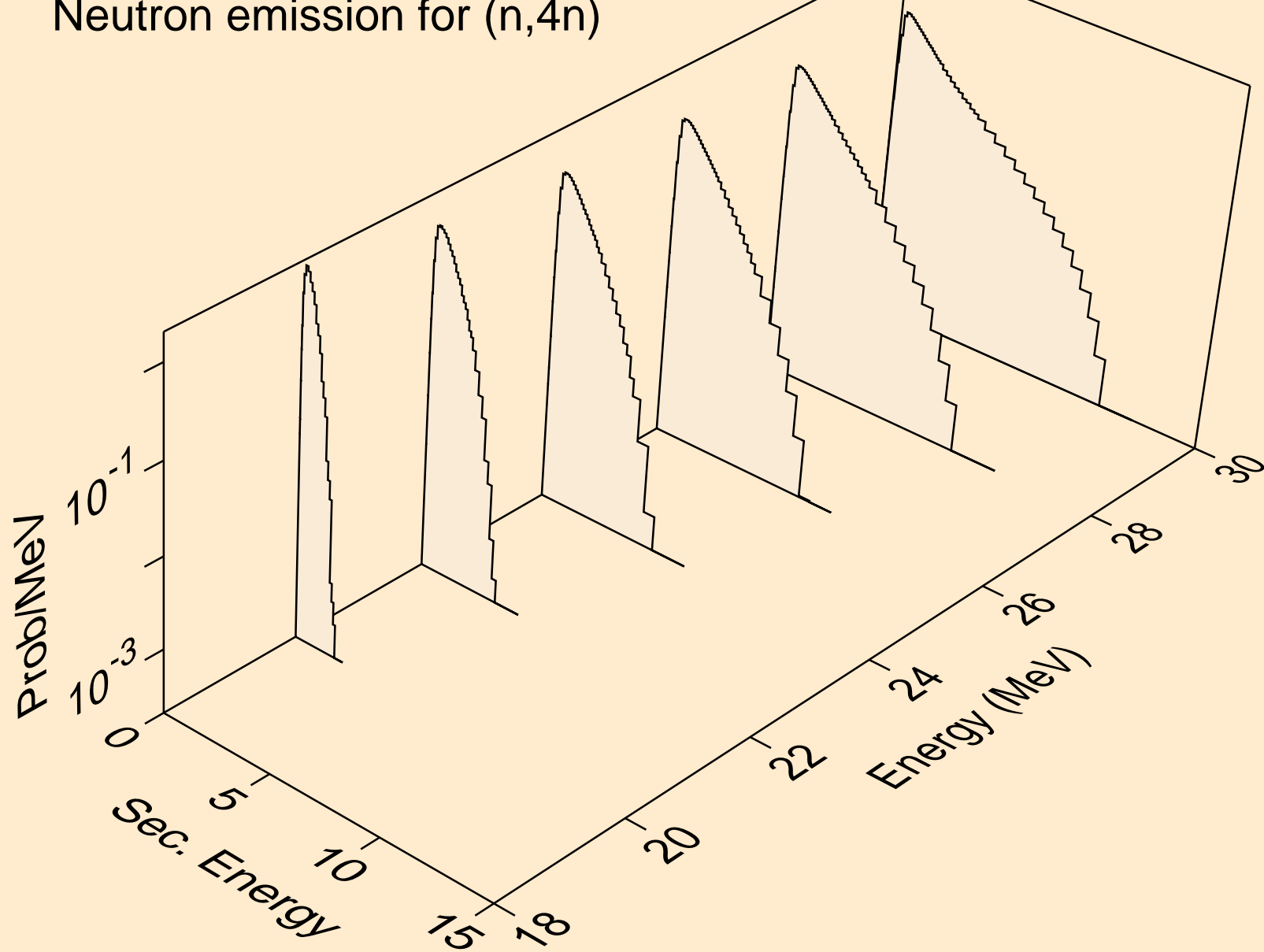

PU242 NEUTRON ACER TENDL-2021 LIBRARY; T=293.6K
Neutron emission for (n,2np)

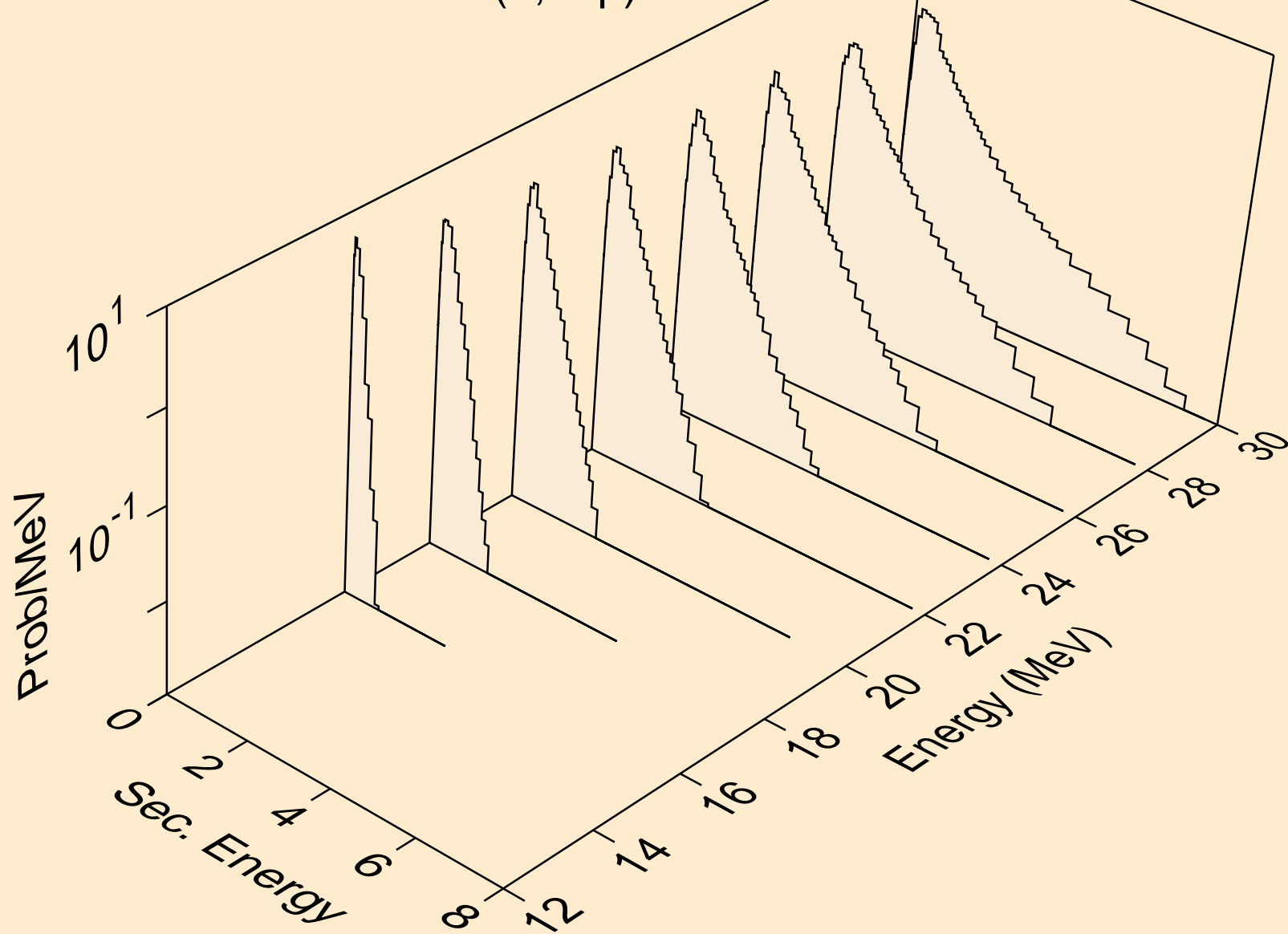

PU242 NEUTRON ACER TENDL-2021 LIBRARY; T=293.6K
Neutron emission for (n,3np)

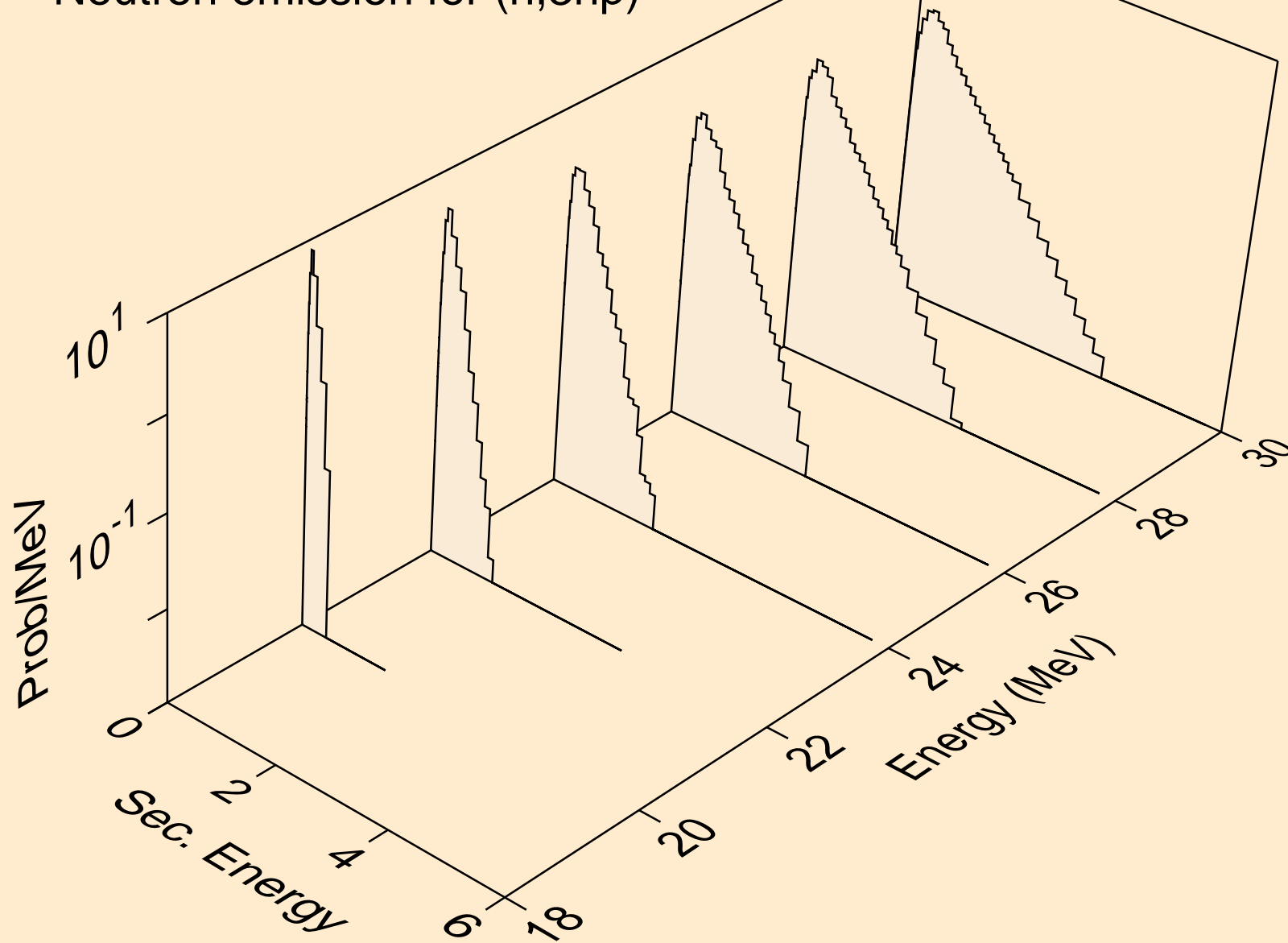

PU242 NEUTRON ACER TENDL-2021 LIBRARY; T=293.6K
Neutron emission for (n,2np)

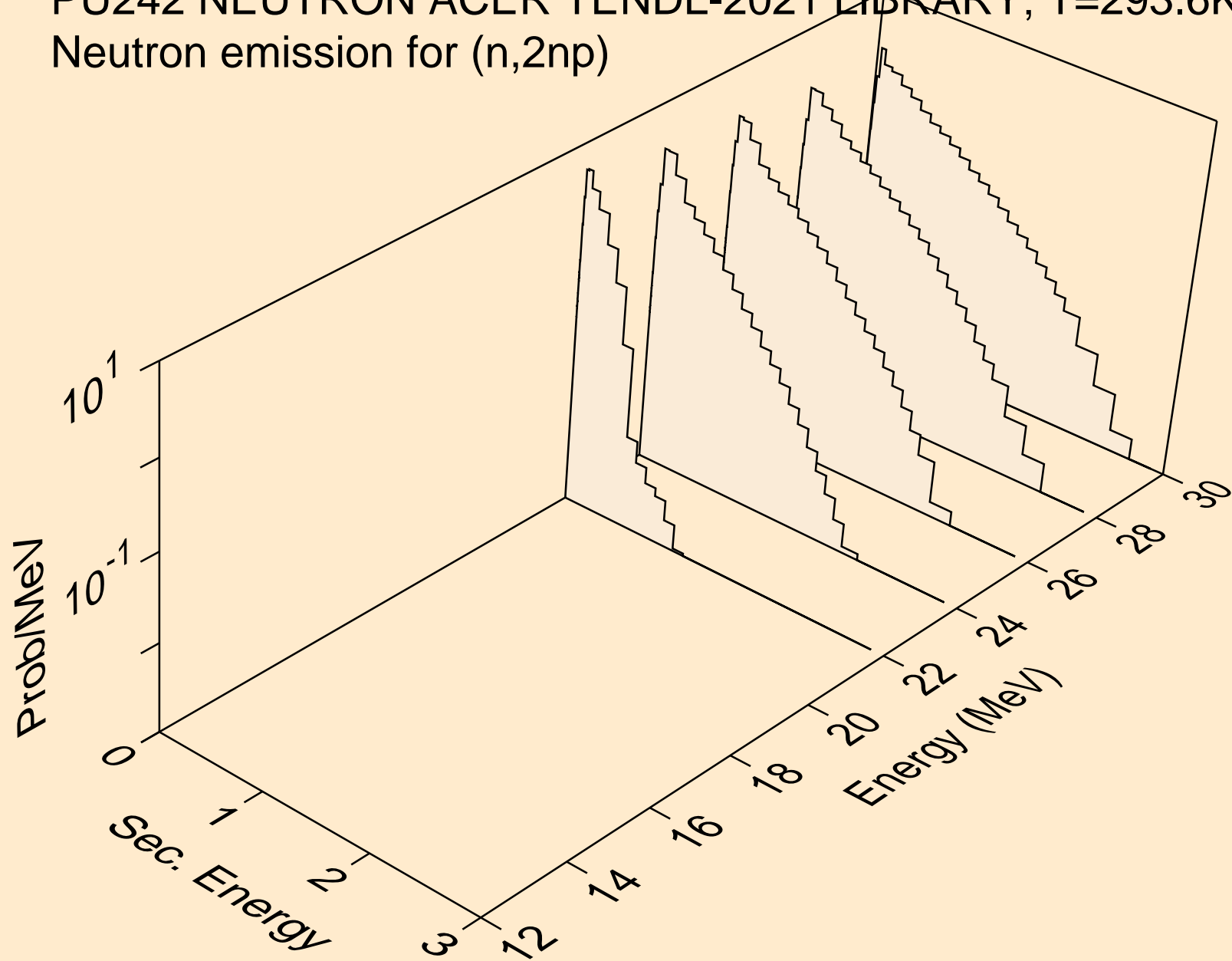

PU242 NEUTRON ACER TENDL-2021 LIBRARY; T=293.6K
Neutron emission for (n,n*c)

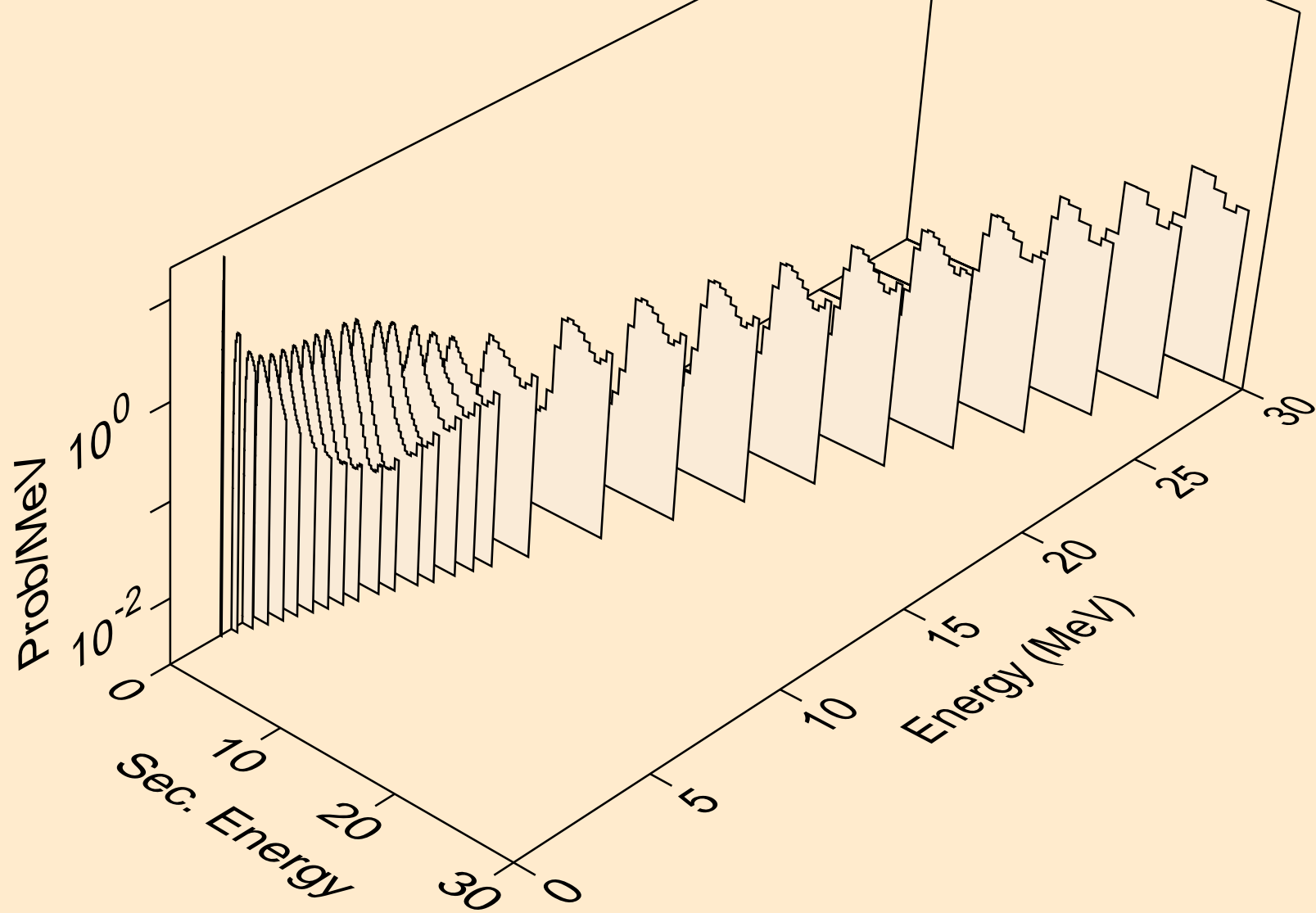

PU242 NEUTRON ACER TENDL-2021 LIBRARY; T=293.6K

Delayed nubar

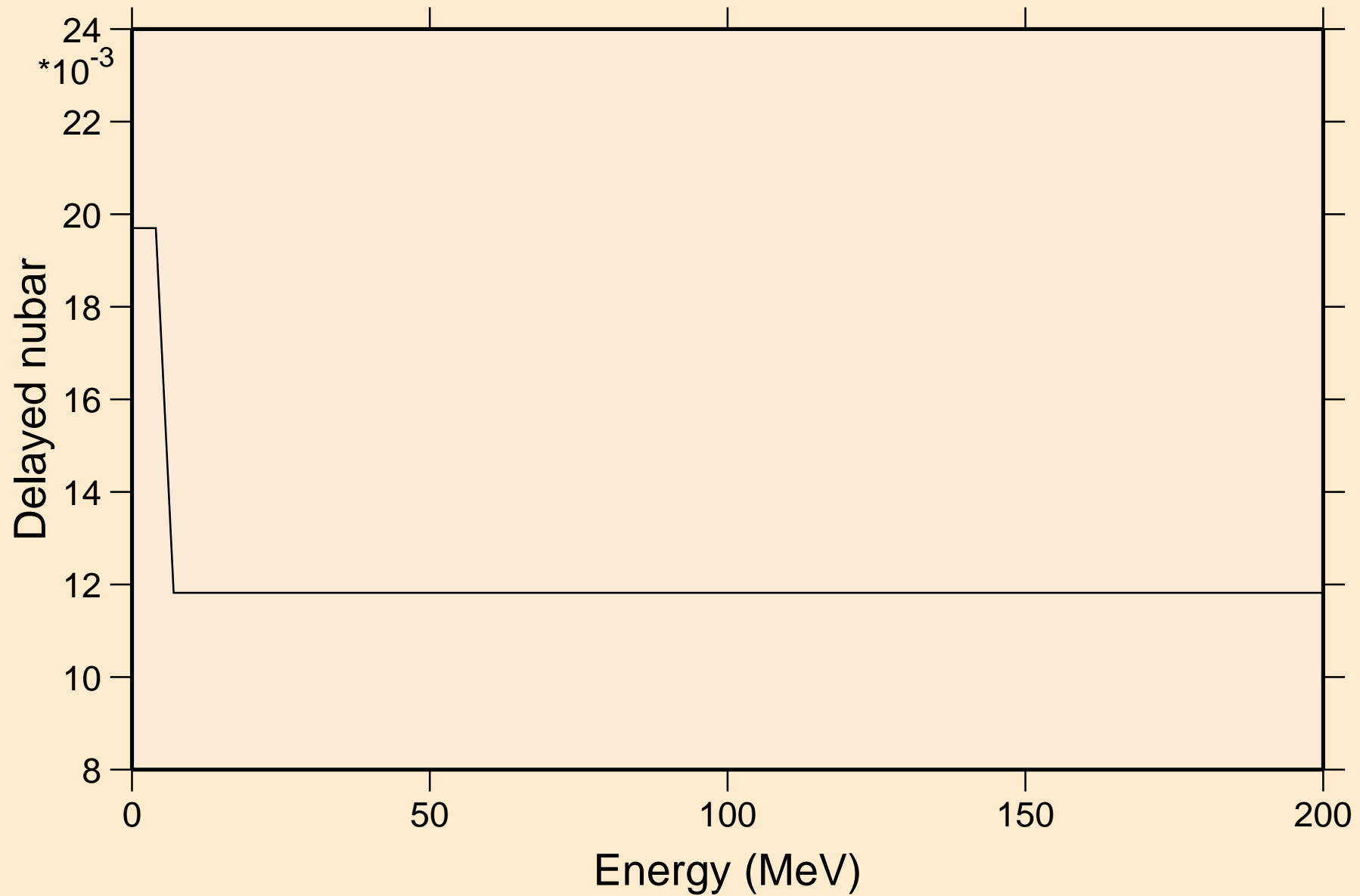

PU242 NEUTRON ACER TENDL-2021 LIBRARY; T=293.6K

Delayed neutron spectra

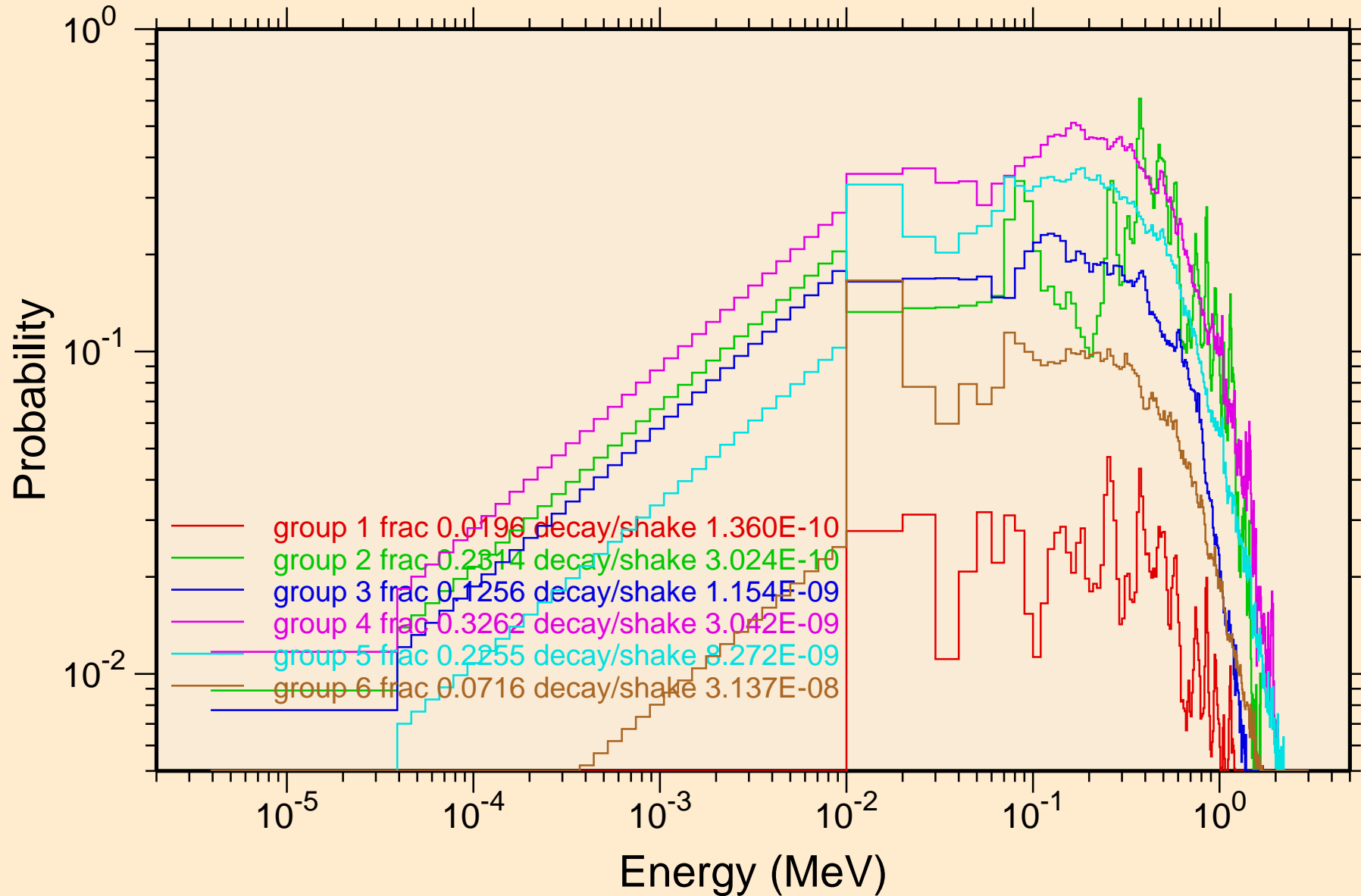

PU242 NEUTRON ACER TENDL-2021 LIBRARY; T=293.6K
Photon emission for (n,x)

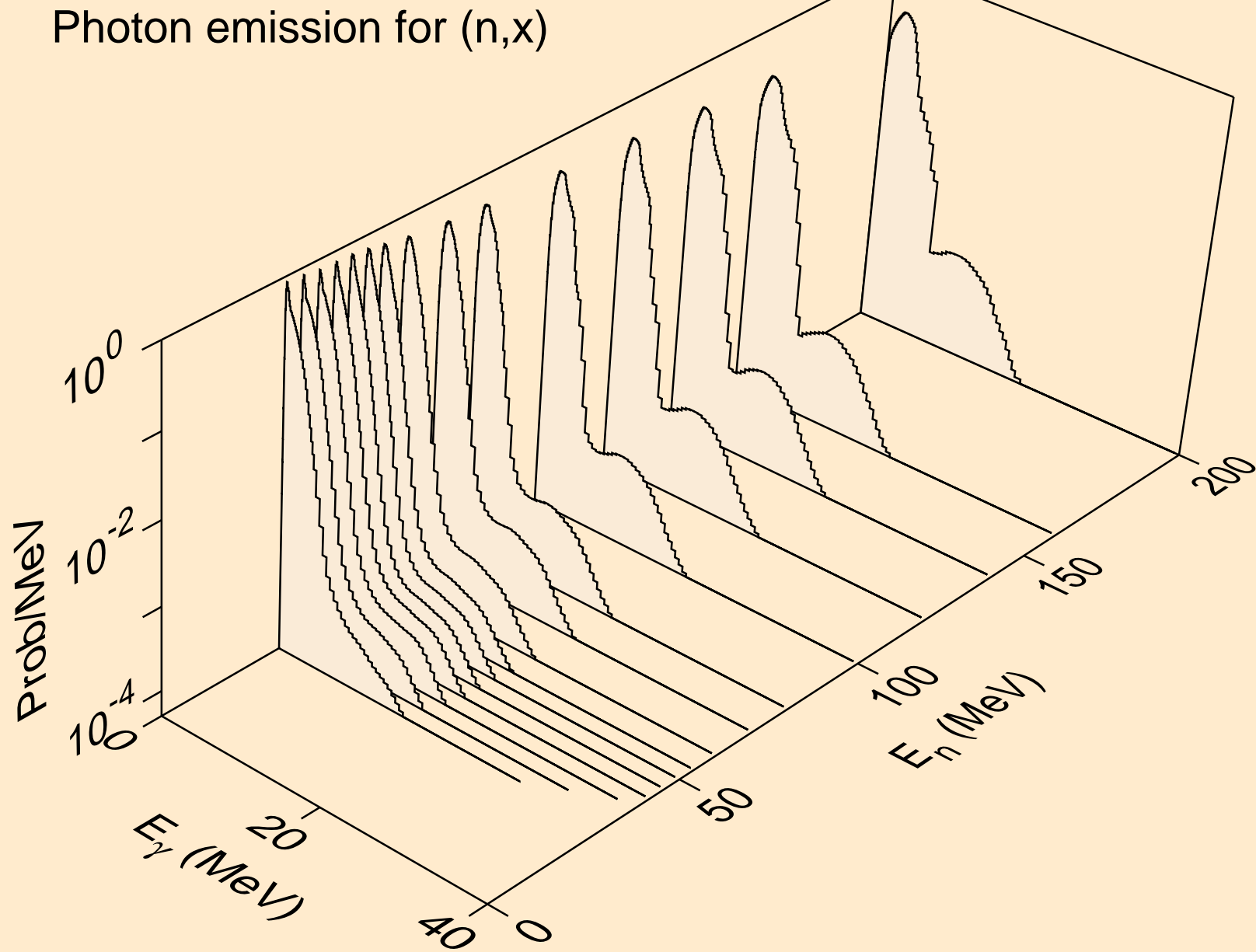

PU242 NEUTRON ACER TENDL-2021 LIBRARY; T=293.6K
Photon emission for (n,2nd)

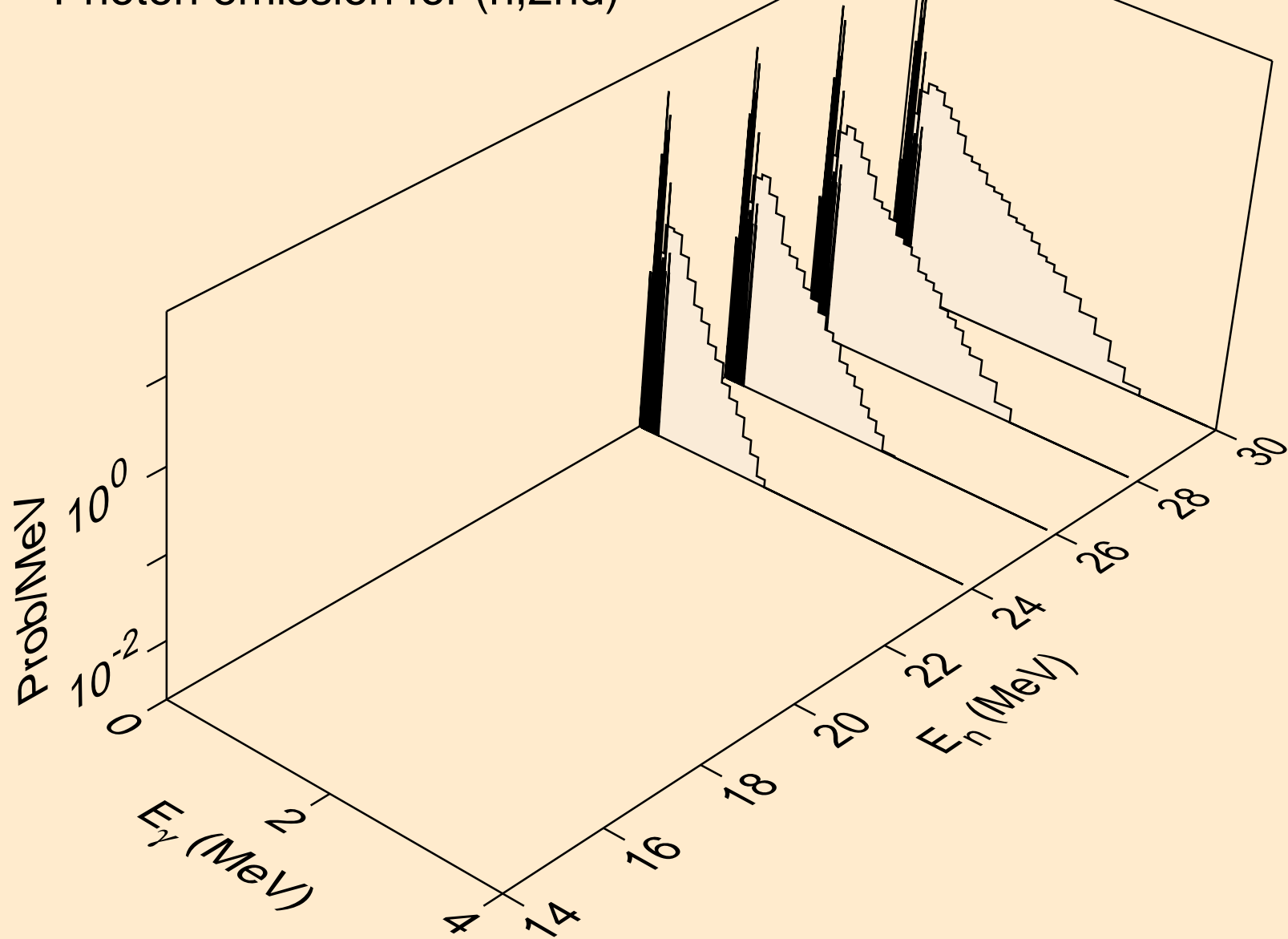

PU242 NEUTRON ACER TENDL-2021 LIBRARY; T=293.6K
Photon emission for (n,2n)

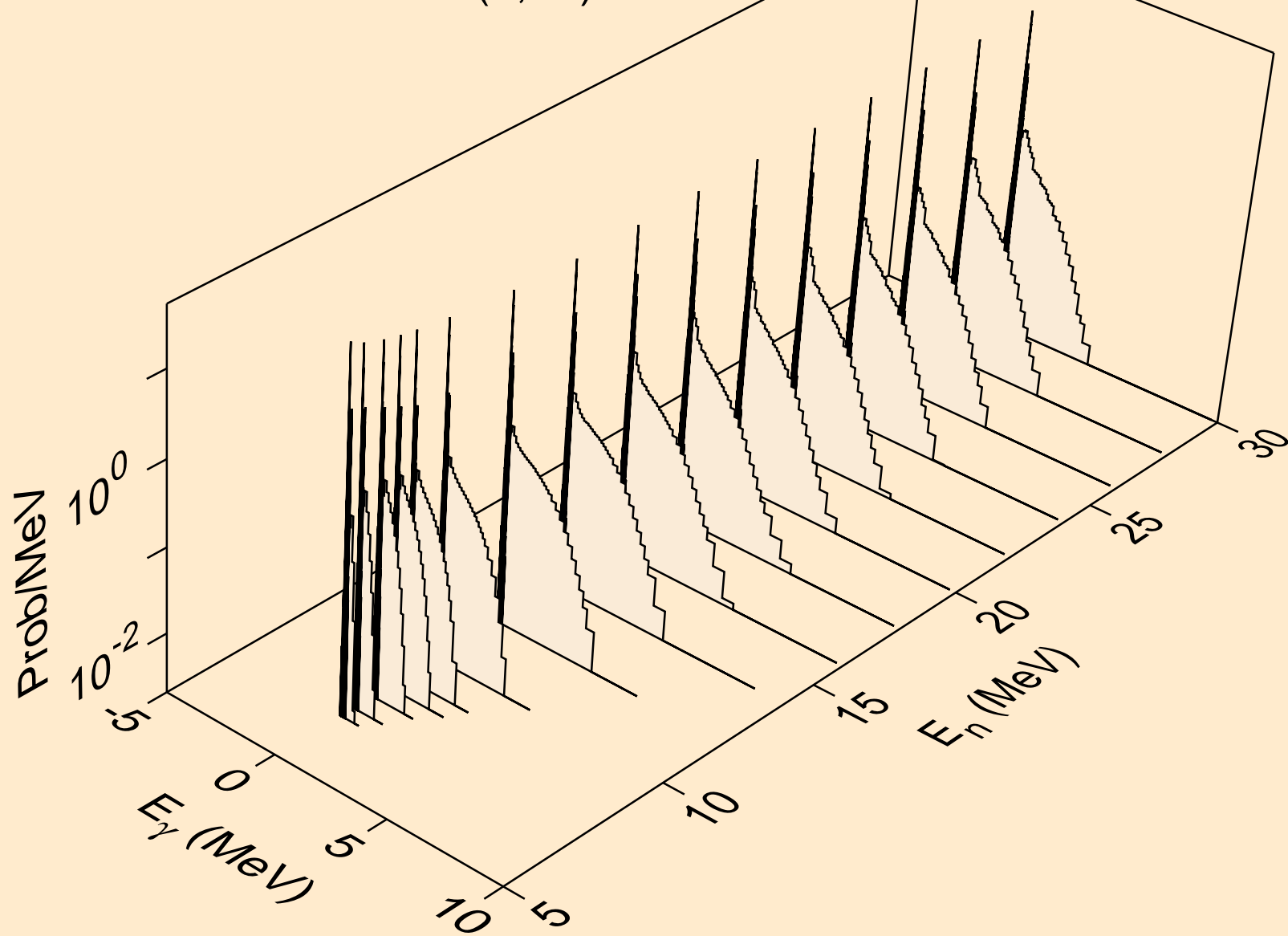

PU242 NEUTRON ACER TENDL-2021 LIBRARY; T=293.6K
Photon emission for (n,3n)

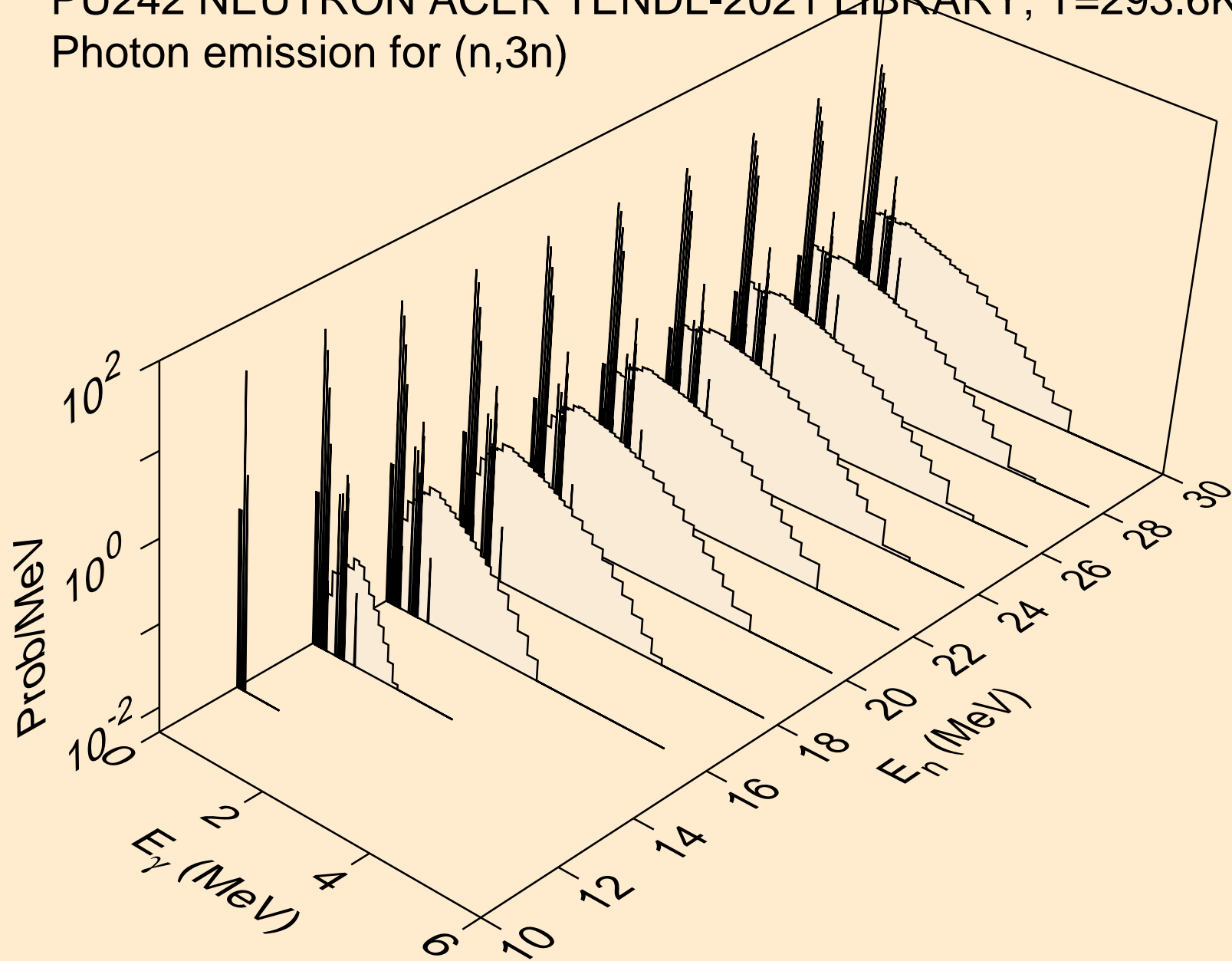

PU242 NEUTRON ACER TENDL-2021 LIBRARY; T=293.6K
Photon emission for (n,n*)a

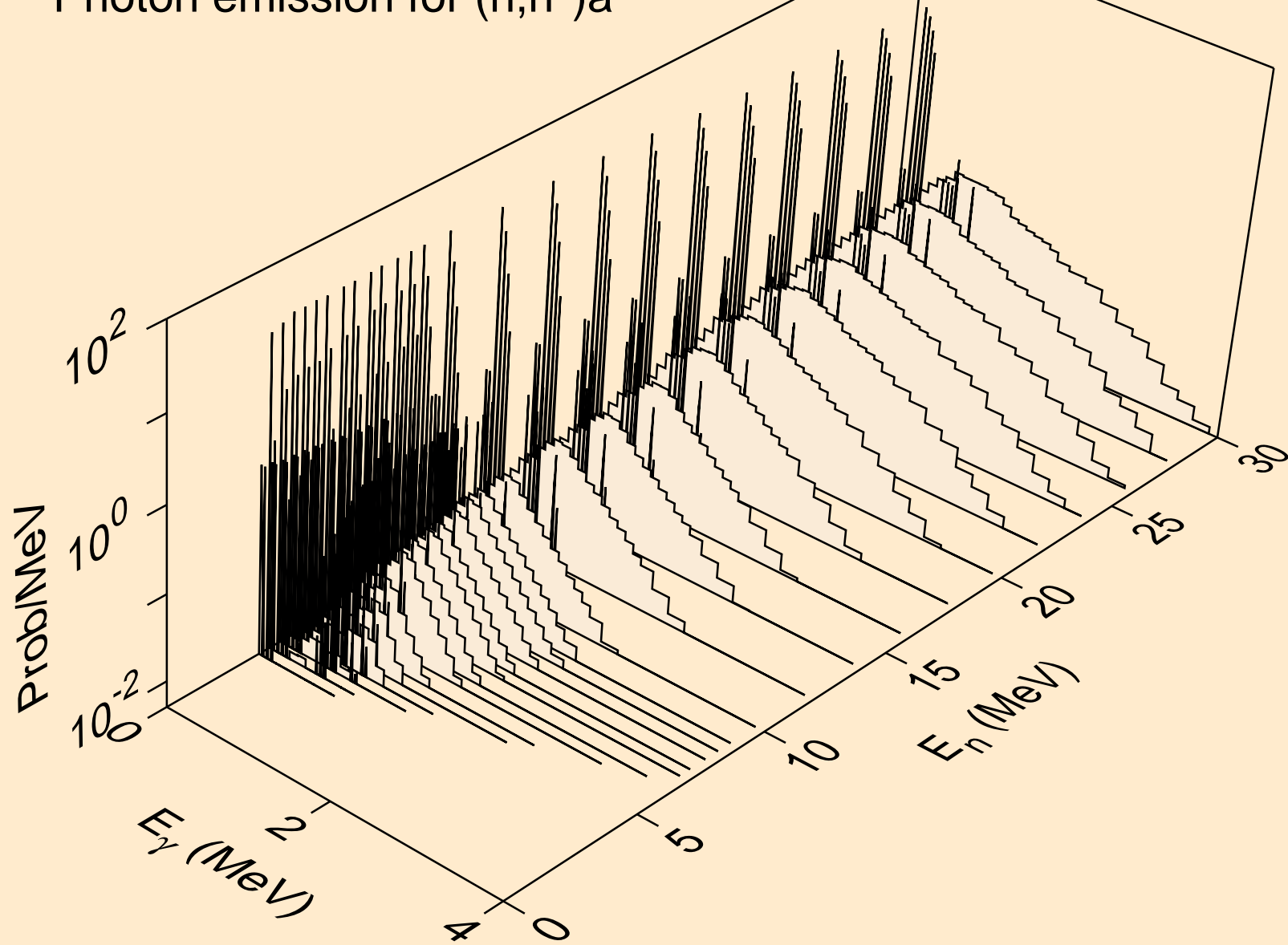

PU242 NEUTRON ACER TENDL-2021 LIBRARY; T=293.6K
Photon emission for (n,2n)a

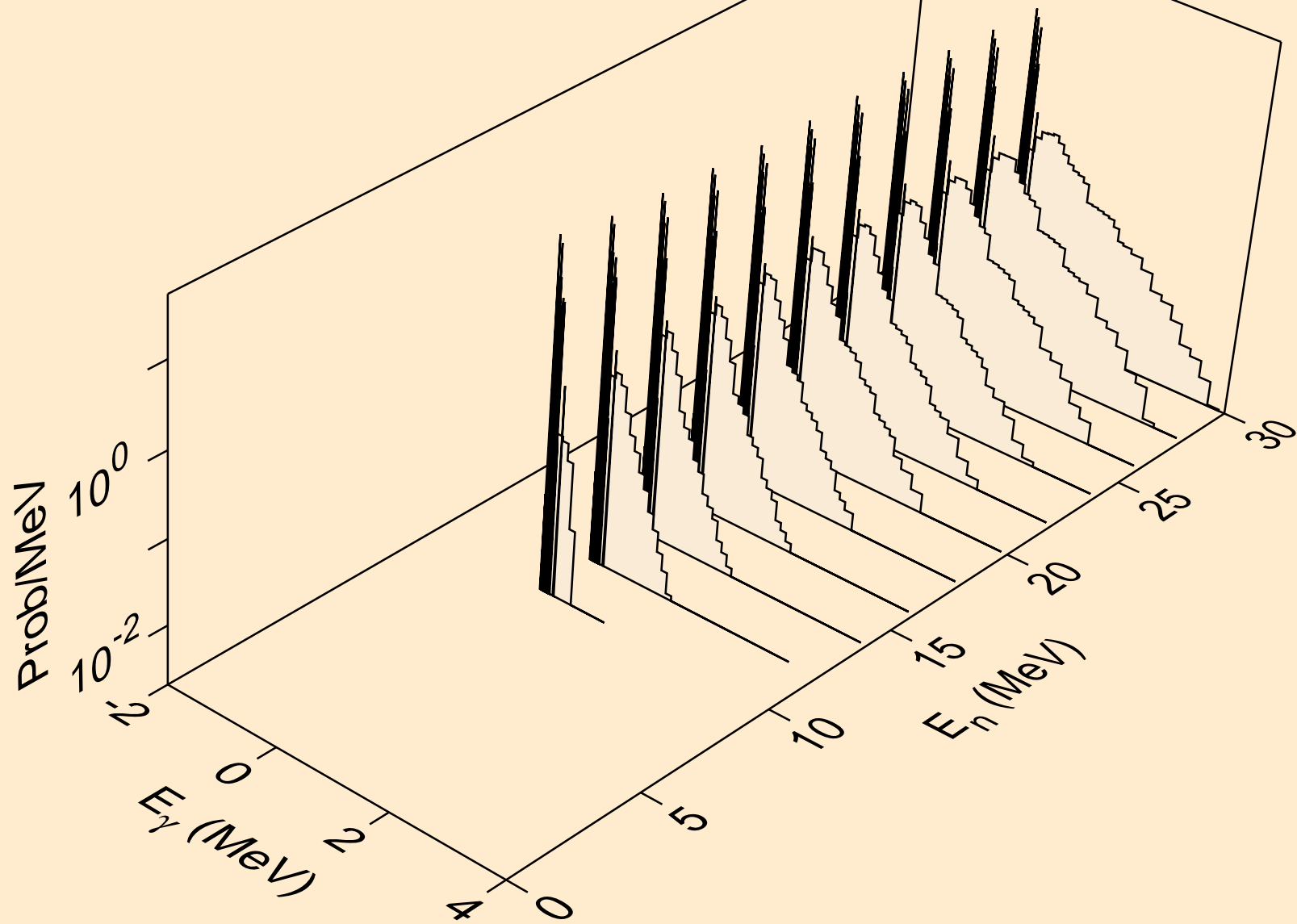

PU242 NEUTRON ACER TENDL-2021 LIBRARY; T=293.6K
Photon emission for (n,3n)a

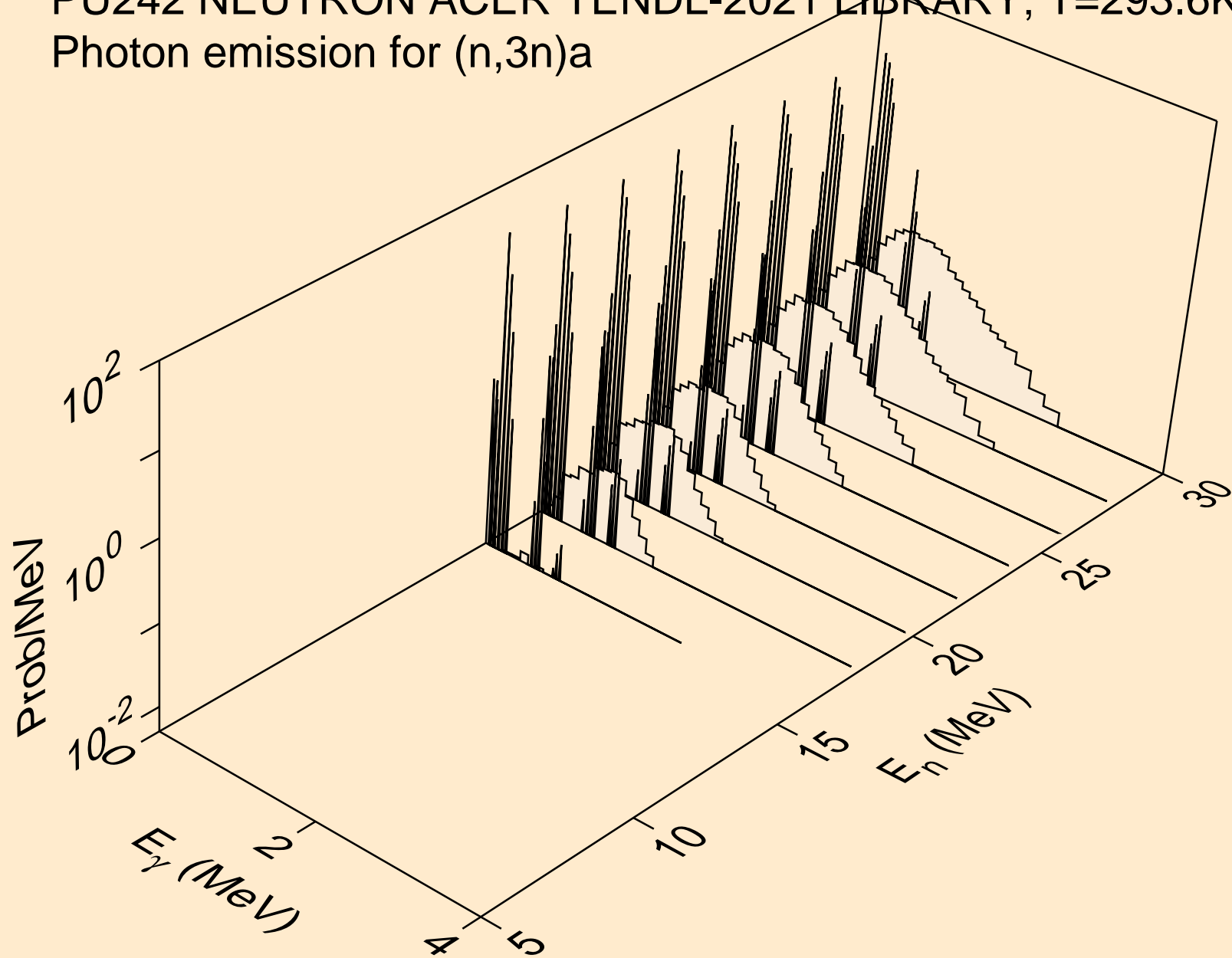

PU242 NEUTRON ACER TENDL-2021 LIBRARY; T=293.6K
Photon emission for (n,n*)p

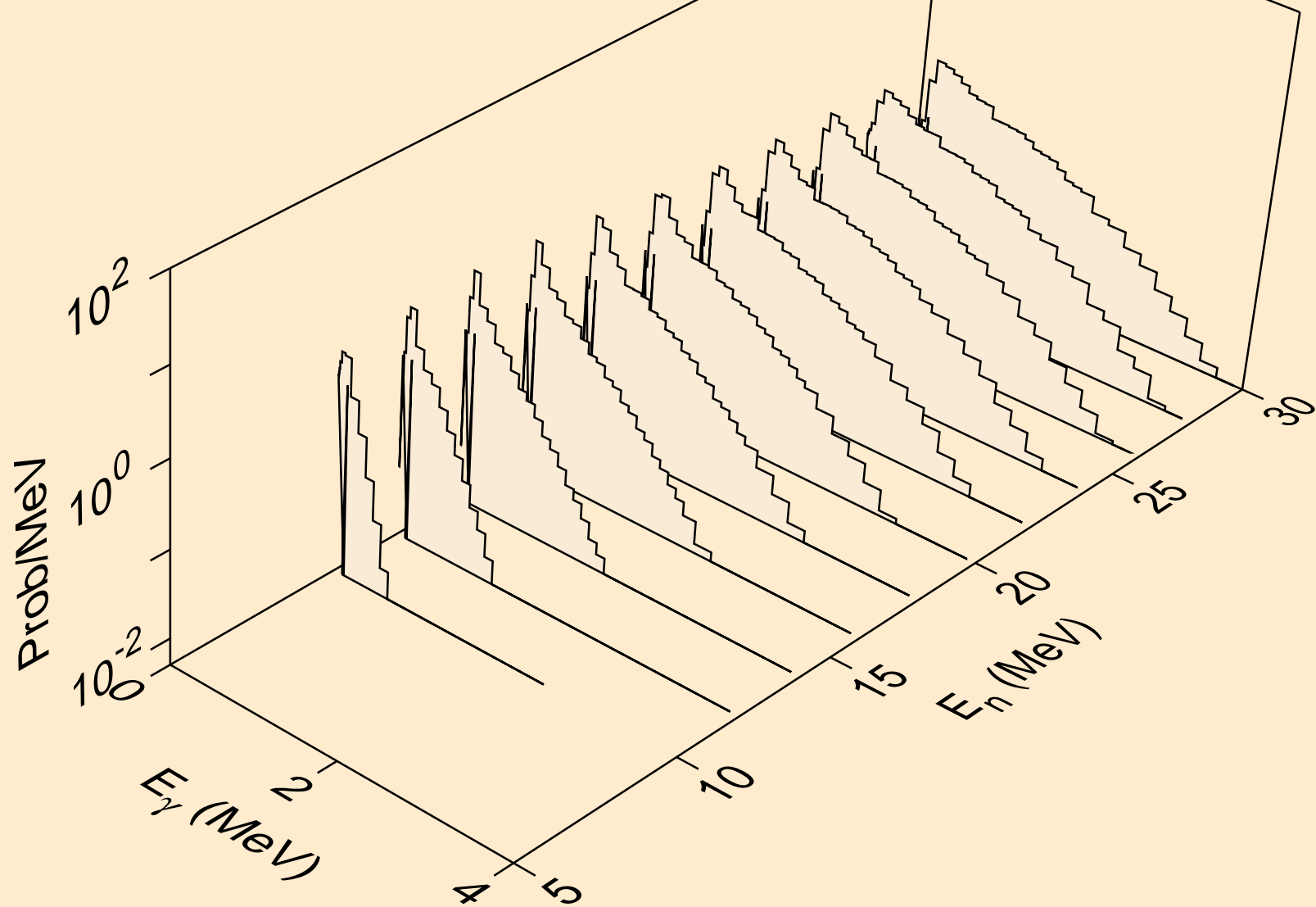

PU242 NEUTRON ACER TENDL-2021 LIBRARY; T=293.6K
Photon emission for (n,n*)d

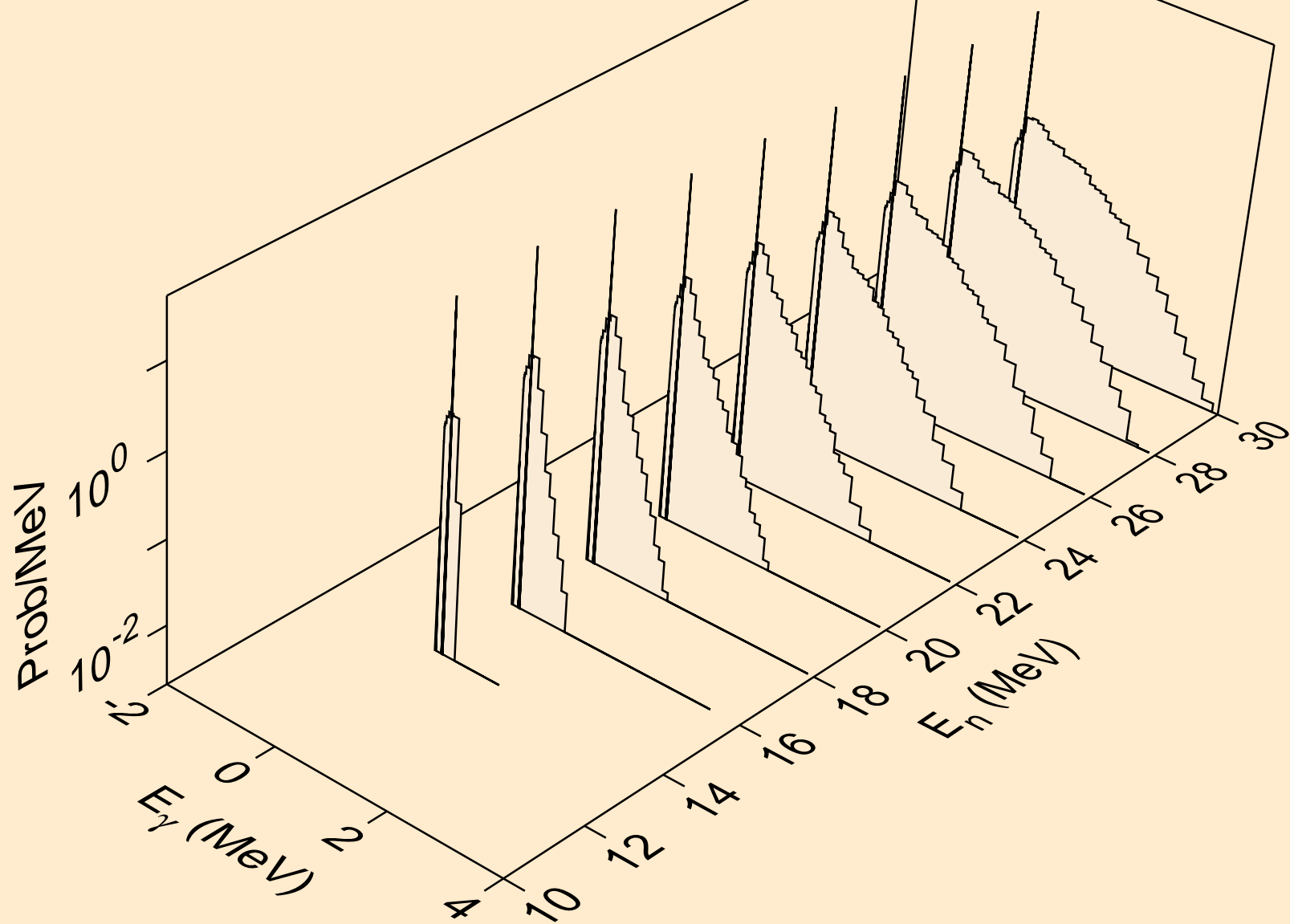

PU242 NEUTRON ACER TENDL-2021 LIBRARY; T=293.6K
Photon emission for (n,n*)t

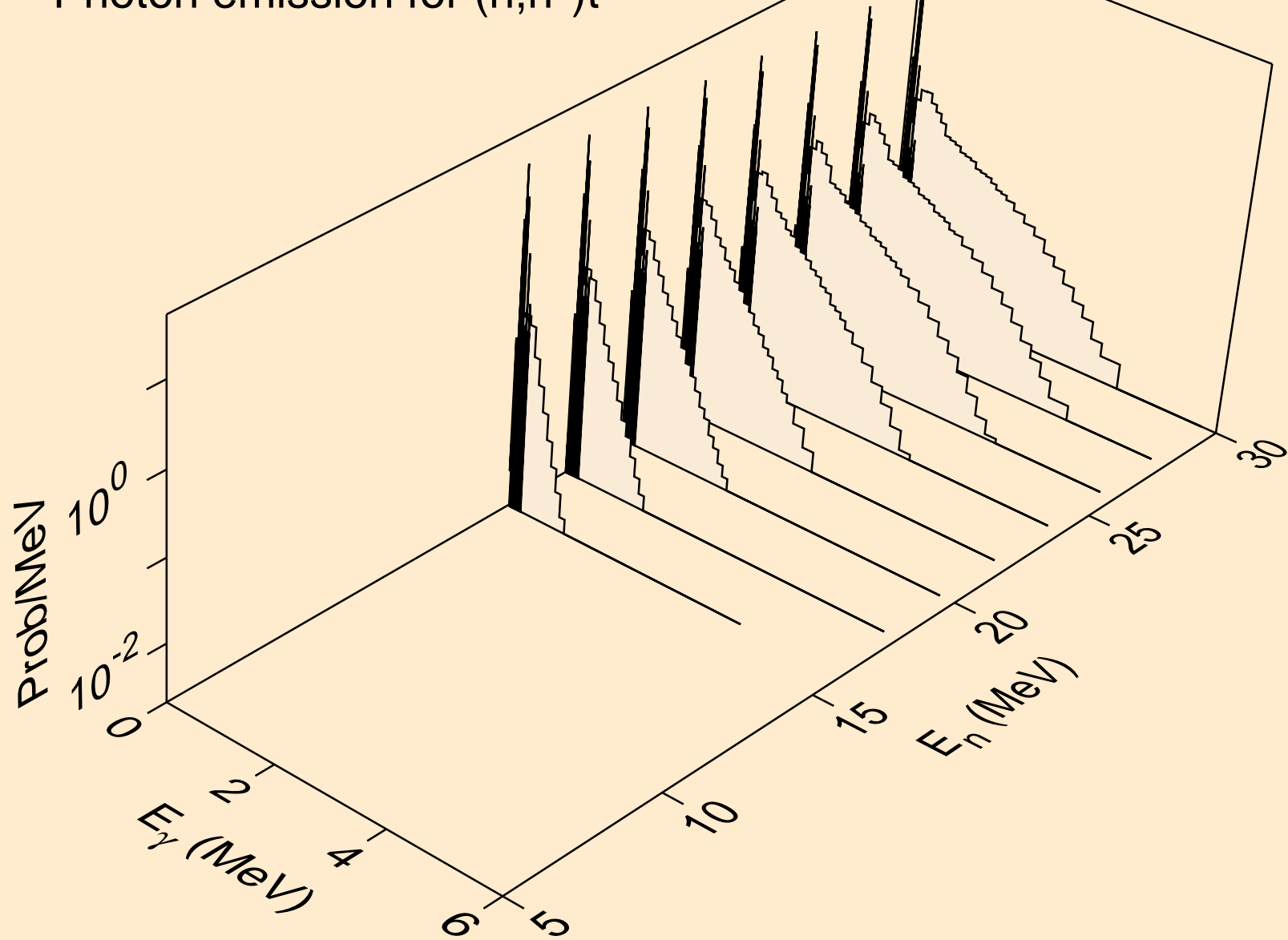

PU242 NEUTRON ACER TENDL-2021 LIBRARY; T=293.6K
Photon emission for (n,n*)he3

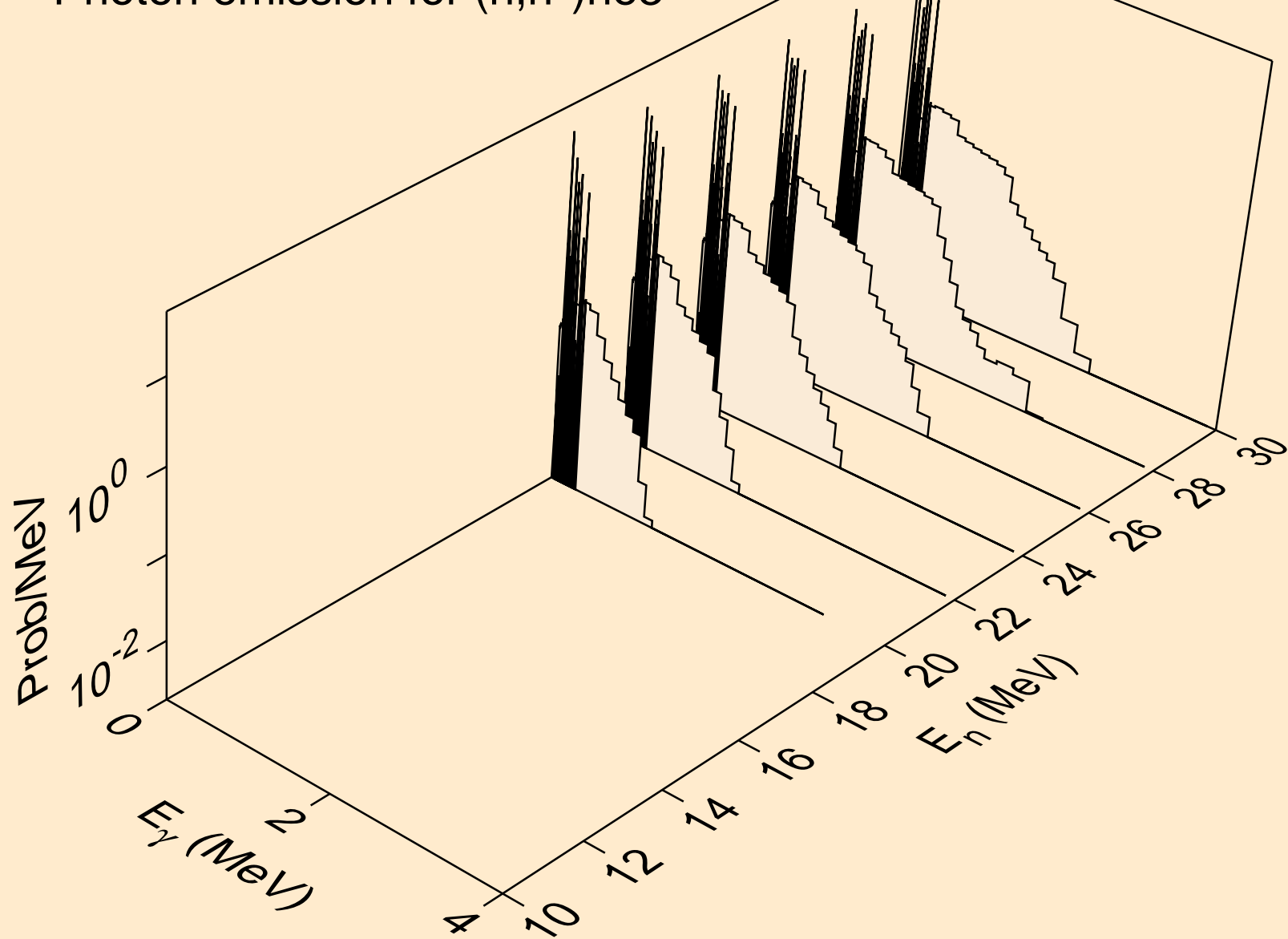

PU242 NEUTRON ACER TENDL-2021 LIBRARY; T=293.6K
Photon emission for (n,4n)

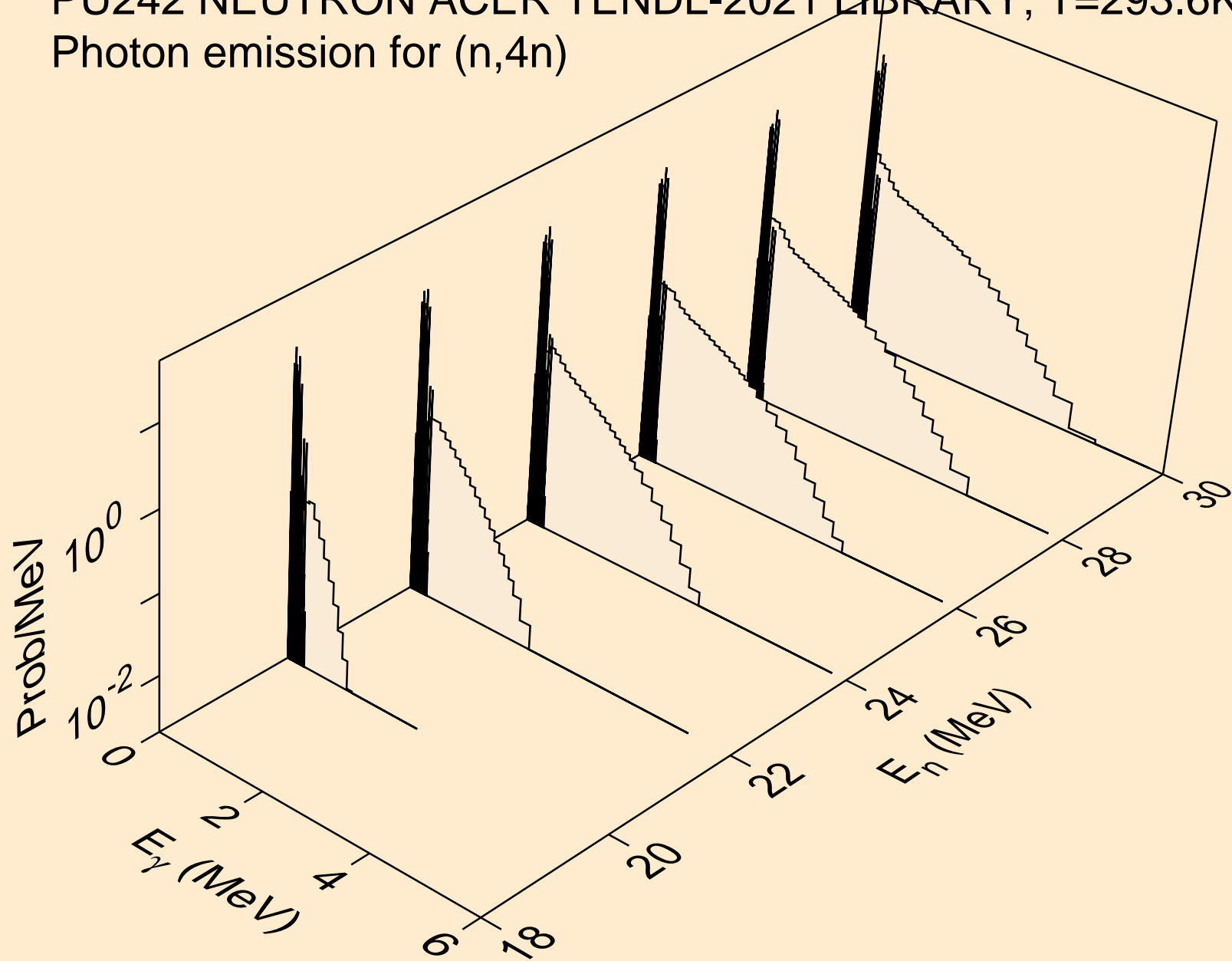

PU242 NEUTRON ACER TENDL-2021 LIBRARY; T=293.6K
Photon emission for (n,2np)

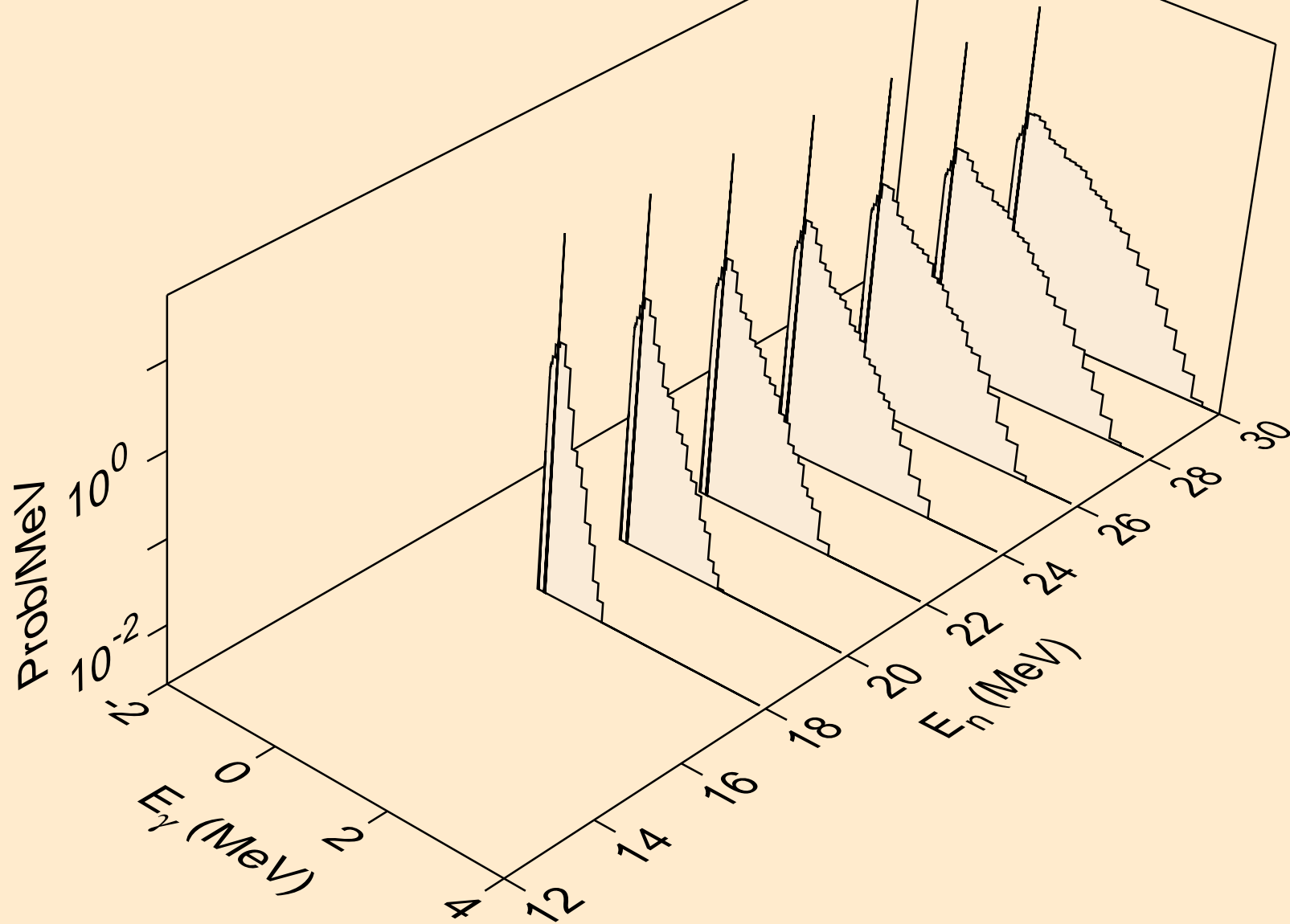

PU242 NEUTRON ACER TENDL-2021 LIBRARY; T=293.6K
Photon emission for (n,3np)

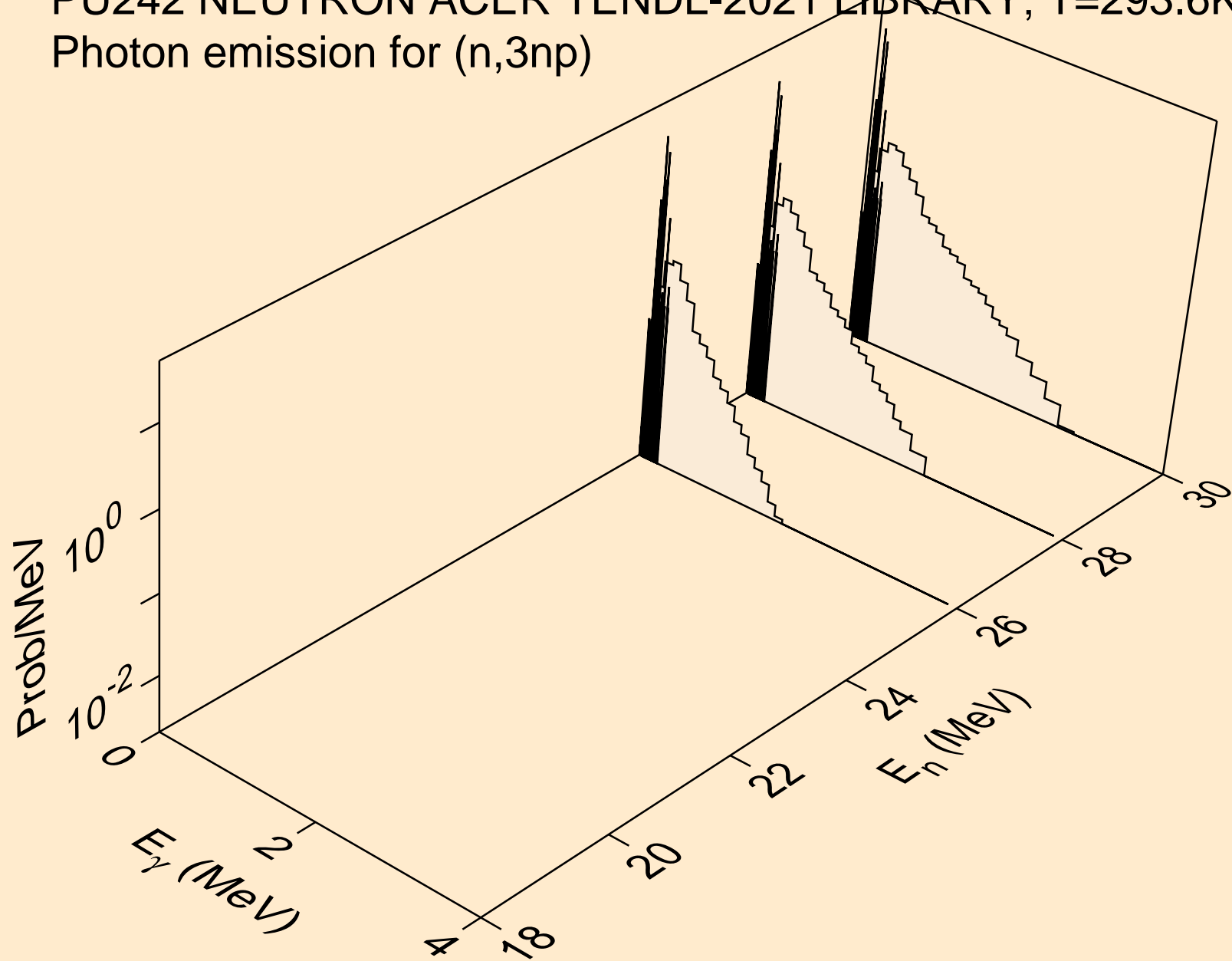

PU242 NEUTRON ACER TENDL-2021 LIBRARY; T=293.6K
Photon emission for (n,2np)

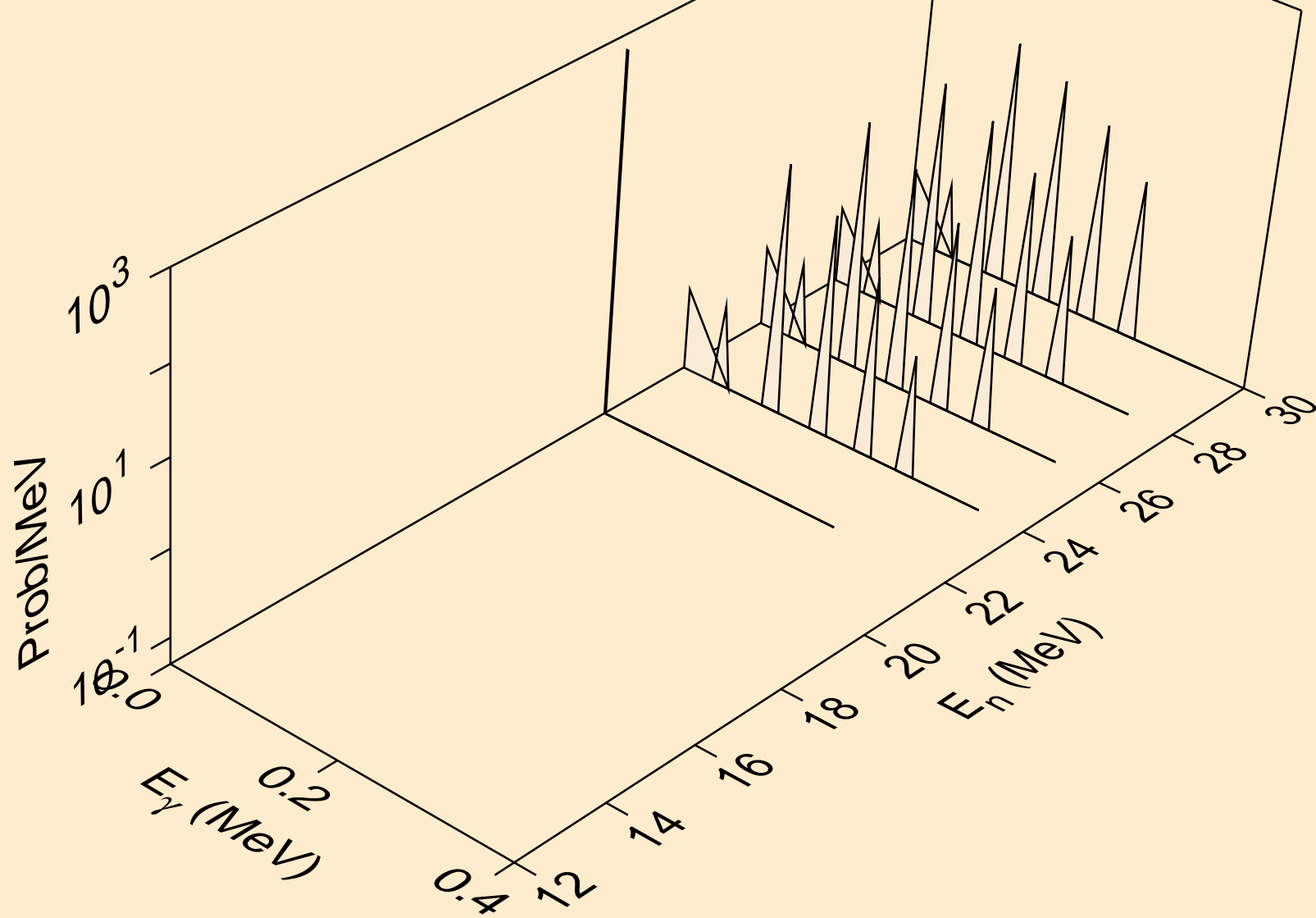

PU242 NEUTRON ACER TENDL-2021 LIBRARY; T=293.6K
Photon emission for (n,n*c)

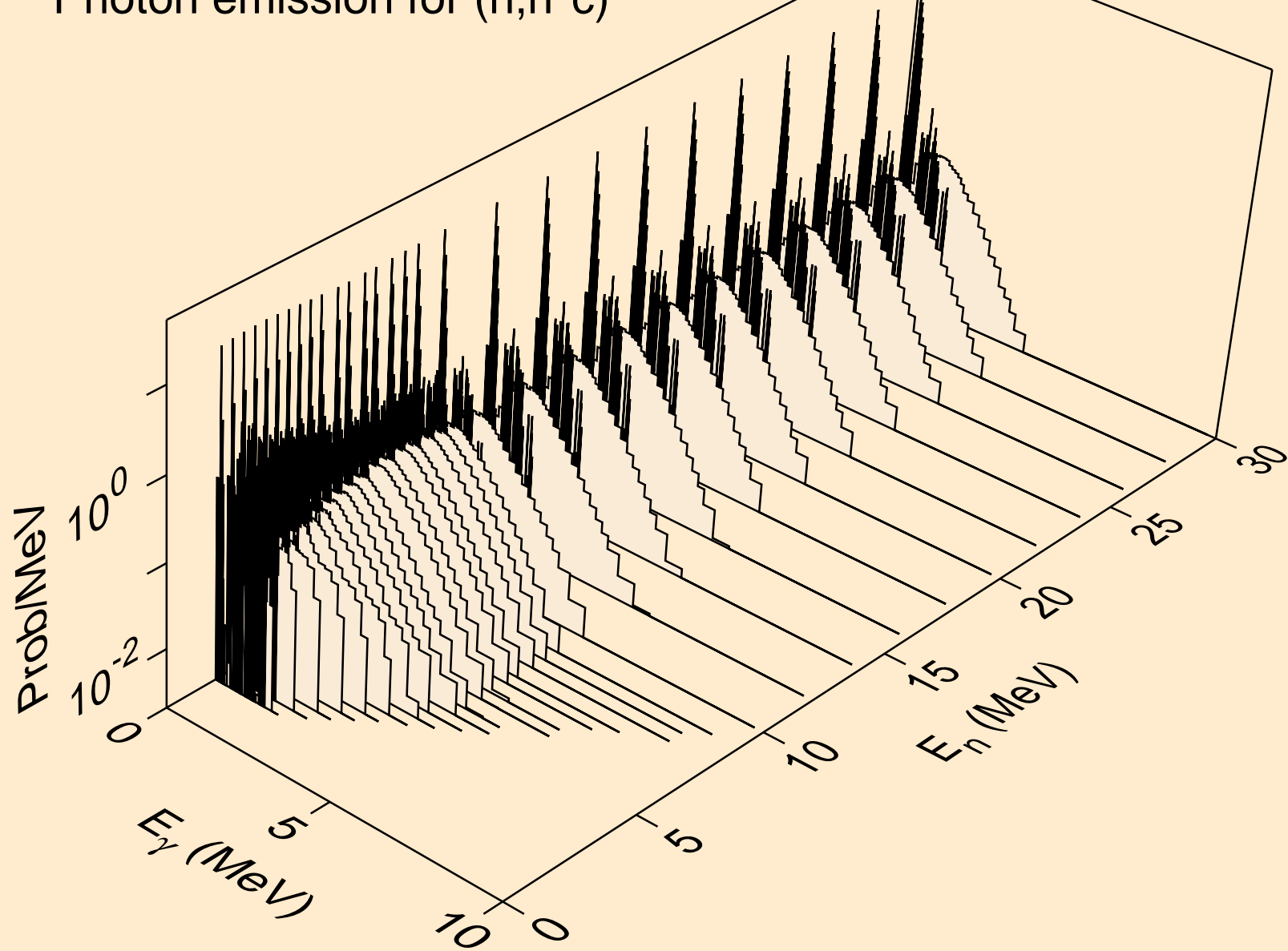

PU242 NEUTRON ACER TENDL-2021 LIBRARY; T=293.6K
Photon emission for (n,gma)

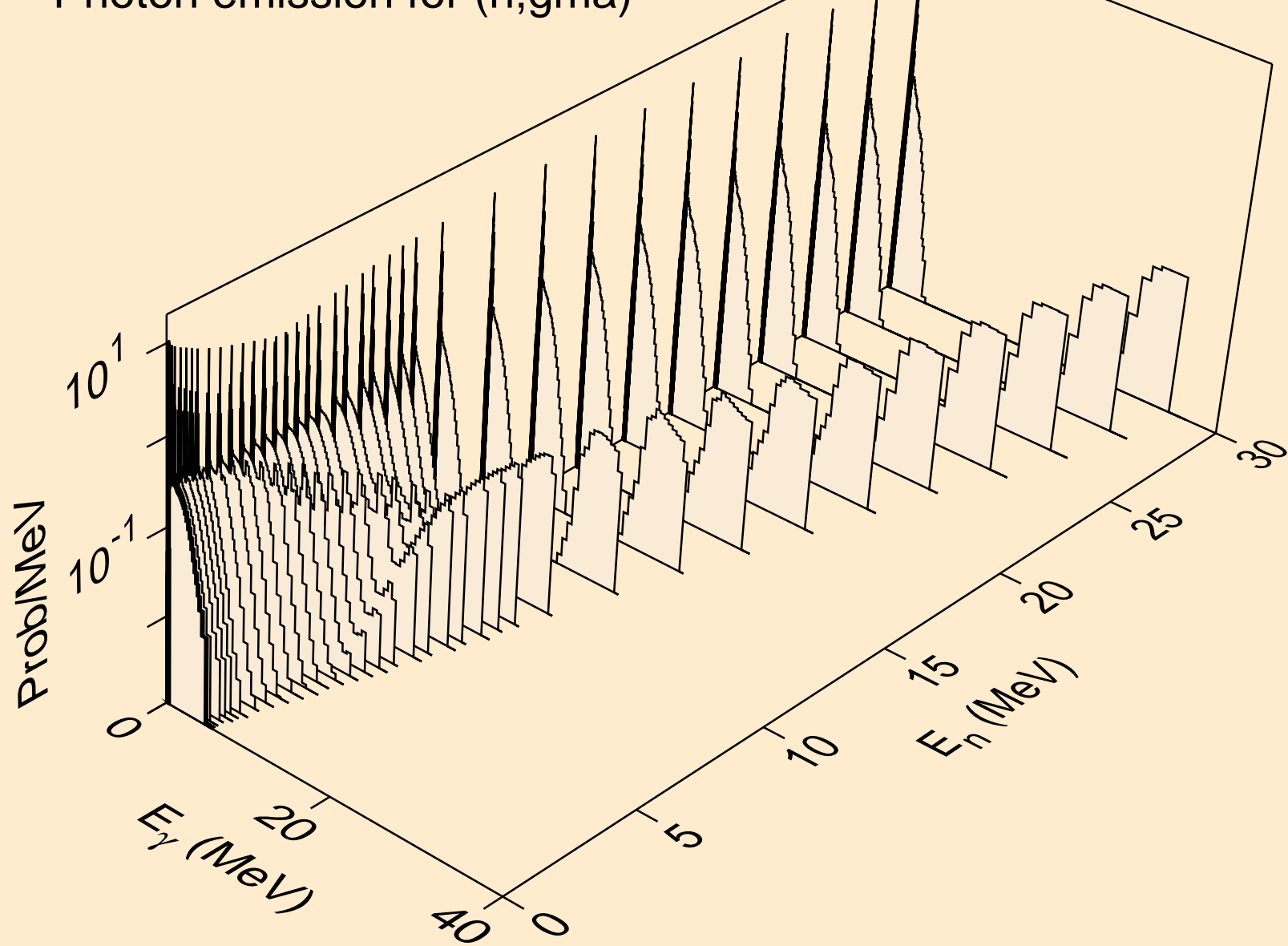

PU242 NEUTRON ACER TENDL-2021 LIBRARY; T=293.6K
Photon emission for (n,p)

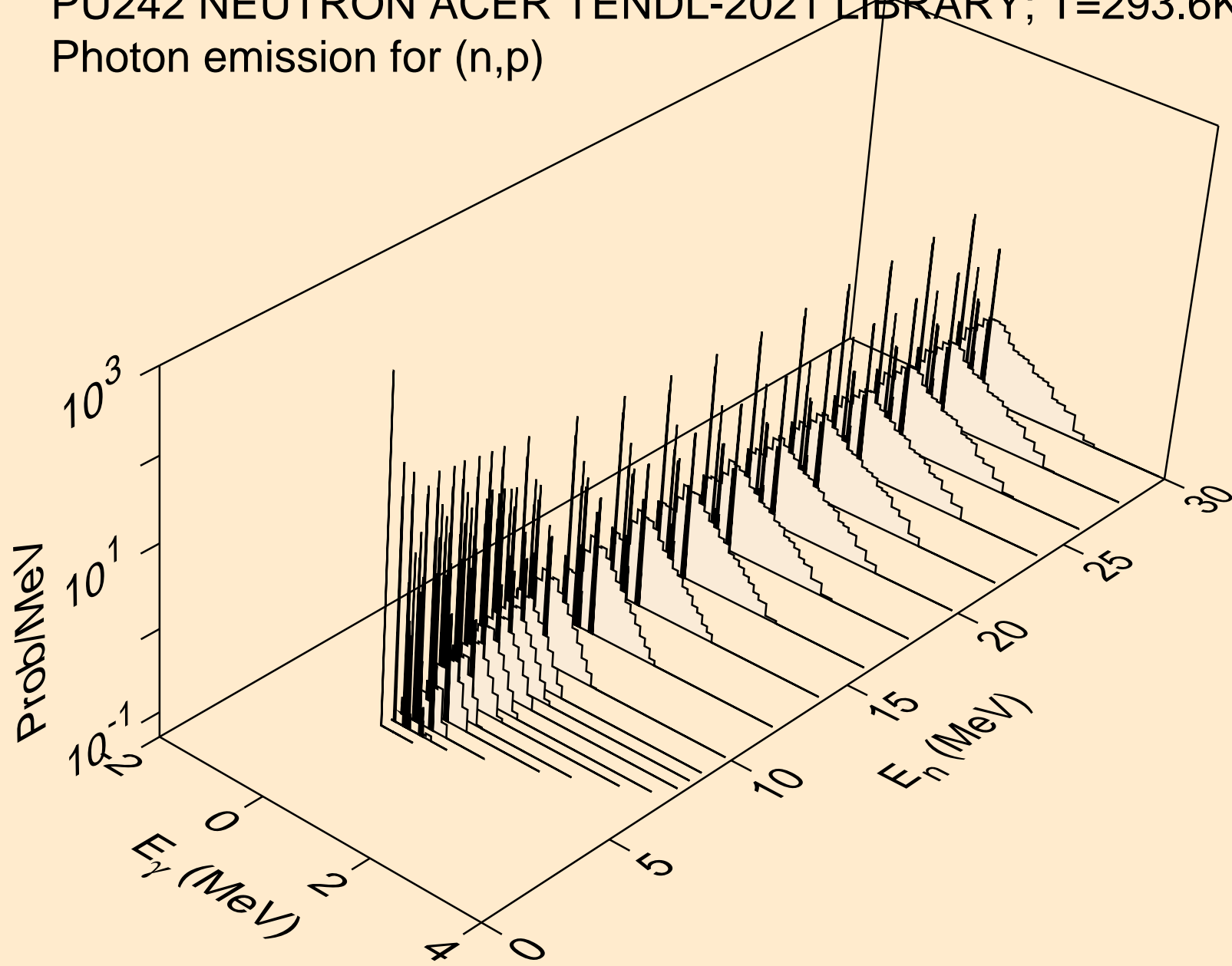

PU242 NEUTRON ACER TENDL-2021 LIBRARY; T=293.6K
Photon emission for (n,d)

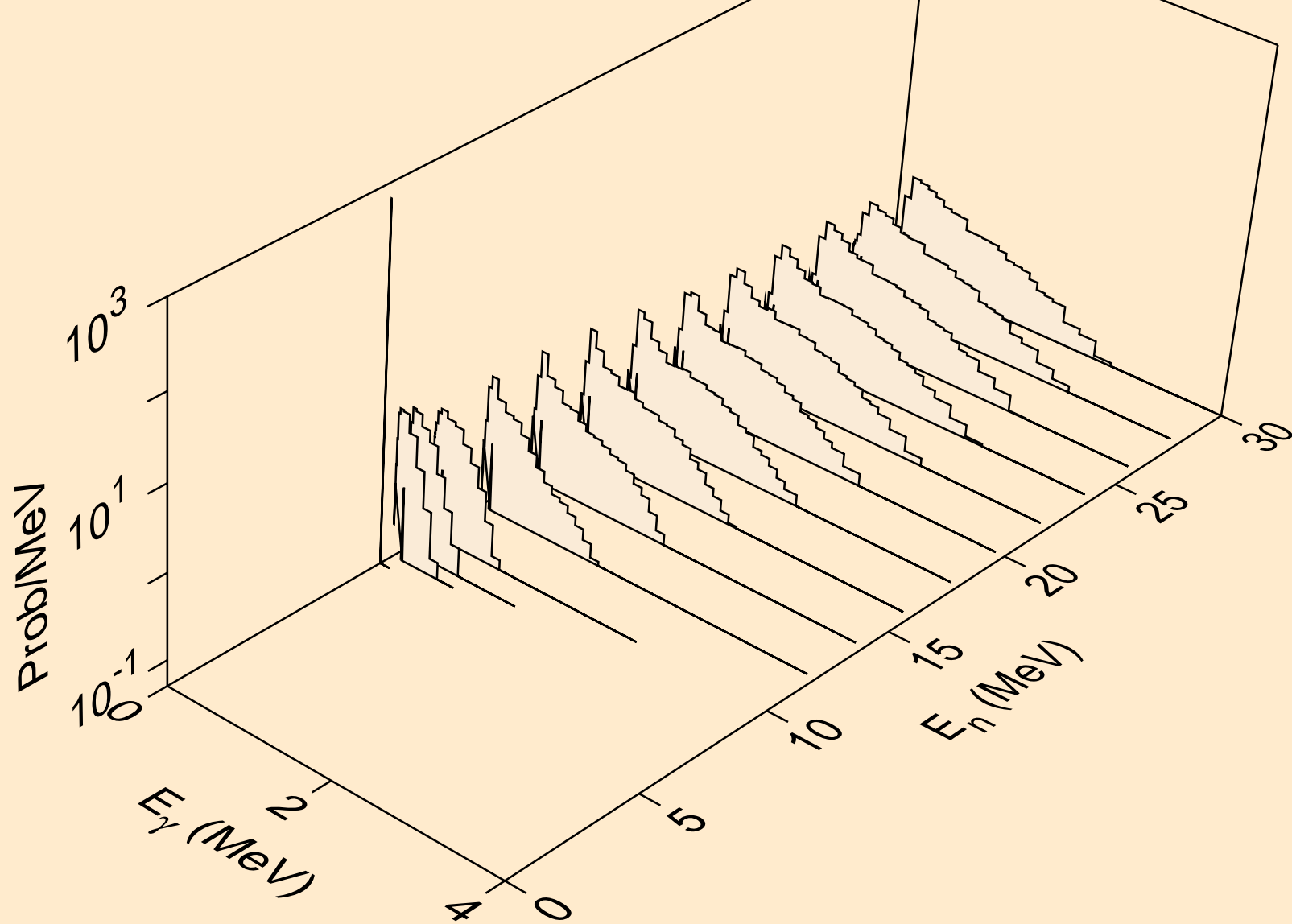

PU242 NEUTRON ACER TENDL-2021 LIBRARY; T=293.6K
Photon emission for (n,t)

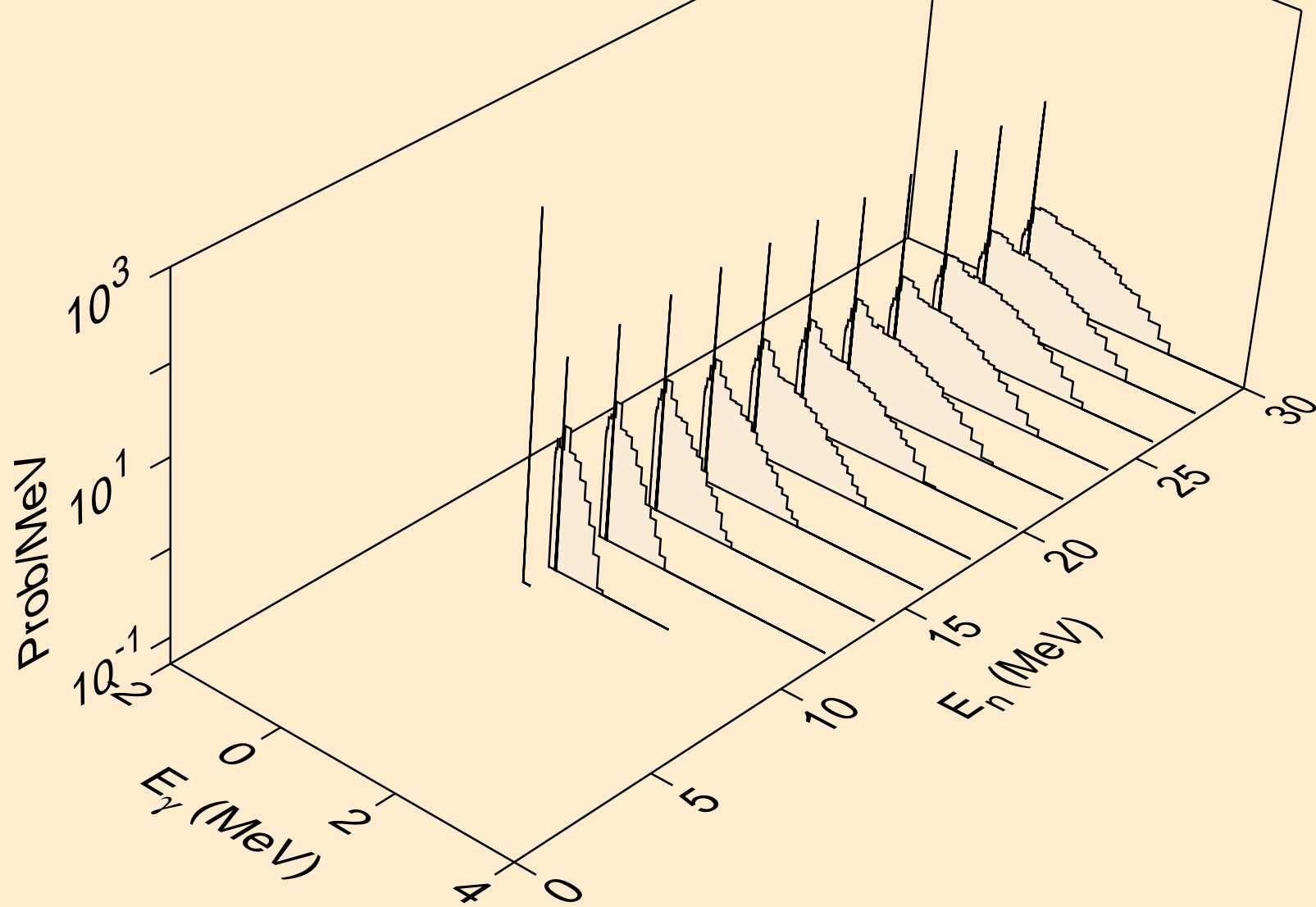

PU242 NEUTRON ACER TENDL-2021 LIBRARY; T=293.6K
Photon emission for (n,he3)

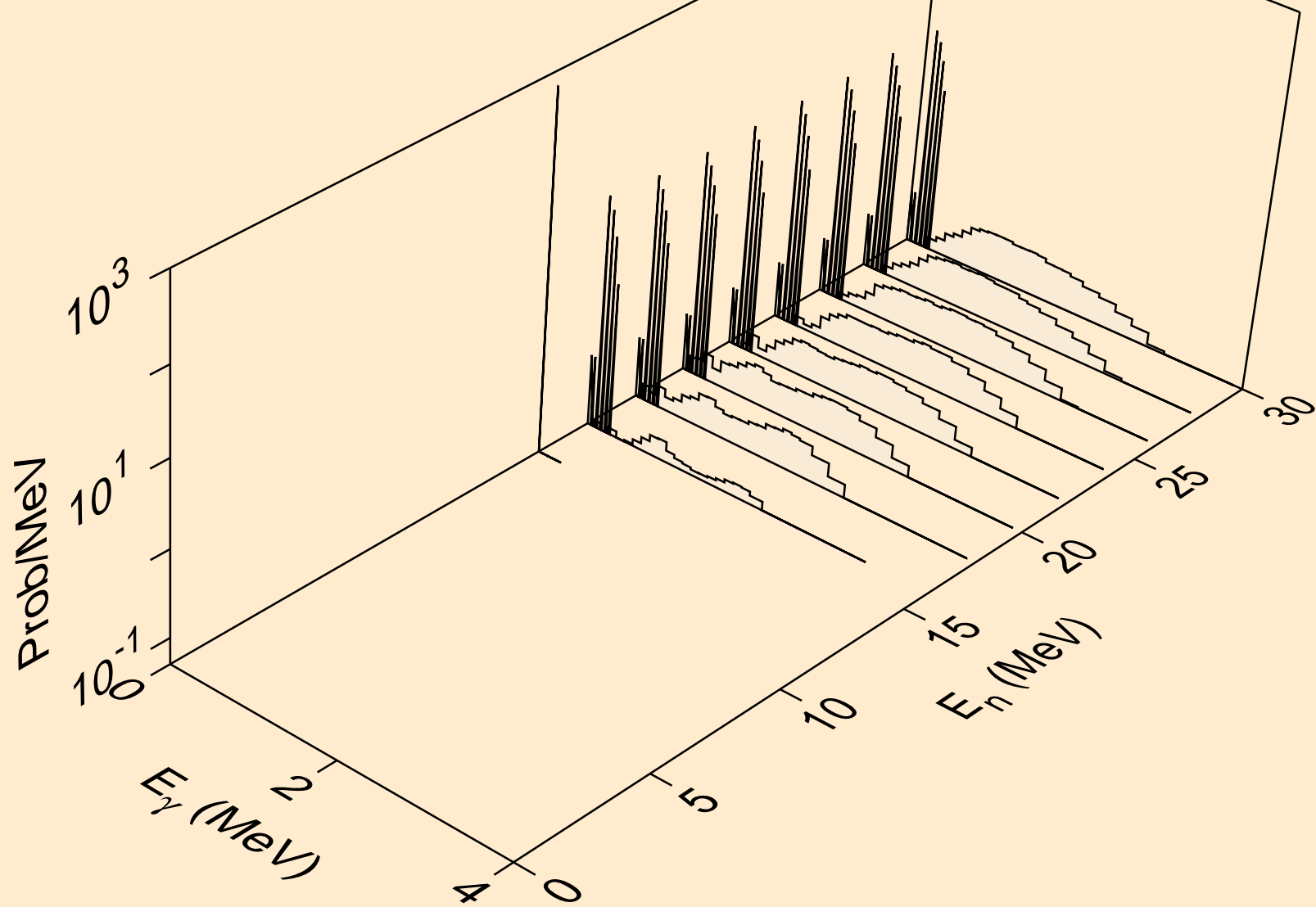

PU242 NEUTRON ACER TENDL-2021 LIBRARY; T=293.6K
Photon emission for (n,a)

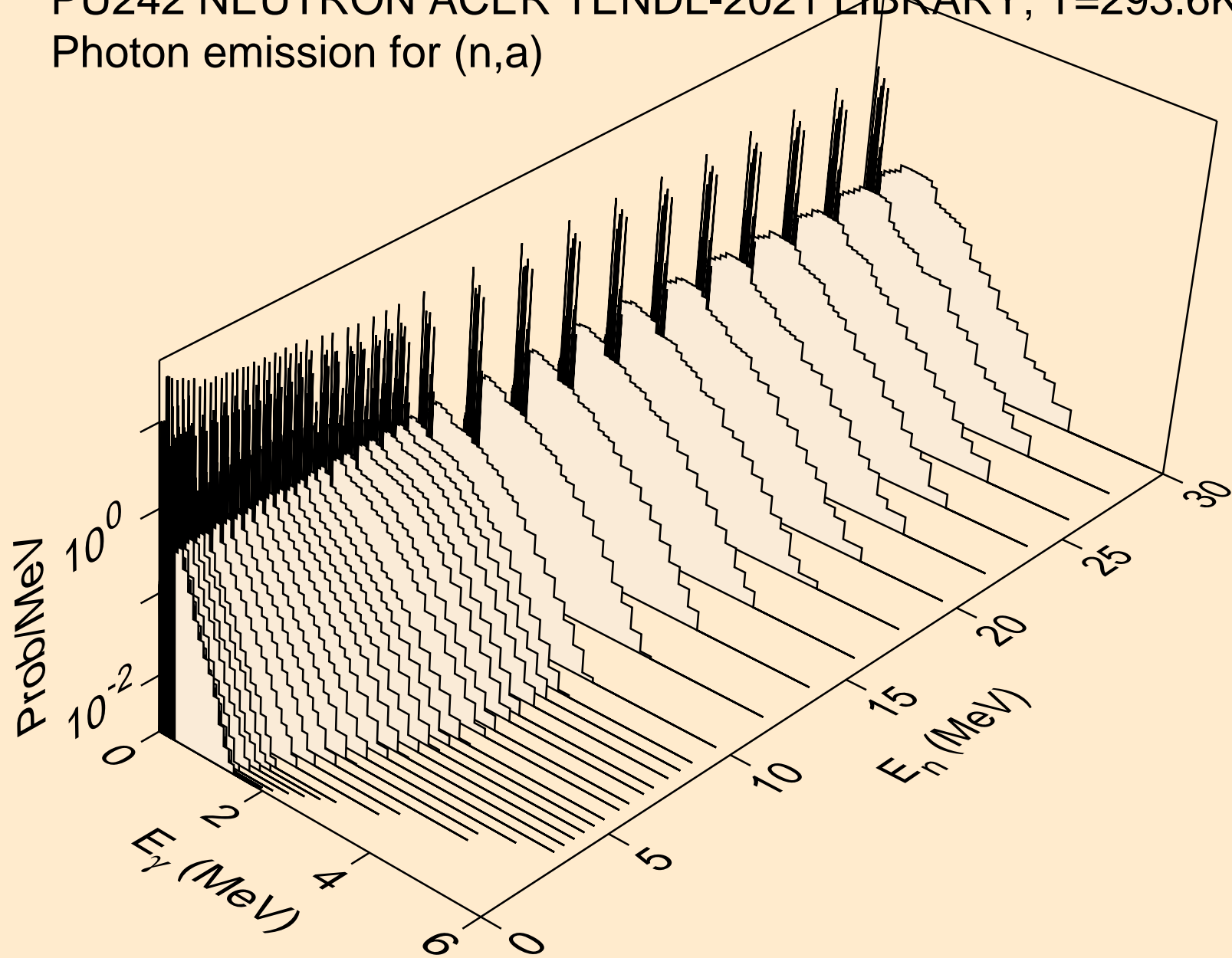

PU242 NEUTRON ACER TENDL-2021 LIBRARY; T=293.6K
Photon emission for (n,2p)

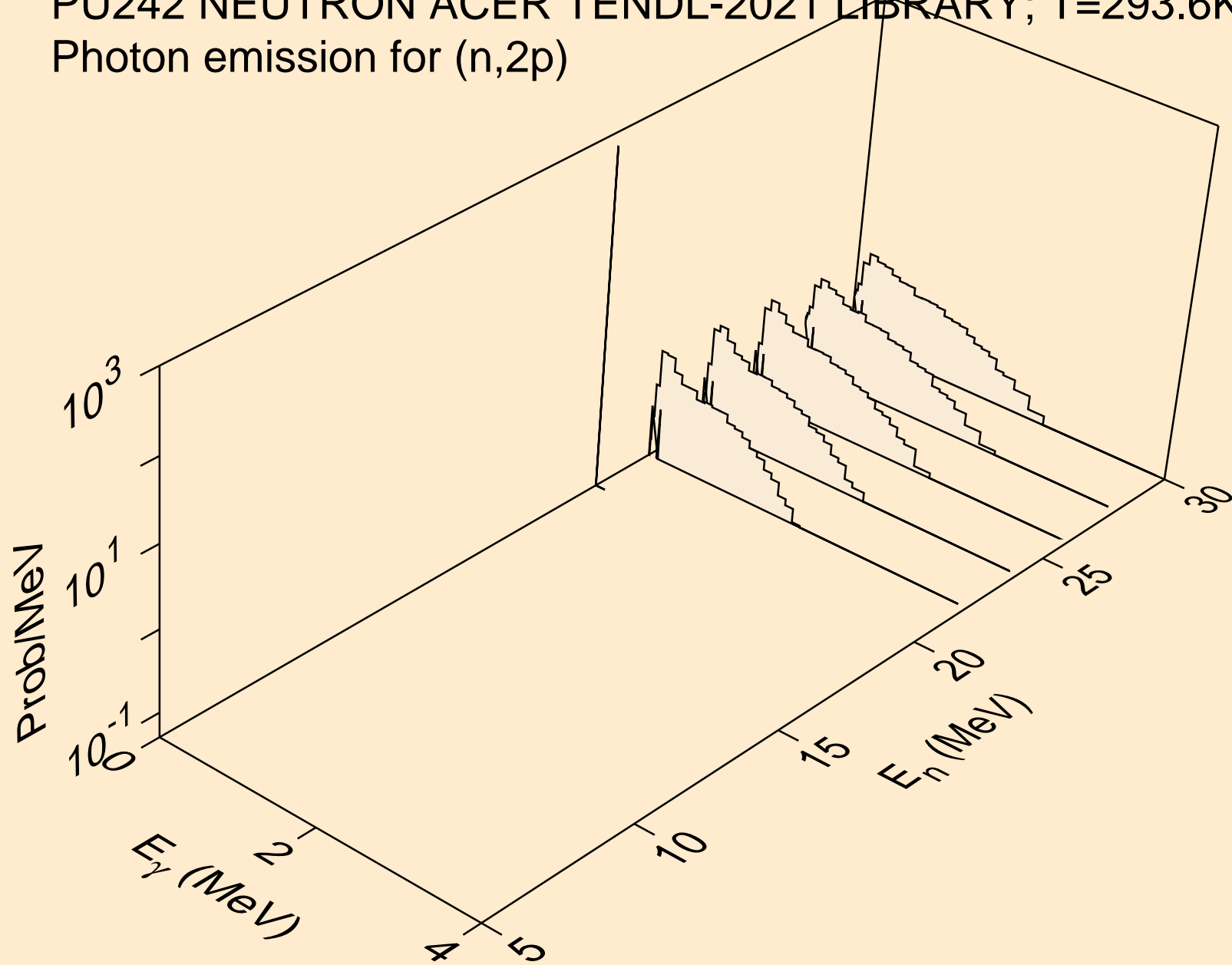

PU242 NEUTRON ACER TENDL-2021 LIBRARY; T=293.6K
thermal capture photon spectrum

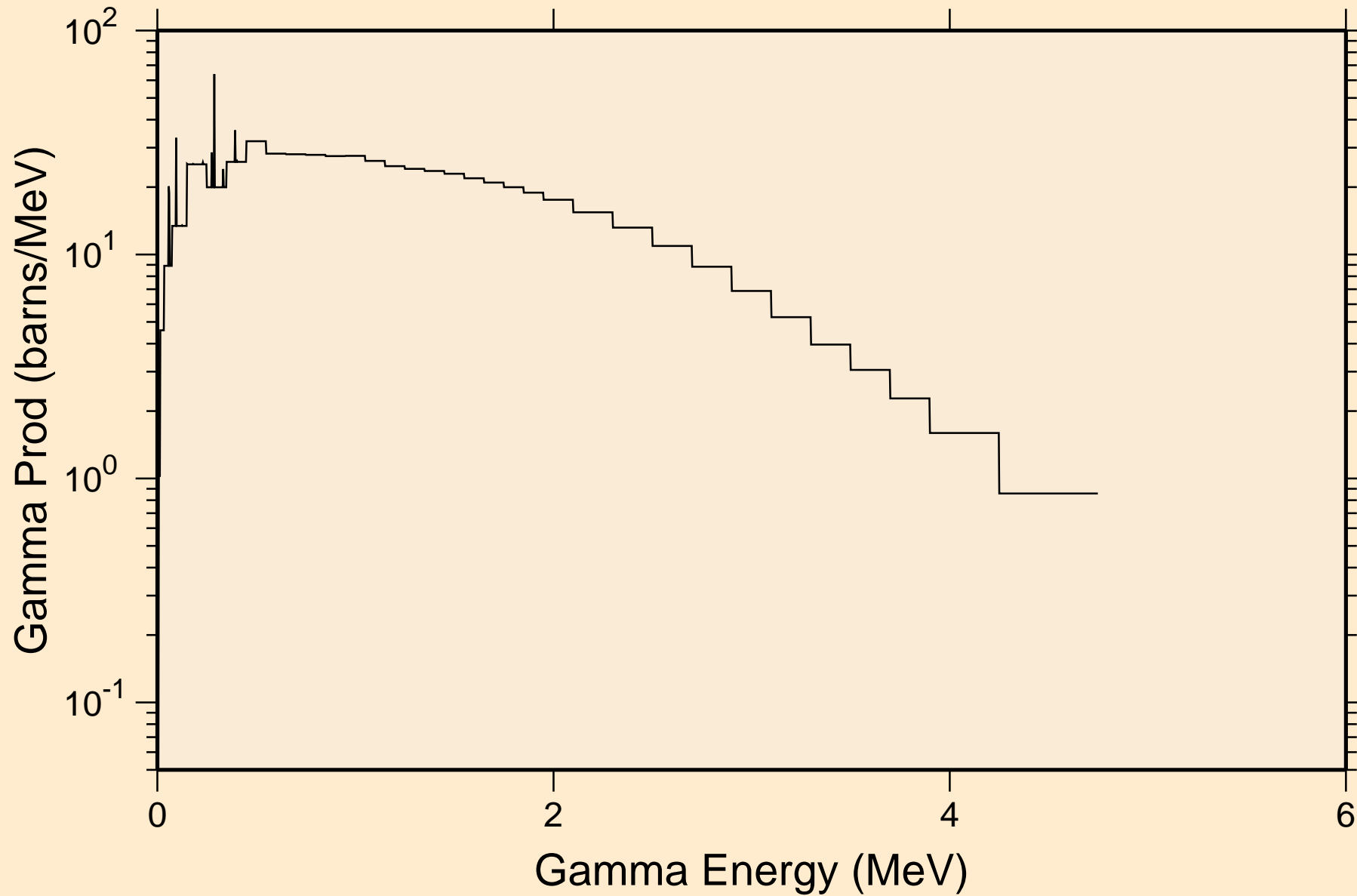

PU242 NEUTRON ACER TENDL-2021 LIBRARY; T=293.6K
14 MeV photon spectrum

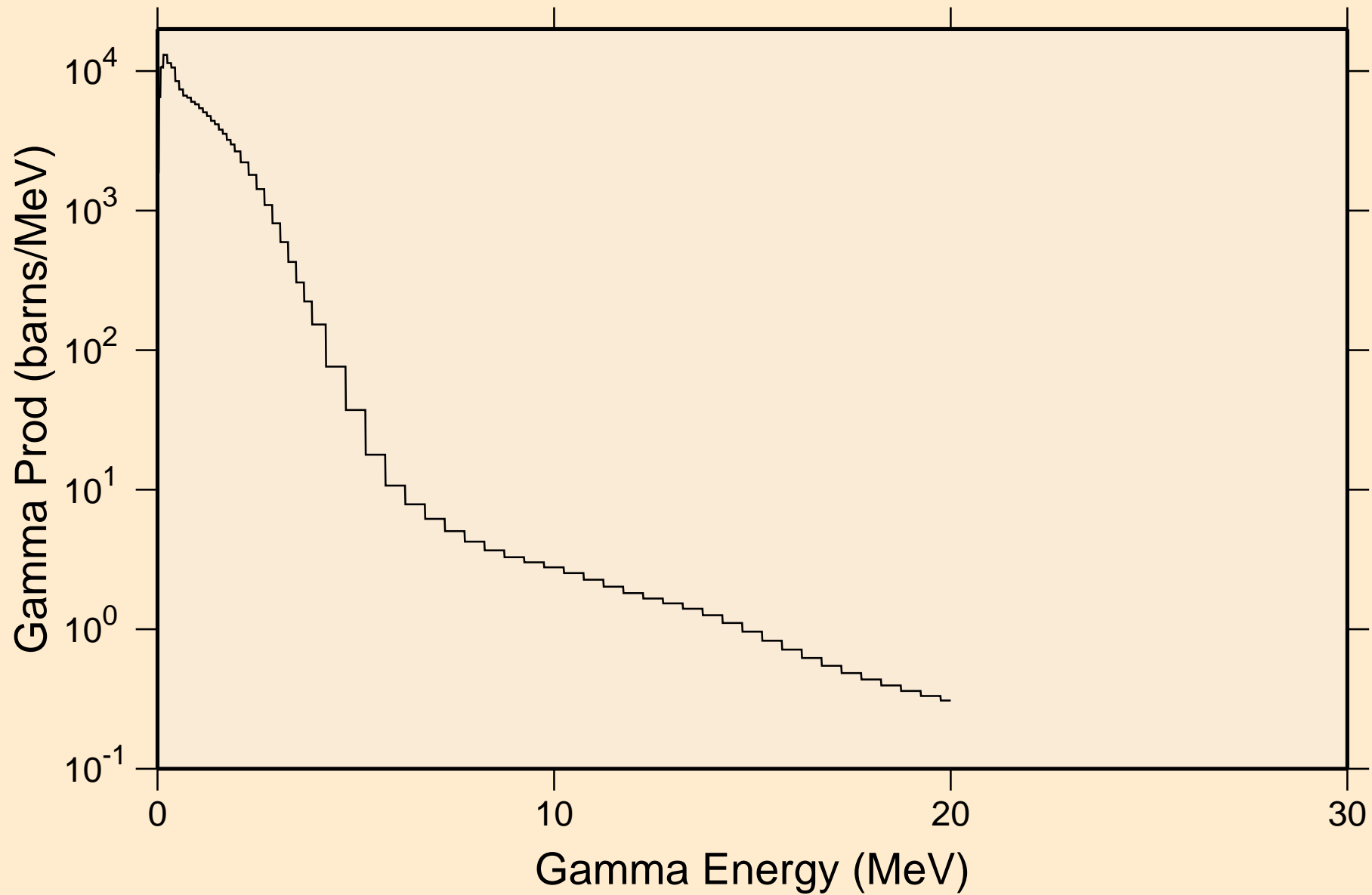

PU242 NEUTRON ACER TENDL-2021 LIBRARY; T=293.6K
Particle heating contributions

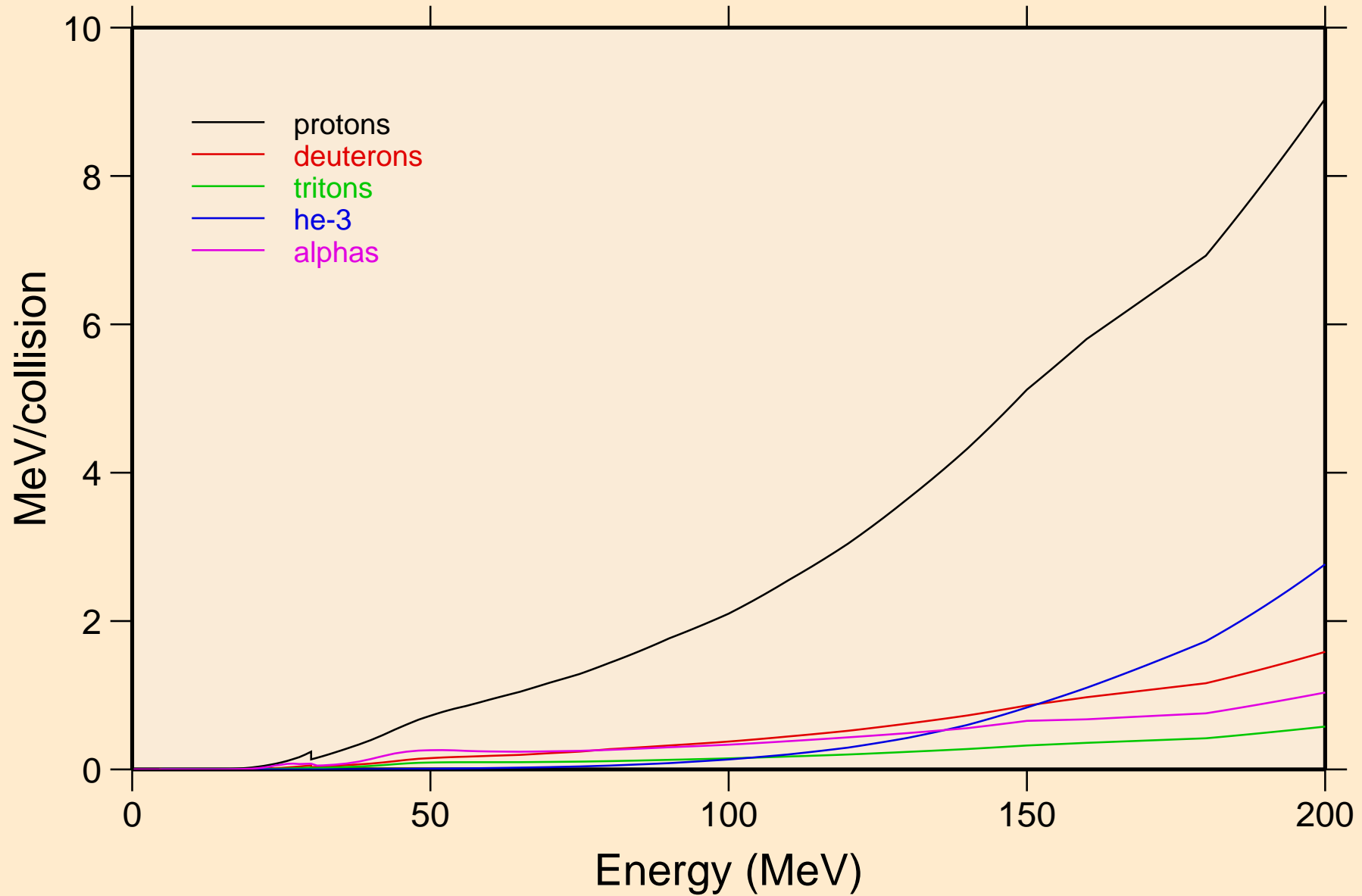

PU242 NEUTRON ACER TENDL-2021 LIBRARY; T=293.6K
Recoil Heating

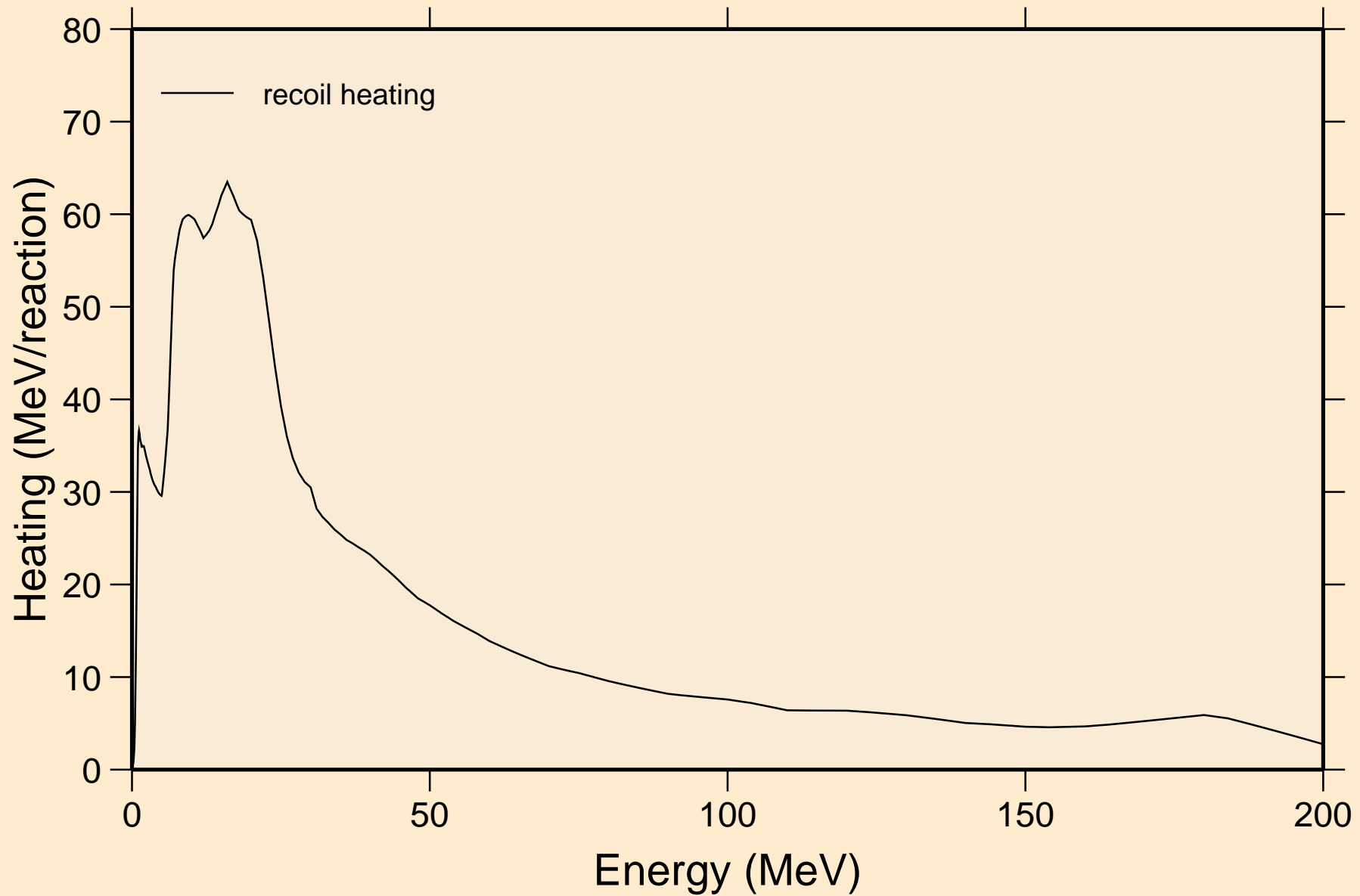

PU242 NEUTRON ACER TENDL-2021 LIBRARY; T=293.6K
Particle production cross sections

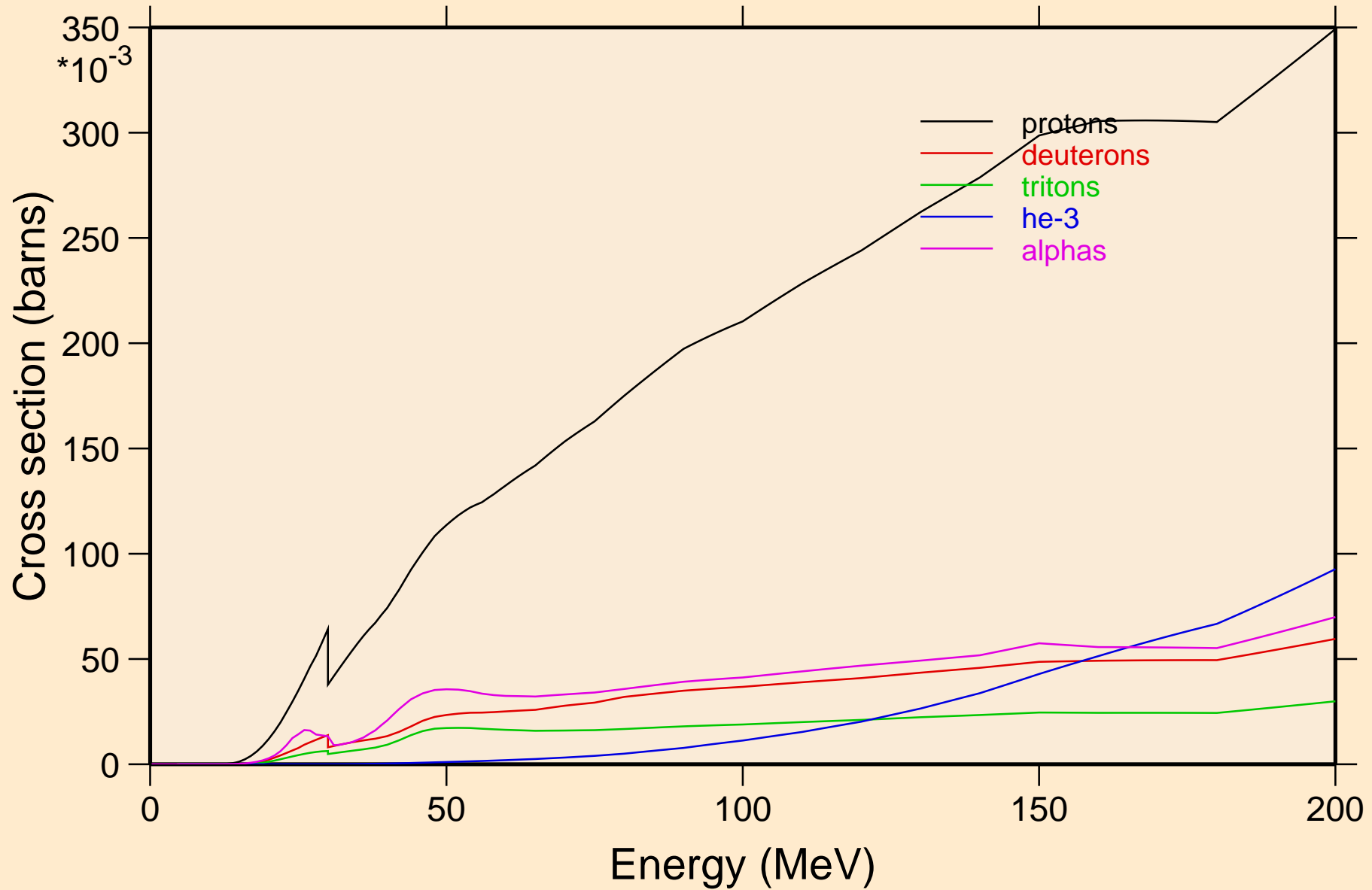

PU242 NEUTRON ACER TENDL-2021 LIBRARY; T=293.6K
protons from (n,x)

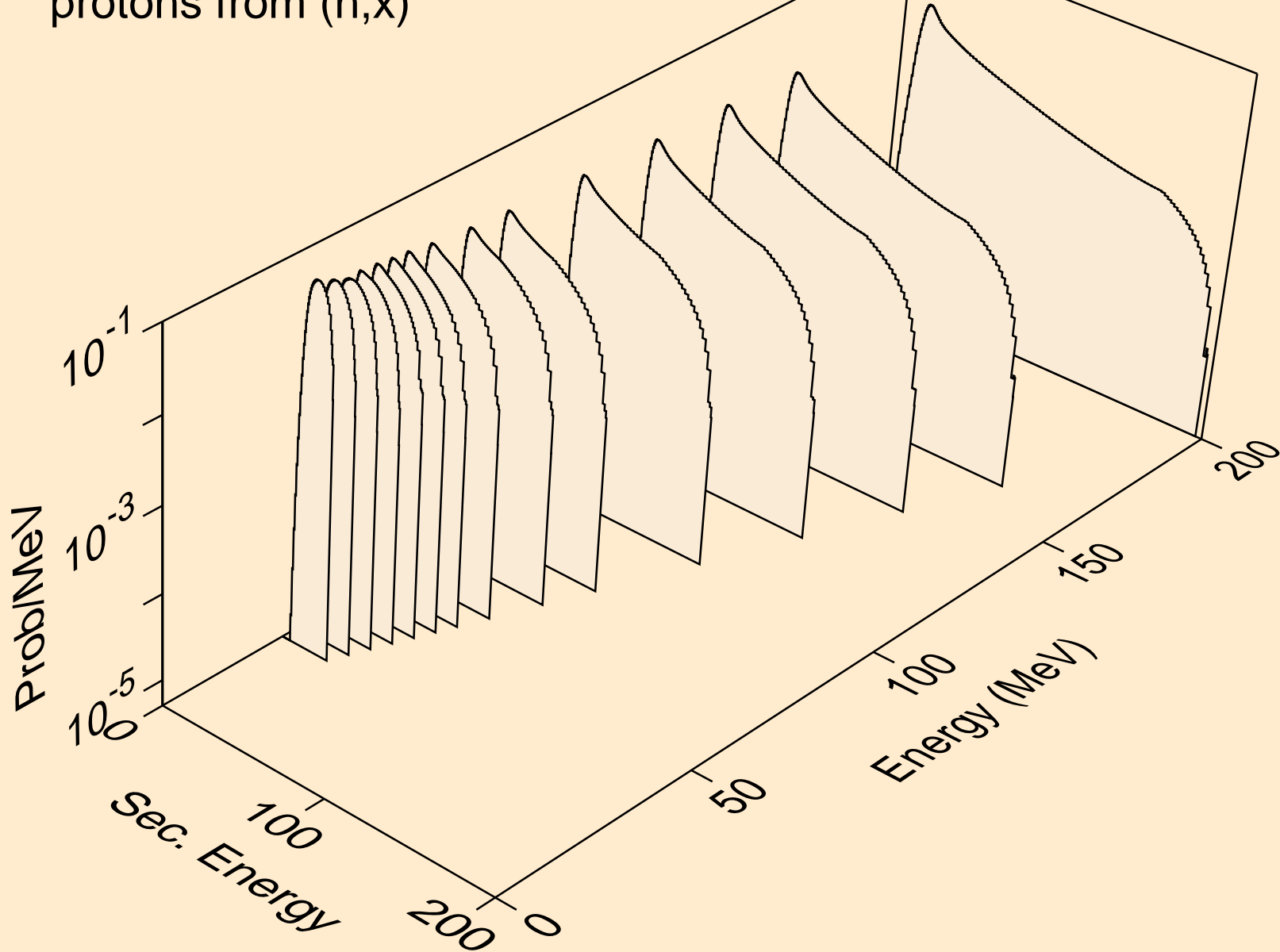

PU242 NEUTRON ACER TENDL-2021 LIBRARY; T=293.6K
protons from (n,n*)p

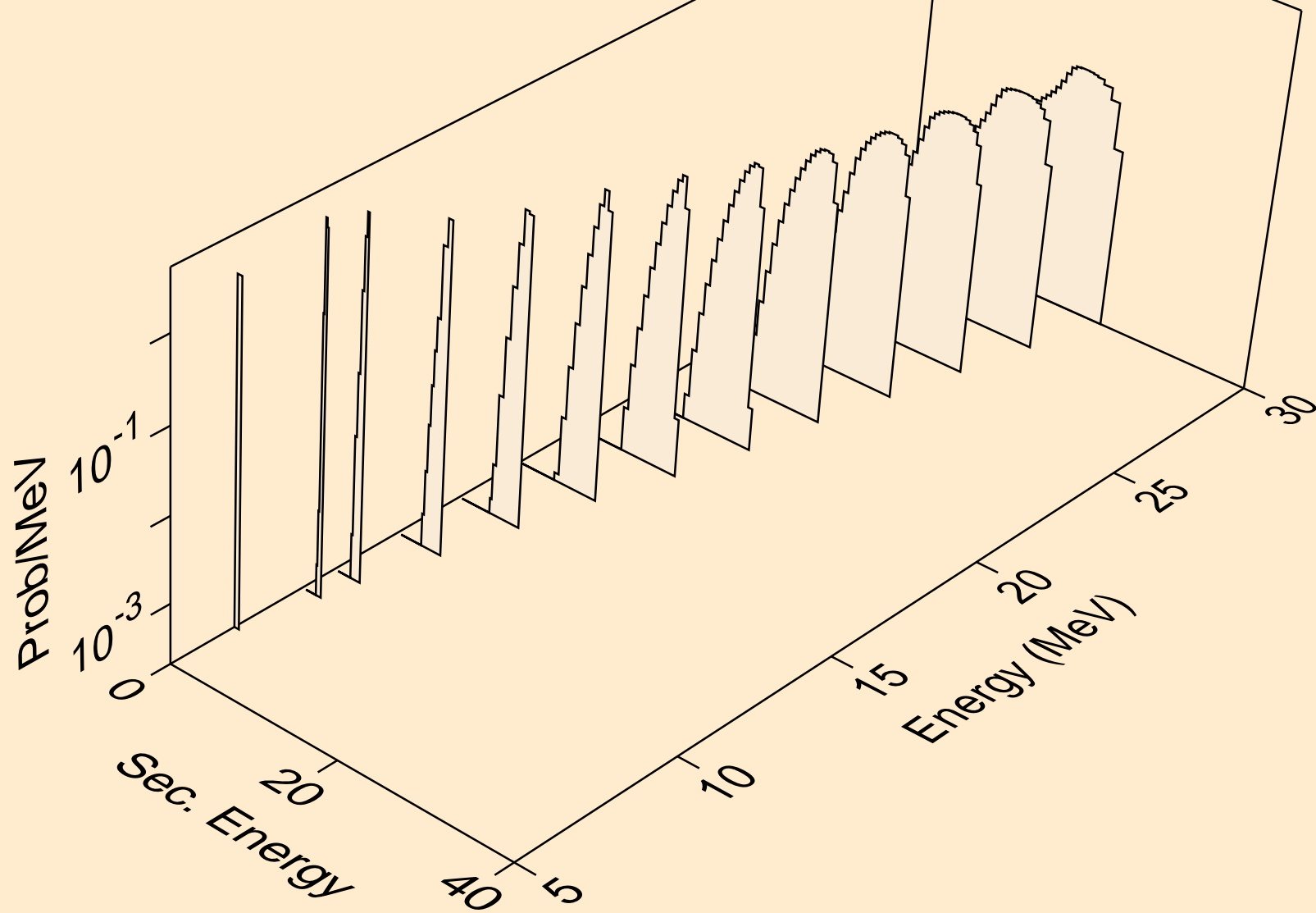

PU242 NEUTRON ACER TENDL-2021 LIBRARY; T=293.6K
protons from (n,2np)

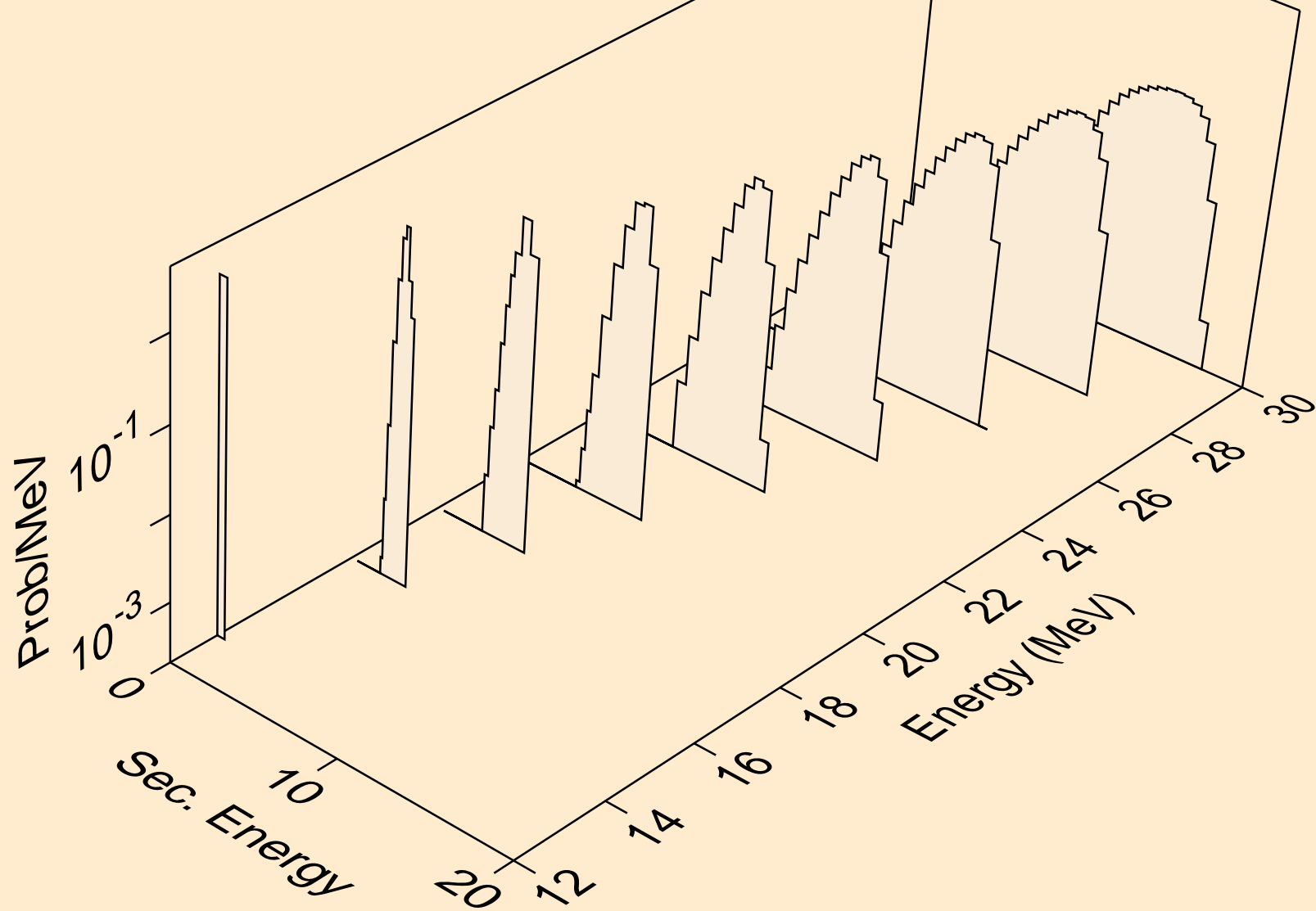

PU242 NEUTRON ACER TENDL-2021 LIBRARY; T=293.6K
protons from (n,3np)

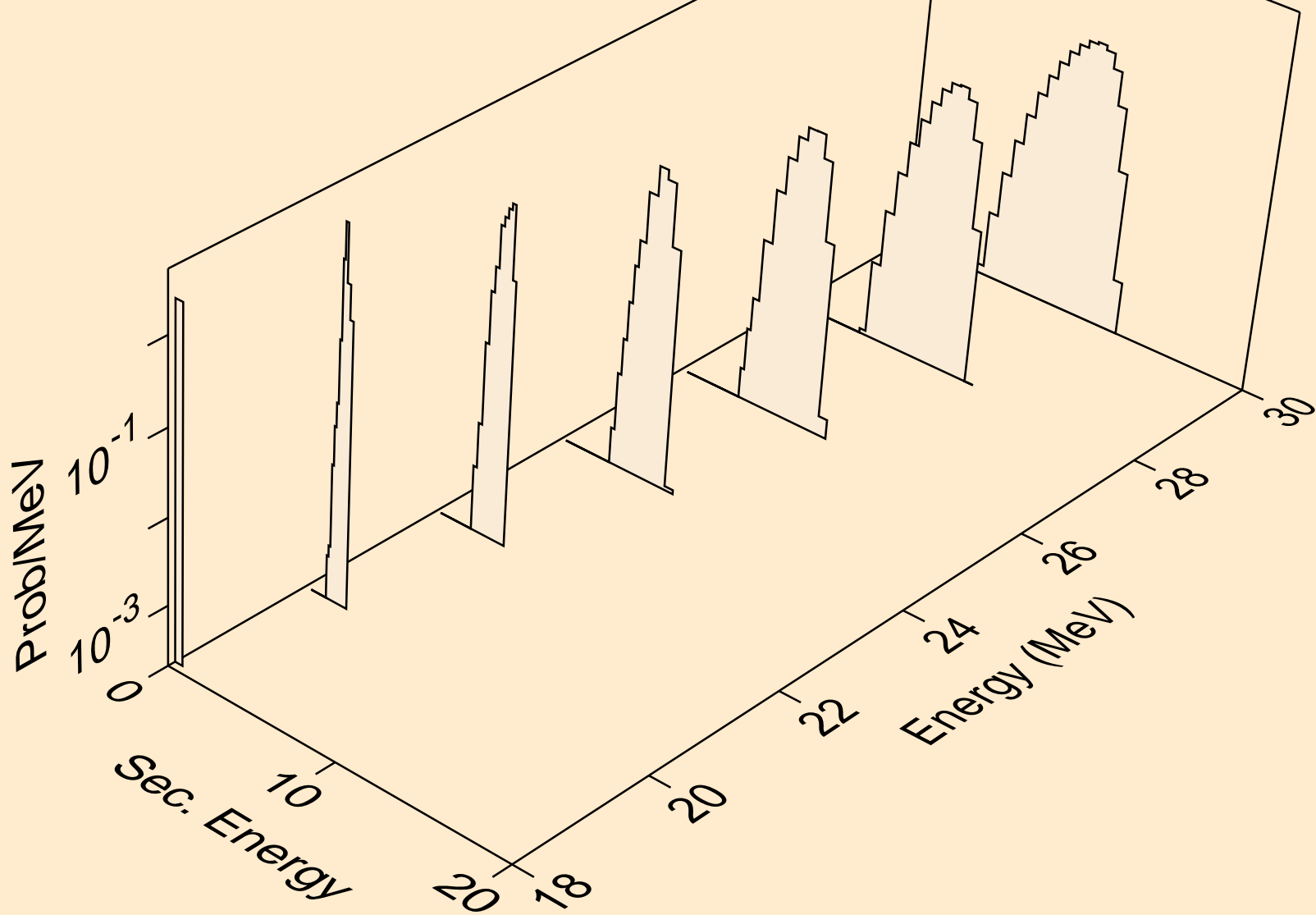

PU242 NEUTRON ACER TENDL-2021 LIBRARY; T=293.6K
protons from (n,2np)

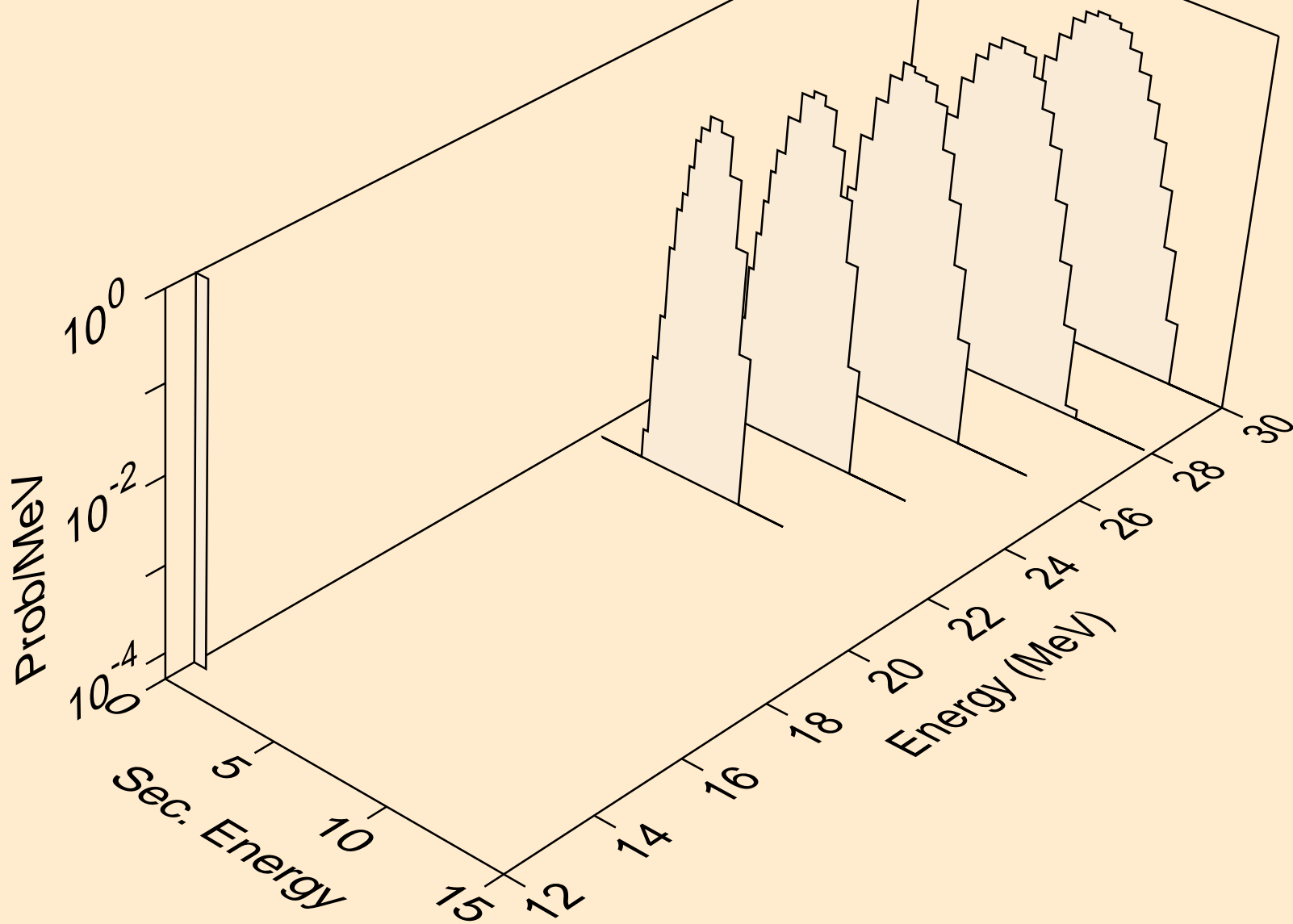

PU242 NEUTRON ACER TENDL-2021 LIBRARY; T=293.6K
protons from (n,p)

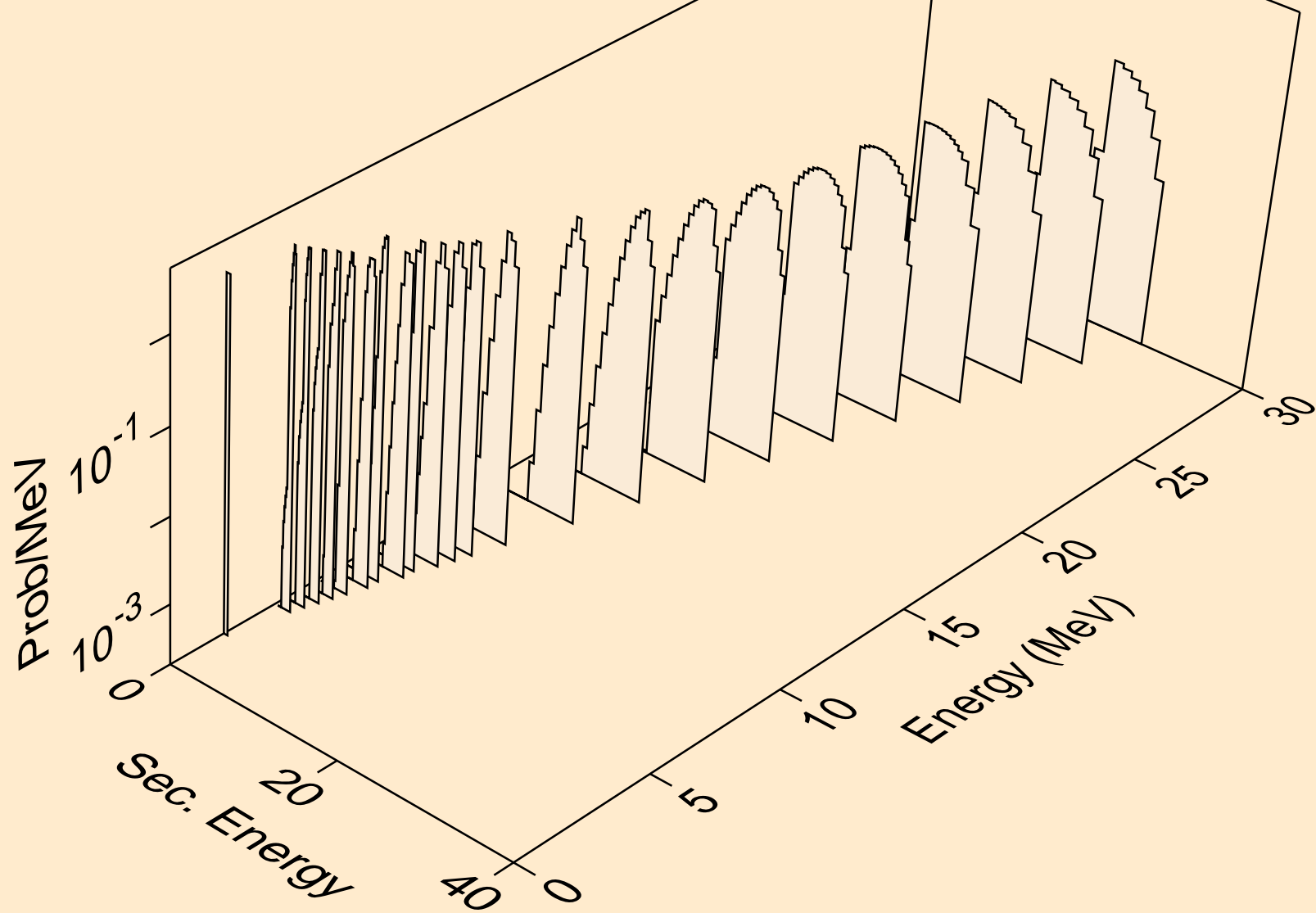

PU242 NEUTRON ACER TENDL-2021 LIBRARY; T=293.6K
protons from (n,2p)

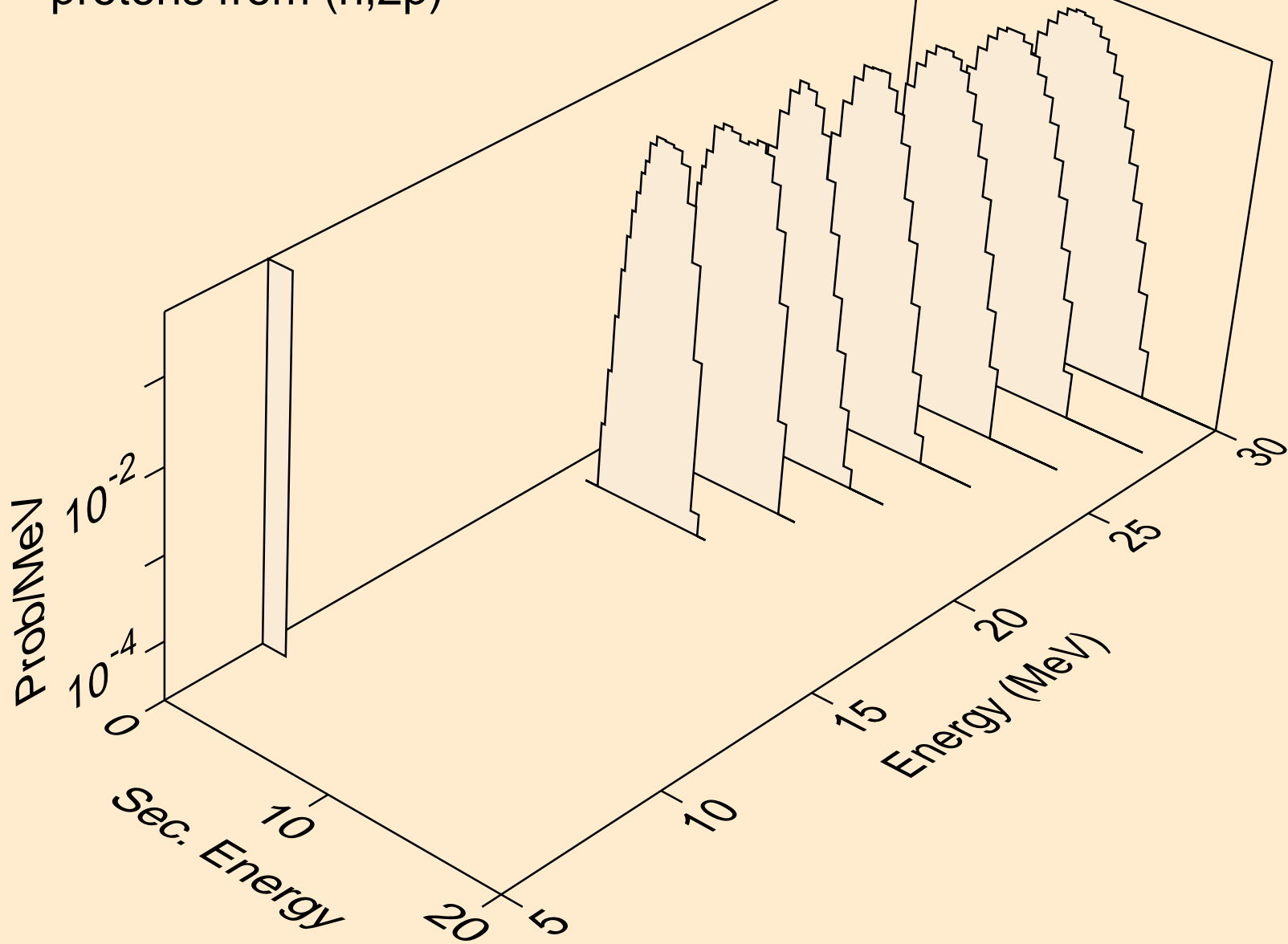

PU242 NEUTRON ACER TENDL-2021 LIBRARY; T=293.6K
deuterons from (n,x)

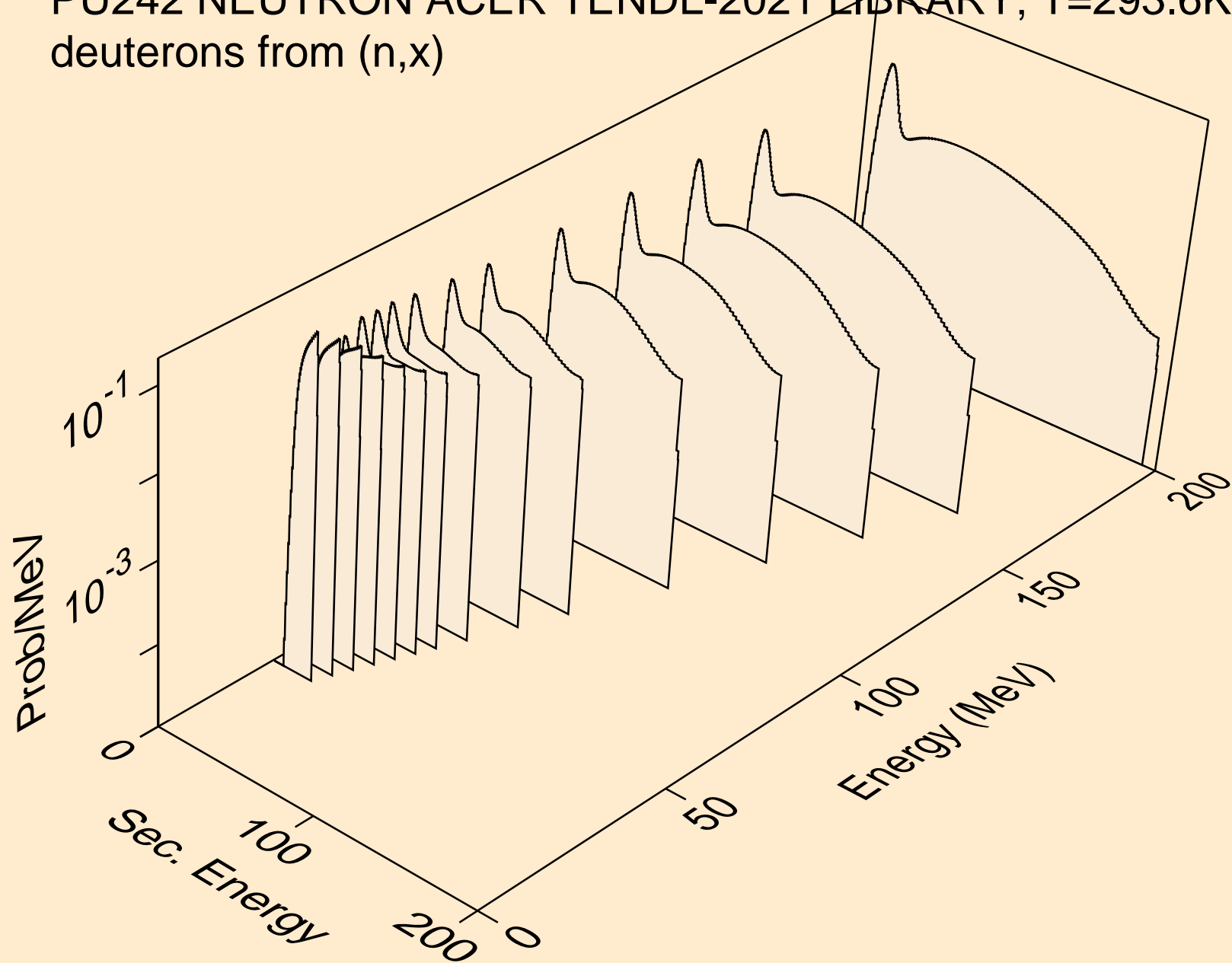

PU242 NEUTRON ACER TENDL-2021 LIBRARY; T=293.6K
deuterons from (n,2nd)

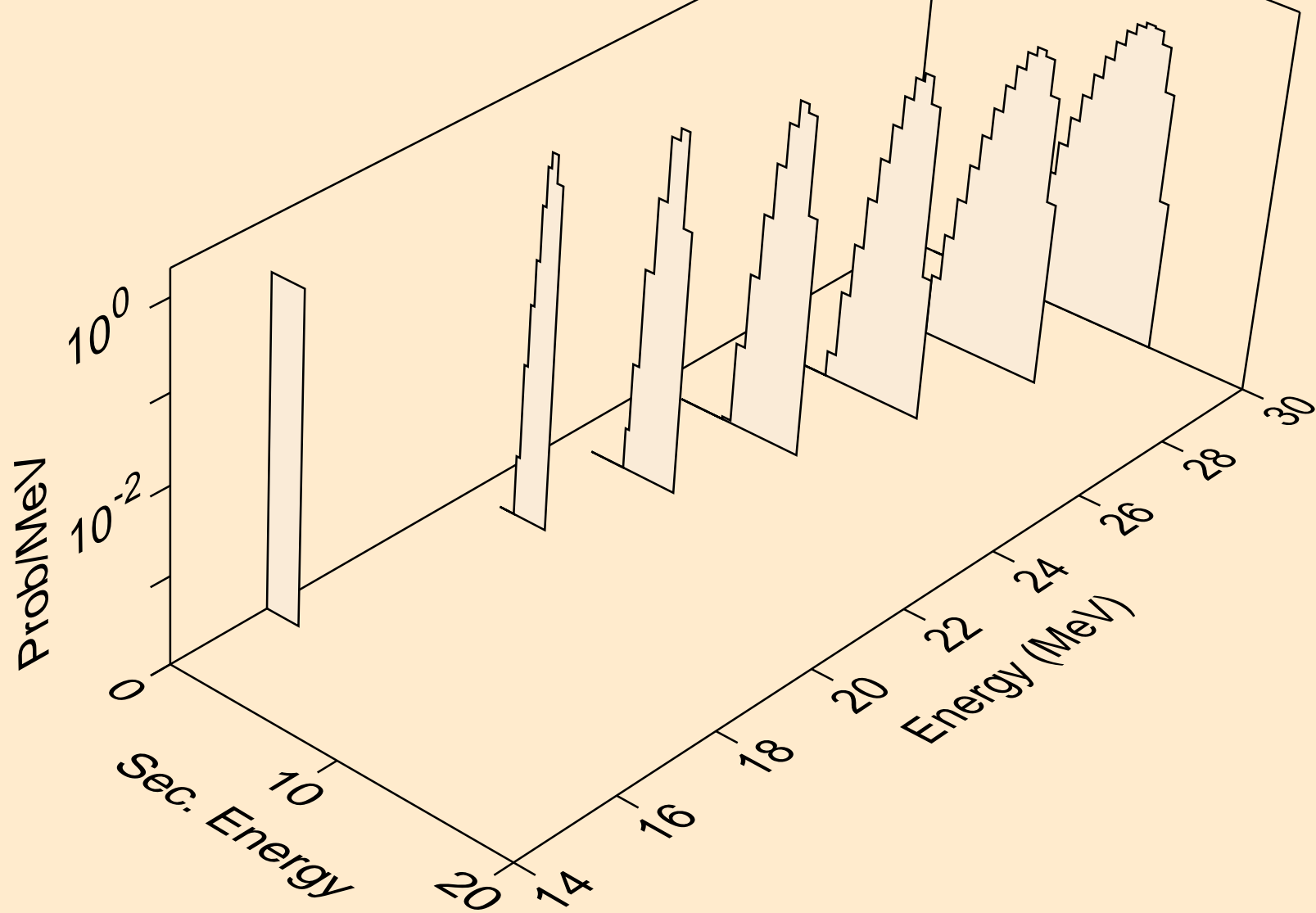

PU242 NEUTRON ACER TENDL-2021 LIBRARY; T=293.6K
deuterons from (n,n*)d

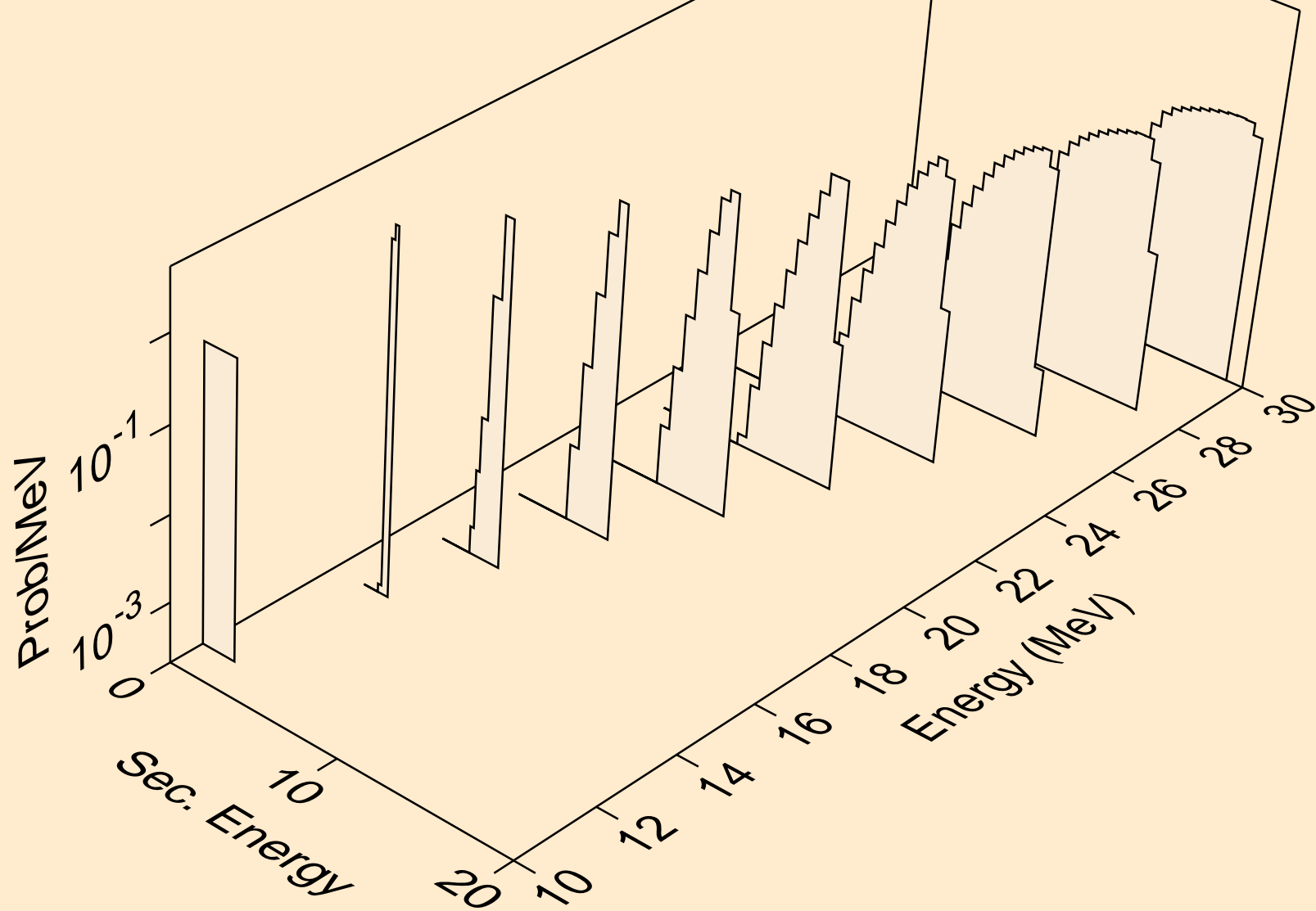

PU242 NEUTRON ACER TENDL-2021 LIBRARY; T=293.6K
deuterons from (n,d)

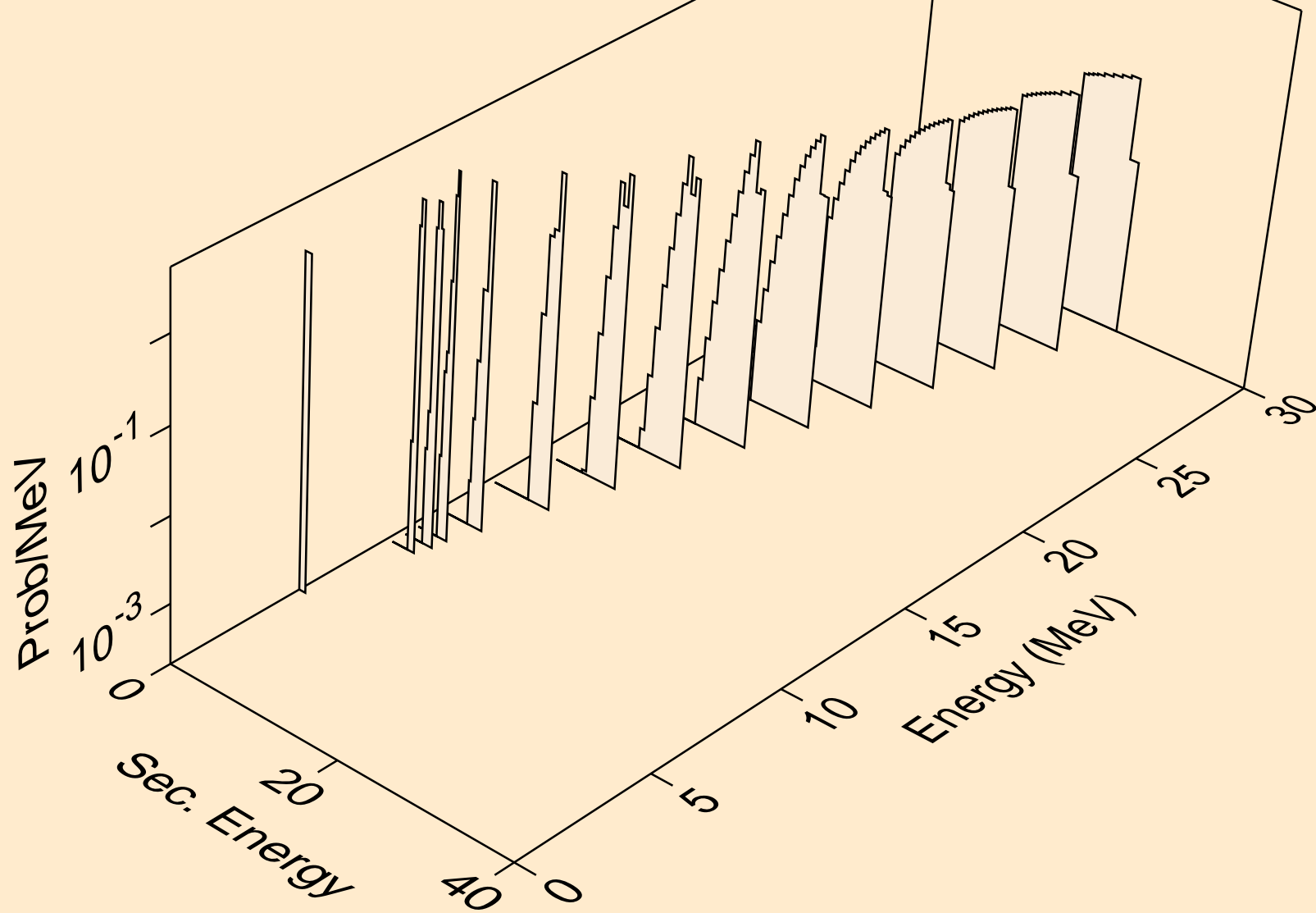

PU242 NEUTRON ACER TENDL-2021 LIBRARY; T=293.6K
tritons from (n,x)

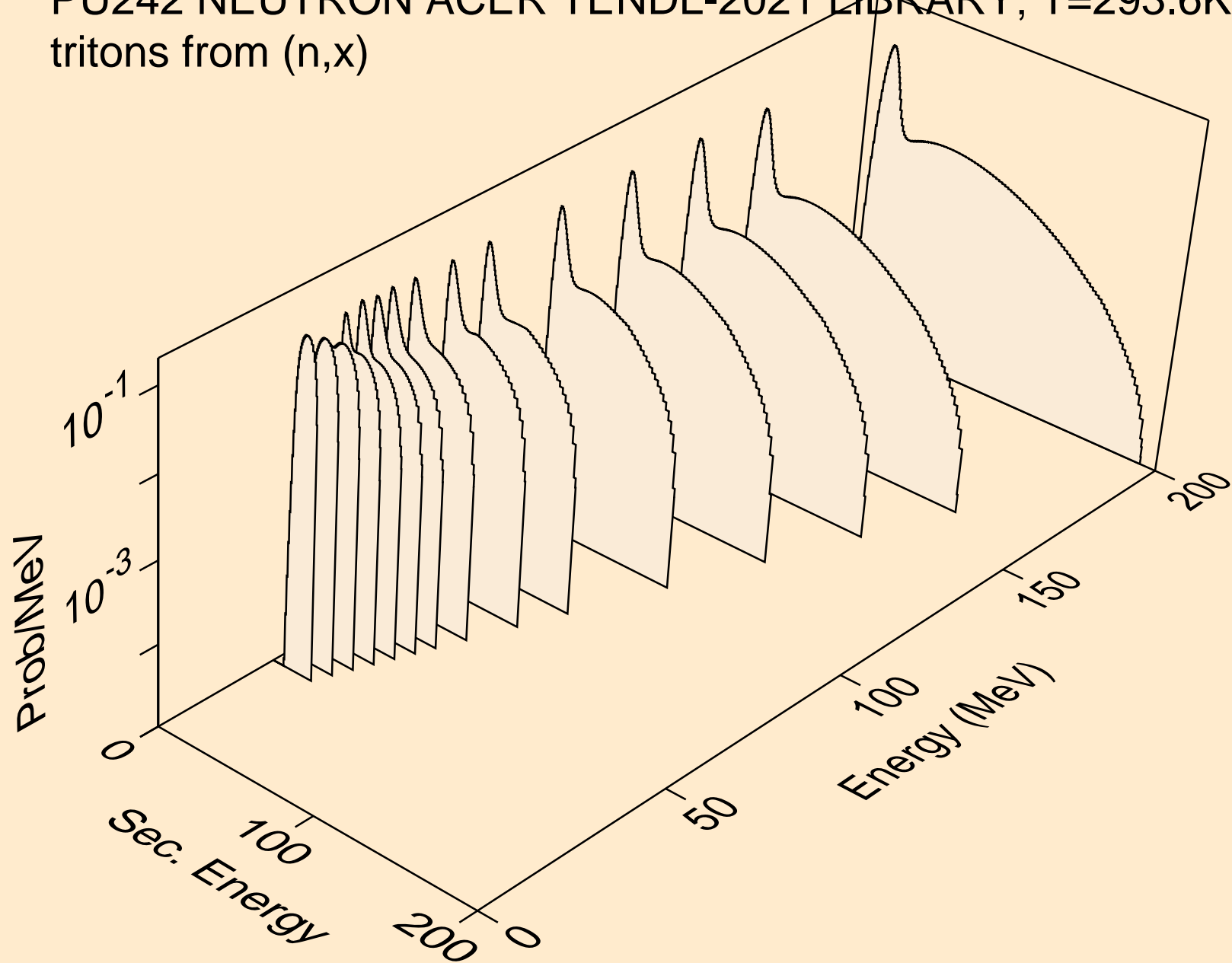

PU242 NEUTRON ACER TENDL-2021 LIBRARY; T=293.6K
tritons from (n,n*)t

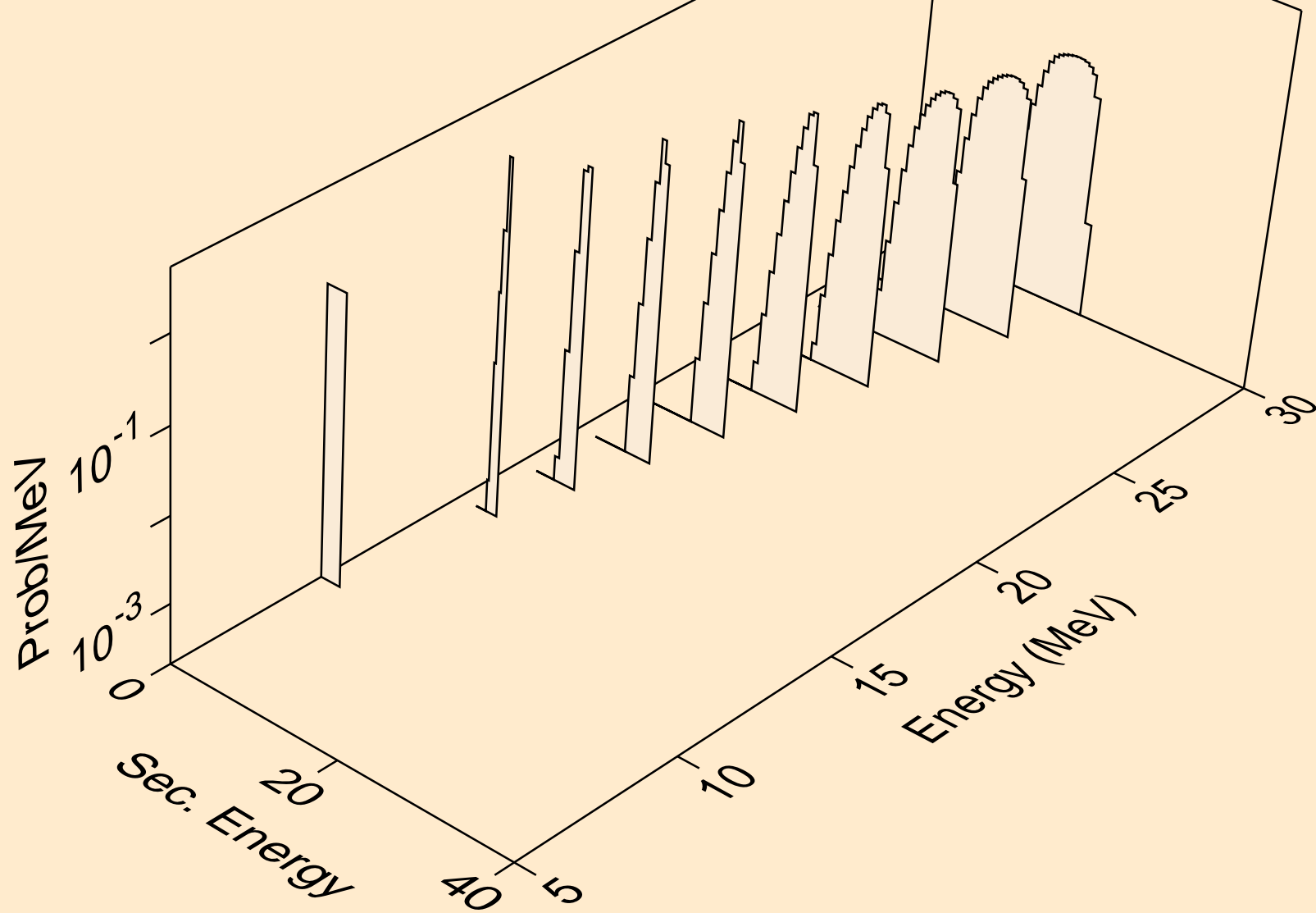

PU242 NEUTRON ACER TENDL-2021 LIBRARY; T=293.6K
tritons from (n,t)

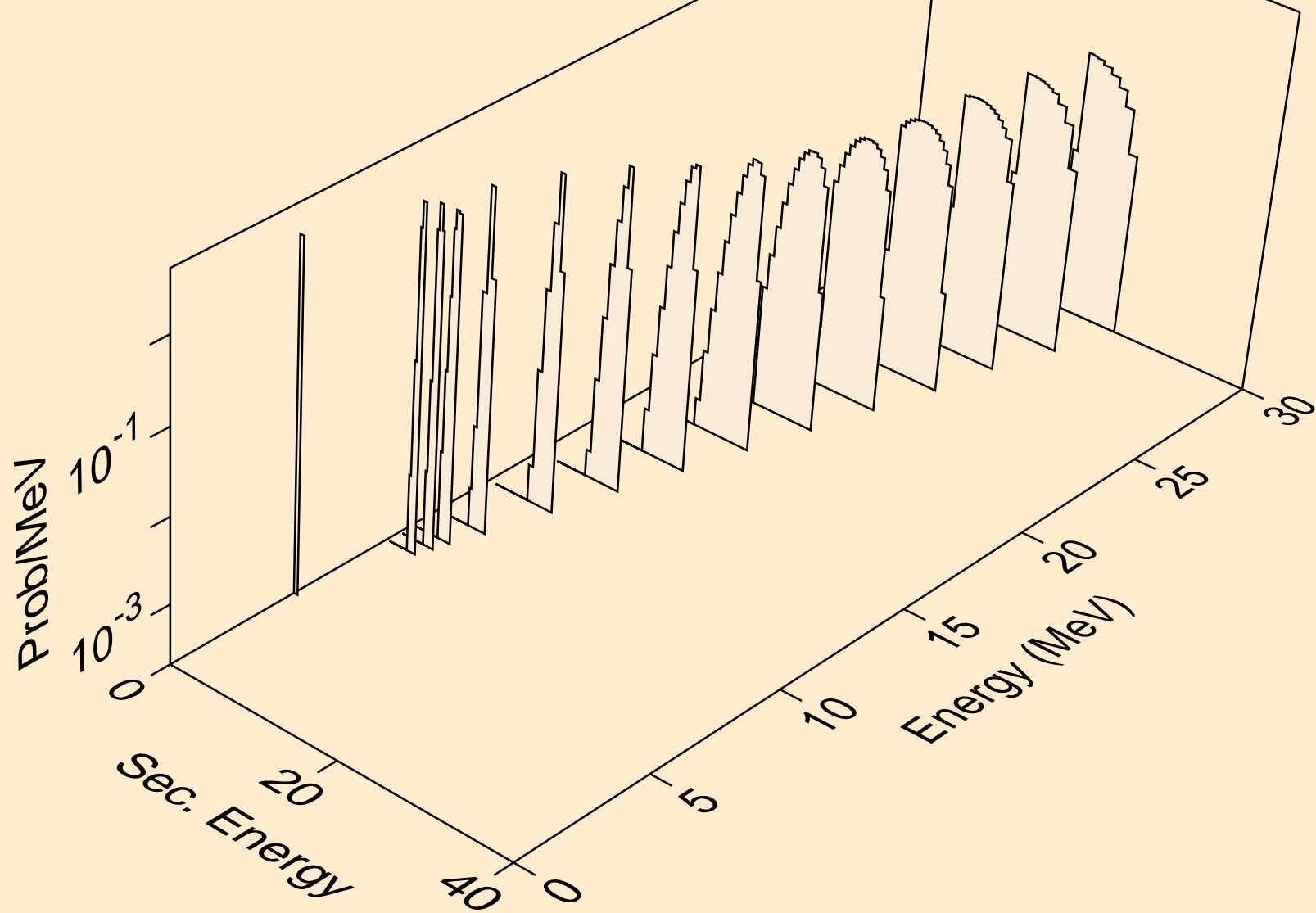

PU242 NEUTRON ACER TENDL-2021 LIBRARY; T=293.6K
he3s from (n,x)

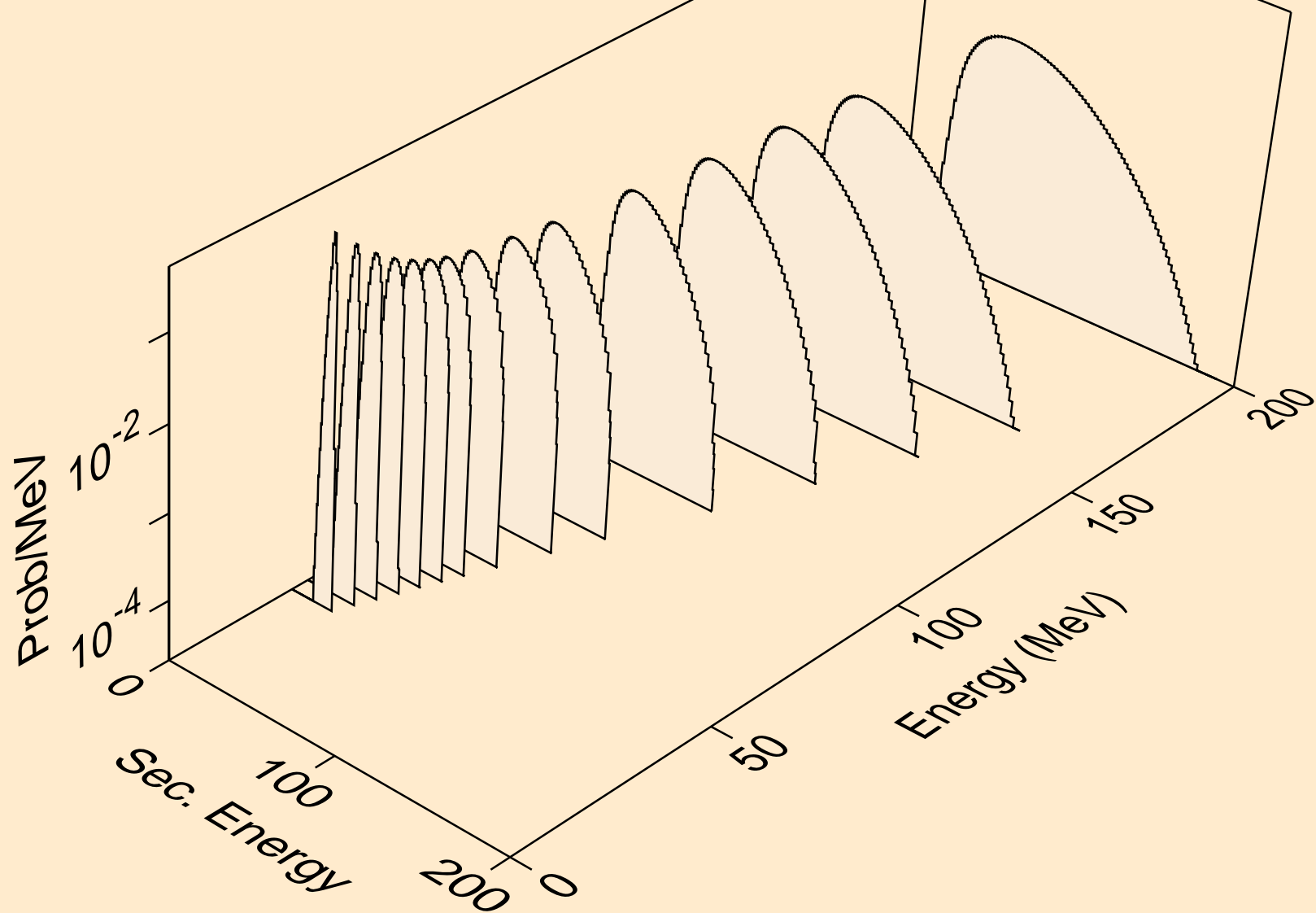

PU242 NEUTRON ACER TENDL-2021 LIBRARY; T=293.6K
he3s from (n,n*)he3

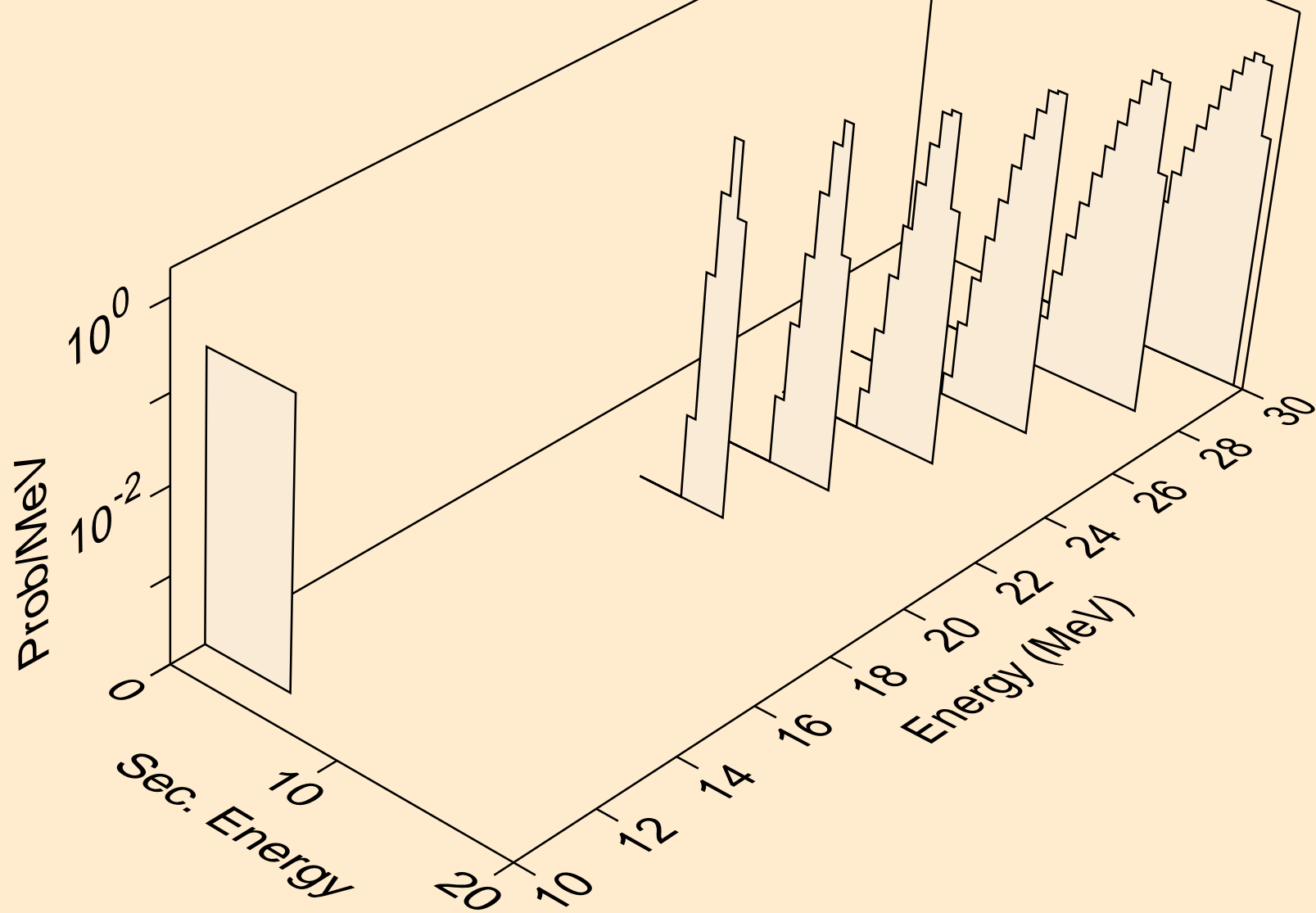

PU242 NEUTRON ACER TENDL-2021 LIBRARY; T=293.6K
he3s from (n,he3)

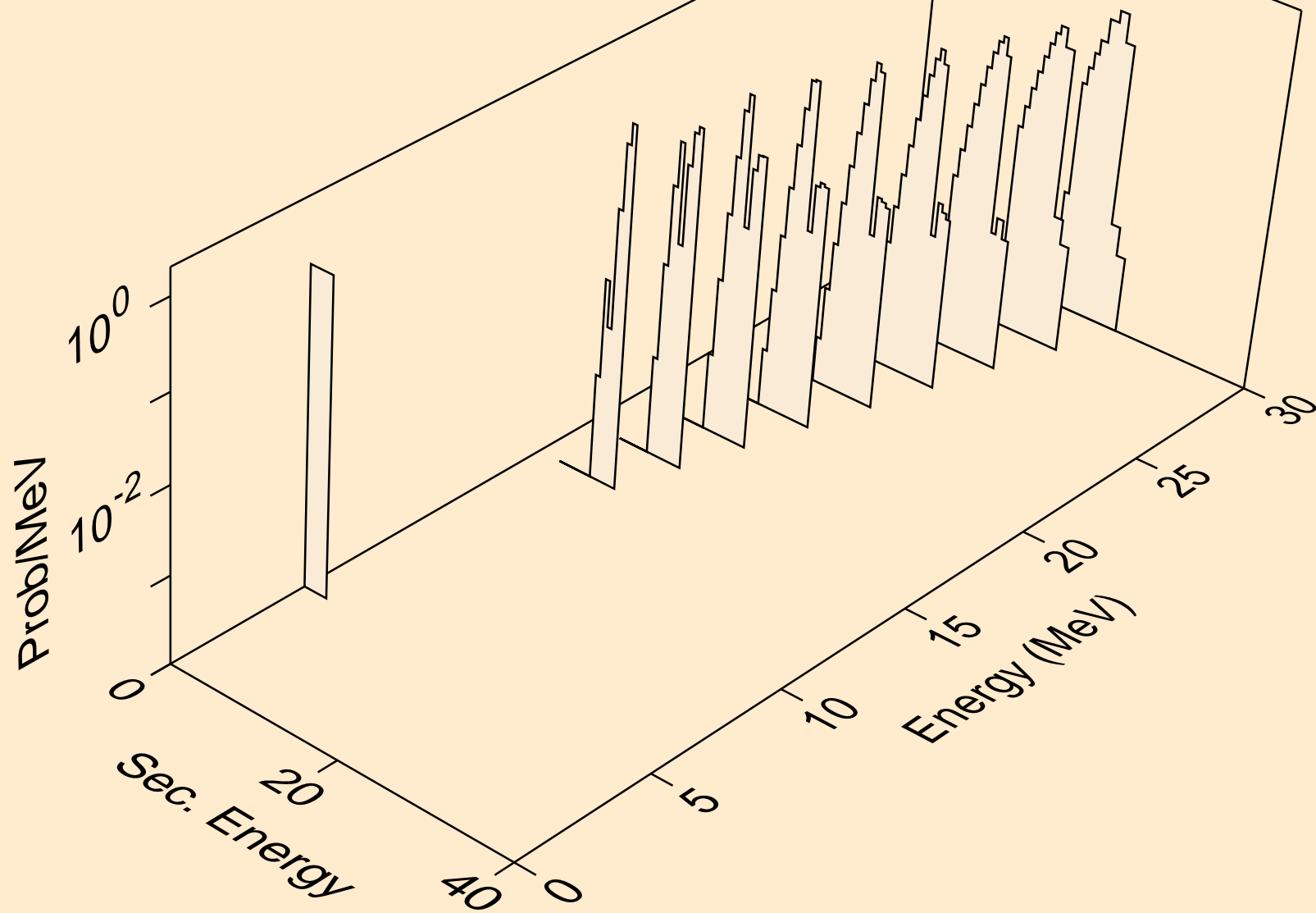

PU242 NEUTRON ACER TENDL-2021 LIBRARY; T=293.6K
alphas from (n,x)

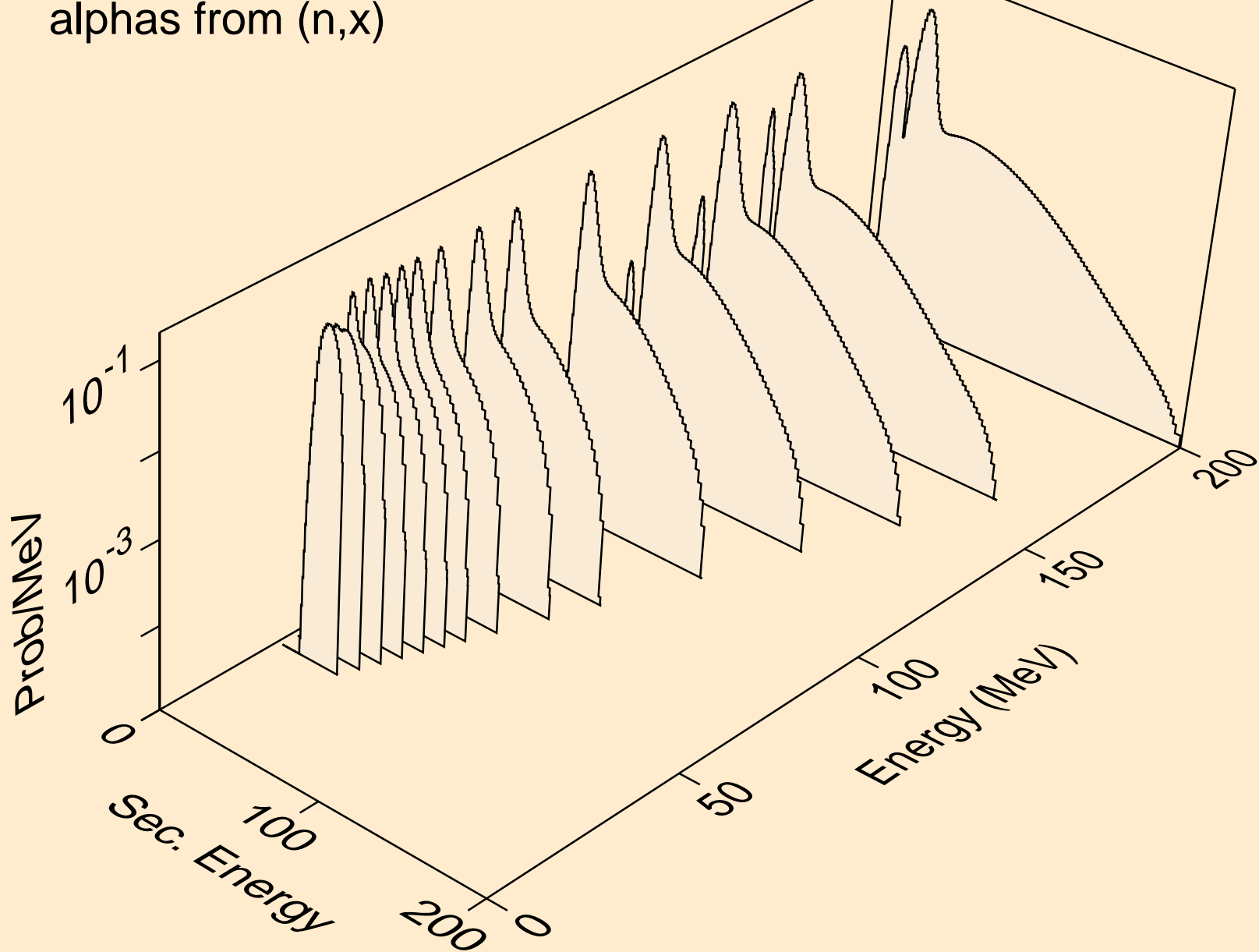

PU242 NEUTRON ACER TENDL-2021 LIBRARY; T=293.6K
alphas from (n,n*)a

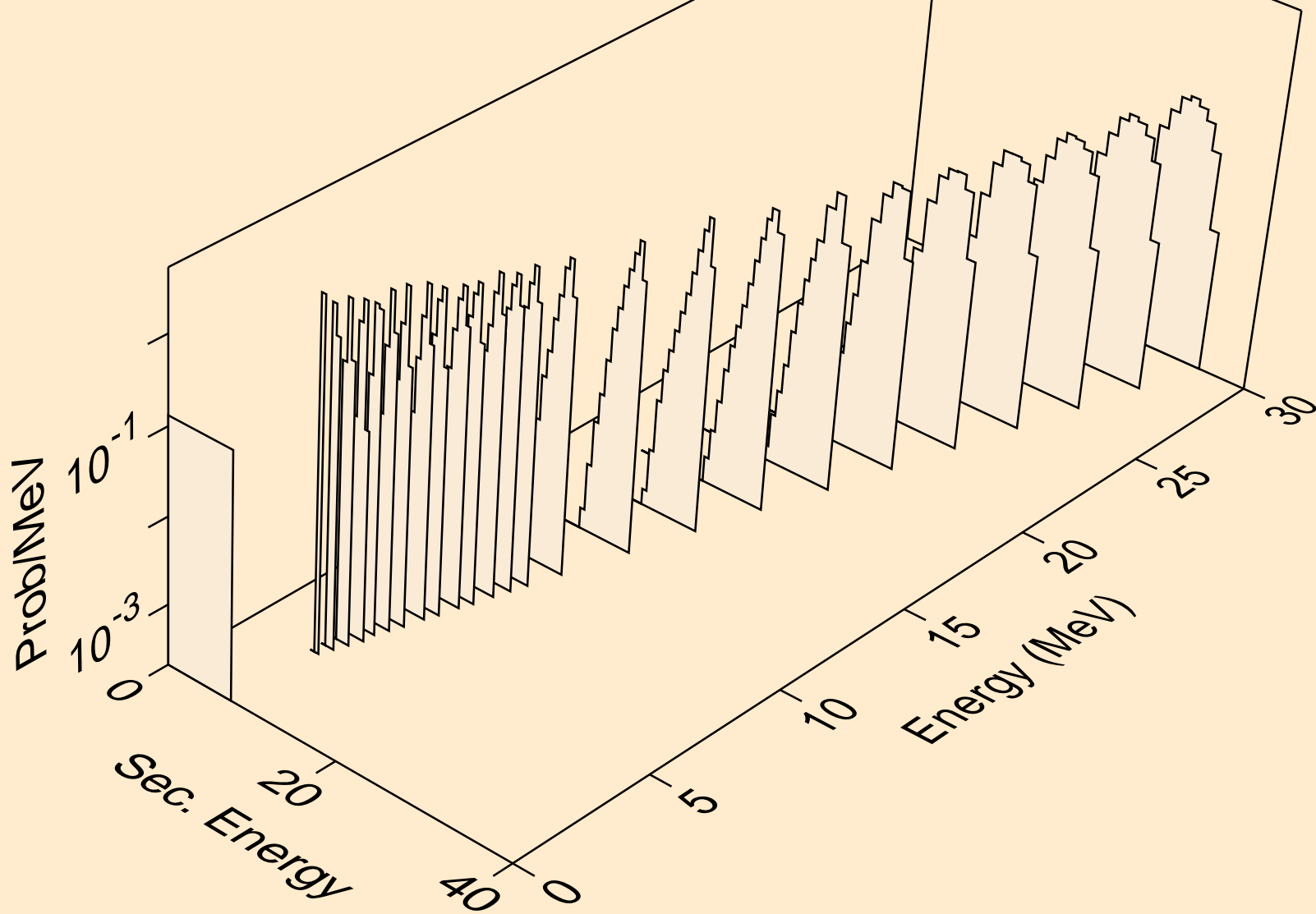

PU242 NEUTRON ACER TENDL-2021 LIBRARY; T=293.6K
alphas from (n,2n)a

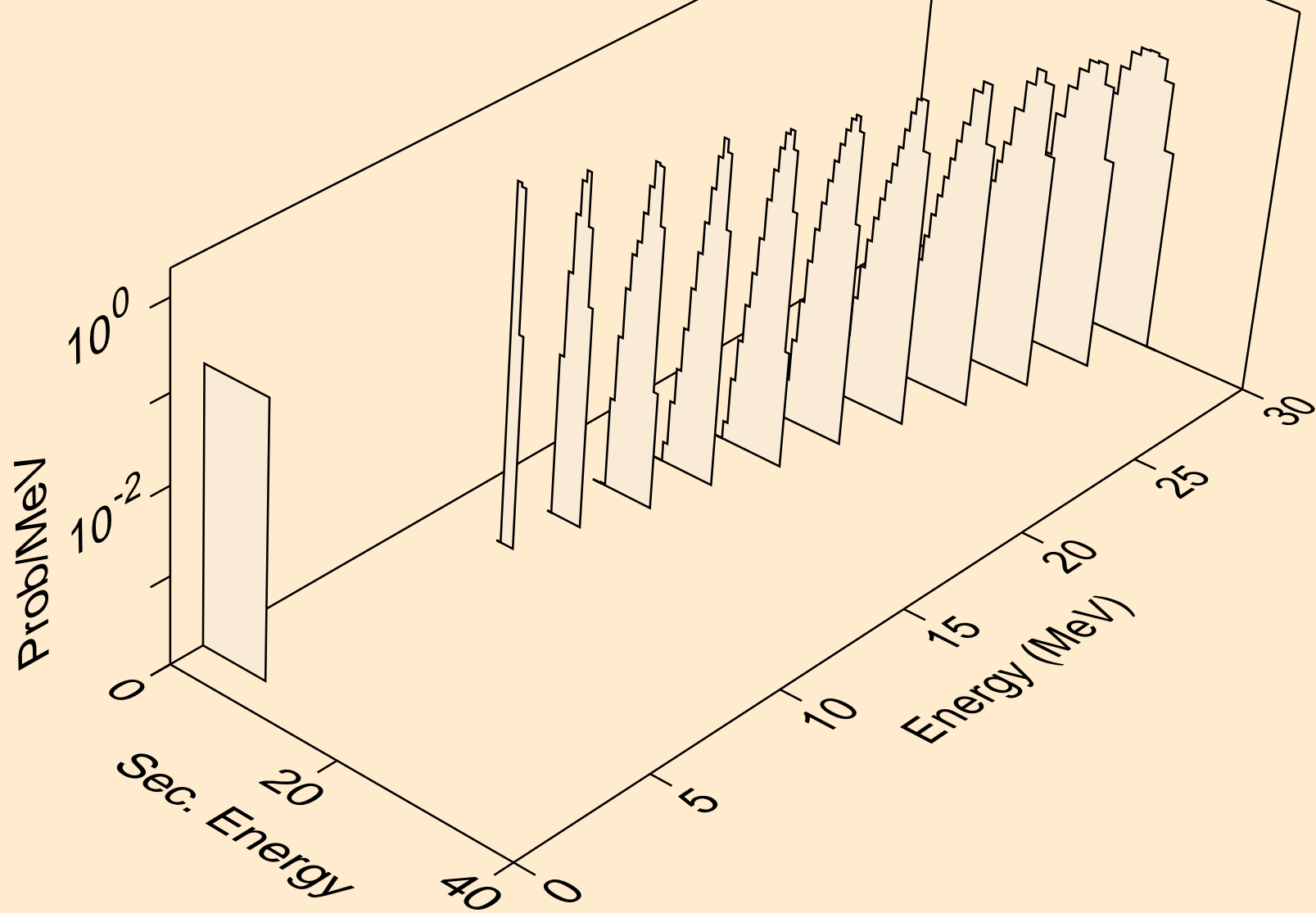

PU242 NEUTRON ACER TENDL-2021 LIBRARY; T=293.6K
alphas from (n,3n)a

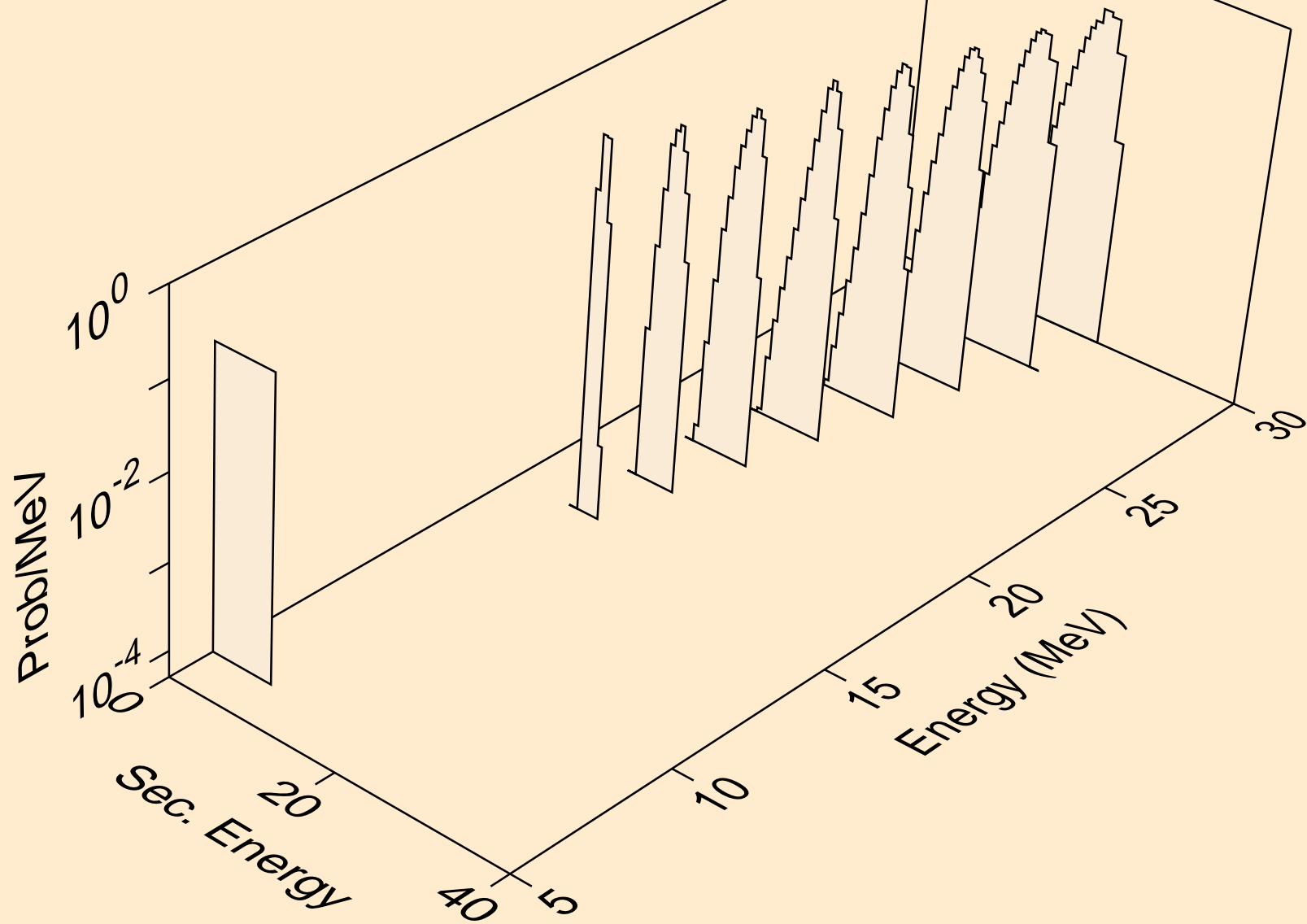

PU242 NEUTRON ACER TENDL-2021 LIBRARY; T=293.6K
alphas from (n,a)

