

RA233 NEUTRON ACER TENDL-2021 LIBRARY; T=293.6K
Principal cross sections

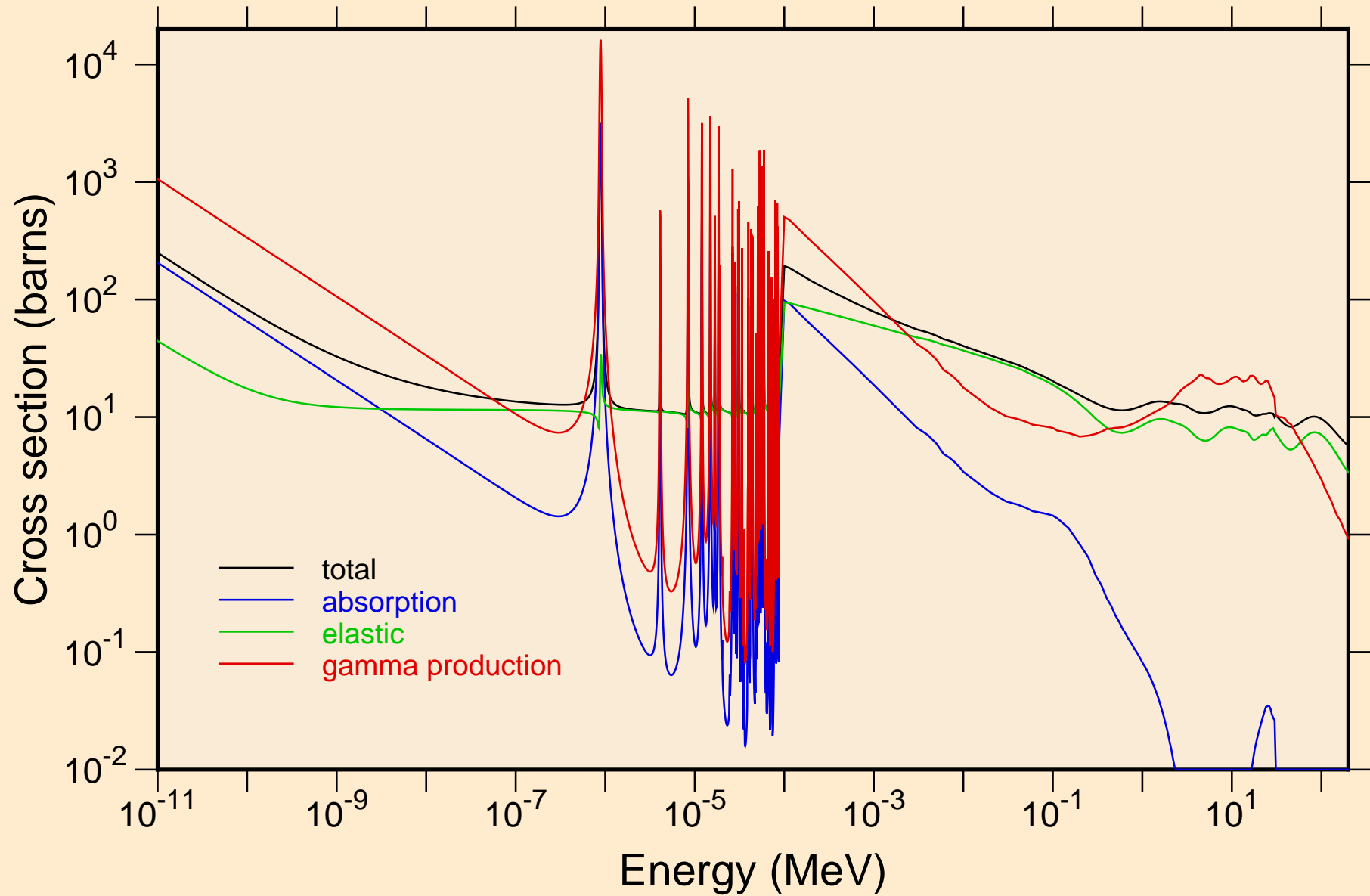

RA233 NEUTRON ACER TENDL-2021 LIBRARY; T=293.6K
resonance total cross section

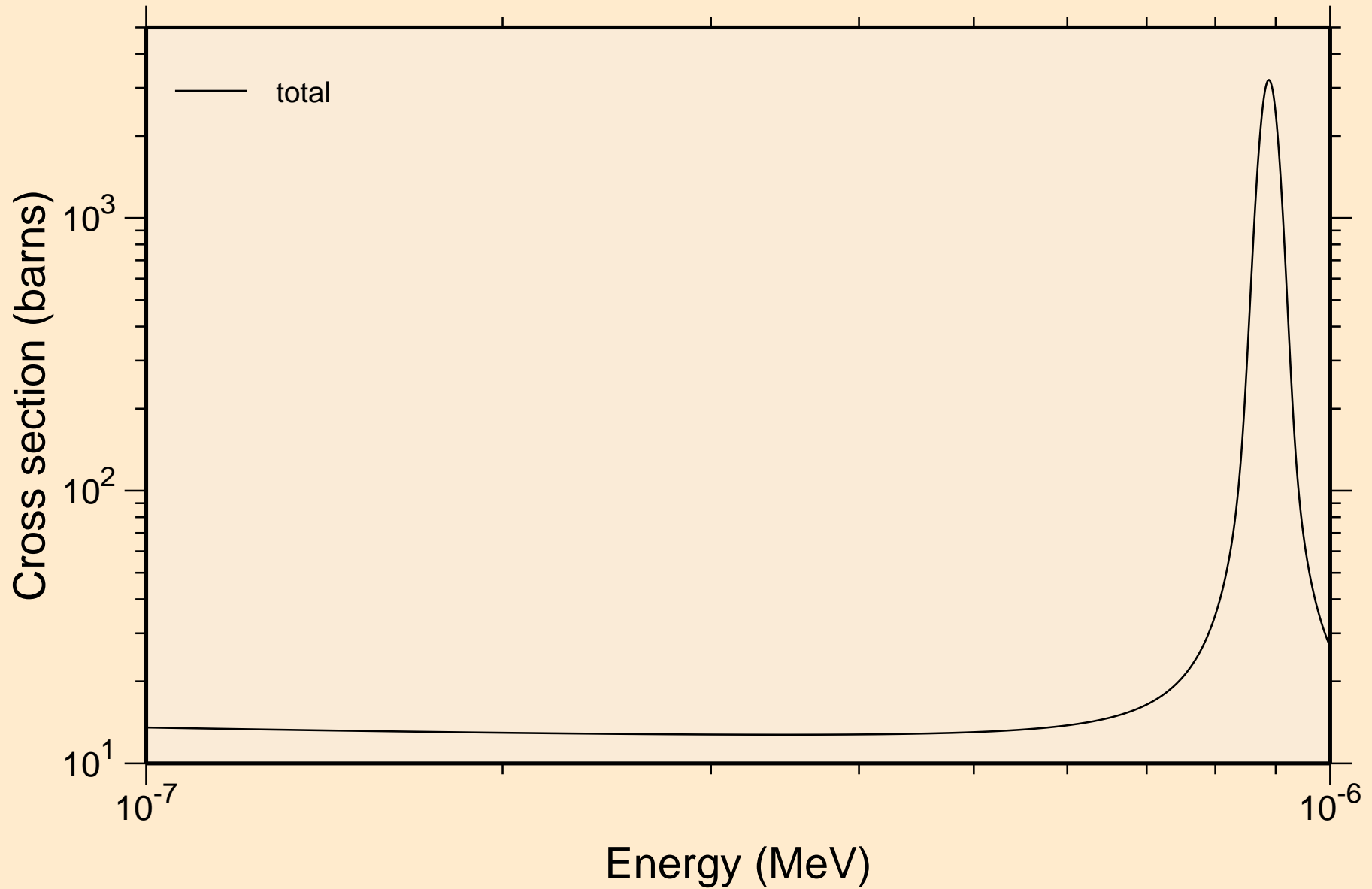

RA233 NEUTRON ACER TENDL-2021 LIBRARY; T=293.6K
resonance total cross section

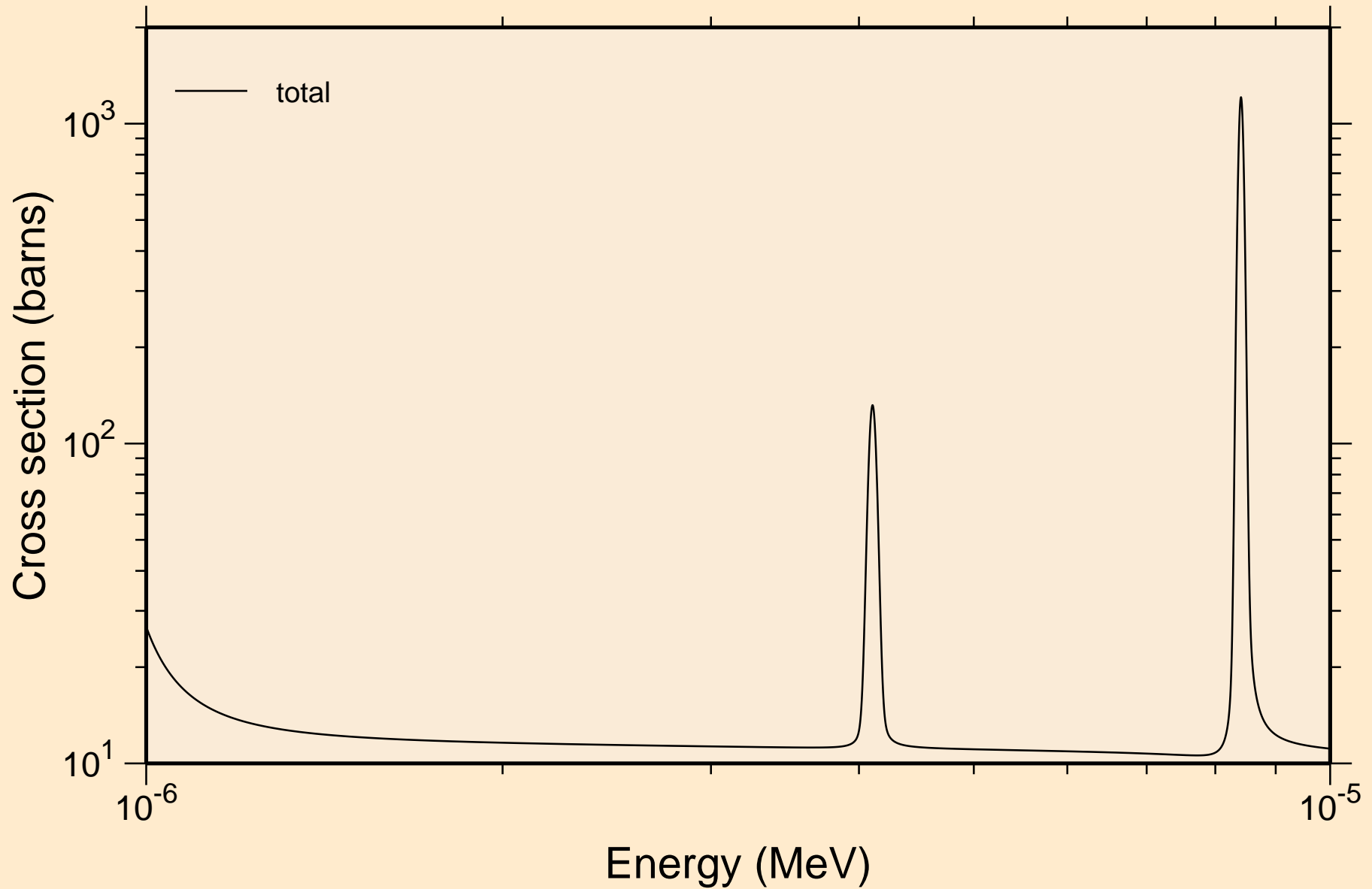

RA233 NEUTRON ACER TENDL-2021 LIBRARY; T=293.6K
resonance total cross section

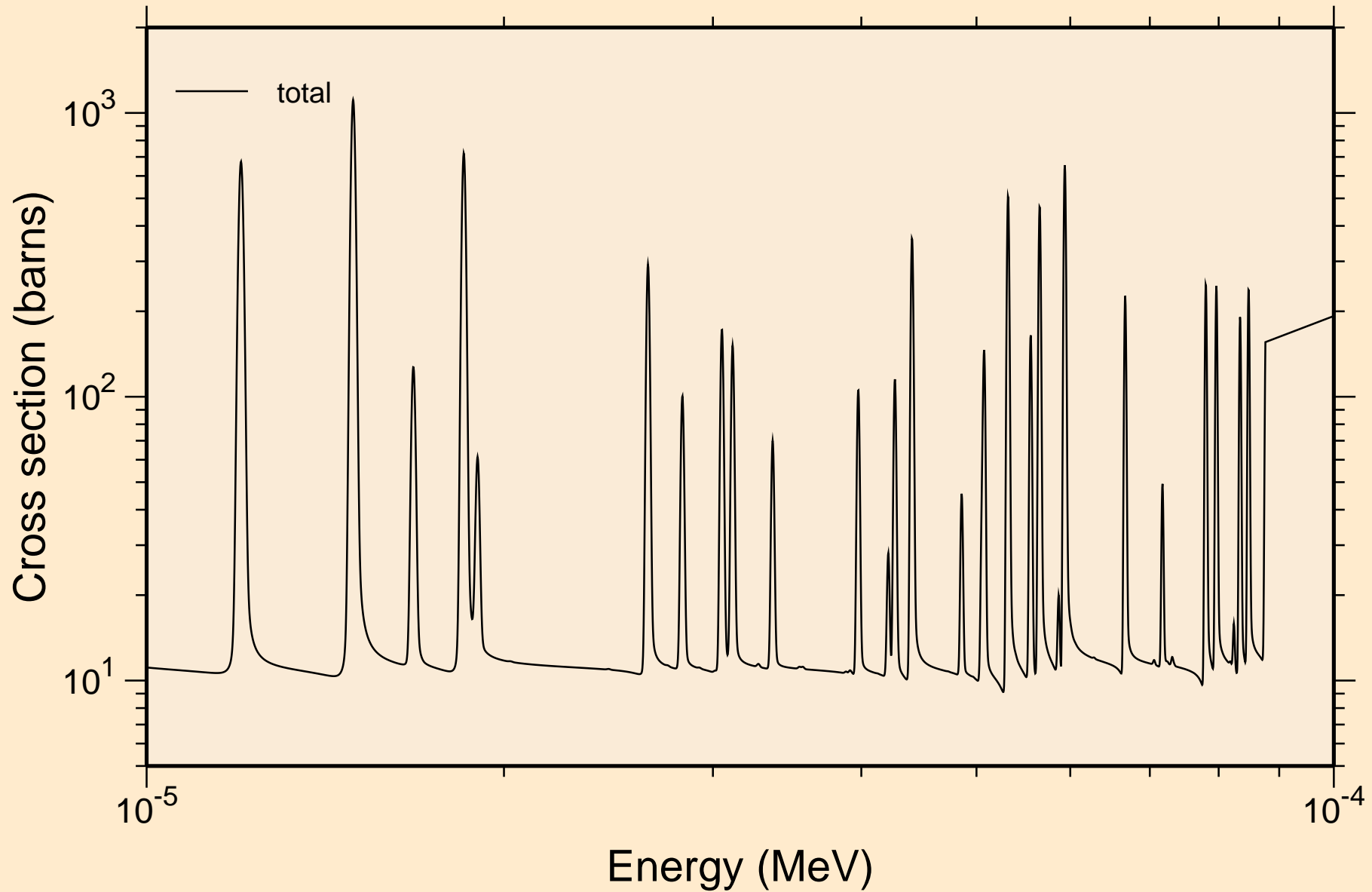

RA233 NEUTRON ACER TENDL-2021 LIBRARY; T=293.6K
resonance total cross section

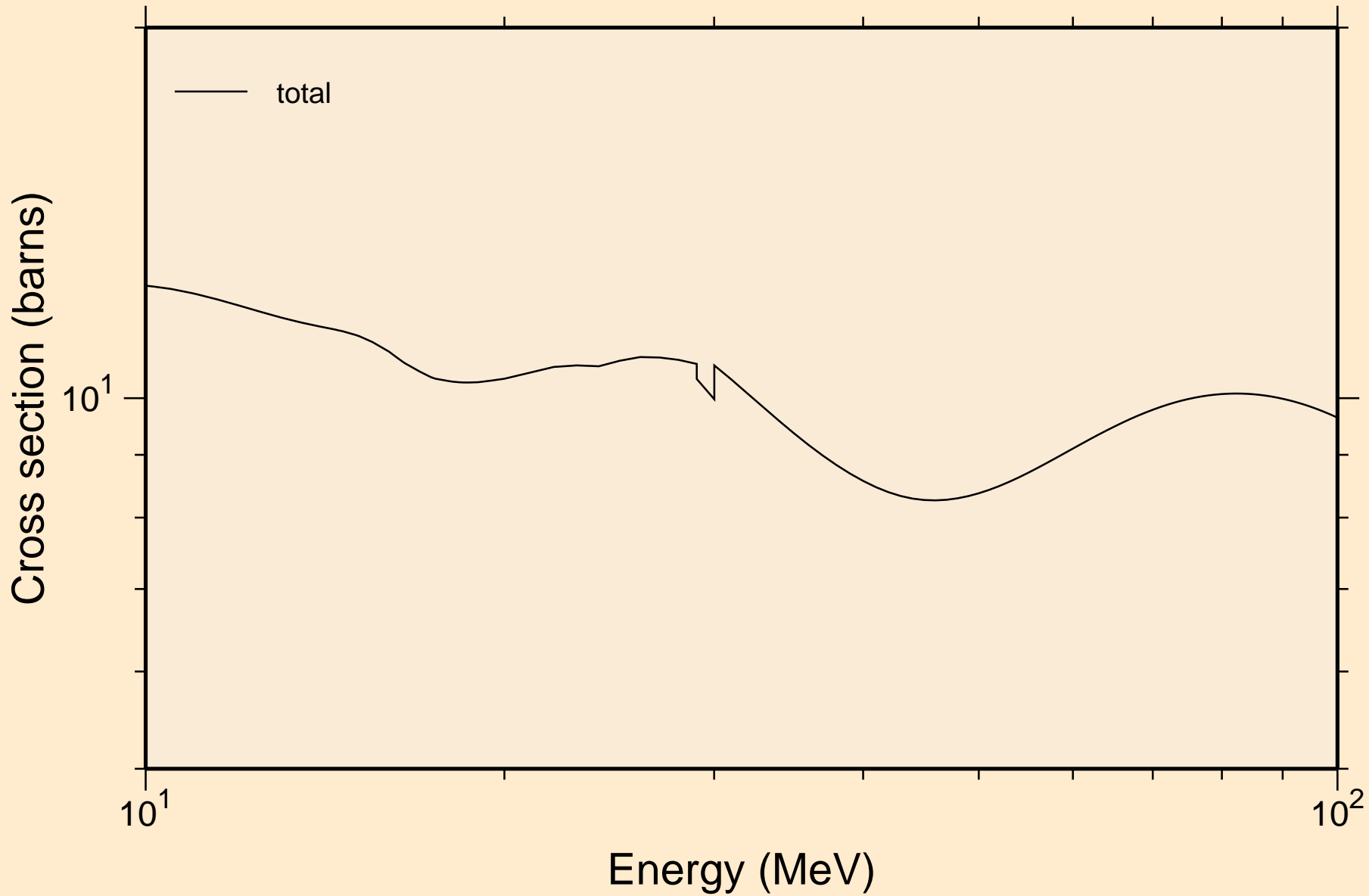

RA233 NEUTRON ACER TENDL-2021 LIBRARY; T=293.6K
resonance absorption cross sections

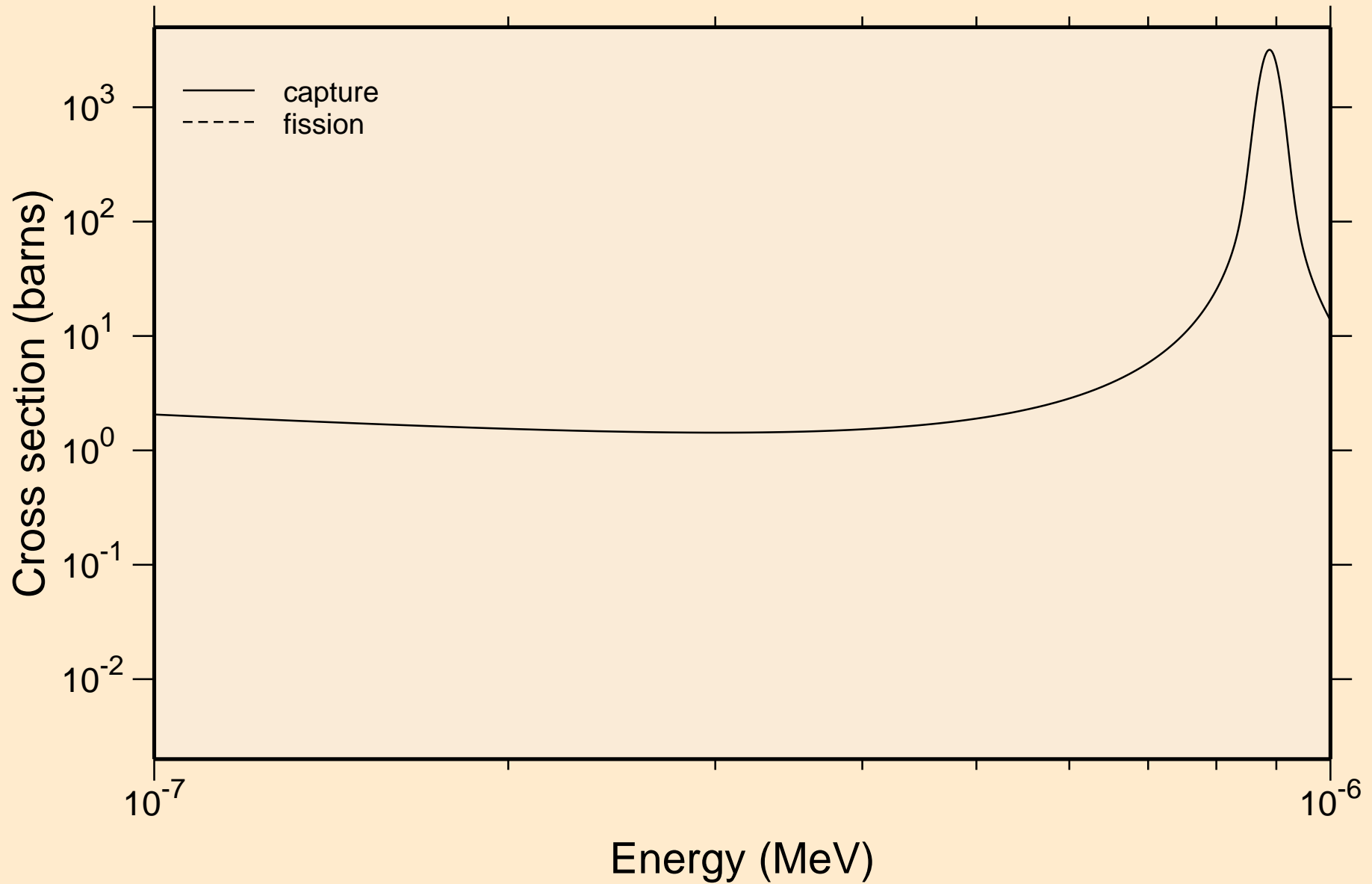

RA233 NEUTRON ACER TENDL-2021 LIBRARY; T=293.6K
resonance absorption cross sections

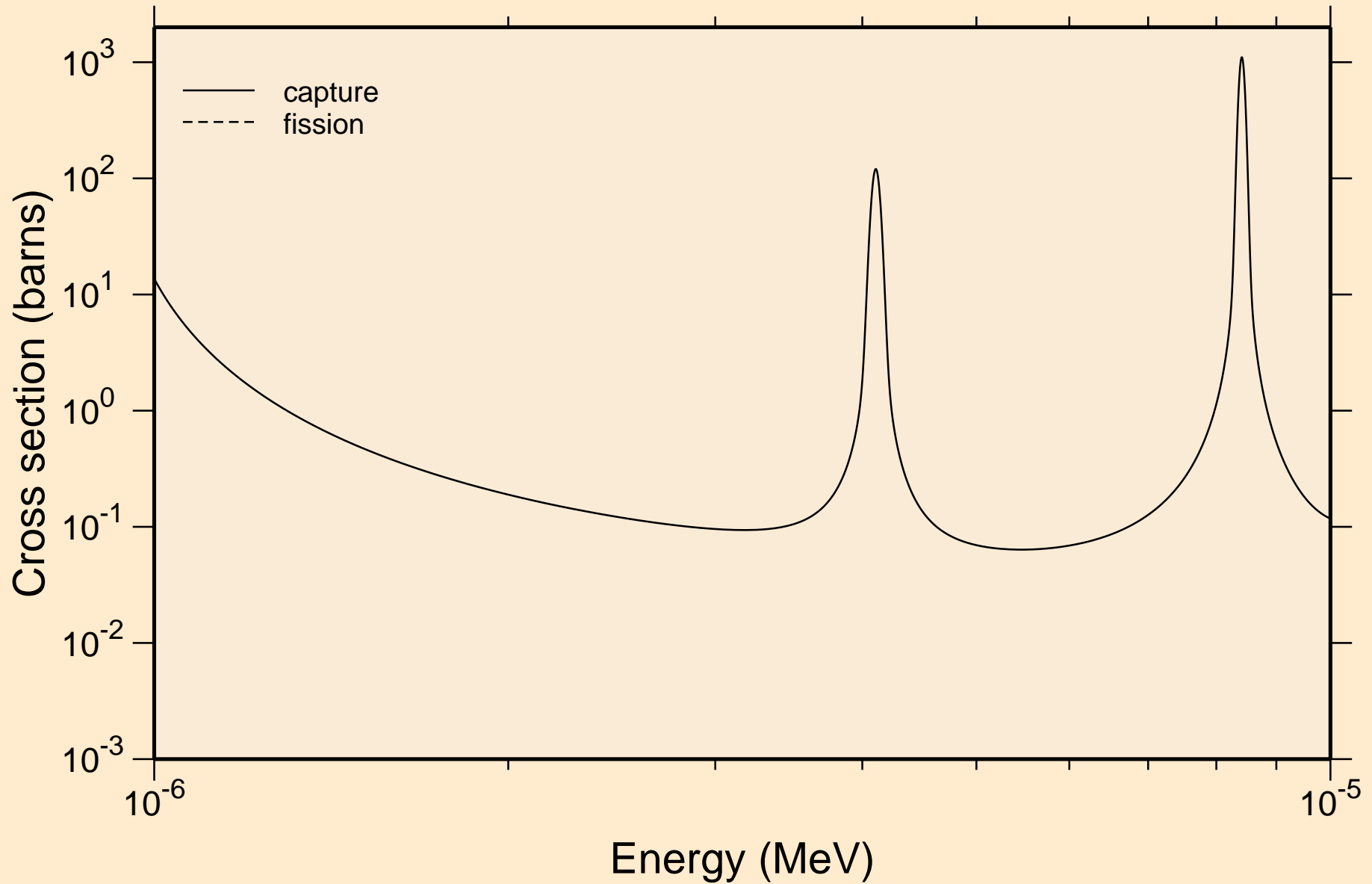

RA233 NEUTRON ACER TENDL-2021 LIBRARY; T=293.6K
resonance absorption cross sections

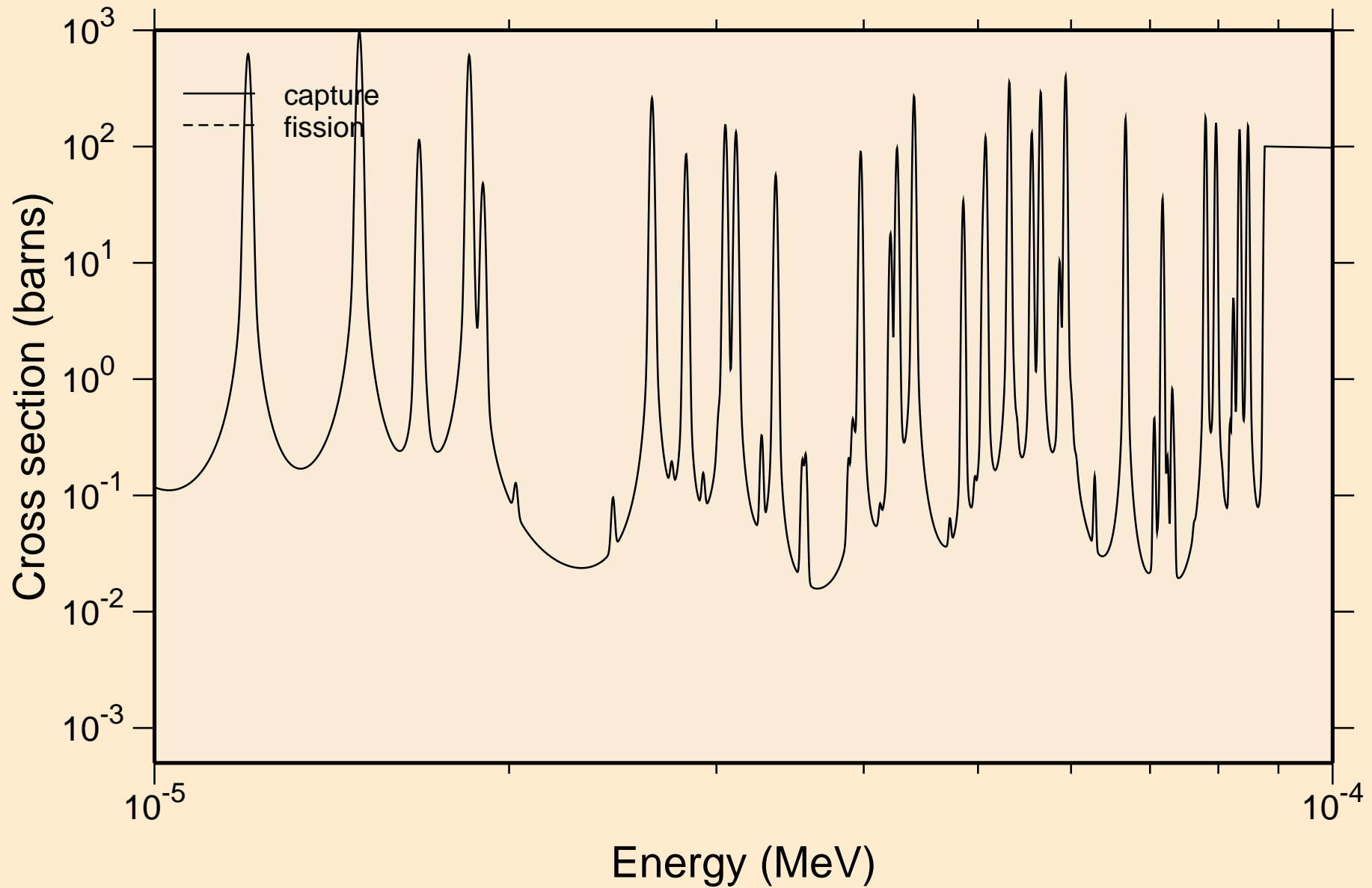

RA233 NEUTRON ACER TENDL-2021 LIBRARY; T=293.6K
resonance absorption cross sections

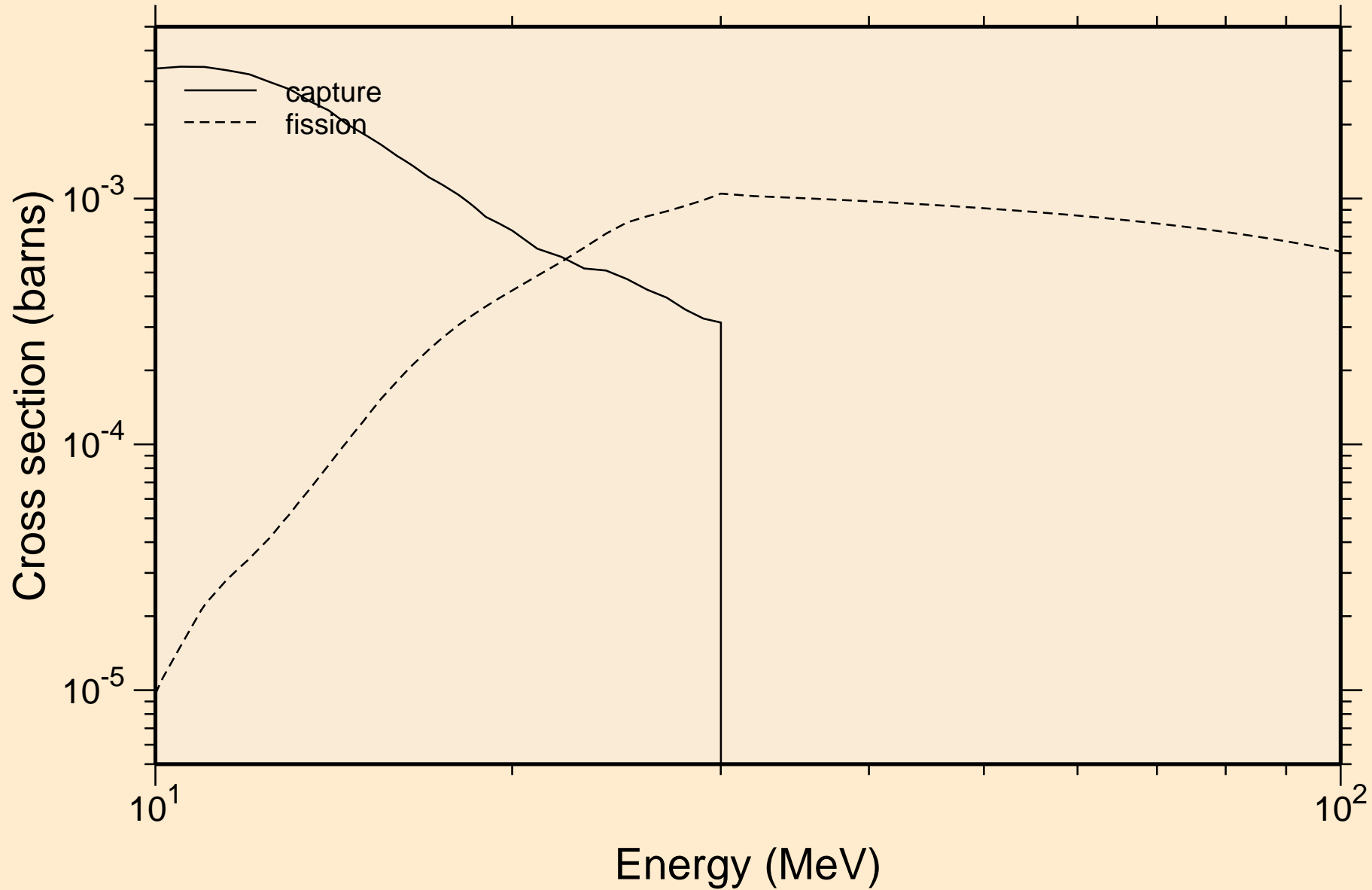

RA233 NEUTRON ACER TENDL-2021 LIBRARY; T=293.6K
Heating

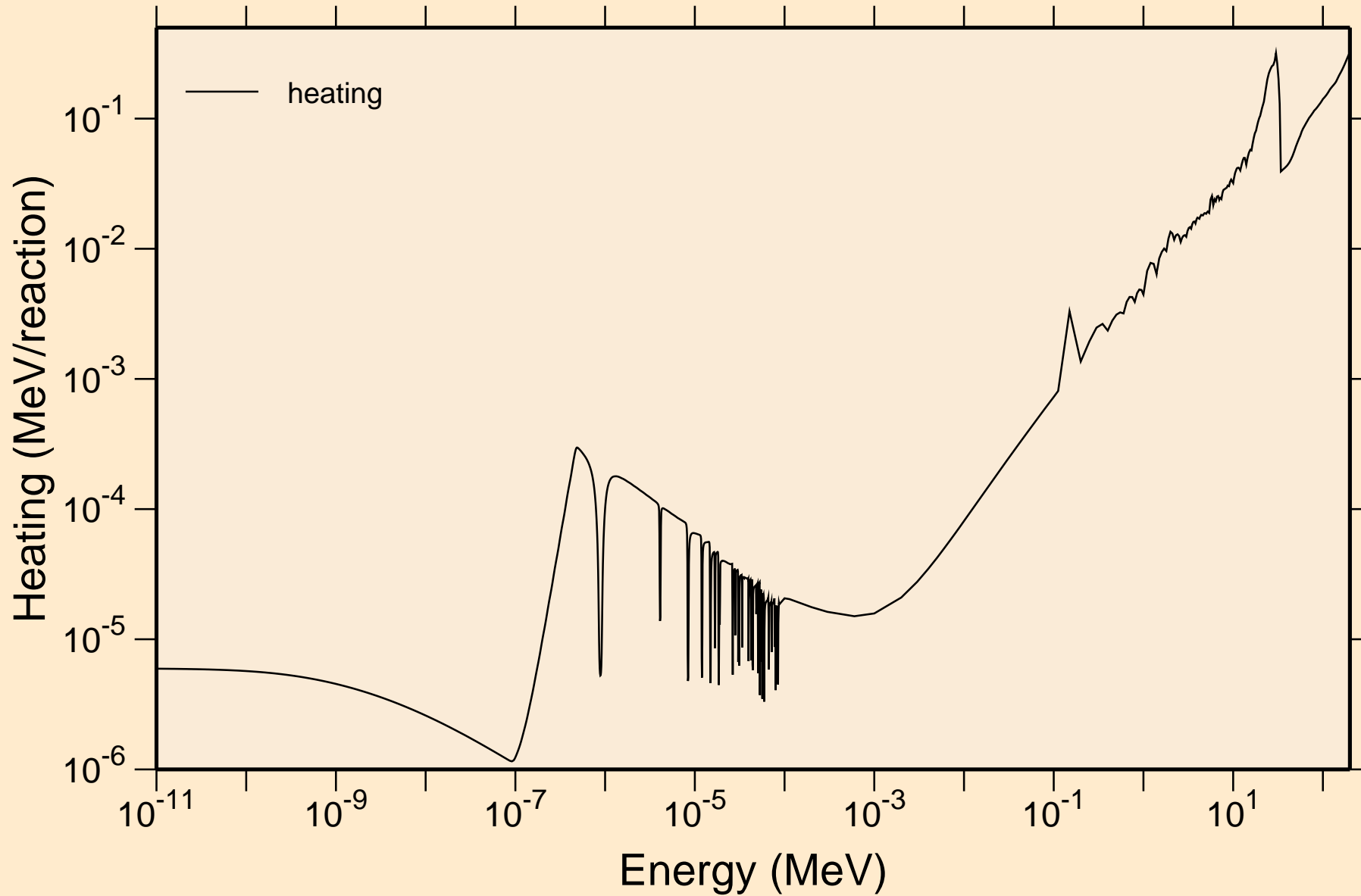

RA233 NEUTRON ACER TENDL-2021 LIBRARY; T=293.6K
Damage

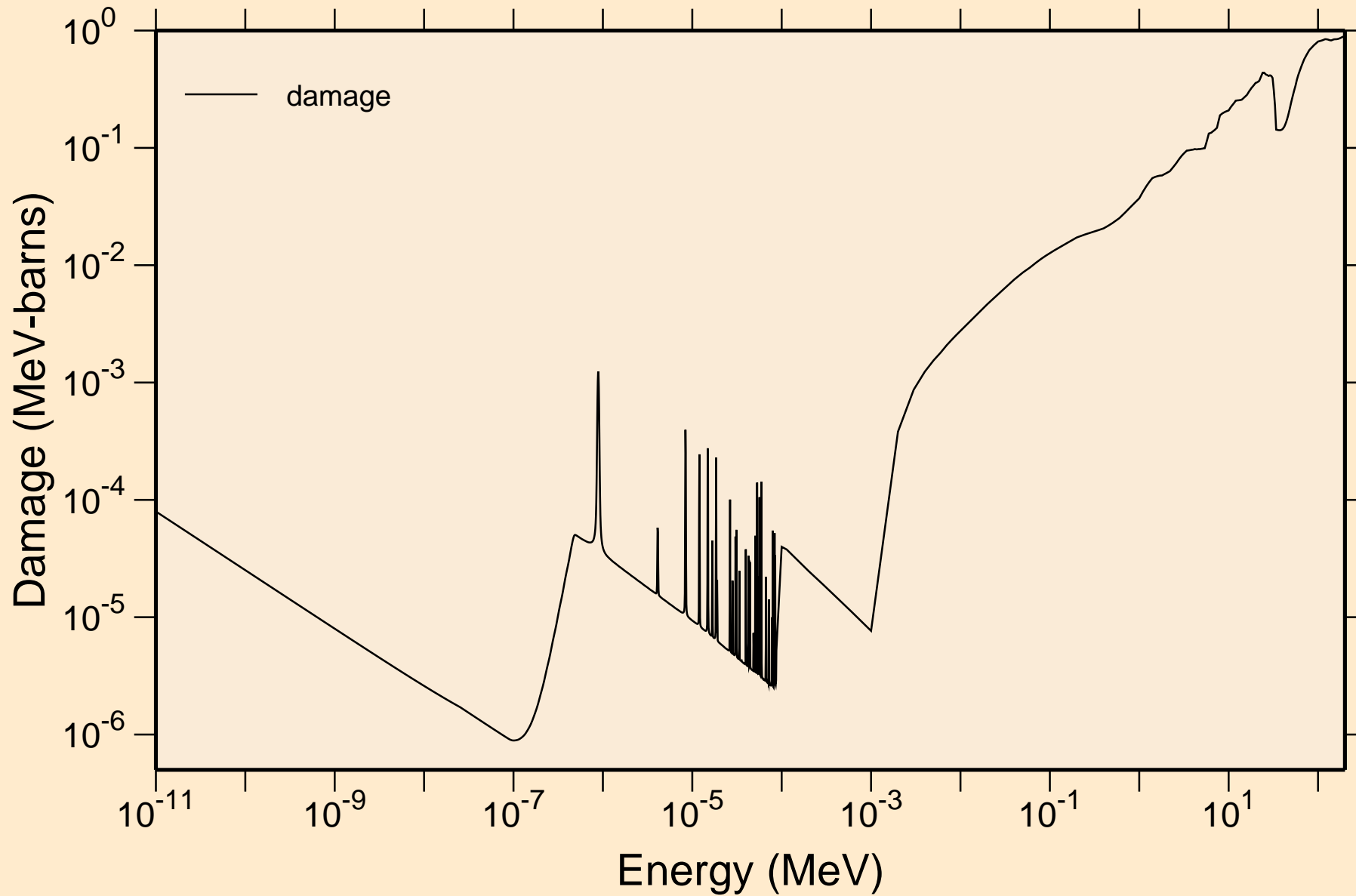

RA233 NEUTRON ACER TENDL-2021 LIBRARY; T=293.6K
Non-threshold reactions

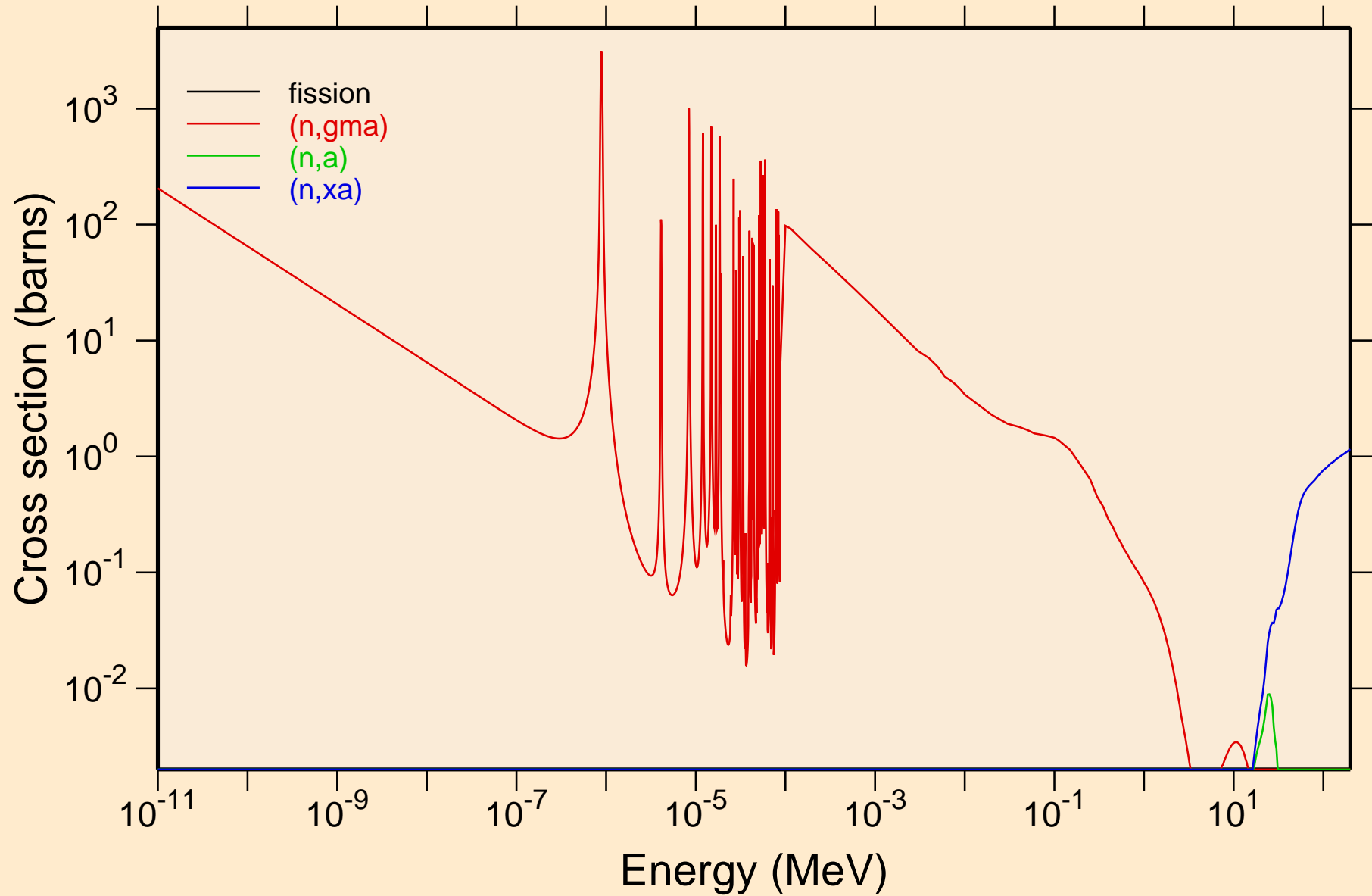

RA233 NEUTRON ACER TENDL-2021 LIBRARY; T=293.6K
Principal cross sections

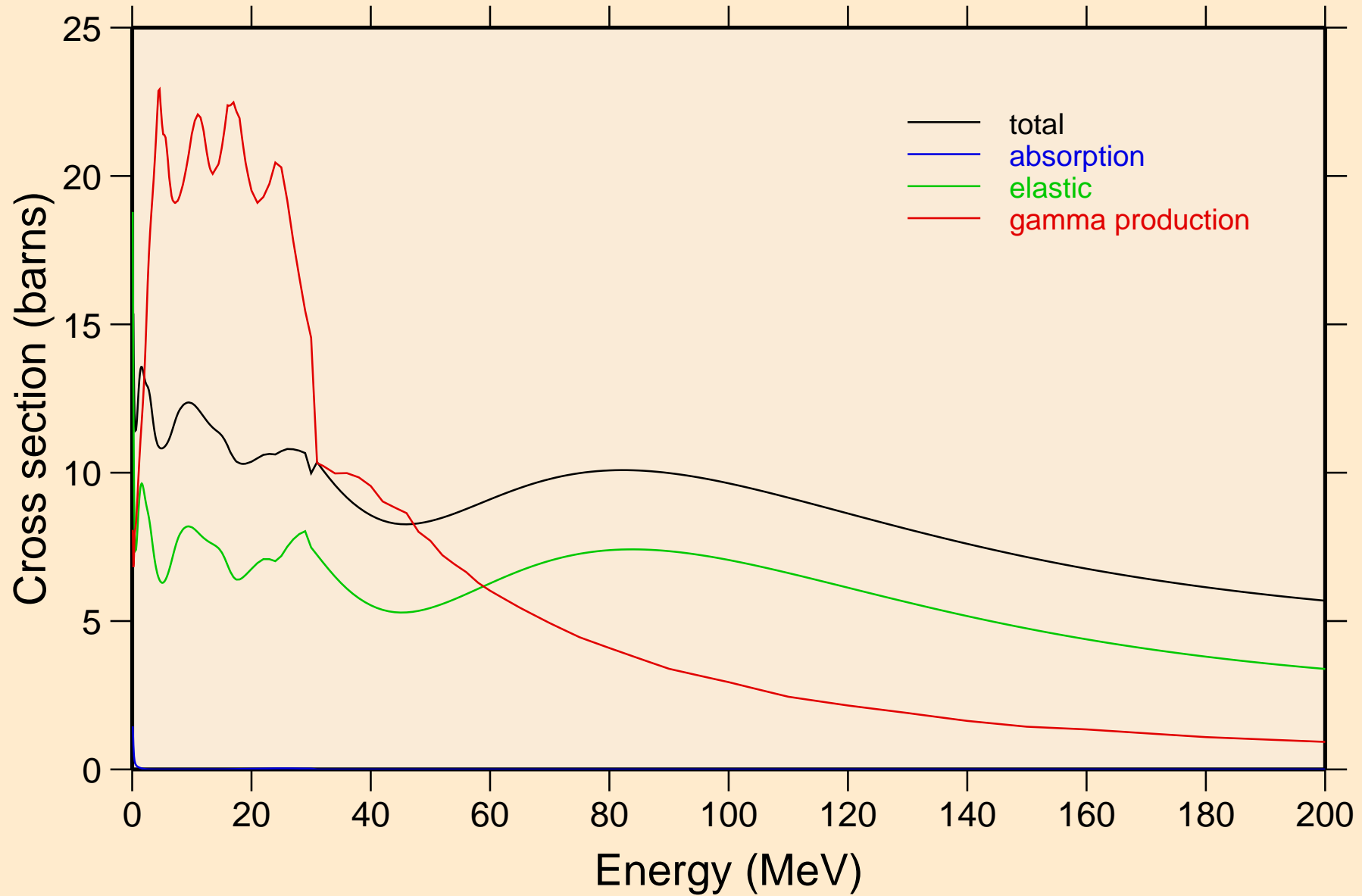

RA233 NEUTRON ACER TENDL-2021 LIBRARY; T=293.6K
Heating

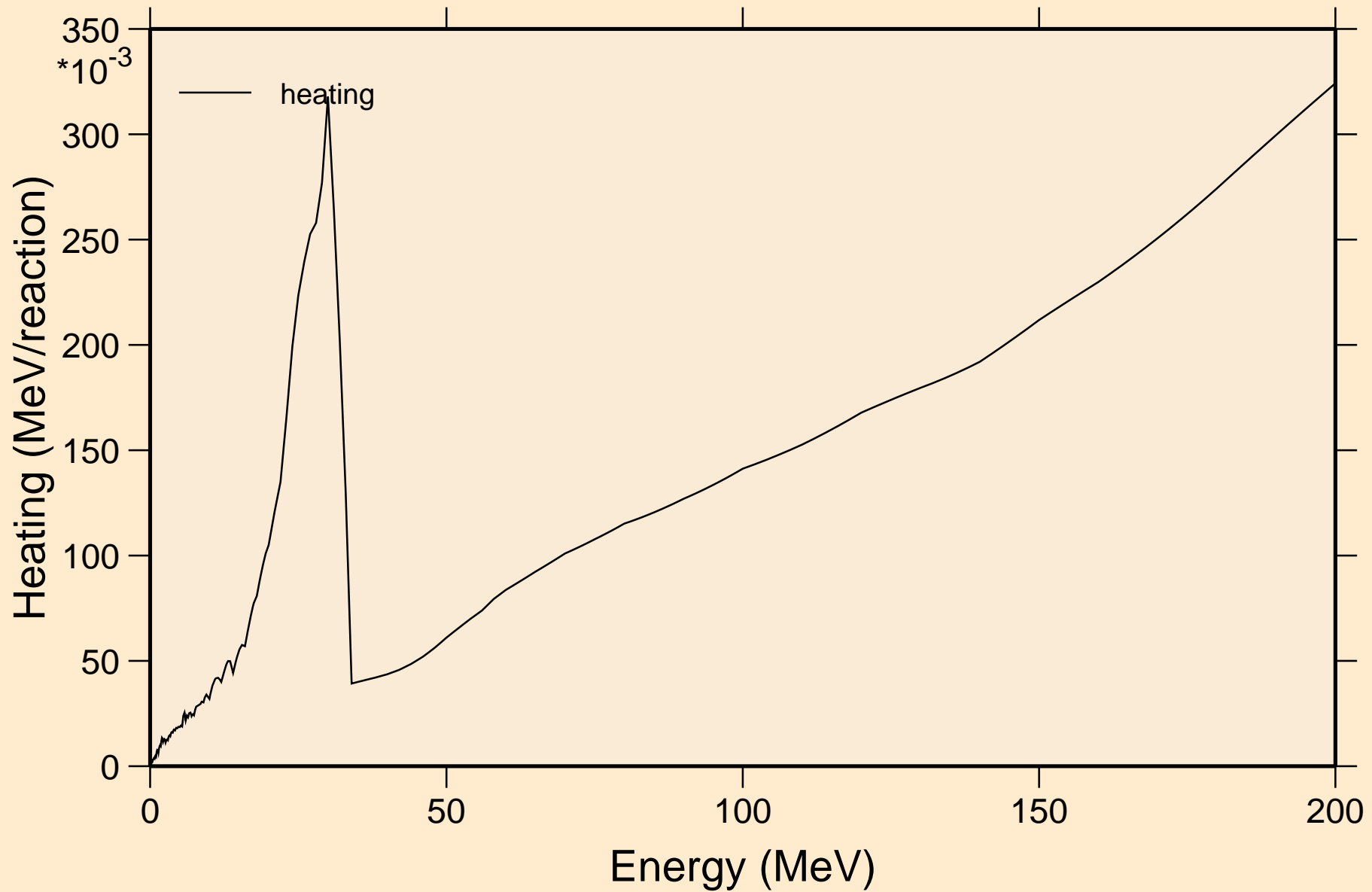

RA233 NEUTRON ACER TENDL-2021 LIBRARY; T=293.6K
Damage

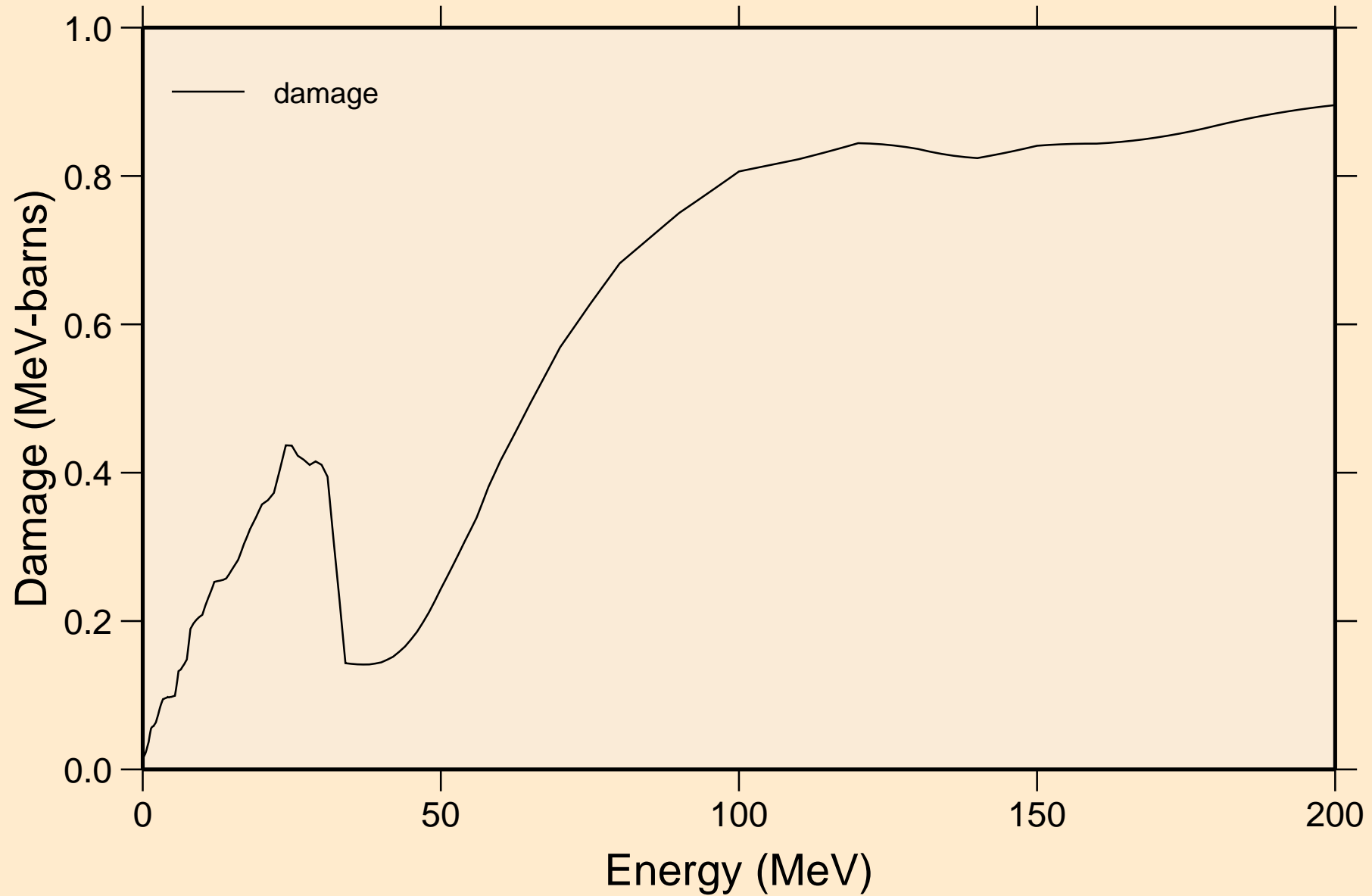

RA233 NEUTRON ACER TENDL-2021 LIBRARY; T=293.6K
Non-threshold reactions

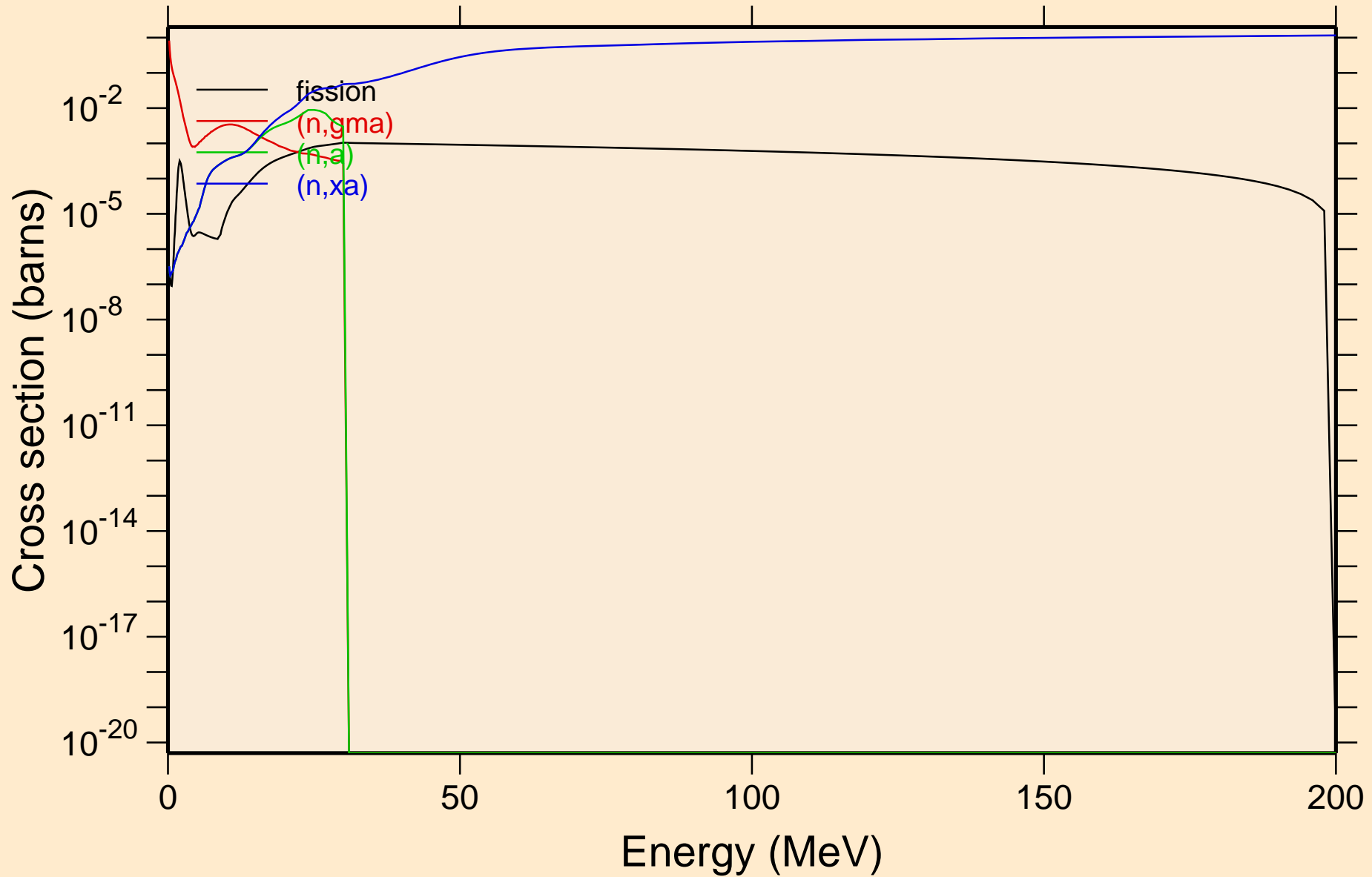

RA233 NEUTRON ACER TENDL-2021 LIBRARY; T=293.6K
Inelastic levels

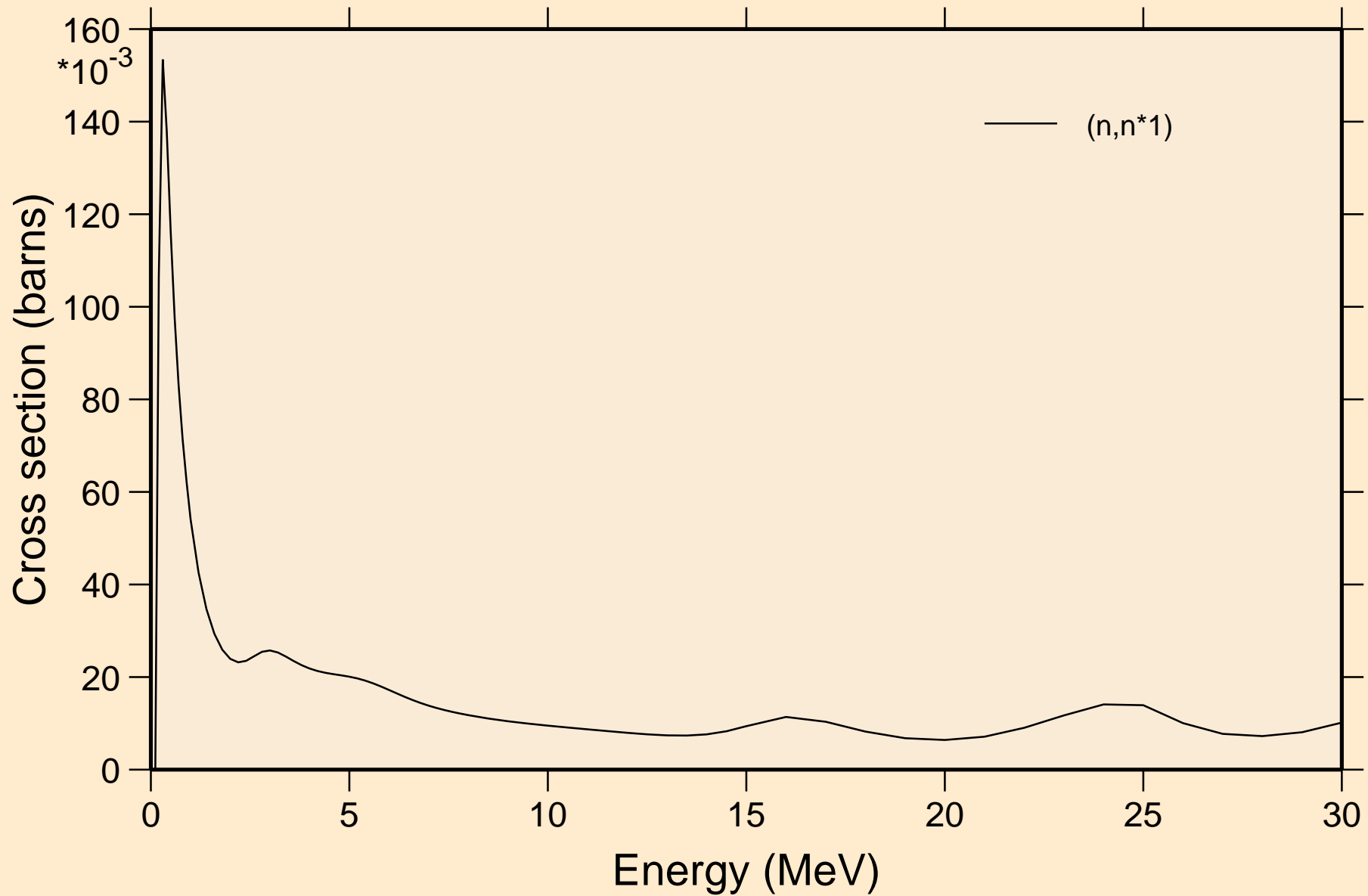

RA233 NEUTRON ACER TENDL-2021 LIBRARY; T=293.6K

Threshold reactions

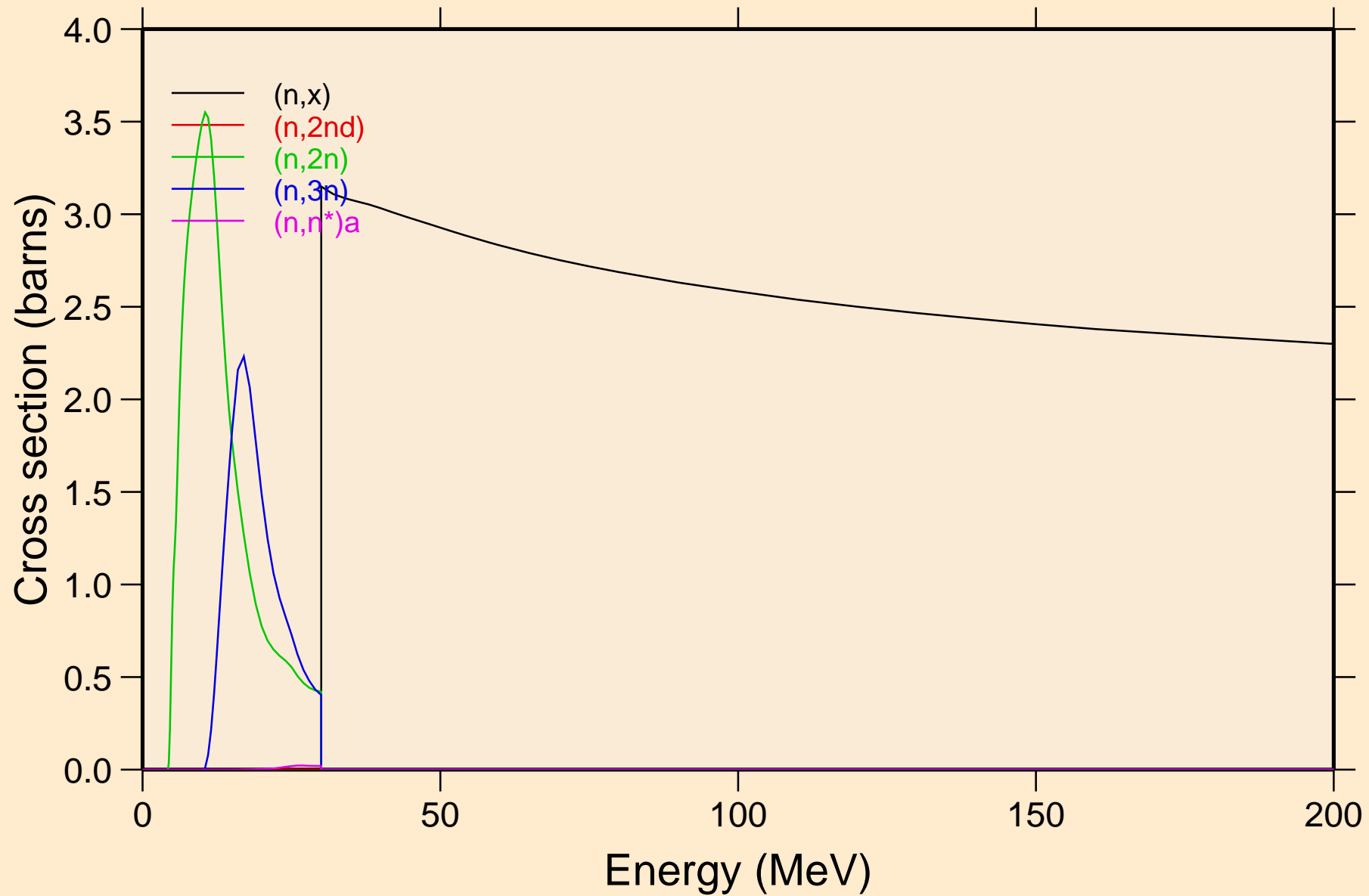

RA233 NEUTRON ACER TENDL-2021 LIBRARY; T=293.6K
Threshold reactions

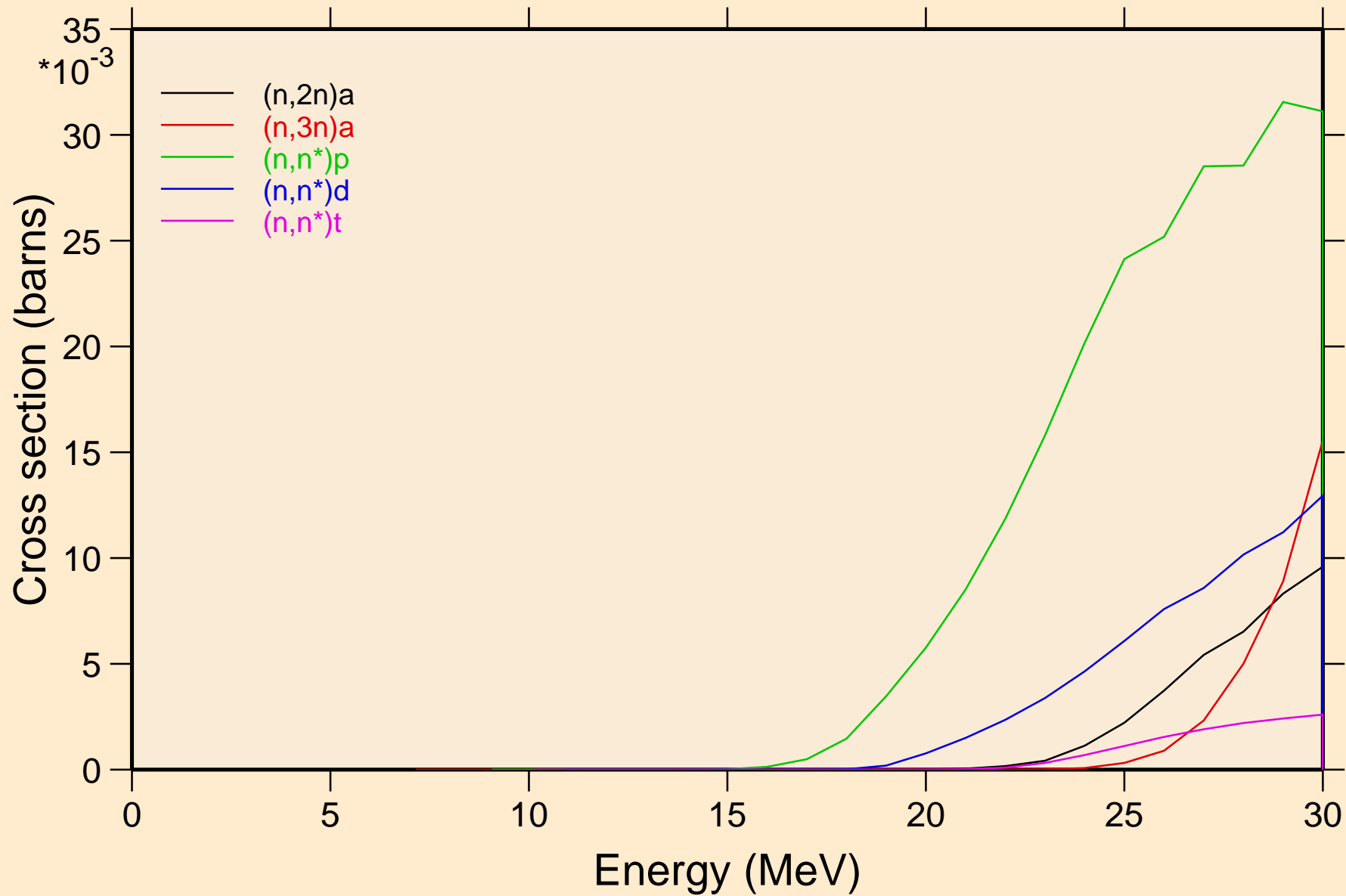

RA233 NEUTRON ACER TENDL-2021 LIBRARY; T=293.6K
Threshold reactions

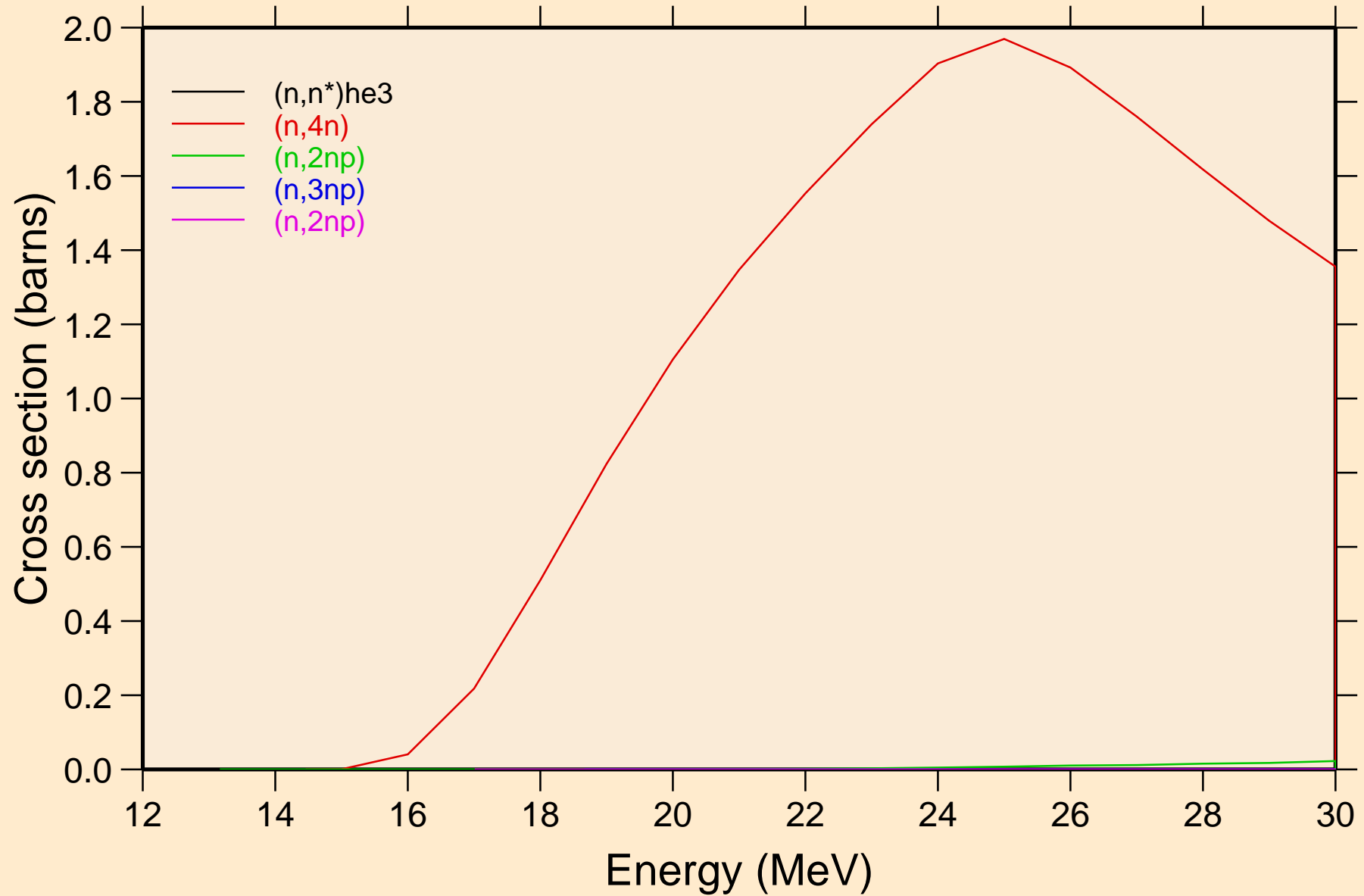

RA233 NEUTRON ACER TENDL-2021 LIBRARY; T=293.6K
Threshold reactions

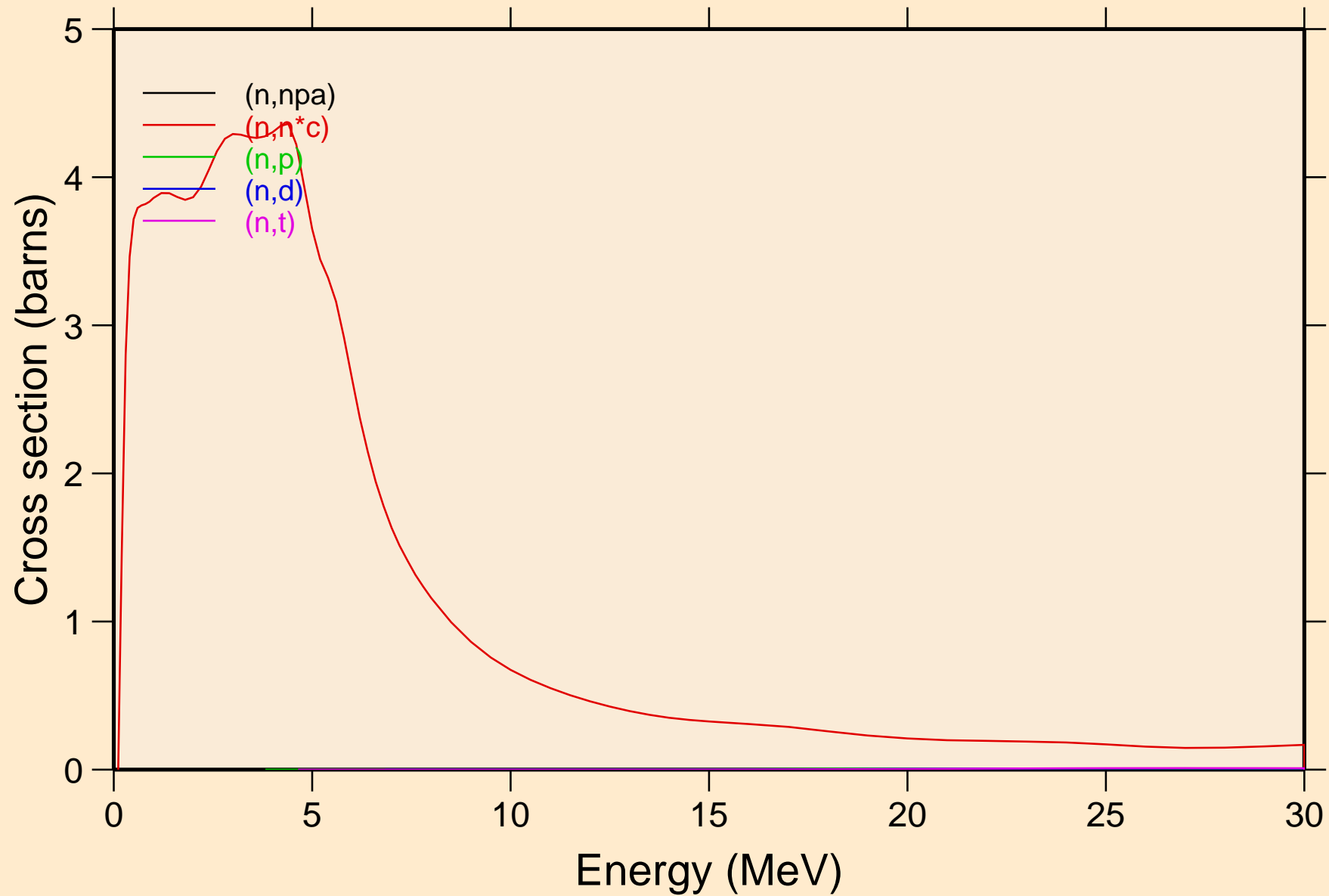

RA233 NEUTRON ACER TENDL-2021 LIBRARY; T=293.6K
Threshold reactions

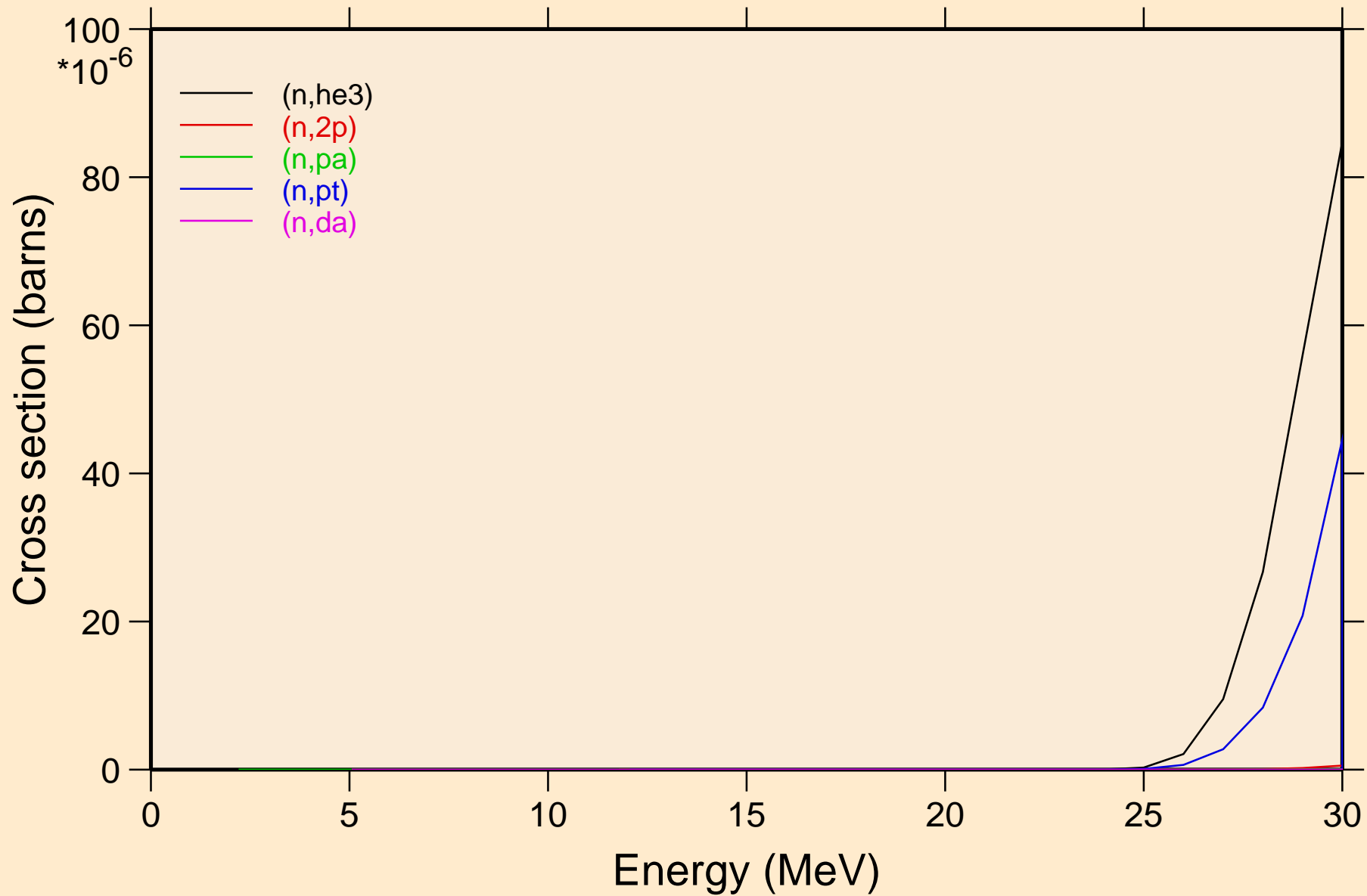

RA233 NEUTRON ACER TENDL-2021 LIBRARY; T=293.6K
Threshold reactions

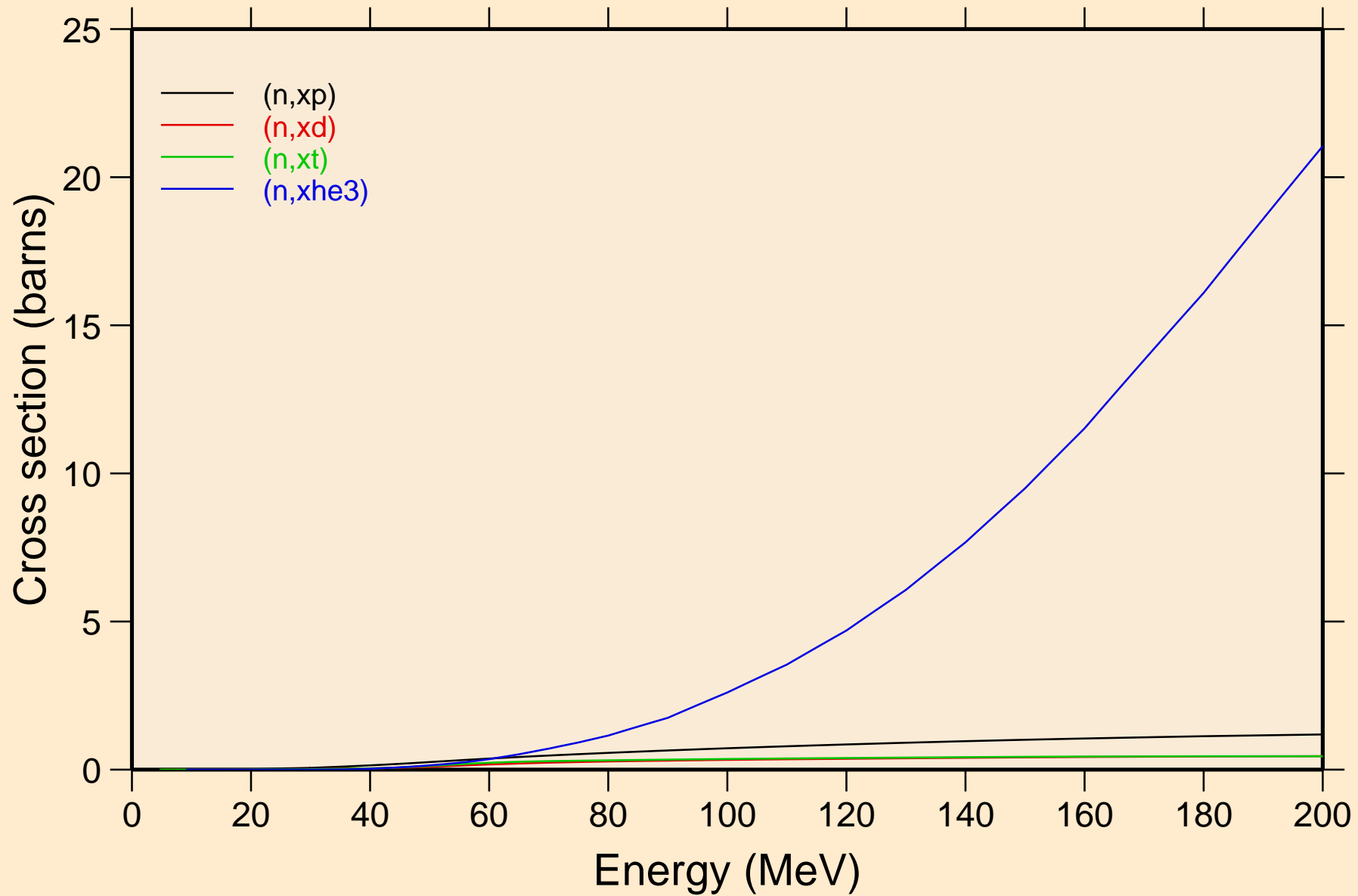

RA233 NEUTRON ACER TENDL-2021 LIBRARY; T=293.6K
angular distribution for elastic

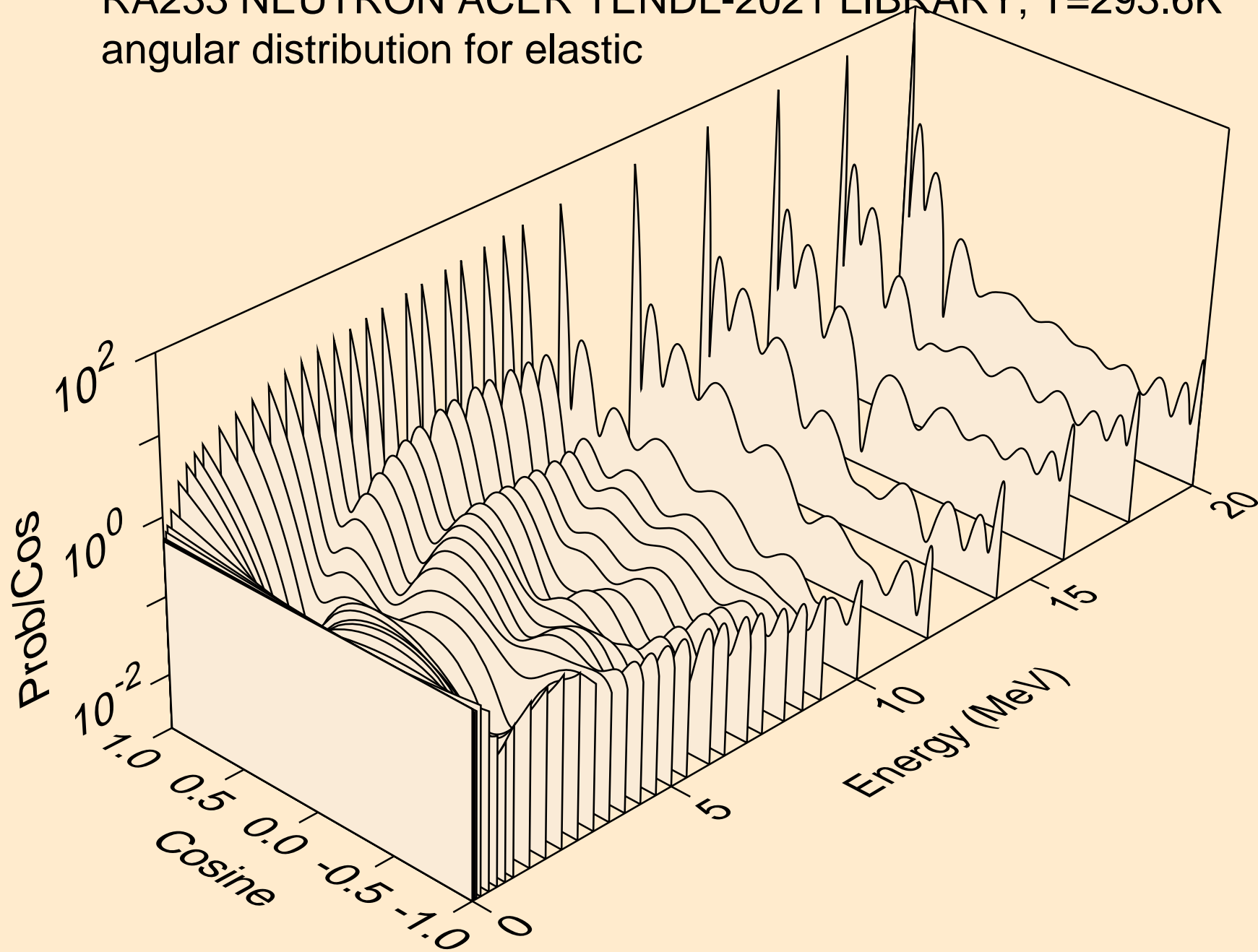

RA233 NEUTRON ACER TENDL-2021 LIBRARY; T=293.6K
angular distribution for elastic

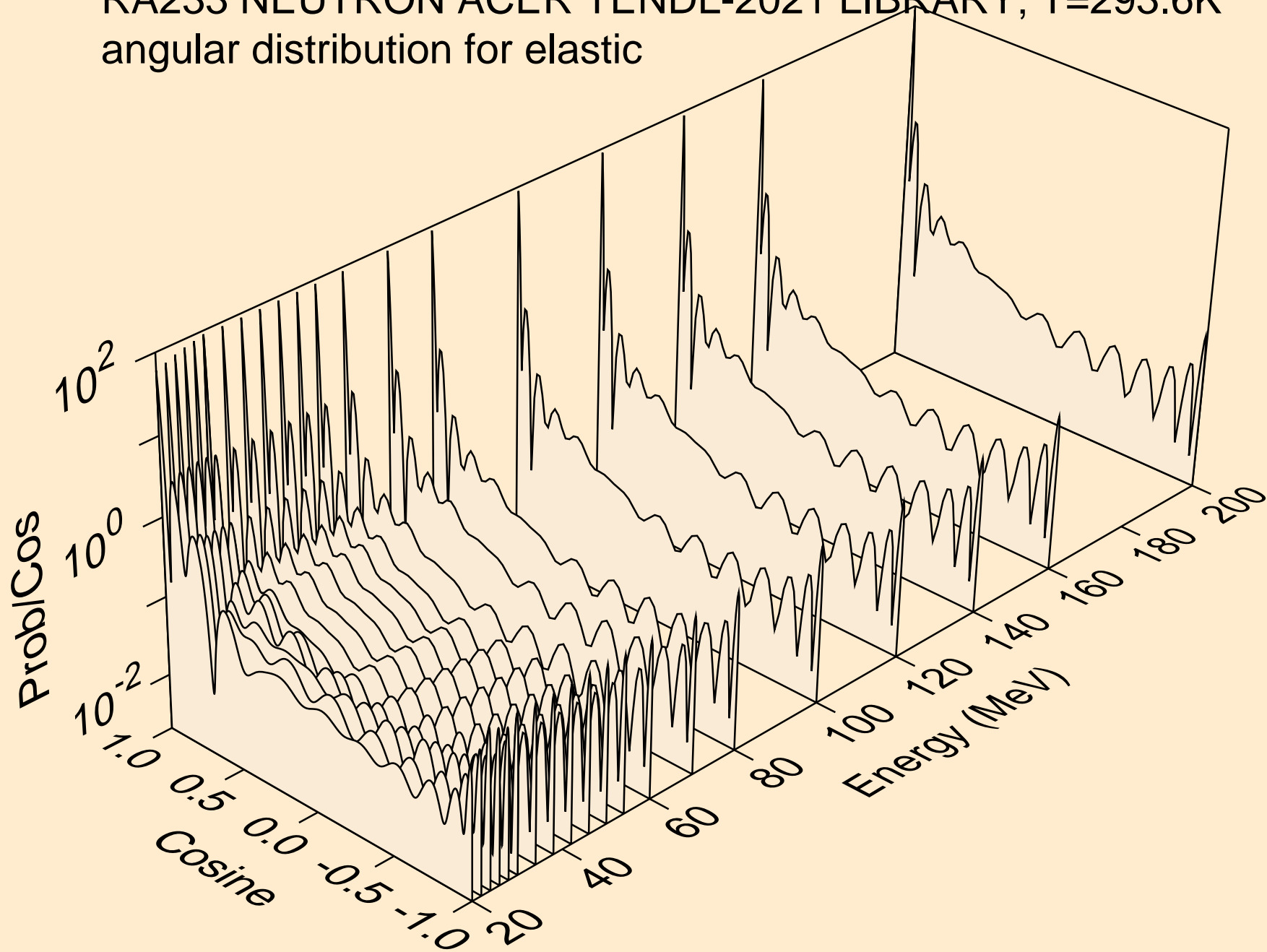

RA233 NEUTRON ACER TENDL-2021 LIBRARY; T=293.6K
angular distribution for (n,n*1)

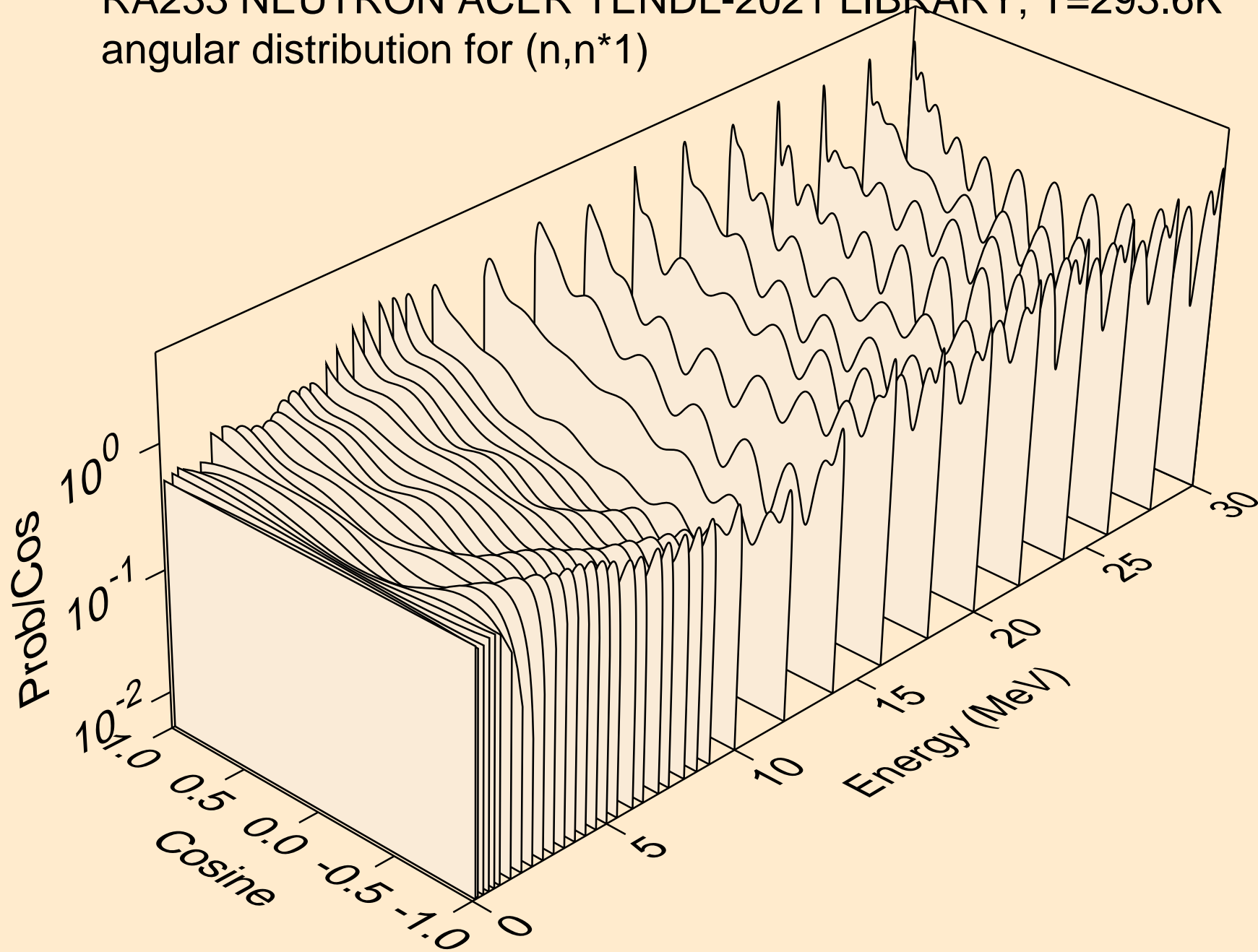

RA233 NEUTRON ACER TENDL-2021 LIBRARY; T=293.6K
Total fission nubar

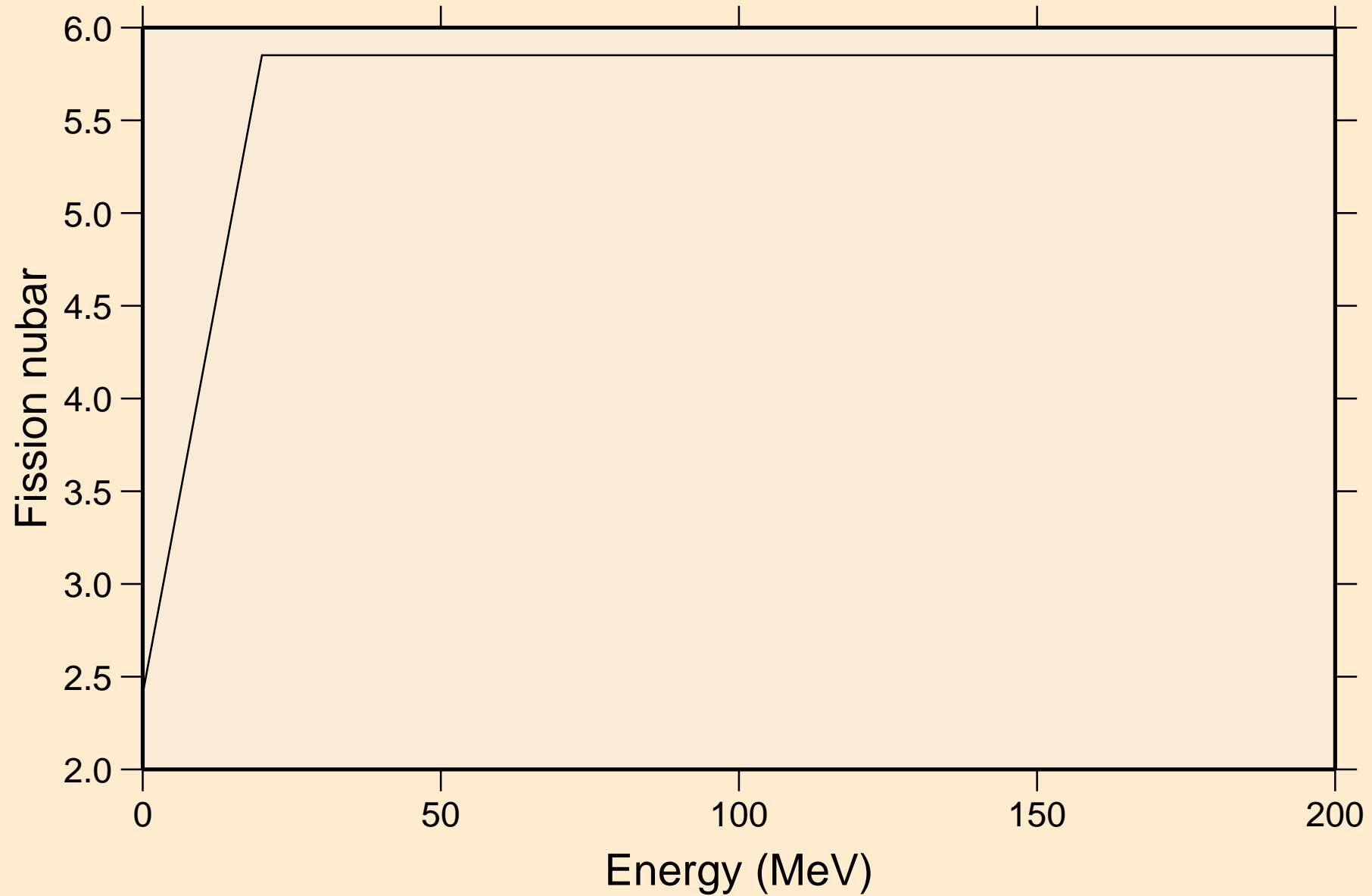

RA233 NEUTRON ACER TENDL-2021 LIBRARY; T=293.6K
Neutron emission for (n,x)

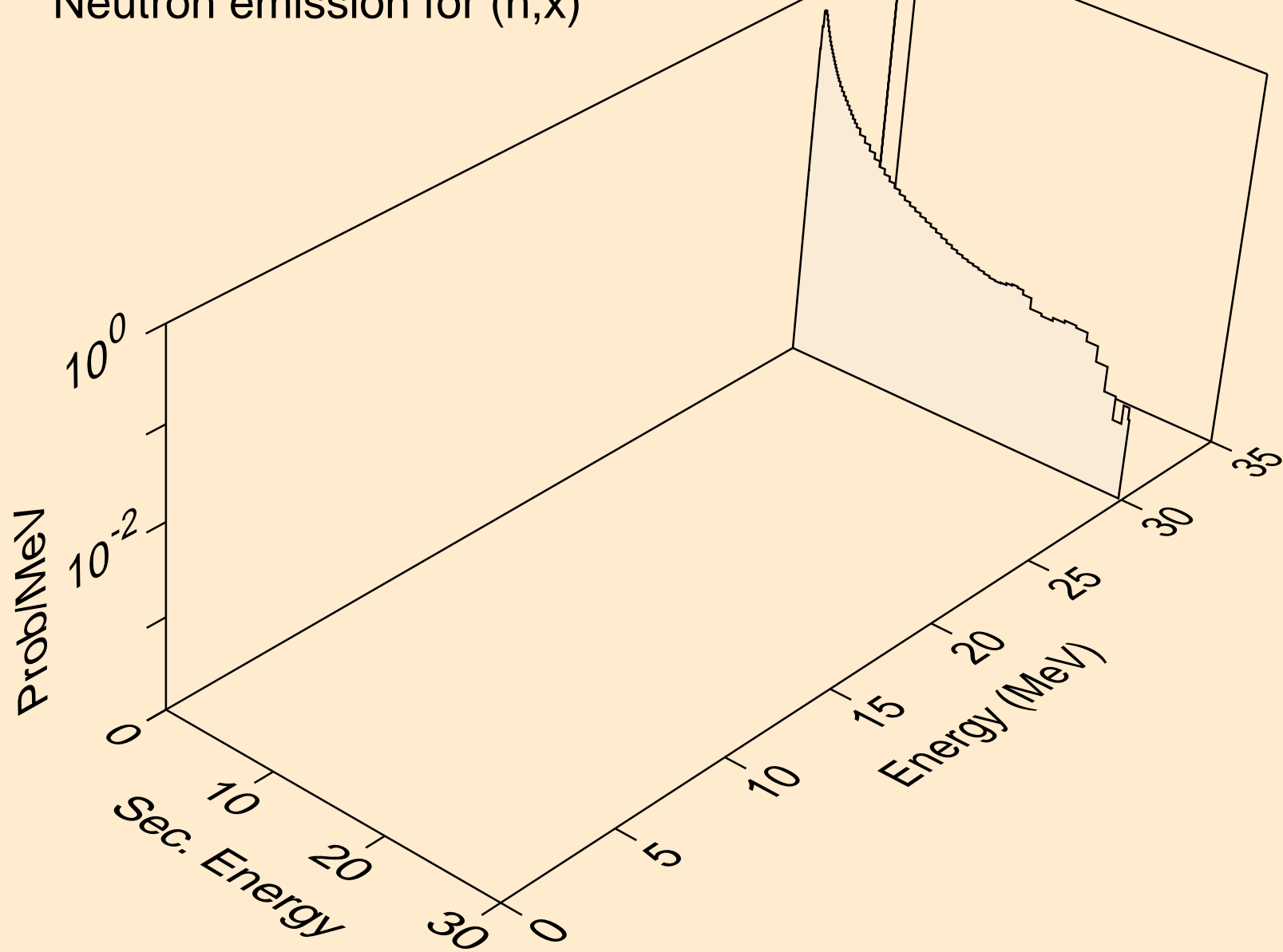

RA233 NEUTRON ACER TENDL-2021 LIBRARY; T=293.6K
Neutron emission for (n,2nd)

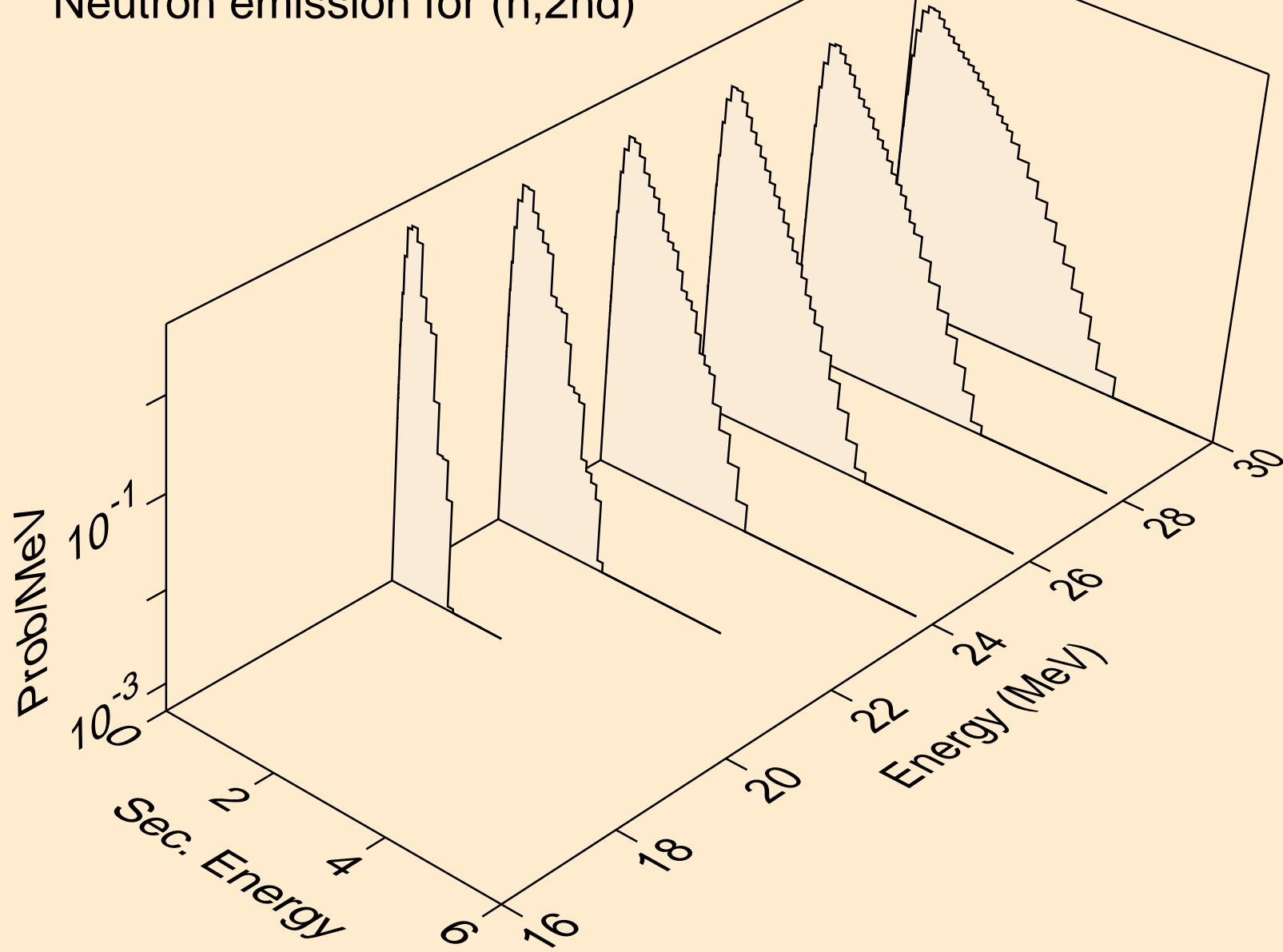

RA233 NEUTRON ACER TENDL-2021 LIBRARY; T=293.6K
Neutron emission for (n,2n)

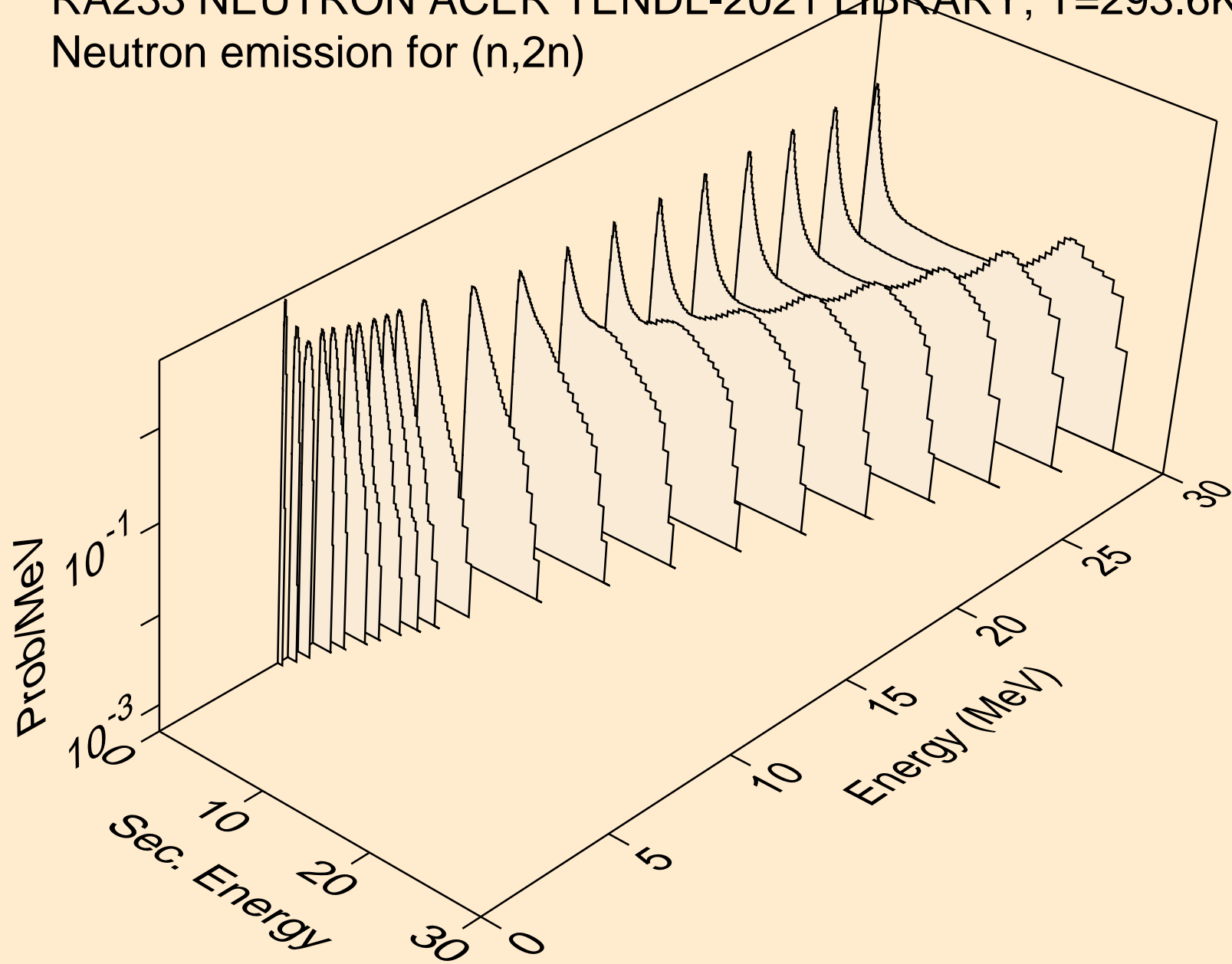

RA233 NEUTRON ACER TENDL-2021 LIBRARY; T=293.6K
Neutron emission for (n,3n)

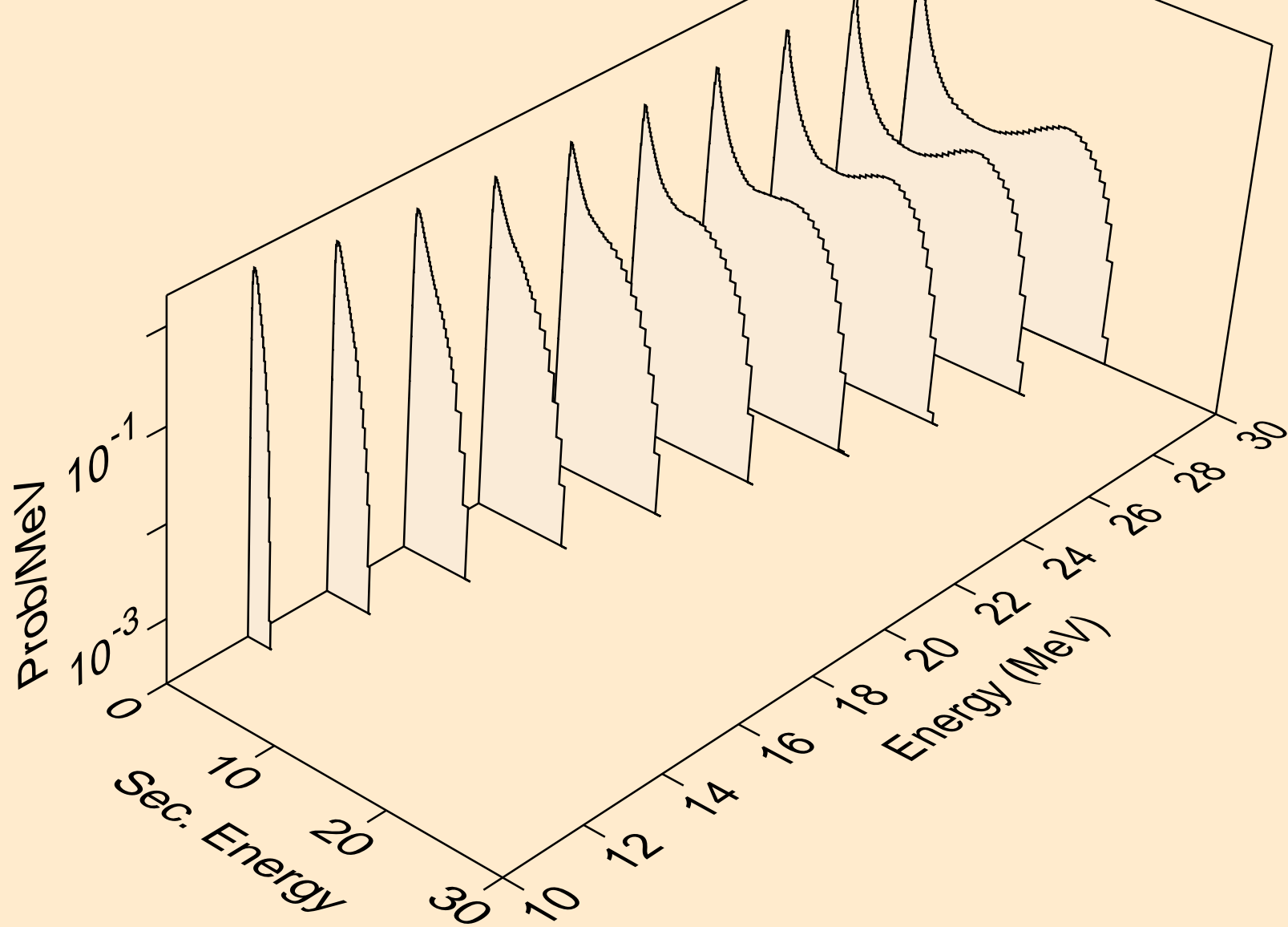

RA233 NEUTRON ACER TENDL-2021 LIBRARY; T=293.6K
Neutron emission for fission

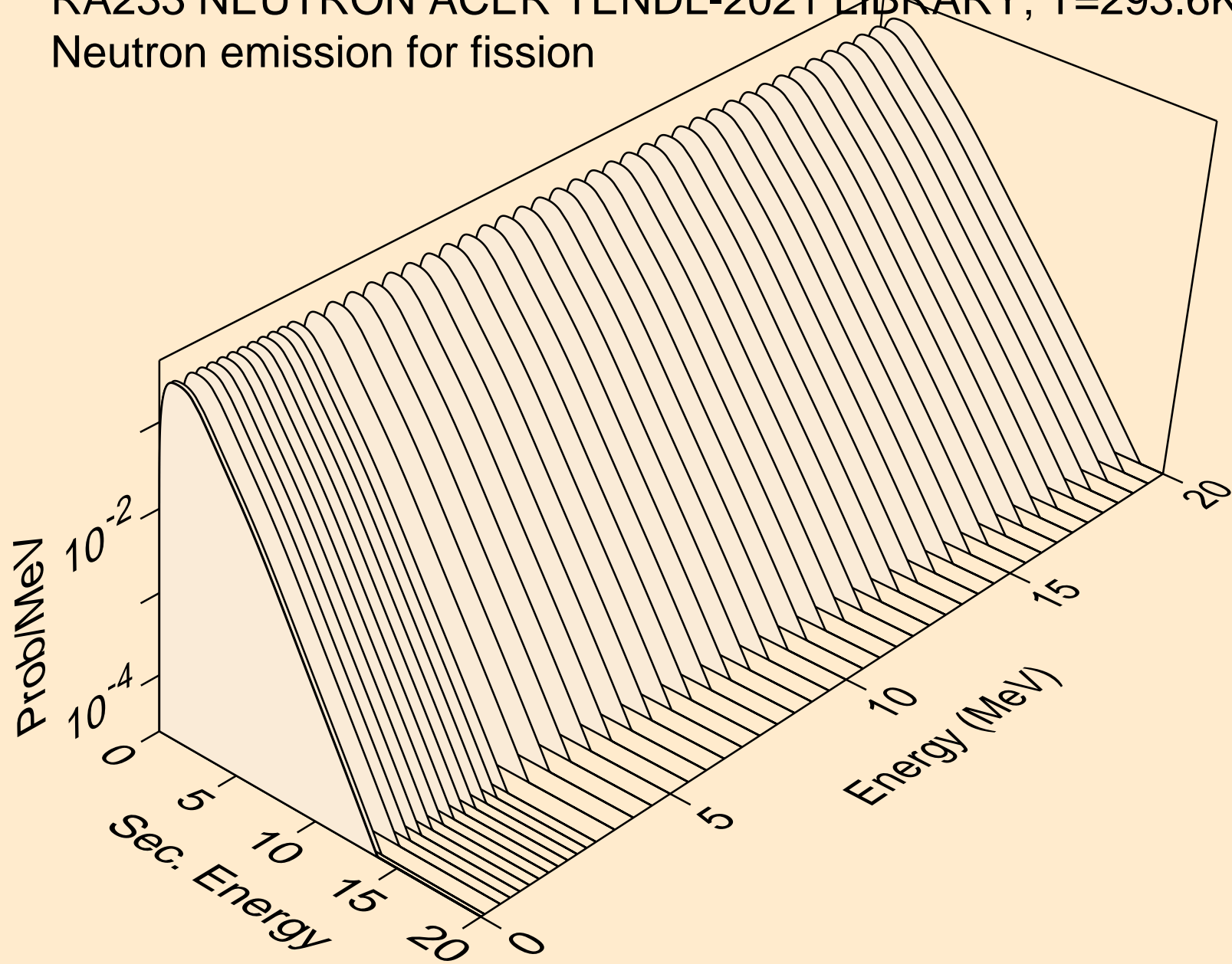

RA233 NEUTRON ACER TENDL-2021 LIBRARY; T=293.6K
Neutron emission for (n,n*)a

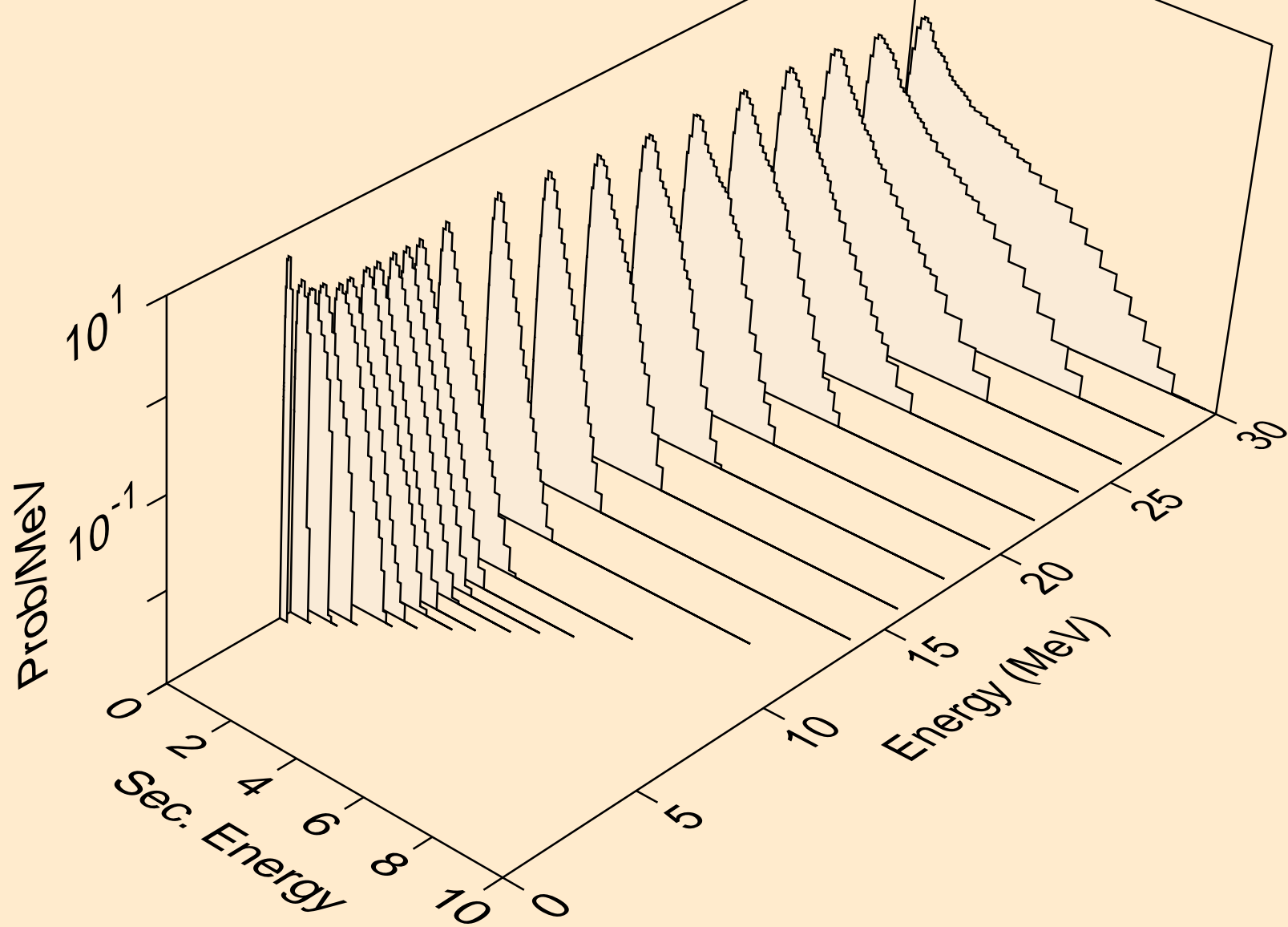

RA233 NEUTRON ACER TENDL-2021 LIBRARY; T=293.6K
Neutron emission for (n,2n)a

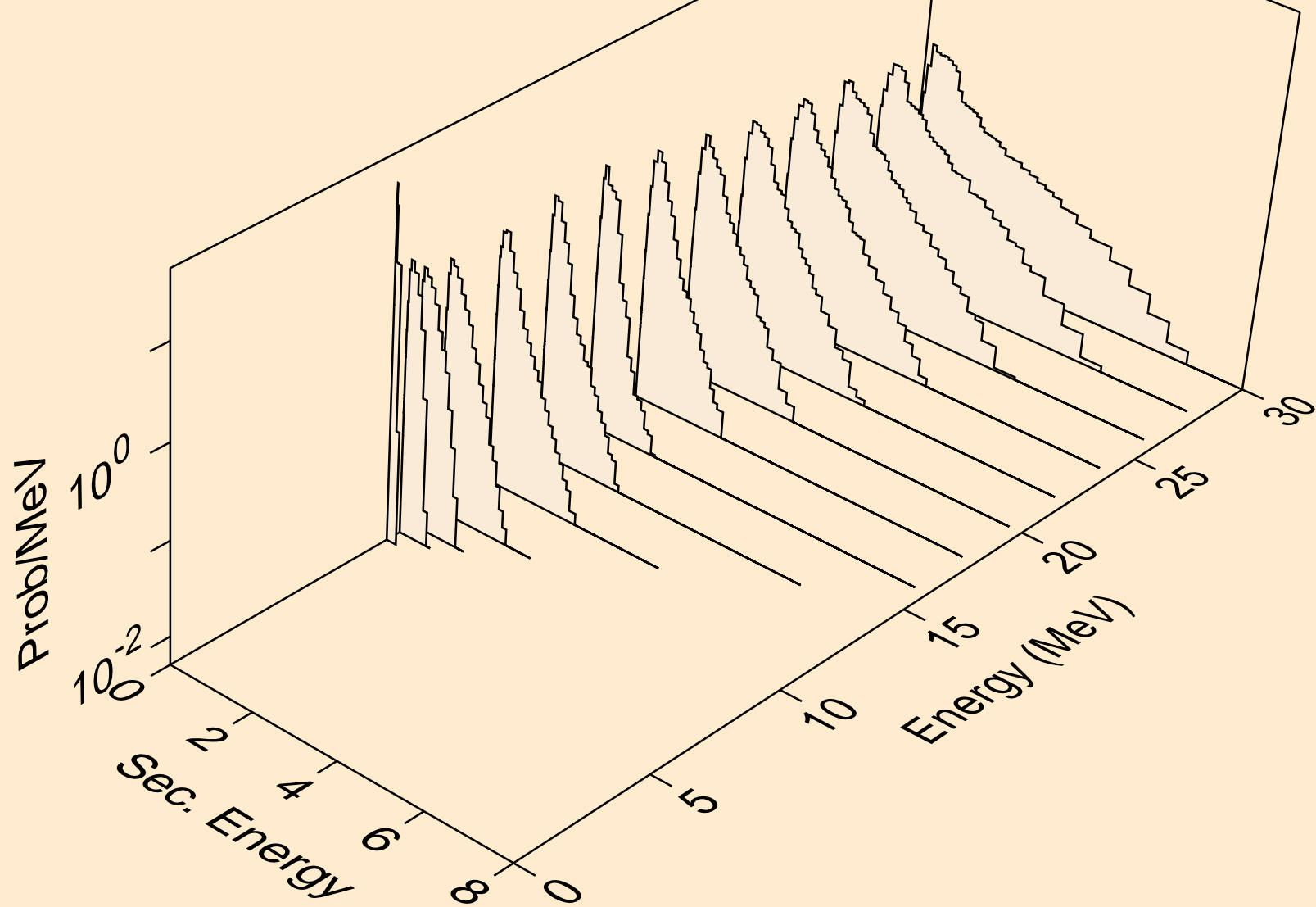

RA233 NEUTRON ACER TENDL-2021 LIBRARY; T=293.6K
Neutron emission for (n,3n)a

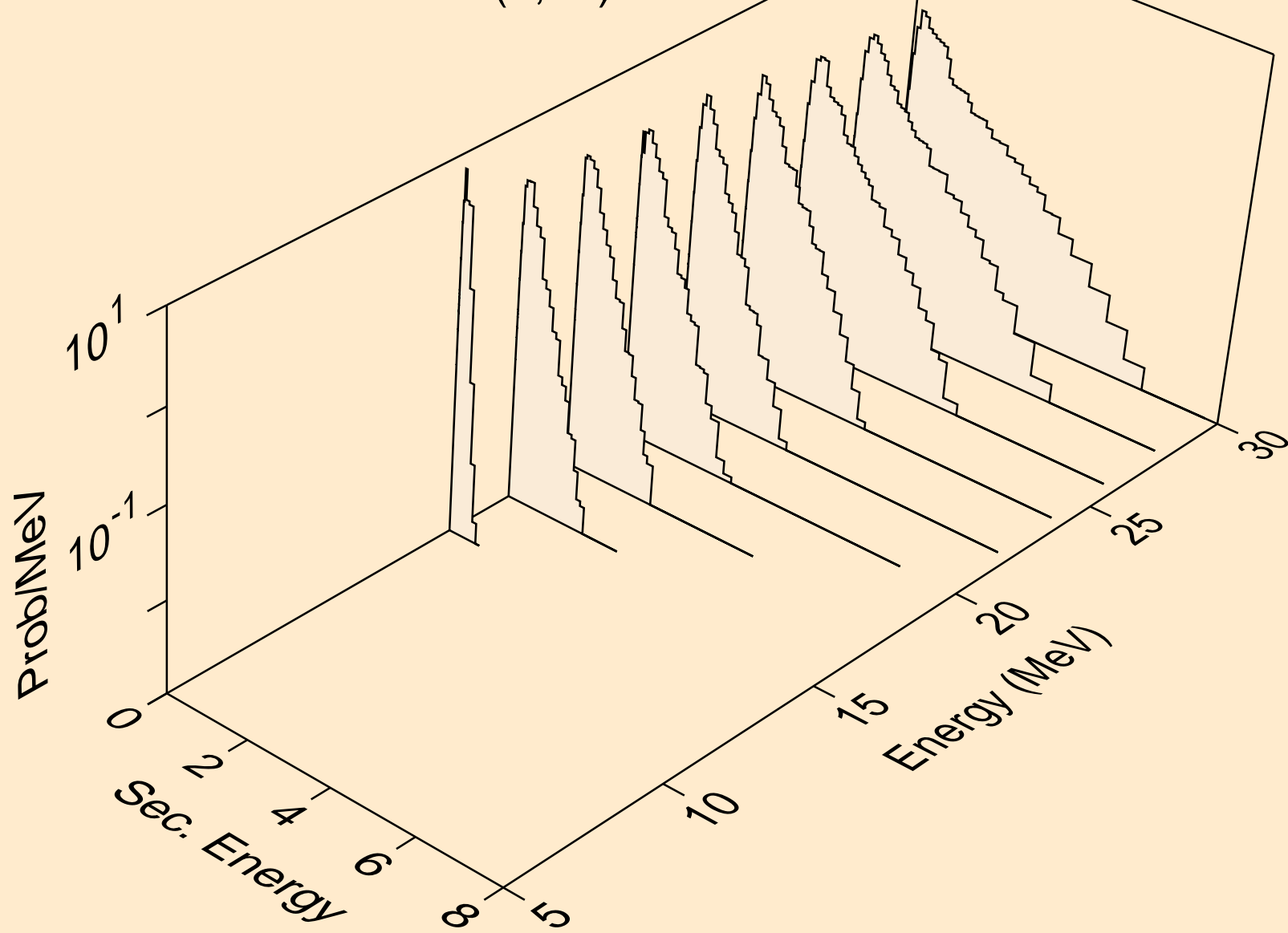

RA233 NEUTRON ACER TENDL-2021 LIBRARY; T=293.6K
Neutron emission for (n,n*)p

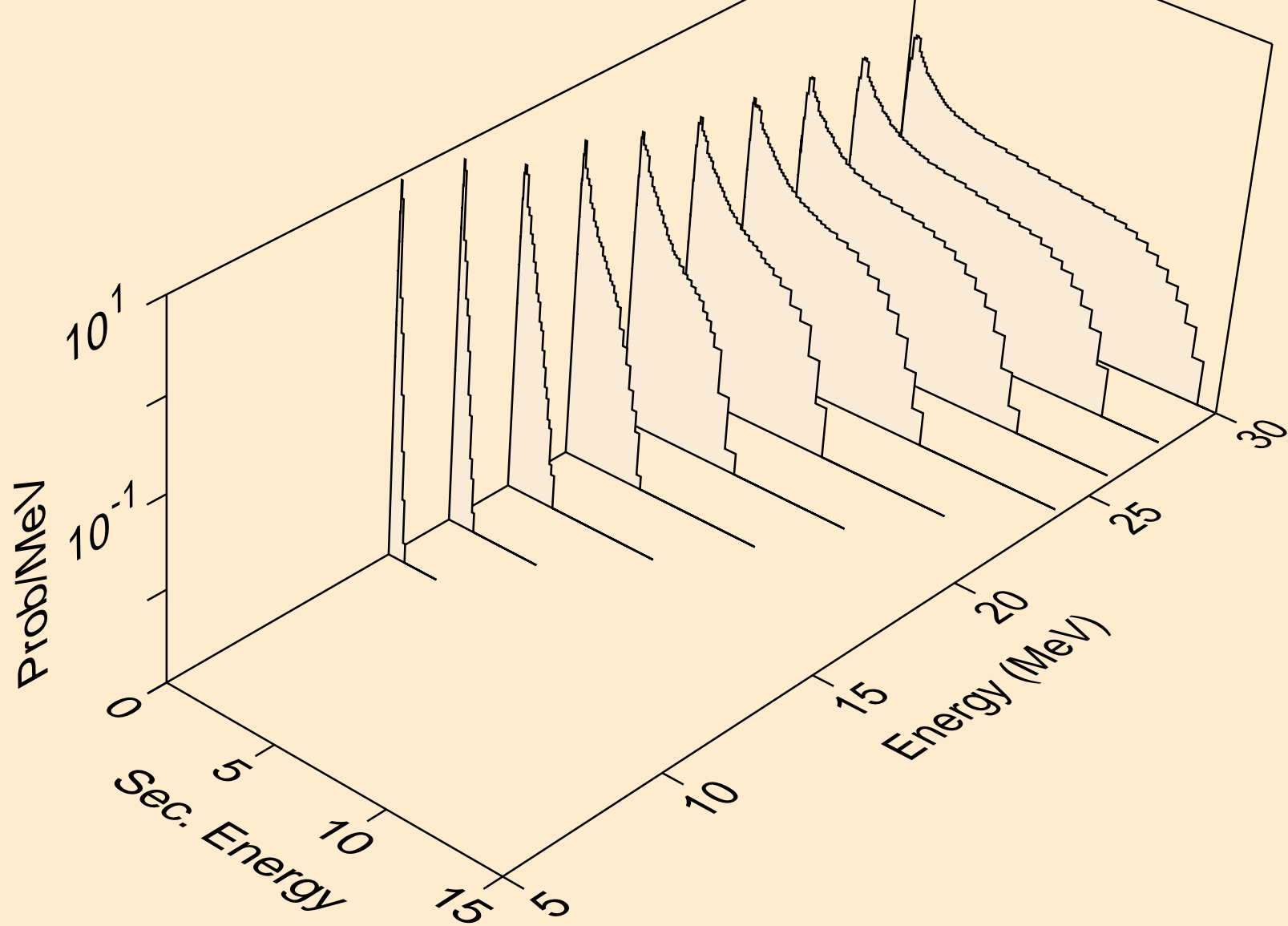

RA233 NEUTRON ACER TENDL-2021 LIBRARY; T=293.6K
Neutron emission for (n,n*)d

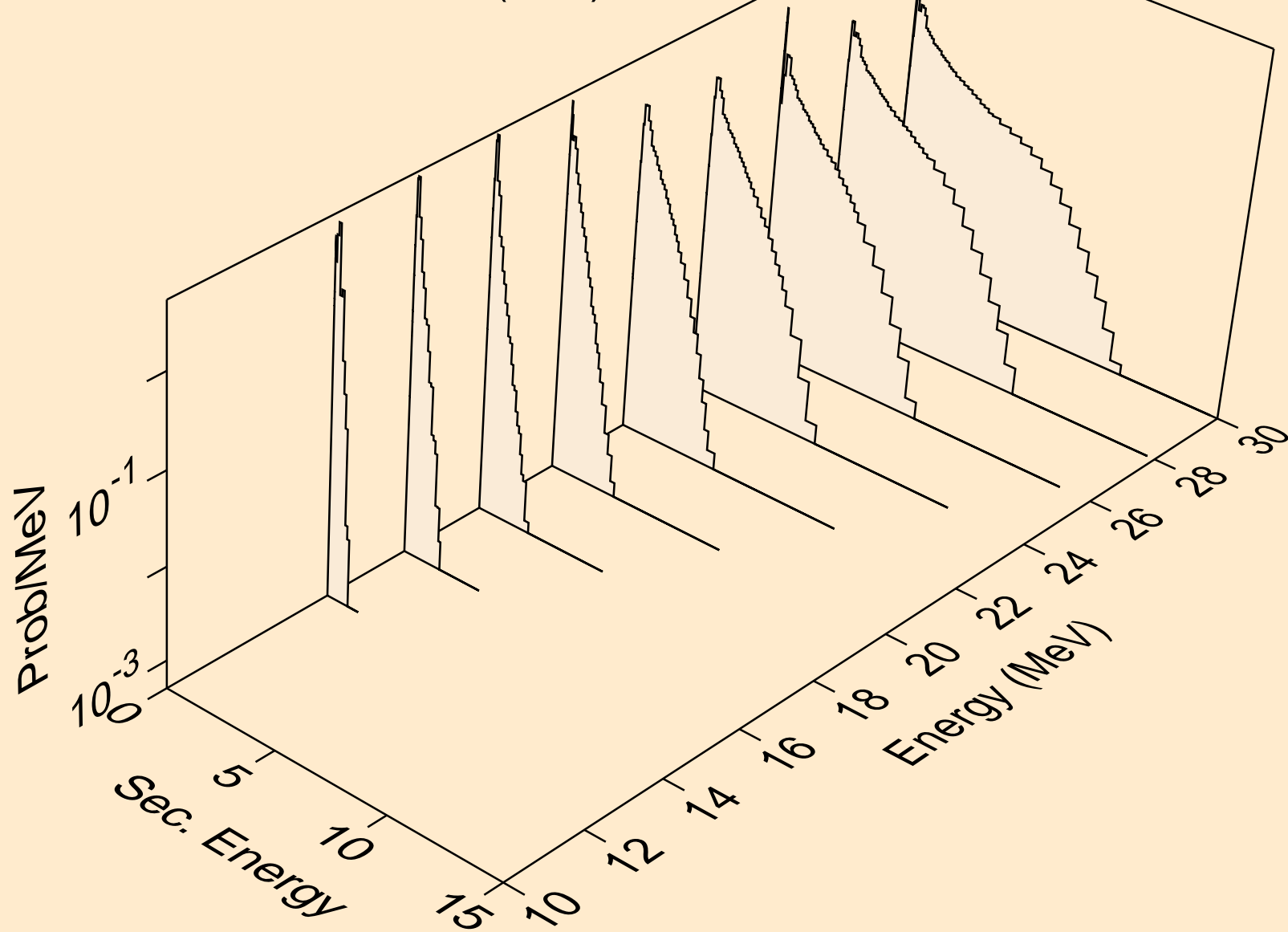

RA233 NEUTRON ACER TENDL-2021 LIBRARY; T=293.6K
Neutron emission for (n,n*)t

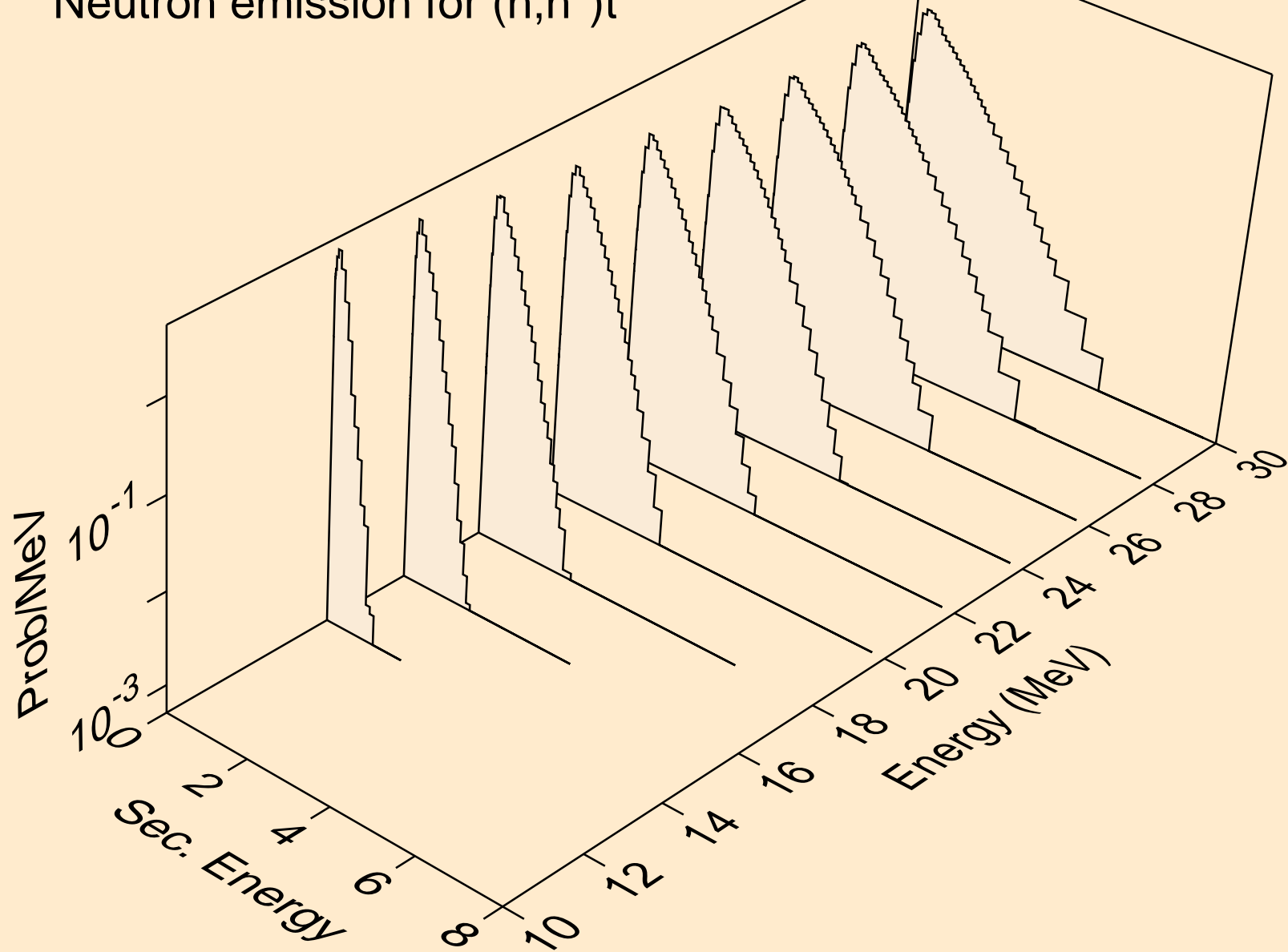

RA233 NEUTRON ACER TENDL-2021 LIBRARY; T=293.6K
Neutron emission for (n,n*)he3

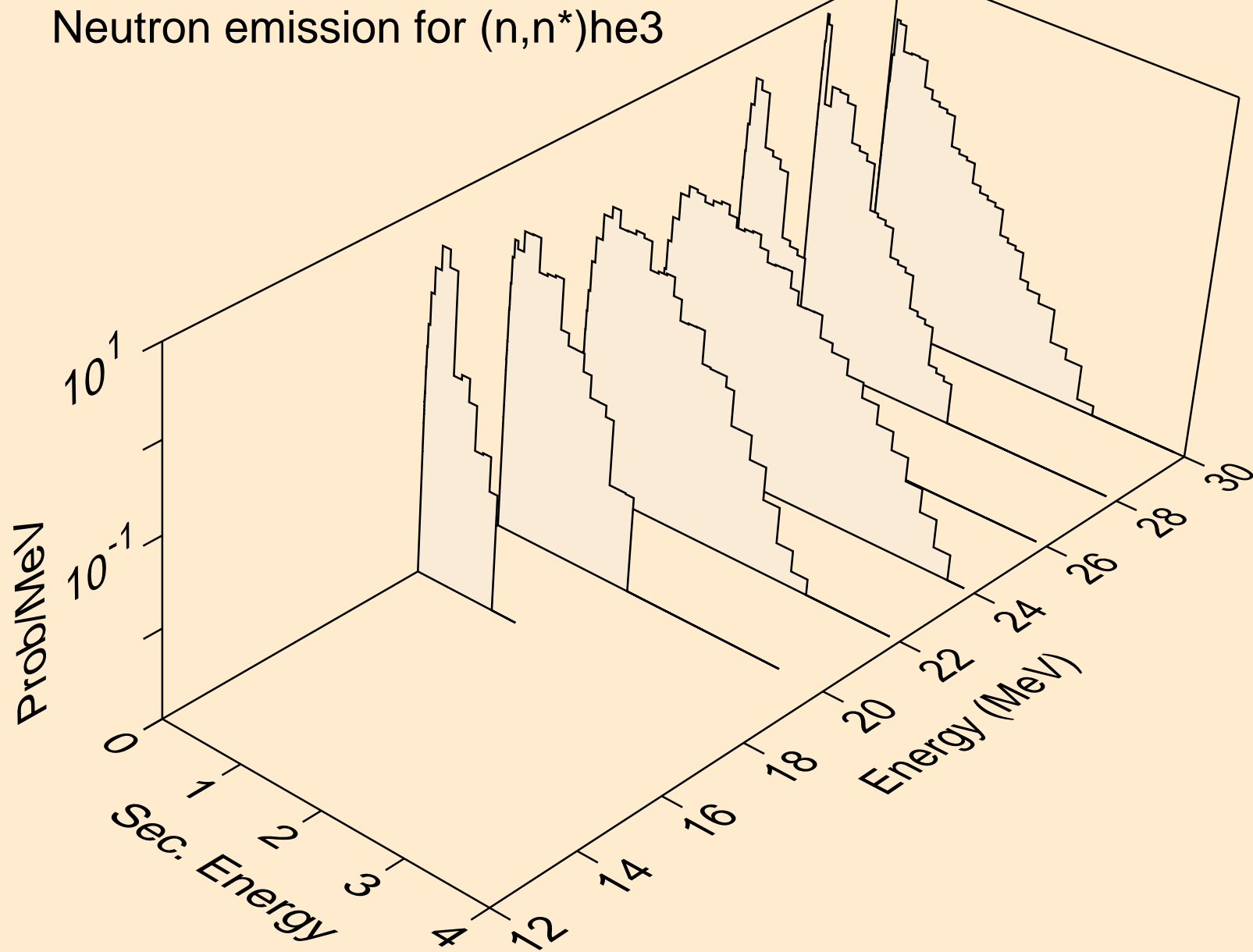

RA233 NEUTRON ACER TENDL-2021 LIBRARY; T=293.6K
Neutron emission for (n,4n)

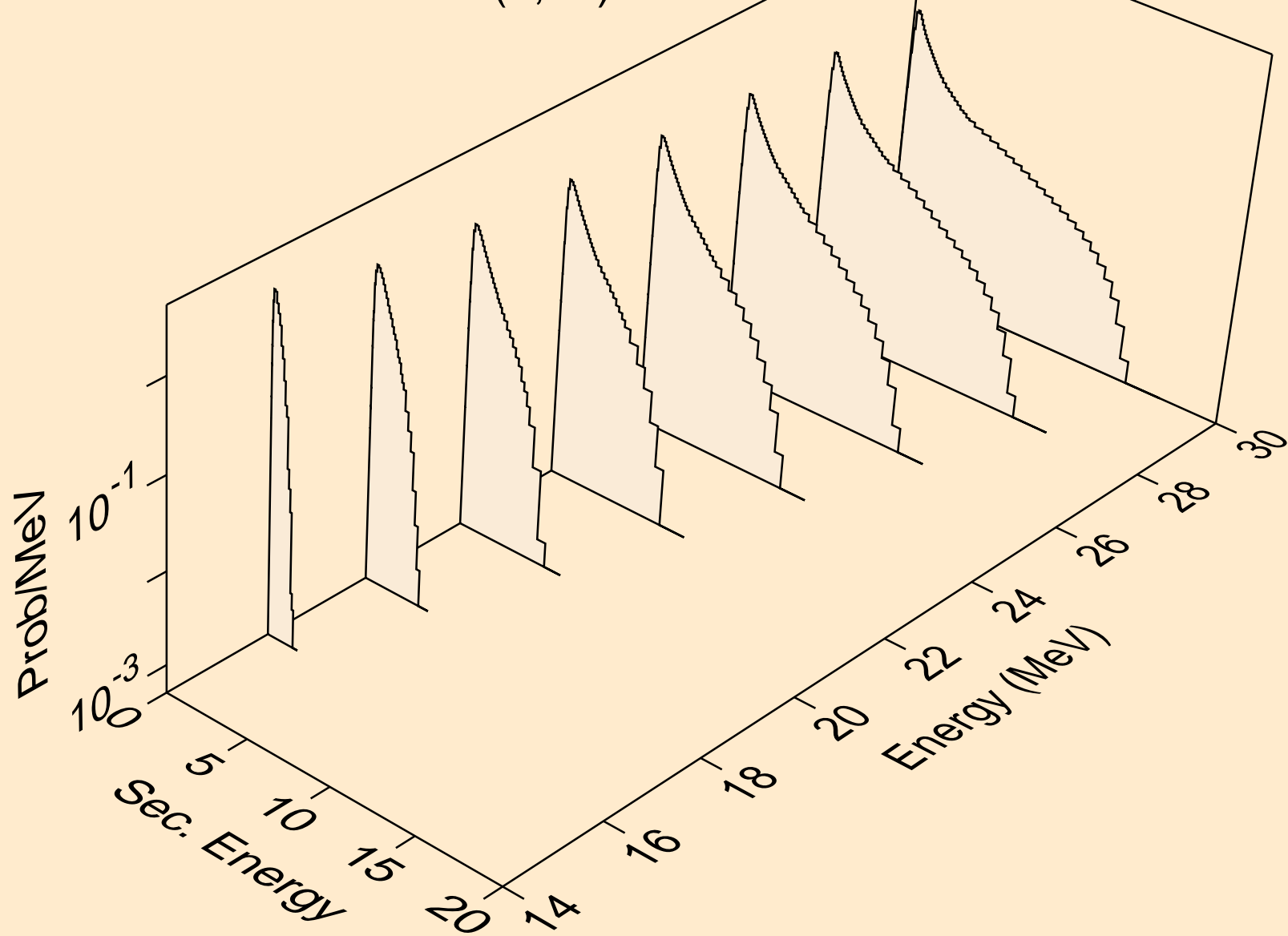

RA233 NEUTRON ACER TENDL-2021 LIBRARY; T=293.6K
Neutron emission for (n,2np)

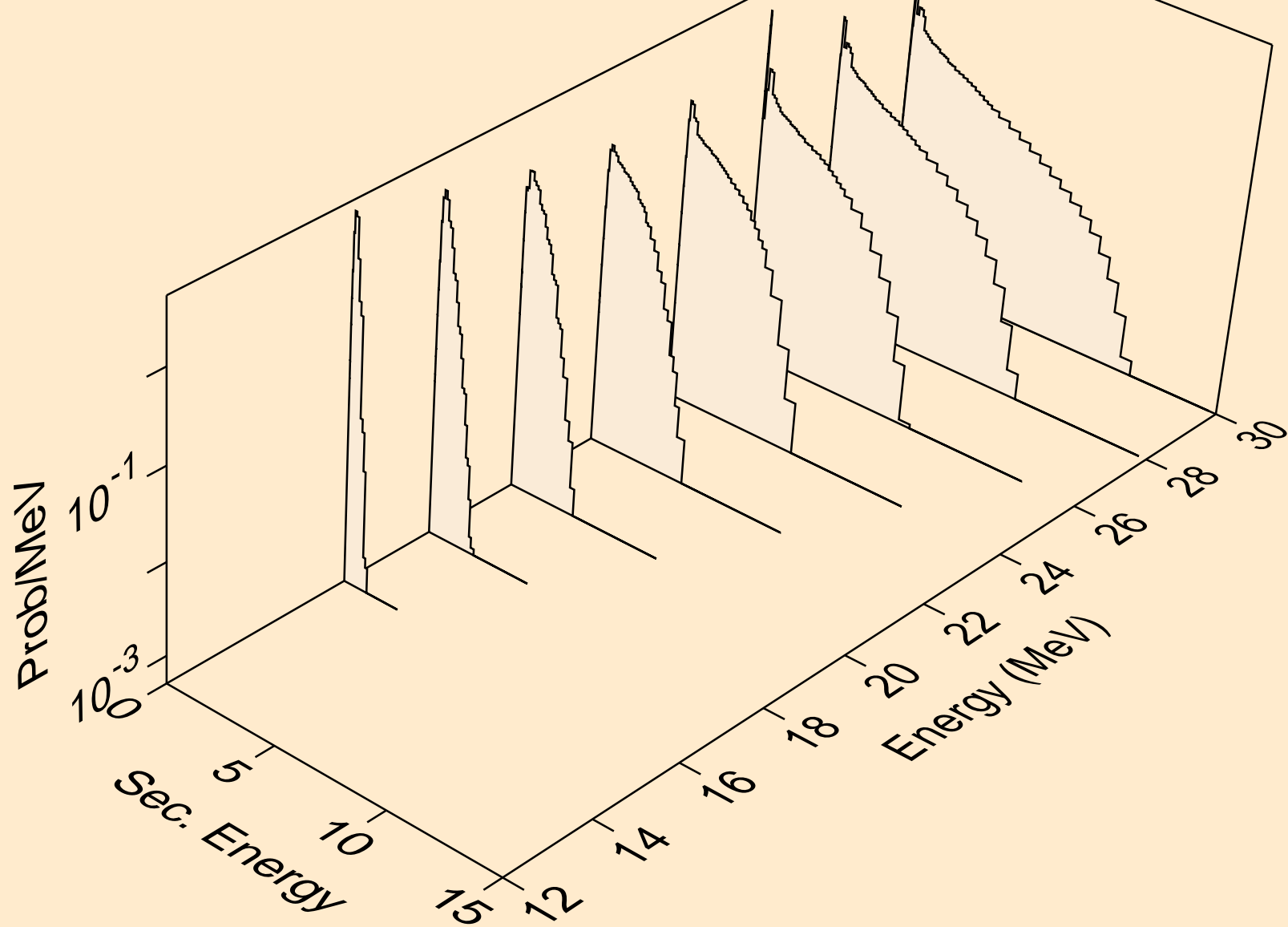

RA233 NEUTRON ACER TENDL-2021 LIBRARY; T=293.6K
Neutron emission for (n,3np)

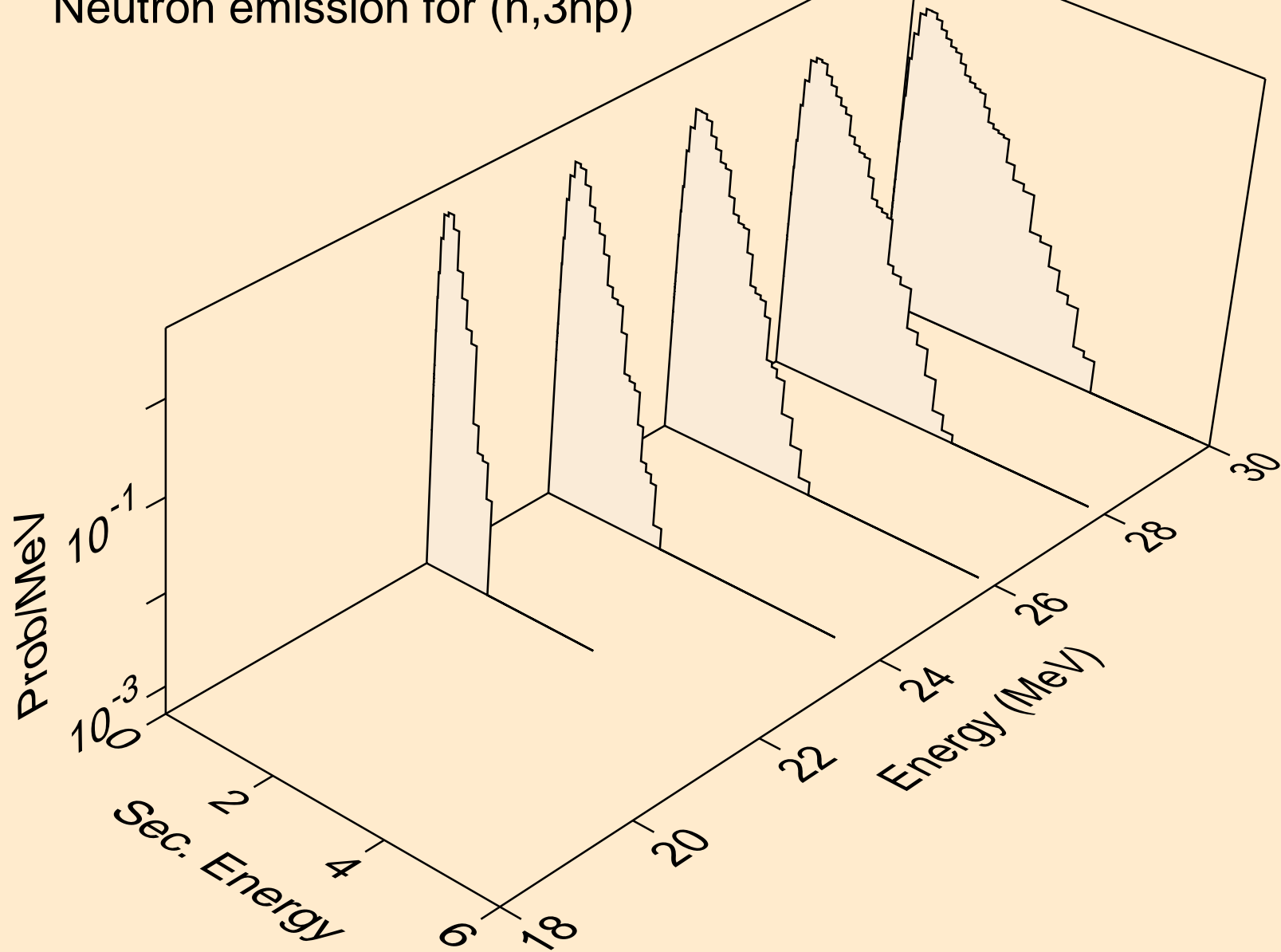

RA233 NEUTRON ACER TENDL-2021 LIBRARY; T=293.6K
Neutron emission for (n,2np)

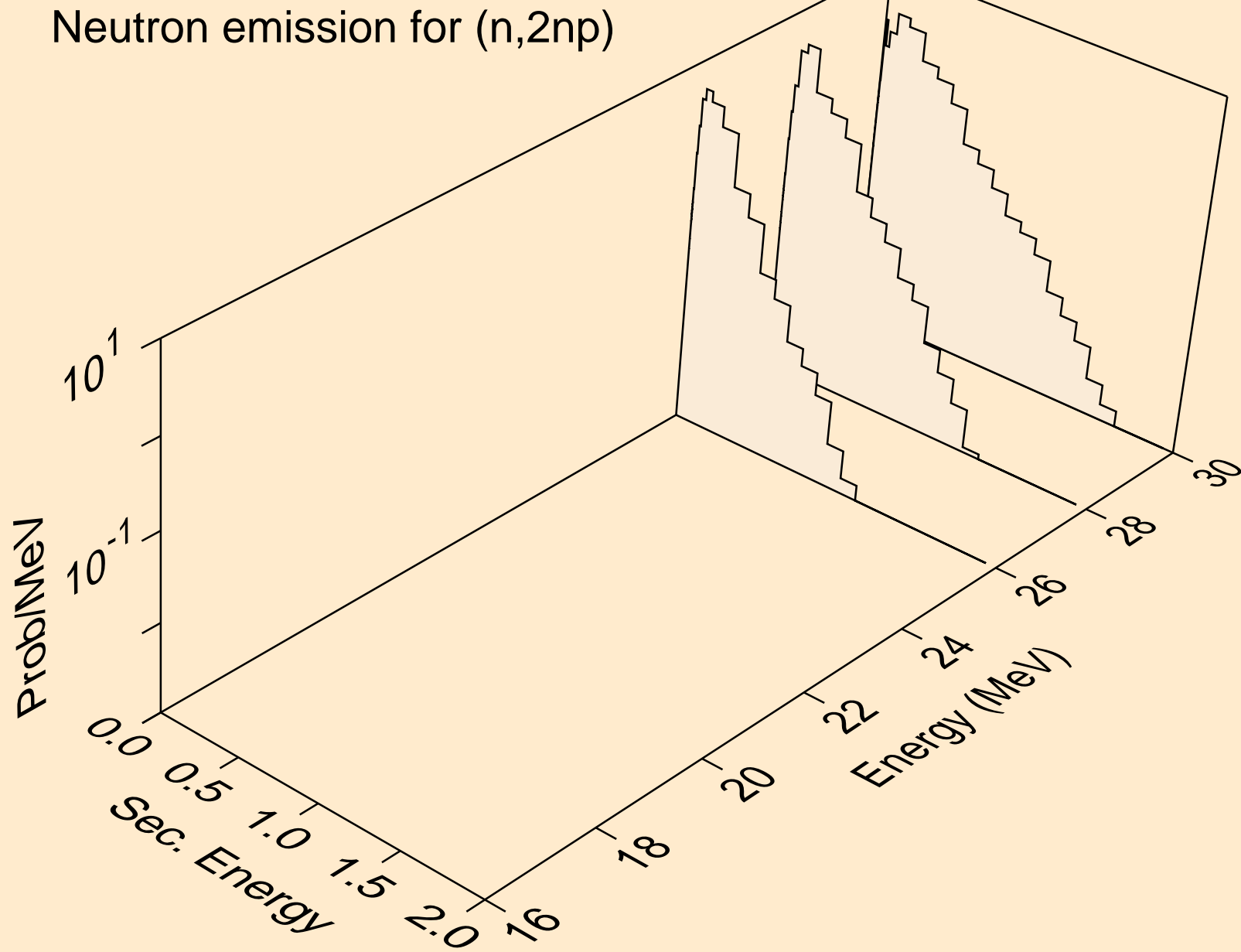

RA233 NEUTRON ACER TENDL-2021 LIBRARY; T=293.6K
Neutron emission for (n,npa)

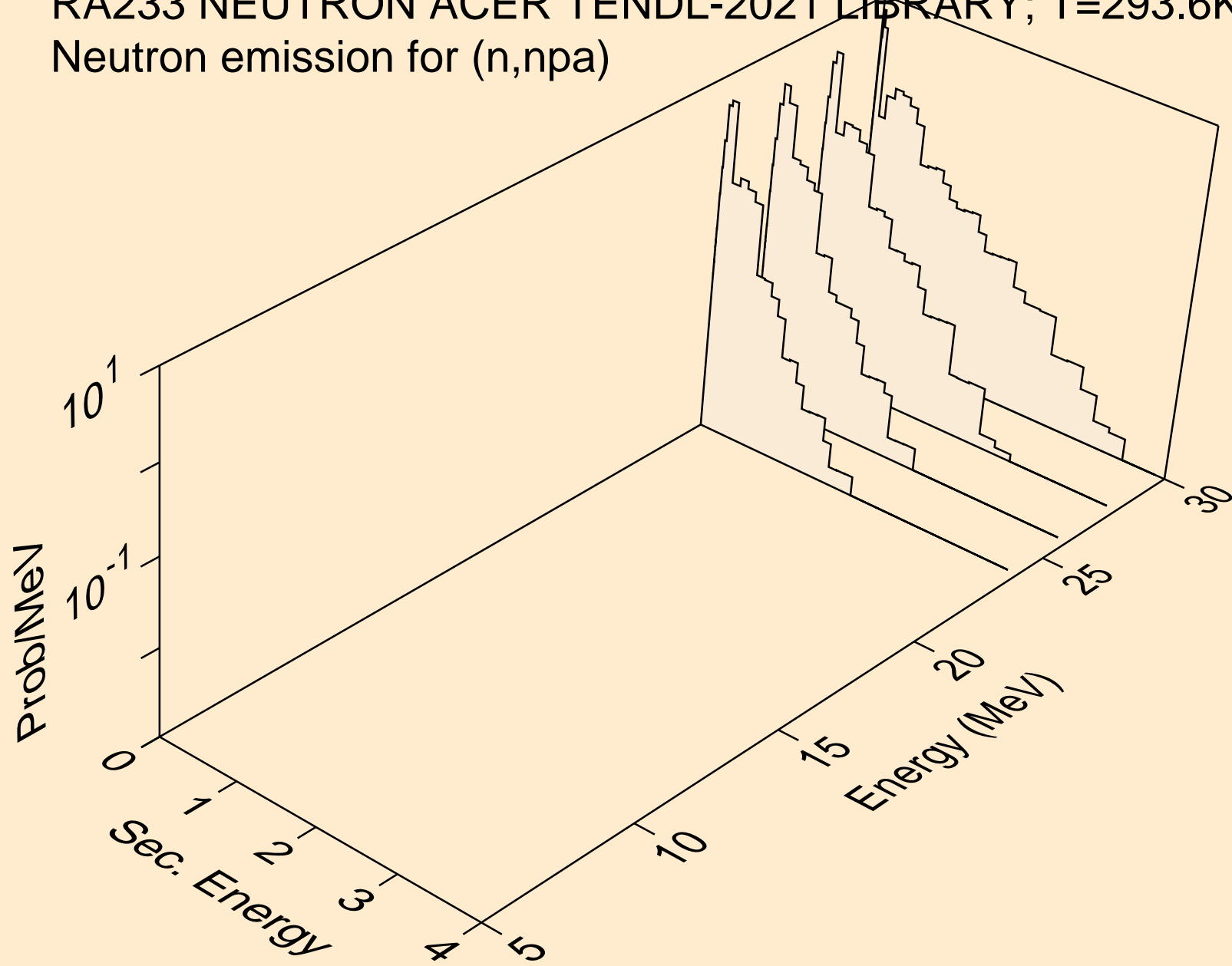

RA233 NEUTRON ACER TENDL-2021 LIBRARY; T=293.6K
Neutron emission for (n,n*c)

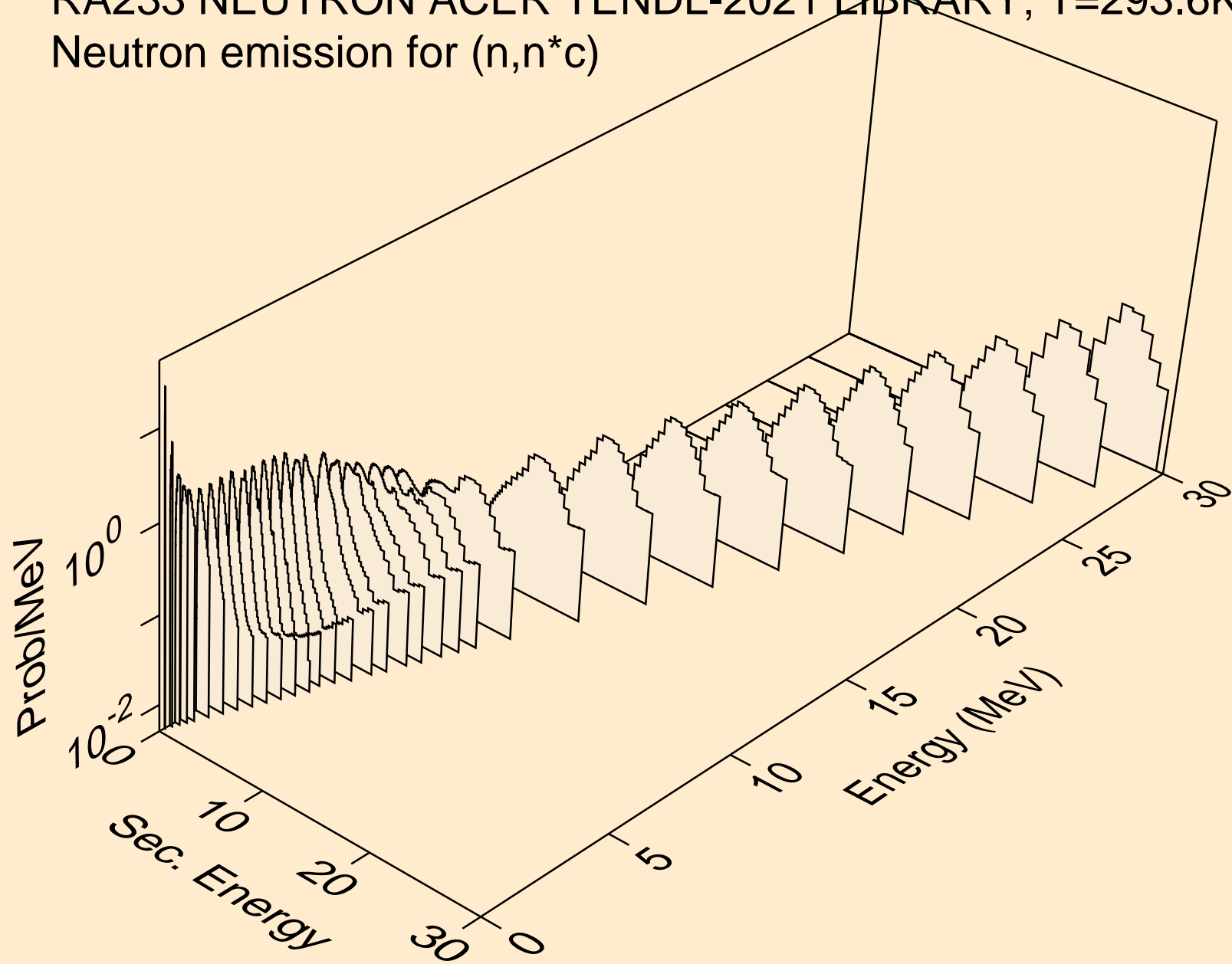

RA233 NEUTRON ACER TENDL-2021 LIBRARY; T=293.6K

Delayed nubar

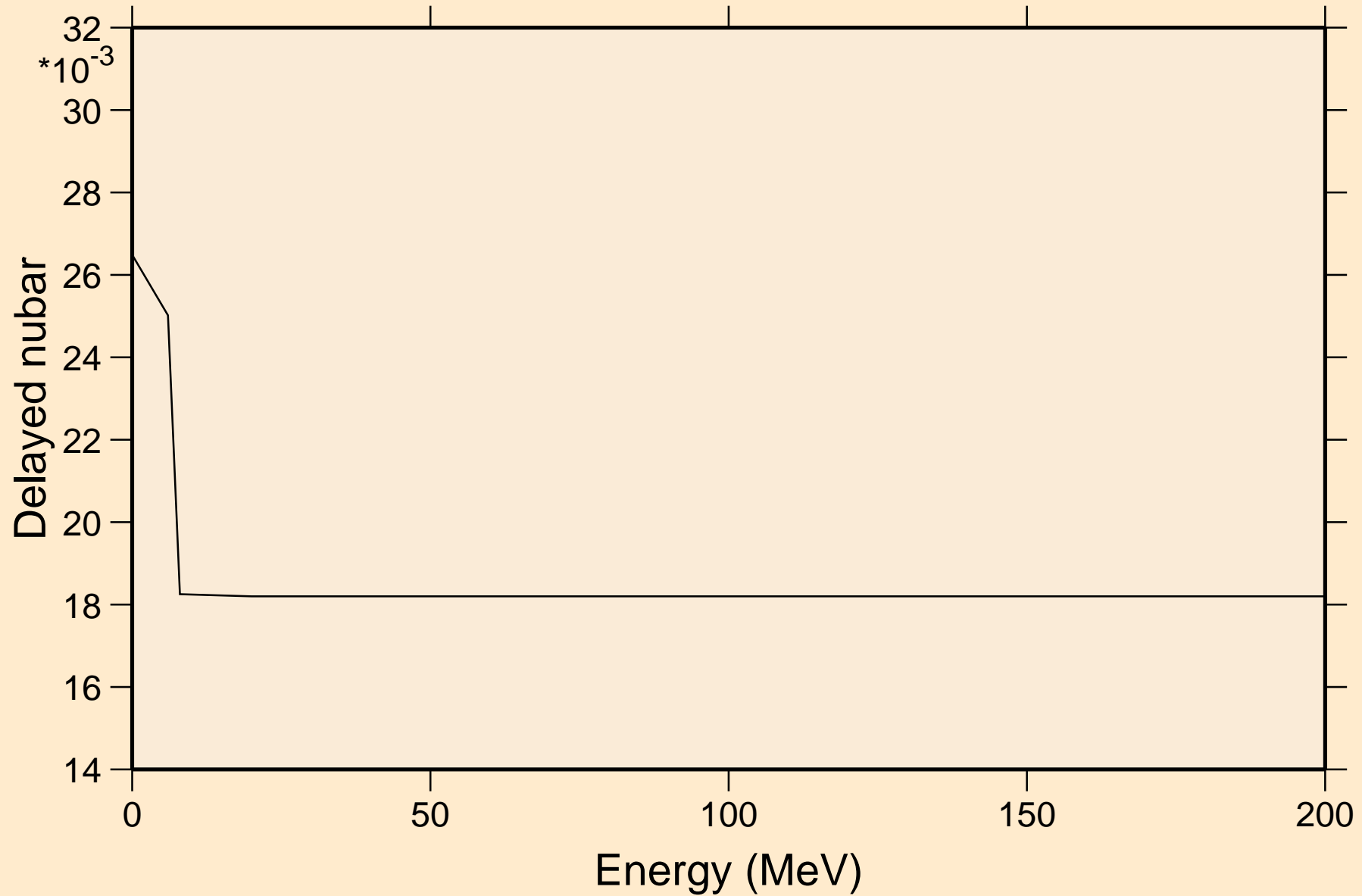

RA233 NEUTRON ACER TENDL-2021 LIBRARY; T=293.6K

Delayed neutron spectra

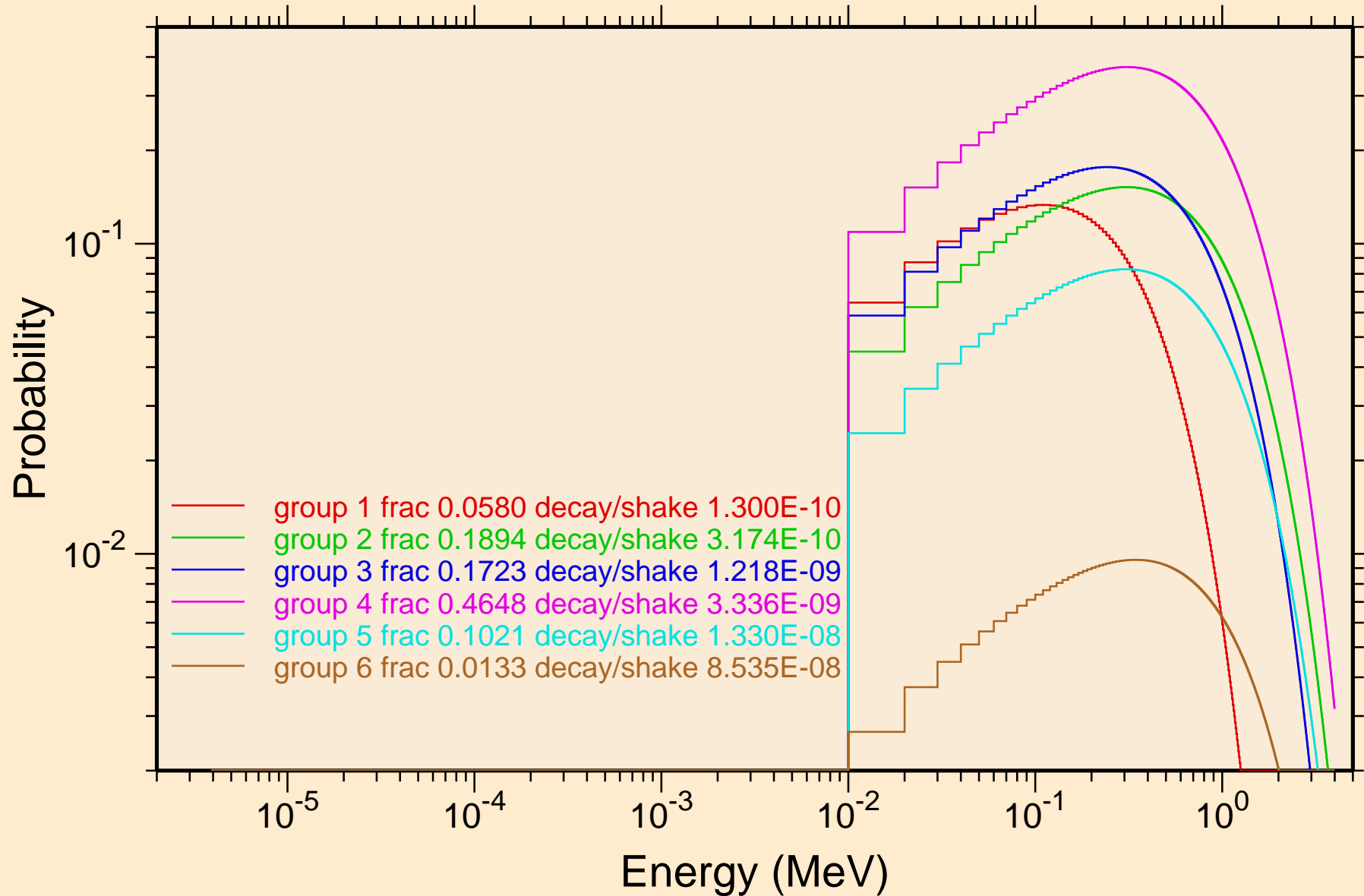

RA233 NEUTRON ACER TENDL-2021 LIBRARY; T=293.6K
Photon emission for (n,x)

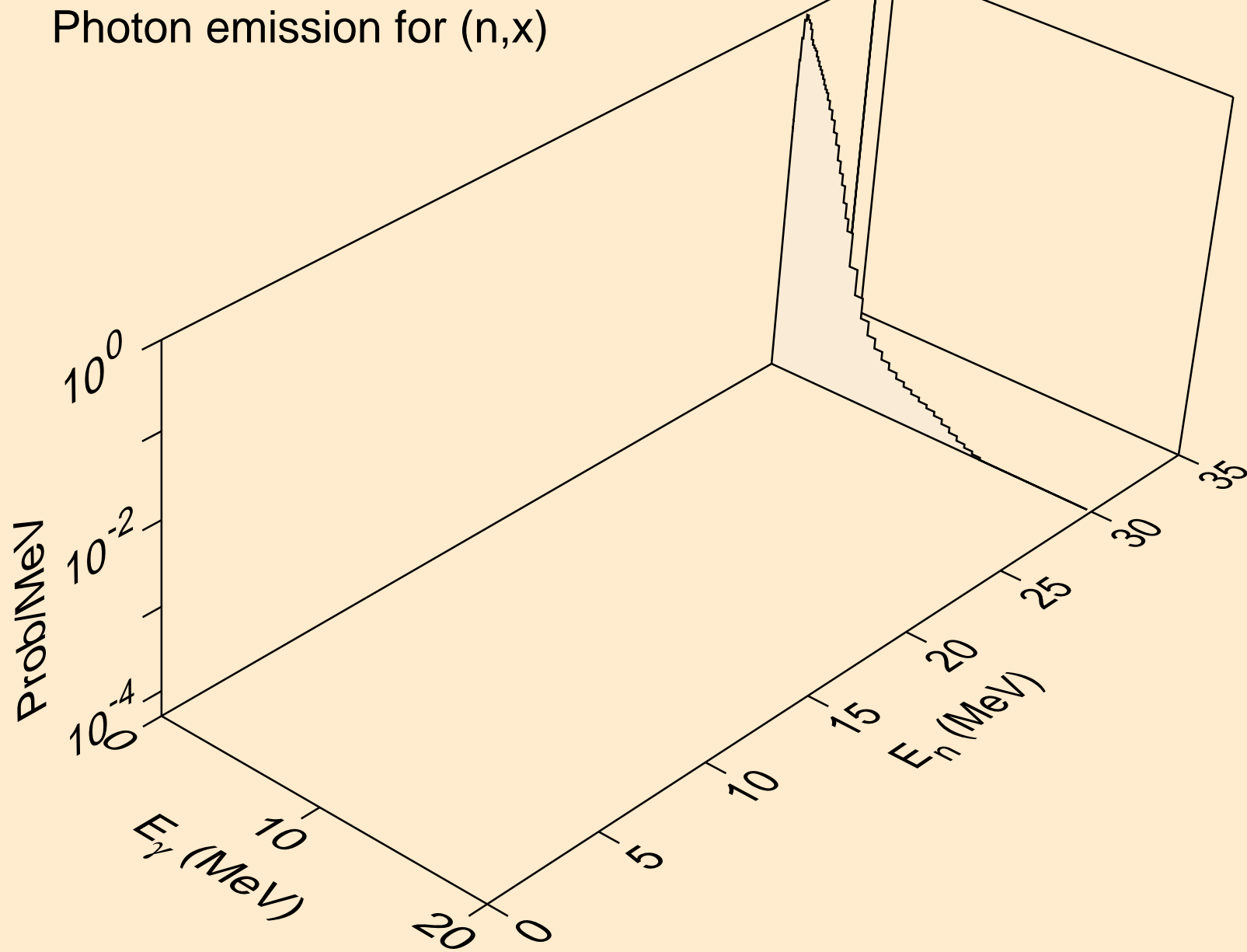

RA233 NEUTRON ACER TENDL-2021 LIBRARY; T=293.6K
Photon emission for (n,2nd)

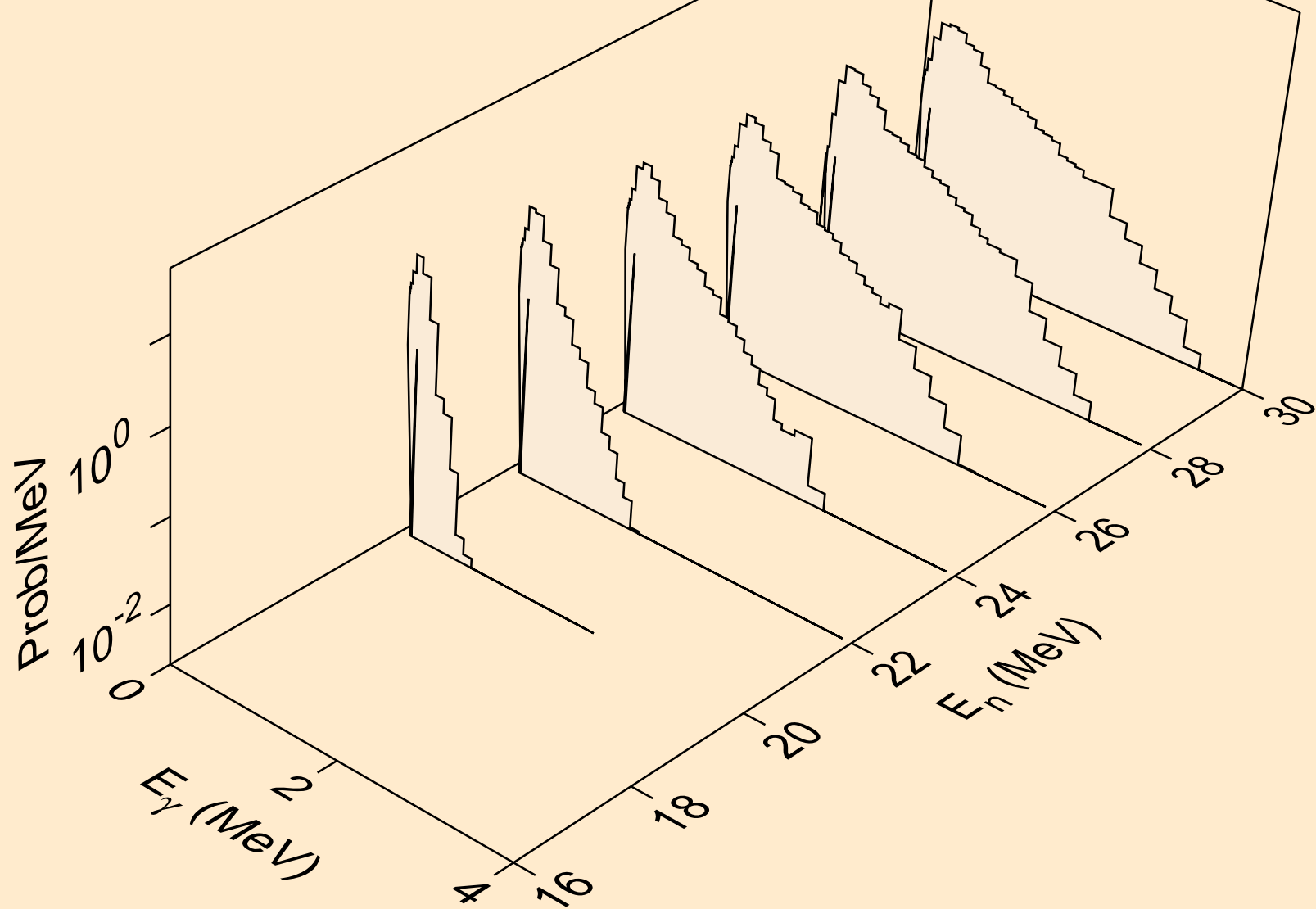

RA233 NEUTRON ACER TENDL-2021 LIBRARY; T=293.6K
Photon emission for (n,2n)

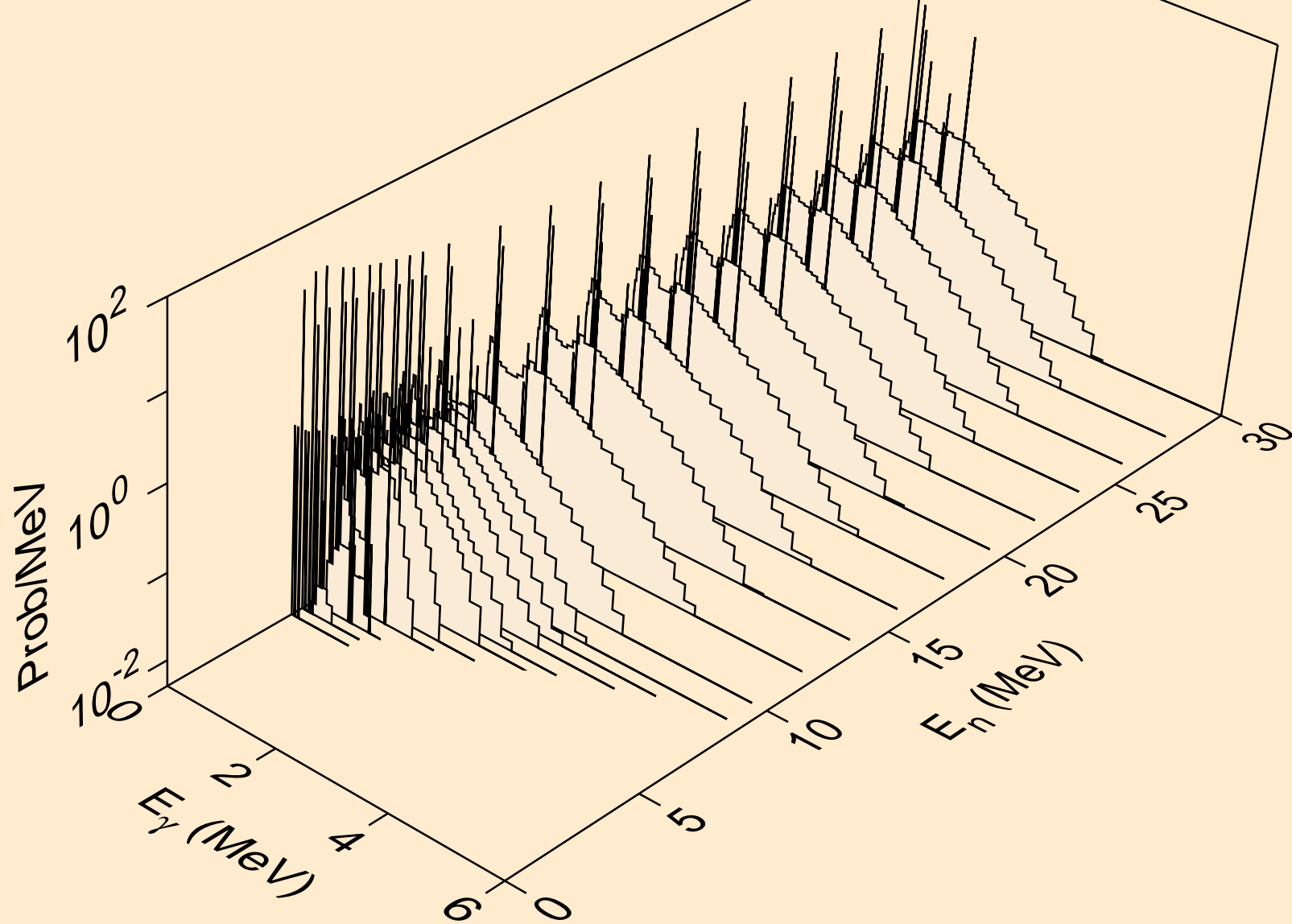

RA233 NEUTRON ACER TENDL-2021 LIBRARY; T=293.6K
Photon emission for (n,3n)

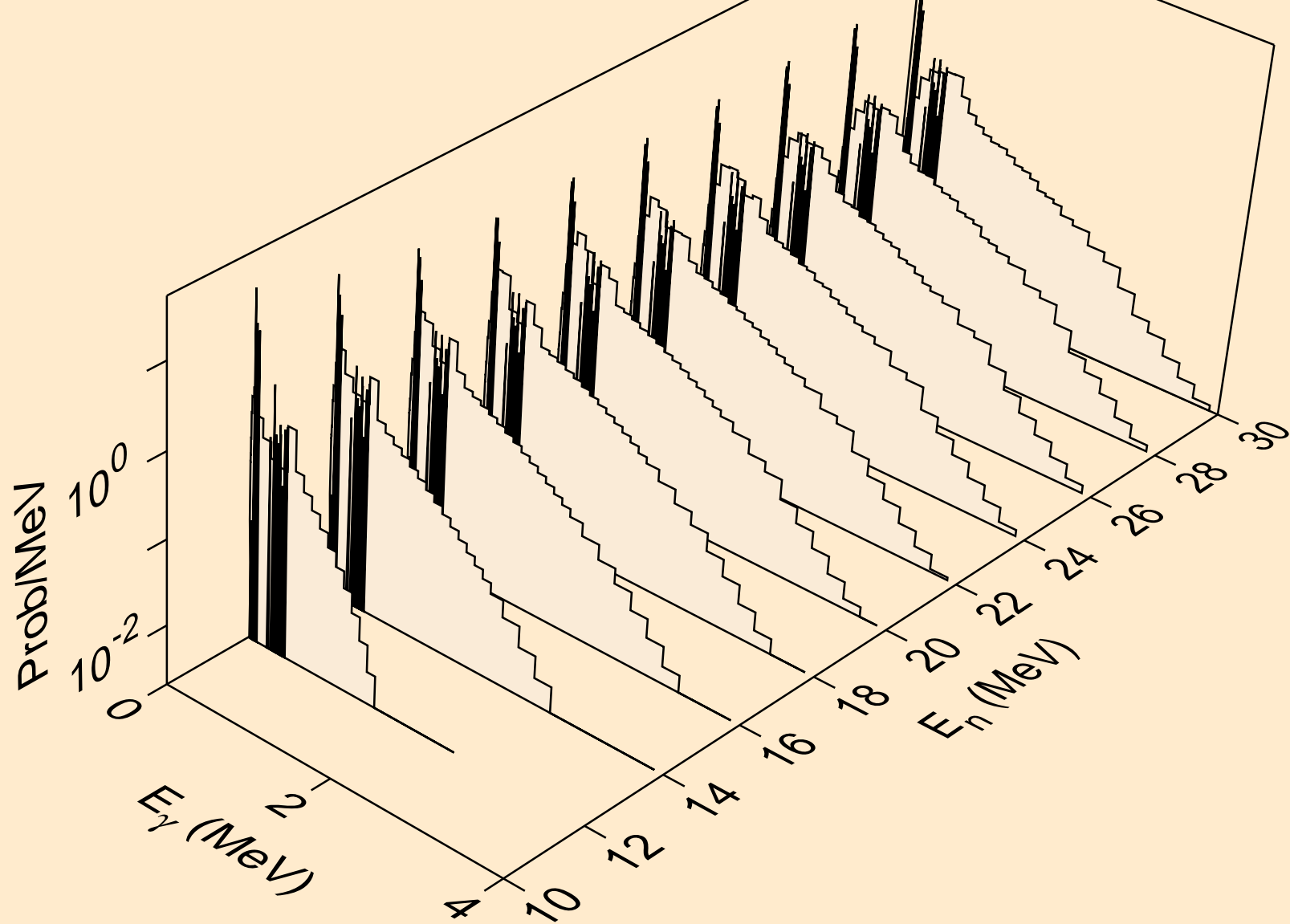

RA233 NEUTRON ACER TENDL-2021 LIBRARY; T=293.6K
Photon emission for (n,n*)a

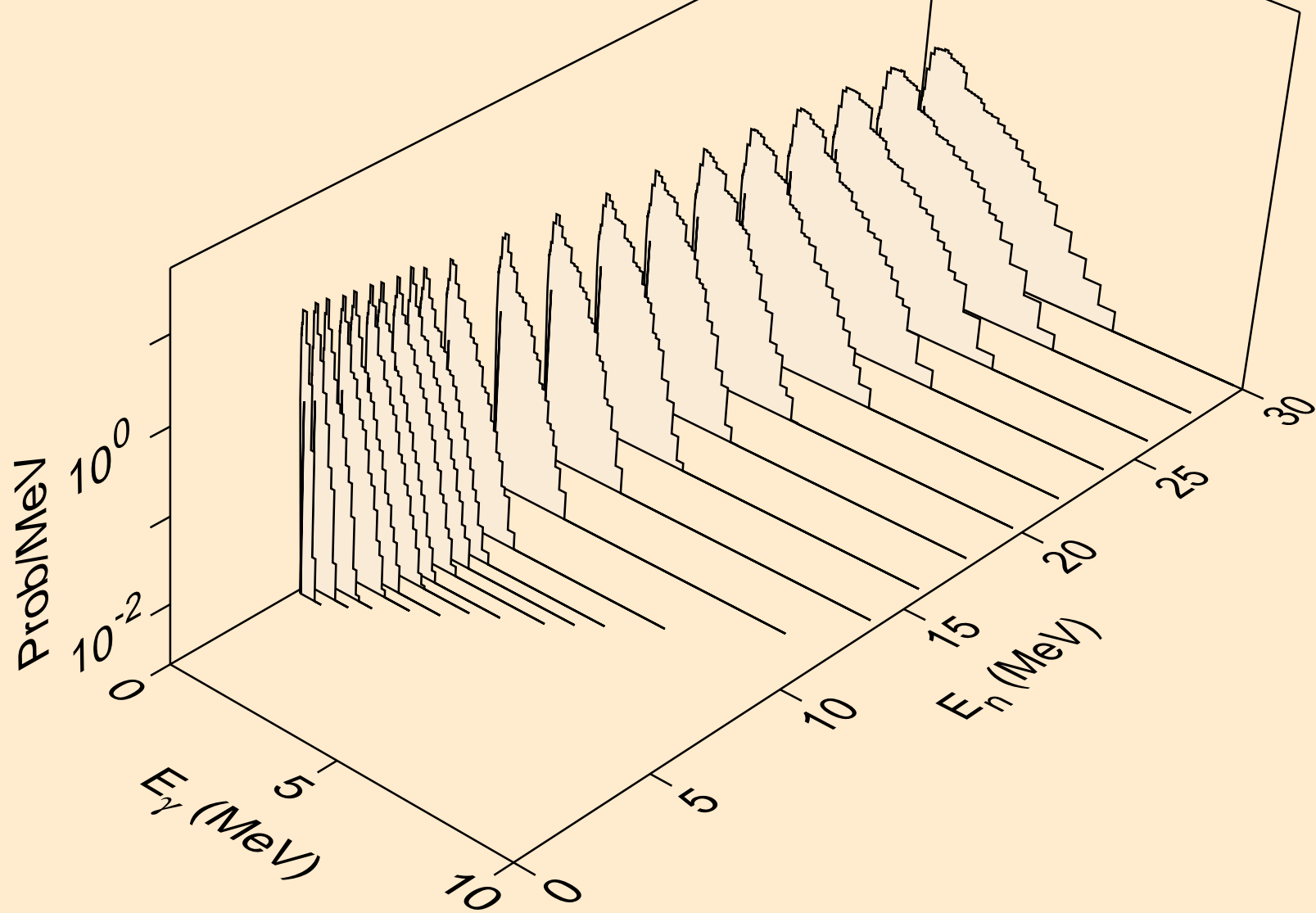

RA233 NEUTRON ACER TENDL-2021 LIBRARY; T=293.6K
Photon emission for (n,2n) α

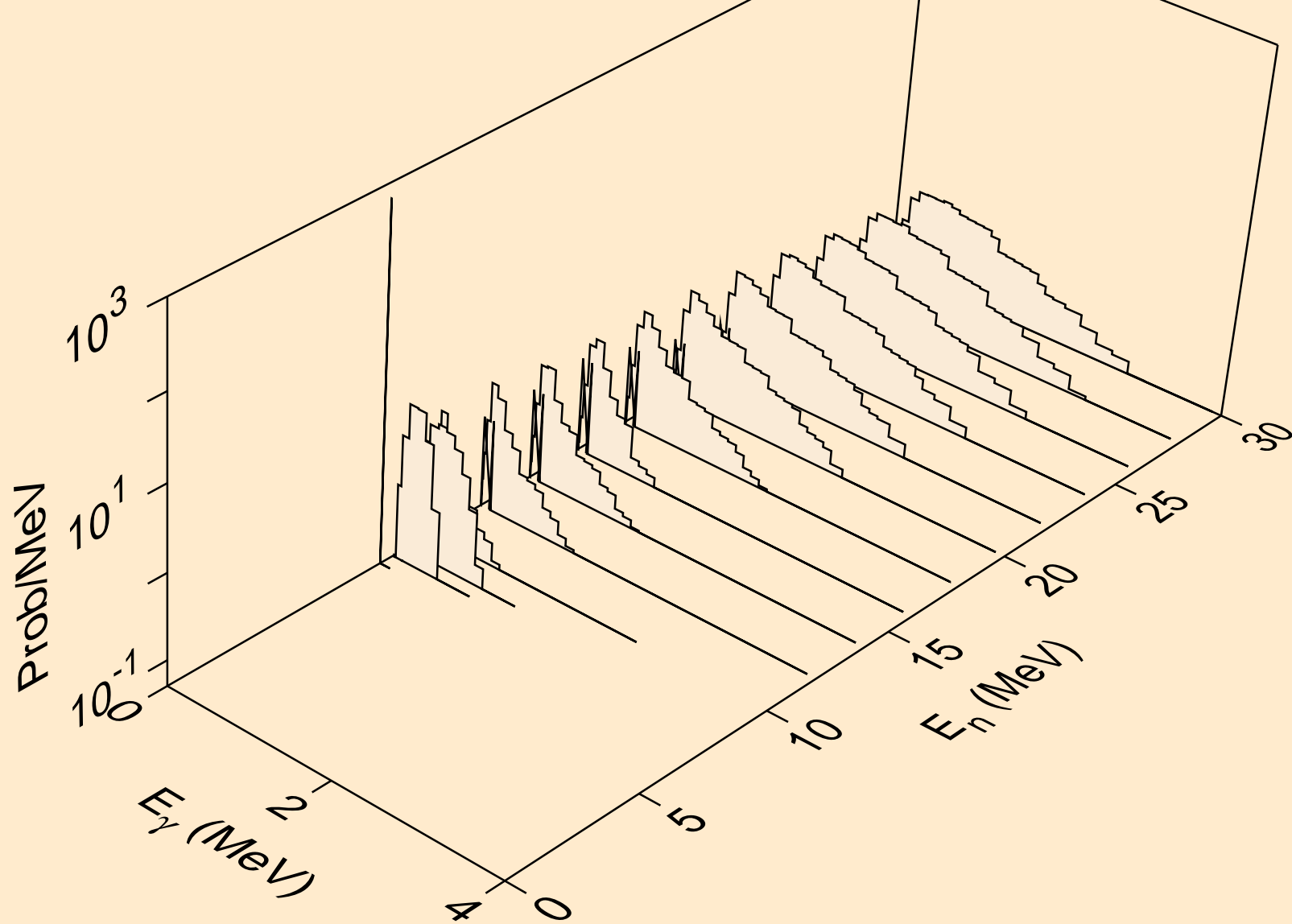

RA233 NEUTRON ACER TENDL-2021 LIBRARY; T=293.6K
Photon emission for (n,3n)a

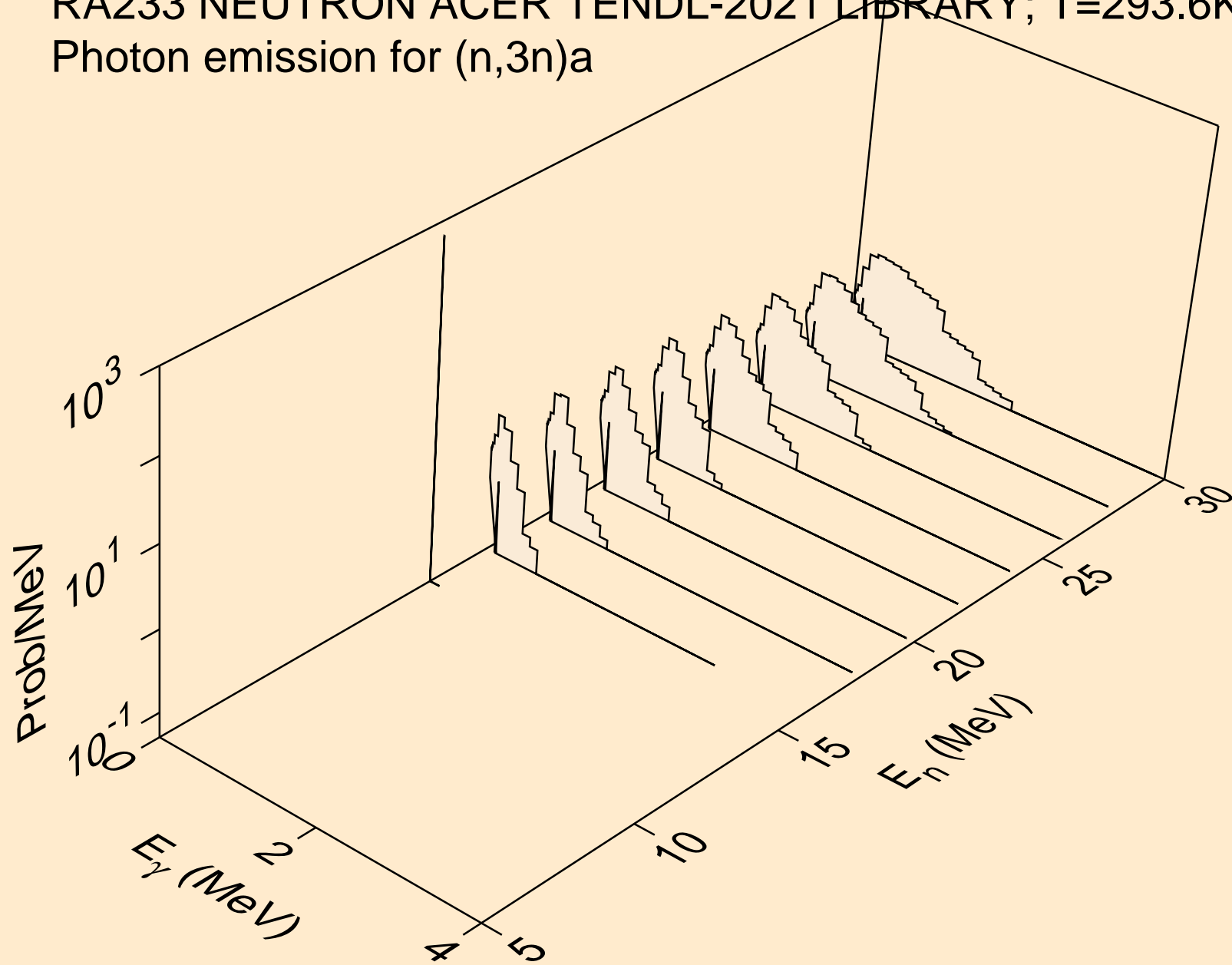

RA233 NEUTRON ACER TENDL-2021 LIBRARY; T=293.6K
Photon emission for (n,n*)p

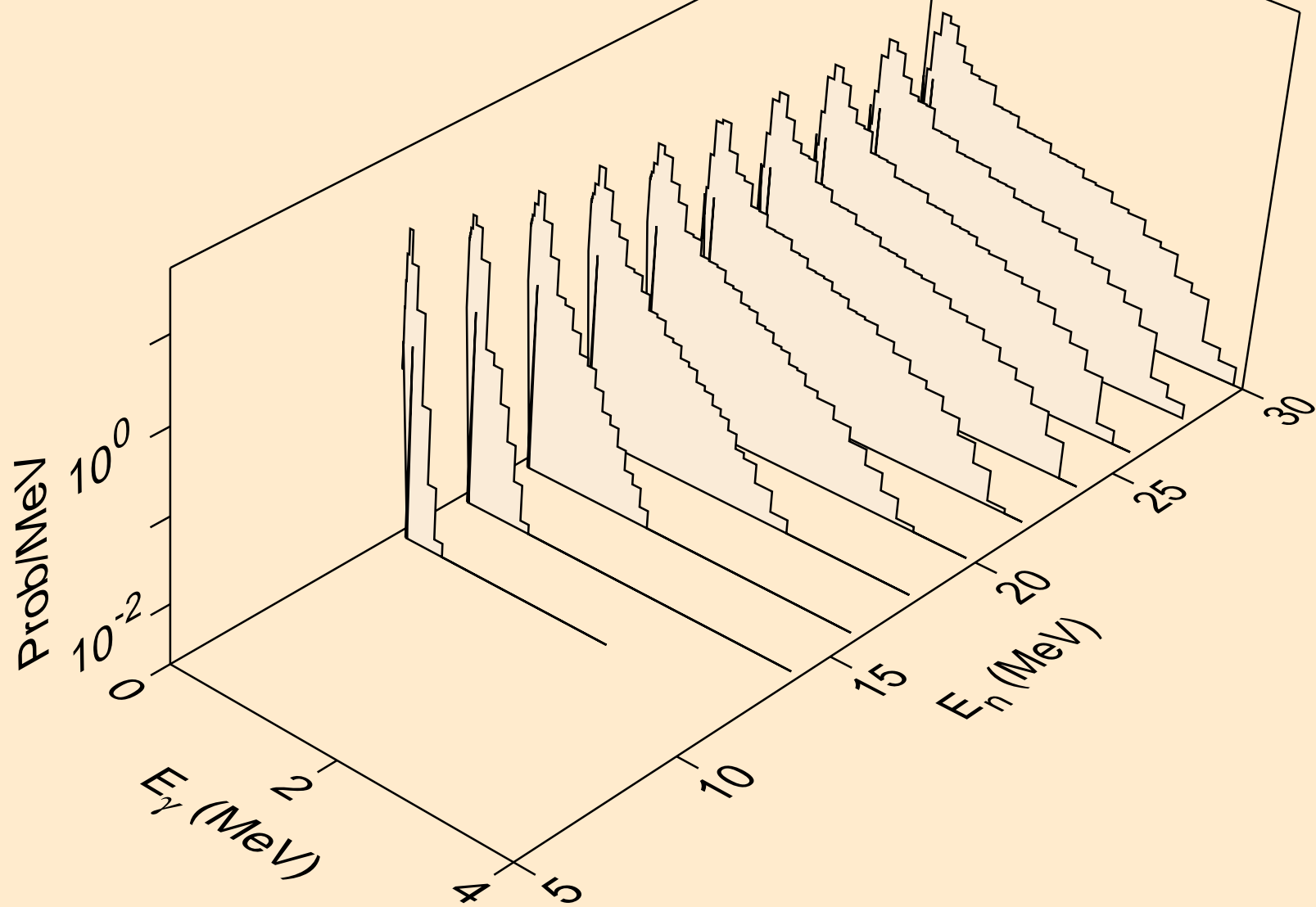

RA233 NEUTRON ACER TENDL-2021 LIBRARY; T=293.6K
Photon emission for (n,n*)d

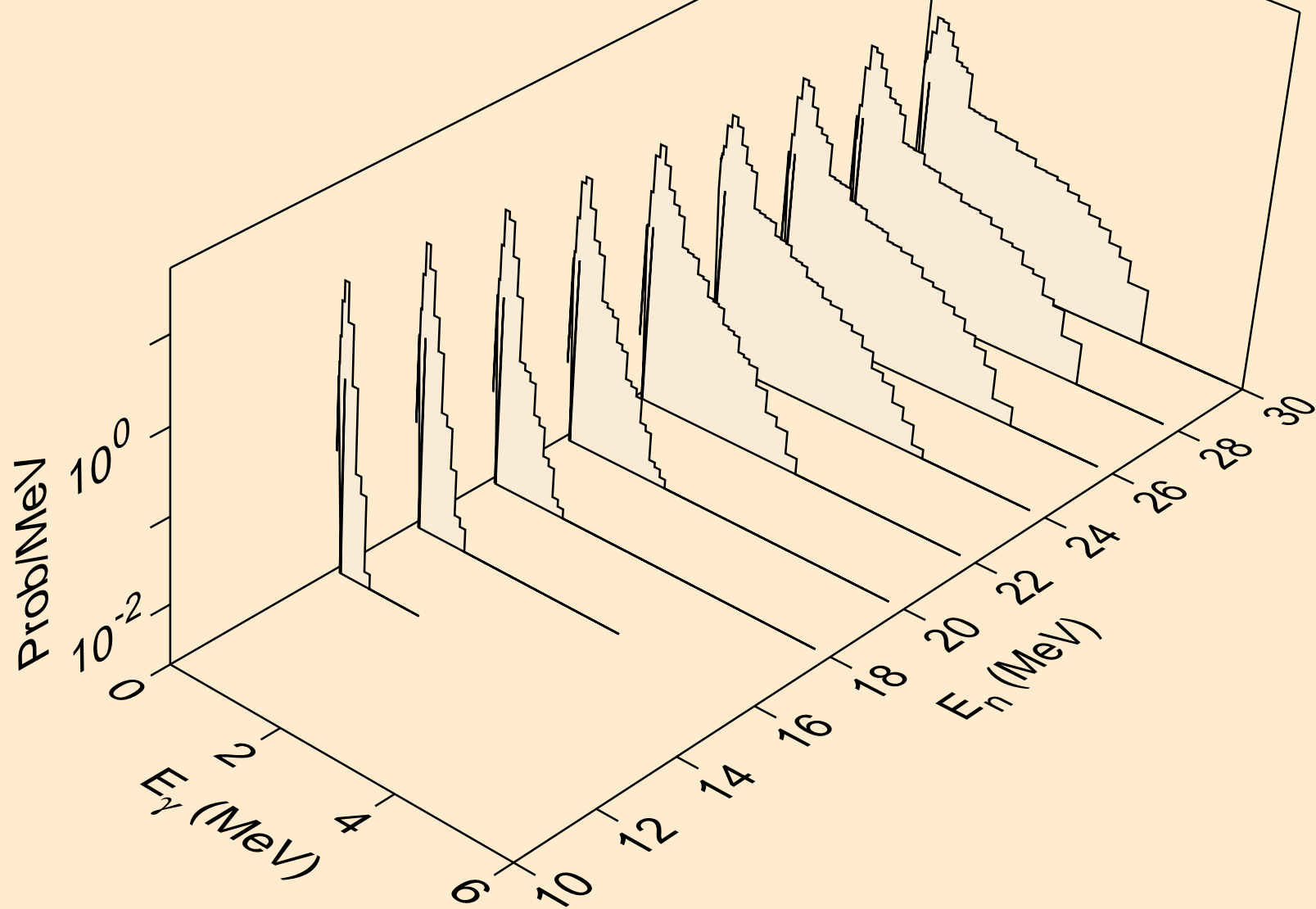

RA233 NEUTRON ACER TENDL-2021 LIBRARY; T=293.6K
Photon emission for (n,n*)t

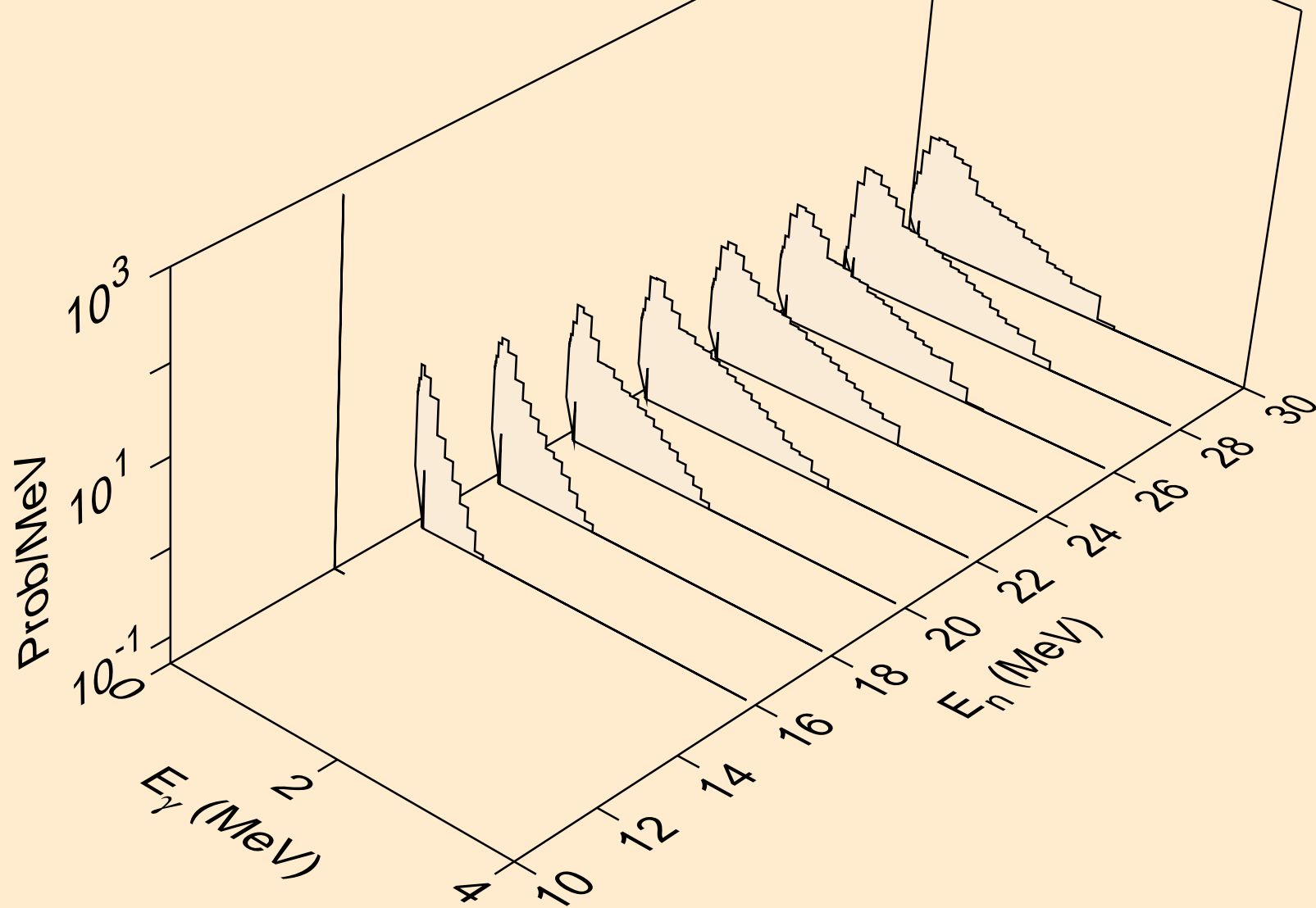

RA233 NEUTRON ACER TENDL-2021 LIBRARY; T=293.6K
Photon emission for (n,n*)he3

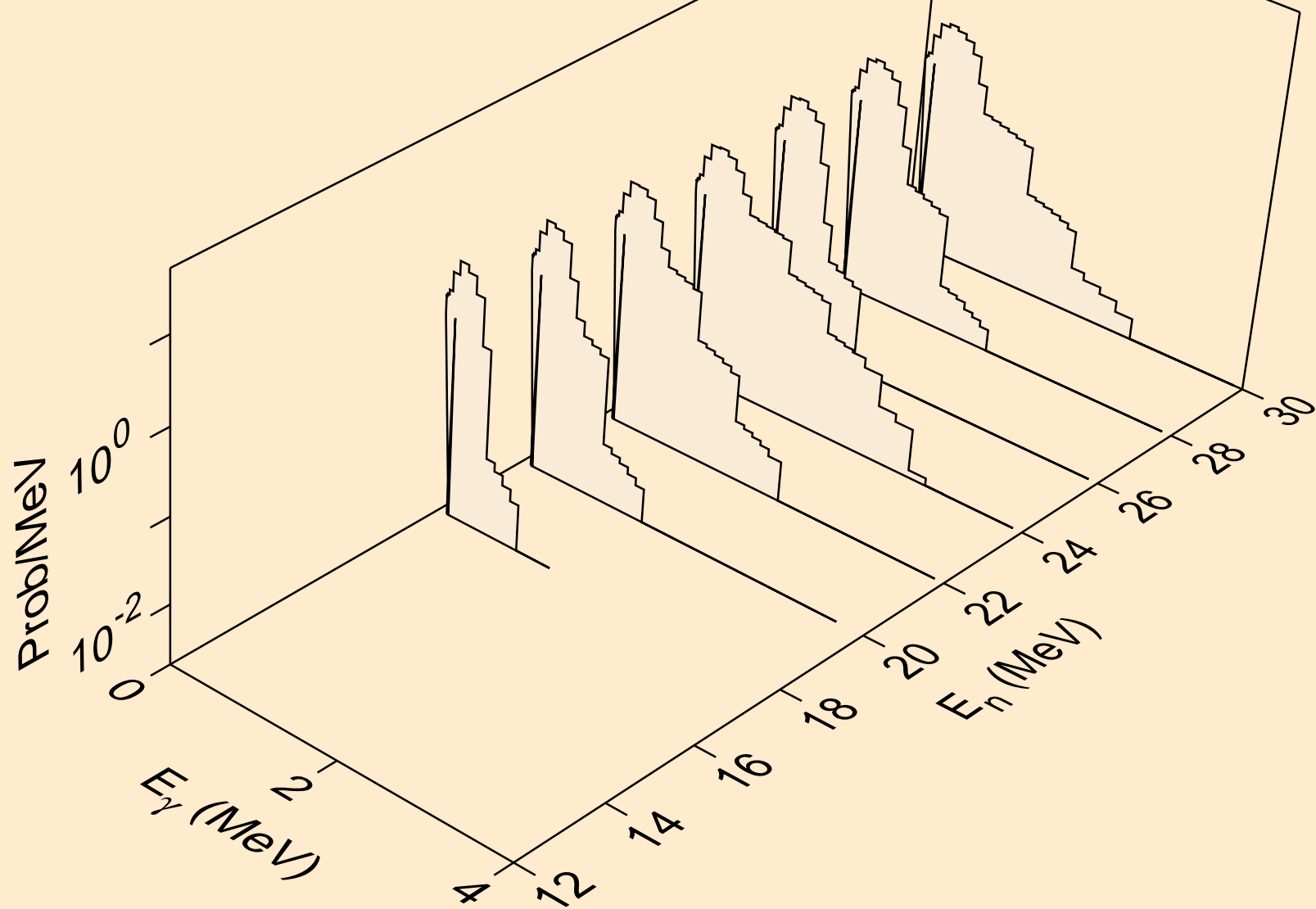

RA233 NEUTRON ACER TENDL-2021 LIBRARY; T=293.6K
Photon emission for (n,4n)

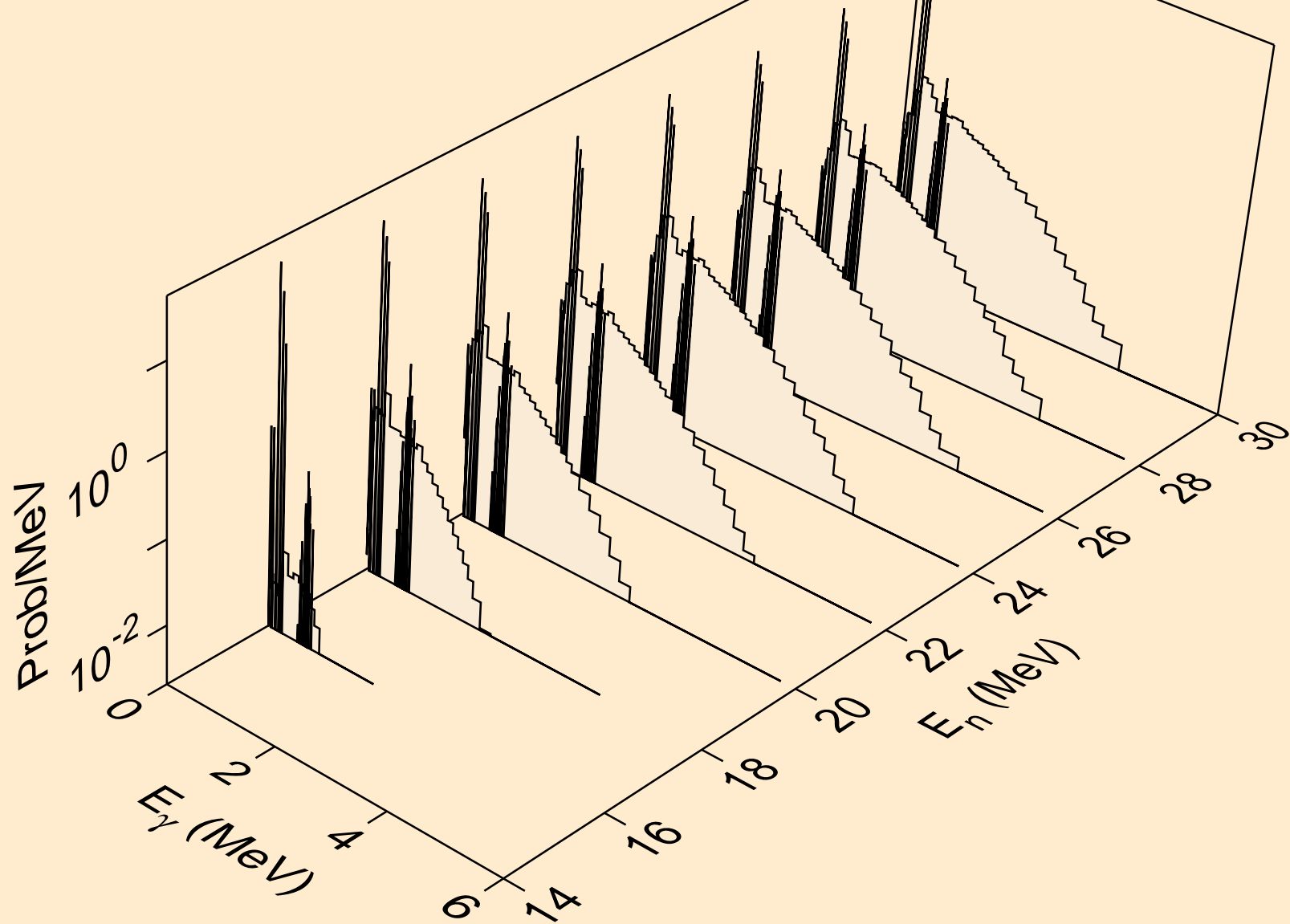

RA233 NEUTRON ACER TENDL-2021 LIBRARY; T=293.6K
Photon emission for (n,2np)

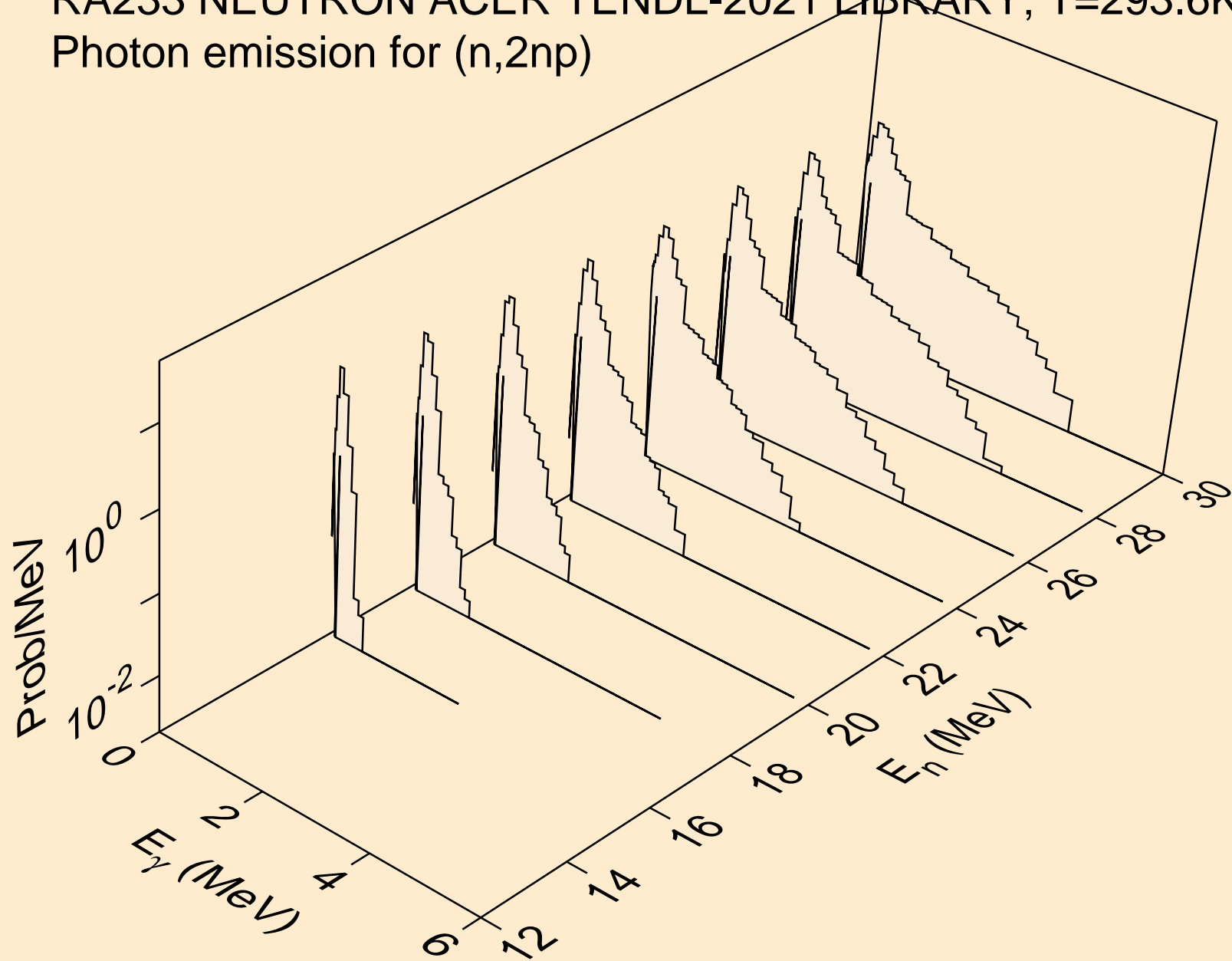

RA233 NEUTRON ACER TENDL-2021 LIBRARY; T=293.6K
Photon emission for (n,3np)

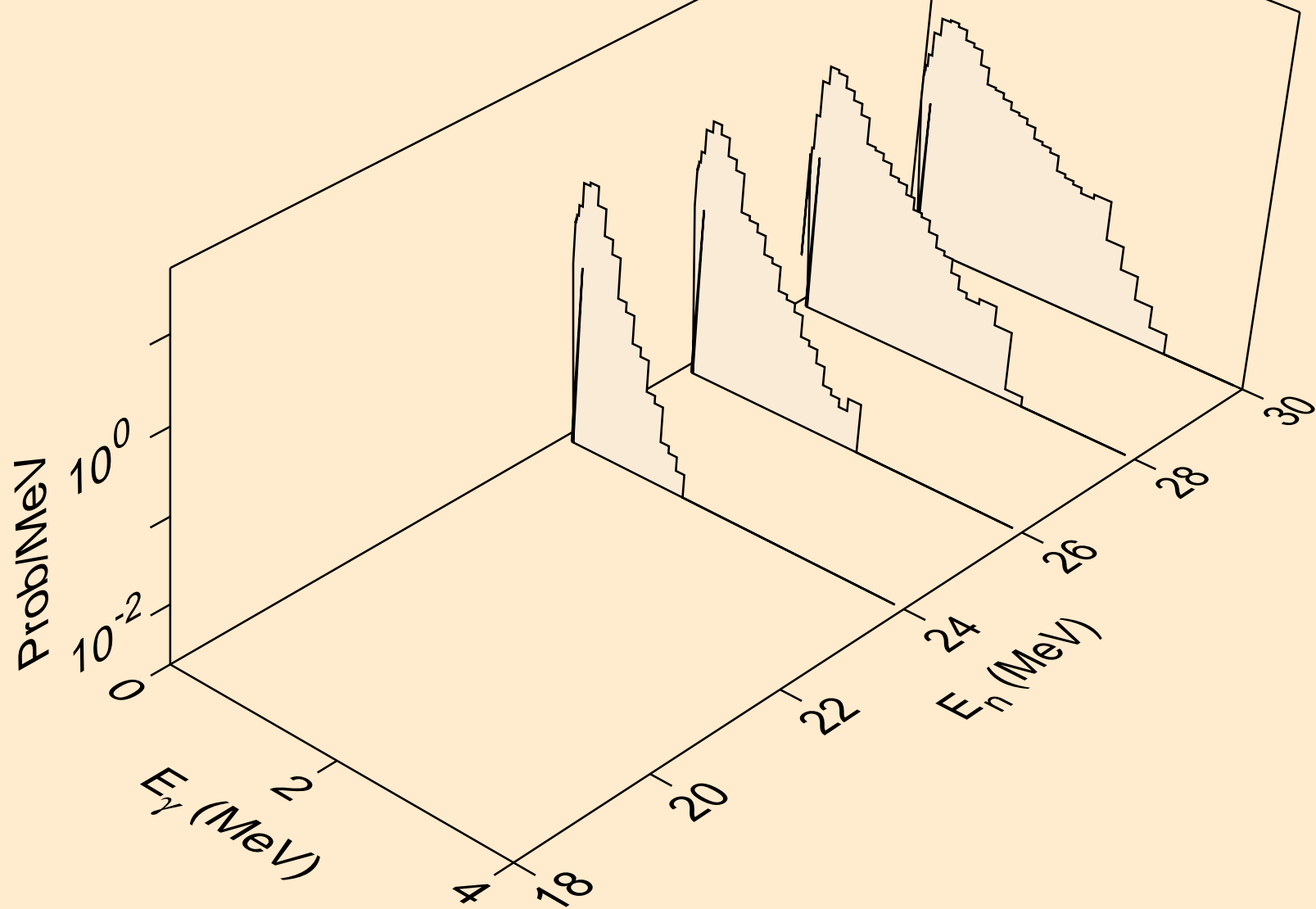

RA233 NEUTRON ACER TENDL-2021 LIBRARY; T=293.6K
Photon emission for (n,2np)

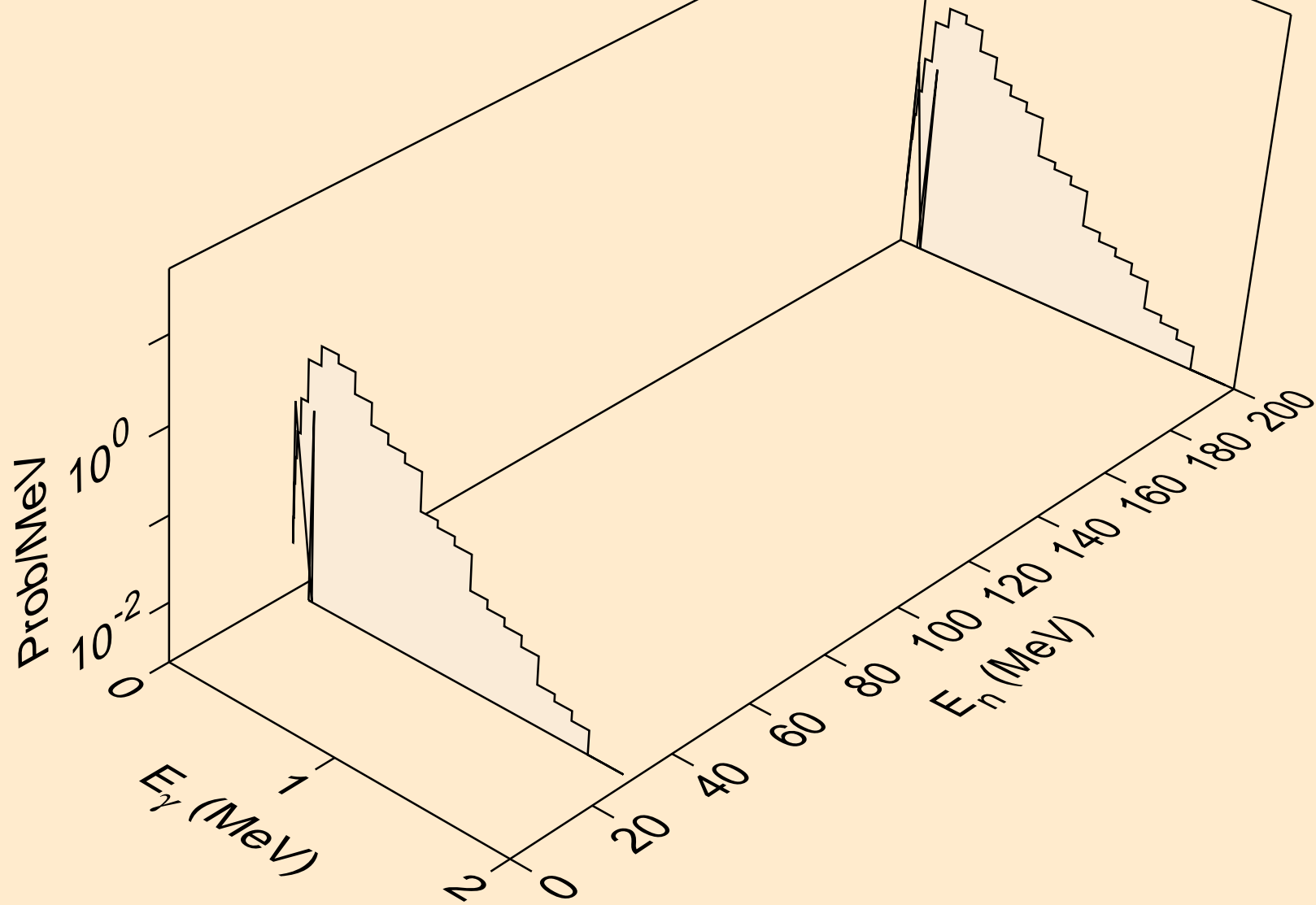

RA233 NEUTRON ACER TENDL-2021 LIBRARY; T=293.6K
Photon emission for (n,npa)

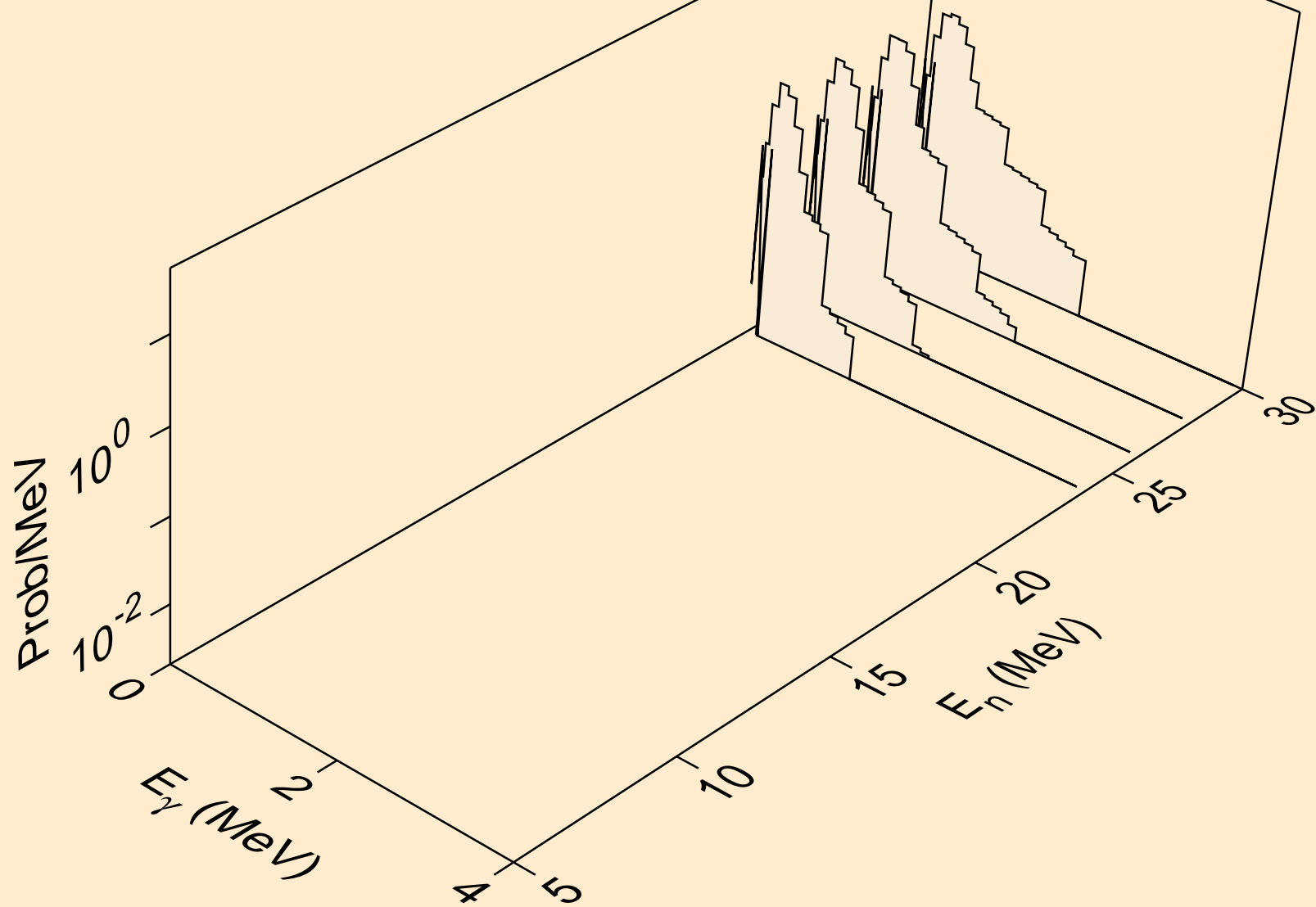

RA233 NEUTRON ACER TENDL-2021 LIBRARY; T=293.6K
Photon emission for (n,n*c)

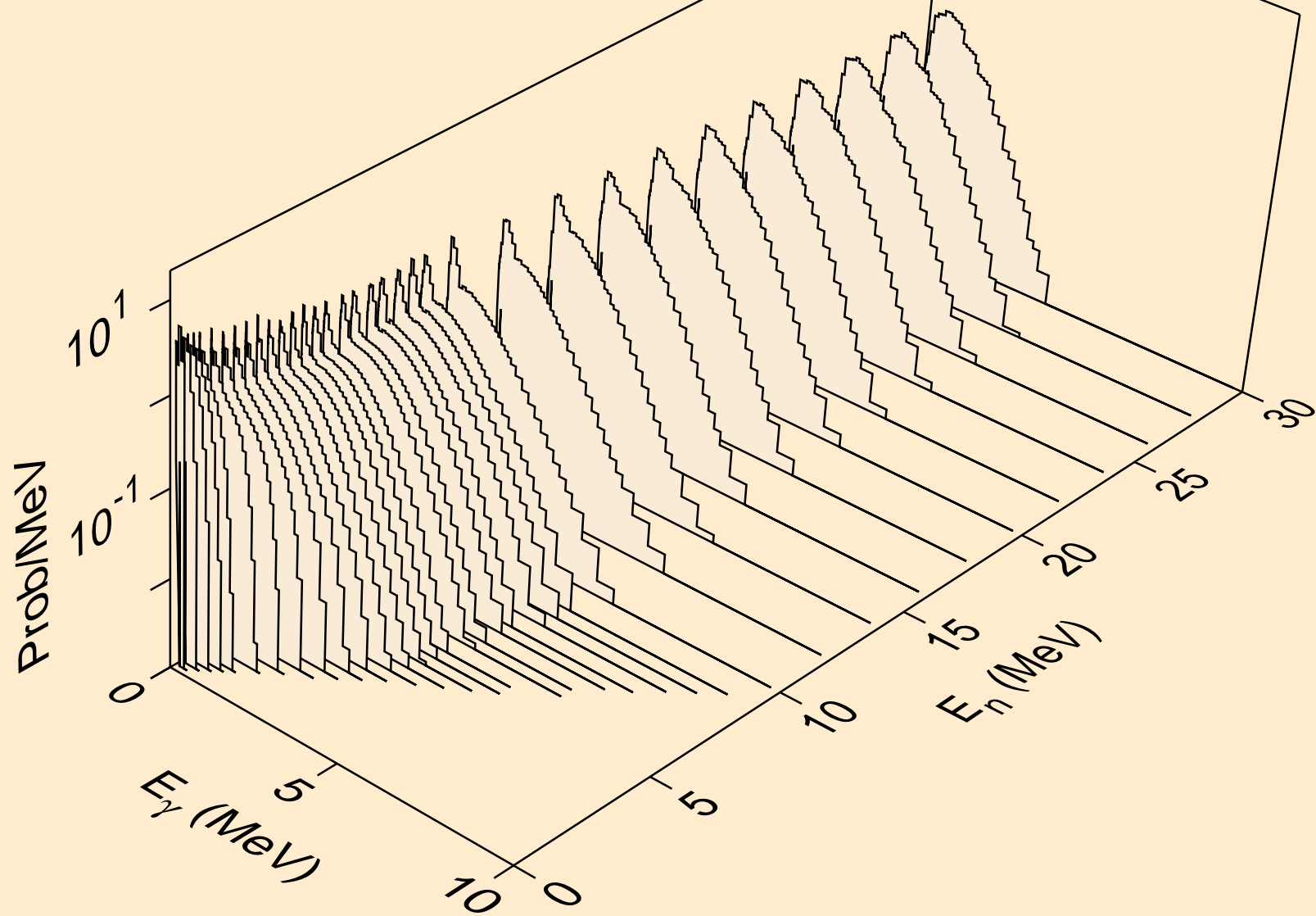

RA233 NEUTRON ACER TENDL-2021 LIBRARY; T=293.6K
Photon emission for (n,gma)

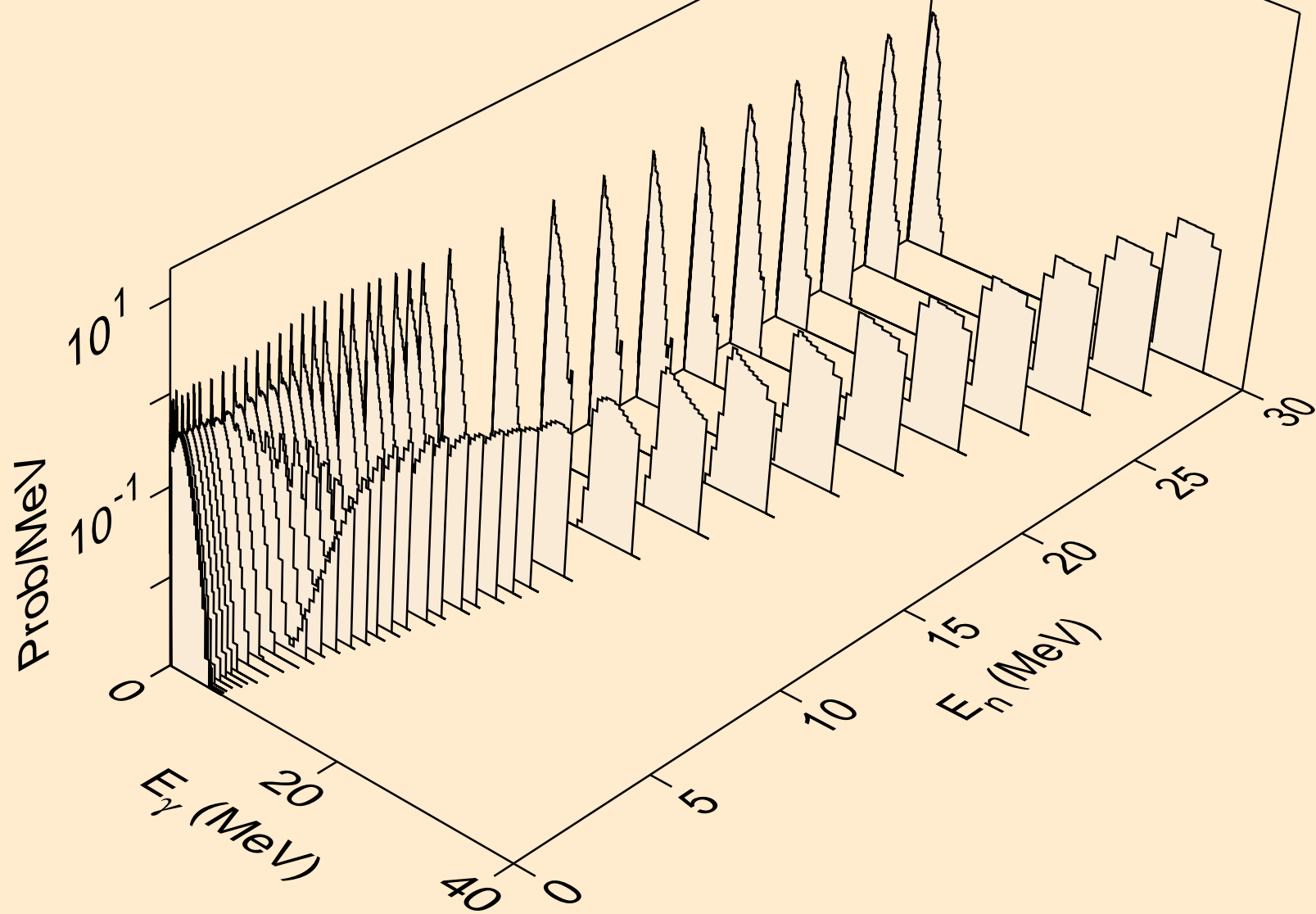

RA233 NEUTRON ACER TENDL-2021 LIBRARY; T=293.6K
Photon emission for (n,p)

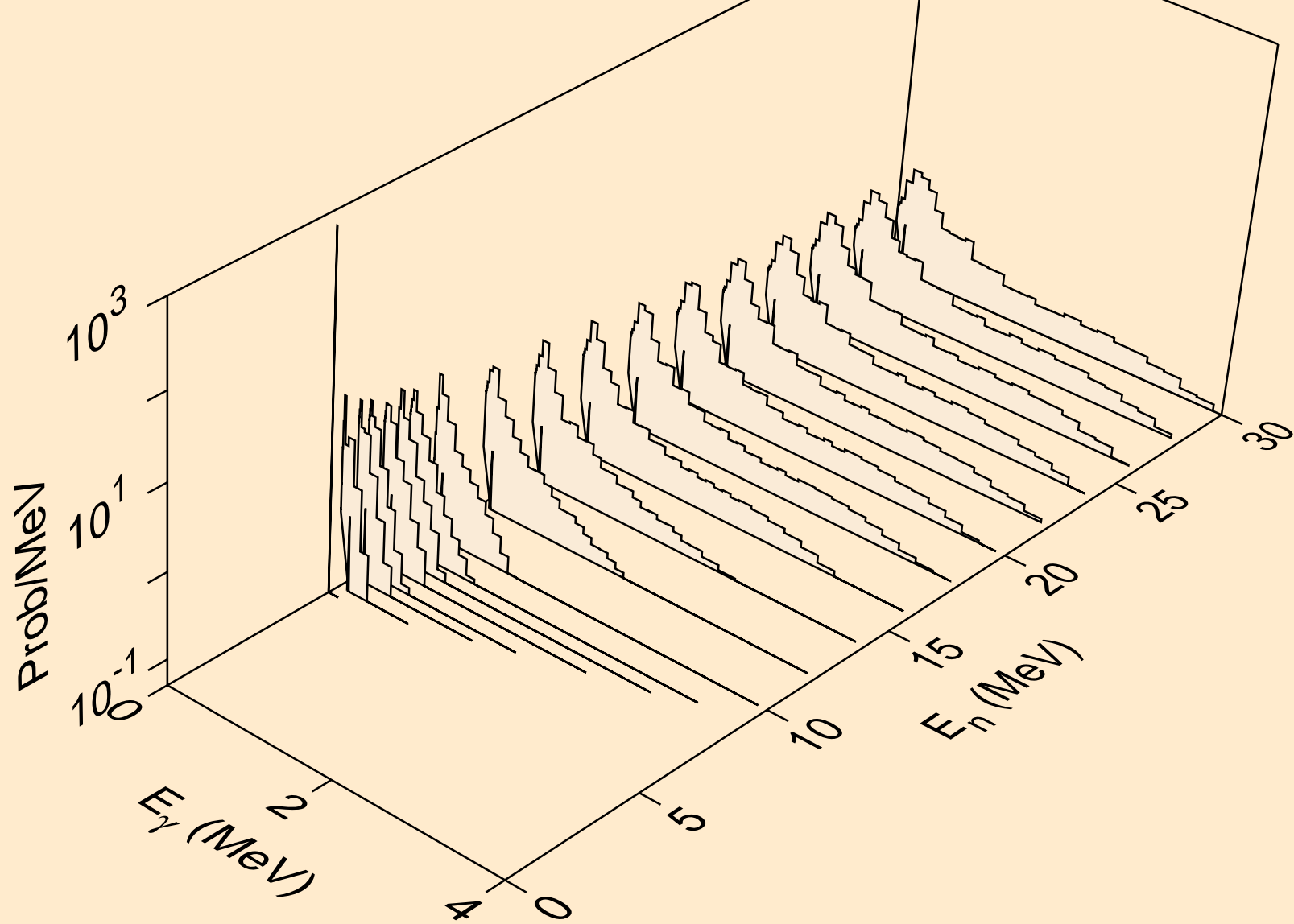

RA233 NEUTRON ACER TENDL-2021 LIBRARY; T=293.6K
Photon emission for (n,d)

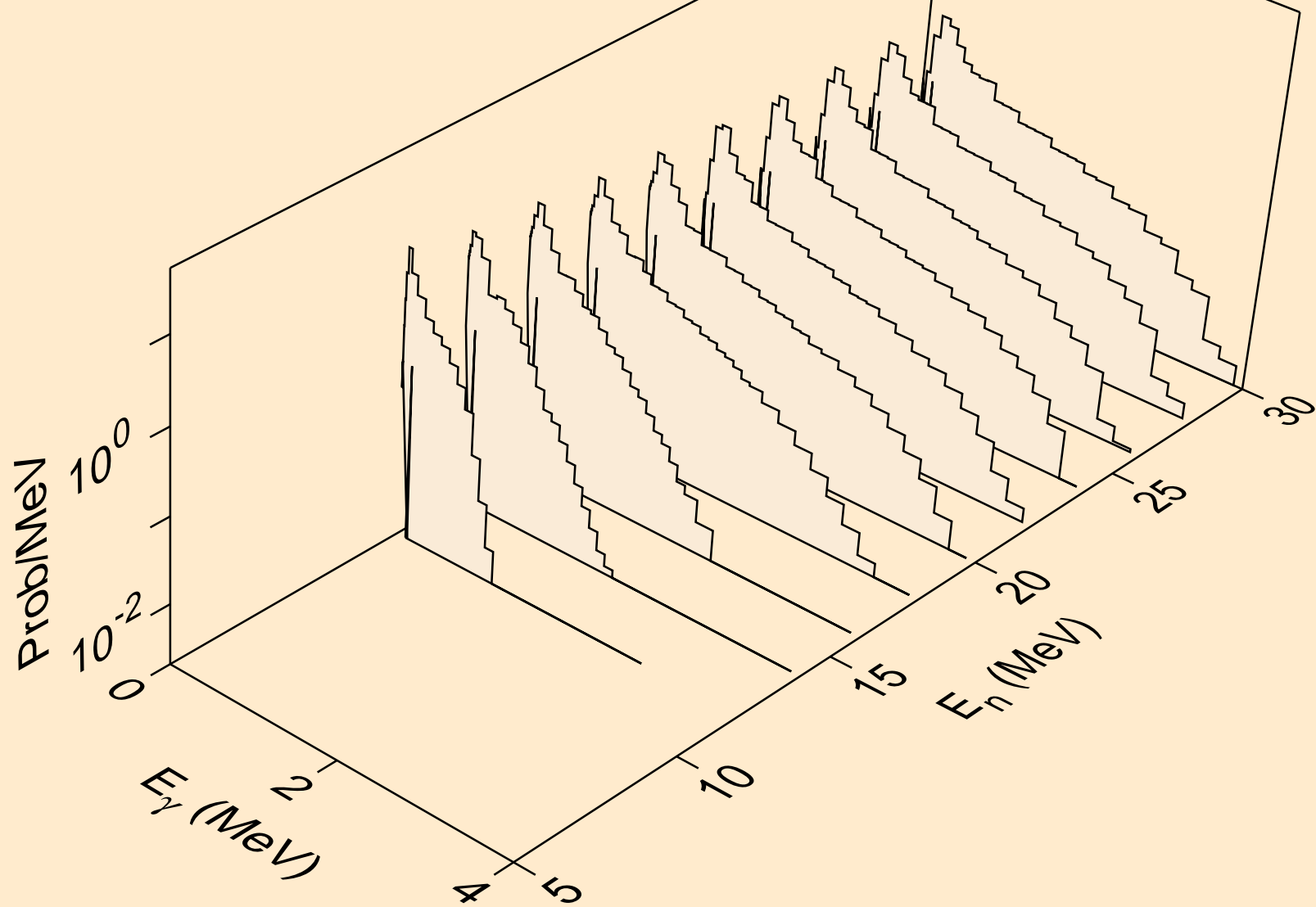

RA233 NEUTRON ACER TENDL-2021 LIBRARY; T=293.6K
Photon emission for (n,t)

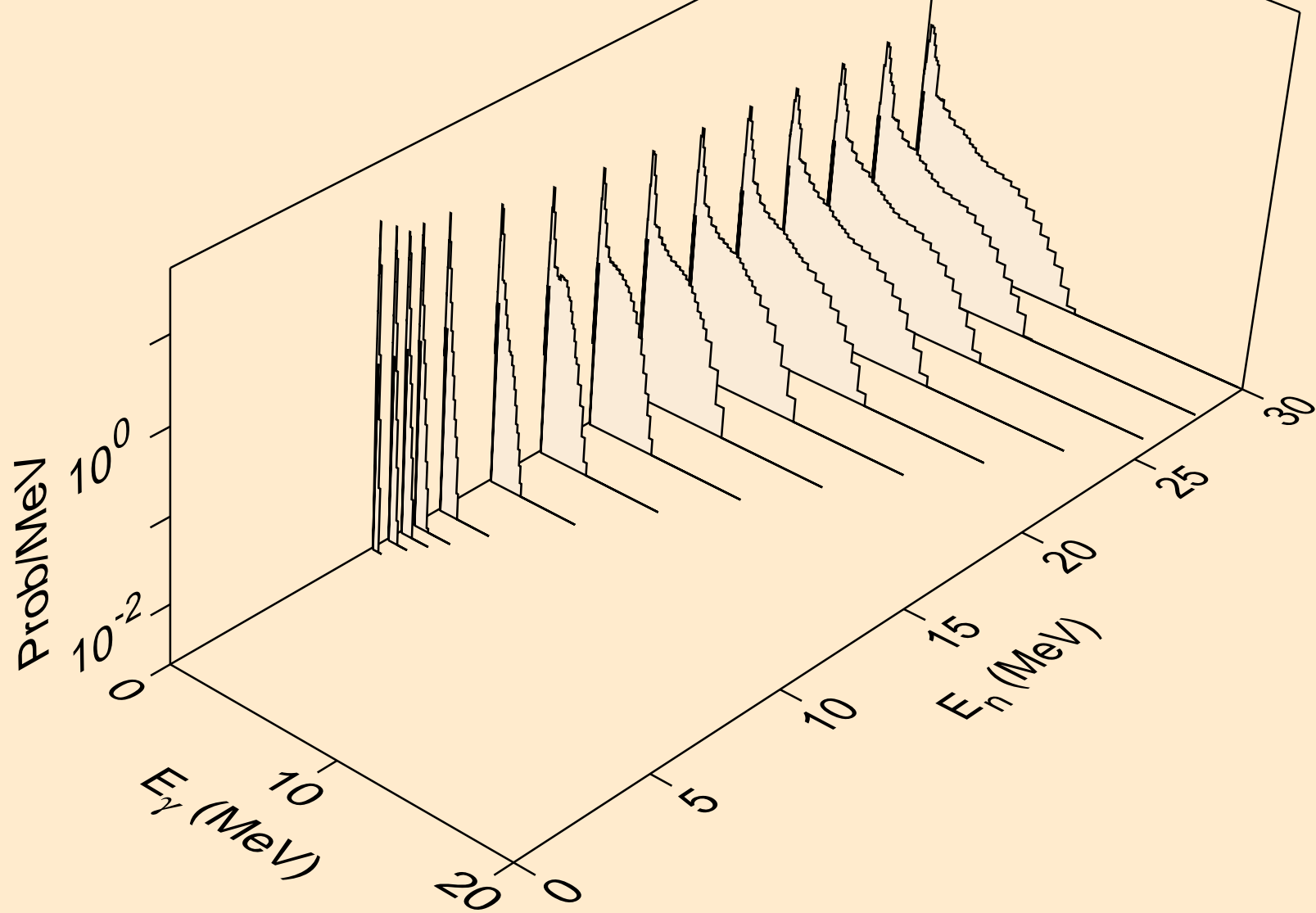

RA233 NEUTRON ACER TENDL-2021 LIBRARY; T=293.6K
Photon emission for (n,he3)

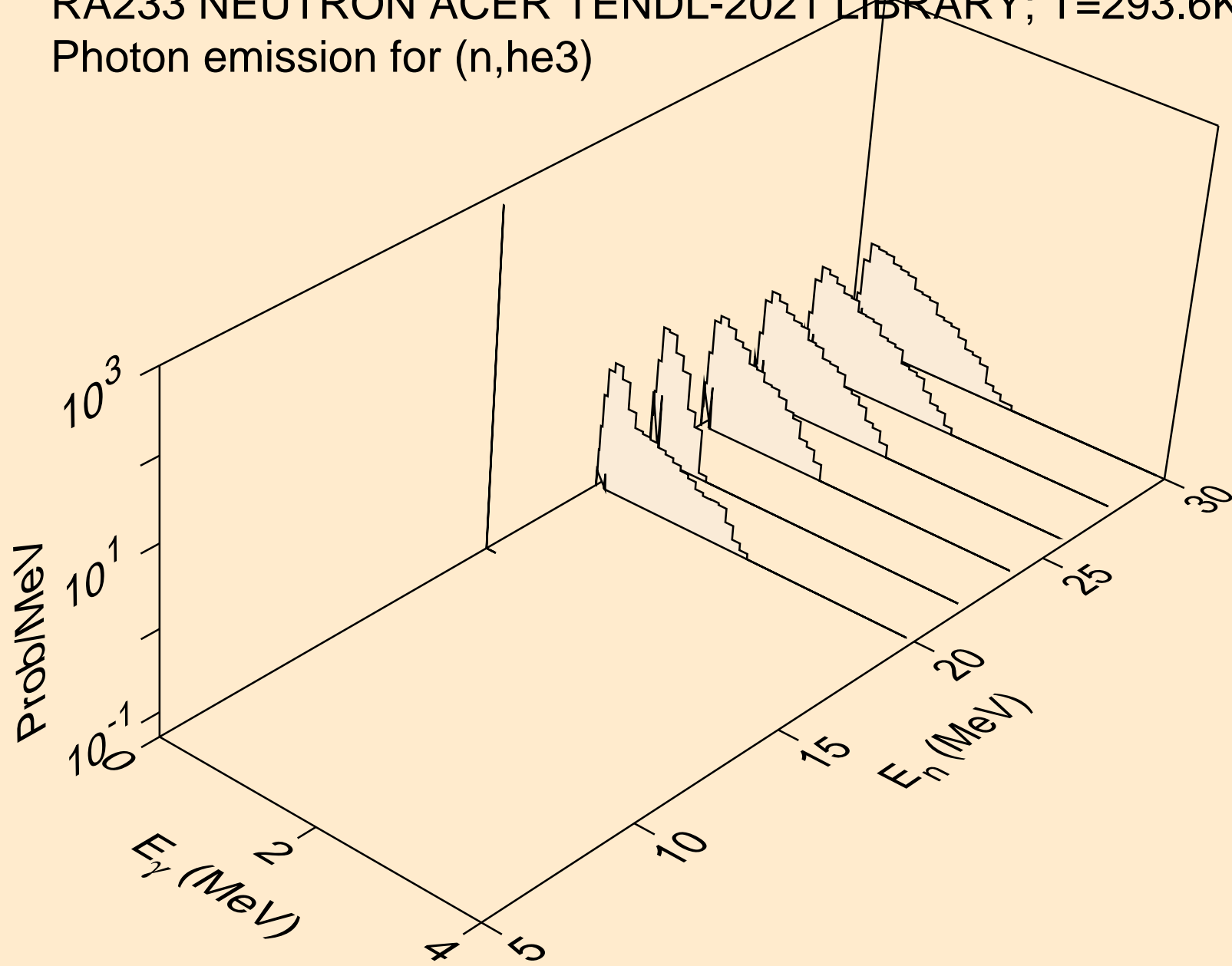

RA233 NEUTRON ACER TENDL-2021 LIBRARY; T=293.6K
Photon emission for (n,a)

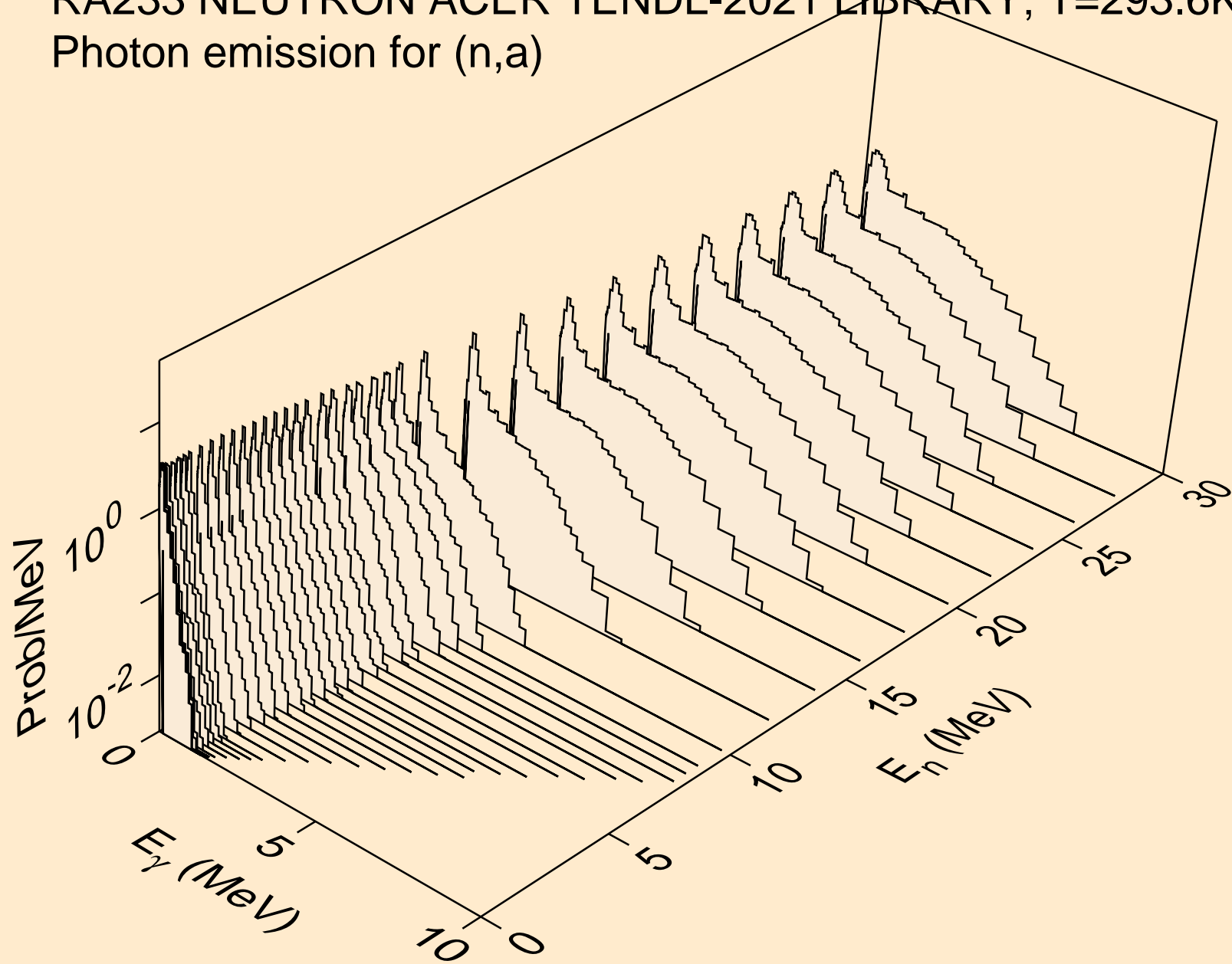

RA233 NEUTRON ACER TENDL-2021 LIBRARY; T=293.6K
Photon emission for (n,2p)

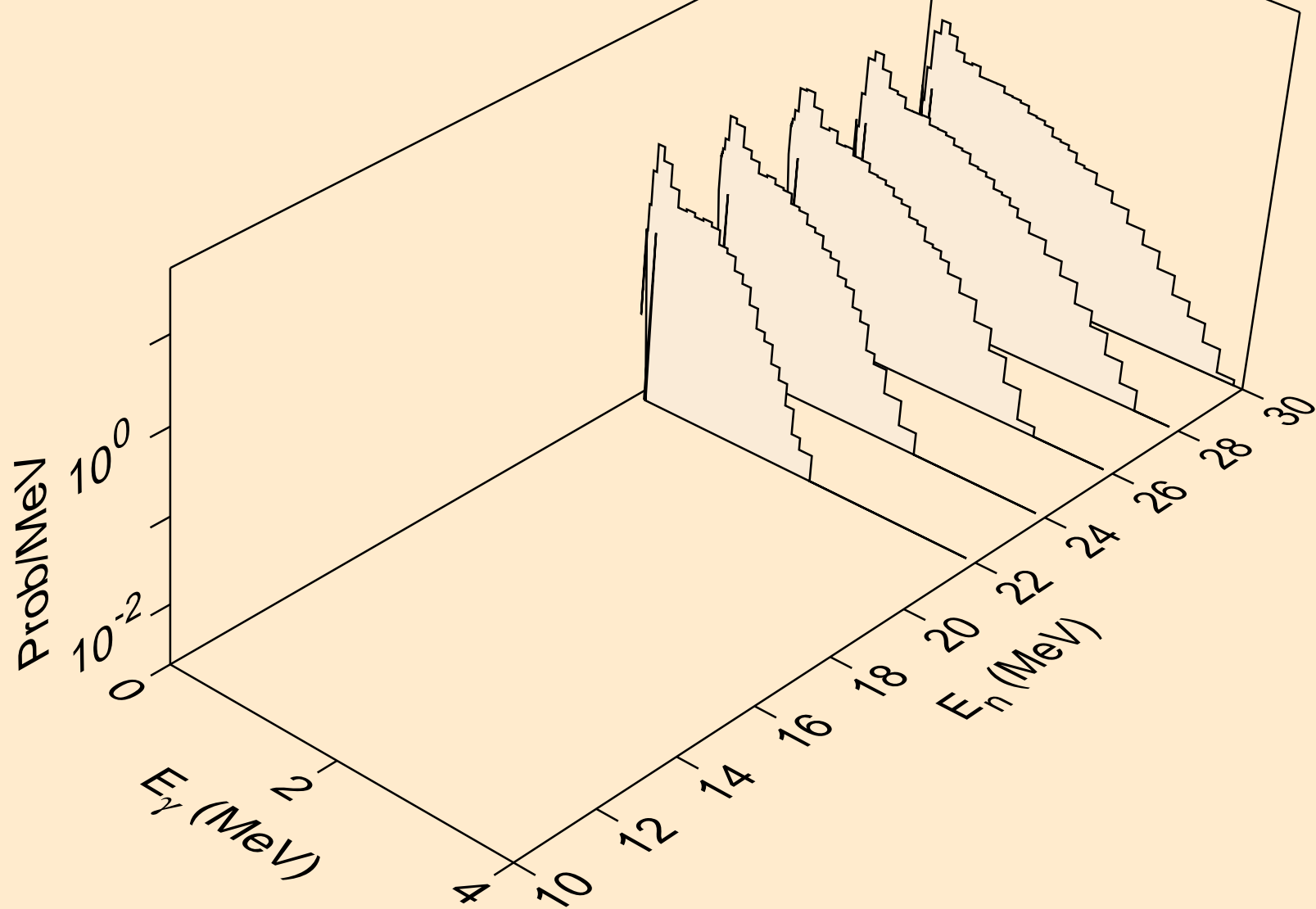

RA233 NEUTRON ACER TENDL-2021 LIBRARY; T=293.6K
Photon emission for (n,p α)

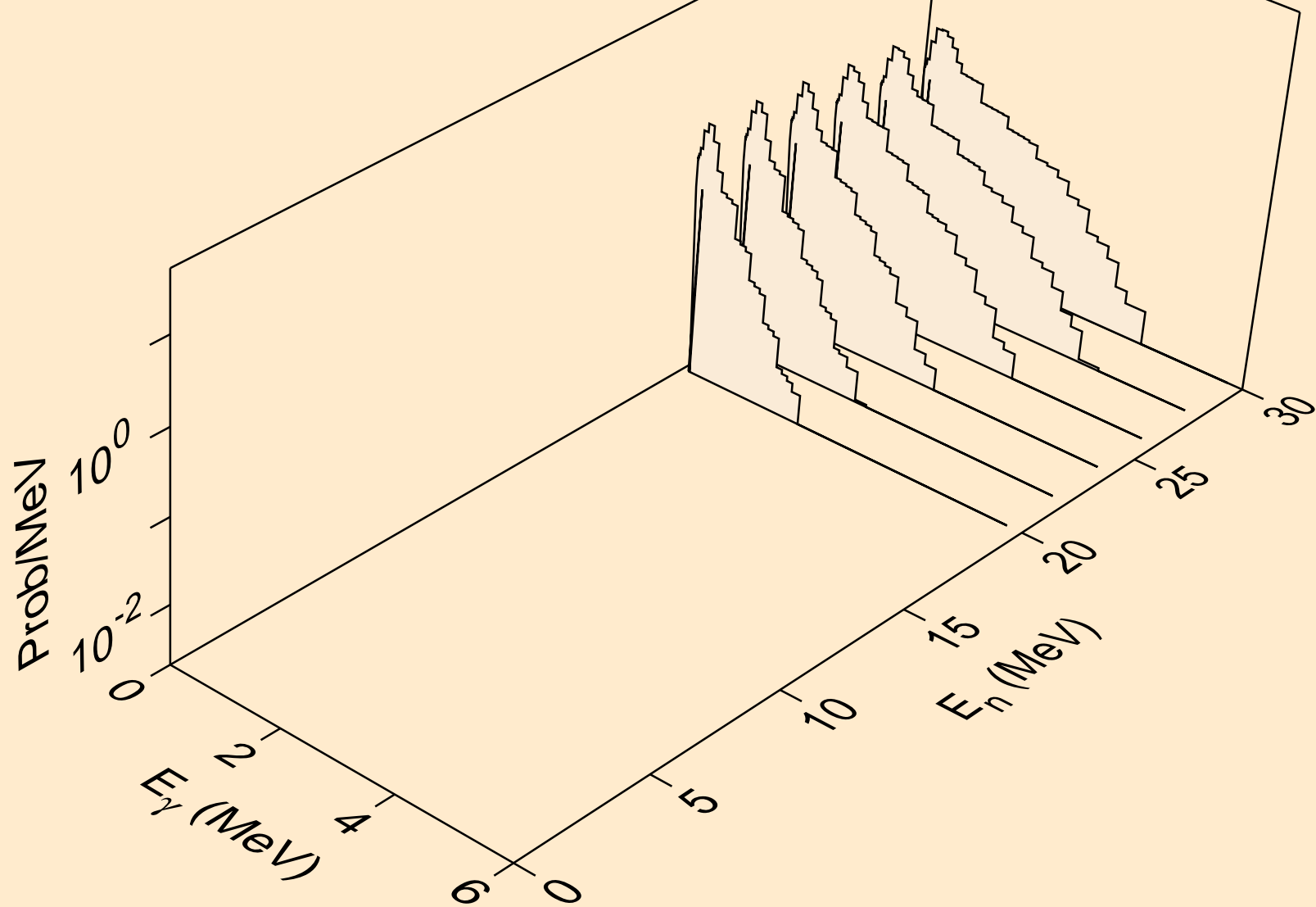

RA233 NEUTRON ACER TENDL-2021 LIBRARY; T=293.6K
Photon emission for (n,pt)

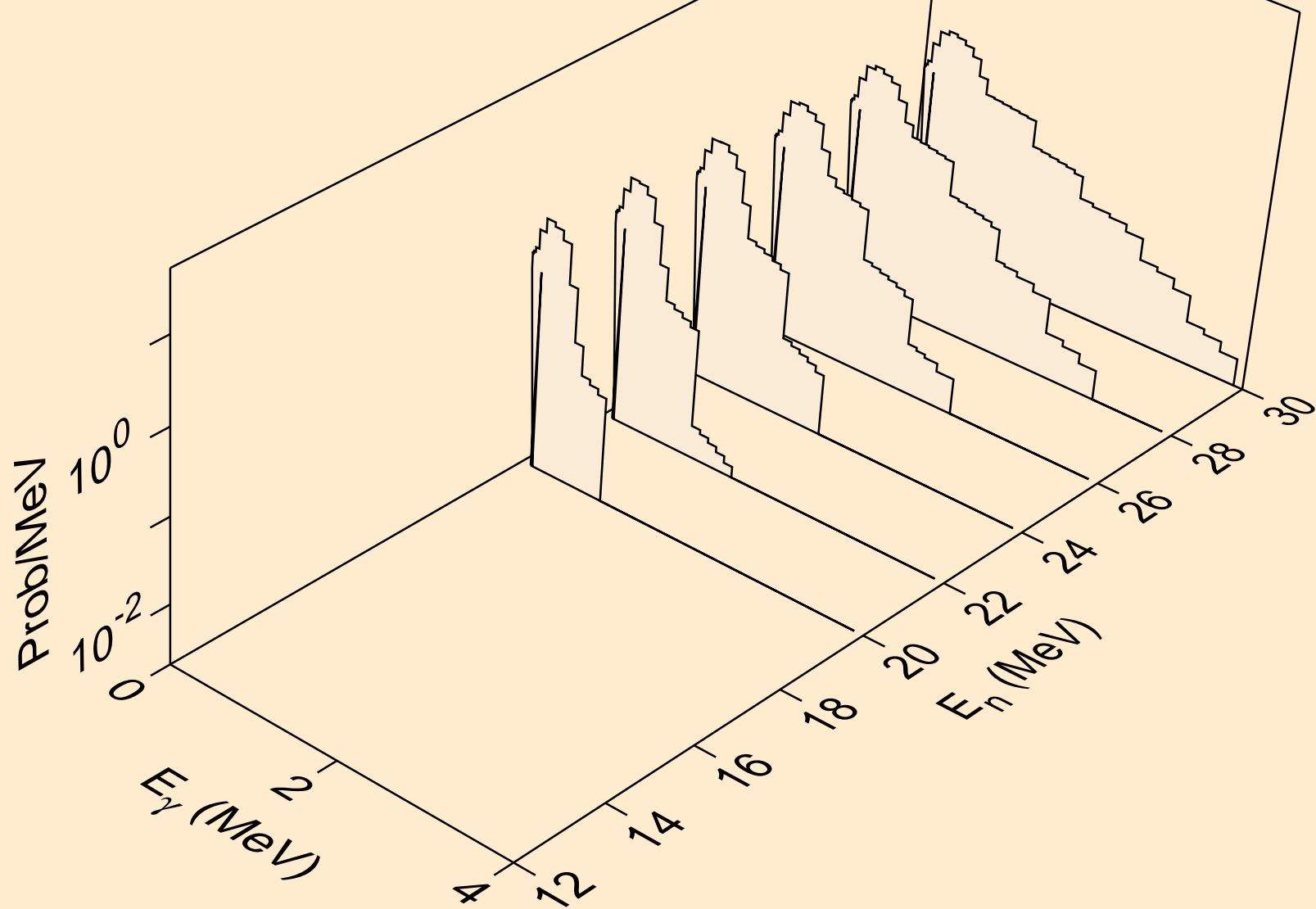

RA233 NEUTRON ACER TENDL-2021 LIBRARY; T=293.6K
Photon emission for (n,da)

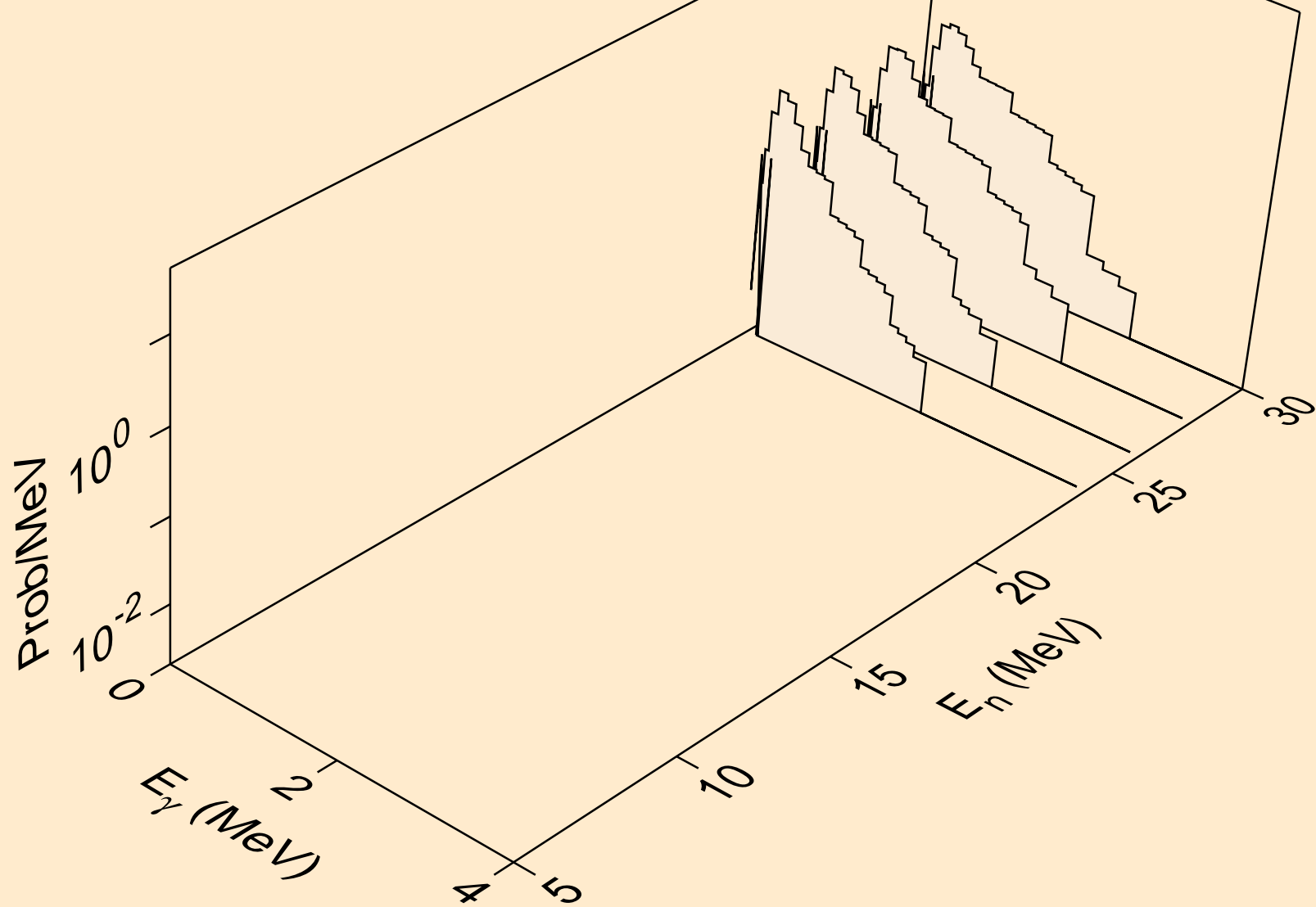

RA233 NEUTRON ACER TENDL-2021 LIBRARY; T=293.6K
thermal capture photon spectrum

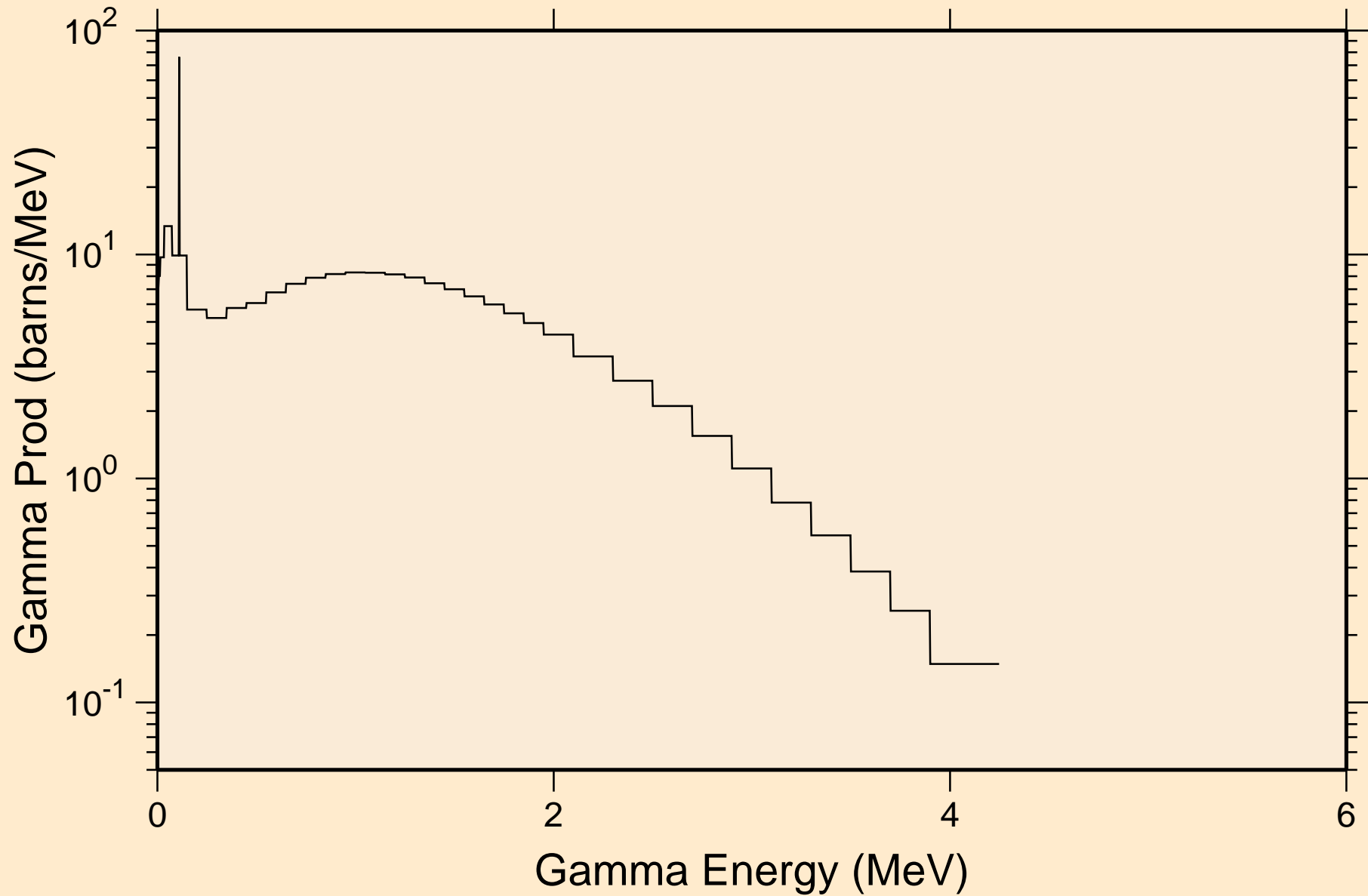

RA233 NEUTRON ACER TENDL-2021 LIBRARY; T=293.6K
14 MeV photon spectrum

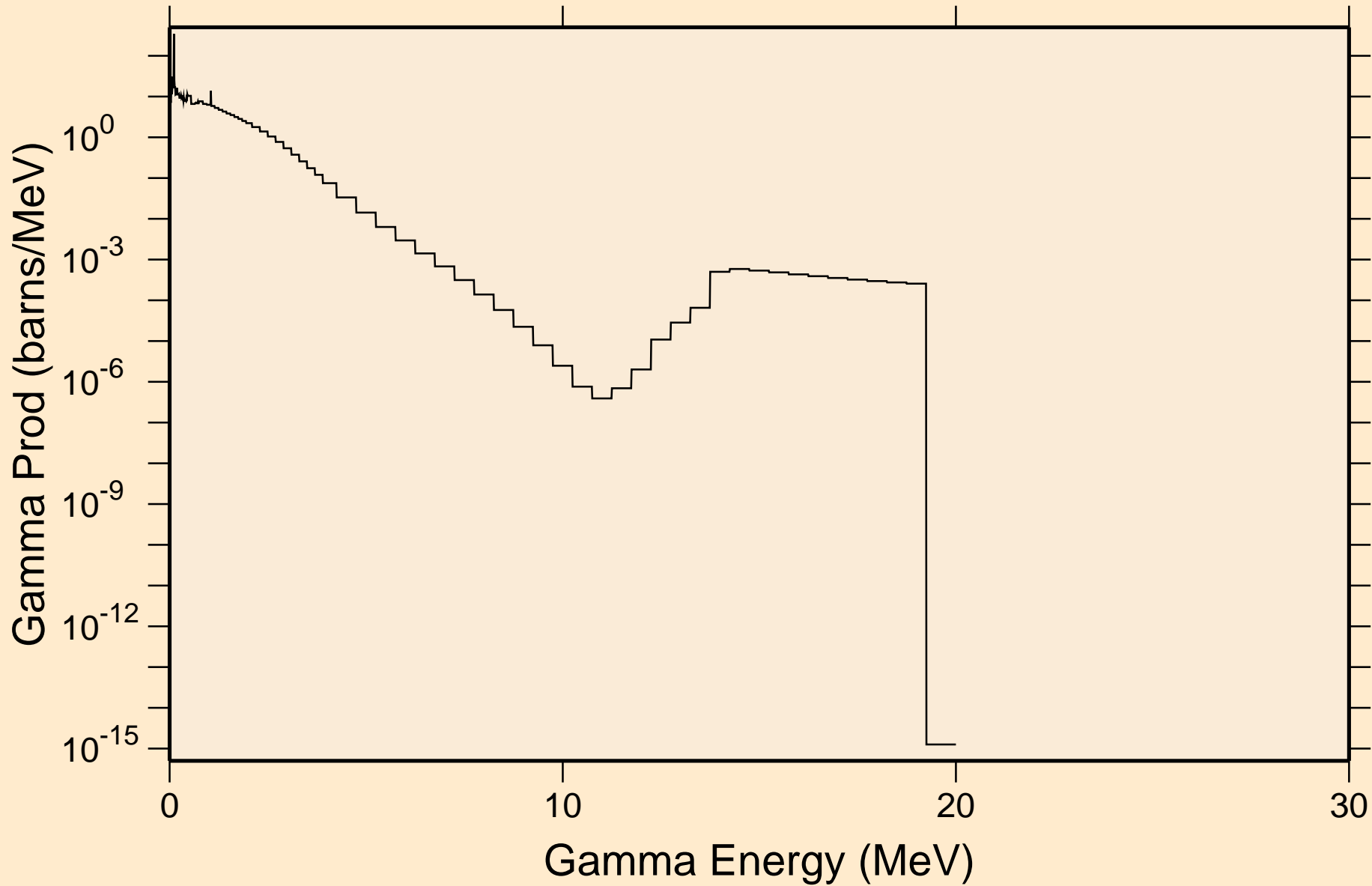

RA233 NEUTRON ACER TENDL-2021 LIBRARY; T=293.6K
Particle heating contributions

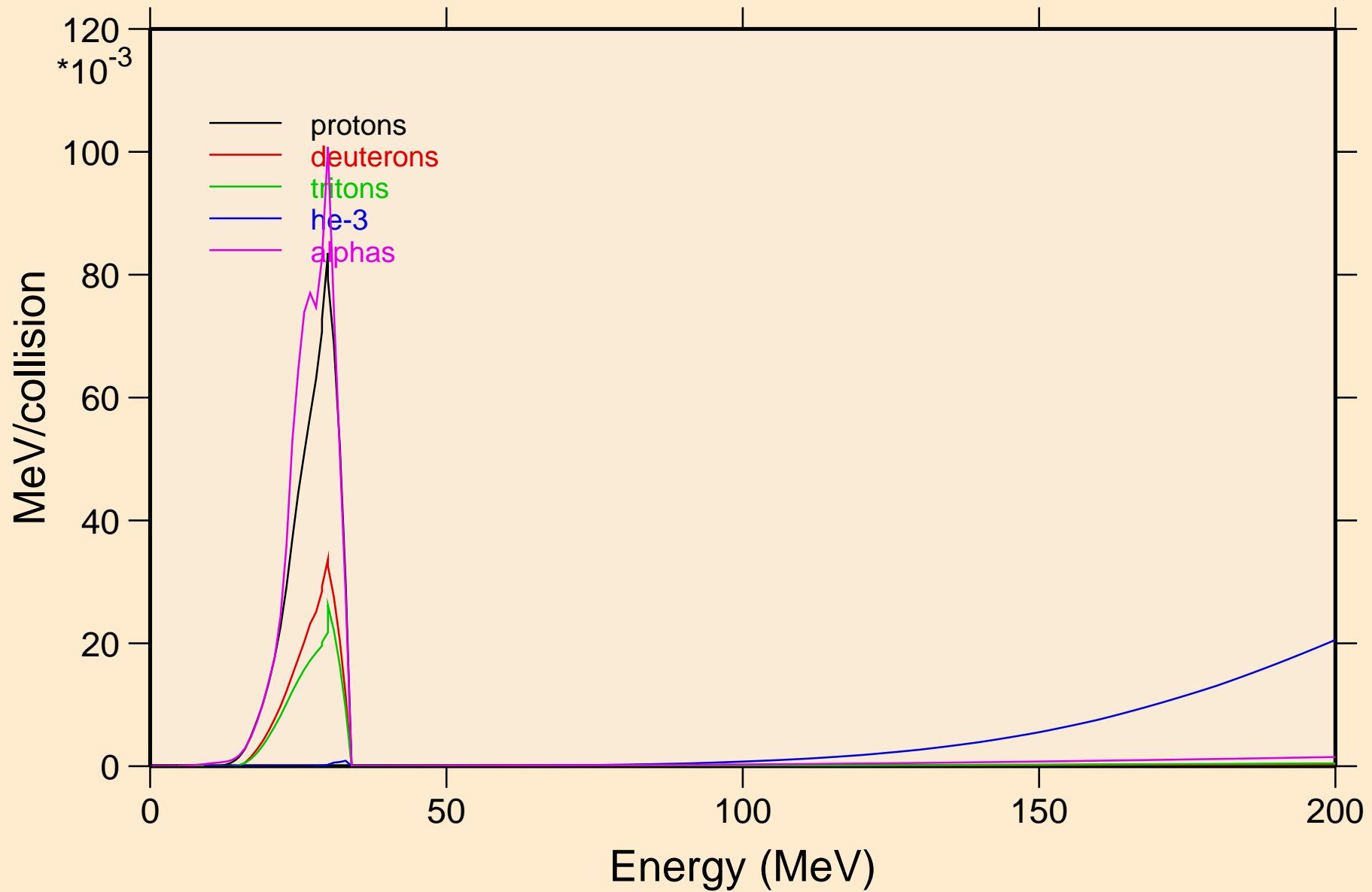

RA233 NEUTRON ACER TENDL-2021 LIBRARY; T=293.6K
Recoil Heating

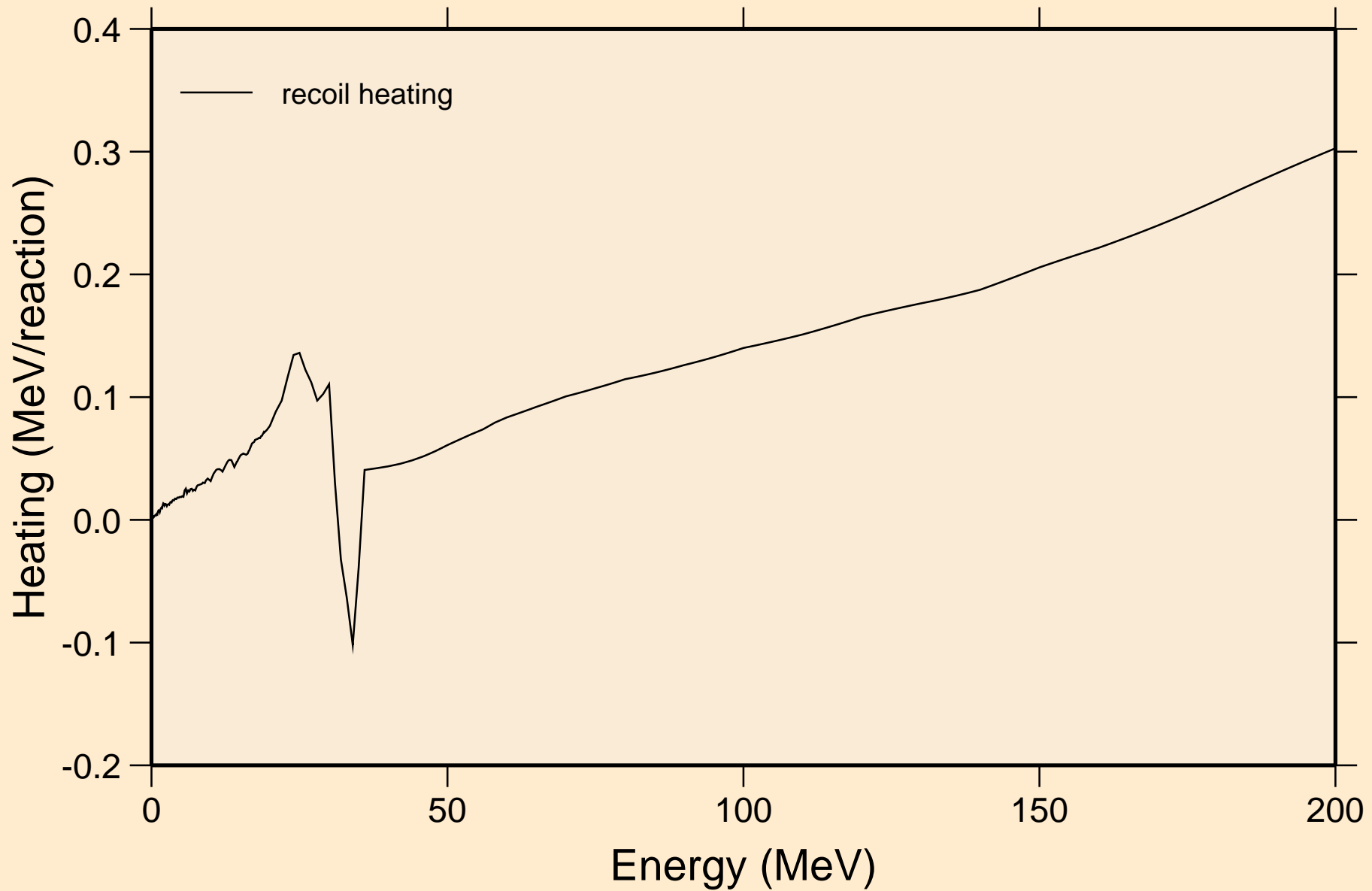

RA233 NEUTRON ACER TENDL-2021 LIBRARY; T=293.6K
Particle production cross sections

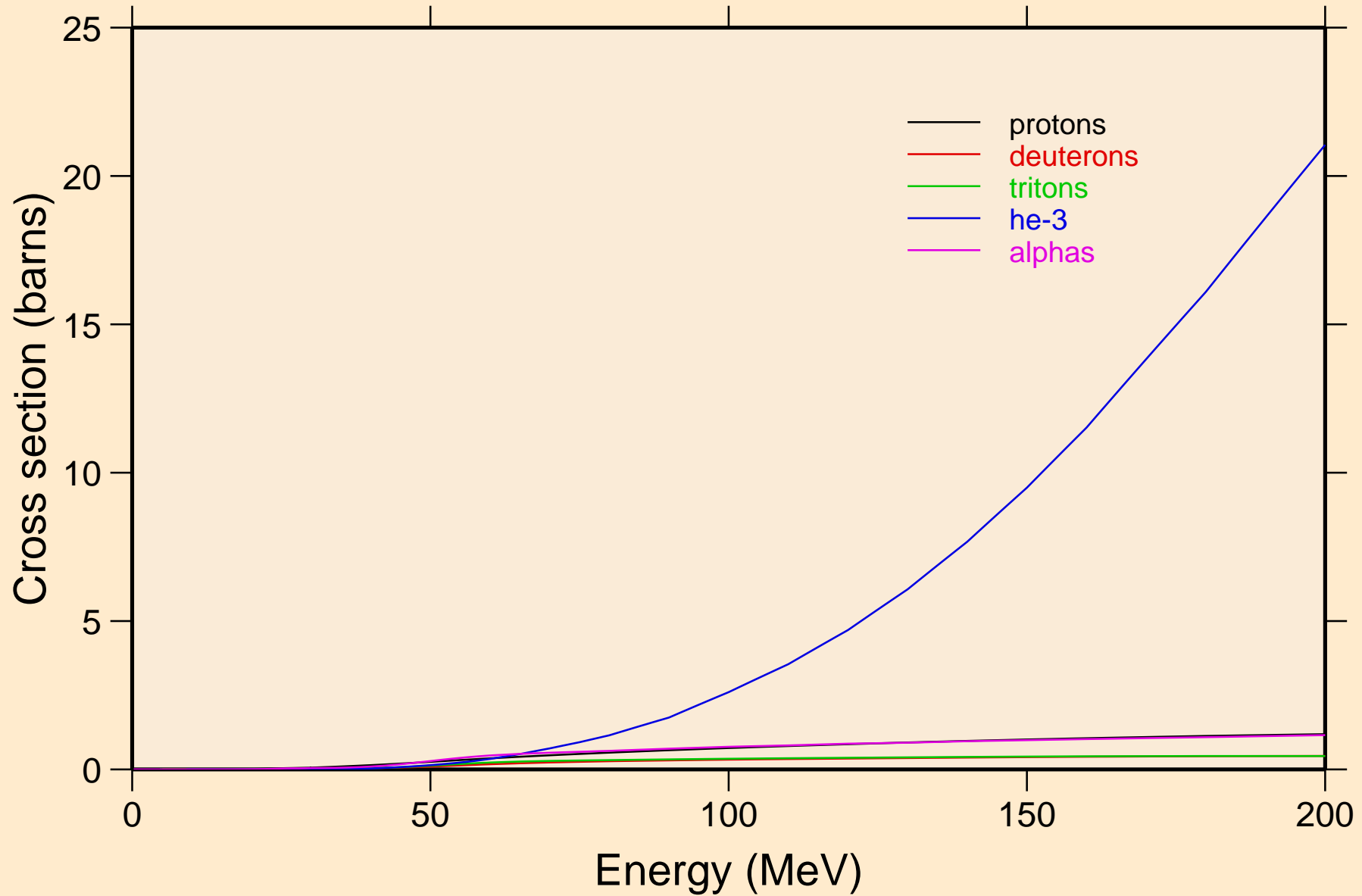

RA233 NEUTRON ACER TENDL-2021 LIBRARY; T=293.6K
protons from (n,x)

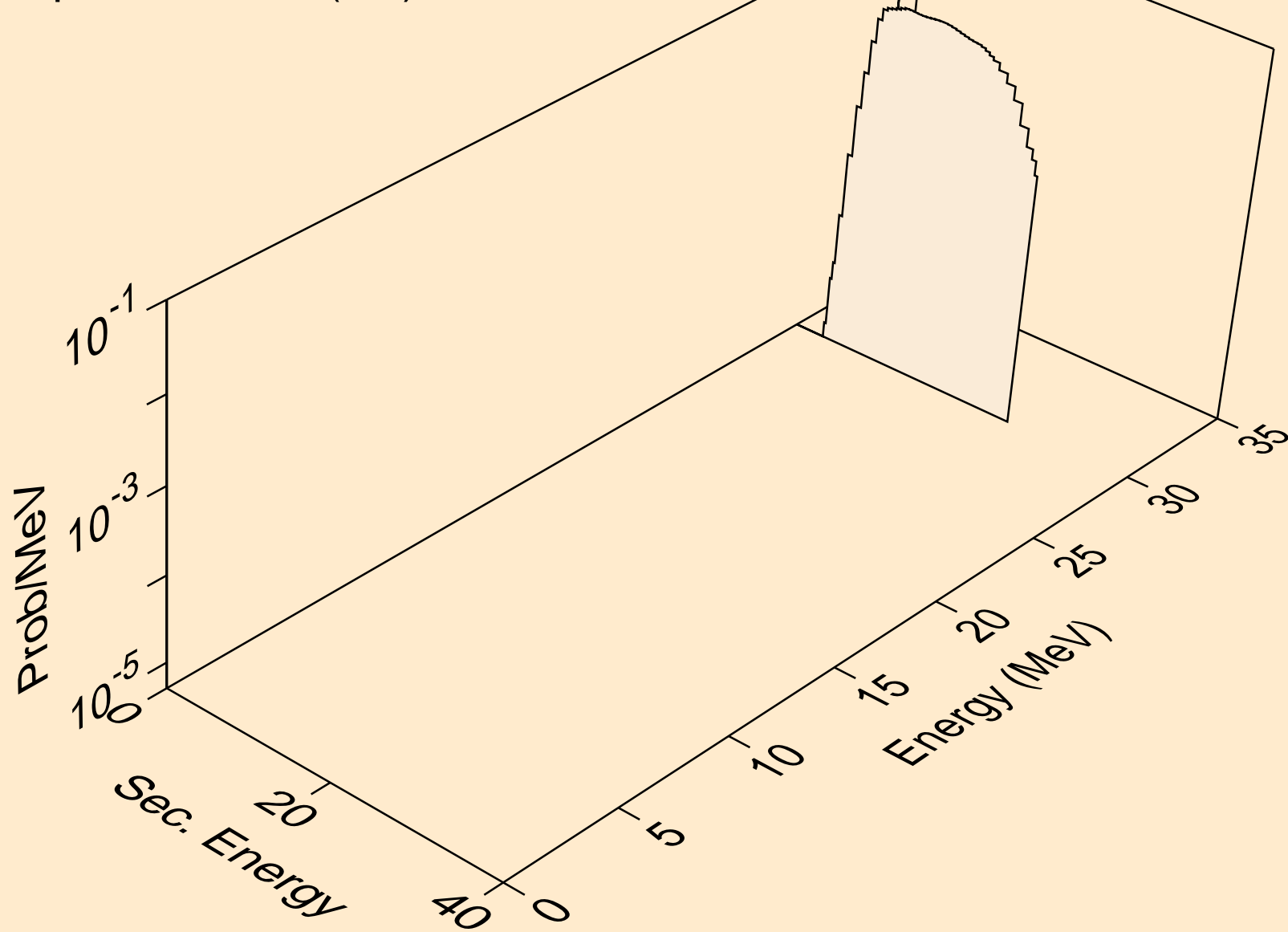

RA233 NEUTRON ACER TENDL-2021 LIBRARY; T=293.6K
protons from (n,n*)p

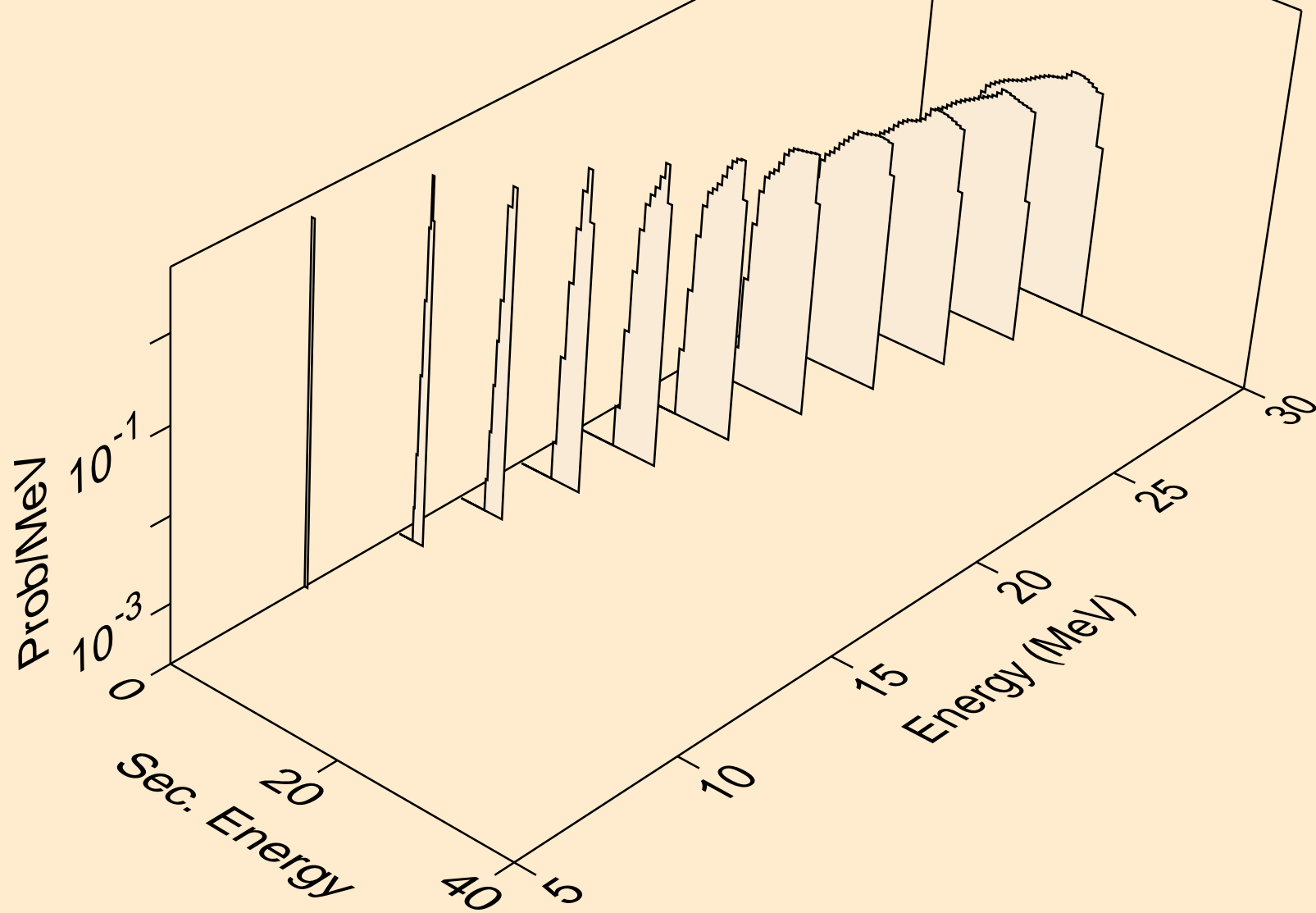

RA233 NEUTRON ACER TENDL-2021 LIBRARY; T=293.6K
protons from (n,2np)

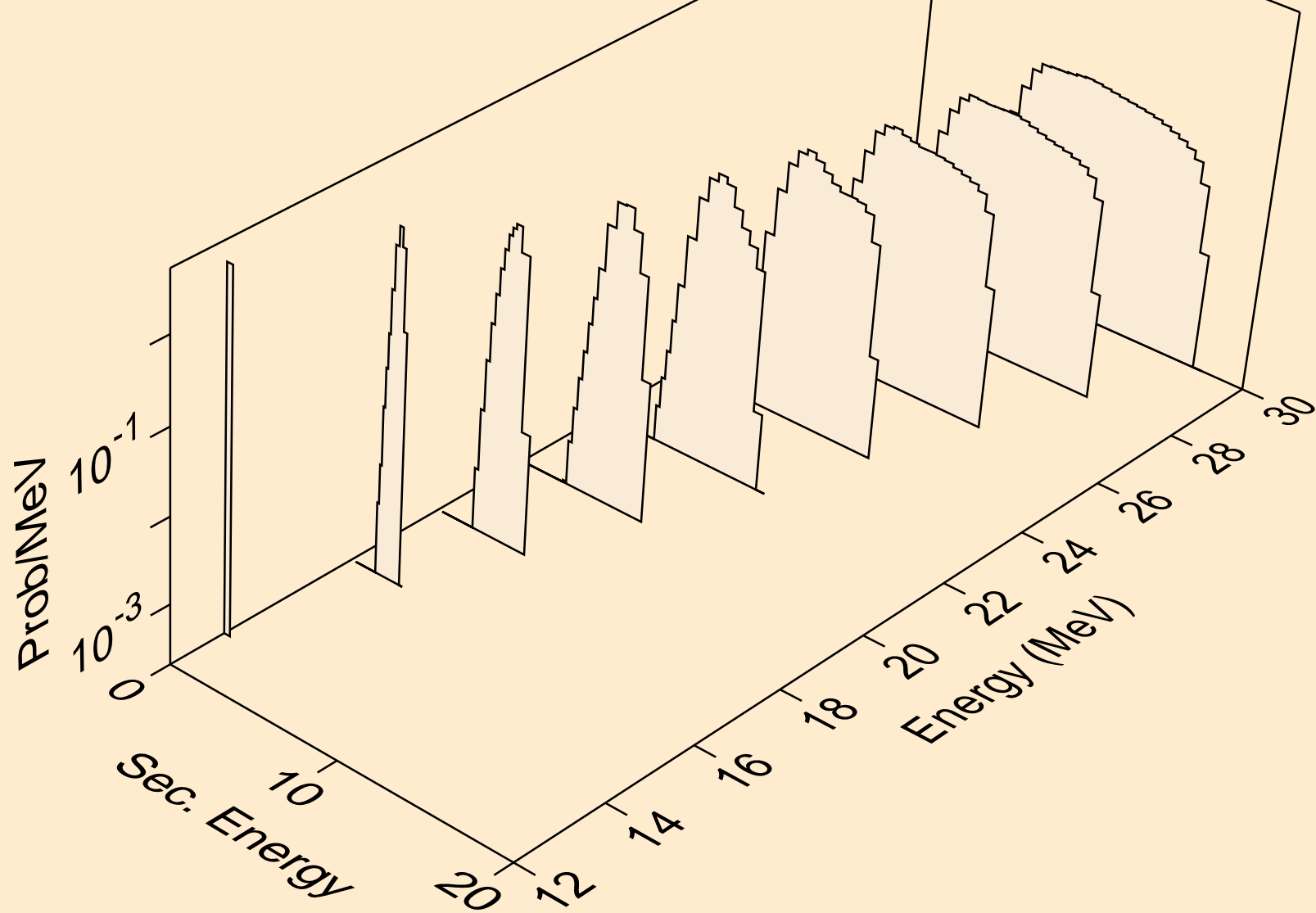

RA233 NEUTRON ACER TENDL-2021 LIBRARY; T=293.6K
protons from (n,3np)

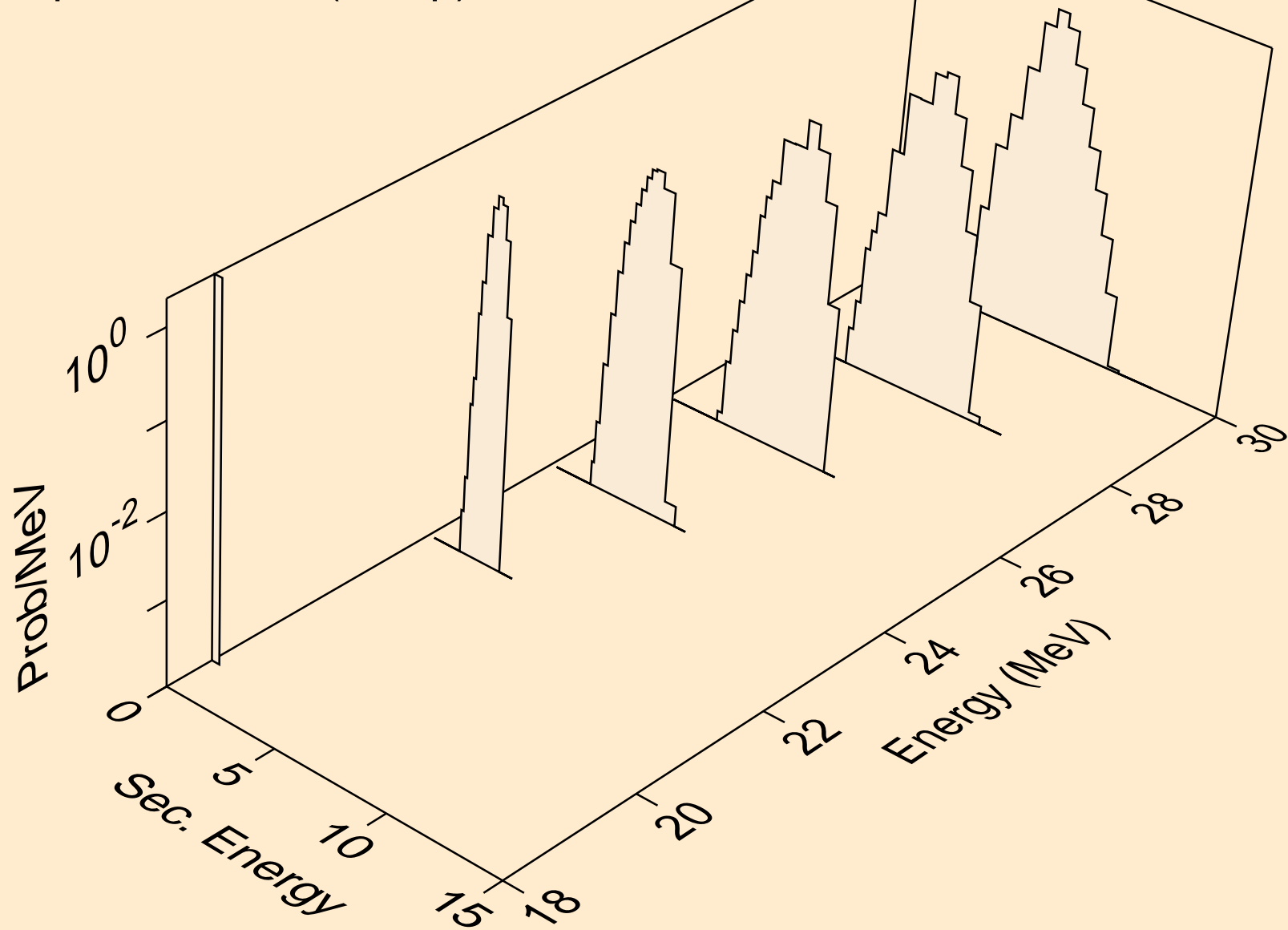

RA233 NEUTRON ACER TENDL-2021 LIBRARY; T=293.6K
protons from (n,2np)

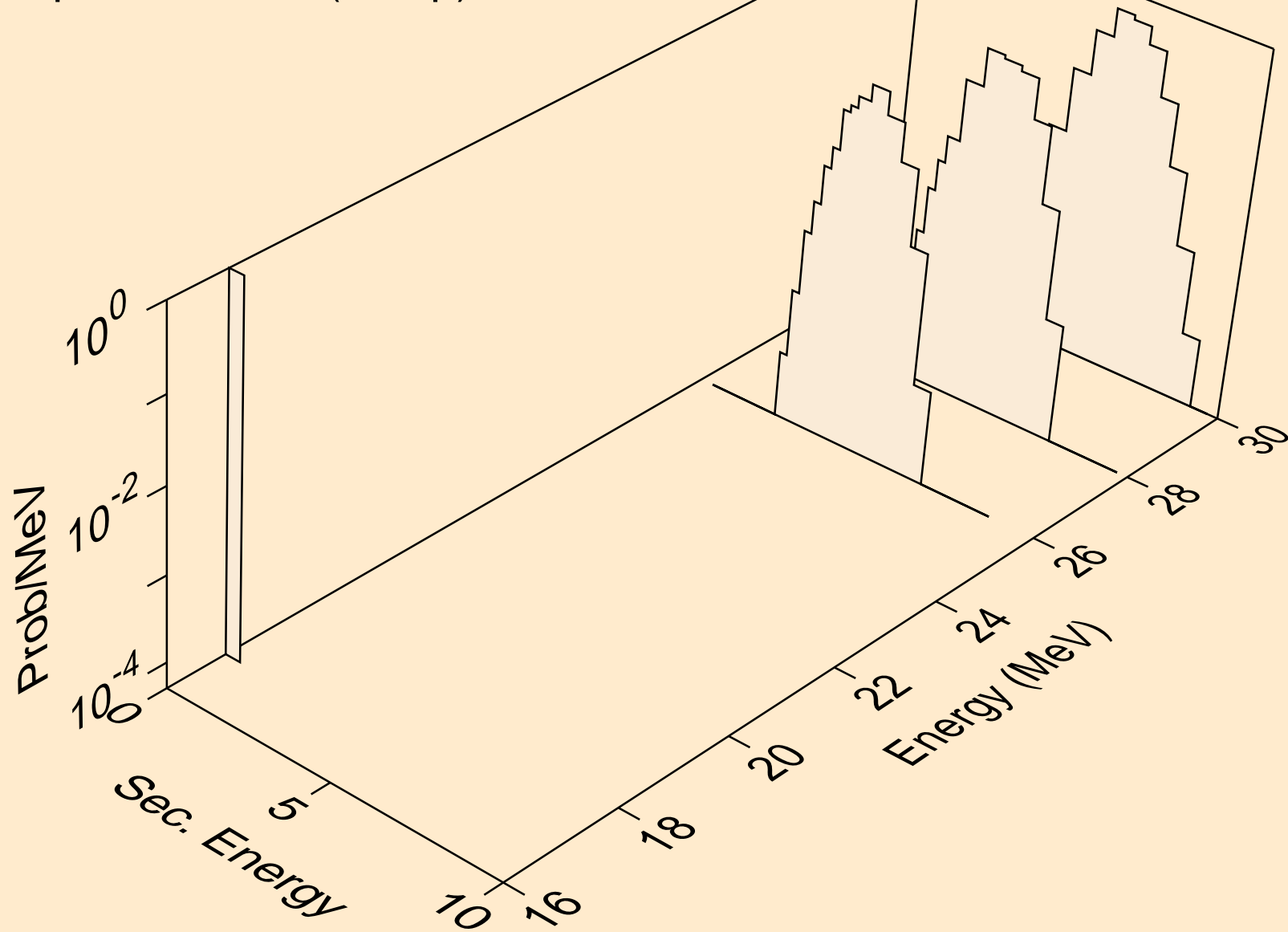

RA233 NEUTRON ACER TENDL-2021 LIBRARY; T=293.6K
protons from (n,npa)

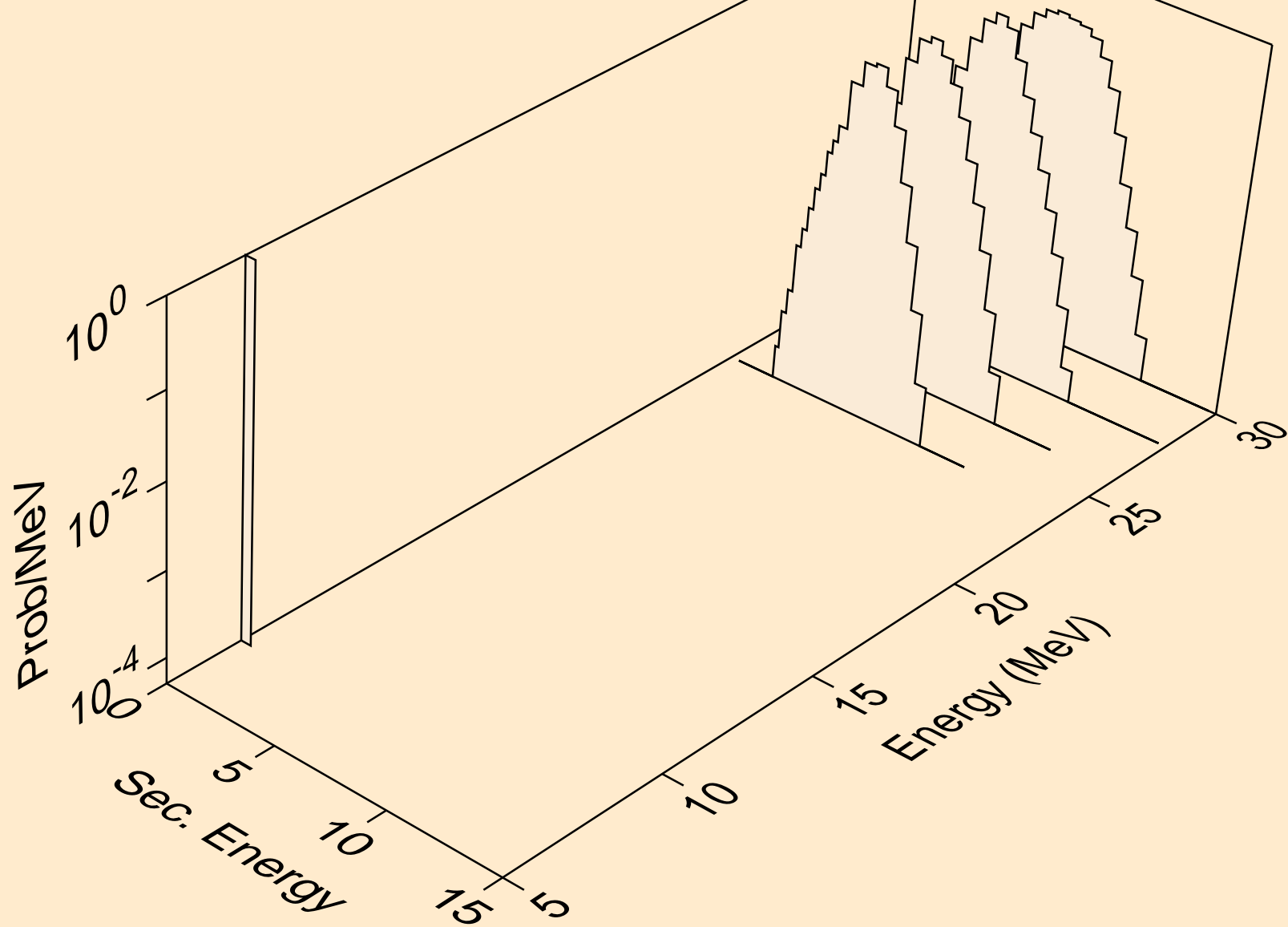

RA233 NEUTRON ACER TENDL-2021 LIBRARY; T=293.6K
protons from (n,p)

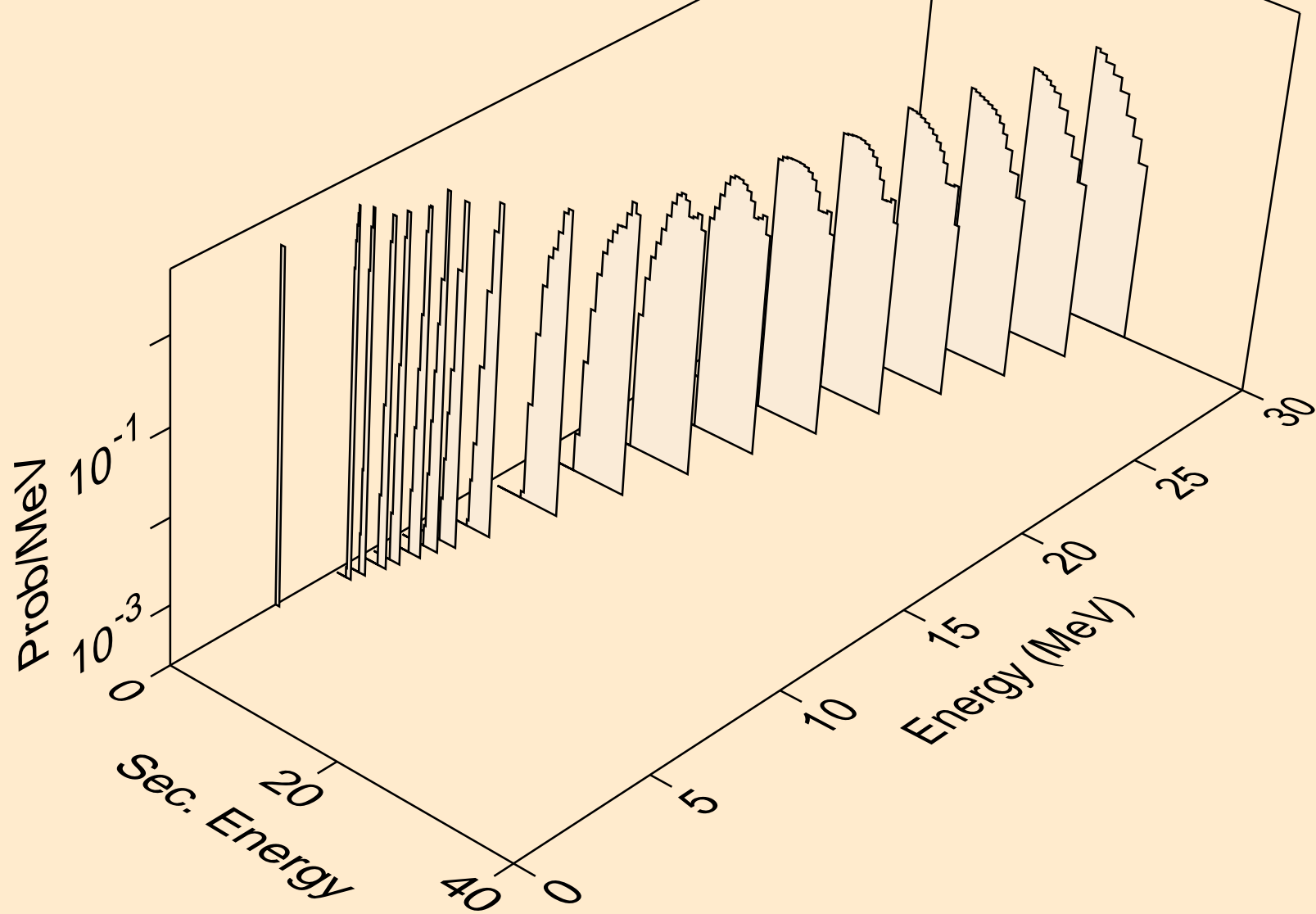

RA233 NEUTRON ACER TENDL-2021 LIBRARY; T=293.6K
protons from (n,2p)

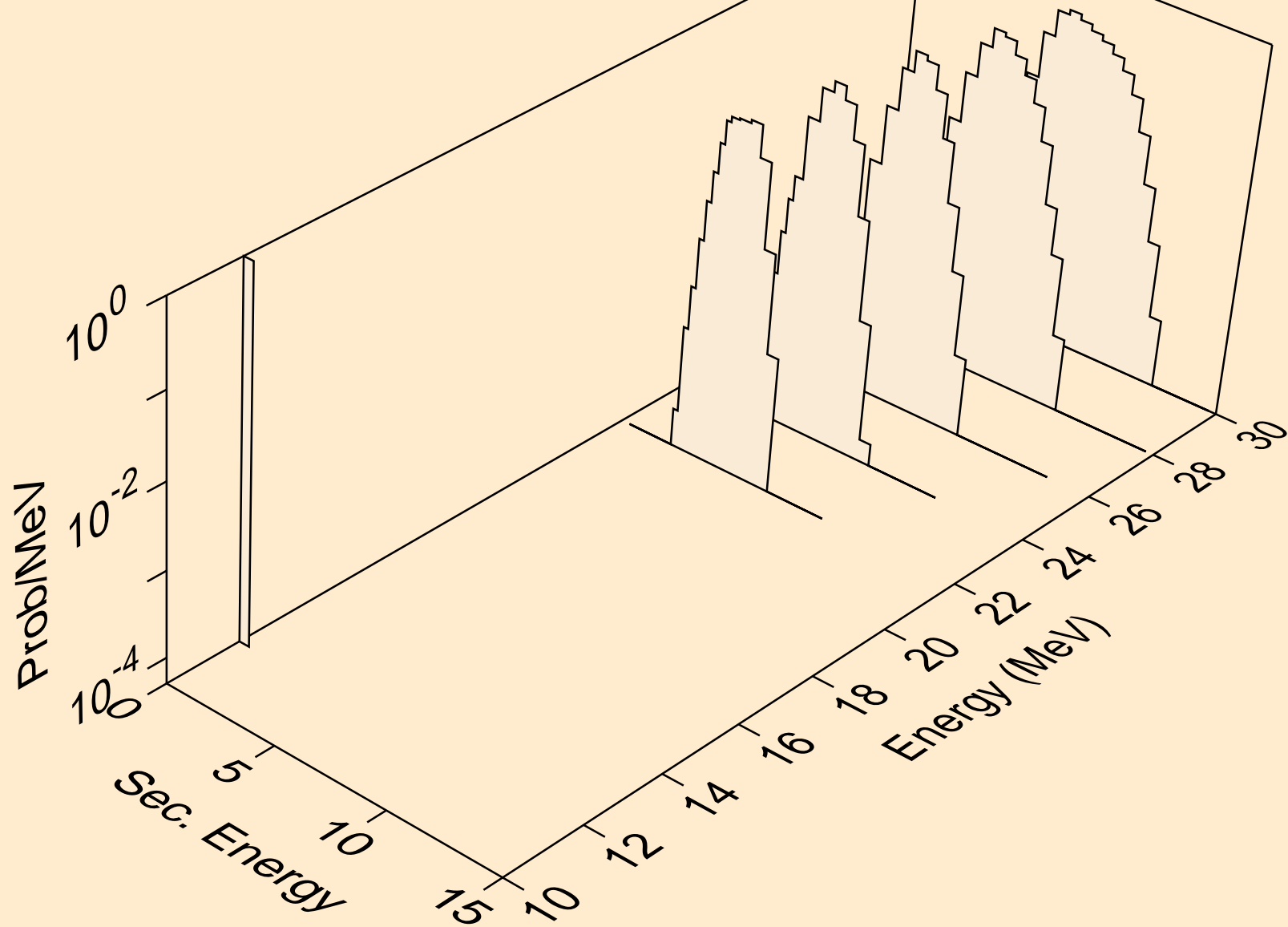

RA233 NEUTRON ACER TENDL-2021 LIBRARY; T=293.6K
protons from (n,pa)

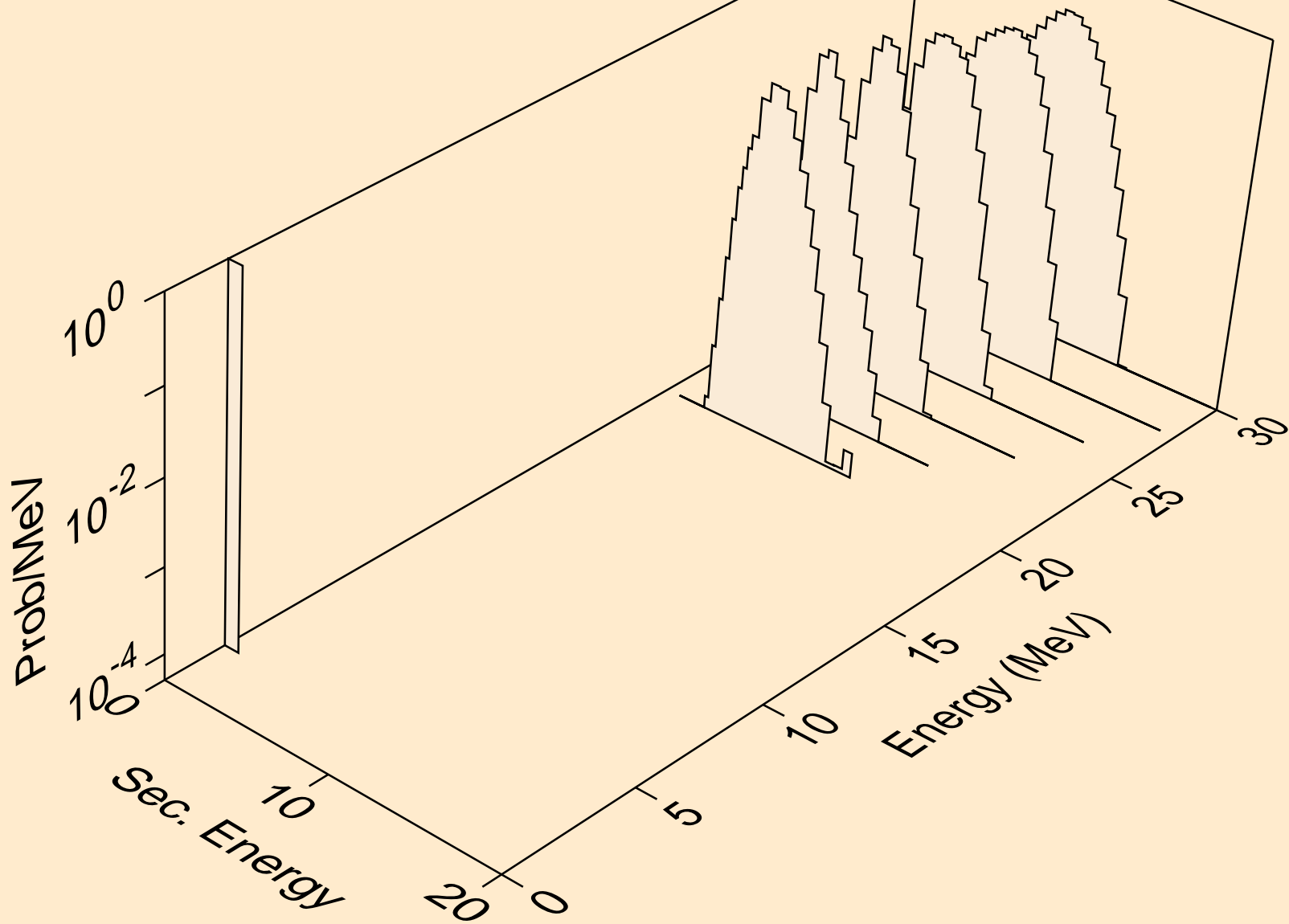

RA233 NEUTRON ACER TENDL-2021 LIBRARY; T=293.6K
protons from (n,pt)

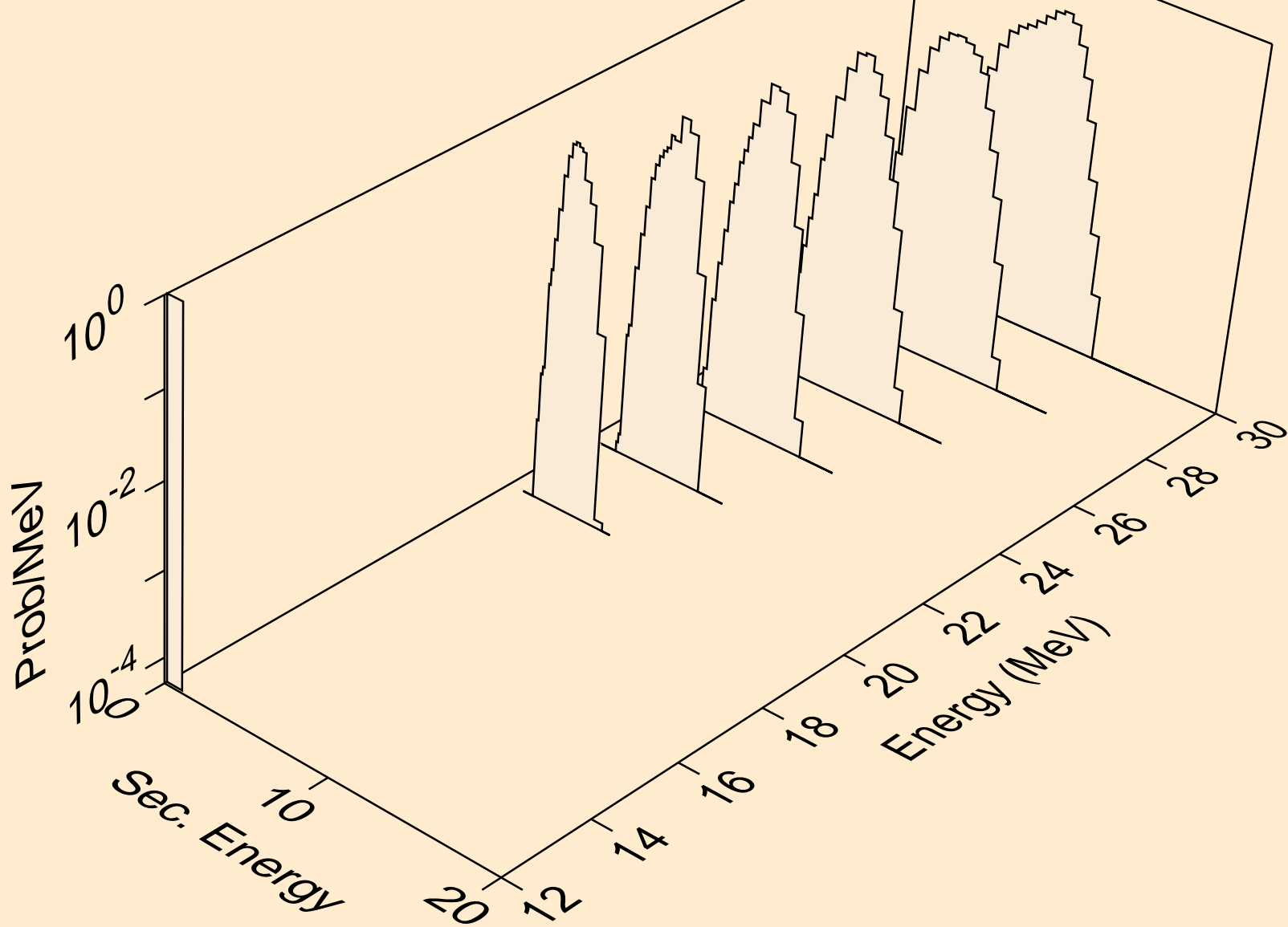

RA233 NEUTRON ACER TENDL-2021 LIBRARY; T=293.6K
deuterons from (n,x)

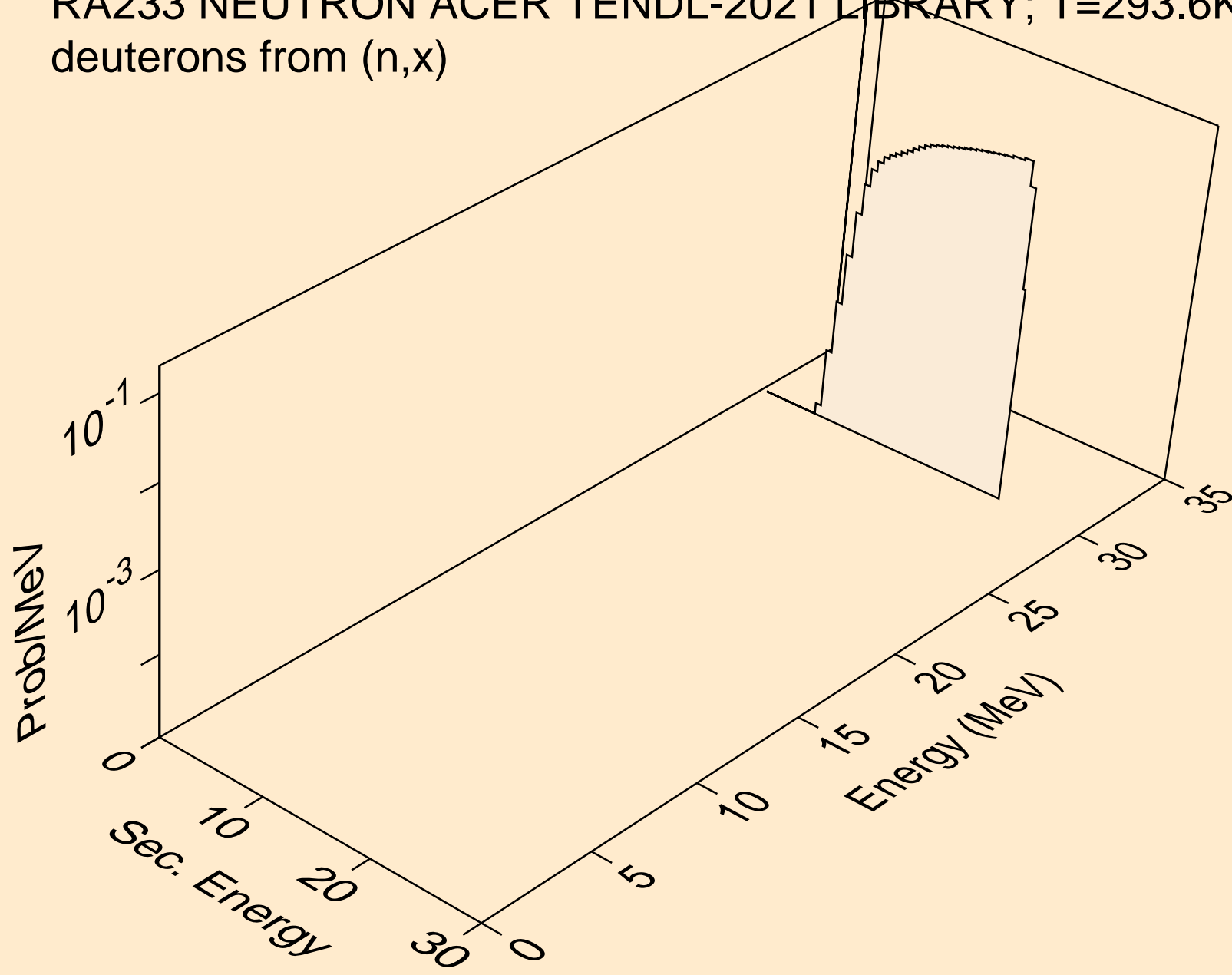

RA233 NEUTRON ACER TENDL-2021 LIBRARY; T=293.6K
deuterons from (n,2nd)

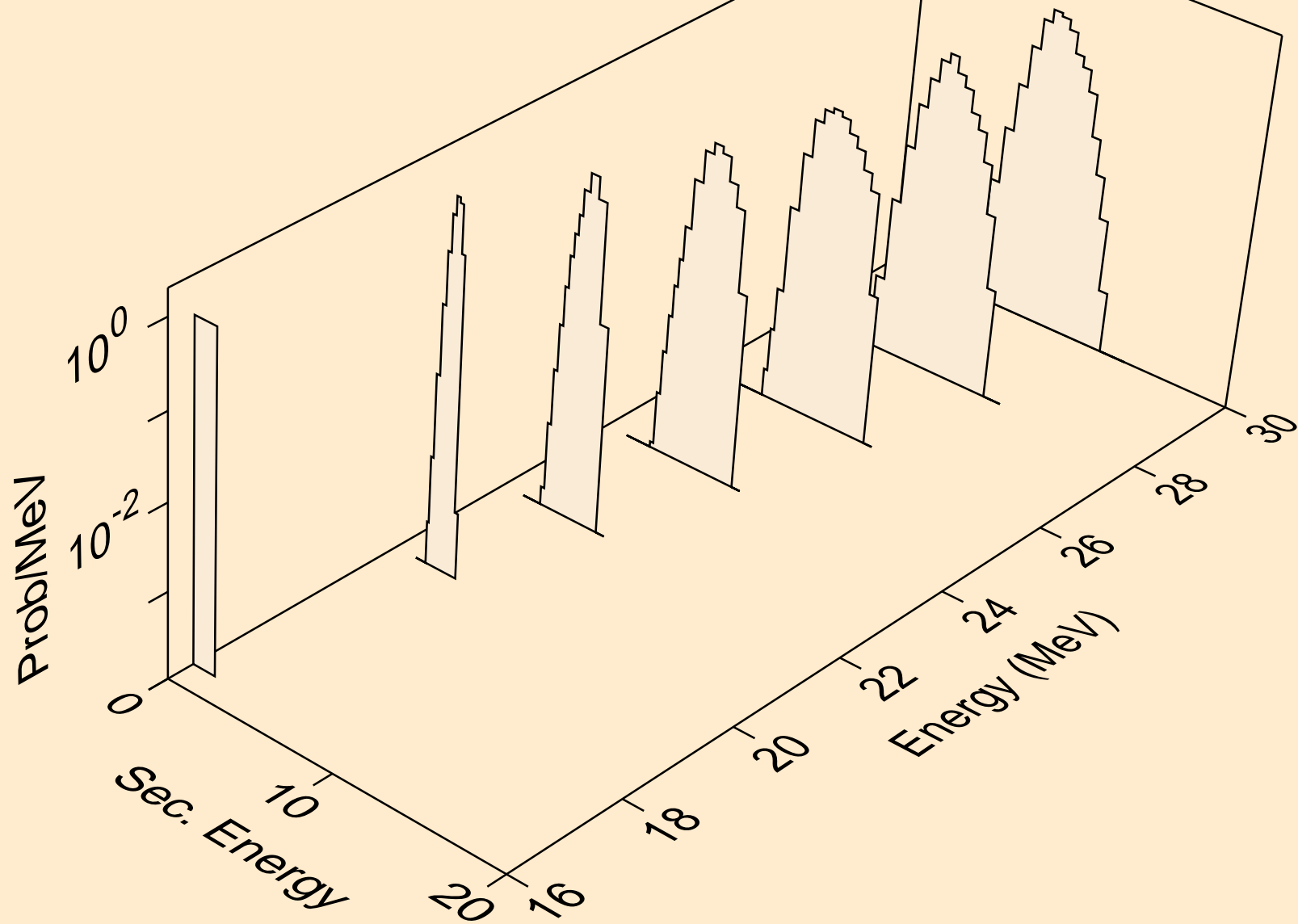

RA233 NEUTRON ACER TENDL-2021 LIBRARY; T=293.6K
deuterons from (n,n*)d

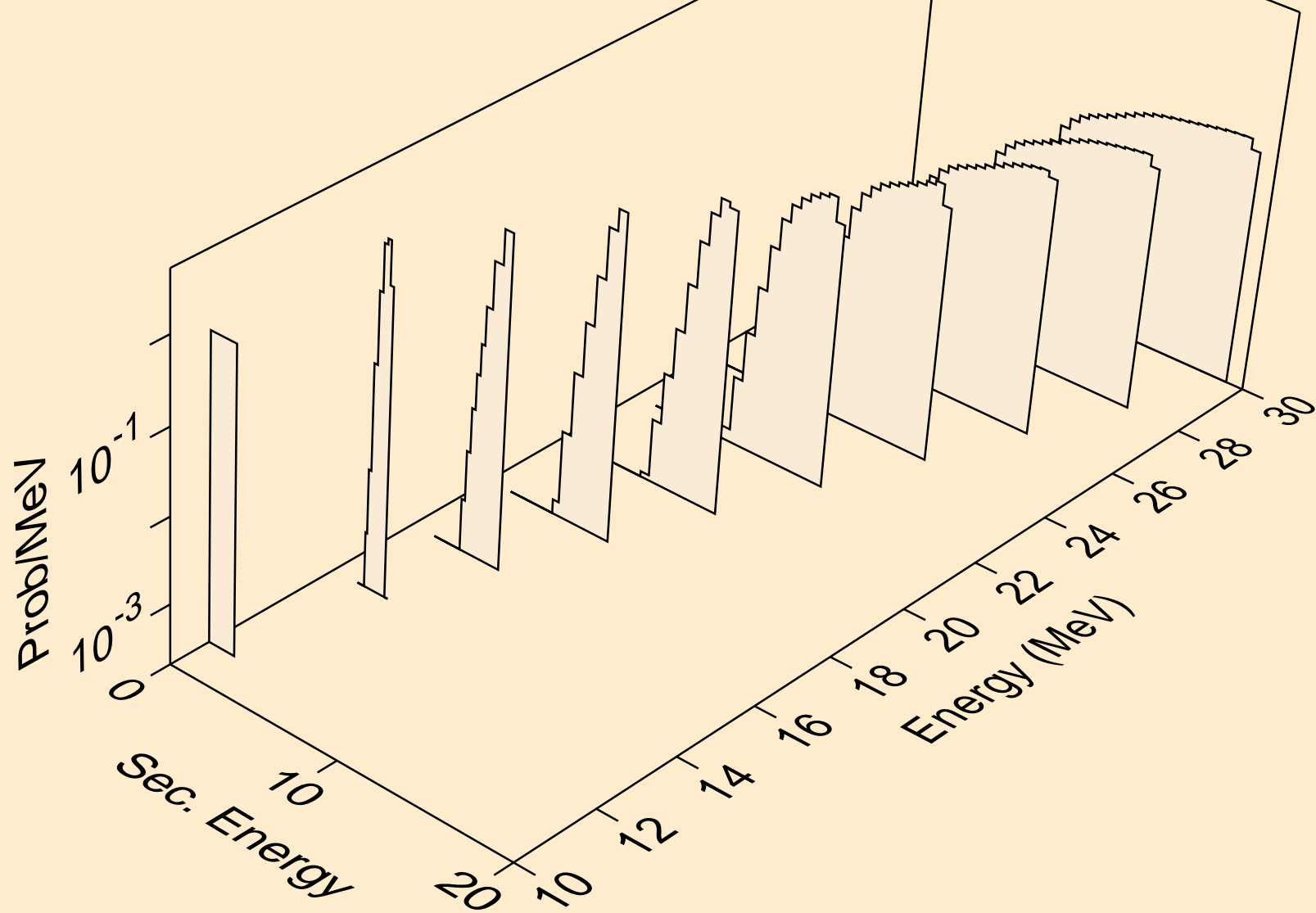

RA233 NEUTRON ACER TENDL-2021 LIBRARY; T=293.6K
deuterons from (n,d)

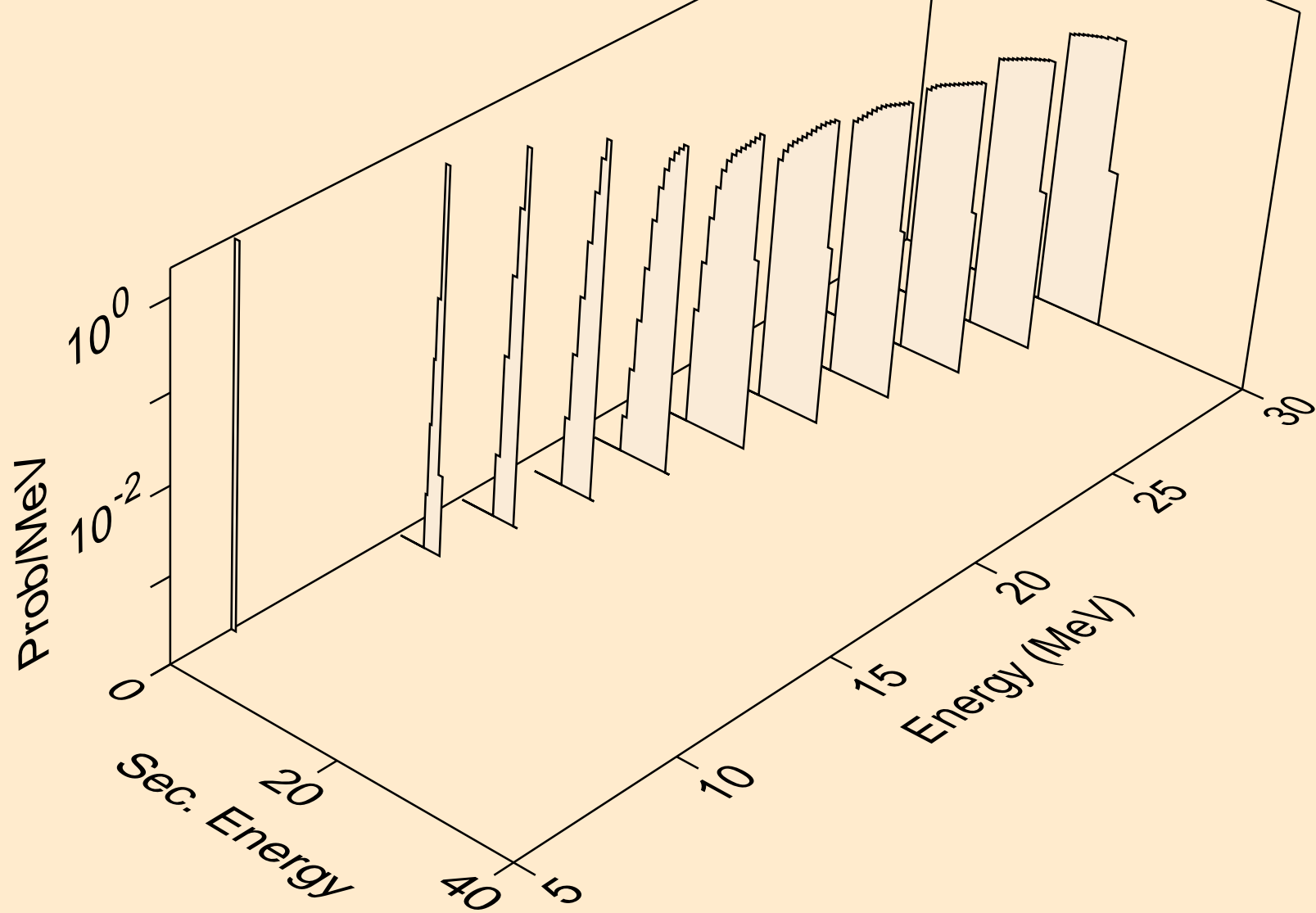

RA233 NEUTRON ACER TENDL-2021 LIBRARY; T=293.6K
deuterons from (n,da)

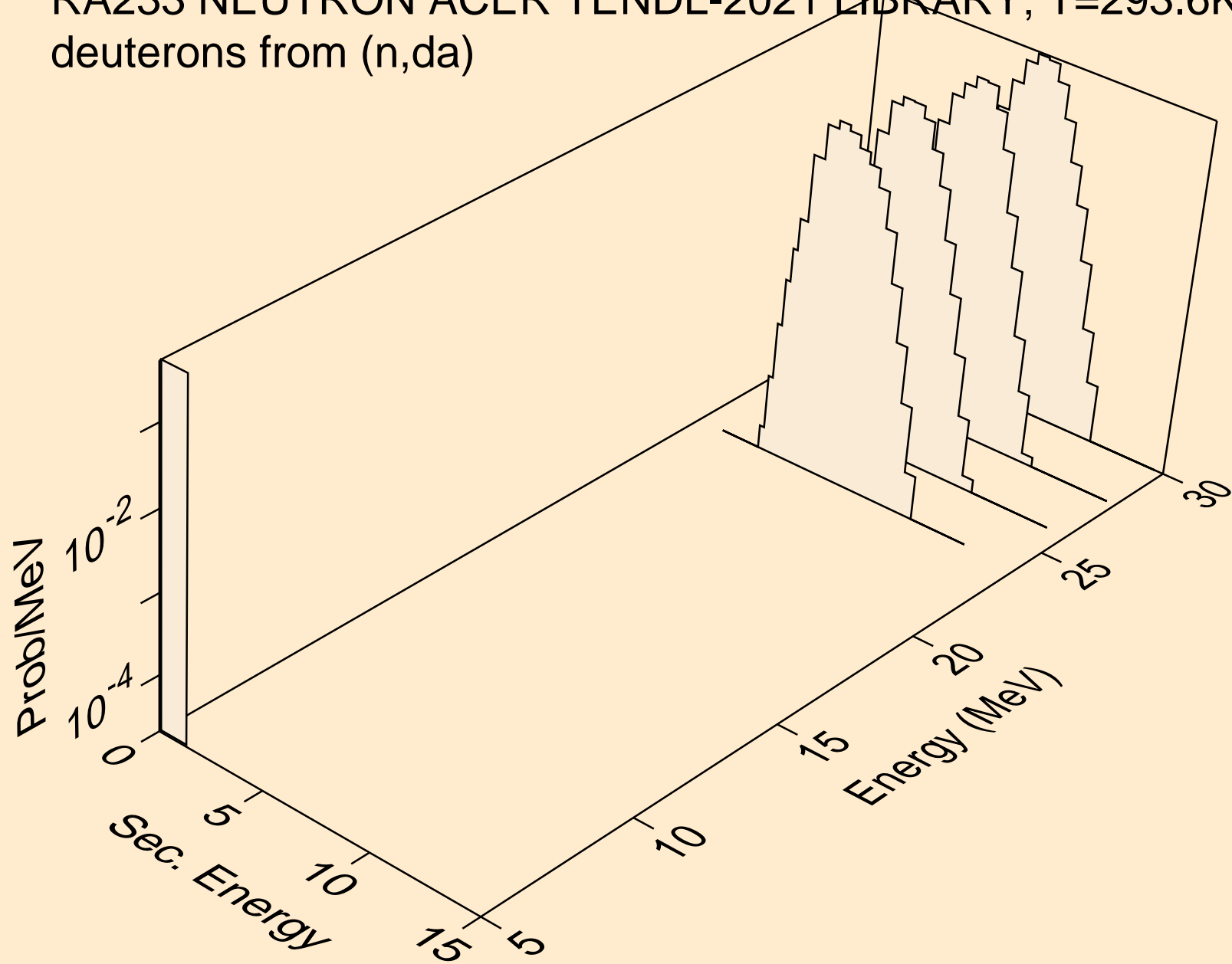

RA233 NEUTRON ACER TENDL-2021 LIBRARY; T=293.6K
tritons from (n,x)

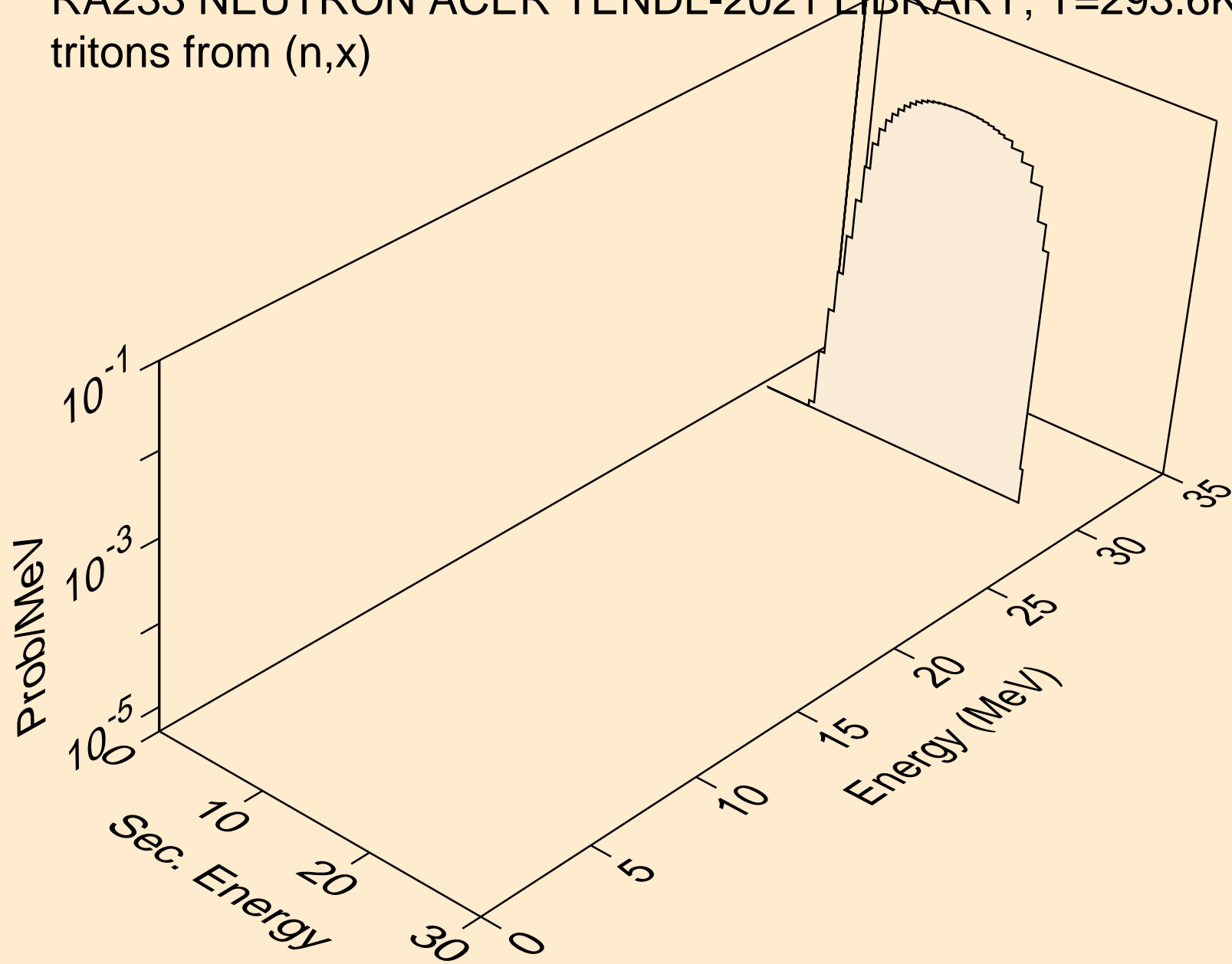

RA233 NEUTRON ACER TENDL-2021 LIBRARY; T=293.6K
tritons from (n,n*)t

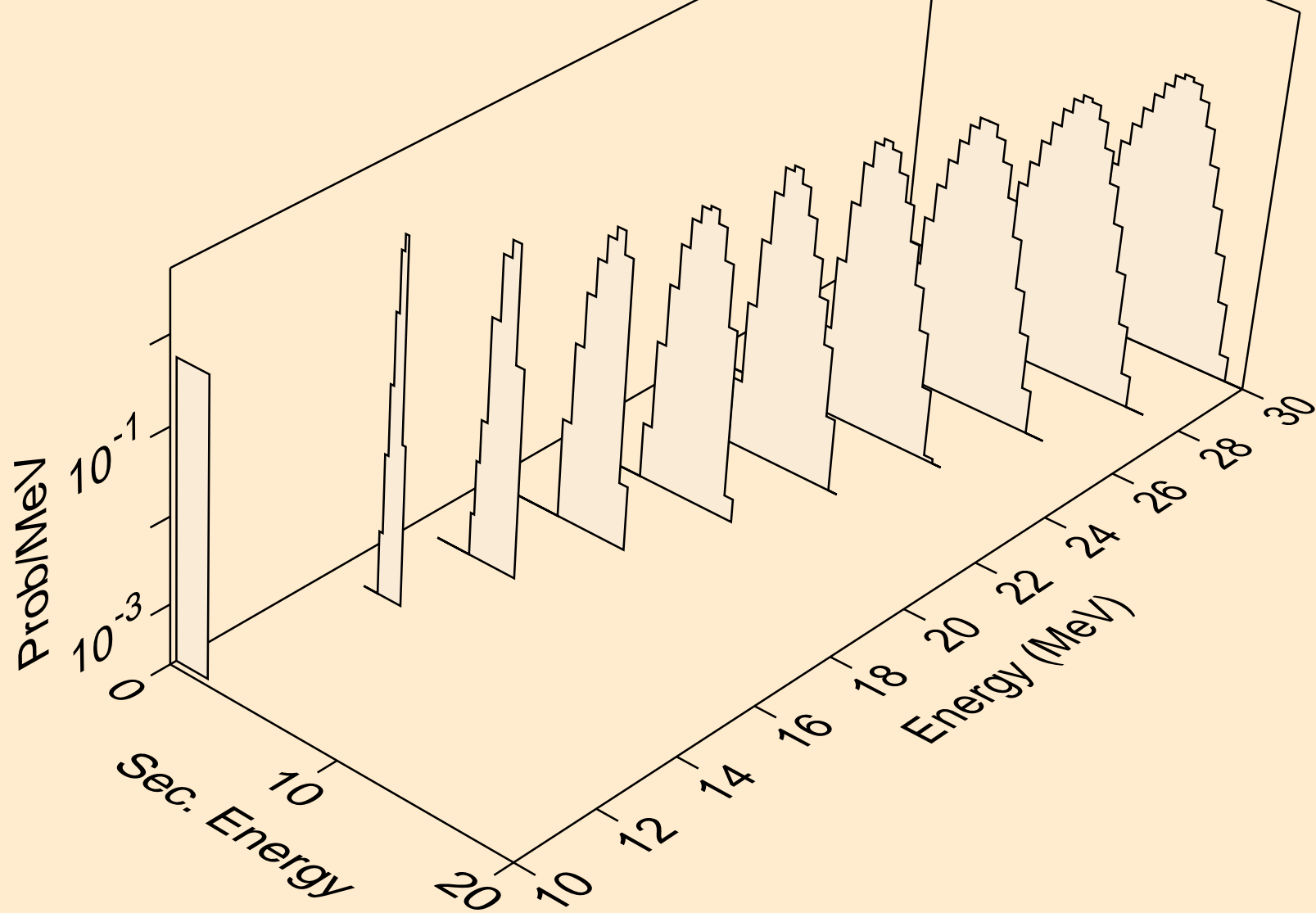

RA233 NEUTRON ACER TENDL-2021 LIBRARY; T=293.6K
tritons from (n,t)

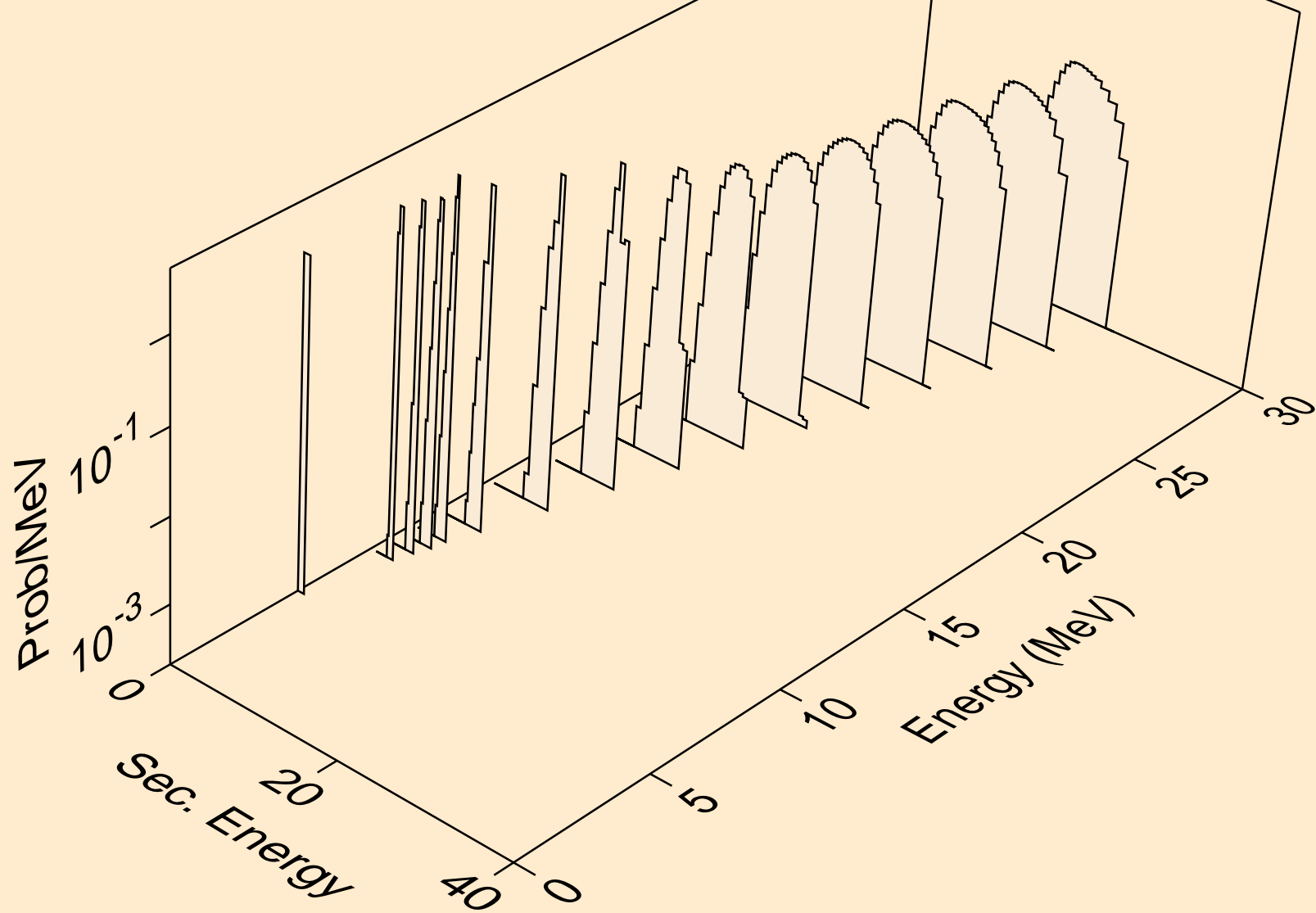

RA233 NEUTRON ACER TENDL-2021 LIBRARY; T=293.6K
tritons from (n,pt)

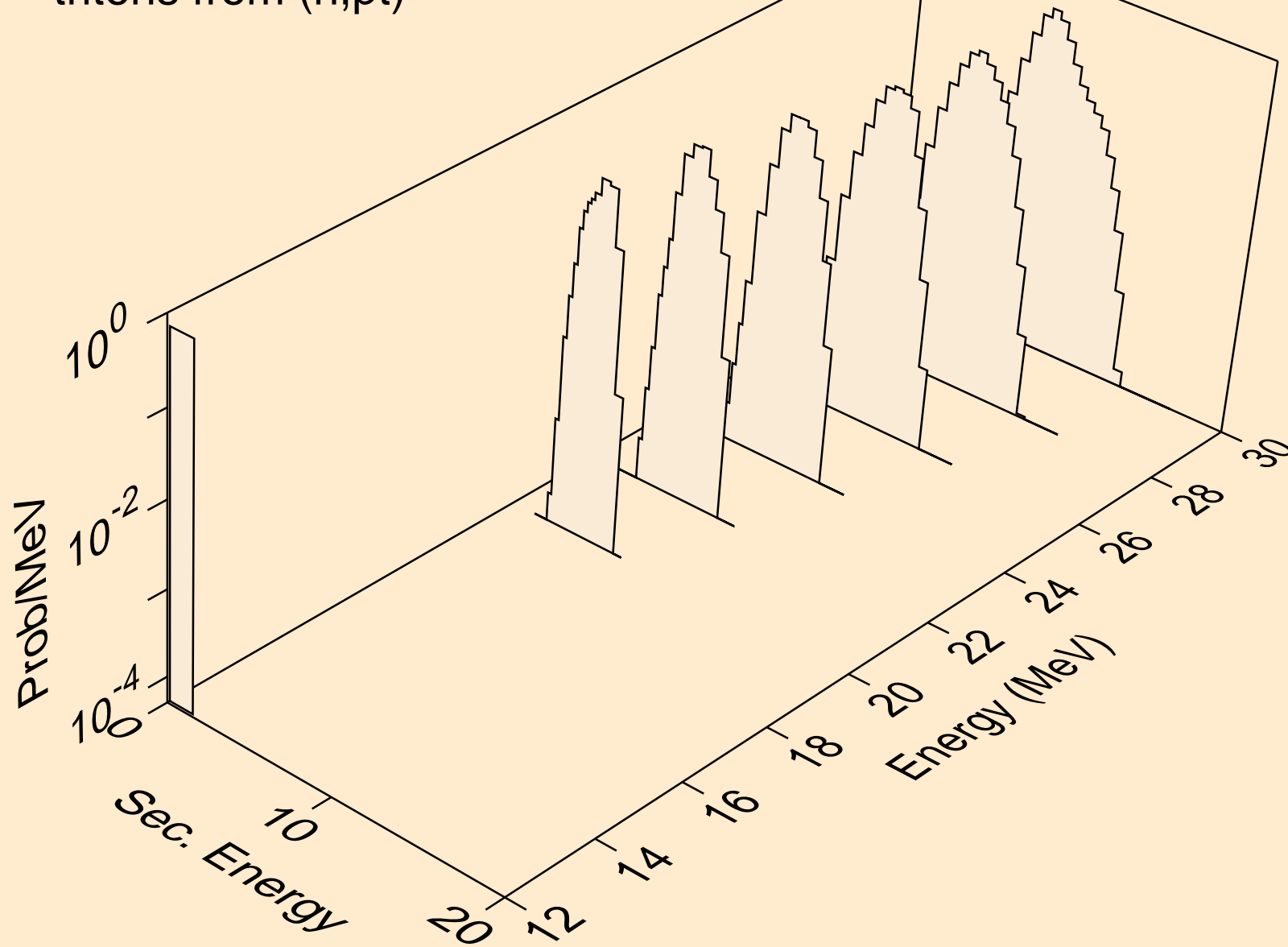

RA233 NEUTRON ACER TENDL-2021 LIBRARY; T=293.6K
he3s from (n,x)

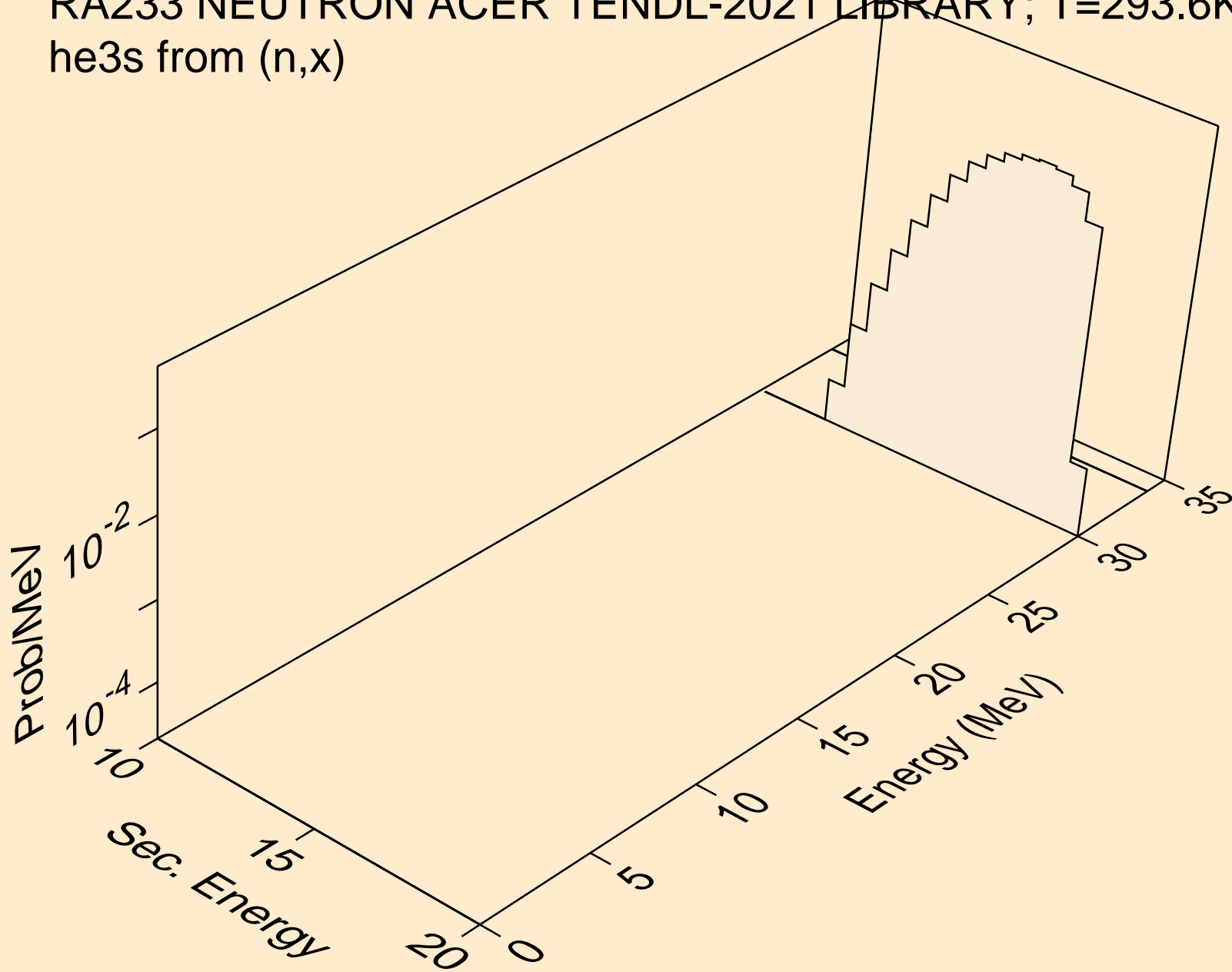

RA233 NEUTRON ACER TENDL-2021 LIBRARY; T=293.6K
he3s from (n,n*)he3

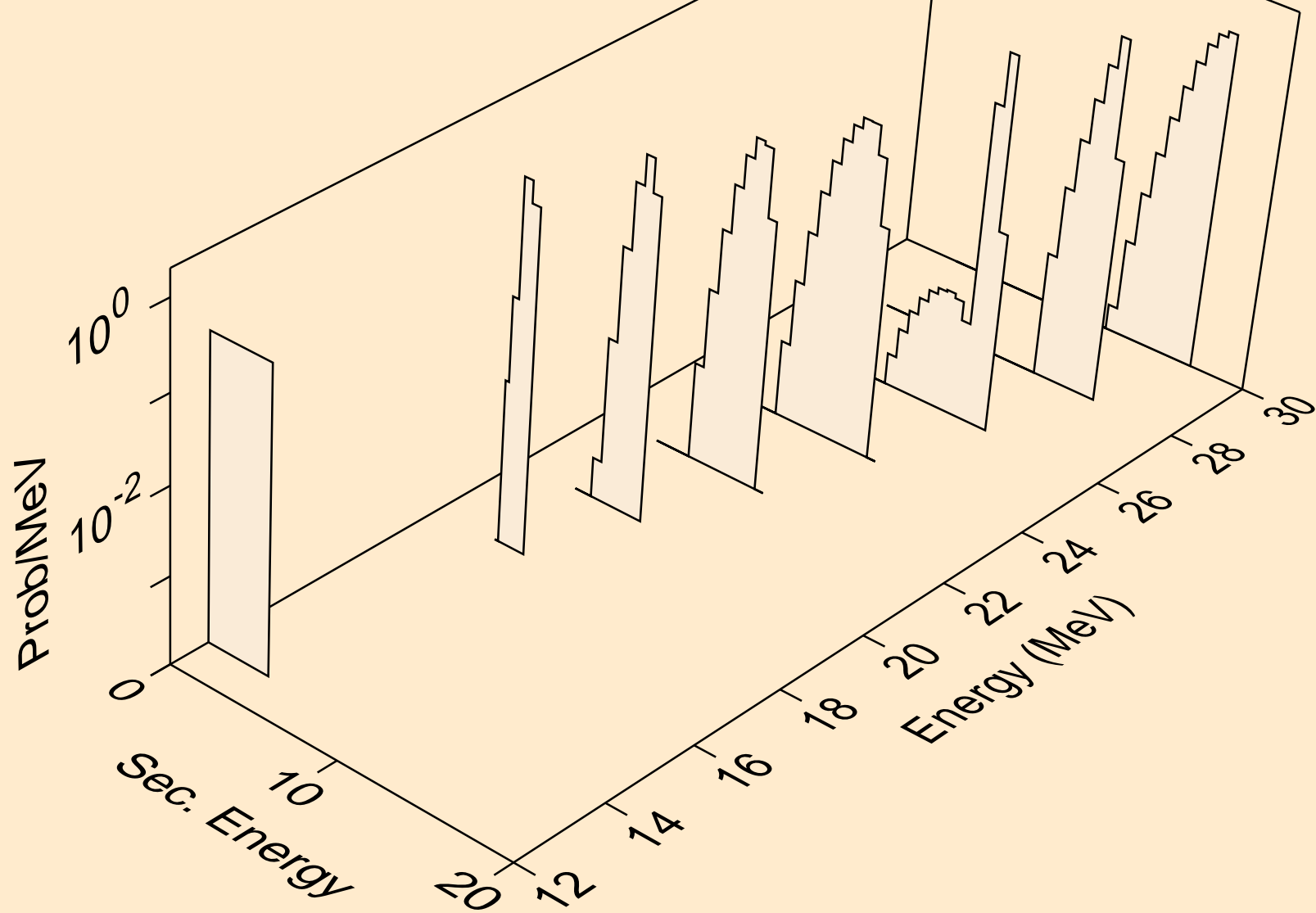

RA233 NEUTRON ACER TENDL-2021 LIBRARY; T=293.6K
he3s from (n,he3)

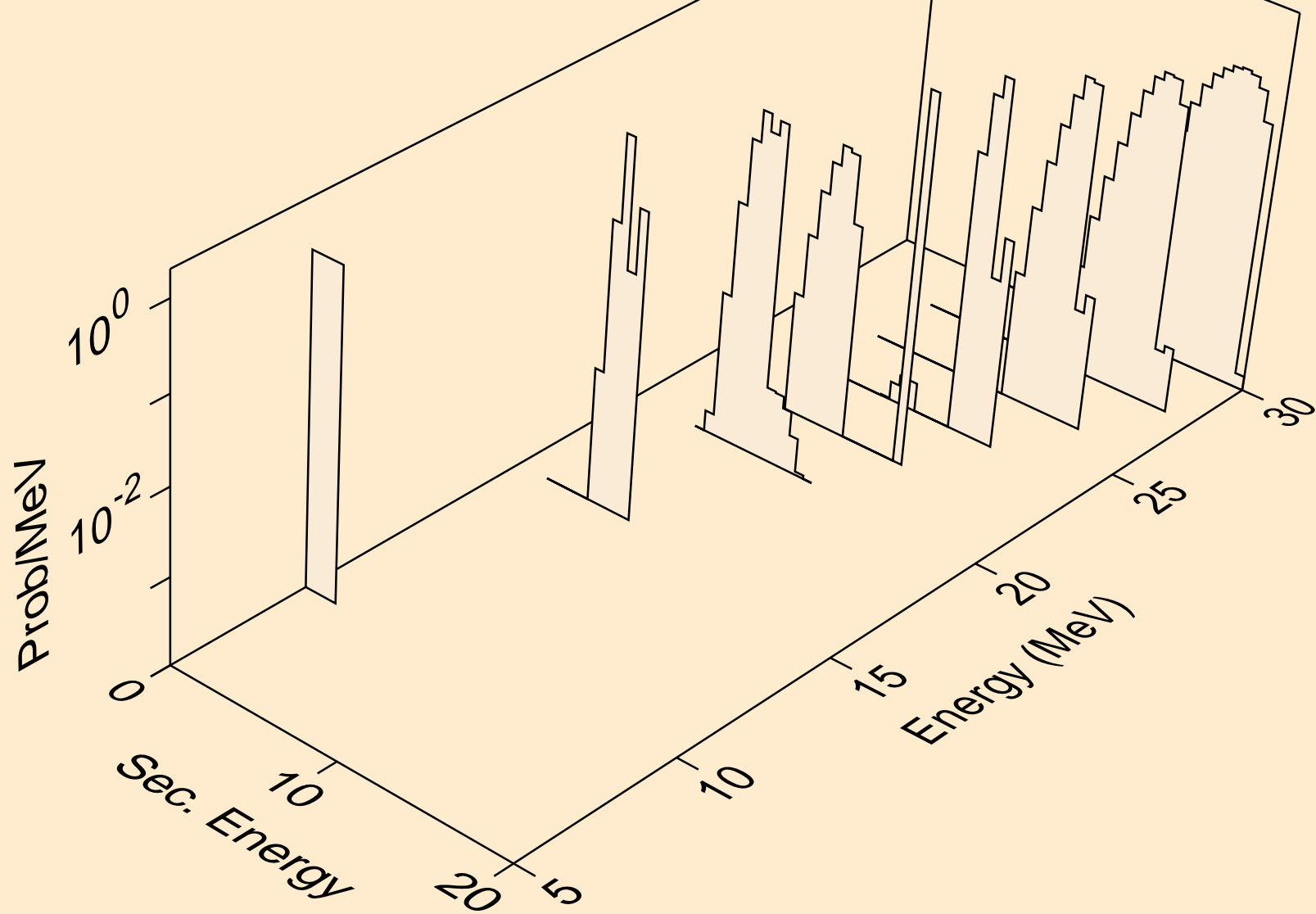

RA233 NEUTRON ACER TENDL-2021 LIBRARY; T=293.6K
alphas from (n,x)

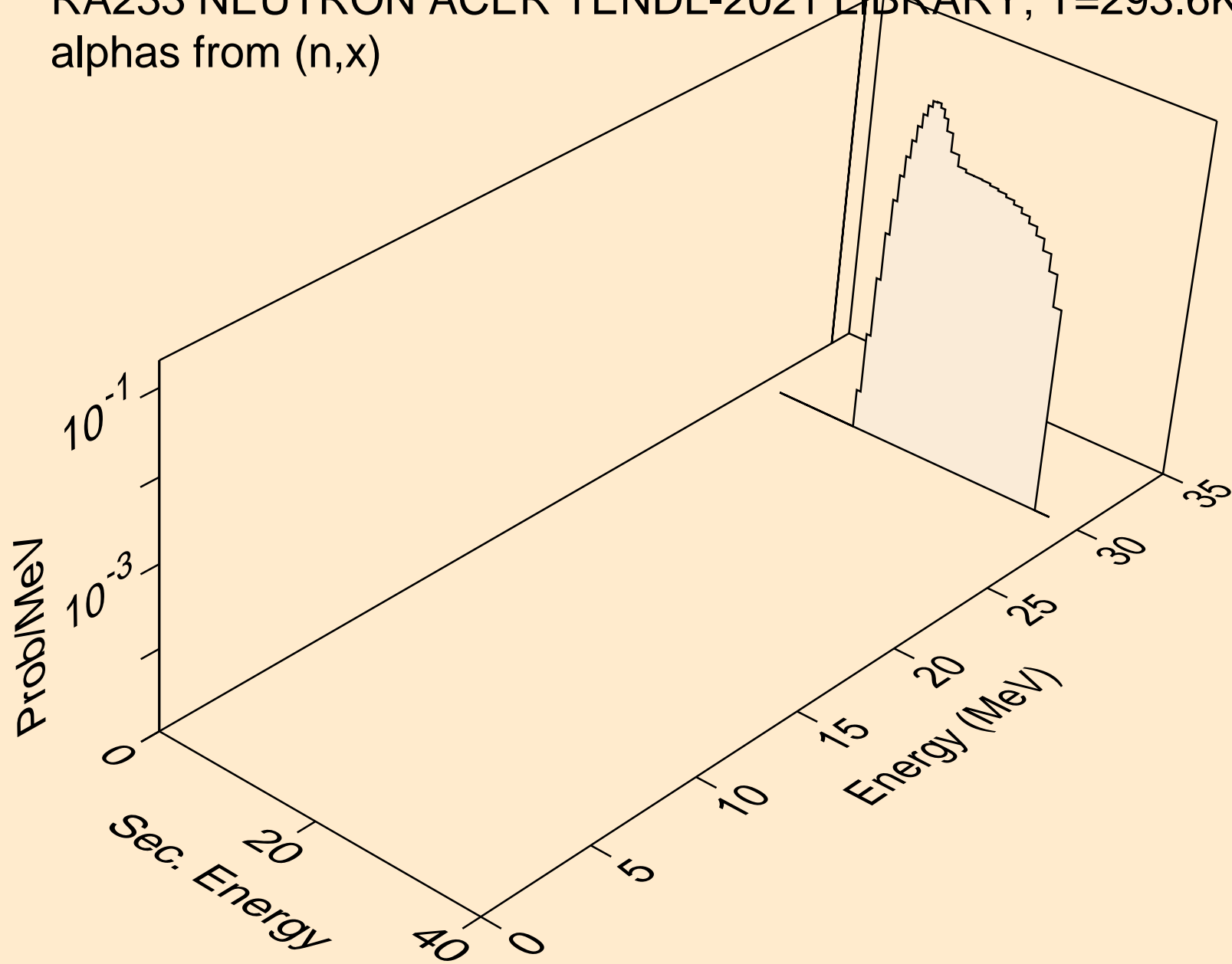

RA233 NEUTRON ACER TENDL-2021 LIBRARY; T=293.6K
alphas from (n,n*)a

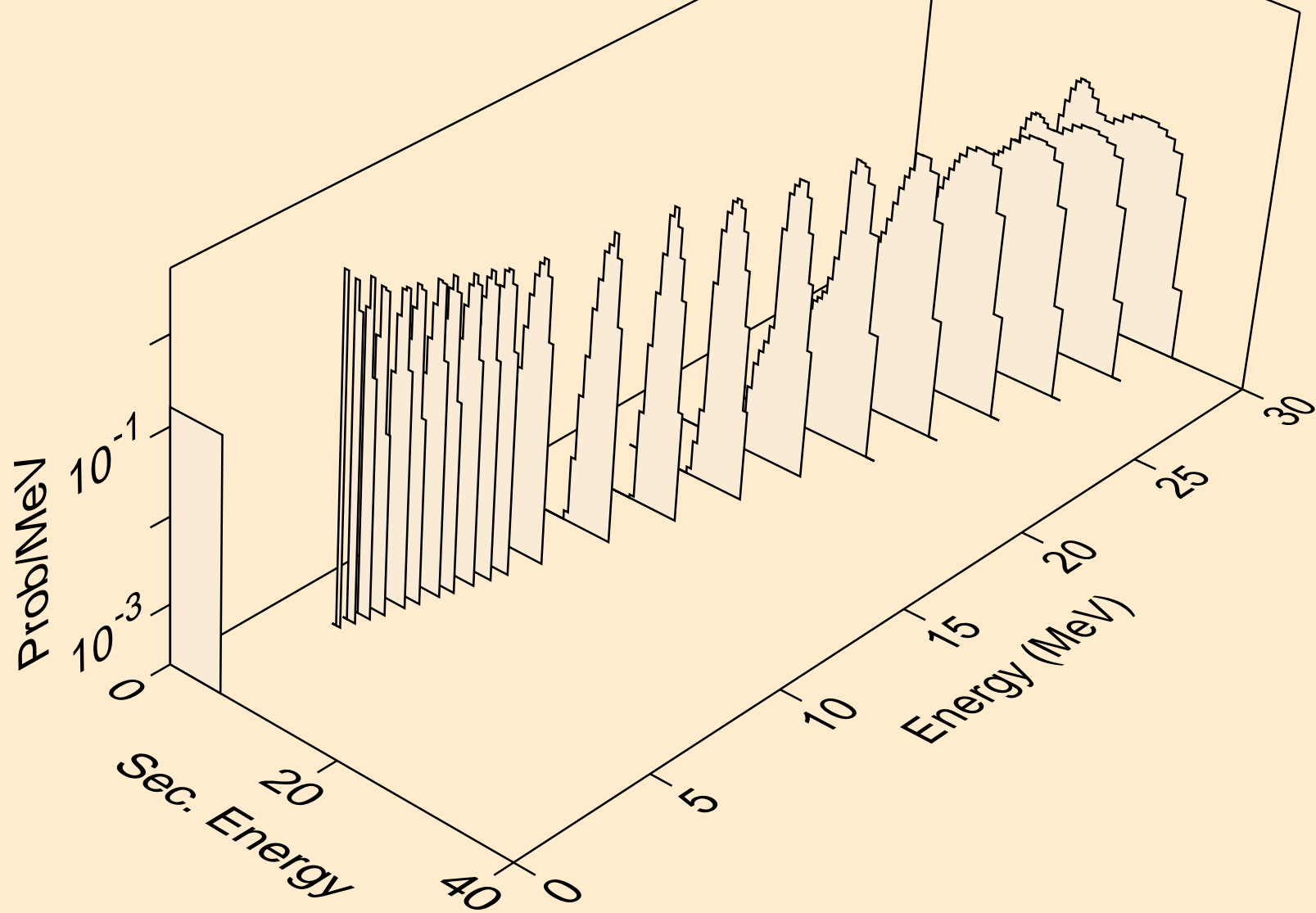

RA233 NEUTRON ACER TENDL-2021 LIBRARY; T=293.6K
alphas from (n,2n)a

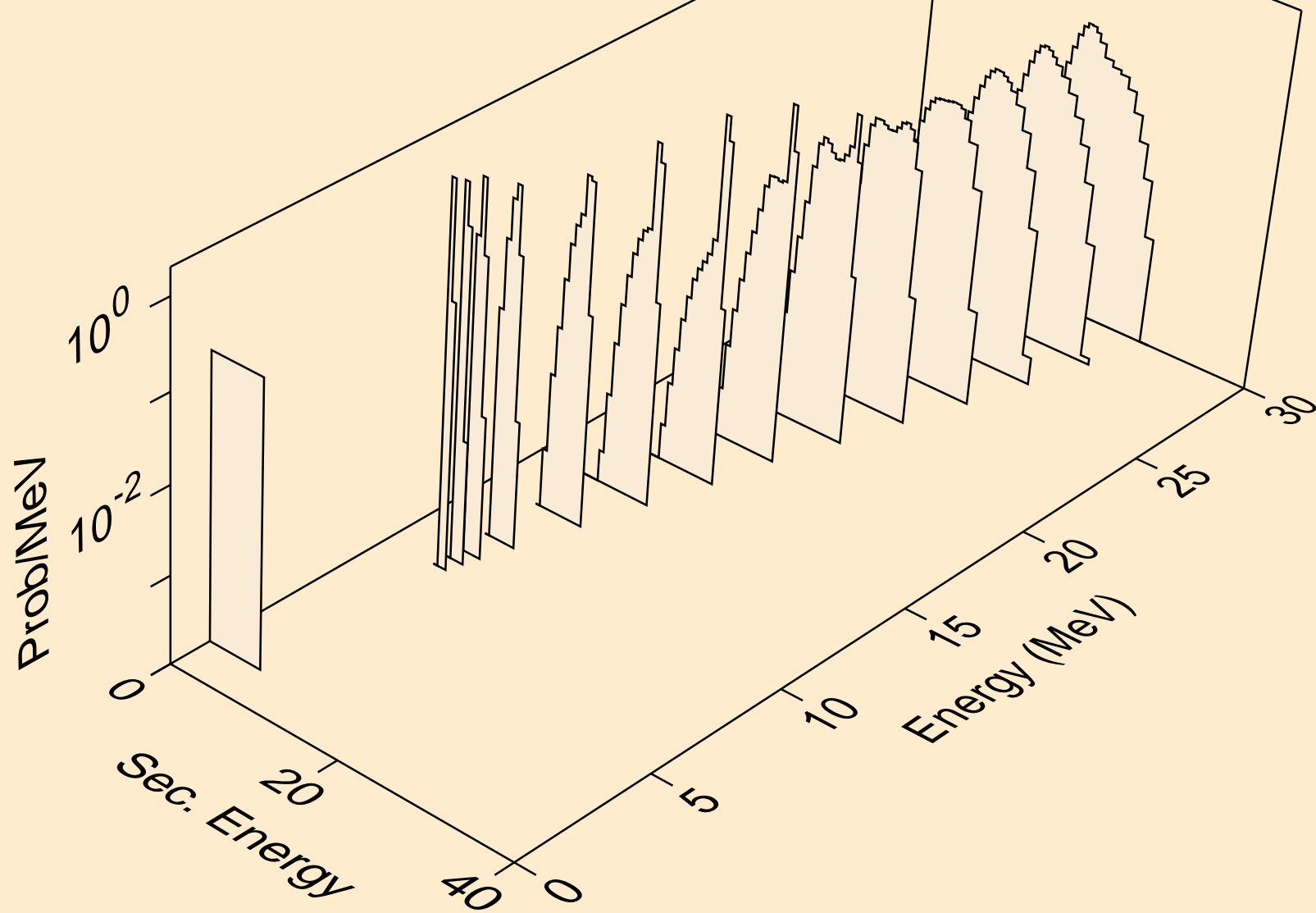

RA233 NEUTRON ACER TENDL-2021 LIBRARY; T=293.6K
alphas from (n,3n)a

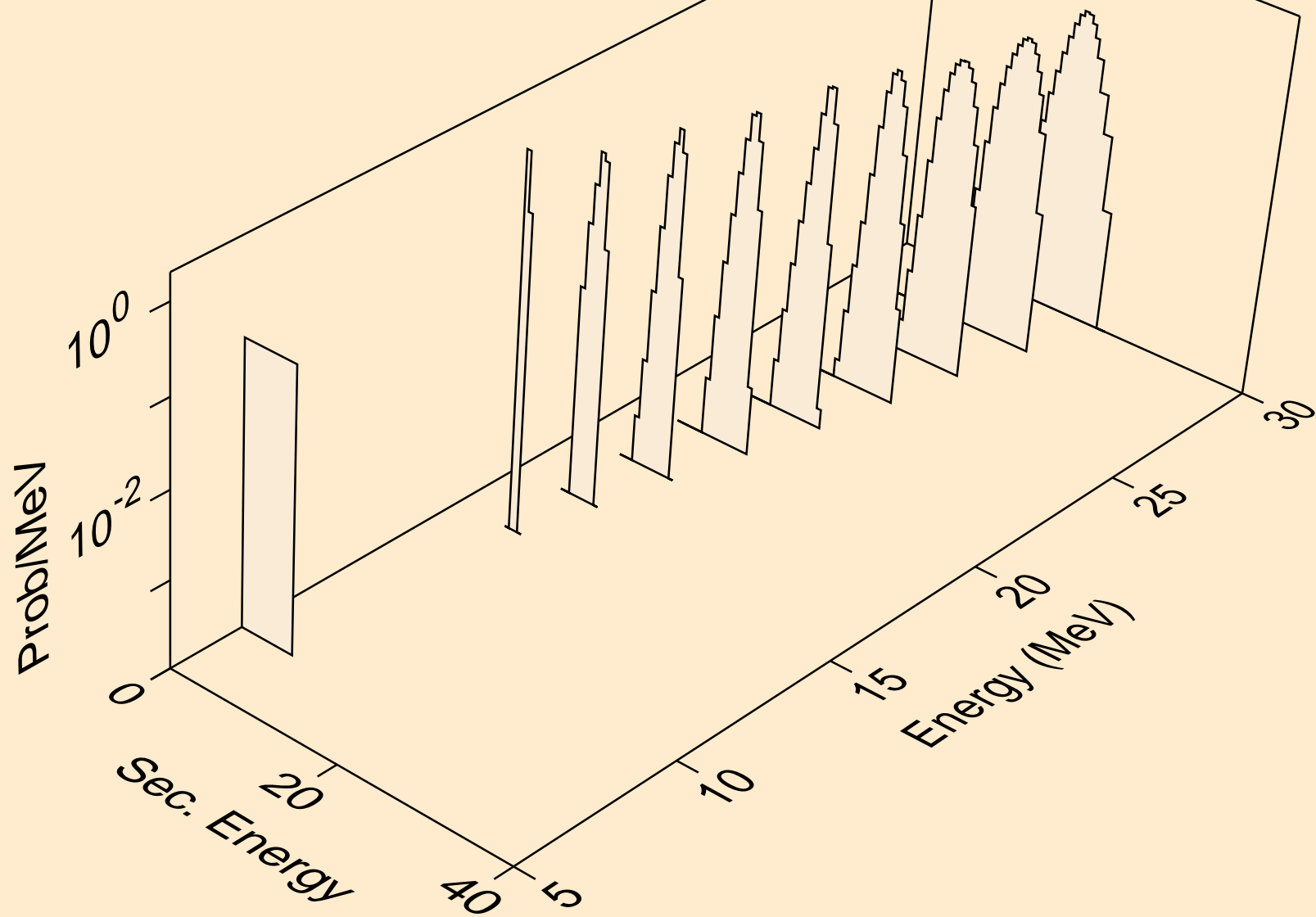

RA233 NEUTRON ACER TENDL-2021 LIBRARY; T=293.6K
alphas from (n,npa)

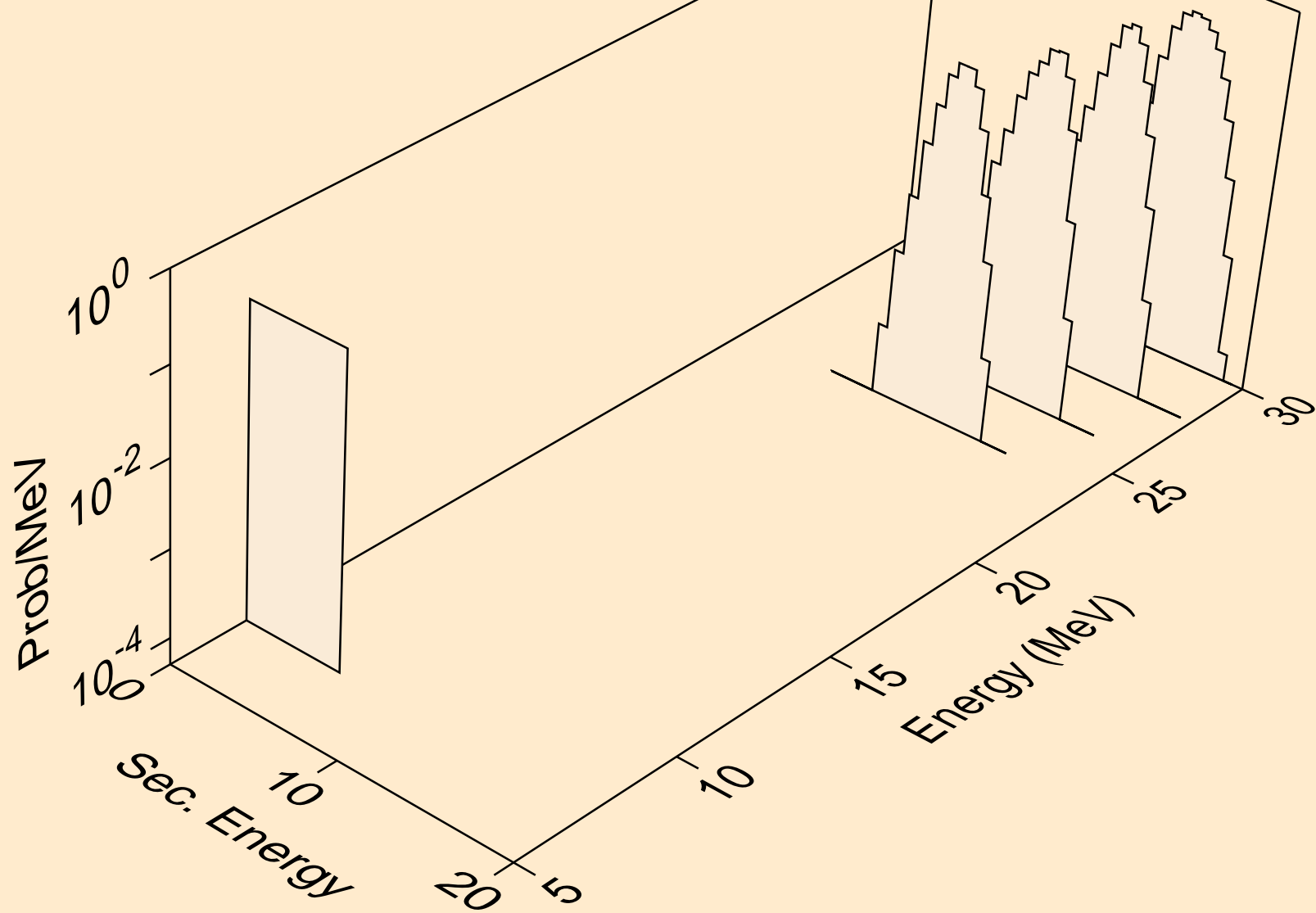

RA233 NEUTRON ACER TENDL-2021 LIBRARY; T=293.6K
alphas from (n,a)

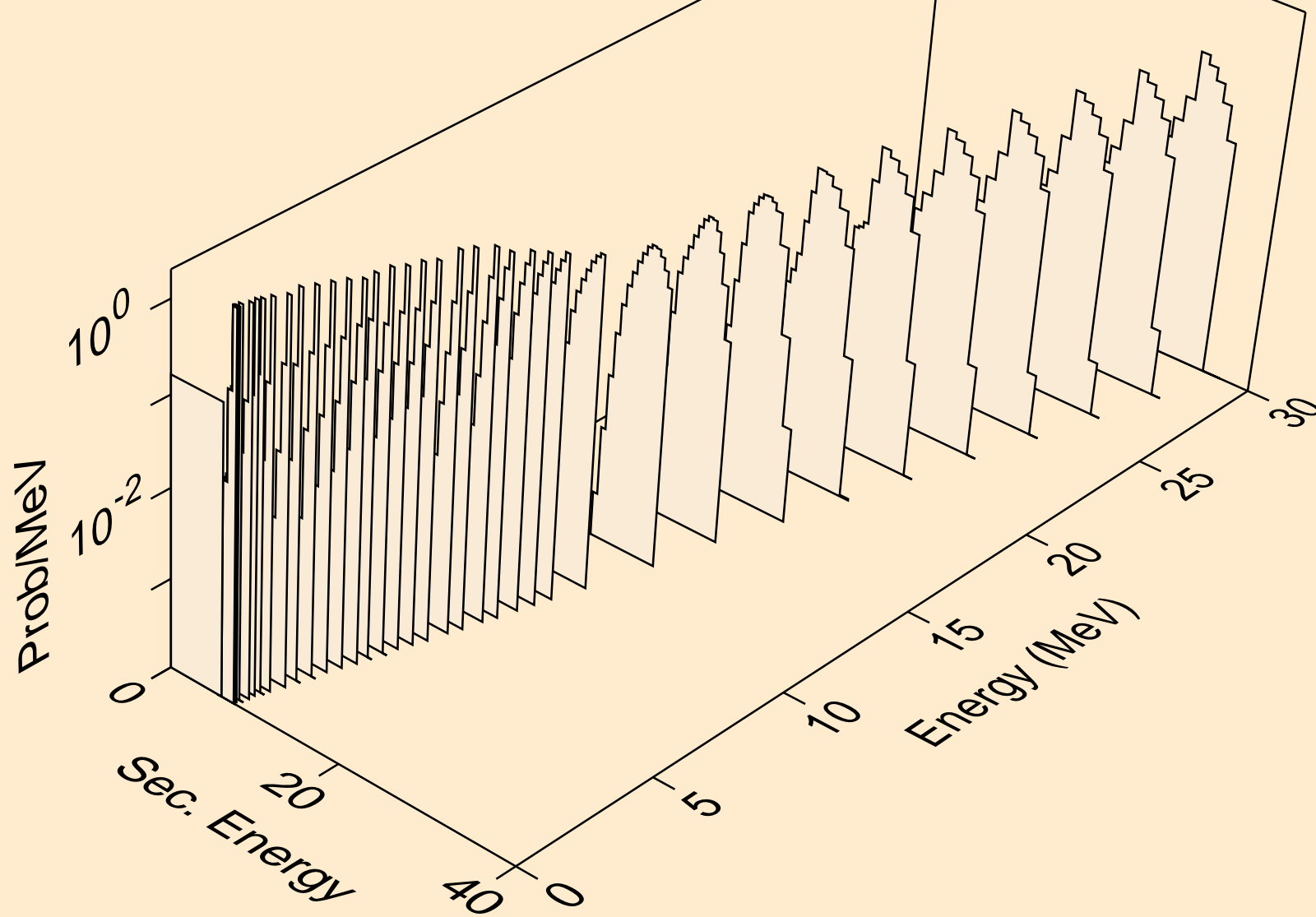

RA233 NEUTRON ACER TENDL-2021 LIBRARY; T=293.6K
alphas from (n,pa)

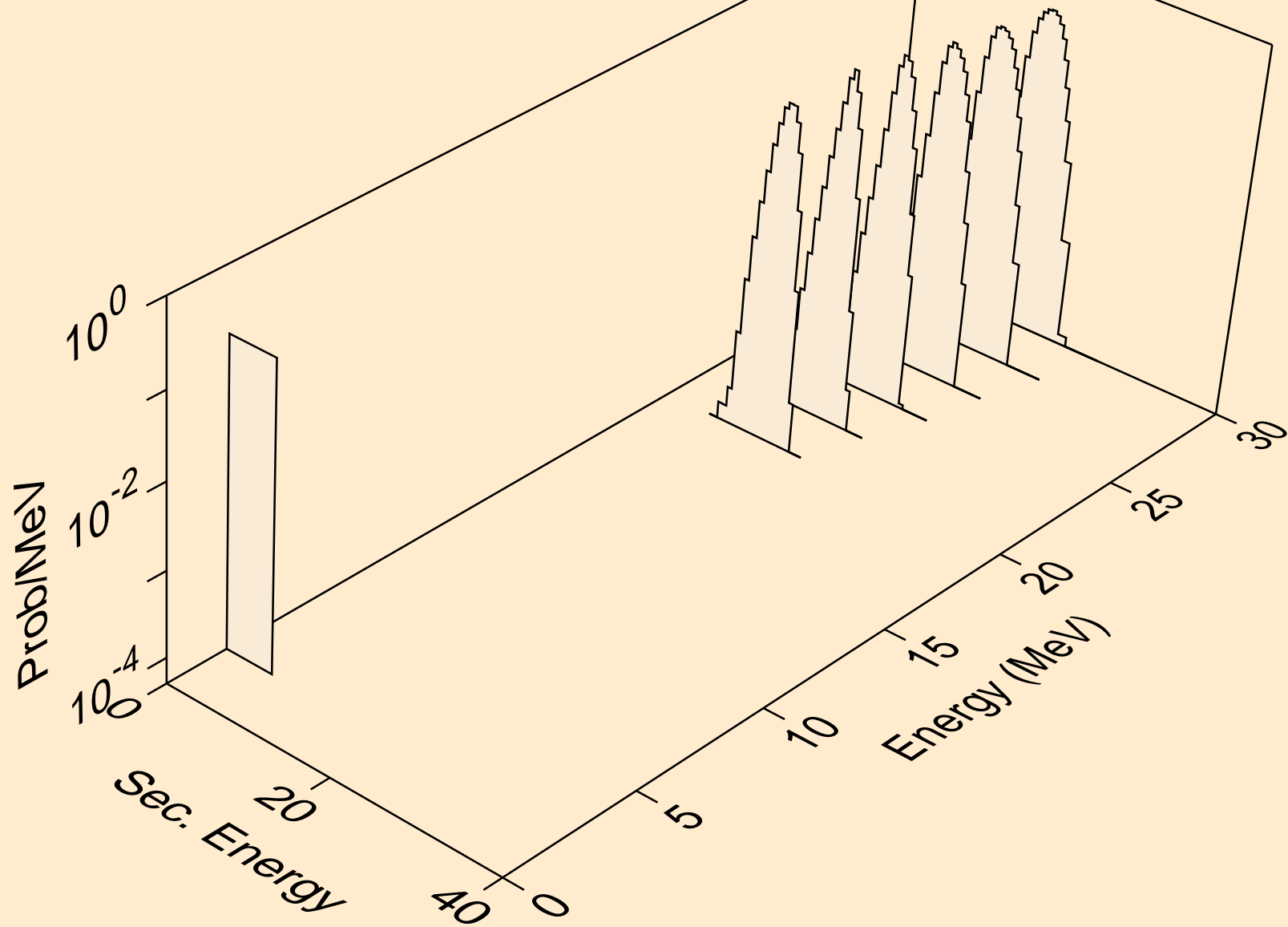

RA233 NEUTRON ACER TENDL-2021 LIBRARY; T=293.6K
alphas from (n,da)

