

RB084M NEUTRON ACER TENDL-2021 LIBRARY; T=293.6K
Principal cross sections

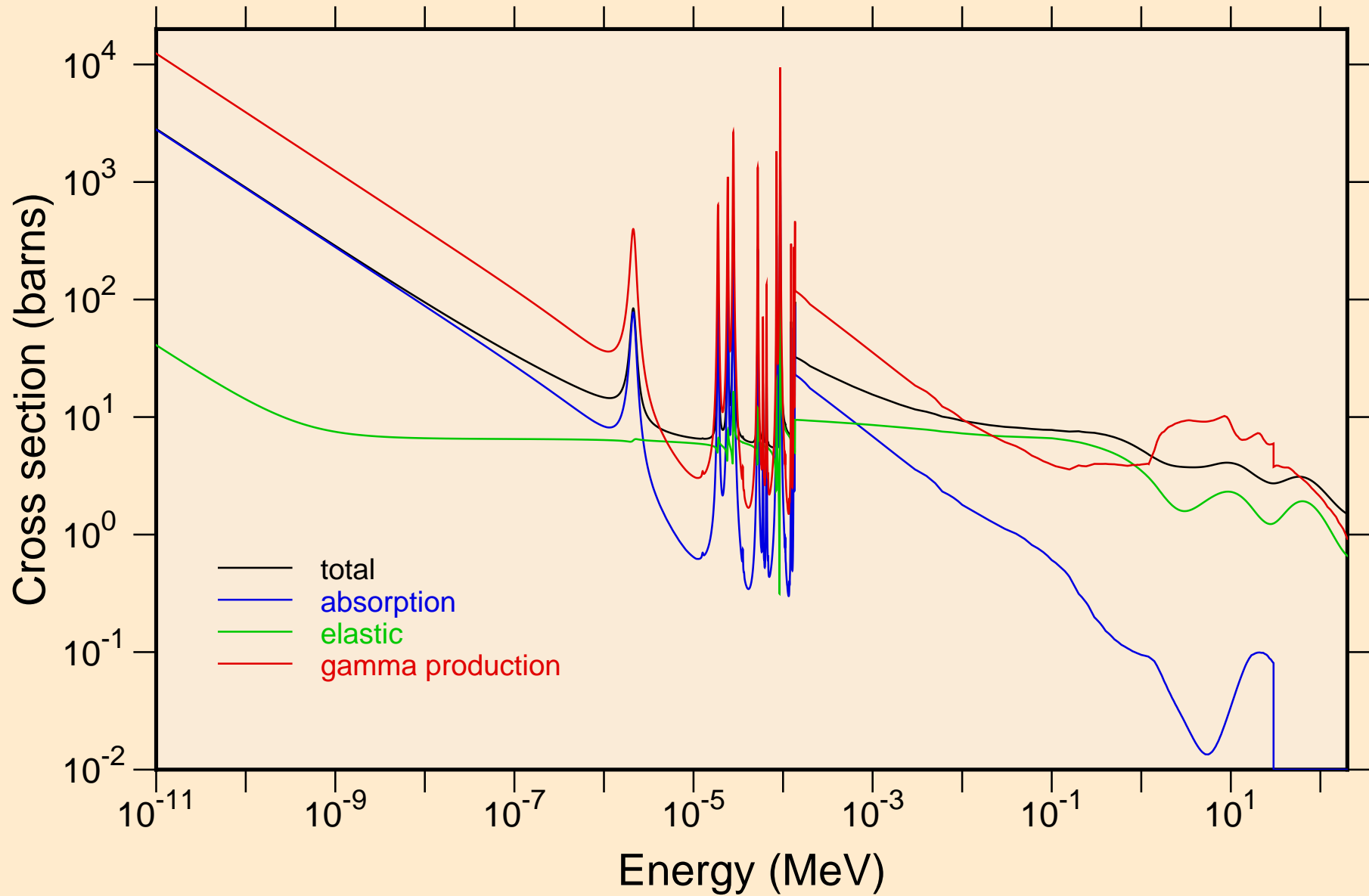

RB084M NEUTRON ACER TENDL-2021 LIBRARY; T=293.6K
resonance total cross section

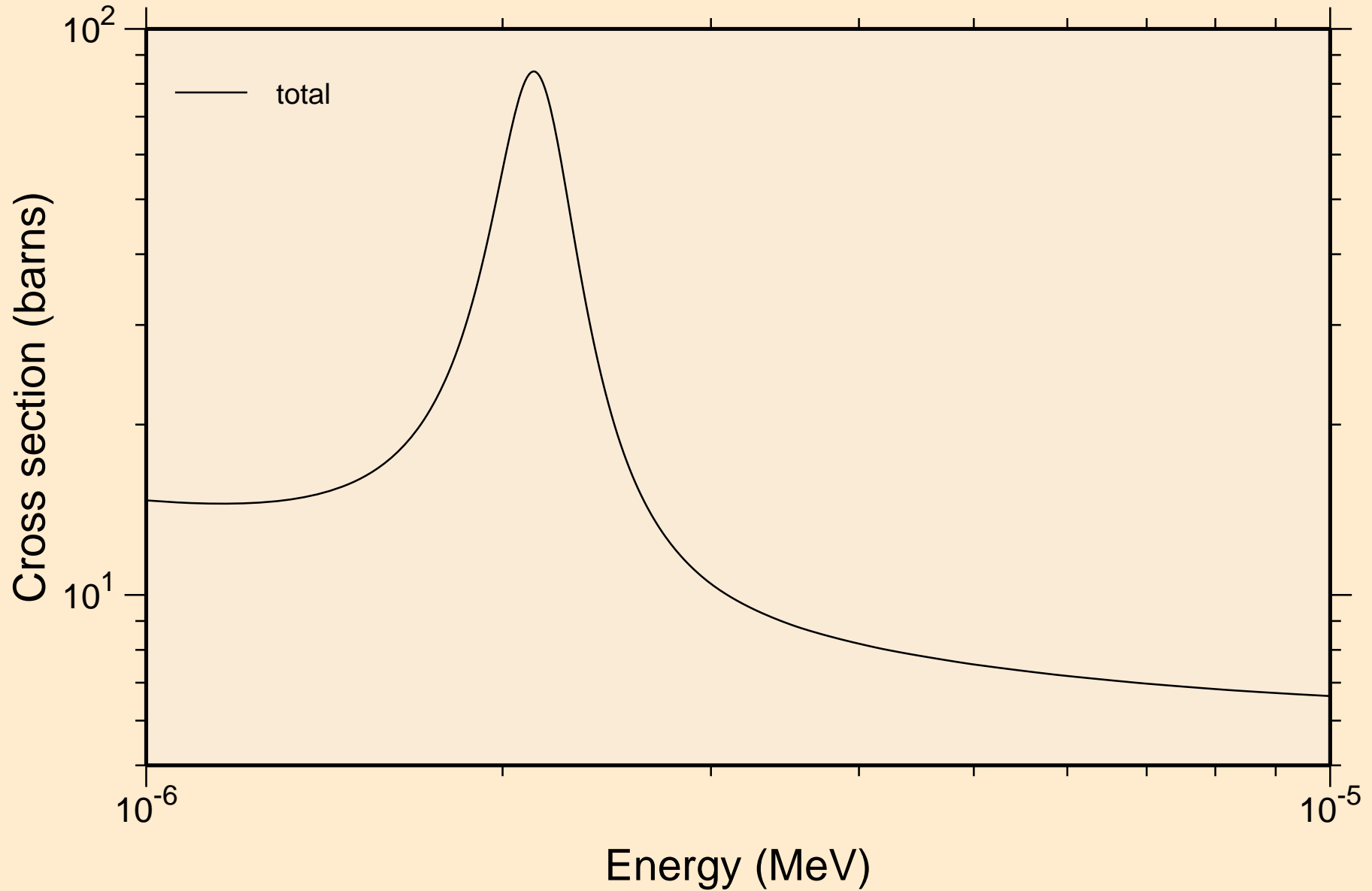

RB084M NEUTRON ACER TENDL-2021 LIBRARY; T=293.6K
resonance total cross section

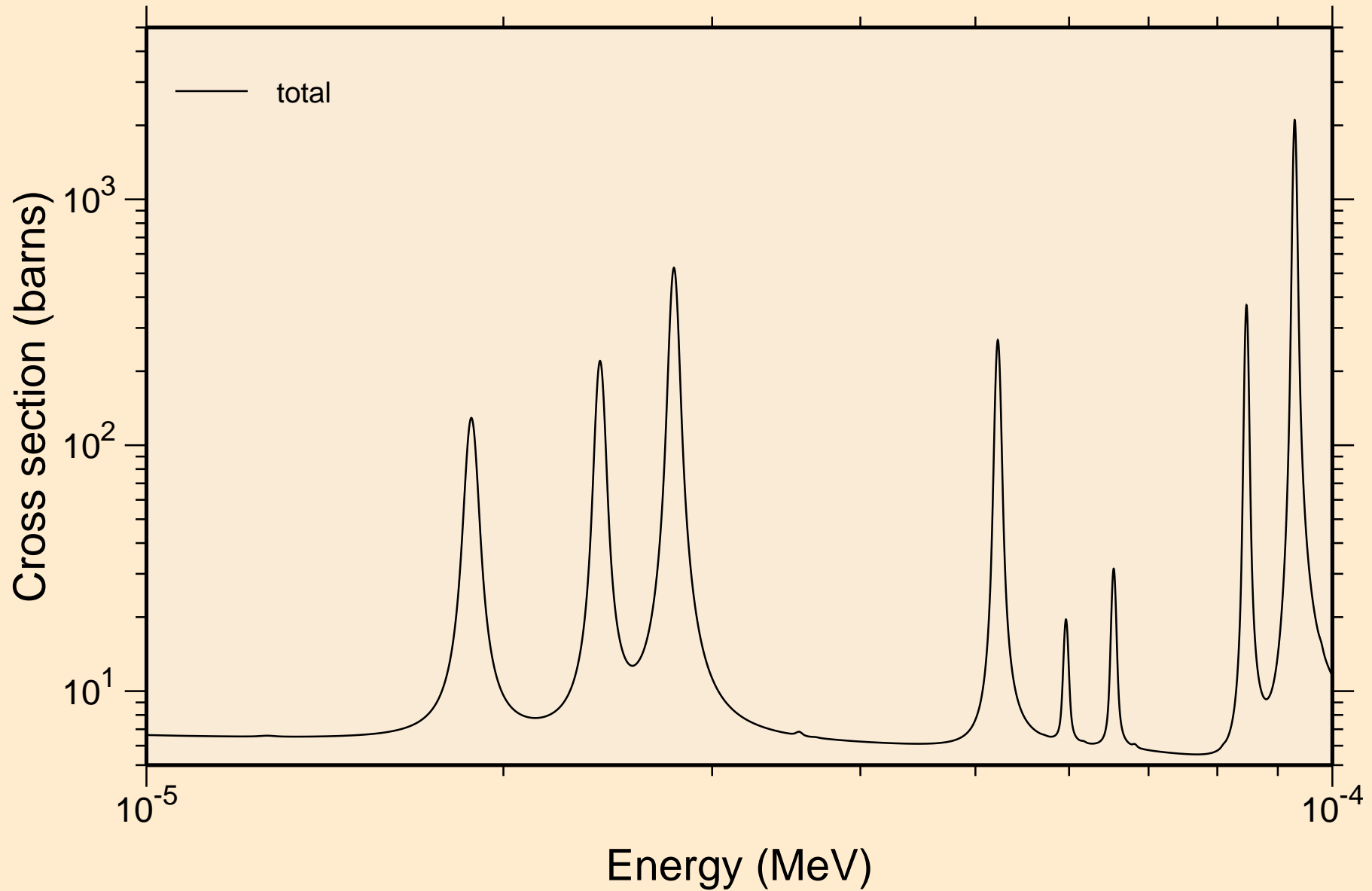

RB084M NEUTRON ACER TENDL-2021 LIBRARY; T=293.6K
resonance total cross section

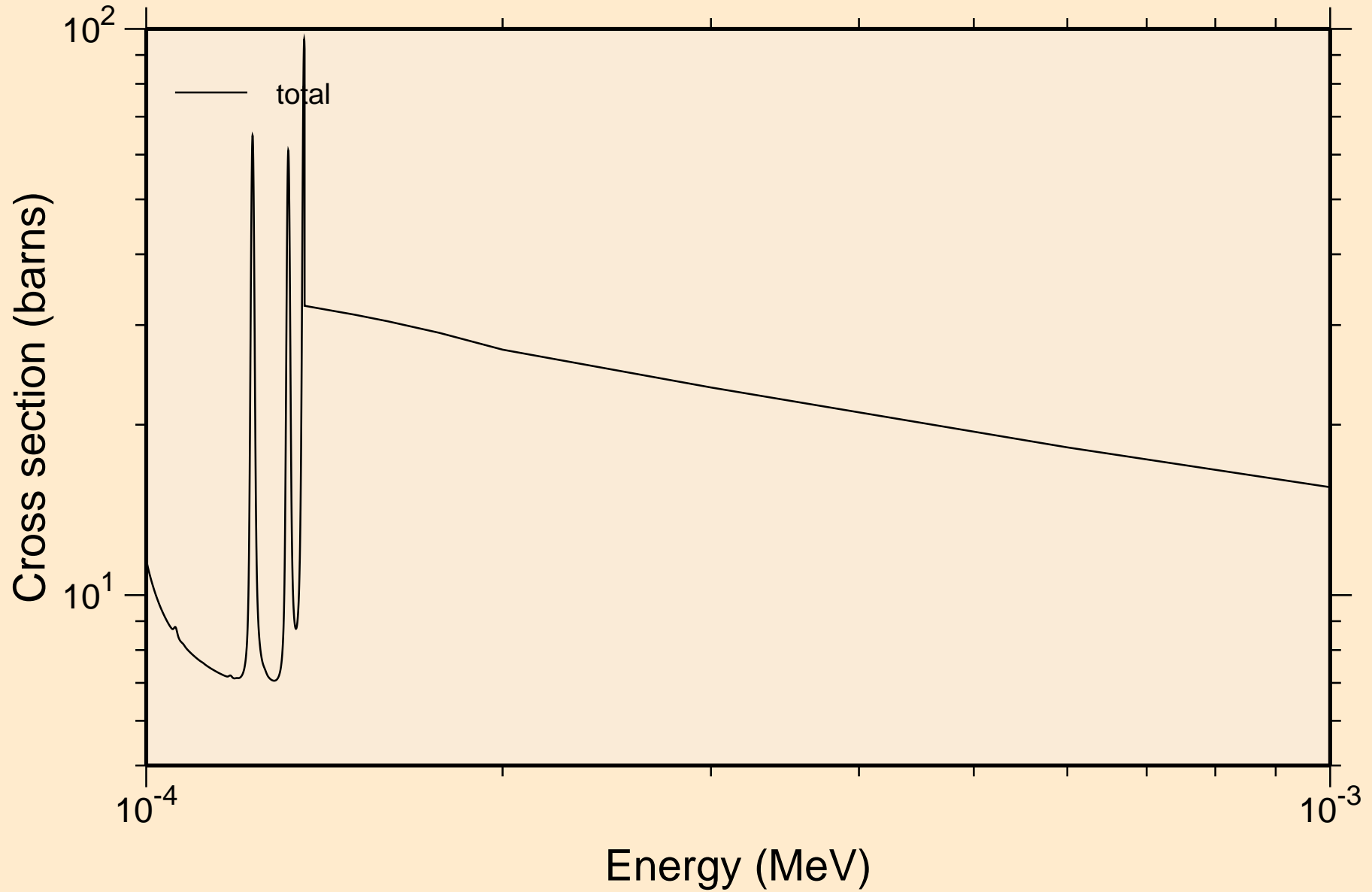

R̄B084M NEUTRON ACER TENDL-2021 LIBRARY; T=293.6K
resonance total cross section

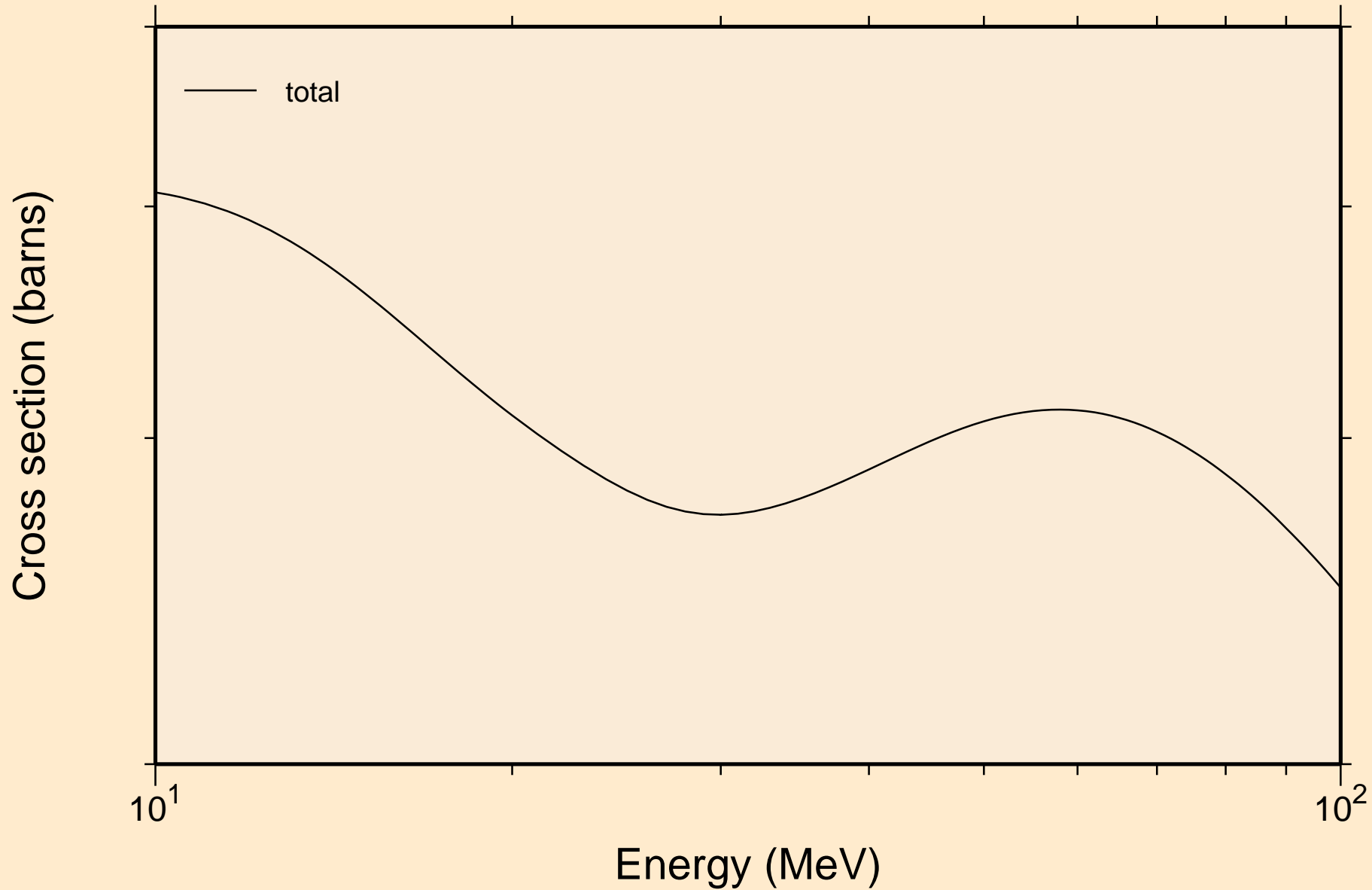

RB084M NEUTRON ACER TENDL-2021 LIBRARY; T=293.6K
resonance absorption cross sections

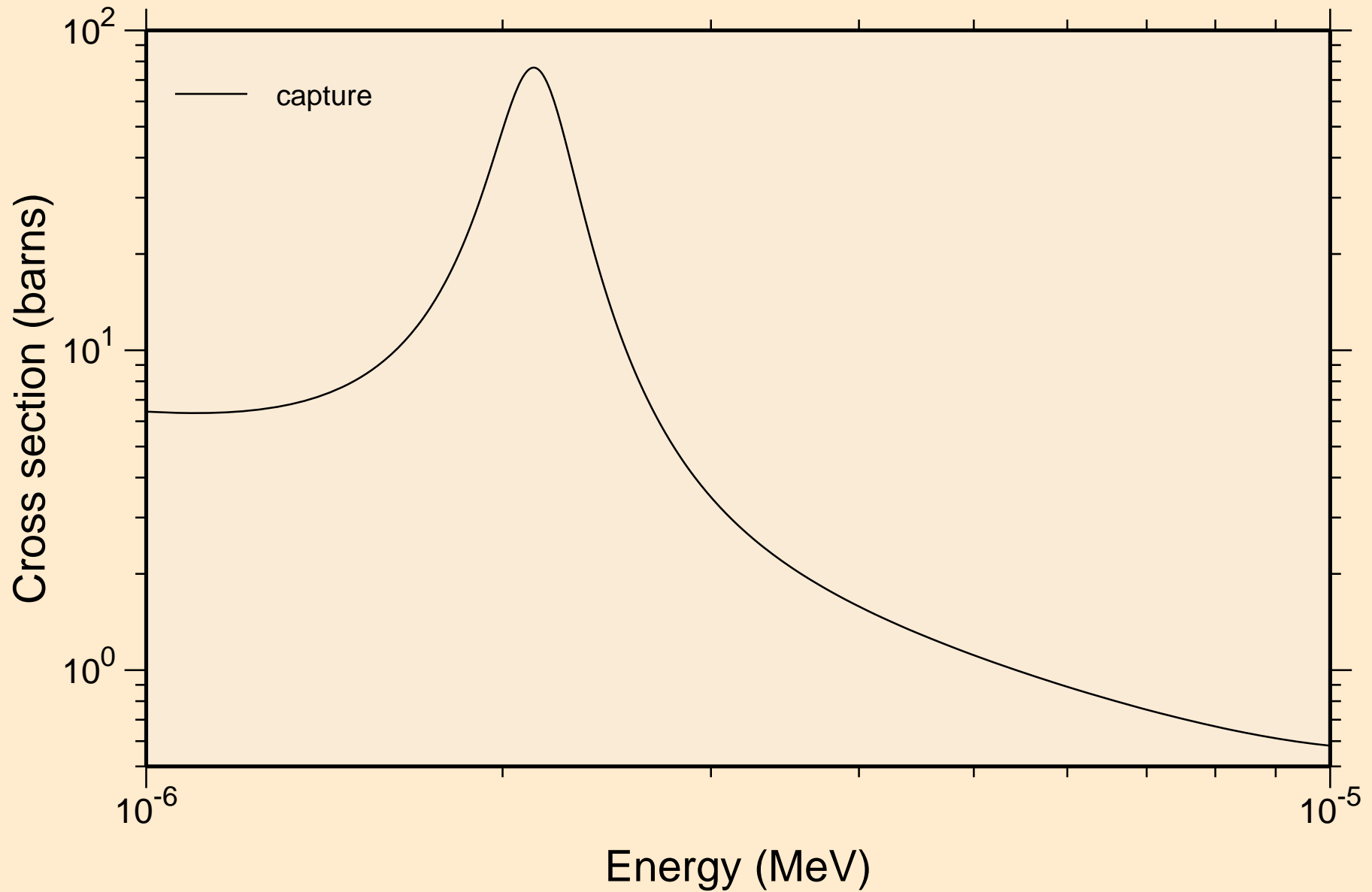

RB084M NEUTRON ACER TENDL-2021 LIBRARY; T=293.6K
resonance absorption cross sections

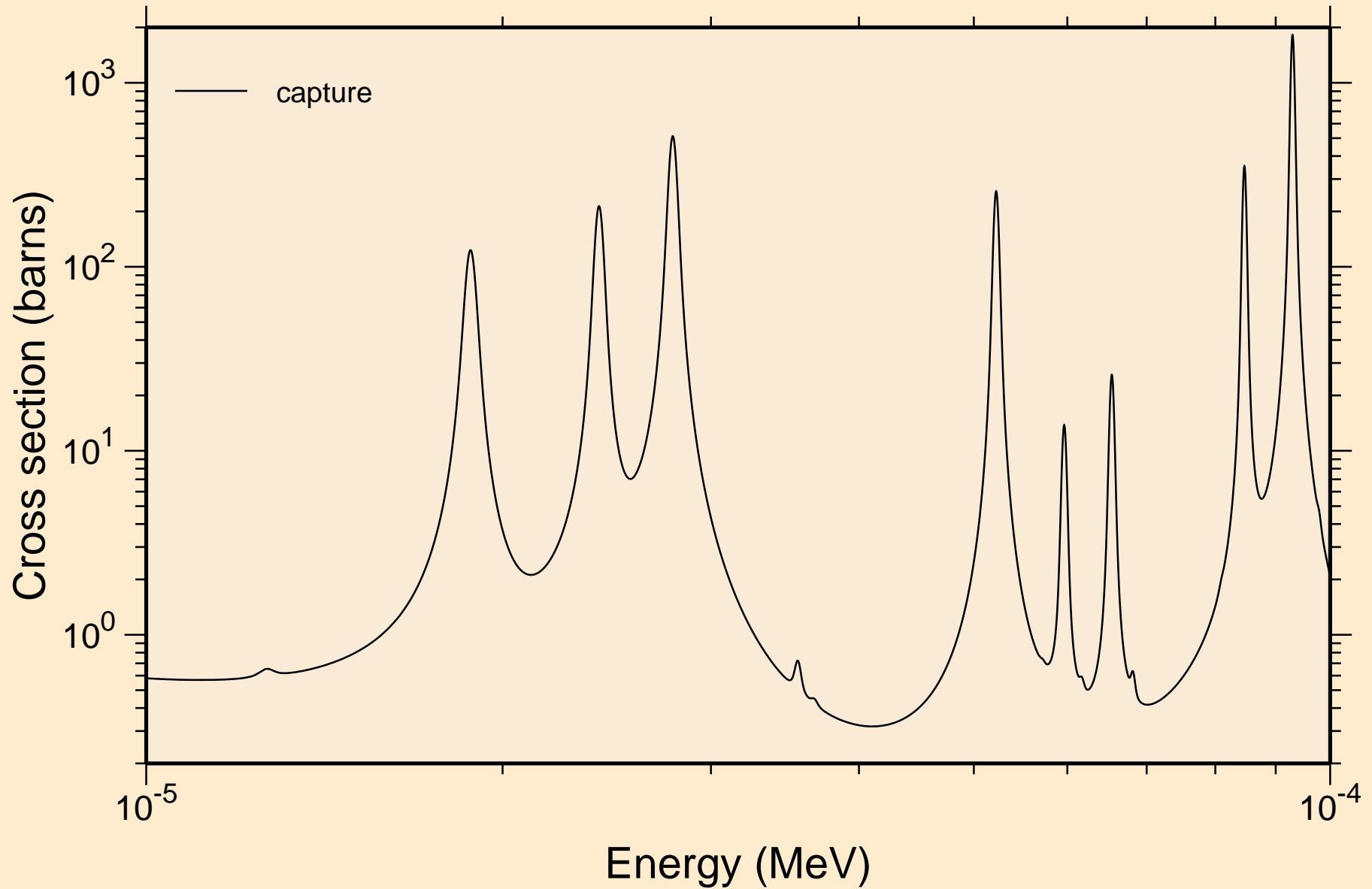

RB084M NEUTRON ACER TENDL-2021 LIBRARY; T=293.6K
resonance absorption cross sections

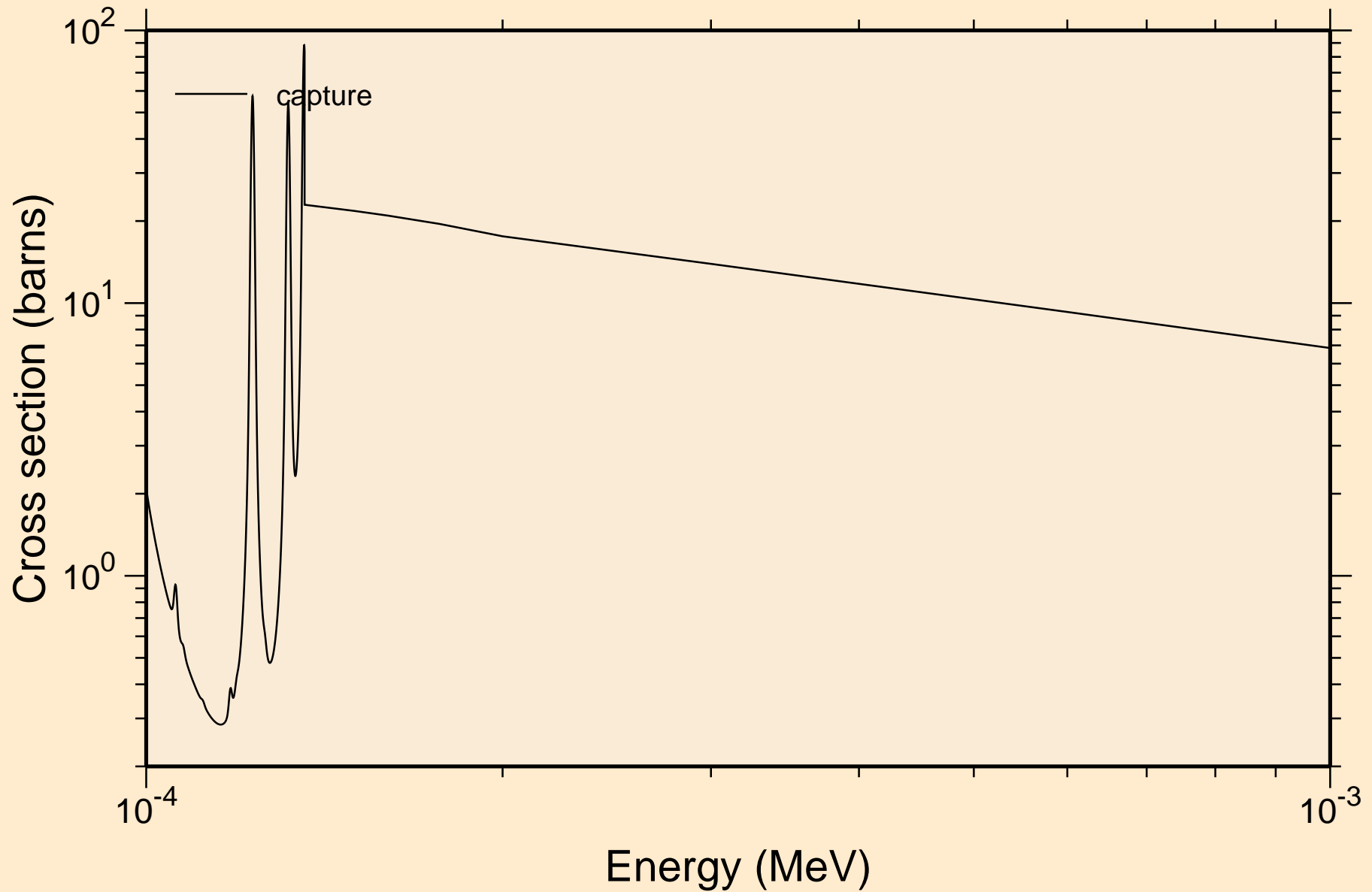

RB084M NEUTRON ACER TENDL-2021 LIBRARY; T=293.6K
resonance absorption cross sections

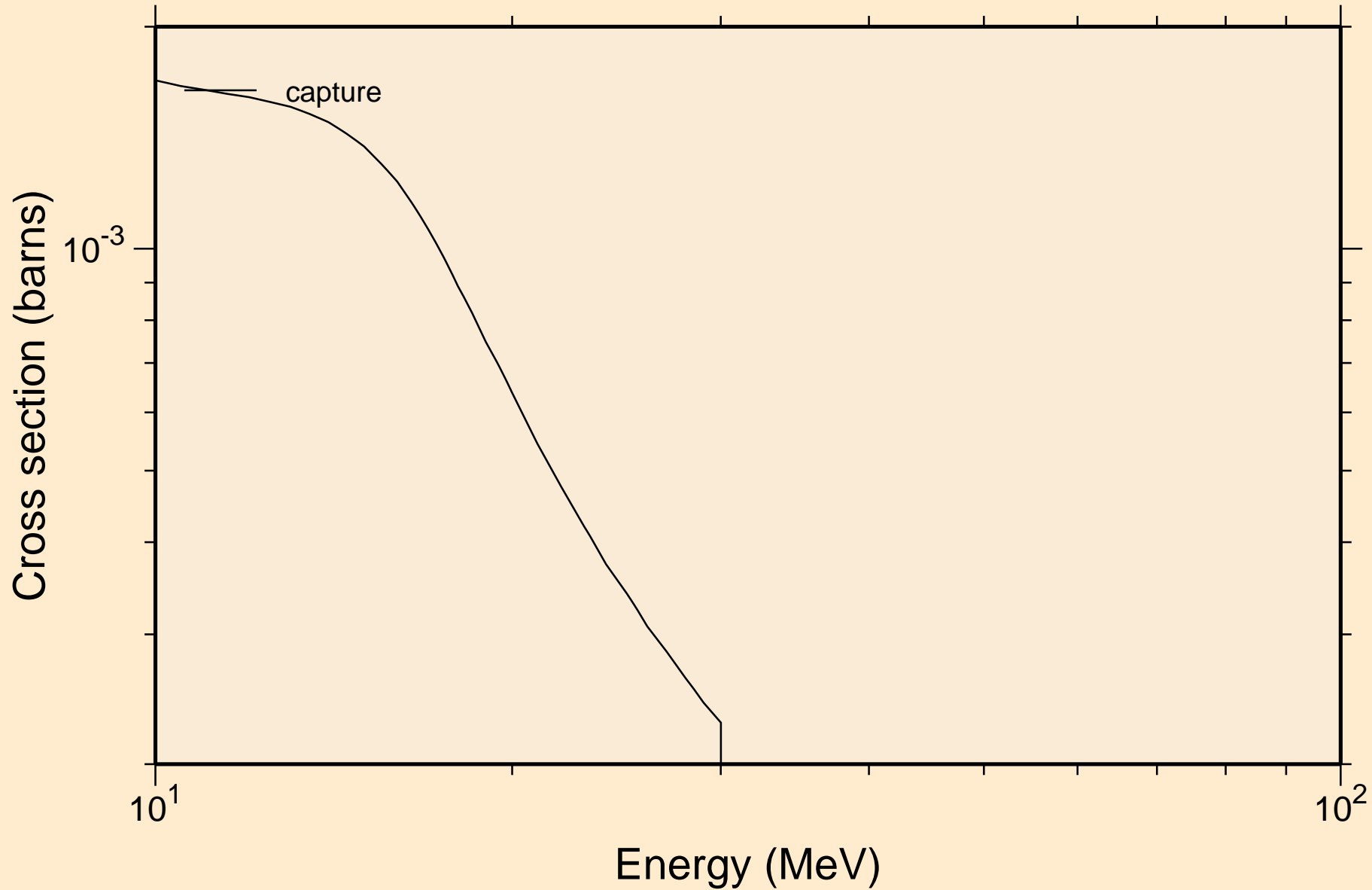

RB084M NEUTRON ACER TENDL-2021 LIBRARY; T=293.6K
Heating

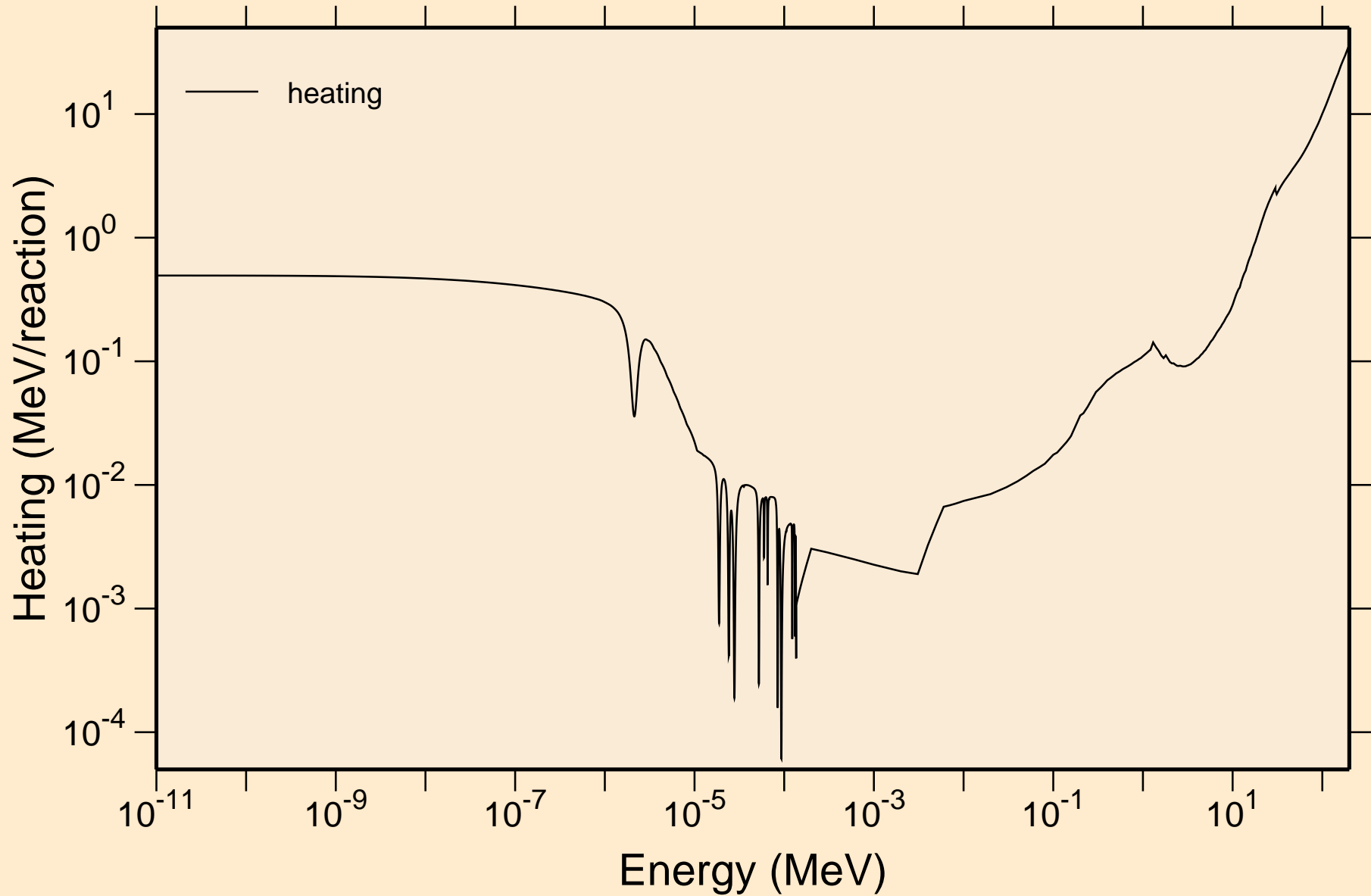

RB084M NEUTRON ACER TENDL-2021 LIBRARY; T=293.6K
Damage

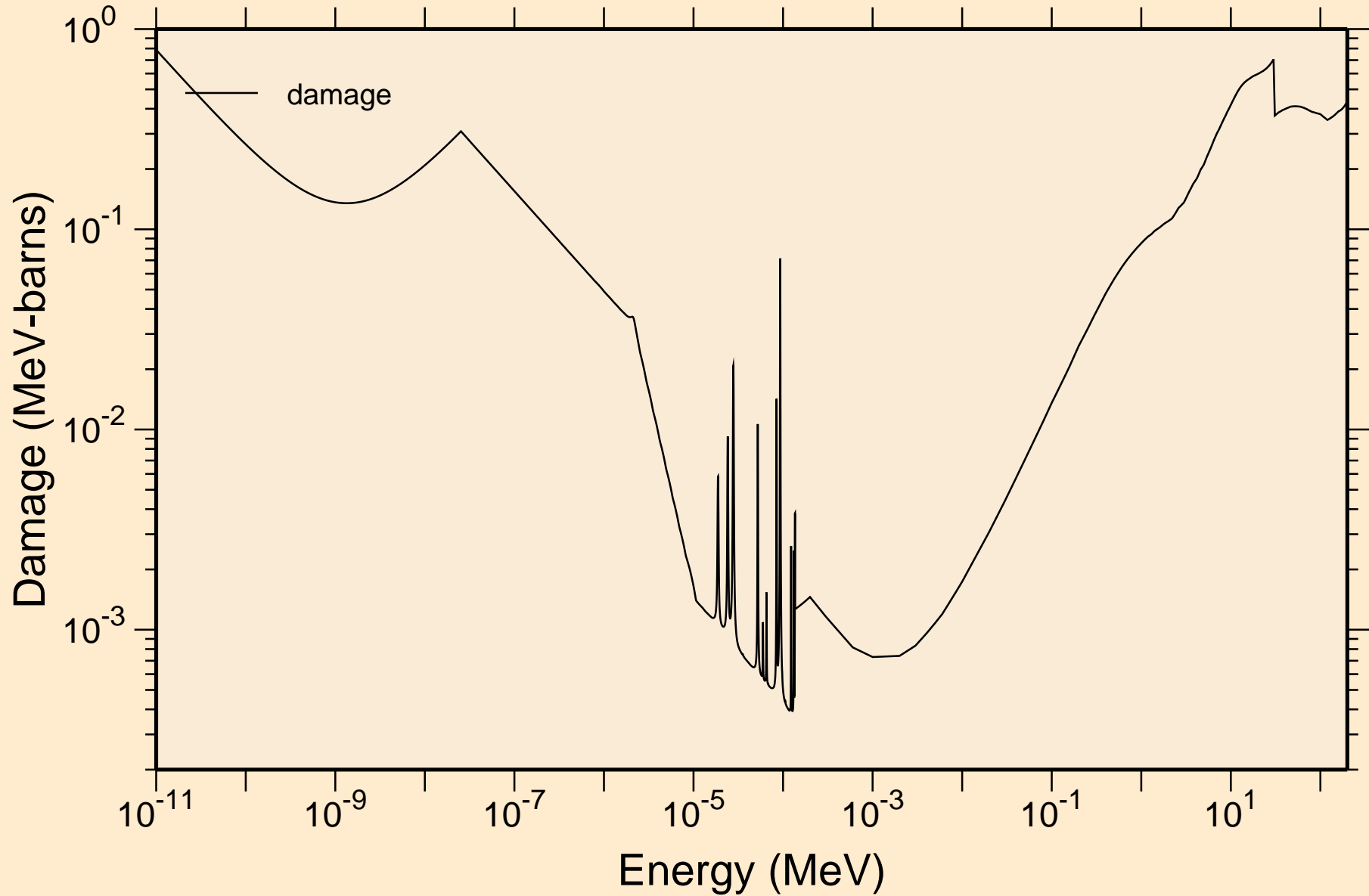

RB084M NEUTRON ACER TENDL-2021 LIBRARY; T=293.6K
Non-threshold reactions

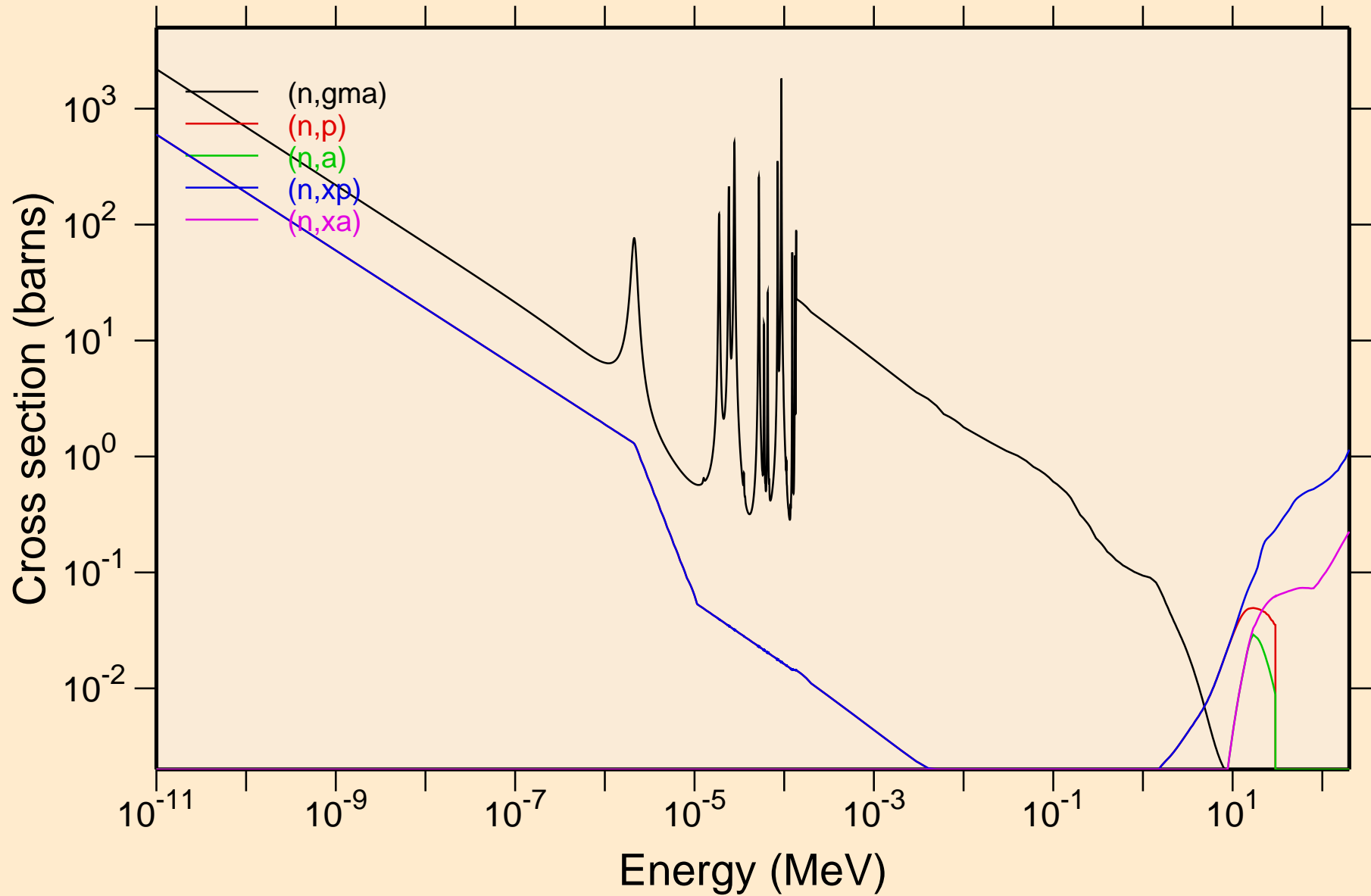

RB084M NEUTRON ACER TENDL-2021 LIBRARY; T=293.6K
Principal cross sections

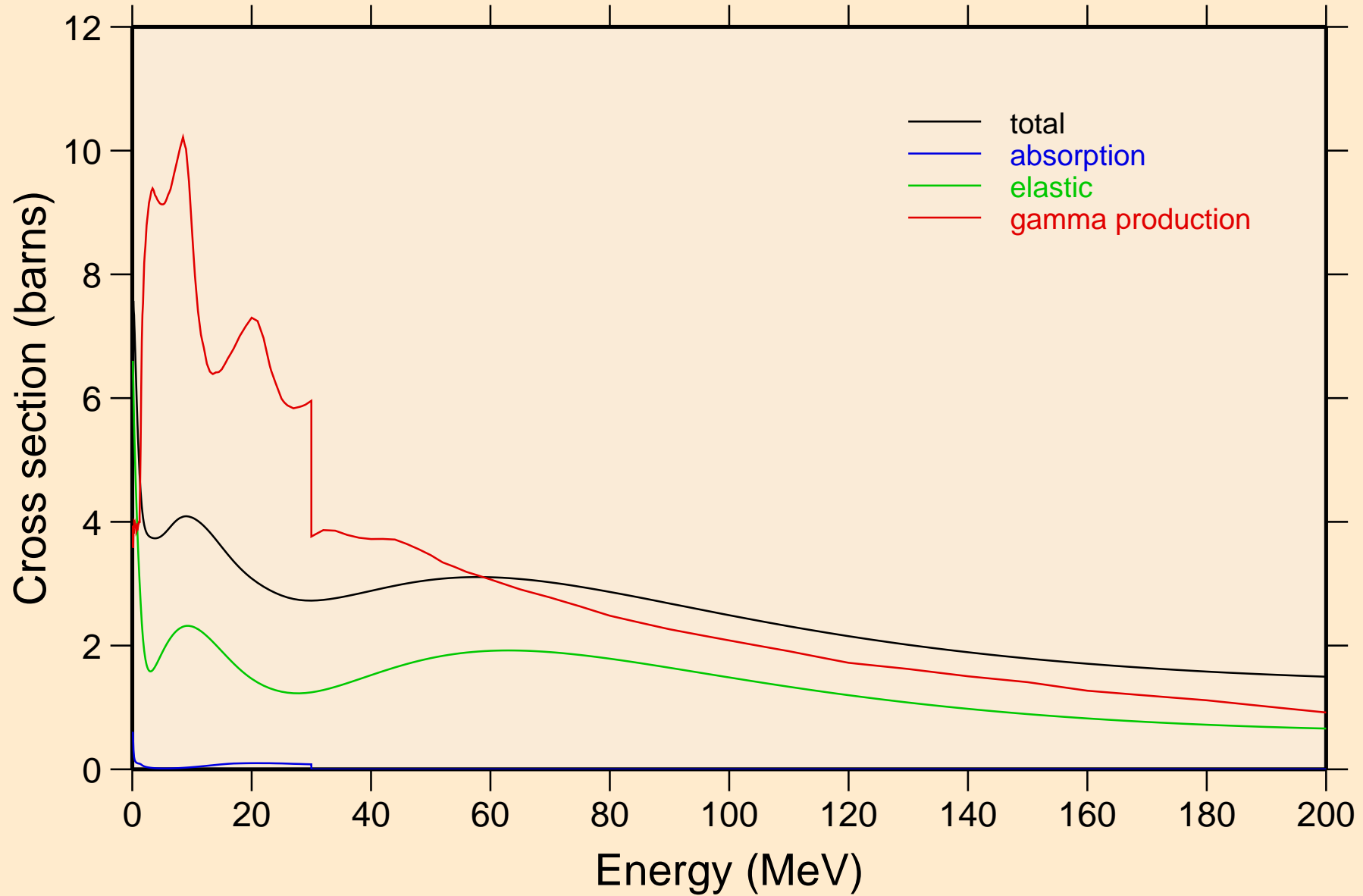

RB084M NEUTRON ACER TENDL-2021 LIBRARY; T=293.6K
Heating

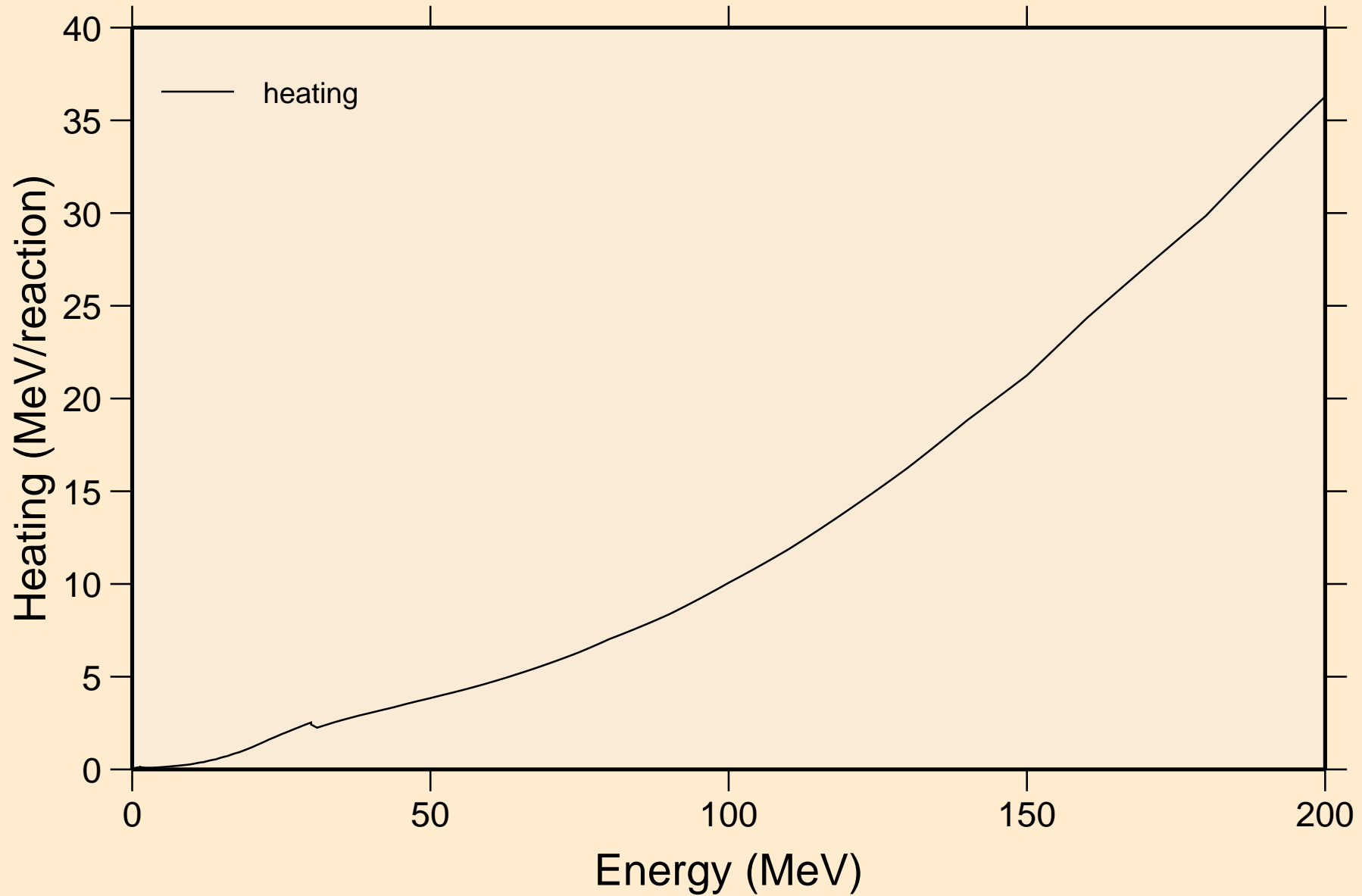

RB084M NEUTRON ACER TENDL-2021 LIBRARY; T=293.6K
Damage

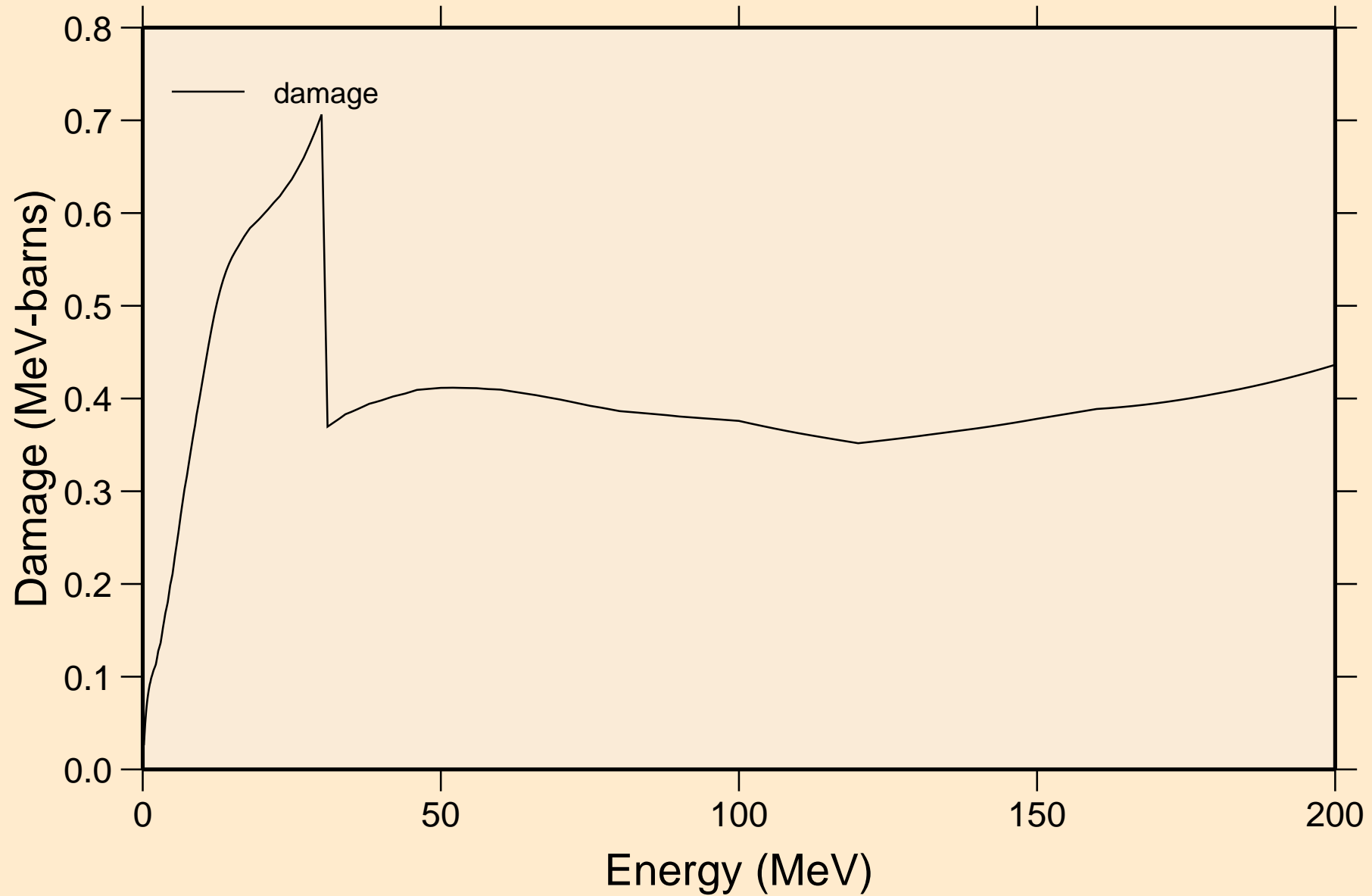

RB084M NEUTRON ACER TENDL-2021 LIBRARY; T=293.6K
Non-threshold reactions

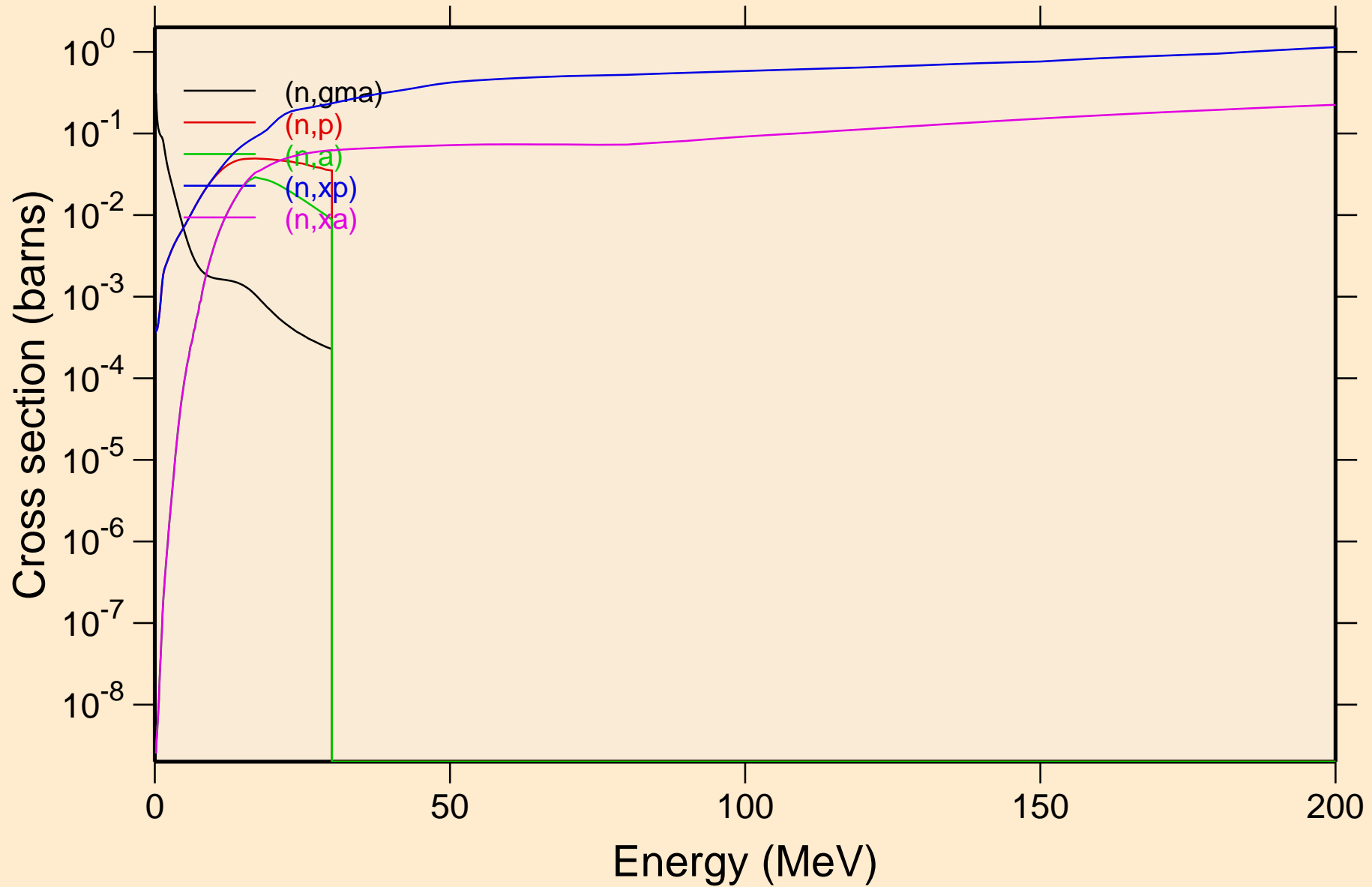

RB084M NEUTRON ACER TENDL-2021 LIBRARY; T=293.6K
Inelastic levels

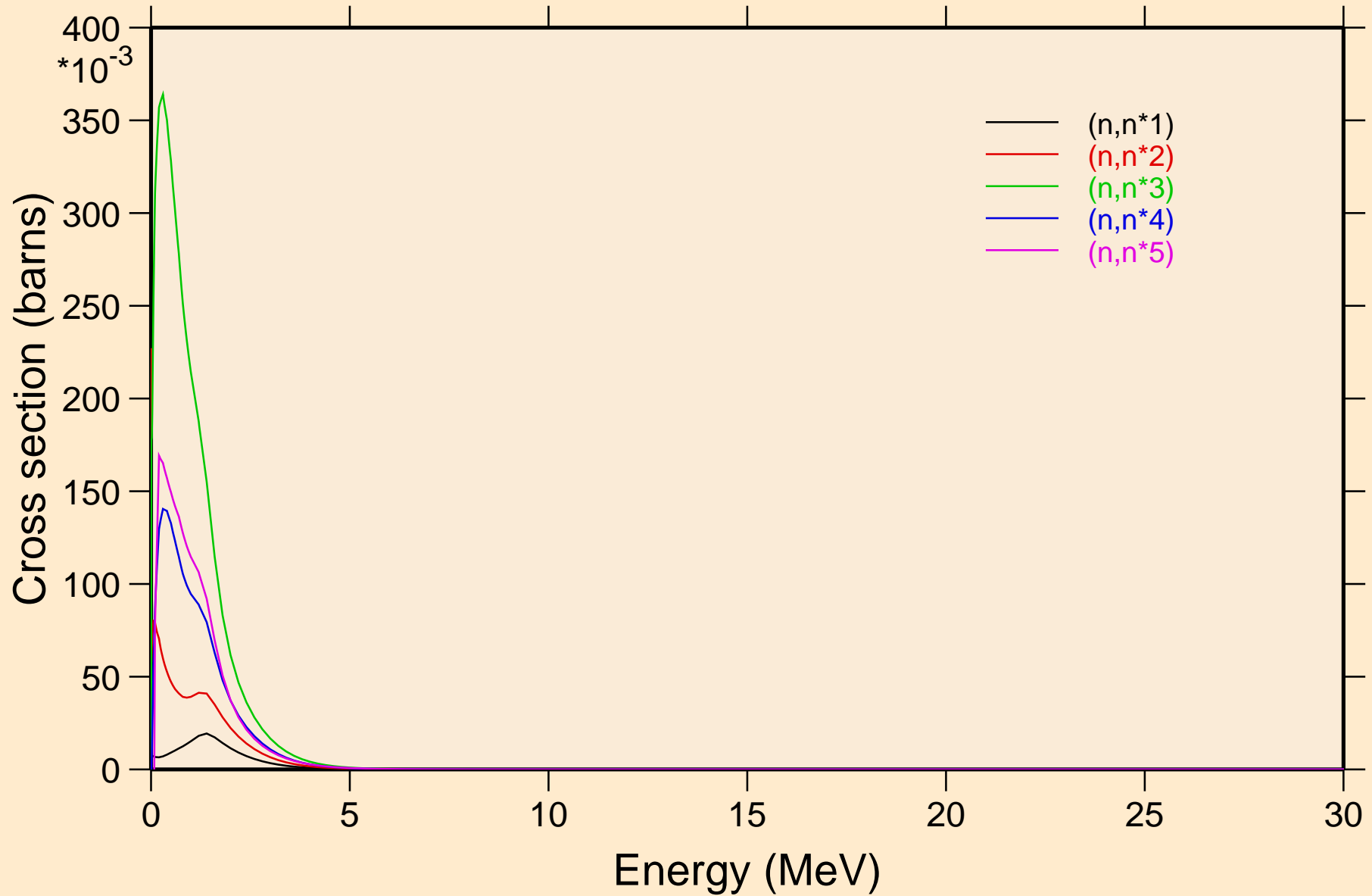

RB084M NEUTRON ACER TENDL-2021 LIBRARY; T=293.6K
Inelastic levels

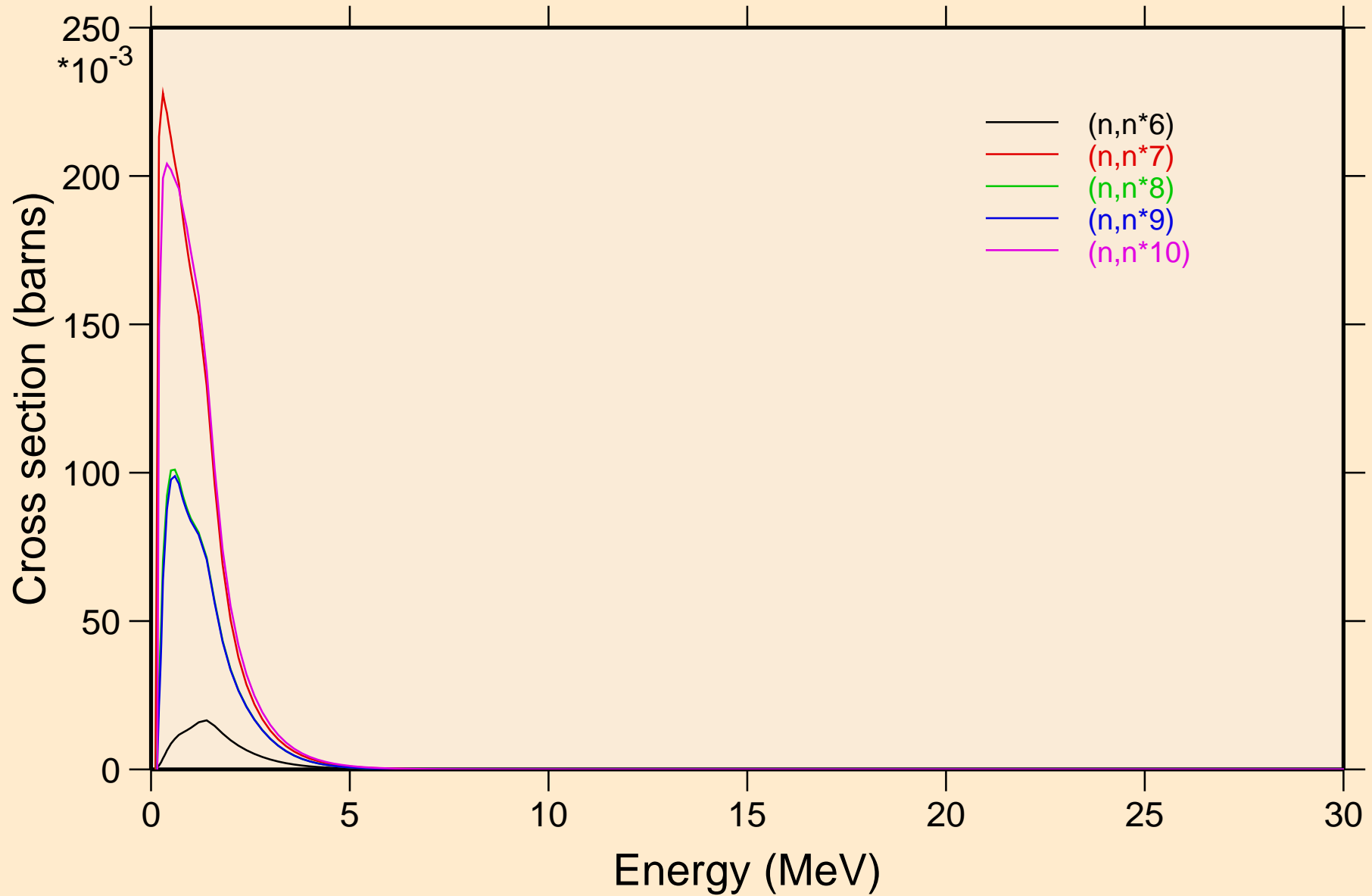

RB084M NEUTRON ACER TENDL-2021 LIBRARY; T=293.6K
Inelastic levels

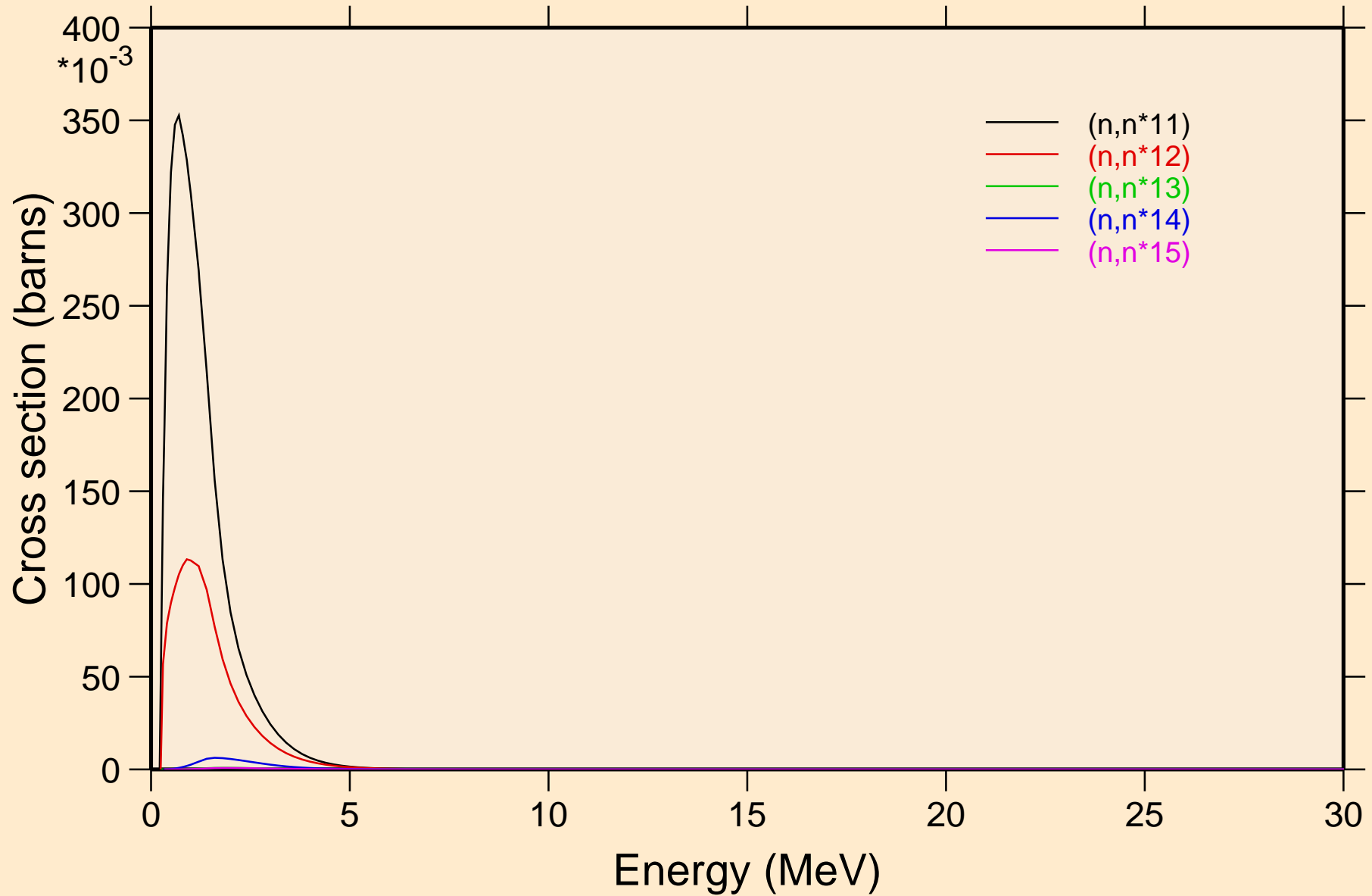

RB084M NEUTRON ACER TENDL-2021 LIBRARY; T=293.6K
Inelastic levels

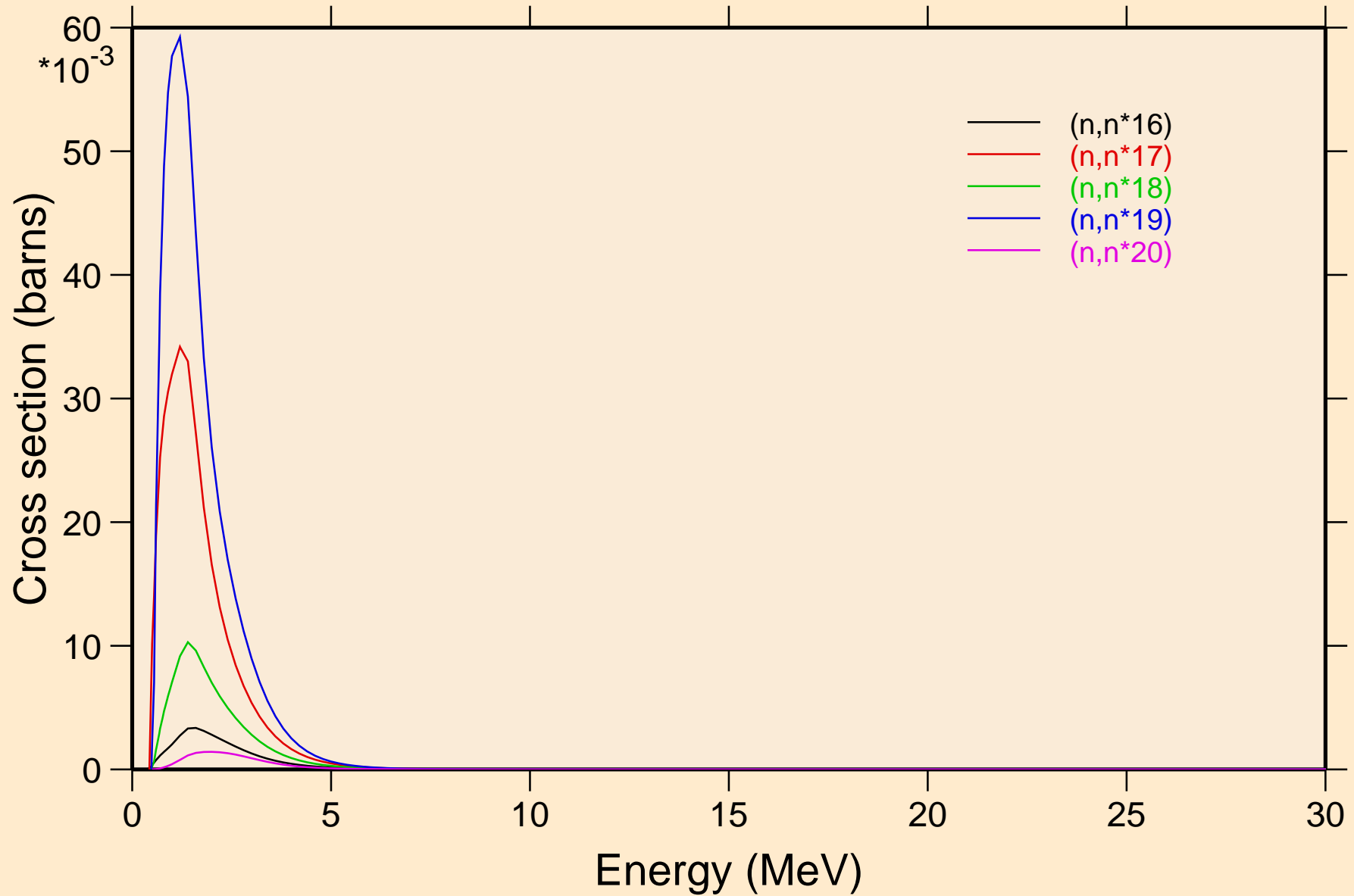

RB084M NEUTRON ACER TENDL-2021 LIBRARY; T=293.6K
Inelastic levels

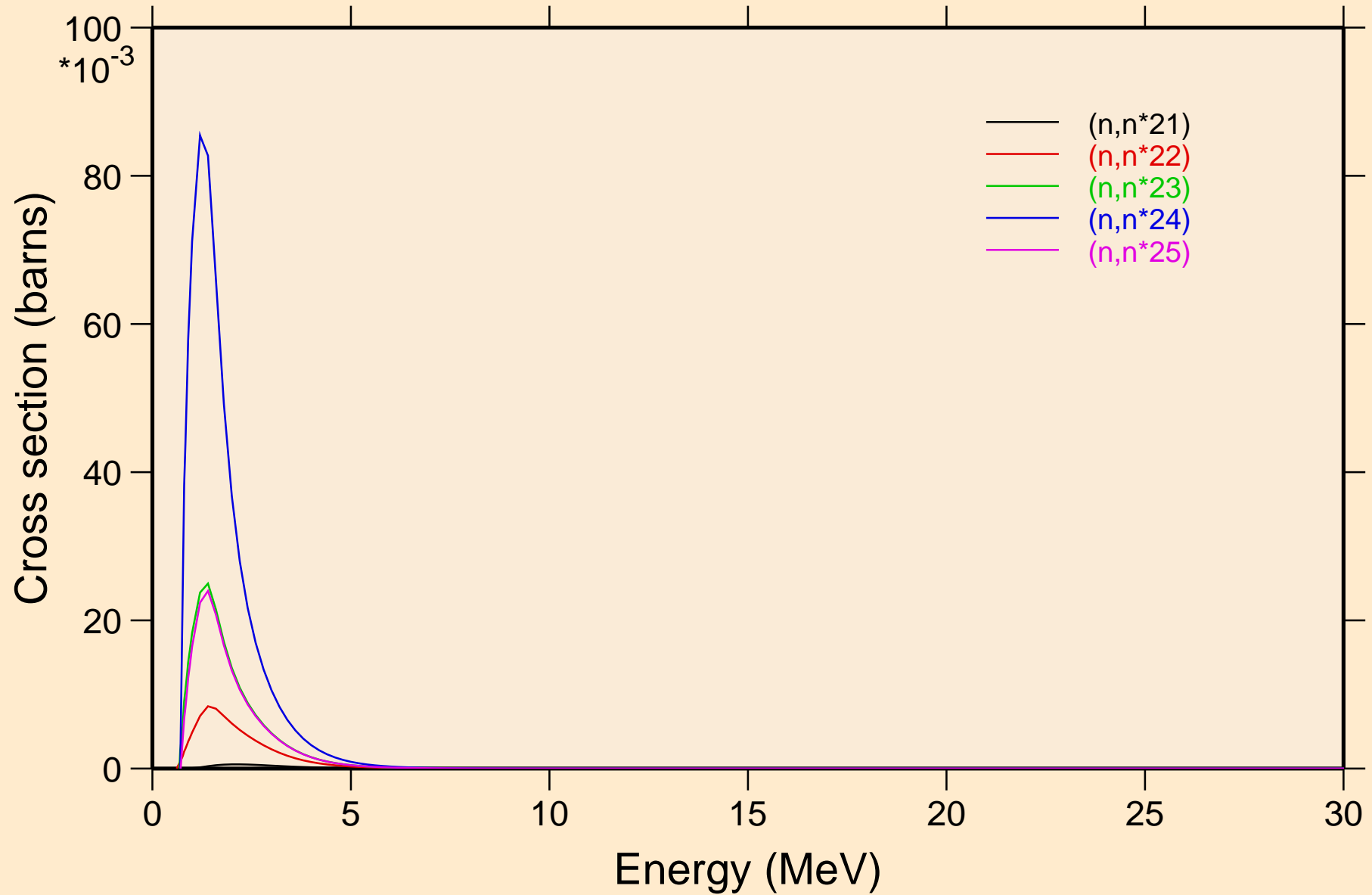

RB084M NEUTRON ACER TENDL-2021 LIBRARY; T=293.6K
Inelastic levels

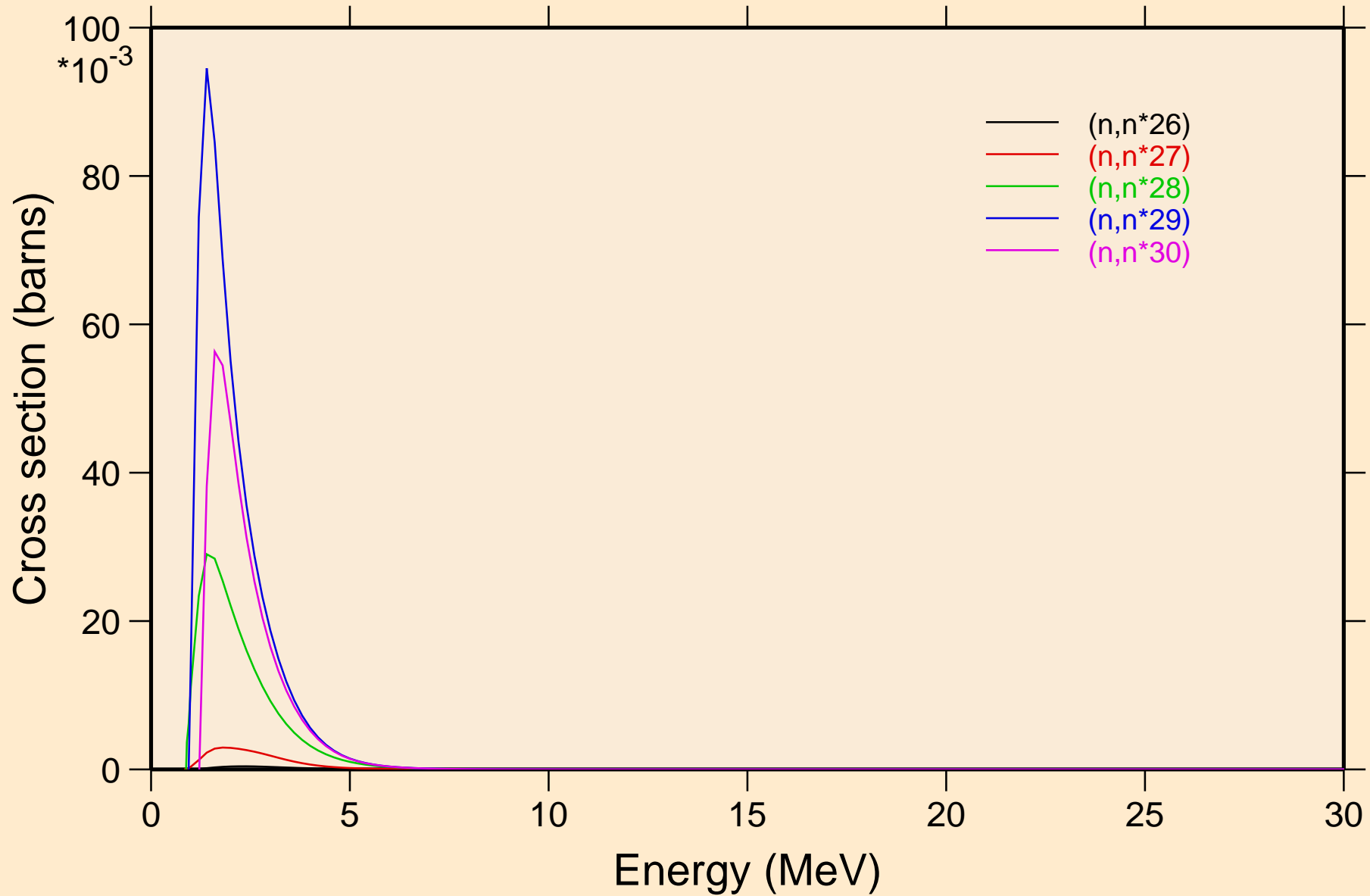

RB084M NEUTRON ACER TENDL-2021 LIBRARY; T=293.6K
Threshold reactions

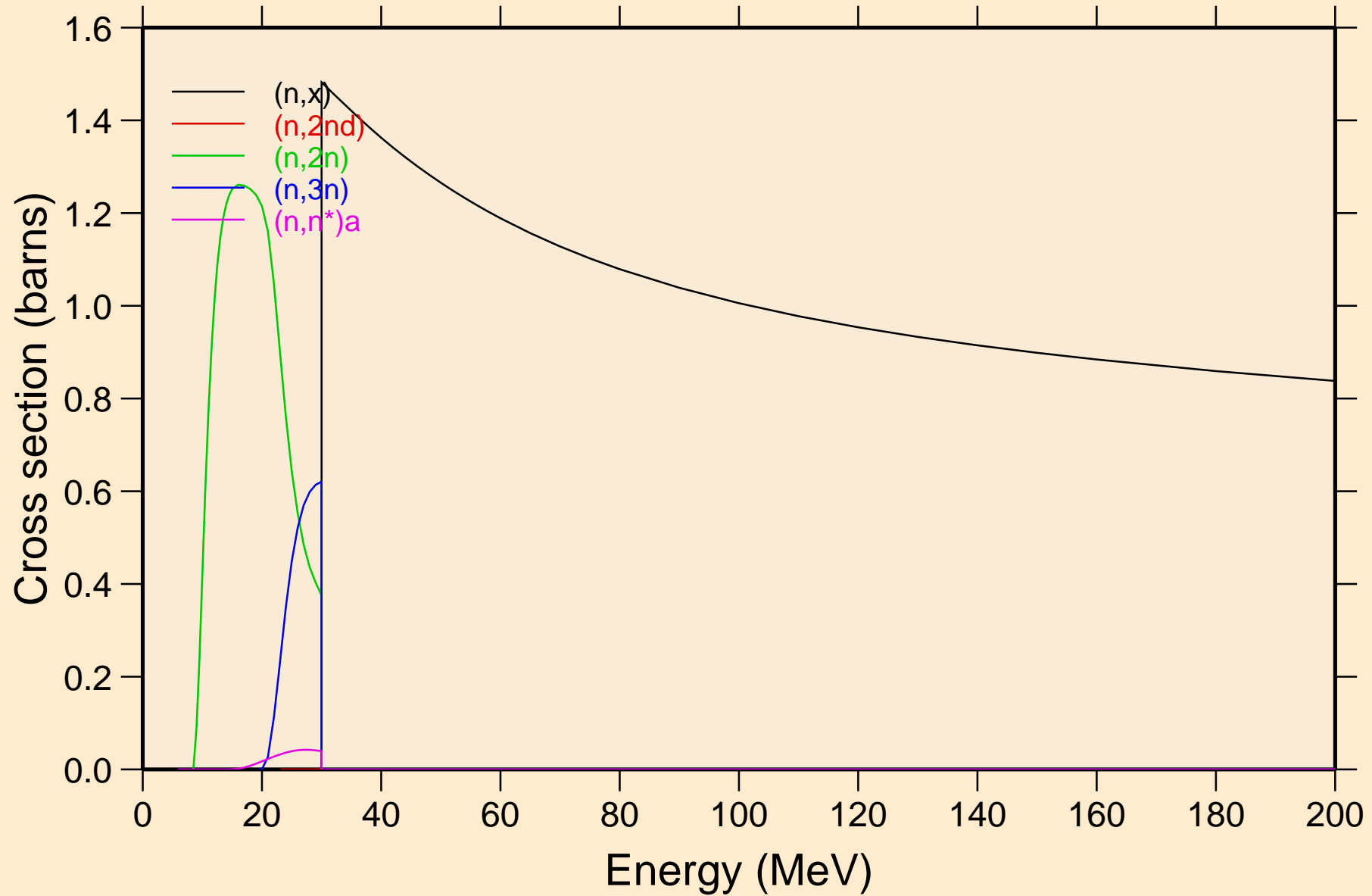

RB084M NEUTRON ACER TENDL-2021 LIBRARY; T=293.6K
Threshold reactions

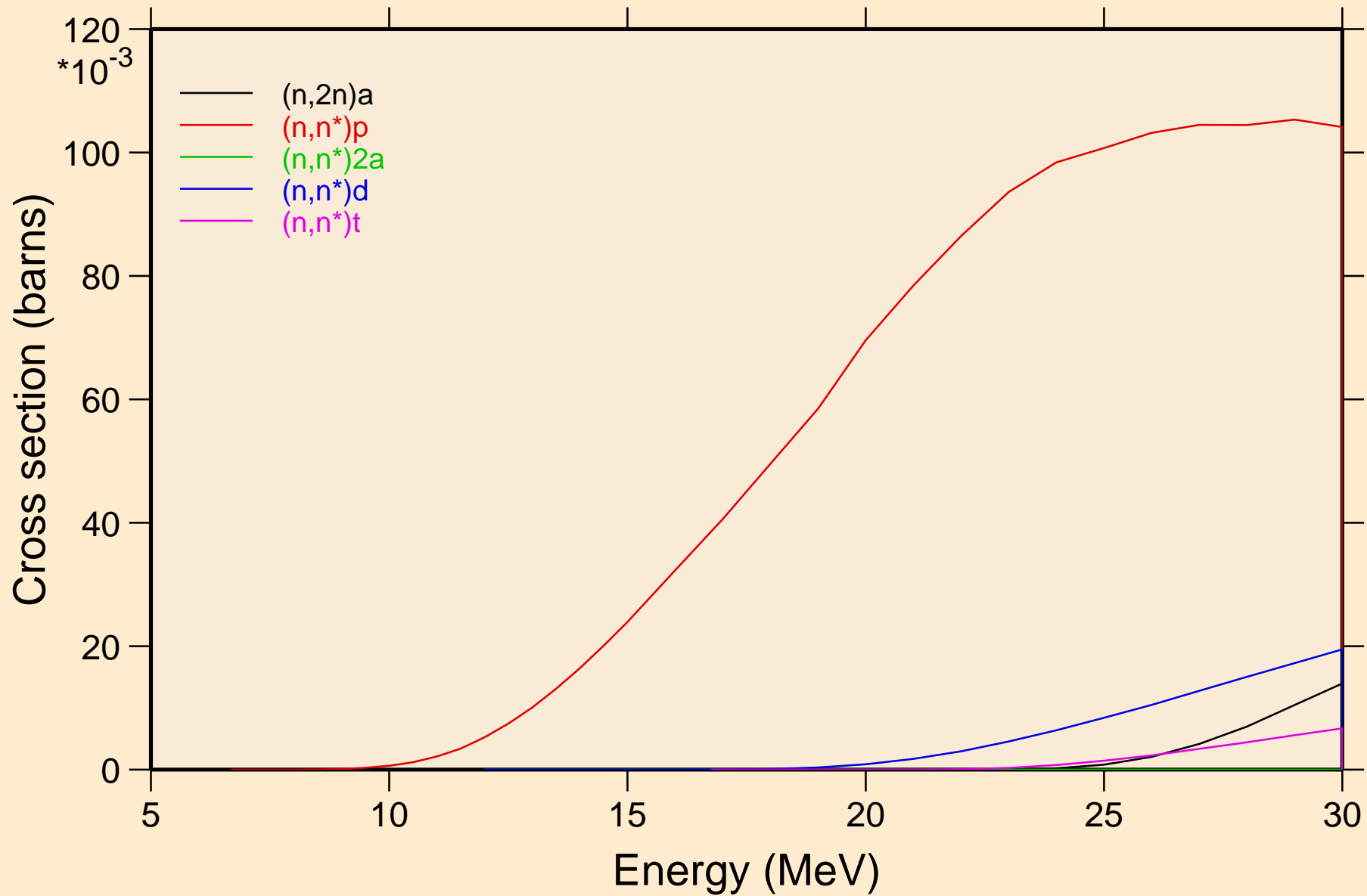

RB084M NEUTRON ACER TENDL-2021 LIBRARY; T=293.6K
Threshold reactions

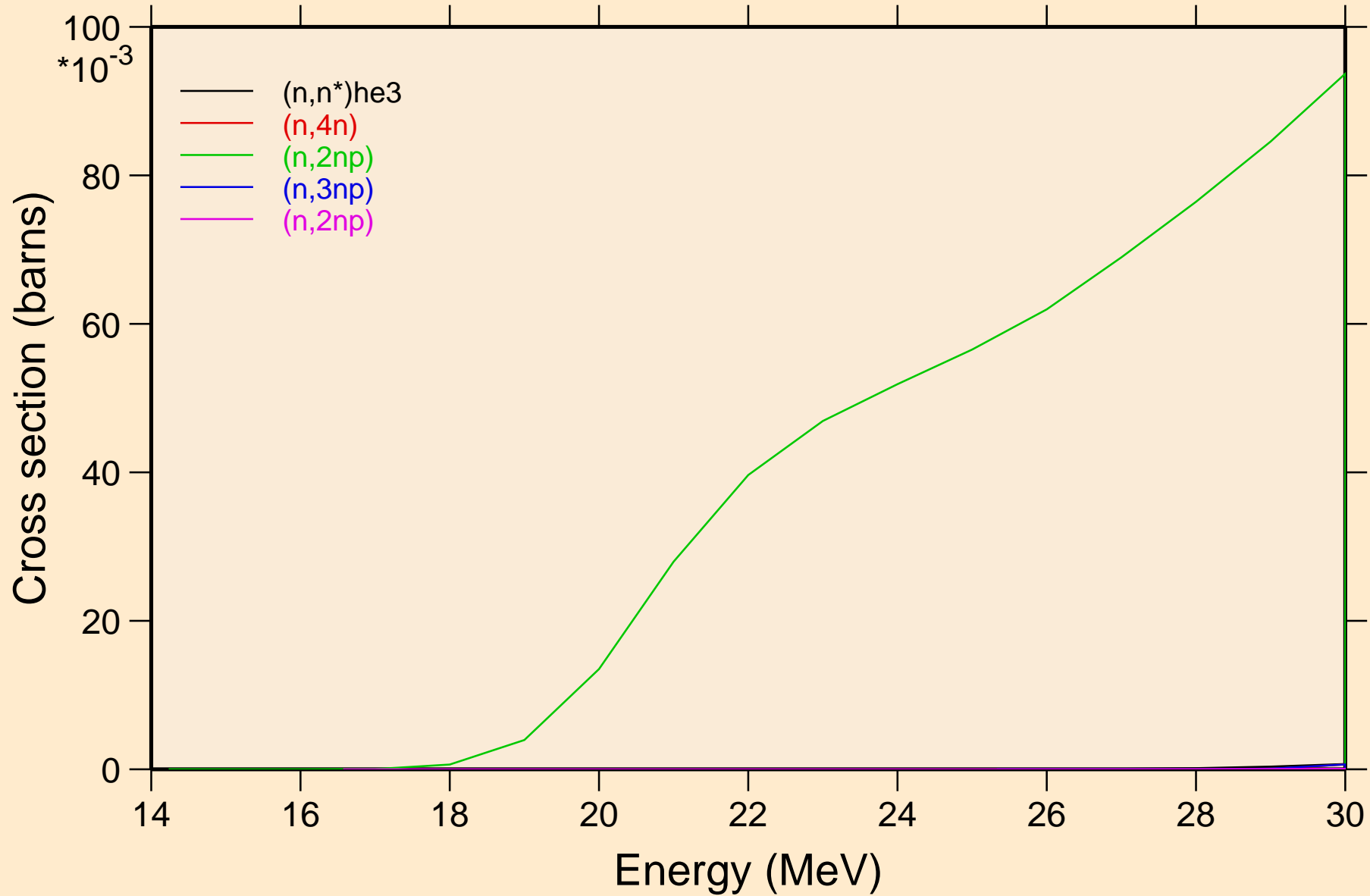

RB084M NEUTRON ACER TENDL-2021 LIBRARY; T=293.6K
Threshold reactions

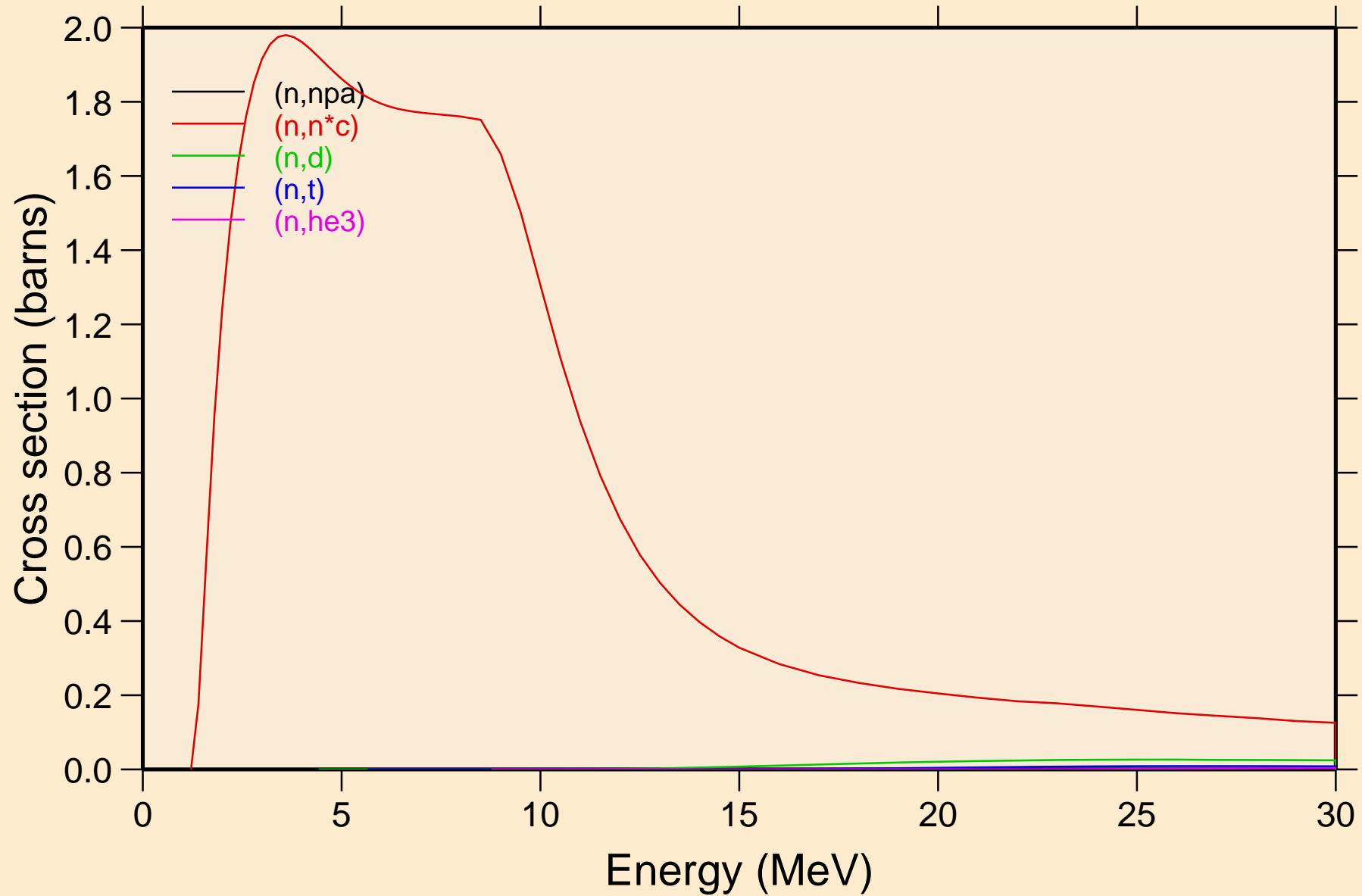

RB084M NEUTRON ACER TENDL-2021 LIBRARY; T=293.6K
Threshold reactions

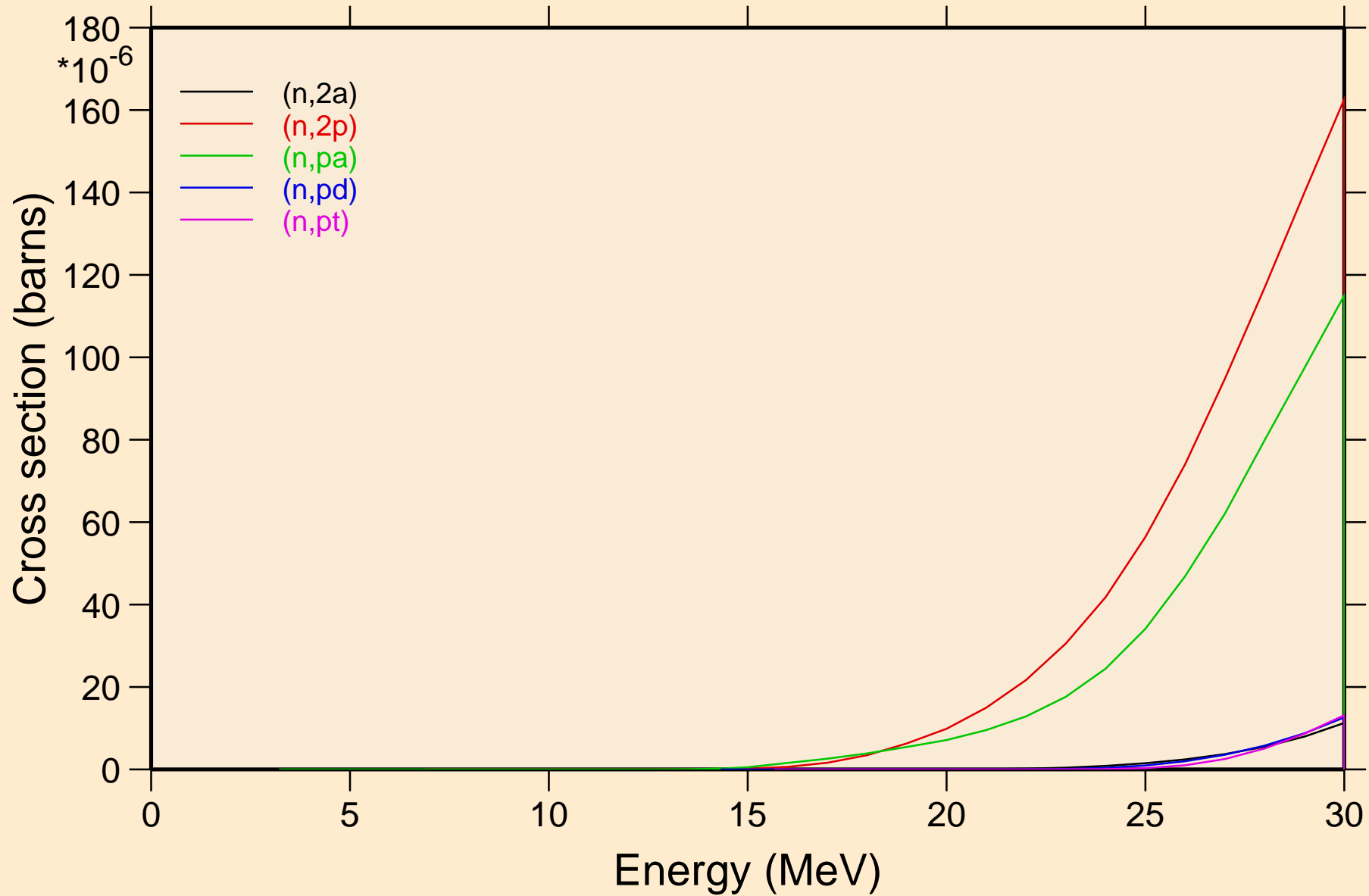

RB084M NEUTRON ACER TENDL-2021 LIBRARY; T=293.6K
Threshold reactions

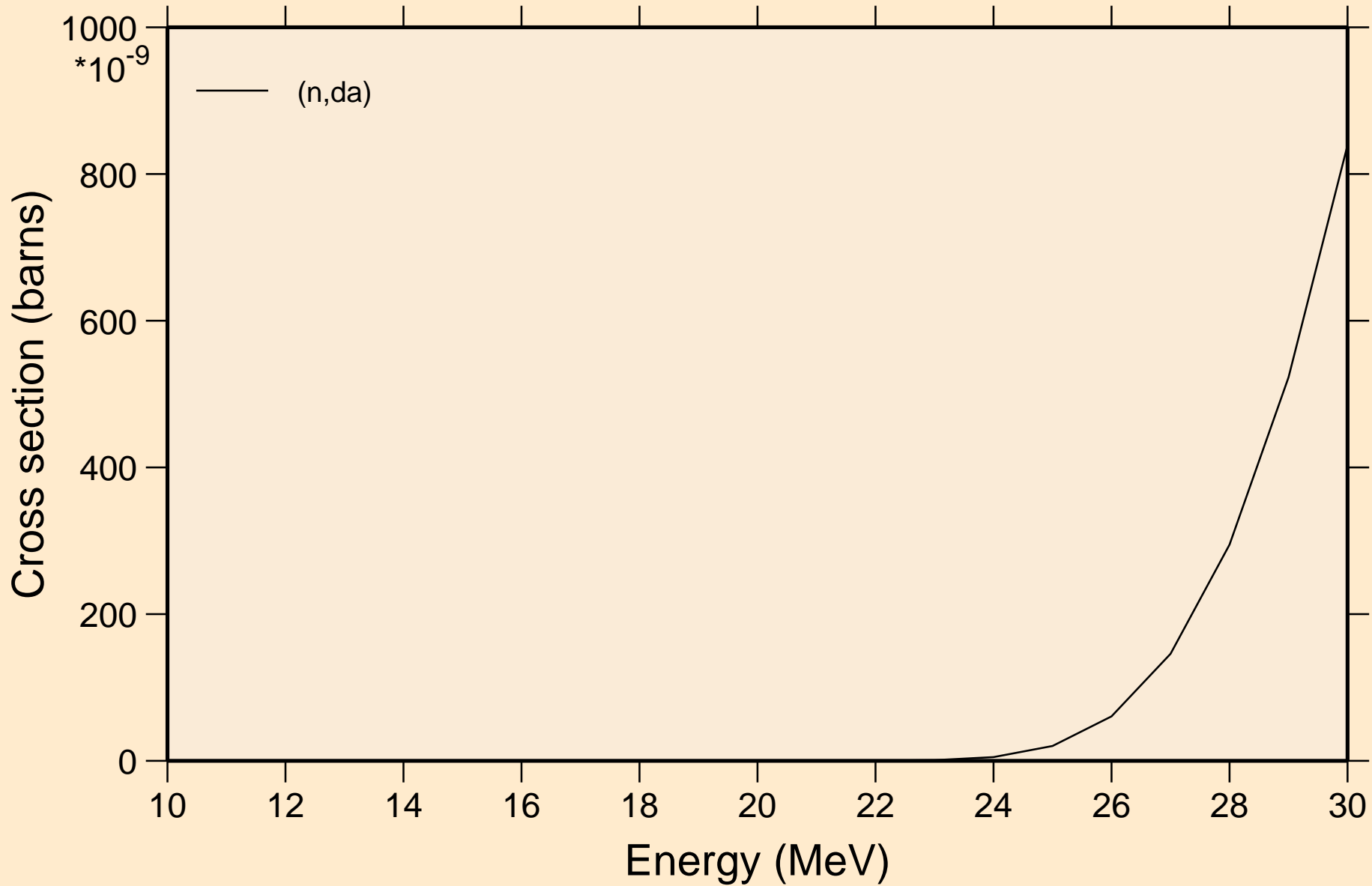

RB084M NEUTRON ACER TENDL-2021 LIBRARY; T=293.6K
Threshold reactions

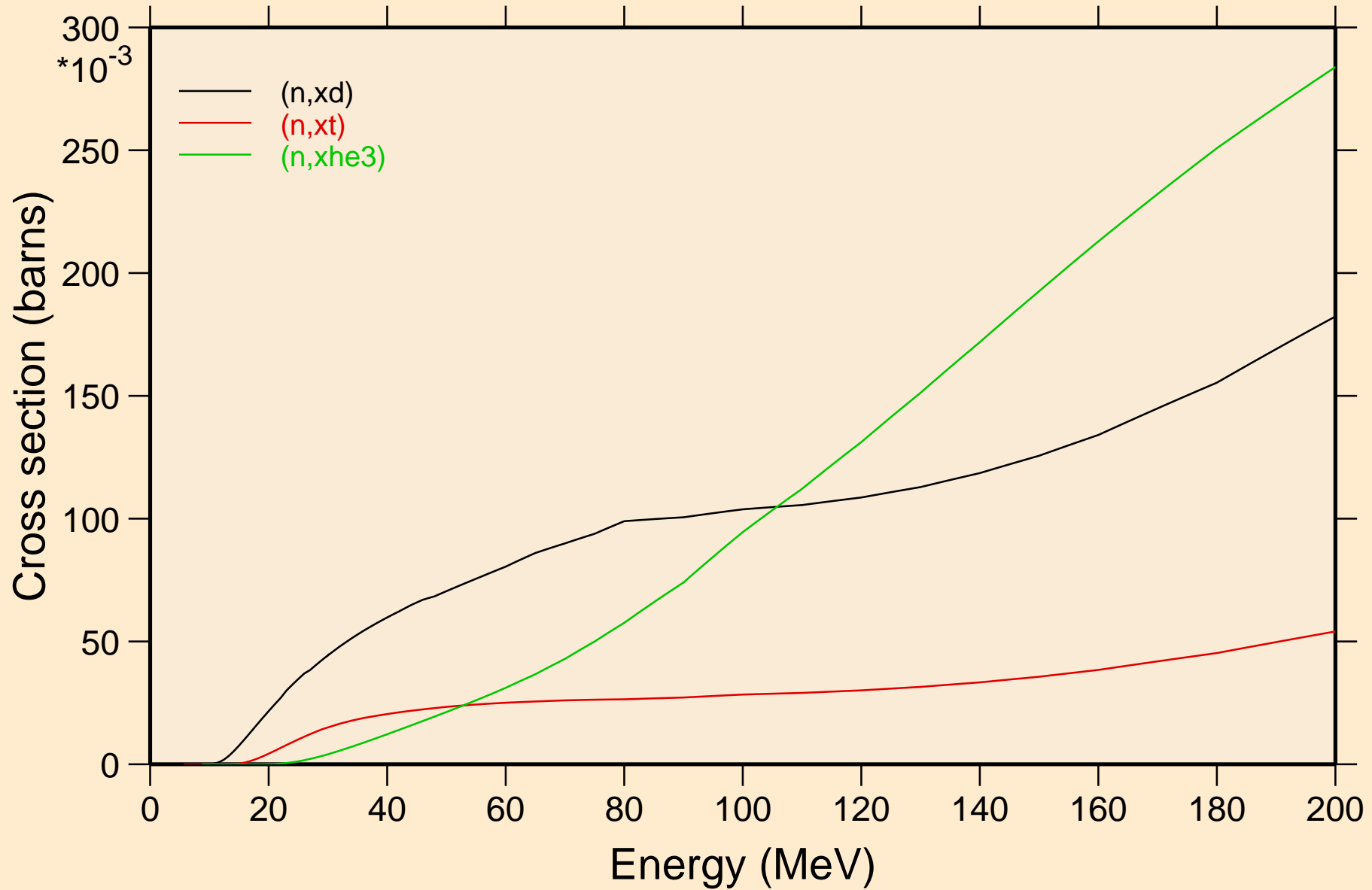

RB084M NEUTRON ACER TENDL-2021 LIBRARY; T=293.6K
angular distribution for elastic

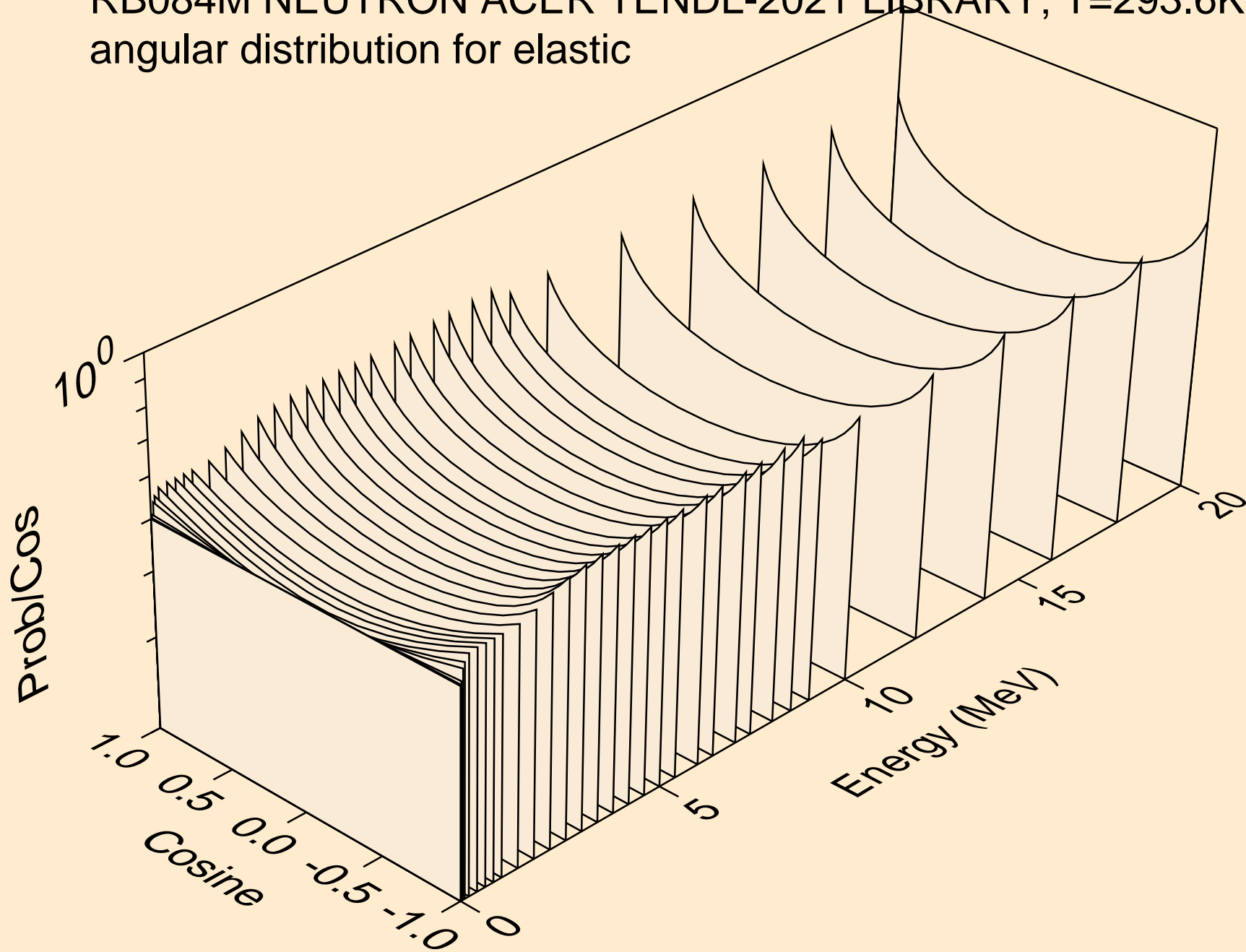

RB084M NEUTRON ACER TENDL-2021 LIBRARY; T=293.6K
angular distribution for elastic

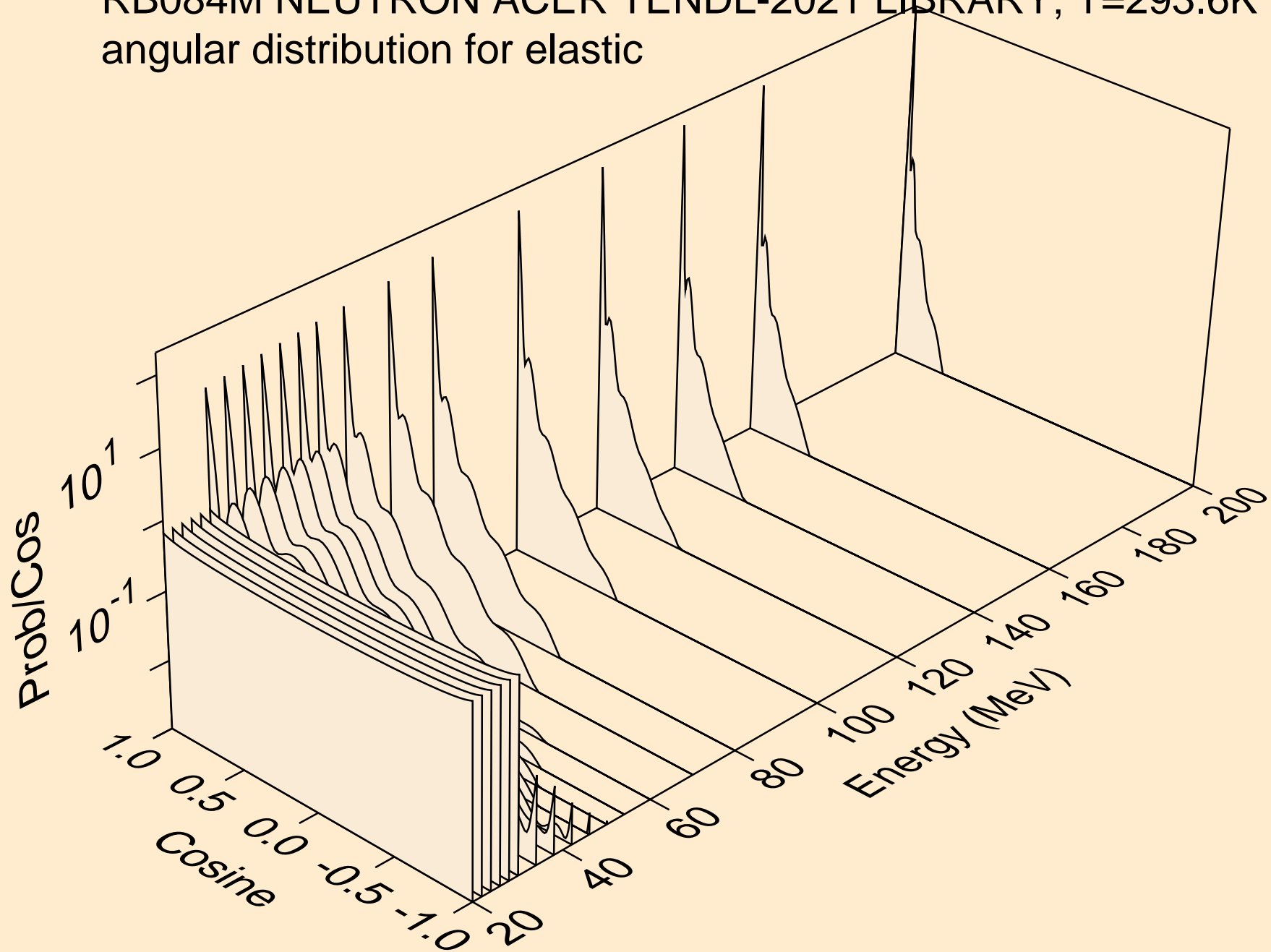

RB084M NEUTRON ACER TENDL-2021 LIBRARY; T=293.6K
angular distribution for (n,n*1)

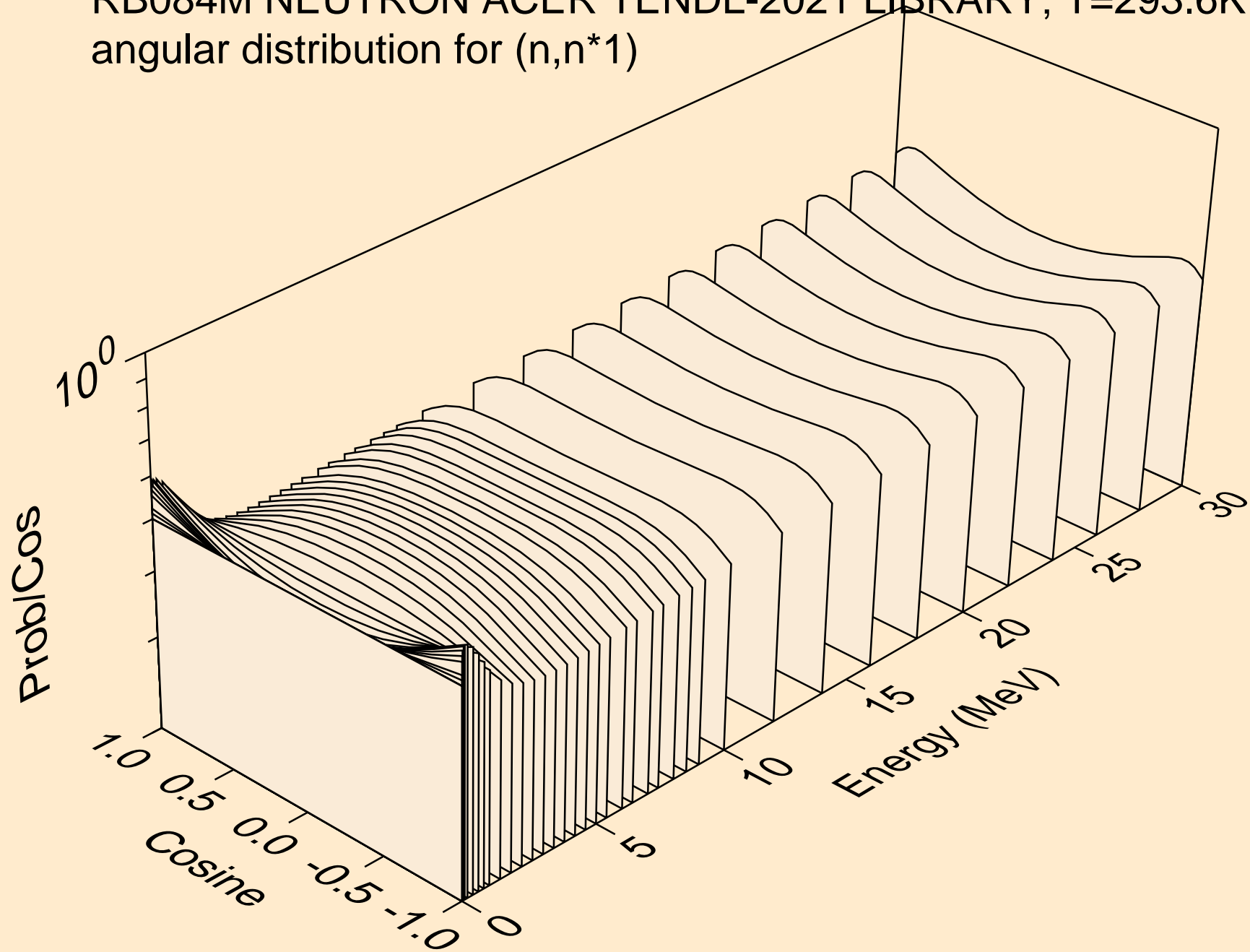

RB084M NEUTRON ACER TENDL-2021 LIBRARY; T=293.6K
angular distribution for (n,n*2)

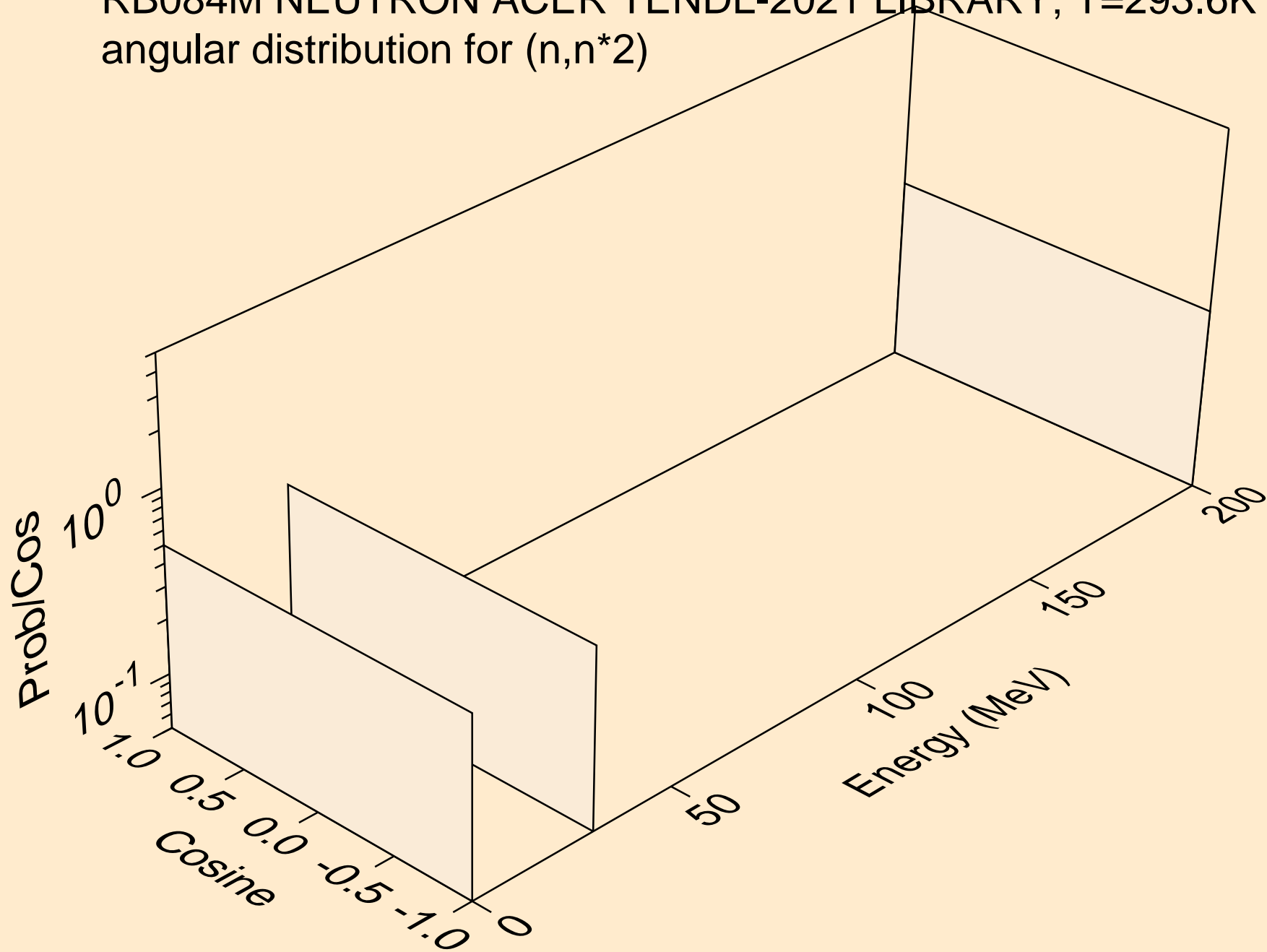

RB084M NEUTRON ACER TENDL-2021 LIBRARY; T=293.6K
angular distribution for (n,n*3)

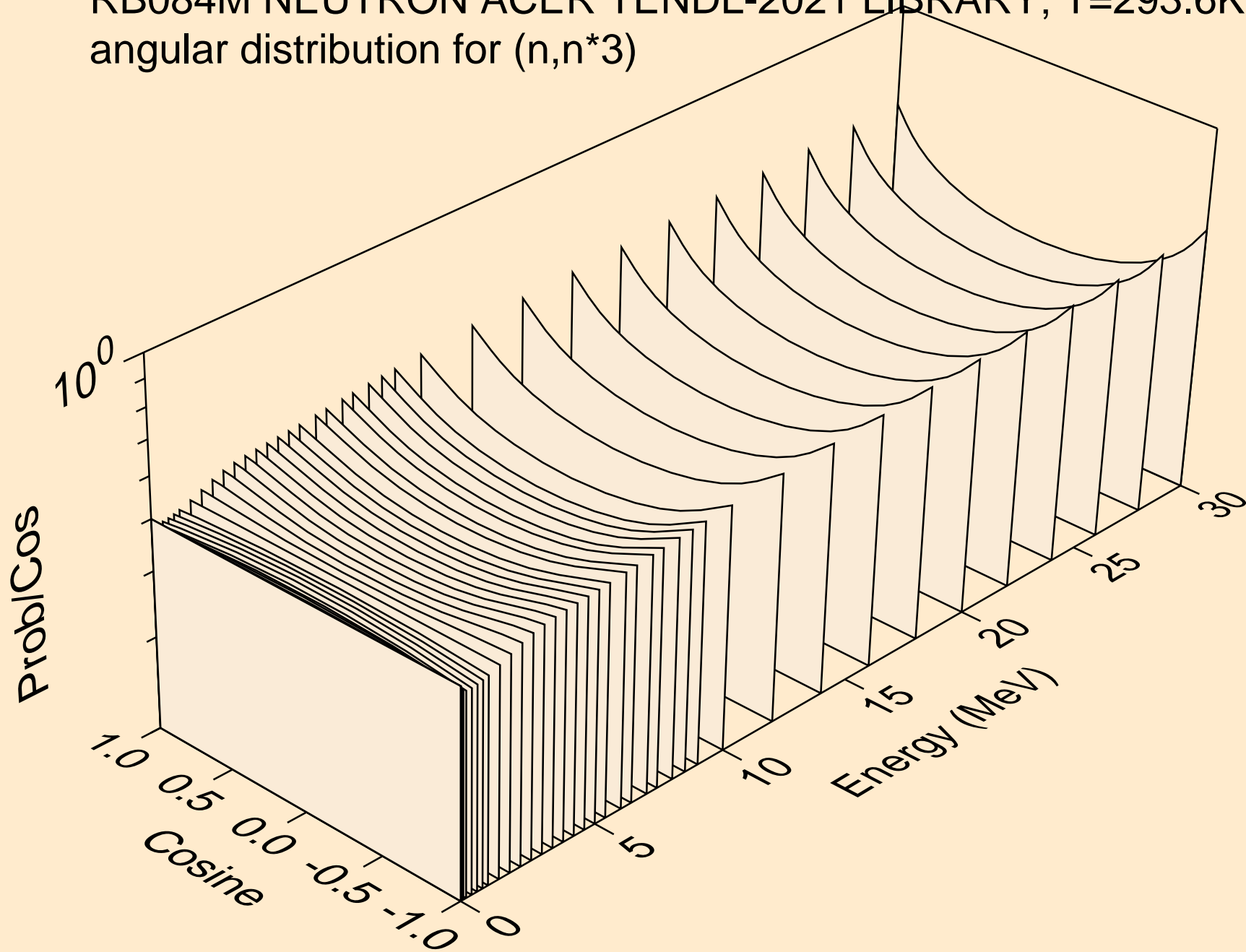

RB084M NEUTRON ACER TENDL-2021 LIBRARY; T=293.6K
angular distribution for (n,n*4)

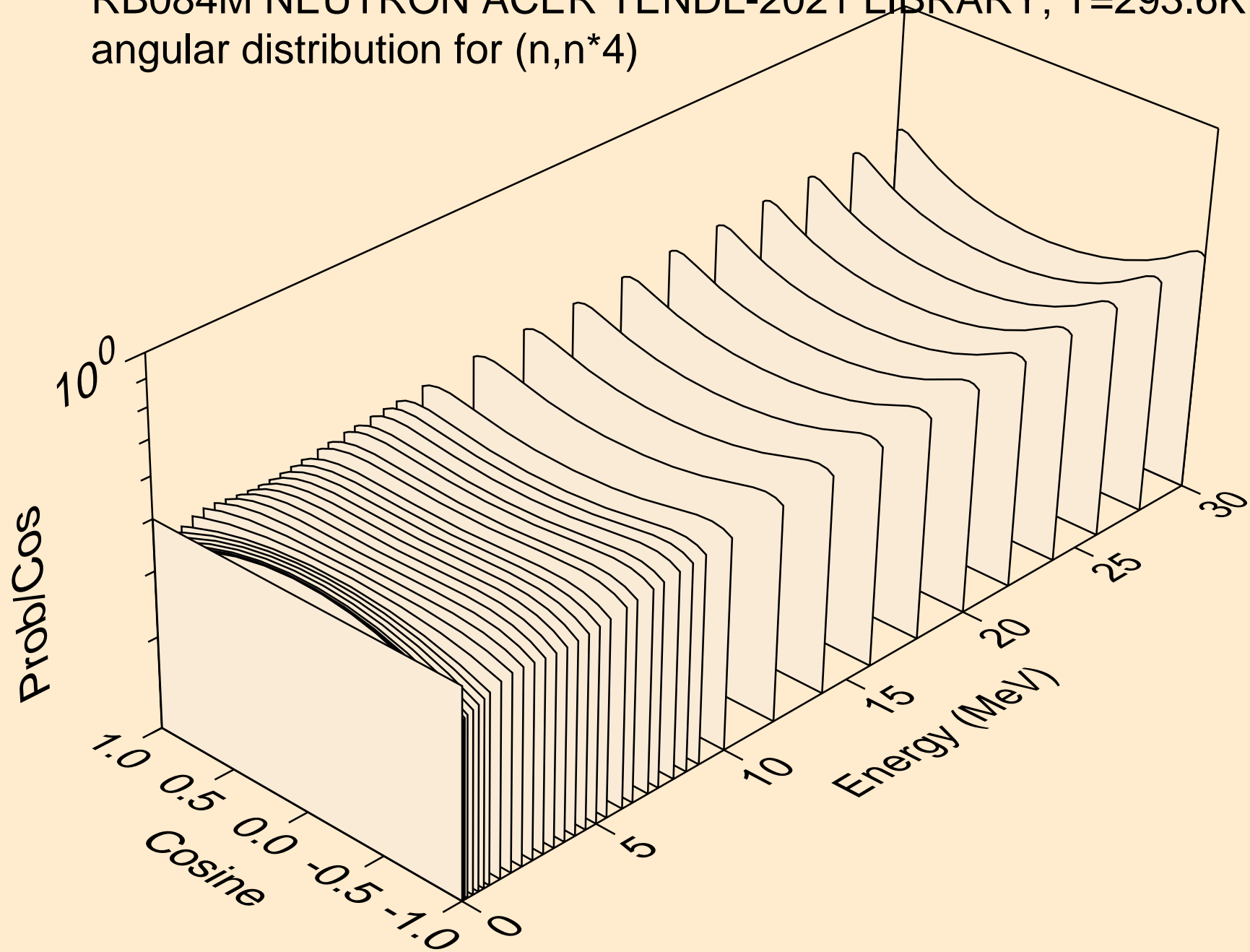

RB084M NEUTRON ACER TENDL-2021 LIBRARY; T=293.6K
angular distribution for (n,n*5)

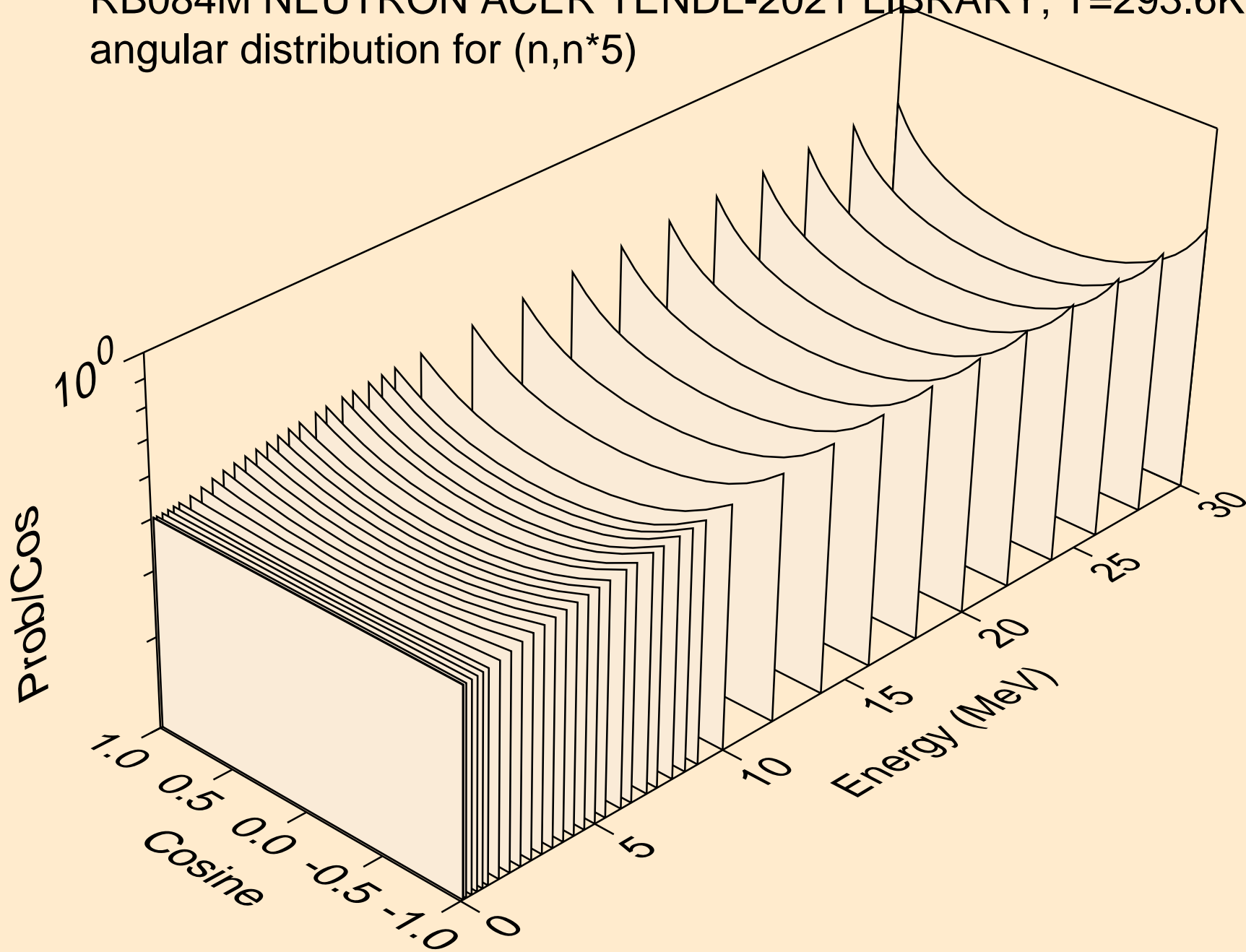

RB084M NEUTRON ACER TENDL-2021 LIBRARY; T=293.6K
angular distribution for (n,n*6)

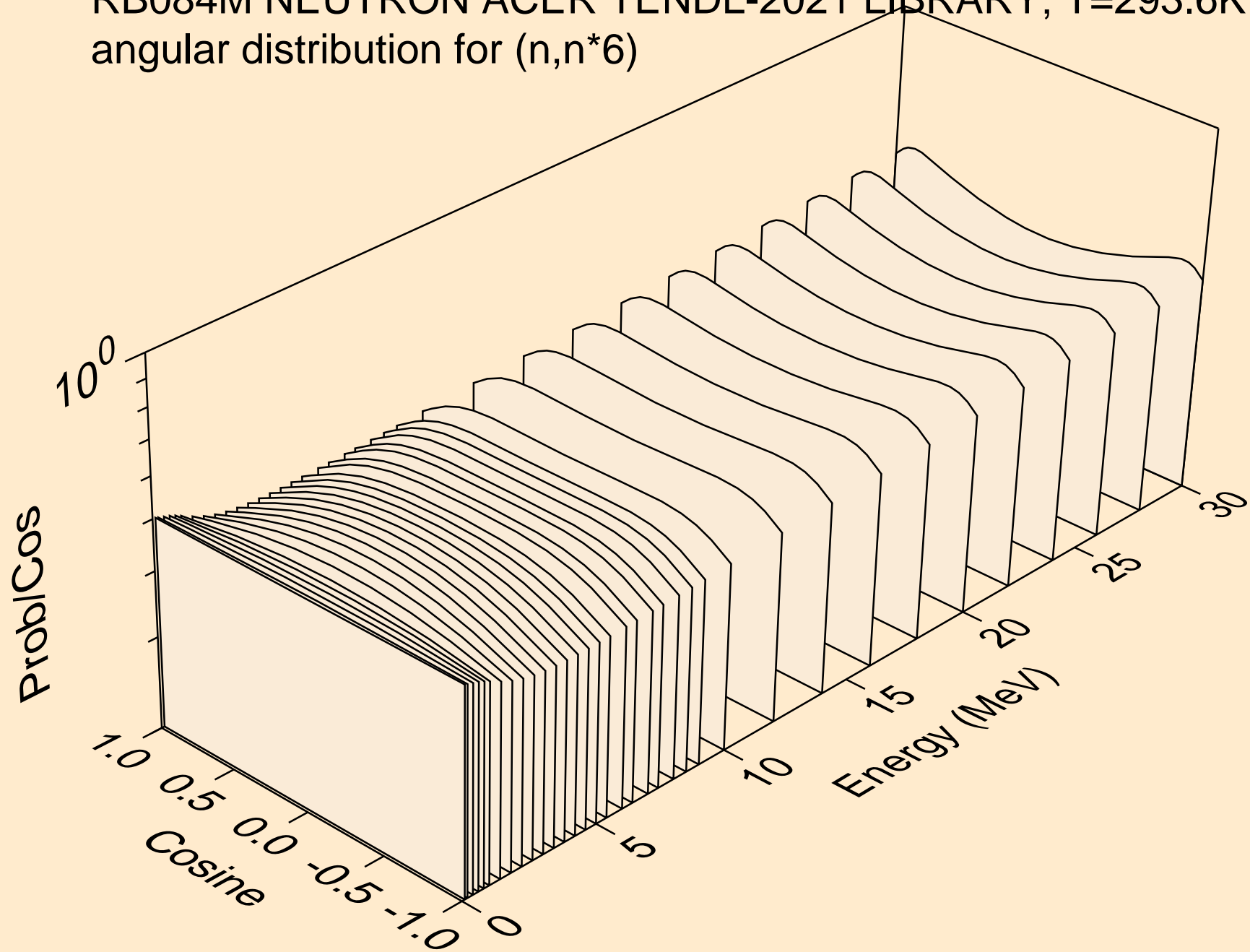

RB084M NEUTRON ACER TENDL-2021 LIBRARY; T=293.6K
angular distribution for (n,n*7)

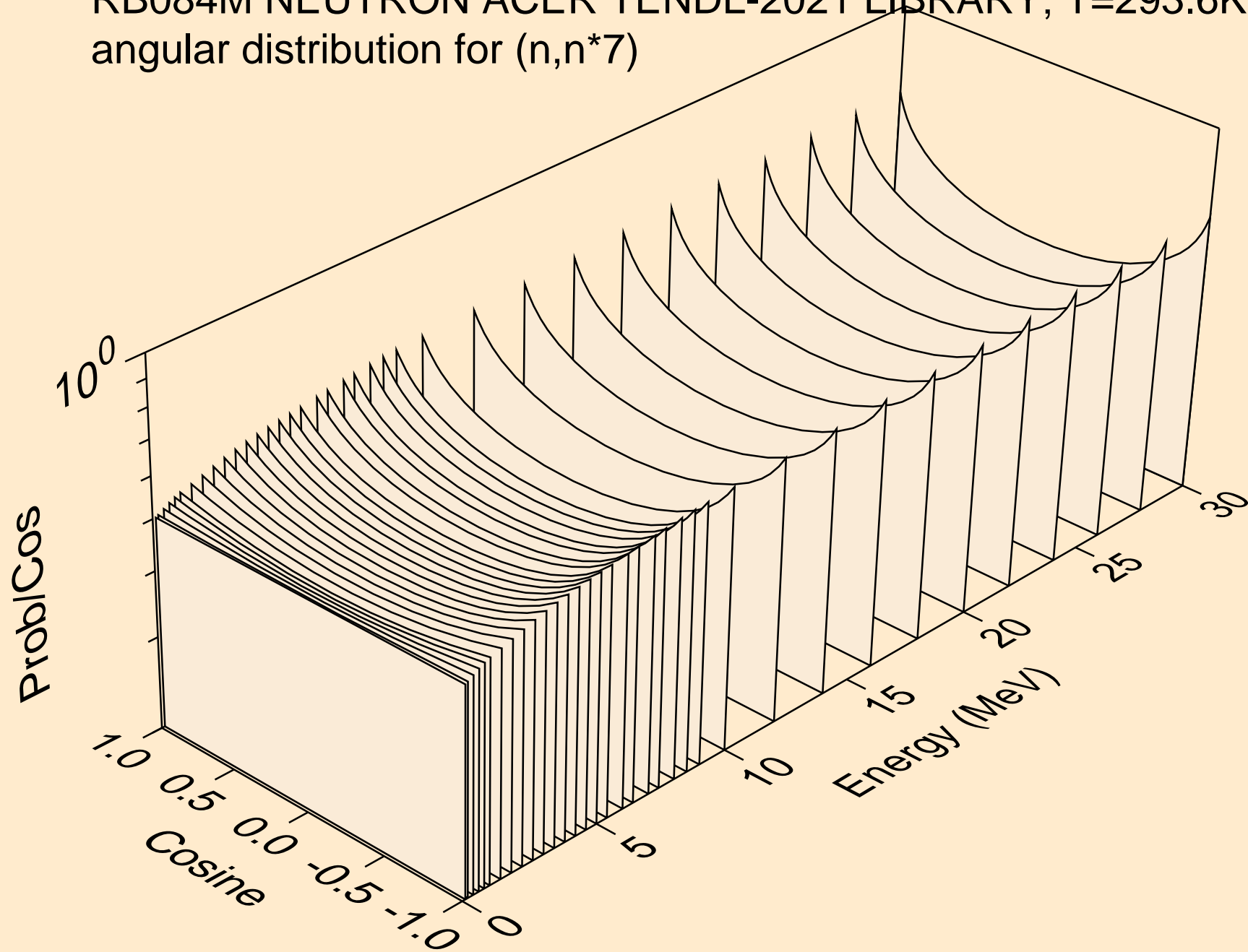

RB084M NEUTRON ACER TENDL-2021 LIBRARY; T=293.6K
angular distribution for (n,n*8)

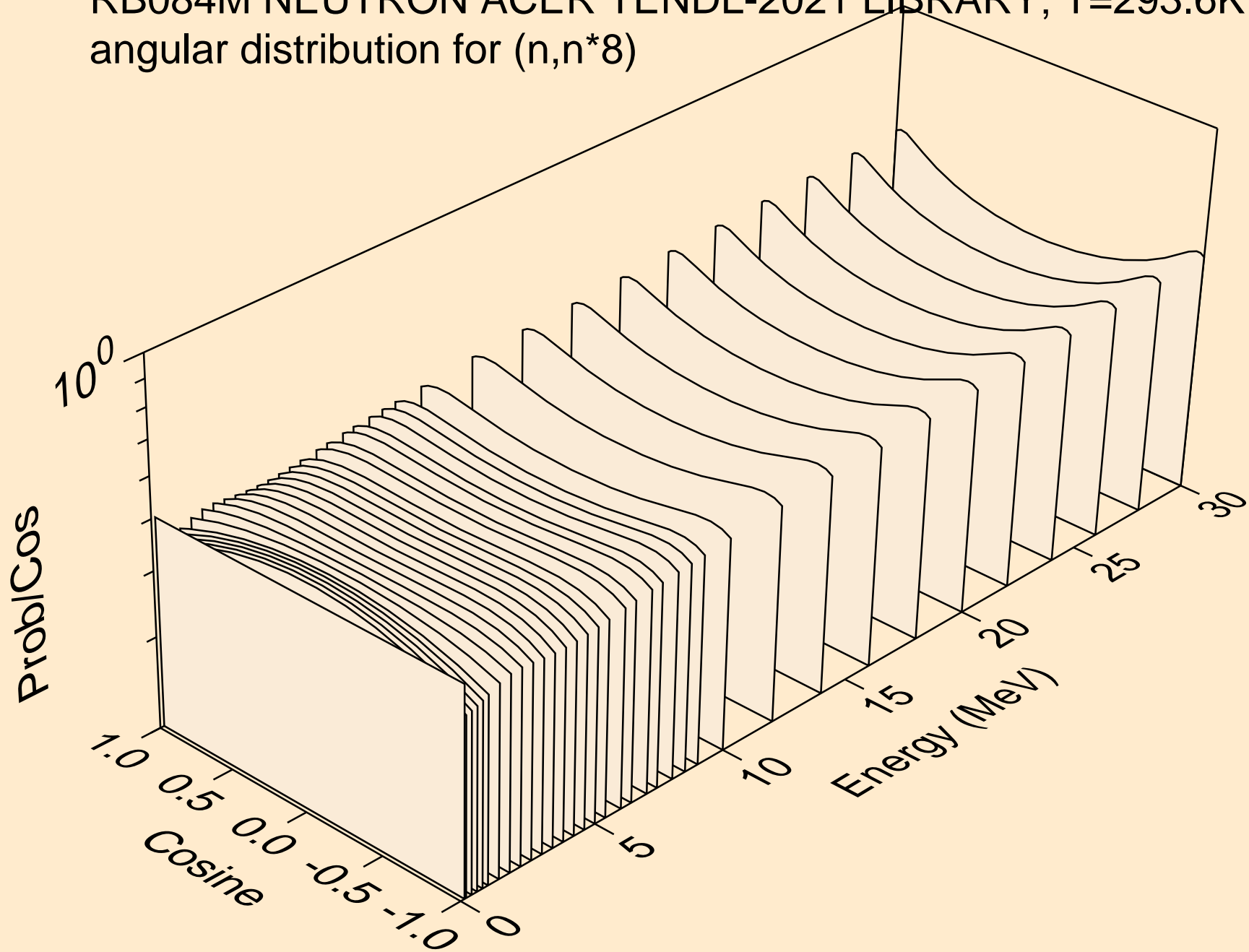

RB084M NEUTRON ACER TENDL-2021 LIBRARY; T=293.6K
angular distribution for (n,n*9)

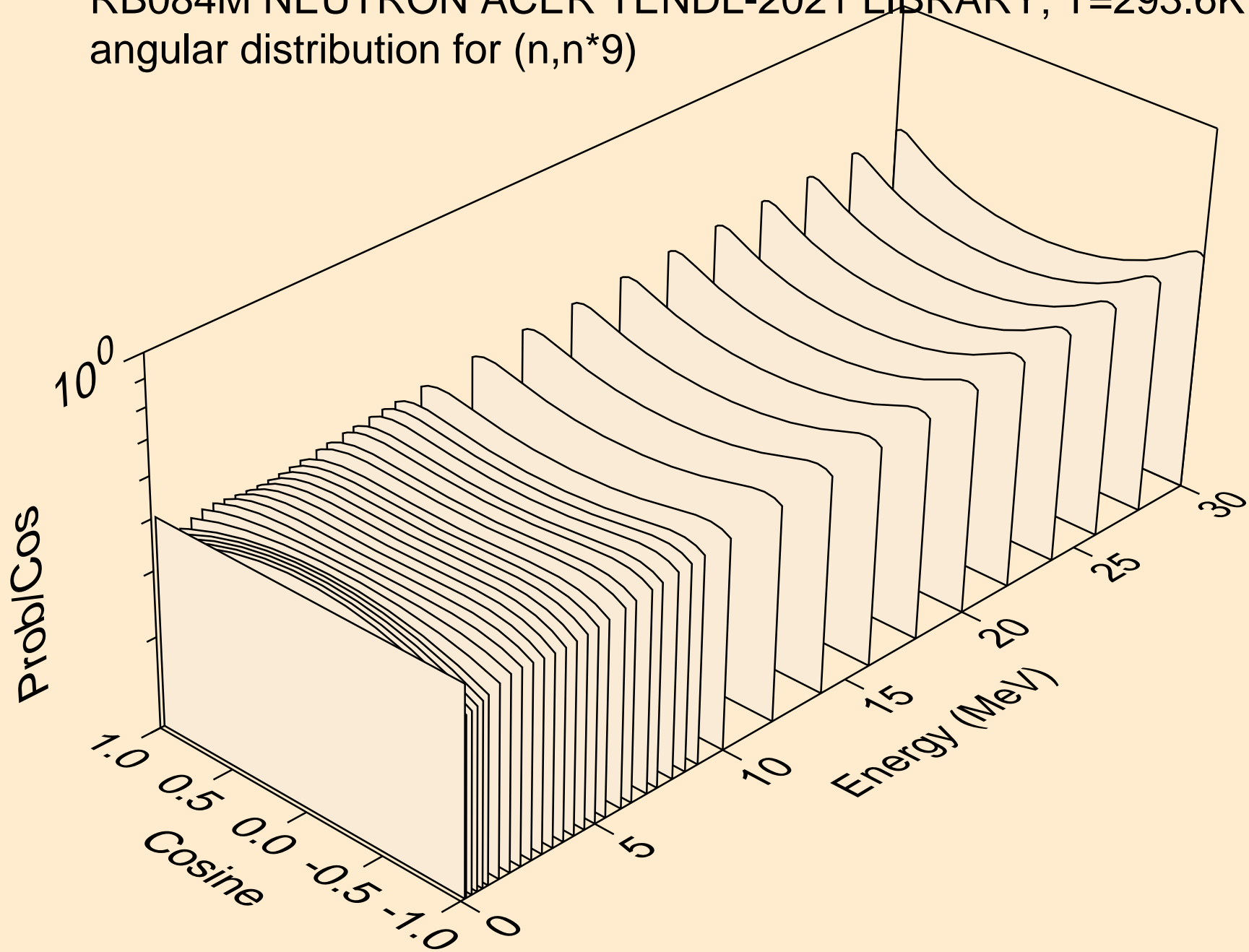

RB084M NEUTRON ACER TENDL-2021 LIBRARY; T=293.6K
angular distribution for (n,n*10)

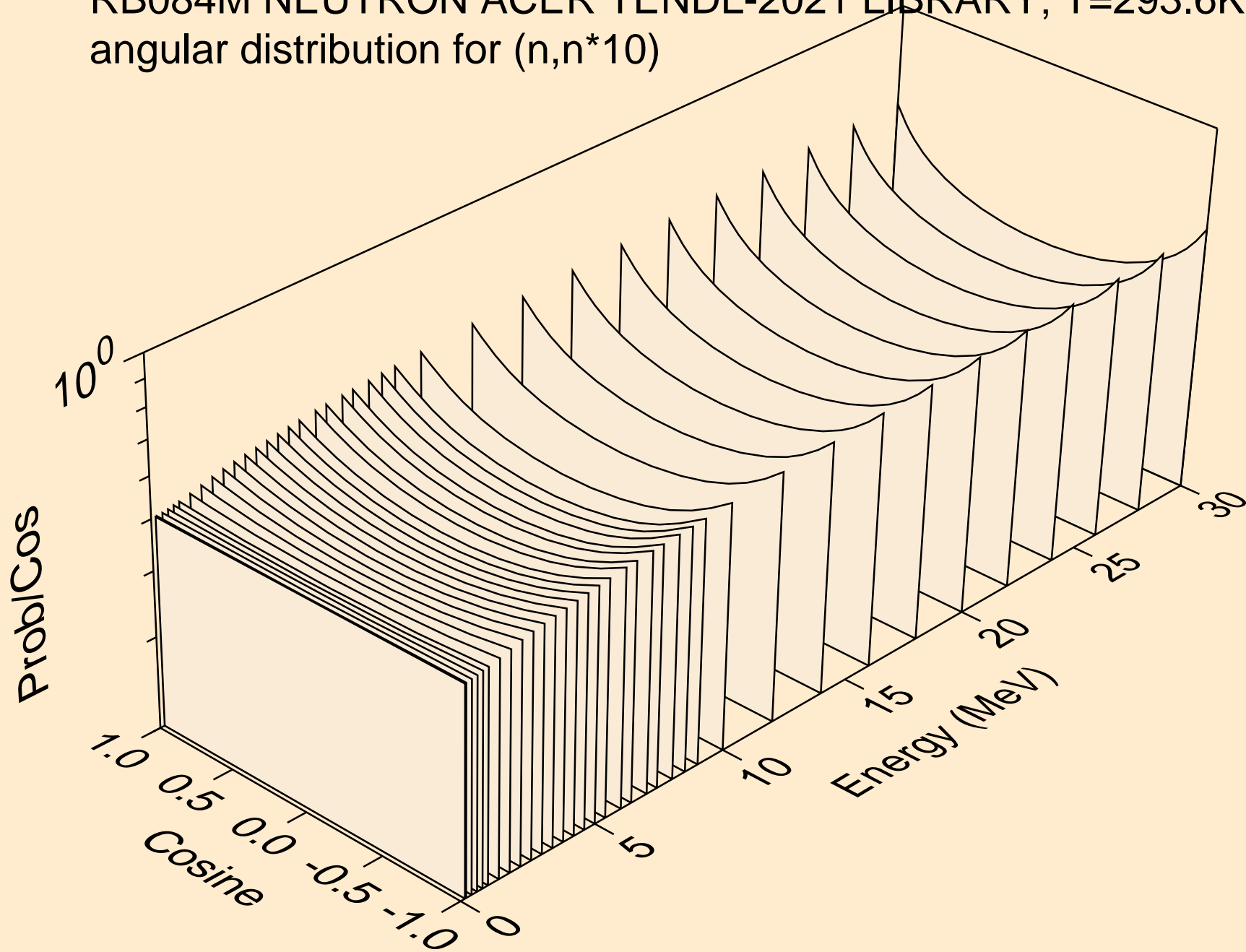

RB084M NEUTRON ACER TENDL-2021 LIBRARY; T=293.6K
angular distribution for (n,n*11)

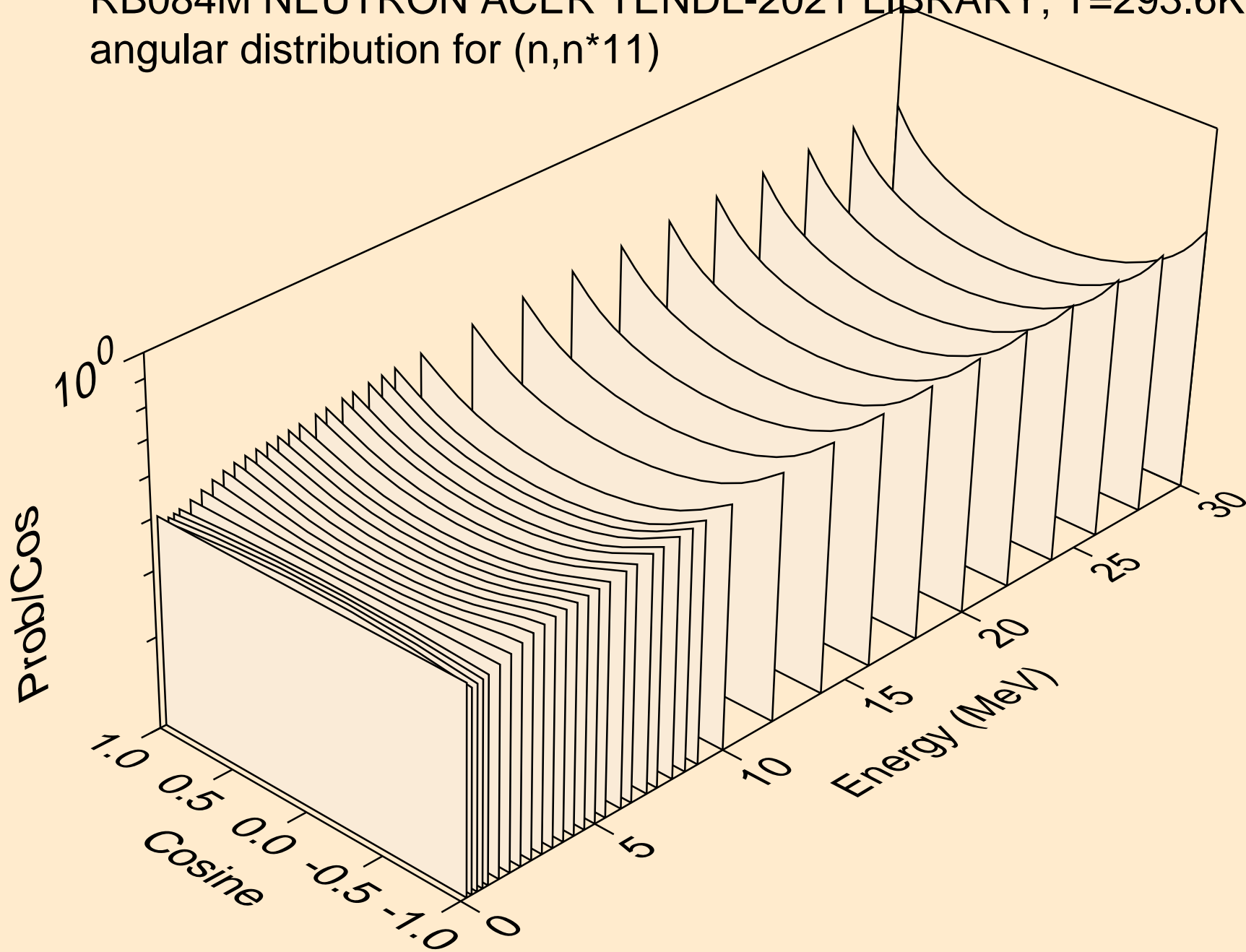

RB084M NEUTRON ACER TENDL-2021 LIBRARY; T=293.6K
angular distribution for (n,n*12)

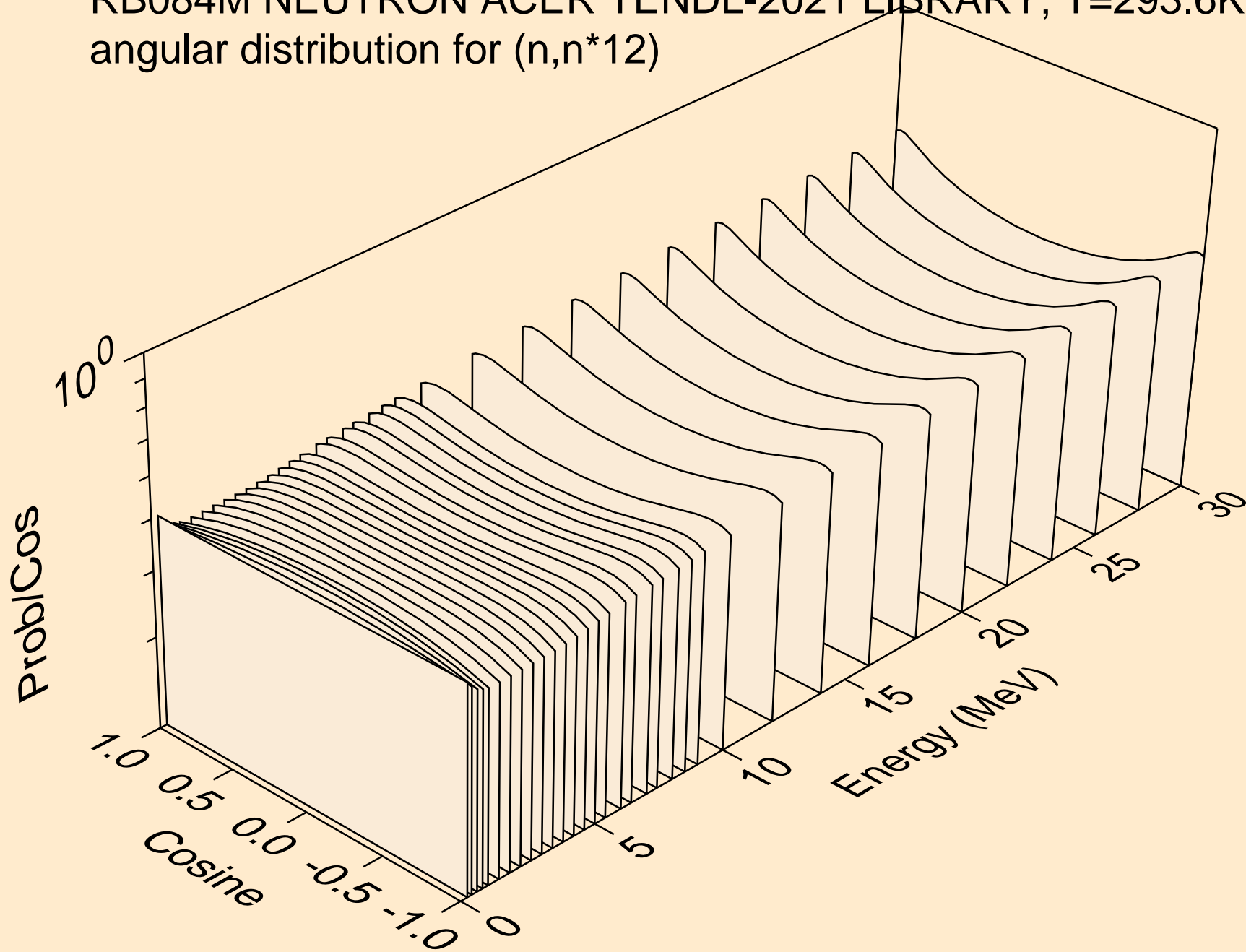

RB084M NEUTRON ACER TENDL-2021 LIBRARY; T=293.6K
angular distribution for (n,n*13)

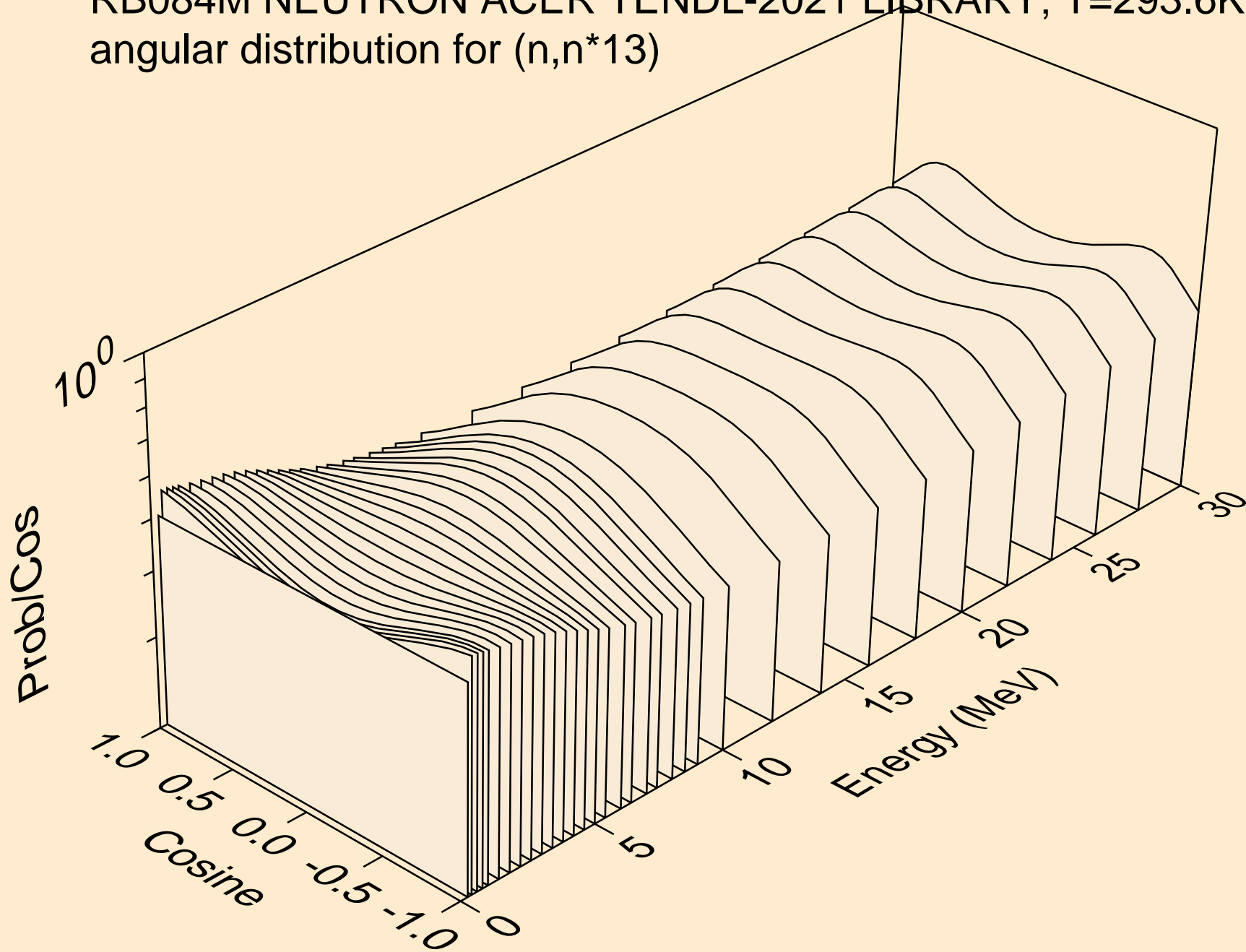

RB084M NEUTRON ACER TENDL-2021 LIBRARY; T=293.6K
angular distribution for (n,n*14)

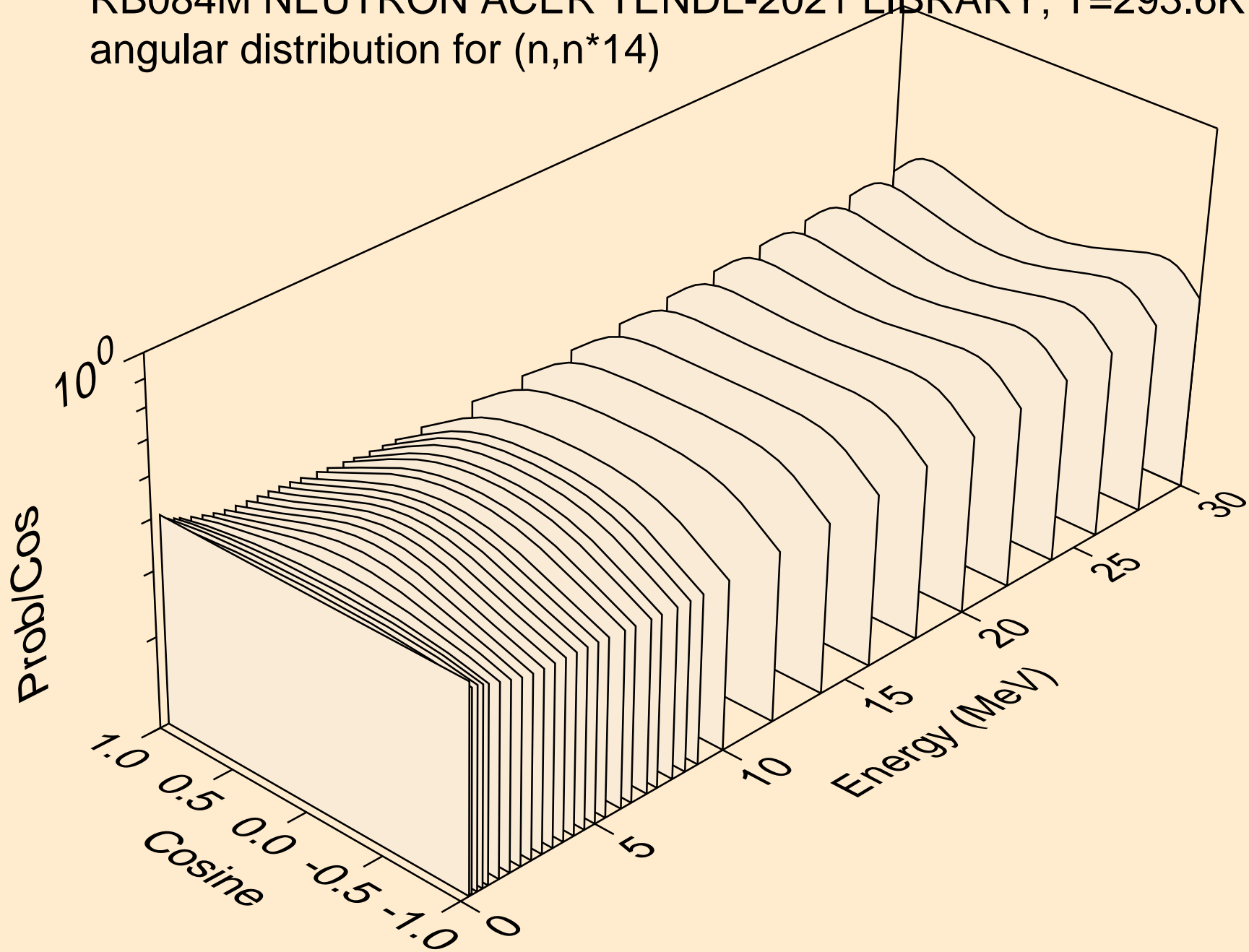

RB084M NEUTRON ACER TENDL-2021 LIBRARY; T=293.6K
angular distribution for (n,n*15)

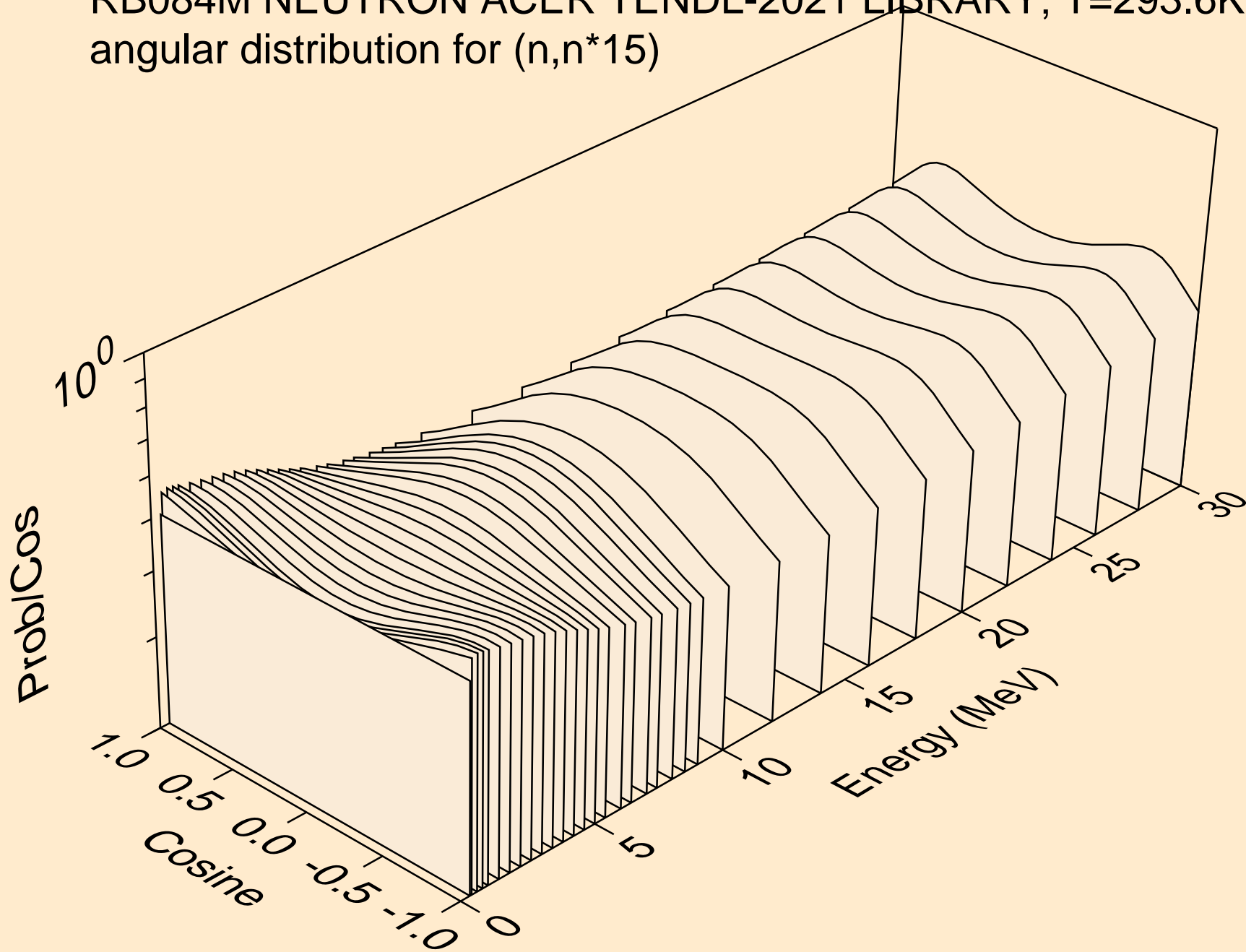

RB084M NEUTRON ACER TENDL-2021 LIBRARY; T=293.6K
angular distribution for (n,n*16)

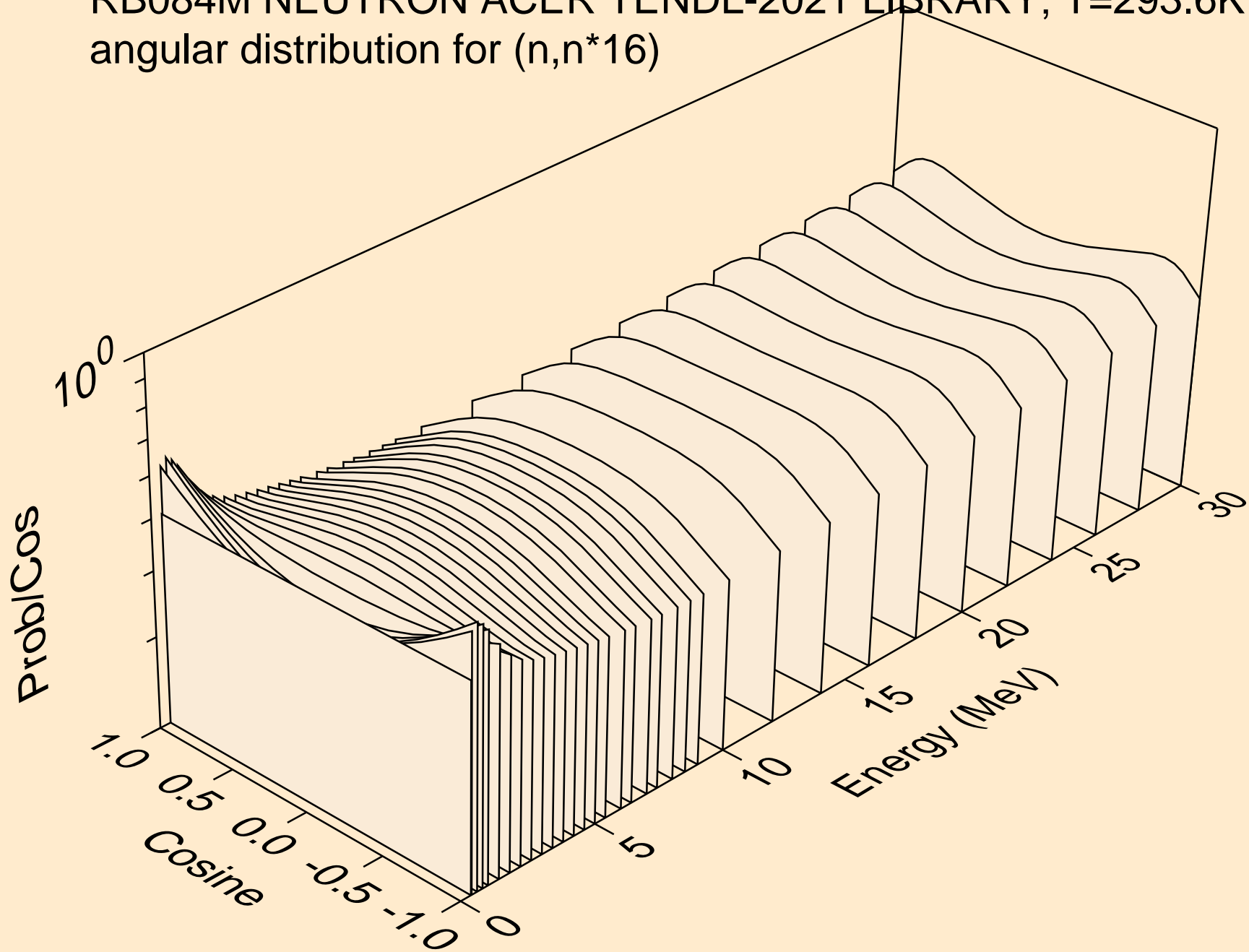

RB084M NEUTRON ACER TENDL-2021 LIBRARY; T=293.6K
angular distribution for (n,n*17)

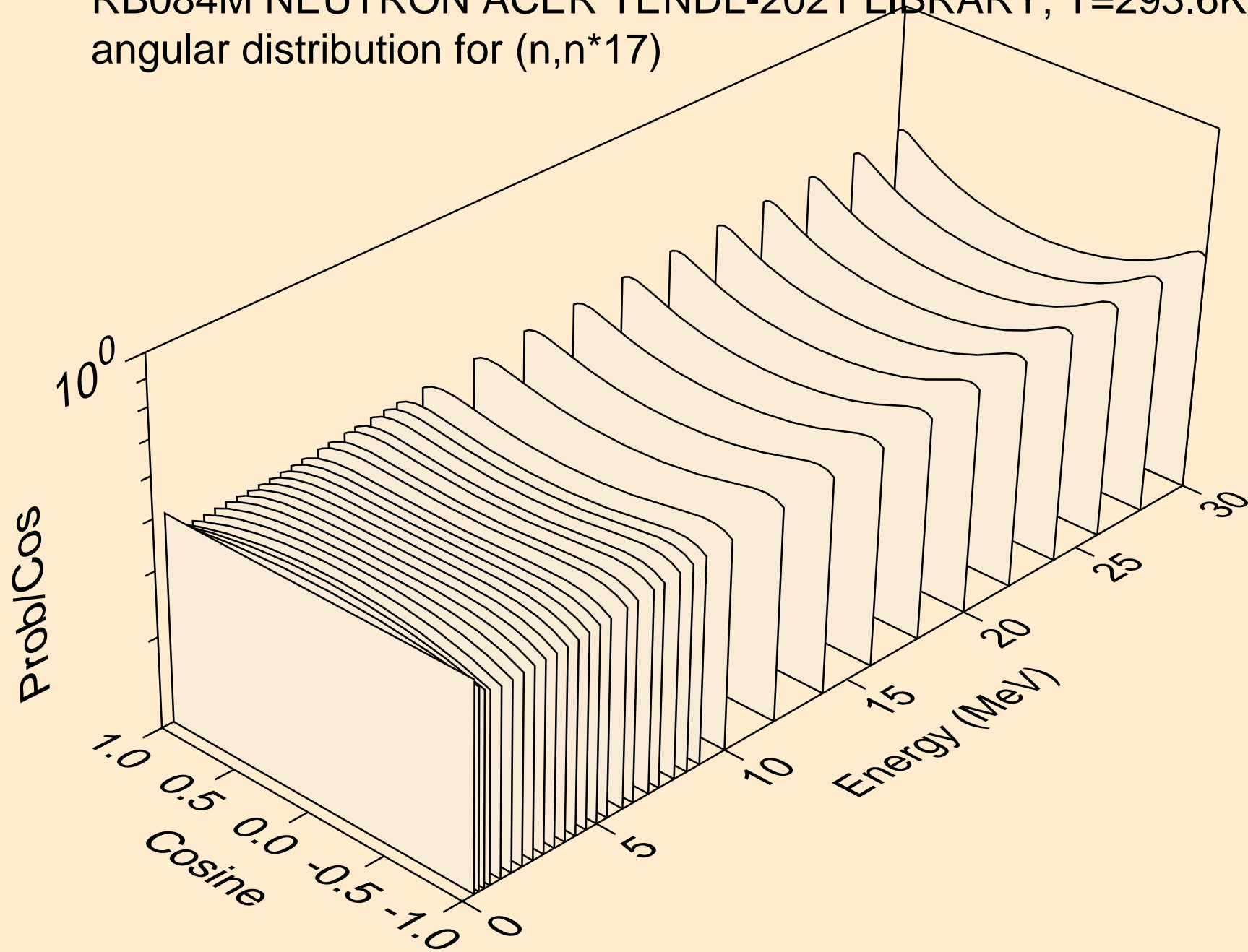

RB084M NEUTRON ACER TENDL-2021 LIBRARY; T=293.6K
angular distribution for (n,n*18)

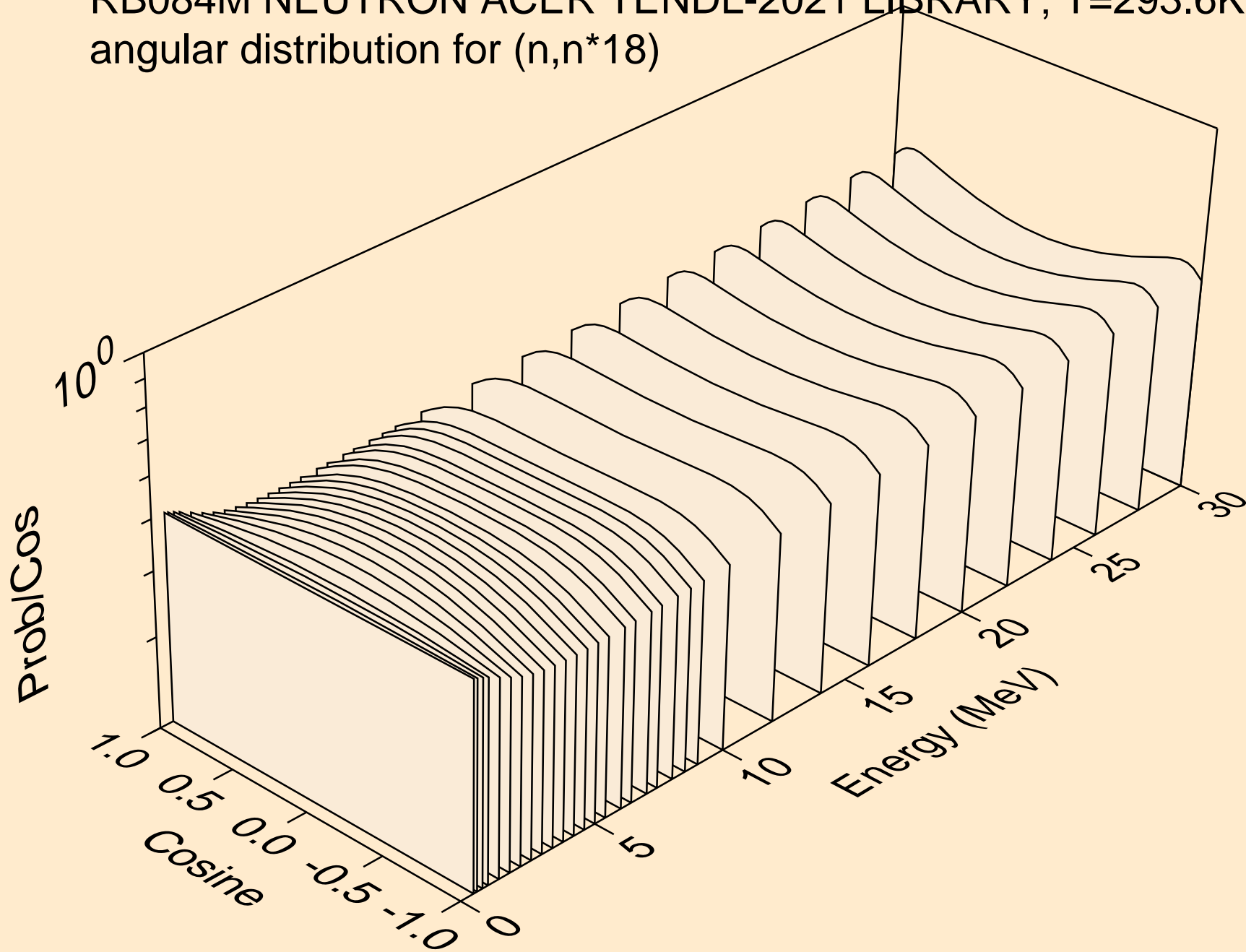

RB084M NEUTRON ACER TENDL-2021 LIBRARY; T=293.6K
angular distribution for (n,n*19)

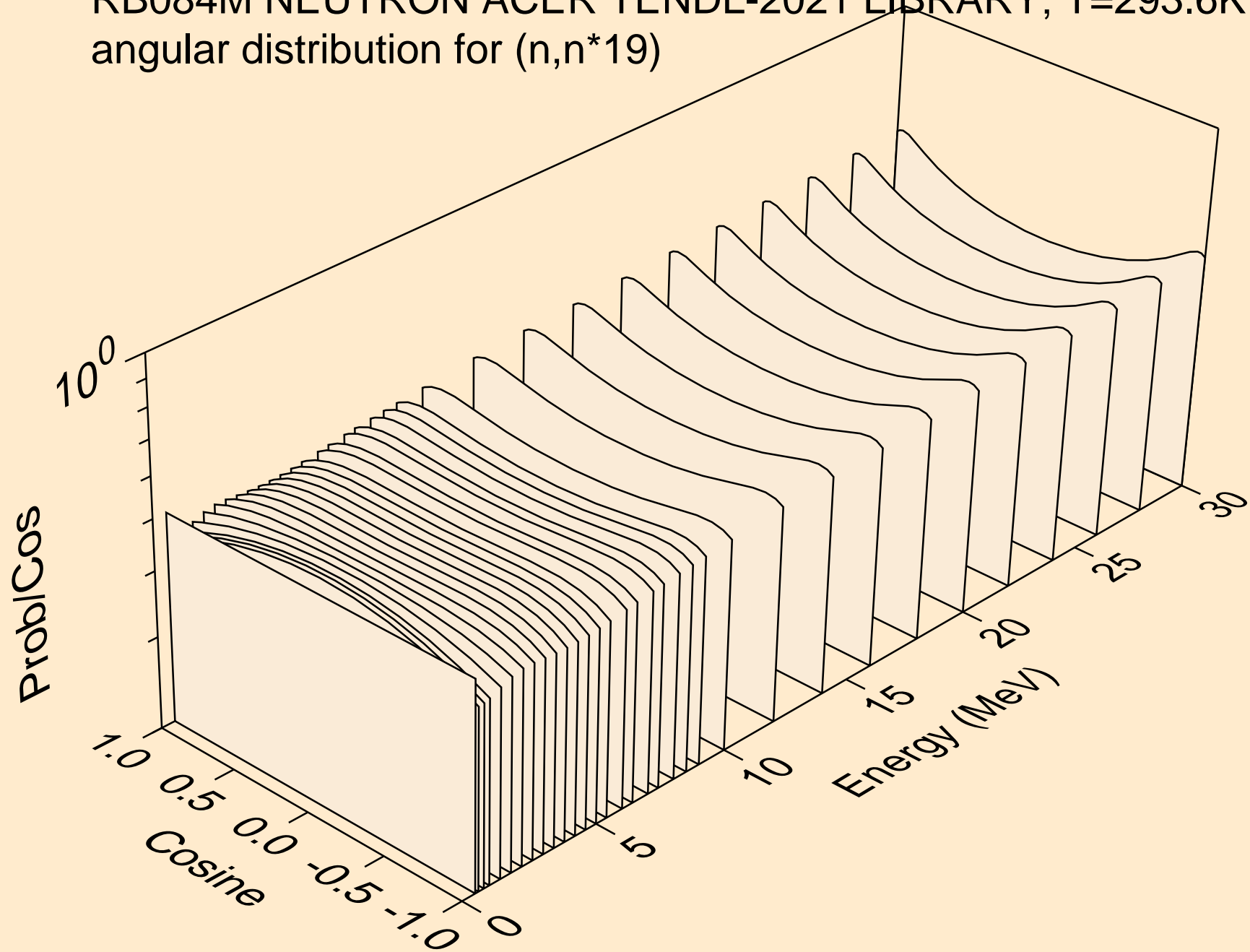

RB084M NEUTRON ACER TENDL-2021 LIBRARY; T=293.6K
angular distribution for (n,n*20)

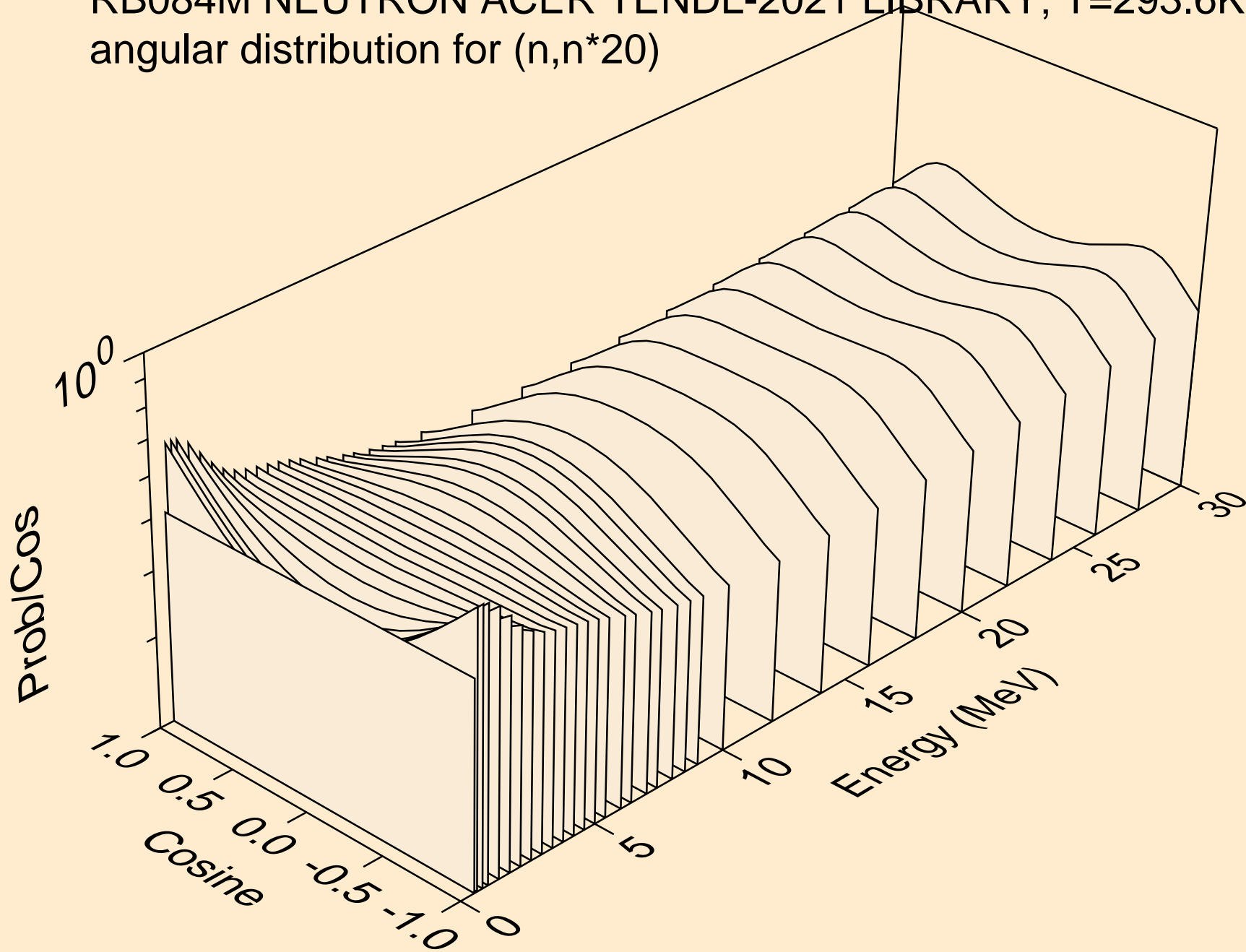

RB084M NEUTRON ACER TENDL-2021 LIBRARY; T=293.6K
angular distribution for (n,n*21)

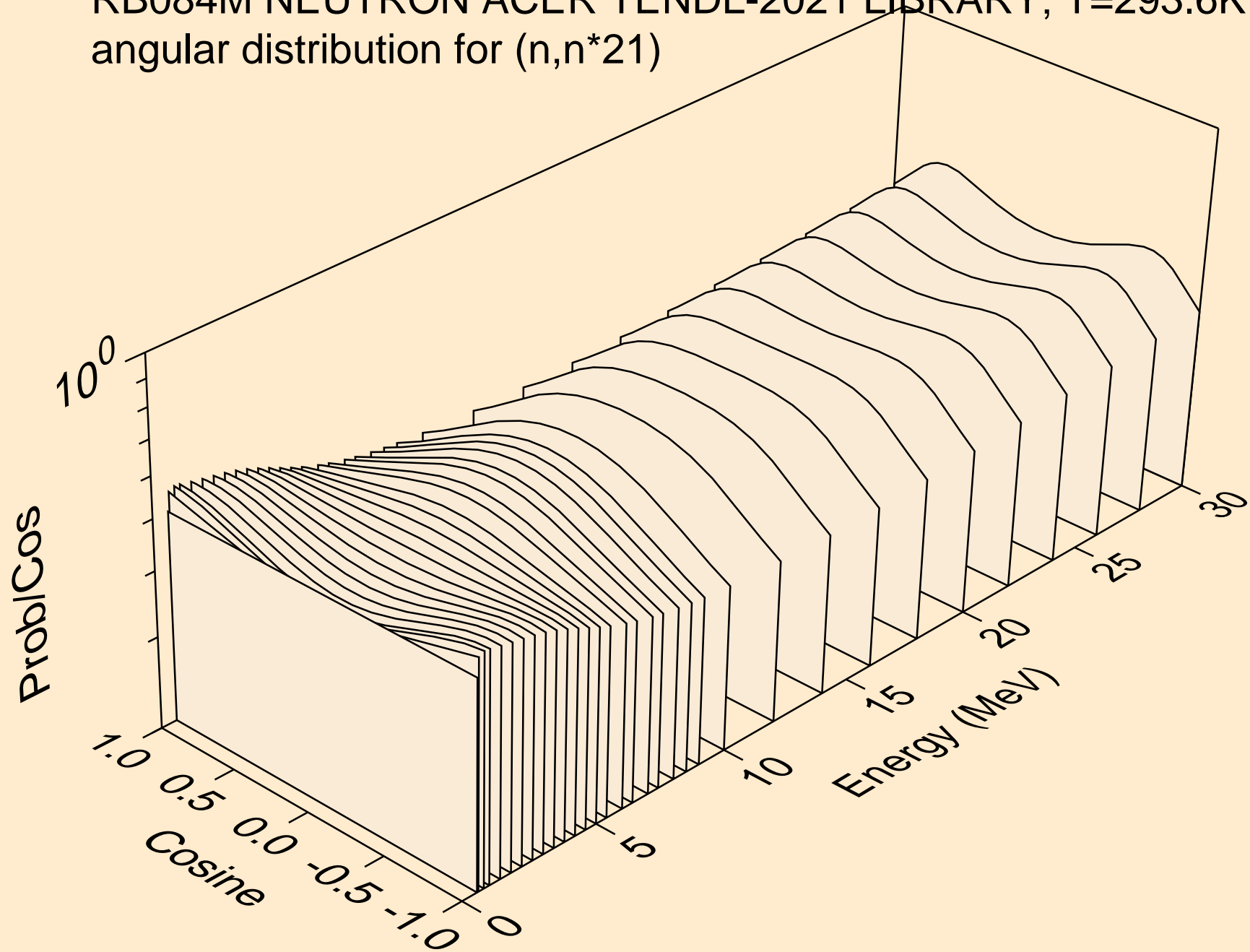

RB084M NEUTRON ACER TENDL-2021 LIBRARY; T=293.6K
angular distribution for (n,n*22)

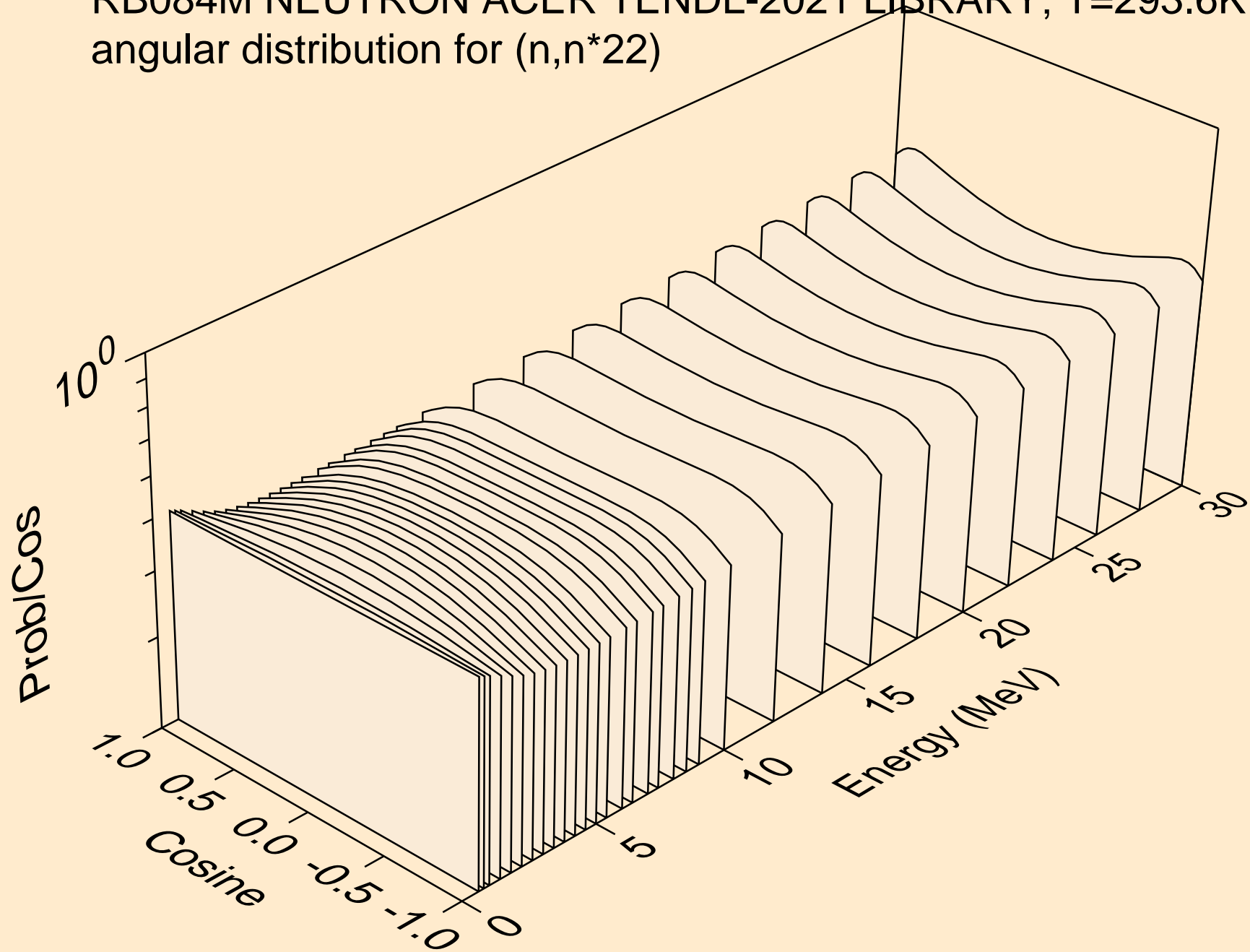

RB084M NEUTRON ACER TENDL-2021 LIBRARY; T=293.6K
angular distribution for (n,n*23)

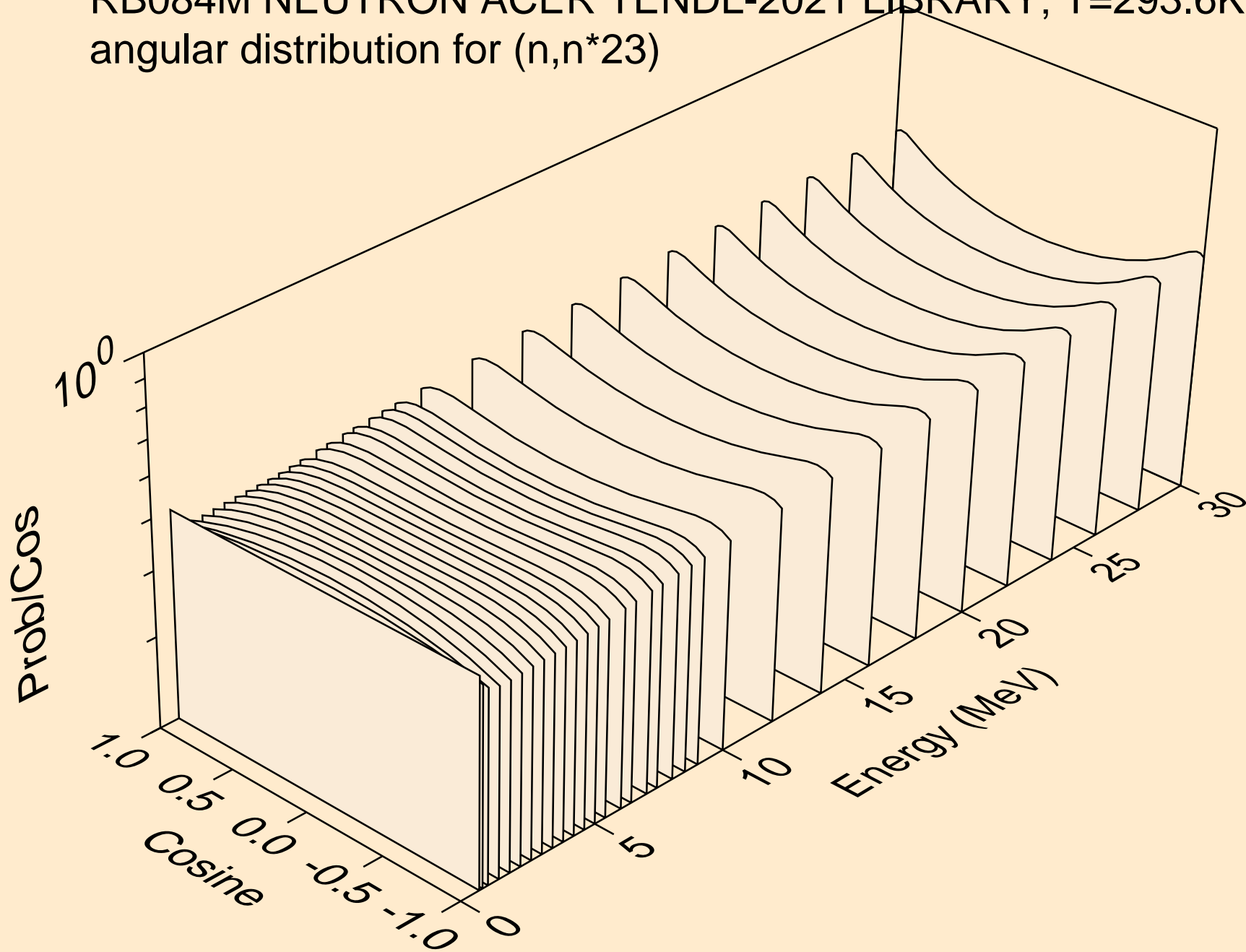

RB084M NEUTRON ACER TENDL-2021 LIBRARY; T=293.6K
angular distribution for (n,n*24)

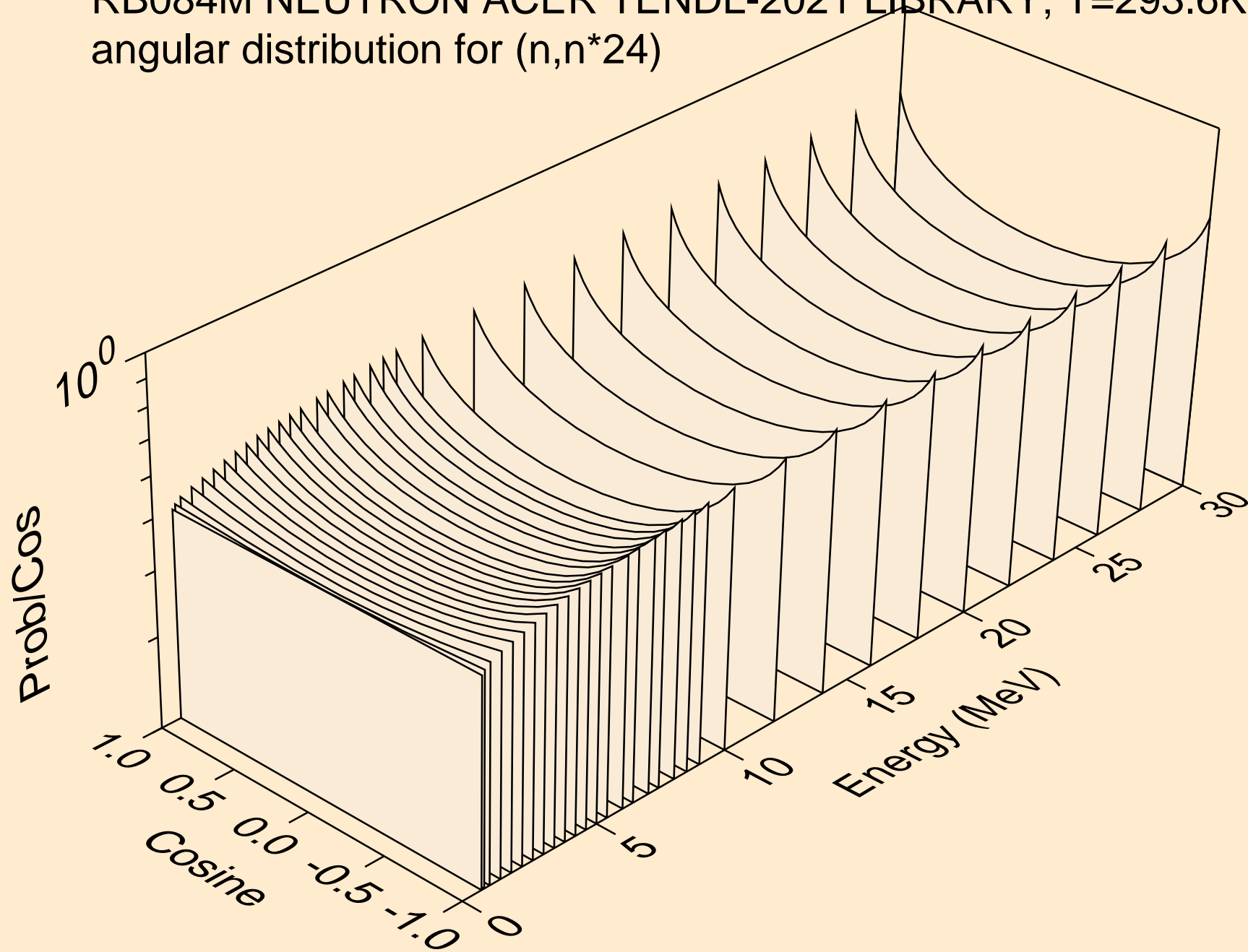

RB084M NEUTRON ACER TENDL-2021 LIBRARY; T=293.6K
angular distribution for (n,n*25)

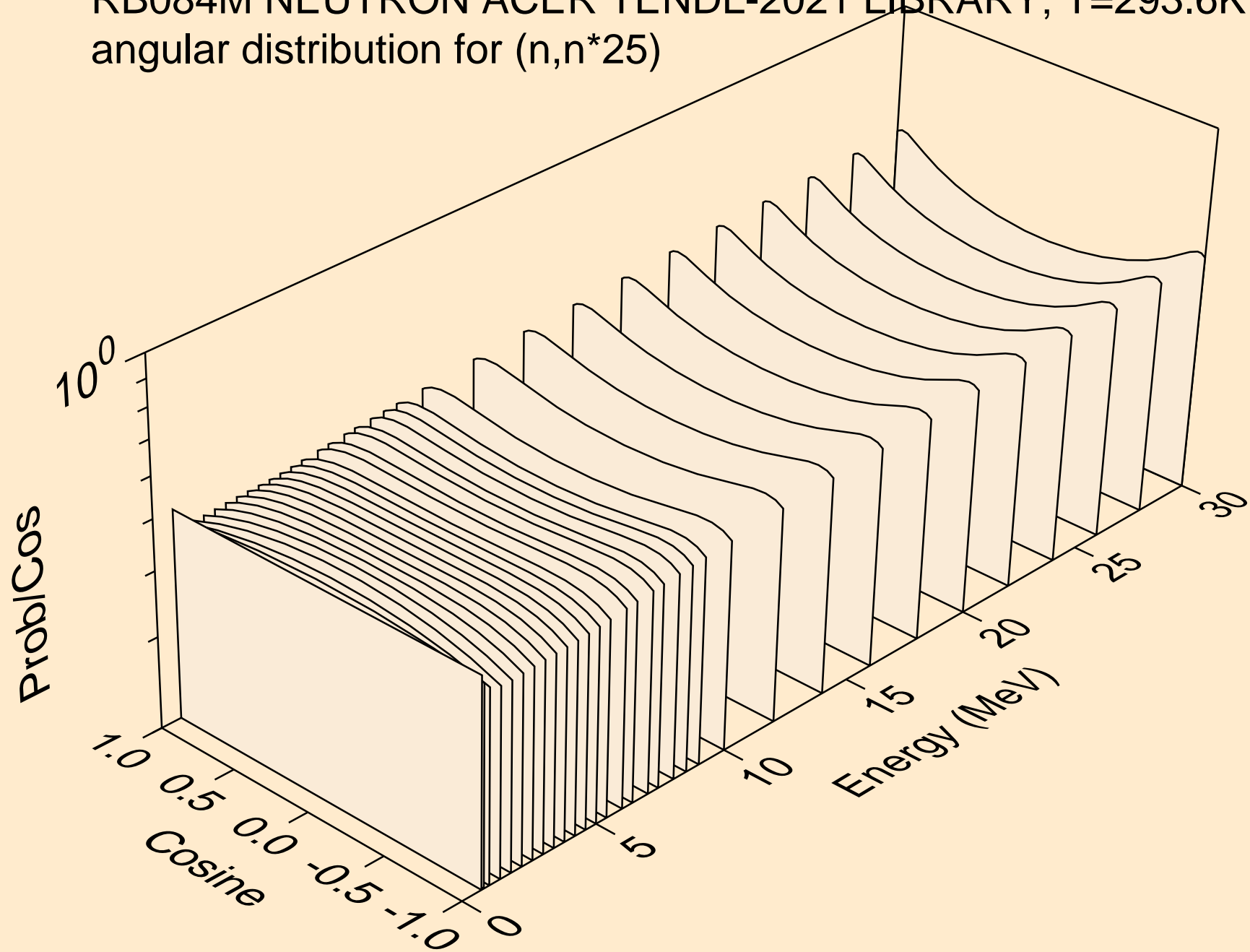

RB084M NEUTRON ACER TENDL-2021 LIBRARY; T=293.6K
angular distribution for (n,n*26)

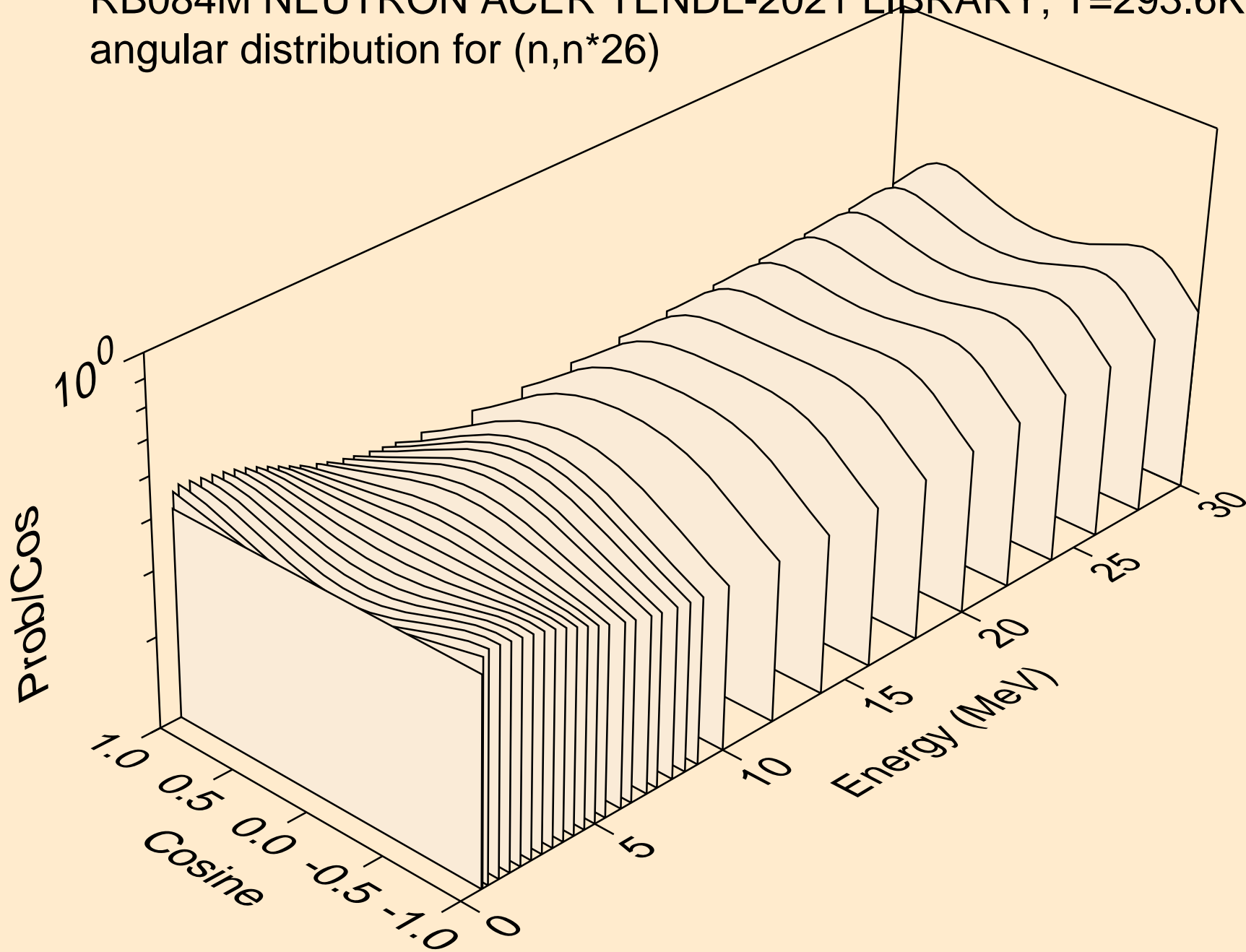

RB084M NEUTRON ACER TENDL-2021 LIBRARY; T=293.6K
angular distribution for (n,n*27)

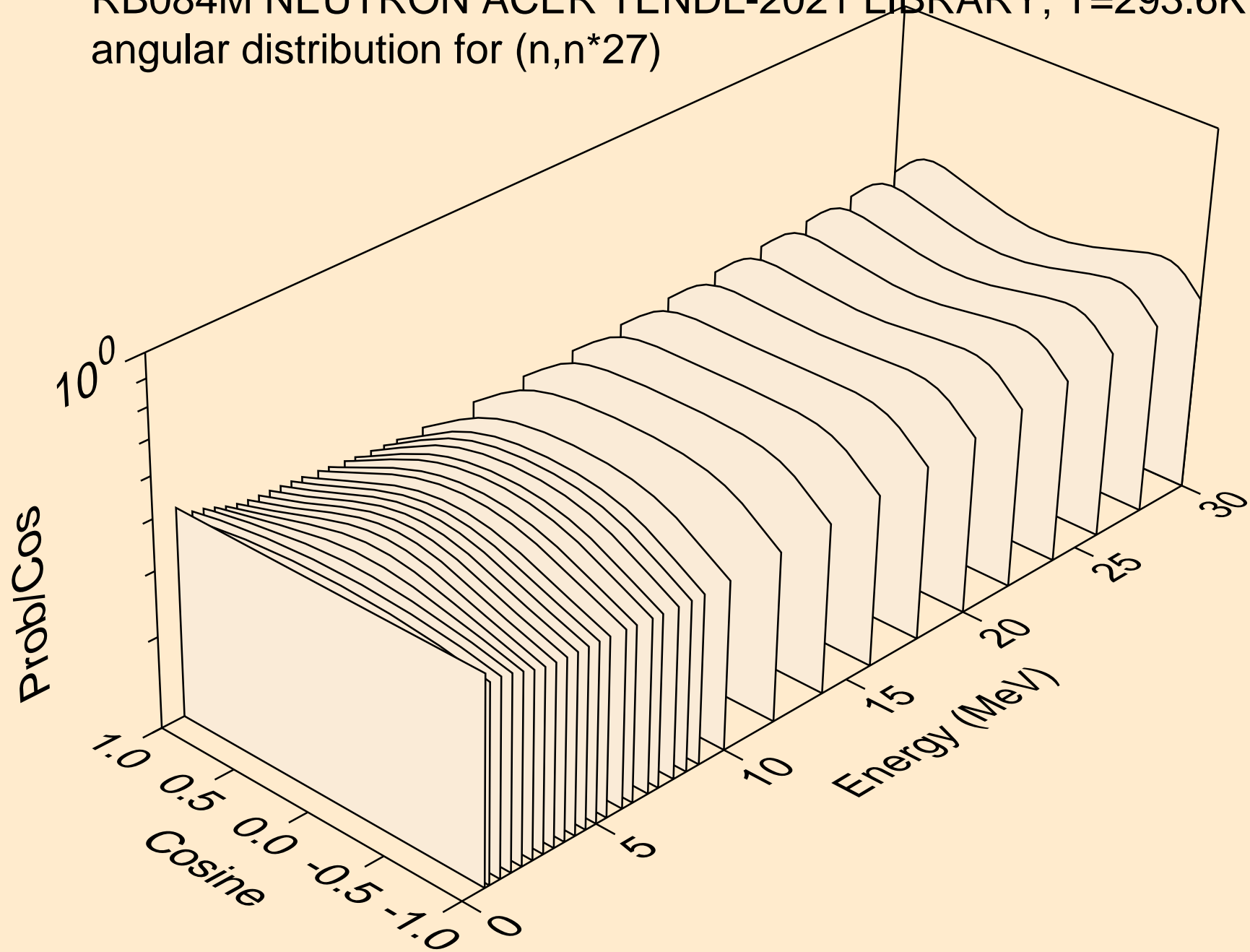

RB084M NEUTRON ACER TENDL-2021 LIBRARY; T=293.6K
angular distribution for (n,n*28)

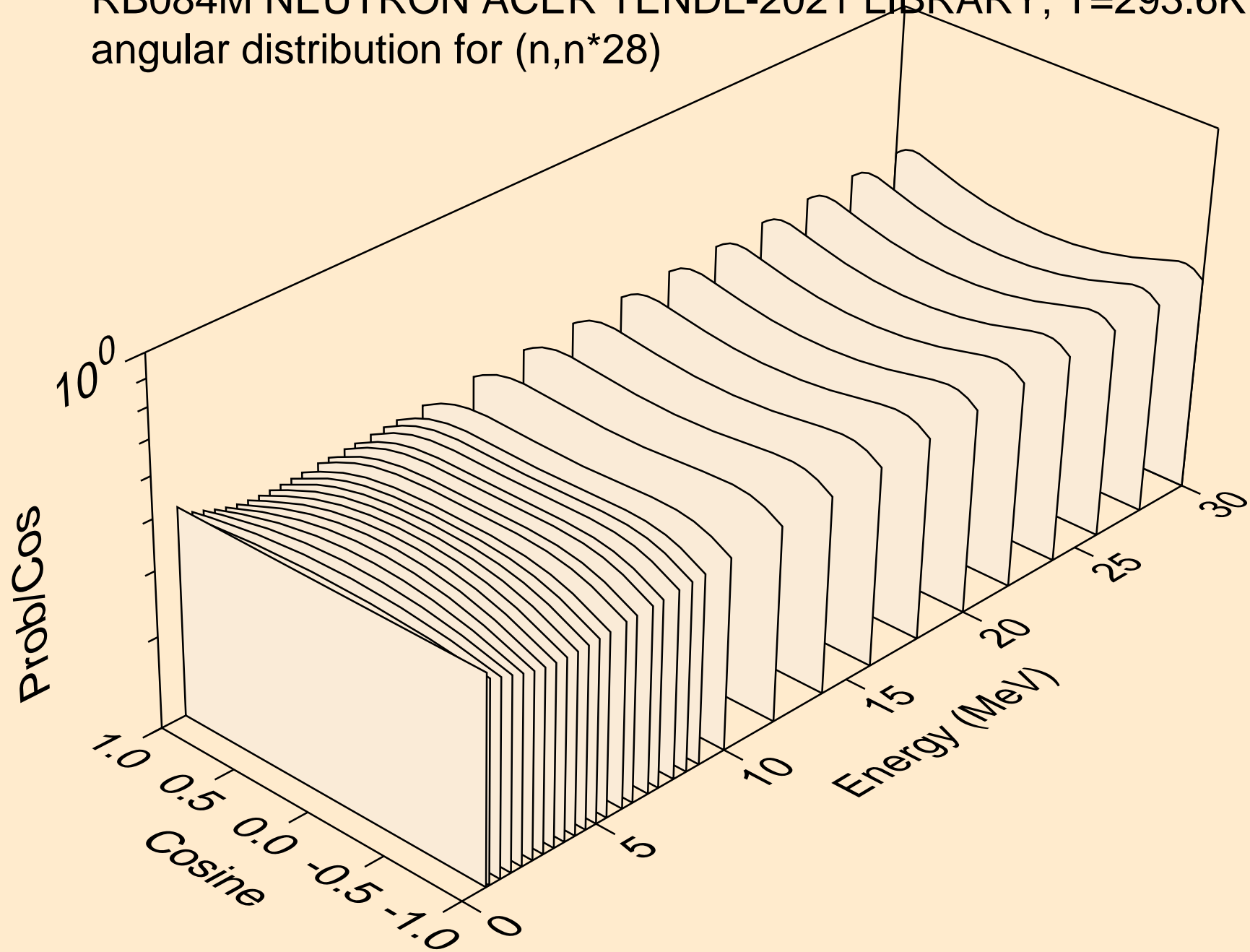

RB084M NEUTRON ACER TENDL-2021 LIBRARY; T=293.6K
angular distribution for (n,n*29)

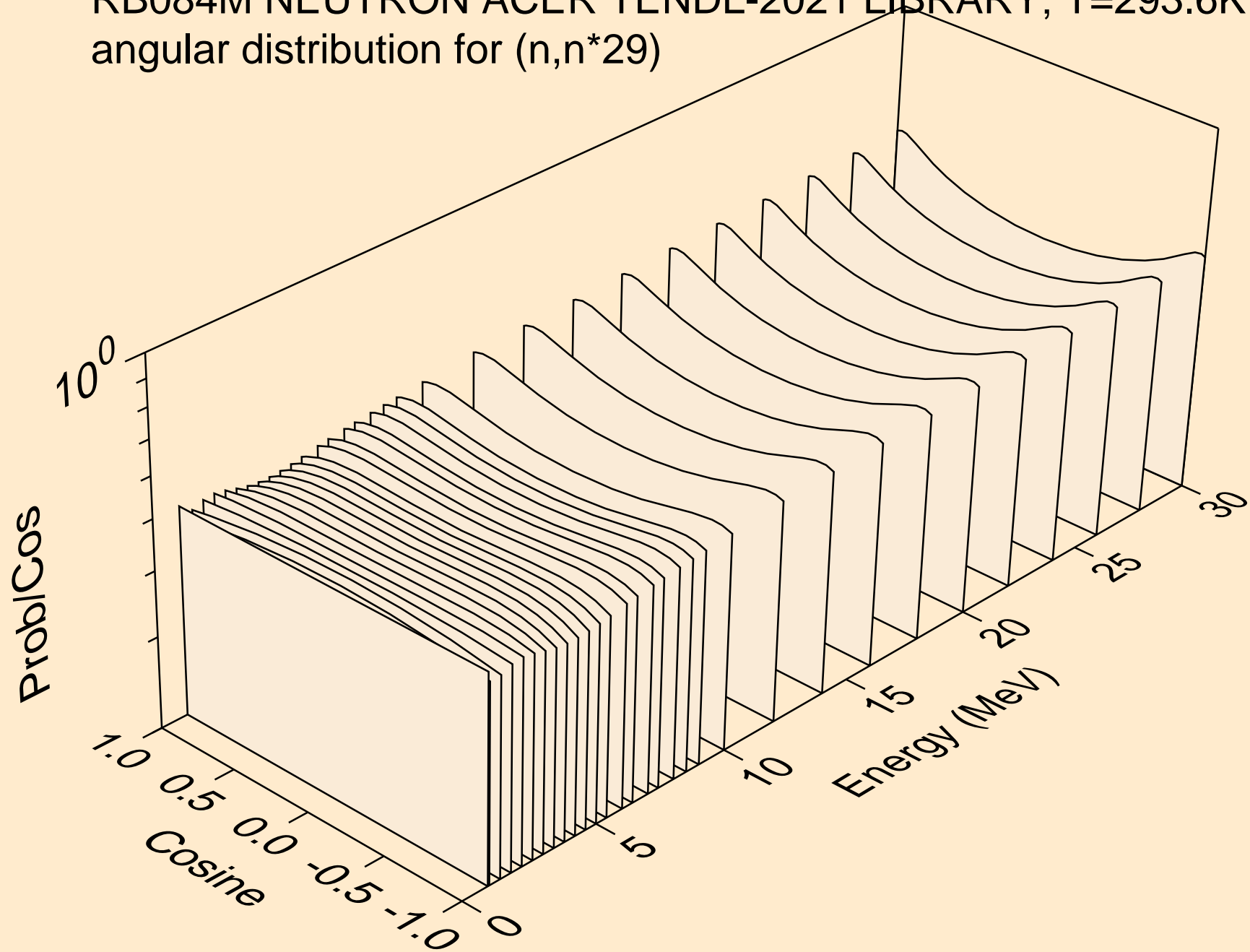

RB084M NEUTRON ACER TENDL-2021 LIBRARY; T=293.6K
angular distribution for (n,n*30)

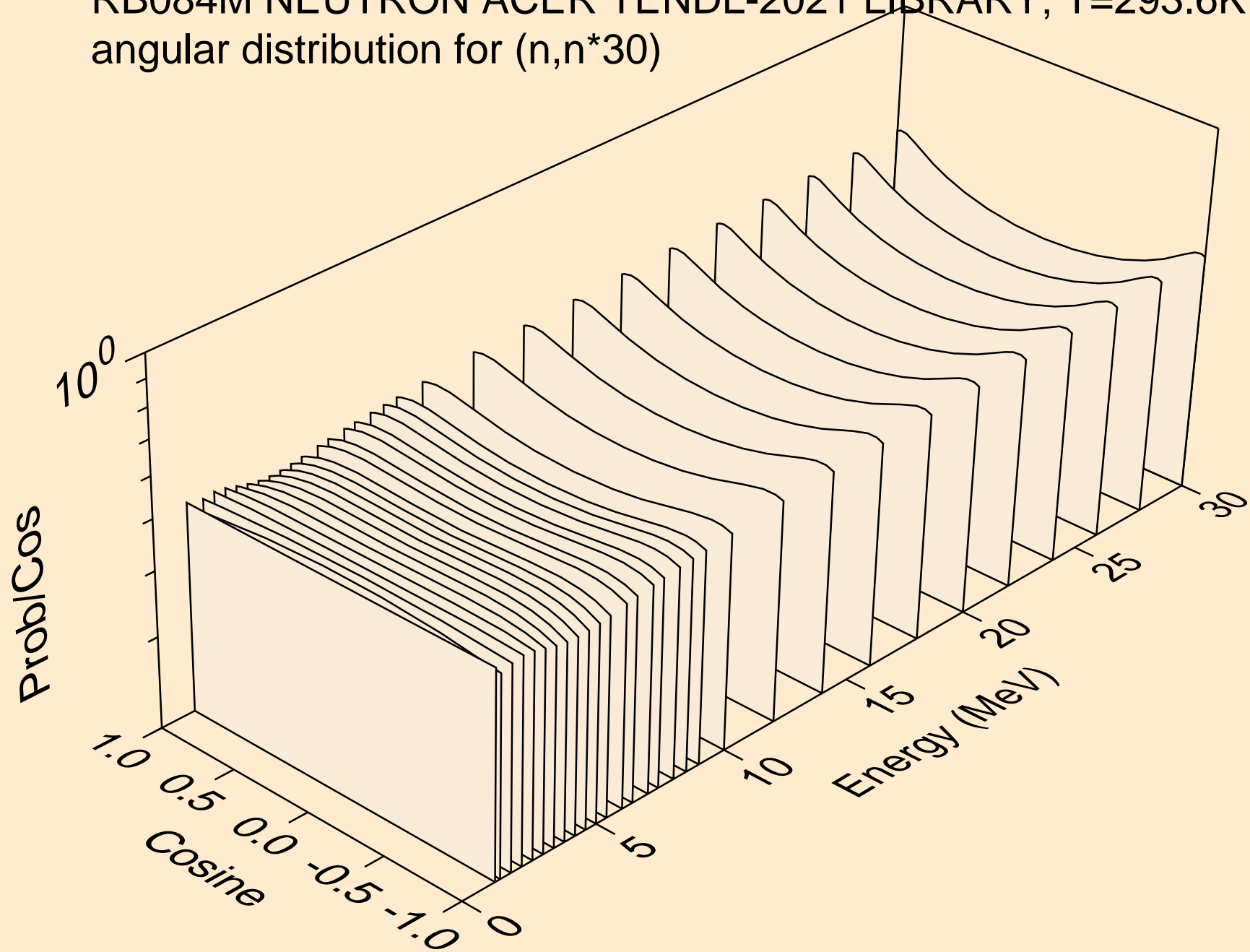

RB084M NEUTRON ACER TENDL-2021 LIBRARY; T=293.6K
Neutron emission for (n,x)

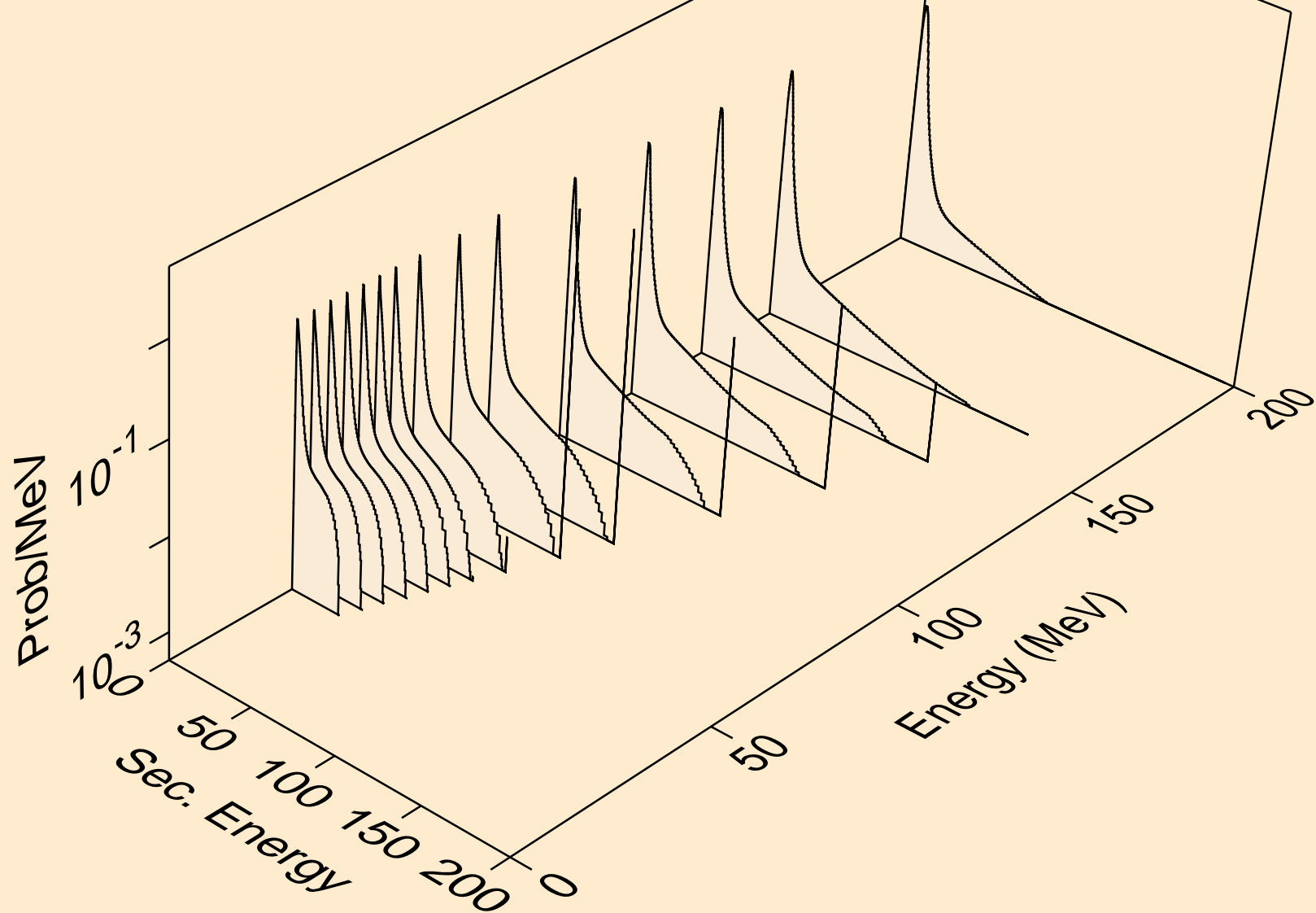

RB084M NEUTRON ACER TENDL-2021 LIBRARY; T=293.6K
Neutron emission for (n,2nd)

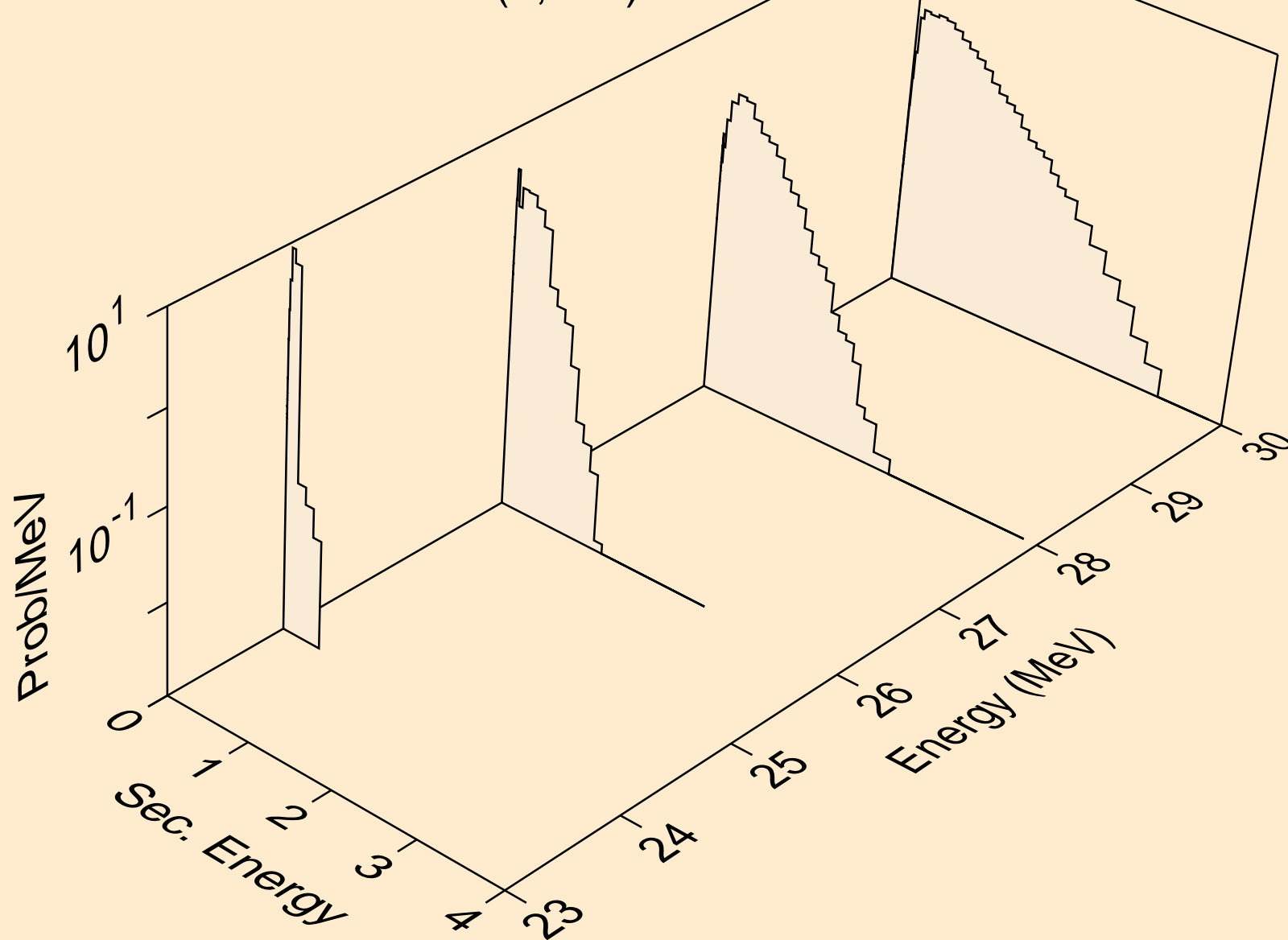

RB084M NEUTRON ACER TENDL-2021 LIBRARY; T=293.6K
Neutron emission for (n,2n)

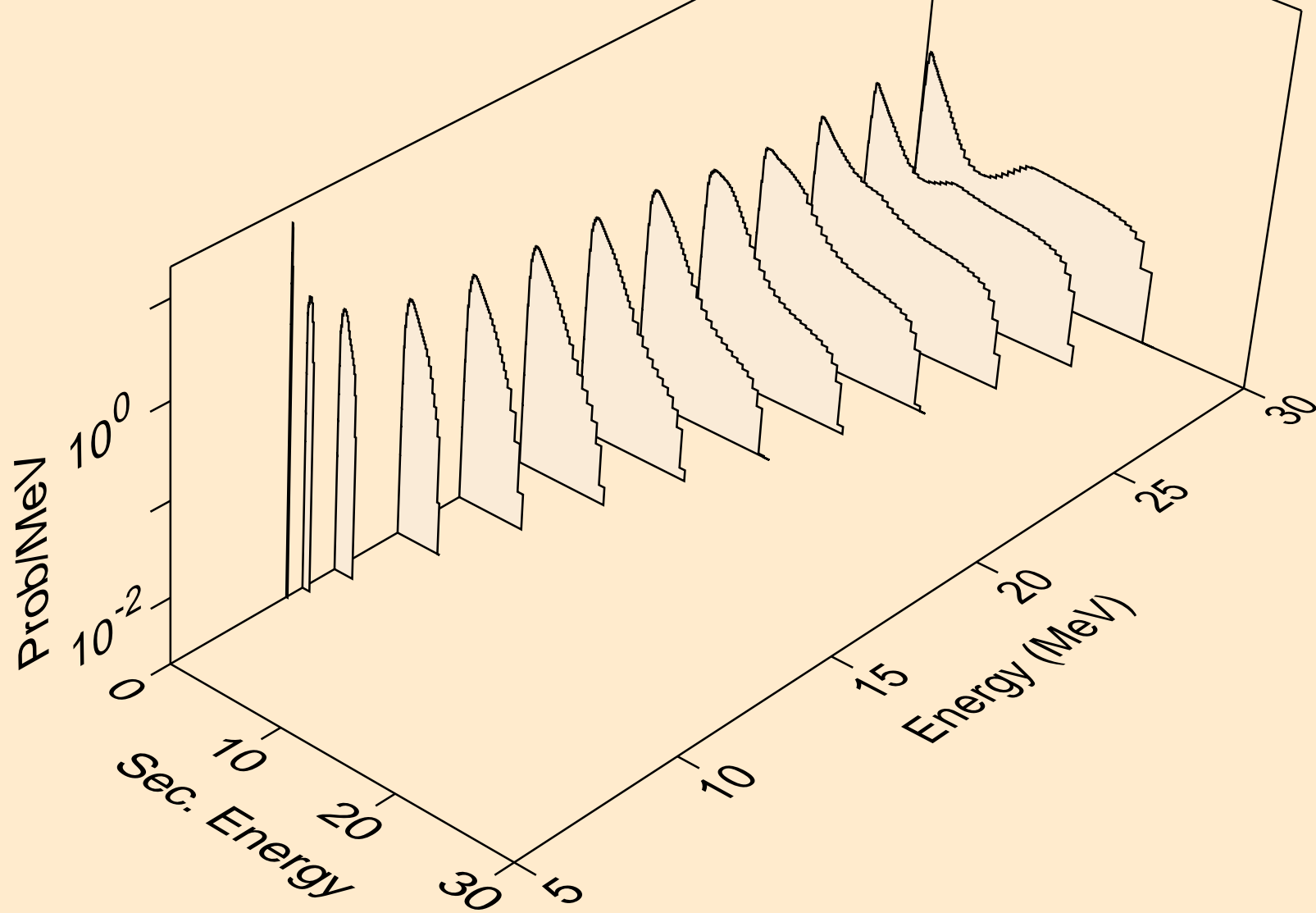

RB084M NEUTRON ACER TENDL-2021 LIBRARY; T=293.6K
Neutron emission for (n,3n)

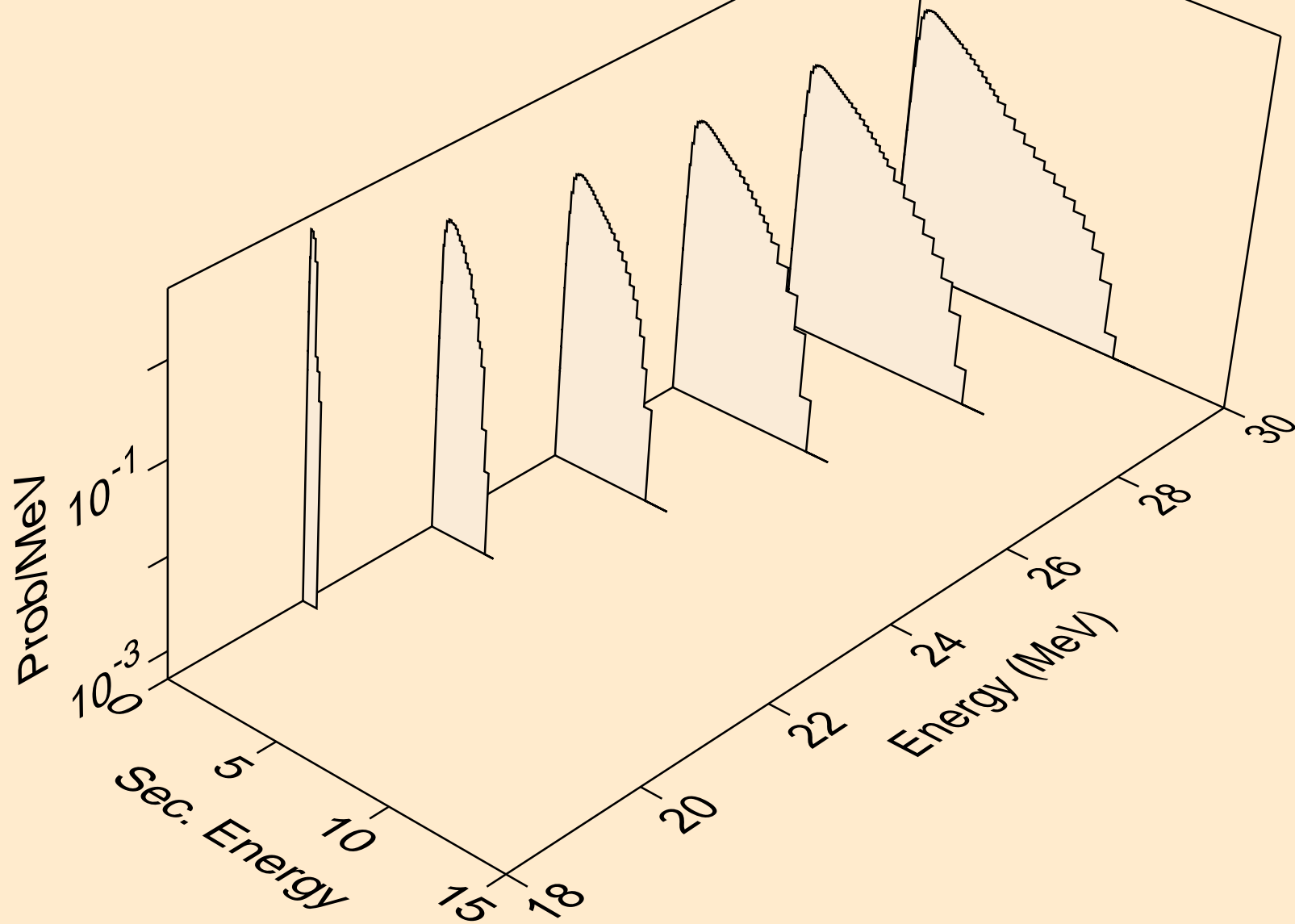

RB084M NEUTRON ACER TENDL-2021 LIBRARY; T=293.6K
Neutron emission for (n,n*)a

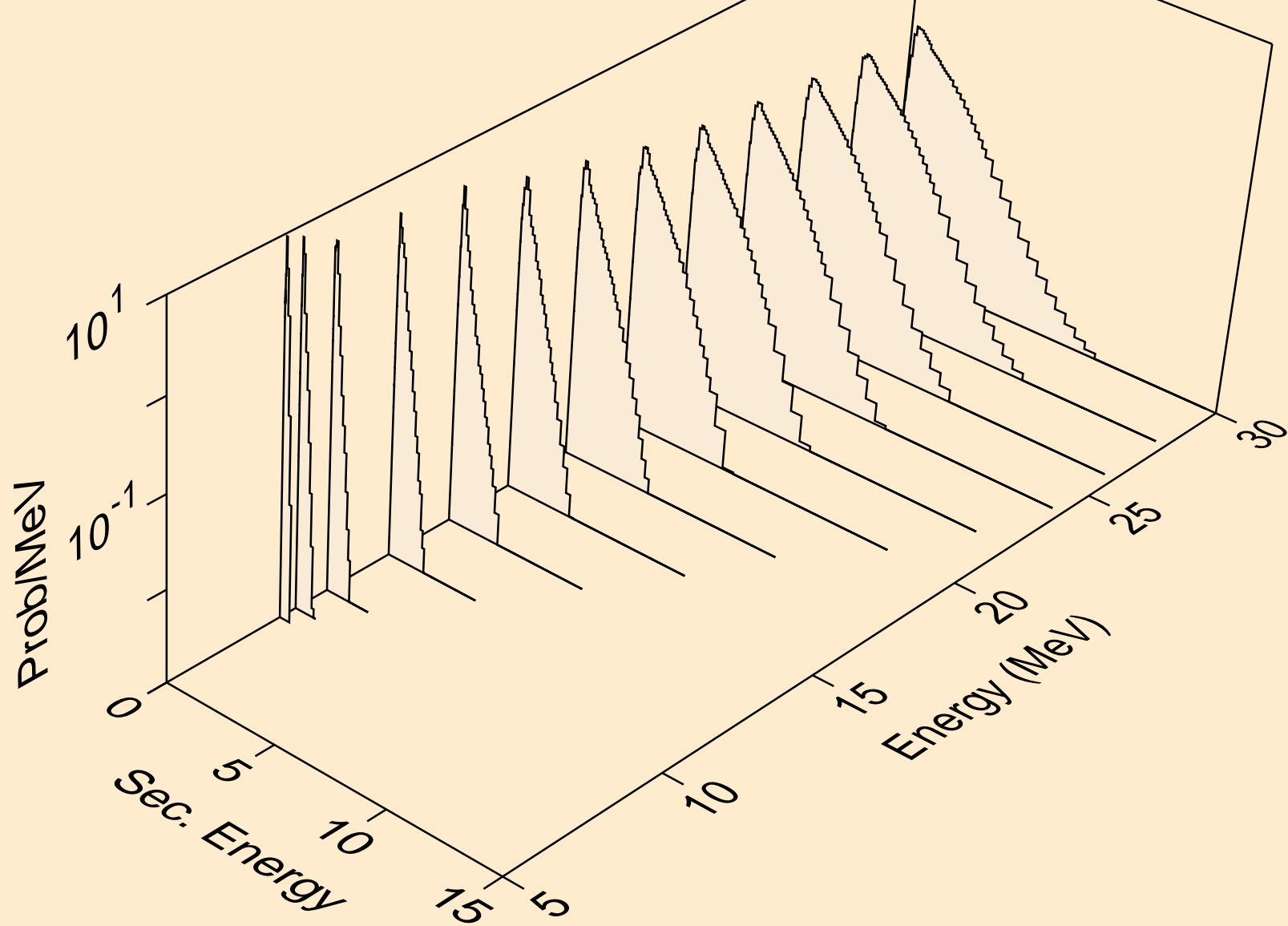

RB084M NEUTRON ACER TENDL-2021 LIBRARY; T=293.6K
Neutron emission for (n,2n)a

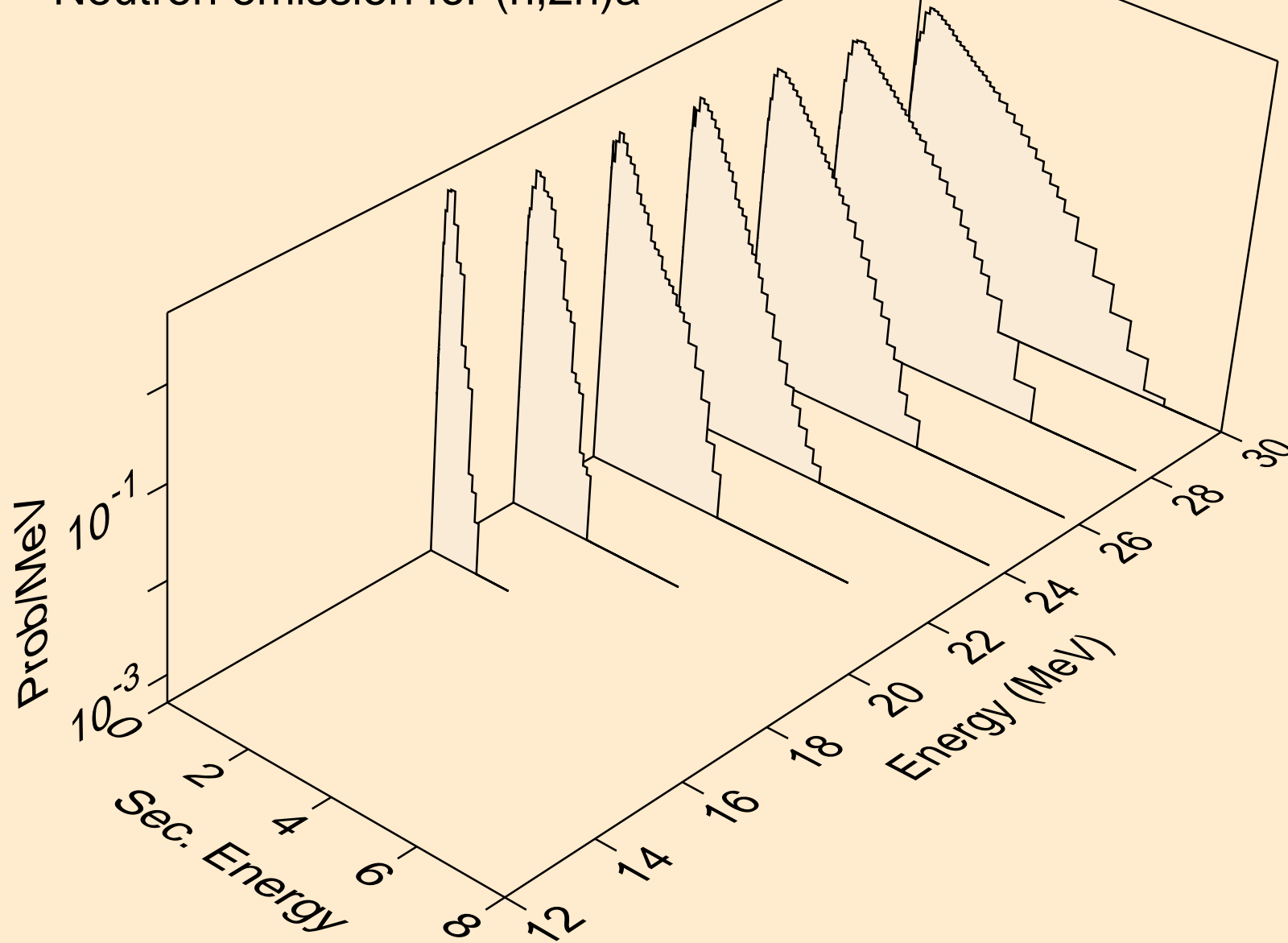

RB084M NEUTRON ACER TENDL-2021 LIBRARY; T=293.6K
Neutron emission for (n,n*)p

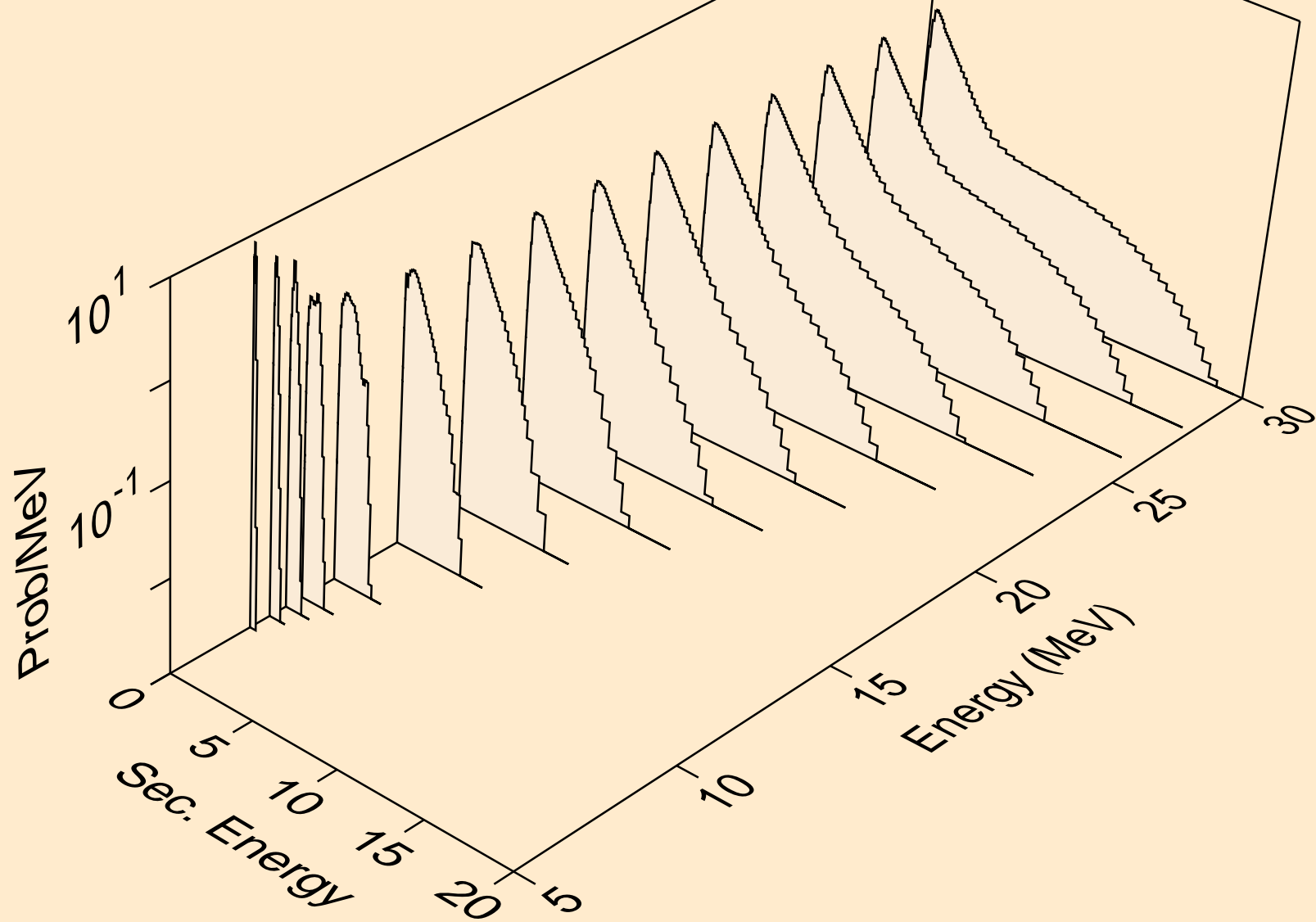

RB084M NEUTRON ACER TENDL-2021 LIBRARY; T=293.6K
Neutron emission for (n,n*)2a

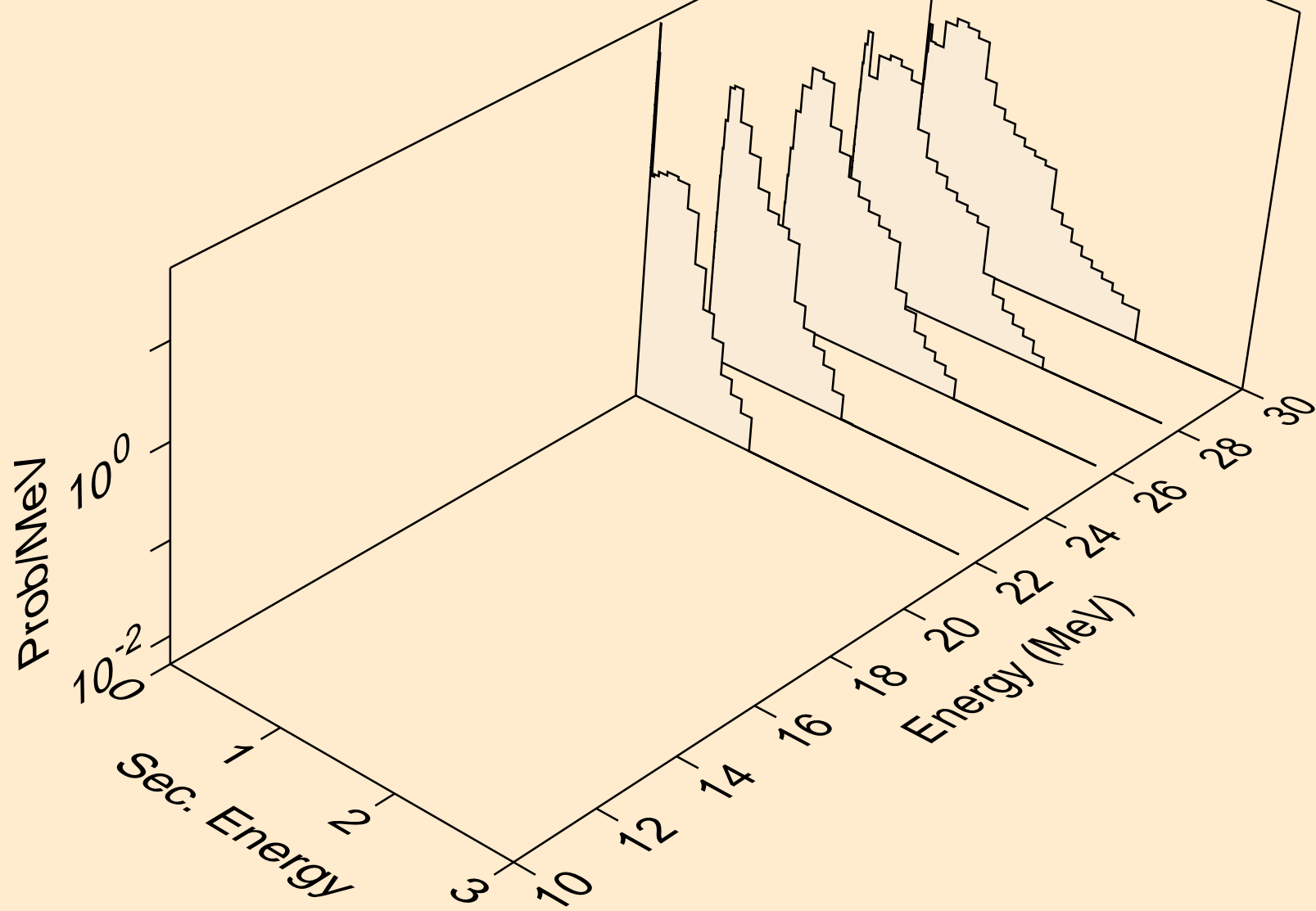

RB084M NEUTRON ACER TENDL-2021 LIBRARY; T=293.6K
Neutron emission for (n,n*)d

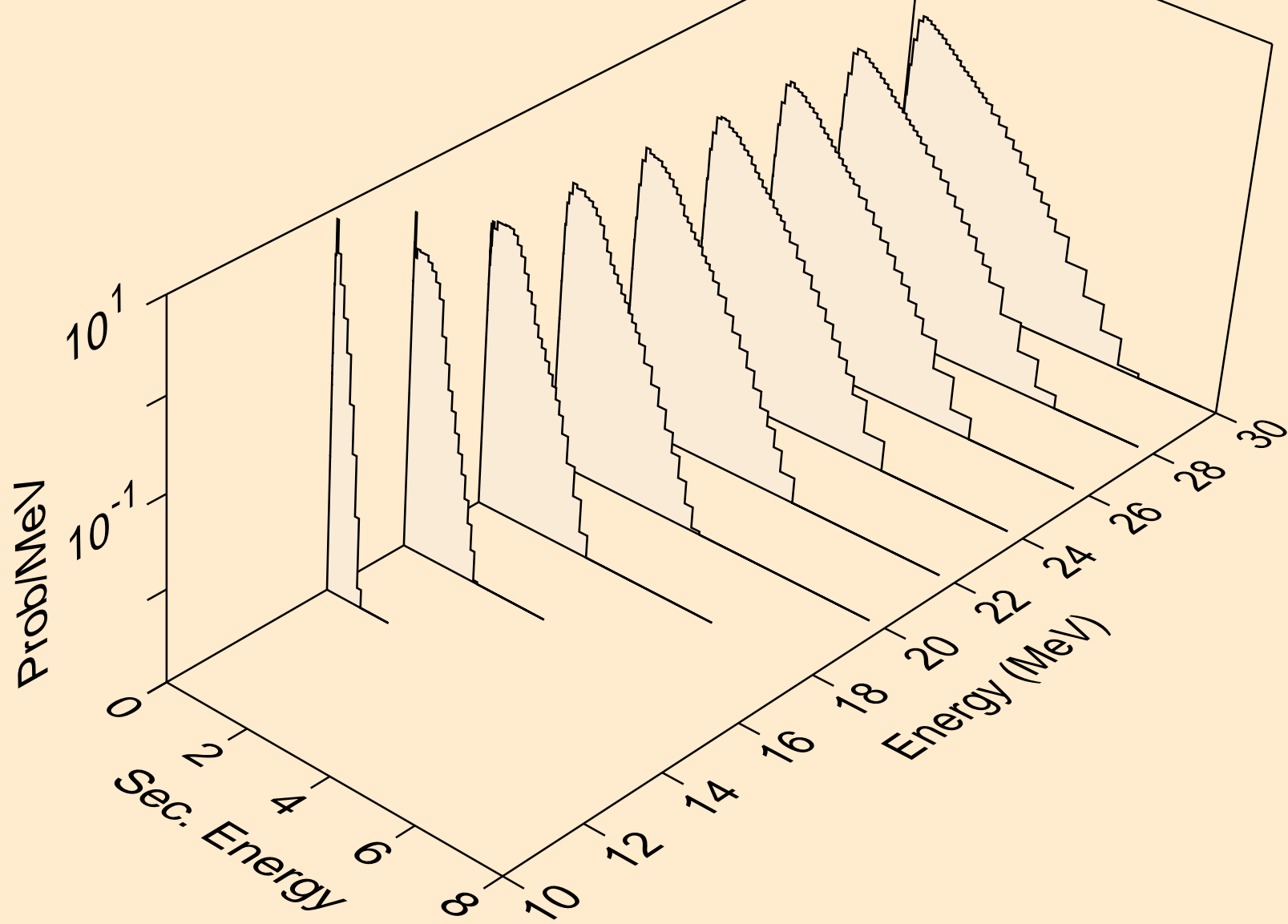

RB084M NEUTRON ACER TENDL-2021 LIBRARY; T=293.6K
Neutron emission for (n,n*)t

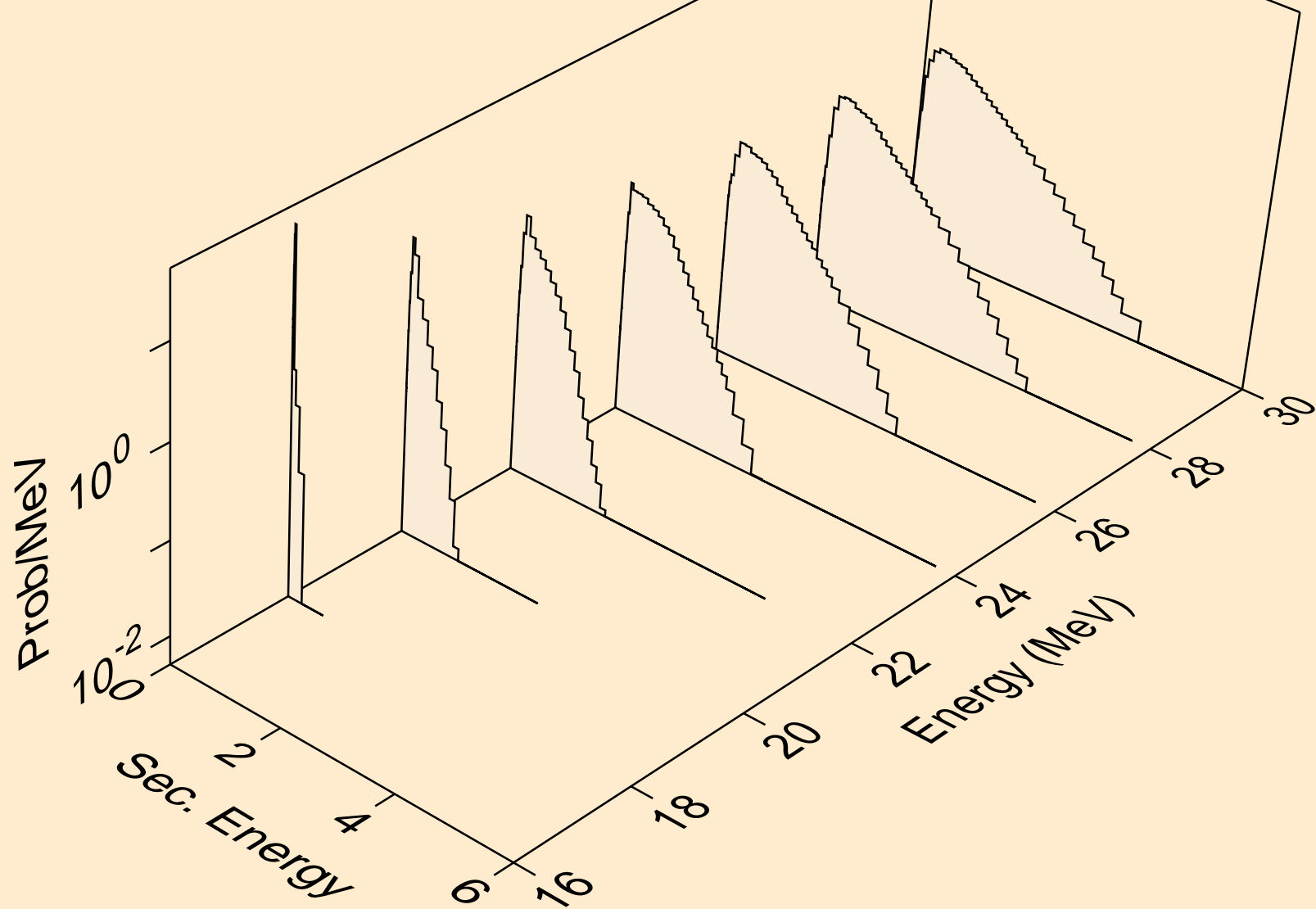

RB084M NEUTRON ACER TENDL-2021 LIBRARY; T=293.6K
Neutron emission for (n,n*)he3

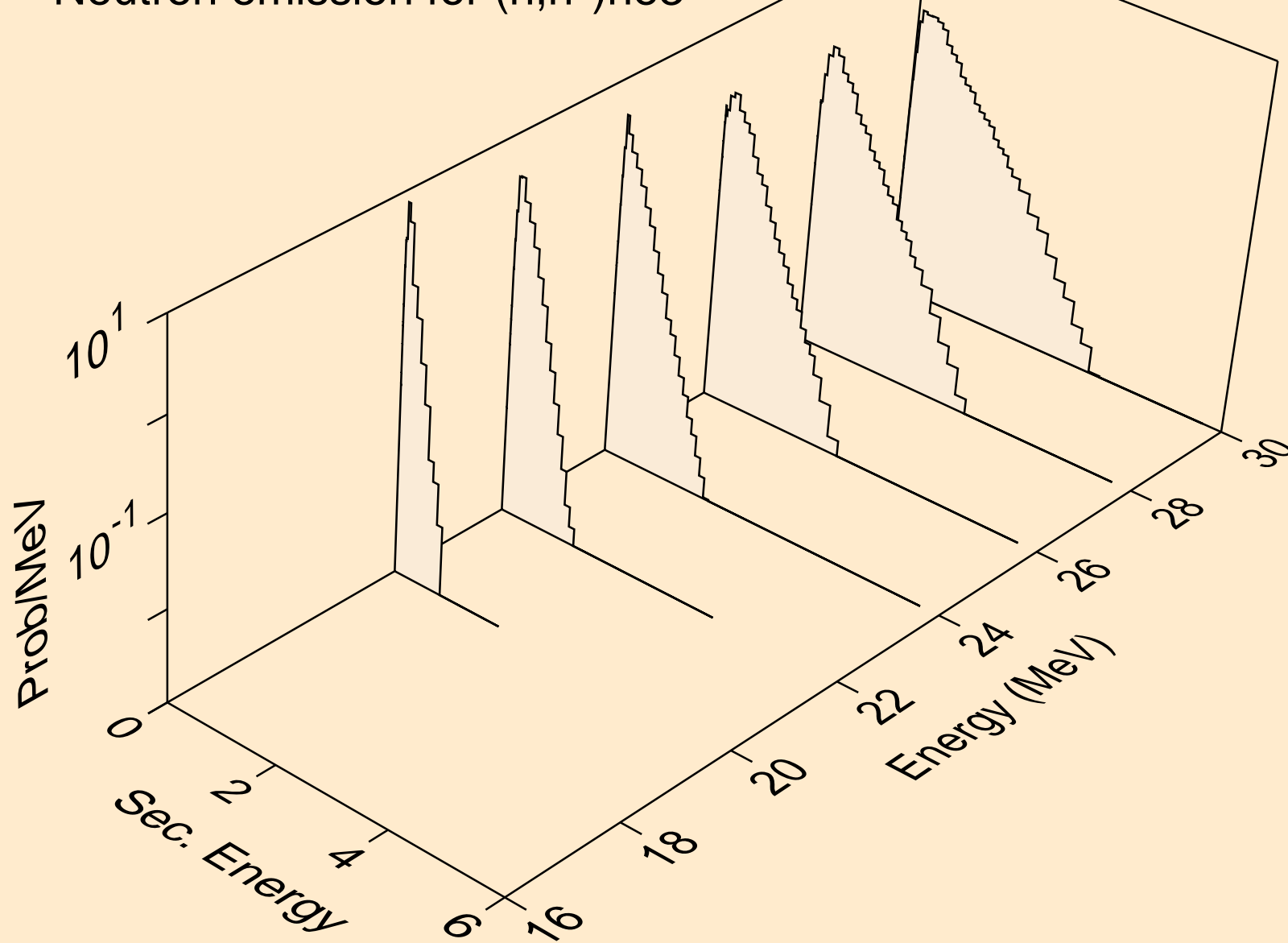

RB084M NEUTRON ACER TENDL-2021 LIBRARY; T=293.6K
Neutron emission for (n,4n)

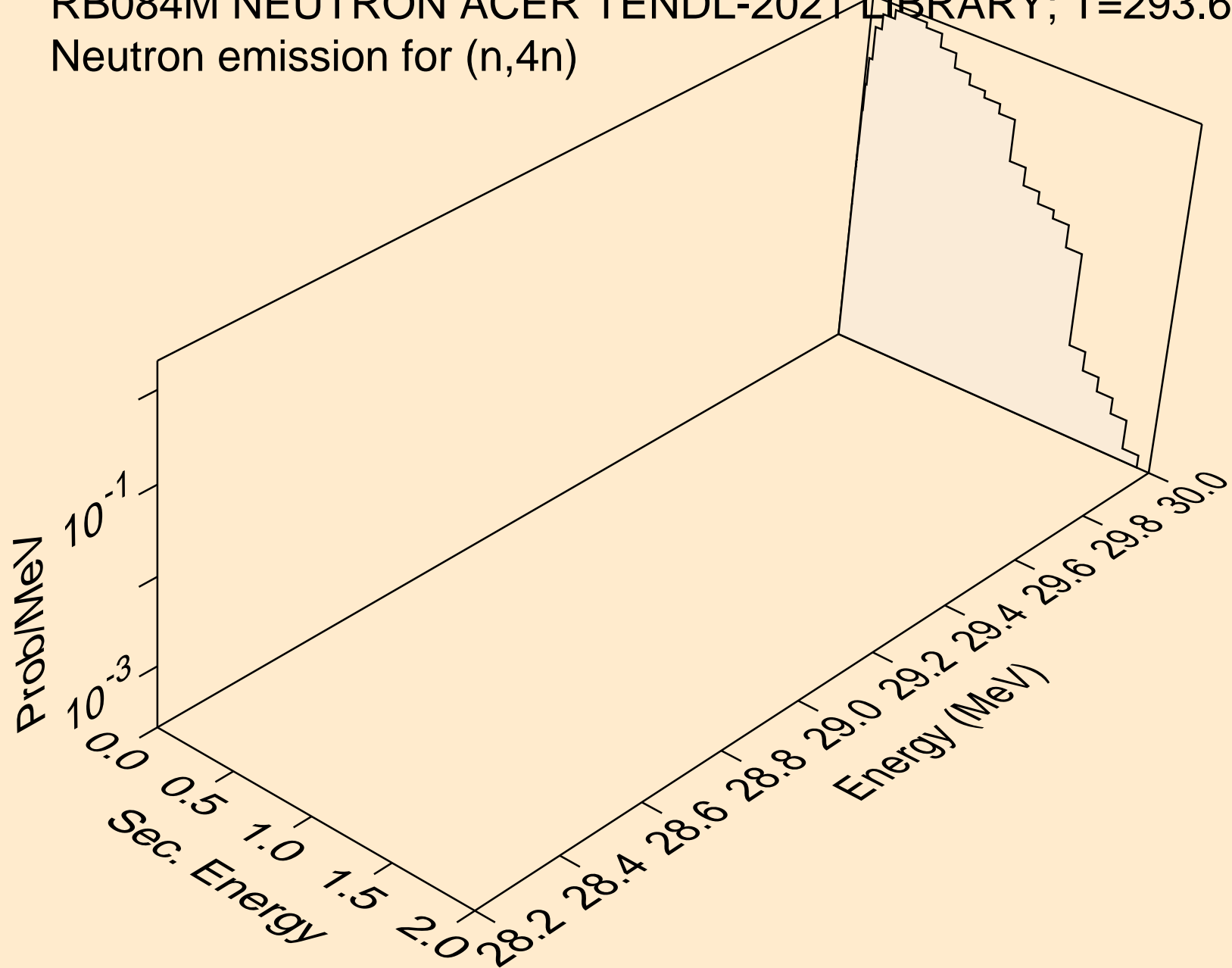

RB084M NEUTRON ACER TENDL-2021 LIBRARY; T=293.6K
Neutron emission for (n,2np)

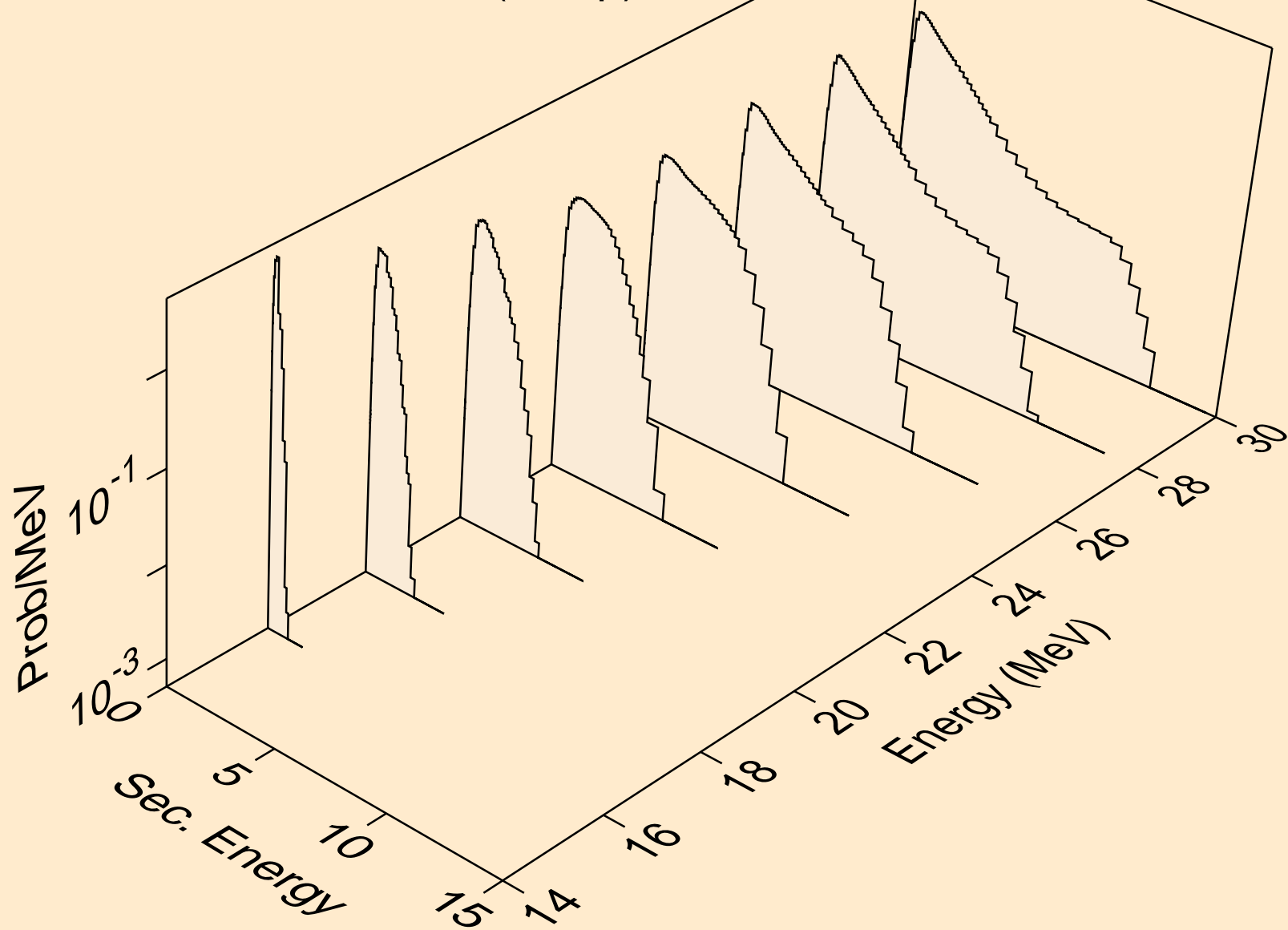

RB084M NEUTRON ACER TENDL-2021 LIBRARY; T=293.6K
Neutron emission for (n,3np)

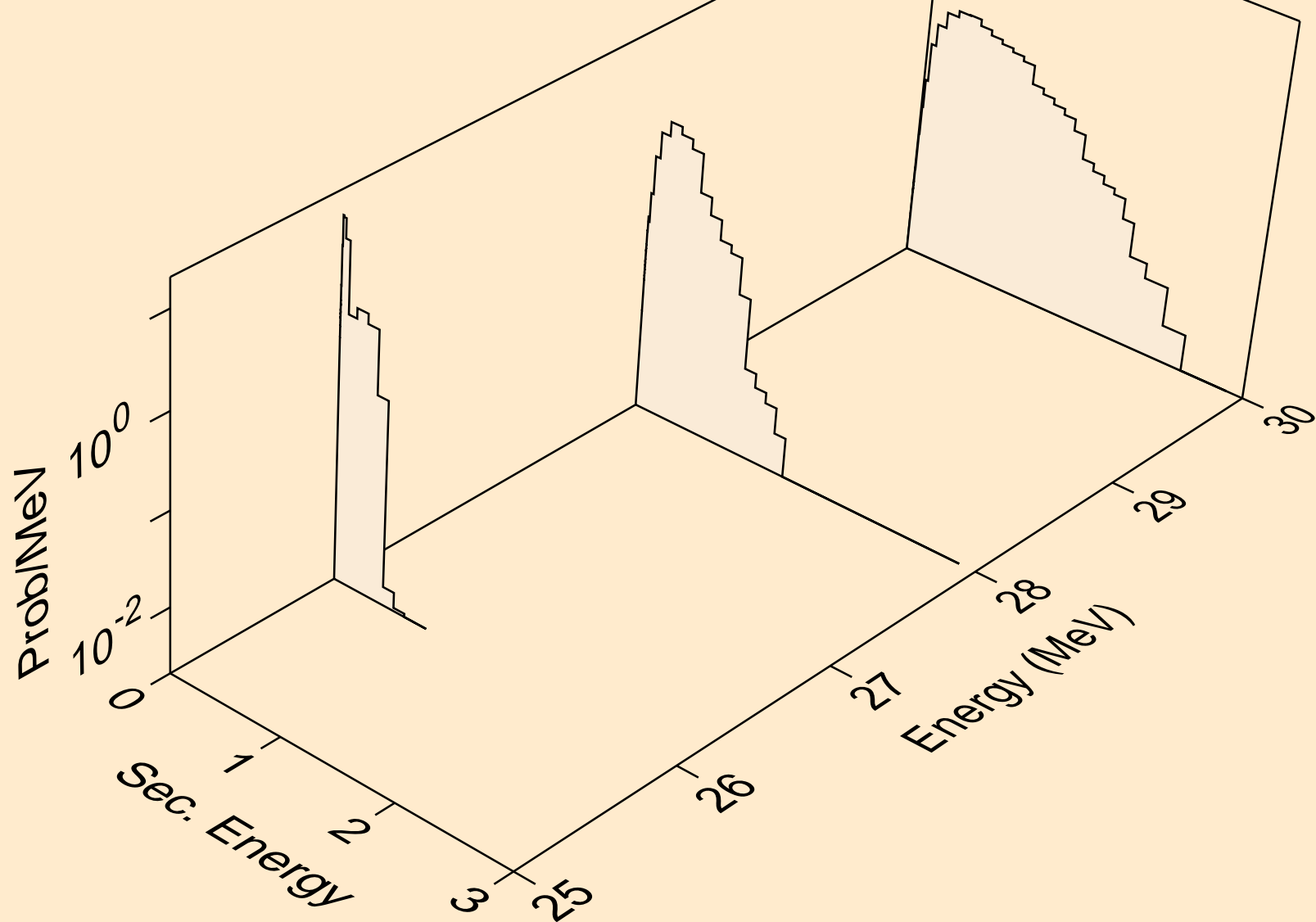

RB084M NEUTRON ACER TENDL-2021 LIBRARY; T=293.6K
Neutron emission for (n,2np)

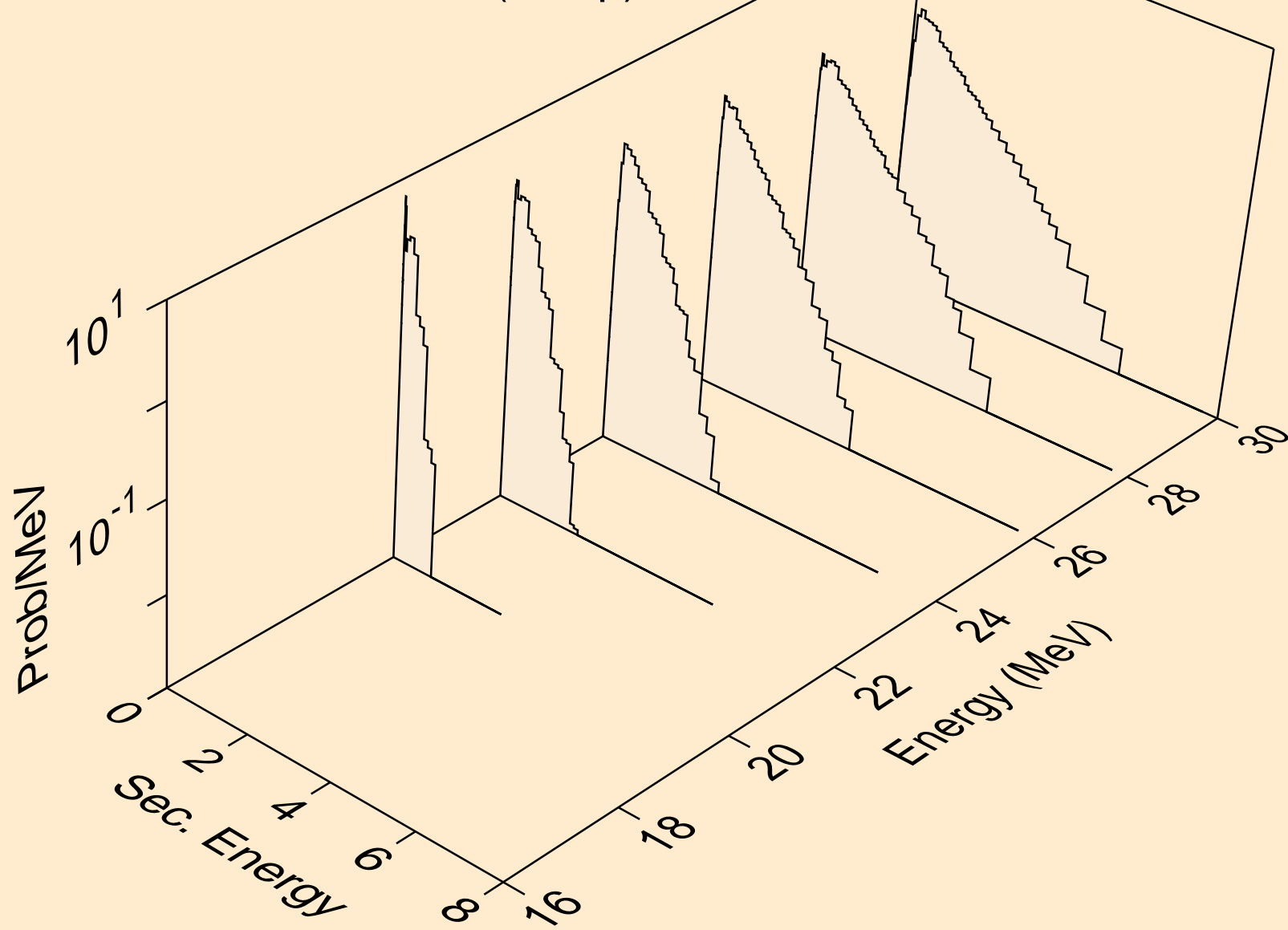

RB084M NEUTRON ACER TENDL-2021 LIBRARY; T=293.6K
Neutron emission for (n,npa)

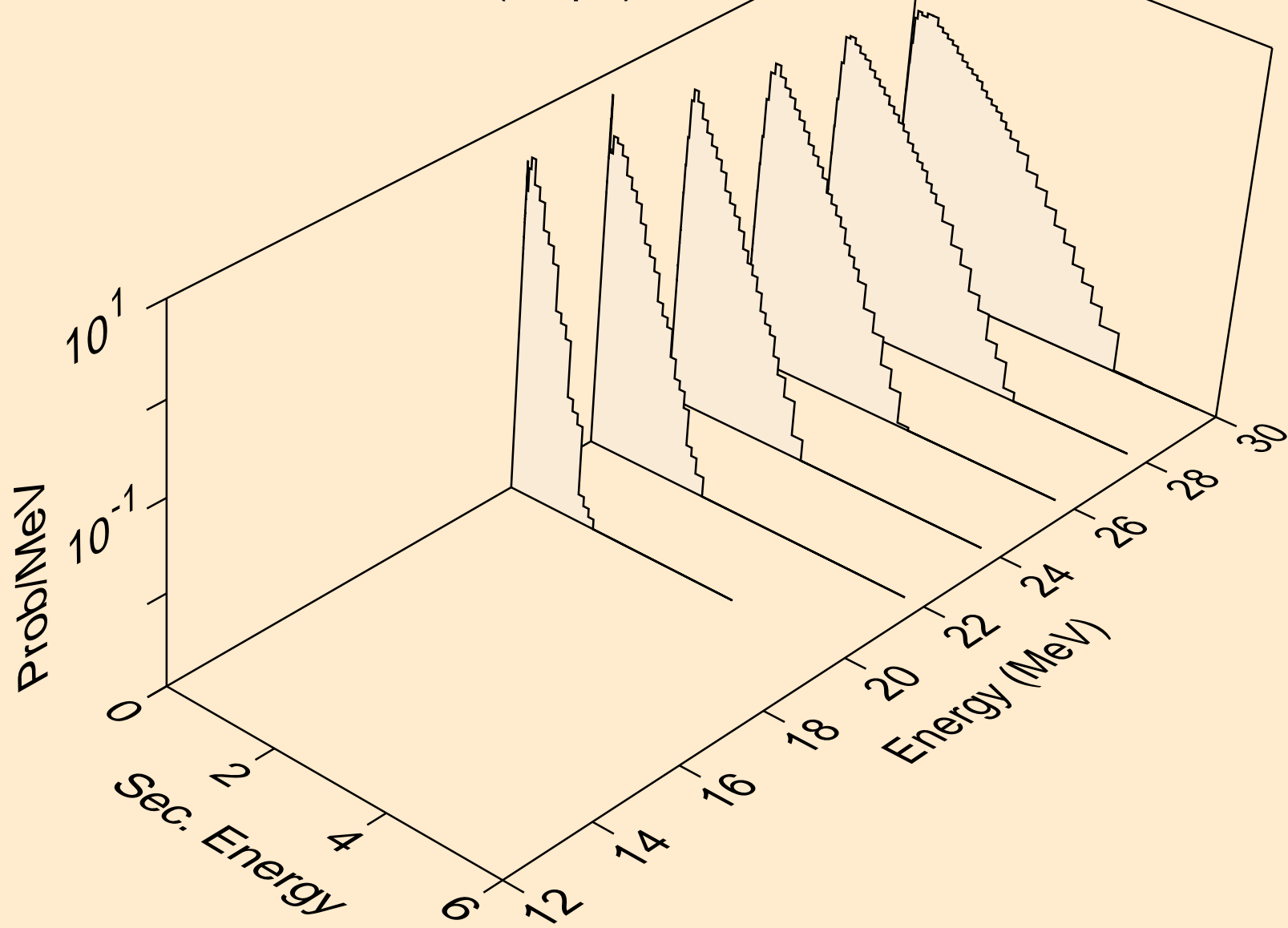

RB084M NEUTRON ACER TENDL-2021 LIBRARY; T=293.6K
Neutron emission for (n,n*c)

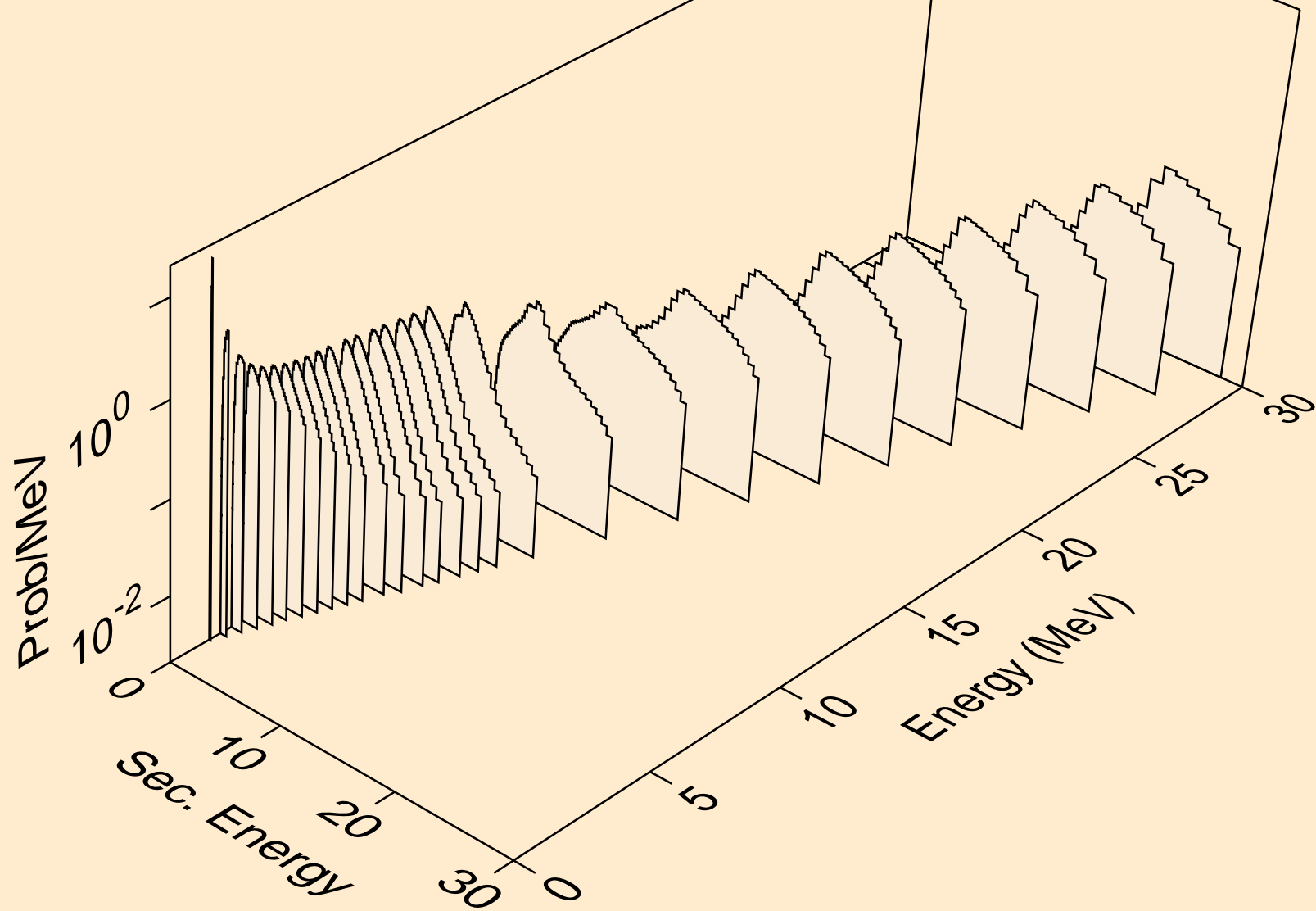

RB084M NEUTRON ACER TENDL-2021 LIBRARY; T=293.6K
Photon emission for (n,x)

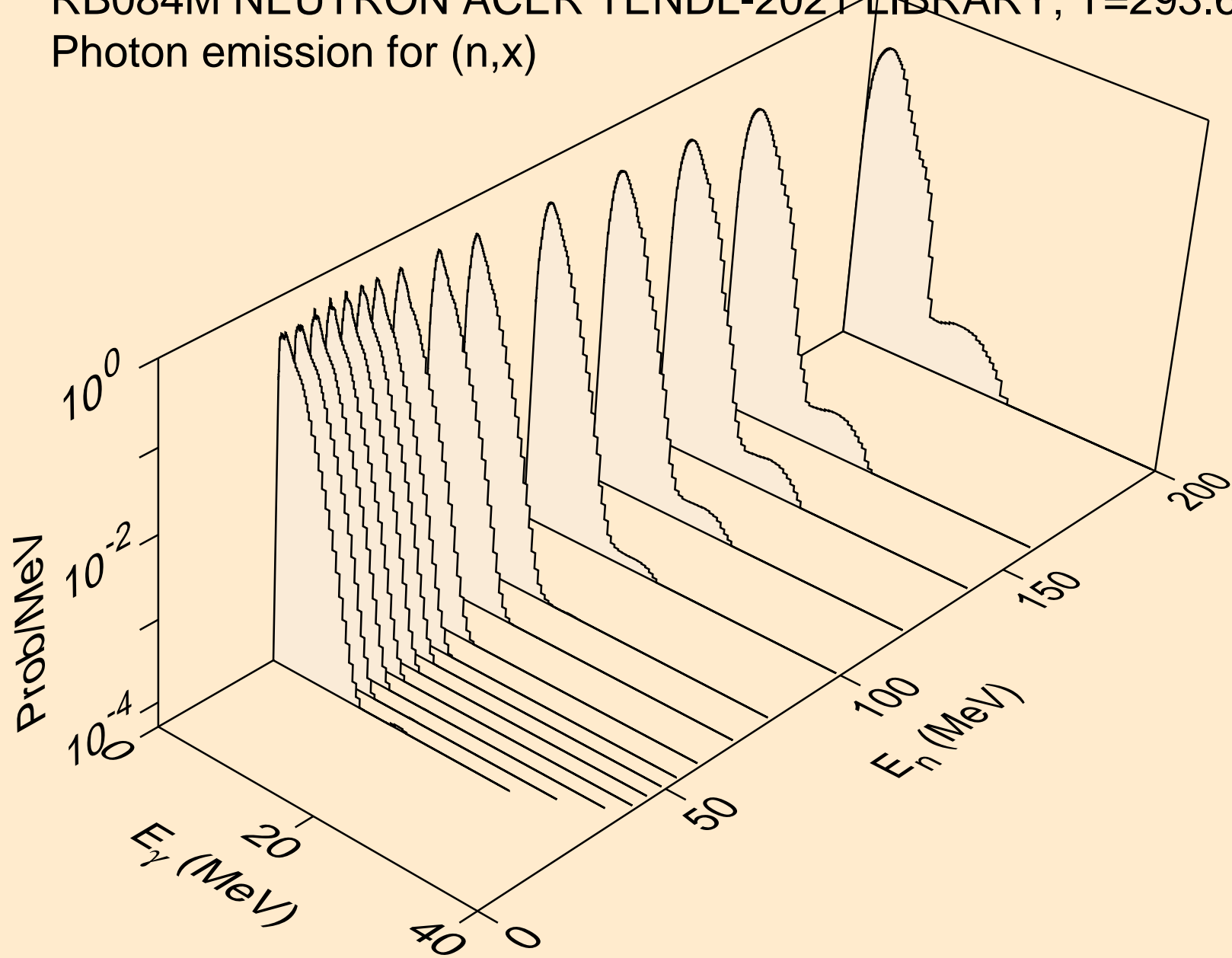

RB084M NEUTRON ACER TENDL-2021 LIBRARY; T=293.6K
Photon emission for (n,2nd)

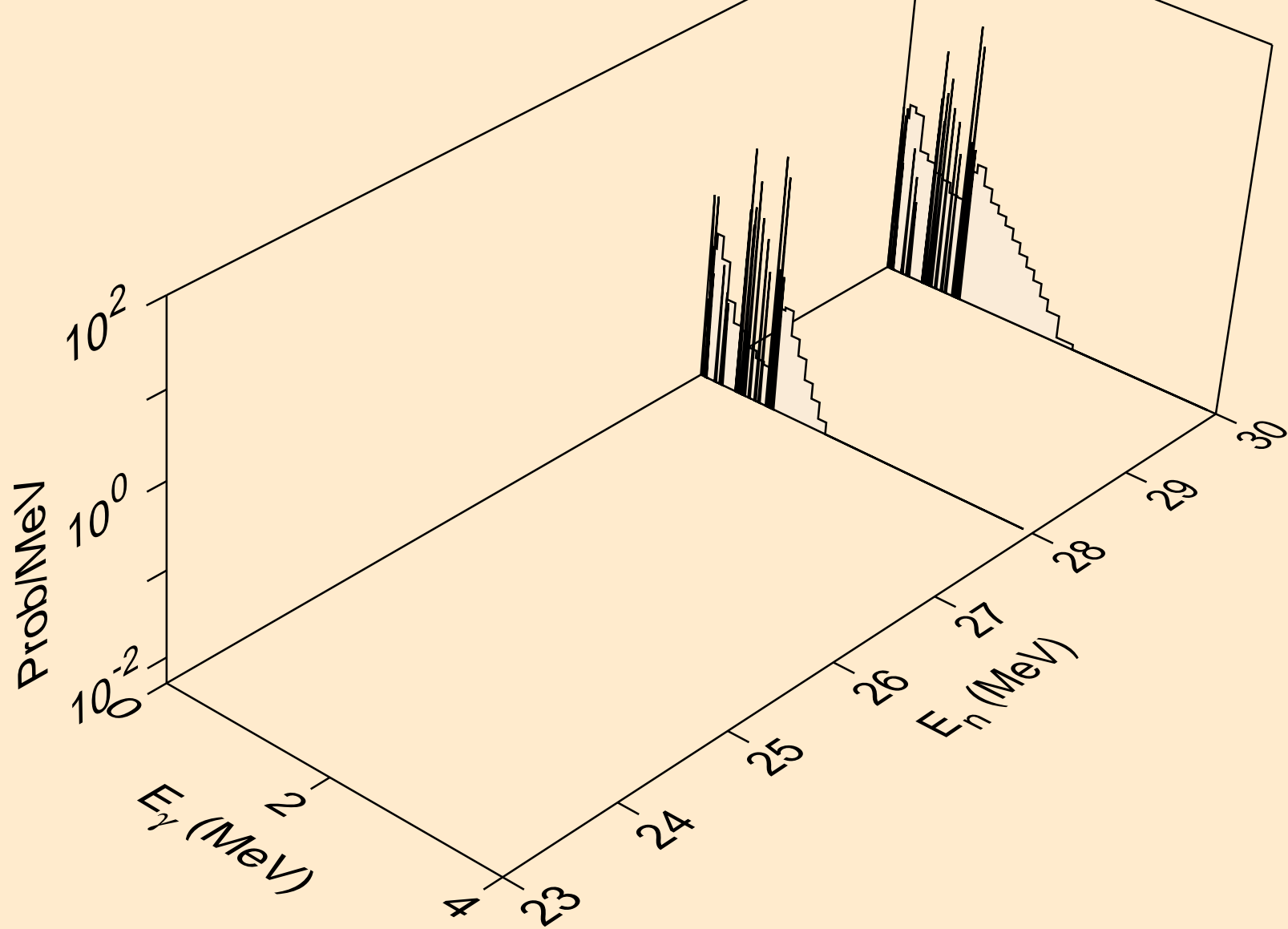

RB084M NEUTRON ACER TENDL-2021 LIBRARY; T=293.6K
Photon emission for (n,2n)

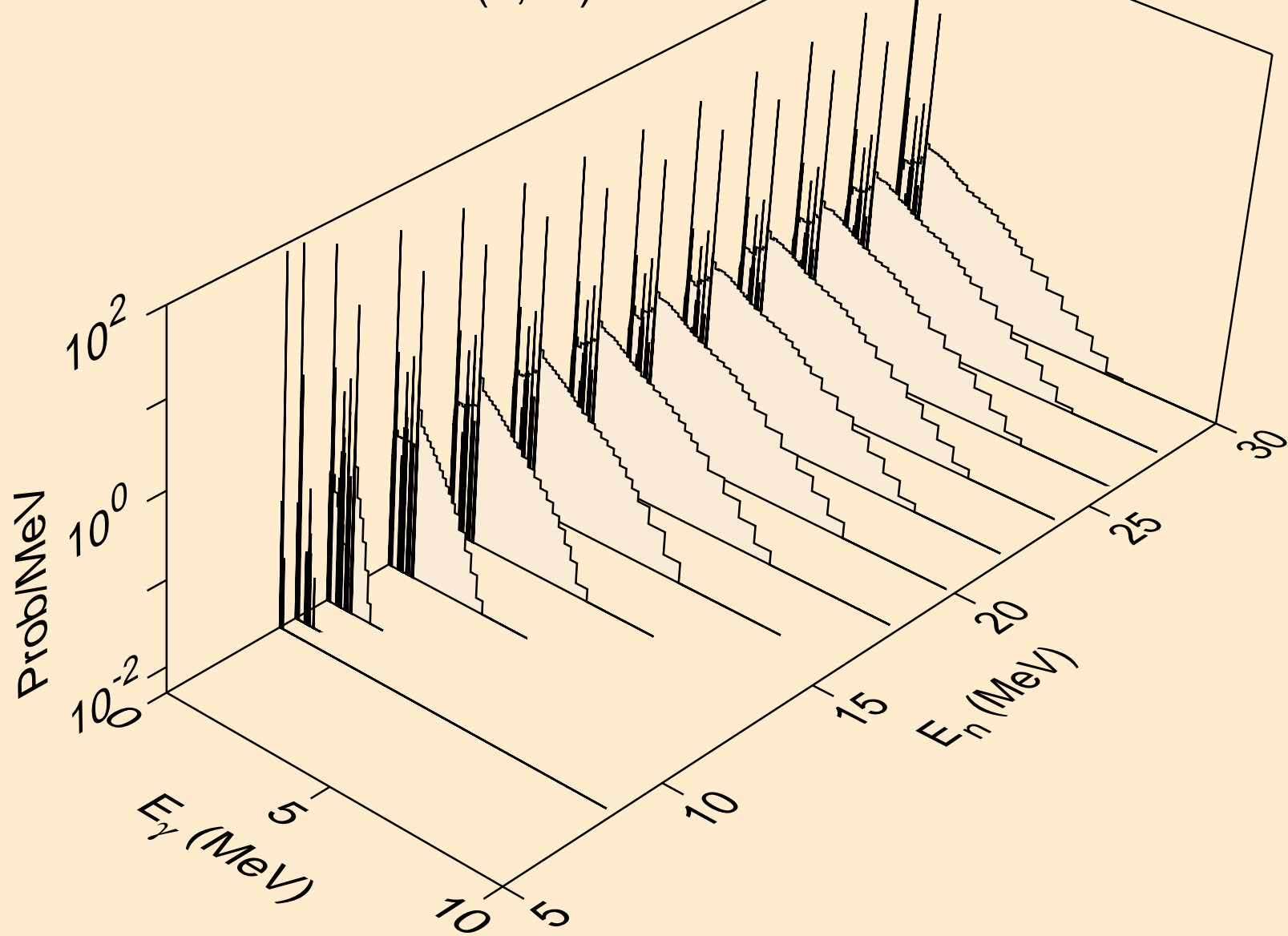

RB084M NEUTRON ACER TENDL-2021 LIBRARY; T=293.6K
Photon emission for (n,3n)

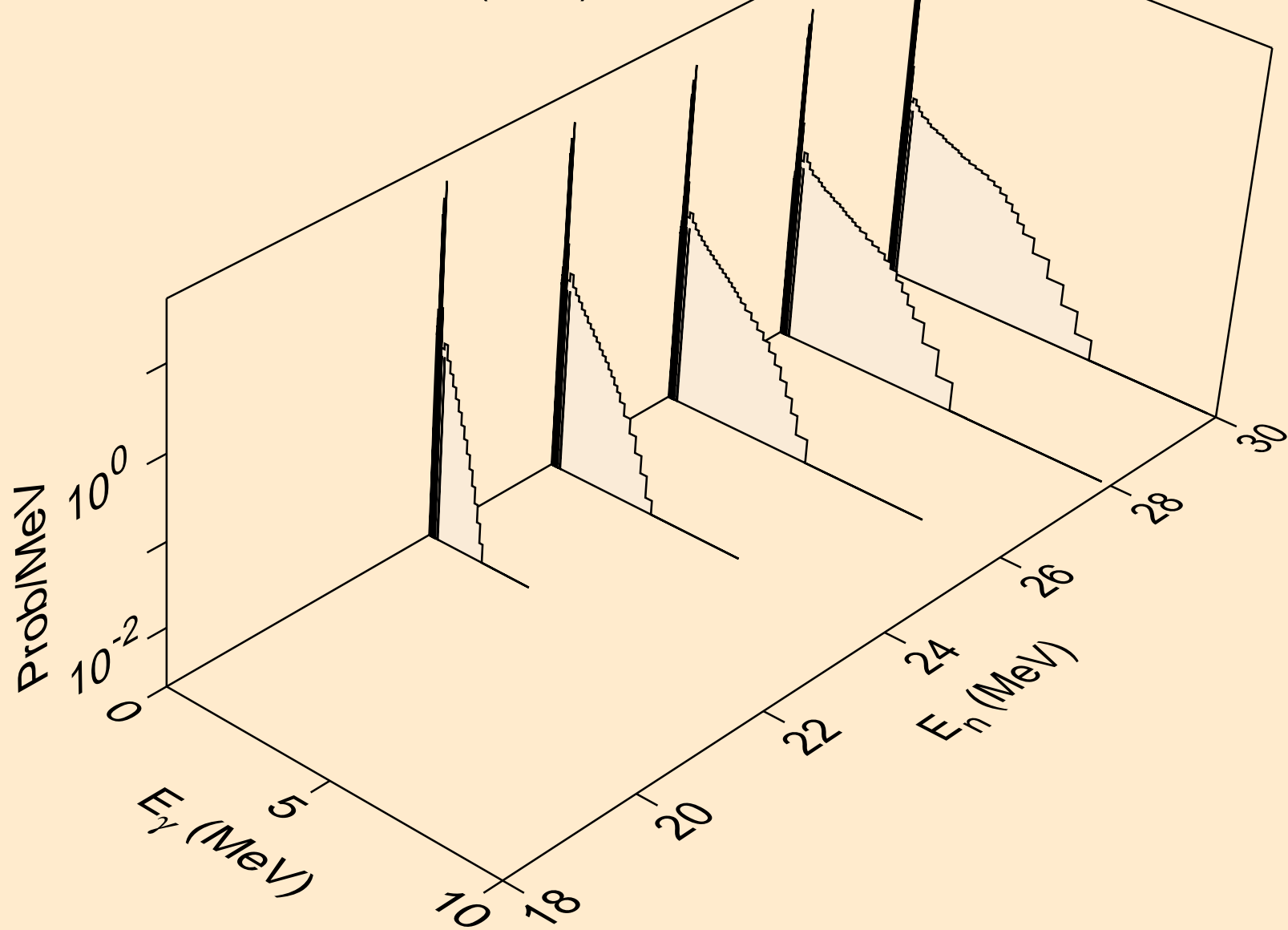

RB084M NEUTRON ACER TENDL-2021 LIBRARY; T=293.6K
Photon emission for (n,n*)a

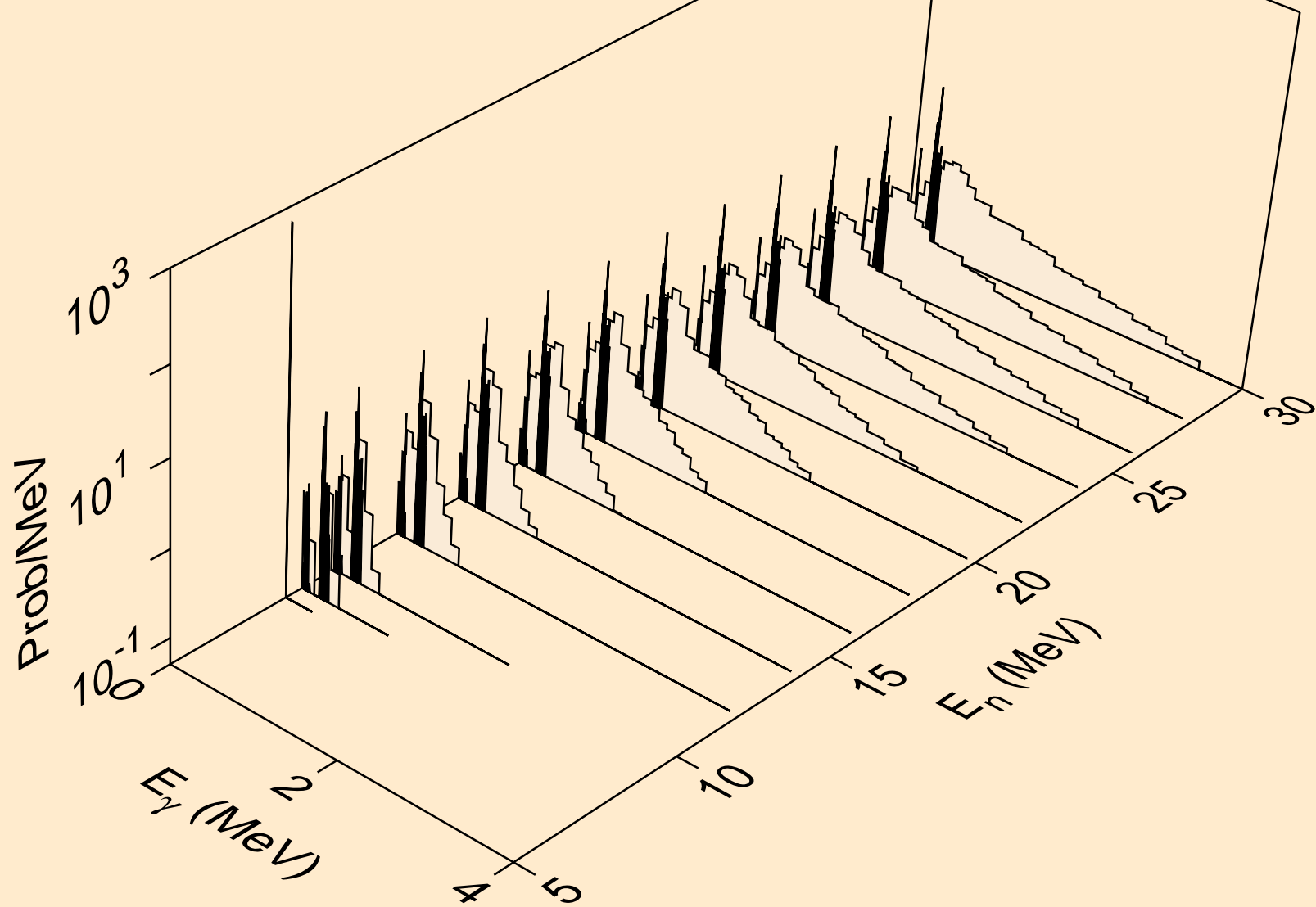

RB084M NEUTRON ACER TENDL-2021 LIBRARY; T=293.6K
Photon emission for (n,2n)a

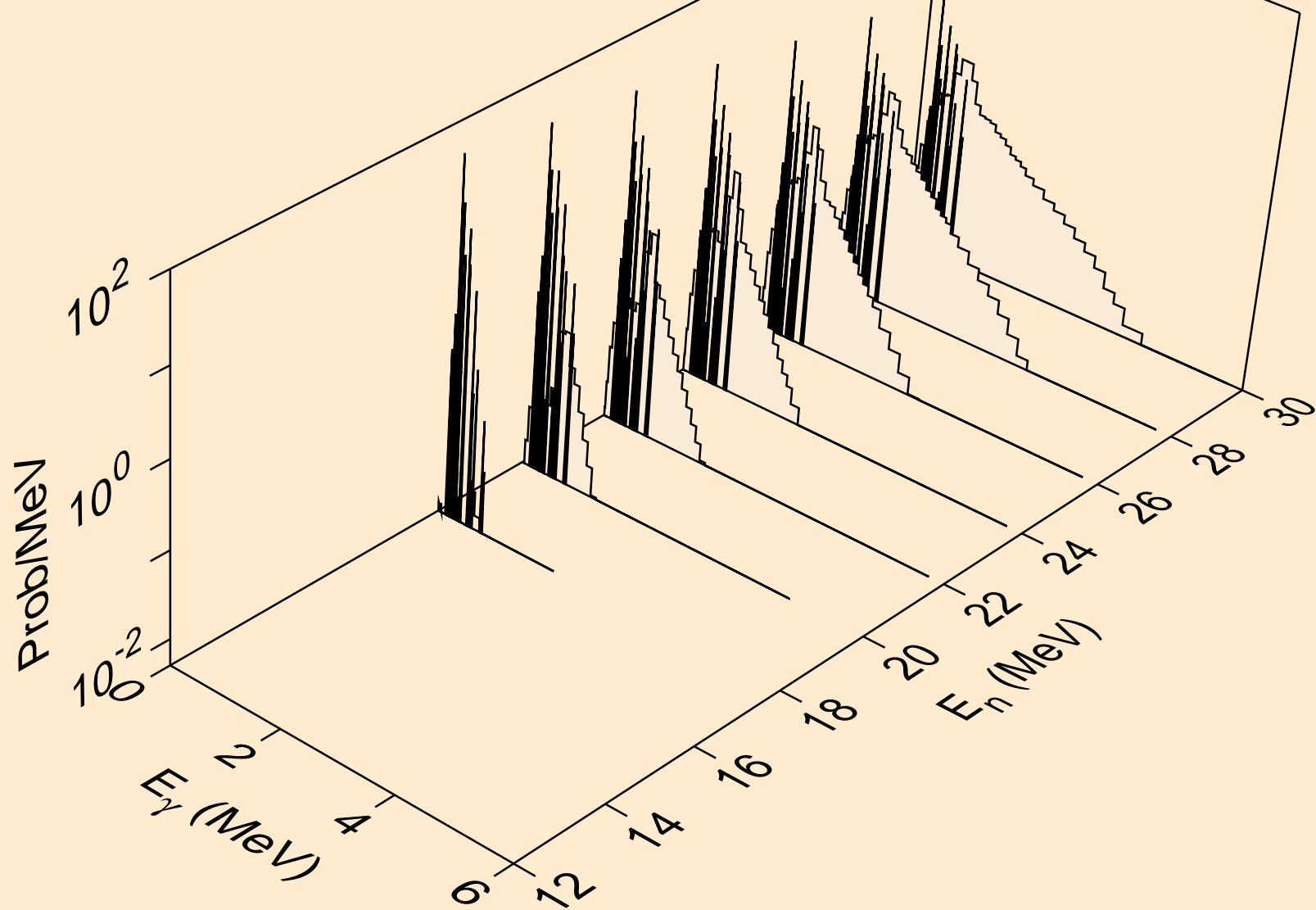

RB084M NEUTRON ACER TENDL-2021 LIBRARY; T=293.6K
Photon emission for (n,n*)p

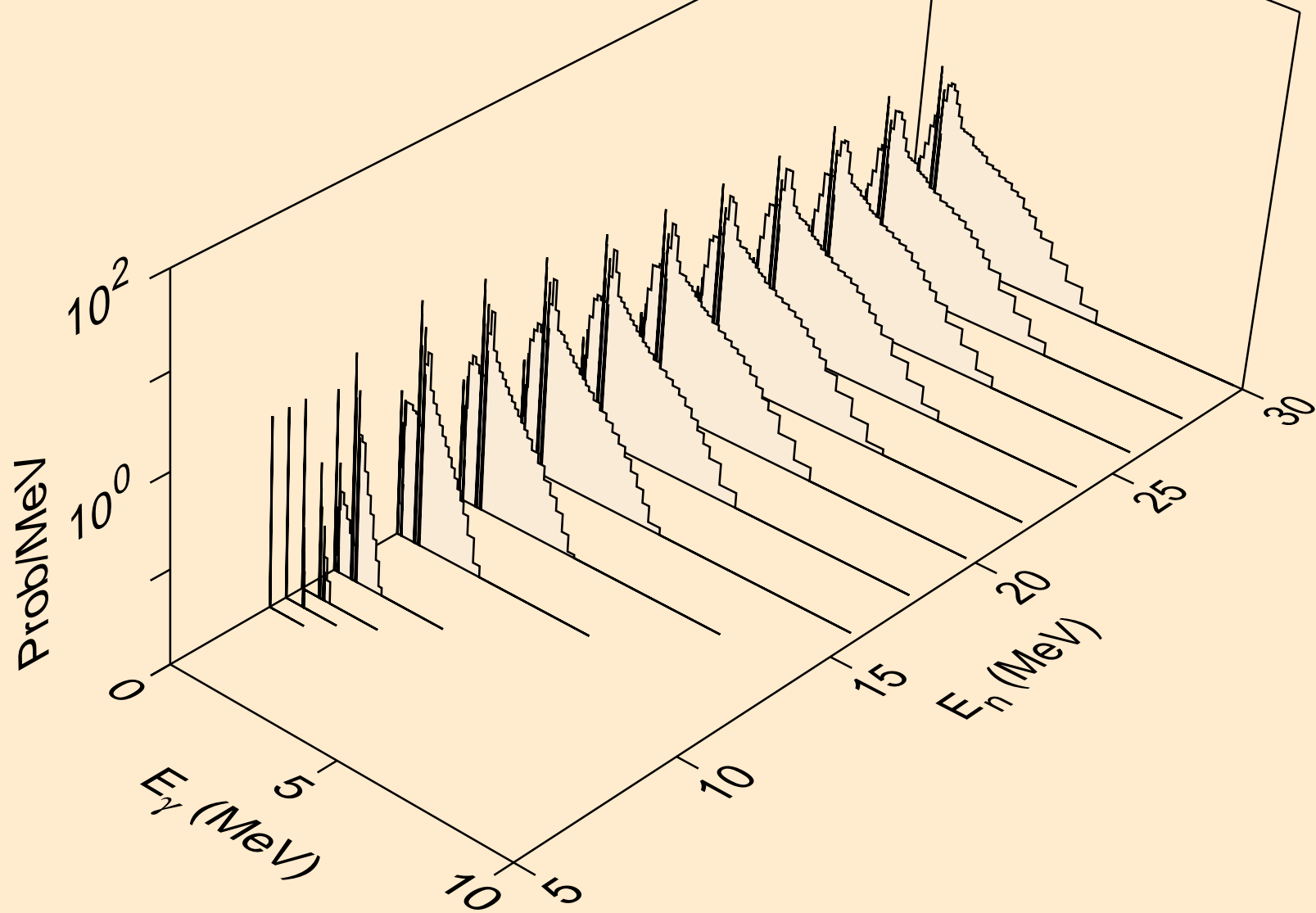

RB084M NEUTRON ACER TENDL-2021 LIBRARY; T=293.6K
Photon emission for (n,n*)2a

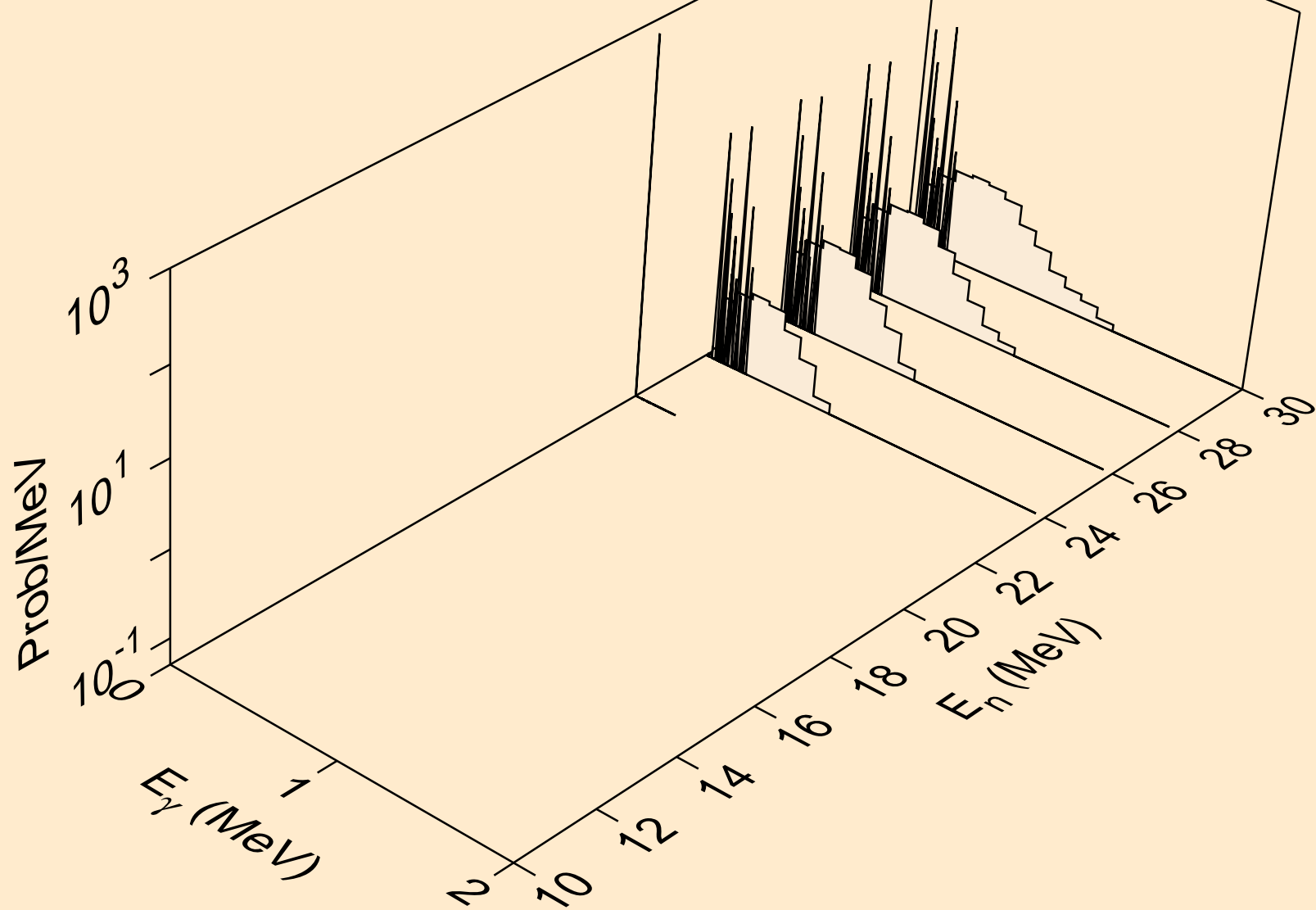

RB084M NEUTRON ACER TENDL-2021 LIBRARY; T=293.6K
Photon emission for (n,n*)d

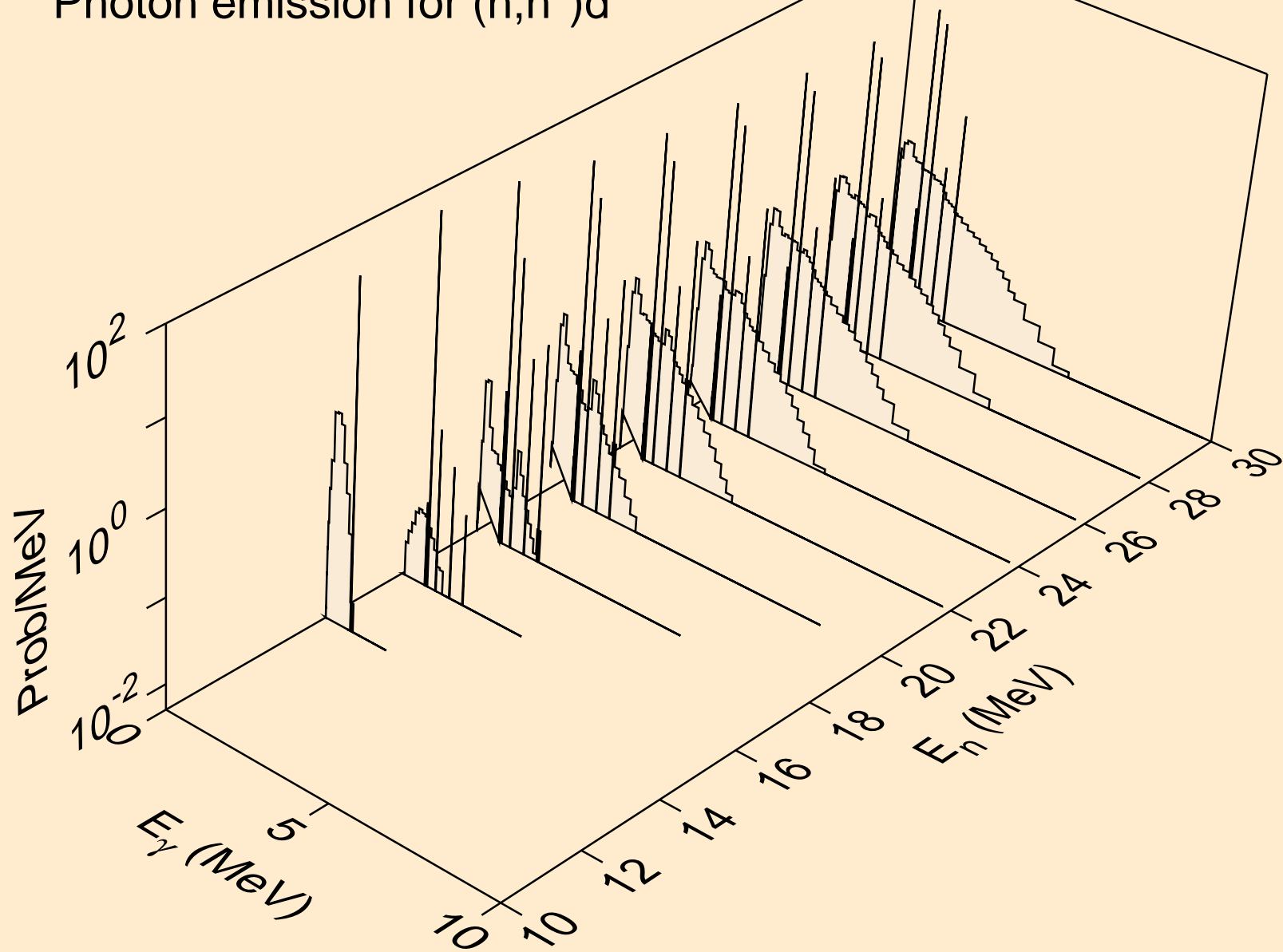

RB084M NEUTRON ACER TENDL-2021 LIBRARY; T=293.6K
Photon emission for (n,n*)t

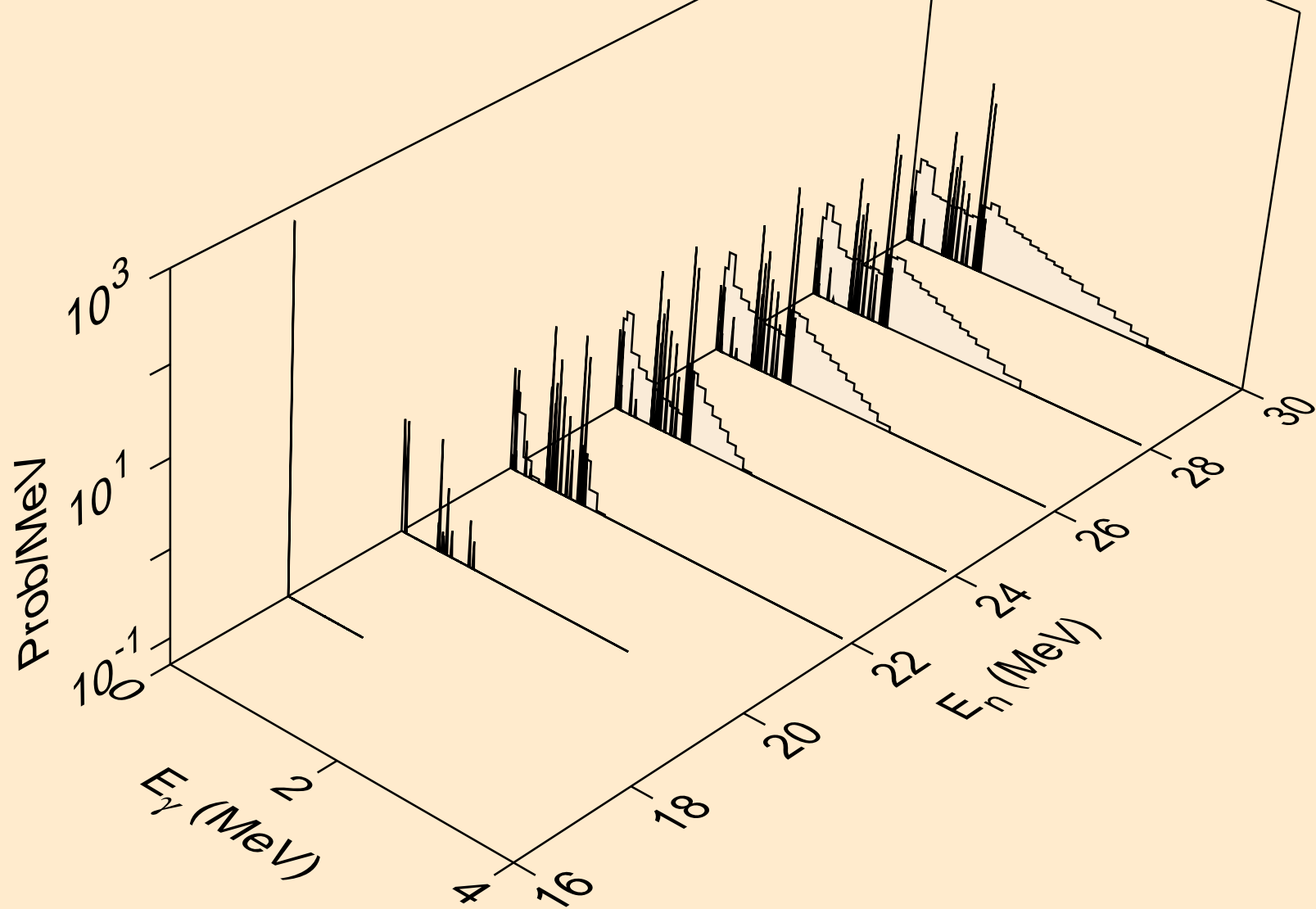

RB084M NEUTRON ACER TENDL-2021 LIBRARY; T=293.6K
Photon emission for (n,n*)he3

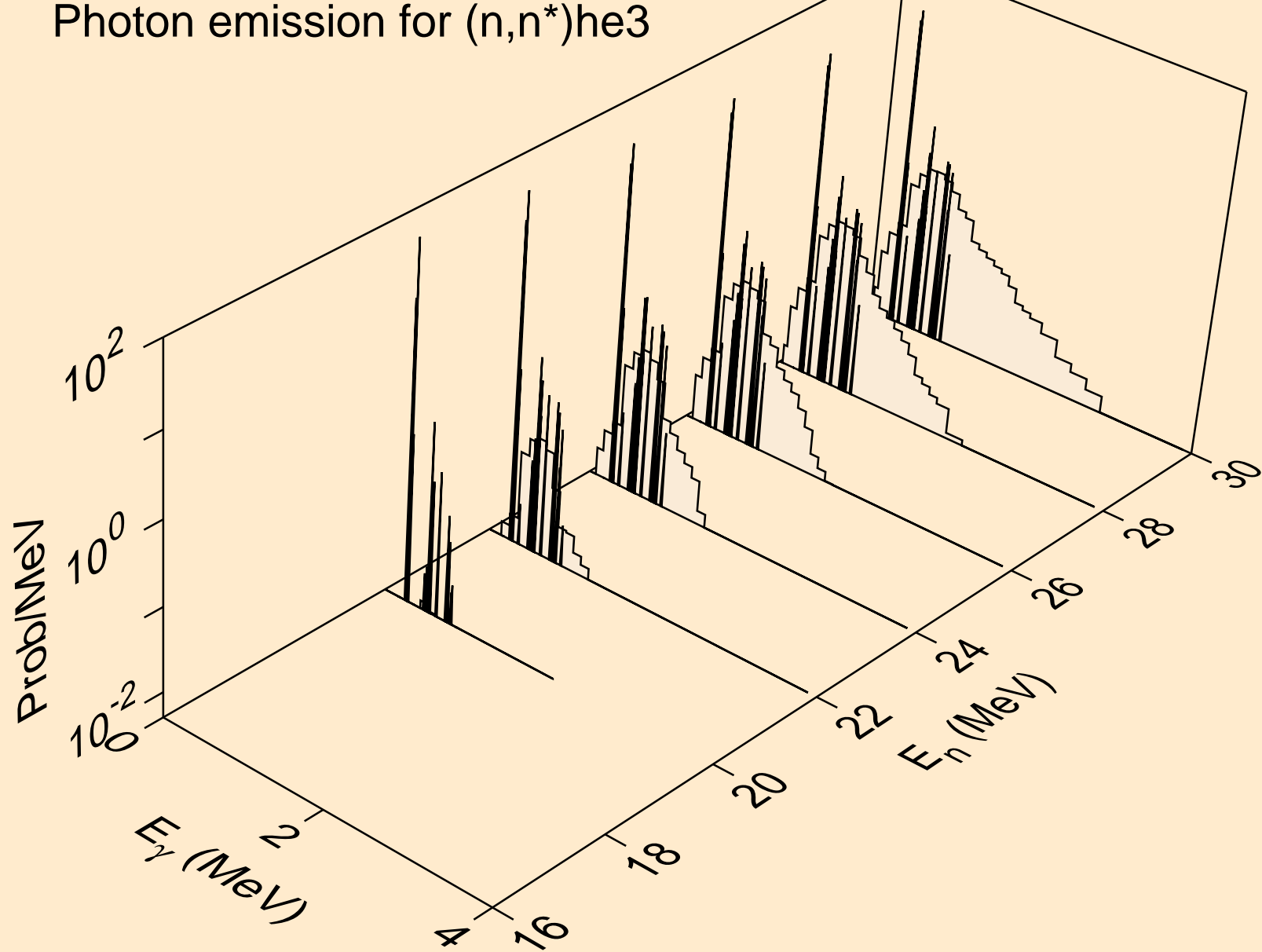

RB084M NEUTRON ACER TENDL-2021 LIBRARY; T=293.6K
Photon emission for (n,4n)

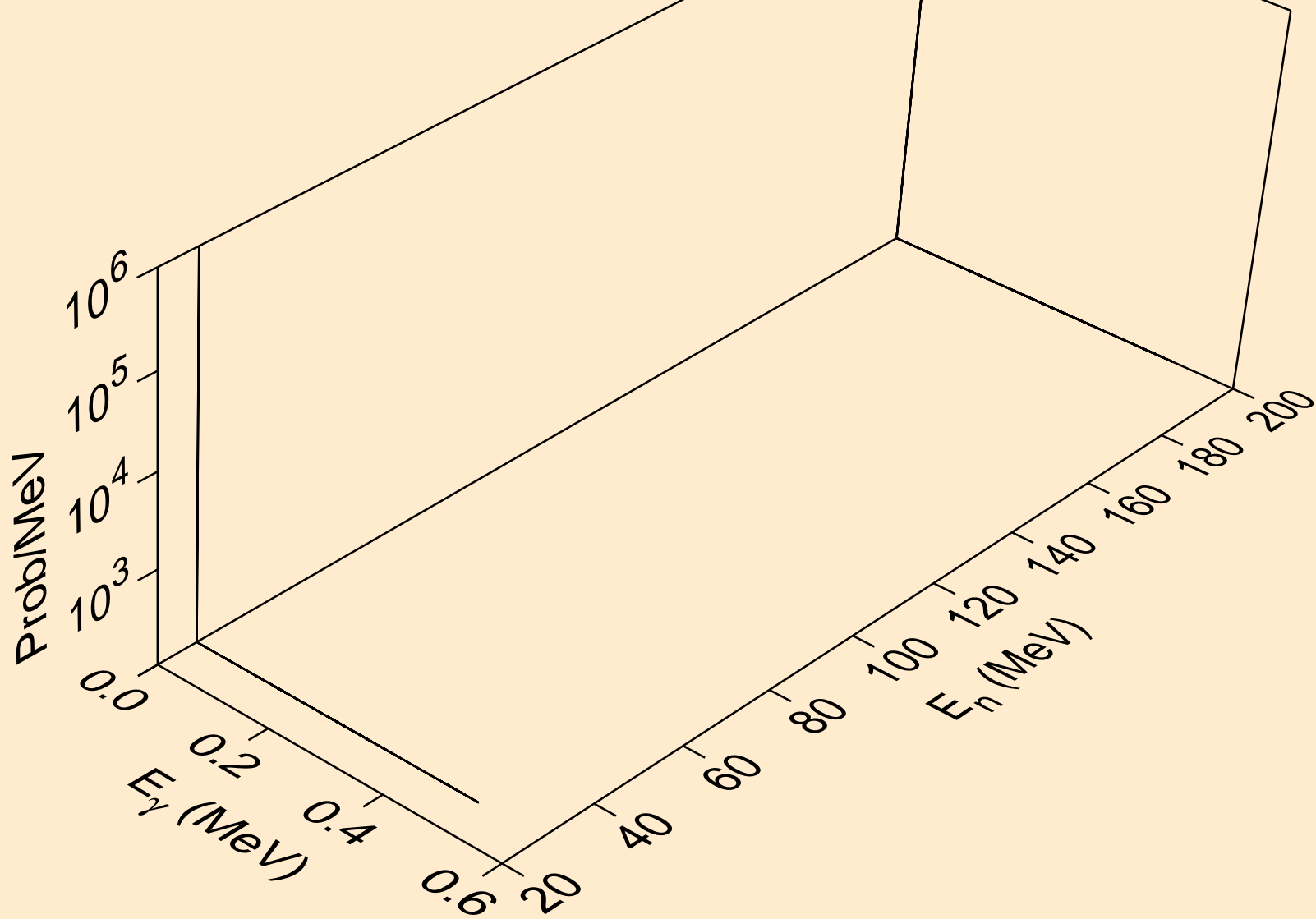

RB084M NEUTRON ACER TENDL-2021 LIBRARY; T=293.6K
Photon emission for (n,2np)

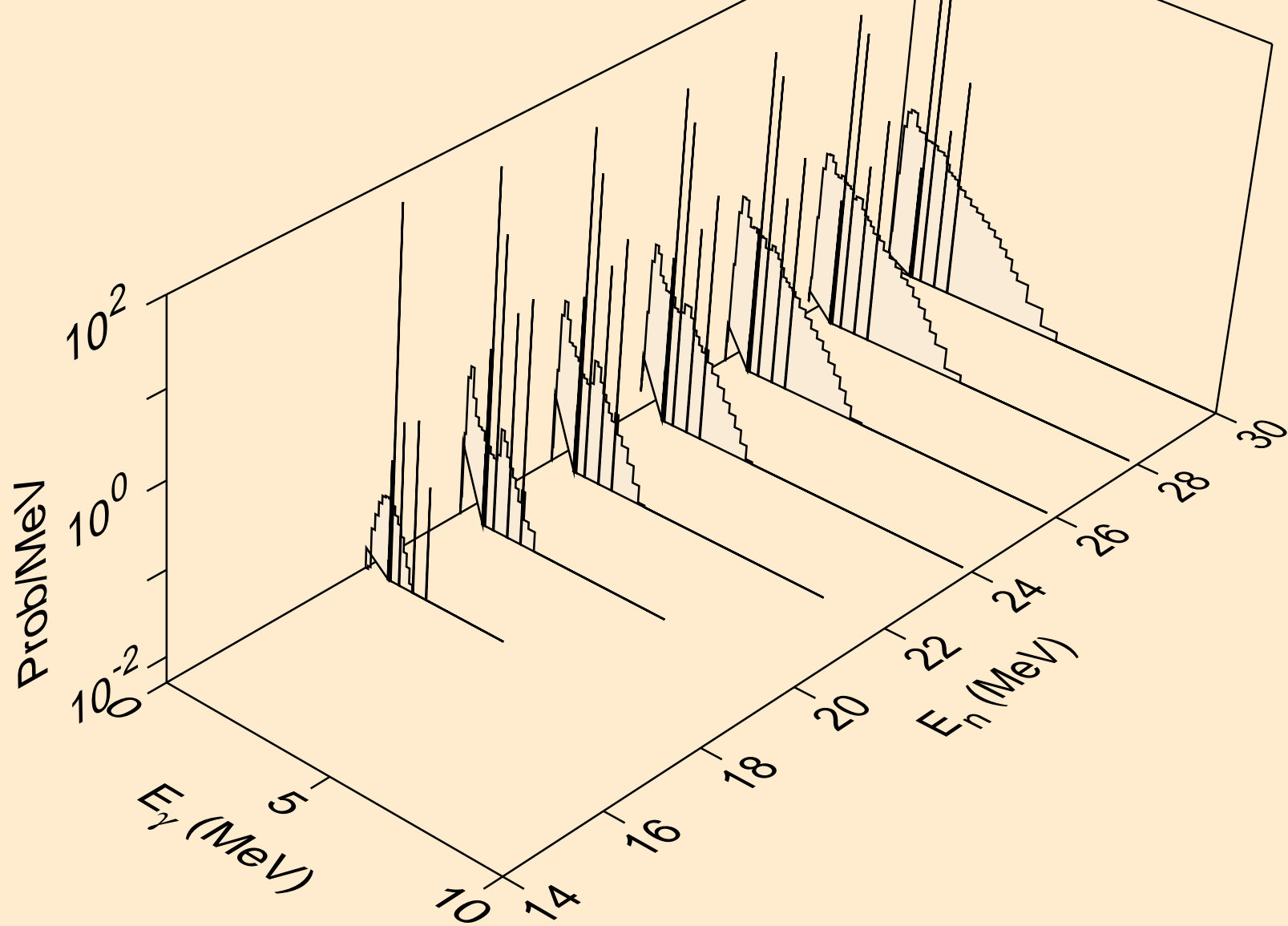

RB084M NEUTRON ACER TENDL-2021 LIBRARY; T=293.6K
Photon emission for (n,3np)

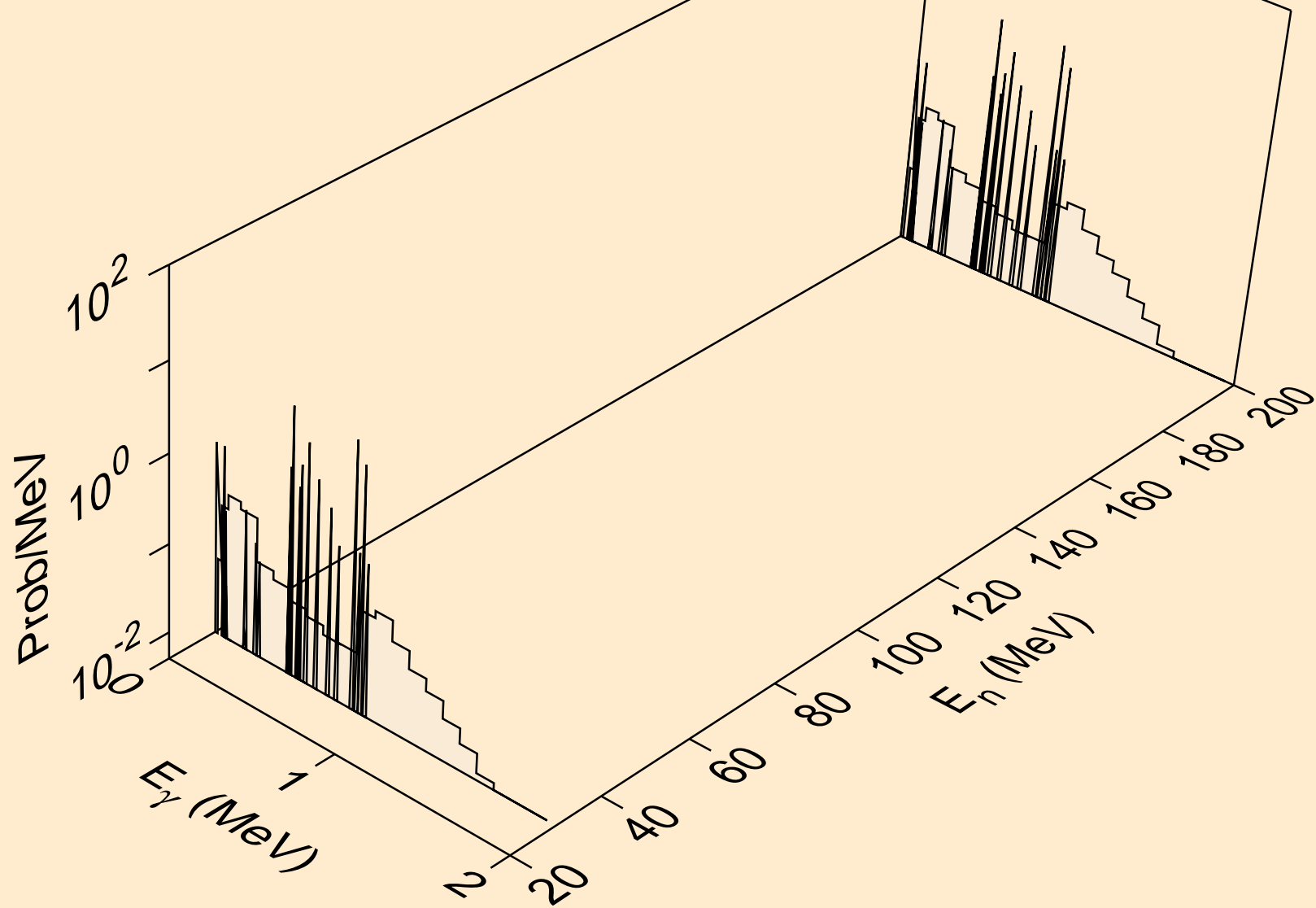

RB084M NEUTRON ACER TENDL-2021 LIBRARY; T=293.6K
Photon emission for (n,2np)

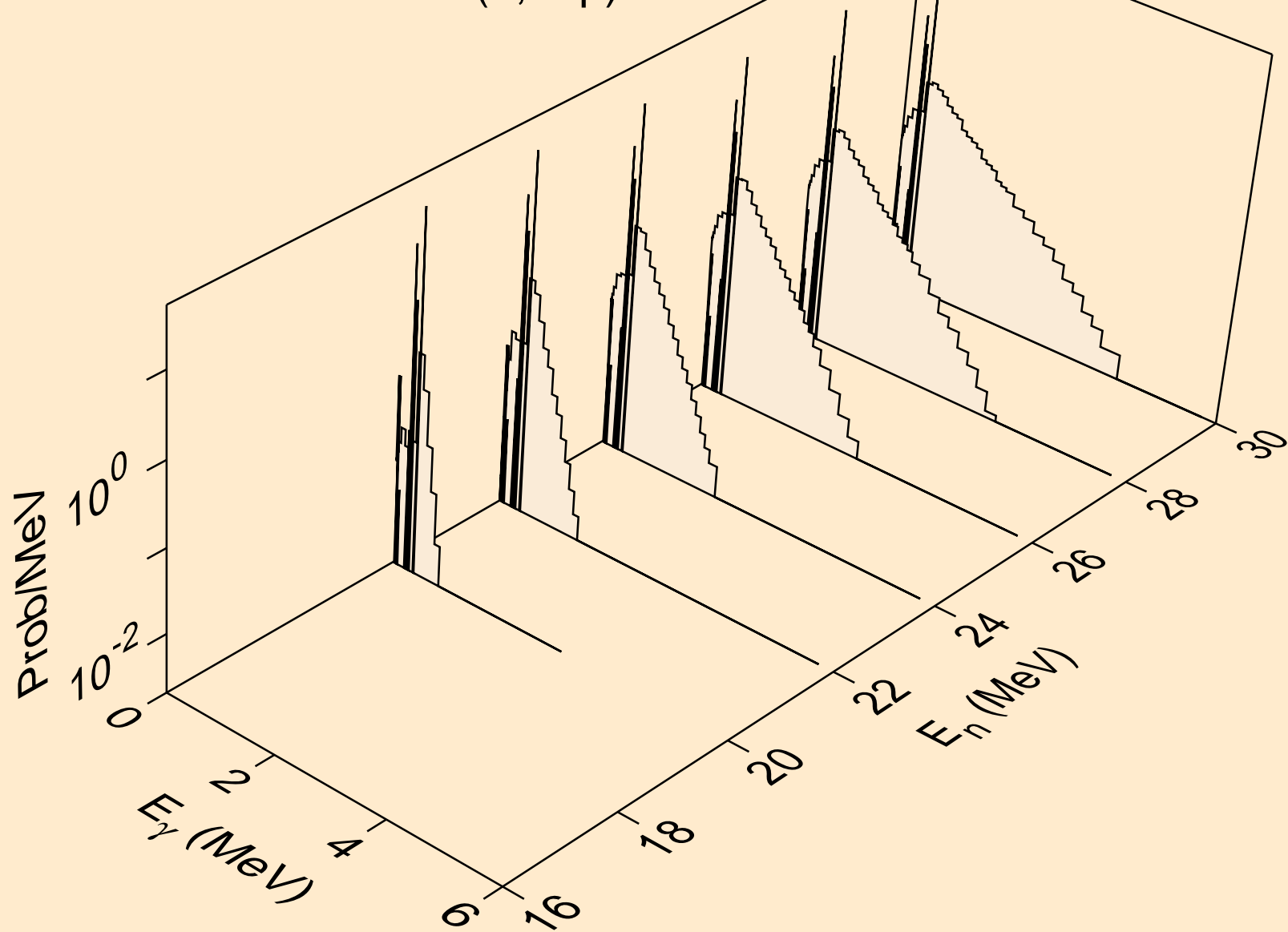

RB084M NEUTRON ACER TENDL-2021 LIBRARY; T=293.6K
Photon emission for (n,npa)

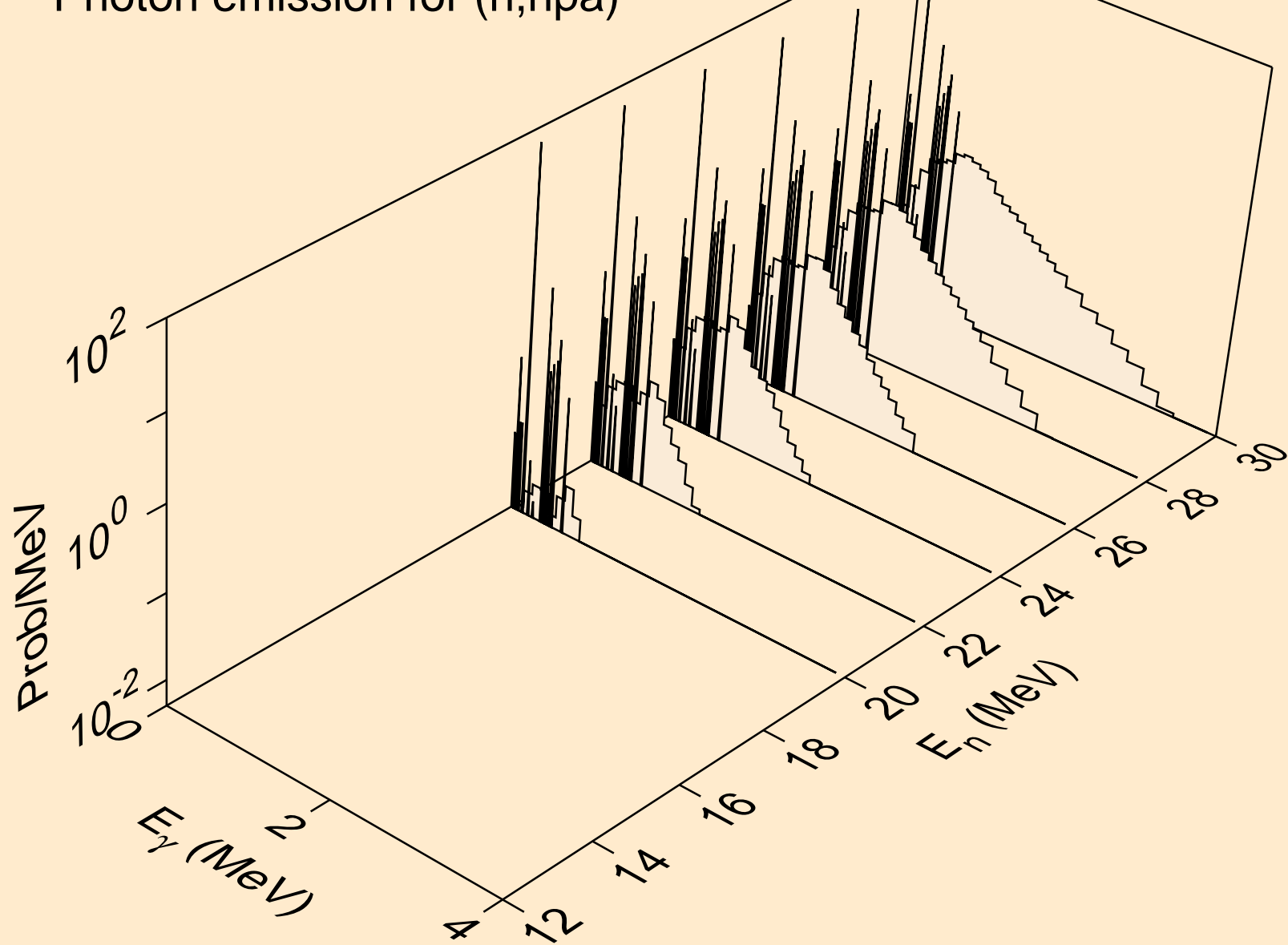

RB084M NEUTRON ACER TENDL-2021 LIBRARY; T=293.6K
Photon emission for (n,n*1)

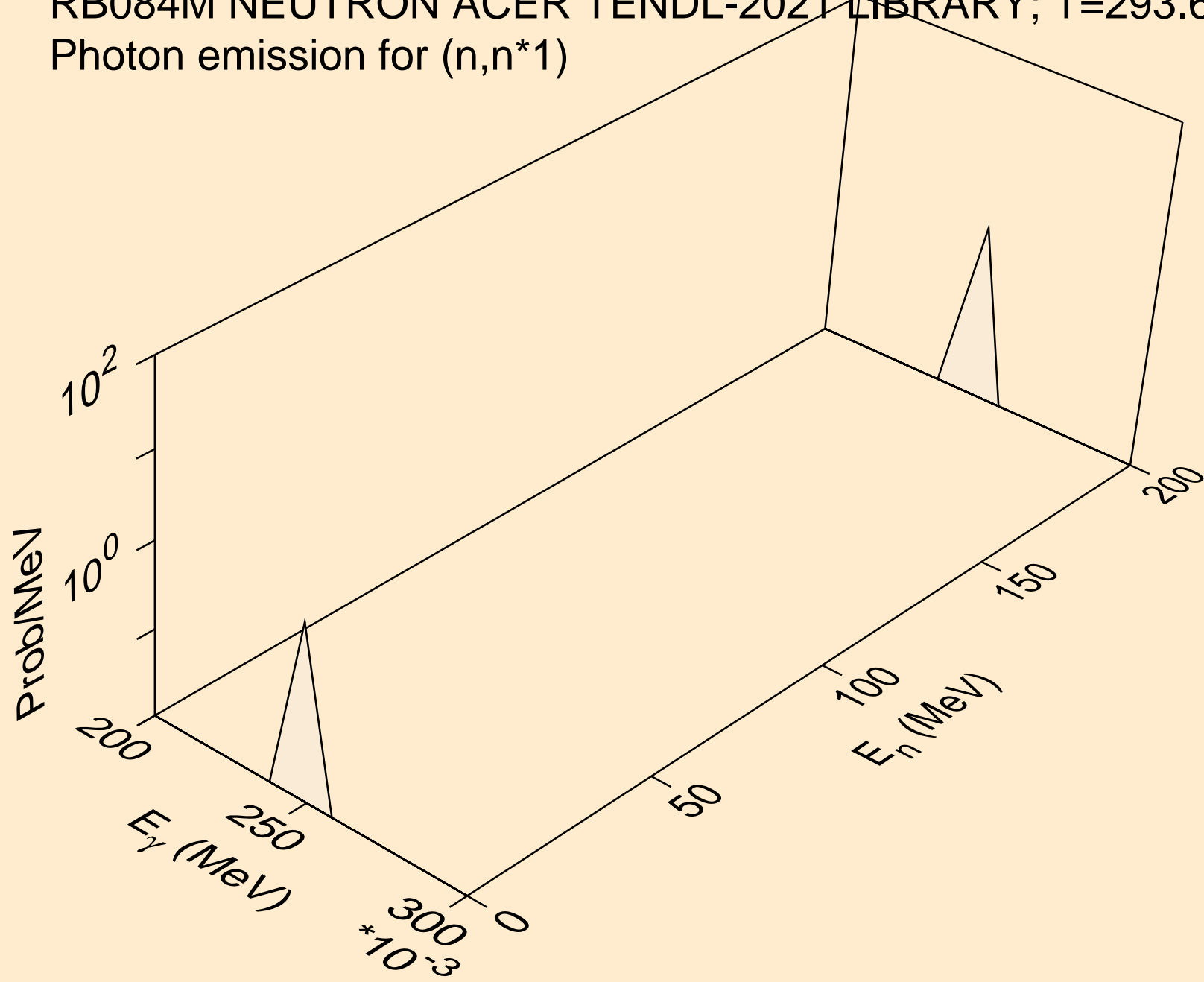

RB084M NEUTRON ACER TENDL-2021 LIBRARY; T=293.6K
Photon emission for (n,n*3)

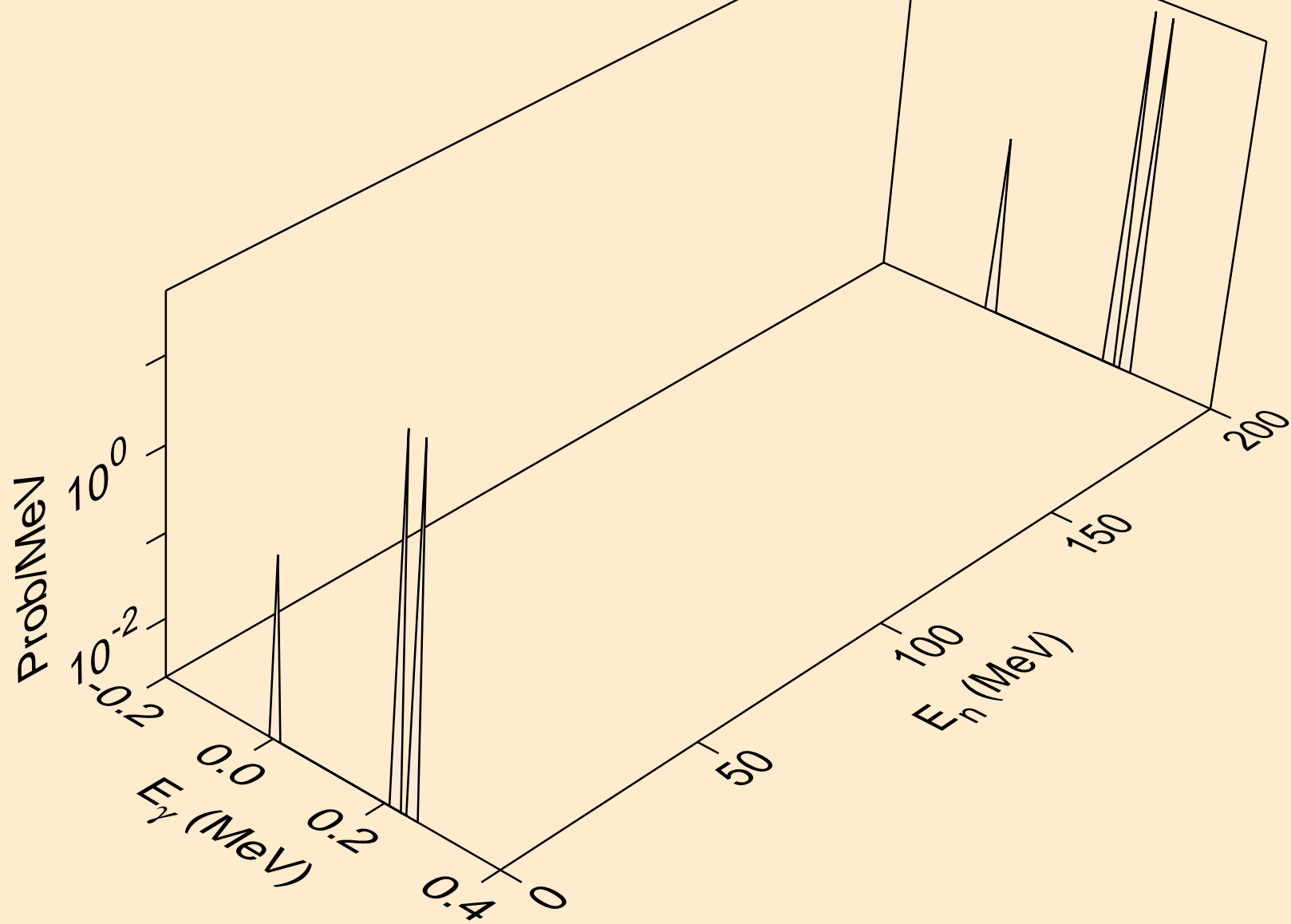

RB084M NEUTRON ACER TENDL-2021 LIBRARY; T=293.6K
Photon emission for (n,n*4)

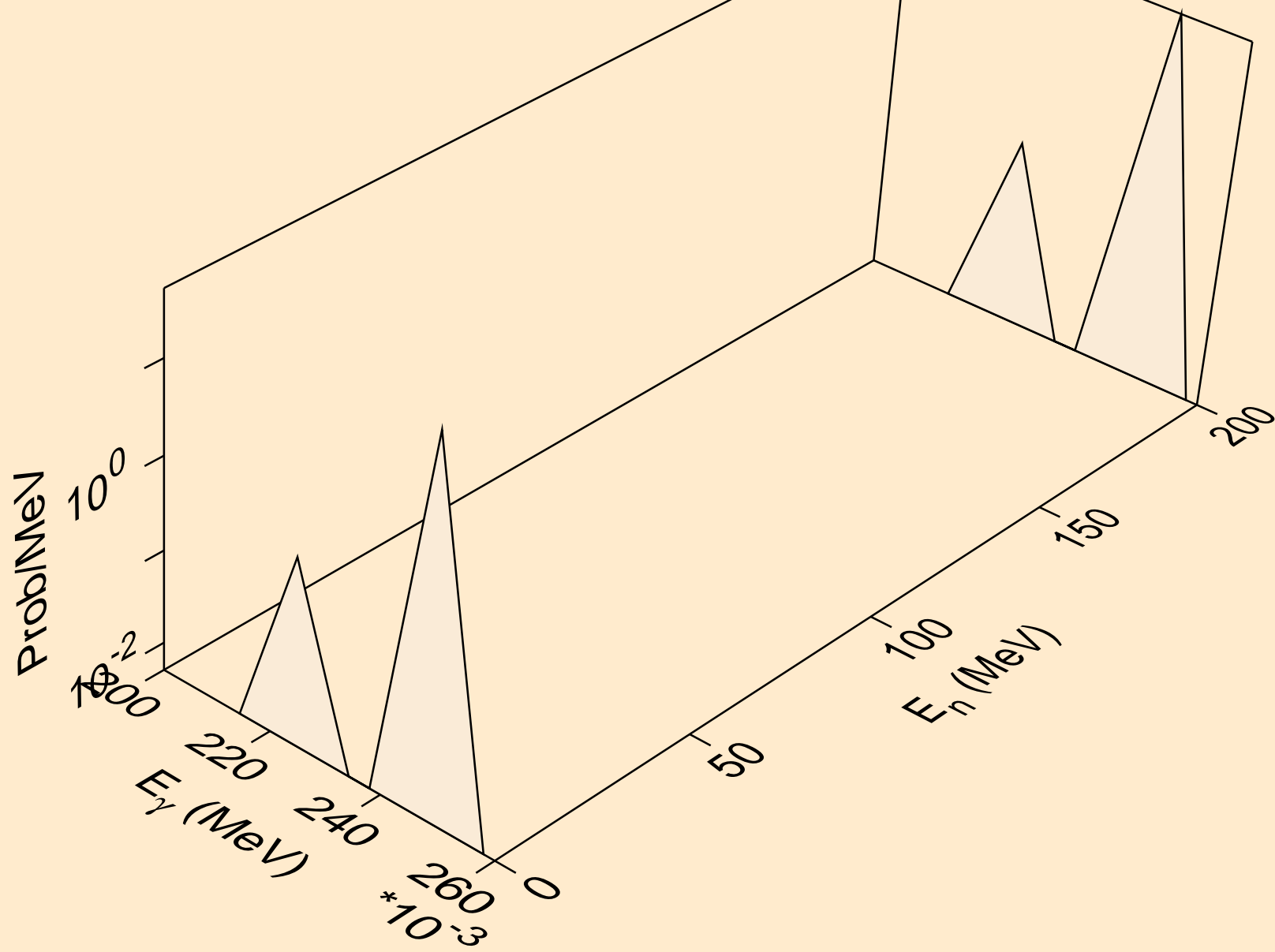

RB084M NEUTRON ACER TENDL-2021 LIBRARY; T=293.6K
Photon emission for (n,n*5)

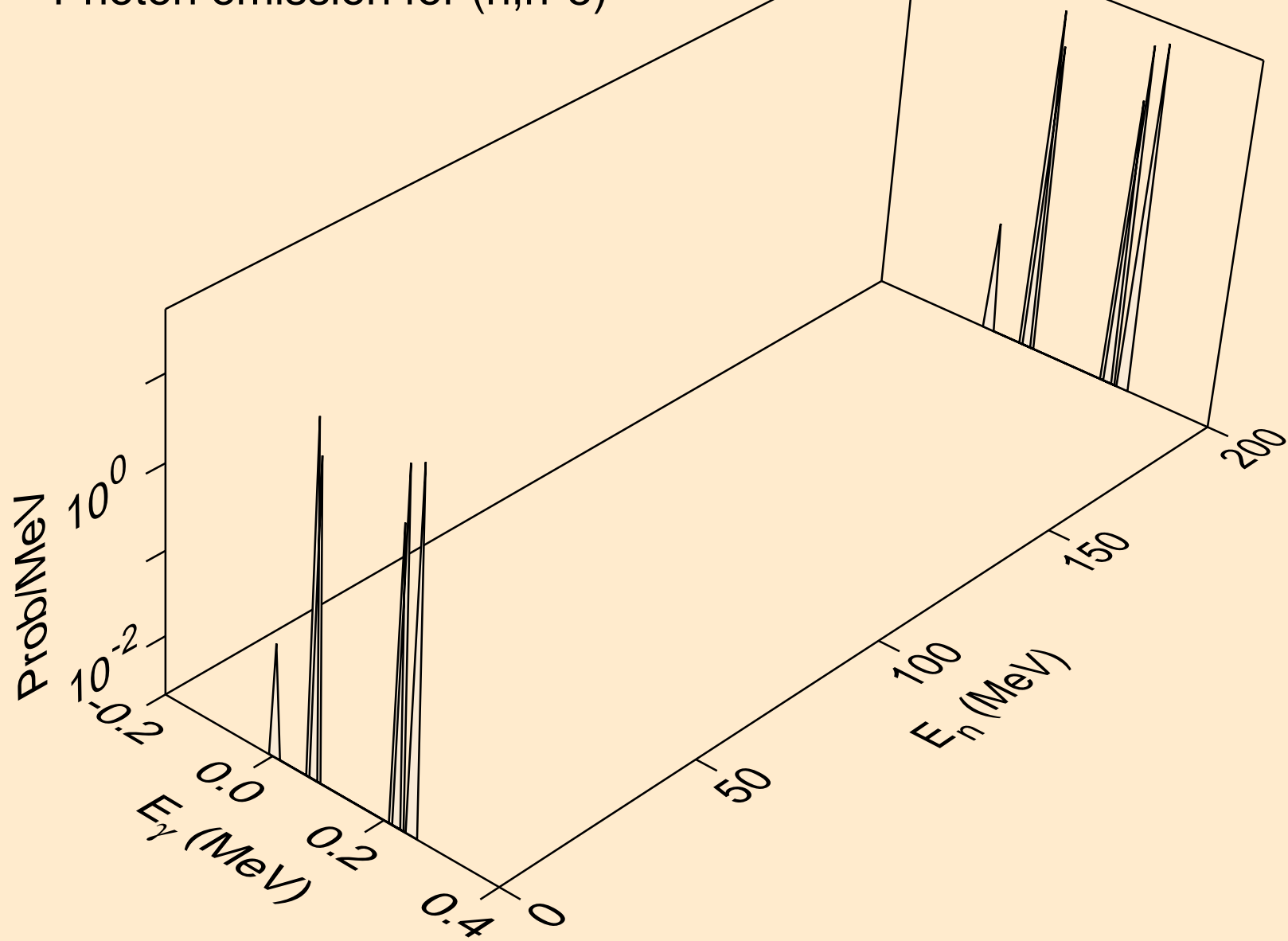

RB084M NEUTRON ACER TENDL-2021 LIBRARY; T=293.6K
Photon emission for (n,n*6)

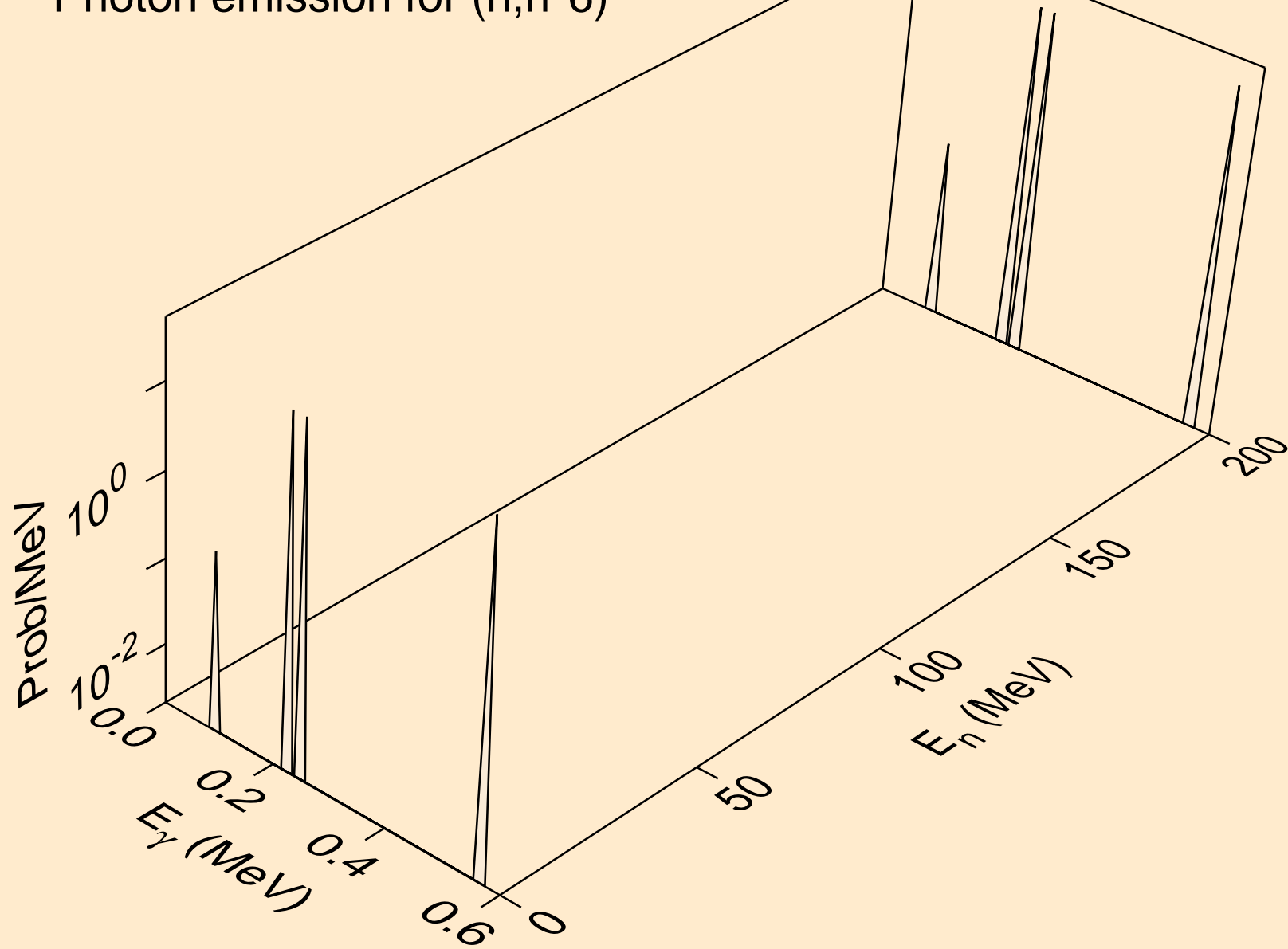

RB084M NEUTRON ACER TENDL-2021 LIBRARY; T=293.6K
Photon emission for (n,n*7)

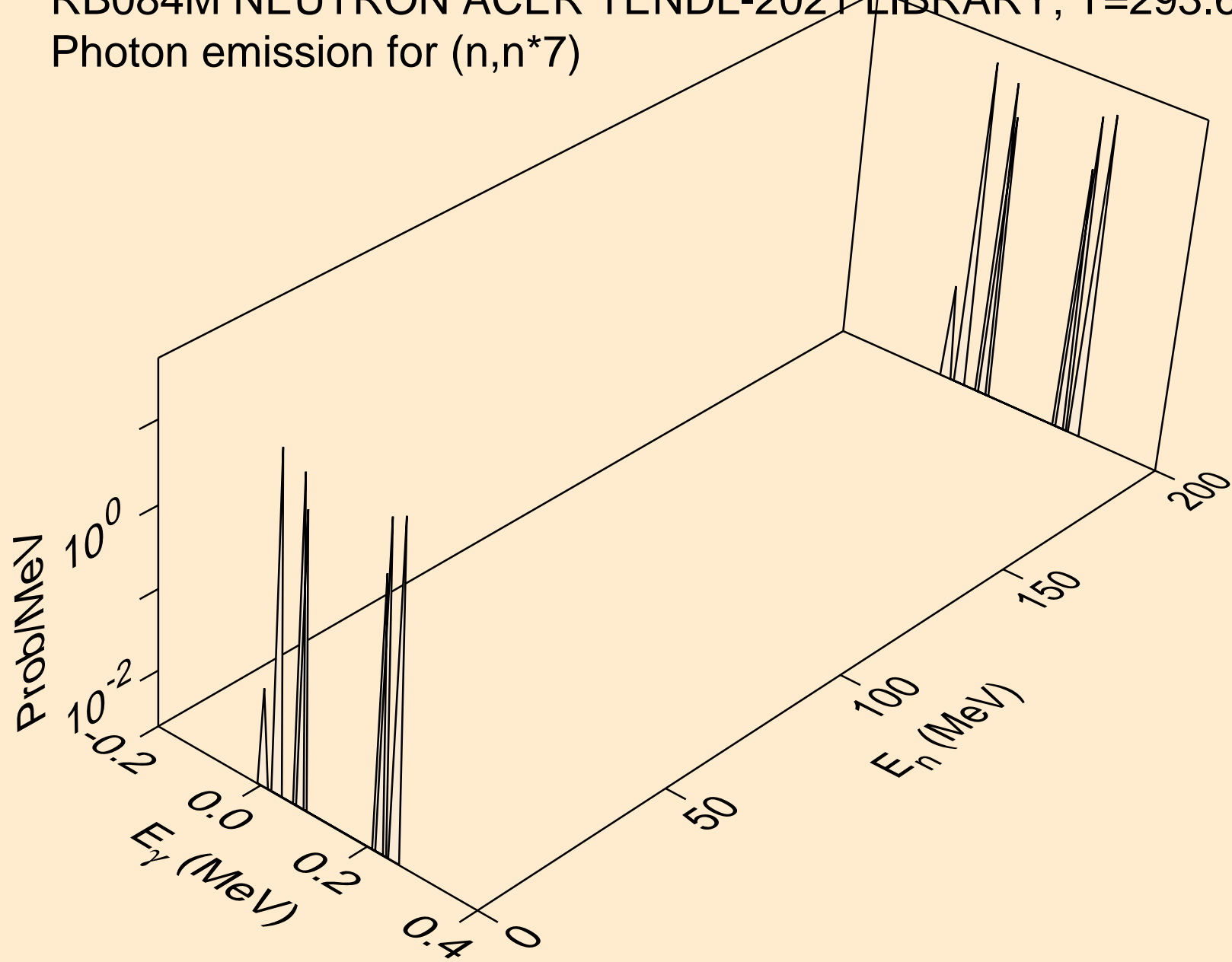

RB084M NEUTRON ACER TENDL-2021 LIBRARY; T=293.6K
Photon emission for (n,n*8)

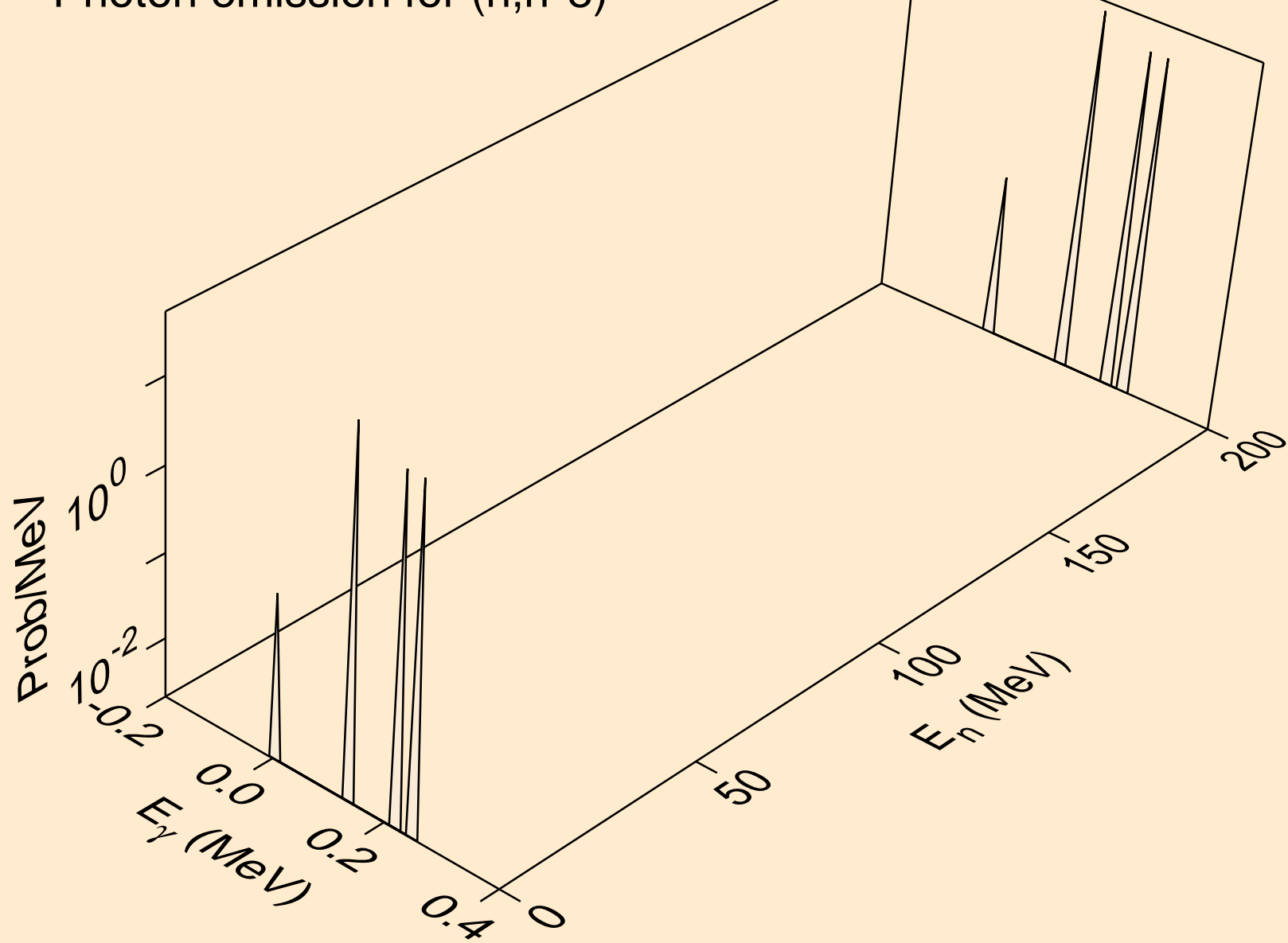

RB084M NEUTRON ACER TENDL-2021 LIBRARY; T=293.6K
Photon emission for (n,n*9)

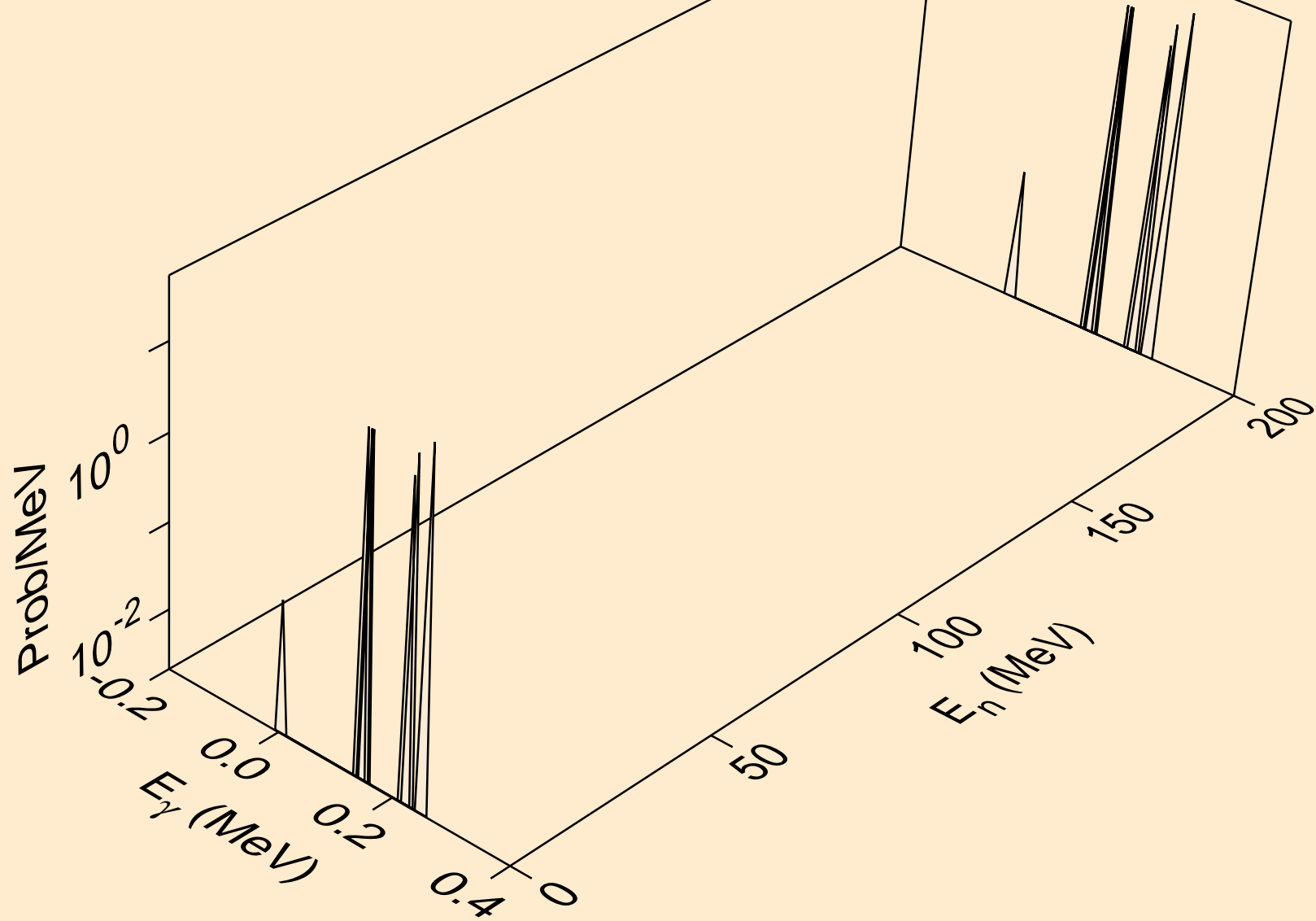

RB084M NEUTRON ACER TENDL-2021 LIBRARY; T=293.6K
Photon emission for (n,n*10)

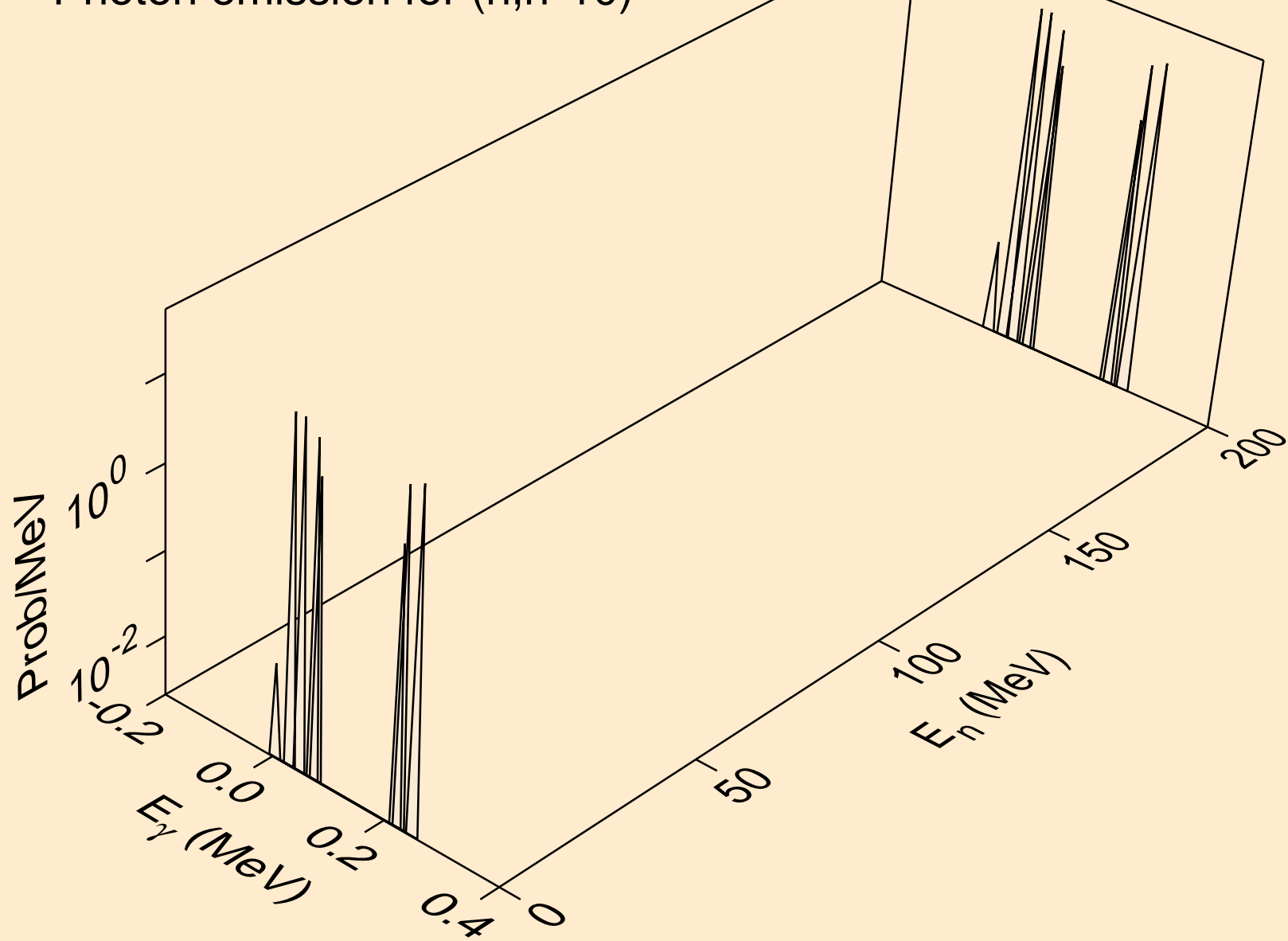

RB084M NEUTRON ACER TENDL-2021 LIBRARY; T=293.6K
Photon emission for (n,n*11)

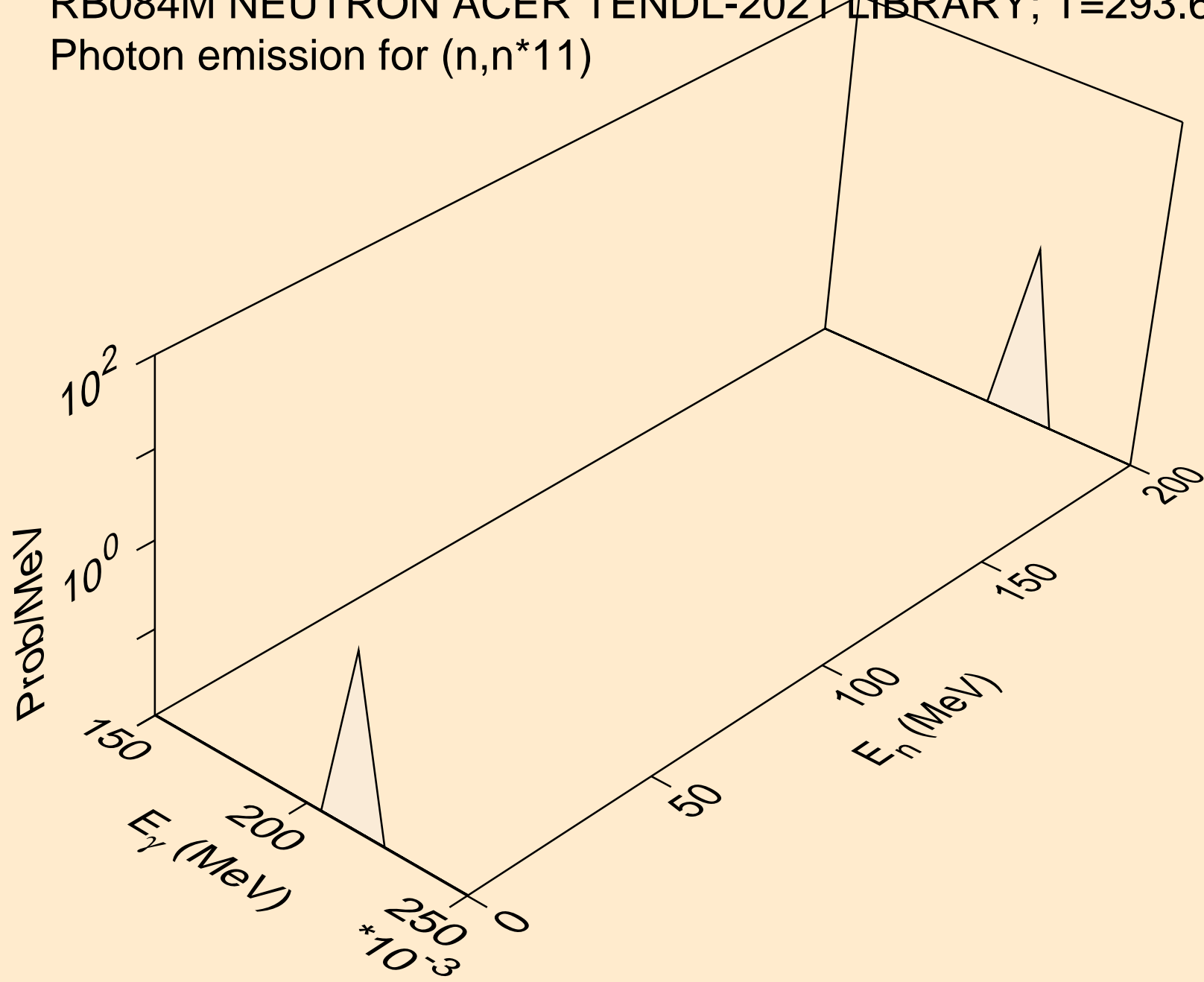

RB084M NEUTRON ACER TENDL-2021 LIBRARY; T=293.6K
Photon emission for (n,n*12)

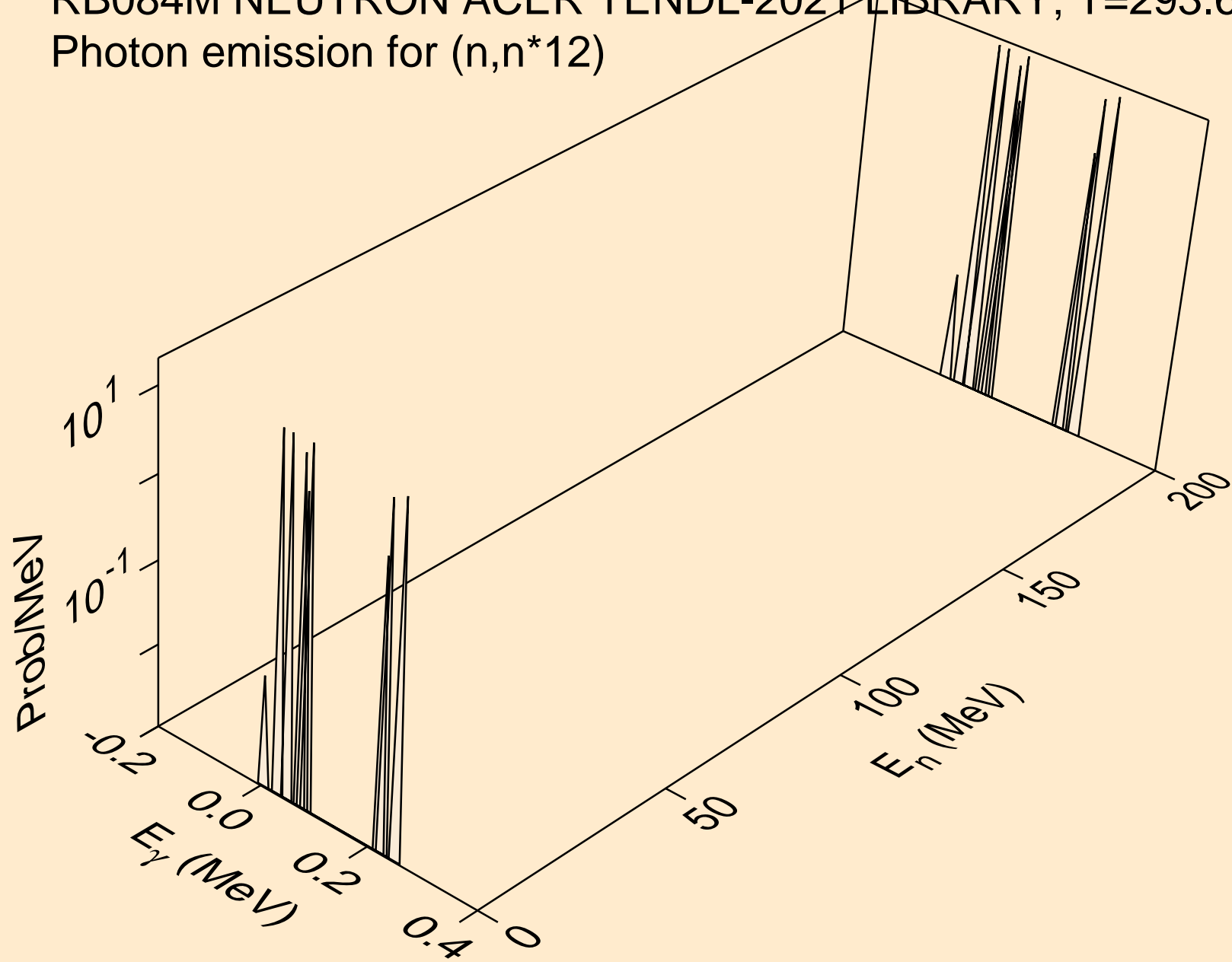

RB084M NEUTRON ACER TENDL-2021 LIBRARY; T=293.6K
Photon emission for (n,n*13)

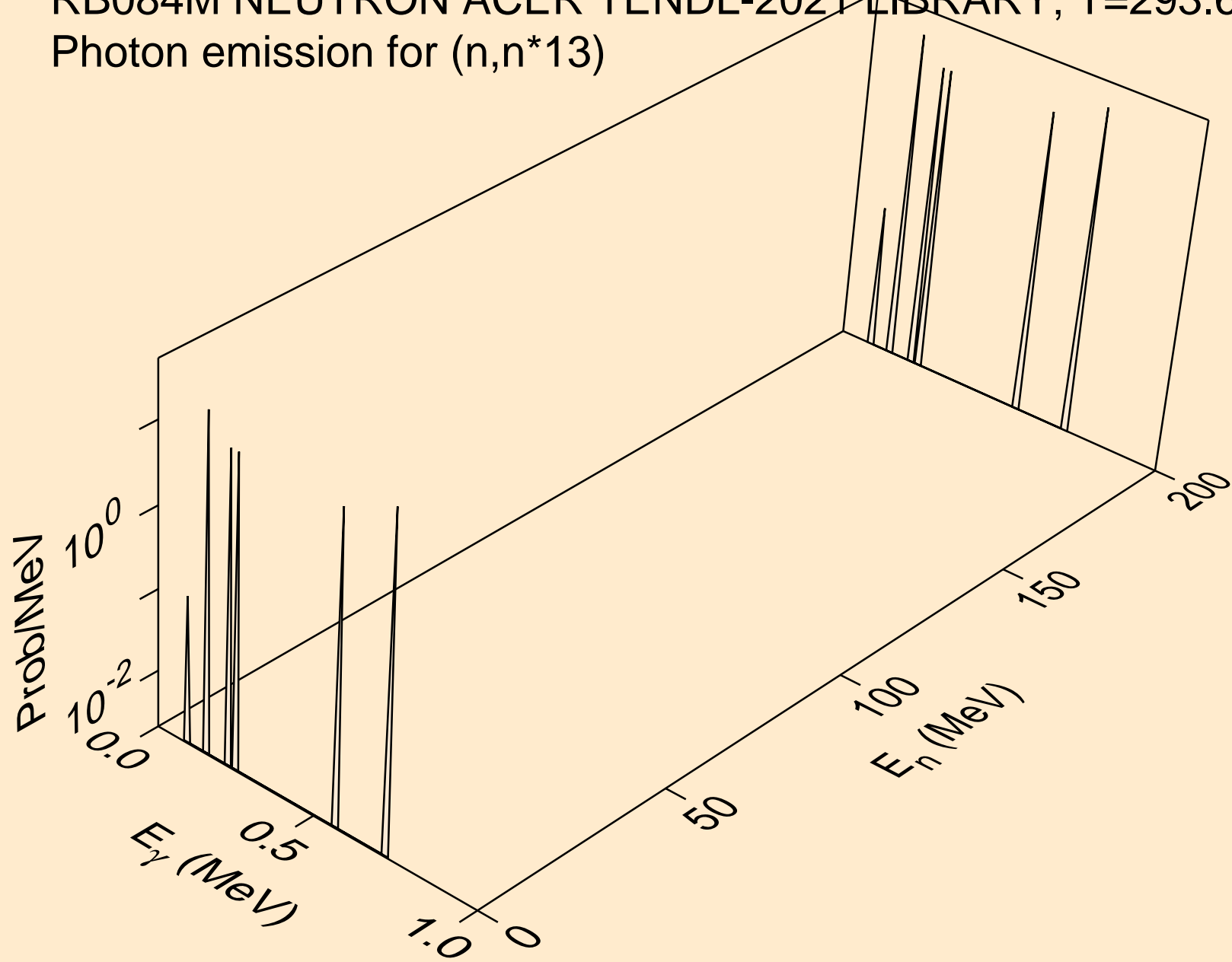

RB084M NEUTRON ACER TENDL-2021 LIBRARY; T=293.6K
Photon emission for (n,n*14)

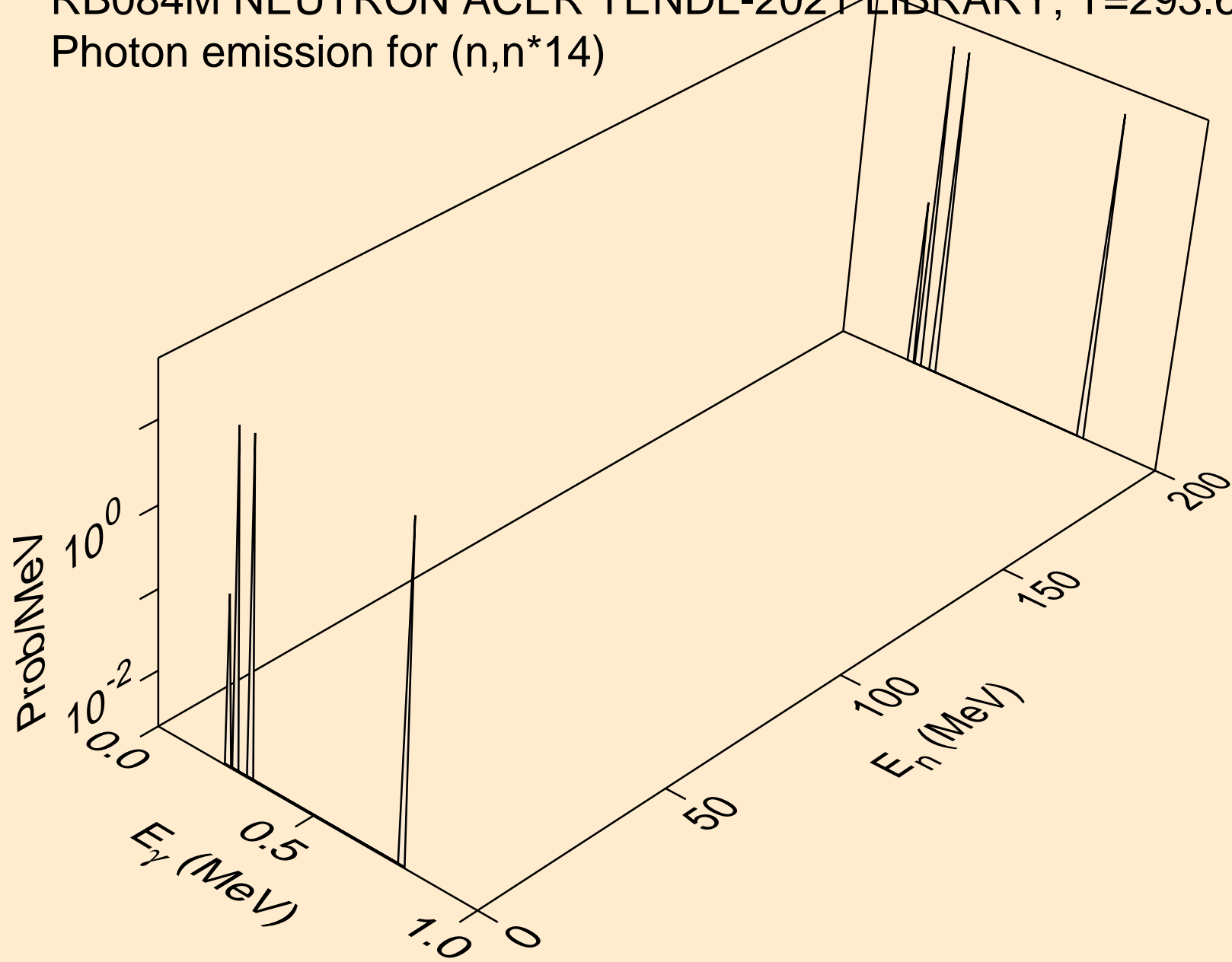

RB084M NEUTRON ACER TENDL-2021 LIBRARY; T=293.6K
Photon emission for (n,n*15)

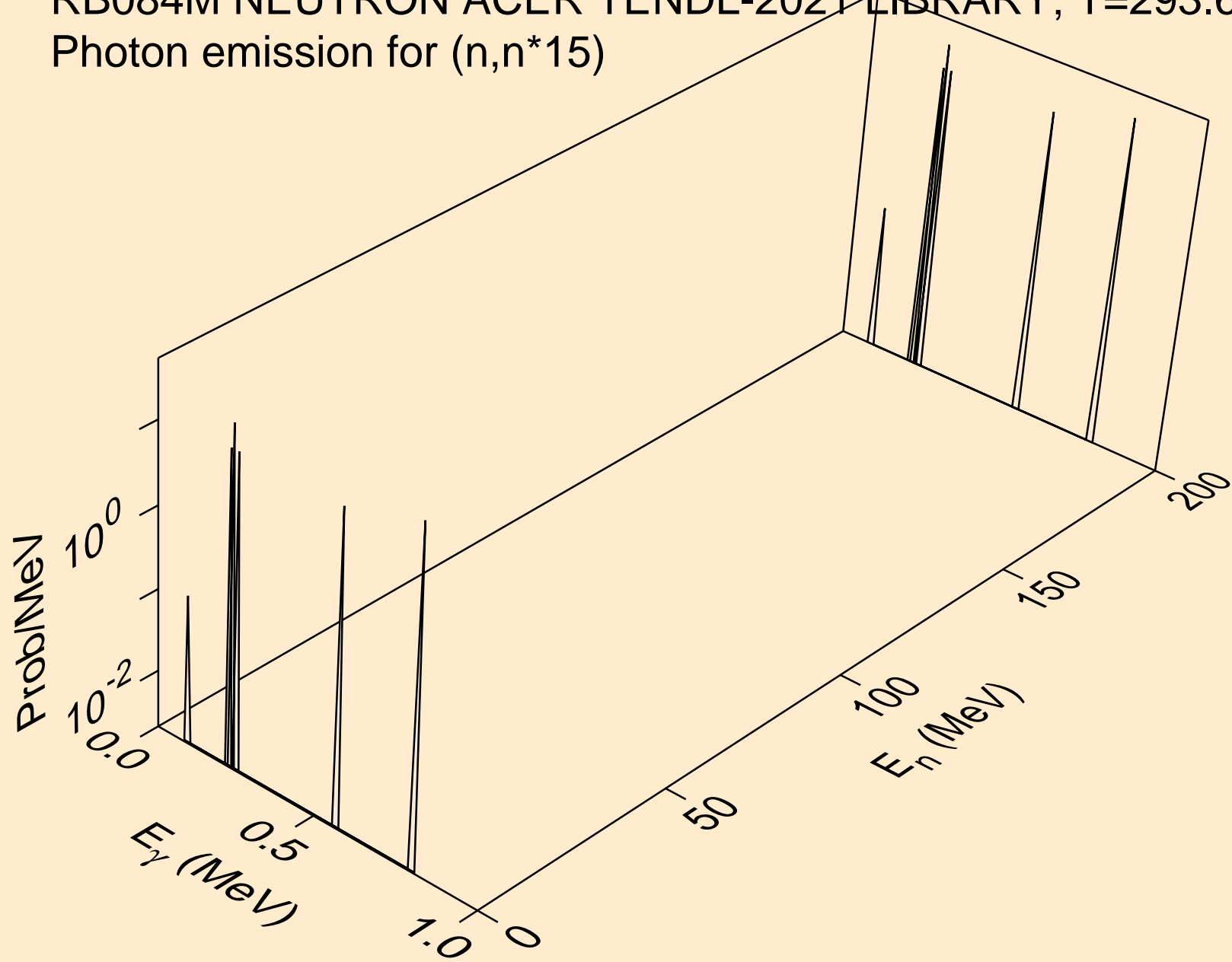

RB084M NEUTRON ACER TENDL-2021 LIBRARY; T=293.6K
Photon emission for (n,n*16)

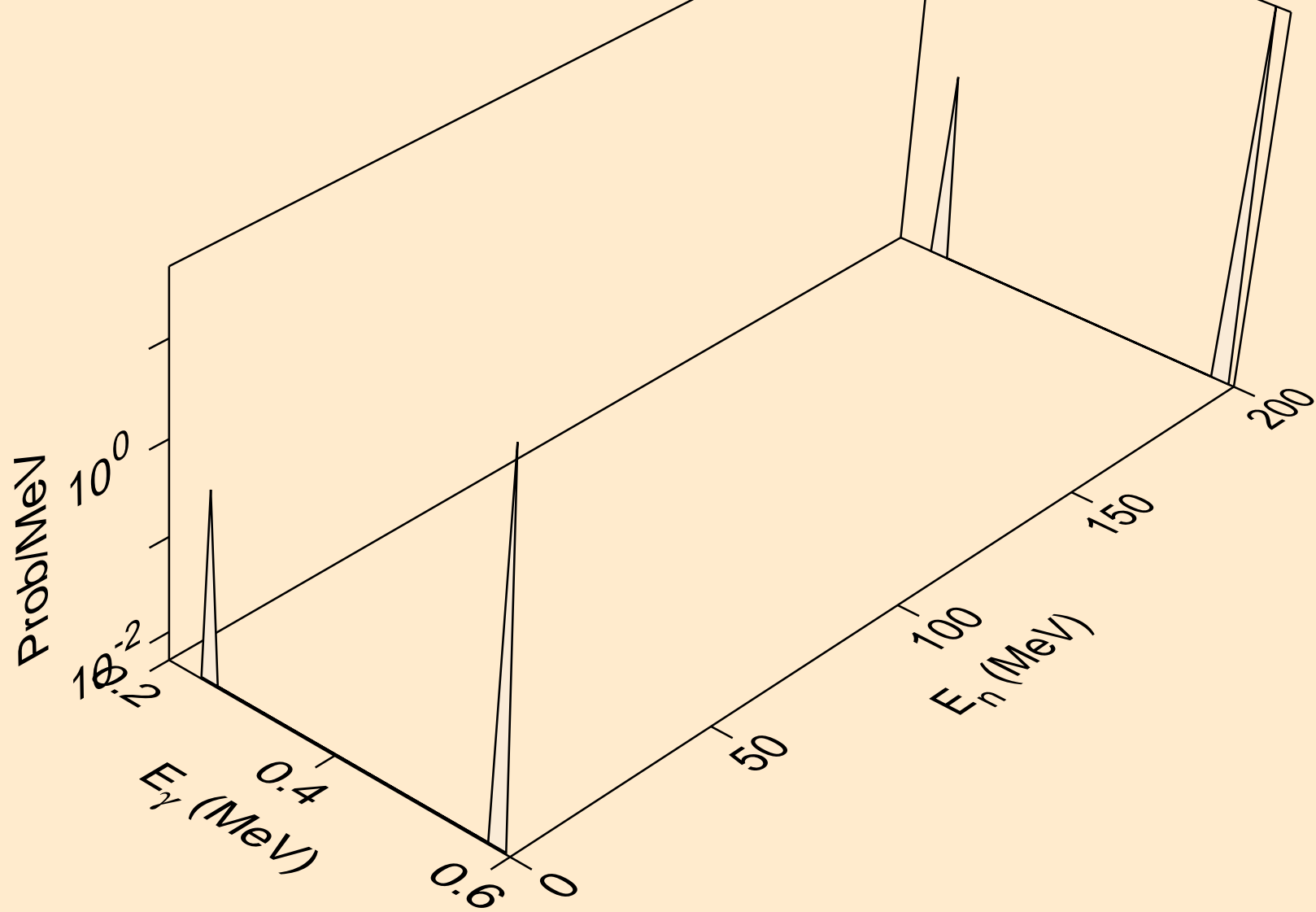

RB084M NEUTRON ACER TENDL-2021 LIBRARY; T=293.6K
Photon emission for (n,n*17)

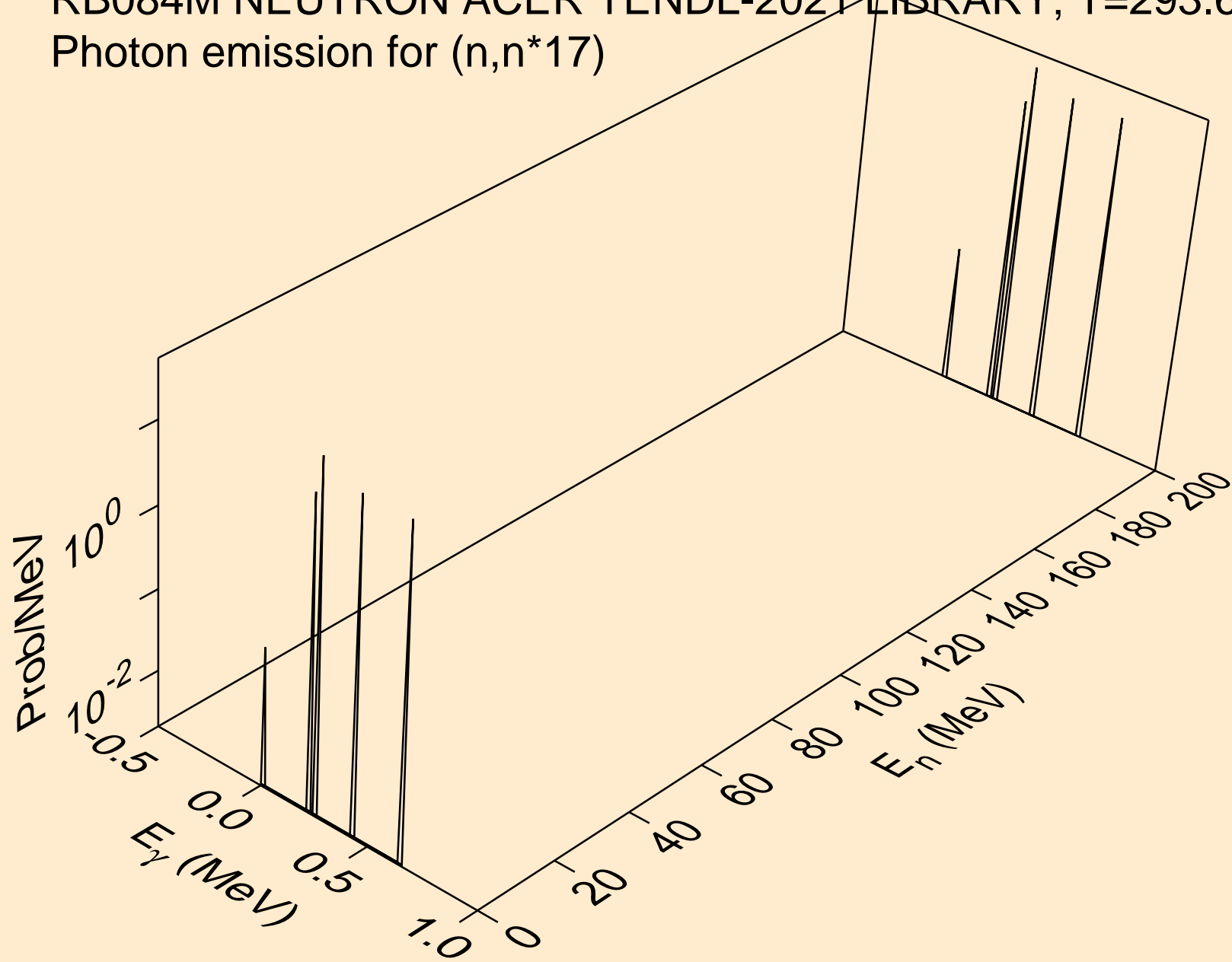

RB084M NEUTRON ACER TENDL-2021 LIBRARY; T=293.6K
Photon emission for (n,n*18)

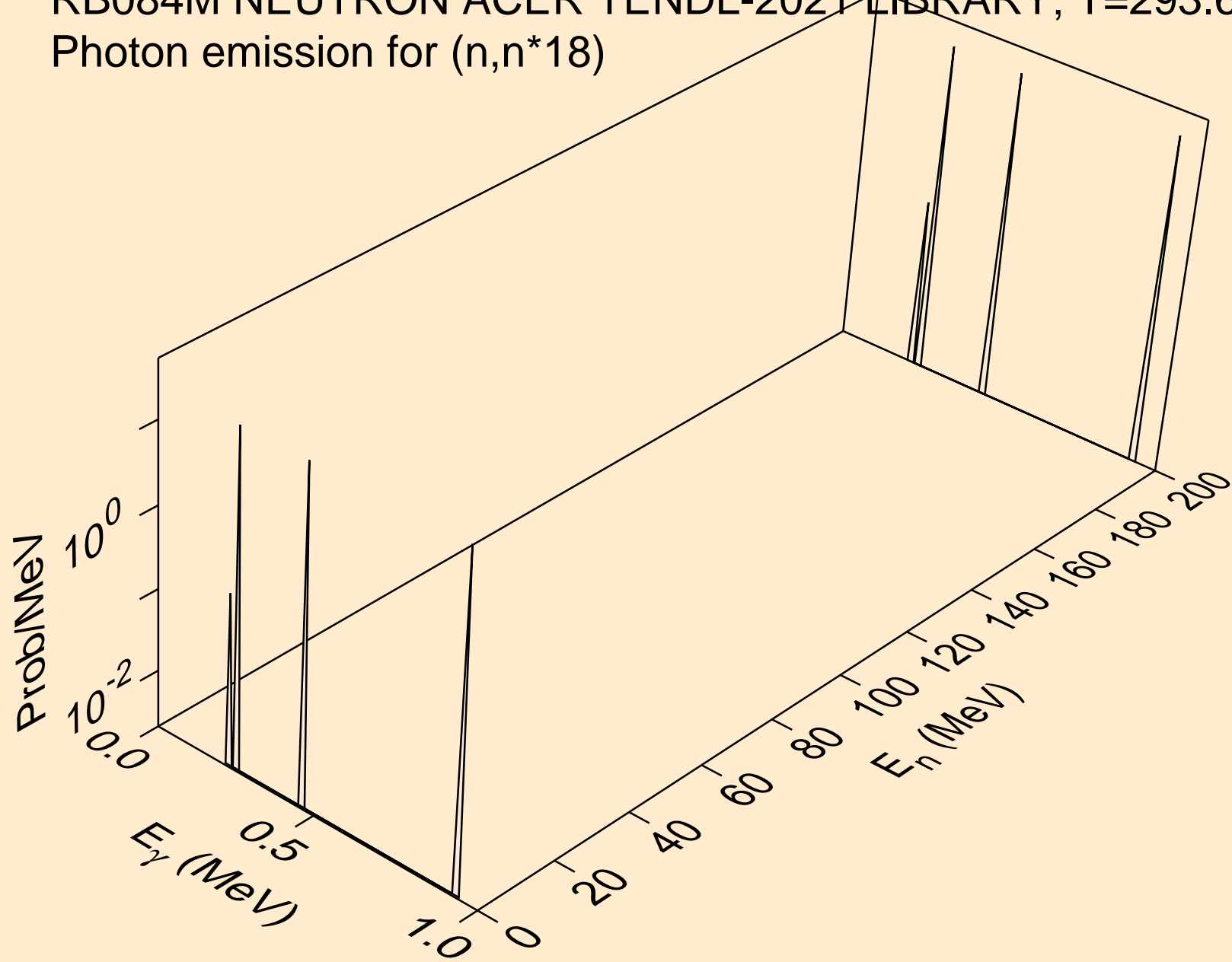

RB084M NEUTRON ACER TENDL-2021 LIBRARY; T=293.6K
Photon emission for (n,n*19)

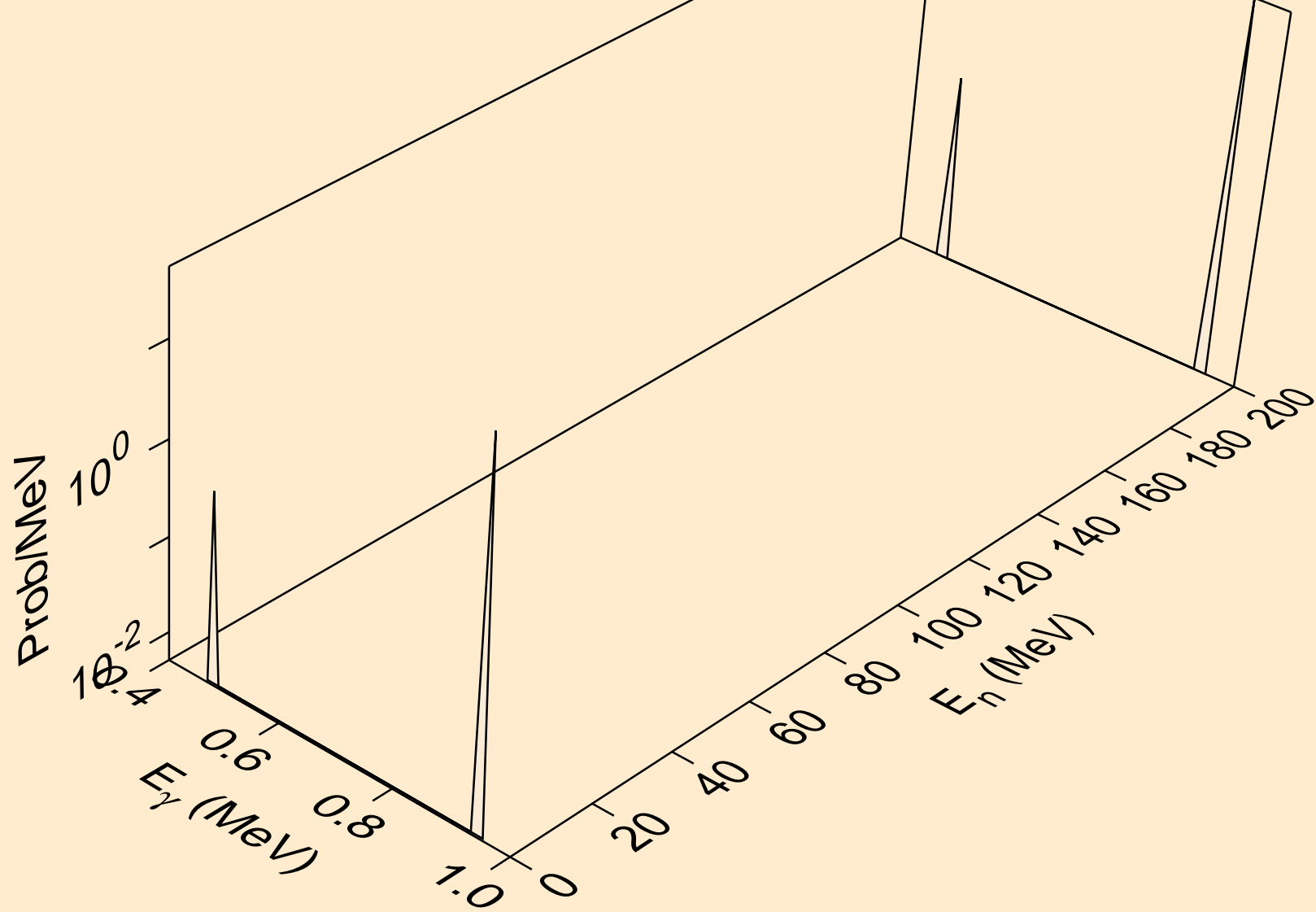

RB084M NEUTRON ACER TENDL-2021 LIBRARY; T=293.6K
Photon emission for (n,n*20)

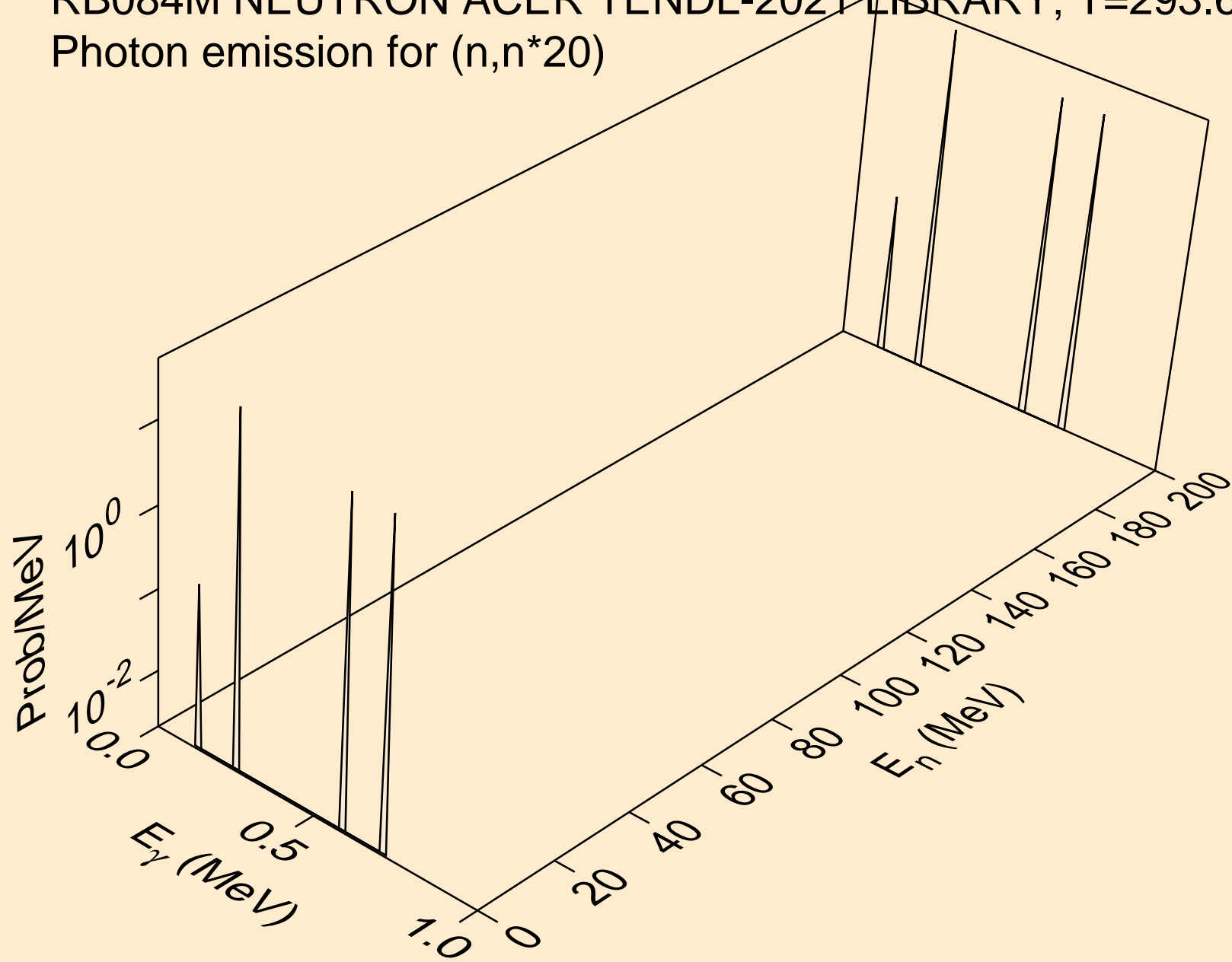

RB084M NEUTRON ACER TENDL-2021 LIBRARY; T=293.6K
Photon emission for (n,n*21)

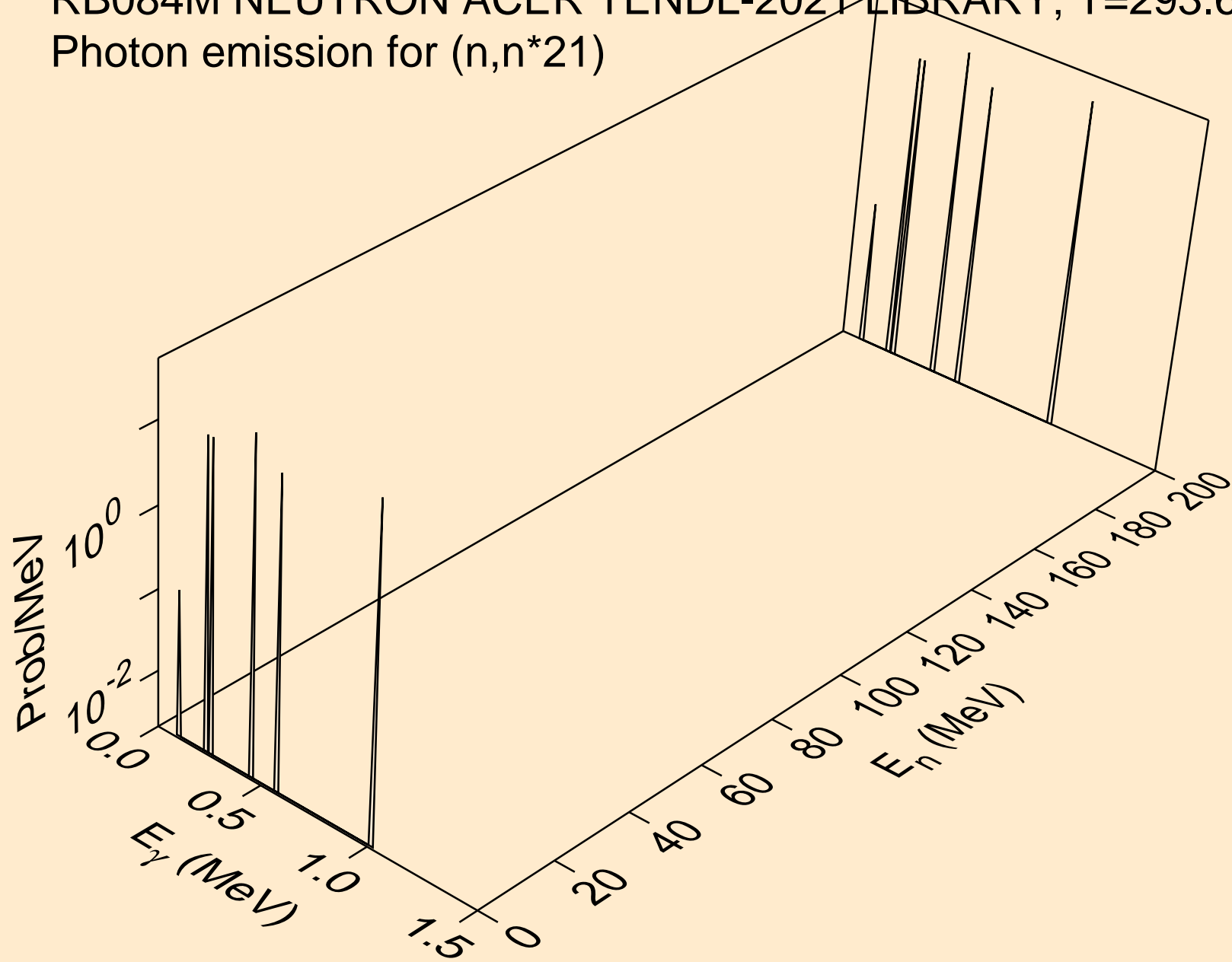

RB084M NEUTRON ACER TENDL-2021 LIBRARY; T=293.6K
Photon emission for (n,n*22)

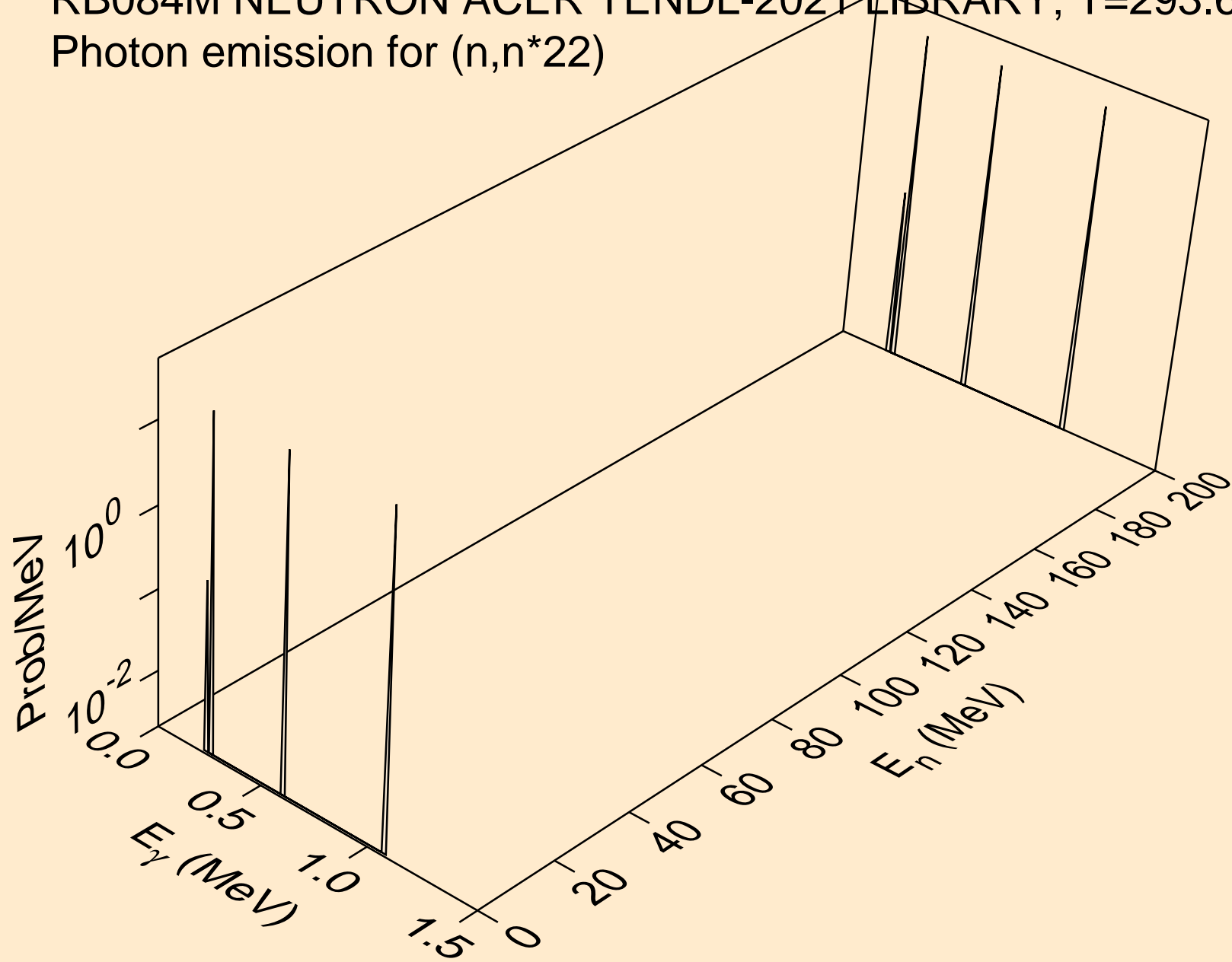

RB084M NEUTRON ACER TENDL-2021 LIBRARY; T=293.6K
Photon emission for (n,n*23)

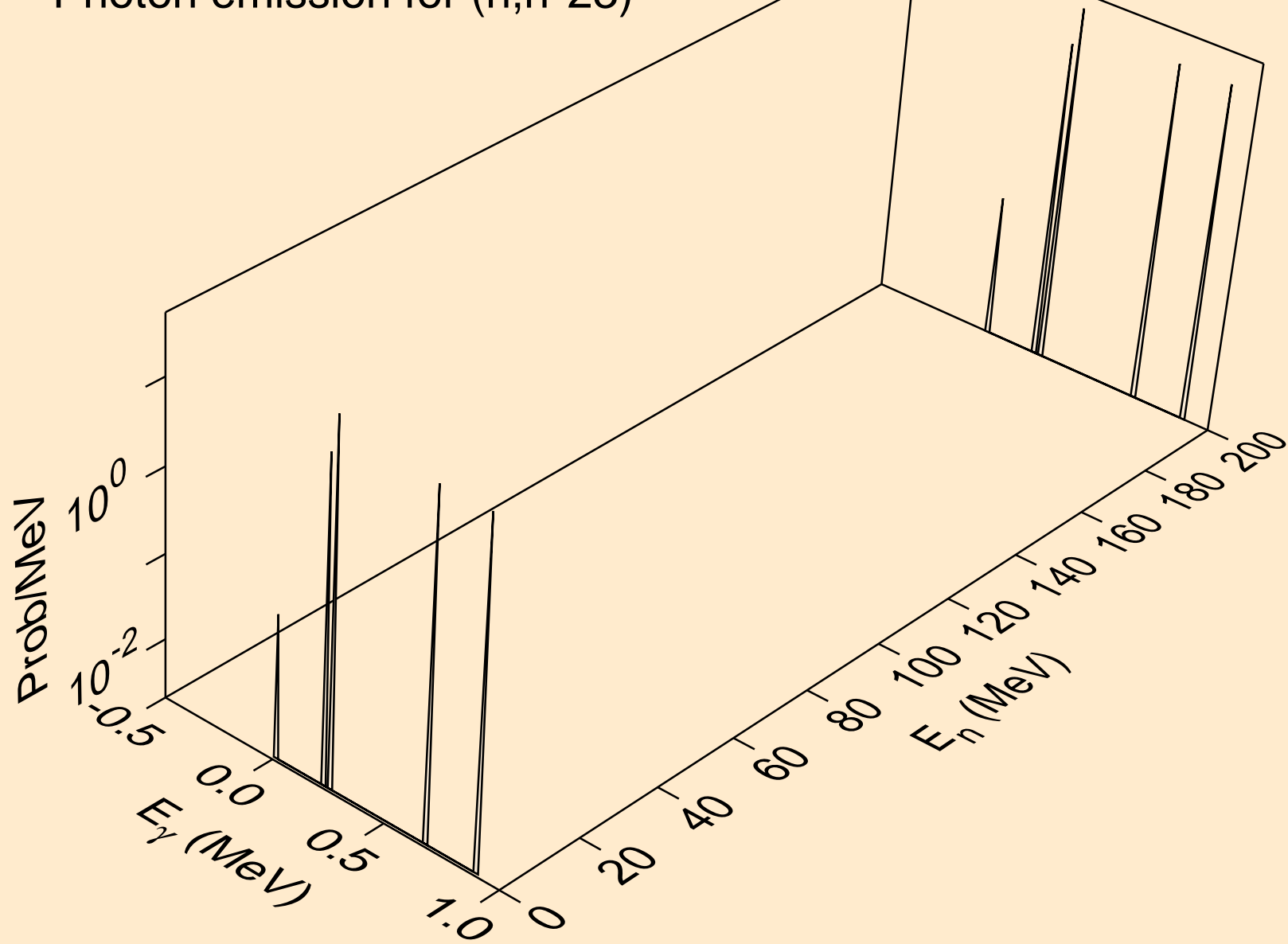

RB084M NEUTRON ACER TENDL-2021 LIBRARY; T=293.6K
Photon emission for (n,n*24)

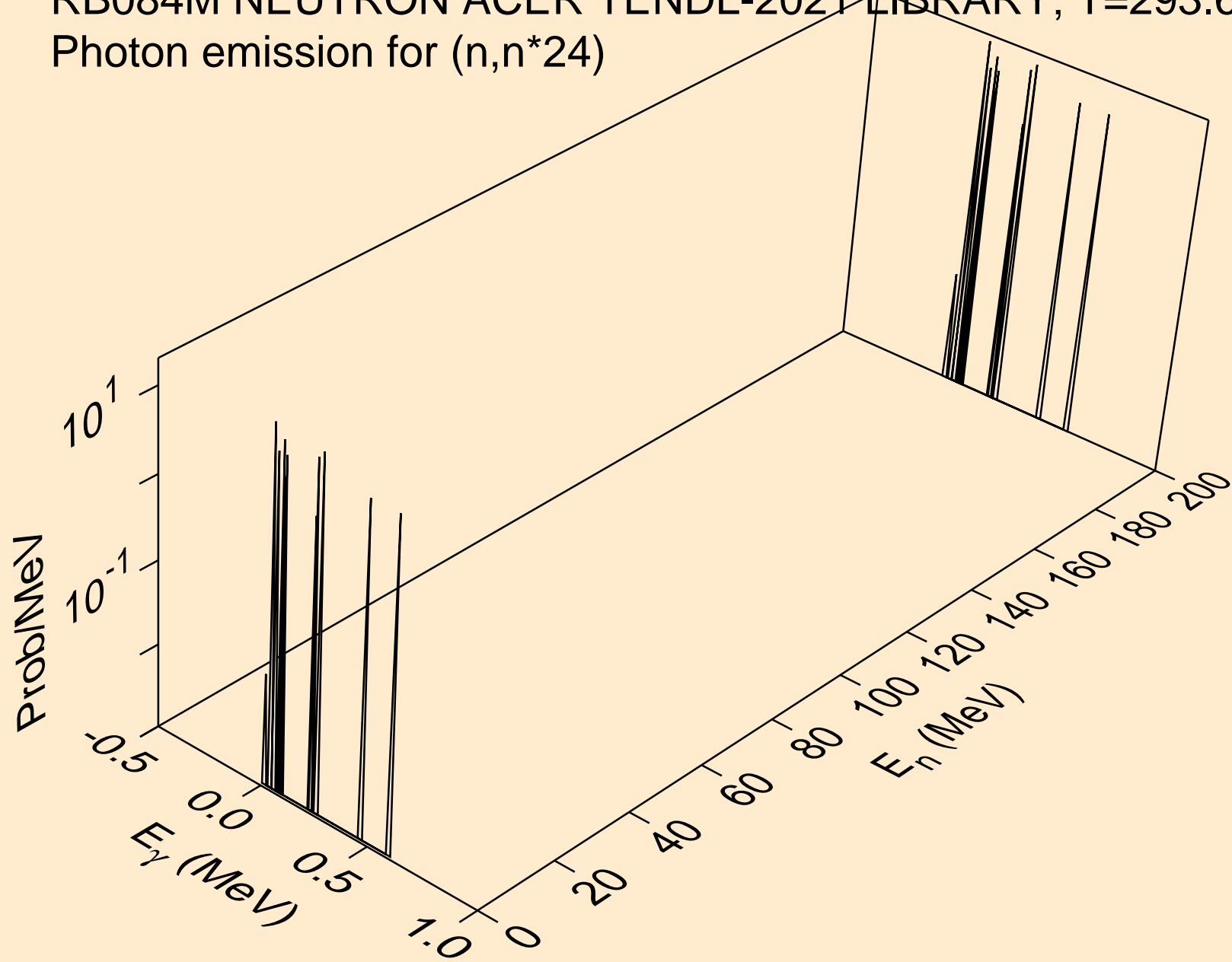

RB084M NEUTRON ACER TENDL-2021 LIBRARY; T=293.6K
Photon emission for (n,n*25)

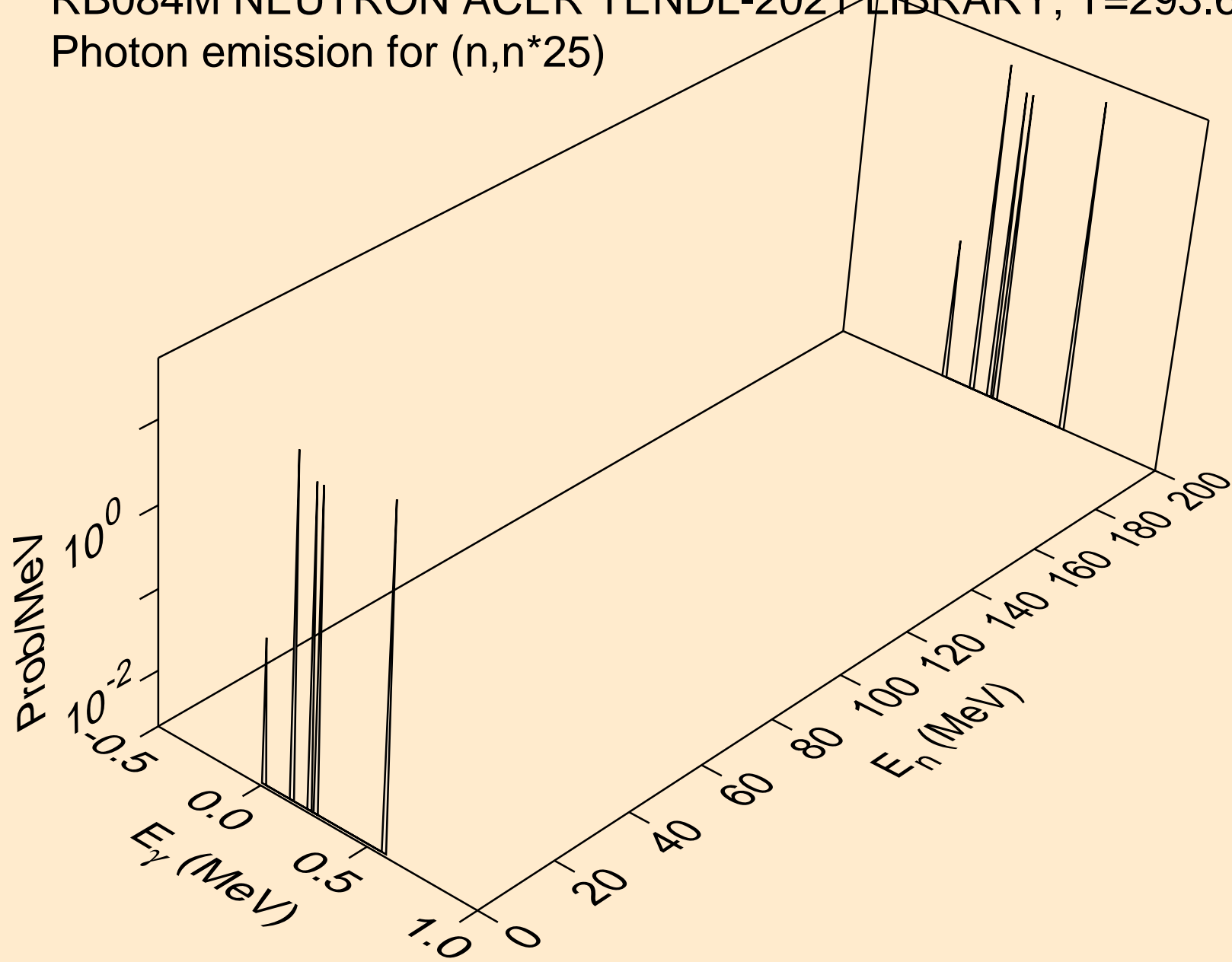

RB084M NEUTRON ACER TENDL-2021 LIBRARY; T=293.6K
Photon emission for (n,n*26)

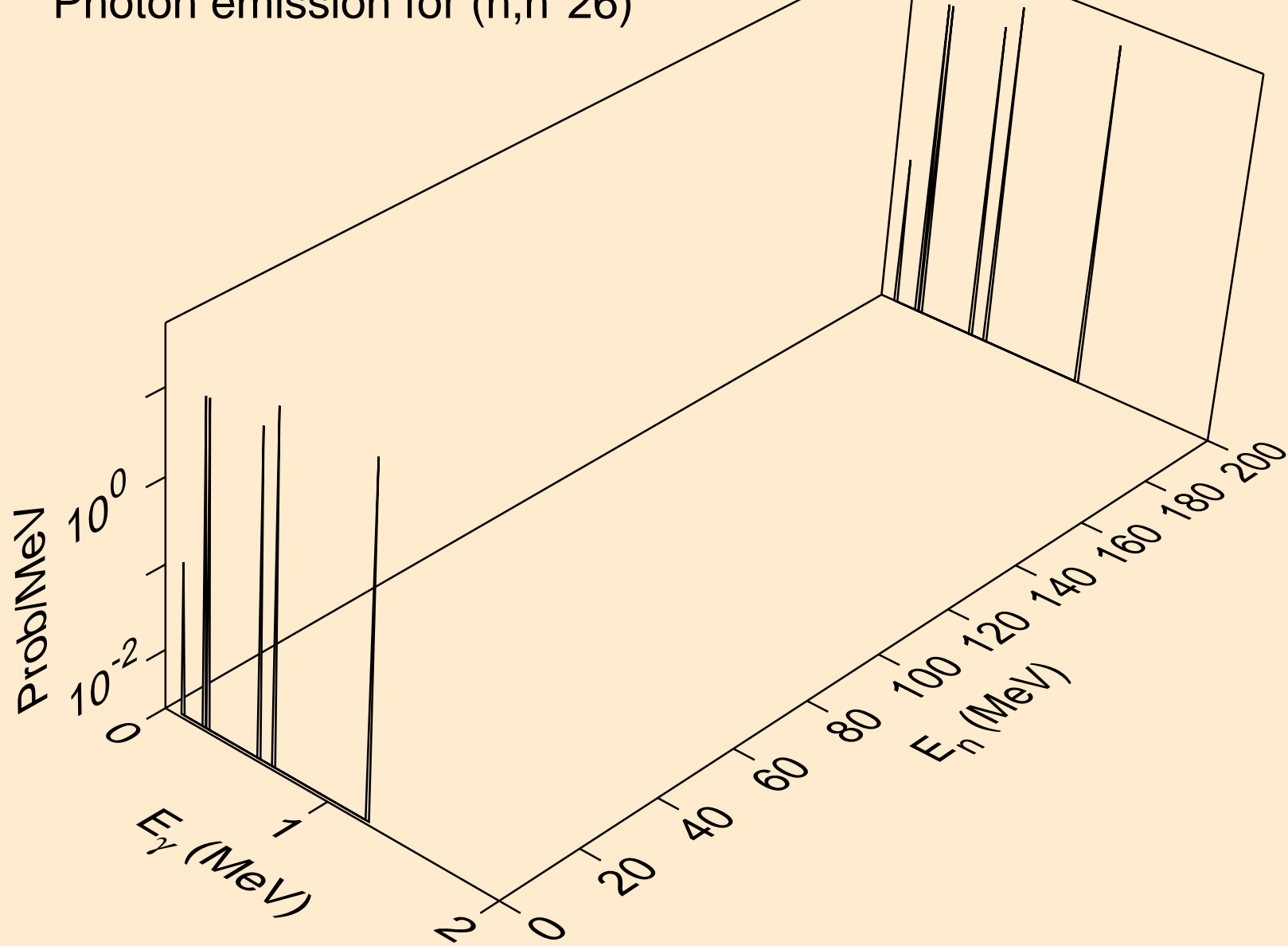

RB084M NEUTRON ACER TENDL-2021 LIBRARY; T=293.6K
Photon emission for (n,n*27)

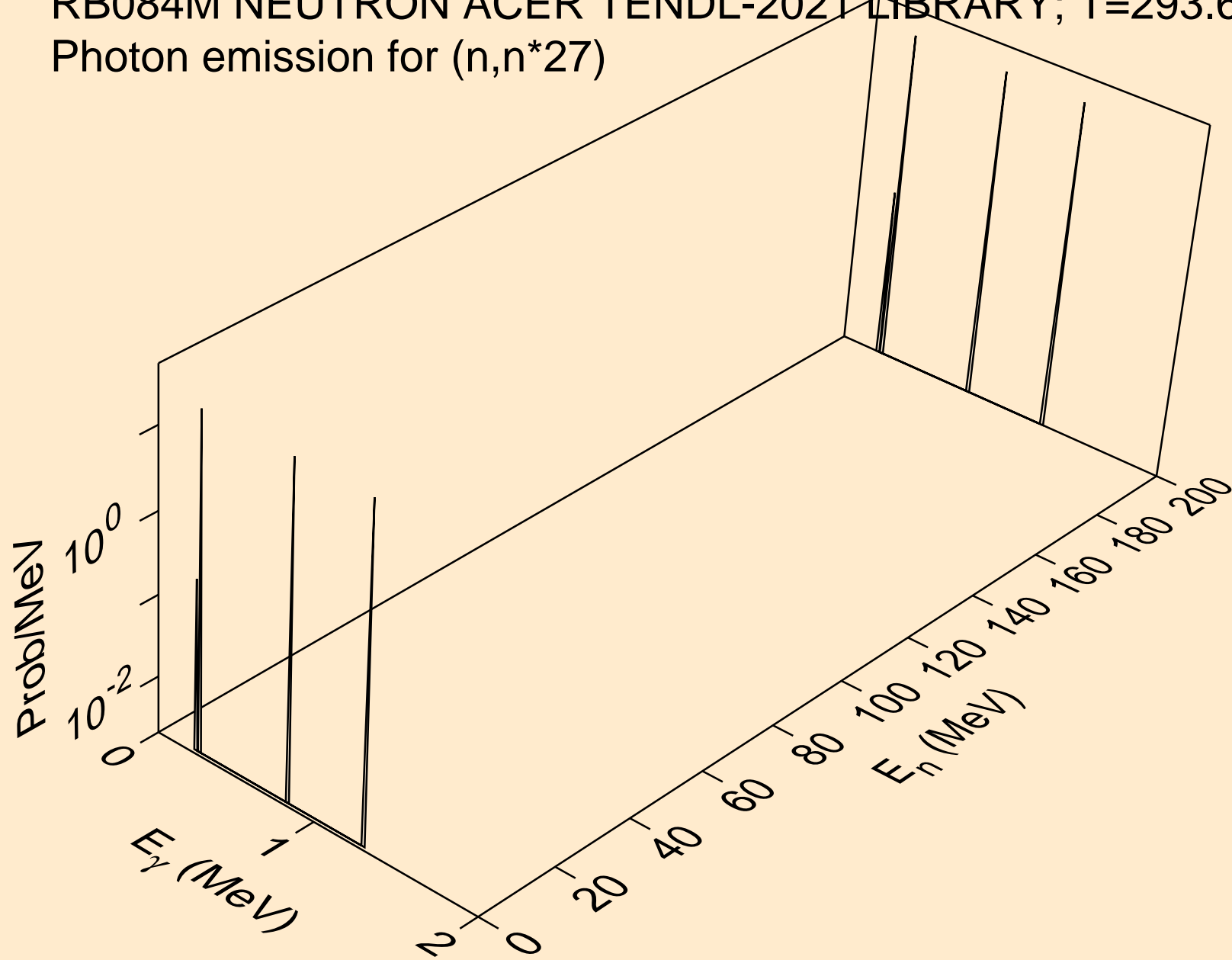

RB084M NEUTRON ACER TENDL-2021 LIBRARY; T=293.6K
Photon emission for (n,n*28)

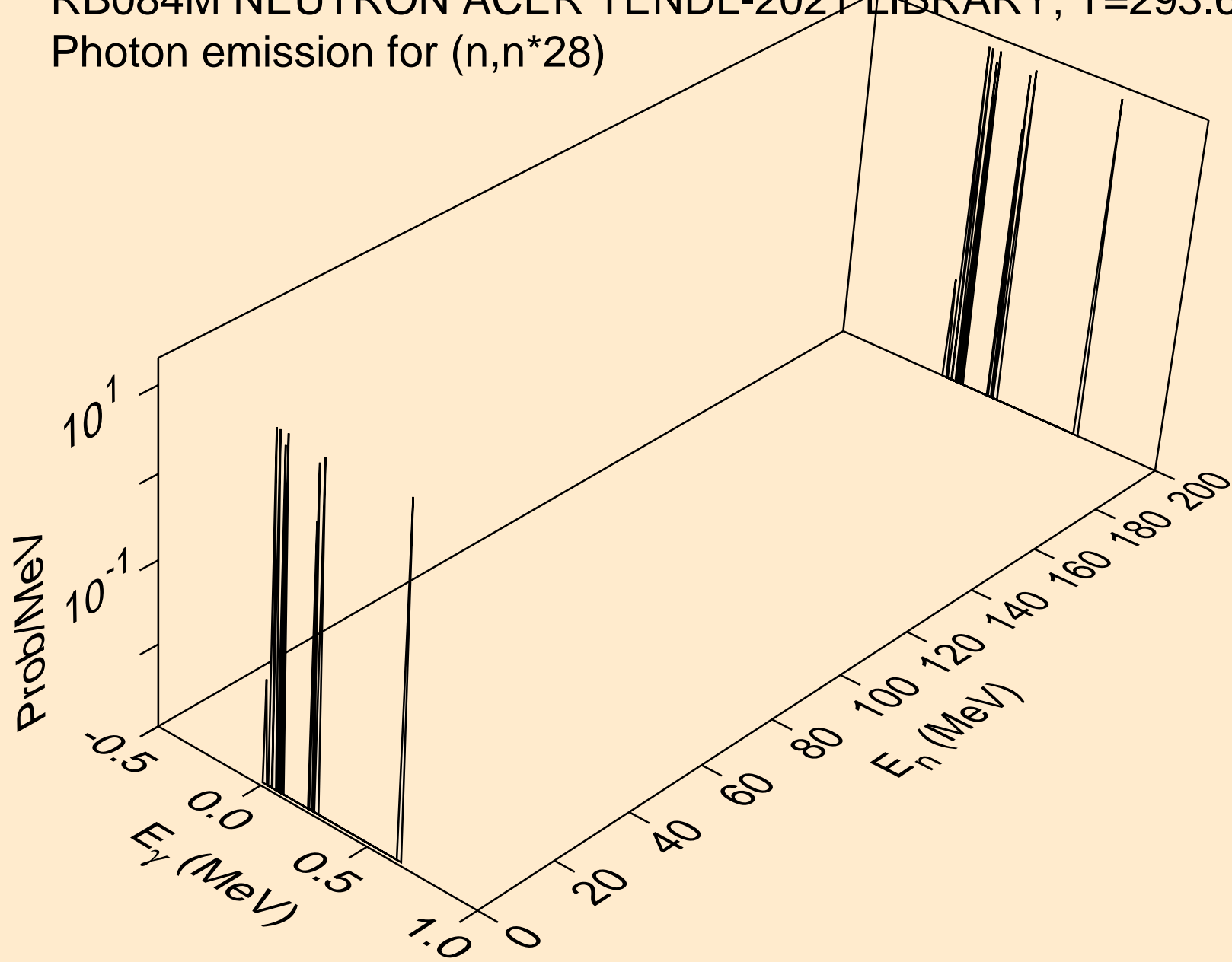

RB084M NEUTRON ACER TENDL-2021 LIBRARY; T=293.6K
Photon emission for (n,n*29)

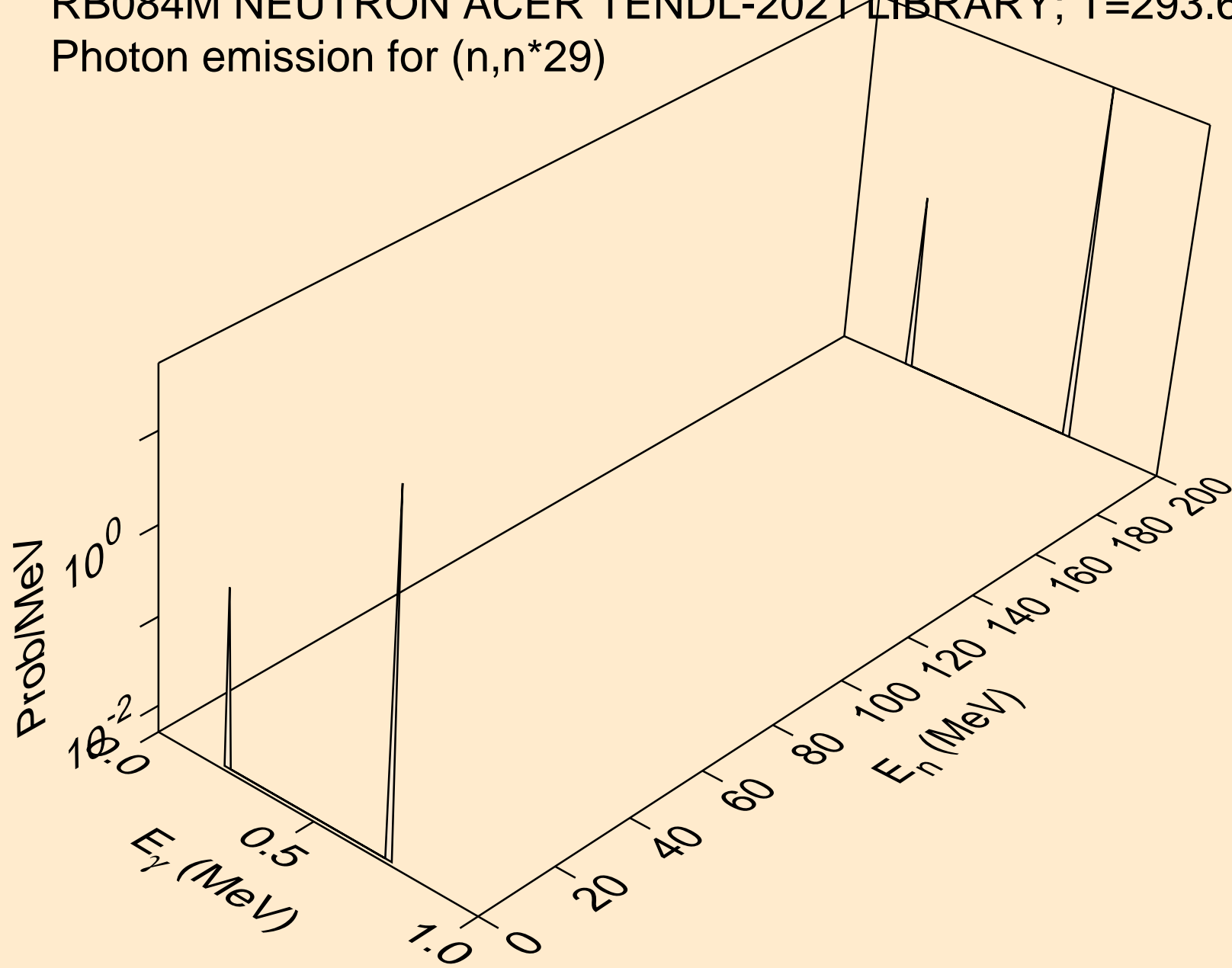

RB084M NEUTRON ACER TENDL-2021 LIBRARY; T=293.6K
Photon emission for (n,n*30)

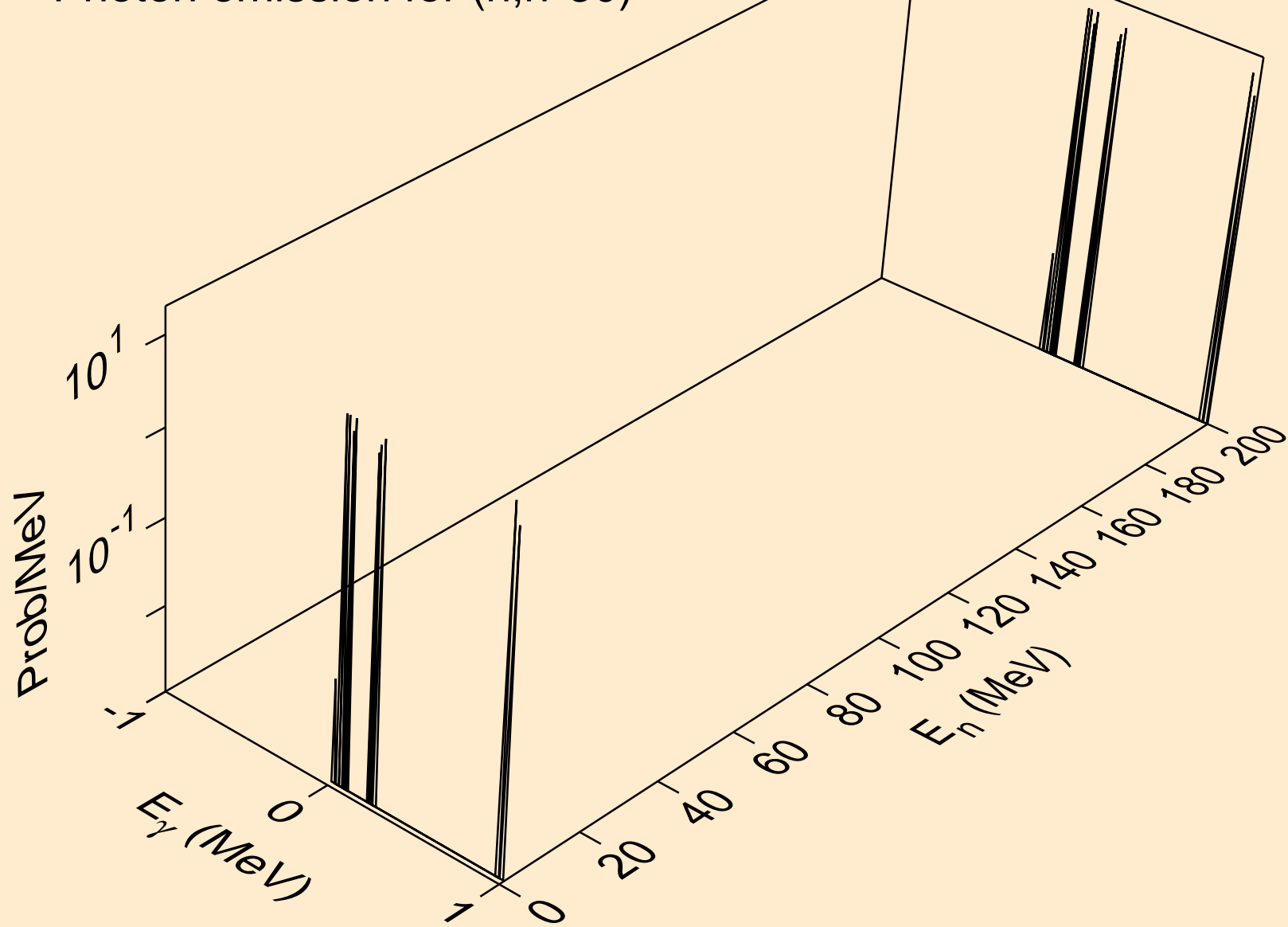

RB084M NEUTRON ACER TENDL-2021 LIBRARY; T=293.6K
Photon emission for (n,n*c)

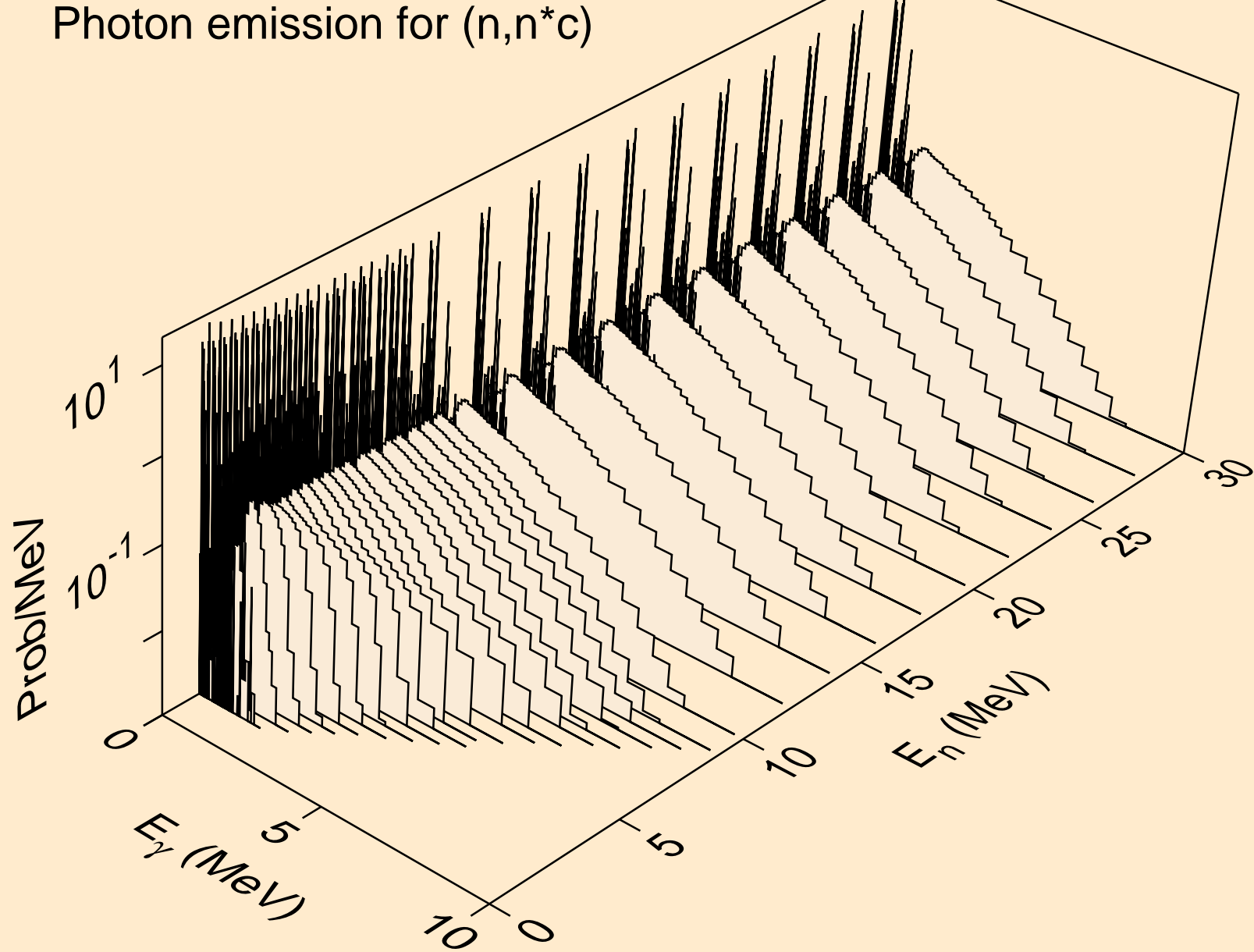

RB084M NEUTRON ACER TENDL-2021 LIBRARY; T=293.6K
Photon emission for (n,gma)

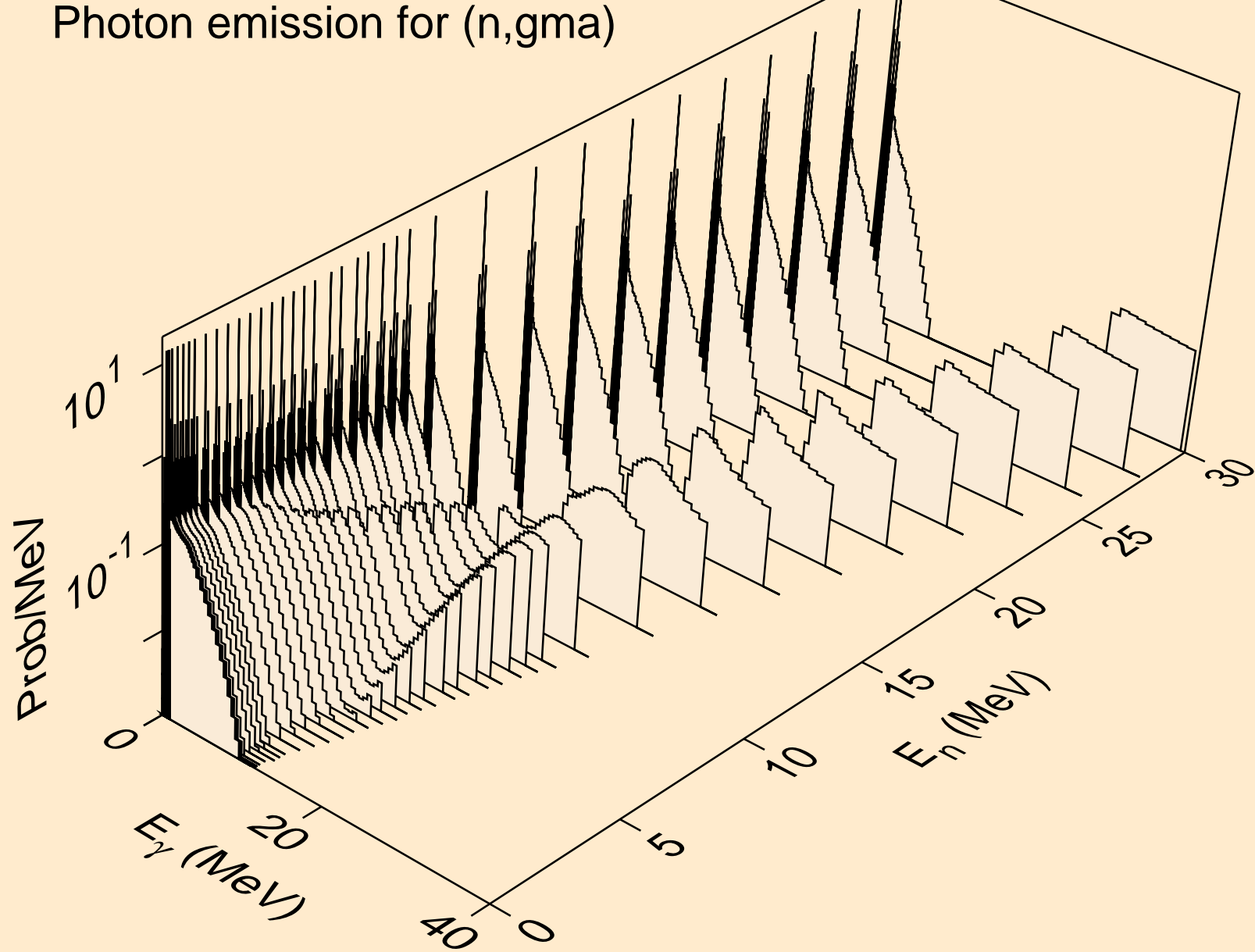

RB084M NEUTRON ACER TENDL-2021 LIBRARY; T=293.6K
Photon emission for (n,p)

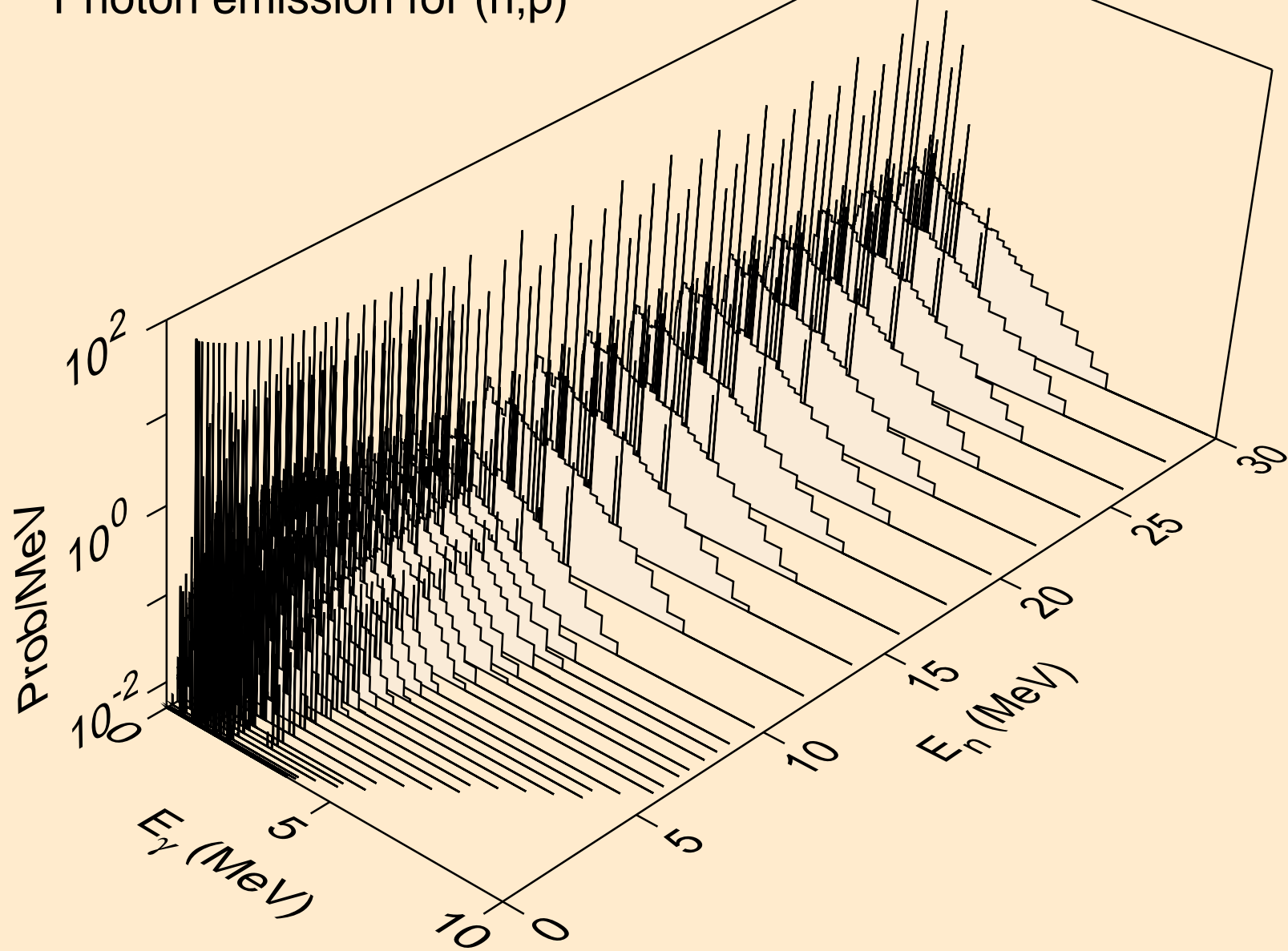

RB084M NEUTRON ACER TENDL-2021 LIBRARY; T=293.6K
Photon emission for (n,d)

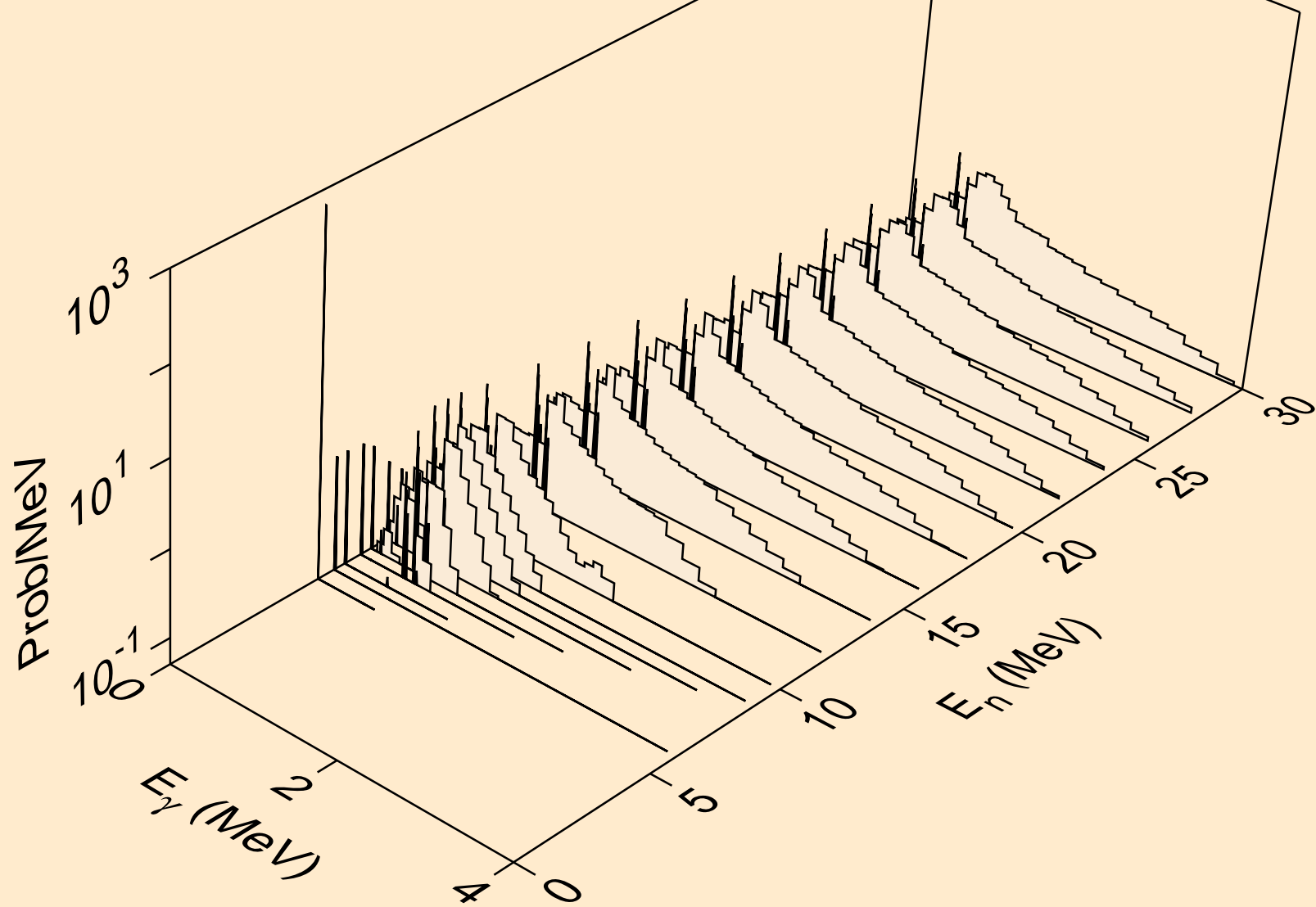

RB084M NEUTRON ACER TENDL-2021 LIBRARY; T=293.6K
Photon emission for (n,t)

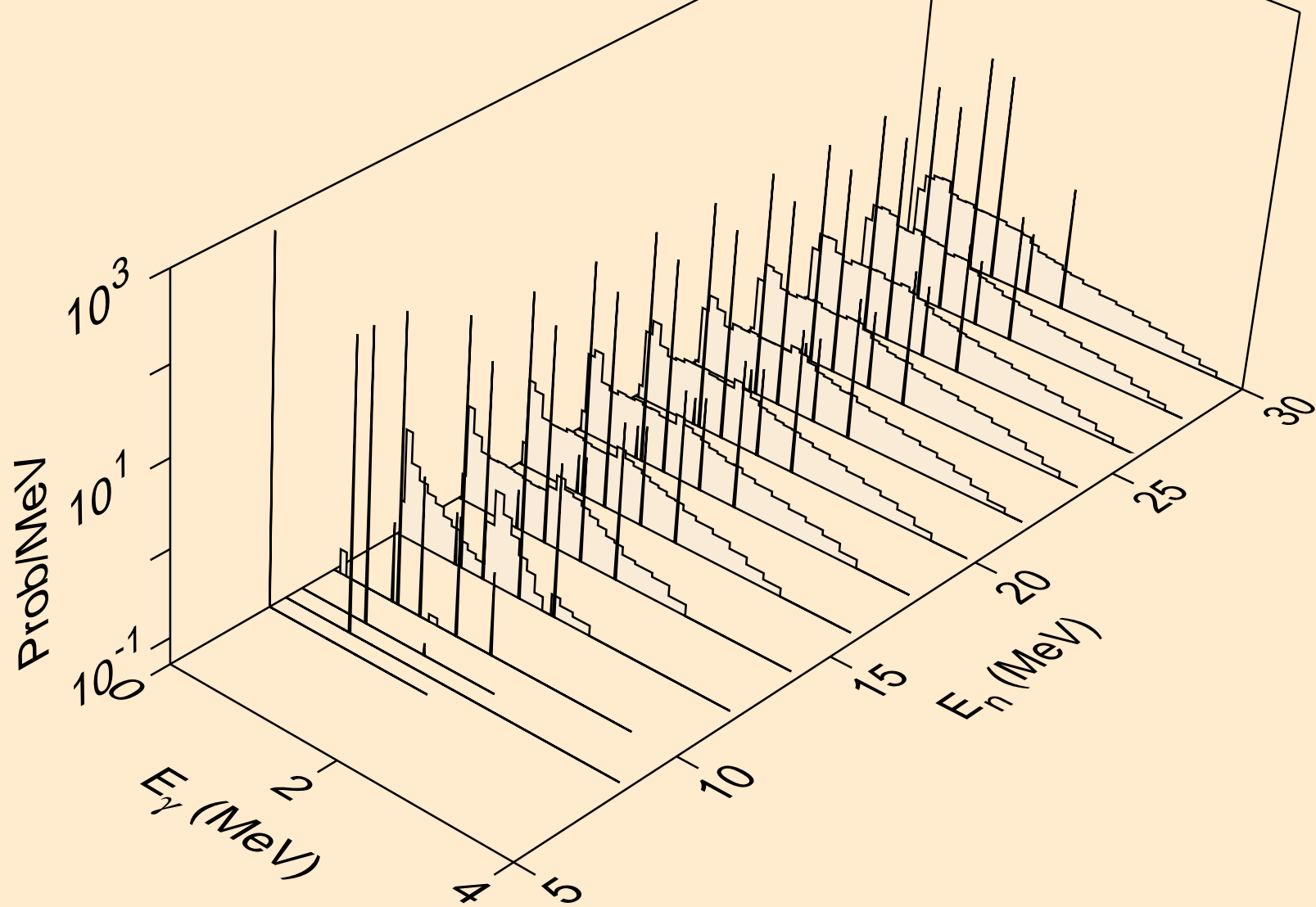

RB084M NEUTRON ACER TENDL-2021 LIBRARY; T=293.6K
Photon emission for (n,he3)

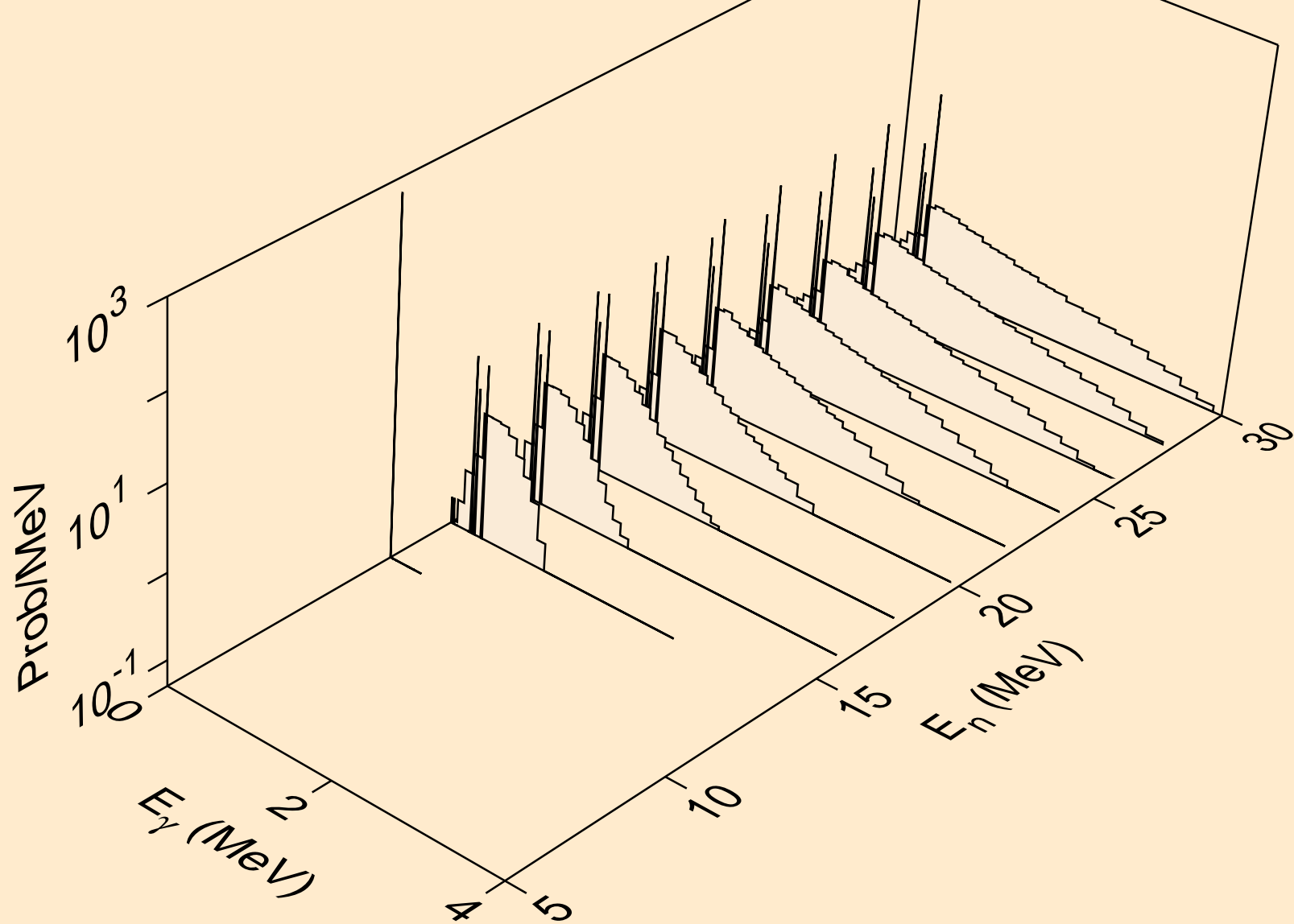

RB084M NEUTRON ACER TENDL-2021 LIBRARY; T=293.6K
Photon emission for (n,a)

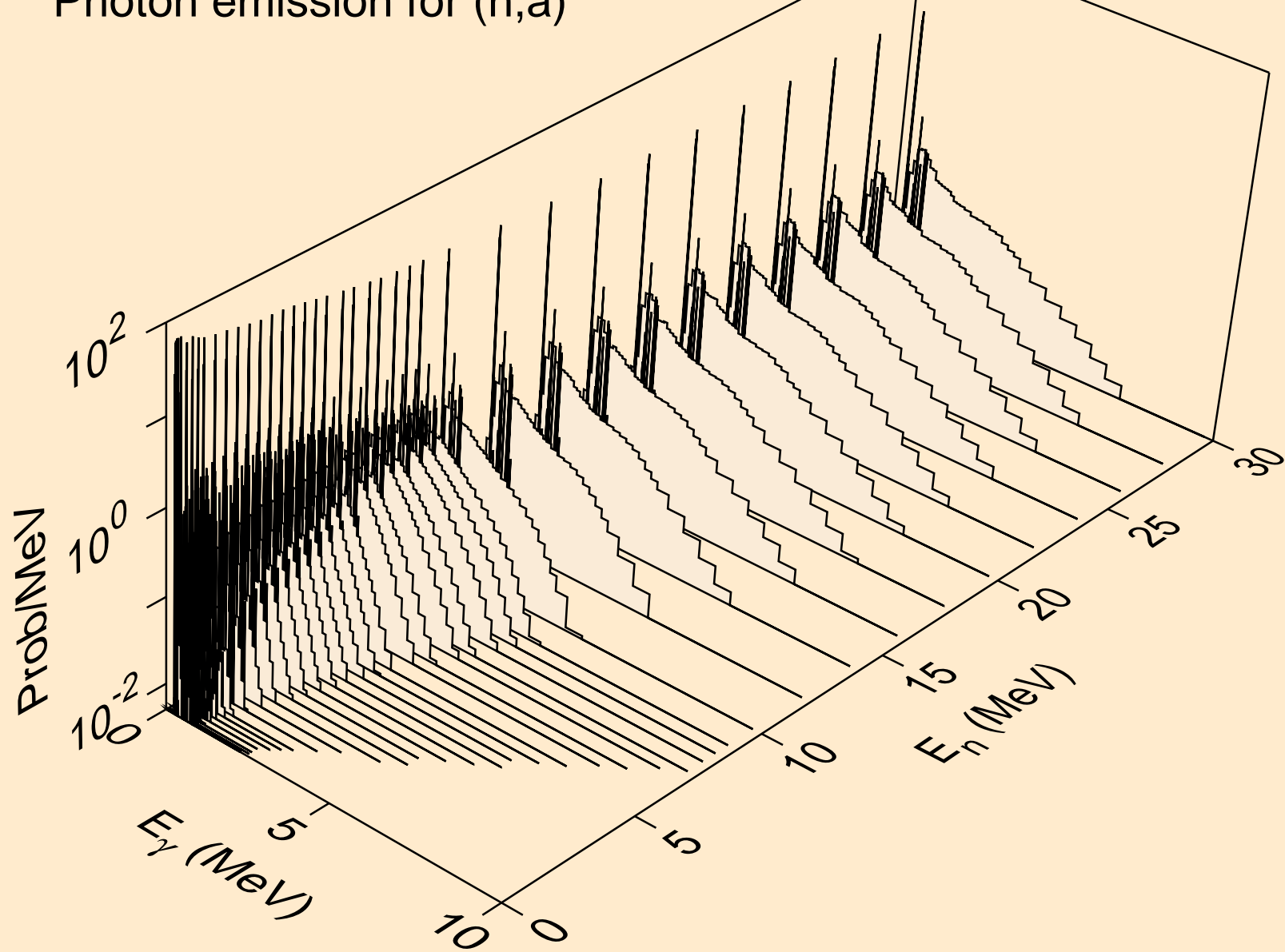

RB084M NEUTRON ACER TENDL-2021 LIBRARY; T=293.6K
Photon emission for (n,2a)

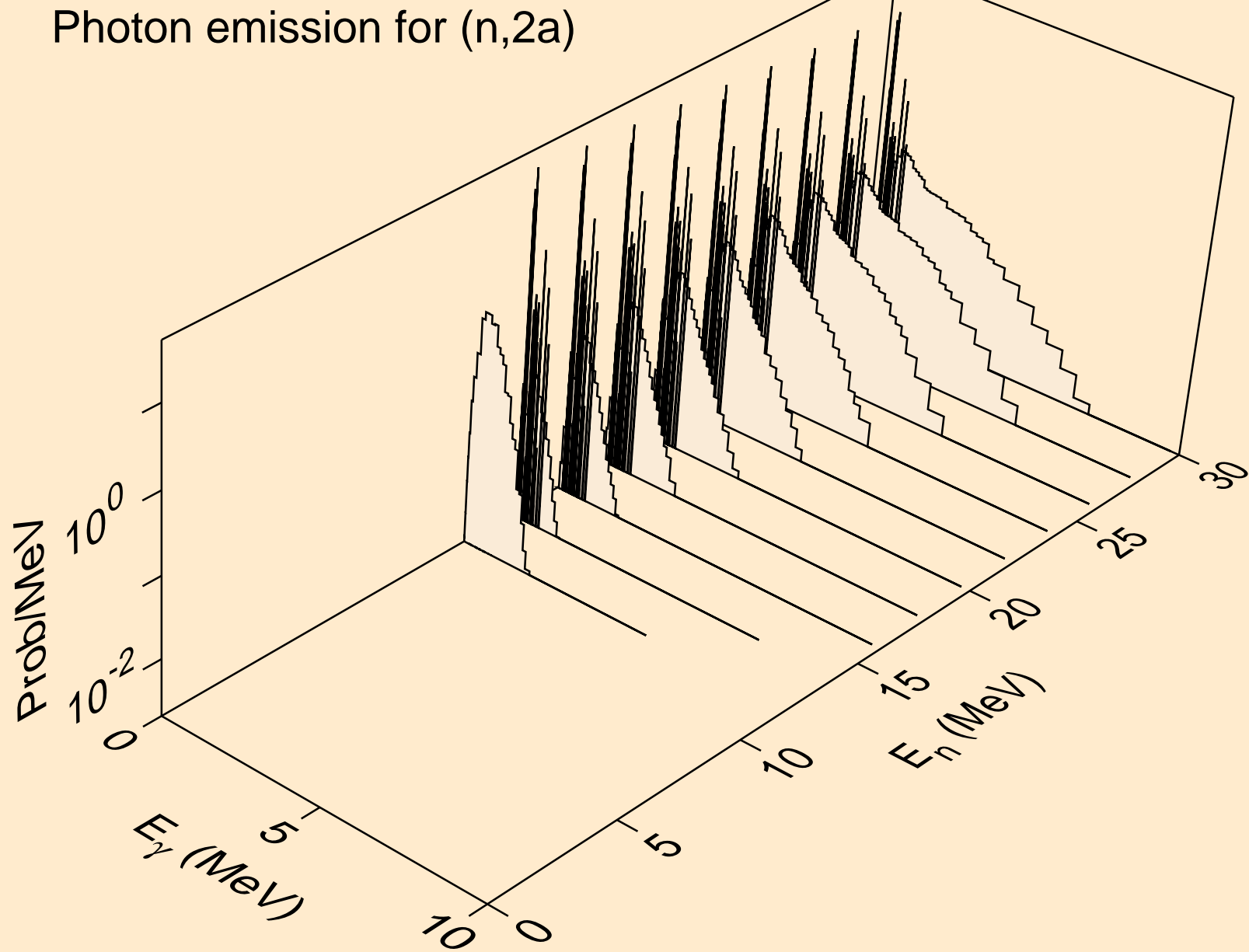

RB084M NEUTRON ACER TENDL-2021 LIBRARY; T=293.6K
Photon emission for (n,2p)

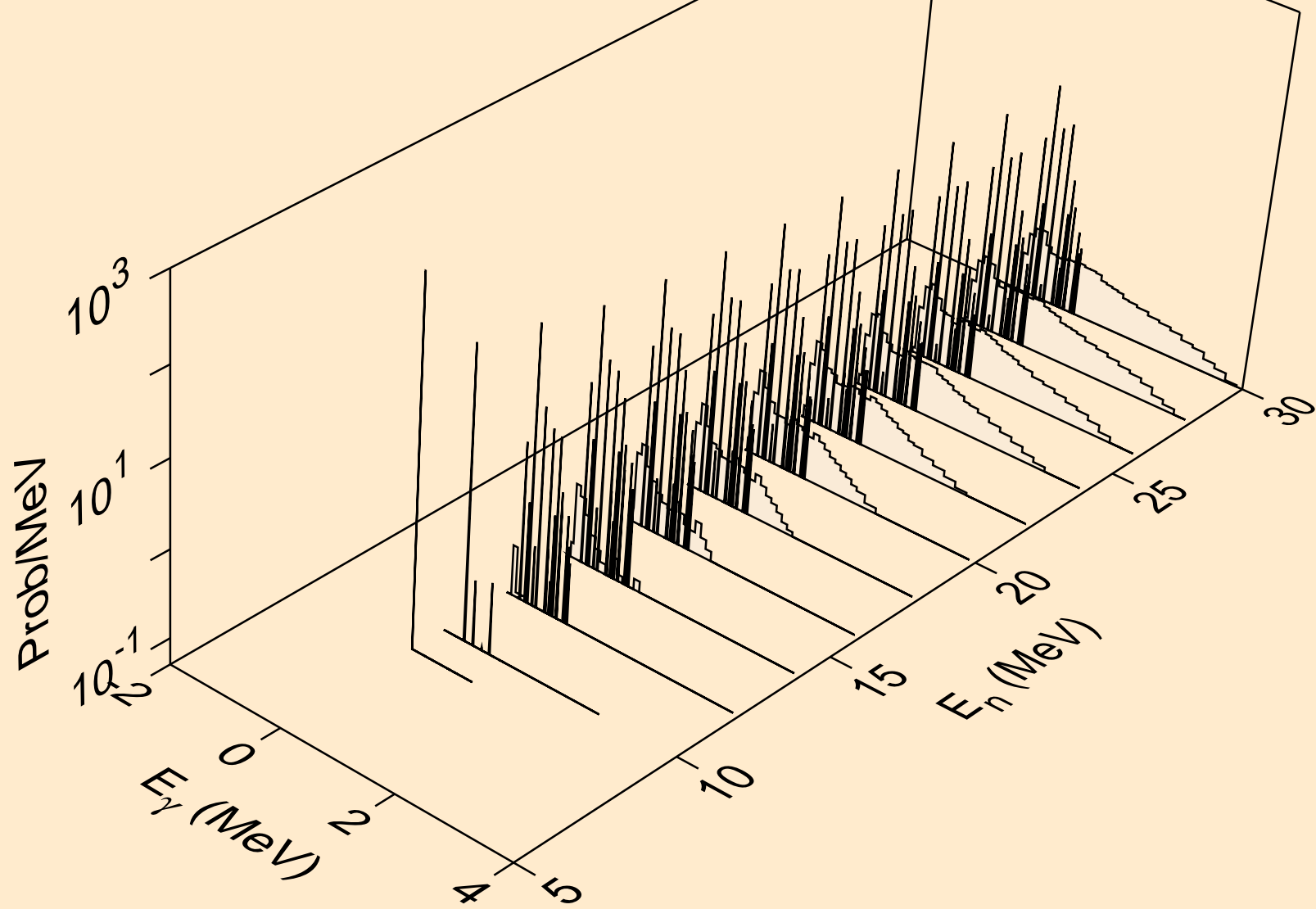

RB084M NEUTRON ACER TENDL-2021 LIBRARY; T=293.6K
Photon emission for (n,p)

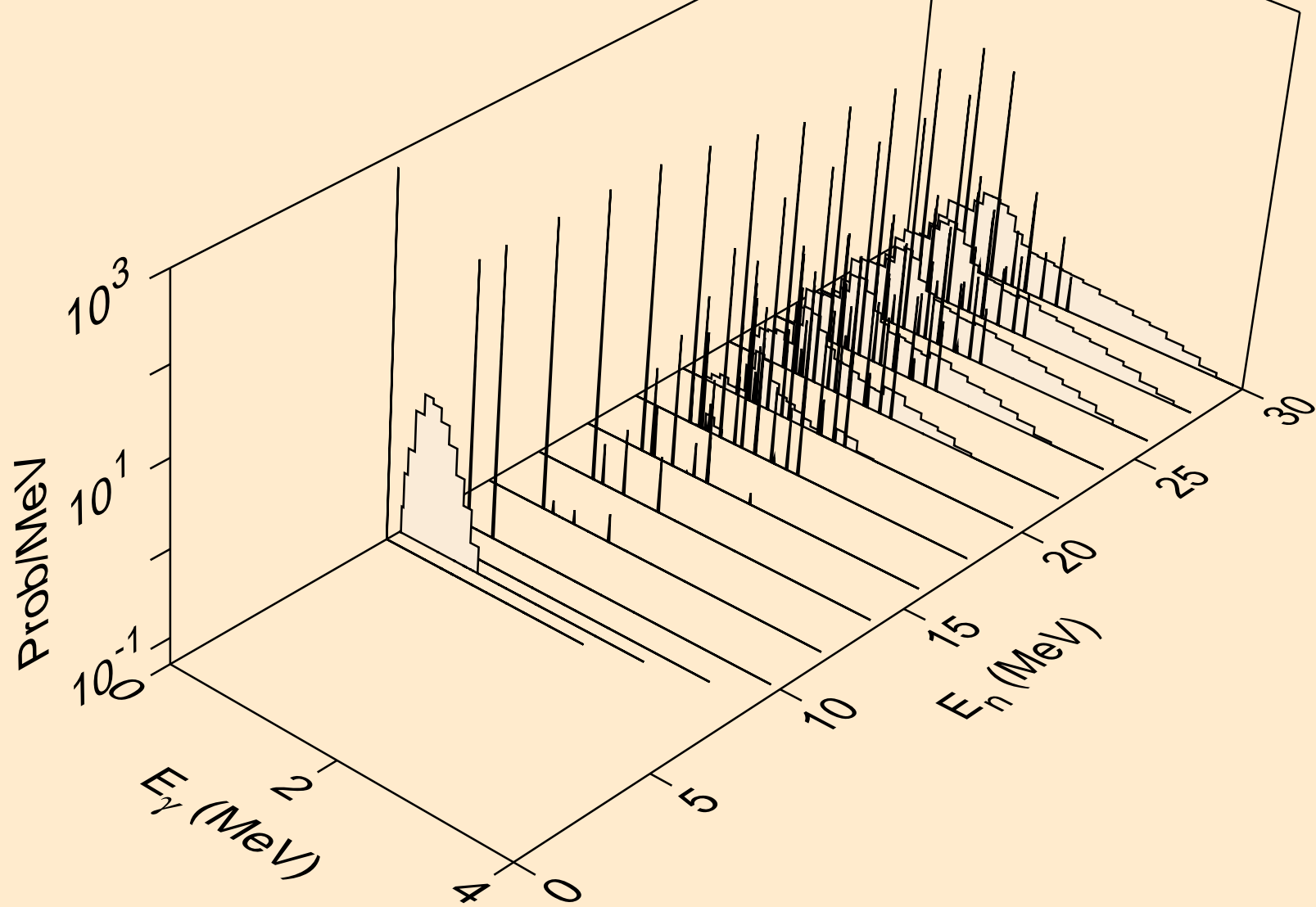

RB084M NEUTRON ACER TENDL-2021 LIBRARY; T=293.6K
Photon emission for (n,pd)

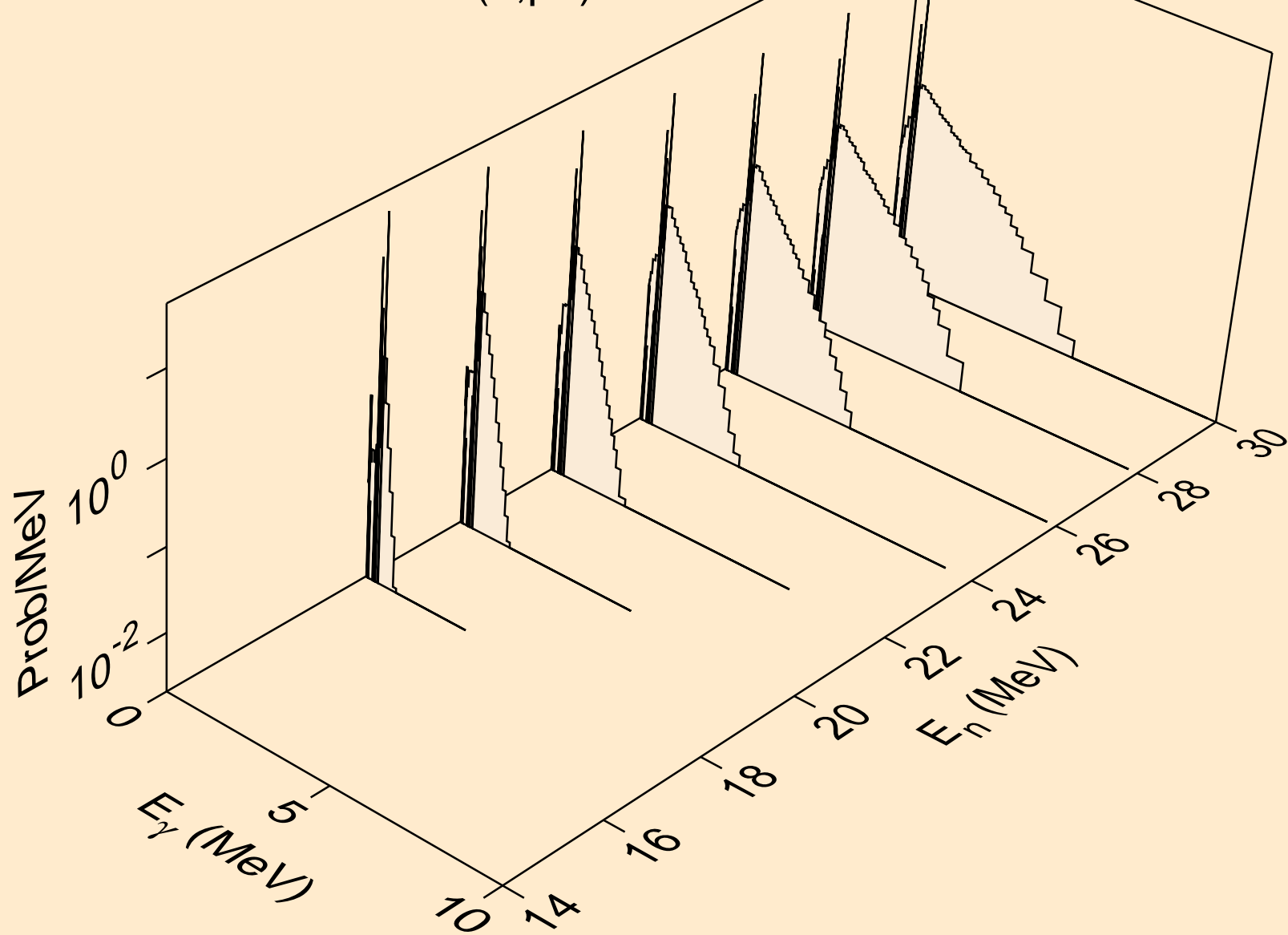

RB084M NEUTRON ACER TENDL-2021 LIBRARY; T=293.6K
Photon emission for (n,pt)

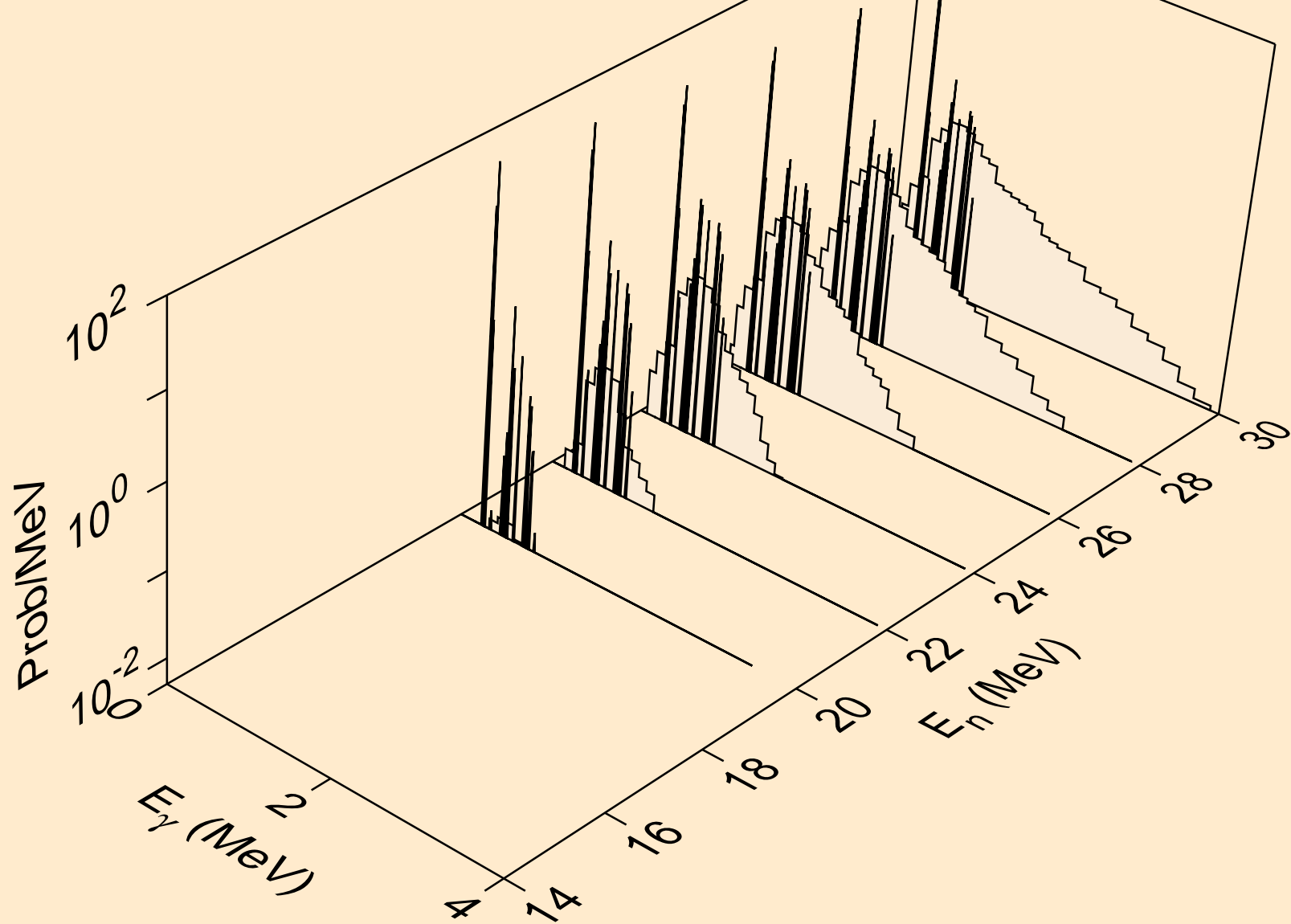

RB084M NEUTRON ACER TENDL-2021 LIBRARY; T=293.6K
Photon emission for (n,da)

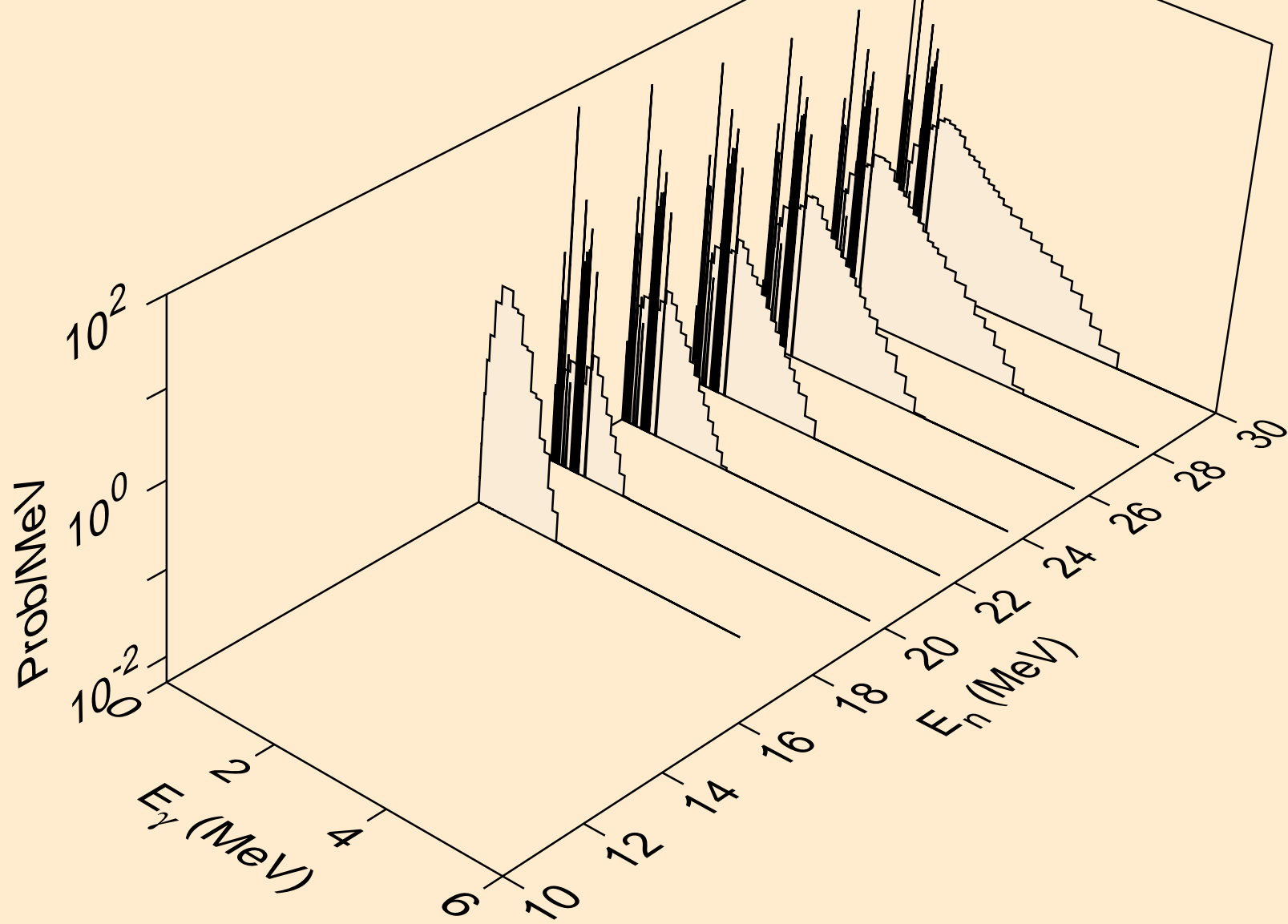

RB084M NEUTRON ACER TENDL-2021 LIBRARY; T=293.6K
thermal capture photon spectrum

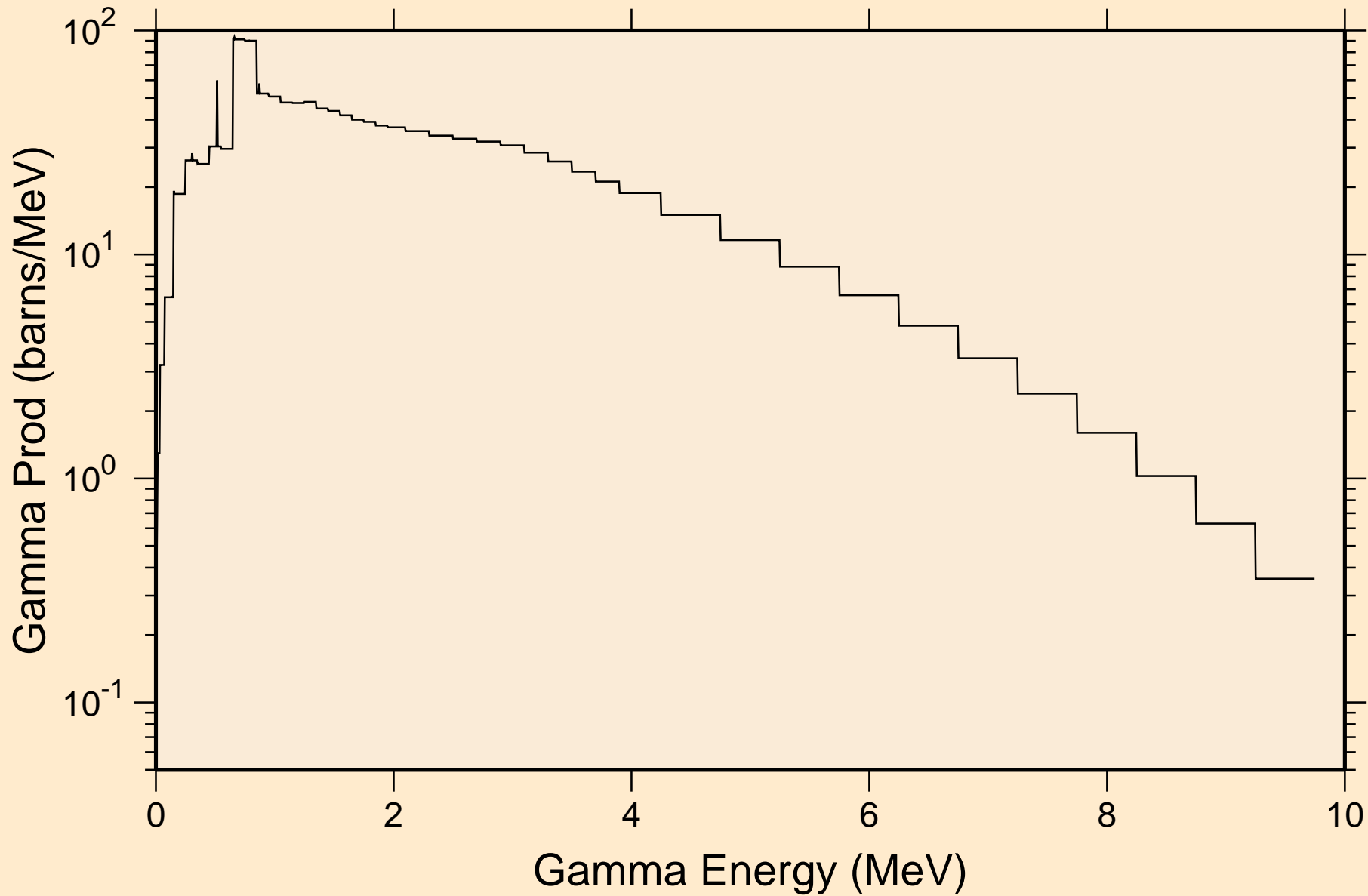

RB084M NEUTRON ACER TENDL-2021 LIBRARY; T=293.6K
14 MeV photon spectrum

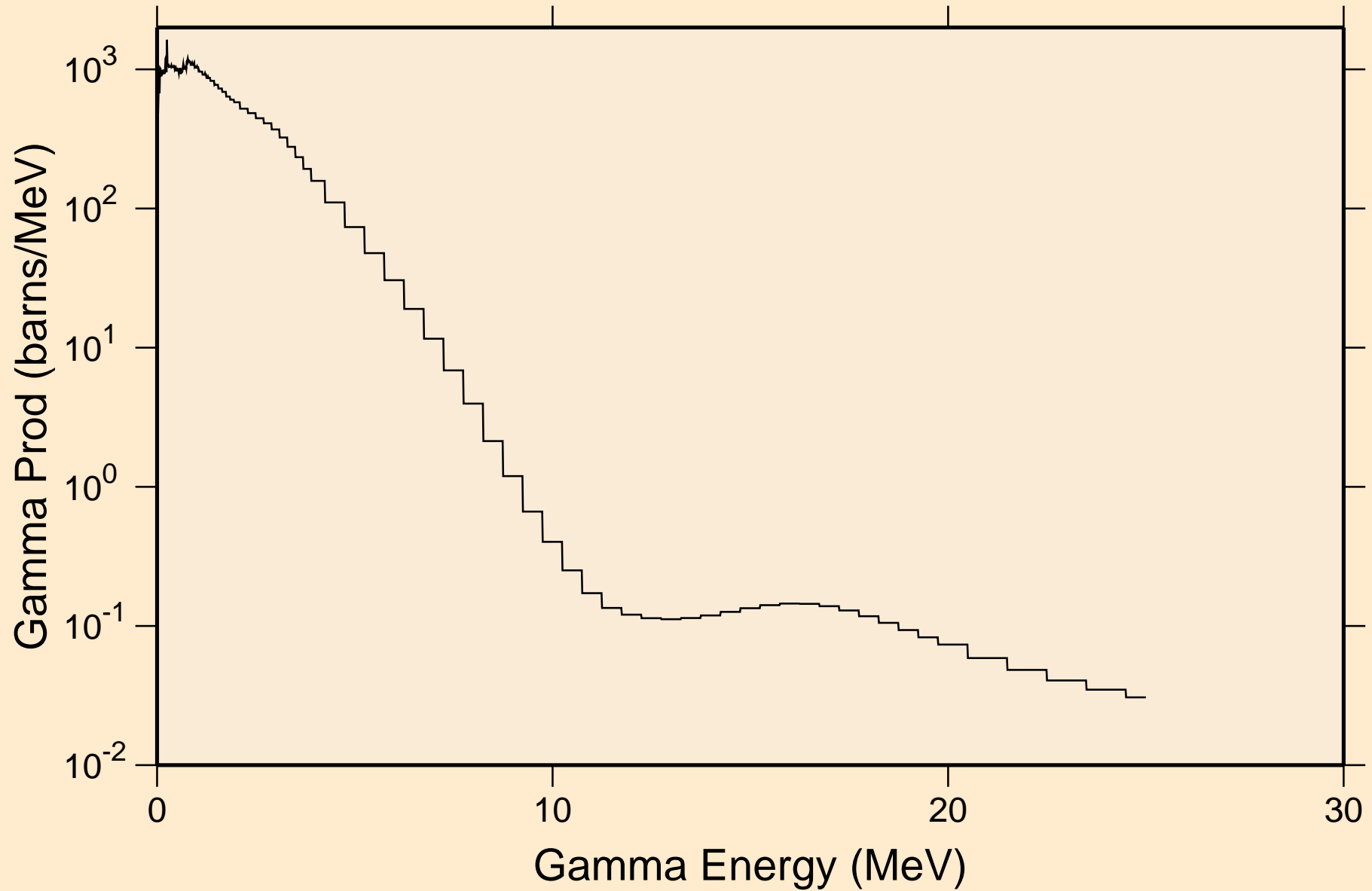

RB084M NEUTRON ACER TENDL-2021 LIBRARY; T=293.6K
Particle heating contributions

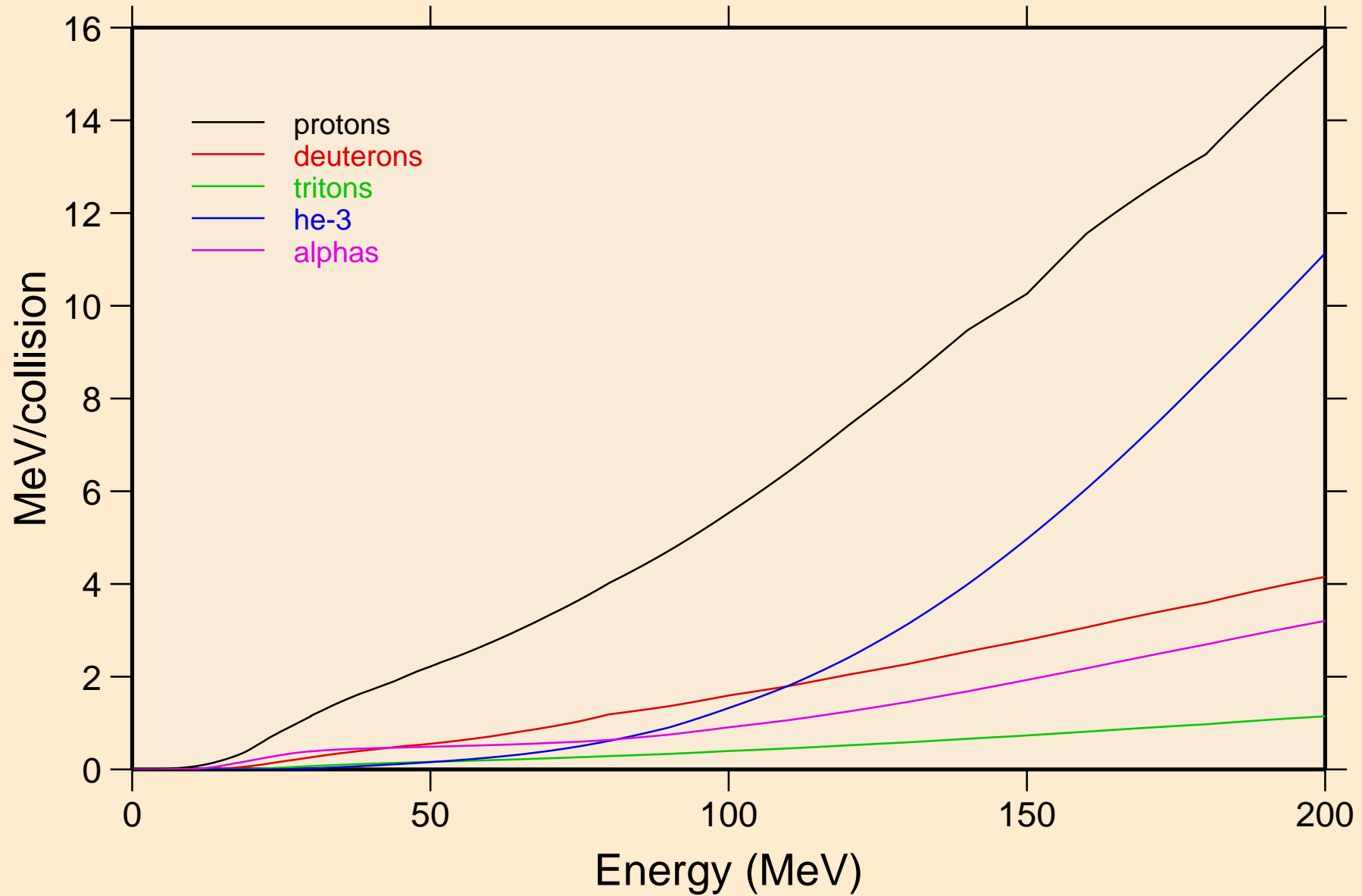

RB084M NEUTRON ACER TENDL-2021 LIBRARY; T=293.6K
Recoil Heating

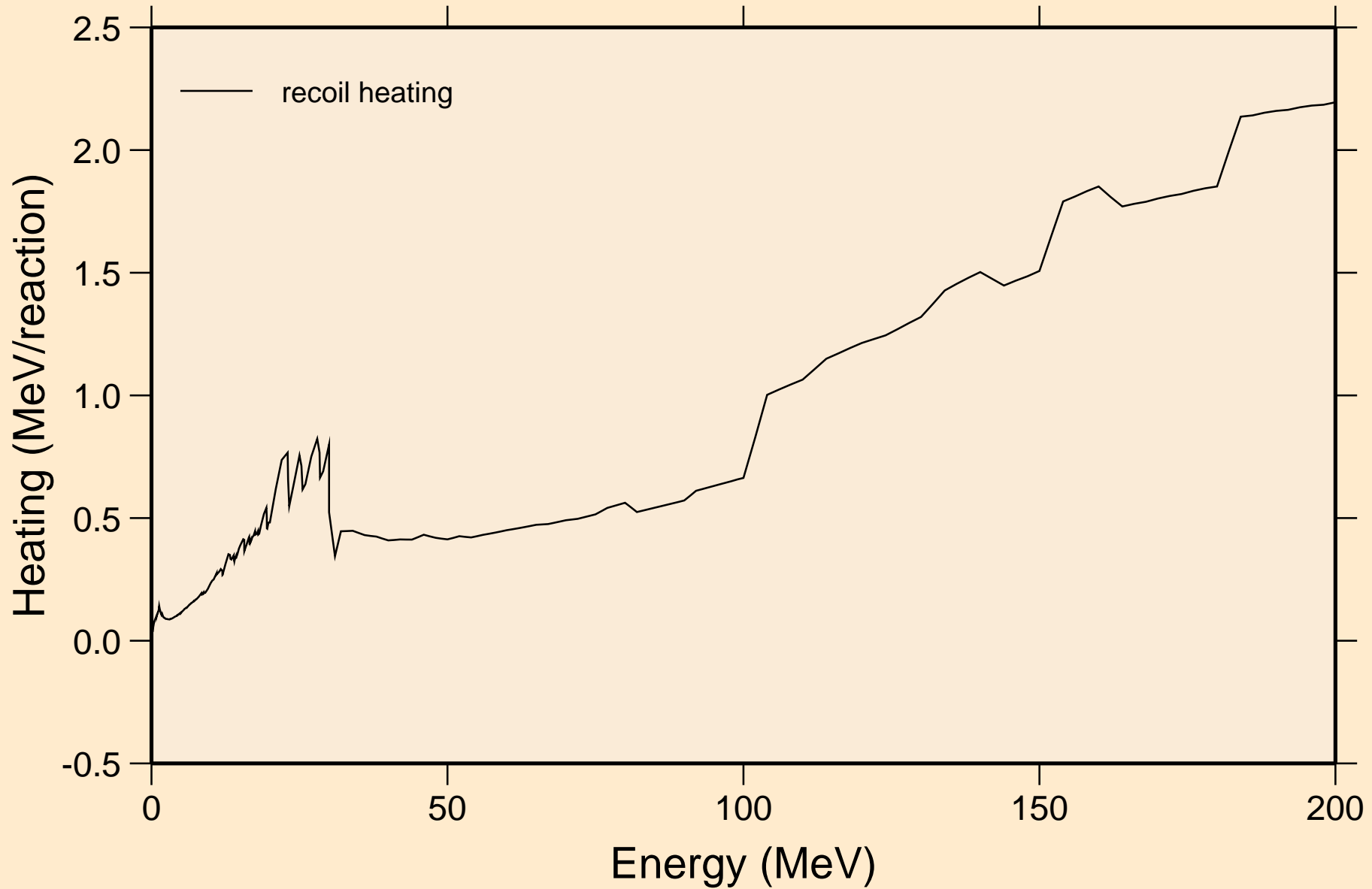

RB084M NEUTRON ACER TENDL-2021 LIBRARY; T=293.6K
Particle production cross sections

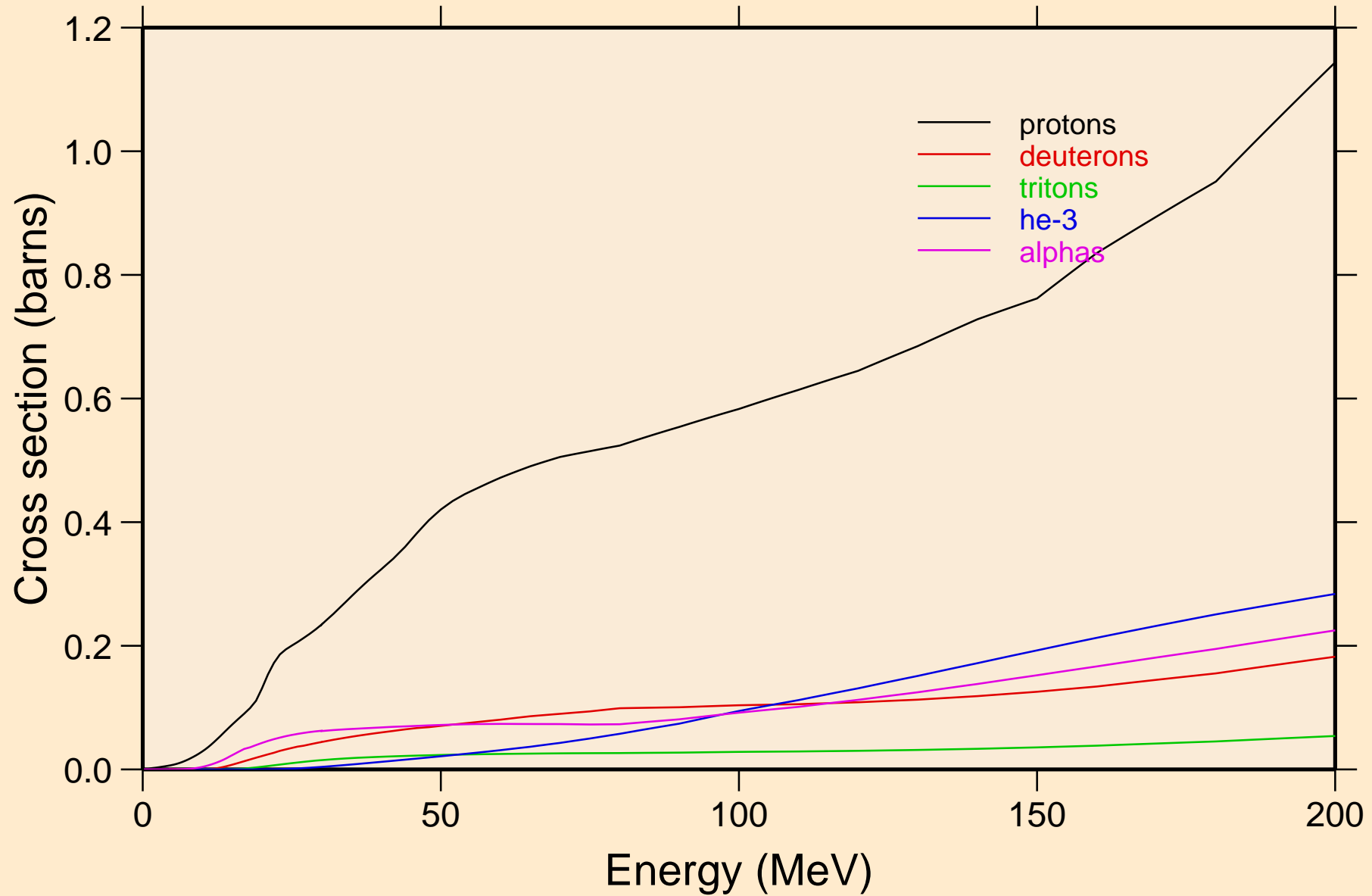

RB084M NEUTRON ACER TENDL-2021 LIBRARY; T=293.6K
protons from (n,x)

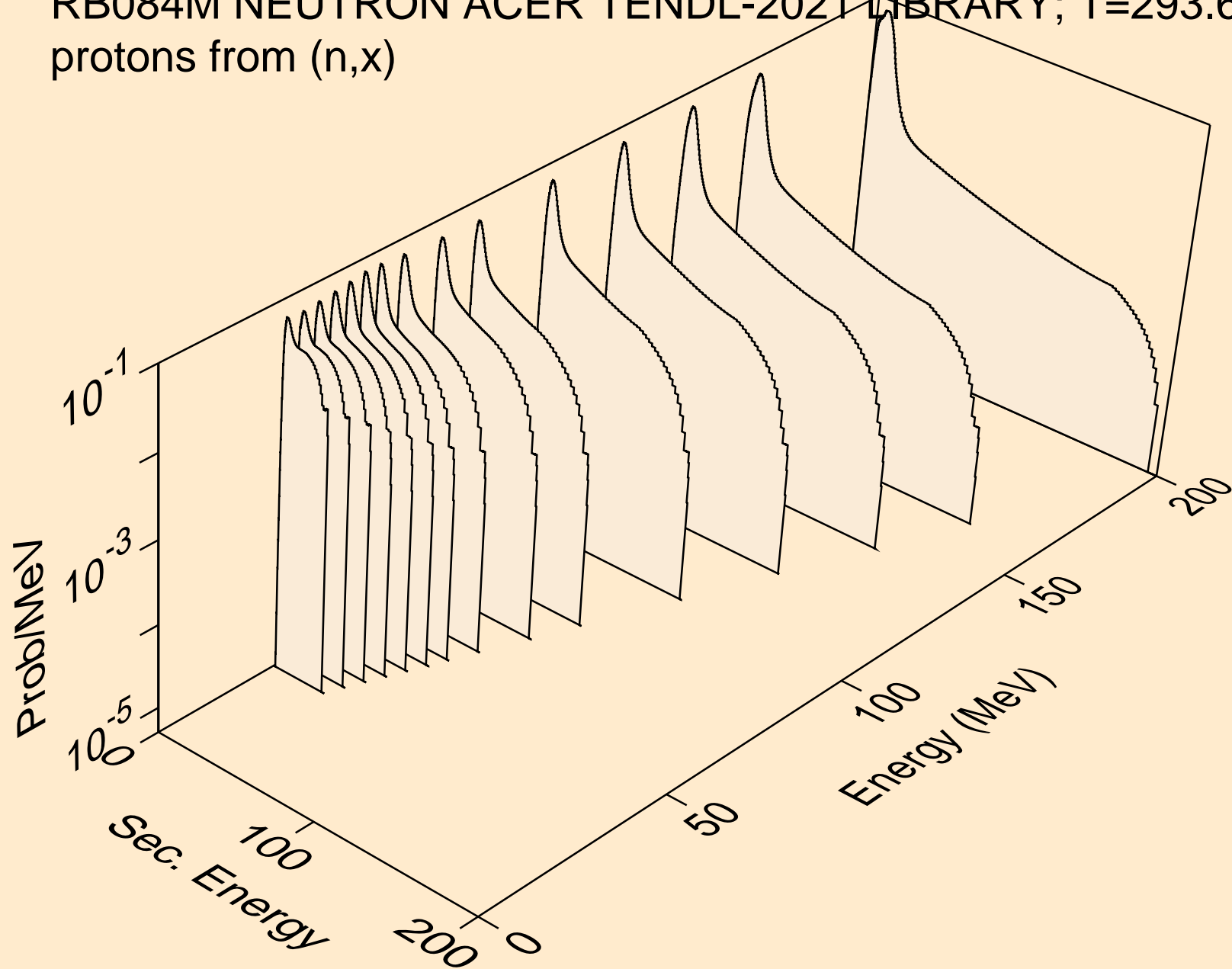

RB084M NEUTRON ACER TENDL-2021 LIBRARY; T=293.6K
protons from (n,n*)p

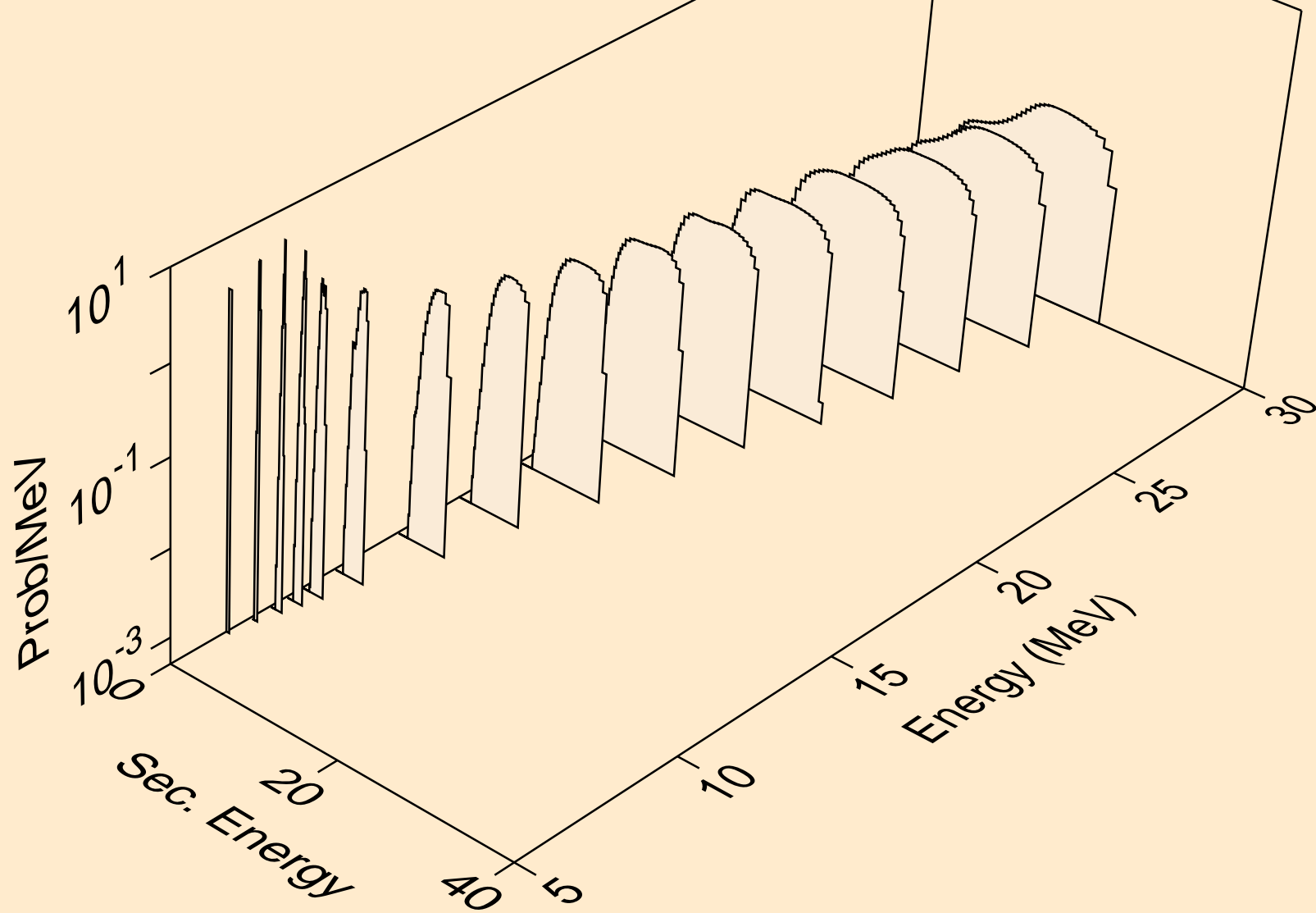

RB084M NEUTRON ACER TENDL-2021 LIBRARY; T=293.6K
protons from (n,2np)

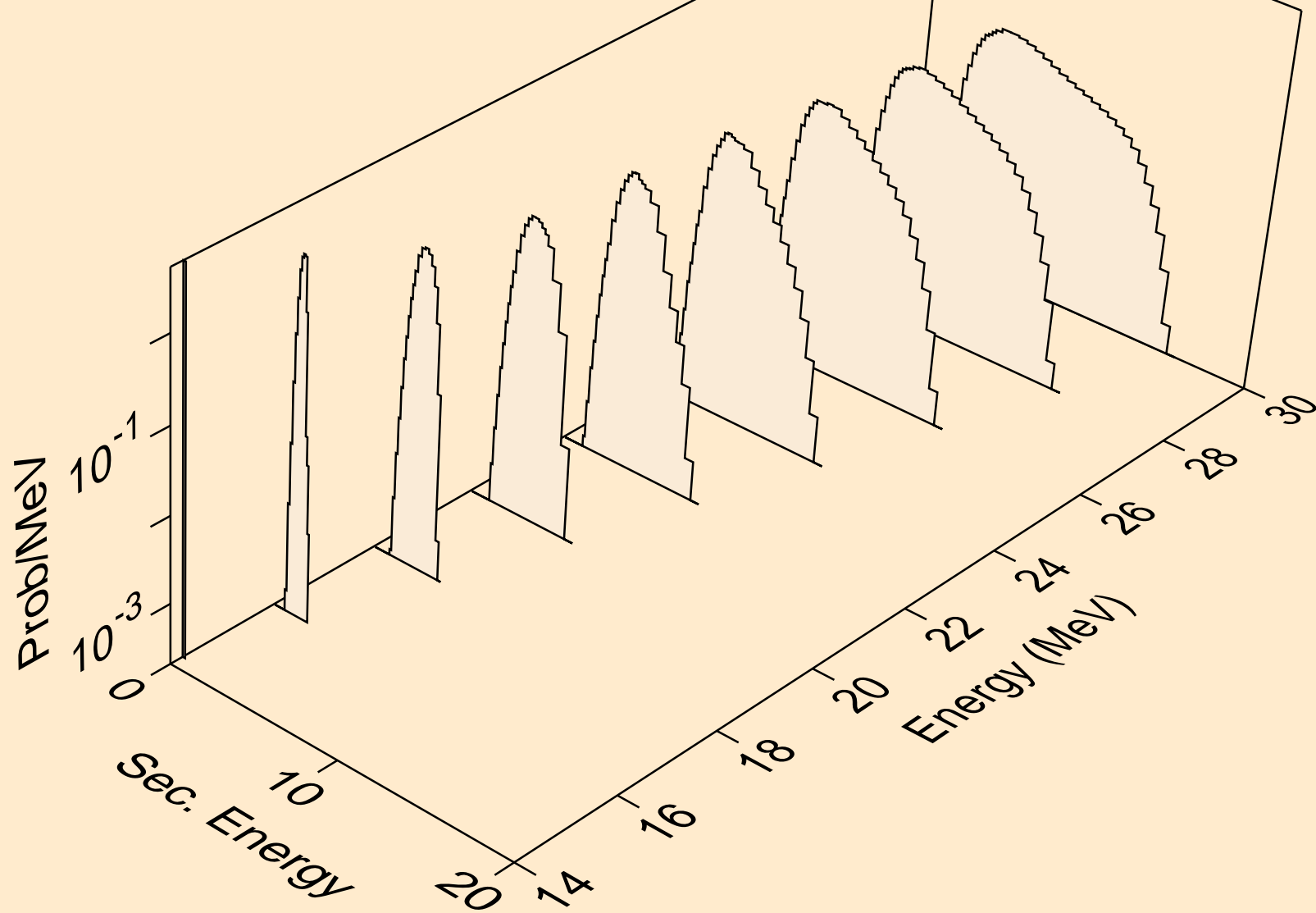

RB084M NEUTRON ACER TENDL-2021 LIBRARY; T=293.6K
protons from (n,3np)

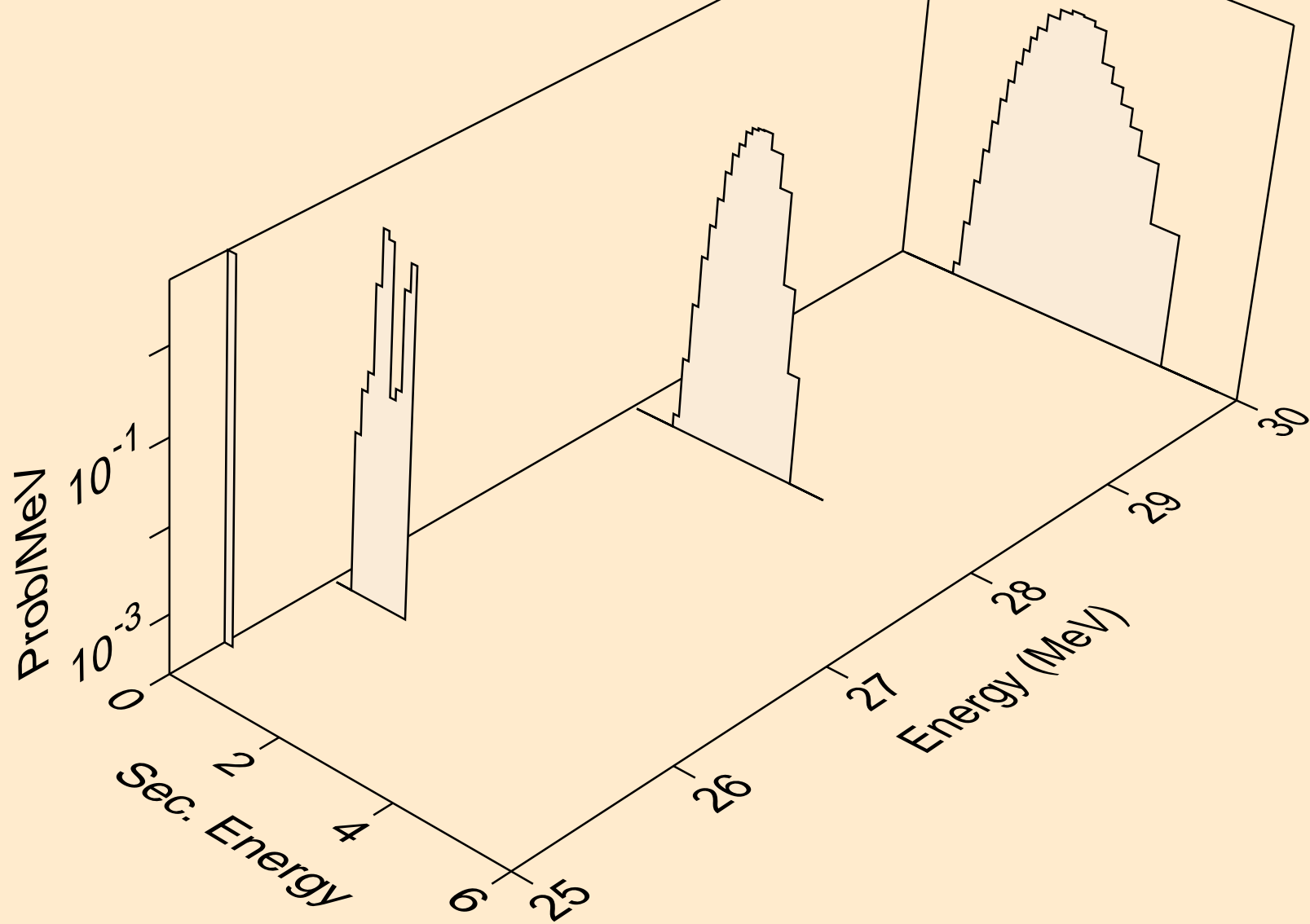

RB084M NEUTRON ACER TENDL-2021 LIBRARY; T=293.6K
protons from (n,2np)

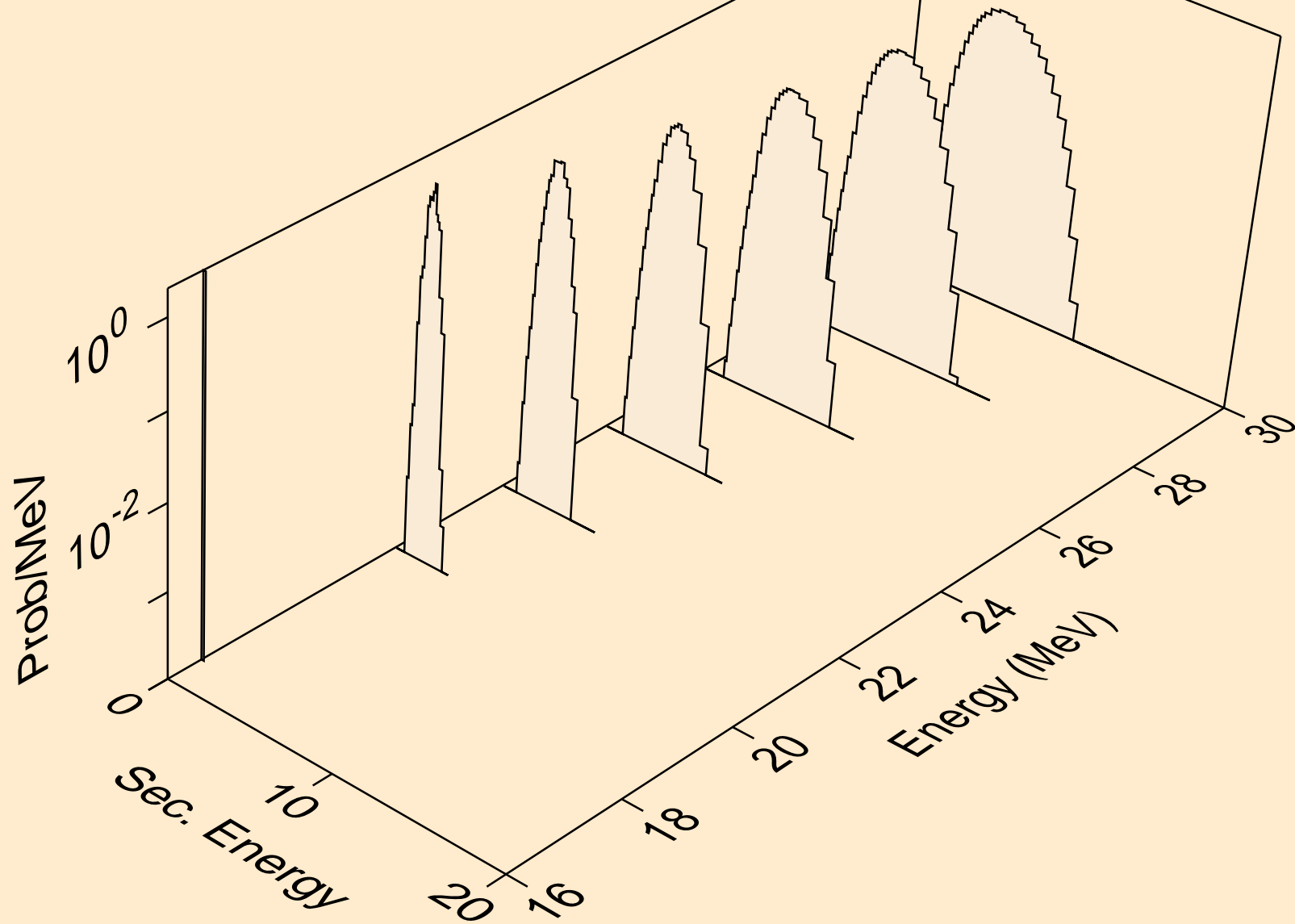

RB084M NEUTRON ACER TENDL-2021 LIBRARY; T=293.6K
protons from (n,npa)

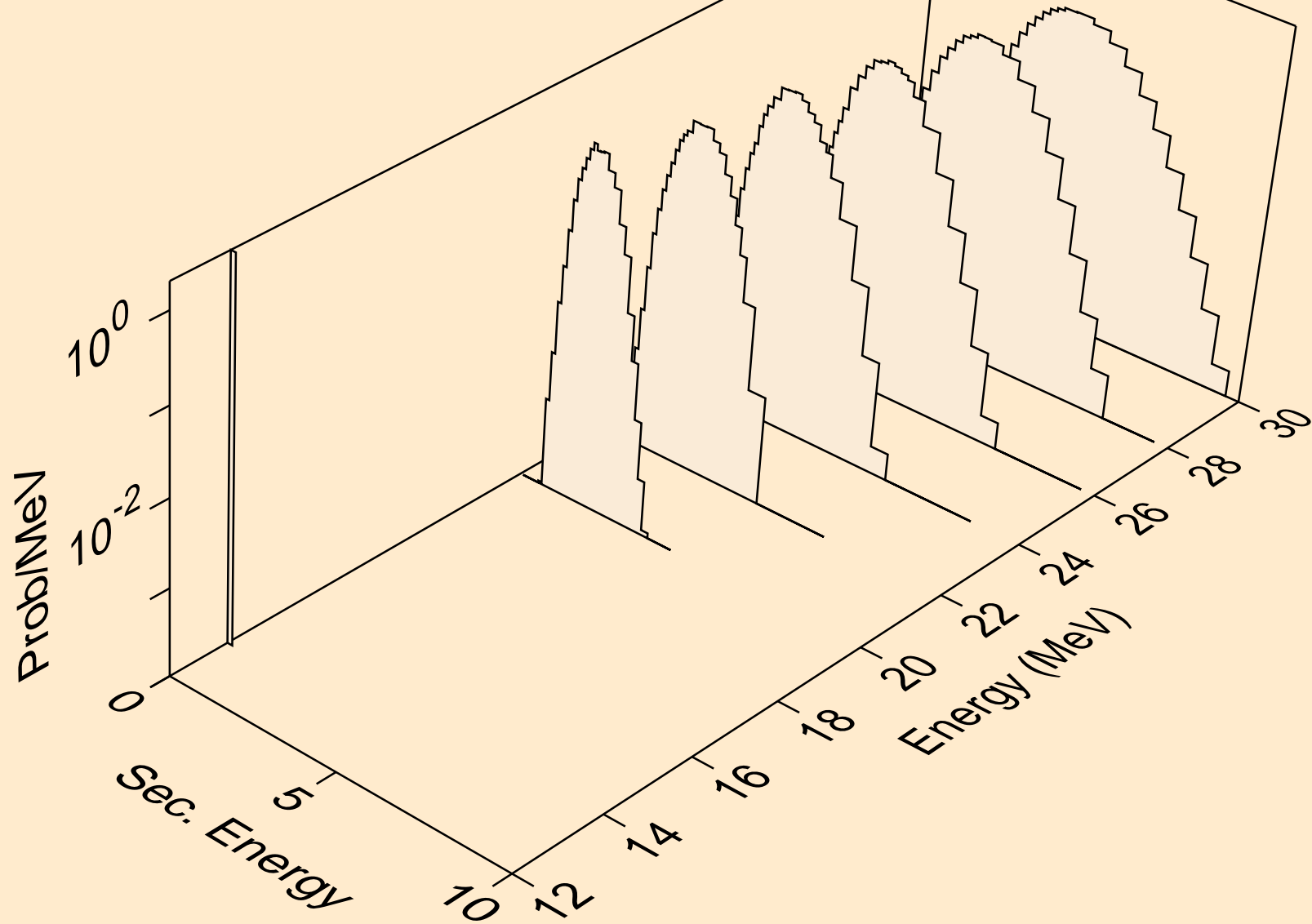

RB084M NEUTRON ACER TENDL-2021 LIBRARY; T=293.6K
protons from (n,p)

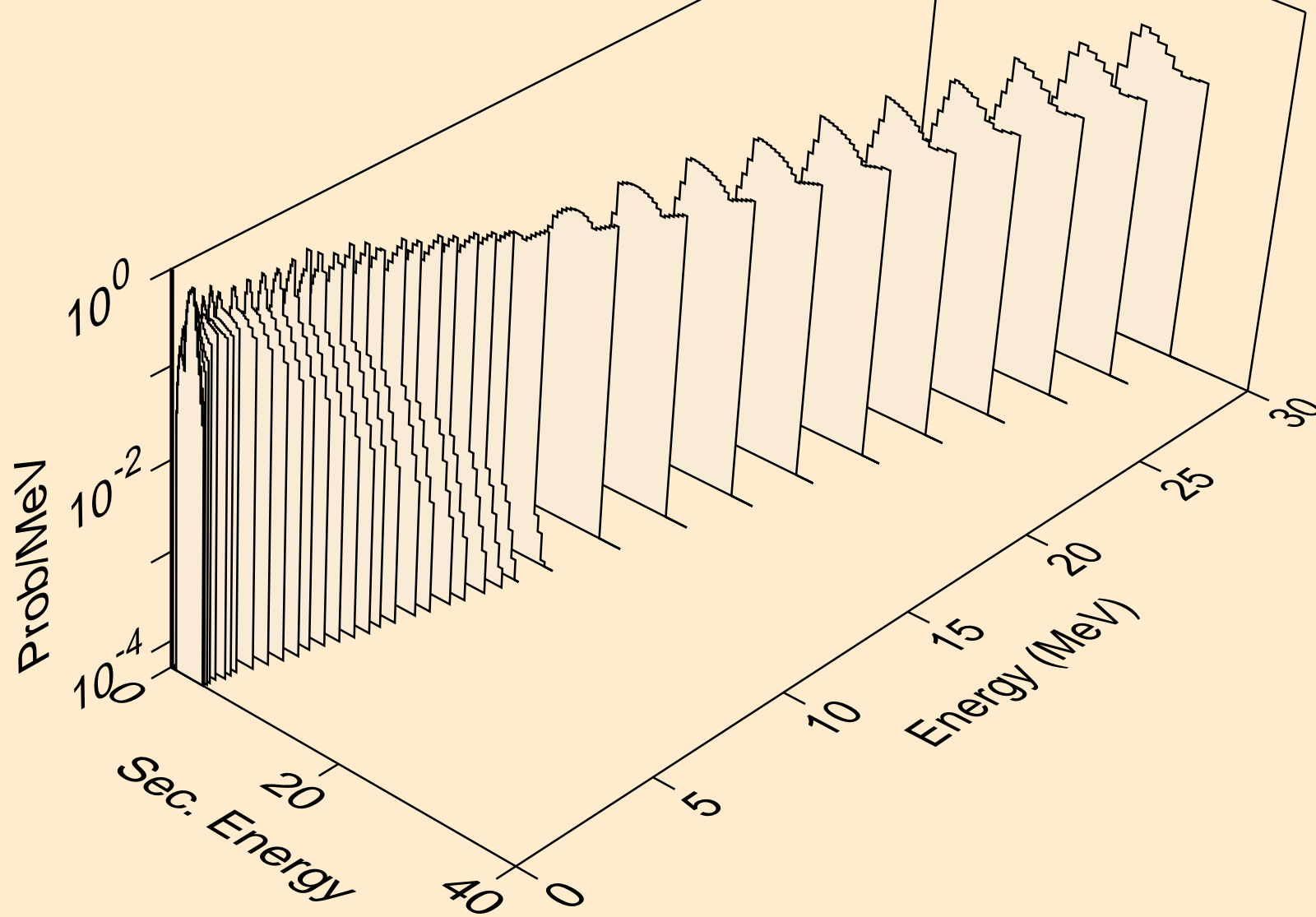

RB084M NEUTRON ACER TENDL-2021 LIBRARY; T=293.6K
protons from (n,2p)

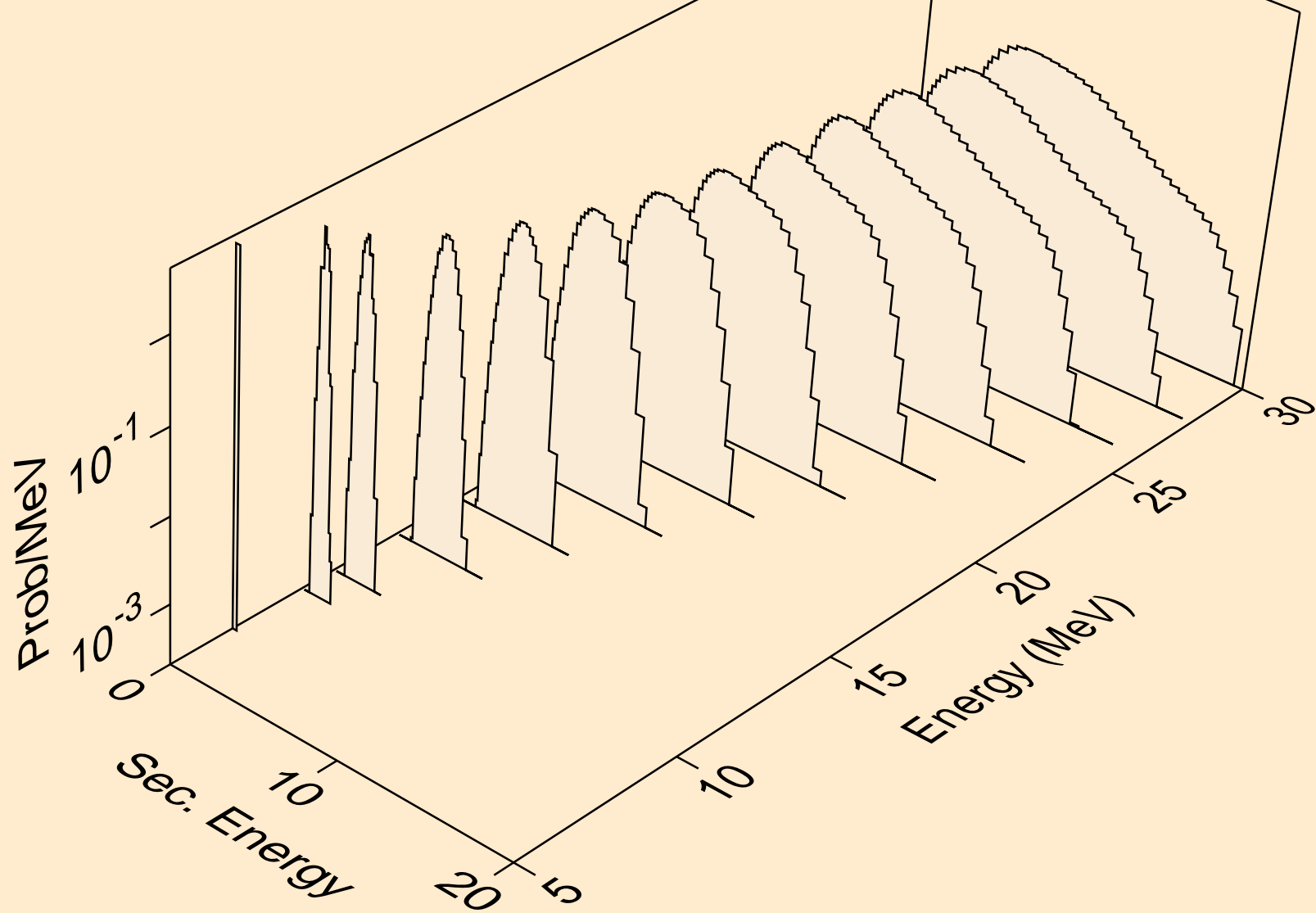

RB084M NEUTRON ACER TENDL-2021 LIBRARY; T=293.6K
protons from (n,p)

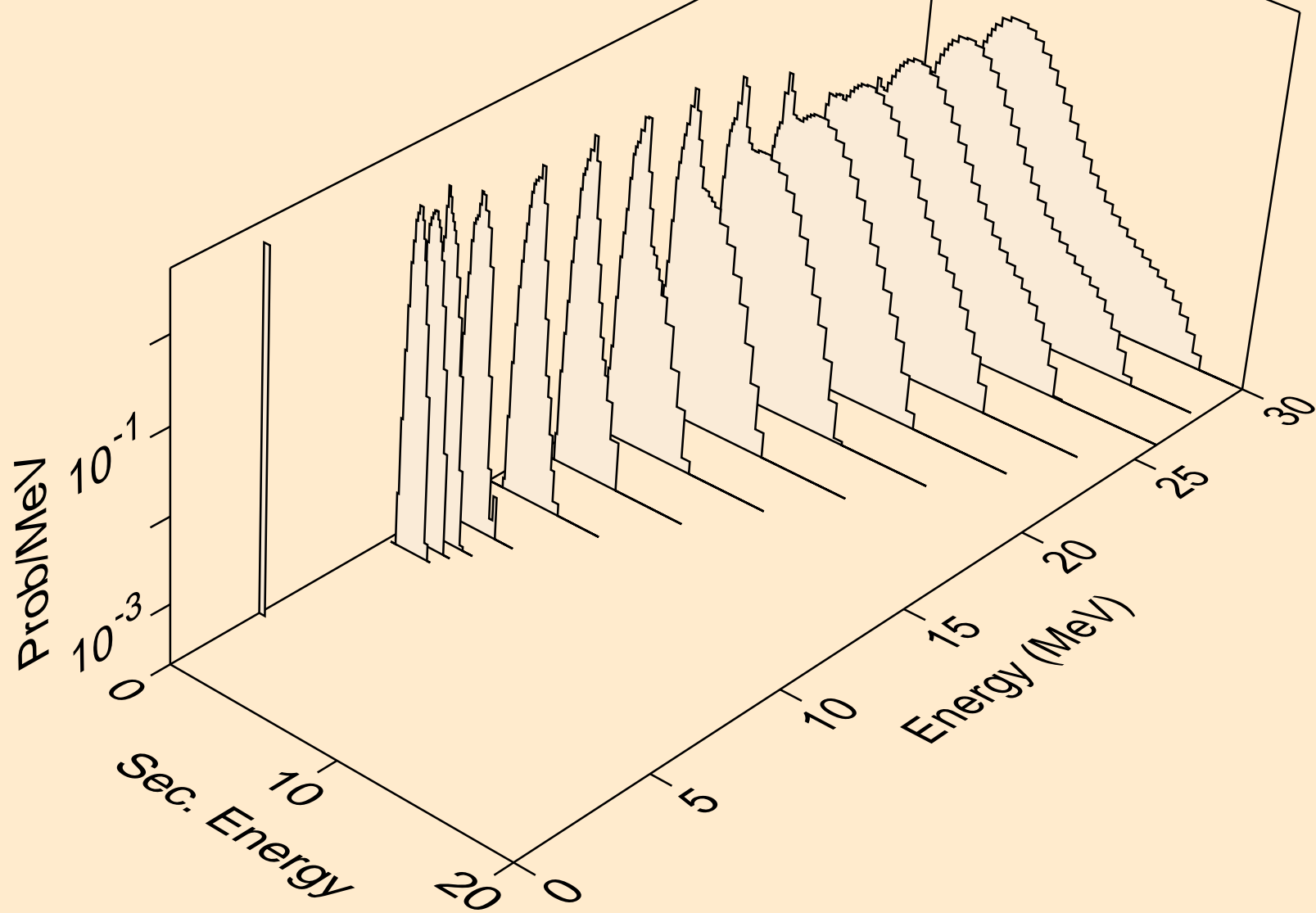

RB084M NEUTRON ACER TENDL-2021 LIBRARY; T=293.6K
protons from (n,pd)

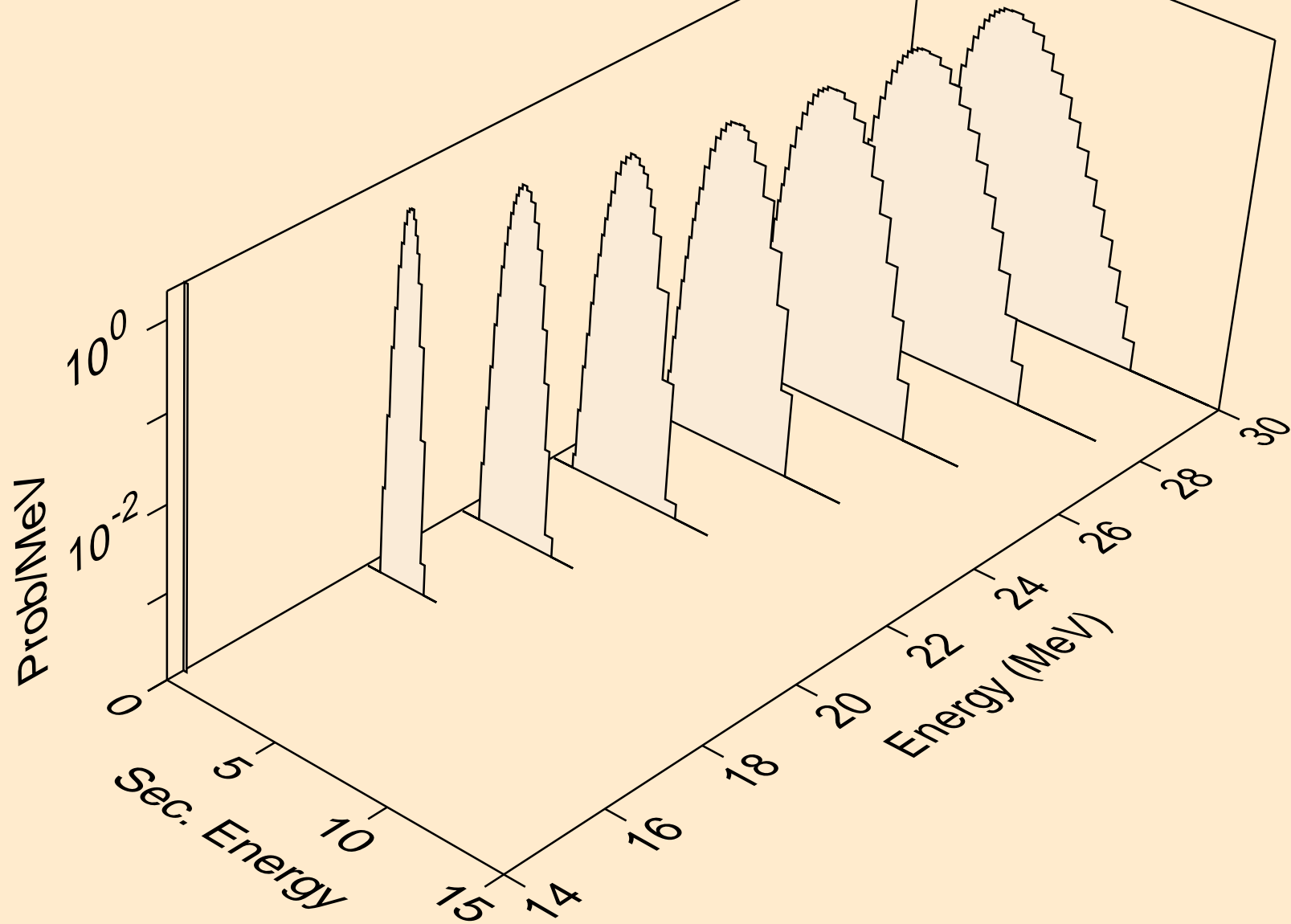

RB084M NEUTRON ACER TENDL-2021 LIBRARY; T=293.6K
protons from (n,pt)

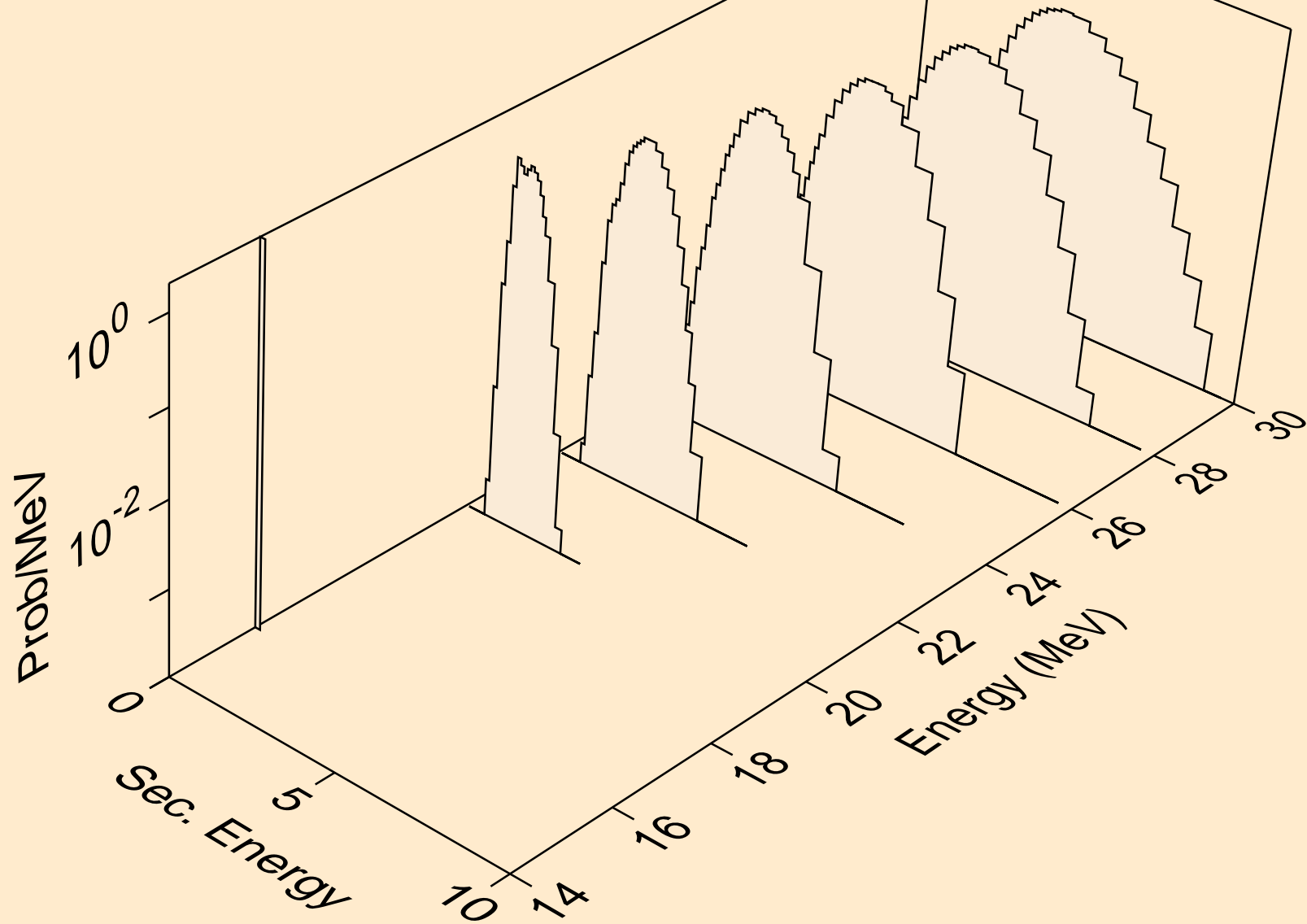

RB084M NEUTRON ACER TENDL-2021 LIBRARY; T=293.6K
deuterons from (n,x)

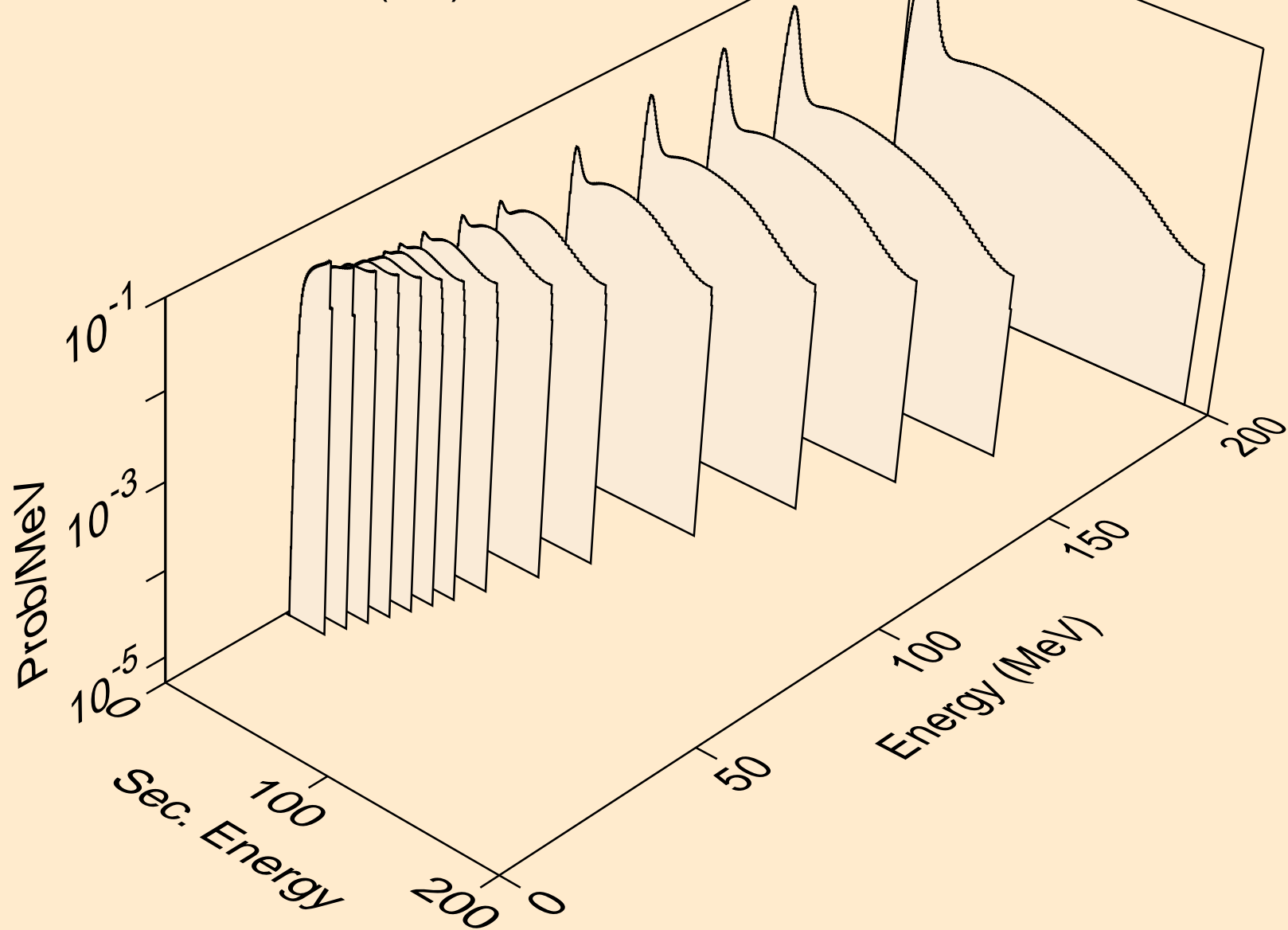

RB084M NEUTRON ACER TENDL-2021 LIBRARY; T=293.6K
deuterons from (n,2nd)

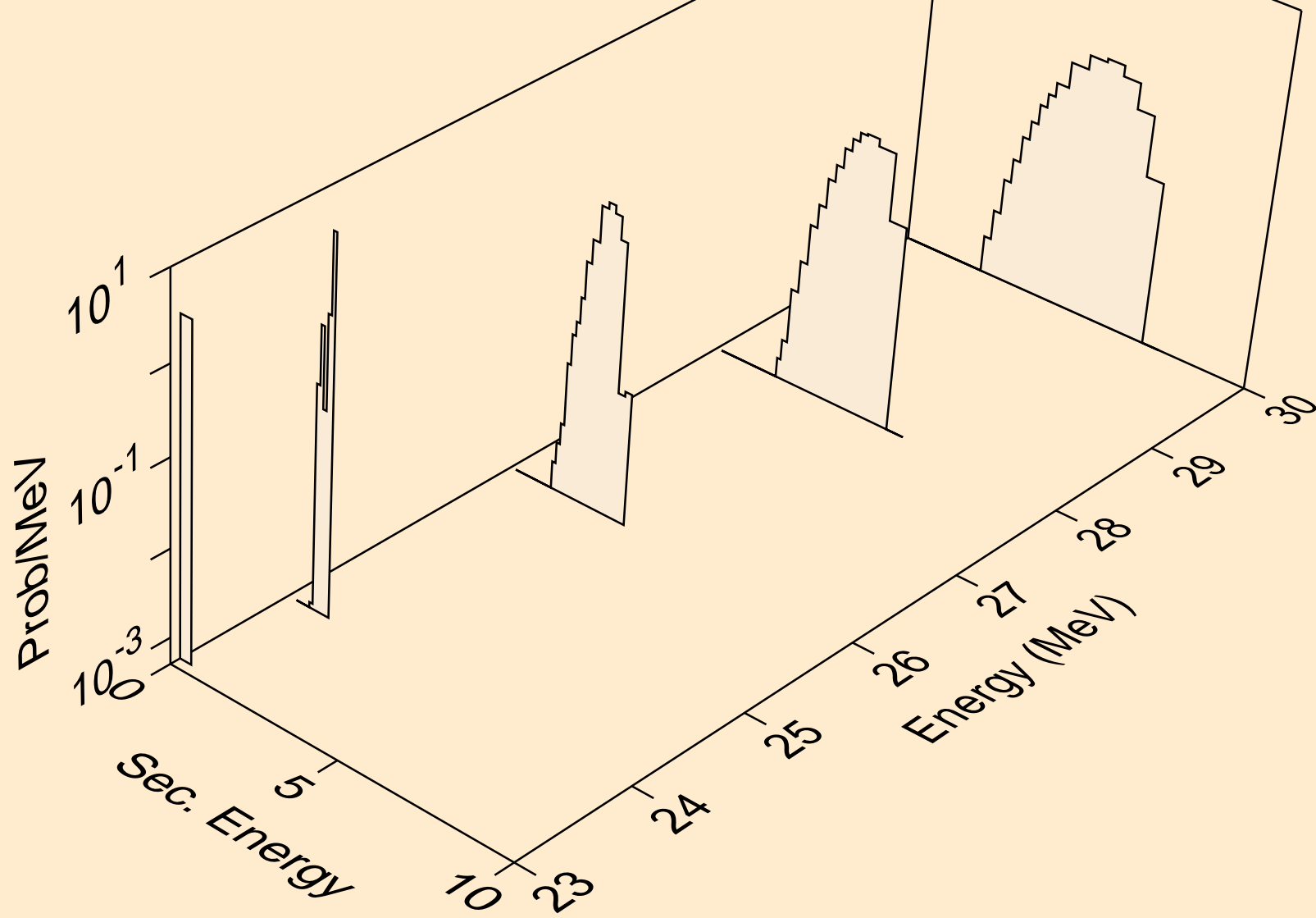

RB084M NEUTRON ACER TENDL-2021 LIBRARY; T=293.6K
deuterons from (n,n*)d

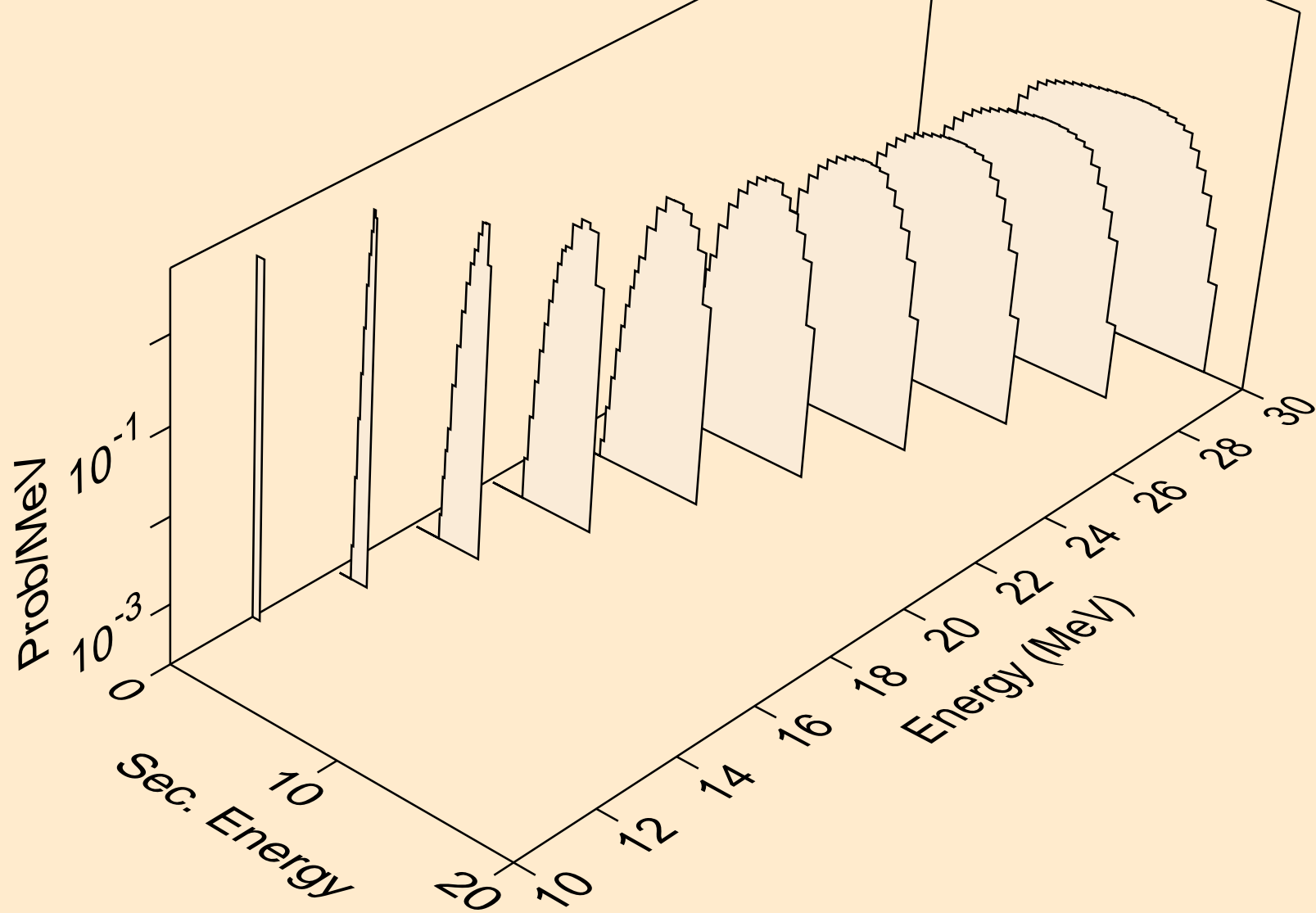

RB084M NEUTRON ACER TENDL-2021 LIBRARY; T=293.6K
deuterons from (n,d)

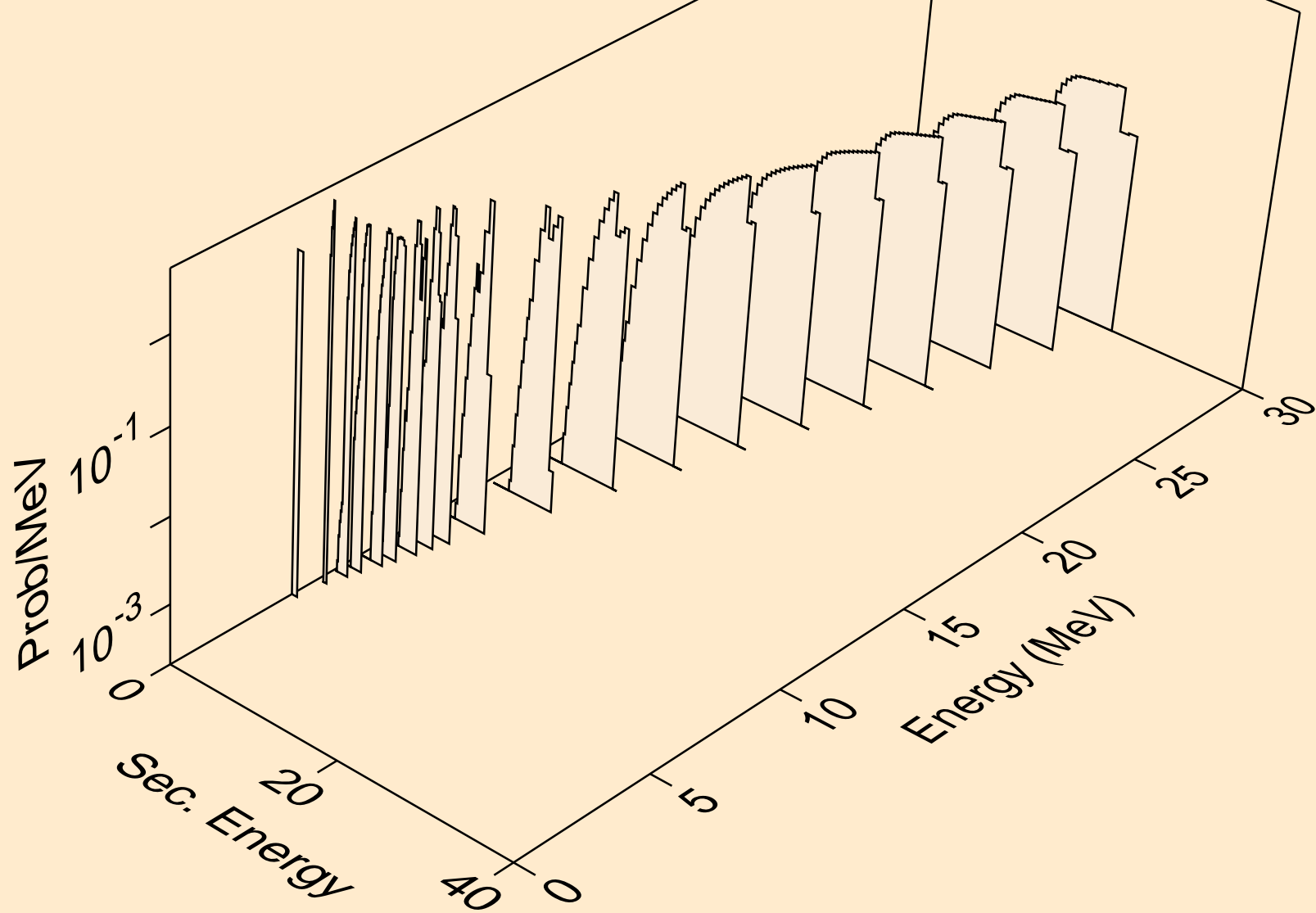

RB084M NEUTRON ACER TENDL-2021 LIBRARY; T=293.6K
deuterons from (n,pd)

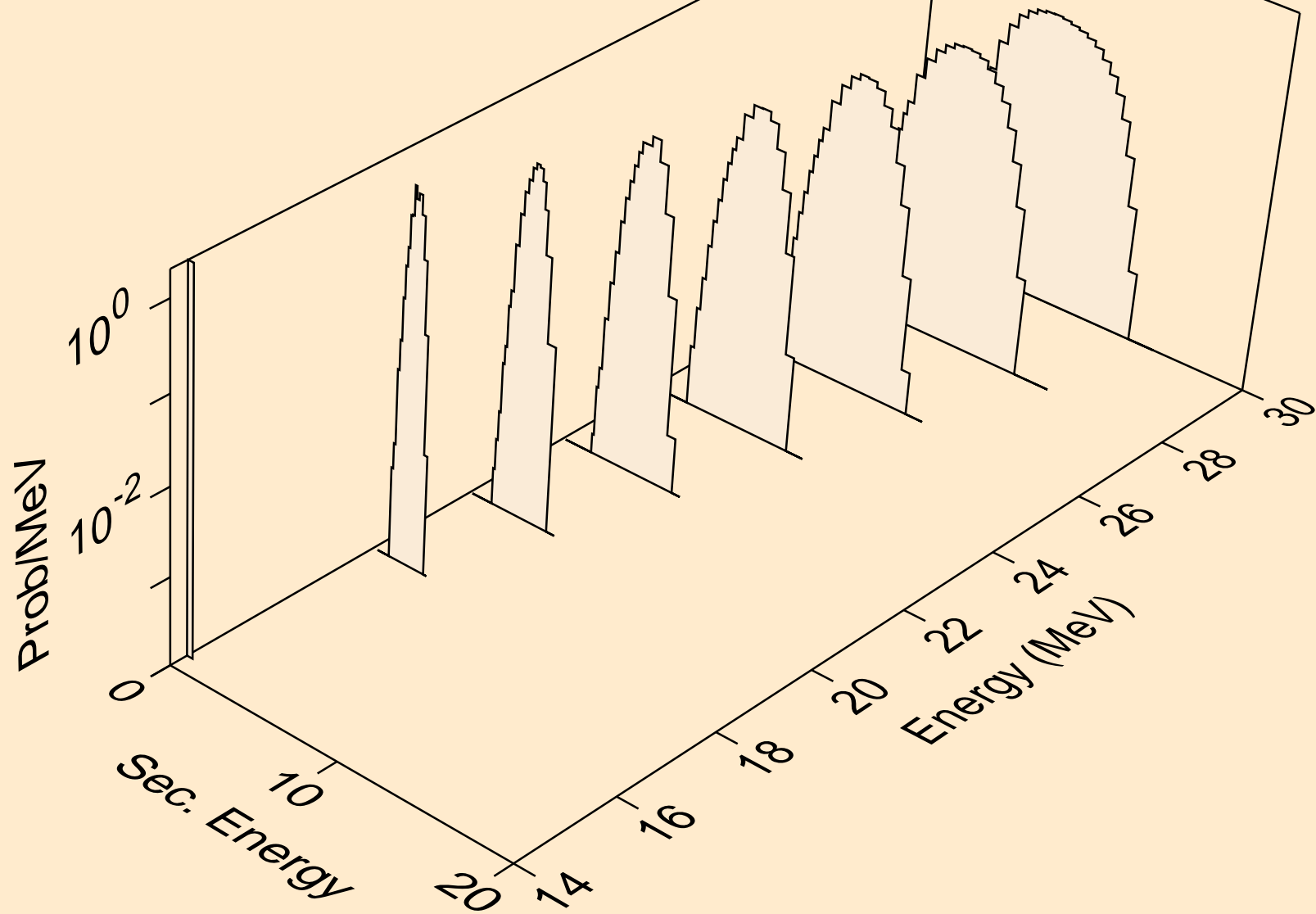

RB084M NEUTRON ACER TENDL-2021 LIBRARY; T=293.6K
deuterons from (n,da)

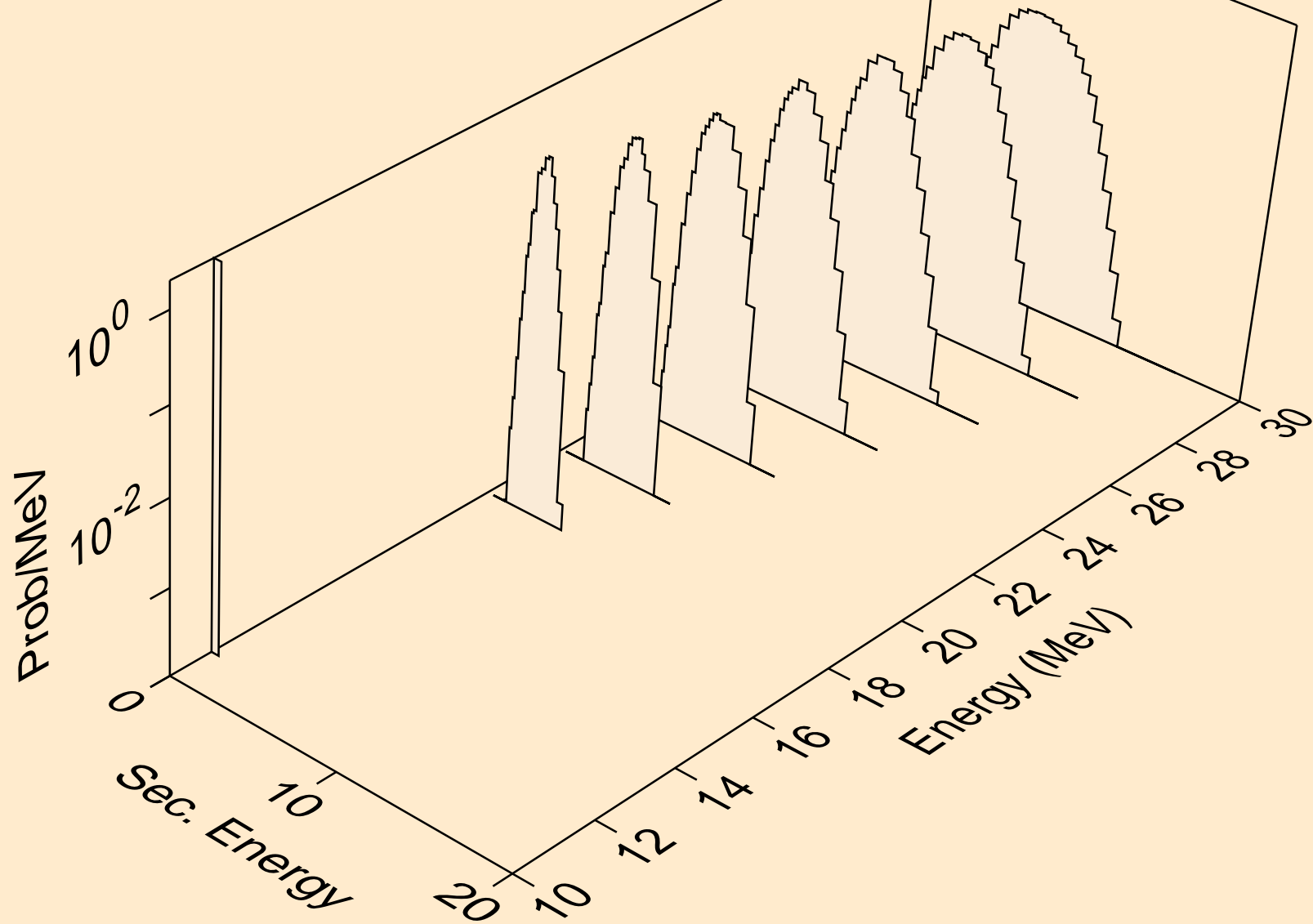

RB084M NEUTRON ACER TENDL-2021 LIBRARY; T=293.6K
tritons from (n,x)

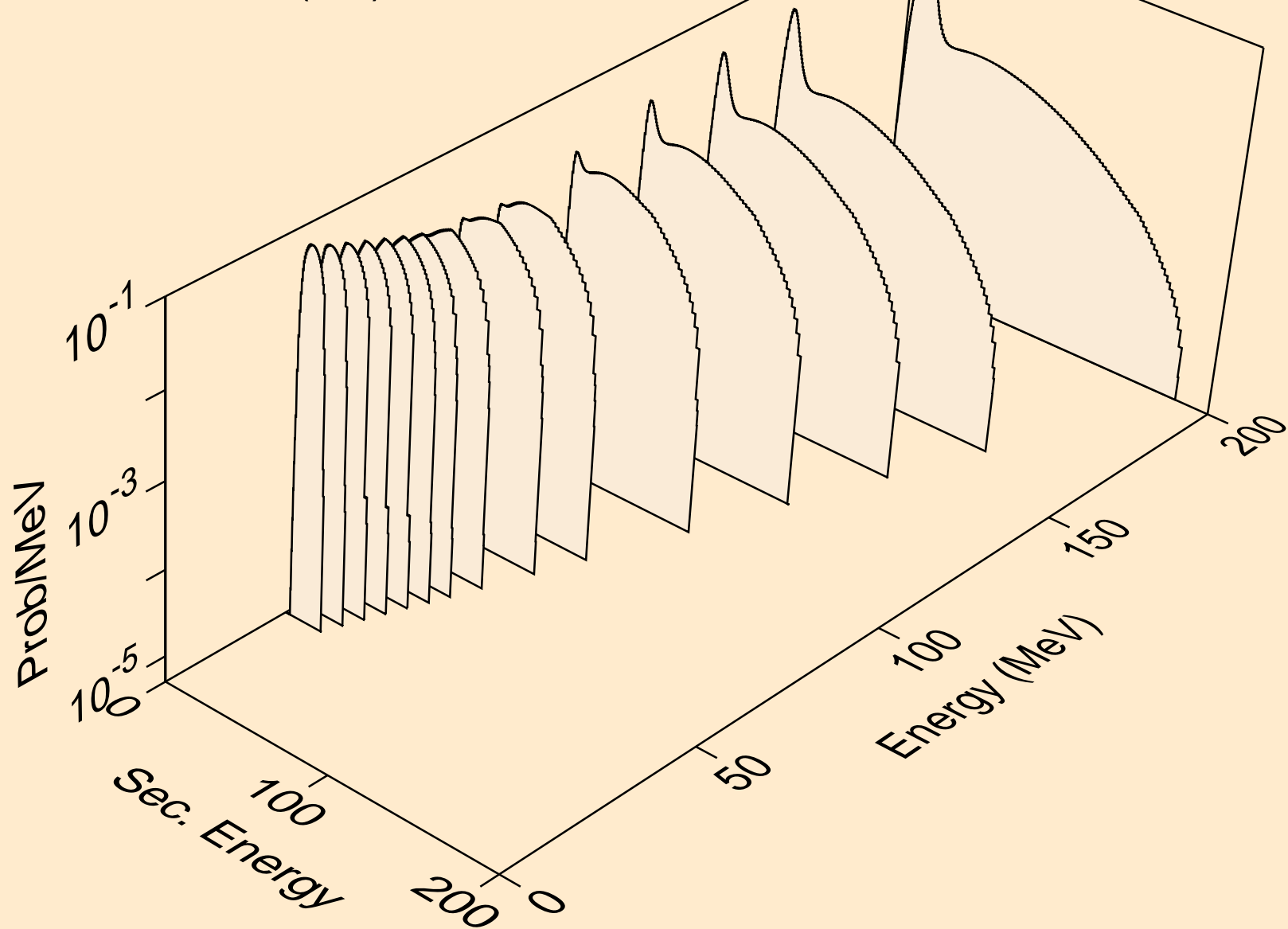

RB084M NEUTRON ACER TENDL-2021 LIBRARY; T=293.6K
tritons from (n,n*)t

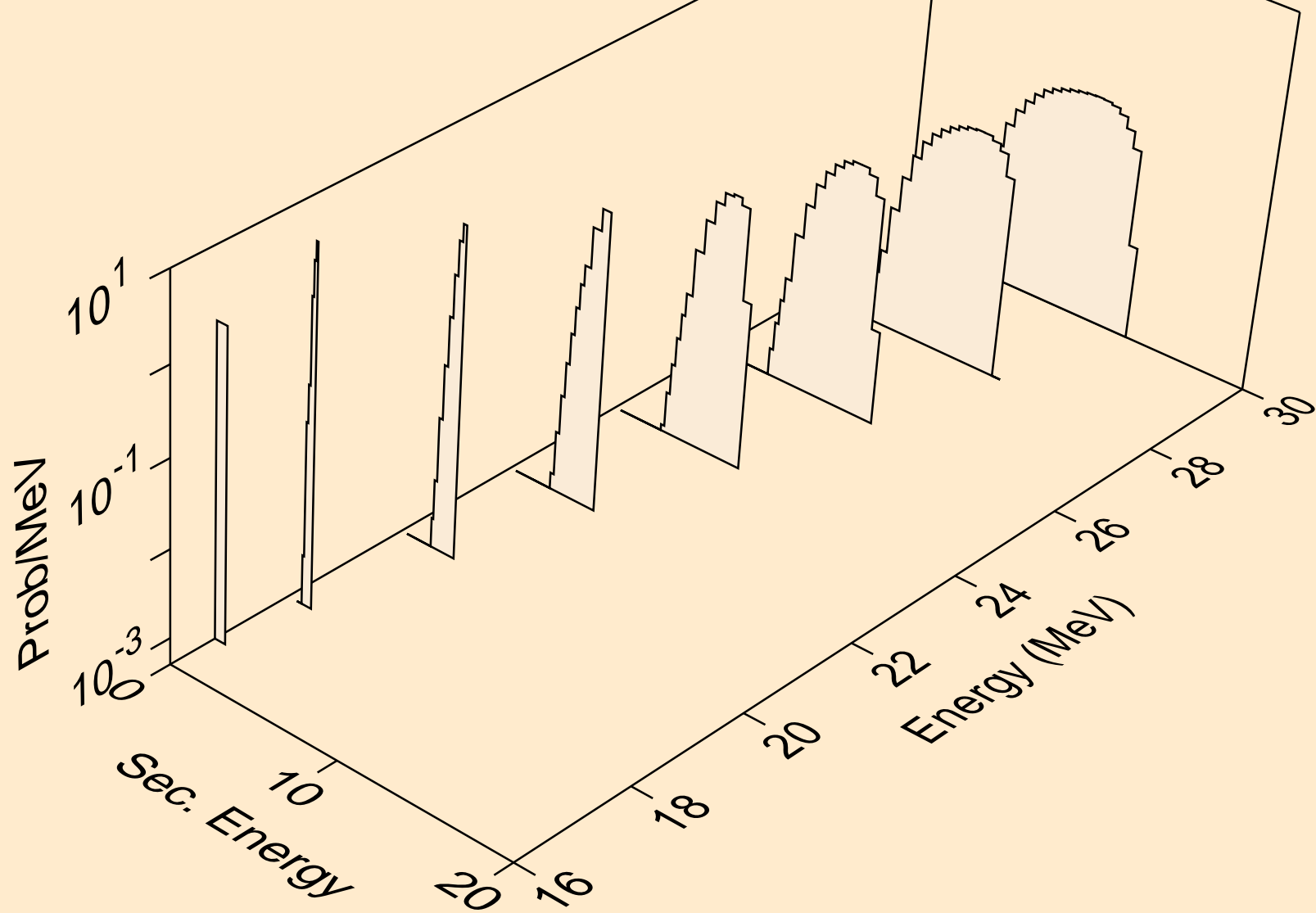

RB084M NEUTRON ACER TENDL-2021 LIBRARY; T=293.6K
tritons from (n,t)

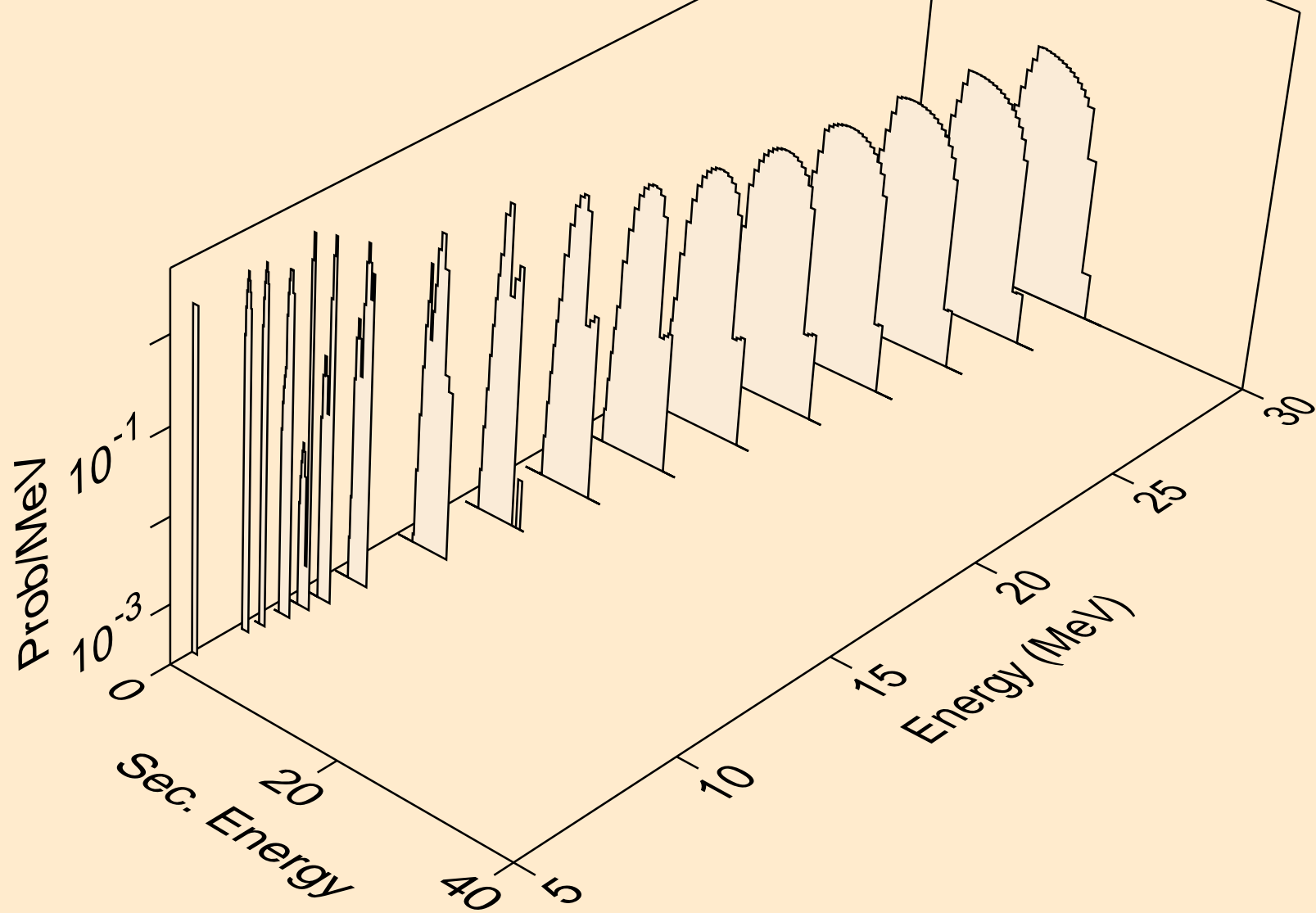

RB084M NEUTRON ACER TENDL-2021 LIBRARY; T=293.6K
tritons from (n,pt)

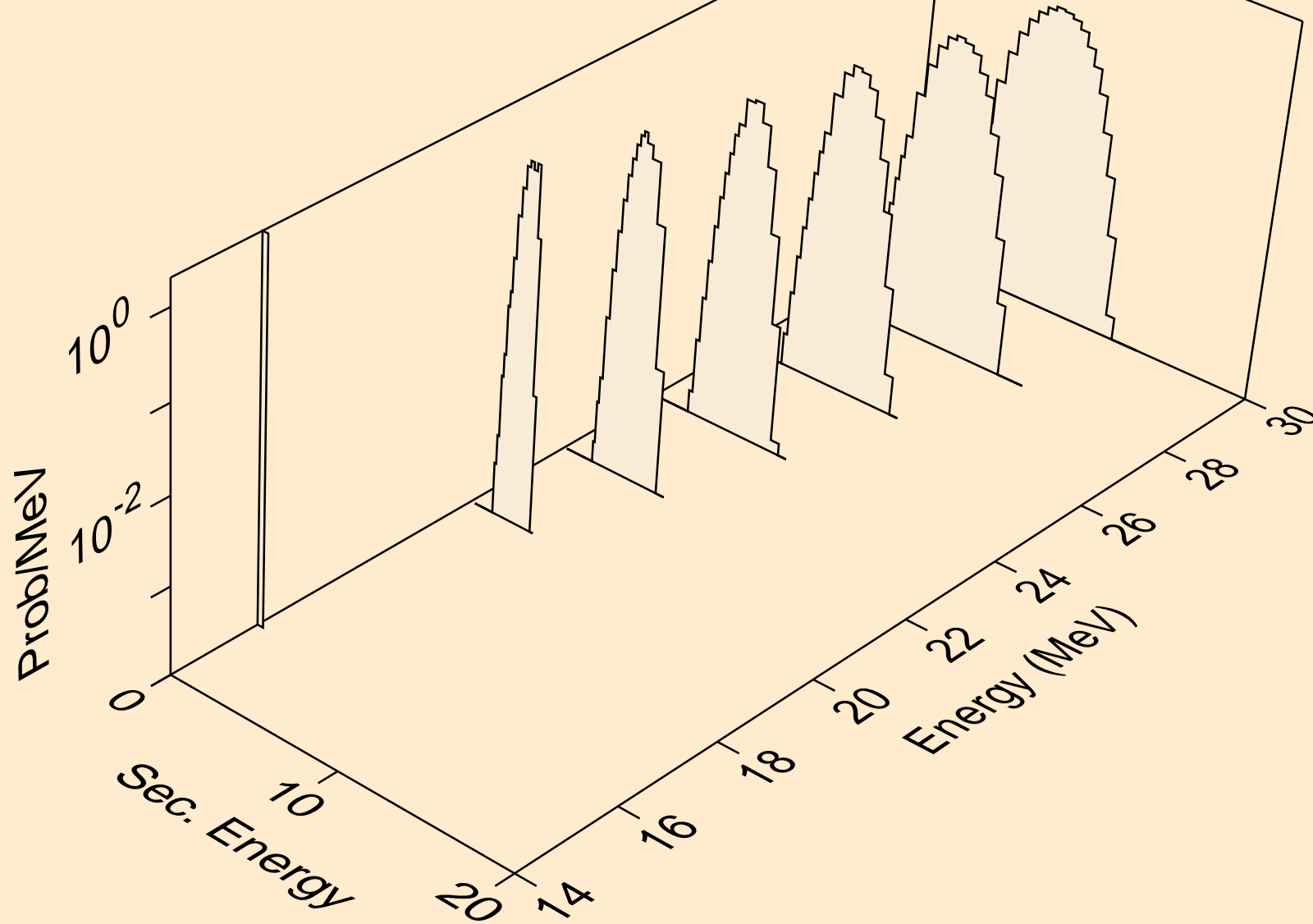

RB084M NEUTRON ACER TENDL-2021 LIBRARY; T=293.6K
he3s from (n,x)

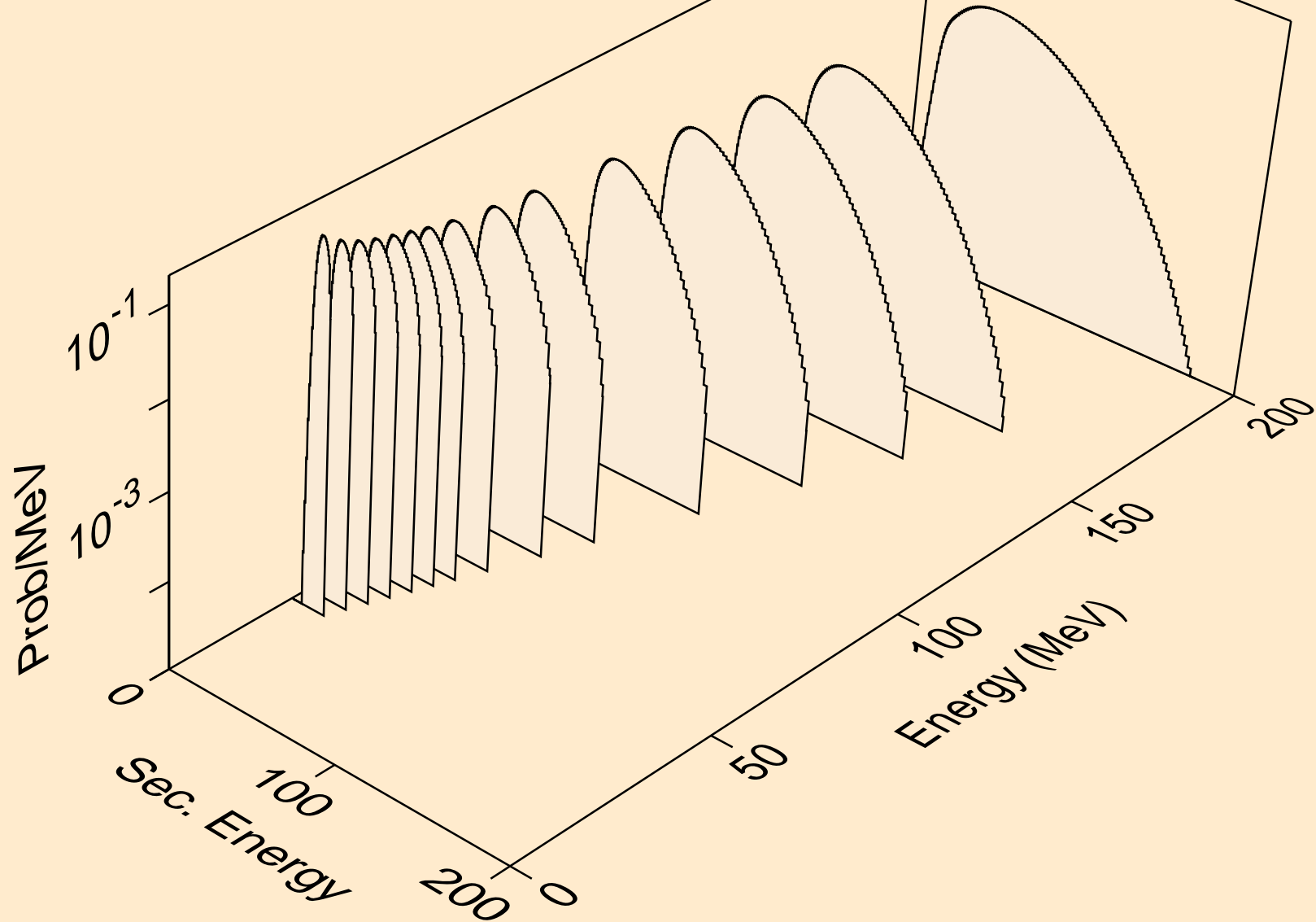

RB084M NEUTRON ACER TENDL-2021 LIBRARY; T=293.6K
he3s from (n,n*)he3

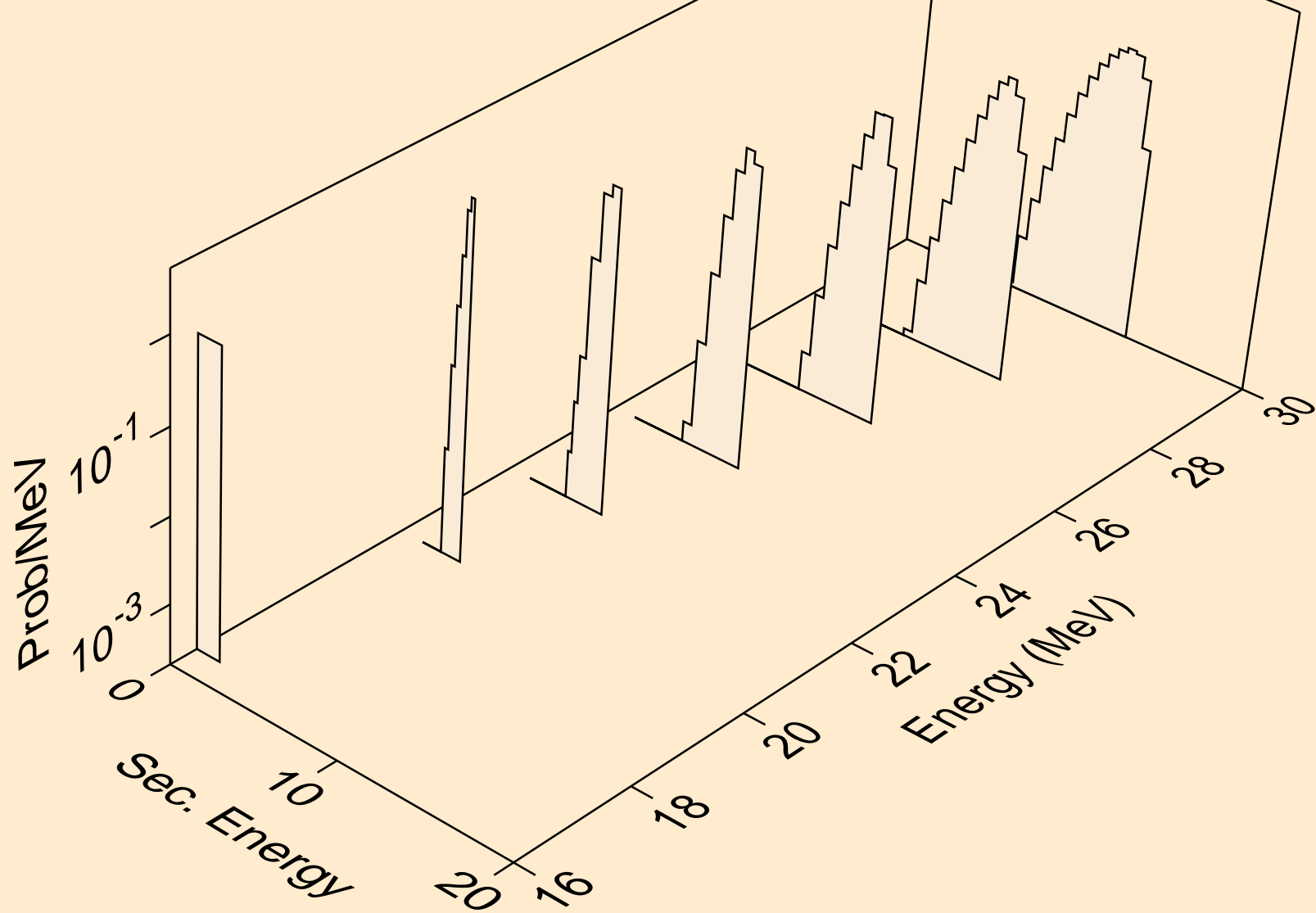

RB084M NEUTRON ACER TENDL-2021 LIBRARY; T=293.6K
he3s from (n,he3)

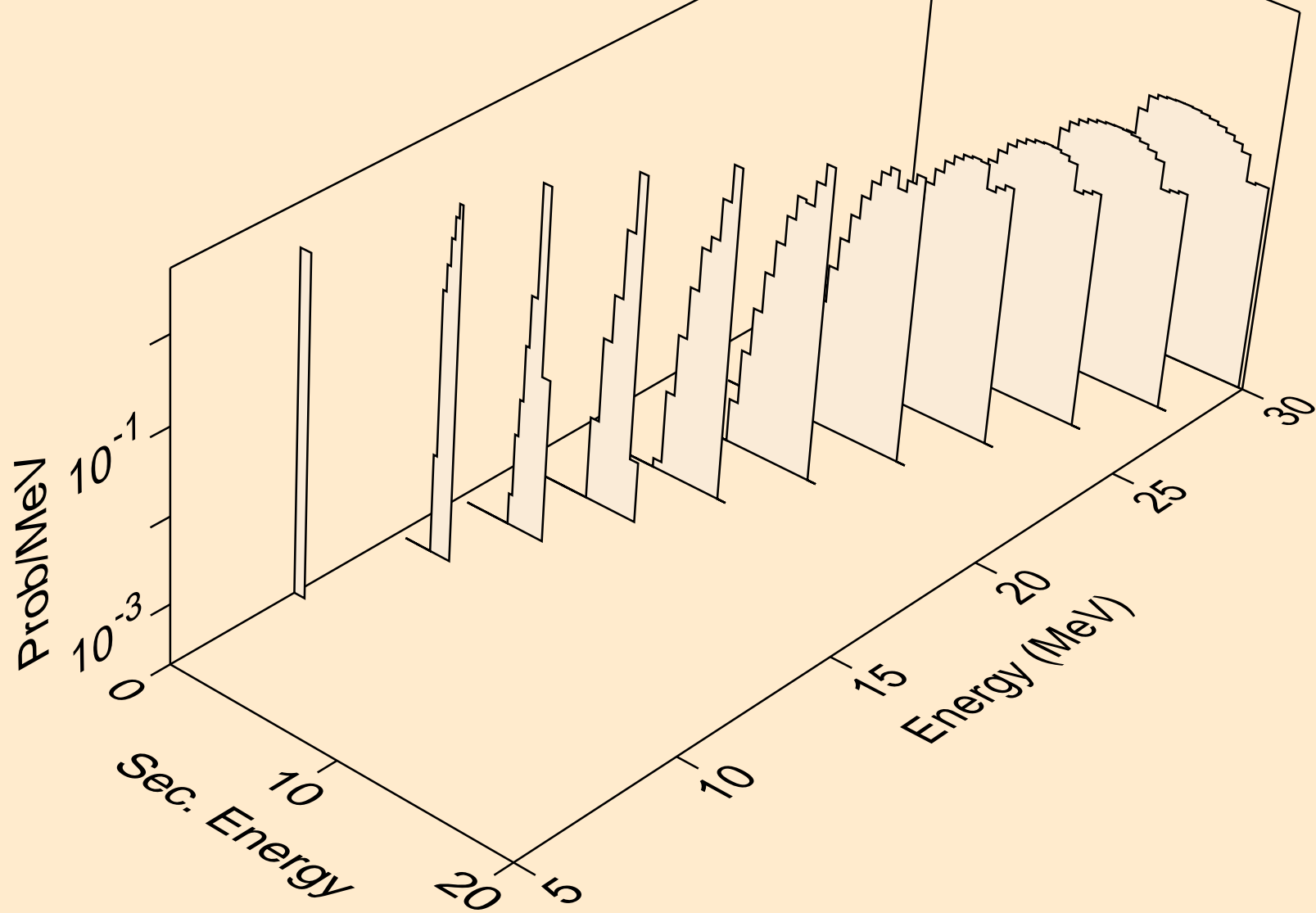

RB084M NEUTRON ACER TENDL-2021 LIBRARY; T=293.6K
alphas from (n,x)

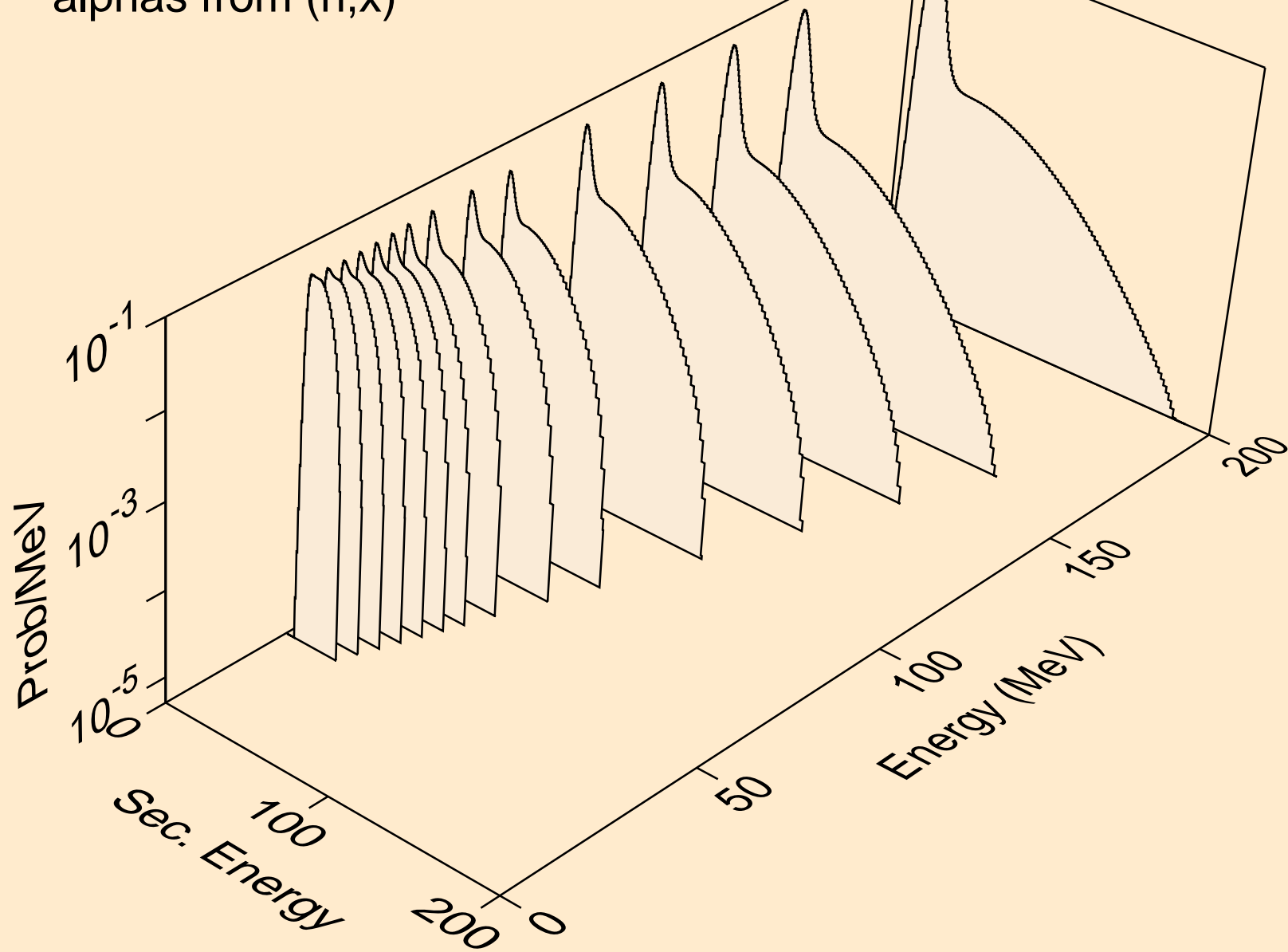

RB084M NEUTRON ACER TENDL-2021 LIBRARY; T=293.6K
alphas from (n,n*)a

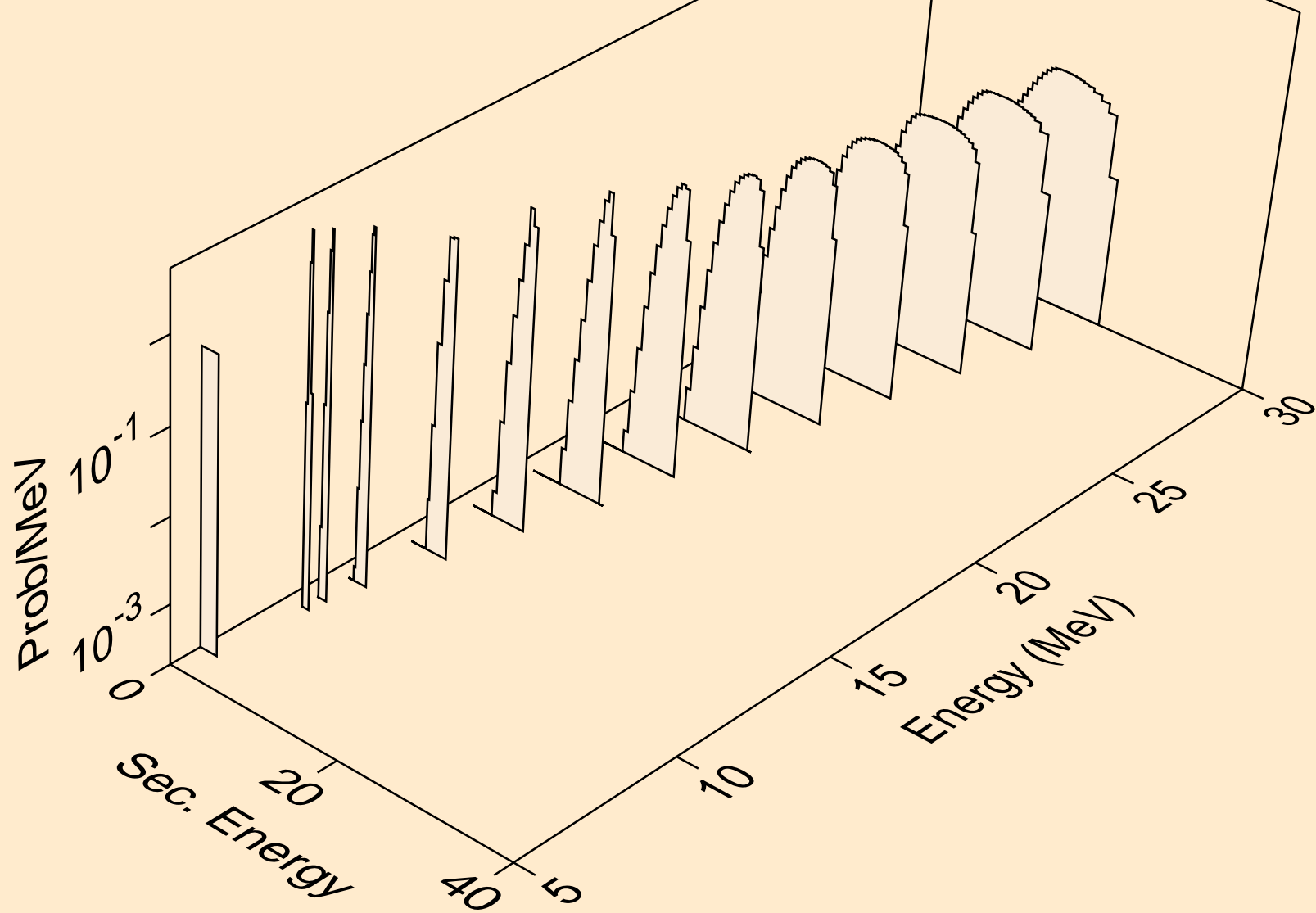

RB084M NEUTRON ACER TENDL-2021 LIBRARY; T=293.6K
alphas from (n,2n)a

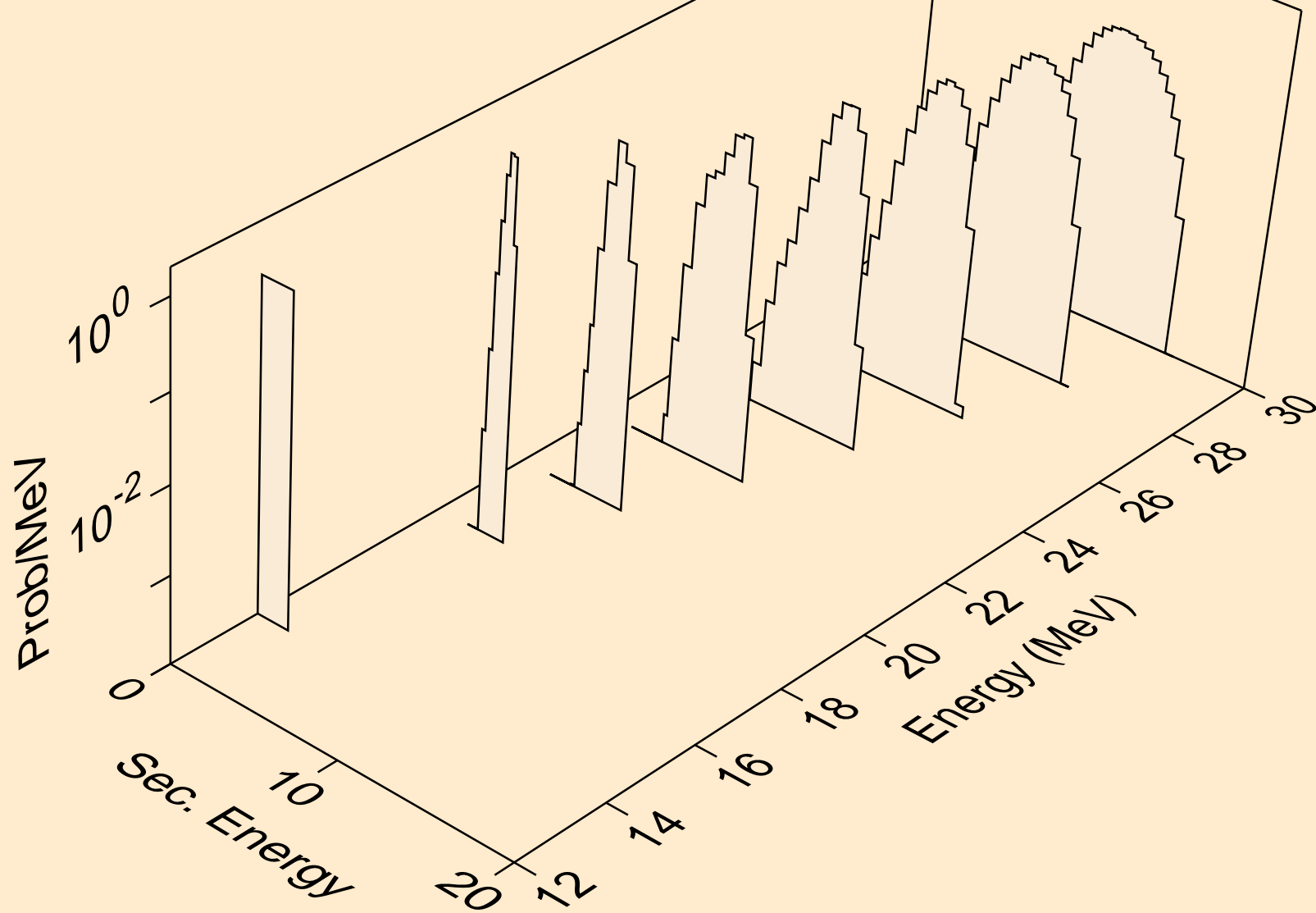

RB084M NEUTRON ACER TENDL-2021 LIBRARY; T=293.6K
alphas from (n,n*)2a

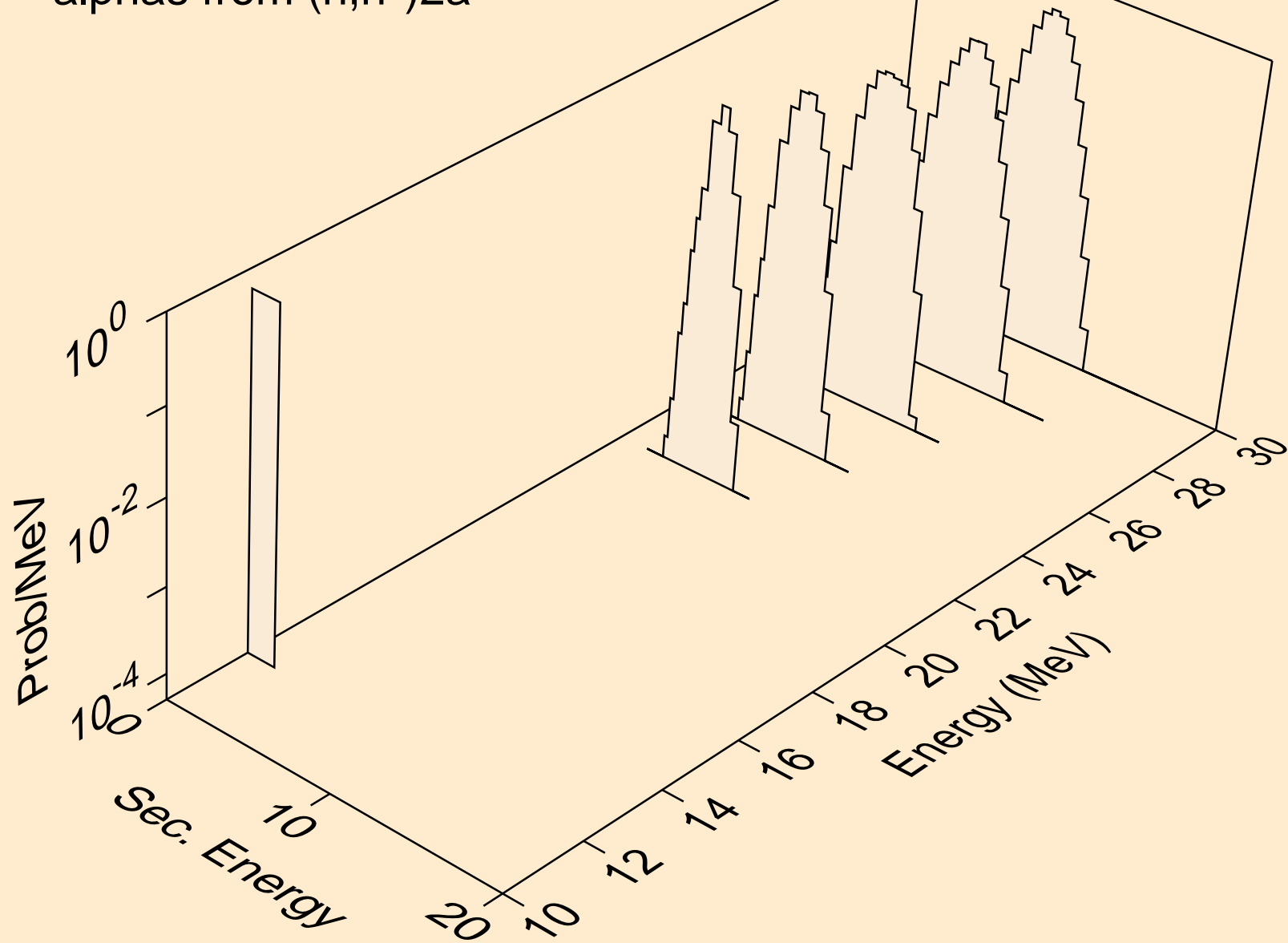

RB084M NEUTRON ACER TENDL-2021 LIBRARY; T=293.6K
alphas from (n,npa)

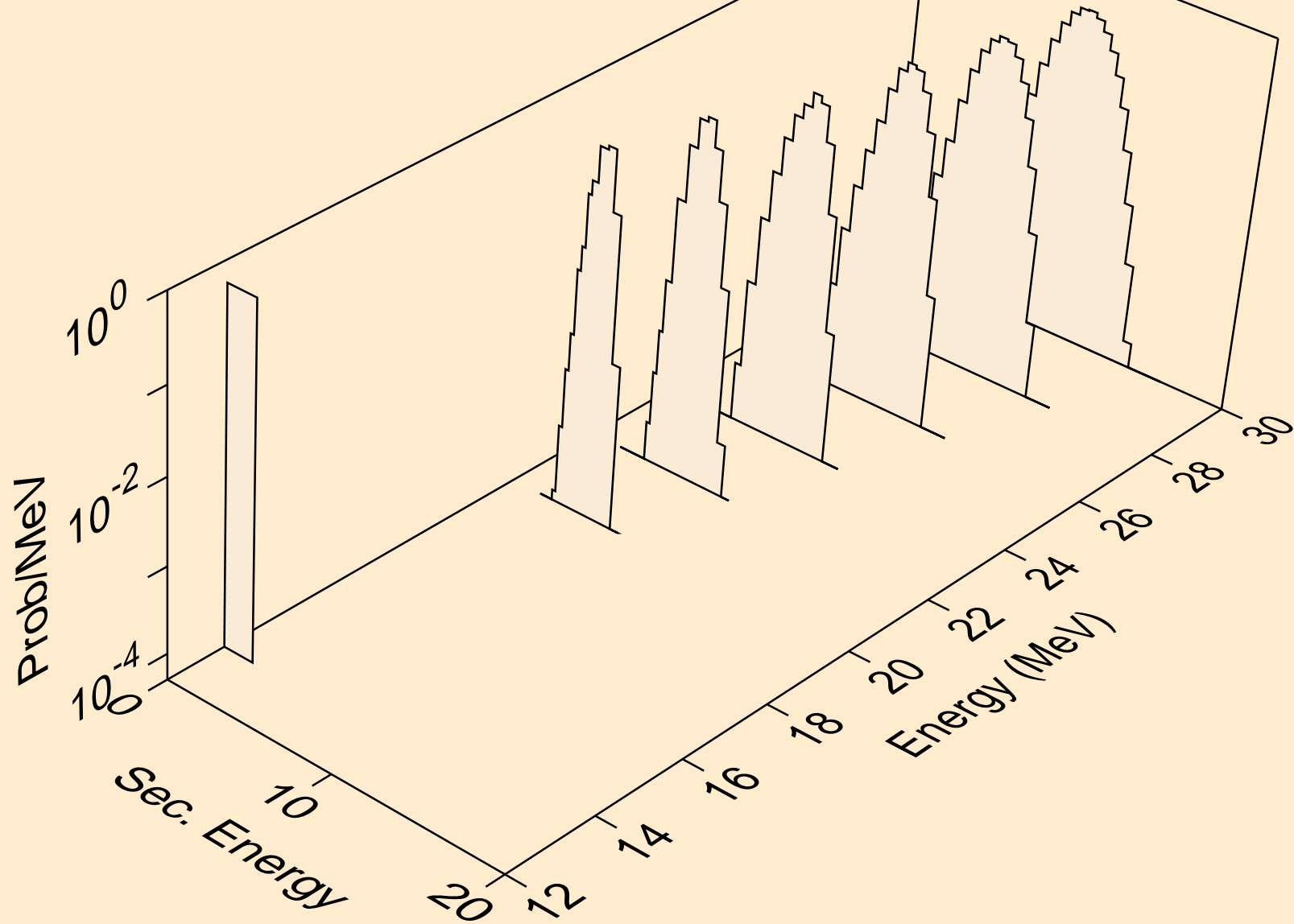

RB084M NEUTRON ACER TENDL-2021 LIBRARY; T=293.6K
alphas from (n,a)

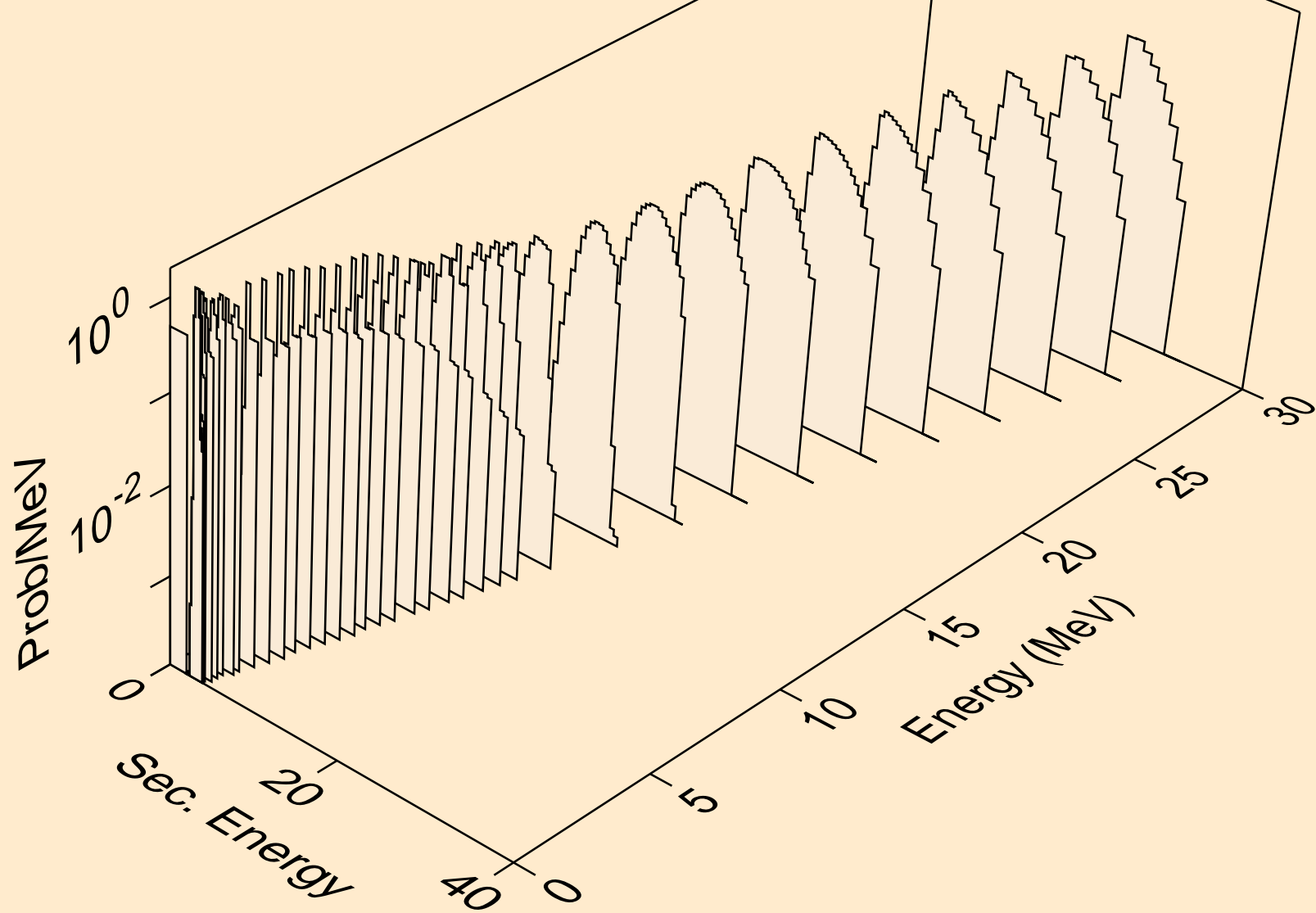

RB084M NEUTRON ACER TENDL-2021 LIBRARY; T=293.6K
alphas from (n,2a)

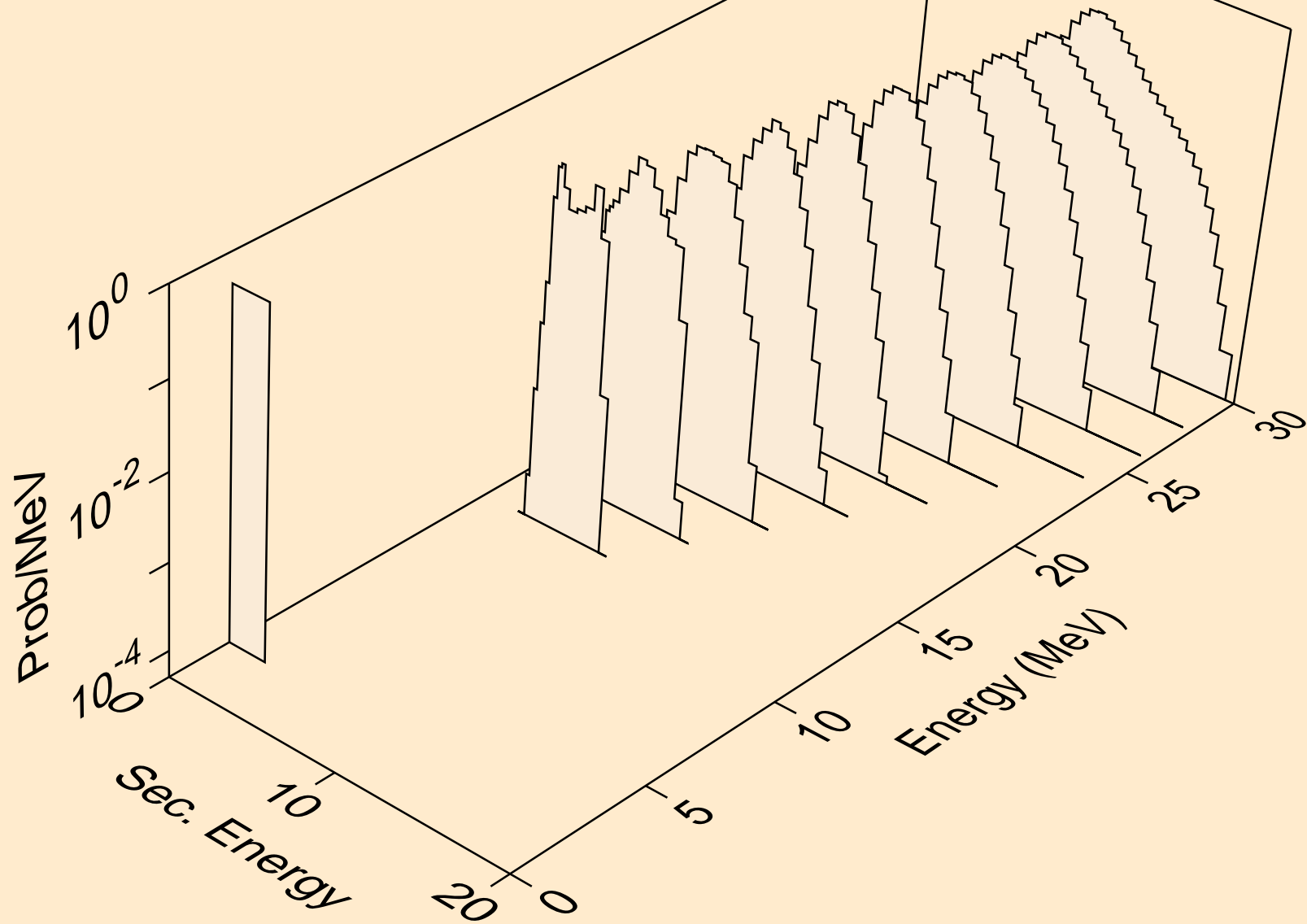

RB084M NEUTRON ACER TENDL-2021 LIBRARY; T=293.6K
alphas from (n,pa)

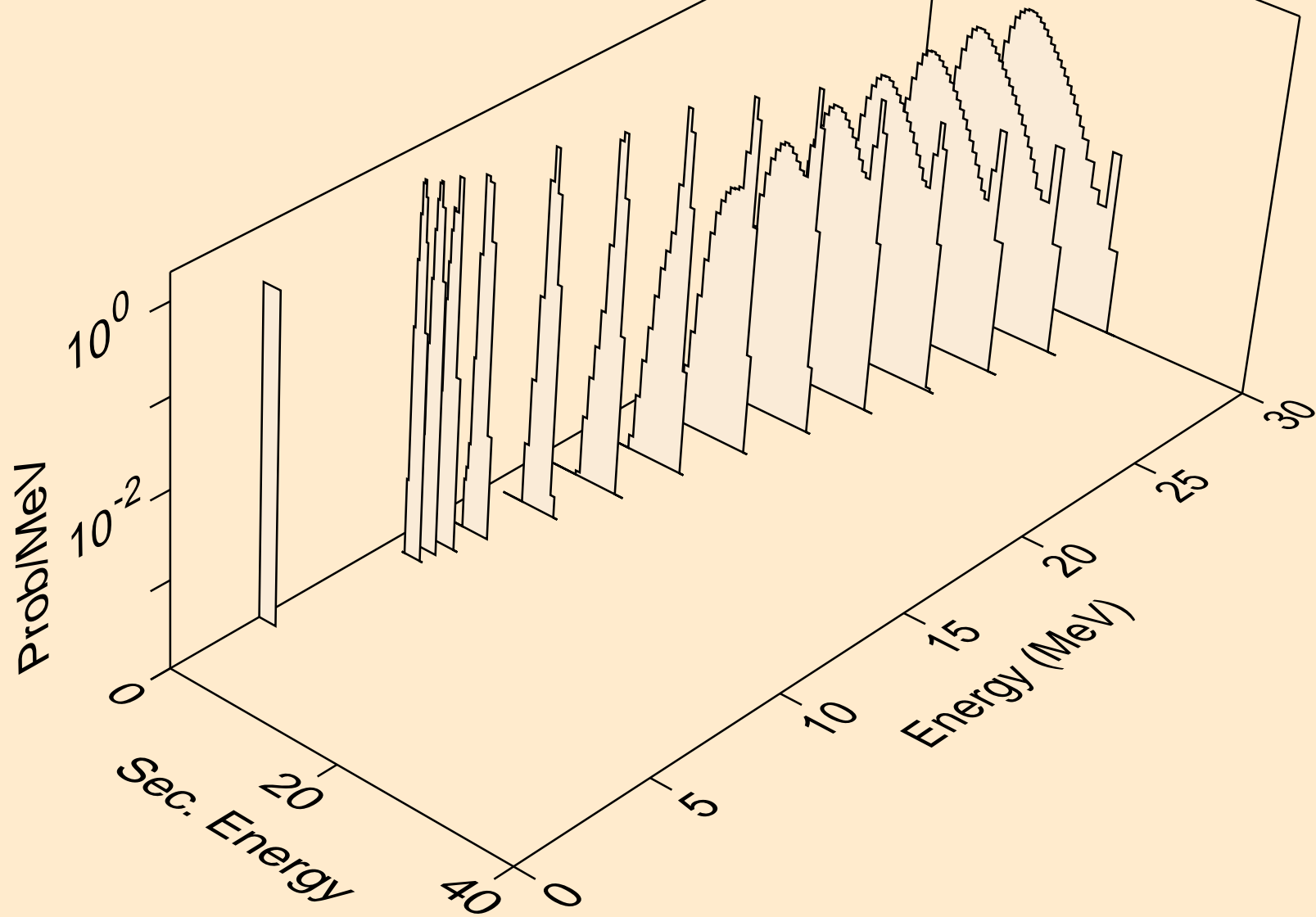

RB084M NEUTRON ACER TENDL-2021 LIBRARY; T=293.6K
alphas from (n,da)

