

RE169M NEUTRON ACER TENDL-2021 LIBRARY; T=293.6K
Principal cross sections

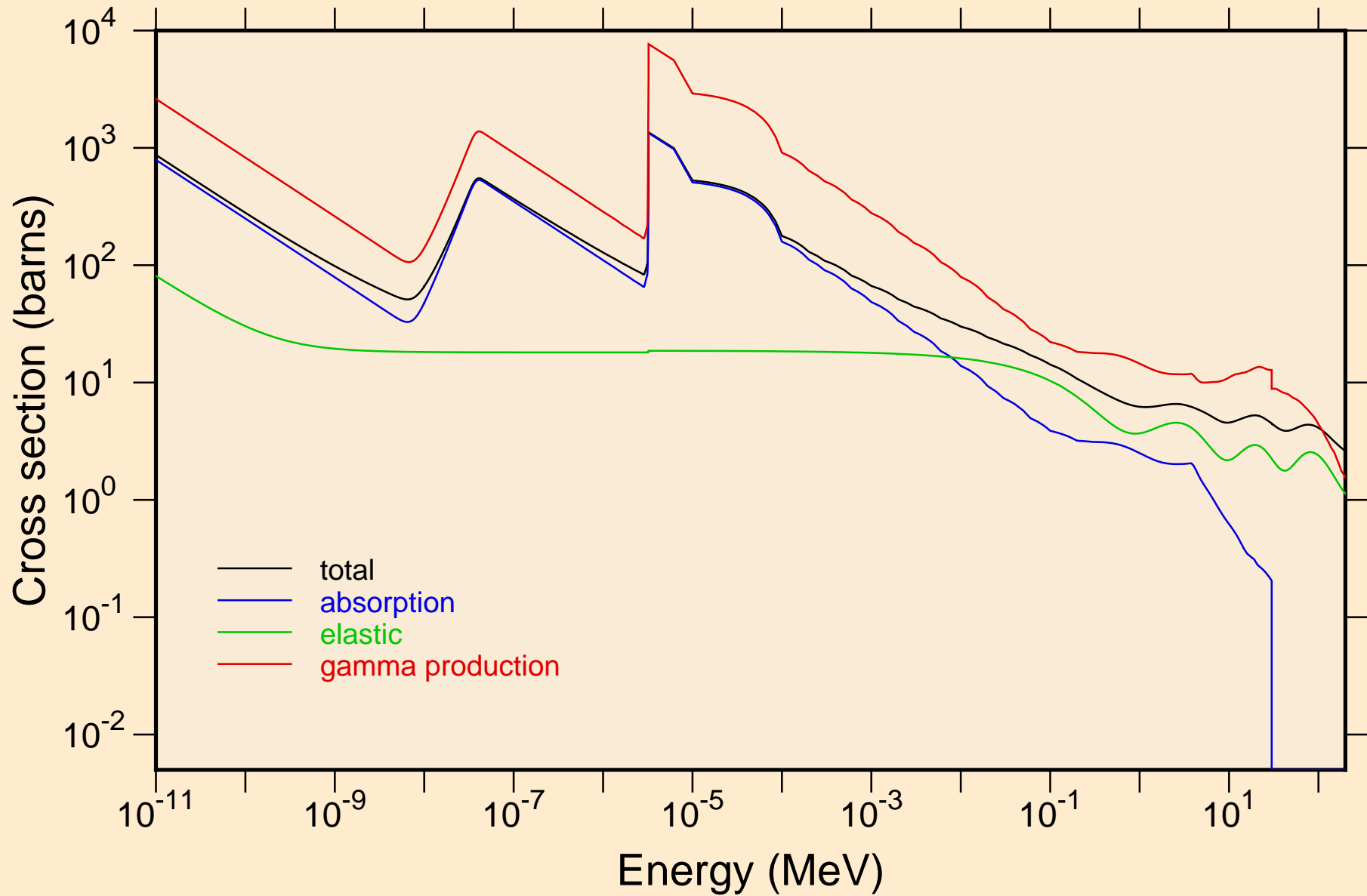

RE169M NEUTRON ACER TENDL-2021 LIBRARY; T=293.6K
Heating

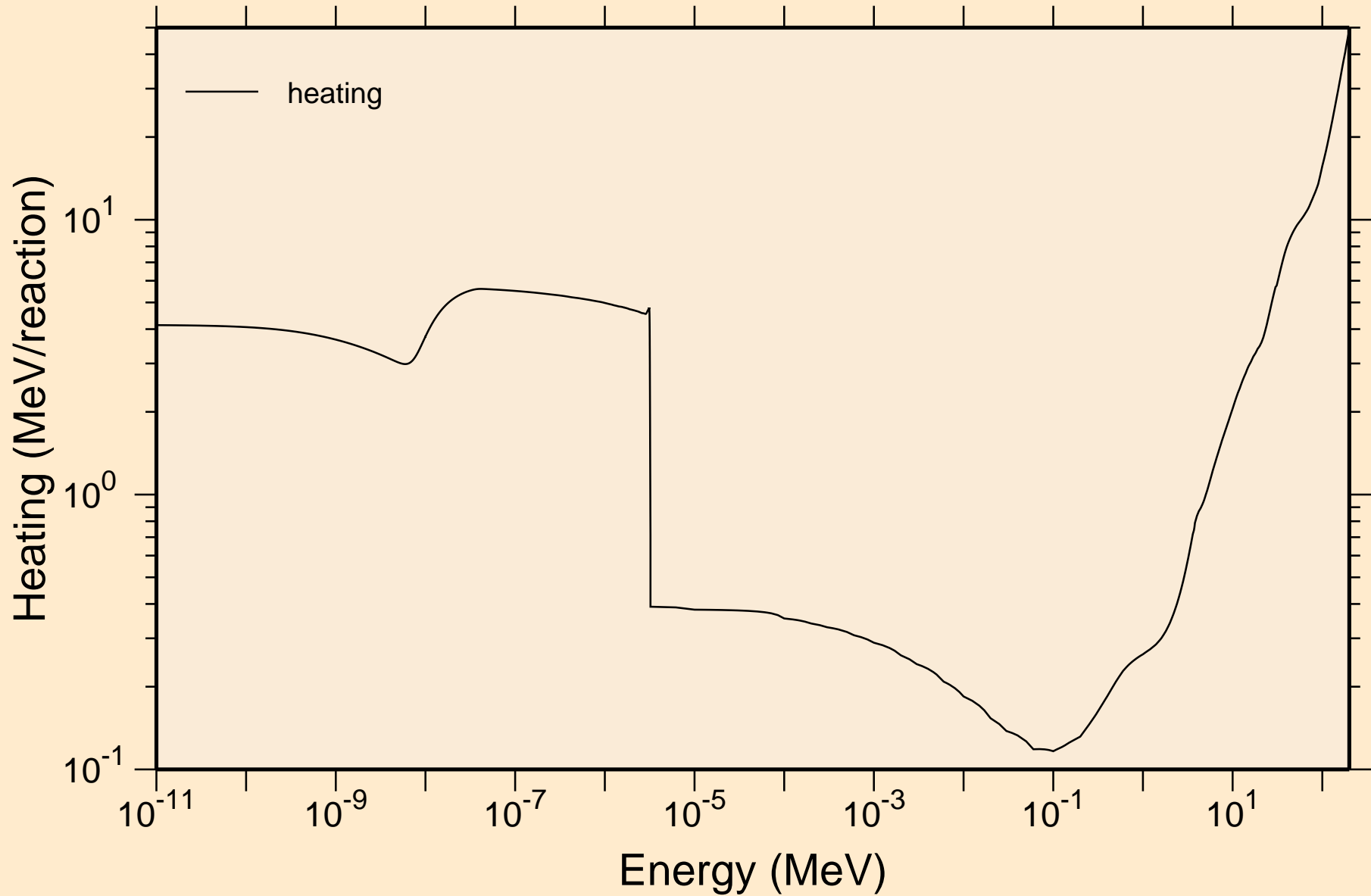

RE169M NEUTRON ACER TENDL-2021 LIBRARY; T=293.6K
Damage

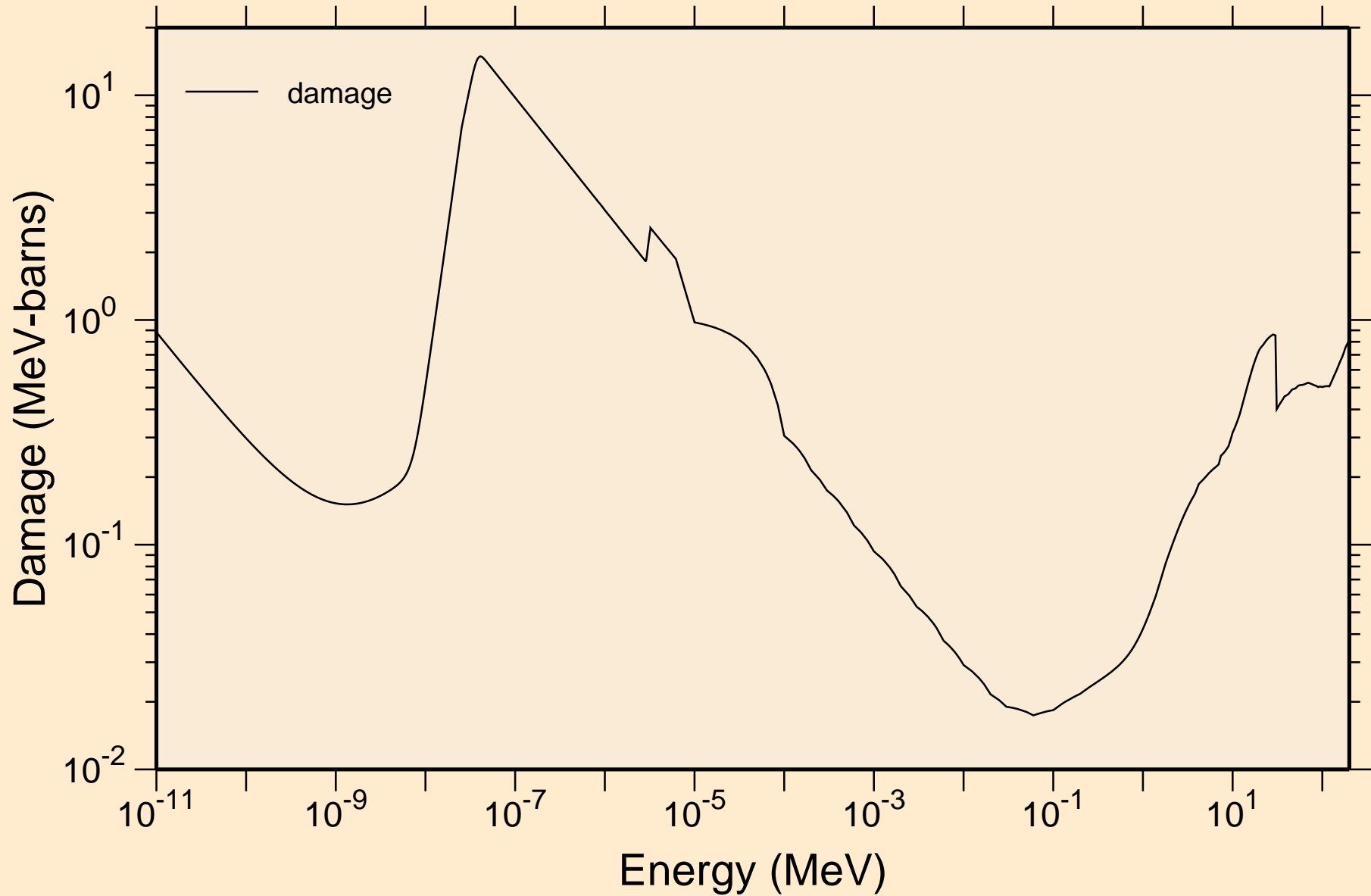

RE169M NEUTRON ACER TENDL-2021 LIBRARY; T=293.6K
Non-threshold reactions

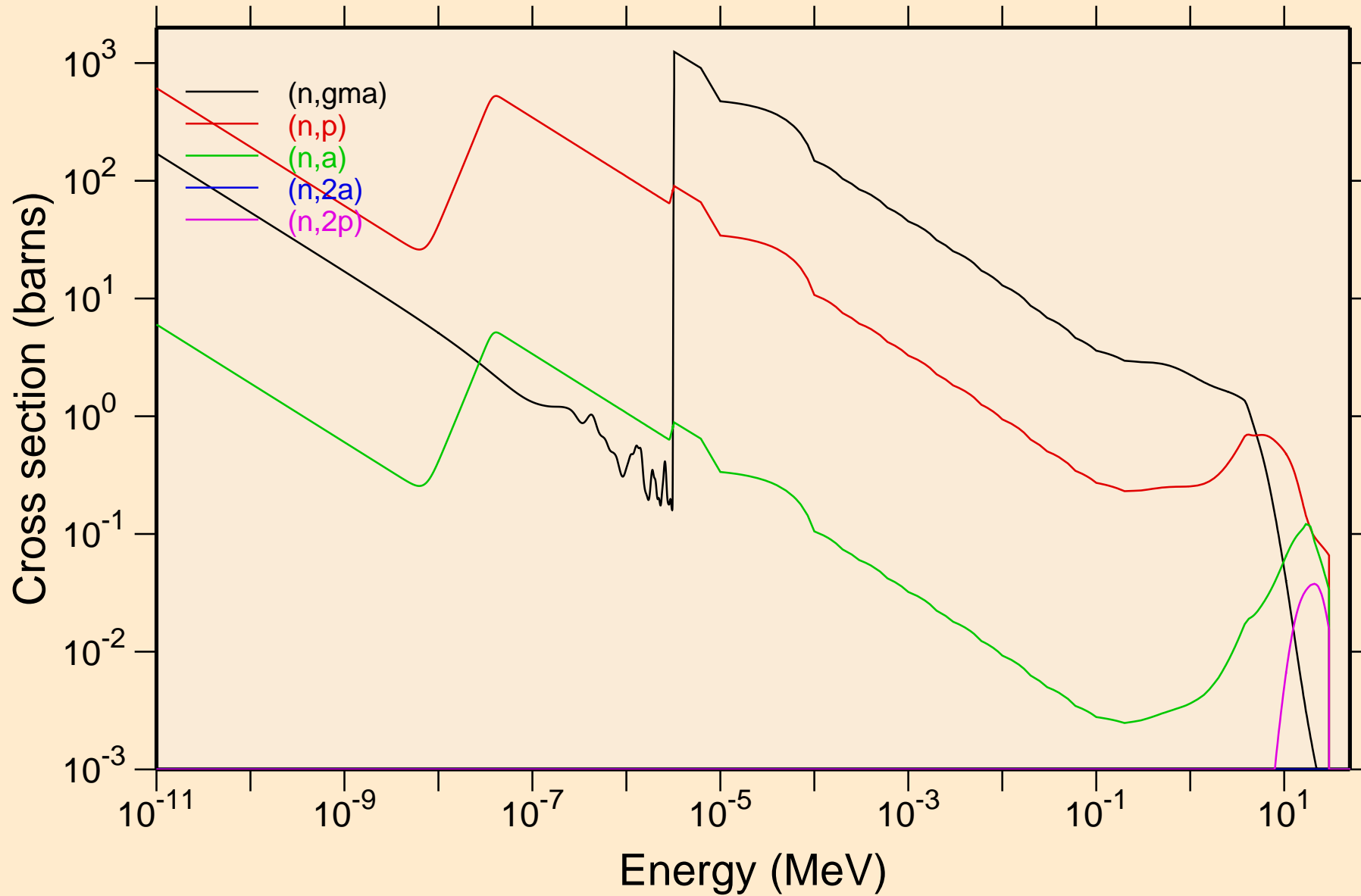

RE169M NEUTRON ACER TENDL-2021 LIBRARY; T=293.6K
Non-threshold reactions

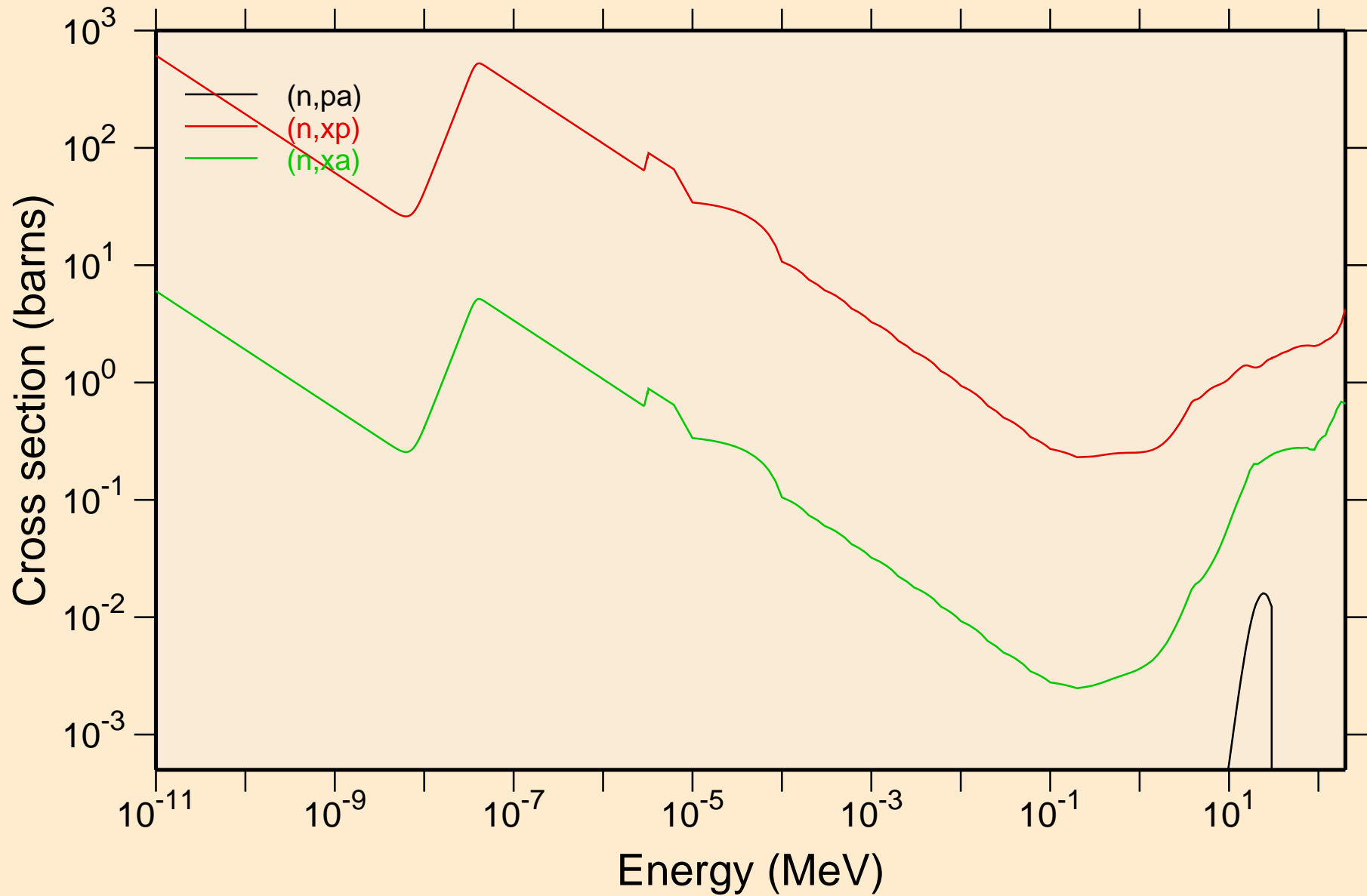

RE169M NEUTRON ACER TENDL-2021 LIBRARY; T=293.6K
Principal cross sections

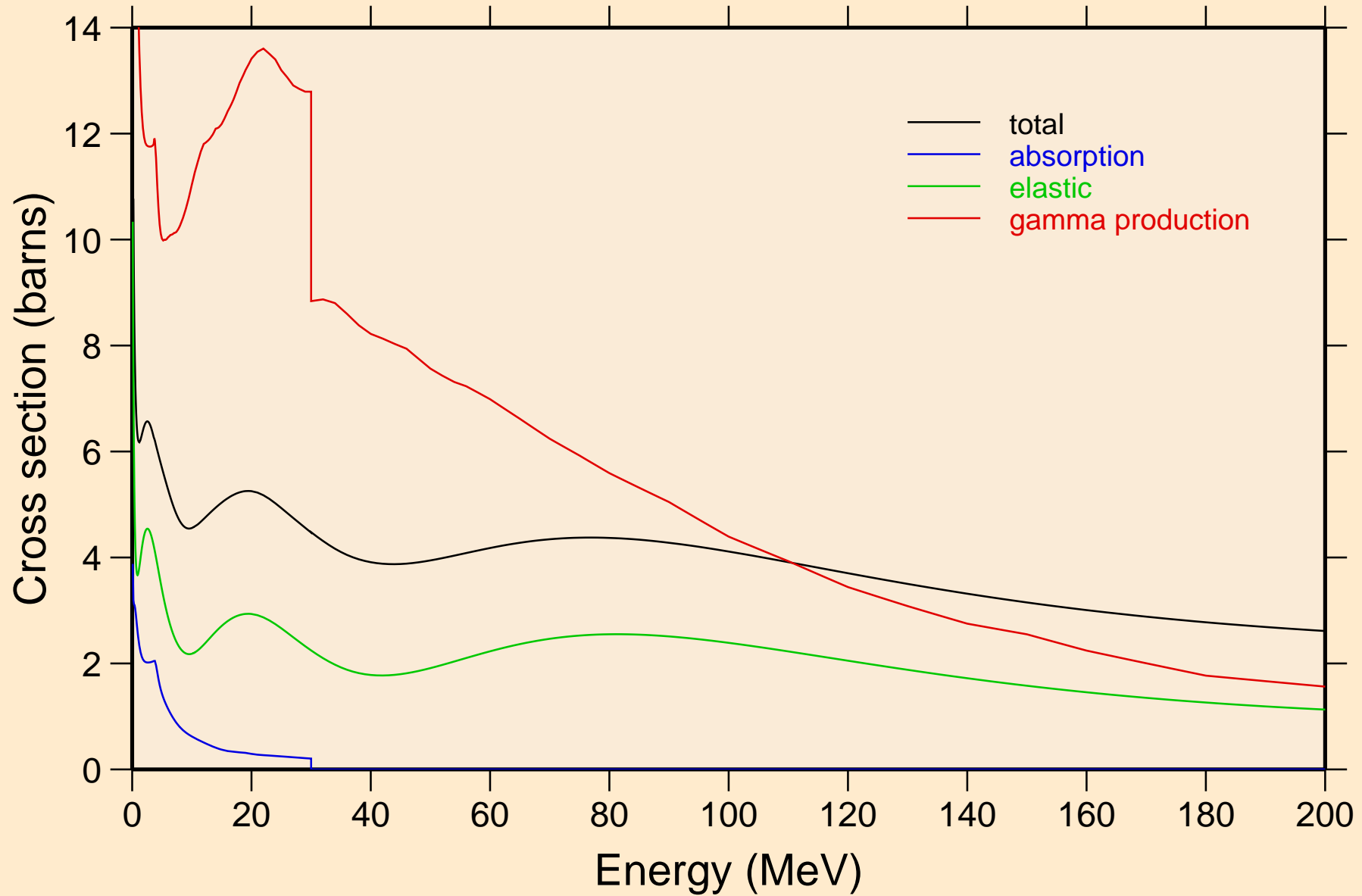

RE169M NEUTRON ACER TENDL-2021 LIBRARY; T=293.6K
Heating

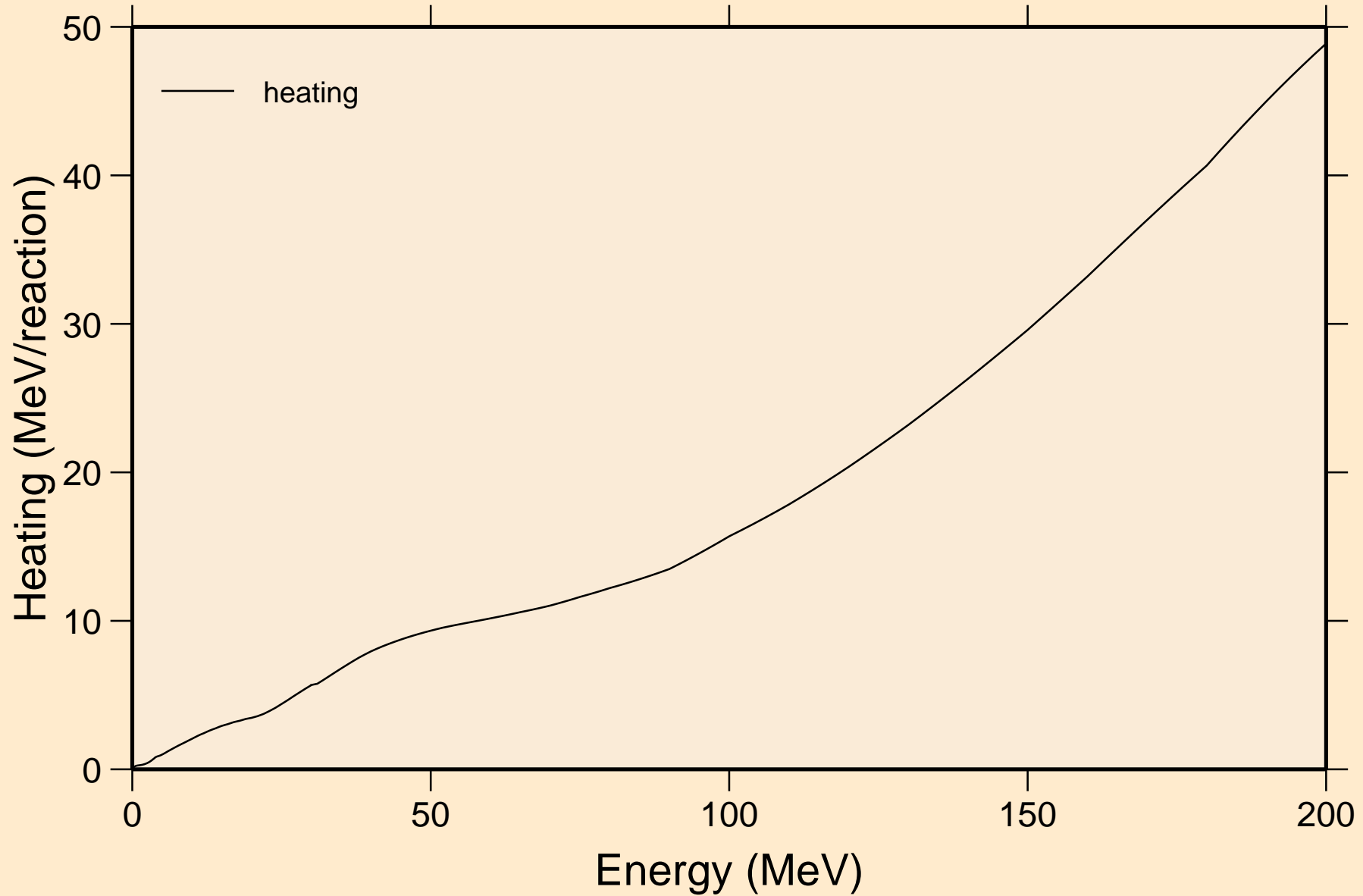

RE169M NEUTRON ACER TENDL-2021 LIBRARY; T=293.6K
Damage

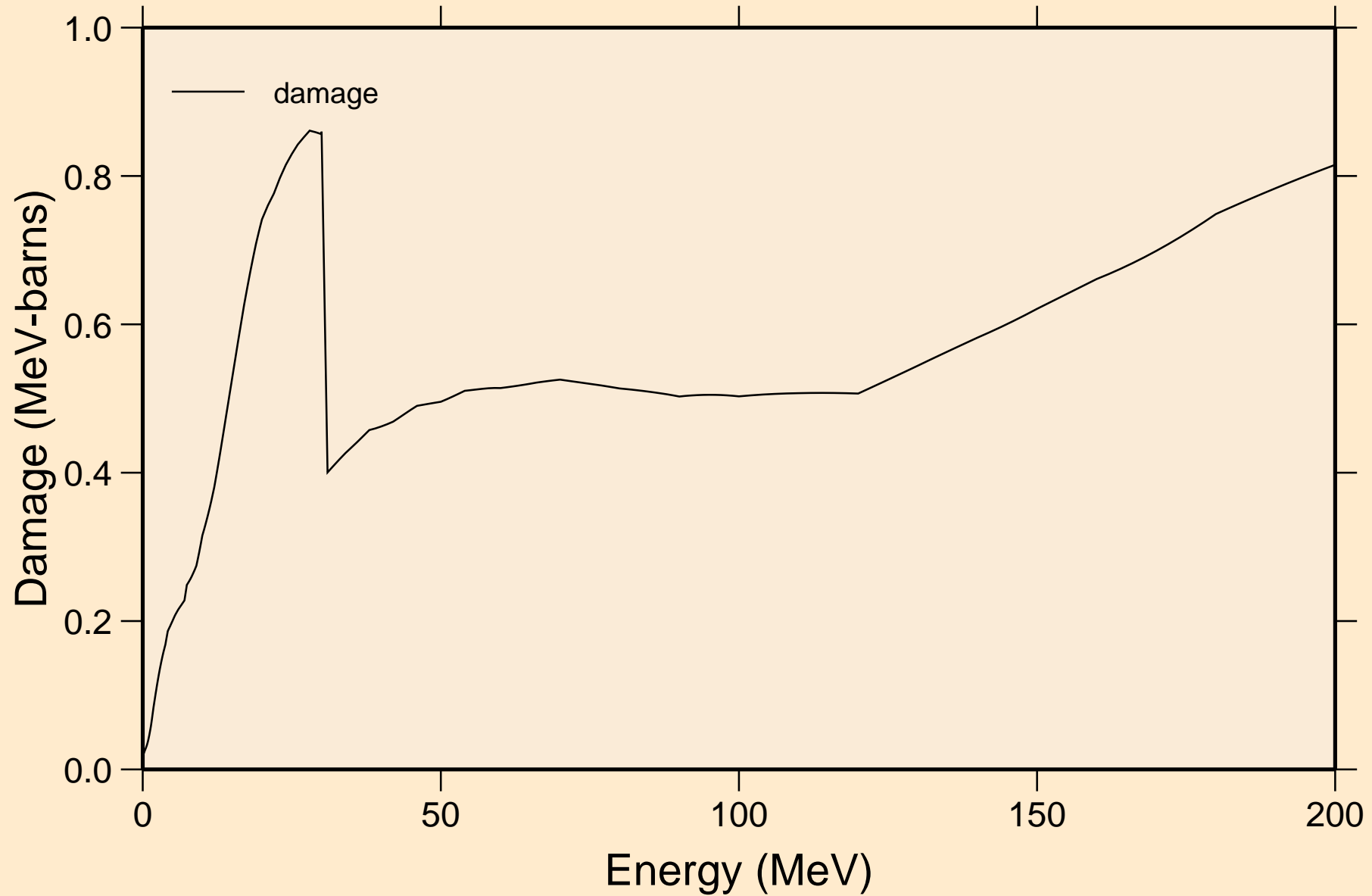

RE169M NEUTRON ACER TENDL-2021 LIBRARY; T=293.6K
Non-threshold reactions

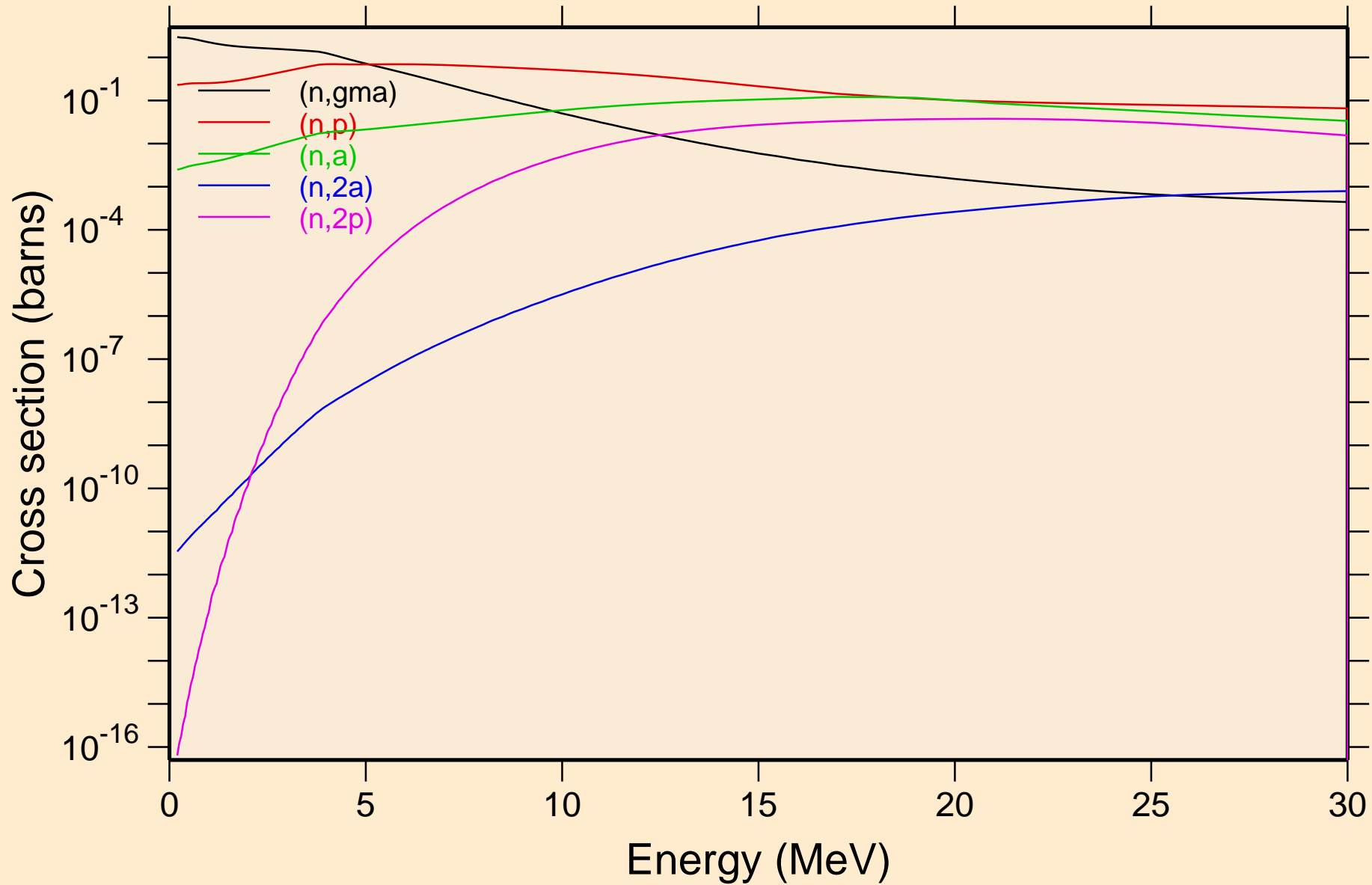

RE169M NEUTRON ACER TENDL-2021 LIBRARY; T=293.6K
Non-threshold reactions

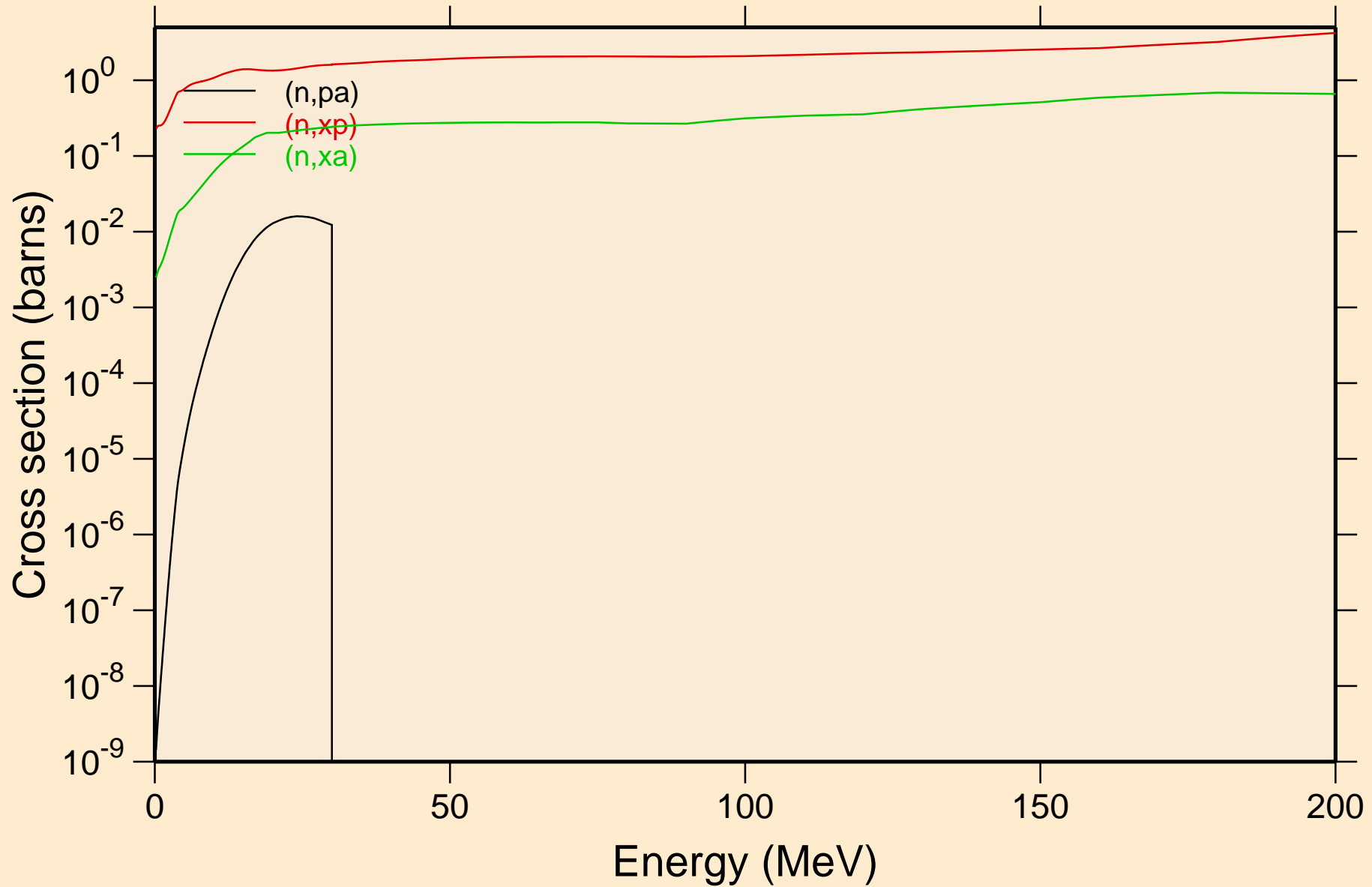

RE169M NEUTRON ACER TENDL-2021 LIBRARY; T=293.6K
Inelastic levels

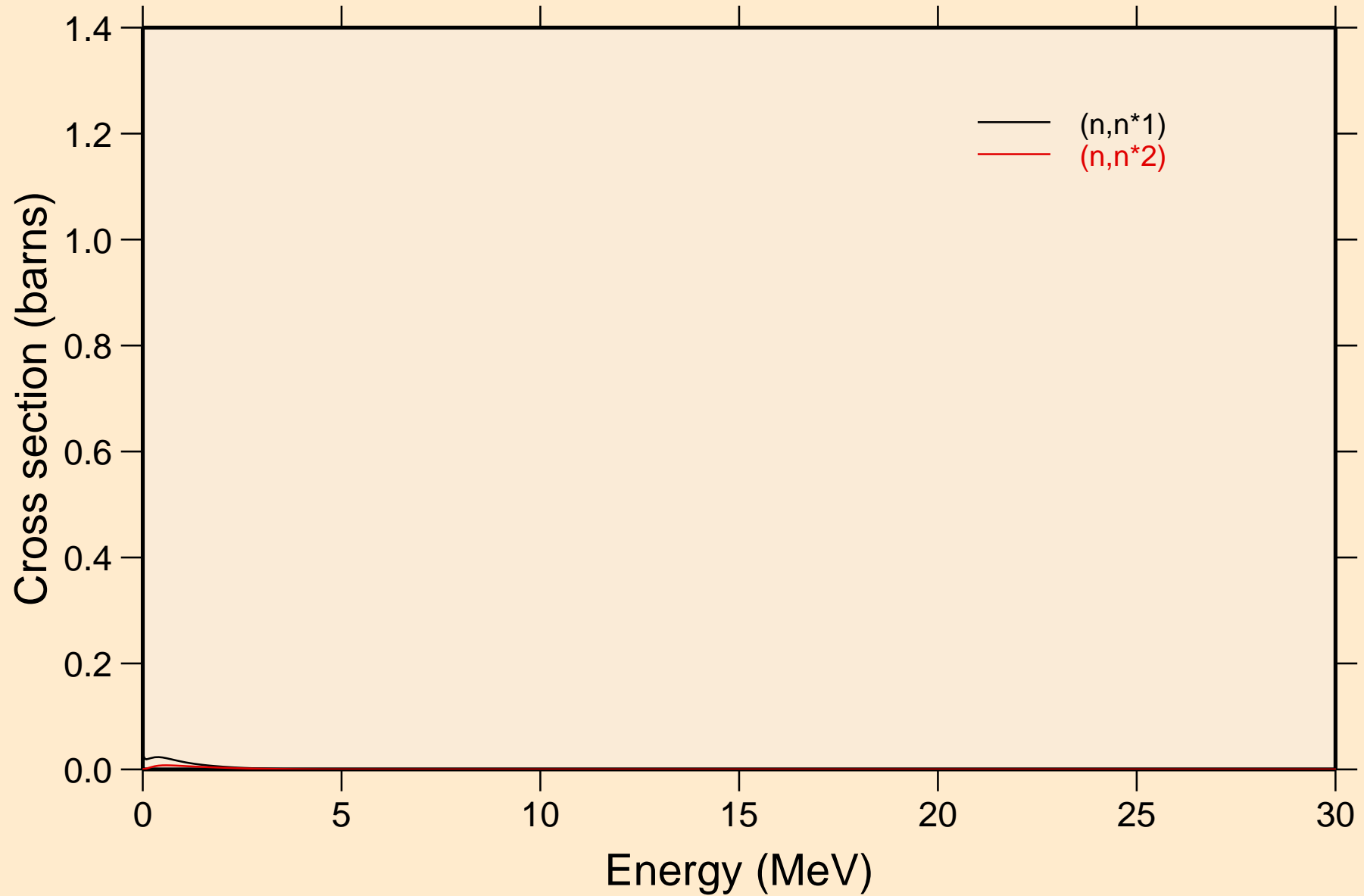

RE169M NEUTRON ACER TENDL-2021 LIBRARY; T=293.6K
Threshold reactions

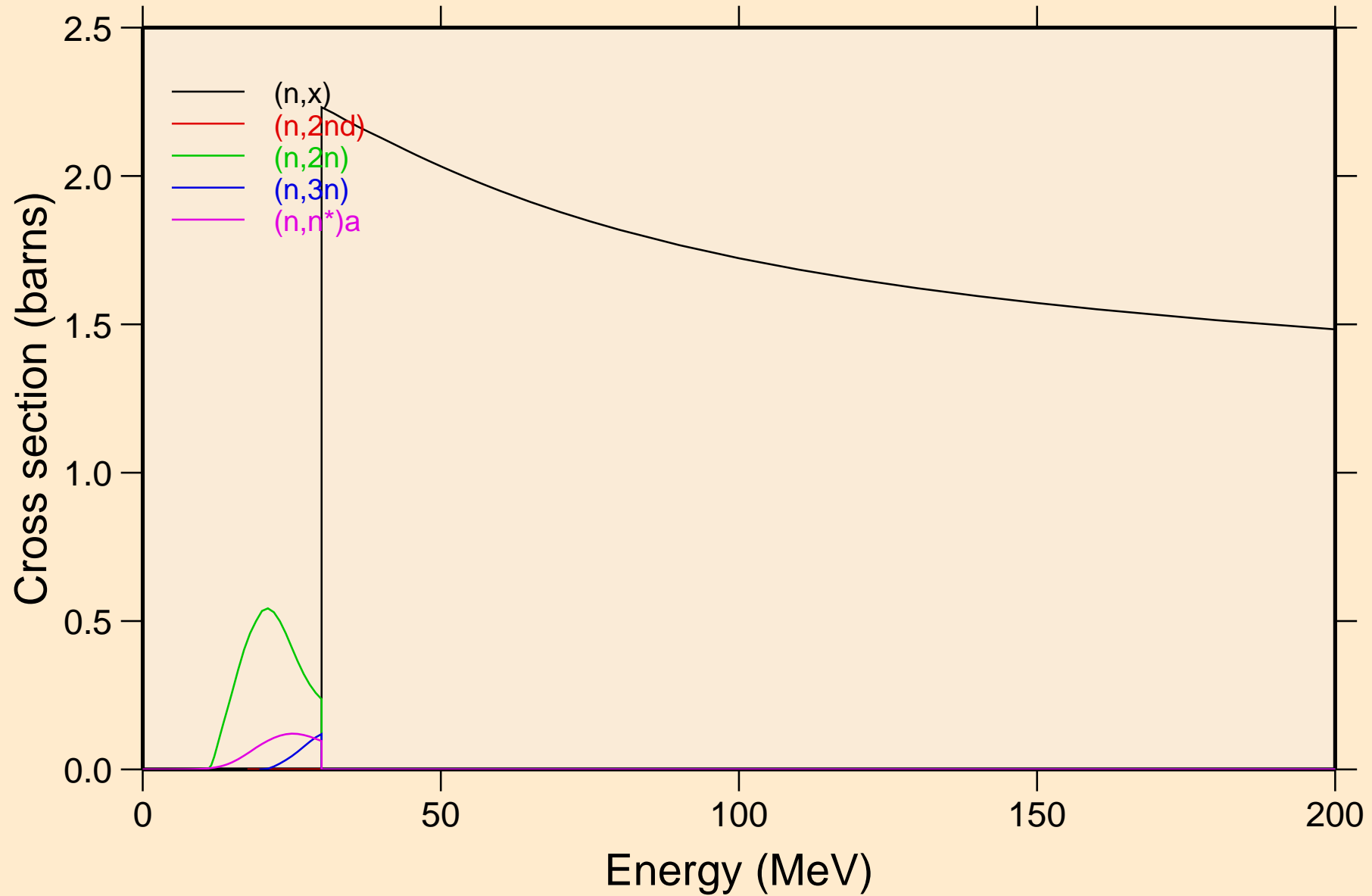

RE169M NEUTRON ACER TENDL-2021 LIBRARY; T=293.6K
Threshold reactions

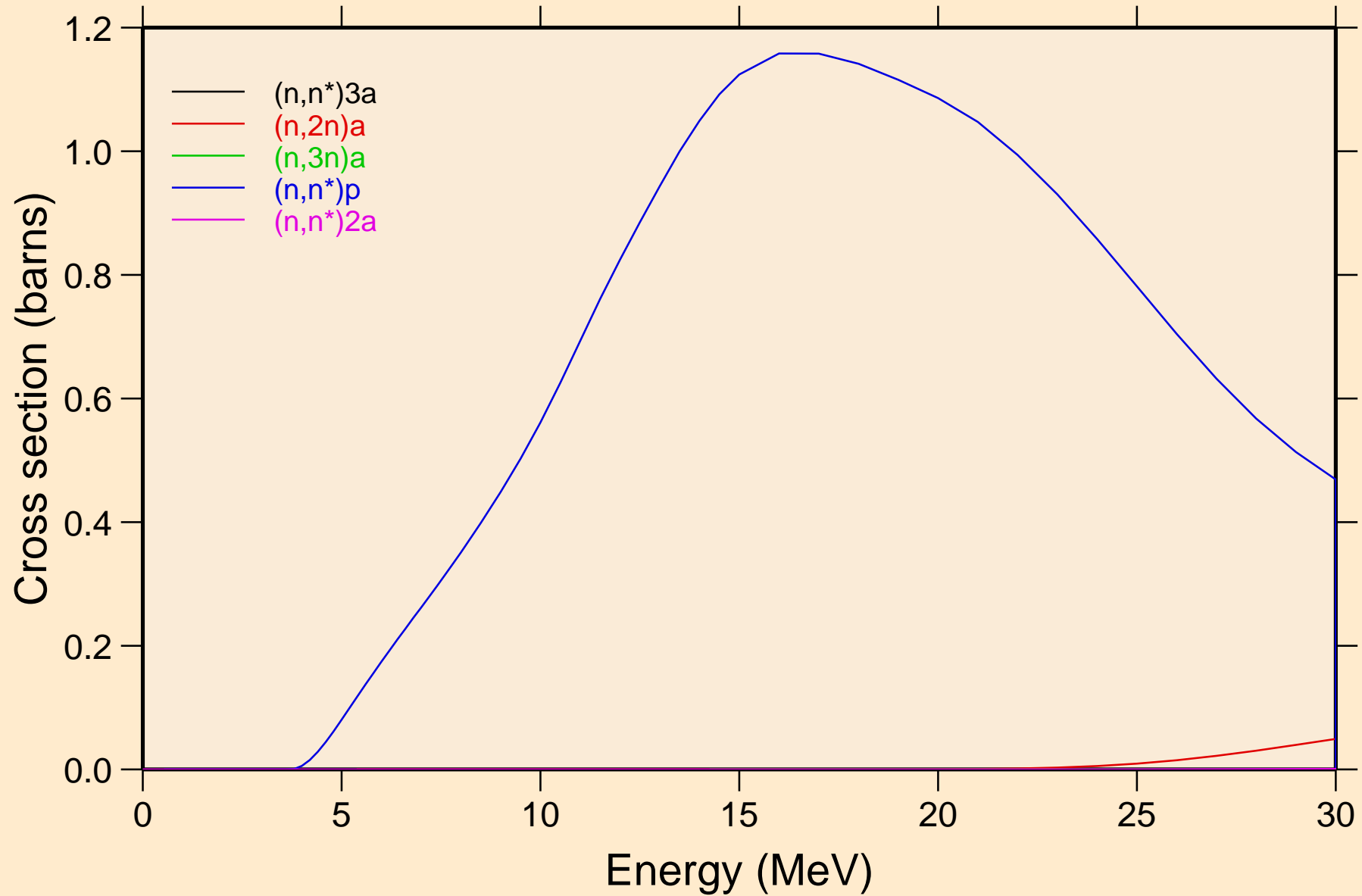

RE169M NEUTRON ACER TENDL-2021 LIBRARY; T=293.6K
Threshold reactions

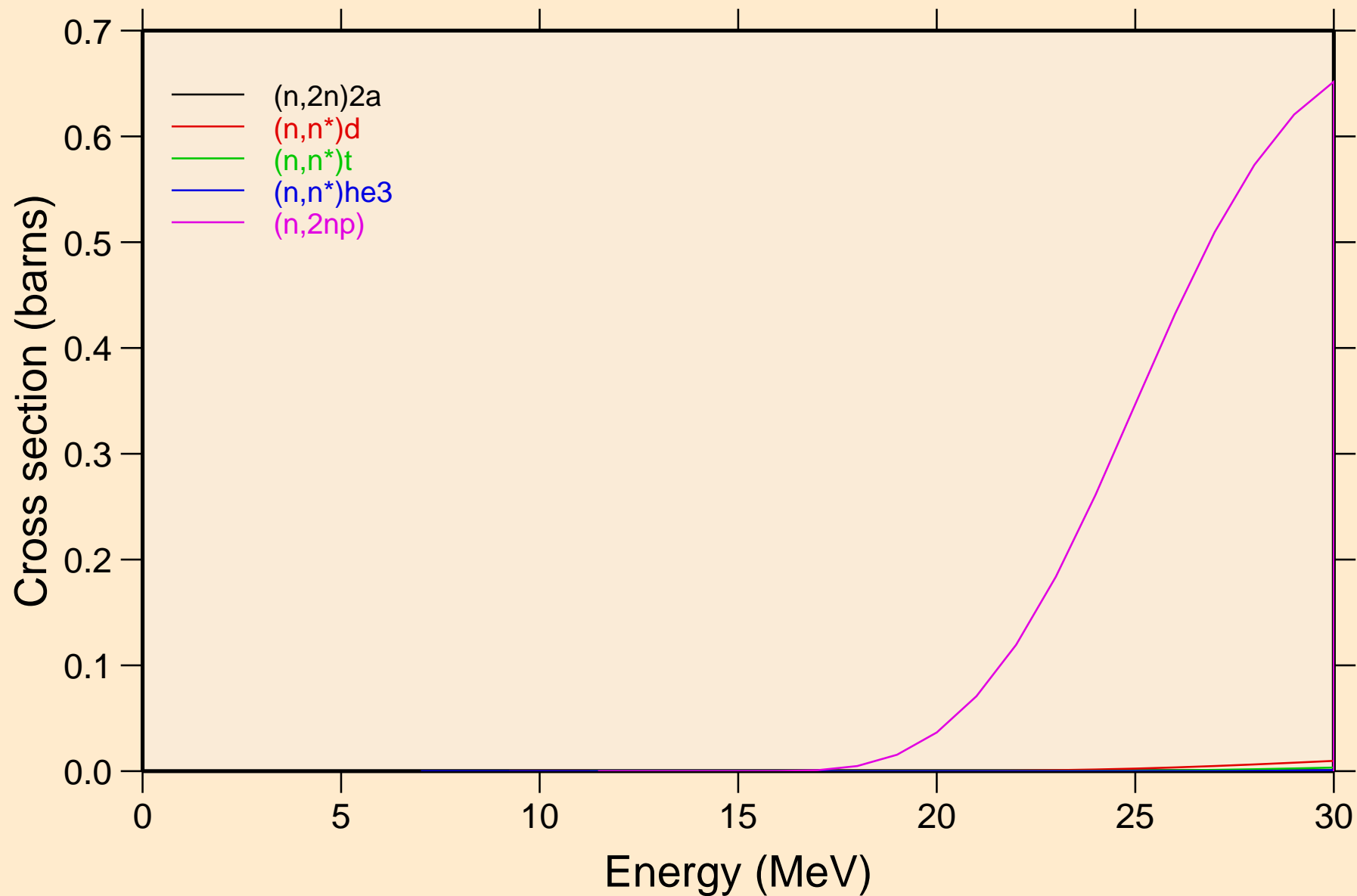

RE169M NEUTRON ACER TENDL-2021 LIBRARY; T=293.6K
Threshold reactions

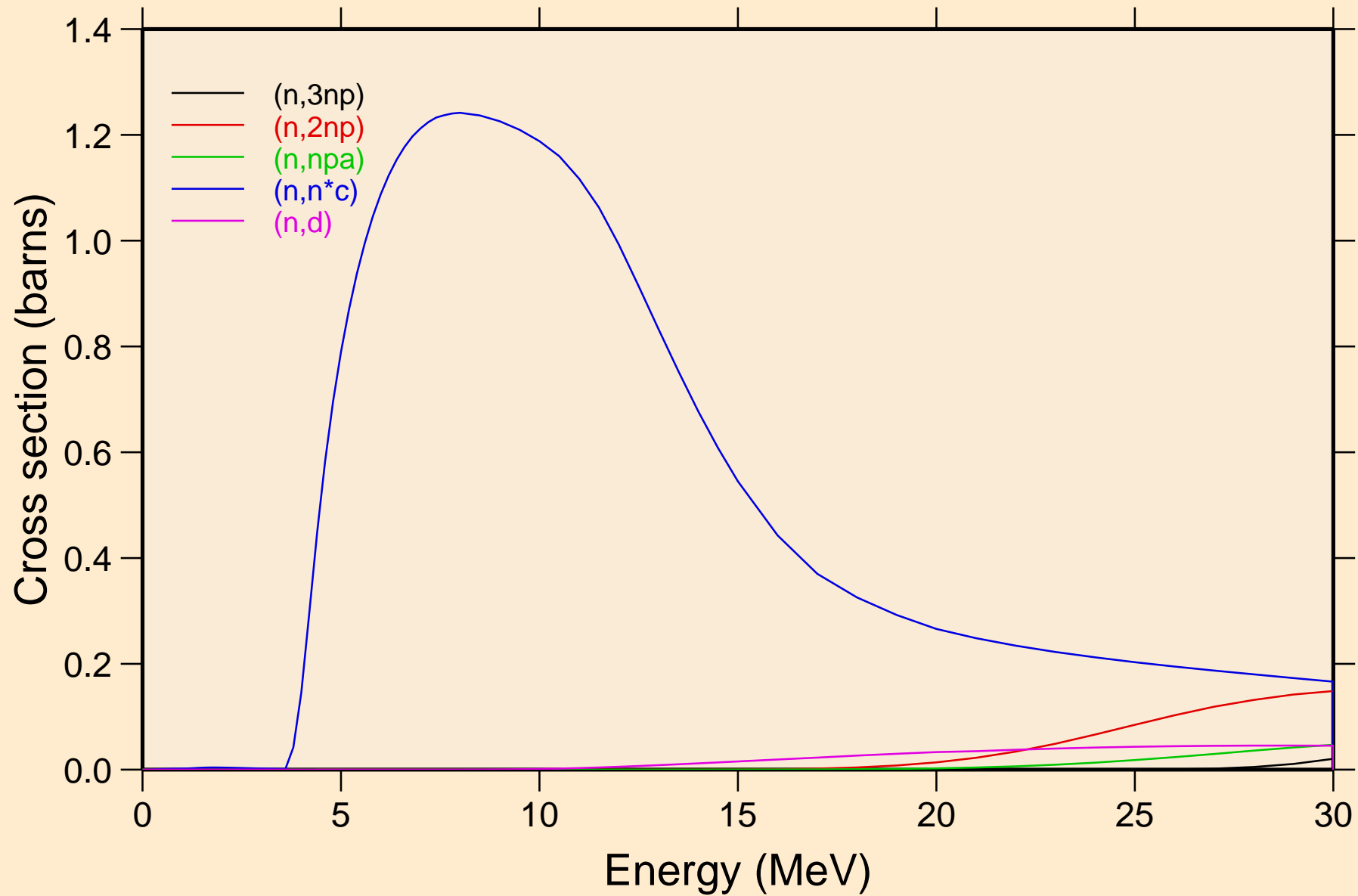

RE169M NEUTRON ACER TENDL-2021 LIBRARY; T=293.6K
Threshold reactions

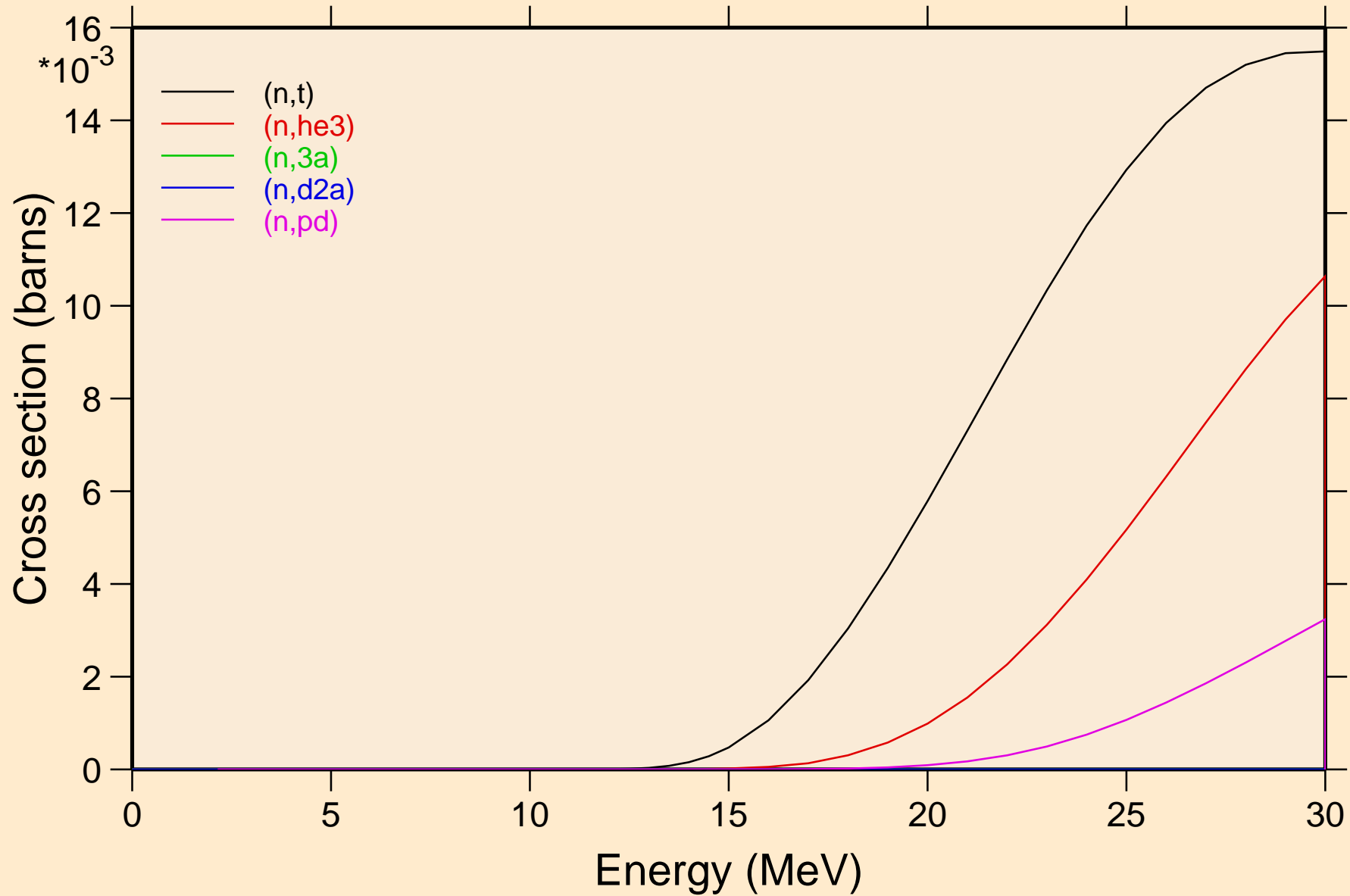

RE169M NEUTRON ACER TENDL-2021 LIBRARY; T=293.6K
Threshold reactions

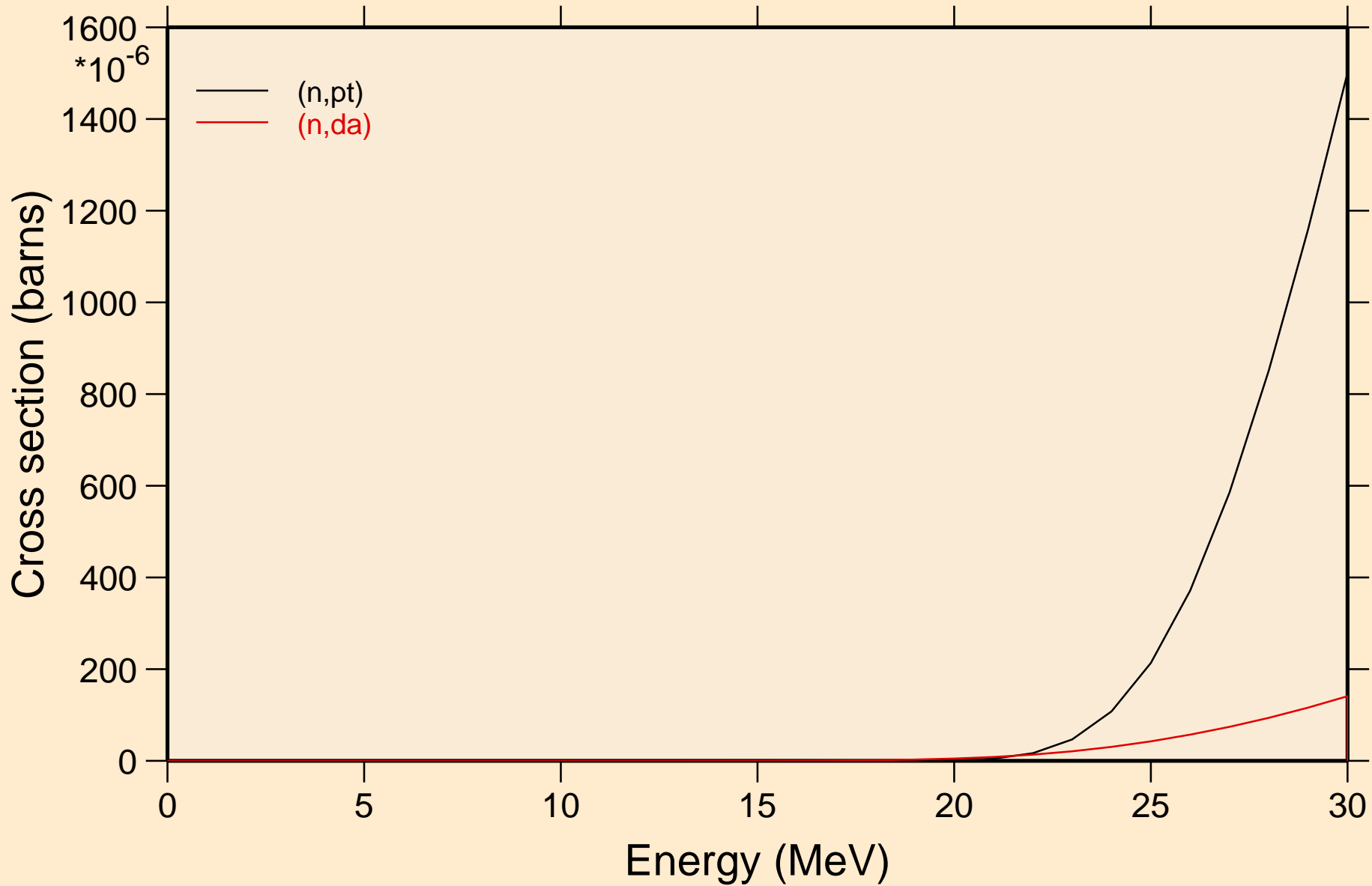

RE169M NEUTRON ACER TENDL-2021 LIBRARY; T=293.6K
Threshold reactions

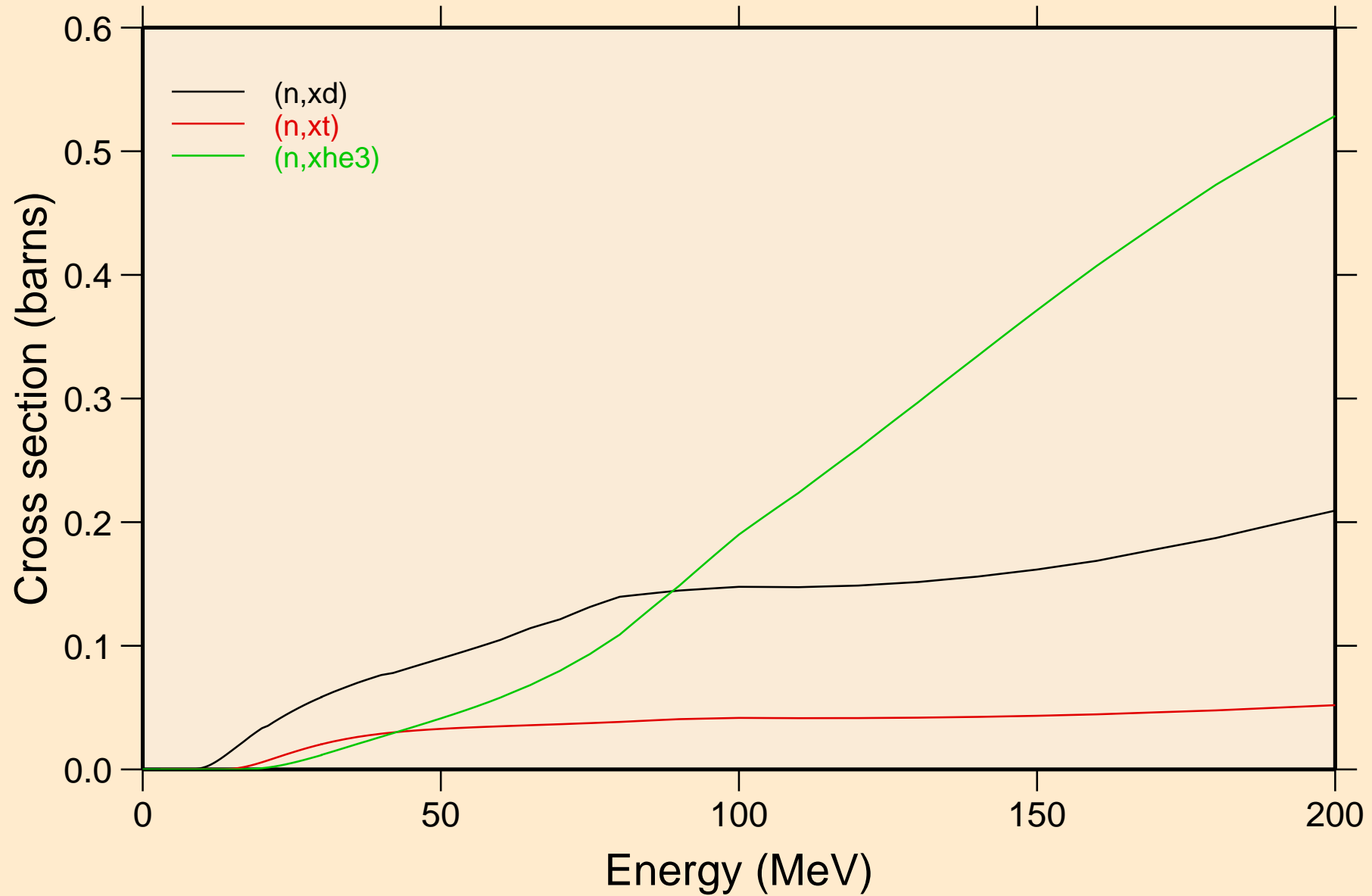

RE169M NEUTRON ACER TENDL-2021 LIBRARY; T=293.6K
angular distribution for elastic

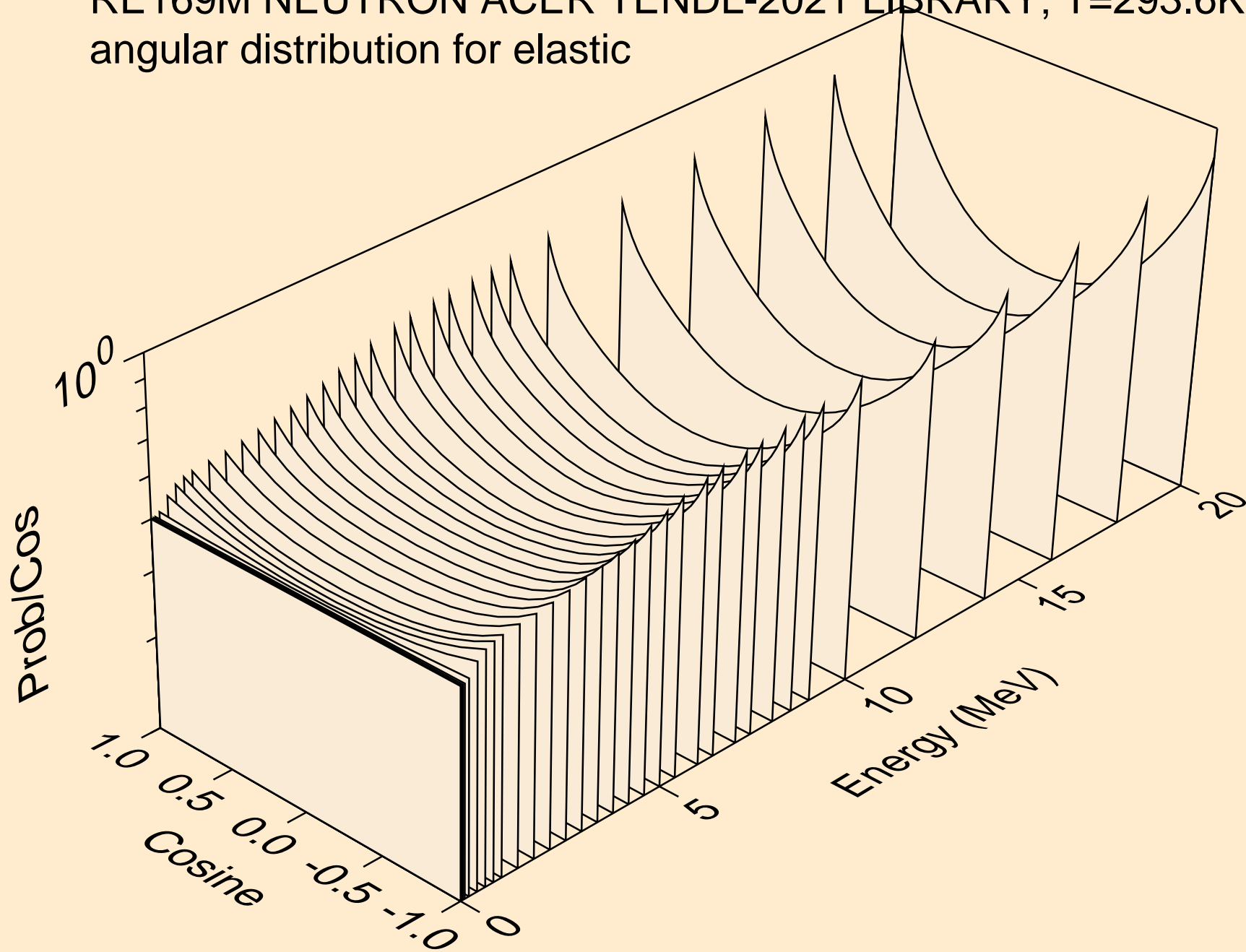

RE169M NEUTRON ACER TENDL-2021 LIBRARY; T=293.6K
angular distribution for elastic

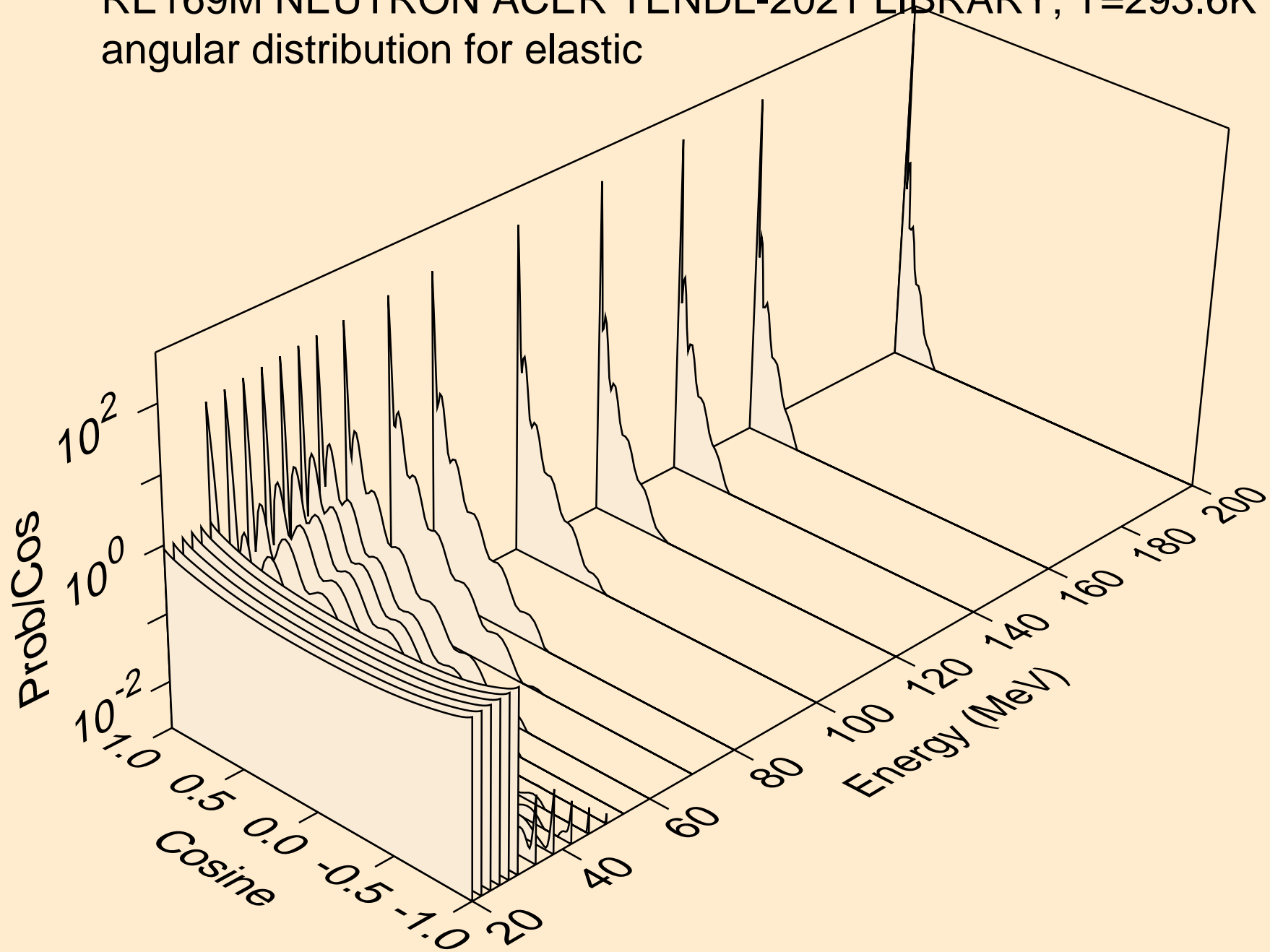

RE169M NEUTRON ACER TENDL-2021 LIBRARY; T=293.6K
angular distribution for (n,n*1)

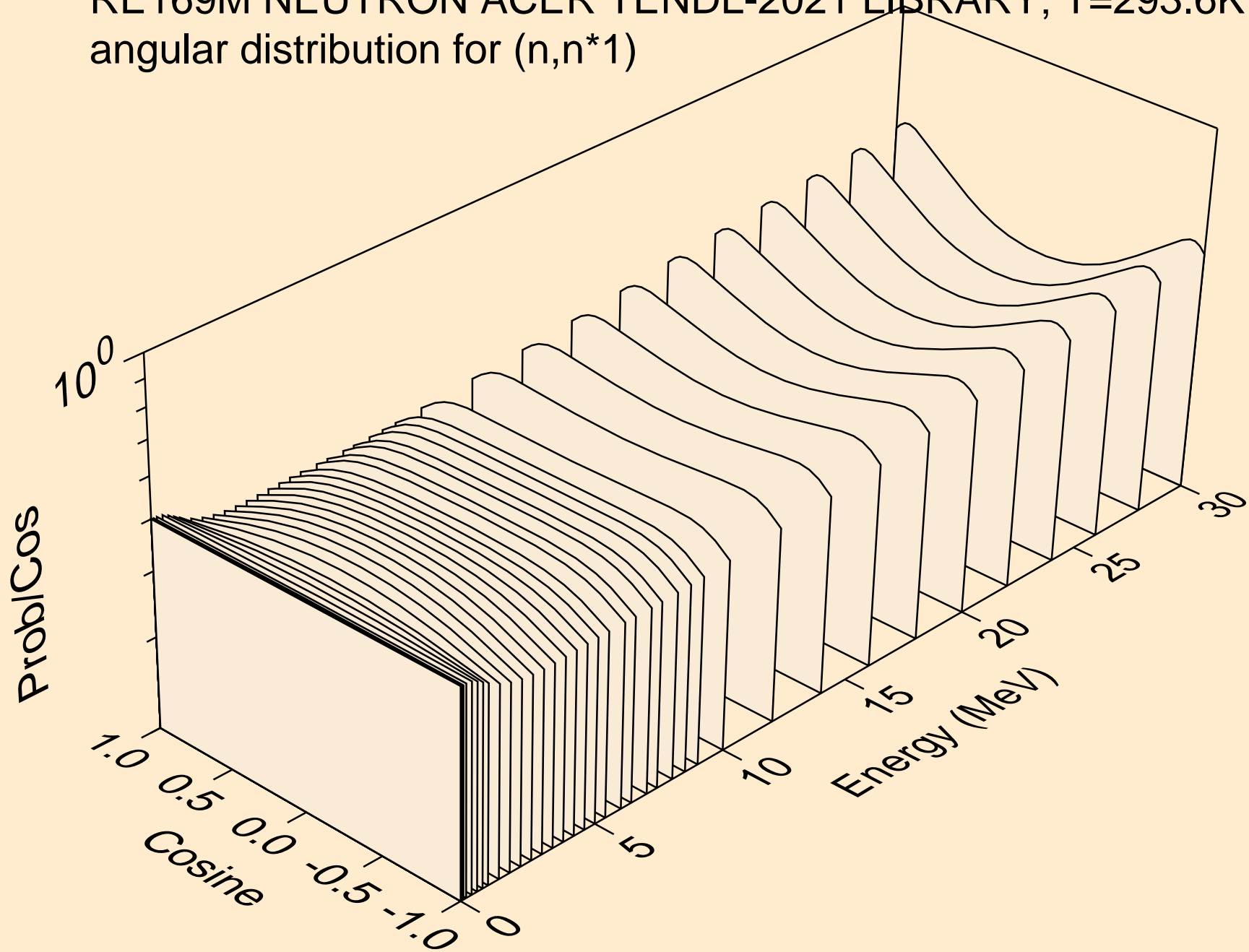

RE169M NEUTRON ACER TENDL-2021 LIBRARY; T=293.6K
angular distribution for (n,n*2)

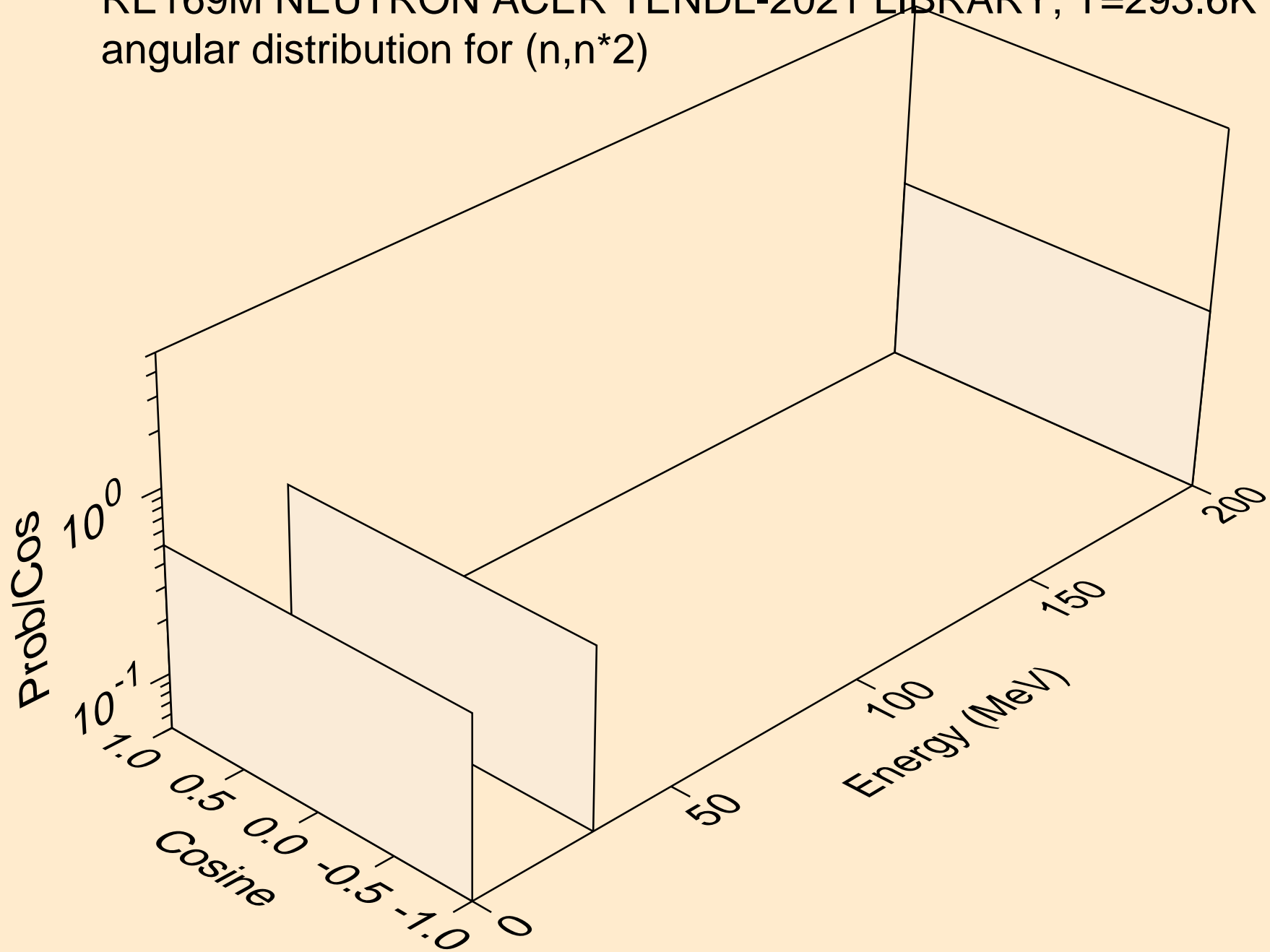

RE169M NEUTRON ACER TENDL-2021 LIBRARY; T=293.6K
Neutron emission for (n,x)

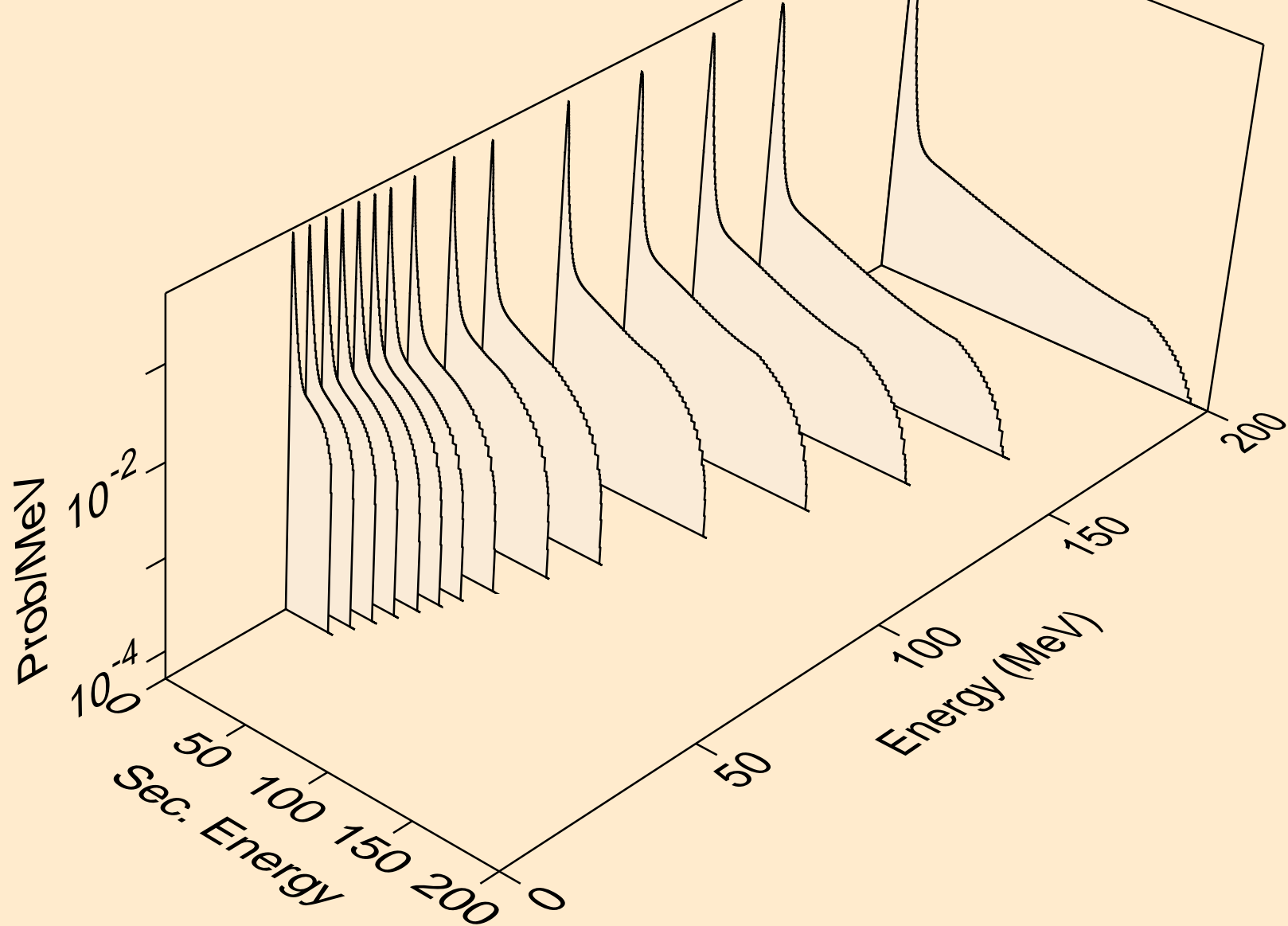

RE169M NEUTRON ACER TENDL-2021 LIBRARY; T=293.6K
Neutron emission for (n,2nd)

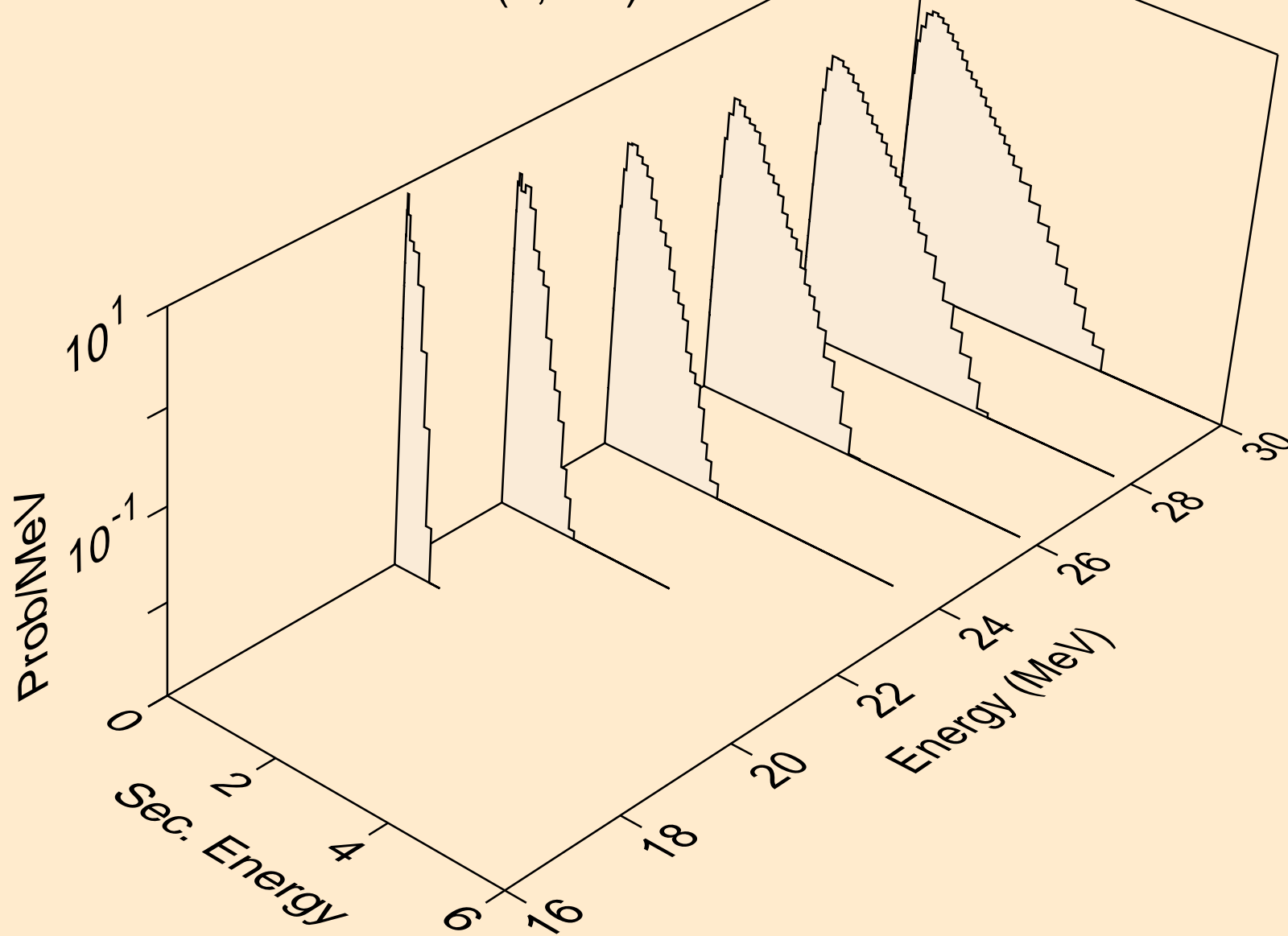

RE169M NEUTRON ACER TENDL-2021 LIBRARY; T=293.6K
Neutron emission for (n,2n)

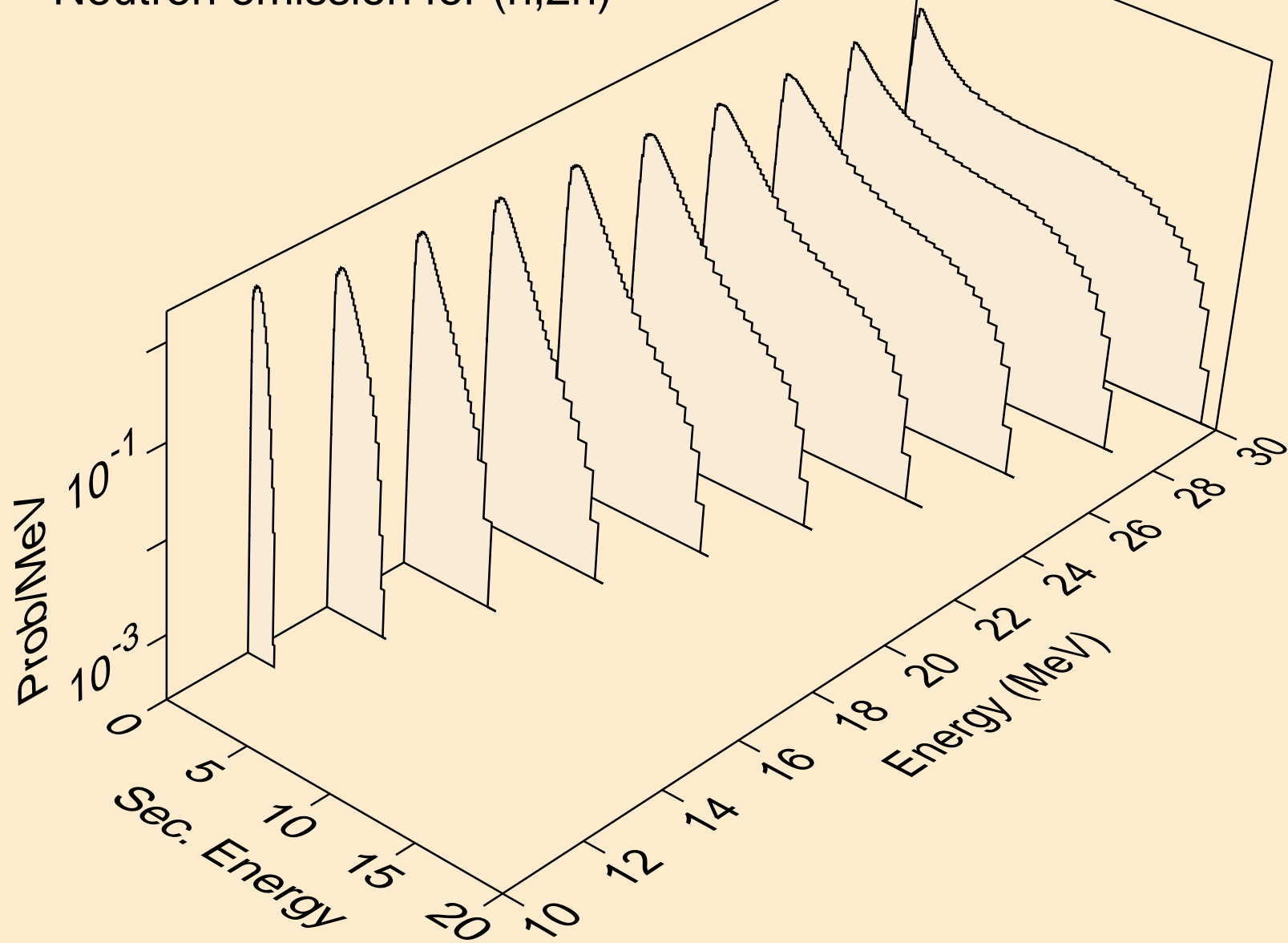

RE169M NEUTRON ACER TENDL-2021 LIBRARY; T=293.6K
Neutron emission for (n,3n)

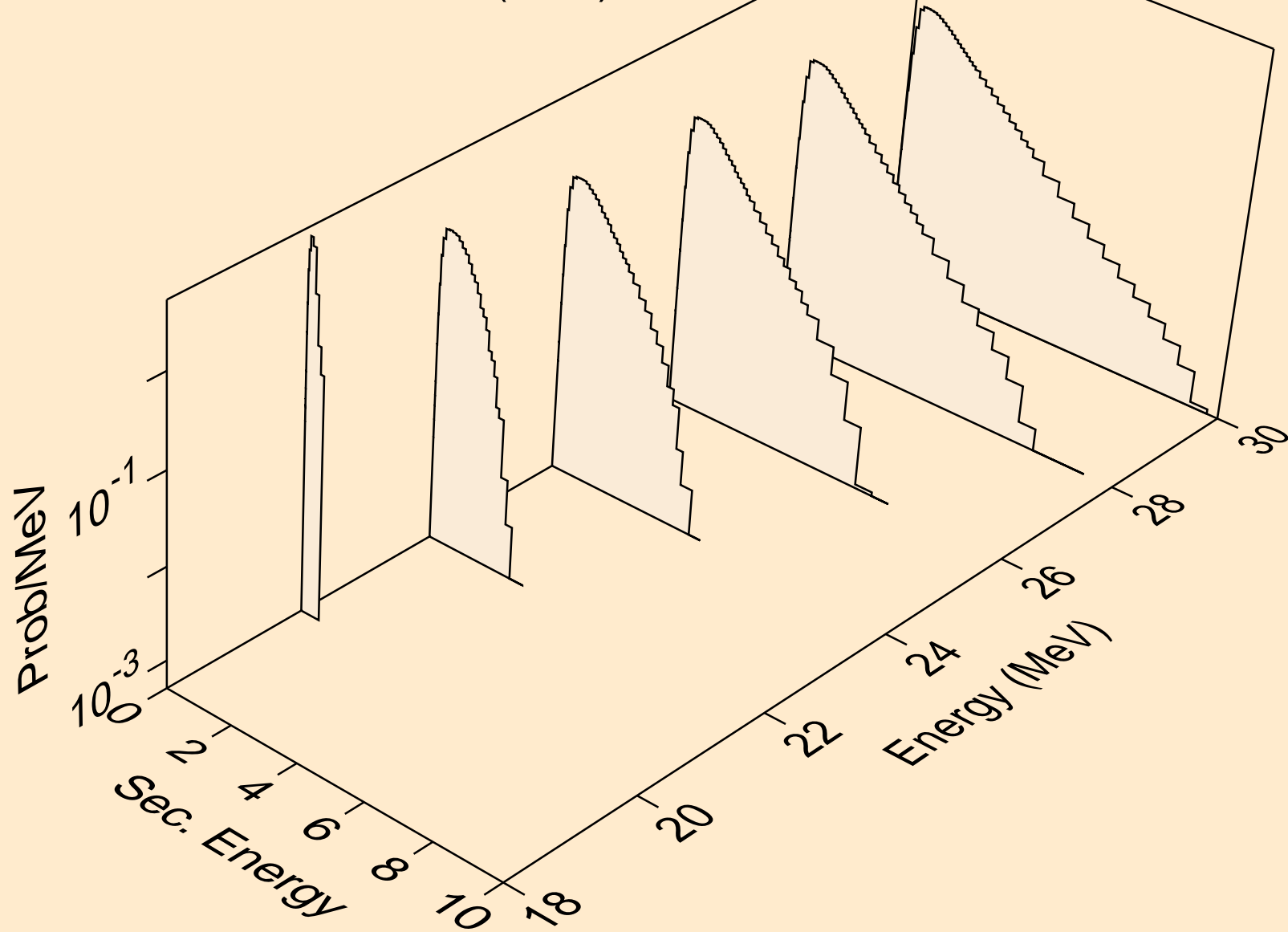

RE169M NEUTRON ACER TENDL-2021 LIBRARY; T=293.6K
Neutron emission for (n,n*)a

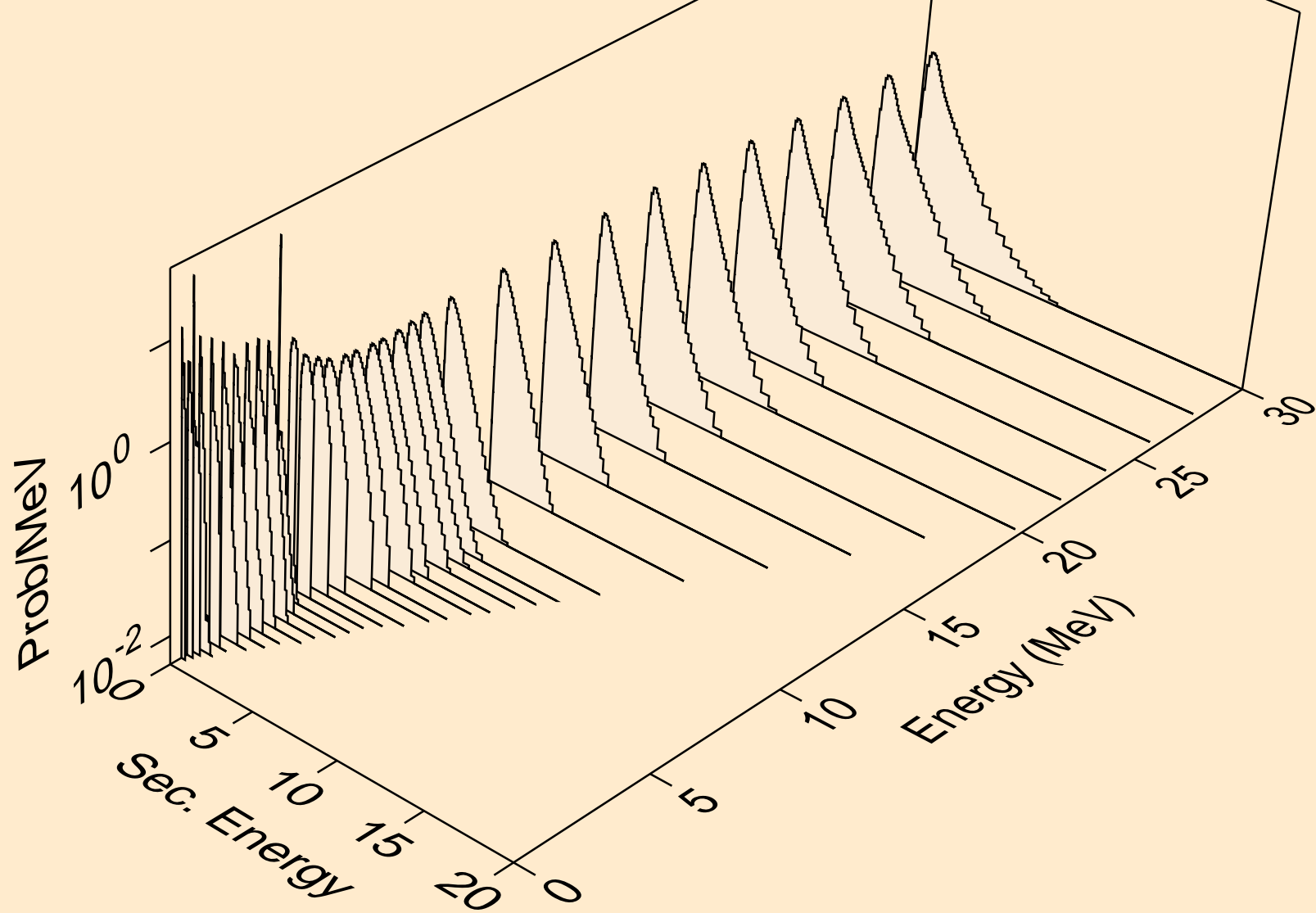

RE169M NEUTRON ACER TENDL-2021 LIBRARY; T=293.6K
Neutron emission for (n,n*)3a

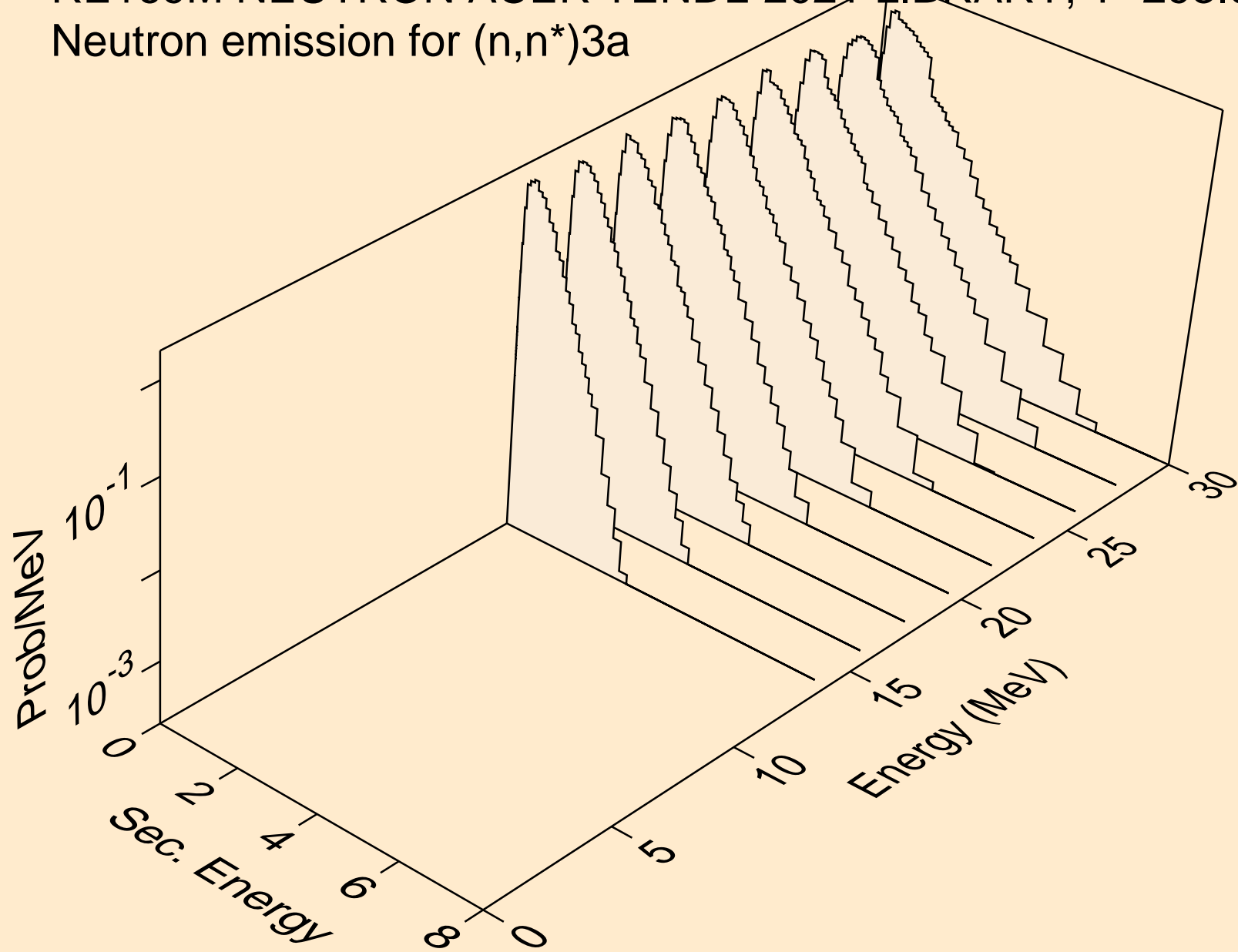

RE169M NEUTRON ACER TENDL-2021 LIBRARY; T=293.6K
Neutron emission for (n,2n)_a

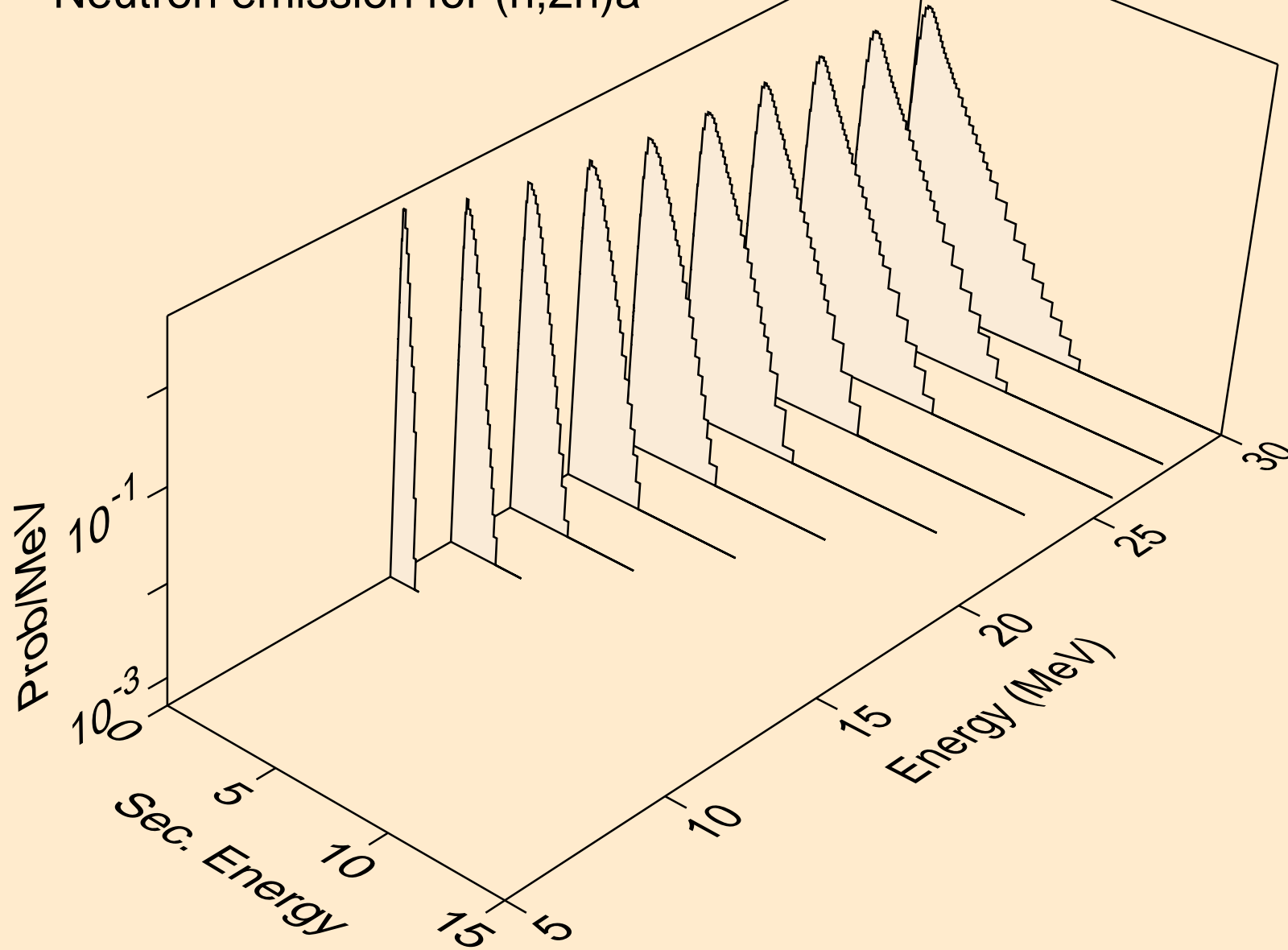

RE169M NEUTRON ACER TENDL-2021 LIBRARY; T=293.6K
Neutron emission for (n,3n)a

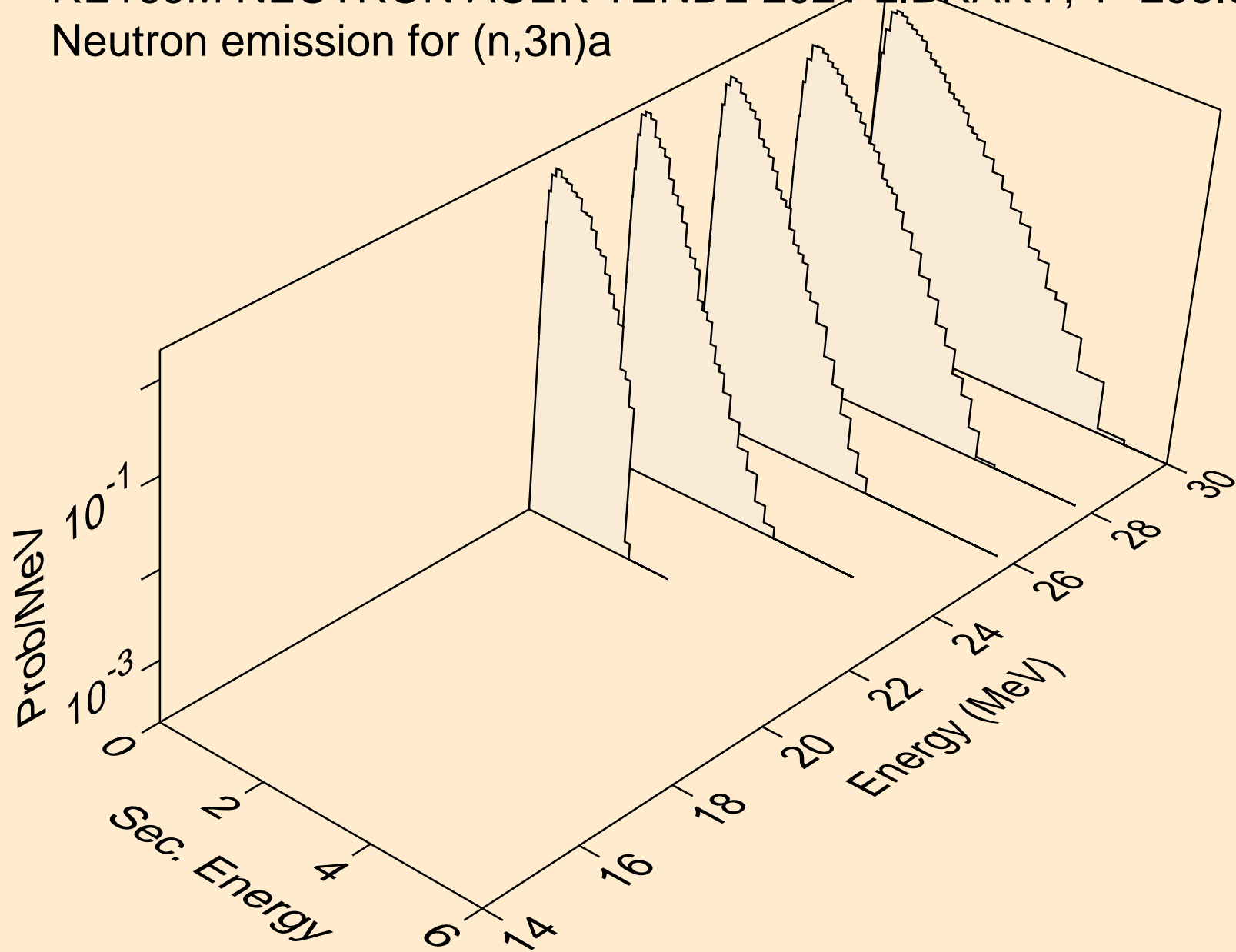

RE169M NEUTRON ACER TENDL-2021 LIBRARY; T=293.6K
Neutron emission for (n,n*)p

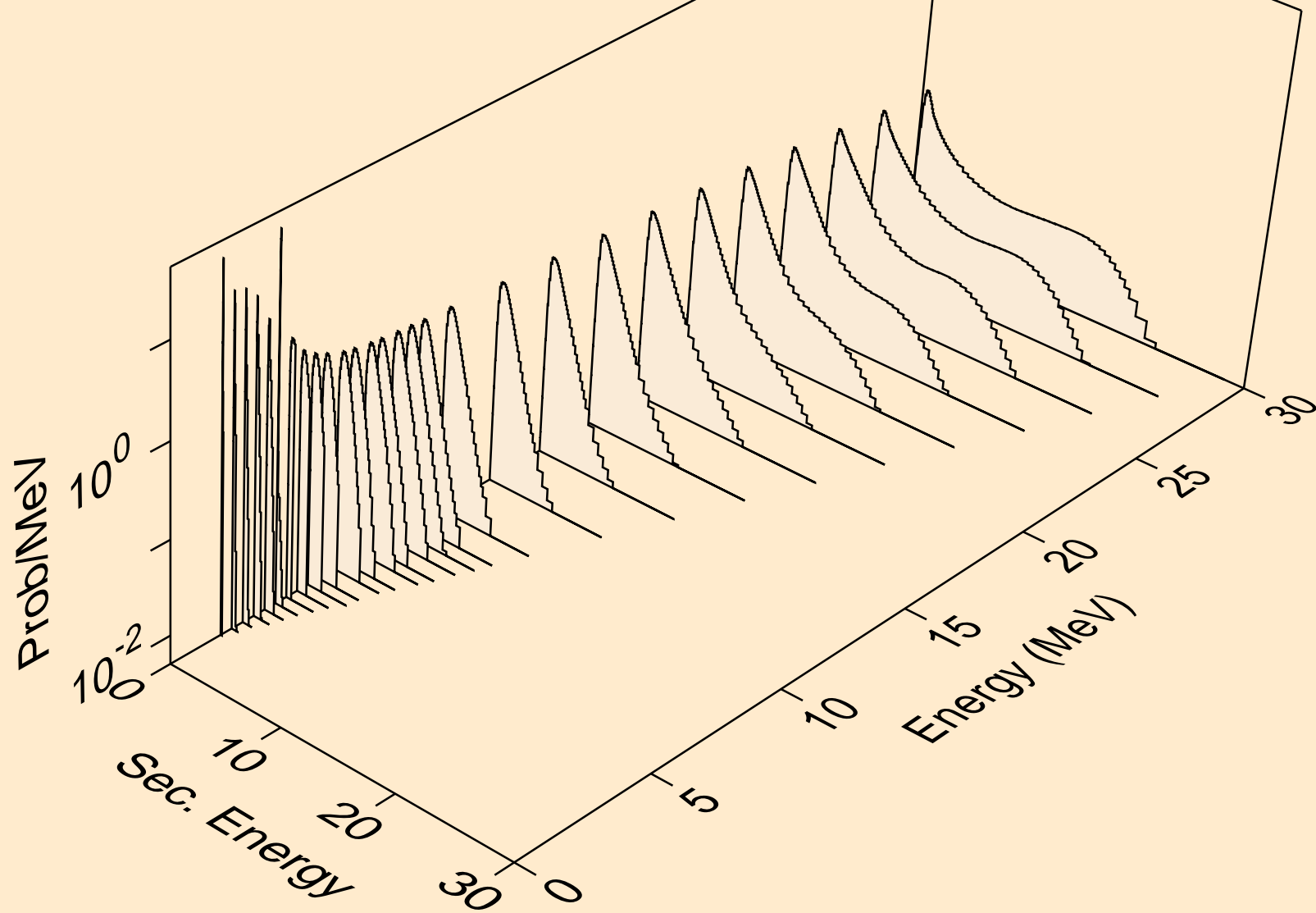

RE169M NEUTRON ACER TENDL-2021 LIBRARY; T=293.6K
Neutron emission for (n,n*)2a

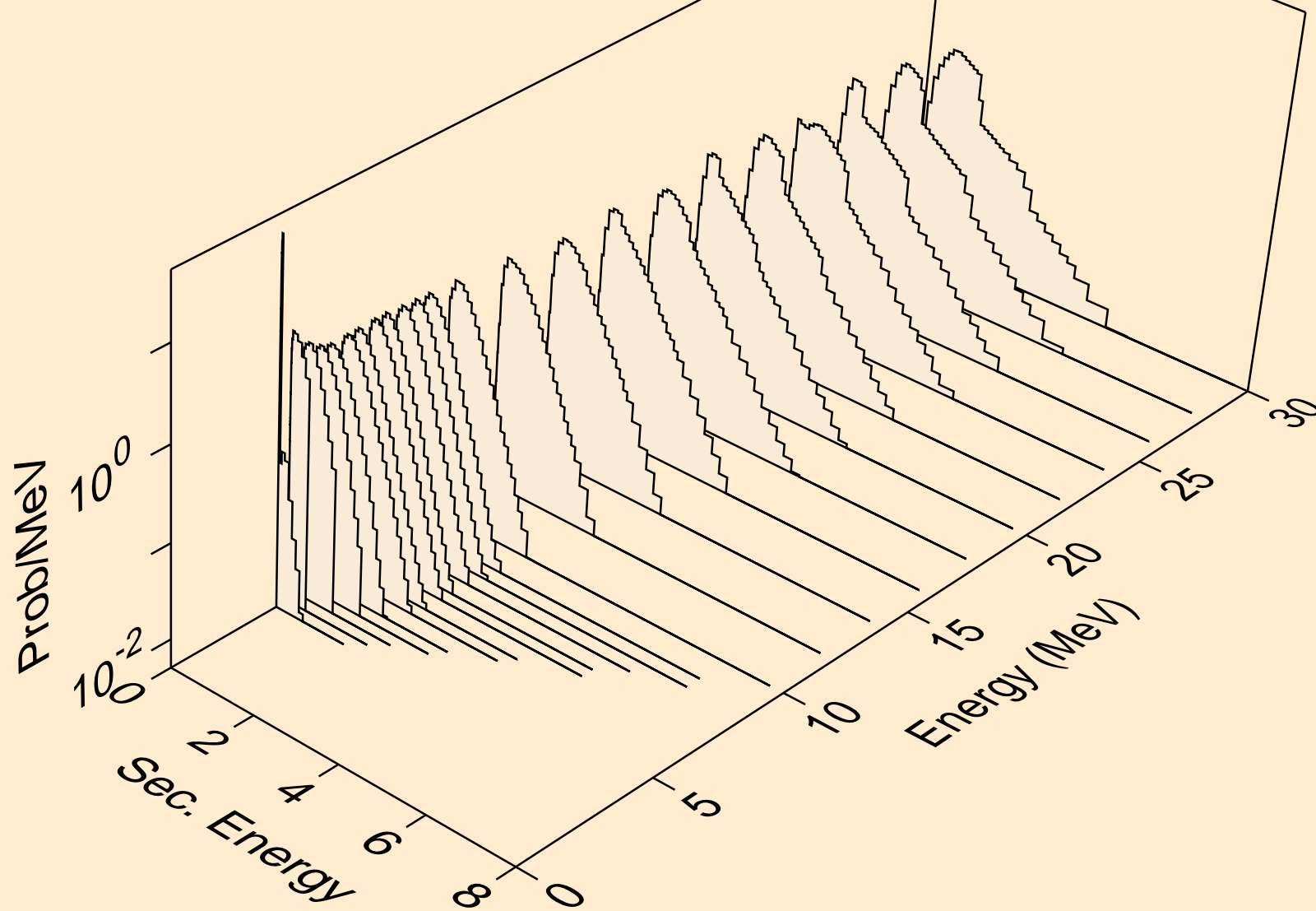

RE169M NEUTRON ACER TENDL-2021 LIBRARY; T=293.6K
Neutron emission for (n,2n)2a

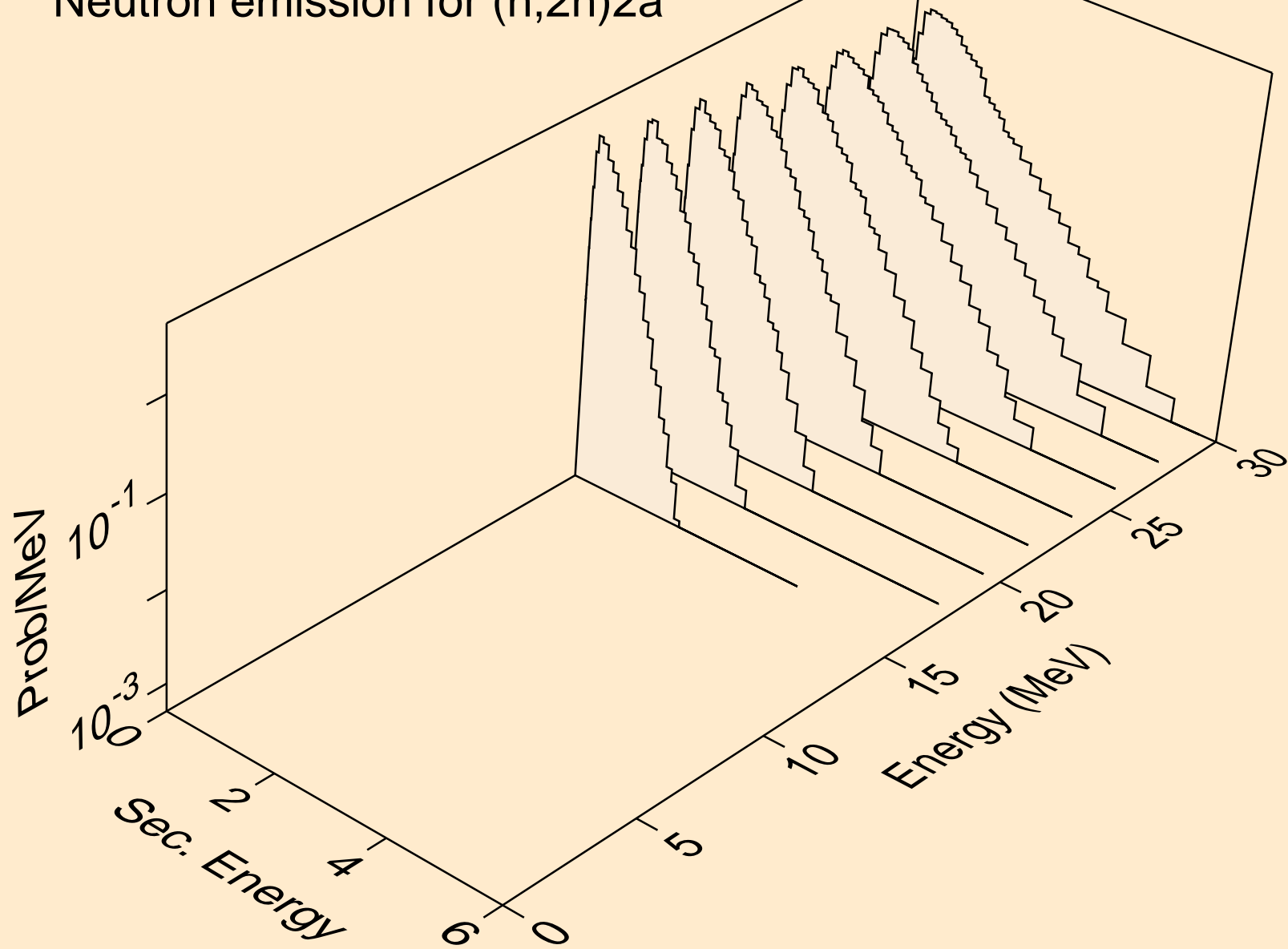

RE169M NEUTRON ACER TENDL-2021 LIBRARY; T=293.6K
Neutron emission for (n,n*)d

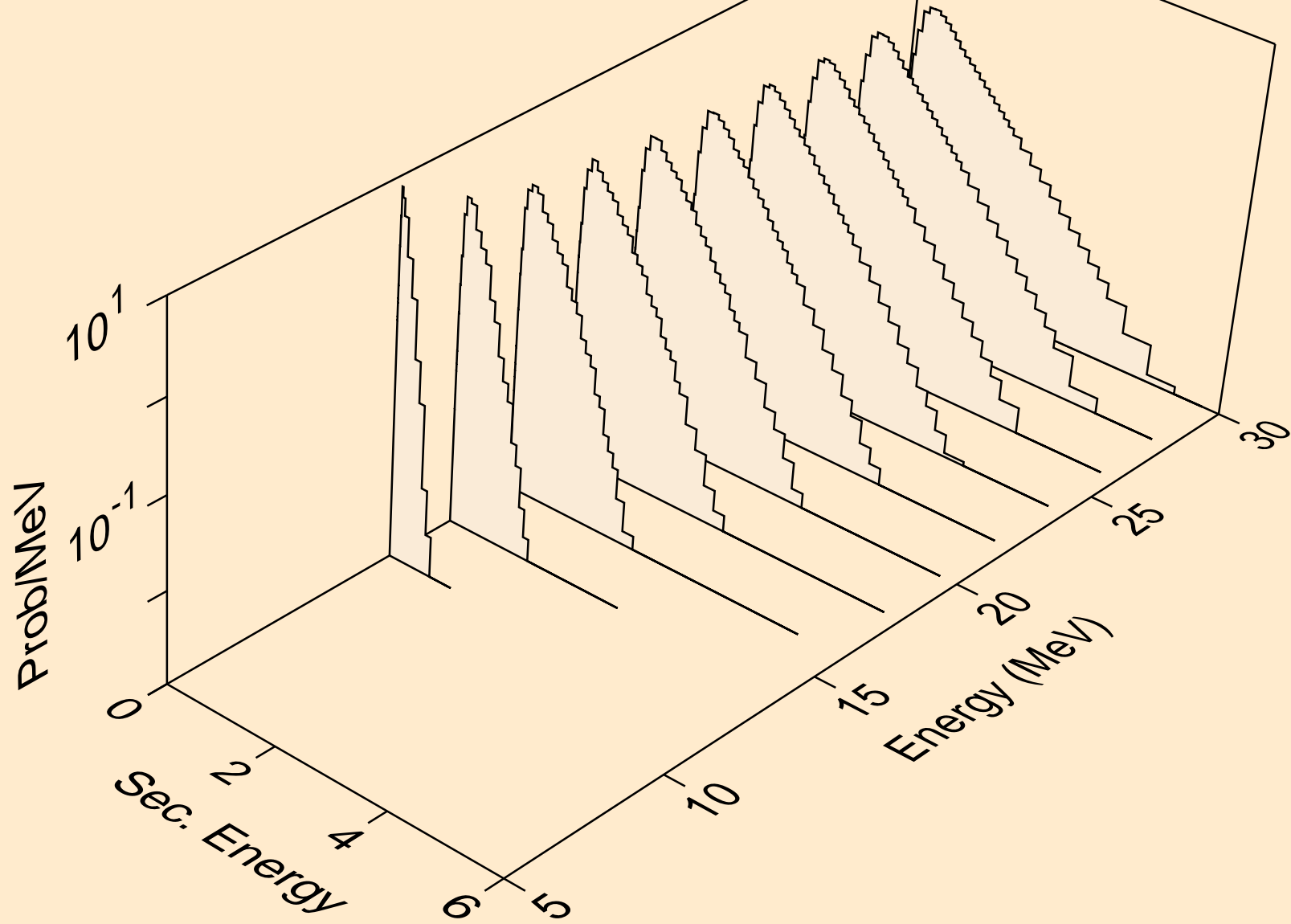

RE169M NEUTRON ACER TENDL-2021 LIBRARY; T=293.6K
Neutron emission for (n,n*)t

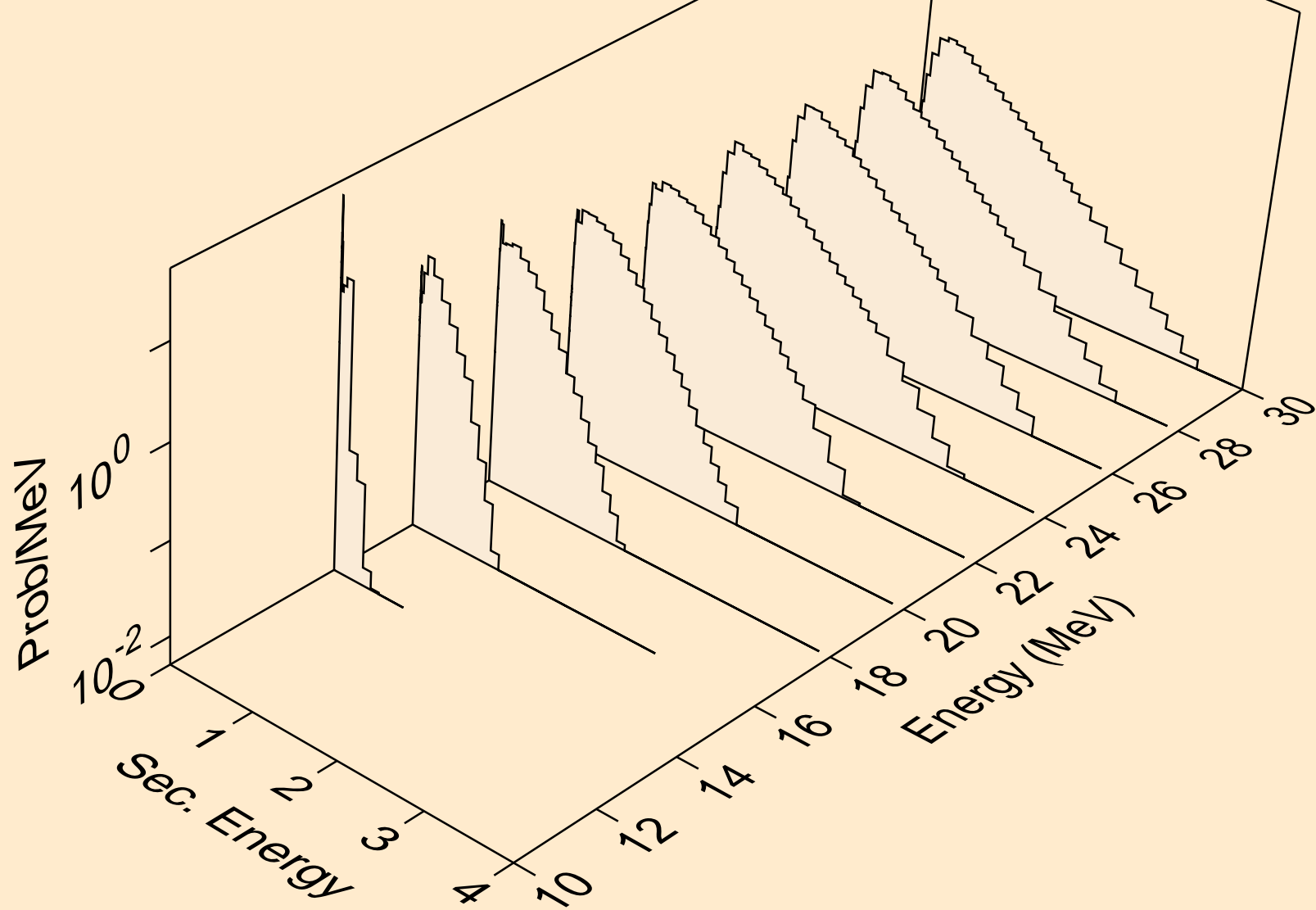

RE169M NEUTRON ACER TENDL-2021 LIBRARY; T=293.6K
Neutron emission for (n,n*)he3

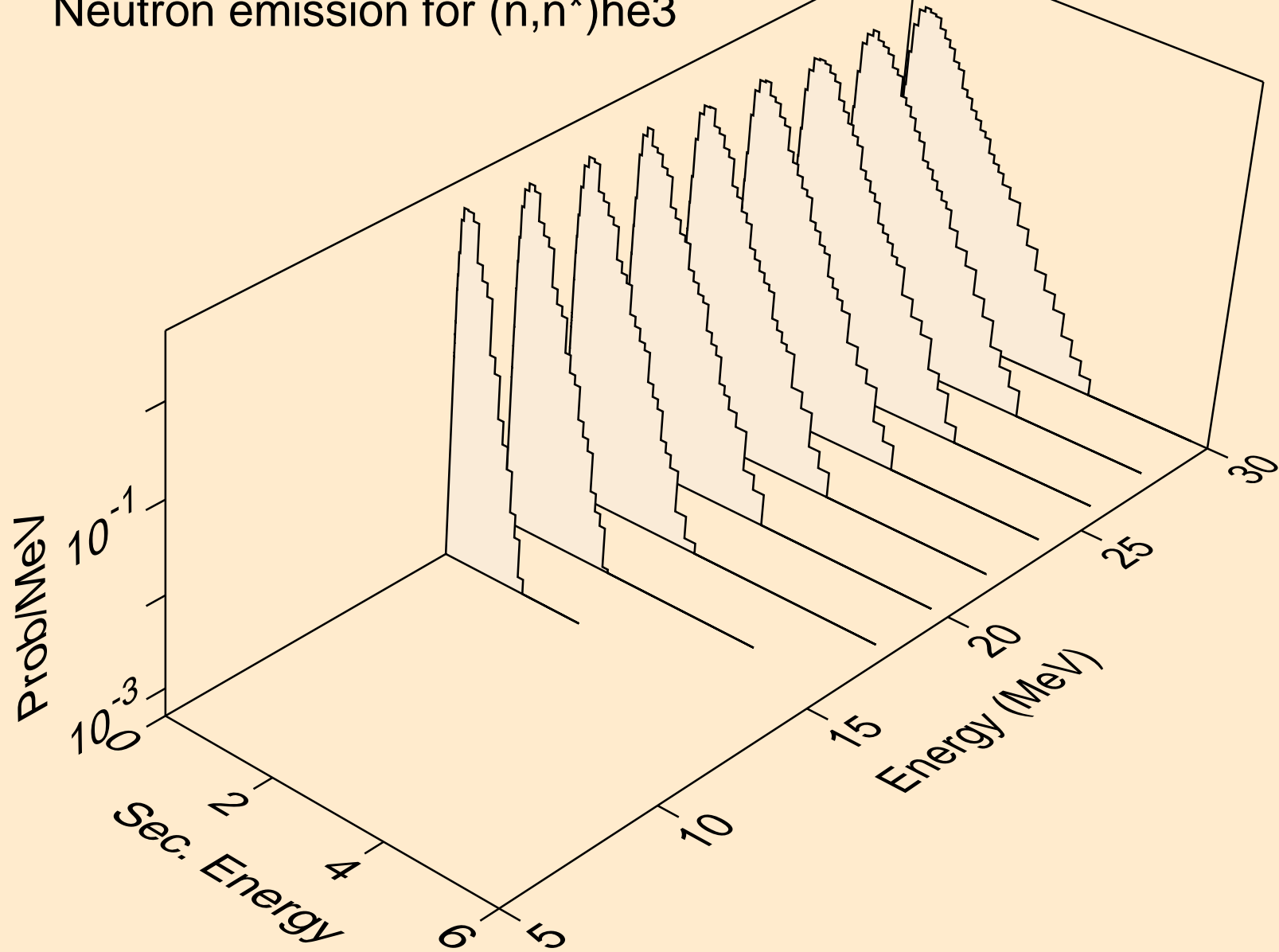

RE169M NEUTRON ACER TENDL-2021 LIBRARY; T=293.6K
Neutron emission for (n,2np)

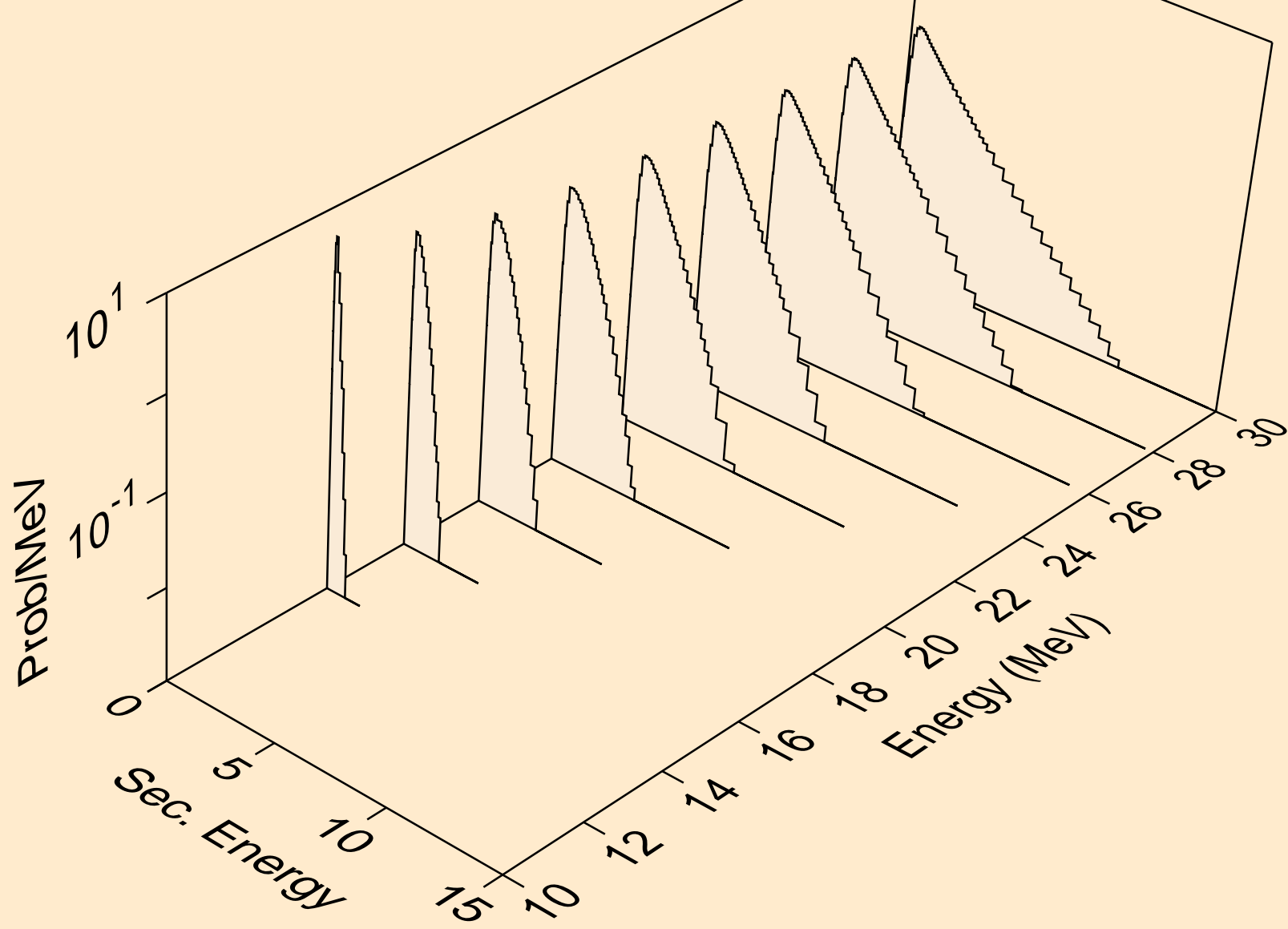

RE169M NEUTRON ACER TENDL-2021 LIBRARY; T=293.6K
Neutron emission for (n,3np)

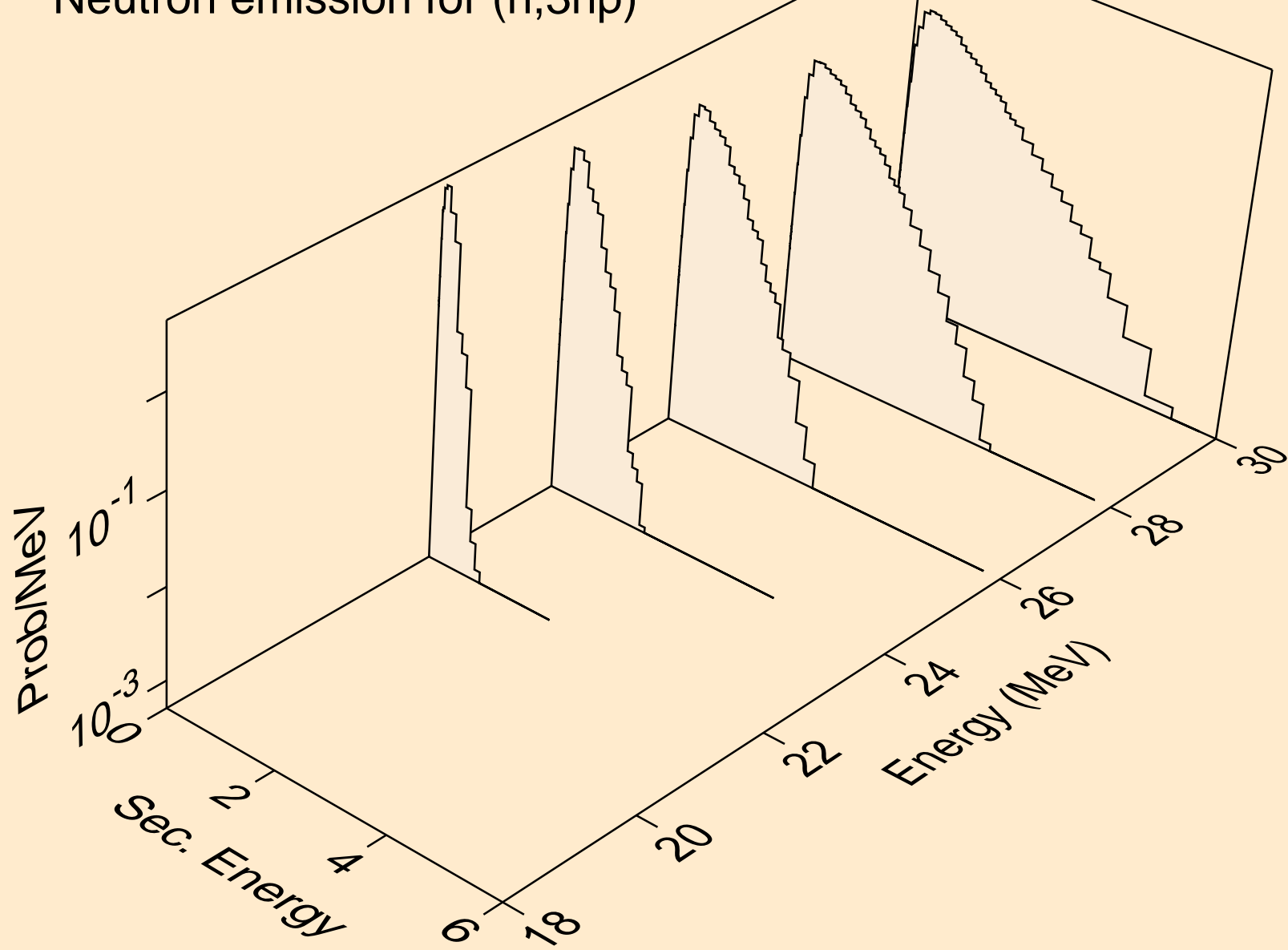

RE169M NEUTRON ACER TENDL-2021 LIBRARY; T=293.6K
Neutron emission for (n,2np)

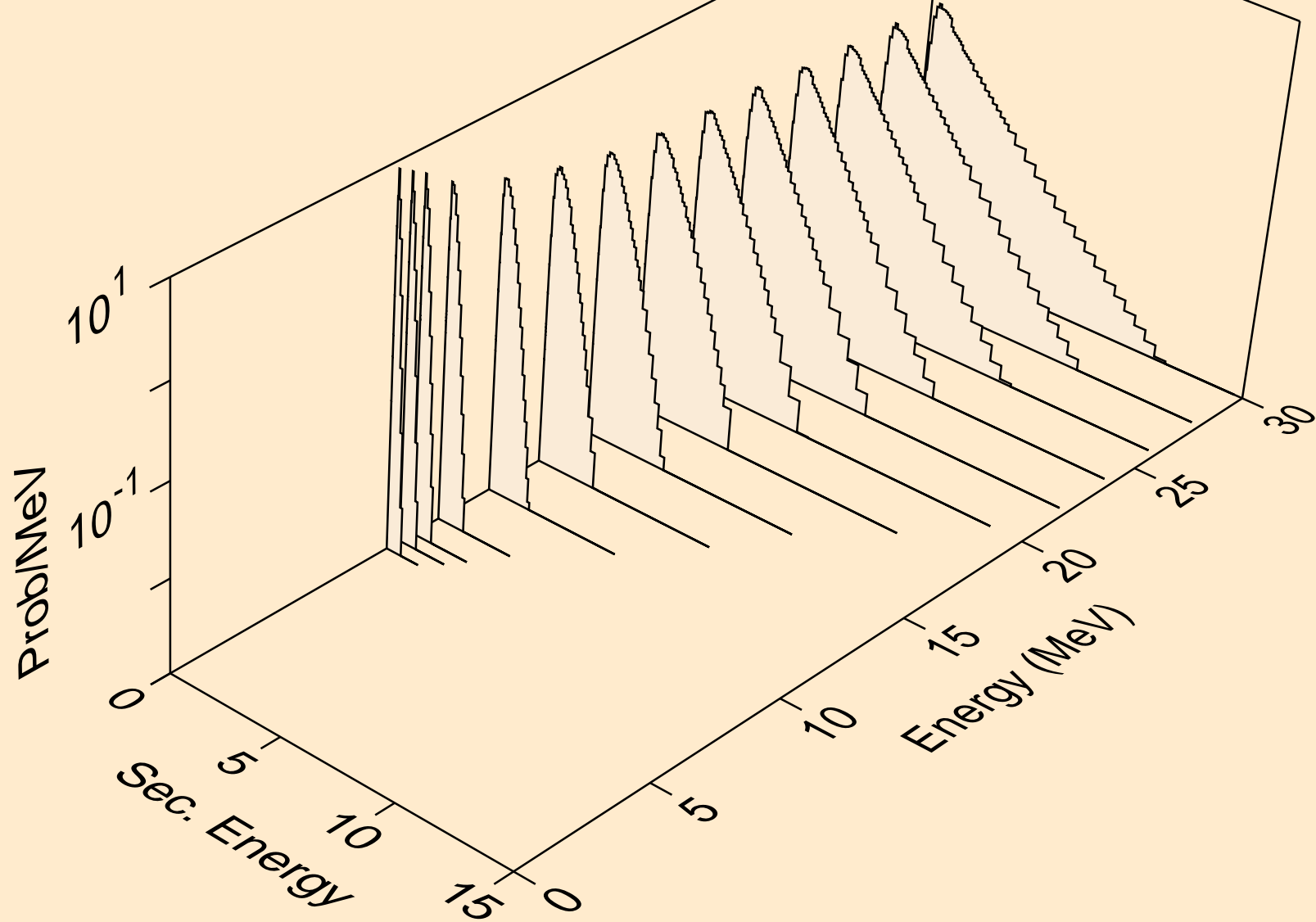

RE169M NEUTRON ACER TENDL-2021 LIBRARY; T=293.6K
Neutron emission for (n,npa)

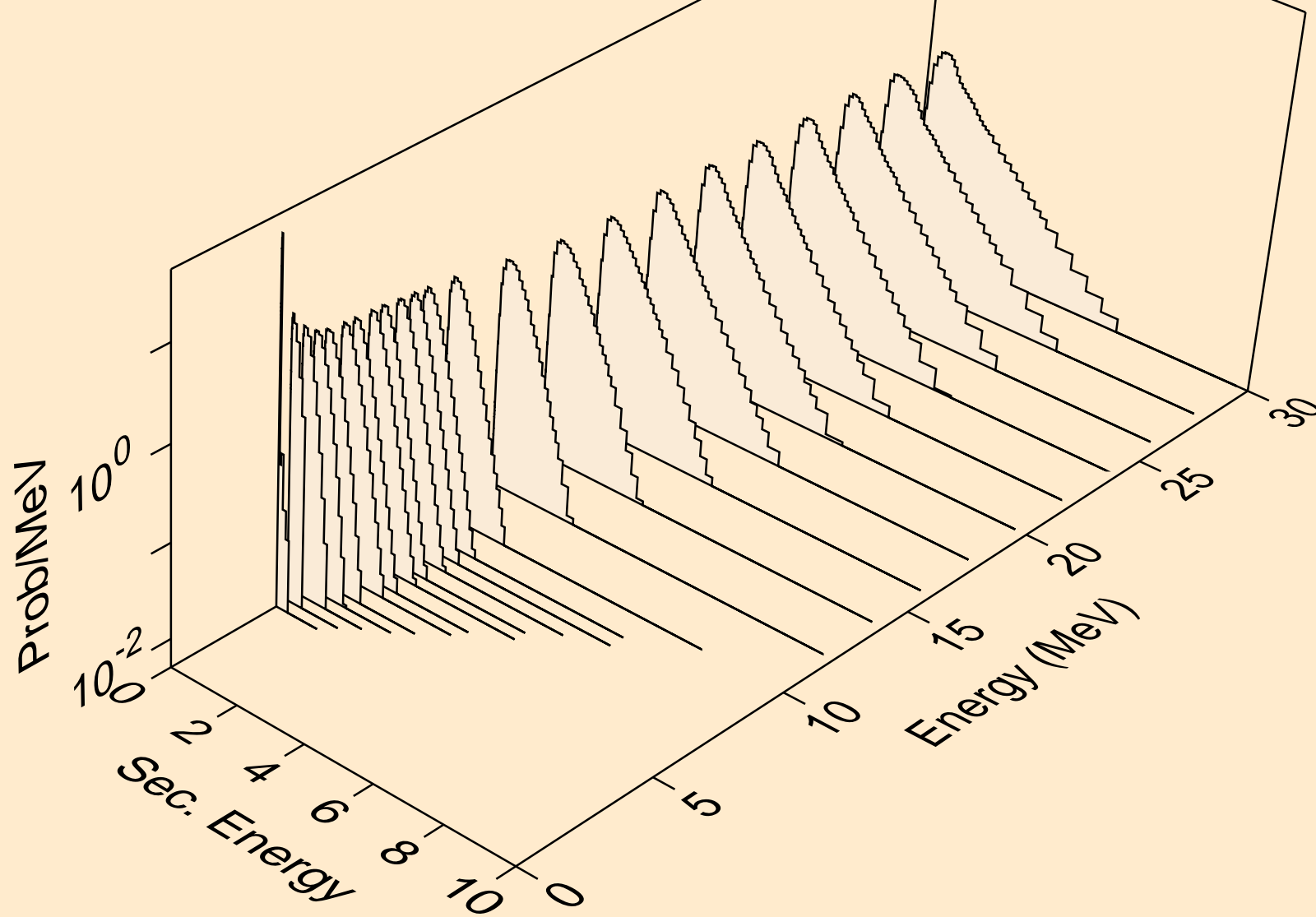

RE169M NEUTRON ACER TENDL-2021 LIBRARY; T=293.6K
Neutron emission for (n,n*c)

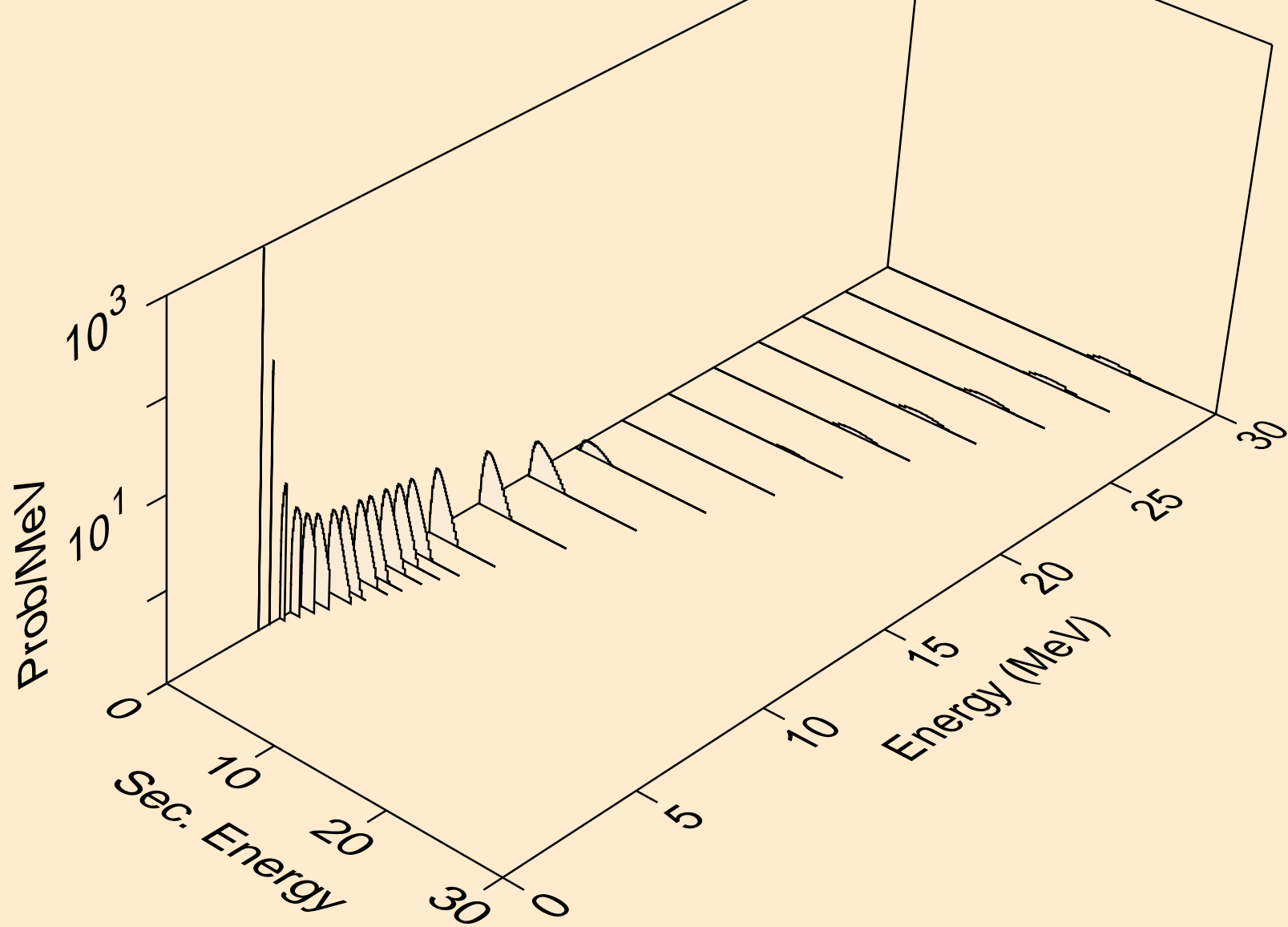

RE169M NEUTRON ACER TENDL-2021 LIBRARY; T=293.6K
Photon emission for (n,x)

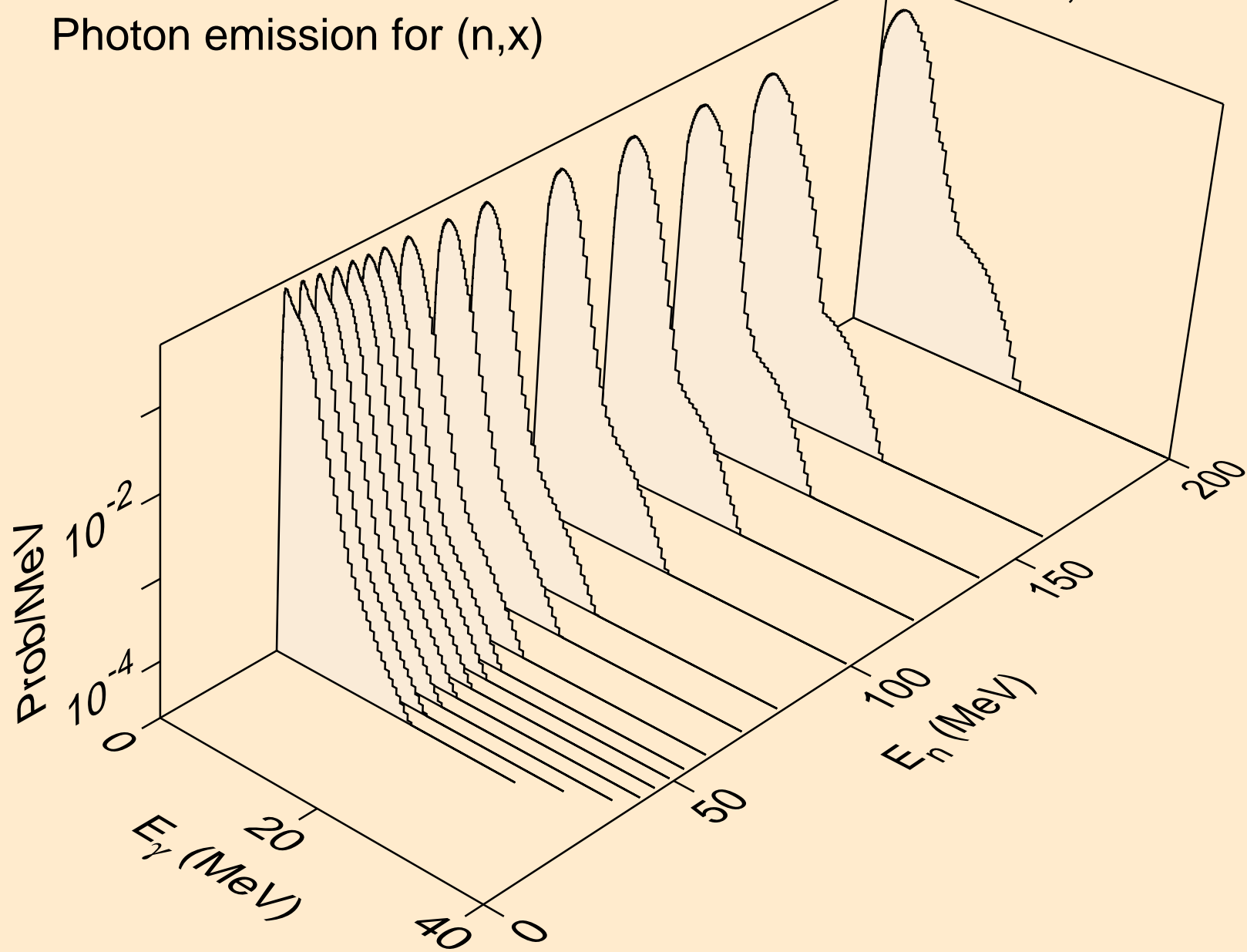

RE169M NEUTRON ACER TENDL-2021 LIBRARY; T=293.6K
Photon emission for (n,2nd)

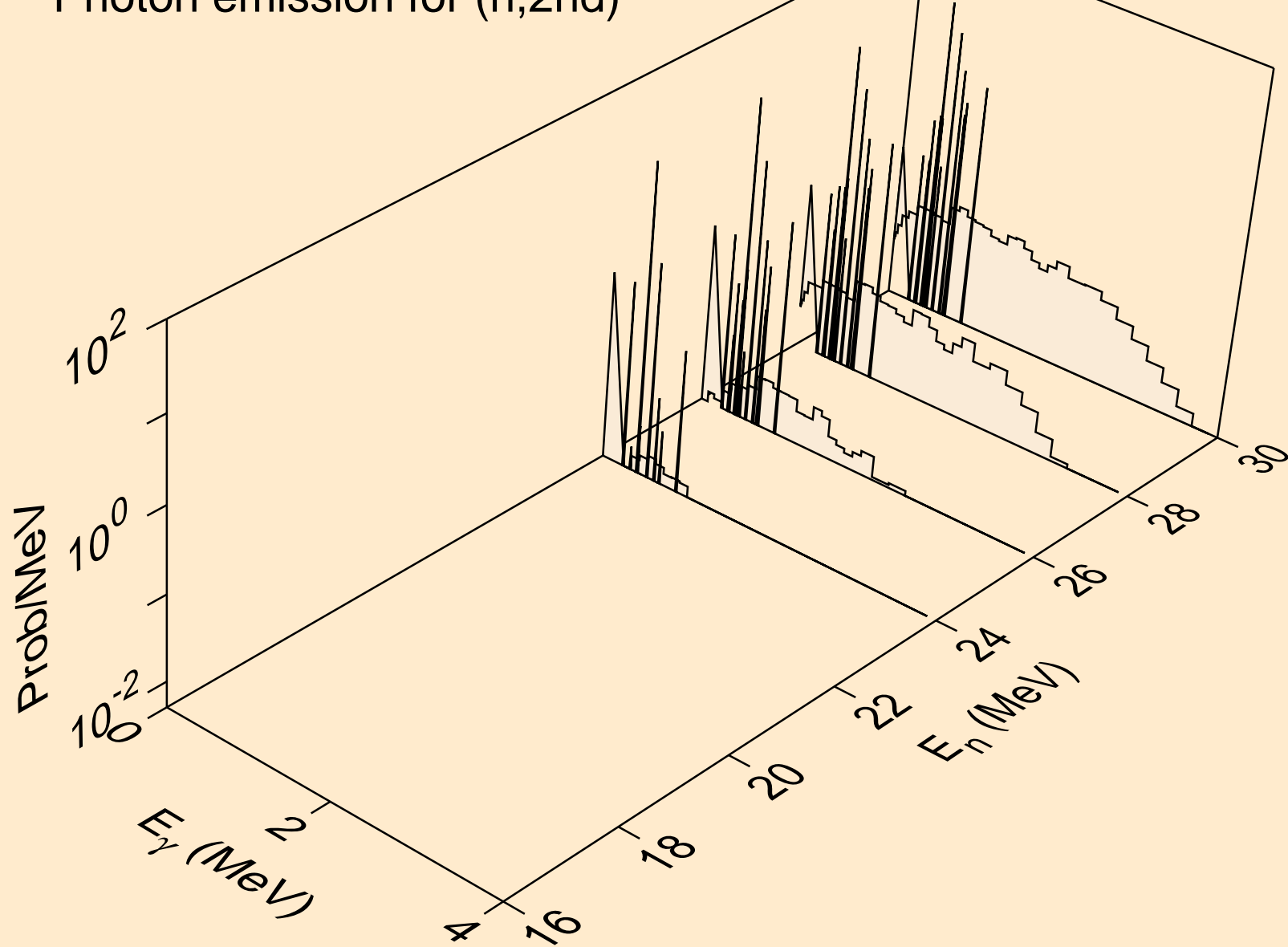

RE169M NEUTRON ACER TENDL-2021 LIBRARY; T=293.6K
Photon emission for (n,2n)

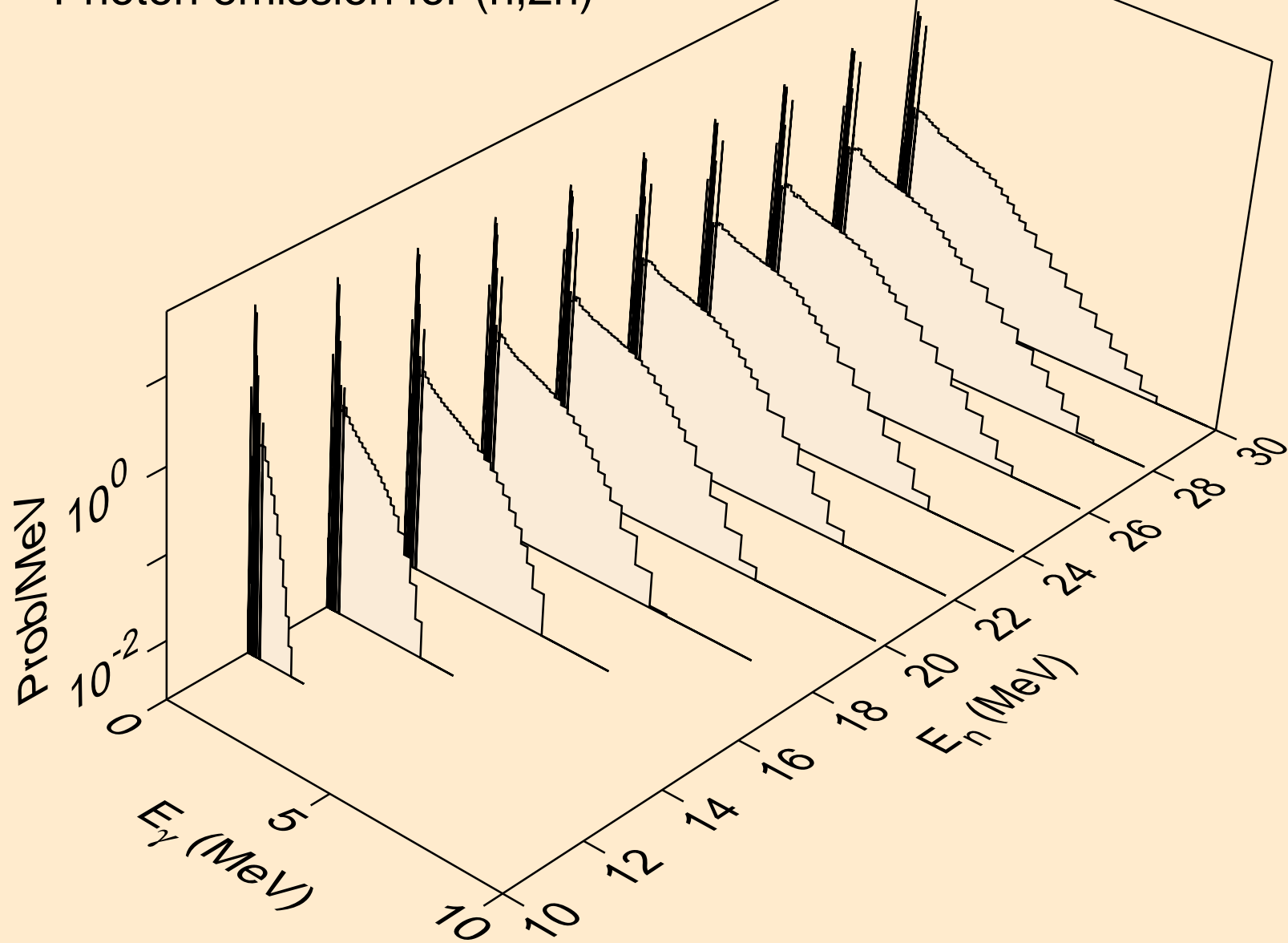

RE169M NEUTRON ACER TENDL-2021 LIBRARY; T=293.6K
Photon emission for (n,3n)

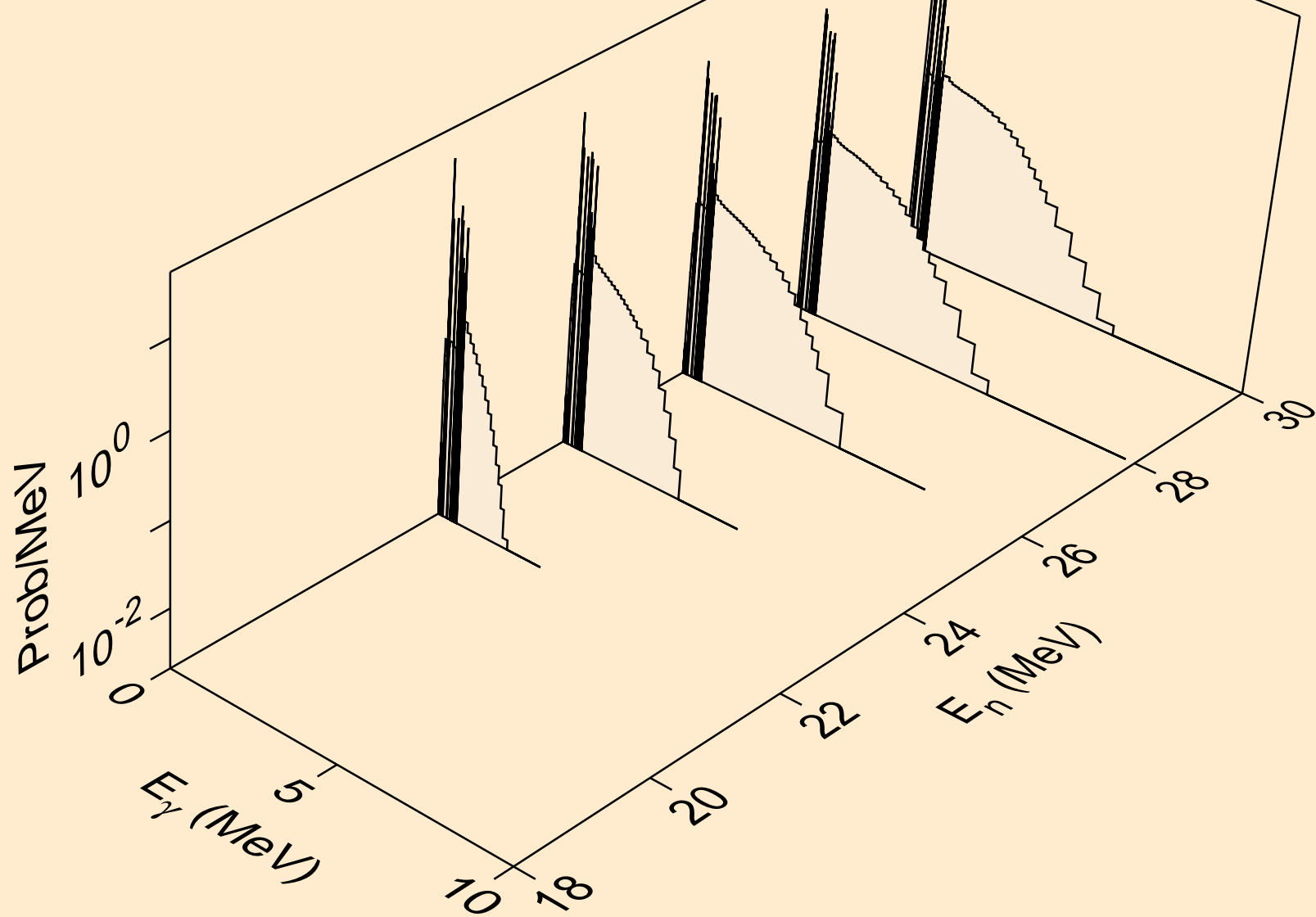

RE169M NEUTRON ACER TENDL-2021 LIBRARY; T=293.6K
Photon emission for (n,n*)a

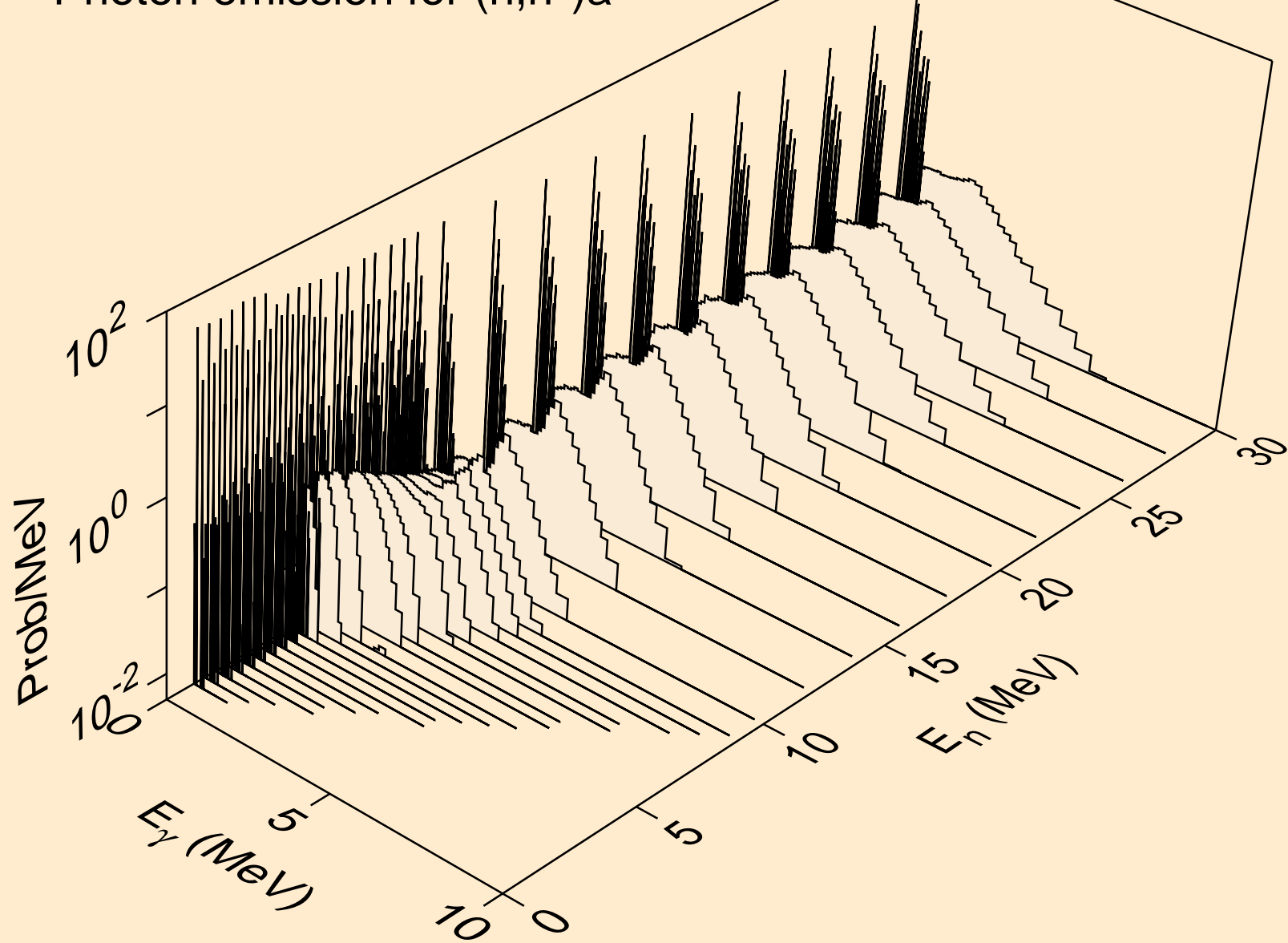

RE169M NEUTRON ACER TENDL-2021 LIBRARY; T=293.6K
Photon emission for (n,n*)3a

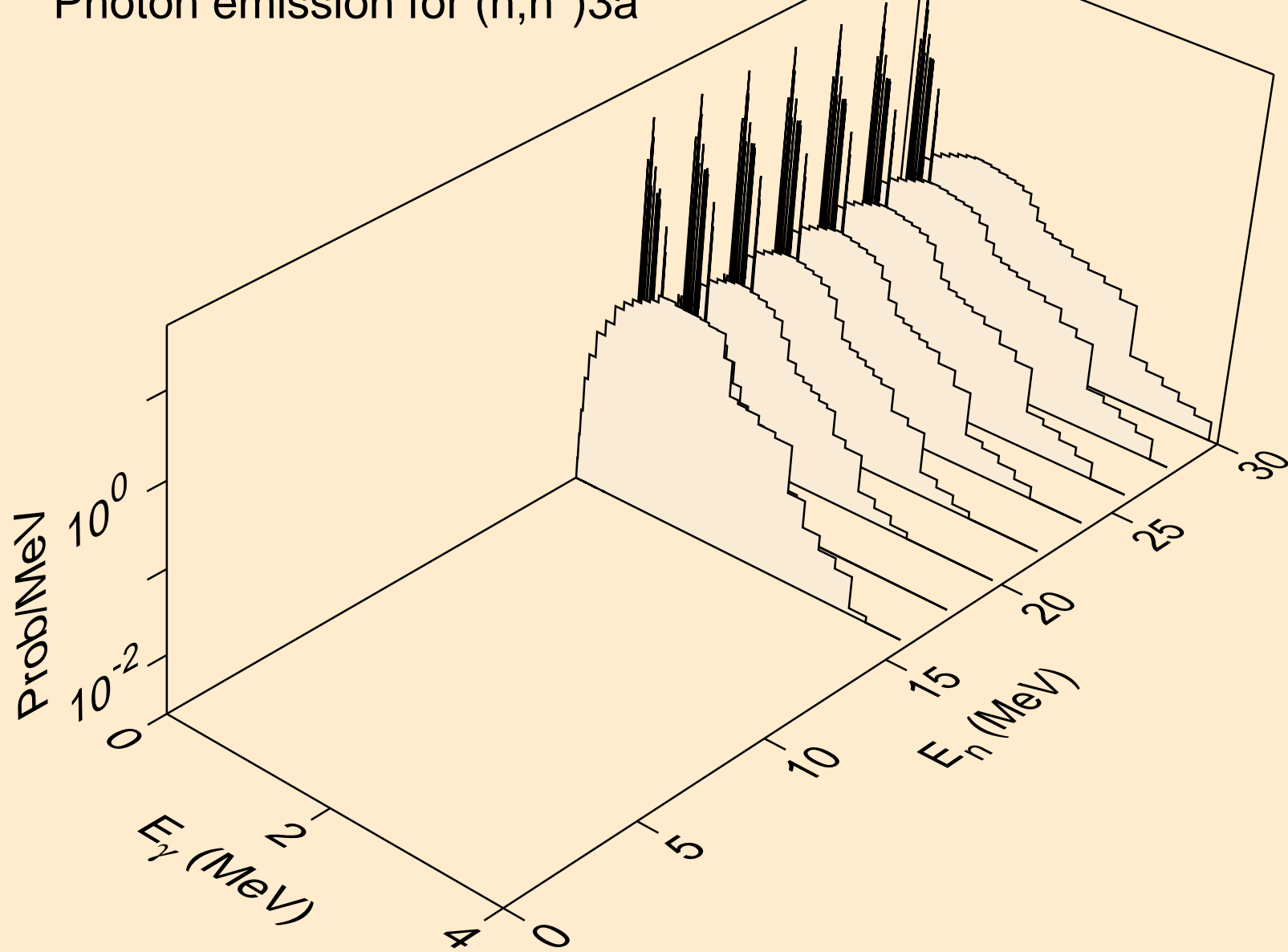

RE169M NEUTRON ACER TENDL-2021 LIBRARY; T=293.6K
Photon emission for (n,2n)a

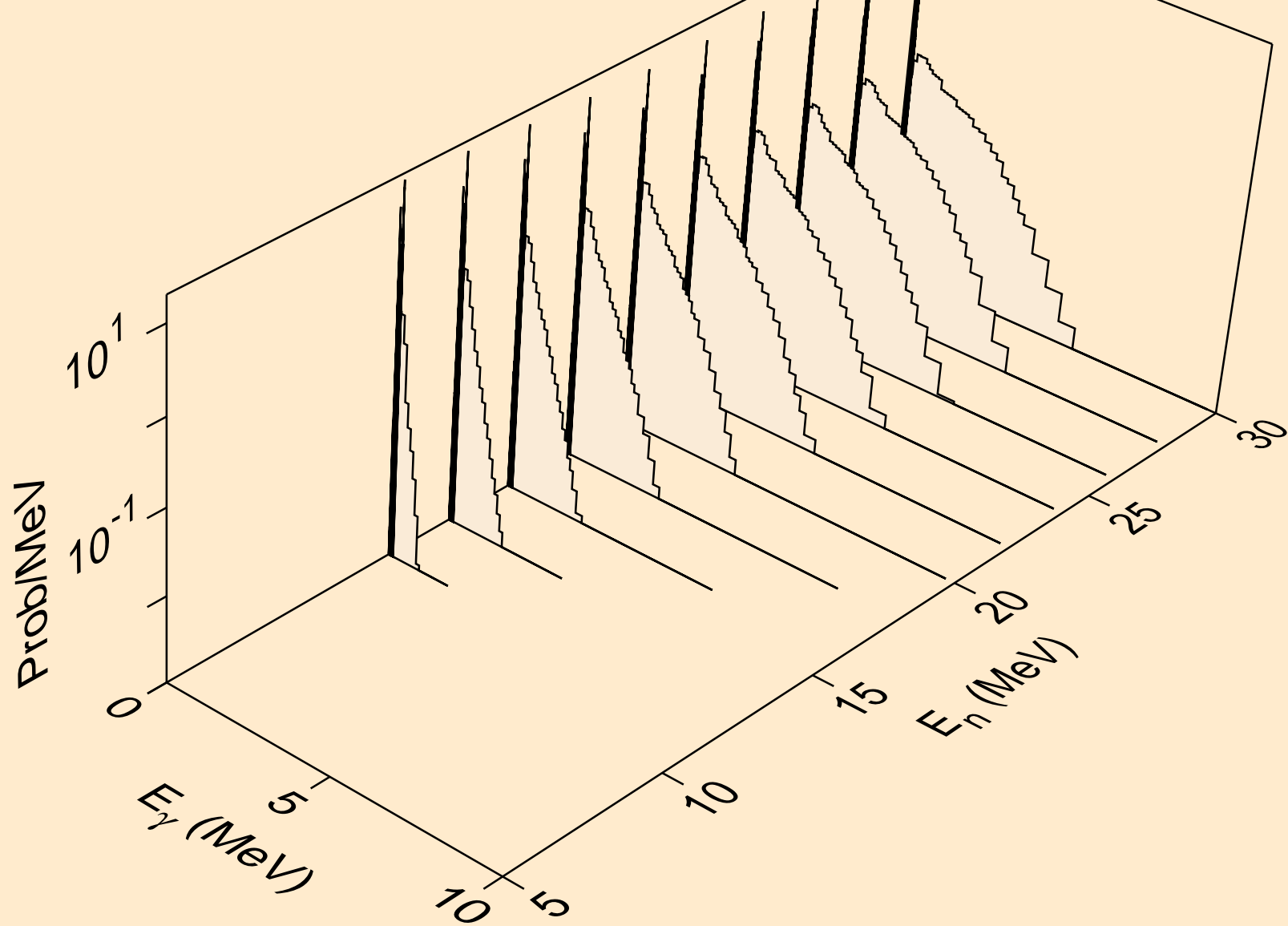

RE169M NEUTRON ACER TENDL-2021 LIBRARY; T=293.6K
Photon emission for (n,3n)a

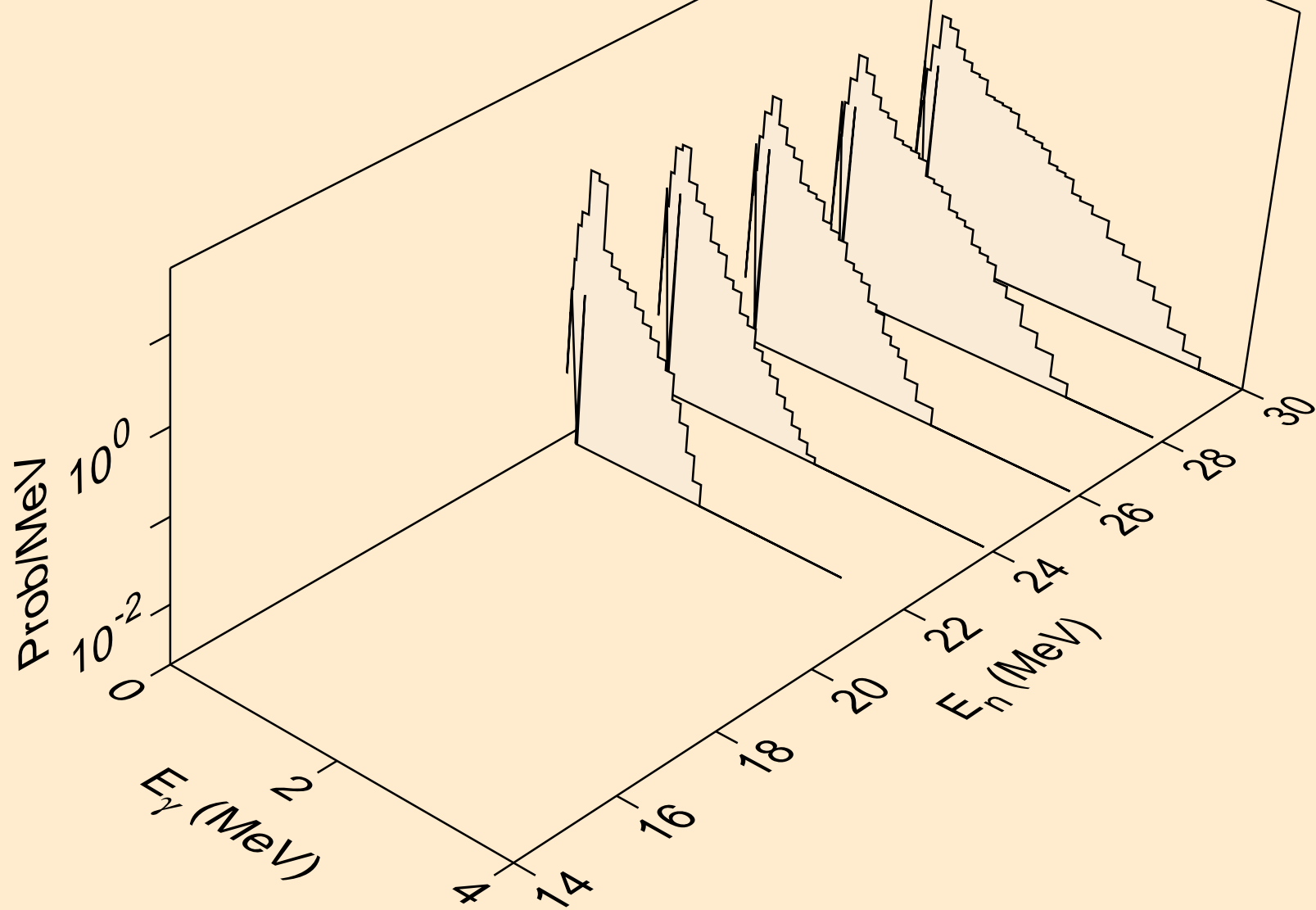

RE169M NEUTRON ACER TENDL-2021 LIBRARY; T=293.6K
Photon emission for (n,n*)p

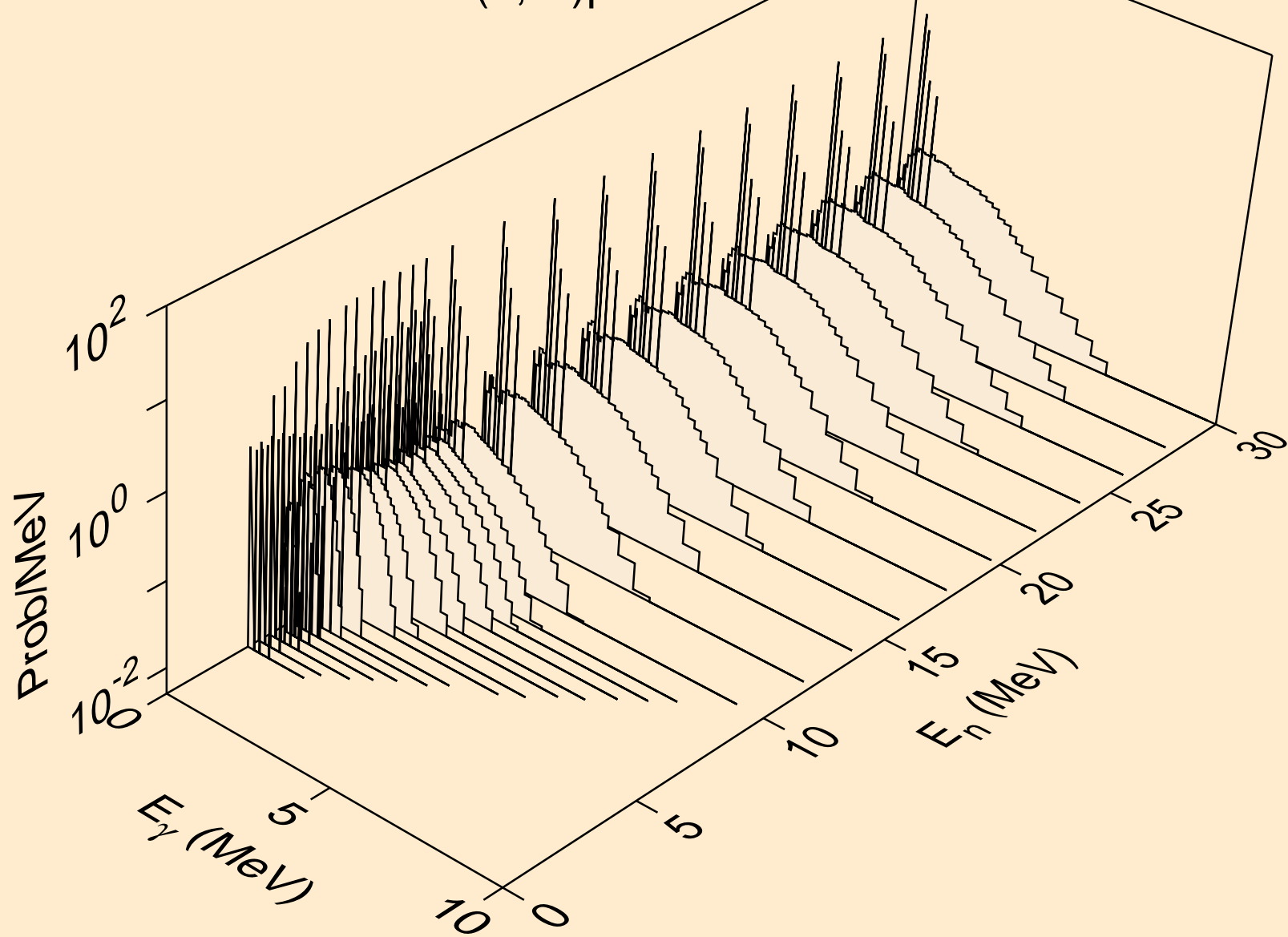

RE169M NEUTRON ACER TENDL-2021 LIBRARY; T=293.6K
Photon emission for (n,n*)2a

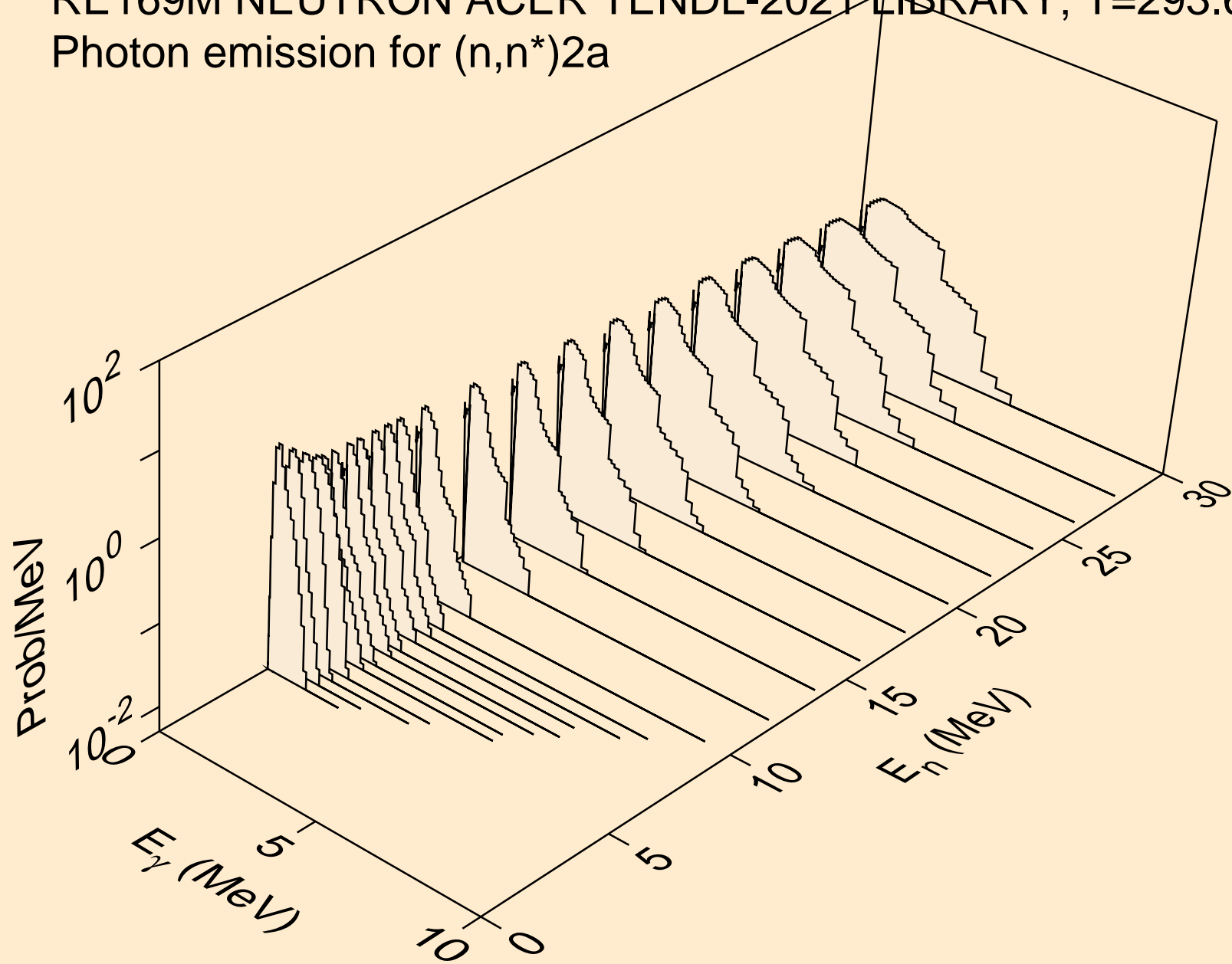

RE169M NEUTRON ACER TENDL-2021 LIBRARY; T=293.6K
Photon emission for (n,2n)2a

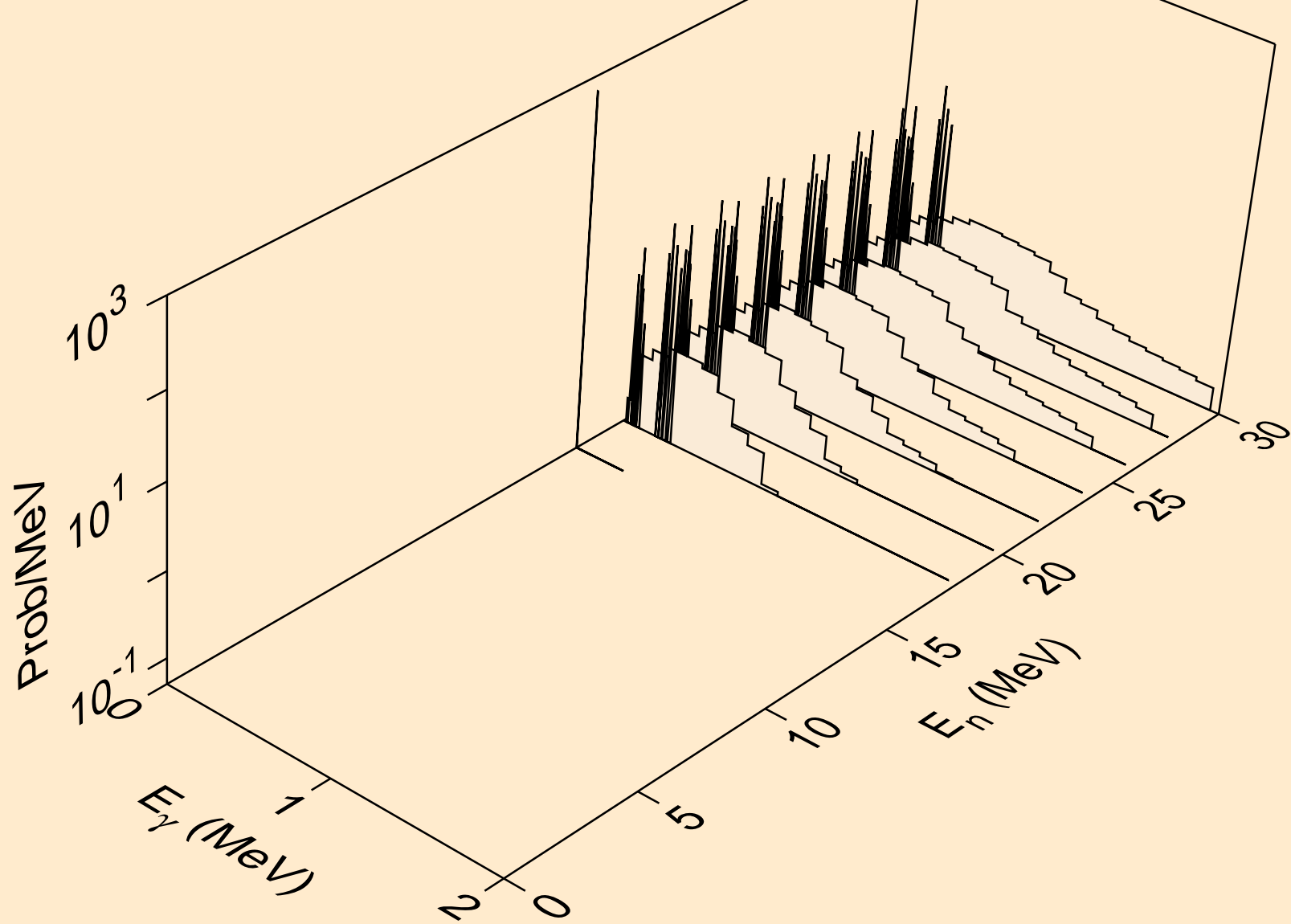

RE169M NEUTRON ACER TENDL-2021 LIBRARY; T=293.6K
Photon emission for (n,n*)d

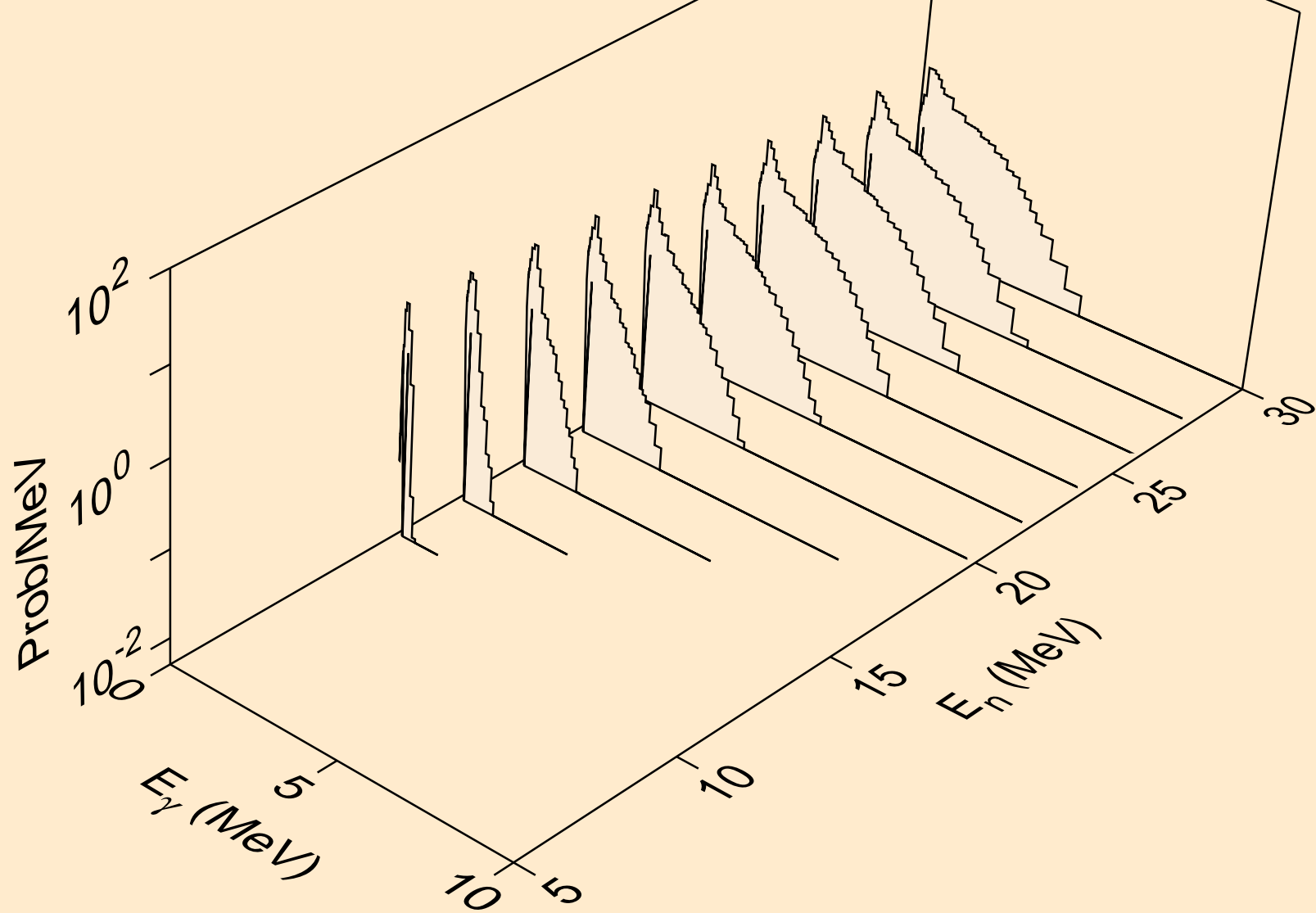

RE169M NEUTRON ACER TENDL-2021 LIBRARY; T=293.6K
Photon emission for (n,n*)t

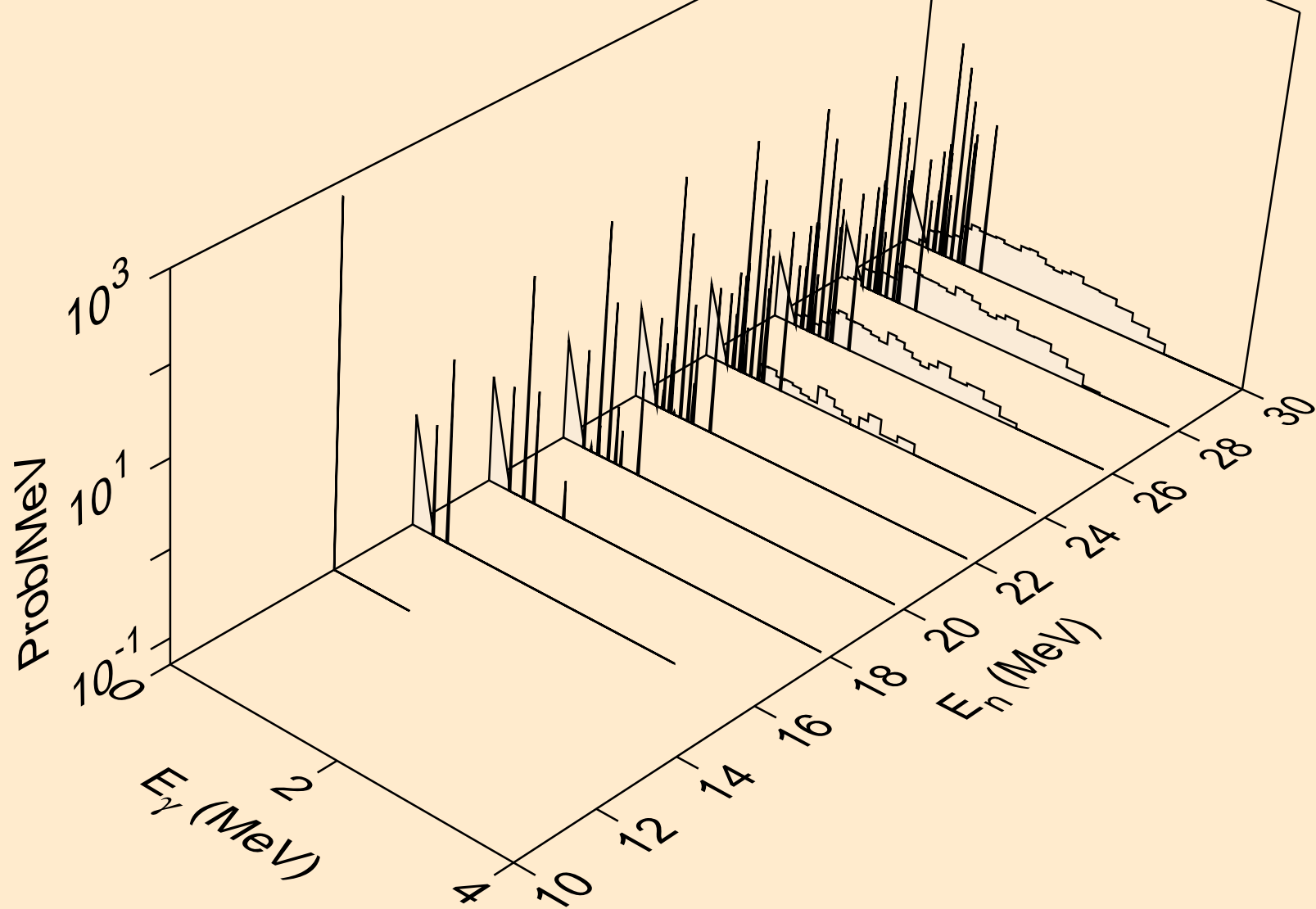

RE169M NEUTRON ACER TENDL-2021 LIBRARY; T=293.6K
Photon emission for (n,n*)he3

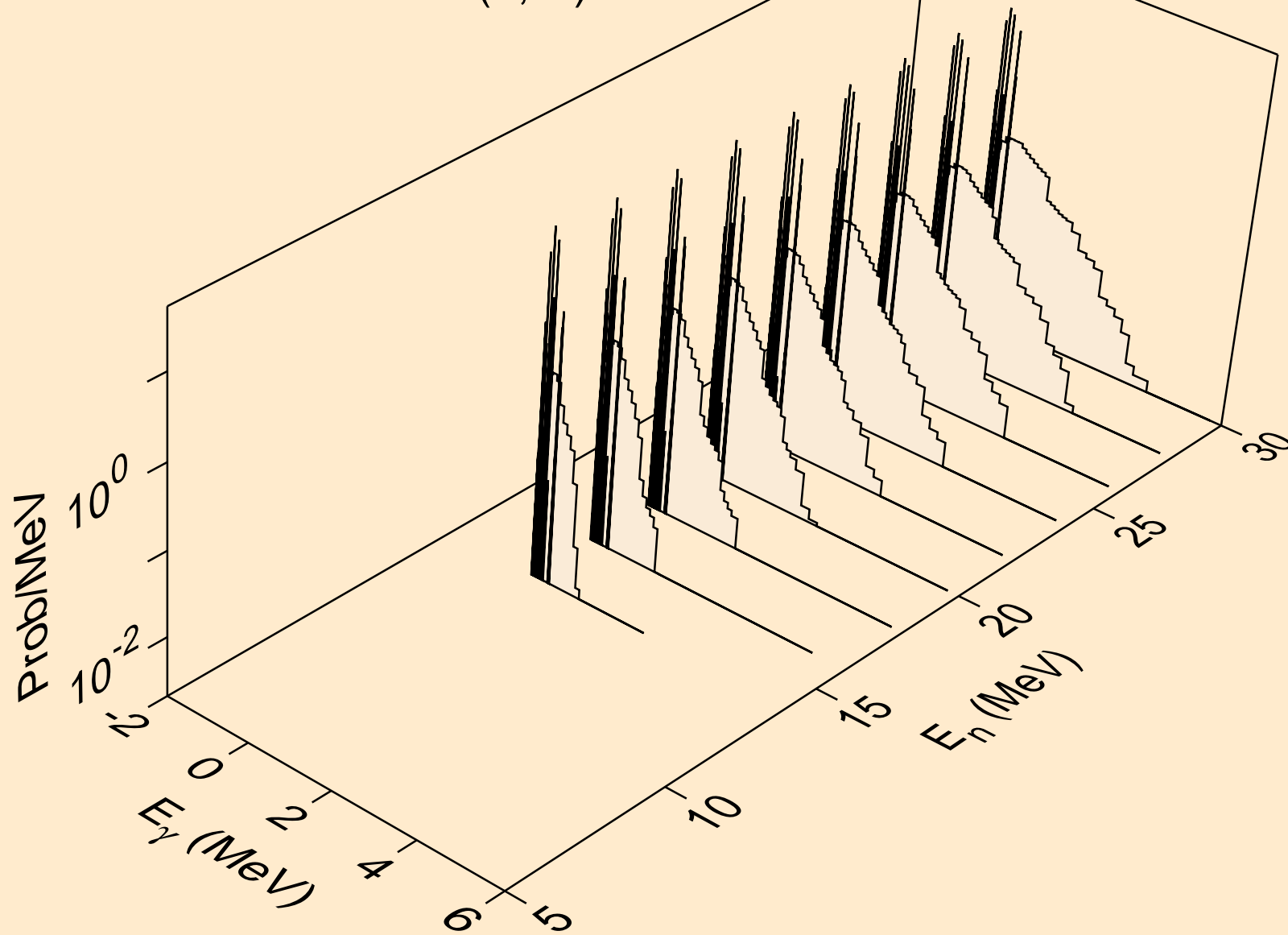

RE169M NEUTRON ACER TENDL-2021 LIBRARY; T=293.6K
Photon emission for (n,2np)

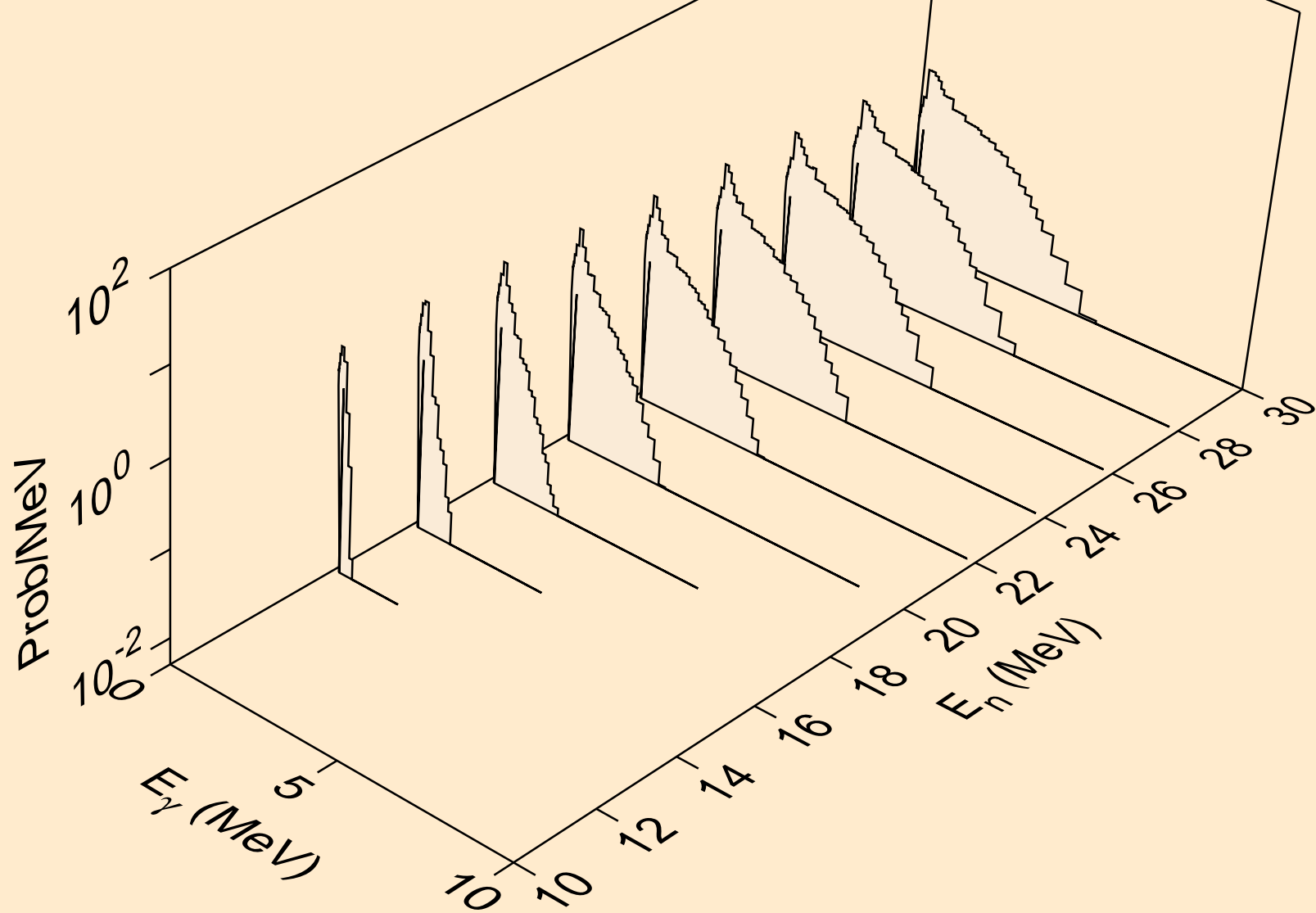

RE169M NEUTRON ACER TENDL-2021 LIBRARY; T=293.6K
Photon emission for (n,3np)

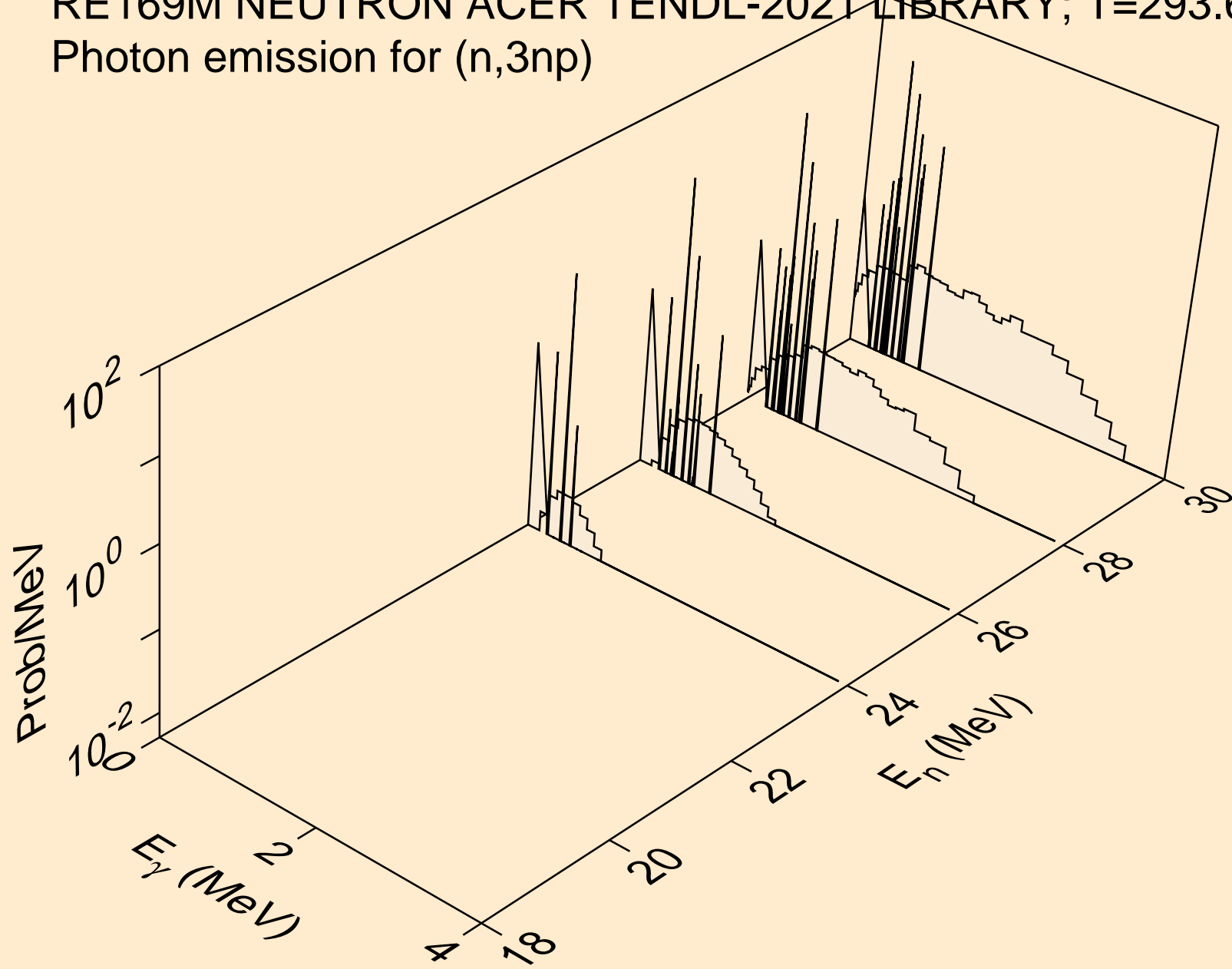

RE169M NEUTRON ACER TENDL-2021 LIBRARY; T=293.6K
Photon emission for (n,2np)

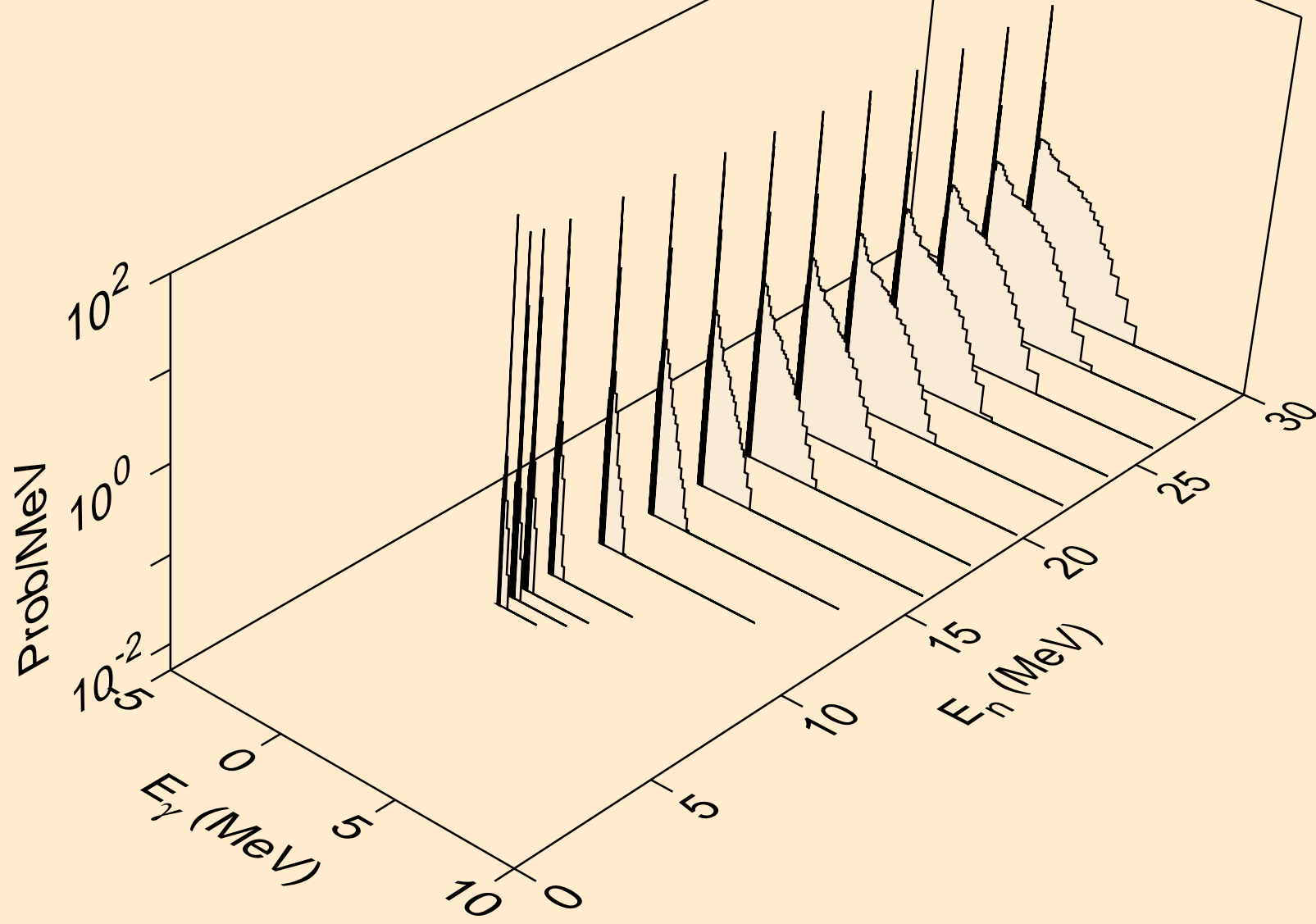

RE169M NEUTRON ACER TENDL-2021 LIBRARY; T=293.6K
Photon emission for (n,npa)

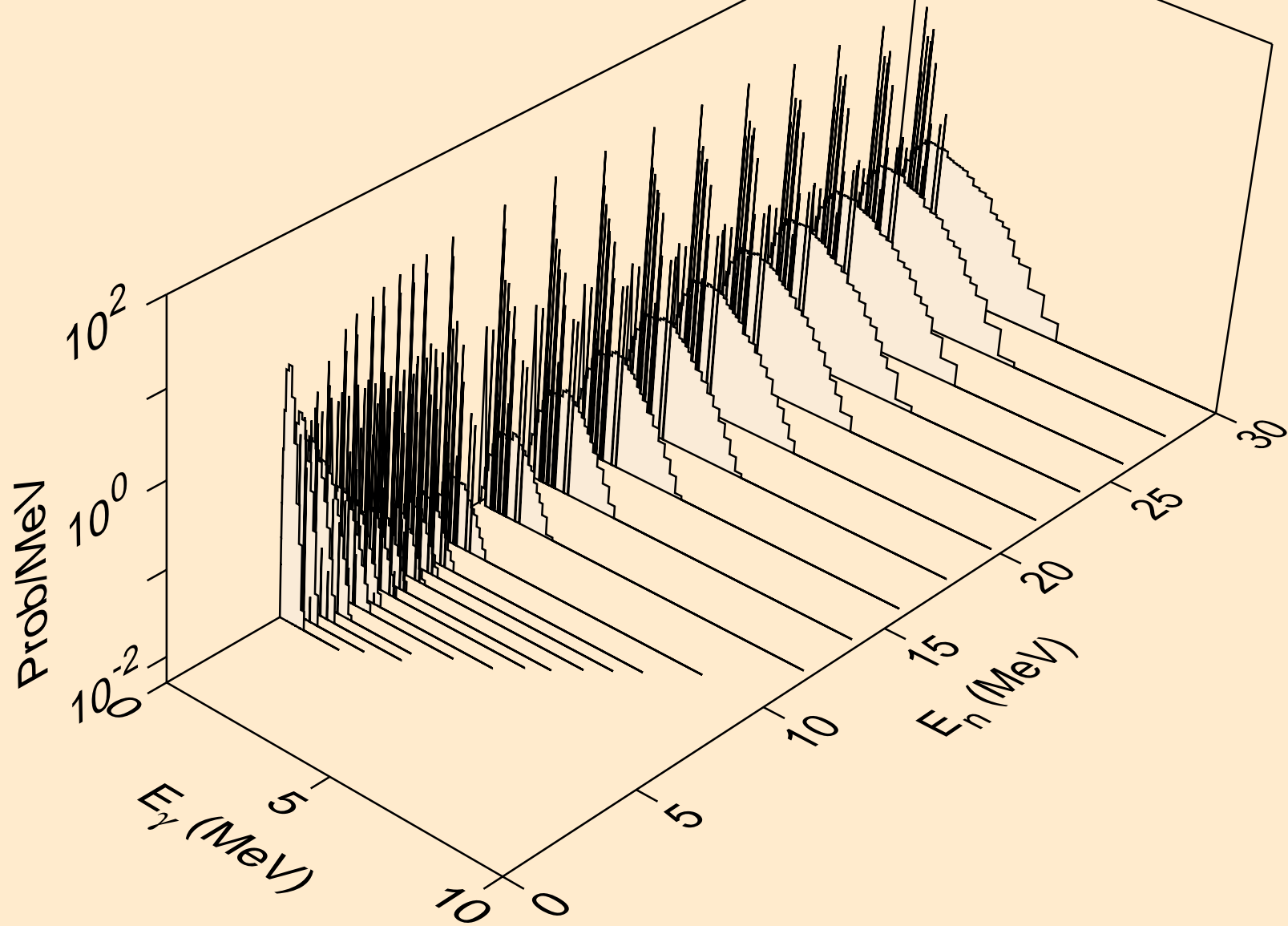

RE169M NEUTRON ACER TENDL-2021 LIBRARY; T=293.6K
Photon emission for (n,n*1)

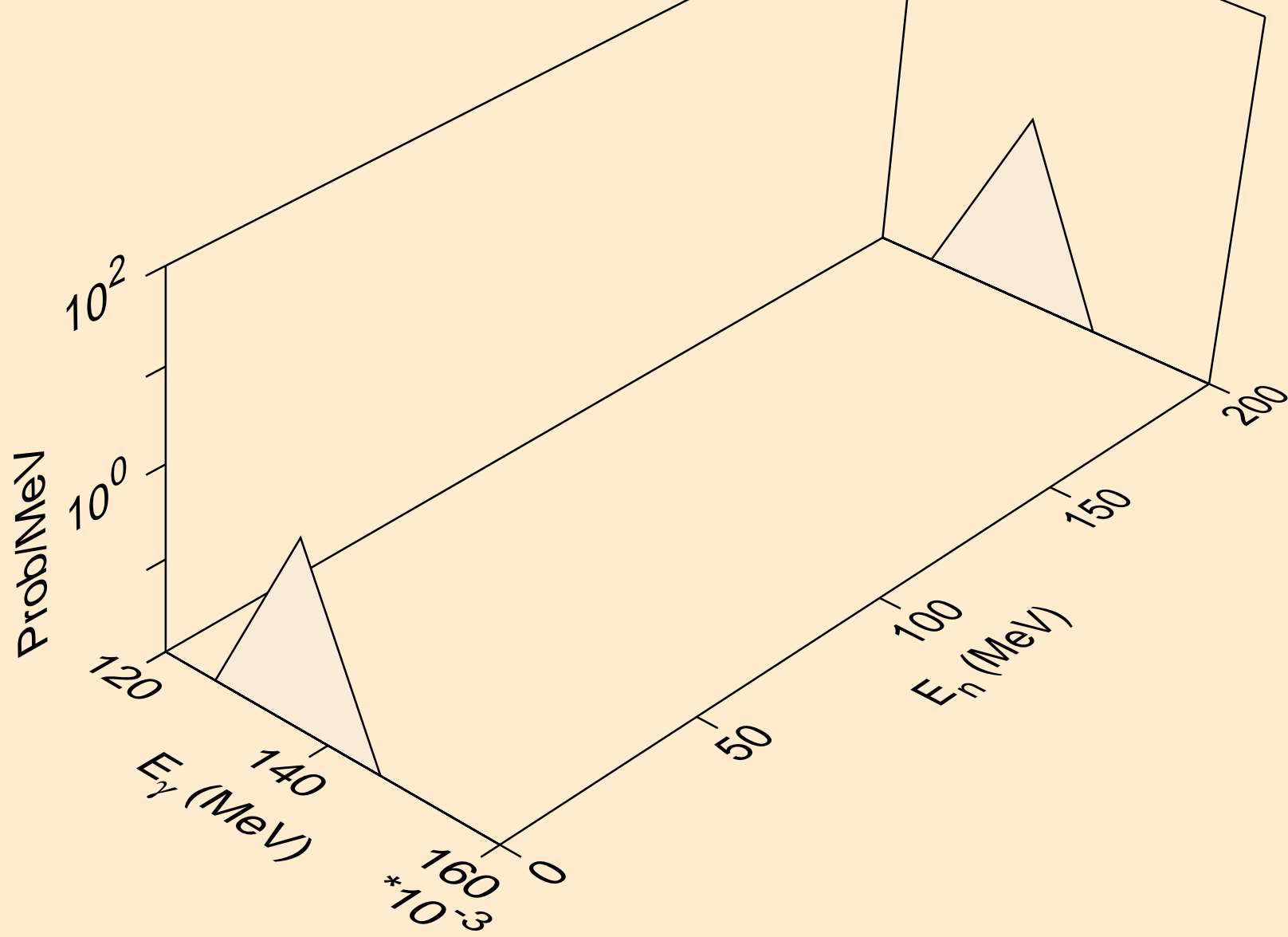

RE169M NEUTRON ACER TENDL-2021 LIBRARY; T=293.6K
Photon emission for (n,n*c)

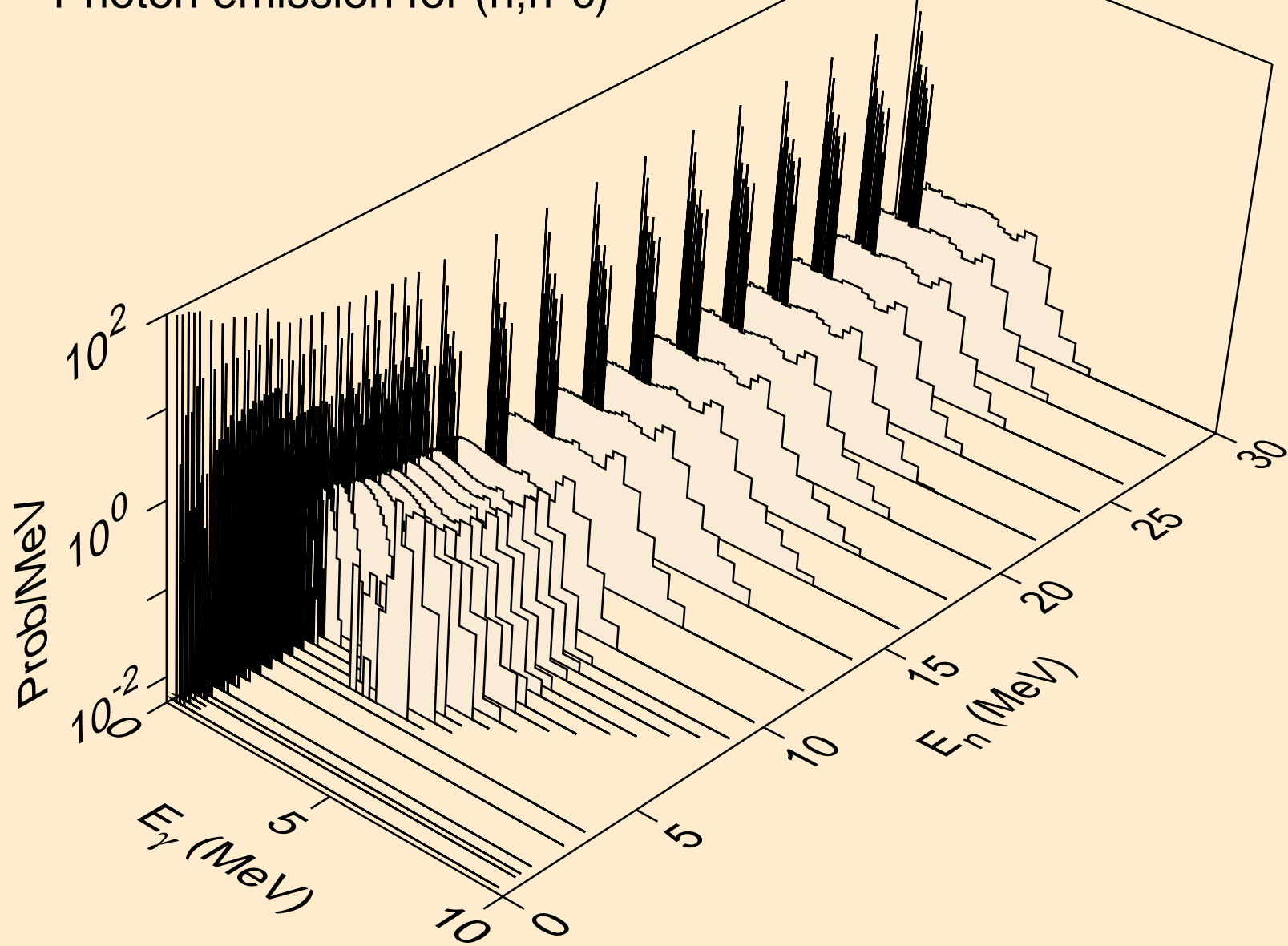

RE169M NEUTRON ACER TENDL-2021 LIBRARY; T=293.6K
Photon emission for (n,gma)

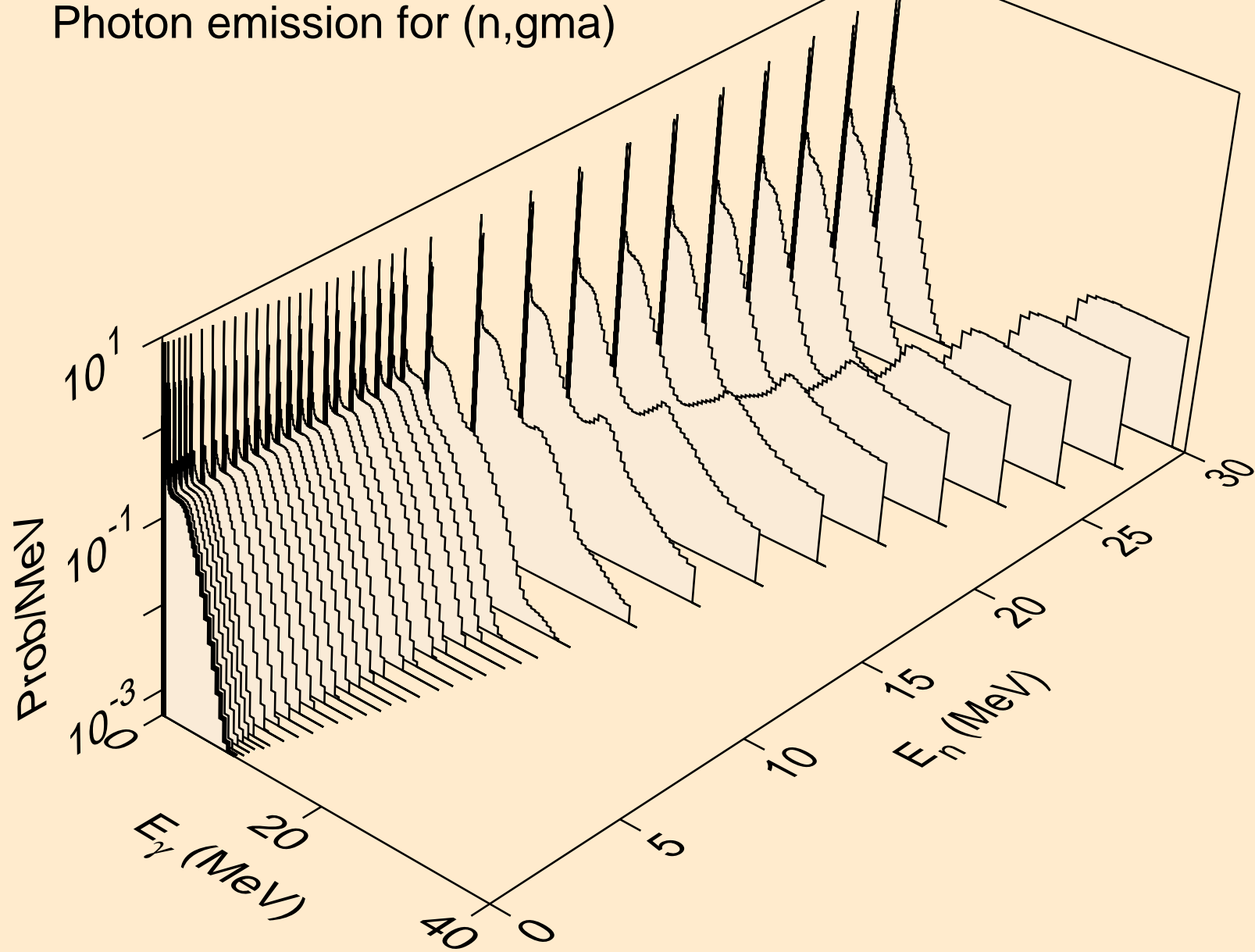

RE169M NEUTRON ACER TENDL-2021 LIBRARY; T=293.6K
Photon emission for (n,p)

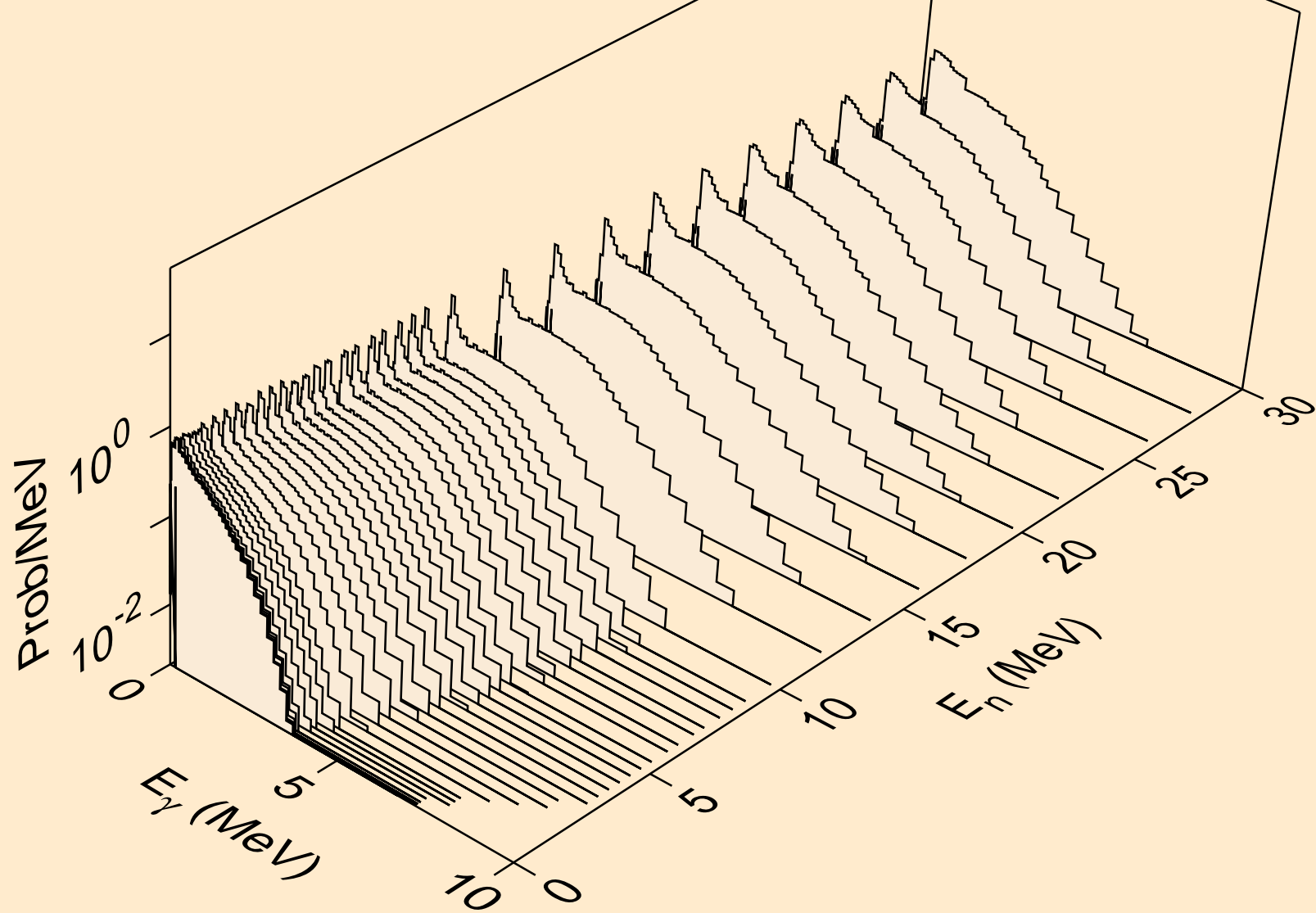

RE169M NEUTRON ACER TENDL-2021 LIBRARY; T=293.6K
Photon emission for (n,d)

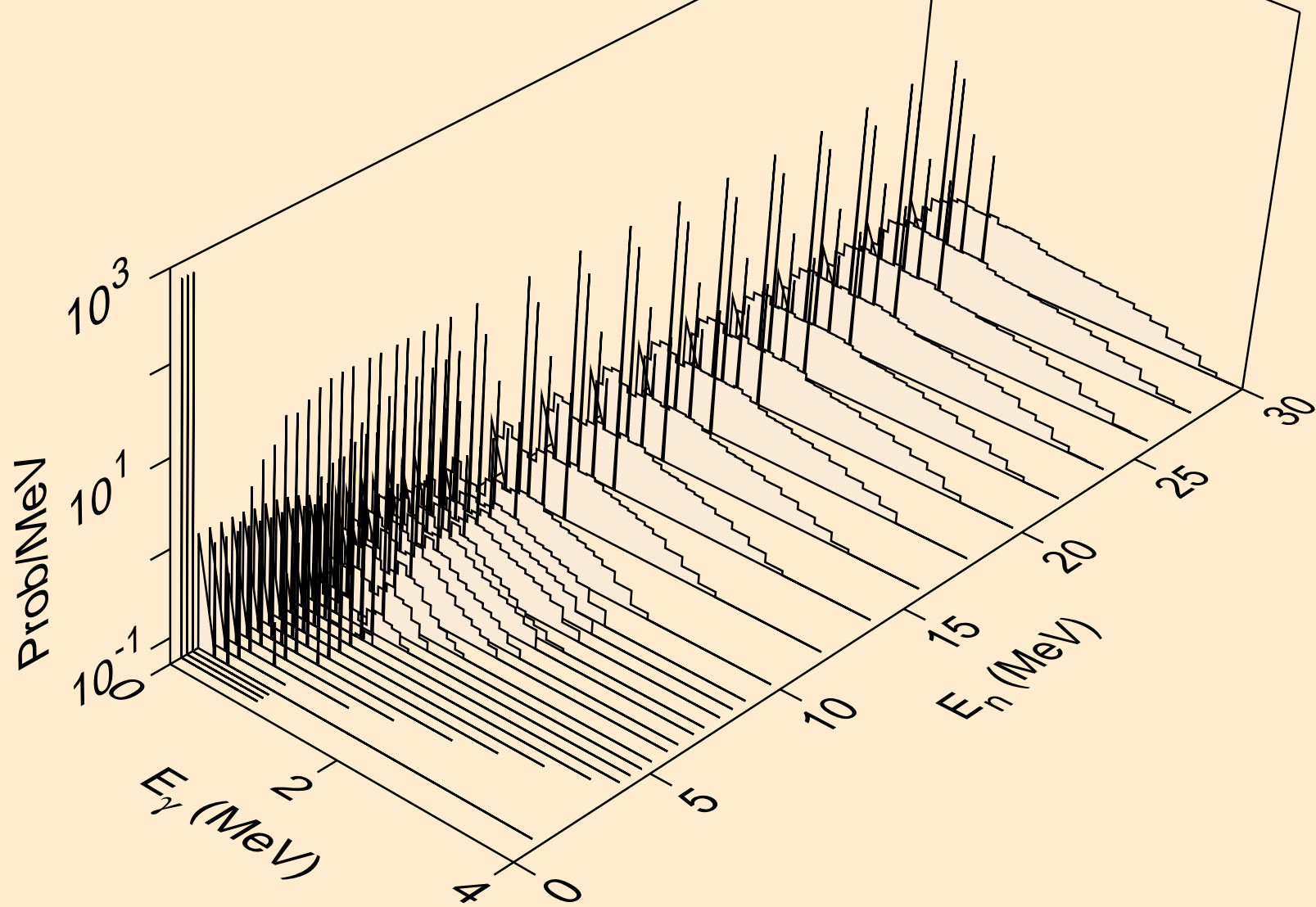

RE169M NEUTRON ACER TENDL-2021 LIBRARY; T=293.6K
Photon emission for (n,t)

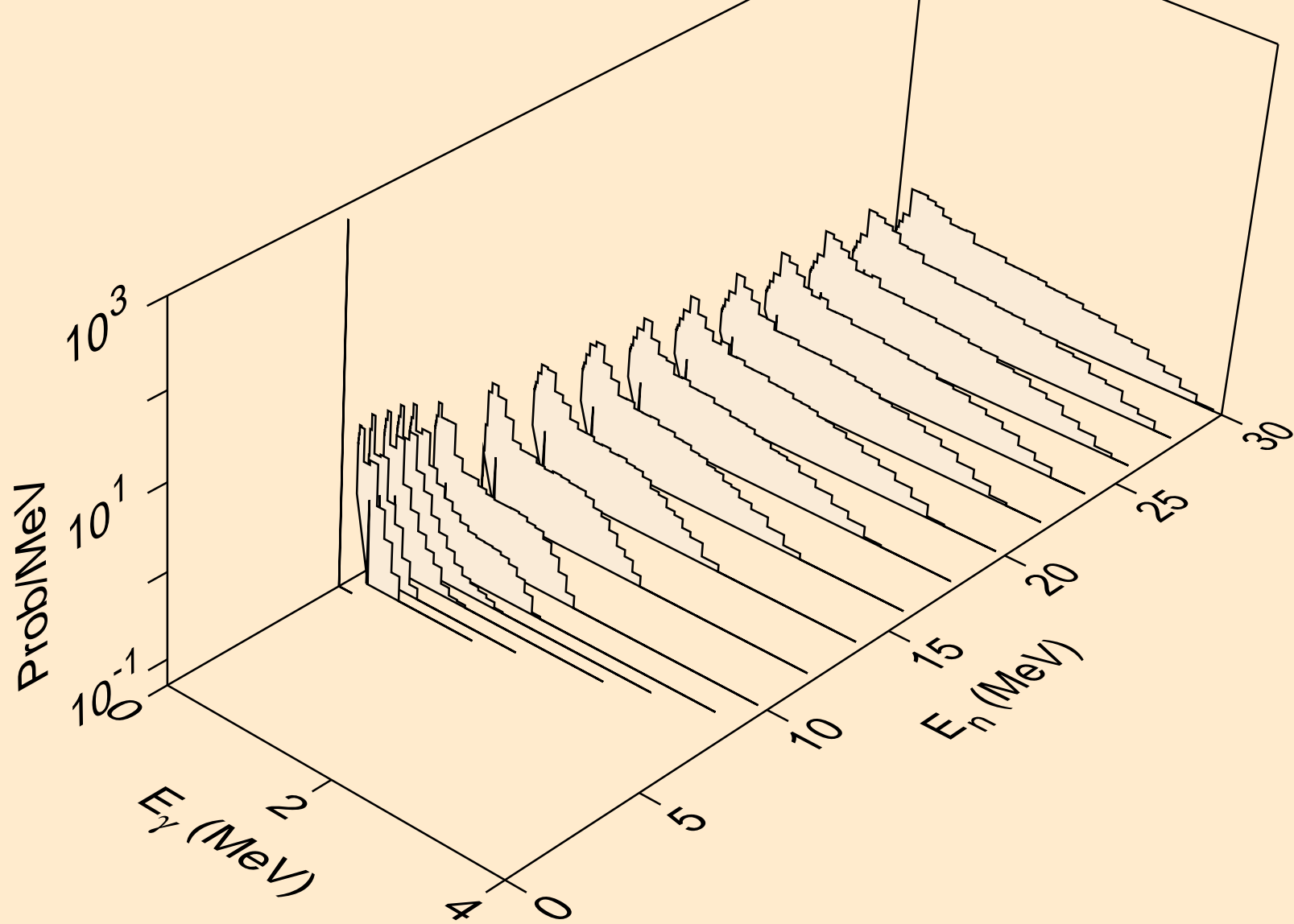

RE169M NEUTRON ACER TENDL-2021 LIBRARY; T=293.6K
Photon emission for (n,he3)

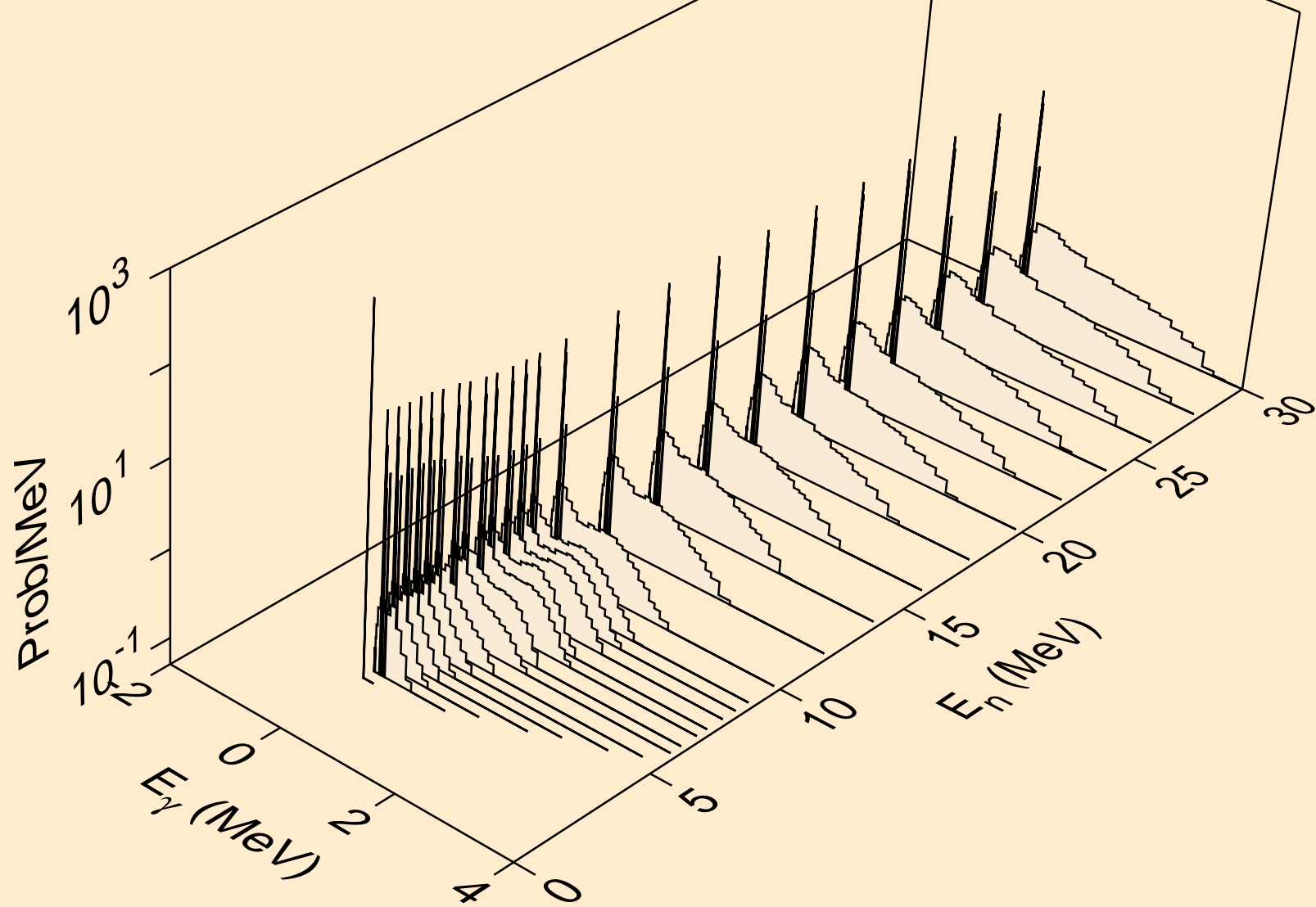

RE169M NEUTRON ACER TENDL-2021 LIBRARY; T=293.6K
Photon emission for (n,a)

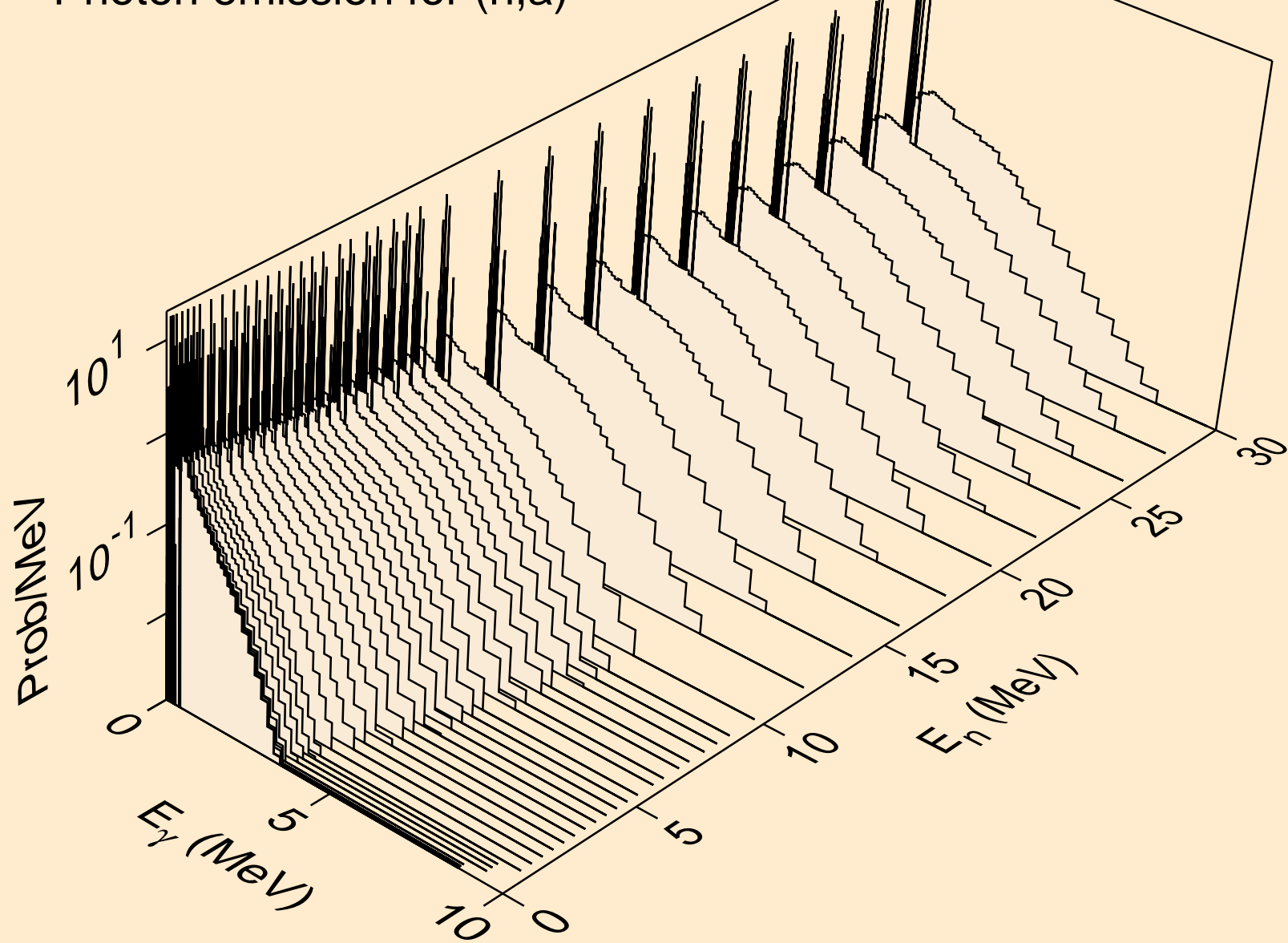

RE169M NEUTRON ACER TENDL-2021 LIBRARY; T=293.6K
Photon emission for (n,2a)

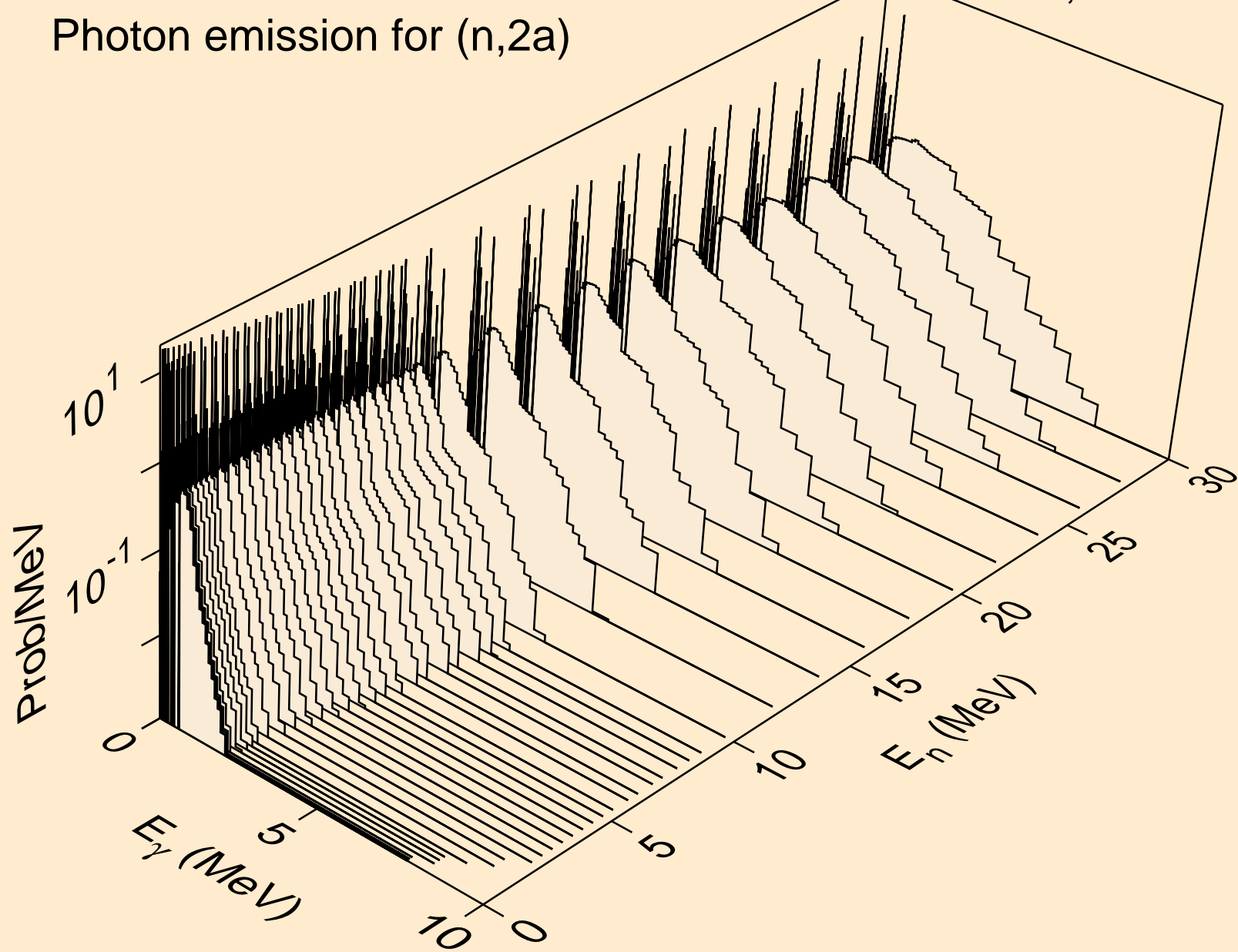

RE169M NEUTRON ACER TENDL-2021 LIBRARY; T=293.6K
Photon emission for (n,3a)

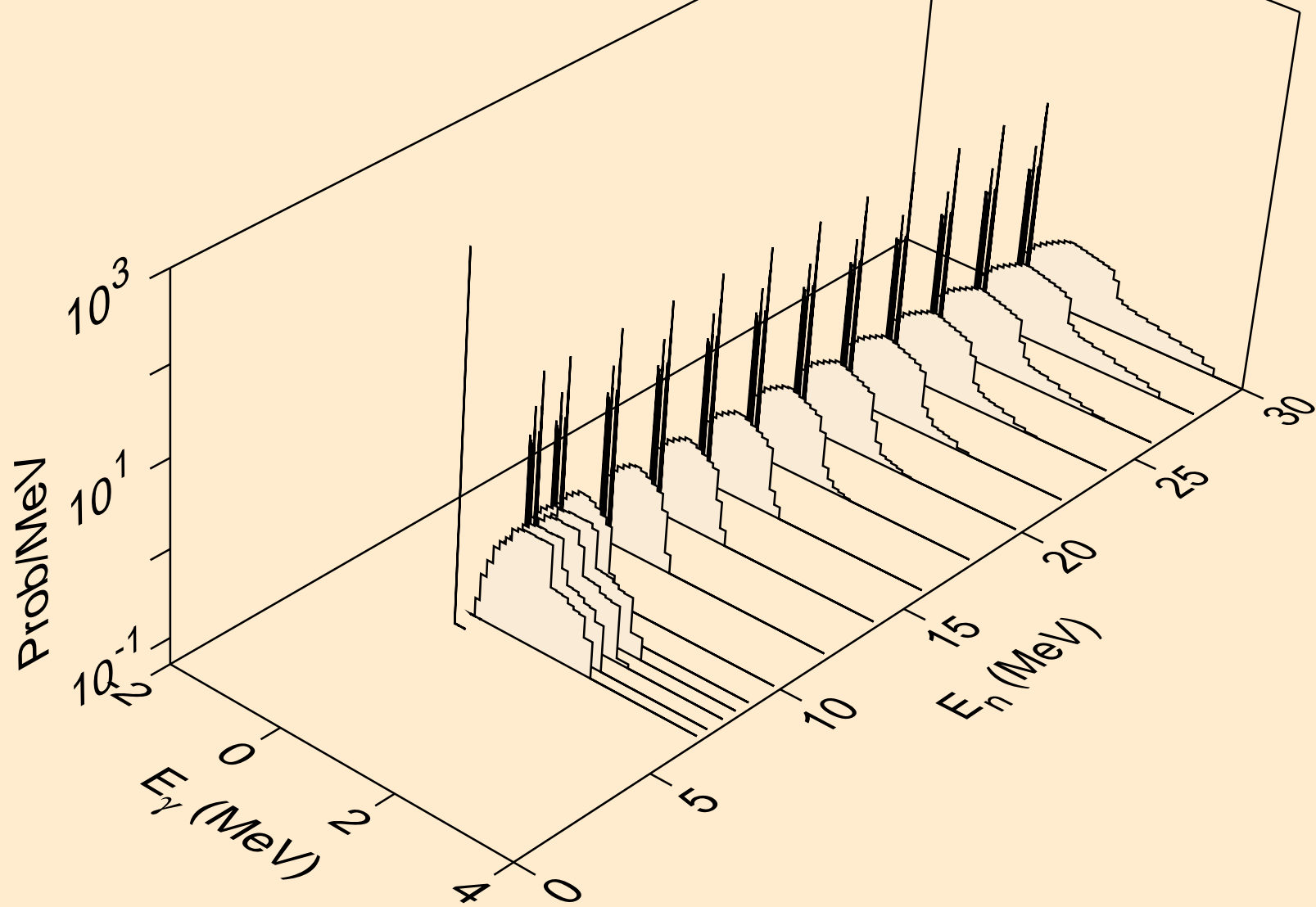

RE169M NEUTRON ACER TENDL-2021 LIBRARY; T=293.6K
Photon emission for (n,2p)

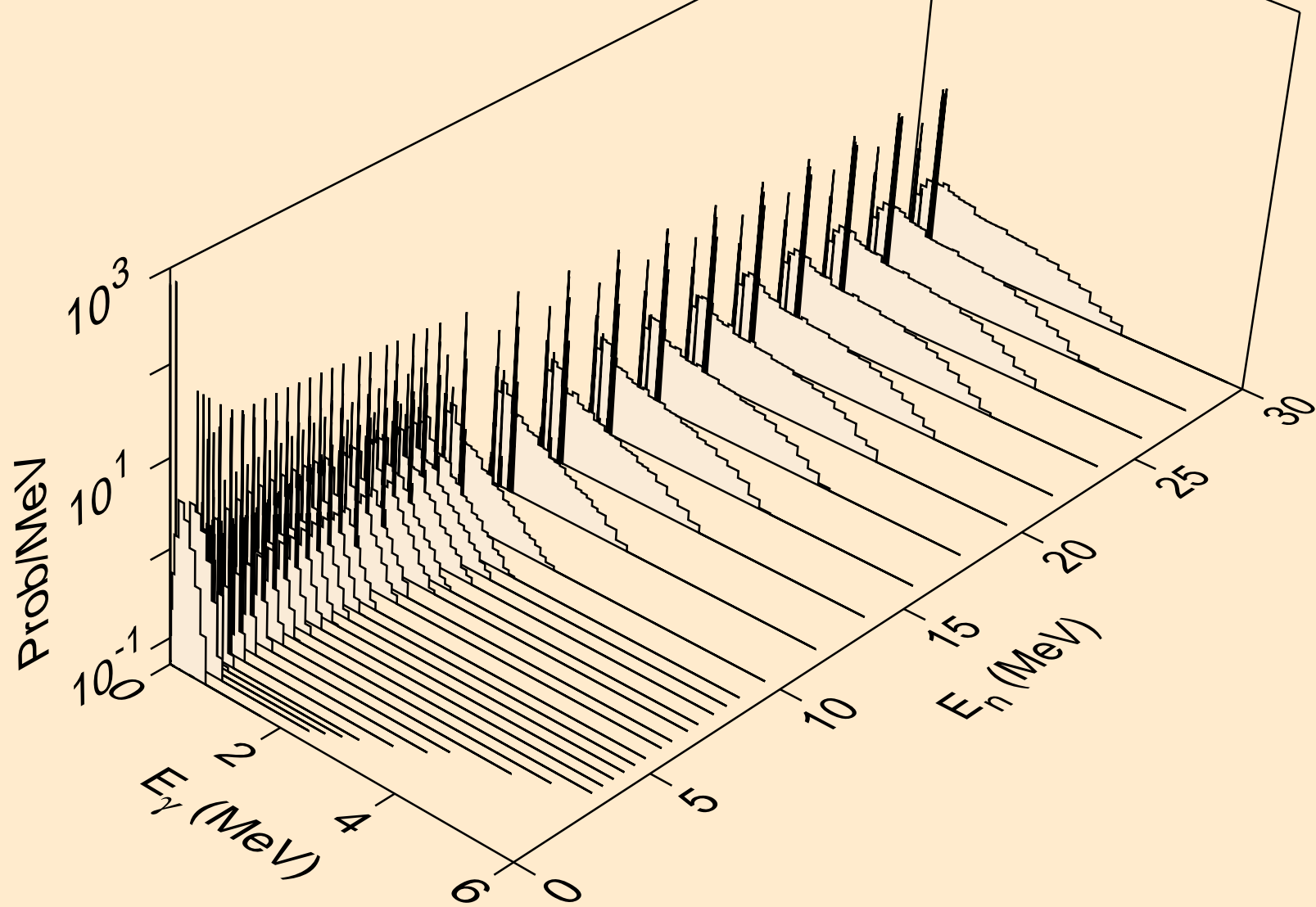

RE169M NEUTRON ACER TENDL-2021 LIBRARY; T=293.6K
Photon emission for (n,p)

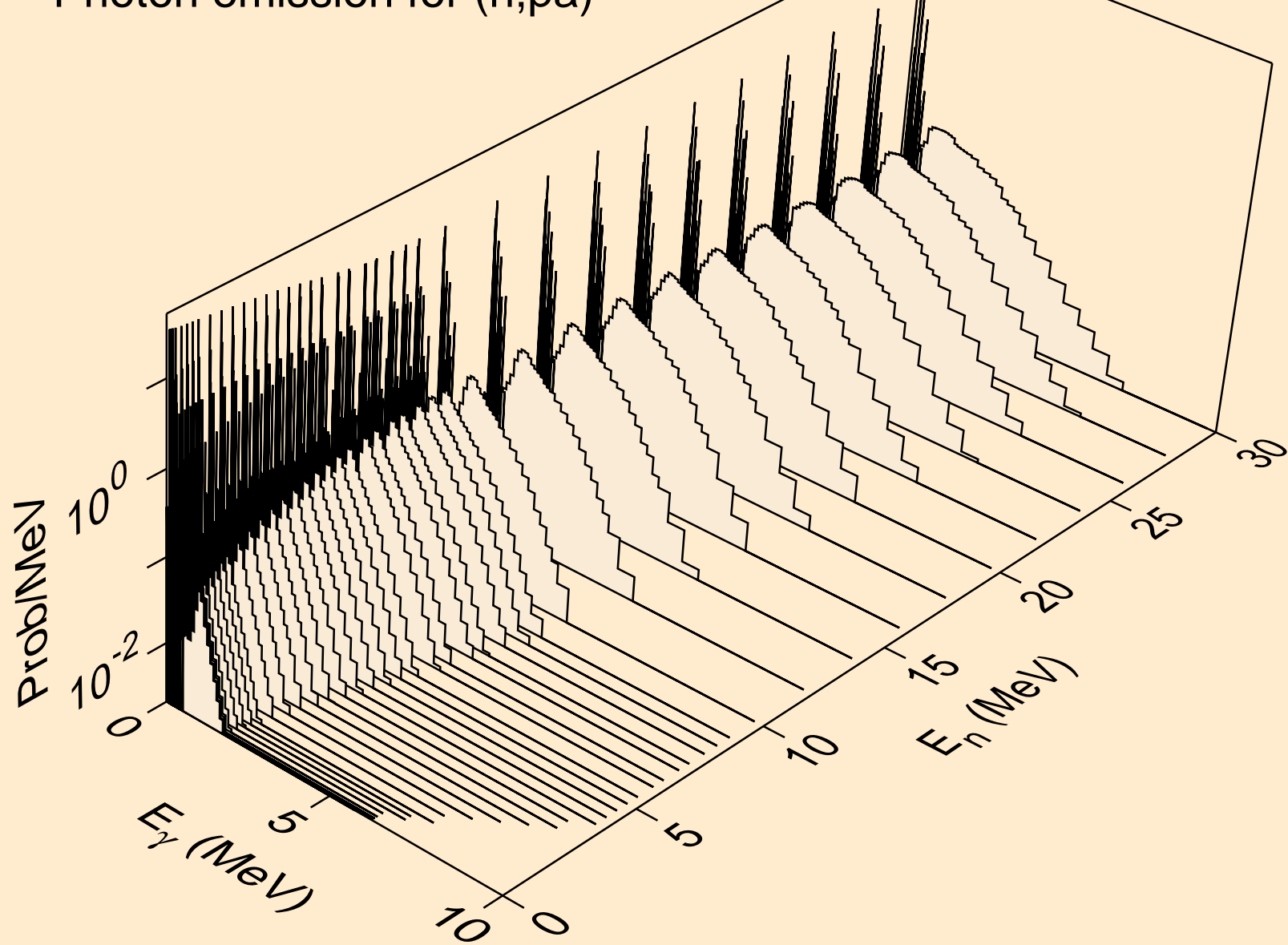

RE169M NEUTRON ACER TENDL-2021 LIBRARY; T=293.6K
Photon emission for (n,d2a)

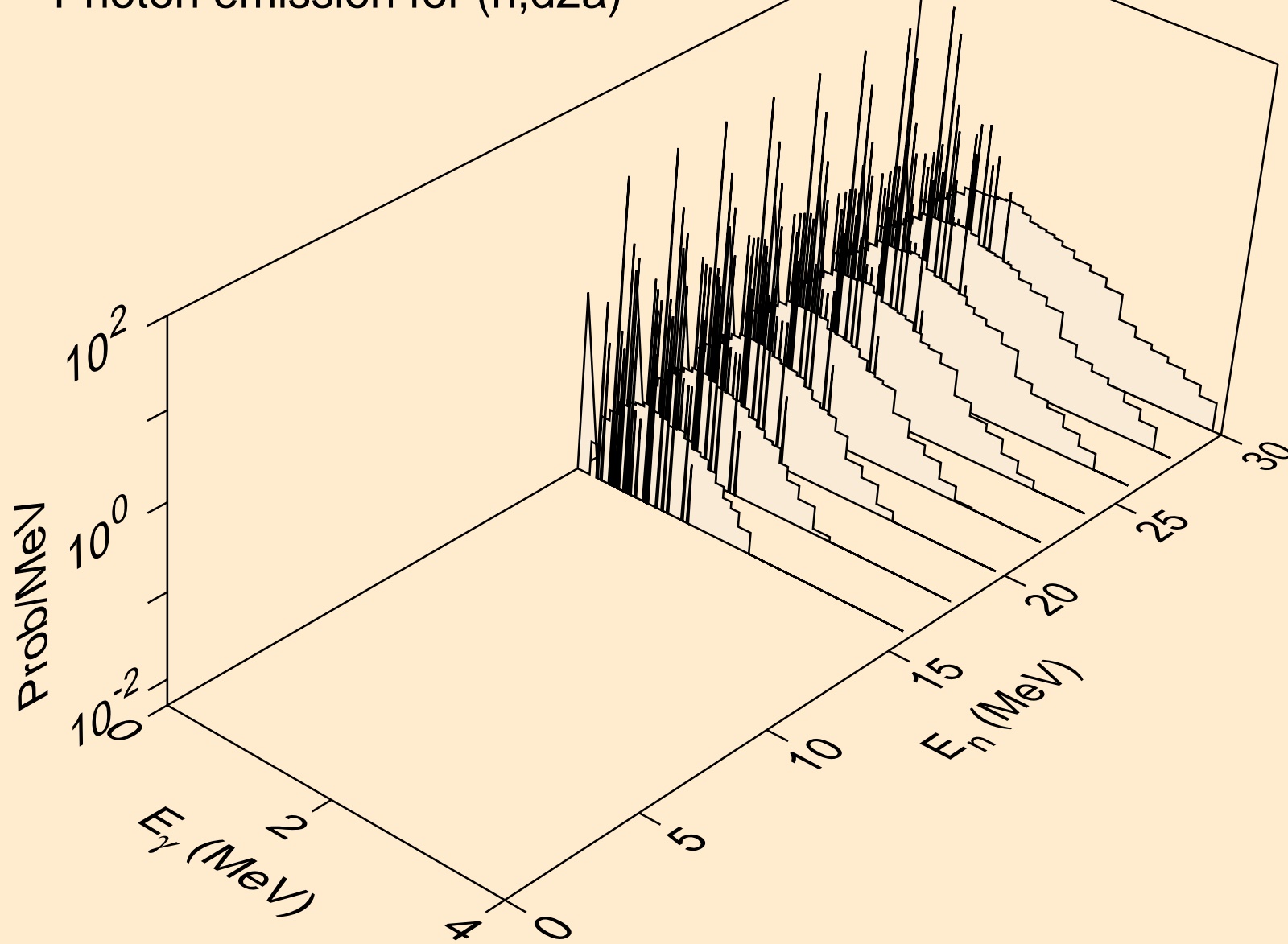

RE169M NEUTRON ACER TENDL-2021 LIBRARY; T=293.6K
Photon emission for (n,pd)

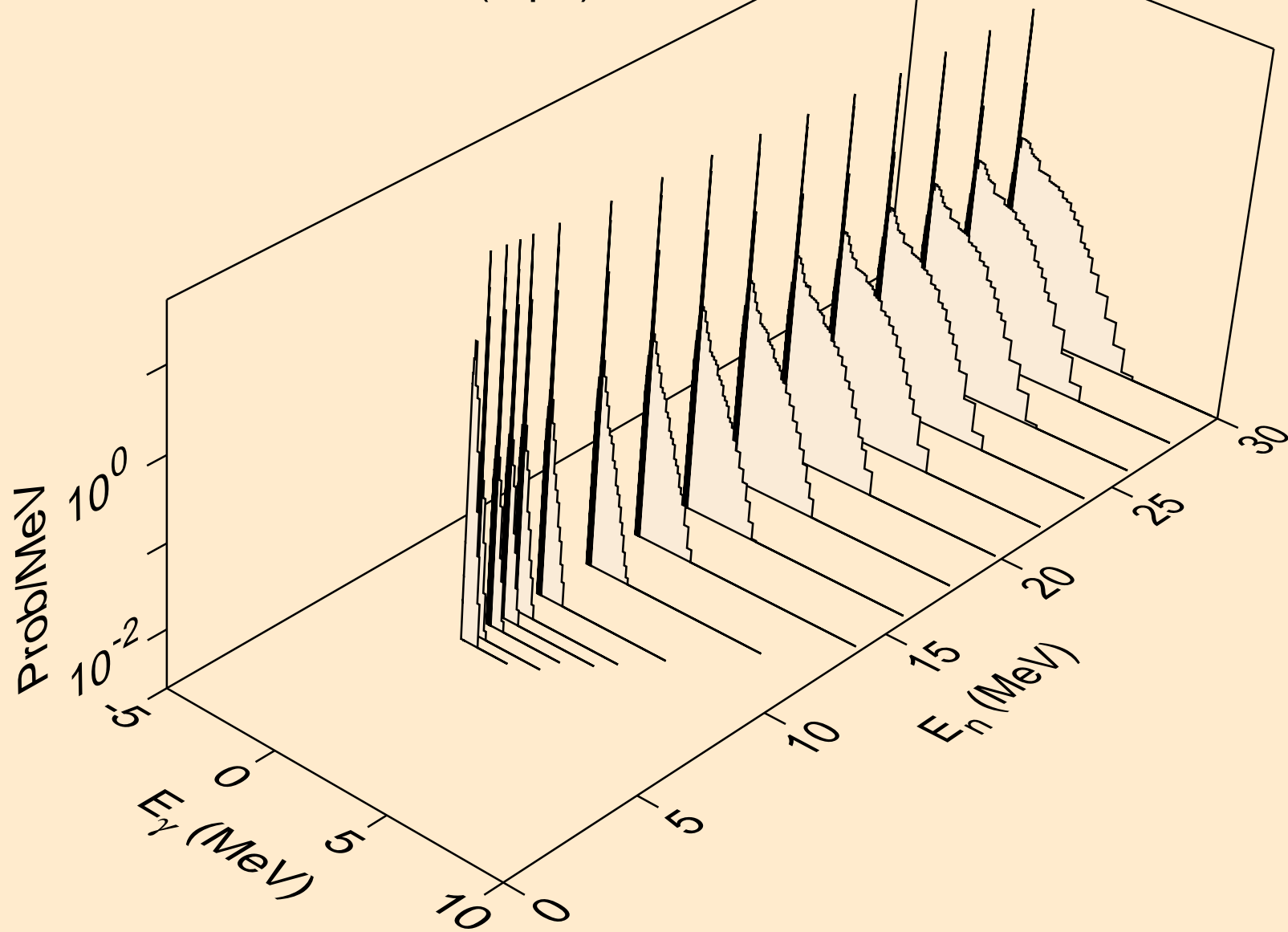

RE169M NEUTRON ACER TENDL-2021 LIBRARY; T=293.6K
Photon emission for (n,pt)

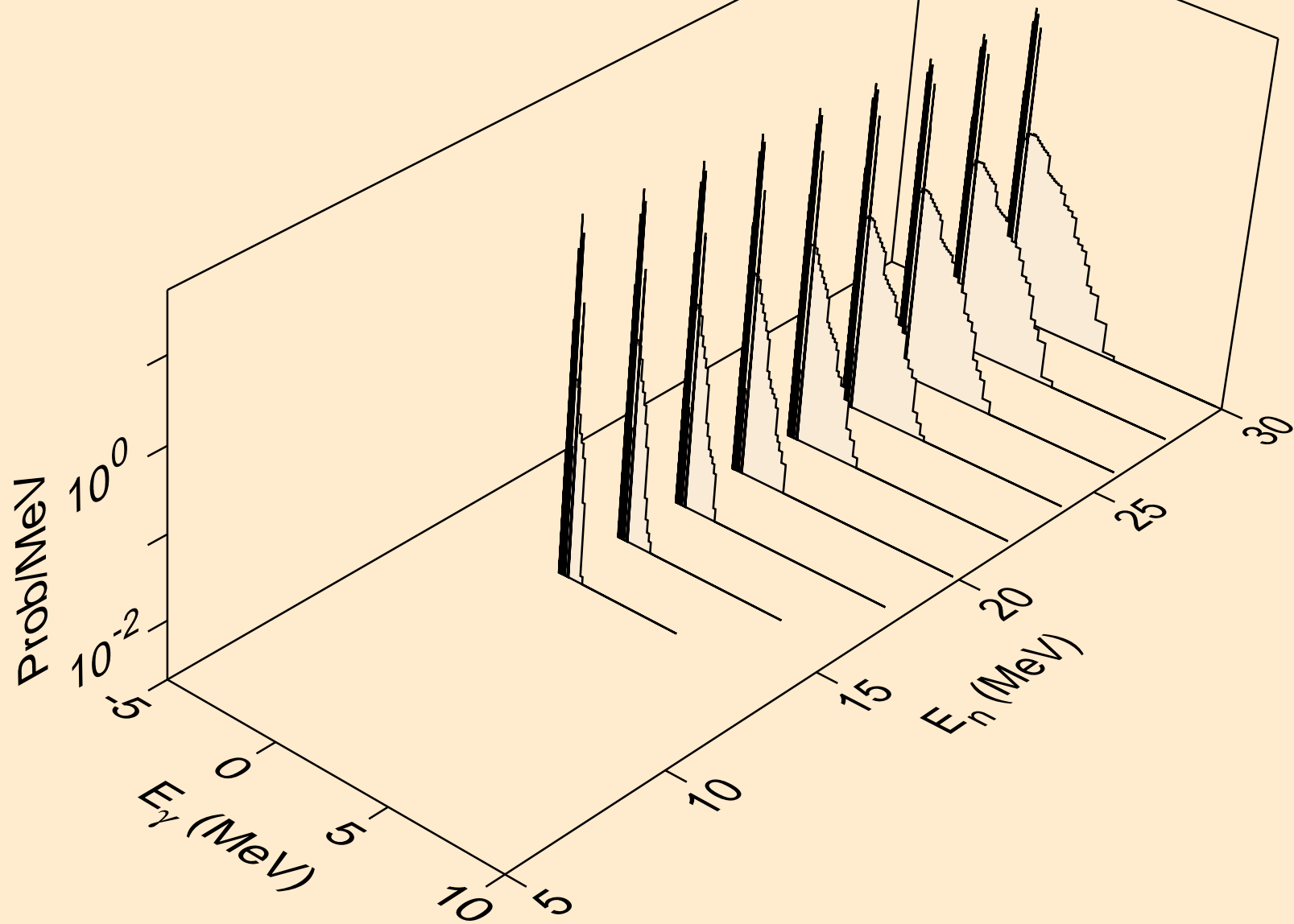

RE169M NEUTRON ACER TENDL-2021 LIBRARY; T=293.6K
Photon emission for (n,da)

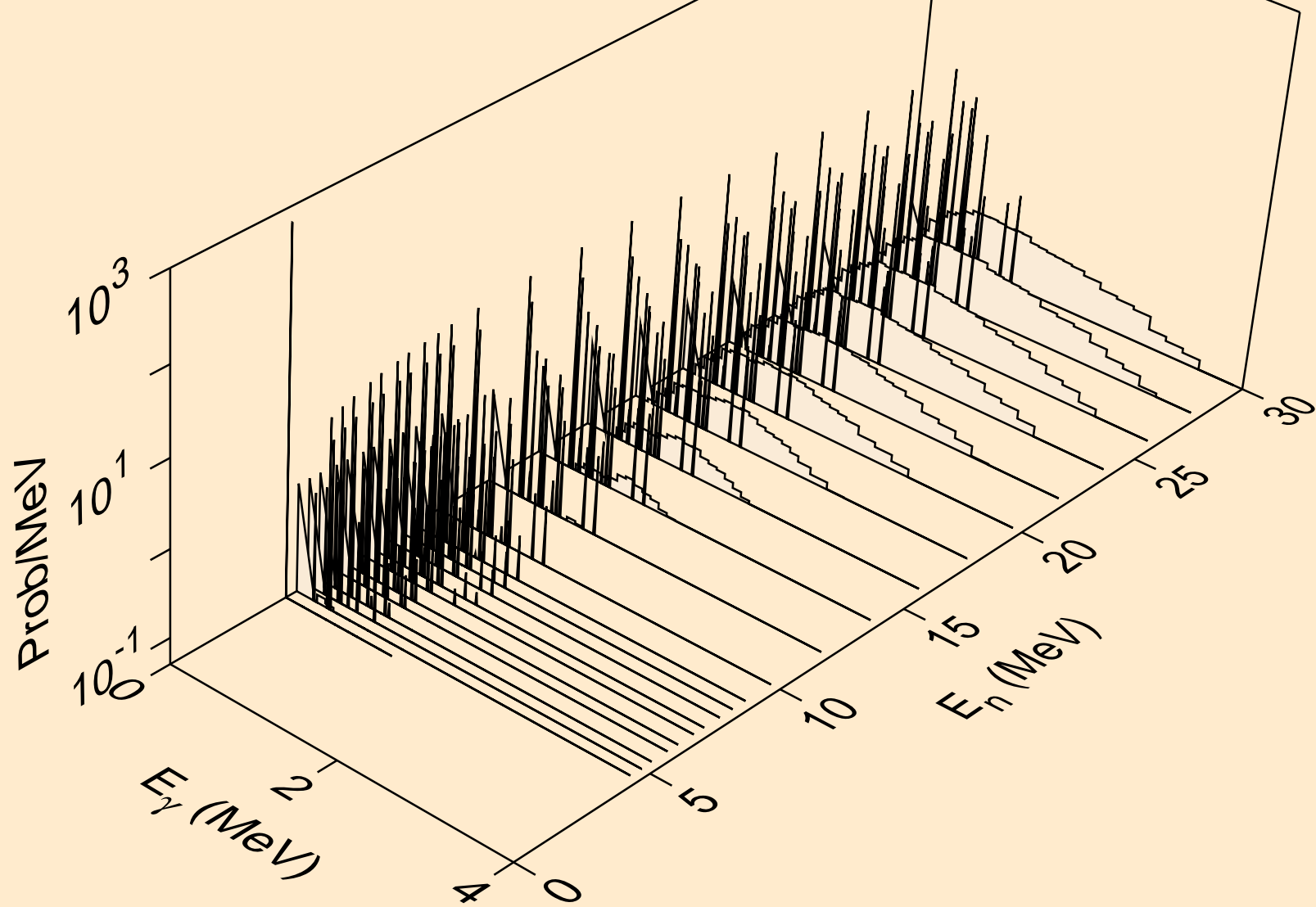

RE169M NEUTRON ACER TENDL-2021 LIBRARY; T=293.6K
thermal capture photon spectrum

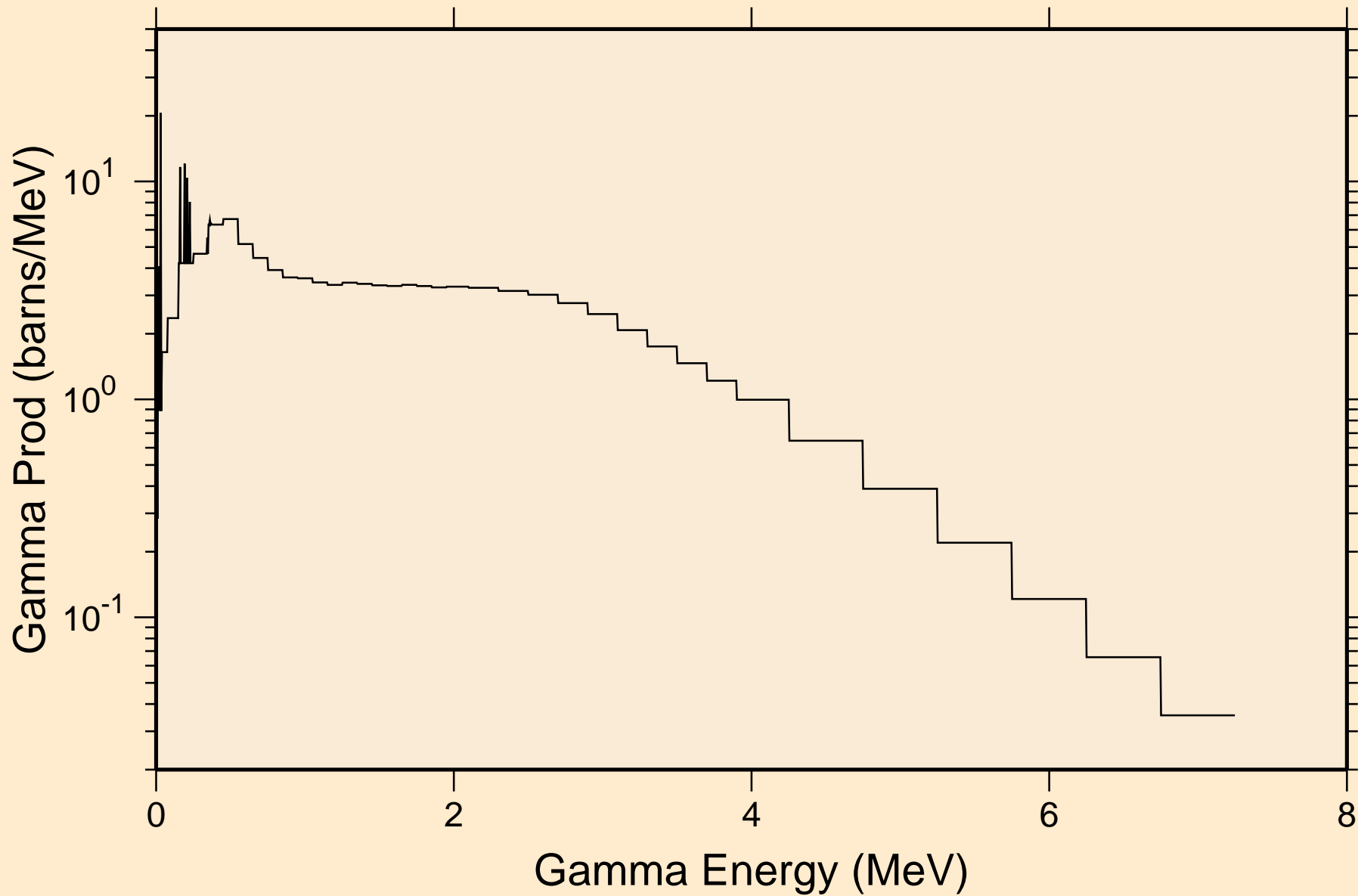

RE169M NEUTRON ACER TENDL-2021 LIBRARY; T=293.6K
14 MeV photon spectrum

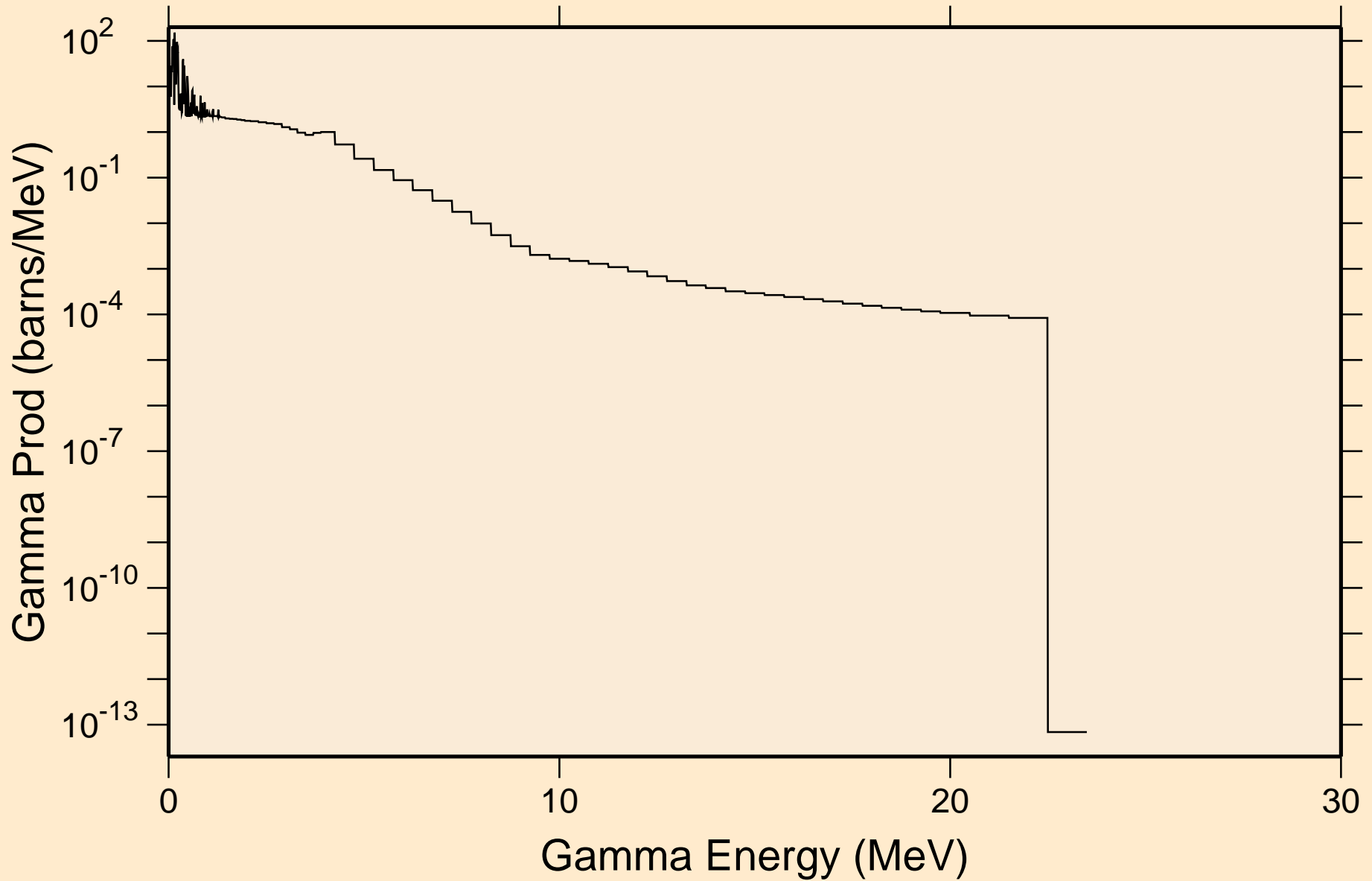

RE169M NEUTRON ACER TENDL-2021 LIBRARY; T=293.6K
Particle heating contributions

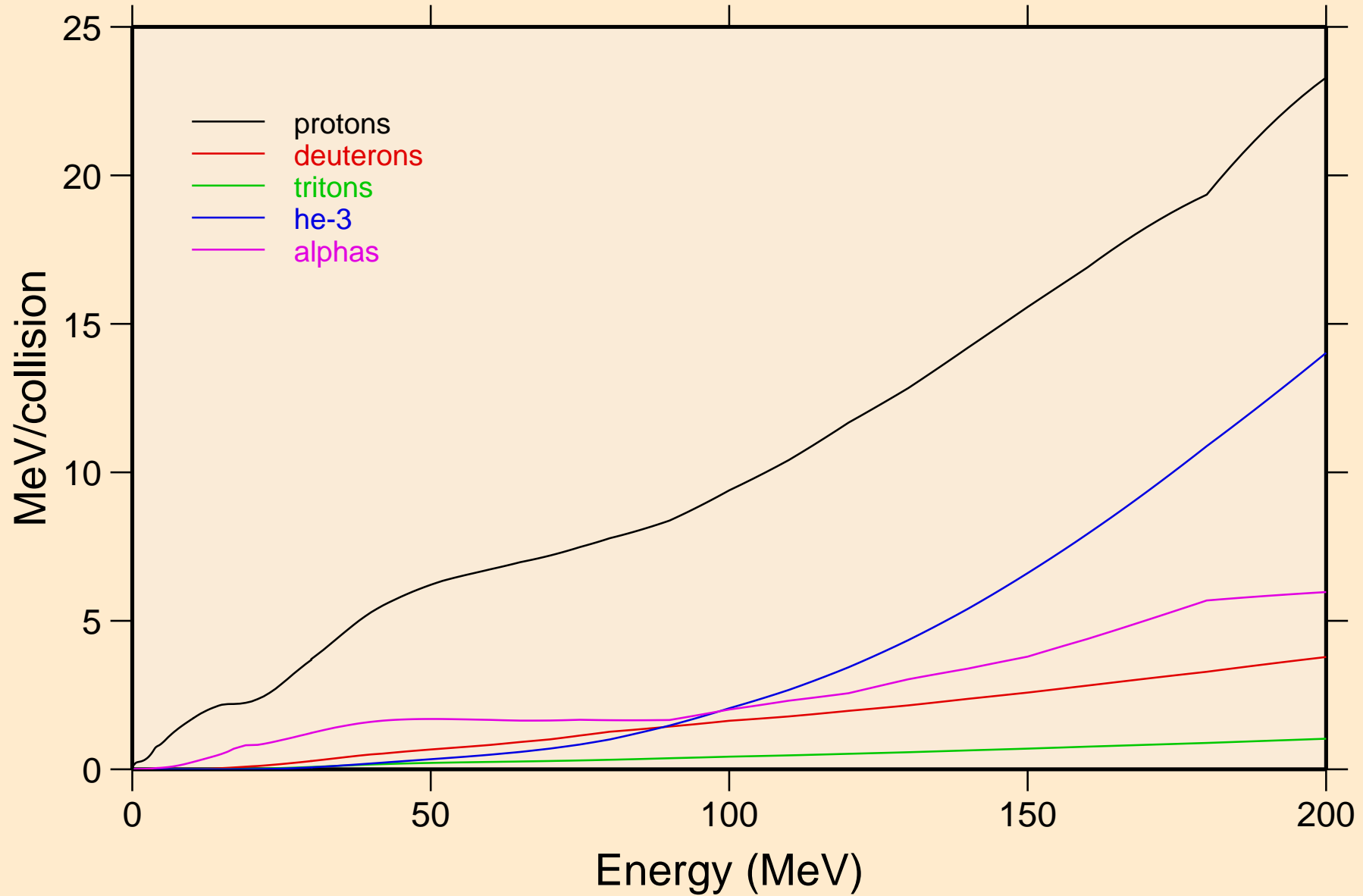

RE169M NEUTRON ACER TENDL-2021 LIBRARY; T=293.6K
Recoil Heating

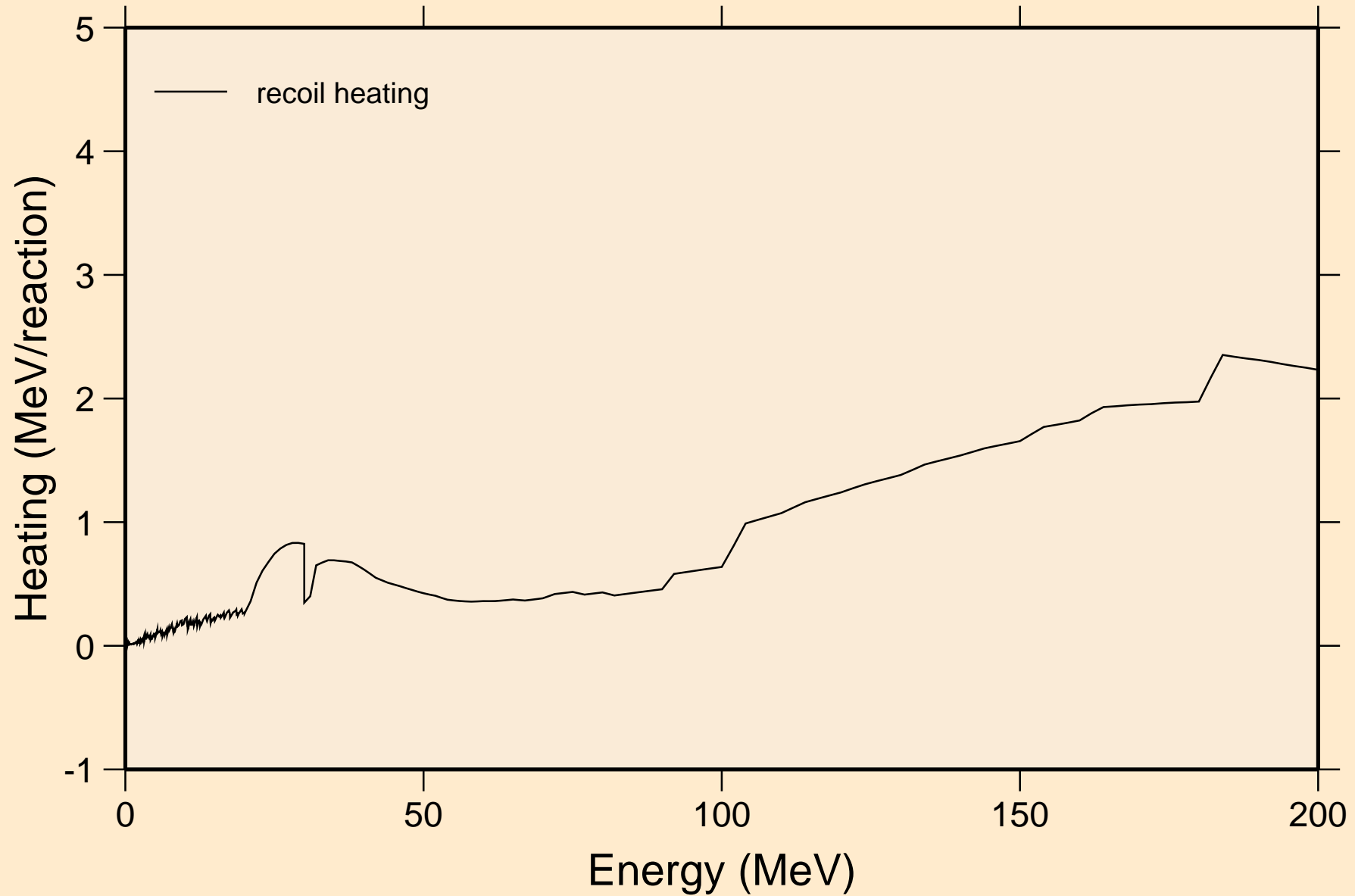

RE169M NEUTRON ACER TENDL-2021 LIBRARY; T=293.6K
Particle production cross sections

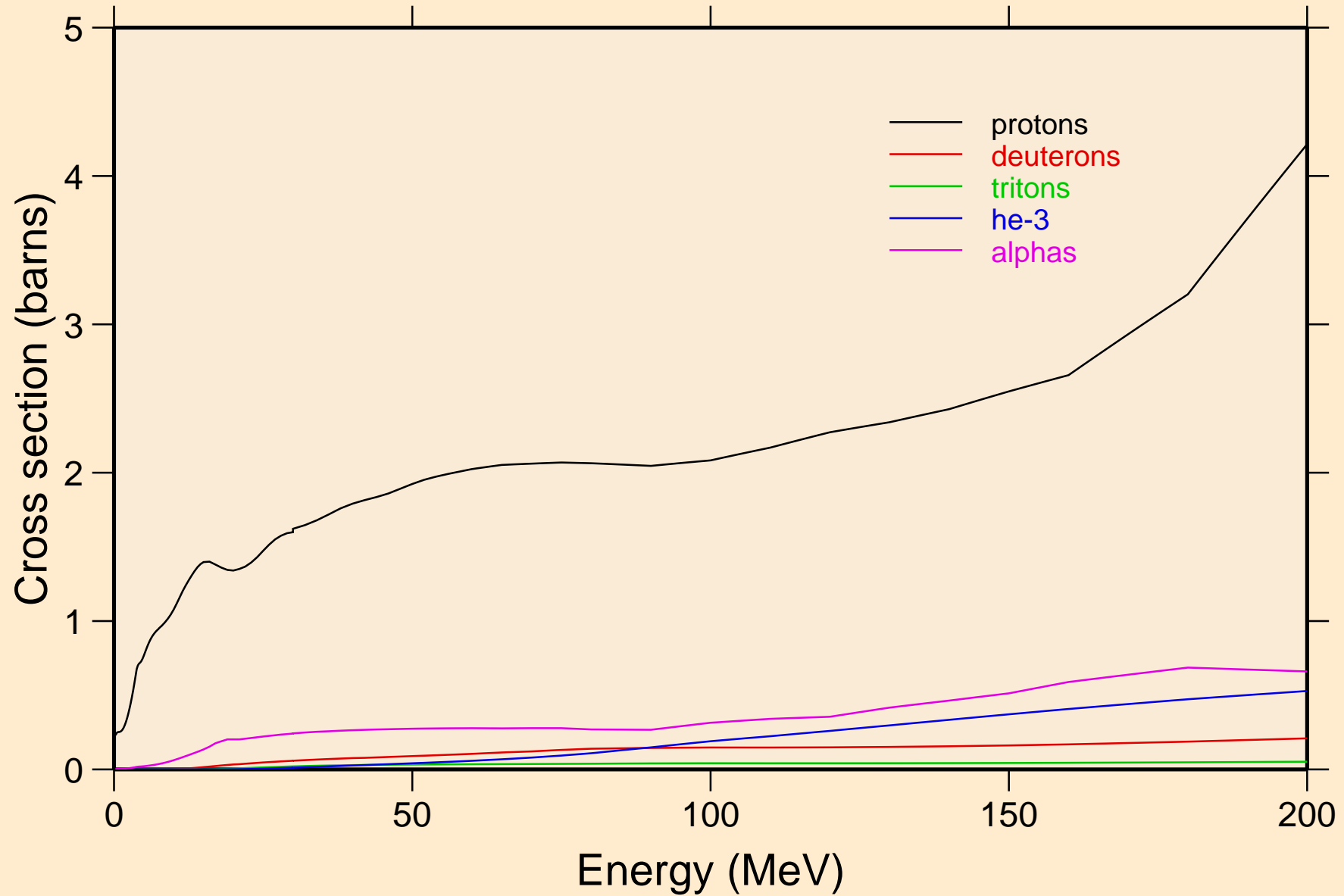

RE169M NEUTRON ACER TENDL-2021 LIBRARY; T=293.6K
protons from (n,x)

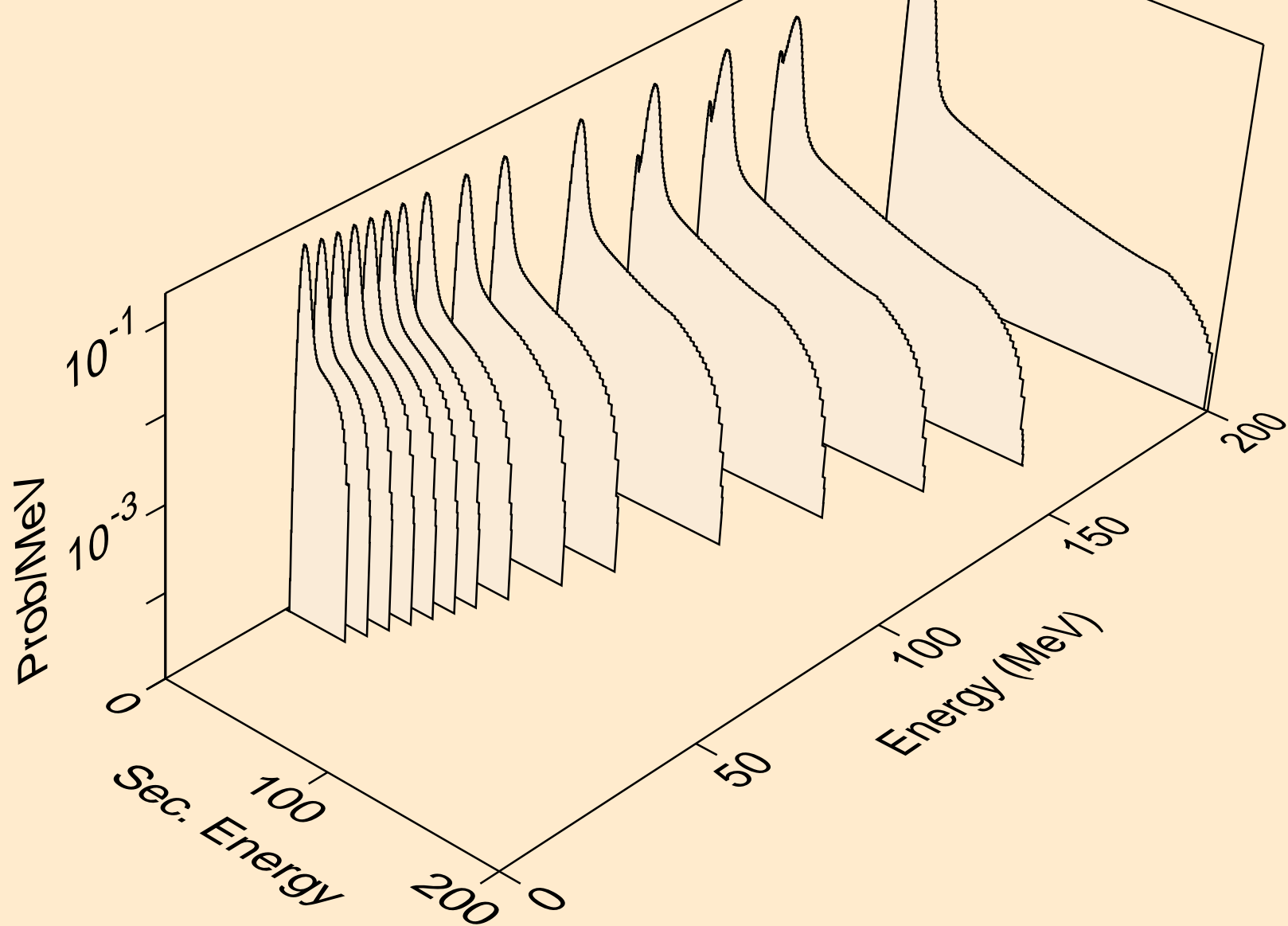

RE169M NEUTRON ACER TENDL-2021 LIBRARY; T=293.6K
protons from (n,n*)p

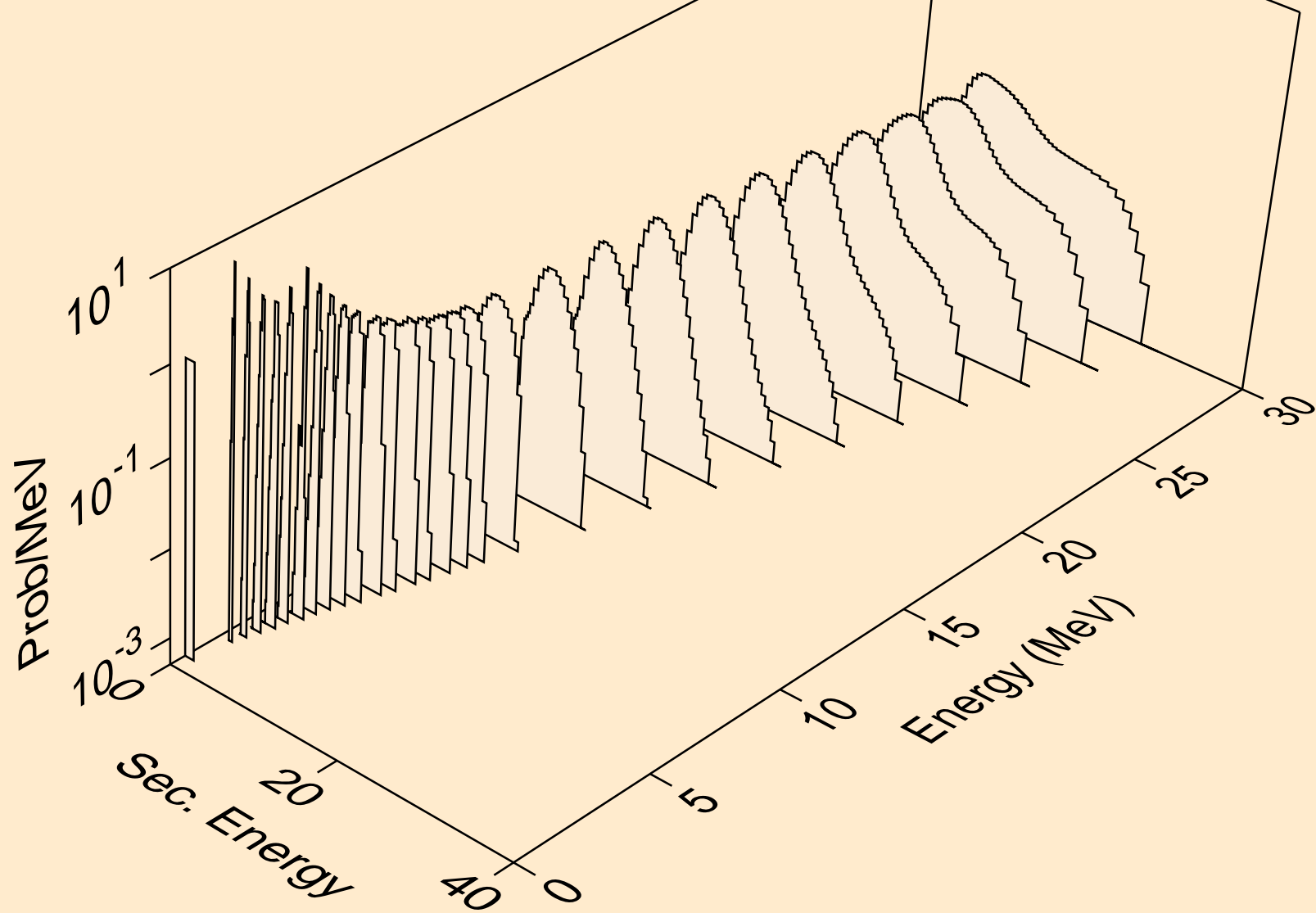

RE169M NEUTRON ACER TENDL-2021 LIBRARY; T=293.6K
protons from (n,2np)

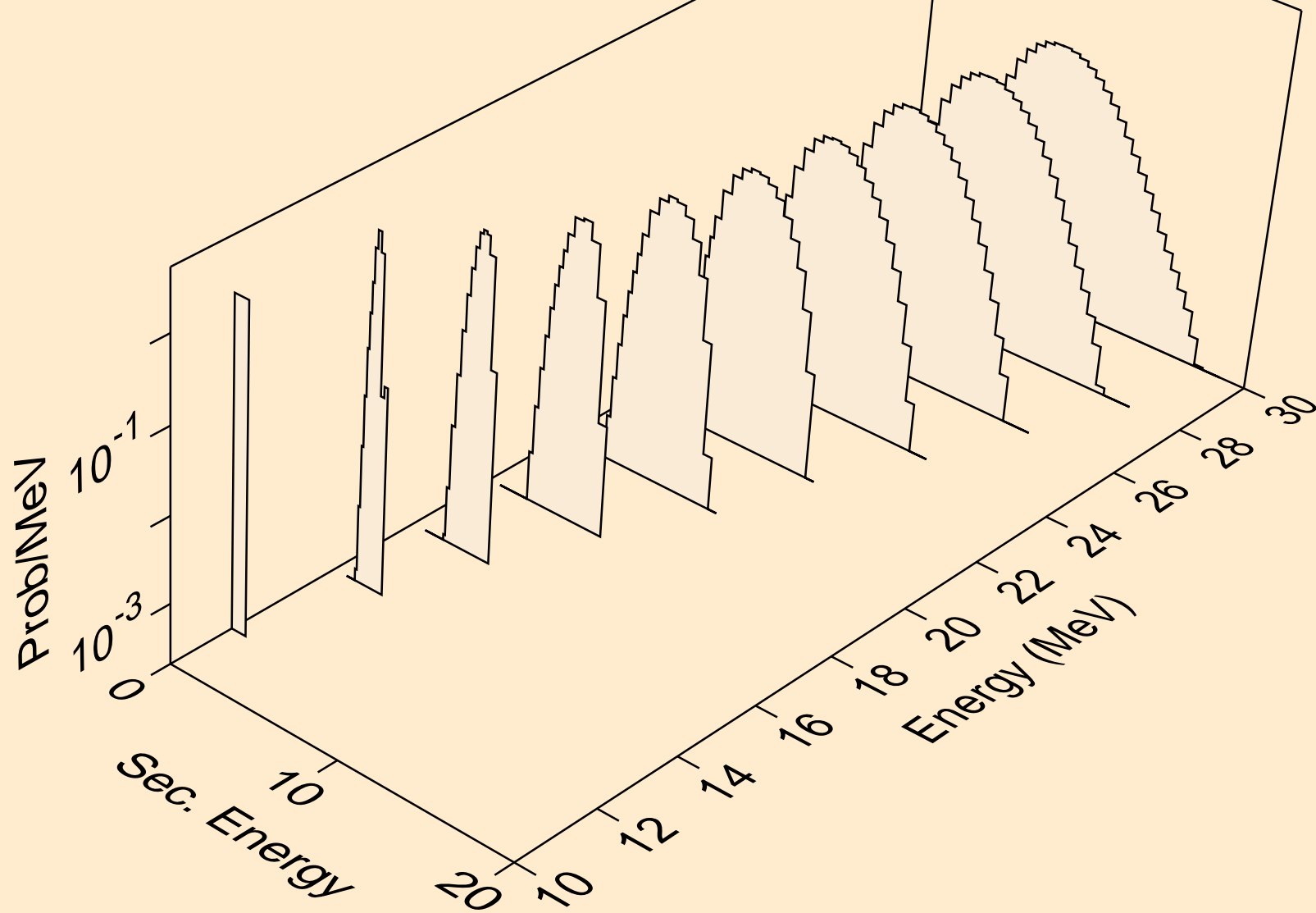

RE169M NEUTRON ACER TENDL-2021 LIBRARY; T=293.6K
protons from (n,3np)

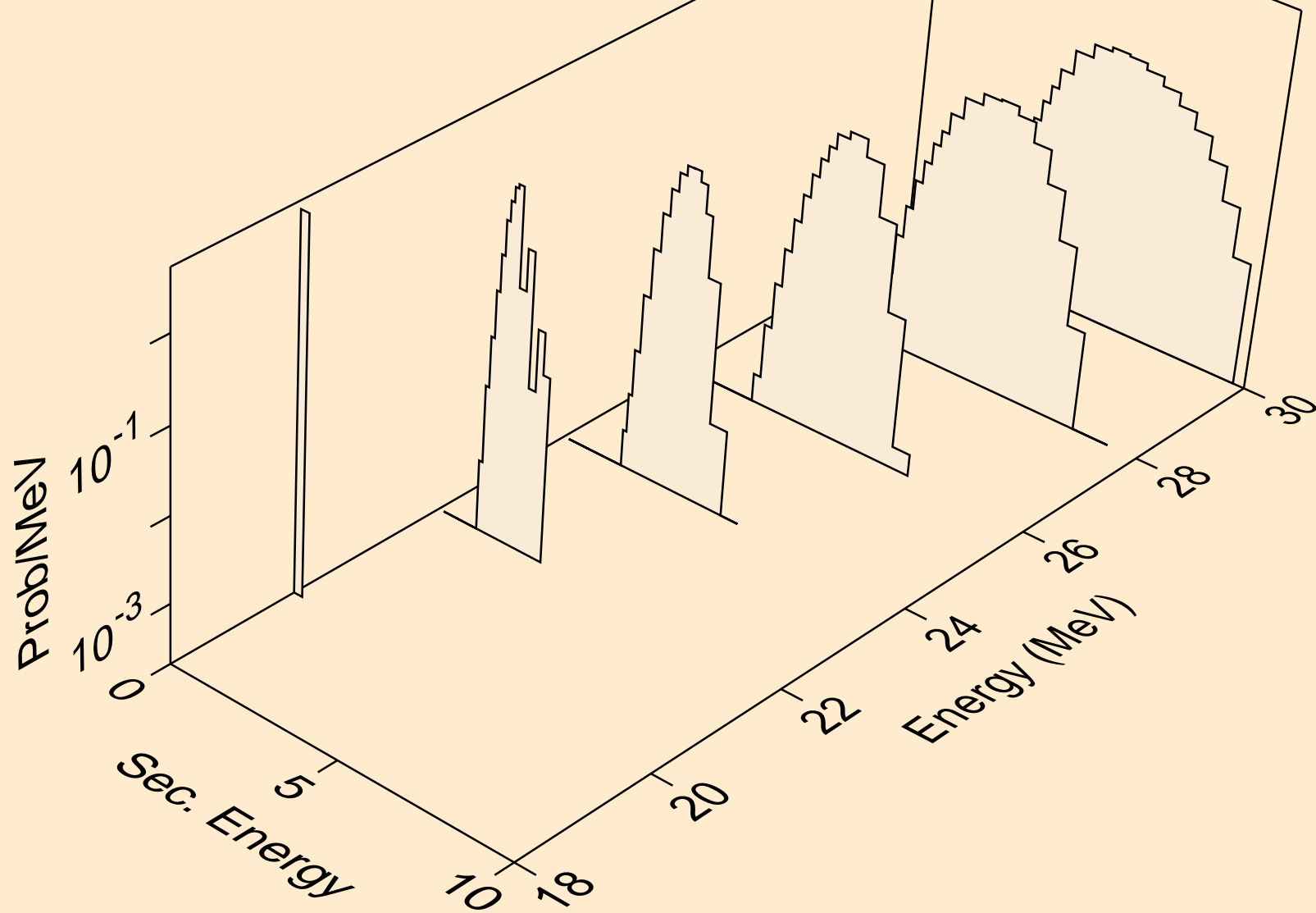

RE169M NEUTRON ACER TENDL-2021 LIBRARY; T=293.6K
protons from (n,2np)

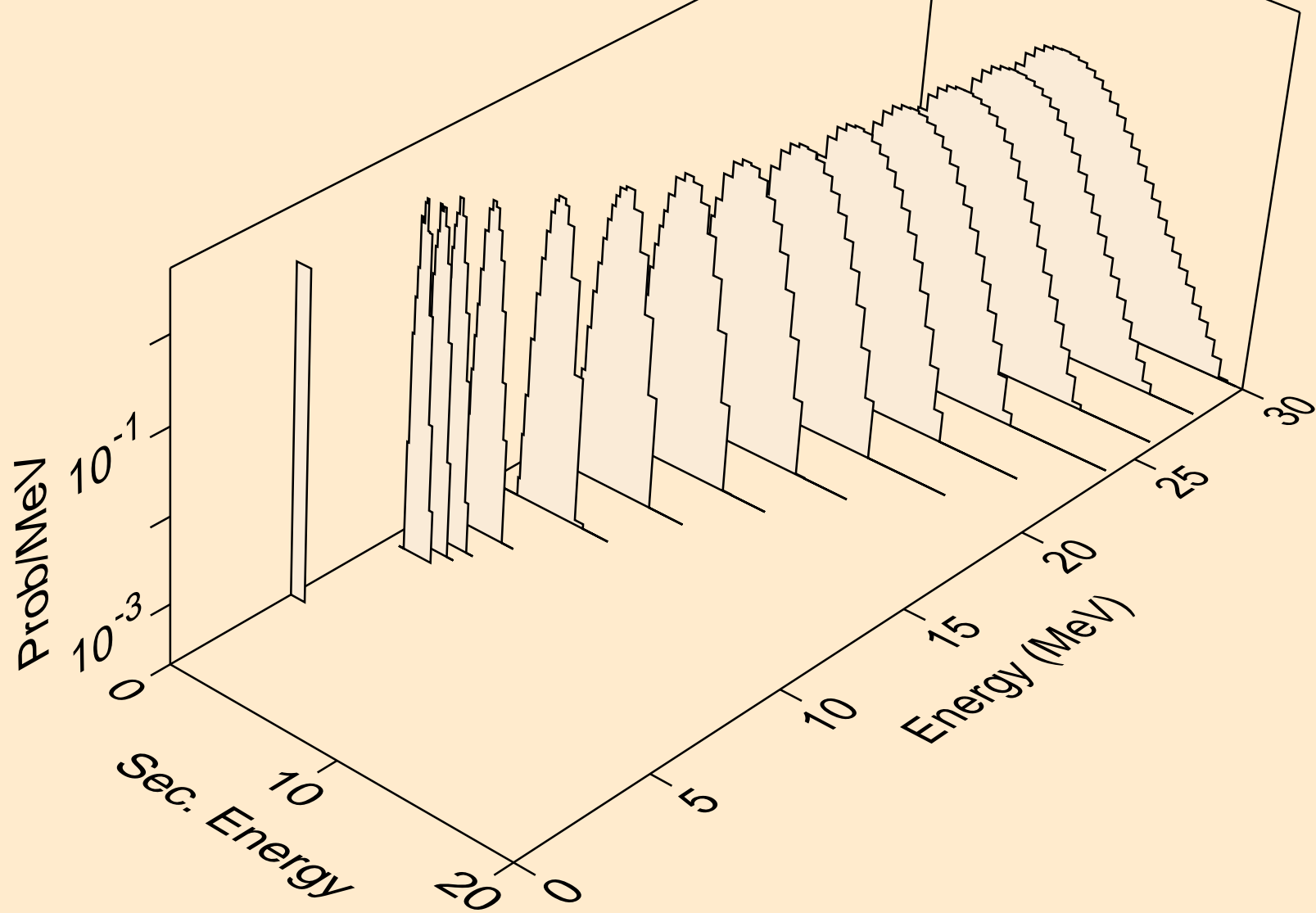

RE169M NEUTRON ACER TENDL-2021 LIBRARY; T=293.6K
protons from (n,npa)

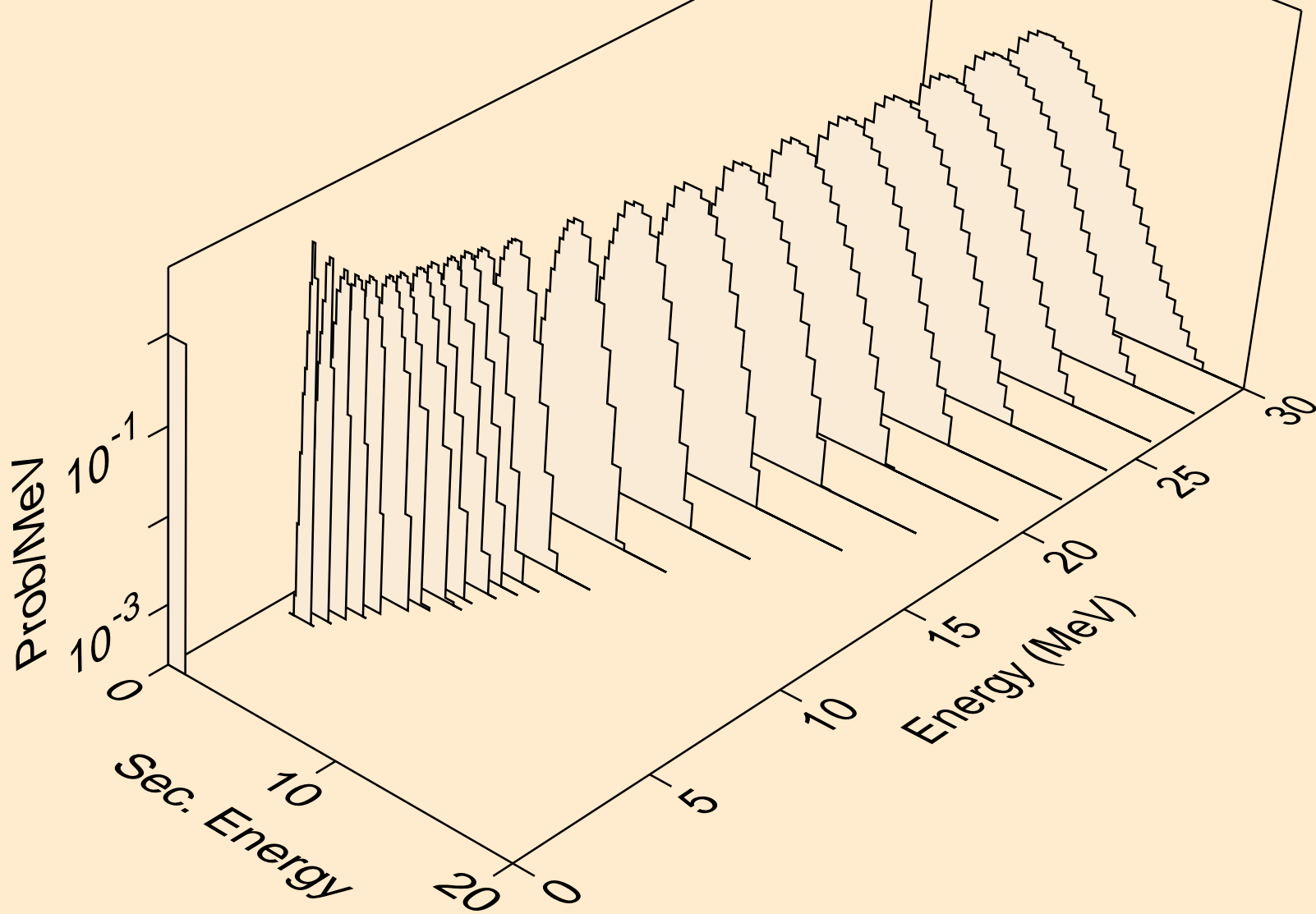

RE169M NEUTRON ACER TENDL-2021 LIBRARY; T=293.6K
protons from (n,p)

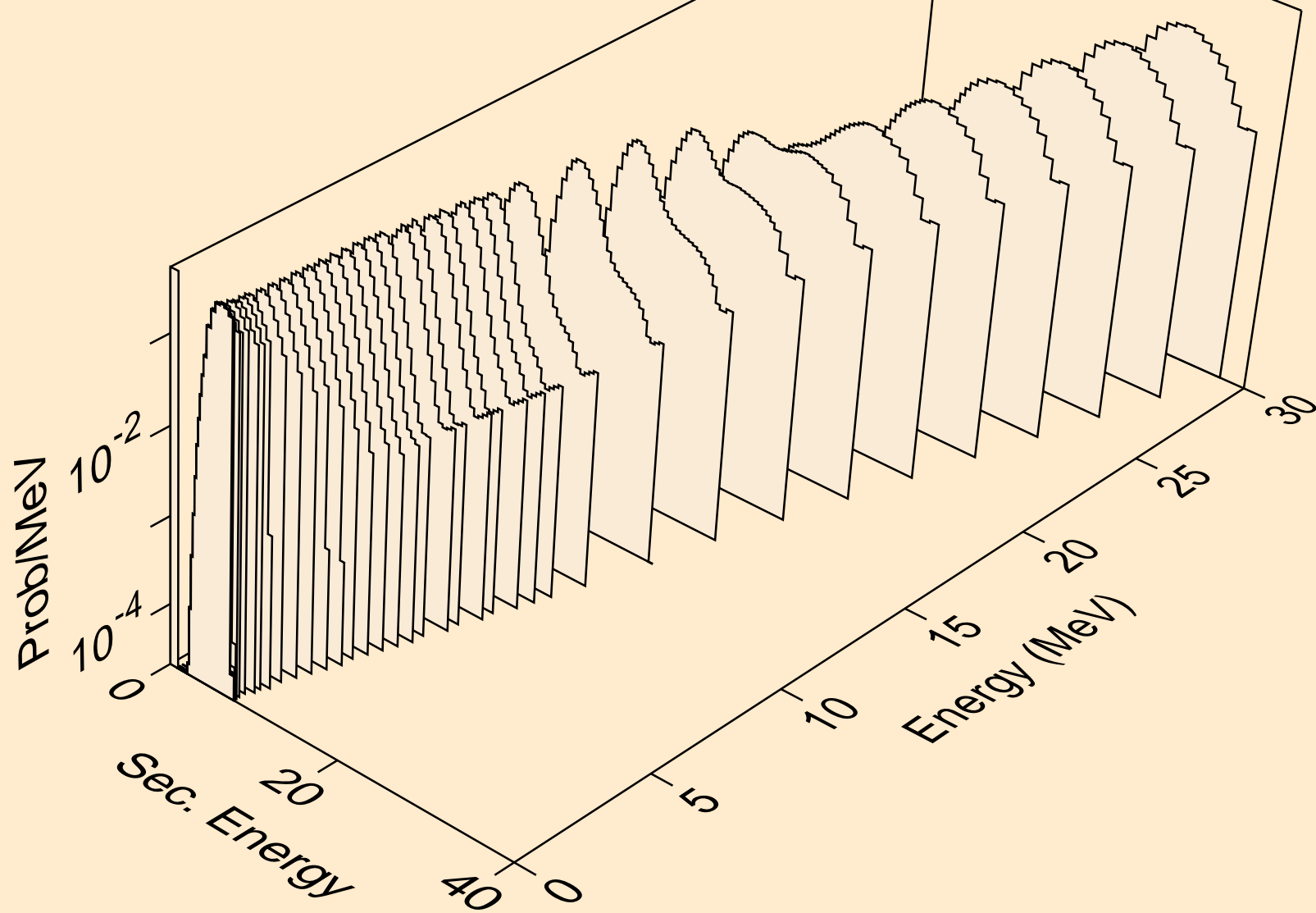

RE169M NEUTRON ACER TENDL-2021 LIBRARY; T=293.6K
protons from (n,2p)

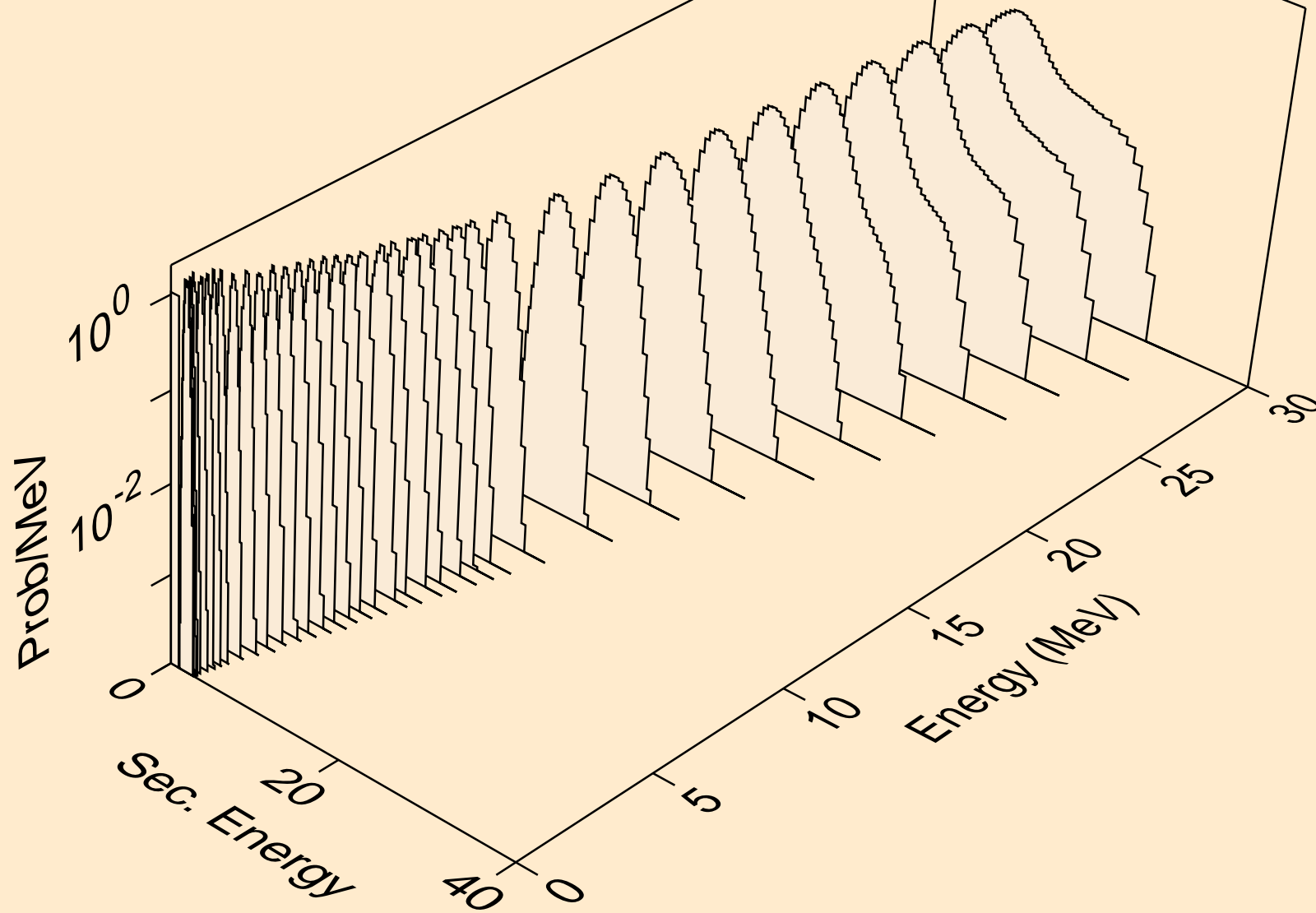

RE169M NEUTRON ACER TENDL-2021 LIBRARY; T=293.6K
protons from (n,p)

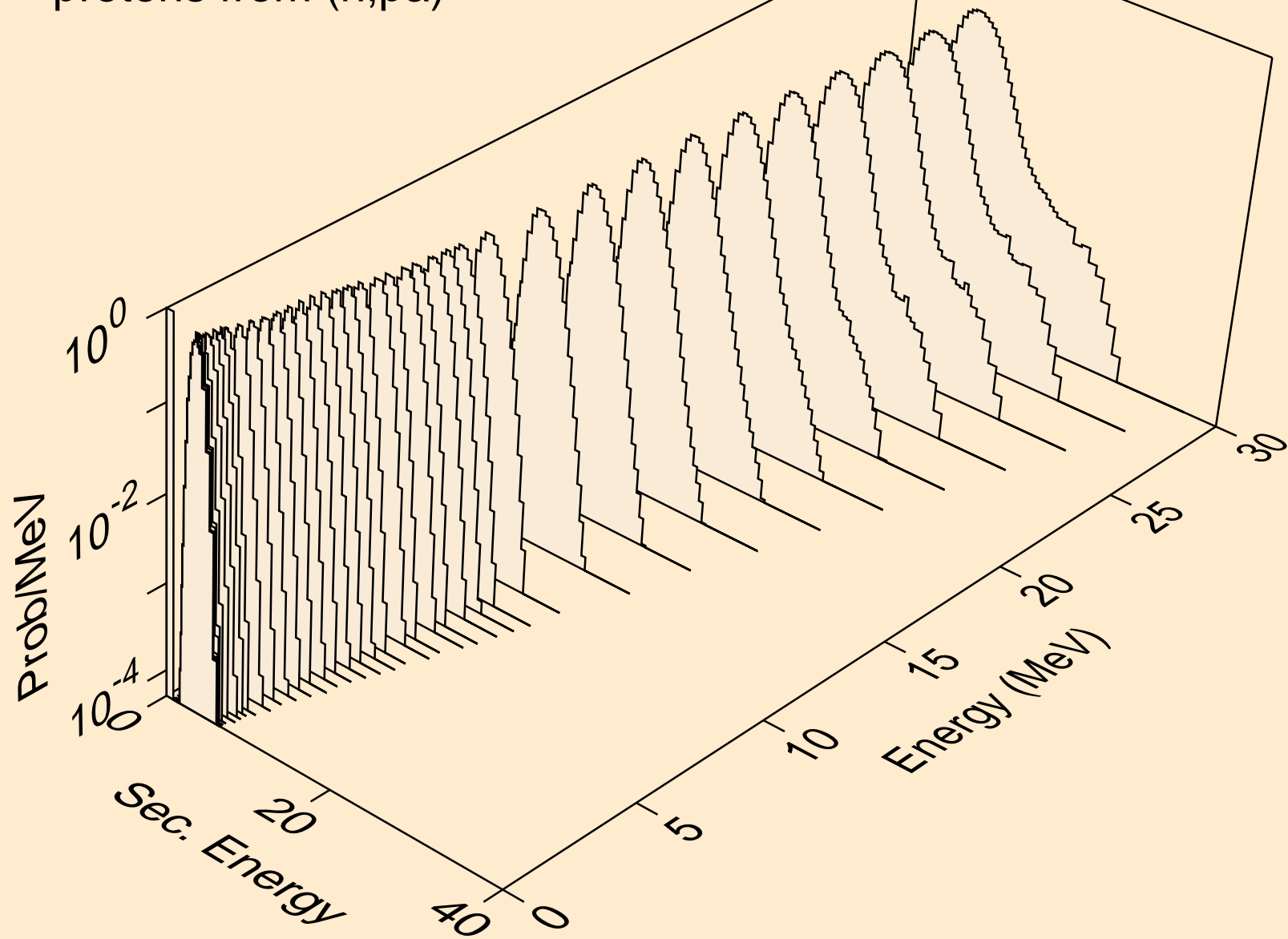

RE169M NEUTRON ACER TENDL-2021 LIBRARY; T=293.6K
protons from (n,pd)

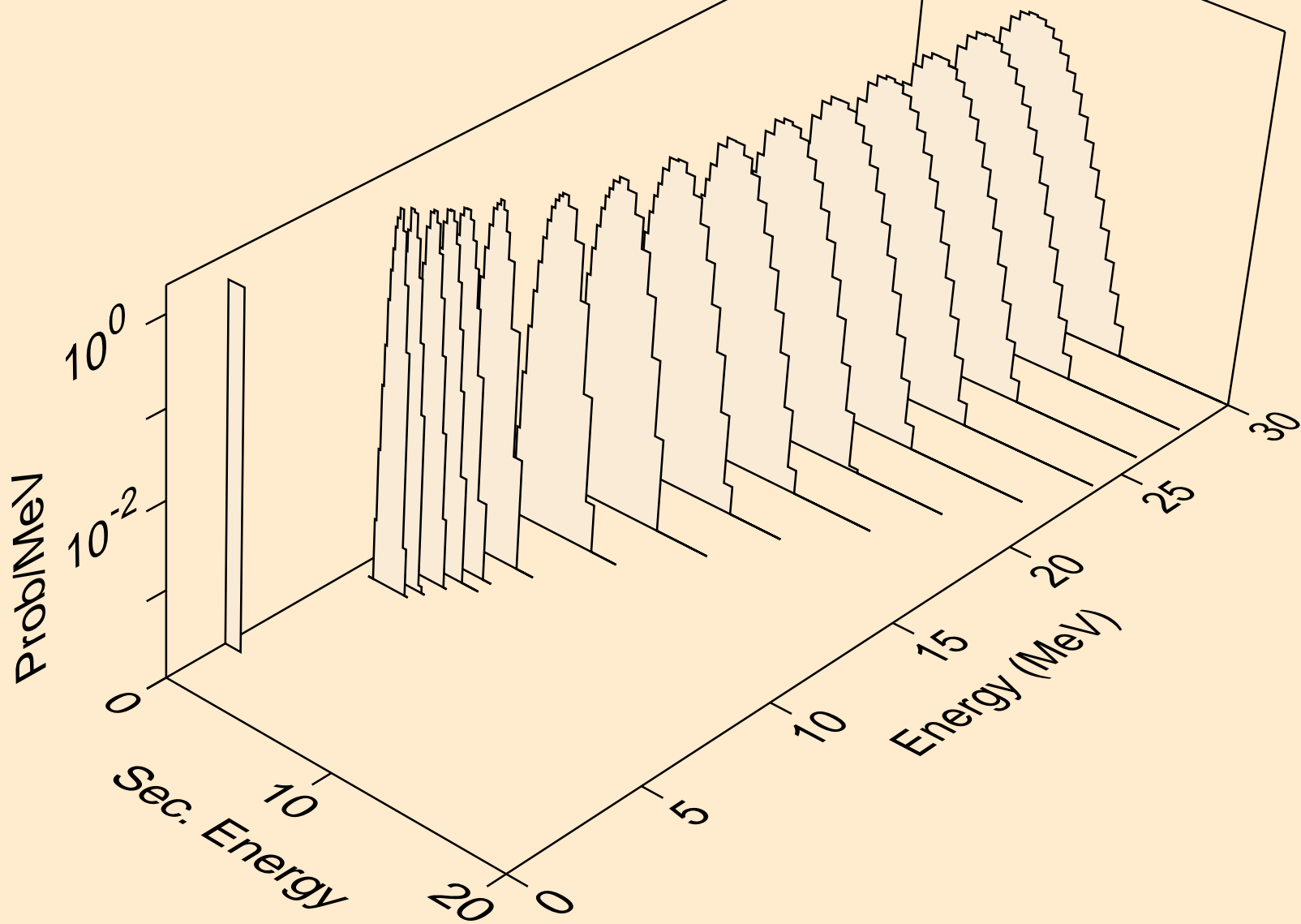

RE169M NEUTRON ACER TENDL-2021 LIBRARY; T=293.6K
protons from (n,pt)

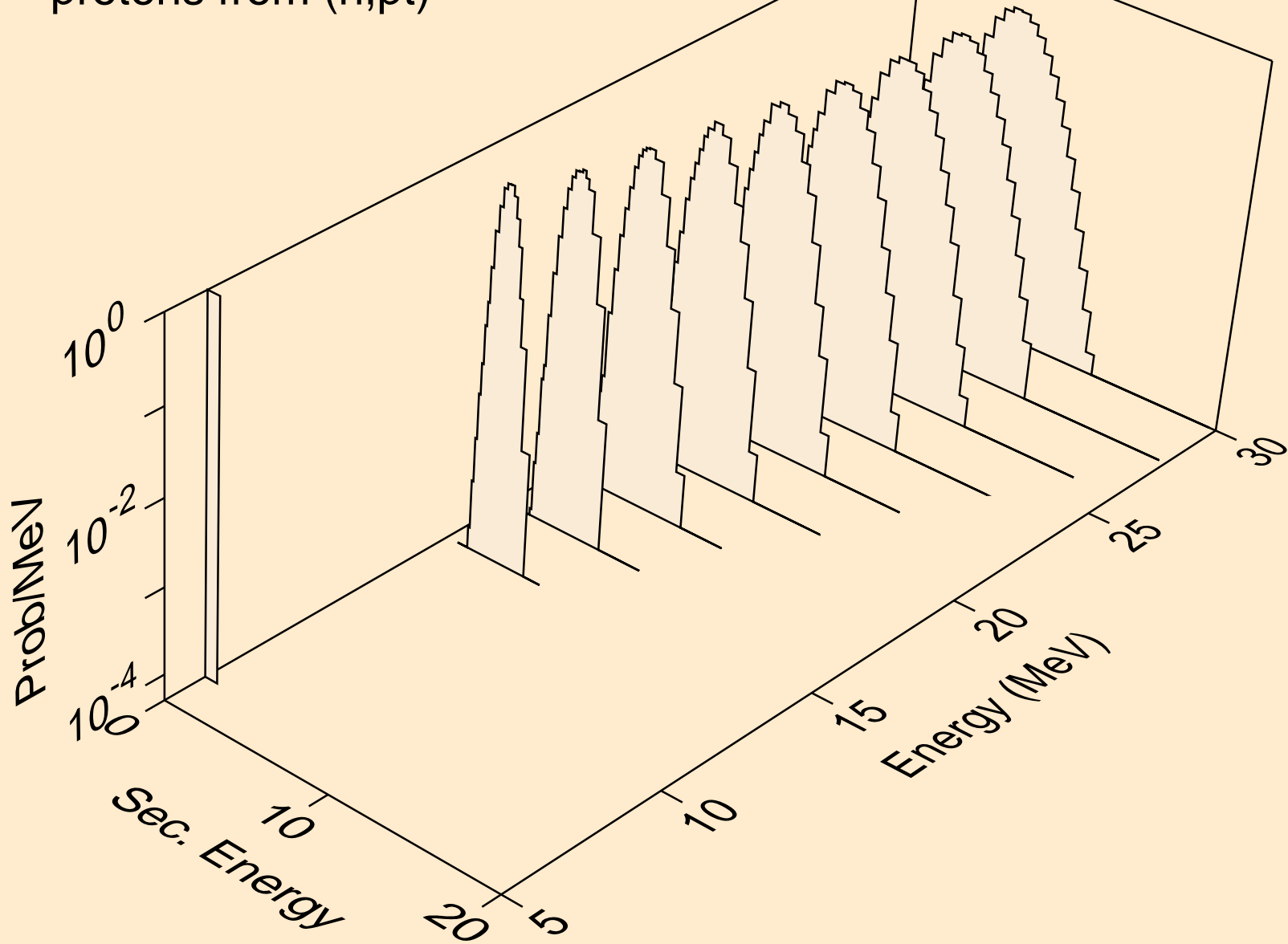

RE169M NEUTRON ACER TENDL-2021 LIBRARY; T=293.6K
deuterons from (n,x)

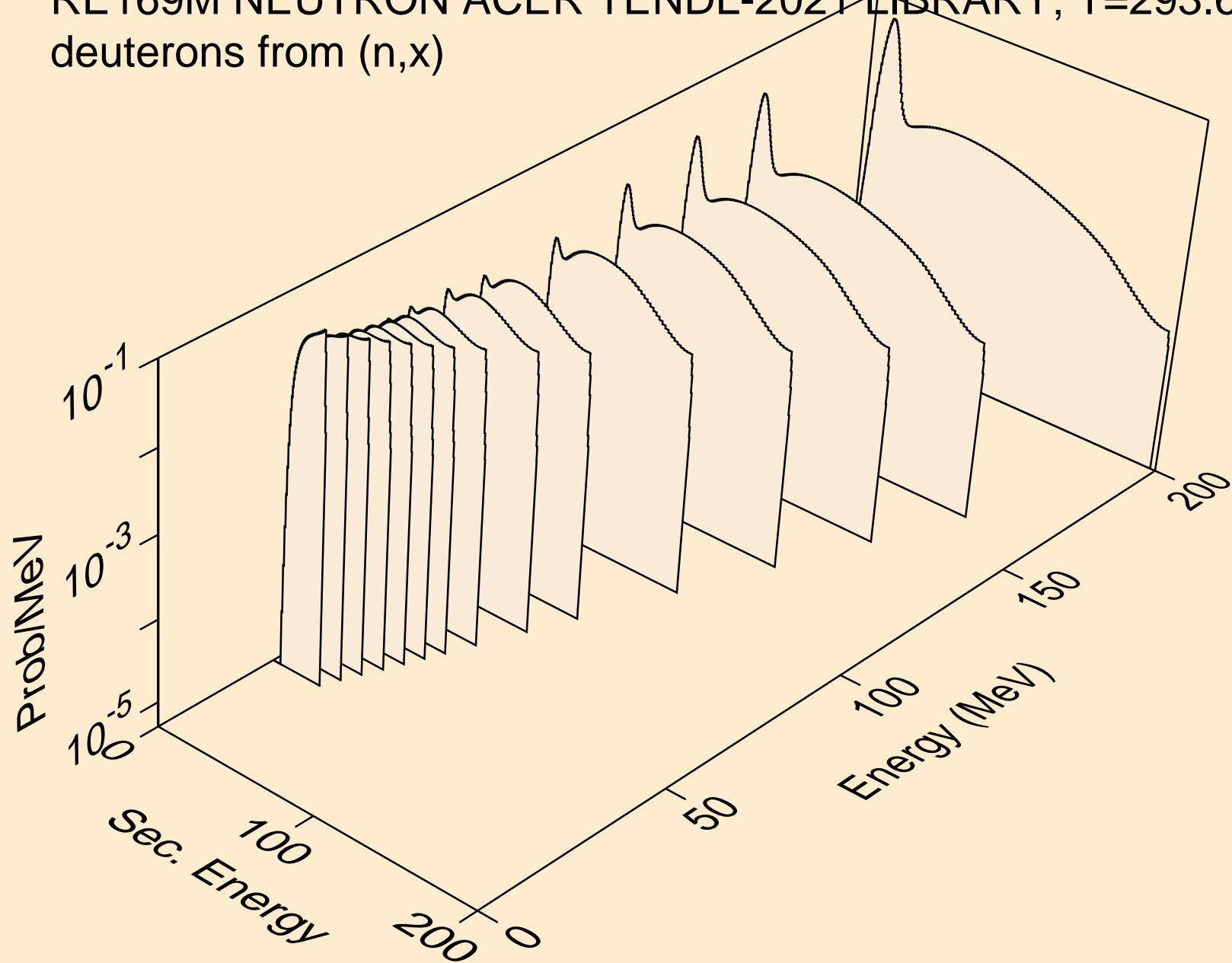

RE169M NEUTRON ACER TENDL-2021 LIBRARY; T=293.6K
deuterons from (n,2nd)

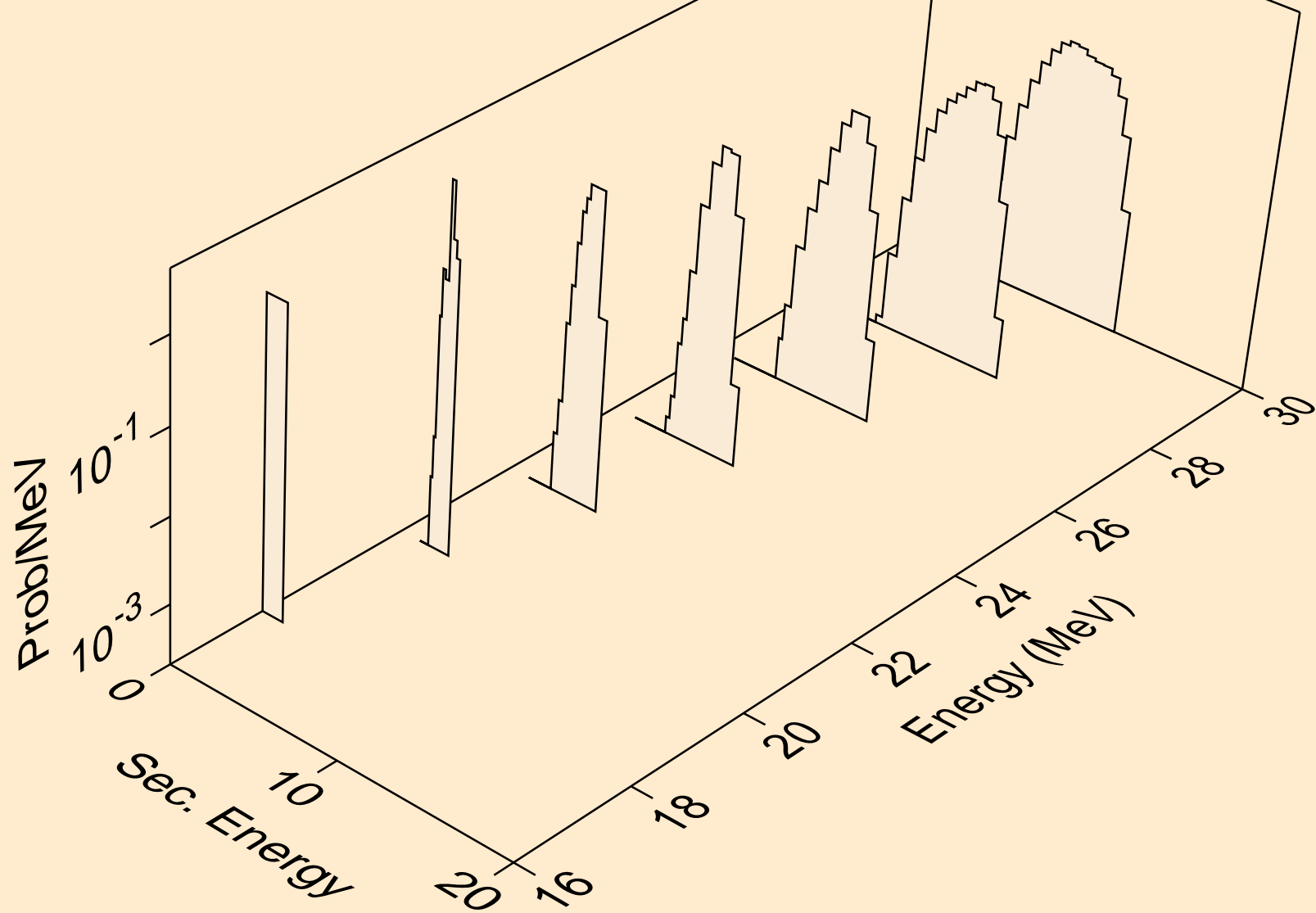

RE169M NEUTRON ACER TENDL-2021 LIBRARY; T=293.6K
deuterons from (n,n*)d

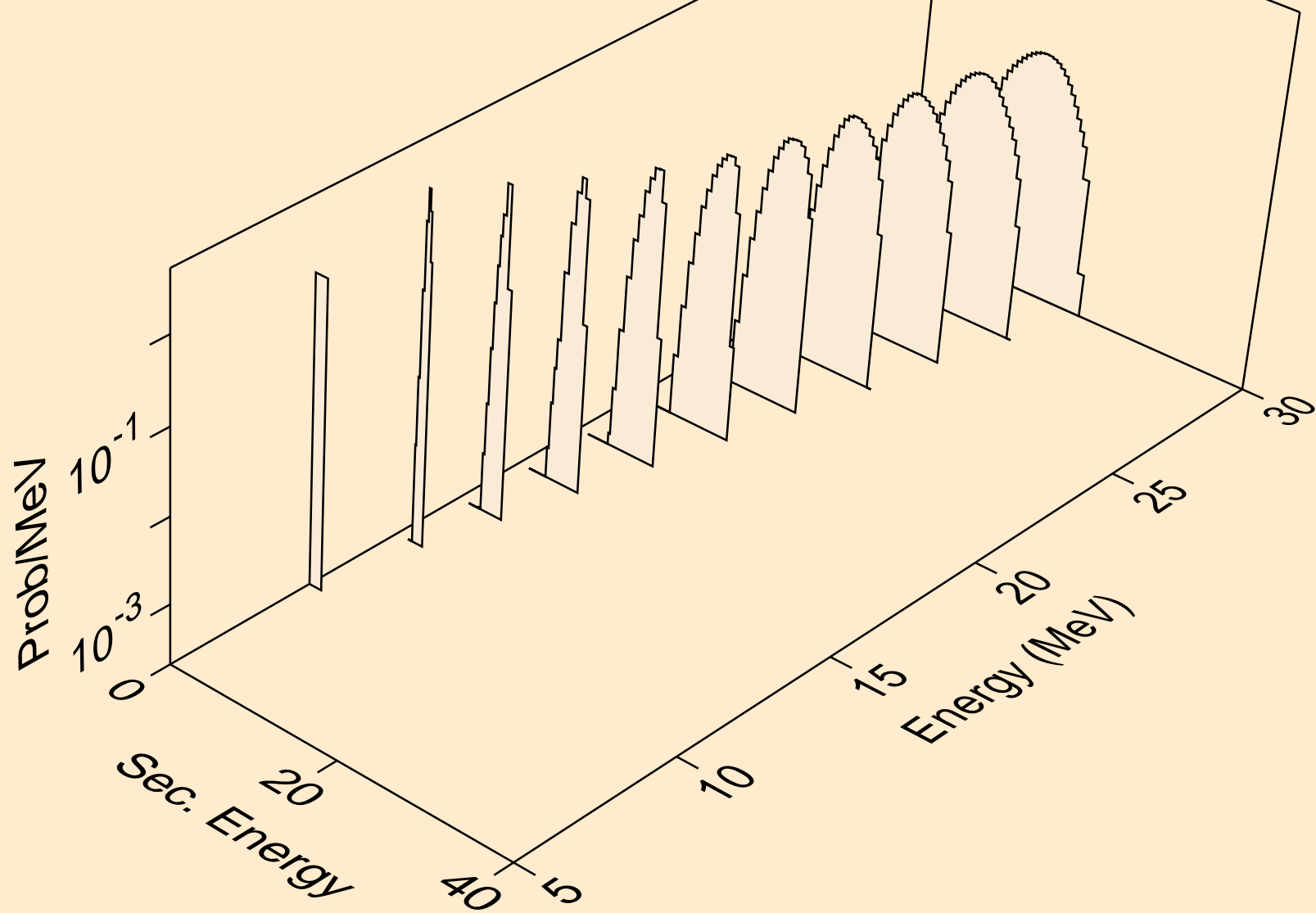

RE169M NEUTRON ACER TENDL-2021 LIBRARY; T=293.6K
deuterons from (n,d)

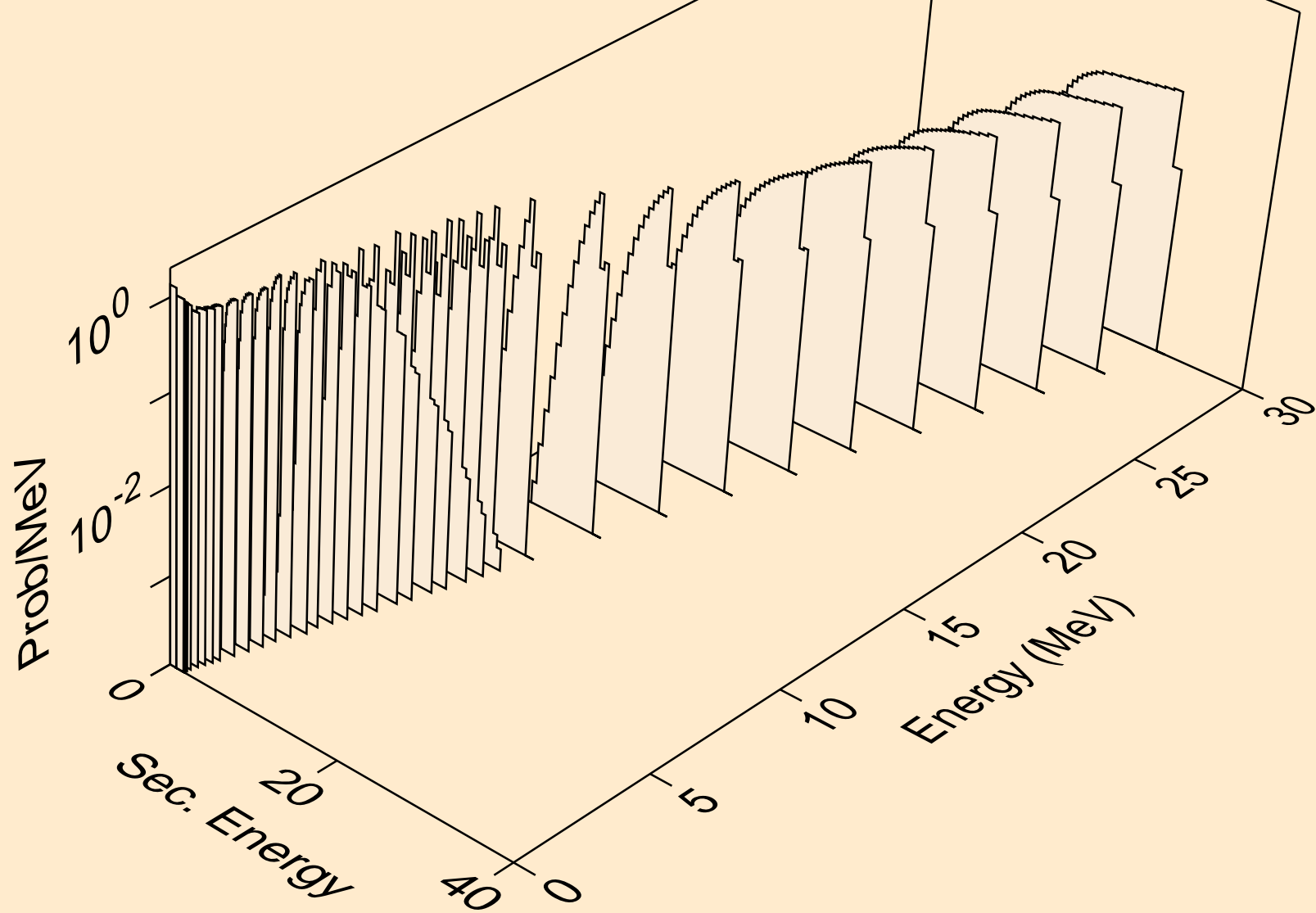

RE169M NEUTRON ACER TENDL-2021 LIBRARY; T=293.6K
deuterons from (n,d2a)

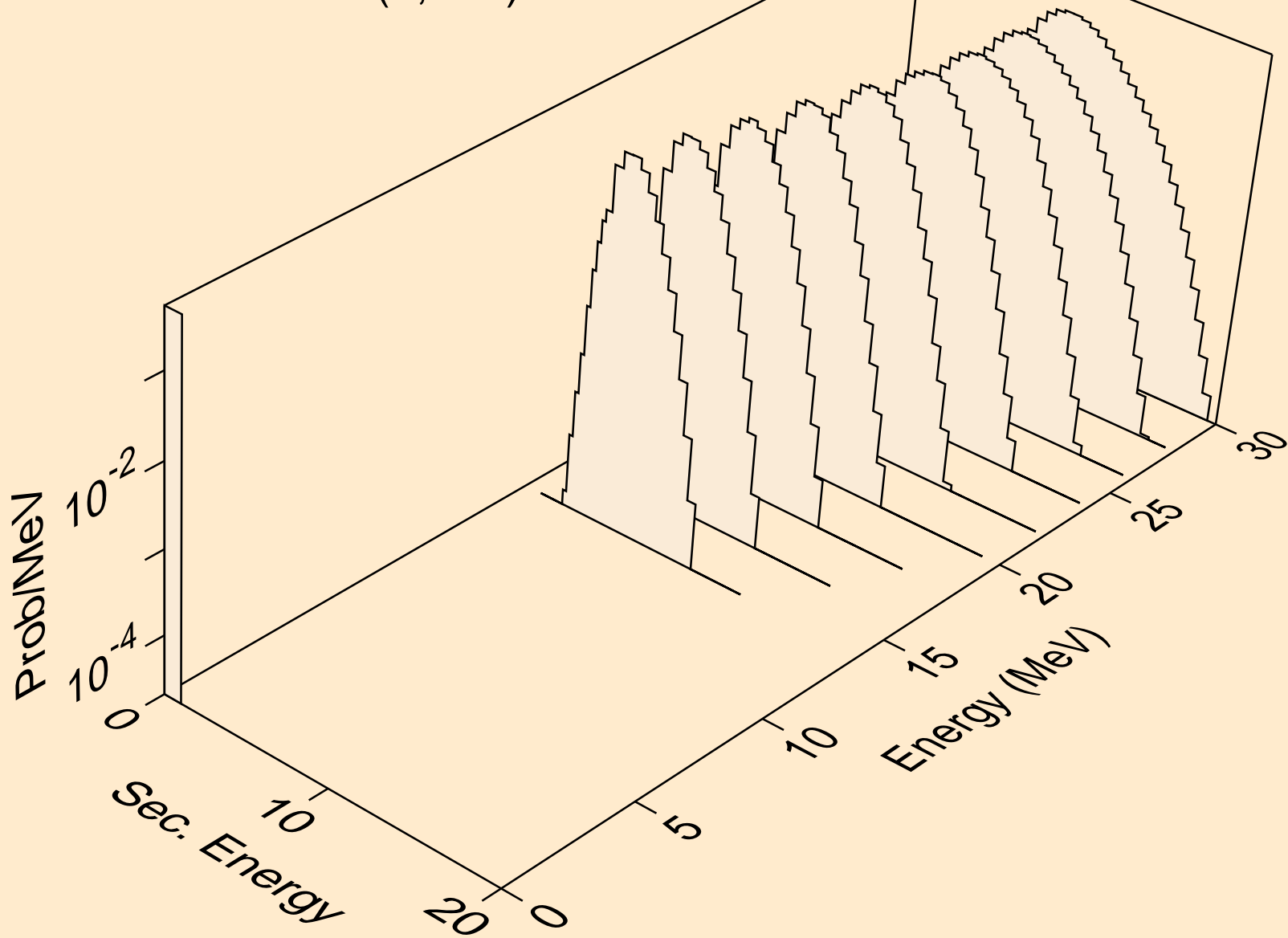

RE169M NEUTRON ACER TENDL-2021 LIBRARY; T=293.6K
deuterons from (n,pd)

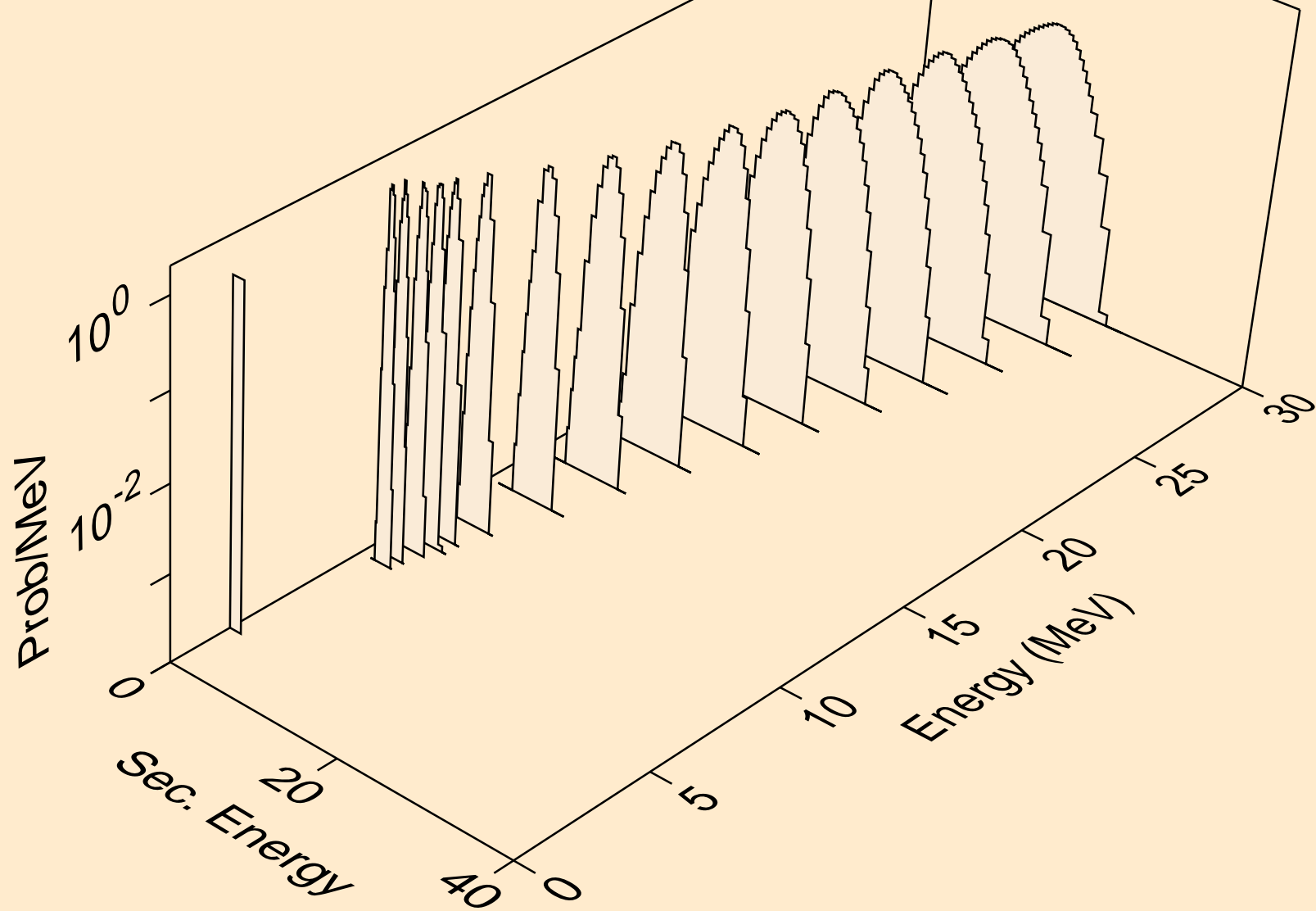

RE169M NEUTRON ACER TENDL-2021 LIBRARY; T=293.6K
deuterons from (n,da)

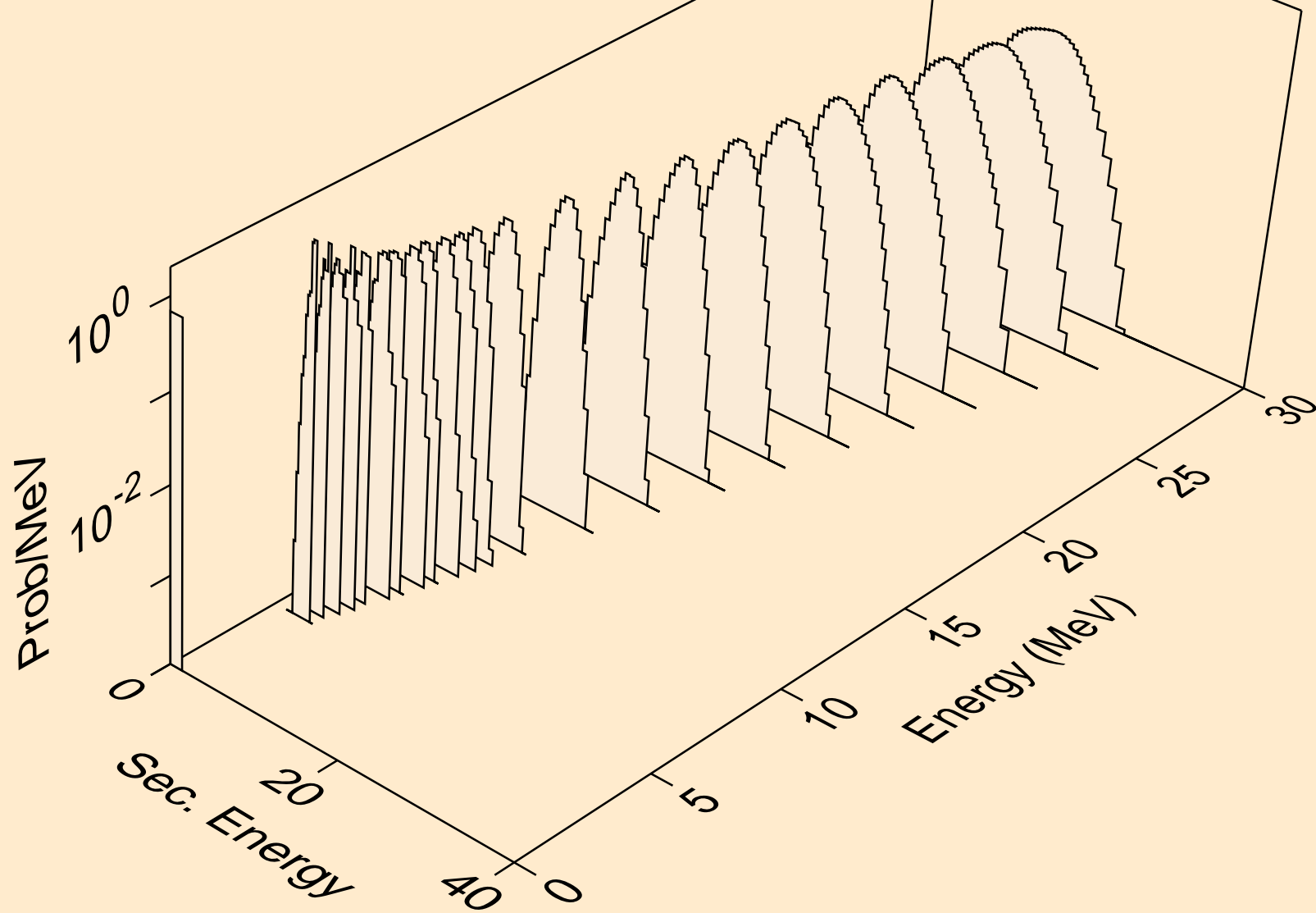

RE169M NEUTRON ACER TENDL-2021 LIBRARY; T=293.6K
tritons from (n,x)

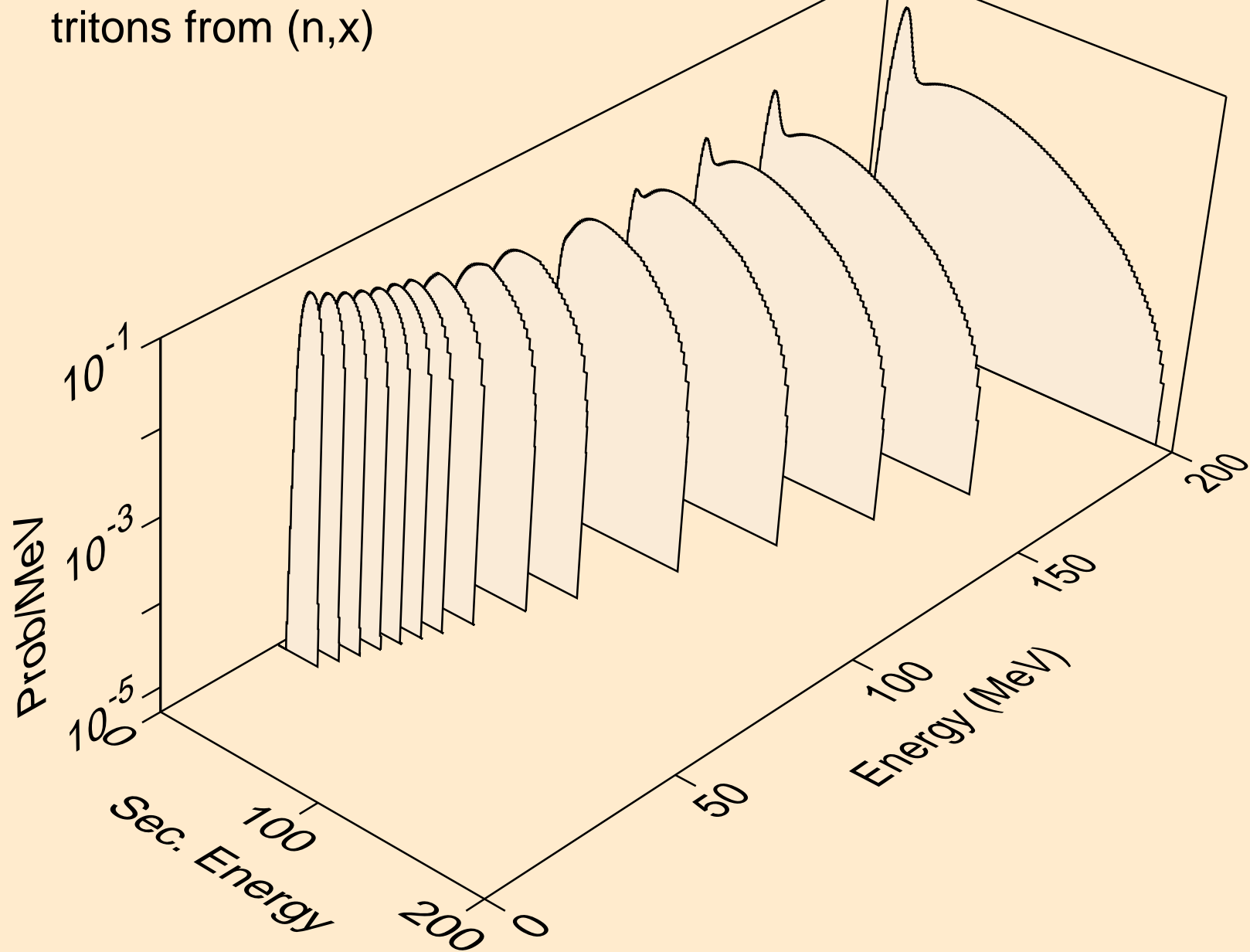

RE169M NEUTRON ACER TENDL-2021 LIBRARY; T=293.6K
tritons from (n,n*)t

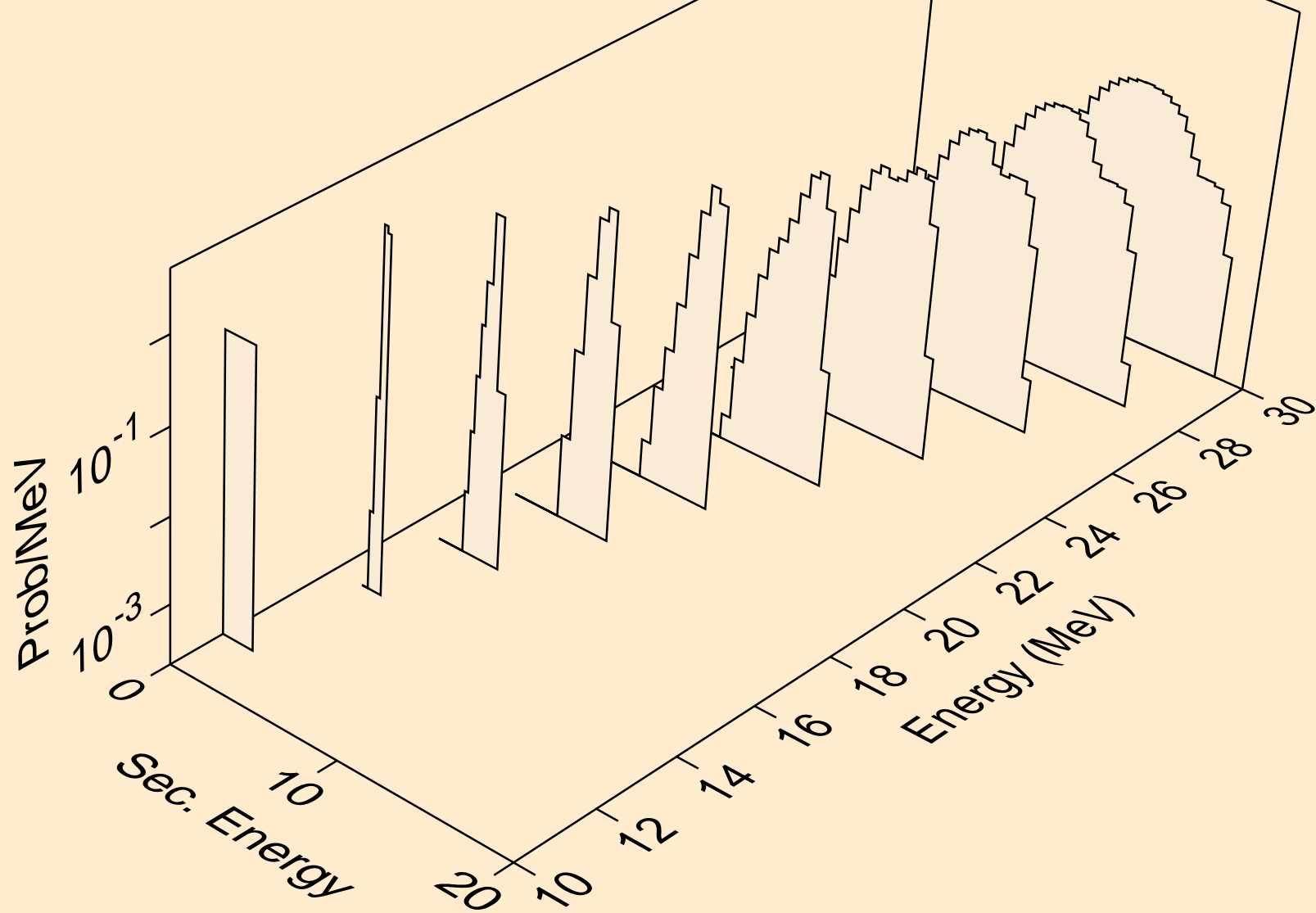

RE169M NEUTRON ACER TENDL-2021 LIBRARY; T=293.6K
tritons from (n,t)

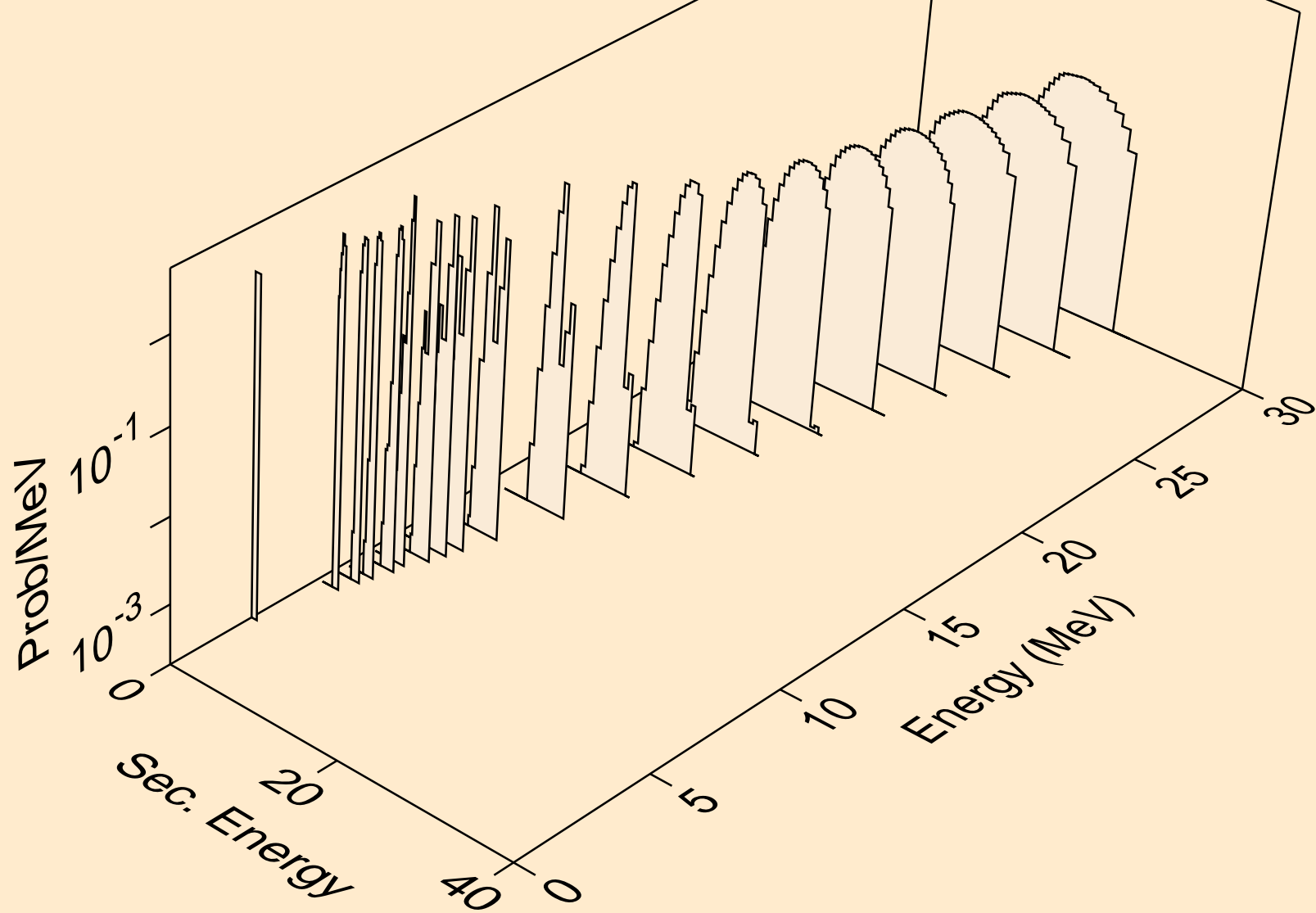

RE169M NEUTRON ACER TENDL-2021 LIBRARY; T=293.6K
tritons from (n,pt)

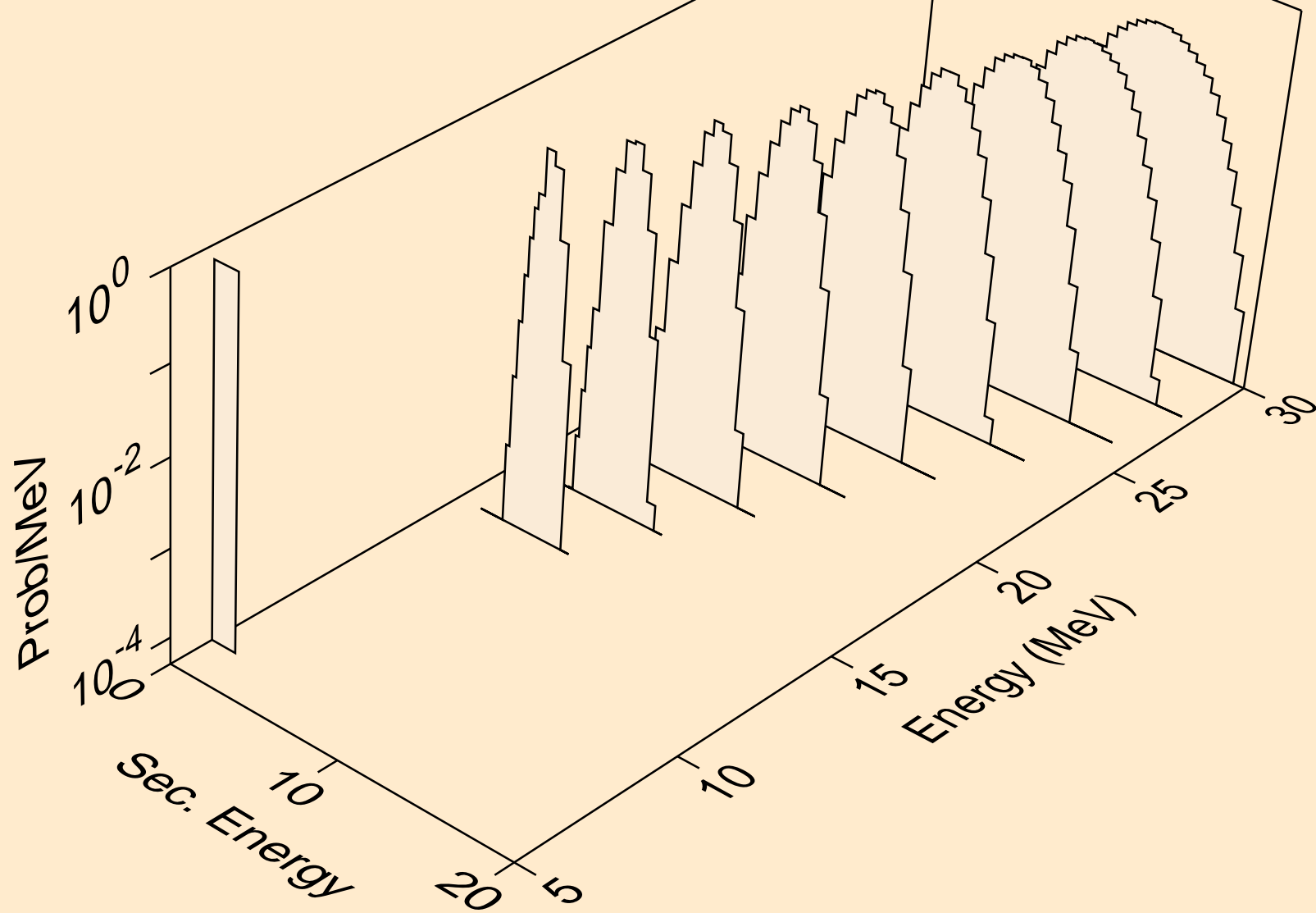

RE169M NEUTRON ACER TENDL-2021 LIBRARY; T=293.6K
he3s from (n,x)

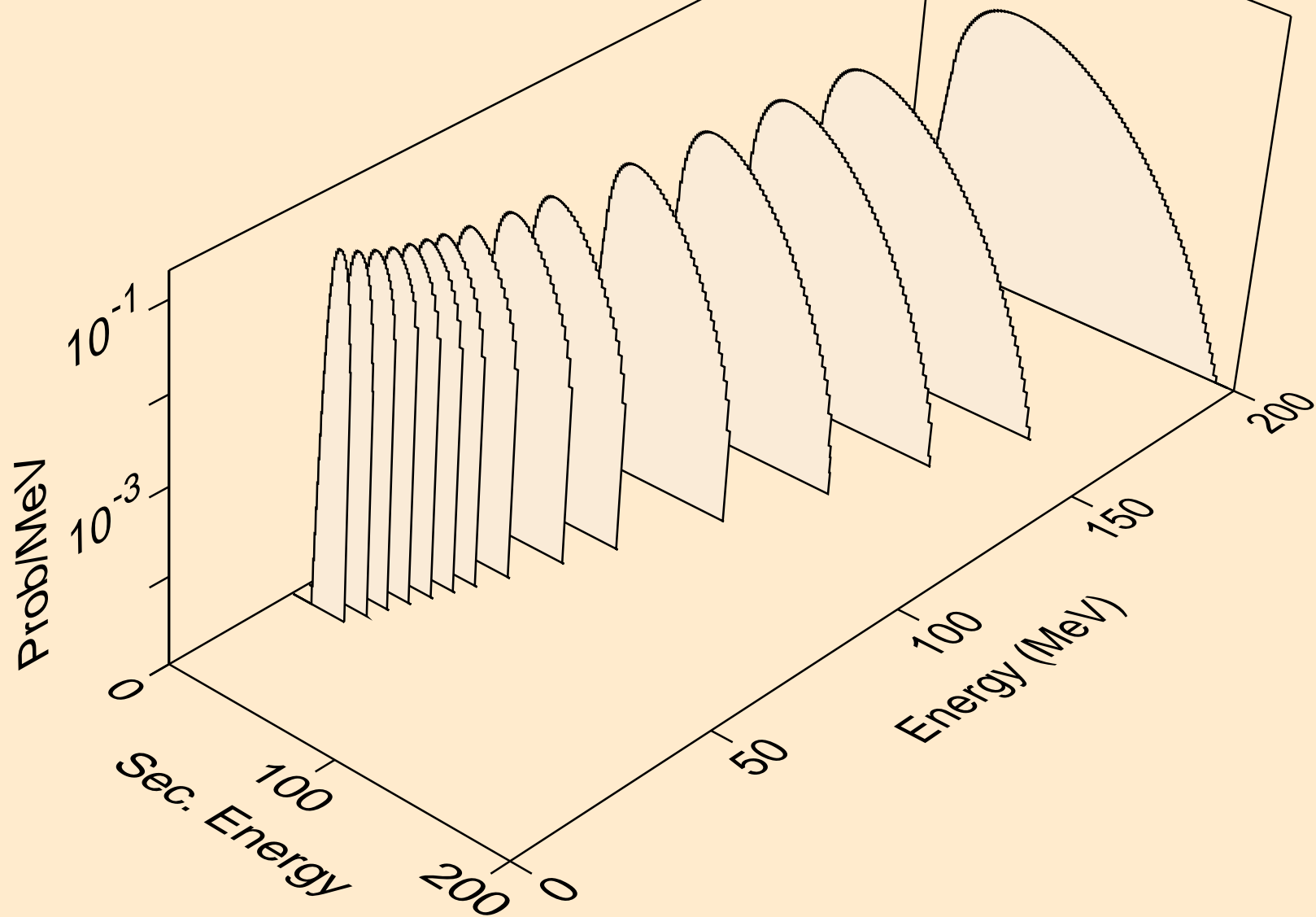

RE169M NEUTRON ACER TENDL-2021 LIBRARY; T=293.6K
he3s from (n,n*)he3

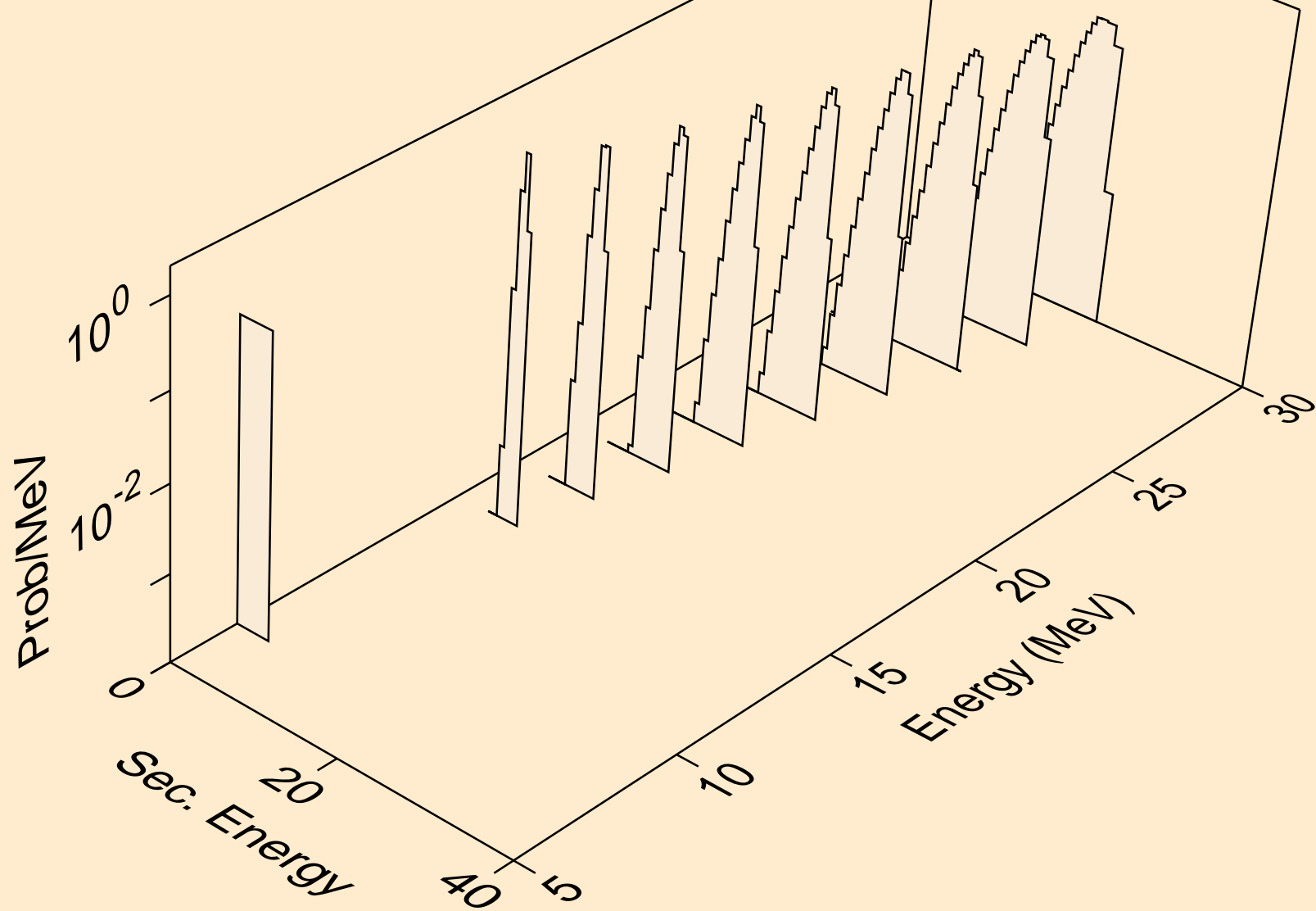

RE169M NEUTRON ACER TENDL-2021 LIBRARY; T=293.6K
he3s from (n,he3)

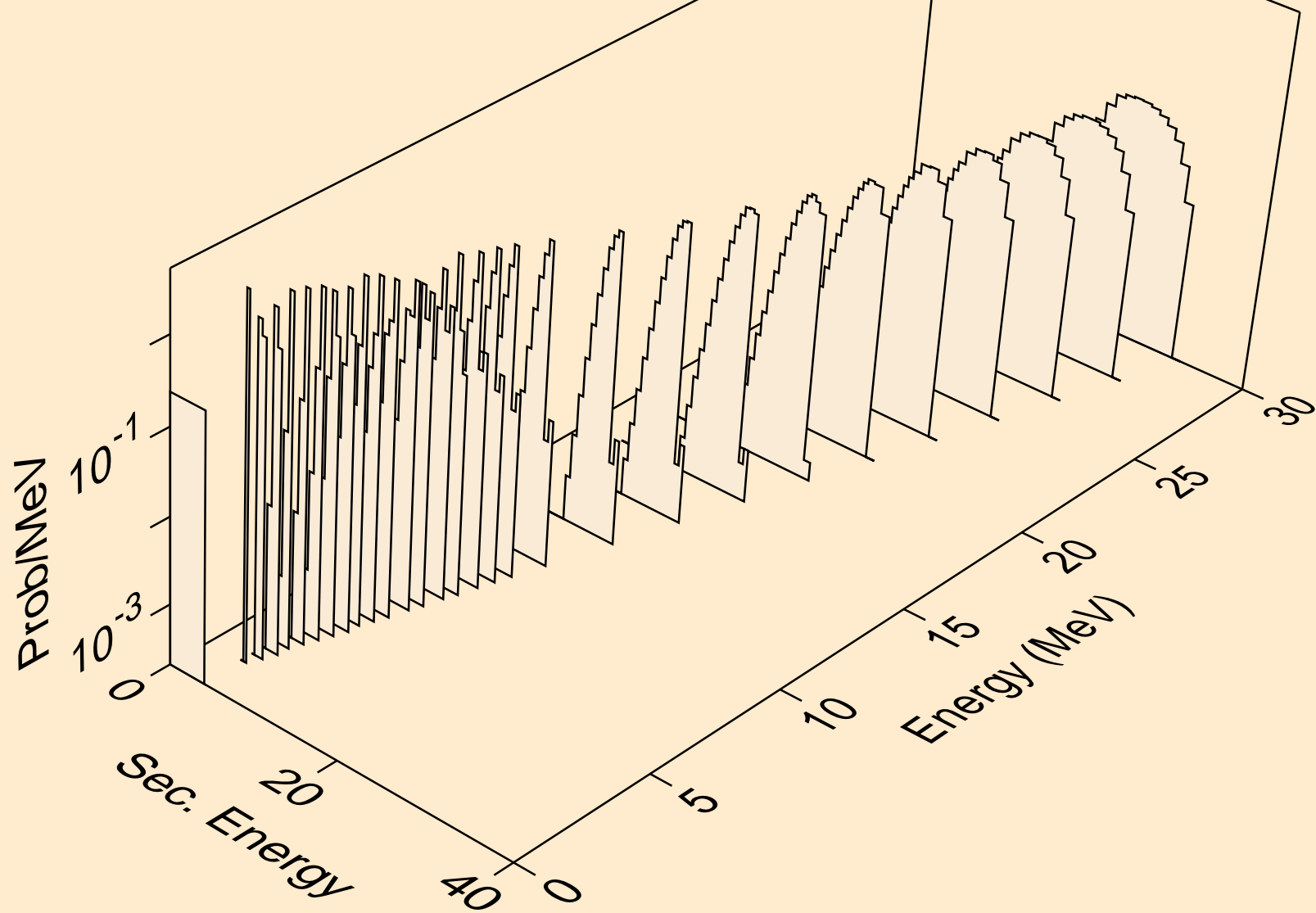

RE169M NEUTRON ACER TENDL-2021 LIBRARY; T=293.6K
alphas from (n,x)

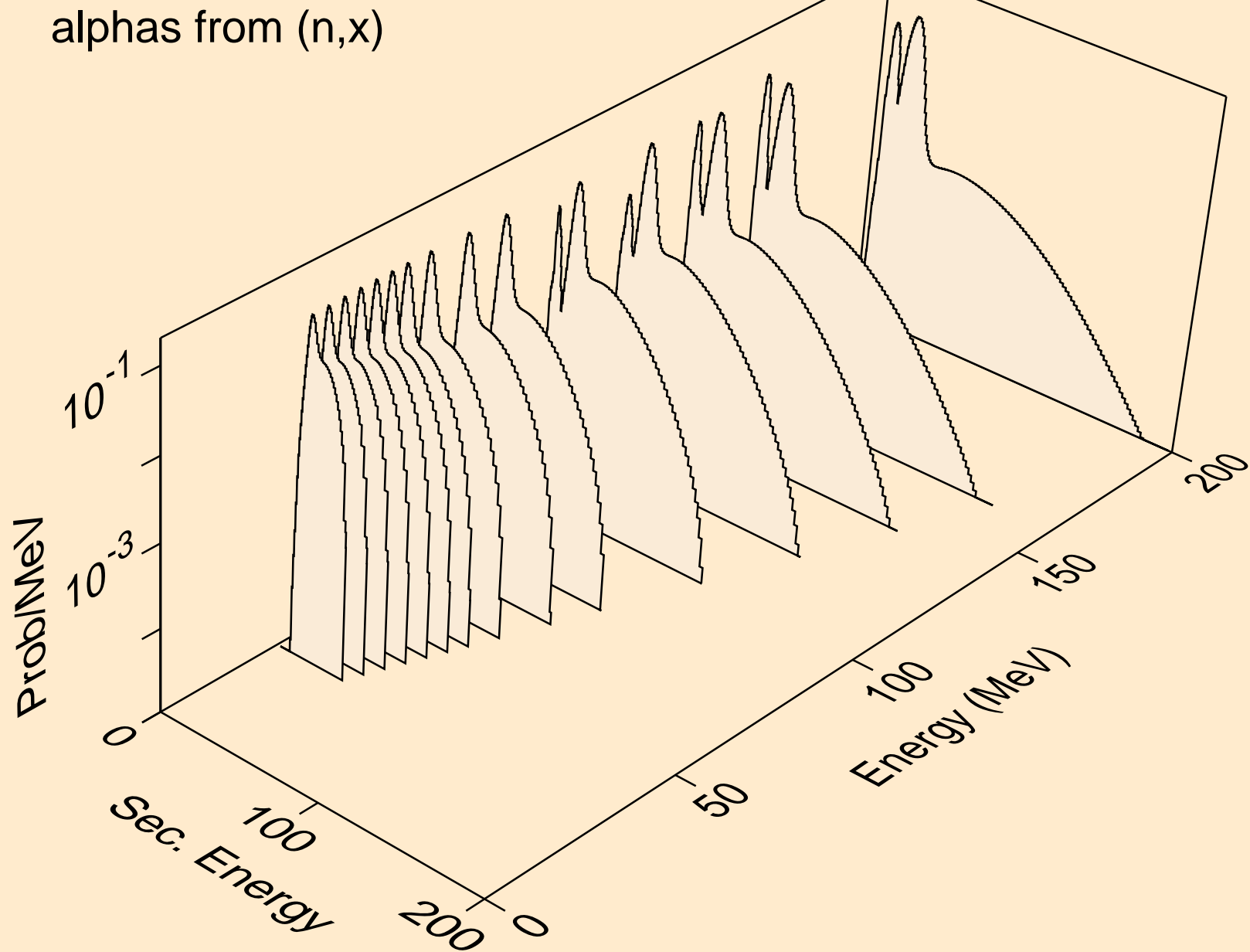

RE169M NEUTRON ACER TENDL-2021 LIBRARY; T=293.6K
alphas from (n,n*)a

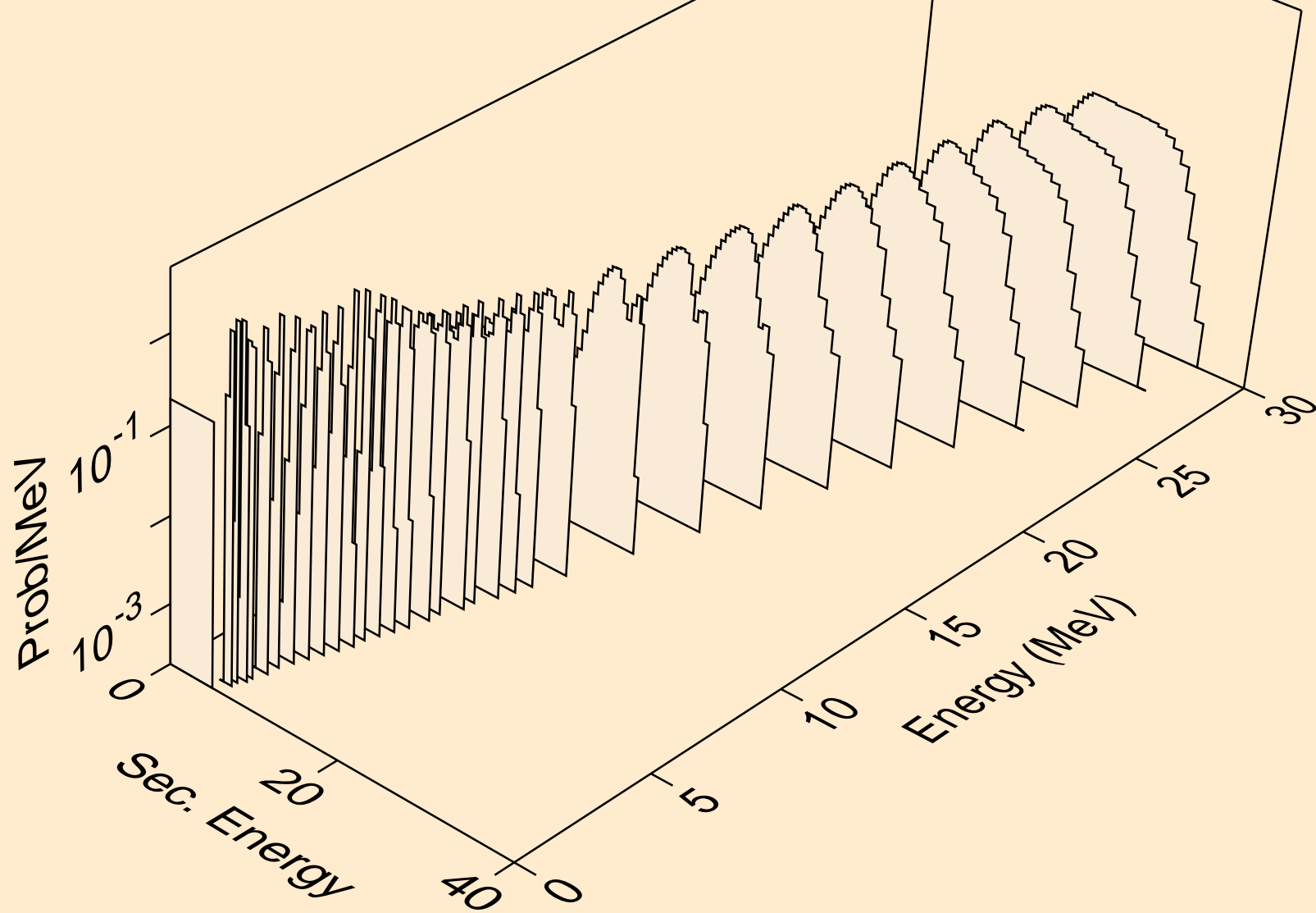

RE169M NEUTRON ACER TENDL-2021 LIBRARY; T=293.6K
alphas from (n,n*)3a

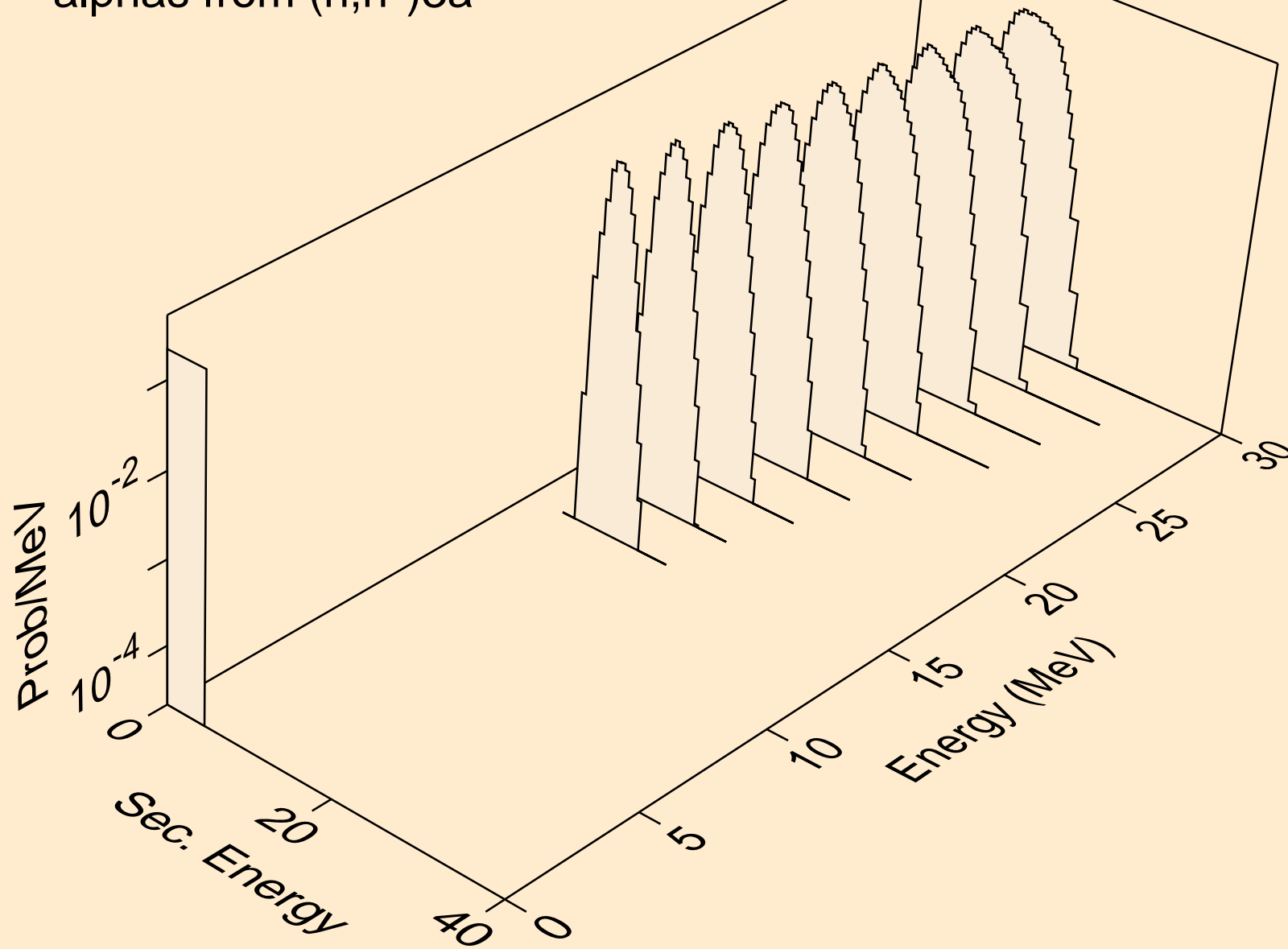

RE169M NEUTRON ACER TENDL-2021 LIBRARY; T=293.6K
alphas from (n,2n)a

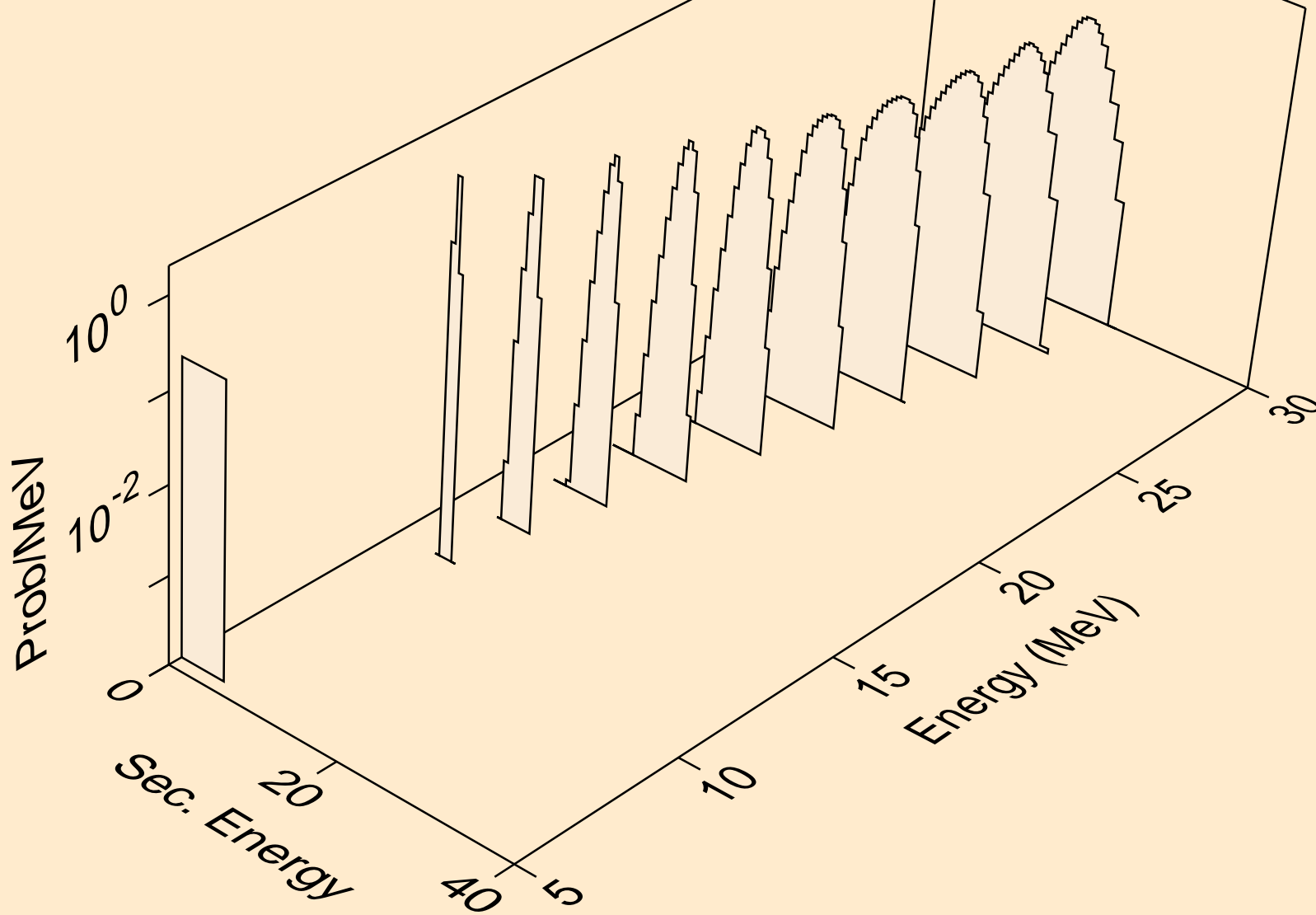

RE169M NEUTRON ACER TENDL-2021 LIBRARY; T=293.6K
alphas from (n,3n)a

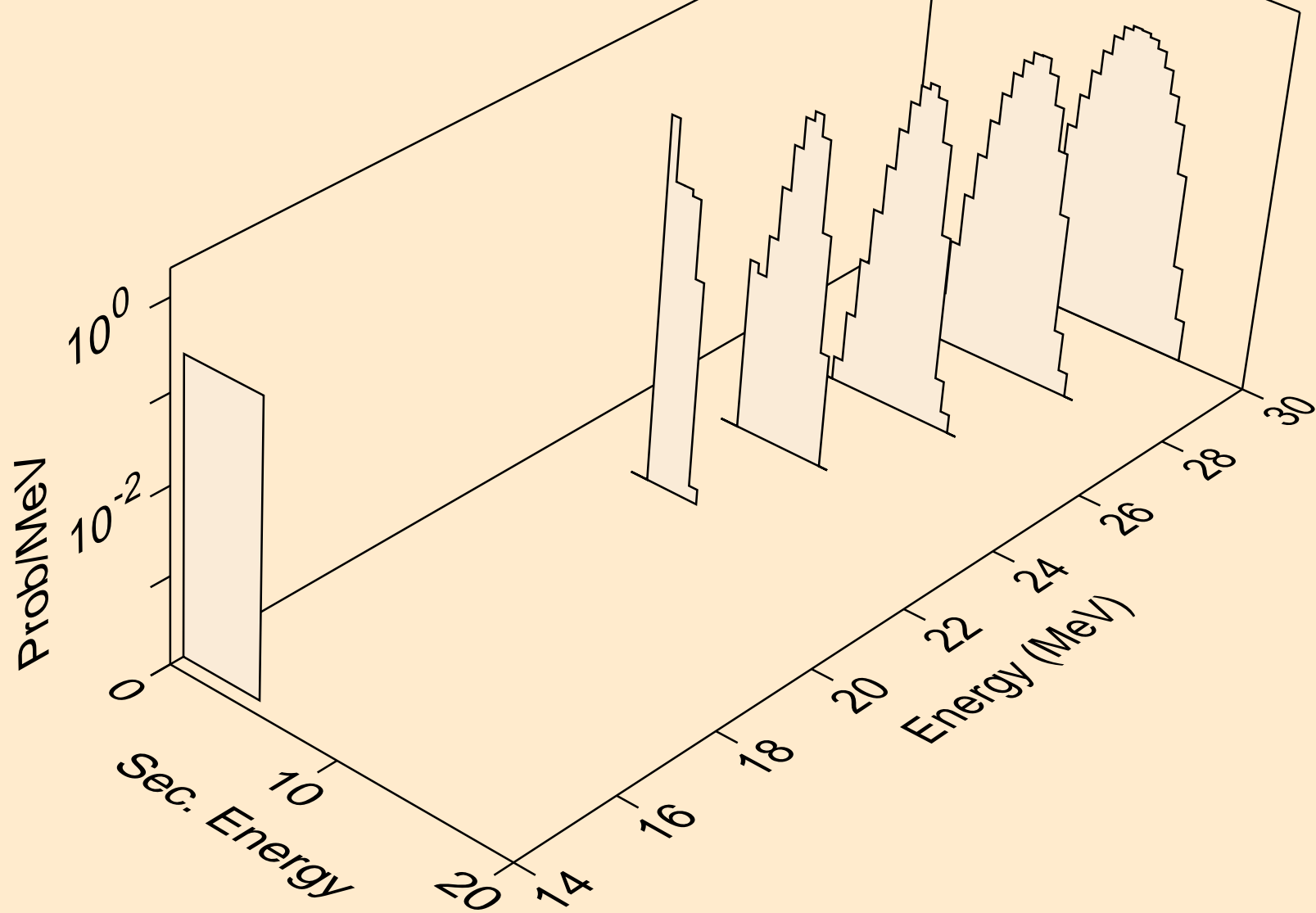

RE169M NEUTRON ACER TENDL-2021 LIBRARY; T=293.6K
alphas from (n,n*)2a

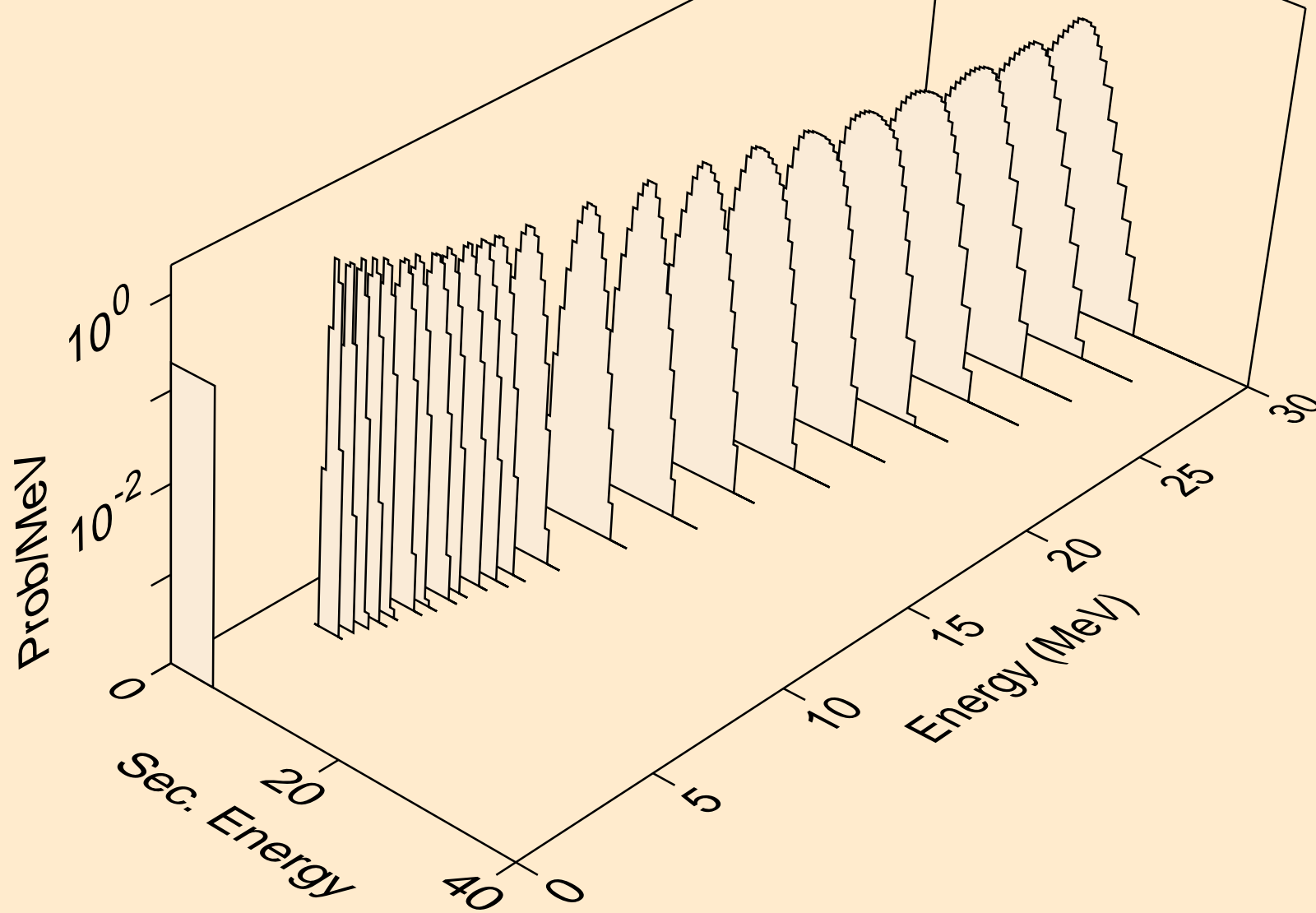

RE169M NEUTRON ACER TENDL-2021 LIBRARY; T=293.6K
alphas from (n,2n)2a

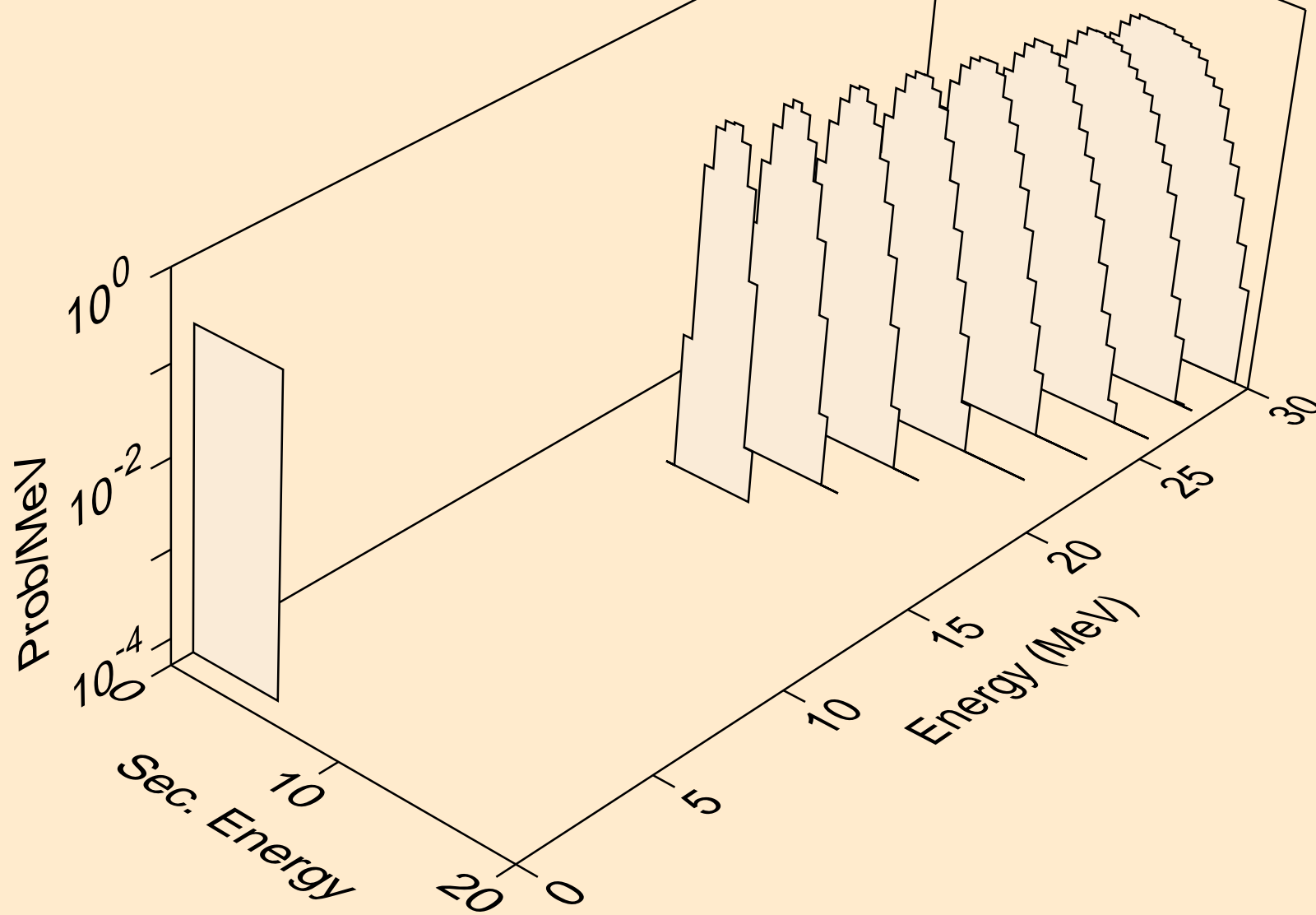

RE169M NEUTRON ACER TENDL-2021 LIBRARY; T=293.6K
alphas from (n,npa)

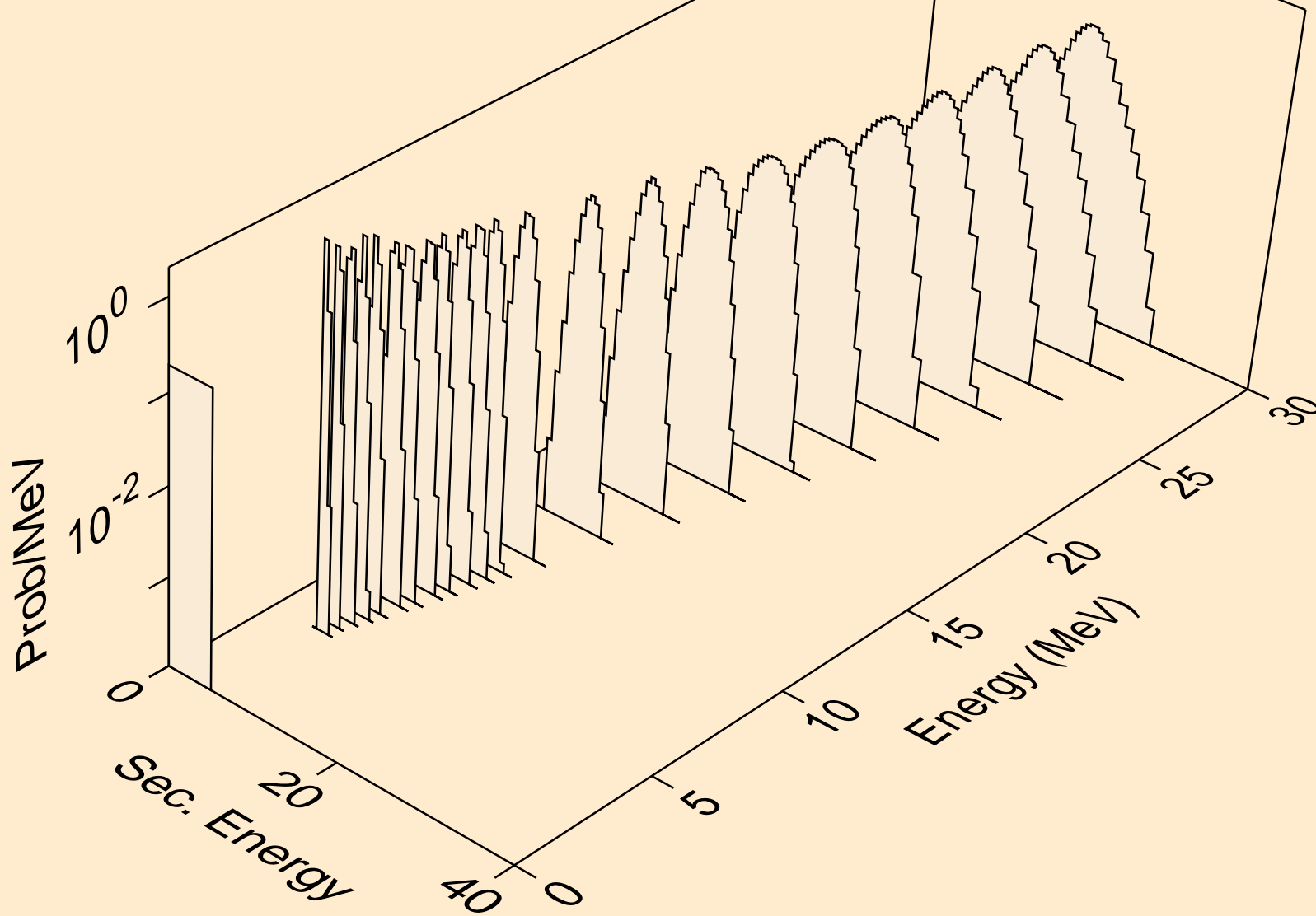

RE169M NEUTRON ACER TENDL-2021 LIBRARY; T=293.6K
alphas from (n,a)

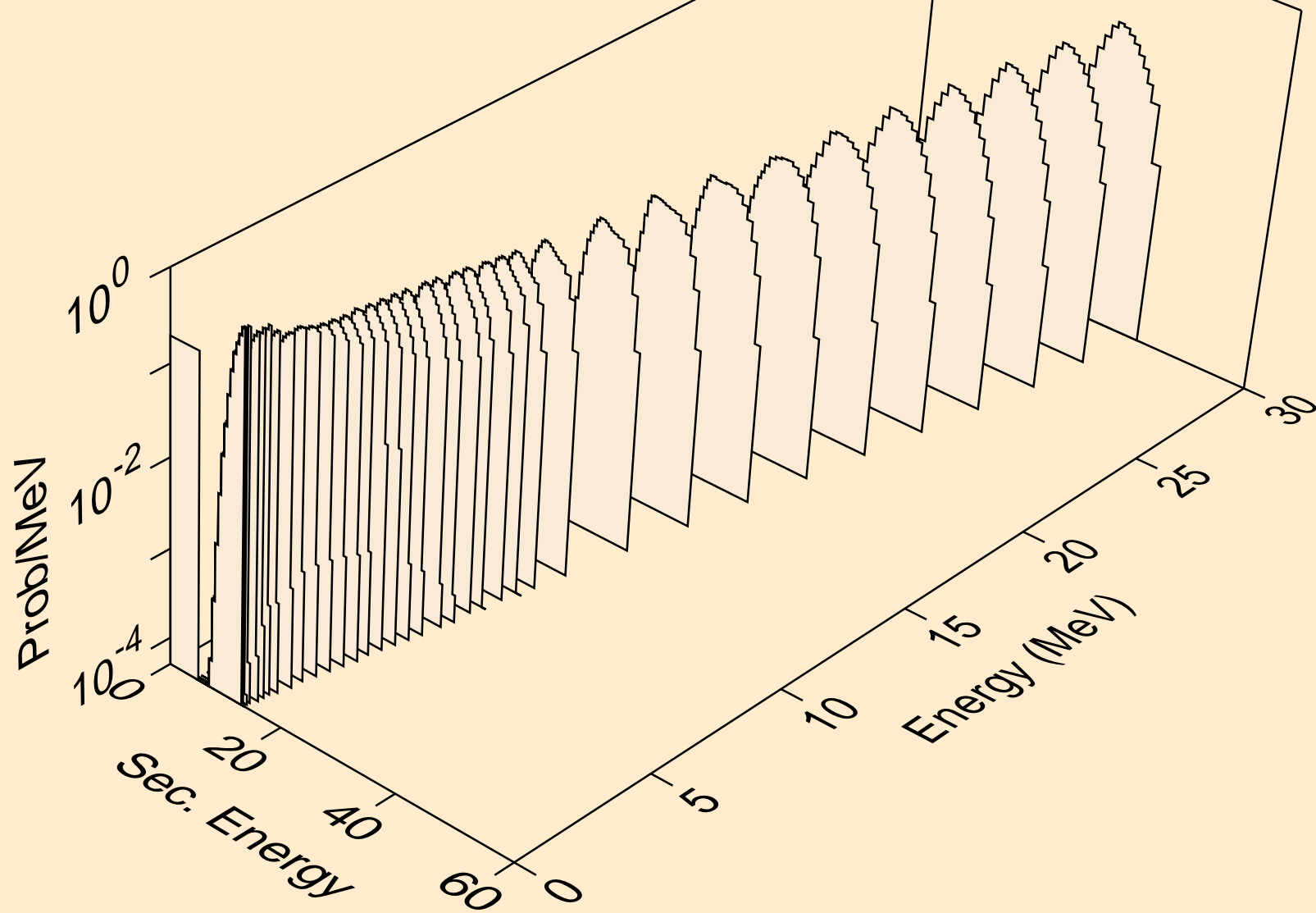

RE169M NEUTRON ACER TENDL-2021 LIBRARY; T=293.6K
alphas from (n,2a)

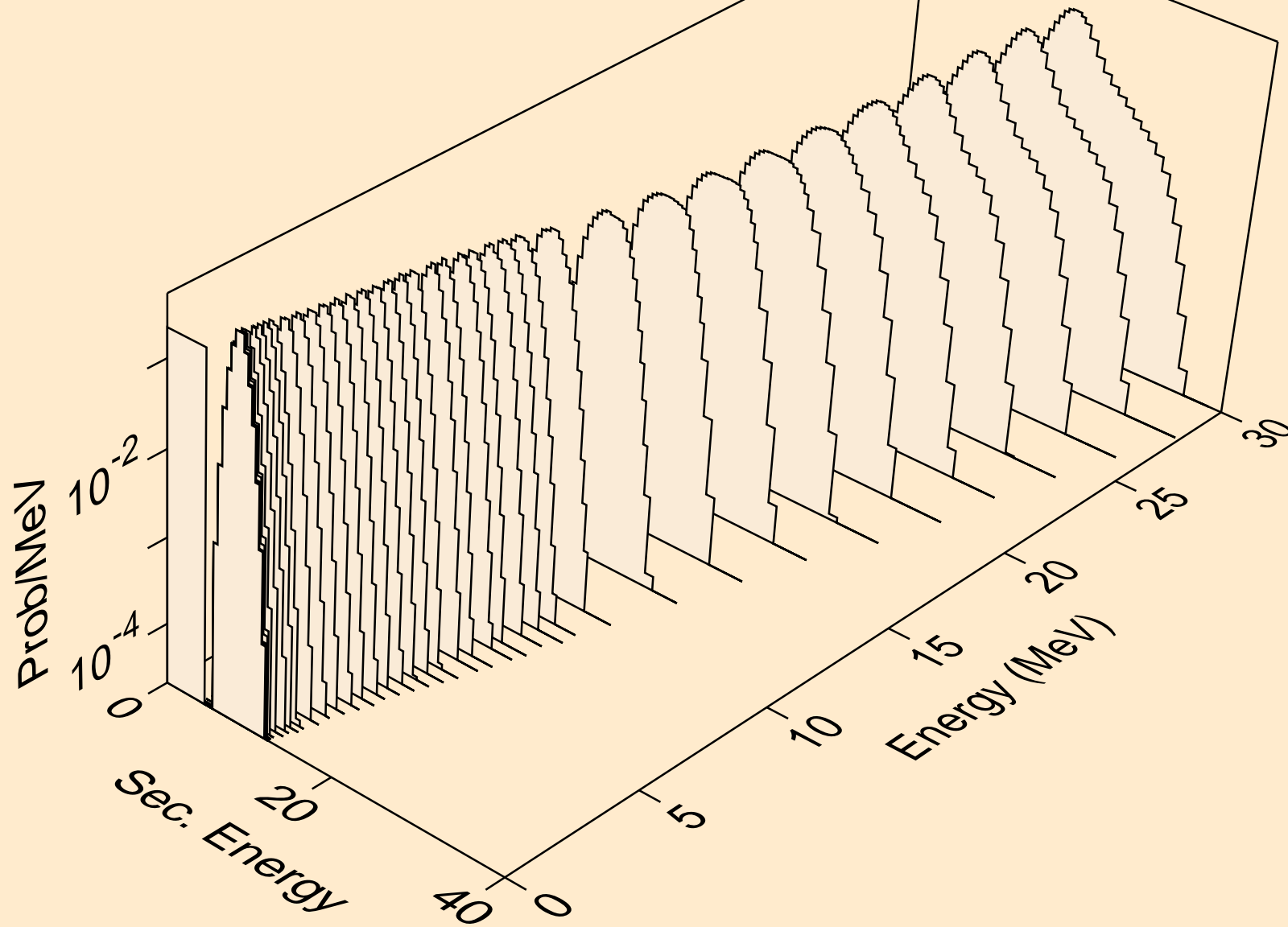

RE169M NEUTRON ACER TENDL-2021 LIBRARY; T=293.6K
alphas from (n,3a)

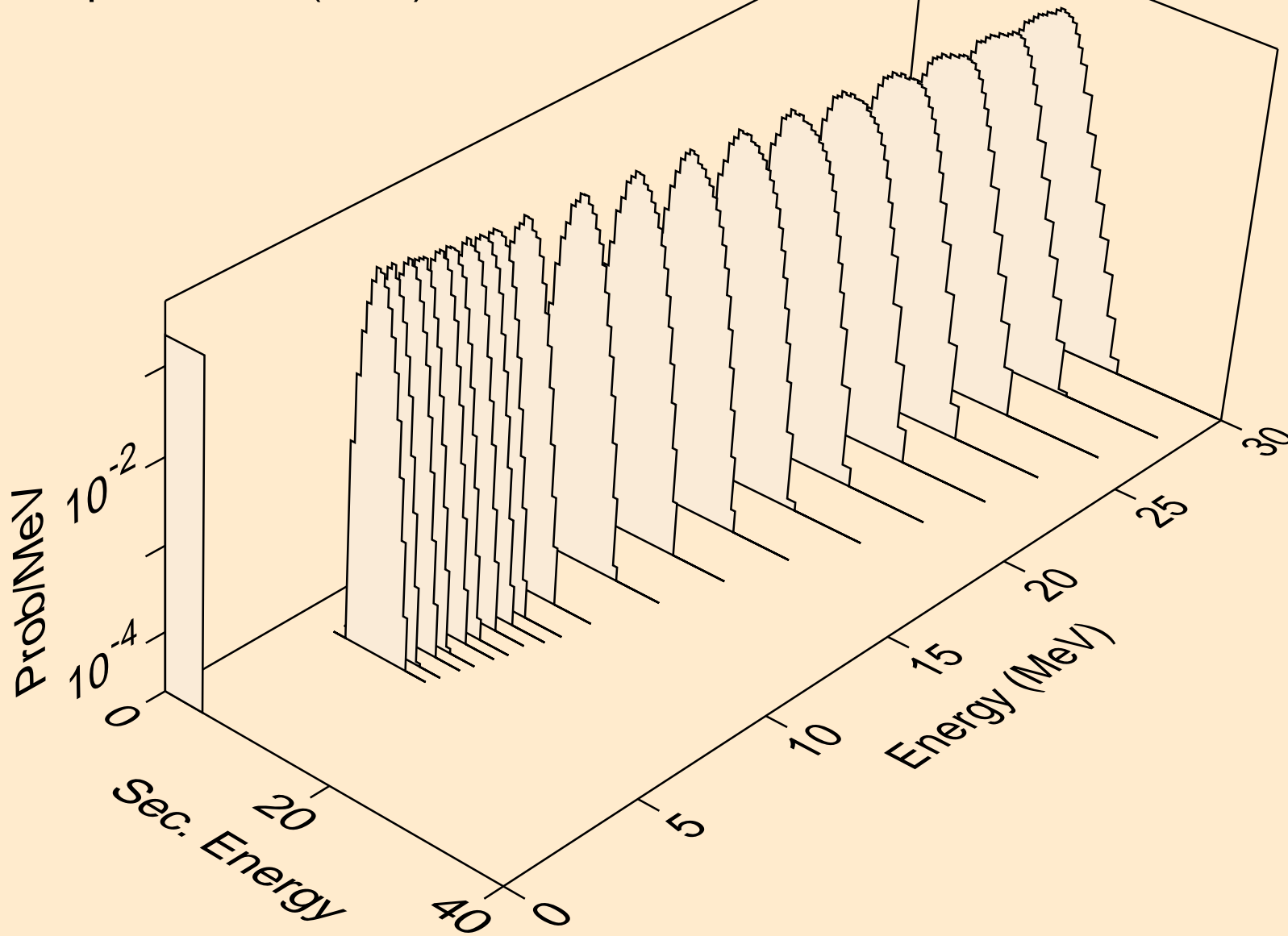

RE169M NEUTRON ACER TENDL-2021 LIBRARY; T=293.6K
alphas from (n,pa)

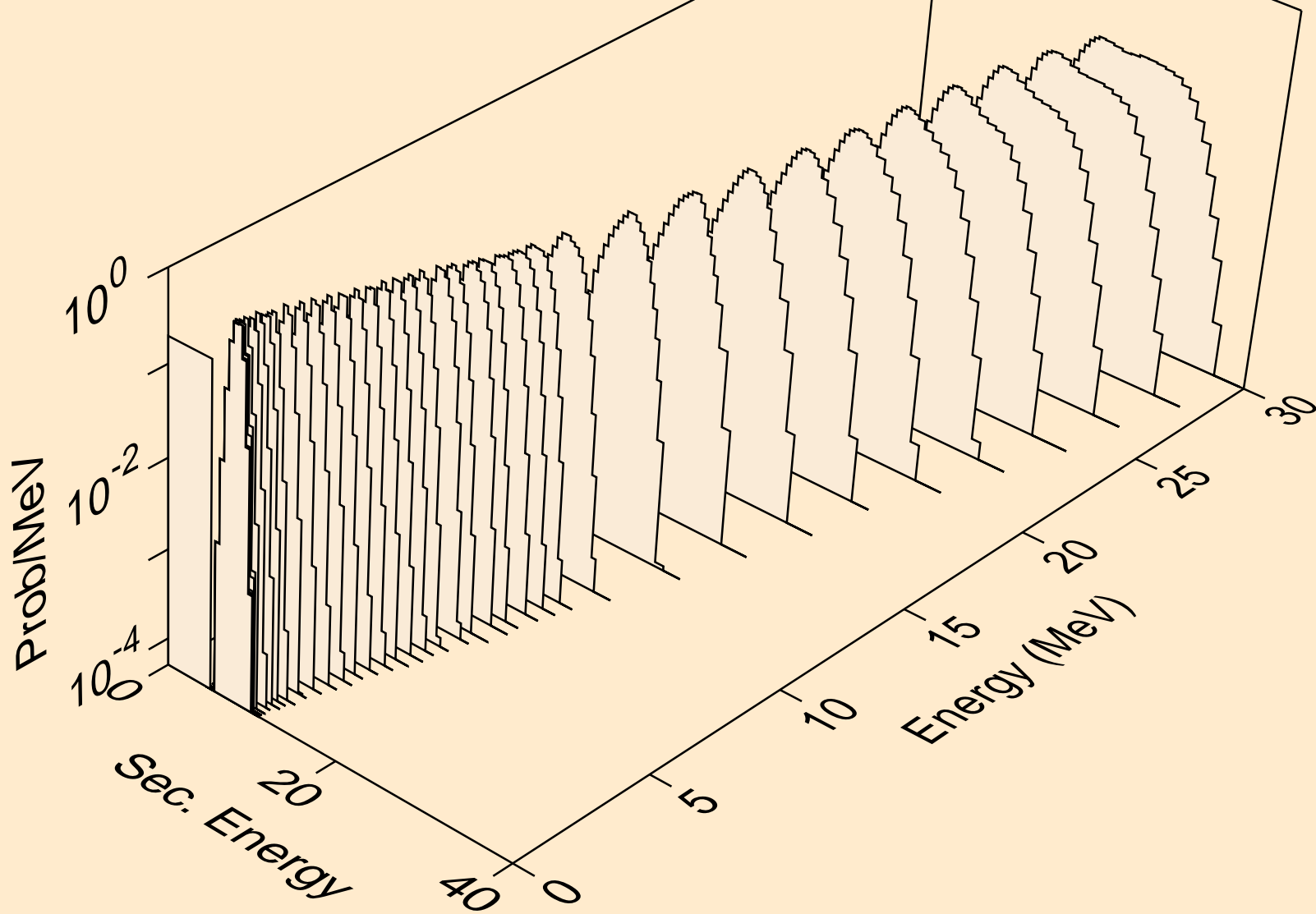

RE169M NEUTRON ACER TENDL-2021 LIBRARY; T=293.6K
alphas from (n,d2a)

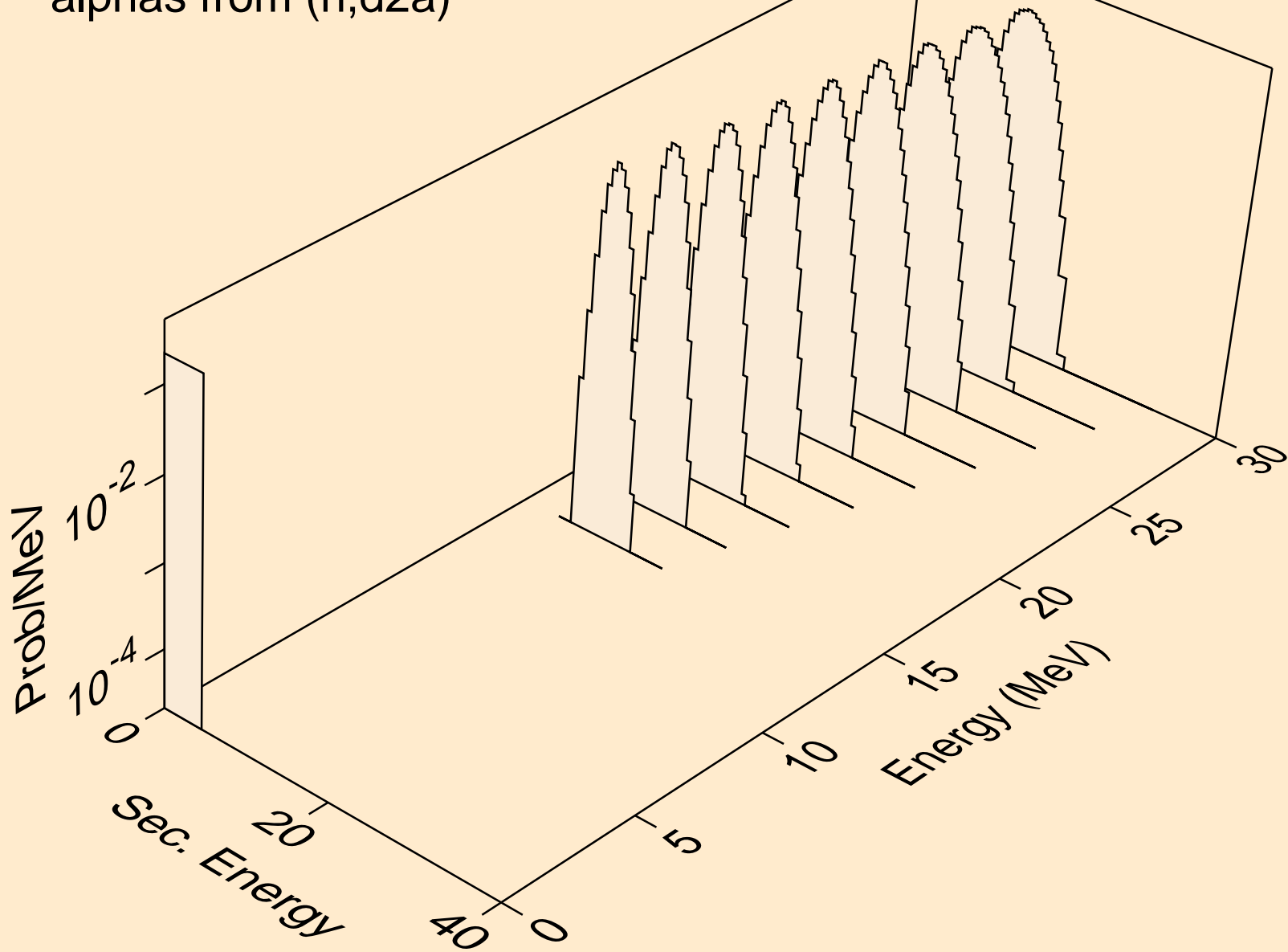

RE169M NEUTRON ACER TENDL-2021 LIBRARY; T=293.6K
alphas from (n,da)

