

# RE170 NEUTRON ACER TENDL-2021 LIBRARY; T=293.6K

## Principal cross sections

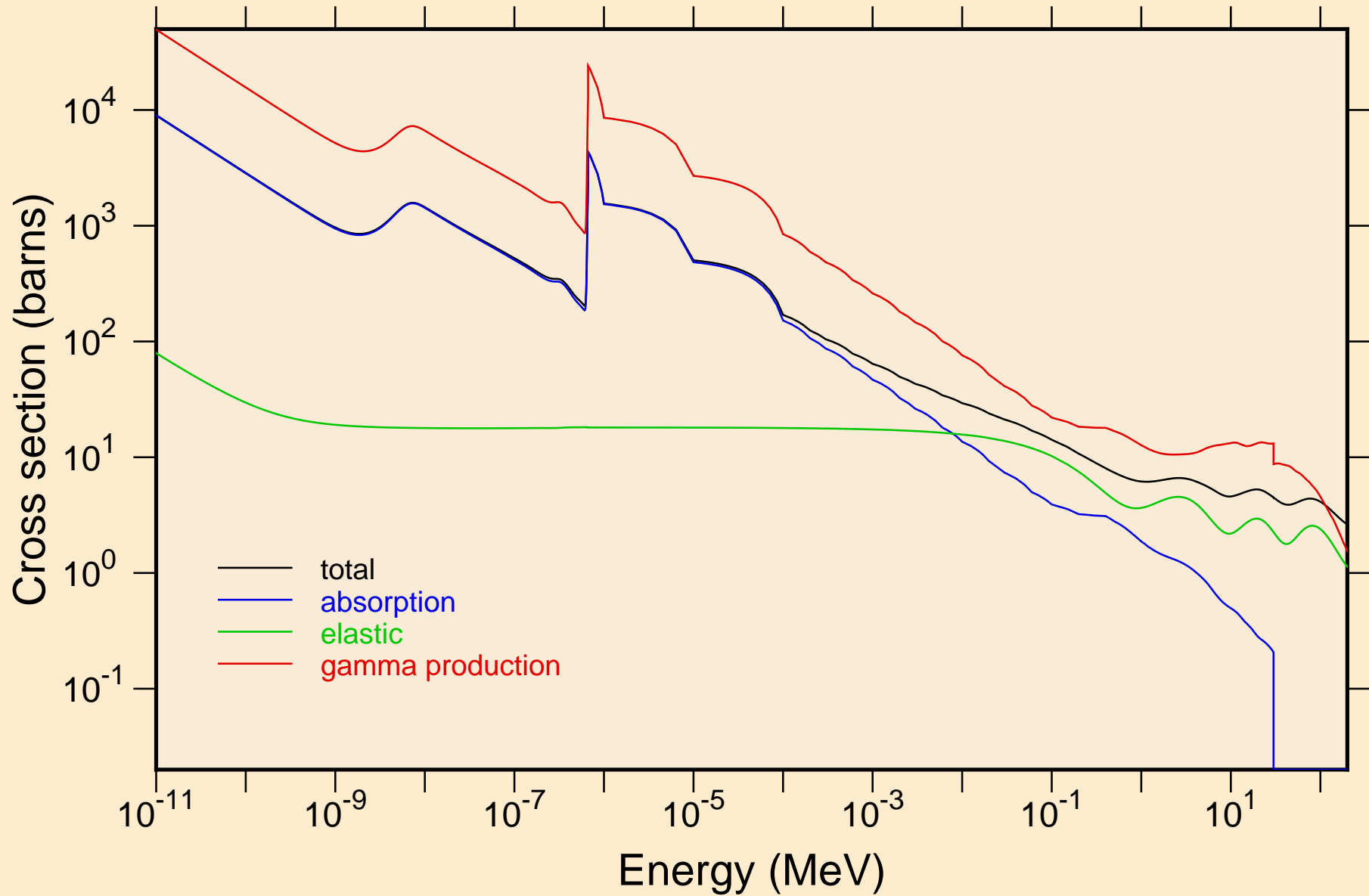

RE170 NEUTRON ACER TENDL-2021 LIBRARY; T=293.6K  
Heating

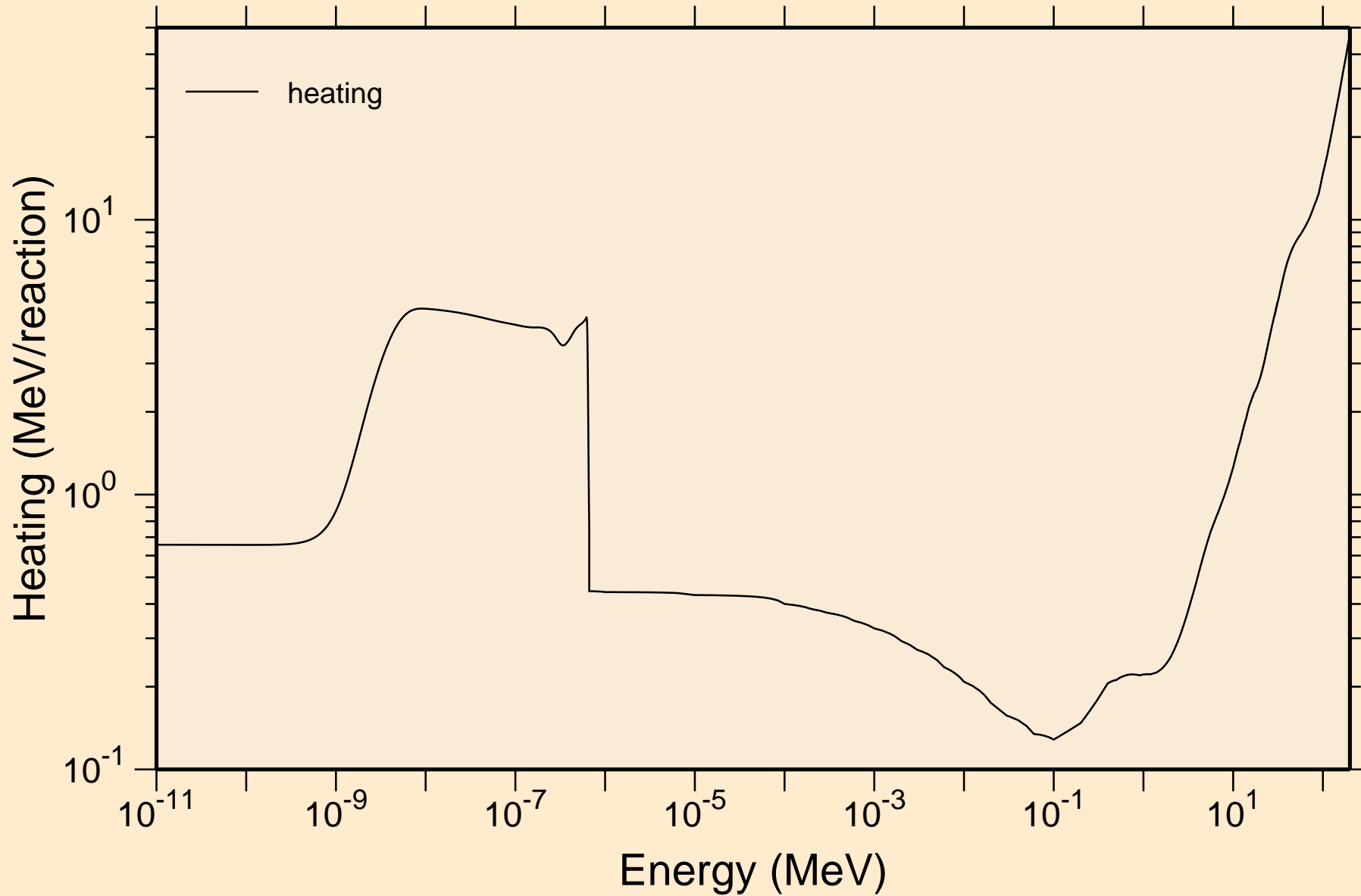

RE170 NEUTRON ACER TENDL-2021 LIBRARY; T=293.6K  
Damage

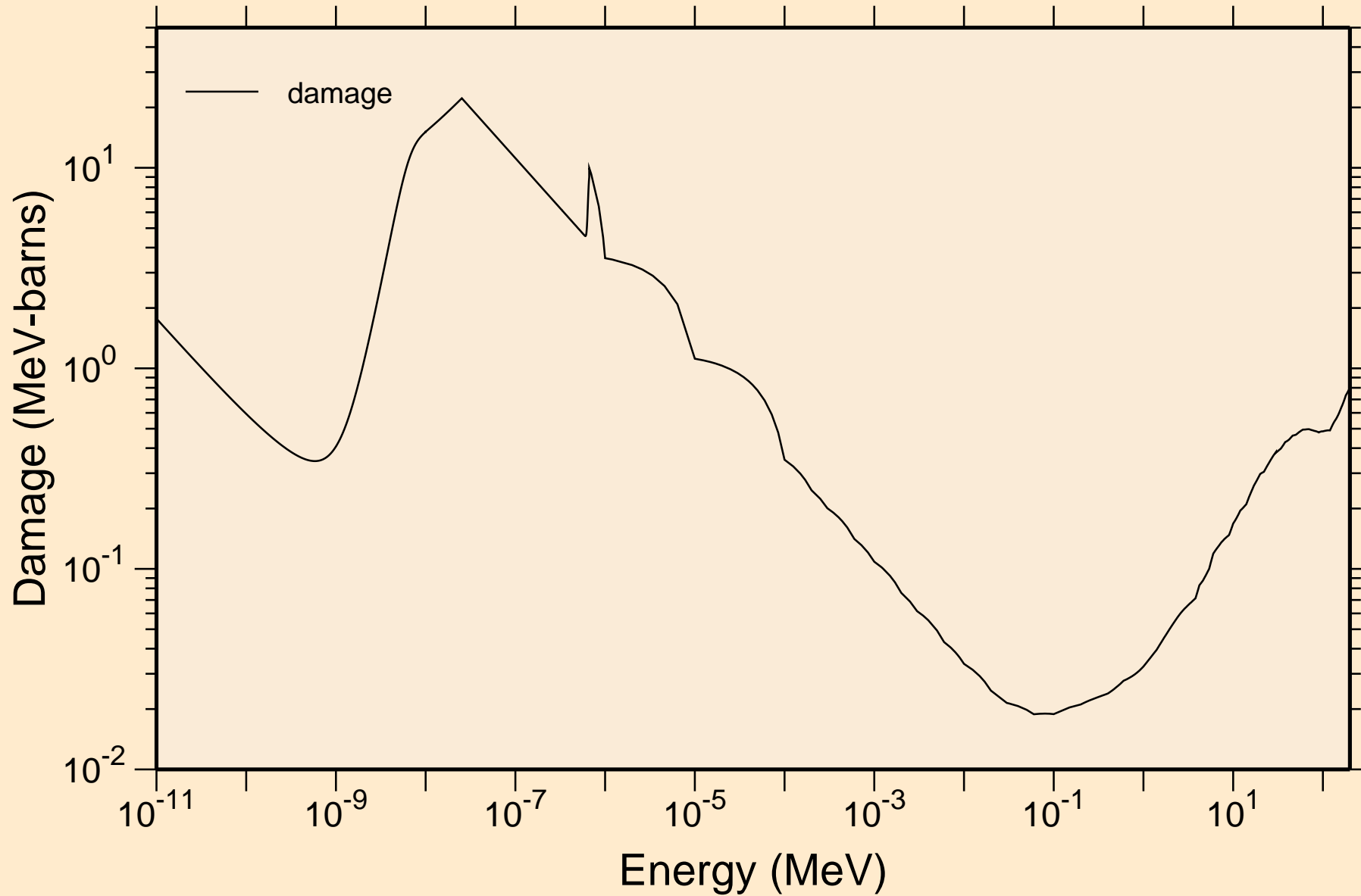

RE170 NEUTRON ACER TENDL-2021 LIBRARY; T=293.6K  
Non-threshold reactions

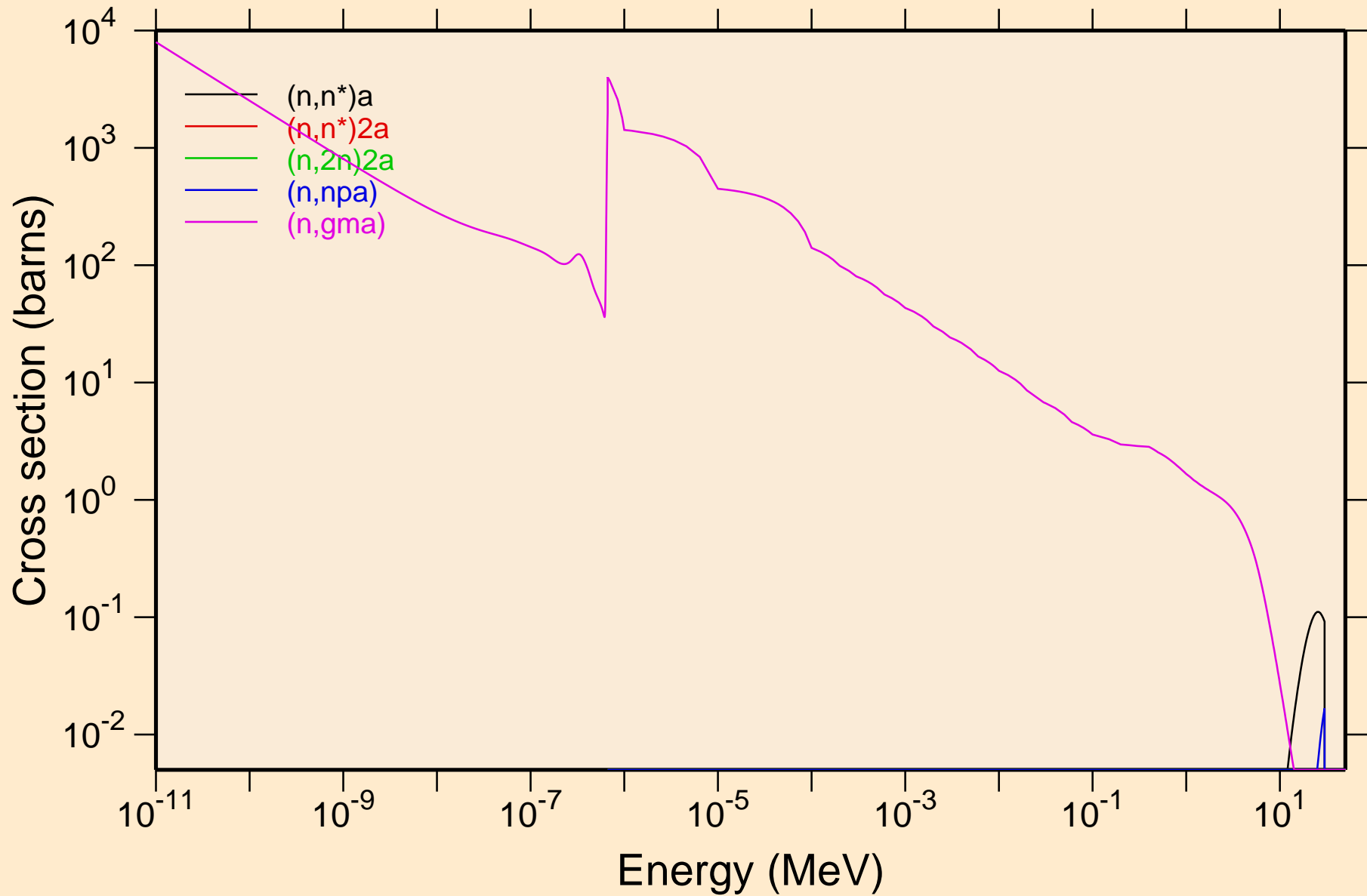

RE170 NEUTRON ACER TENDL-2021 LIBRARY; T=293.6K  
Non-threshold reactions

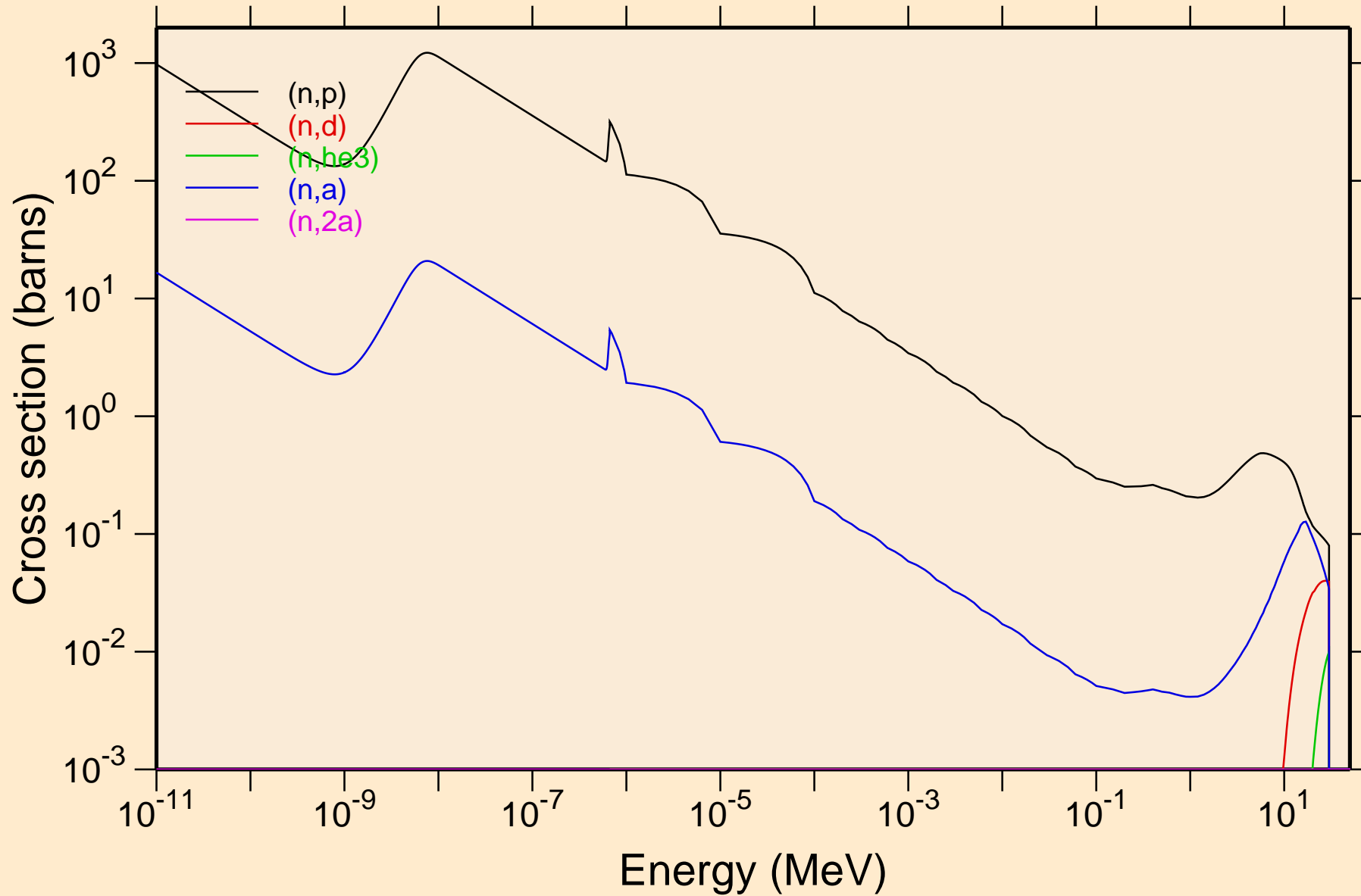

RE170 NEUTRON ACER TENDL-2021 LIBRARY; T=293.6K  
Non-threshold reactions

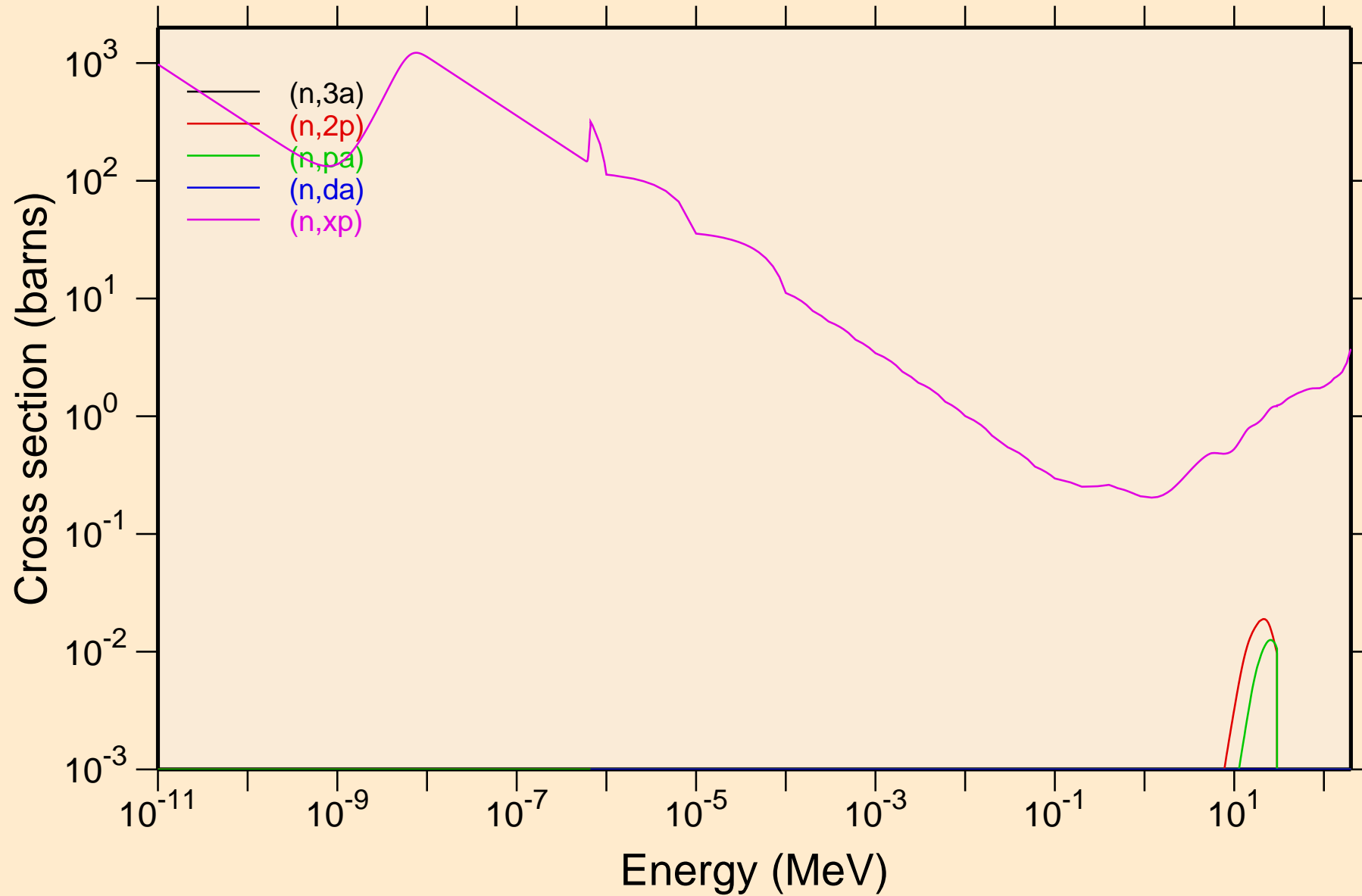

RE170 NEUTRON ACER TENDL-2021 LIBRARY; T=293.6K  
Non-threshold reactions

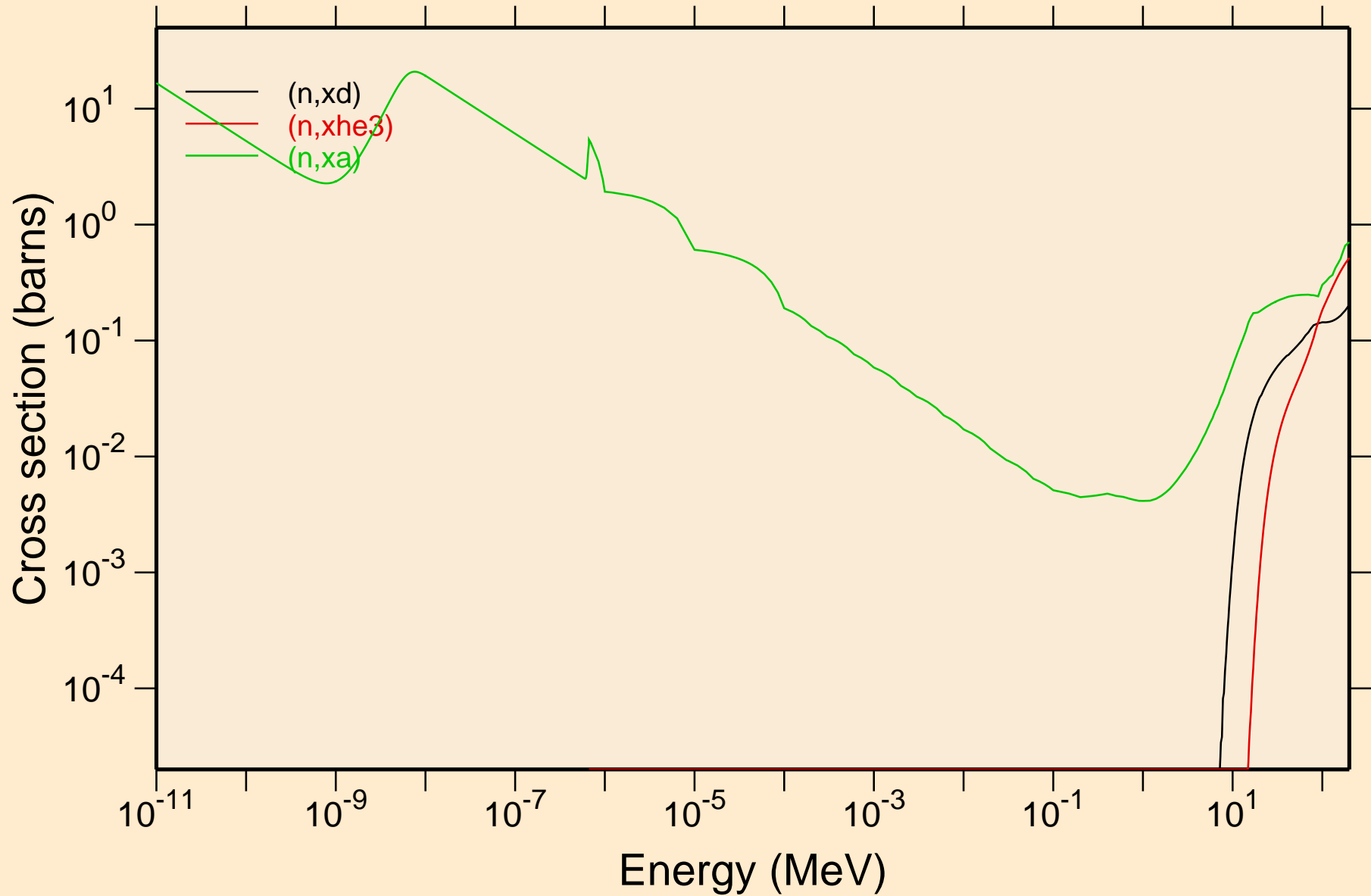

RE170 NEUTRON ACER TENDL-2021 LIBRARY; T=293.6K  
Principal cross sections

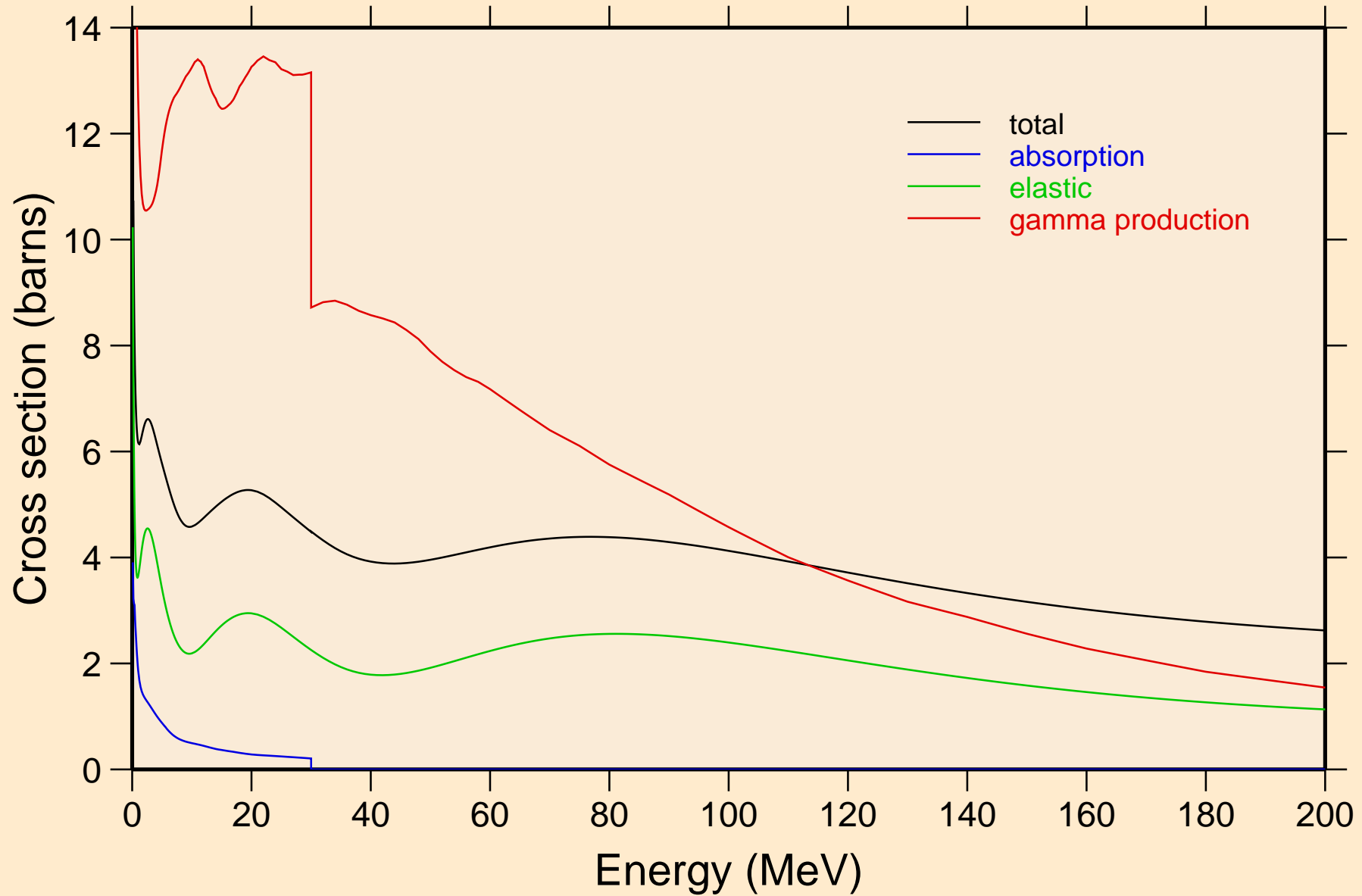



RE170 NEUTRON ACER TENDL-2021 LIBRARY; T=293.6K

Heating

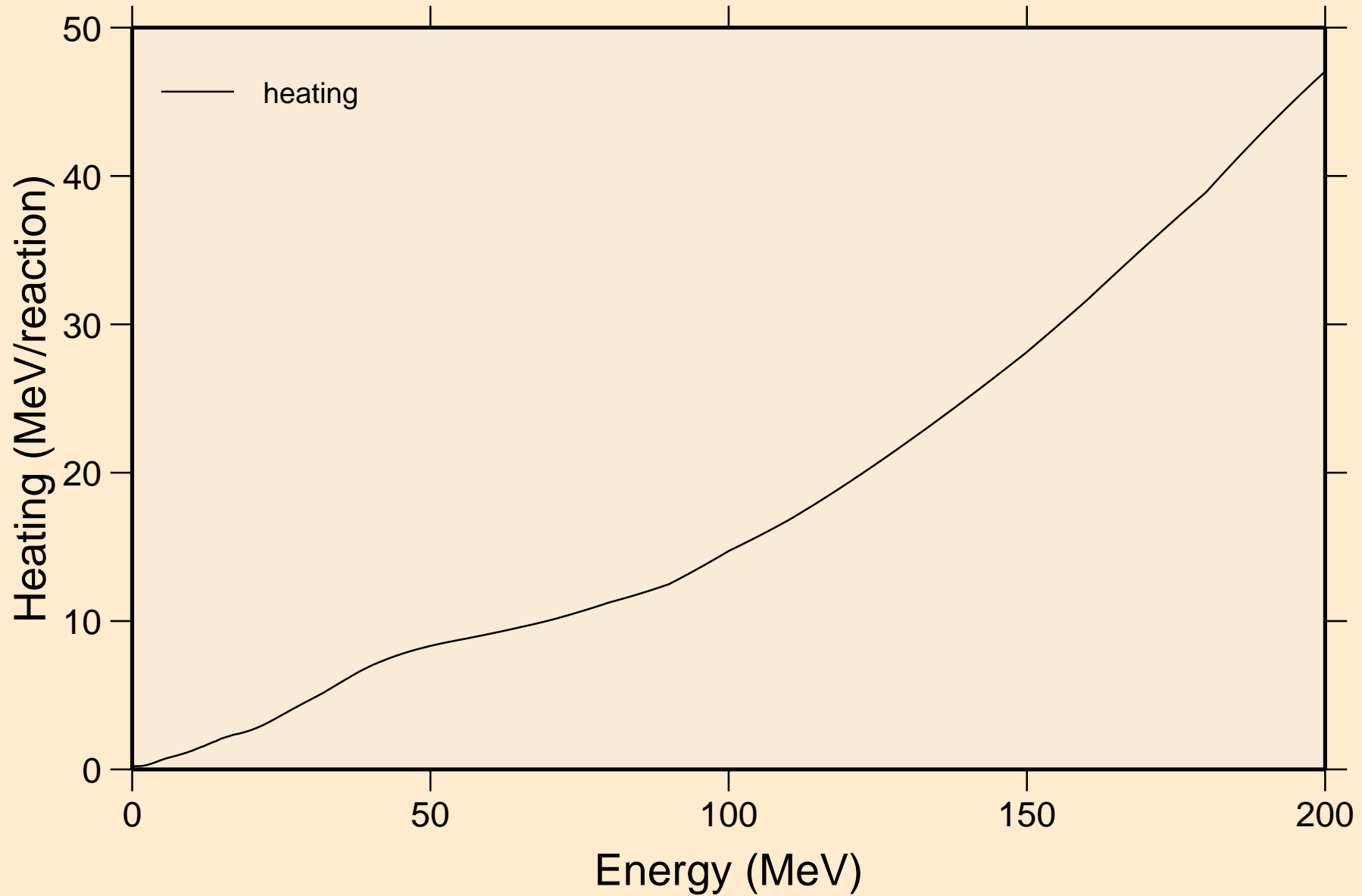

RE170 NEUTRON ACER TENDL-2021 LIBRARY; T=293.6K  
Damage

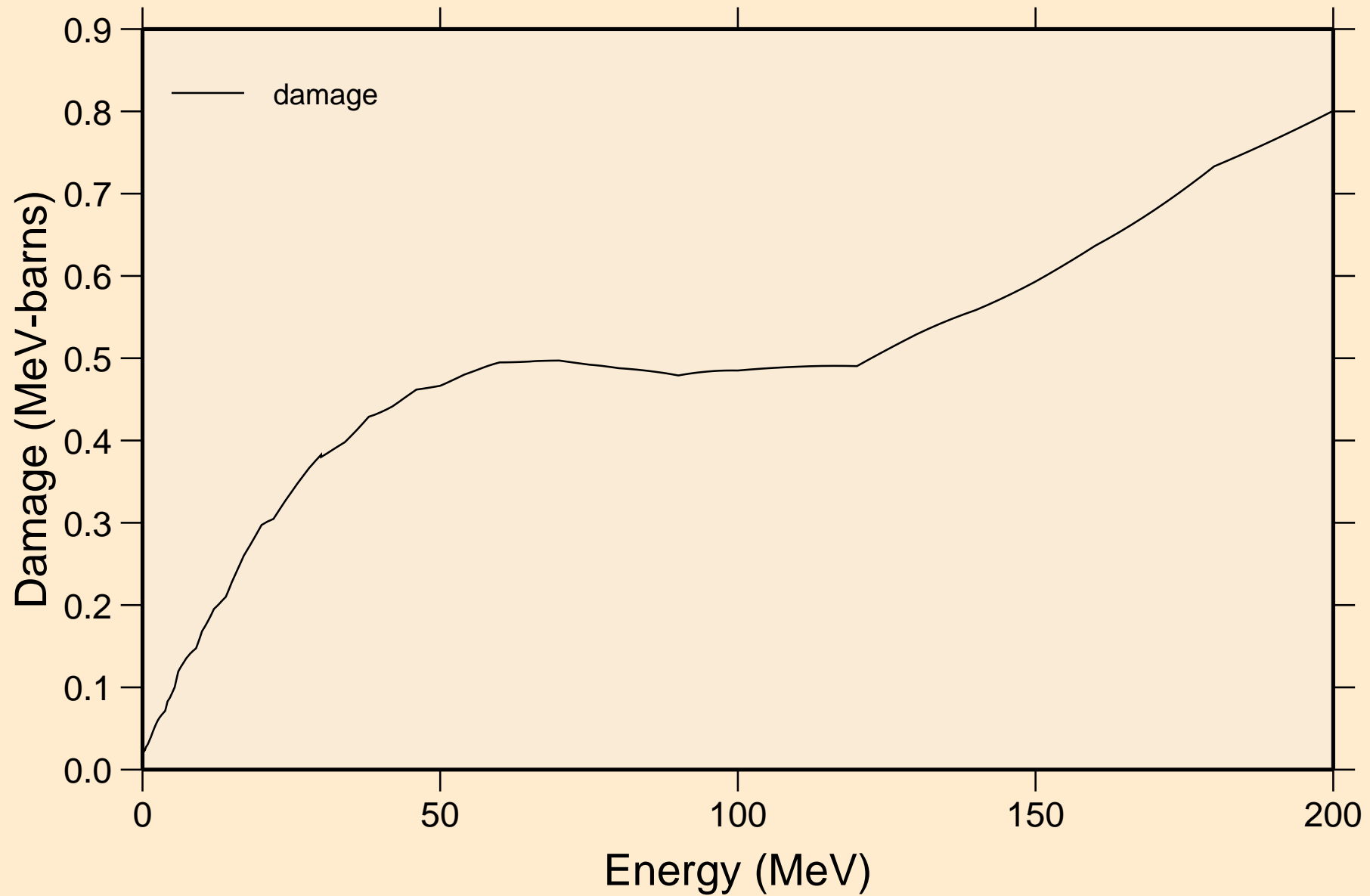

RE170 NEUTRON ACER TENDL-2021 LIBRARY; T=293.6K  
Non-threshold reactions

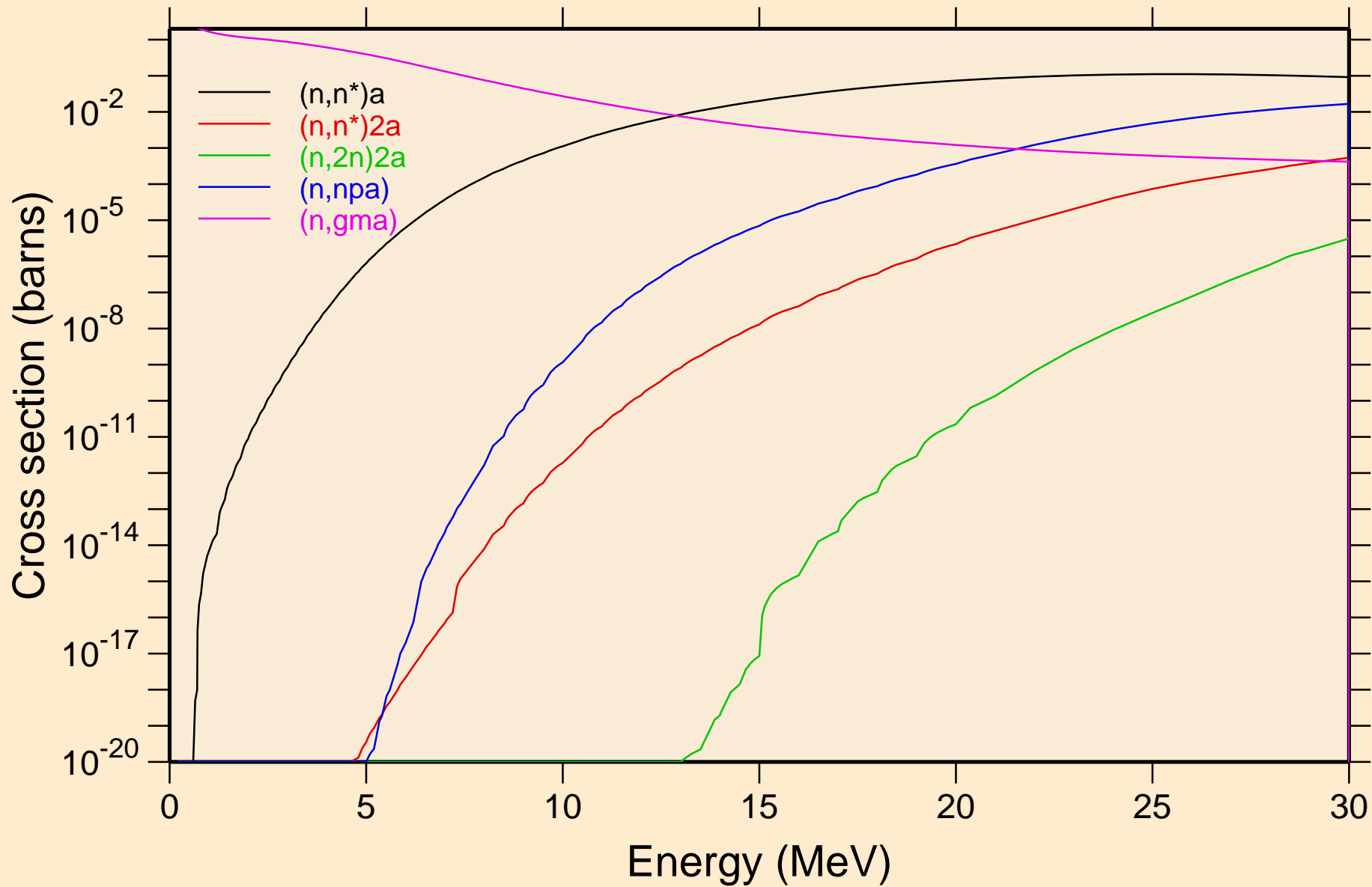

RE170 NEUTRON ACER TENDL-2021 LIBRARY; T=293.6K  
Non-threshold reactions

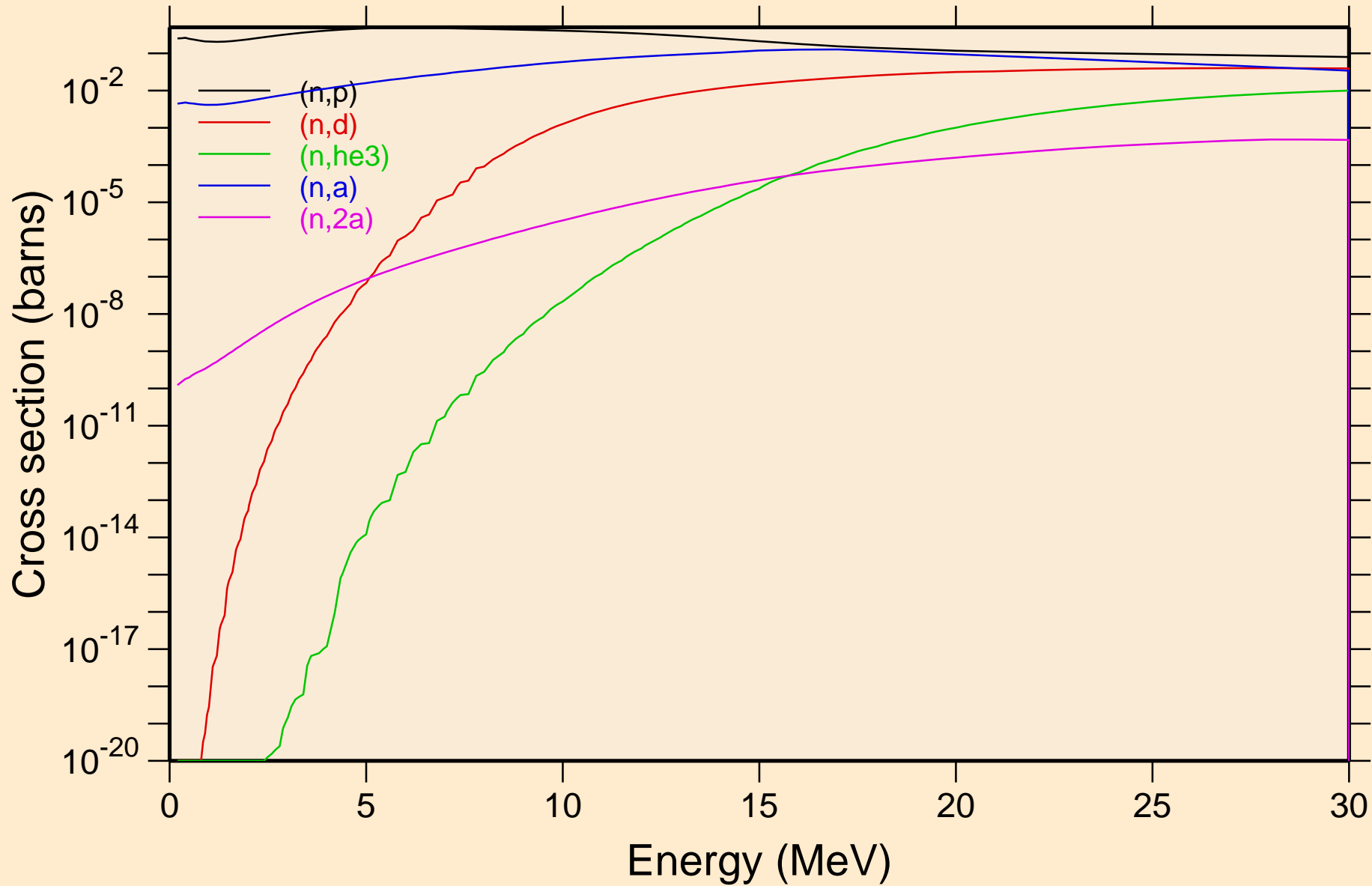

RE170 NEUTRON ACER TENDL-2021 LIBRARY; T=293.6K  
Non-threshold reactions

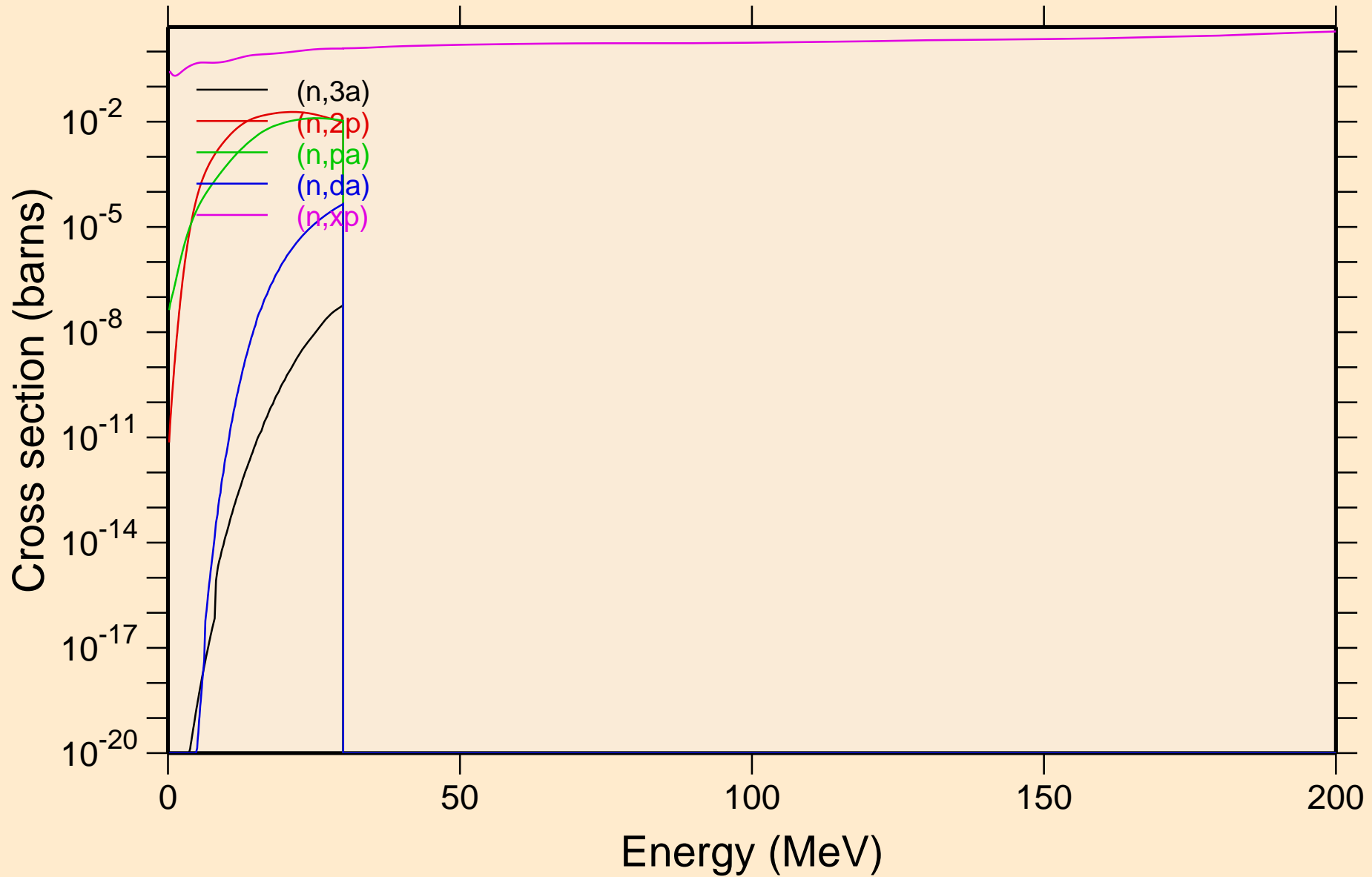

RE170 NEUTRON ACER TENDL-2021 LIBRARY; T=293.6K  
Non-threshold reactions

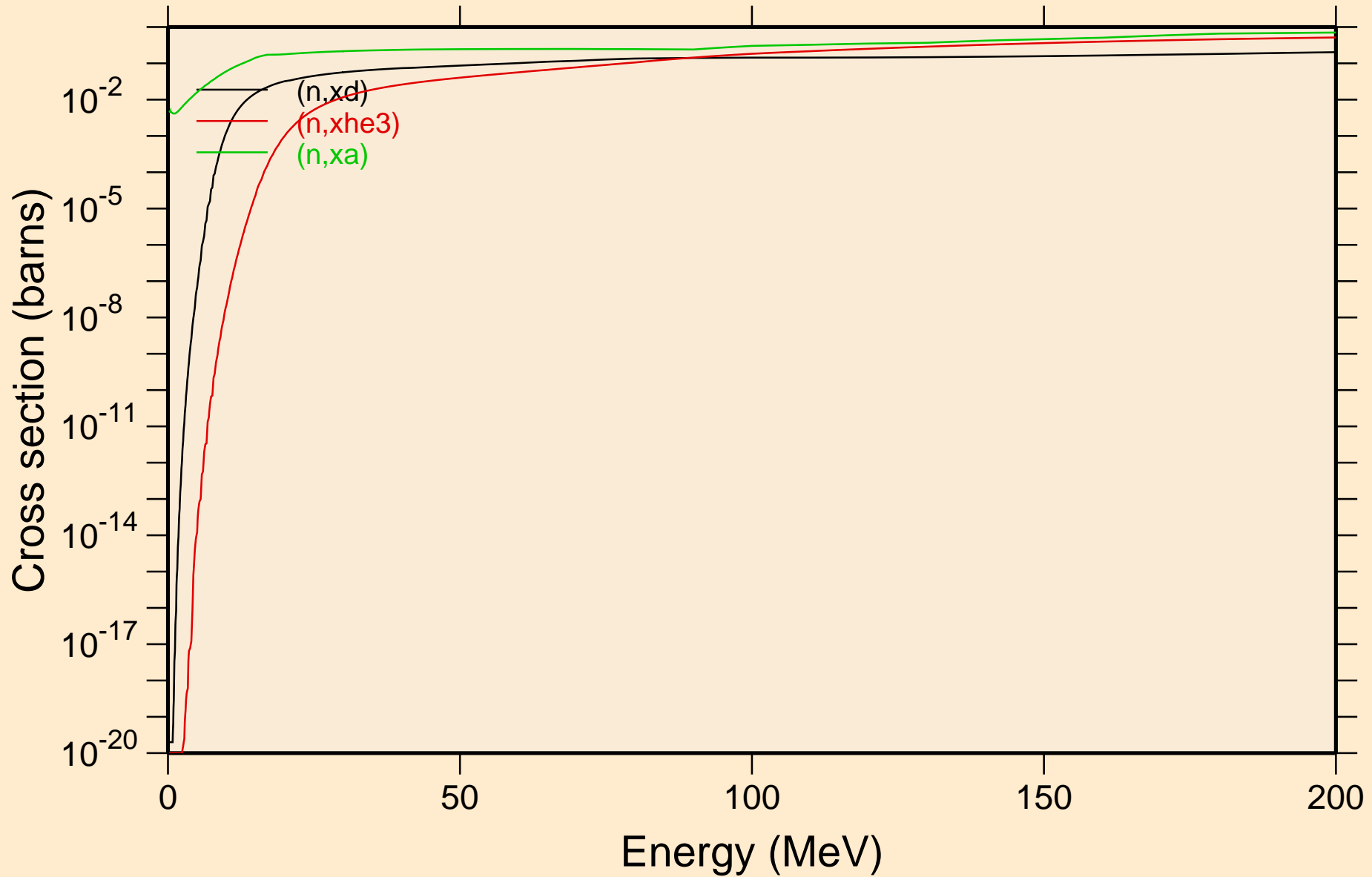

RE170 NEUTRON ACER TENDL-2021 LIBRARY; T=293.6K  
Inelastic levels

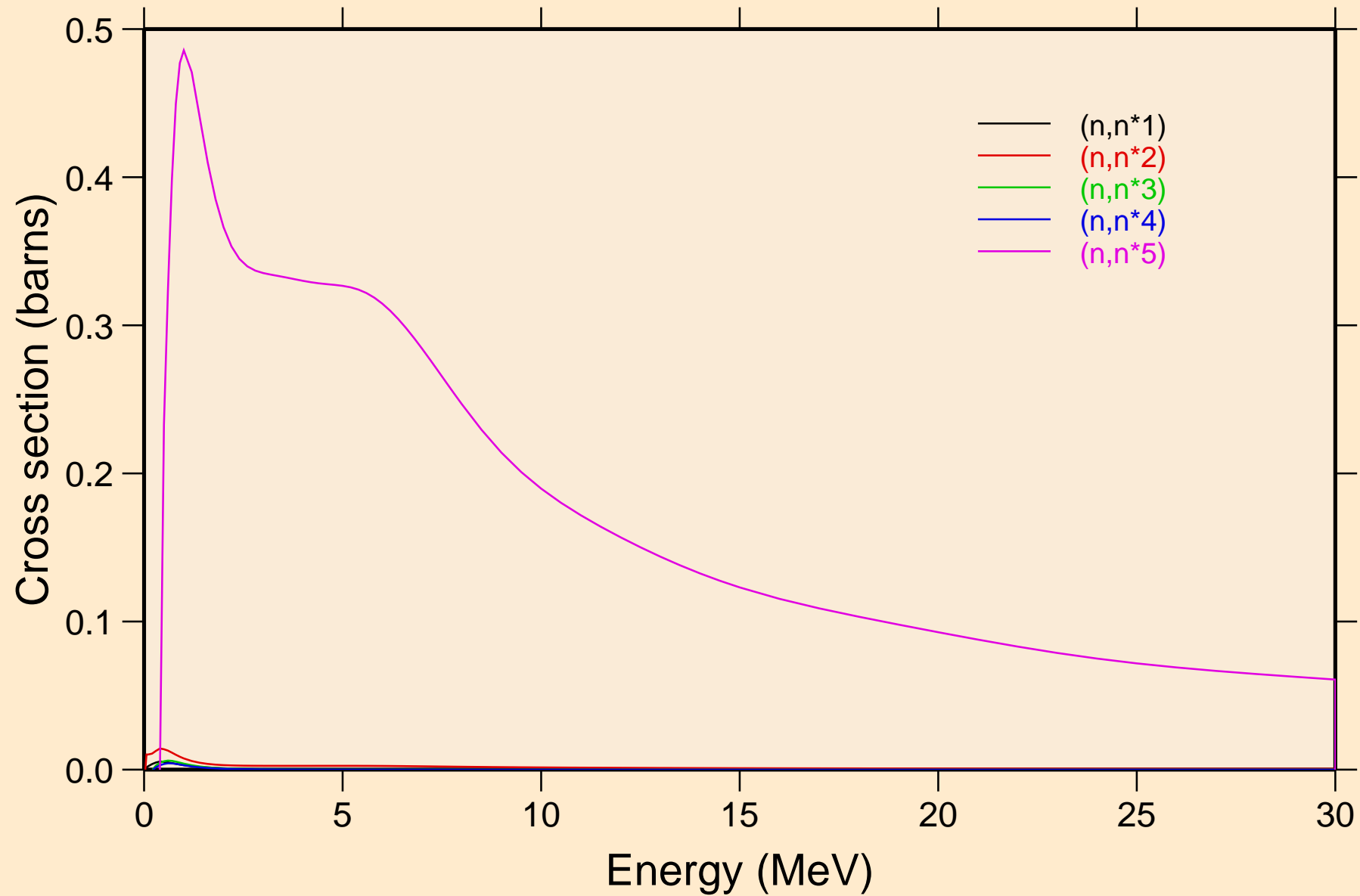

RE170 NEUTRON ACER TENDL-2021 LIBRARY; T=293.6K  
Inelastic levels

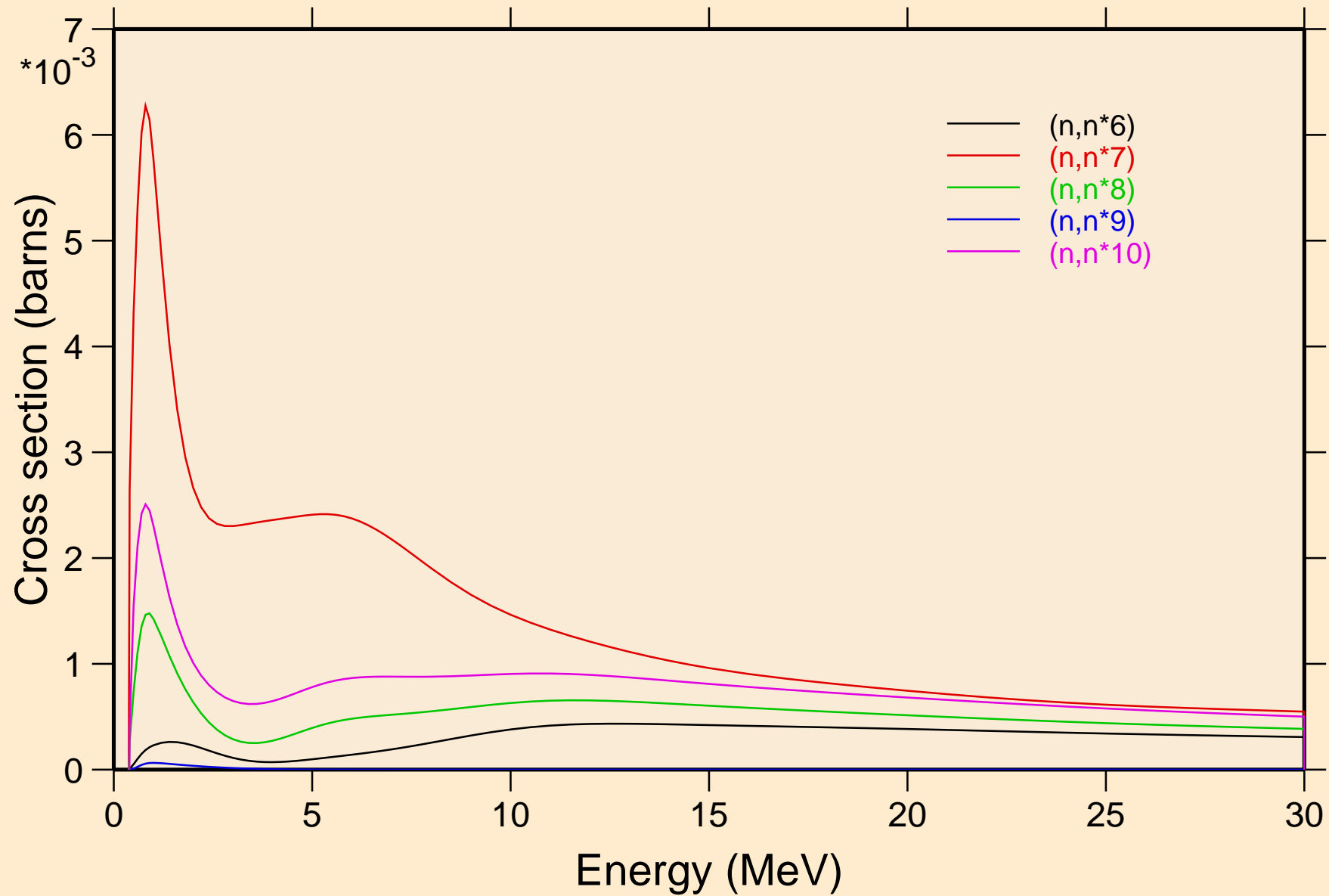



RE170 NEUTRON ACER TENDL-2021 LIBRARY; T=293.6K  
Inelastic levels

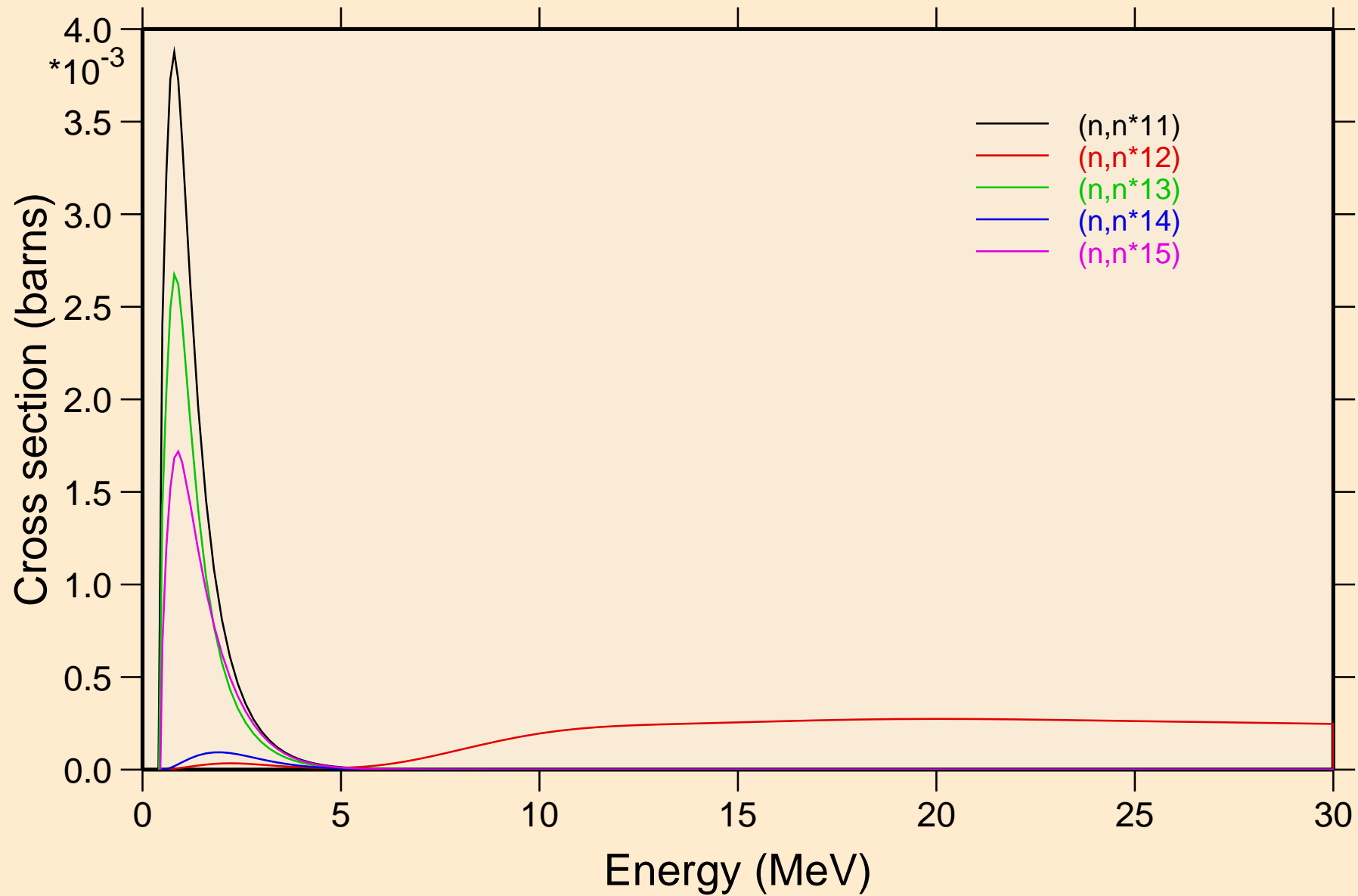

RE170 NEUTRON ACER TENDL-2021 LIBRARY; T=293.6K  
Inelastic levels

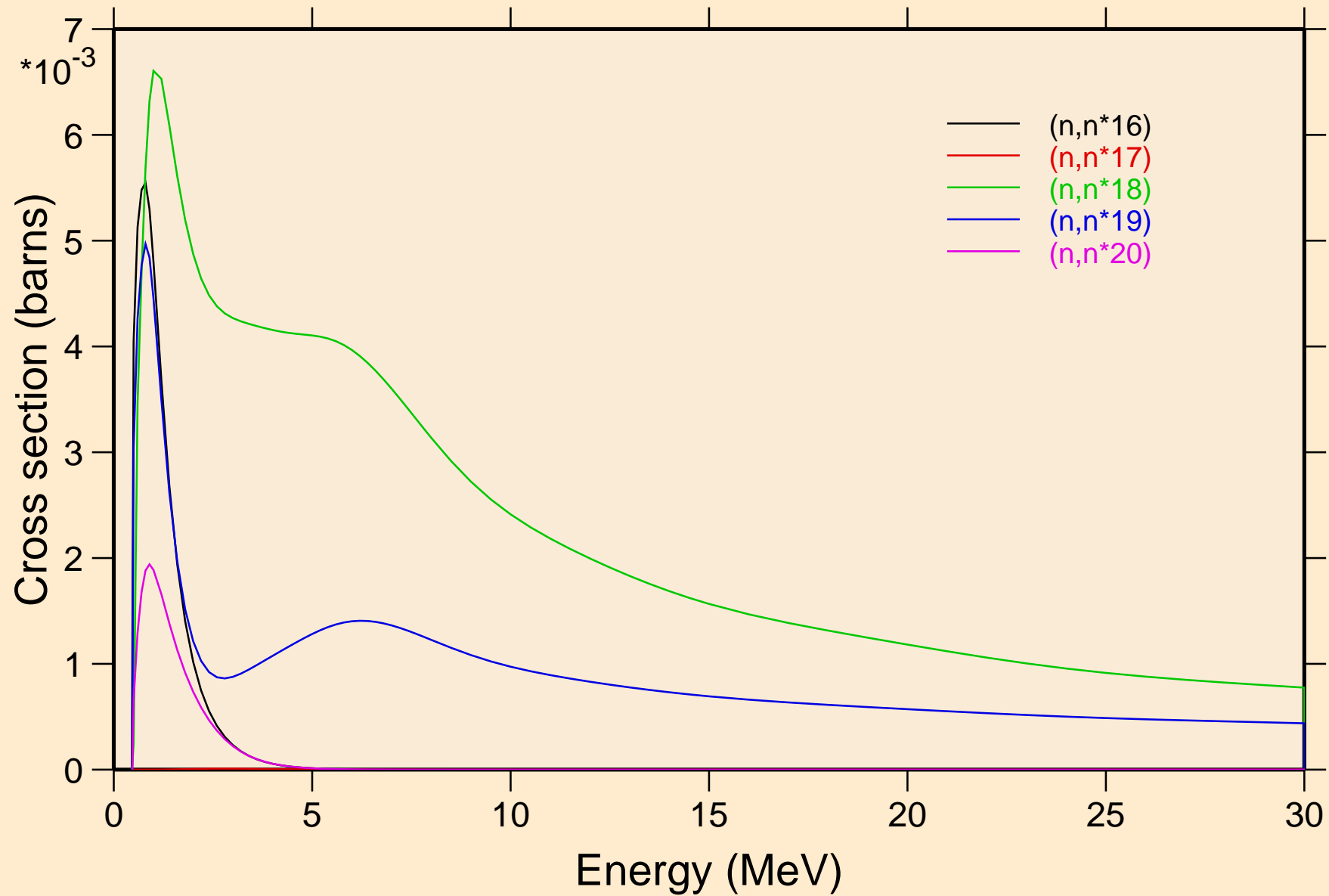

RE170 NEUTRON ACER TENDL-2021 LIBRARY; T=293.6K  
Inelastic levels

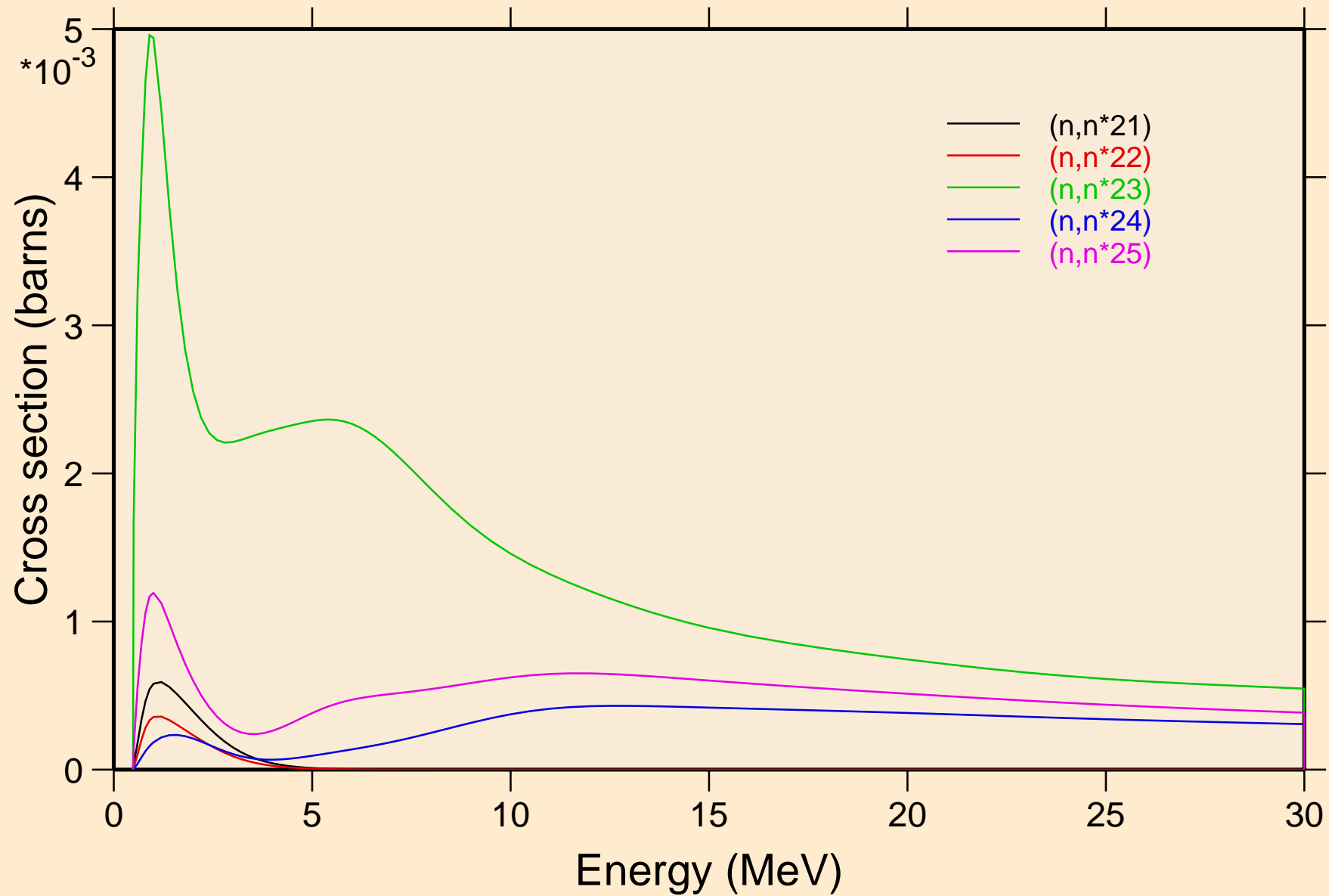

RE170 NEUTRON ACER TENDL-2021 LIBRARY; T=293.6K  
Inelastic levels

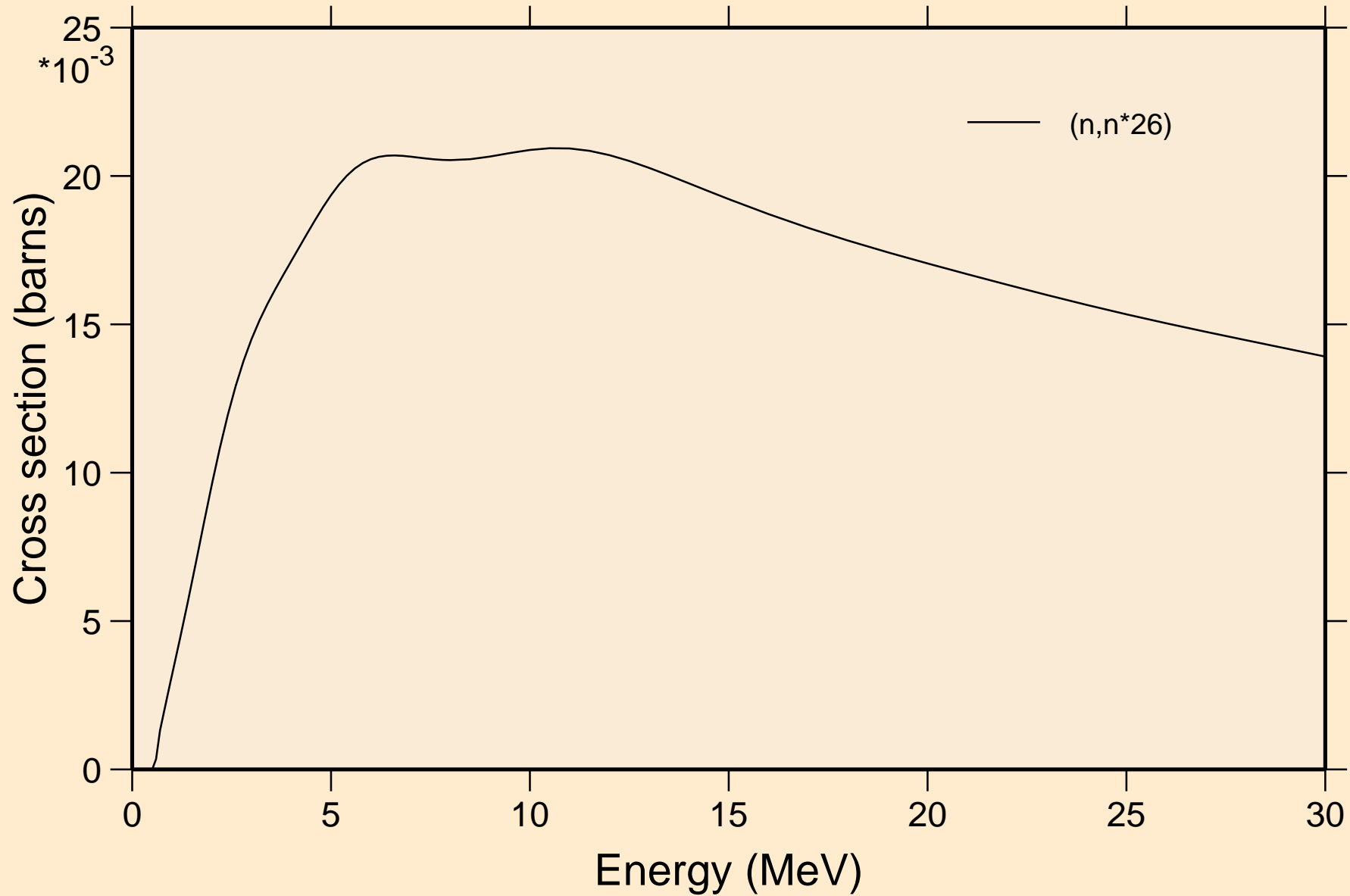

RE170 NEUTRON ACER TENDL-2021 LIBRARY; T=293.6K  
Threshold reactions

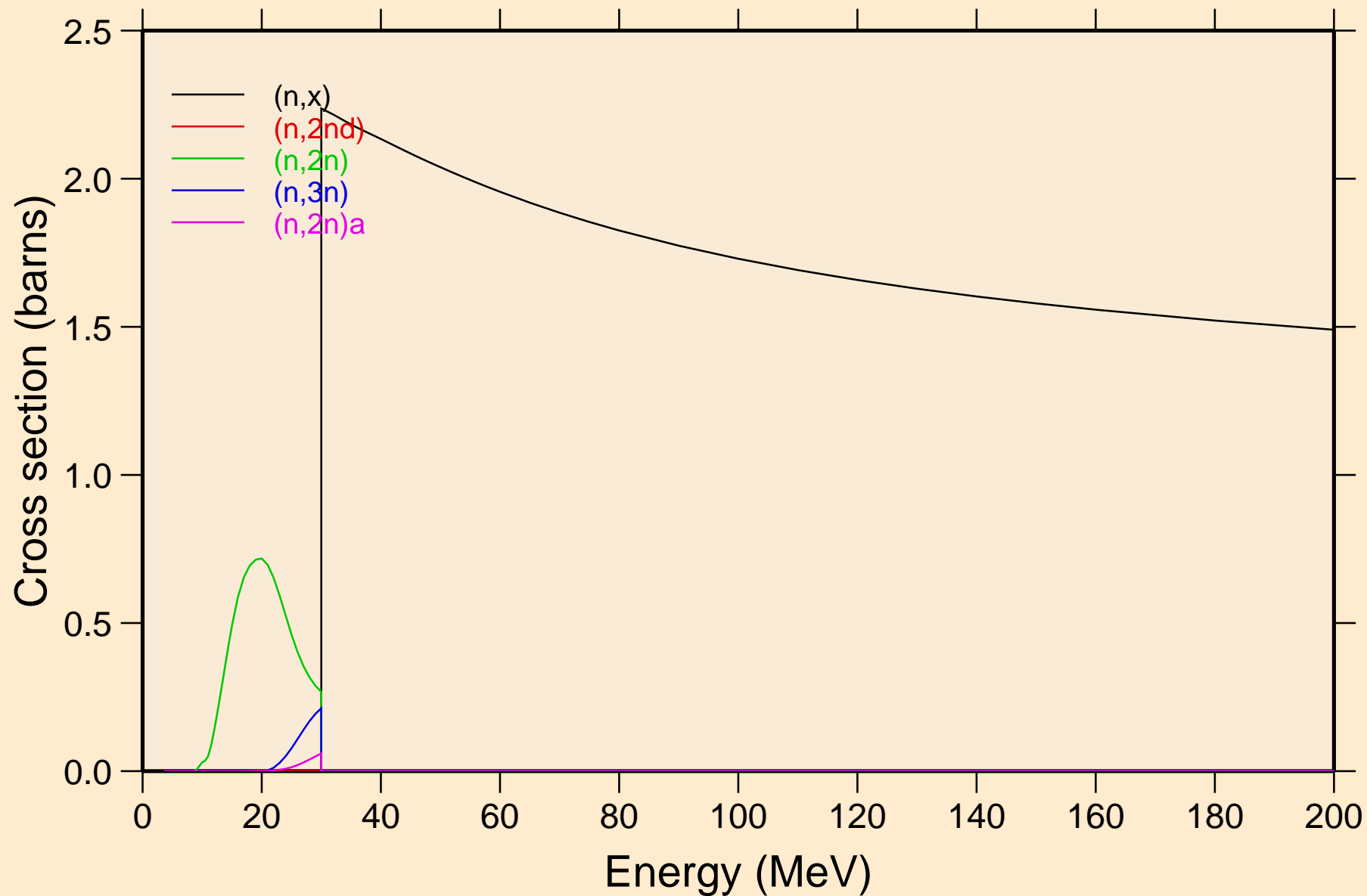

RE170 NEUTRON ACER TENDL-2021 LIBRARY; T=293.6K  
Threshold reactions

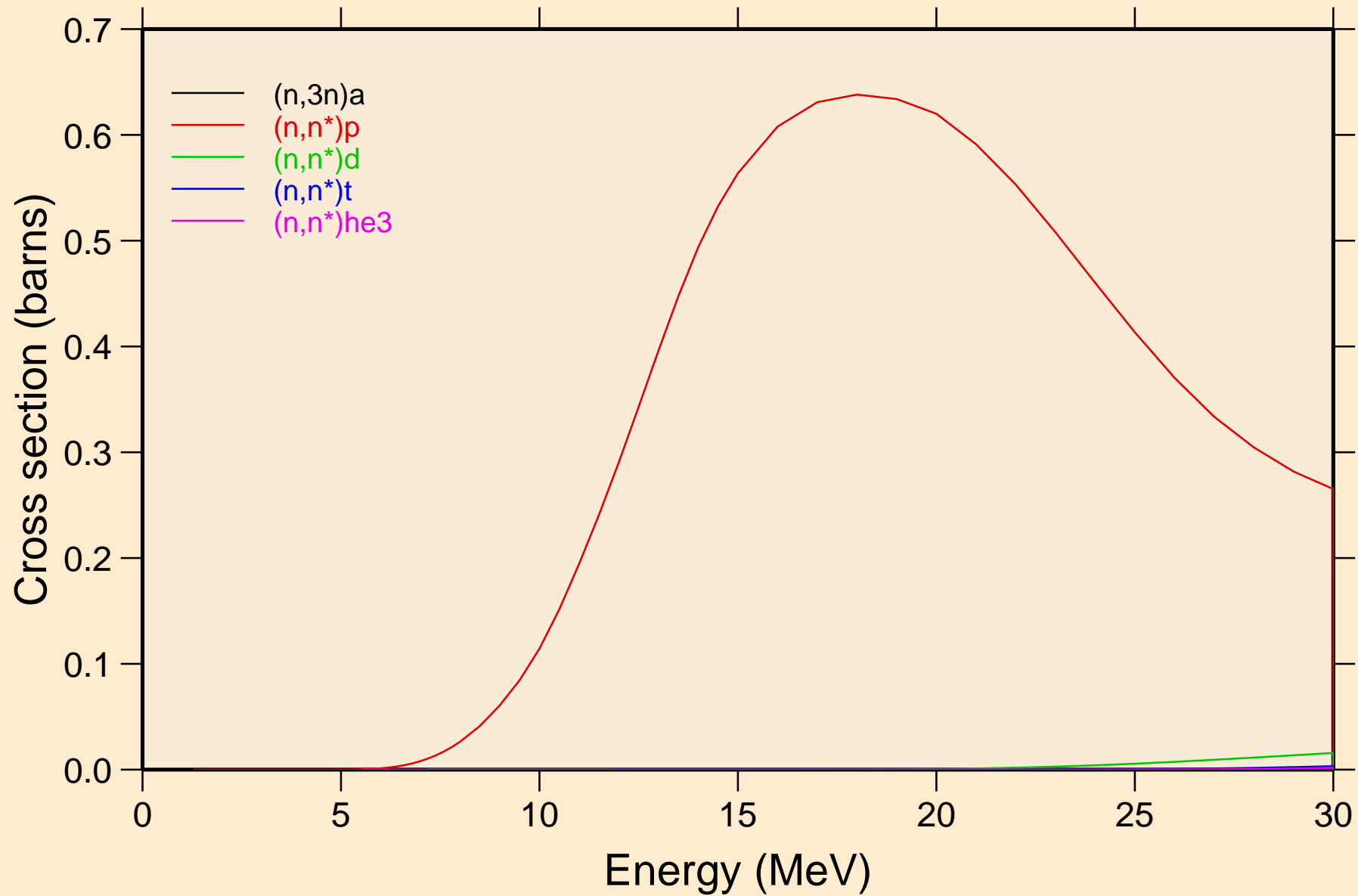

RE170 NEUTRON ACER TENDL-2021 LIBRARY; T=293.6K  
Threshold reactions

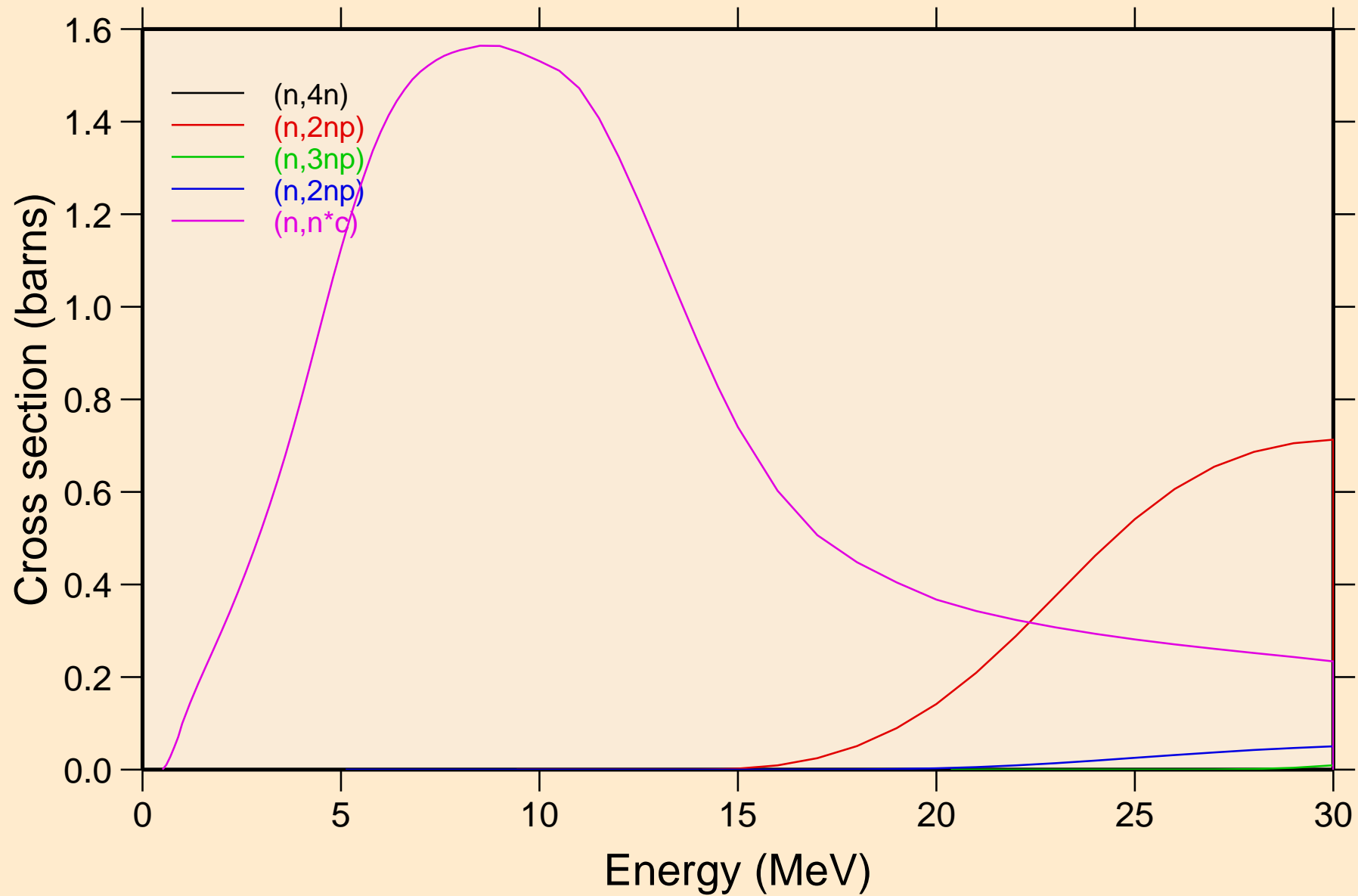

RE170 NEUTRON ACER TENDL-2021 LIBRARY; T=293.6K  
Threshold reactions

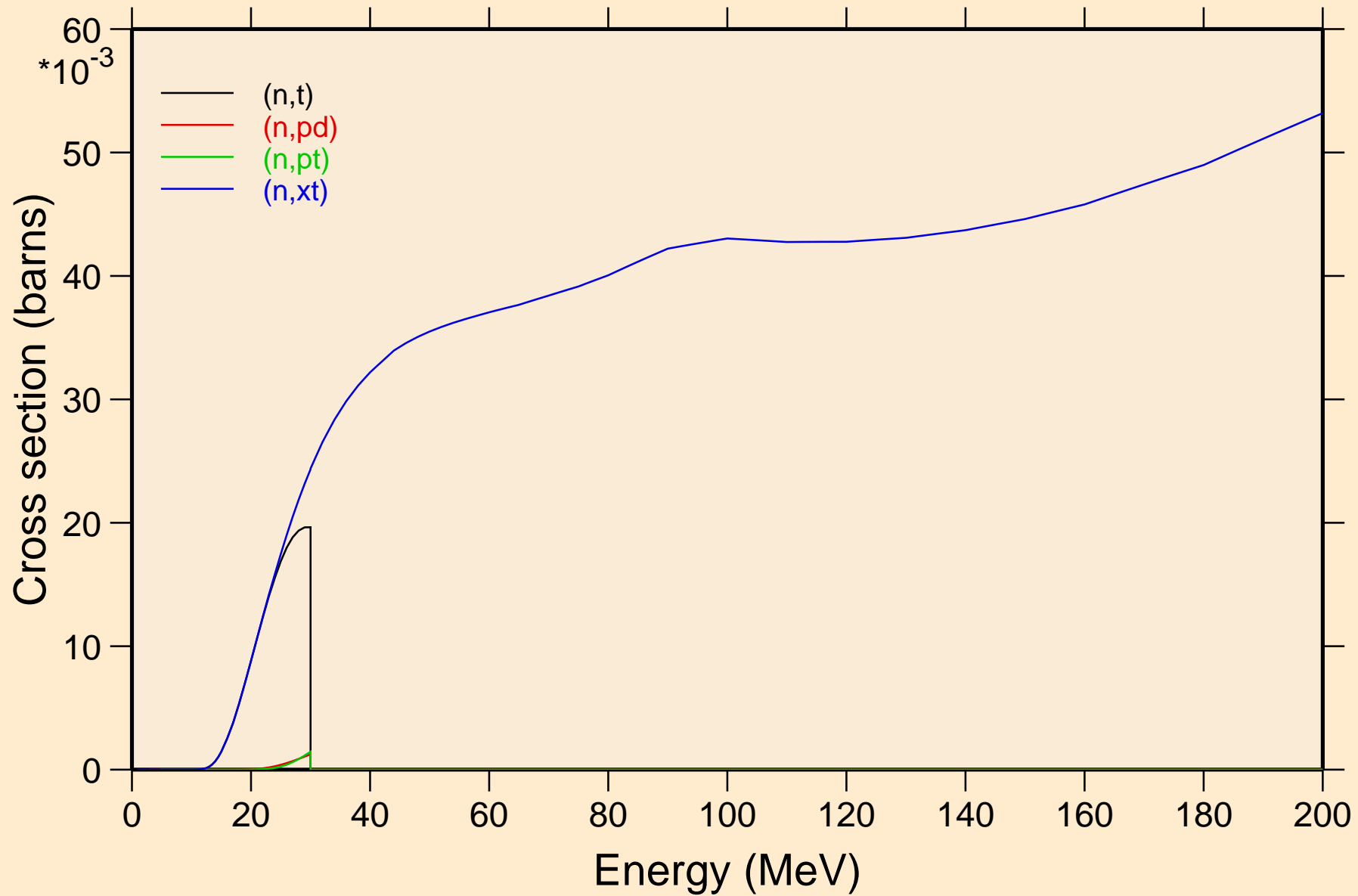



RE170 NEUTRON ACER TENDL-2021 LIBRARY; T=293.6K  
angular distribution for elastic

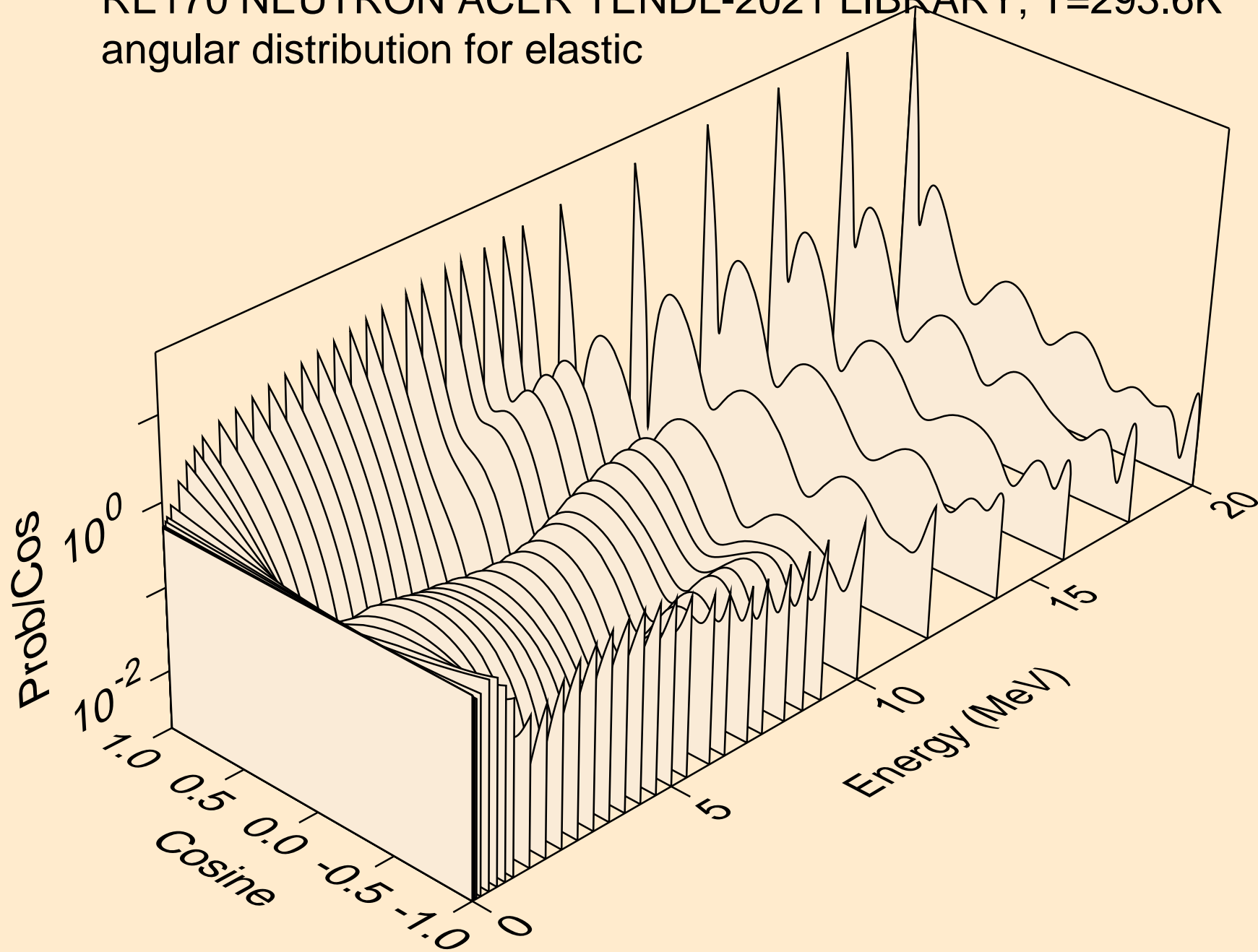

RE170 NEUTRON ACER TENDL-2021 LIBRARY; T=293.6K  
angular distribution for elastic

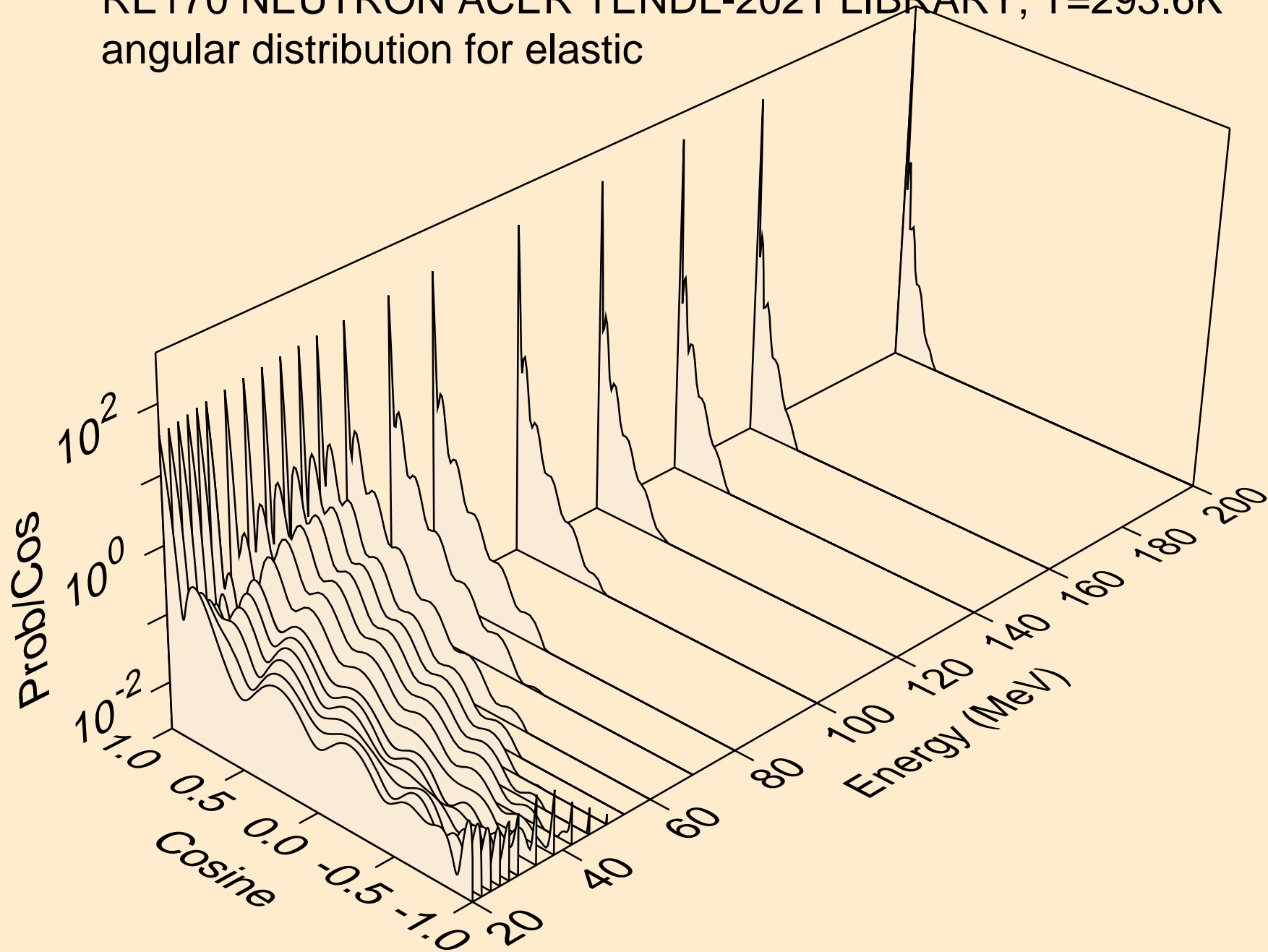

RE170 NEUTRON ACER TENDL-2021 LIBRARY; T=293.6K  
angular distribution for (n,n\*1)

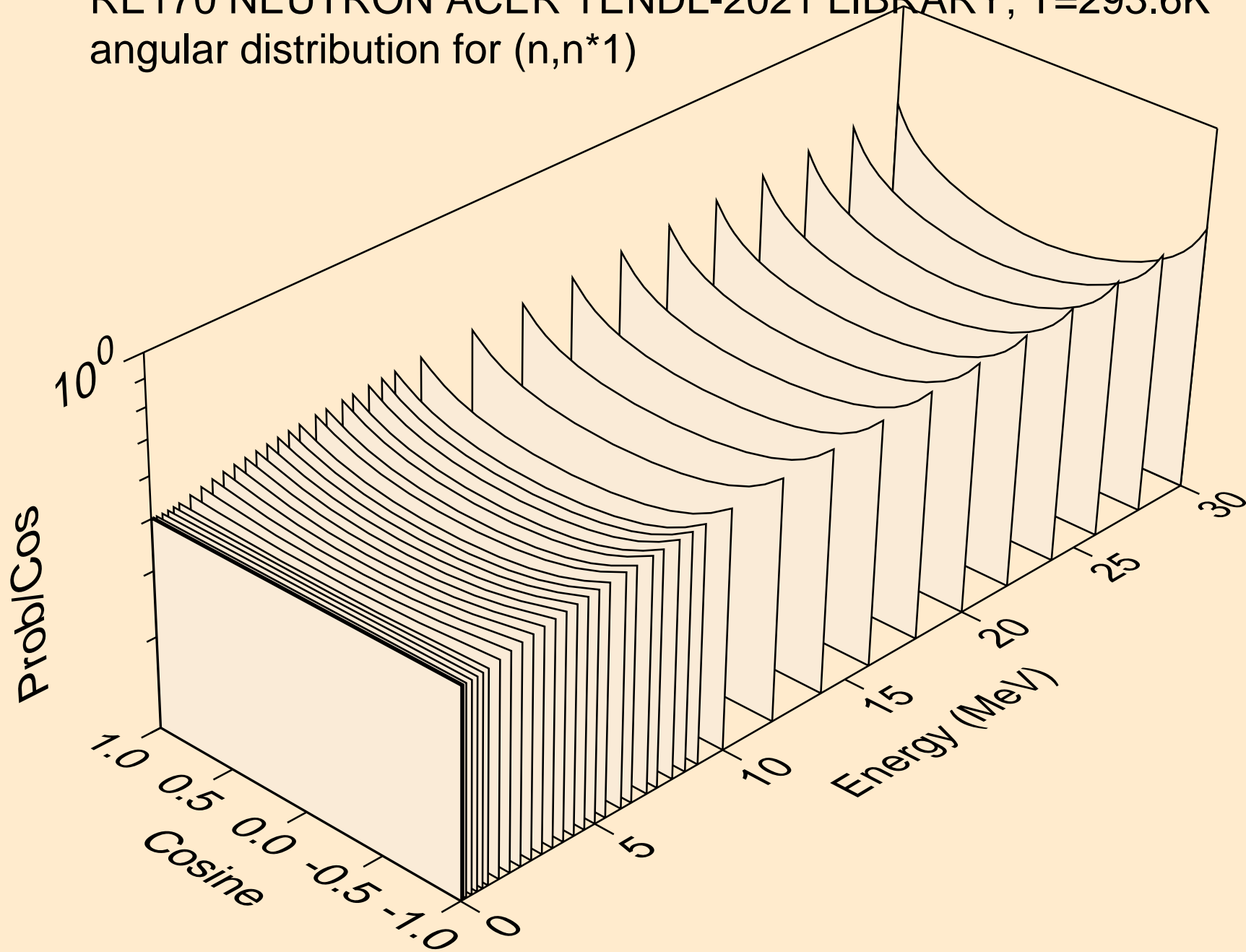

RE170 NEUTRON ACER TENDL-2021 LIBRARY; T=293.6K  
angular distribution for (n,n\*2)

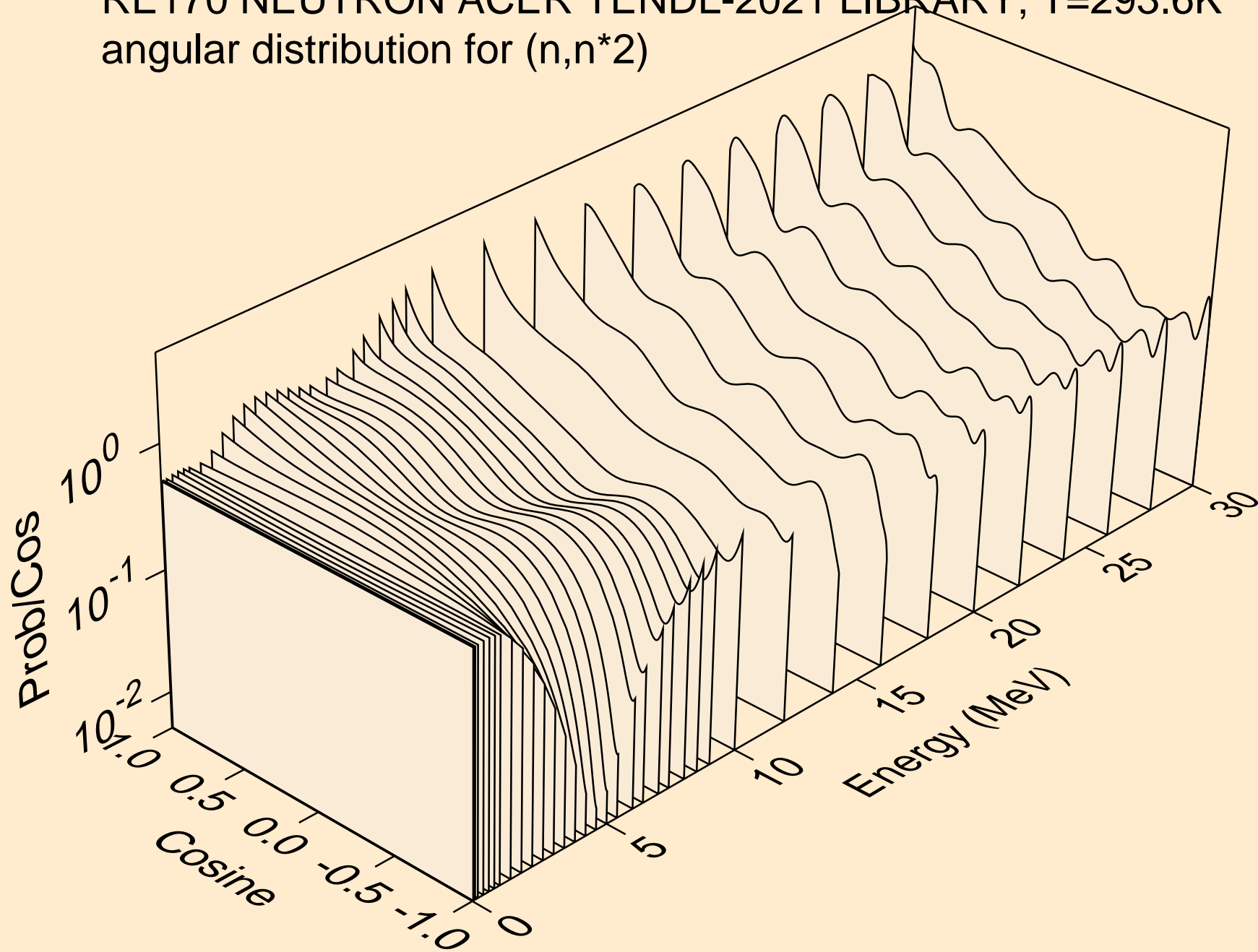

RE170 NEUTRON ACER TENDL-2021 LIBRARY; T=293.6K  
angular distribution for (n,n\*3)

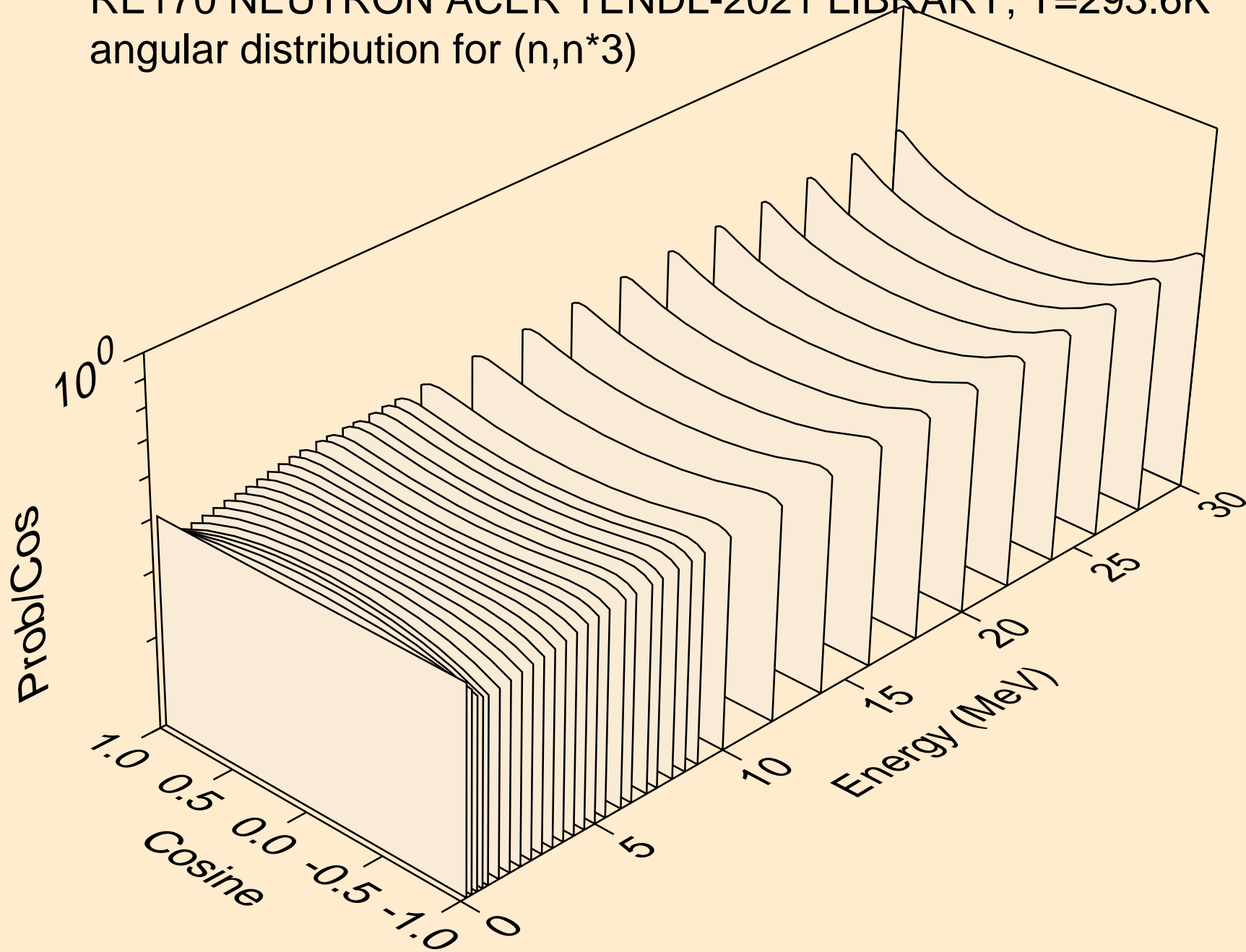

RE170 NEUTRON ACER TENDL-2021 LIBRARY; T=293.6K  
angular distribution for (n,n\*4)

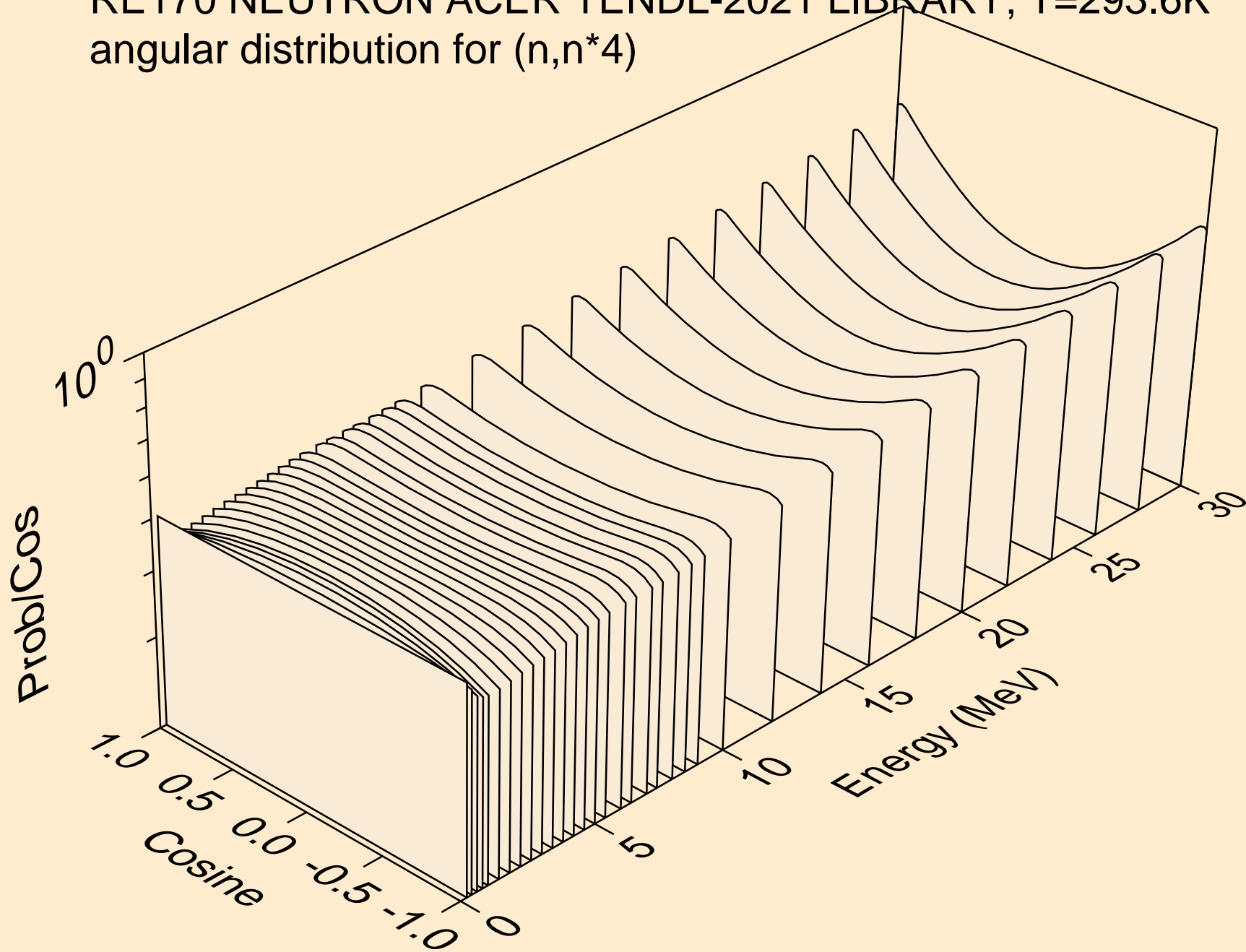

RE170 NEUTRON ACER TENDL-2021 LIBRARY; T=293.6K  
angular distribution for (n,n\*5)

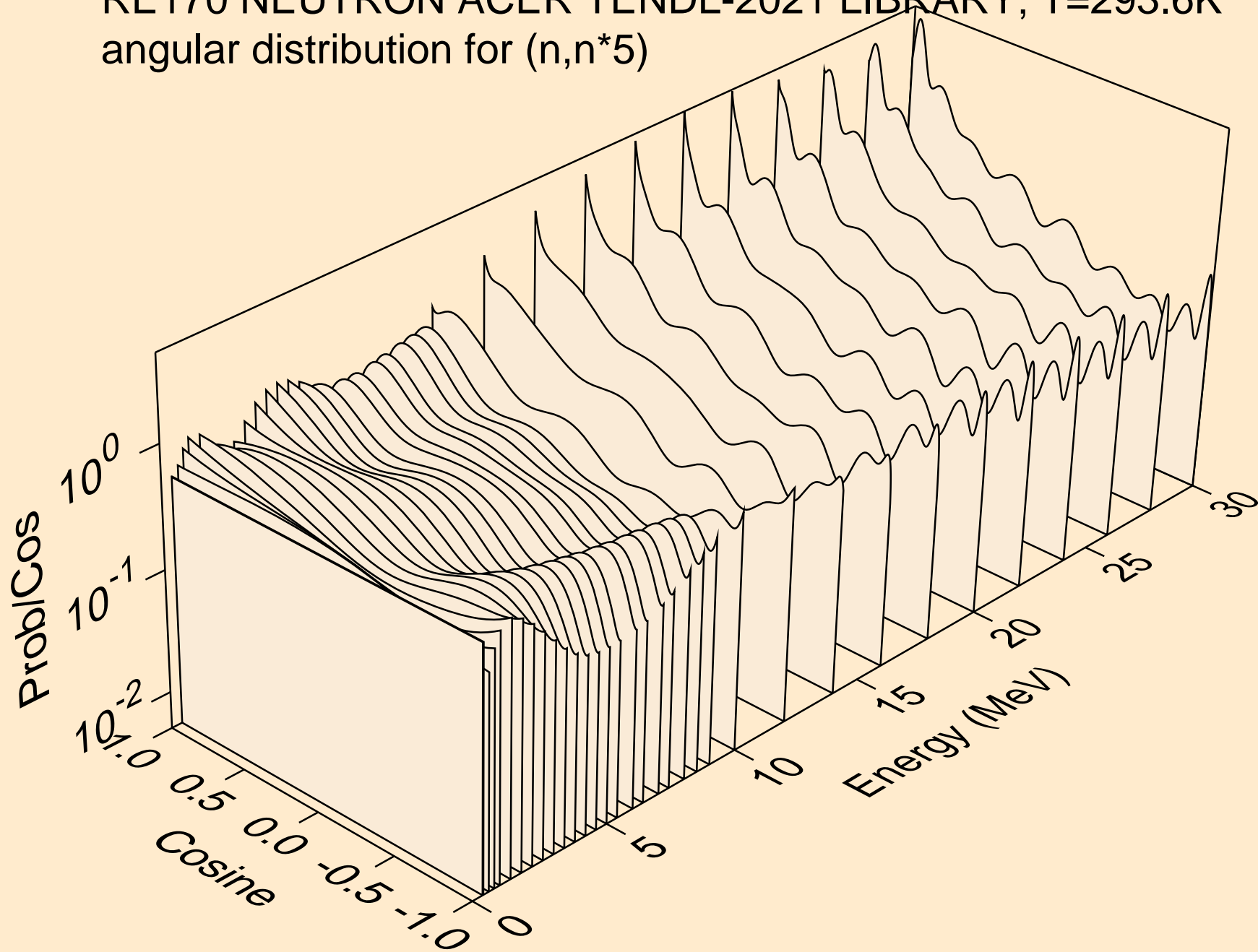

RE170 NEUTRON ACER TENDL-2021 LIBRARY; T=293.6K  
angular distribution for (n,n\*6)

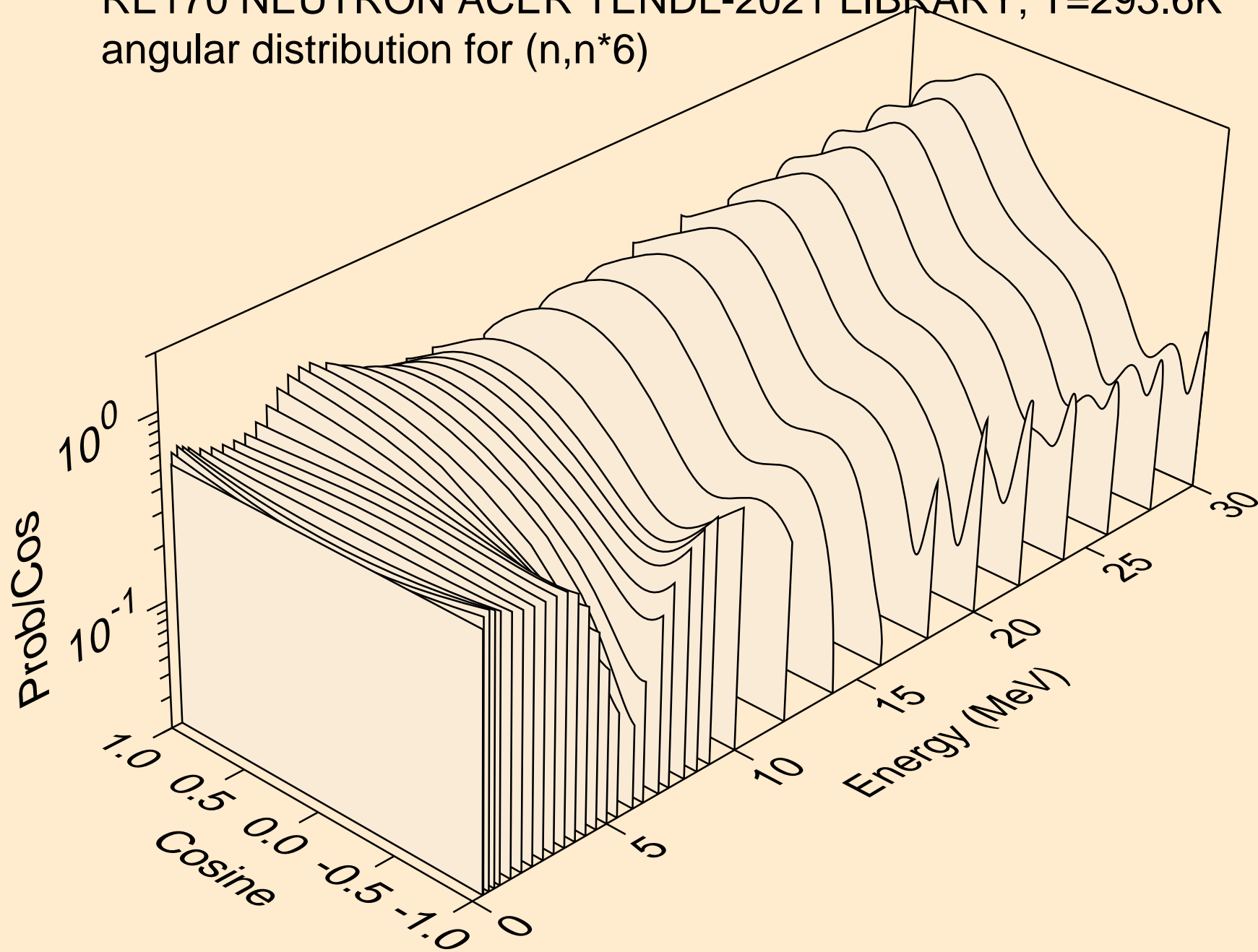



RE170 NEUTRON ACER TENDL-2021 LIBRARY; T=293.6K  
angular distribution for (n,n\*7)

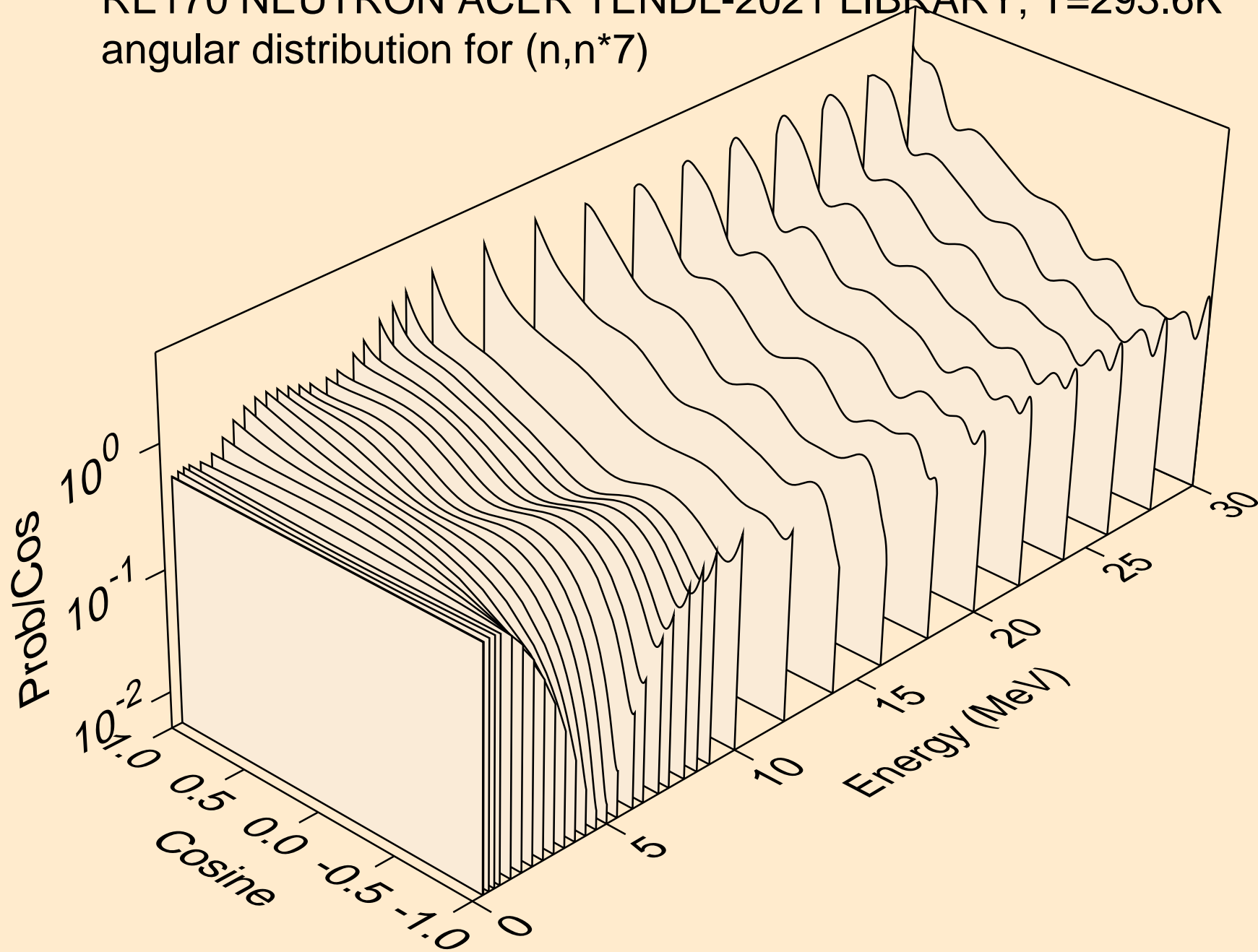

RE170 NEUTRON ACER TENDL-2021 LIBRARY; T=293.6K  
angular distribution for (n,n\*8)

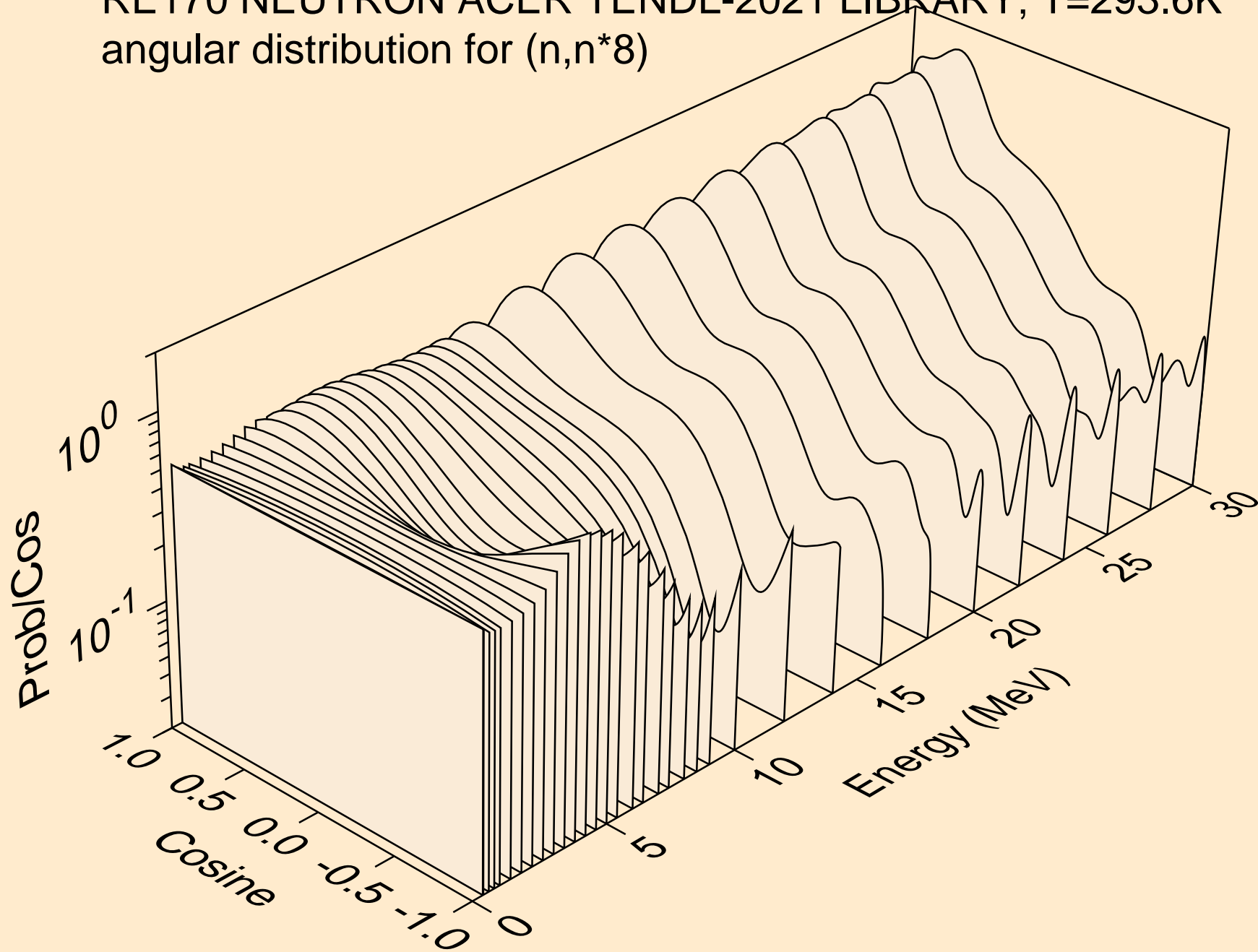

RE170 NEUTRON ACER TENDL-2021 LIBRARY; T=293.6K  
angular distribution for (n,n\*9)

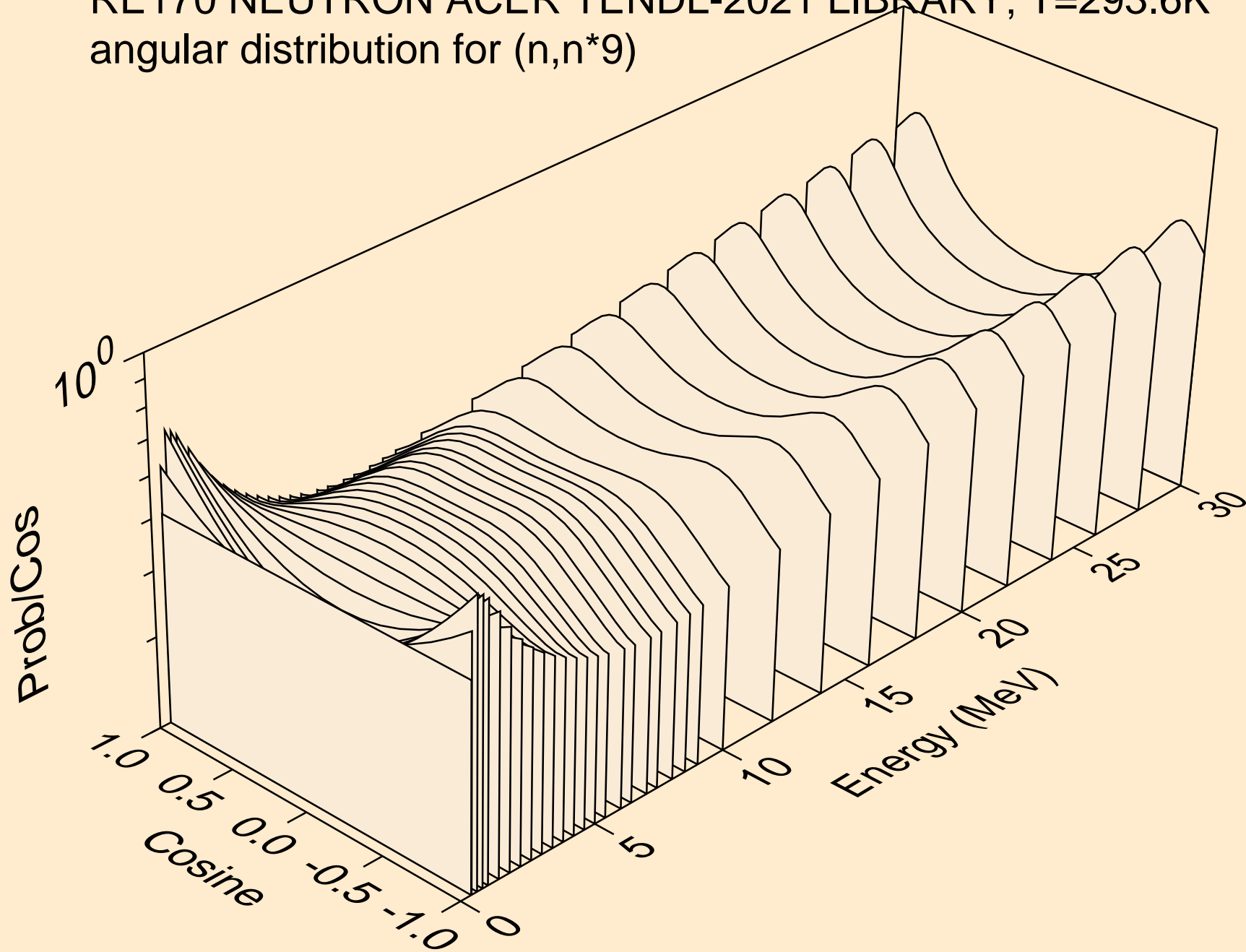

RE170 NEUTRON ACER TENDL-2021 LIBRARY; T=293.6K  
angular distribution for (n,n\*10)

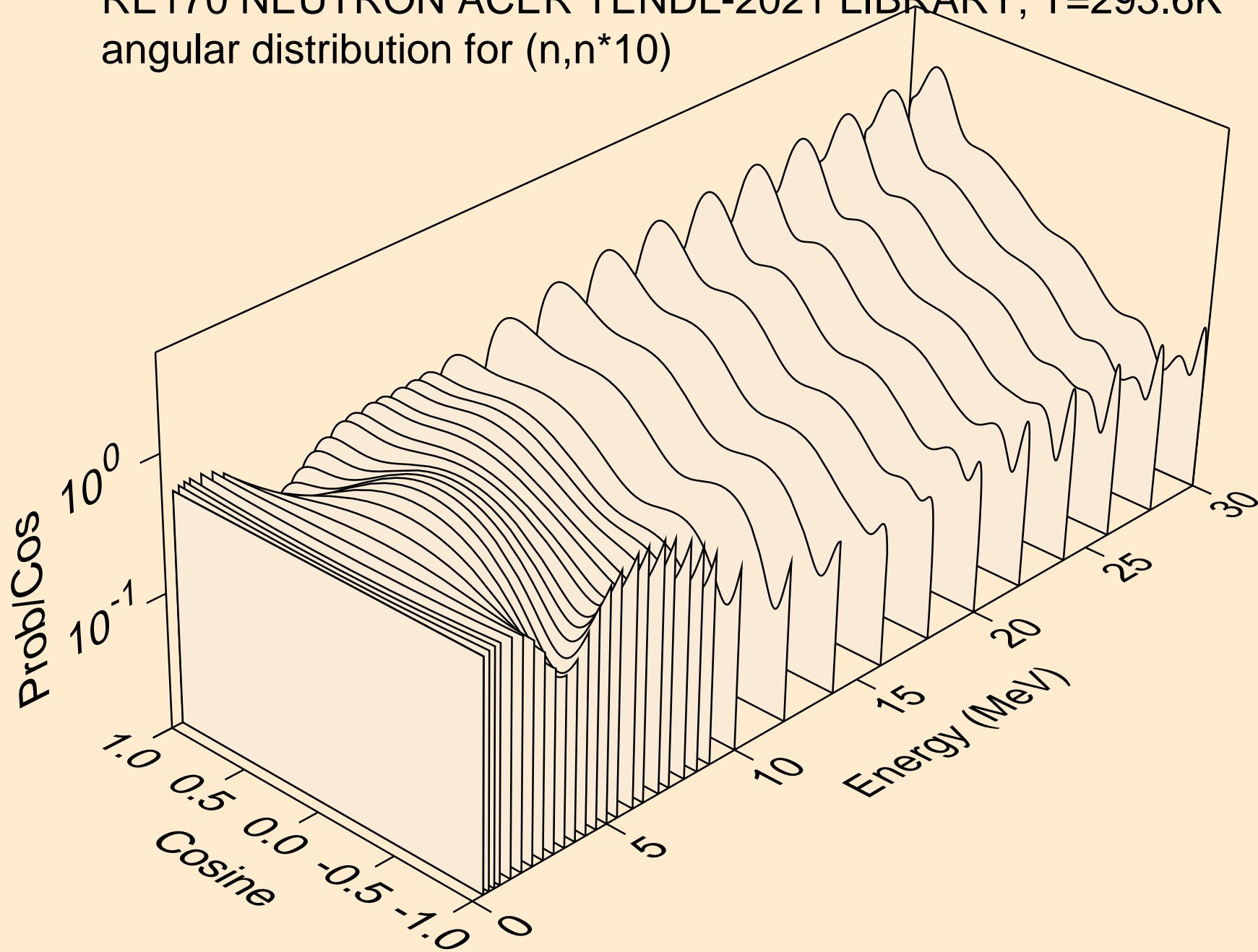

RE170 NEUTRON ACER TENDL-2021 LIBRARY; T=293.6K  
angular distribution for (n,n\*11)

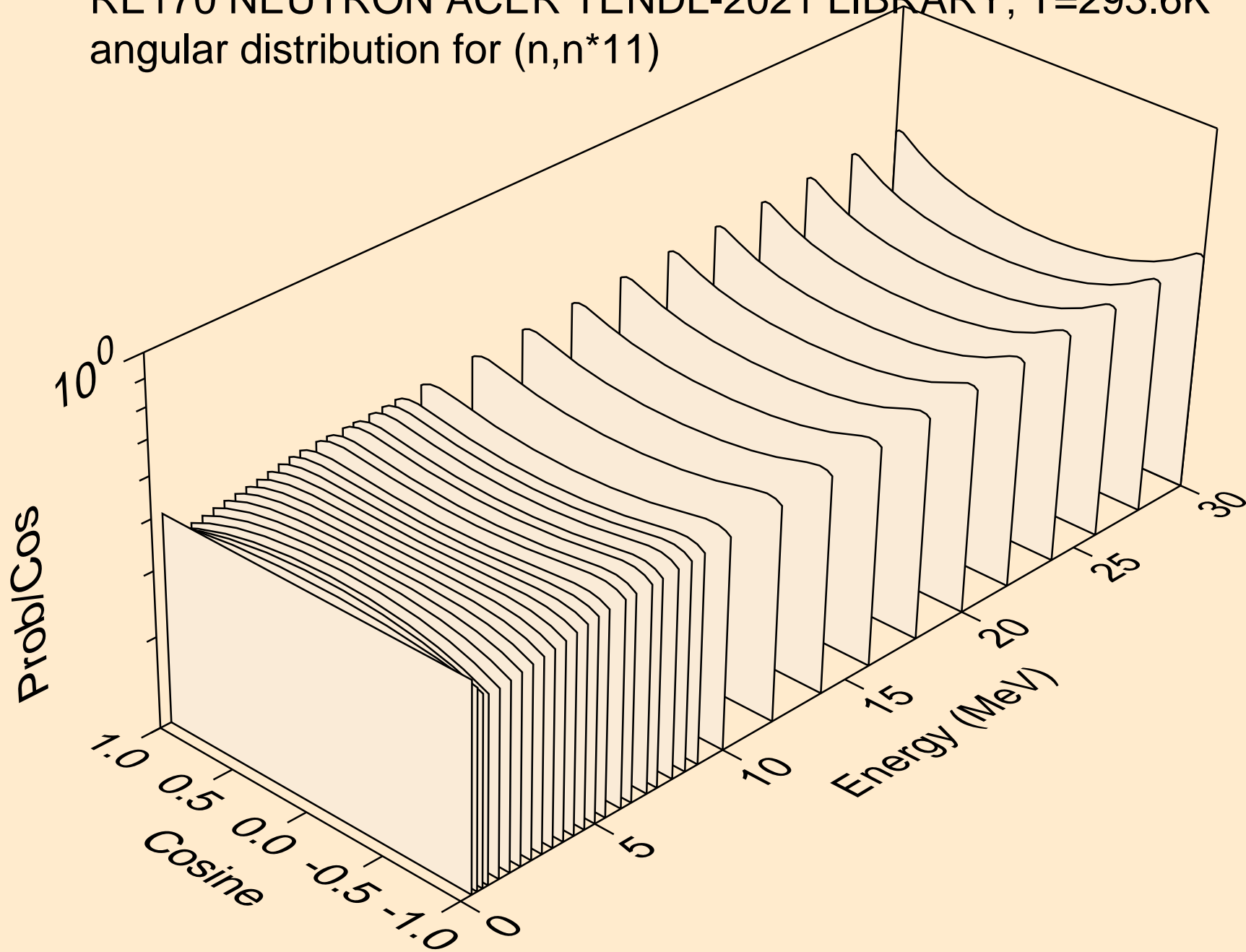

RE170 NEUTRON ACER TENDL-2021 LIBRARY; T=293.6K  
angular distribution for (n,n\*12)

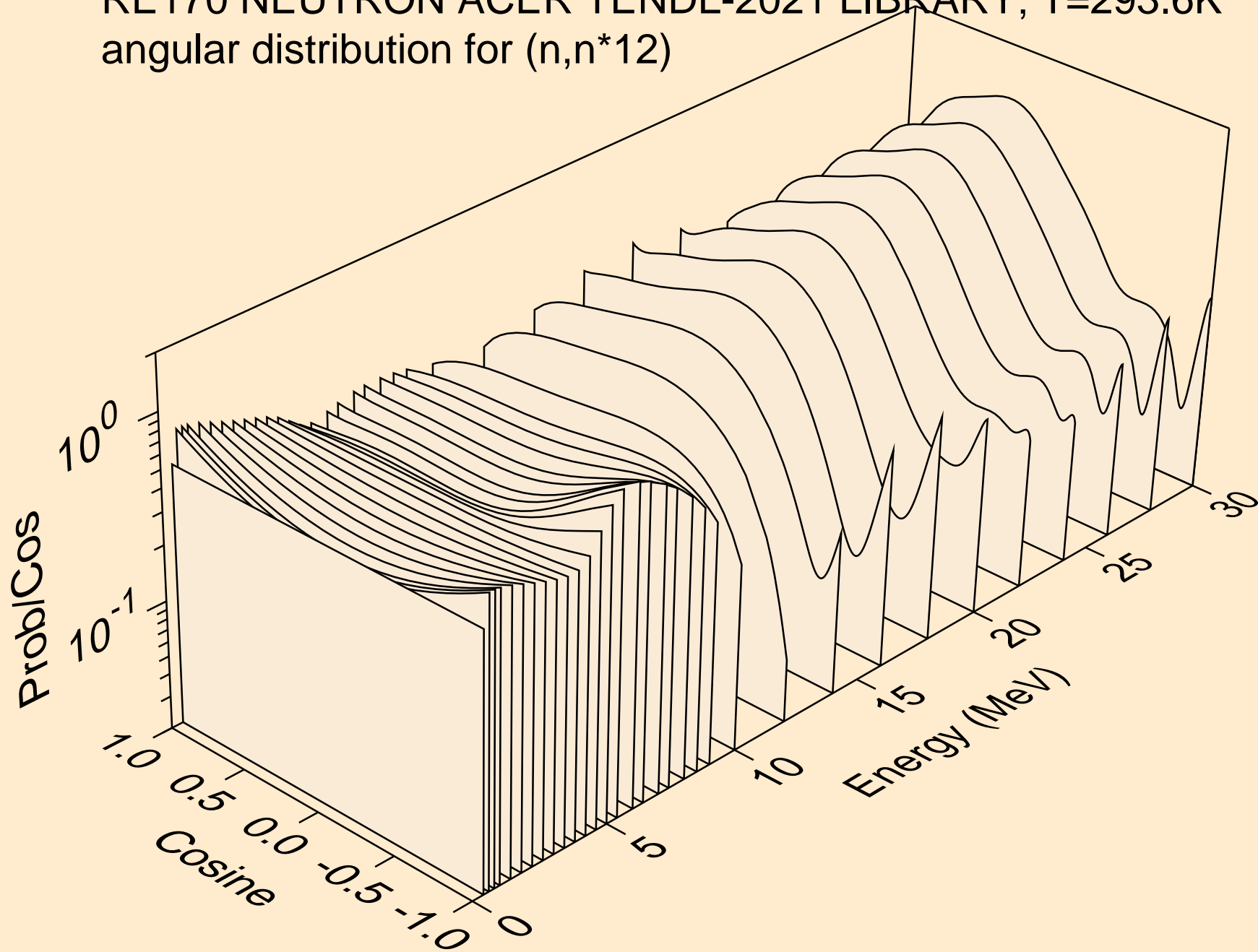

RE170 NEUTRON ACER TENDL-2021 LIBRARY; T=293.6K  
angular distribution for (n,n\*13)

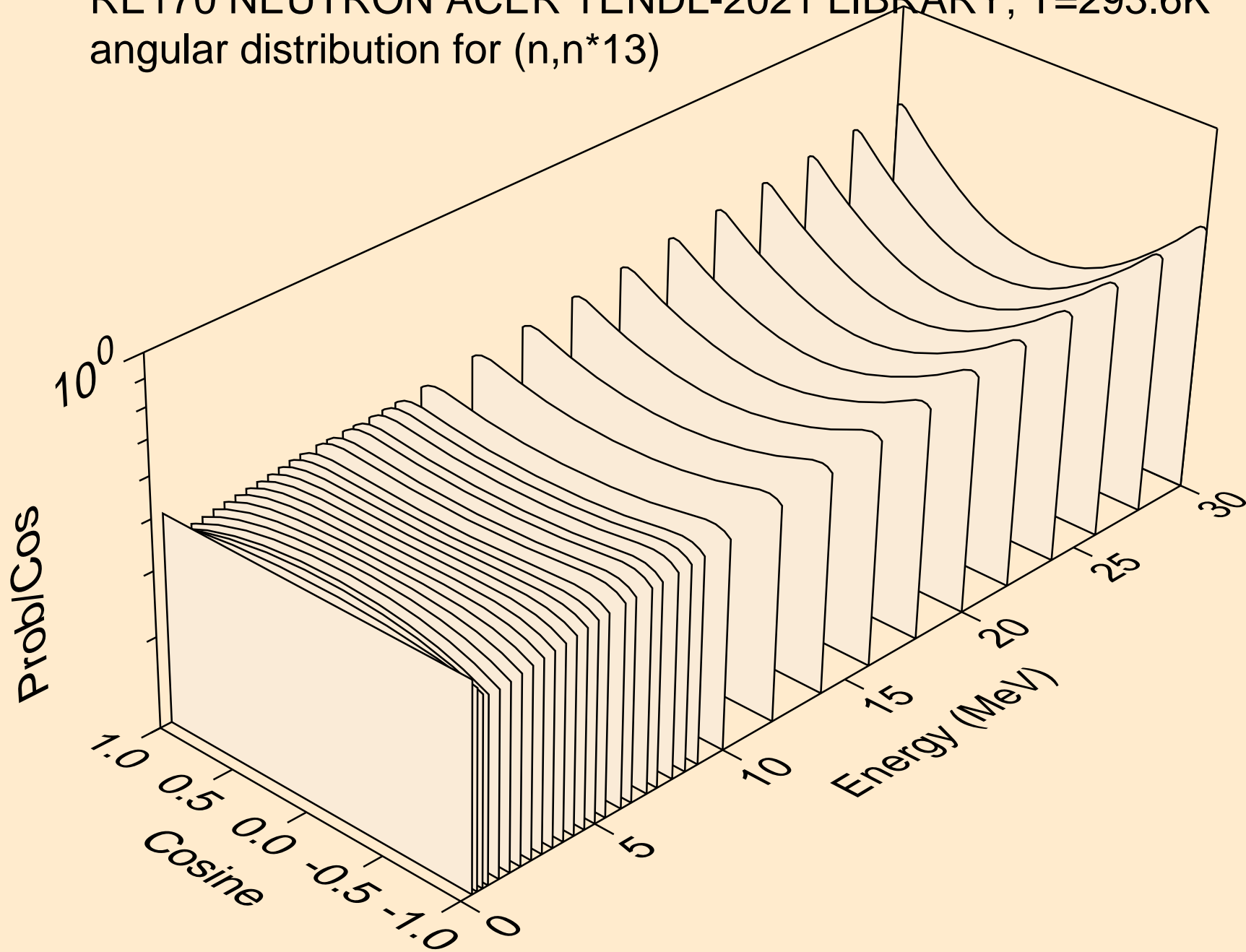

RE170 NEUTRON ACER TENDL-2021 LIBRARY; T=293.6K  
angular distribution for (n,n\*14)

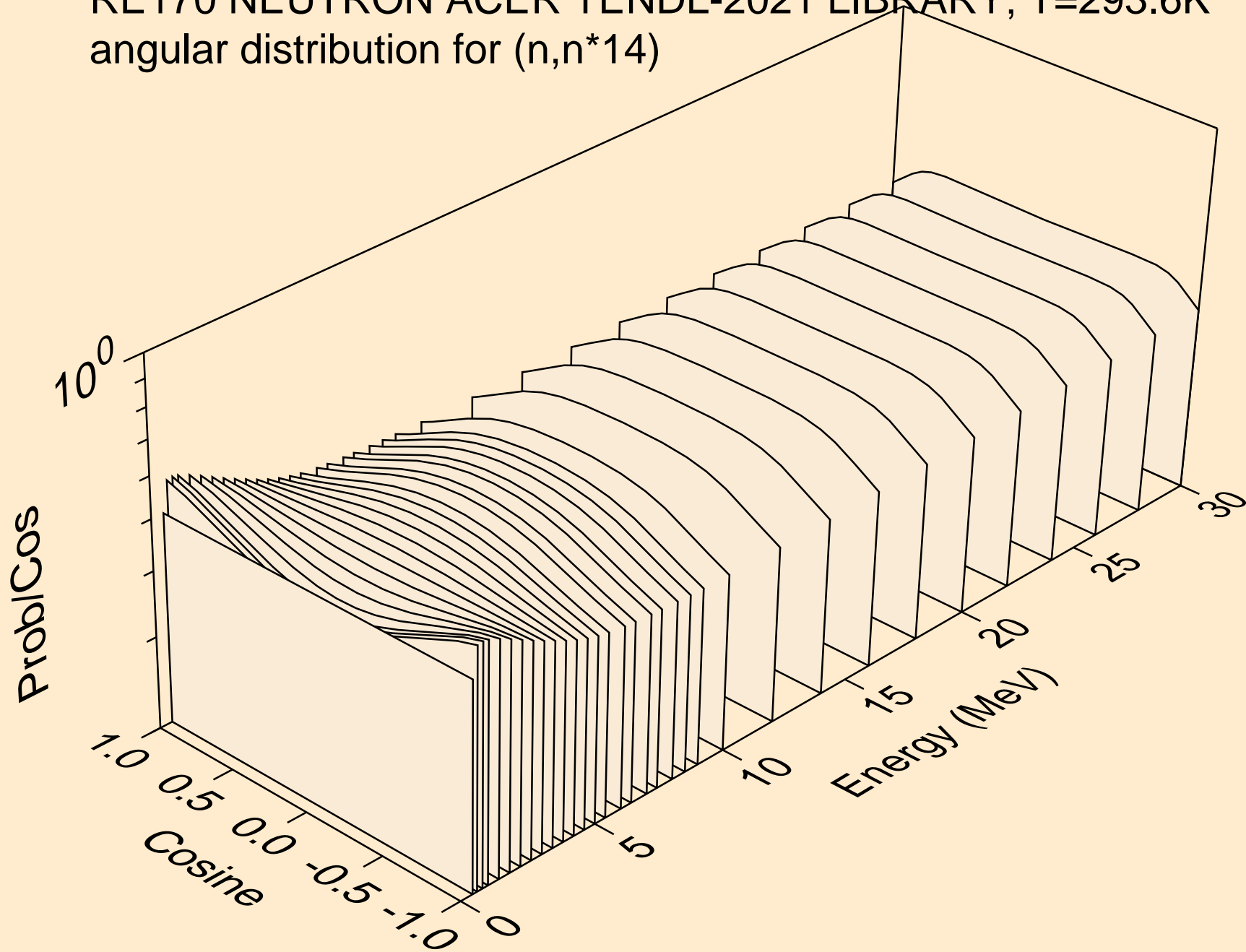



RE170 NEUTRON ACER TENDL-2021 LIBRARY; T=293.6K  
angular distribution for (n,n\*15)

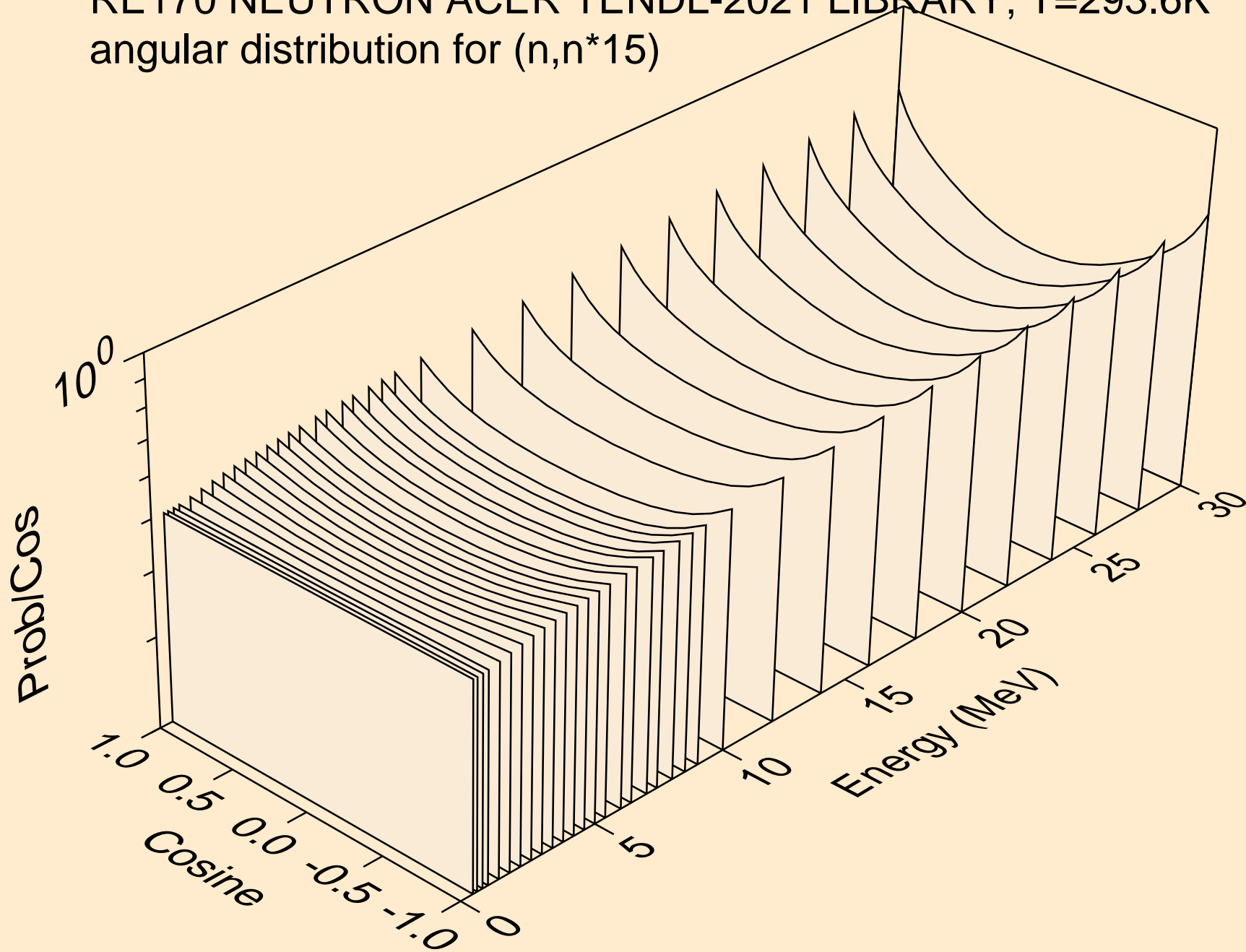

RE170 NEUTRON ACER TENDL-2021 LIBRARY; T=293.6K  
angular distribution for (n,n\*16)

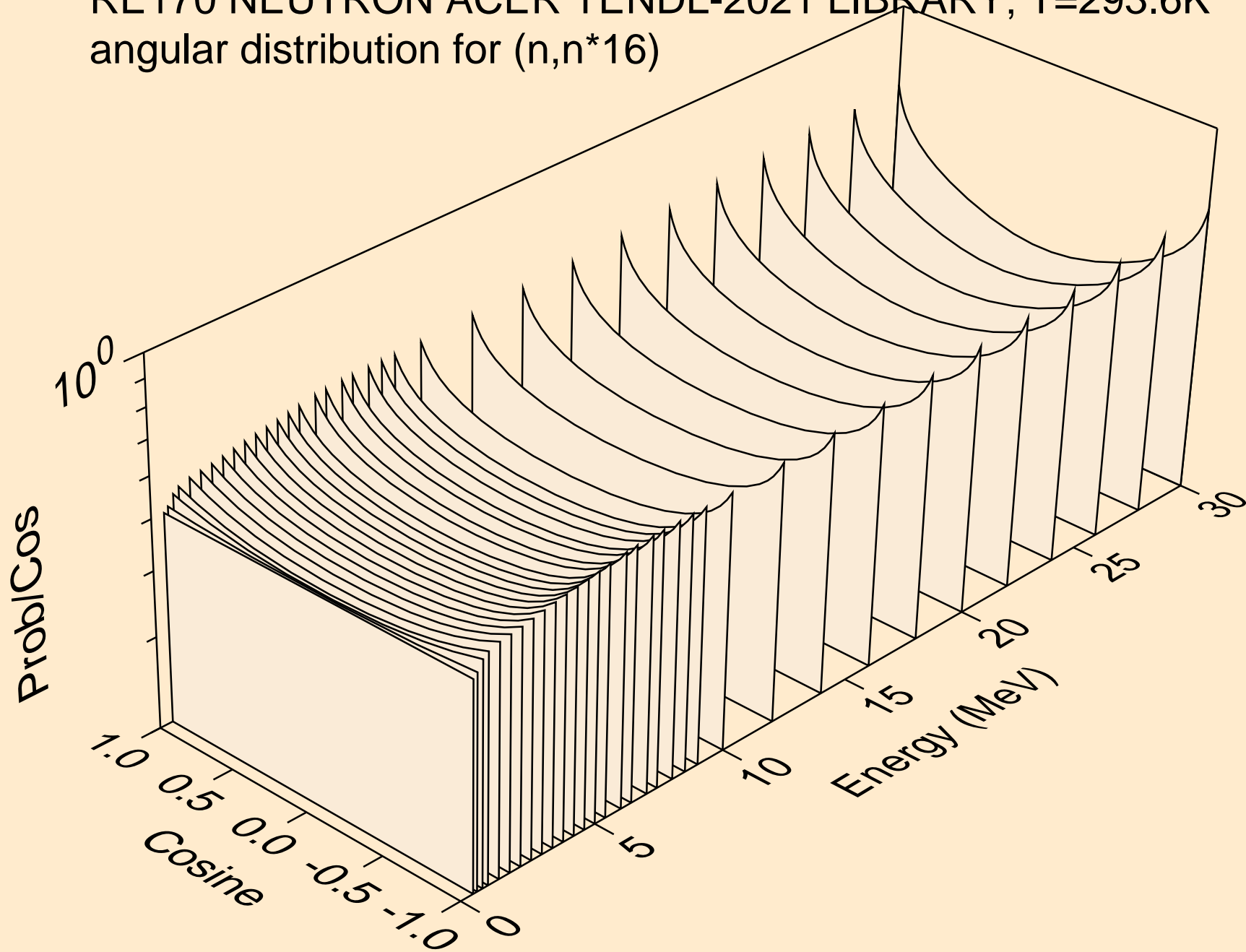

RE170 NEUTRON ACER TENDL-2021 LIBRARY; T=293.6K  
angular distribution for (n,n\*17)

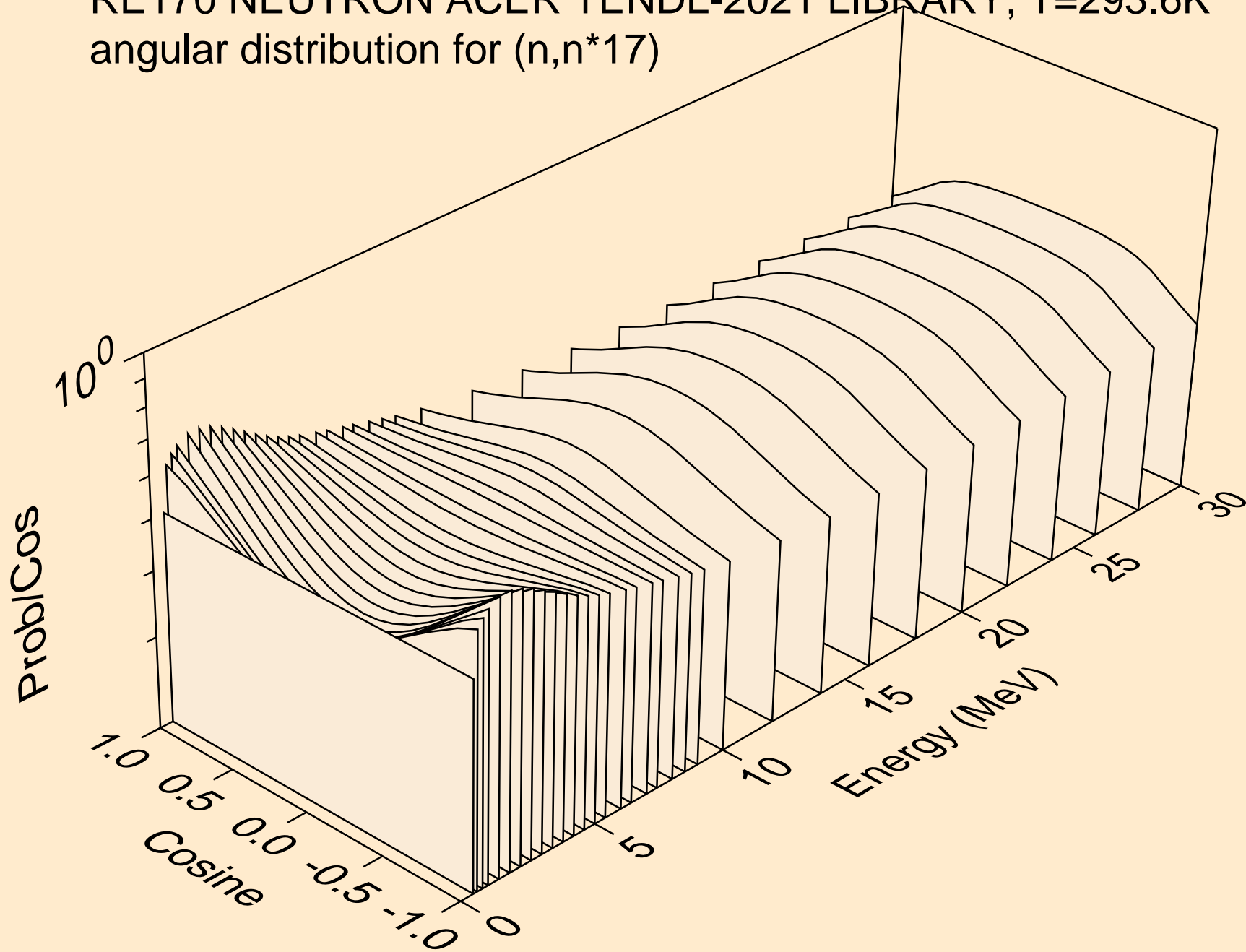

RE170 NEUTRON ACER TENDL-2021 LIBRARY; T=293.6K  
angular distribution for (n,n\*18)

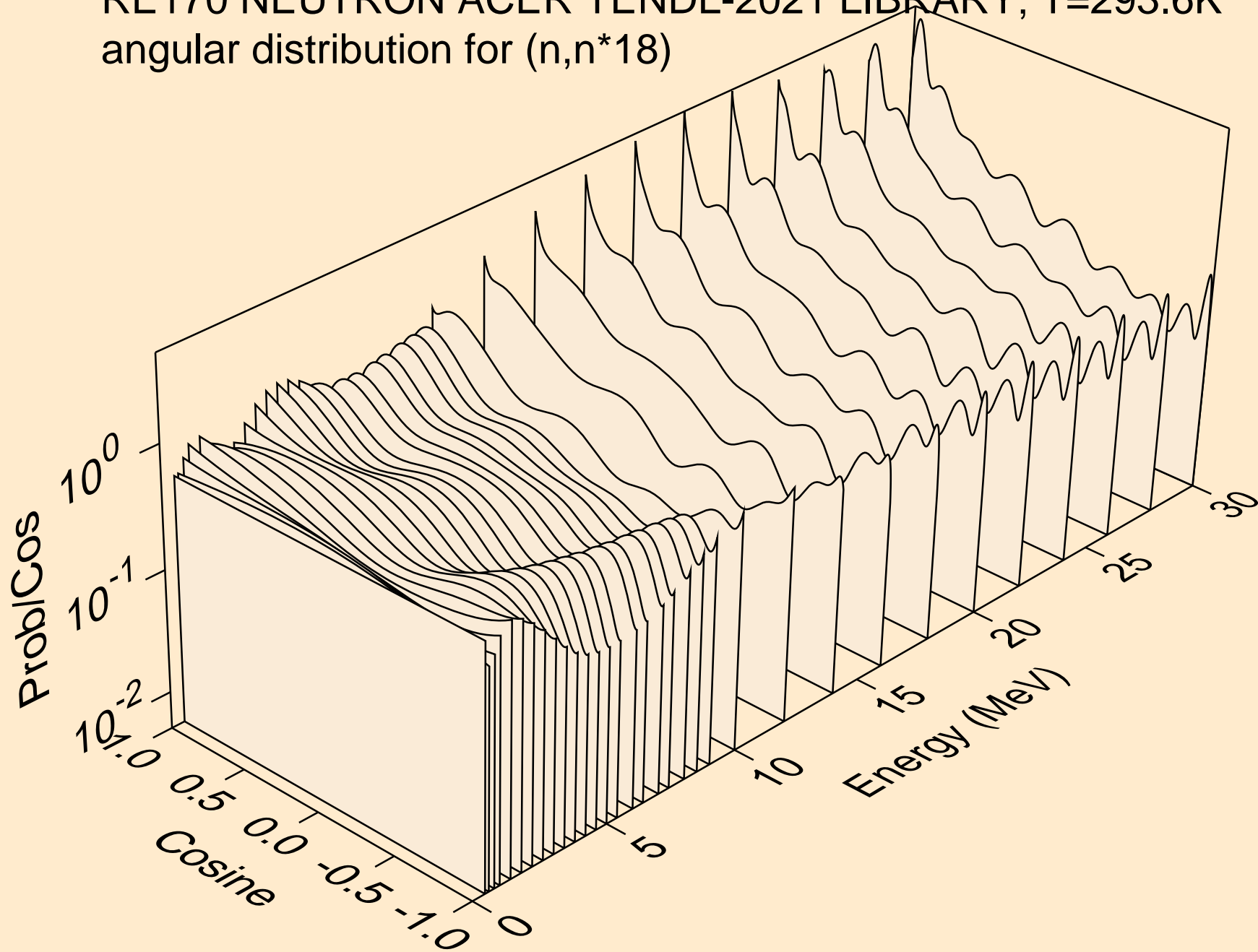

RE170 NEUTRON ACER TENDL-2021 LIBRARY; T=293.6K  
angular distribution for (n,n\*19)

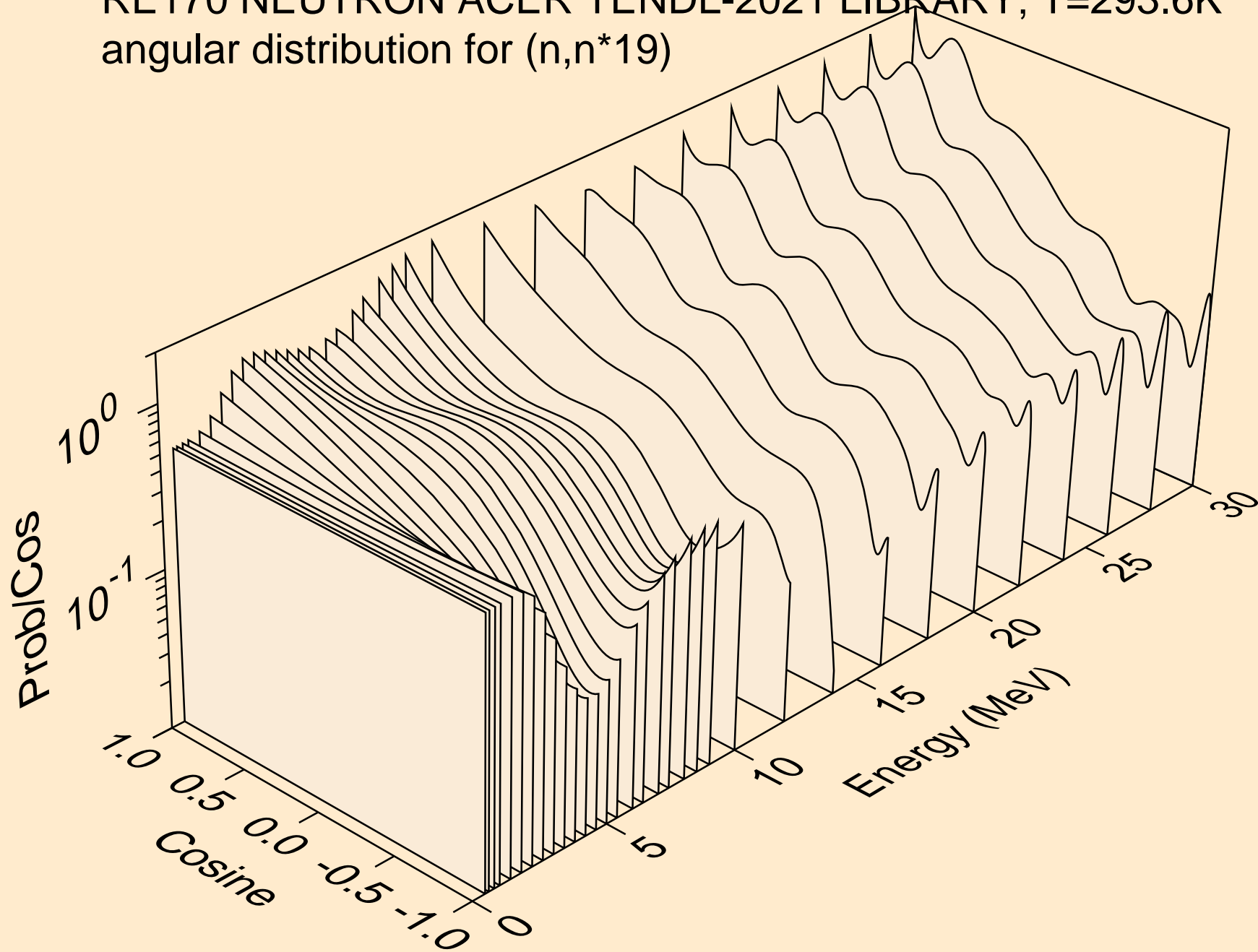

RE170 NEUTRON ACER TENDL-2021 LIBRARY; T=293.6K  
angular distribution for (n,n\*20)

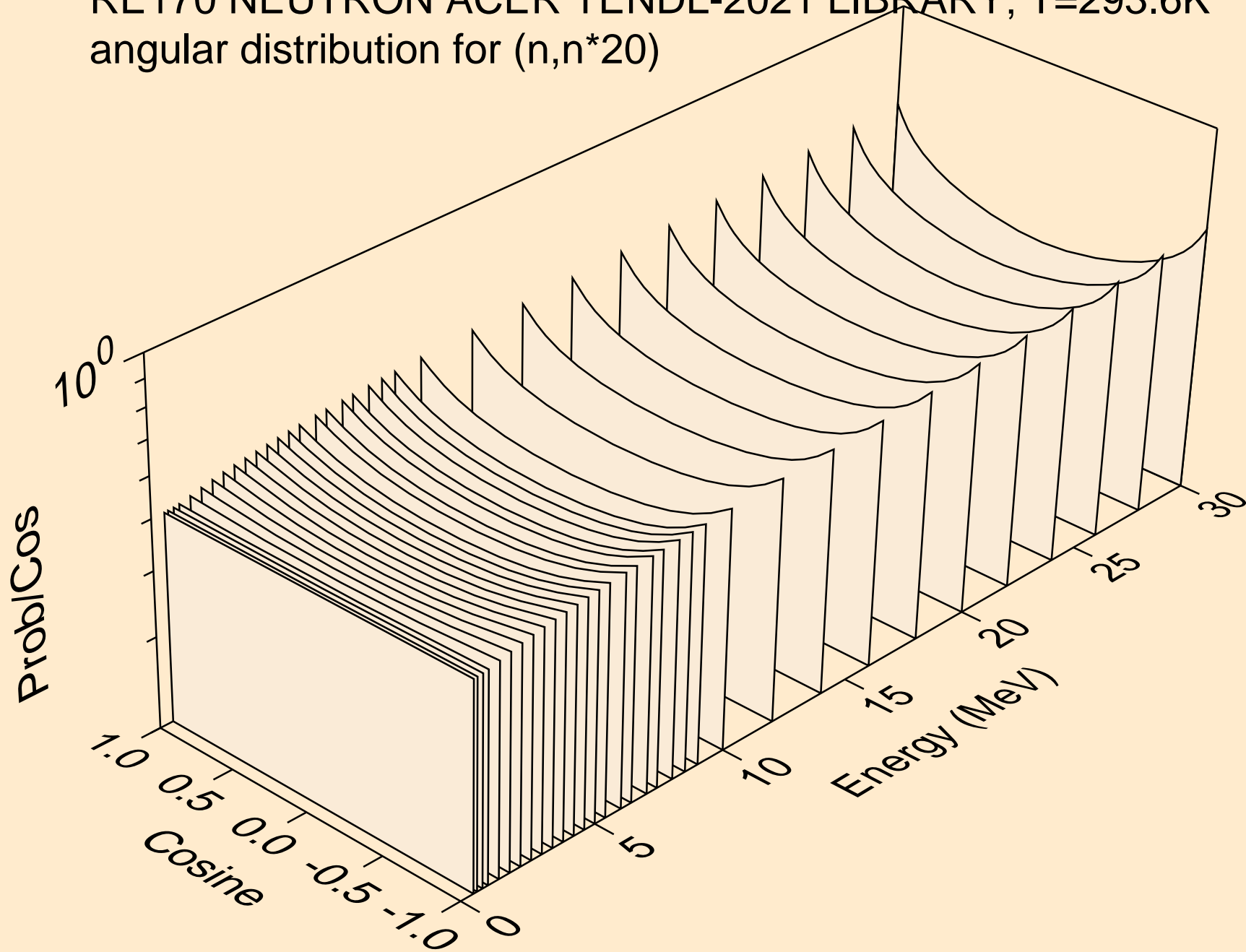

RE170 NEUTRON ACER TENDL-2021 LIBRARY; T=293.6K  
angular distribution for (n,n\*21)

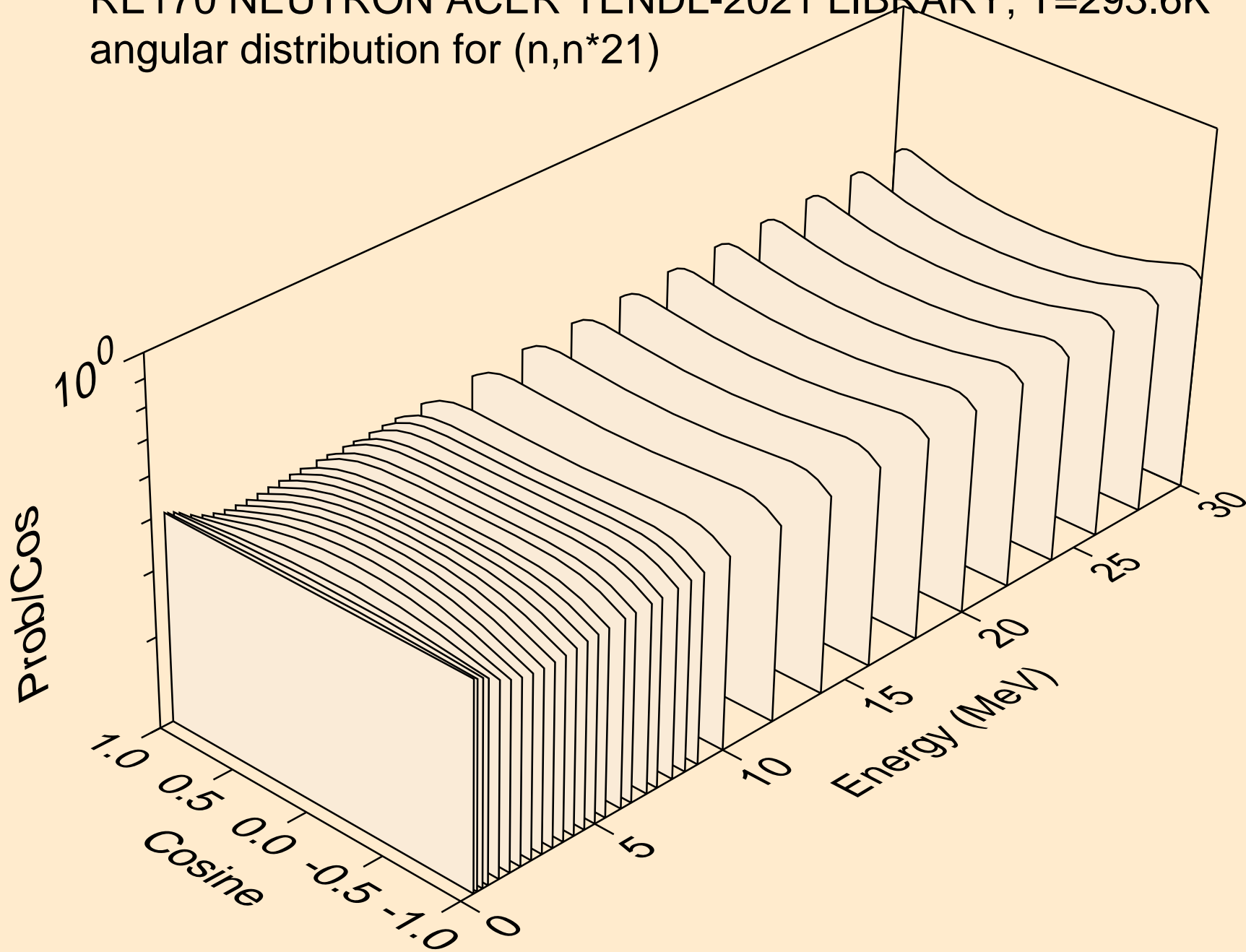

RE170 NEUTRON ACER TENDL-2021 LIBRARY; T=293.6K  
angular distribution for (n,n\*22)

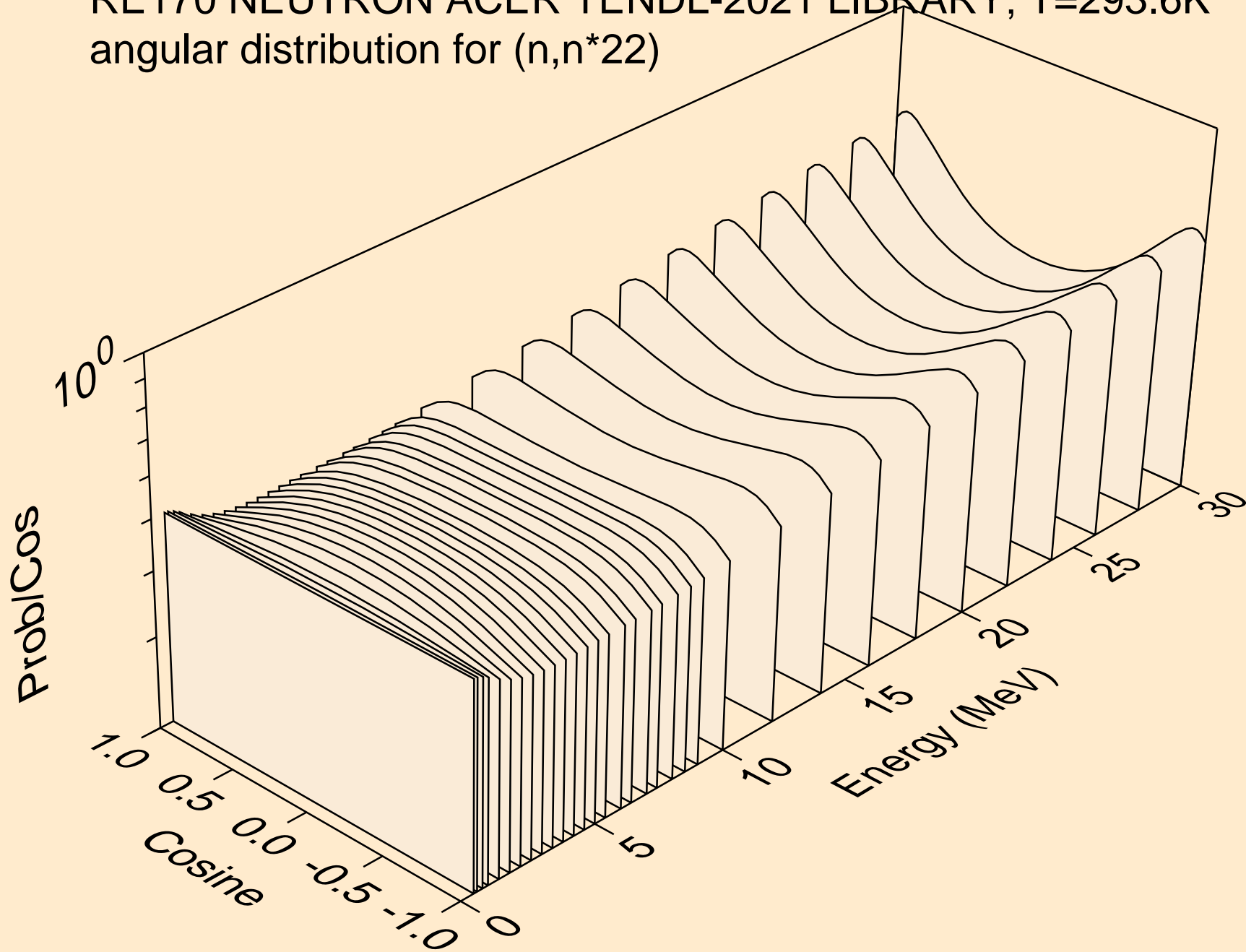



RE170 NEUTRON ACER TENDL-2021 LIBRARY; T=293.6K  
angular distribution for (n,n\*23)

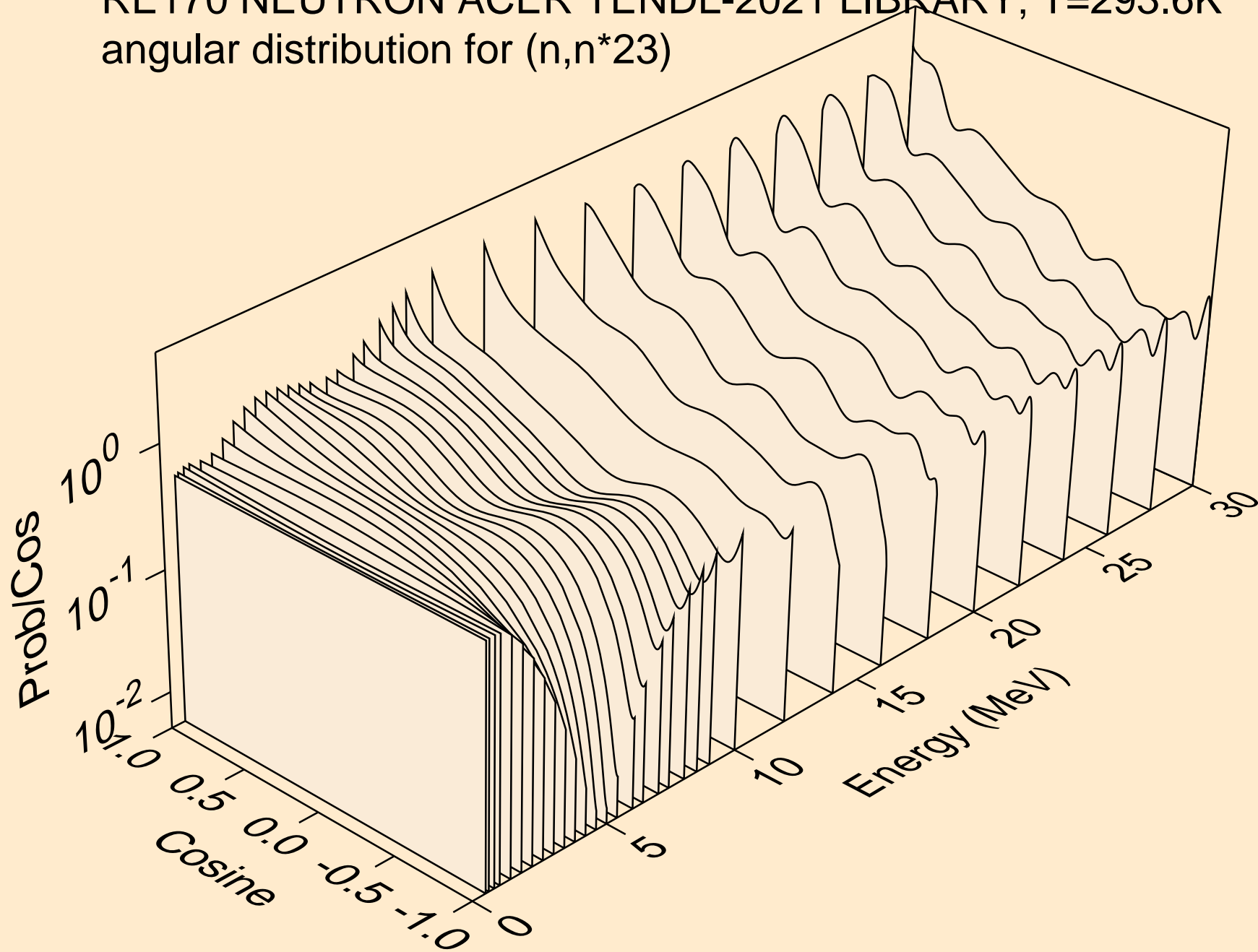

RE170 NEUTRON ACER TENDL-2021 LIBRARY; T=293.6K  
angular distribution for (n,n\*24)

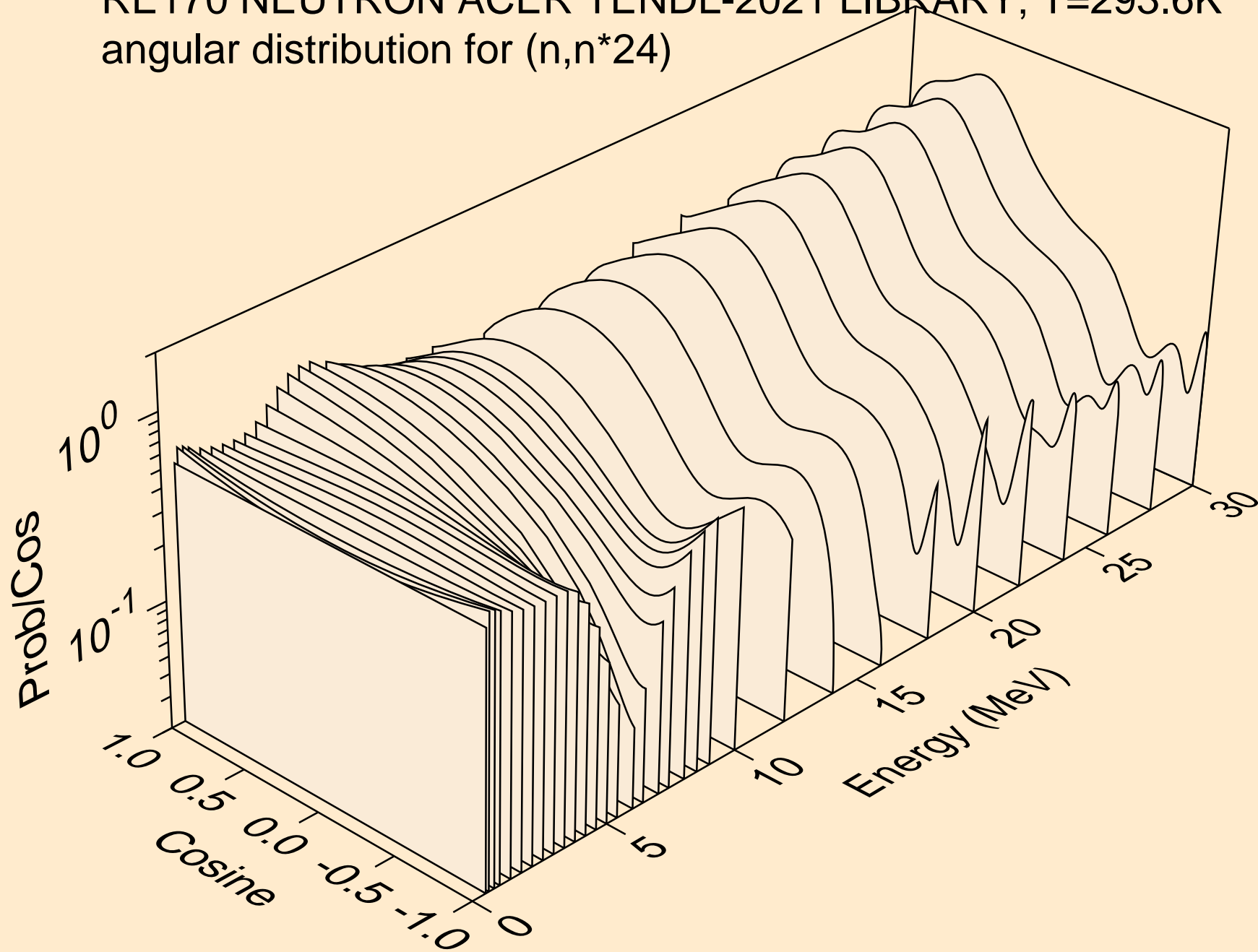

RE170 NEUTRON ACER TENDL-2021 LIBRARY; T=293.6K  
angular distribution for (n,n\*25)

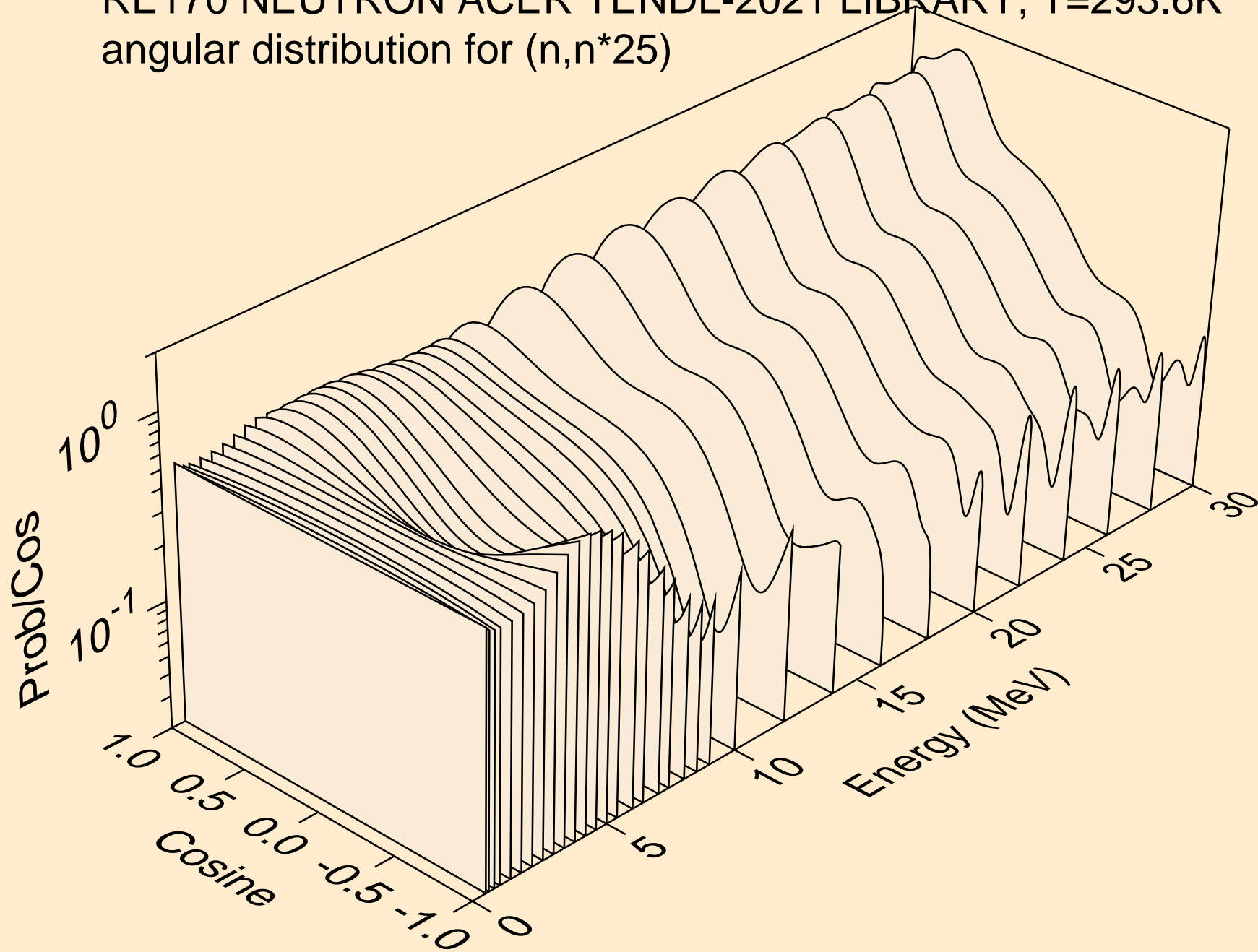

RE170 NEUTRON ACER TENDL-2021 LIBRARY; T=293.6K  
angular distribution for (n,n\*26)

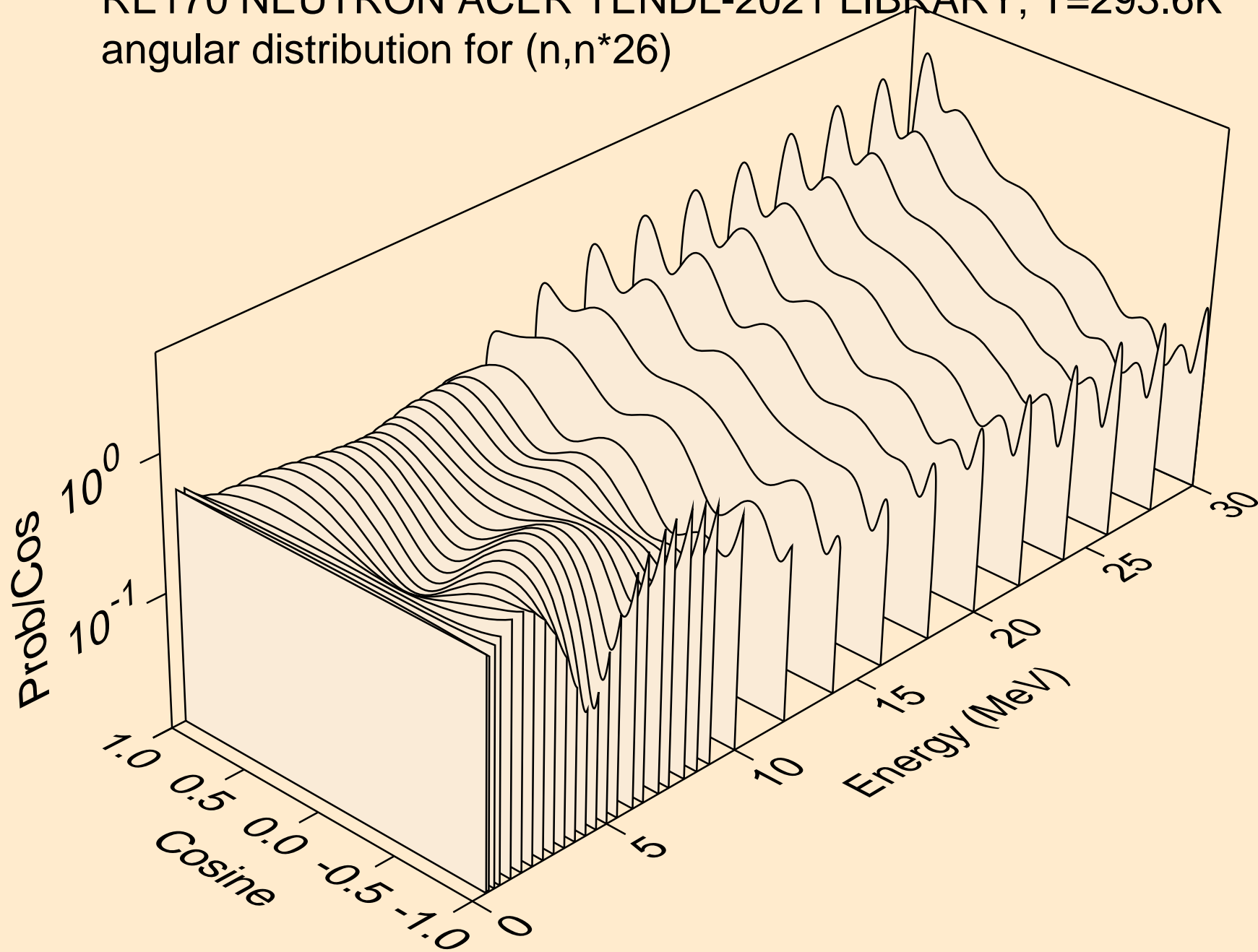

RE170 NEUTRON ACER TENDL-2021 LIBRARY; T=293.6K  
Neutron emission for (n,x)

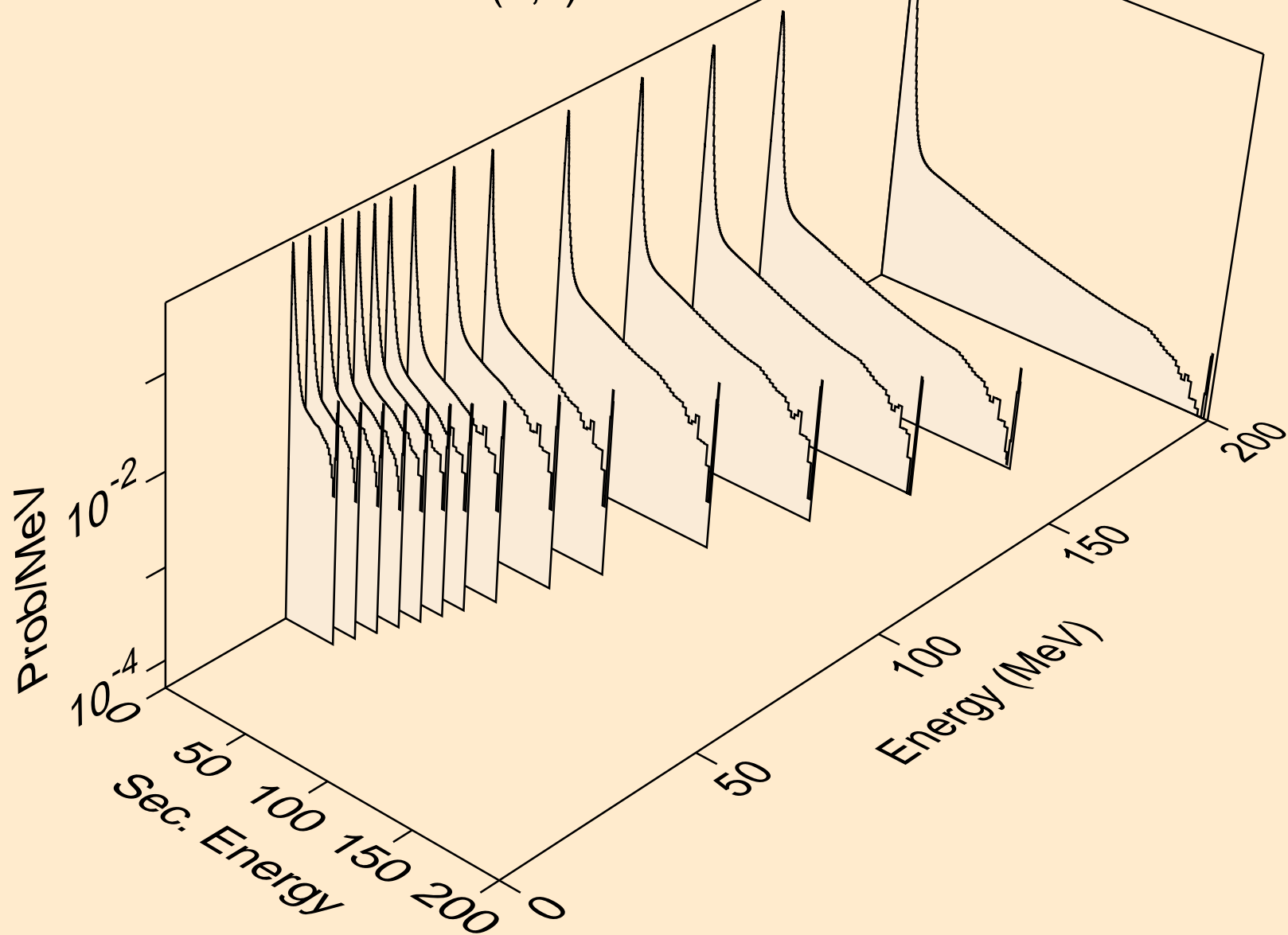

RE170 NEUTRON ACER TENDL-2021 LIBRARY; T=293.6K  
Neutron emission for (n,2nd)

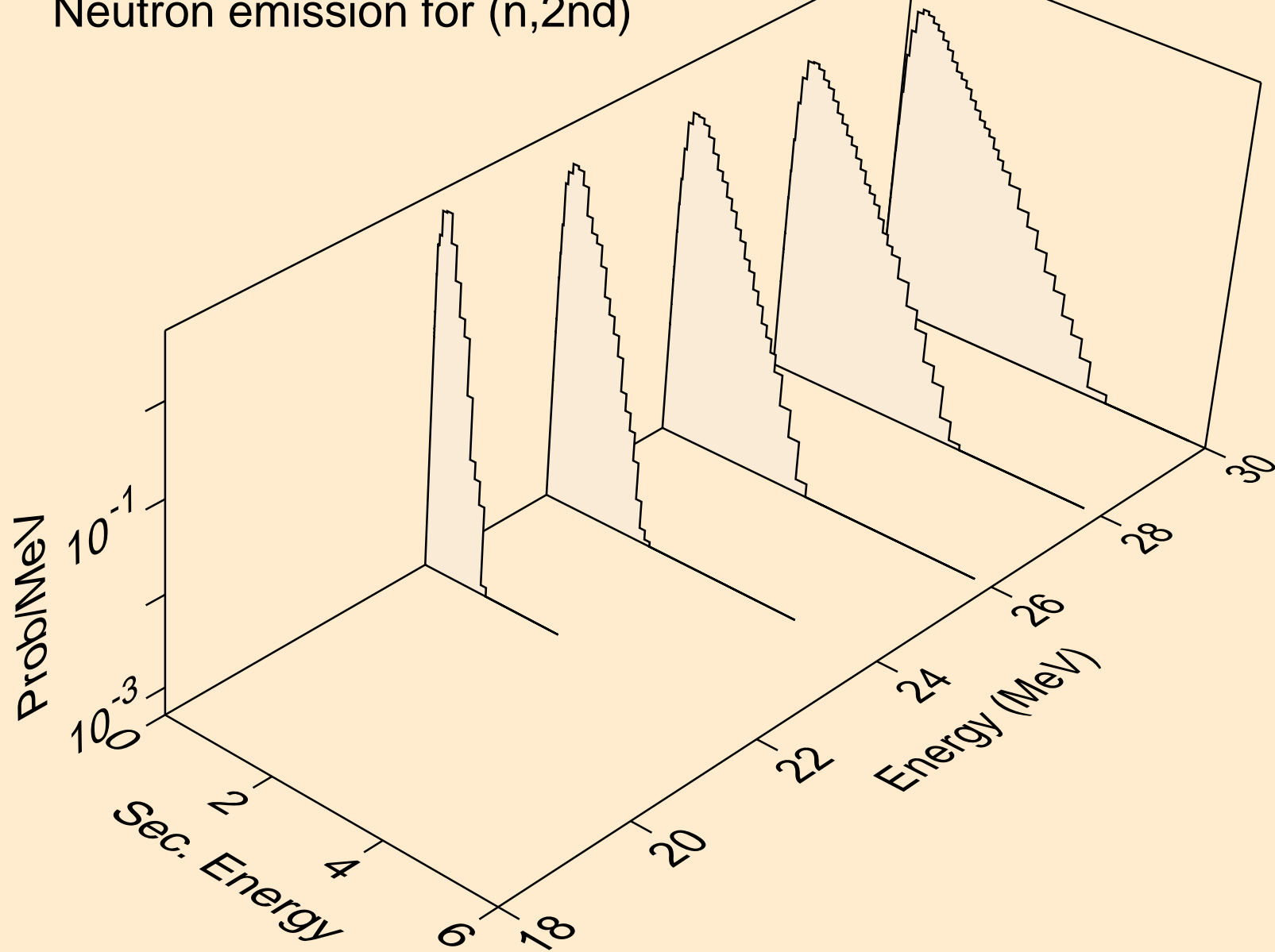

RE170 NEUTRON ACER TENDL-2021 LIBRARY; T=293.6K  
Neutron emission for (n,2n)

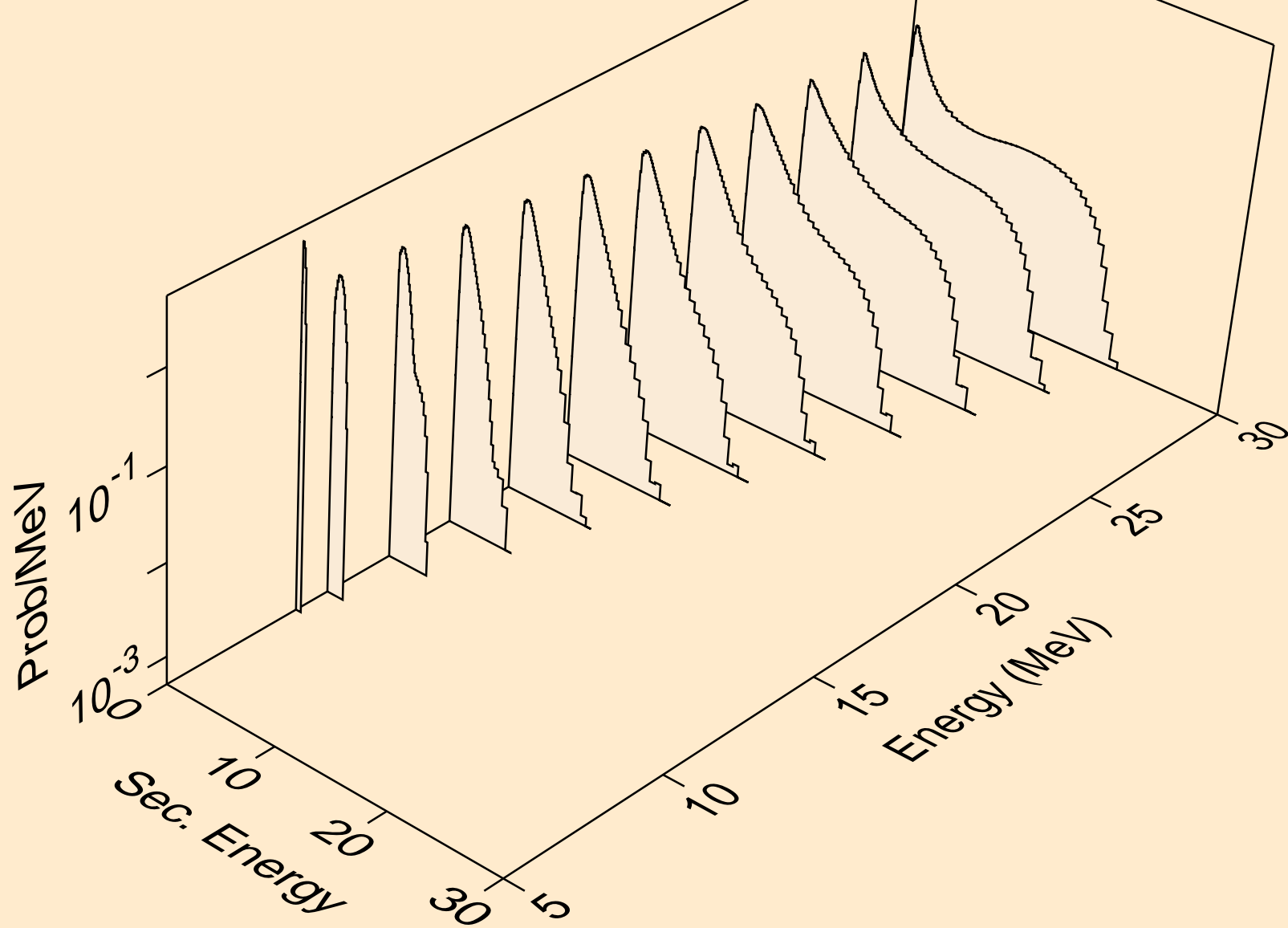

RE170 NEUTRON ACER TENDL-2021 LIBRARY; T=293.6K  
Neutron emission for (n,3n)

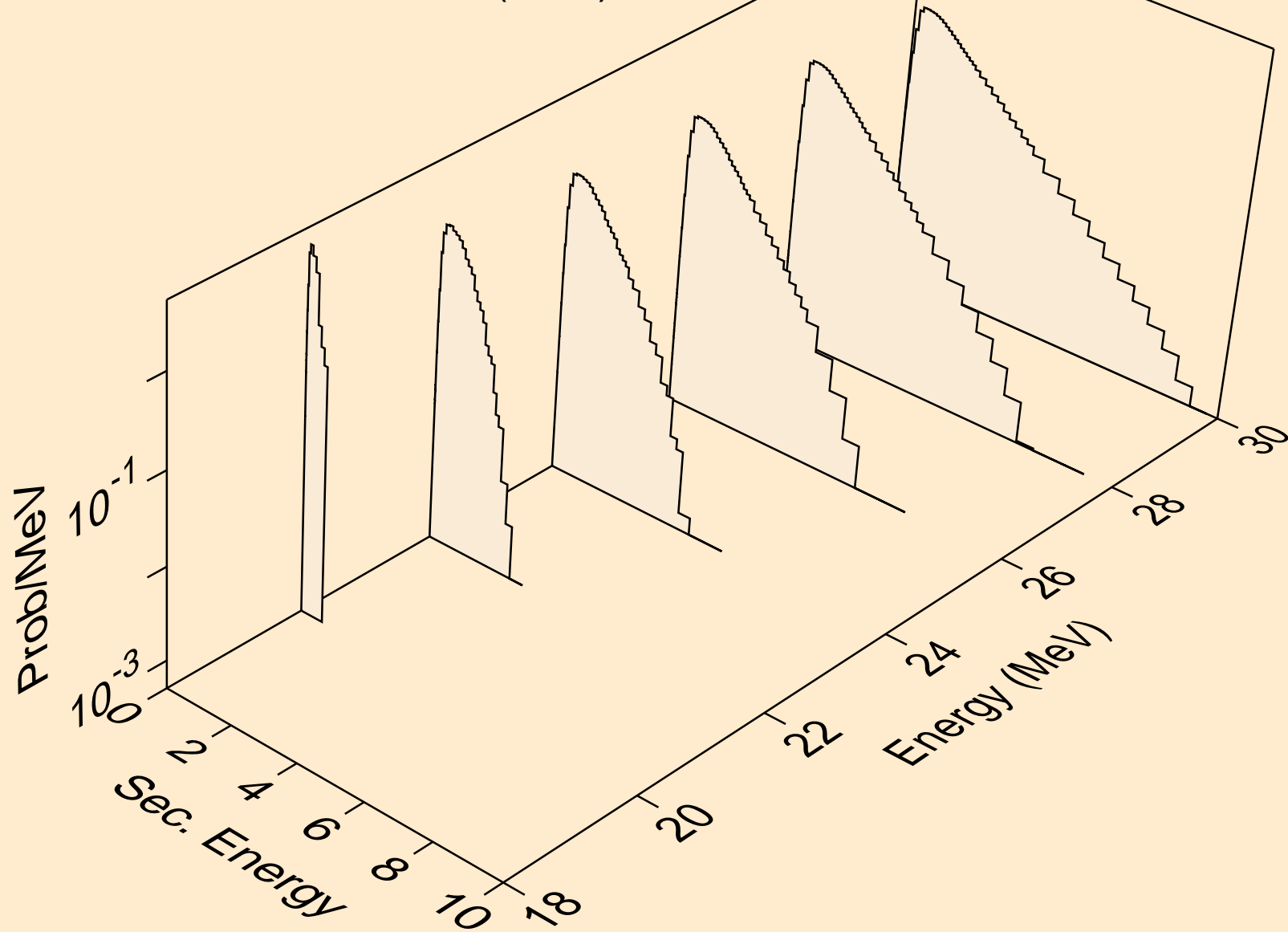



RE170 NEUTRON ACER TENDL-2021 LIBRARY; T=293.6K  
Neutron emission for (n,n\*)a

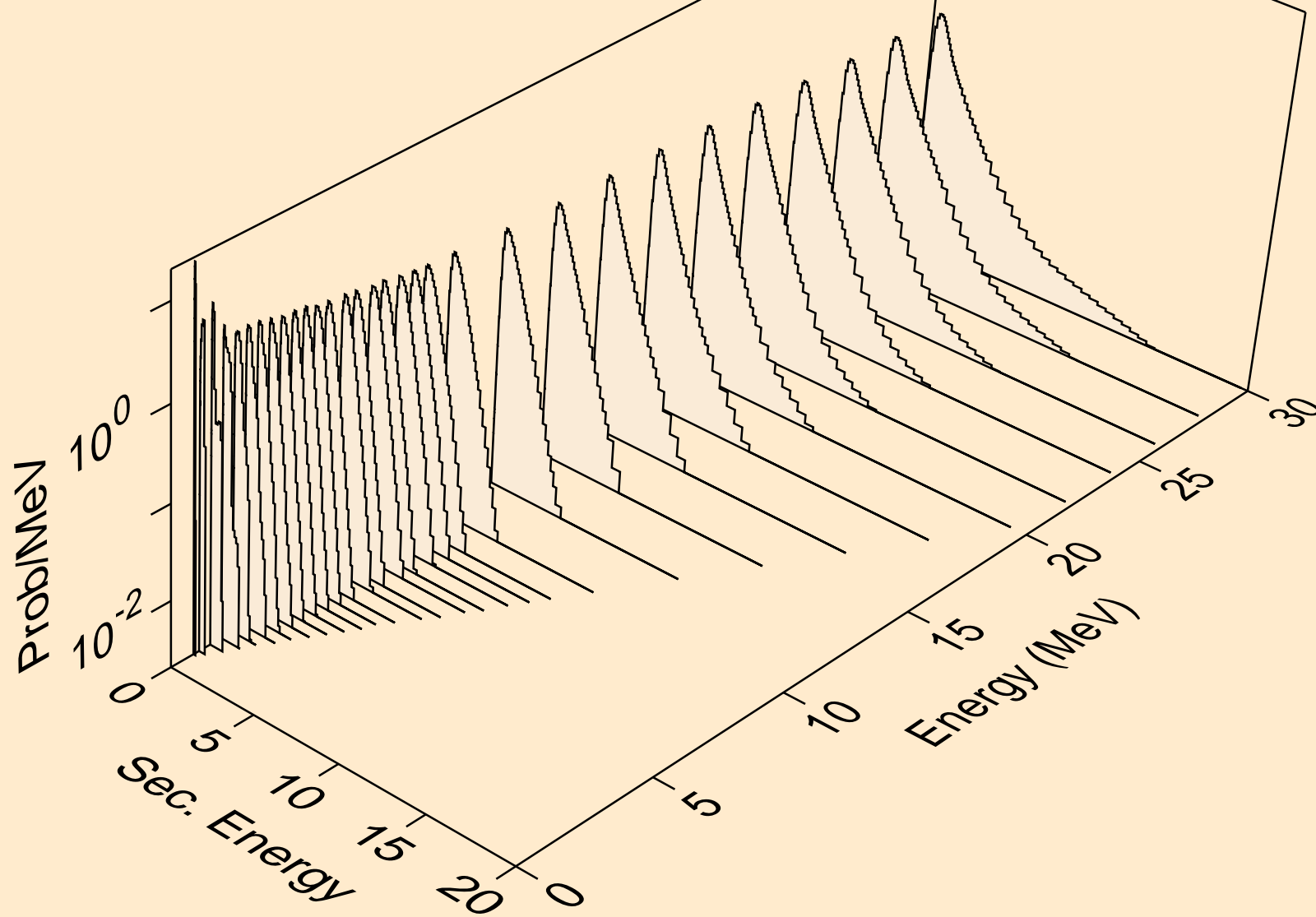

RE170 NEUTRON ACER TENDL-2021 LIBRARY; T=293.6K  
Neutron emission for (n,2n)<sub>a</sub>

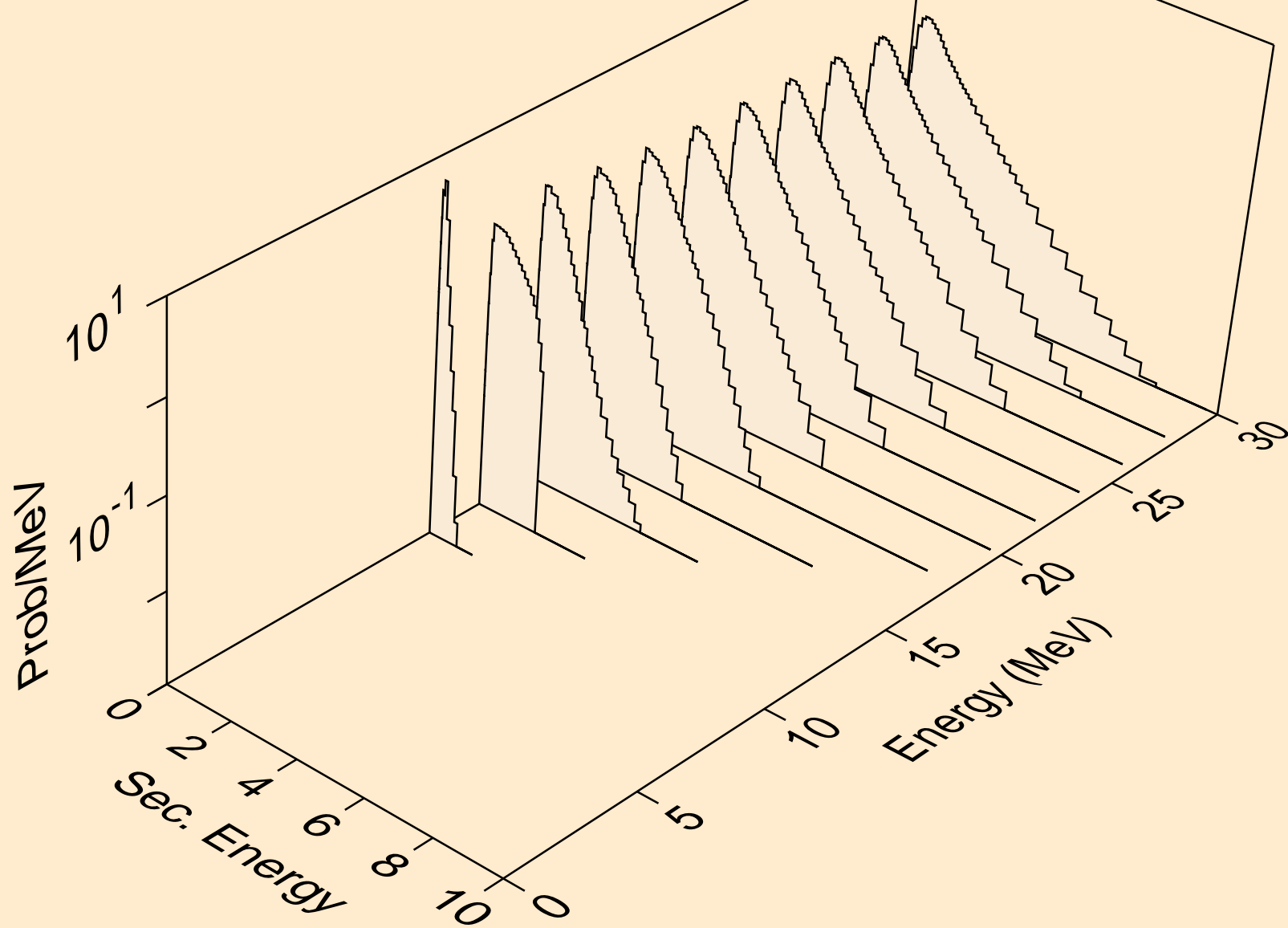

RE170 NEUTRON ACER TENDL-2021 LIBRARY; T=293.6K  
Neutron emission for (n,3n)a

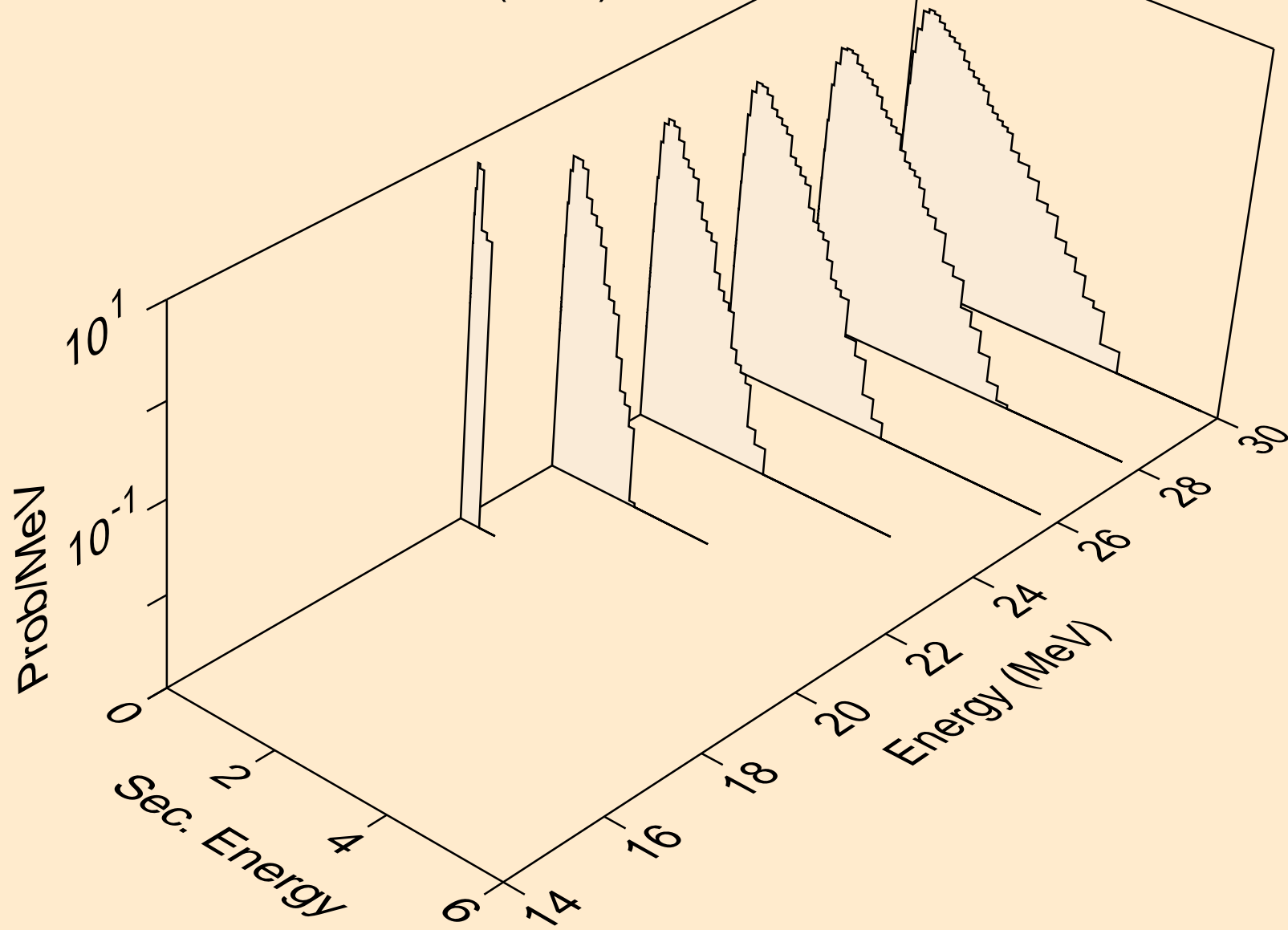

RE170 NEUTRON ACER TENDL-2021 LIBRARY; T=293.6K  
Neutron emission for (n,n\*)p

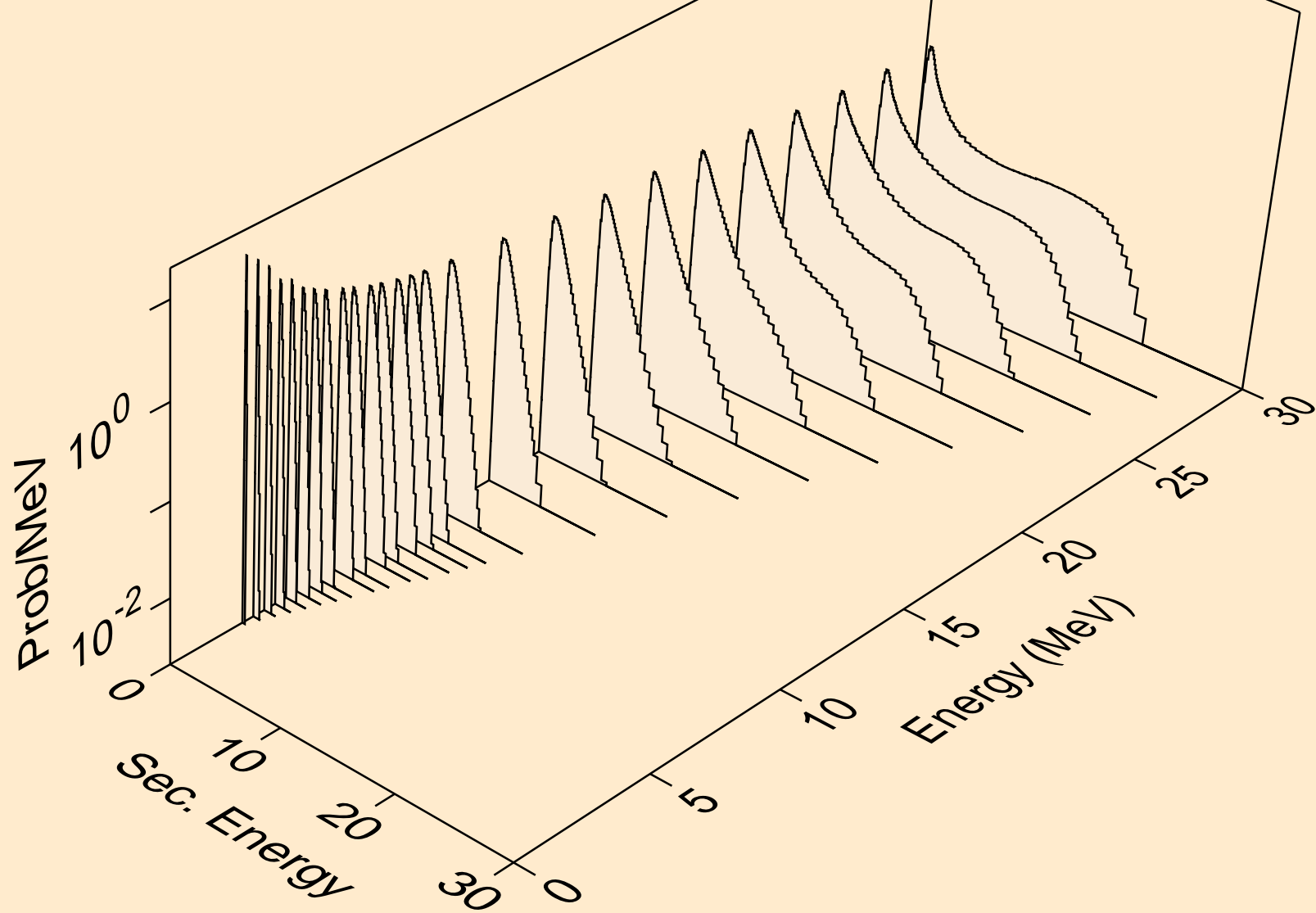

RE170 NEUTRON ACER TENDL-2021 LIBRARY; T=293.6K  
Neutron emission for (n,n\*)2a

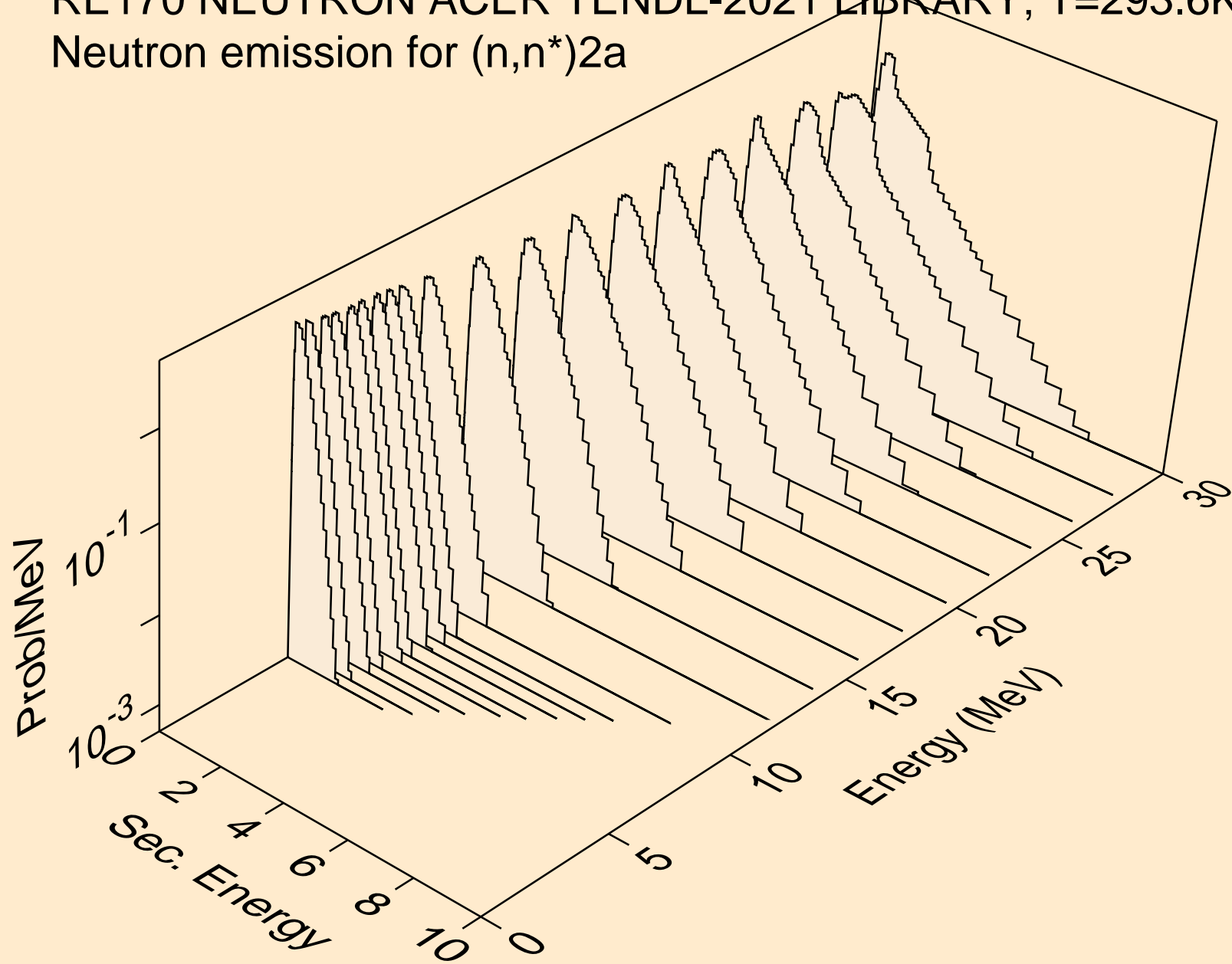

RE170 NEUTRON ACER TENDL-2021 LIBRARY; T=293.6K  
Neutron emission for (n,2n)2a

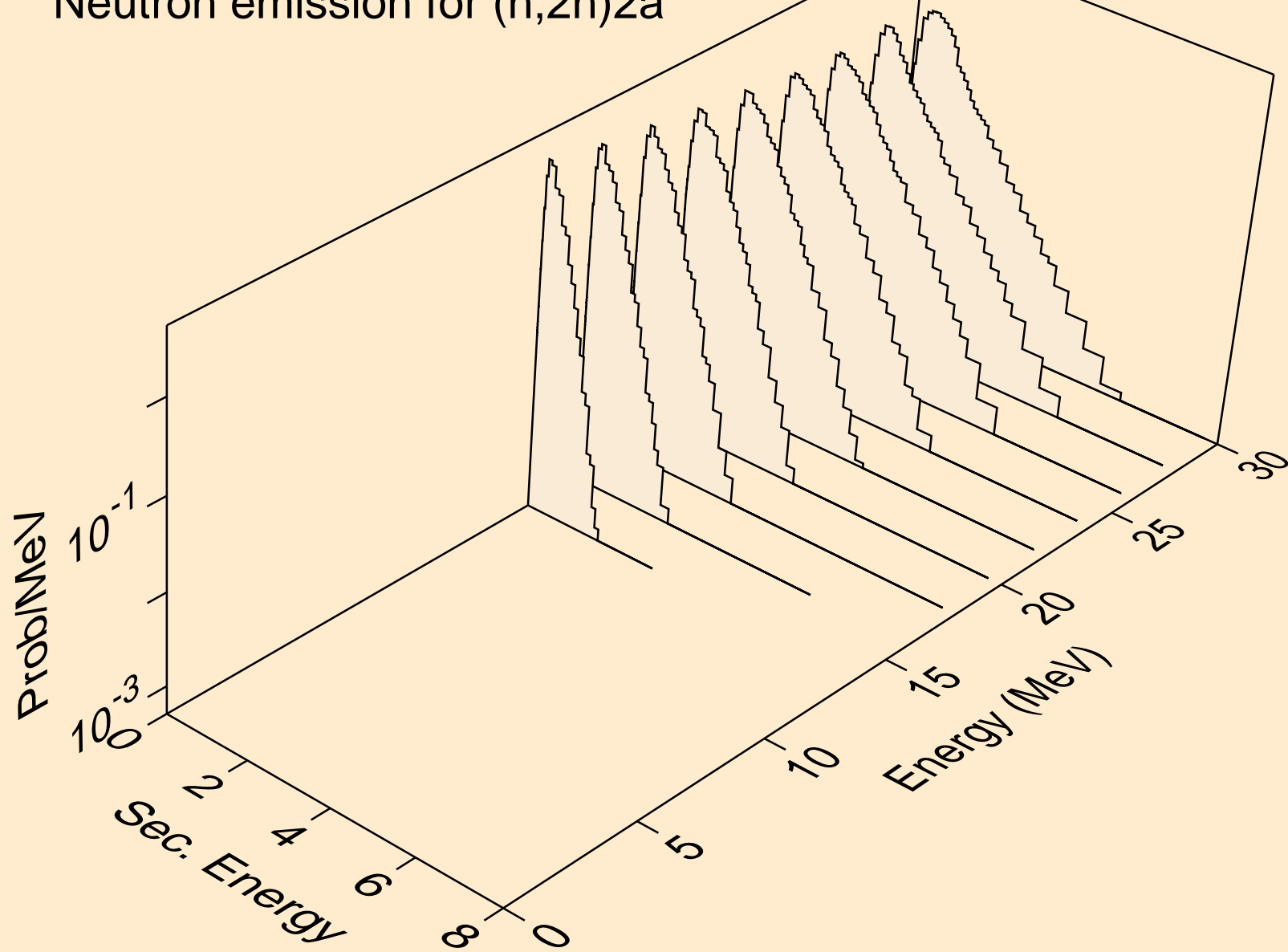

RE170 NEUTRON ACER TENDL-2021 LIBRARY; T=293.6K  
Neutron emission for (n,n\*)d

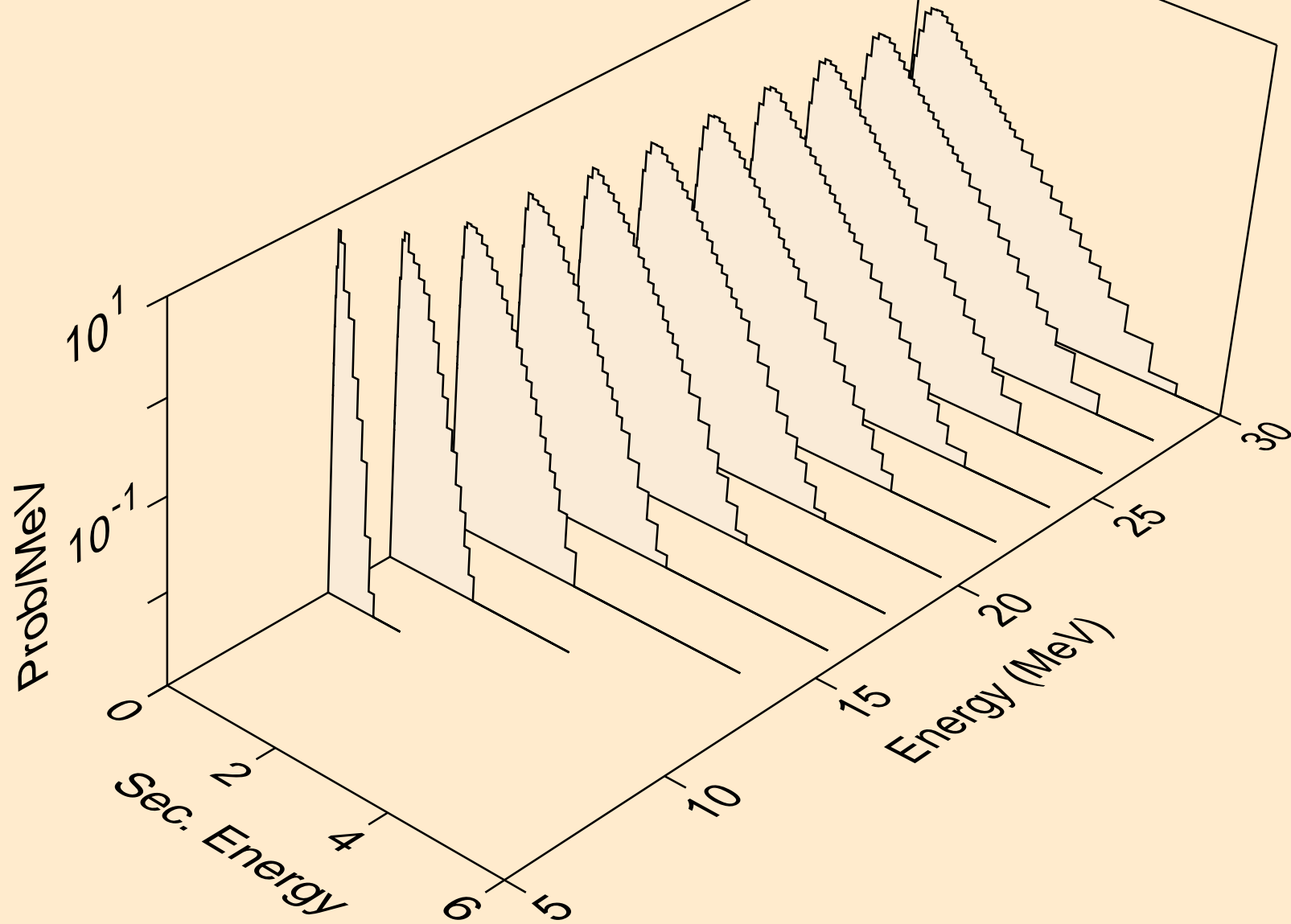

RE170 NEUTRON ACER TENDL-2021 LIBRARY; T=293.6K  
Neutron emission for (n,n\*)t

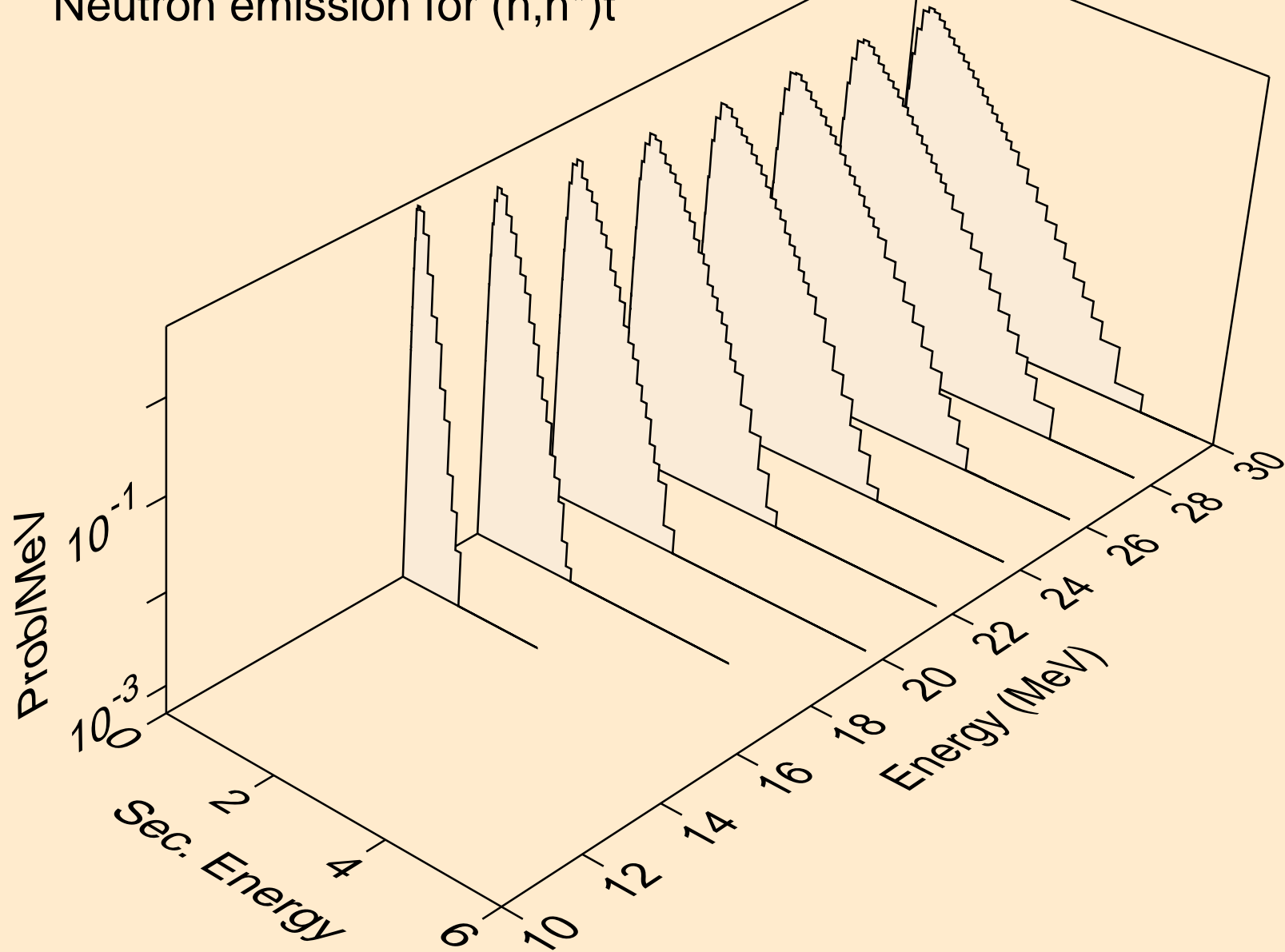



RE170 NEUTRON ACER TENDL-2021 LIBRARY; T=293.6K  
Neutron emission for (n,n\*)he3

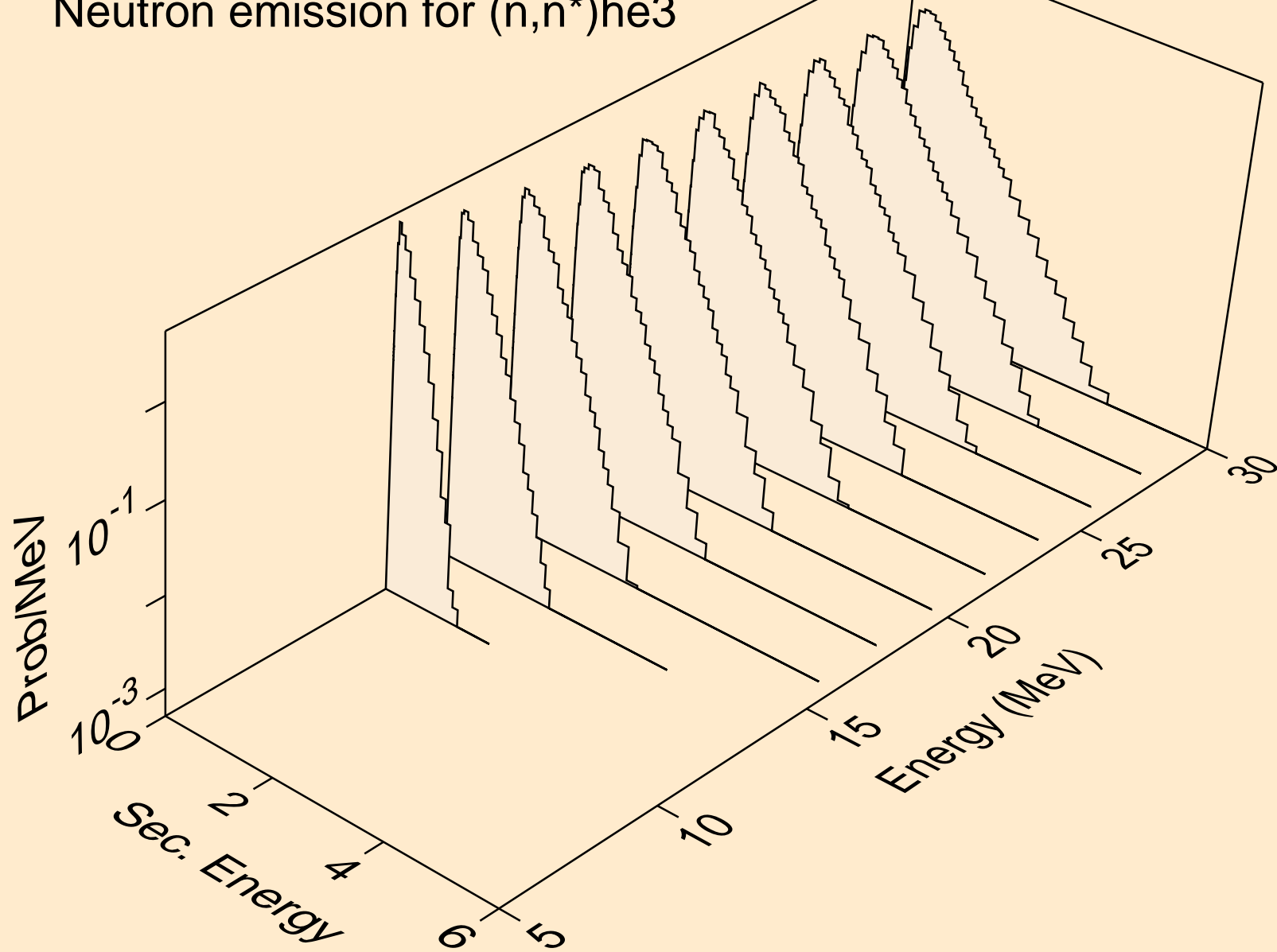

RE170 NEUTRON ACER TENDL-2021 LIBRARY; T=293.6K  
Neutron emission for (n,4n)

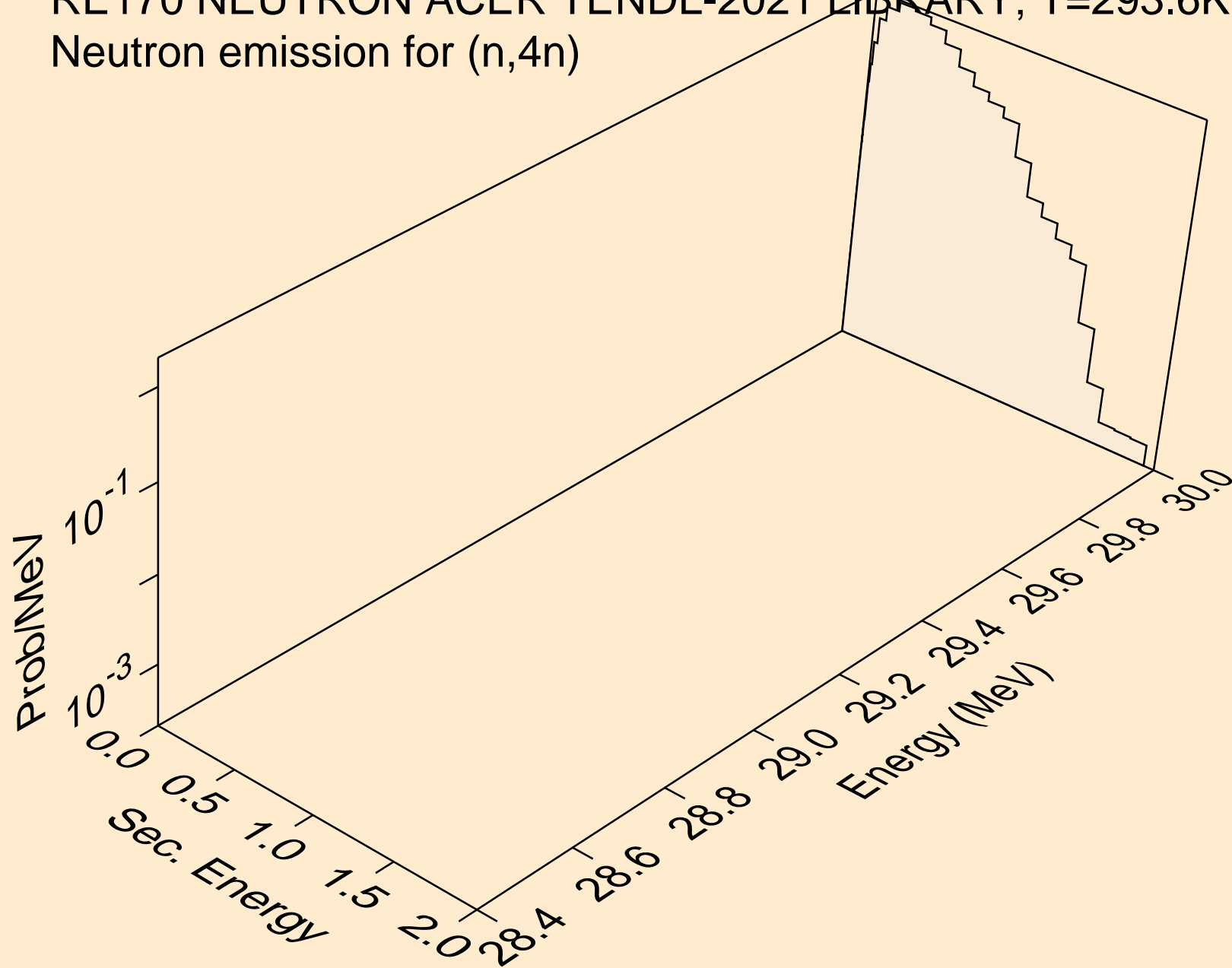

RE170 NEUTRON ACER TENDL-2021 LIBRARY; T=293.6K  
Neutron emission for (n,2np)

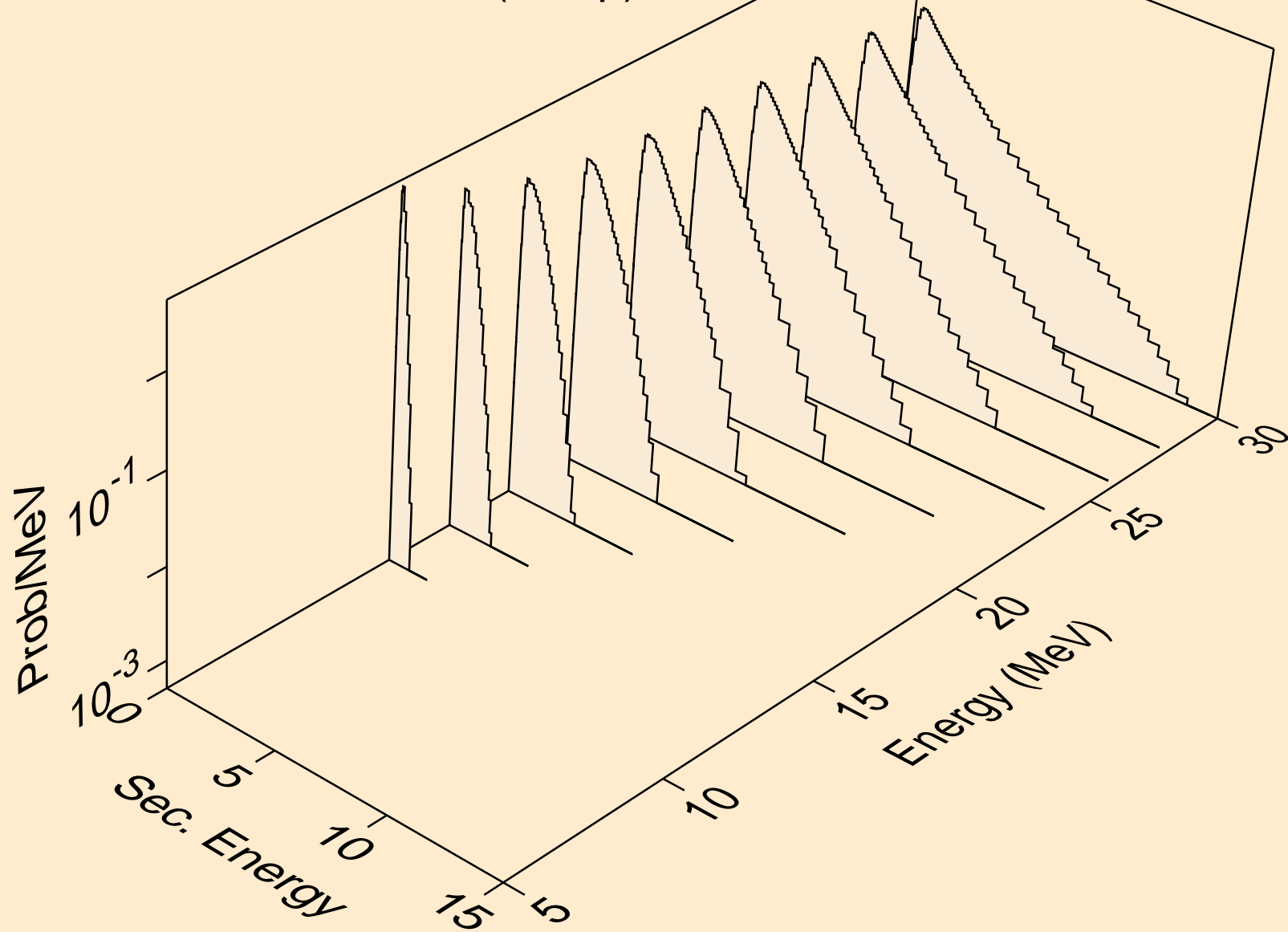

RE170 NEUTRON ACER TENDL-2021 LIBRARY; T=293.6K  
Neutron emission for (n,3np)

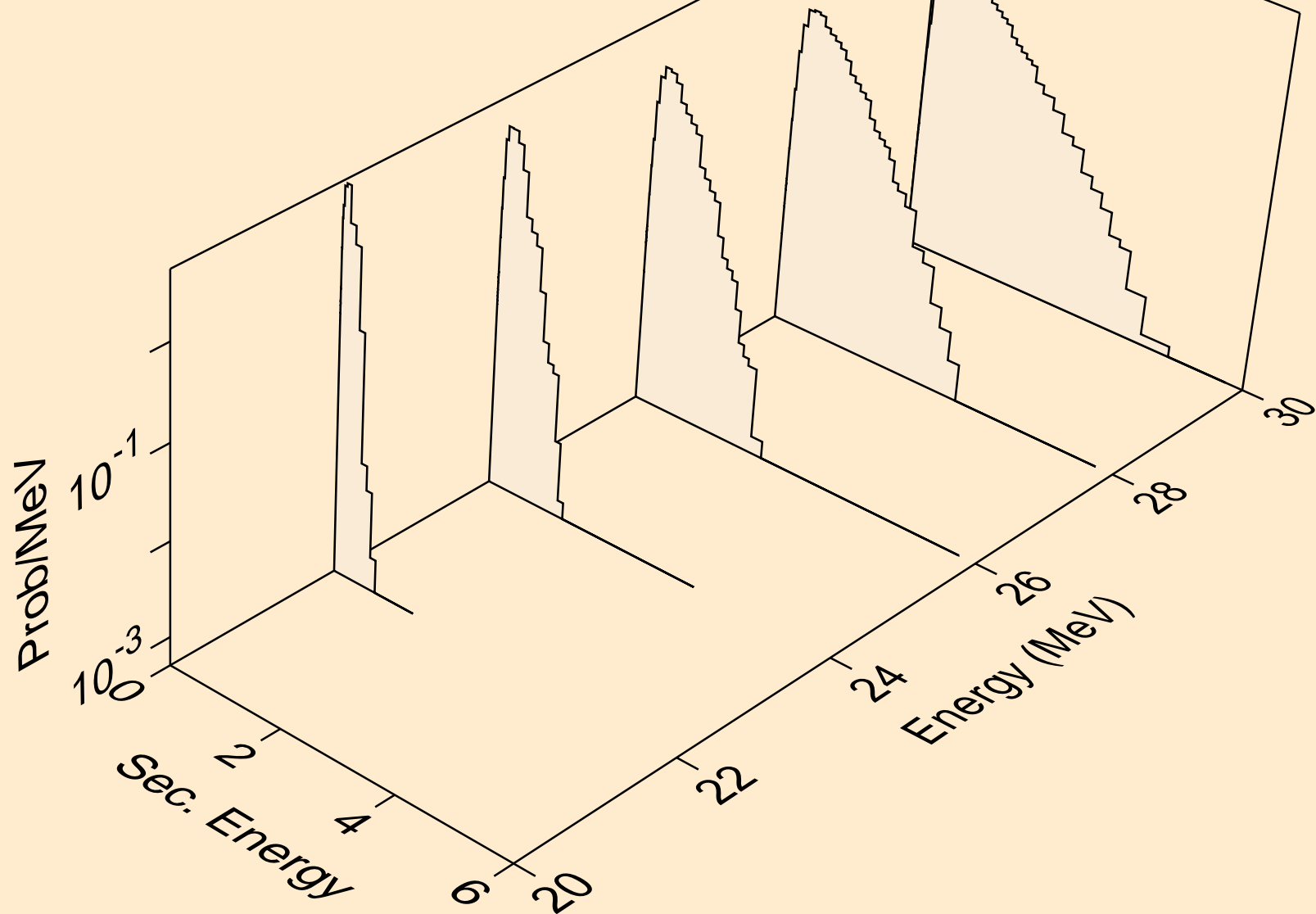

RE170 NEUTRON ACER TENDL-2021 LIBRARY; T=293.6K  
Neutron emission for (n,2np)

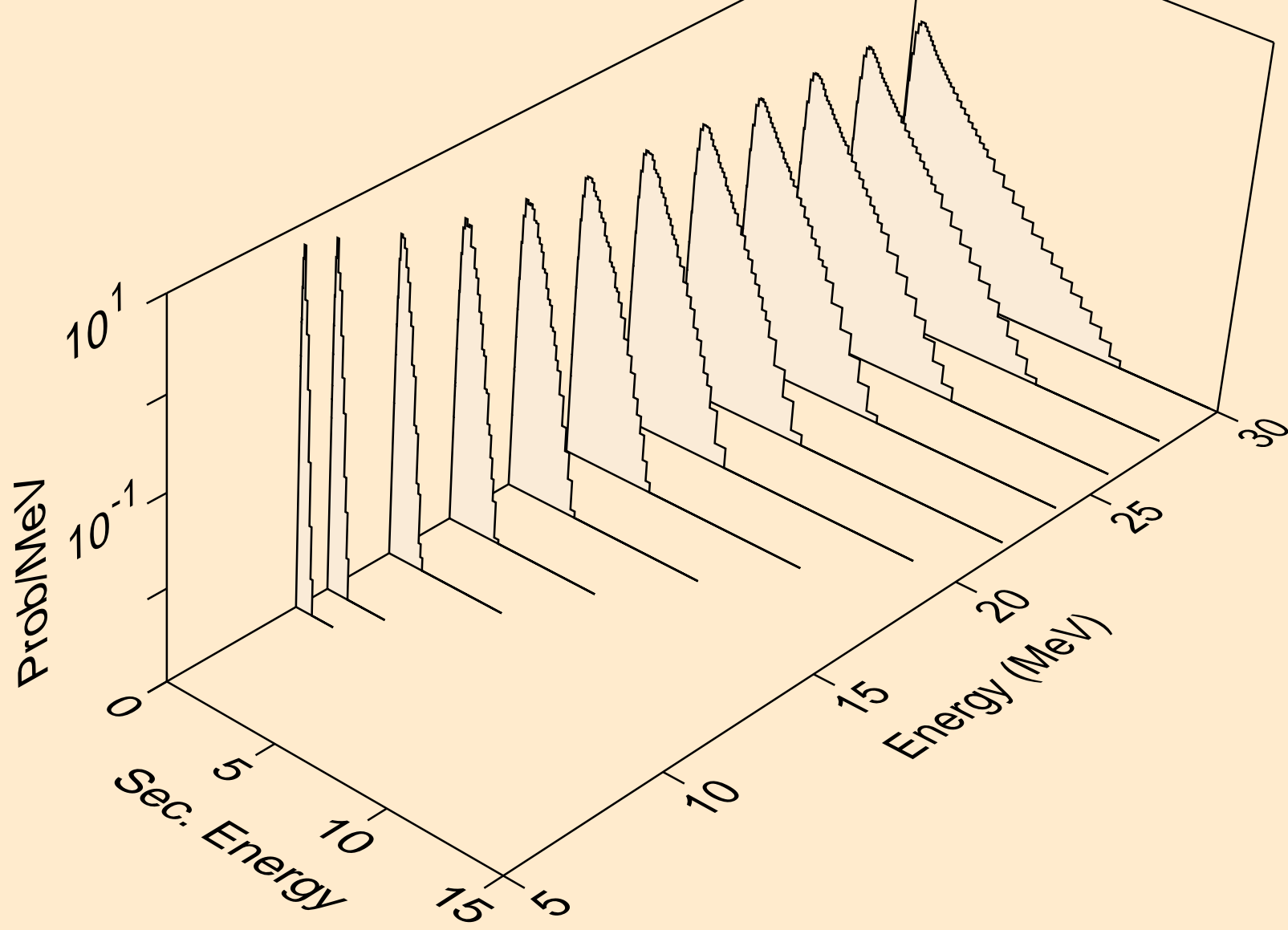

RE170 NEUTRON ACER TENDL-2021 LIBRARY; T=293.6K  
Neutron emission for (n,npa)

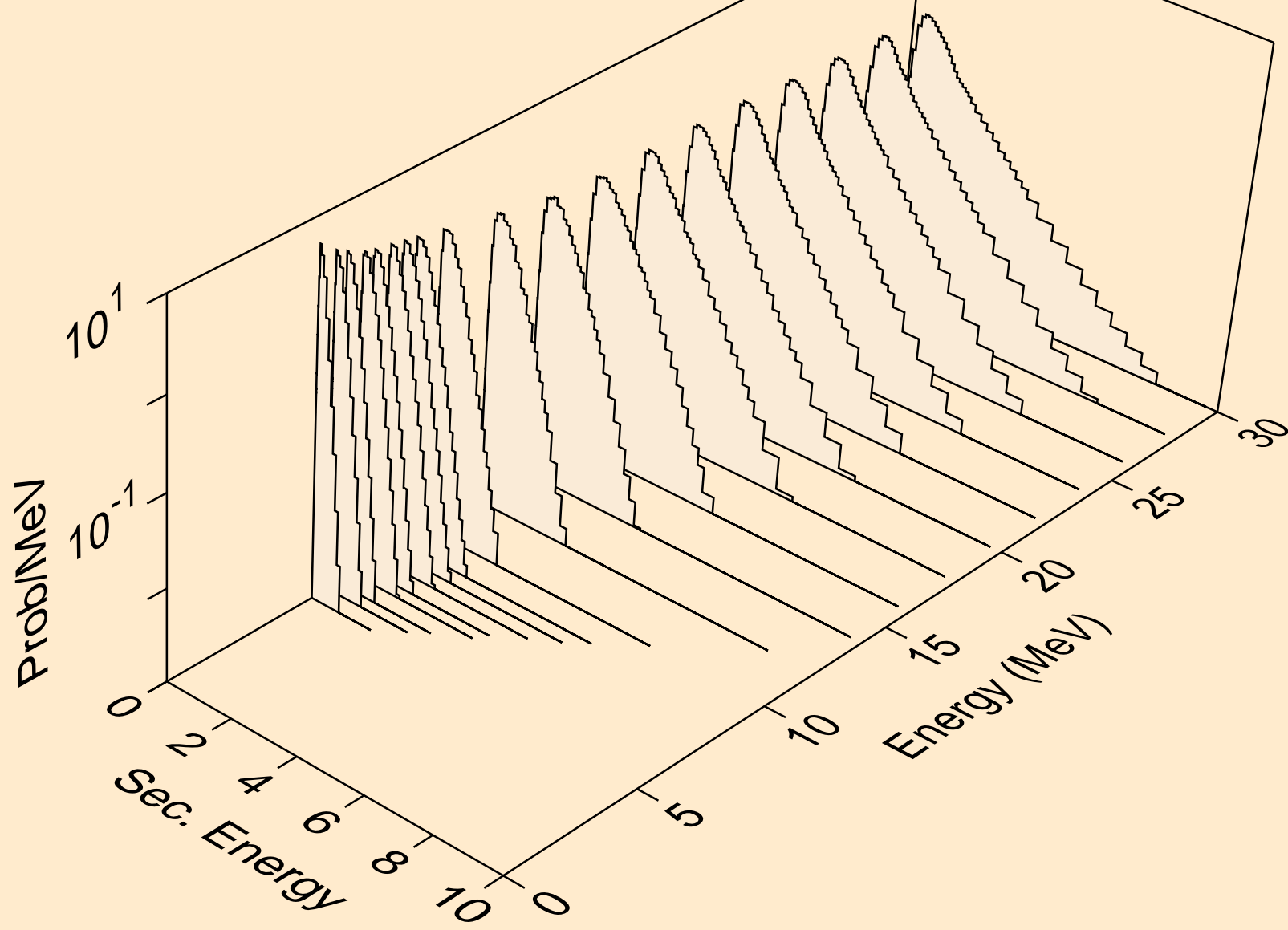

RE170 NEUTRON ACER TENDL-2021 LIBRARY; T=293.6K  
Neutron emission for (n,n\*c)

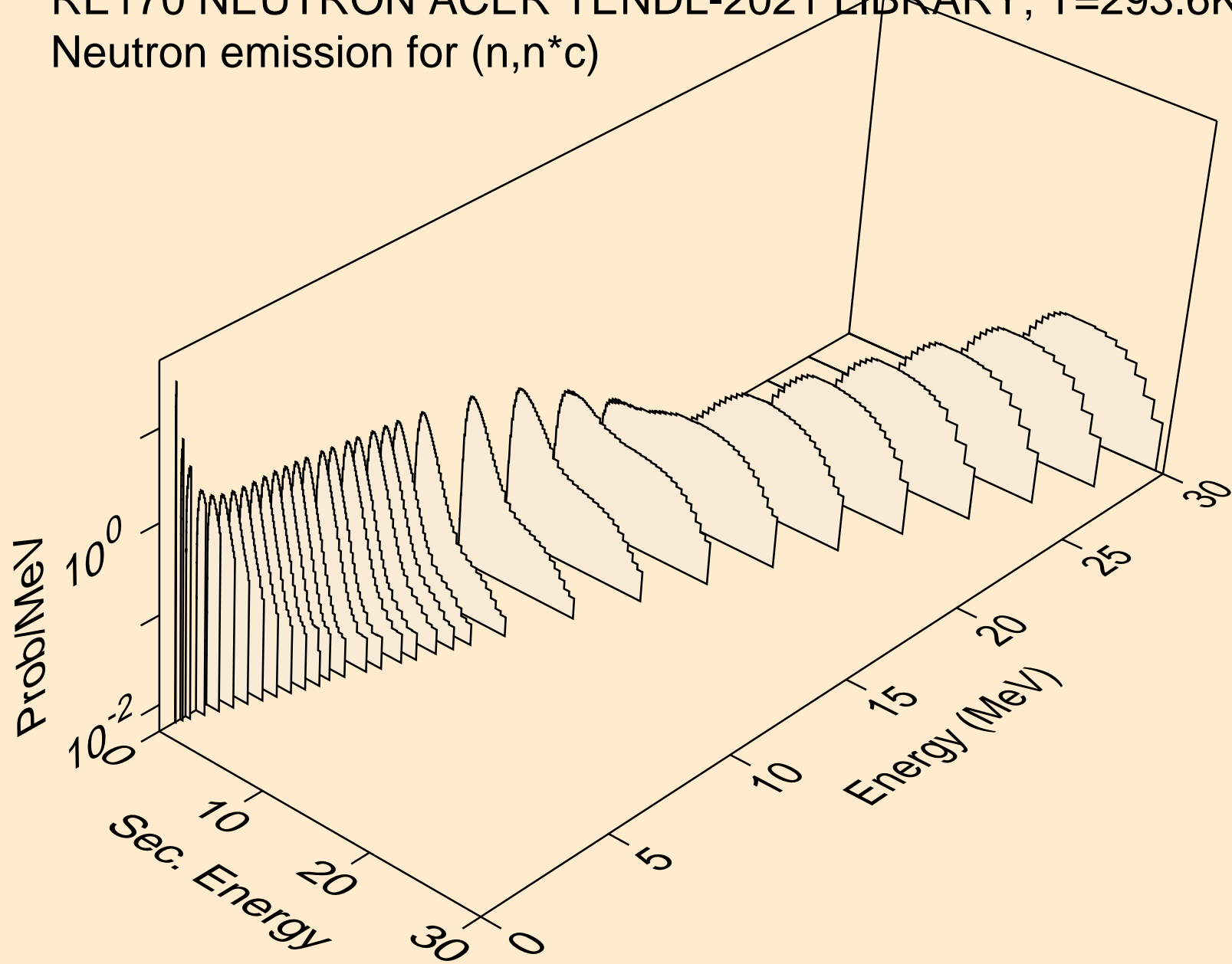

RE170 NEUTRON ACER TENDL-2021 LIBRARY; T=293.6K  
Photon emission for (n,x)

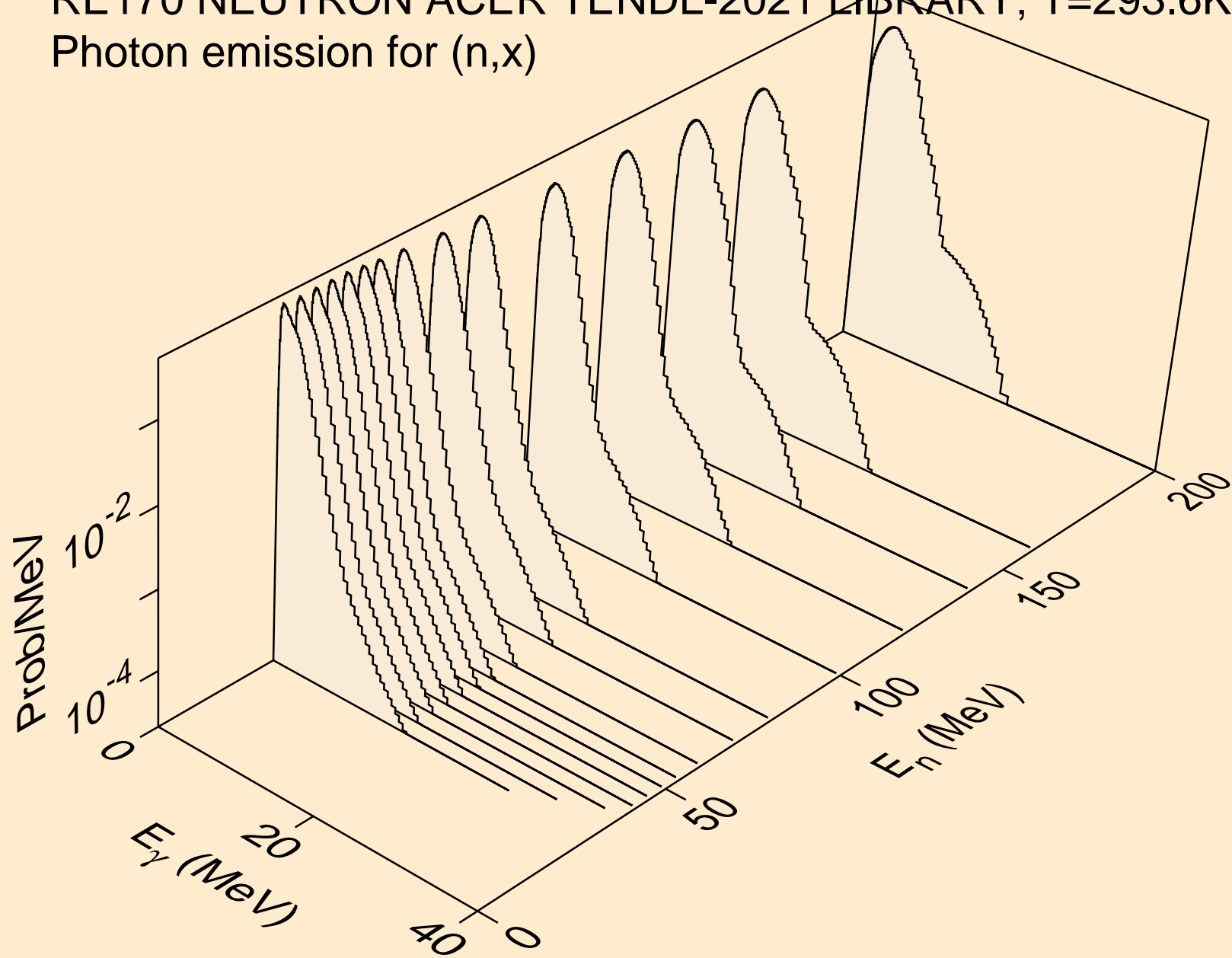



RE170 NEUTRON ACER TENDL-2021 LIBRARY; T=293.6K  
Photon emission for (n,2nd)

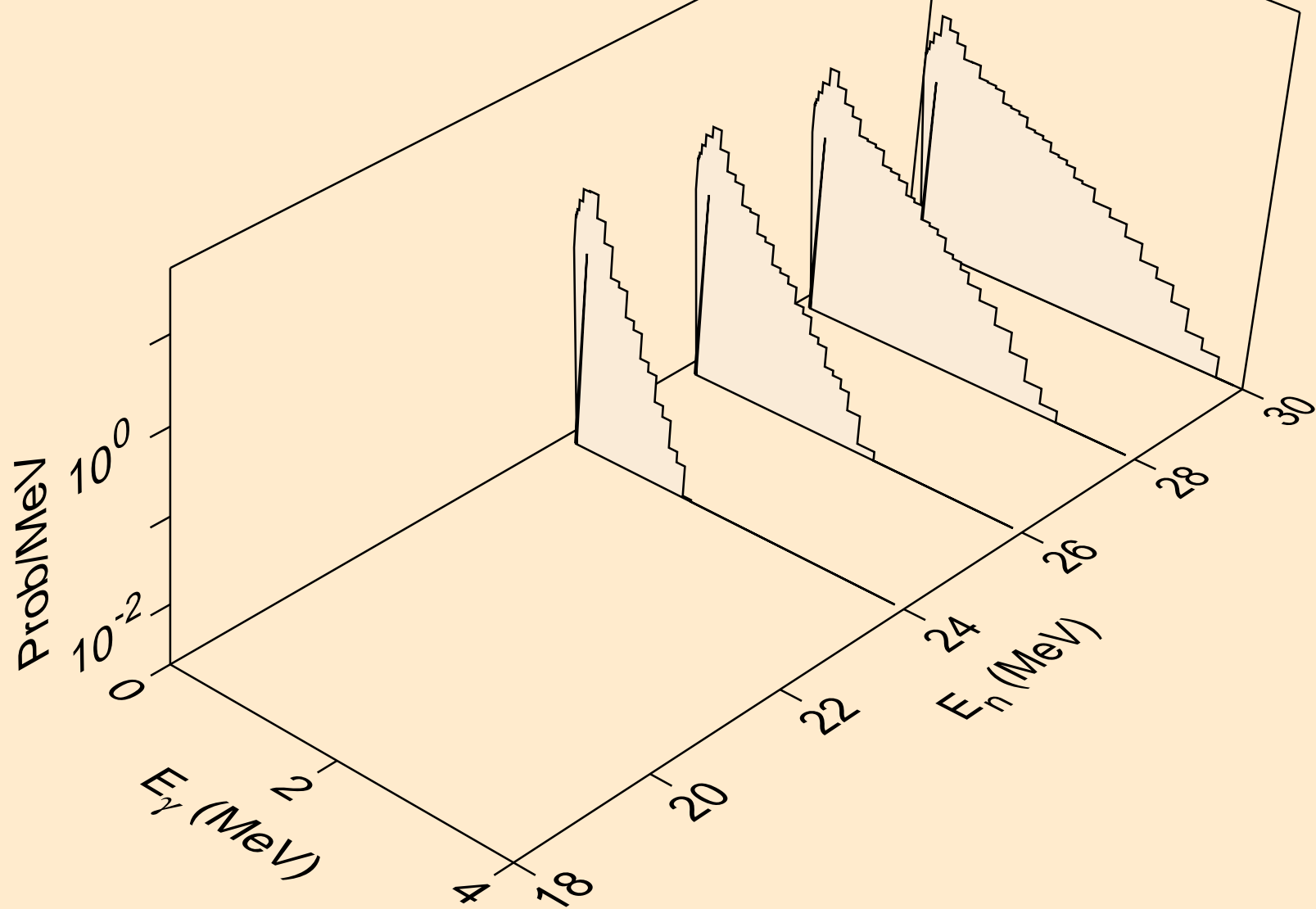

RE170 NEUTRON ACER TENDL-2021 LIBRARY; T=293.6K  
Photon emission for (n,2n)

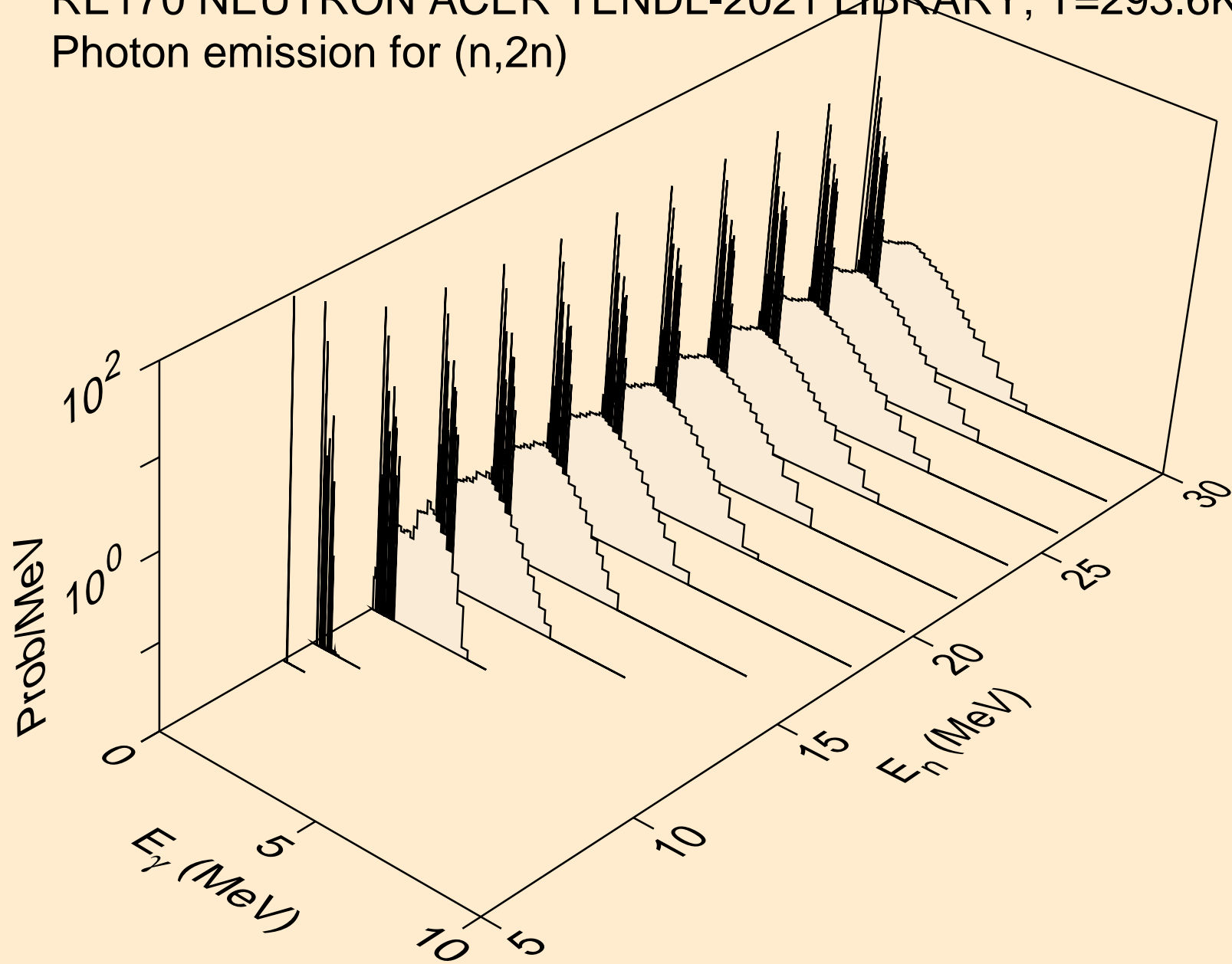

RE170 NEUTRON ACER TENDL-2021 LIBRARY; T=293.6K  
Photon emission for (n,3n)

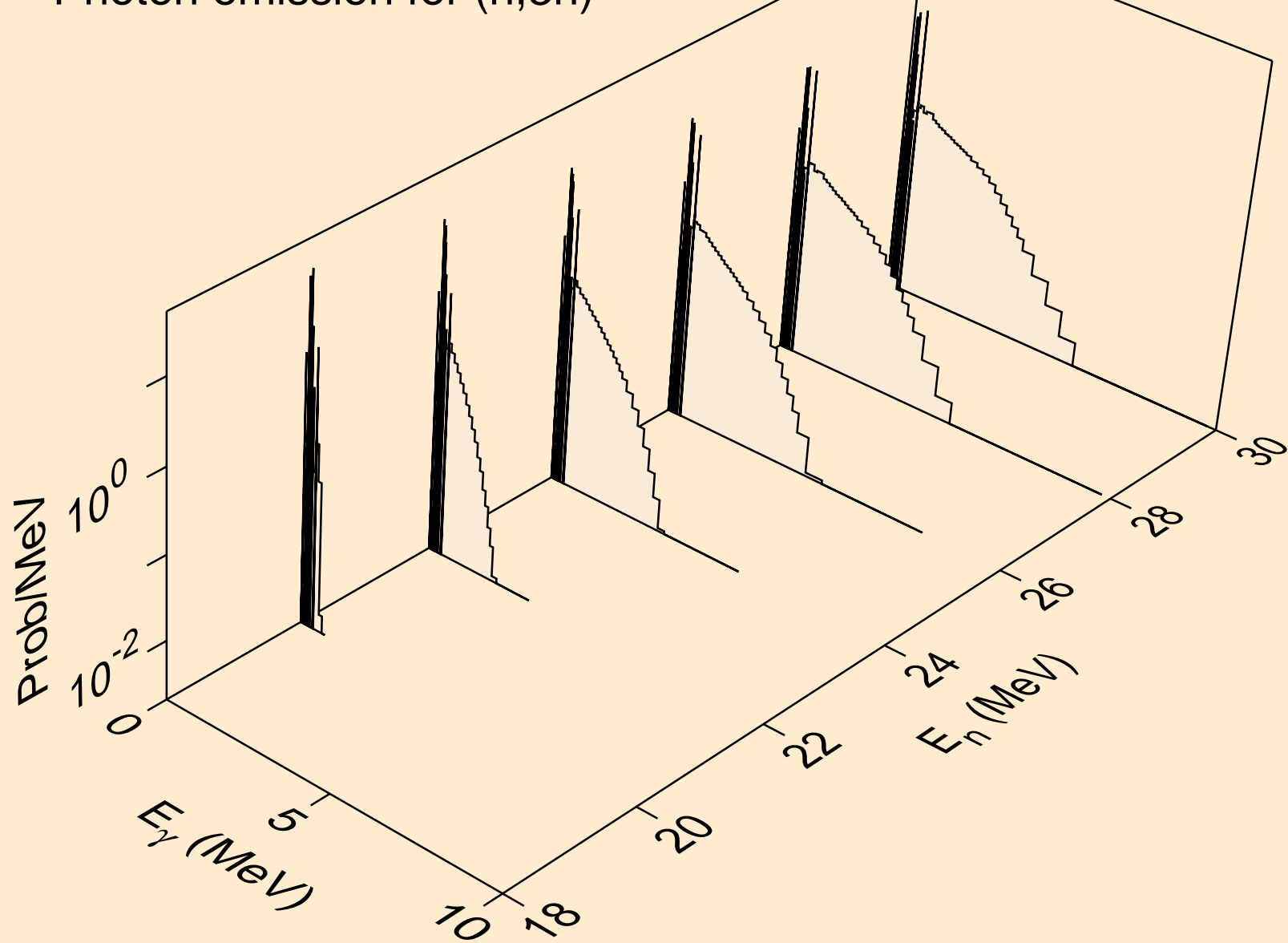

RE170 NEUTRON ACER TENDL-2021 LIBRARY; T=293.6K  
Photon emission for (n,n\*)a

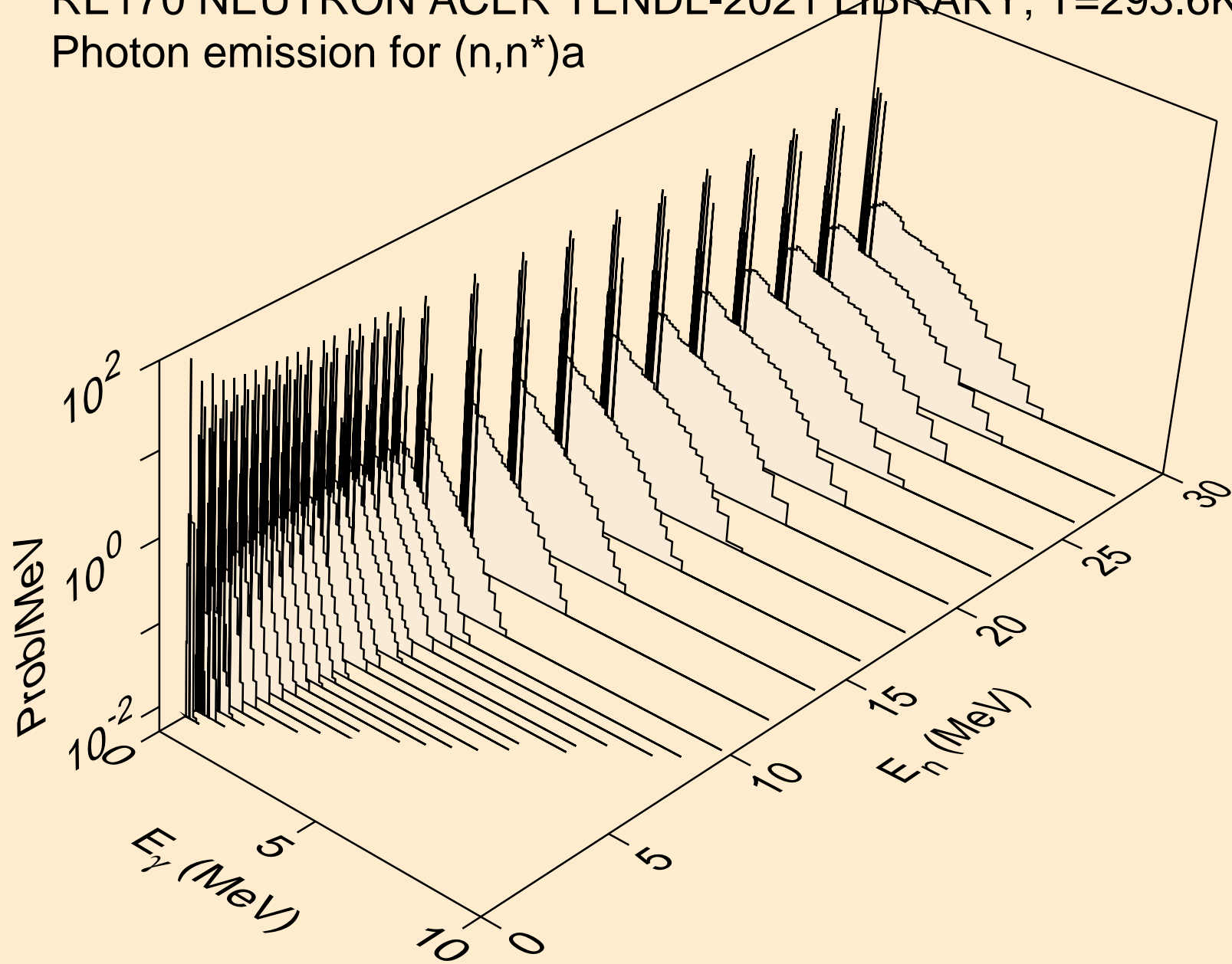

RE170 NEUTRON ACER TENDL-2021 LIBRARY; T=293.6K  
Photon emission for (n,2n)a

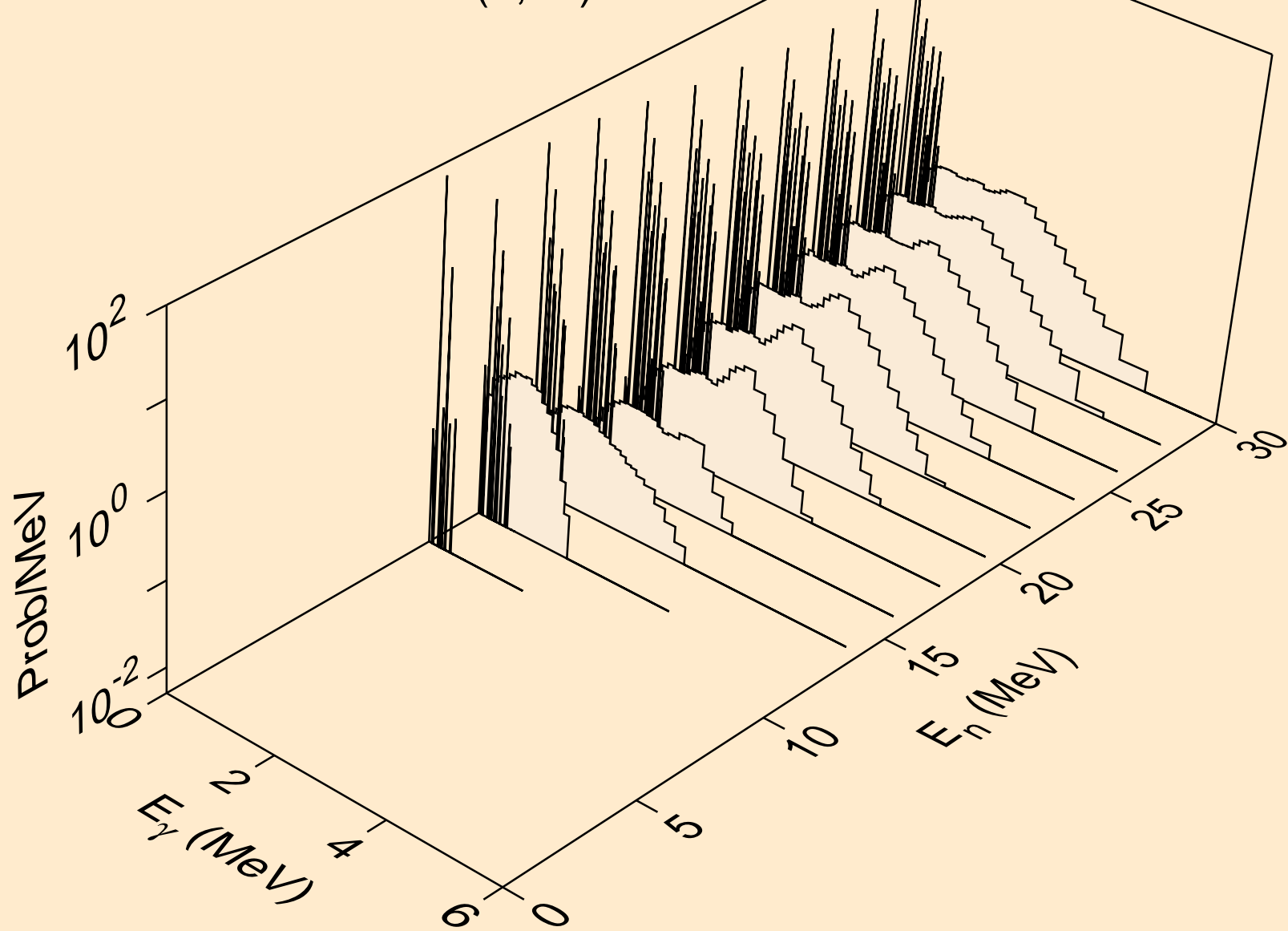

RE170 NEUTRON ACER TENDL-2021 LIBRARY; T=293.6K  
Photon emission for (n,3n)a

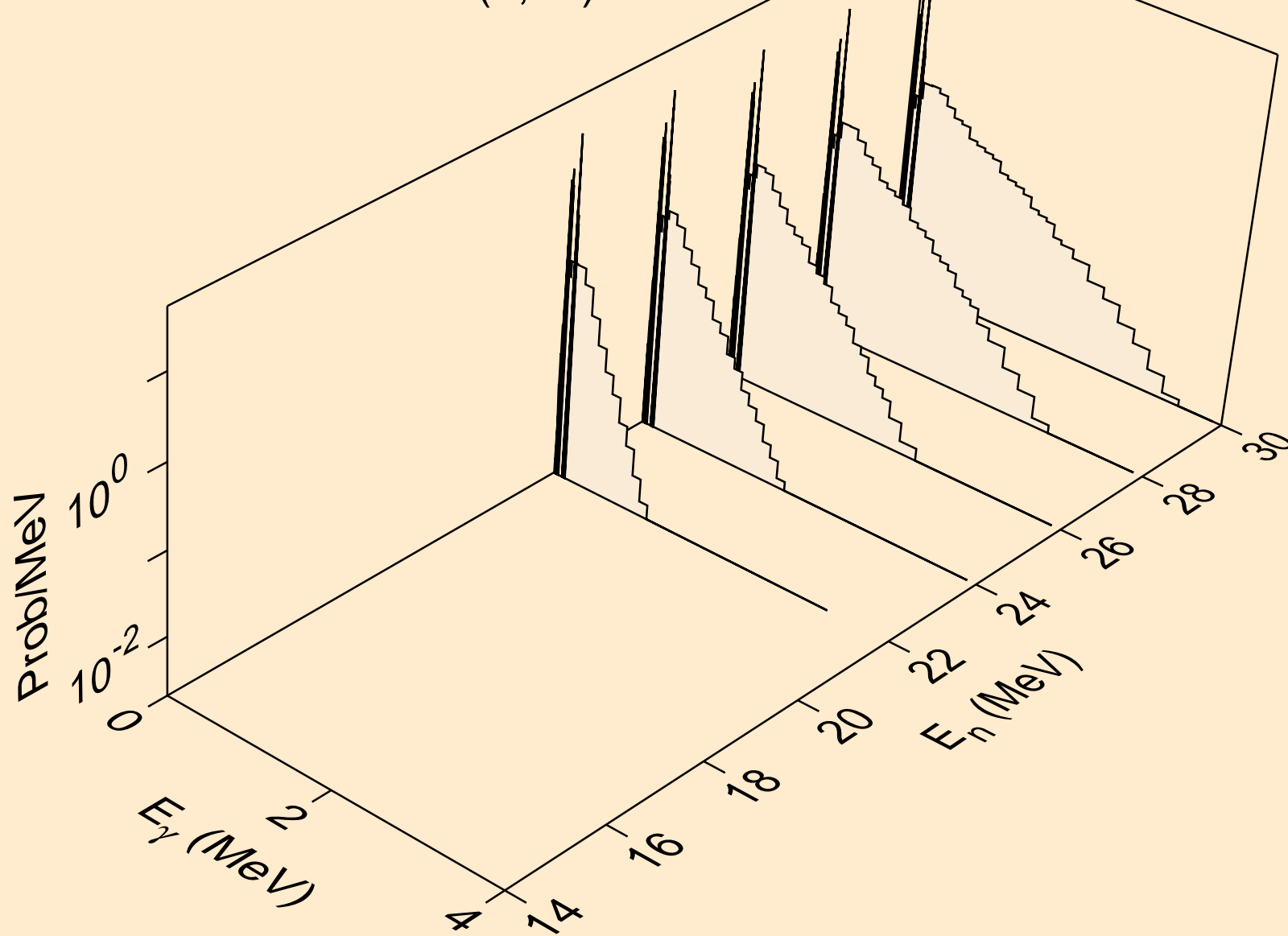

RE170 NEUTRON ACER TENDL-2021 LIBRARY; T=293.6K  
Photon emission for (n,n\*)p

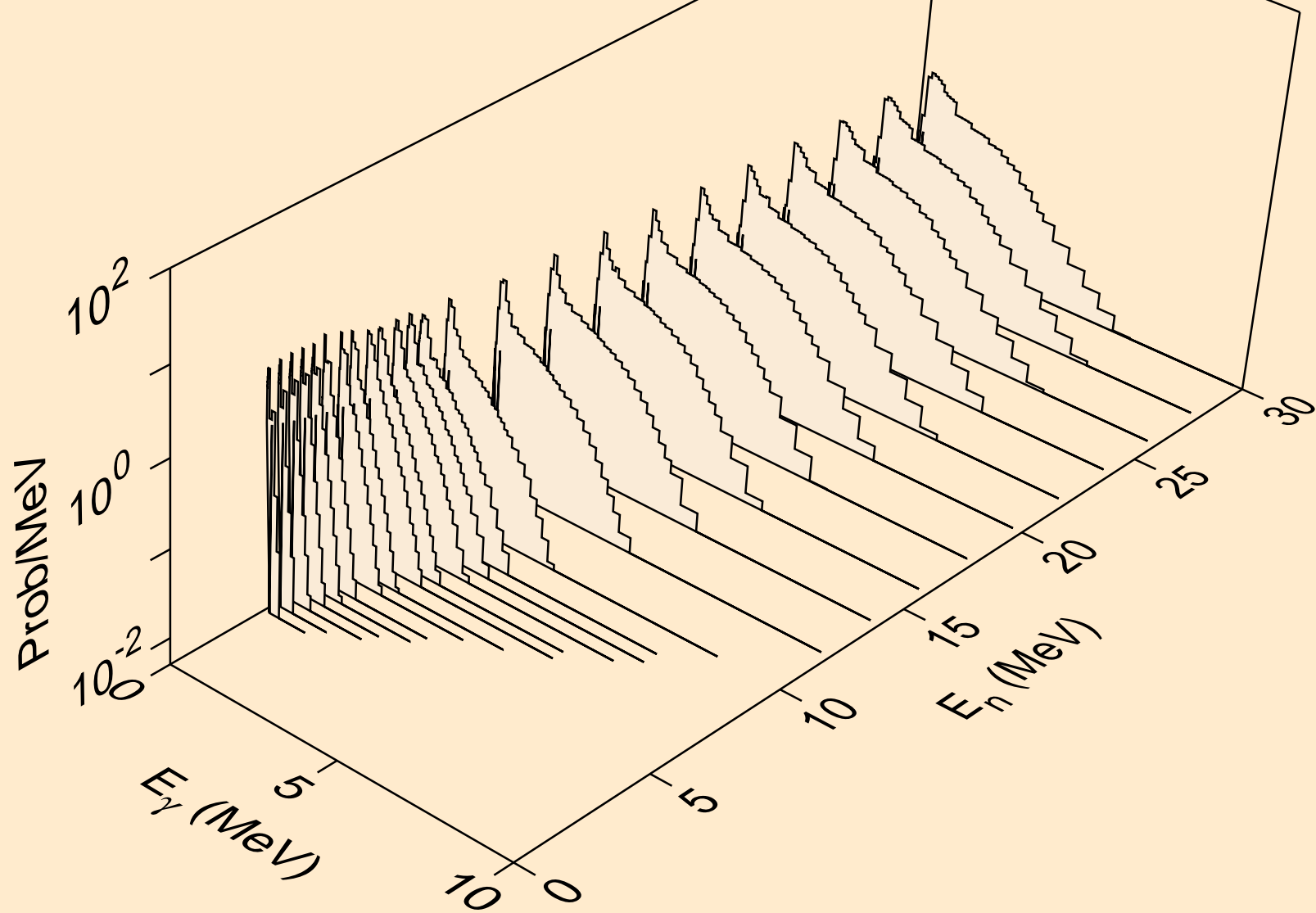

RE170 NEUTRON ACER TENDL-2021 LIBRARY; T=293.6K  
Photon emission for (n,n\*)2a

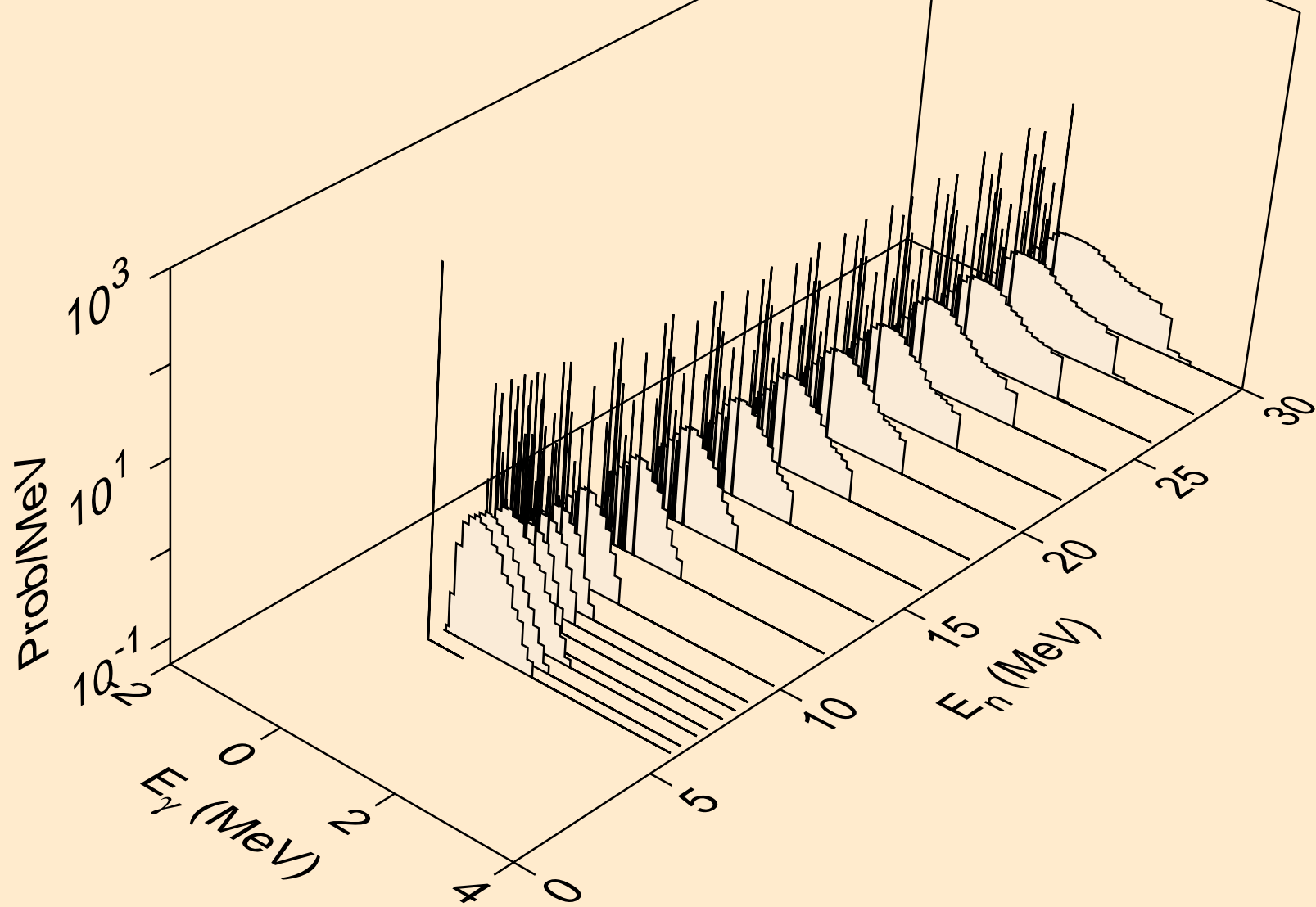



RE170 NEUTRON ACER TENDL-2021 LIBRARY; T=293.6K  
Photon emission for (n,2n)2a

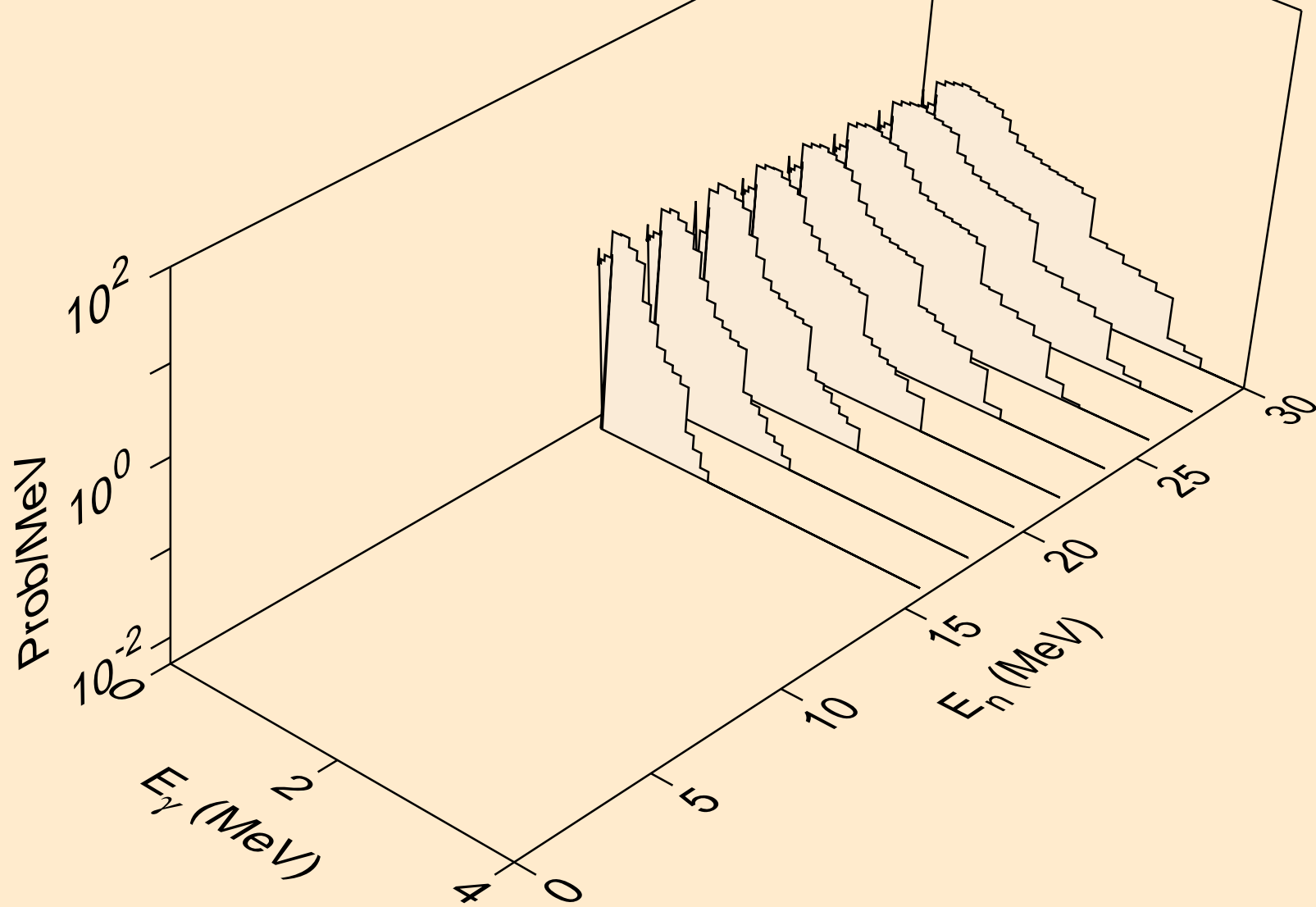

RE170 NEUTRON ACER TENDL-2021 LIBRARY; T=293.6K  
Photon emission for (n,n\*)d

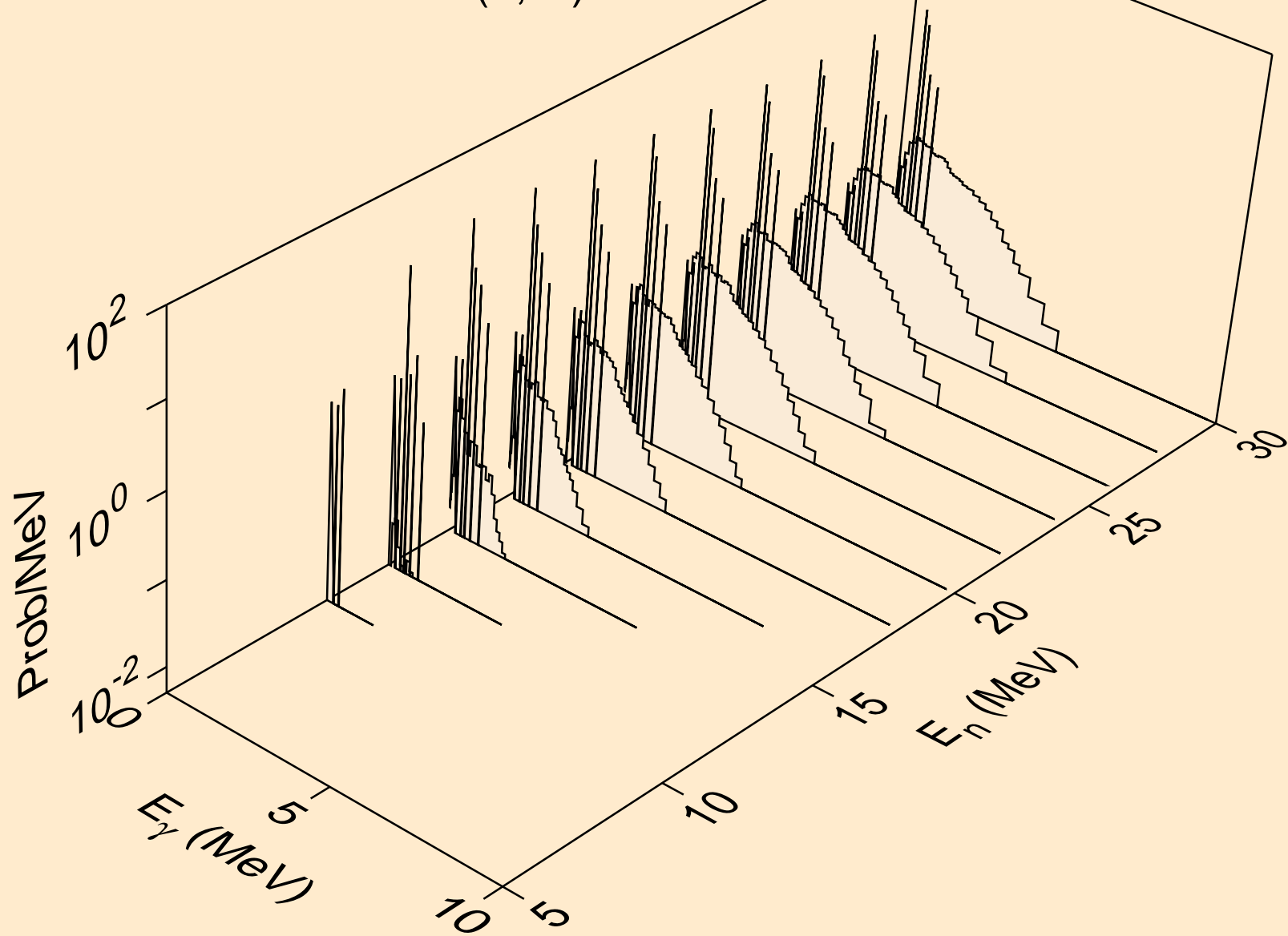

RE170 NEUTRON ACER TENDL-2021 LIBRARY; T=293.6K  
Photon emission for (n,n\*)t

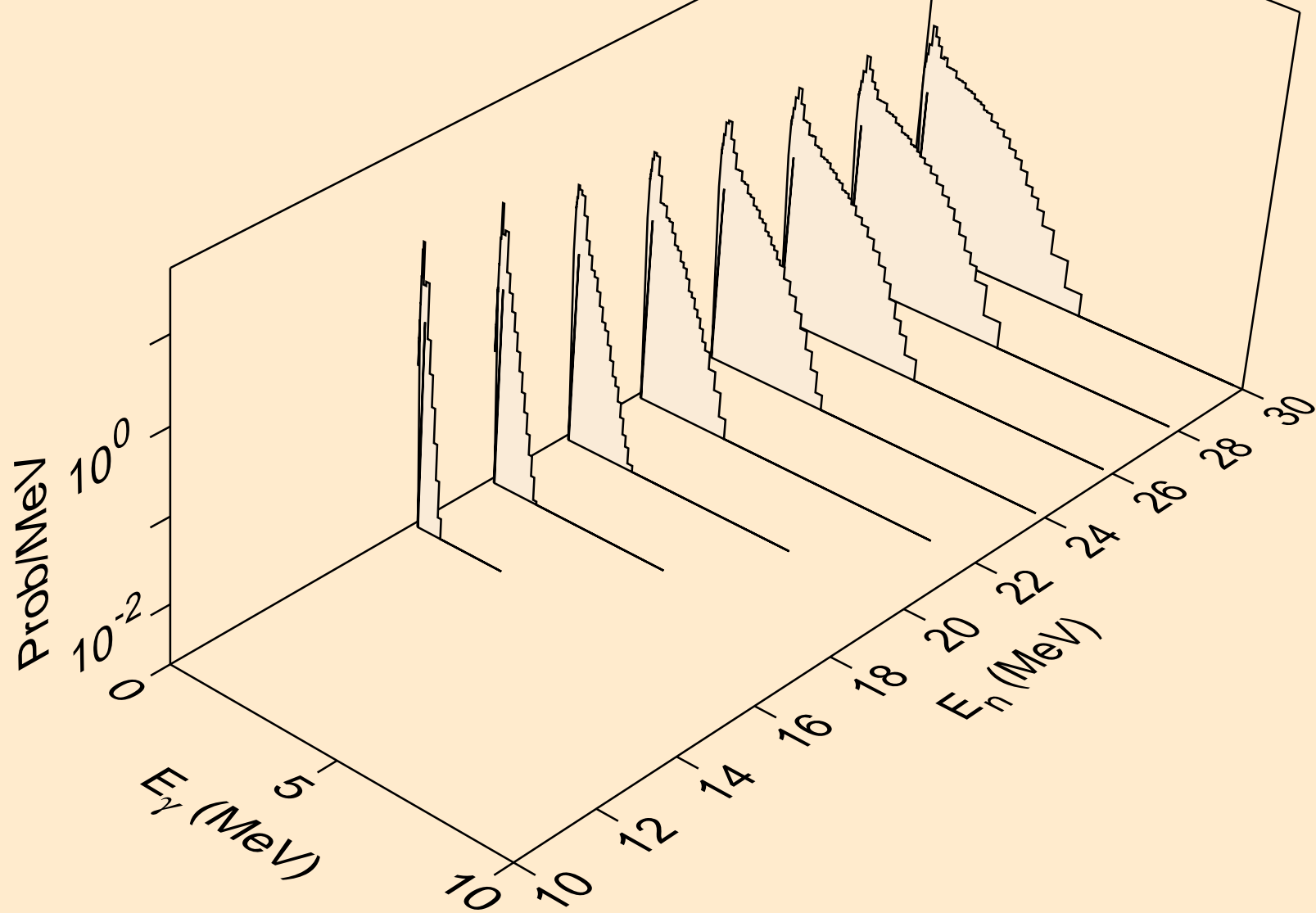

RE170 NEUTRON ACER TENDL-2021 LIBRARY; T=293.6K  
Photon emission for (n,n\*)he3

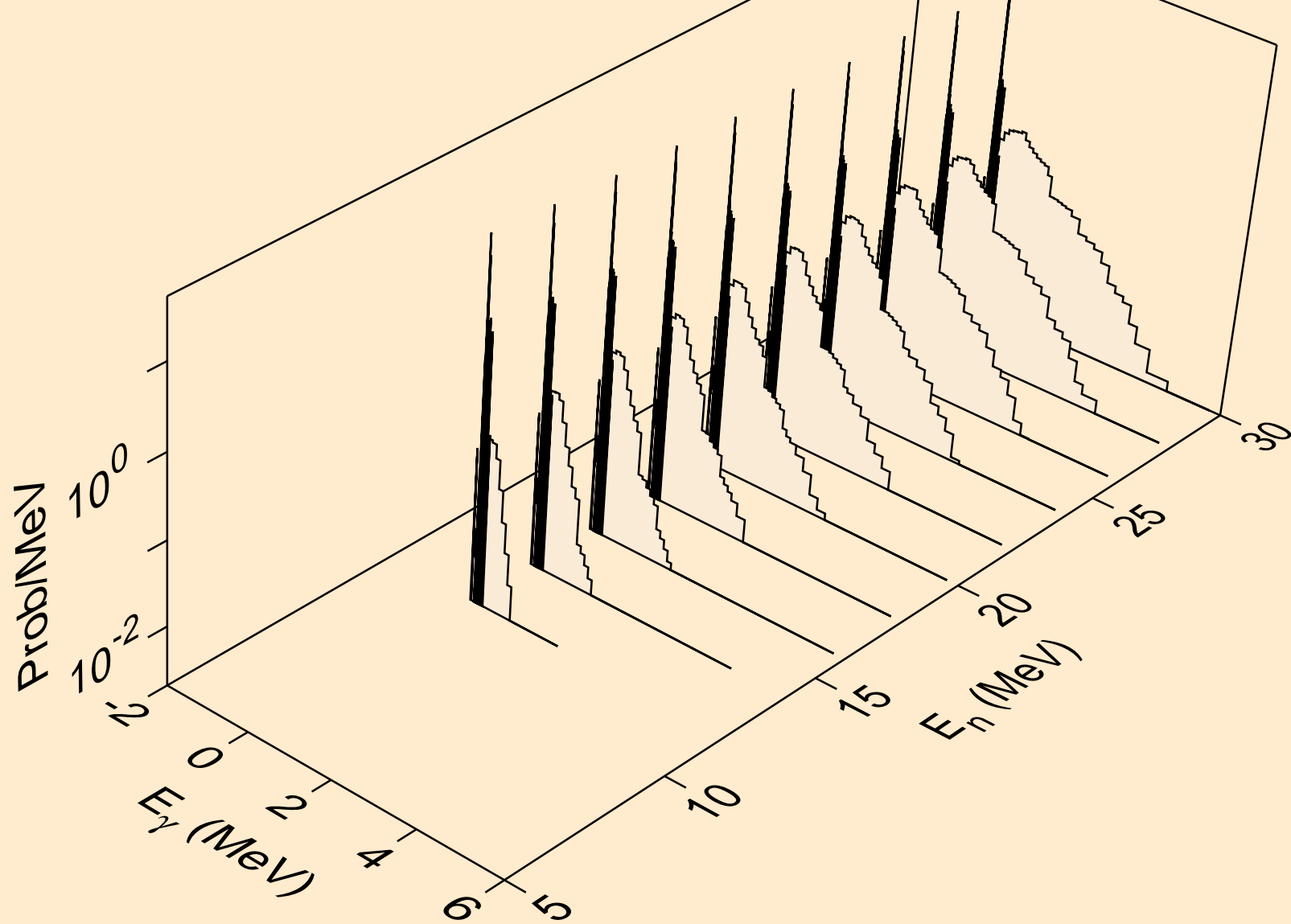

RE170 NEUTRON ACER TENDL-2021 LIBRARY; T=293.6K  
Photon emission for (n,4n)

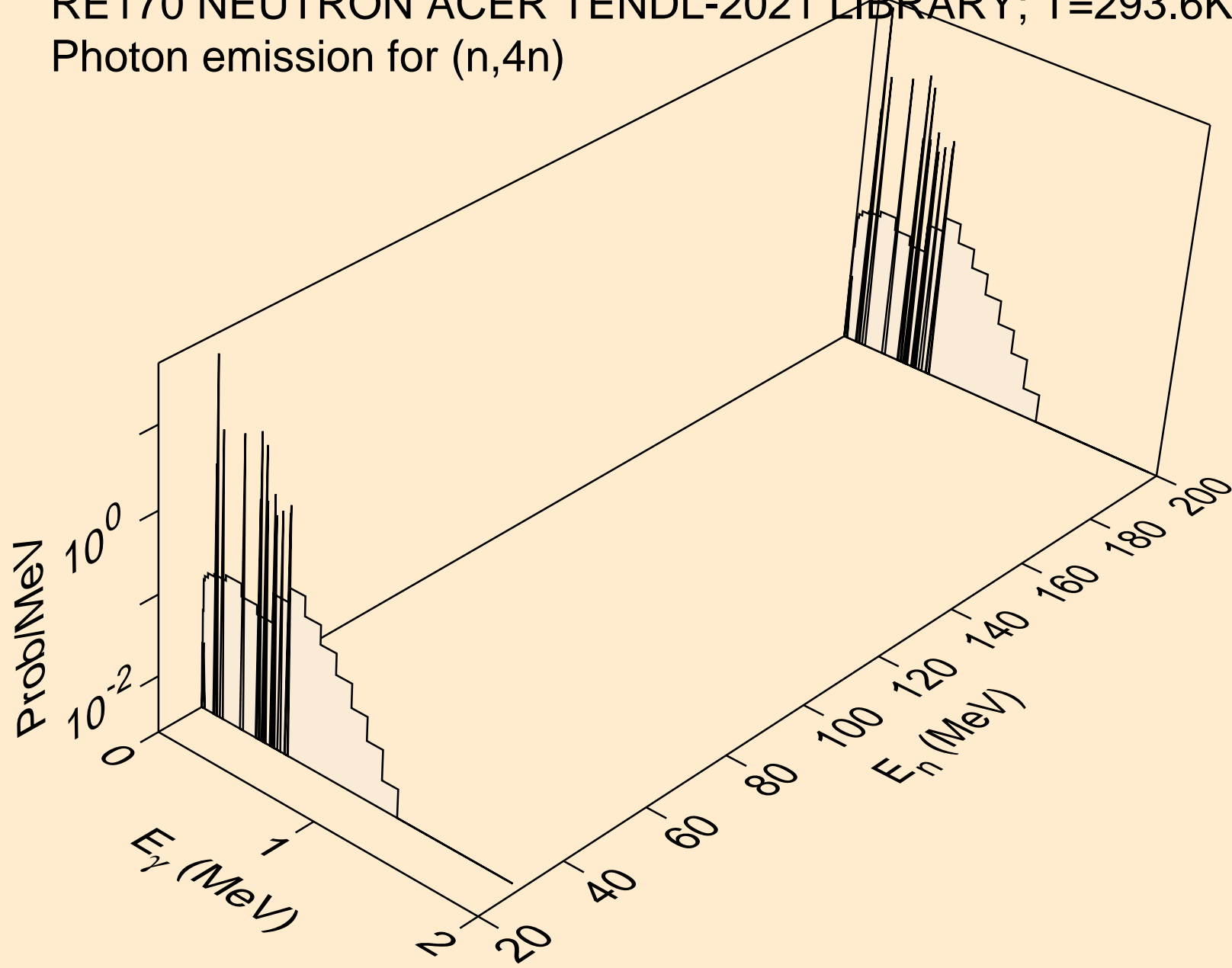

RE170 NEUTRON ACER TENDL-2021 LIBRARY; T=293.6K  
Photon emission for (n,2np)

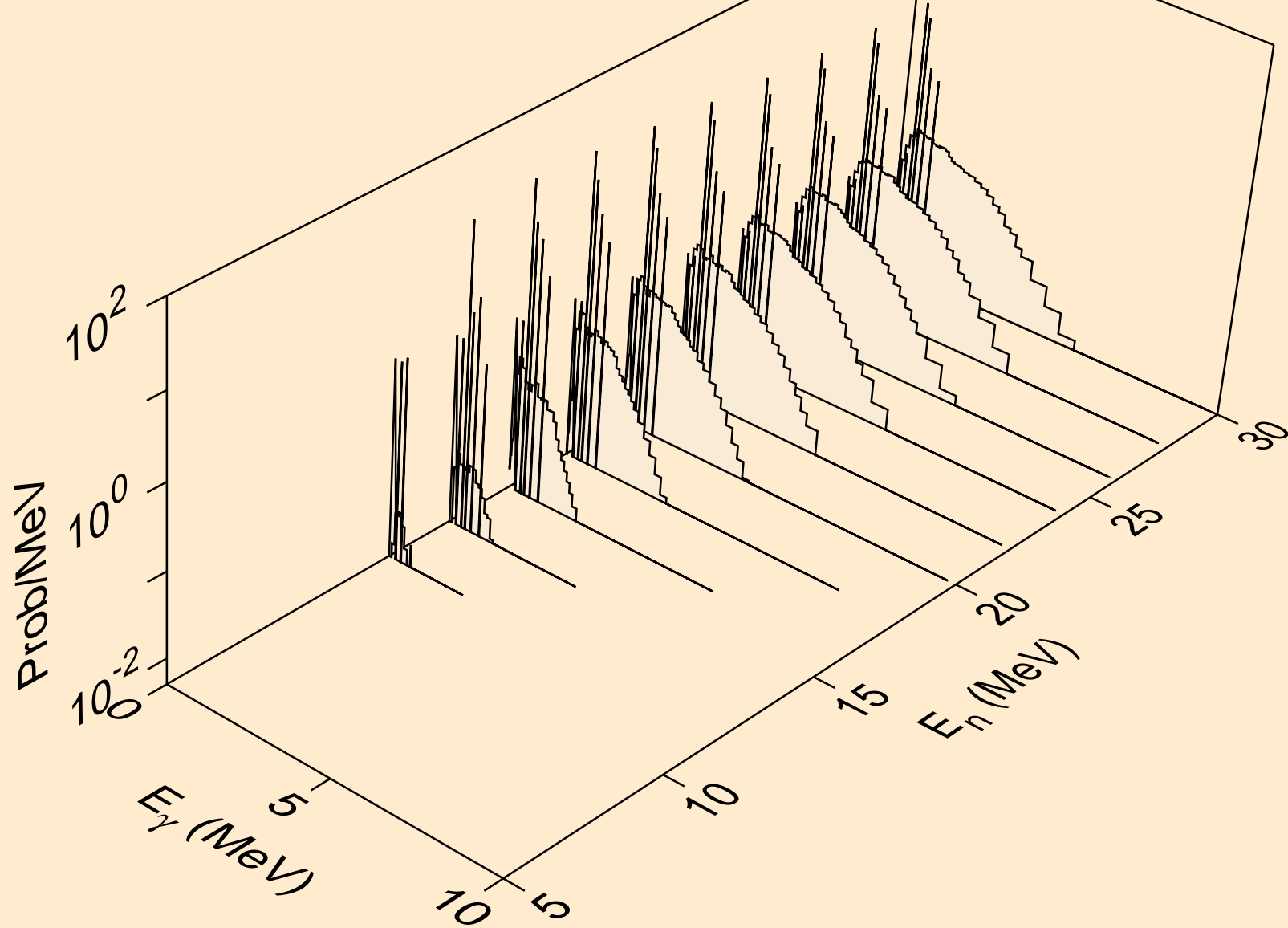

RE170 NEUTRON ACER TENDL-2021 LIBRARY; T=293.6K  
Photon emission for (n,3np)

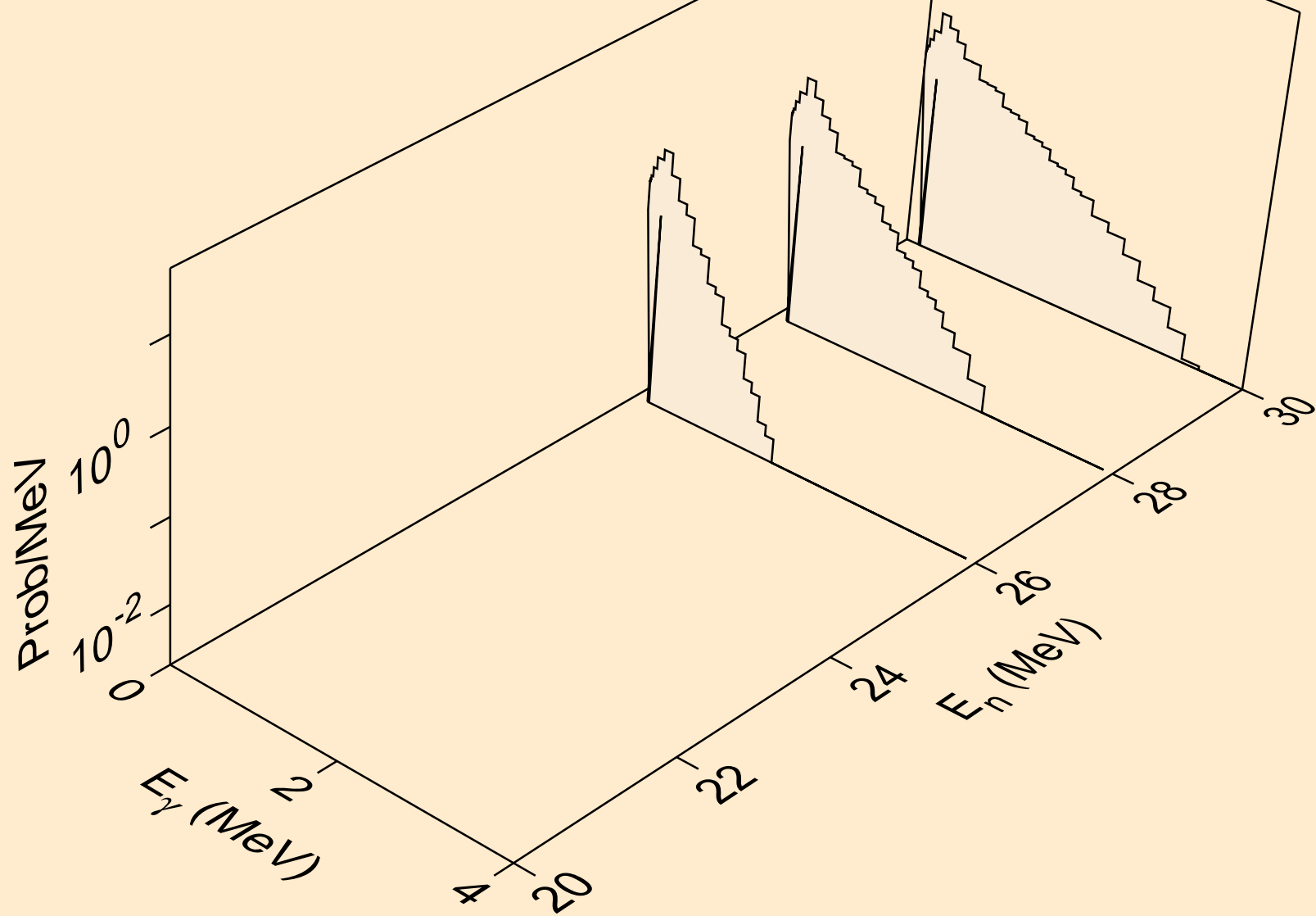

RE170 NEUTRON ACER TENDL-2021 LIBRARY; T=293.6K  
Photon emission for (n,2np)

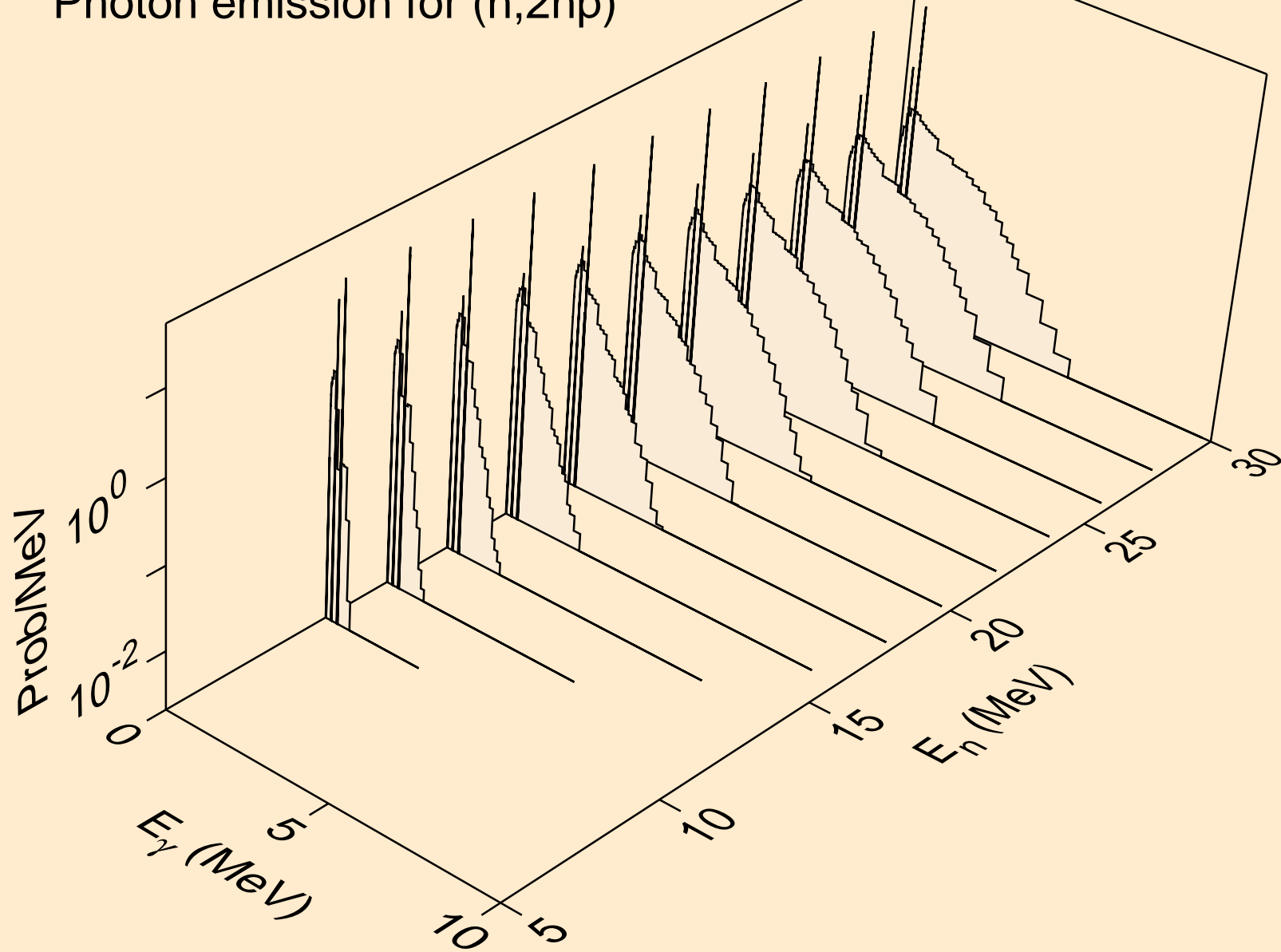



RE170 NEUTRON ACER TENDL-2021 LIBRARY; T=293.6K  
Photon emission for (n,npa)

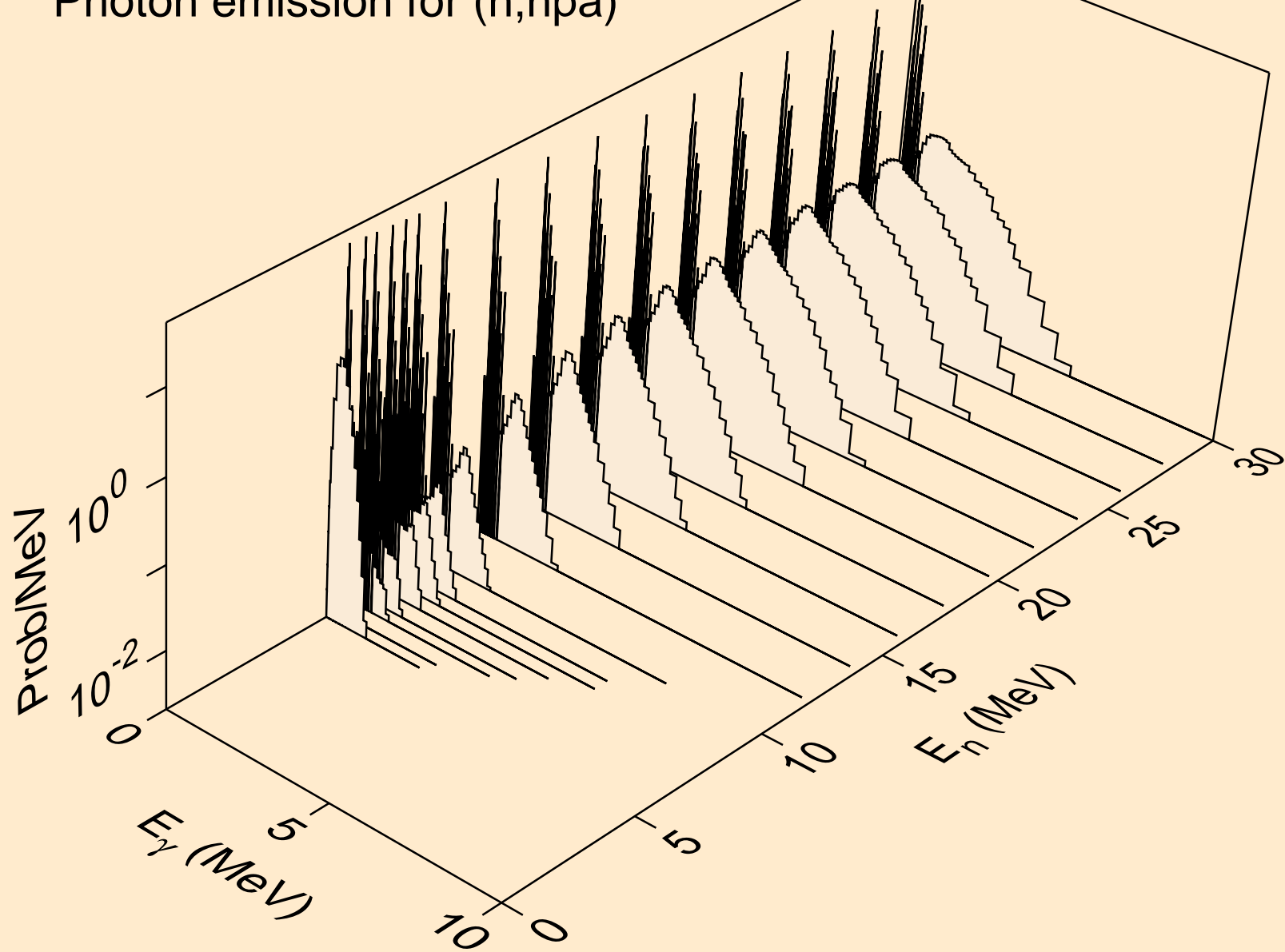

RE170 NEUTRON ACER TENDL-2021 LIBRARY; T=293.6K  
Photon emission for (n,n\*c)

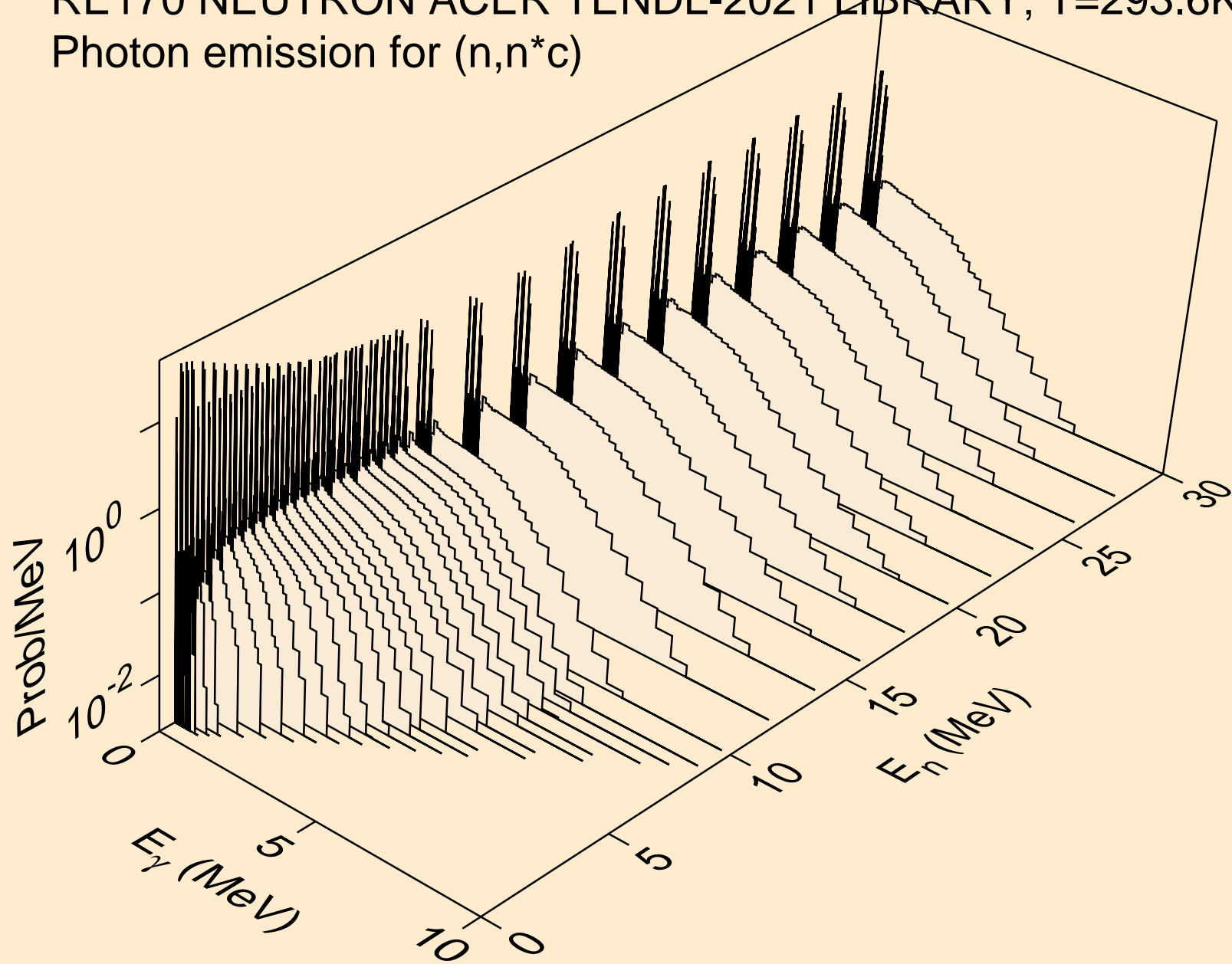

RE170 NEUTRON ACER TENDL-2021 LIBRARY; T=293.6K  
Photon emission for (n,gma)

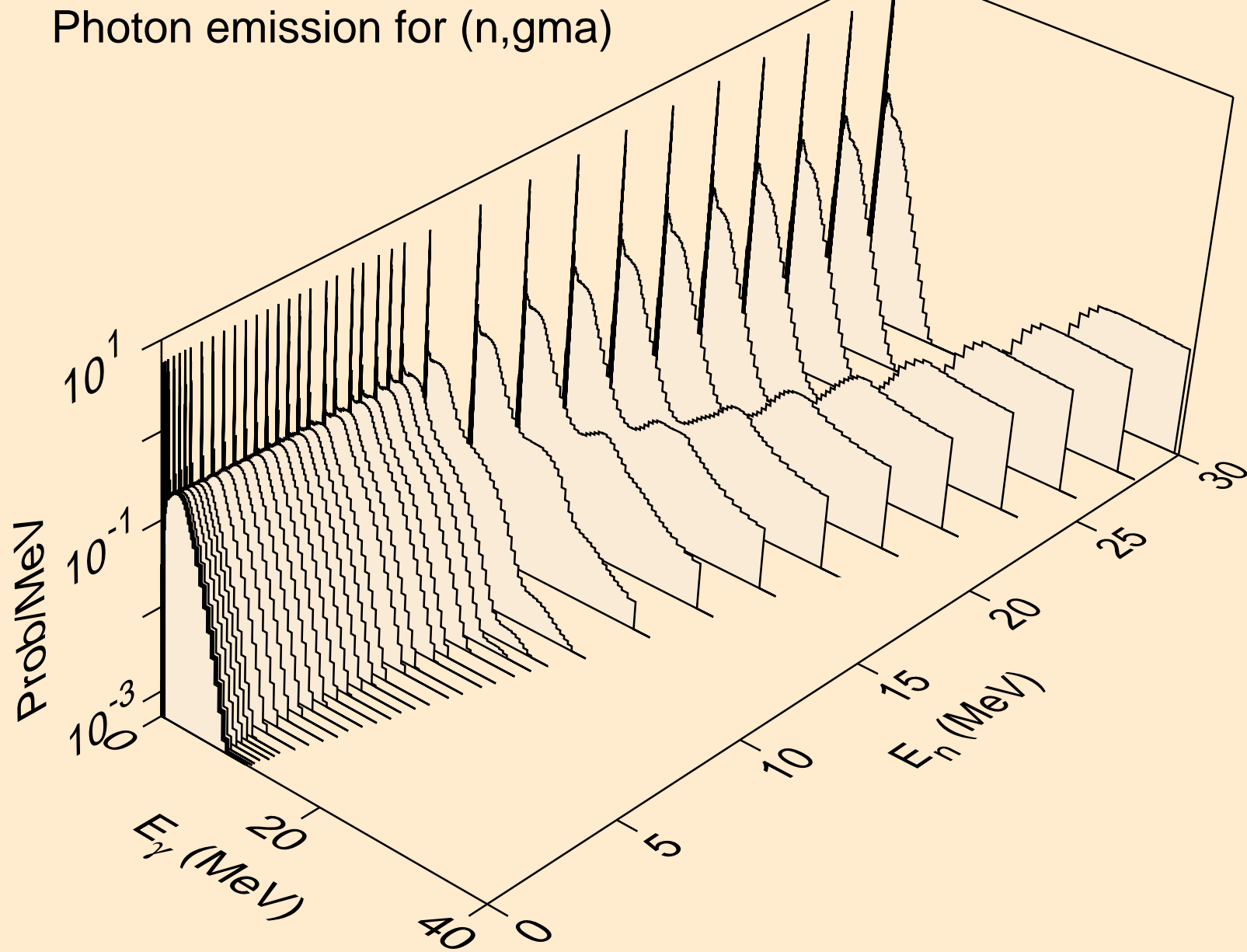

RE170 NEUTRON ACER TENDL-2021 LIBRARY; T=293.6K  
Photon emission for (n,p)

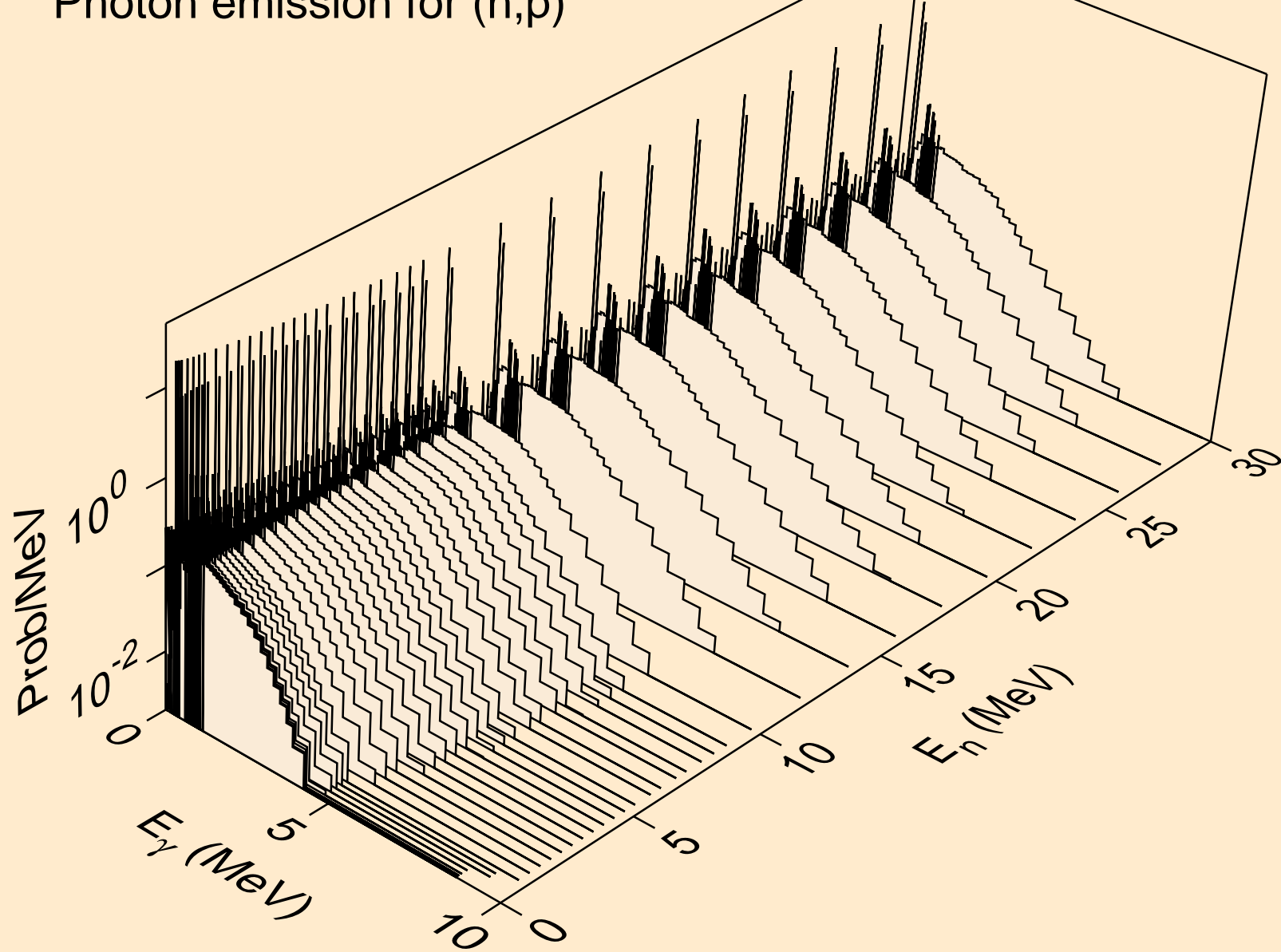

RE170 NEUTRON ACER TENDL-2021 LIBRARY; T=293.6K  
Photon emission for (n,d)

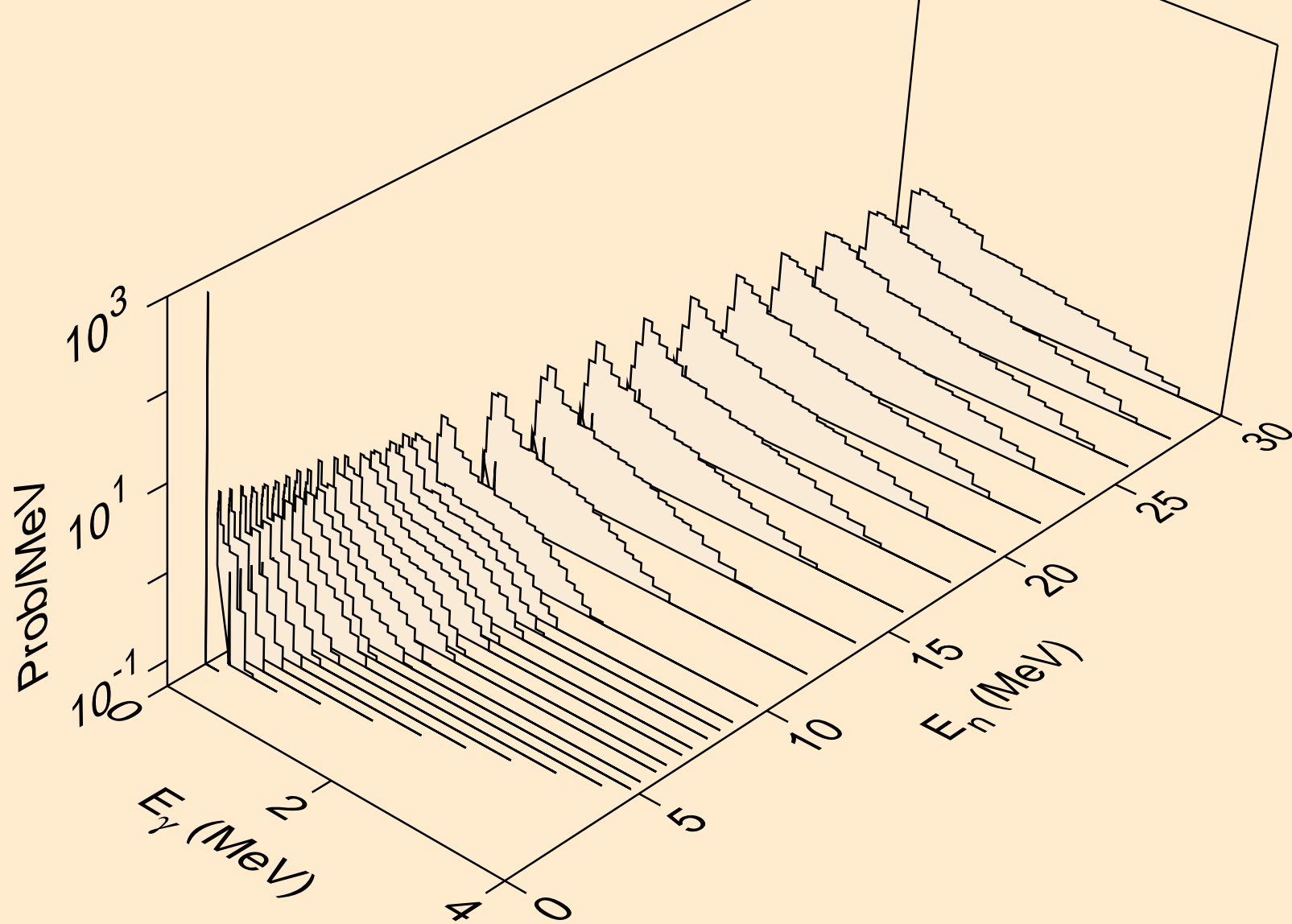

RE170 NEUTRON ACER TENDL-2021 LIBRARY; T=293.6K  
Photon emission for (n,t)

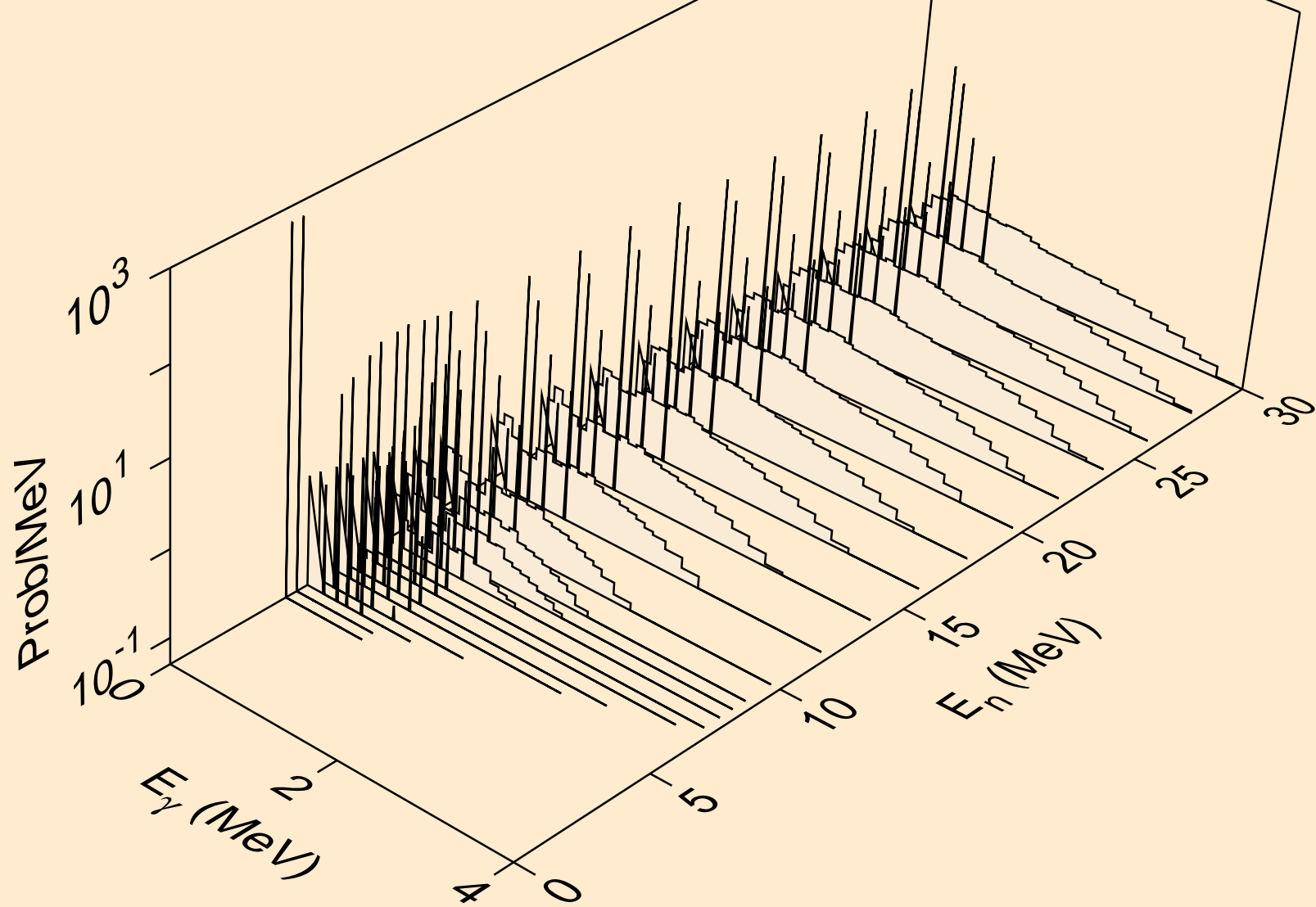

RE170 NEUTRON ACER TENDL-2021 LIBRARY; T=293.6K  
Photon emission for (n,he3)

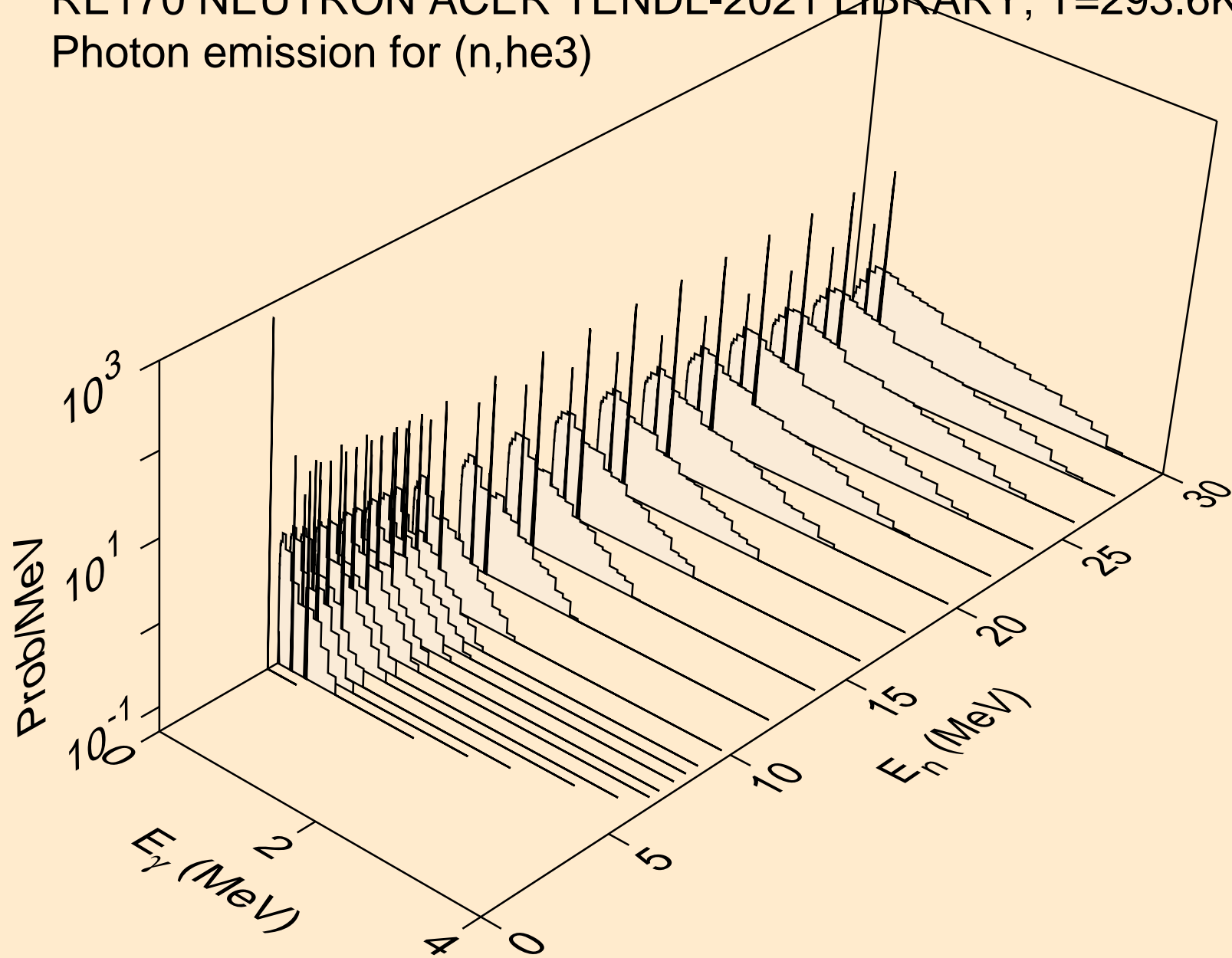

RE170 NEUTRON ACER TENDL-2021 LIBRARY; T=293.6K  
Photon emission for (n,a)

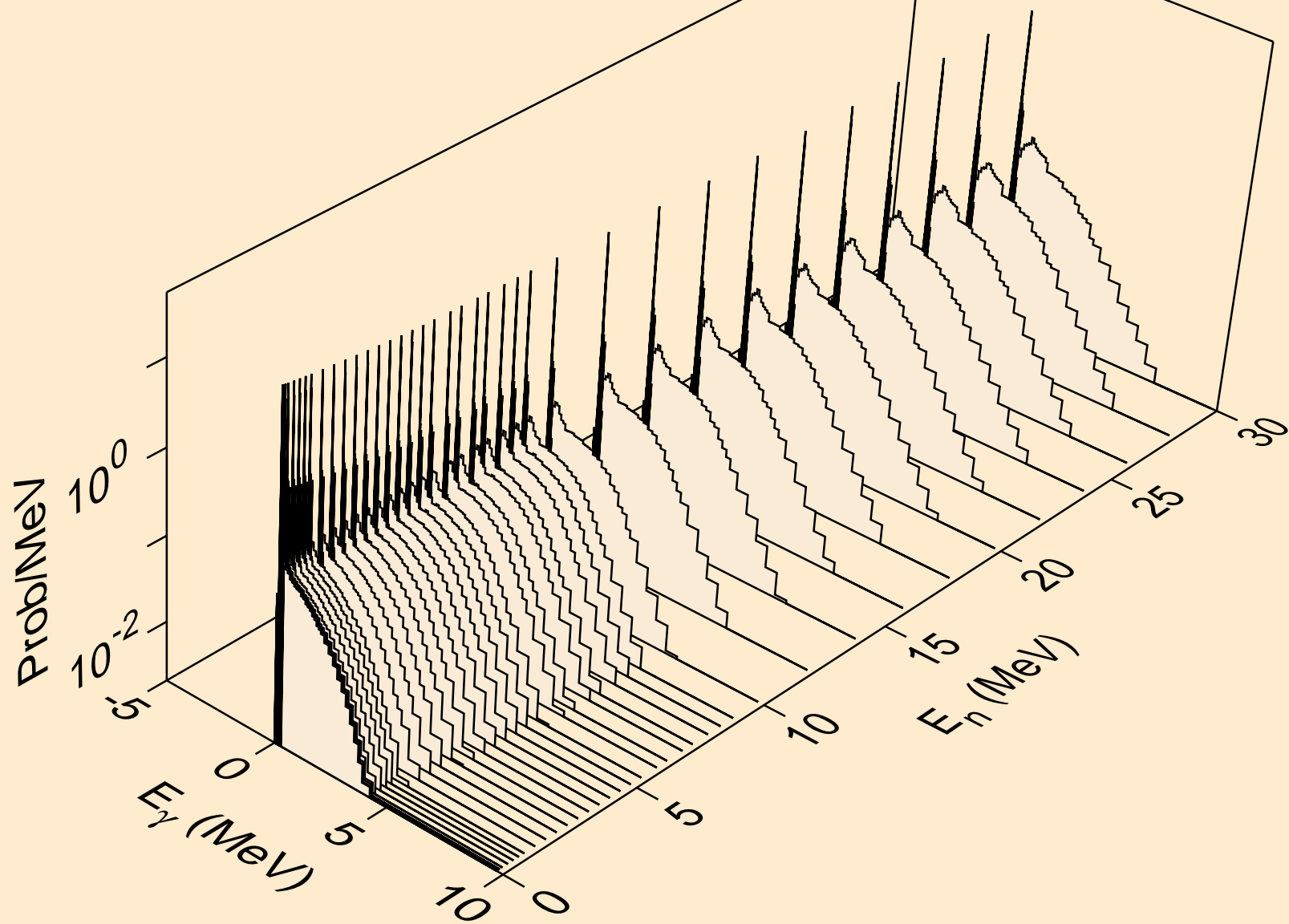



RE170 NEUTRON ACER TENDL-2021 LIBRARY; T=293.6K  
Photon emission for (n,2a)

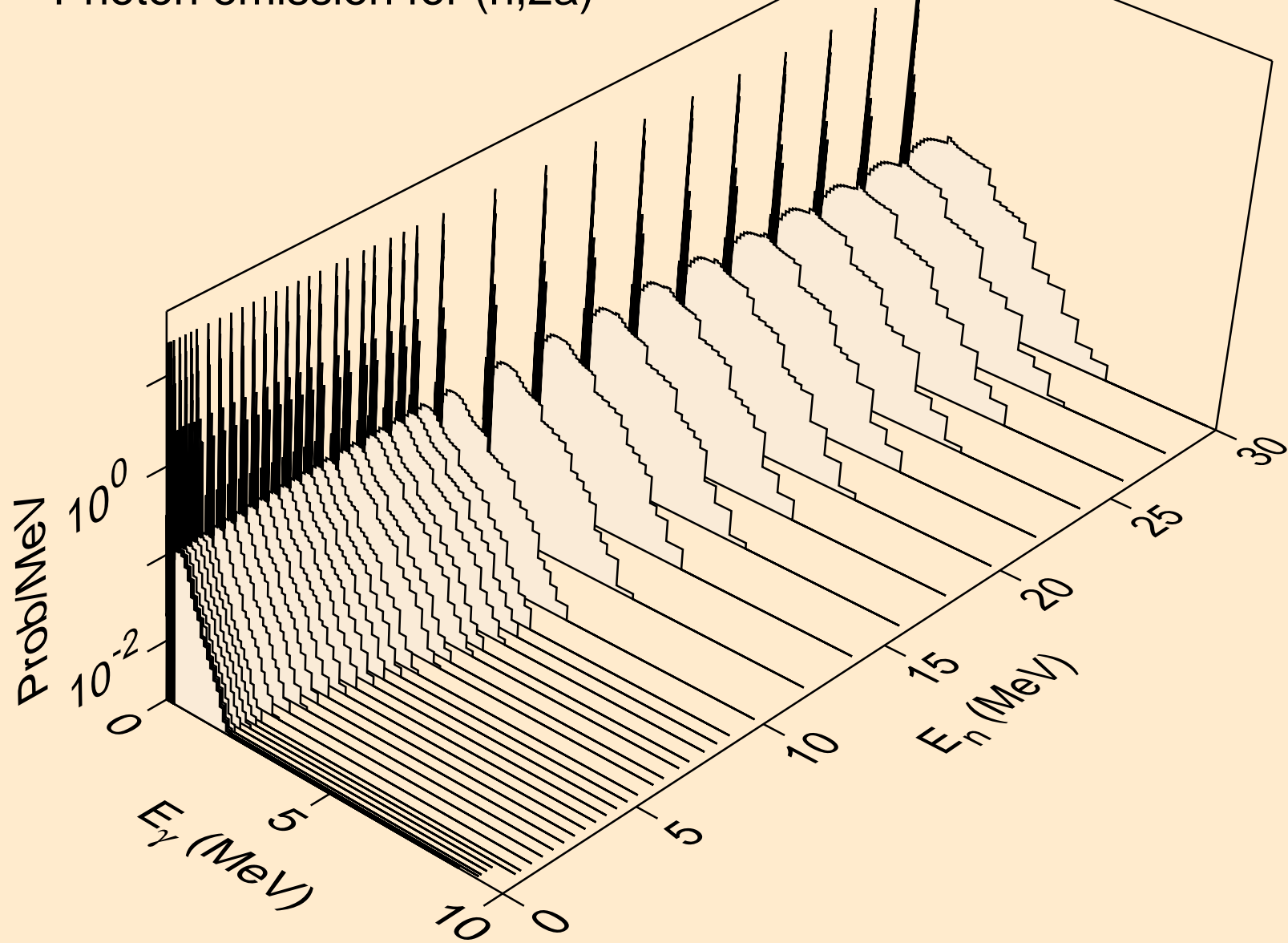

RE170 NEUTRON ACER TENDL-2021 LIBRARY; T=293.6K  
Photon emission for (n,3a)

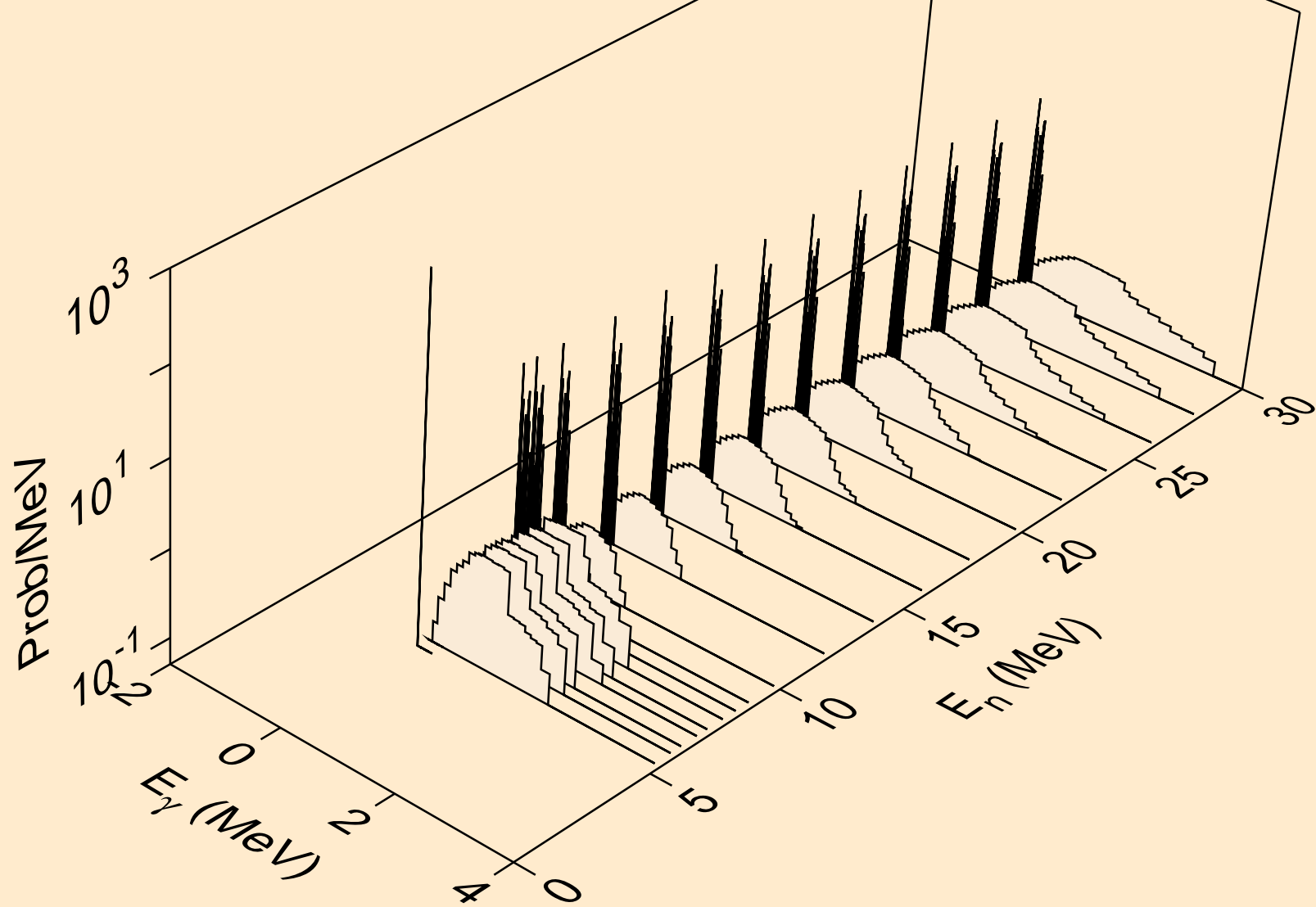

RE170 NEUTRON ACER TENDL-2021 LIBRARY; T=293.6K  
Photon emission for (n,2p)

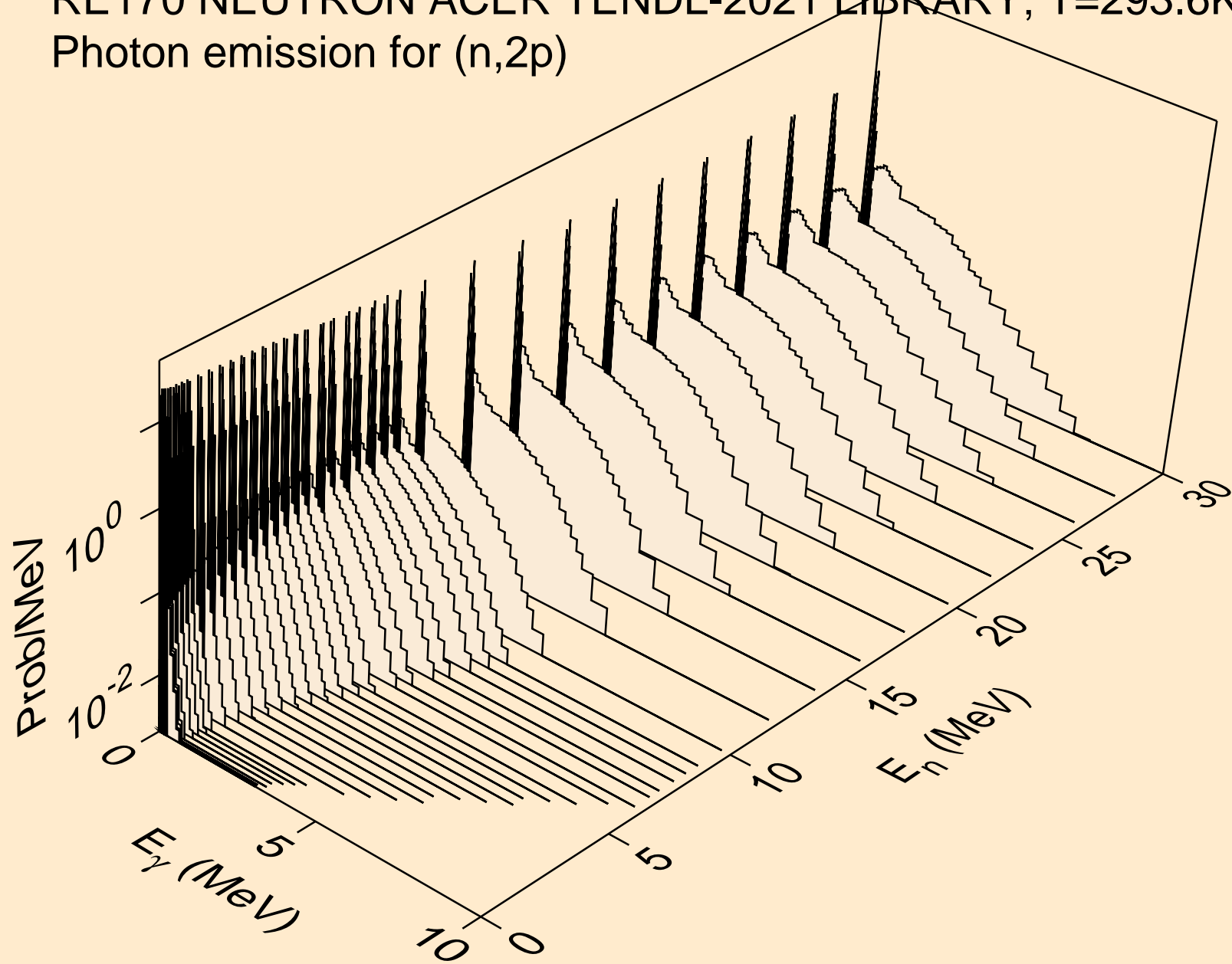

RE170 NEUTRON ACER TENDL-2021 LIBRARY; T=293.6K  
Photon emission for (n,p)

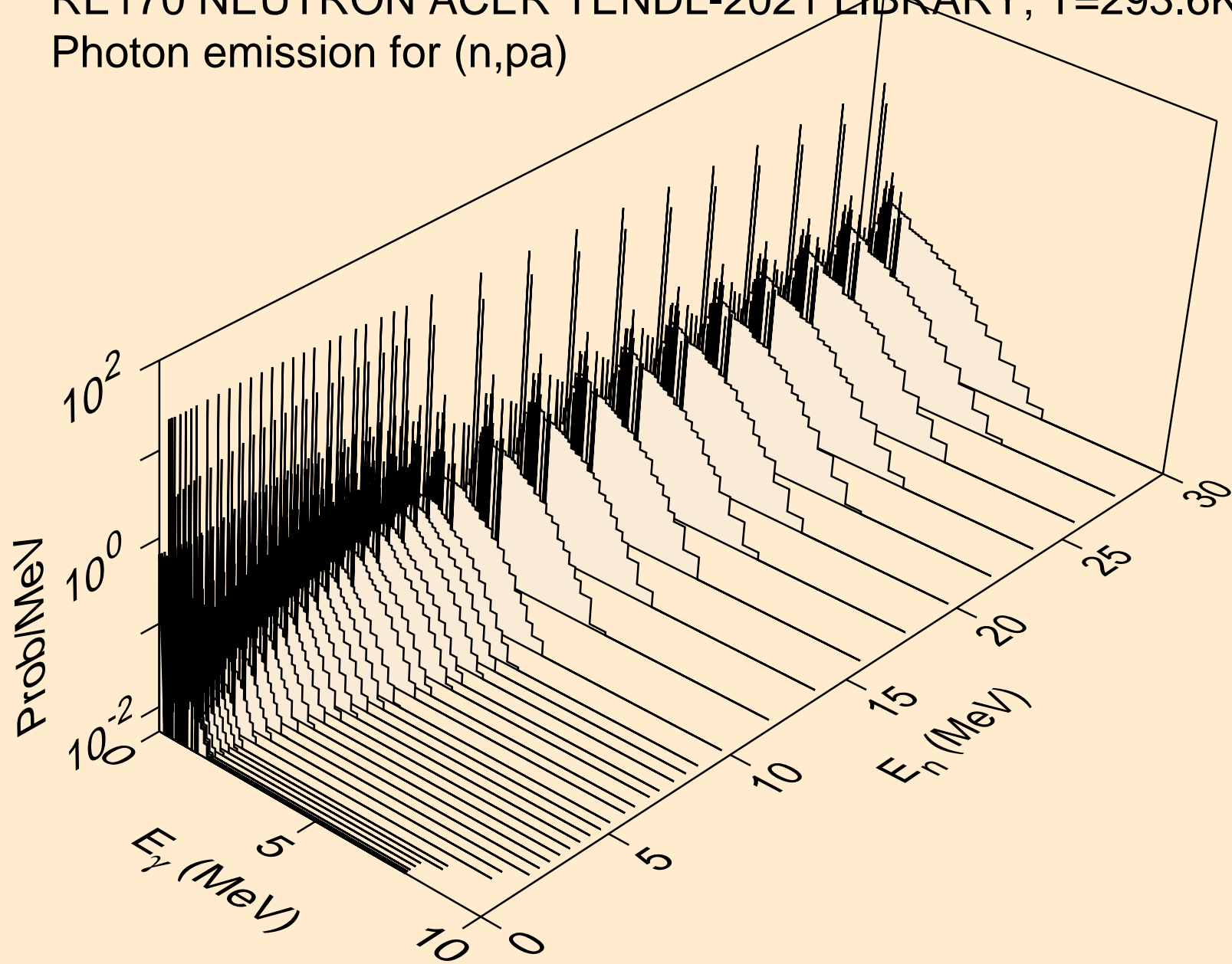

RE170 NEUTRON ACER TENDL-2021 LIBRARY; T=293.6K  
Photon emission for (n,pd)

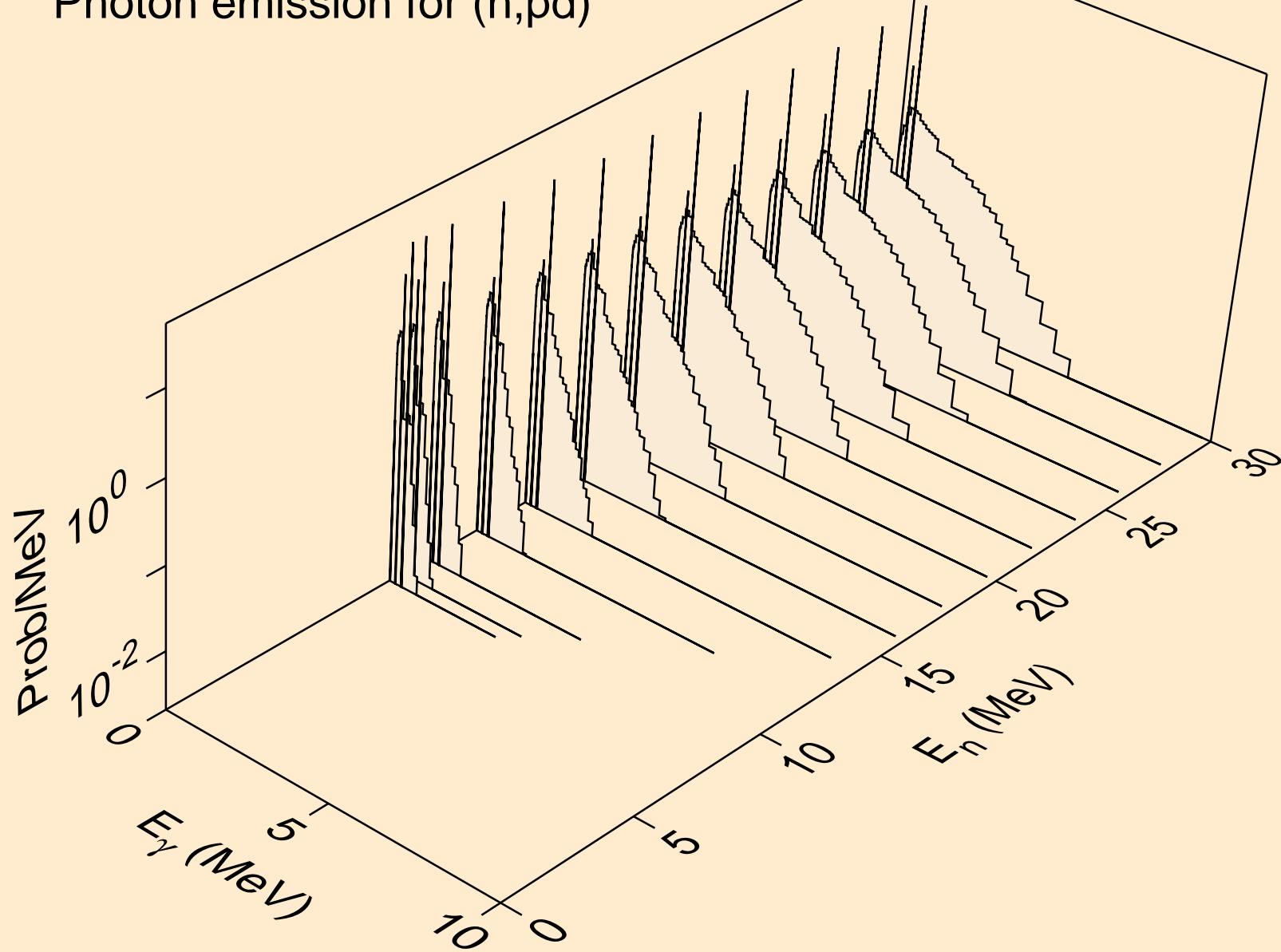

RE170 NEUTRON ACER TENDL-2021 LIBRARY; T=293.6K  
Photon emission for (n,pt)

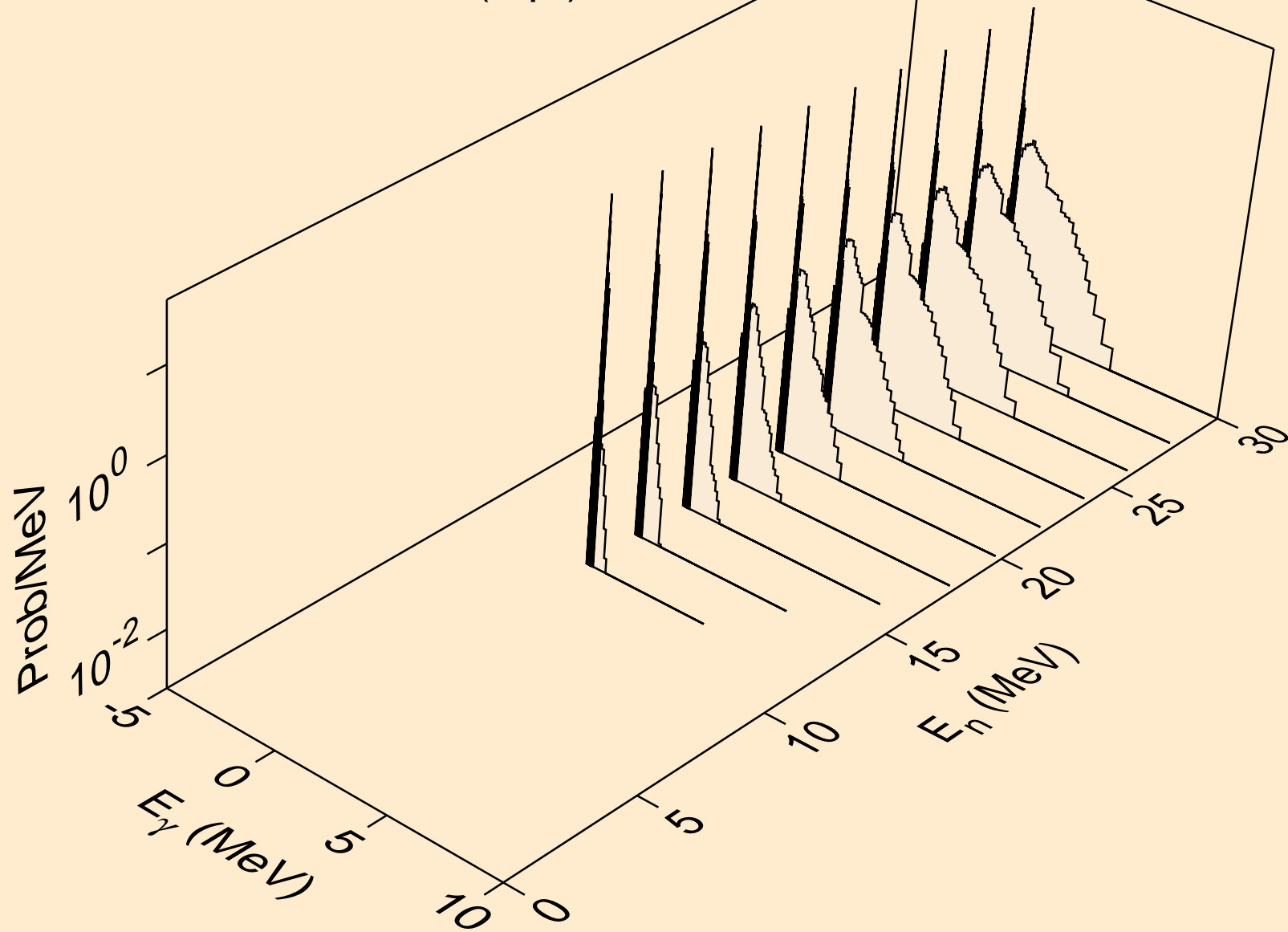

RE170 NEUTRON ACER TENDL-2021 LIBRARY; T=293.6K  
Photon emission for (n,da)

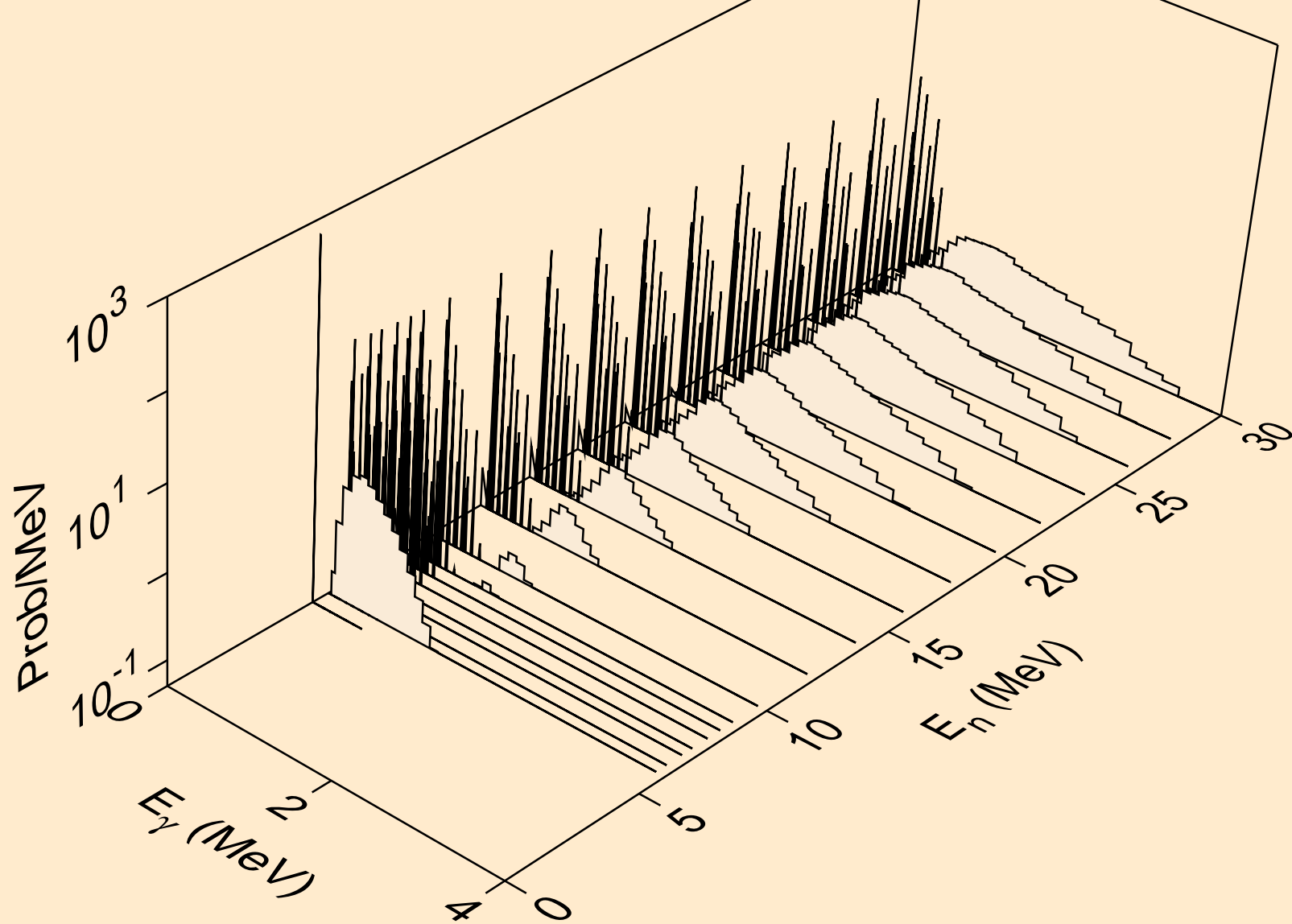

RE170 NEUTRON ACER TENDL-2021 LIBRARY; T=293.6K  
thermal capture photon spectrum

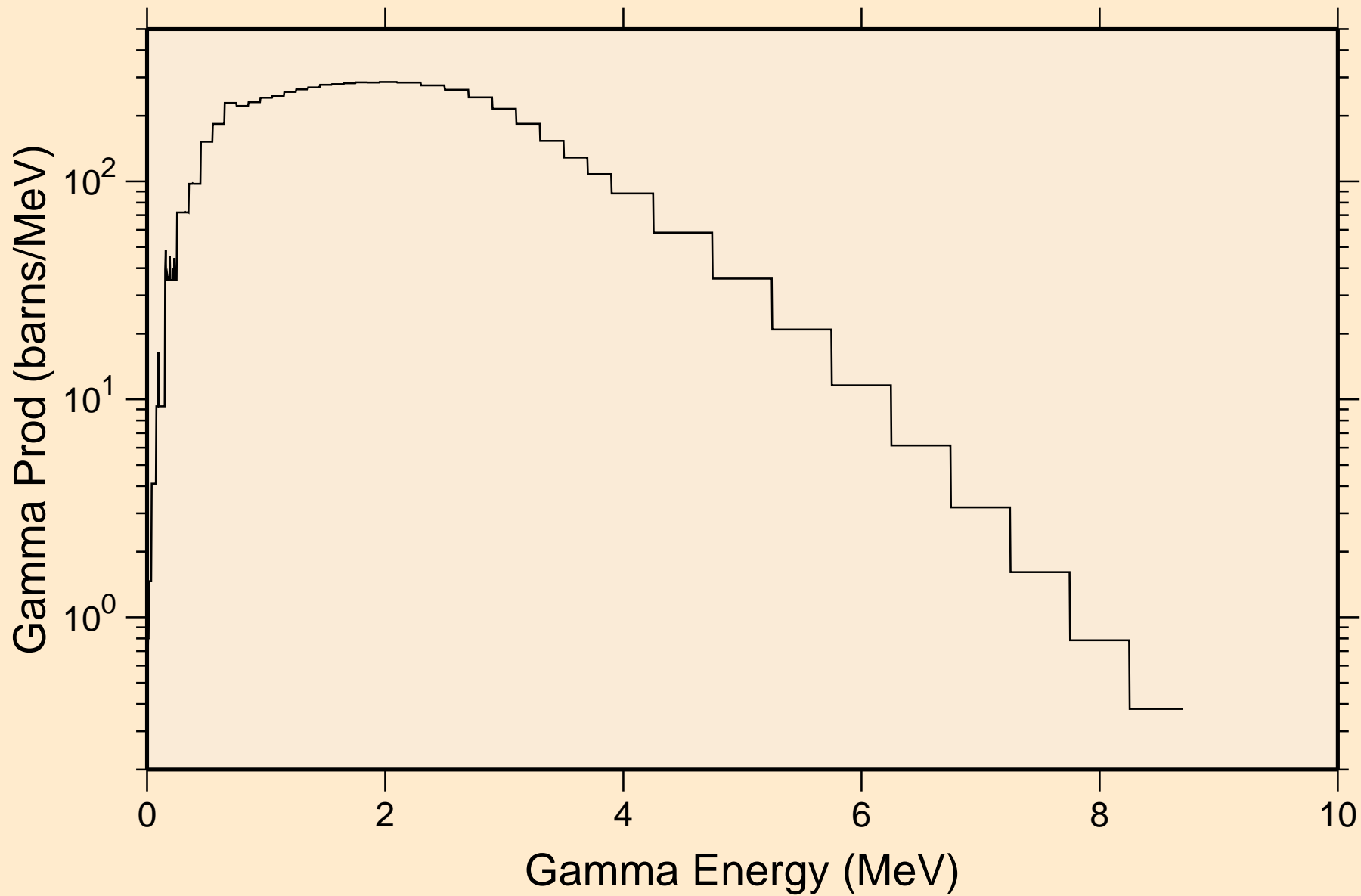



RE170 NEUTRON ACER TENDL-2021 LIBRARY; T=293.6K  
14 MeV photon spectrum

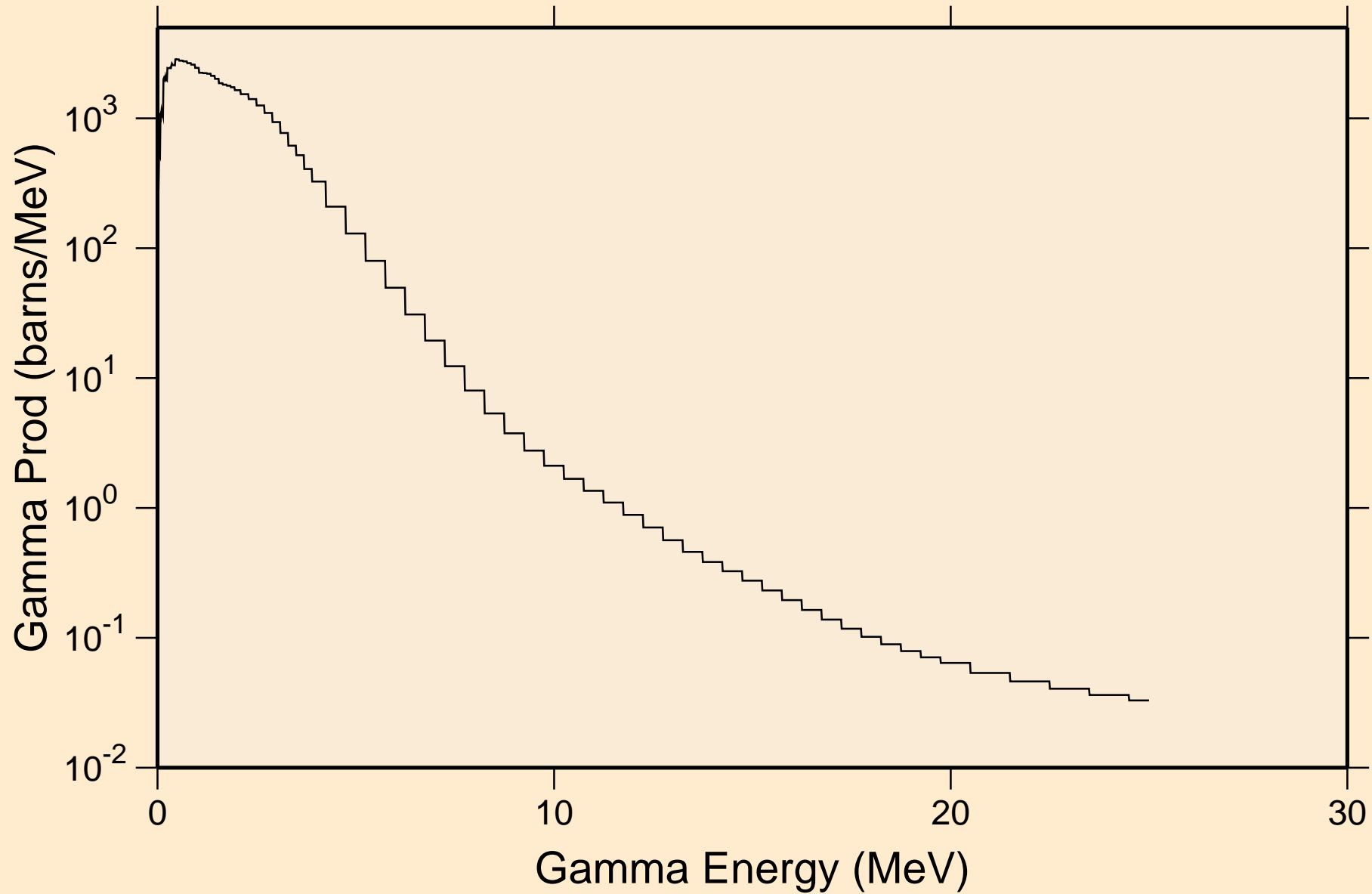

RE170 NEUTRON ACER TENDL-2021 LIBRARY; T=293.6K  
Particle heating contributions

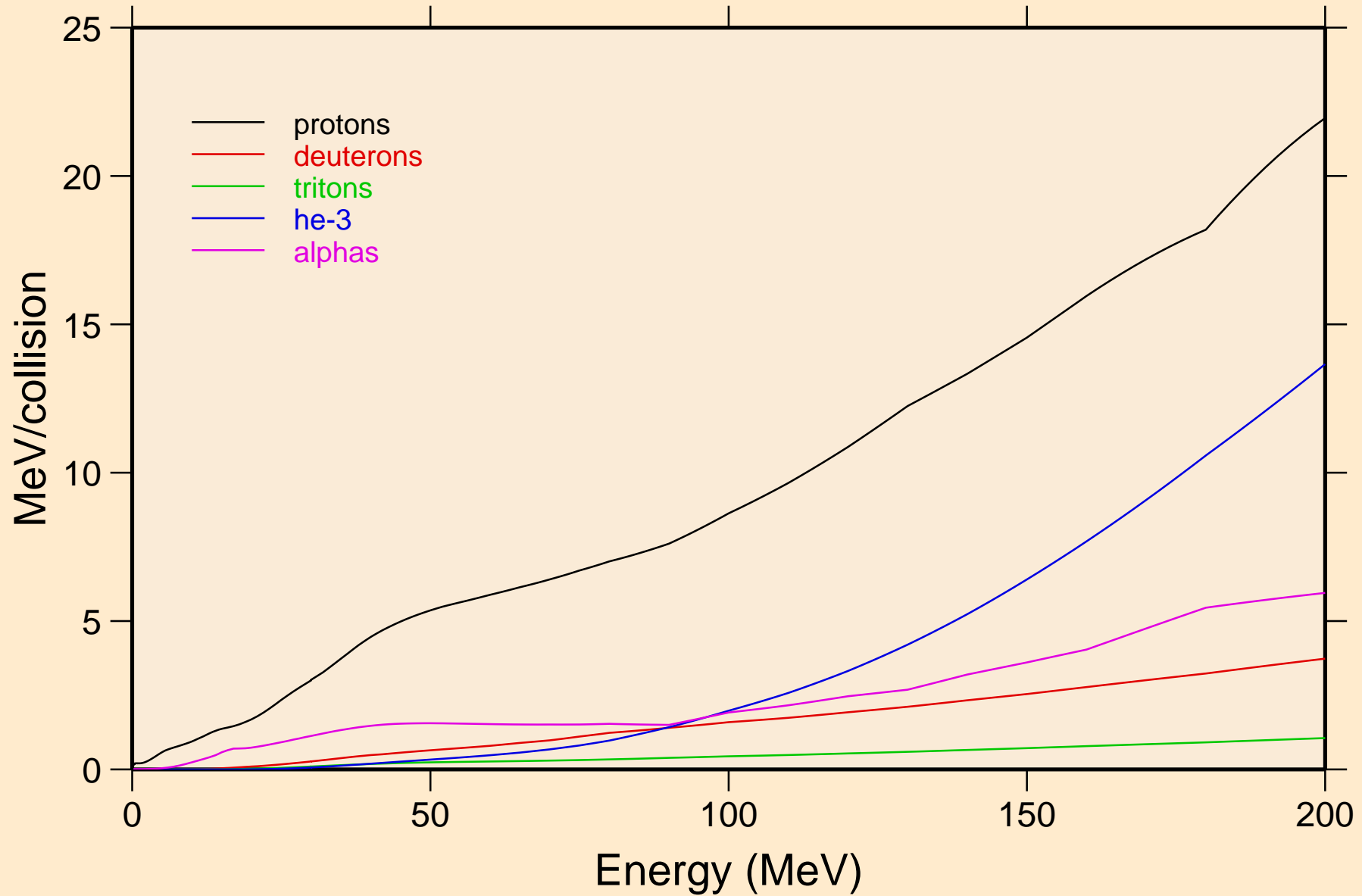

RE170 NEUTRON ACER TENDL-2021 LIBRARY; T=293.6K  
Recoil Heating

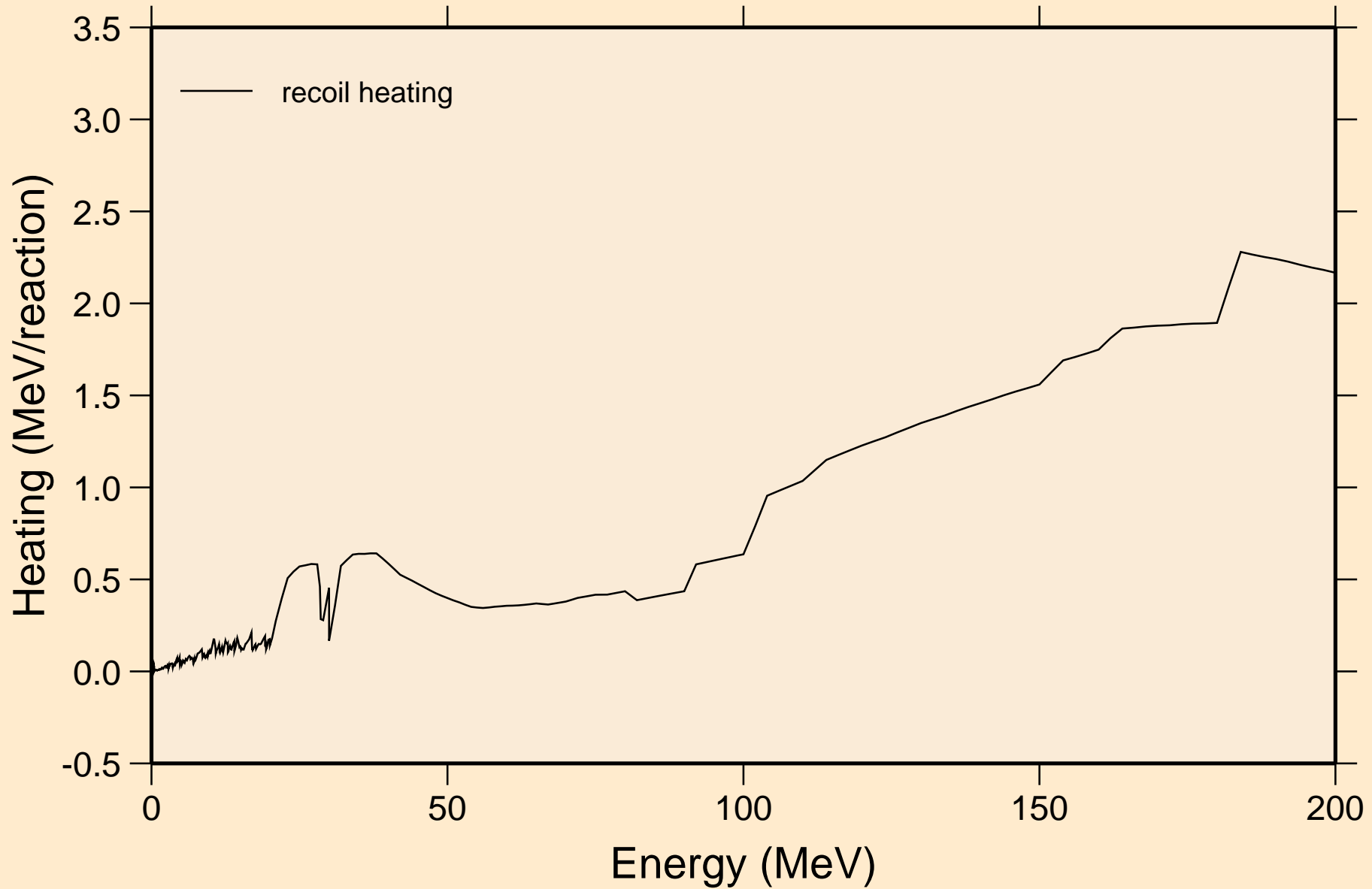

RE170 NEUTRON ACER TENDL-2021 LIBRARY; T=293.6K  
Particle production cross sections

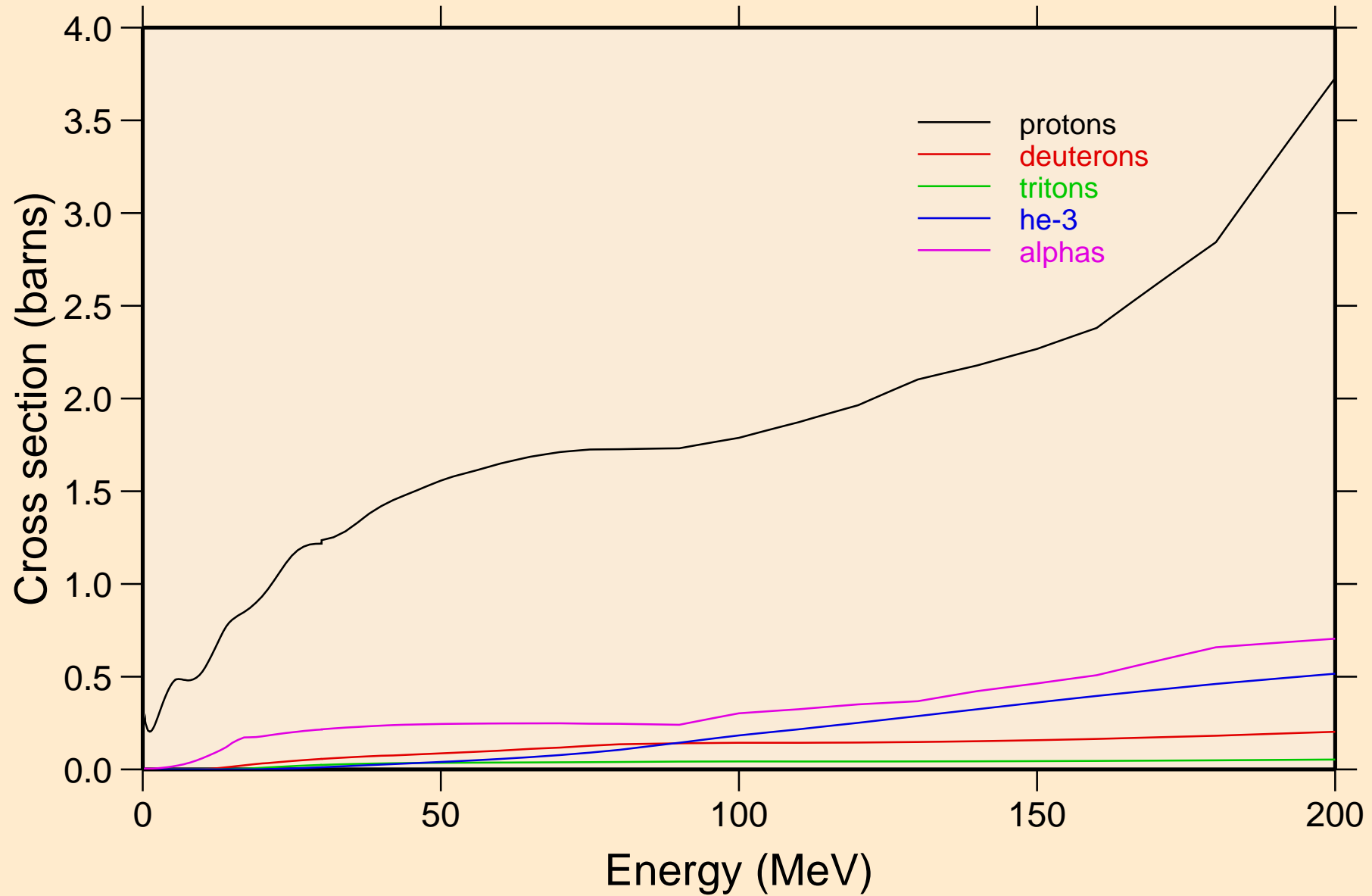

RE170 NEUTRON ACER TENDL-2021 LIBRARY; T=293.6K  
protons from (n,x)

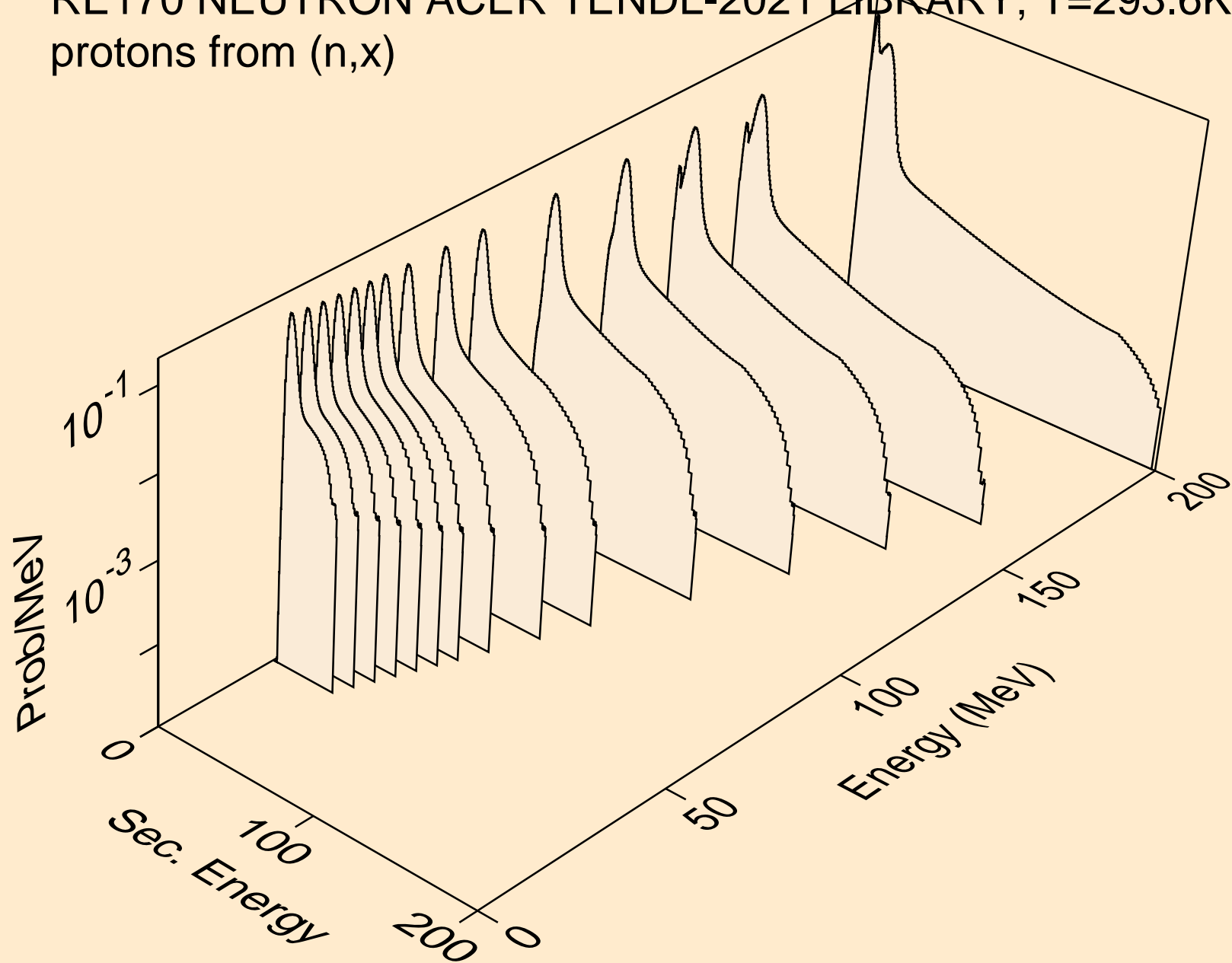

RE170 NEUTRON ACER TENDL-2021 LIBRARY; T=293.6K  
protons from (n,n\*)p

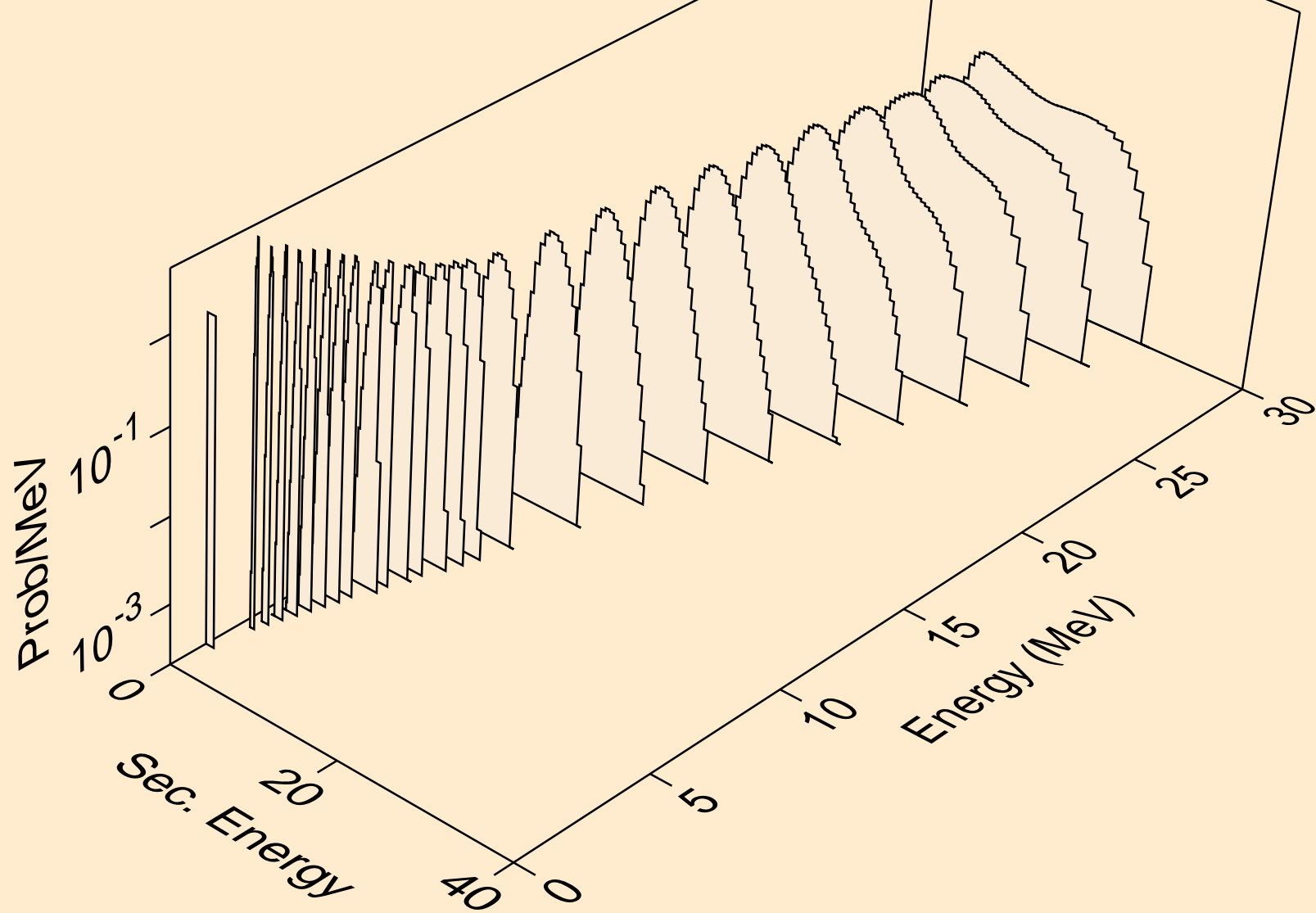

RE170 NEUTRON ACER TENDL-2021 LIBRARY; T=293.6K  
protons from (n,2np)

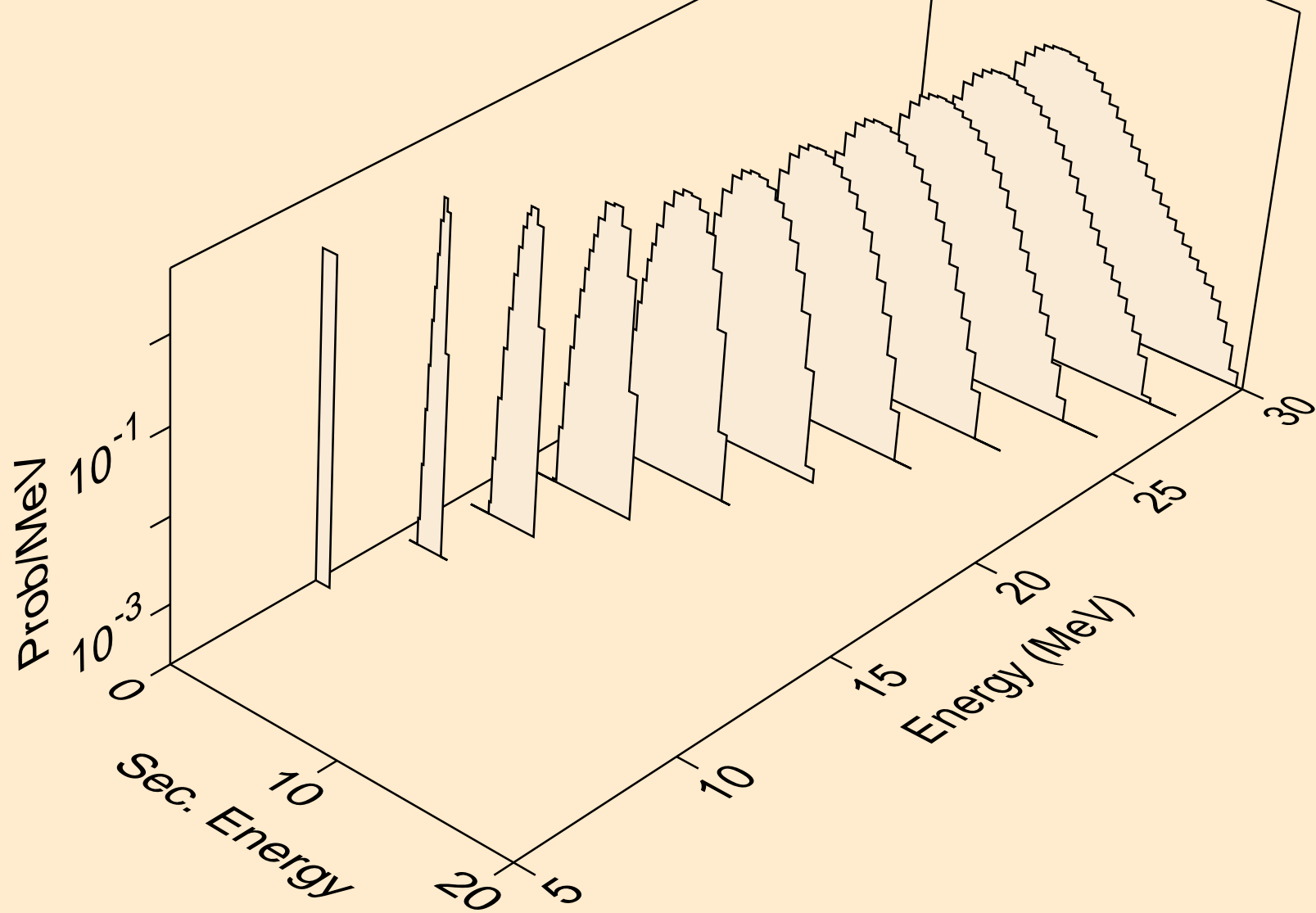

RE170 NEUTRON ACER TENDL-2021 LIBRARY; T=293.6K  
protons from (n,3np)

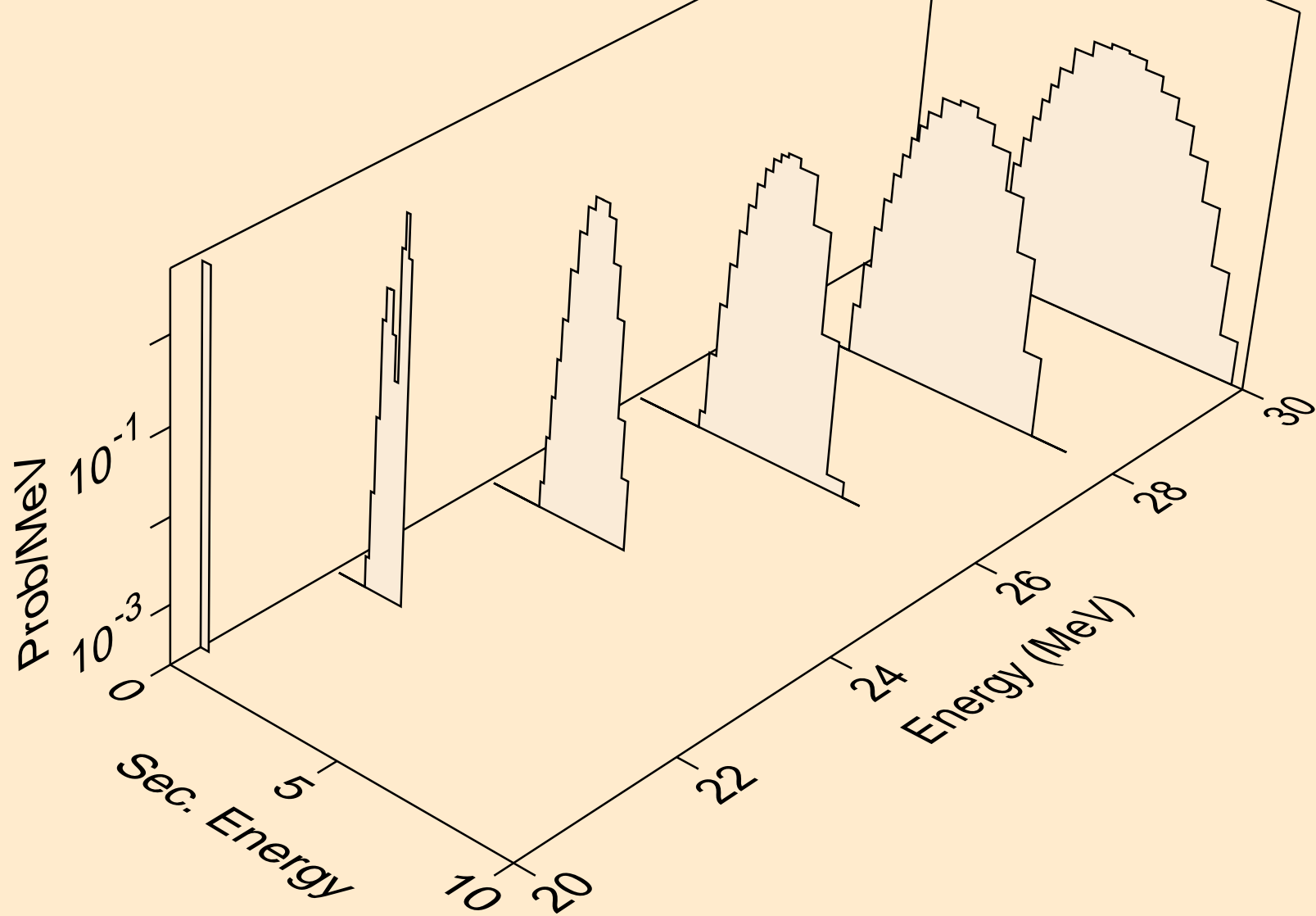



RE170 NEUTRON ACER TENDL-2021 LIBRARY; T=293.6K  
protons from (n,2np)

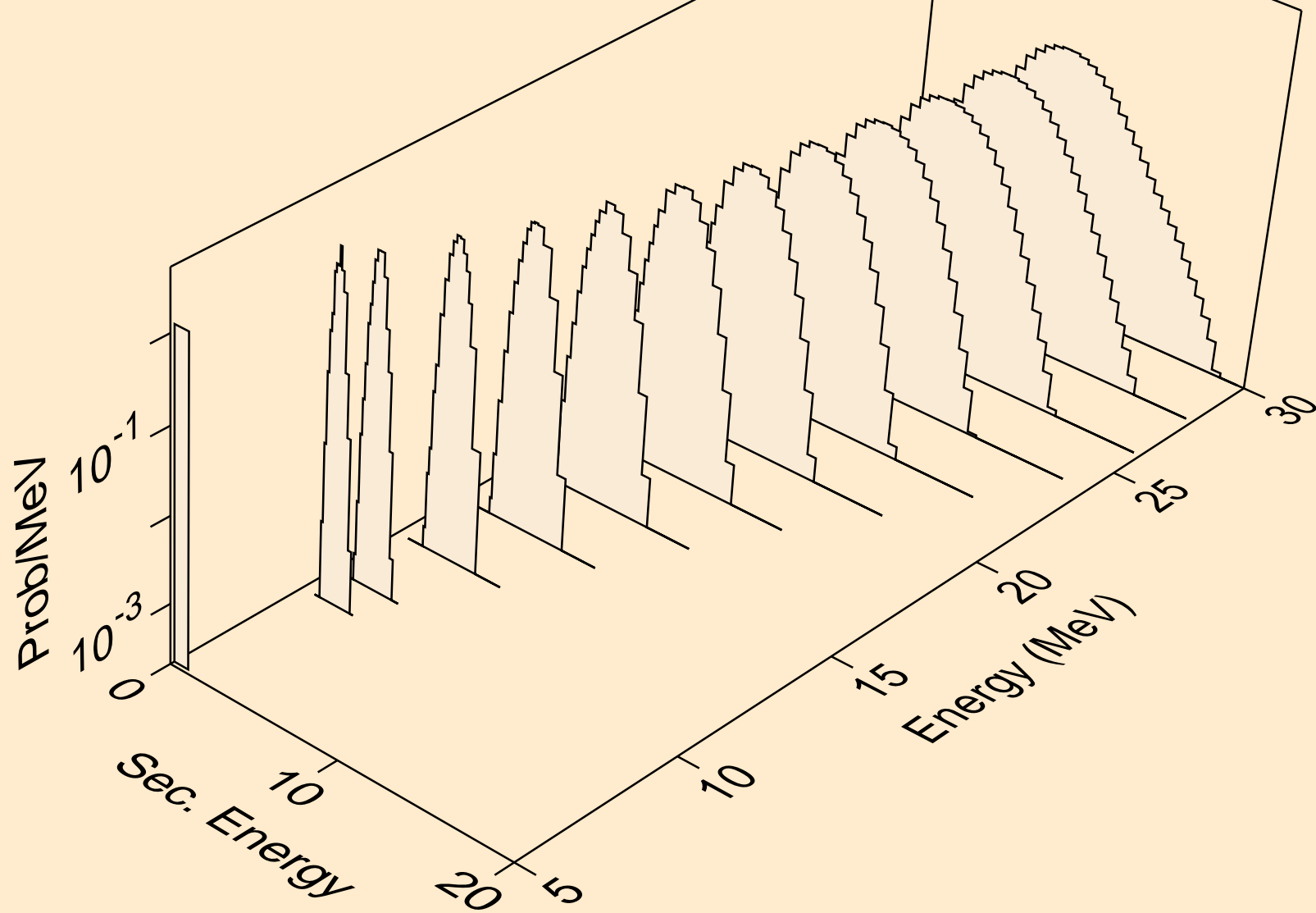

RE170 NEUTRON ACER TENDL-2021 LIBRARY; T=293.6K  
protons from (n,npa)

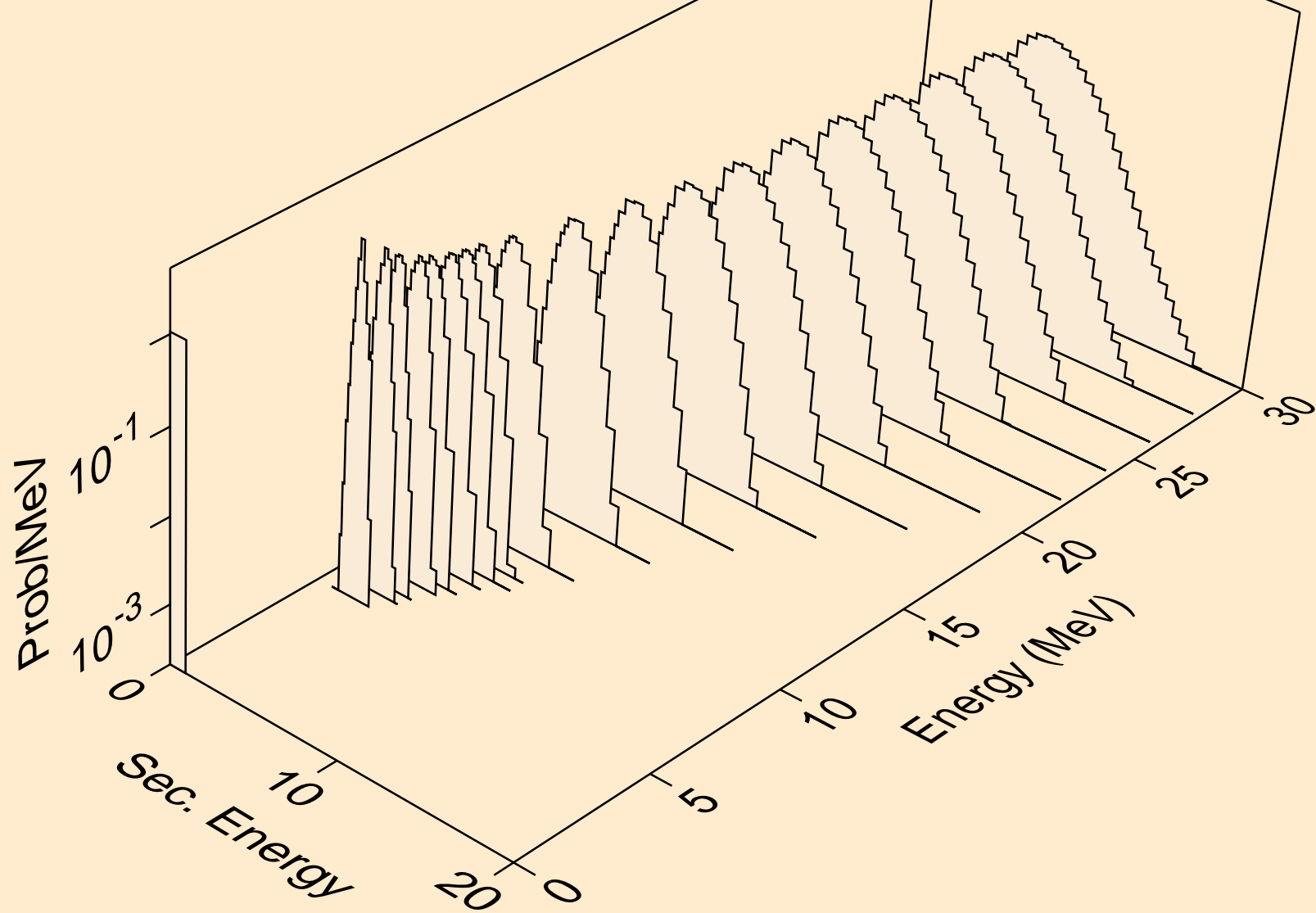

RE170 NEUTRON ACER TENDL-2021 LIBRARY; T=293.6K  
protons from (n,p)

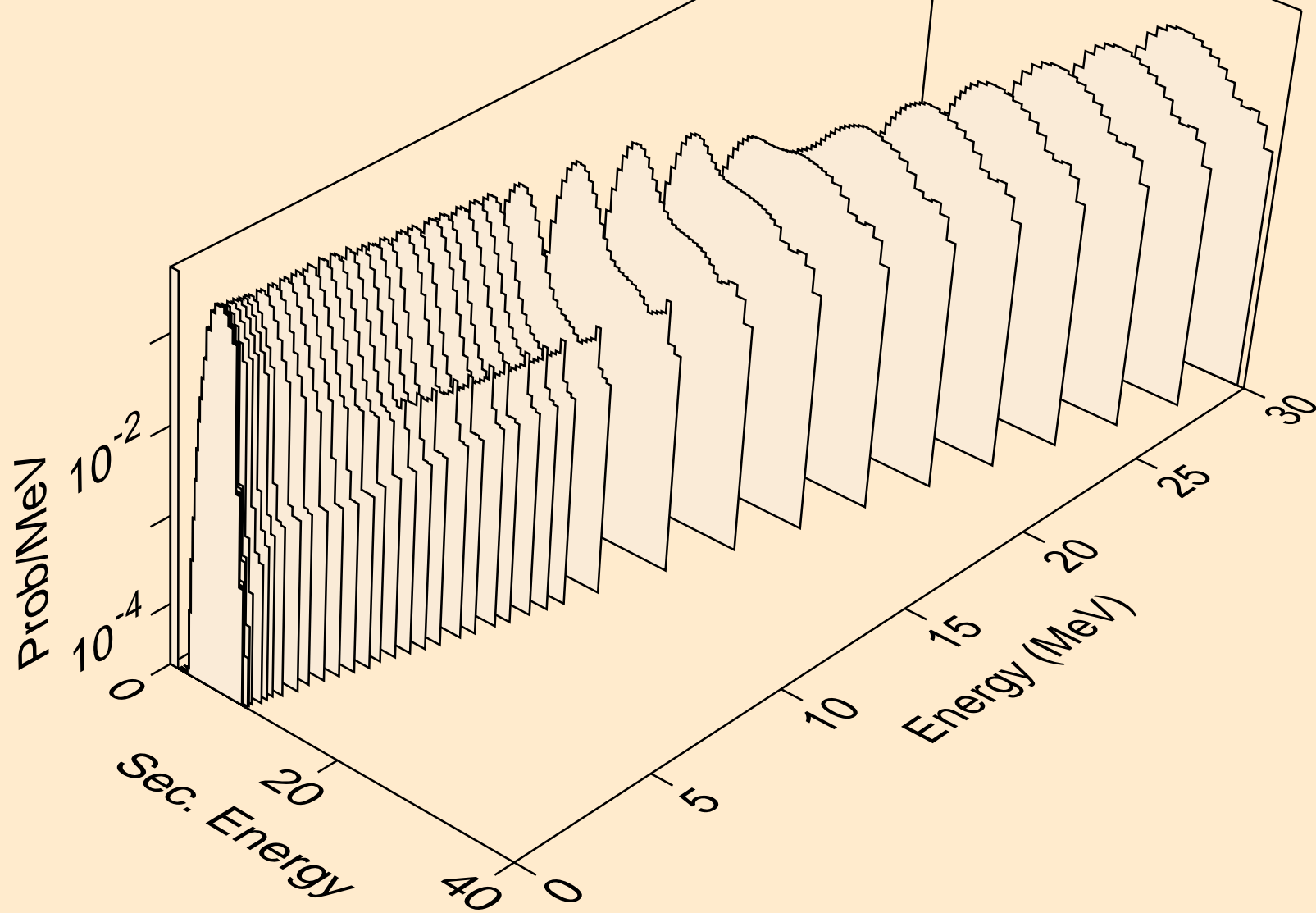

RE170 NEUTRON ACER TENDL-2021 LIBRARY; T=293.6K  
protons from (n,2p)

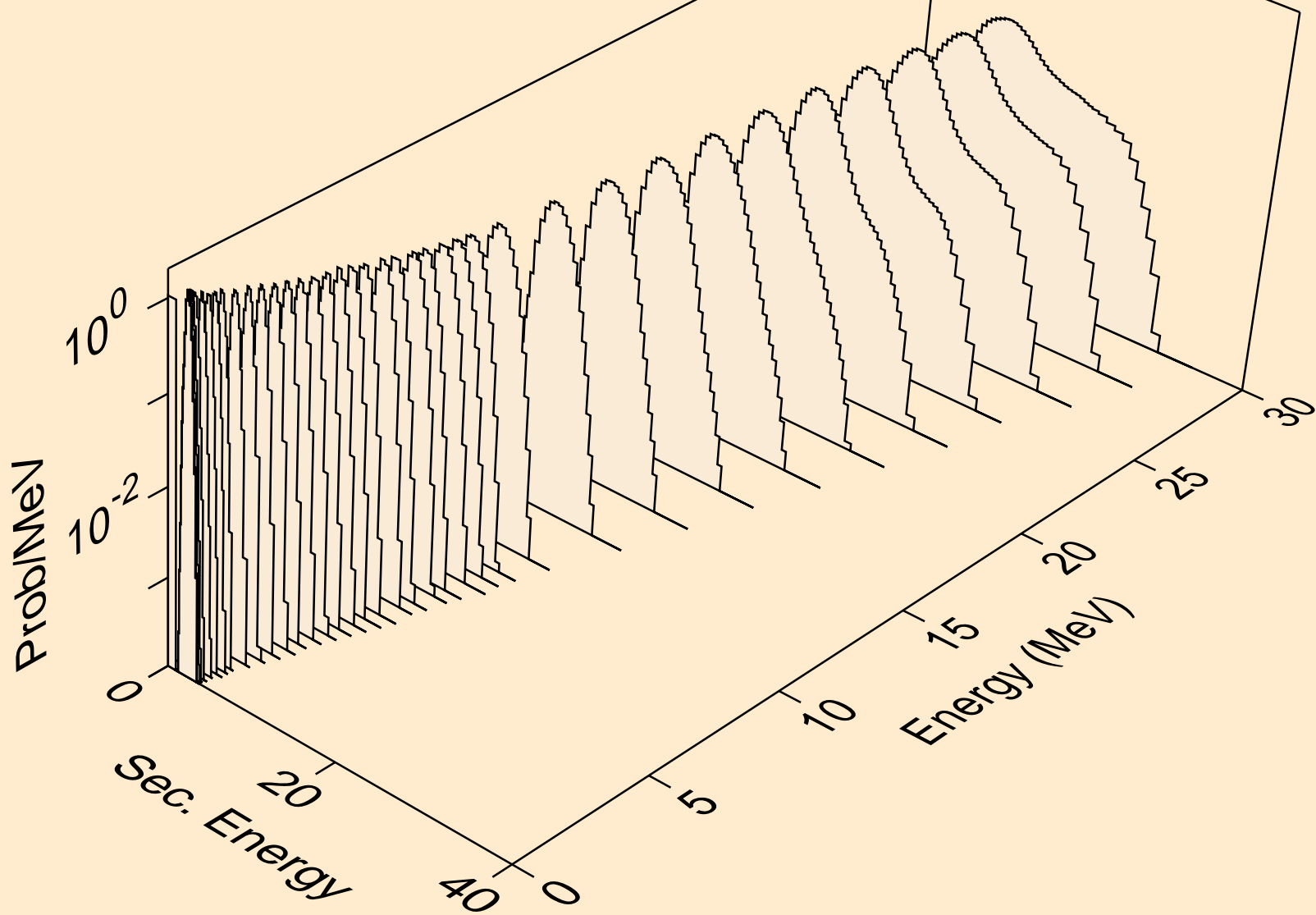

RE170 NEUTRON ACER TENDL-2021 LIBRARY; T=293.6K  
protons from (n,p)

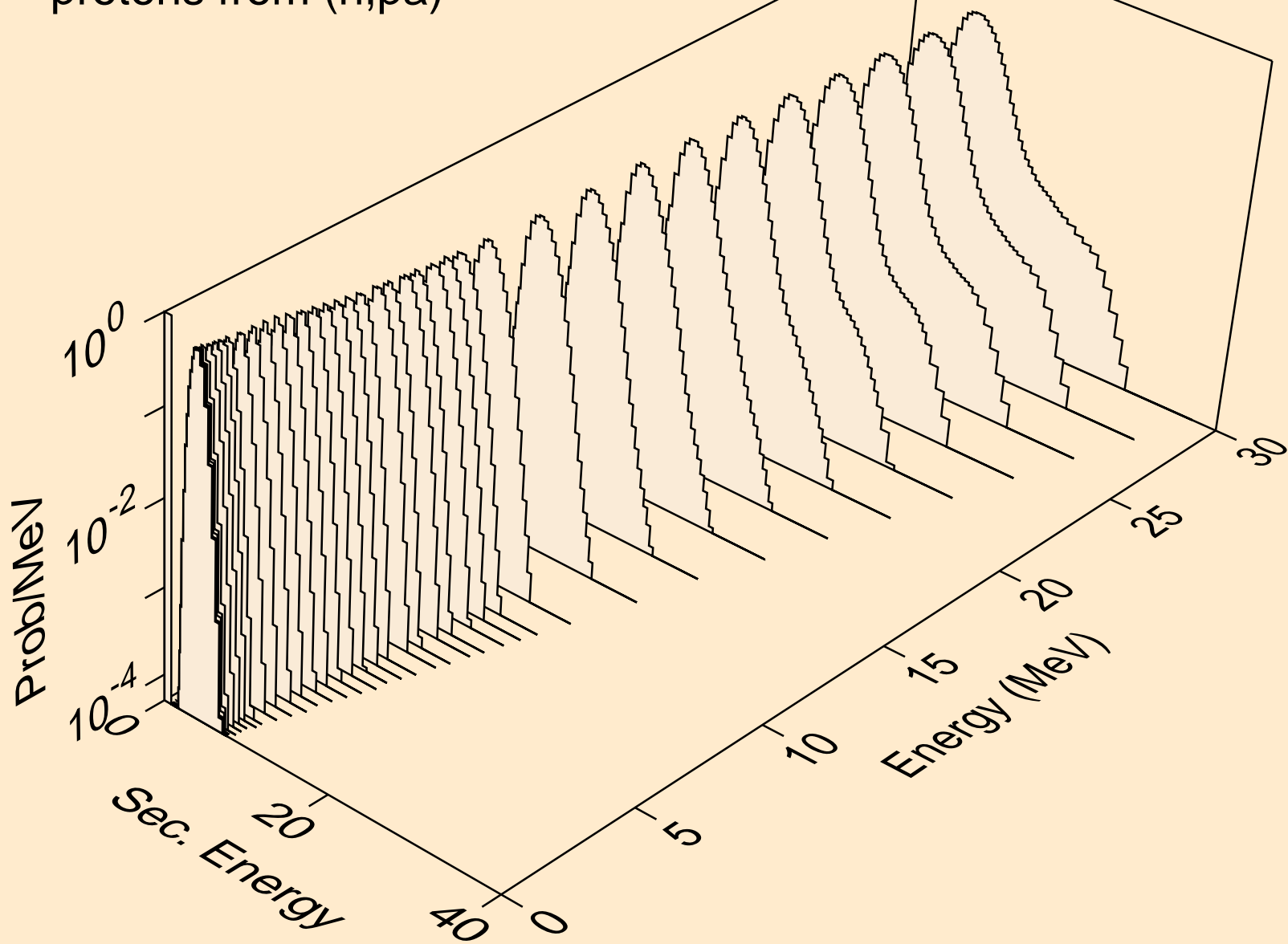

RE170 NEUTRON ACER TENDL-2021 LIBRARY; T=293.6K  
protons from (n,pd)

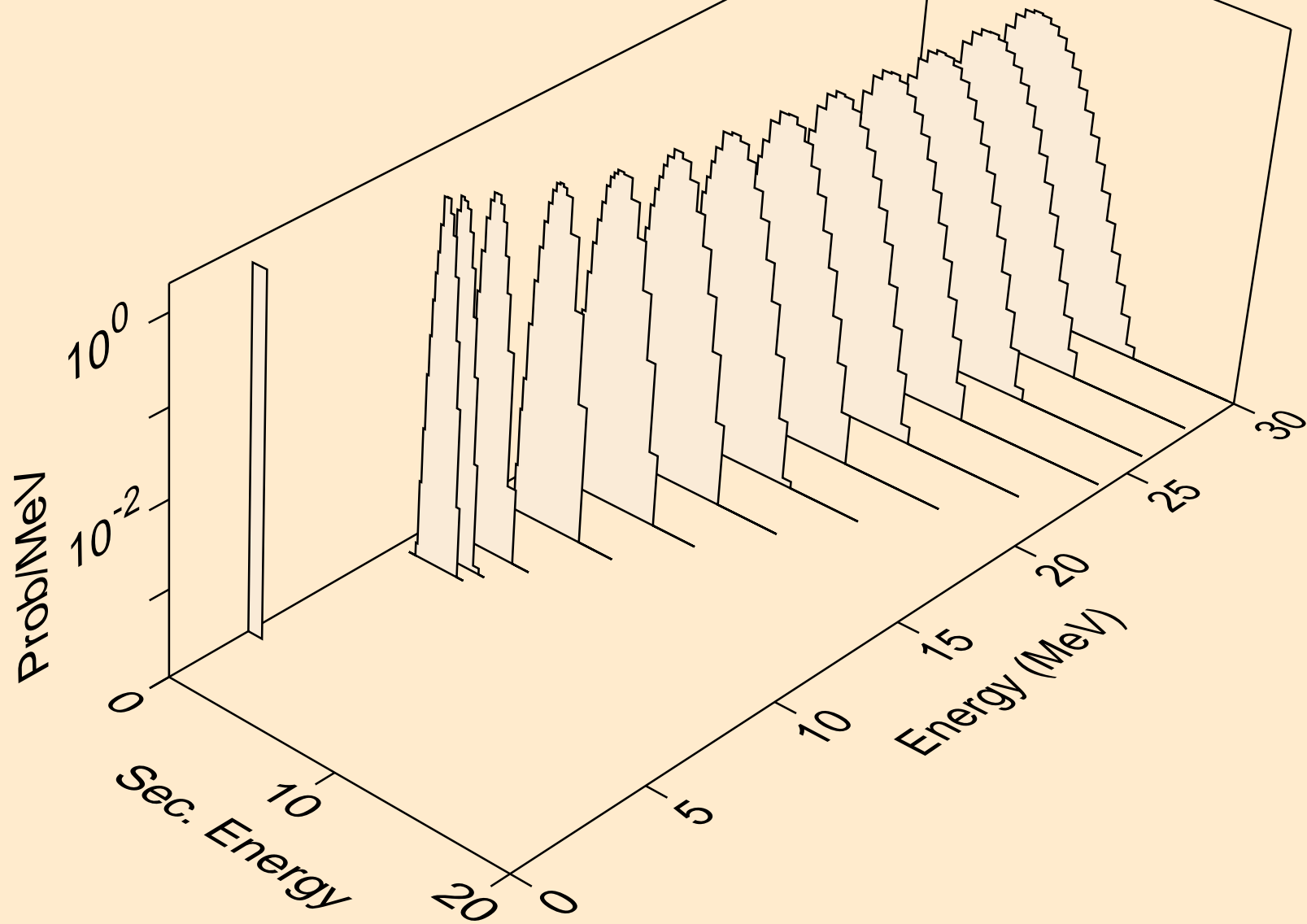

RE170 NEUTRON ACER TENDL-2021 LIBRARY; T=293.6K  
protons from (n,pt)

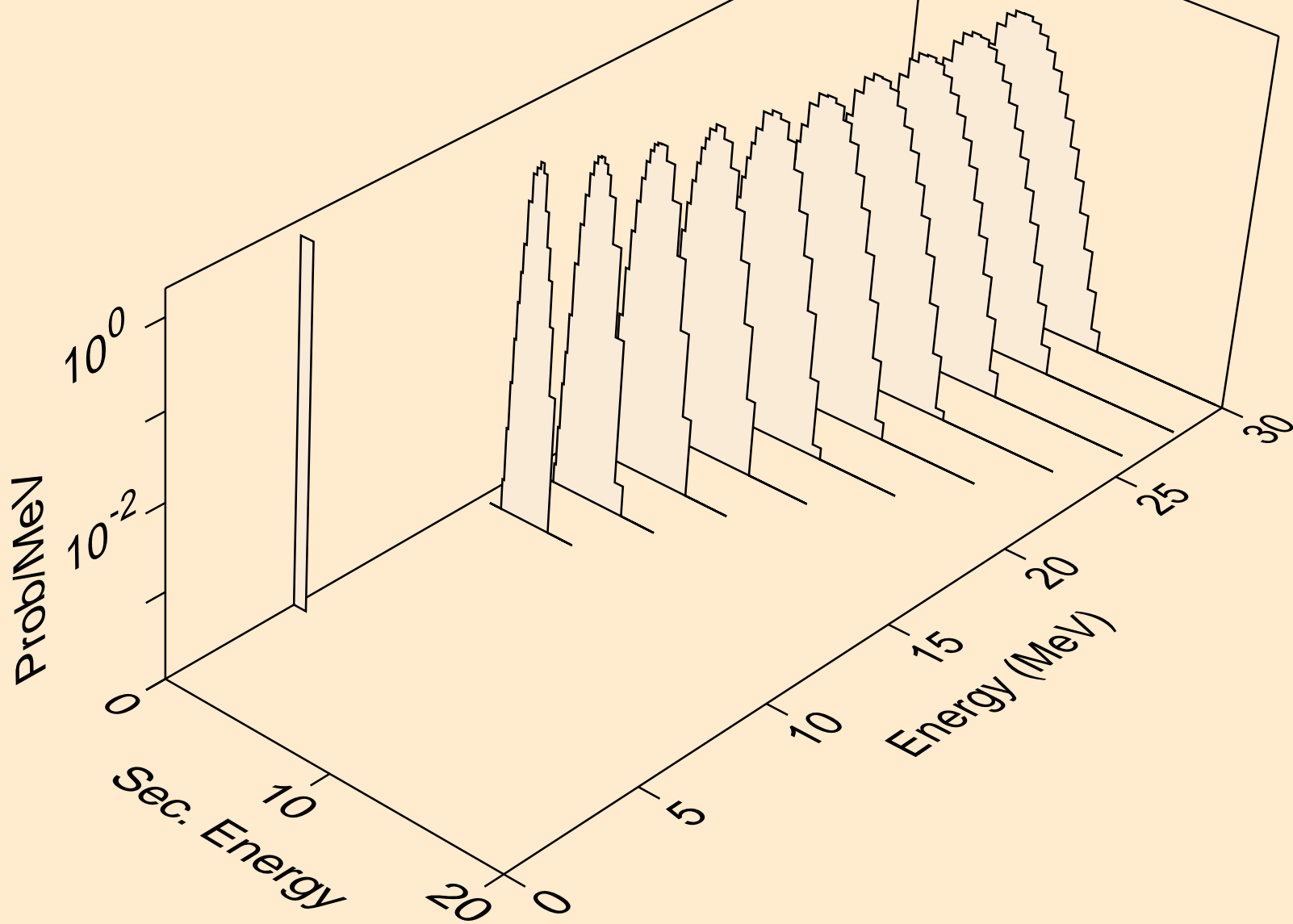

RE170 NEUTRON ACER TENDL-2021 LIBRARY; T=293.6K  
deuterons from (n,x)

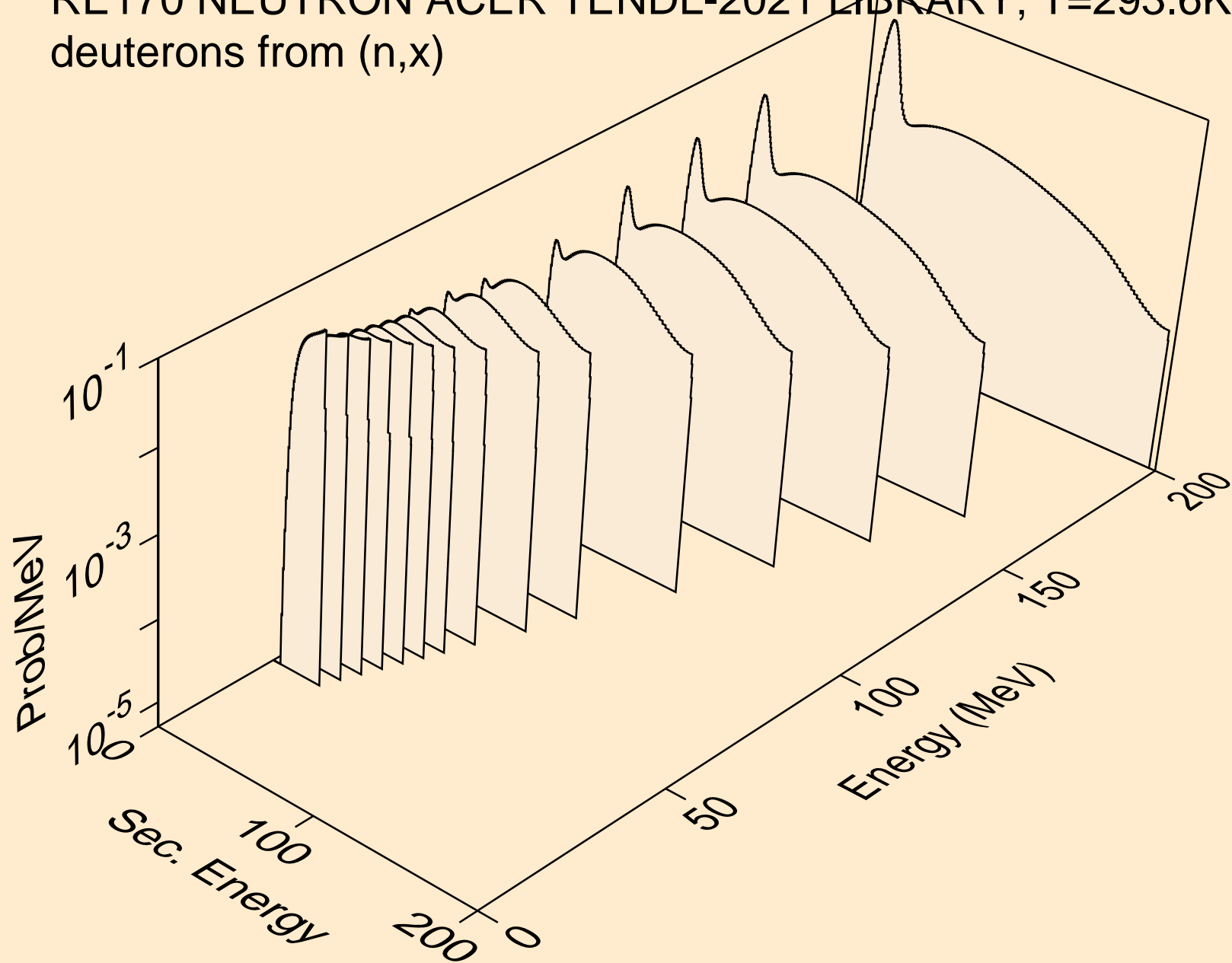



RE170 NEUTRON ACER TENDL-2021 LIBRARY; T=293.6K  
deuterons from (n,2nd)

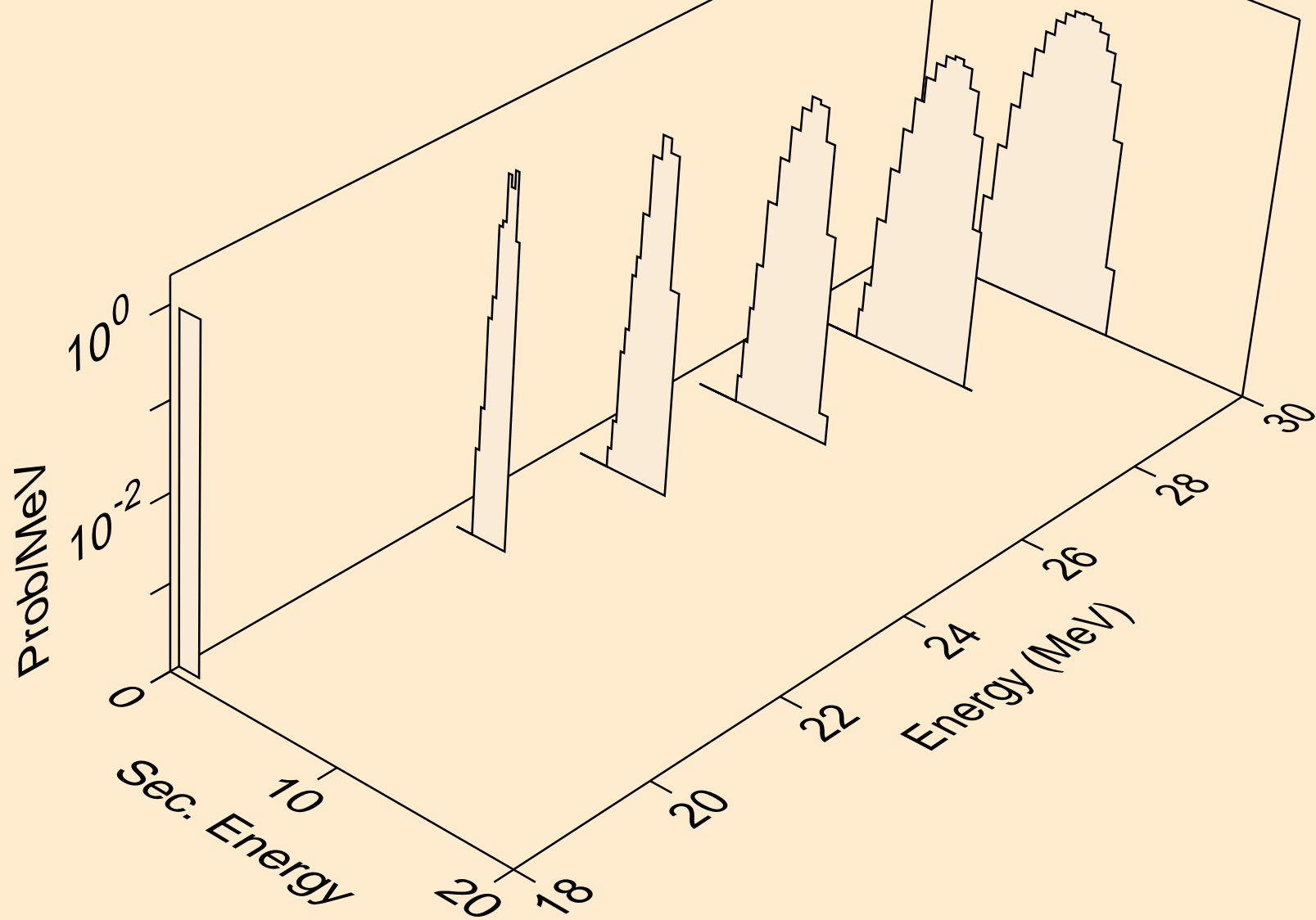

RE170 NEUTRON ACER TENDL-2021 LIBRARY; T=293.6K  
deuterons from (n,n\*)d

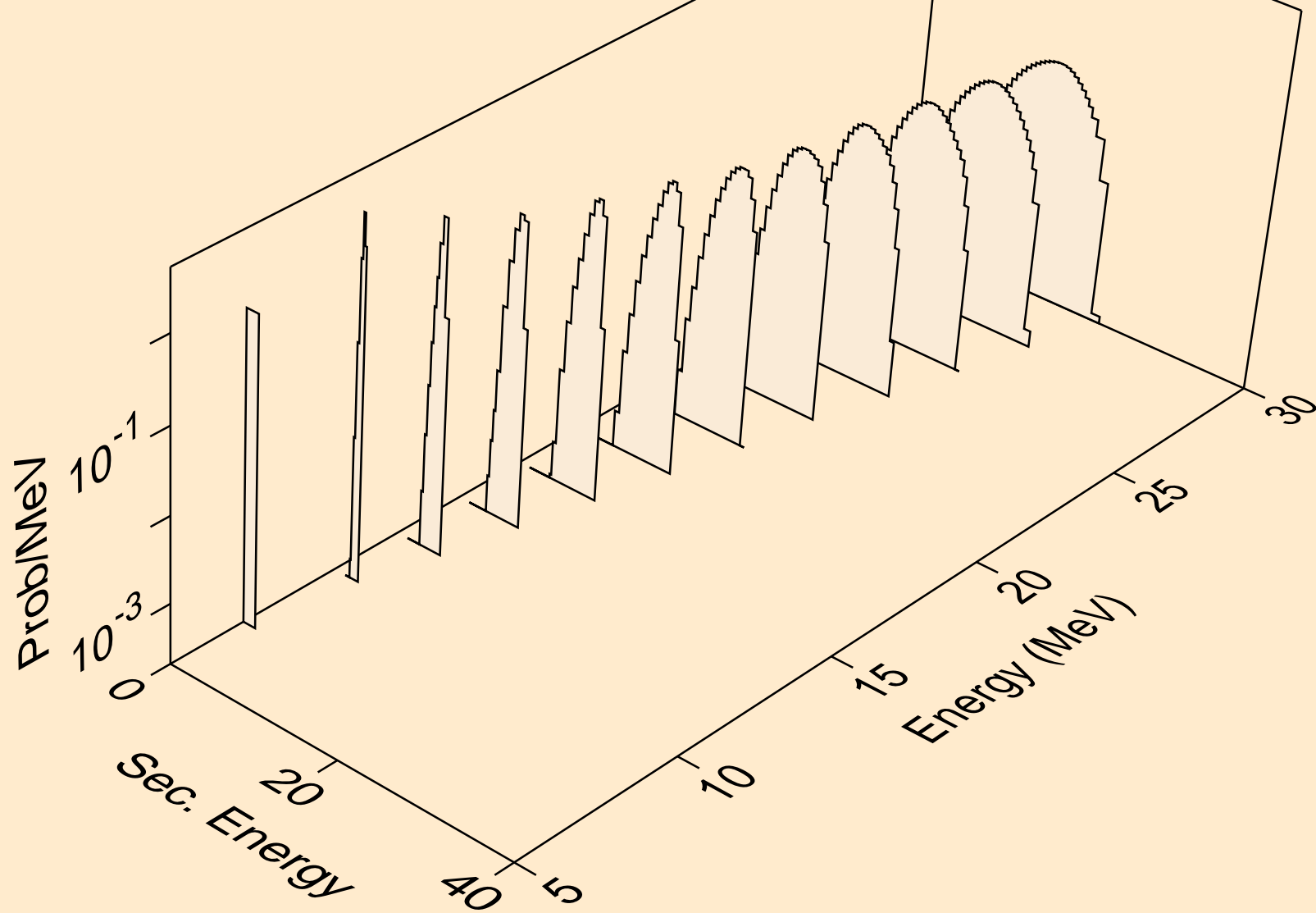

RE170 NEUTRON ACER TENDL-2021 LIBRARY; T=293.6K  
deuterons from (n,d)

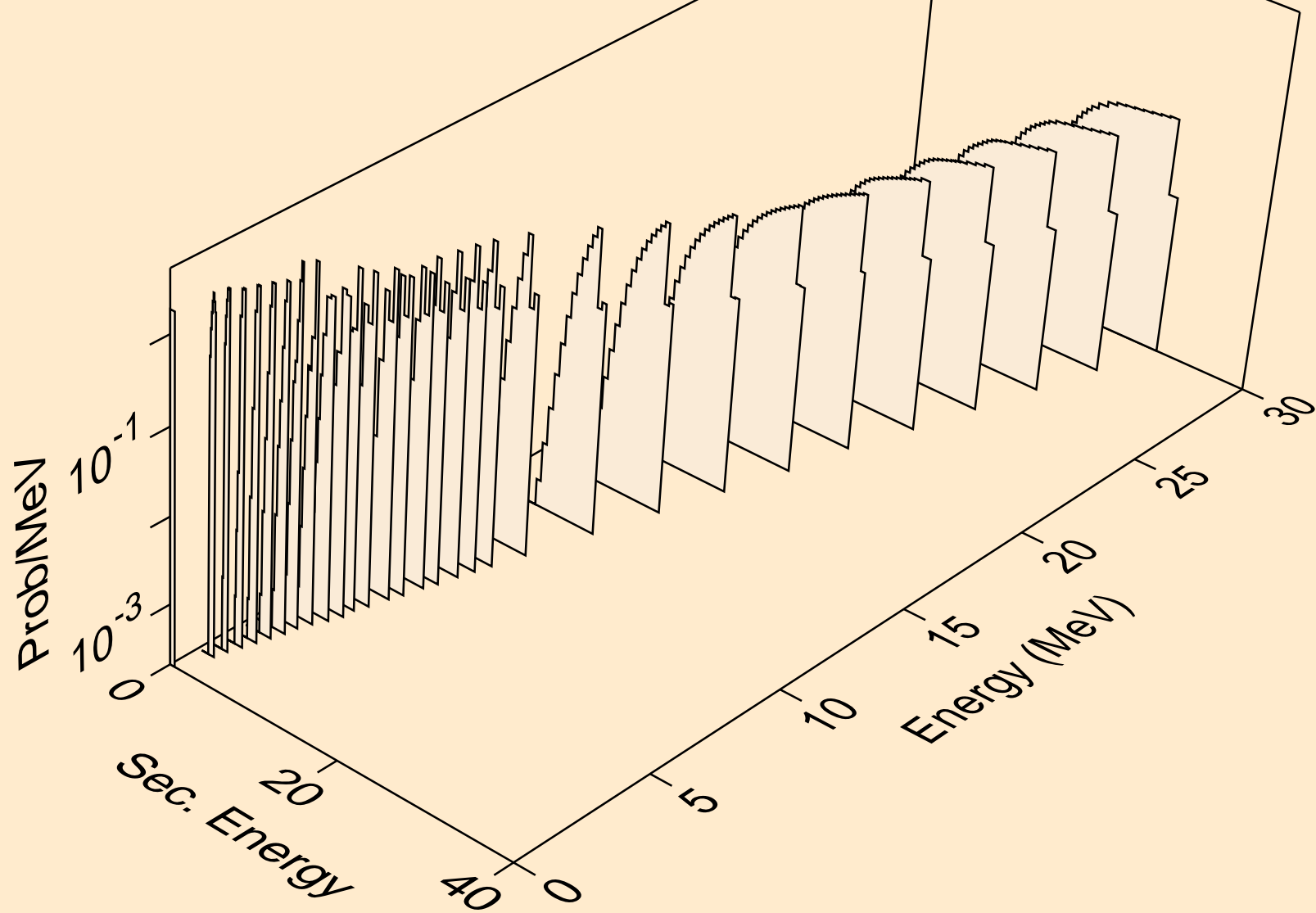

RE170 NEUTRON ACER TENDL-2021 LIBRARY; T=293.6K  
deuterons from (n,pd)

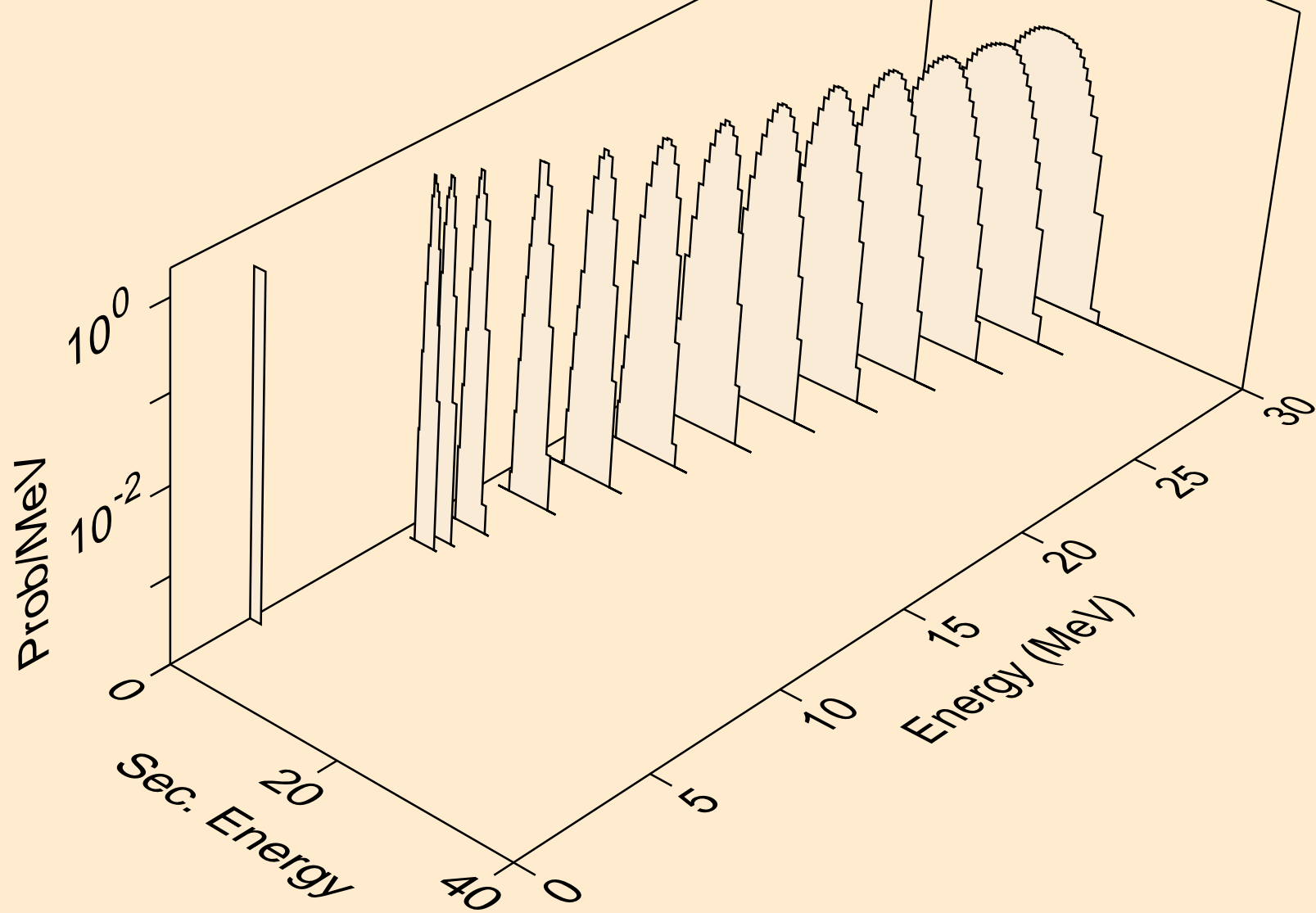

RE170 NEUTRON ACER TENDL-2021 LIBRARY; T=293.6K  
deuterons from (n,da)

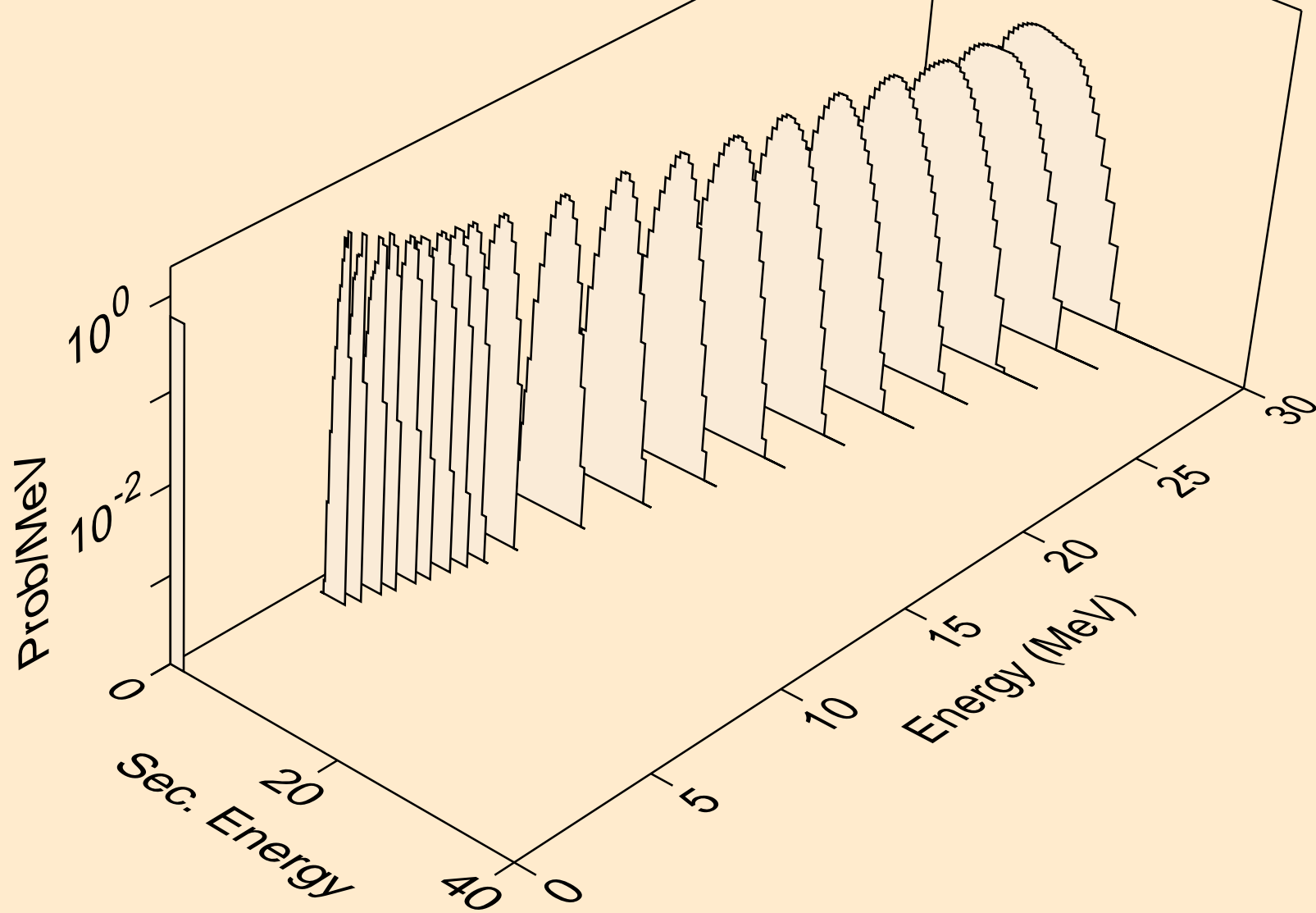

RE170 NEUTRON ACER TENDL-2021 LIBRARY; T=293.6K  
tritons from (n,x)

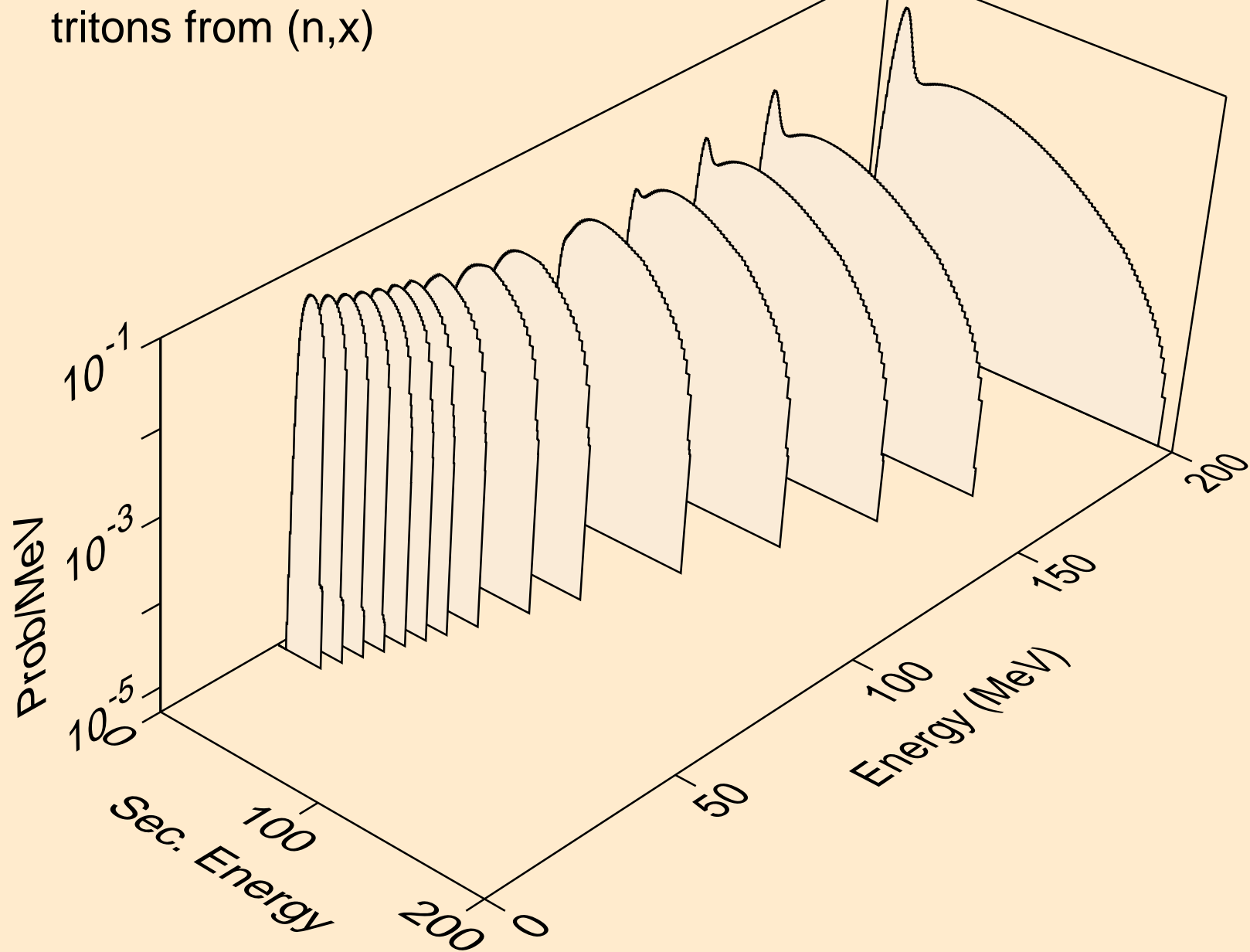

RE170 NEUTRON ACER TENDL-2021 LIBRARY; T=293.6K  
tritons from (n,n\*)t

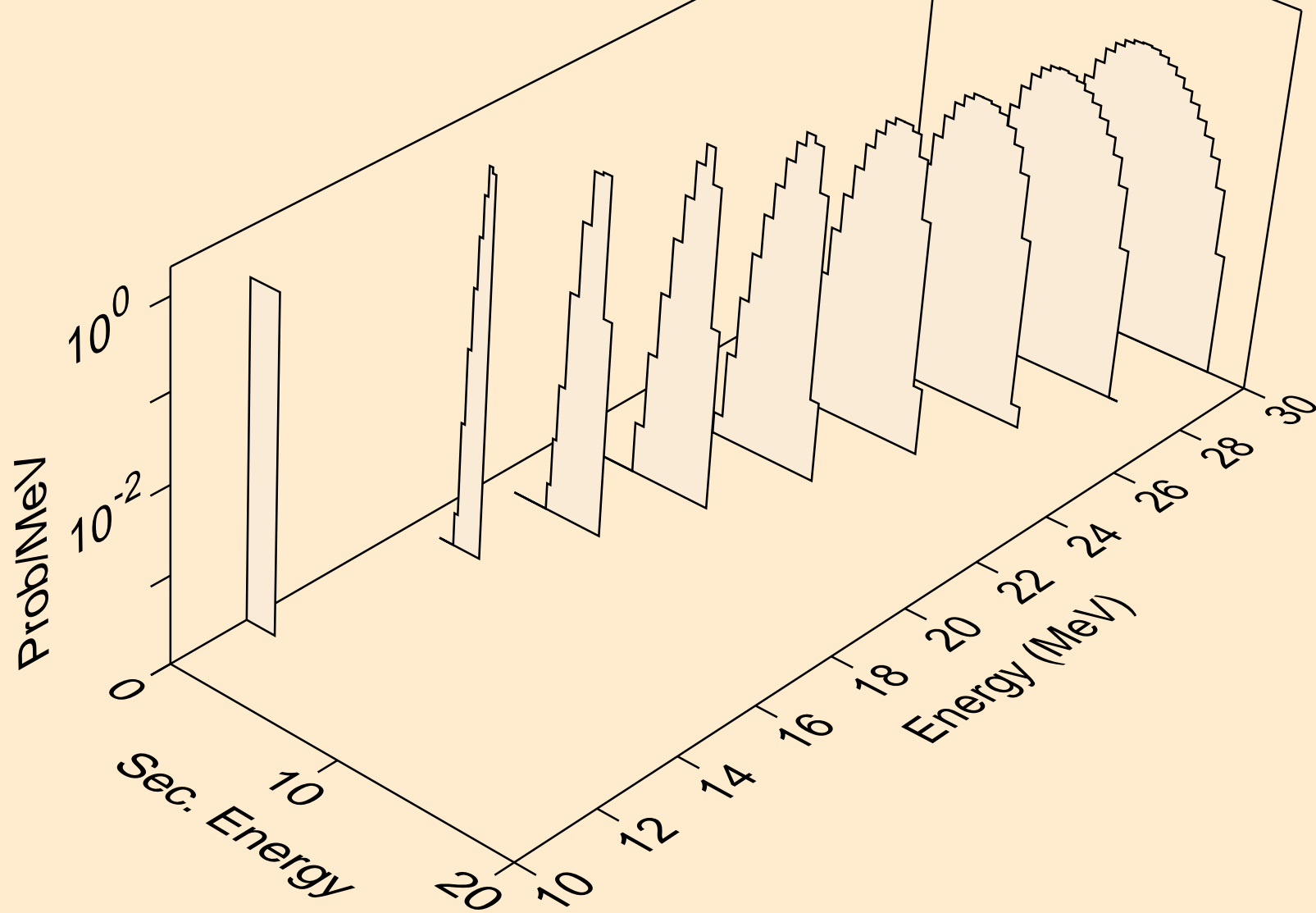

RE170 NEUTRON ACER TENDL-2021 LIBRARY; T=293.6K  
tritons from (n,t)

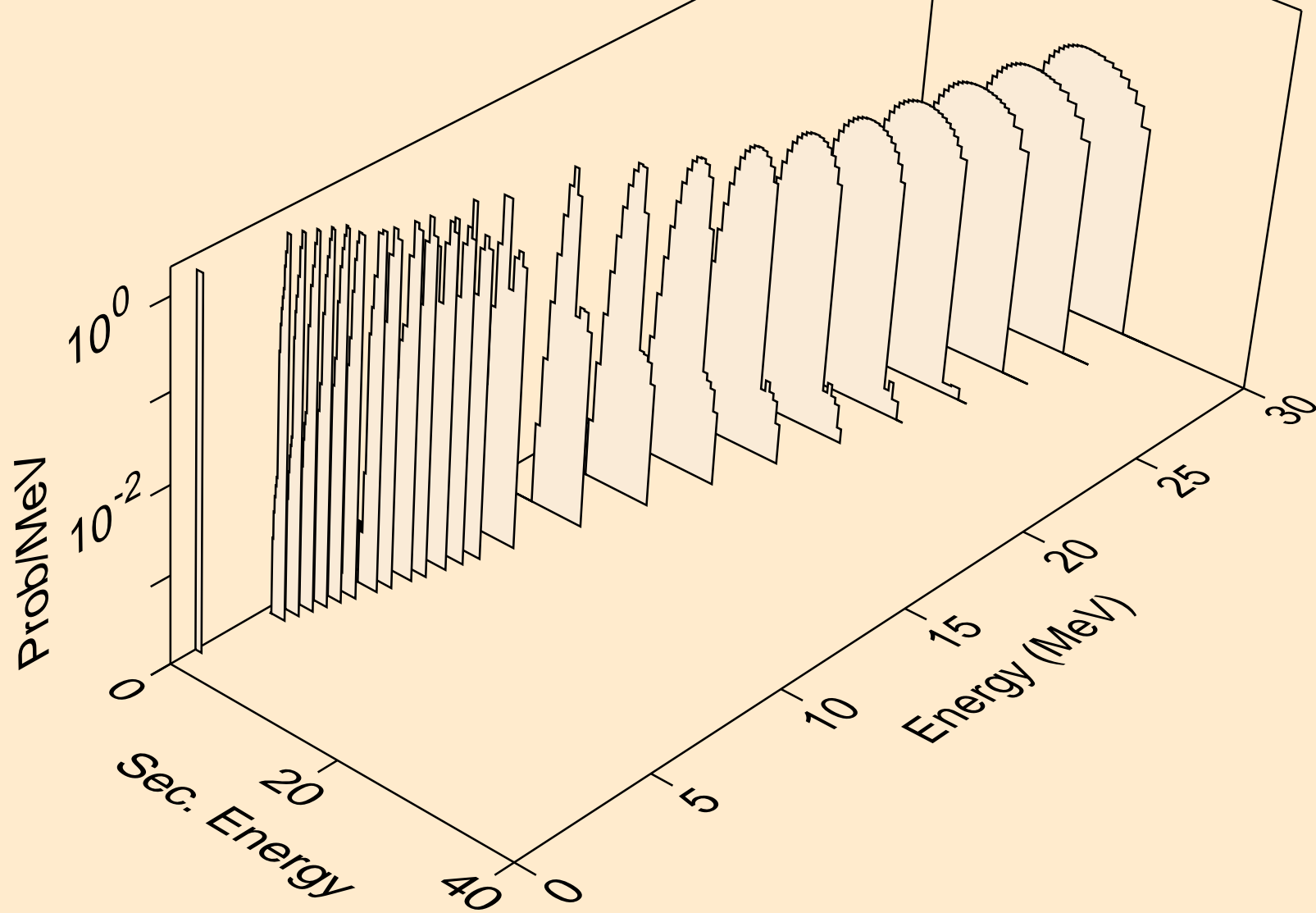



RE170 NEUTRON ACER TENDL-2021 LIBRARY; T=293.6K  
tritons from (n,pt)

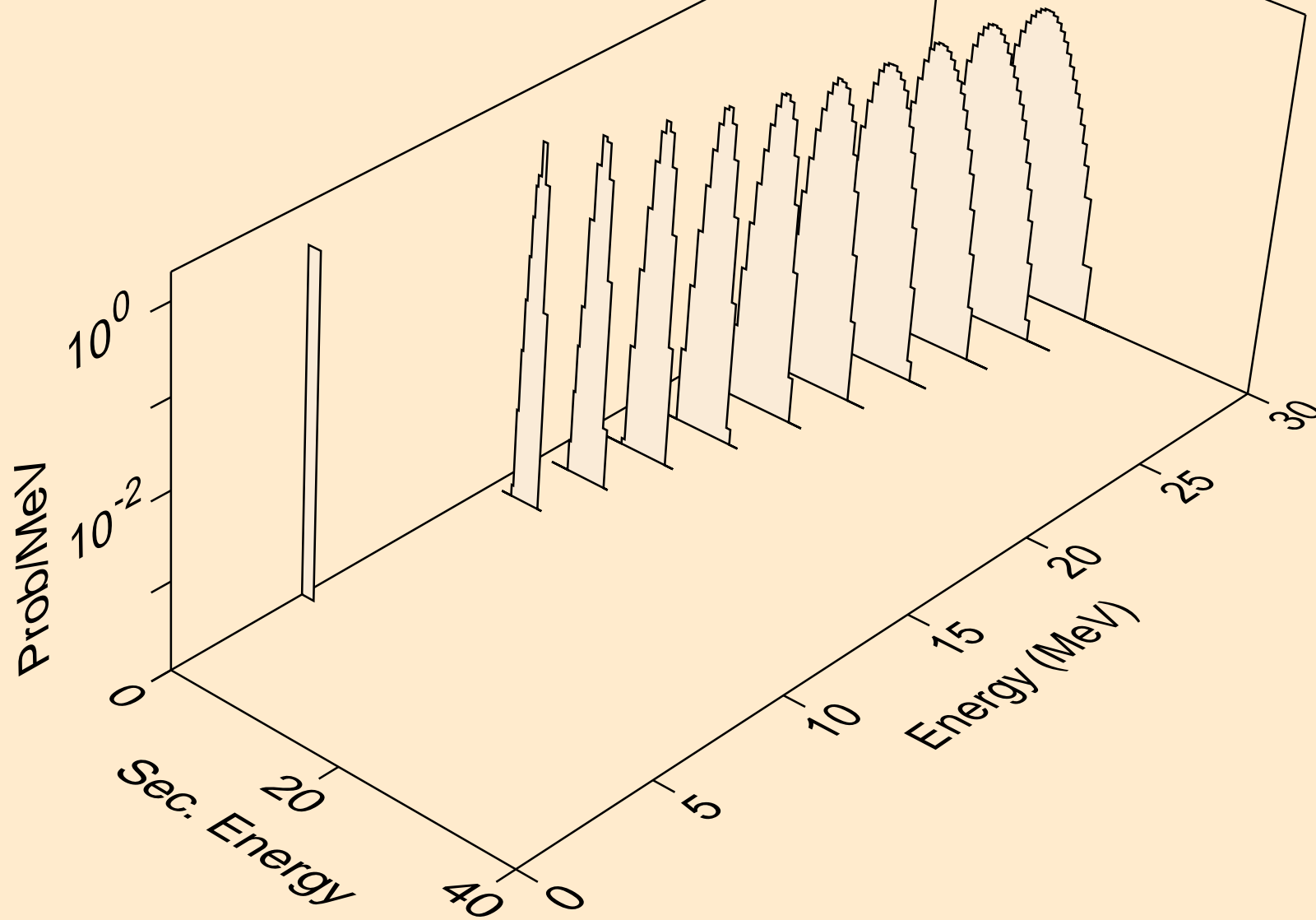

RE170 NEUTRON ACER TENDL-2021 LIBRARY; T=293.6K  
he3s from (n,x)

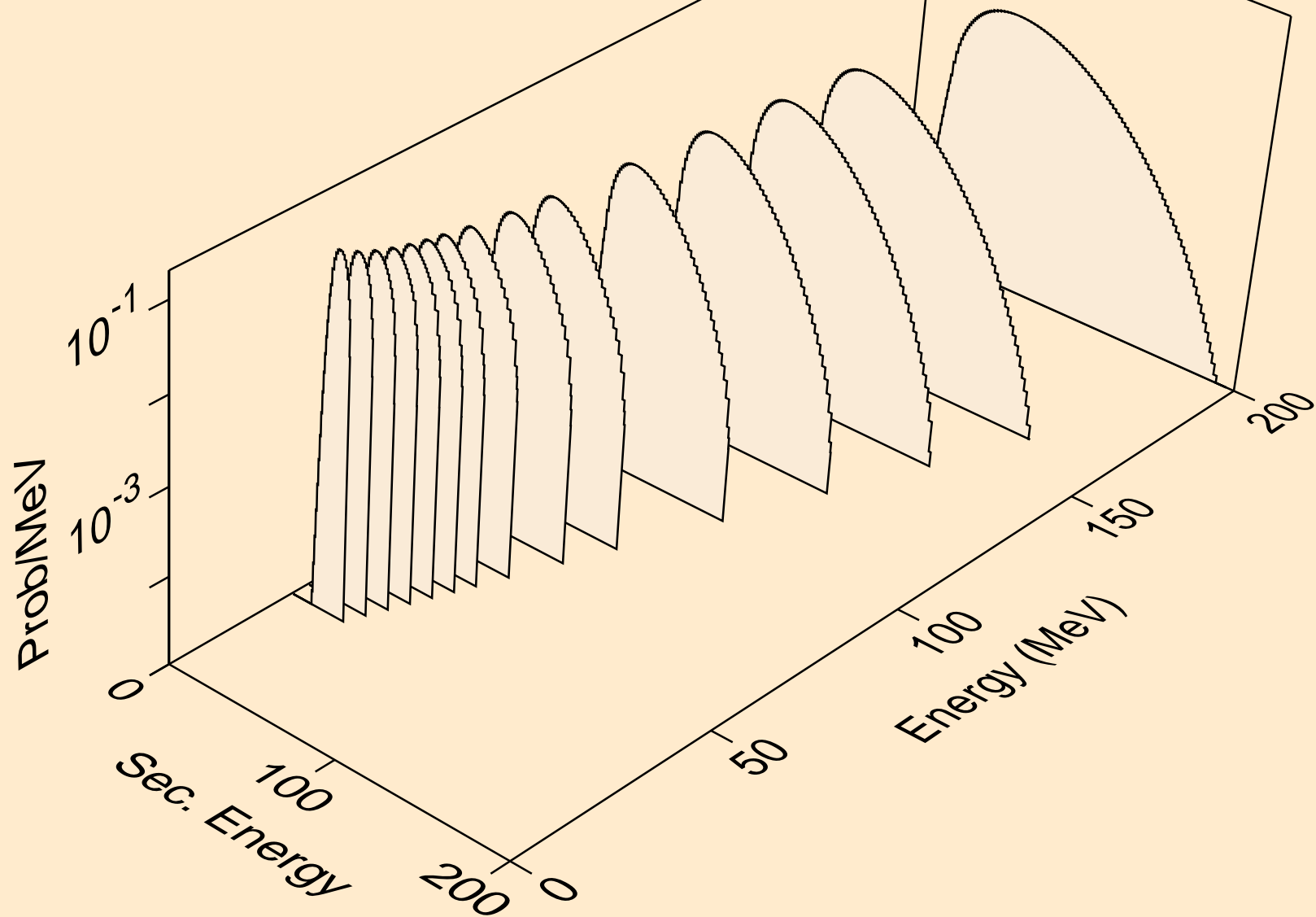

RE170 NEUTRON ACER TENDL-2021 LIBRARY; T=293.6K  
he3s from (n,n\*)he3

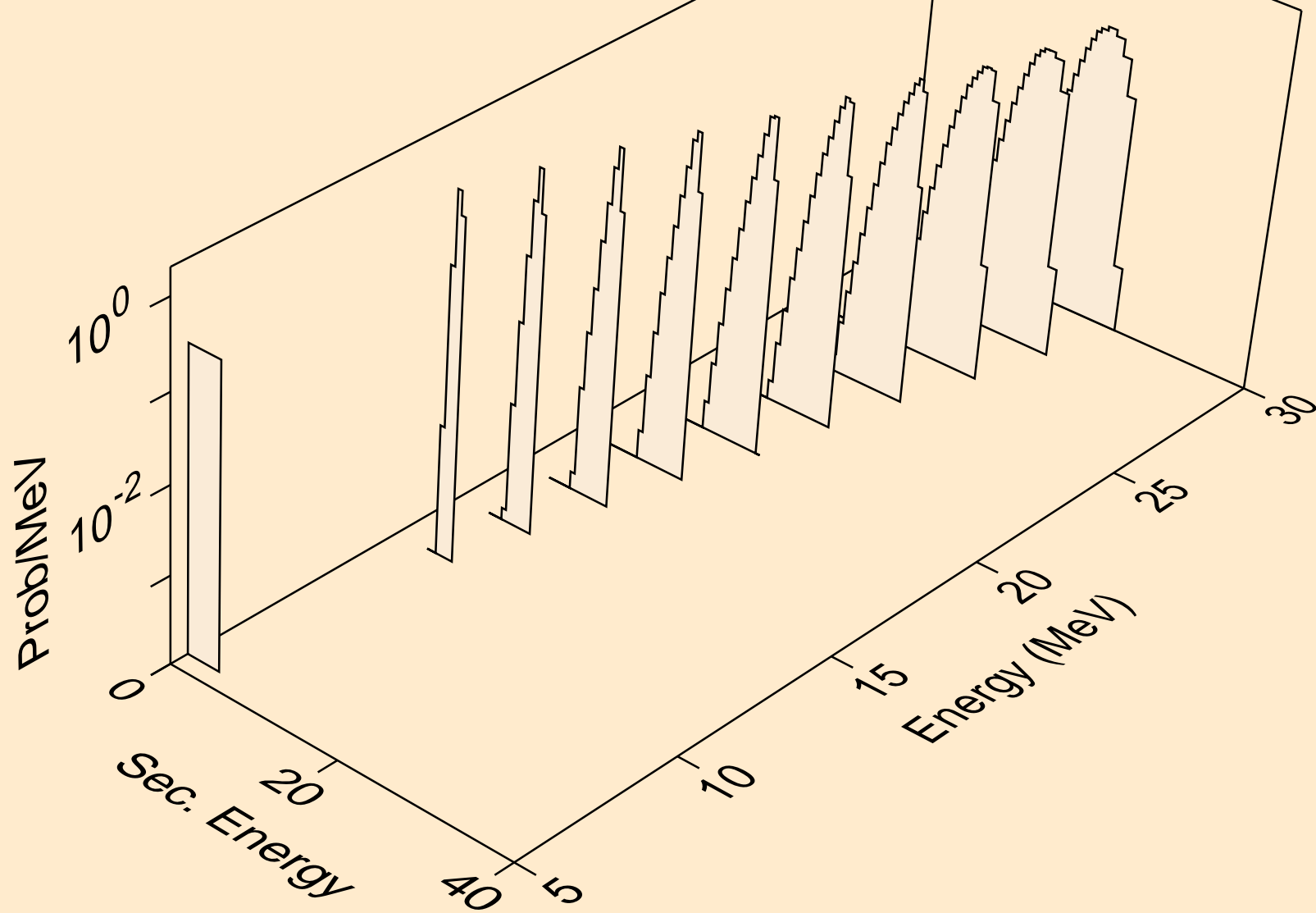

RE170 NEUTRON ACER TENDL-2021 LIBRARY; T=293.6K  
he3s from (n,he3)

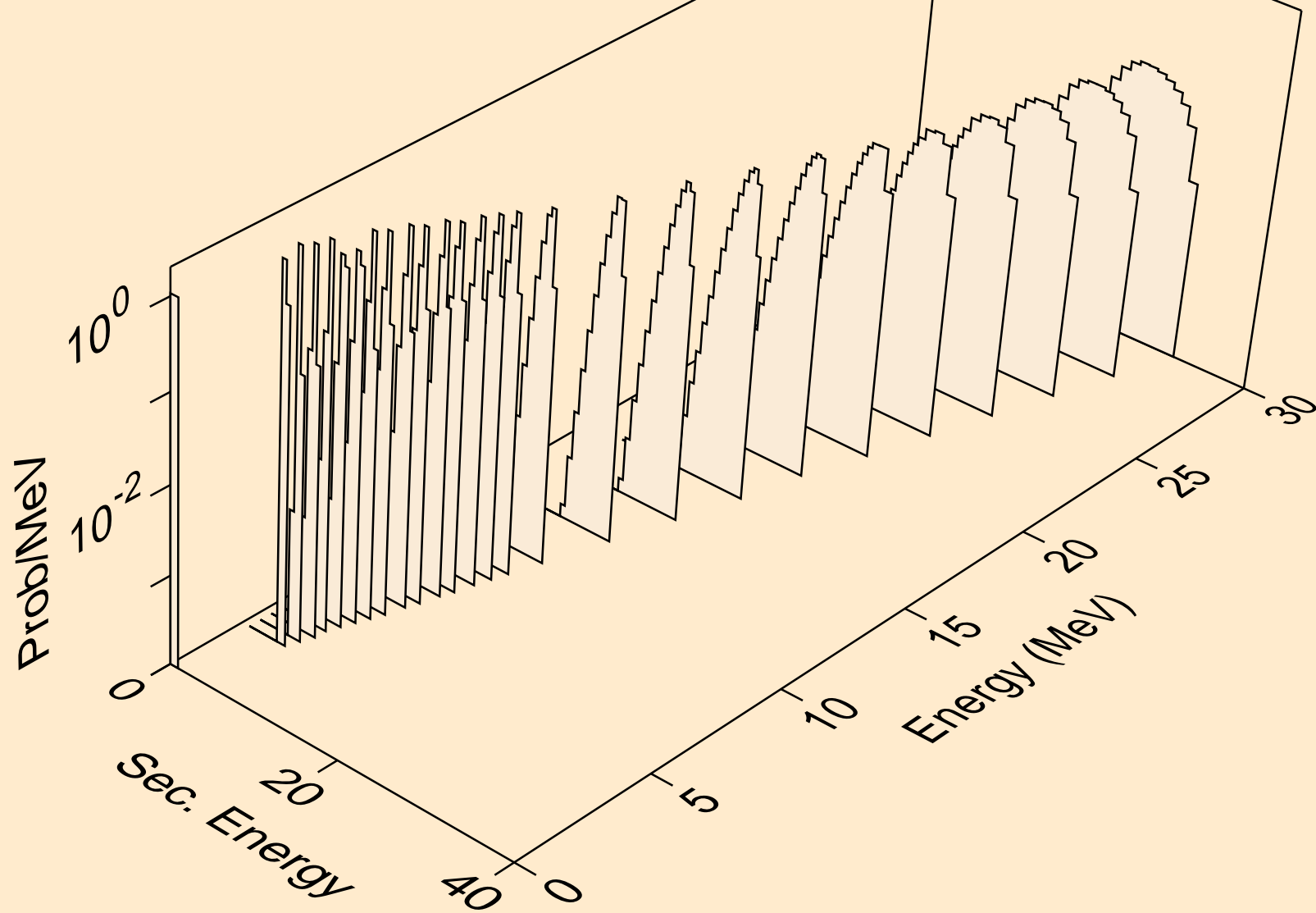

RE170 NEUTRON ACER TENDL-2021 LIBRARY; T=293.6K  
alphas from (n,x)

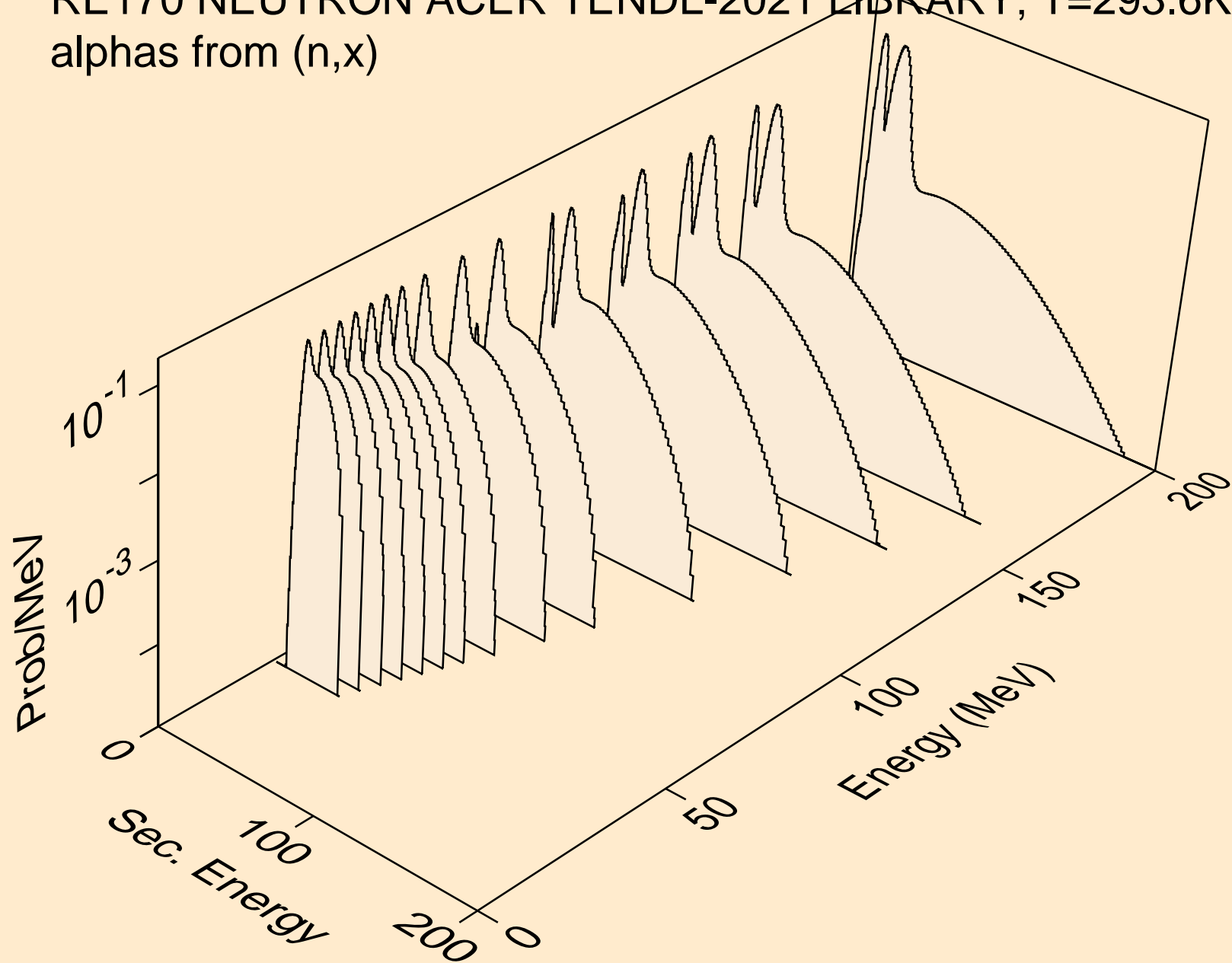

RE170 NEUTRON ACER TENDL-2021 LIBRARY; T=293.6K  
alphas from (n,n\*)a

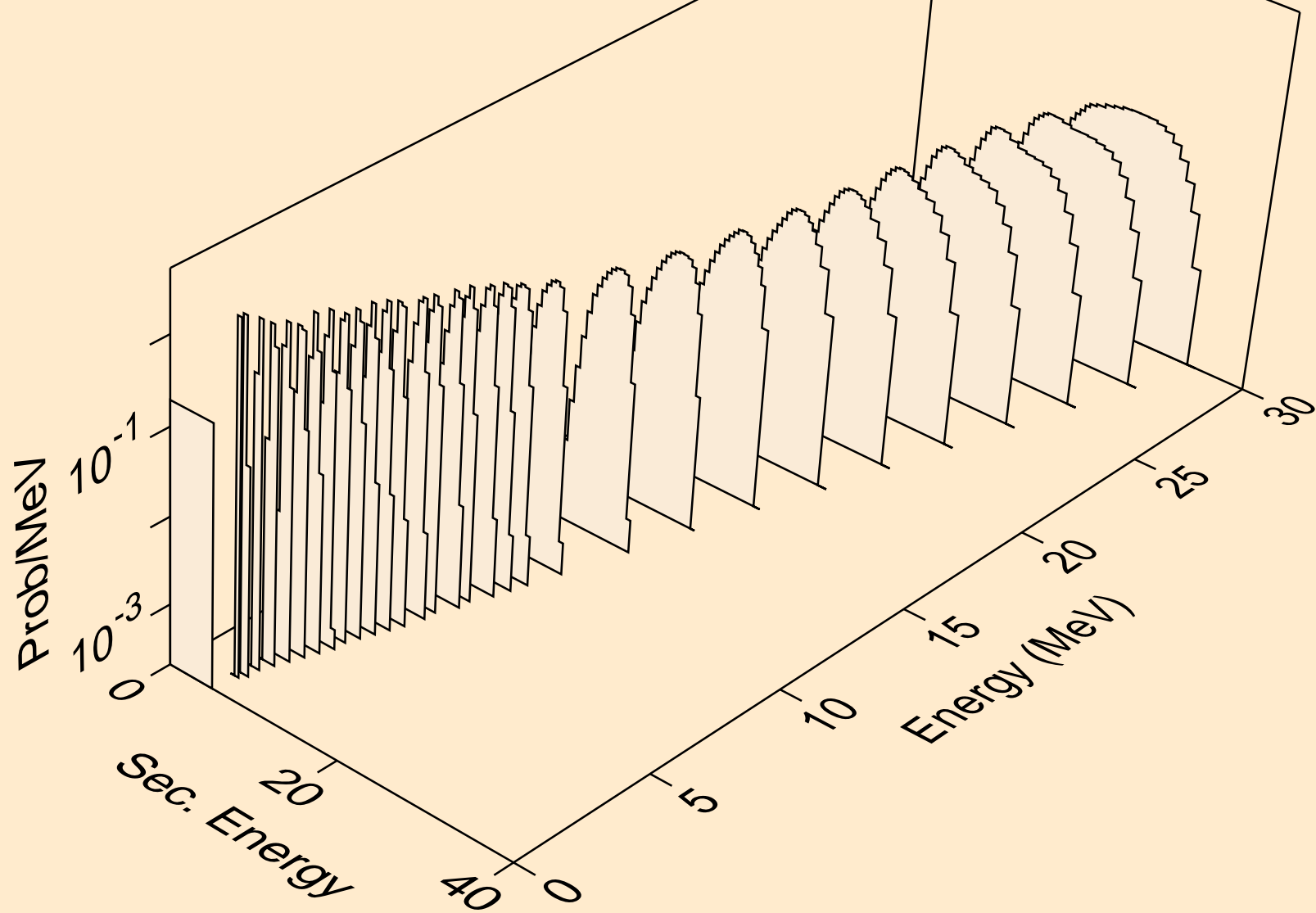

RE170 NEUTRON ACER TENDL-2021 LIBRARY; T=293.6K  
alphas from (n,2n)a

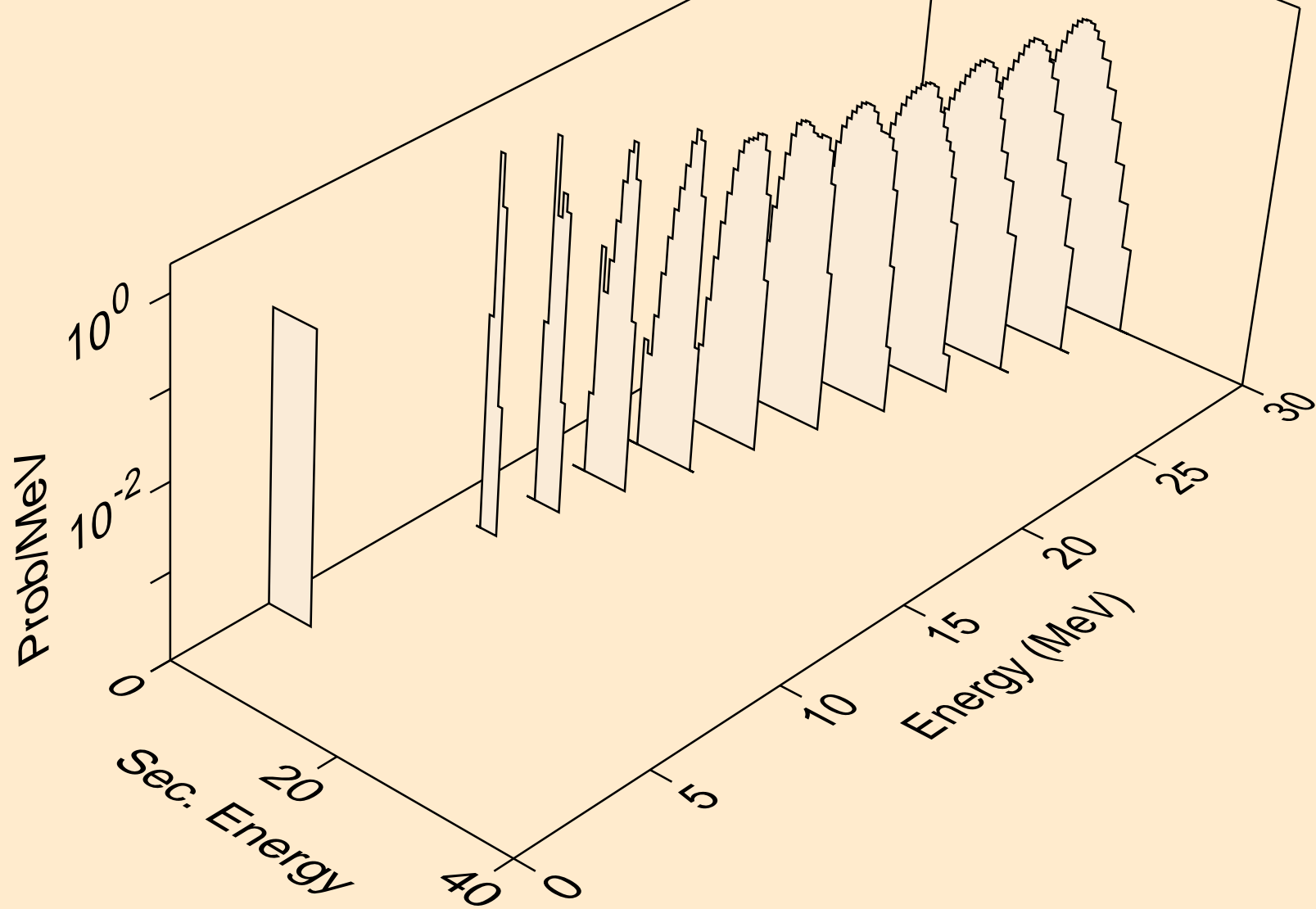

RE170 NEUTRON ACER TENDL-2021 LIBRARY; T=293.6K  
alphas from (n,3n)a

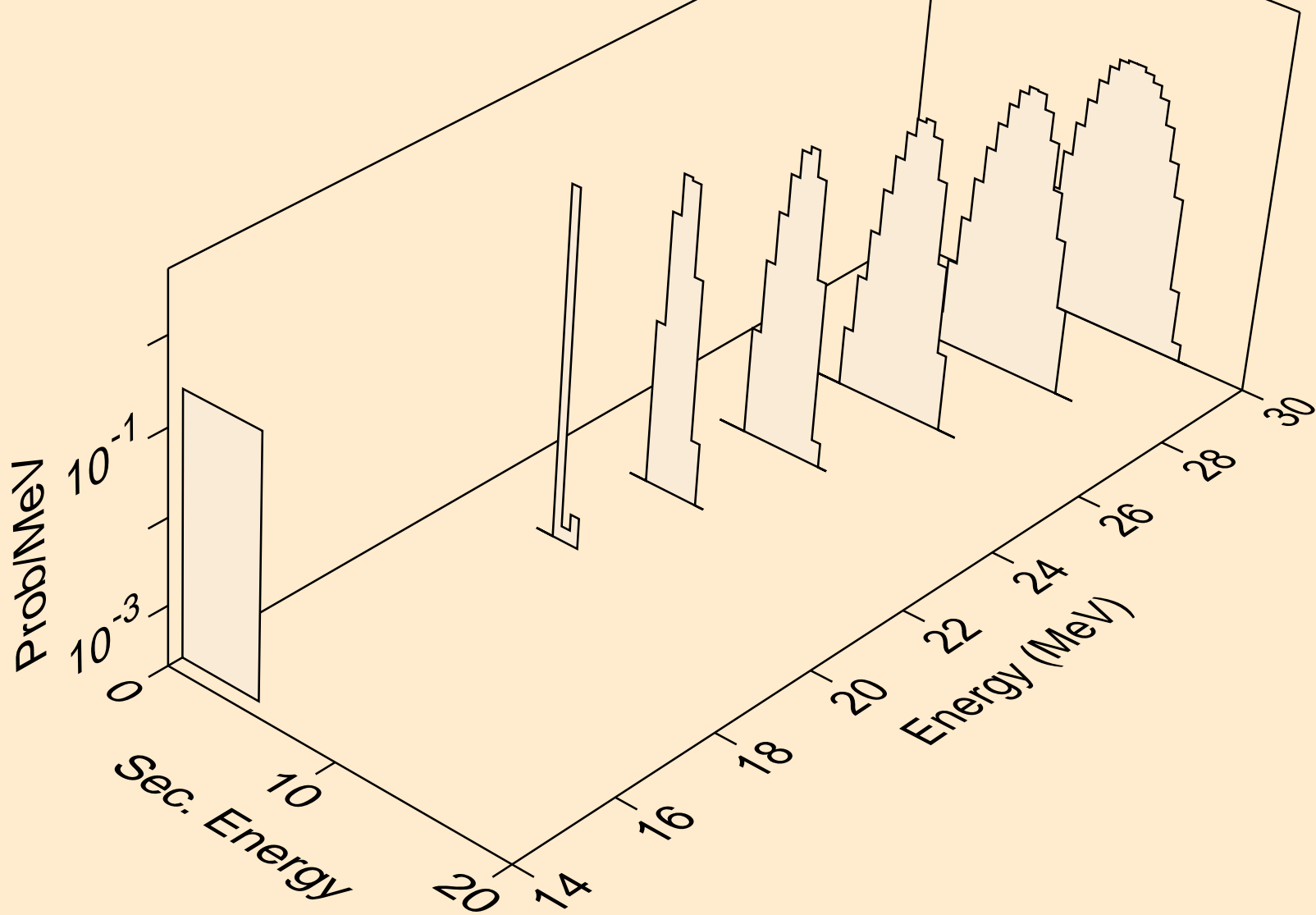



RE170 NEUTRON ACER TENDL-2021 LIBRARY; T=293.6K  
alphas from (n,n\*)2a

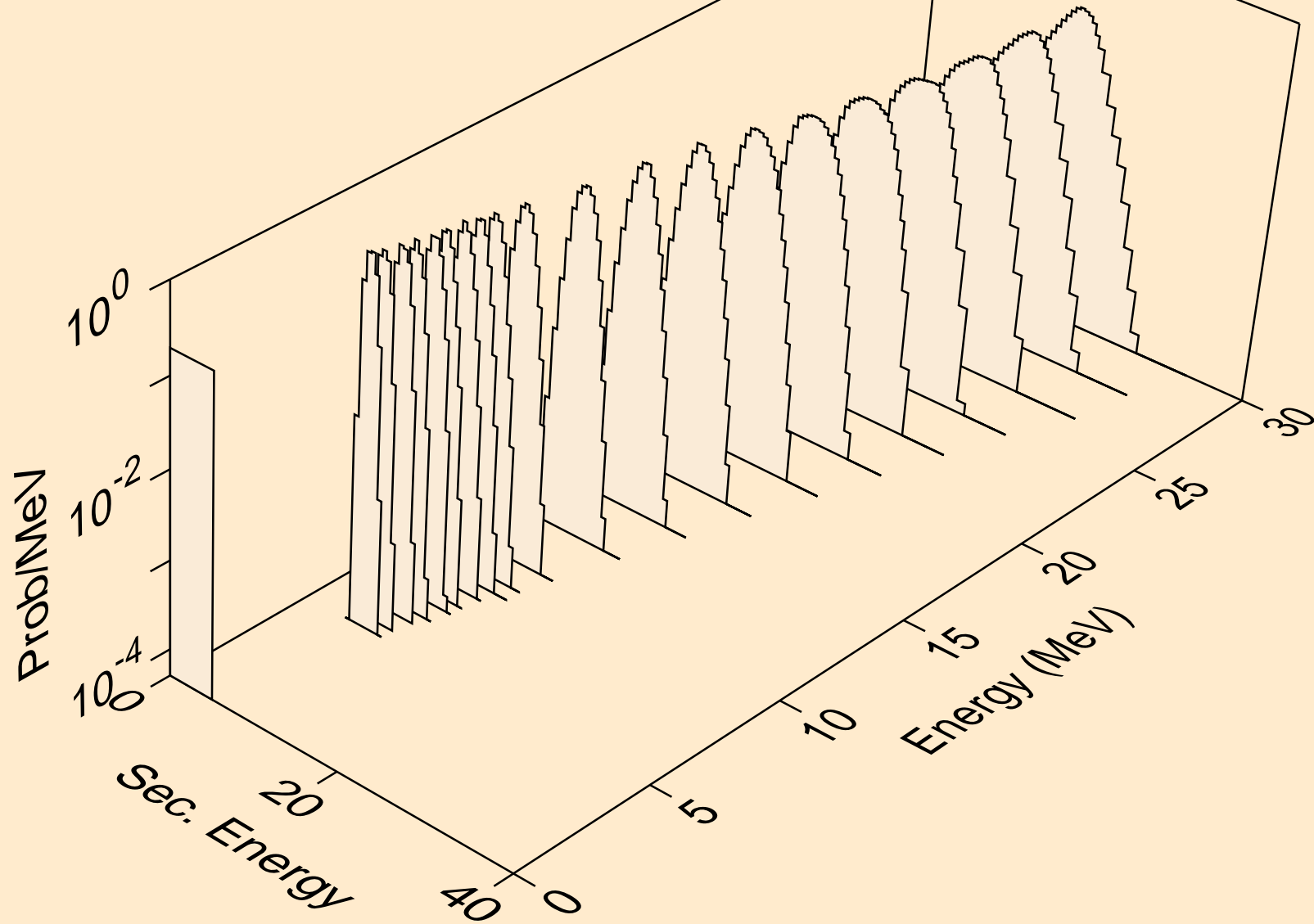

RE170 NEUTRON ACER TENDL-2021 LIBRARY; T=293.6K  
alphas from (n,2n)2a

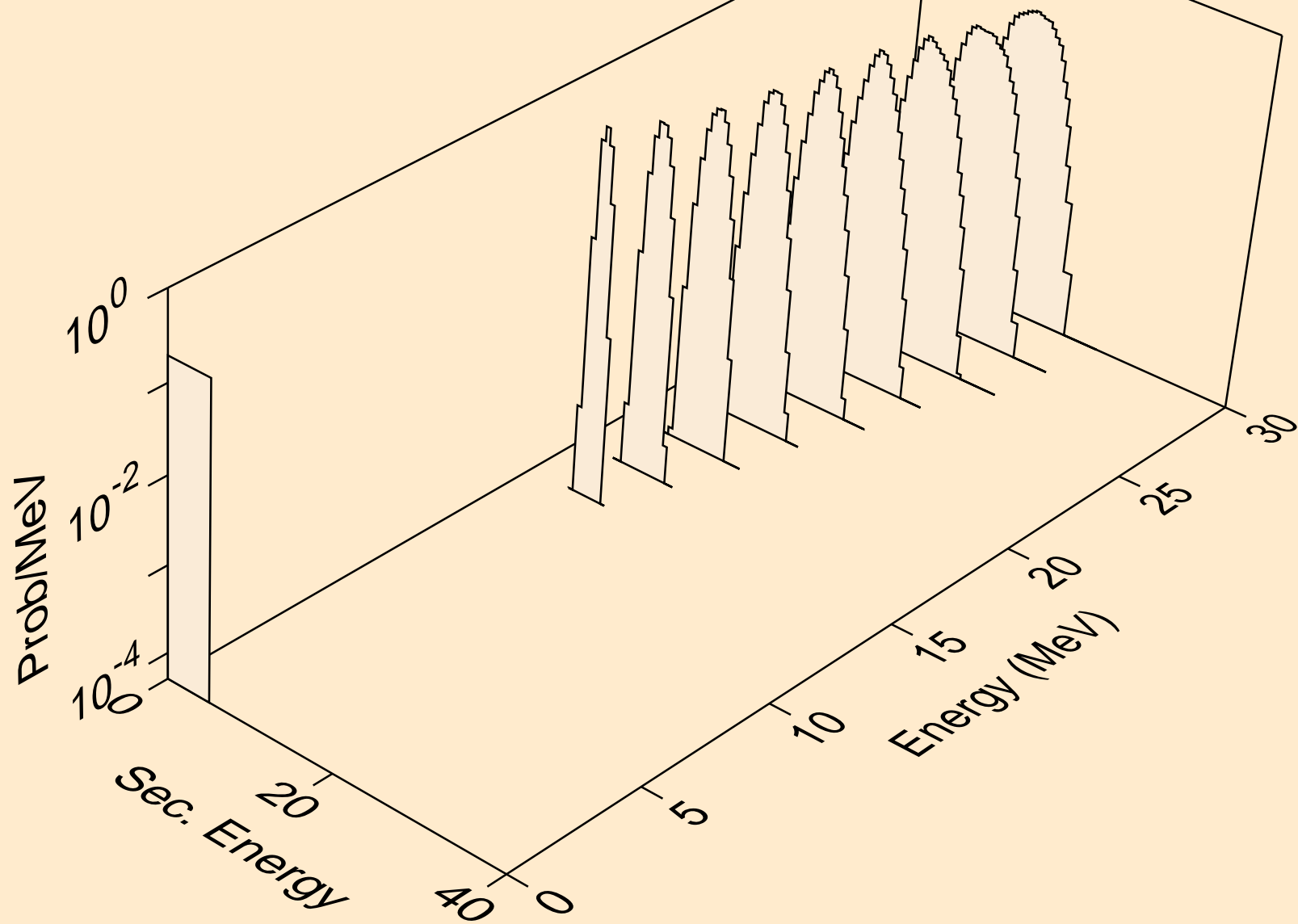

RE170 NEUTRON ACER TENDL-2021 LIBRARY; T=293.6K  
alphas from (n,npa)

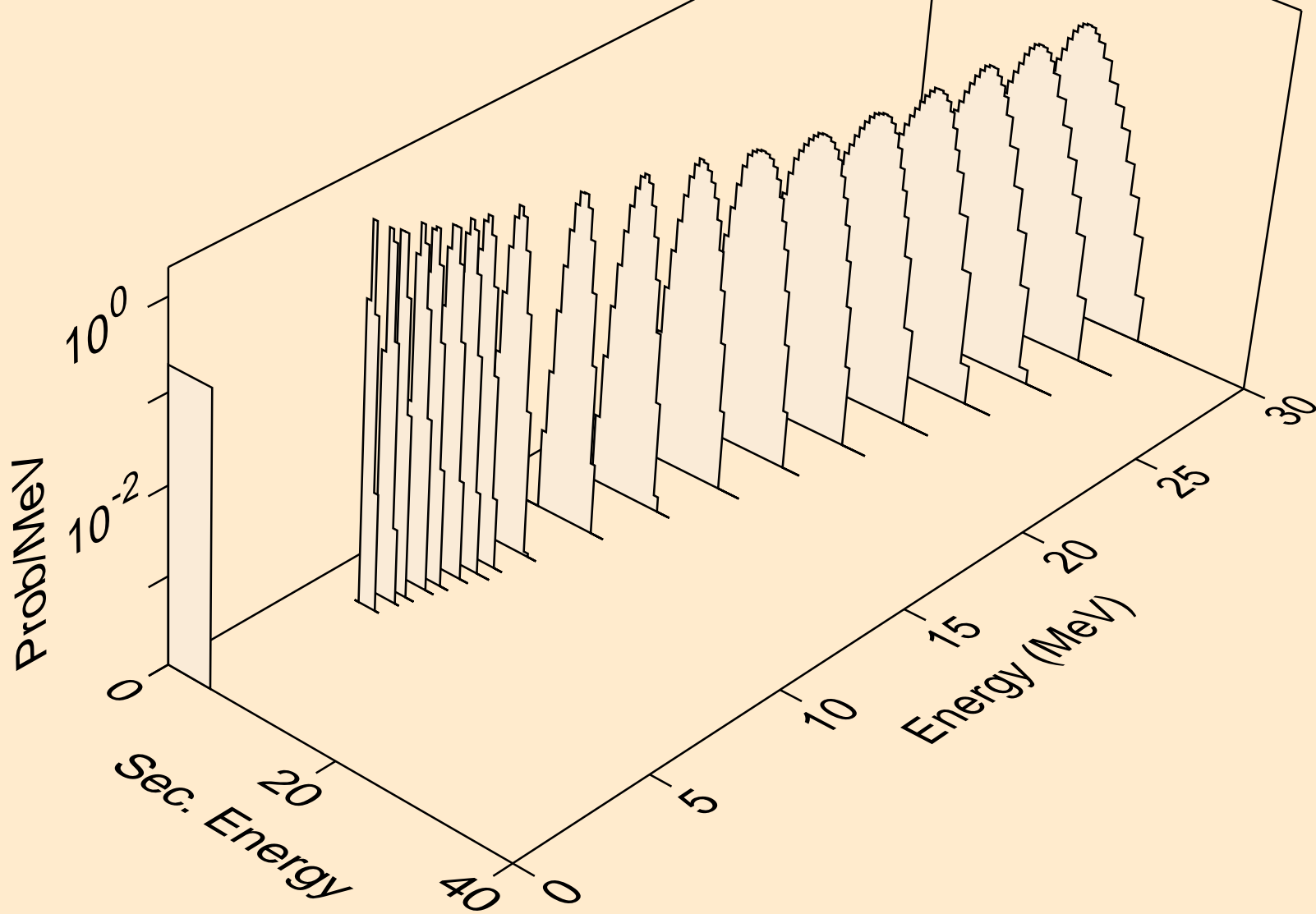

RE170 NEUTRON ACER TENDL-2021 LIBRARY; T=293.6K  
alphas from (n,a)

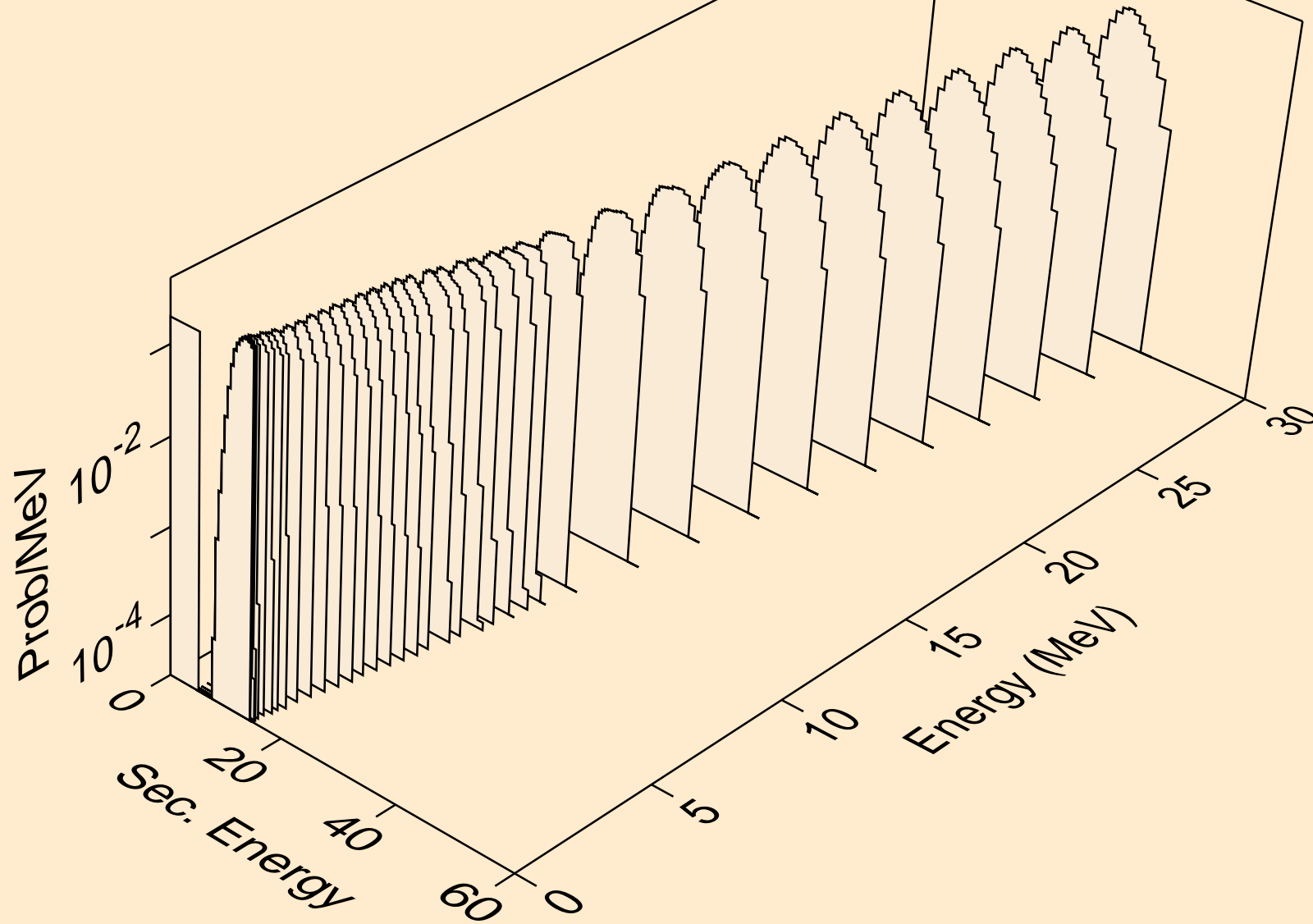

RE170 NEUTRON ACER TENDL-2021 LIBRARY; T=293.6K  
alphas from (n,2a)

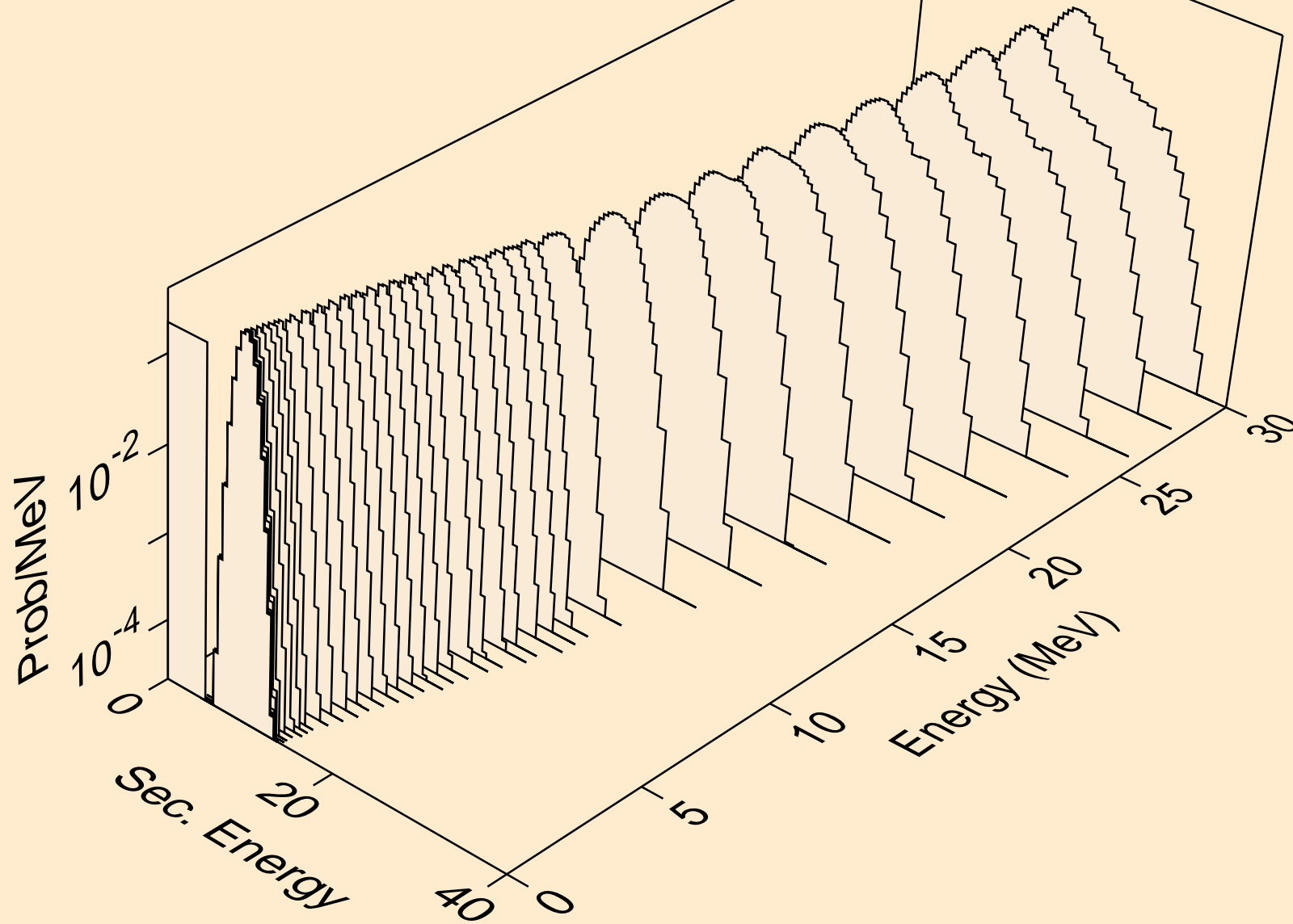

RE170 NEUTRON ACER TENDL-2021 LIBRARY; T=293.6K  
alphas from (n,3a)

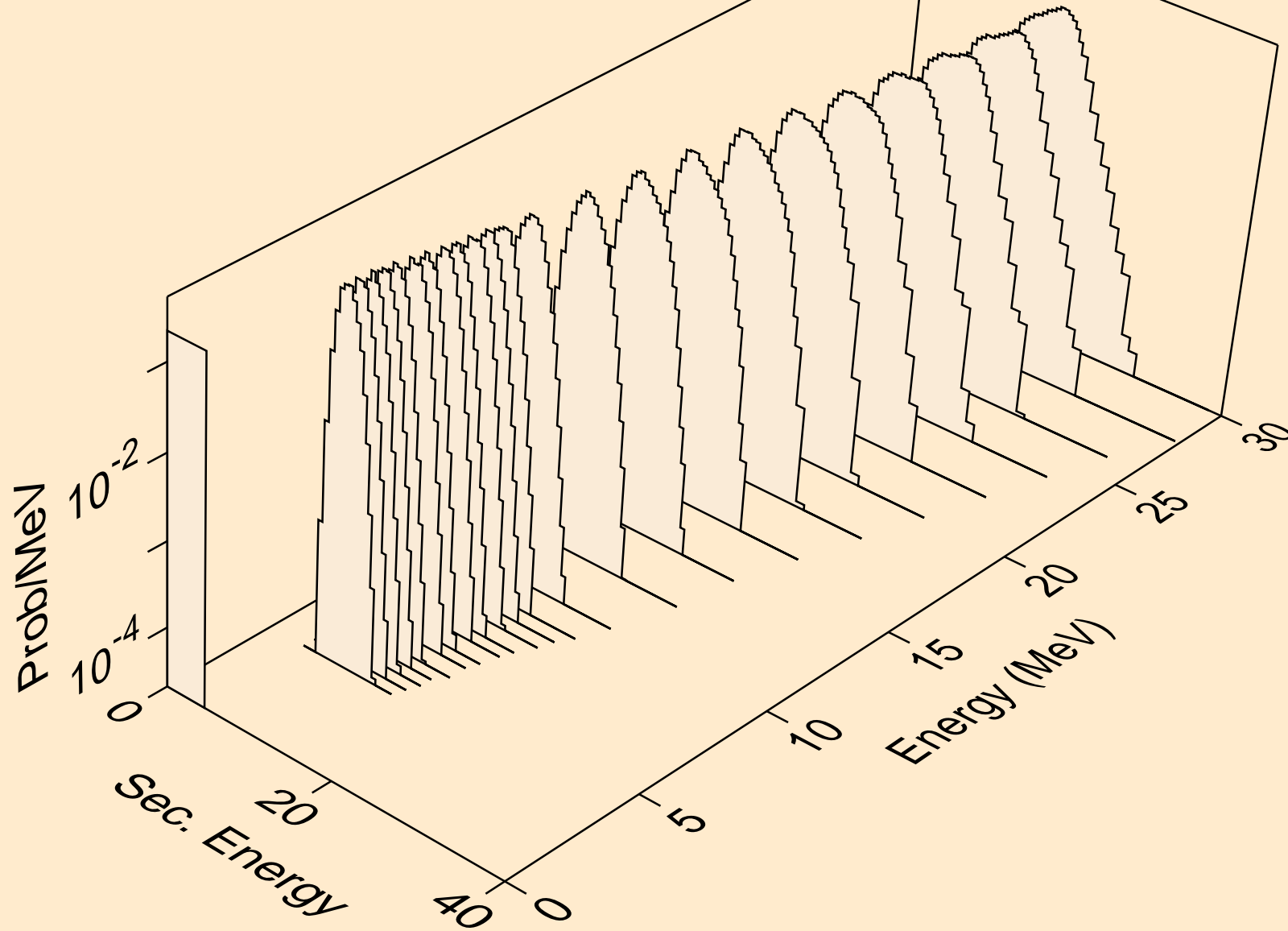

RE170 NEUTRON ACER TENDL-2021 LIBRARY; T=293.6K  
alphas from (n,p)

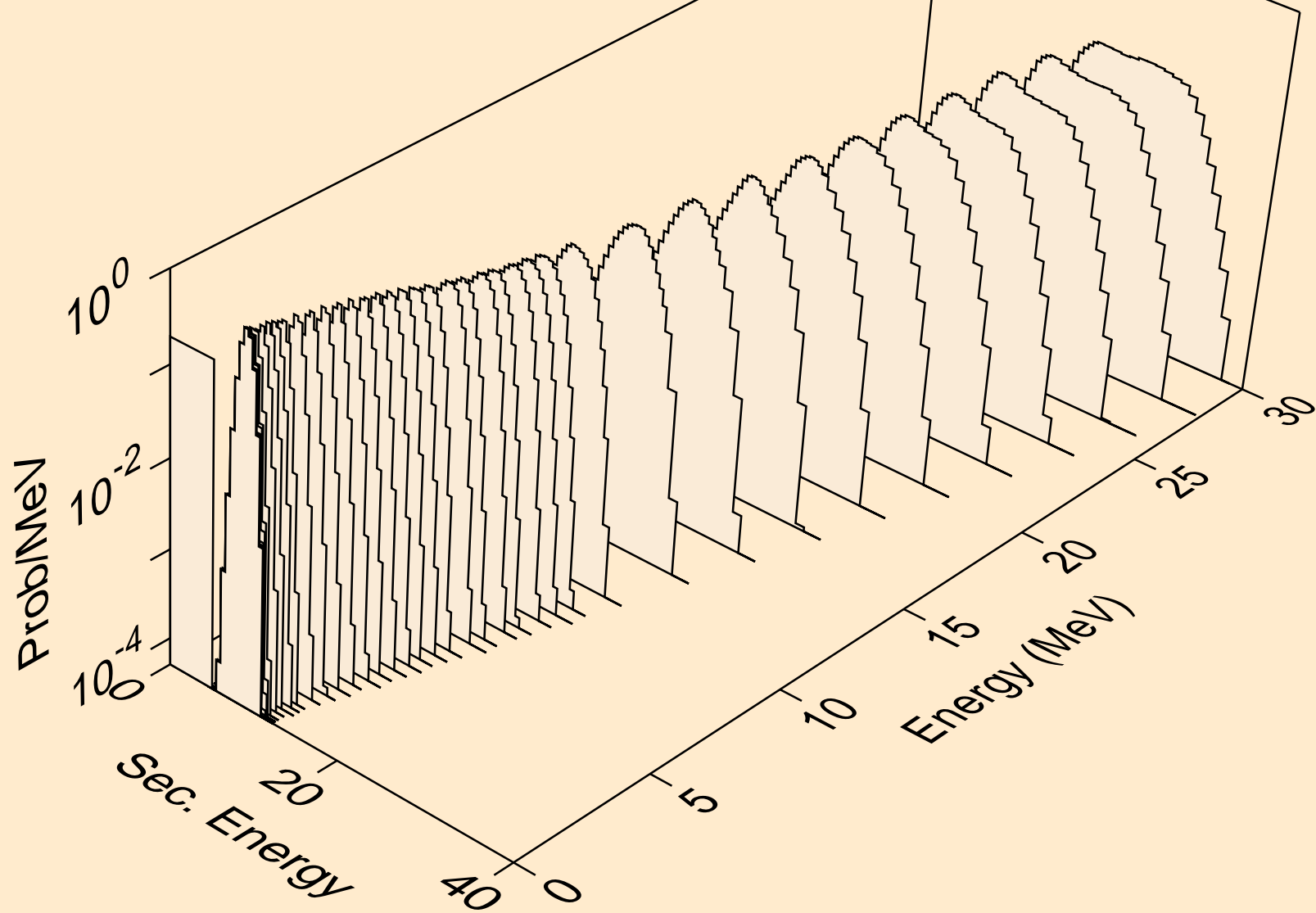

RE170 NEUTRON ACER TENDL-2021 LIBRARY; T=293.6K  
alphas from (n,da)

