

RE190 NEUTRON ACER TENDL-2021 LIBRARY; T=293.6K
Principal cross sections

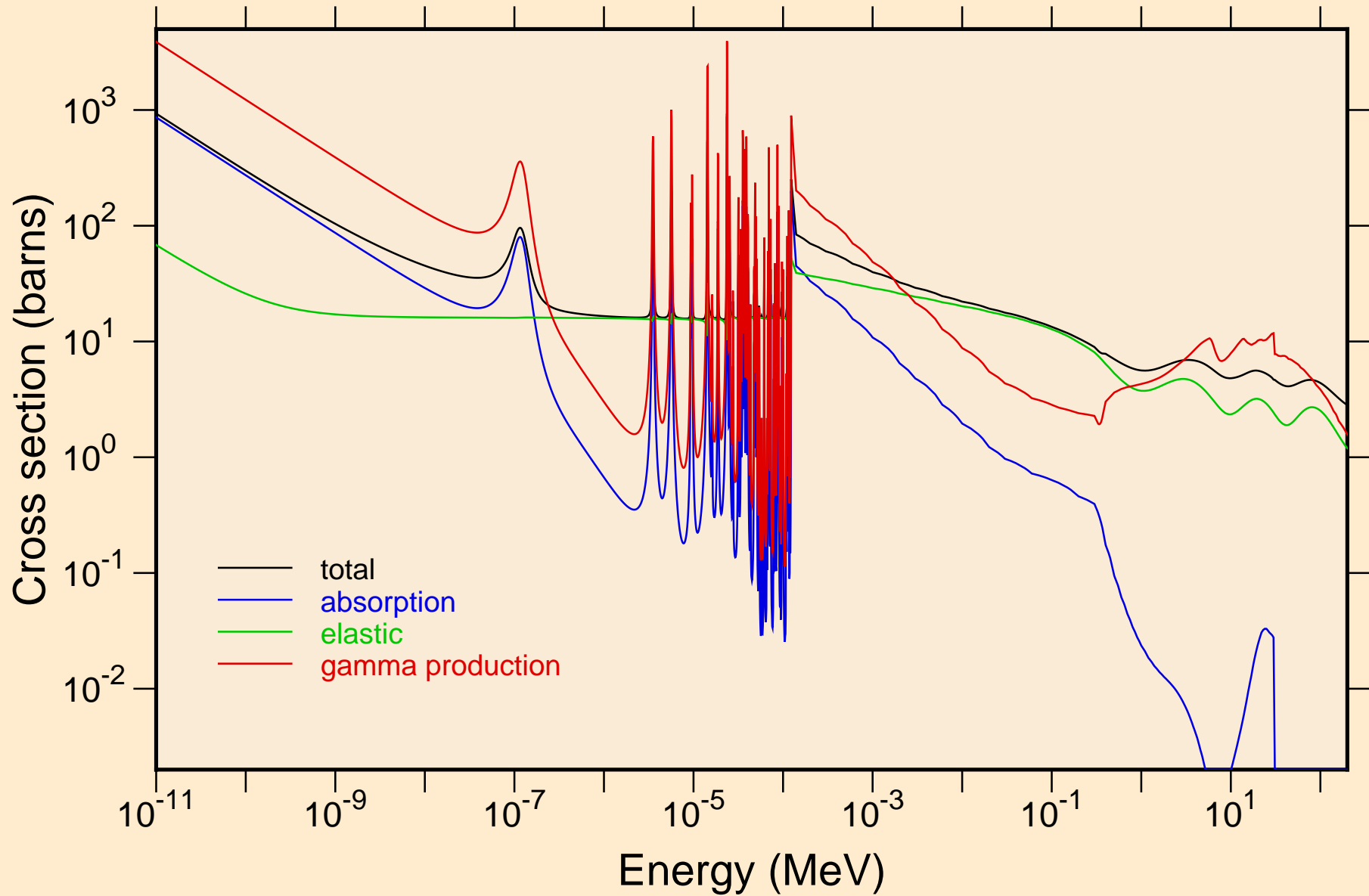

RE190 NEUTRON ACER TENDL-2021 LIBRARY; T=293.6K
resonance total cross section

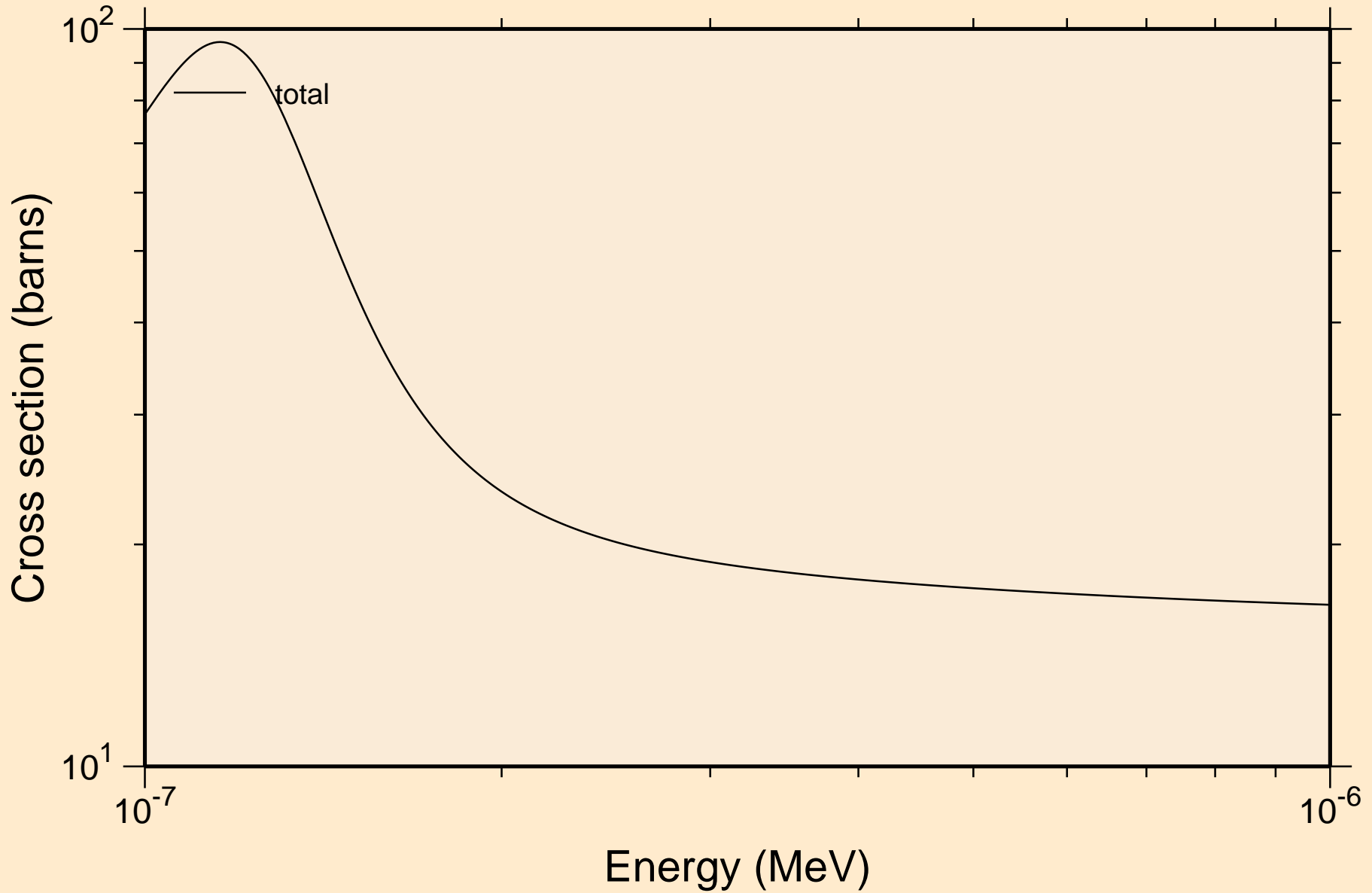

RE190 NEUTRON ACER TENDL-2021 LIBRARY; T=293.6K
resonance total cross section

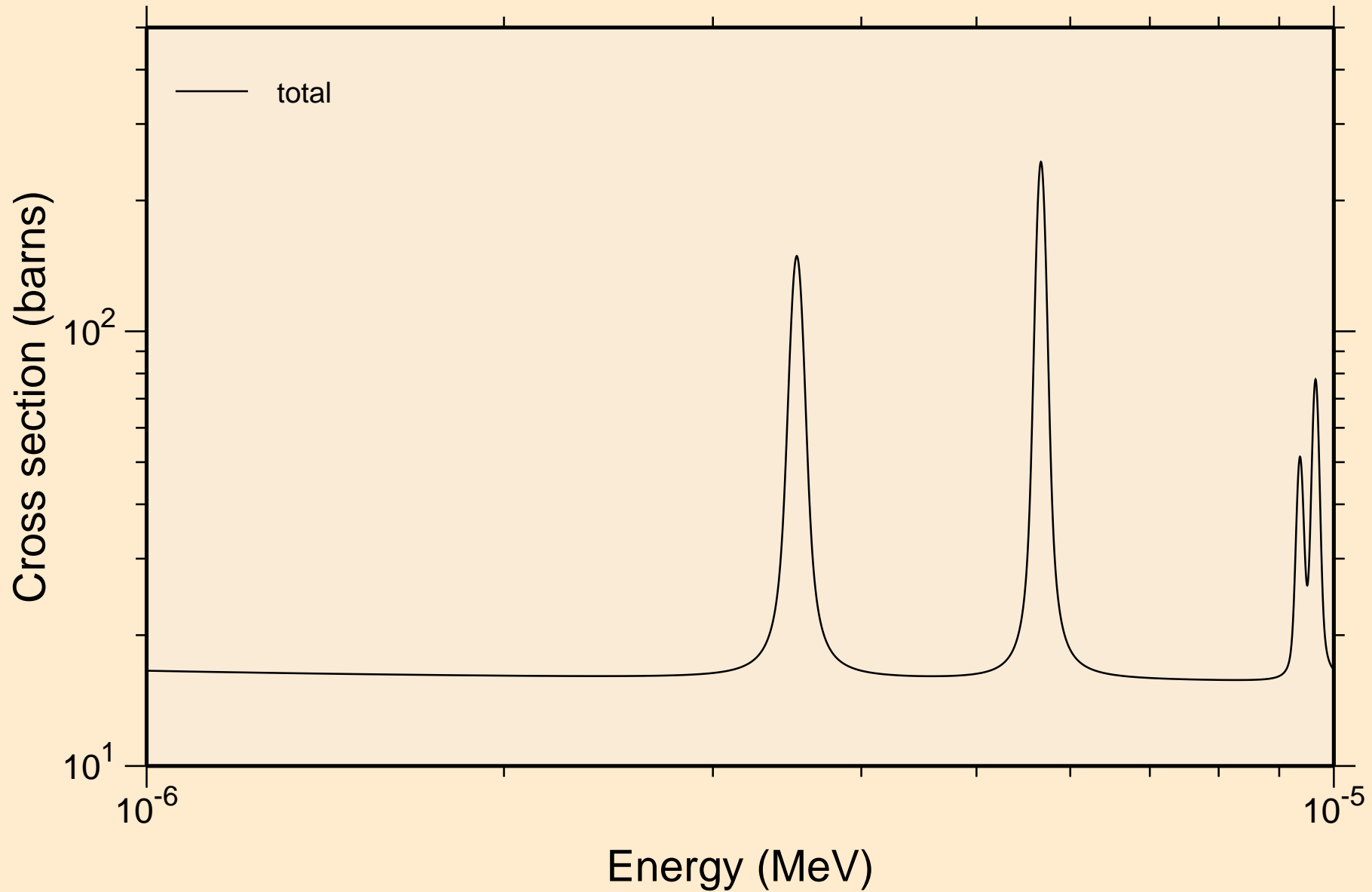

RE190 NEUTRON ACER TENDL-2021 LIBRARY; T=293.6K
resonance total cross section

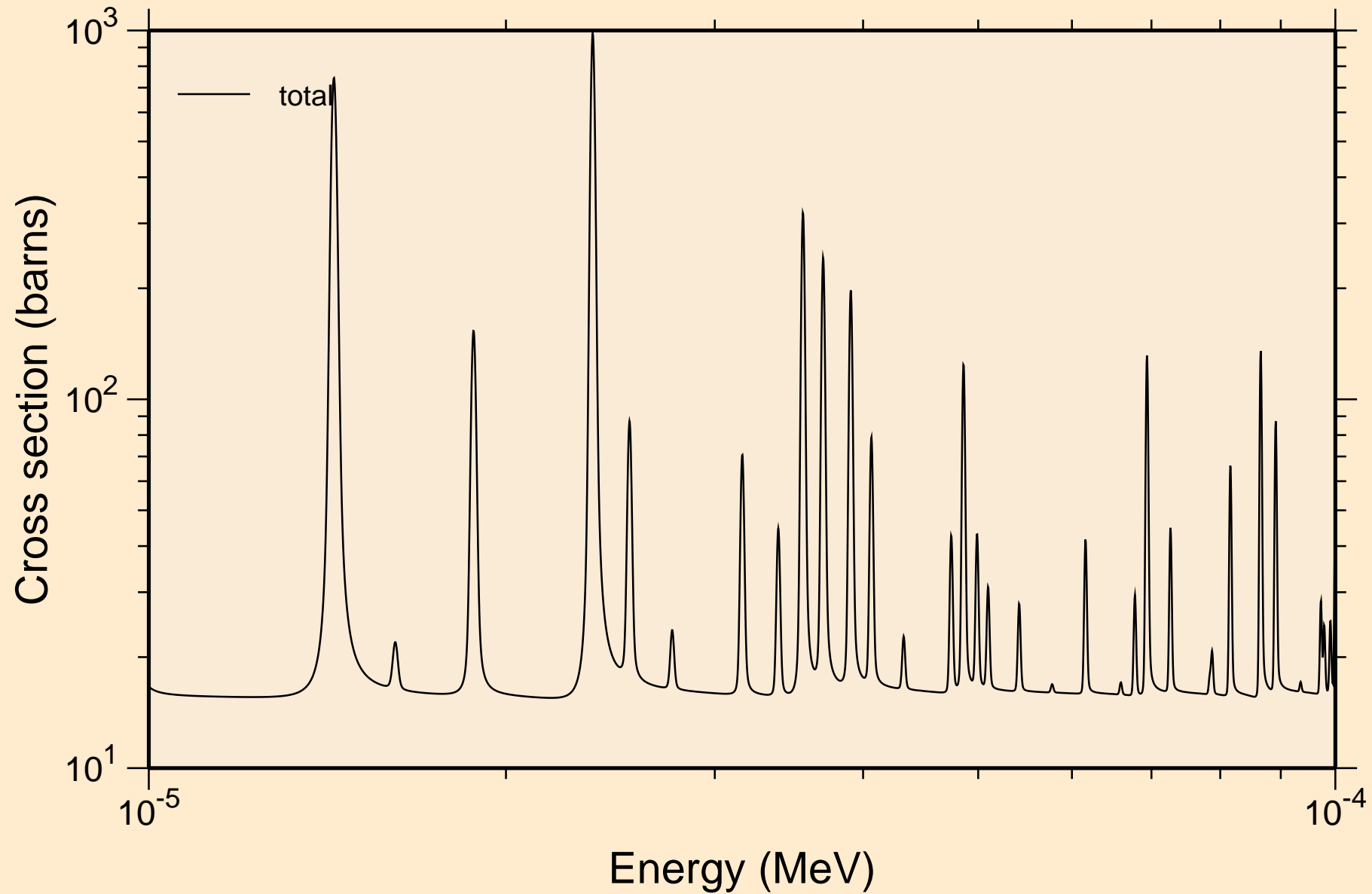

RE190 NEUTRON ACER TENDL-2021 LIBRARY; T=293.6K
resonance total cross section

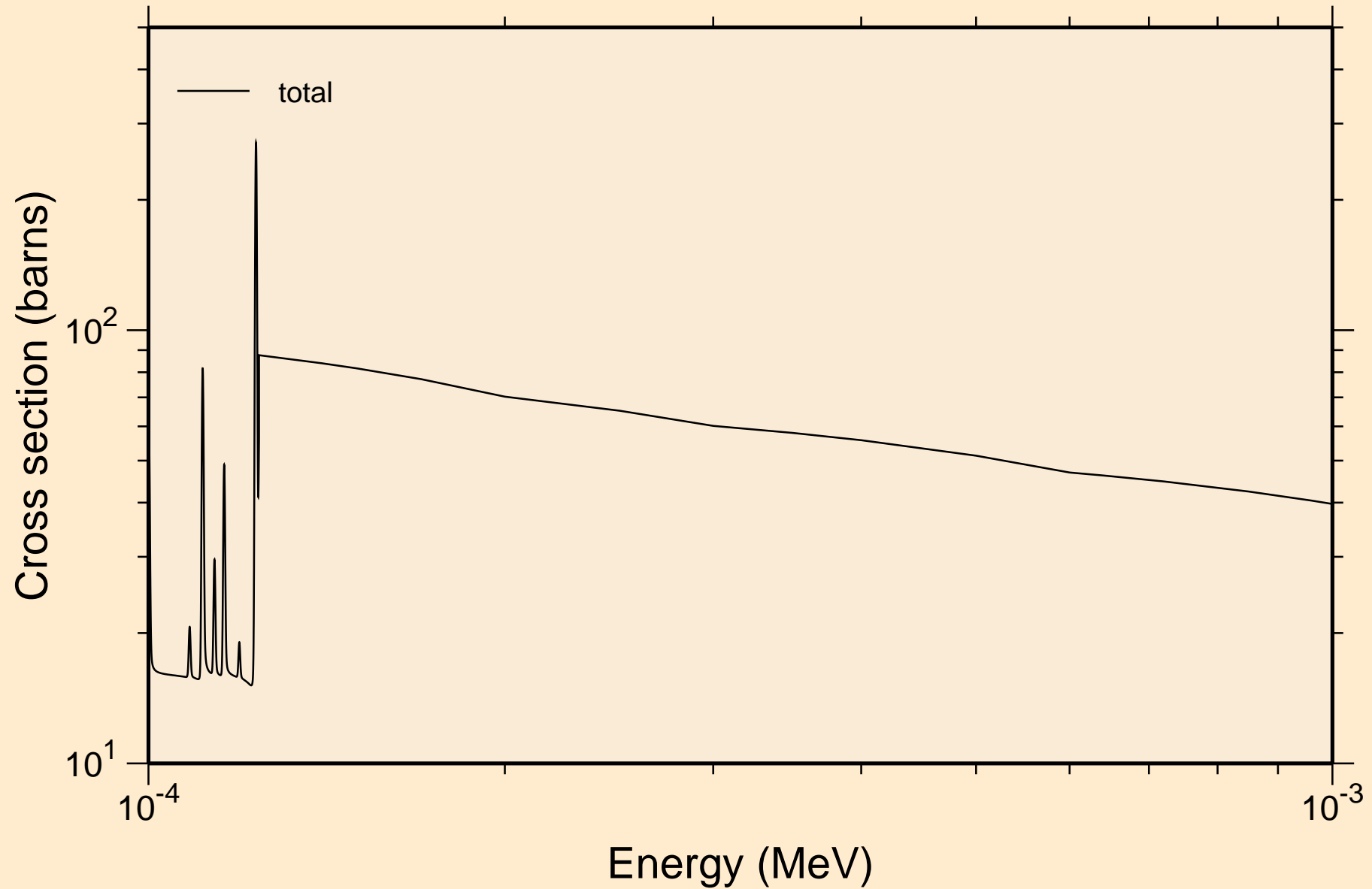

RE190 NEUTRON ACER TENDL-2021 LIBRARY; T=293.6K
resonance total cross section

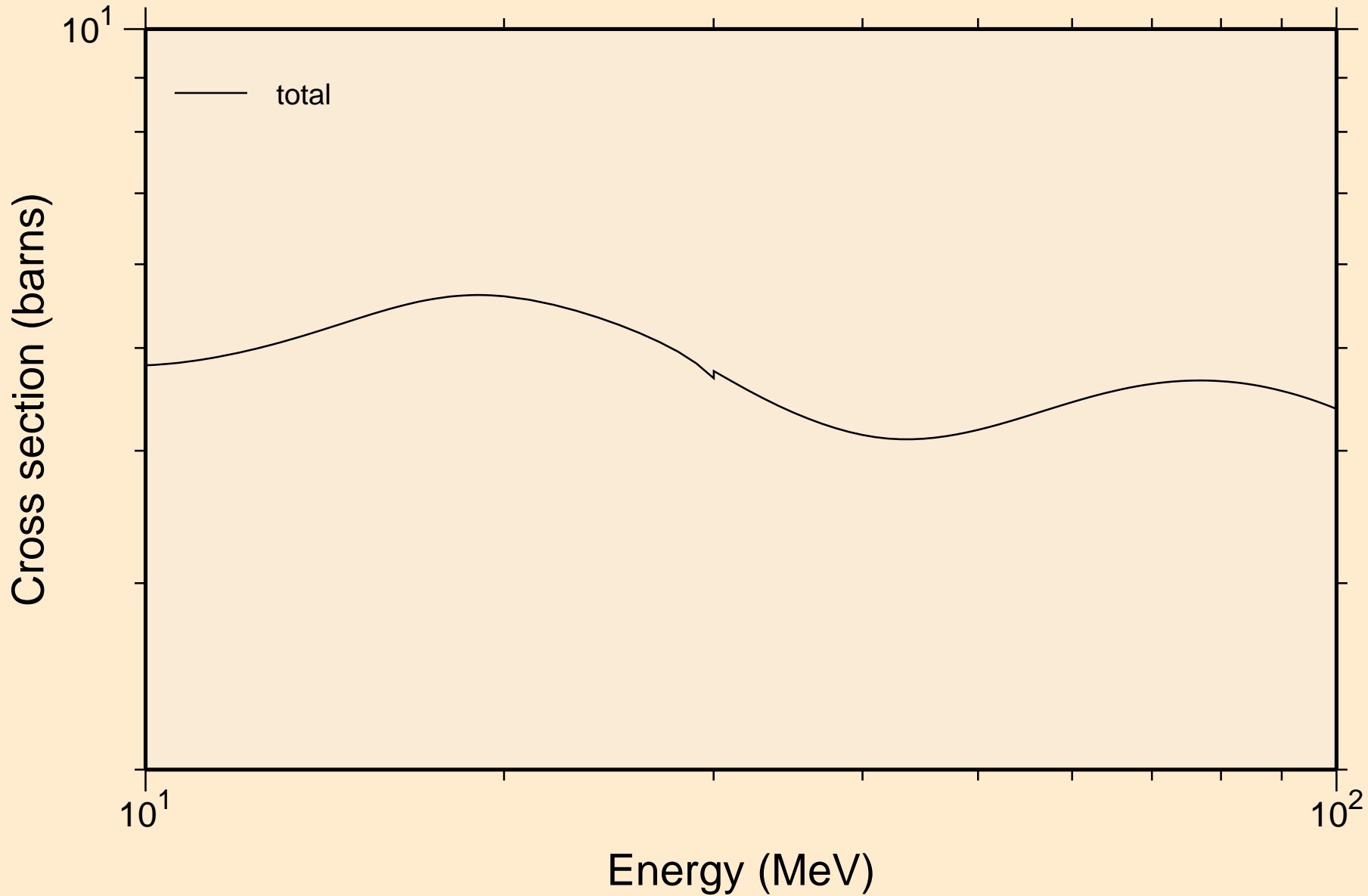

RE190 NEUTRON ACER TENDL-2021 LIBRARY; T=293.6K
resonance absorption cross sections

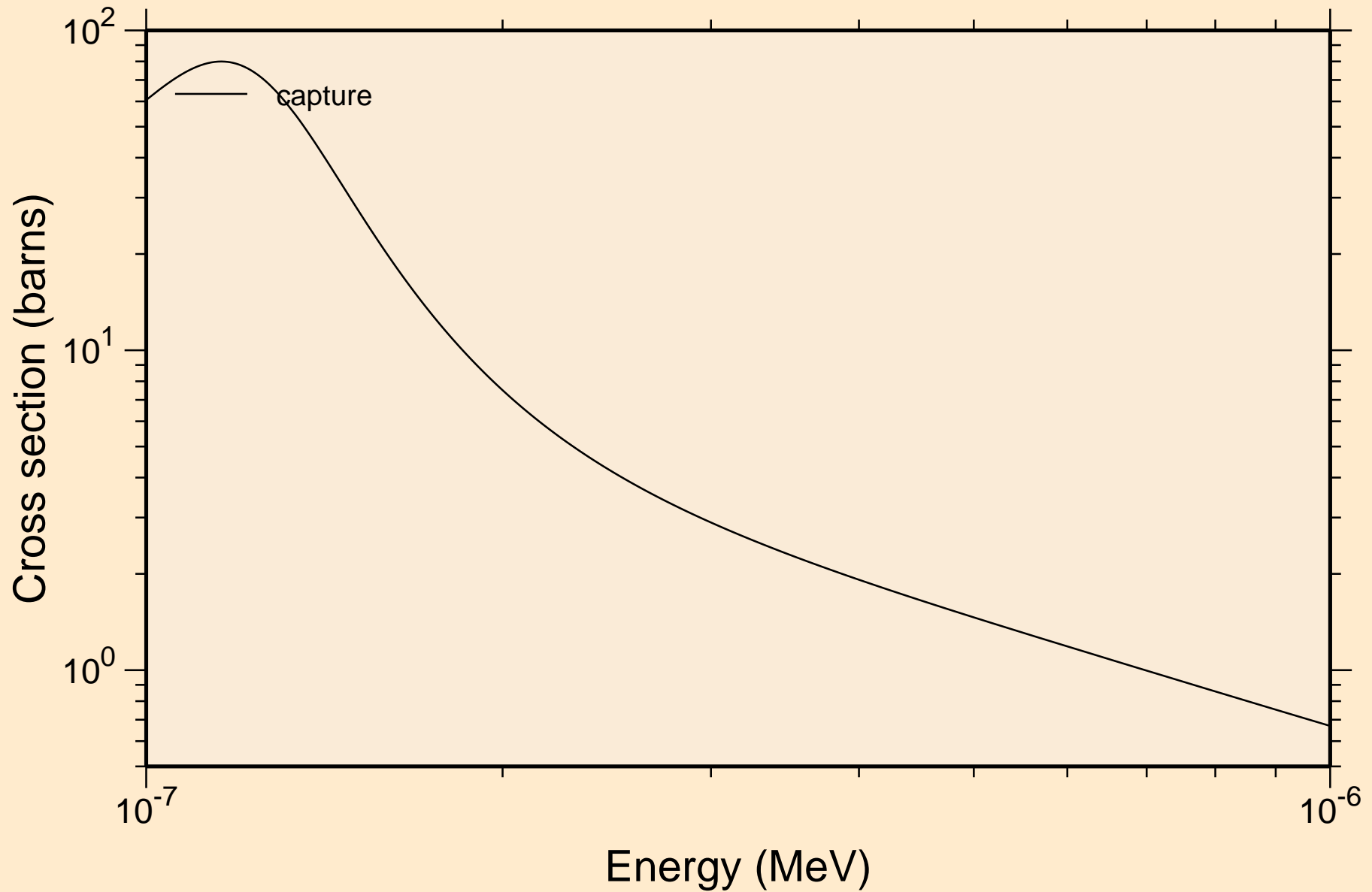

RE190 NEUTRON ACER TENDL-2021 LIBRARY; T=293.6K
resonance absorption cross sections

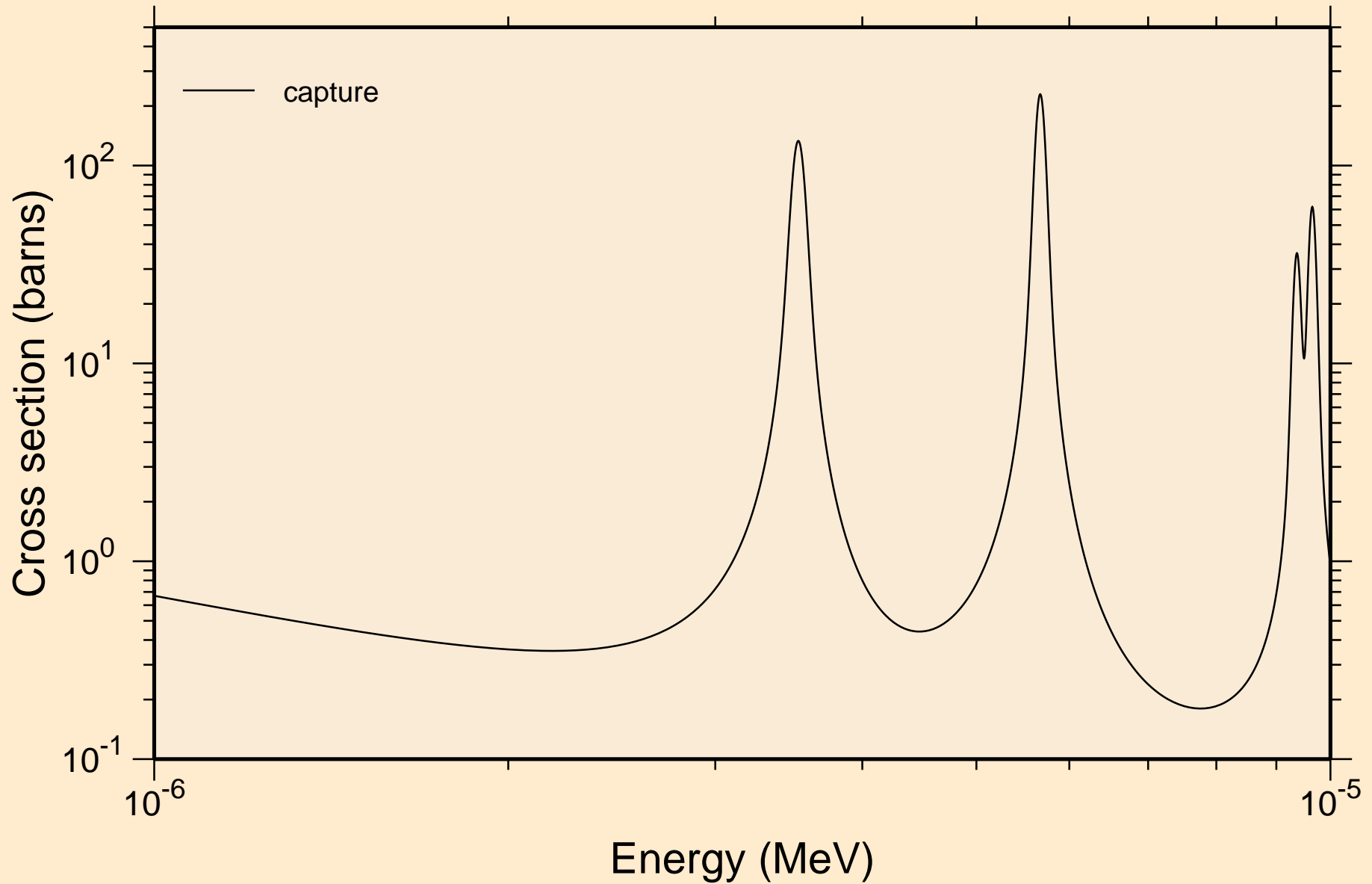

RE190 NEUTRON ACER TENDL-2021 LIBRARY; T=293.6K
resonance absorption cross sections

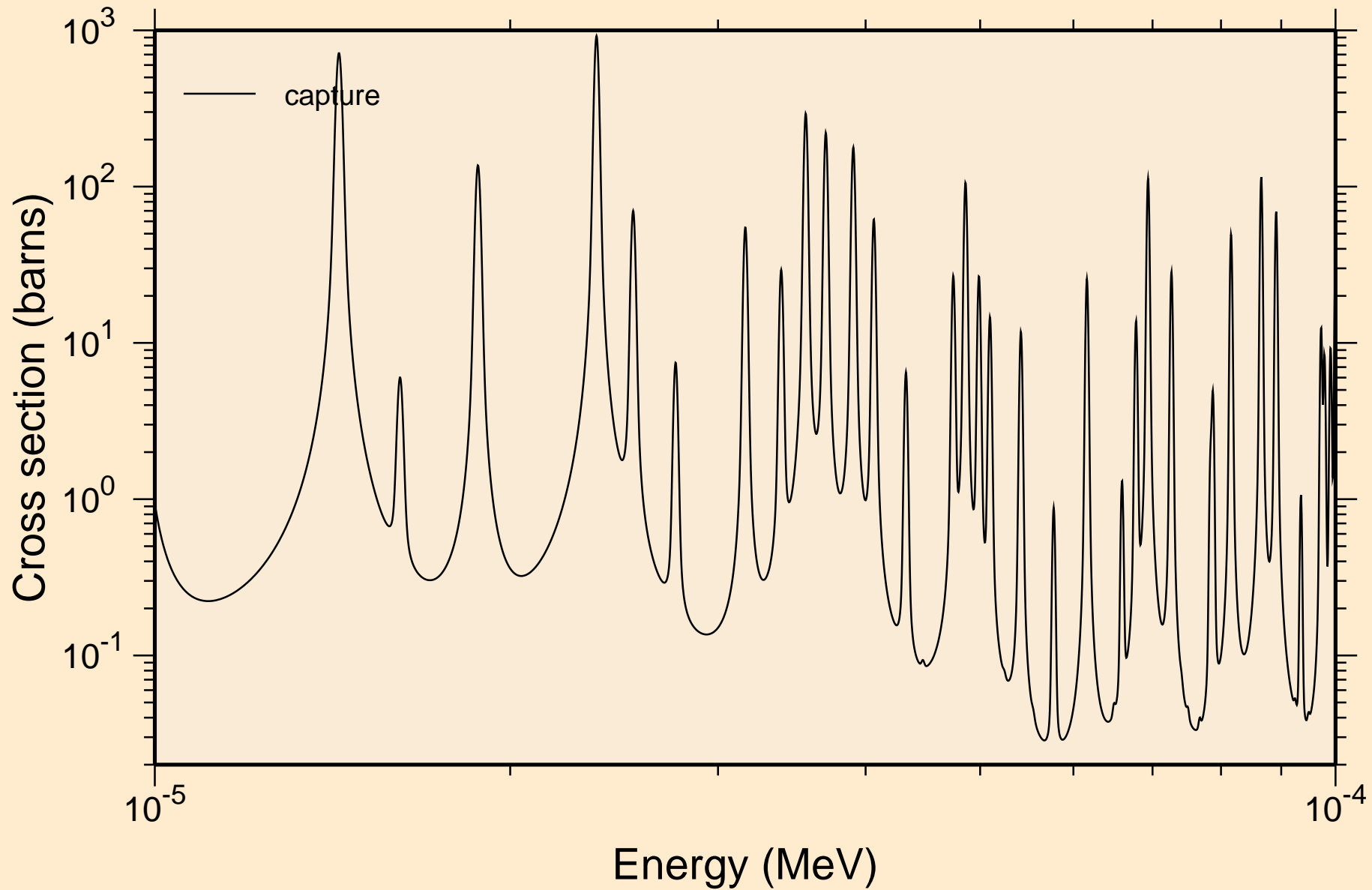

RE190 NEUTRON ACER TENDL-2021 LIBRARY; T=293.6K
resonance absorption cross sections

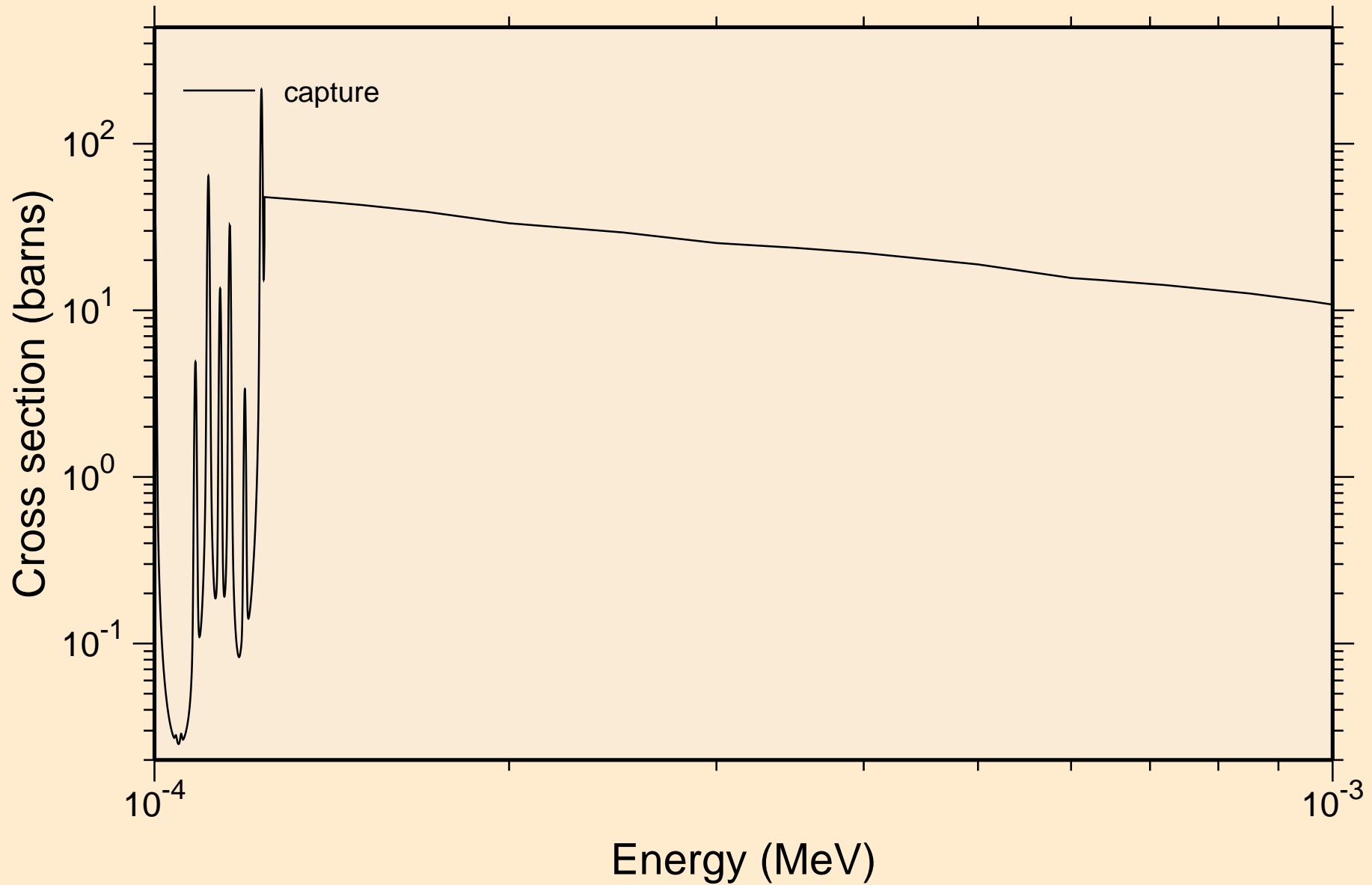

RE190 NEUTRON ACER TENDL-2021 LIBRARY; T=293.6K
resonance absorption cross sections

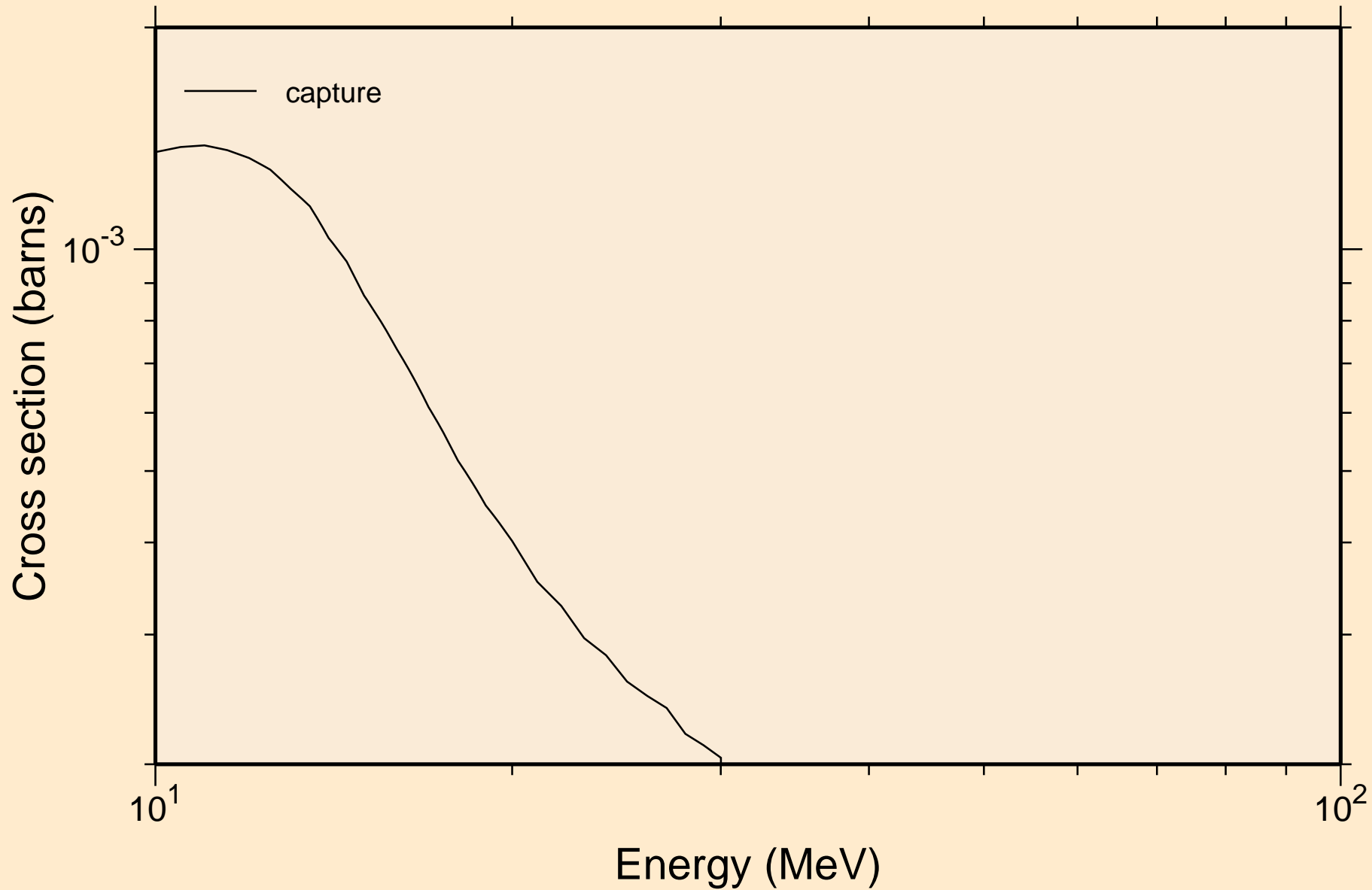

RE190 NEUTRON ACER TENDL-2021 LIBRARY; T=293.6K
Heating

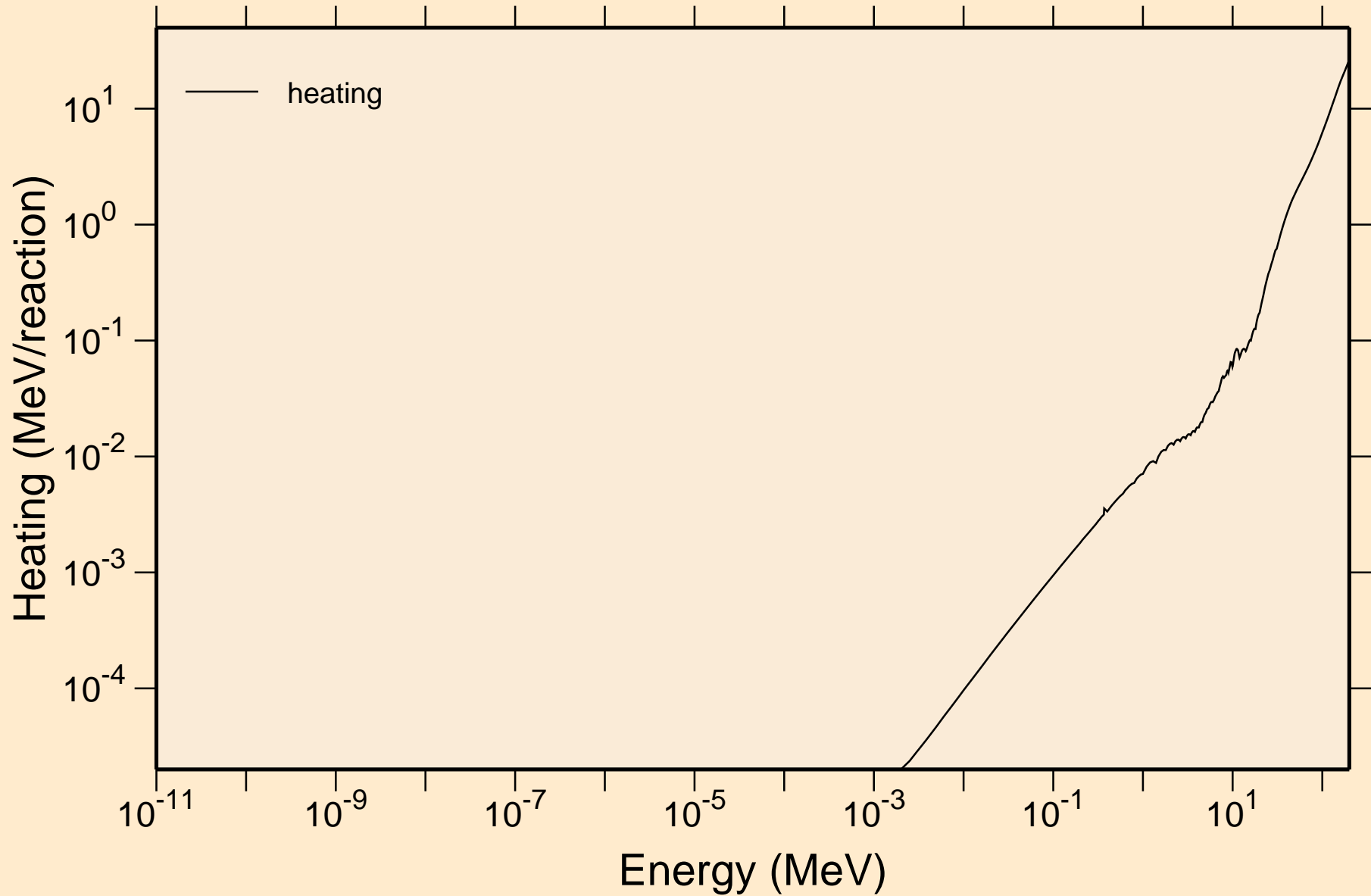

RE190 NEUTRON ACER TENDL-2021 LIBRARY; T=293.6K
Damage

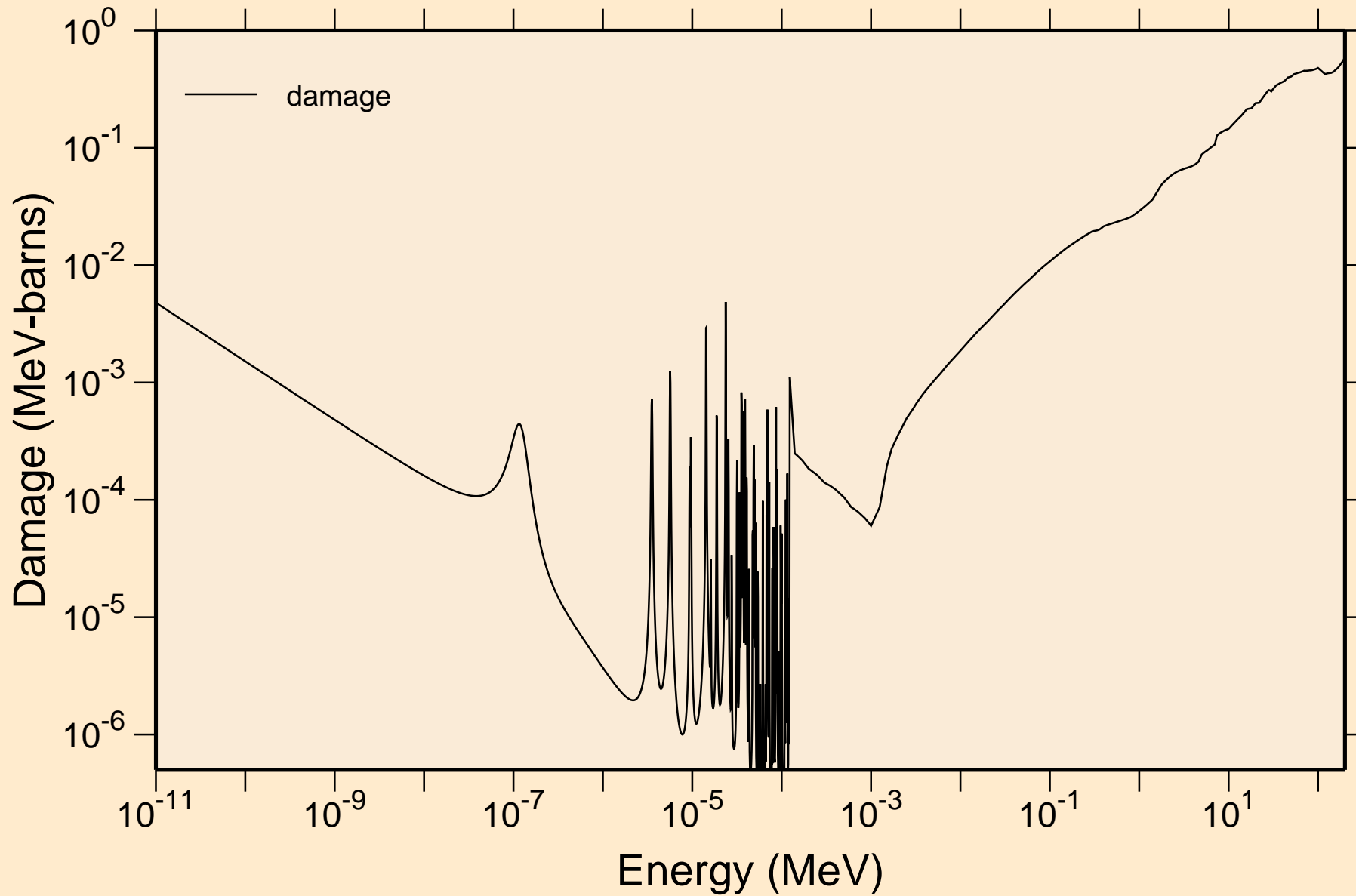

RE190 NEUTRON ACER TENDL-2021 LIBRARY; T=293.6K
Non-threshold reactions

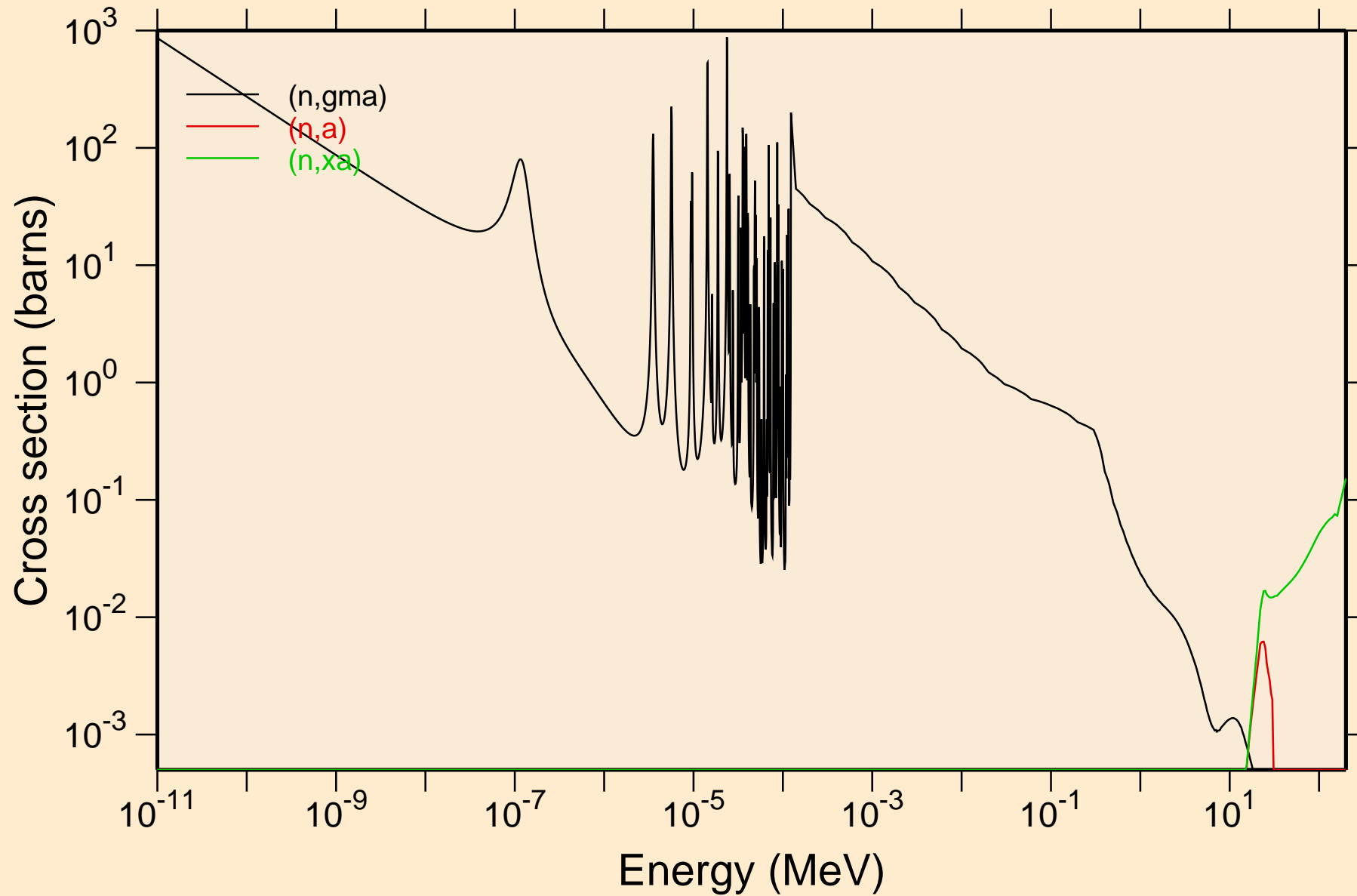

RE190 NEUTRON ACER TENDL-2021 LIBRARY; T=293.6K
Principal cross sections

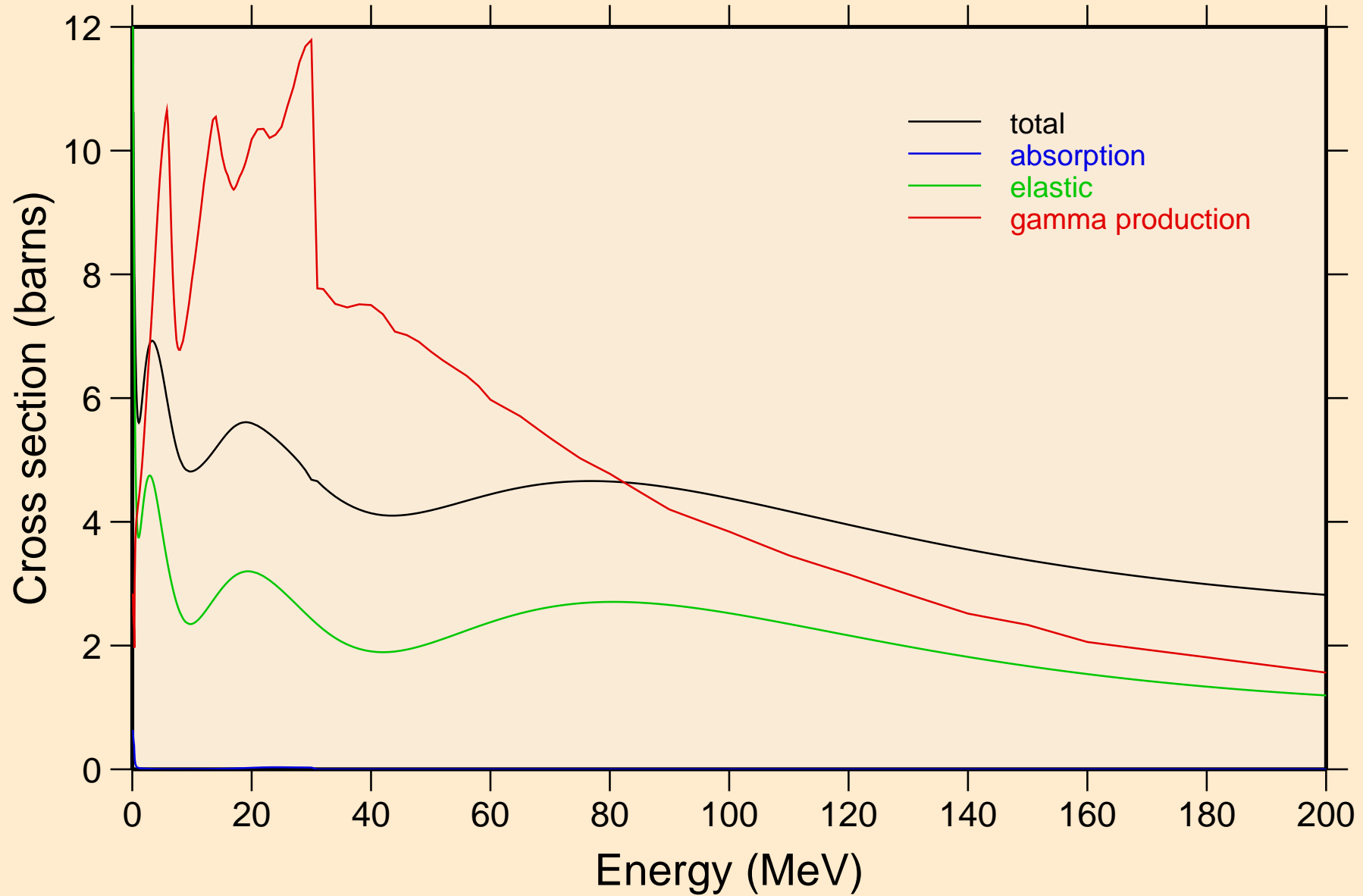

RE190 NEUTRON ACER TENDL-2021 LIBRARY; T=293.6K
Heating

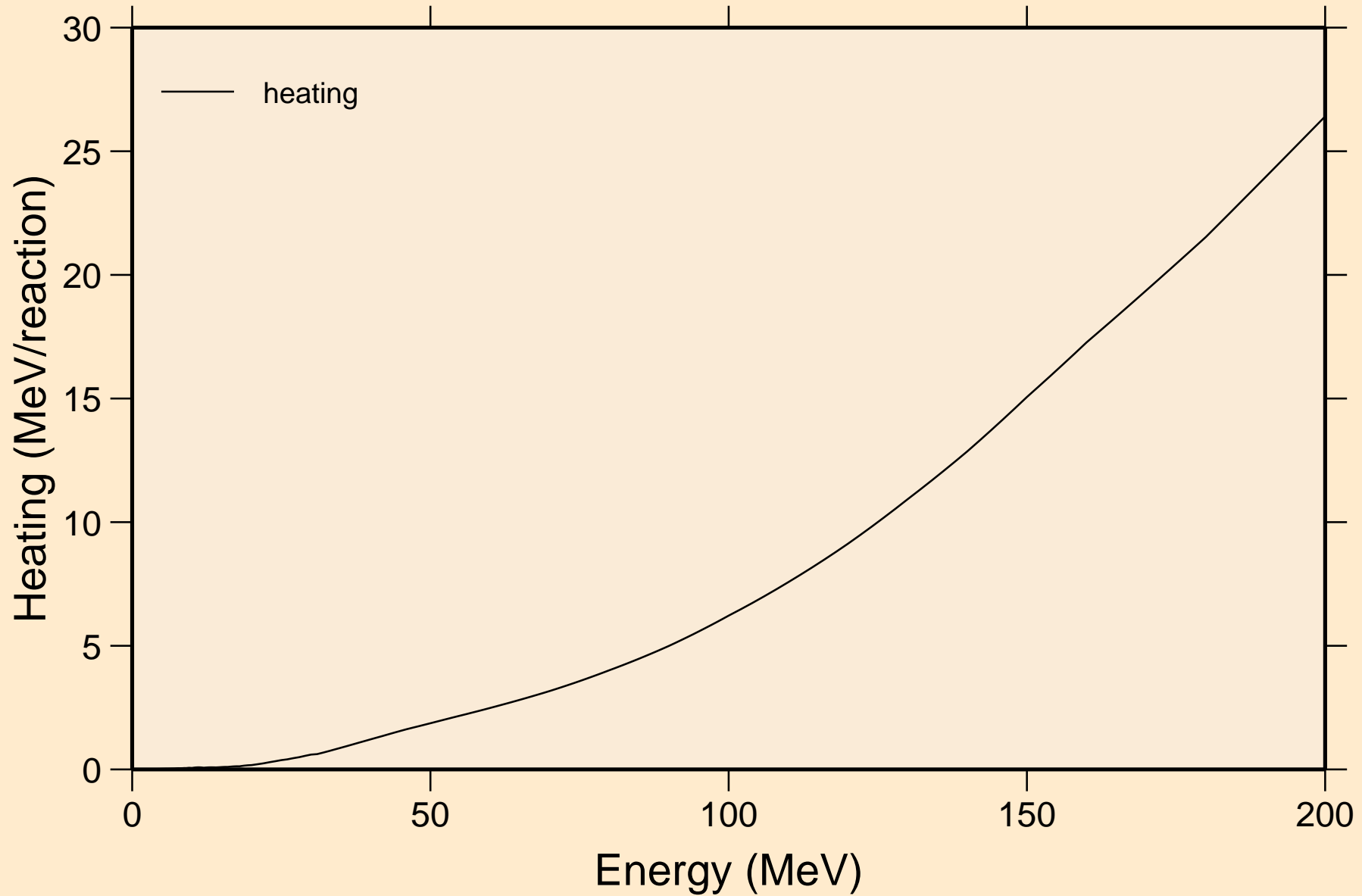

RE190 NEUTRON ACER TENDL-2021 LIBRARY; T=293.6K
Damage

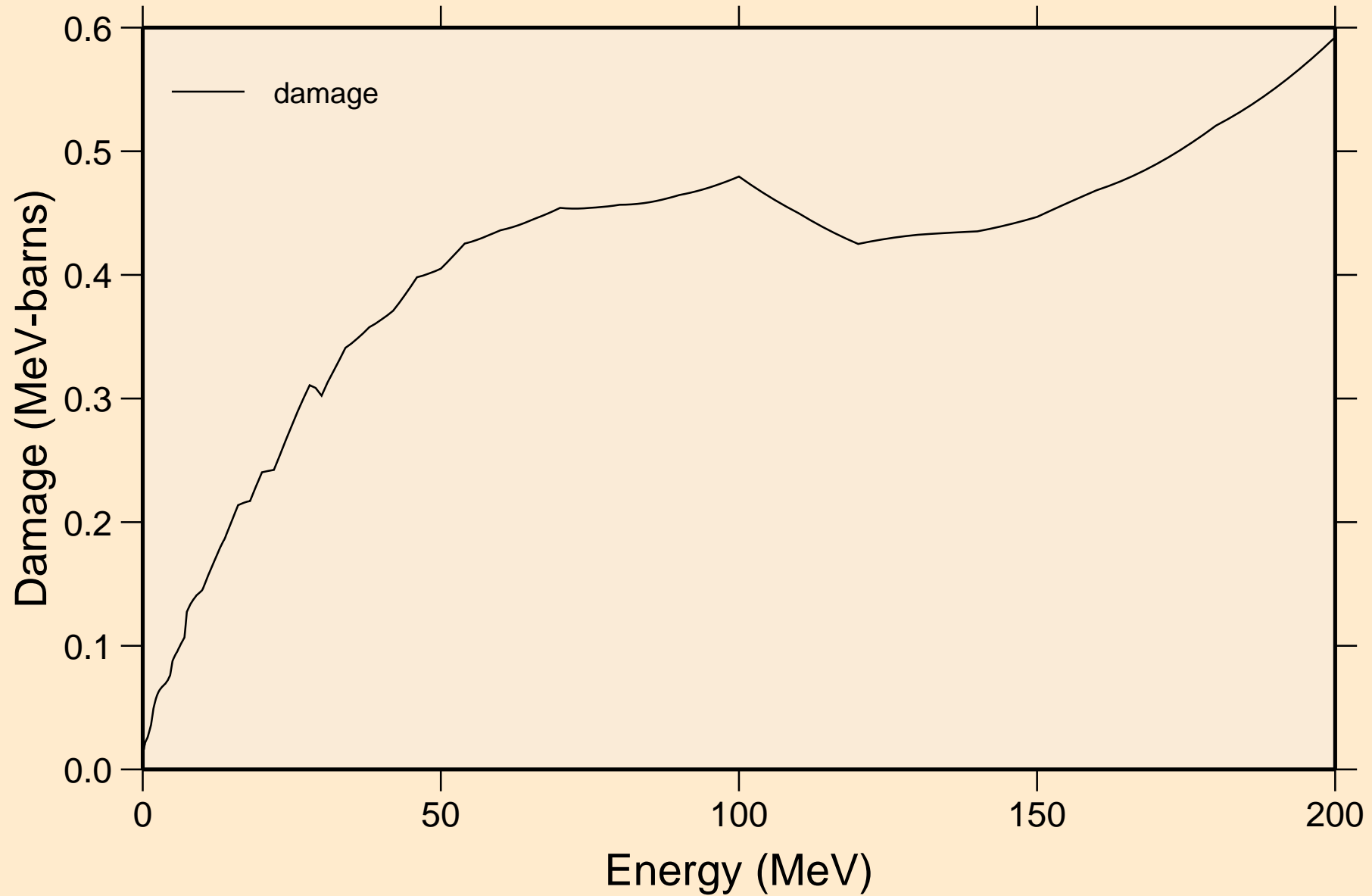

RE190 NEUTRON ACER TENDL-2021 LIBRARY; T=293.6K
Non-threshold reactions

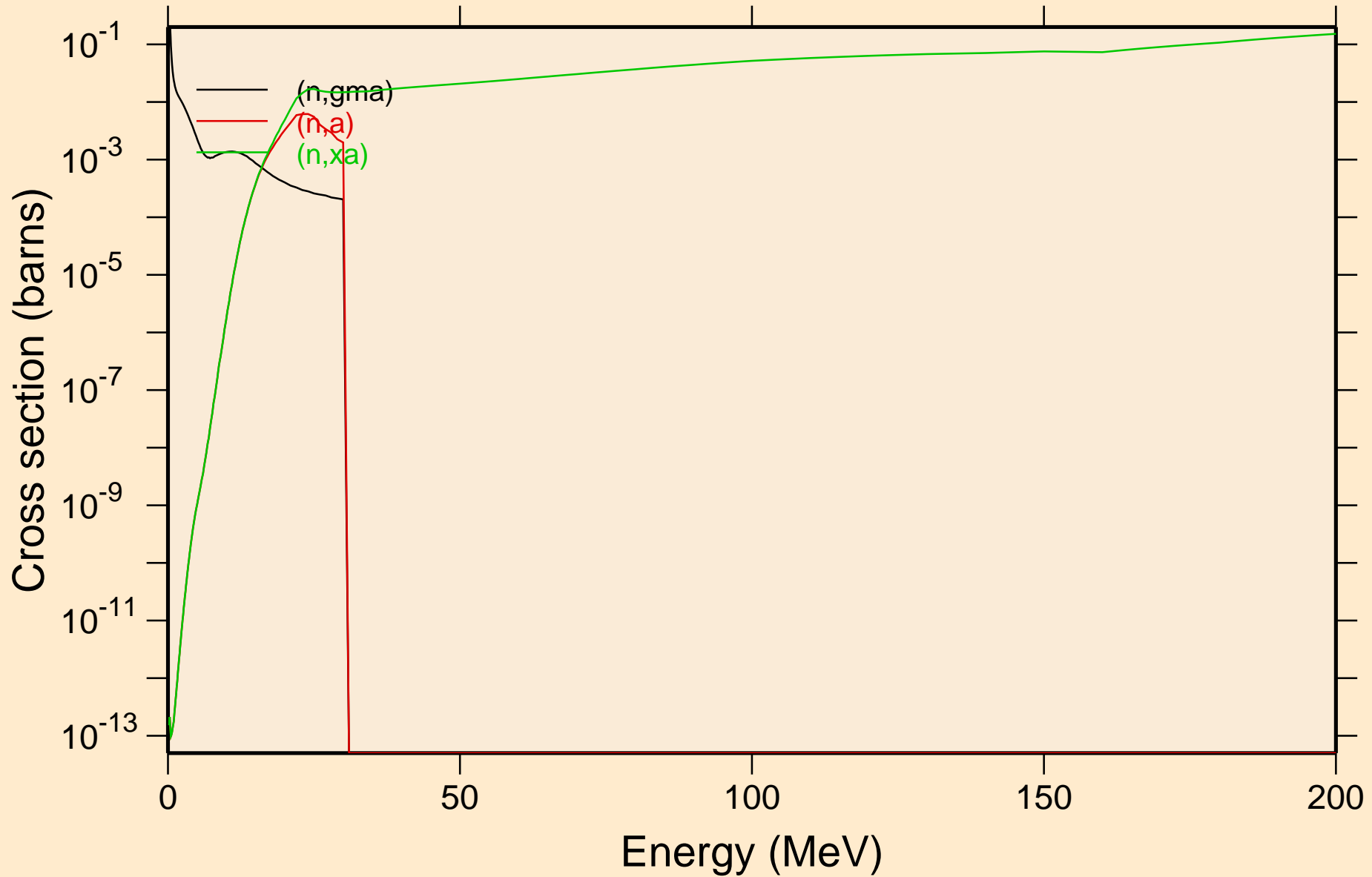

RE190 NEUTRON ACER TENDL-2021 LIBRARY; T=293.6K
Inelastic levels

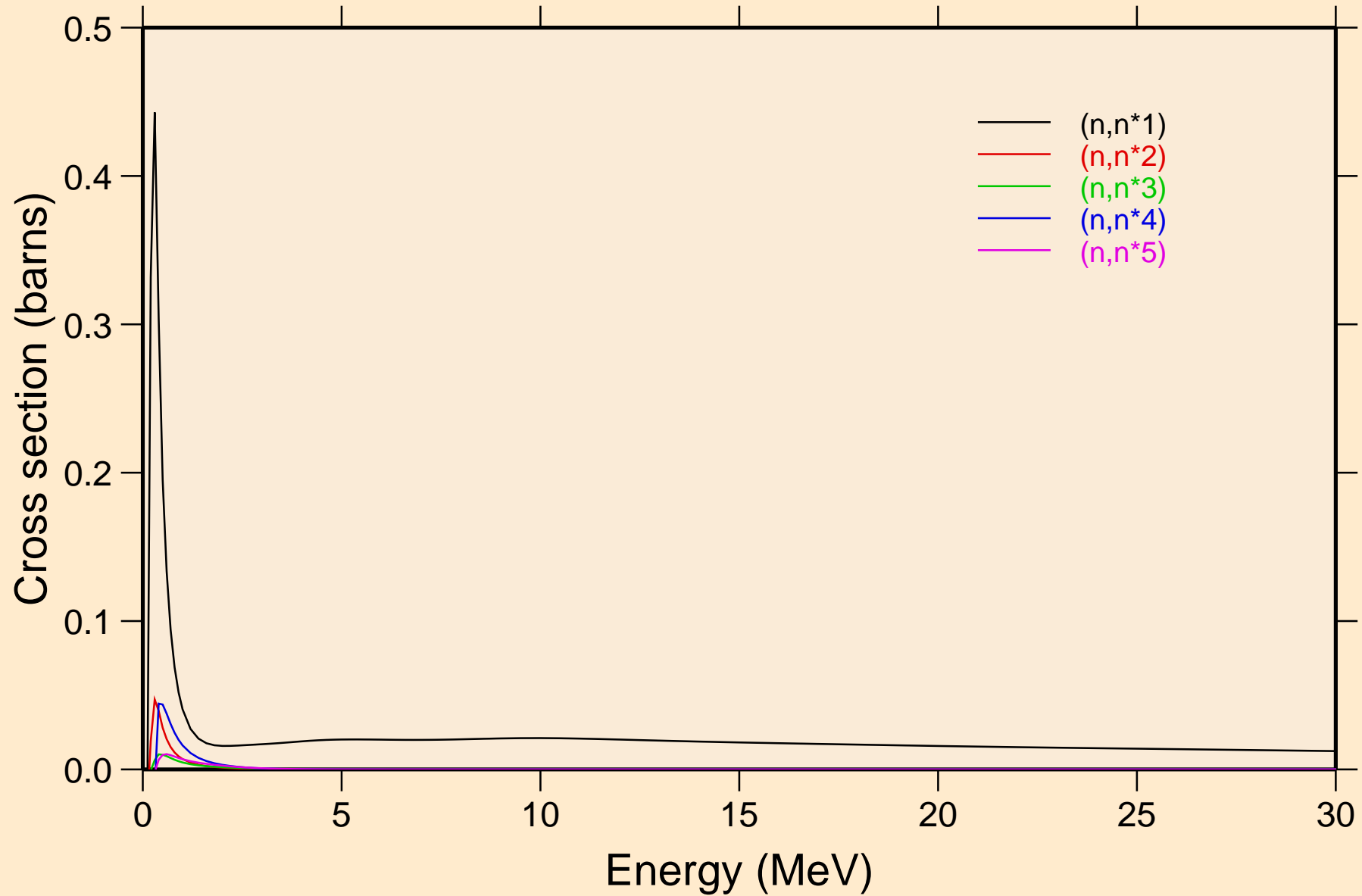

RE190 NEUTRON ACER TENDL-2021 LIBRARY; T=293.6K
Inelastic levels

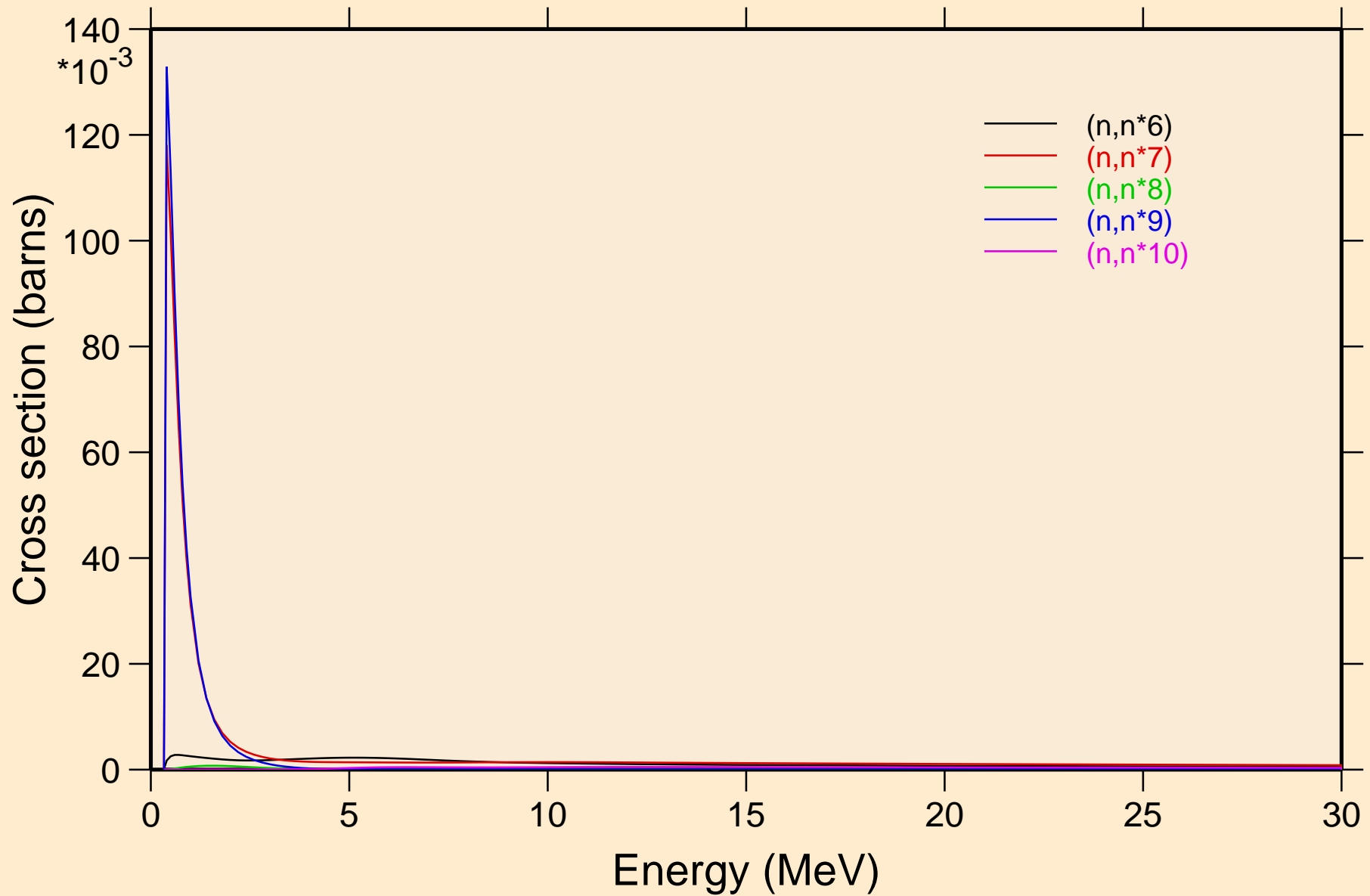

RE190 NEUTRON ACER TENDL-2021 LIBRARY; T=293.6K
Inelastic levels

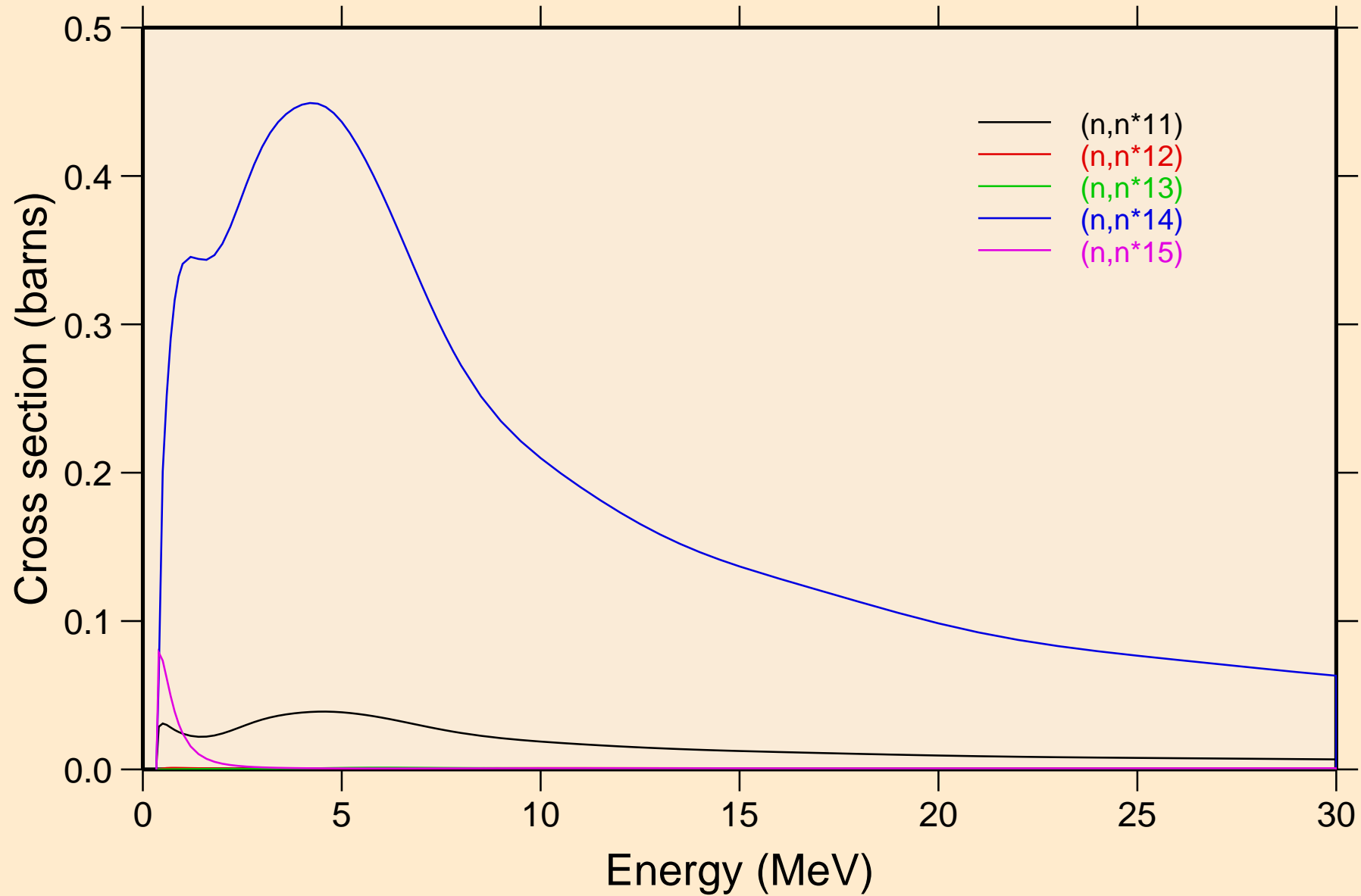

RE190 NEUTRON ACER TENDL-2021 LIBRARY; T=293.6K
Inelastic levels

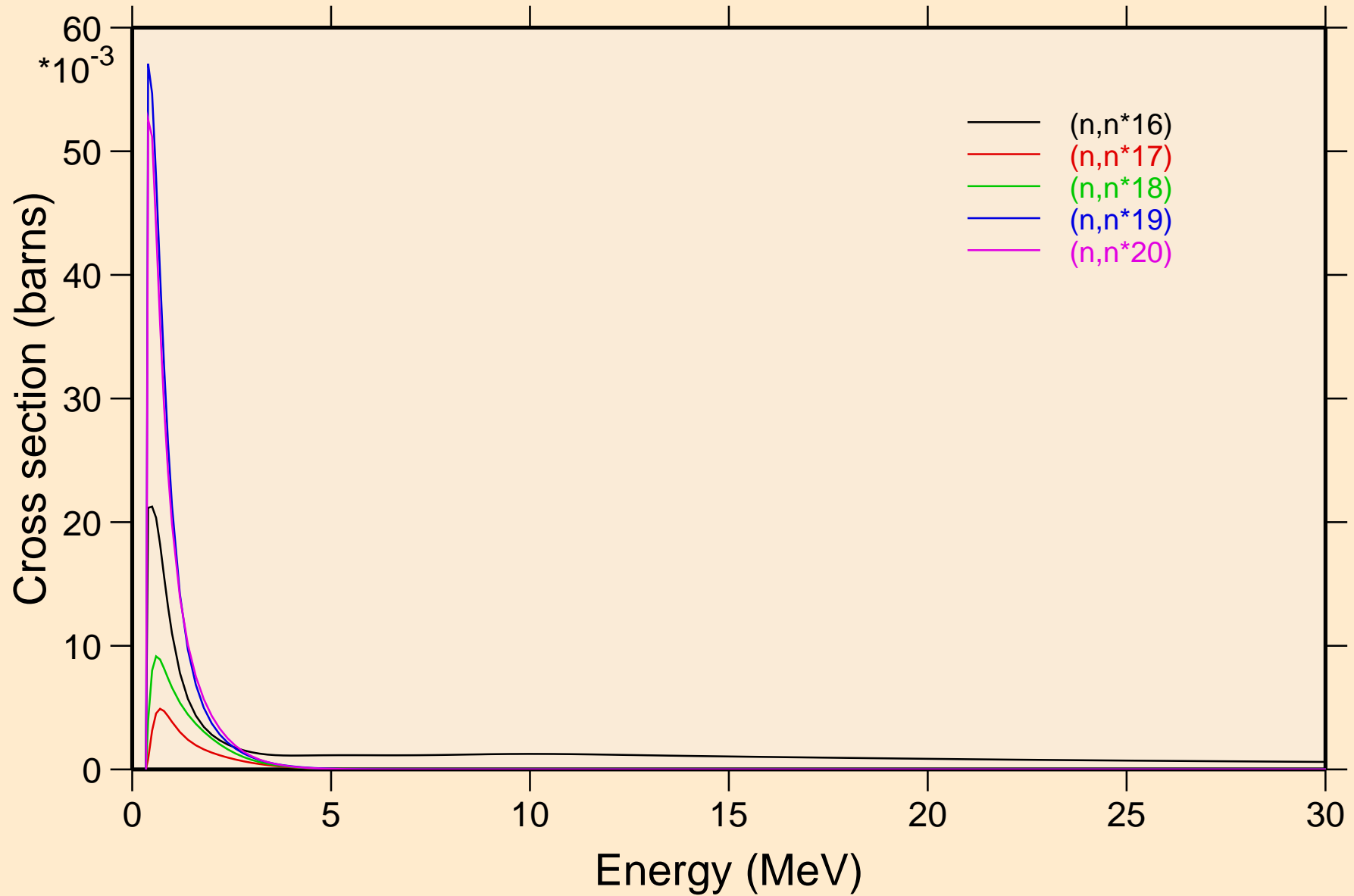

RE190 NEUTRON ACER TENDL-2021 LIBRARY; T=293.6K
Inelastic levels

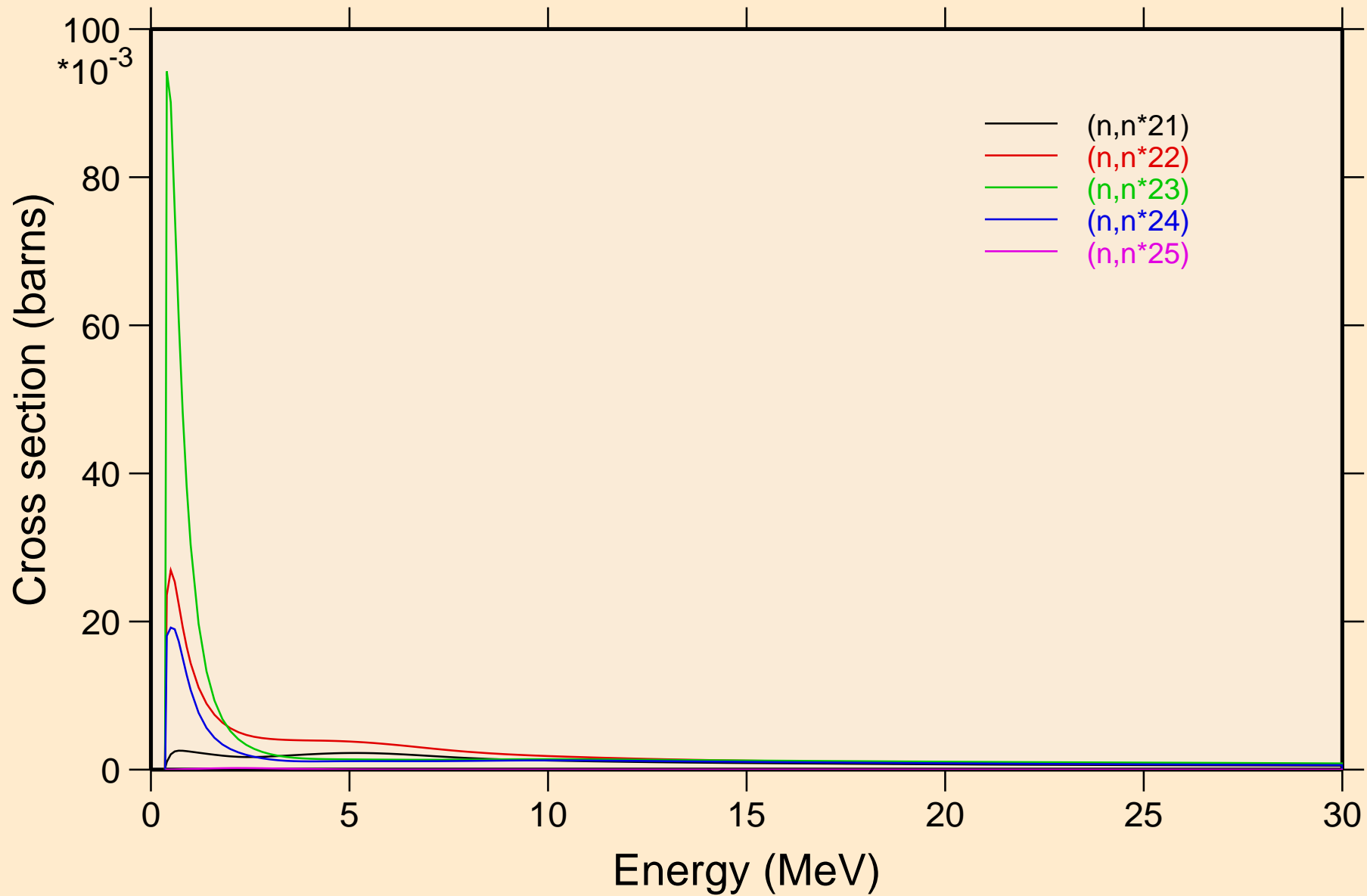

RE190 NEUTRON ACER TENDL-2021 LIBRARY; T=293.6K
Inelastic levels

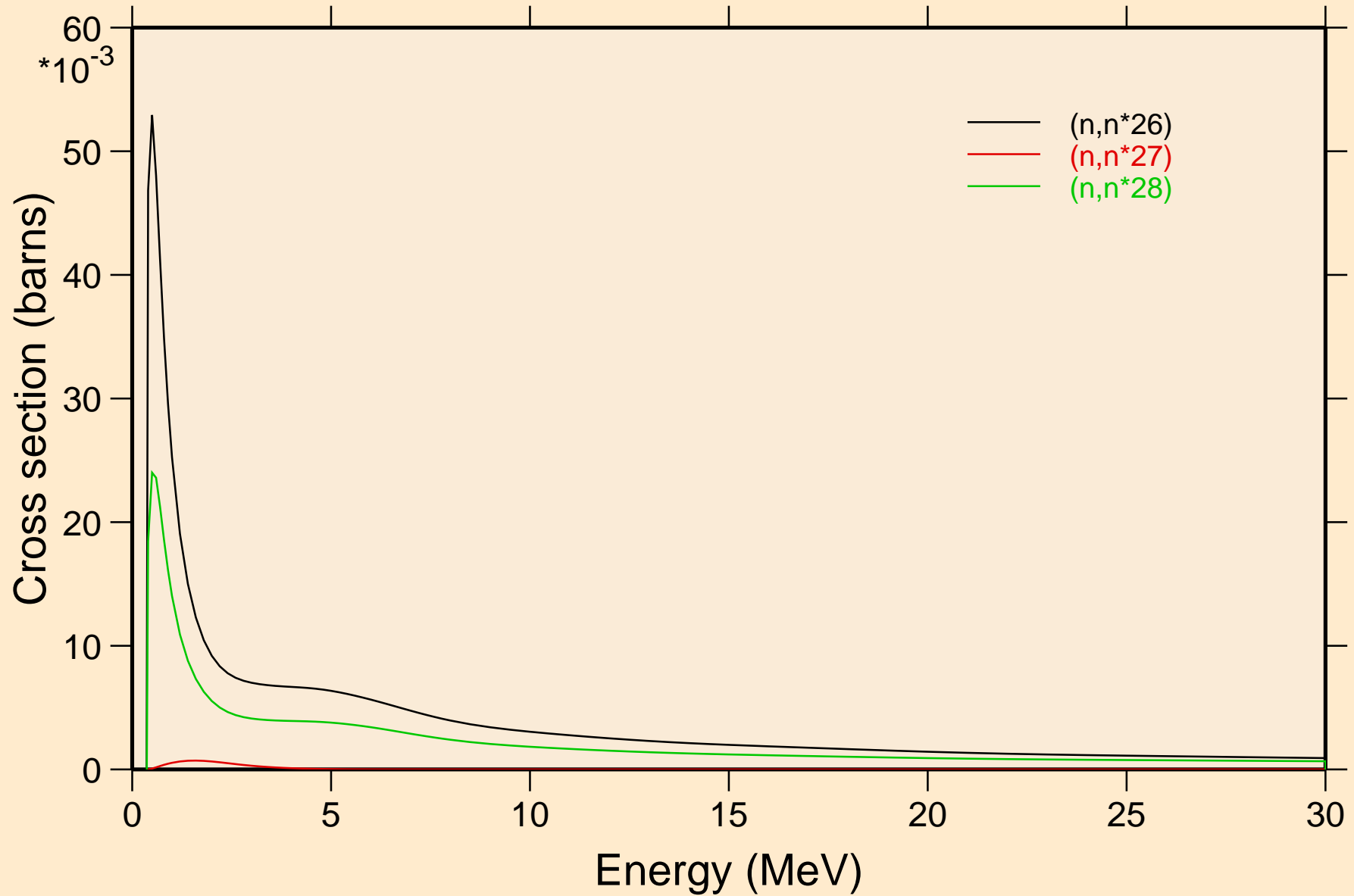

RE190 NEUTRON ACER TENDL-2021 LIBRARY; T=293.6K
Threshold reactions

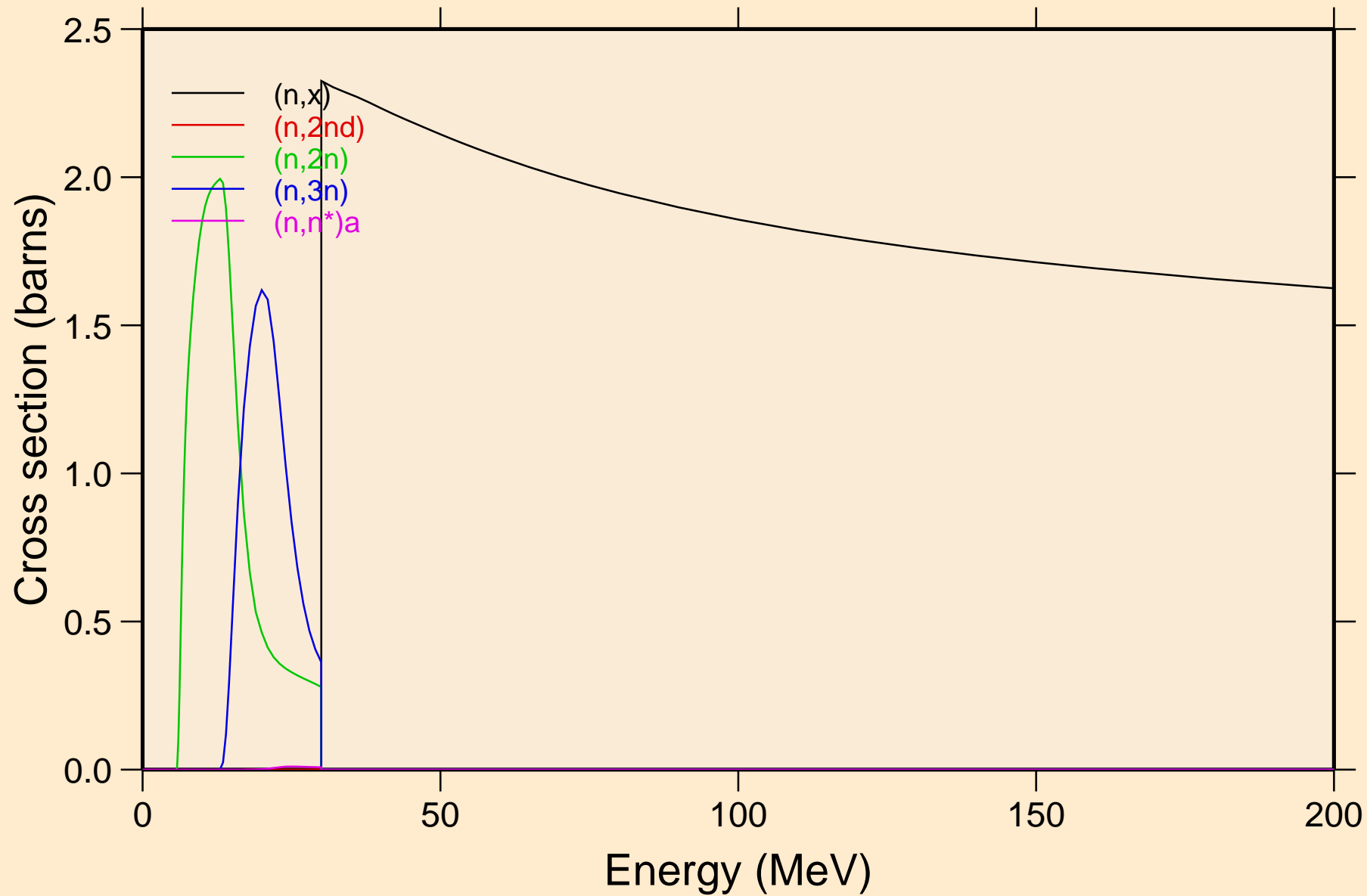

RE190 NEUTRON ACER TENDL-2021 LIBRARY; T=293.6K
Threshold reactions

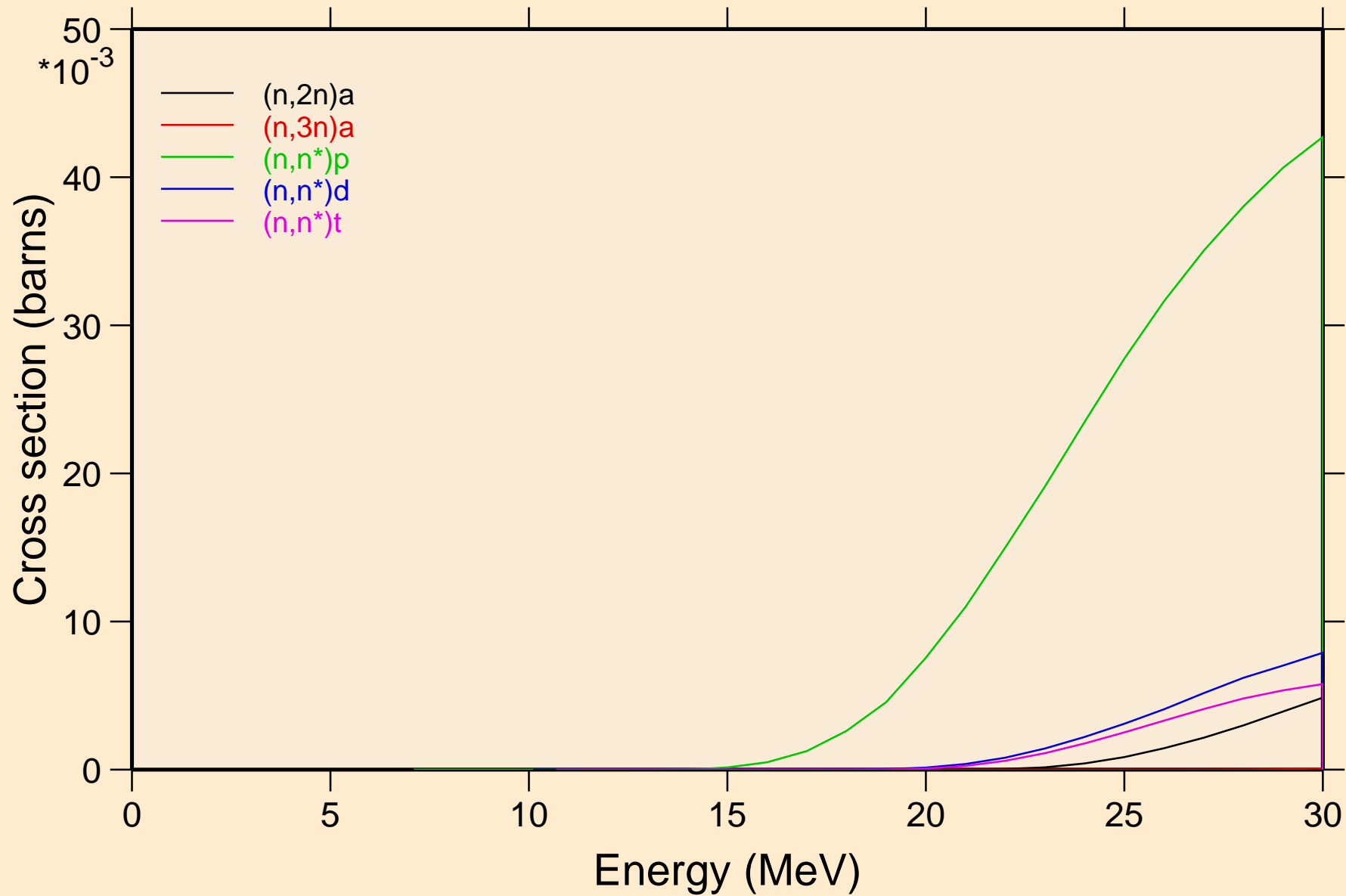

RE190 NEUTRON ACER TENDL-2021 LIBRARY; T=293.6K
Threshold reactions

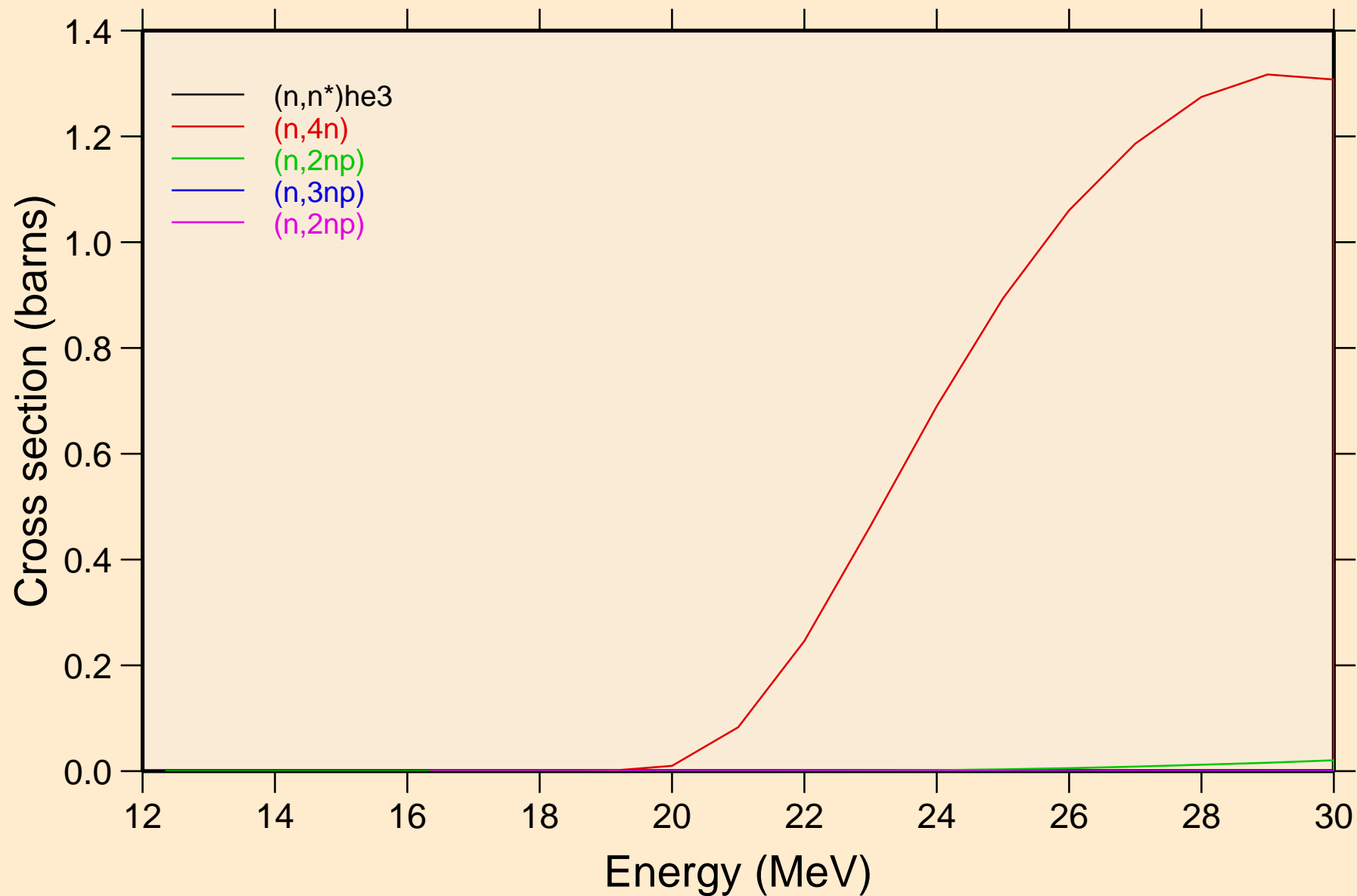

RE190 NEUTRON ACER TENDL-2021 LIBRARY; T=293.6K
Threshold reactions

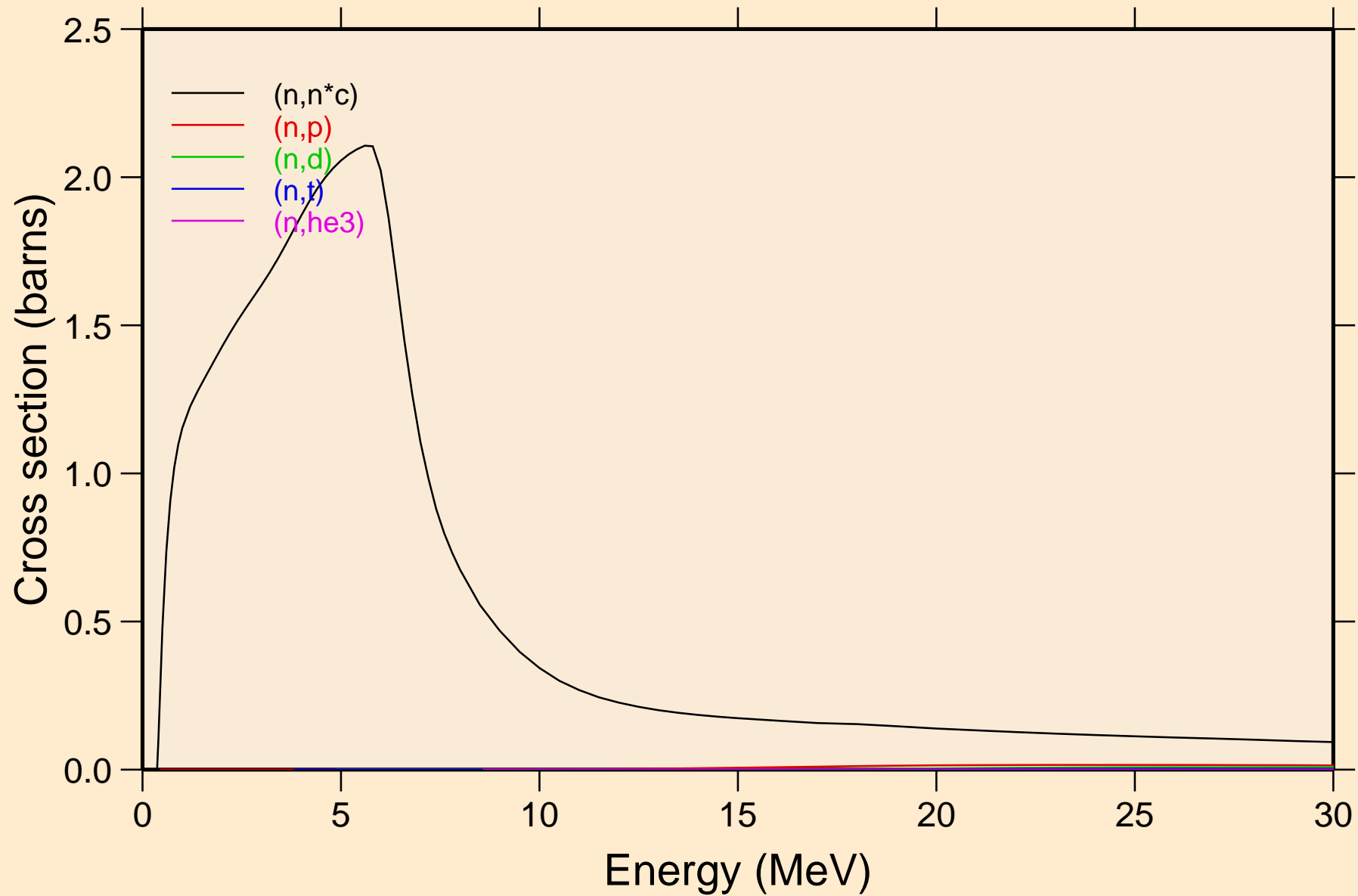

RE190 NEUTRON ACER TENDL-2021 LIBRARY; T=293.6K
Threshold reactions

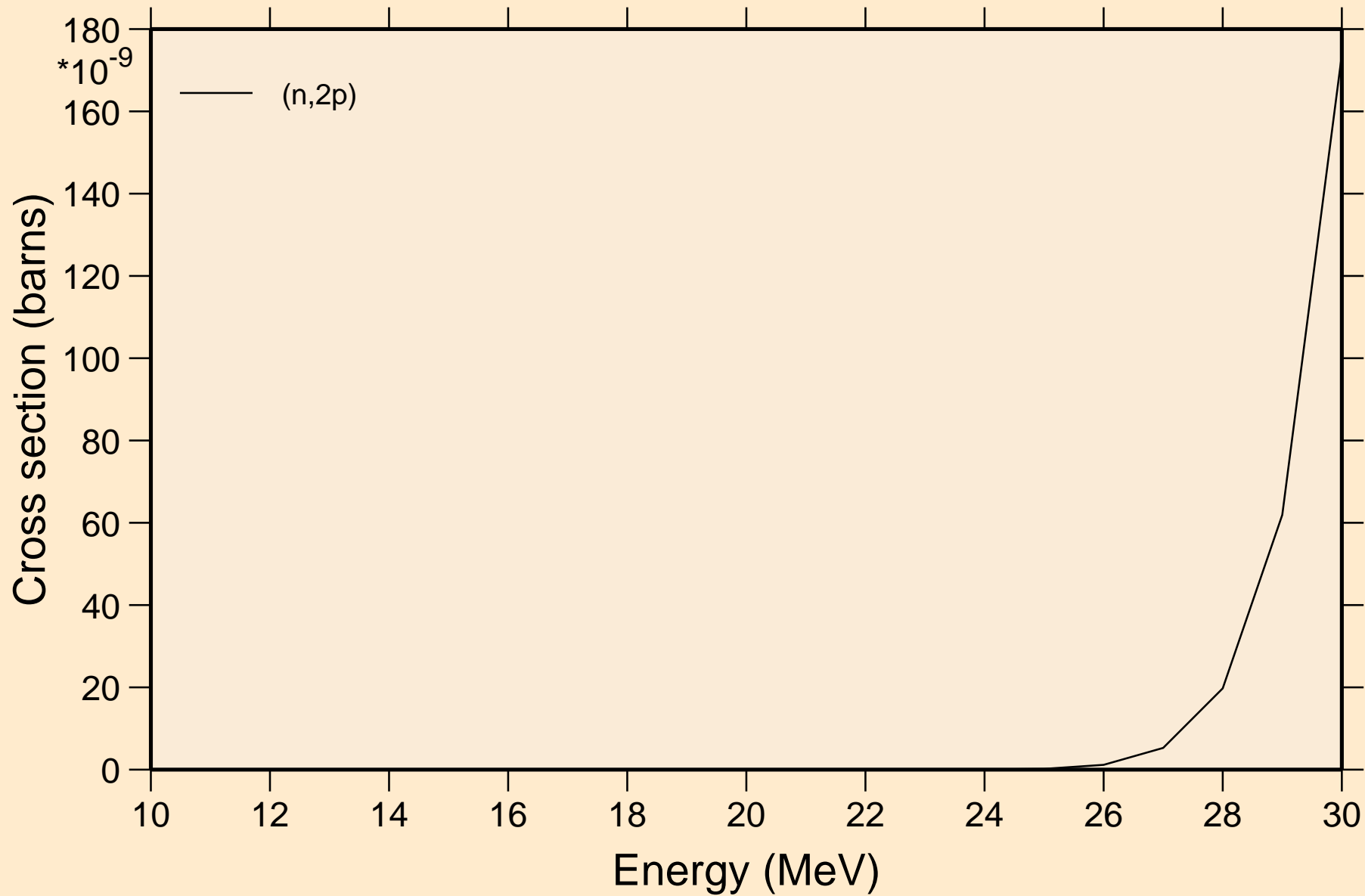

RE190 NEUTRON ACER TENDL-2021 LIBRARY; T=293.6K
Threshold reactions

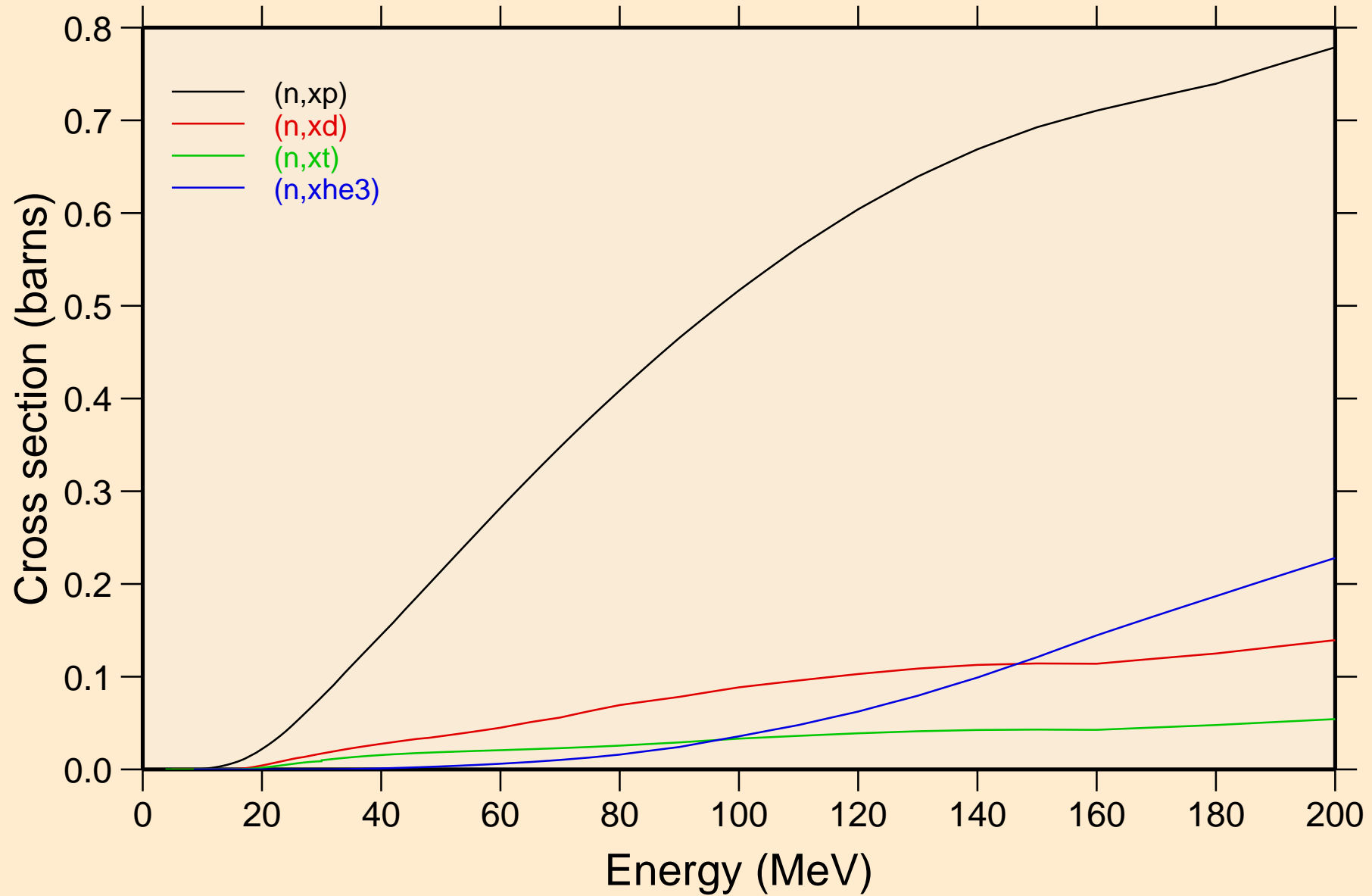

RE190 NEUTRON ACER TENDL-2021 LIBRARY; T=293.6K
angular distribution for elastic

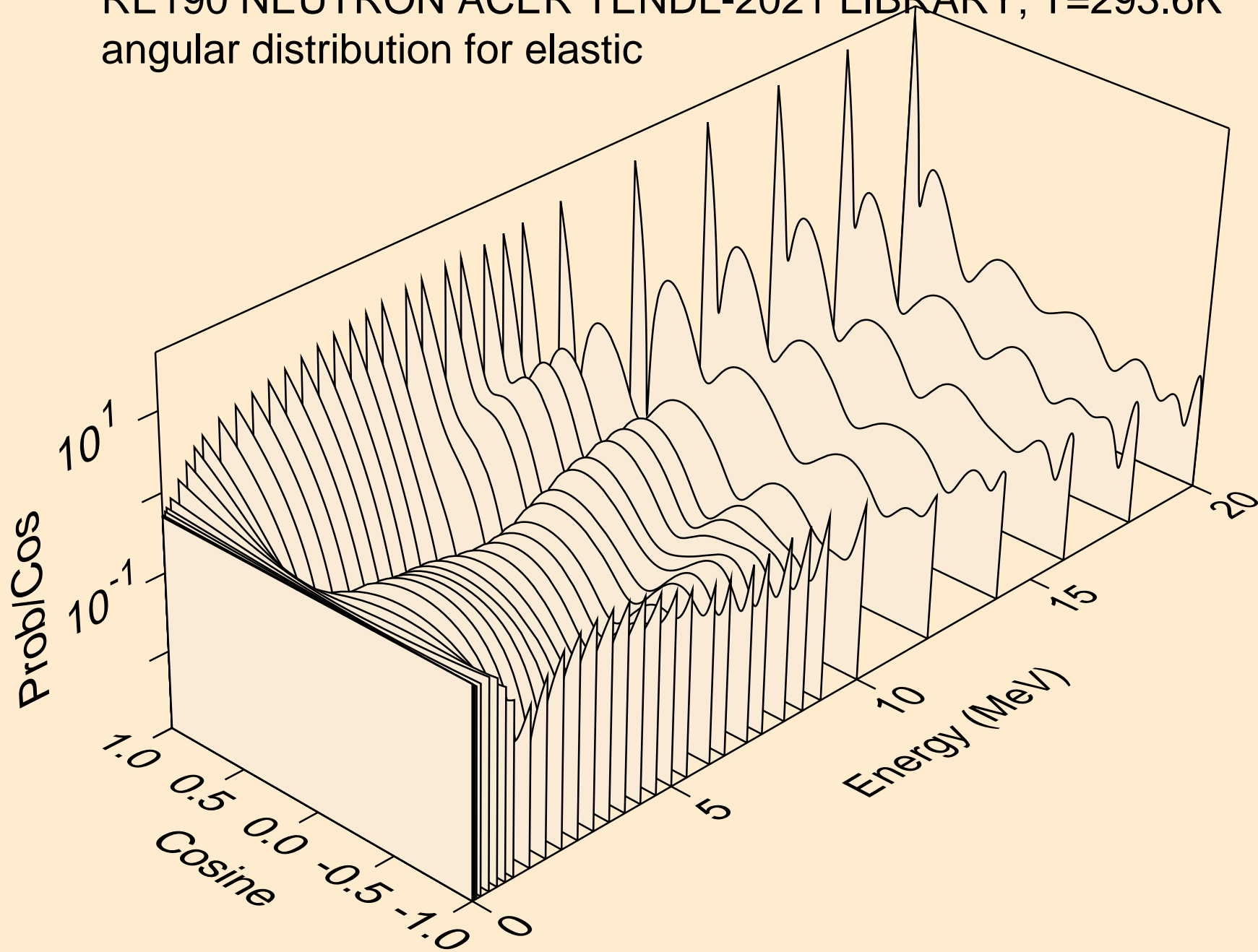

RE190 NEUTRON ACER TENDL-2021 LIBRARY; T=293.6K
angular distribution for elastic

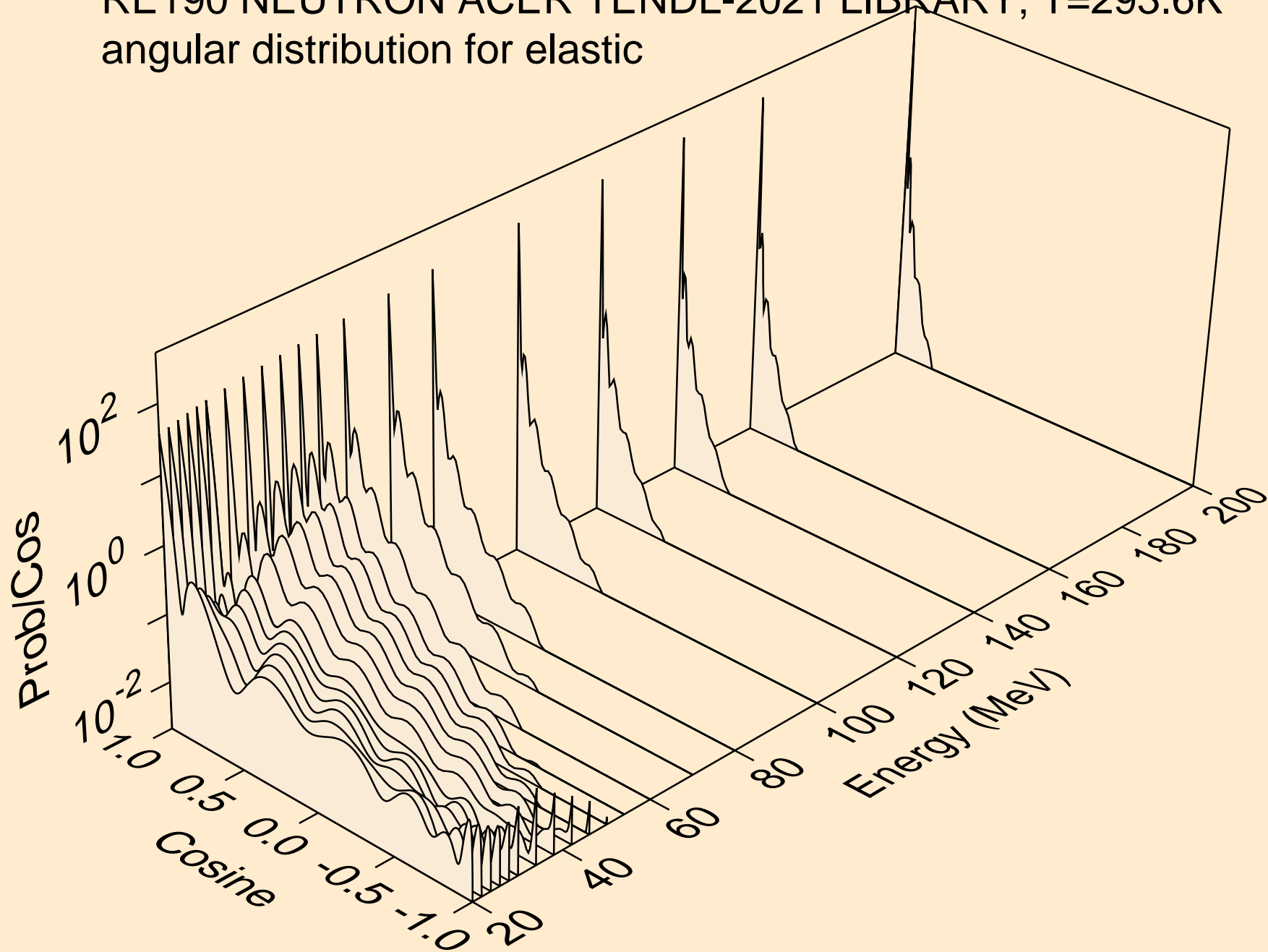

RE190 NEUTRON ACER TENDL-2021 LIBRARY; T=293.6K
angular distribution for (n,n*1)

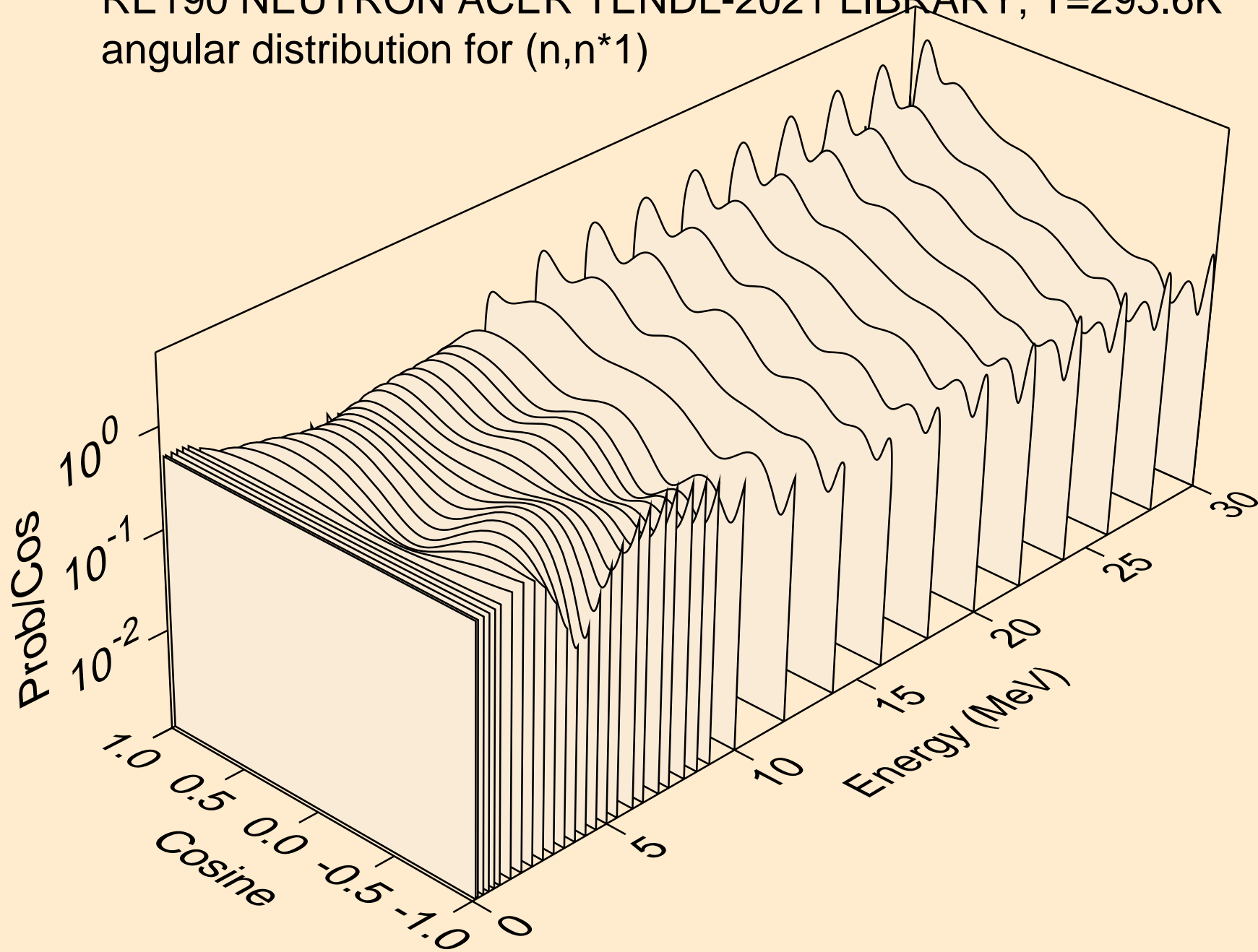

RE190 NEUTRON ACER TENDL-2021 LIBRARY; T=293.6K
angular distribution for (n,n*2)

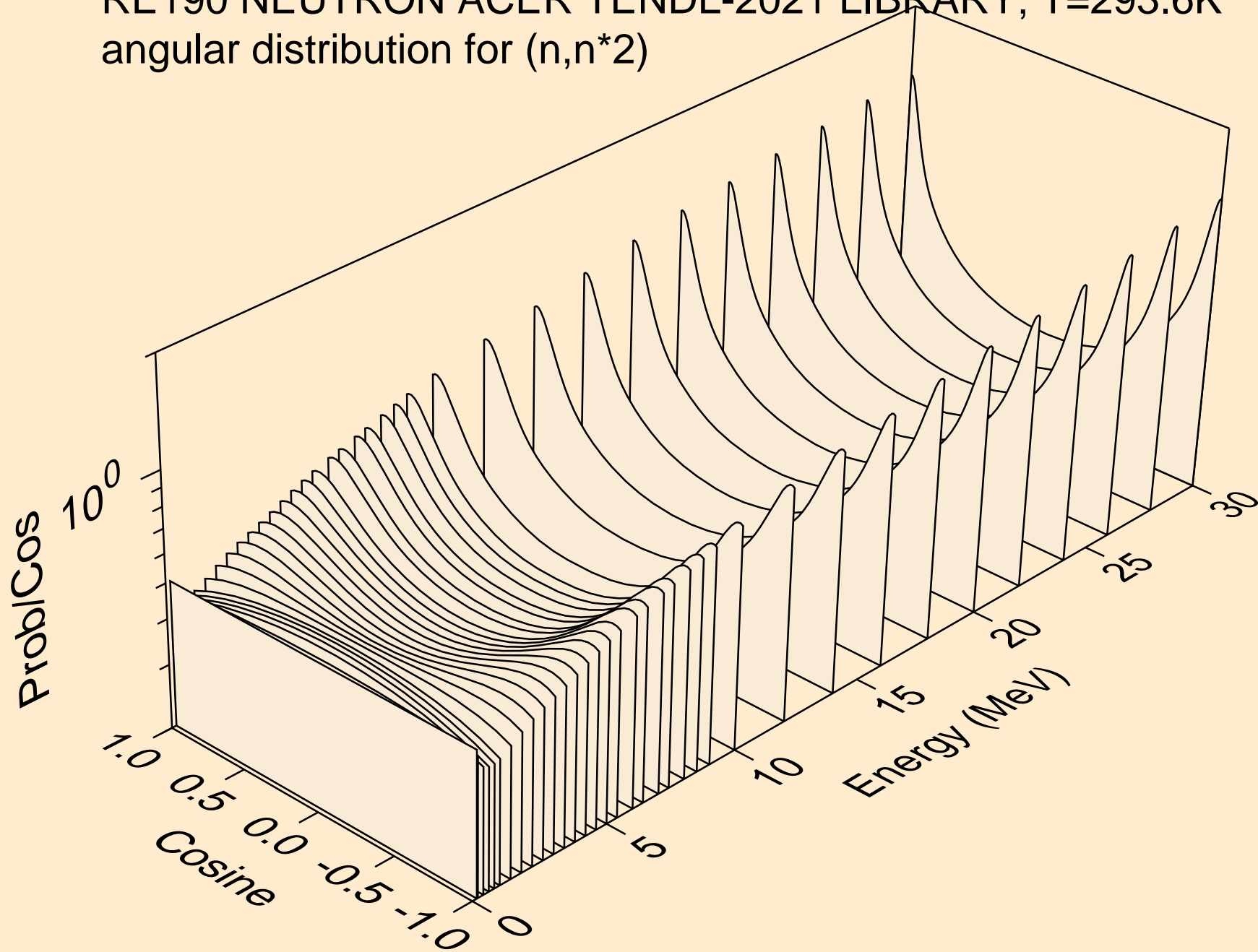

RE190 NEUTRON ACER TENDL-2021 LIBRARY; T=293.6K
angular distribution for (n,n*3)

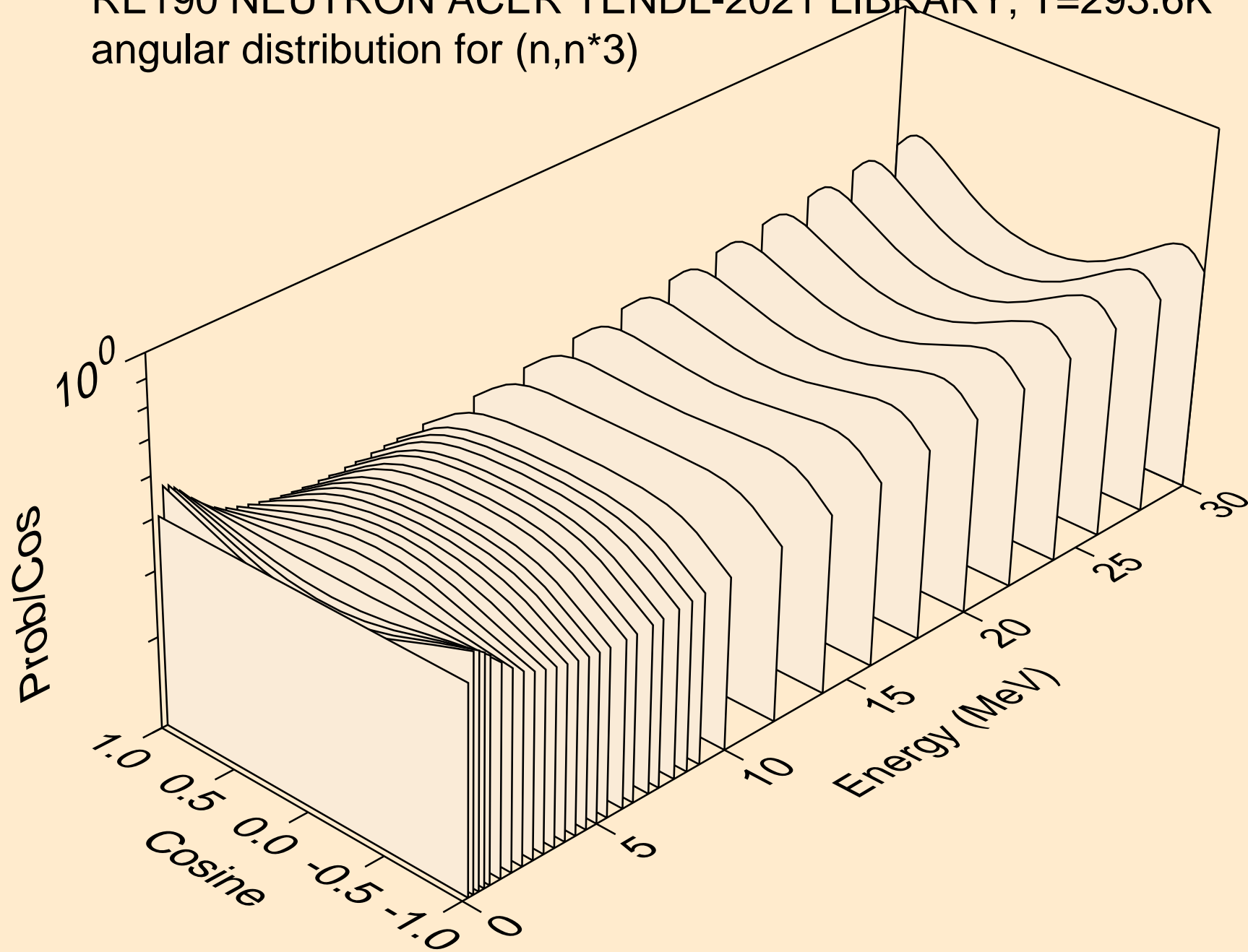

RE190 NEUTRON ACER TENDL-2021 LIBRARY; T=293.6K
angular distribution for (n,n*4)

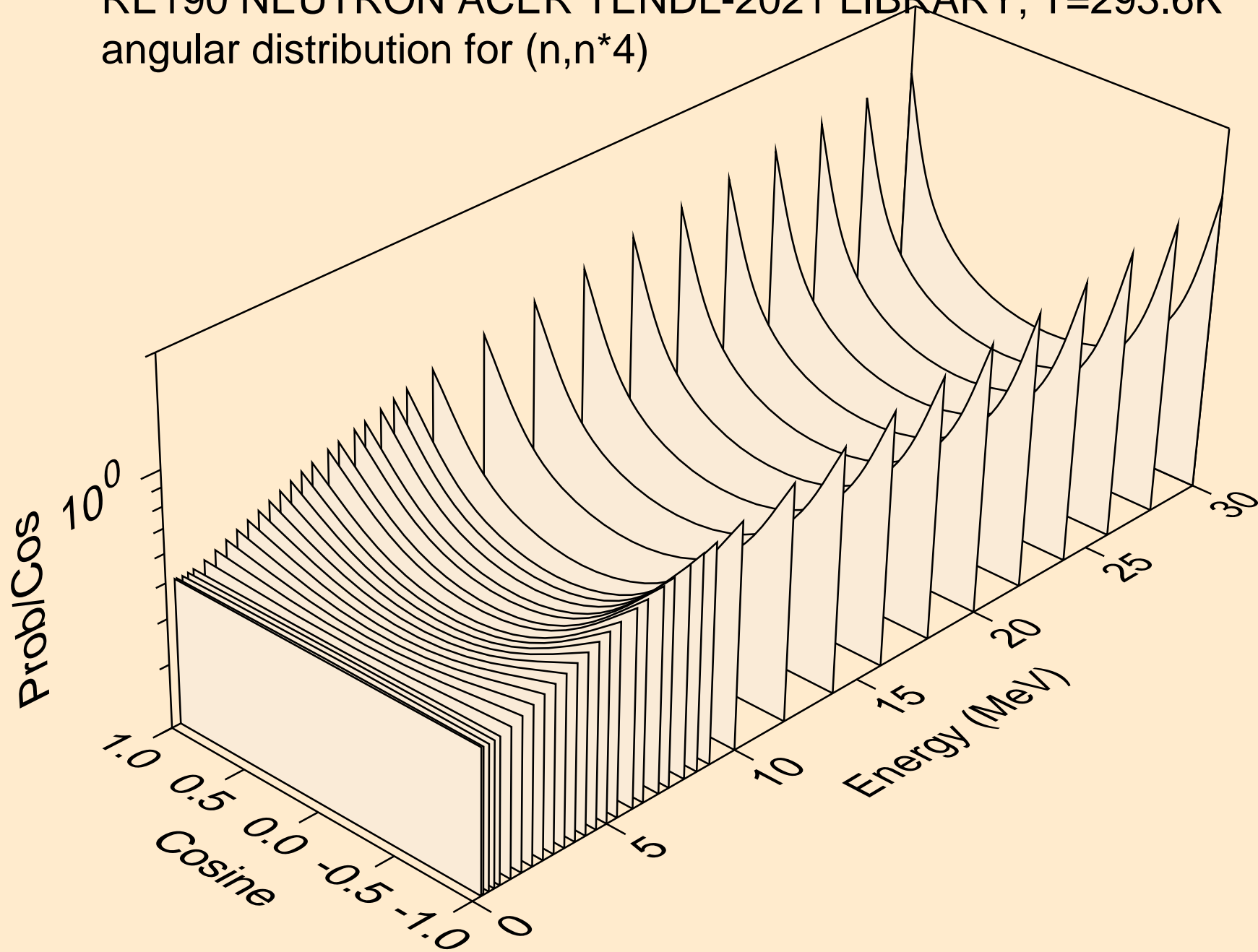

RE190 NEUTRON ACER TENDL-2021 LIBRARY; T=293.6K
angular distribution for (n,n*5)

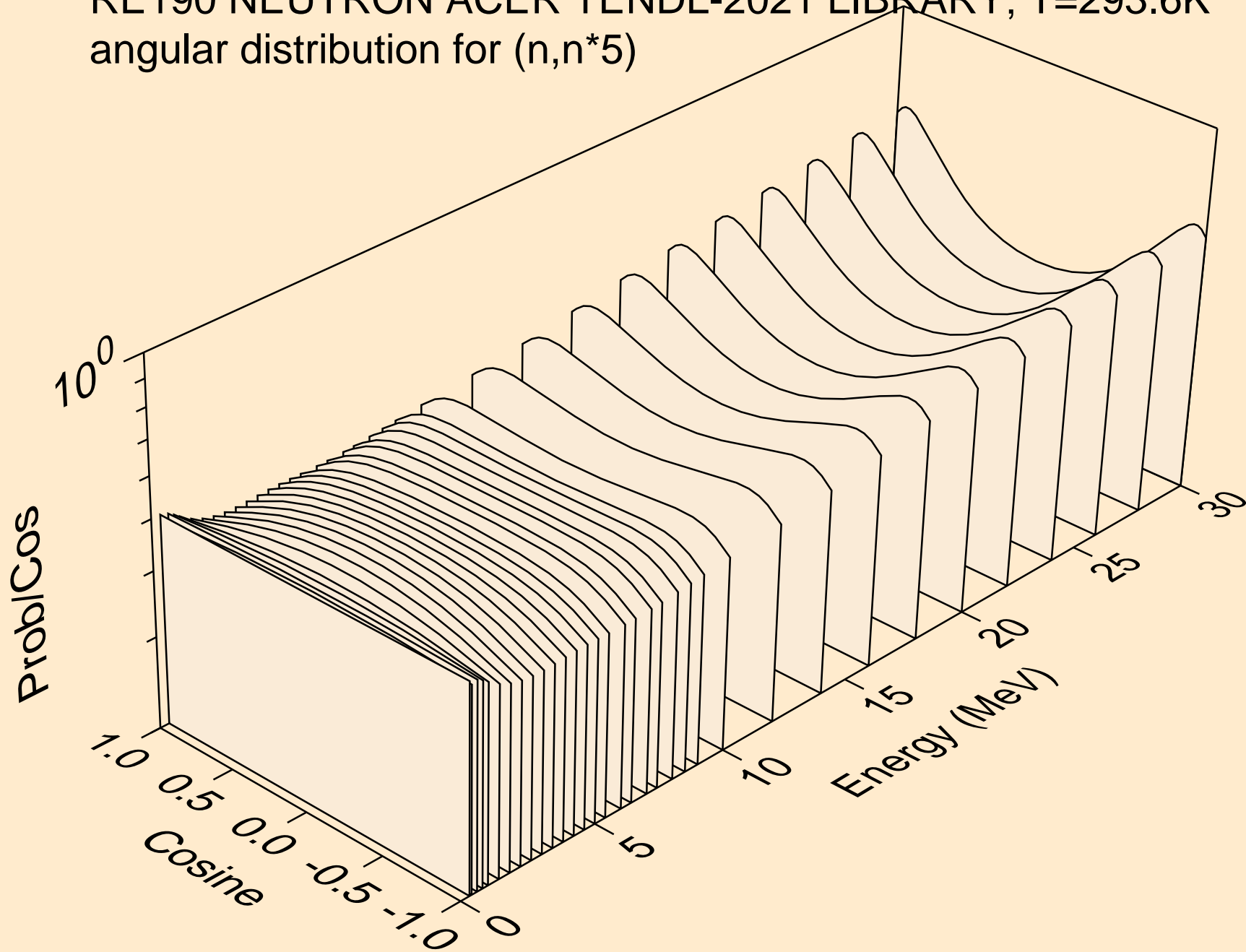

RE190 NEUTRON ACER TENDL-2021 LIBRARY; T=293.6K
angular distribution for (n,n*6)

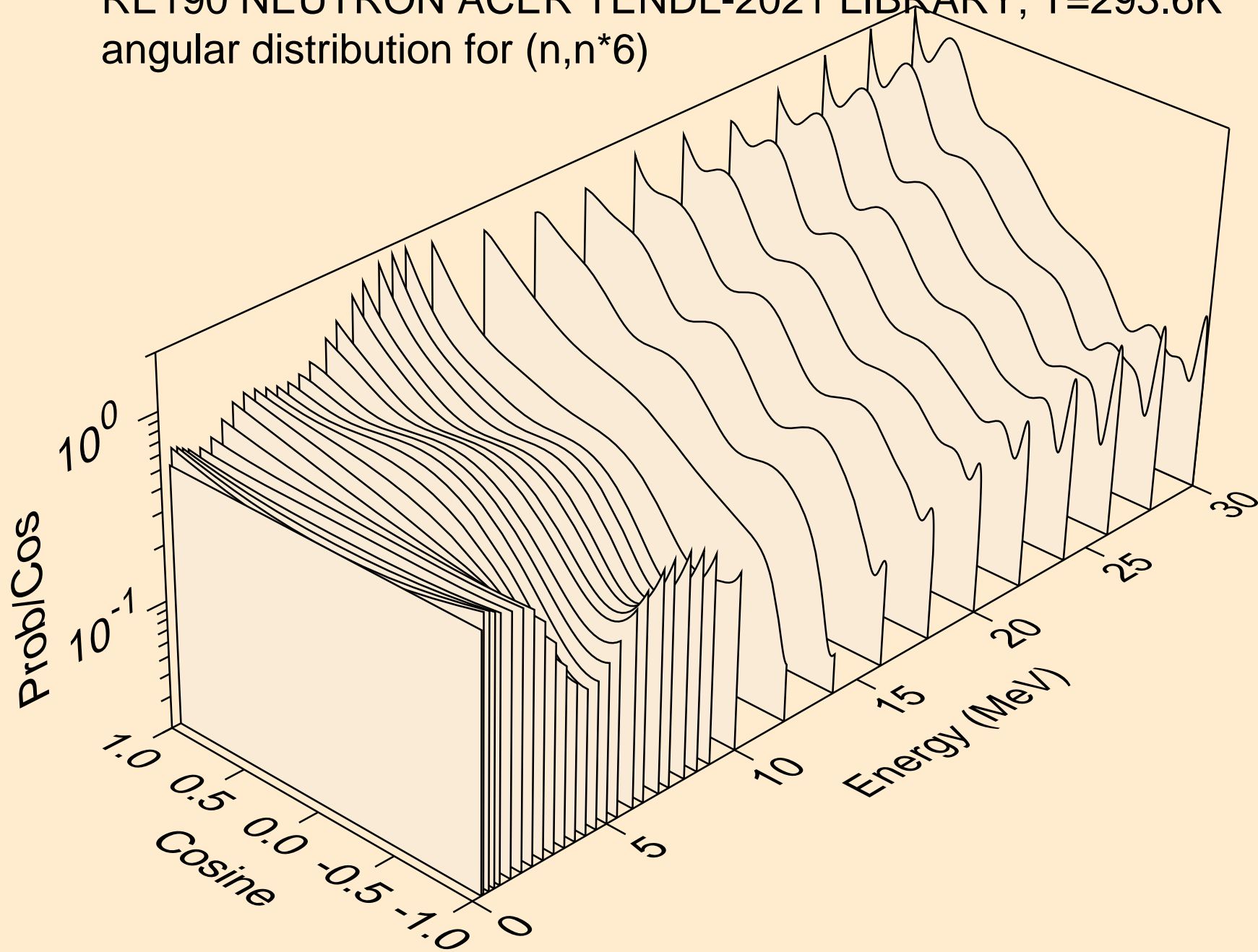

RE190 NEUTRON ACER TENDL-2021 LIBRARY; T=293.6K
angular distribution for (n,n*7)

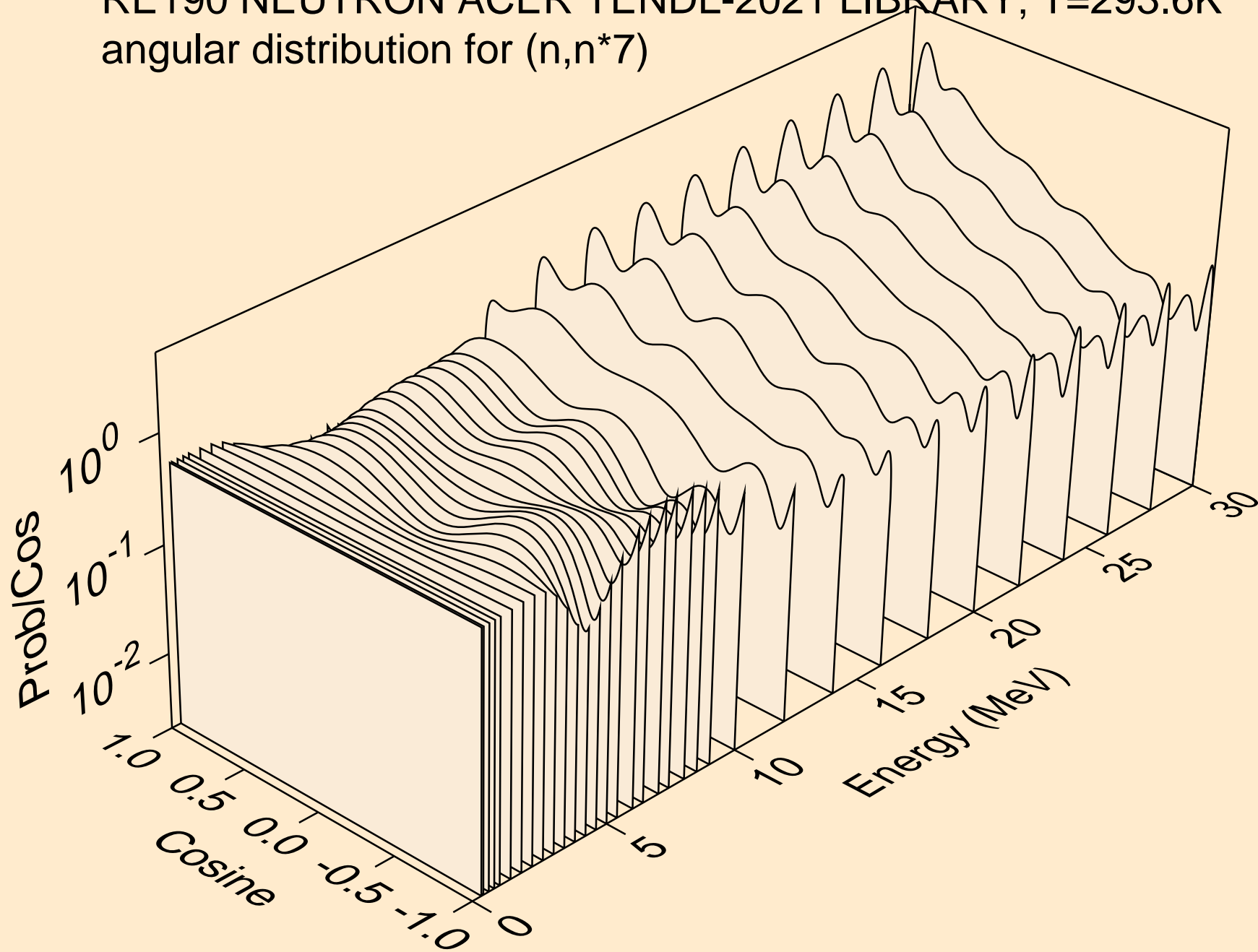

RE190 NEUTRON ACER TENDL-2021 LIBRARY; T=293.6K
angular distribution for (n,n*8)

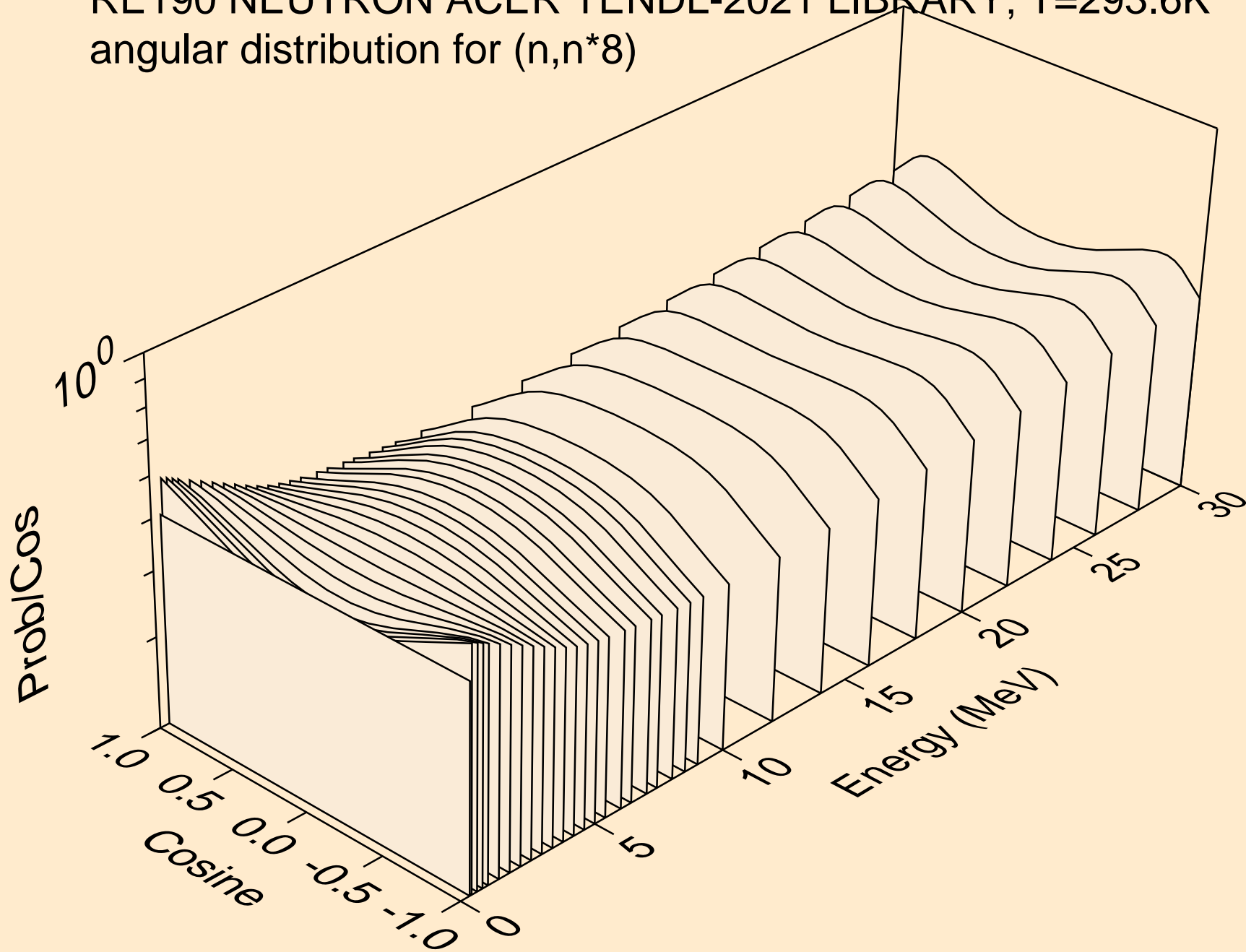

RE190 NEUTRON ACER TENDL-2021 LIBRARY; T=293.6K
angular distribution for (n,n*9)

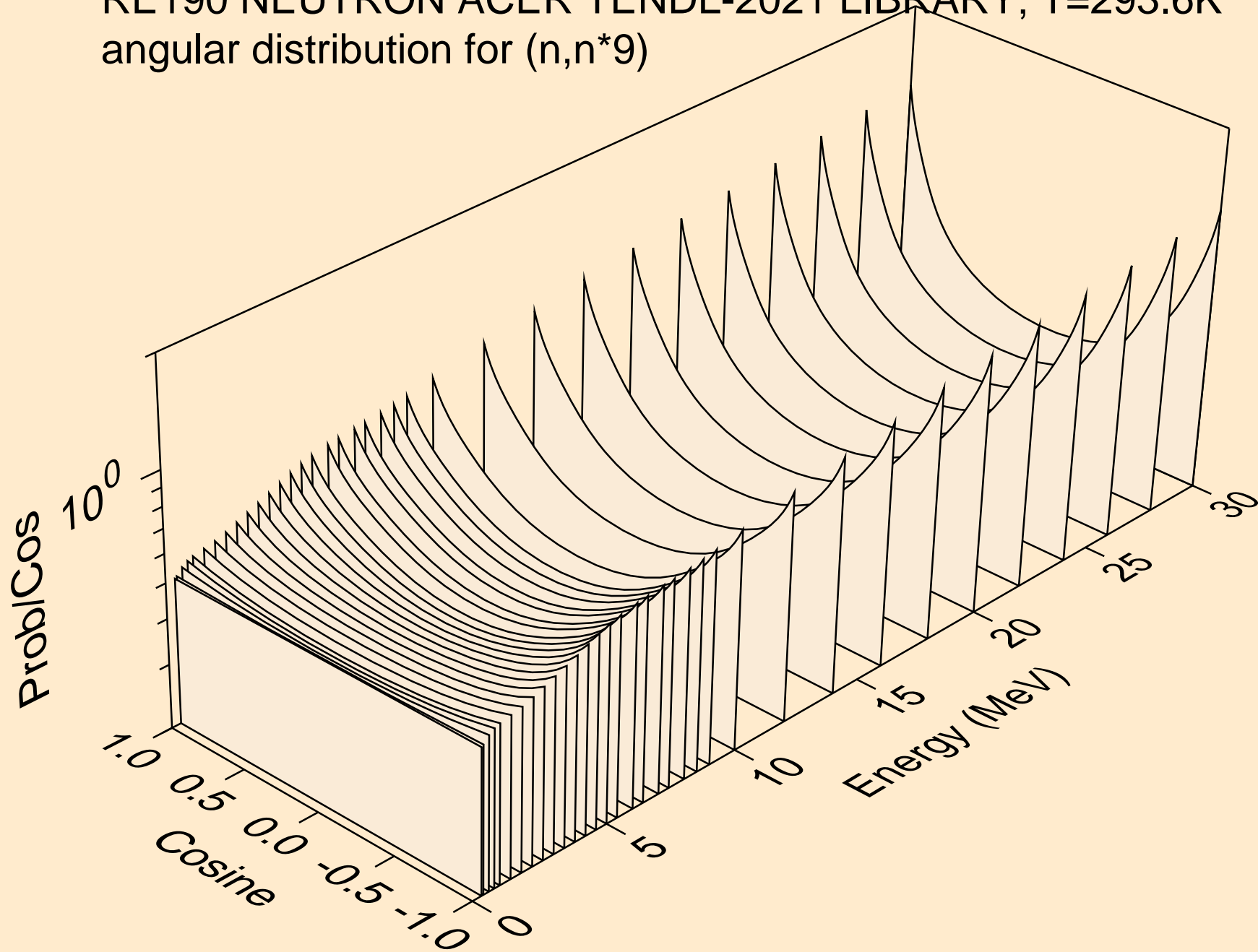

RE190 NEUTRON ACER TENDL-2021 LIBRARY; T=293.6K
angular distribution for (n,n*10)

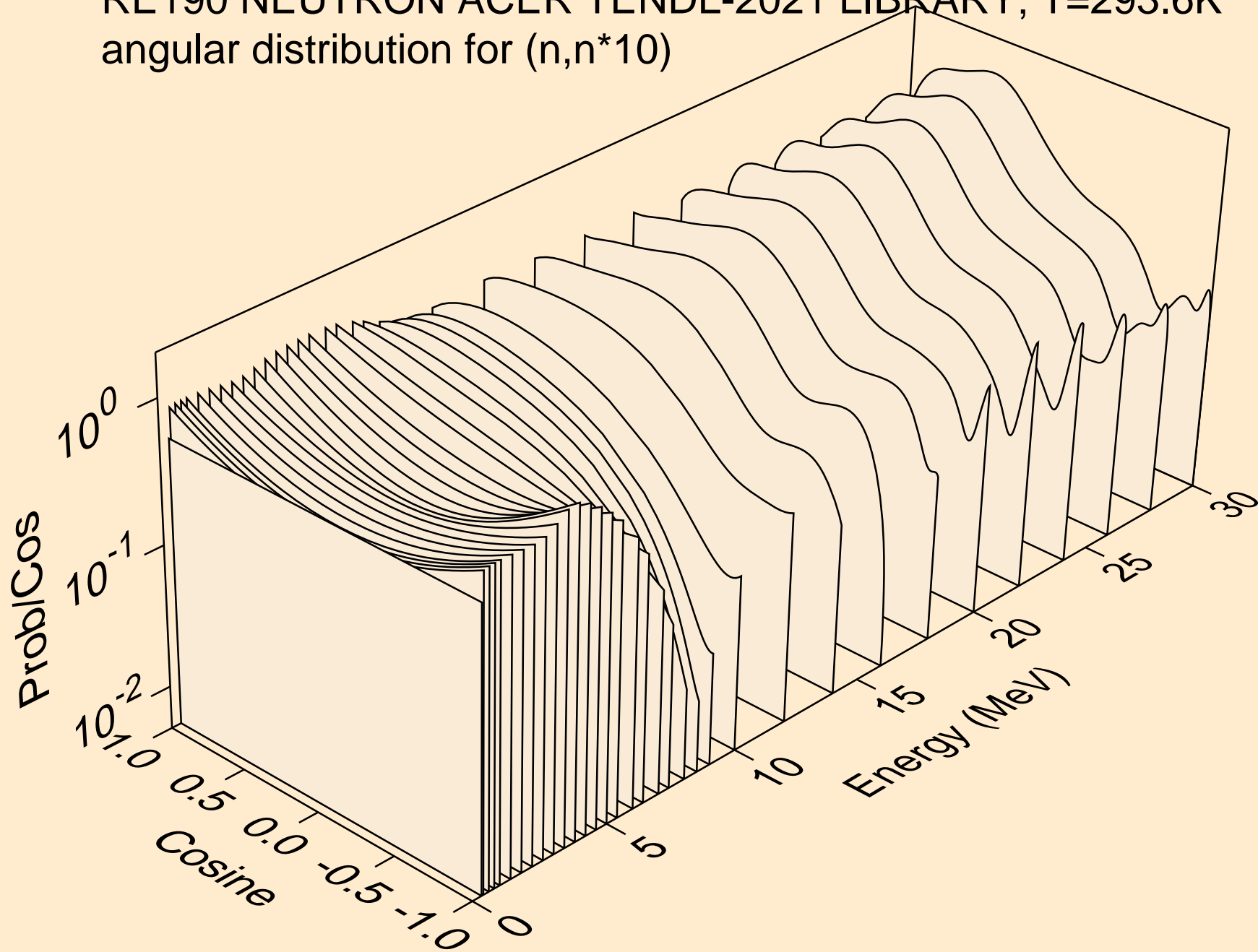

RE190 NEUTRON ACER TENDL-2021 LIBRARY; T=293.6K
angular distribution for (n,n*11)

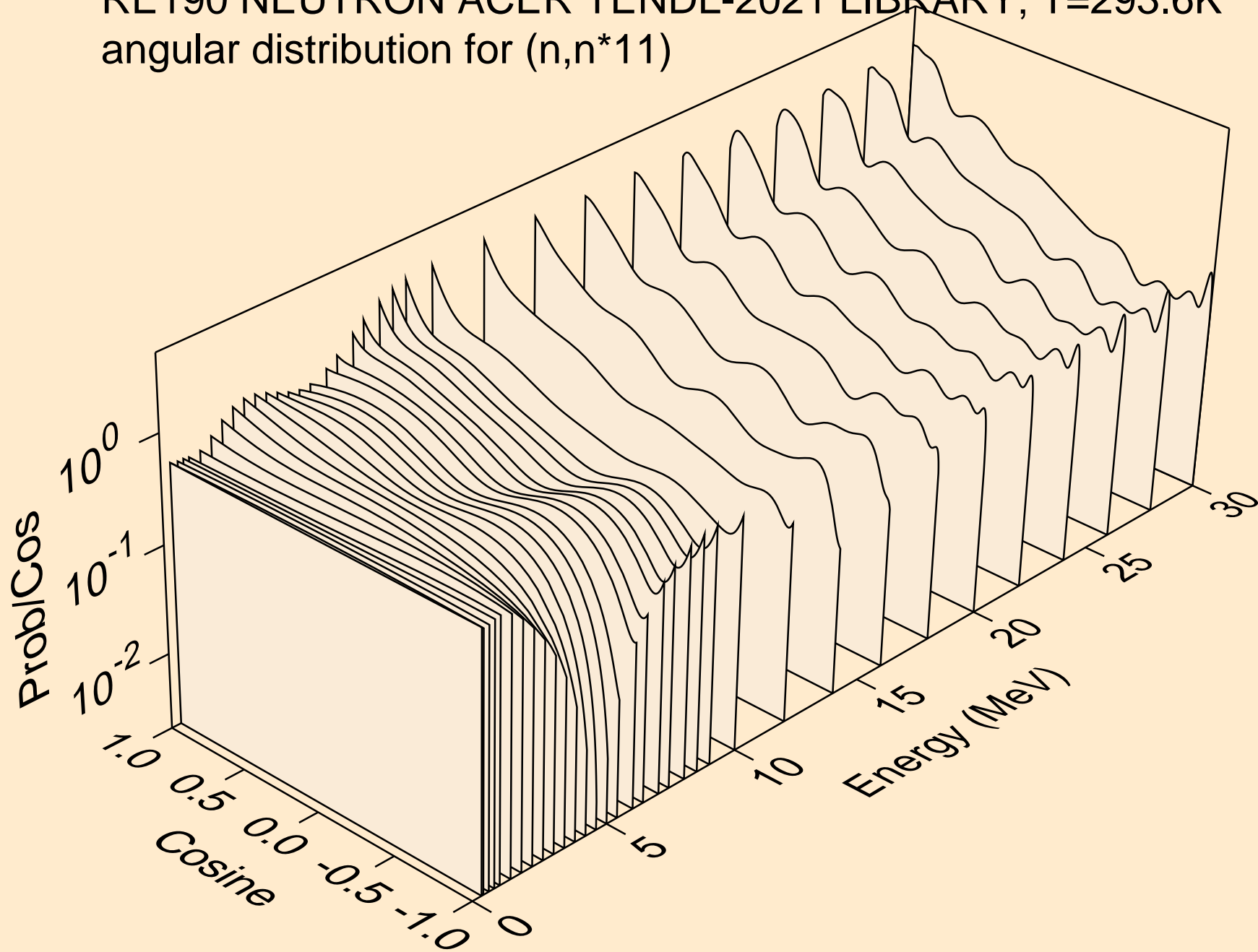

RE190 NEUTRON ACER TENDL-2021 LIBRARY; T=293.6K
angular distribution for (n,n*12)

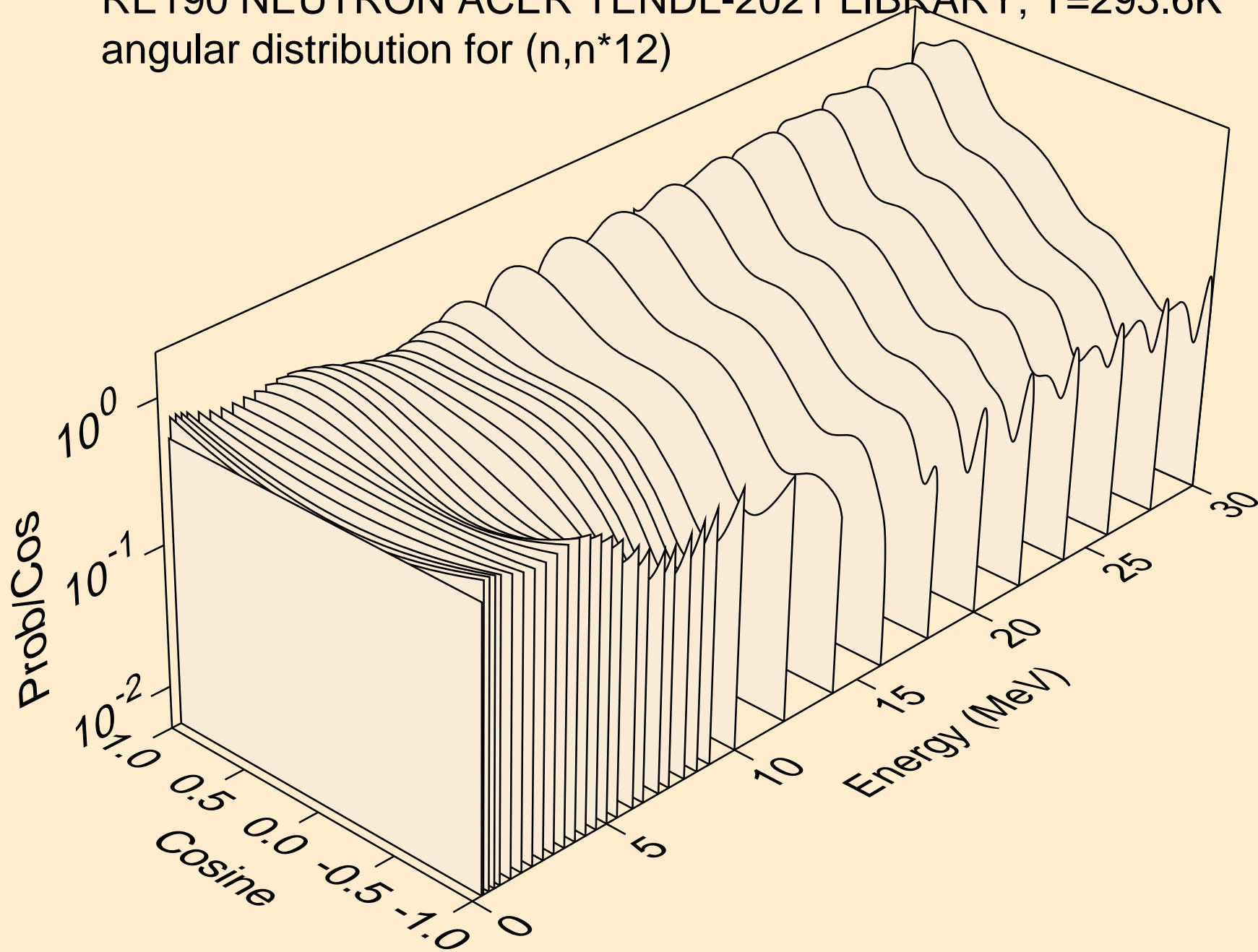

RE190 NEUTRON ACER TENDL-2021 LIBRARY; T=293.6K
angular distribution for (n,n*13)

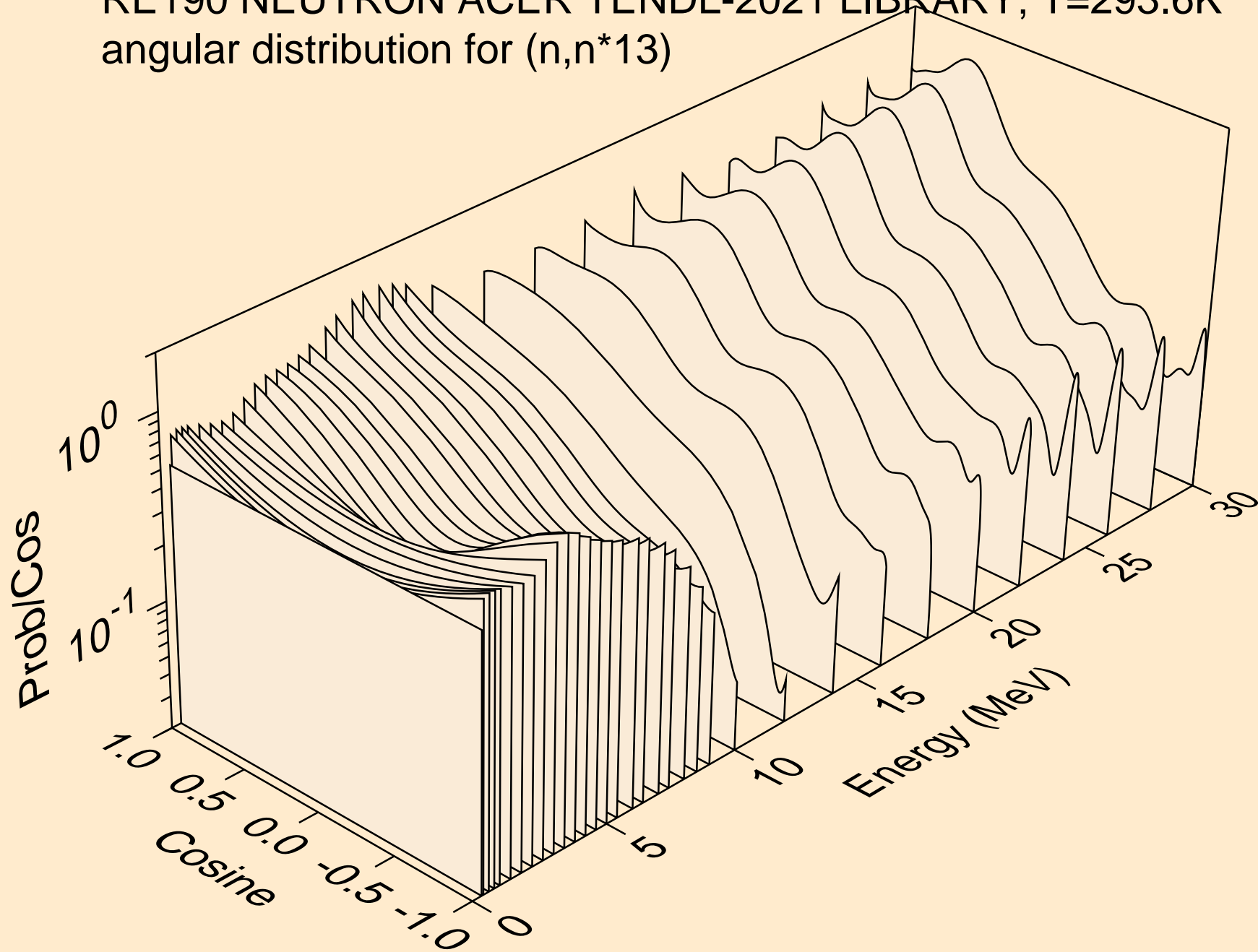

RE190 NEUTRON ACER TENDL-2021 LIBRARY; T=293.6K
angular distribution for (n,n*14)

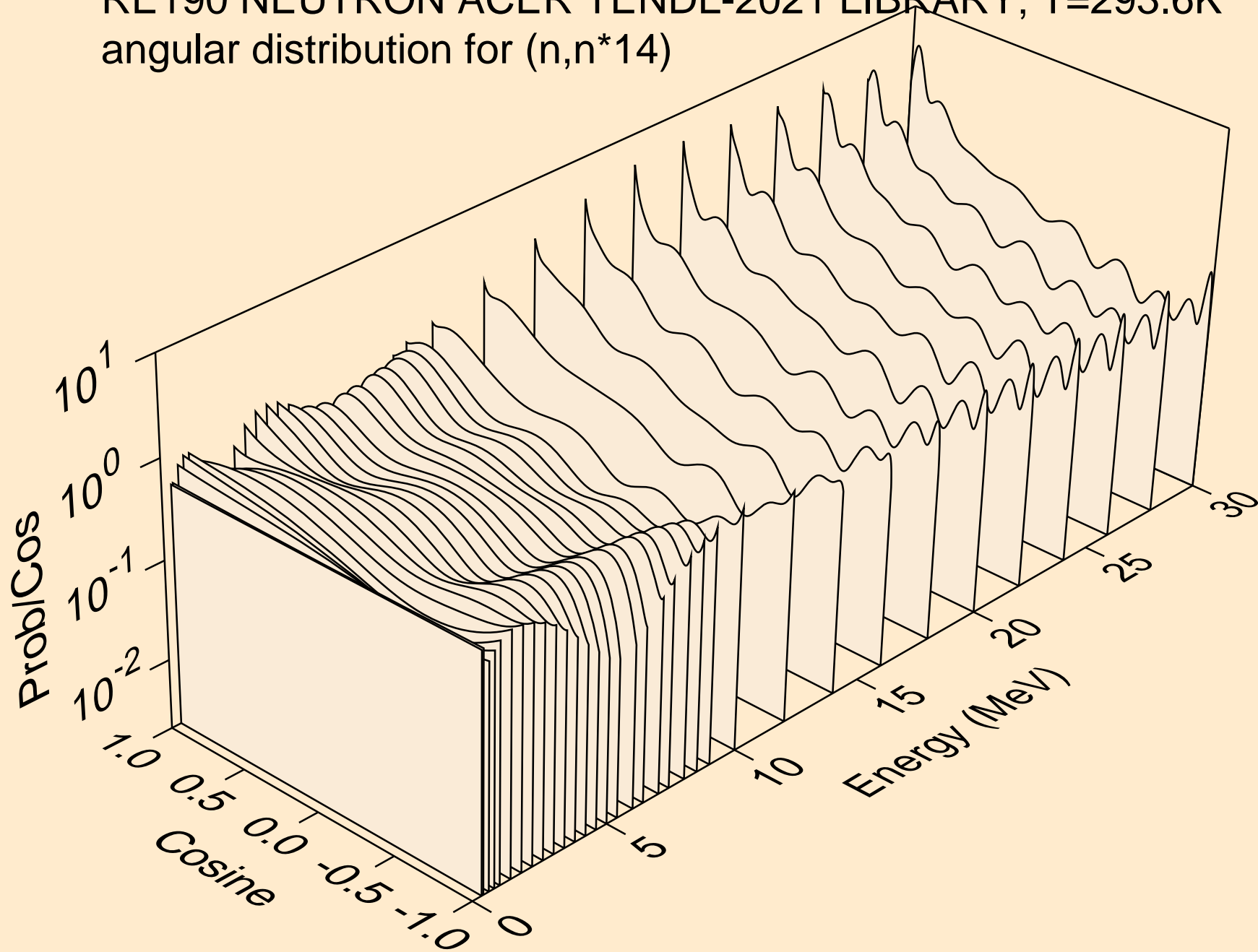

RE190 NEUTRON ACER TENDL-2021 LIBRARY; T=293.6K
angular distribution for (n,n*15)

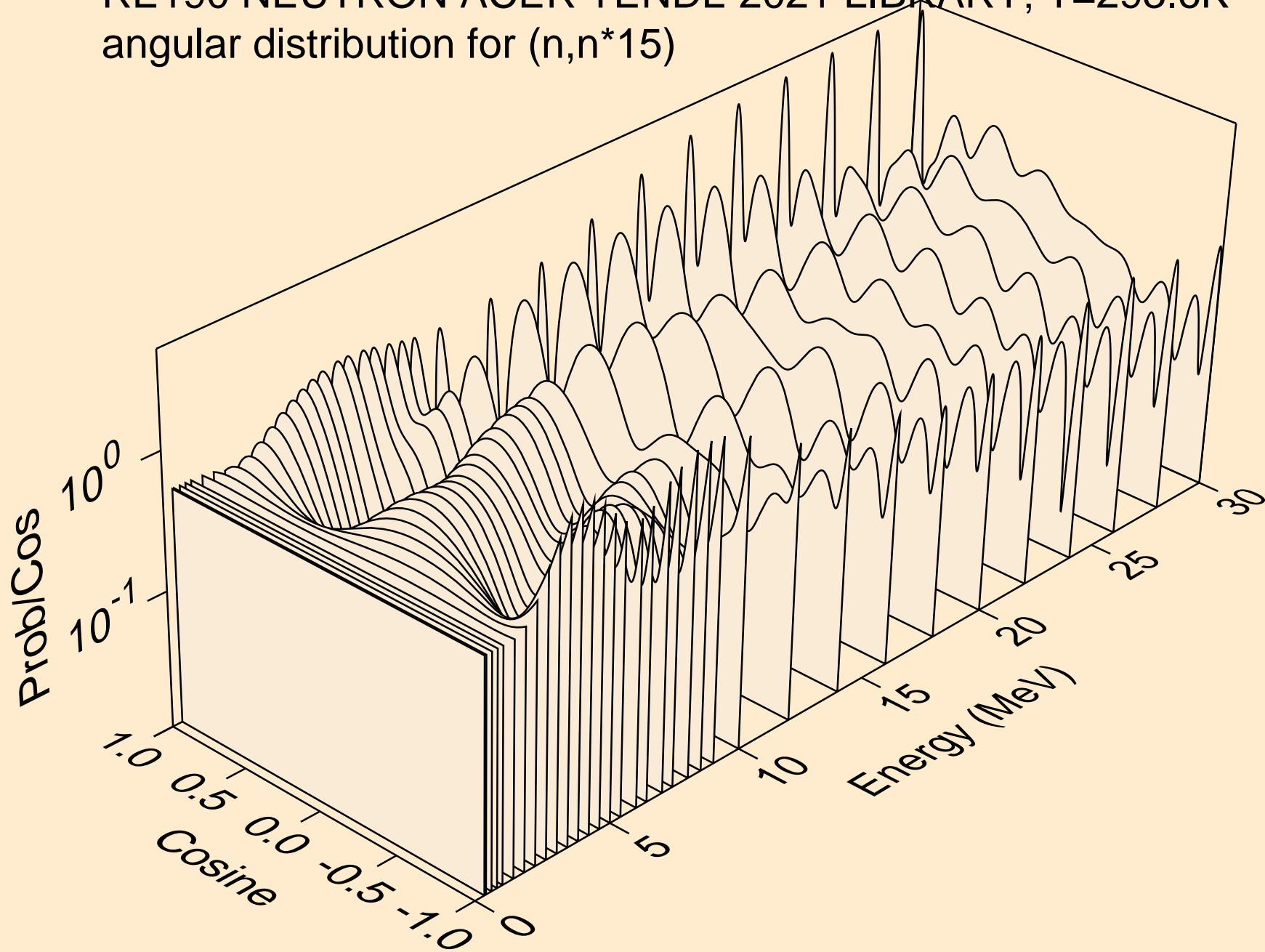

RE190 NEUTRON ACER TENDL-2021 LIBRARY; T=293.6K
angular distribution for (n,n*16)

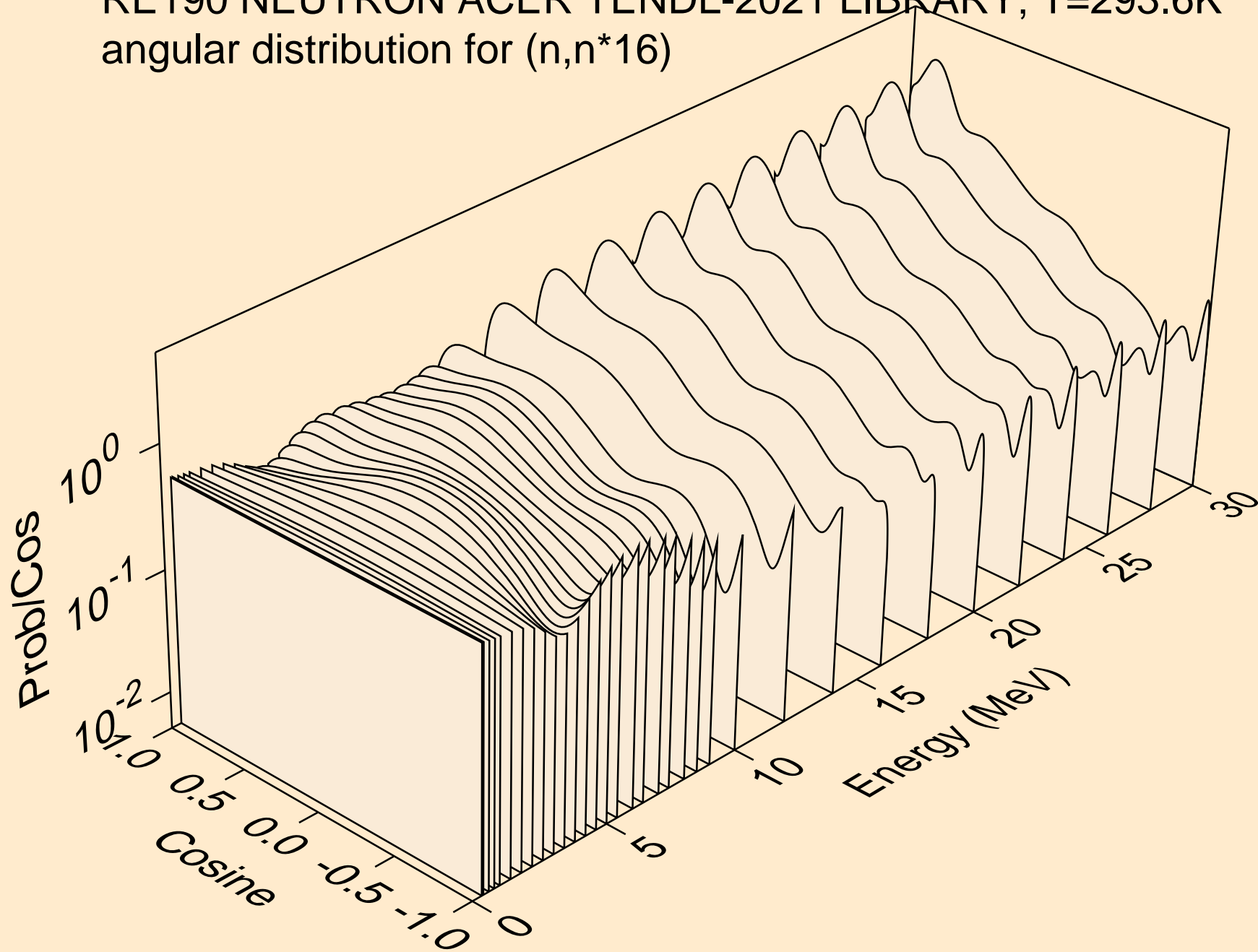

RE190 NEUTRON ACER TENDL-2021 LIBRARY; T=293.6K
angular distribution for (n,n*17)

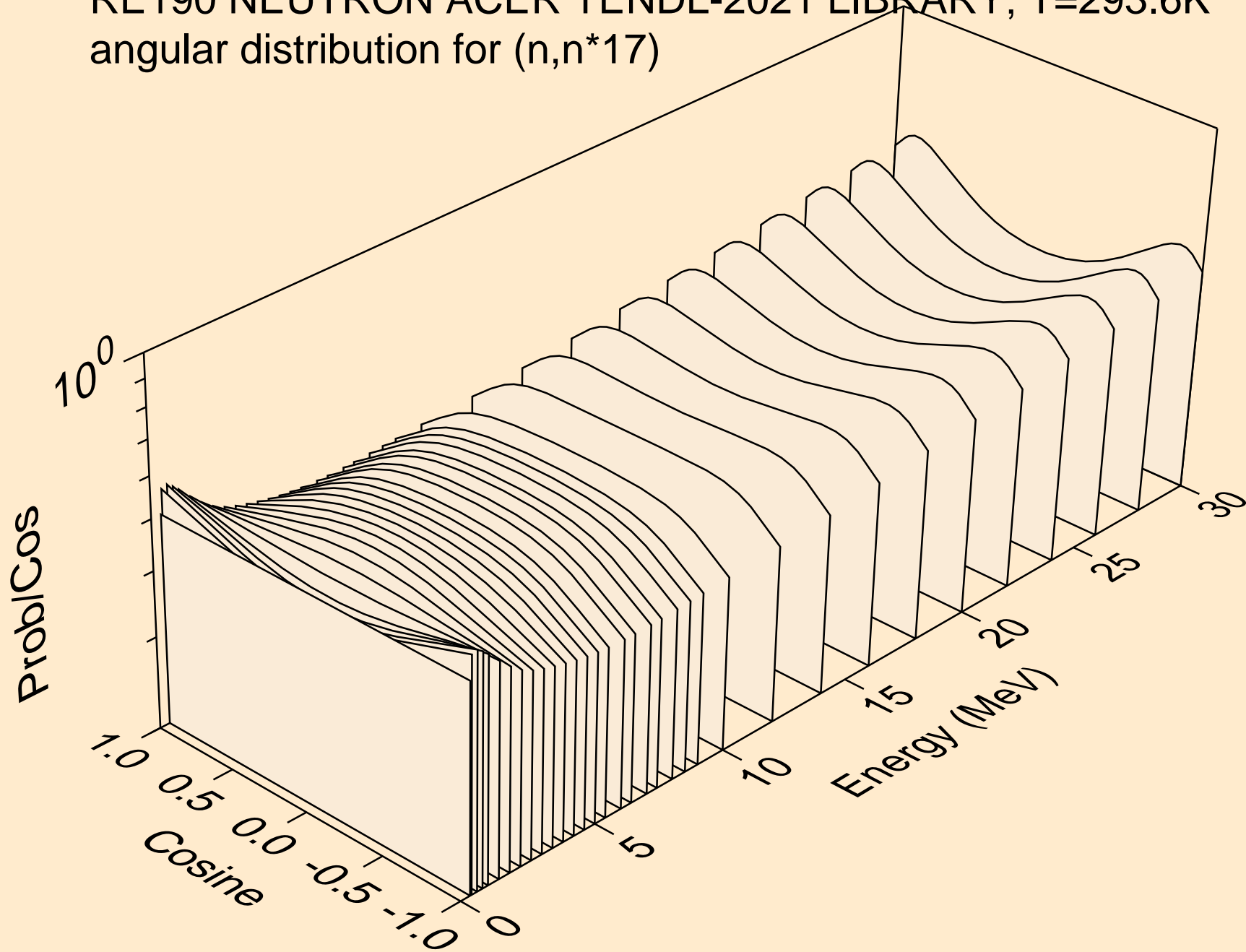

RE190 NEUTRON ACER TENDL-2021 LIBRARY; T=293.6K
angular distribution for (n,n*18)

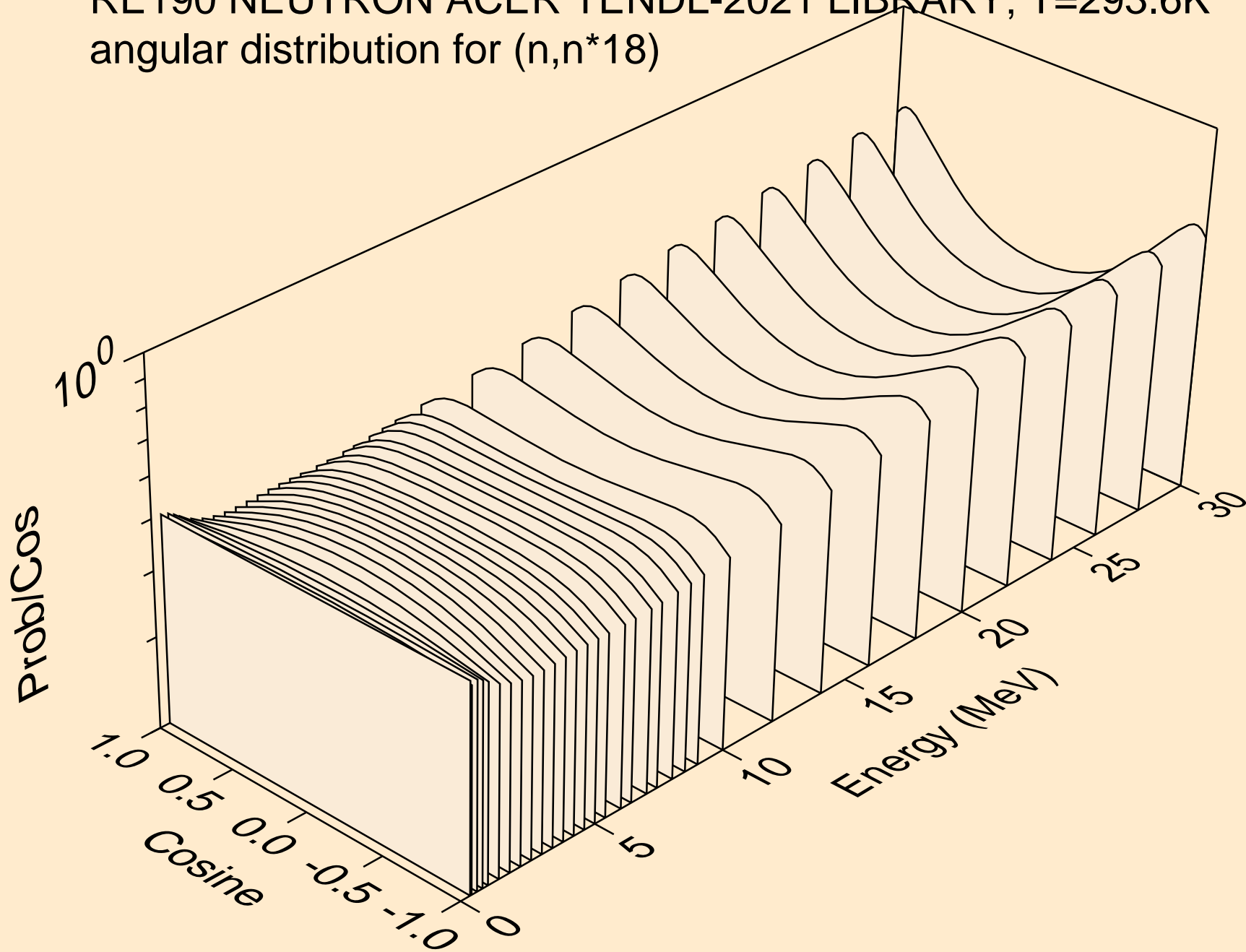

RE190 NEUTRON ACER TENDL-2021 LIBRARY; T=293.6K
angular distribution for (n,n*19)

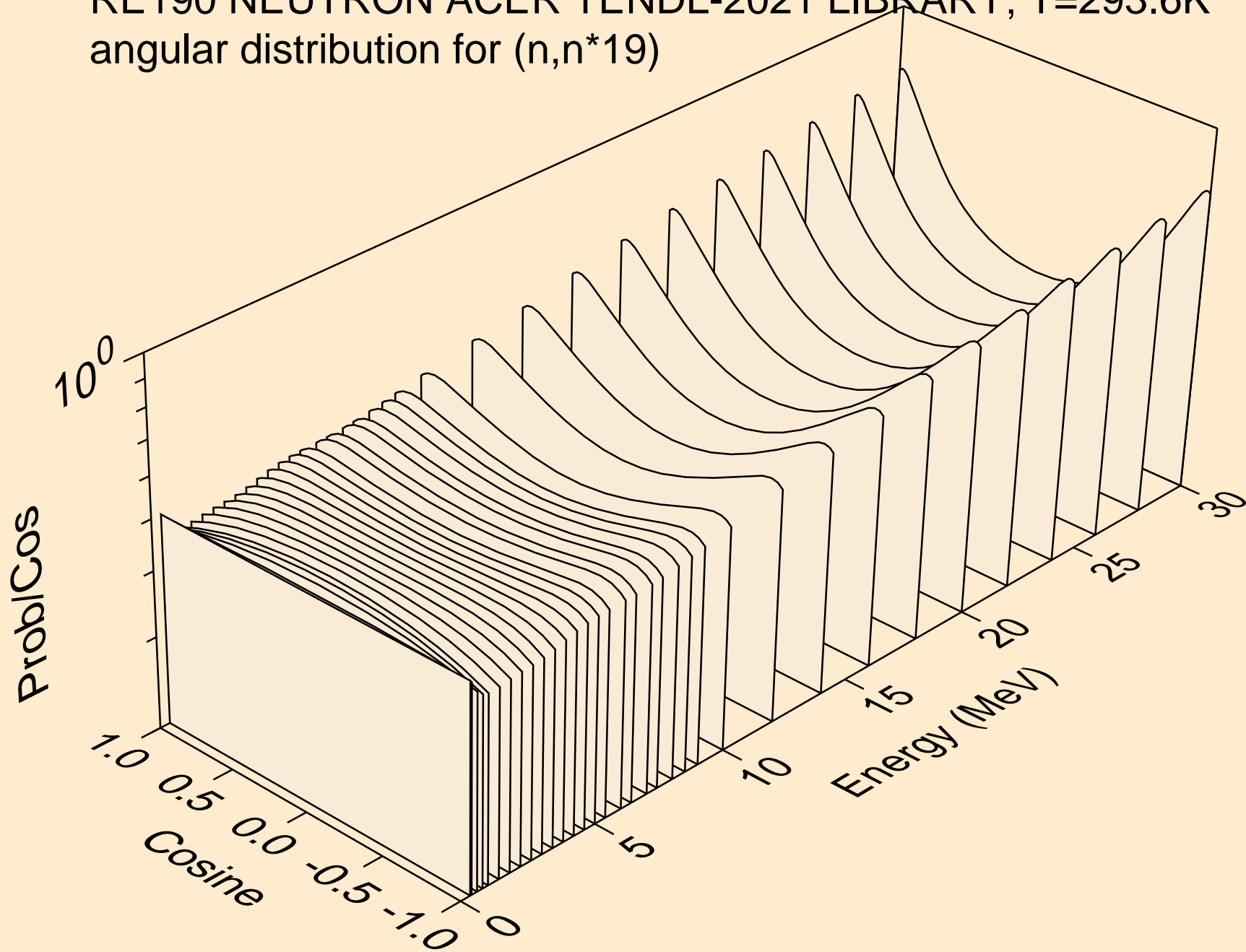

RE190 NEUTRON ACER TENDL-2021 LIBRARY; T=293.6K
angular distribution for (n,n*20)

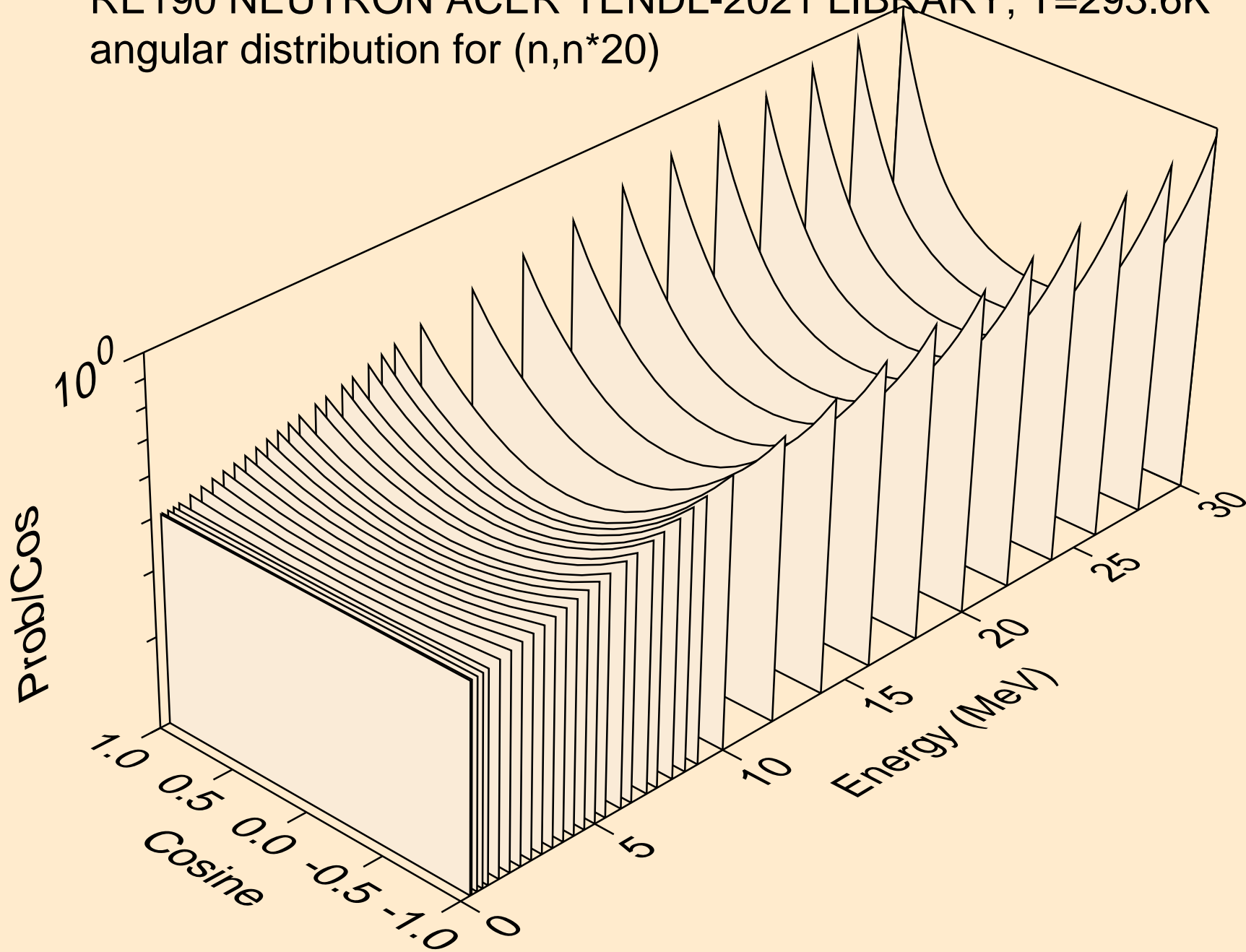

RE190 NEUTRON ACER TENDL-2021 LIBRARY; T=293.6K
angular distribution for (n,n*21)

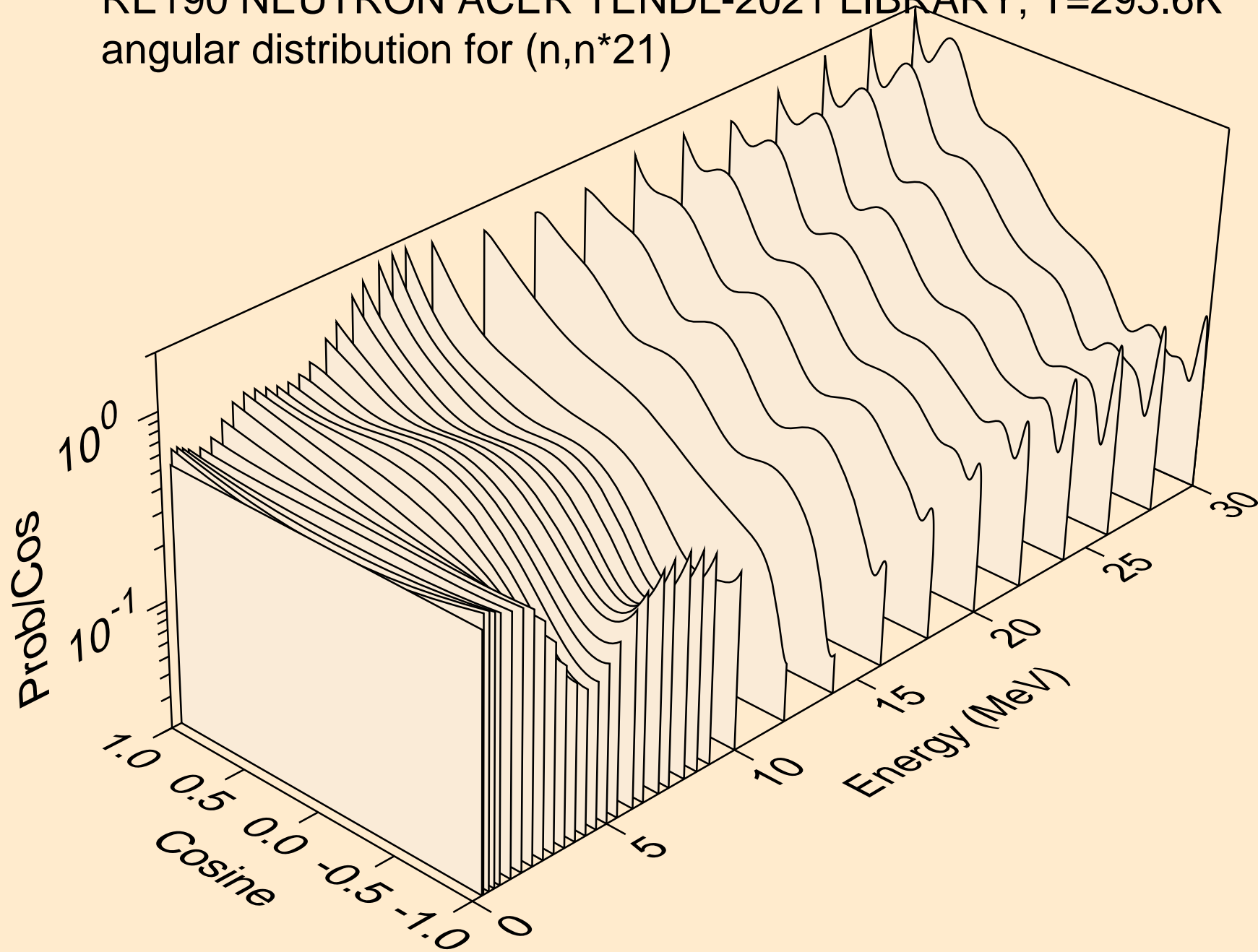

RE190 NEUTRON ACER TENDL-2021 LIBRARY; T=293.6K
angular distribution for (n,n*22)

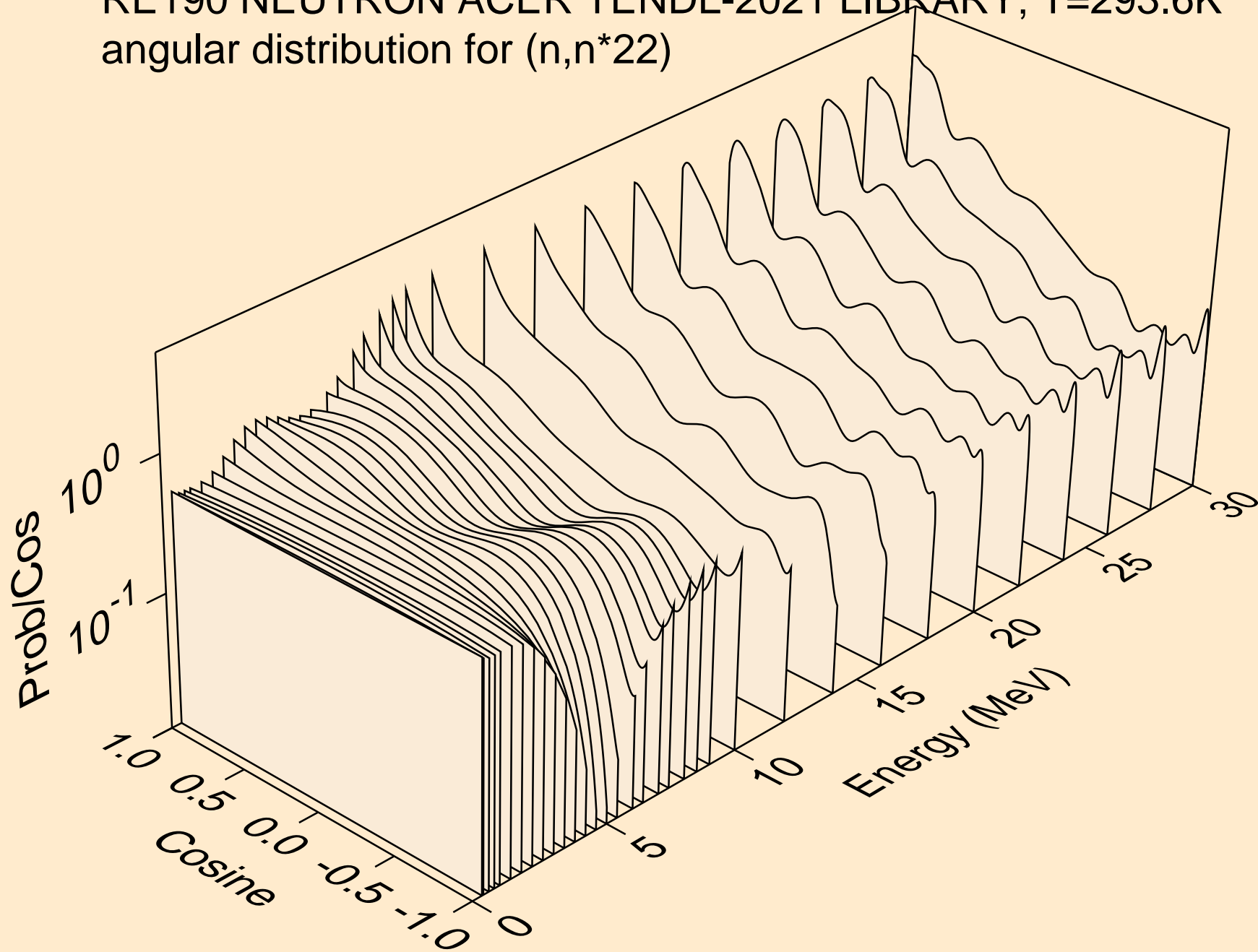

RE190 NEUTRON ACER TENDL-2021 LIBRARY; T=293.6K
angular distribution for (n,n*23)

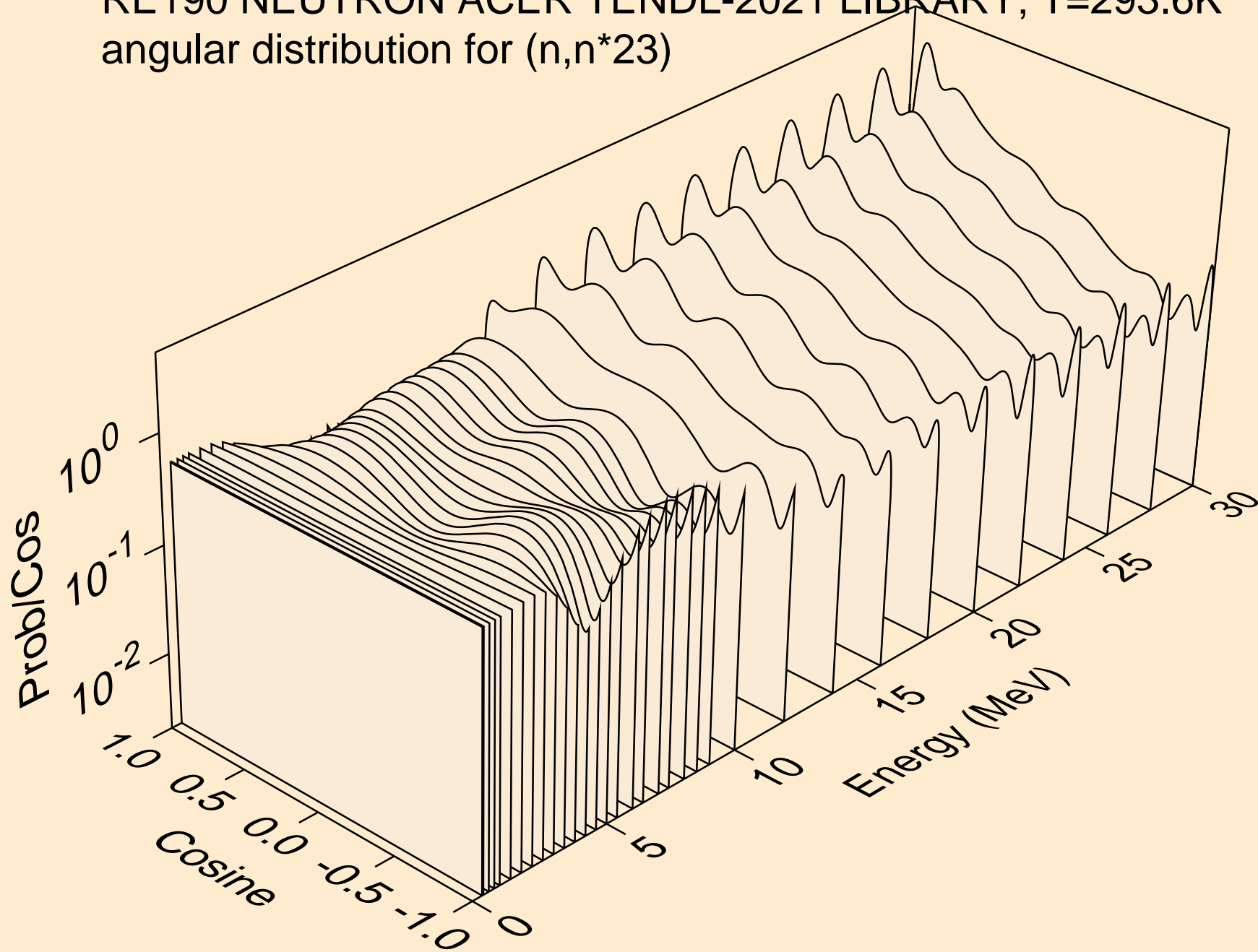

RE190 NEUTRON ACER TENDL-2021 LIBRARY; T=293.6K
angular distribution for (n,n*24)

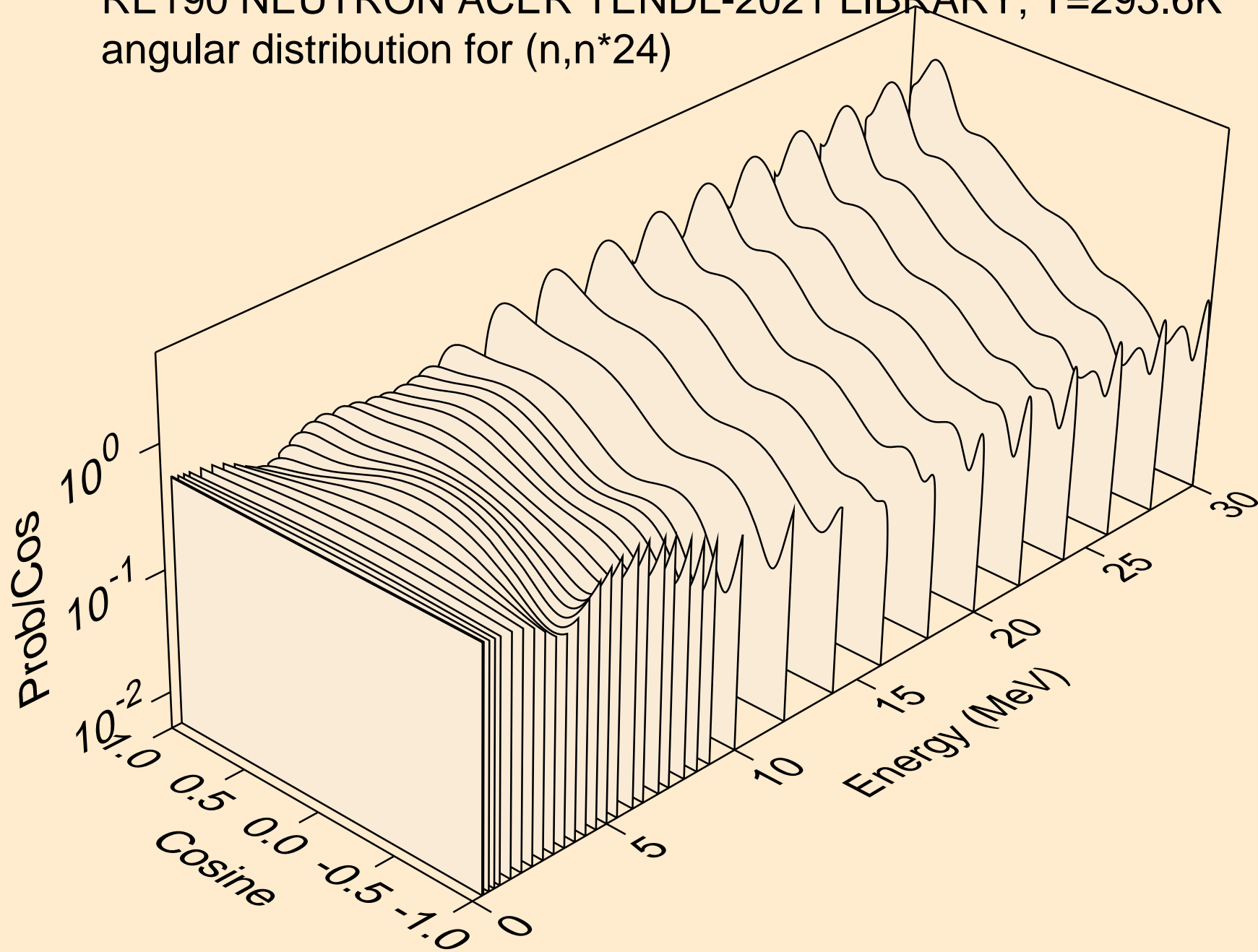

RE190 NEUTRON ACER TENDL-2021 LIBRARY; T=293.6K
angular distribution for (n,n*25)

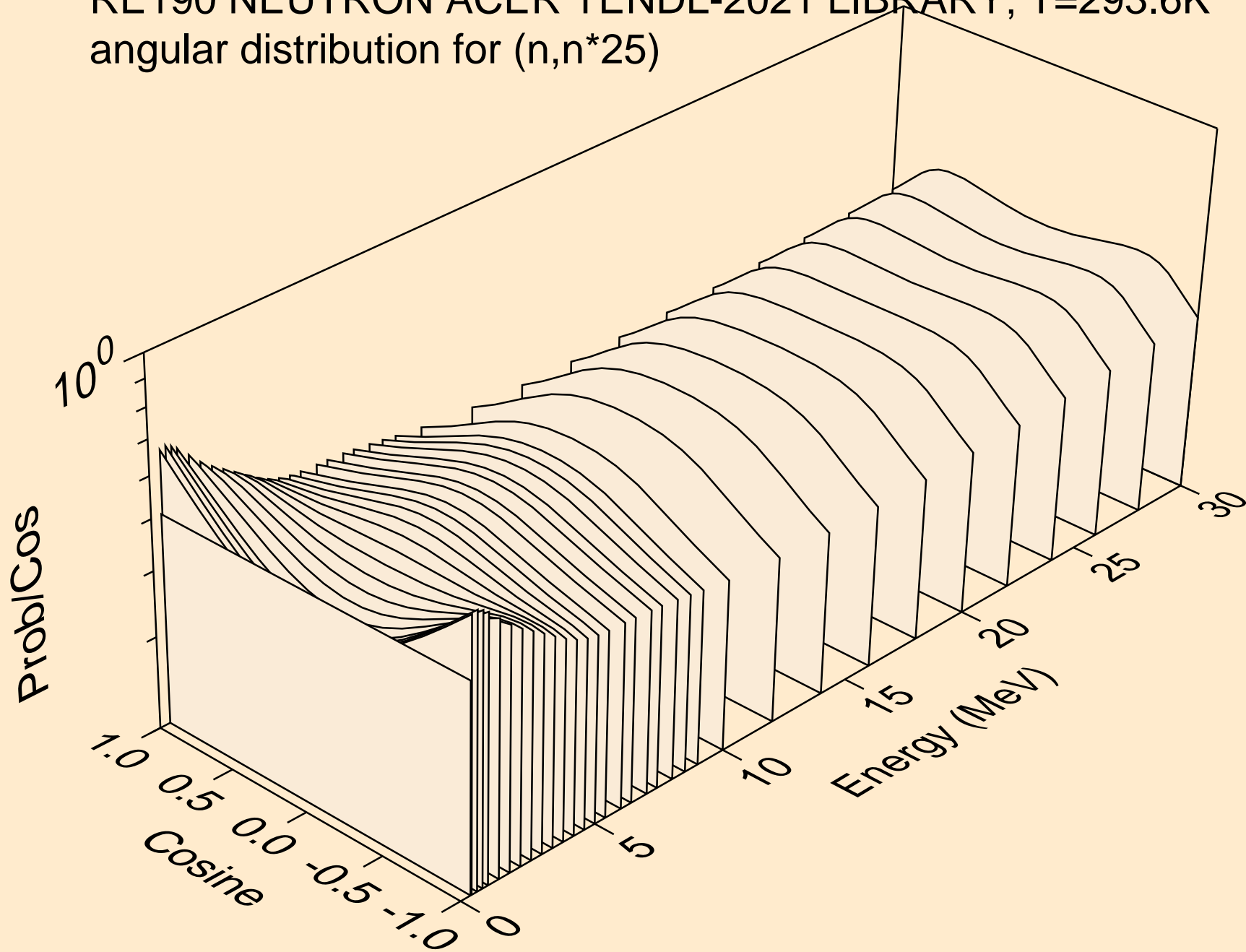

RE190 NEUTRON ACER TENDL-2021 LIBRARY; T=293.6K
angular distribution for (n,n*26)

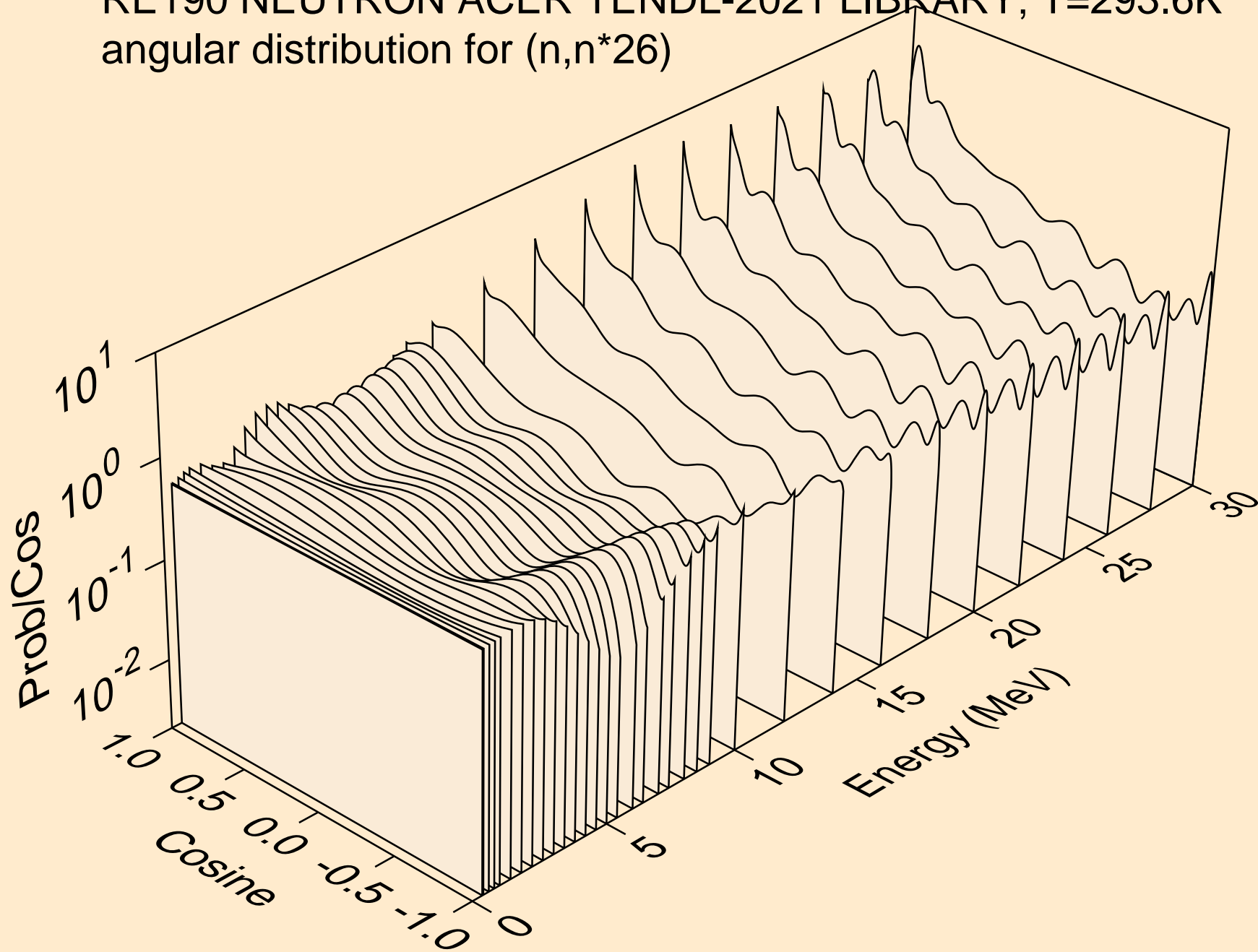

RE190 NEUTRON ACER TENDL-2021 LIBRARY; T=293.6K
angular distribution for (n,n*27)

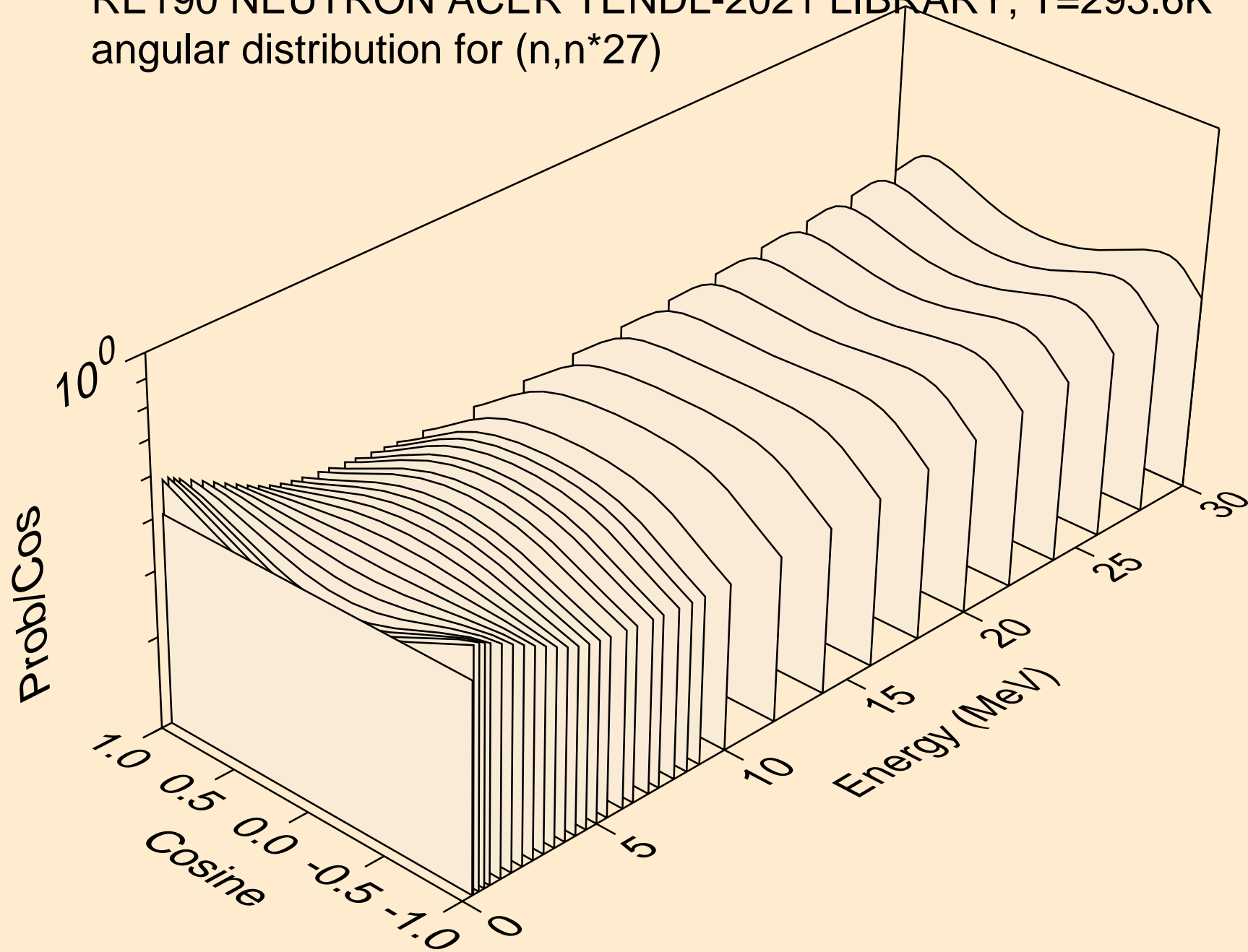

RE190 NEUTRON ACER TENDL-2021 LIBRARY; T=293.6K
angular distribution for (n,n*28)

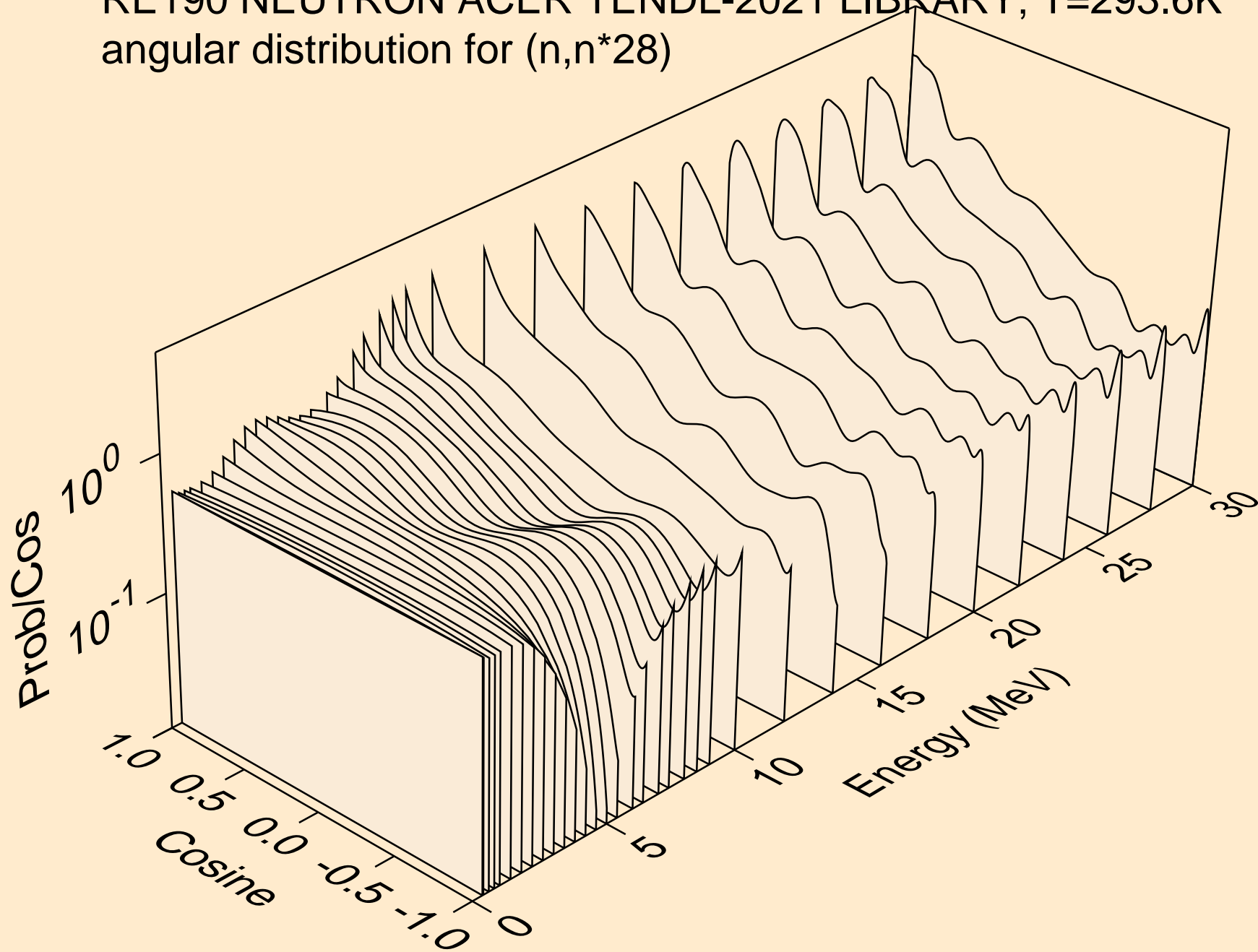

RE190 NEUTRON ACER TENDL-2021 LIBRARY; T=293.6K
Neutron emission for (n,x)

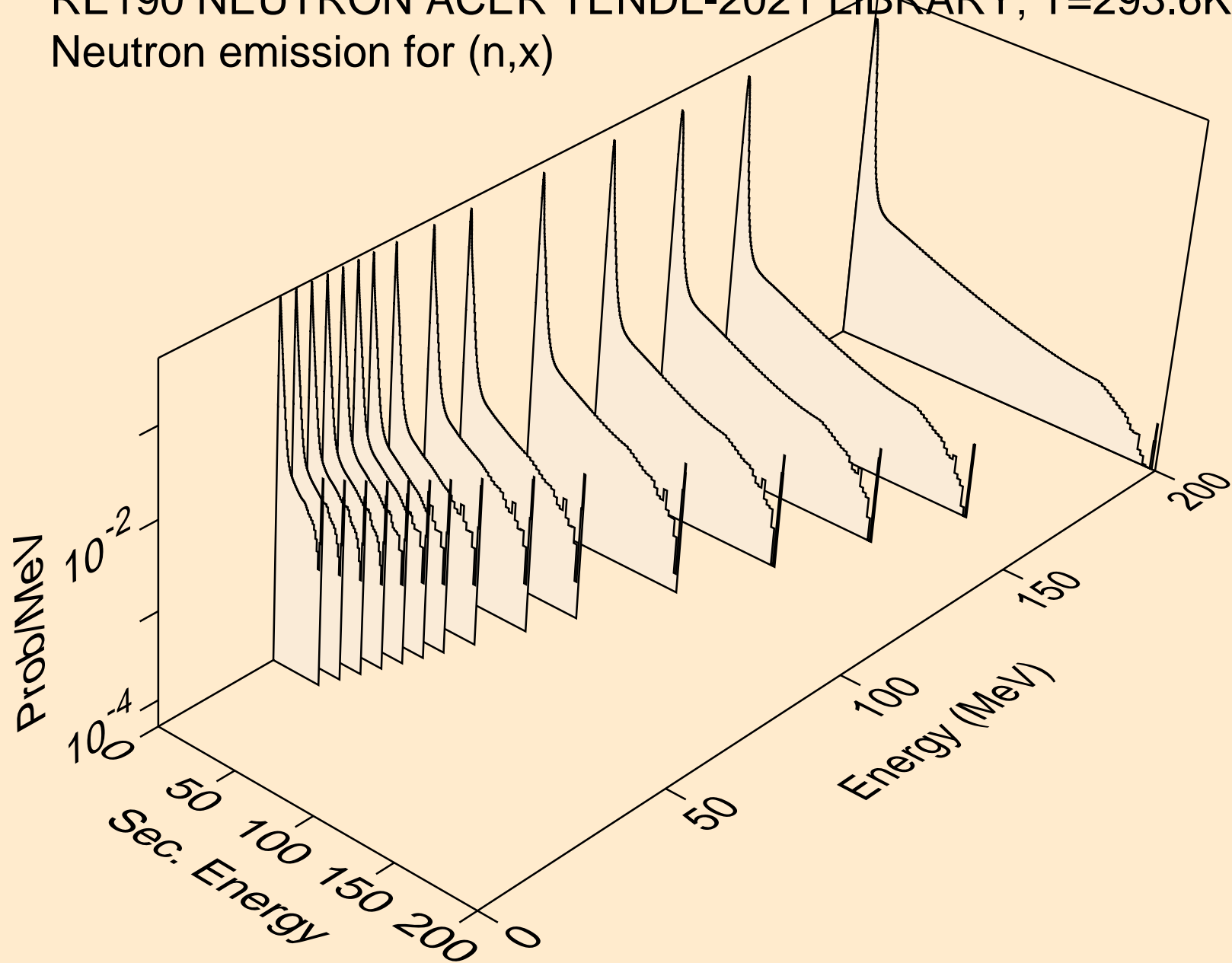

RE190 NEUTRON ACER TENDL-2021 LIBRARY; T=293.6K
Neutron emission for (n,2nd)

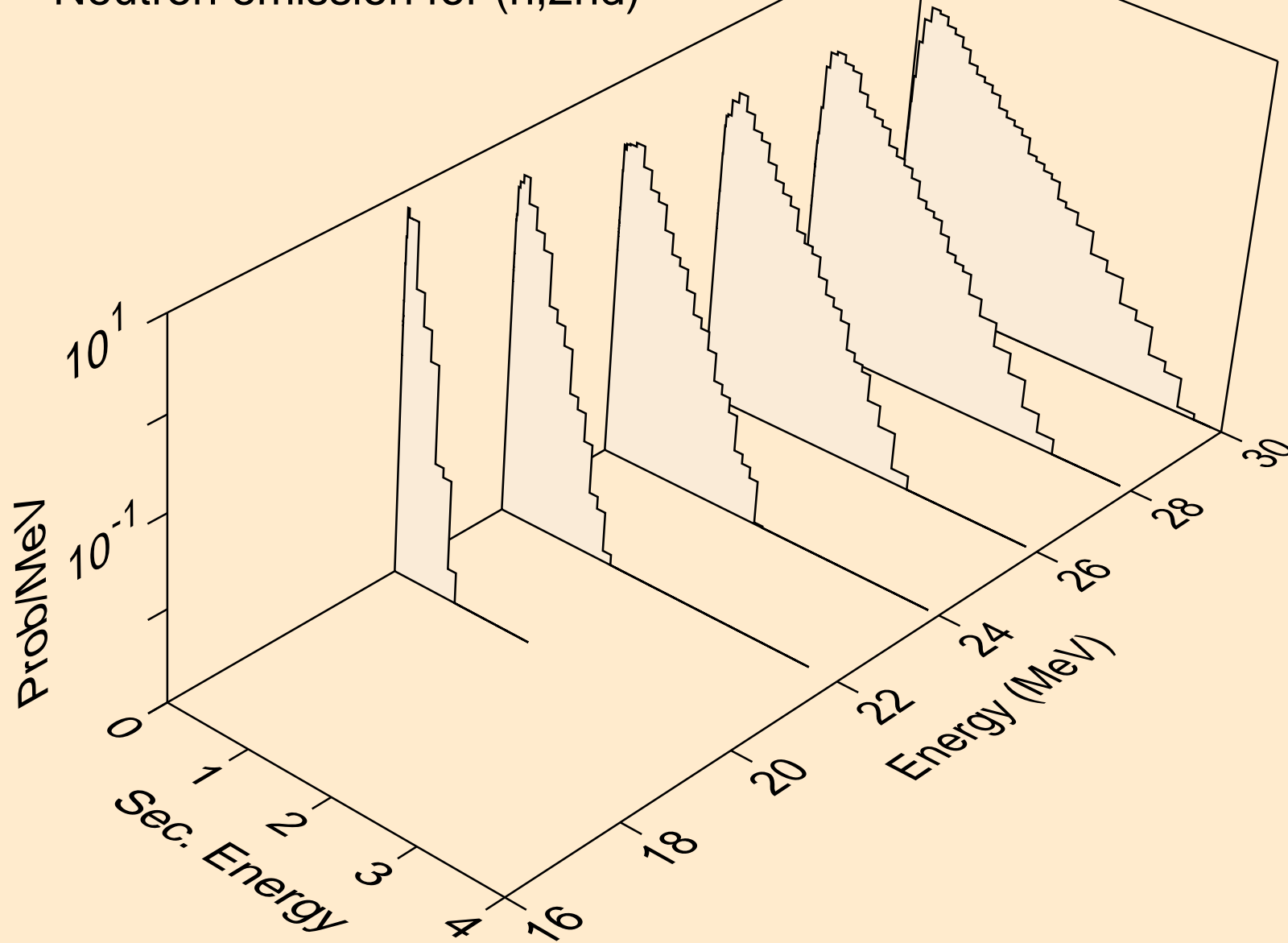

RE190 NEUTRON ACER TENDL-2021 LIBRARY; T=293.6K
Neutron emission for (n,2n)

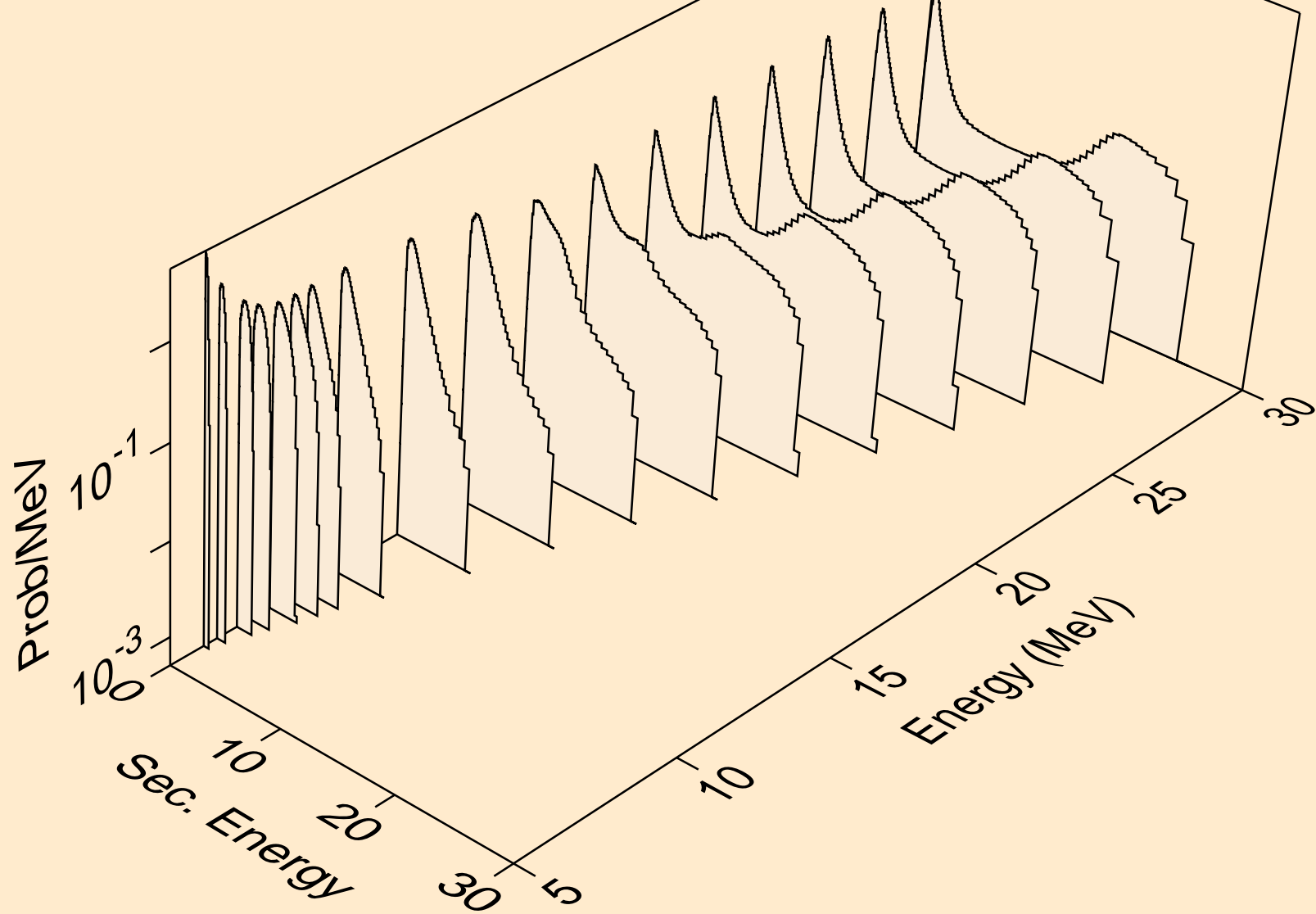

RE190 NEUTRON ACER TENDL-2021 LIBRARY; T=293.6K
Neutron emission for (n,3n)

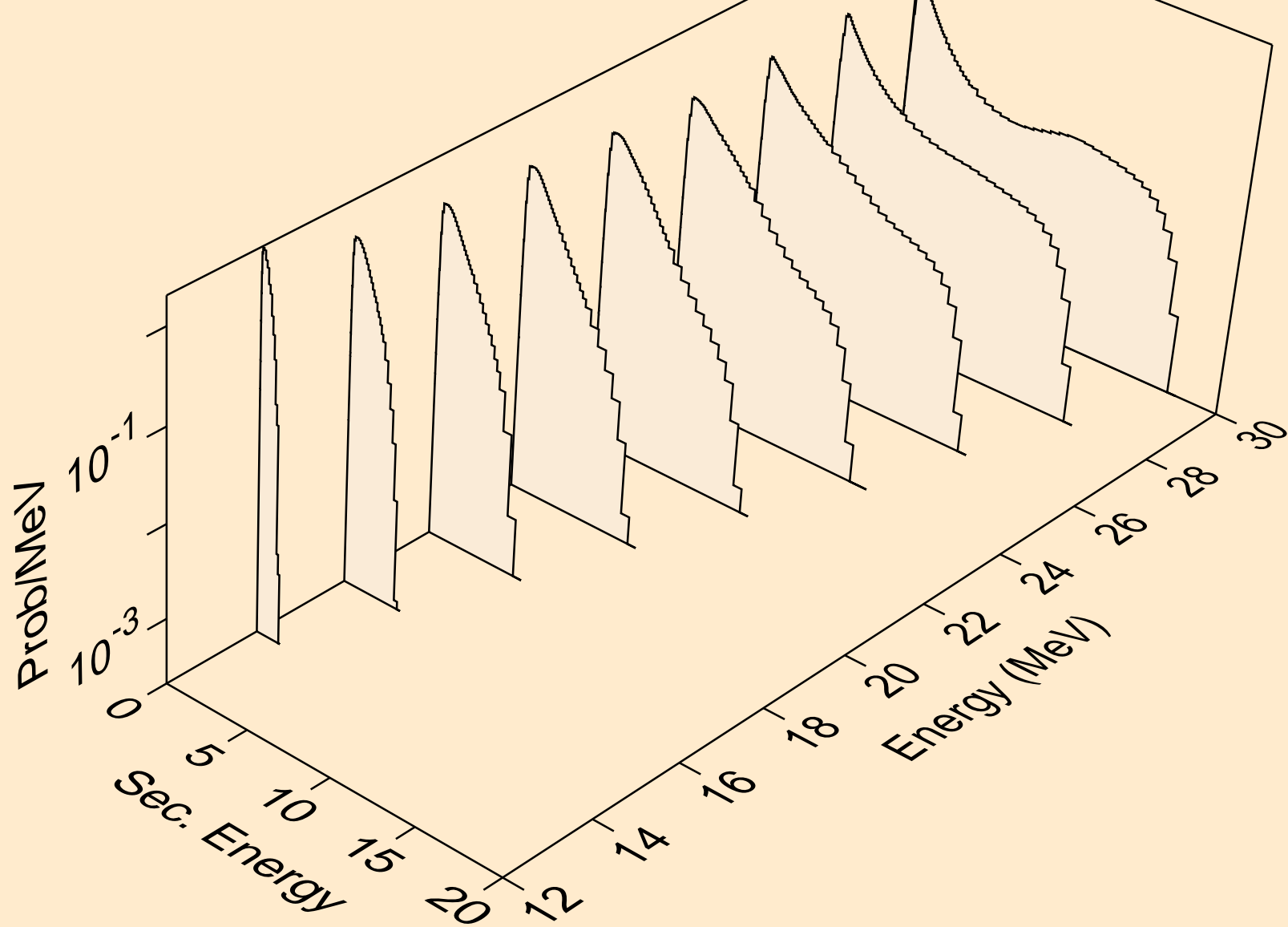

RE190 NEUTRON ACER TENDL-2021 LIBRARY; T=293.6K
Neutron emission for (n,n*)a

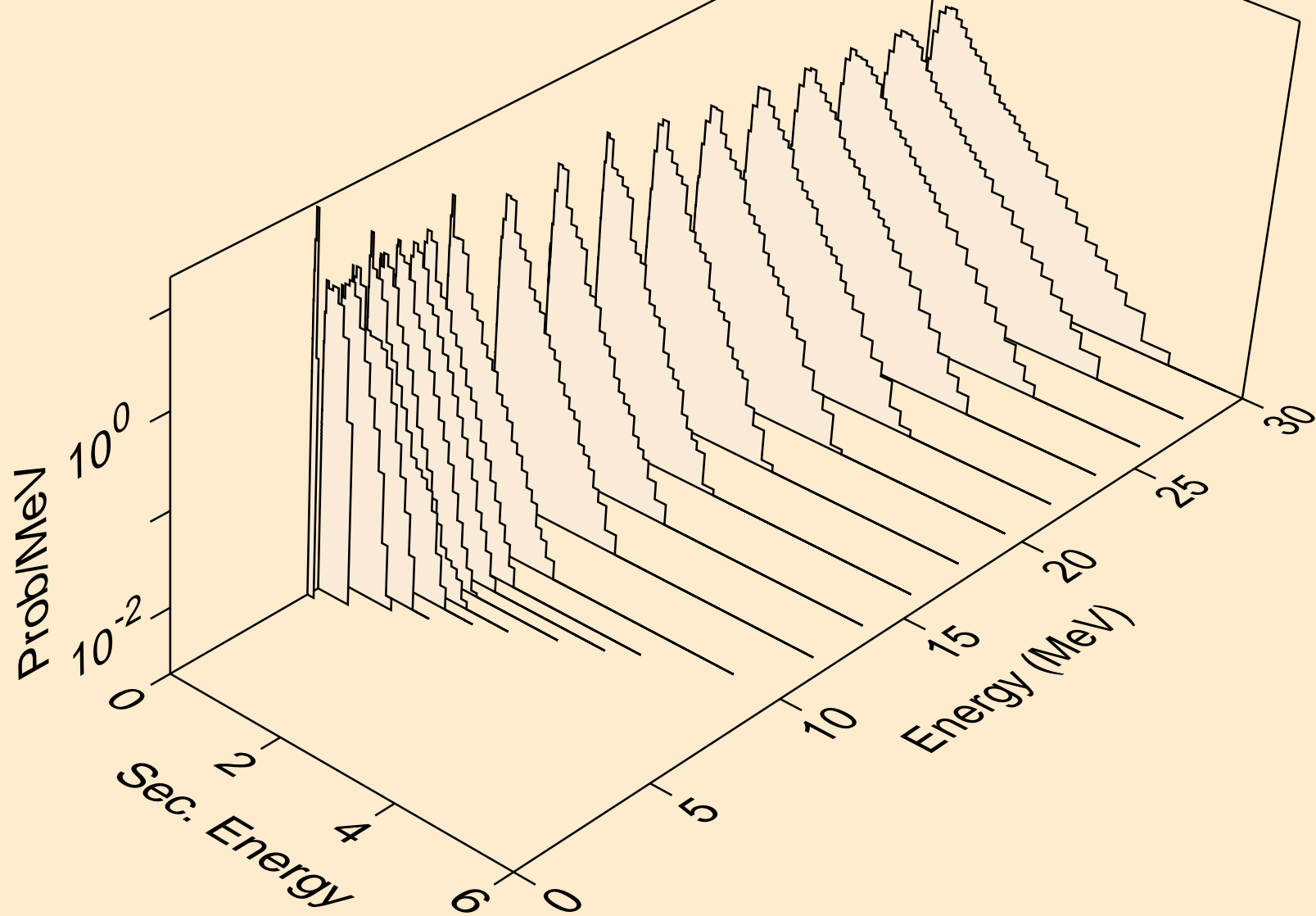

RE190 NEUTRON ACER TENDL-2021 LIBRARY; T=293.6K
Neutron emission for (n,2n)a

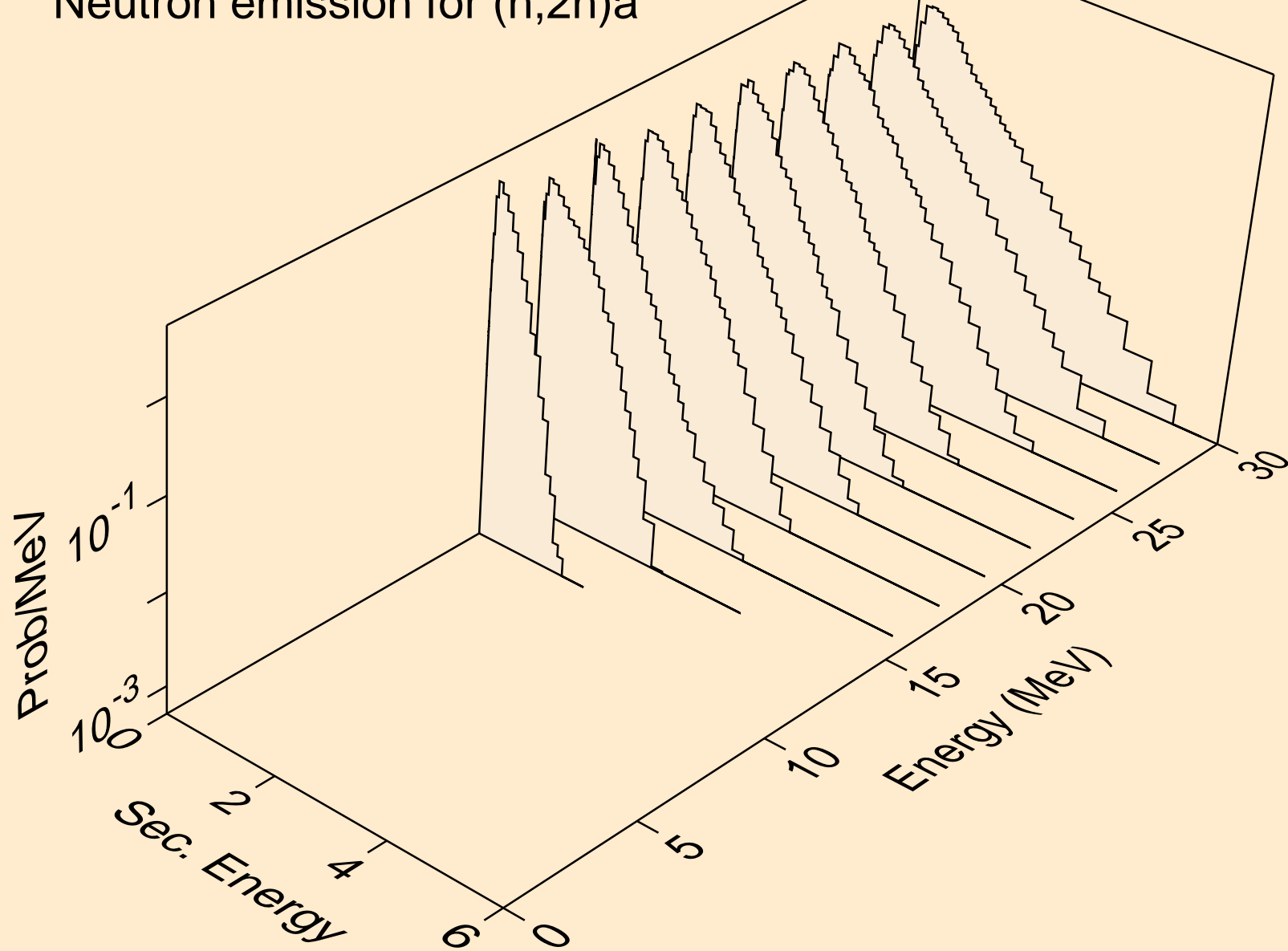

RE190 NEUTRON ACER TENDL-2021 LIBRARY; T=293.6K
Neutron emission for (n,3n)a

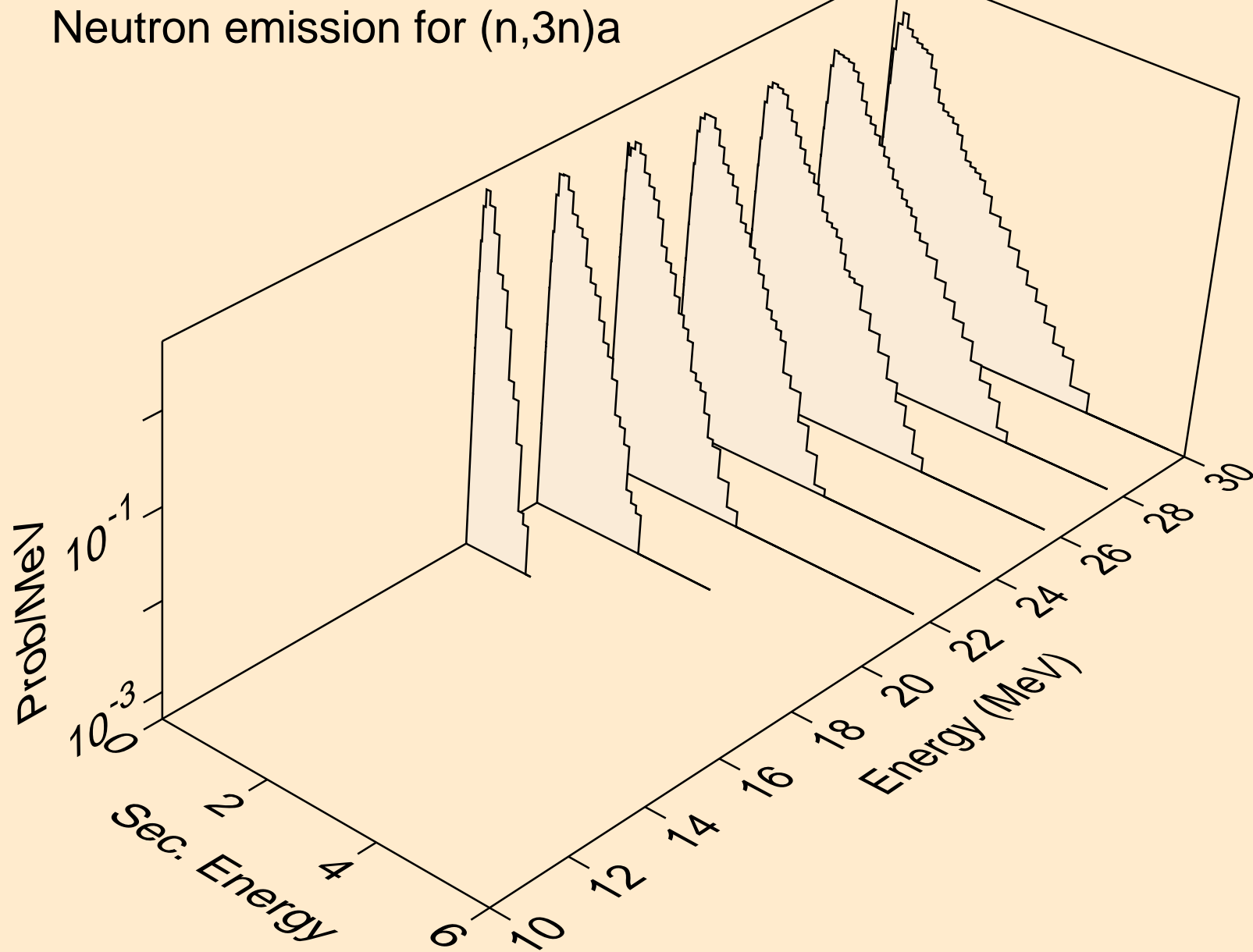

RE190 NEUTRON ACER TENDL-2021 LIBRARY; T=293.6K
Neutron emission for (n,n*)p

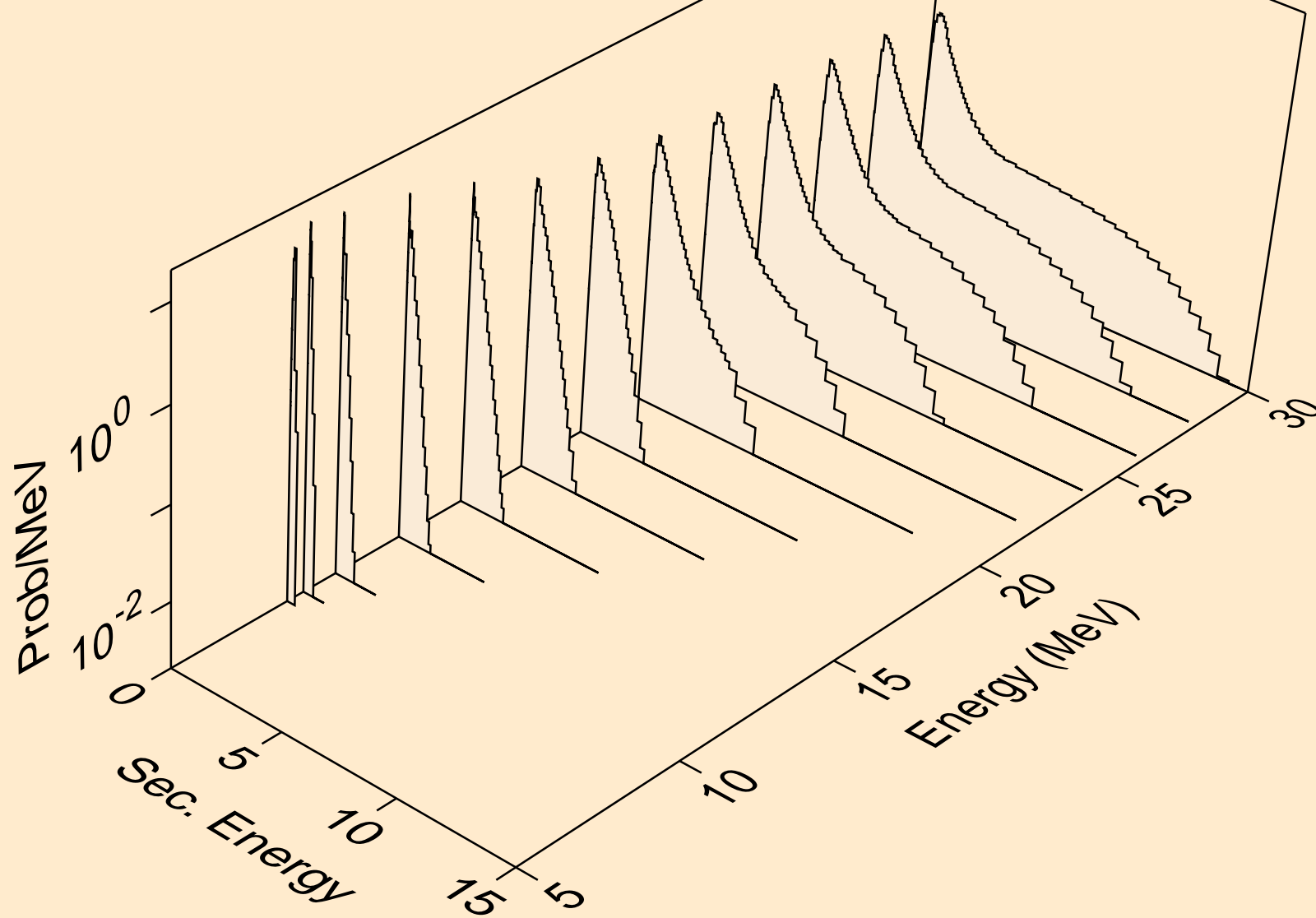

RE190 NEUTRON ACER TENDL-2021 LIBRARY; T=293.6K
Neutron emission for (n,n*)d

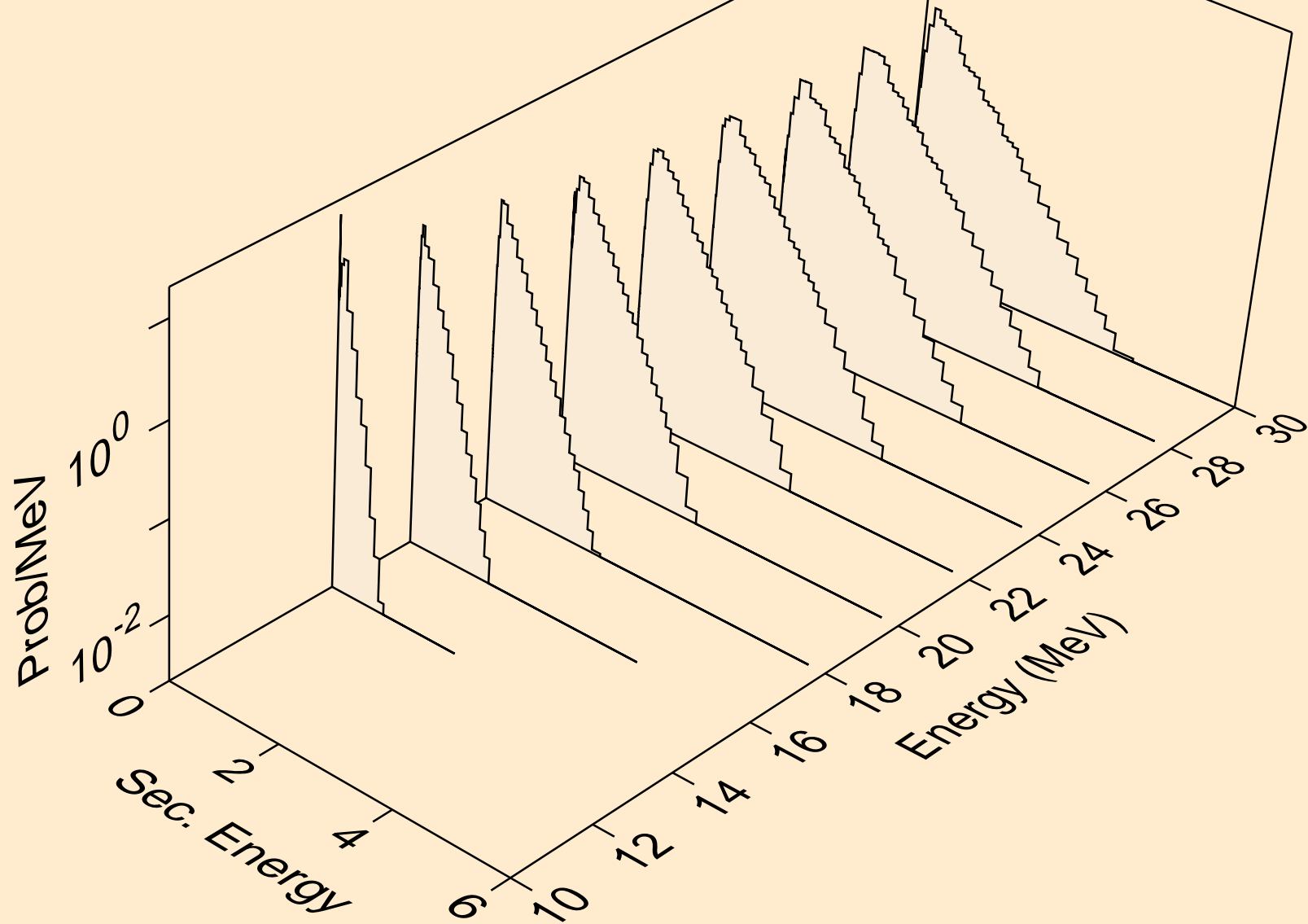

RE190 NEUTRON ACER TENDL-2021 LIBRARY; T=293.6K
Neutron emission for (n,n*)t

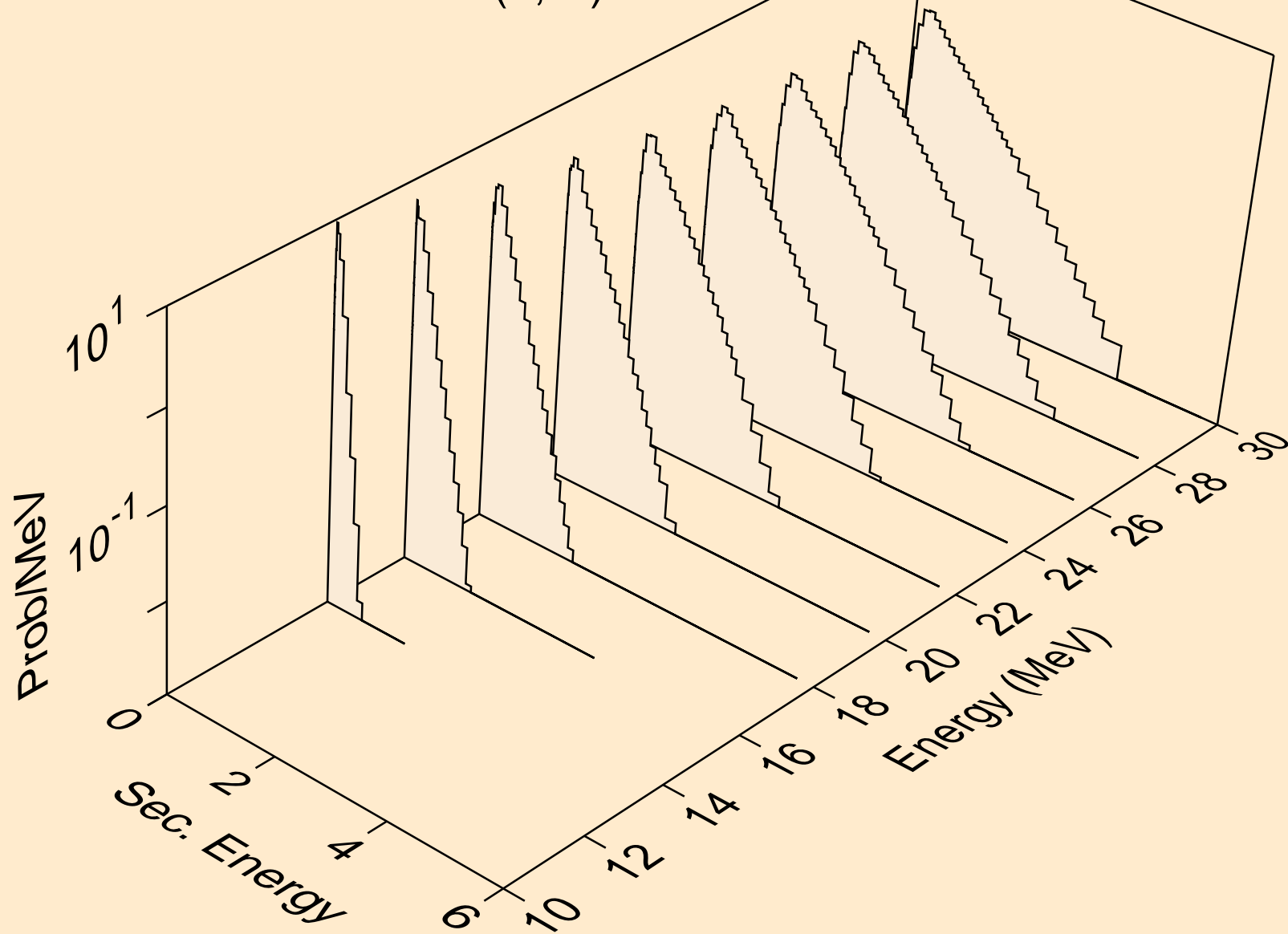

RE190 NEUTRON ACER TENDL-2021 LIBRARY; T=293.6K
Neutron emission for (n,n*)he3

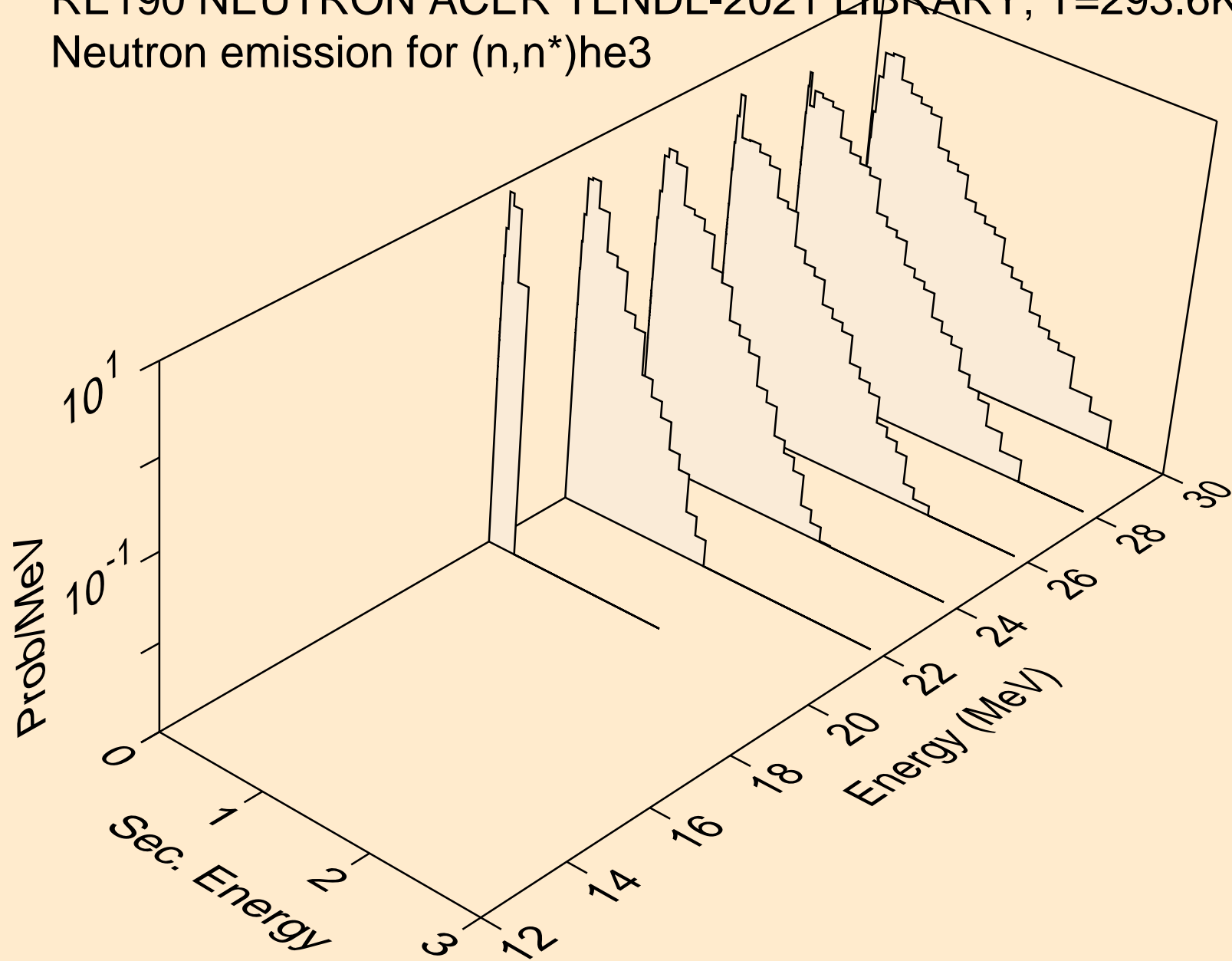

RE190 NEUTRON ACER TENDL-2021 LIBRARY; T=293.6K
Neutron emission for (n,4n)

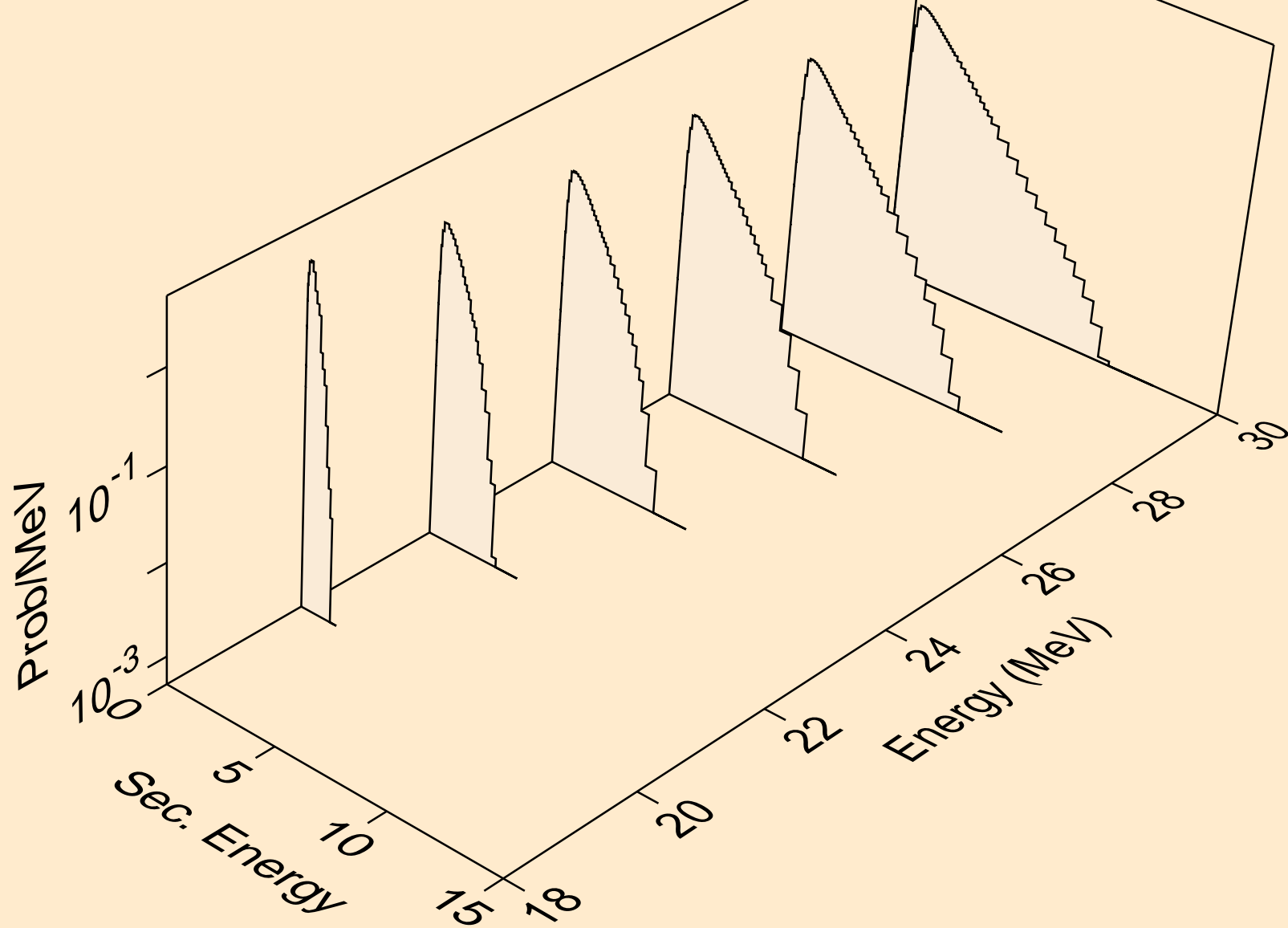

RE190 NEUTRON ACER TENDL-2021 LIBRARY; T=293.6K
Neutron emission for (n,2np)

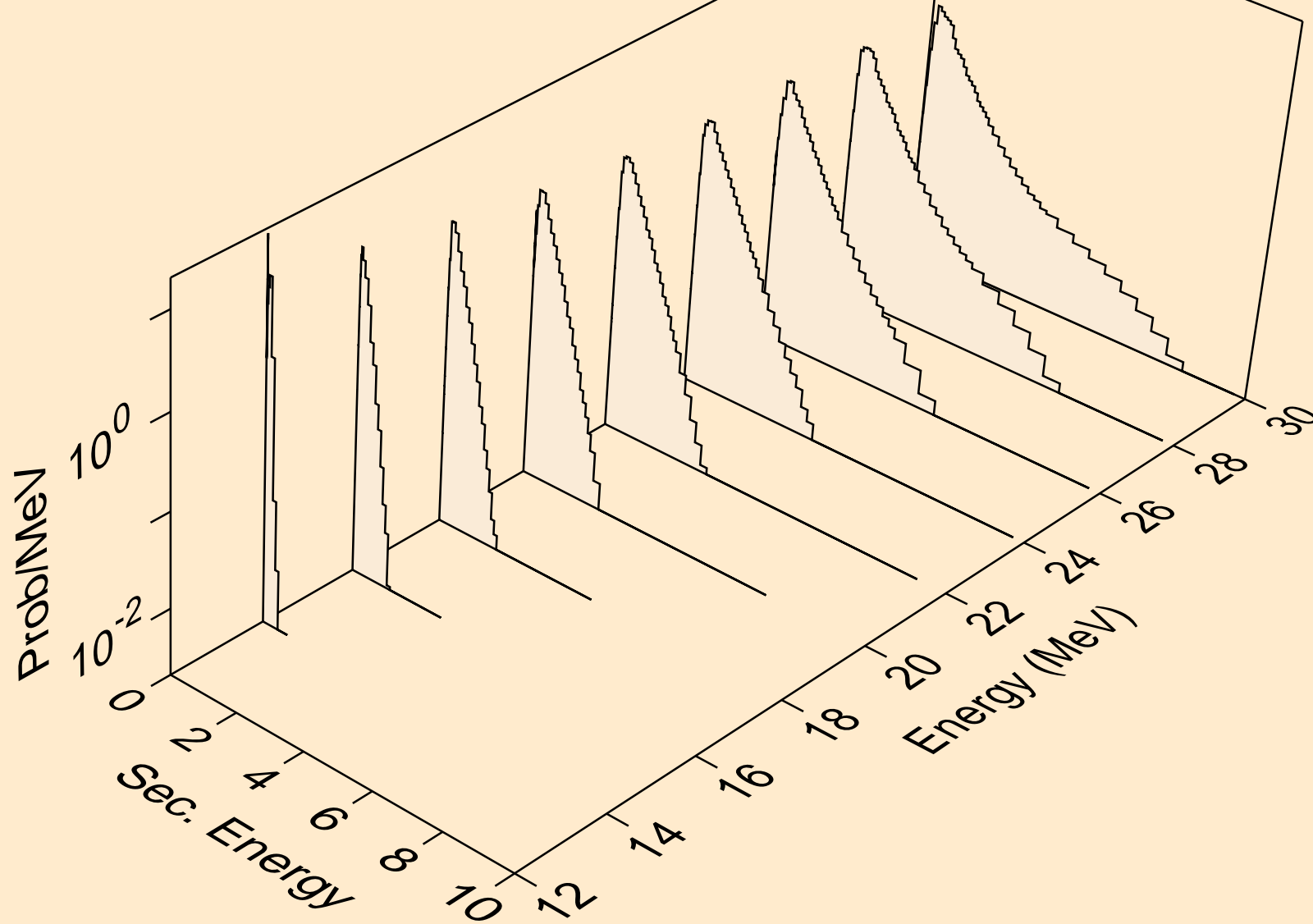

RE190 NEUTRON ACER TENDL-2021 LIBRARY; T=293.6K
Neutron emission for (n,3np)

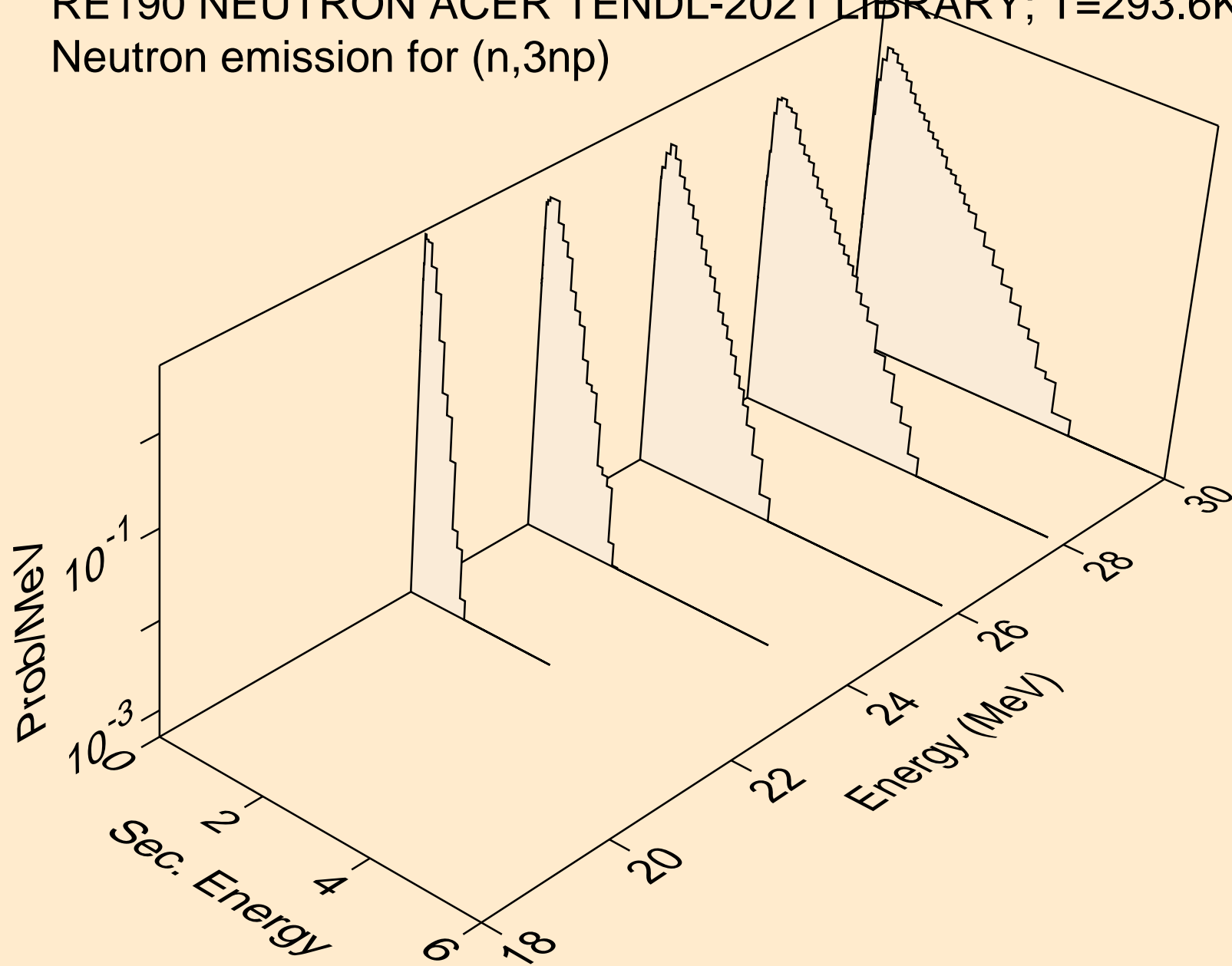

RE190 NEUTRON ACER TENDL-2021 LIBRARY; T=293.6K
Neutron emission for (n,2np)

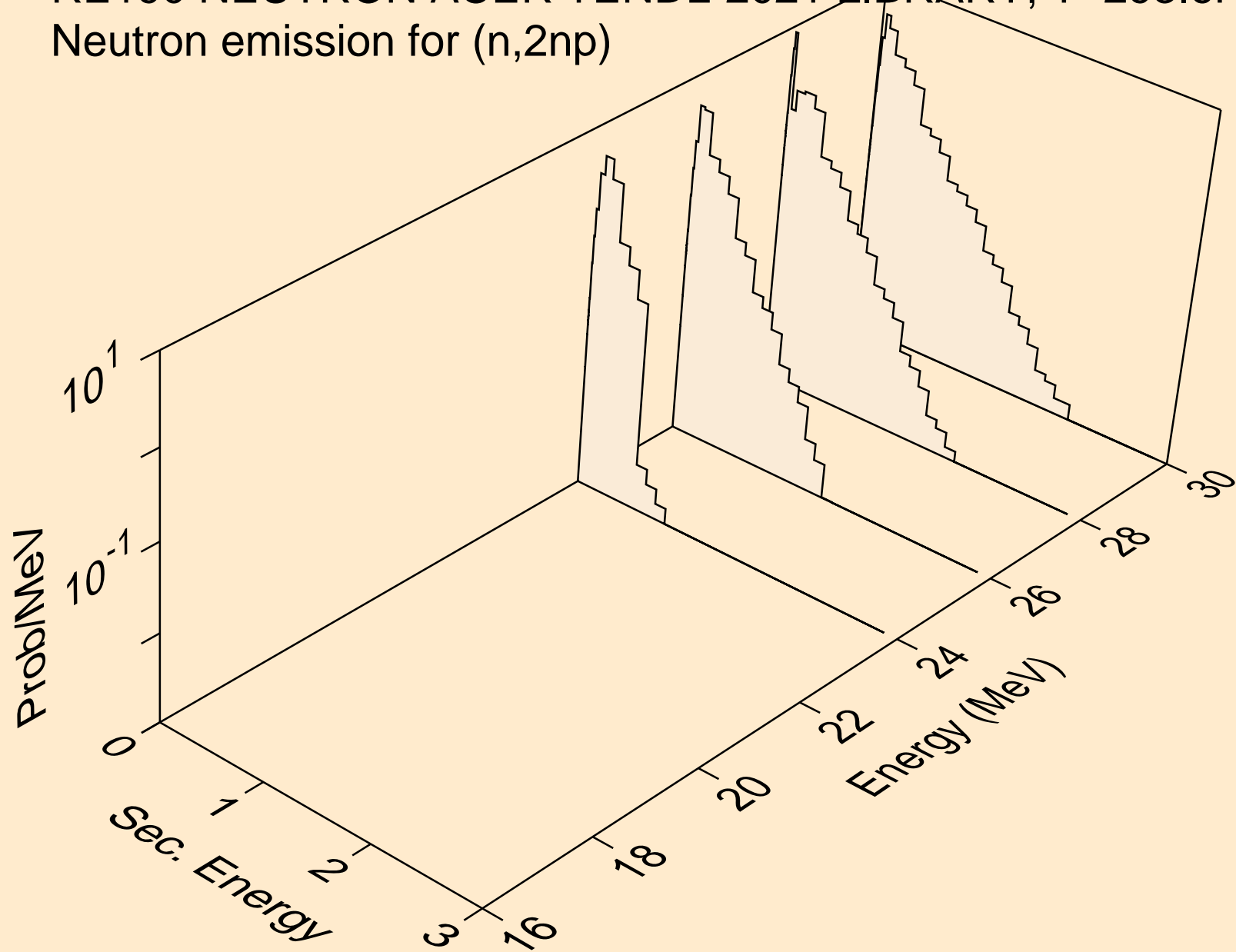

RE190 NEUTRON ACER TENDL-2021 LIBRARY; T=293.6K
Neutron emission for (n,n*c)

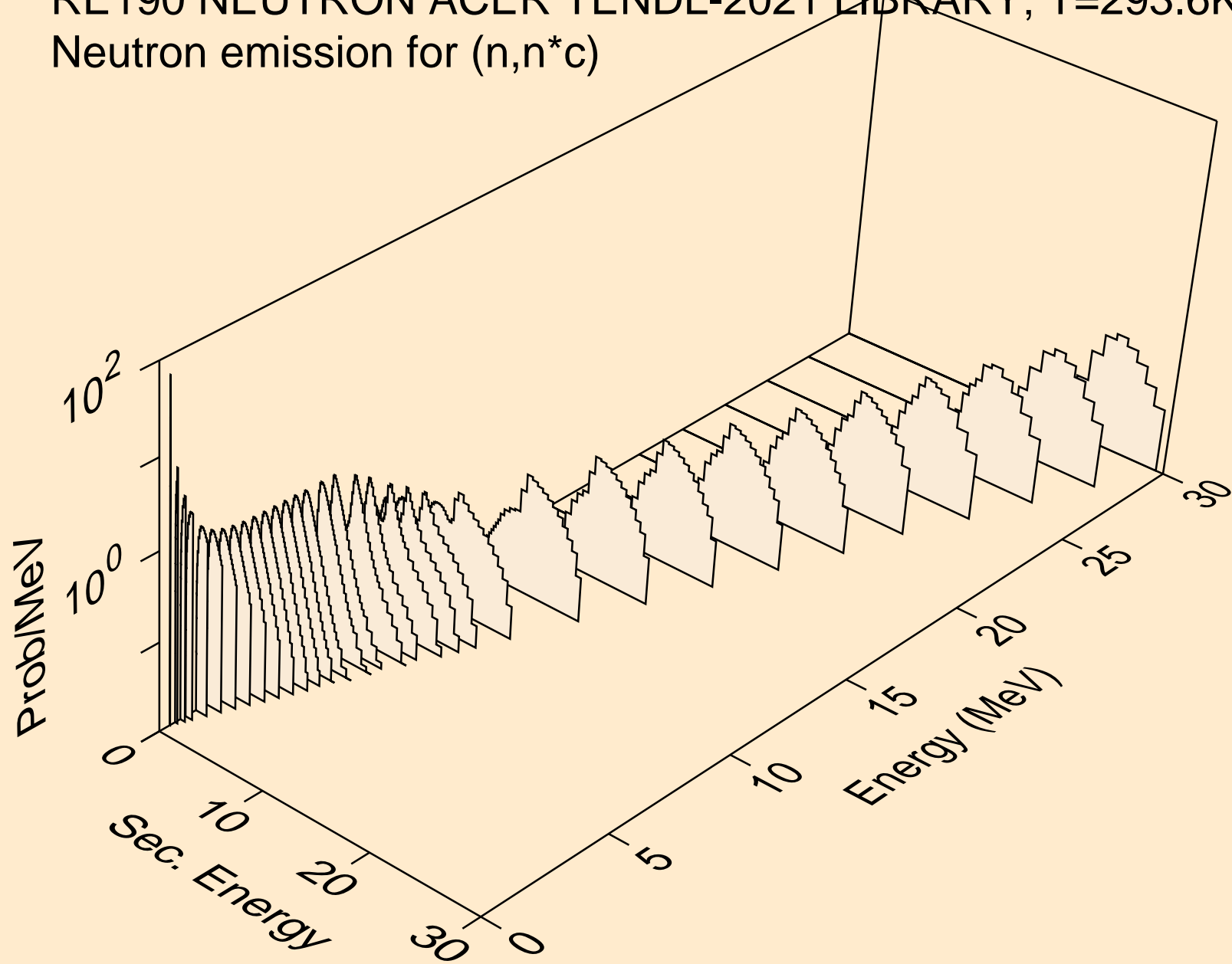

RE190 NEUTRON ACER TENDL-2021 LIBRARY; T=293.6K
Photon emission for (n,x)

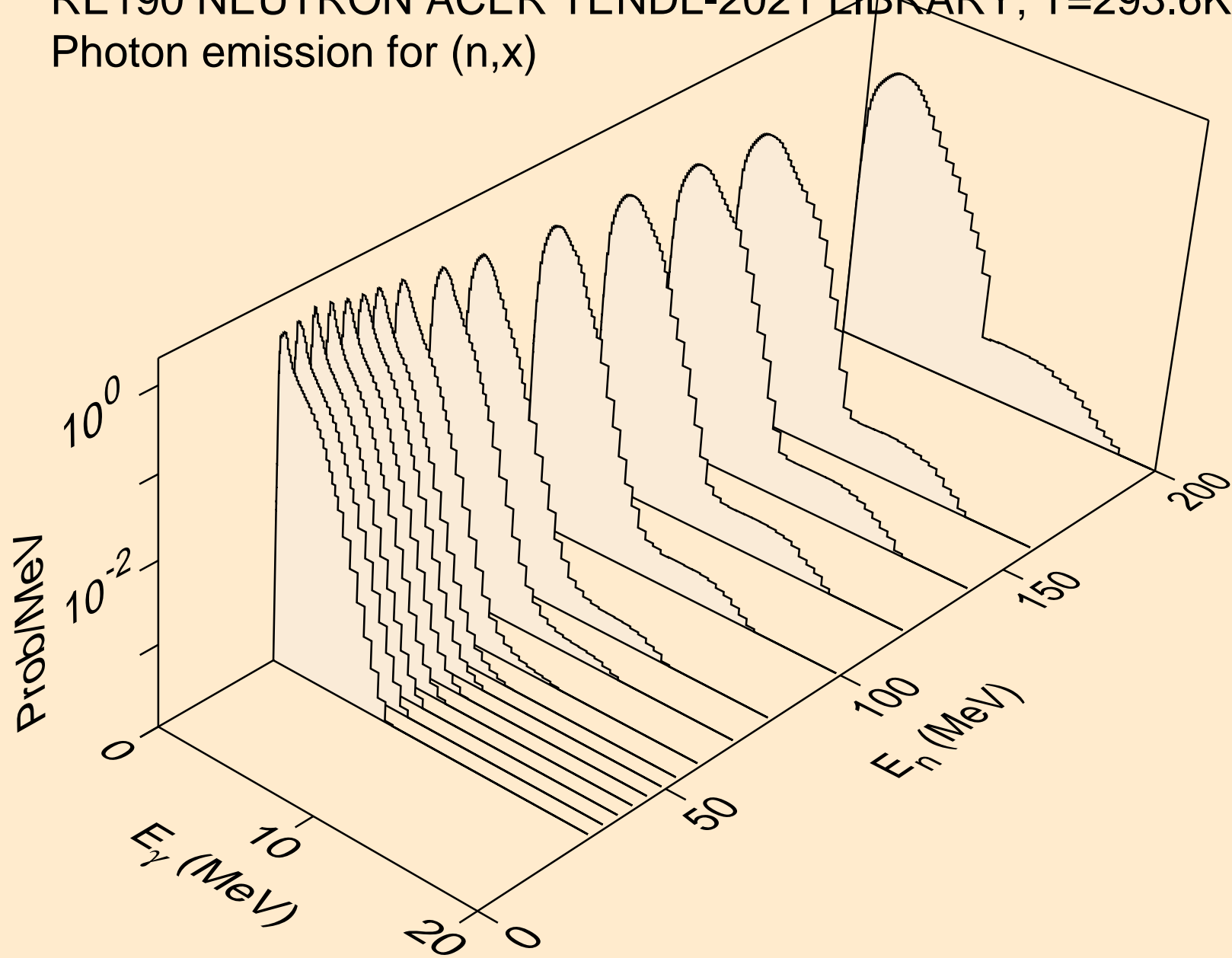

RE190 NEUTRON ACER TENDL-2021 LIBRARY; T=293.6K
Photon emission for (n,2nd)

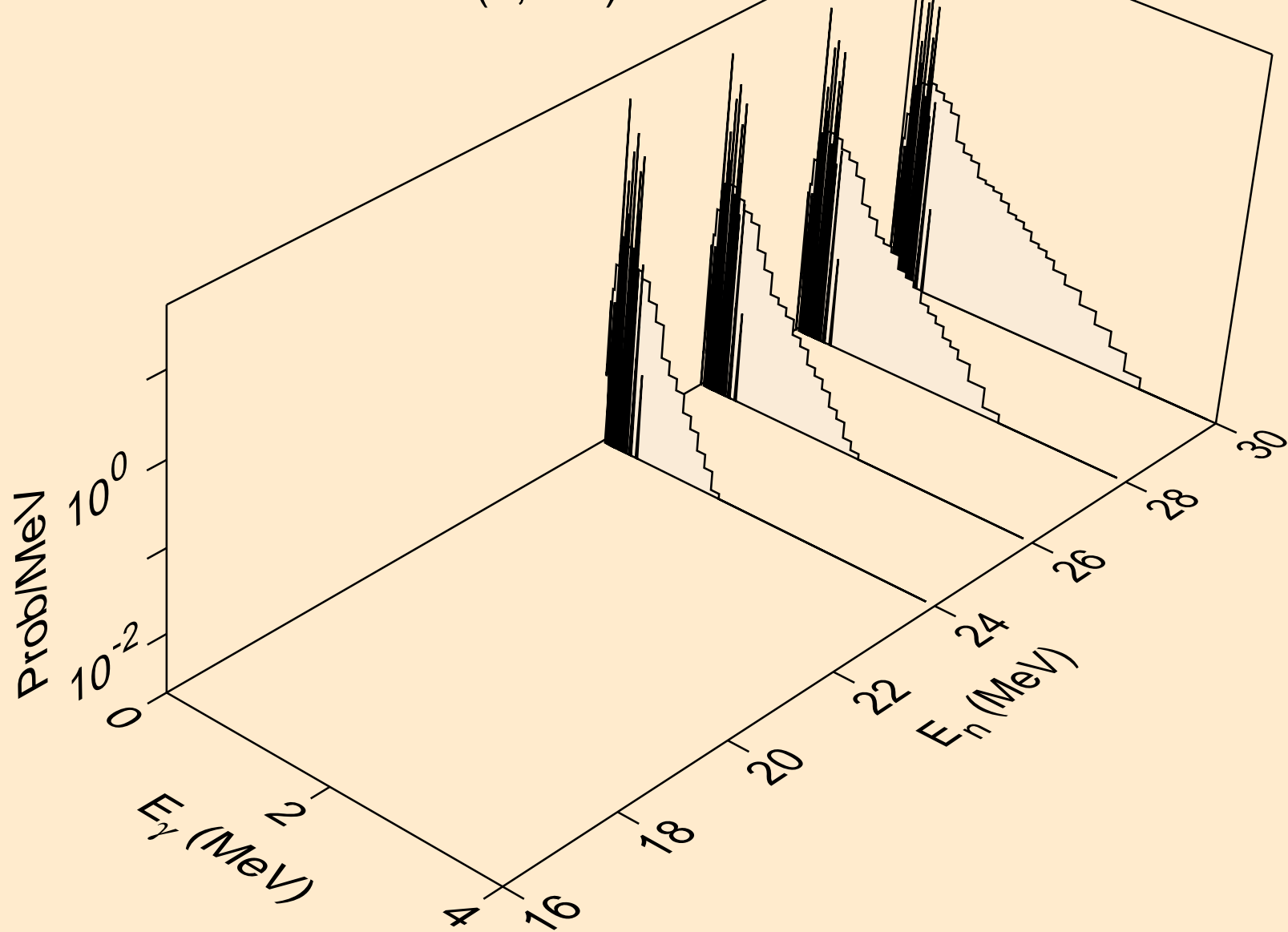

RE190 NEUTRON ACER TENDL-2021 LIBRARY; T=293.6K
Photon emission for (n,2n)

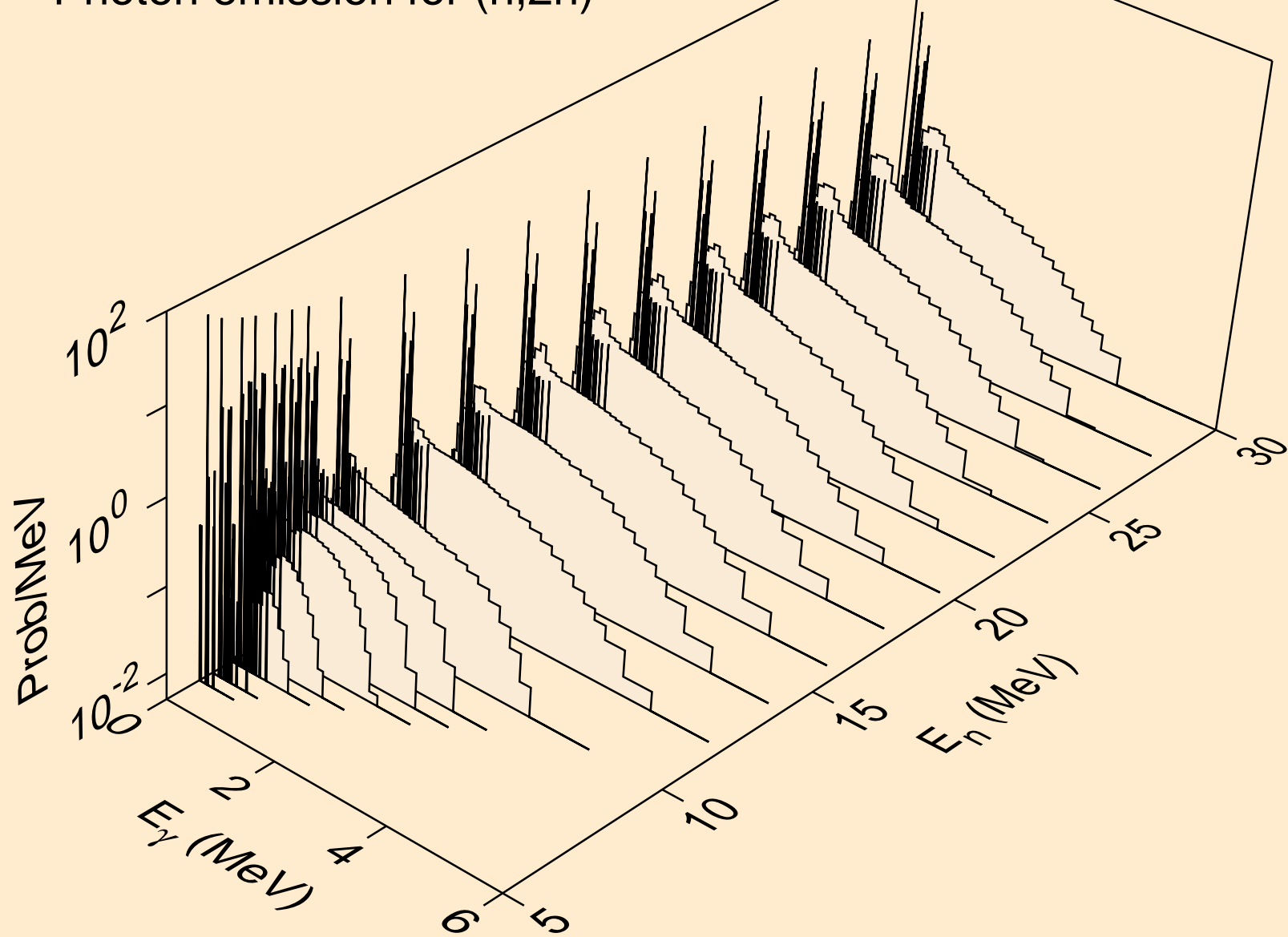

RE190 NEUTRON ACER TENDL-2021 LIBRARY; T=293.6K
Photon emission for (n,3n)

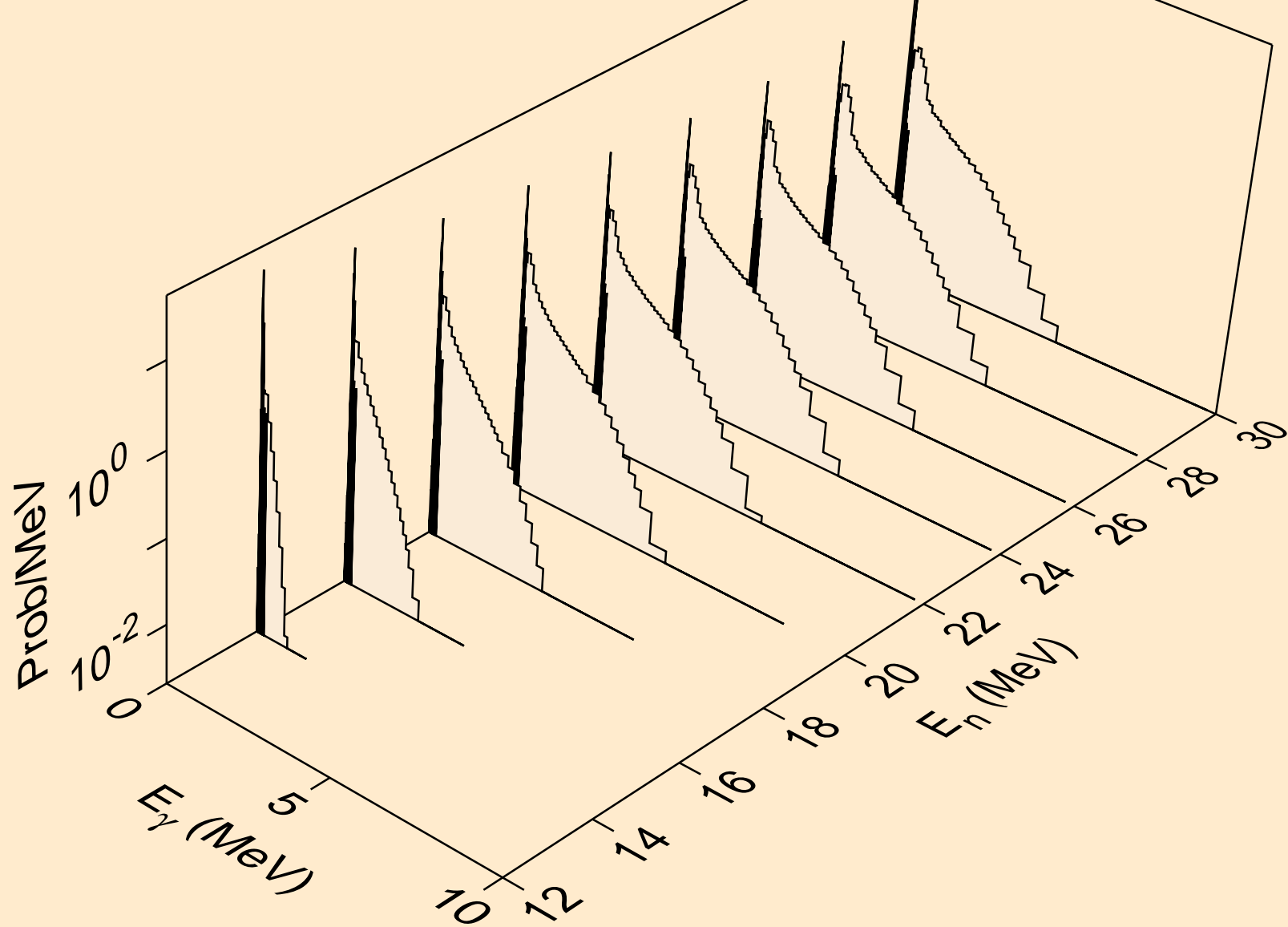

RE190 NEUTRON ACER TENDL-2021 LIBRARY; T=293.6K
Photon emission for (n,n*)a

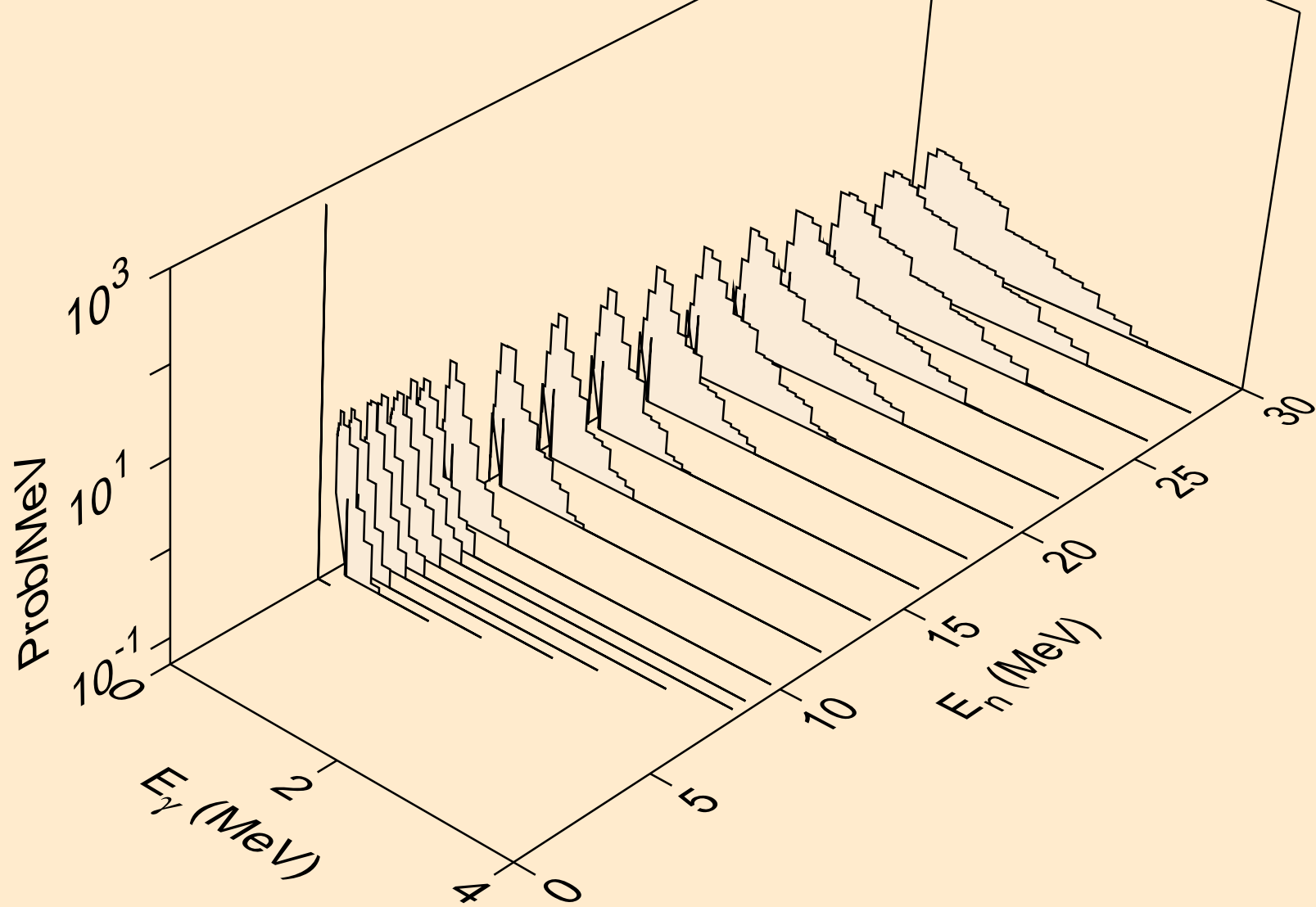

RE190 NEUTRON ACER TENDL-2021 LIBRARY; T=293.6K
Photon emission for (n,2n)a

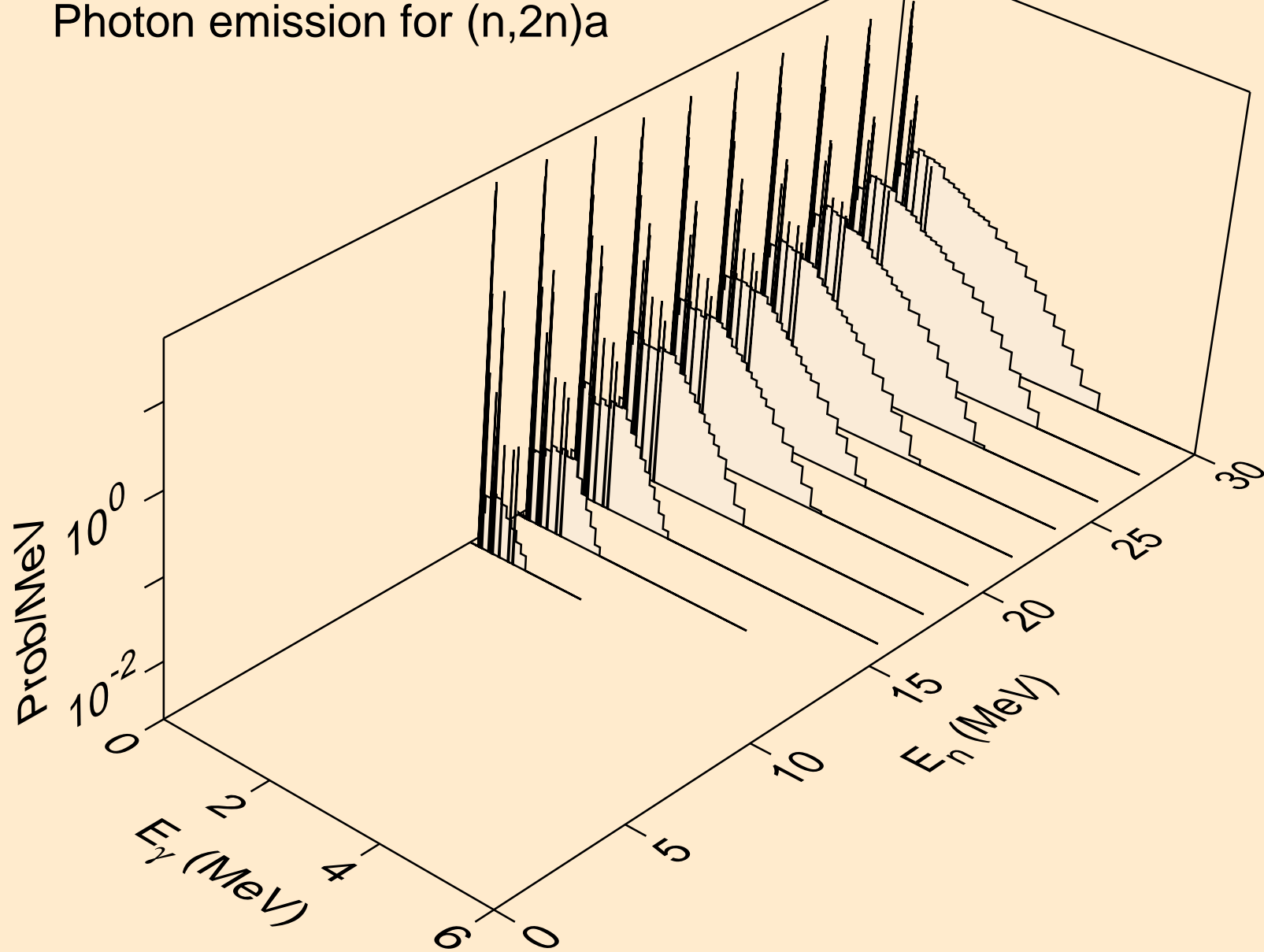

RE190 NEUTRON ACER TENDL-2021 LIBRARY; T=293.6K
Photon emission for (n,3n)a

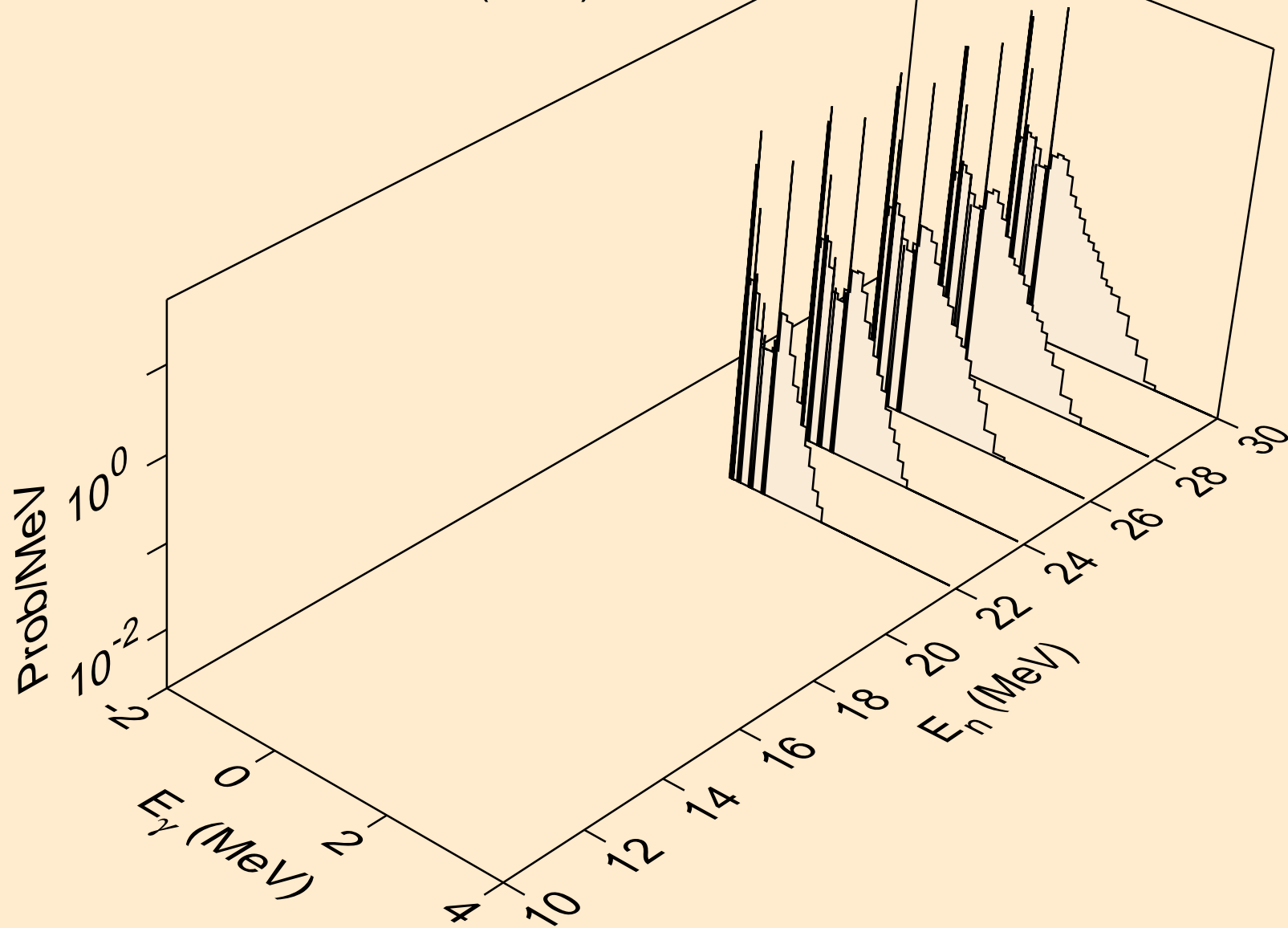

RE190 NEUTRON ACER TENDL-2021 LIBRARY; T=293.6K
Photon emission for (n,n*)p

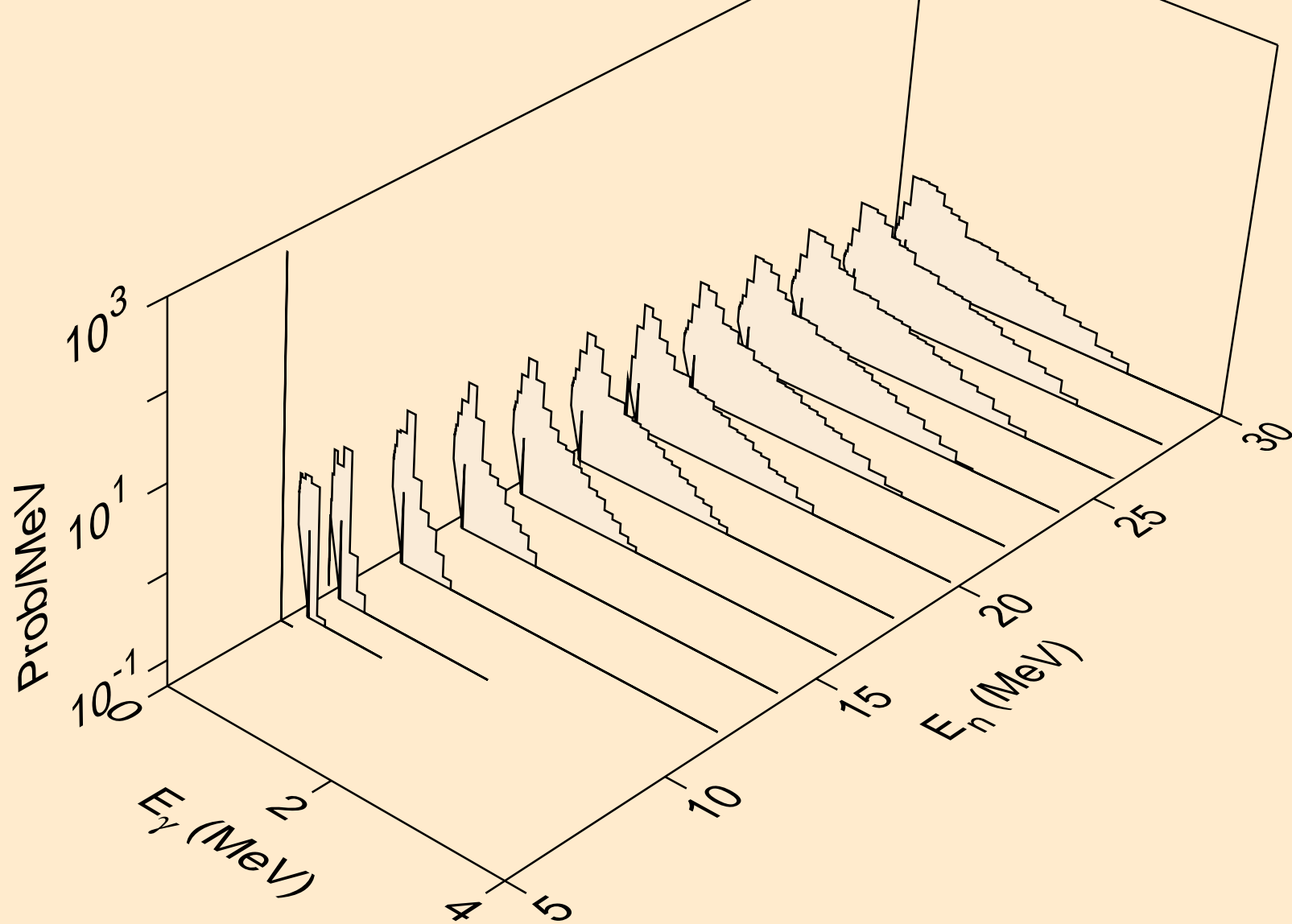

RE190 NEUTRON ACER TENDL-2021 LIBRARY; T=293.6K
Photon emission for (n,n*)d

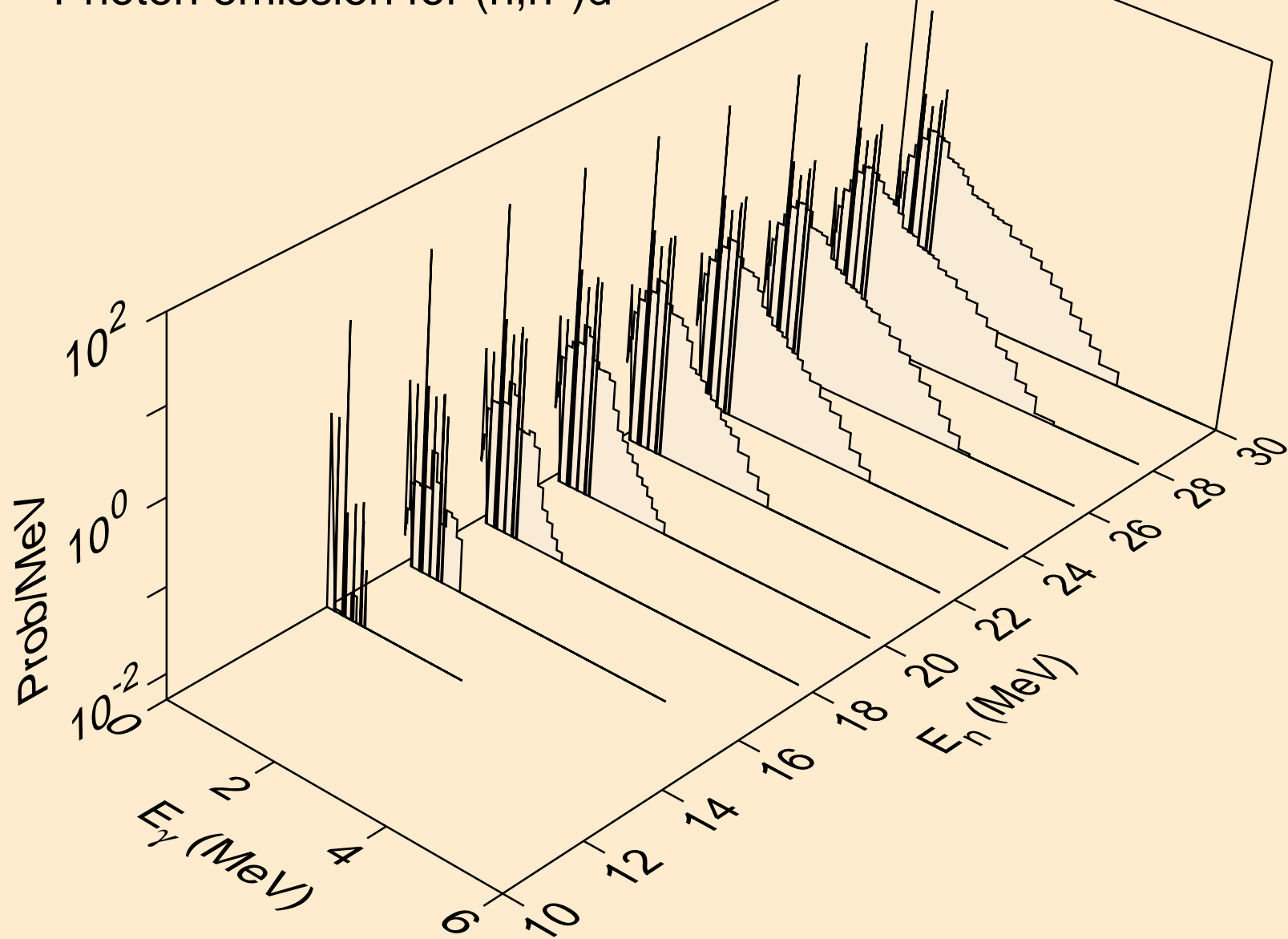

RE190 NEUTRON ACER TENDL-2021 LIBRARY; T=293.6K
Photon emission for (n,n*)t

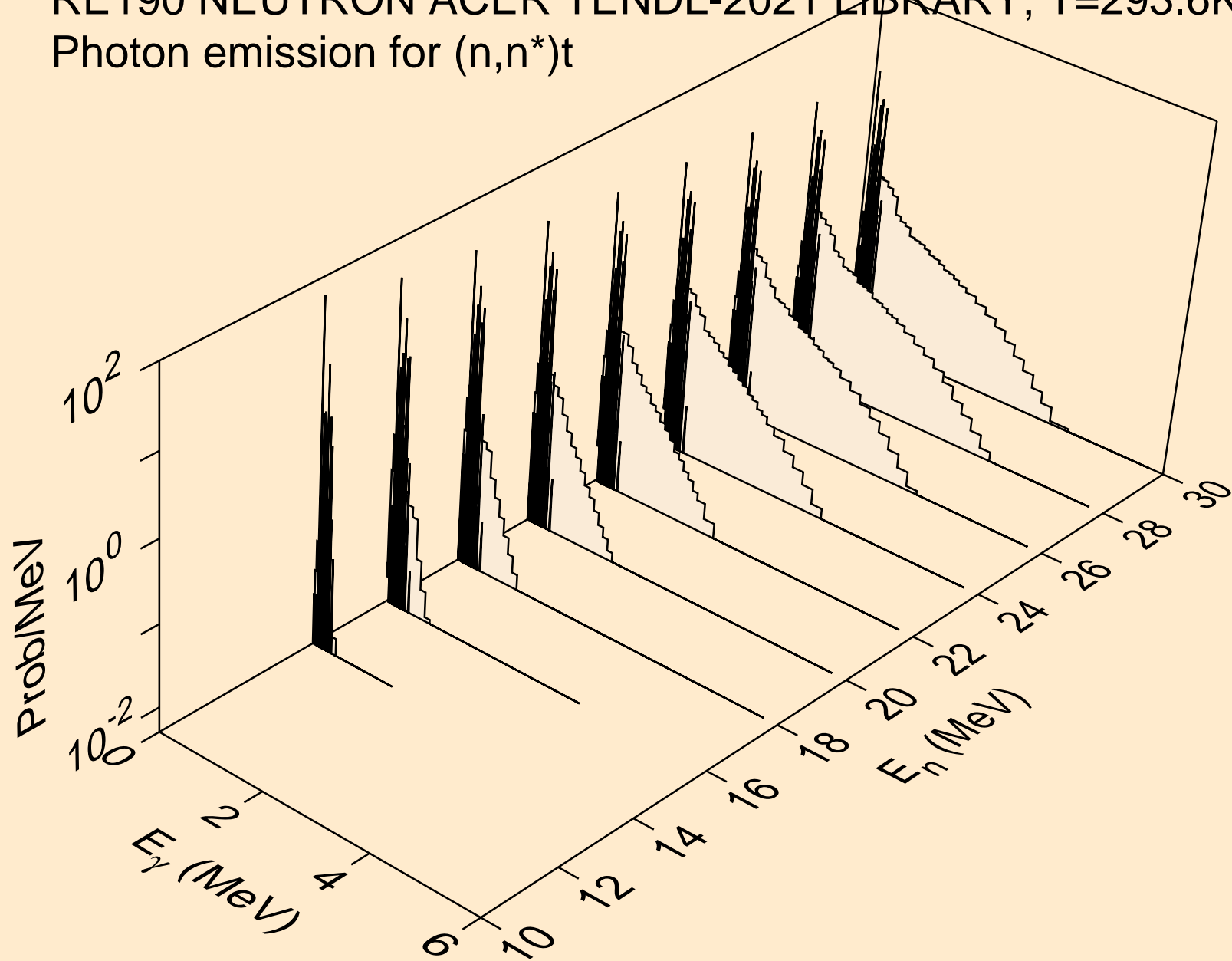

RE190 NEUTRON ACER TENDL-2021 LIBRARY; T=293.6K
Photon emission for (n,n*)he3

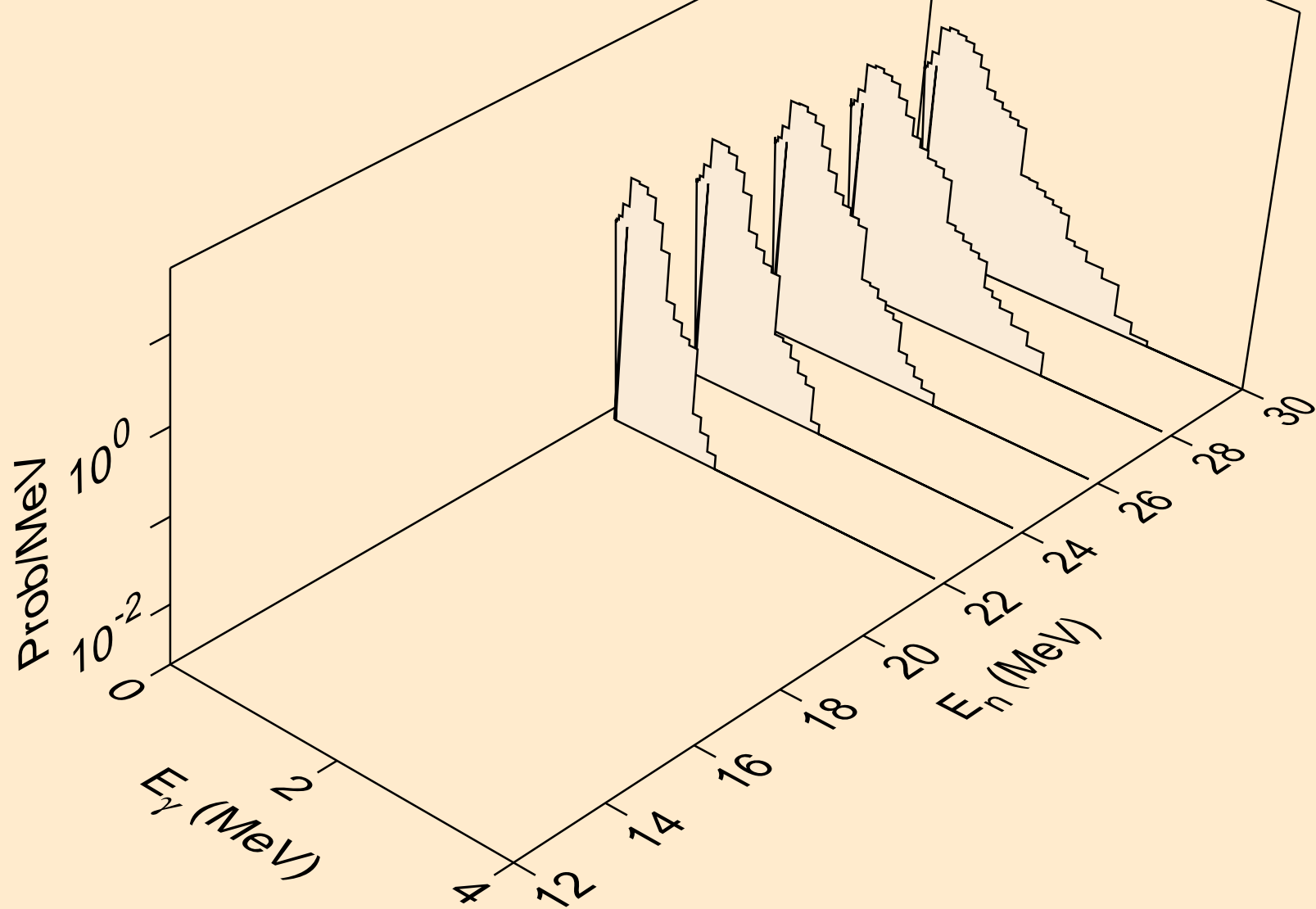

RE190 NEUTRON ACER TENDL-2021 LIBRARY; T=293.6K
Photon emission for (n,4n)

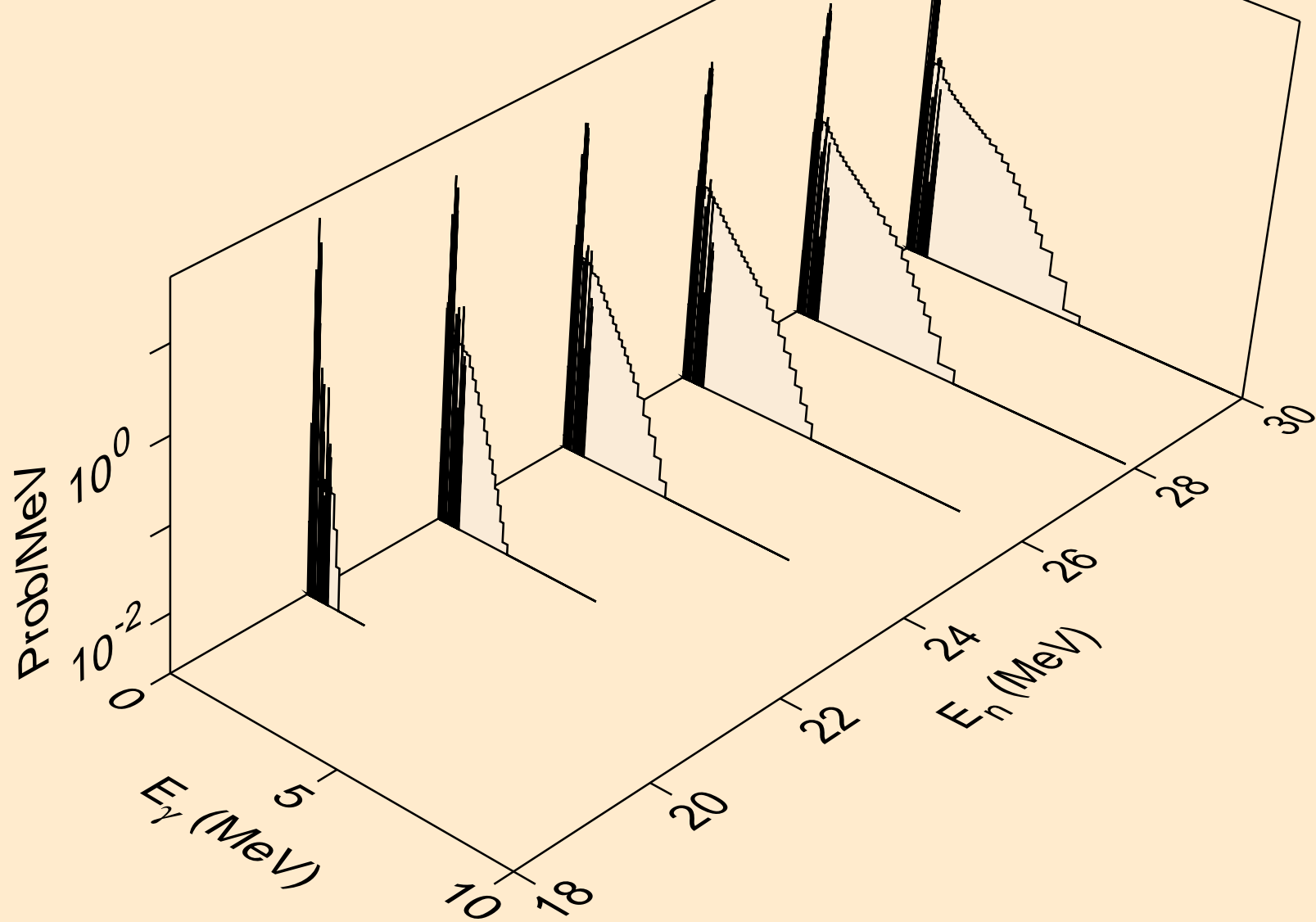

RE190 NEUTRON ACER TENDL-2021 LIBRARY; T=293.6K
Photon emission for (n,2np)

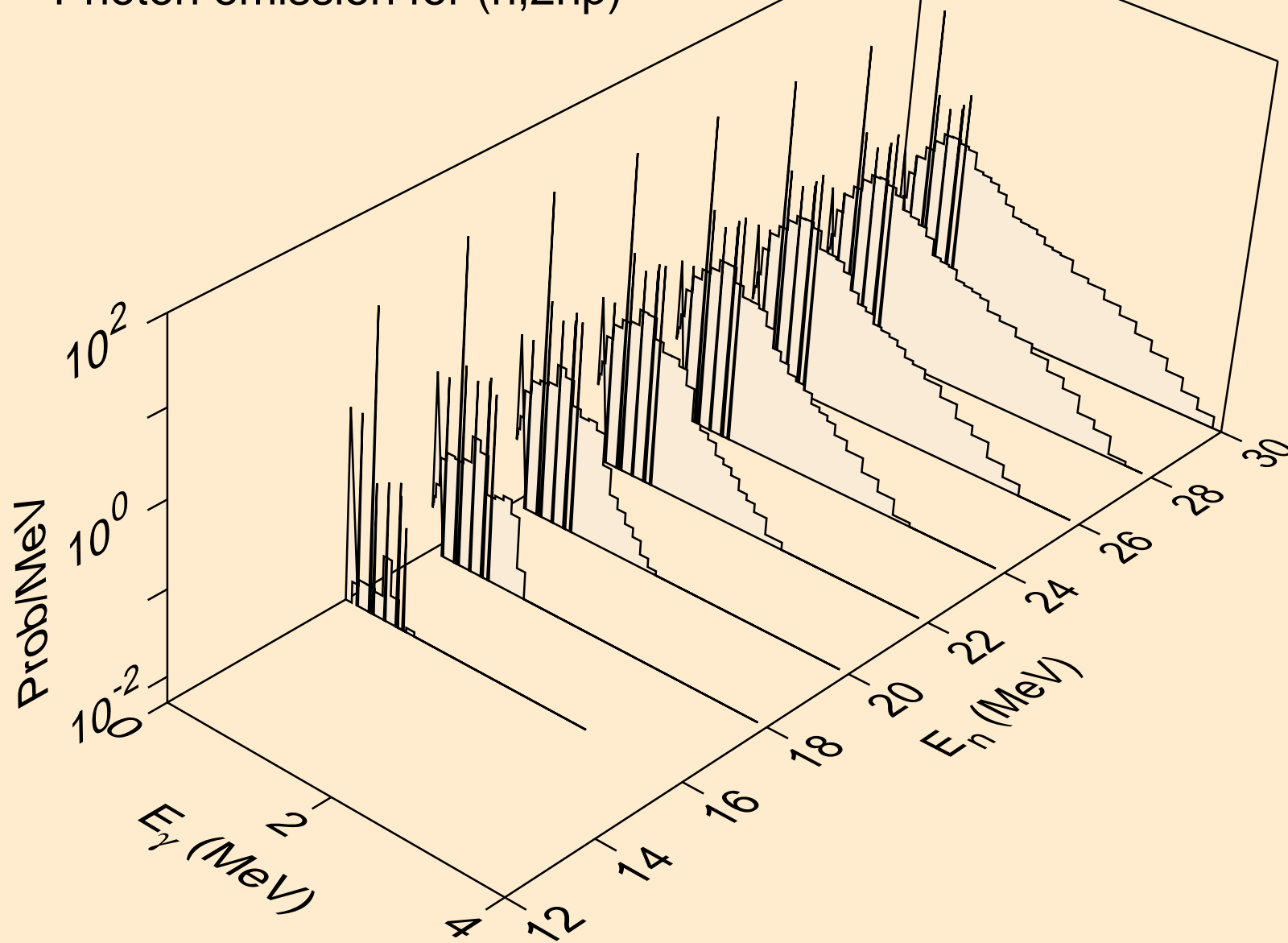

RE190 NEUTRON ACER TENDL-2021 LIBRARY; T=293.6K
Photon emission for (n,3np)

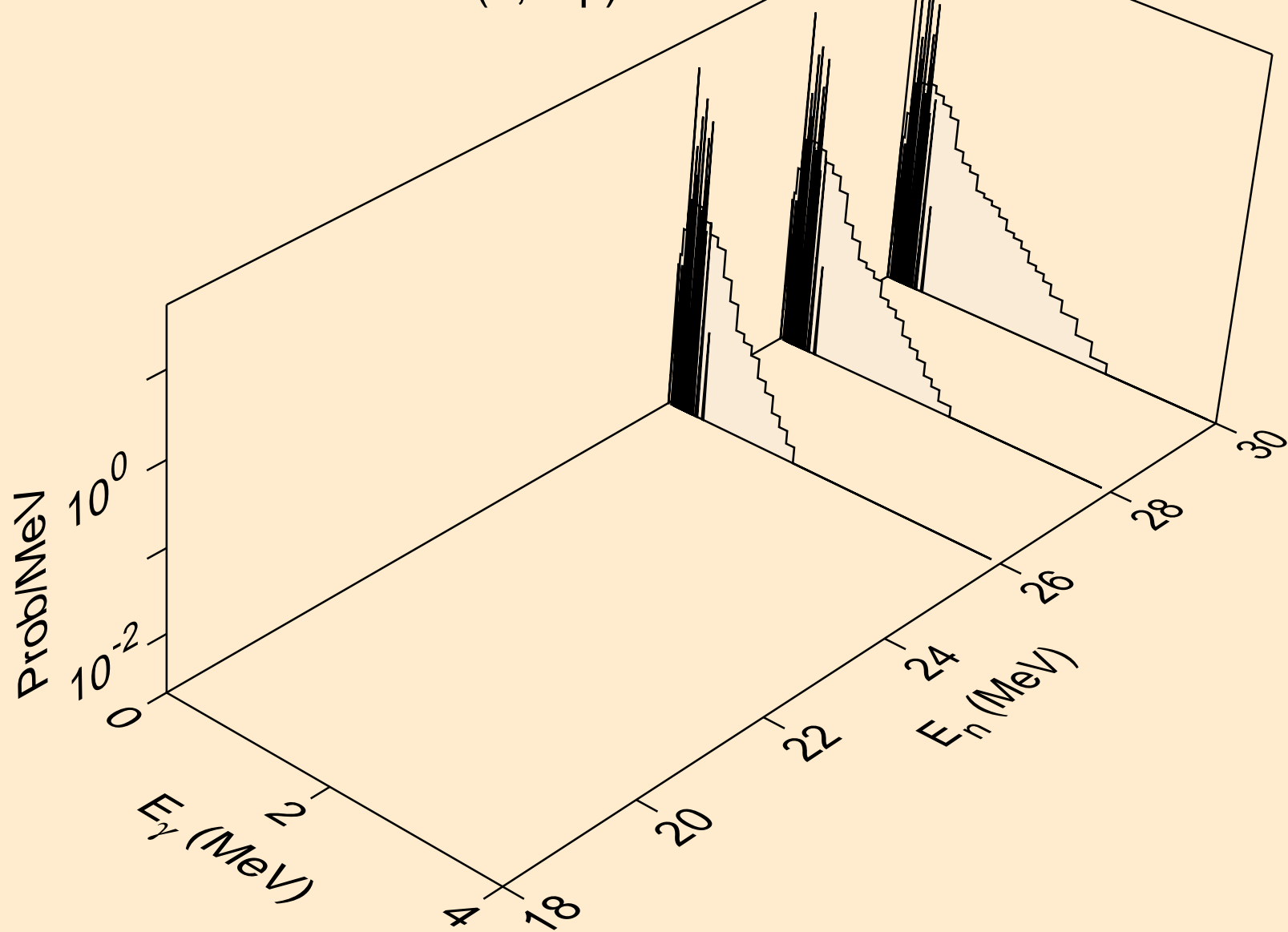

RE190 NEUTRON ACER TENDL-2021 LIBRARY; T=293.6K
Photon emission for (n,2np)

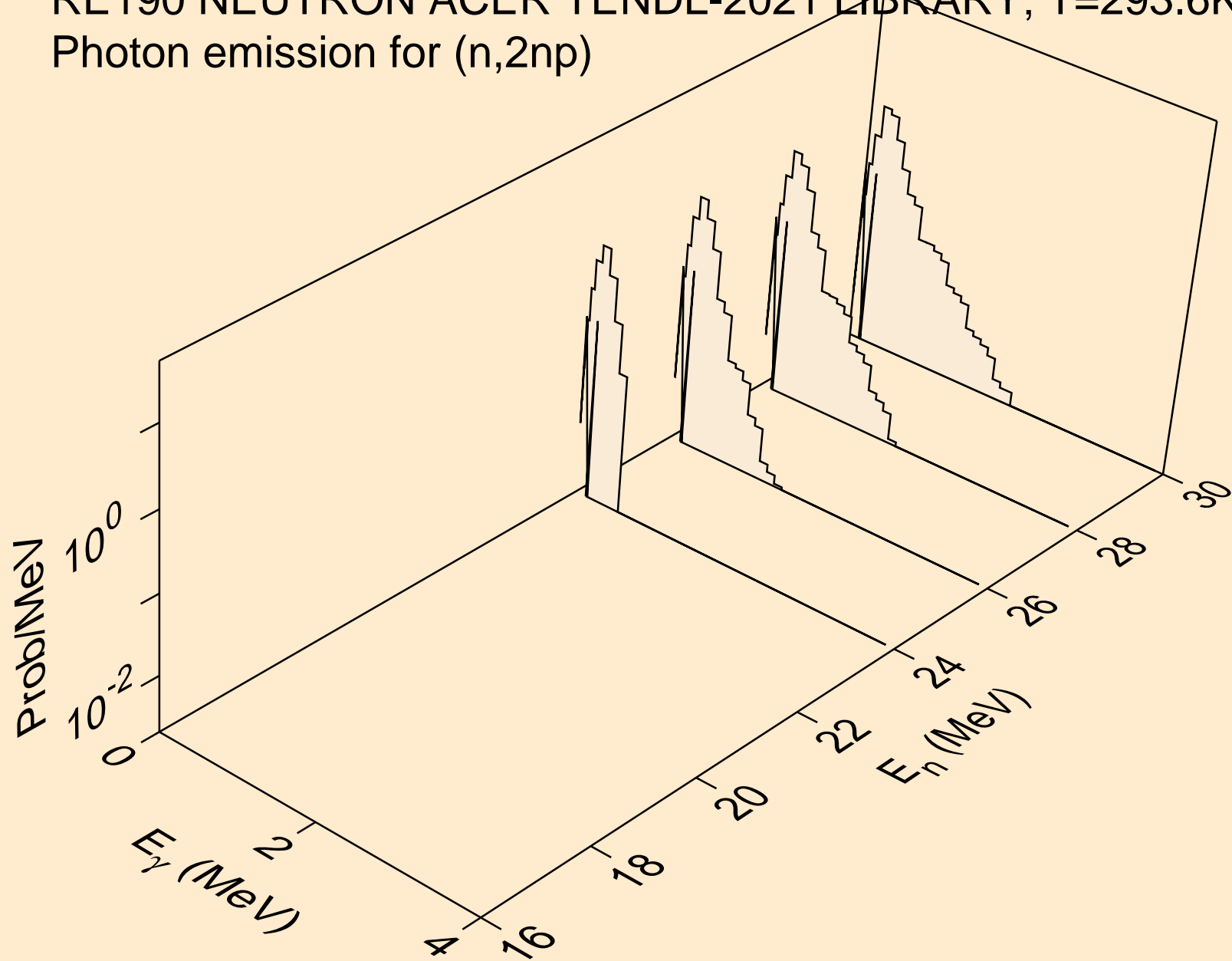

RE190 NEUTRON ACER TENDL-2021 LIBRARY; T=293.6K
Photon emission for (n,n*c)

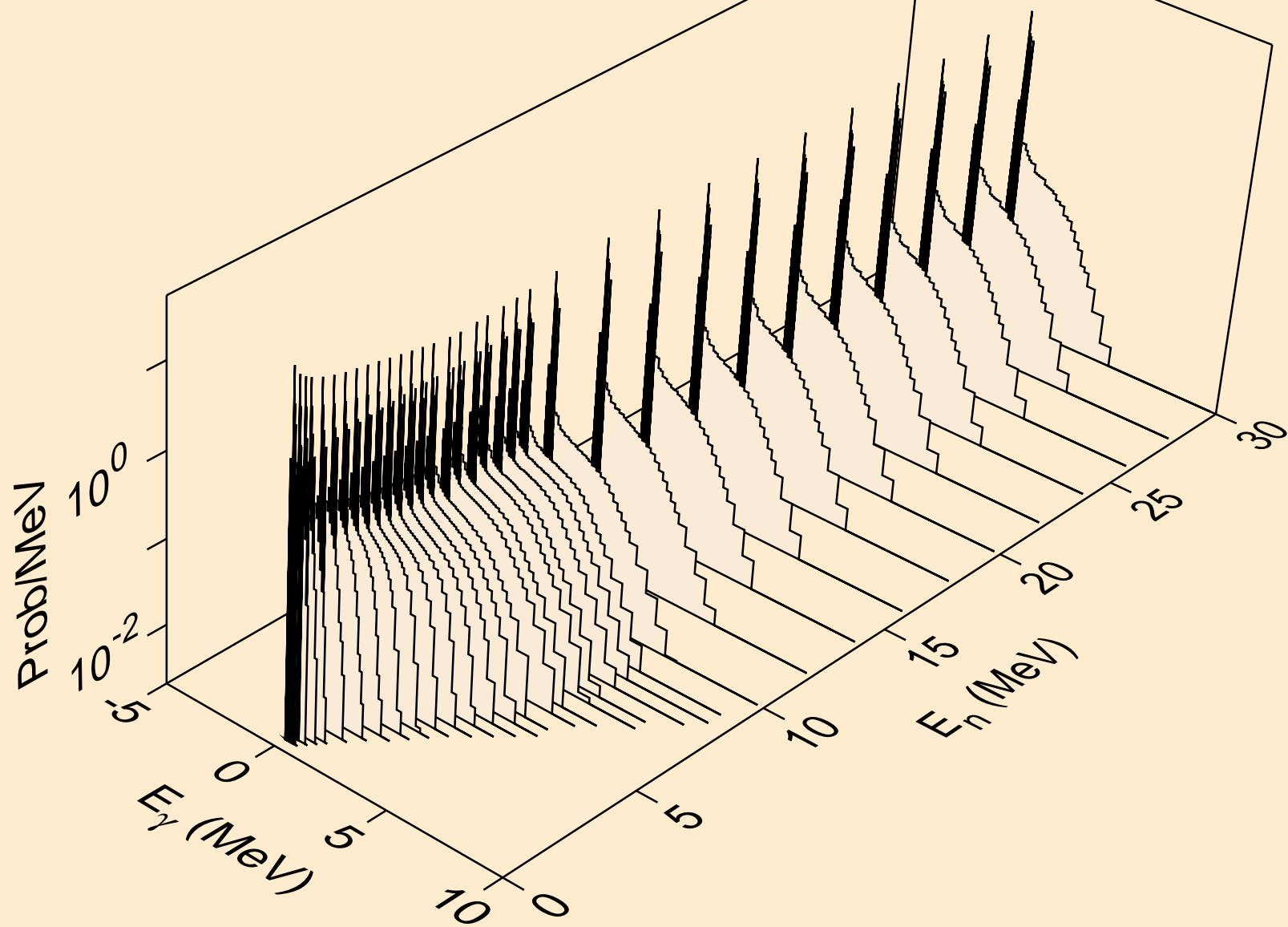

RE190 NEUTRON ACER TENDL-2021 LIBRARY; T=293.6K
Photon emission for (n,gma)

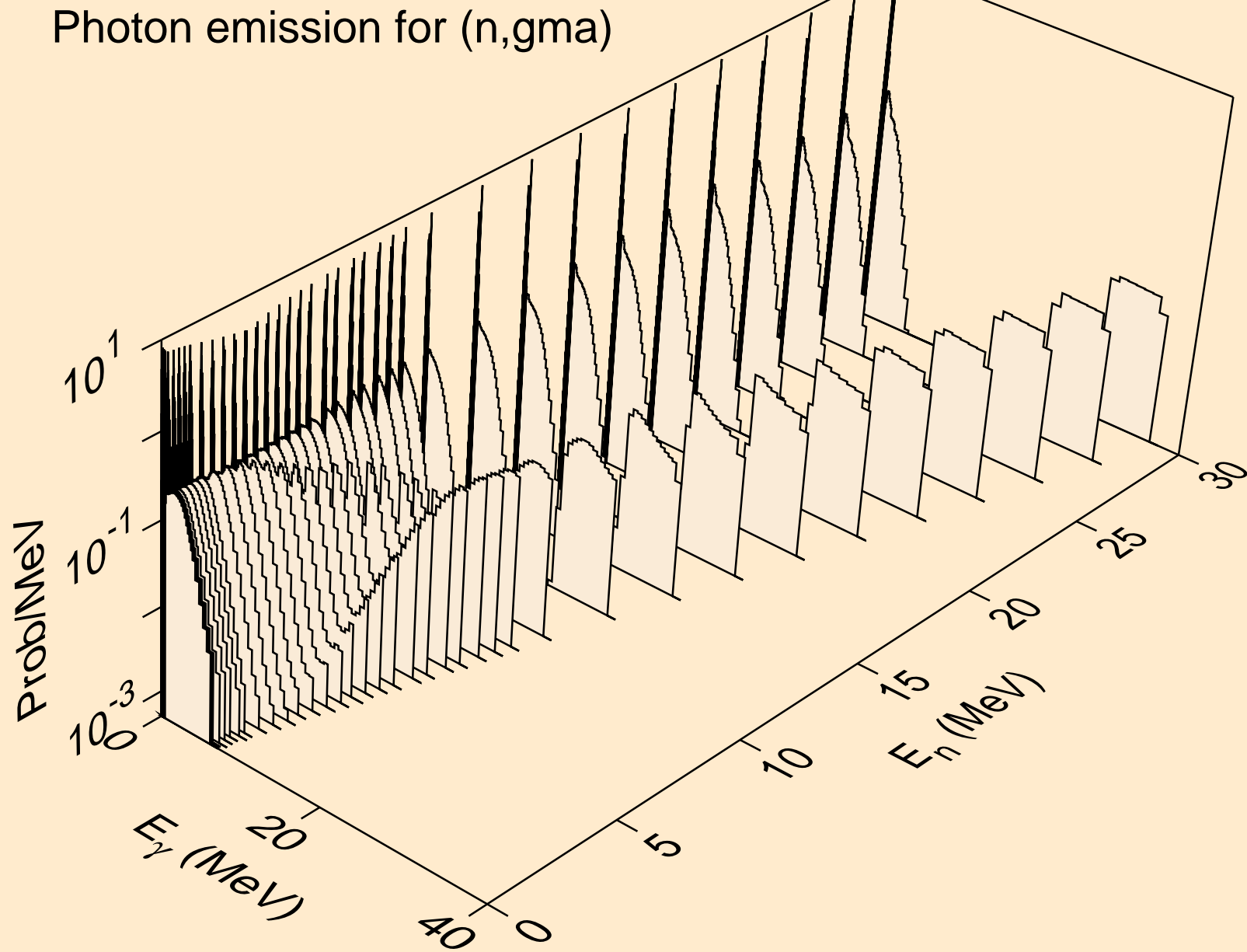

RE190 NEUTRON ACER TENDL-2021 LIBRARY; T=293.6K
Photon emission for (n,p)

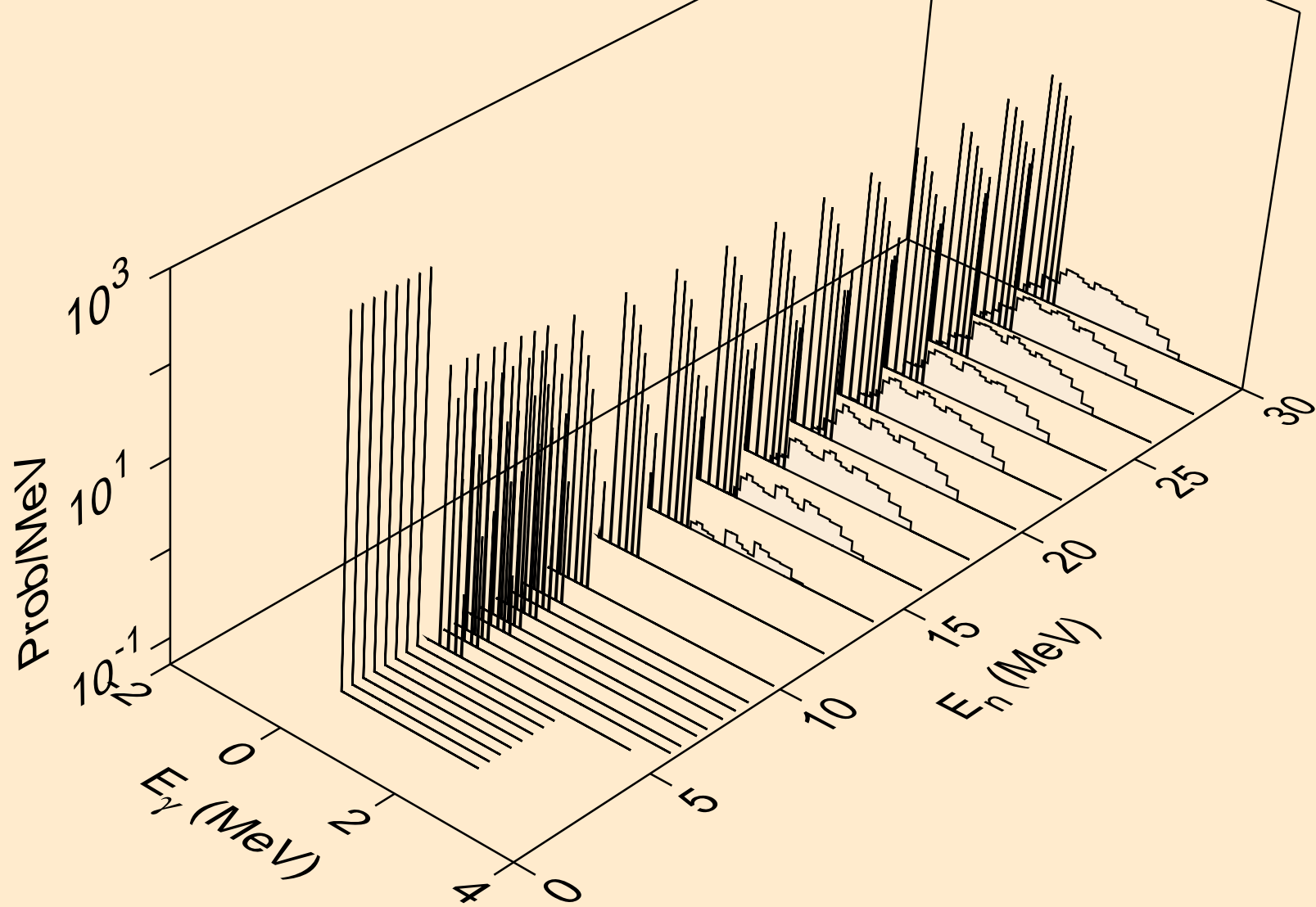

RE190 NEUTRON ACER TENDL-2021 LIBRARY; T=293.6K
Photon emission for (n,d)

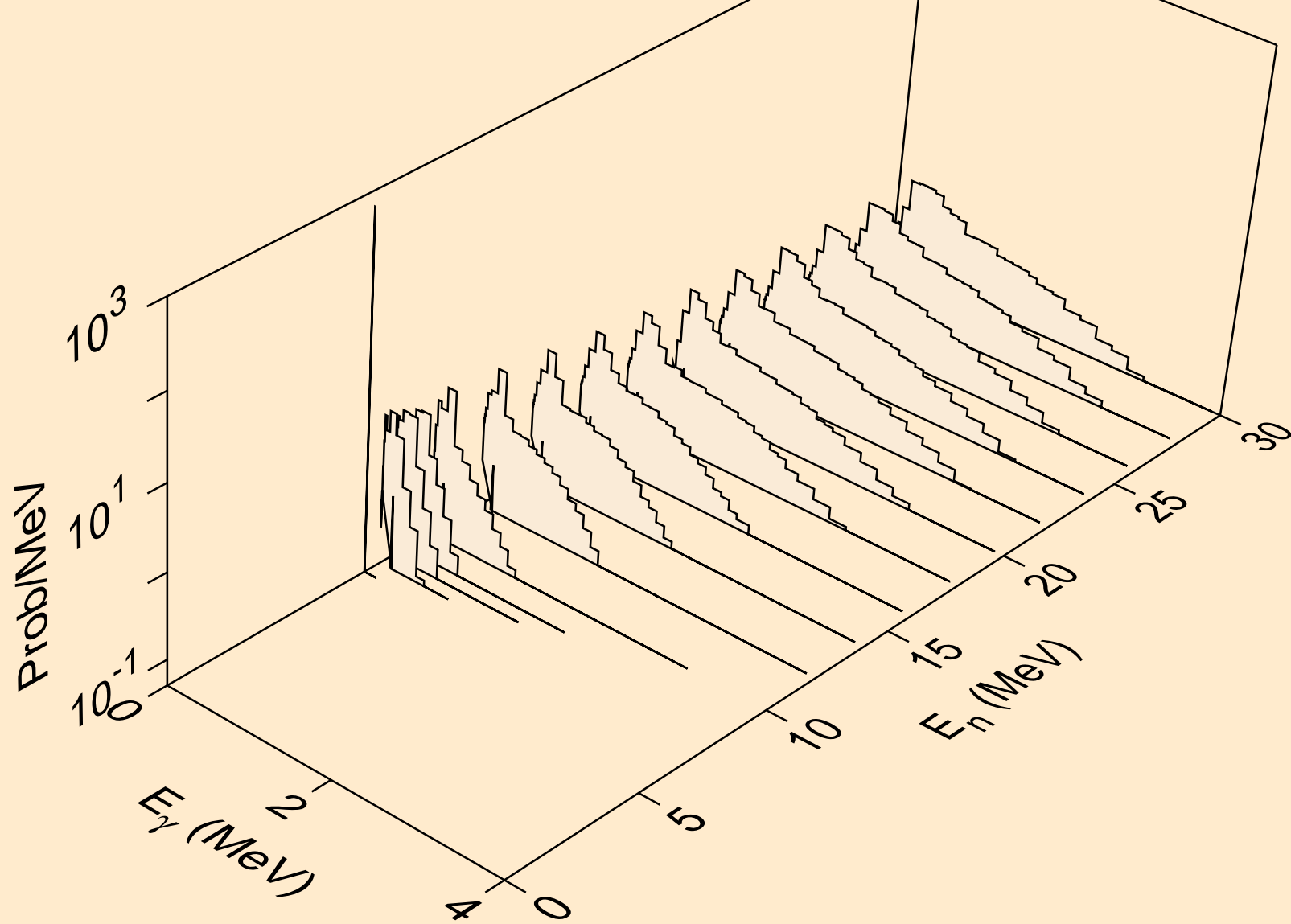

RE190 NEUTRON ACER TENDL-2021 LIBRARY; T=293.6K
Photon emission for (n,t)

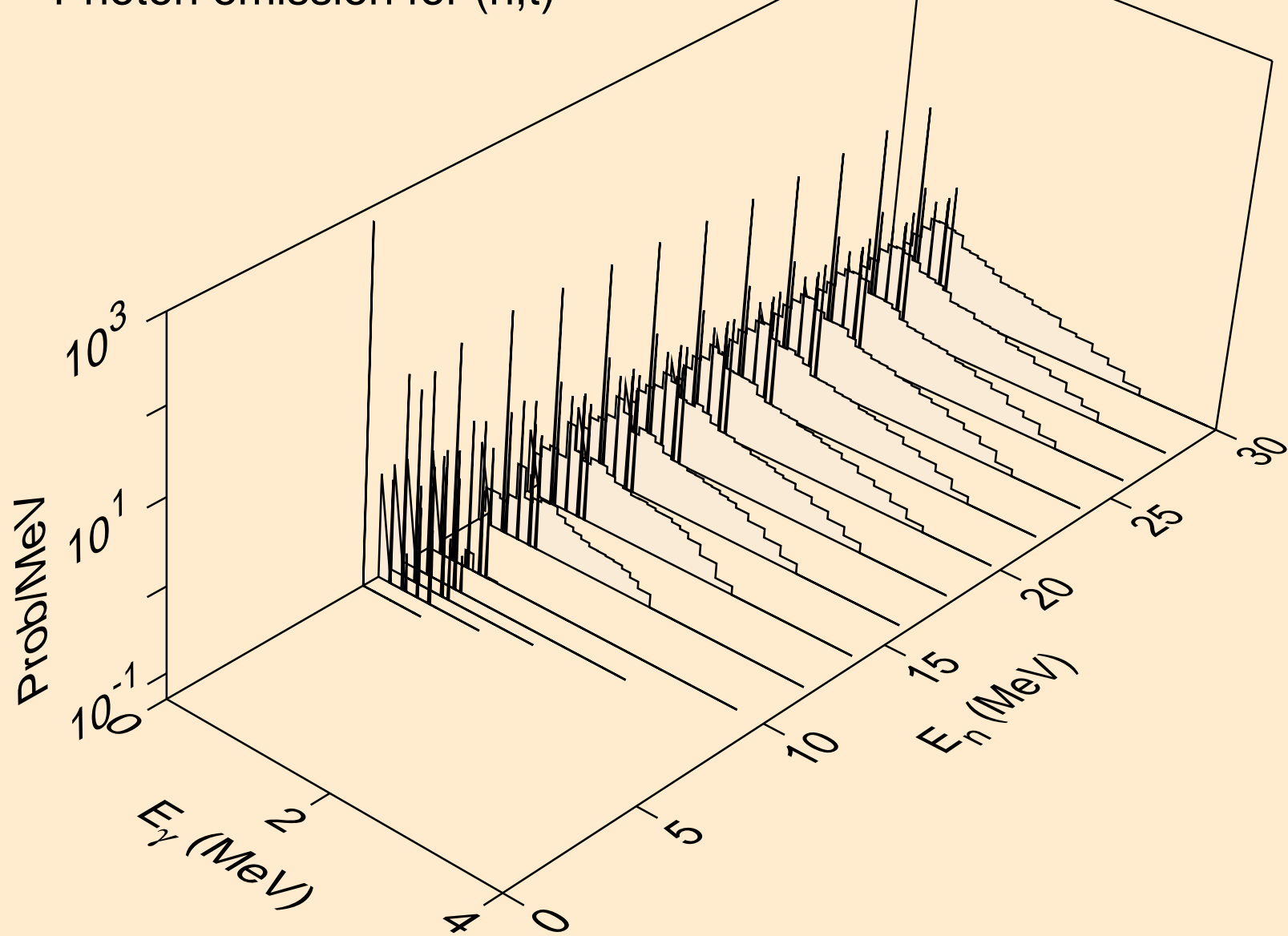

RE190 NEUTRON ACER TENDL-2021 LIBRARY; T=293.6K
Photon emission for (n,he3)

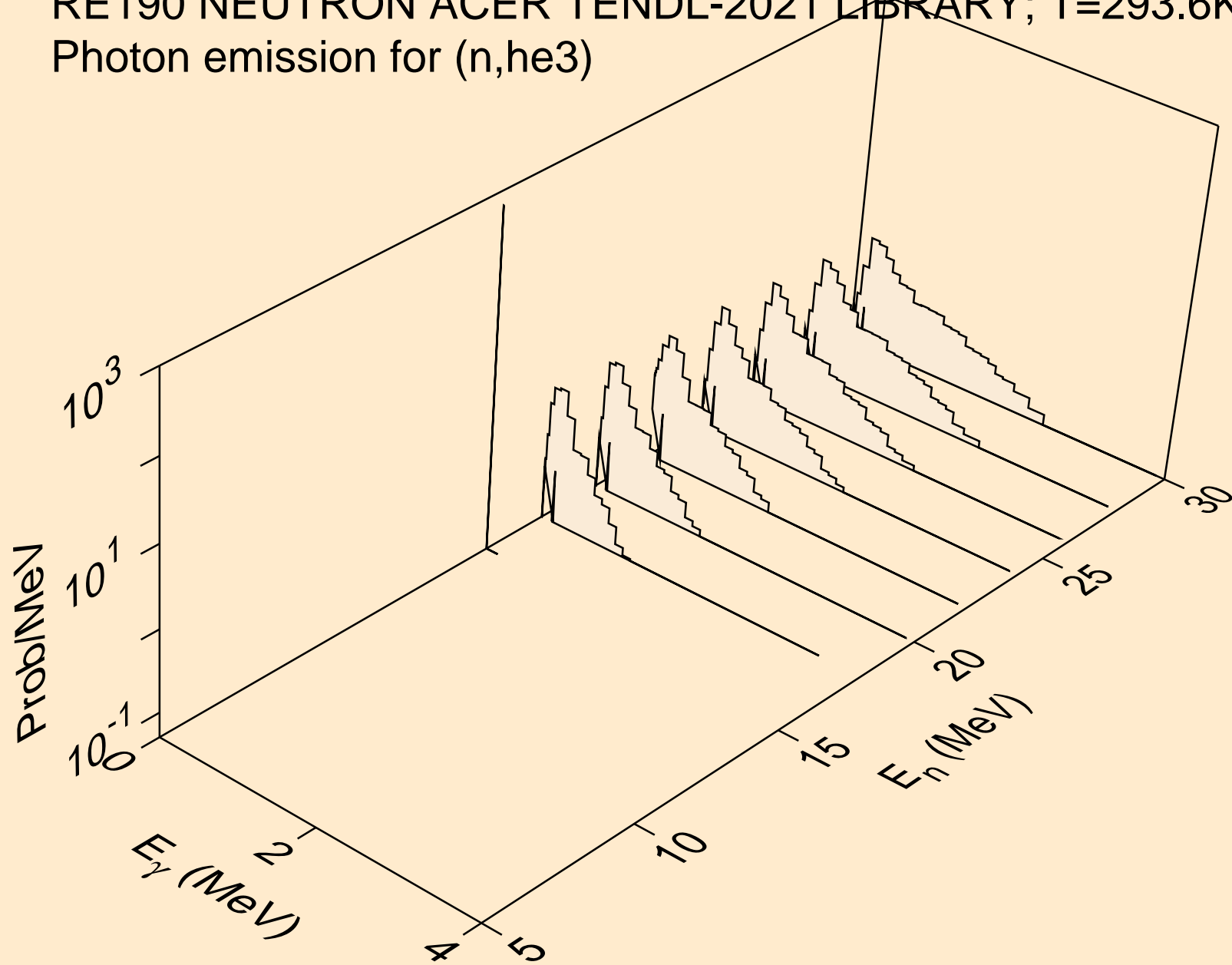

RE190 NEUTRON ACER TENDL-2021 LIBRARY; T=293.6K
Photon emission for (n,a)

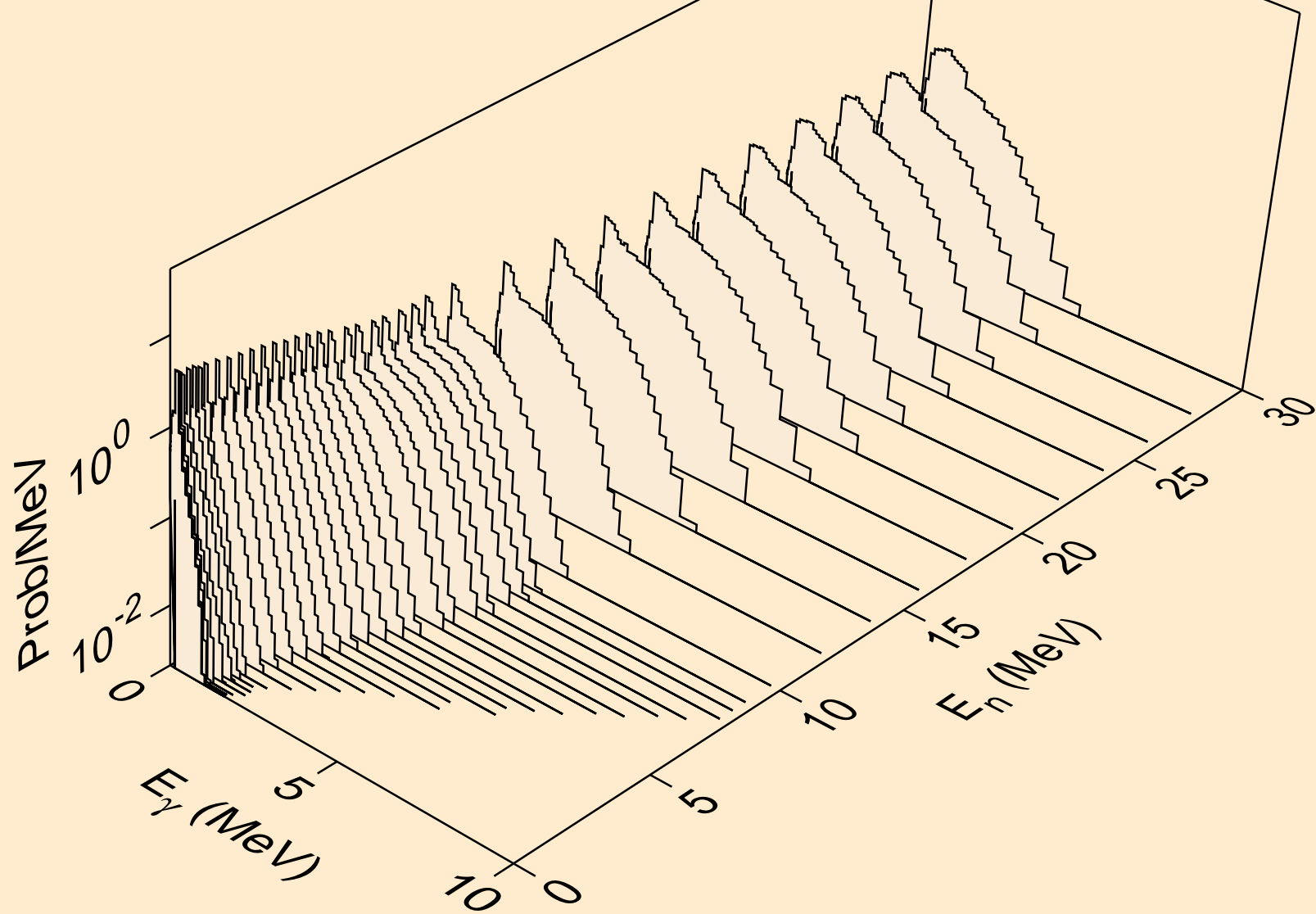

RE190 NEUTRON ACER TENDL-2021 LIBRARY; T=293.6K
Photon emission for (n,2p)

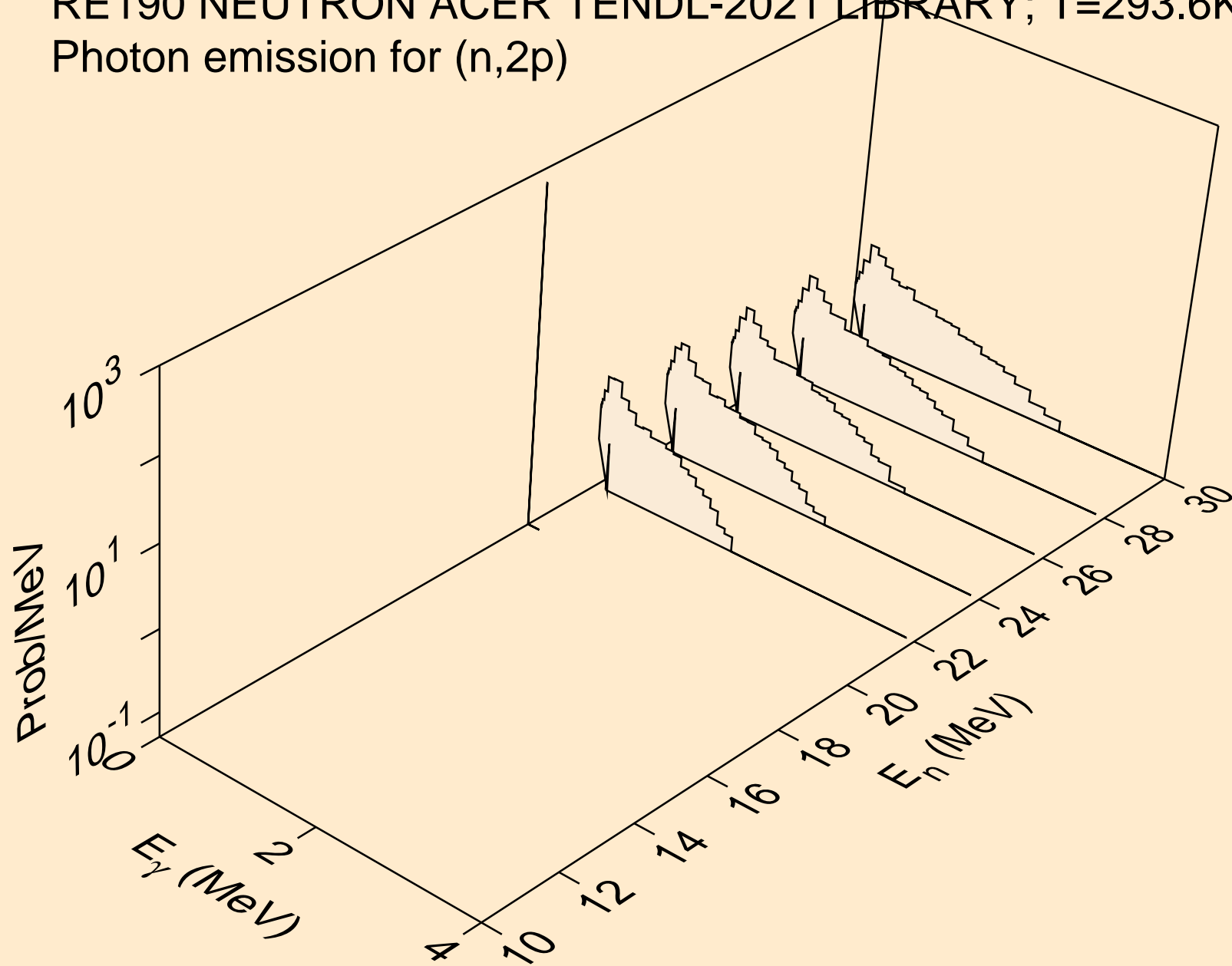

RE190 NEUTRON ACER TENDL-2021 LIBRARY; T=293.6K
thermal capture photon spectrum

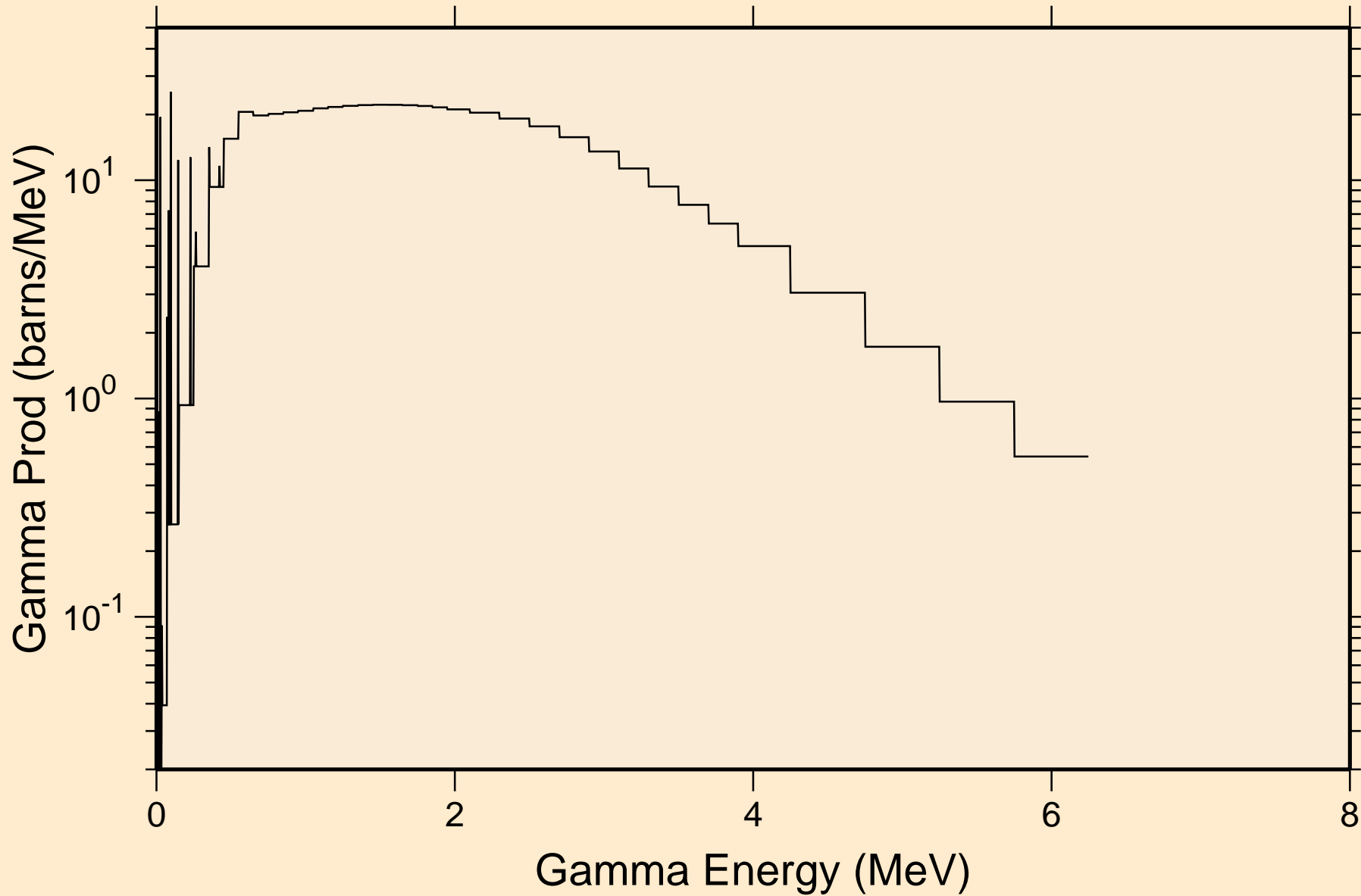

RE190 NEUTRON ACER TENDL-2021 LIBRARY; T=293.6K
14 MeV photon spectrum

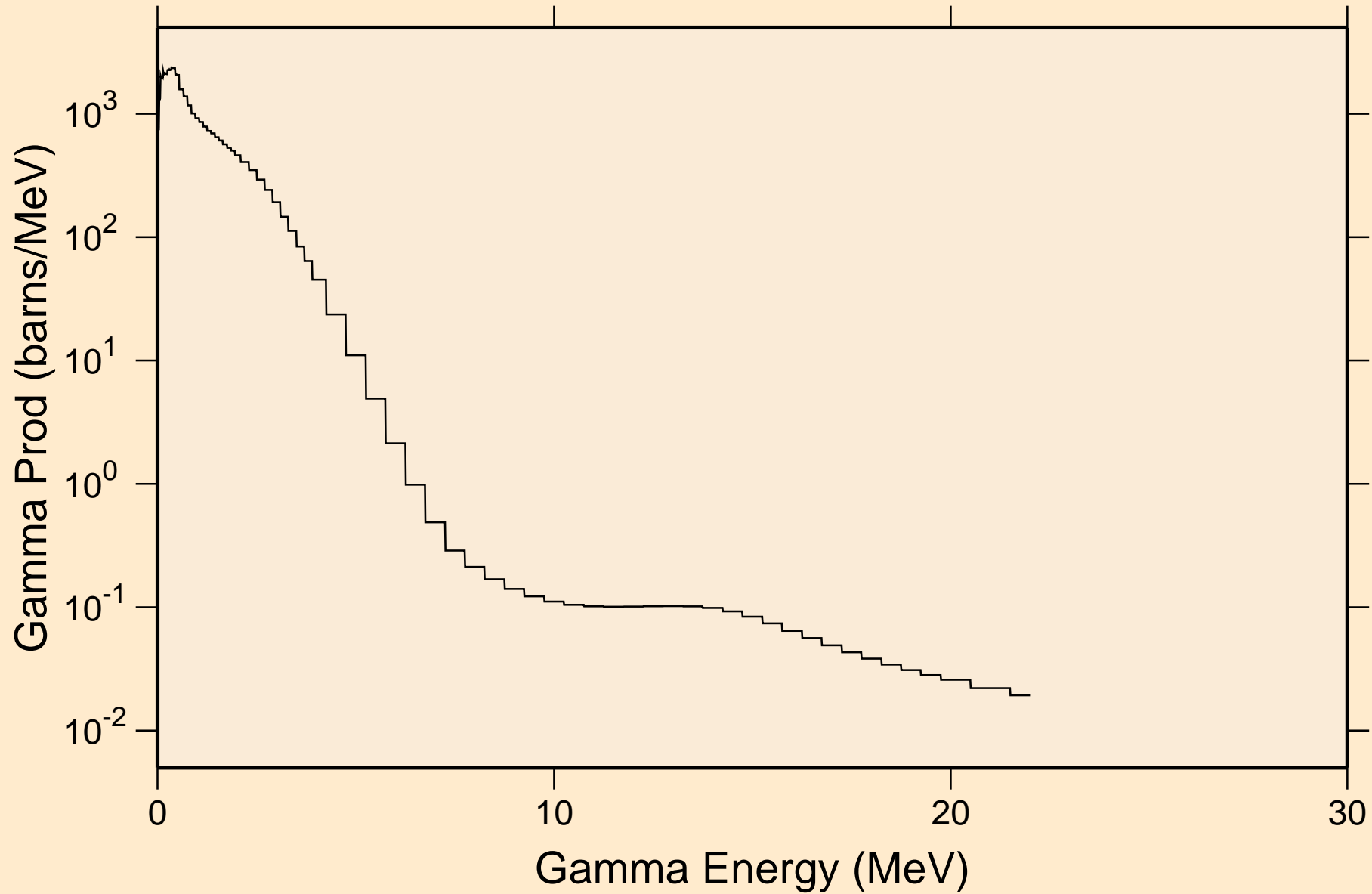

RE190 NEUTRON ACER TENDL-2021 LIBRARY; T=293.6K
Particle heating contributions

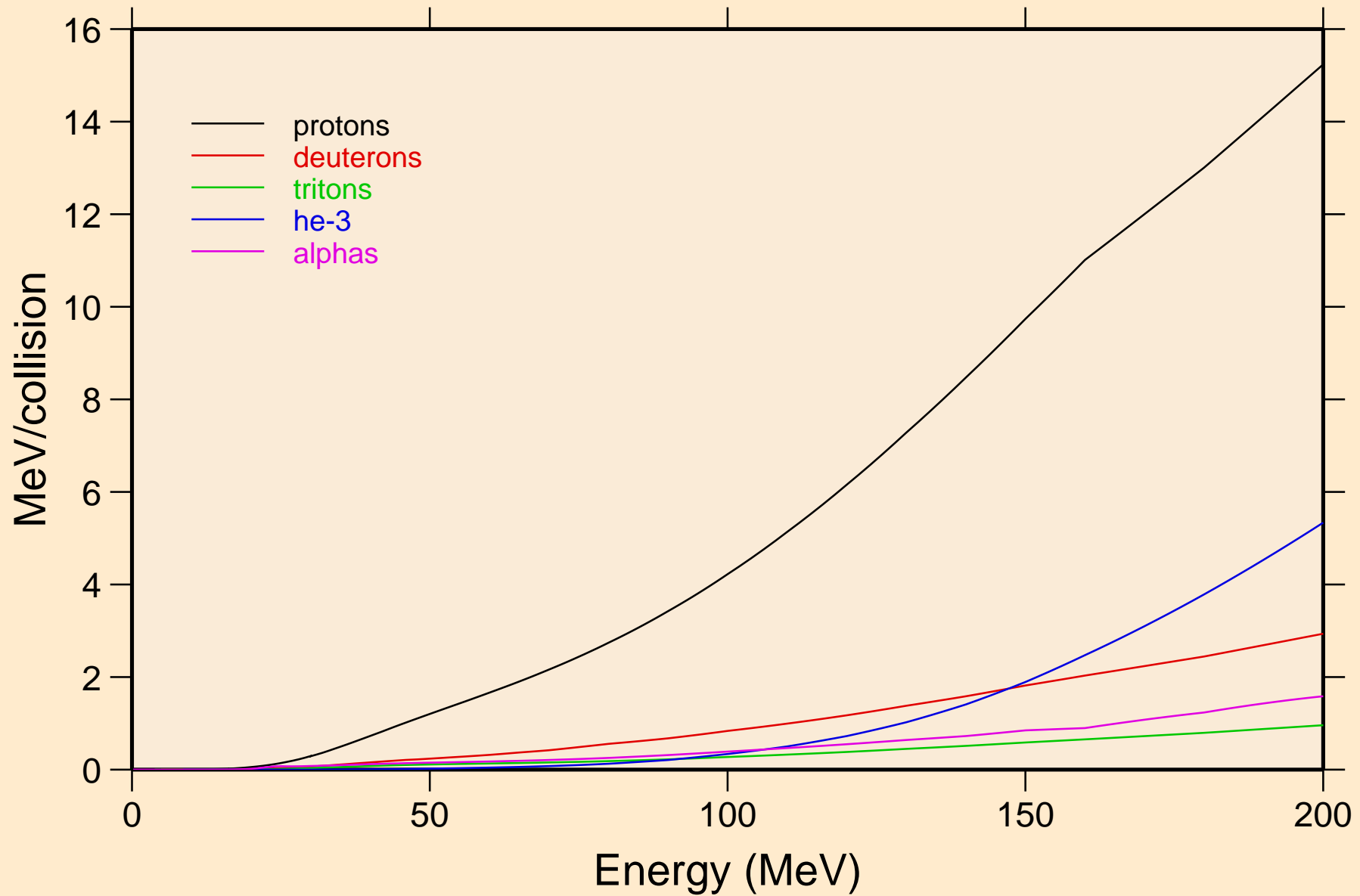

RE190 NEUTRON ACER TENDL-2021 LIBRARY; T=293.6K
Recoil Heating

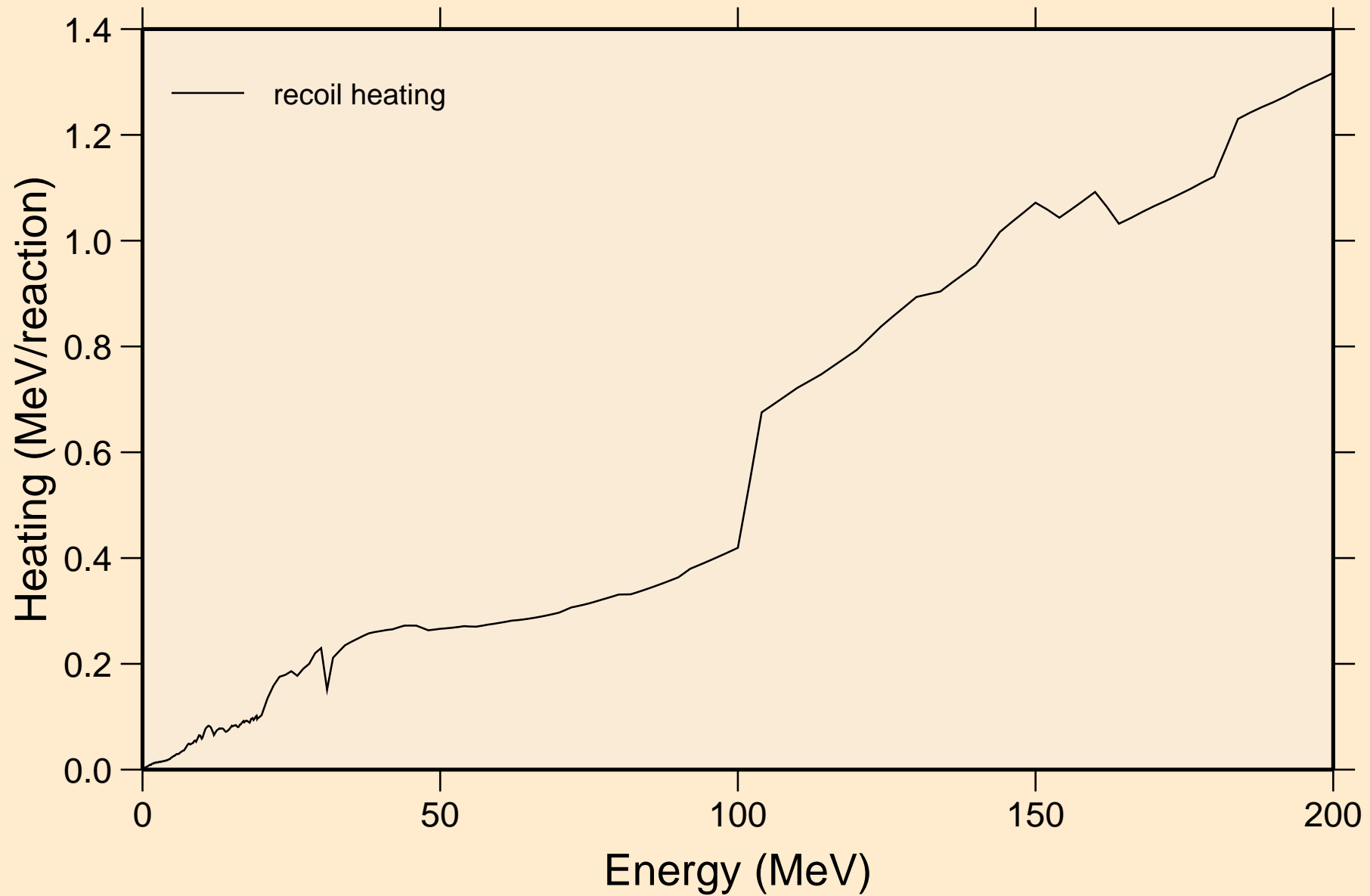

RE190 NEUTRON ACER TENDL-2021 LIBRARY; T=293.6K
Particle production cross sections

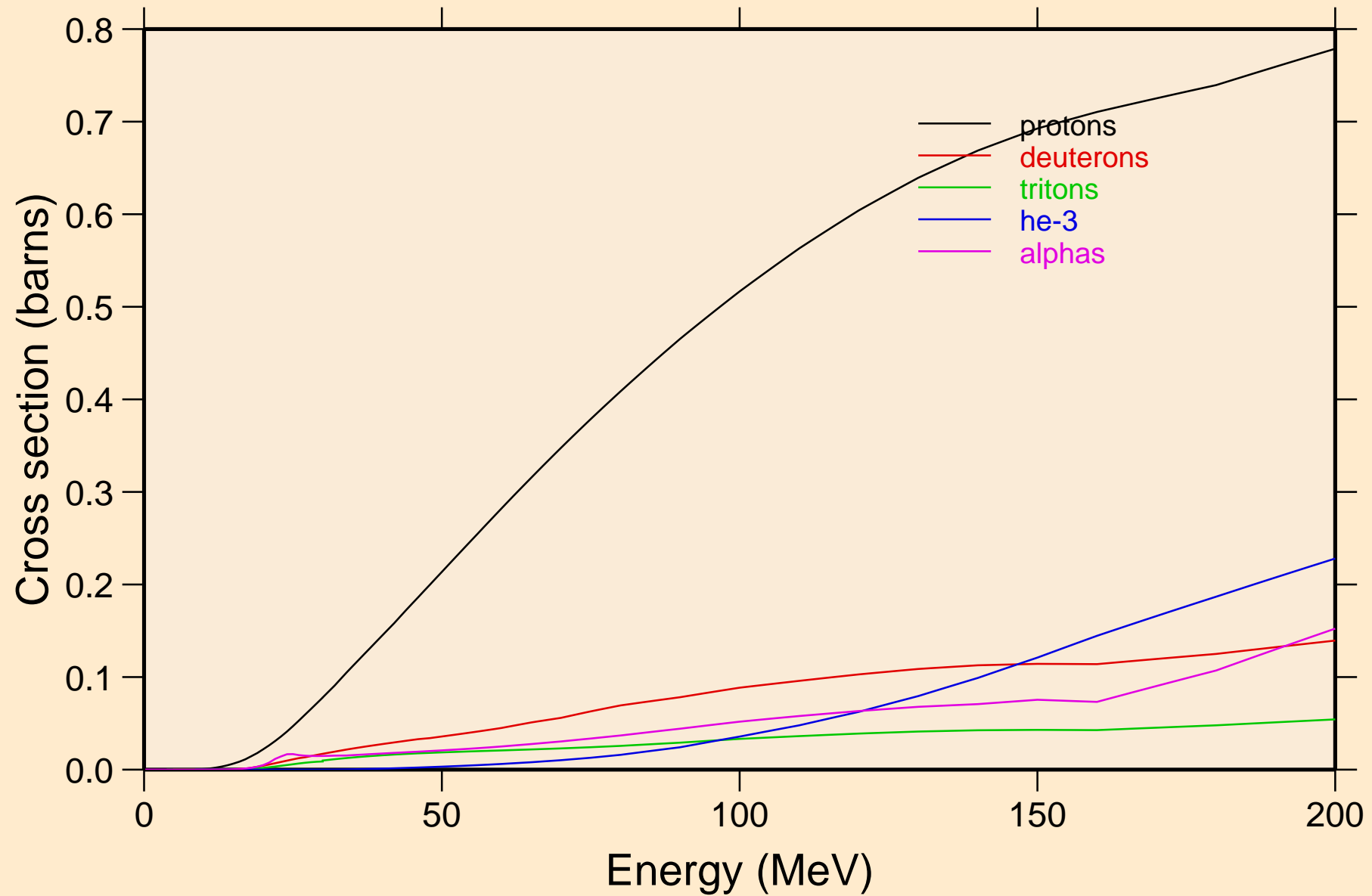

RE190 NEUTRON ACER TENDL-2021 LIBRARY; T=293.6K
protons from (n,x)

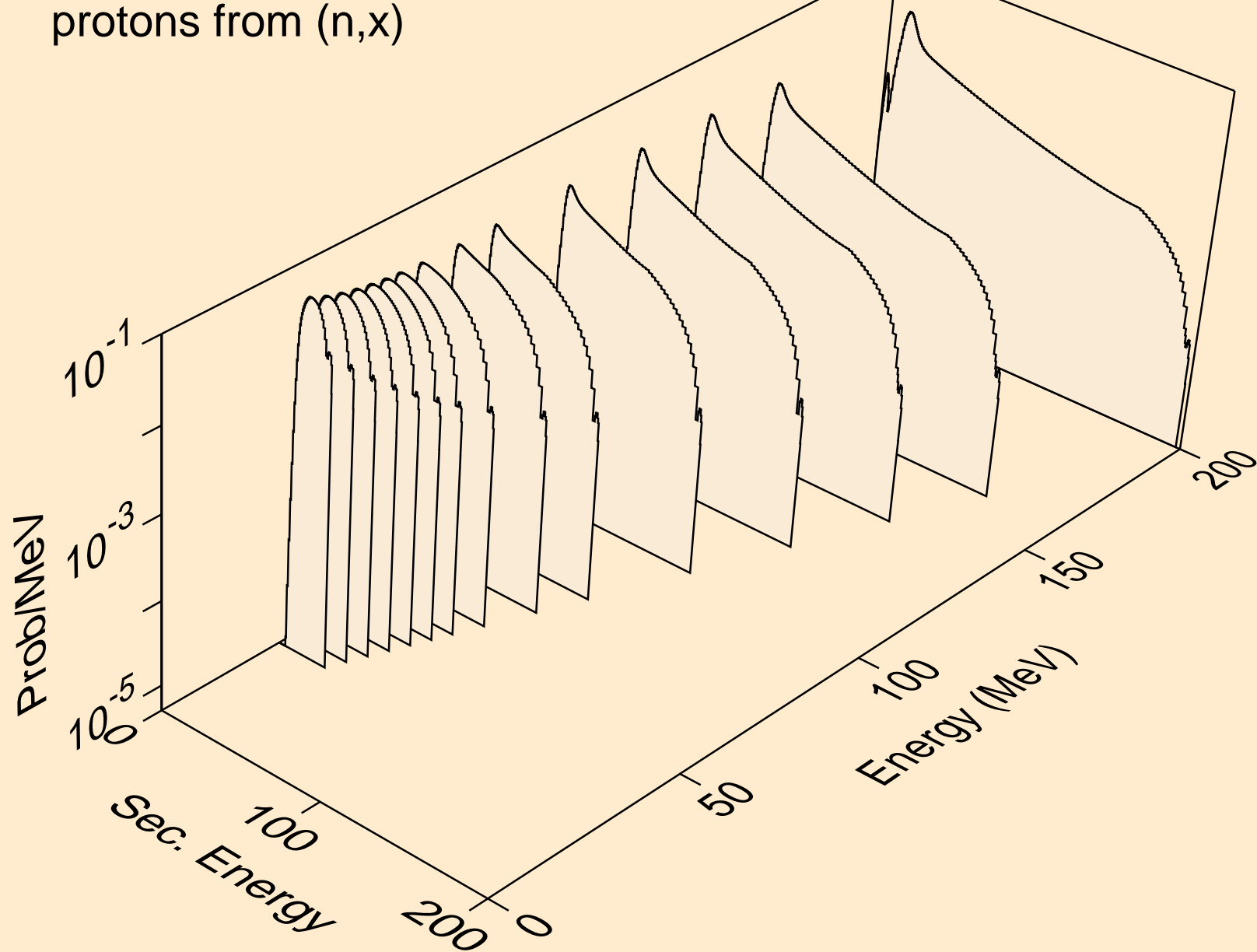

RE190 NEUTRON ACER TENDL-2021 LIBRARY; T=293.6K
protons from (n,n*)p

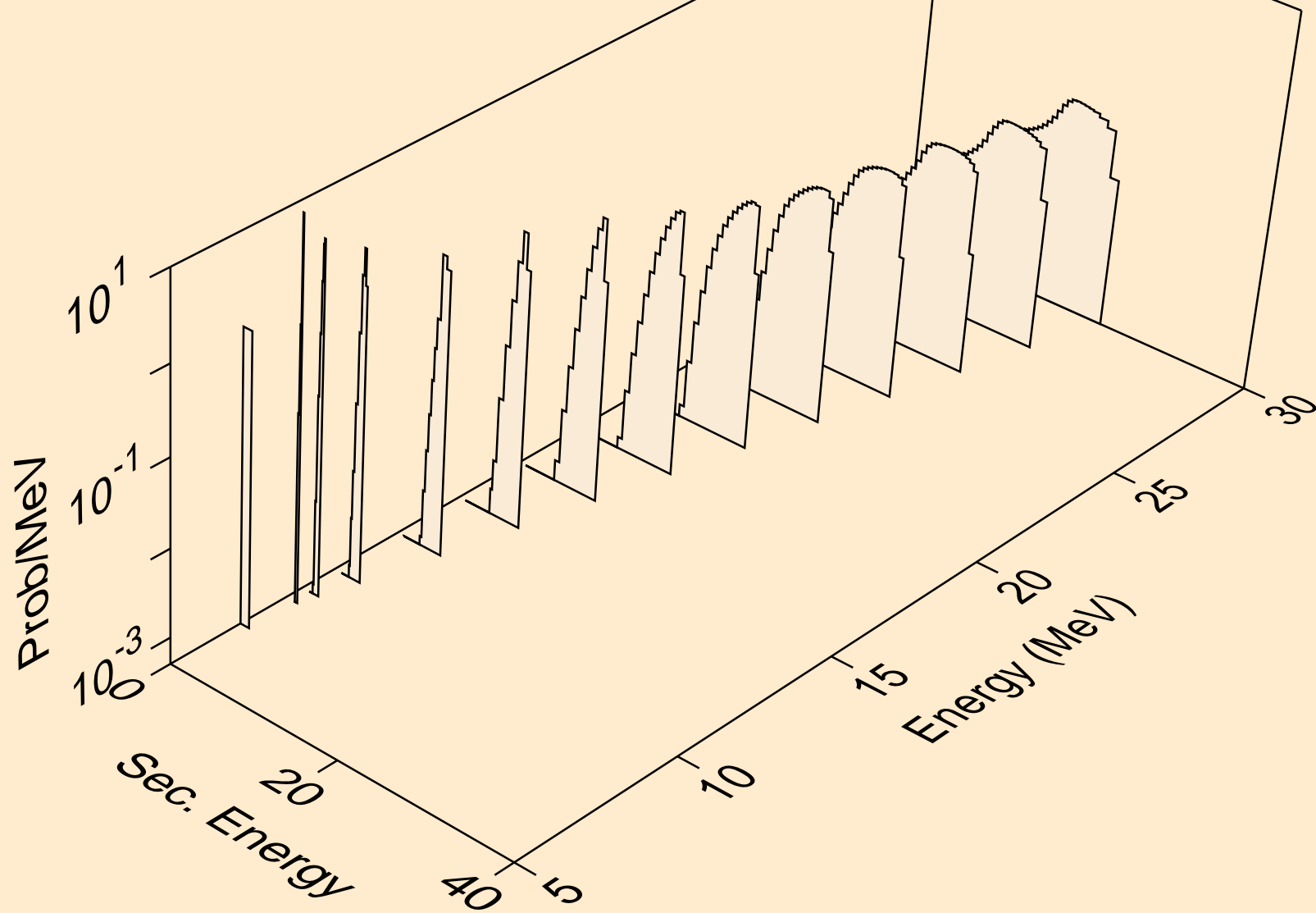

RE190 NEUTRON ACER TENDL-2021 LIBRARY; T=293.6K
protons from (n,2np)

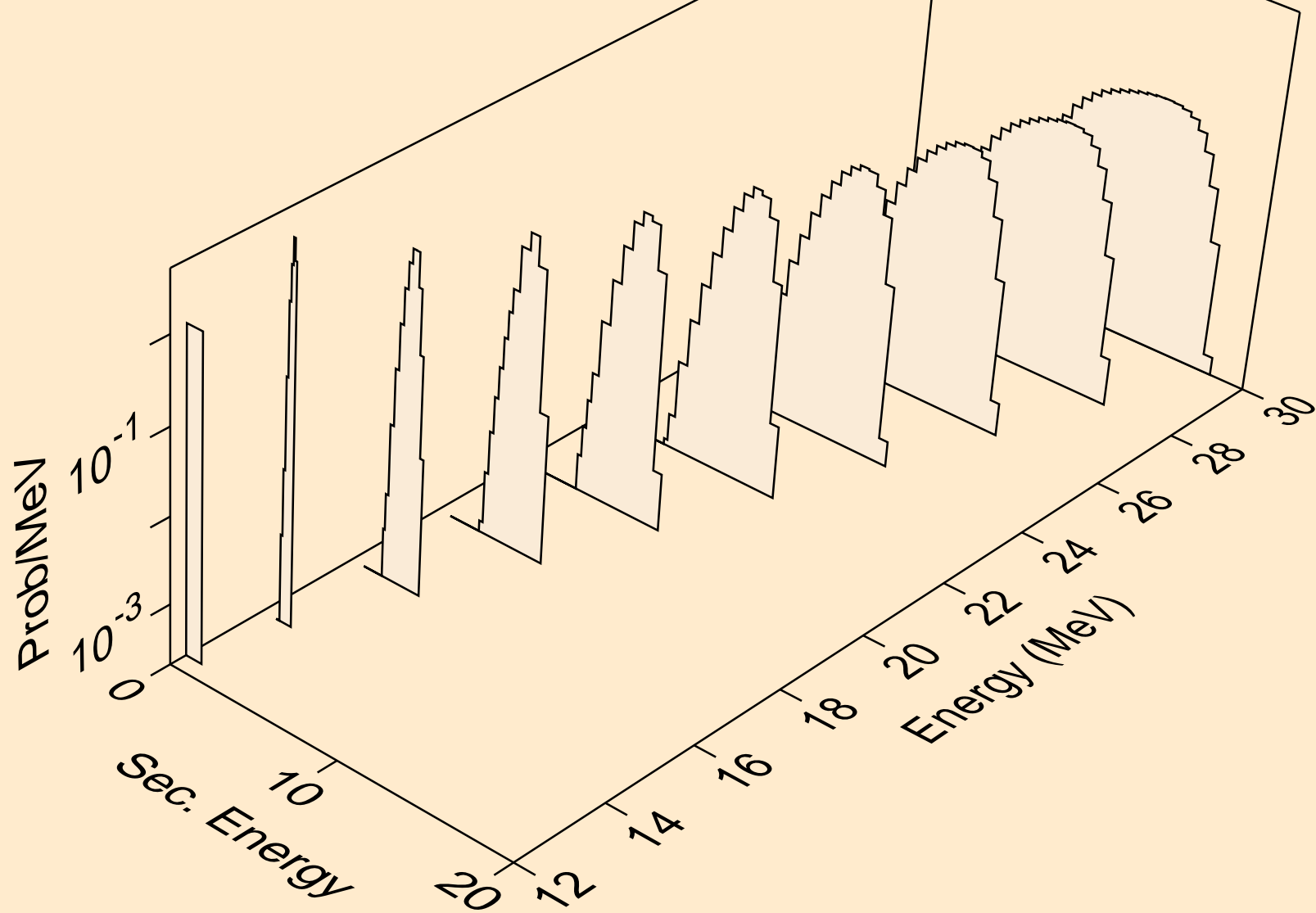

RE190 NEUTRON ACER TENDL-2021 LIBRARY; T=293.6K
protons from (n,3np)

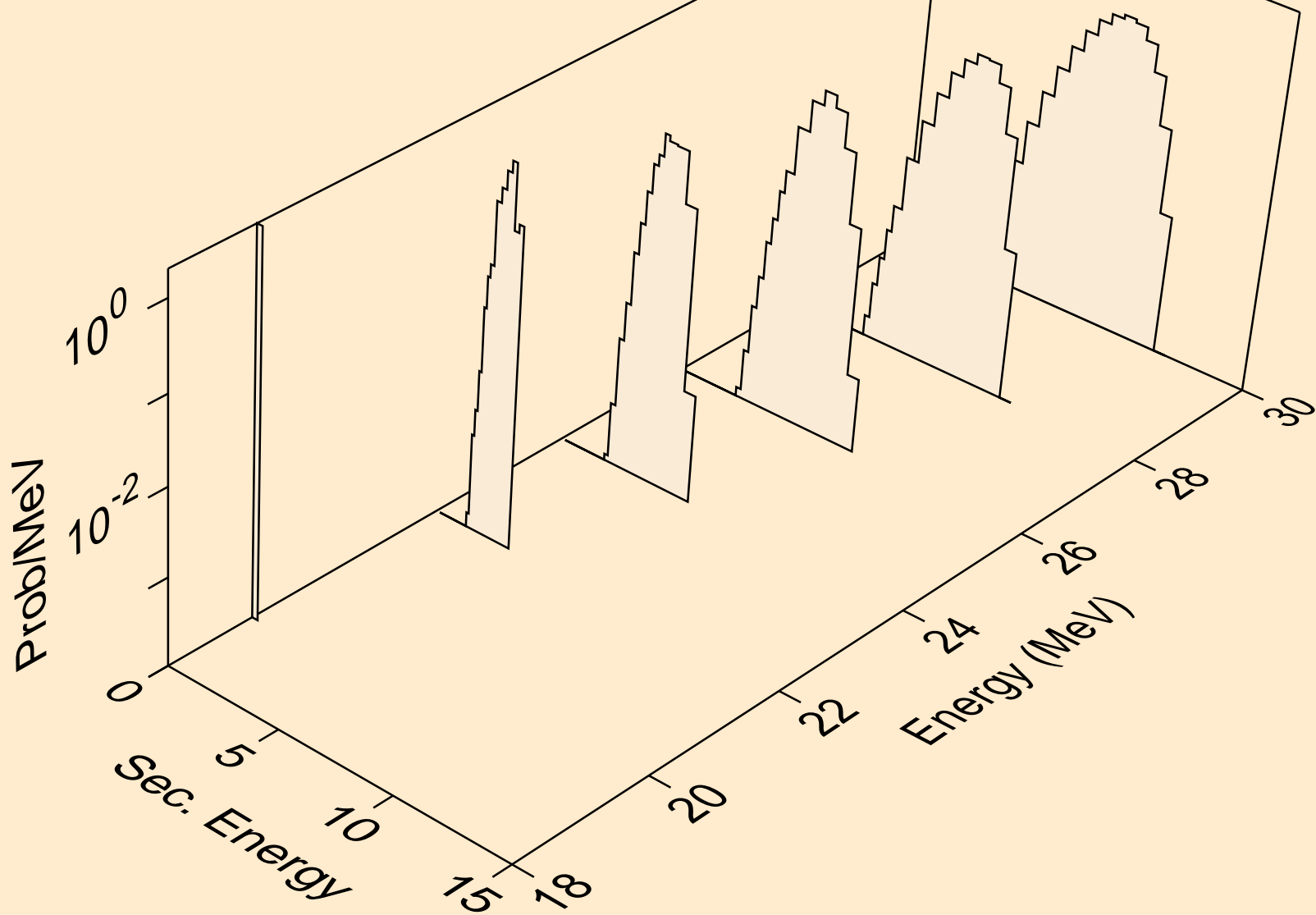

RE190 NEUTRON ACER TENDL-2021 LIBRARY; T=293.6K
protons from (n,2np)

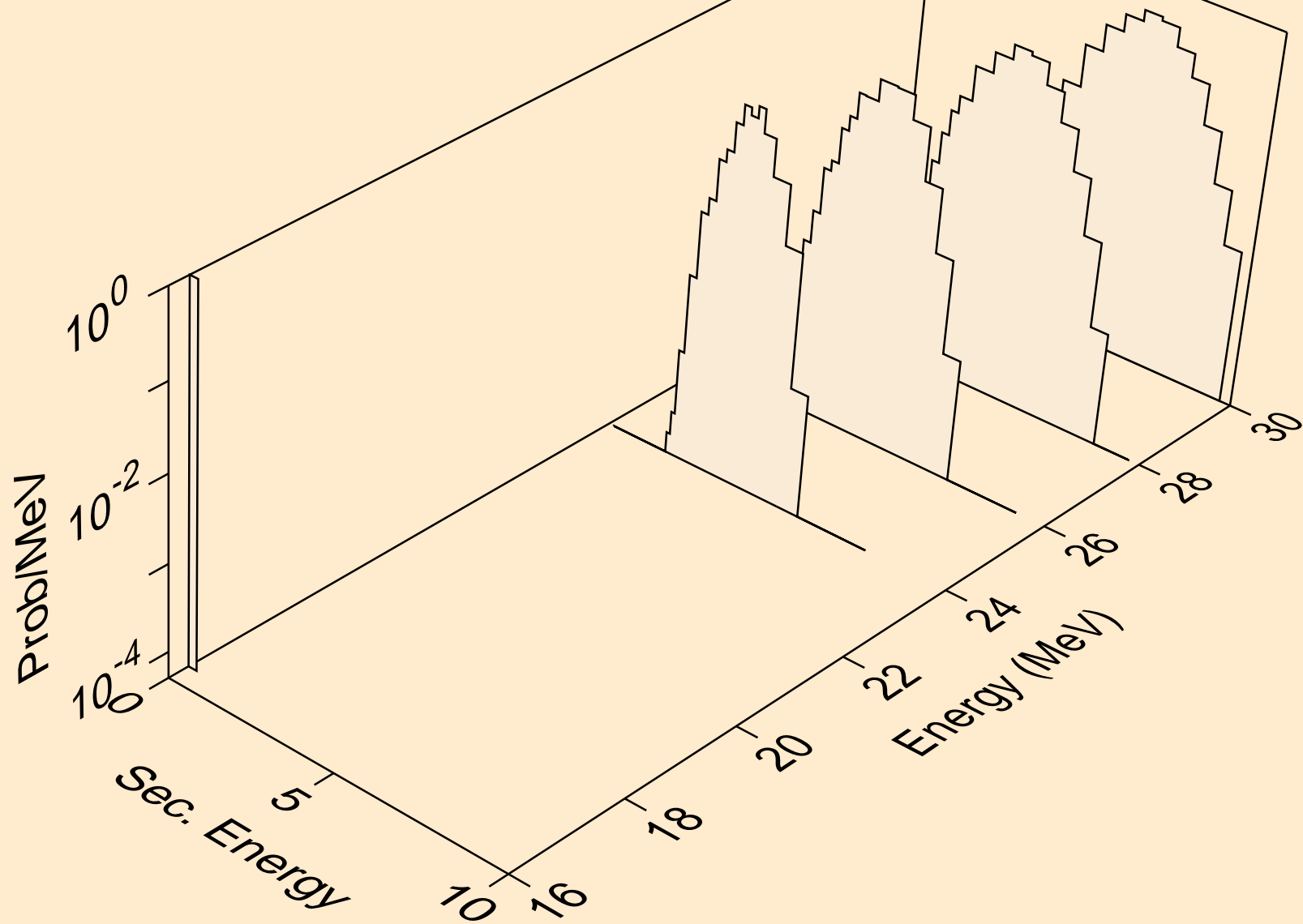

RE190 NEUTRON ACER TENDL-2021 LIBRARY; T=293.6K
protons from (n,p)

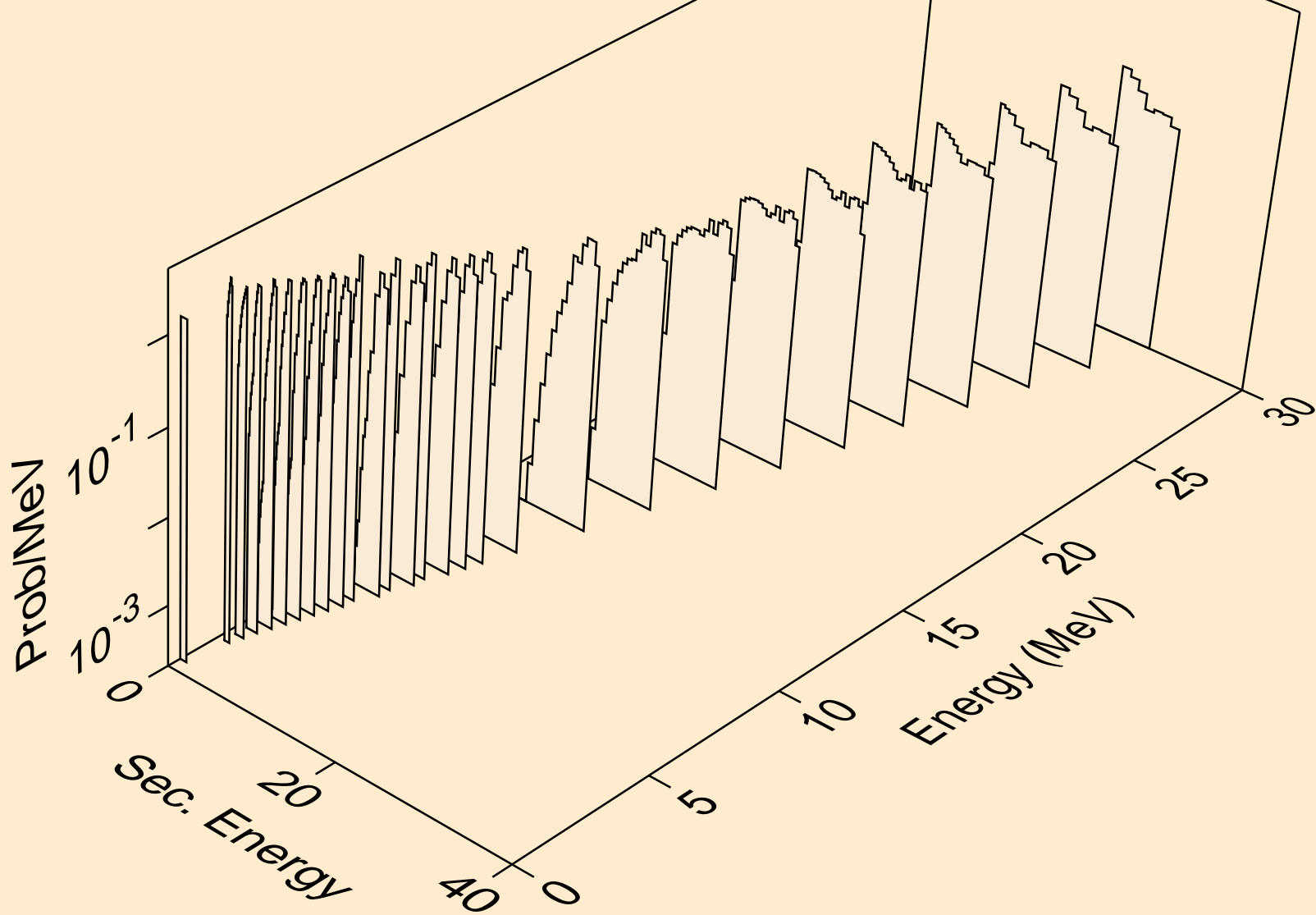

RE190 NEUTRON ACER TENDL-2021 LIBRARY; T=293.6K
protons from (n,2p)

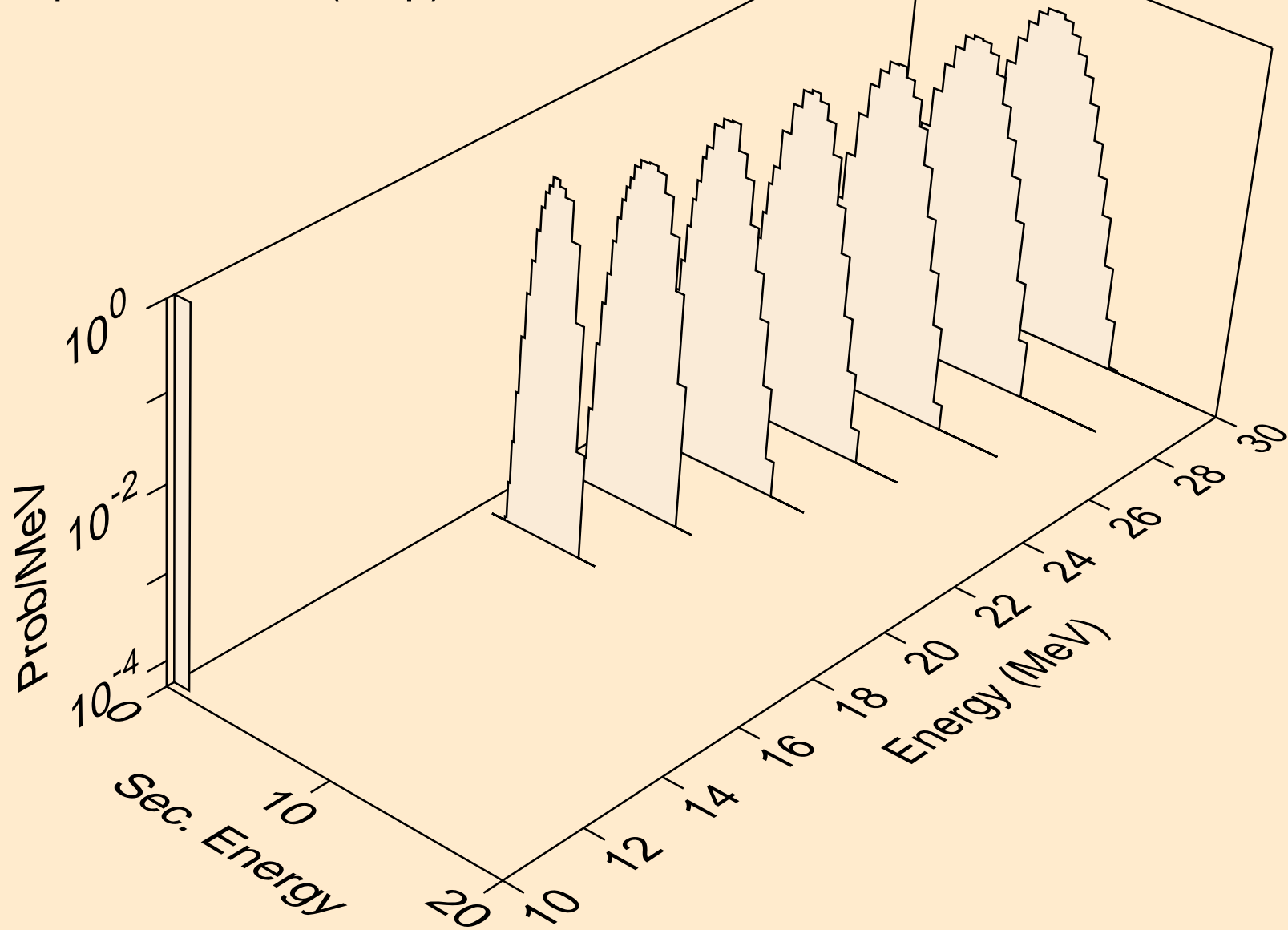

RE190 NEUTRON ACER TENDL-2021 LIBRARY; T=293.6K
deuterons from (n,x)

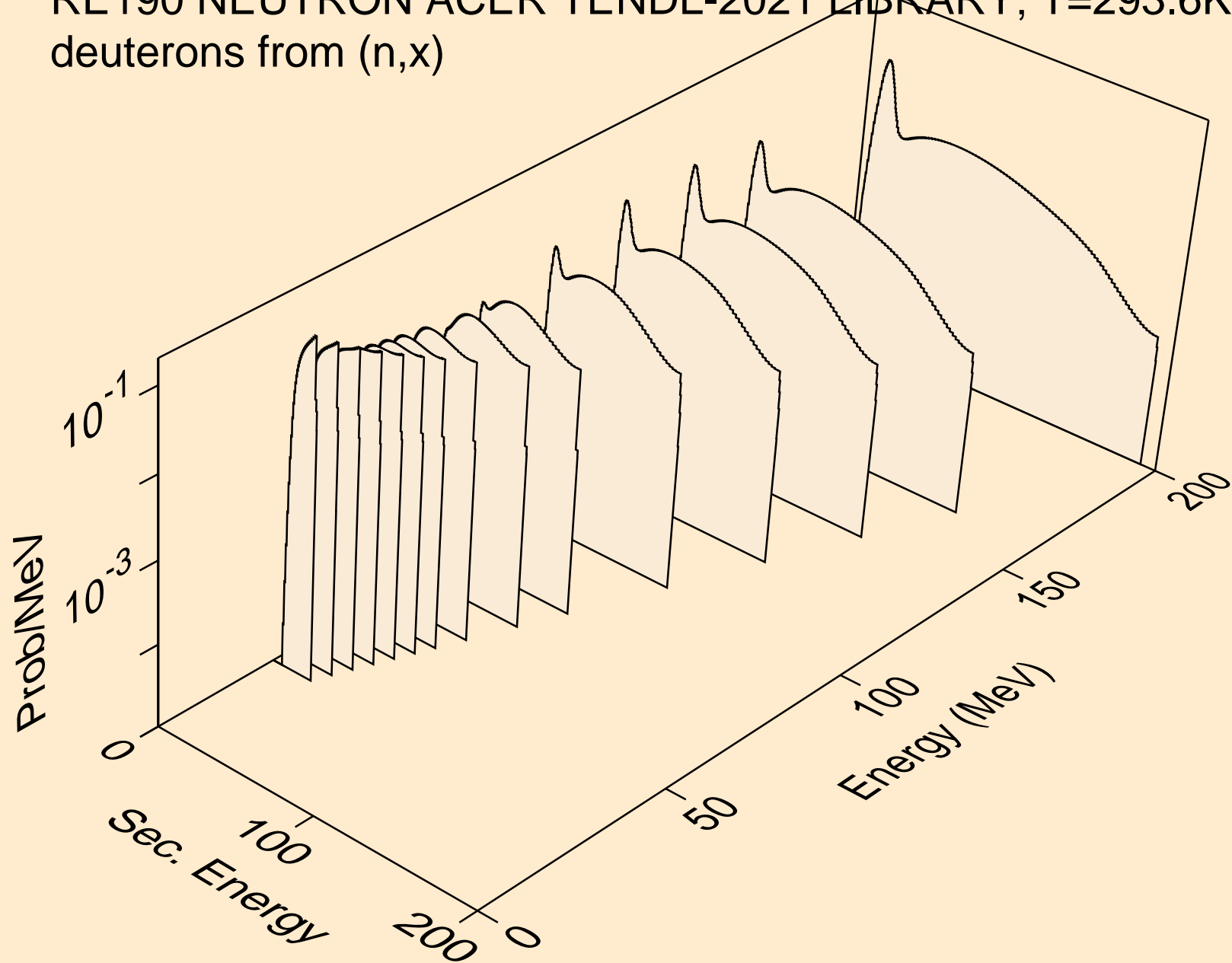

RE190 NEUTRON ACER TENDL-2021 LIBRARY; T=293.6K
deuterons from (n,2nd)

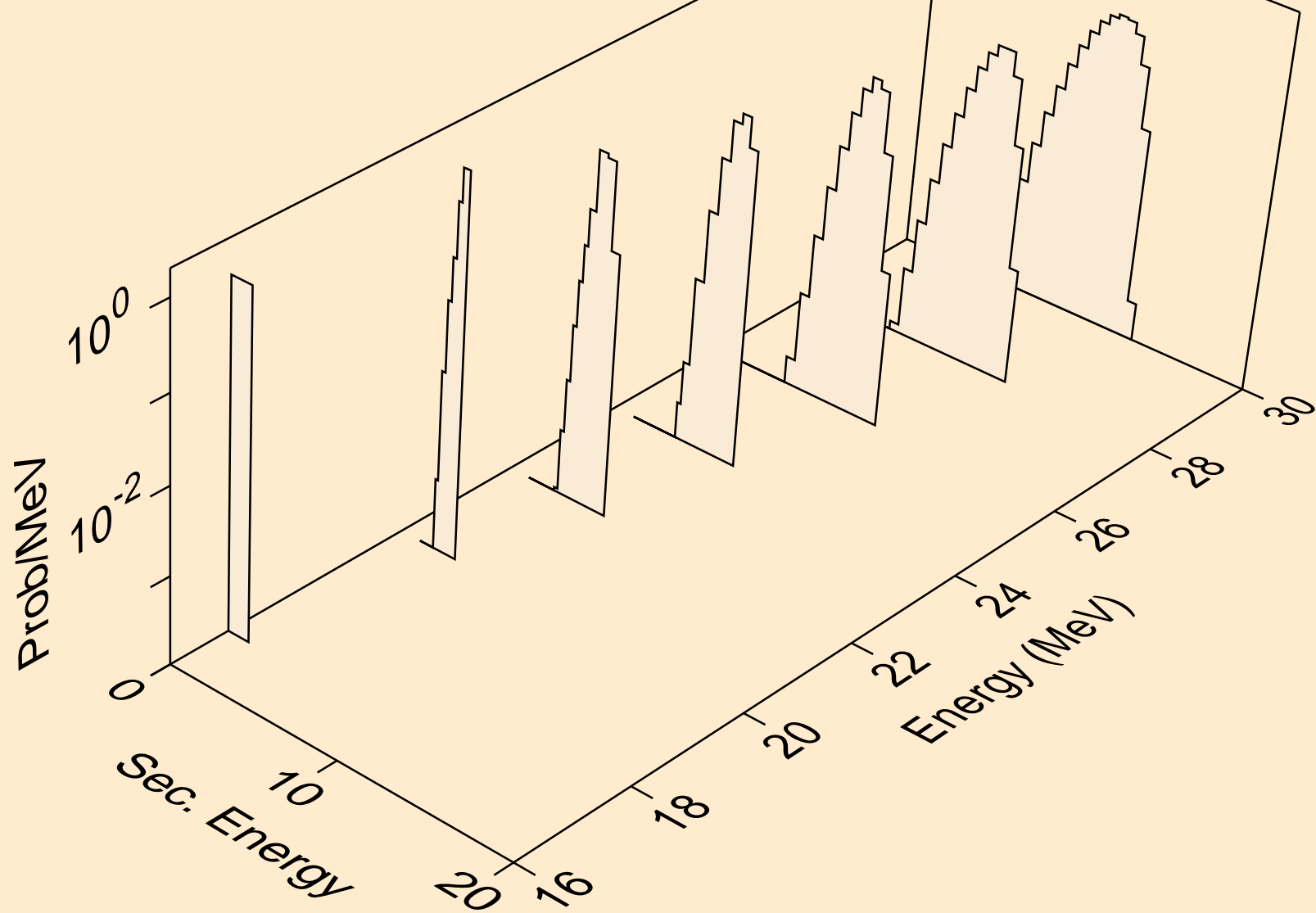

RE190 NEUTRON ACER TENDL-2021 LIBRARY; T=293.6K
deuterons from (n,n*)d

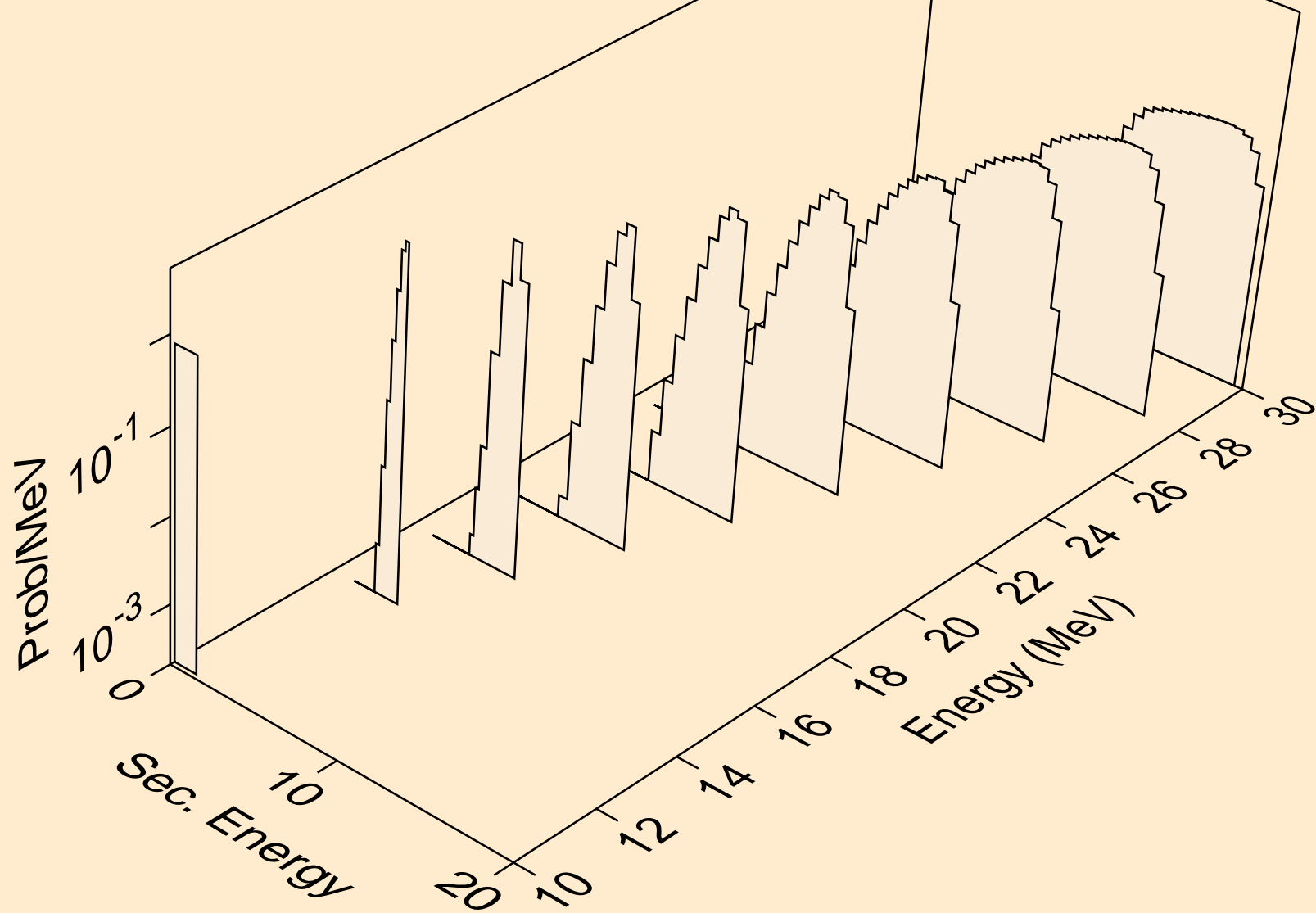

RE190 NEUTRON ACER TENDL-2021 LIBRARY; T=293.6K
deuterons from (n,d)

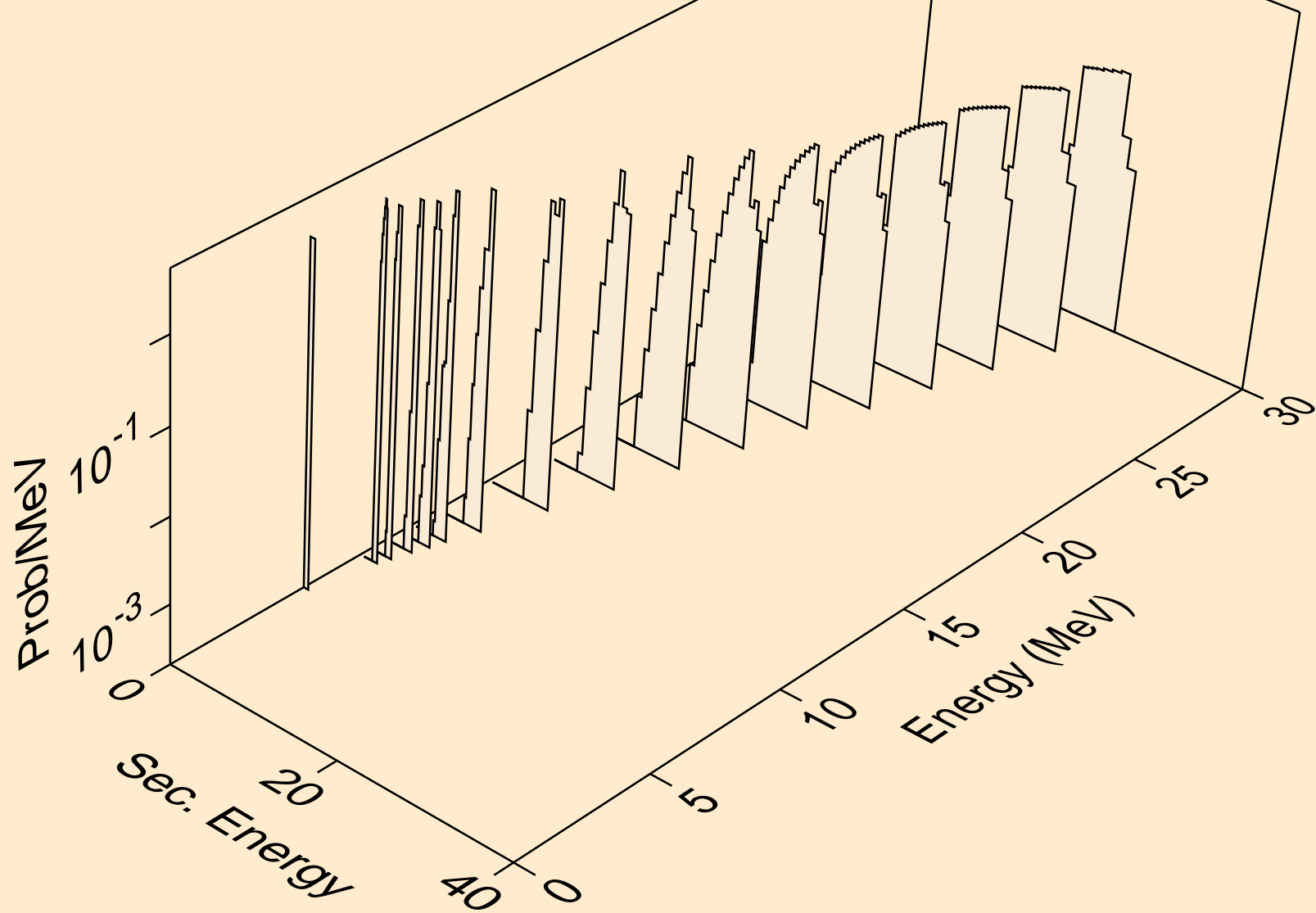

RE190 NEUTRON ACER TENDL-2021 LIBRARY; T=293.6K
tritons from (n,x)

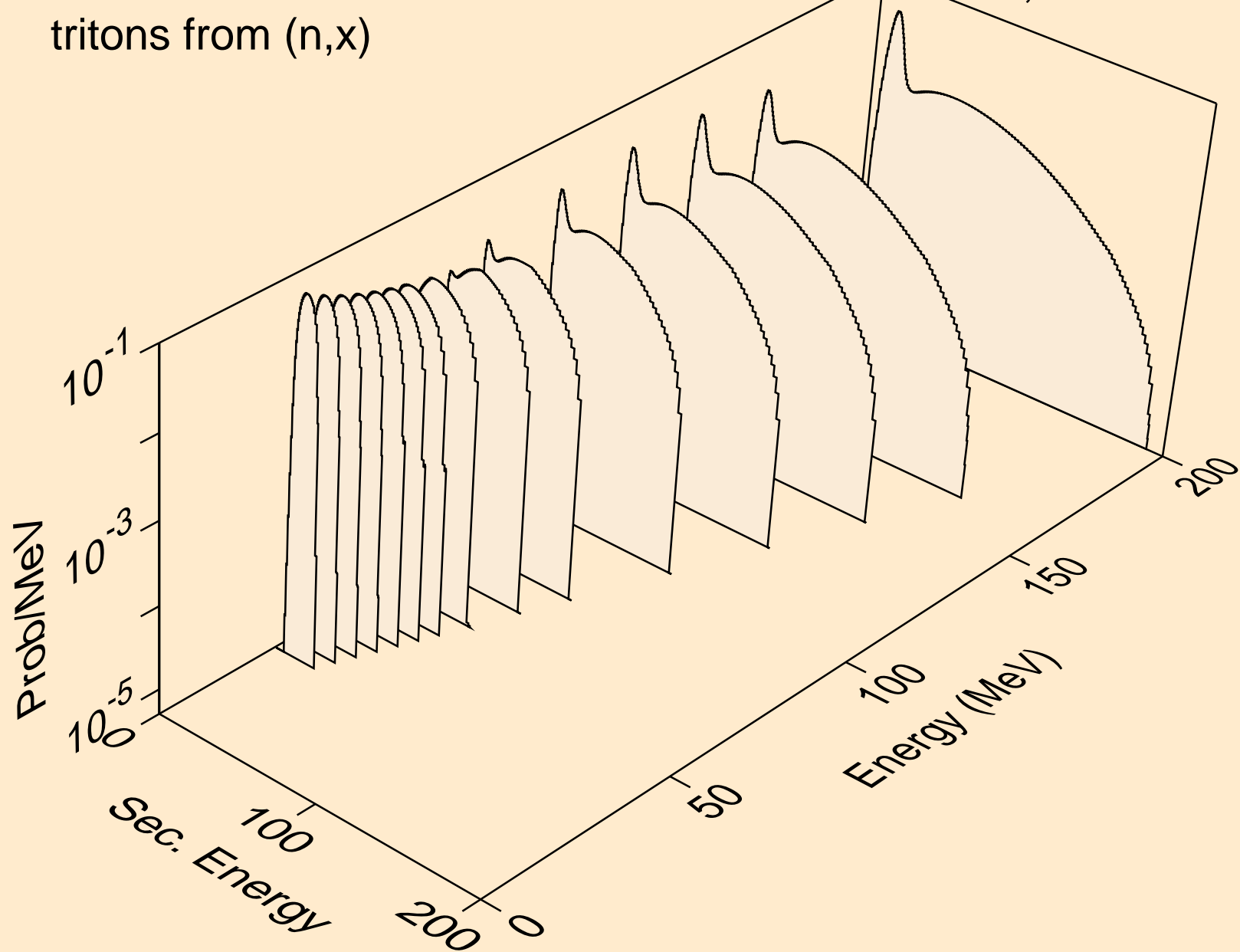

RE190 NEUTRON ACER TENDL-2021 LIBRARY; T=293.6K
tritons from (n,n*)t

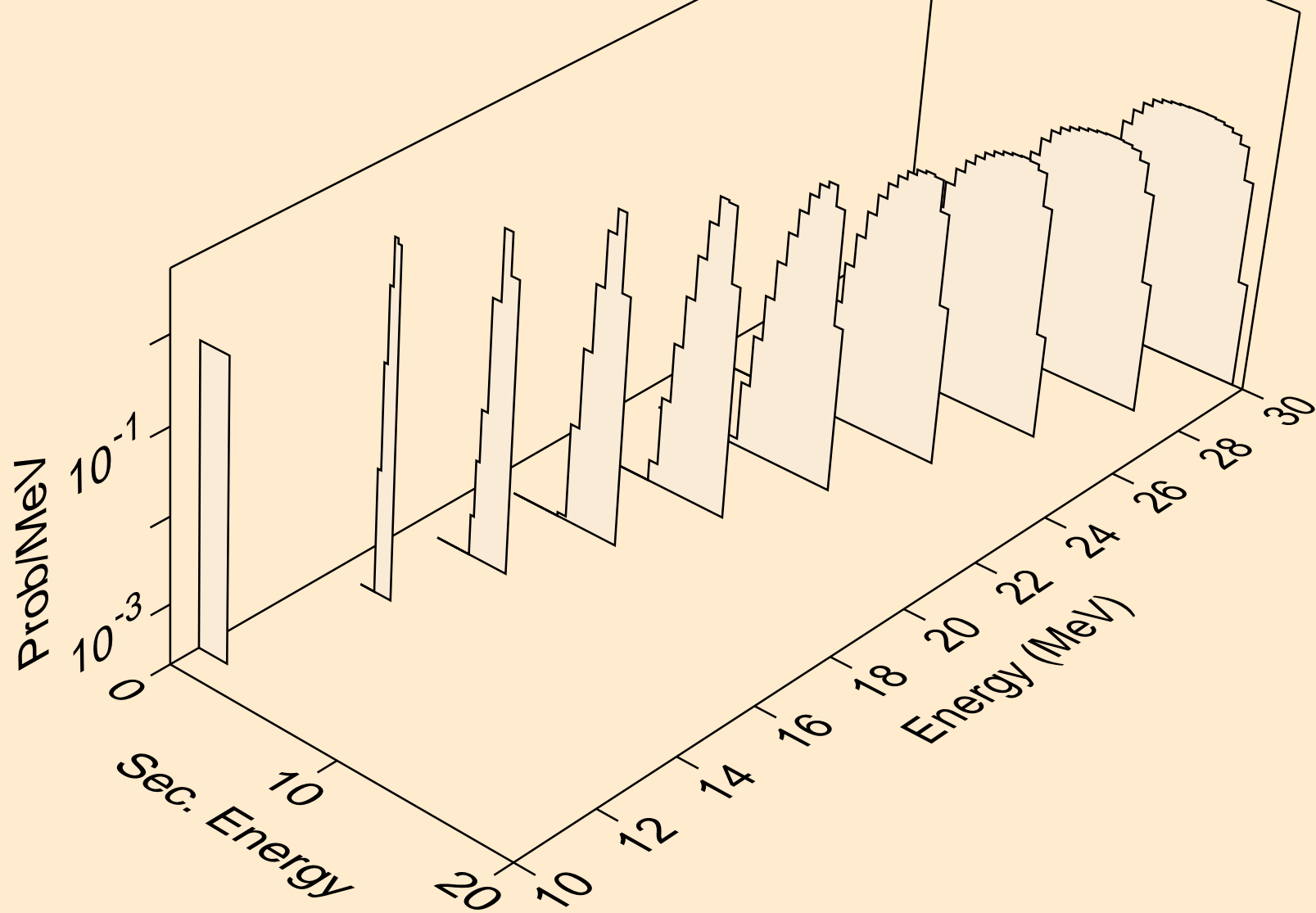

RE190 NEUTRON ACER TENDL-2021 LIBRARY; T=293.6K
tritons from (n,t)

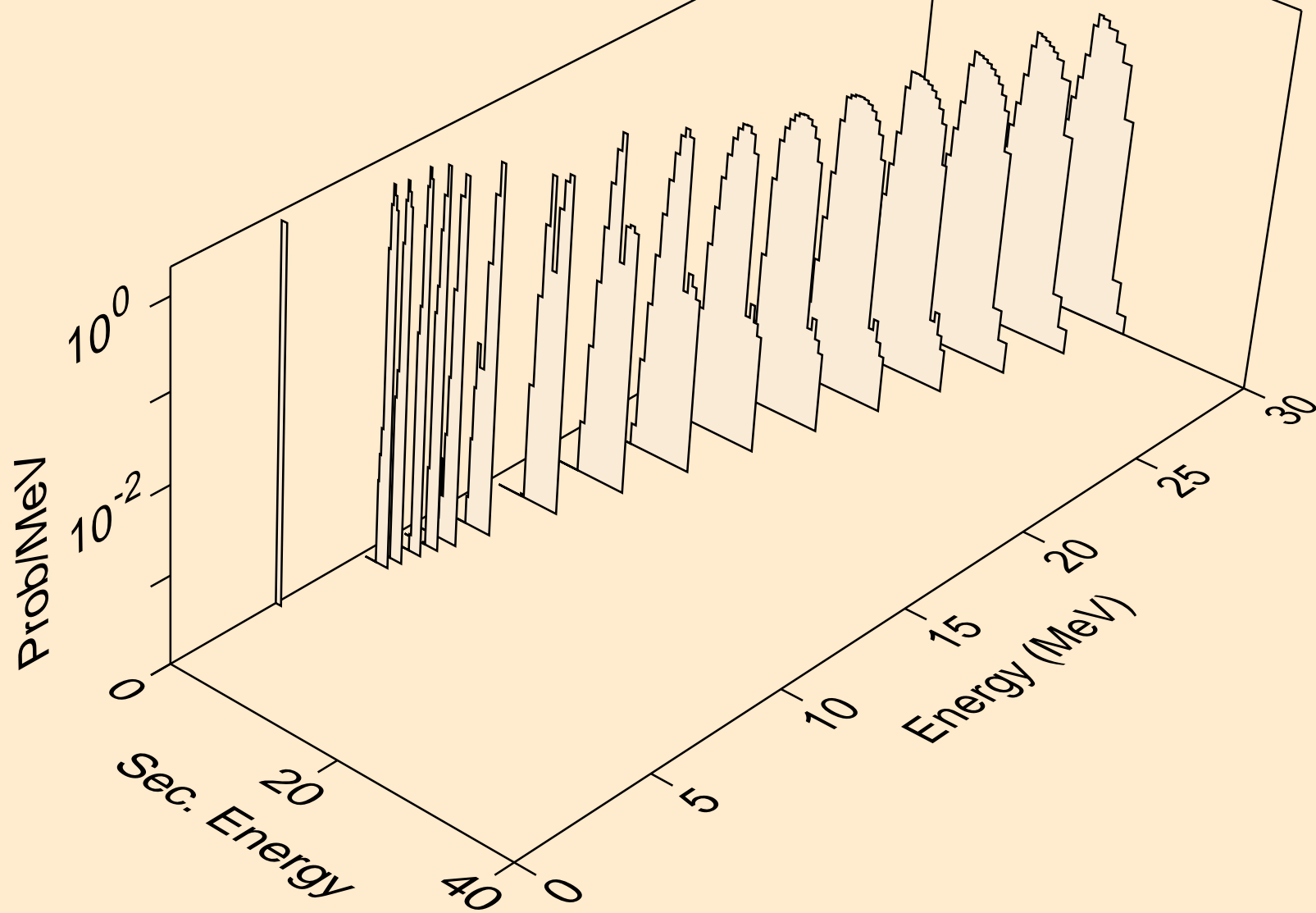

RE190 NEUTRON ACER TENDL-2021 LIBRARY; T=293.6K
he3s from (n,x)

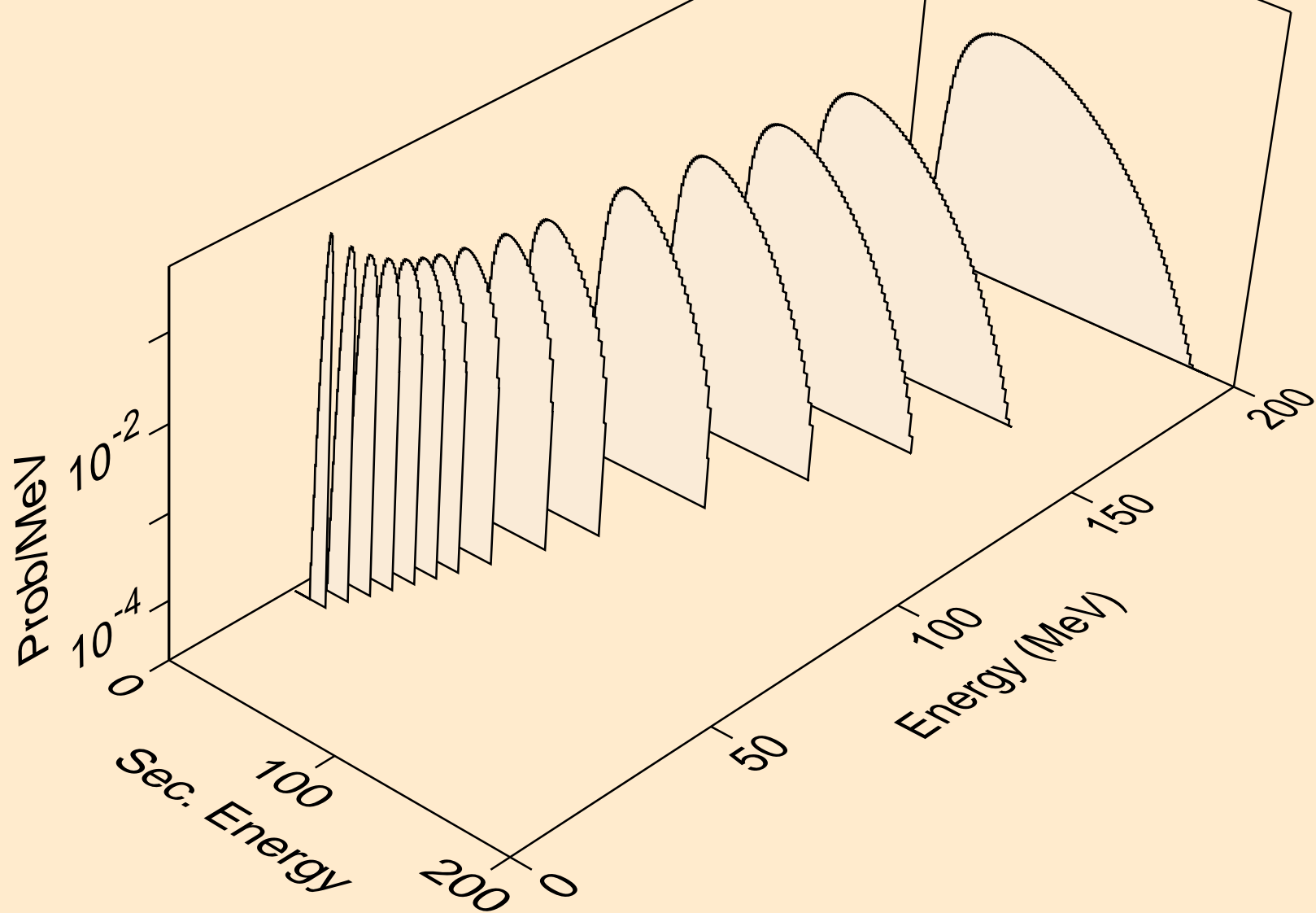

RE190 NEUTRON ACER TENDL-2021 LIBRARY; T=293.6K
he3s from (n,n*)he3

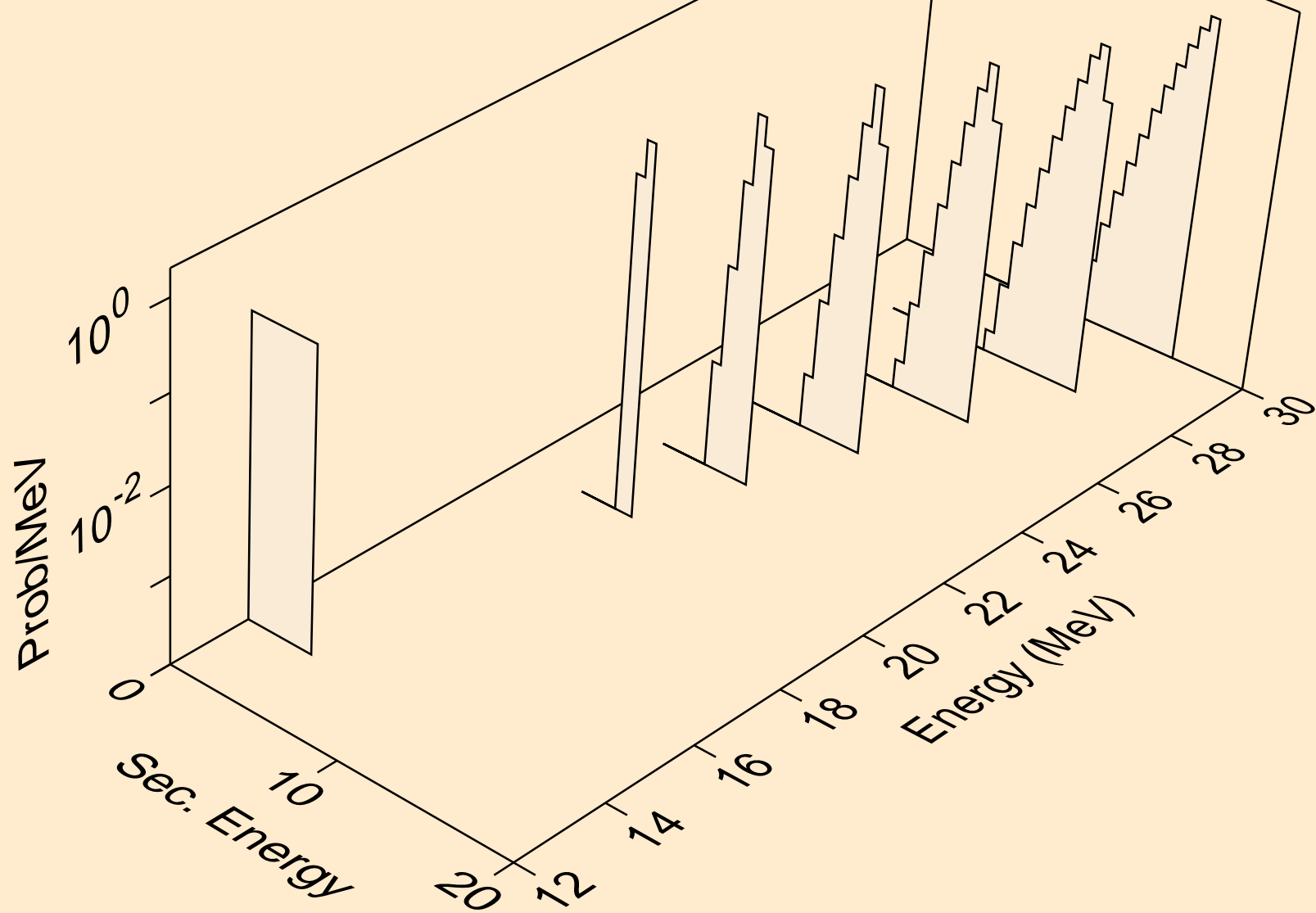

RE190 NEUTRON ACER TENDL-2021 LIBRARY; T=293.6K
he3s from (n,he3)

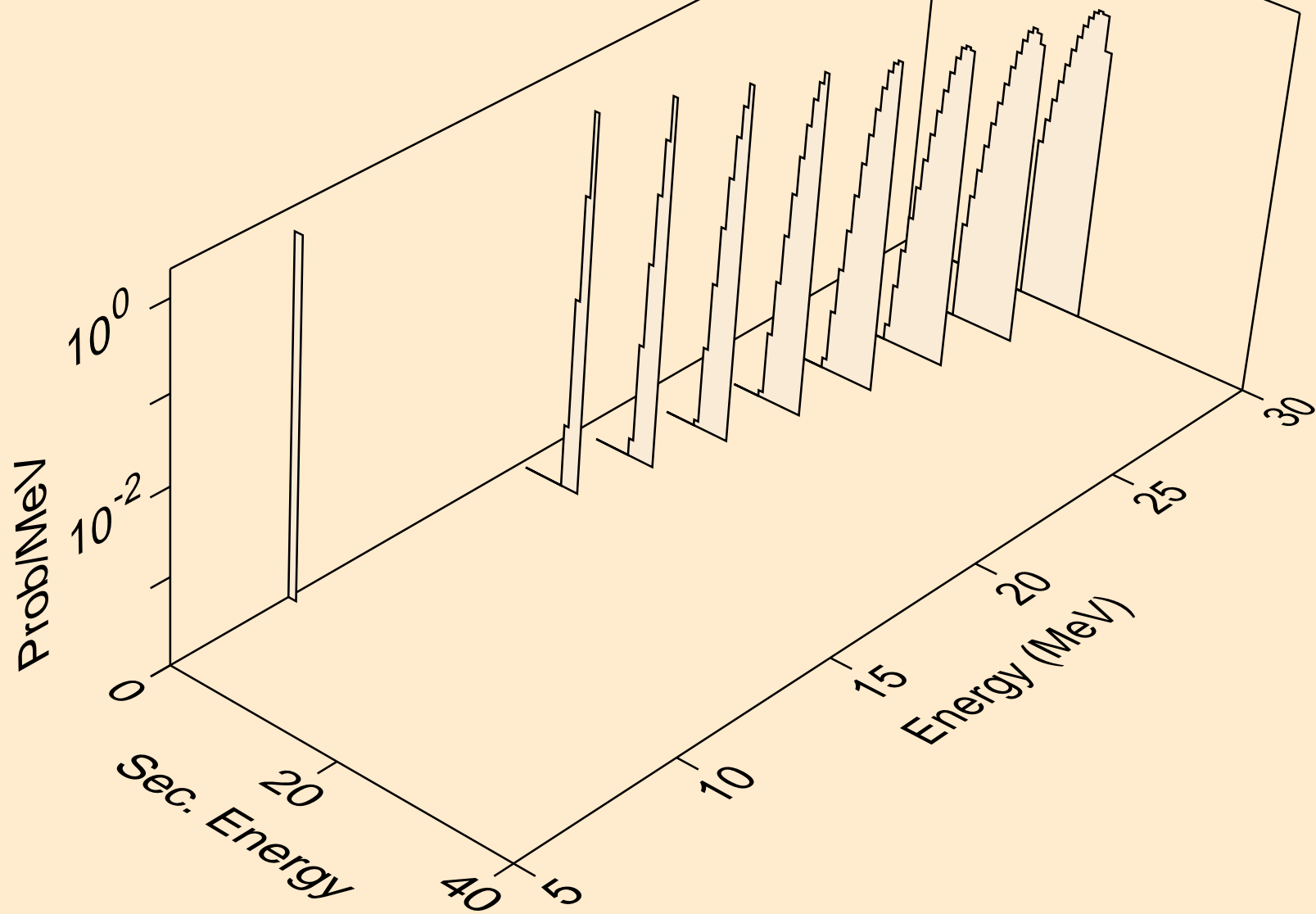

RE190 NEUTRON ACER TENDL-2021 LIBRARY; T=293.6K
alphas from (n,x)

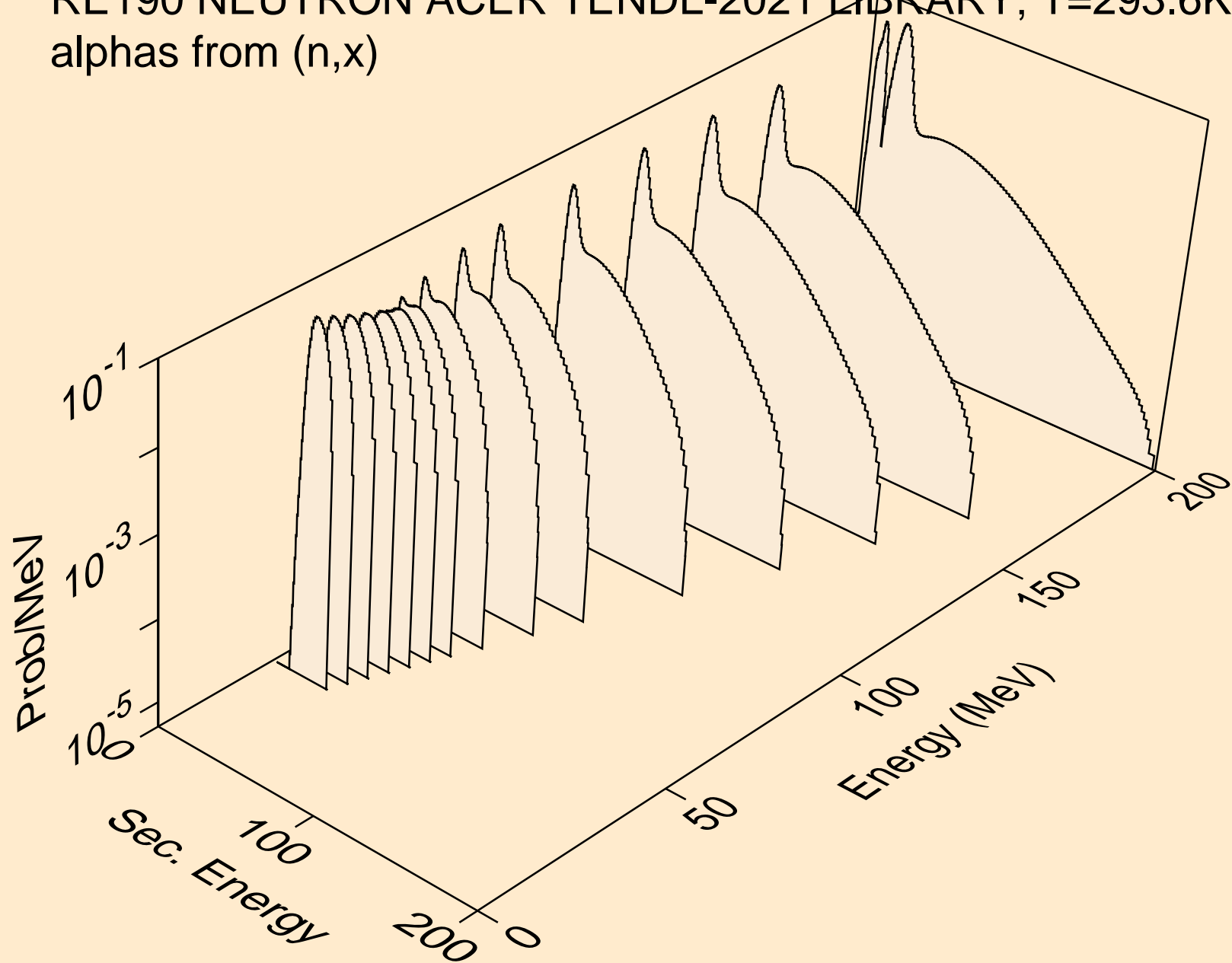

RE190 NEUTRON ACER TENDL-2021 LIBRARY; T=293.6K
alphas from (n,n*)a

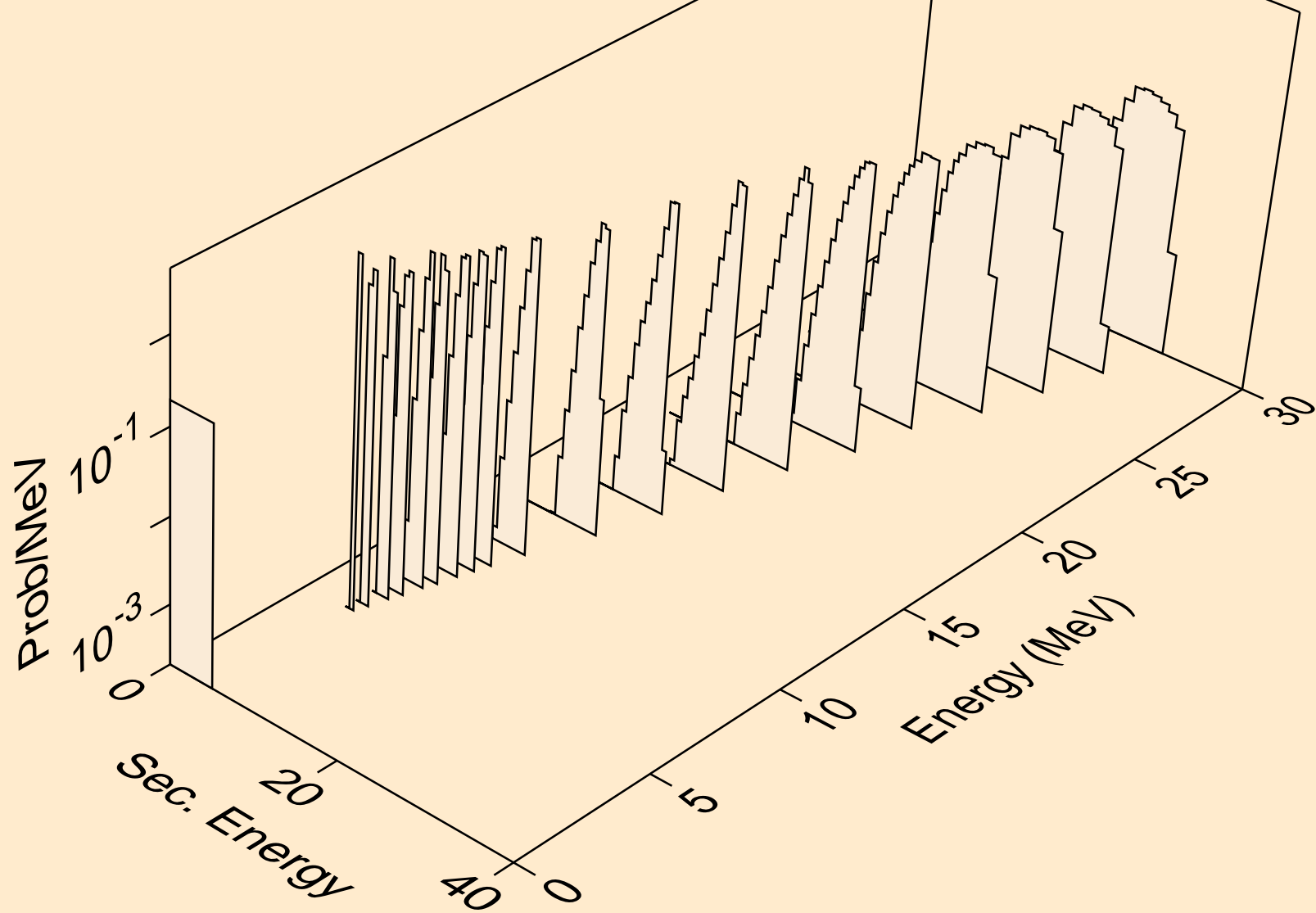

RE190 NEUTRON ACER TENDL-2021 LIBRARY; T=293.6K
alphas from (n,2n)a

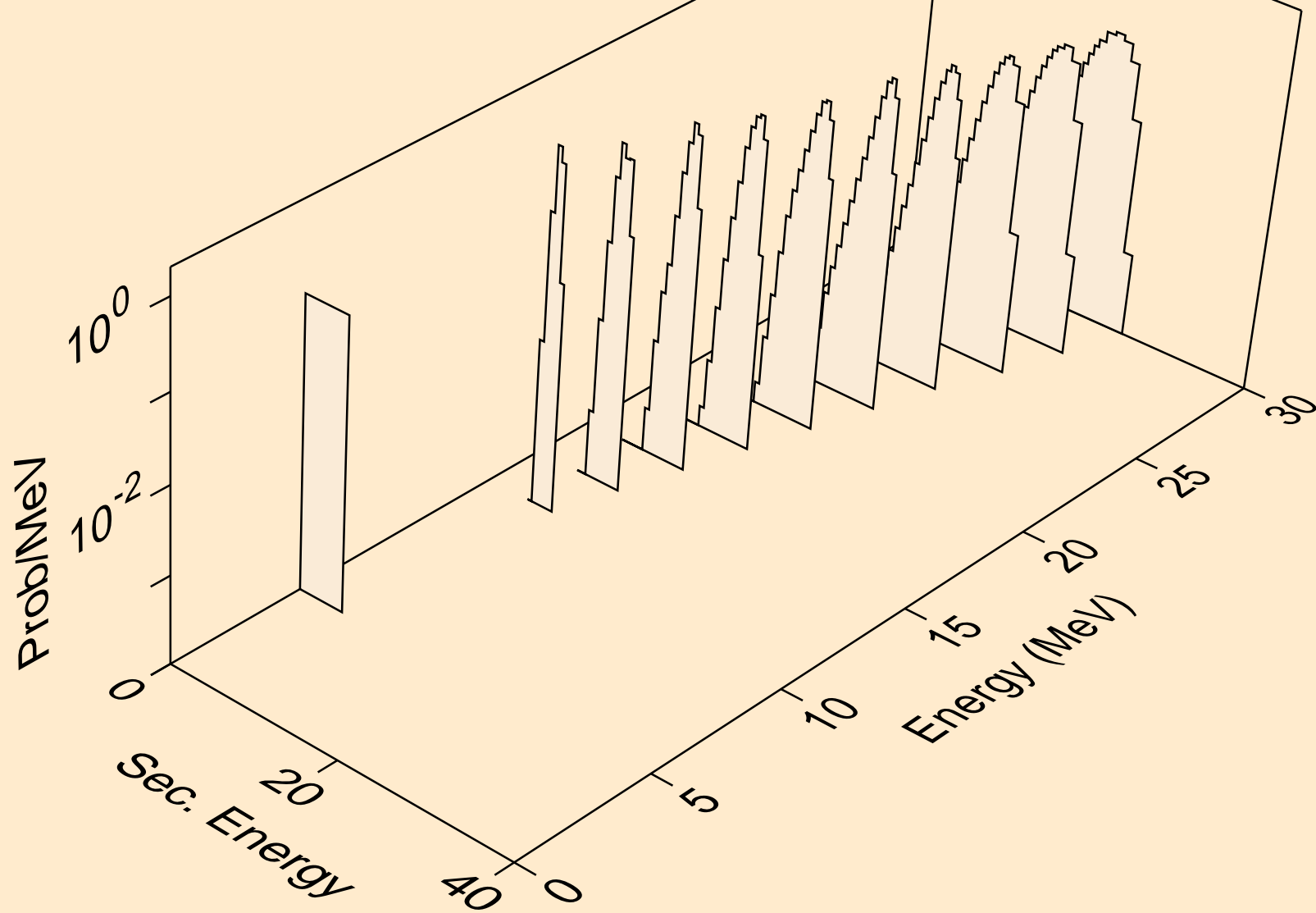

RE190 NEUTRON ACER TENDL-2021 LIBRARY; T=293.6K
alphas from (n,3n)a

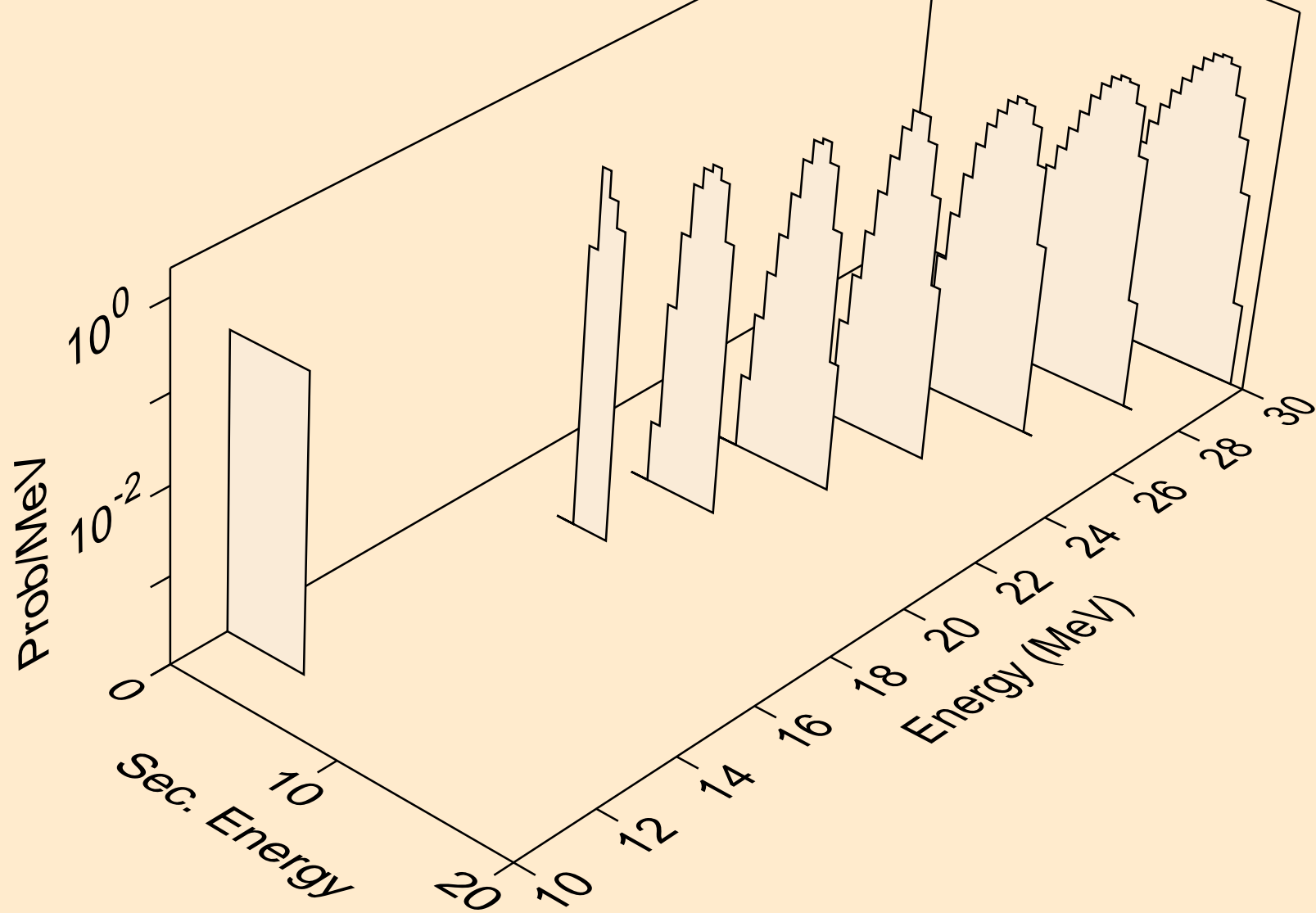

RE190 NEUTRON ACER TENDL-2021 LIBRARY; T=293.6K
alphas from (n,a)

