

RE192 NEUTRON ACER TENDL-2021 LIBRARY; T=293.6K  
Principal cross sections

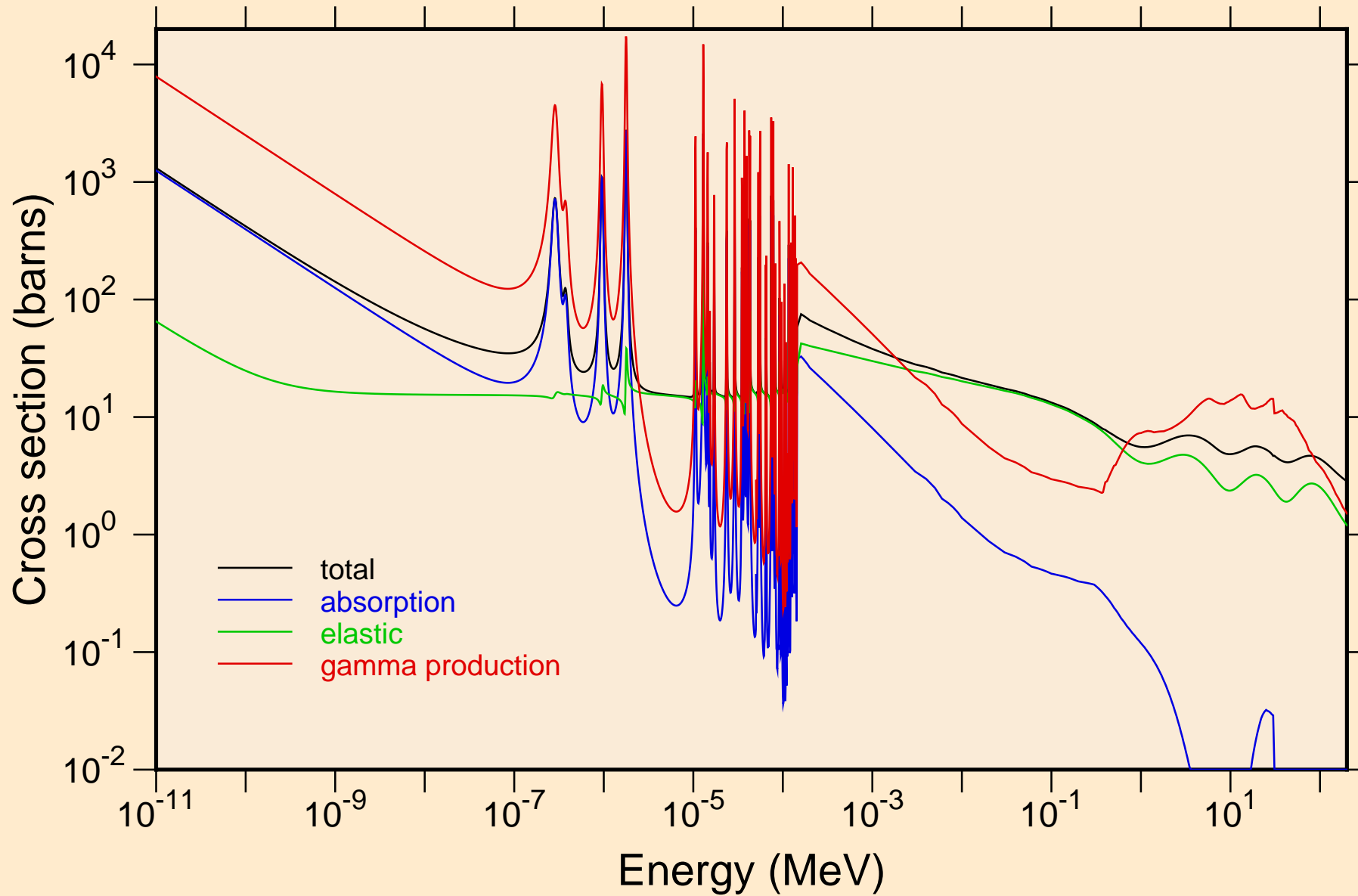

RE192 NEUTRON ACER TENDL-2021 LIBRARY; T=293.6K  
resonance total cross section

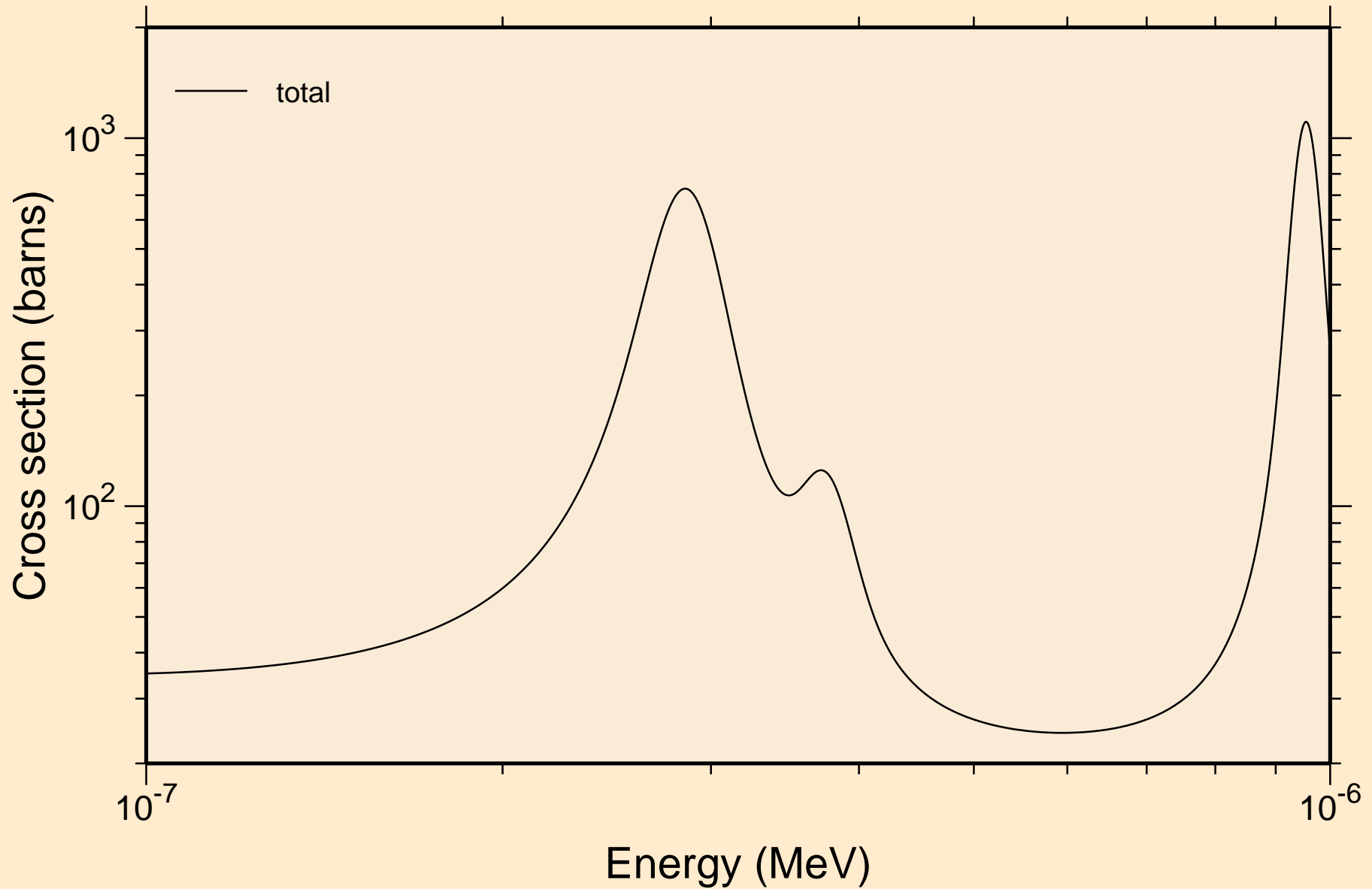

RE192 NEUTRON ACER TENDL-2021 LIBRARY; T=293.6K  
resonance total cross section

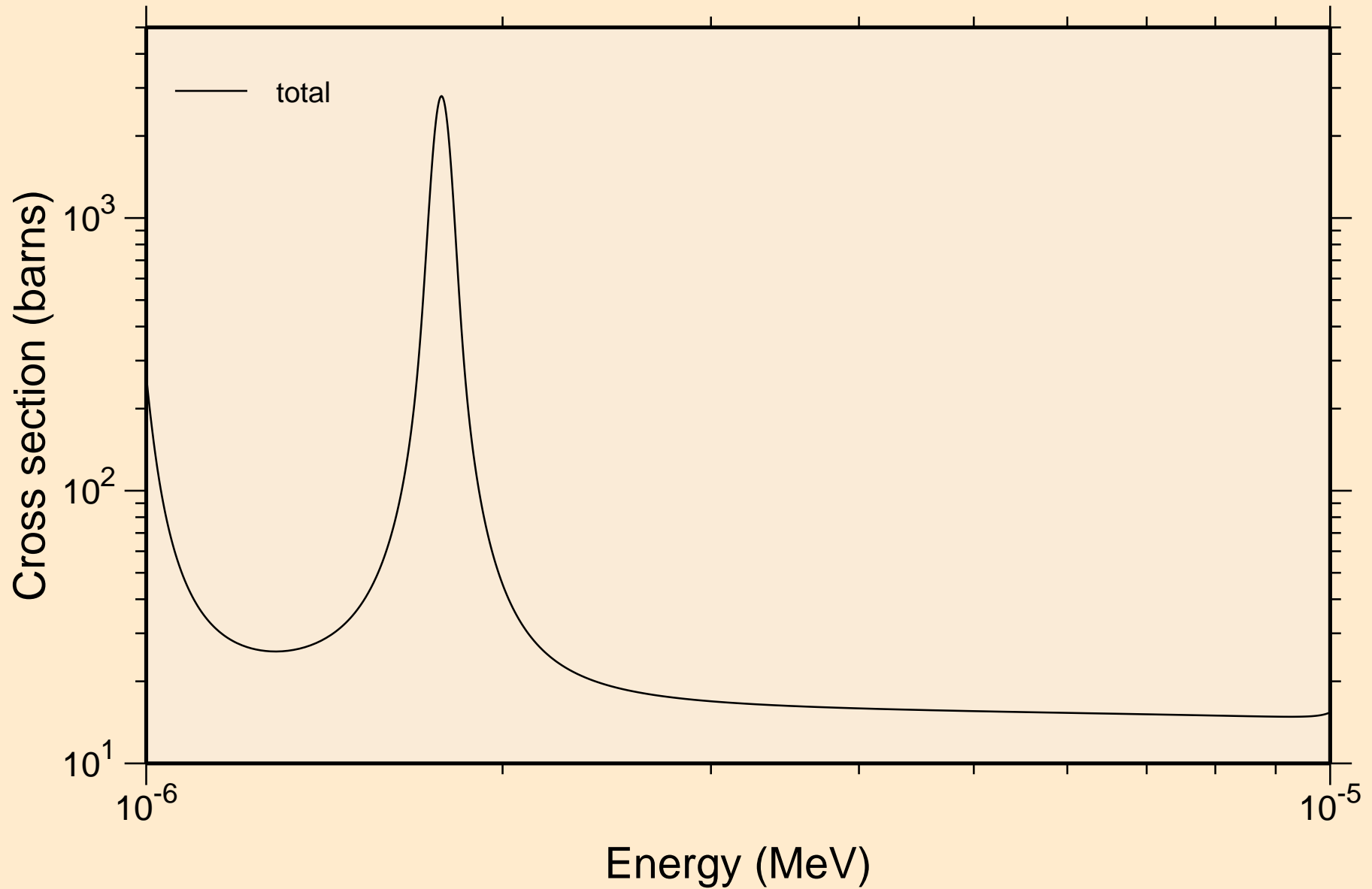

RE192 NEUTRON ACER TENDL-2021 LIBRARY; T=293.6K  
resonance total cross section

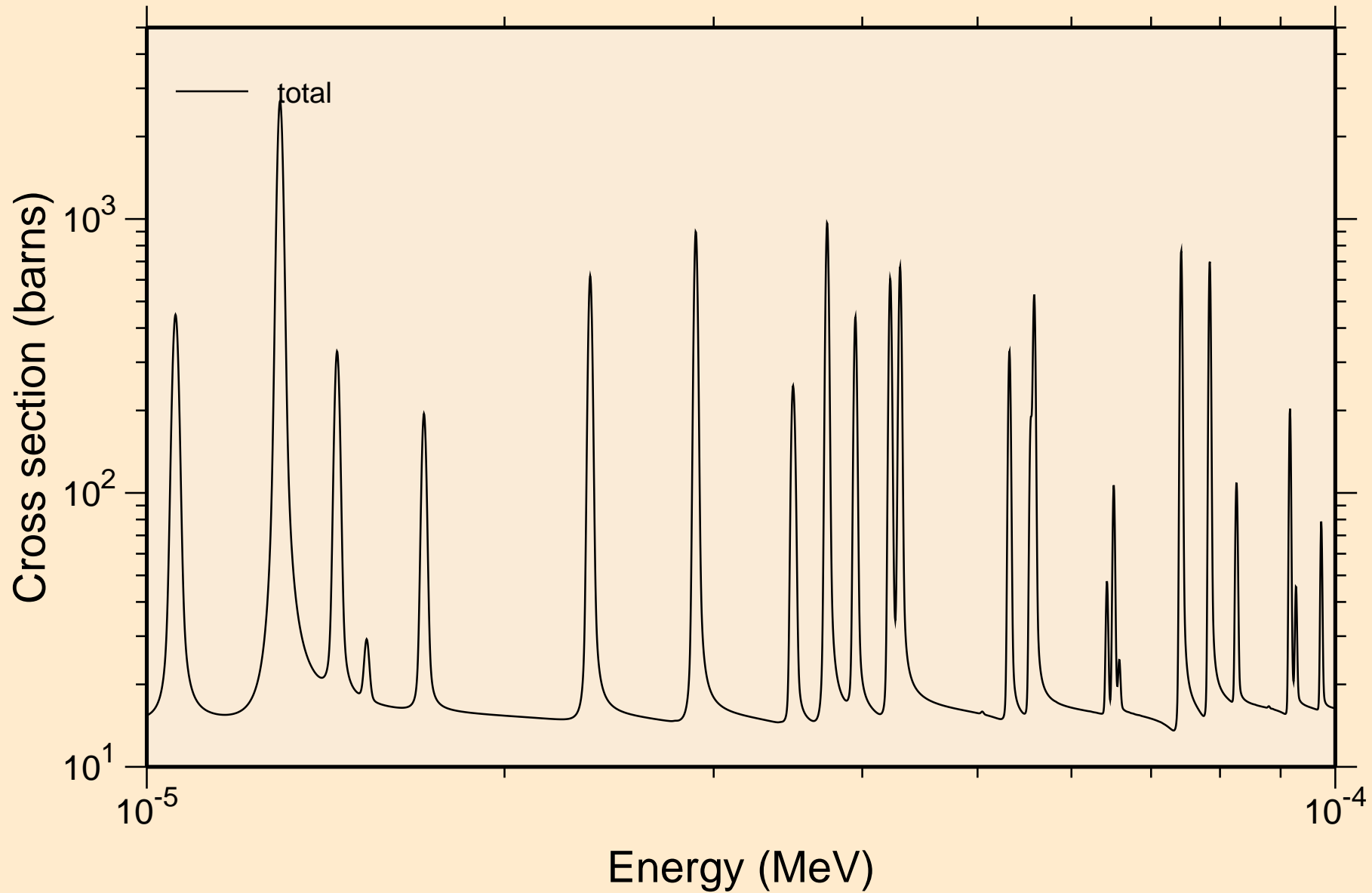

RE192 NEUTRON ACER TENDL-2021 LIBRARY; T=293.6K  
resonance total cross section

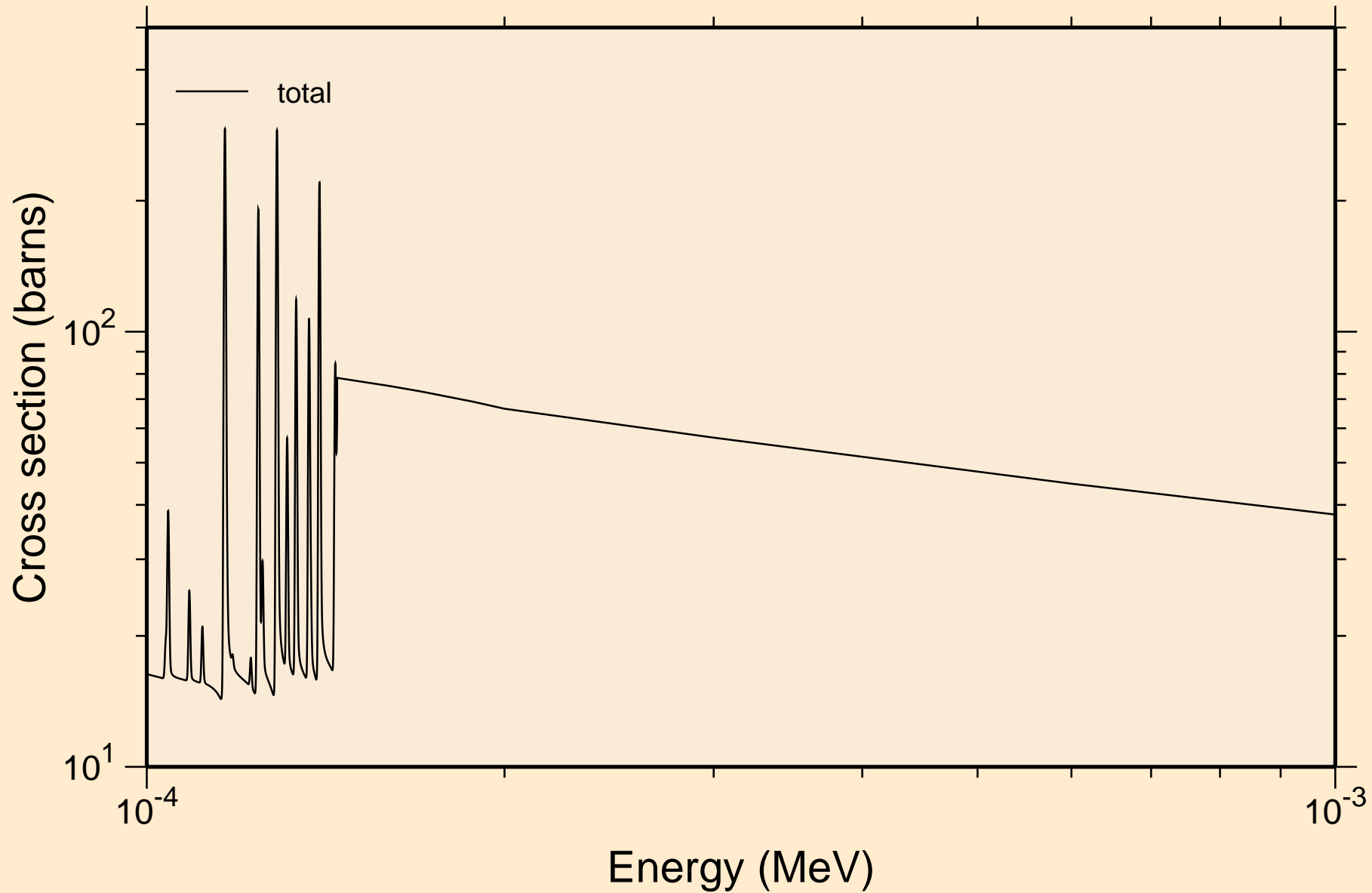

RE192 NEUTRON ACER TENDL-2021 LIBRARY; T=293.6K  
resonance total cross section

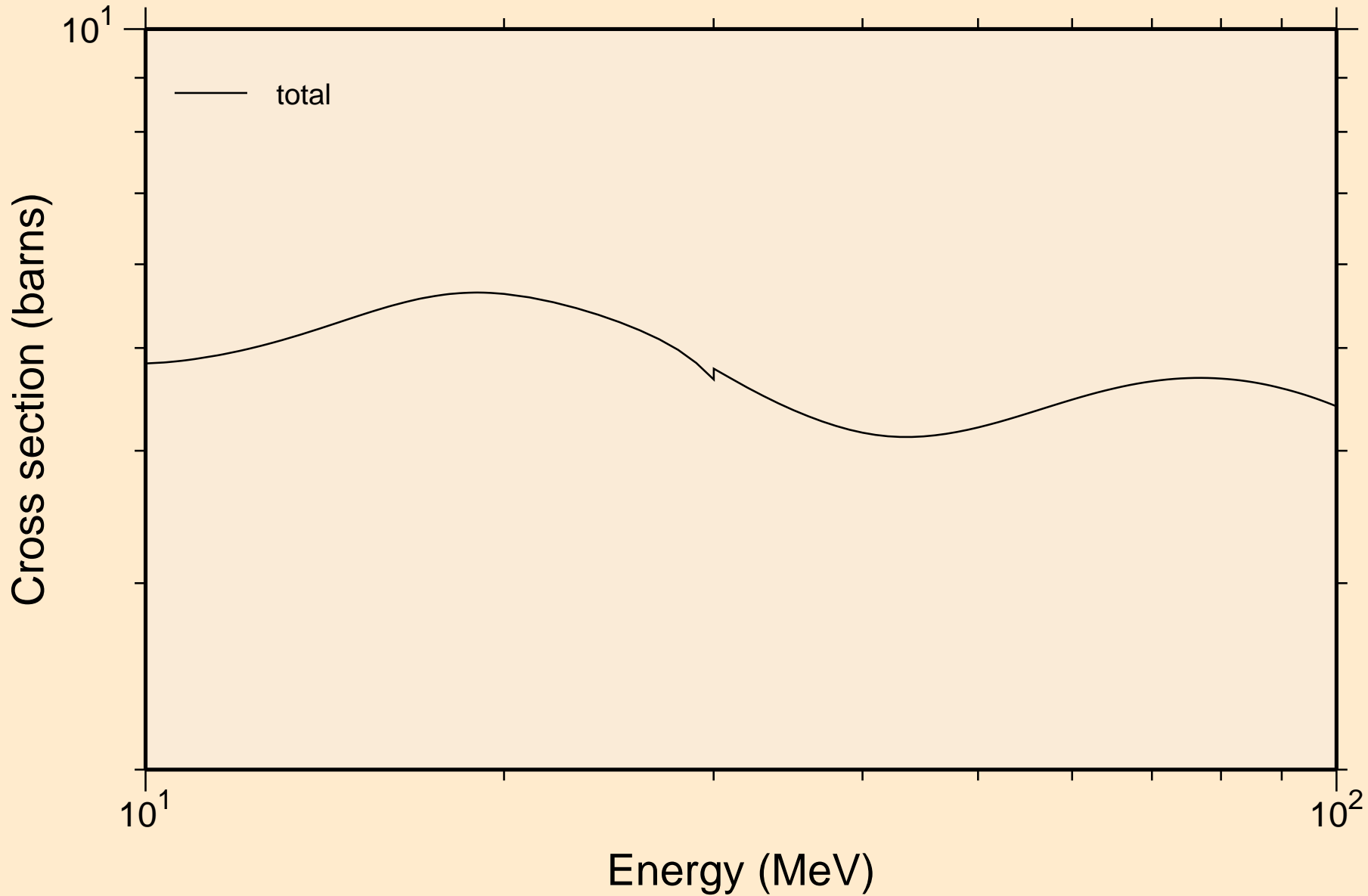

RE192 NEUTRON ACER TENDL-2021 LIBRARY; T=293.6K  
resonance absorption cross sections

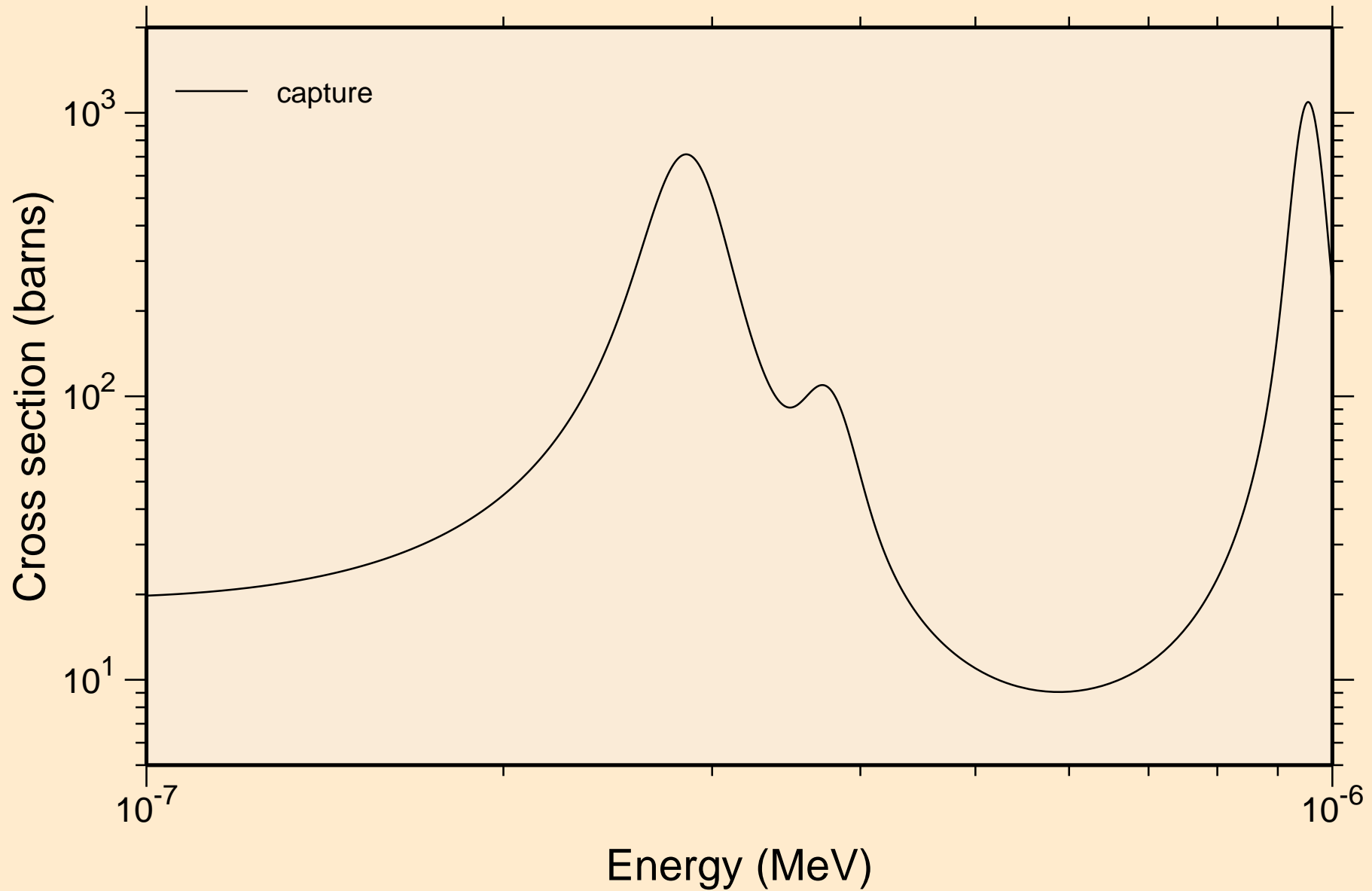

RE192 NEUTRON ACER TENDL-2021 LIBRARY; T=293.6K  
resonance absorption cross sections

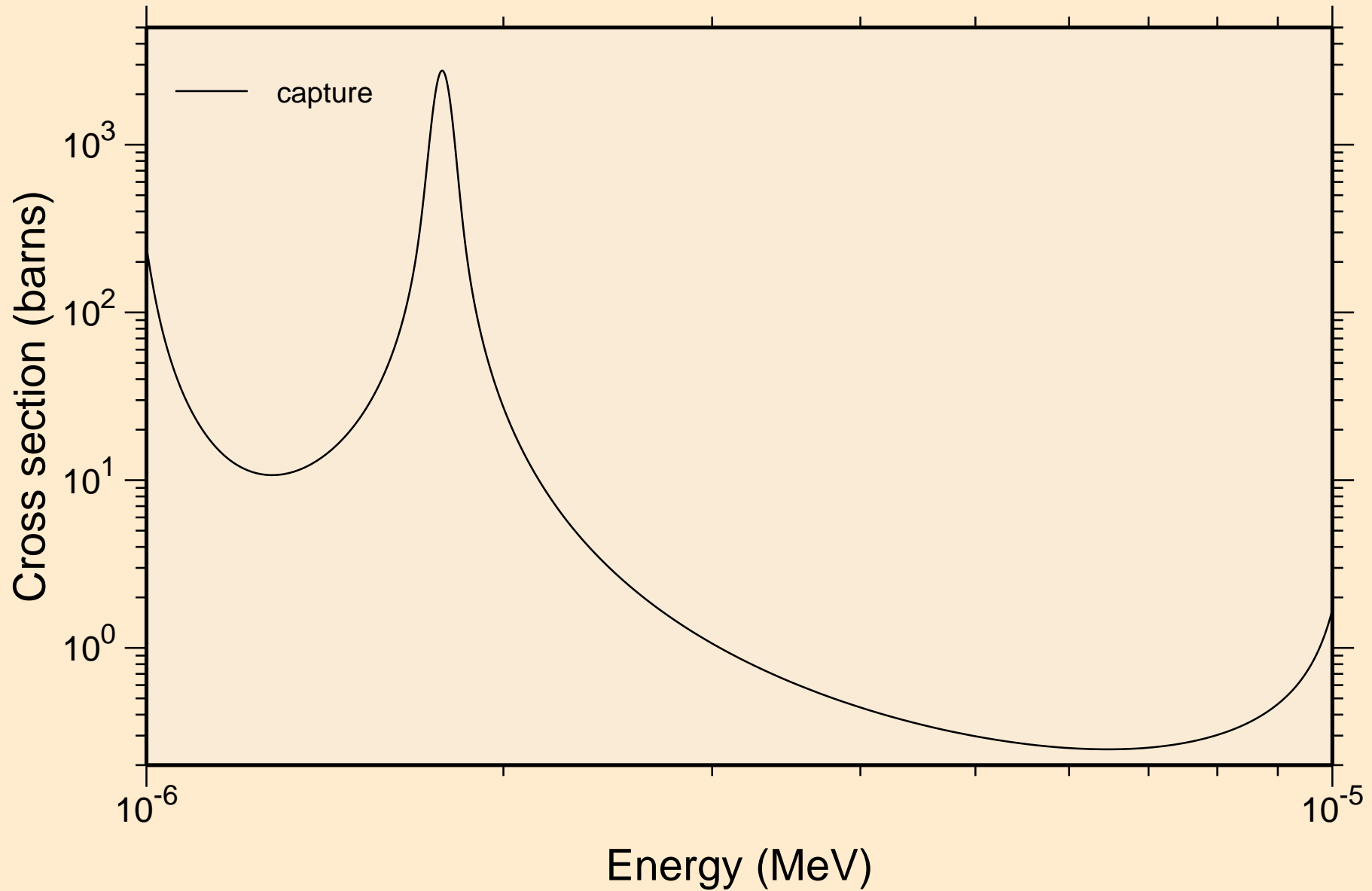



RE192 NEUTRON ACER TENDL-2021 LIBRARY; T=293.6K  
resonance absorption cross sections

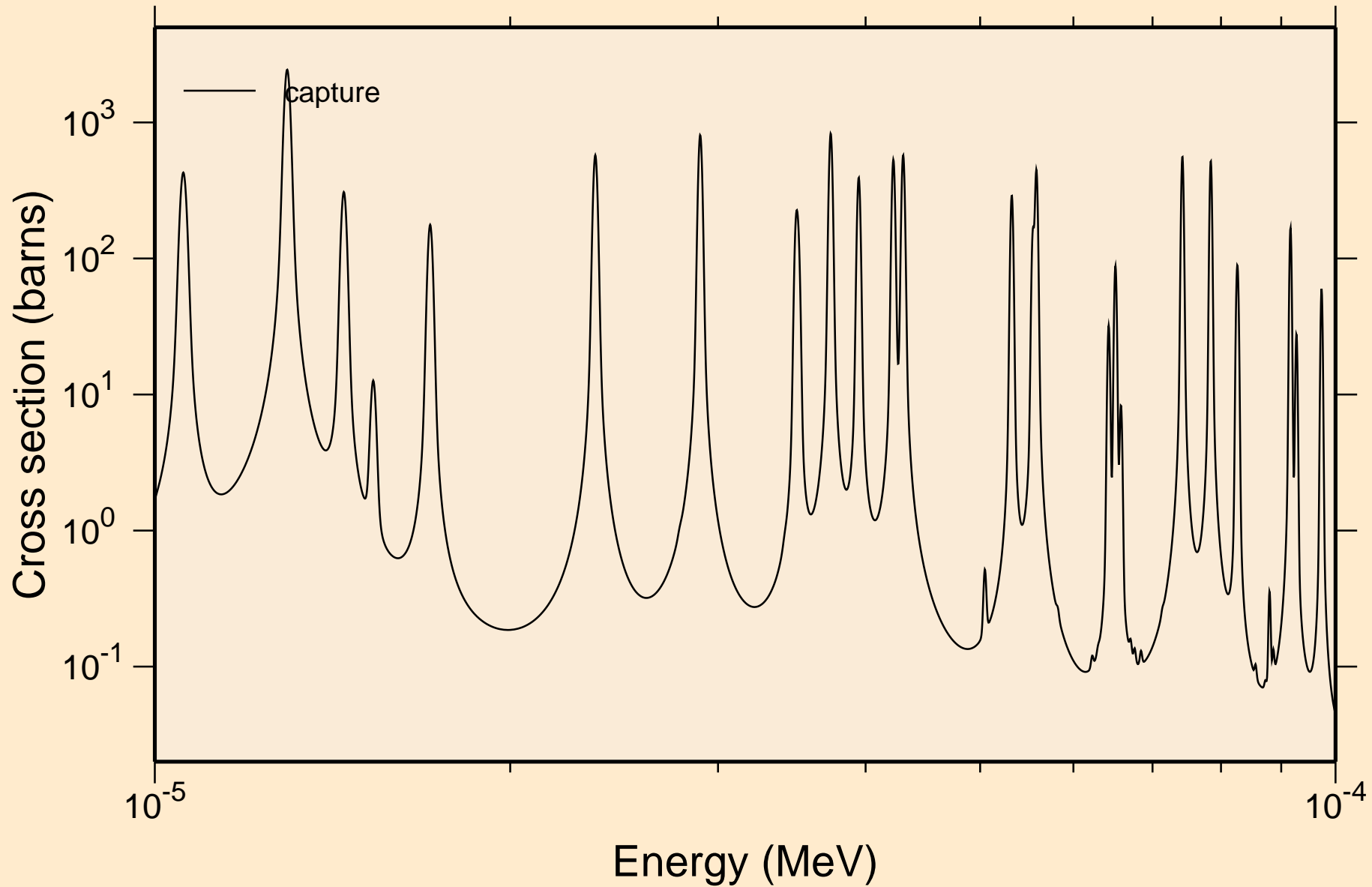

RE192 NEUTRON ACER TENDL-2021 LIBRARY; T=293.6K  
resonance absorption cross sections

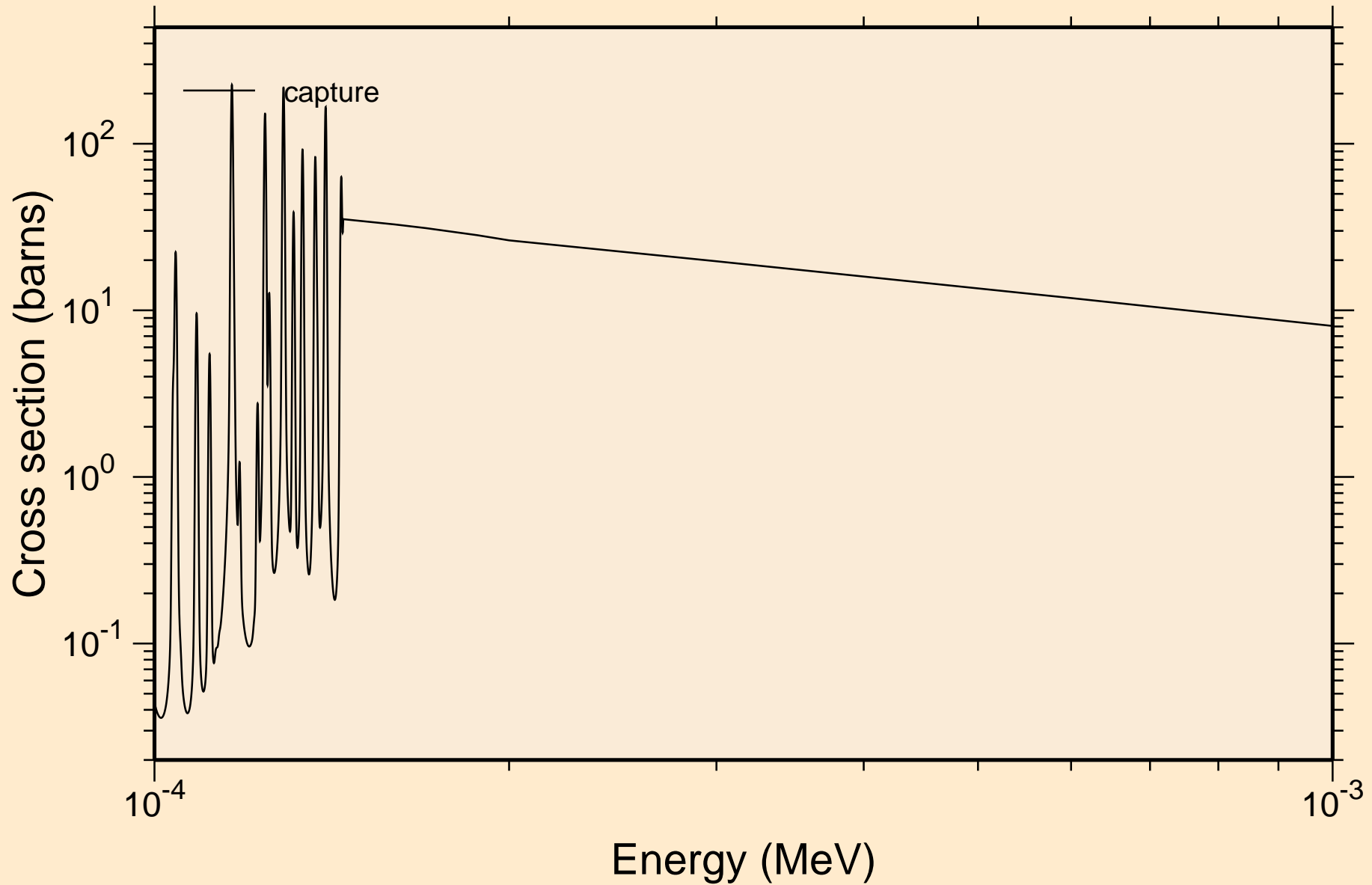

RE192 NEUTRON ACER TENDL-2021 LIBRARY; T=293.6K  
resonance absorption cross sections

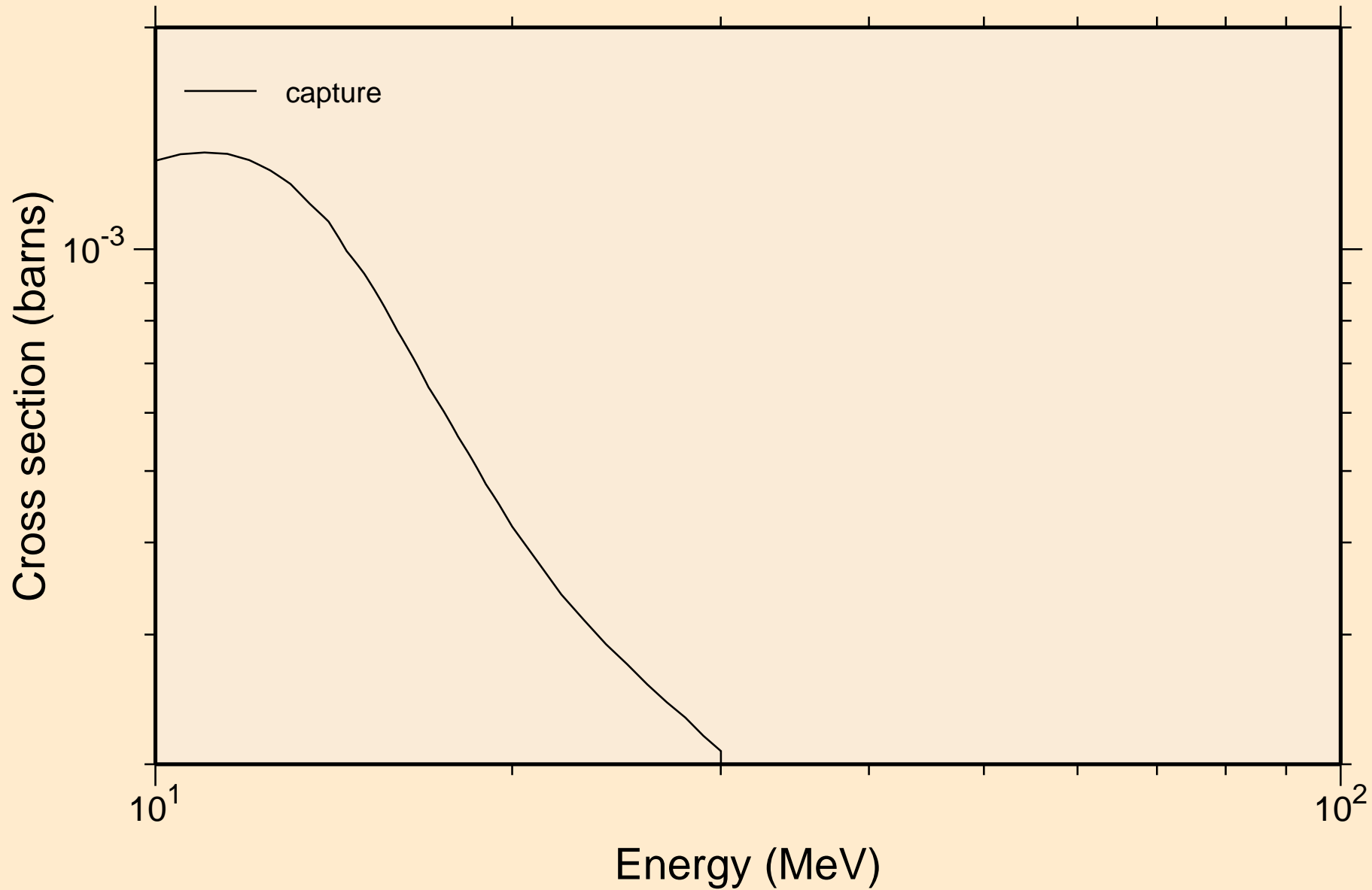

RE192 NEUTRON ACER TENDL-2021 LIBRARY; T=293.6K  
Heating

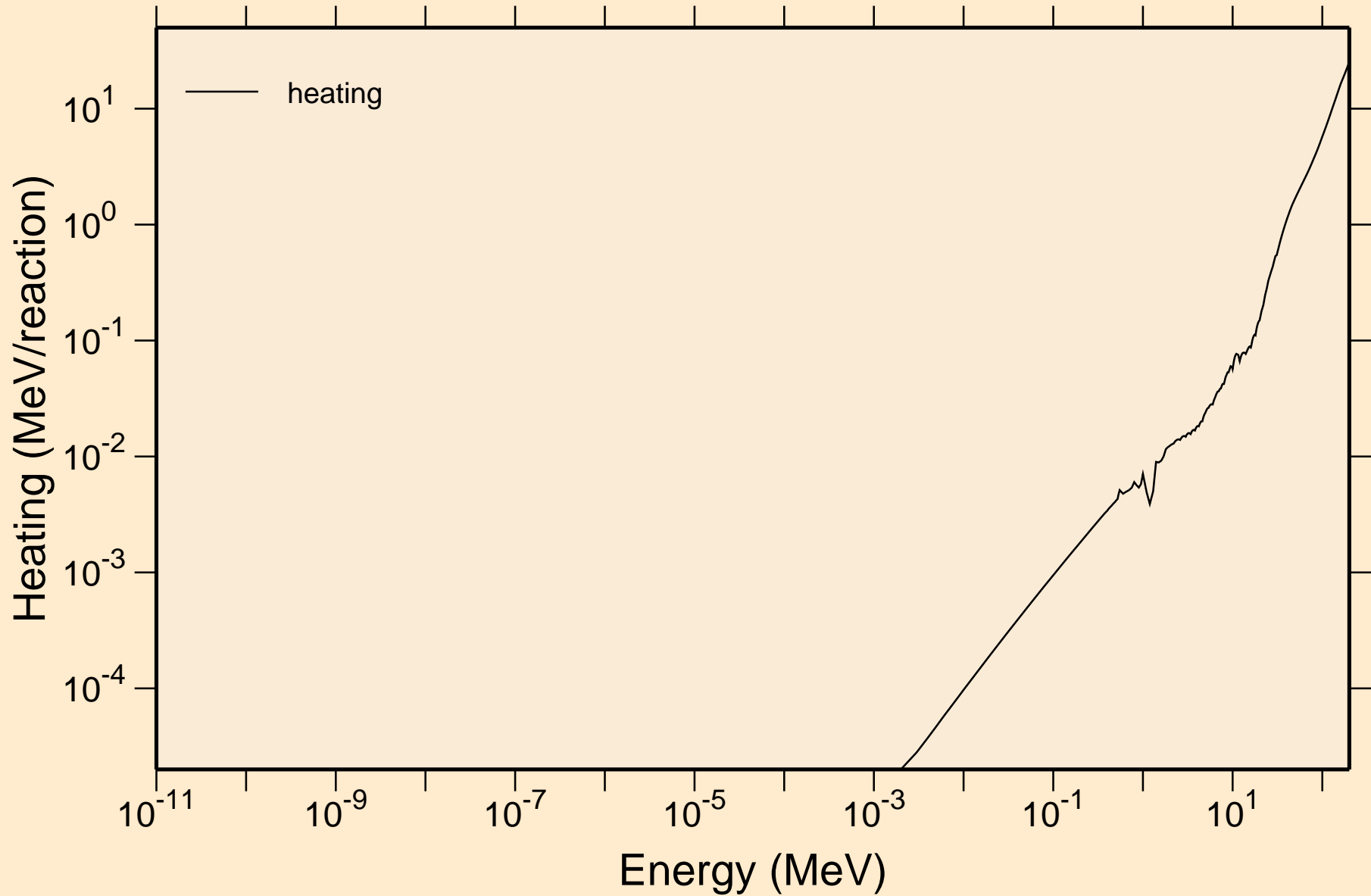

RE192 NEUTRON ACER TENDL-2021 LIBRARY; T=293.6K  
Damage

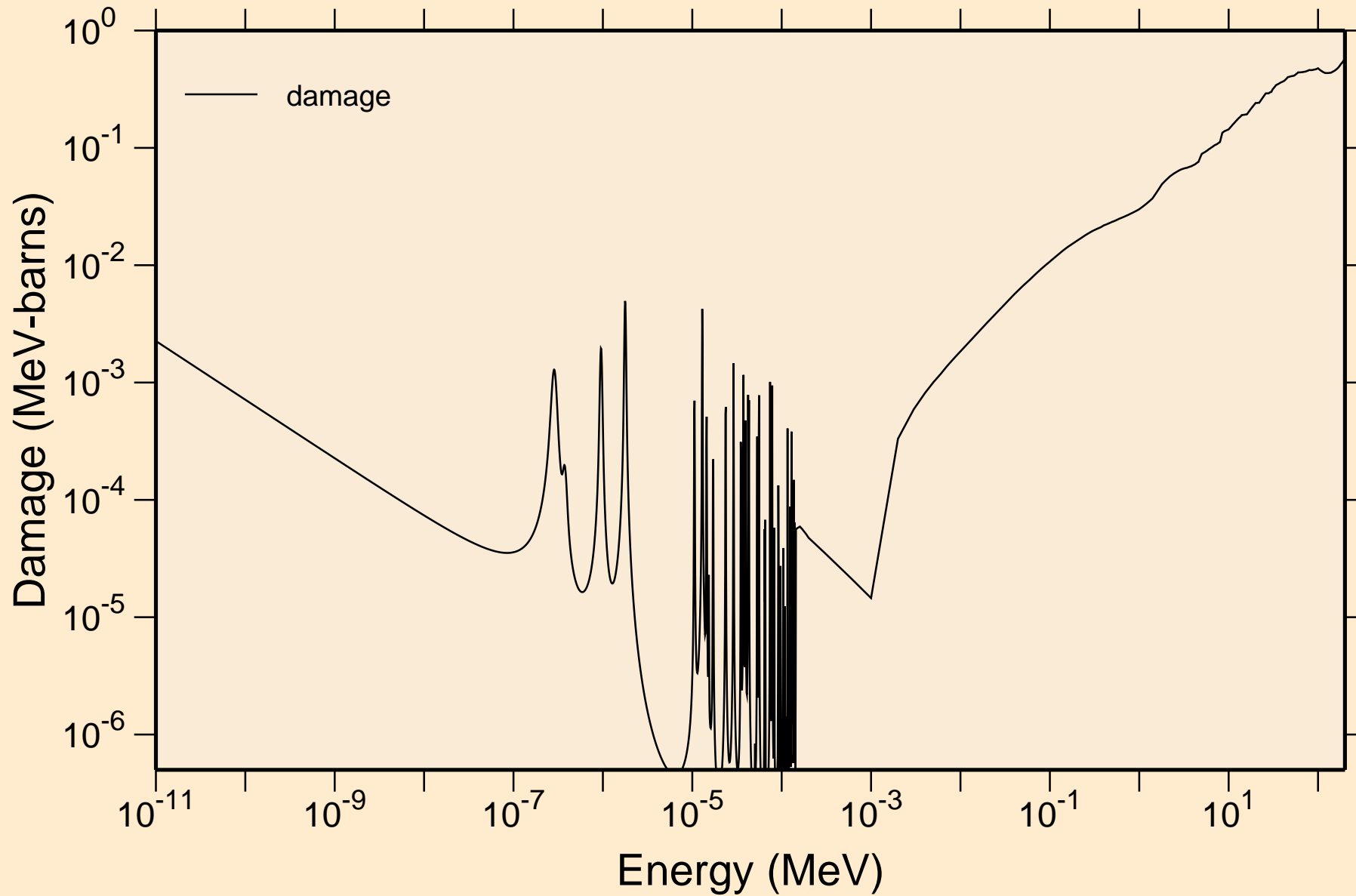

RE192 NEUTRON ACER TENDL-2021 LIBRARY; T=293.6K  
Non-threshold reactions

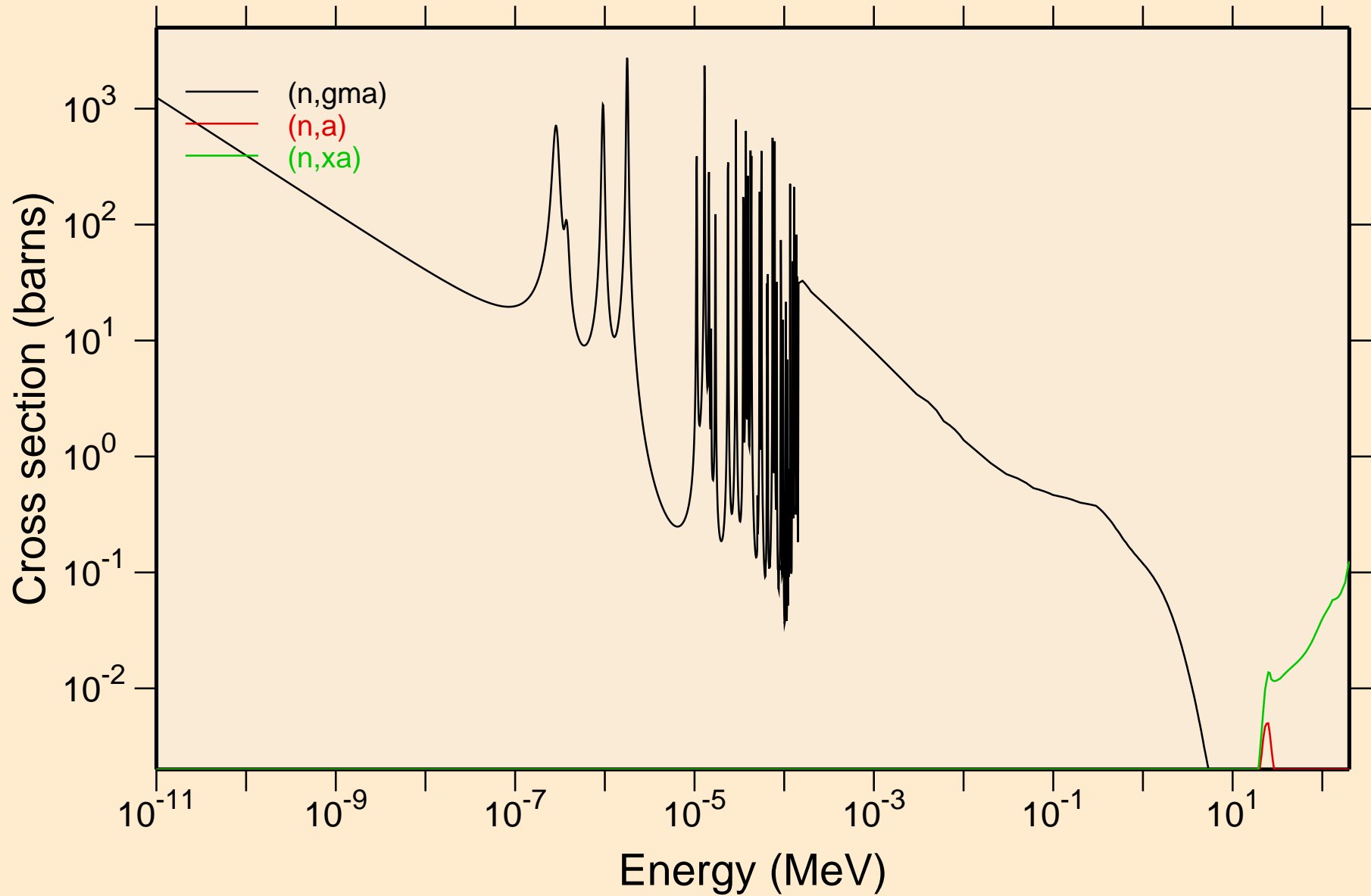

RE192 NEUTRON ACER TENDL-2021 LIBRARY; T=293.6K  
Principal cross sections

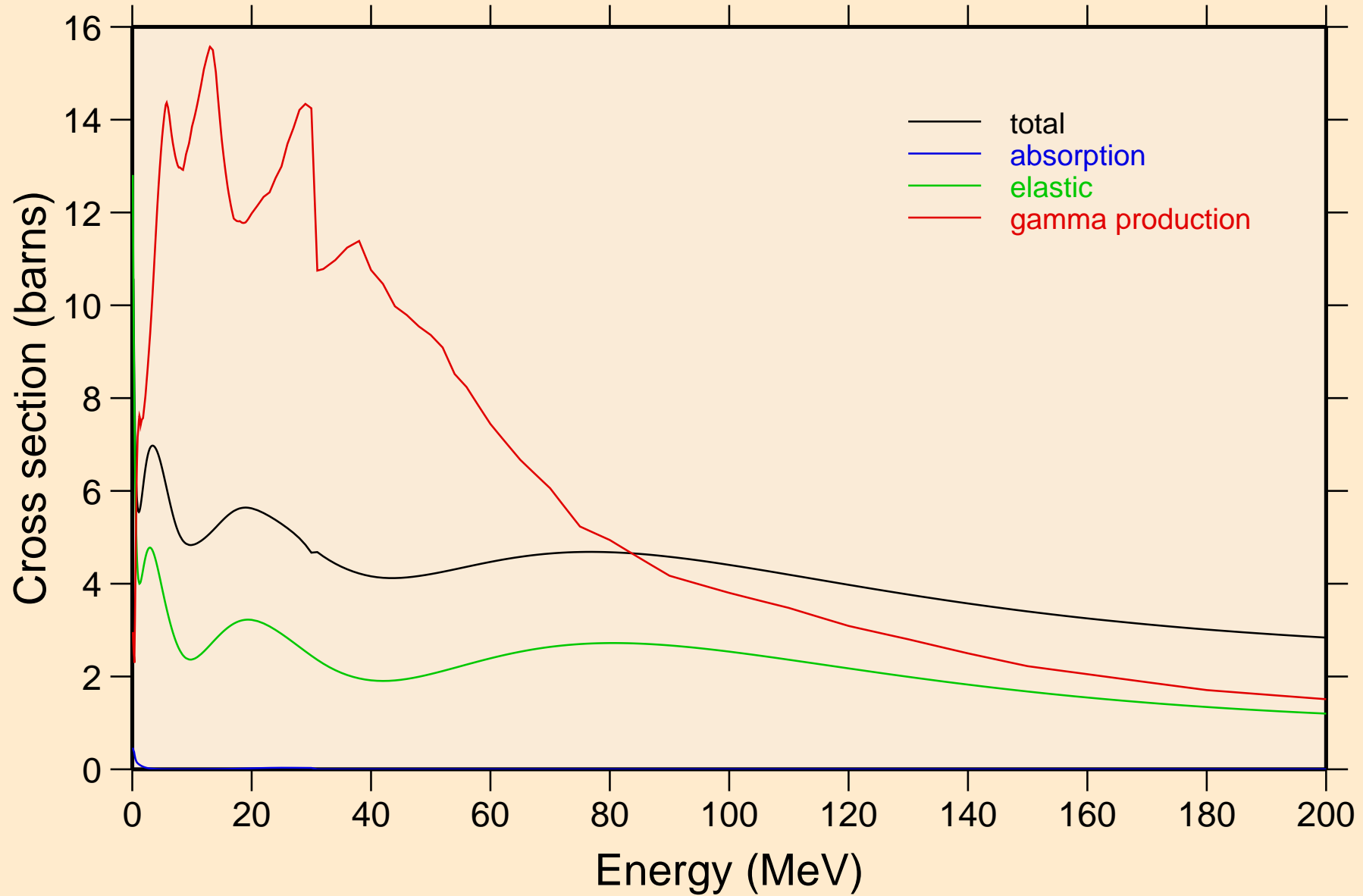

RE192 NEUTRON ACER TENDL-2021 LIBRARY; T=293.6K  
Heating

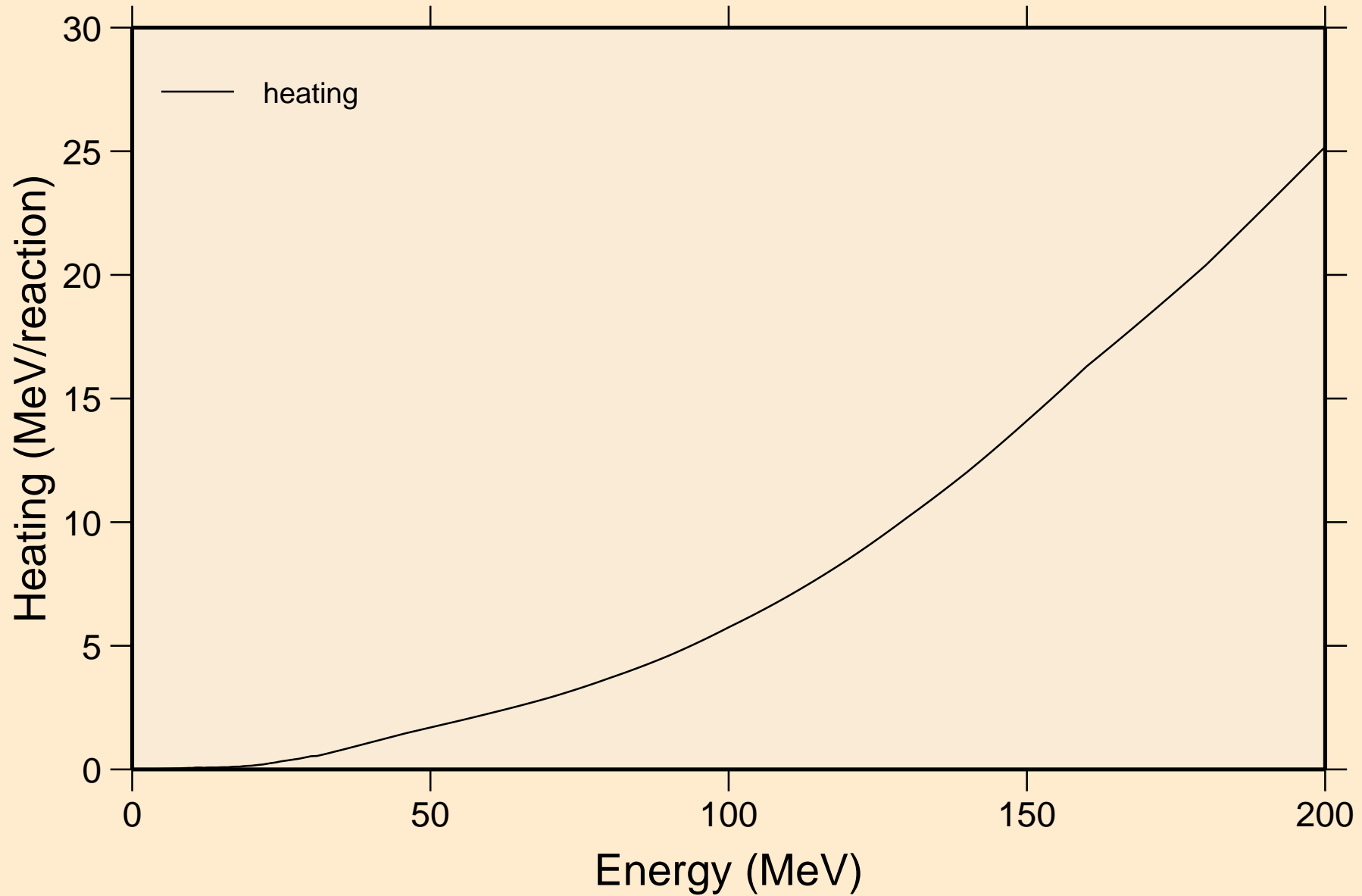



RE192 NEUTRON ACER TENDL-2021 LIBRARY; T=293.6K  
Damage

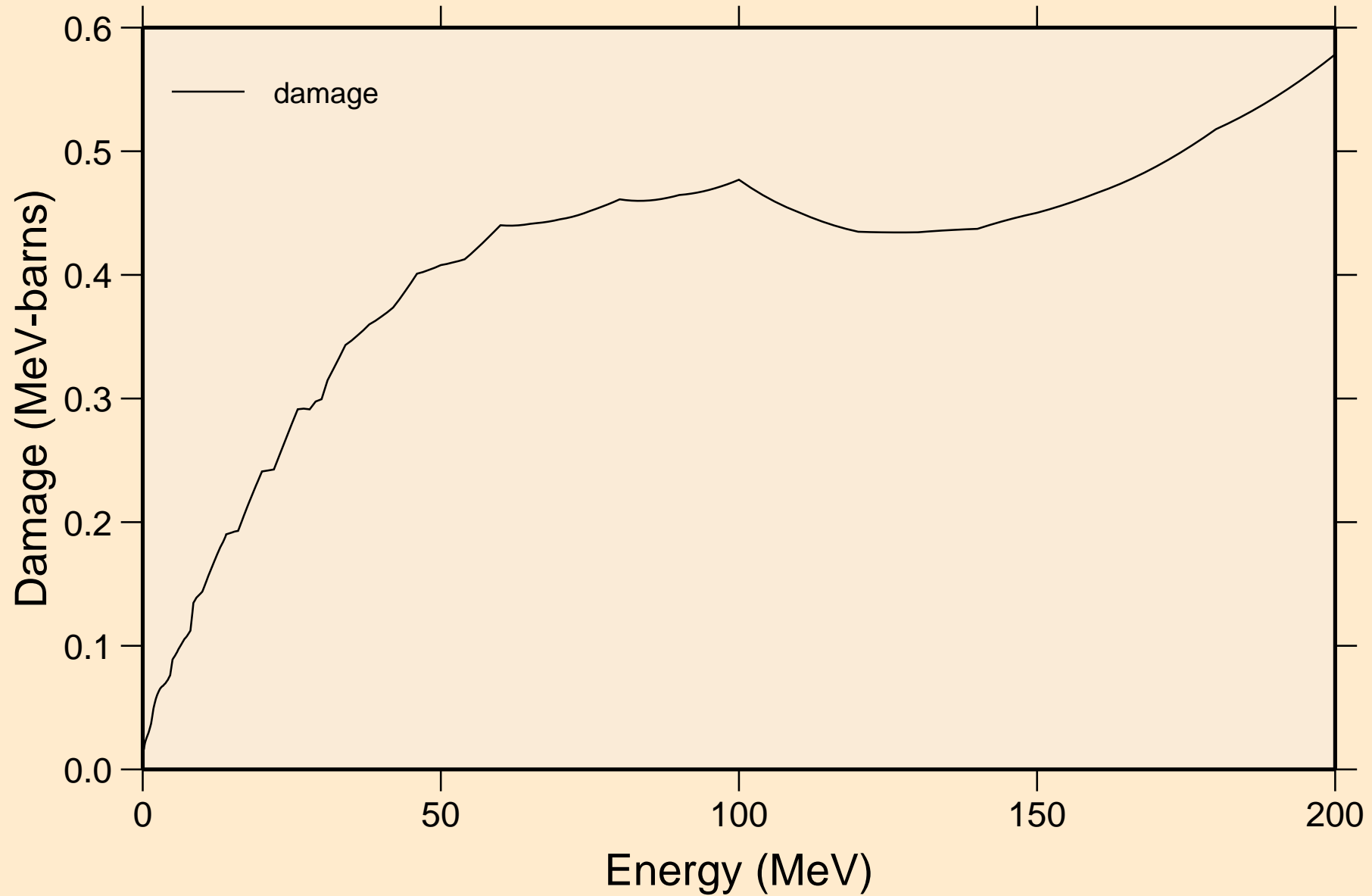

RE192 NEUTRON ACER TENDL-2021 LIBRARY; T=293.6K  
Non-threshold reactions

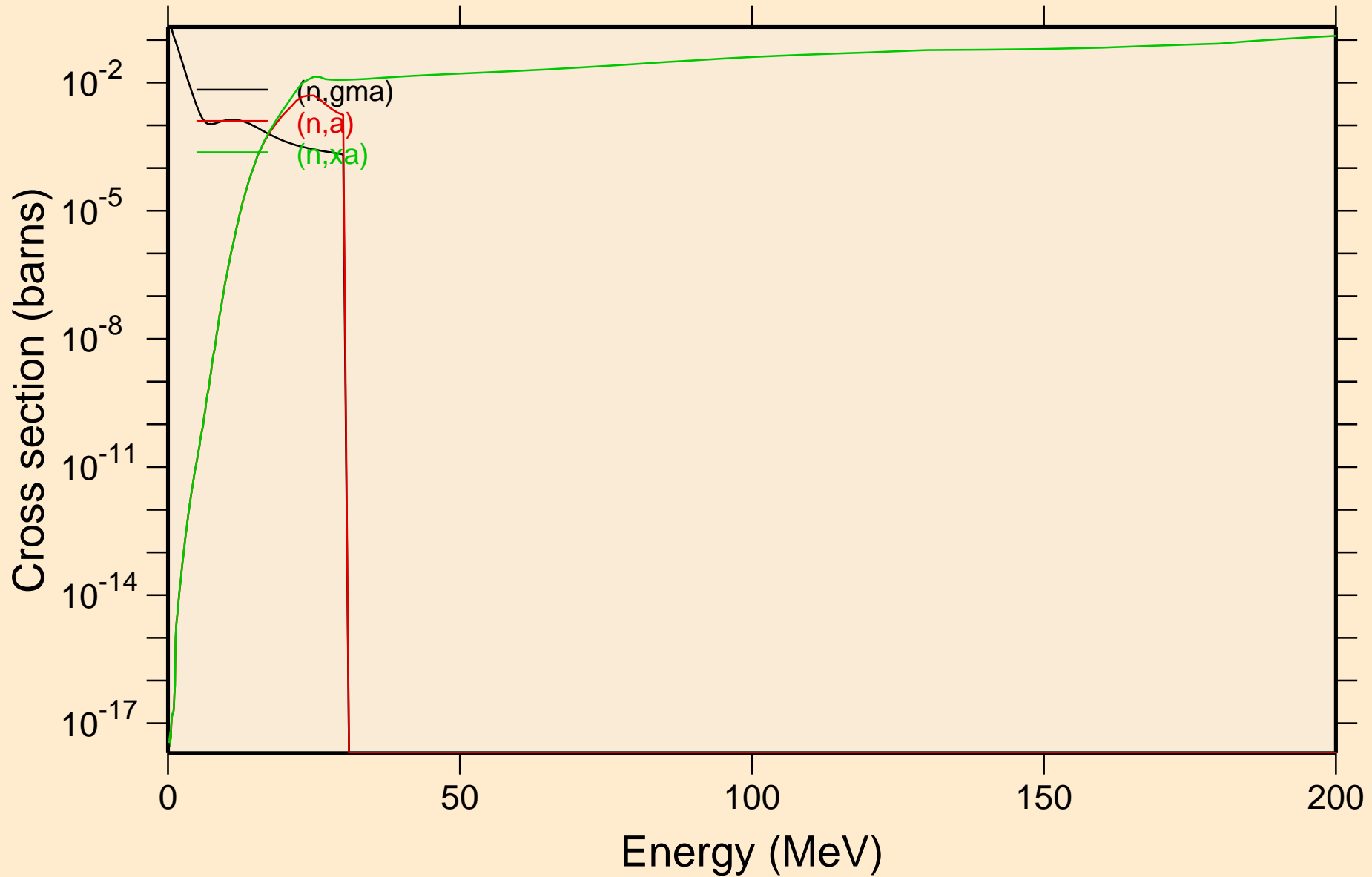

RE192 NEUTRON ACER TENDL-2021 LIBRARY; T=293.6K  
Inelastic levels

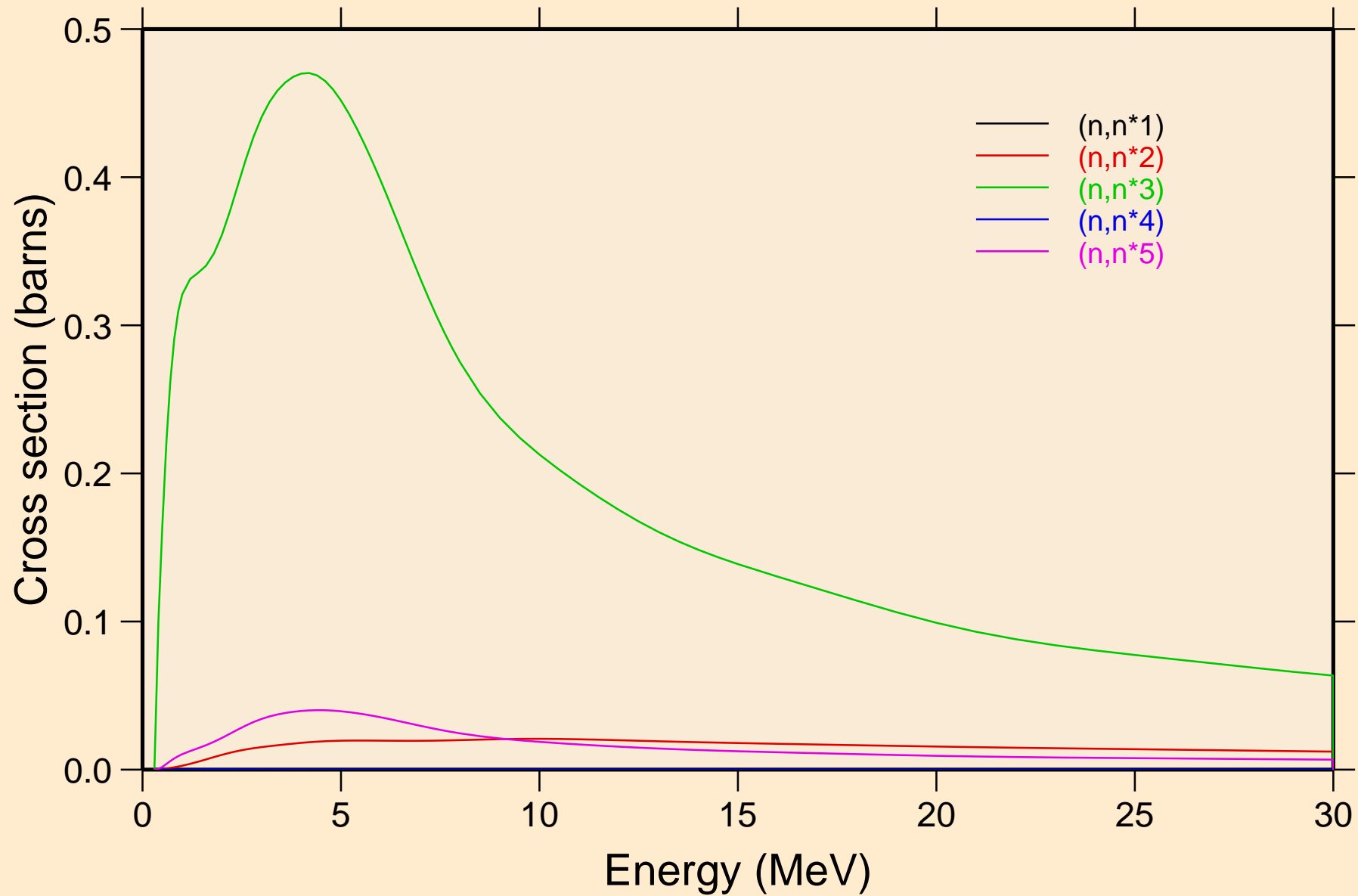

RE192 NEUTRON ACER TENDL-2021 LIBRARY; T=293.6K  
Inelastic levels

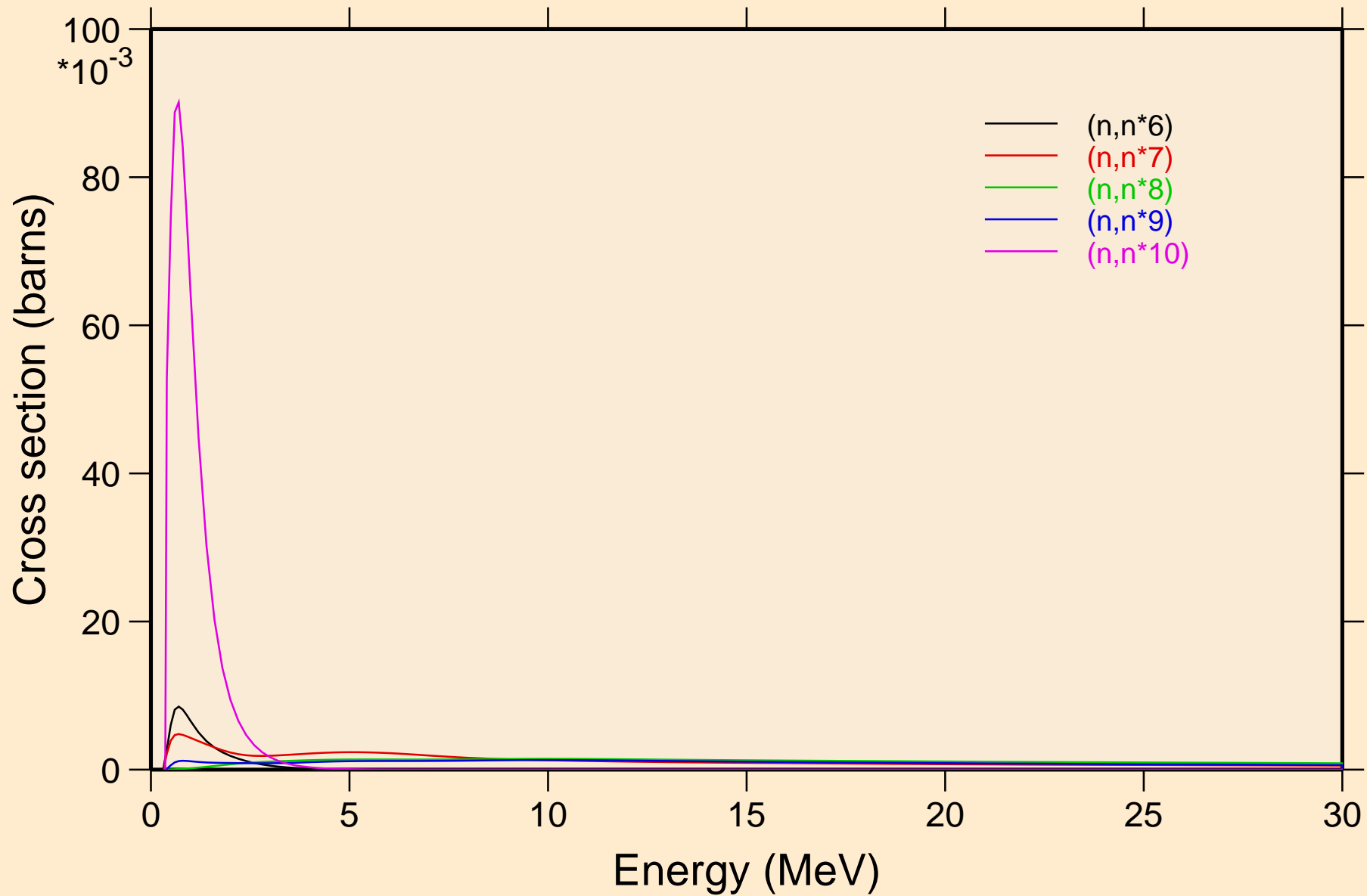

RE192 NEUTRON ACER TENDL-2021 LIBRARY; T=293.6K  
Inelastic levels

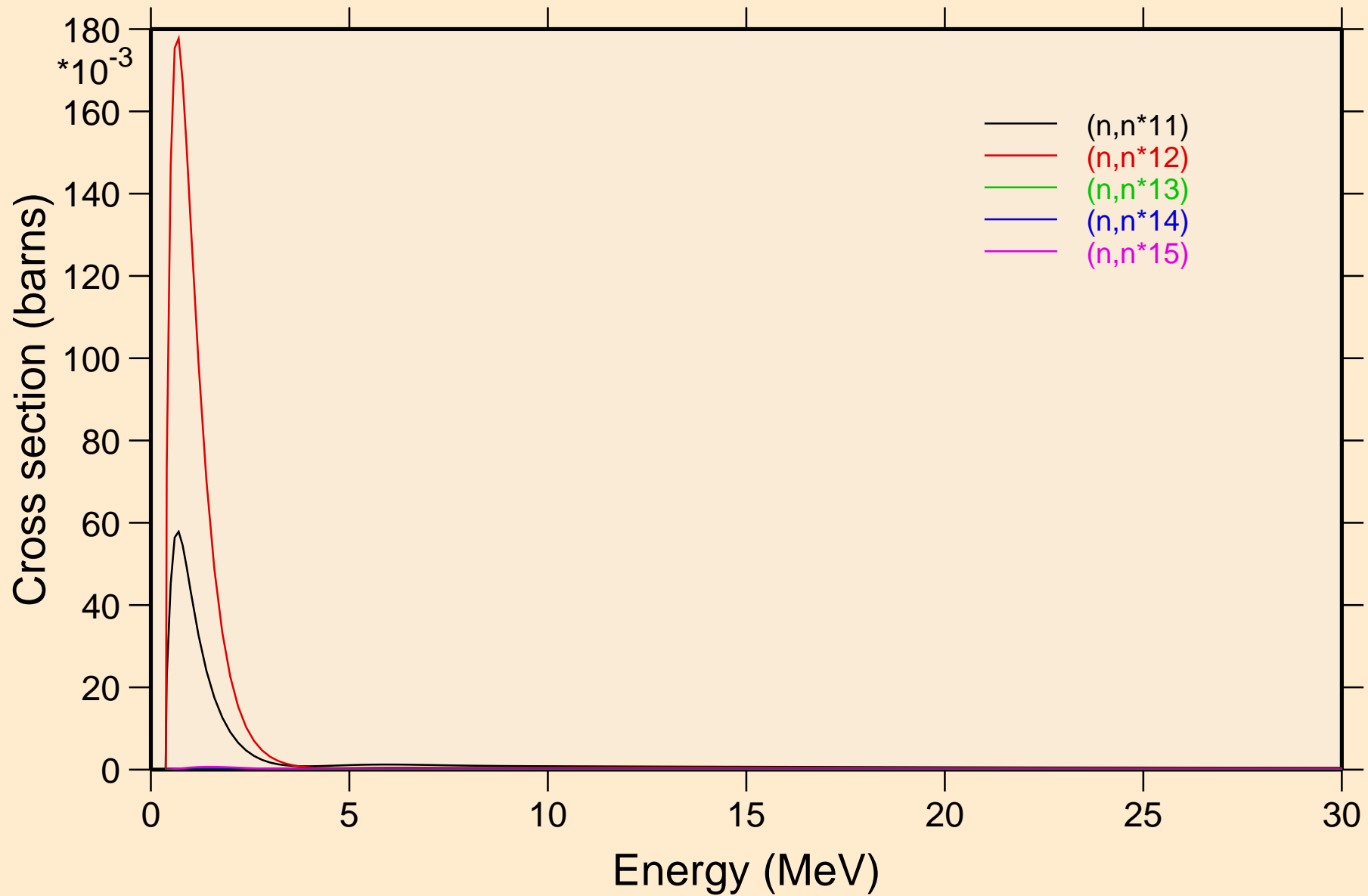

RE192 NEUTRON ACER TENDL-2021 LIBRARY; T=293.6K  
Inelastic levels

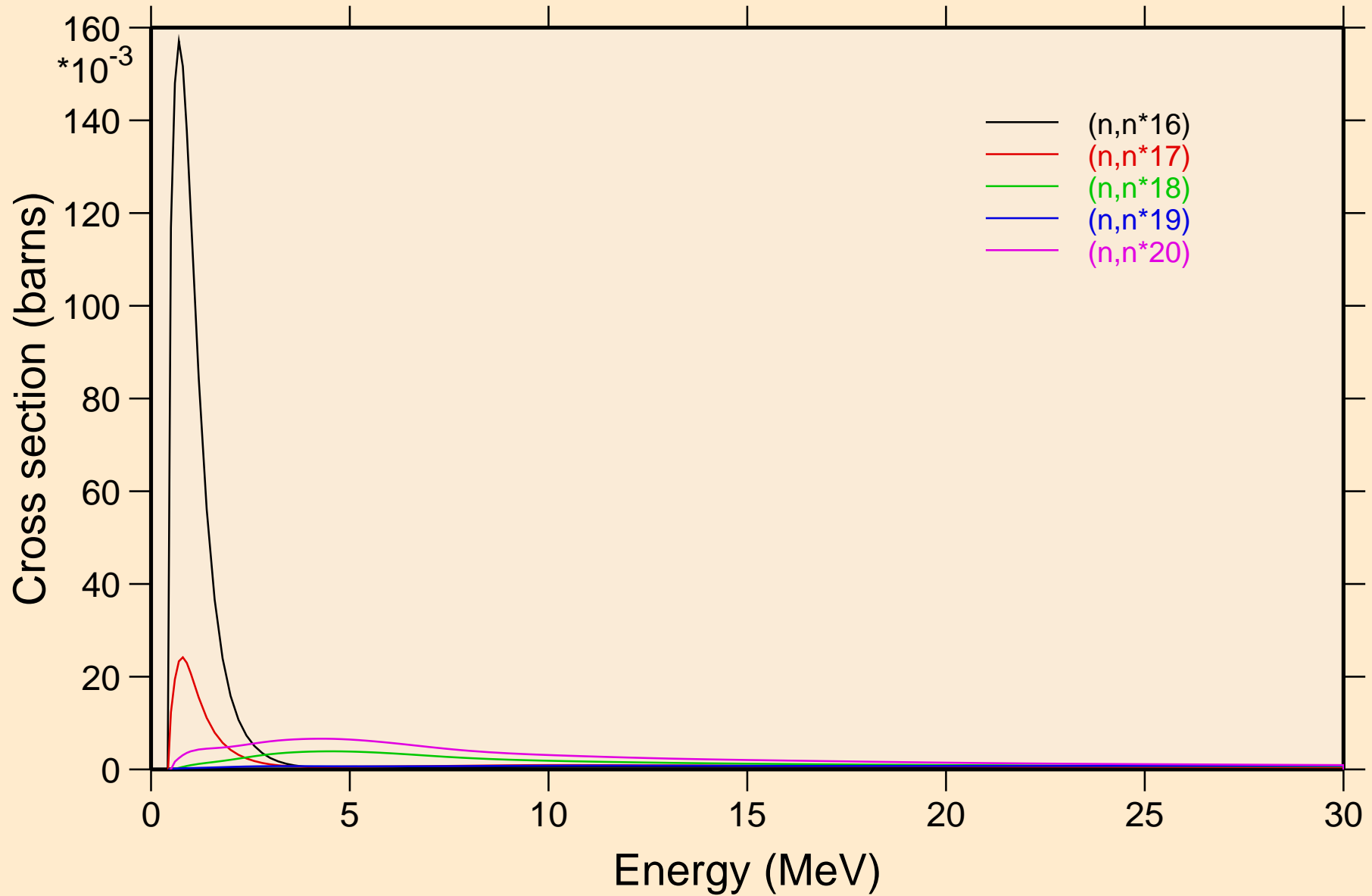

RE192 NEUTRON ACER TENDL-2021 LIBRARY; T=293.6K  
Inelastic levels

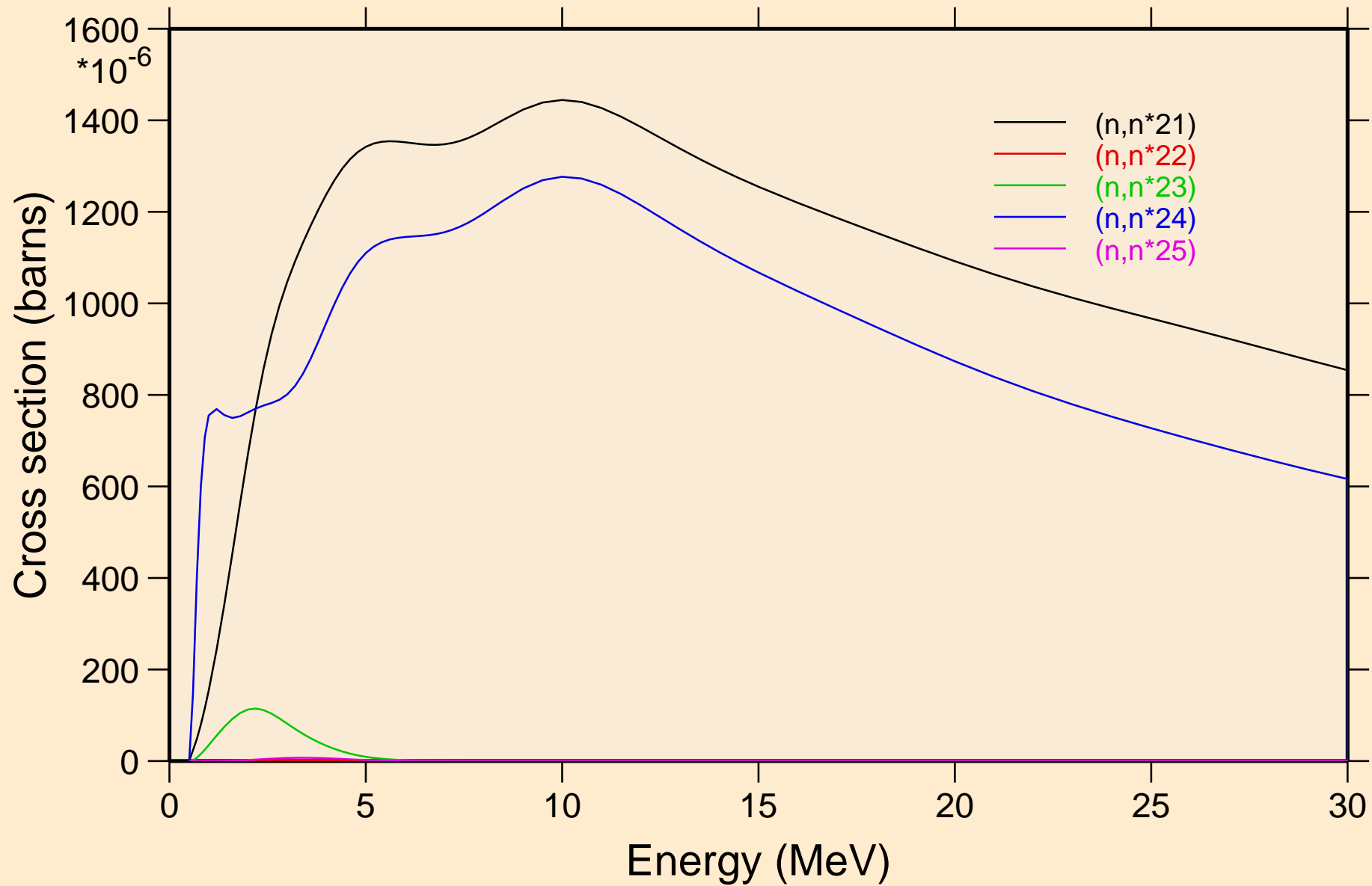

RE192 NEUTRON ACER TENDL-2021 LIBRARY; T=293.6K  
Inelastic levels

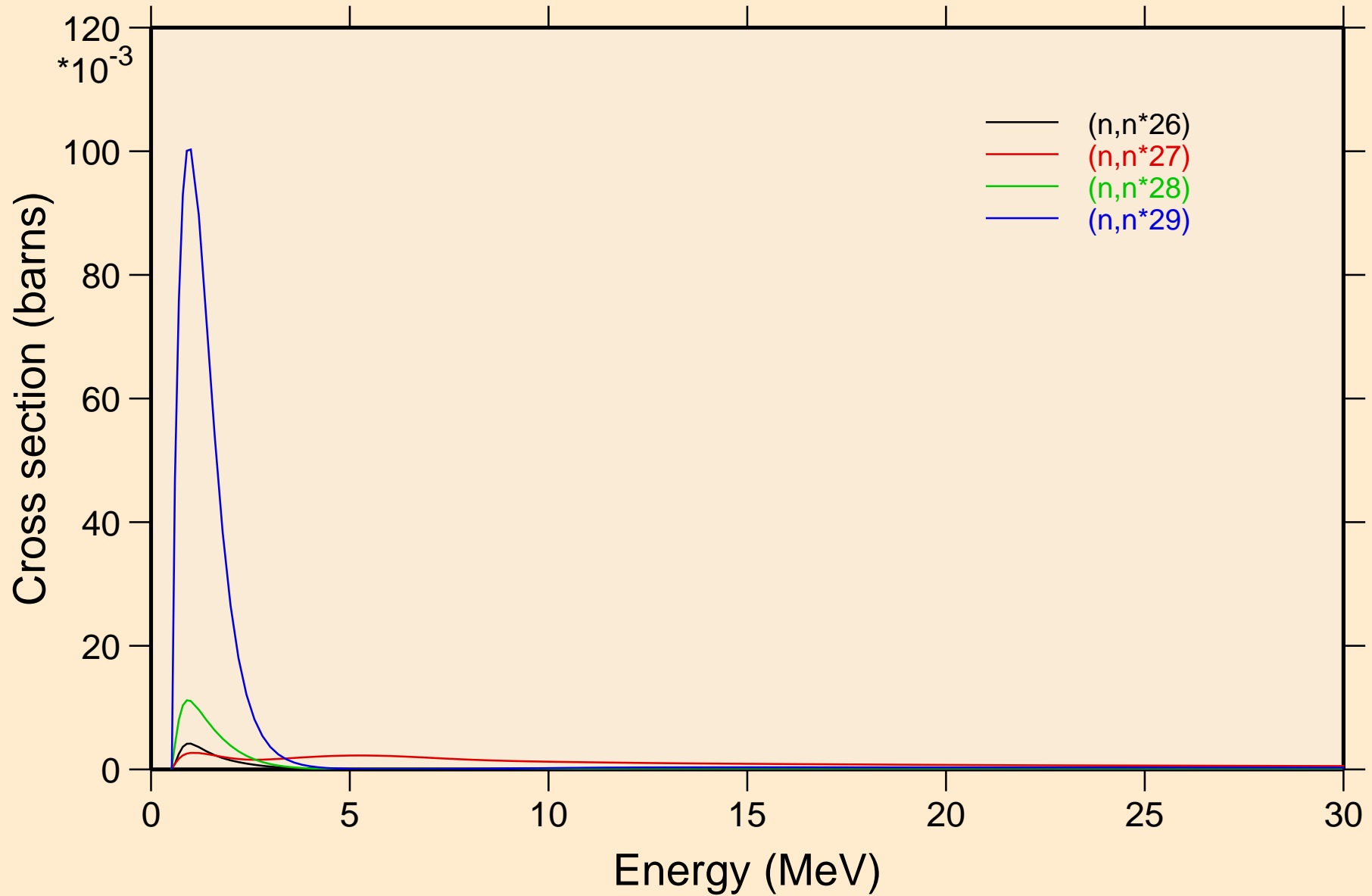



RE192 NEUTRON ACER TENDL-2021 LIBRARY; T=293.6K  
Threshold reactions

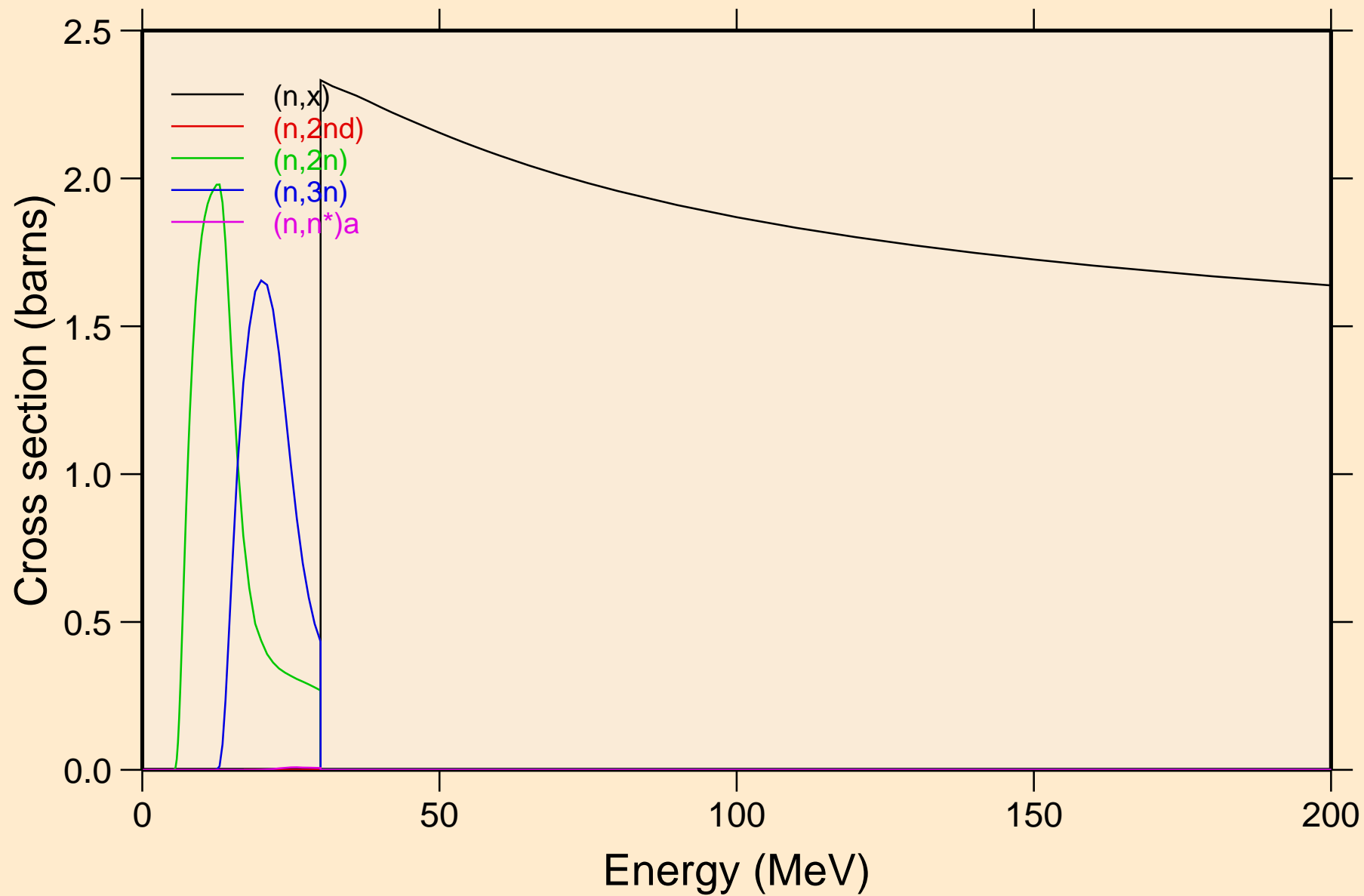

# RE192 NEUTRON ACER TENDL-2021 LIBRARY; T=293.6K

## Threshold reactions

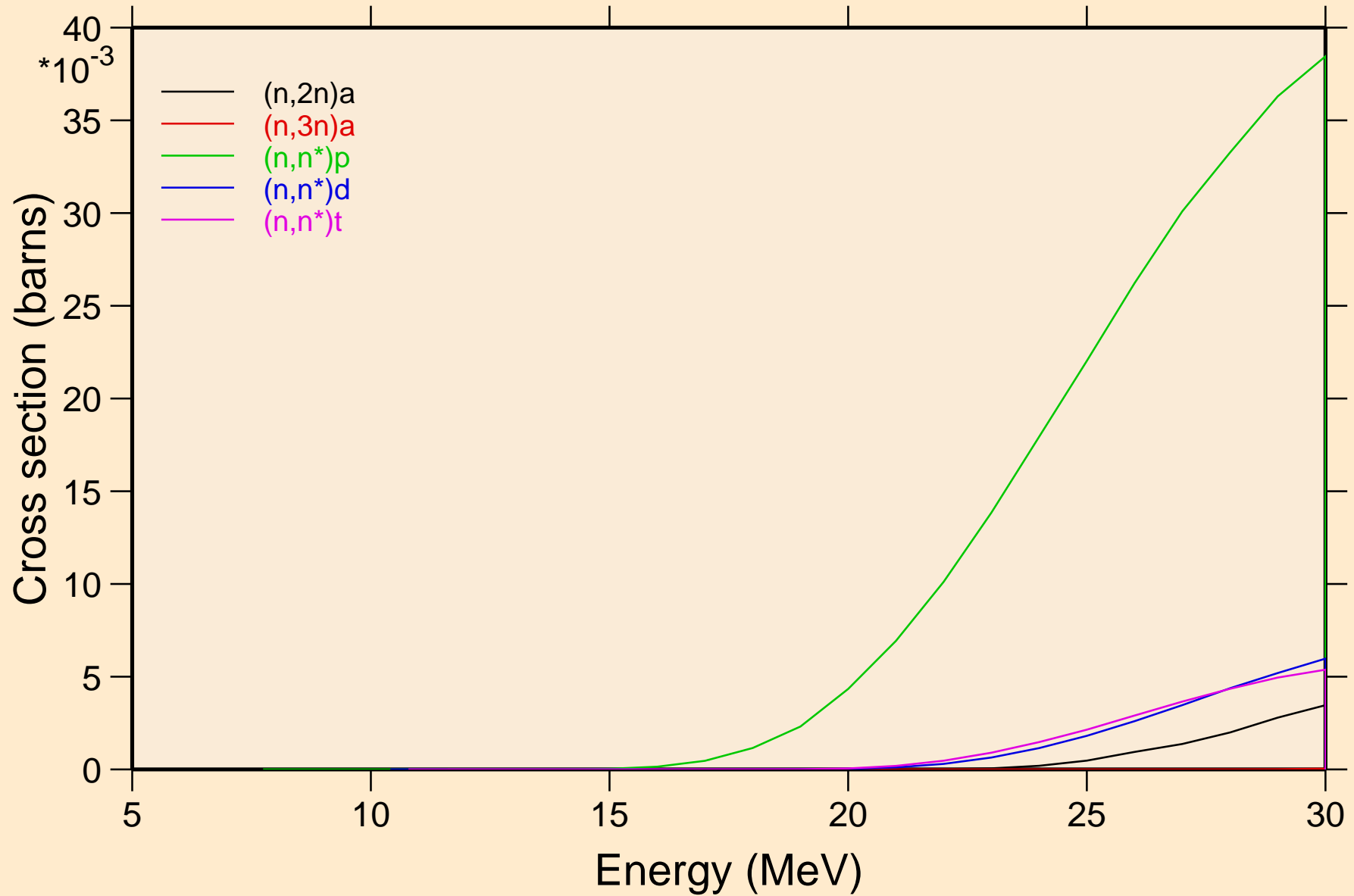

RE192 NEUTRON ACER TENDL-2021 LIBRARY; T=293.6K  
Threshold reactions

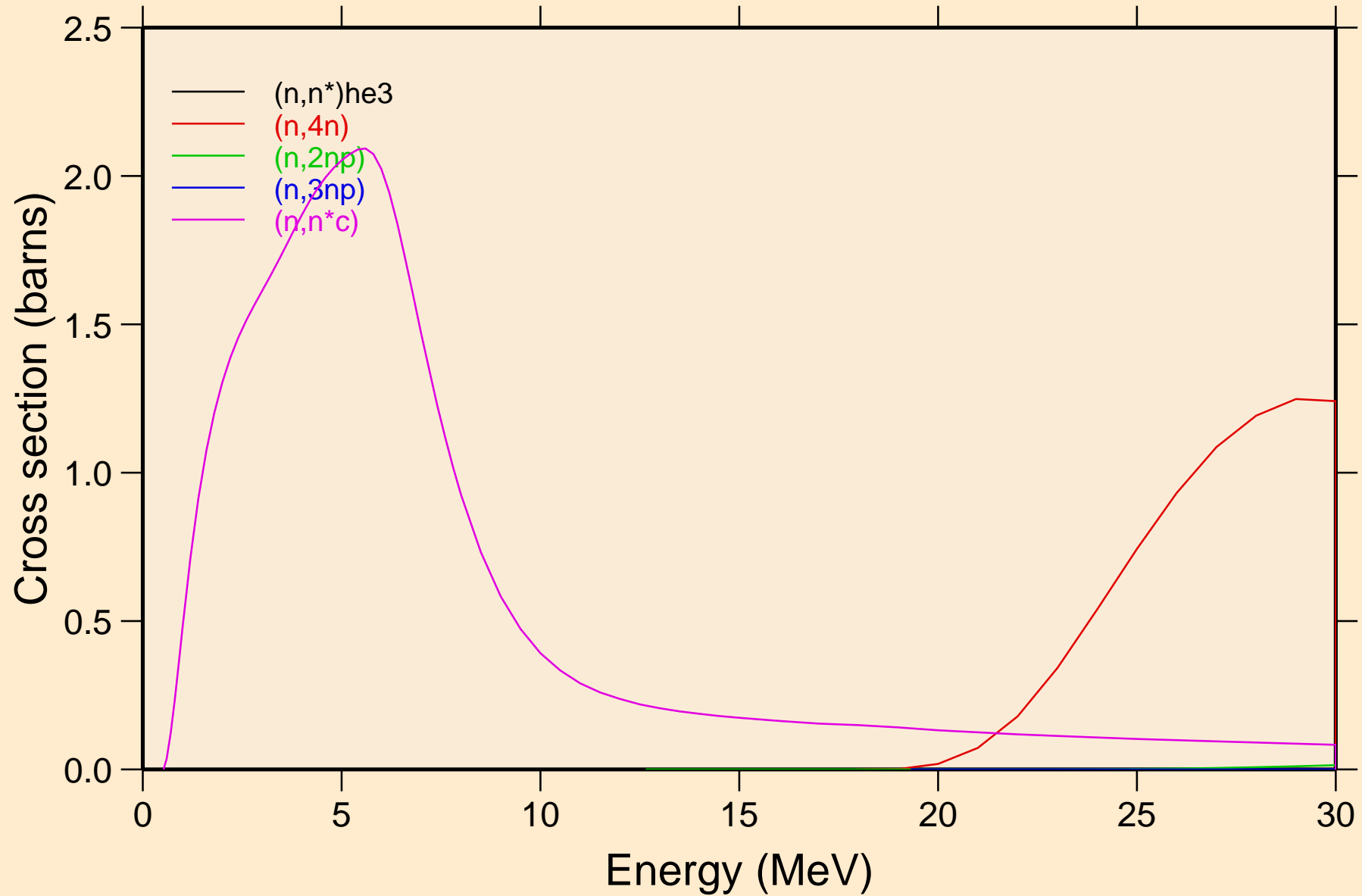

RE192 NEUTRON ACER TENDL-2021 LIBRARY; T=293.6K  
Threshold reactions

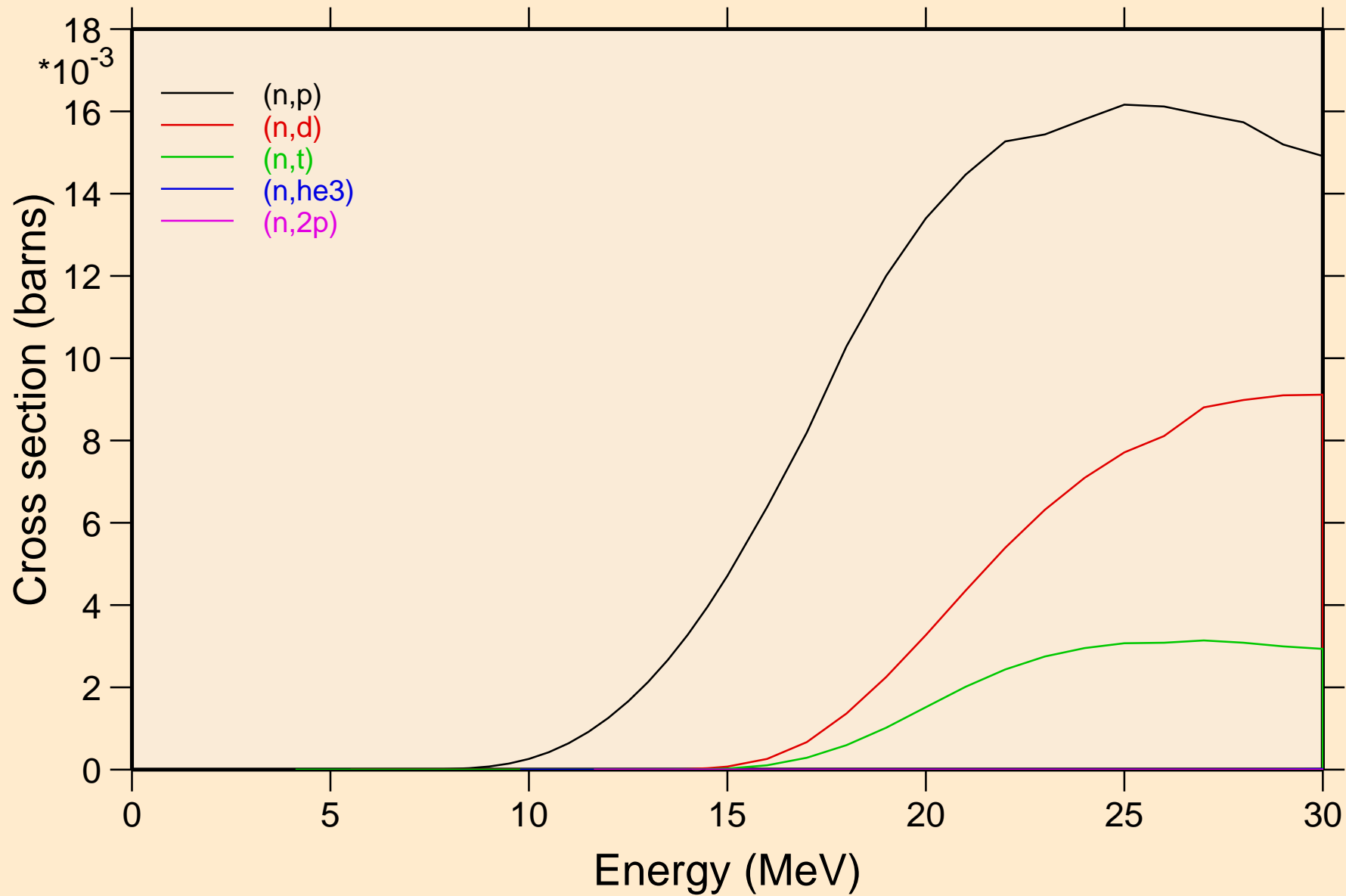

RE192 NEUTRON ACER TENDL-2021 LIBRARY; T=293.6K  
Threshold reactions

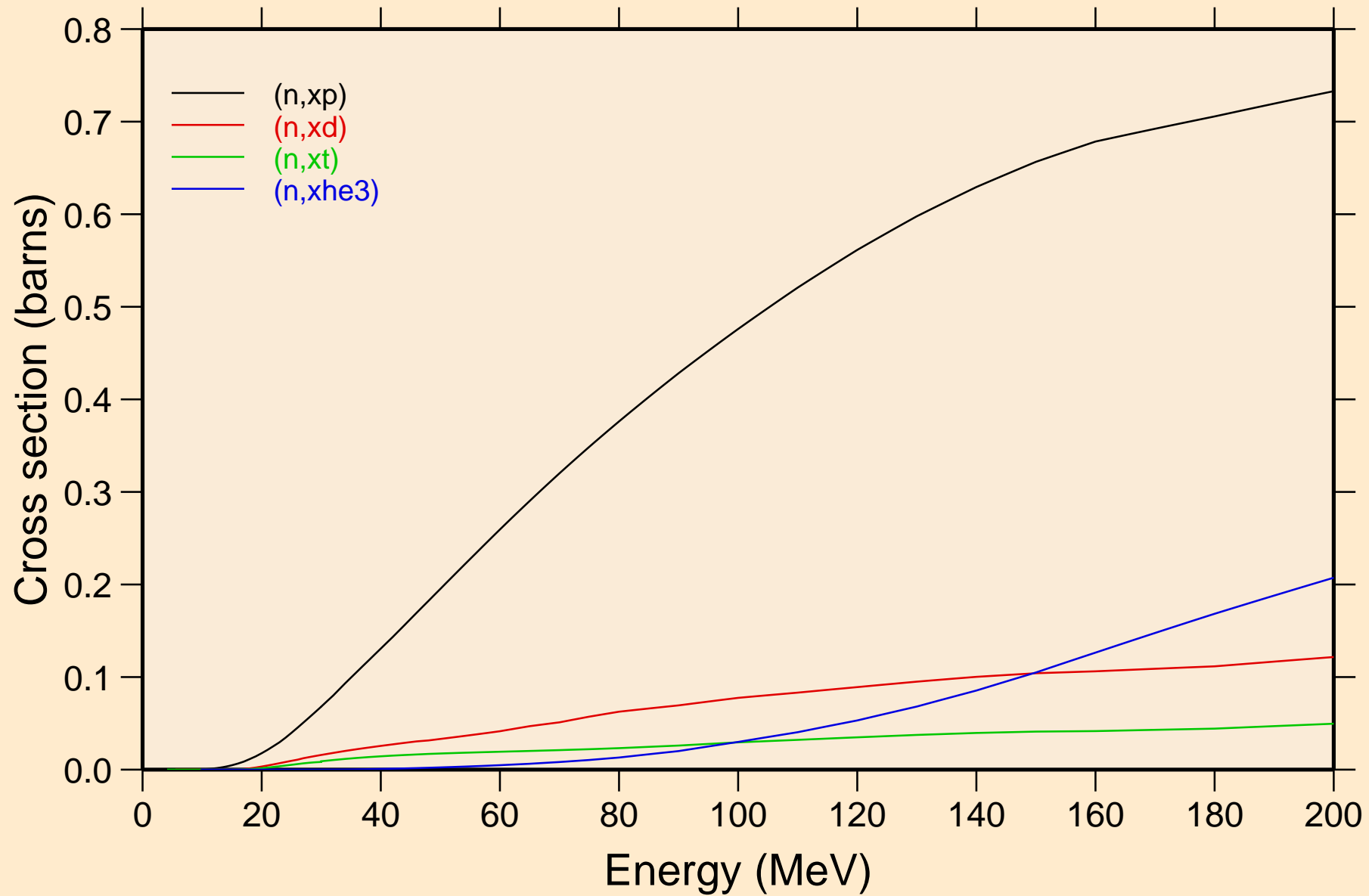

RE192 NEUTRON ACER TENDL-2021 LIBRARY; T=293.6K  
angular distribution for elastic

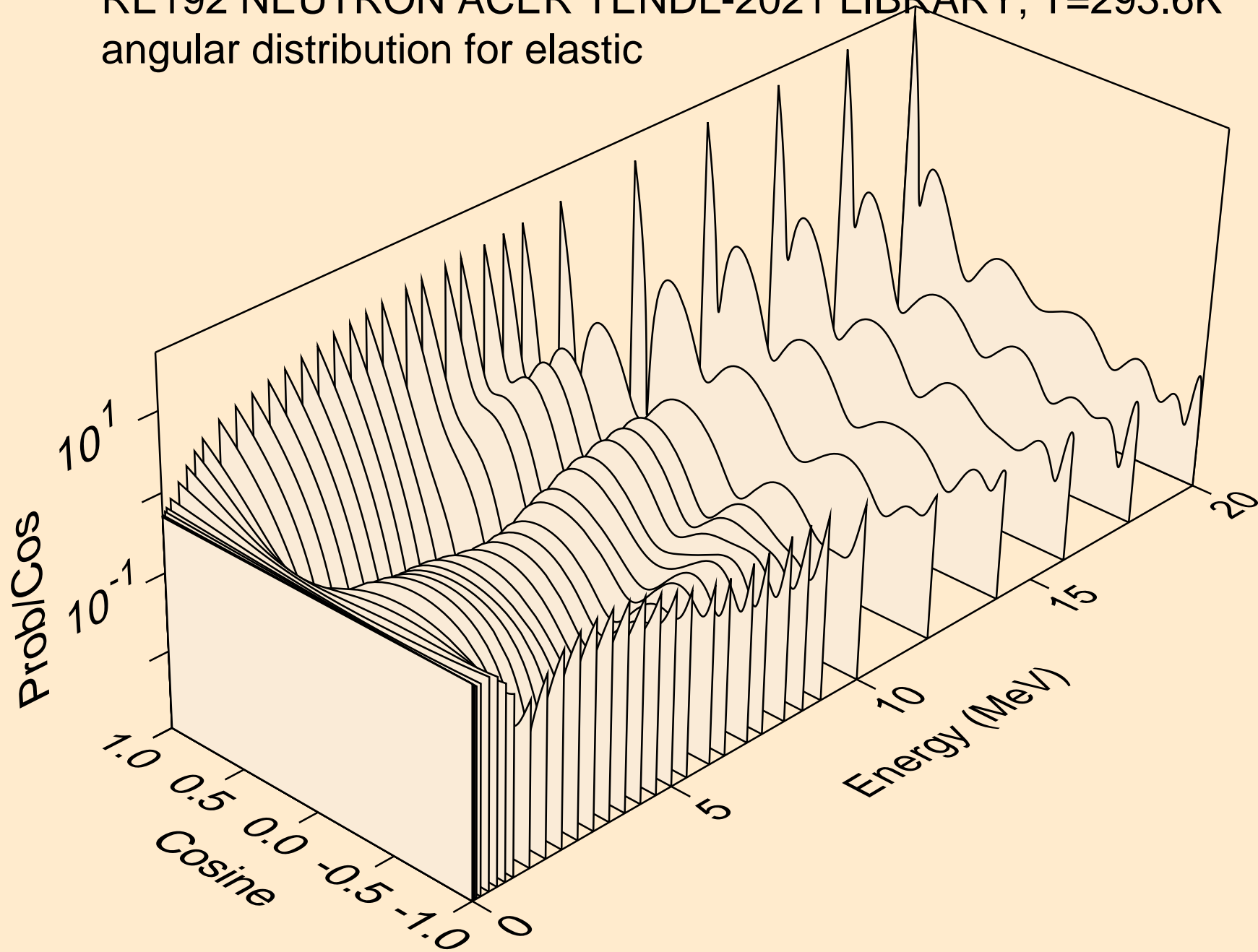

RE192 NEUTRON ACER TENDL-2021 LIBRARY; T=293.6K  
angular distribution for elastic

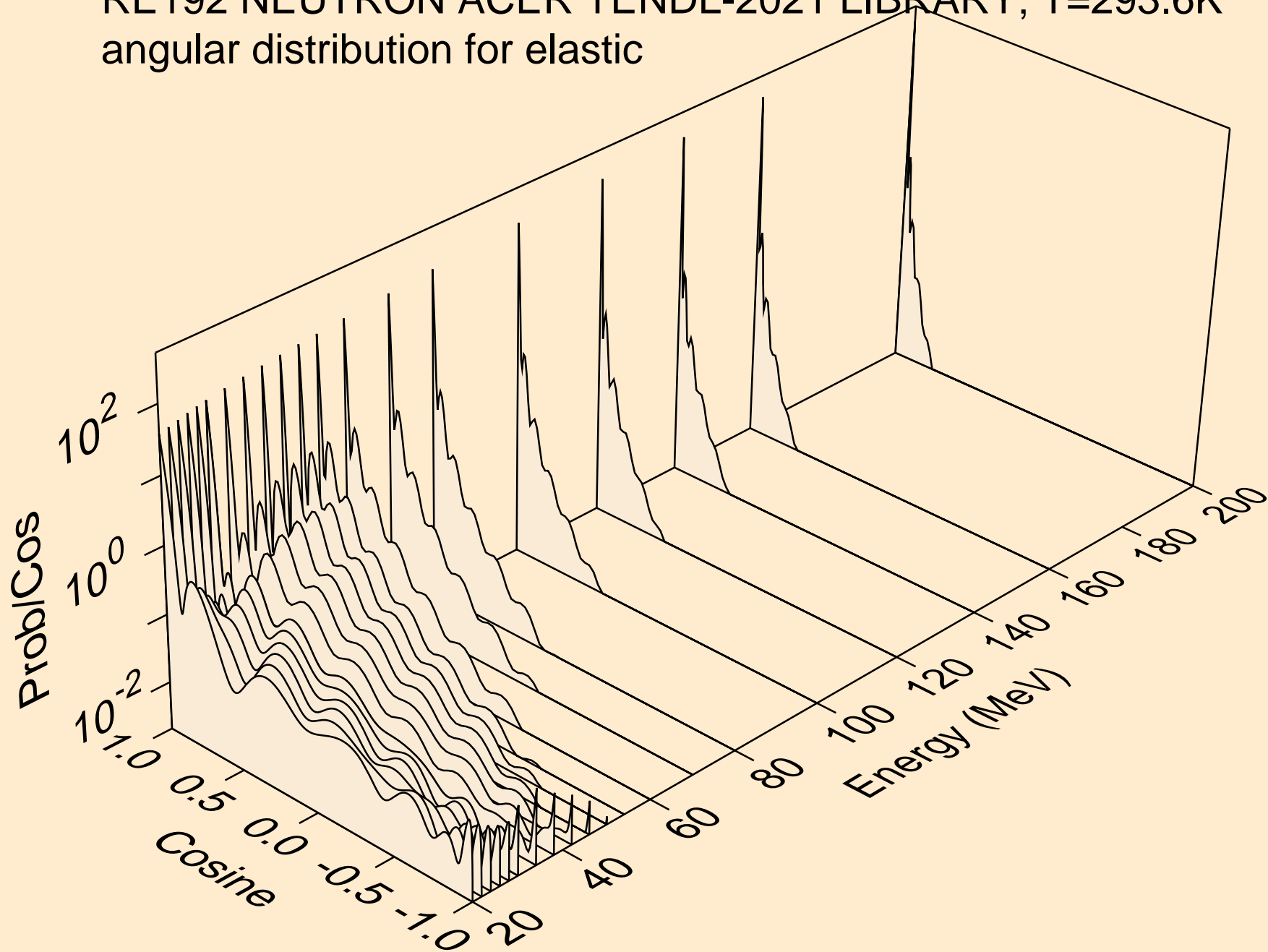

RE192 NEUTRON ACER TENDL-2021 LIBRARY; T=293.6K  
angular distribution for (n,n\*1)

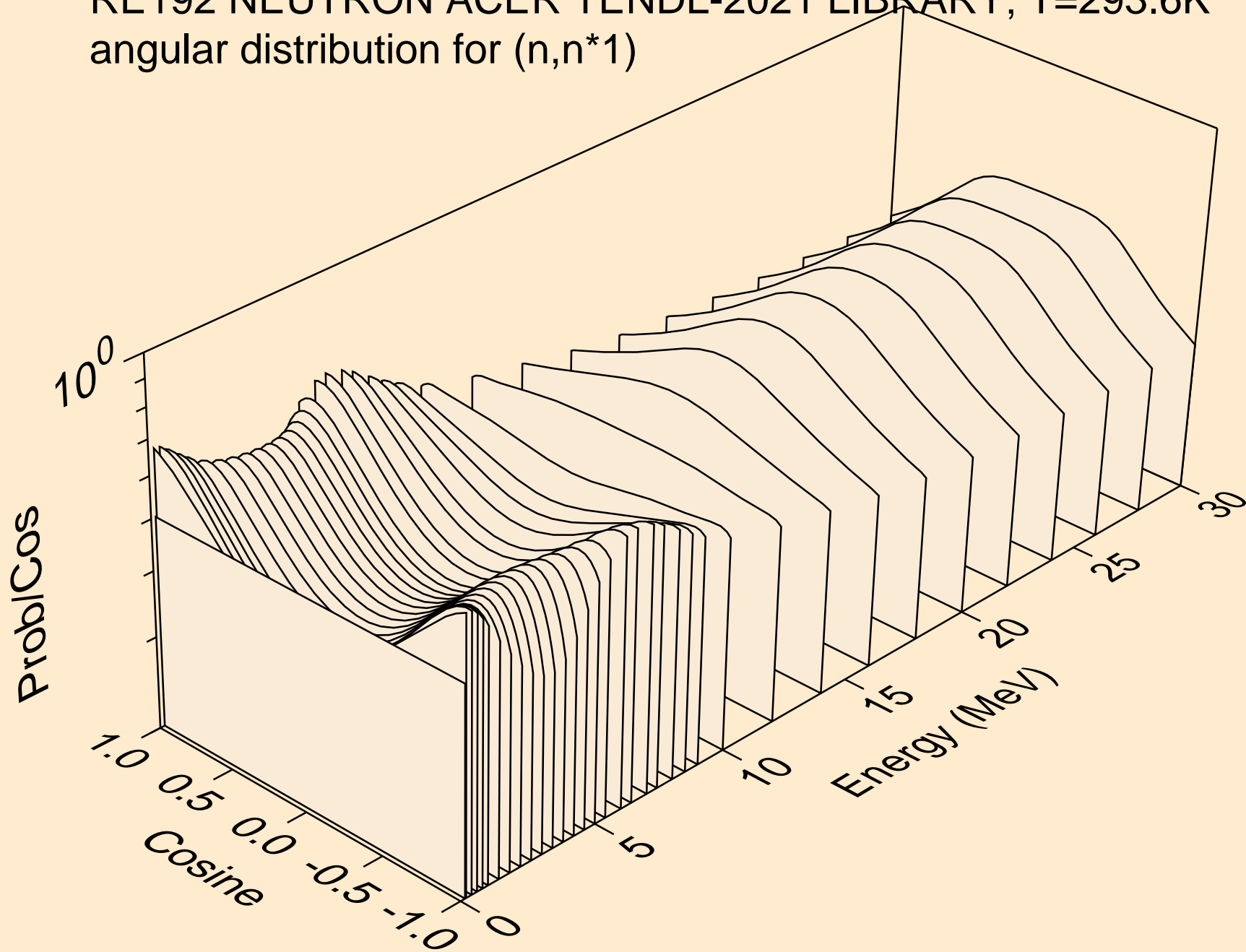



RE192 NEUTRON ACER TENDL-2021 LIBRARY; T=293.6K  
angular distribution for (n,n\*2)

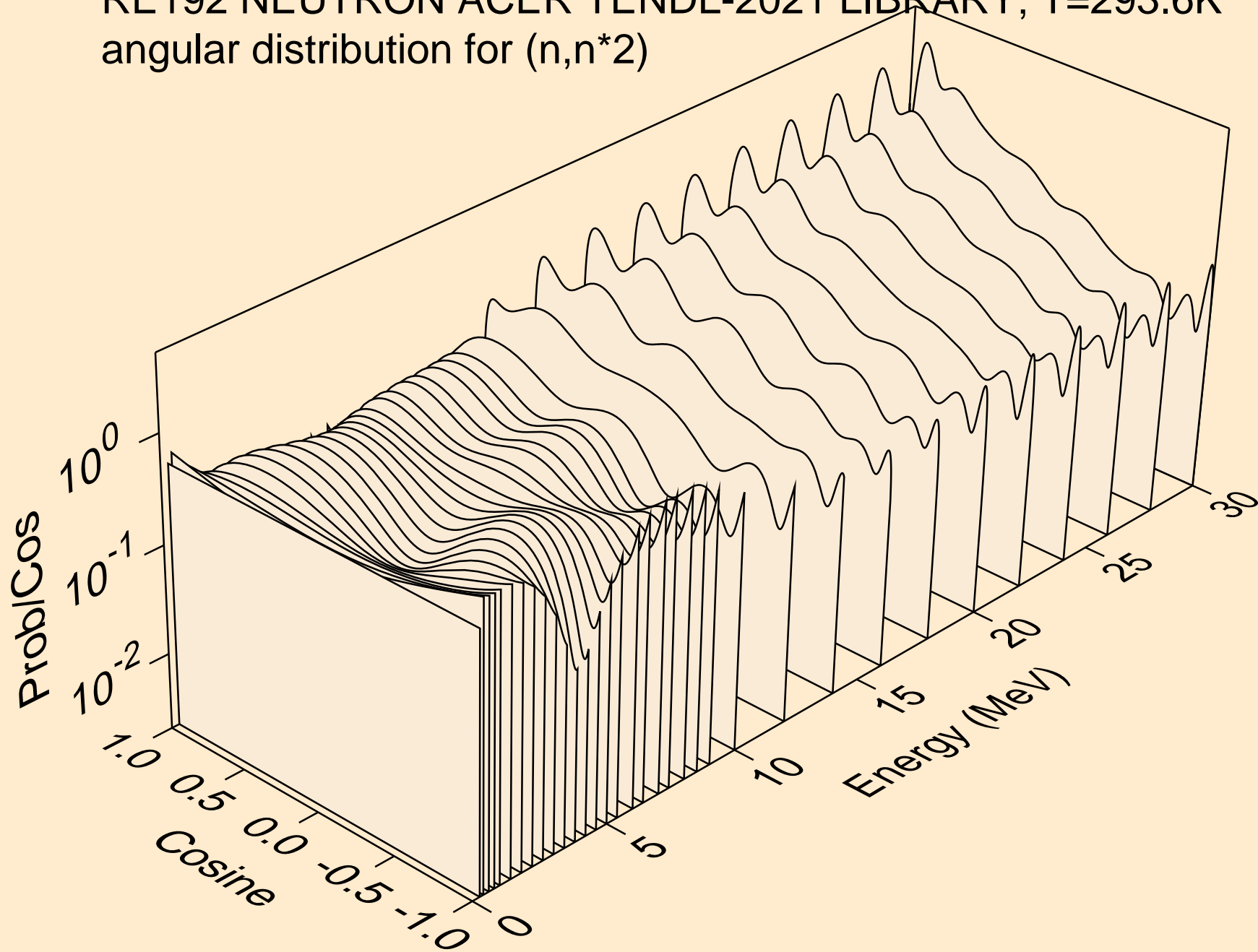

RE192 NEUTRON ACER TENDL-2021 LIBRARY; T=293.6K  
angular distribution for (n,n\*3)

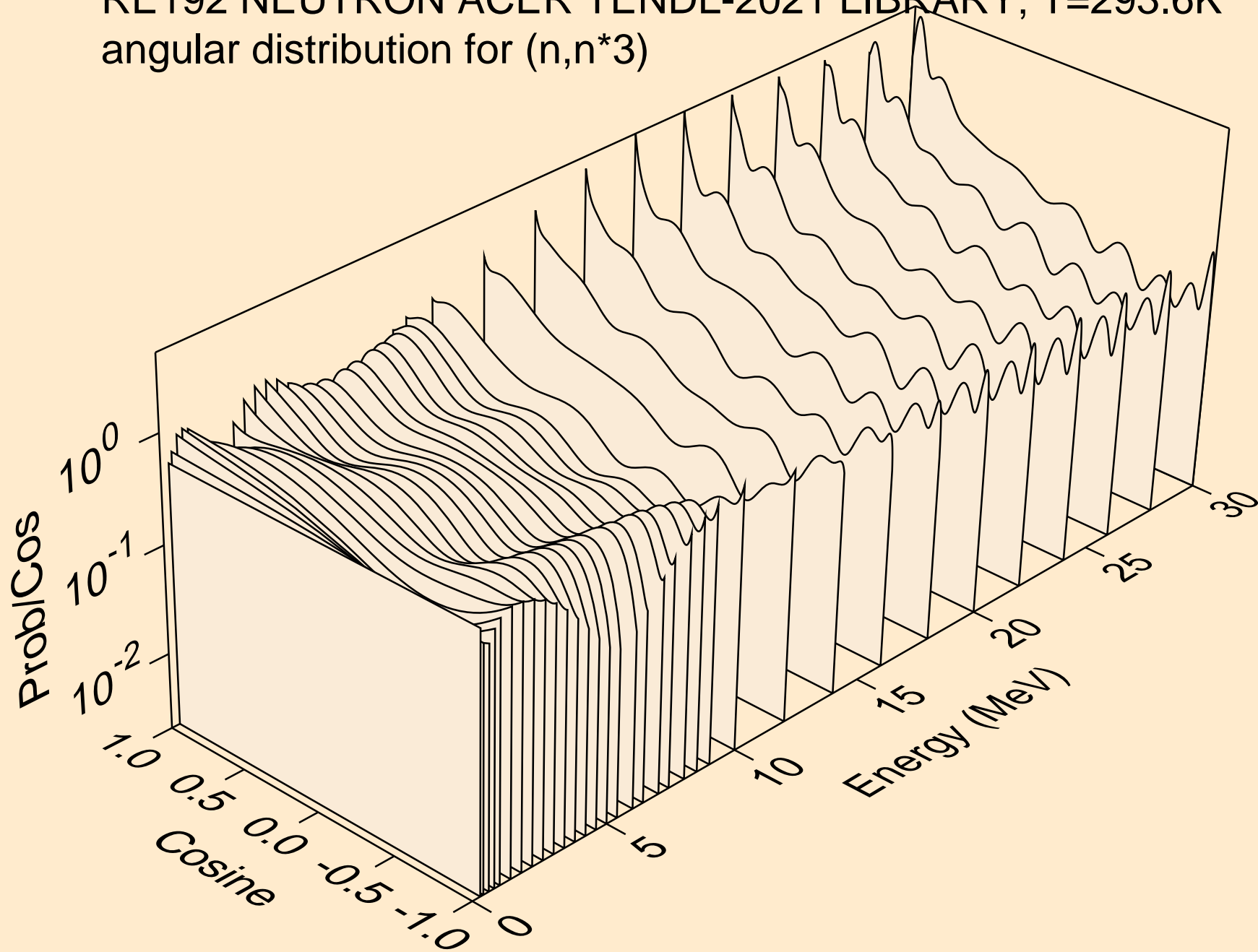

RE192 NEUTRON ACER TENDL-2021 LIBRARY; T=293.6K  
angular distribution for (n,n\*4)

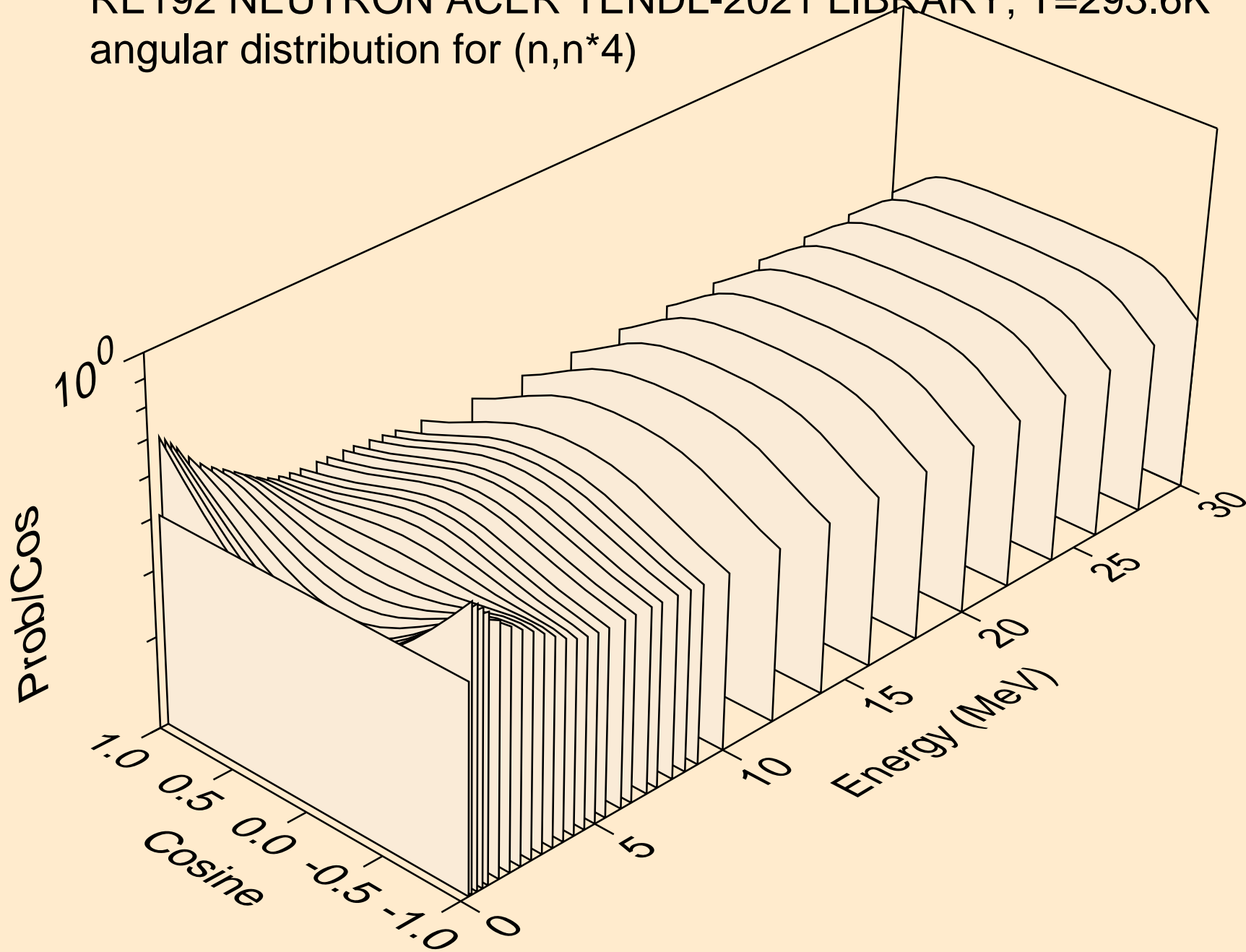

RE192 NEUTRON ACER TENDL-2021 LIBRARY; T=293.6K  
angular distribution for (n,n\*5)

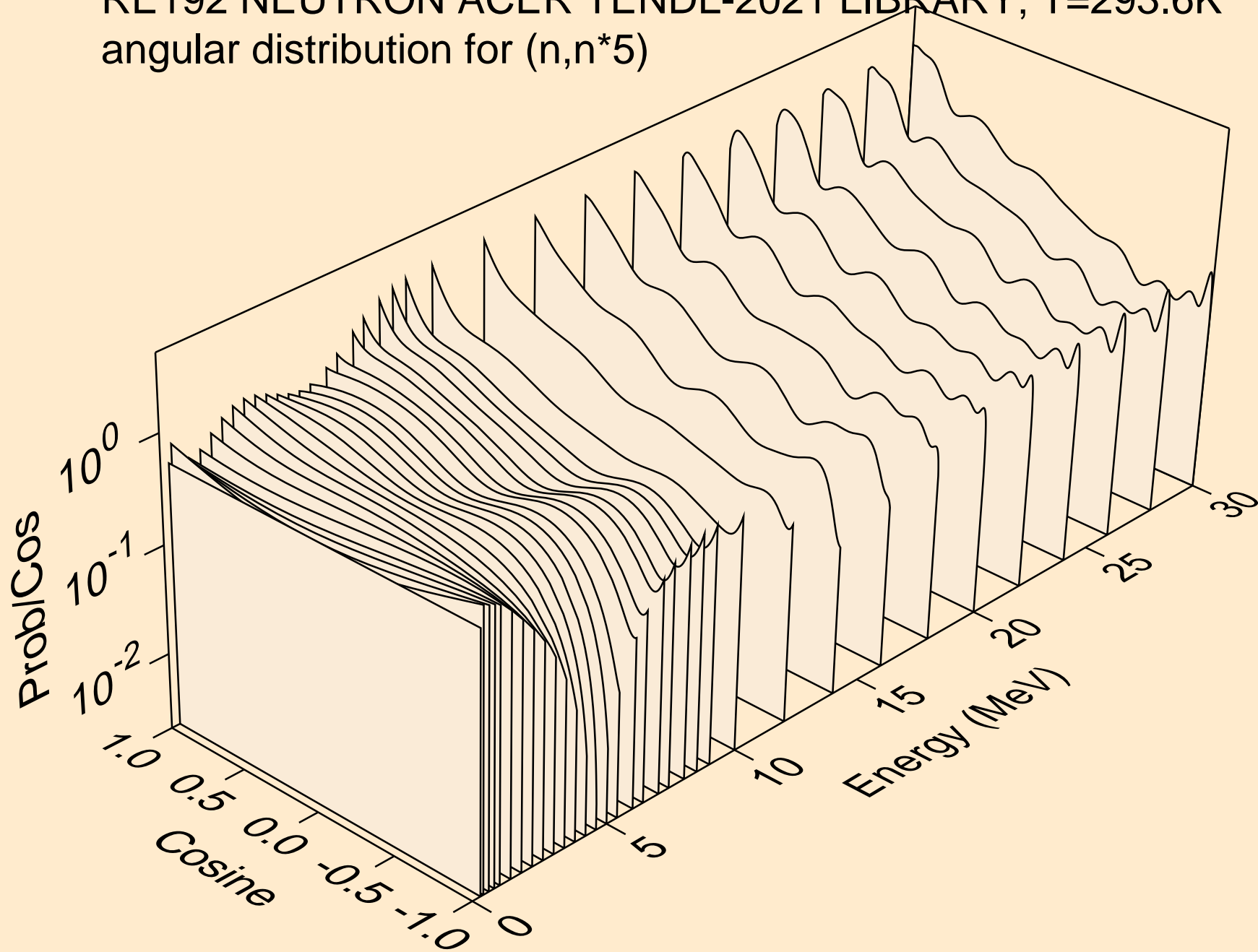

RE192 NEUTRON ACER TENDL-2021 LIBRARY; T=293.6K  
angular distribution for (n,n\*6)

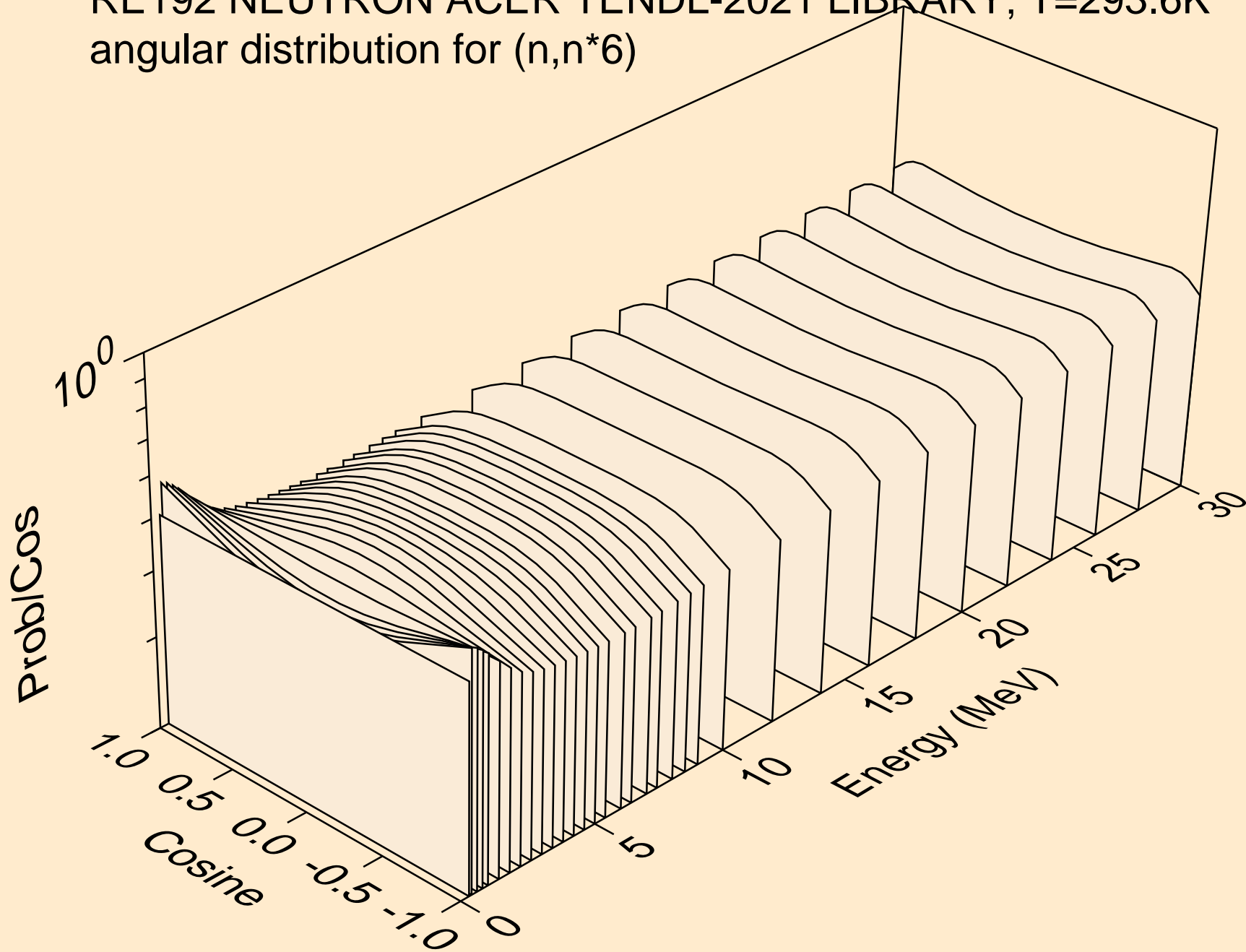

RE192 NEUTRON ACER TENDL-2021 LIBRARY; T=293.6K  
angular distribution for (n,n\*7)

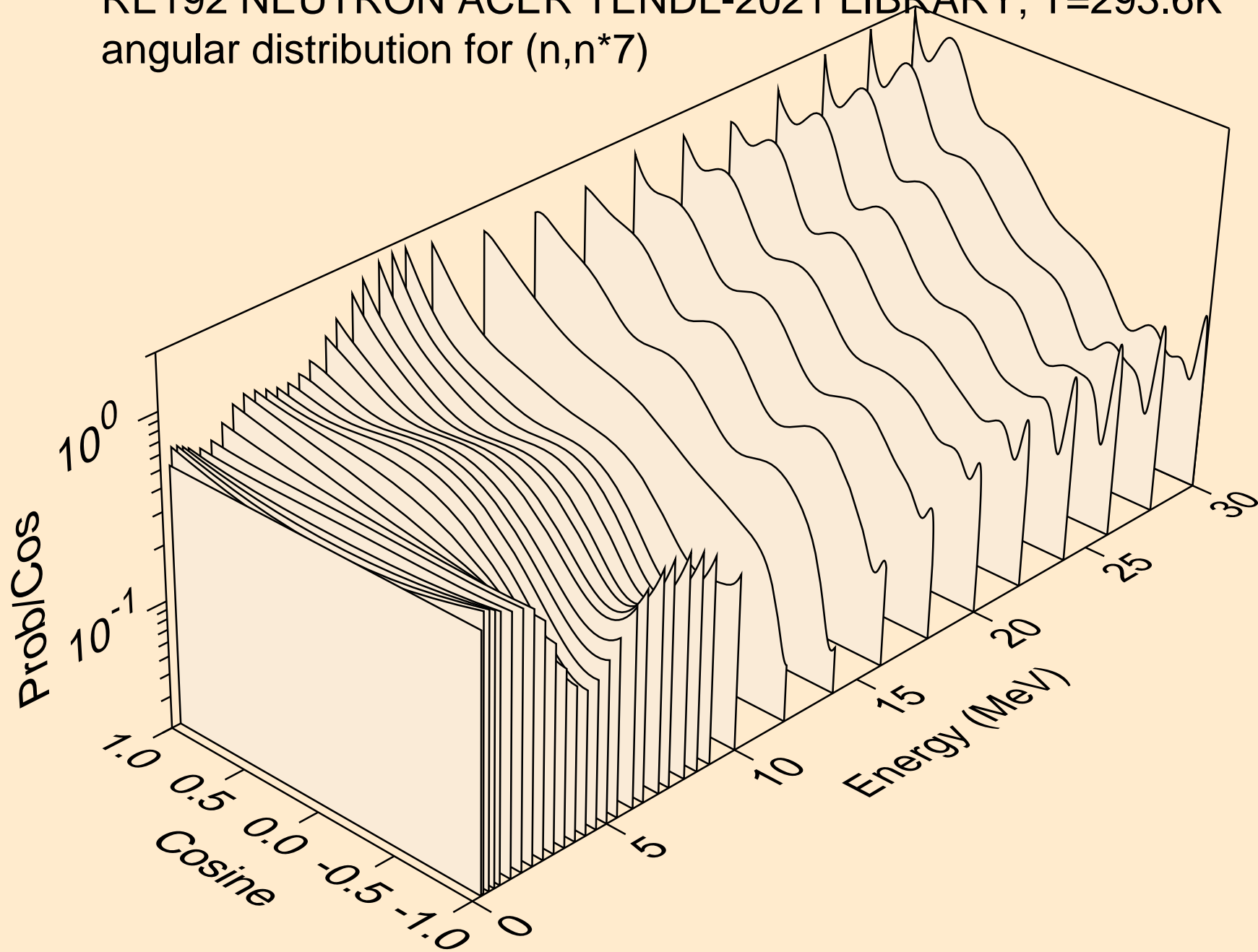

RE192 NEUTRON ACER TENDL-2021 LIBRARY; T=293.6K  
angular distribution for (n,n\*8)

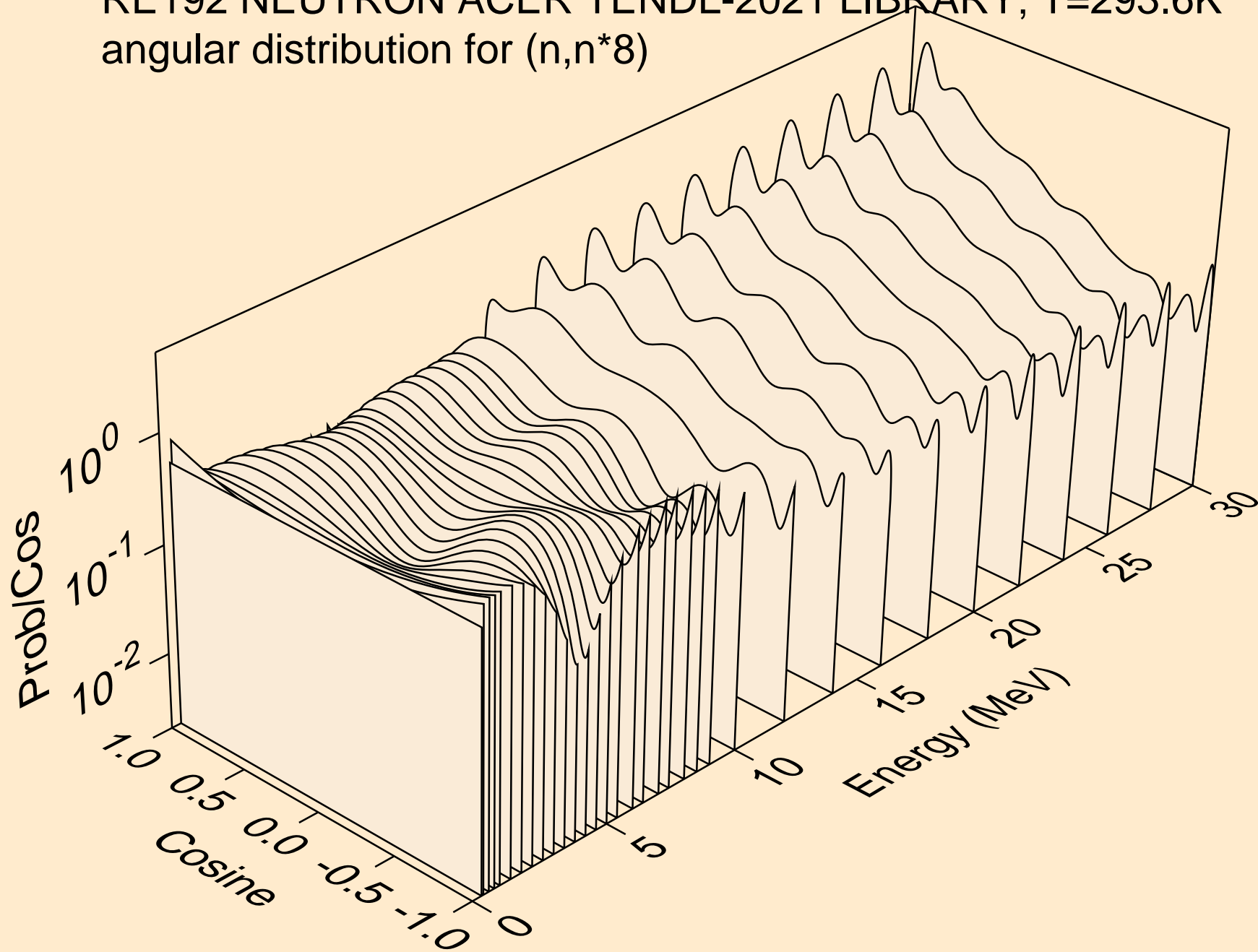

RE192 NEUTRON ACER TENDL-2021 LIBRARY; T=293.6K  
angular distribution for (n,n\*9)

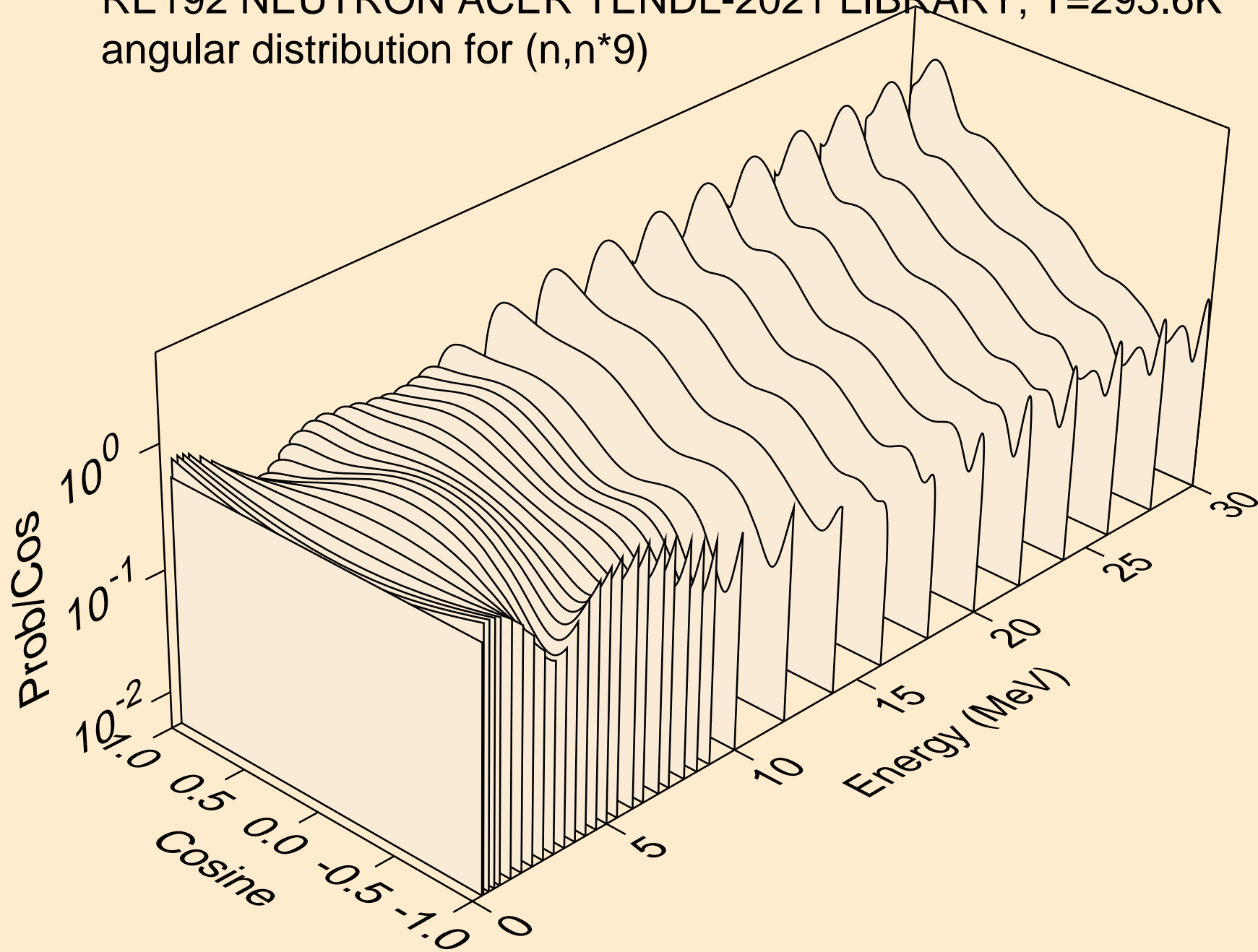



RE192 NEUTRON ACER TENDL-2021 LIBRARY; T=293.6K  
angular distribution for (n,n\*10)

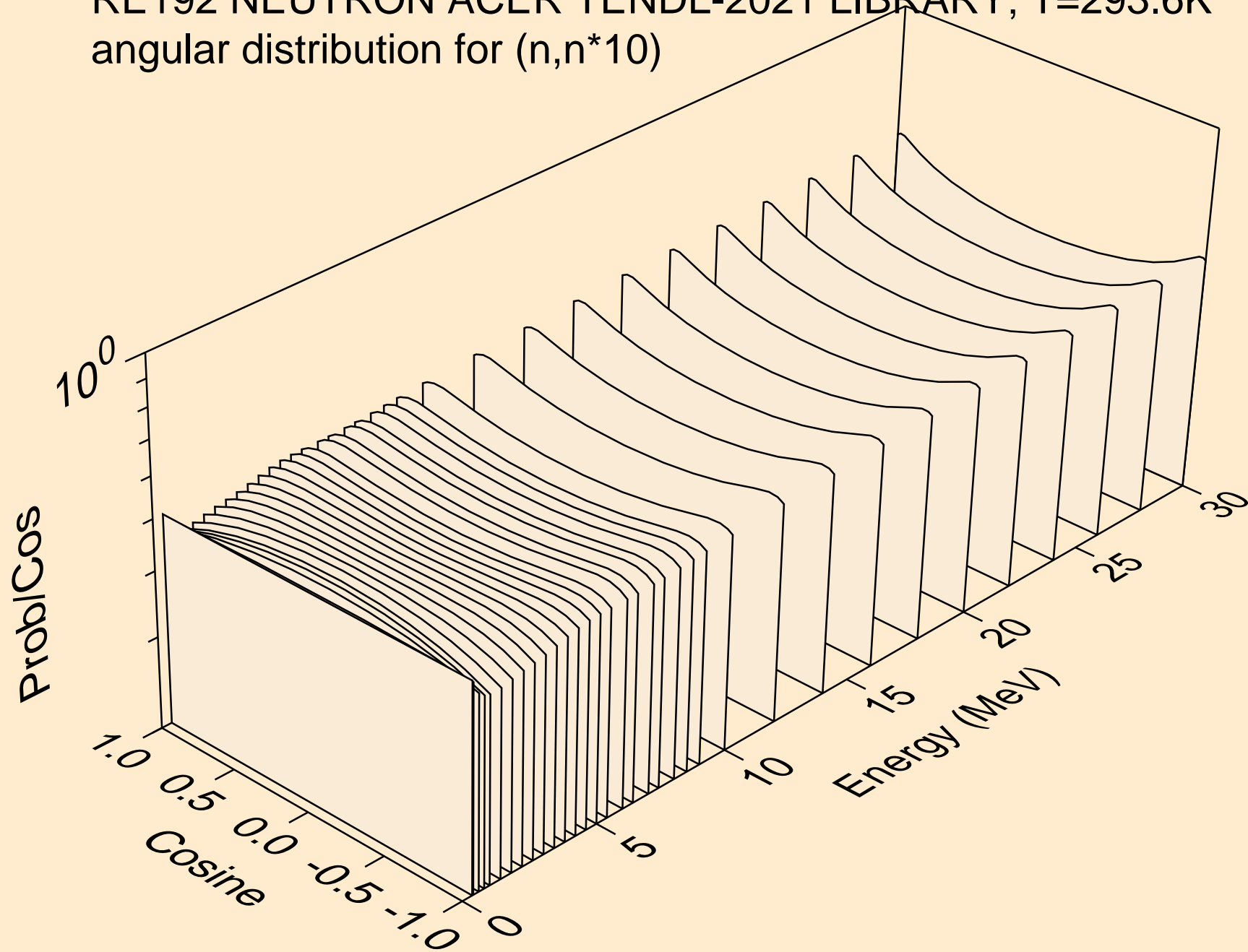

RE192 NEUTRON ACER TENDL-2021 LIBRARY; T=293.6K  
angular distribution for (n,n\*11)

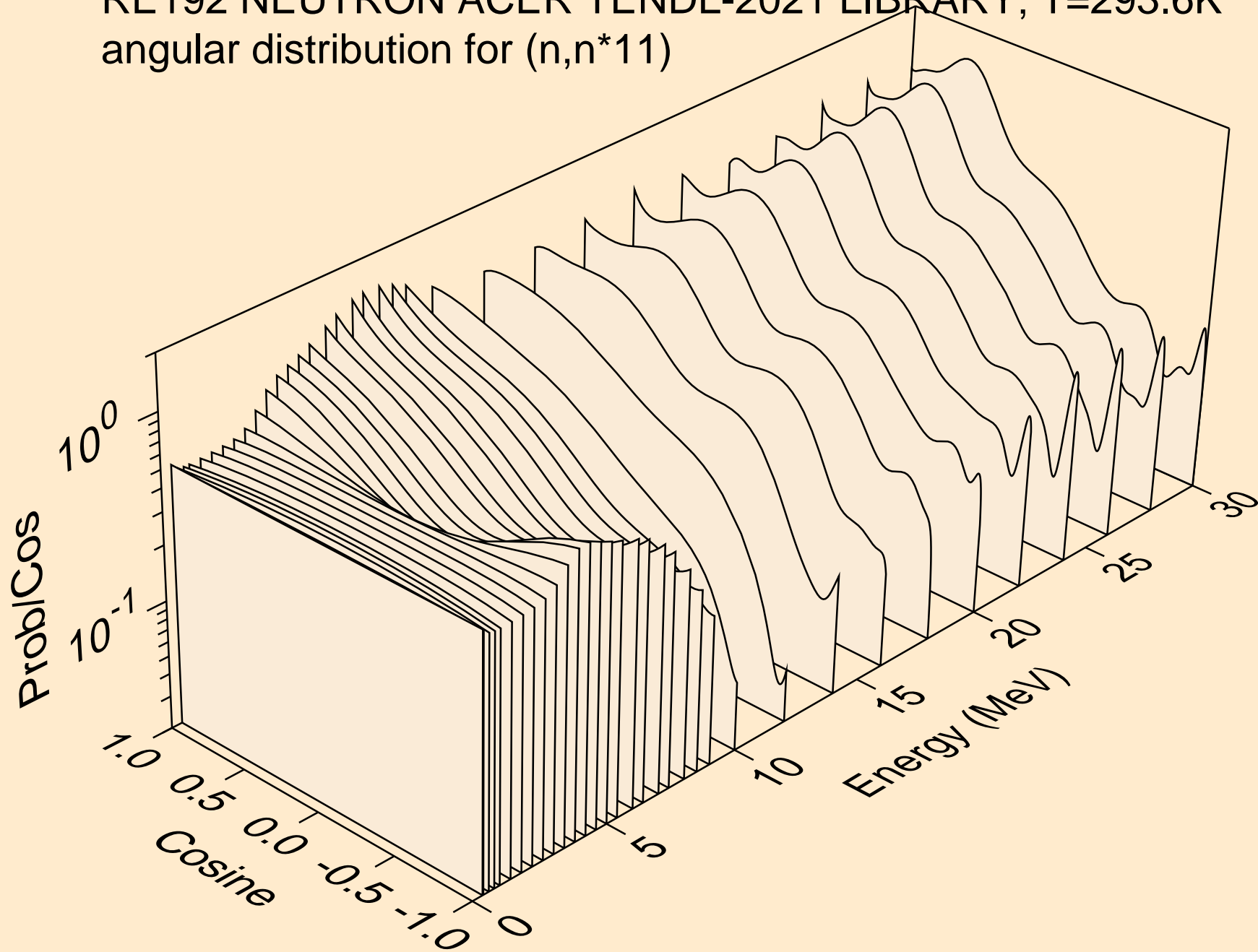

RE192 NEUTRON ACER TENDL-2021 LIBRARY; T=293.6K  
angular distribution for (n,n\*12)

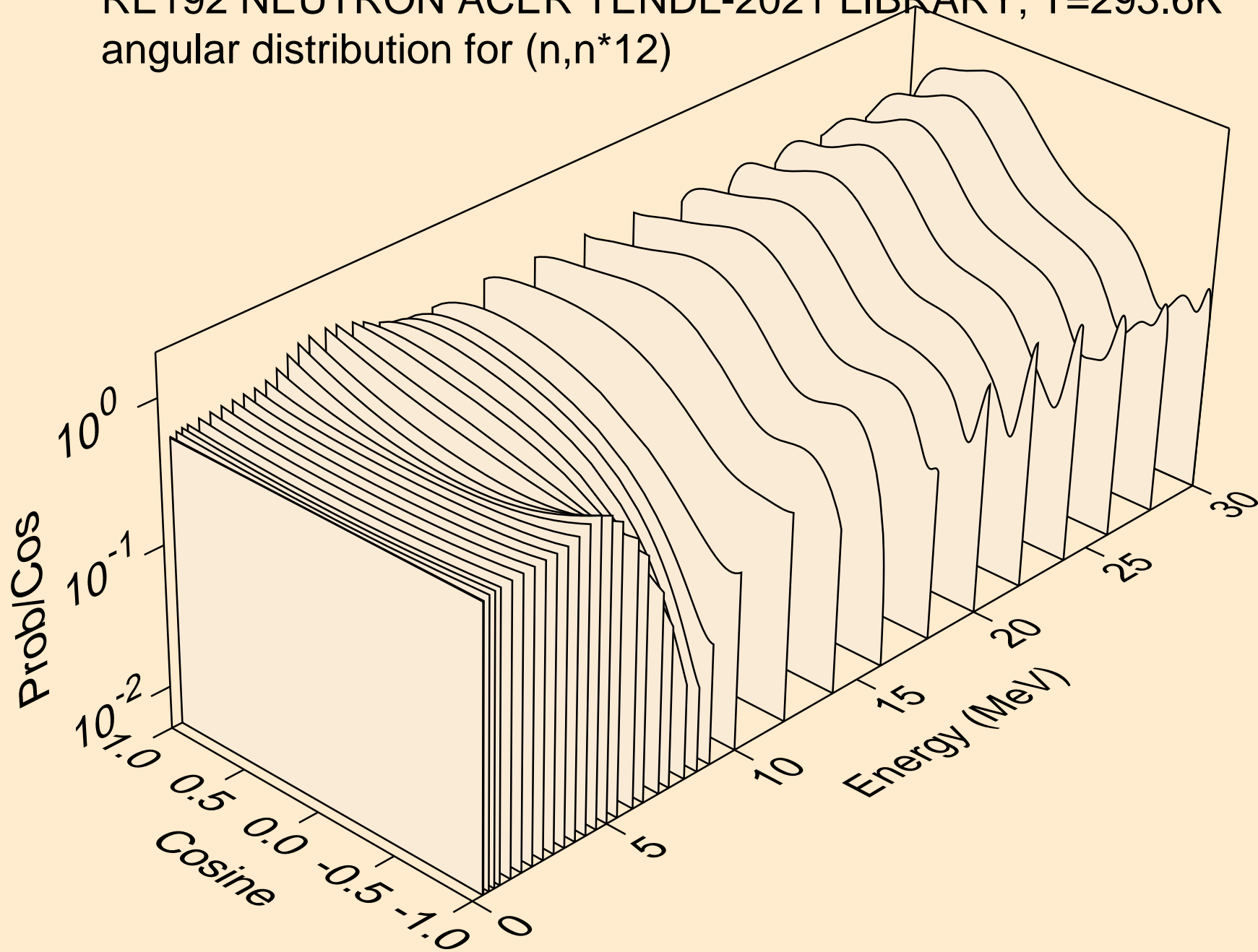

RE192 NEUTRON ACER TENDL-2021 LIBRARY; T=293.6K  
angular distribution for (n,n\*13)

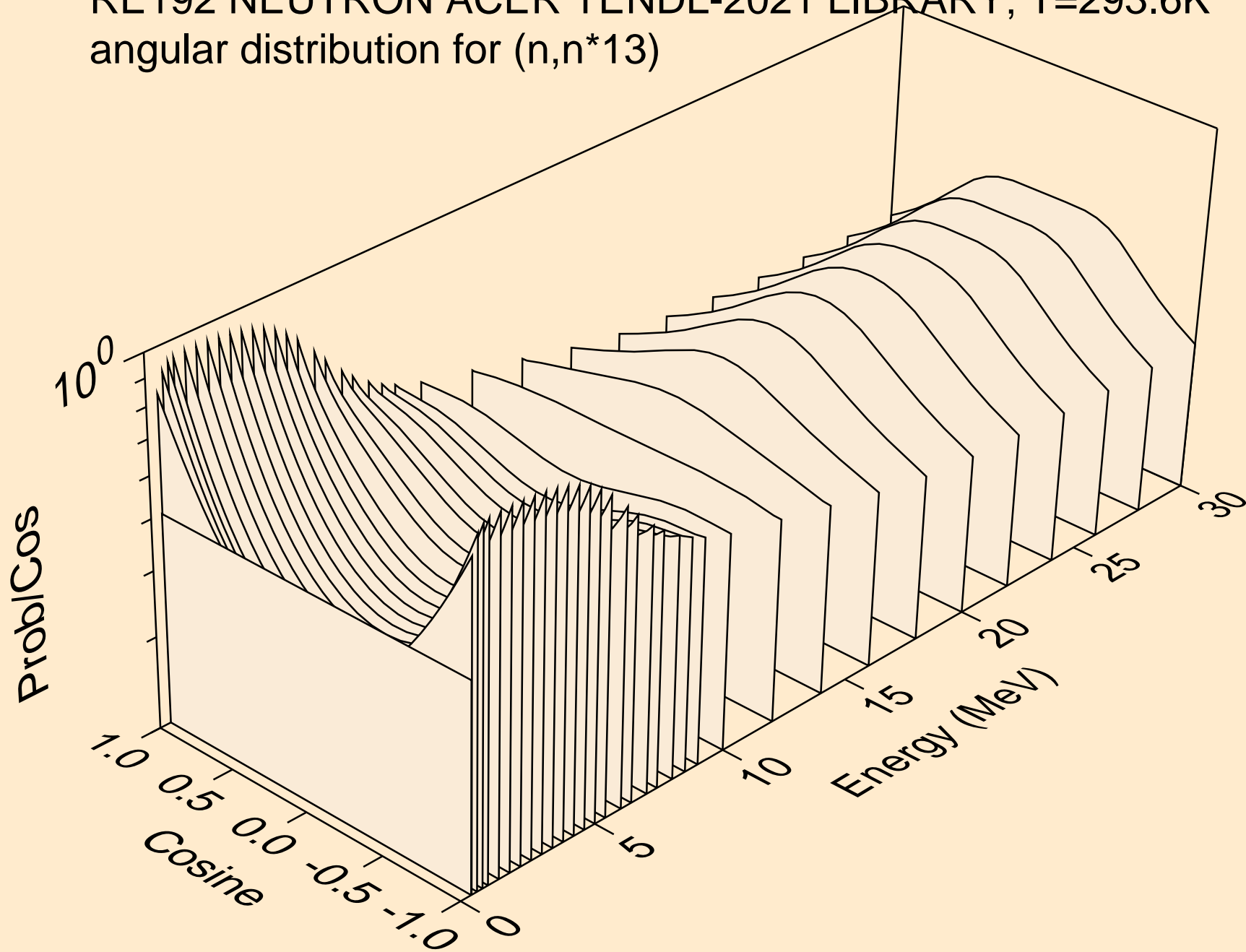

RE192 NEUTRON ACER TENDL-2021 LIBRARY; T=293.6K  
angular distribution for (n,n\*14)

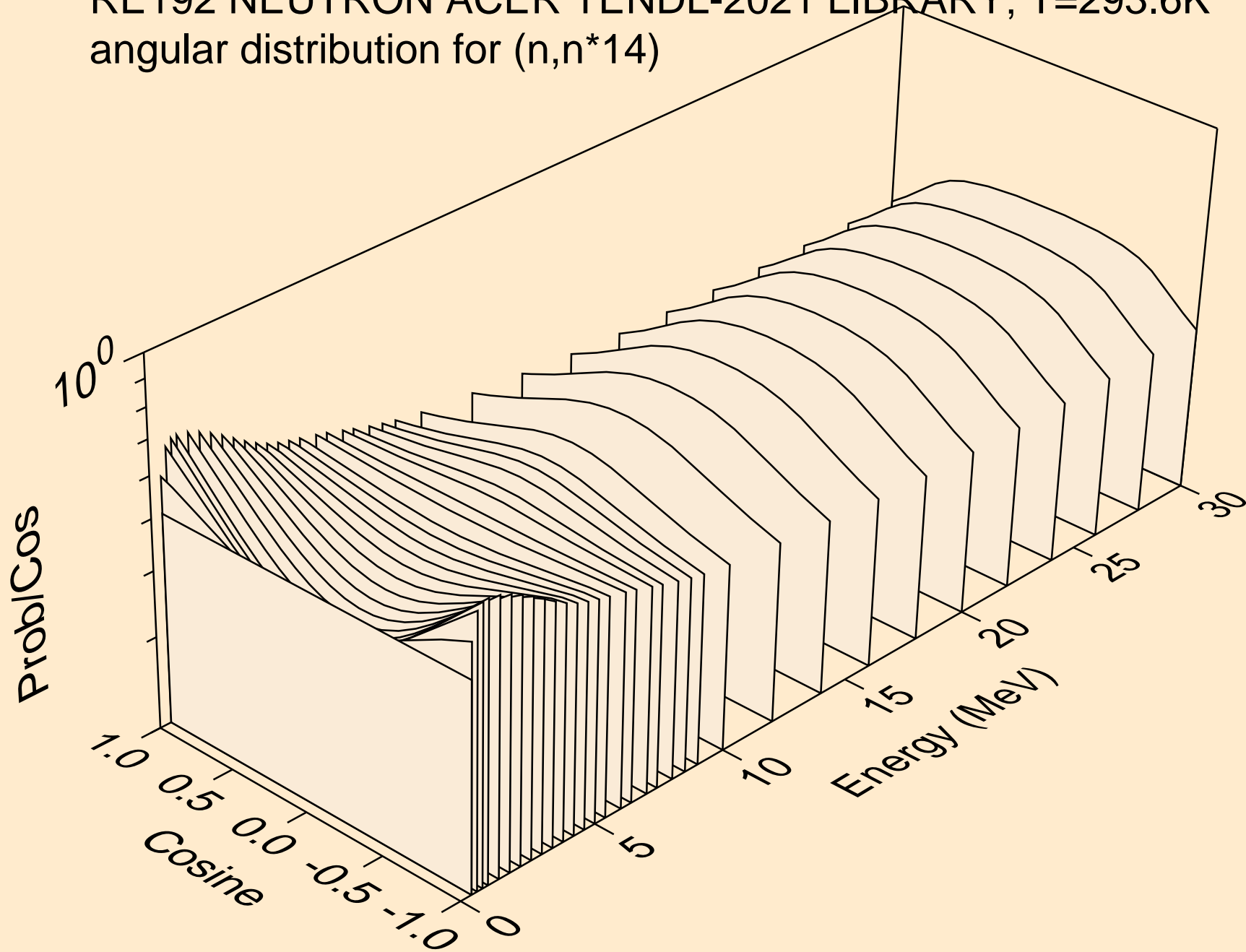

RE192 NEUTRON ACER TENDL-2021 LIBRARY; T=293.6K  
angular distribution for (n,n\*15)

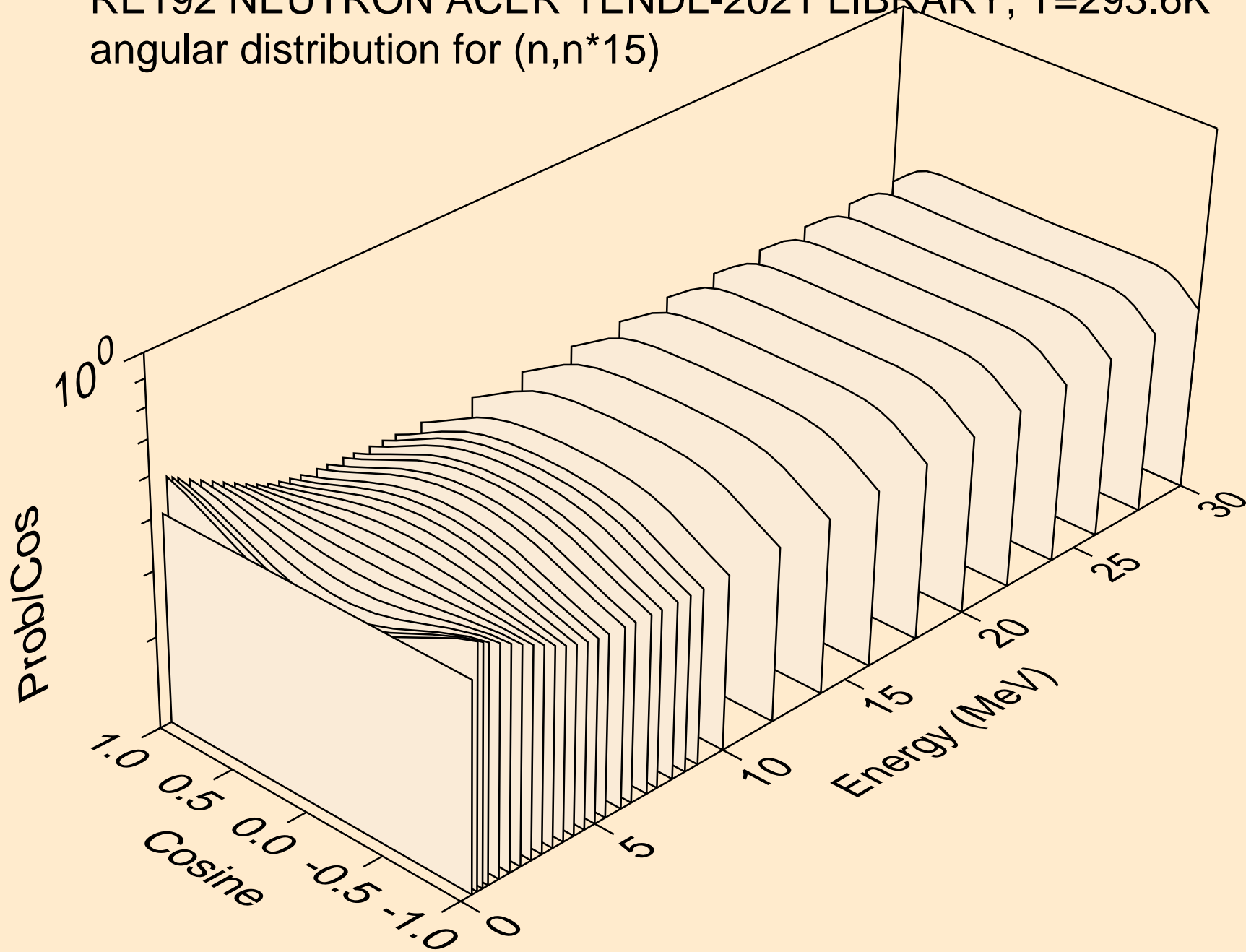

RE192 NEUTRON ACER TENDL-2021 LIBRARY; T=293.6K  
angular distribution for (n,n\*16)

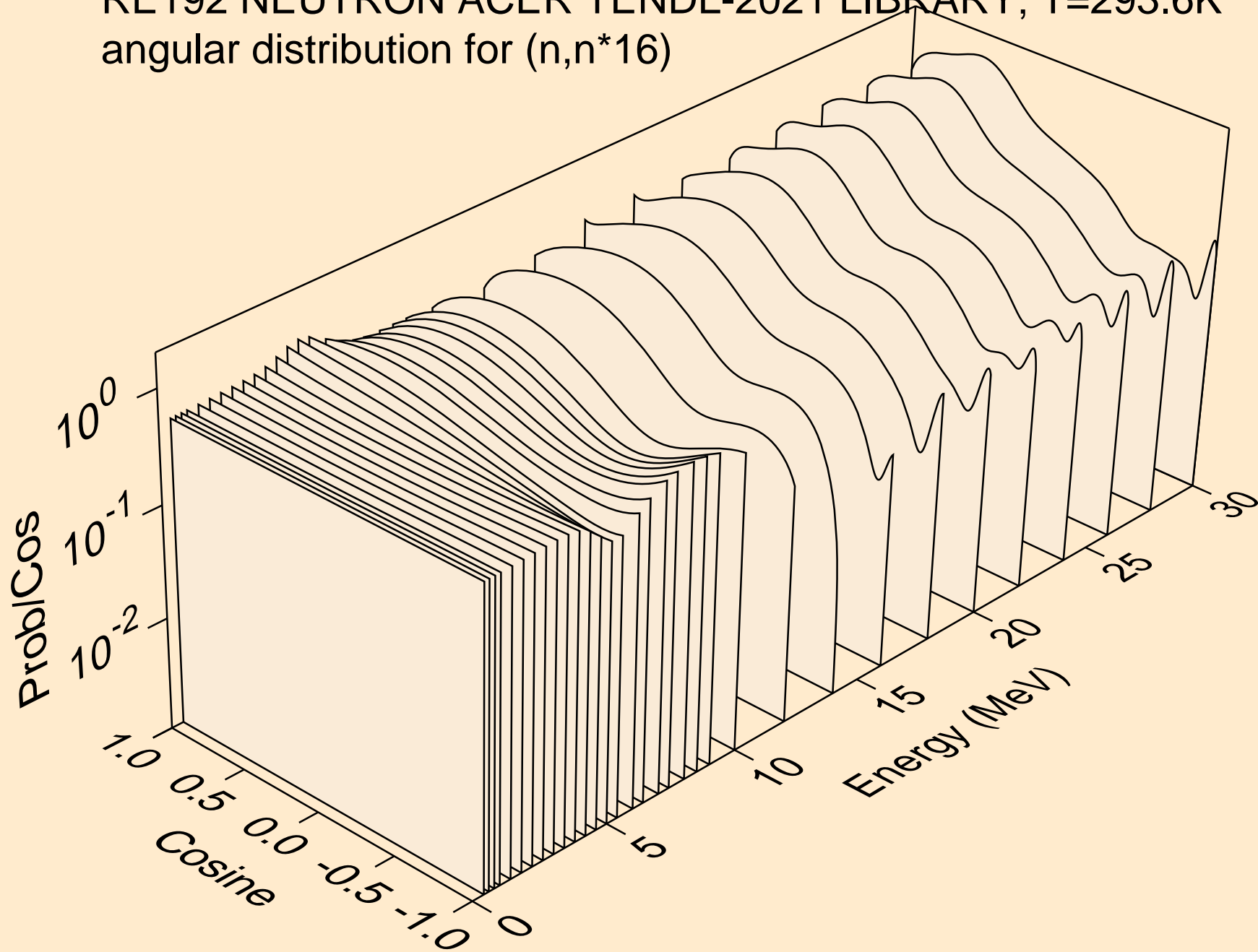

RE192 NEUTRON ACER TENDL-2021 LIBRARY; T=293.6K  
angular distribution for (n,n\*17)

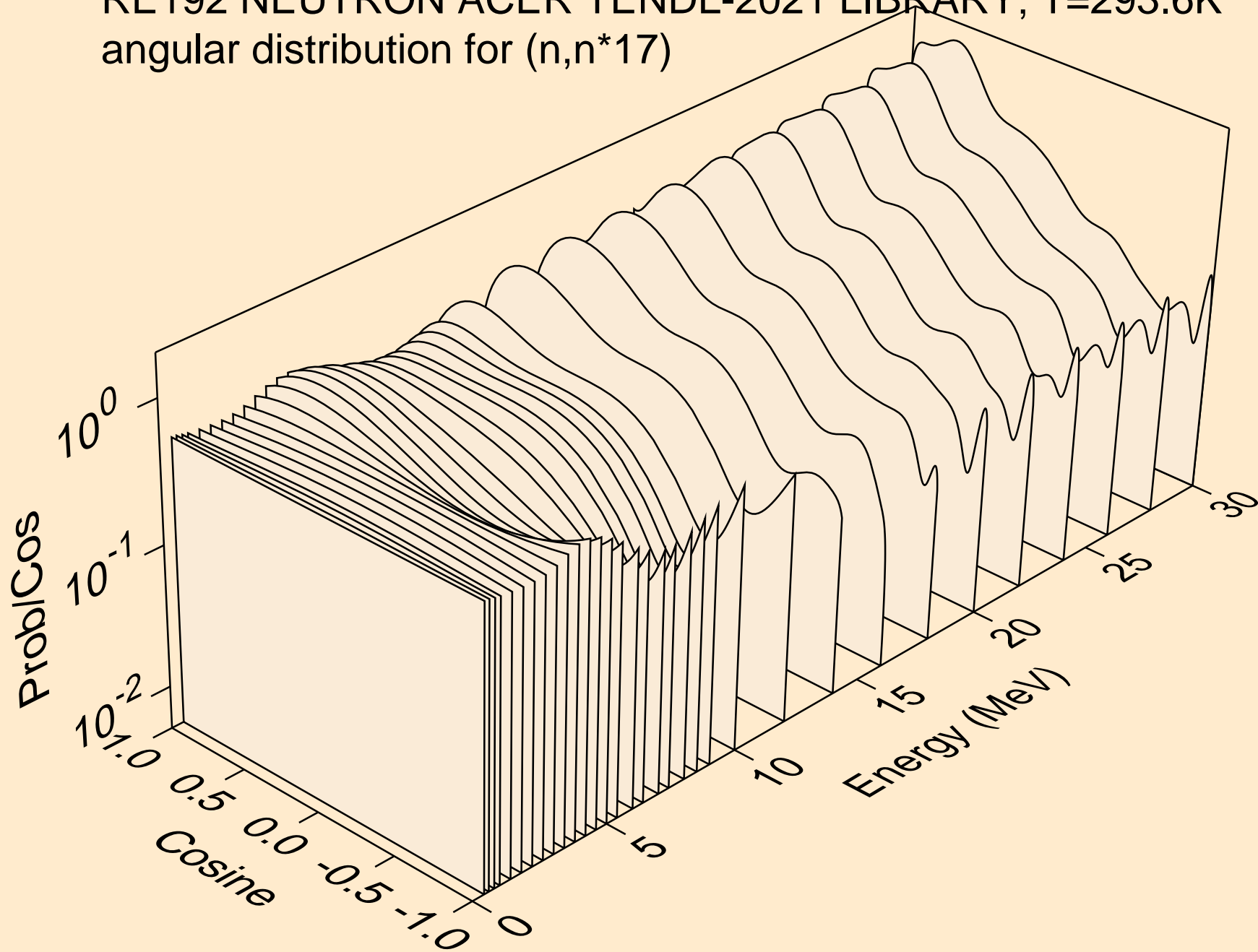



RE192 NEUTRON ACER TENDL-2021 LIBRARY; T=293.6K  
angular distribution for (n,n\*18)

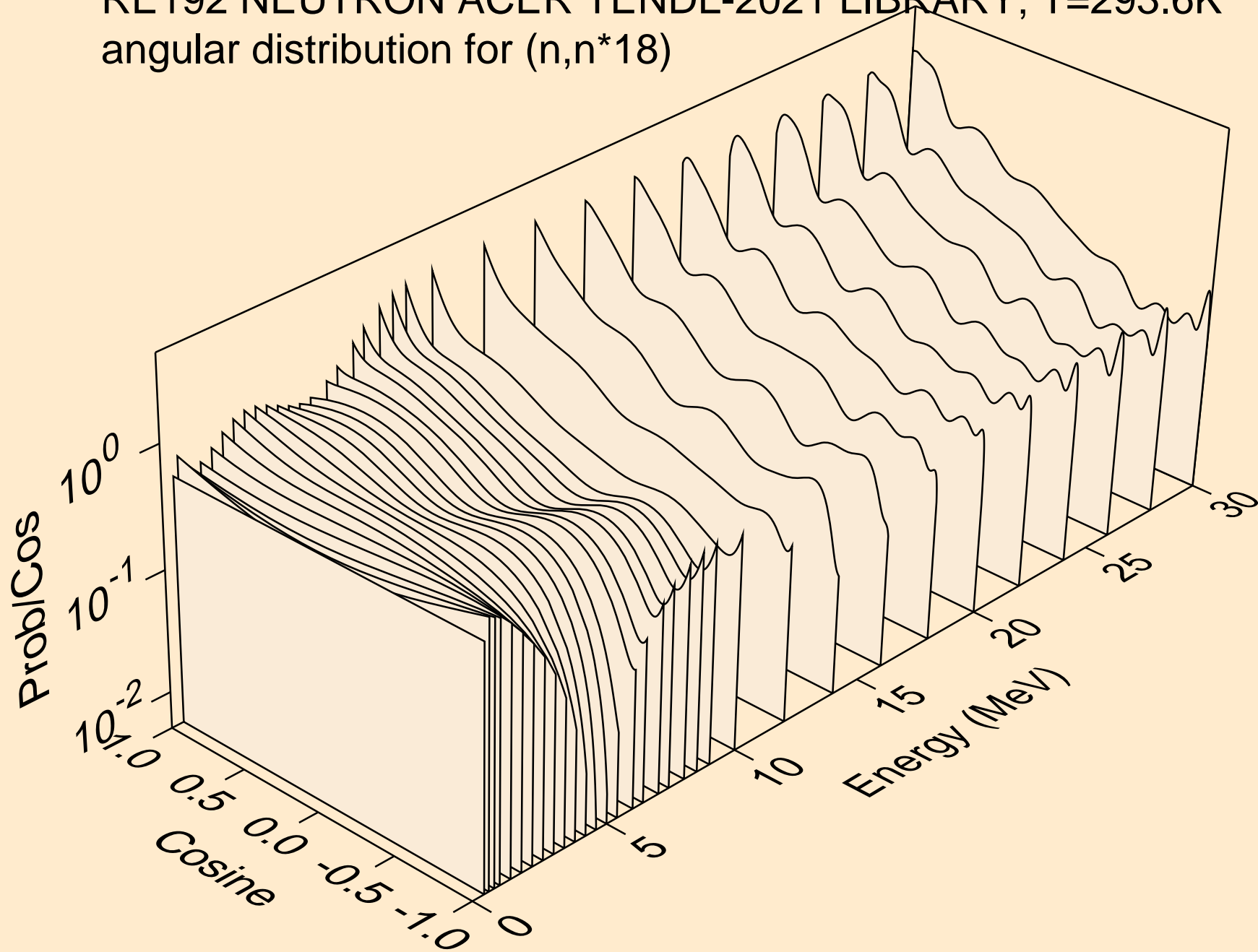

RE192 NEUTRON ACER TENDL-2021 LIBRARY; T=293.6K  
angular distribution for (n,n\*19)

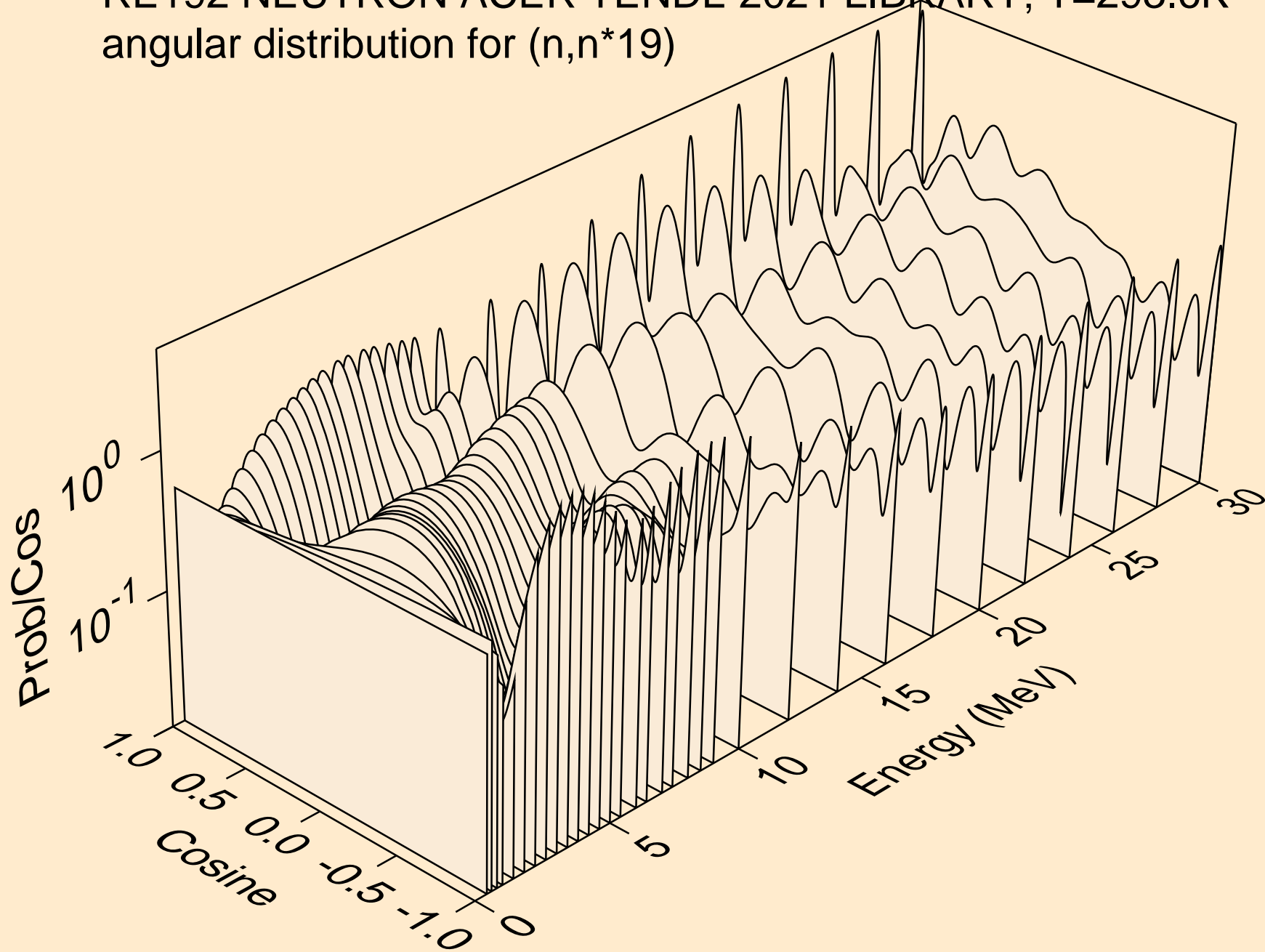

RE192 NEUTRON ACER TENDL-2021 LIBRARY; T=293.6K  
angular distribution for (n,n\*20)

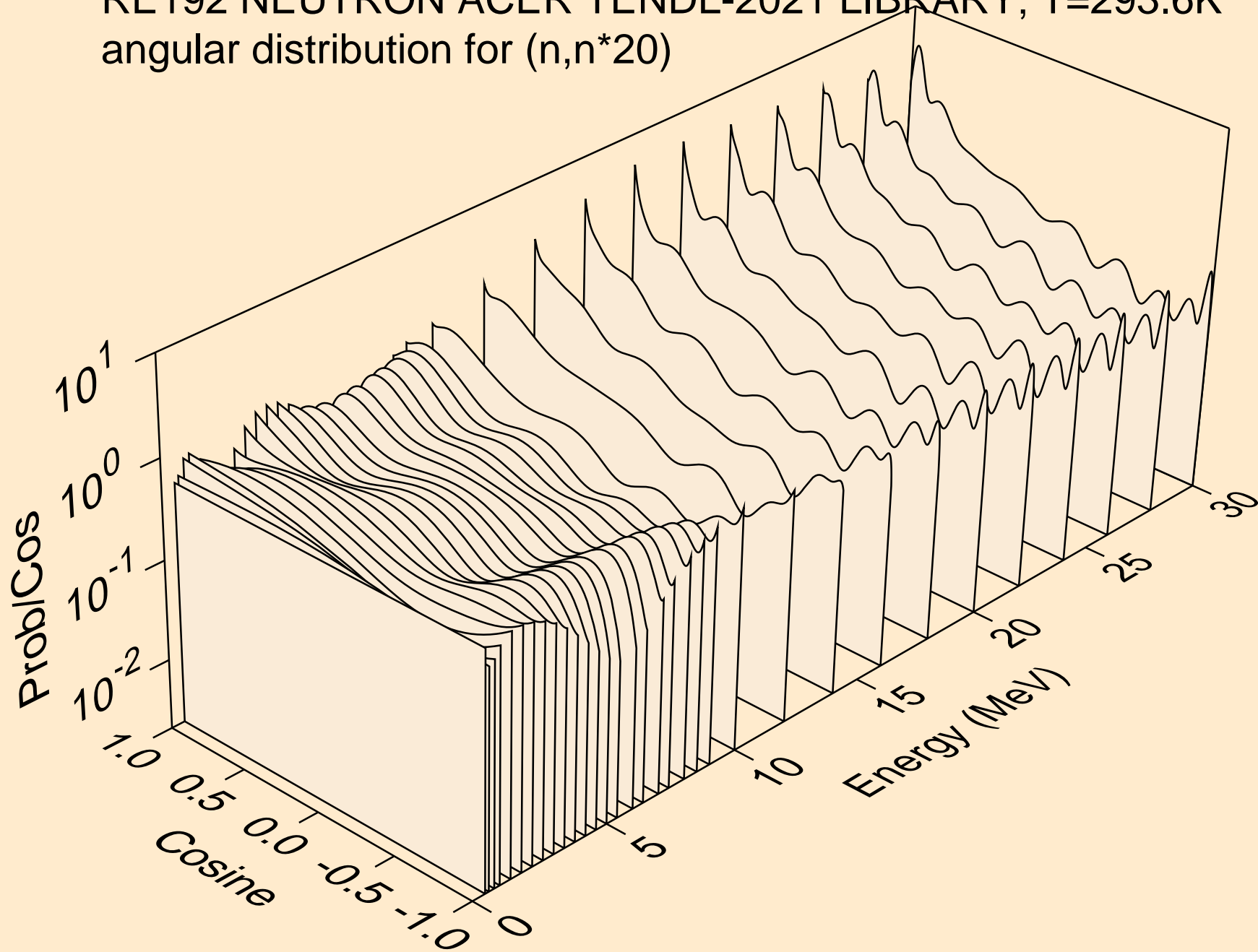

RE192 NEUTRON ACER TENDL-2021 LIBRARY; T=293.6K  
angular distribution for (n,n\*21)

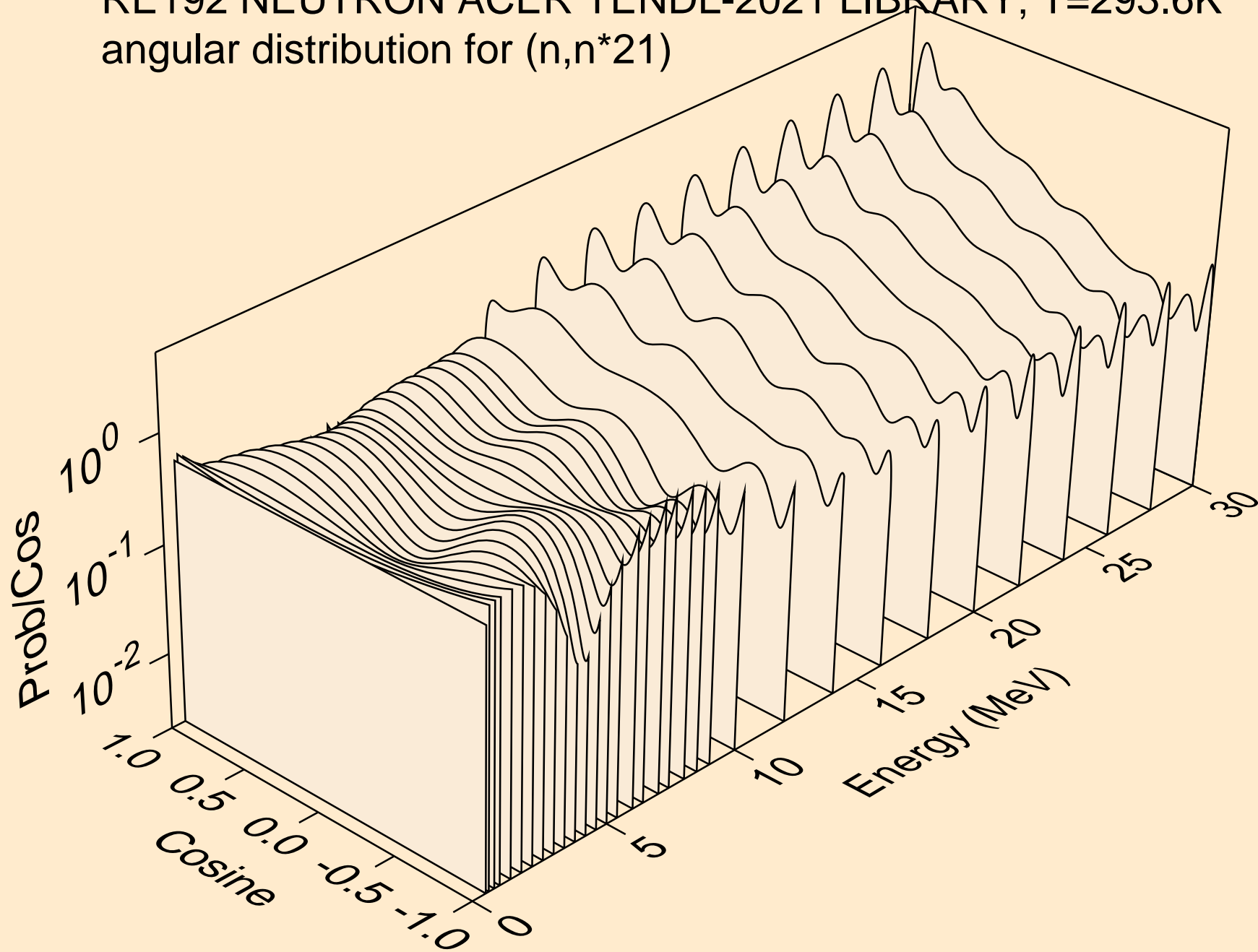

RE192 NEUTRON ACER TENDL-2021 LIBRARY; T=293.6K  
angular distribution for (n,n\*22)

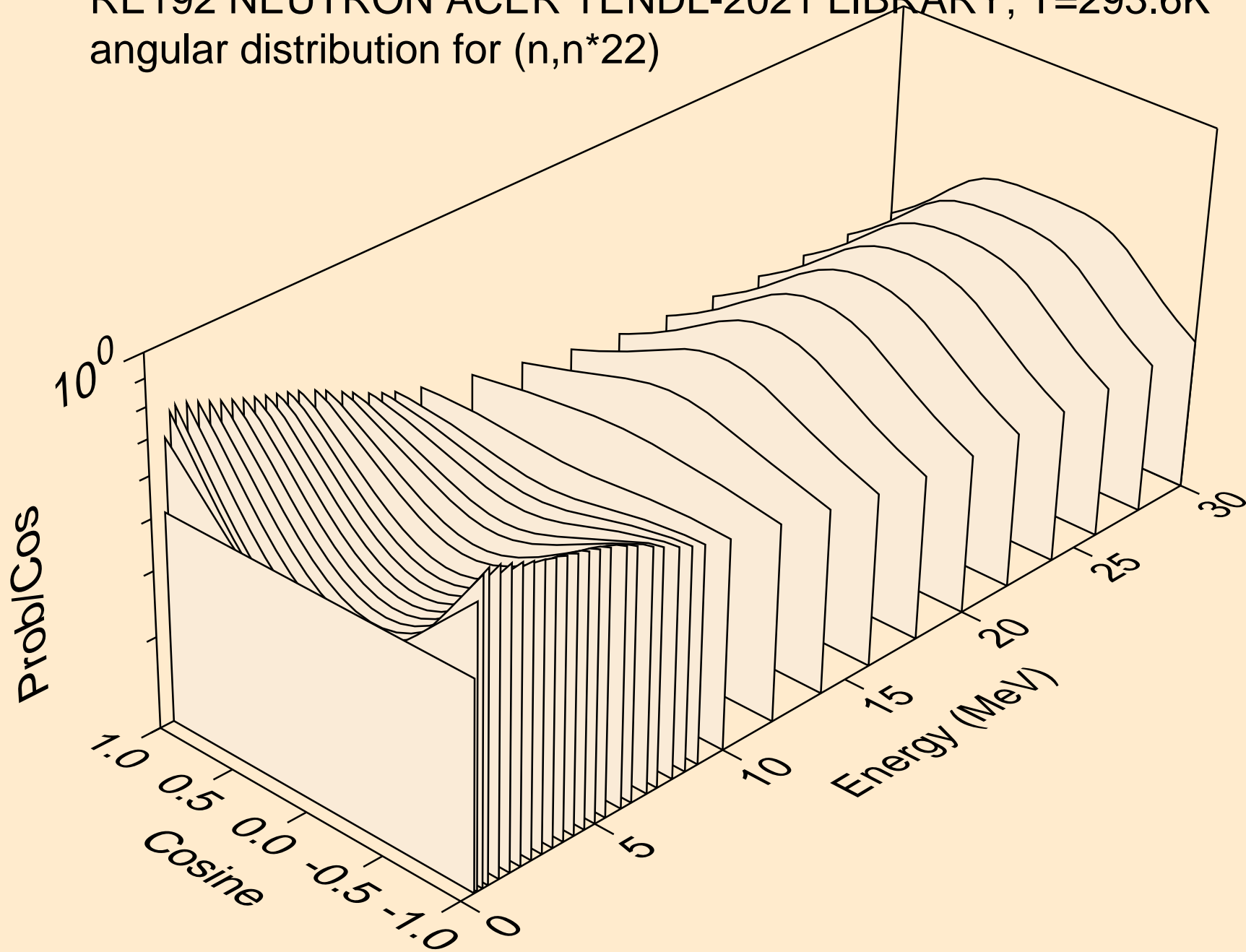

RE192 NEUTRON ACER TENDL-2021 LIBRARY; T=293.6K  
angular distribution for (n,n\*23)

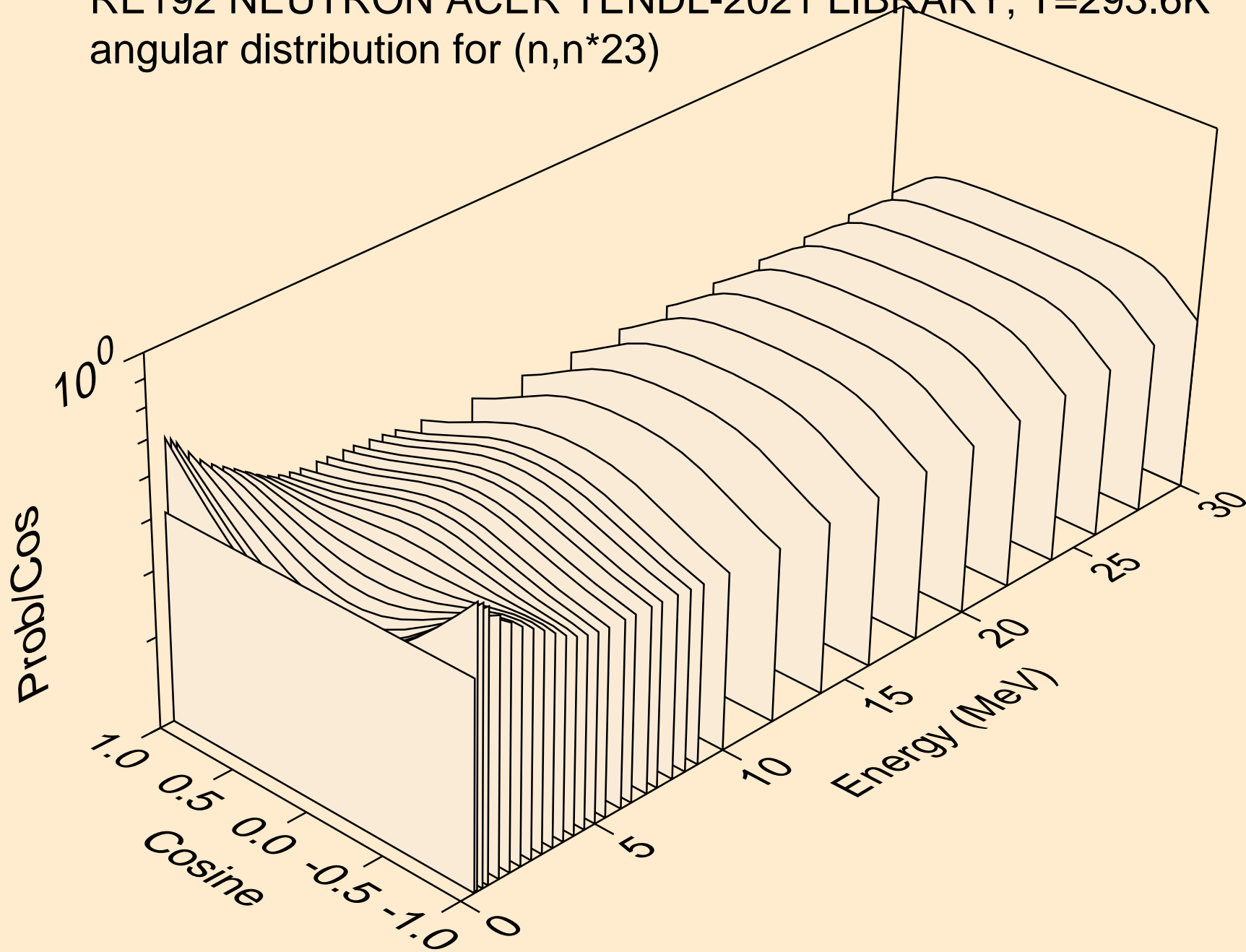

RE192 NEUTRON ACER TENDL-2021 LIBRARY; T=293.6K  
angular distribution for (n,n\*24)

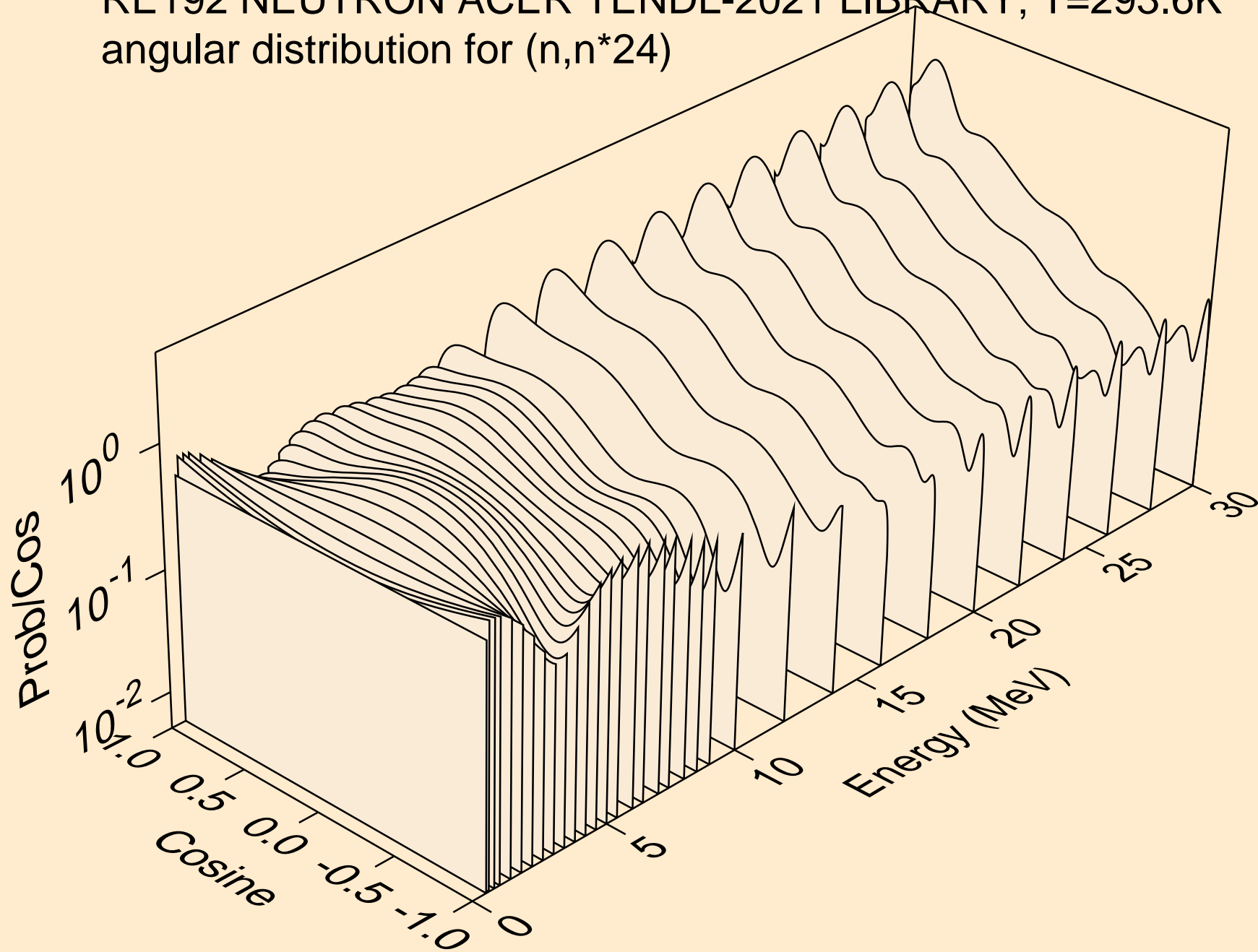

RE192 NEUTRON ACER TENDL-2021 LIBRARY; T=293.6K  
angular distribution for (n,n\*25)

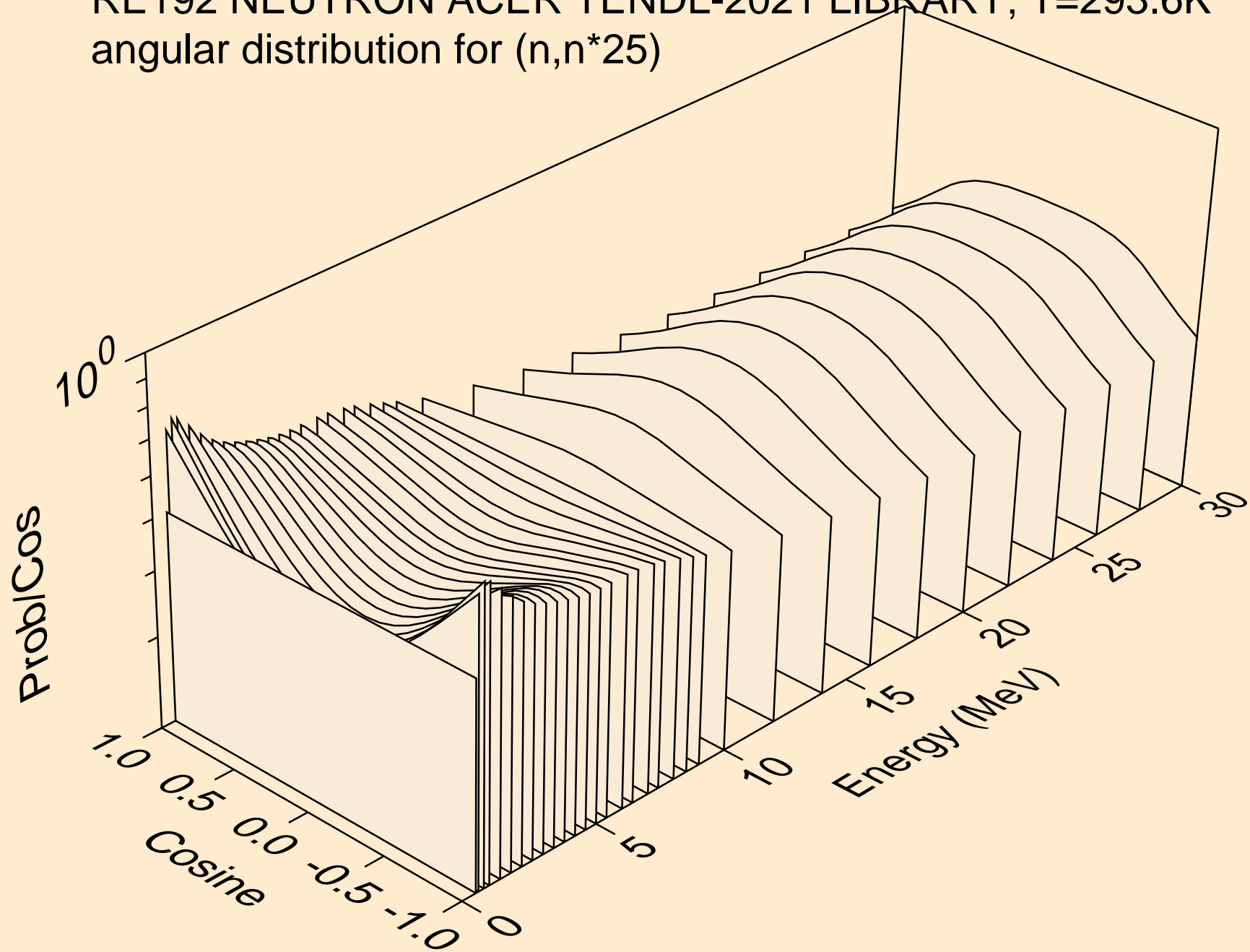



RE192 NEUTRON ACER TENDL-2021 LIBRARY; T=293.6K  
angular distribution for (n,n\*26)

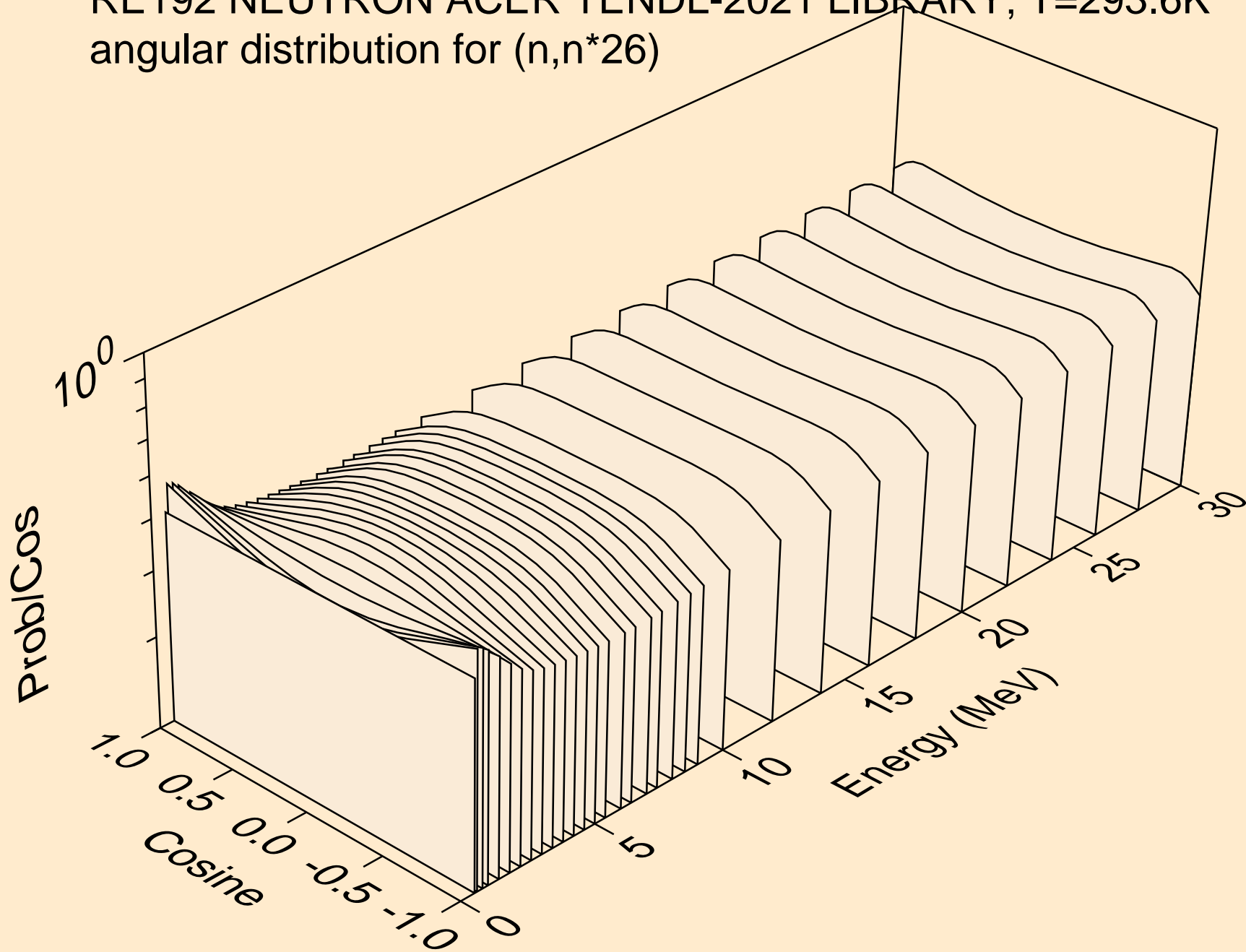

RE192 NEUTRON ACER TENDL-2021 LIBRARY; T=293.6K  
angular distribution for (n,n\*27)

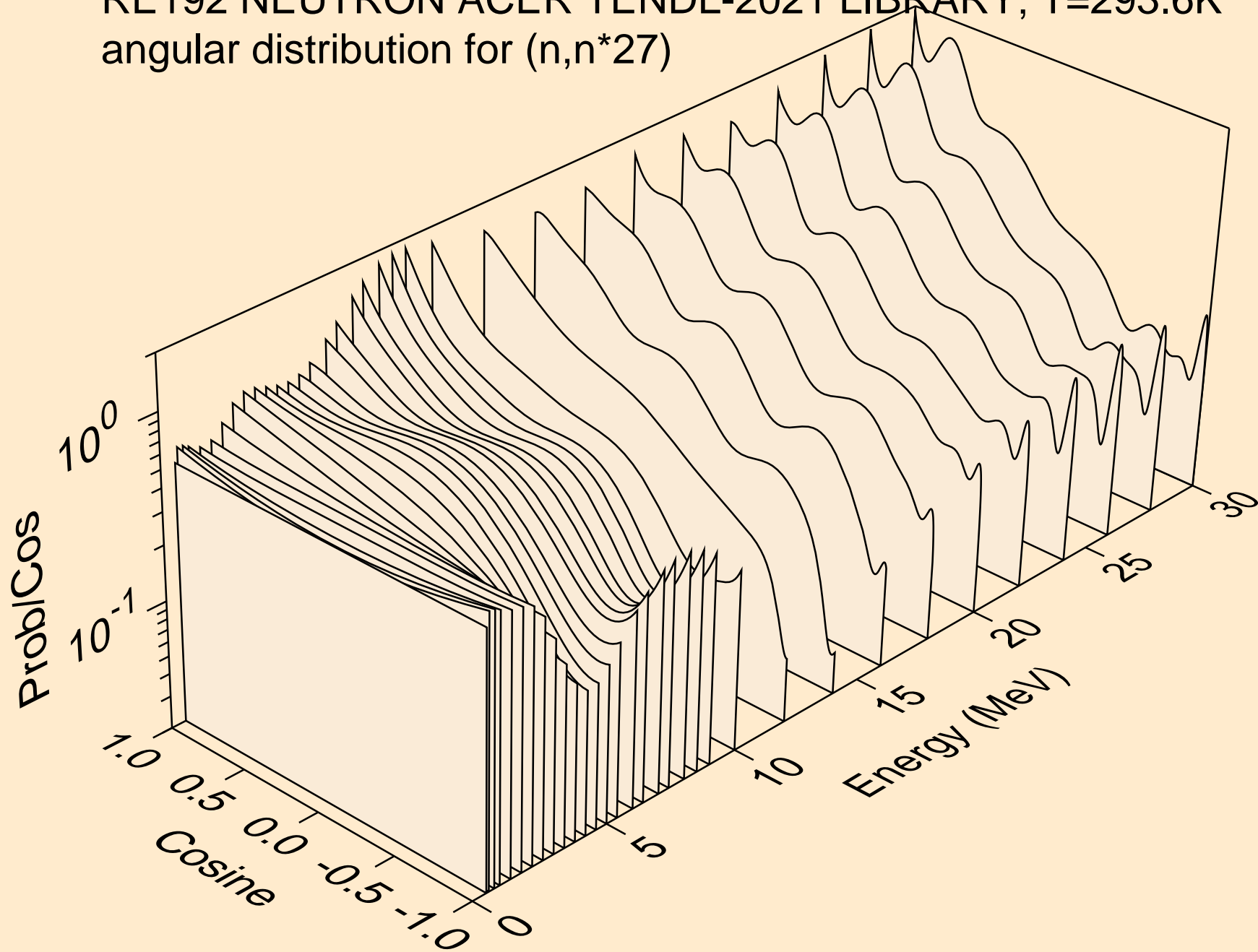

RE192 NEUTRON ACER TENDL-2021 LIBRARY; T=293.6K  
angular distribution for (n,n\*28)

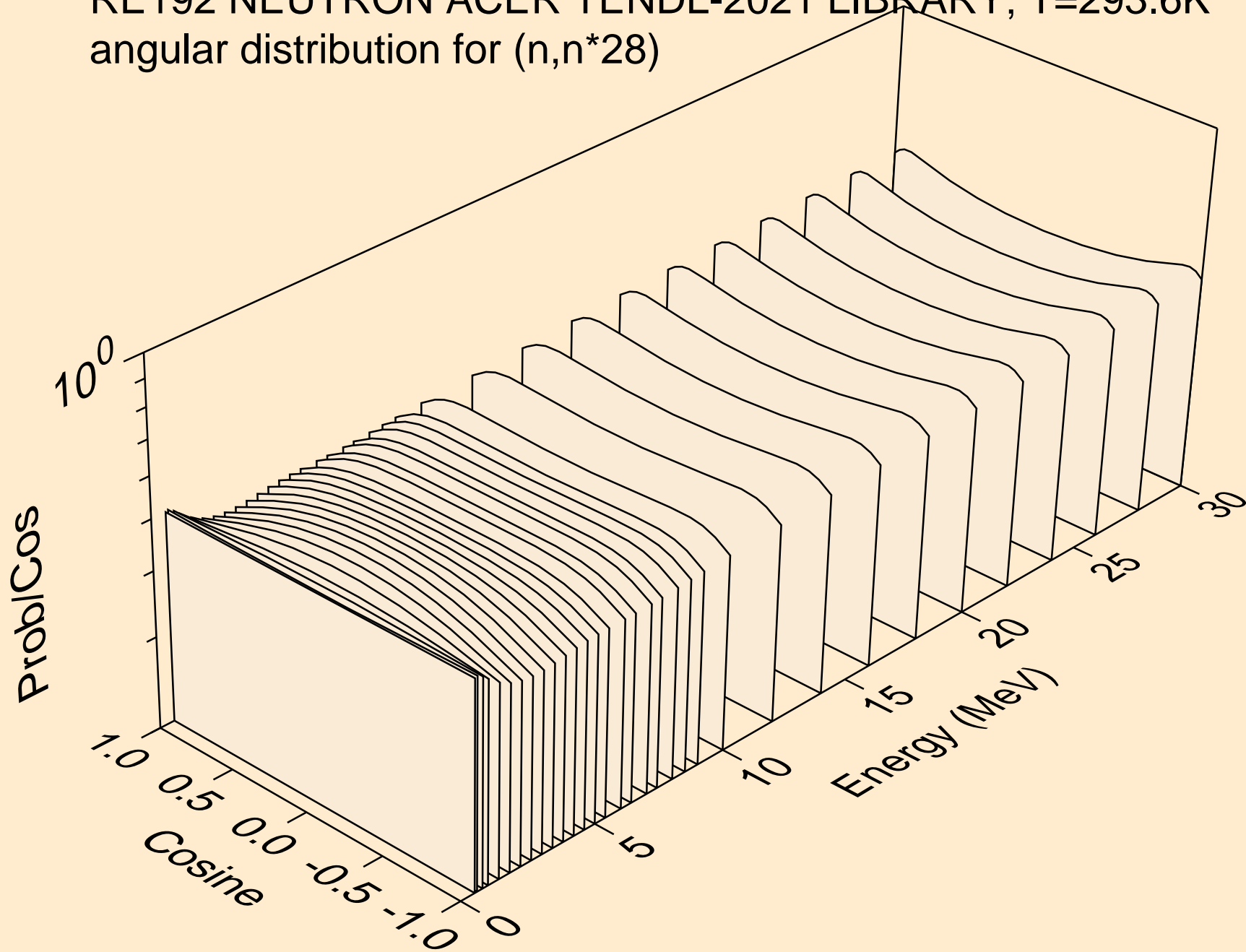

RE192 NEUTRON ACER TENDL-2021 LIBRARY; T=293.6K  
angular distribution for (n,n\*29)

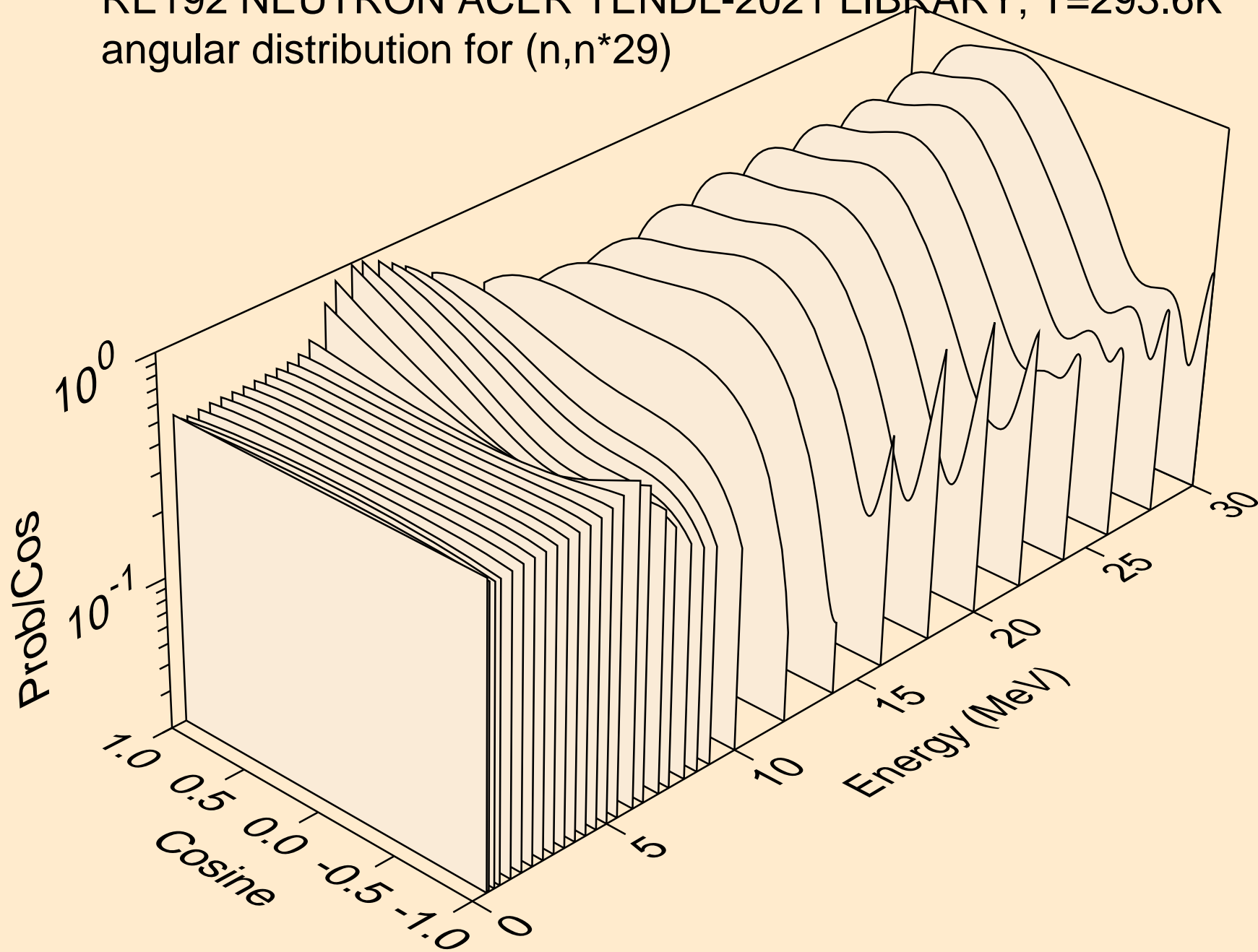

RE192 NEUTRON ACER TENDL-2021 LIBRARY; T=293.6K  
Neutron emission for (n,x)

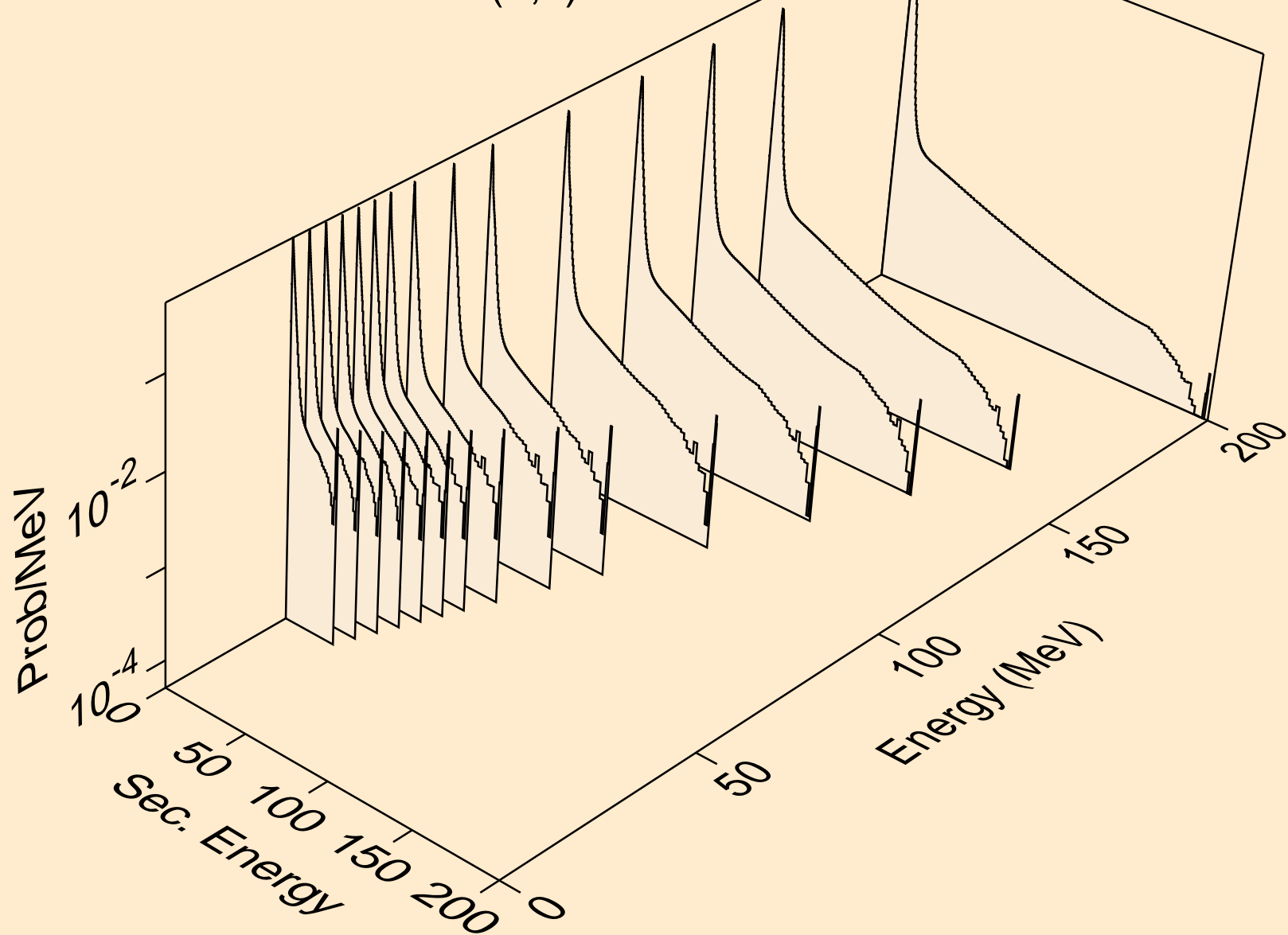

RE192 NEUTRON ACER TENDL-2021 LIBRARY; T=293.6K  
Neutron emission for (n,2nd)

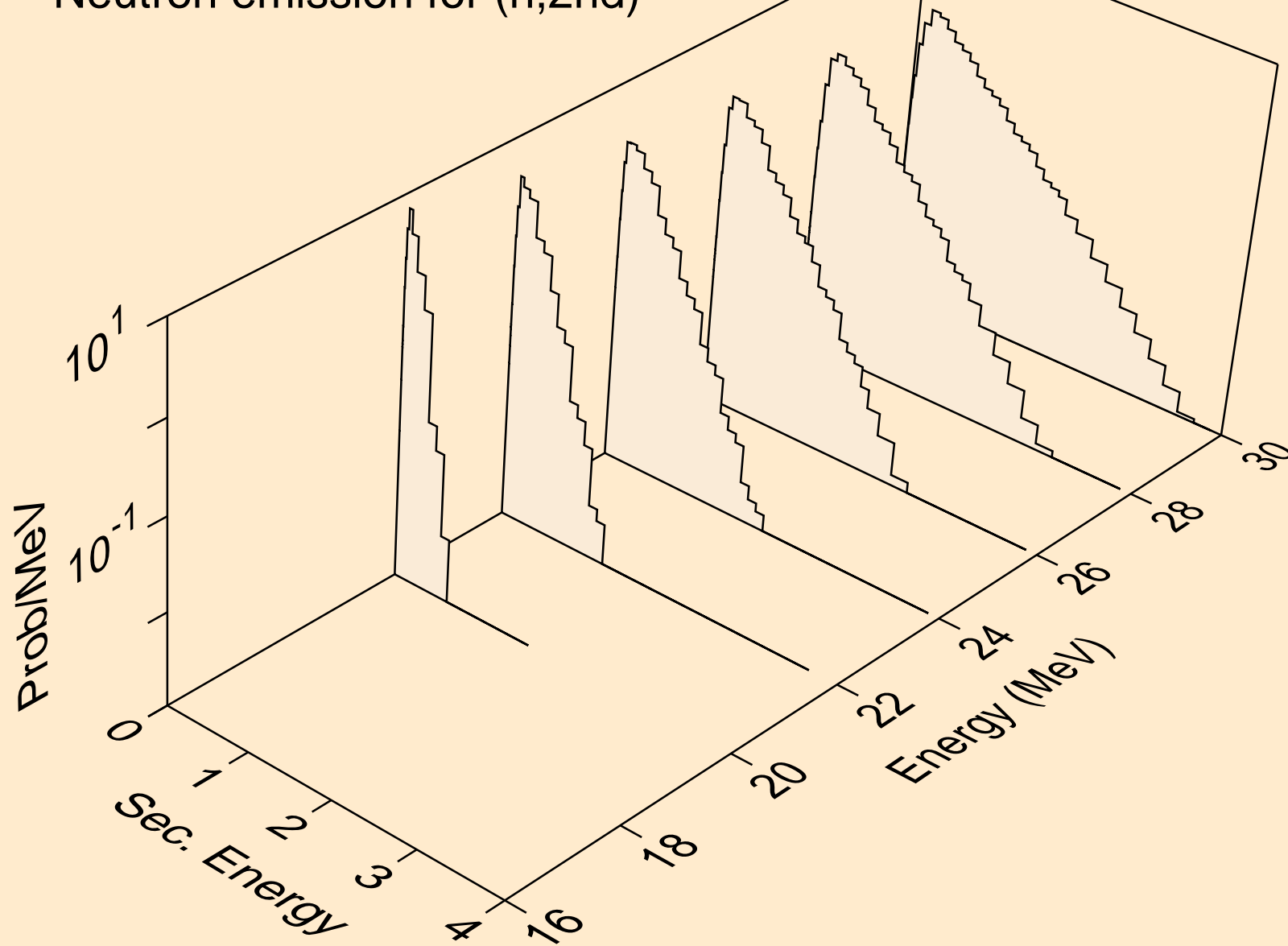

RE192 NEUTRON ACER TENDL-2021 LIBRARY; T=293.6K  
Neutron emission for (n,2n)

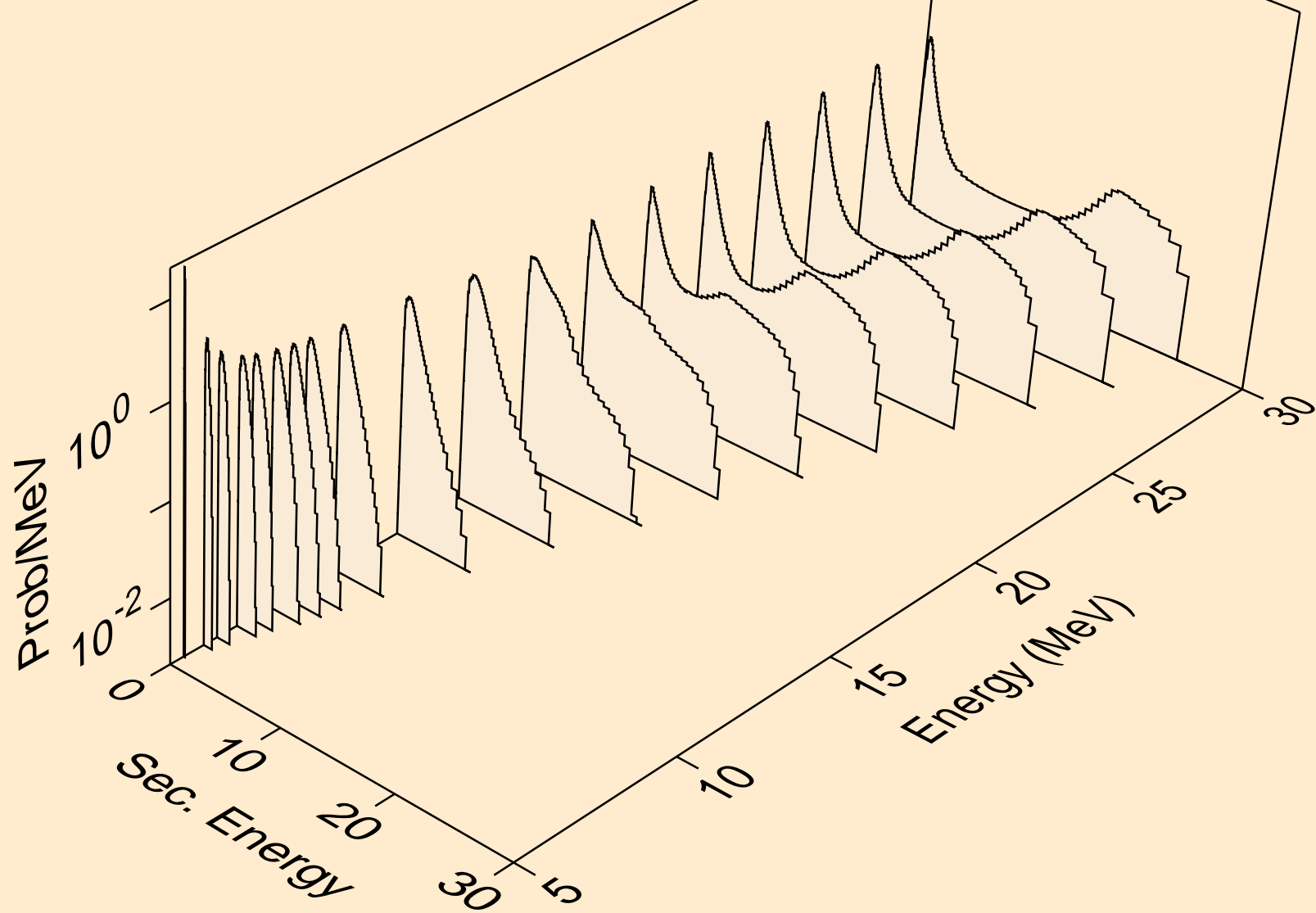

RE192 NEUTRON ACER TENDL-2021 LIBRARY; T=293.6K  
Neutron emission for (n,3n)

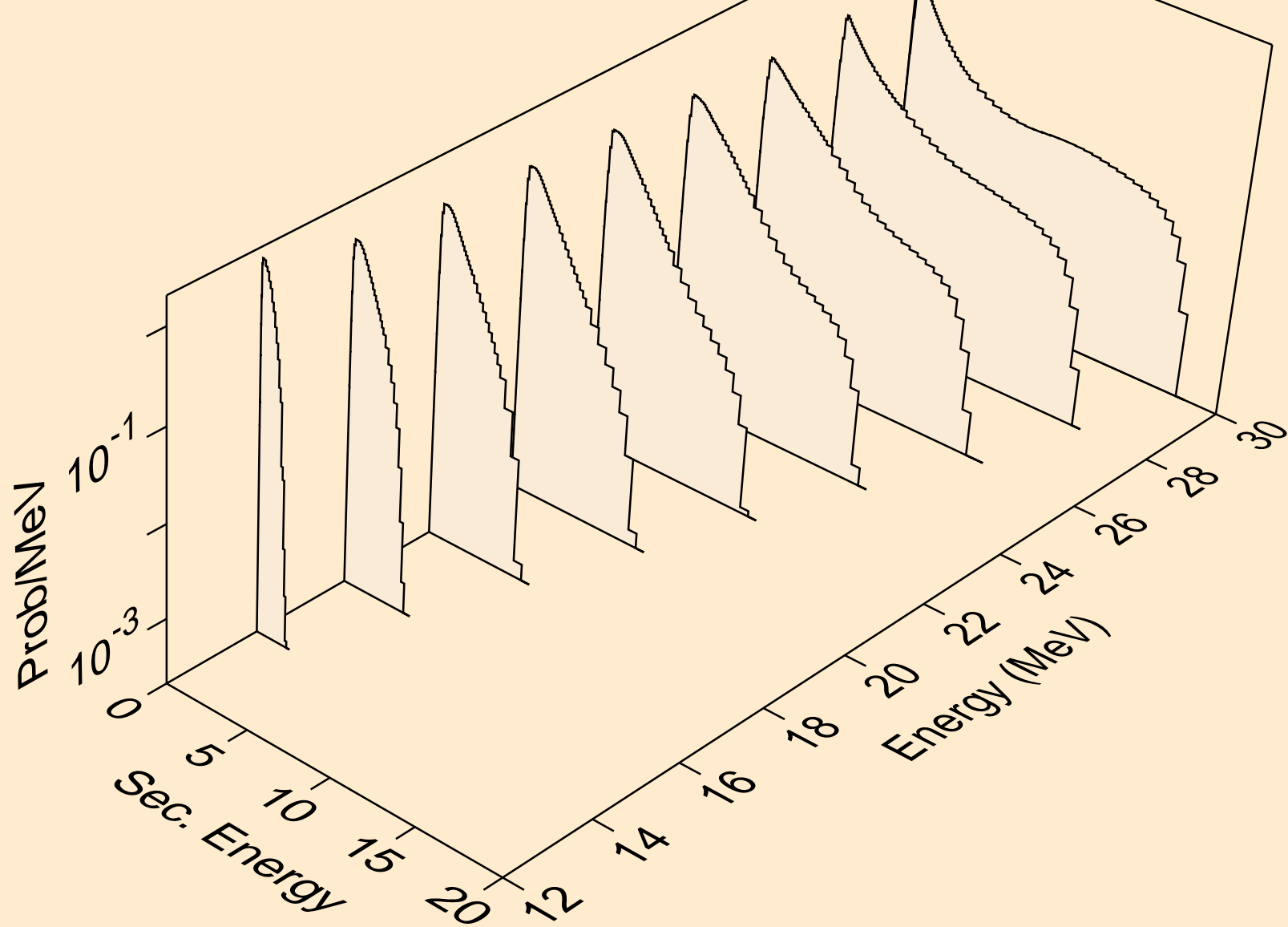



RE192 NEUTRON ACER TENDL-2021 LIBRARY; T=293.6K  
Neutron emission for (n,n\*)a

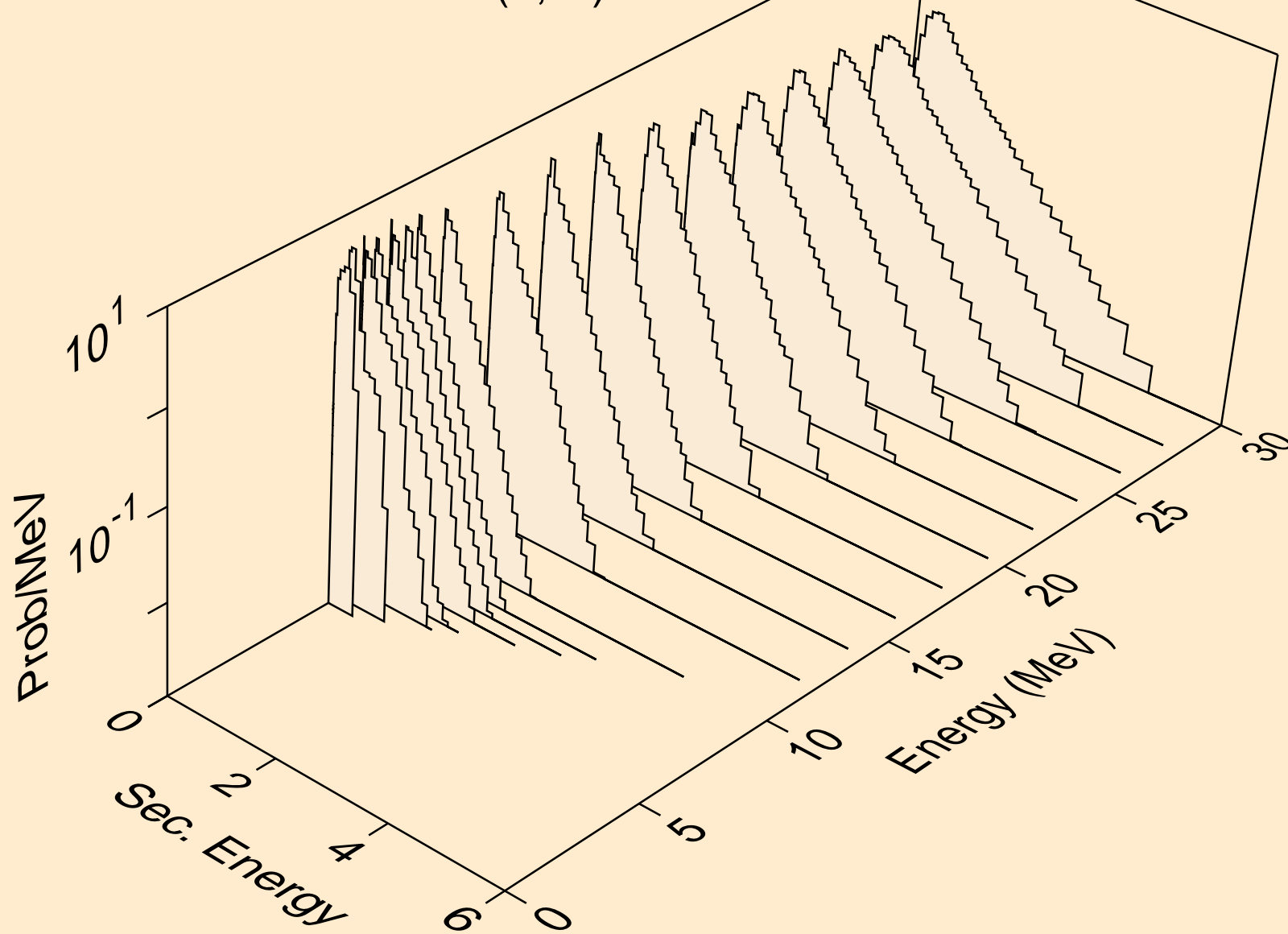

RE192 NEUTRON ACER TENDL-2021 LIBRARY; T=293.6K  
Neutron emission for (n,2n)<sub>a</sub>

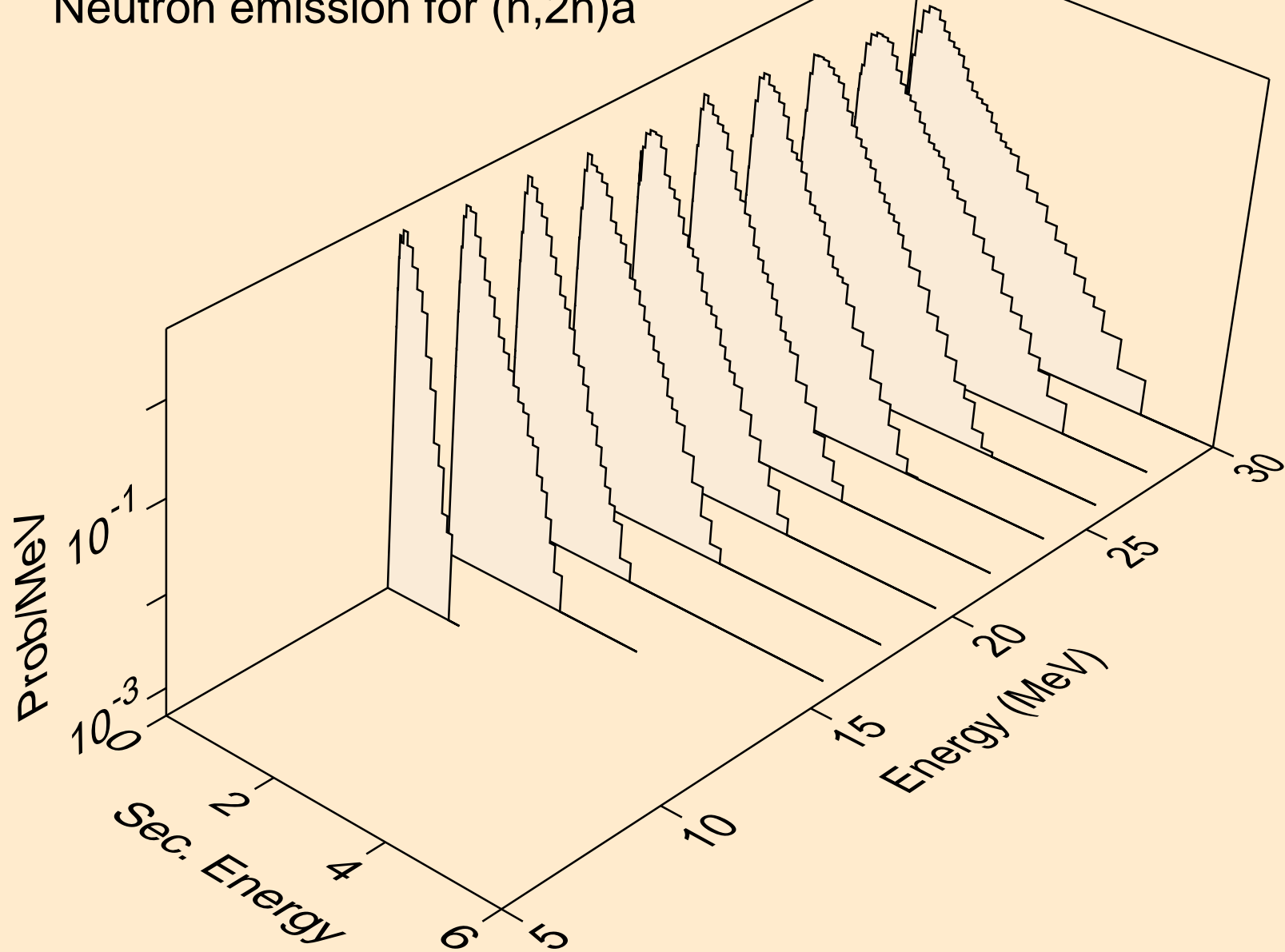

RE192 NEUTRON ACER TENDL-2021 LIBRARY; T=293.6K  
Neutron emission for (n,3n)a

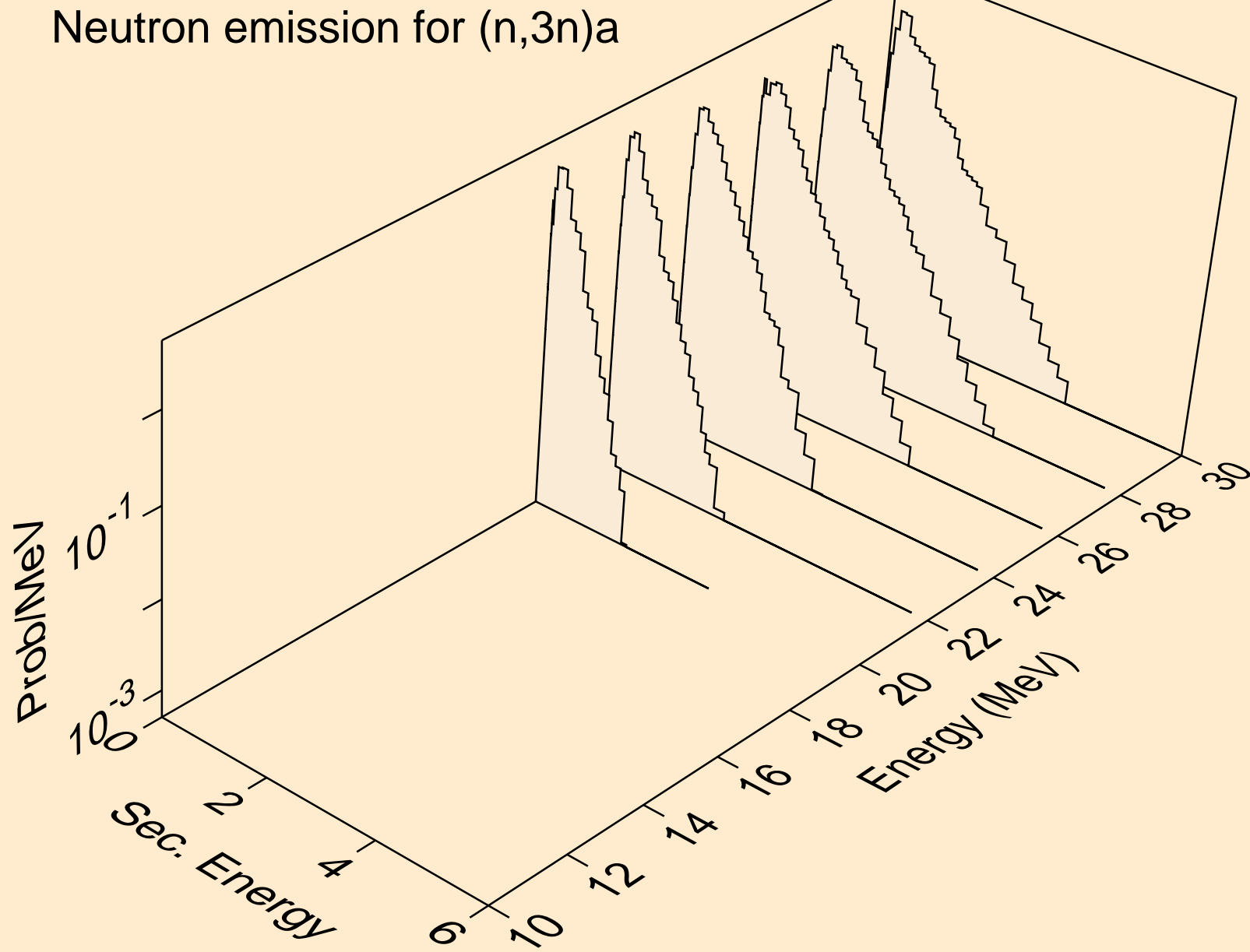

RE192 NEUTRON ACER TENDL-2021 LIBRARY; T=293.6K  
Neutron emission for (n,n\*)p

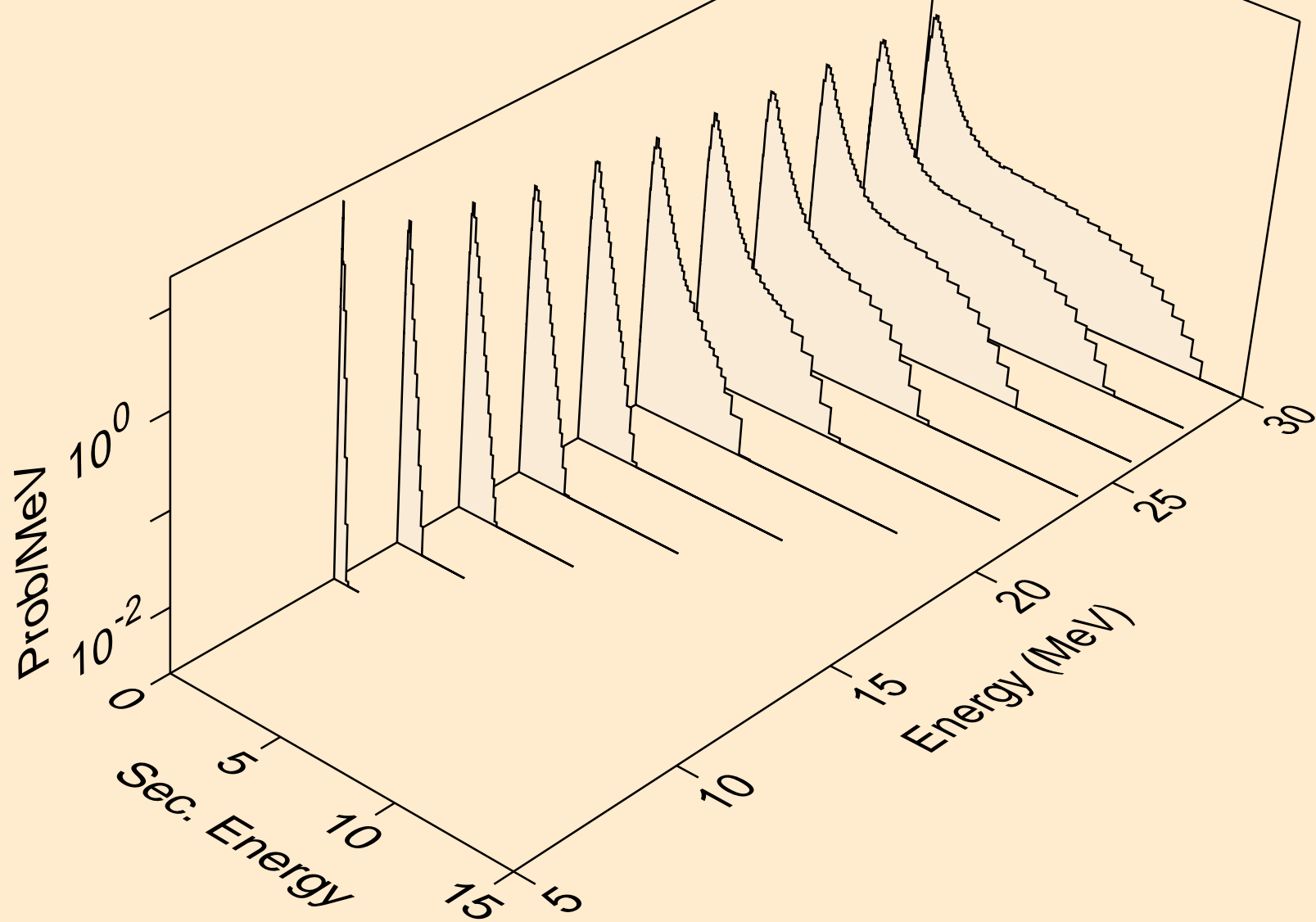

RE192 NEUTRON ACER TENDL-2021 LIBRARY; T=293.6K  
Neutron emission for (n,n\*)d

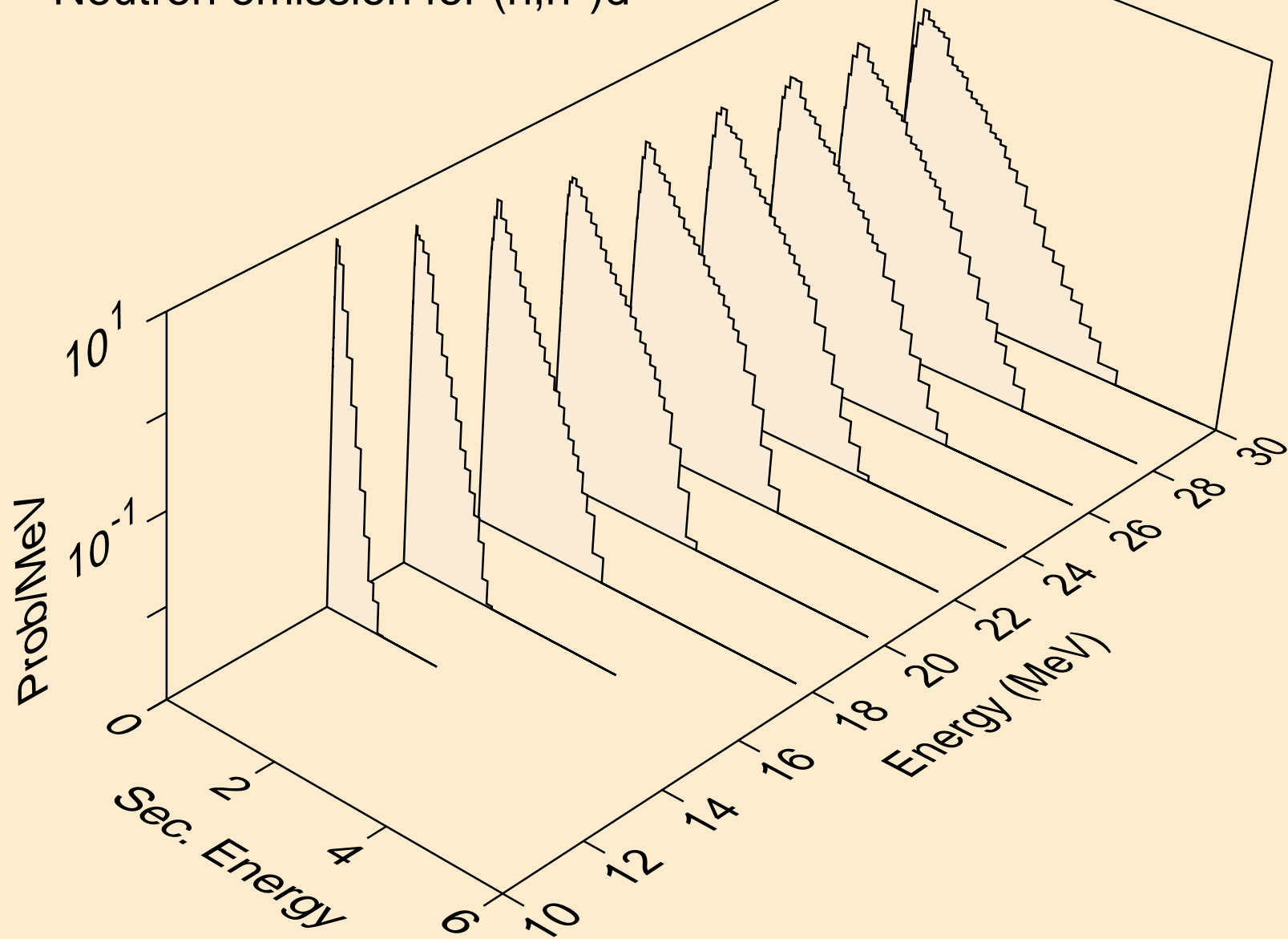

RE192 NEUTRON ACER TENDL-2021 LIBRARY; T=293.6K  
Neutron emission for (n,n\*)t

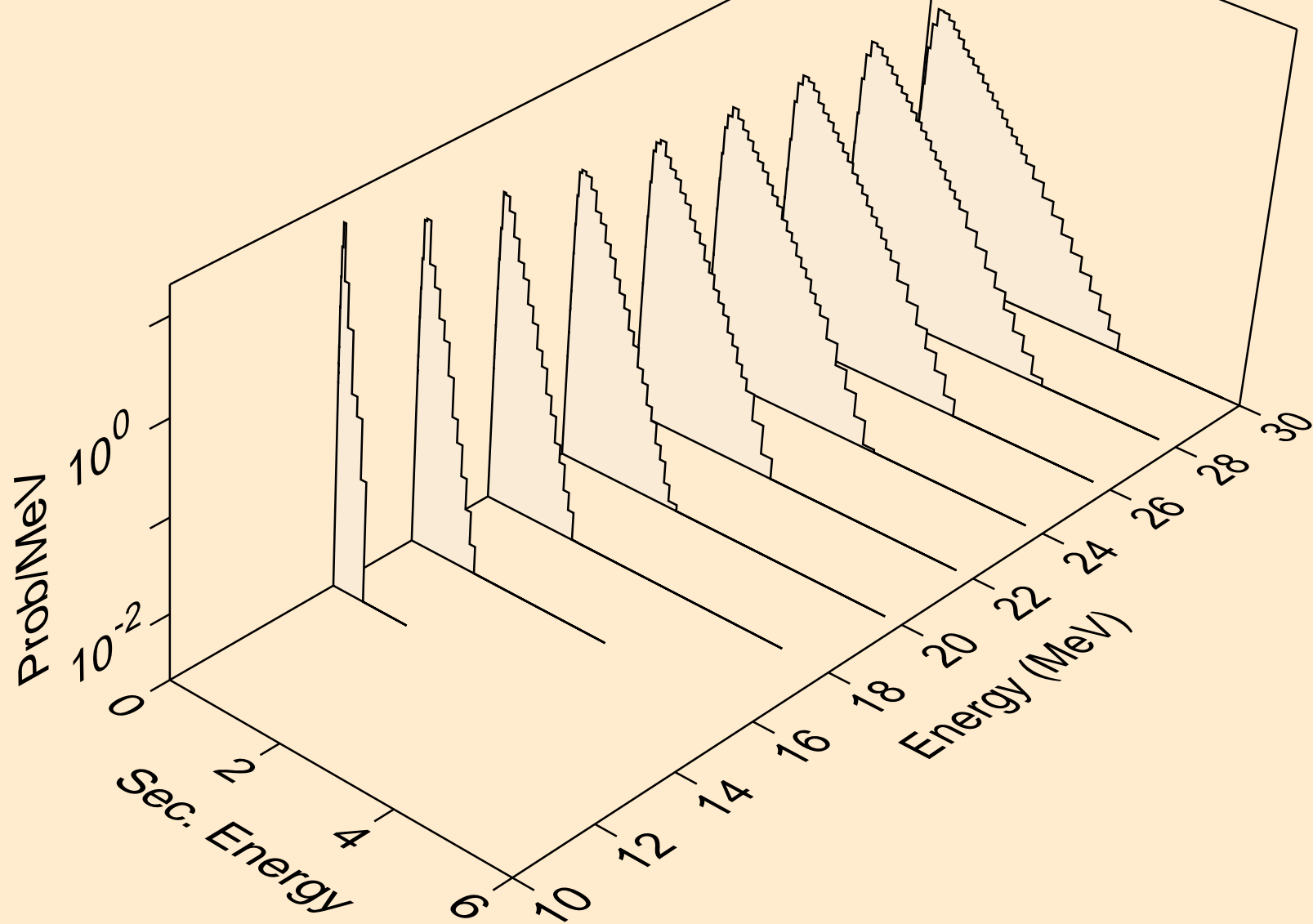

RE192 NEUTRON ACER TENDL-2021 LIBRARY; T=293.6K  
Neutron emission for (n,n\*)he3

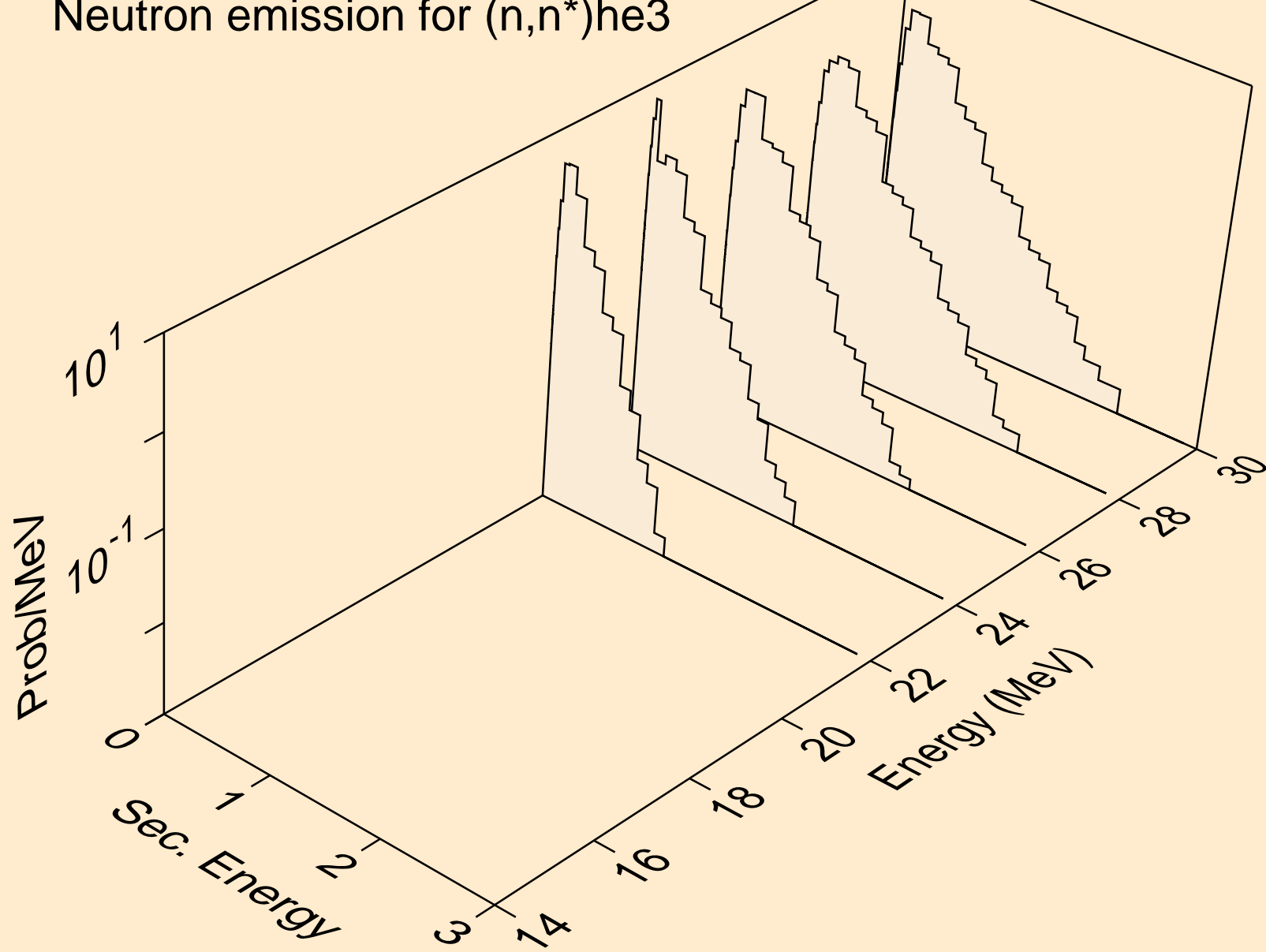

RE192 NEUTRON ACER TENDL-2021 LIBRARY; T=293.6K  
Neutron emission for (n,4n)

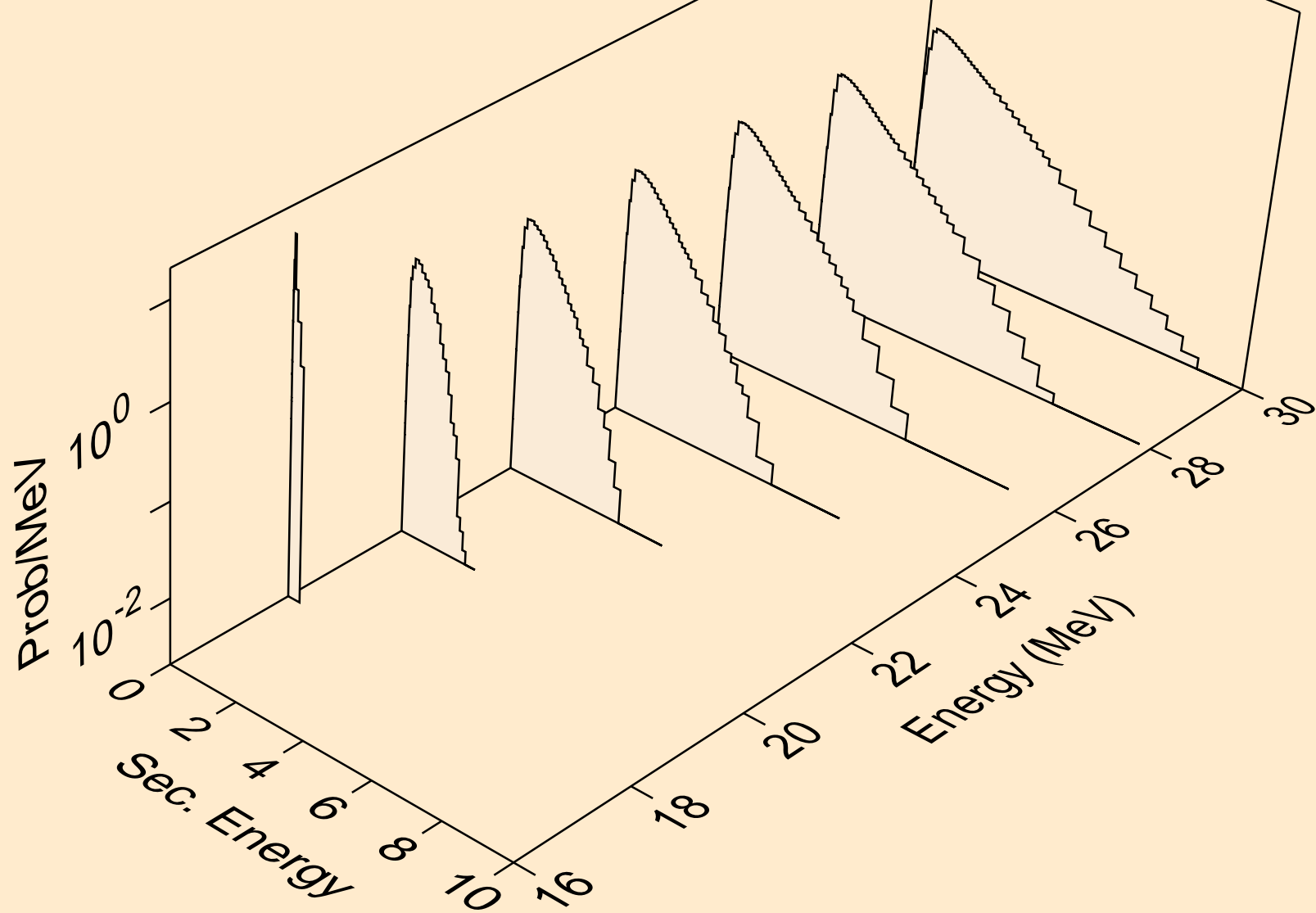



RE192 NEUTRON ACER TENDL-2021 LIBRARY; T=293.6K  
Neutron emission for (n,2np)

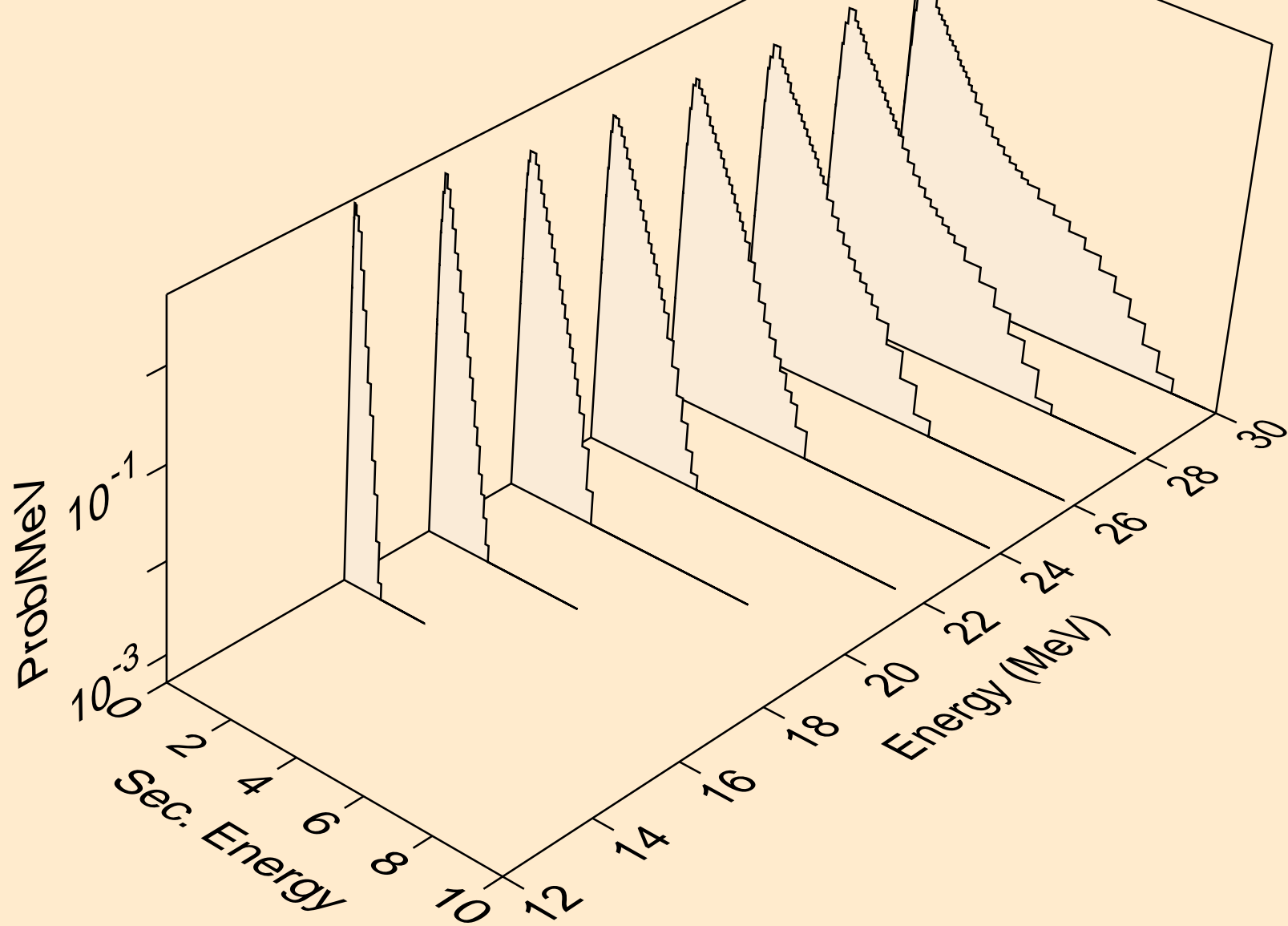

RE192 NEUTRON ACER TENDL-2021 LIBRARY; T=293.6K  
Neutron emission for (n,3np)

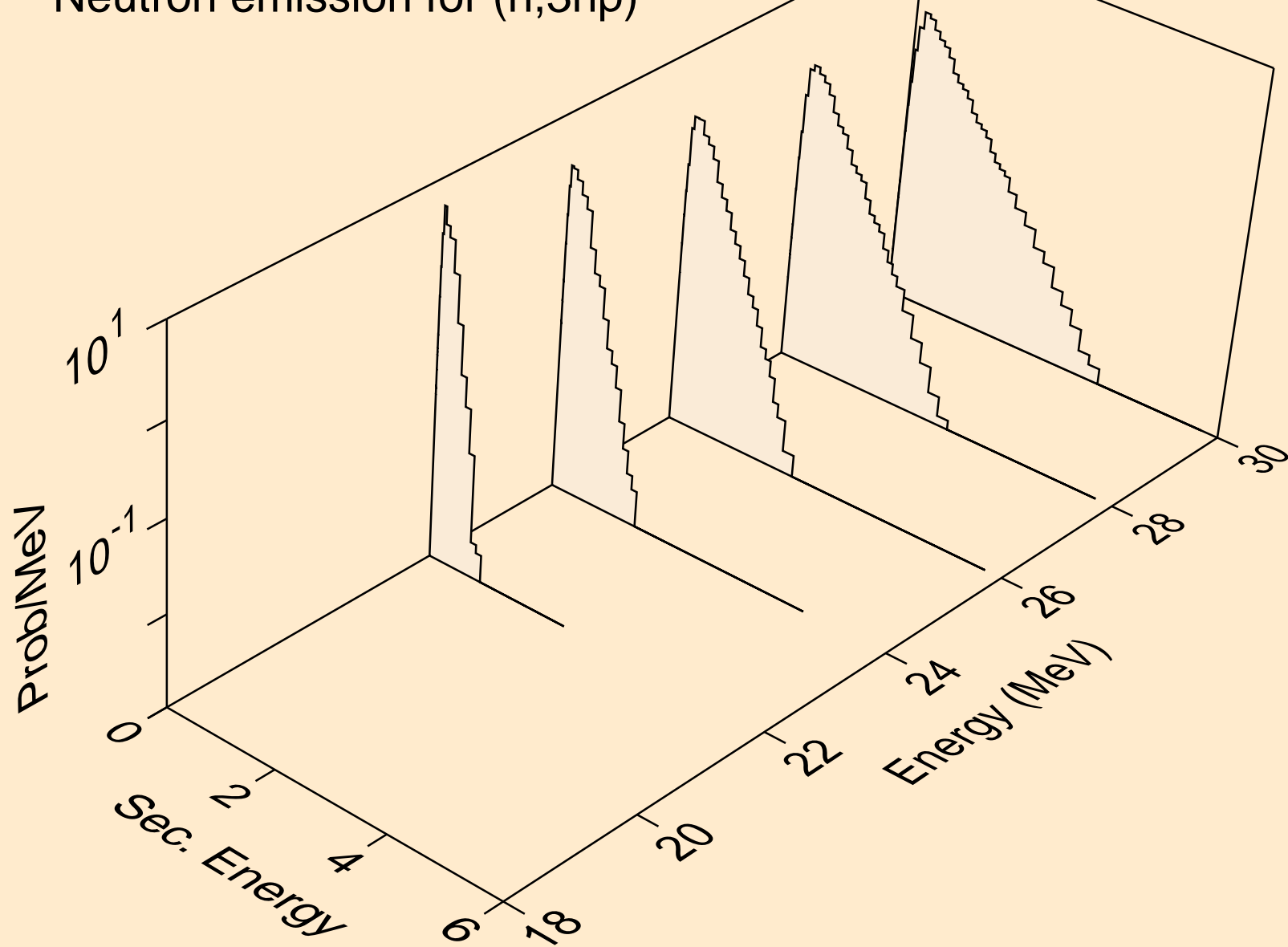

RE192 NEUTRON ACER TENDL-2021 LIBRARY; T=293.6K  
Neutron emission for (n,n\*c)

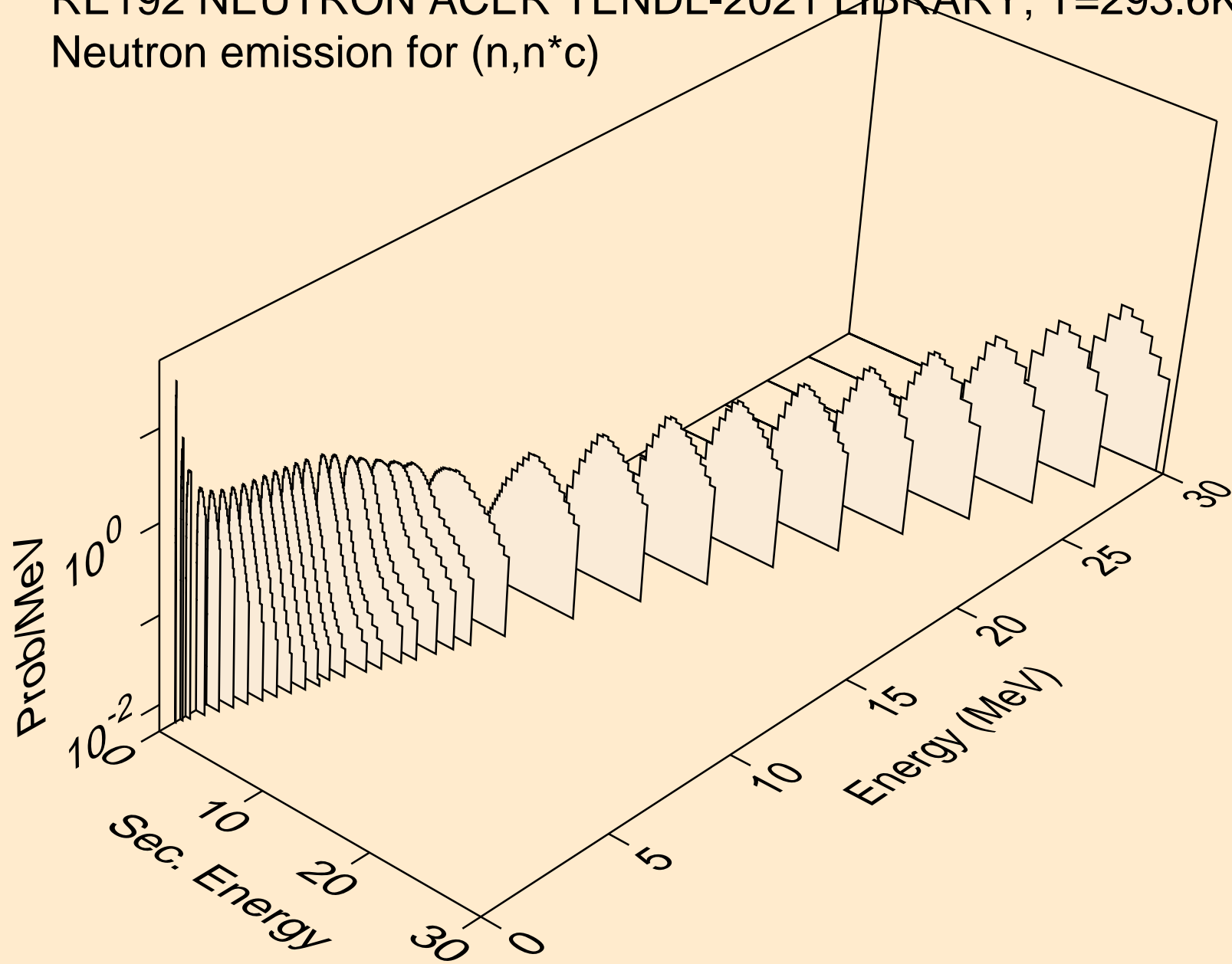

RE192 NEUTRON ACER TENDL-2021 LIBRARY; T=293.6K  
Photon emission for (n,x)

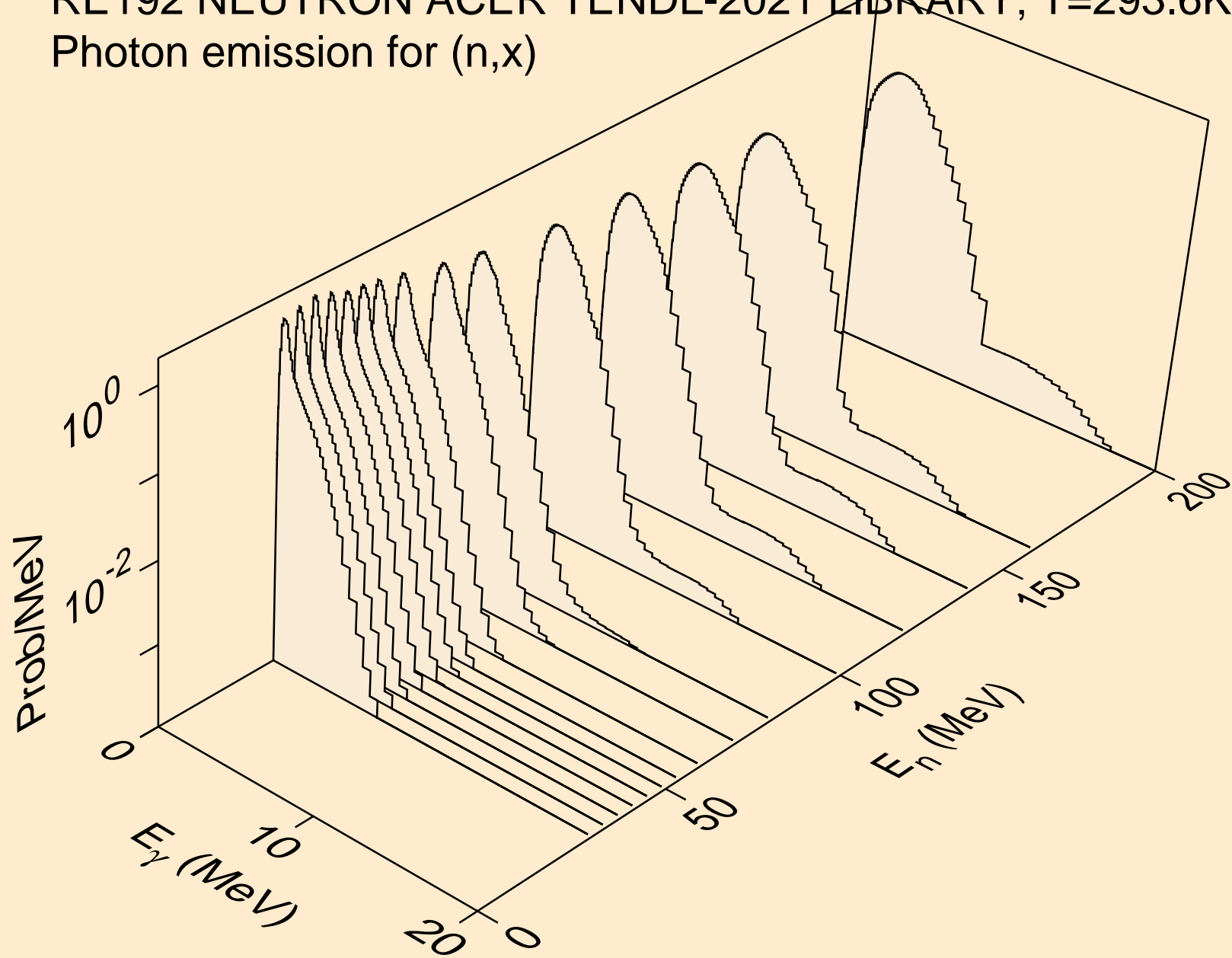

RE192 NEUTRON ACER TENDL-2021 LIBRARY; T=293.6K  
Photon emission for (n,2nd)

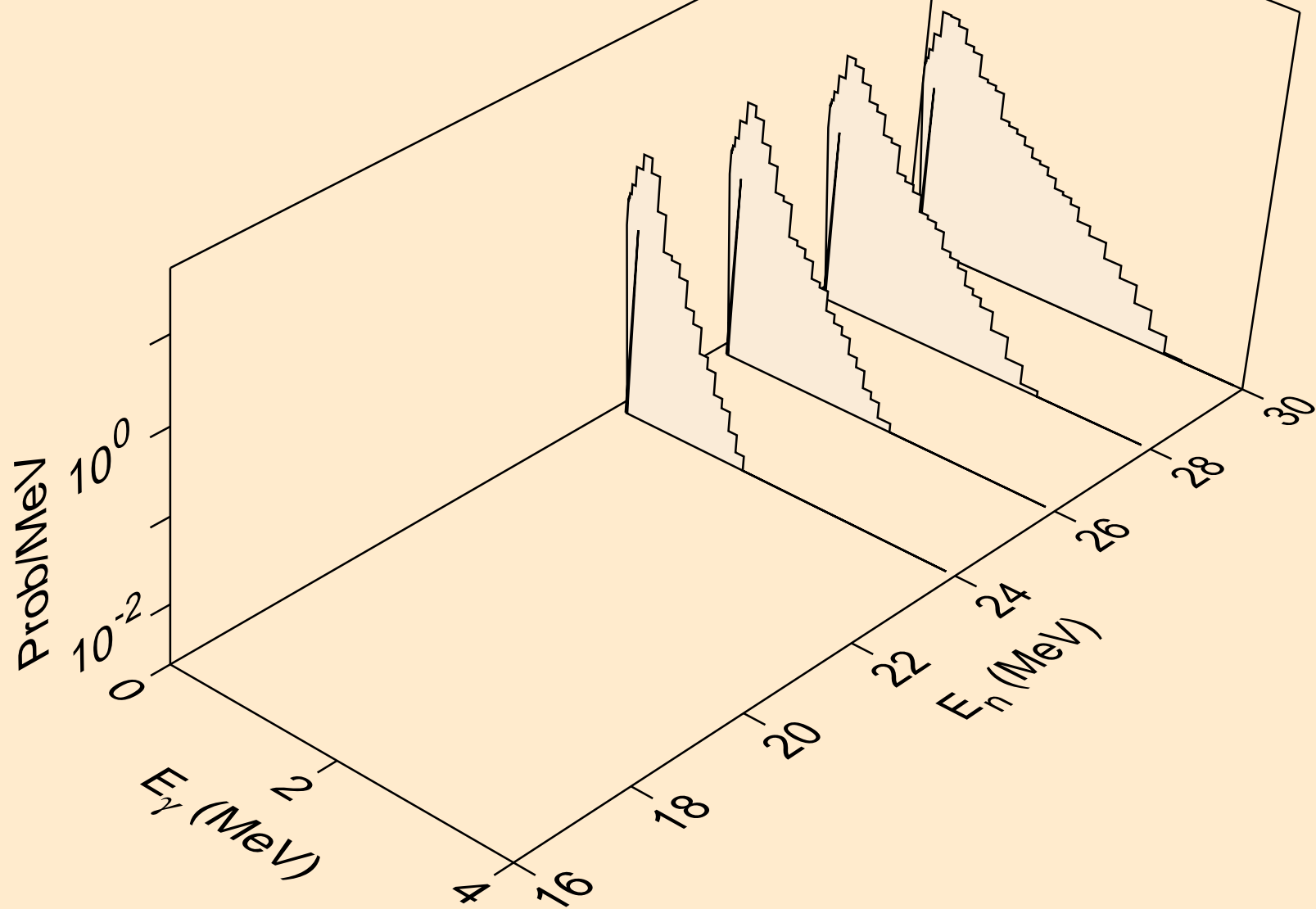

RE192 NEUTRON ACER TENDL-2021 LIBRARY; T=293.6K  
Photon emission for (n,2n)

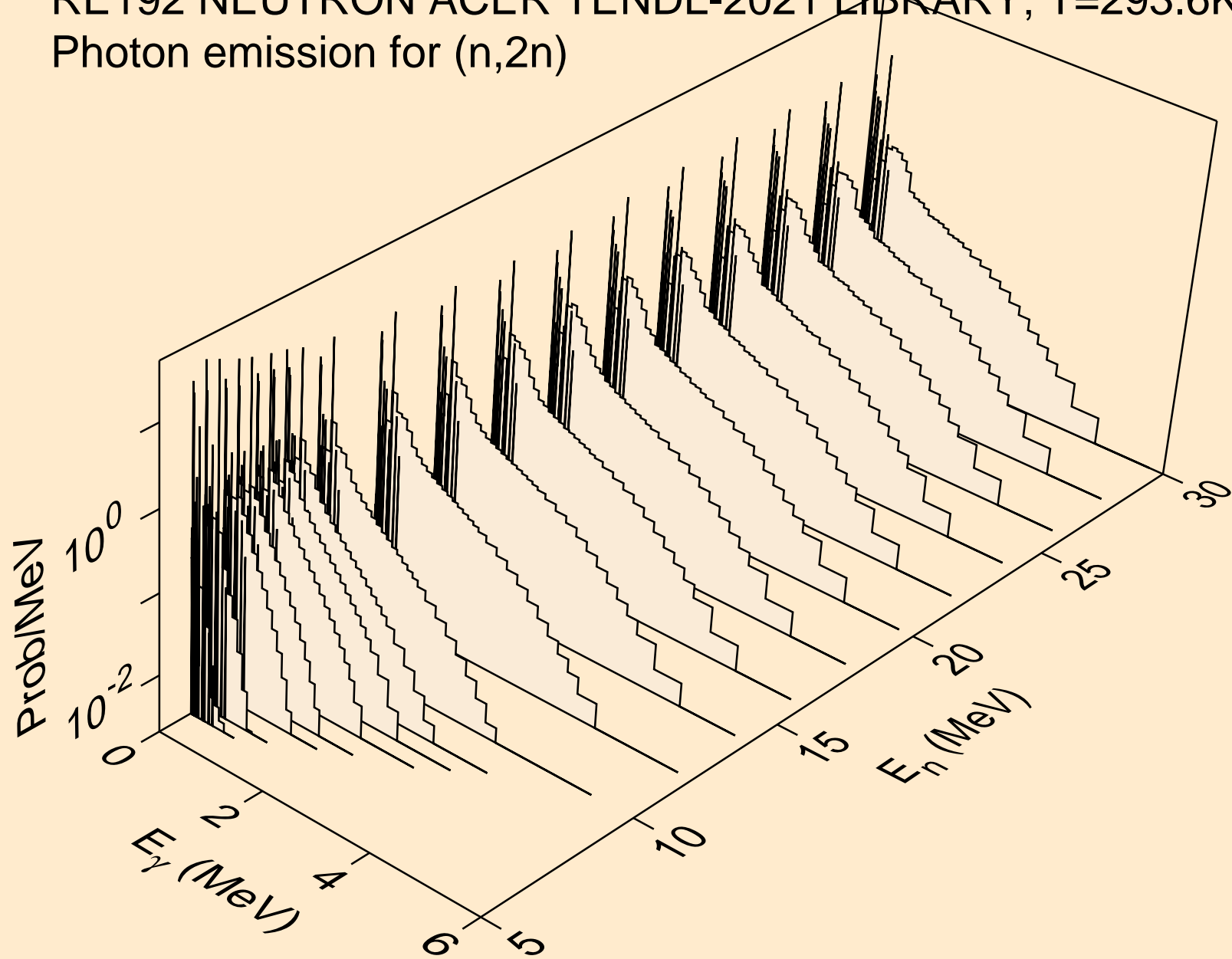

RE192 NEUTRON ACER TENDL-2021 LIBRARY; T=293.6K  
Photon emission for (n,3n)

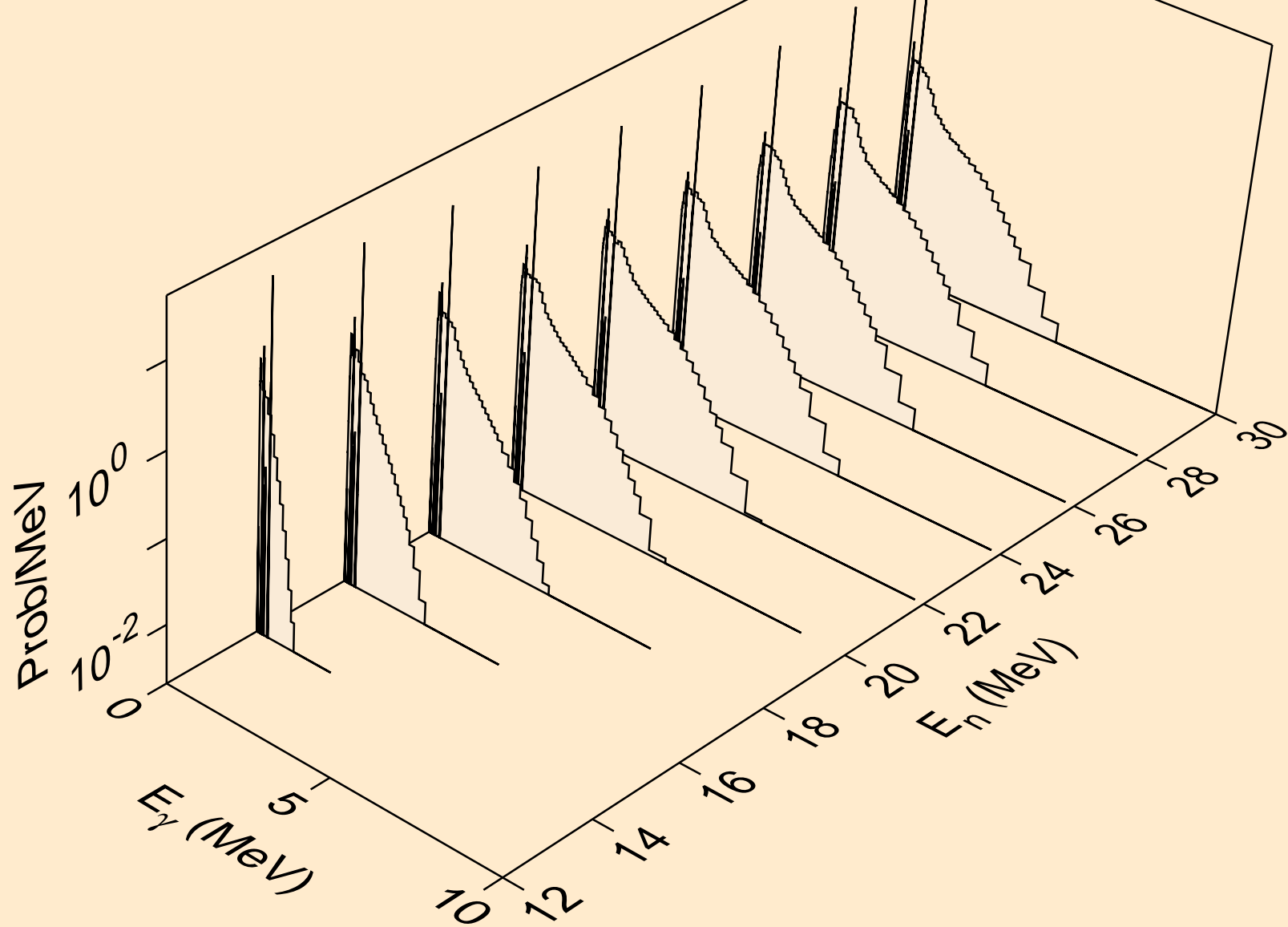

RE192 NEUTRON ACER TENDL-2021 LIBRARY; T=293.6K  
Photon emission for (n,n\*)a

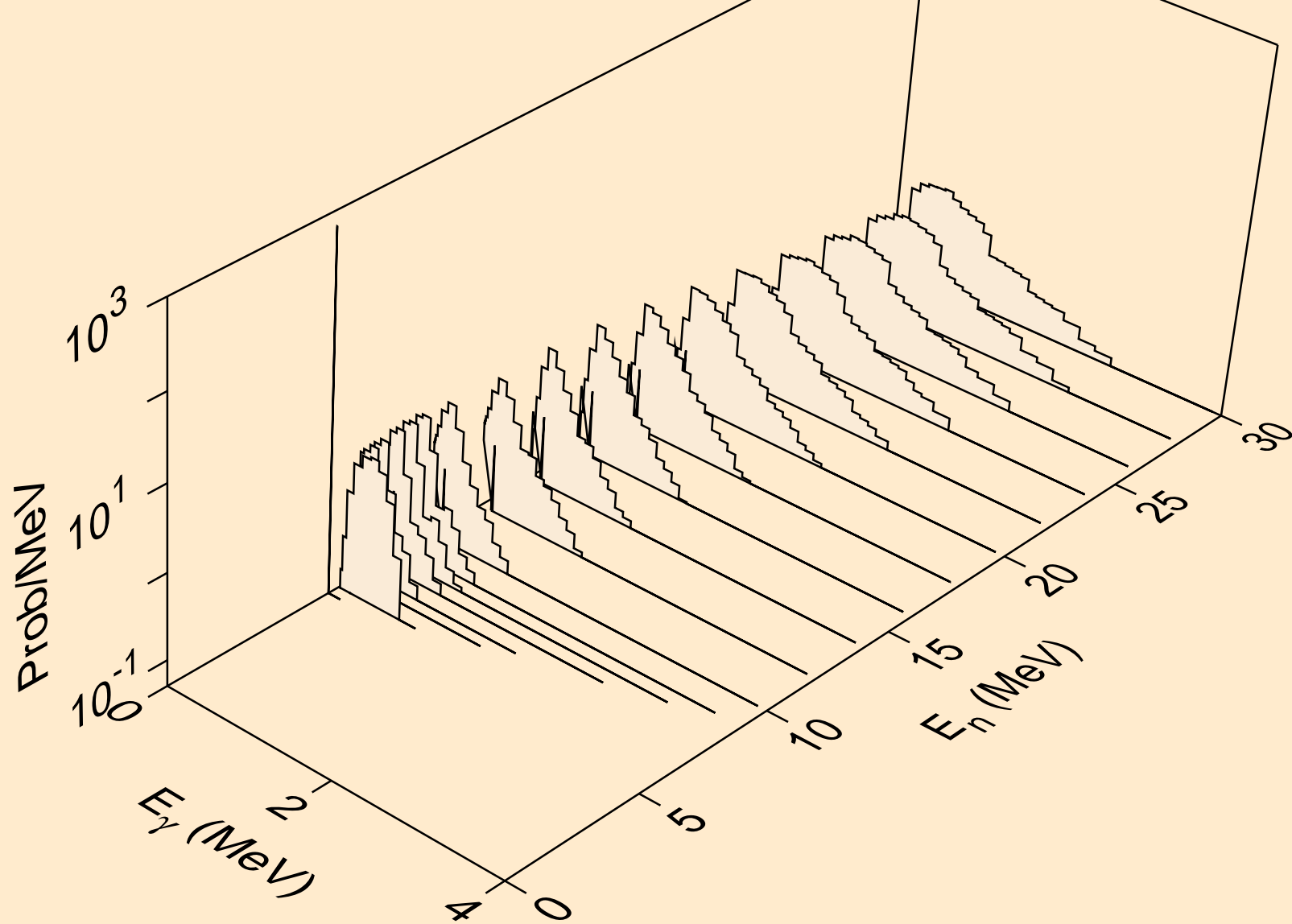



RE192 NEUTRON ACER TENDL-2021 LIBRARY; T=293.6K  
Photon emission for (n,2n)a

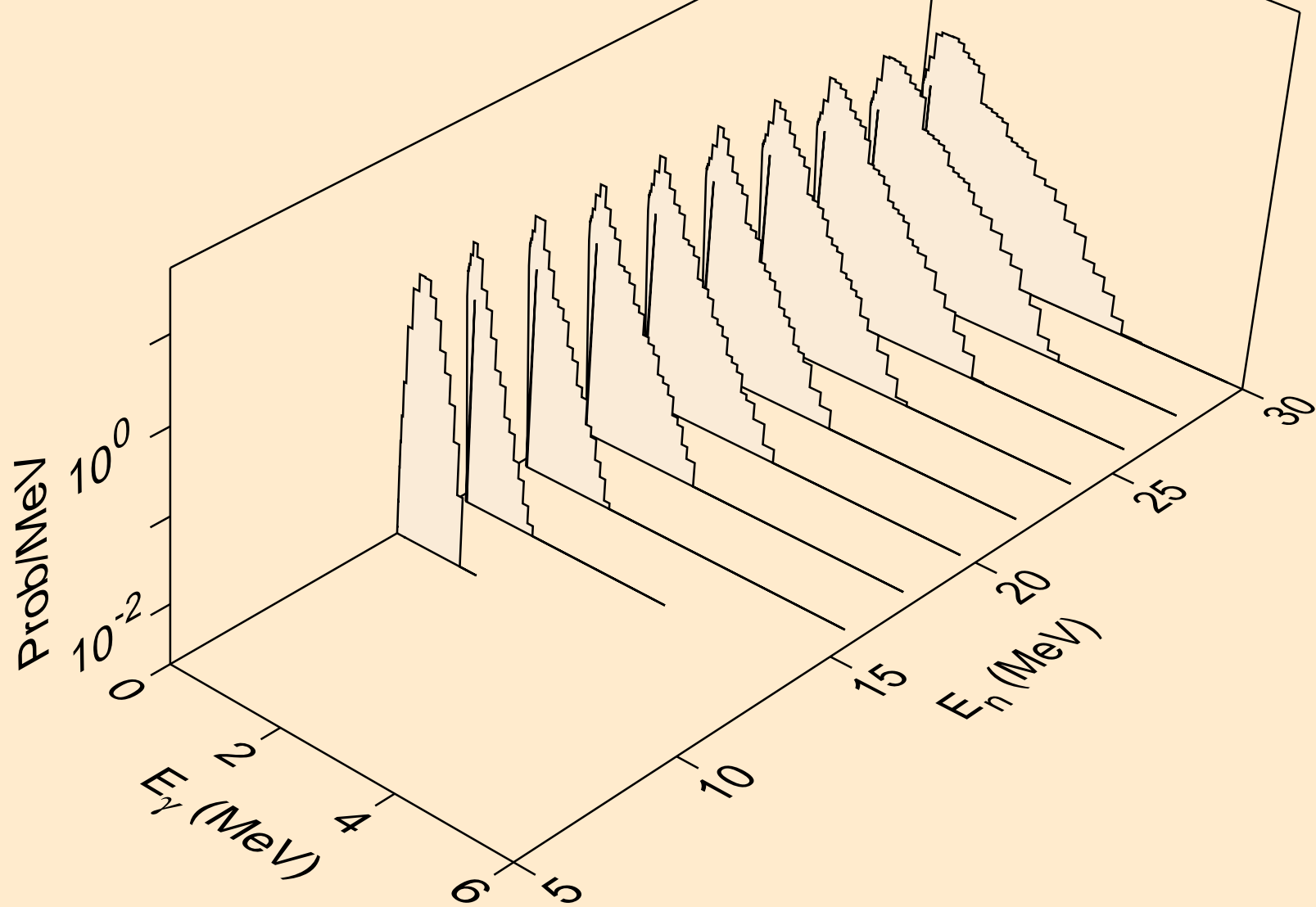

RE192 NEUTRON ACER TENDL-2021 LIBRARY; T=293.6K  
Photon emission for (n,3n)a

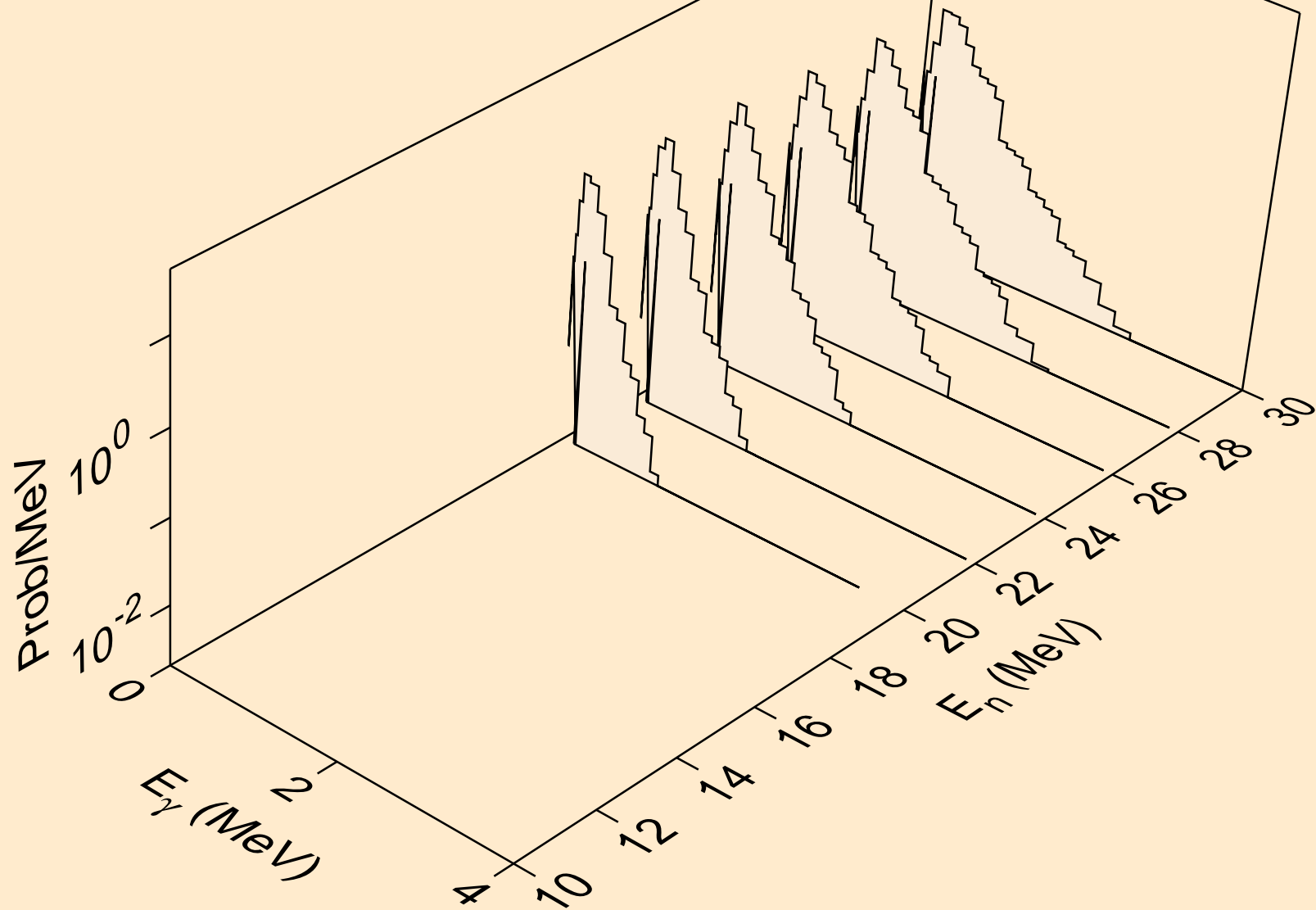

RE192 NEUTRON ACER TENDL-2021 LIBRARY; T=293.6K  
Photon emission for (n,n\*)p

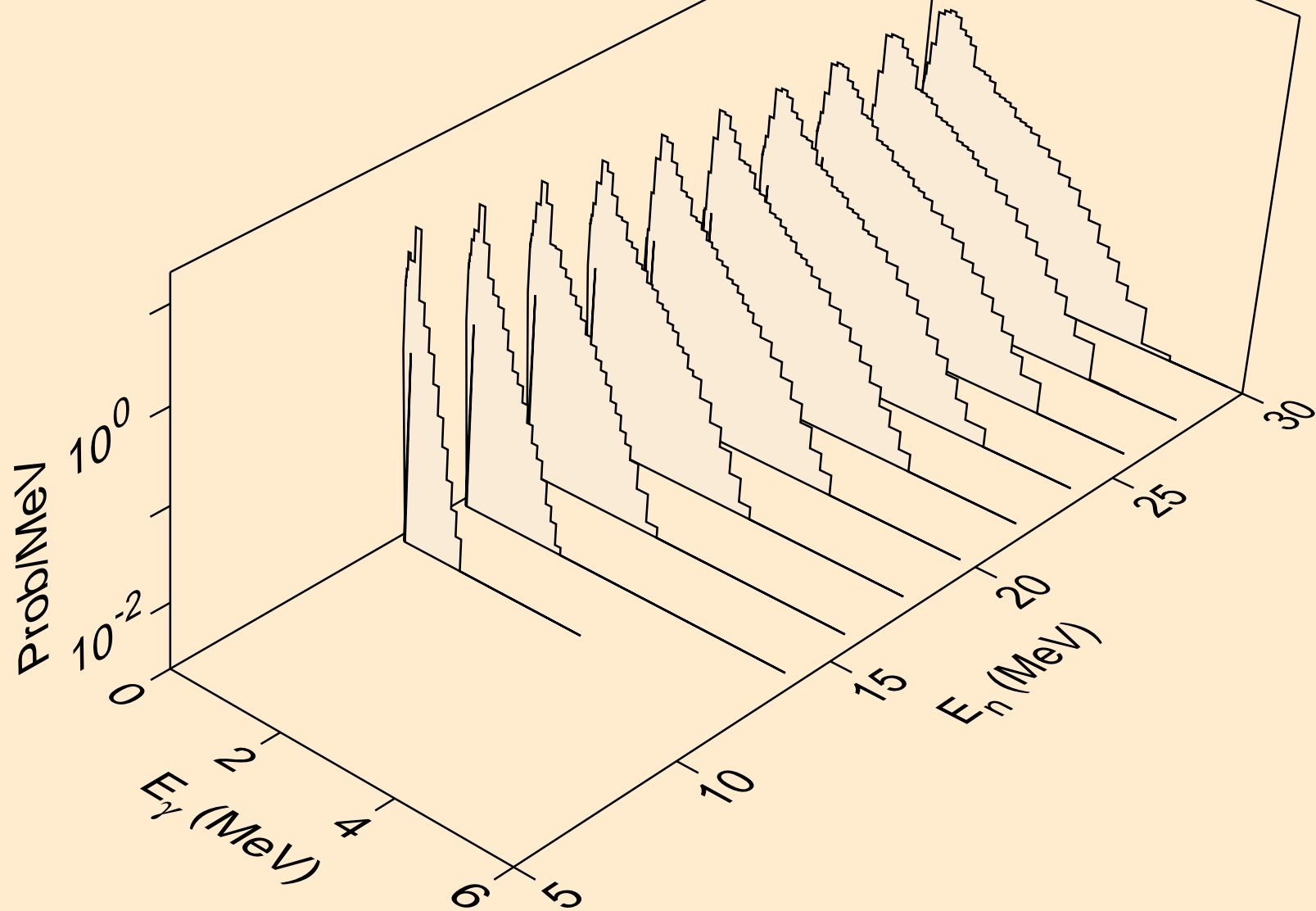

RE192 NEUTRON ACER TENDL-2021 LIBRARY; T=293.6K  
Photon emission for (n,n\*)d

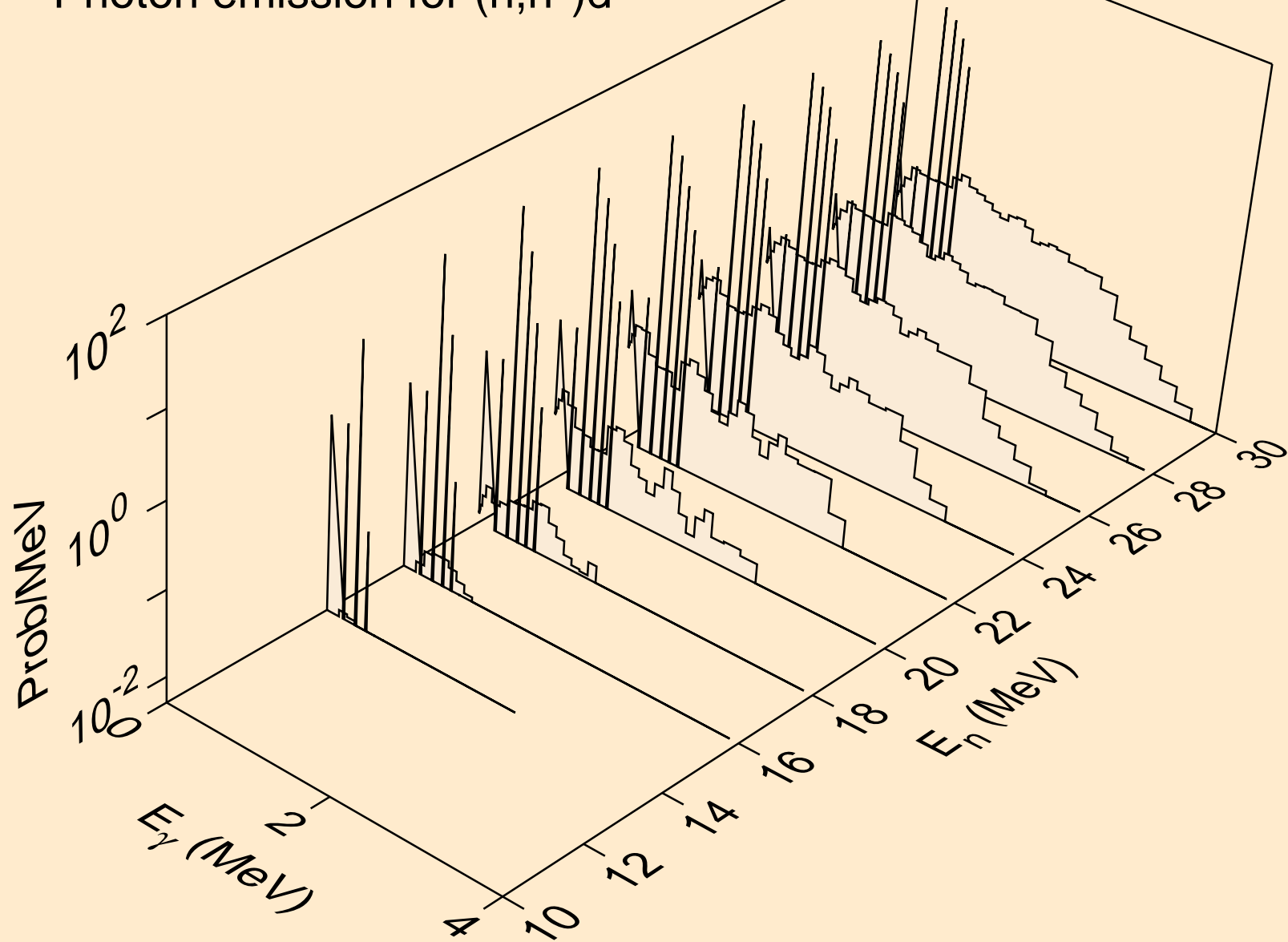

RE192 NEUTRON ACER TENDL-2021 LIBRARY; T=293.6K  
Photon emission for (n,n\*)t

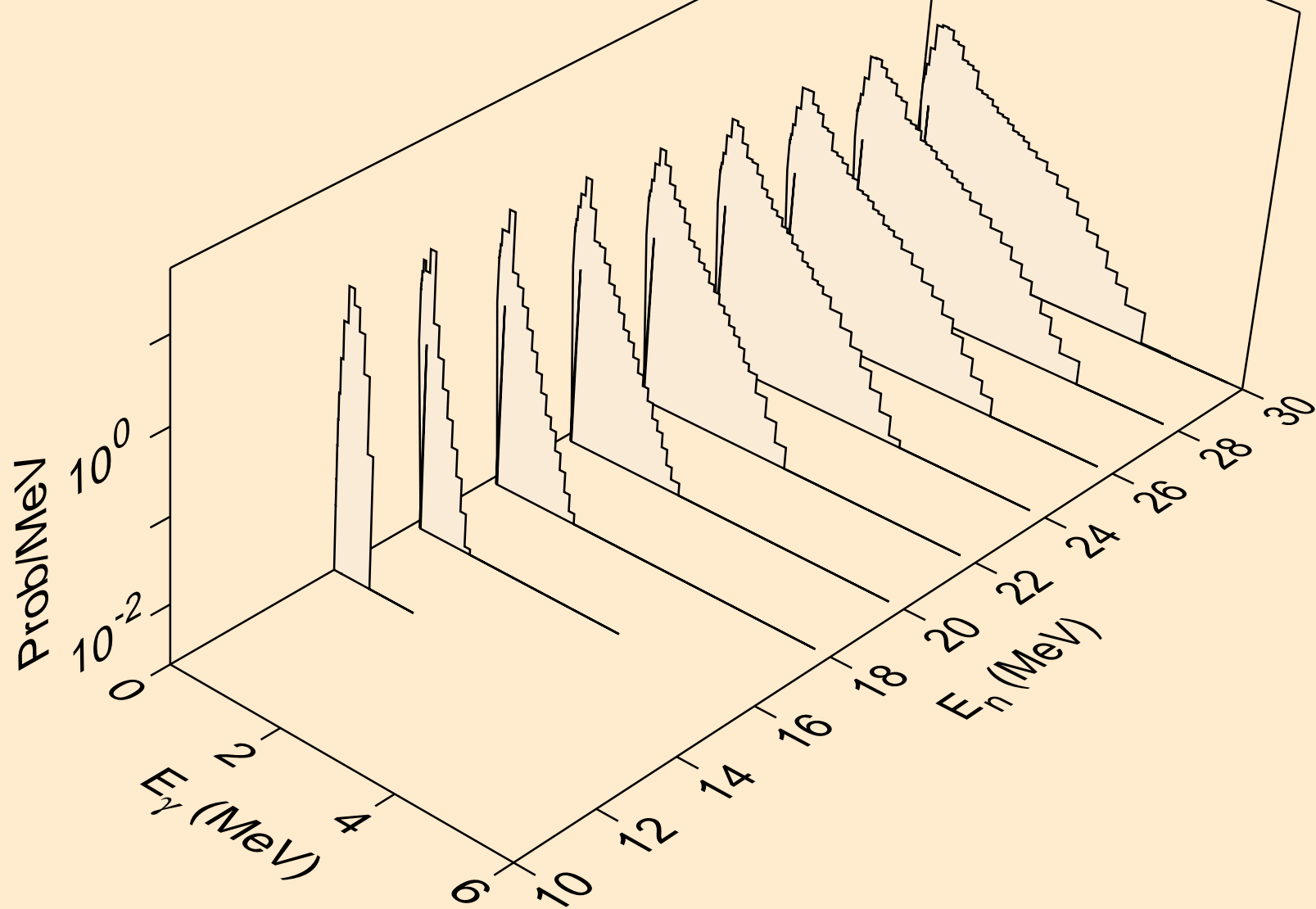

RE192 NEUTRON ACER TENDL-2021 LIBRARY; T=293.6K  
Photon emission for (n,n\*)he3

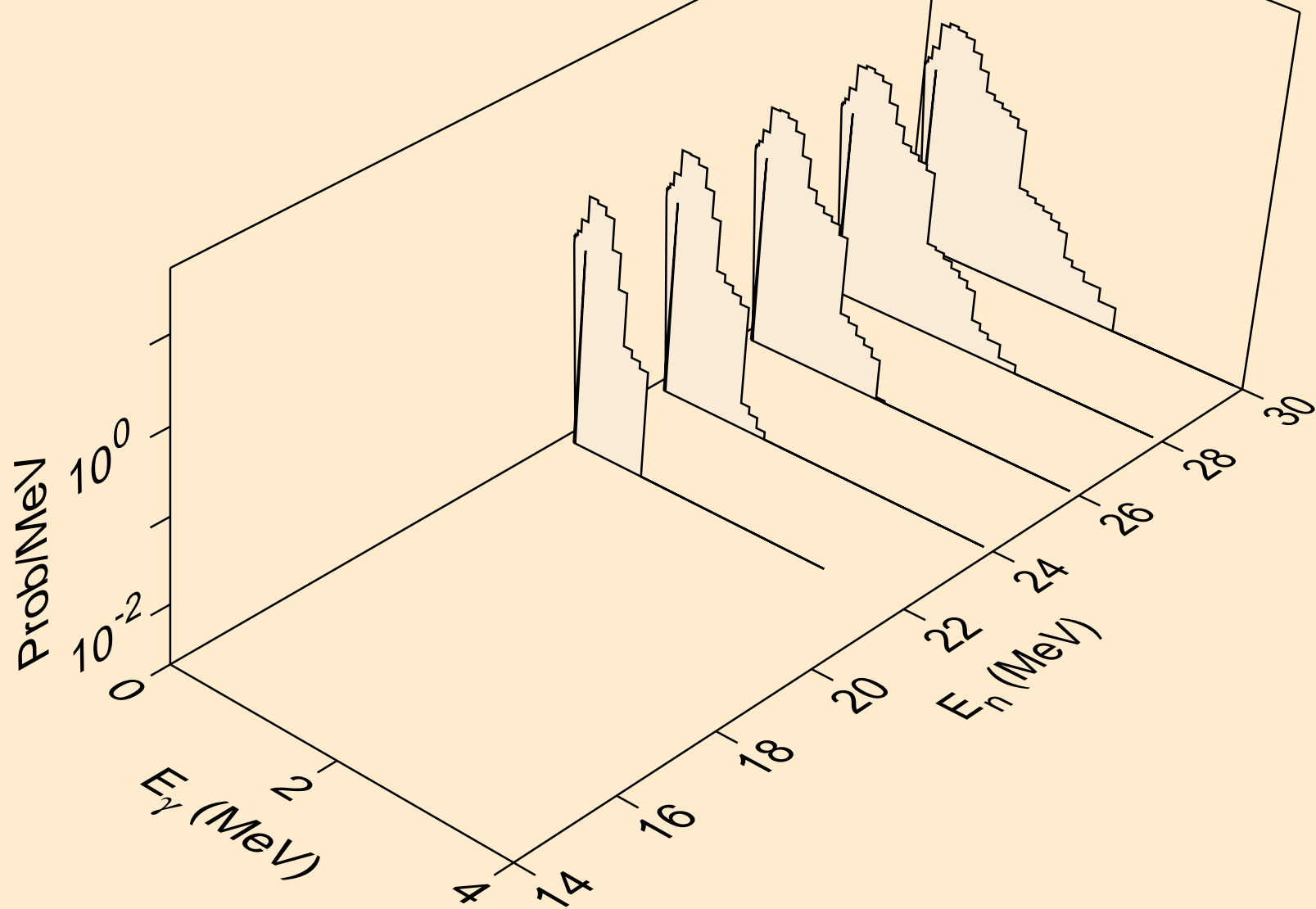

RE192 NEUTRON ACER TENDL-2021 LIBRARY; T=293.6K  
Photon emission for (n,4n)

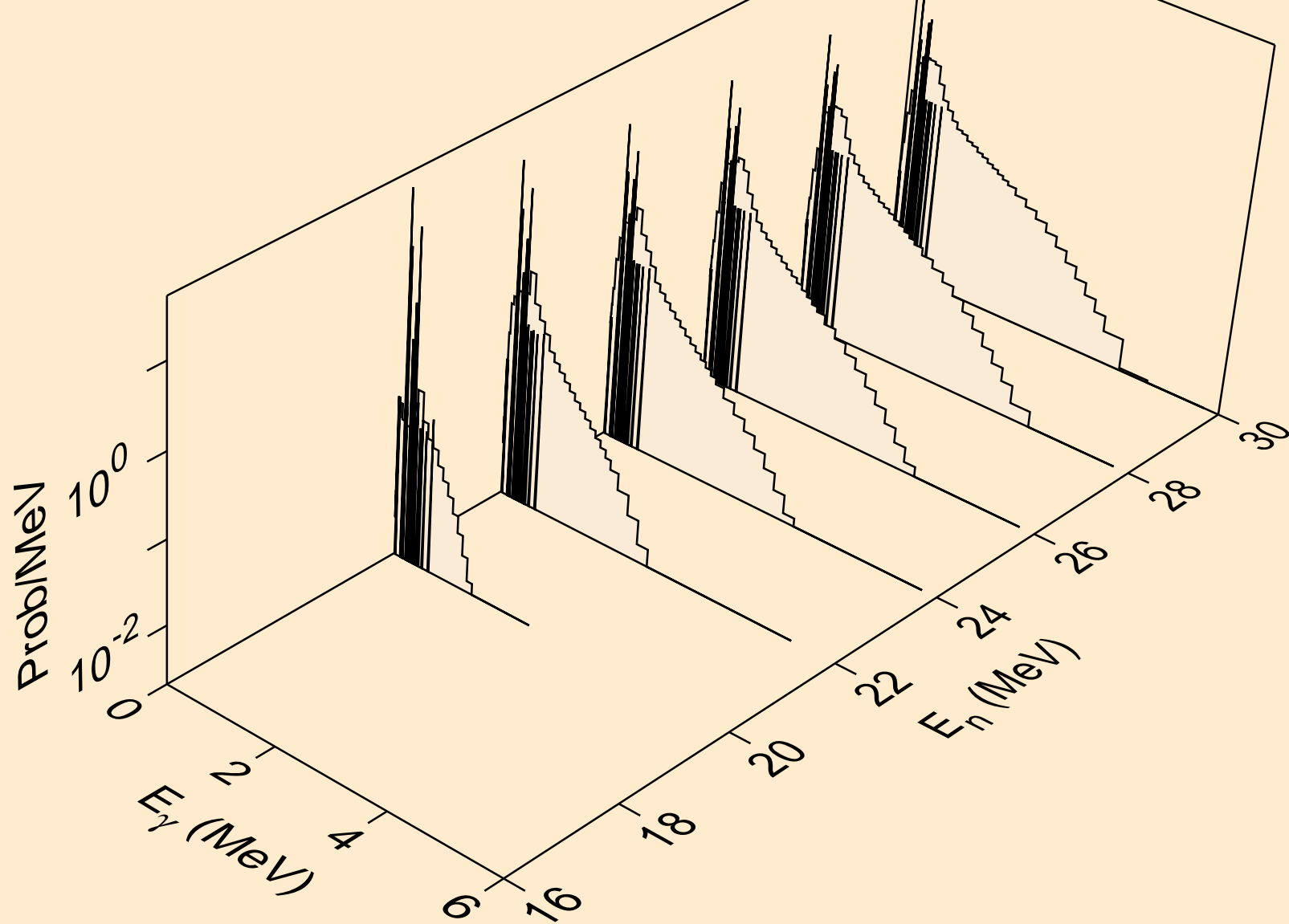

RE192 NEUTRON ACER TENDL-2021 LIBRARY; T=293.6K  
Photon emission for (n,2np)

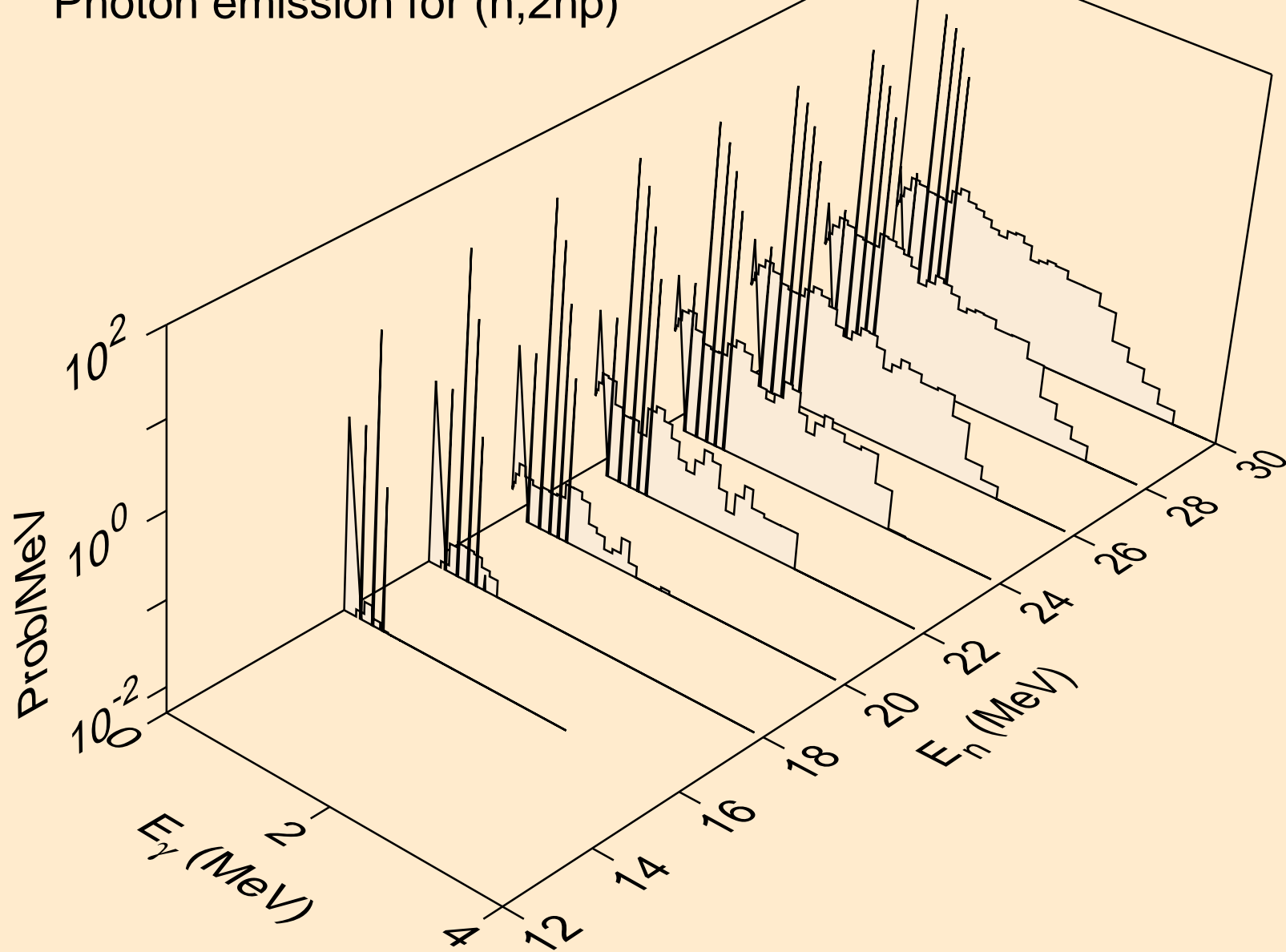



RE192 NEUTRON ACER TENDL-2021 LIBRARY; T=293.6K  
Photon emission for (n,3np)

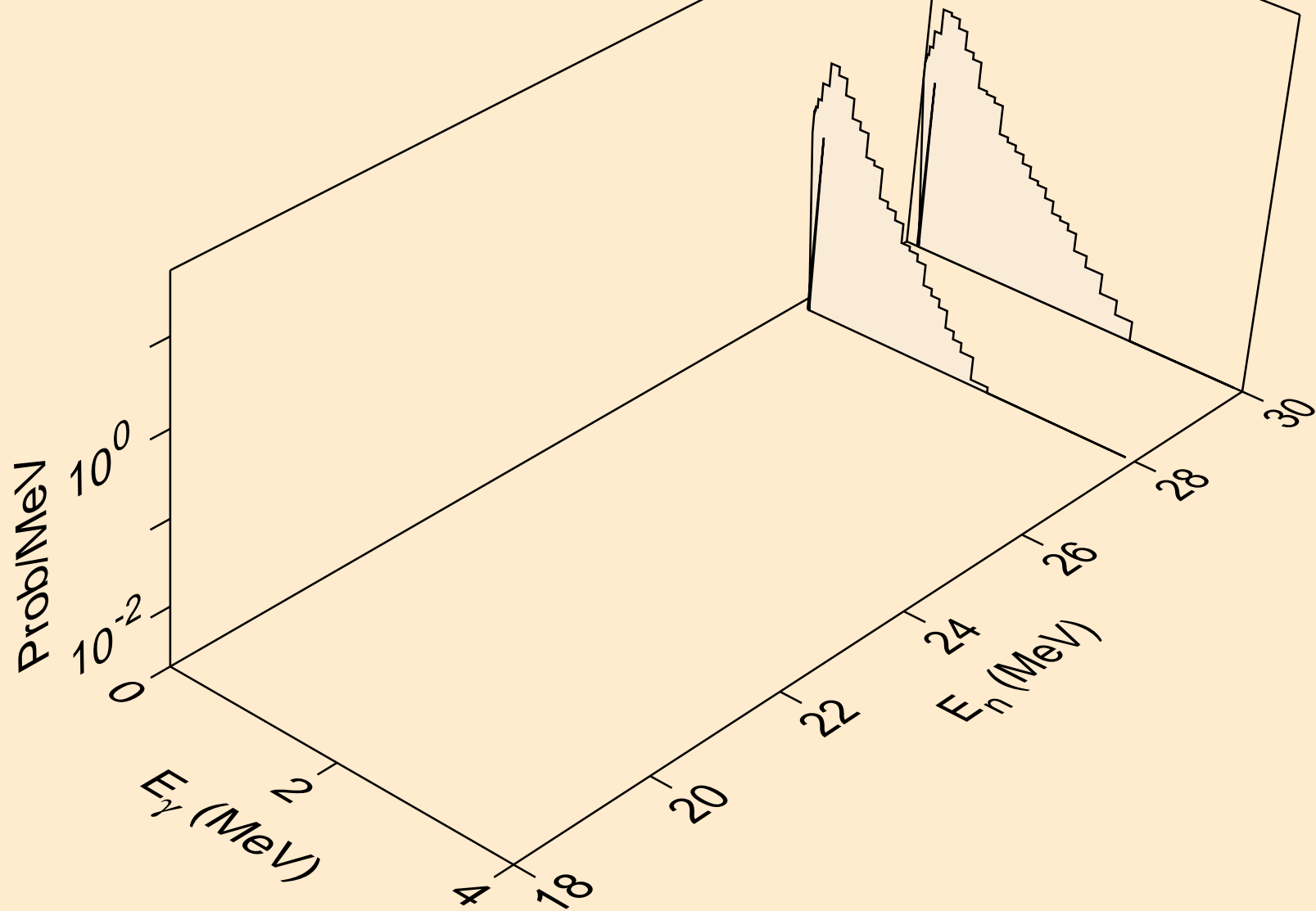

RE192 NEUTRON ACER TENDL-2021 LIBRARY; T=293.6K  
Photon emission for (n,n\*c)

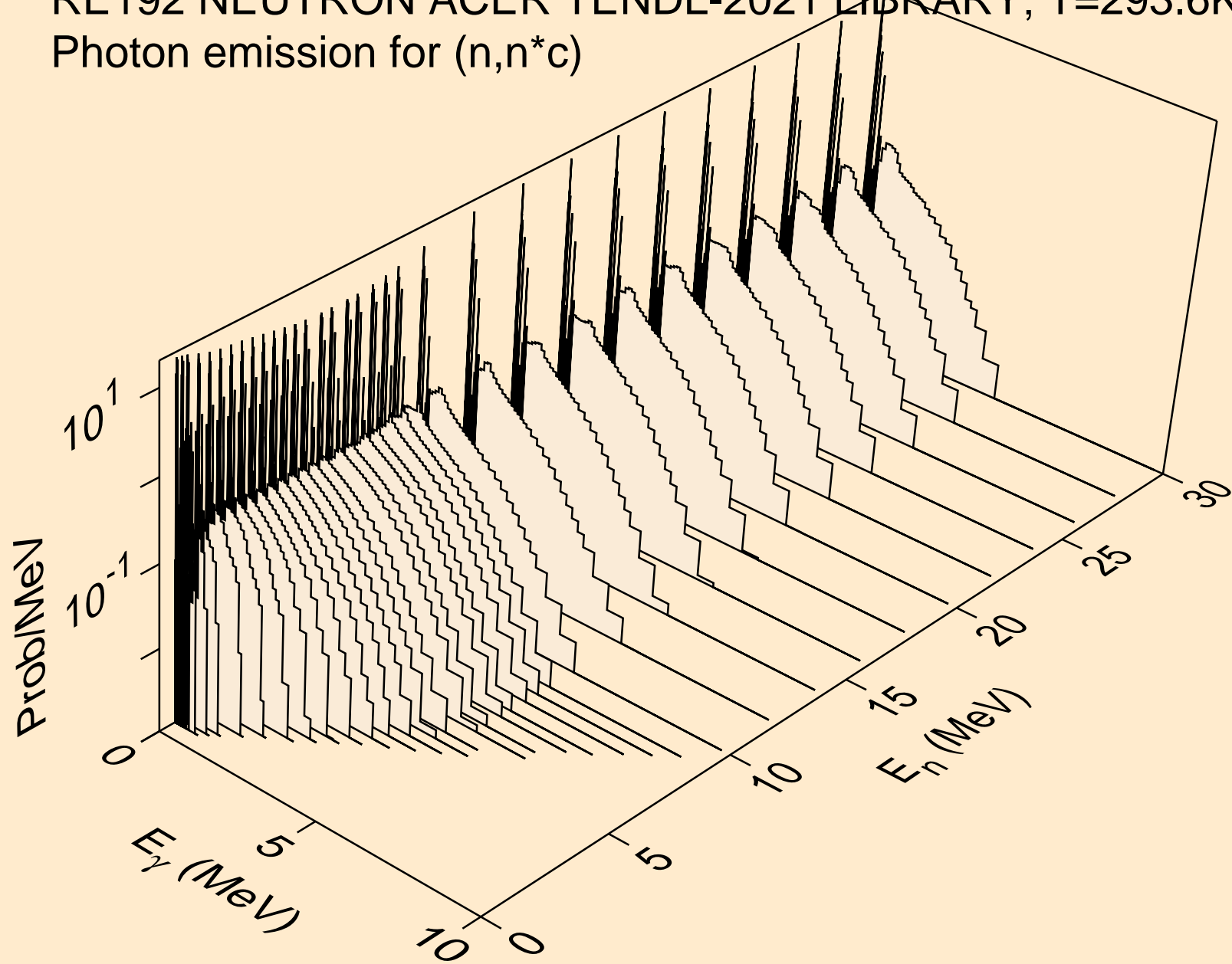

RE192 NEUTRON ACER TENDL-2021 LIBRARY; T=293.6K  
Photon emission for (n,gma)

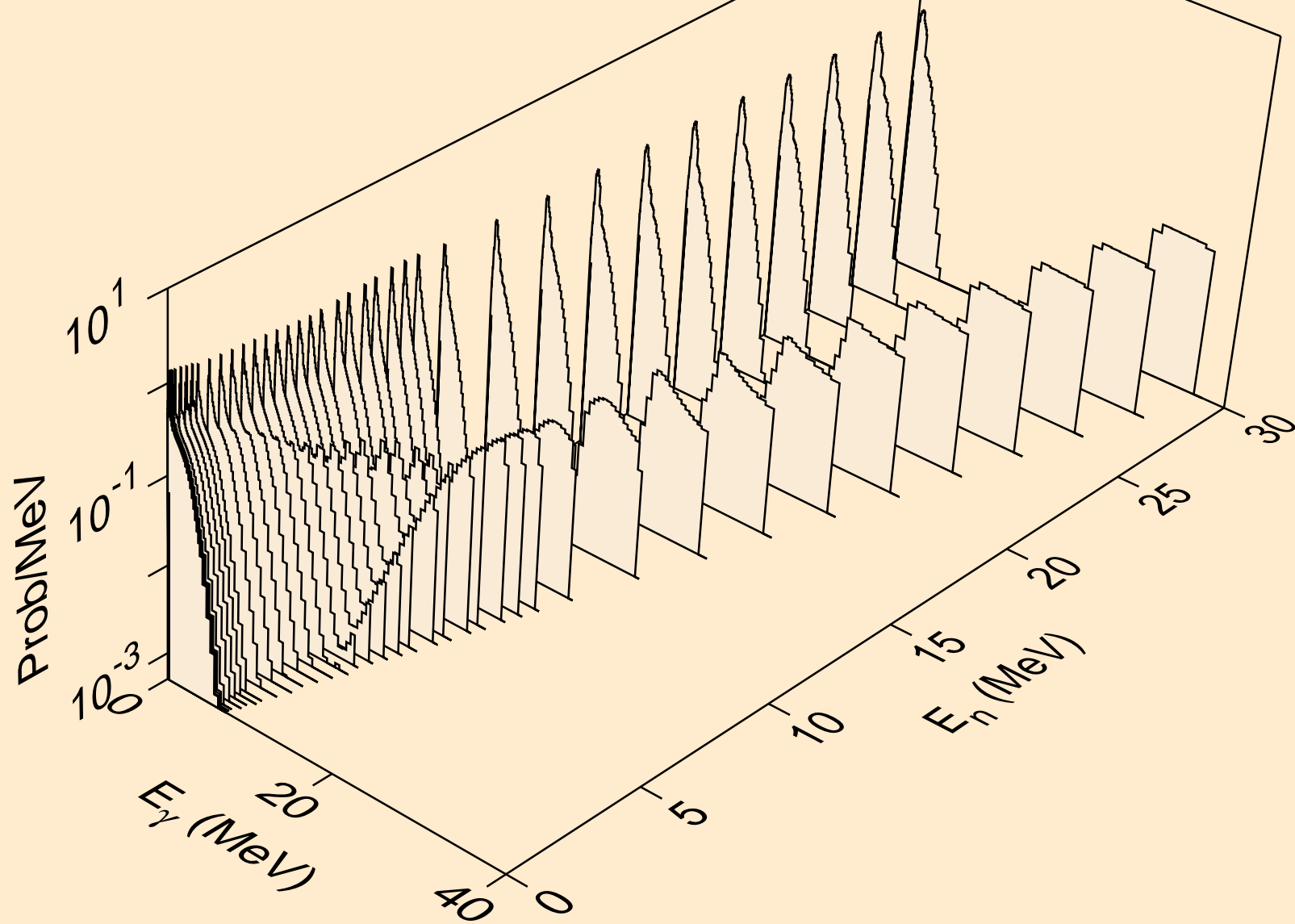

RE192 NEUTRON ACER TENDL-2021 LIBRARY; T=293.6K  
Photon emission for (n,p)

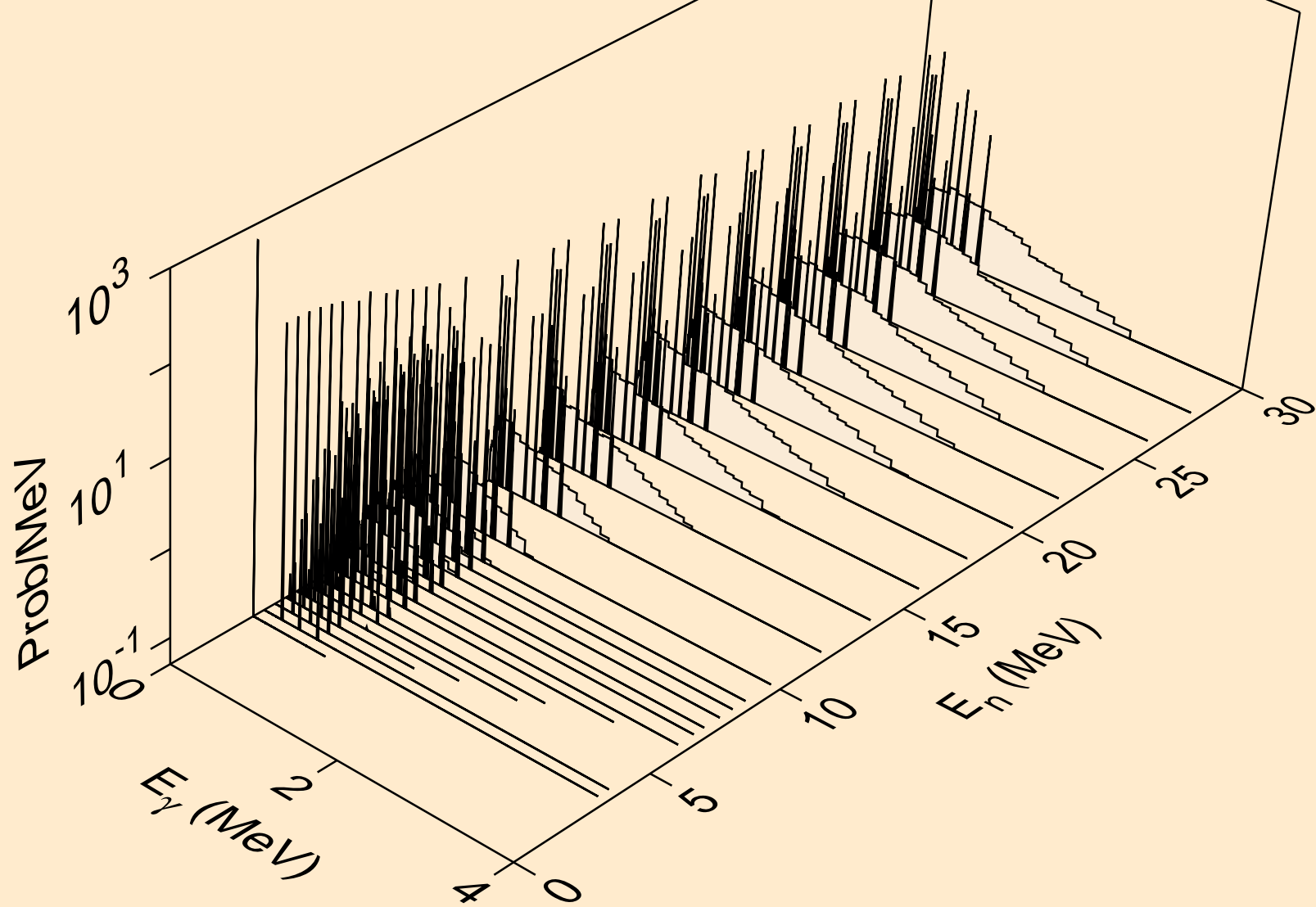

RE192 NEUTRON ACER TENDL-2021 LIBRARY; T=293.6K  
Photon emission for (n,d)

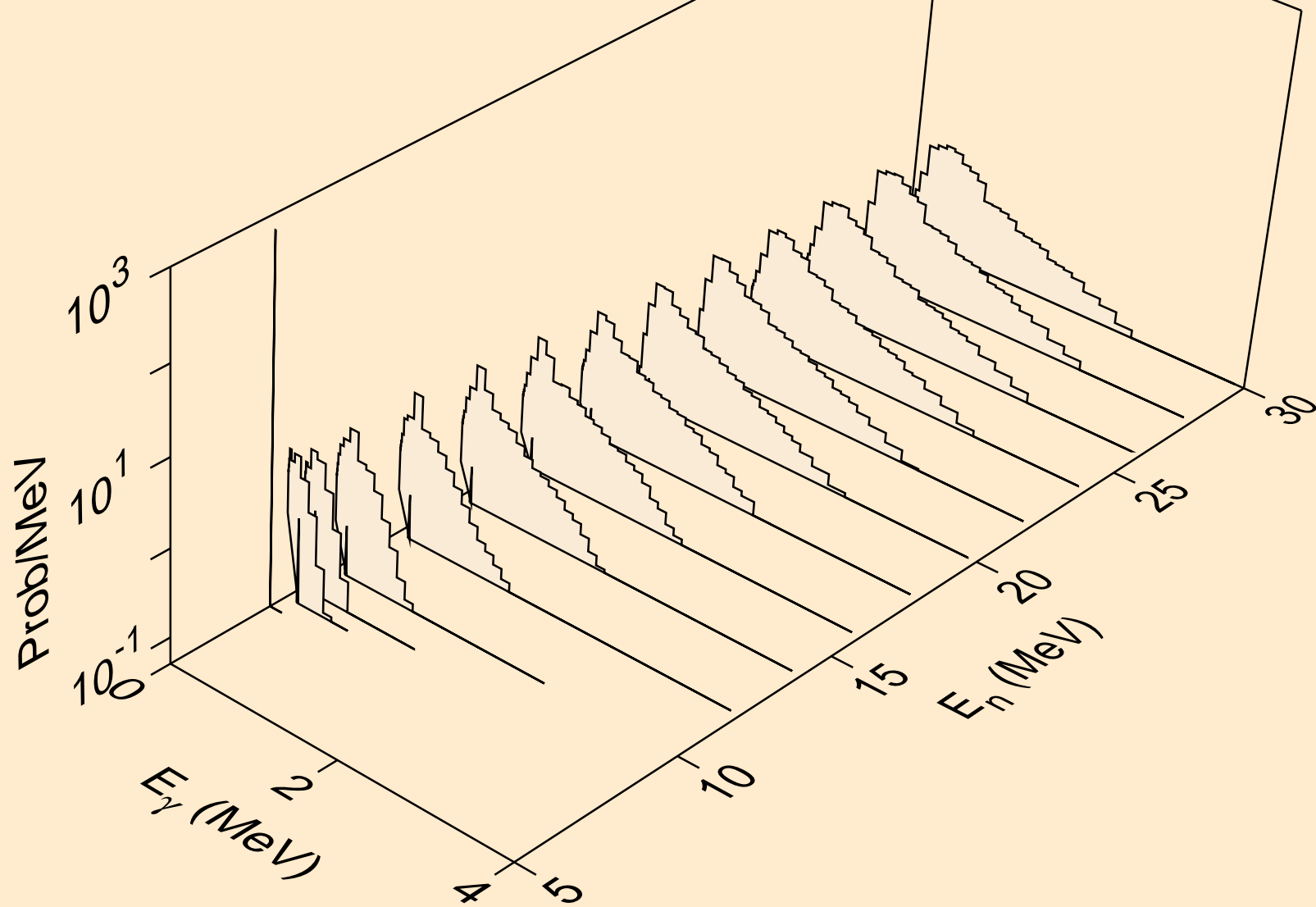

RE192 NEUTRON ACER TENDL-2021 LIBRARY; T=293.6K  
Photon emission for (n,t)

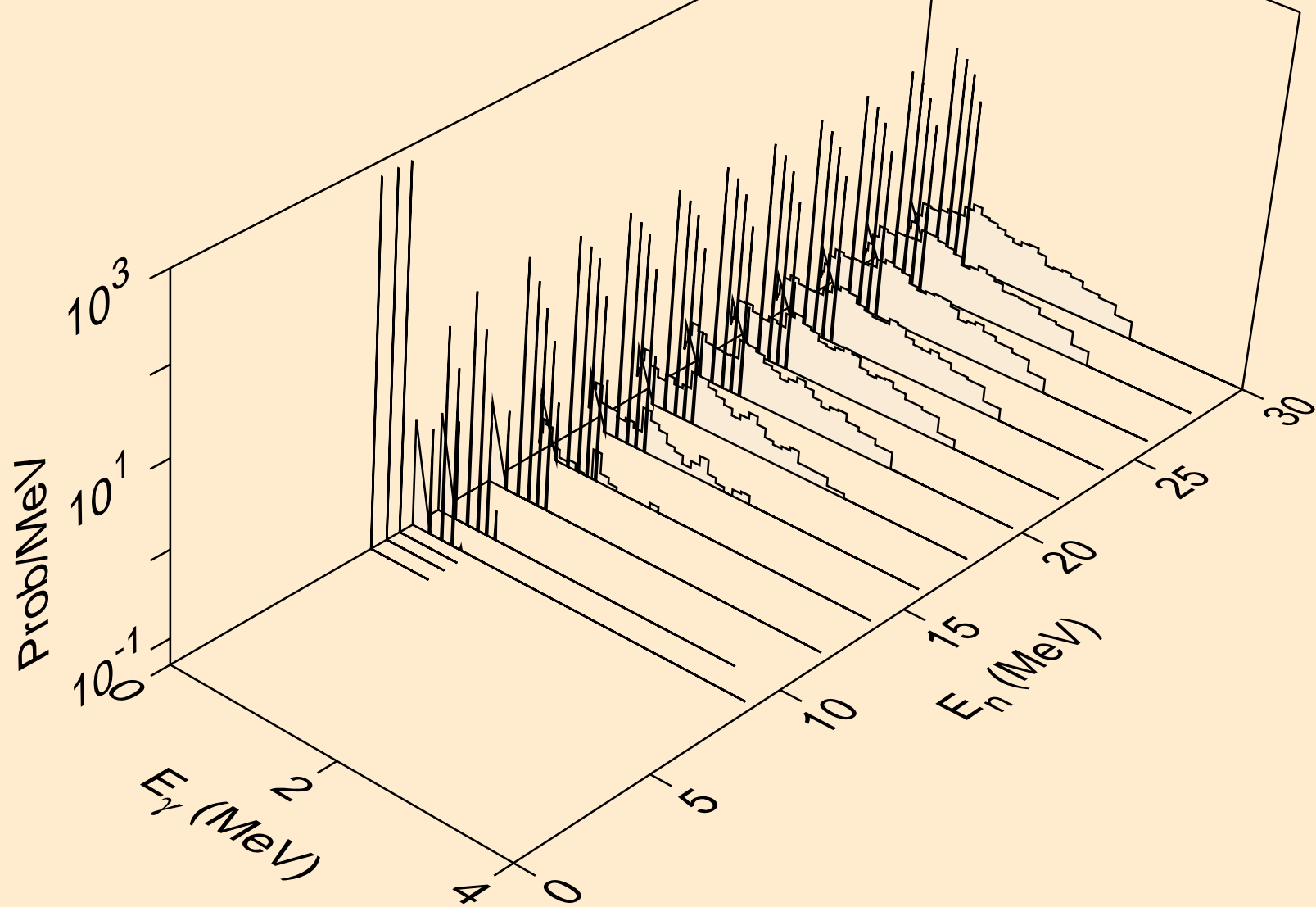

RE192 NEUTRON ACER TENDL-2021 LIBRARY; T=293.6K  
Photon emission for (n,he3)

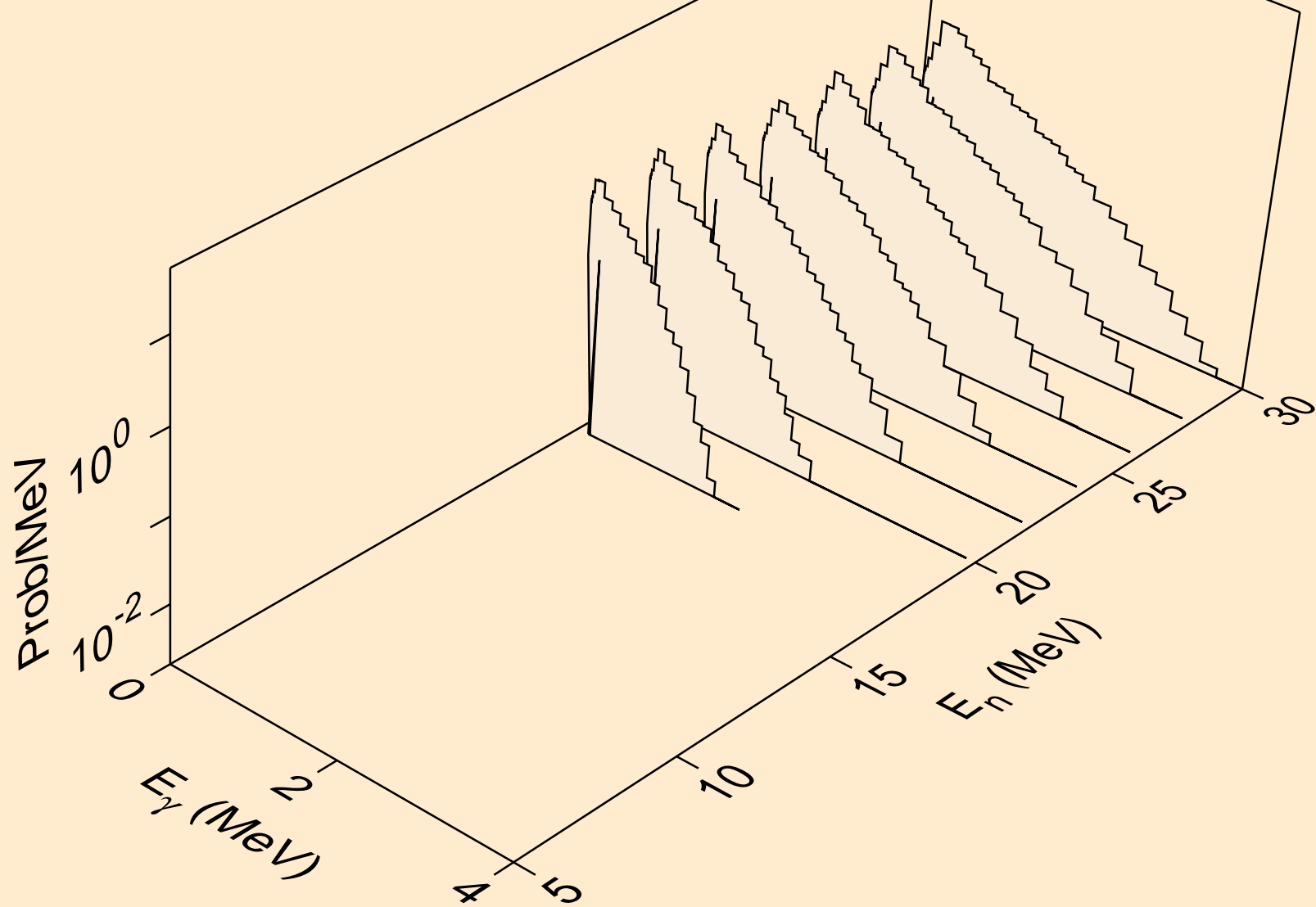

RE192 NEUTRON ACER TENDL-2021 LIBRARY; T=293.6K  
Photon emission for (n,a)

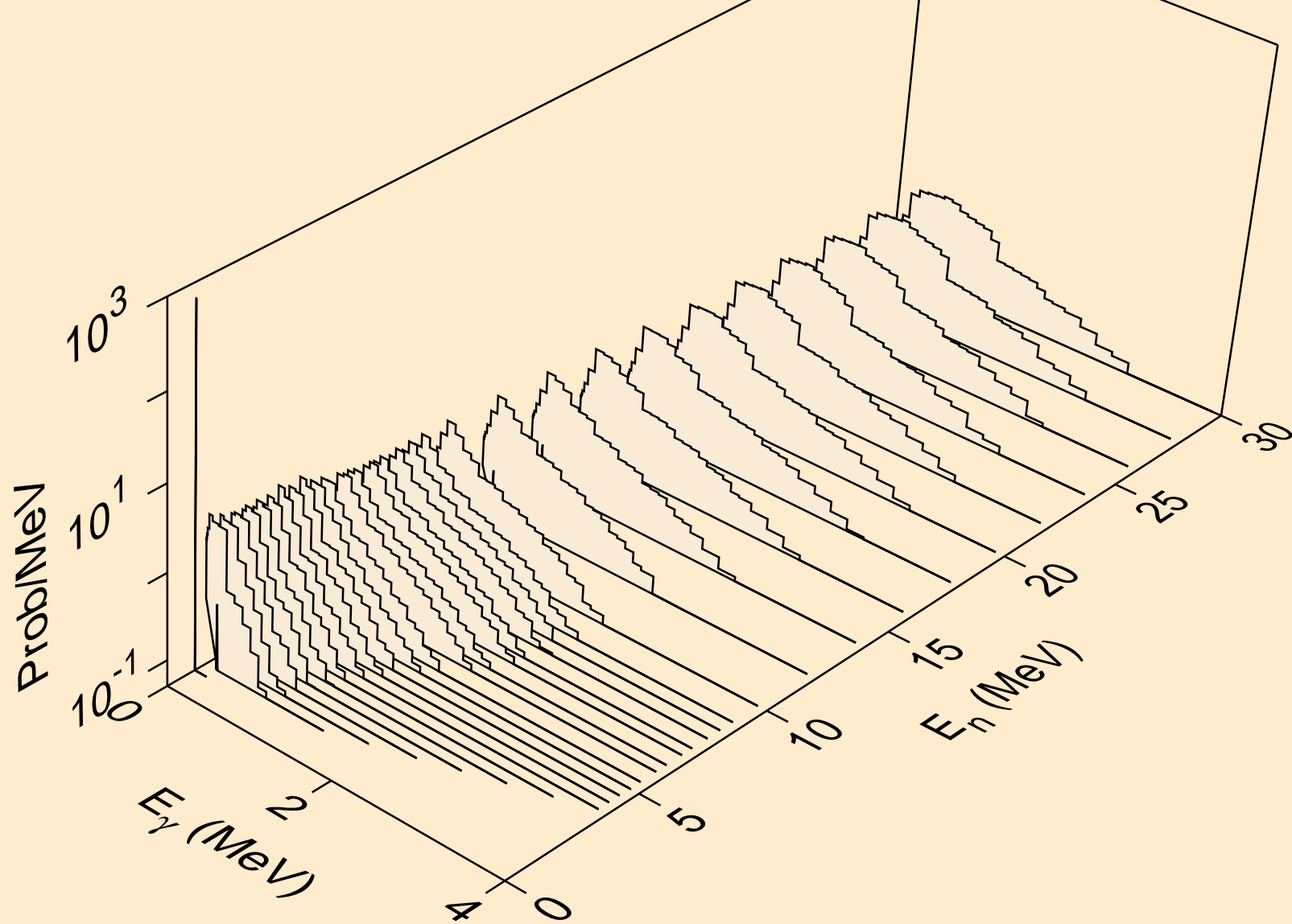



RE192 NEUTRON ACER TENDL-2021 LIBRARY; T=293.6K  
Photon emission for (n,2p)

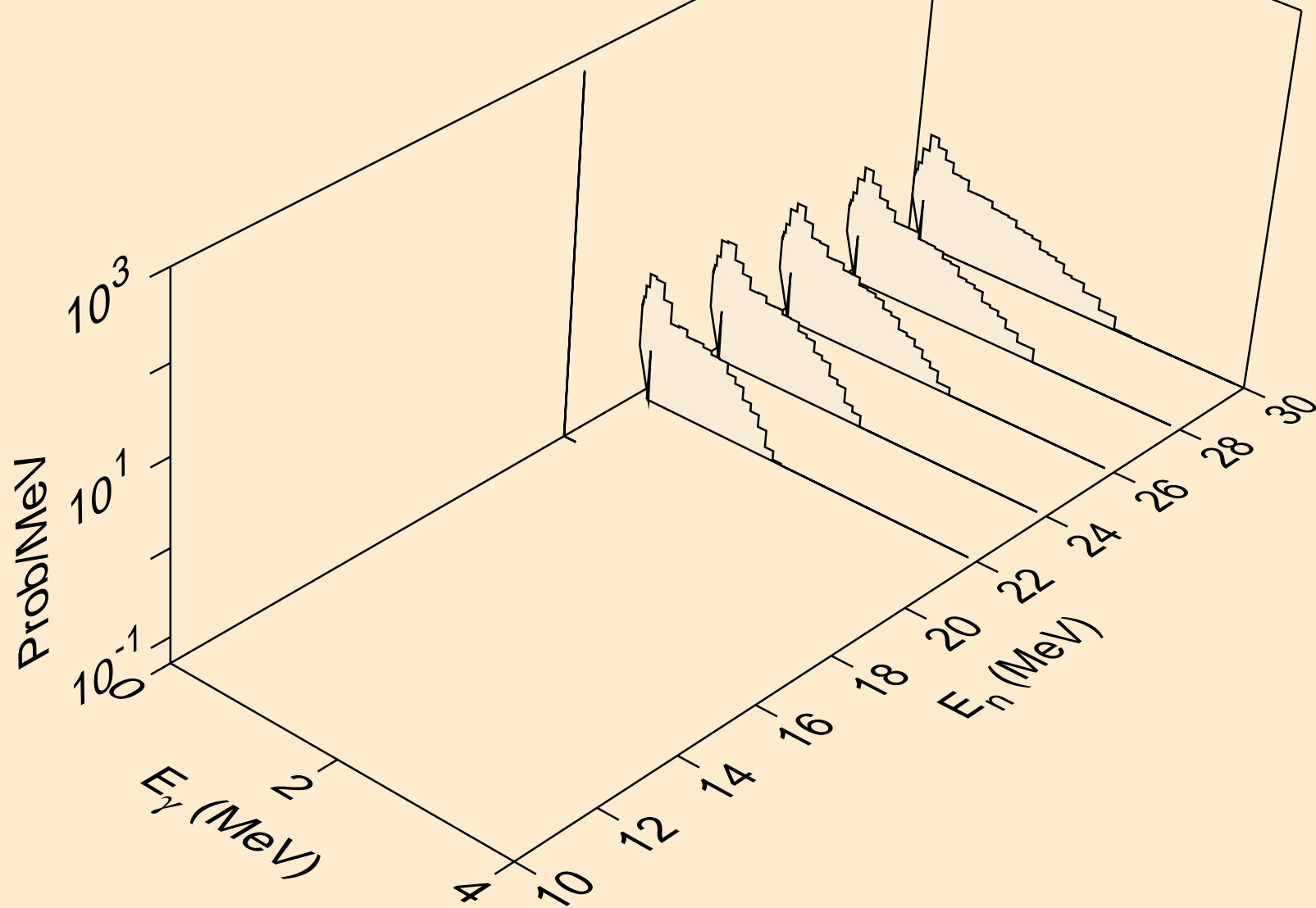

RE192 NEUTRON ACER TENDL-2021 LIBRARY; T=293.6K  
thermal capture photon spectrum

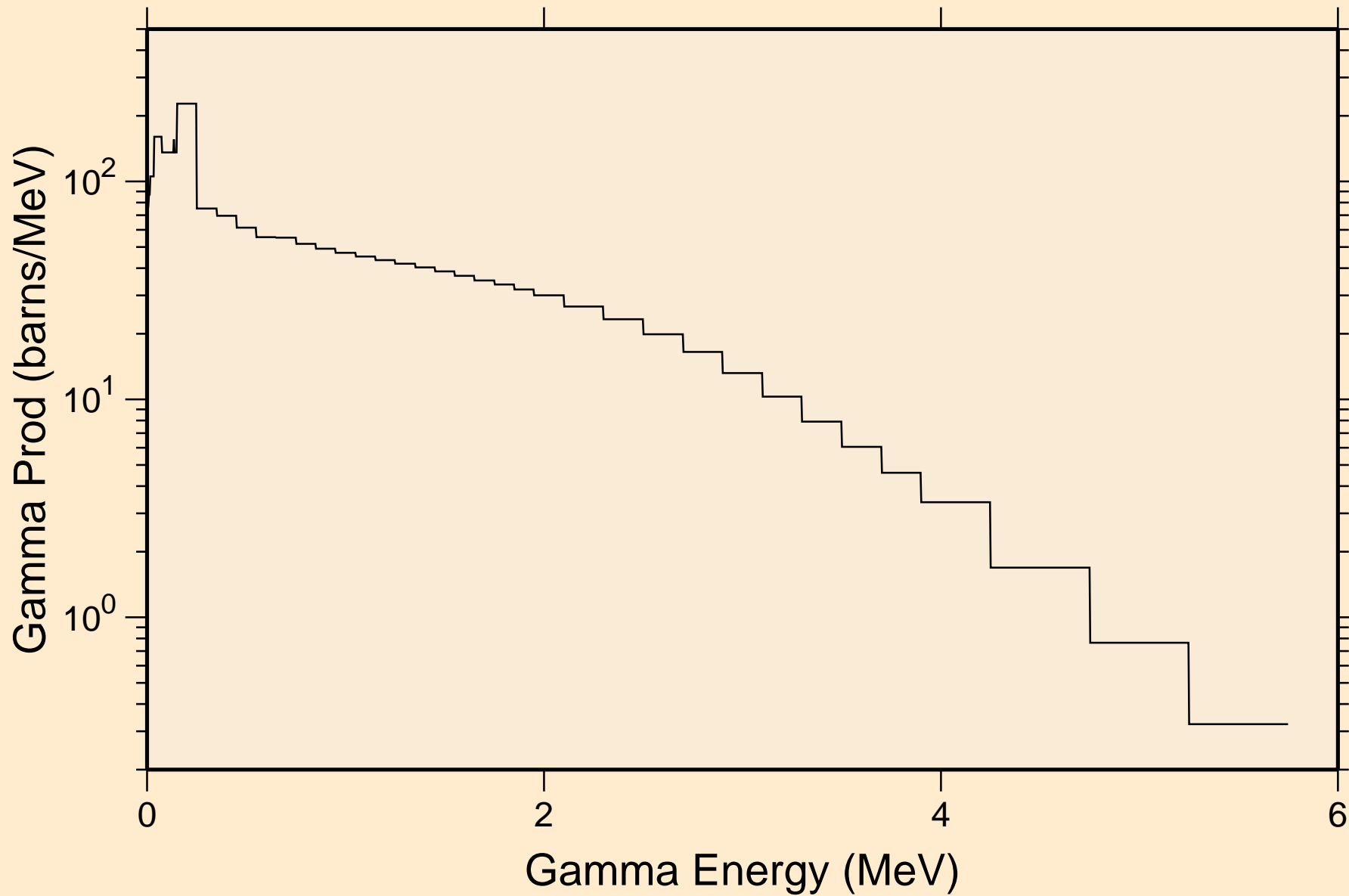

RE192 NEUTRON ACER TENDL-2021 LIBRARY; T=293.6K  
14 MeV photon spectrum

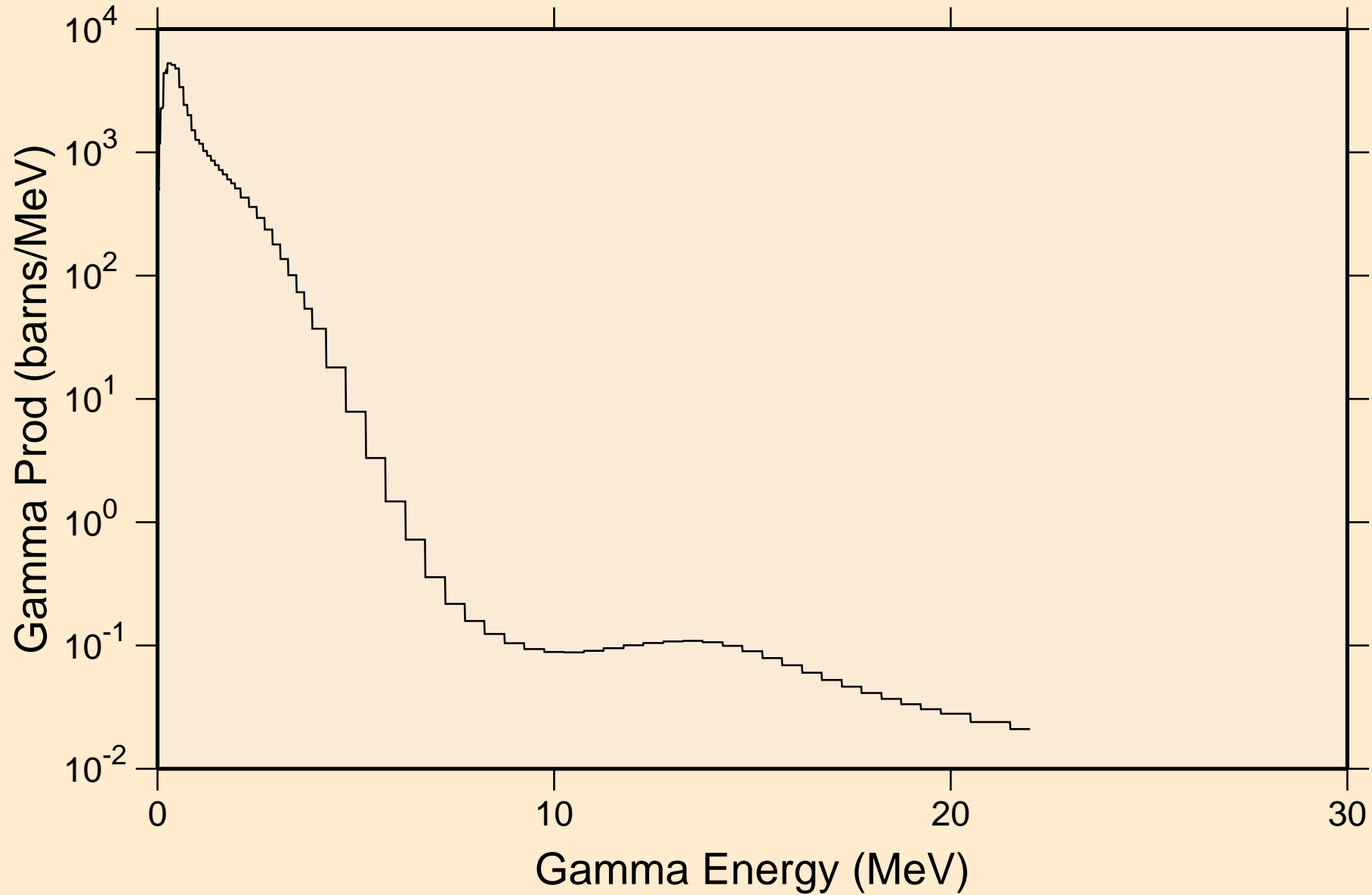

RE192 NEUTRON ACER TENDL-2021 LIBRARY; T=293.6K  
Particle heating contributions

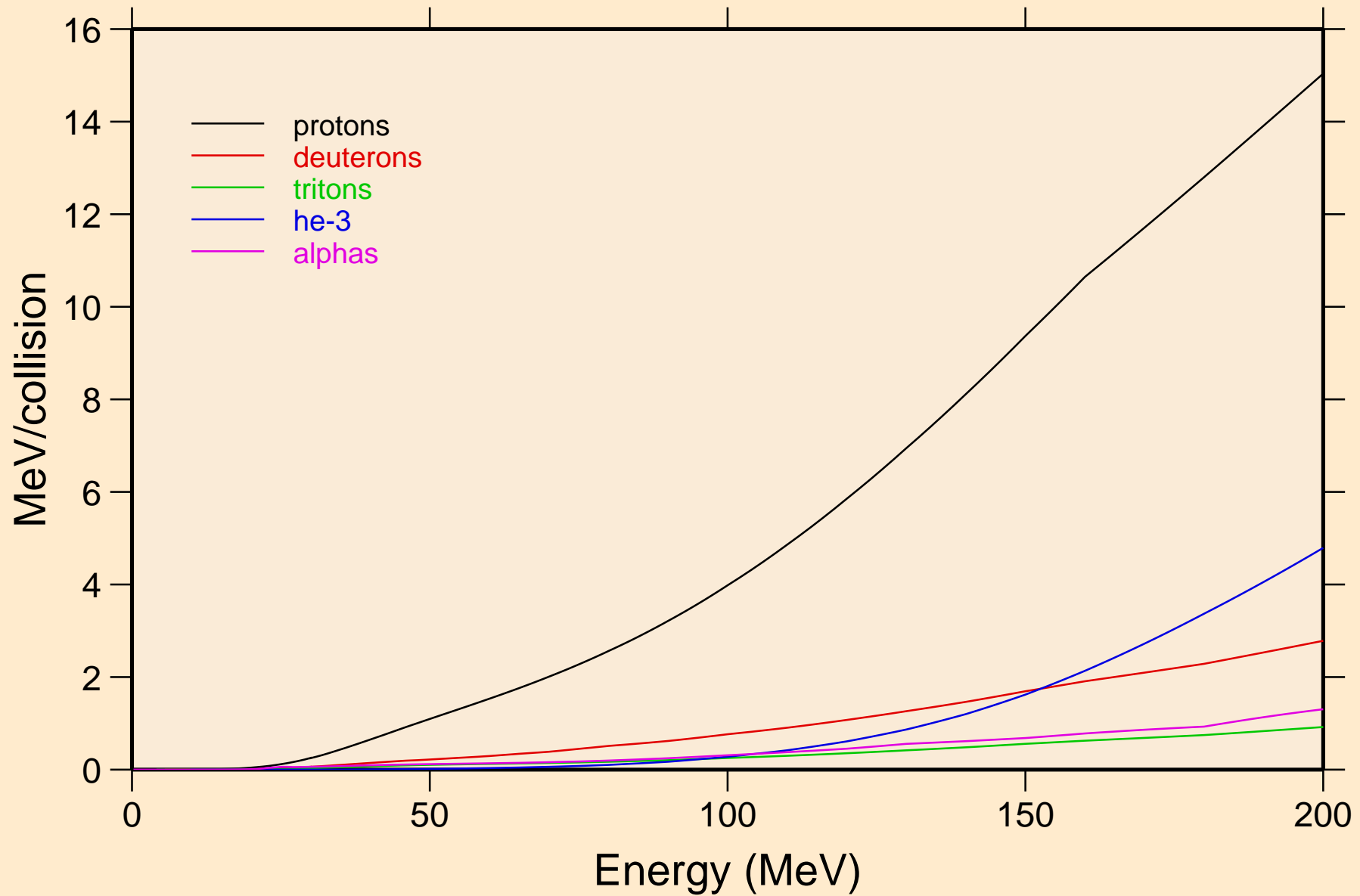

RE192 NEUTRON ACER TENDL-2021 LIBRARY; T=293.6K  
Recoil Heating

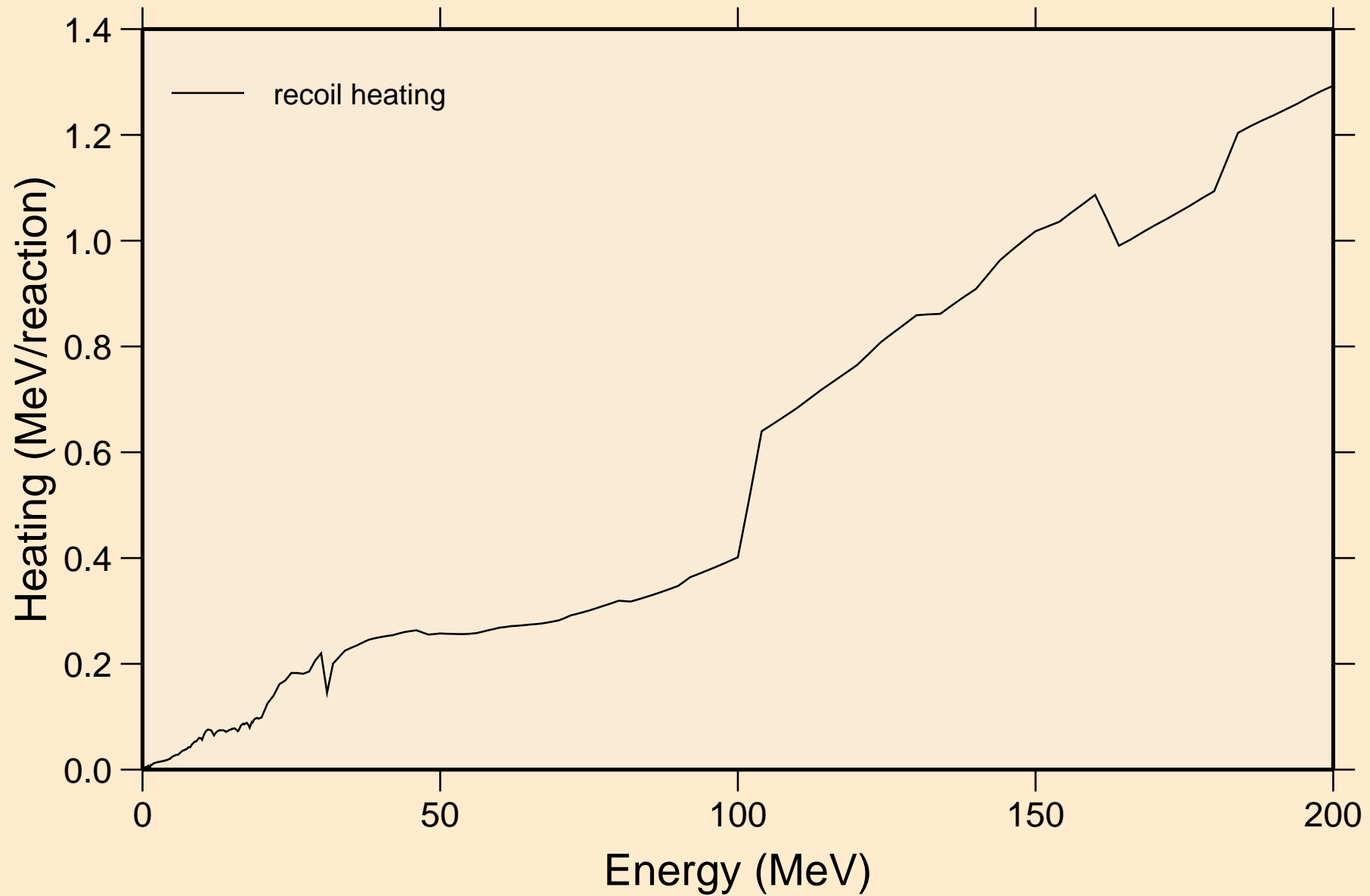

RE192 NEUTRON ACER TENDL-2021 LIBRARY; T=293.6K  
Particle production cross sections

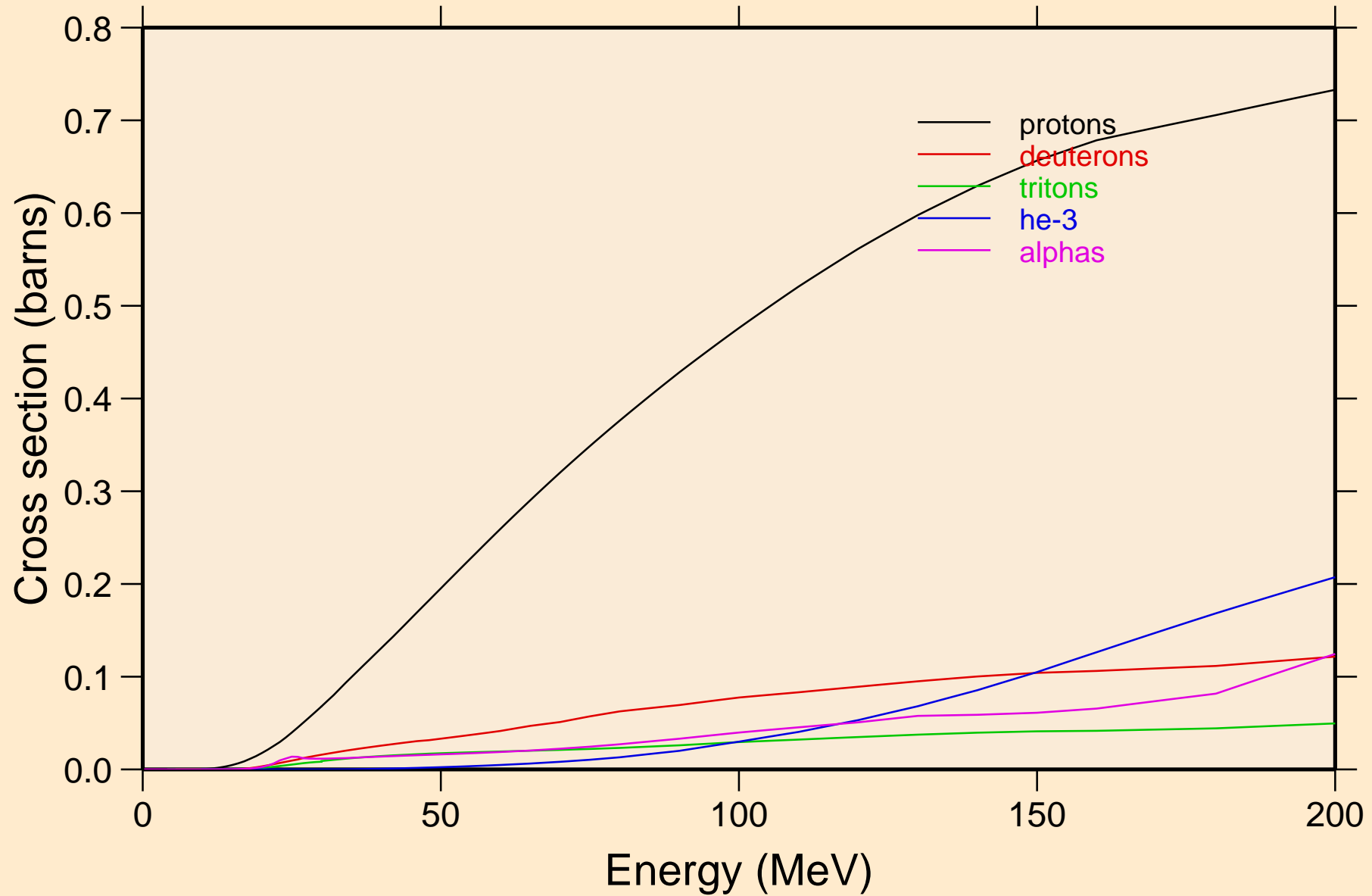

RE192 NEUTRON ACER TENDL-2021 LIBRARY; T=293.6K  
protons from (n,x)

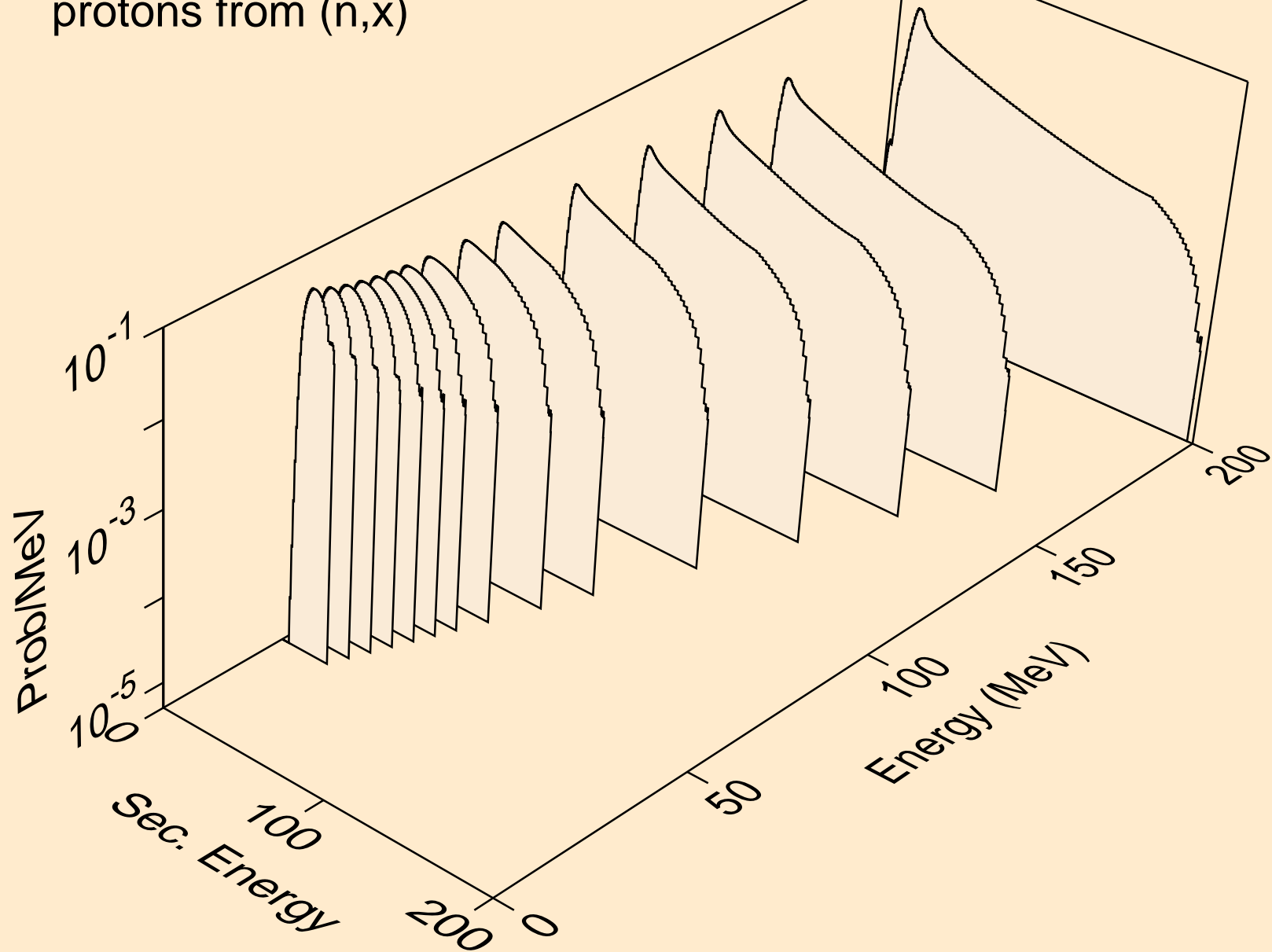

RE192 NEUTRON ACER TENDL-2021 LIBRARY; T=293.6K  
protons from (n,n\*)p

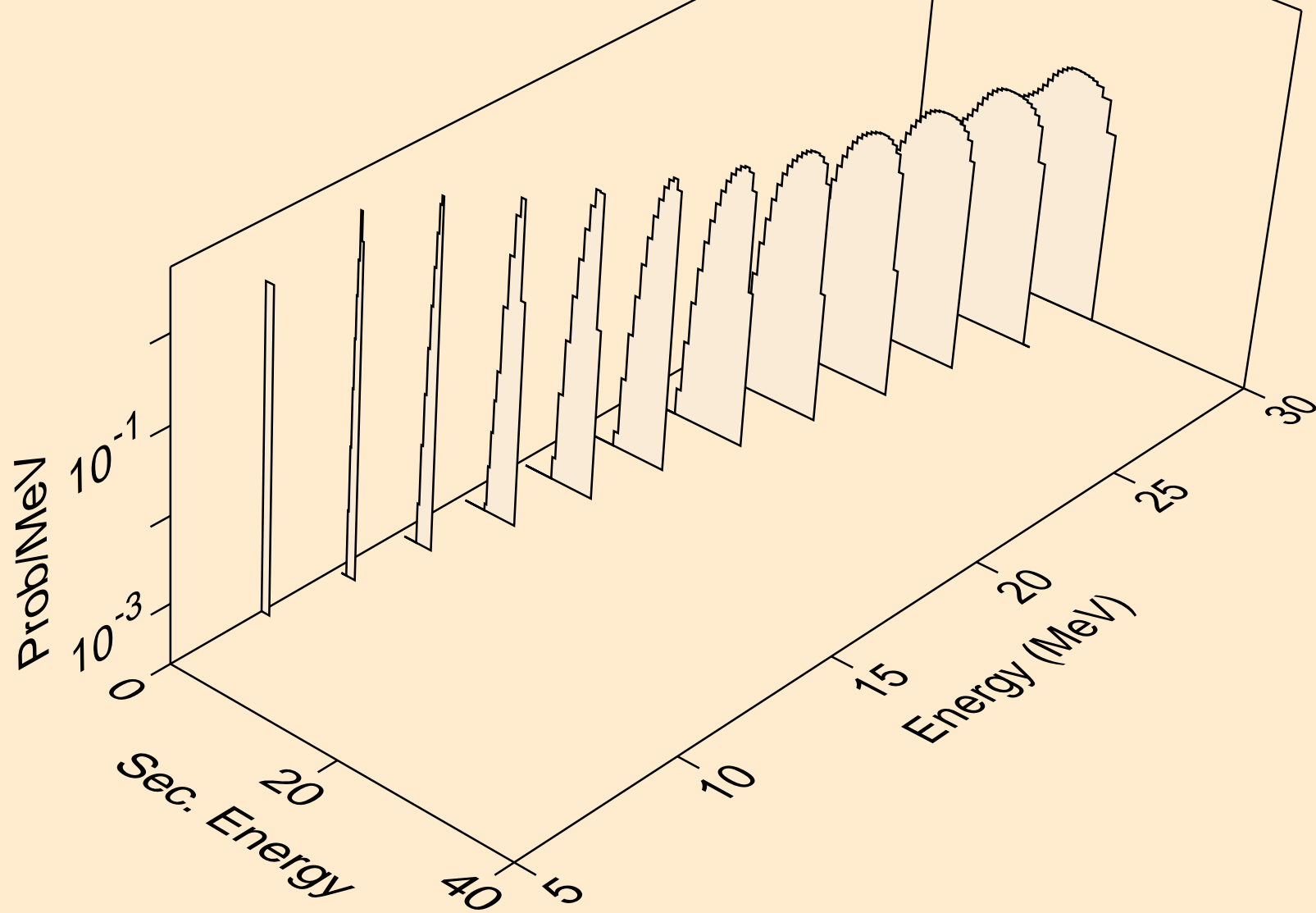



RE192 NEUTRON ACER TENDL-2021 LIBRARY; T=293.6K  
protons from (n,2np)

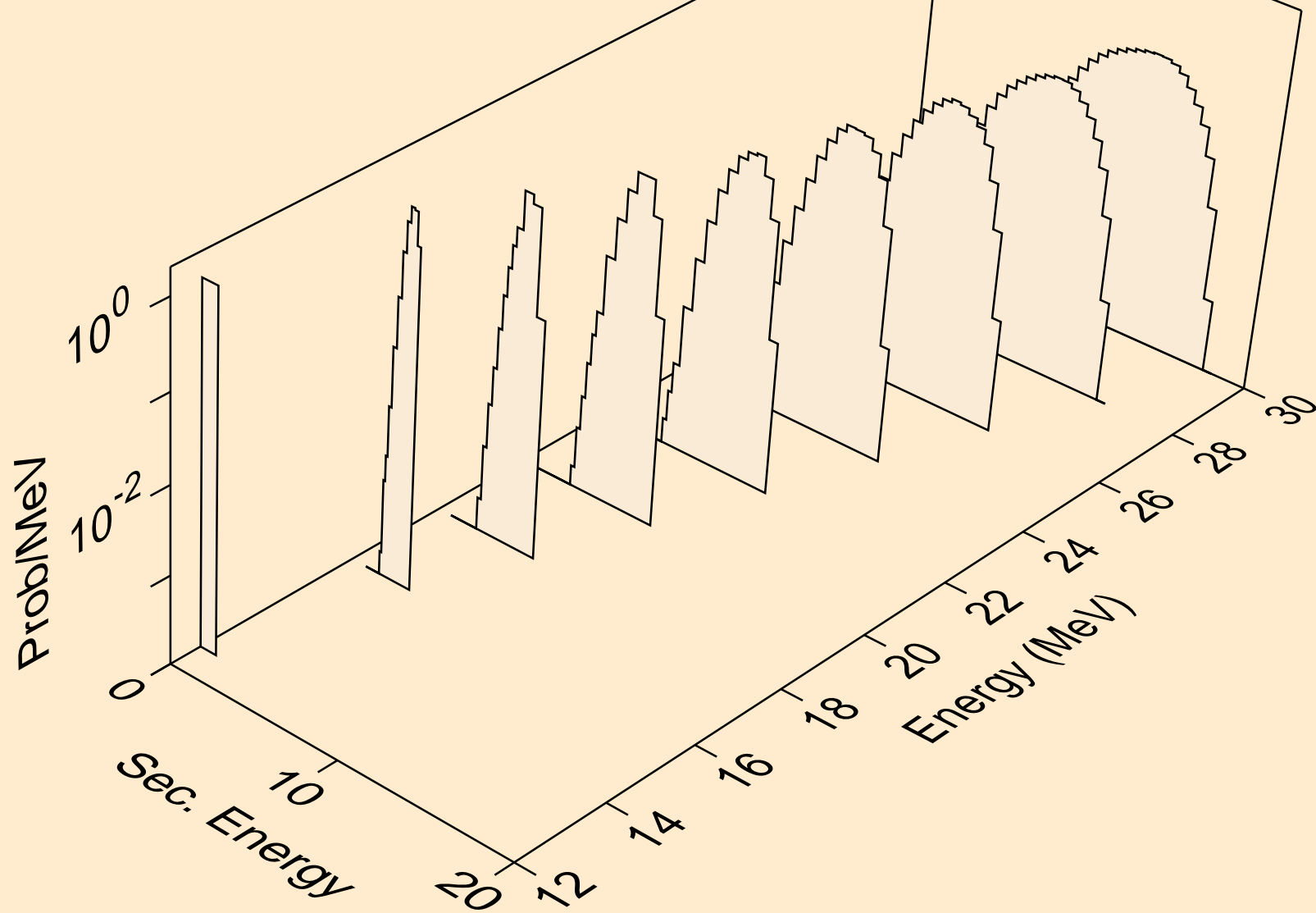

RE192 NEUTRON ACER TENDL-2021 LIBRARY; T=293.6K  
protons from (n,3np)

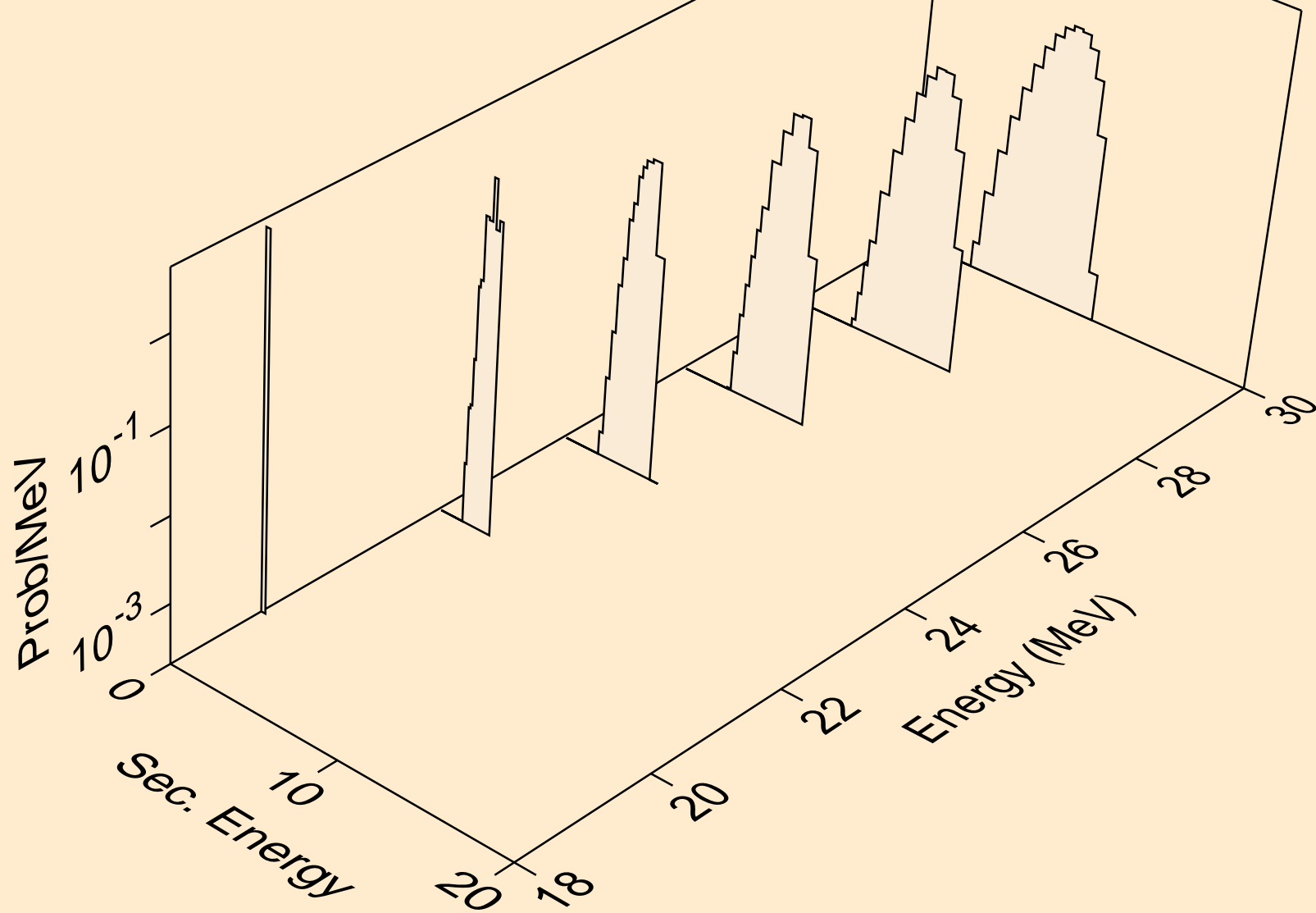

RE192 NEUTRON ACER TENDL-2021 LIBRARY; T=293.6K  
protons from (n,p)

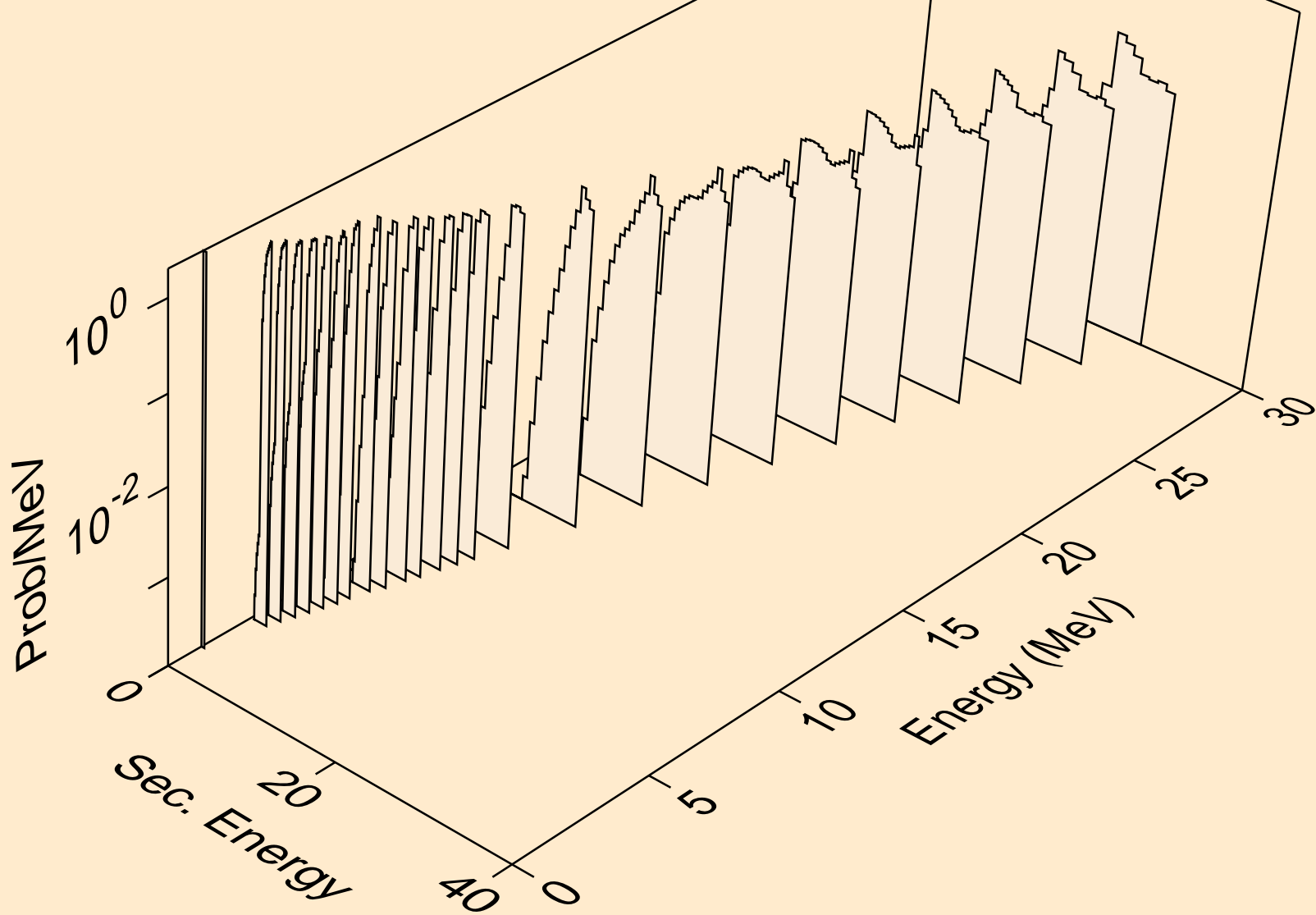

RE192 NEUTRON ACER TENDL-2021 LIBRARY; T=293.6K  
protons from (n,2p)

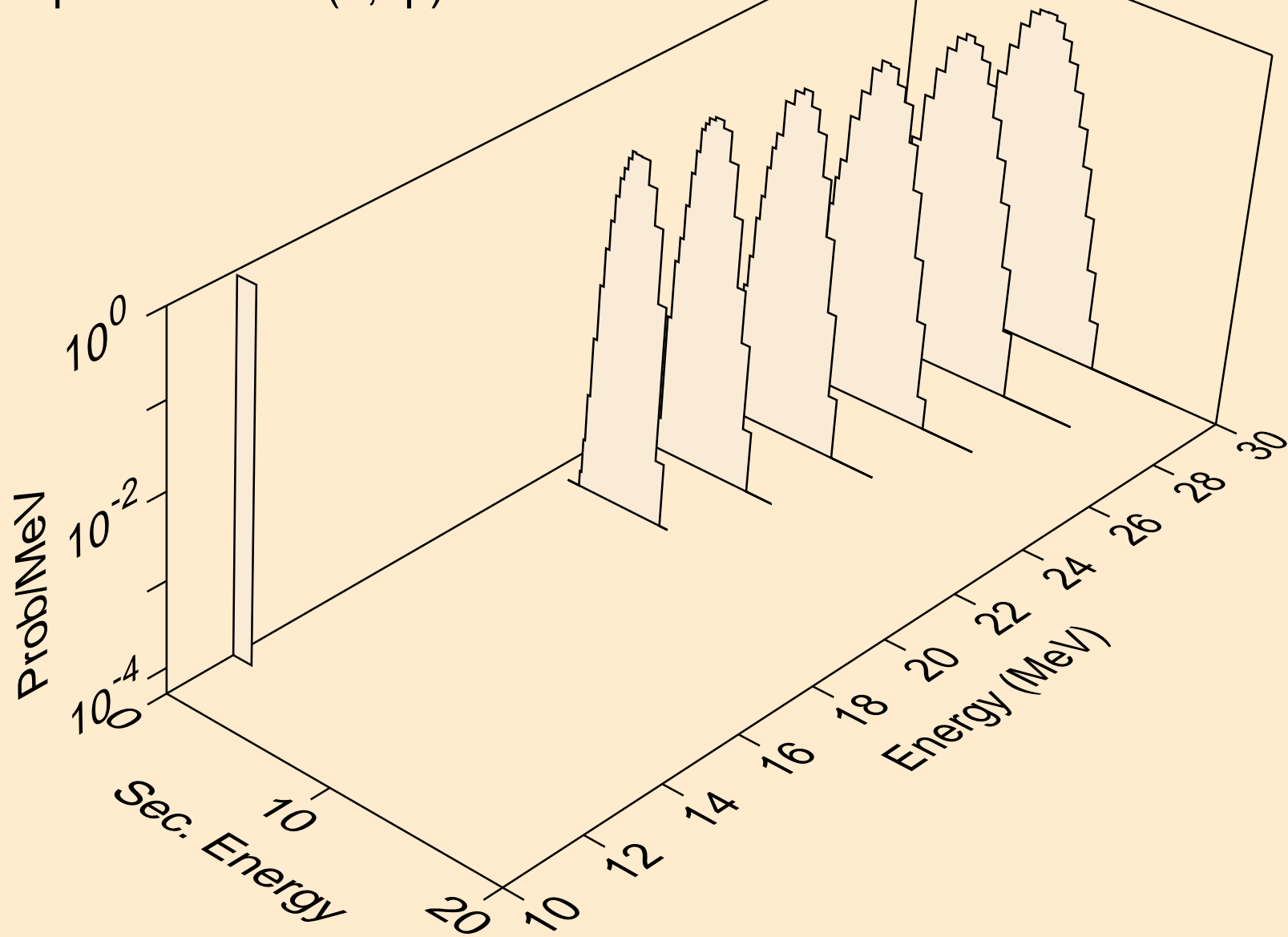

RE192 NEUTRON ACER TENDL-2021 LIBRARY; T=293.6K  
deuterons from (n,x)

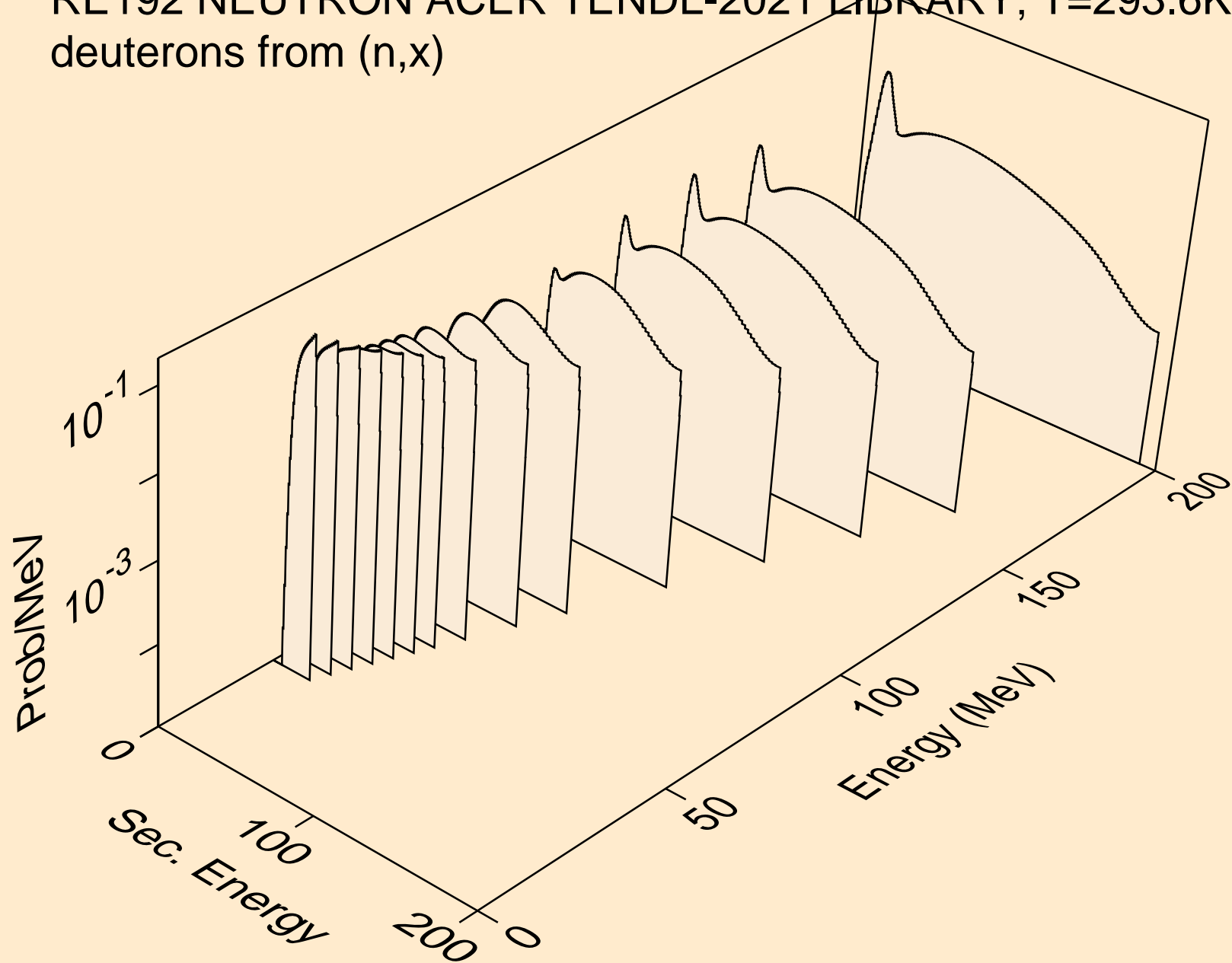

RE192 NEUTRON ACER TENDL-2021 LIBRARY; T=293.6K  
deuterons from (n,2nd)

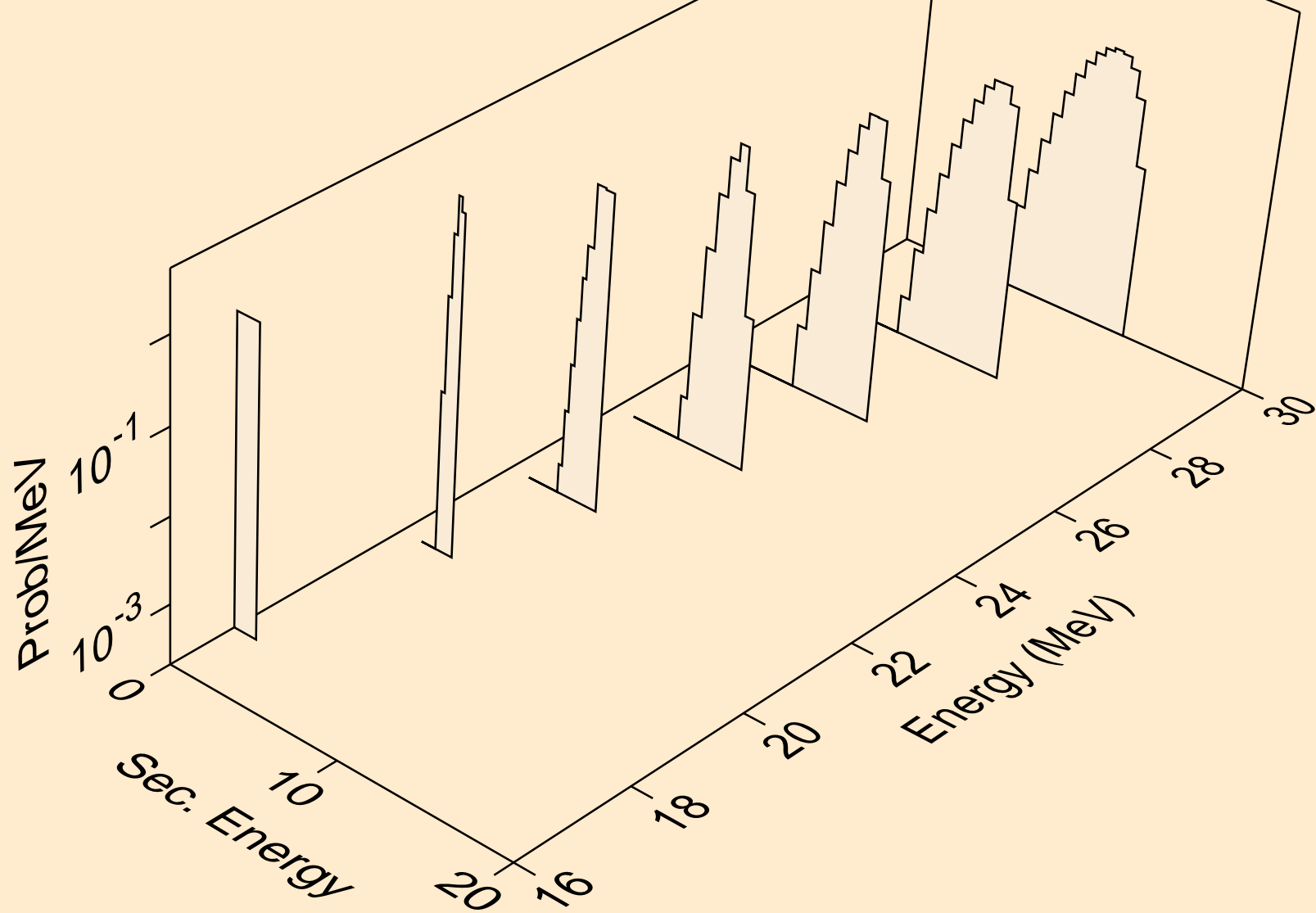

RE192 NEUTRON ACER TENDL-2021 LIBRARY; T=293.6K  
deuterons from (n,n\*)d

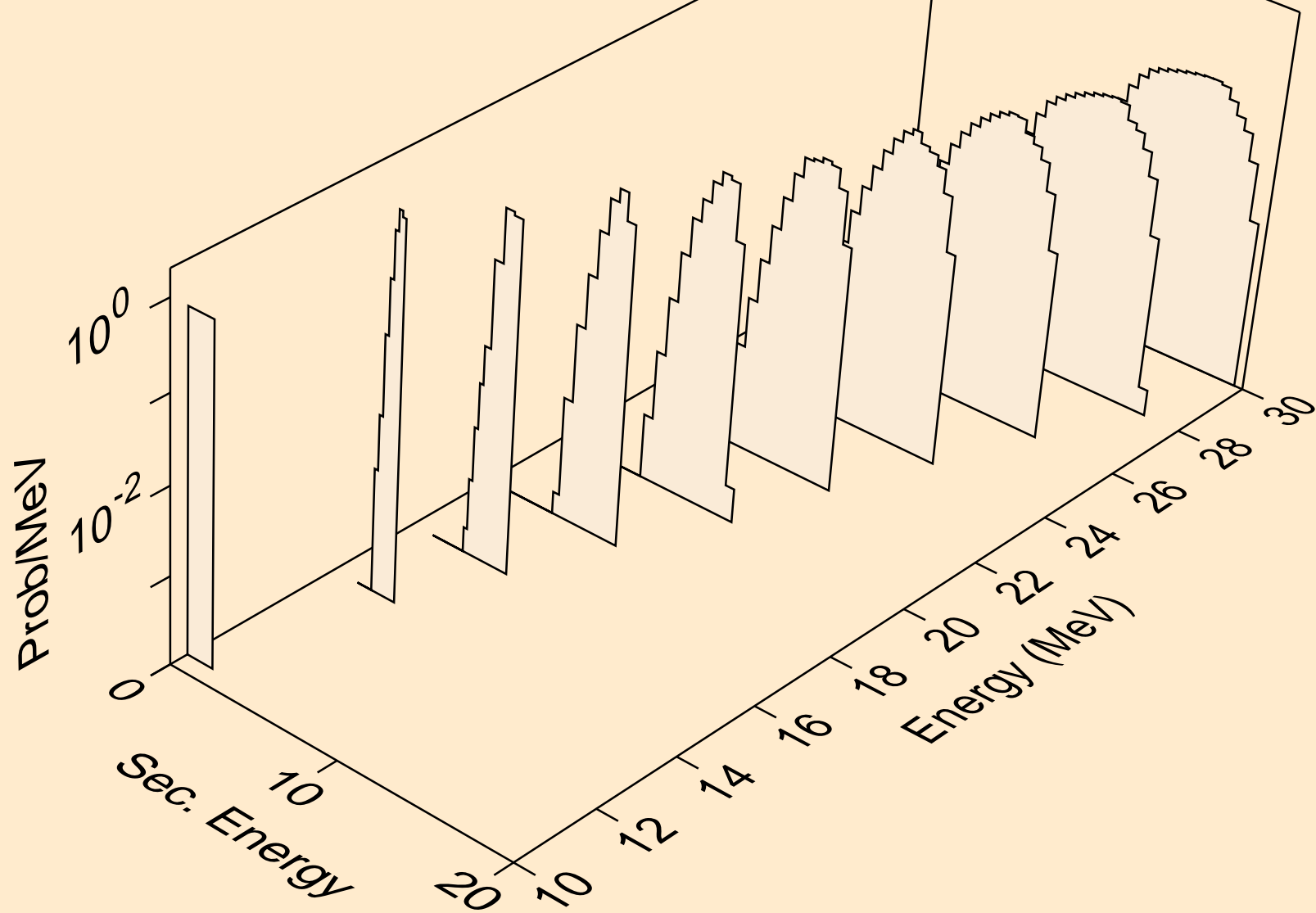

RE192 NEUTRON ACER TENDL-2021 LIBRARY; T=293.6K  
deuterons from (n,d)

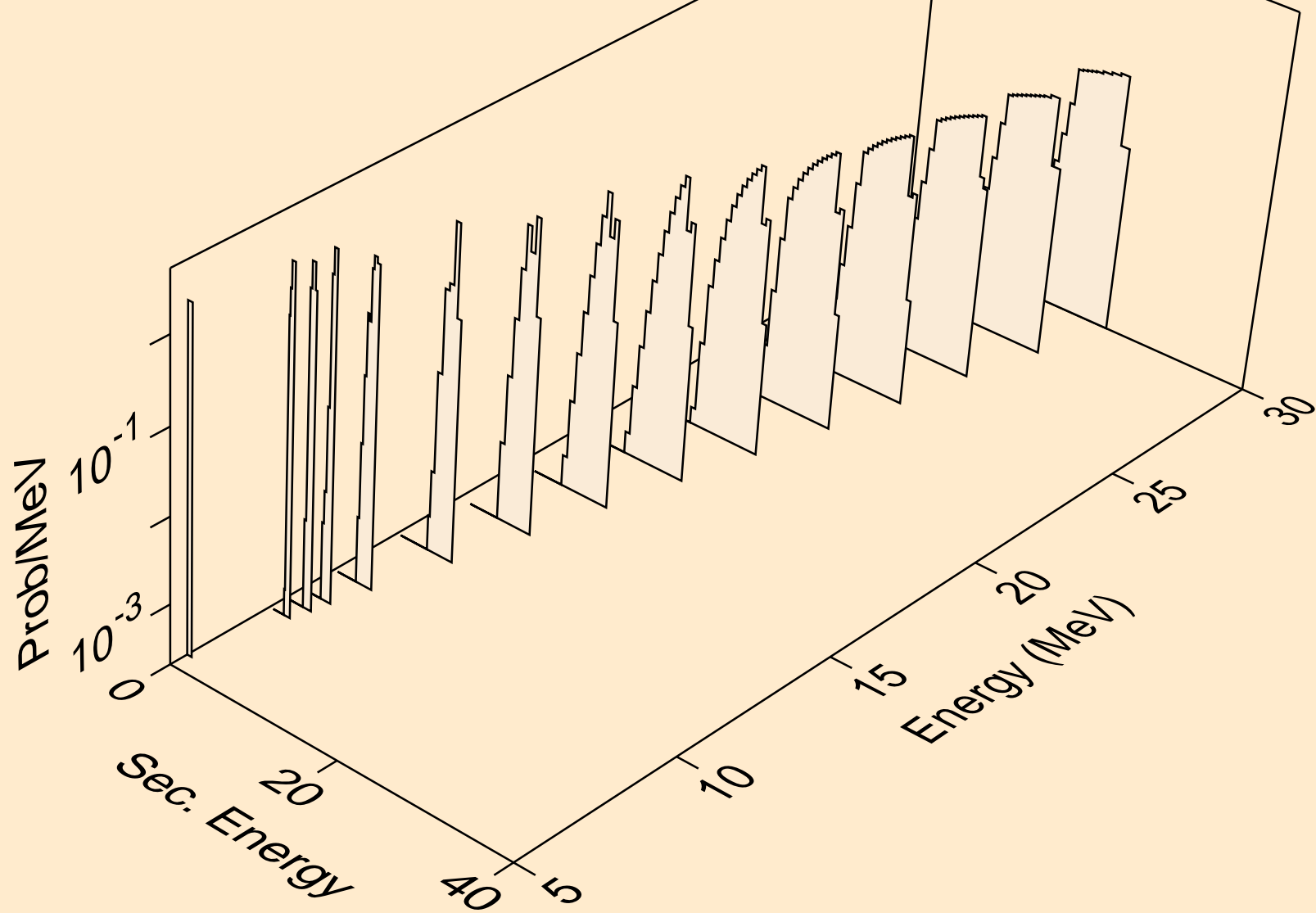



RE192 NEUTRON ACER TENDL-2021 LIBRARY; T=293.6K  
tritons from (n,x)

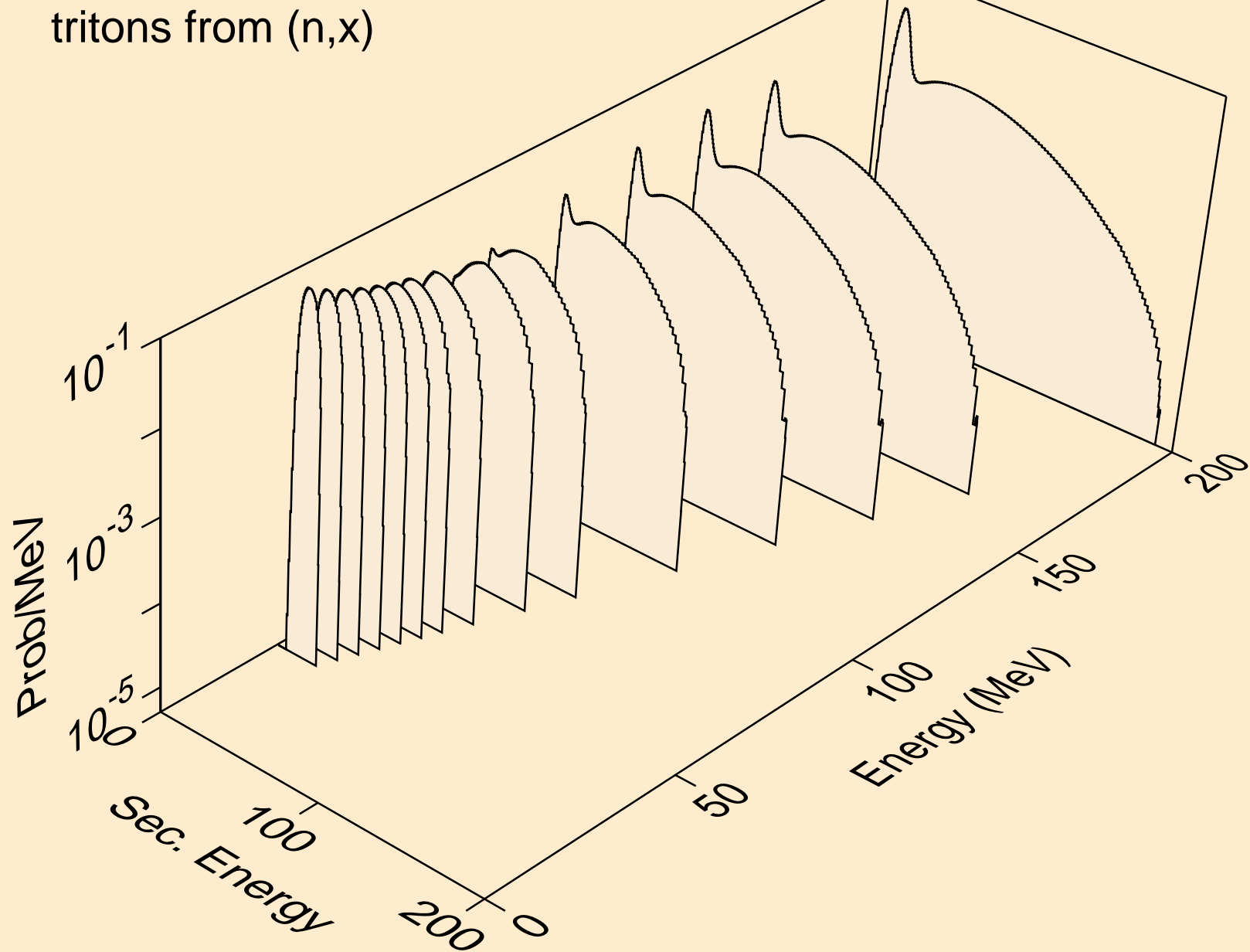

RE192 NEUTRON ACER TENDL-2021 LIBRARY; T=293.6K  
tritons from (n,n\*)t

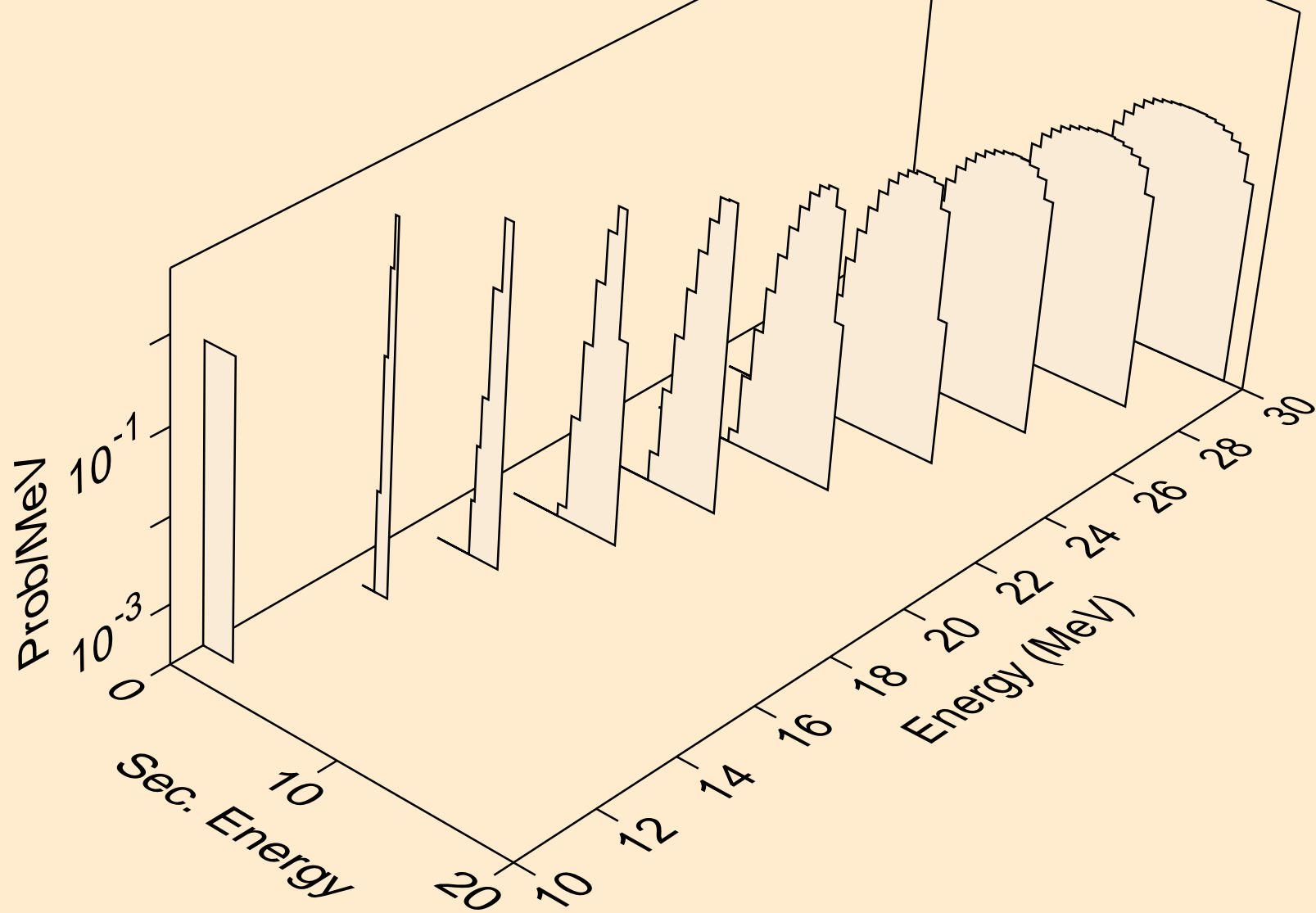

RE192 NEUTRON ACER TENDL-2021 LIBRARY; T=293.6K  
tritons from (n,t)

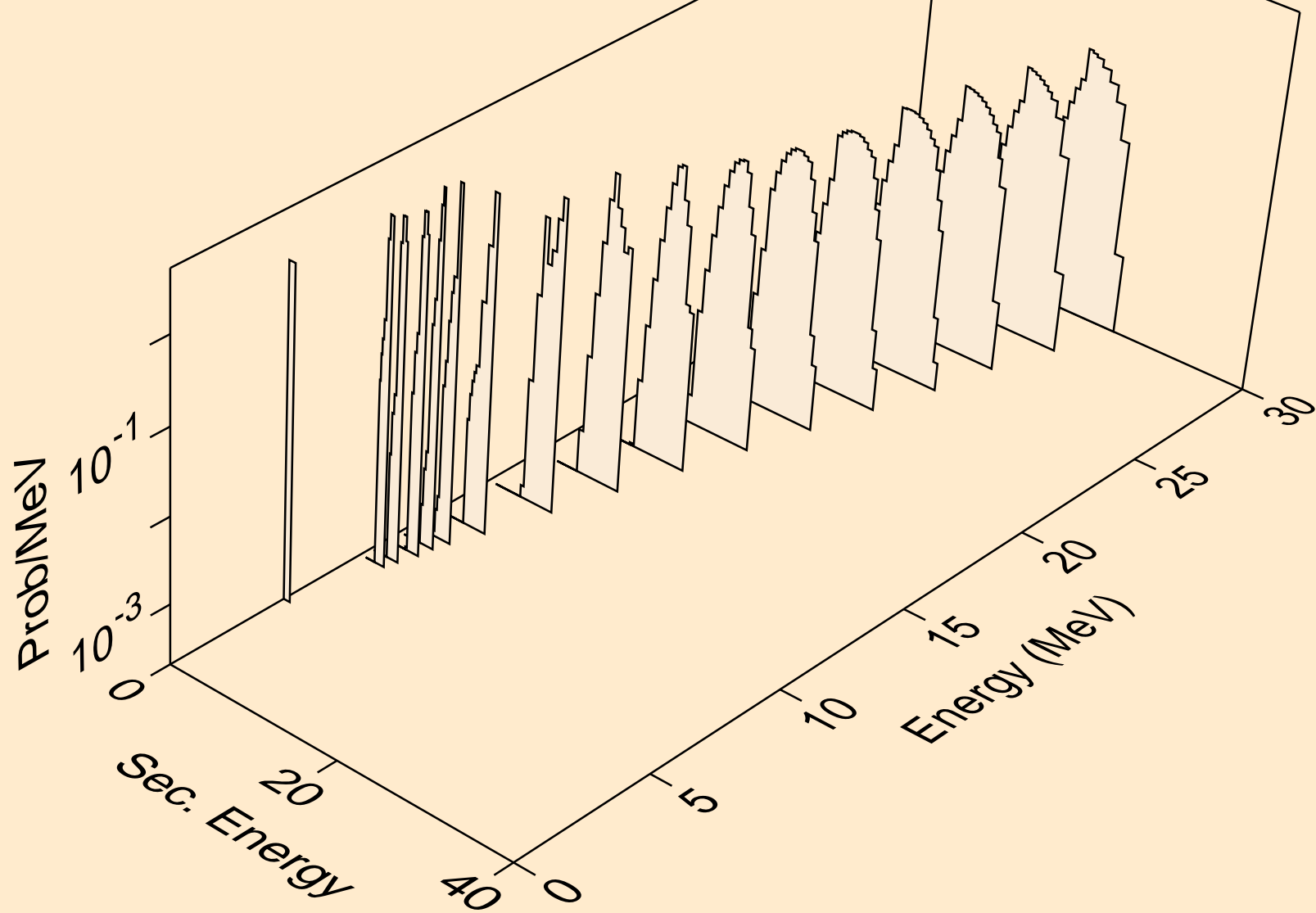

RE192 NEUTRON ACER TENDL-2021 LIBRARY; T=293.6K  
he3s from (n,x)

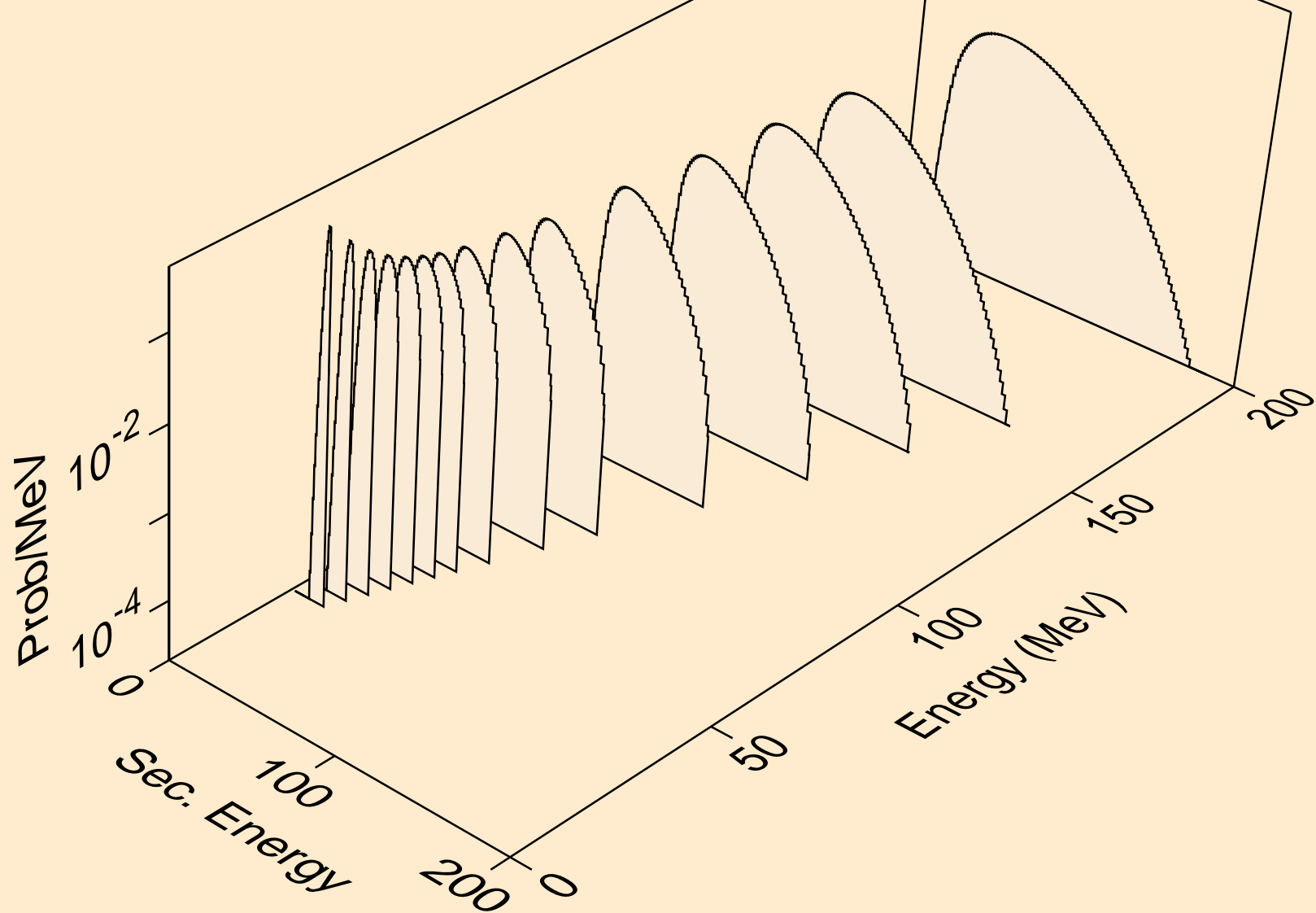

RE192 NEUTRON ACER TENDL-2021 LIBRARY; T=293.6K  
he3s from (n,n\*)he3

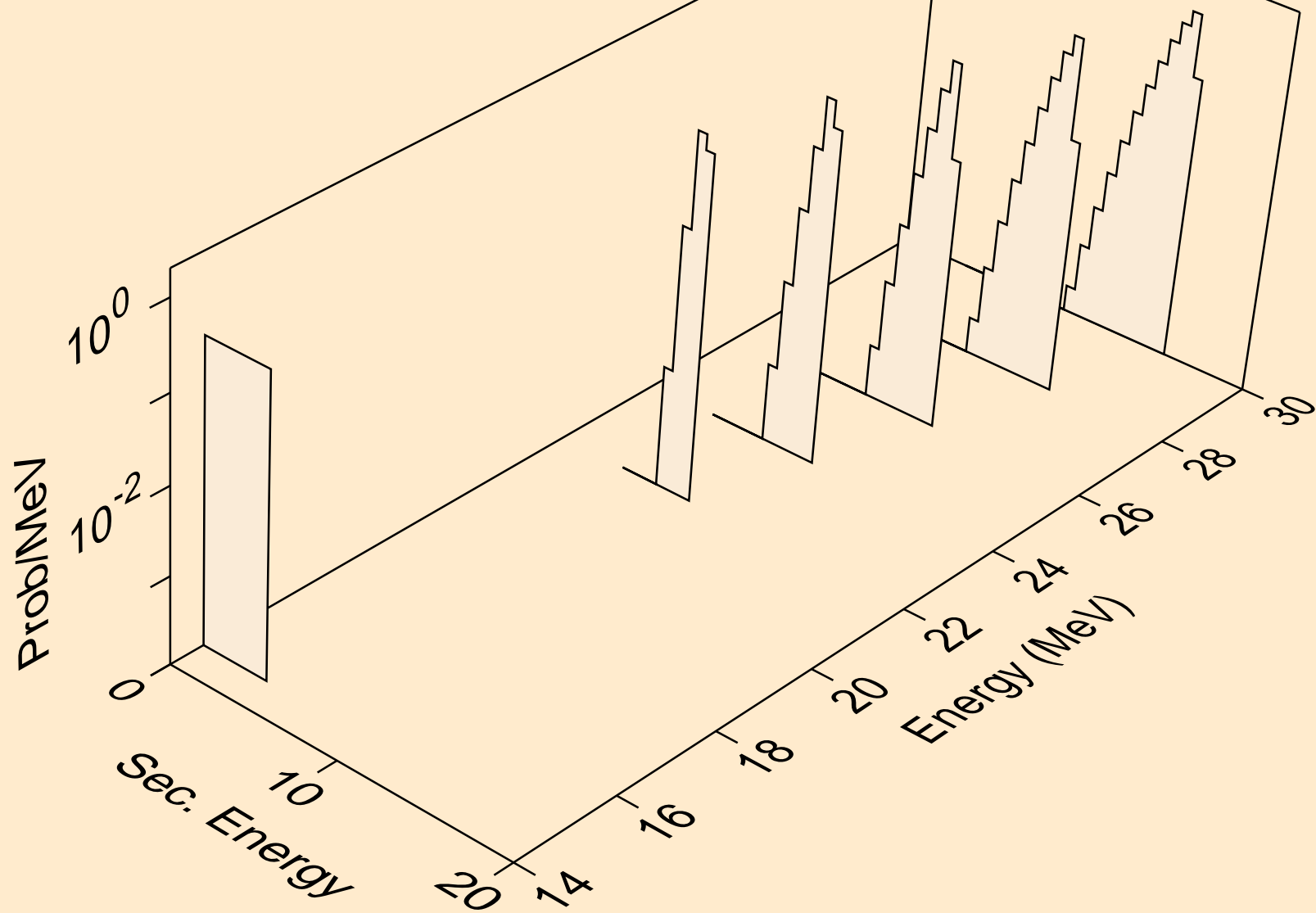

RE192 NEUTRON ACER TENDL-2021 LIBRARY; T=293.6K  
he3s from (n,he3)

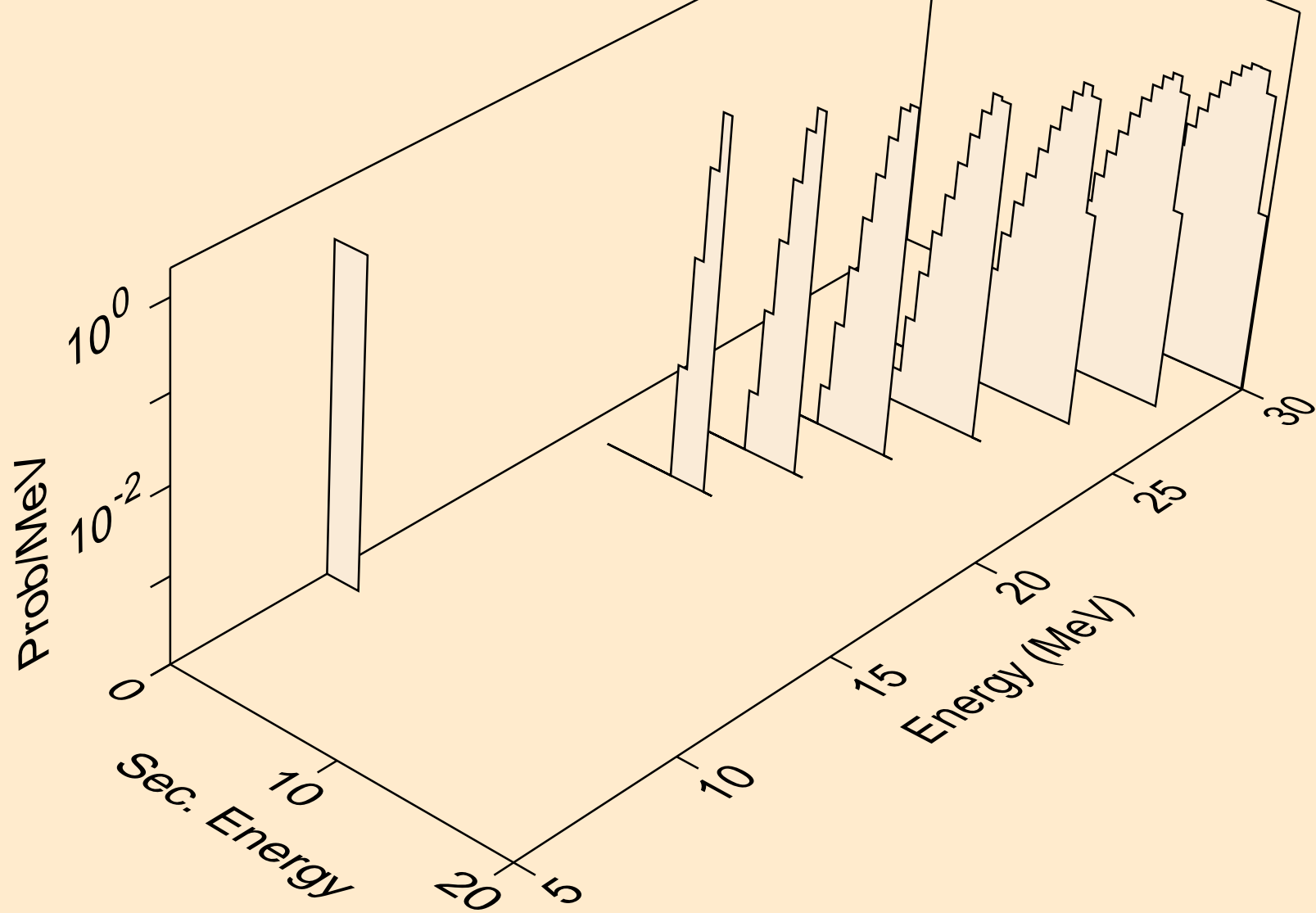

RE192 NEUTRON ACER TENDL-2021 LIBRARY; T=293.6K  
alphas from (n,x)

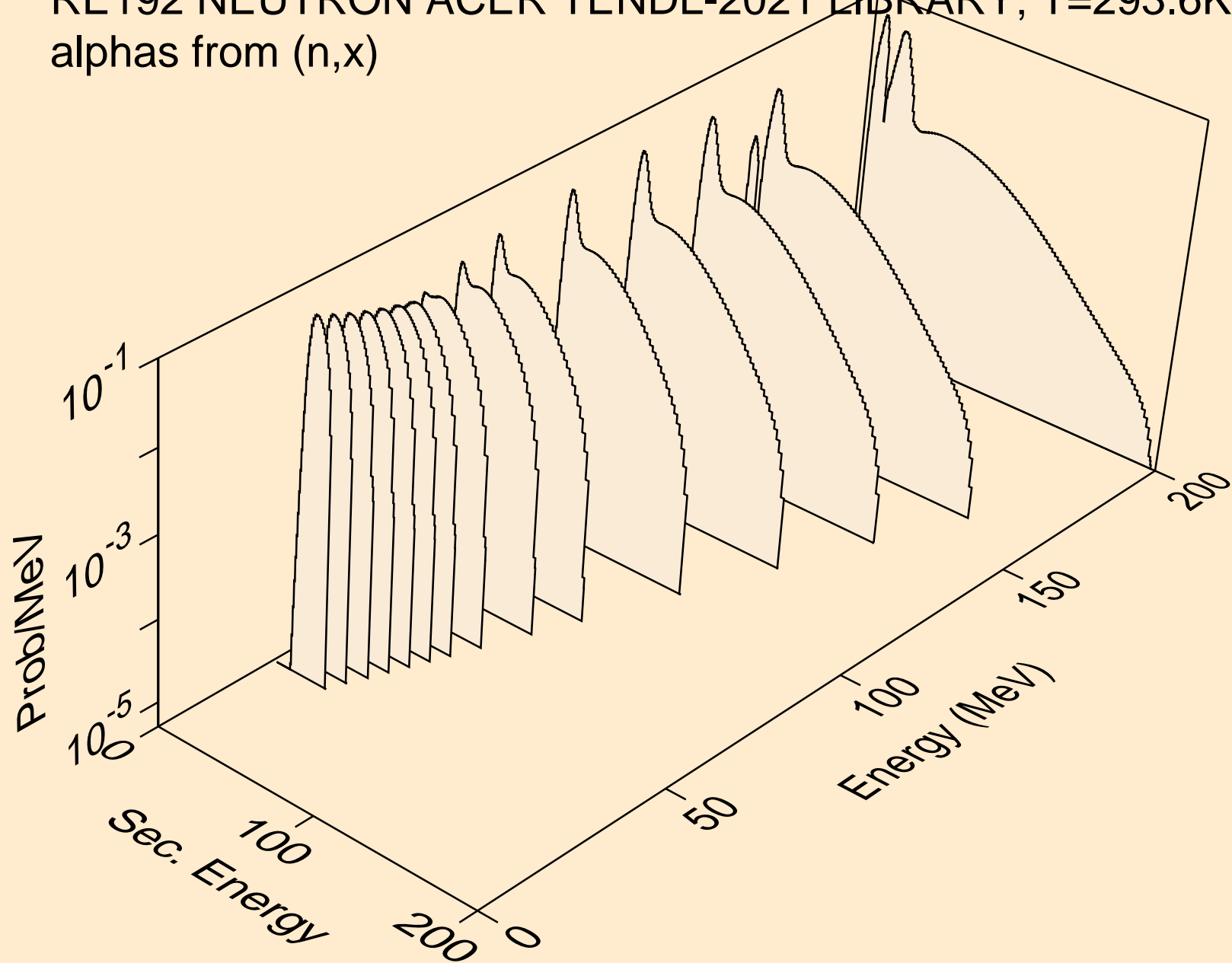

RE192 NEUTRON ACER TENDL-2021 LIBRARY; T=293.6K  
alphas from (n,n\*)a

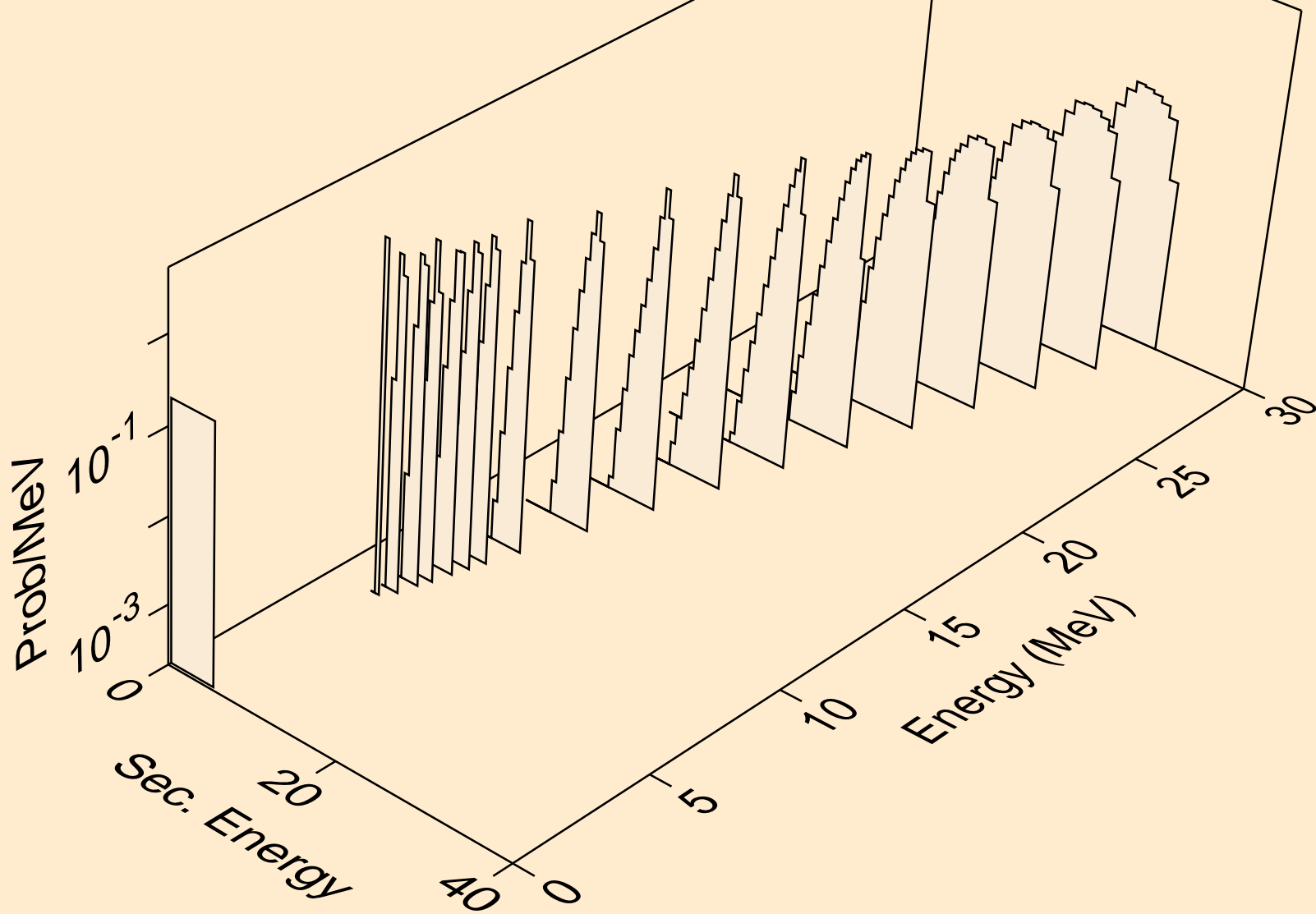



RE192 NEUTRON ACER TENDL-2021 LIBRARY; T=293.6K  
alphas from (n,2n)a

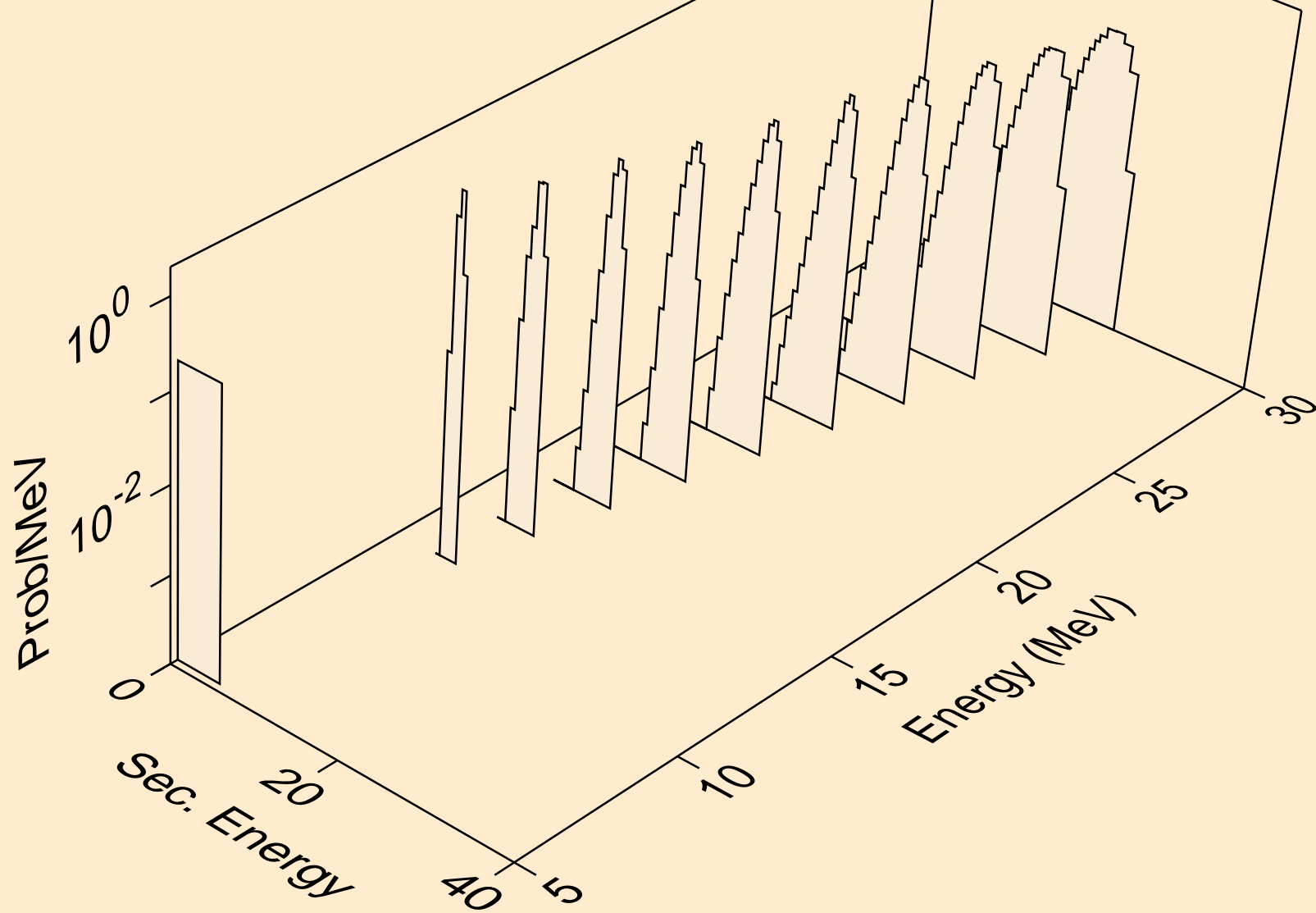

RE192 NEUTRON ACER TENDL-2021 LIBRARY; T=293.6K  
alphas from (n,3n)a

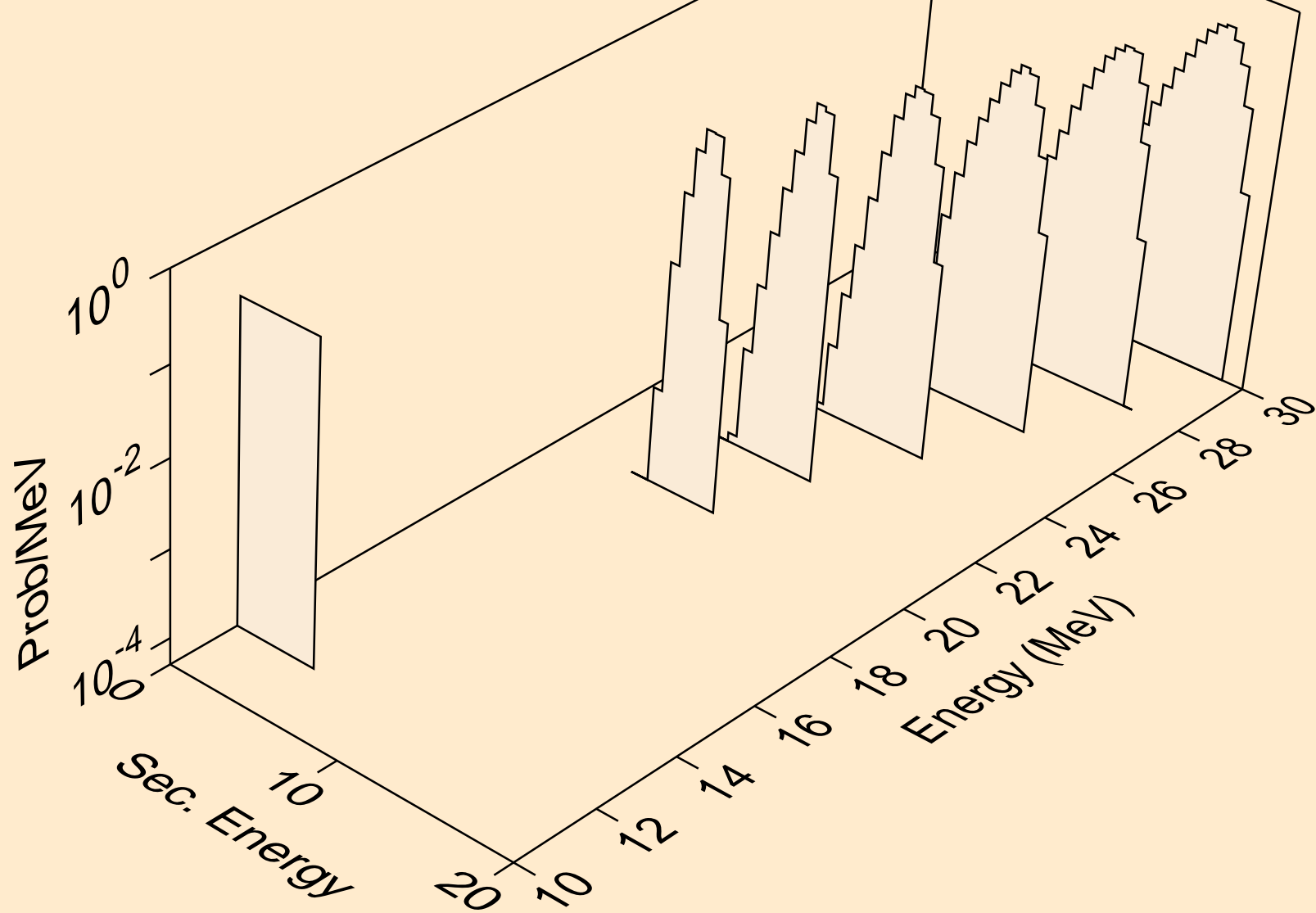

RE192 NEUTRON ACER TENDL-2021 LIBRARY; T=293.6K  
alphas from (n,a)

