

RF263 NEUTRON ACER TENDL-2021 LIBRARY; T=293.6K

Principal cross sections

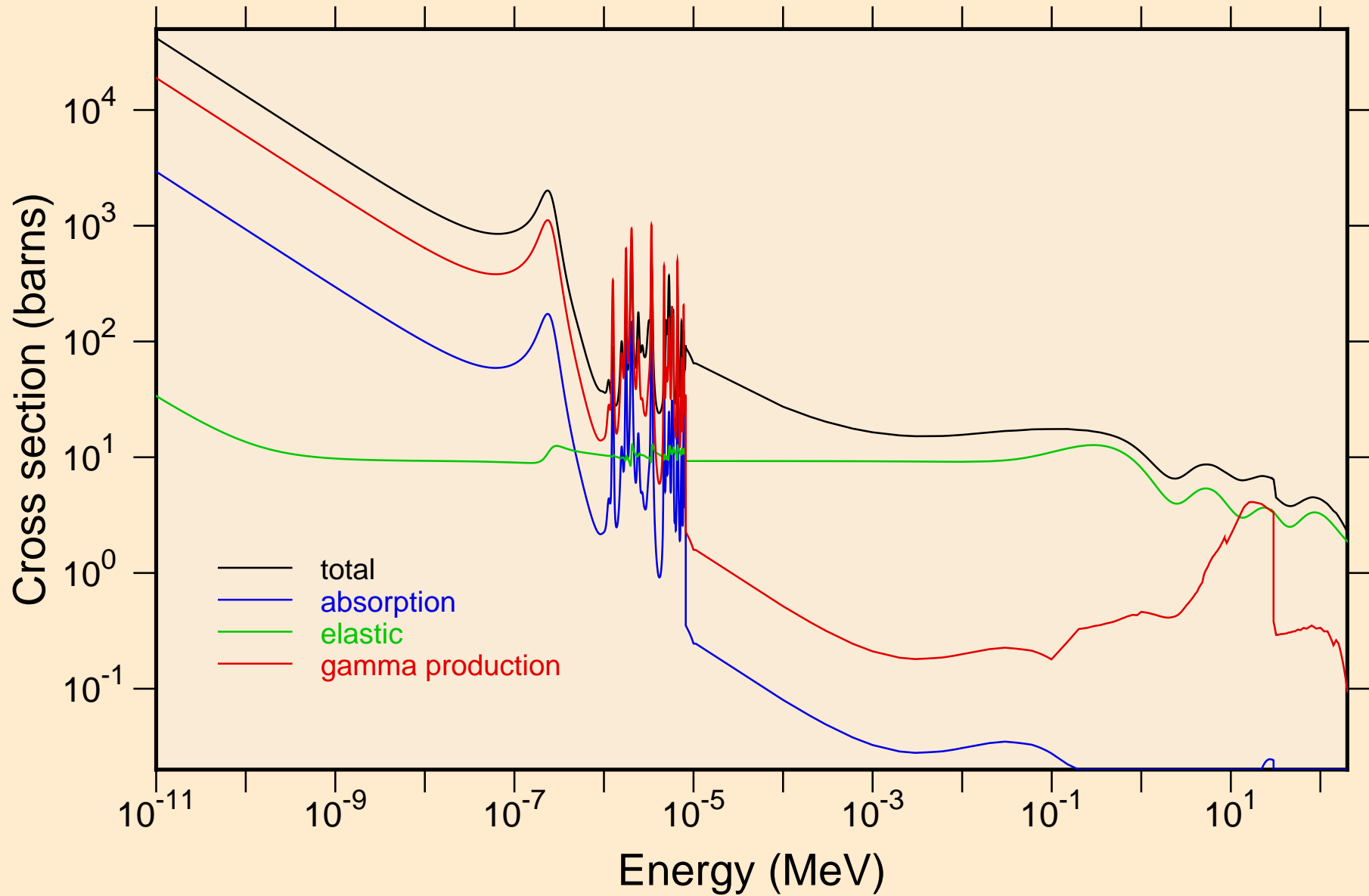

RF263 NEUTRON ACER TENDL-2021 LIBRARY; T=293.6K
resonance total cross section

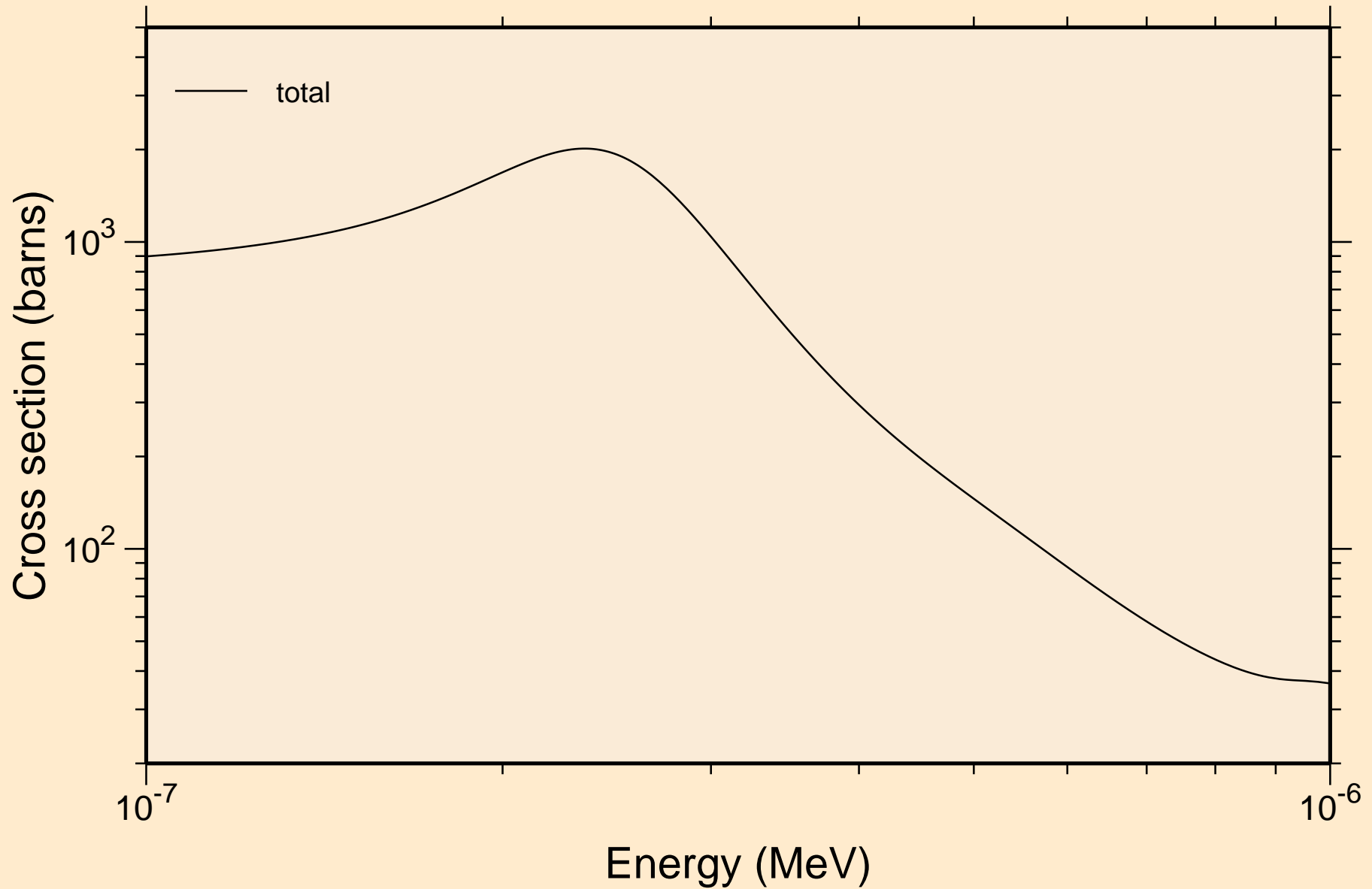

RF263 NEUTRON ACER TENDL-2021 LIBRARY; T=293.6K
resonance total cross section

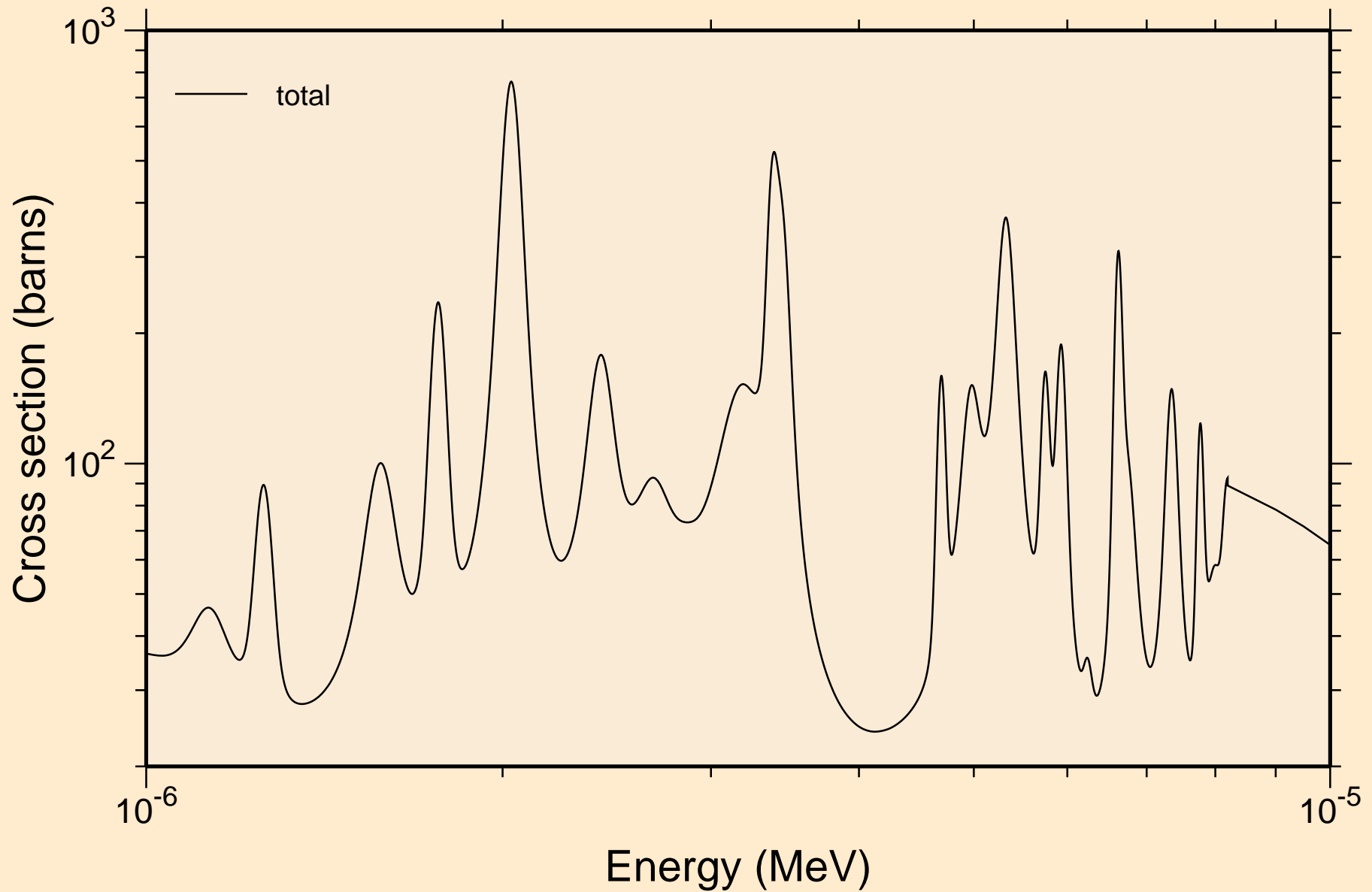

RF263 NEUTRON ACER TENDL-2021 LIBRARY; T=293.6K
resonance total cross section

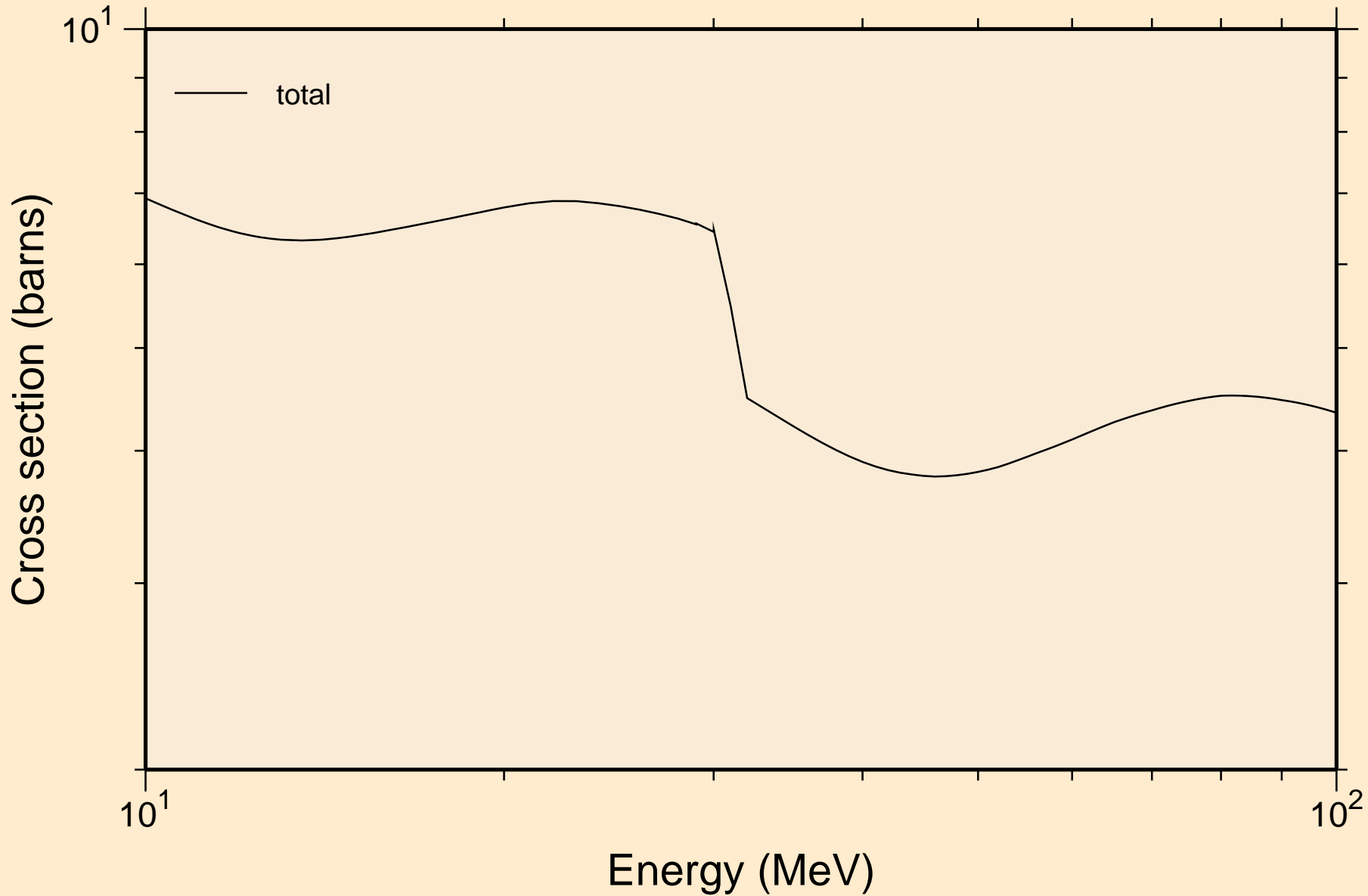

RF263 NEUTRON ACER TENDL-2021 LIBRARY; T=293.6K
resonance absorption cross sections

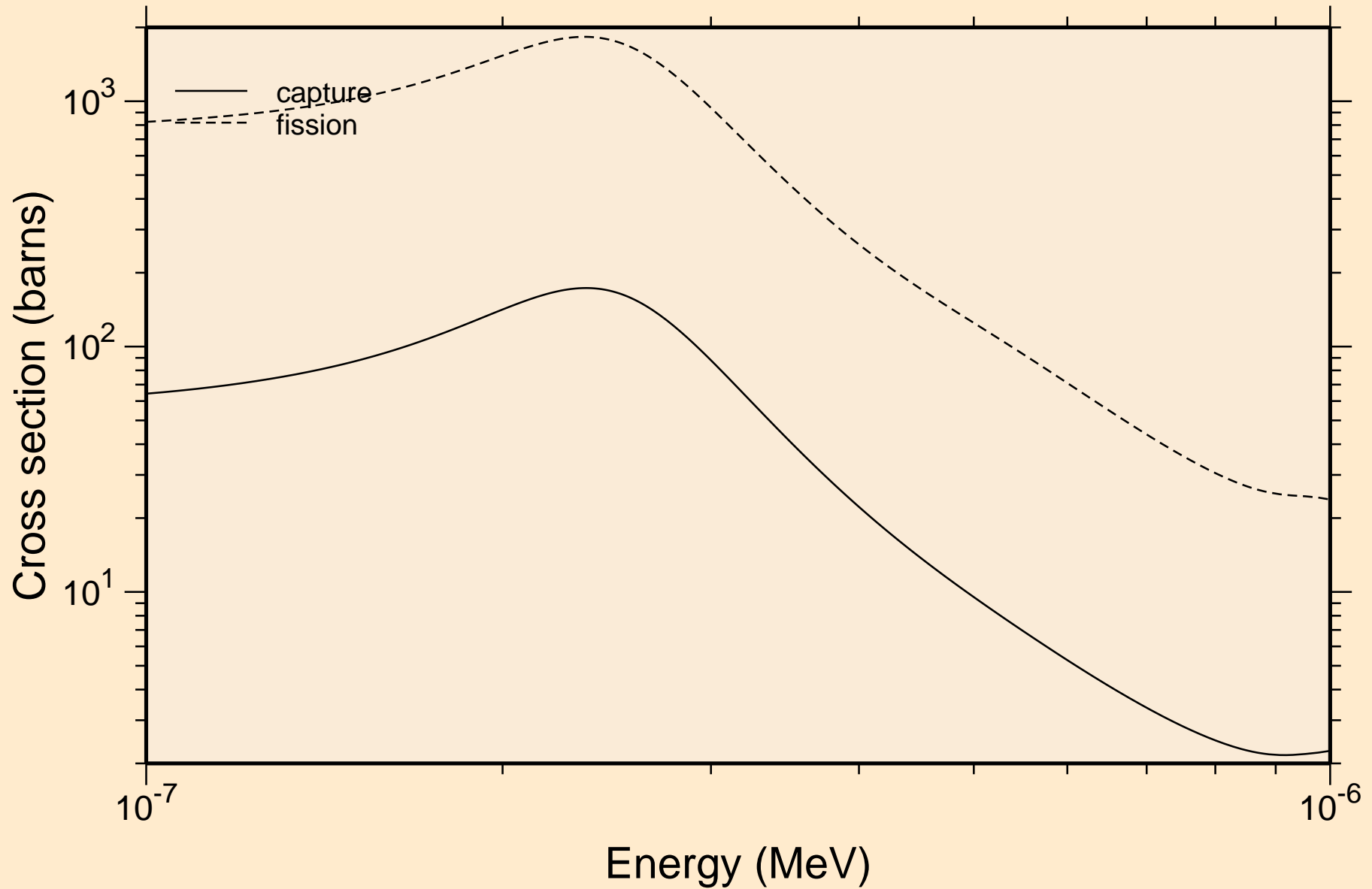

RF263 NEUTRON ACER TENDL-2021 LIBRARY; T=293.6K
resonance absorption cross sections

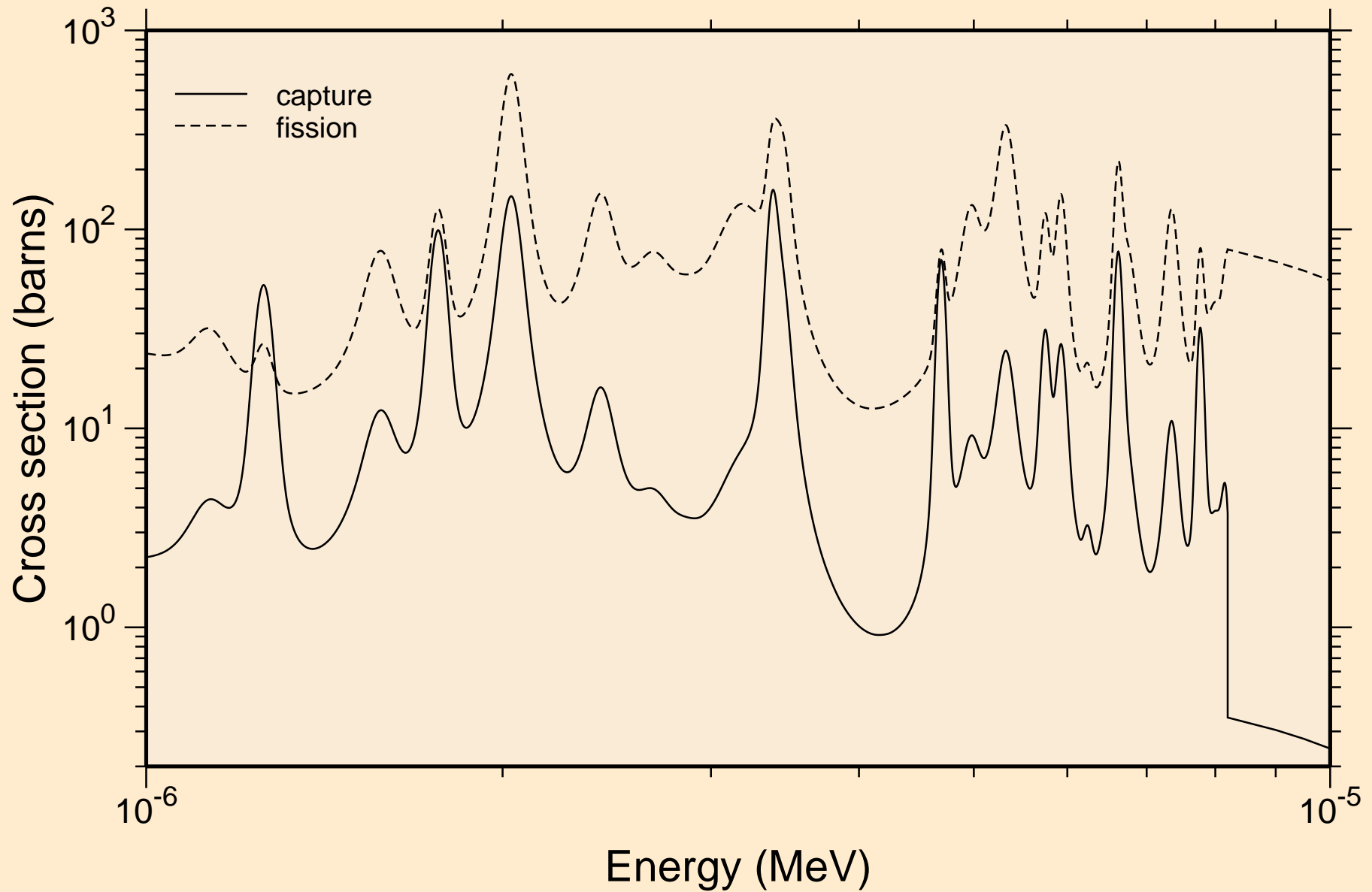

RF263 NEUTRON ACER TENDL-2021 LIBRARY; T=293.6K
resonance absorption cross sections

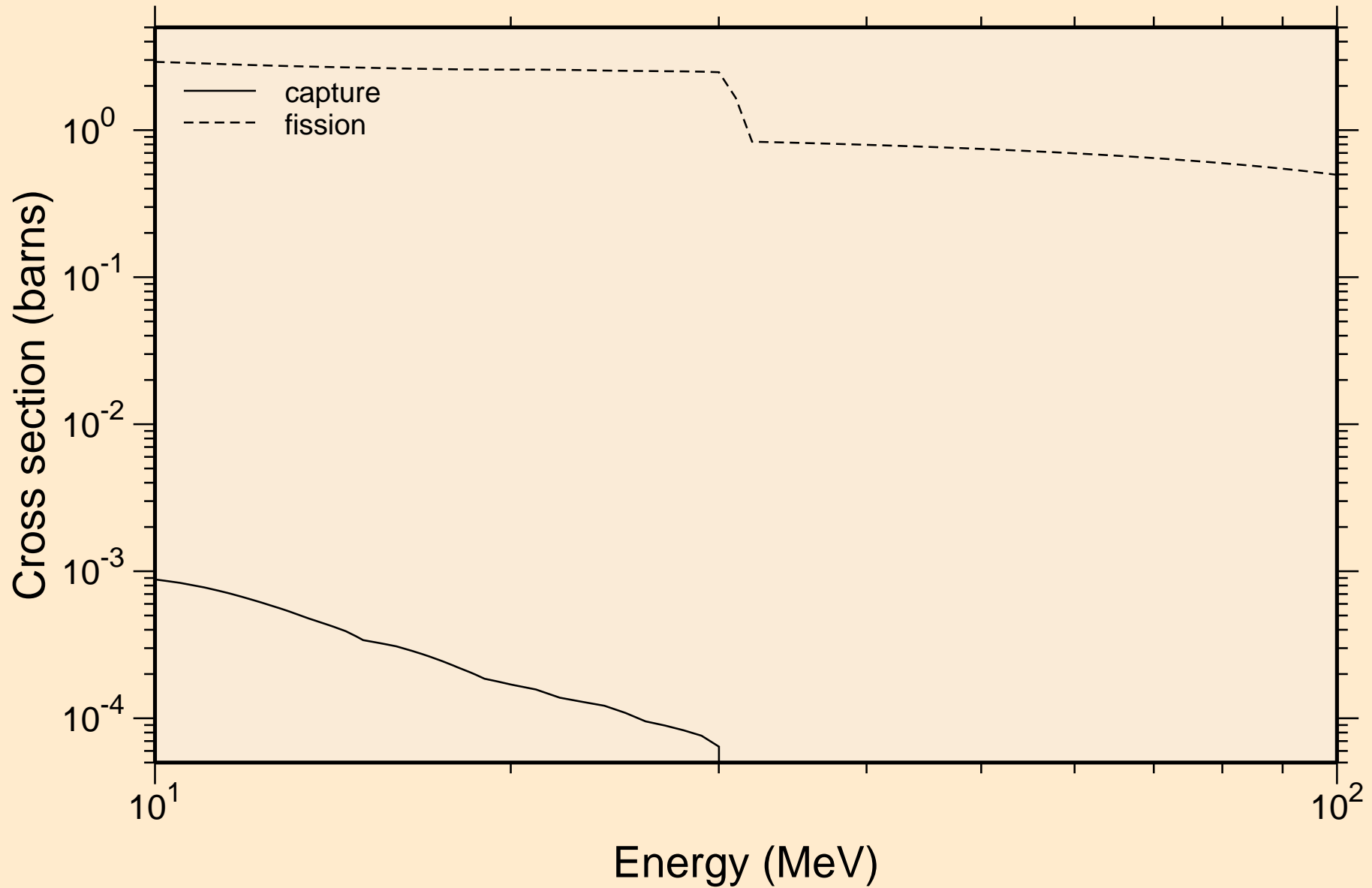

RF263 NEUTRON ACER TENDL-2021 LIBRARY; T=293.6K
Heating

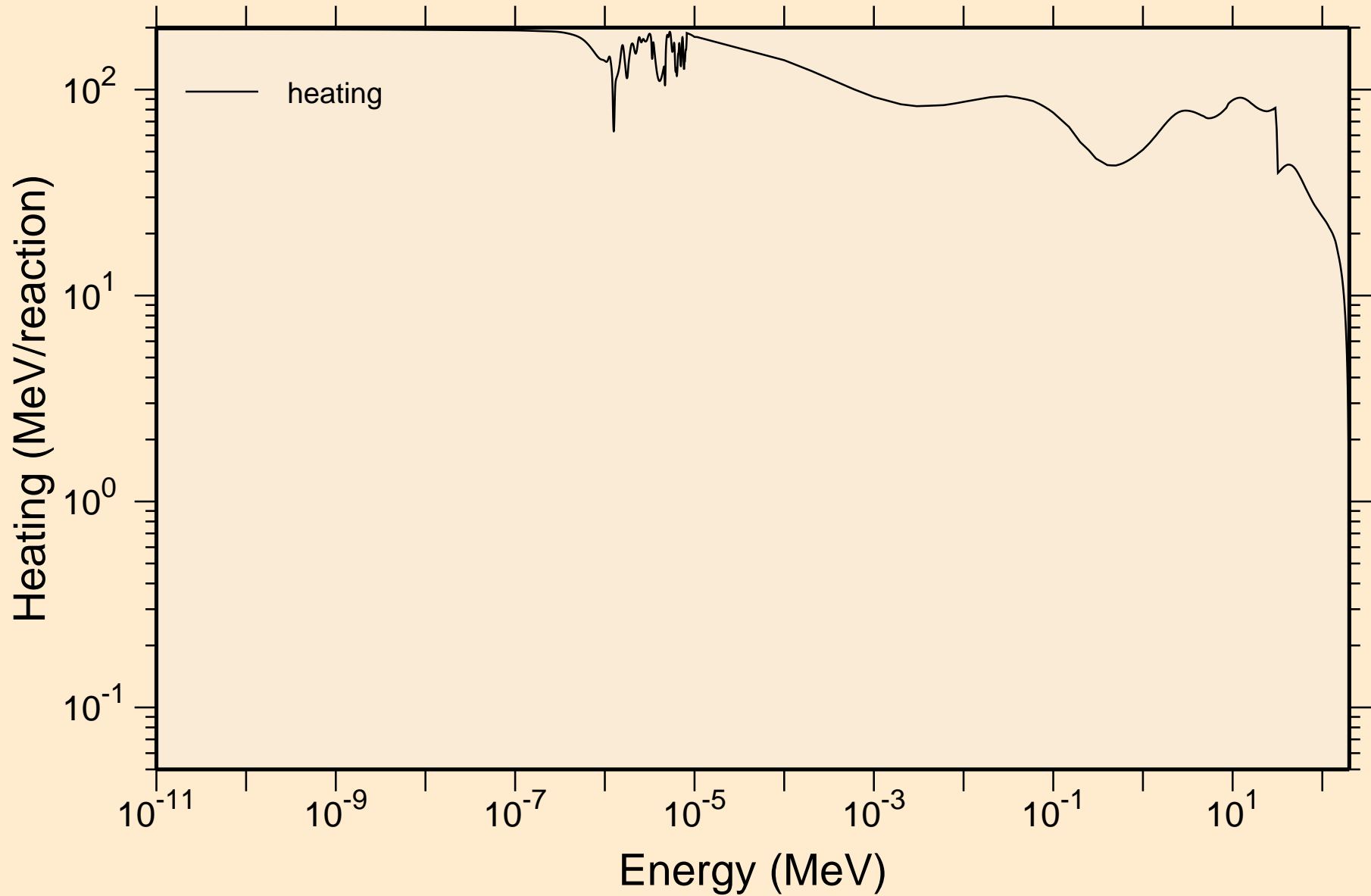

RF263 NEUTRON ACER TENDL-2021 LIBRARY; T=293.6K
Damage

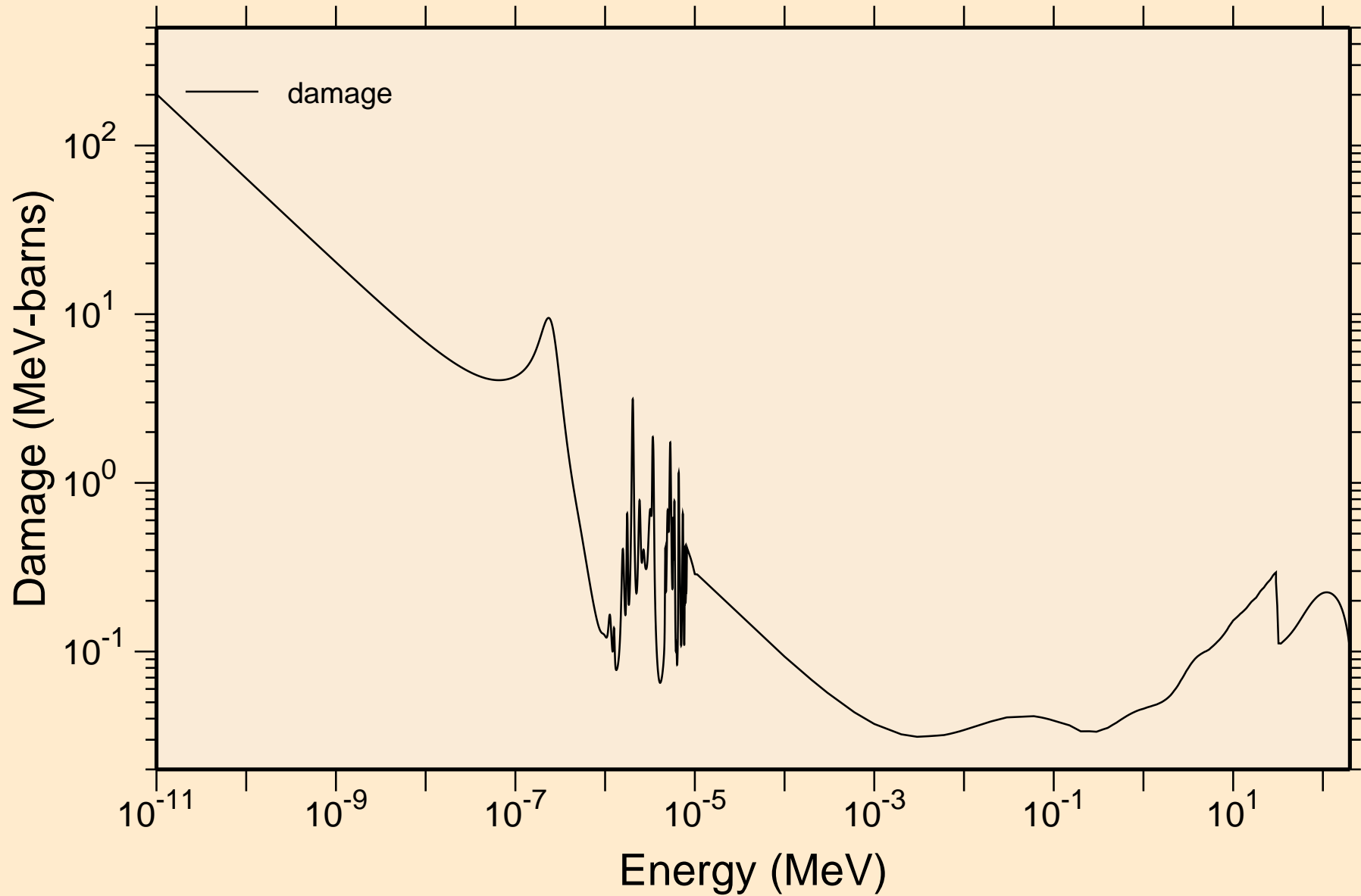

RF263 NEUTRON ACER TENDL-2021 LIBRARY; T=293.6K

Non-threshold reactions

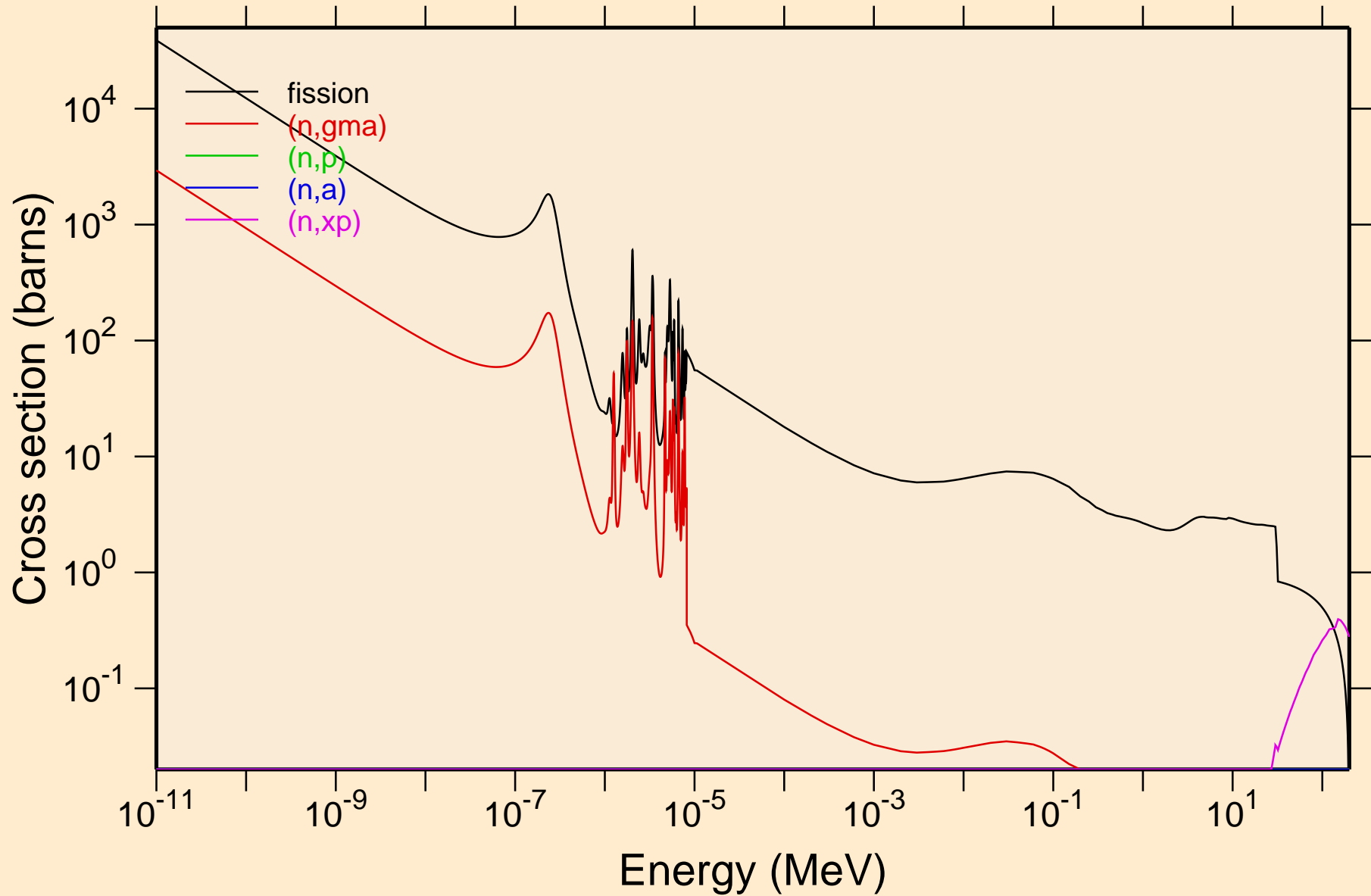

RF263 NEUTRON ACER TENDL-2021 LIBRARY; T=293.6K
Non-threshold reactions

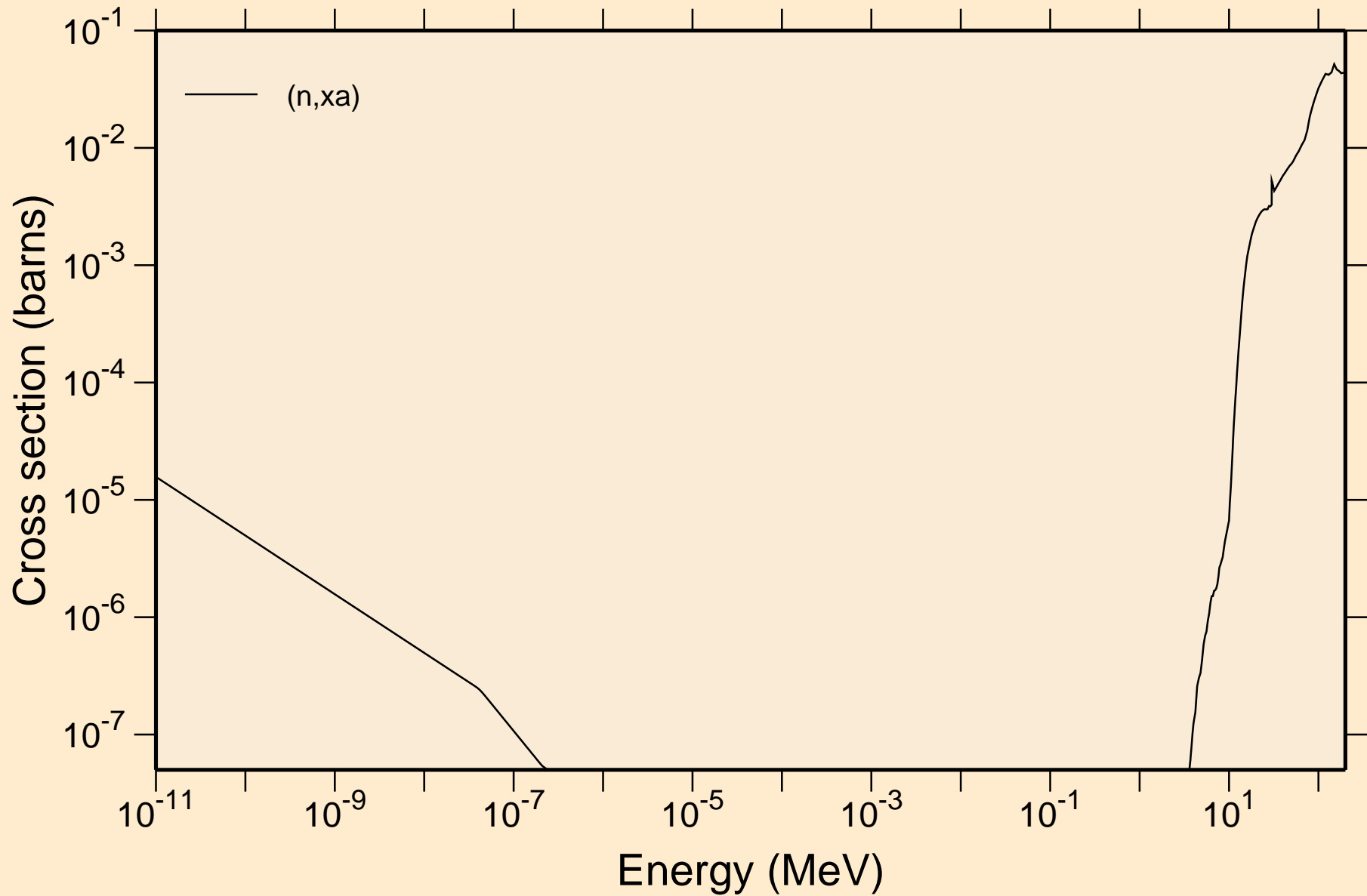

RF263 NEUTRON ACER TENDL-2021 LIBRARY; T=293.6K
Principal cross sections

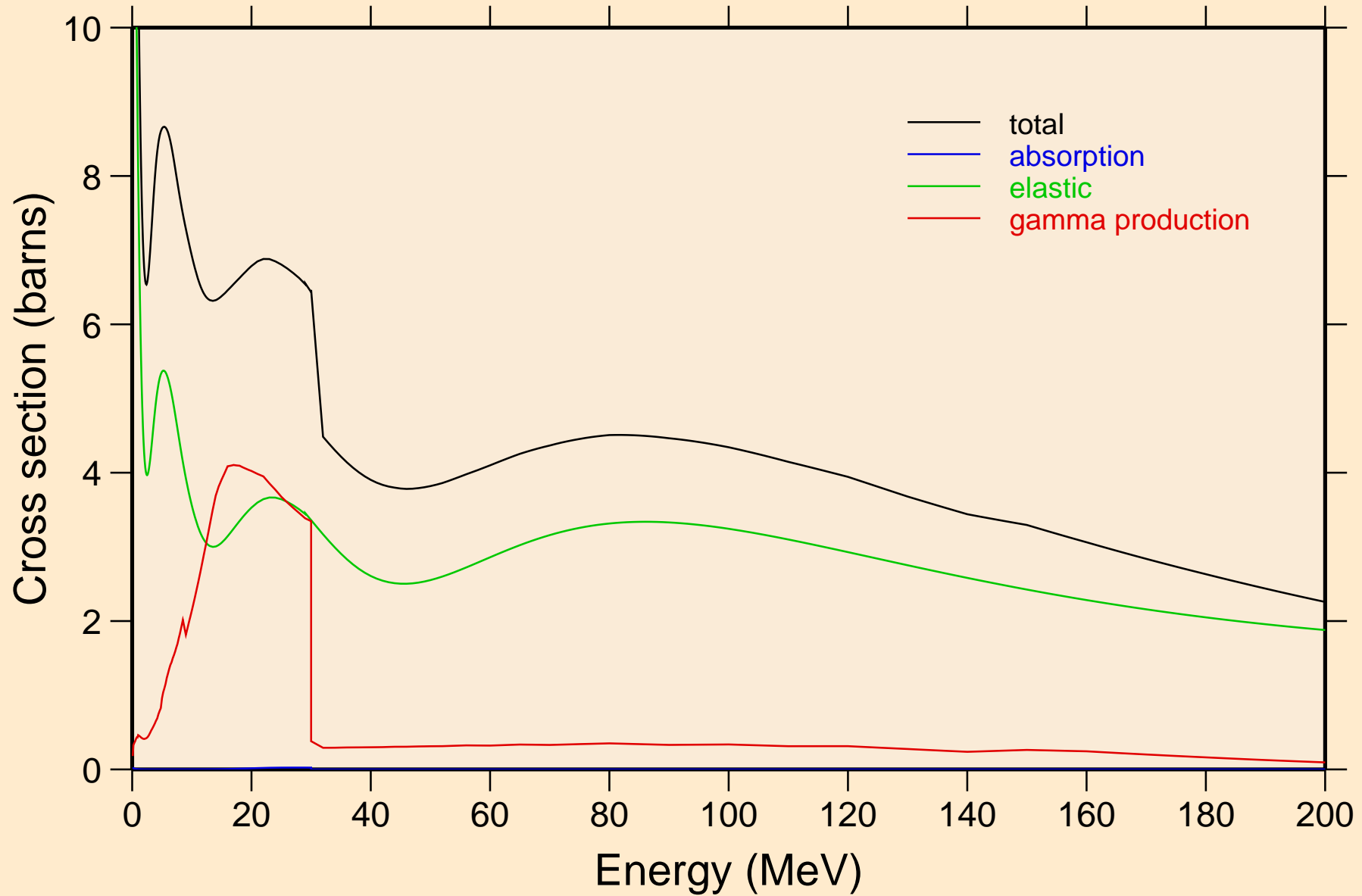

RF263 NEUTRON ACER TENDL-2021 LIBRARY; T=293.6K
Heating

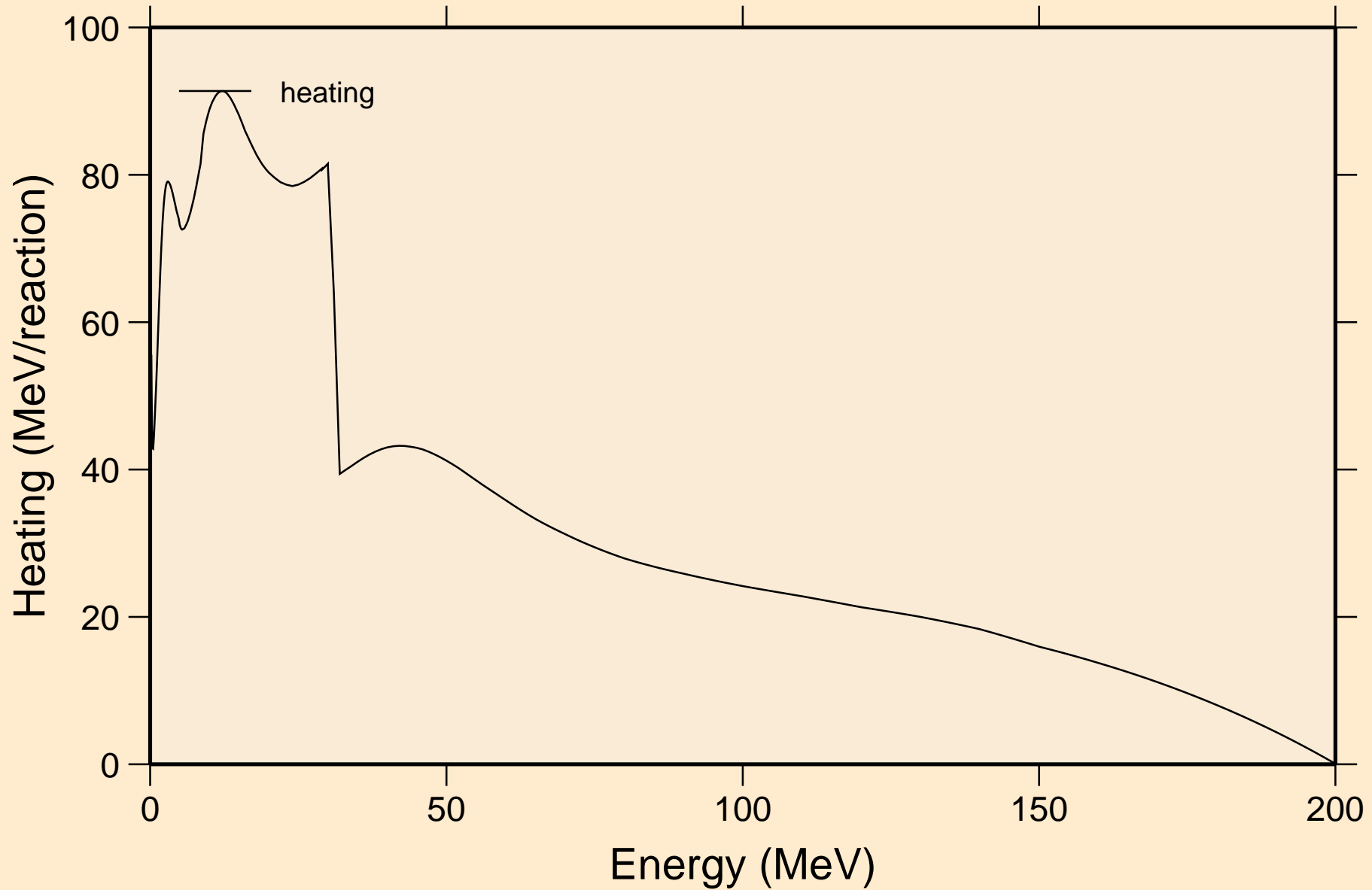

RF263 NEUTRON ACER TENDL-2021 LIBRARY; T=293.6K
Damage

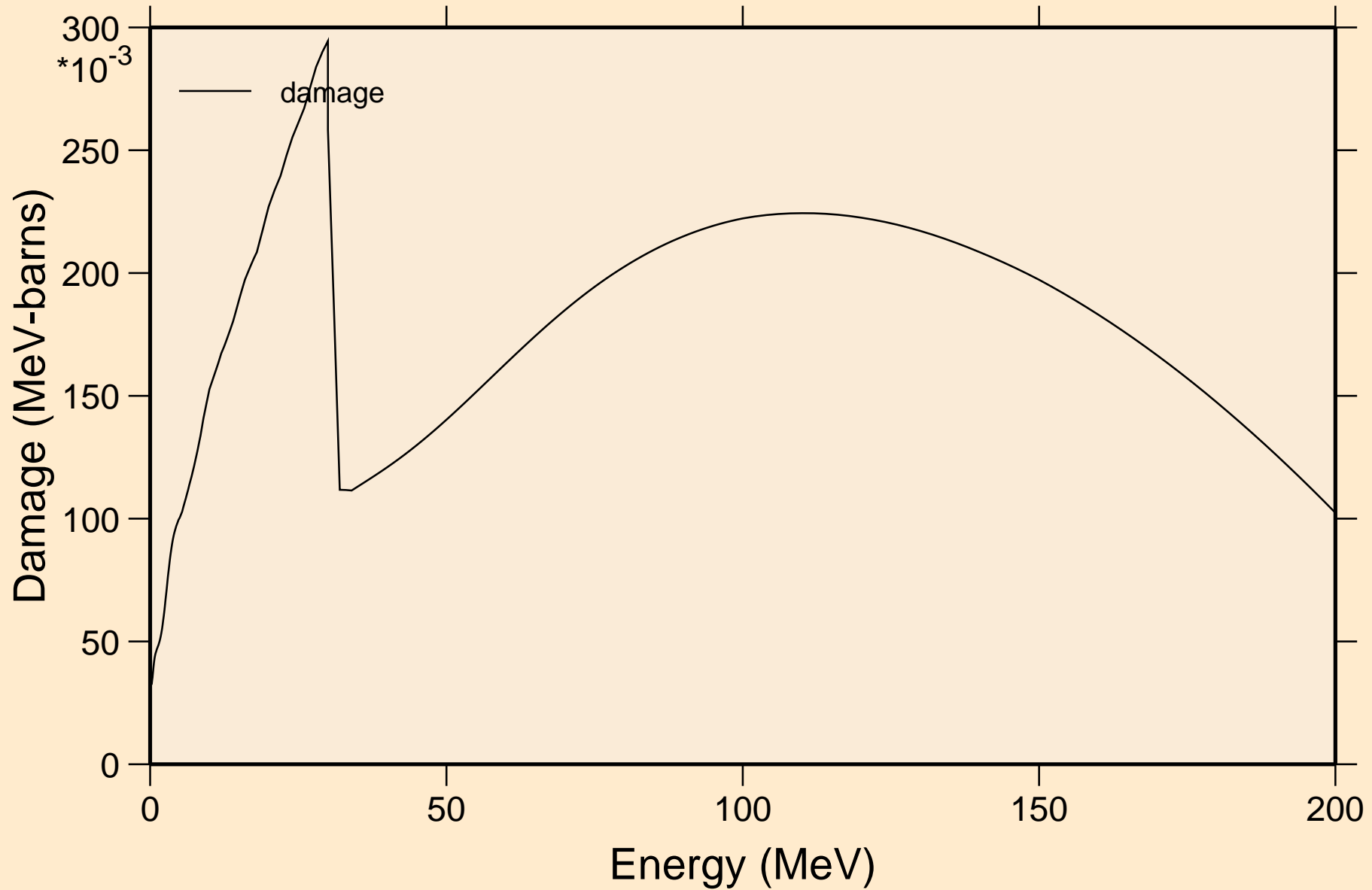

RF263 NEUTRON ACER TENDL-2021 LIBRARY; T=293.6K

Non-threshold reactions

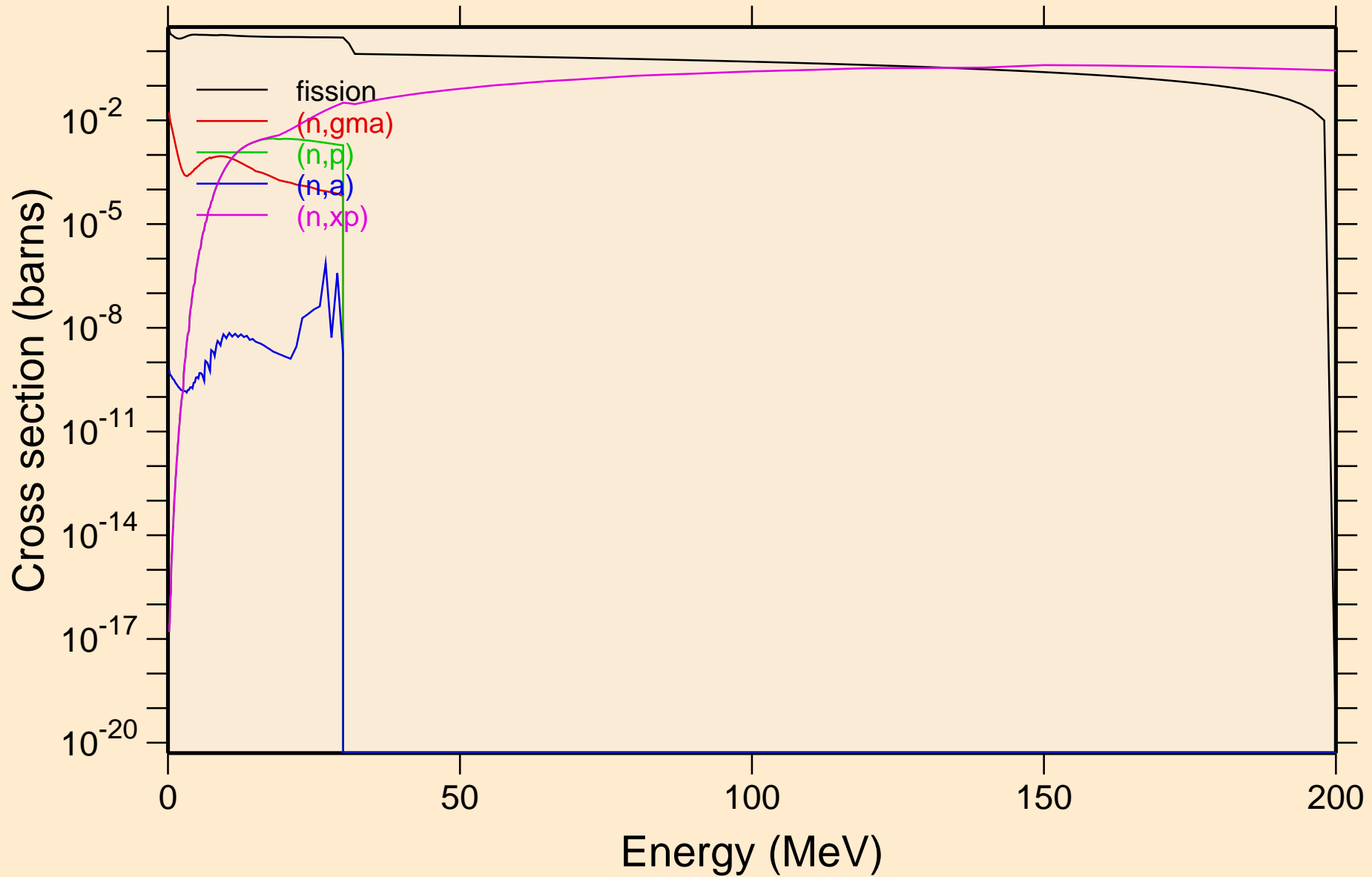

RF263 NEUTRON ACER TENDL-2021 LIBRARY; T=293.6K
Non-threshold reactions

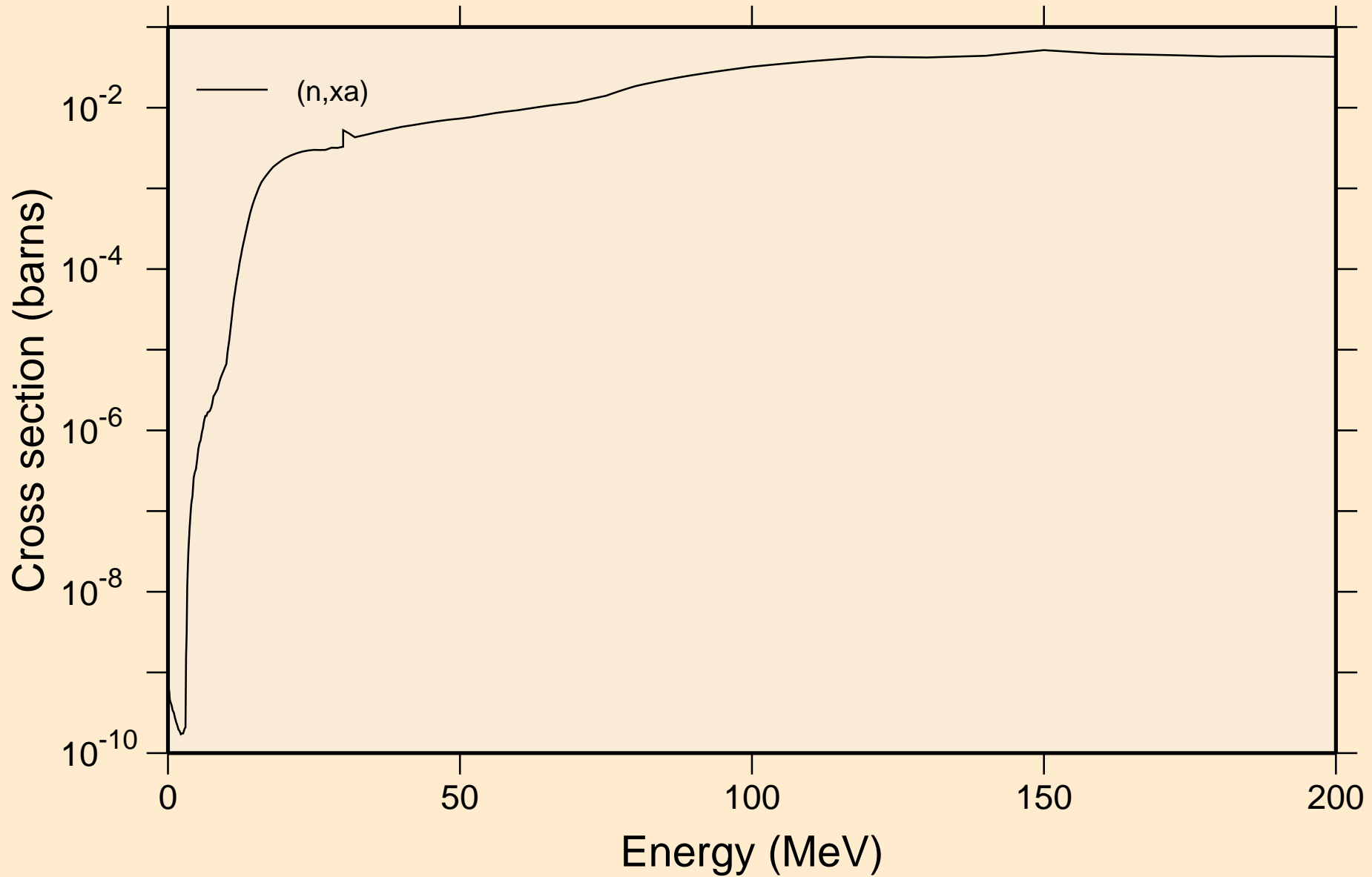

RF263 NEUTRON ACER TENDL-2021 LIBRARY; T=293.6K
Inelastic levels

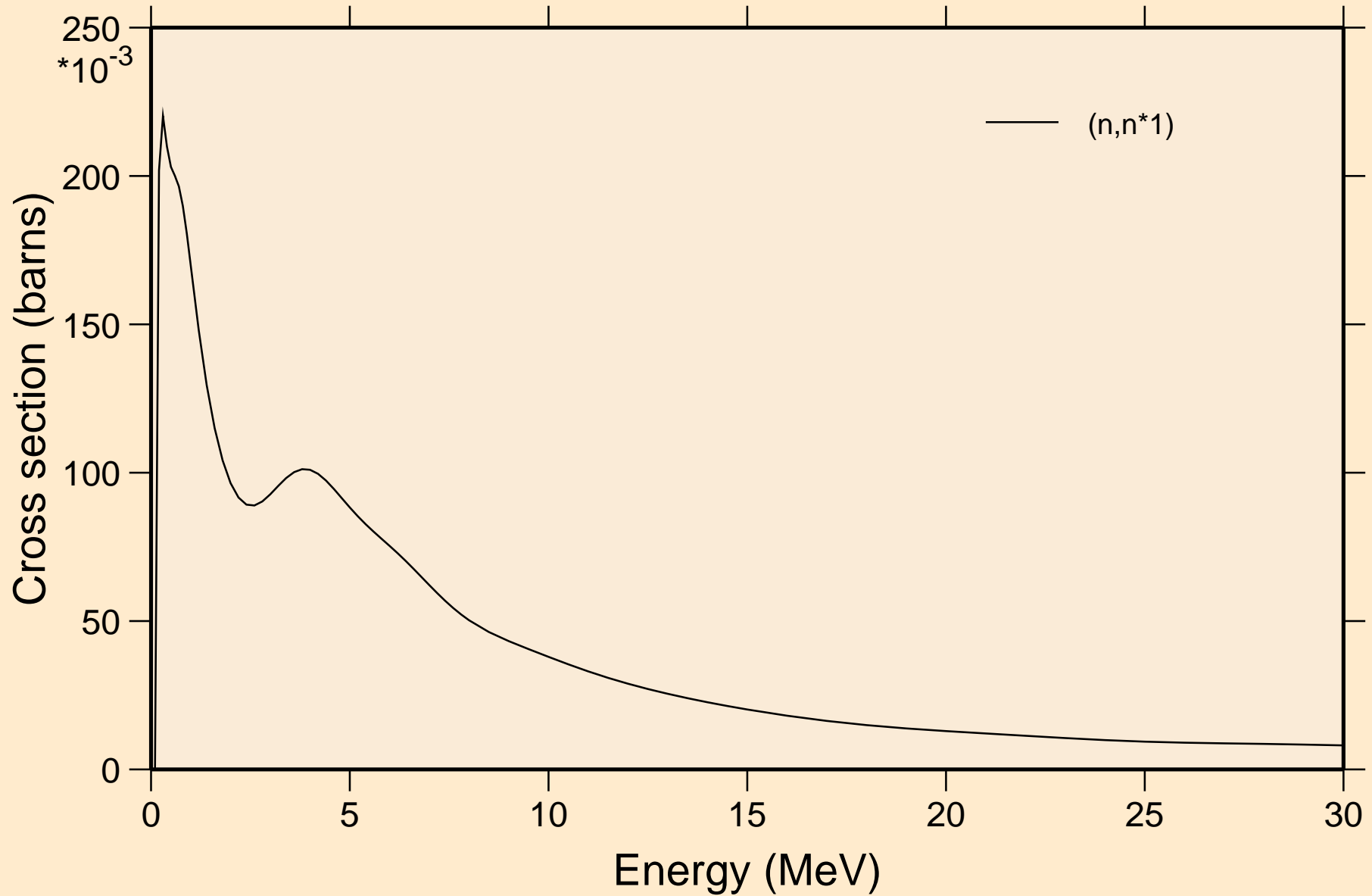

RF263 NEUTRON ACER TENDL-2021 LIBRARY; T=293.6K
Threshold reactions

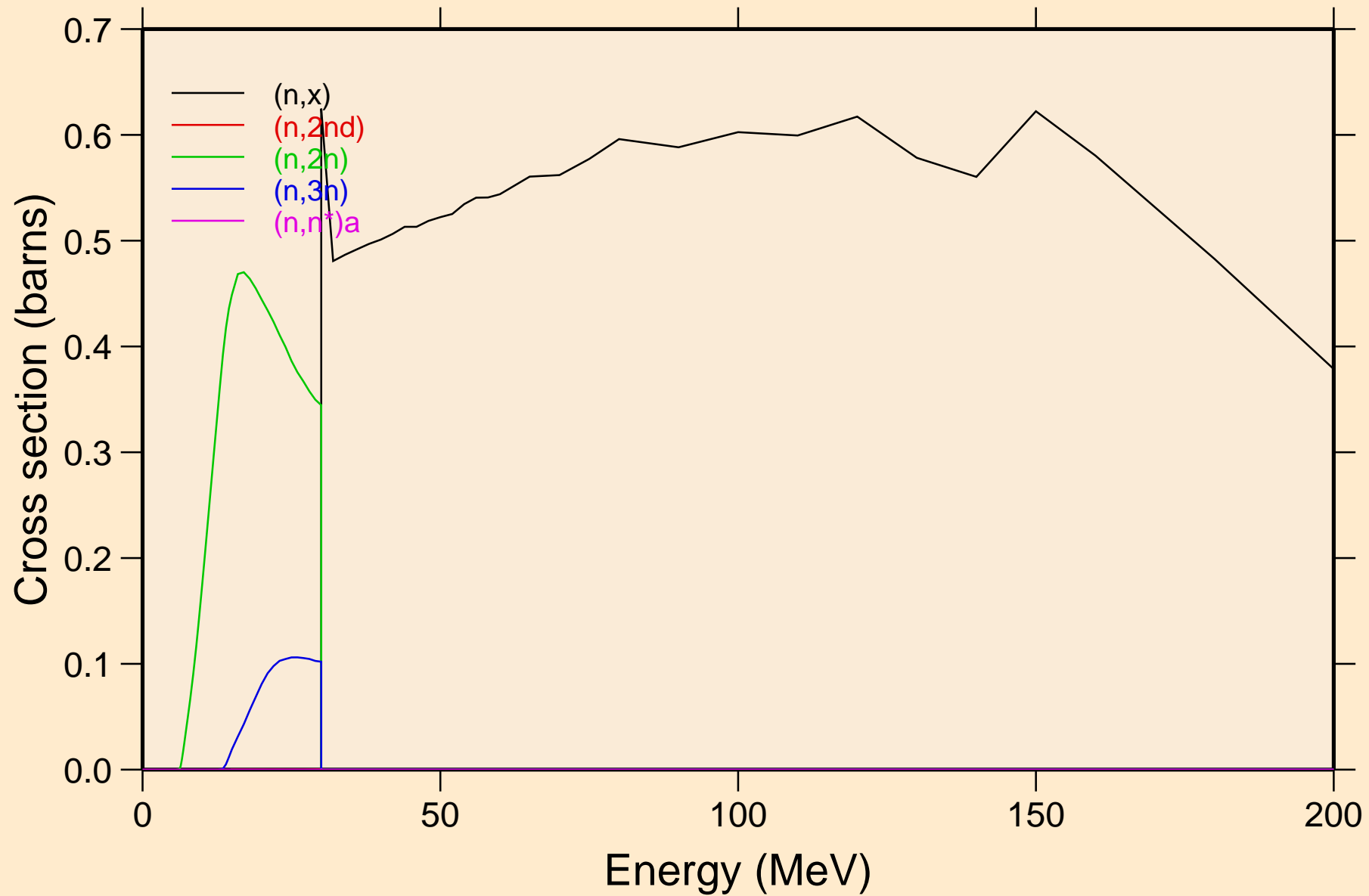

RF263 NEUTRON ACER TENDL-2021 LIBRARY; T=293.6K
Threshold reactions

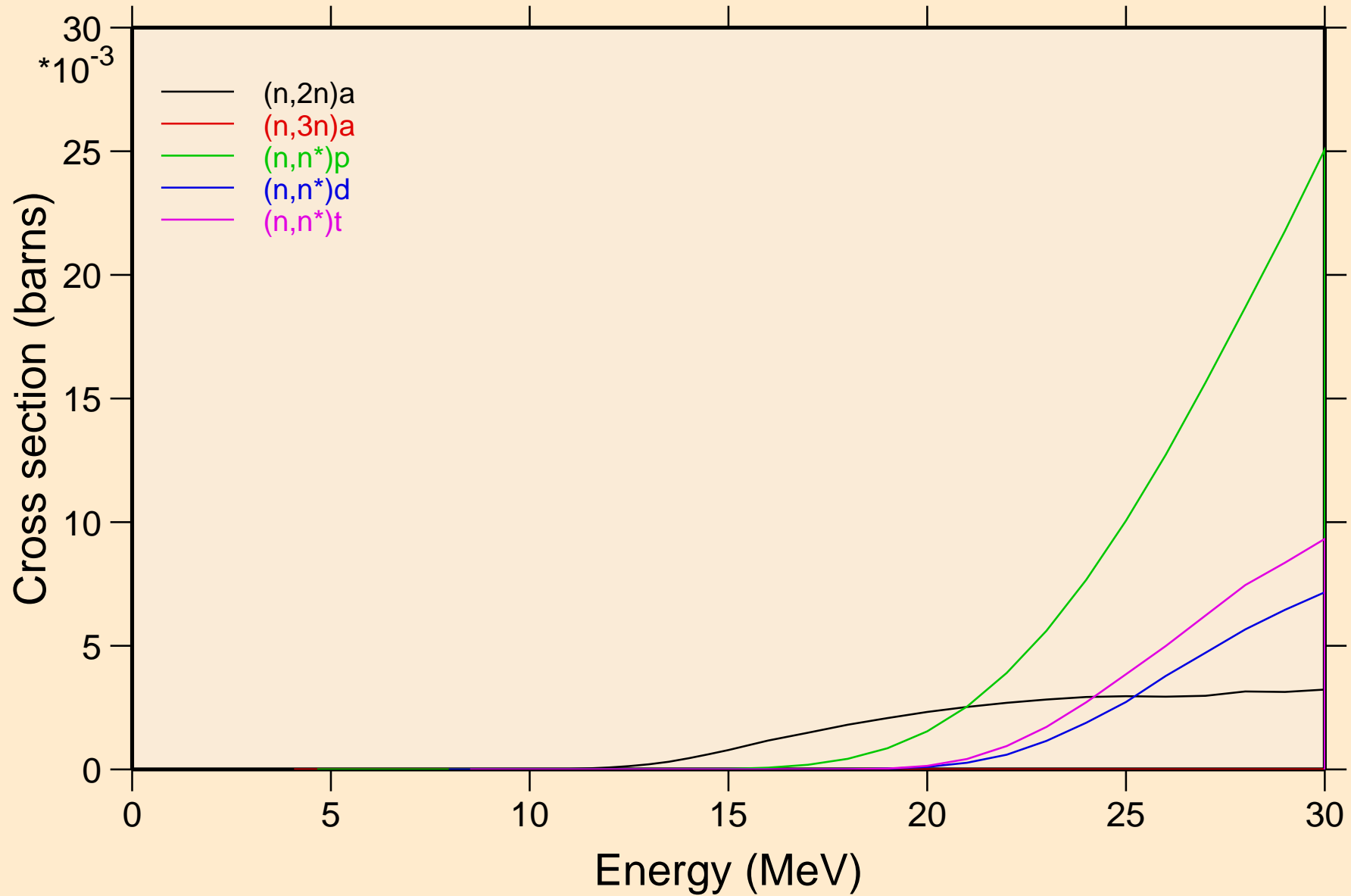

RF263 NEUTRON ACER TENDL-2021 LIBRARY; T=293.6K
Threshold reactions

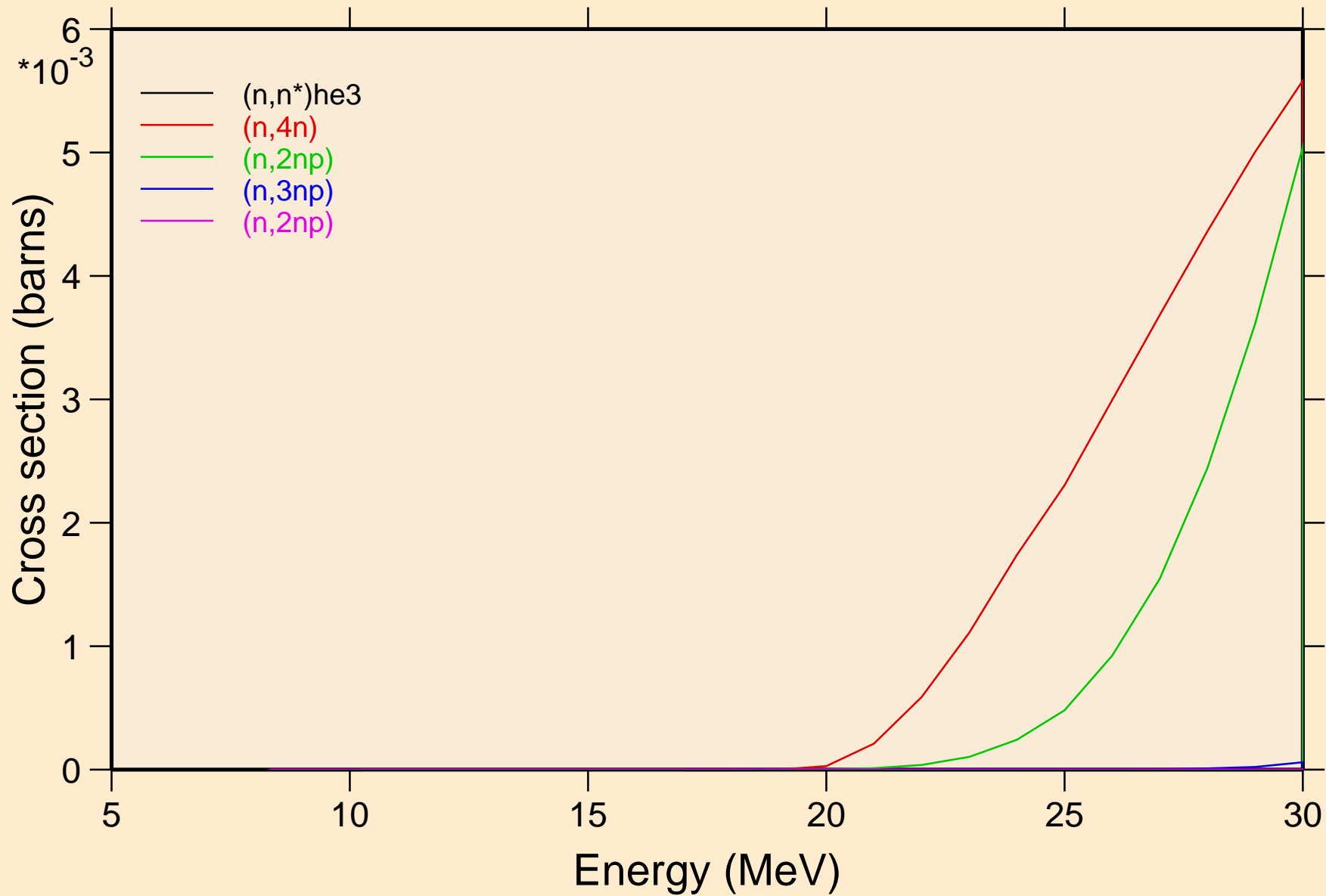

RF263 NEUTRON ACER TENDL-2021 LIBRARY; T=293.6K
Threshold reactions

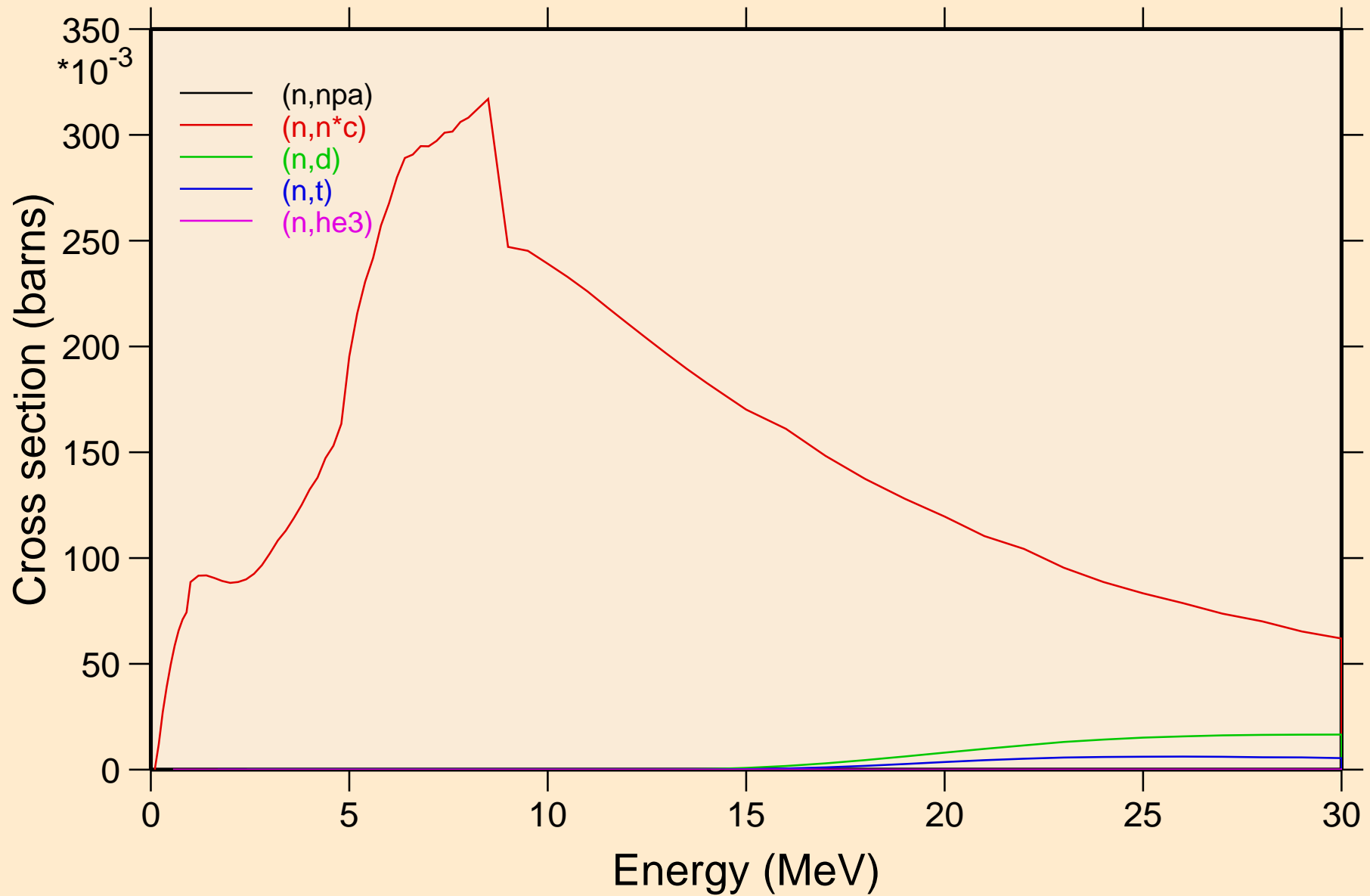

RF263 NEUTRON ACER TENDL-2021 LIBRARY; T=293.6K
Threshold reactions

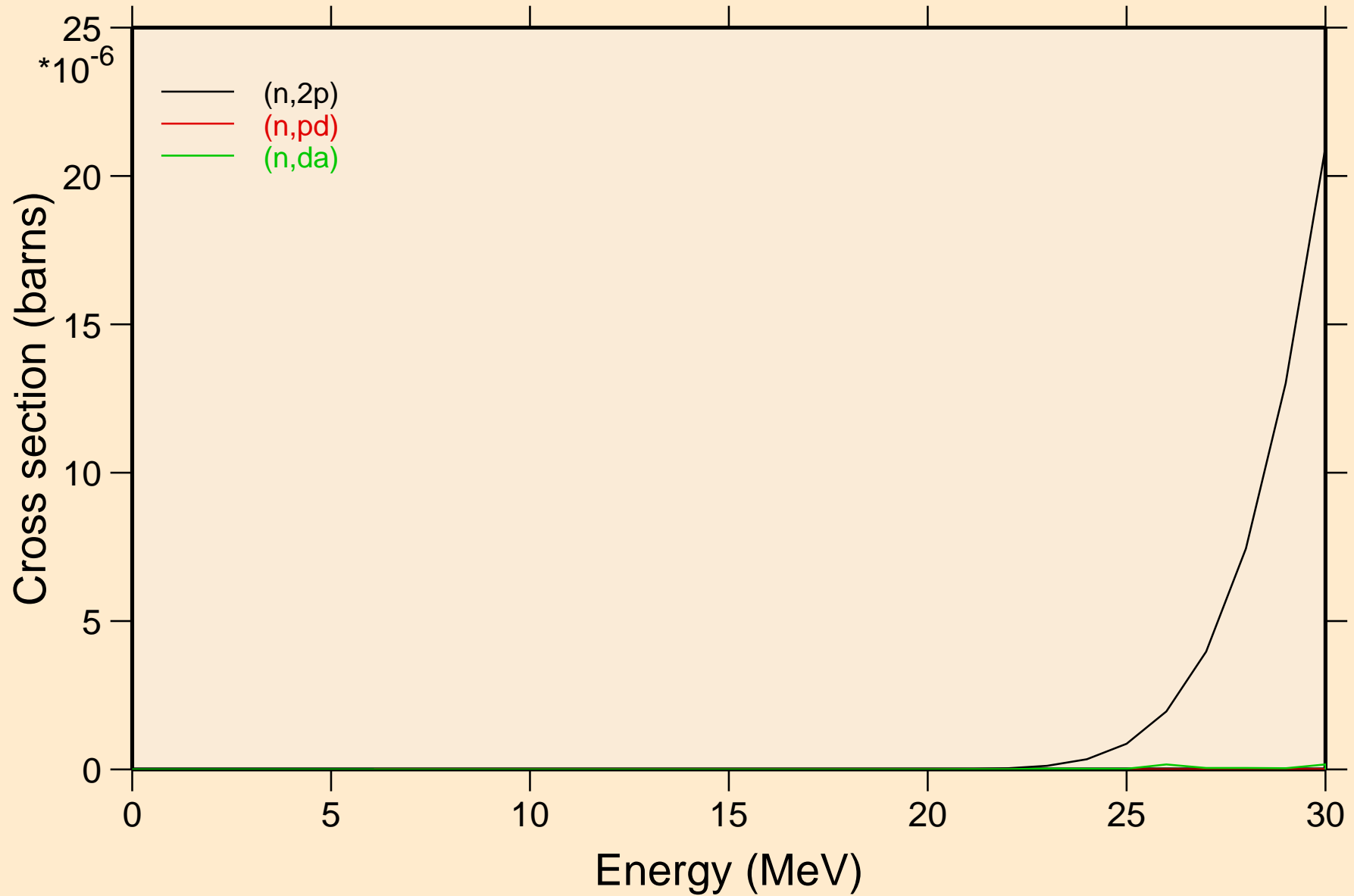

RF263 NEUTRON ACER TENDL-2021 LIBRARY; T=293.6K
Threshold reactions

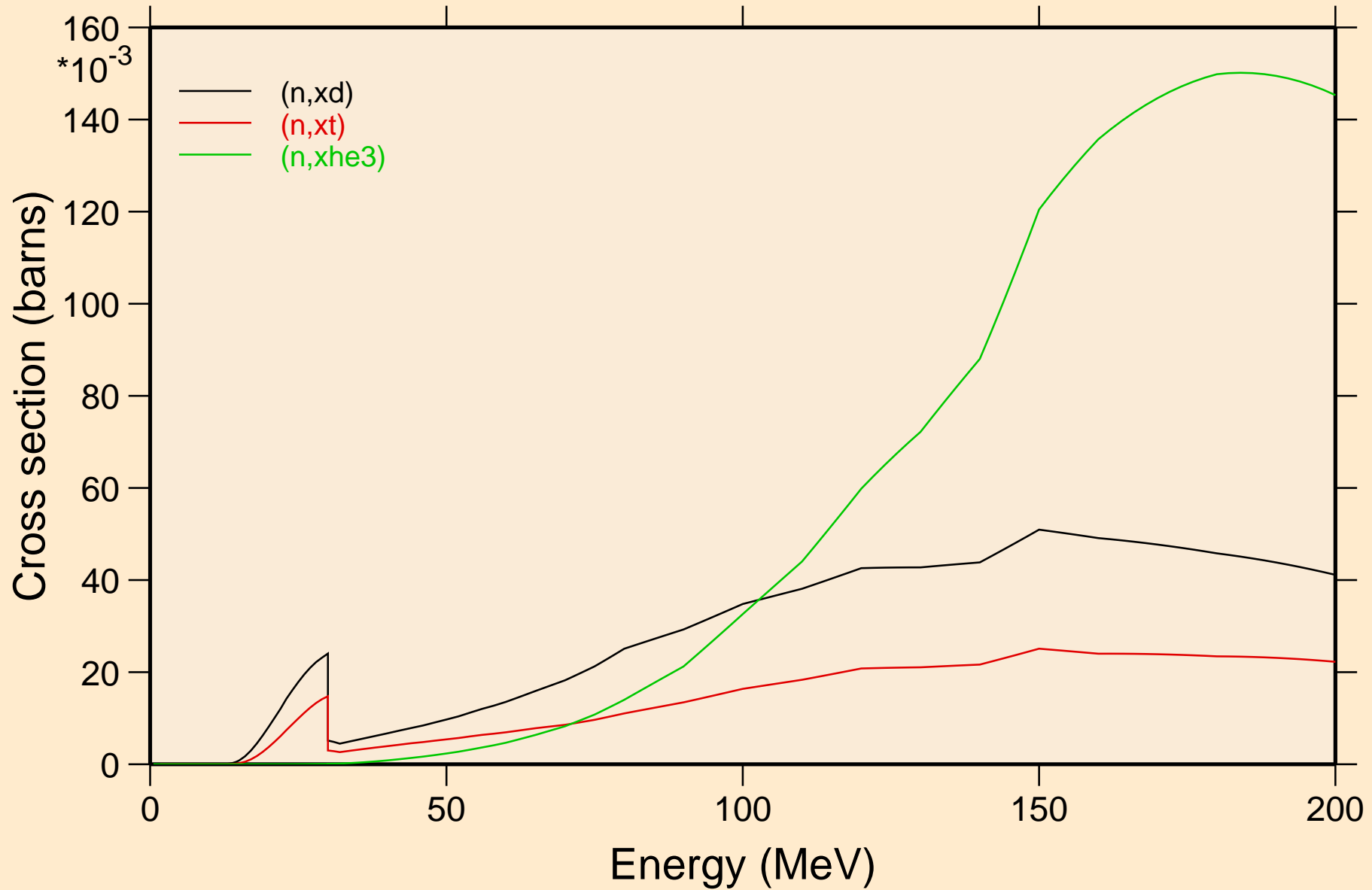

RF263 NEUTRON ACER TENDL-2021 LIBRARY; T=293.6K
angular distribution for elastic

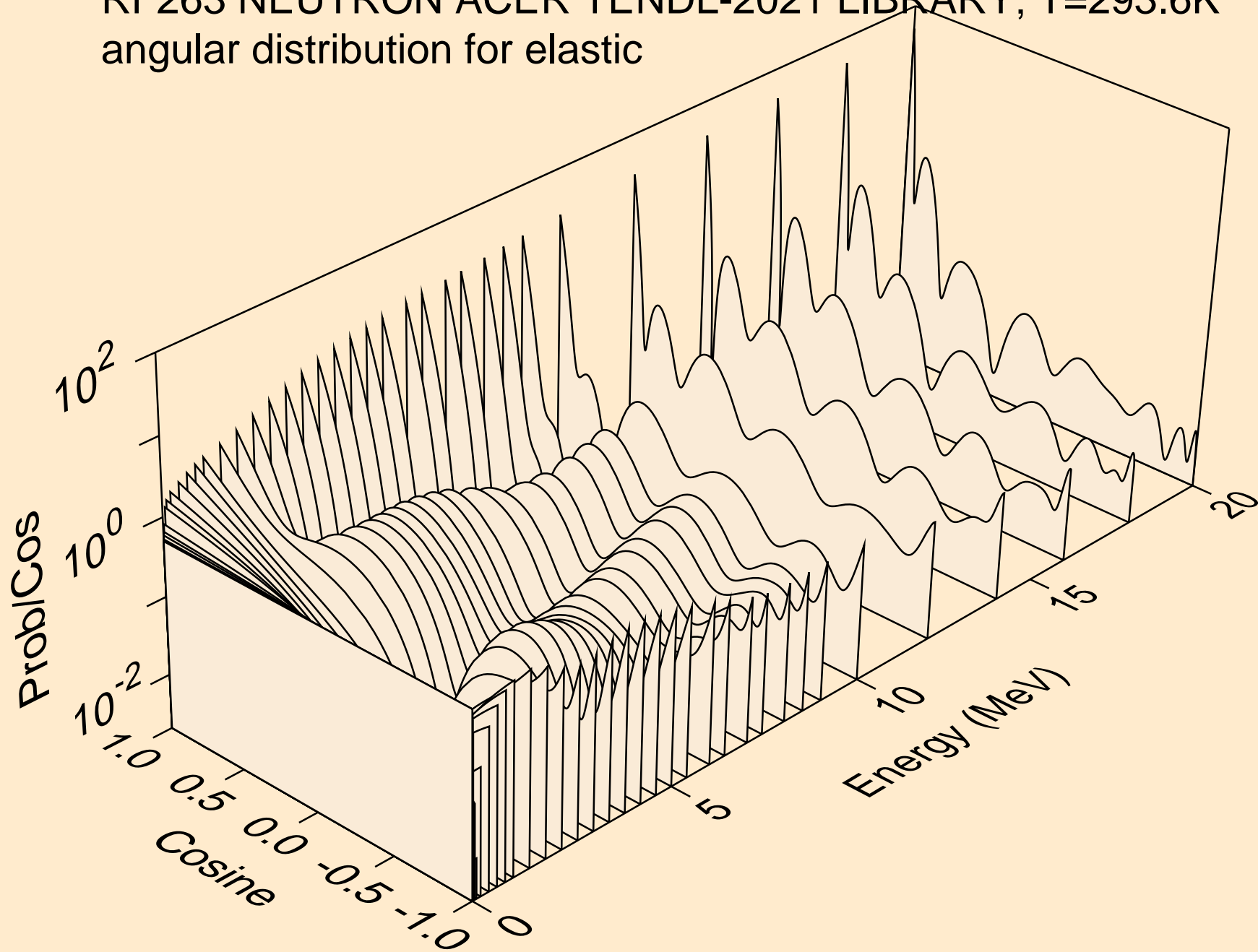

RF263 NEUTRON ACER TENDL-2021 LIBRARY; T=293.6K
angular distribution for elastic

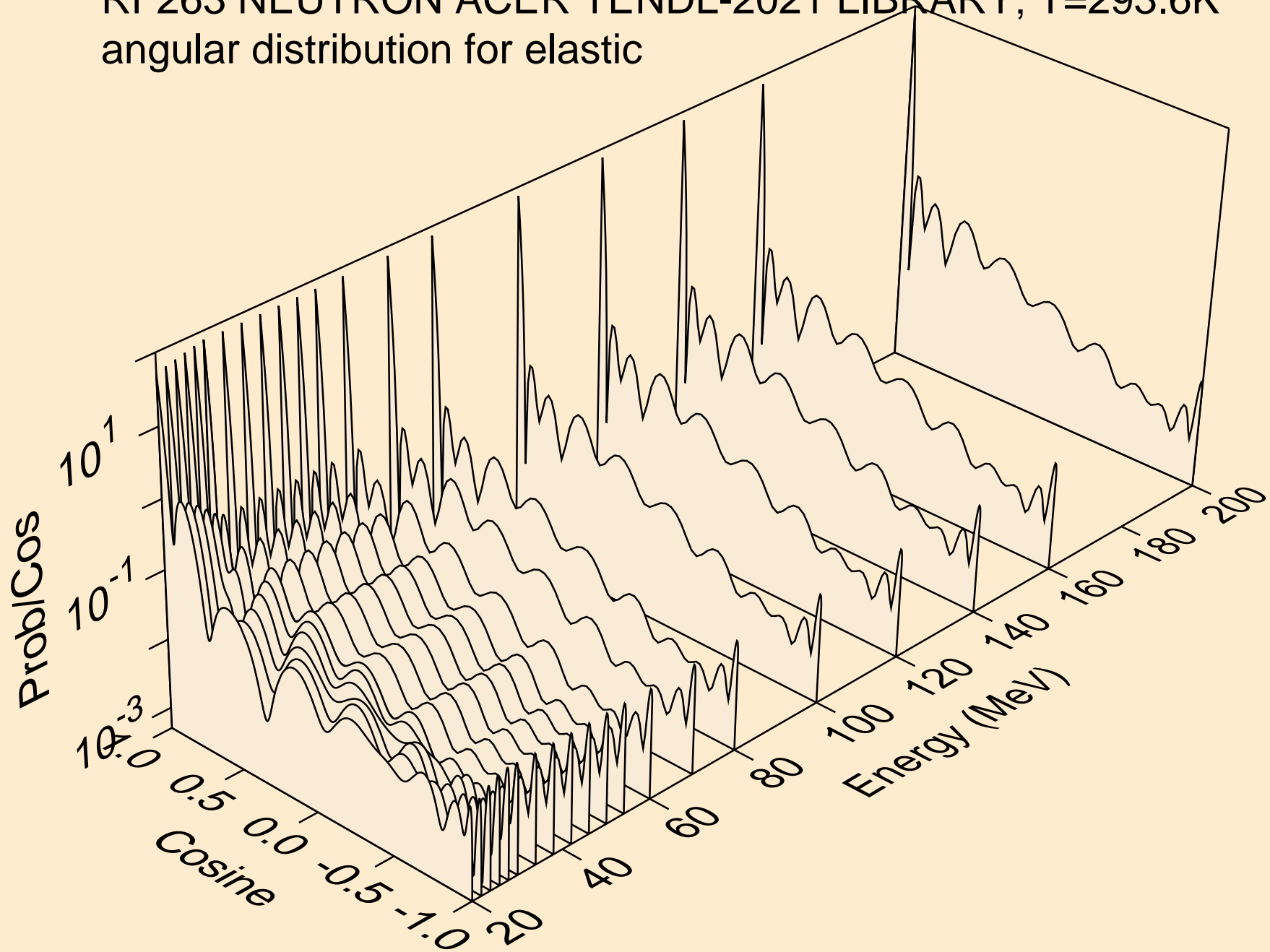

RF263 NEUTRON ACER TENDL-2021 LIBRARY; T=293.6K
angular distribution for (n,n*1)

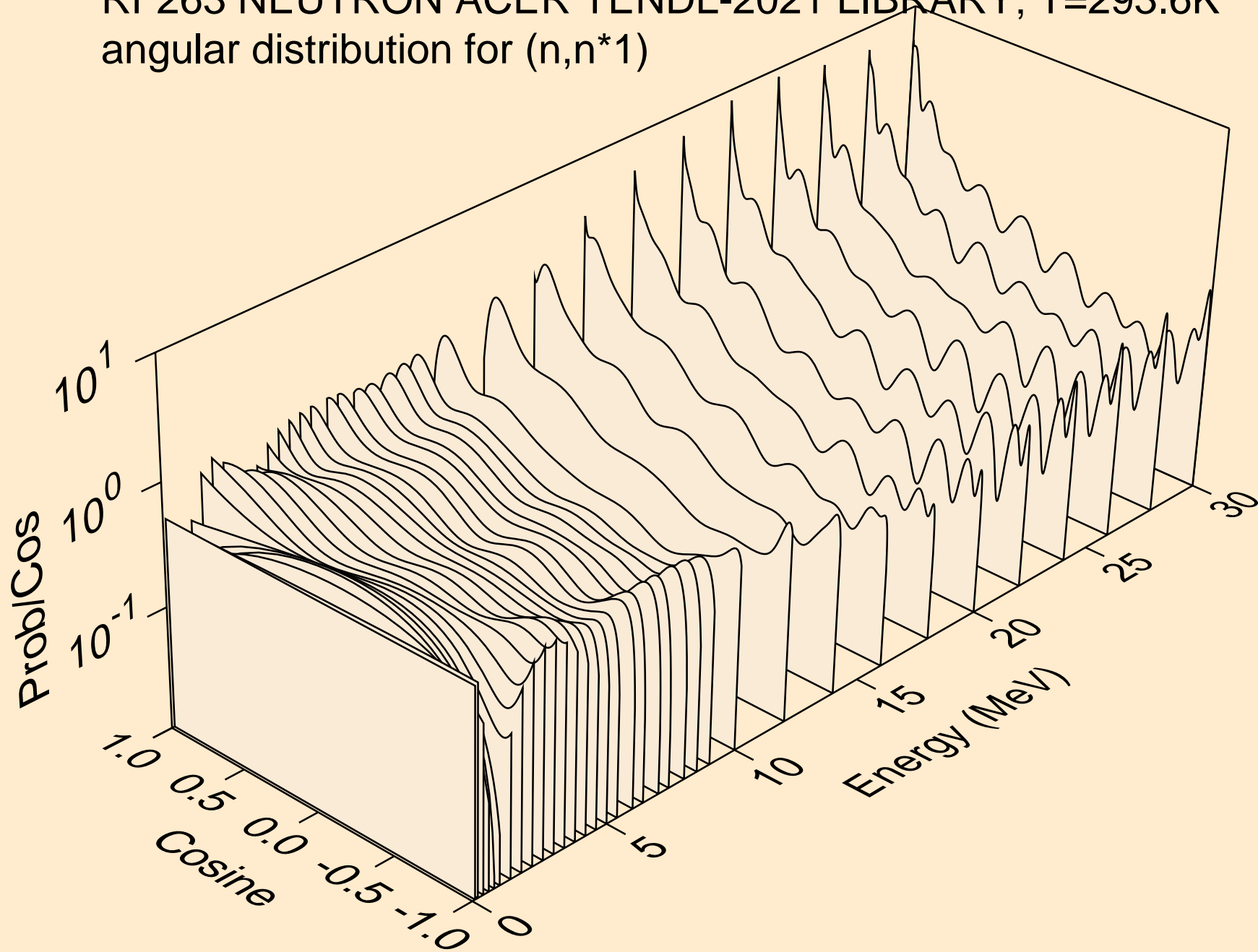

RF263 NEUTRON ACER TENDL-2021 LIBRARY; T=293.6K
Total fission nubar

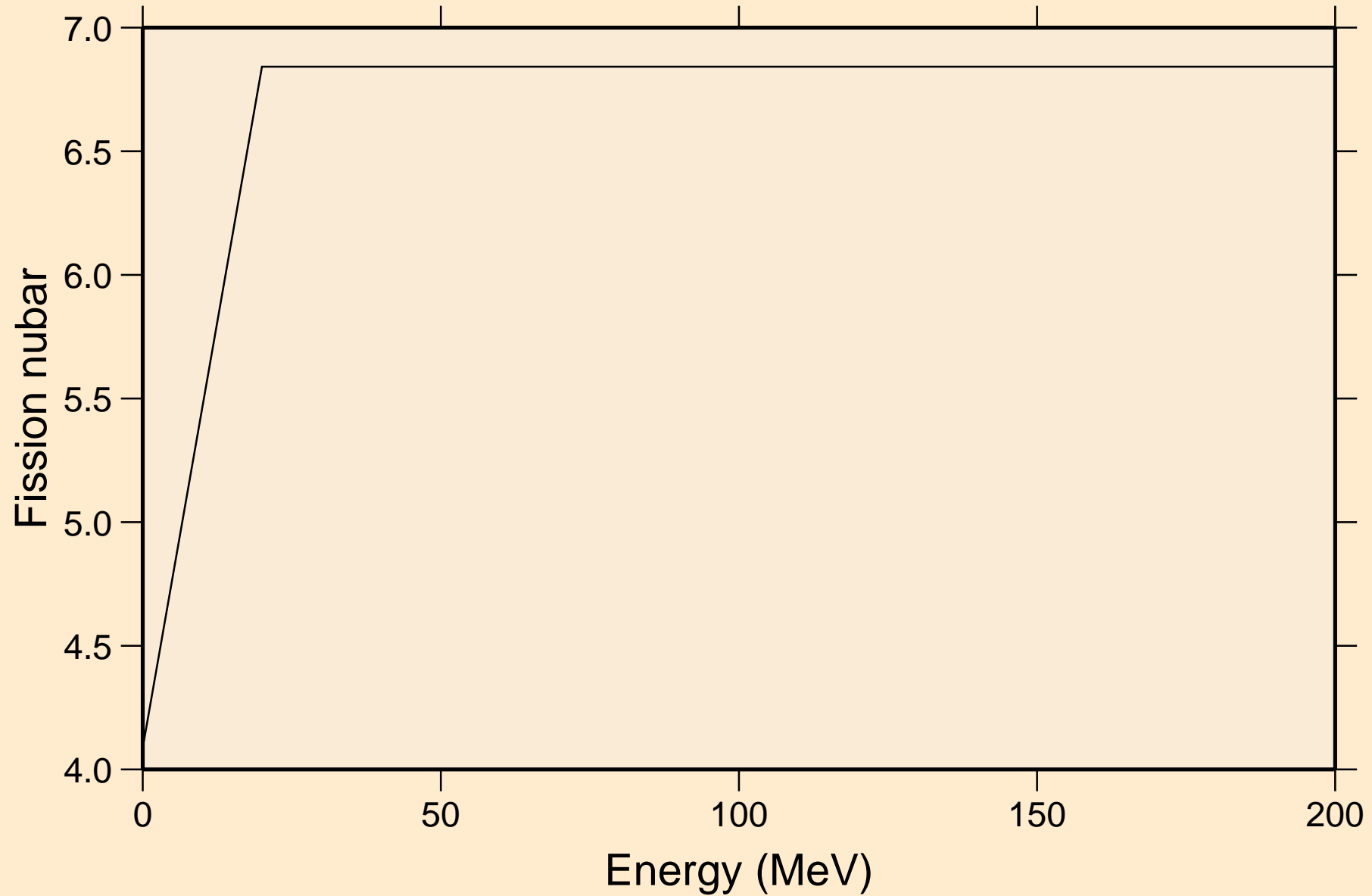

RF263 NEUTRON ACER TENDL-2021 LIBRARY; T=293.6K
Neutron emission for (n,x)

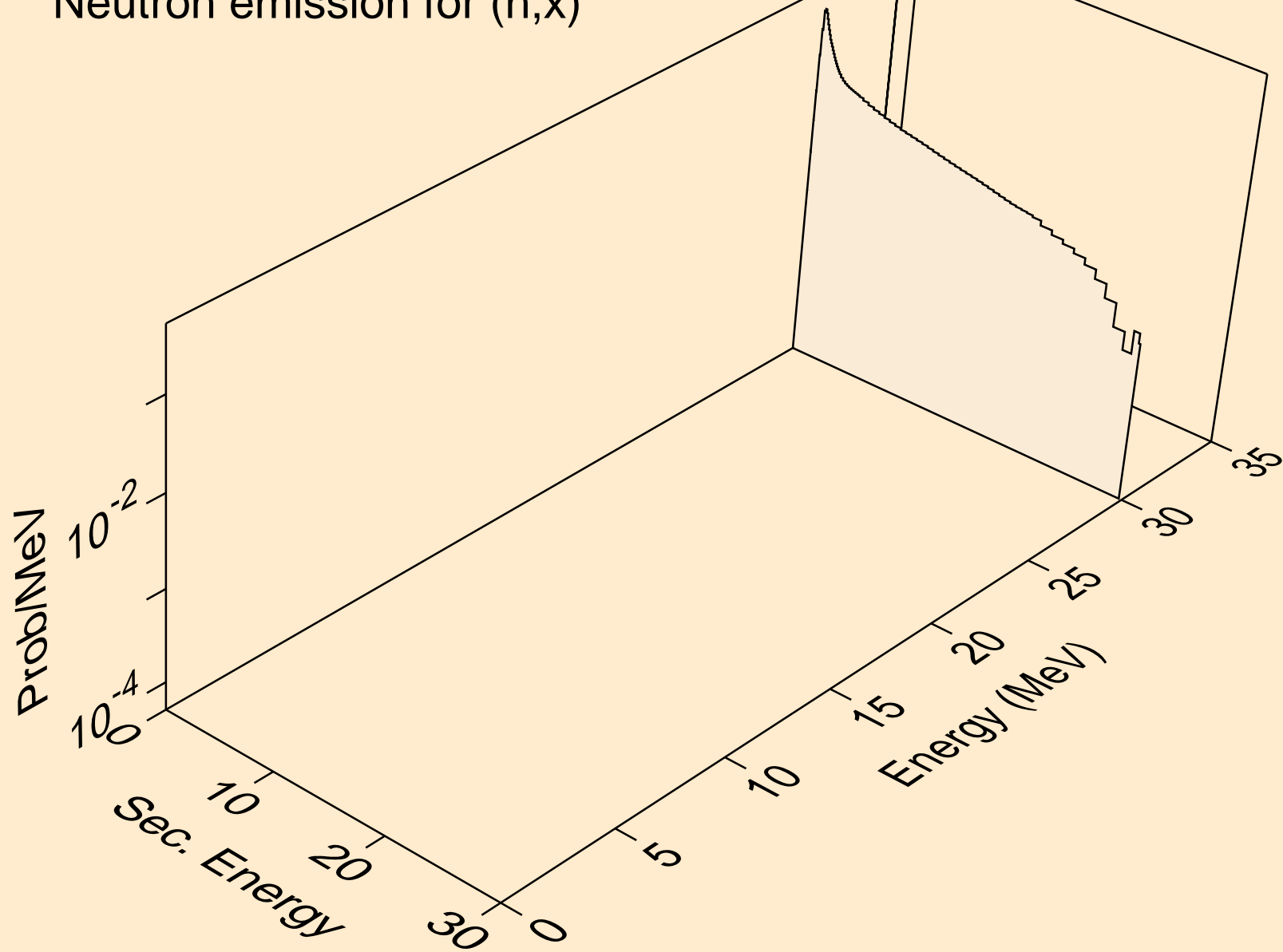

RF263 NEUTRON ACER TENDL-2021 LIBRARY; T=293.6K
Neutron emission for (n,2nd)

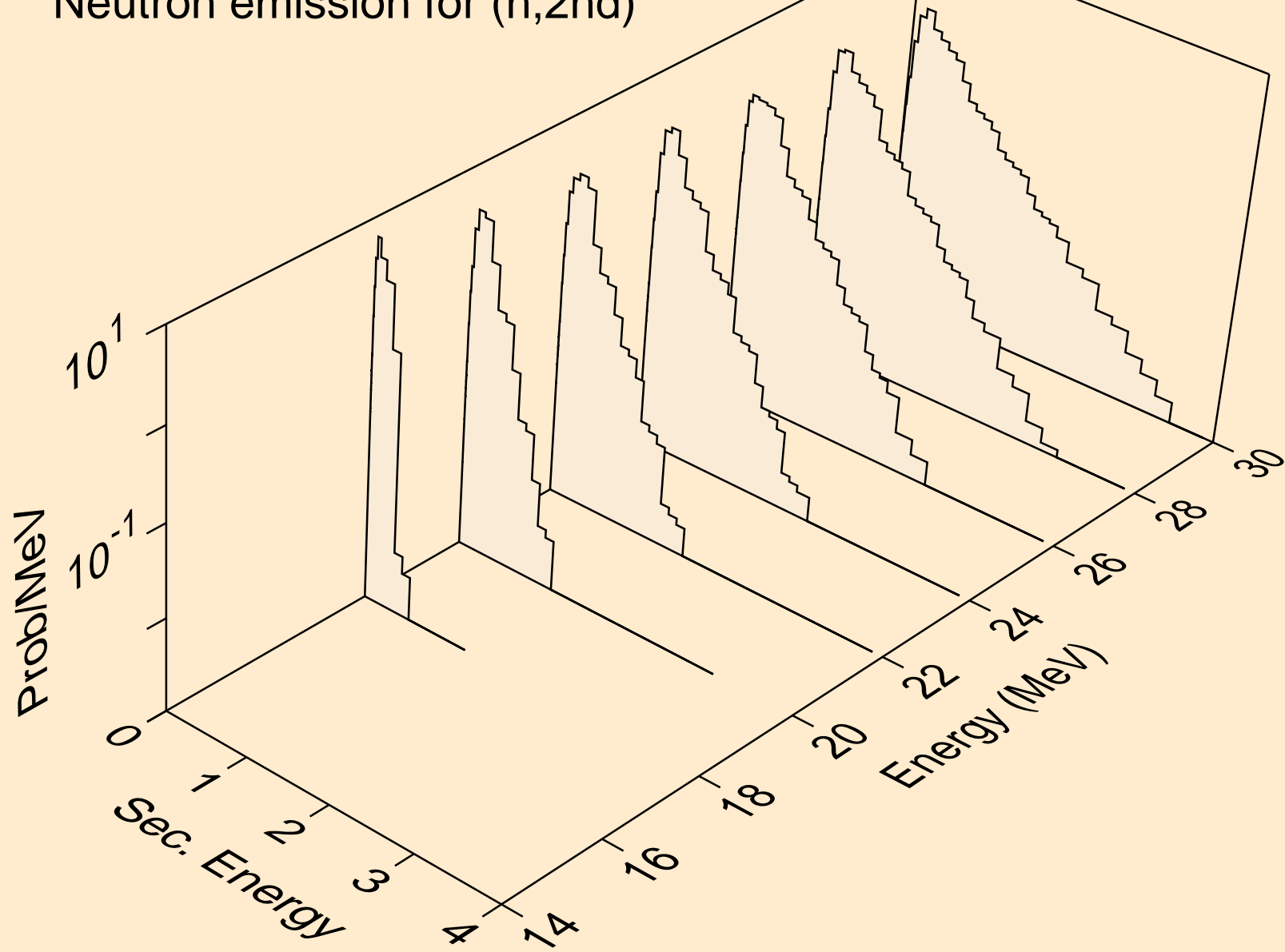

RF263 NEUTRON ACER TENDL-2021 LIBRARY; T=293.6K
Neutron emission for (n,2n)

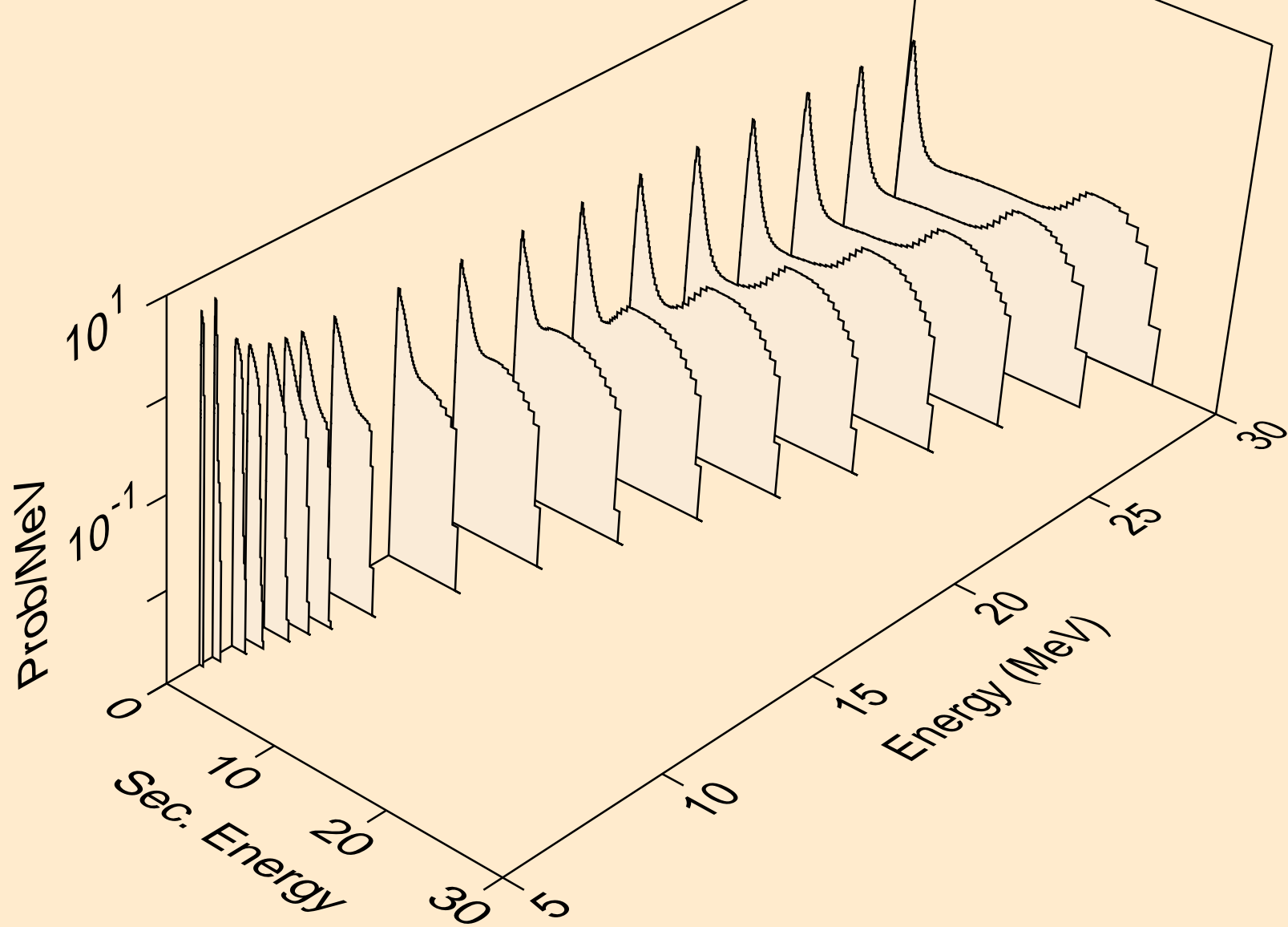

RF263 NEUTRON ACER TENDL-2021 LIBRARY; T=293.6K
Neutron emission for (n,3n)

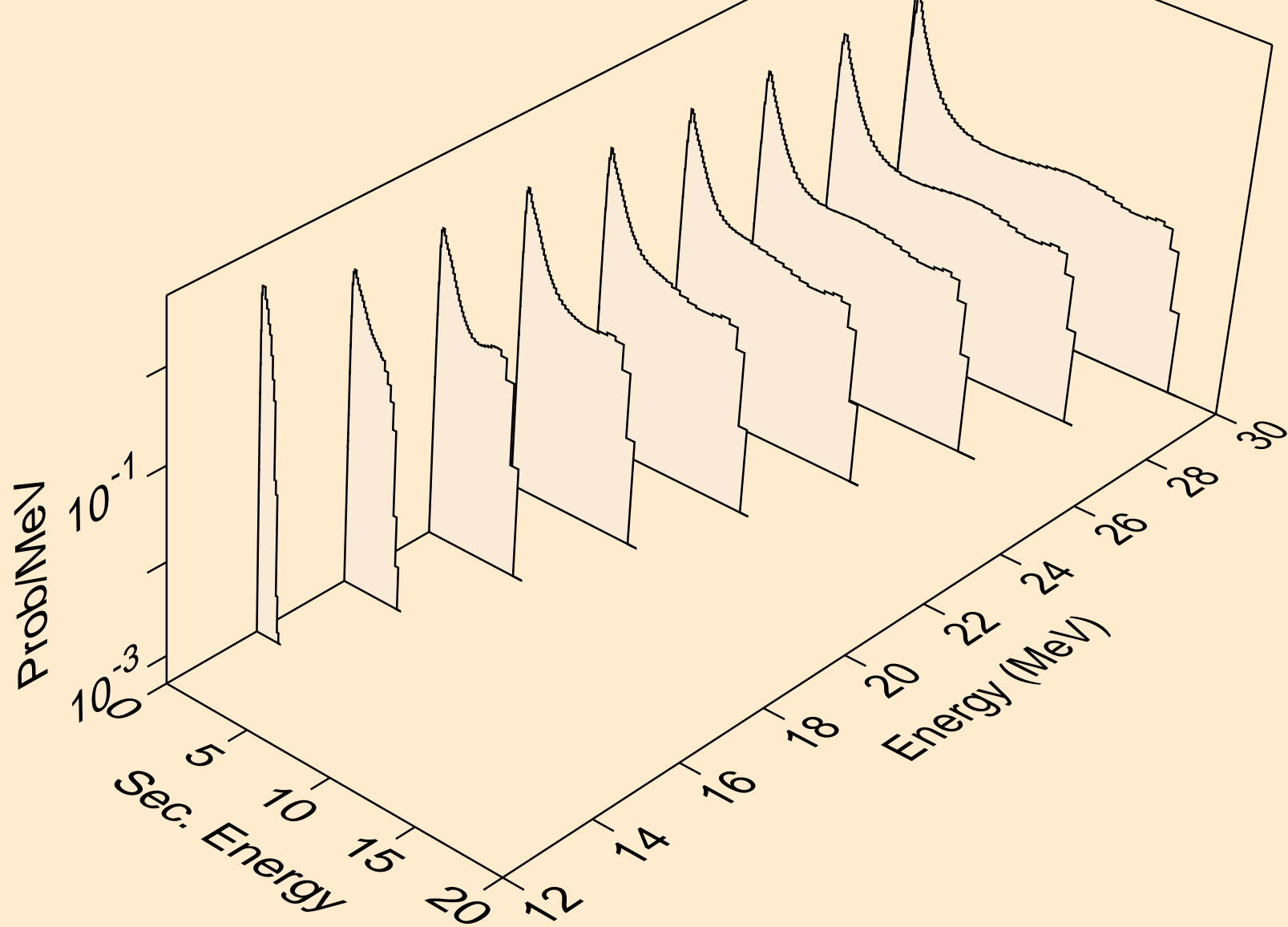

RF263 NEUTRON ACER TENDL-2021 LIBRARY; T=293.6K
Neutron emission for fission

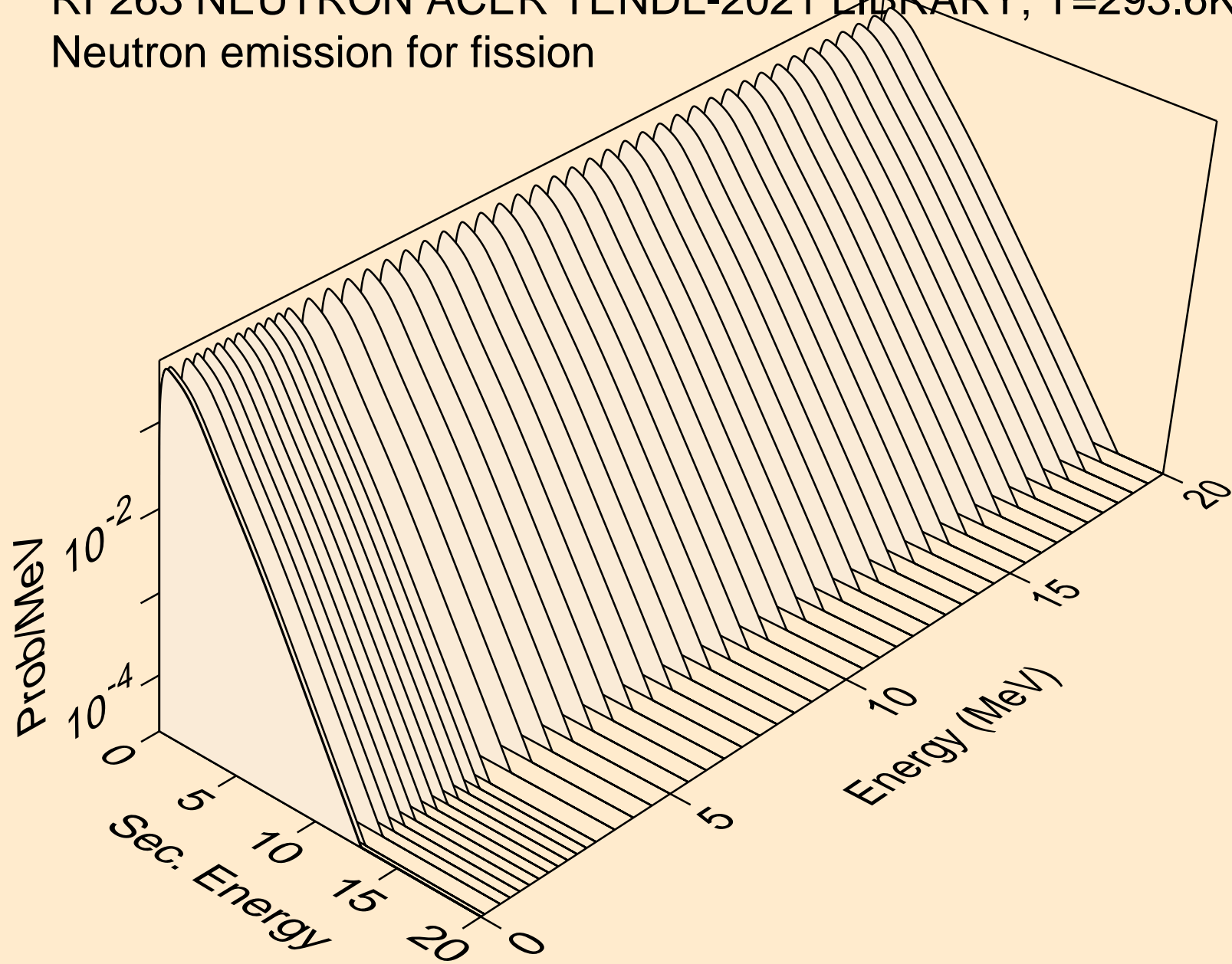

RF263 NEUTRON ACER TENDL-2021 LIBRARY; T=293.6K
Neutron emission for (n,n*)a

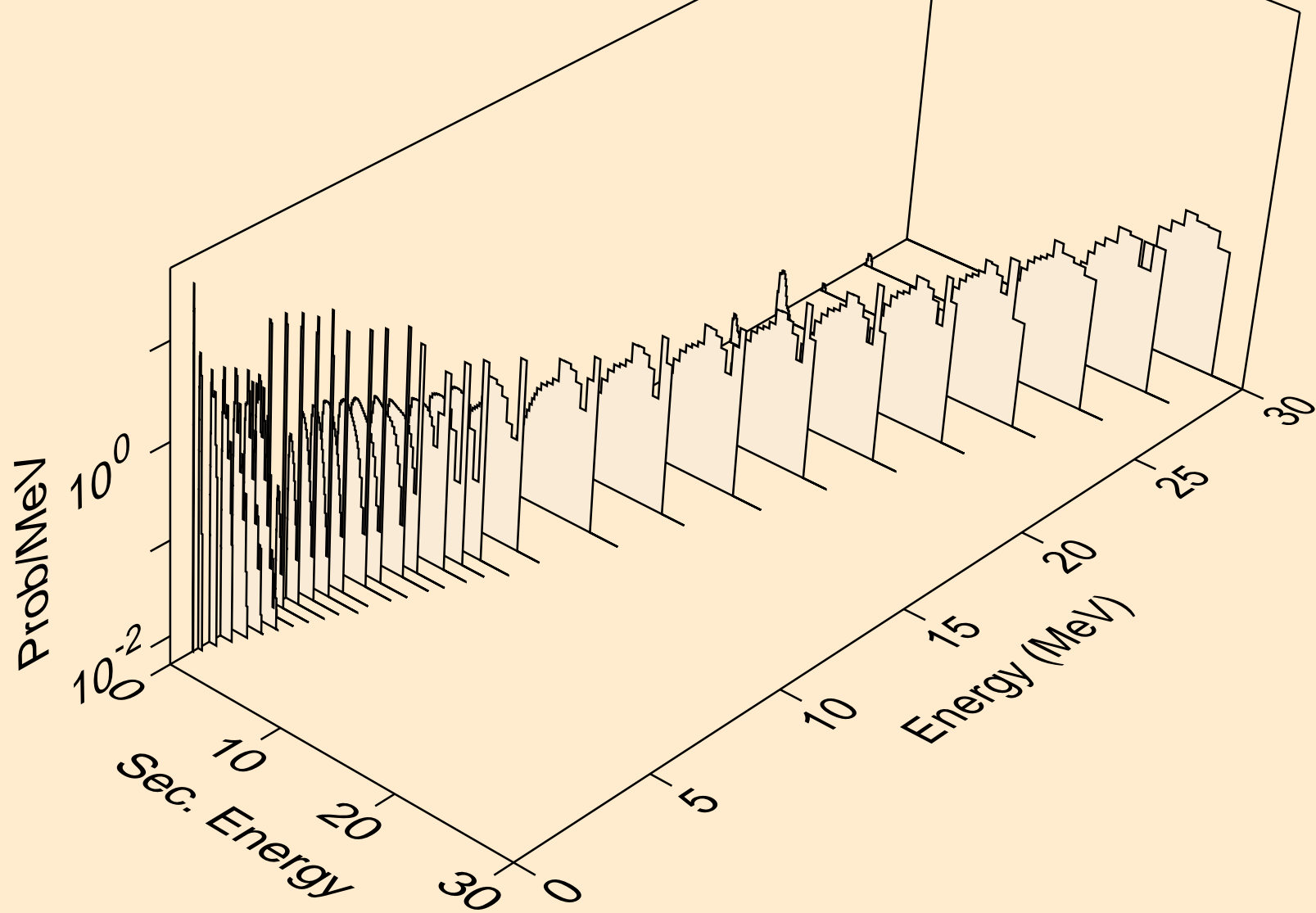

RF263 NEUTRON ACER TENDL-2021 LIBRARY; T=293.6K
Neutron emission for (n,2n)a

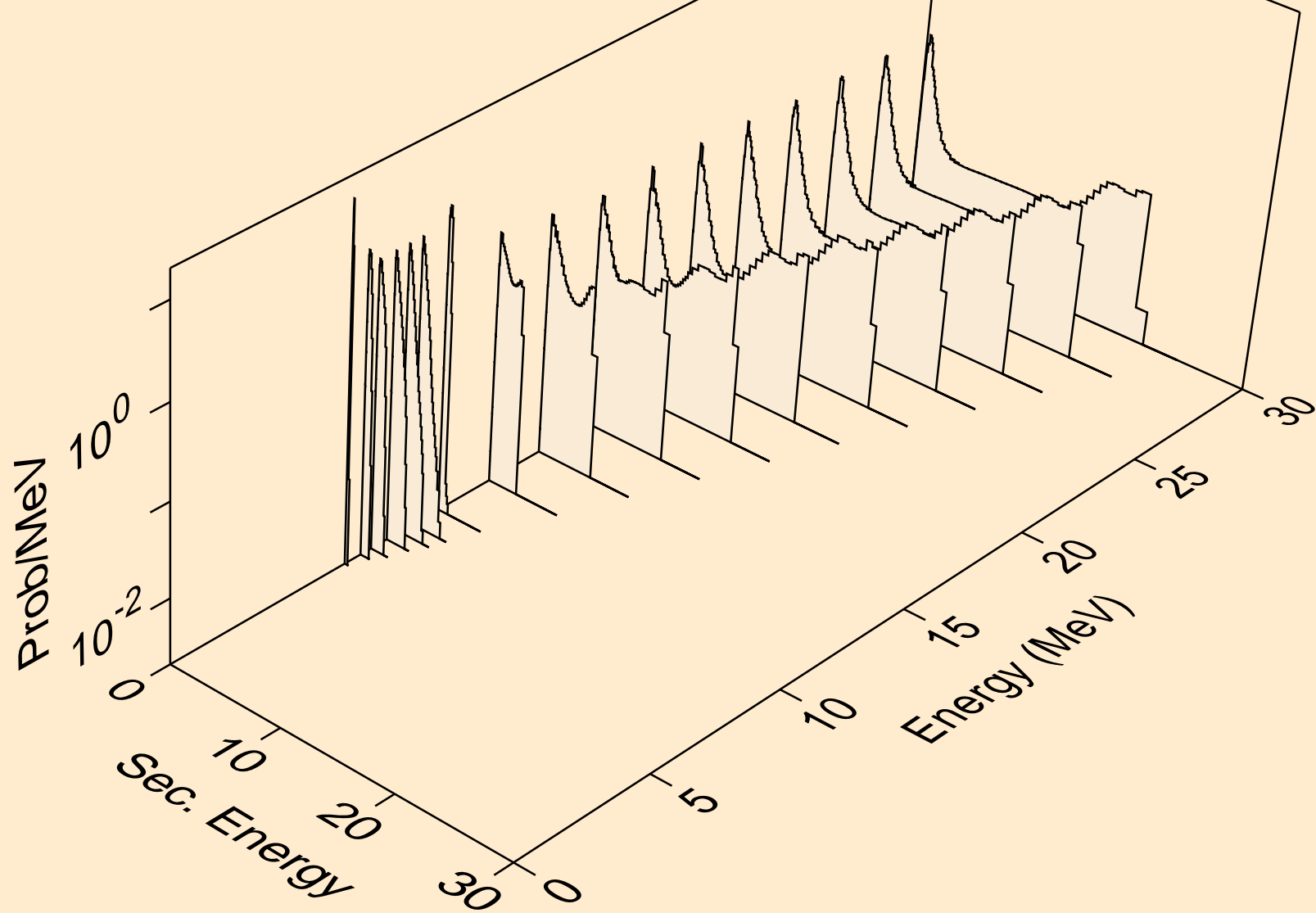

RF263 NEUTRON ACER TENDL-2021 LIBRARY; T=293.6K
Neutron emission for (n,3n)a

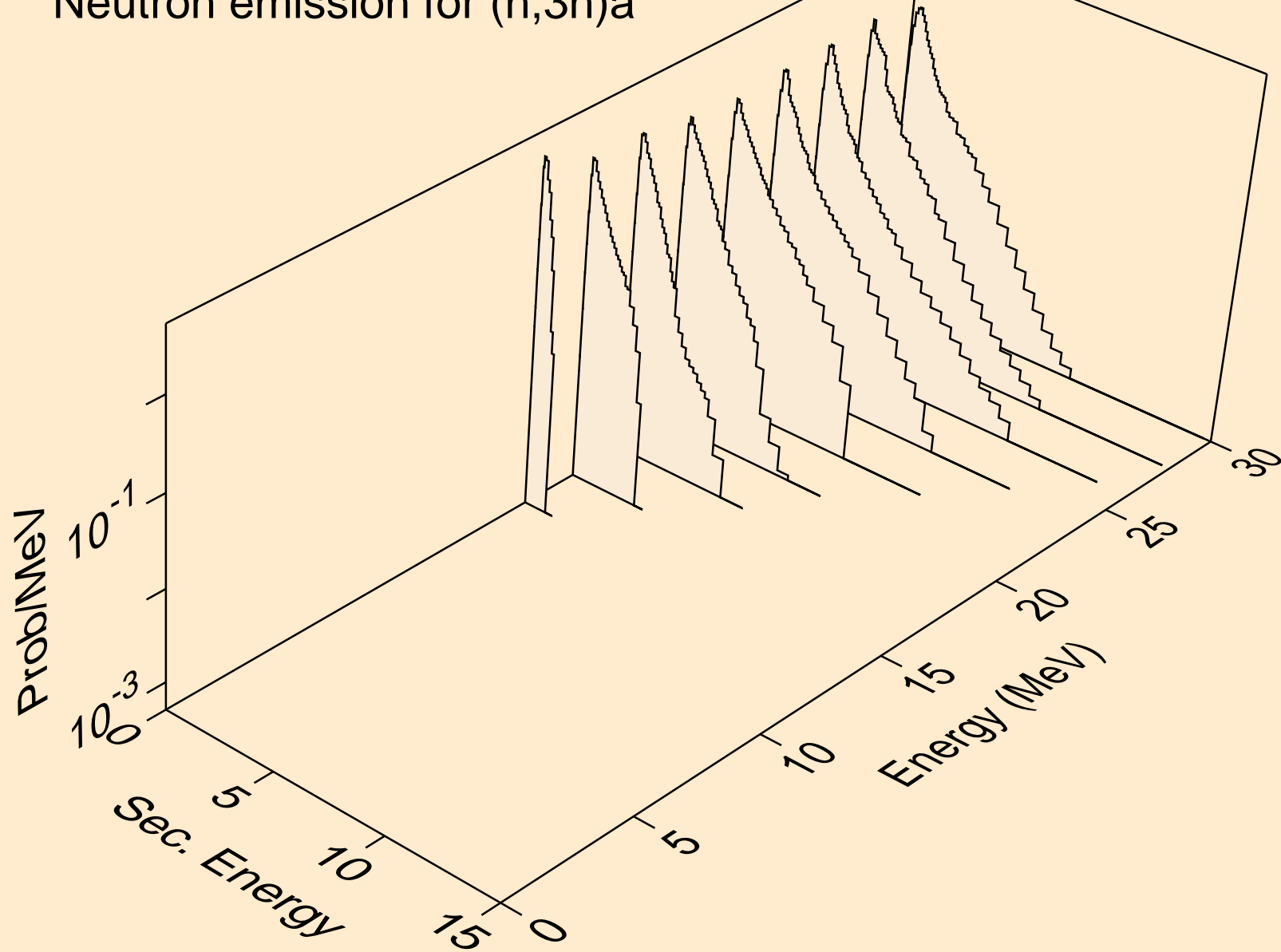

RF263 NEUTRON ACER TENDL-2021 LIBRARY; T=293.6K
Neutron emission for (n,n*)p

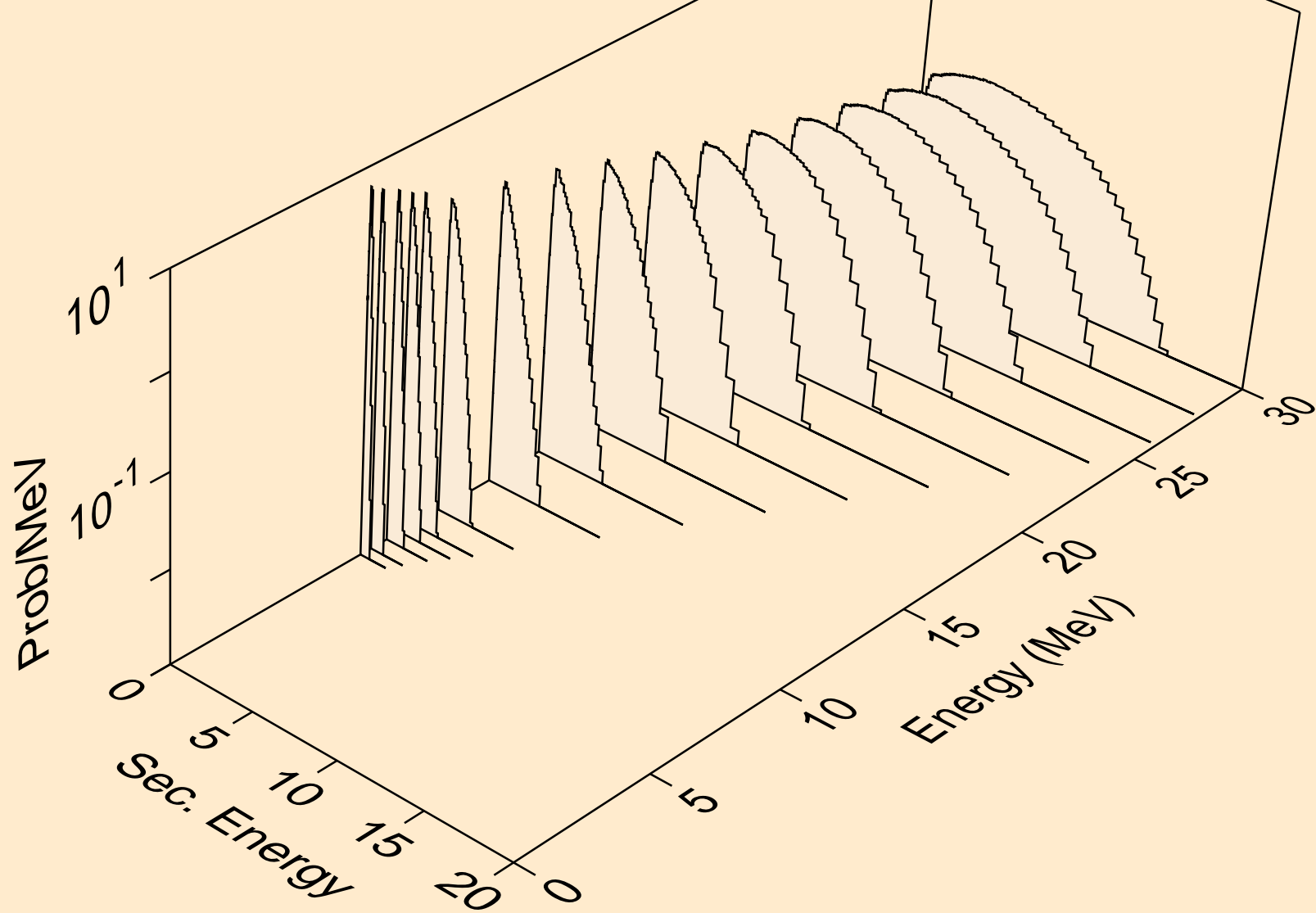

RF263 NEUTRON ACER TENDL-2021 LIBRARY; T=293.6K
Neutron emission for (n,n*)d

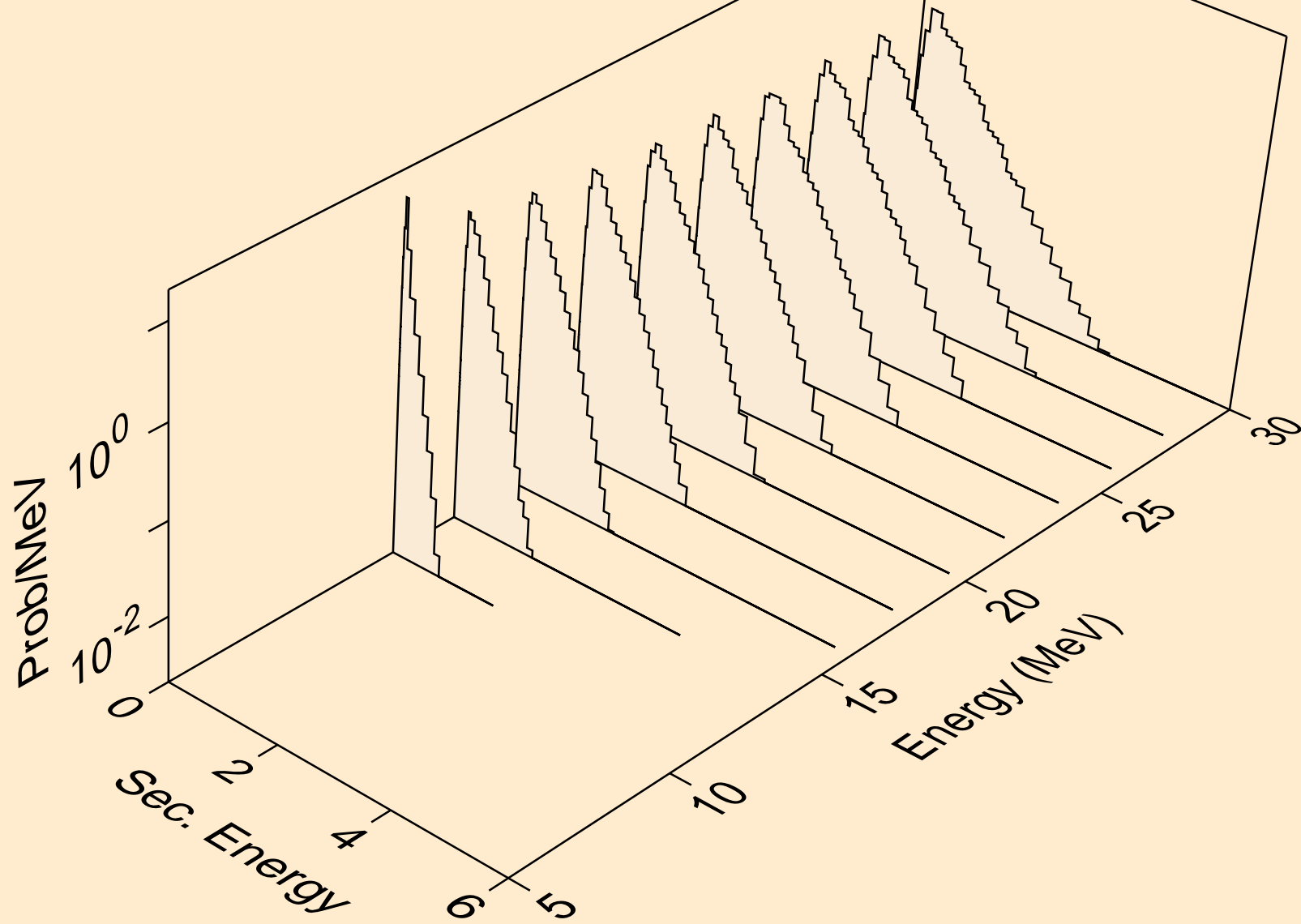

RF263 NEUTRON ACER TENDL-2021 LIBRARY; T=293.6K
Neutron emission for (n,n*)t

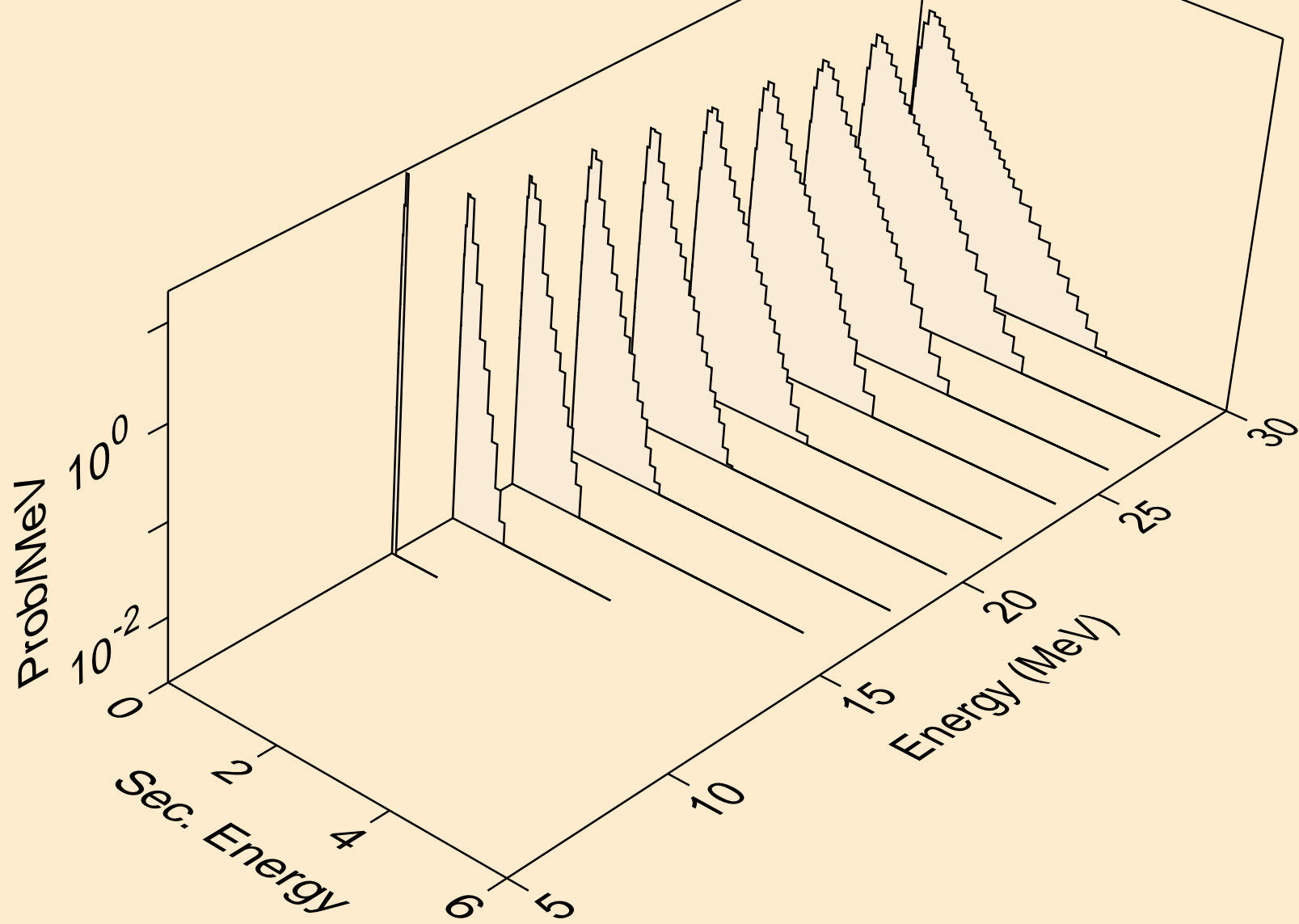

RF263 NEUTRON ACER TENDL-2021 LIBRARY; T=293.6K
Neutron emission for (n,n*)he3

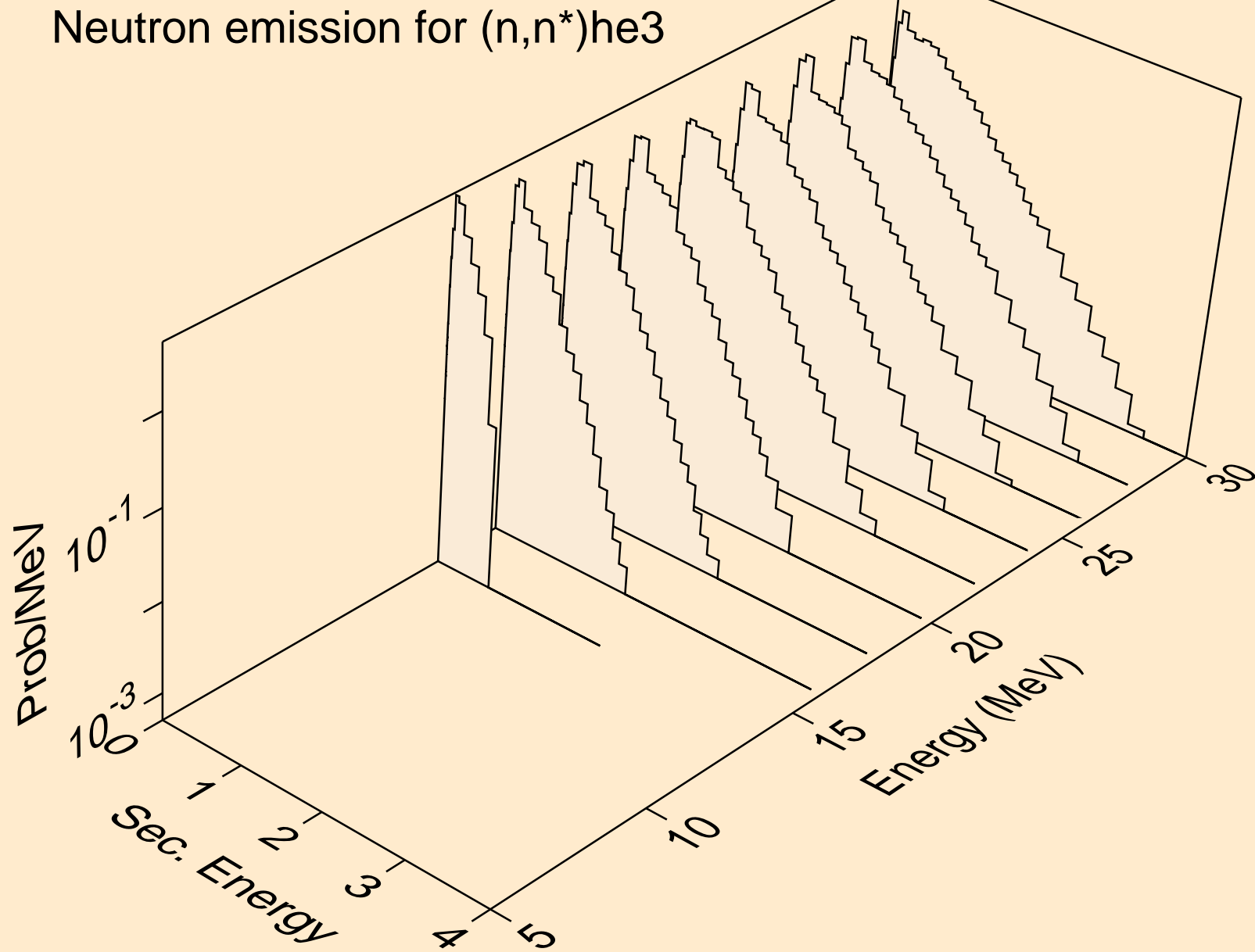

RF263 NEUTRON ACER TENDL-2021 LIBRARY; T=293.6K
Neutron emission for (n,4n)

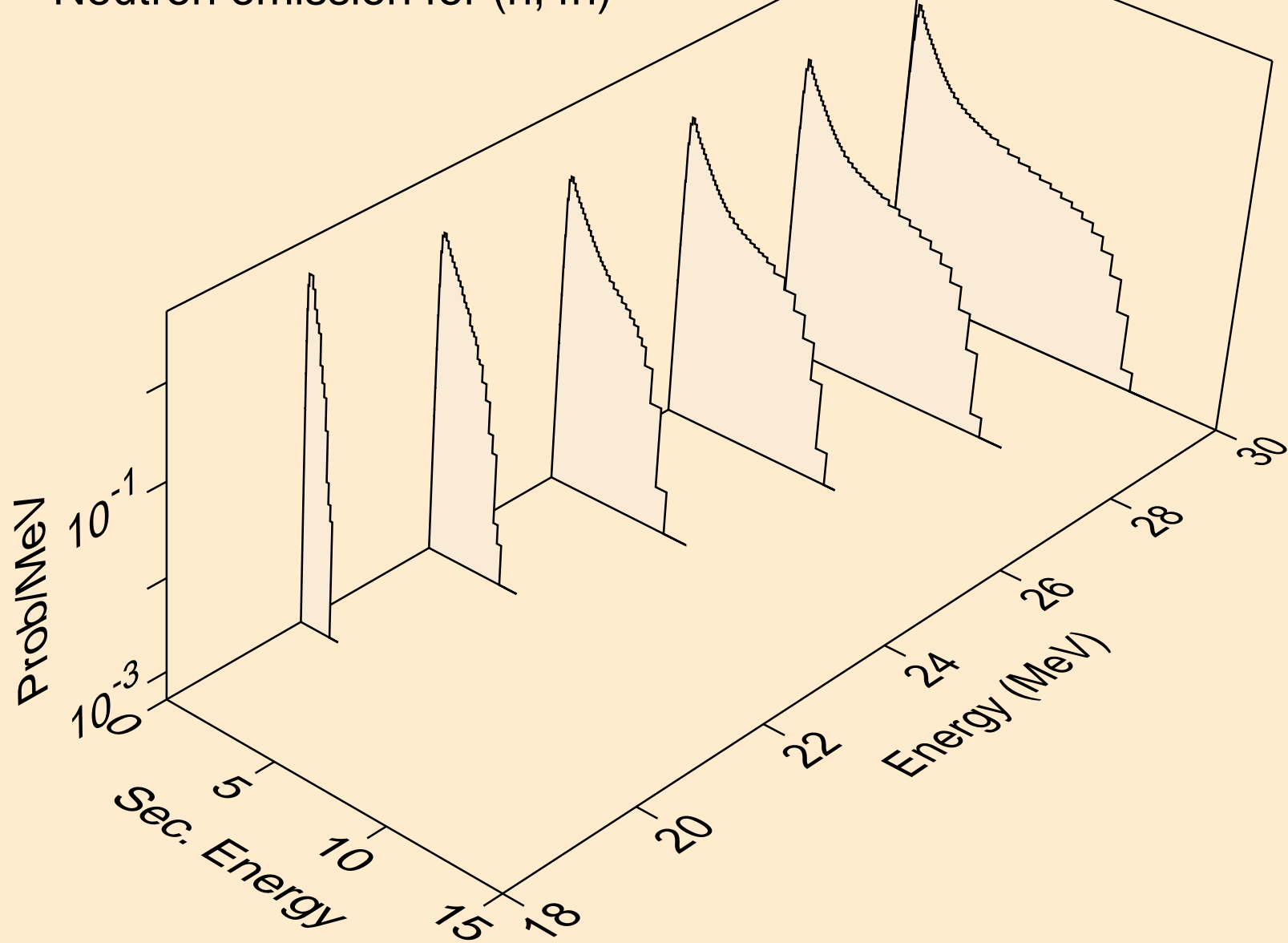

RF263 NEUTRON ACER TENDL-2021 LIBRARY; T=293.6K
Neutron emission for (n,2np)

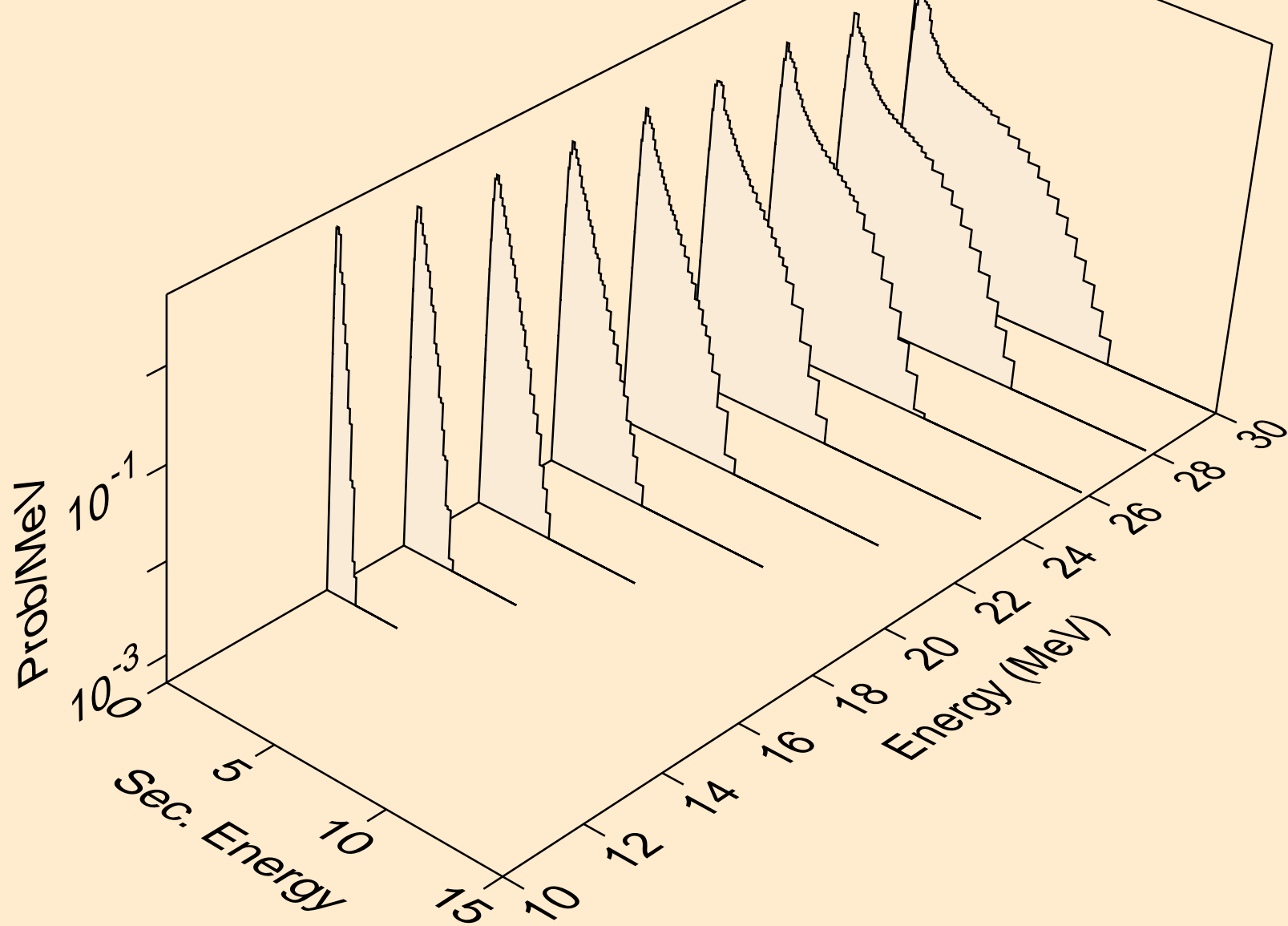

RF263 NEUTRON ACER TENDL-2021 LIBRARY; T=293.6K
Neutron emission for (n,3np)

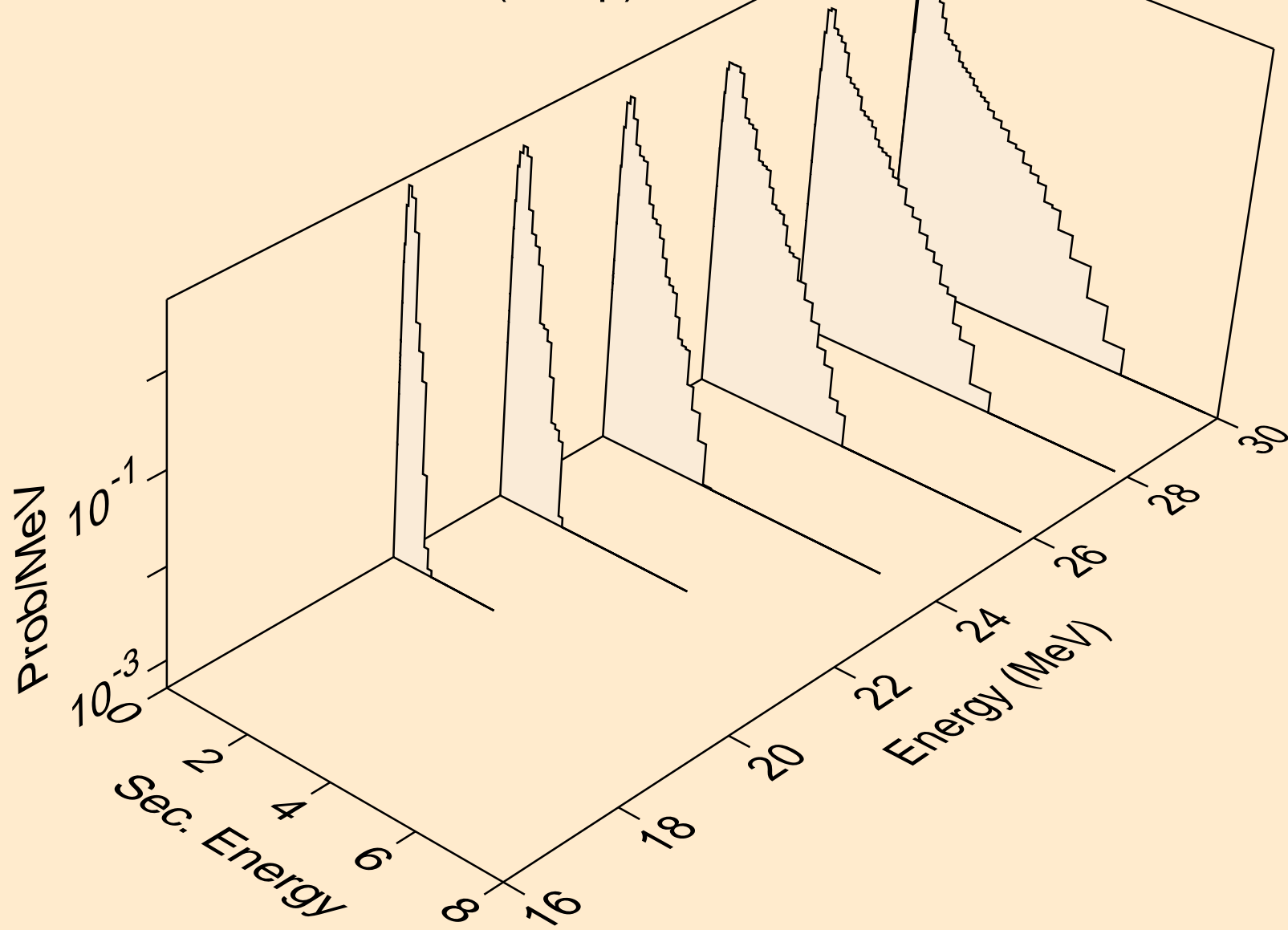

RF263 NEUTRON ACER TENDL-2021 LIBRARY; T=293.6K
Neutron emission for (n,2np)

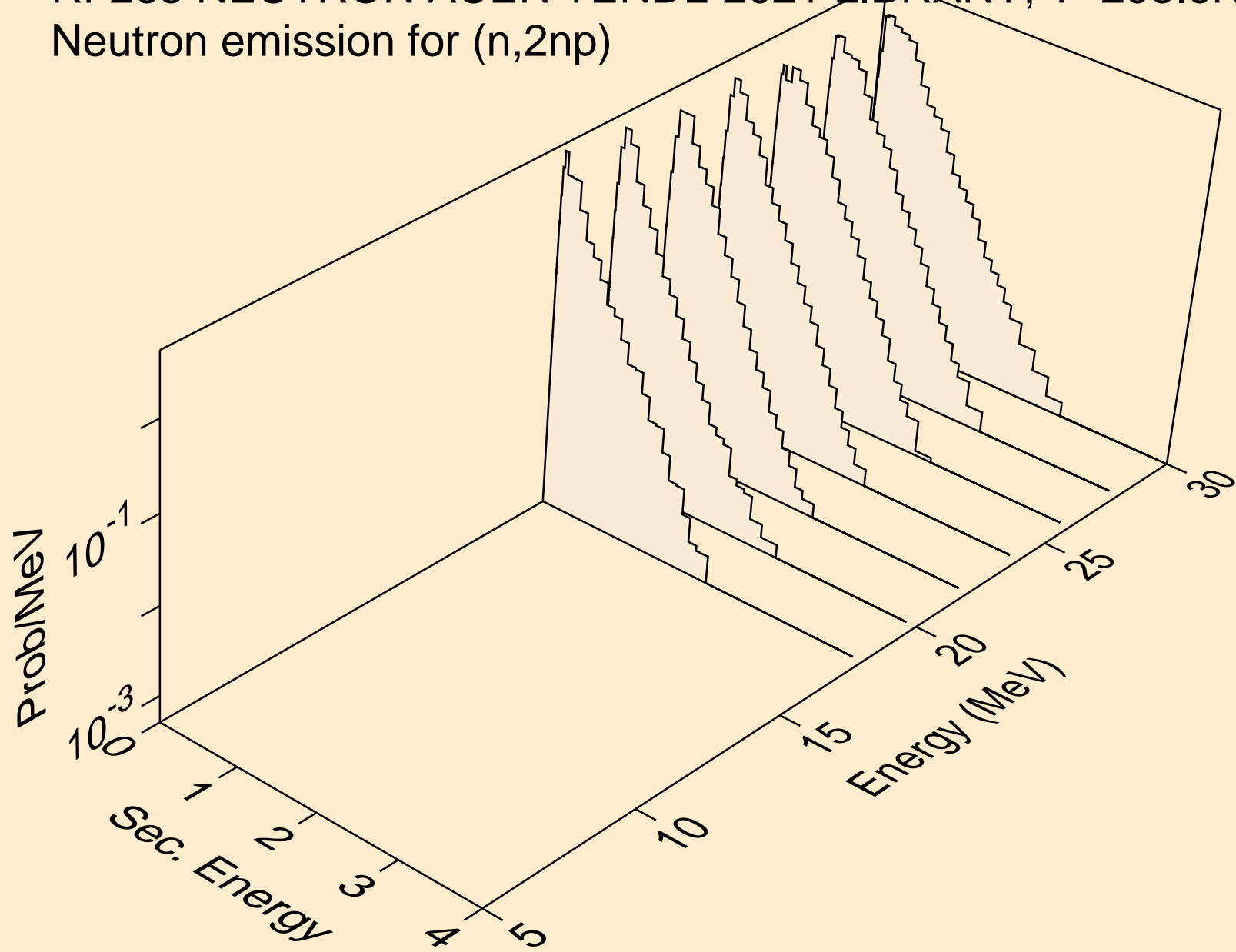

RF263 NEUTRON ACER TENDL-2021 LIBRARY; T=293.6K
Neutron emission for (n,npa)

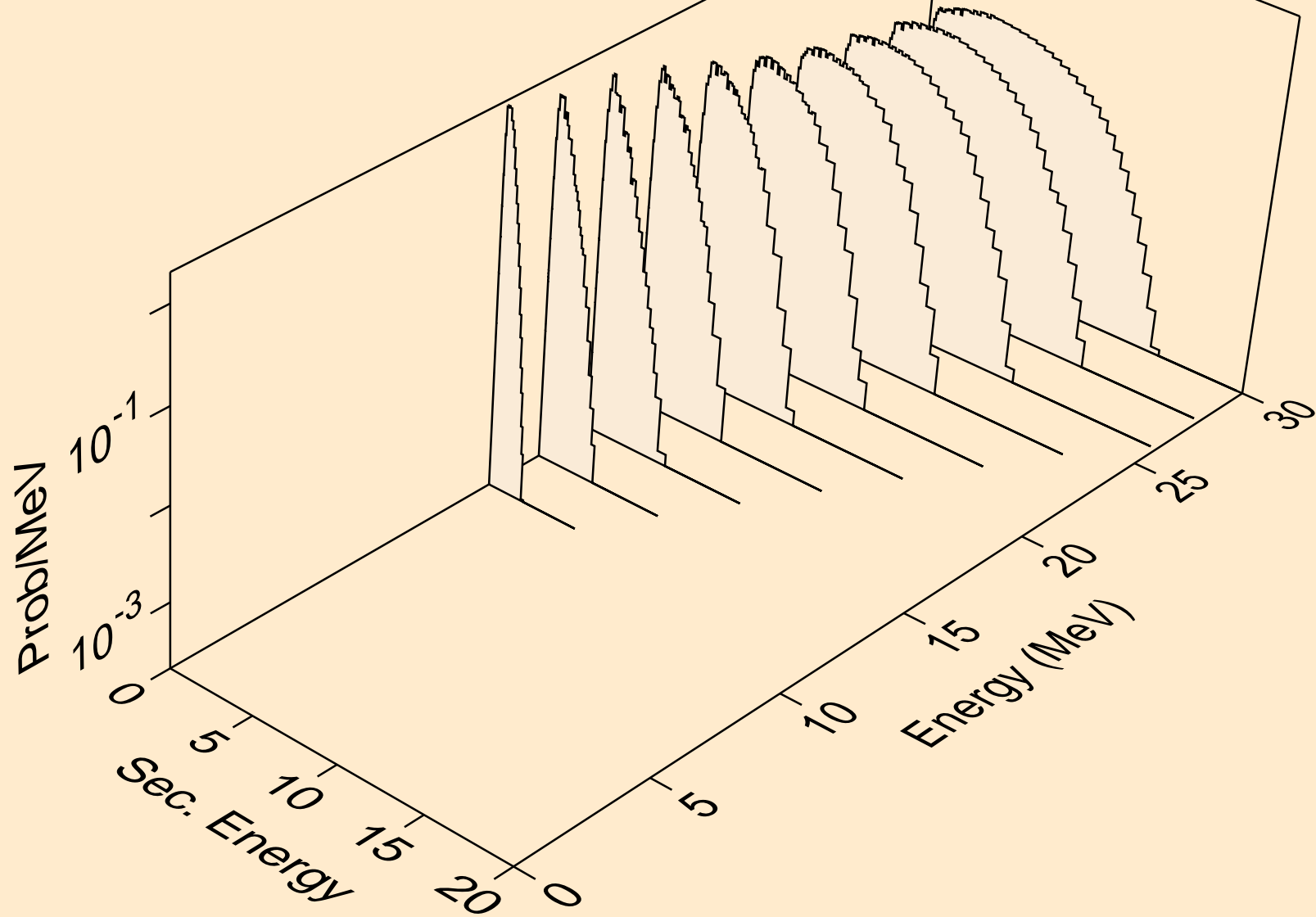

RF263 NEUTRON ACER TENDL-2021 LIBRARY; T=293.6K
Neutron emission for (n,n*c)

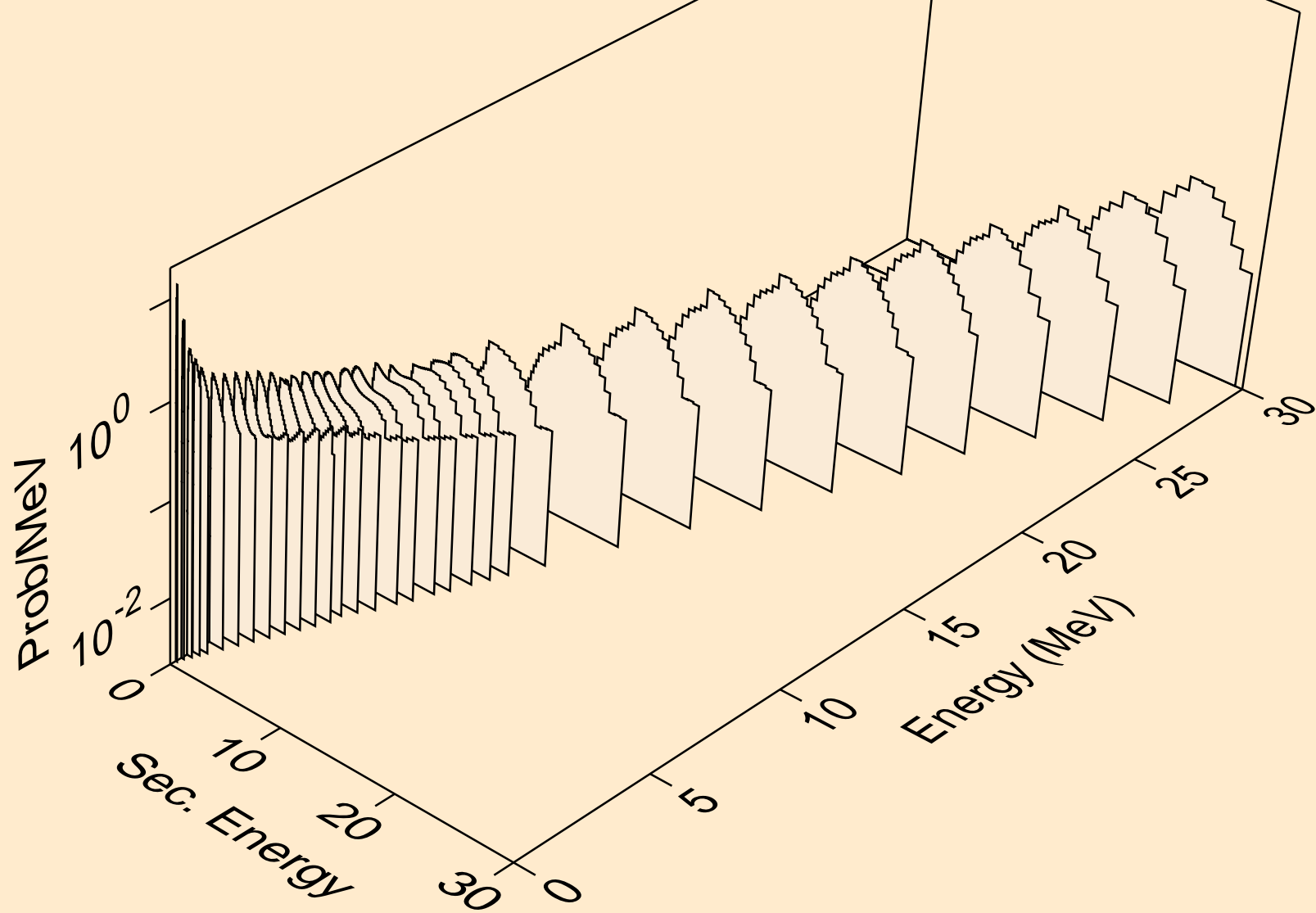

RF263 NEUTRON ACER TENDL-2021 LIBRARY; T=293.6K

Delayed nubar

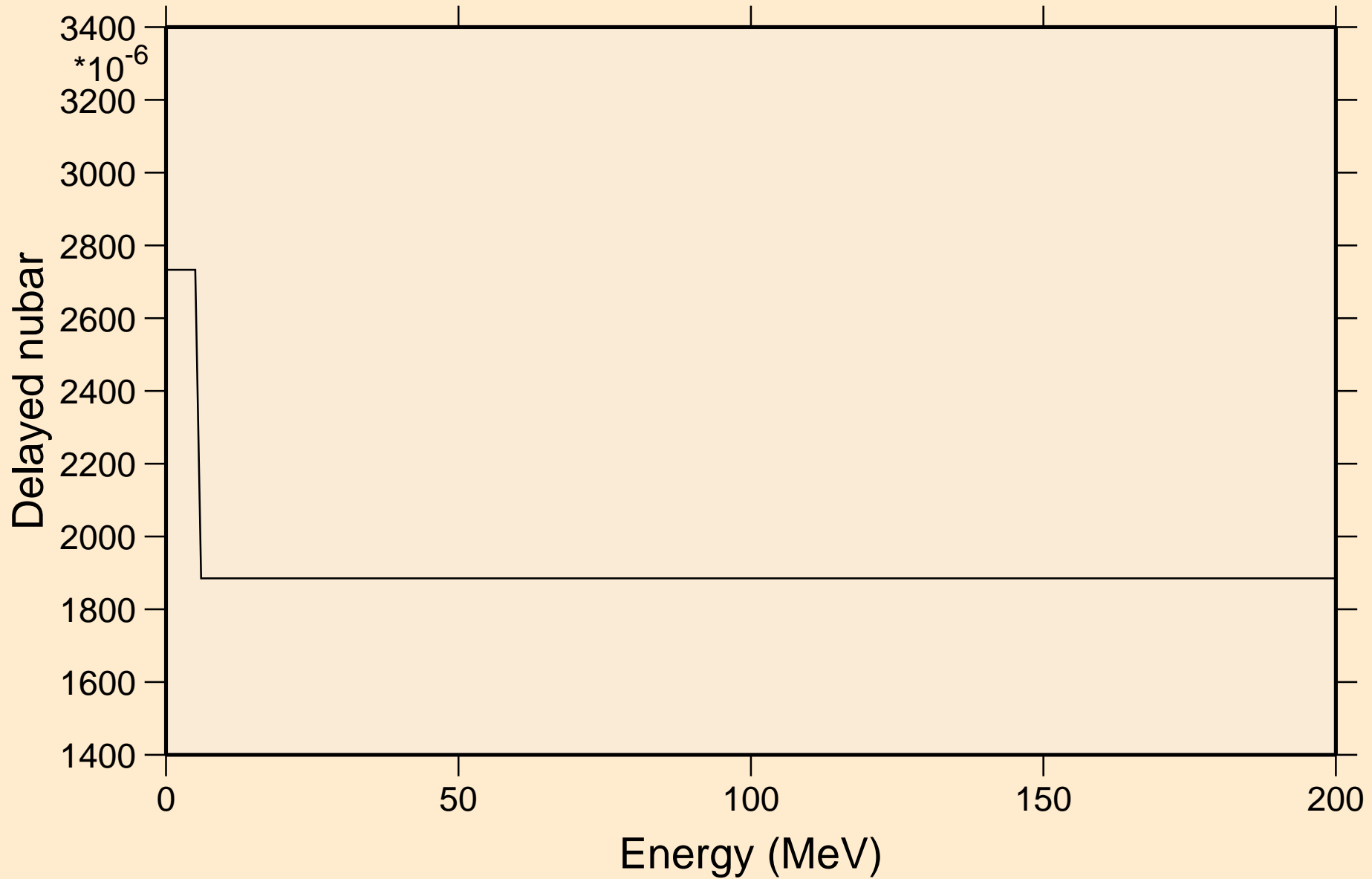

RF263 NEUTRON ACER TENDL-2021 LIBRARY; T=293.6K

Delayed neutron spectra

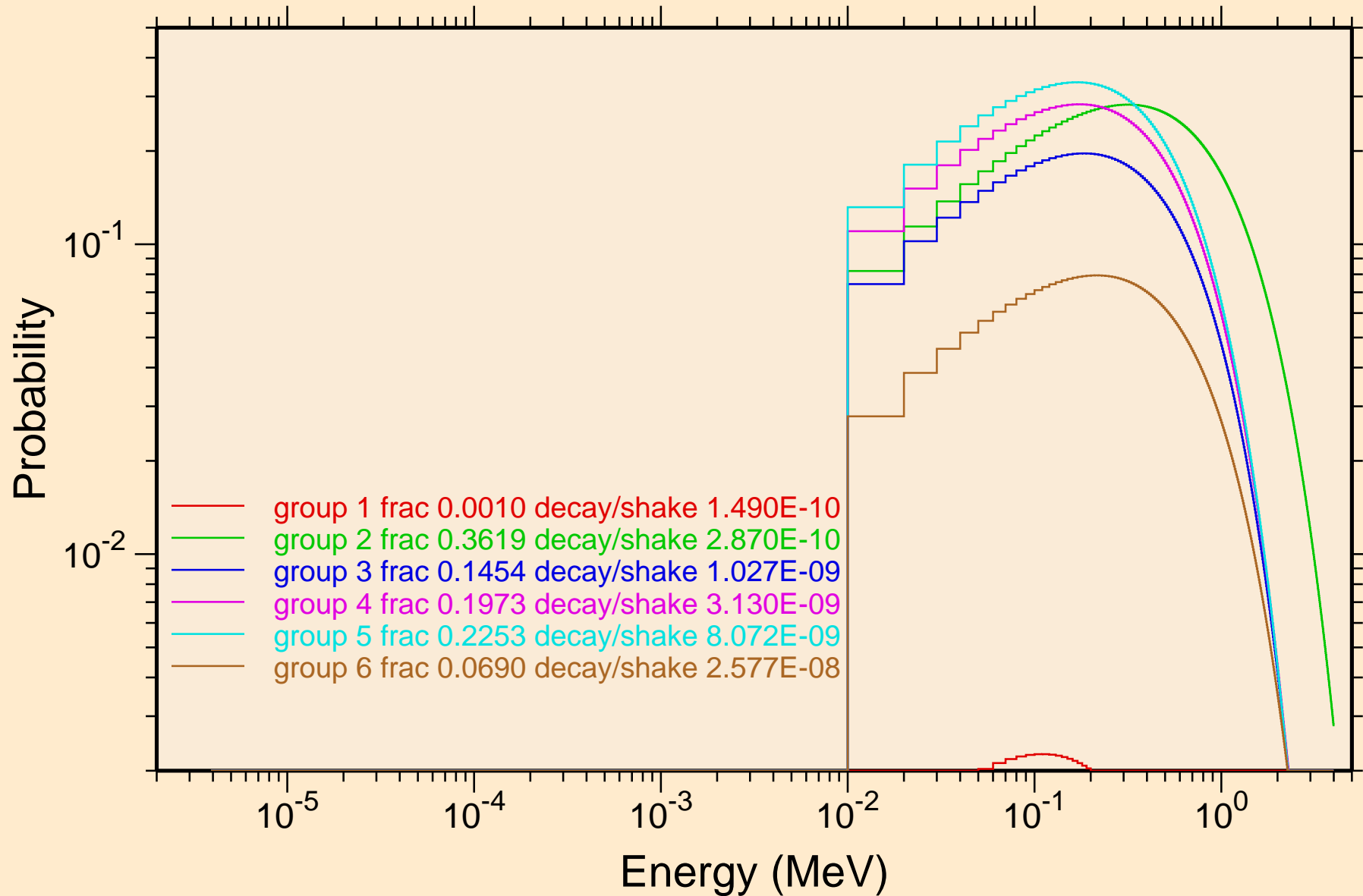

RF263 NEUTRON ACER TENDL-2021 LIBRARY; T=293.6K
Photon emission for (n,x)

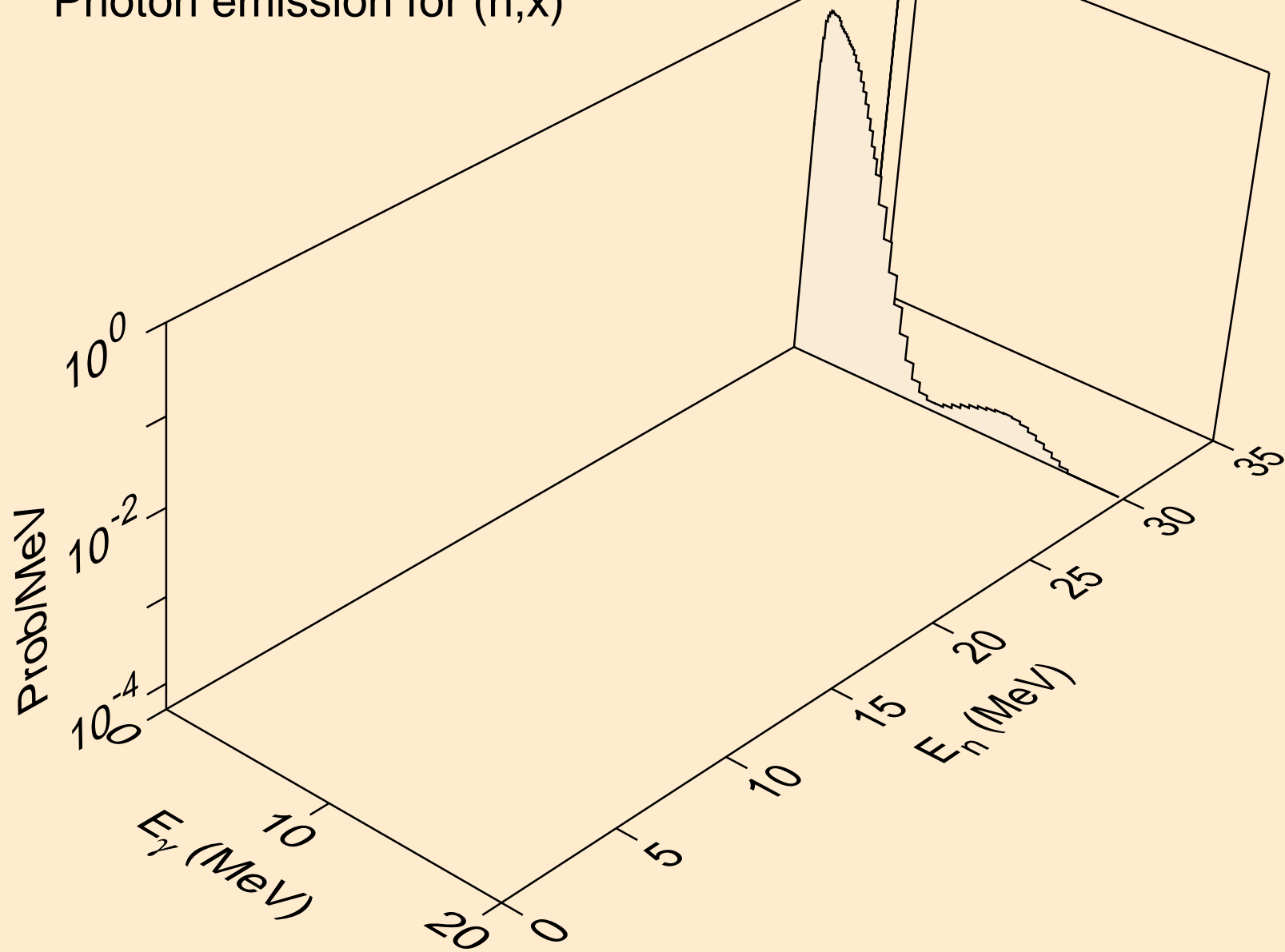

RF263 NEUTRON ACER TENDL-2021 LIBRARY; T=293.6K
Photon emission for (n,2nd)

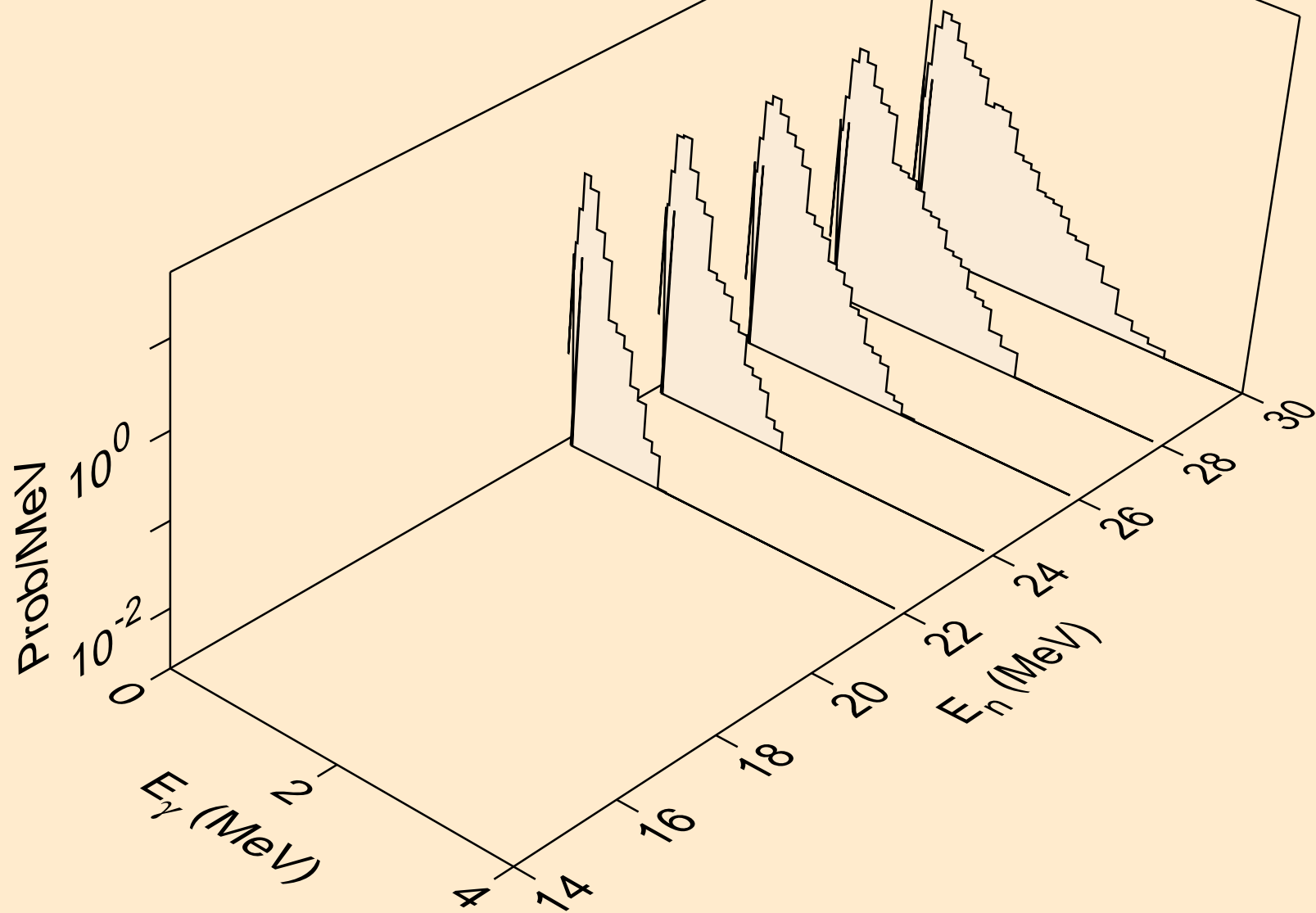

RF263 NEUTRON ACER TENDL-2021 LIBRARY; T=293.6K
Photon emission for (n,2n)

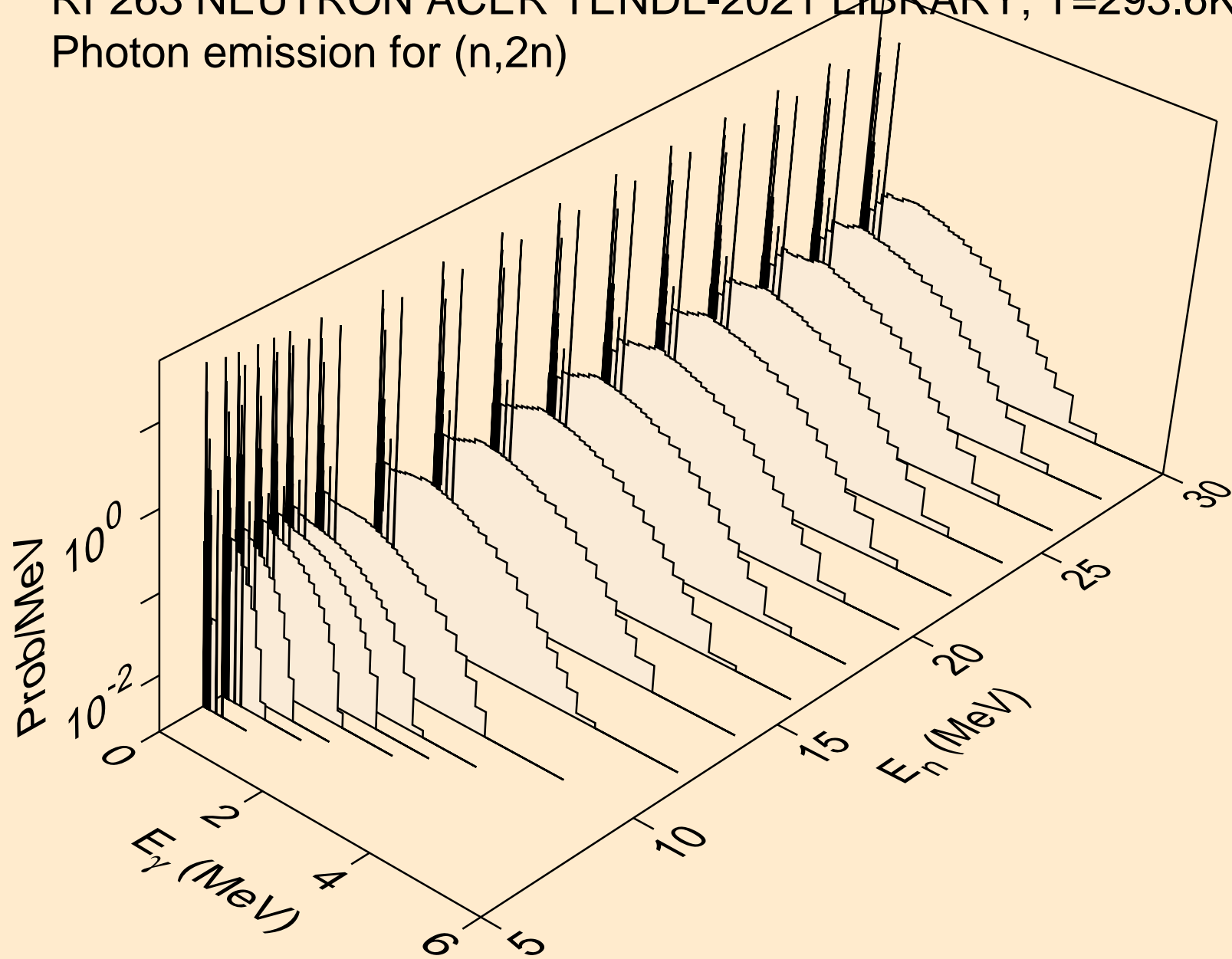

RF263 NEUTRON ACER TENDL-2021 LIBRARY; T=293.6K
Photon emission for (n,3n)

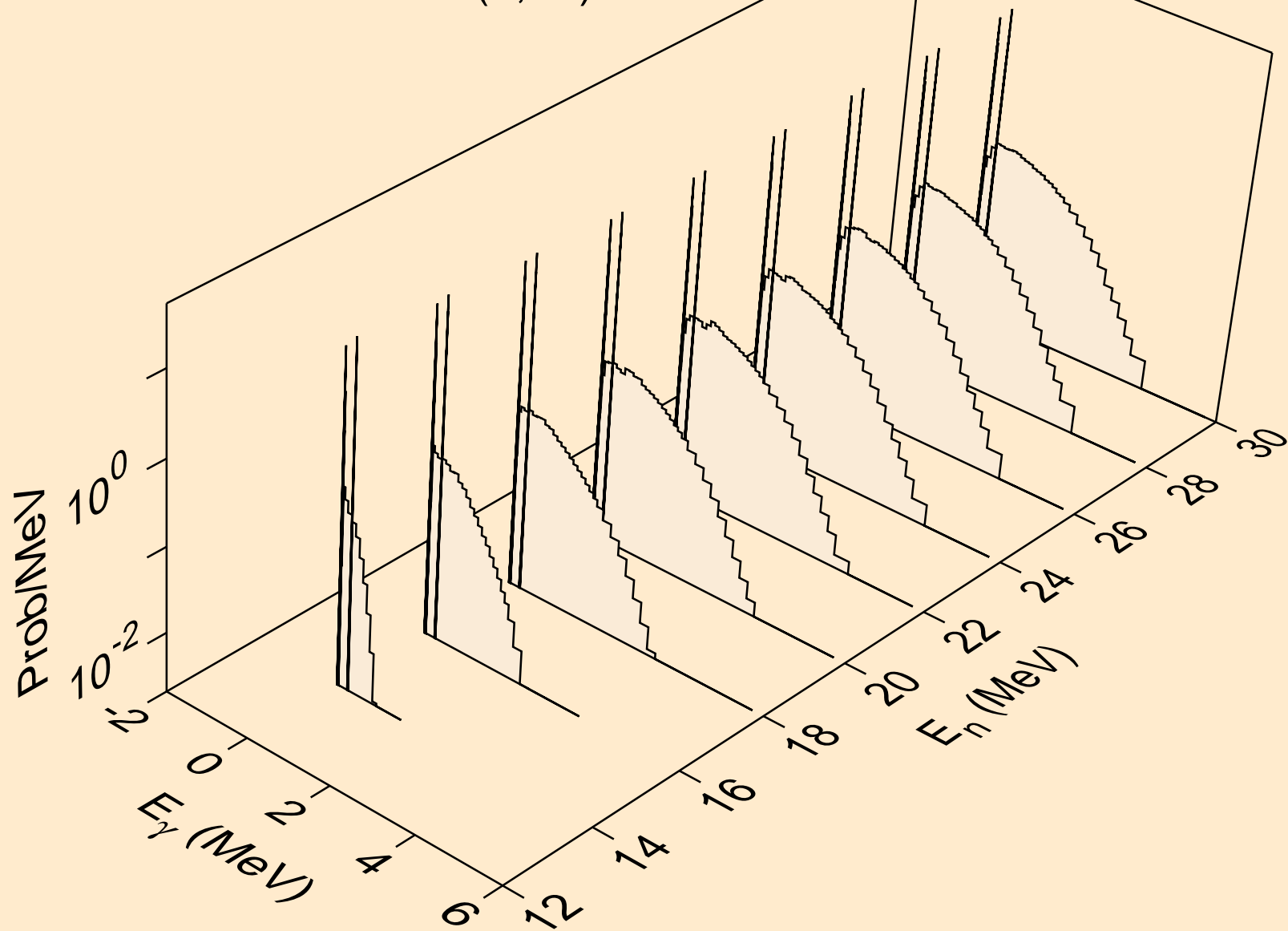

RF263 NEUTRON ACER TENDL-2021 LIBRARY; T=293.6K
Photon emission for (n,n*)a

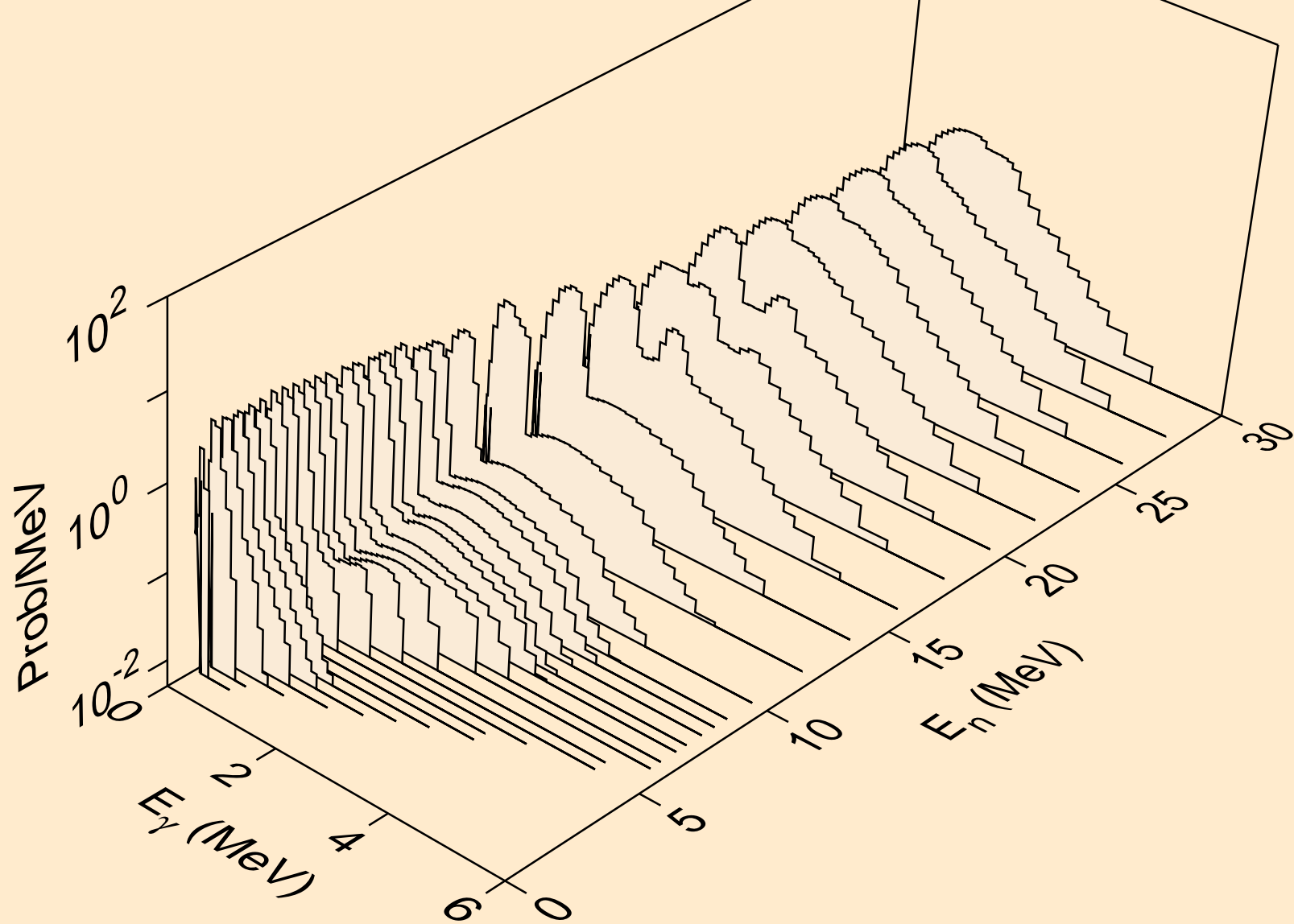

RF263 NEUTRON ACER TENDL-2021 LIBRARY; T=293.6K
Photon emission for (n,2n) α

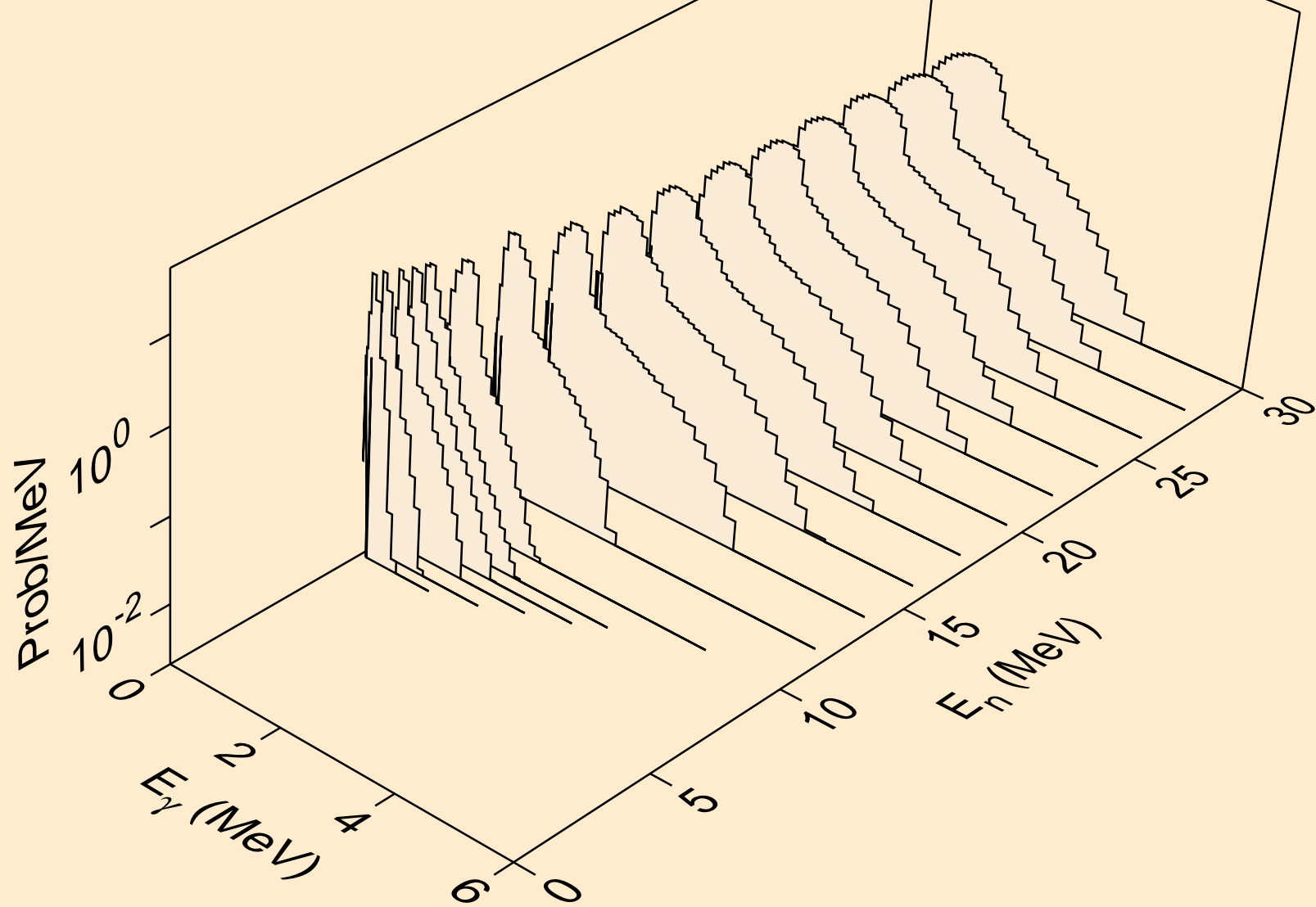

RF263 NEUTRON ACER TENDL-2021 LIBRARY; T=293.6K
Photon emission for (n,3n) α

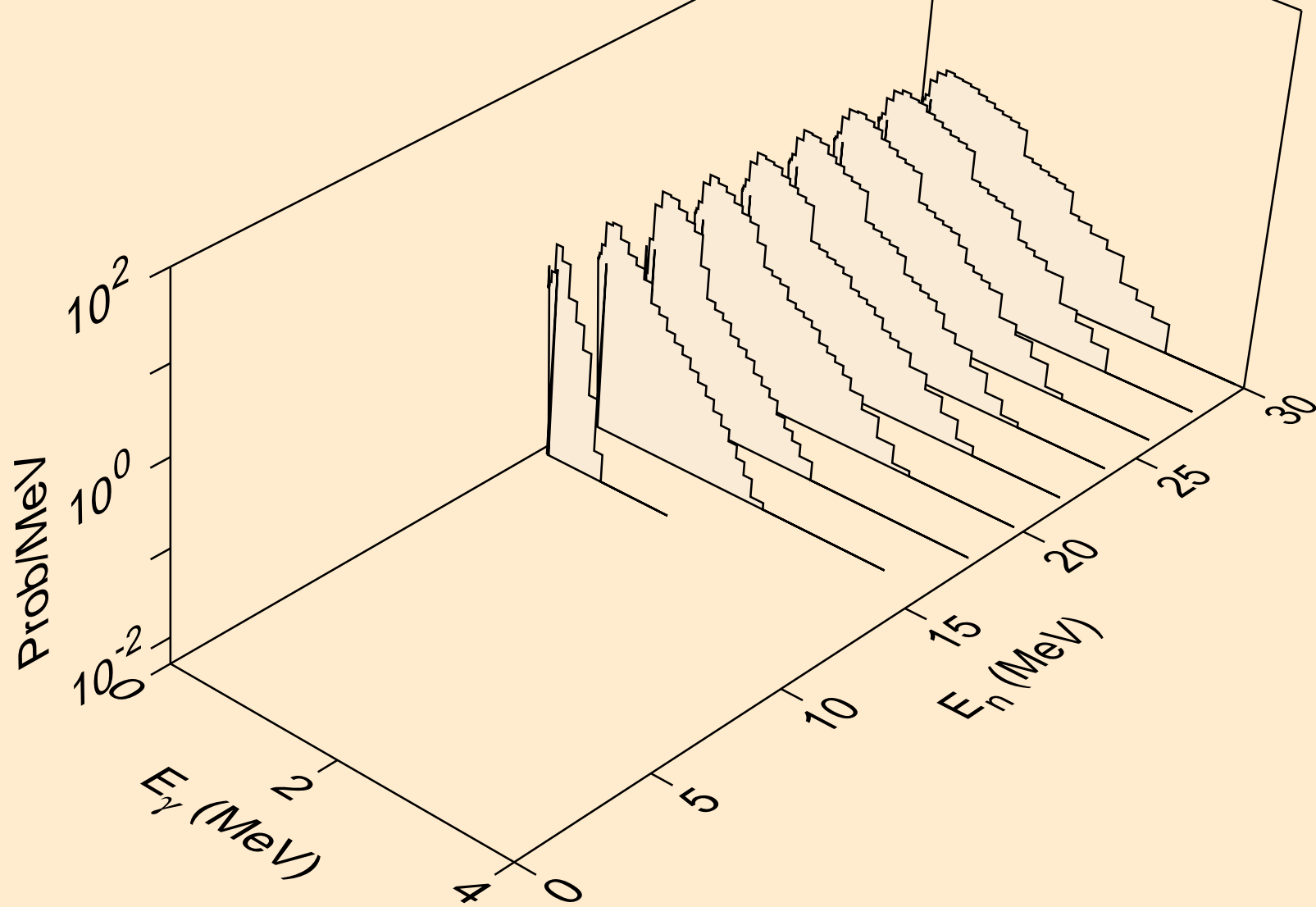

RF263 NEUTRON ACER TENDL-2021 LIBRARY; T=293.6K
Photon emission for (n,n*)p

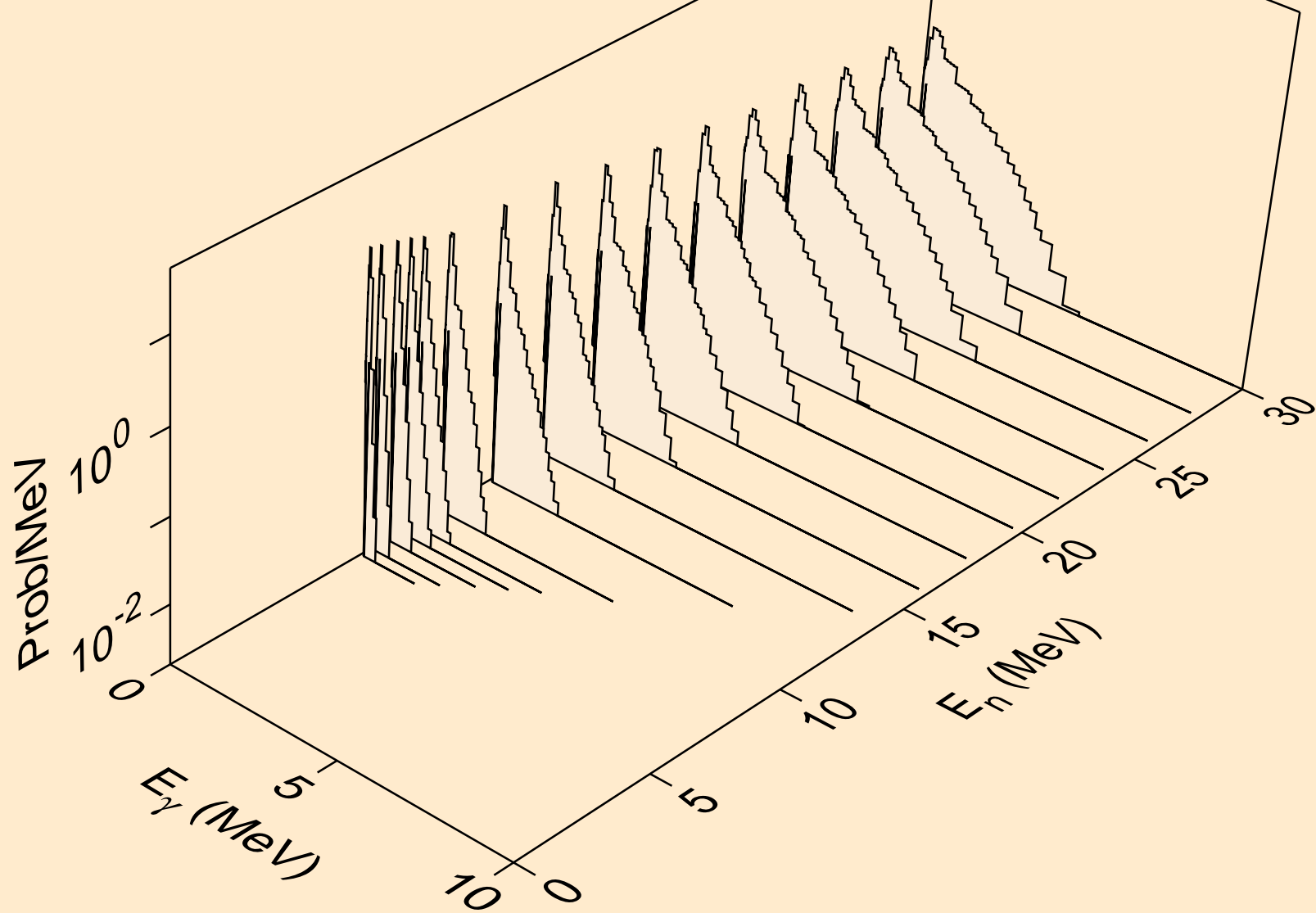

RF263 NEUTRON ACER TENDL-2021 LIBRARY; T=293.6K
Photon emission for (n,n*)d

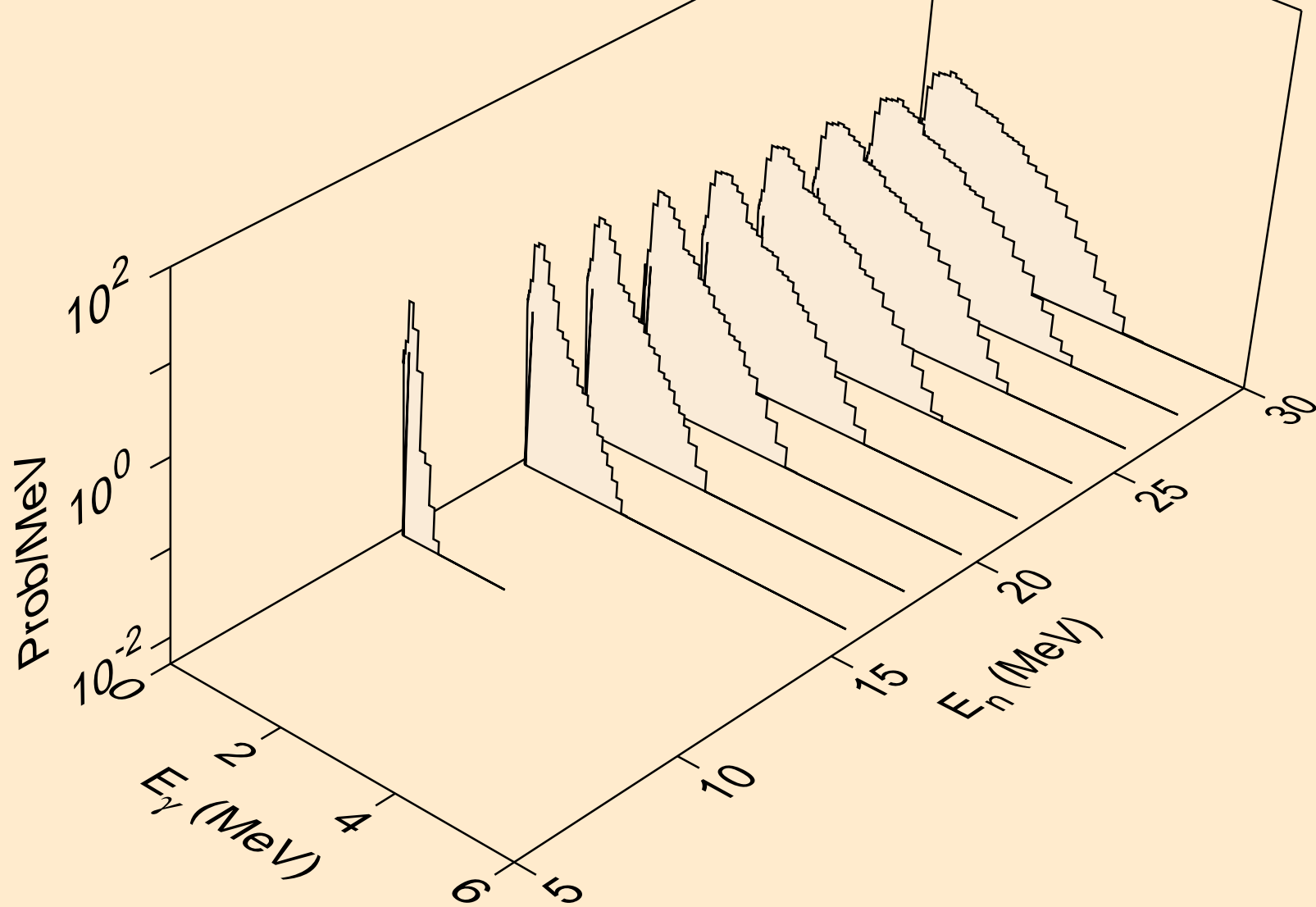

RF263 NEUTRON ACER TENDL-2021 LIBRARY; T=293.6K
Photon emission for (n,n*)t

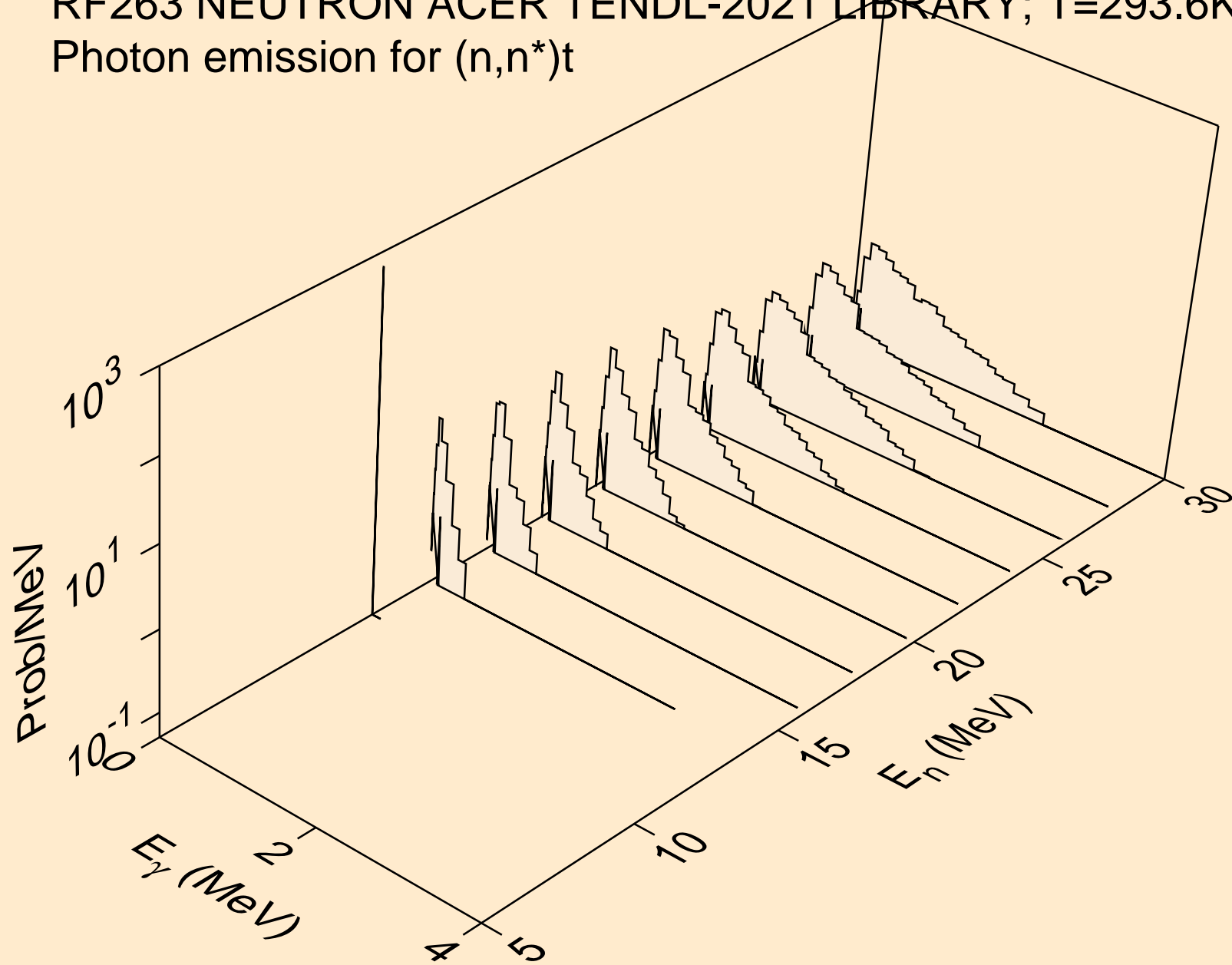

RF263 NEUTRON ACER TENDL-2021 LIBRARY; T=293.6K
Photon emission for (n,n*)he3

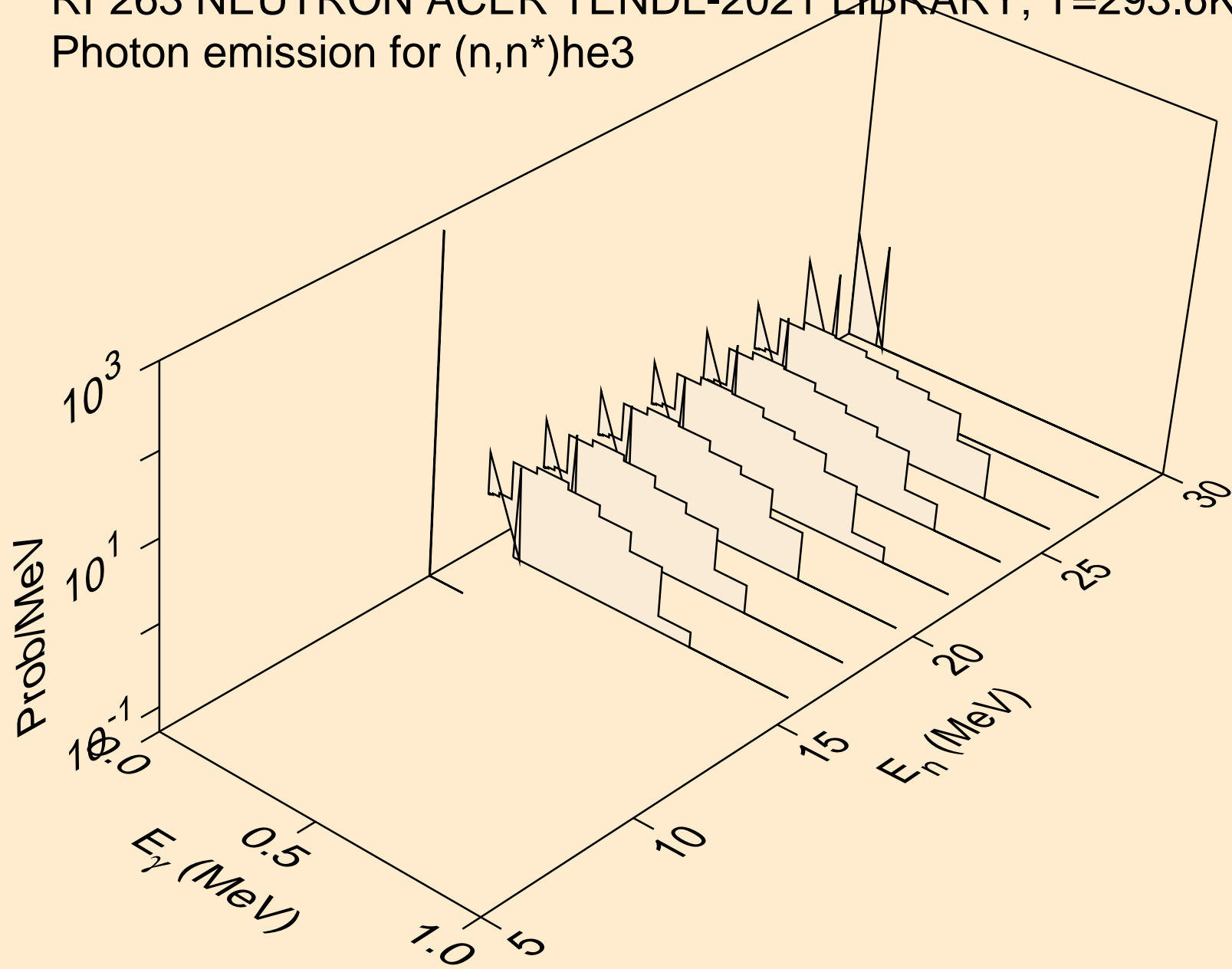

RF263 NEUTRON ACER TENDL-2021 LIBRARY; T=293.6K
Photon emission for (n,4n)

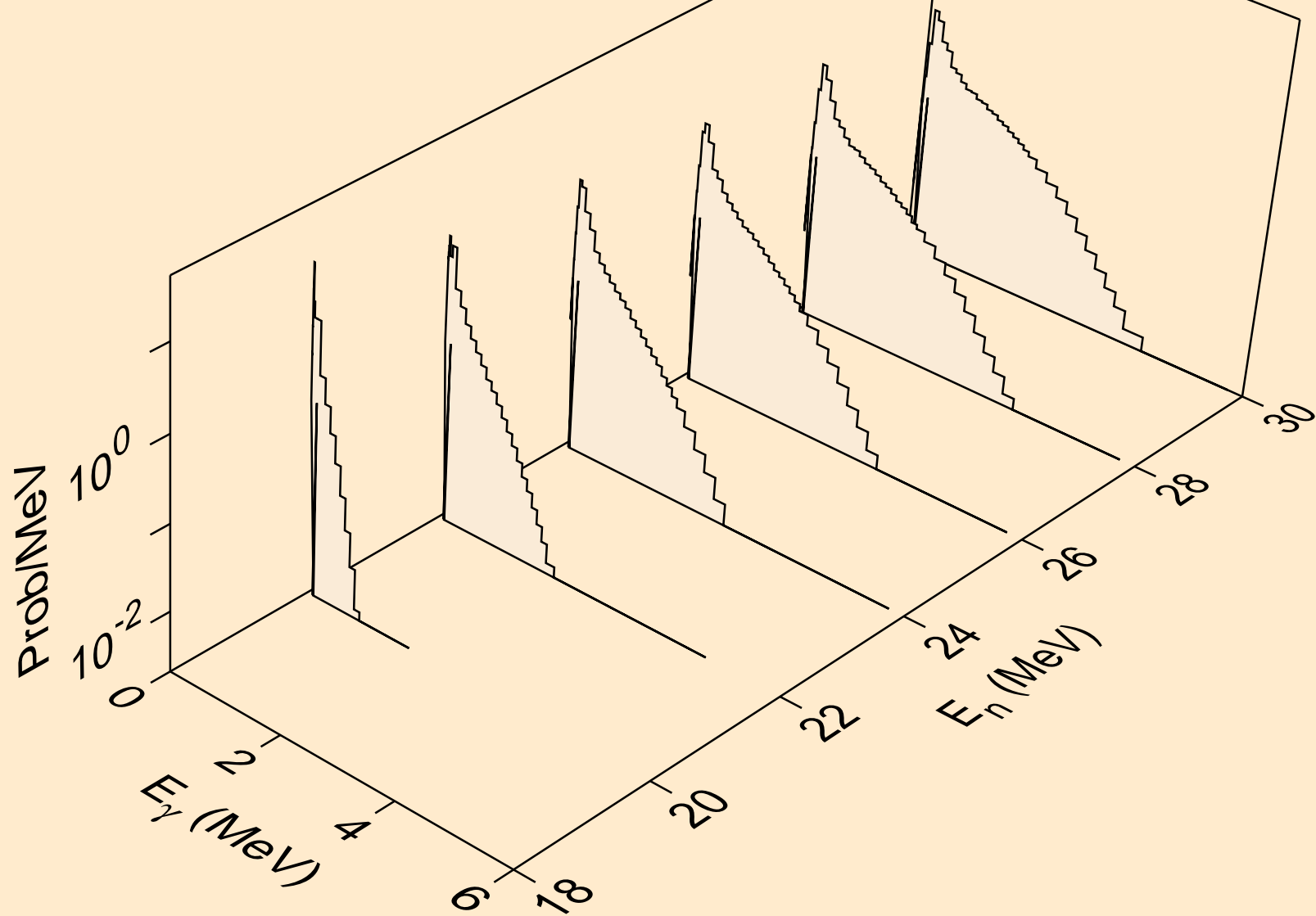

RF263 NEUTRON ACER TENDL-2021 LIBRARY; T=293.6K
Photon emission for (n,2np)

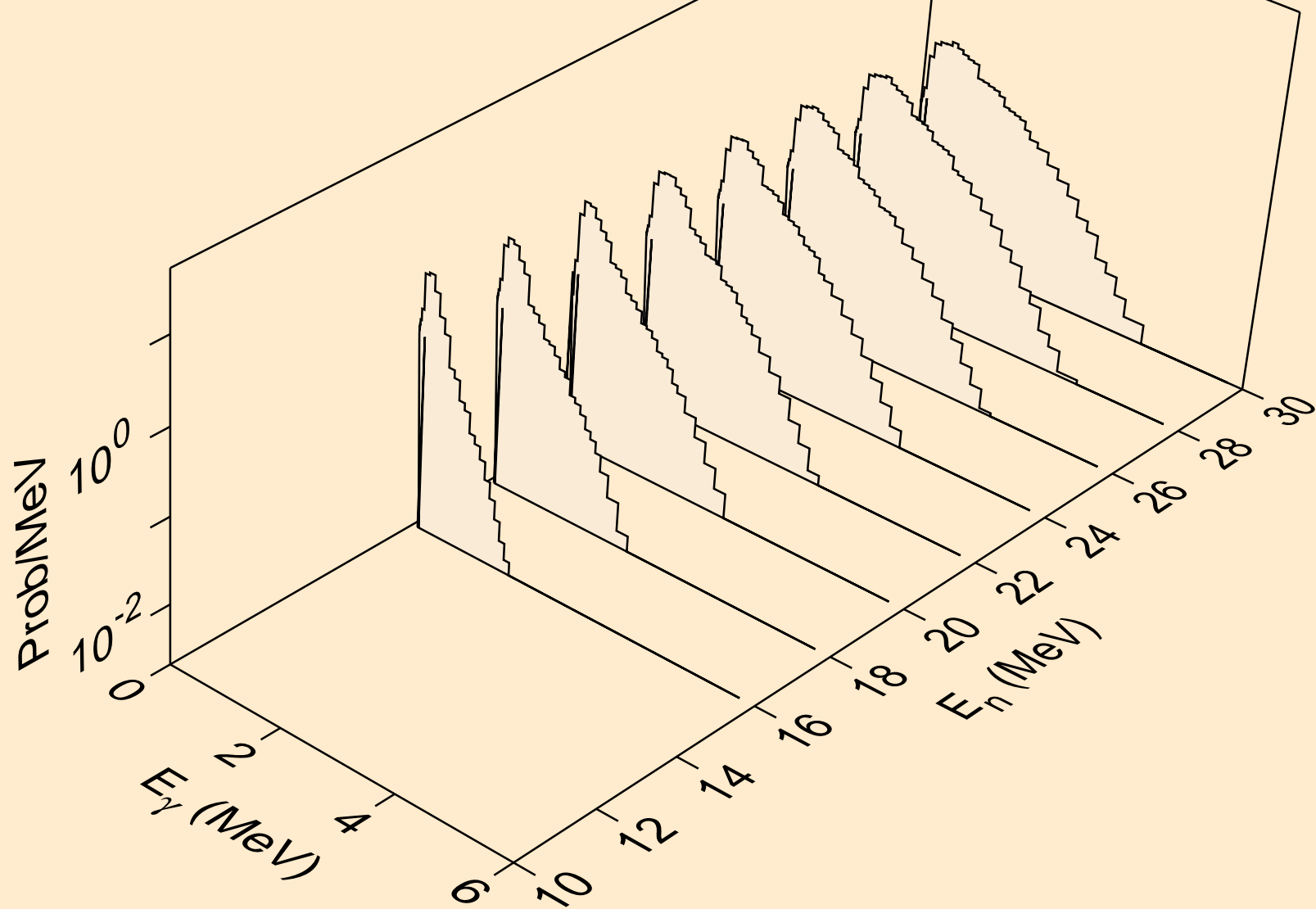

RF263 NEUTRON ACER TENDL-2021 LIBRARY; T=293.6K
Photon emission for (n,3np)

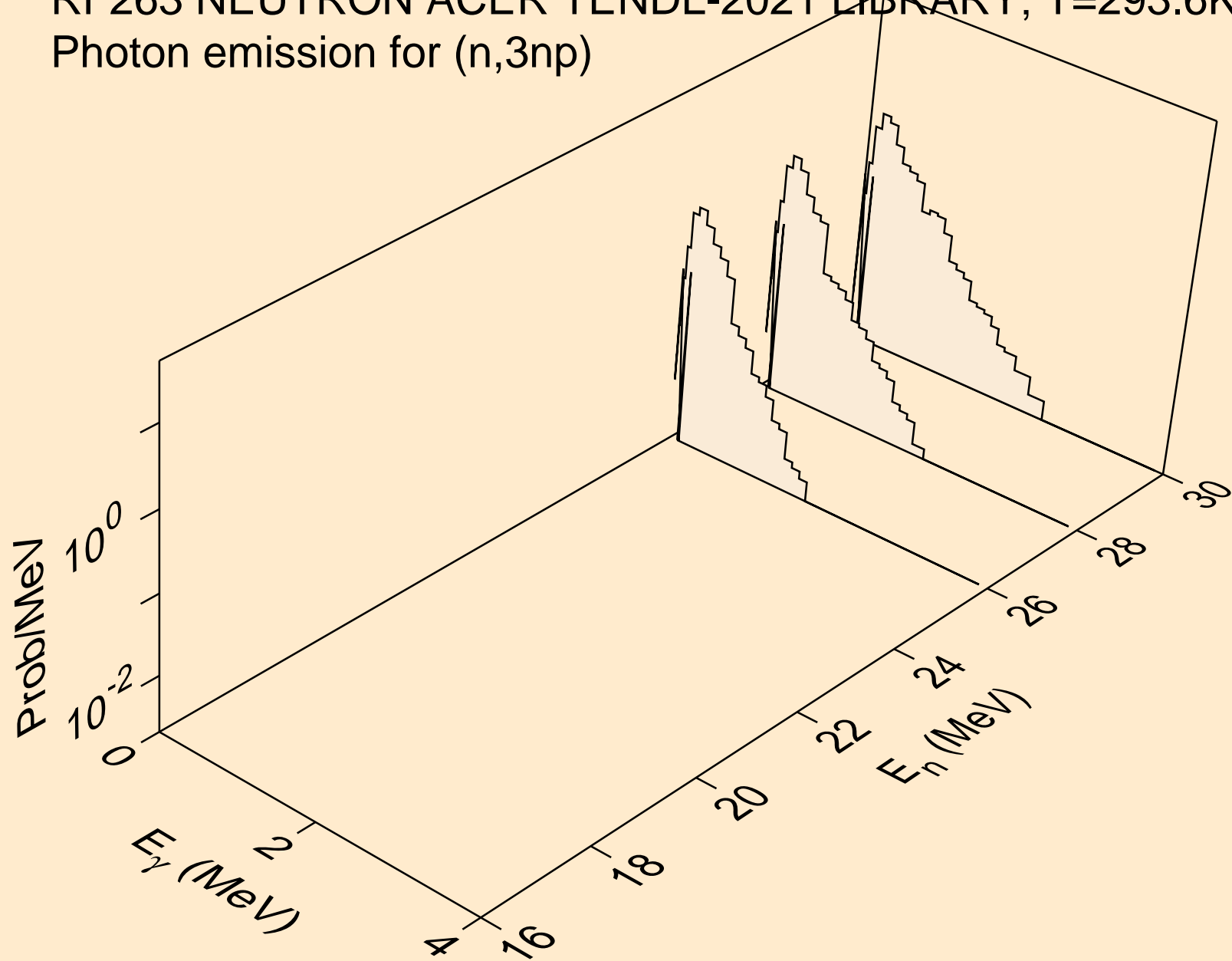

RF263 NEUTRON ACER TENDL-2021 LIBRARY; T=293.6K
Photon emission for (n,2np)

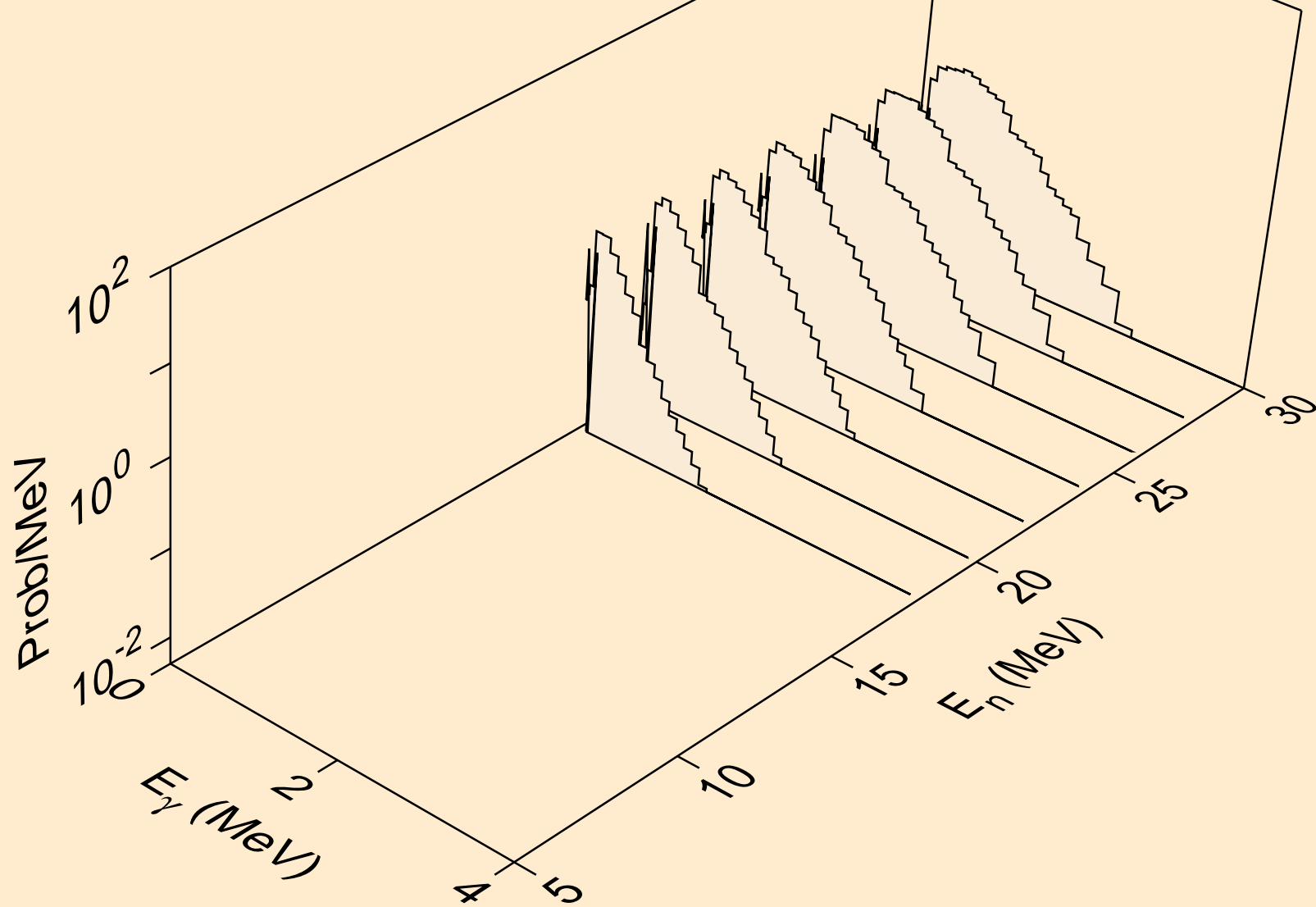

RF263 NEUTRON ACER TENDL-2021 LIBRARY; T=293.6K
Photon emission for (n,npa)

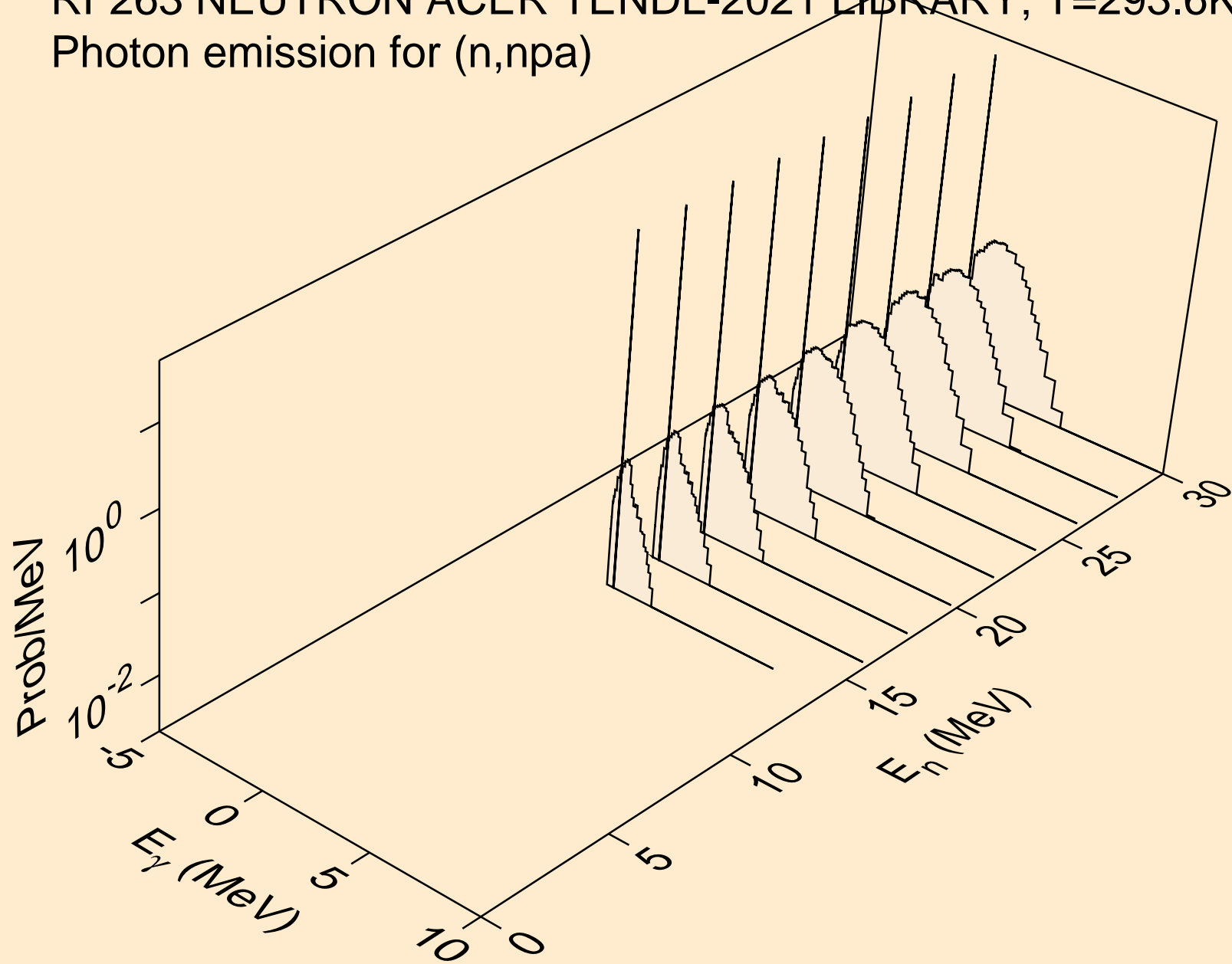

RF263 NEUTRON ACER TENDL-2021 LIBRARY; T=293.6K
Photon emission for (n,n*c)

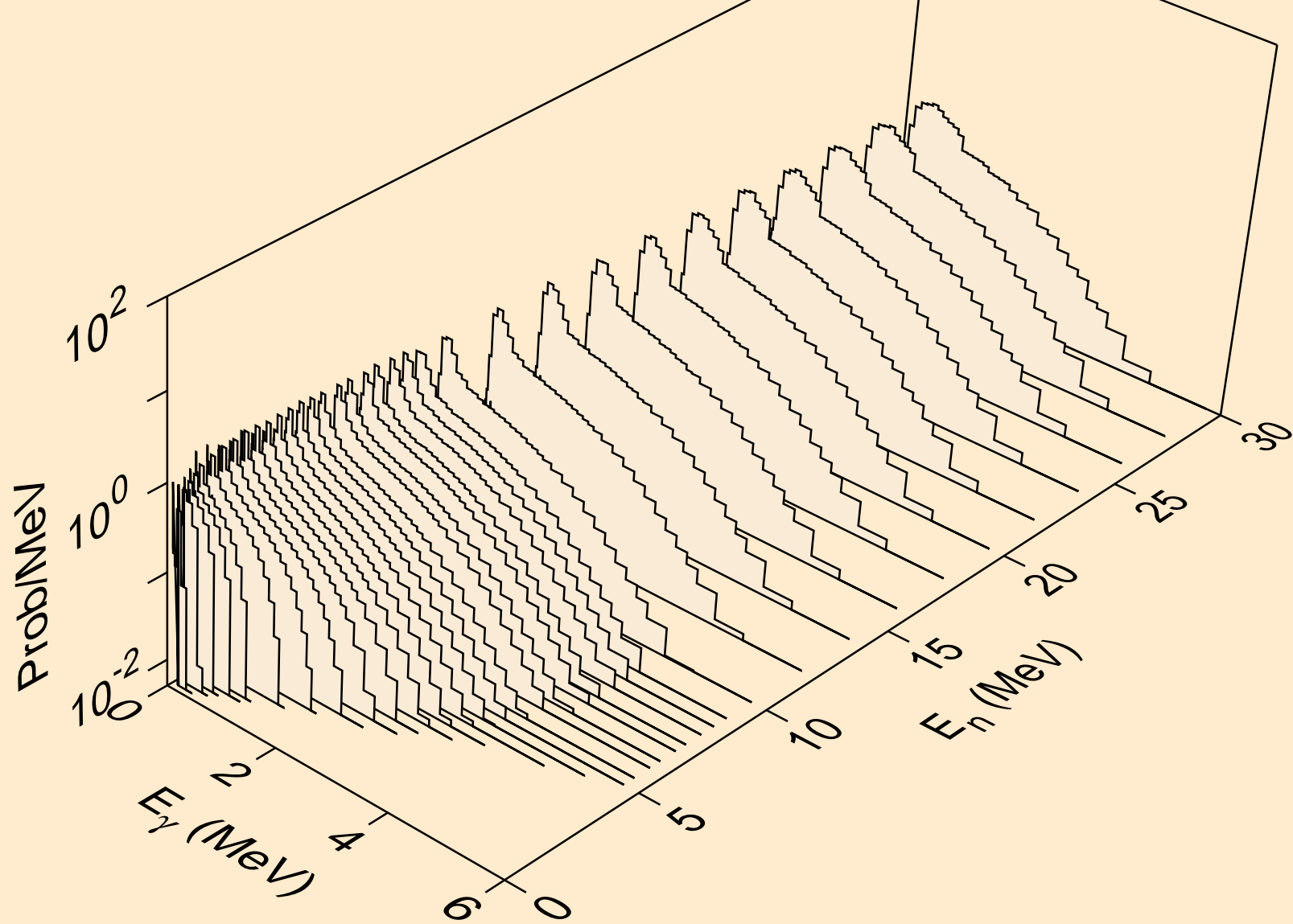

RF263 NEUTRON ACER TENDL-2021 LIBRARY; T=293.6K
Photon emission for (n,gma)

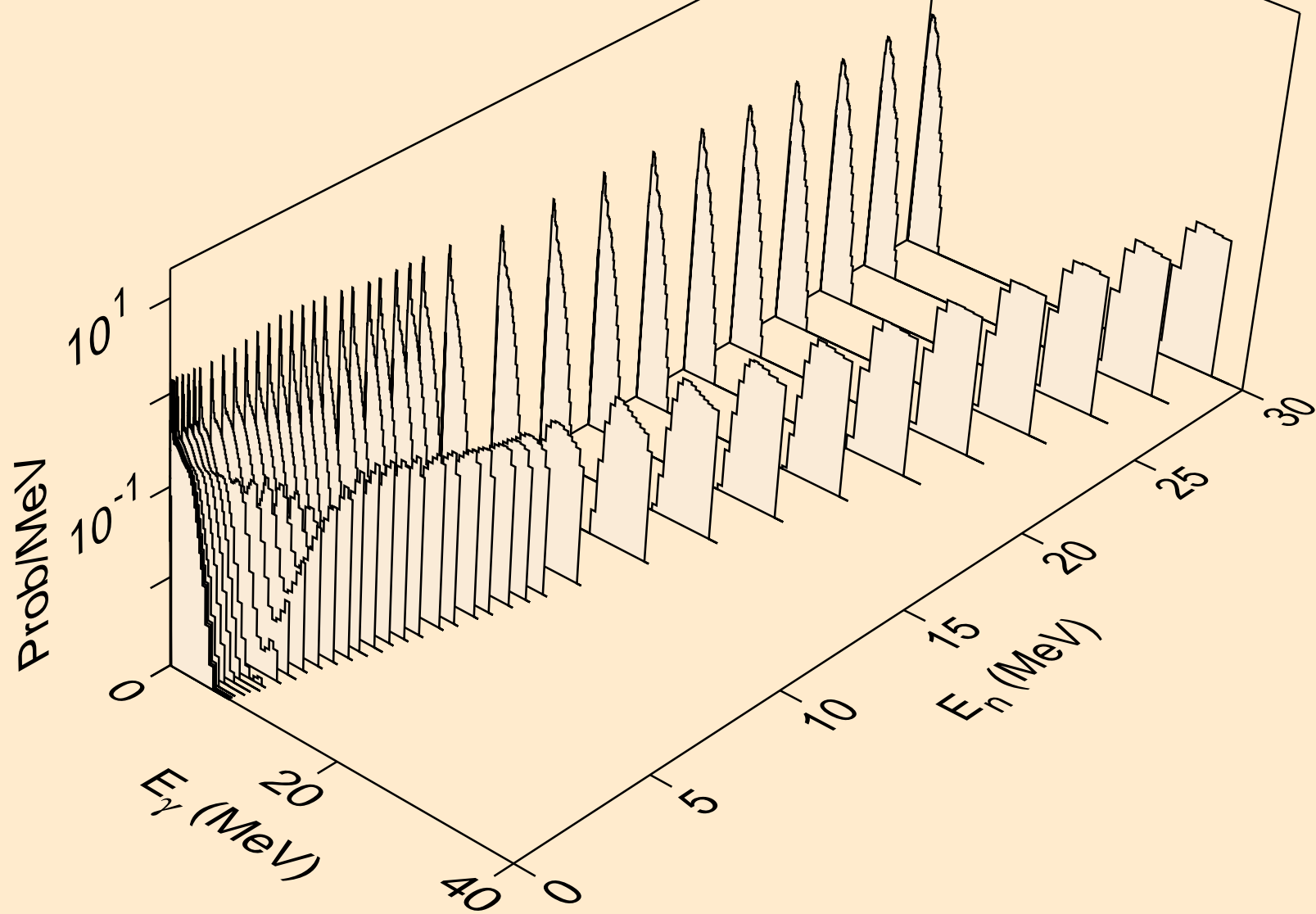

RF263 NEUTRON ACER TENDL-2021 LIBRARY; T=293.6K
Photon emission for (n,p)

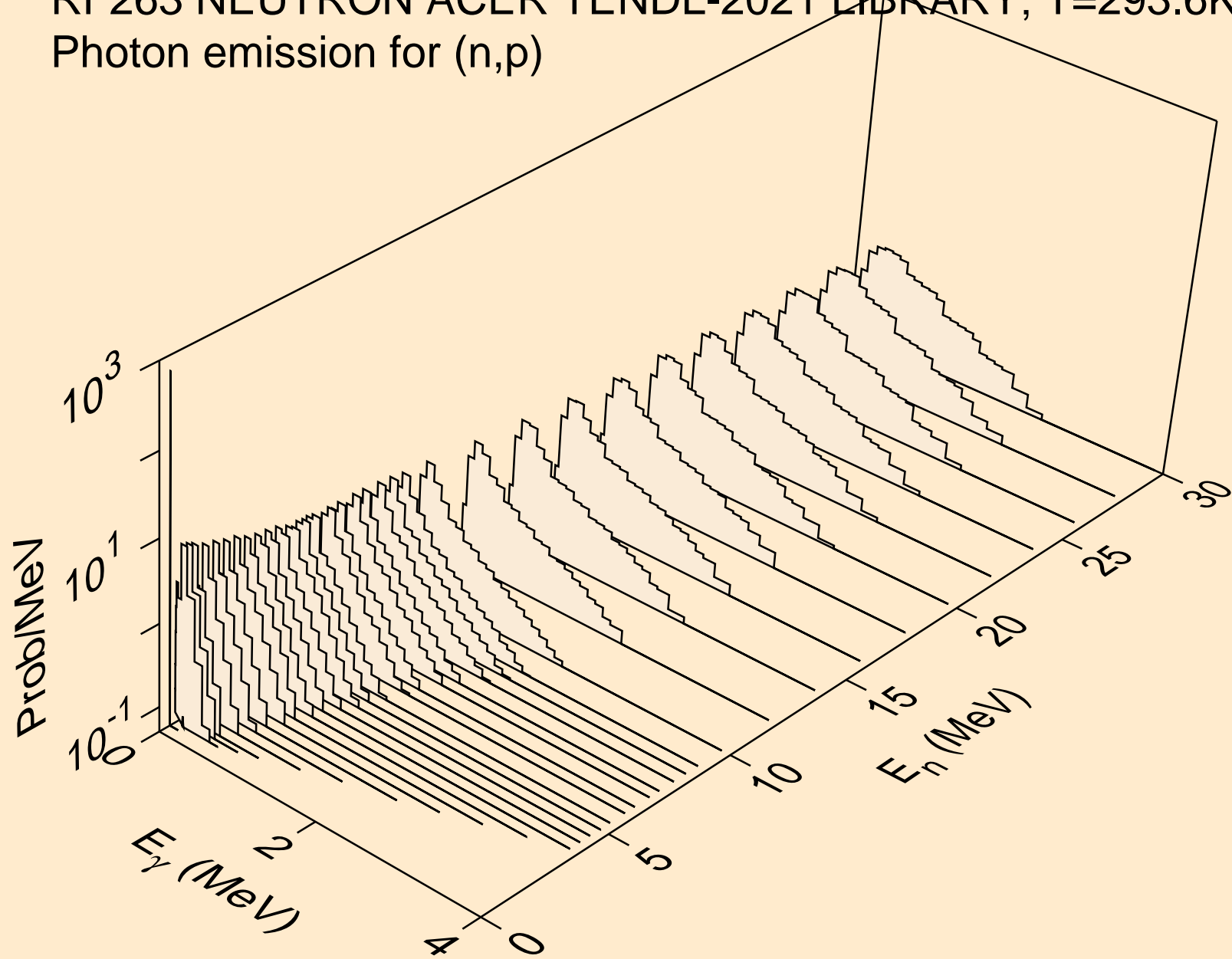

RF263 NEUTRON ACER TENDL-2021 LIBRARY; T=293.6K
Photon emission for (n,d)

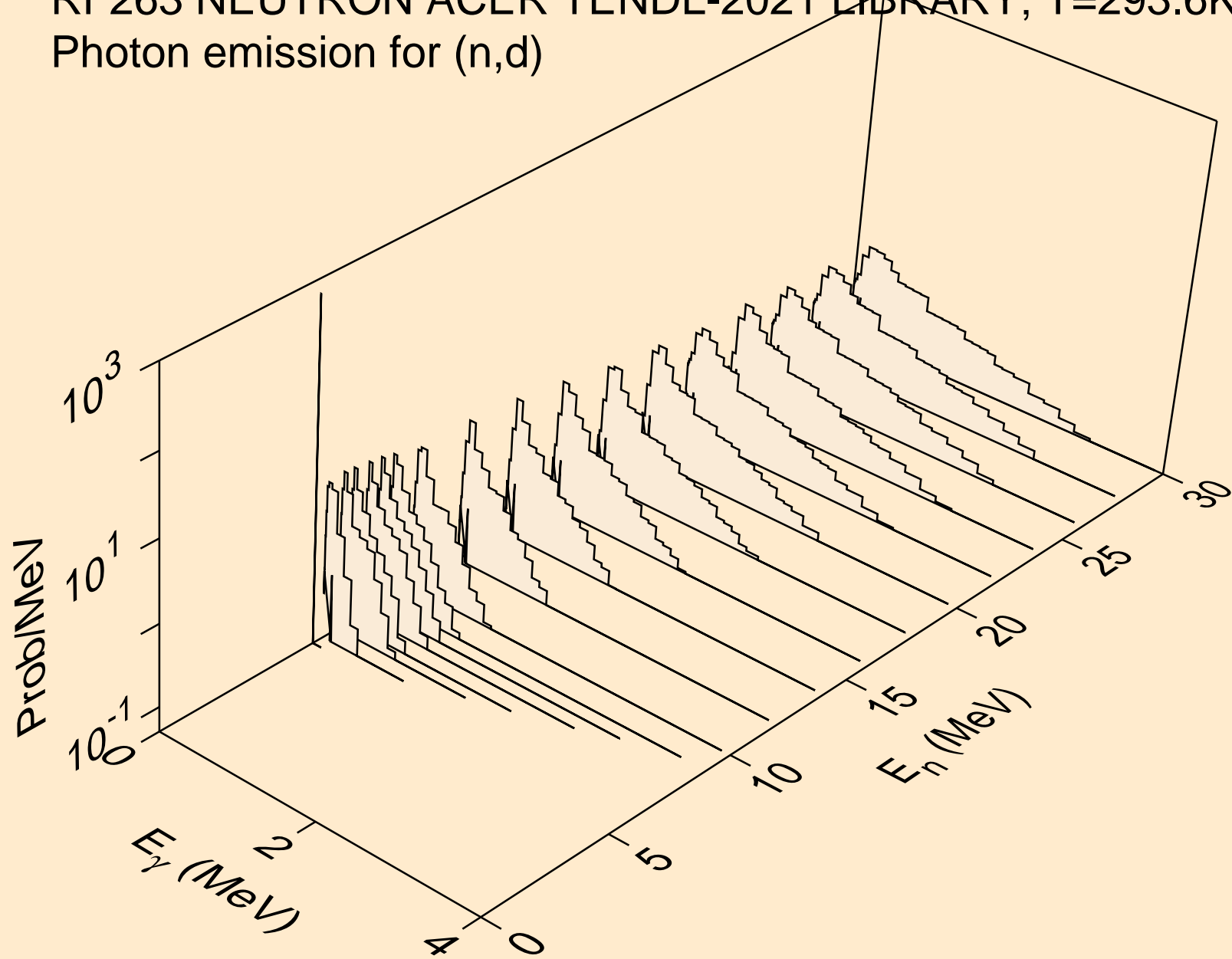

RF263 NEUTRON ACER TENDL-2021 LIBRARY; T=293.6K
Photon emission for (n,t)

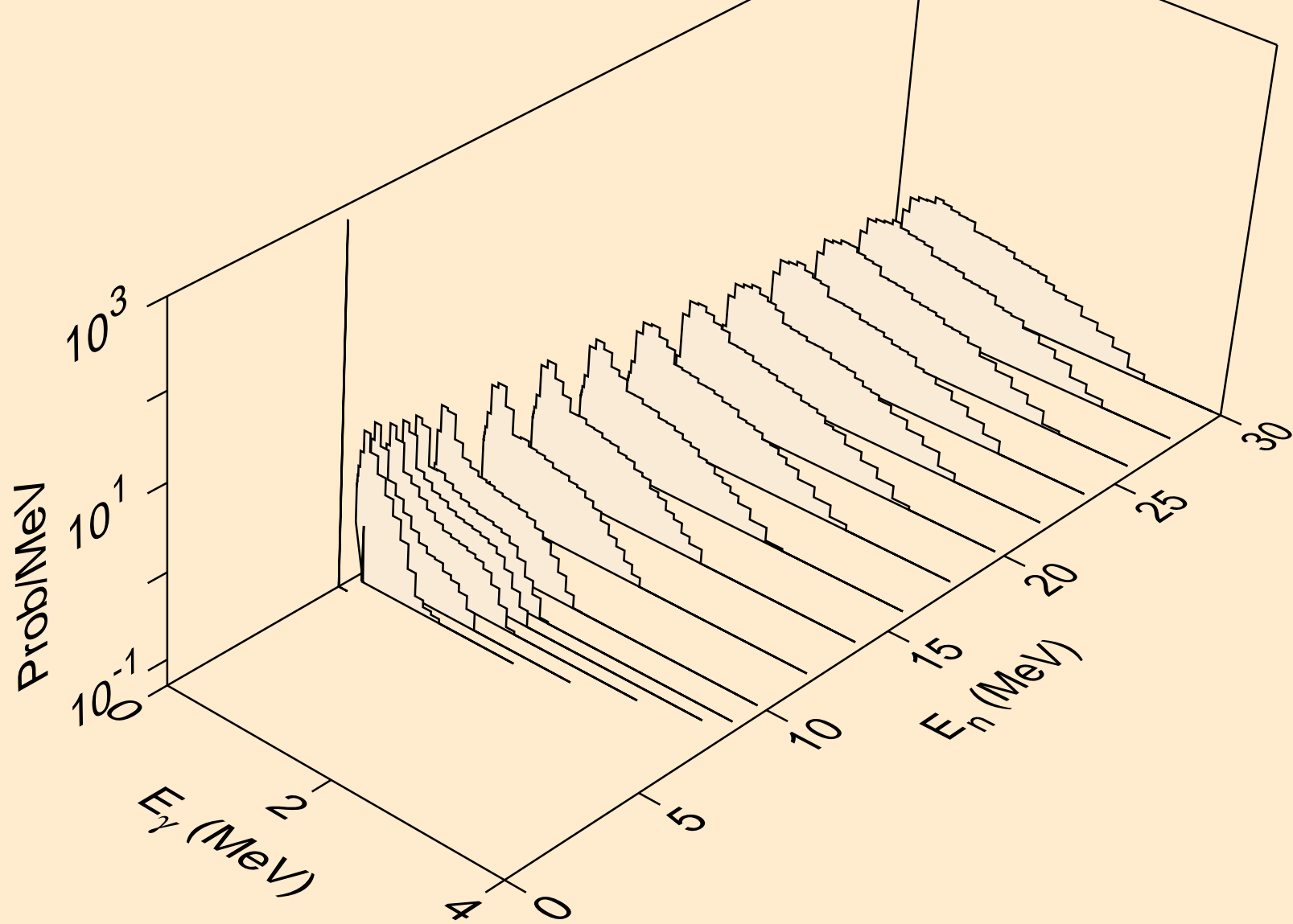

RF263 NEUTRON ACER TENDL-2021 LIBRARY; T=293.6K
Photon emission for (n,he3)

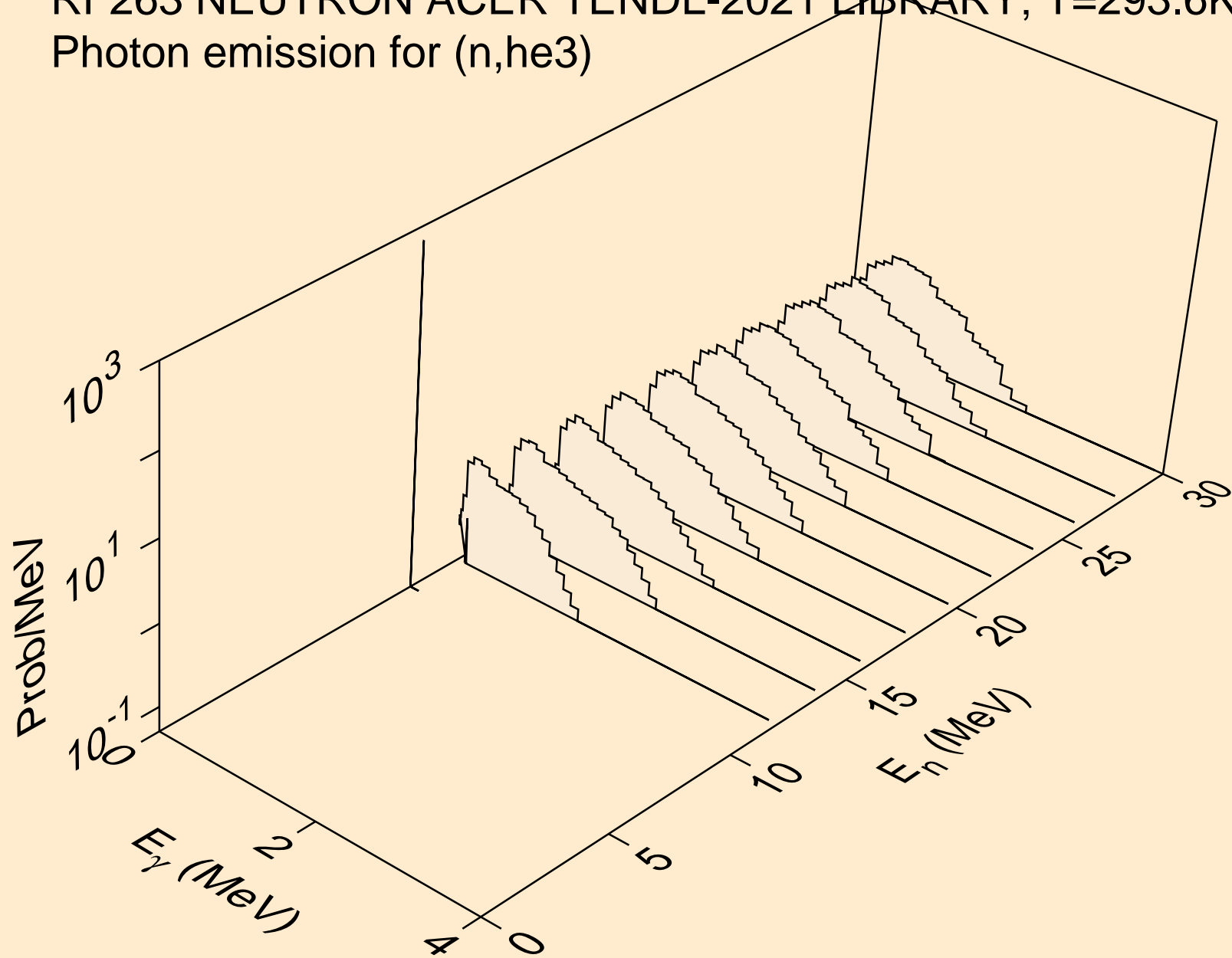

RF263 NEUTRON ACER TENDL-2021 LIBRARY; T=293.6K
Photon emission for (n,a)

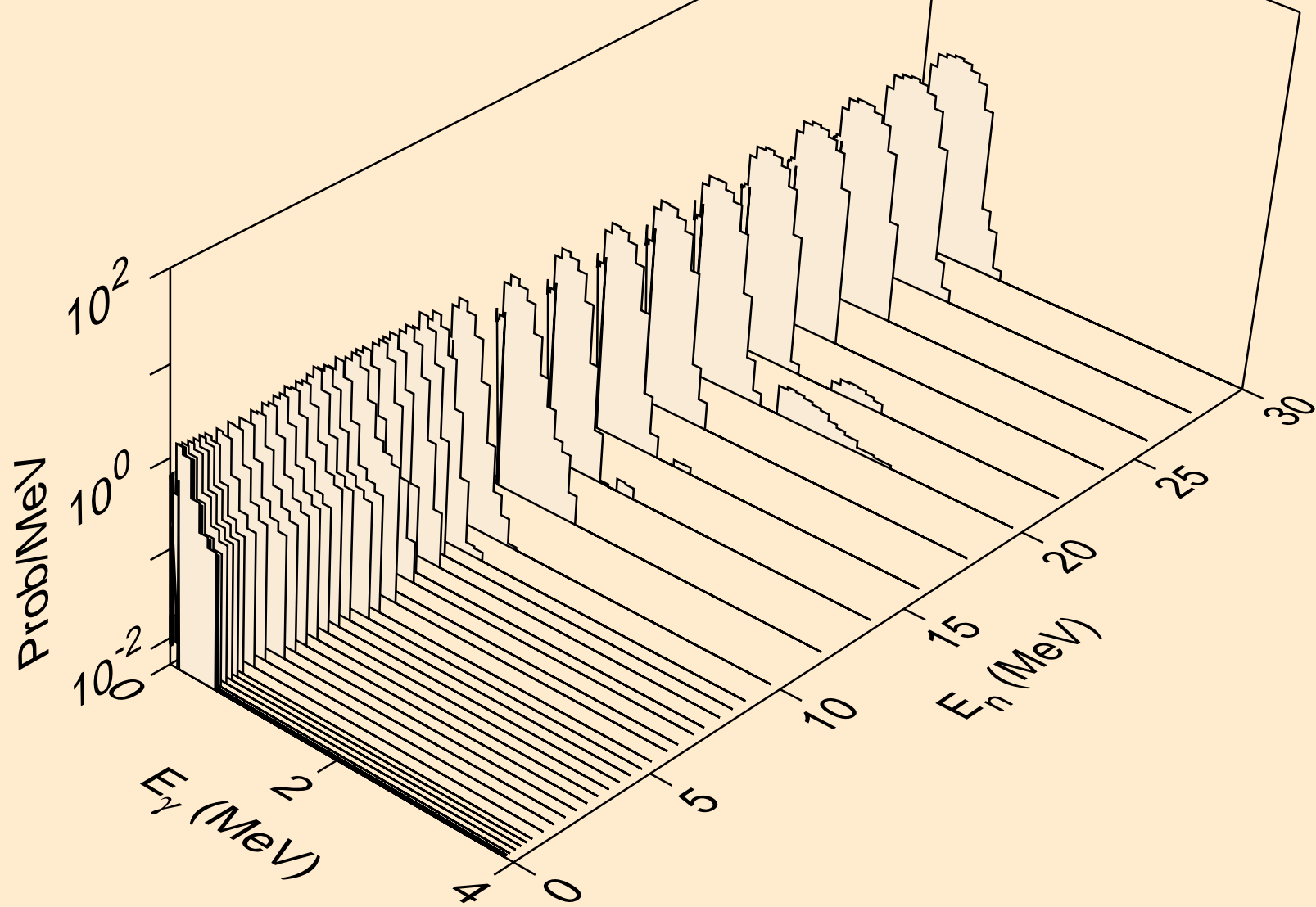

RF263 NEUTRON ACER TENDL-2021 LIBRARY; T=293.6K
Photon emission for (n,2p)

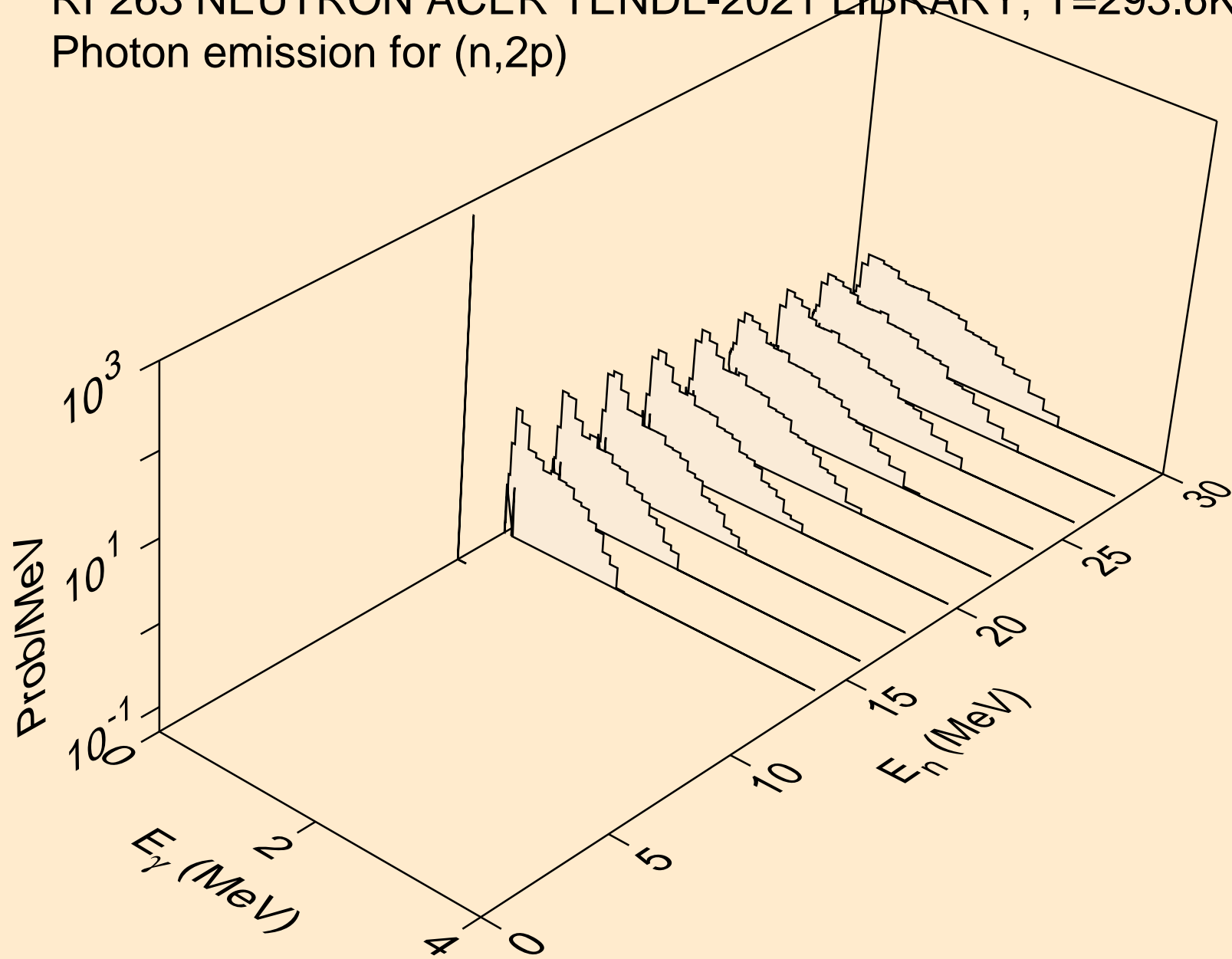

RF263 NEUTRON ACER TENDL-2021 LIBRARY; T=293.6K
Photon emission for (n,pd)

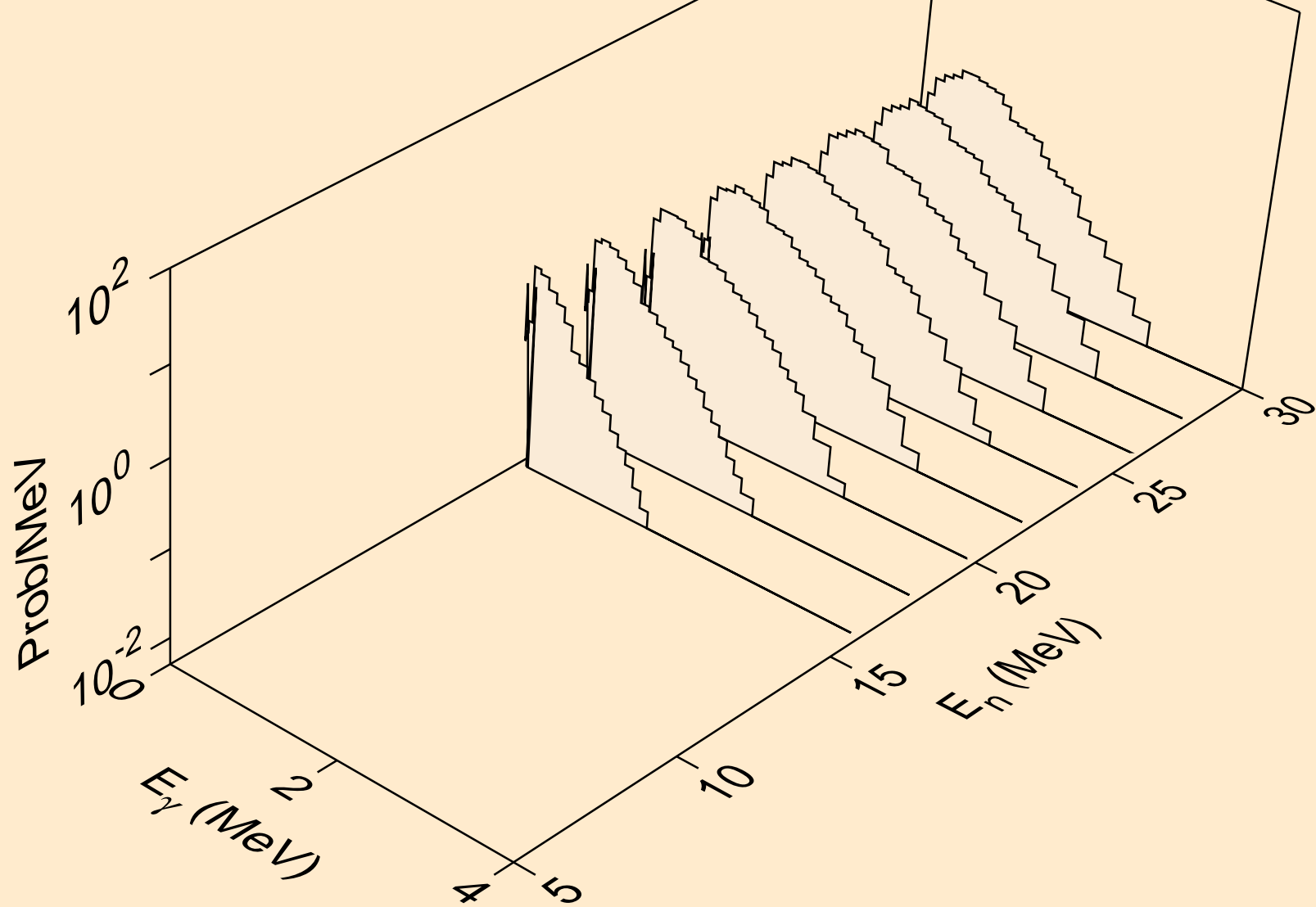

RF263 NEUTRON ACER TENDL-2021 LIBRARY; T=293.6K
Photon emission for (n,da)

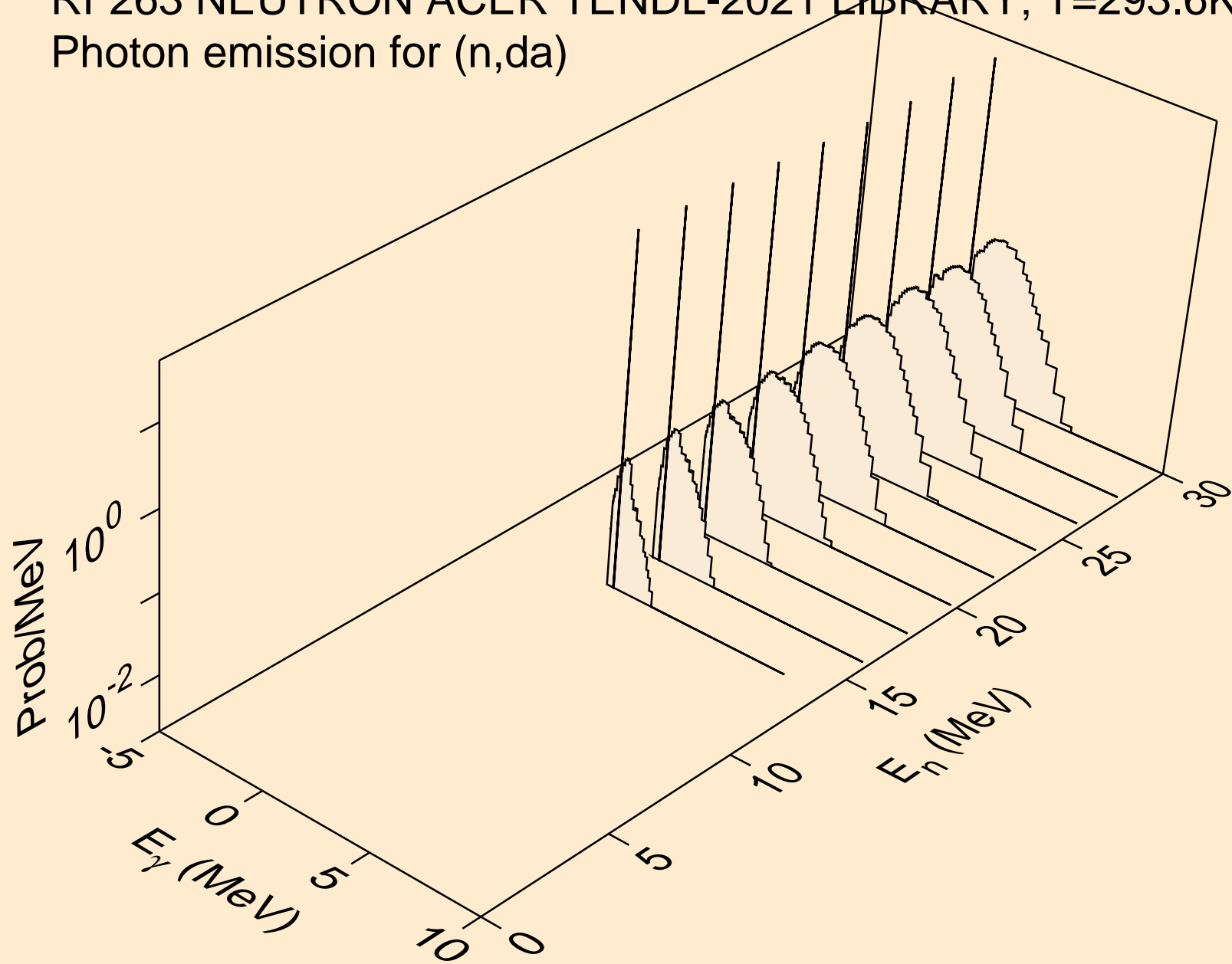

RF263 NEUTRON ACER TENDL-2021 LIBRARY; T=293.6K
thermal capture photon spectrum

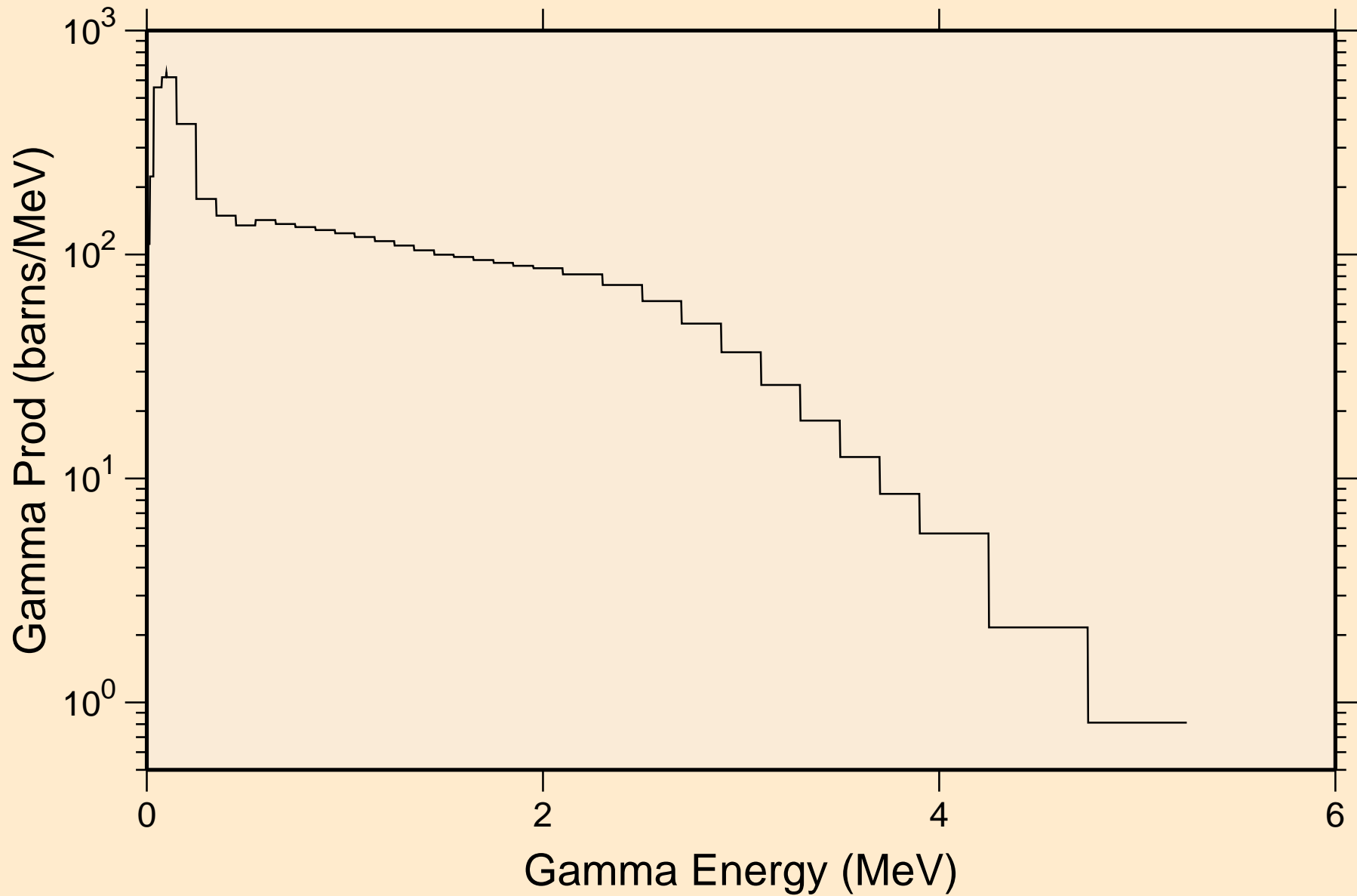

RF263 NEUTRON ACER TENDL-2021 LIBRARY; T=293.6K
14 MeV photon spectrum

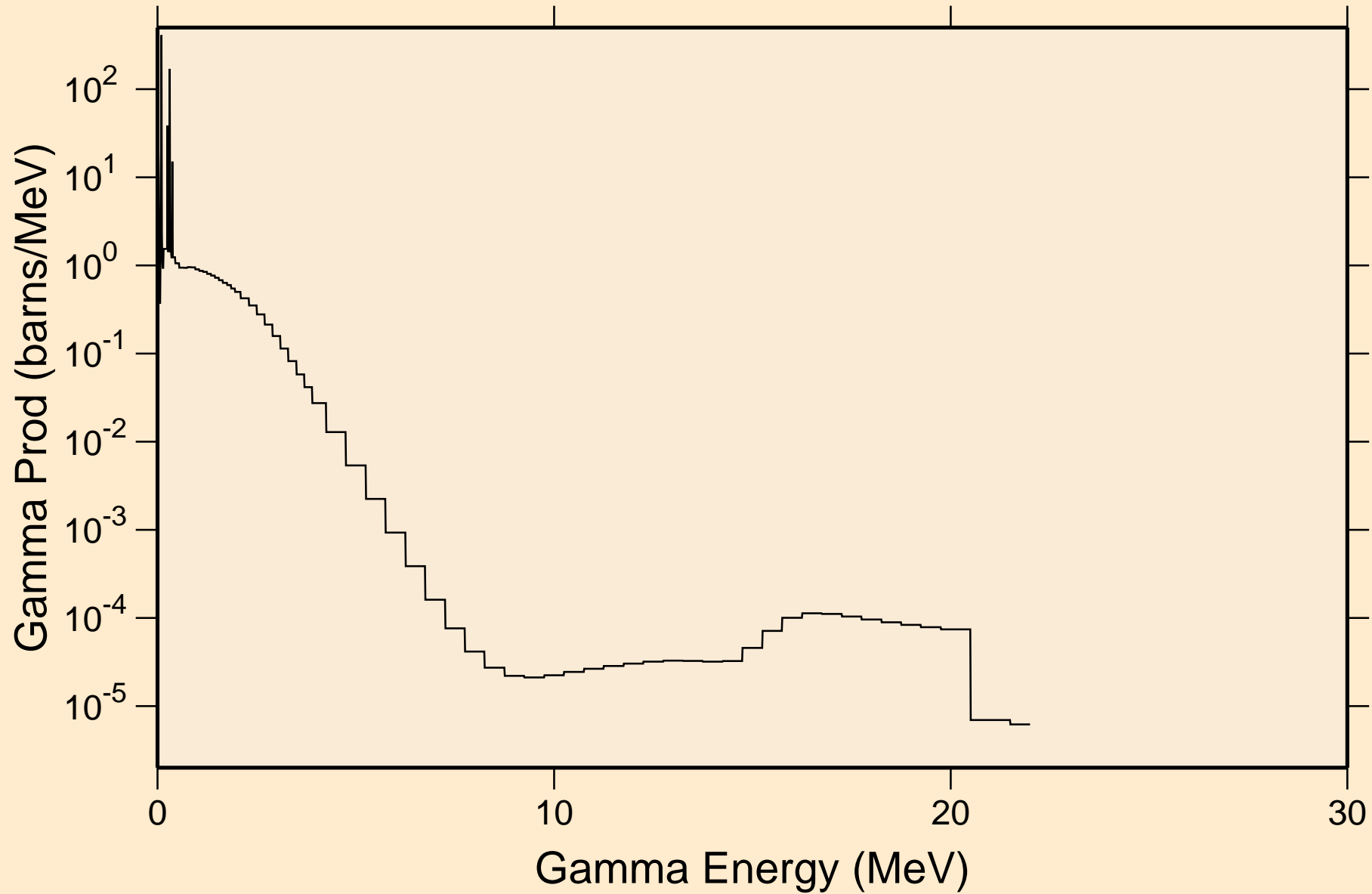

RF263 NEUTRON ACER TENDL-2021 LIBRARY; T=293.6K

Particle heating contributions

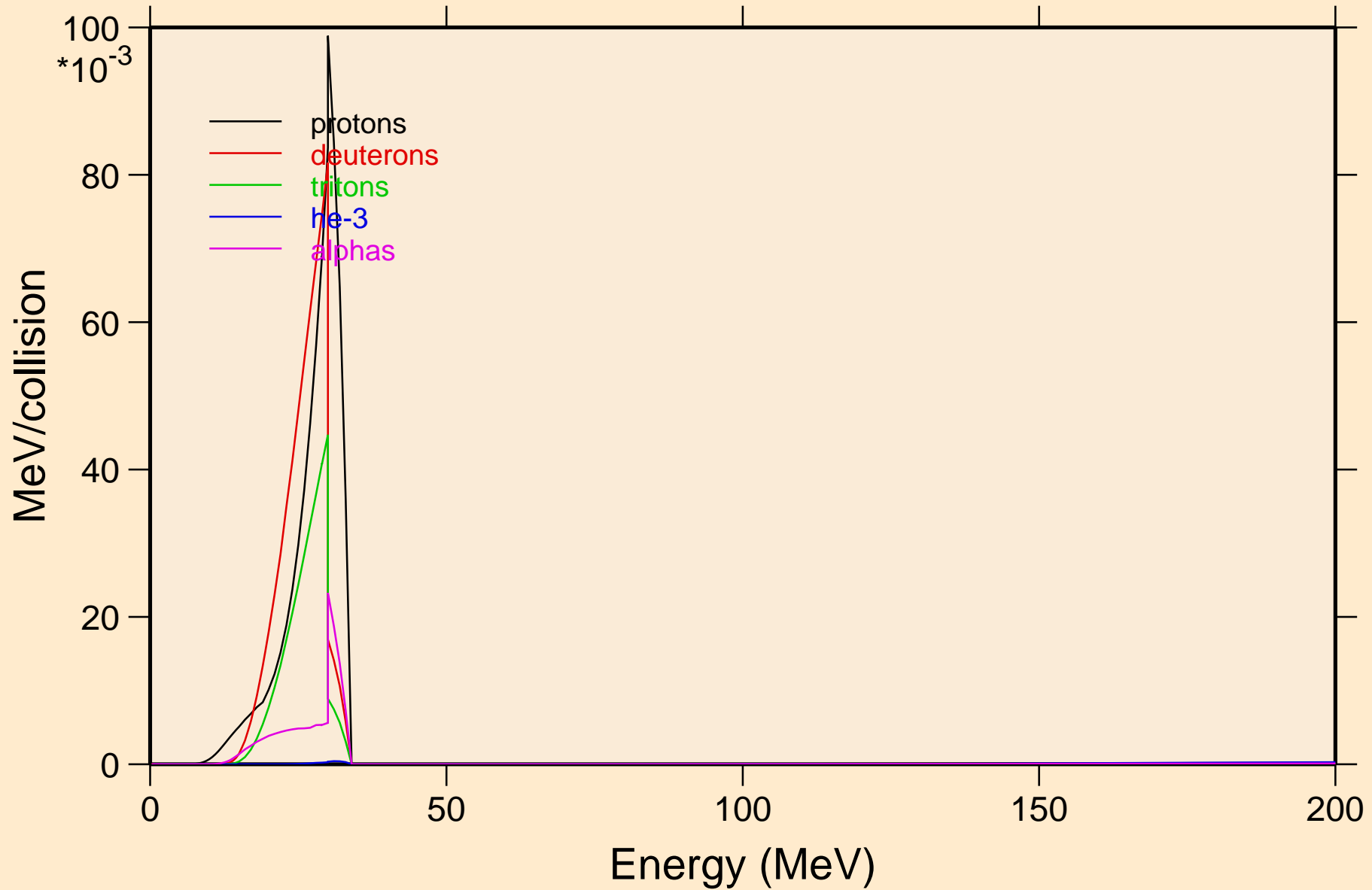

RF263 NEUTRON ACER TENDL-2021 LIBRARY; T=293.6K
Recoil Heating

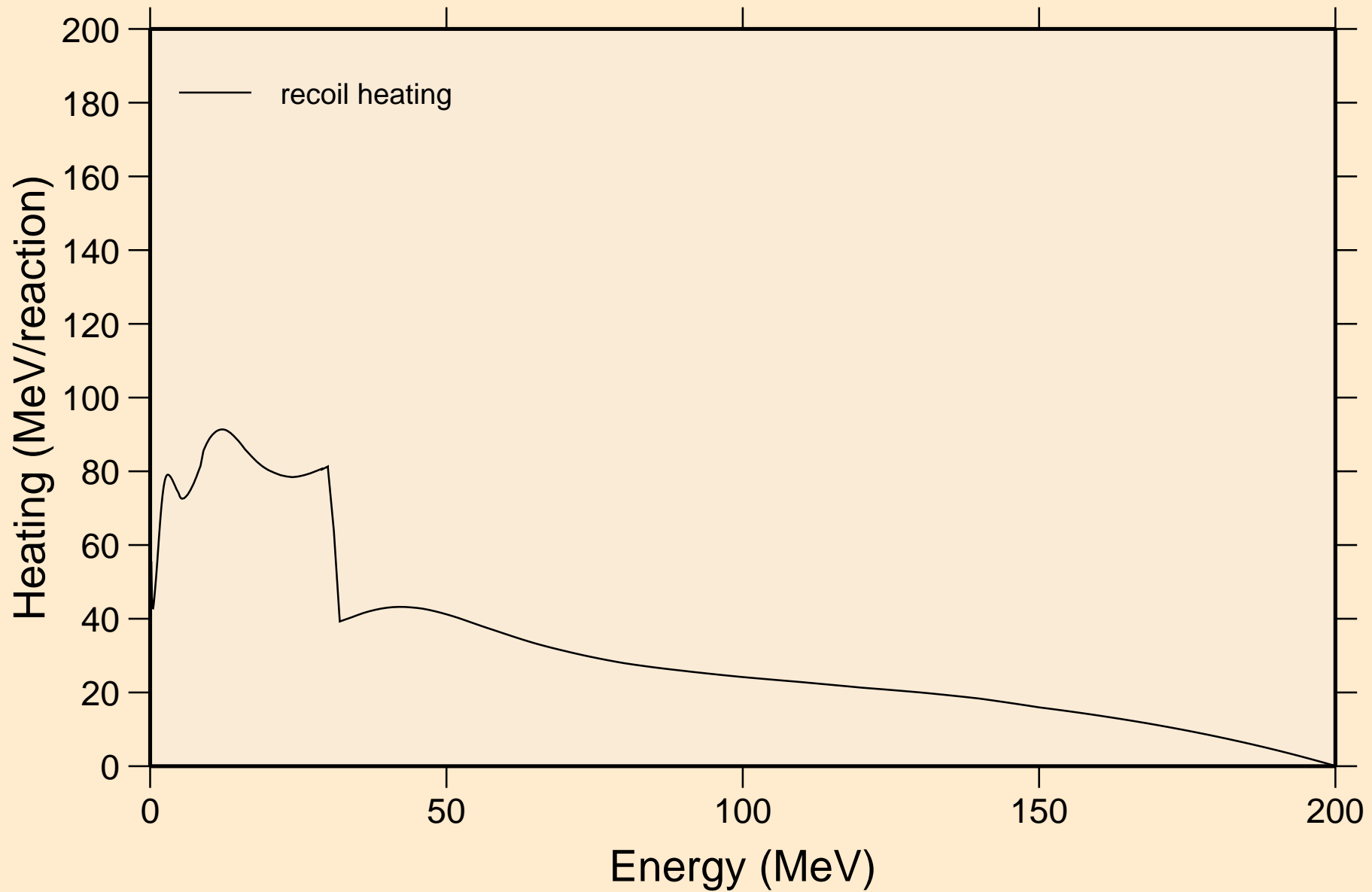

RF263 NEUTRON ACER TENDL-2021 LIBRARY; T=293.6K

Particle production cross sections

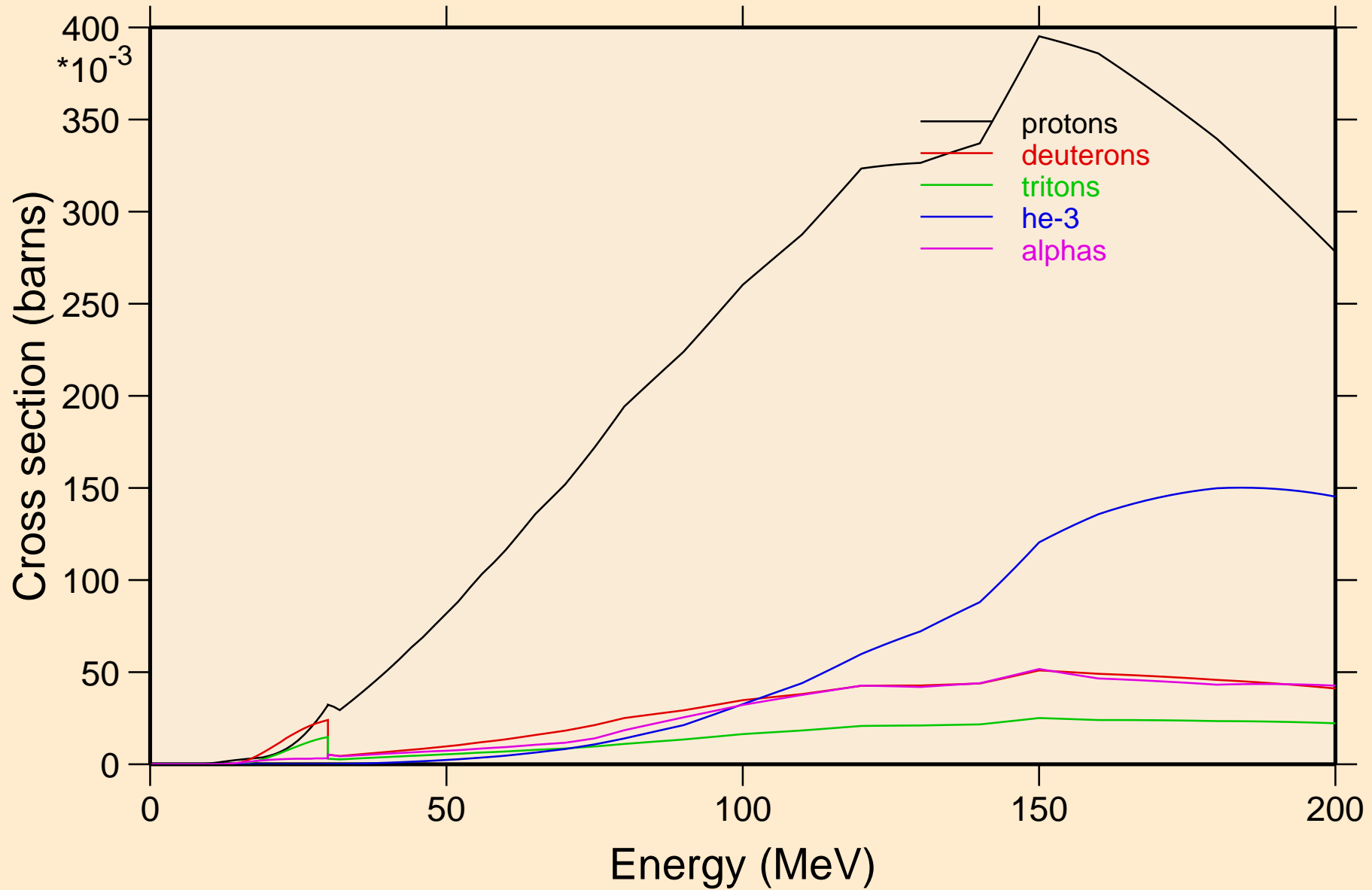

RF263 NEUTRON ACER TENDL-2021 LIBRARY; T=293.6K
protons from (n,x)

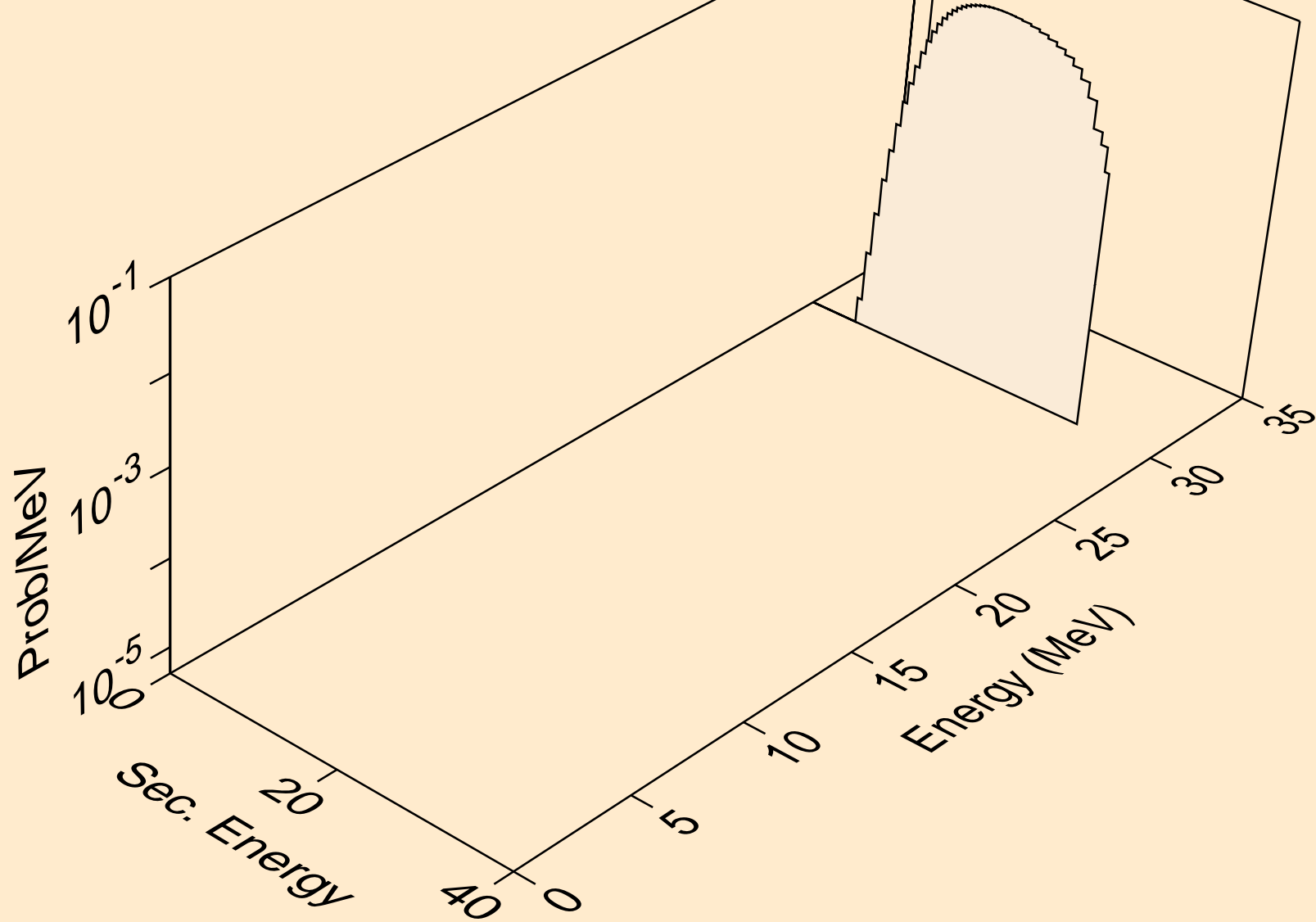

RF263 NEUTRON ACER TENDL-2021 LIBRARY; T=293.6K
protons from (n,n*)p

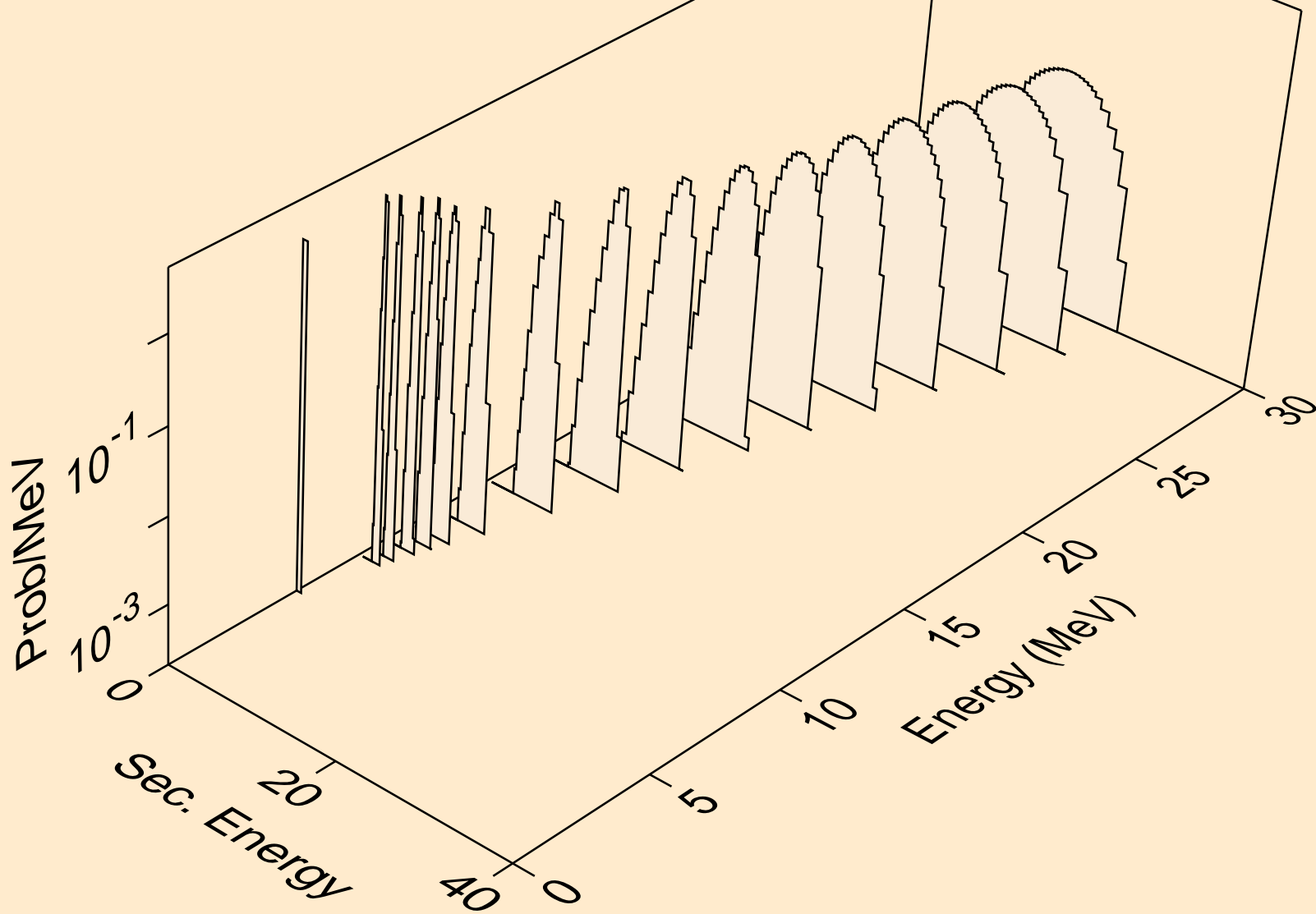

RF263 NEUTRON ACER TENDL-2021 LIBRARY; T=293.6K
protons from (n,2np)

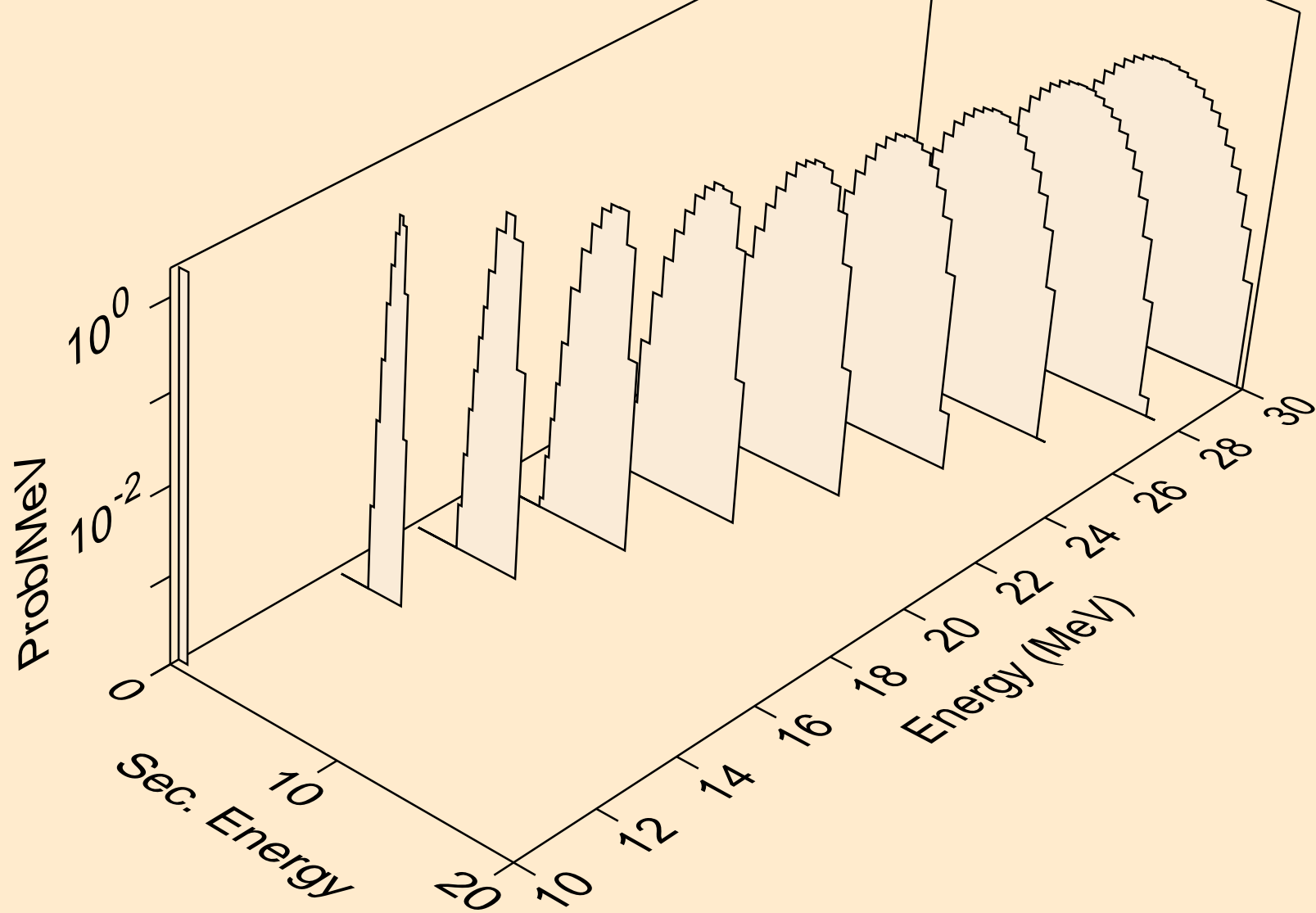

RF263 NEUTRON ACER TENDL-2021 LIBRARY; T=293.6K
protons from (n,3np)

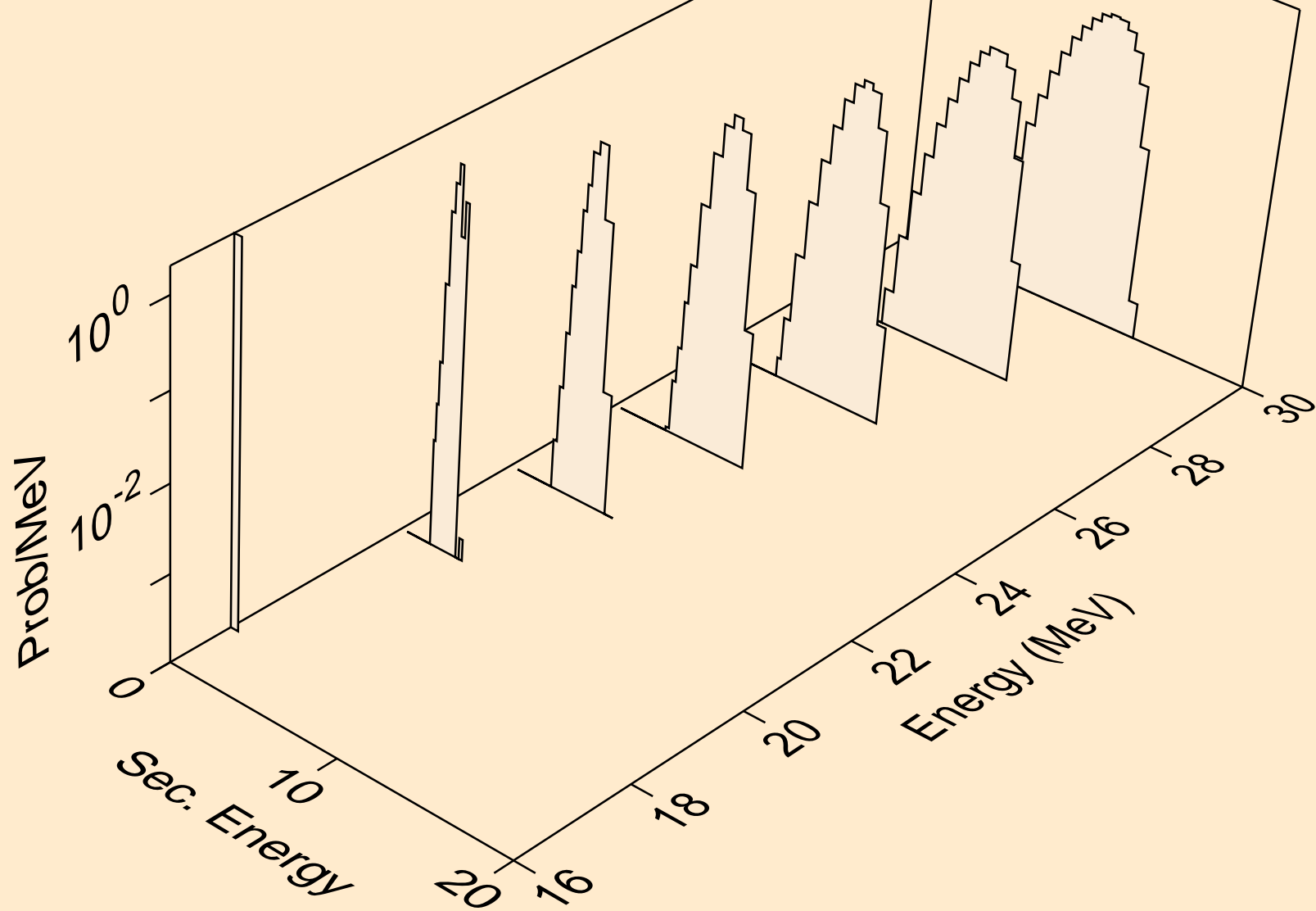

RF263 NEUTRON ACER TENDL-2021 LIBRARY; T=293.6K
protons from (n,2np)

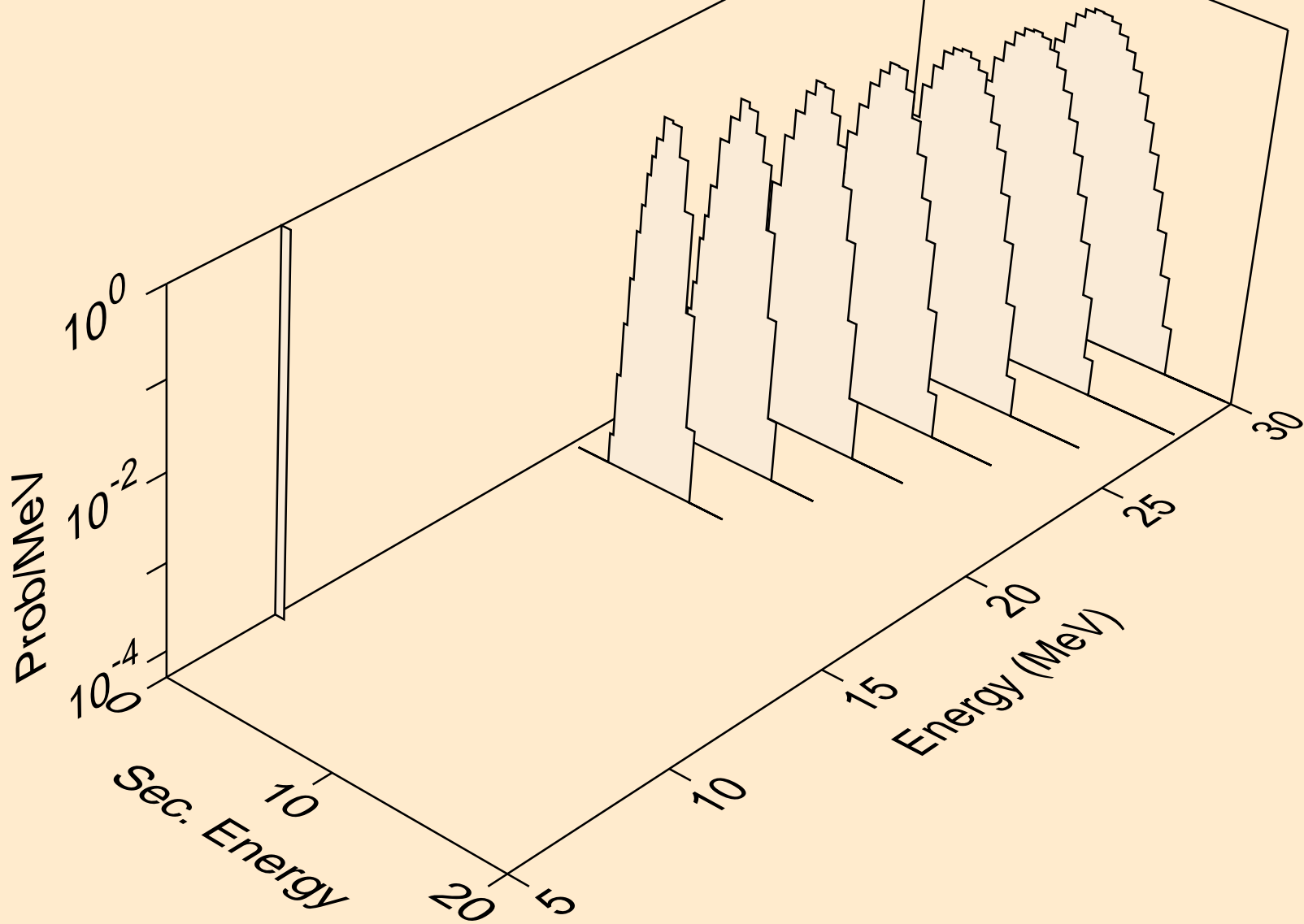

RF263 NEUTRON ACER TENDL-2021 LIBRARY; T=293.6K
protons from (n,npa)

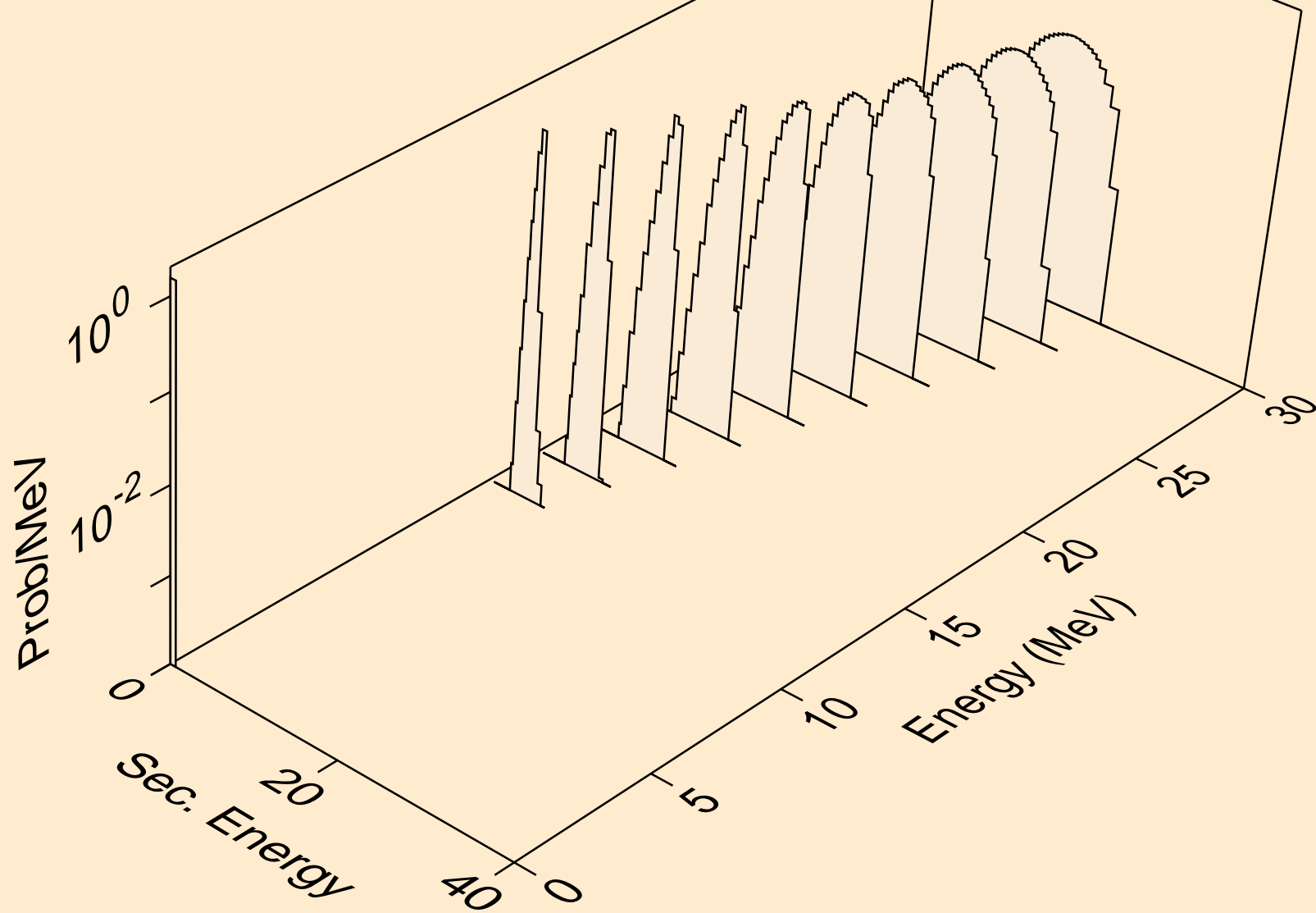

RF263 NEUTRON ACER TENDL-2021 LIBRARY; T=293.6K
protons from (n,p)

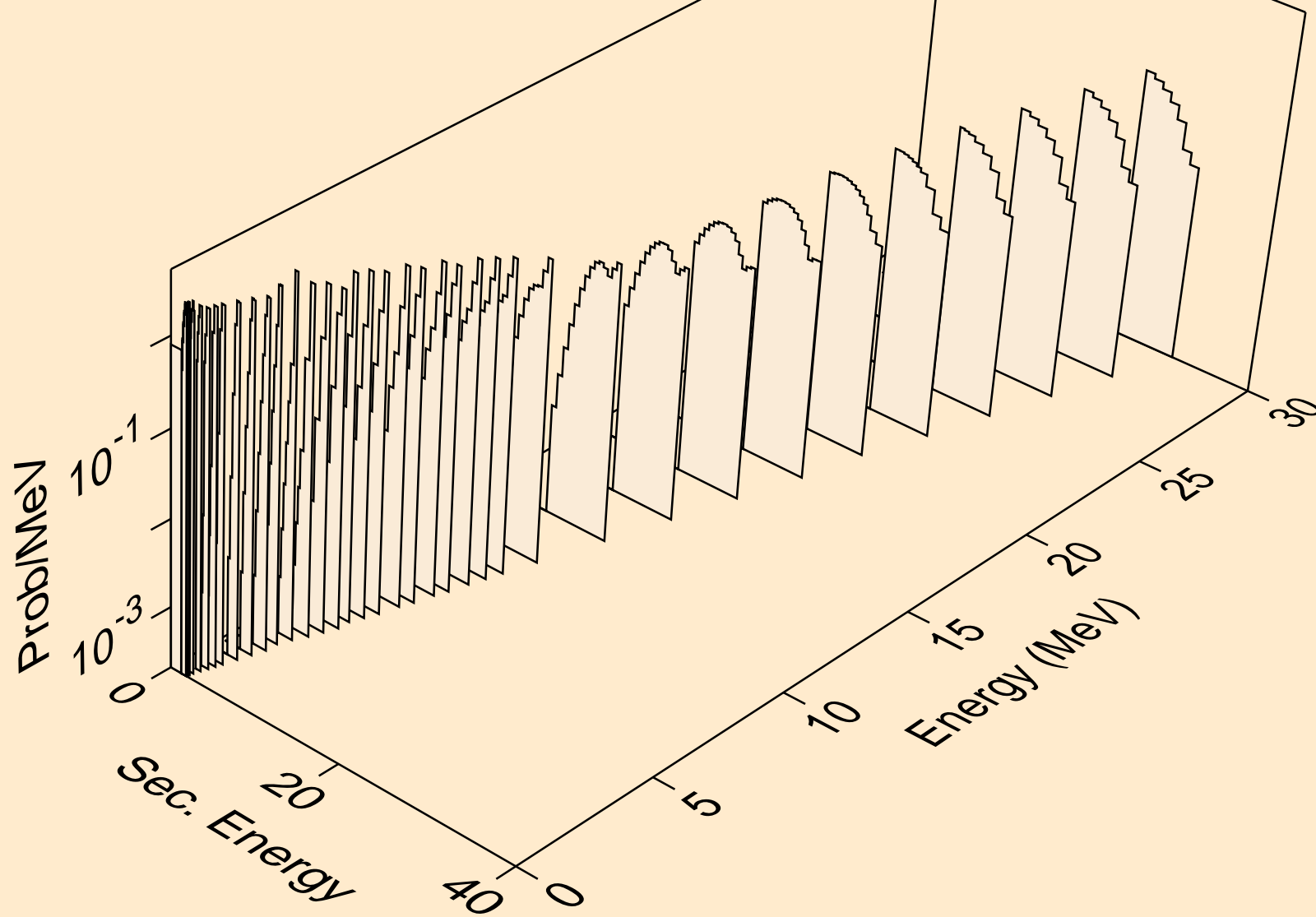

RF263 NEUTRON ACER TENDL-2021 LIBRARY; T=293.6K
protons from (n,2p)

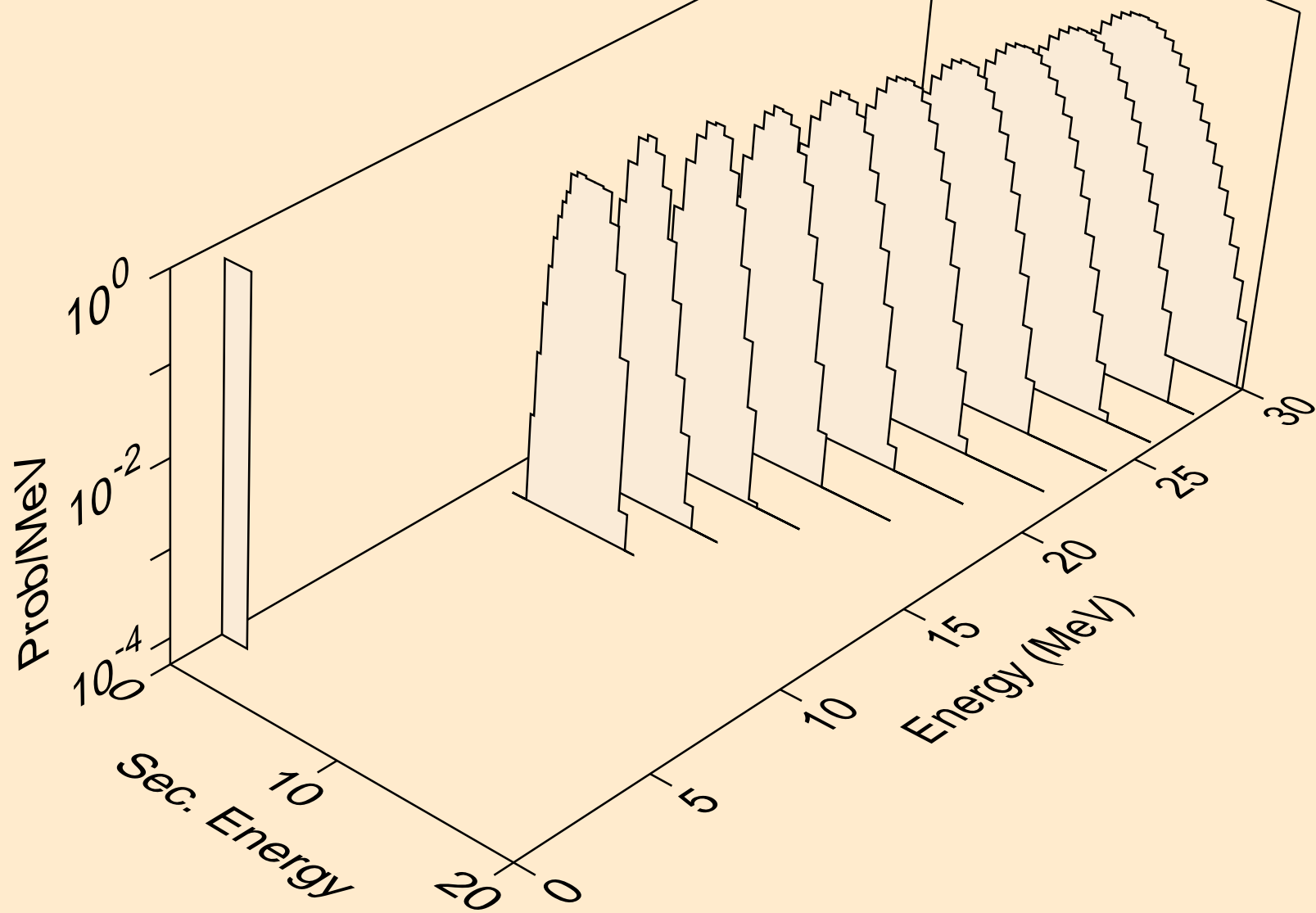

RF263 NEUTRON ACER TENDL-2021 LIBRARY; T=293.6K
protons from (n,pd)

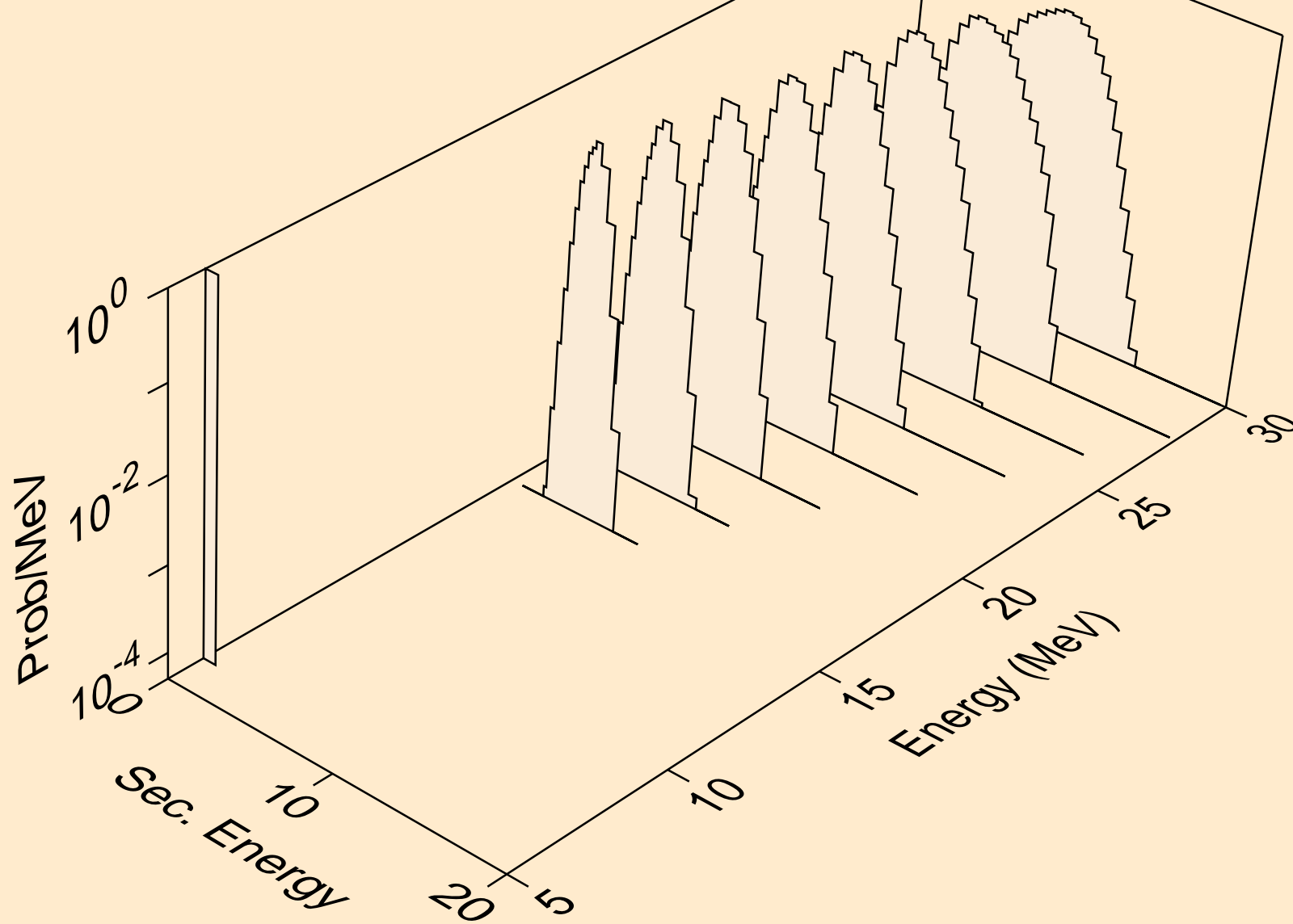

RF263 NEUTRON ACER TENDL-2021 LIBRARY; T=293.6K
deuterons from (n,x)

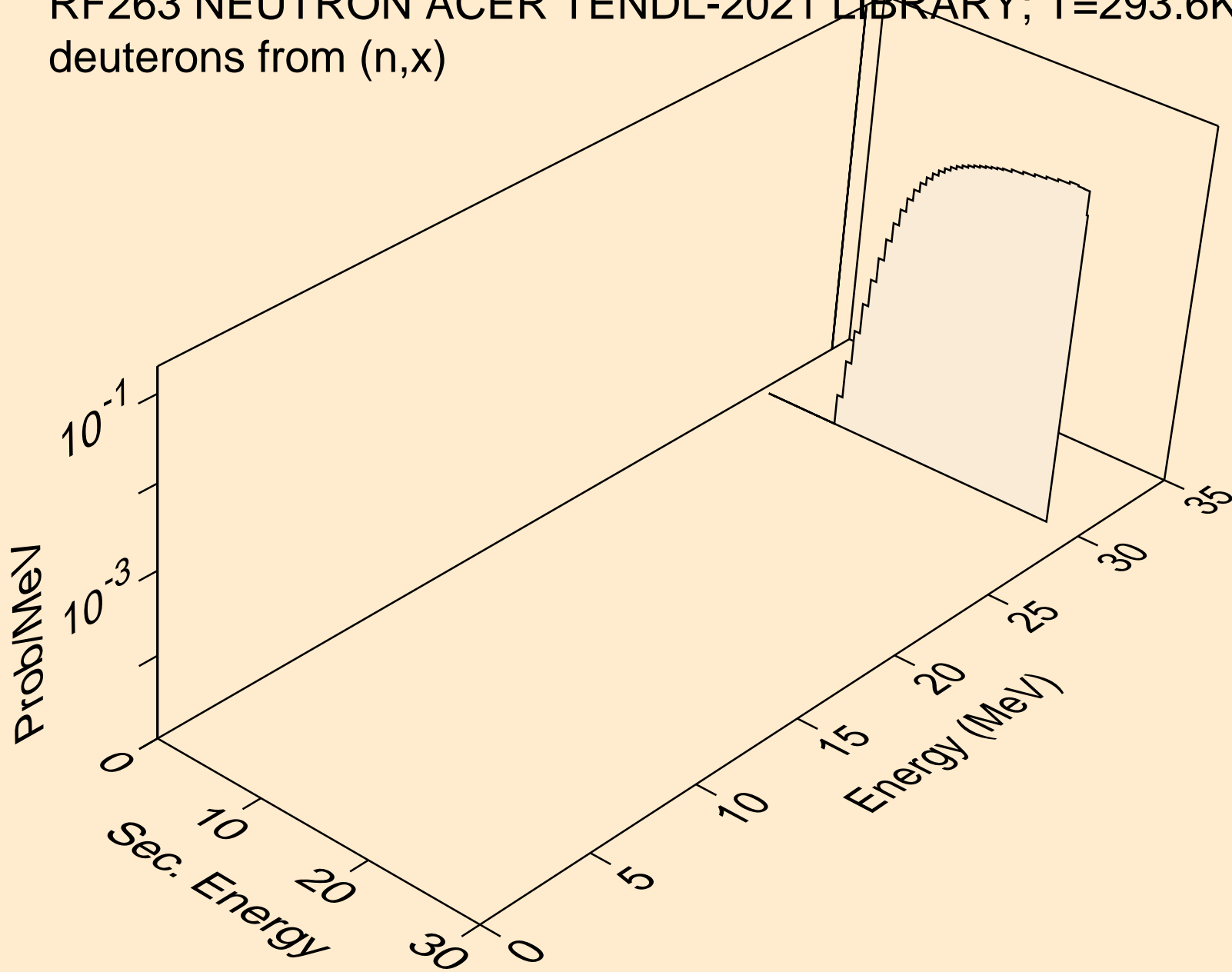

RF263 NEUTRON ACER TENDL-2021 LIBRARY; T=293.6K
deuterons from (n,2nd)

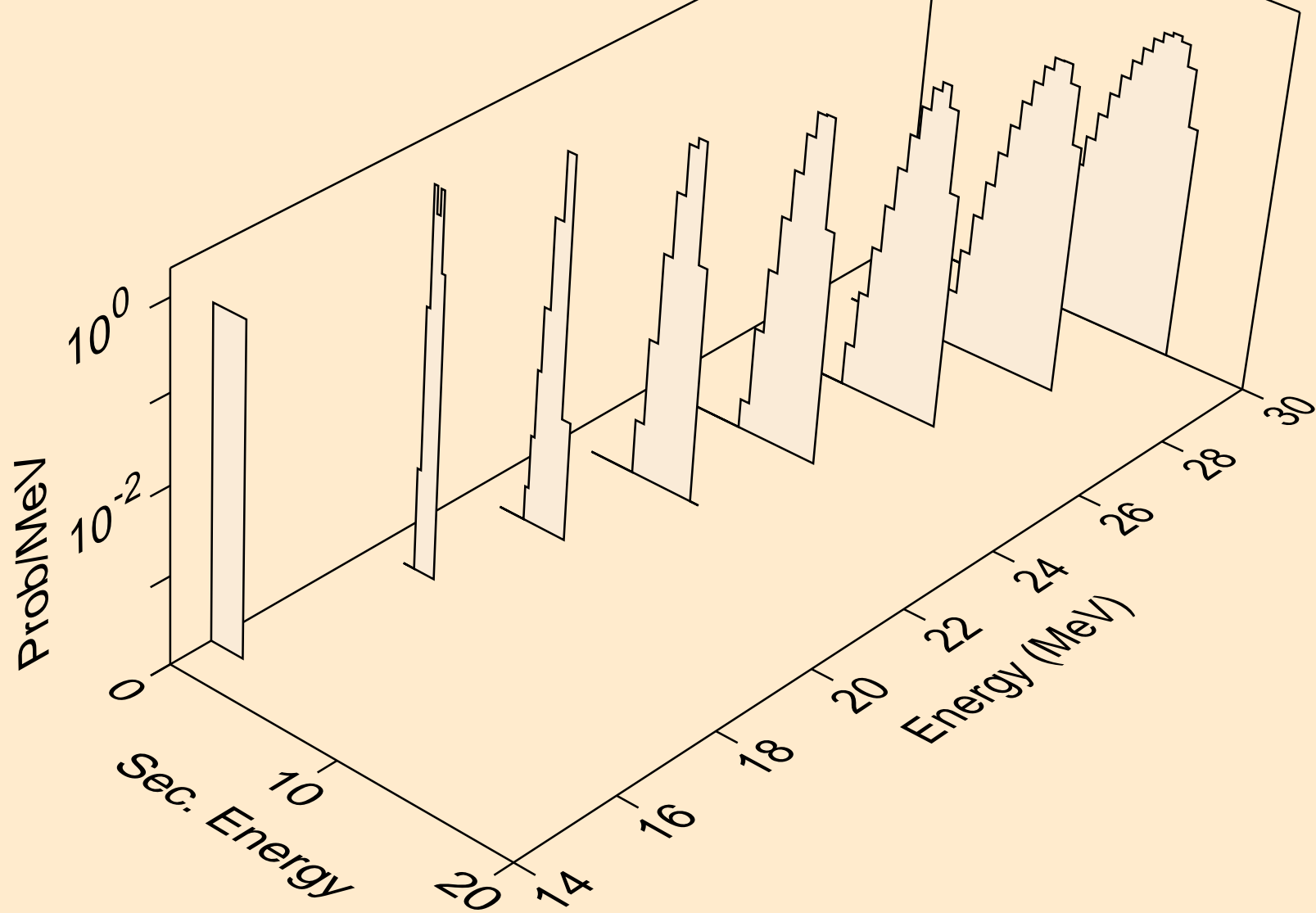

RF263 NEUTRON ACER TENDL-2021 LIBRARY; T=293.6K
deuterons from (n,n*)d

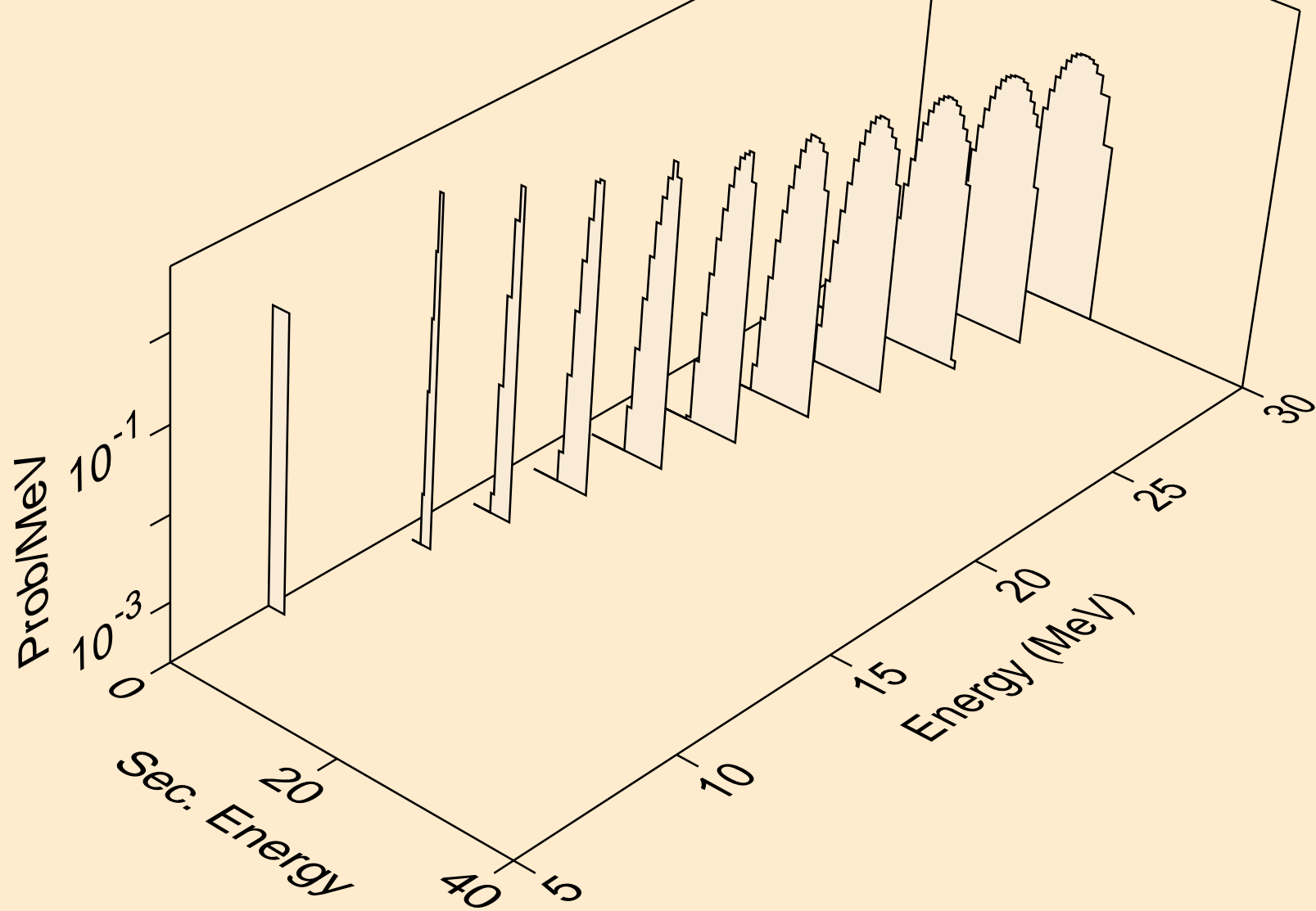

RF263 NEUTRON ACER TENDL-2021 LIBRARY; T=293.6K
deuterons from (n,d)

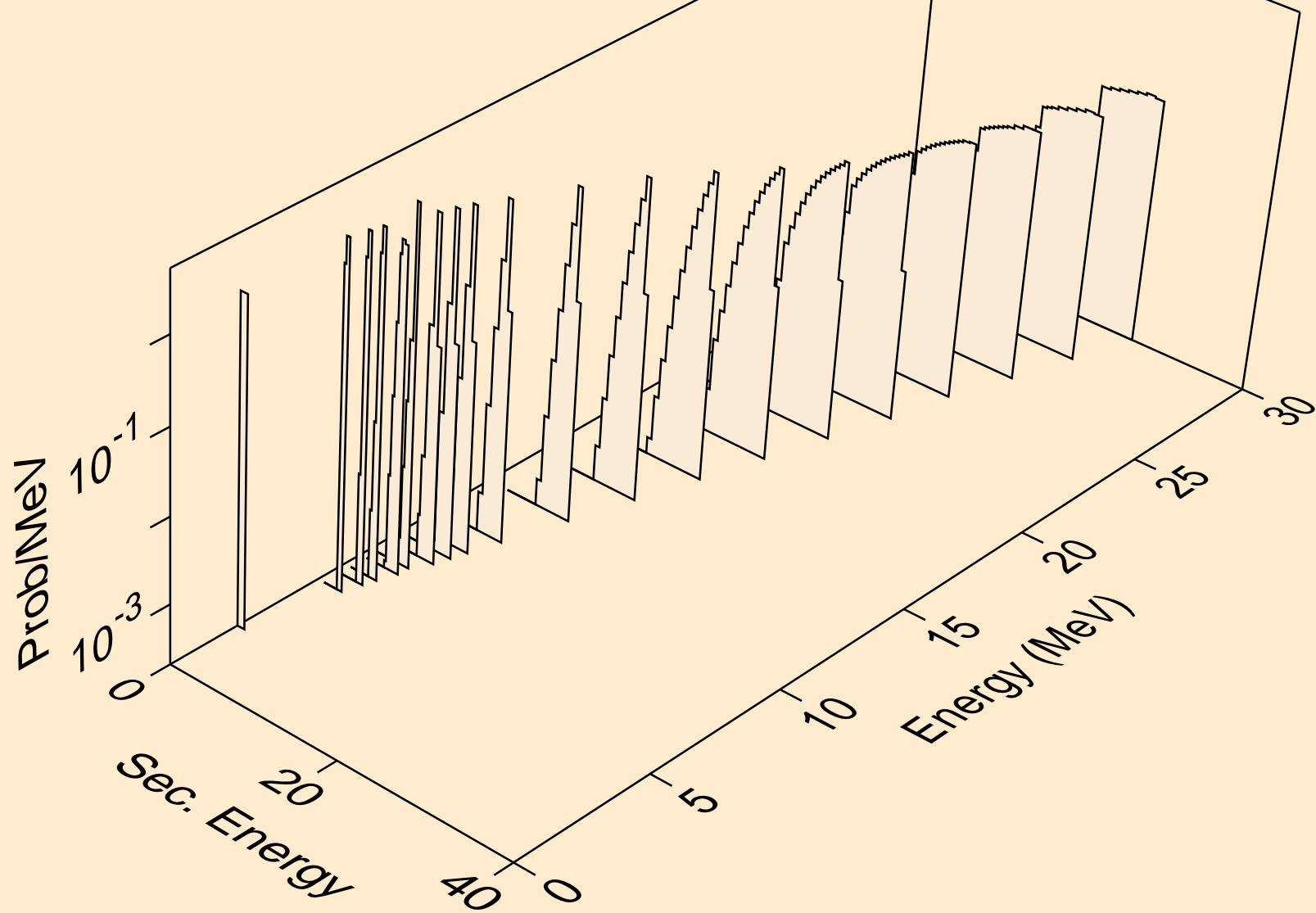

RF263 NEUTRON ACER TENDL-2021 LIBRARY; T=293.6K
deuterons from (n,pd)

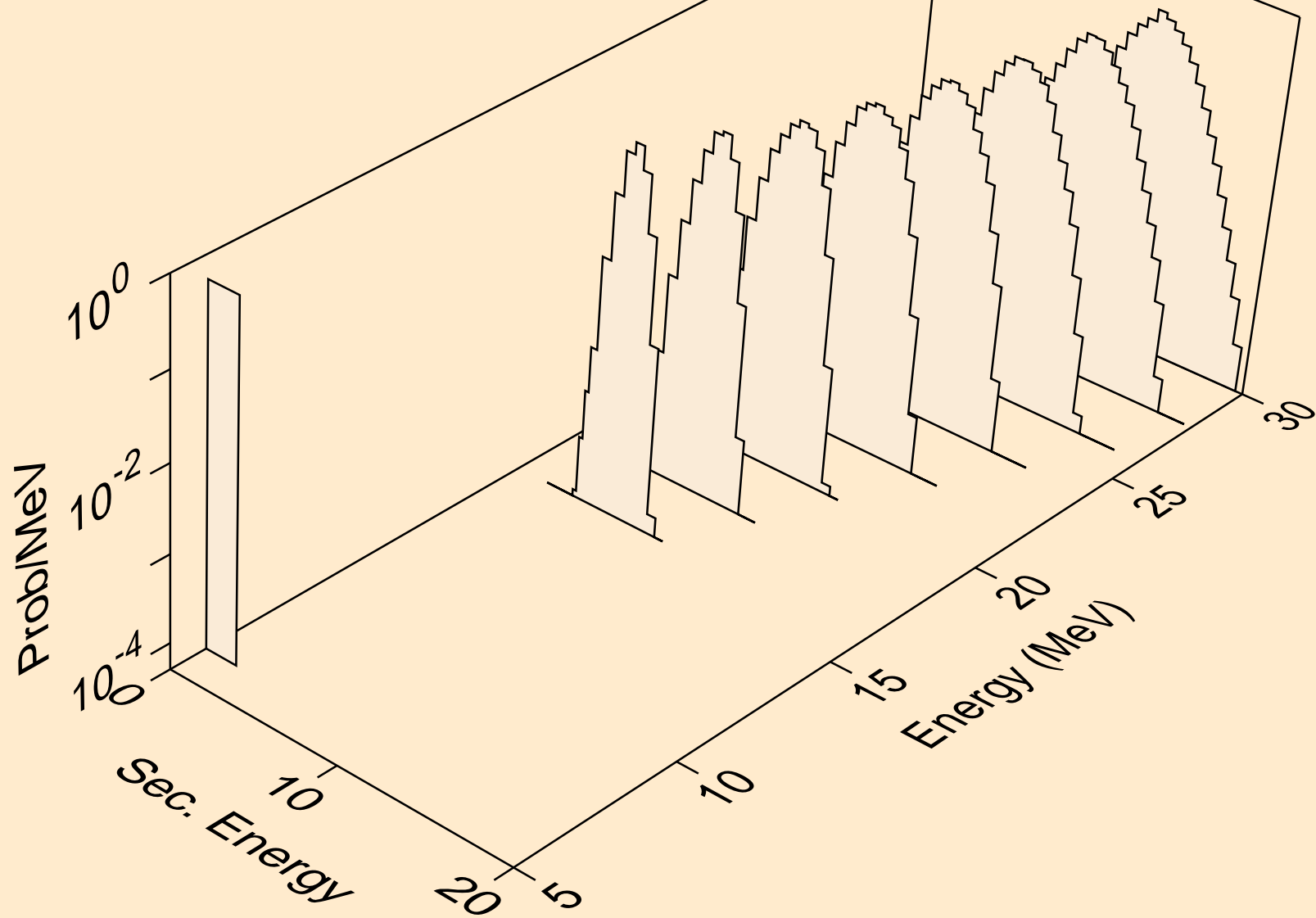

RF263 NEUTRON ACER TENDL-2021 LIBRARY; T=293.6K
deuterons from (n,da)

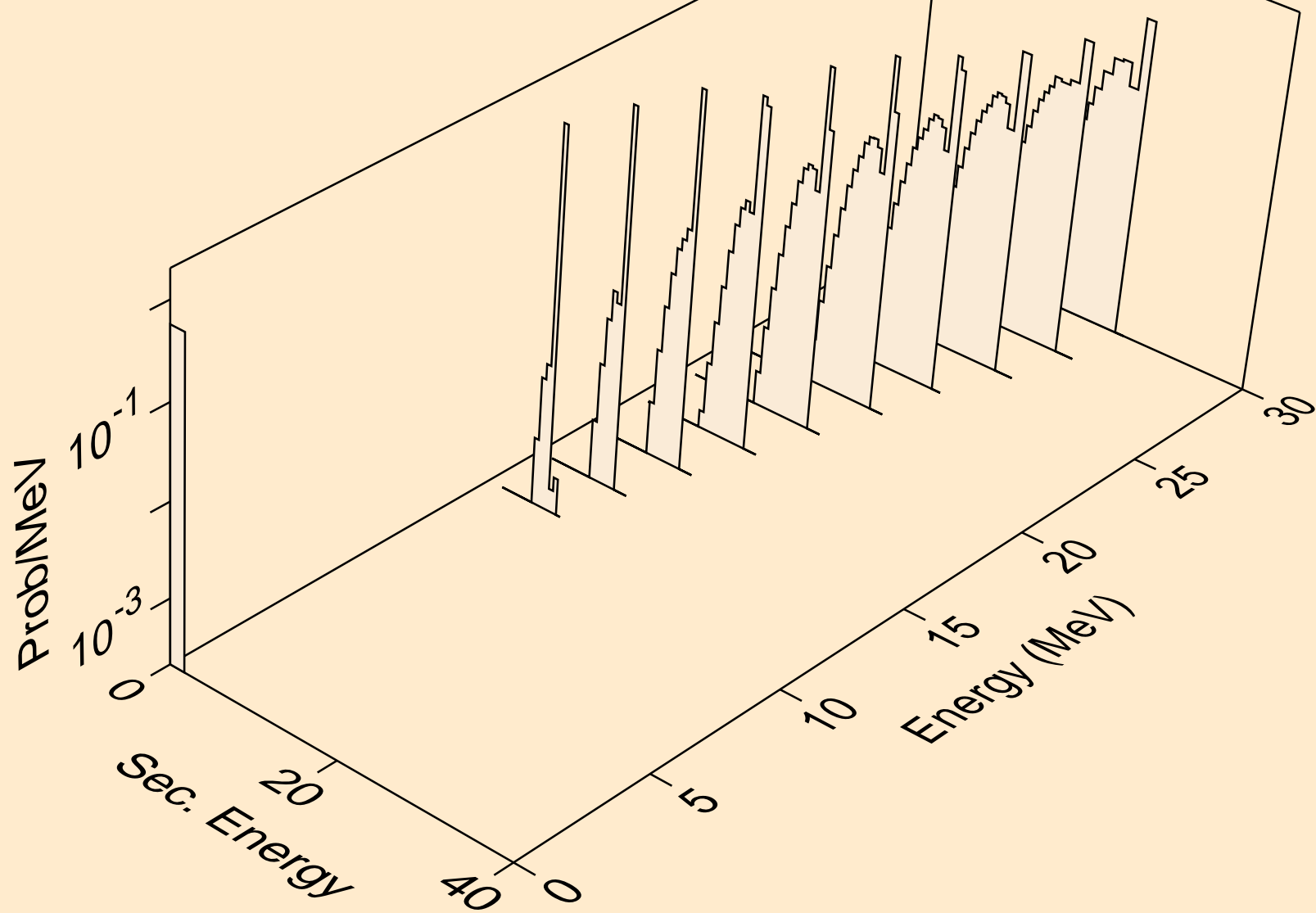

RF263 NEUTRON ACER TENDL-2021 LIBRARY; T=293.6K
tritons from (n,x)

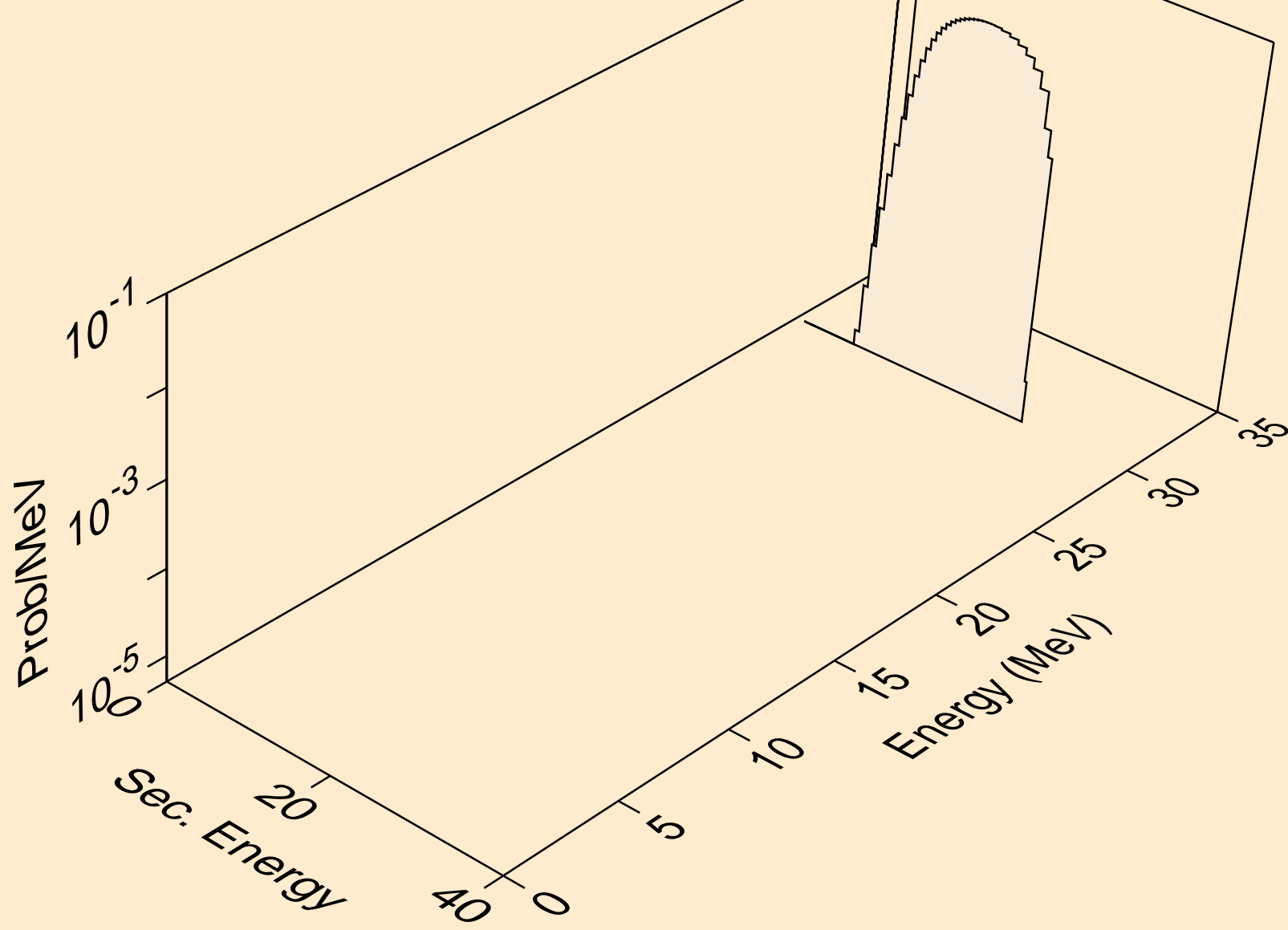

RF263 NEUTRON ACER TENDL-2021 LIBRARY; T=293.6K
tritons from (n,n*)t

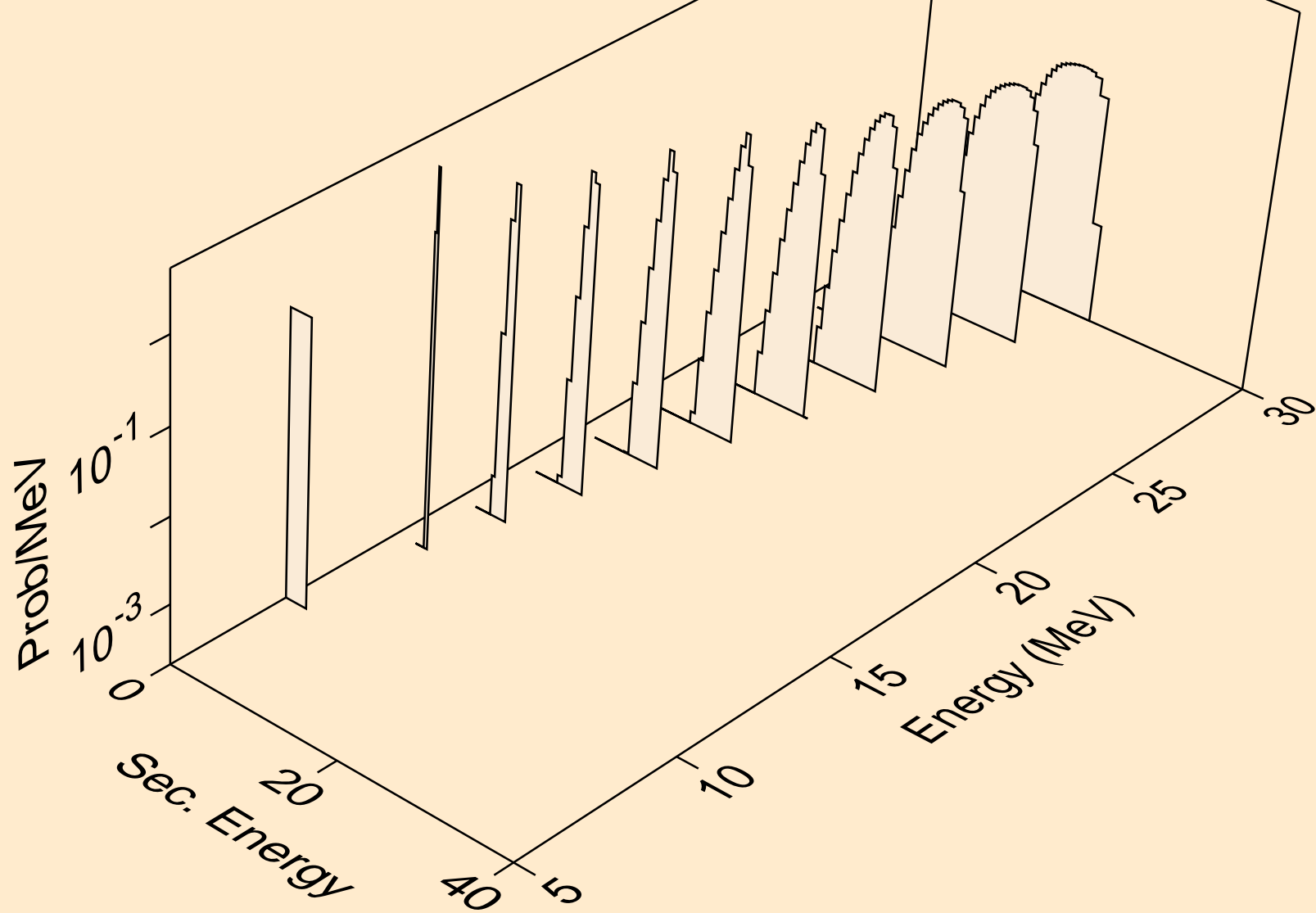

RF263 NEUTRON ACER TENDL-2021 LIBRARY; T=293.6K
tritons from (n,t)

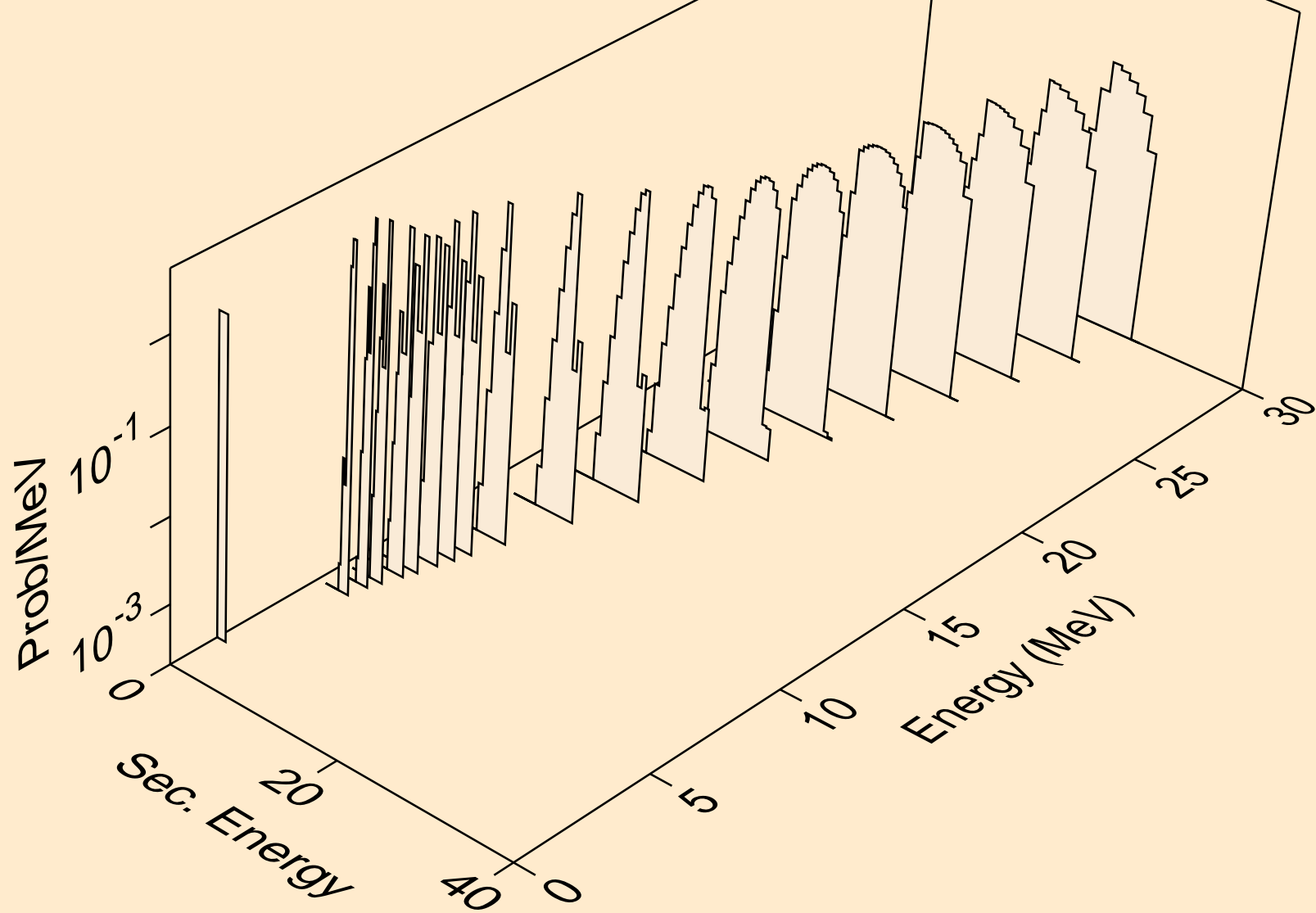

RF263 NEUTRON ACER TENDL-2021 LIBRARY; T=293.6K
he3s from (n,x)

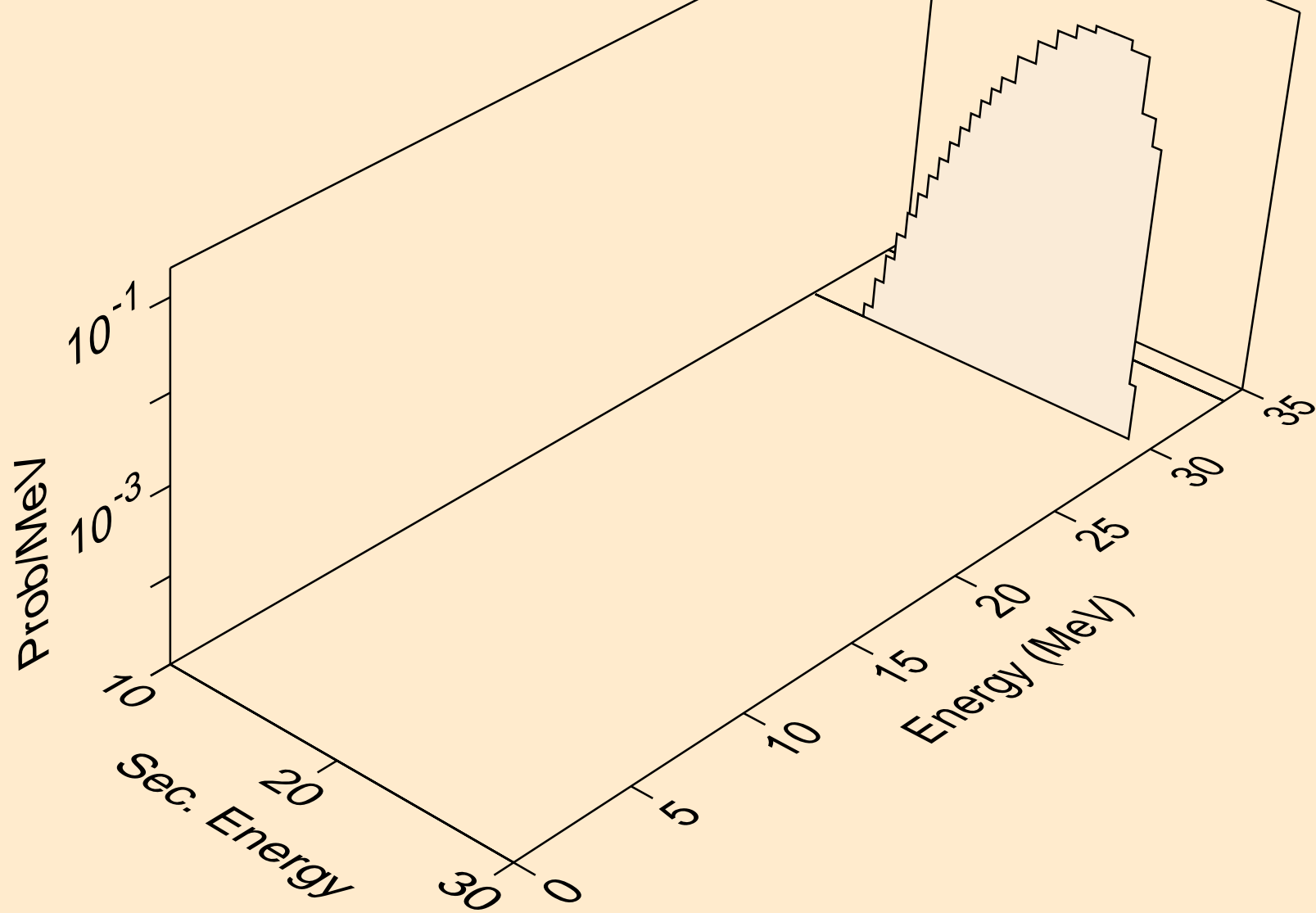

RF263 NEUTRON ACER TENDL-2021 LIBRARY; T=293.6K
he3s from (n,n*)he3

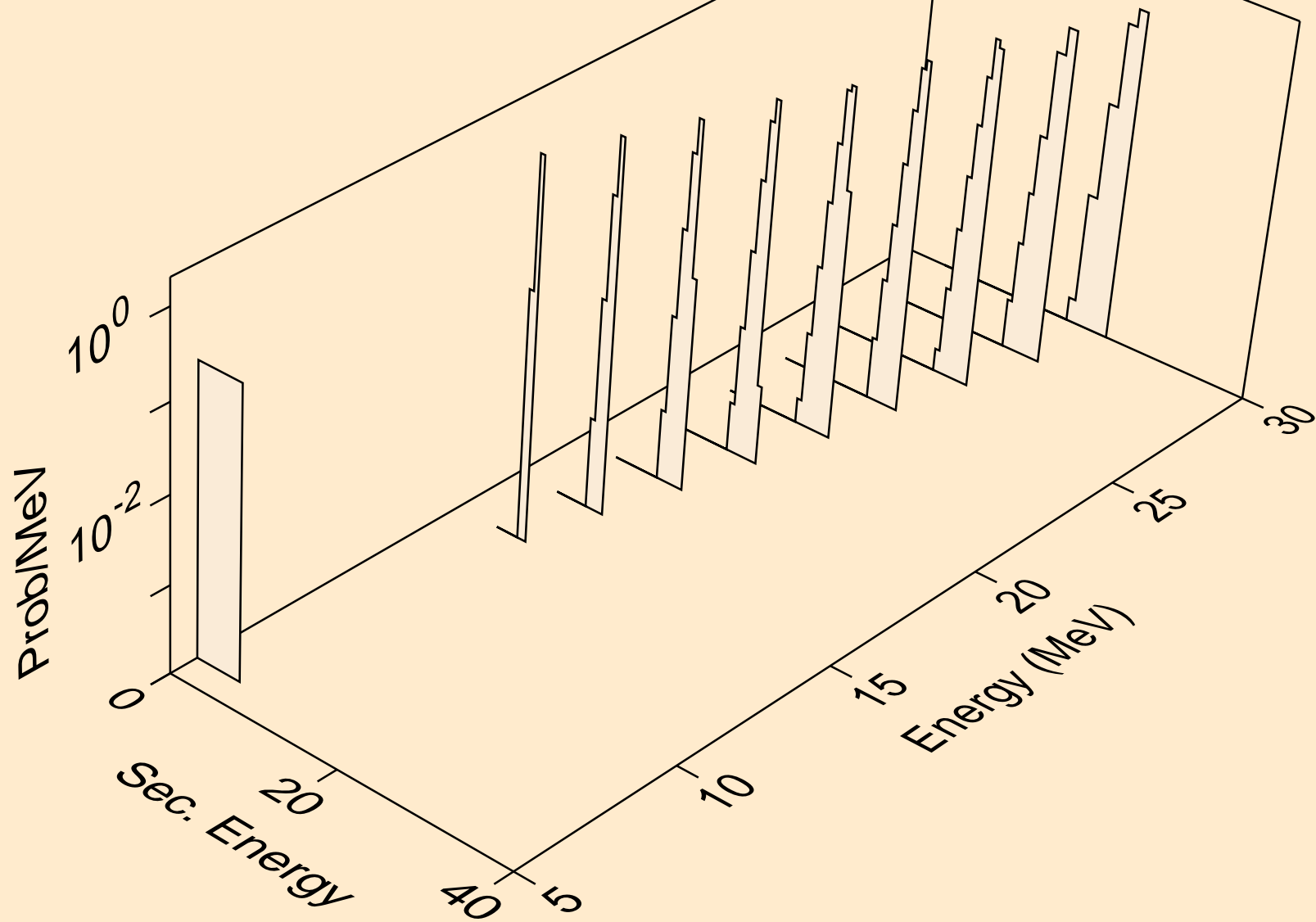

RF263 NEUTRON ACER TENDL-2021 LIBRARY; T=293.6K
he3s from (n,he3)

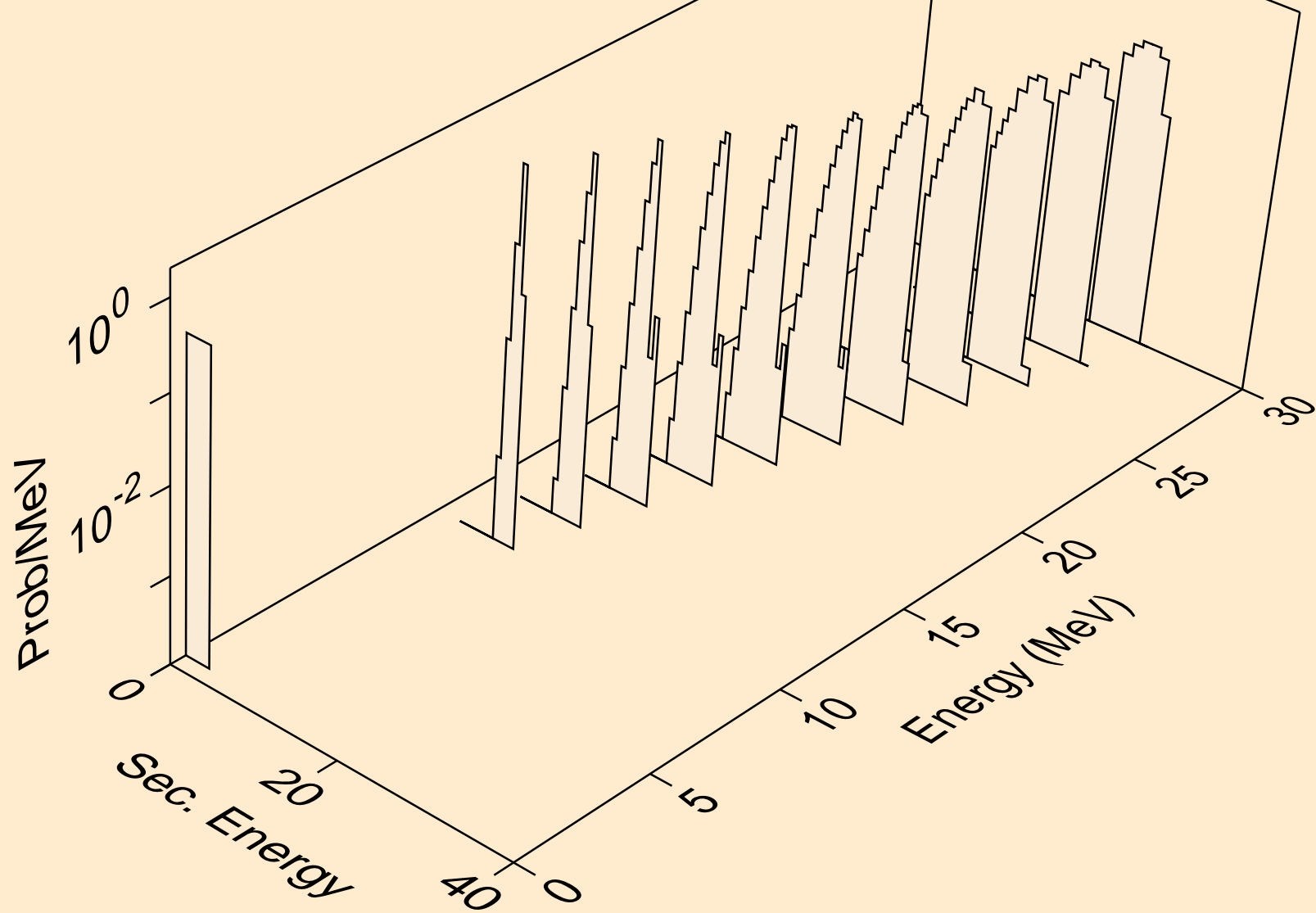

RF263 NEUTRON ACER TENDL-2021 LIBRARY; T=293.6K
alphas from (n,x)

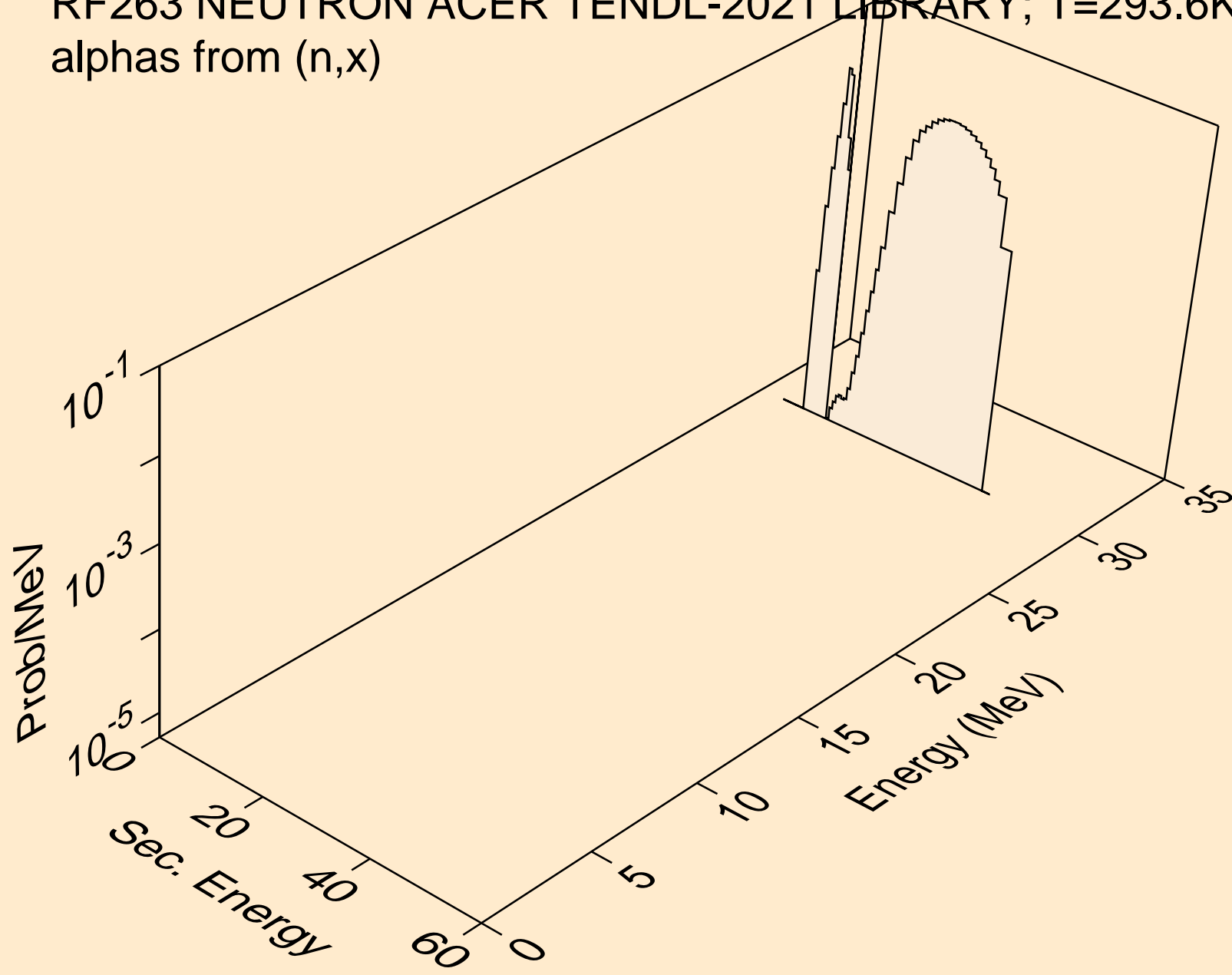

RF263 NEUTRON ACER TENDL-2021 LIBRARY; T=293.6K
alphas from (n,n*)a

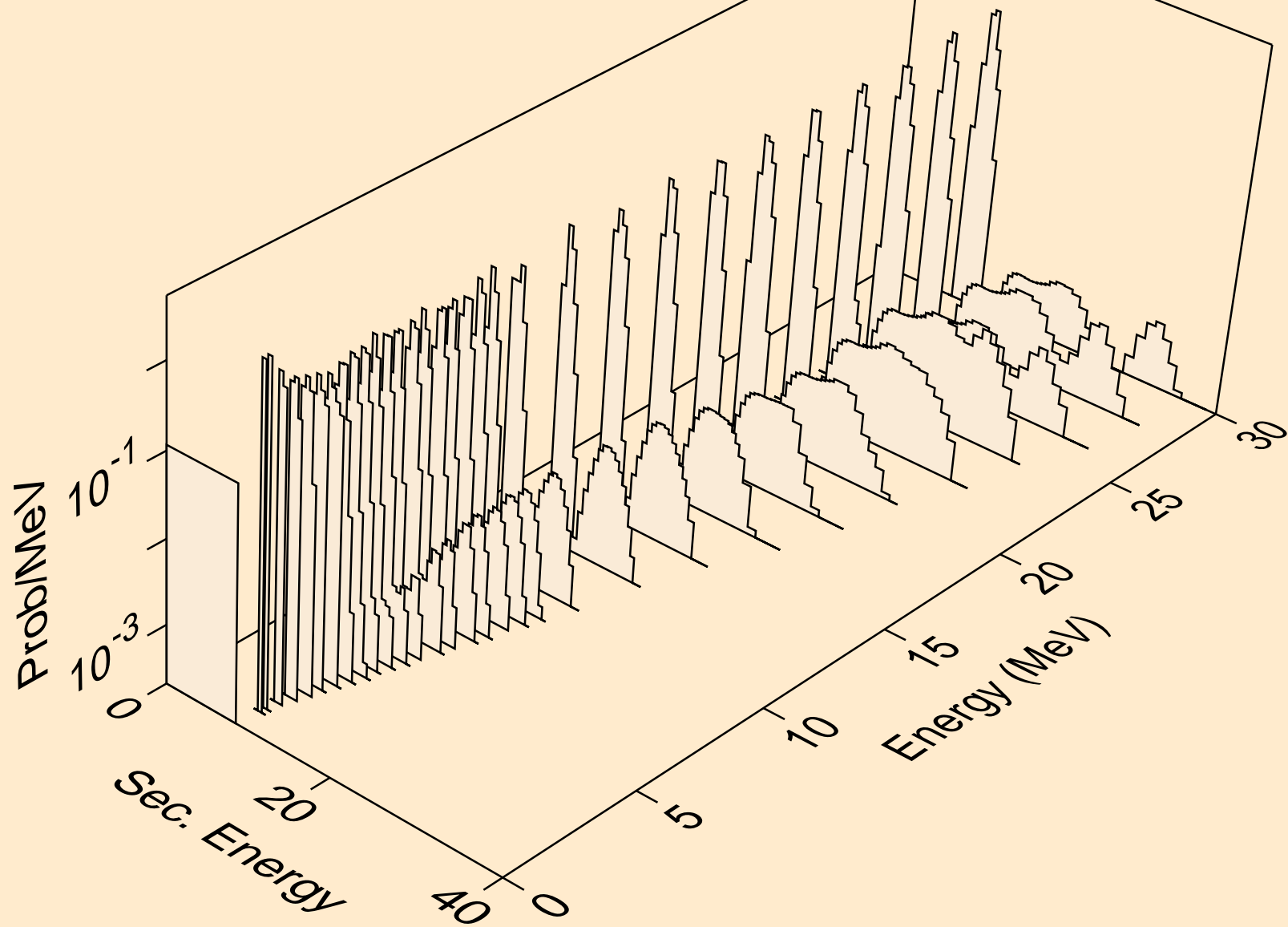

RF263 NEUTRON ACER TENDL-2021 LIBRARY; T=293.6K
alphas from (n,2n)a

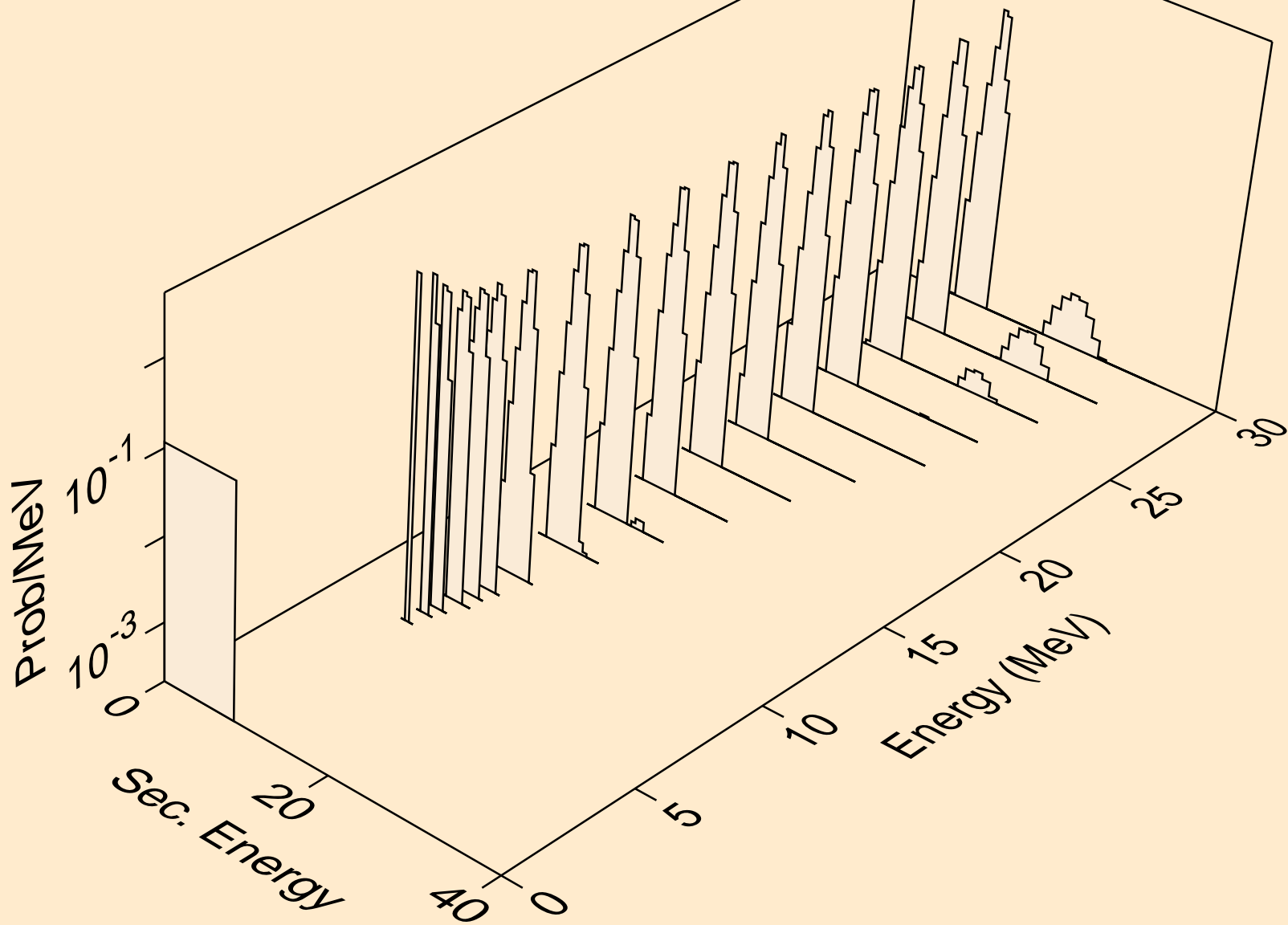

RF263 NEUTRON ACER TENDL-2021 LIBRARY; T=293.6K
alphas from (n,3n)a

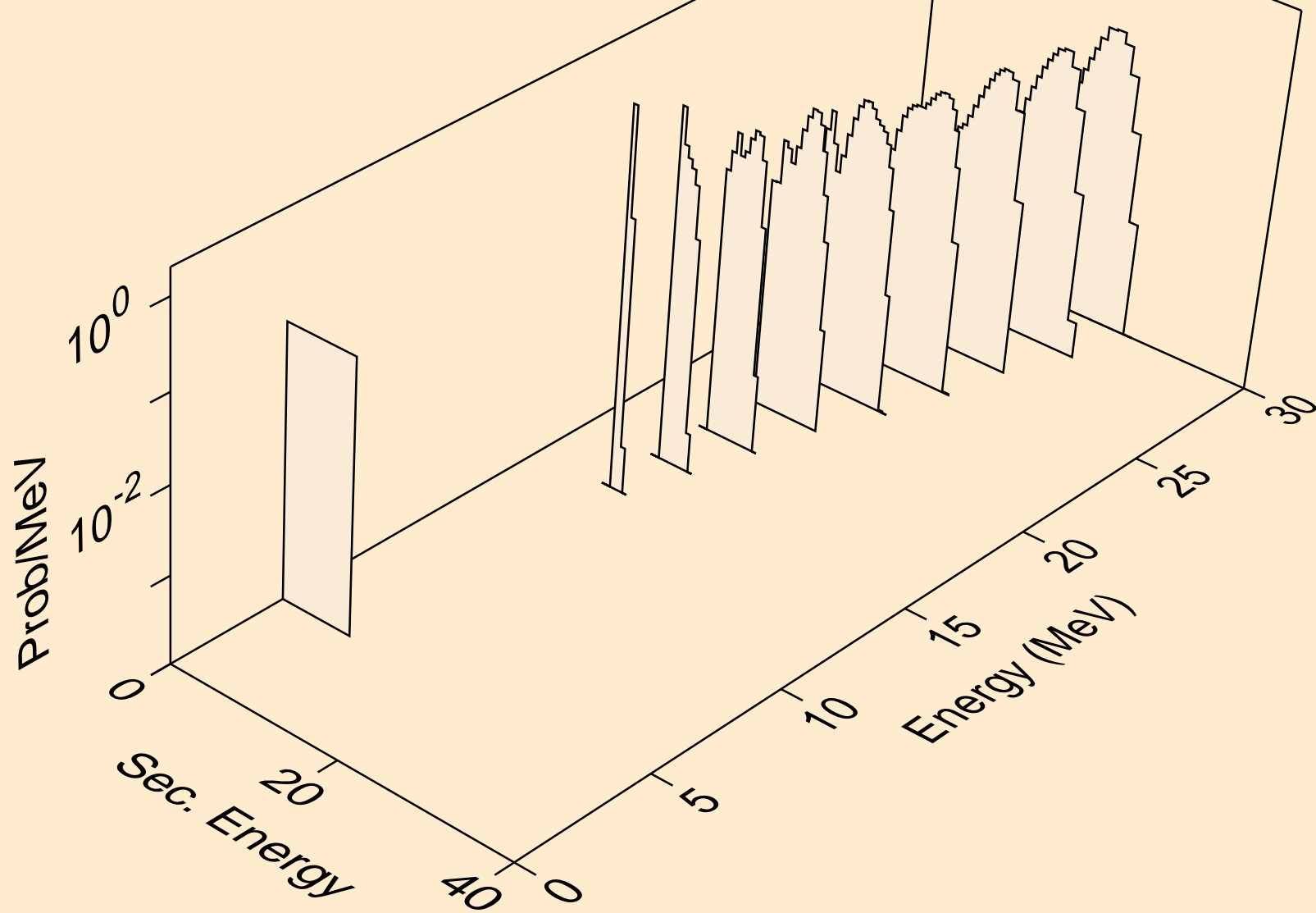

RF263 NEUTRON ACER TENDL-2021 LIBRARY; T=293.6K
alphas from (n,npa)

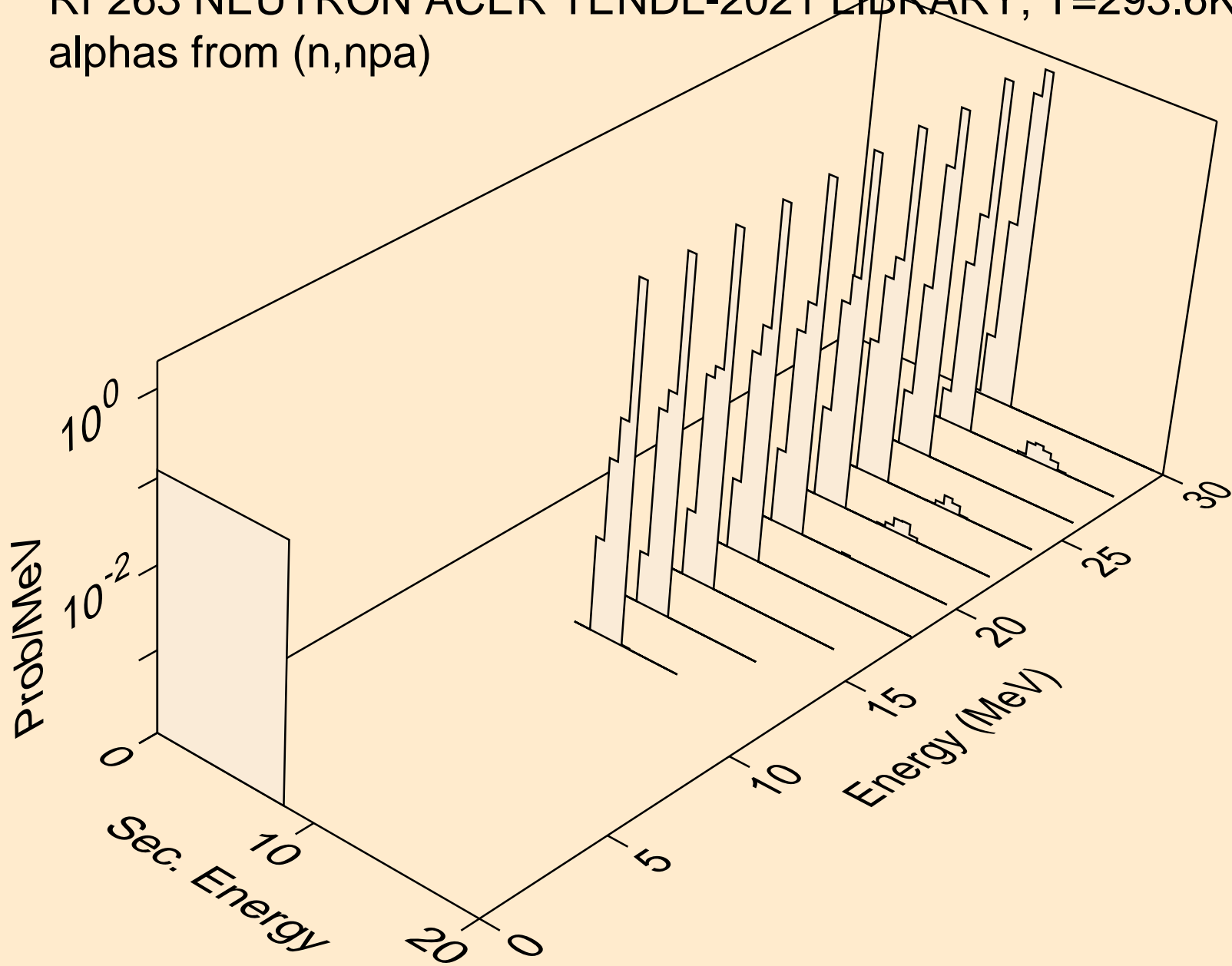

RF263 NEUTRON ACER TENDL-2021 LIBRARY; T=293.6K
alphas from (n,a)

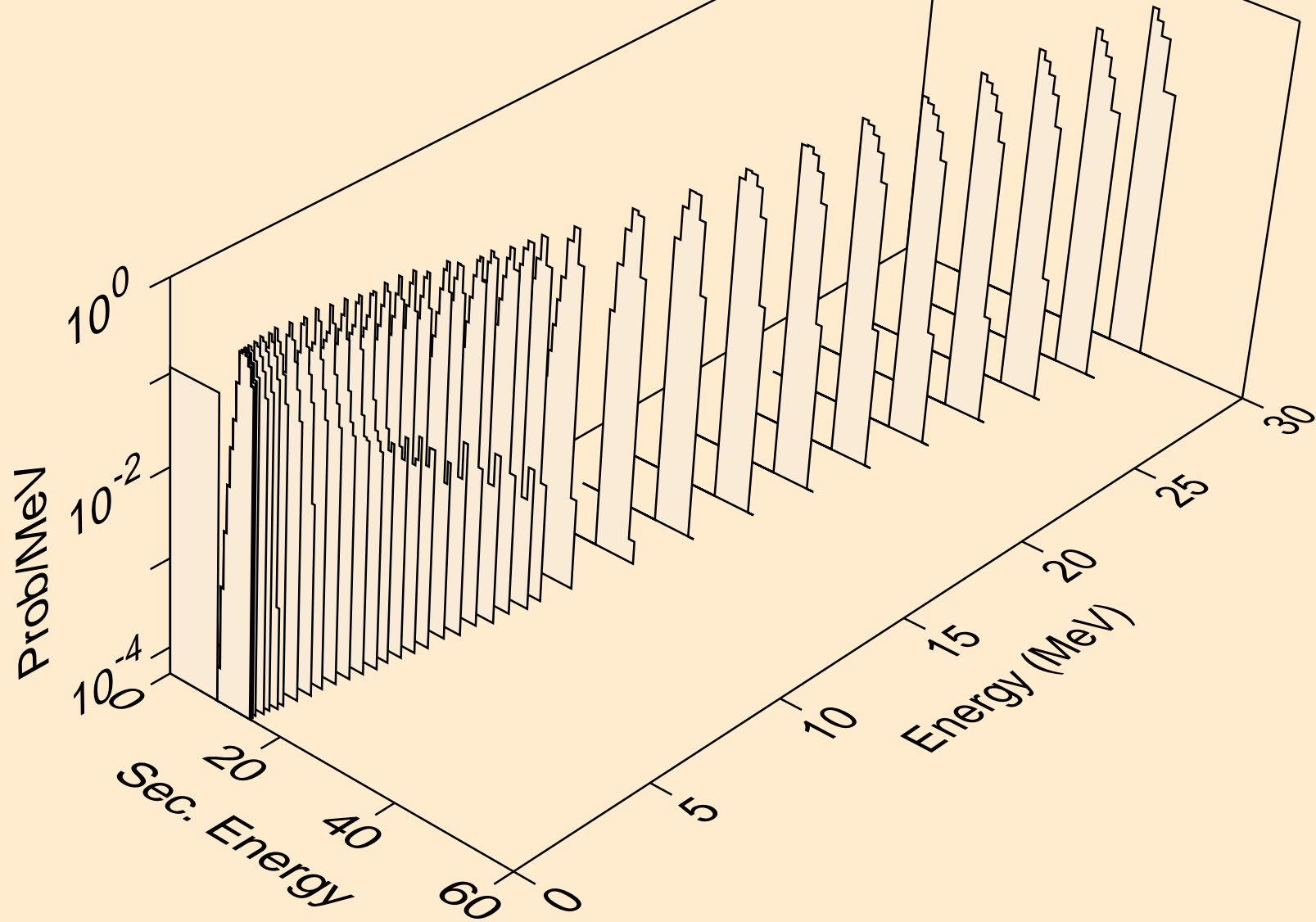

RF263 NEUTRON ACER TENDL-2021 LIBRARY; T=293.6K
alphas from (n,da)

