

RF265 NEUTRON ACER TENDL-2021 LIBRARY; T=293.6K

Principal cross sections

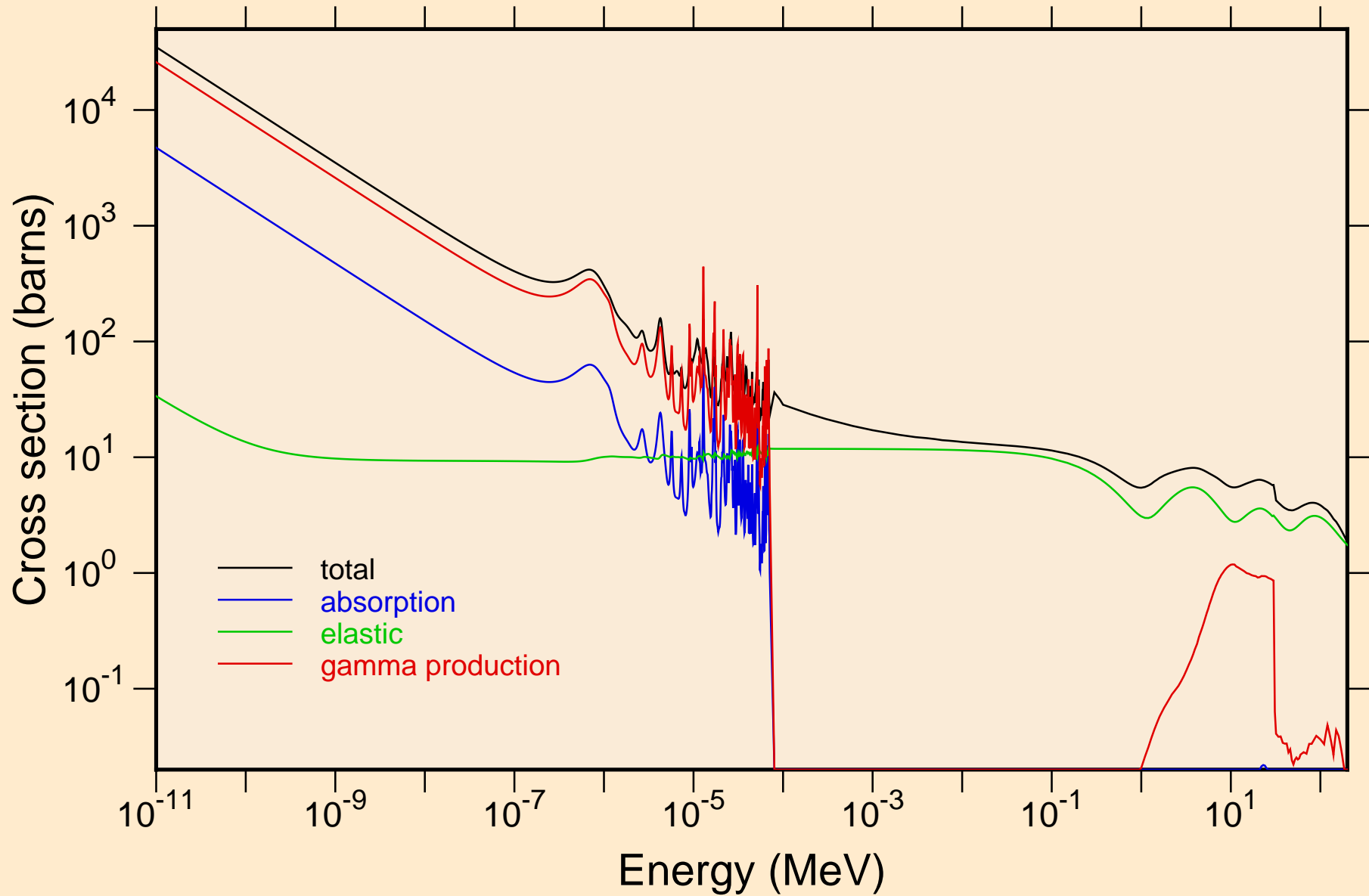

RF265 NEUTRON ACER TENDL-2021 LIBRARY; T=293.6K
resonance total cross section

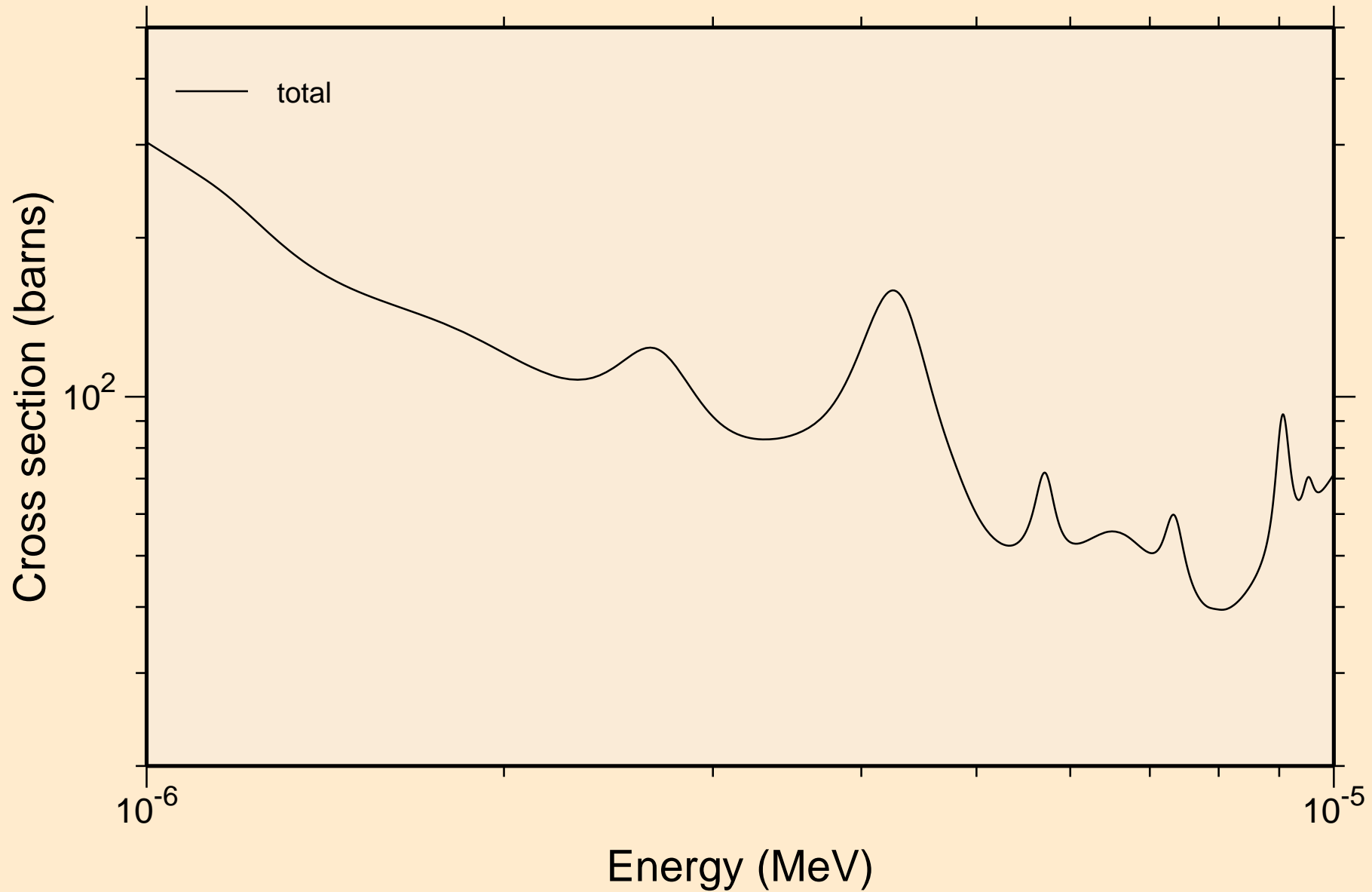

RF265 NEUTRON ACER TENDL-2021 LIBRARY; T=293.6K
resonance total cross section

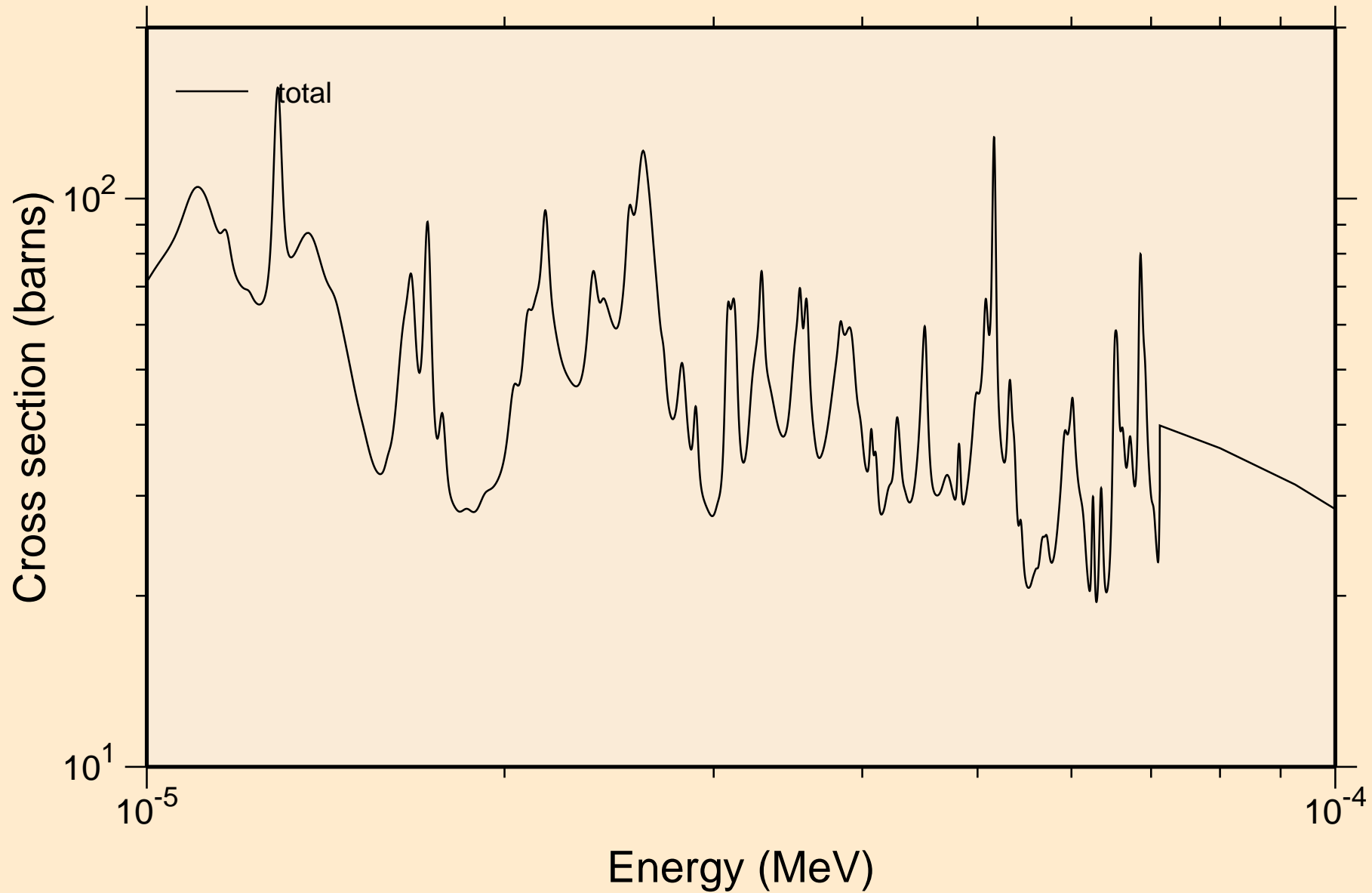

RF265 NEUTRON ACER TENDL-2021 LIBRARY; T=293.6K
resonance total cross section

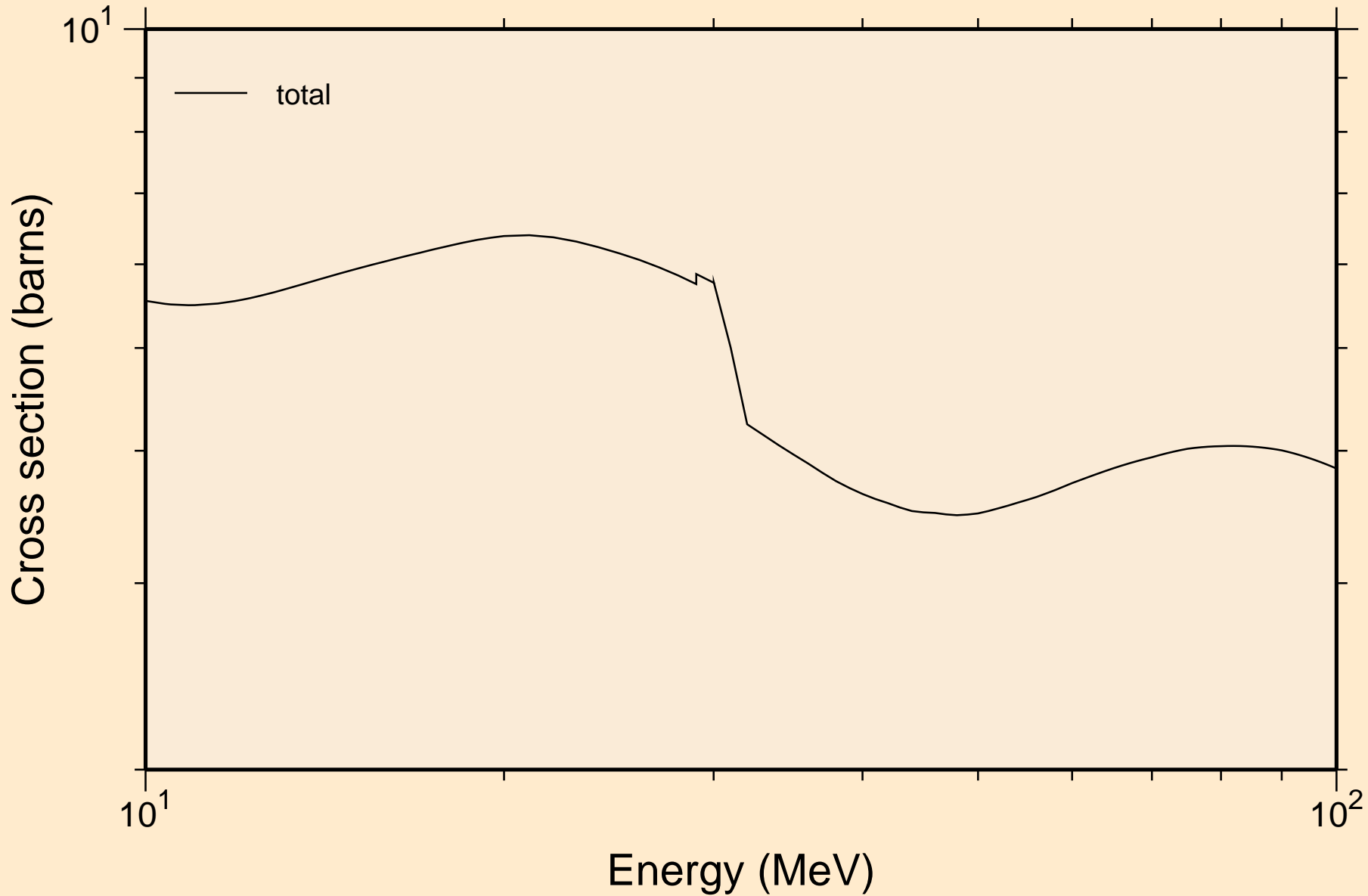

RF265 NEUTRON ACER TENDL-2021 LIBRARY; T=293.6K
resonance absorption cross sections

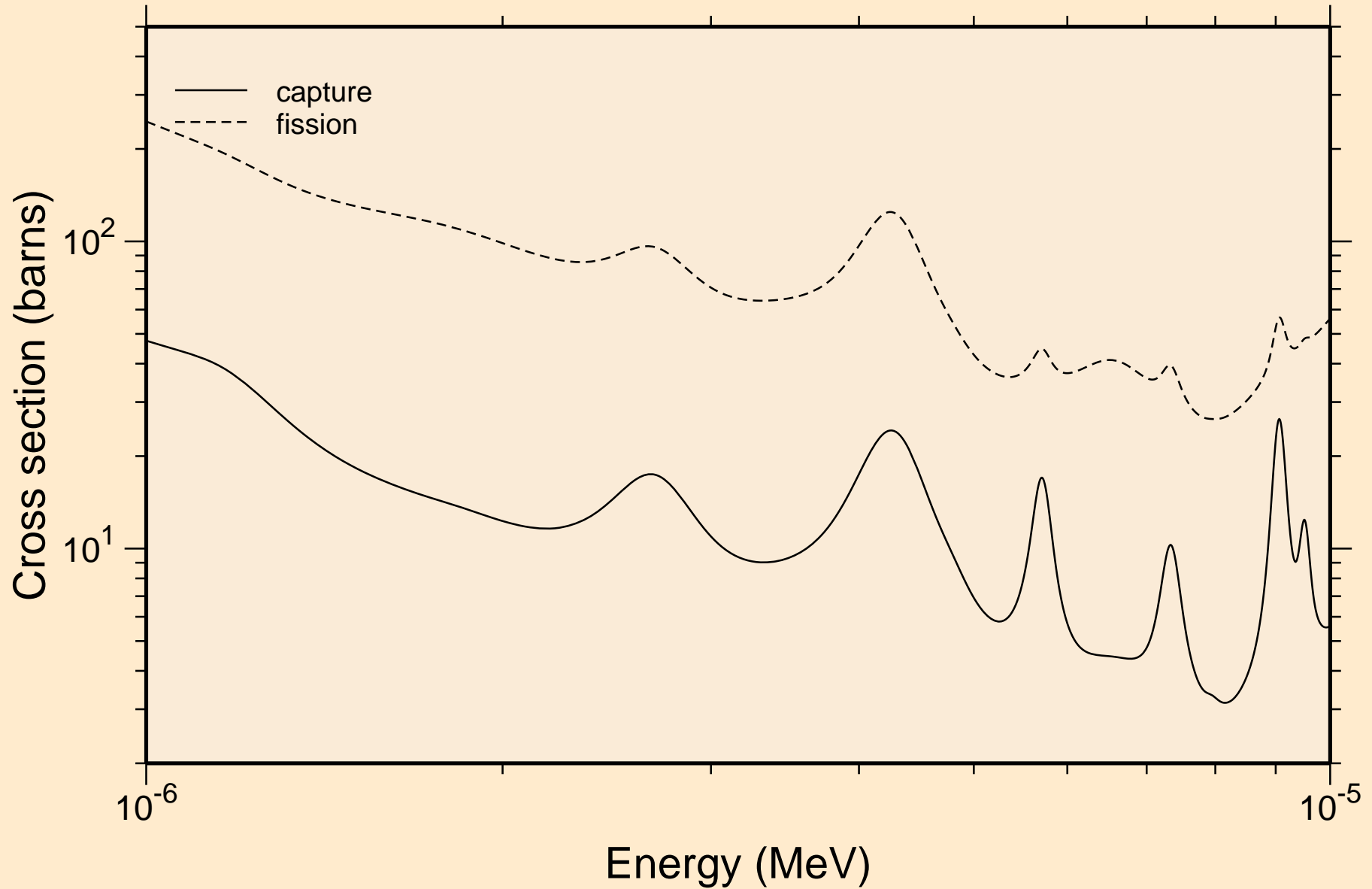

RF265 NEUTRON ACER TENDL-2021 LIBRARY; T=293.6K
resonance absorption cross sections

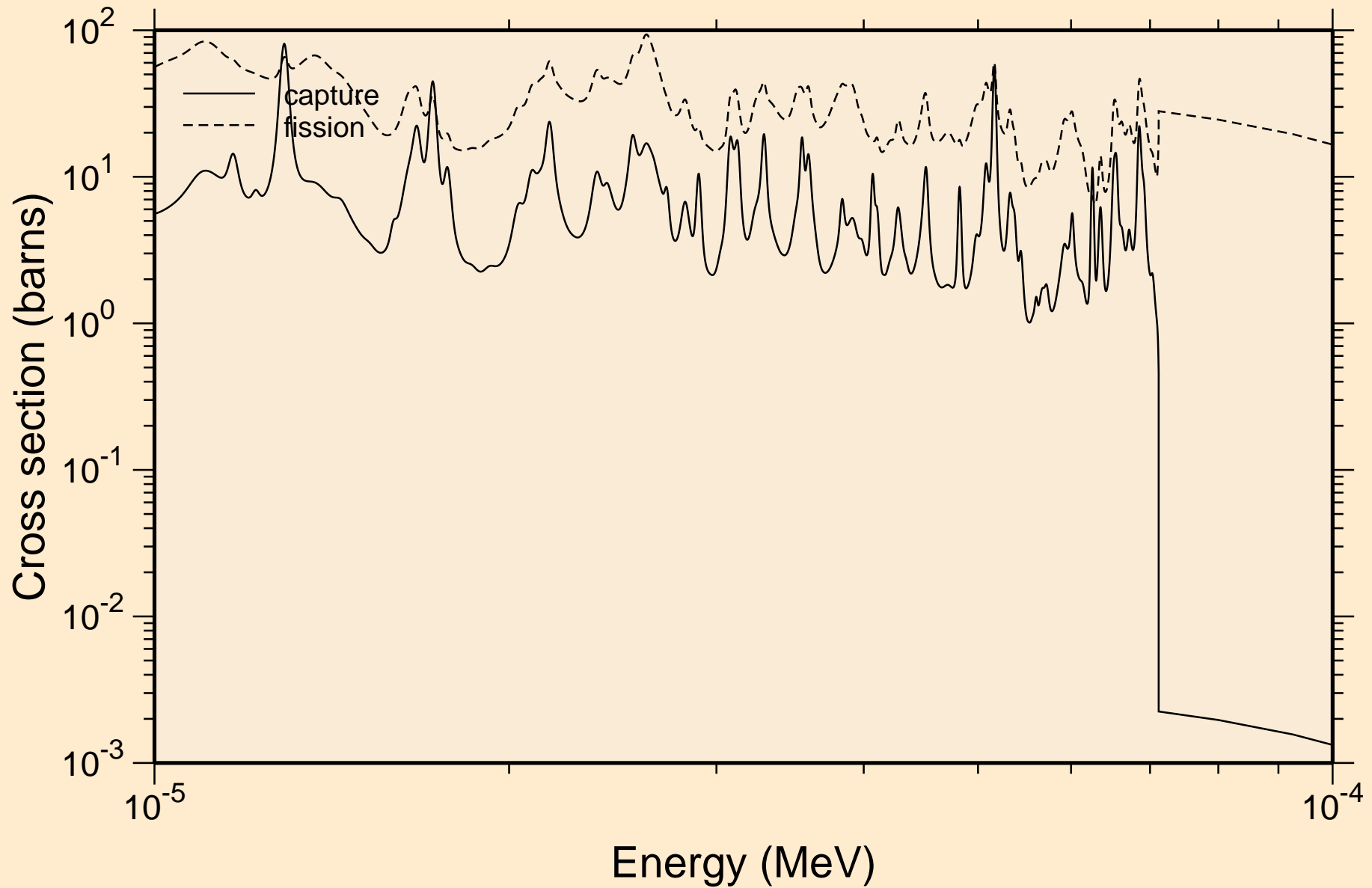

RF265 NEUTRON ACER TENDL-2021 LIBRARY; T=293.6K
resonance absorption cross sections

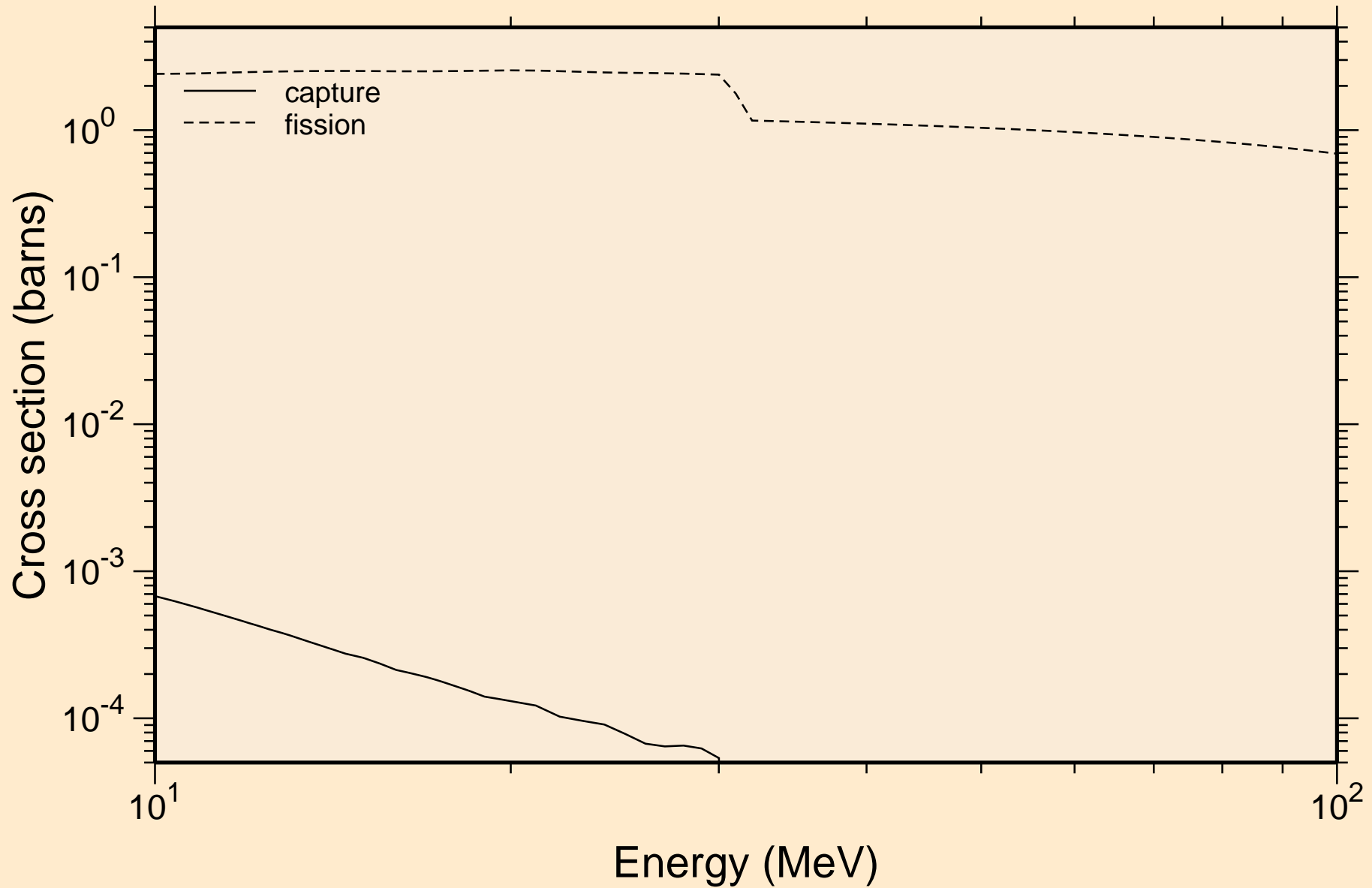

RF265 NEUTRON ACER TENDL-2021 LIBRARY; T=293.6K
Heating

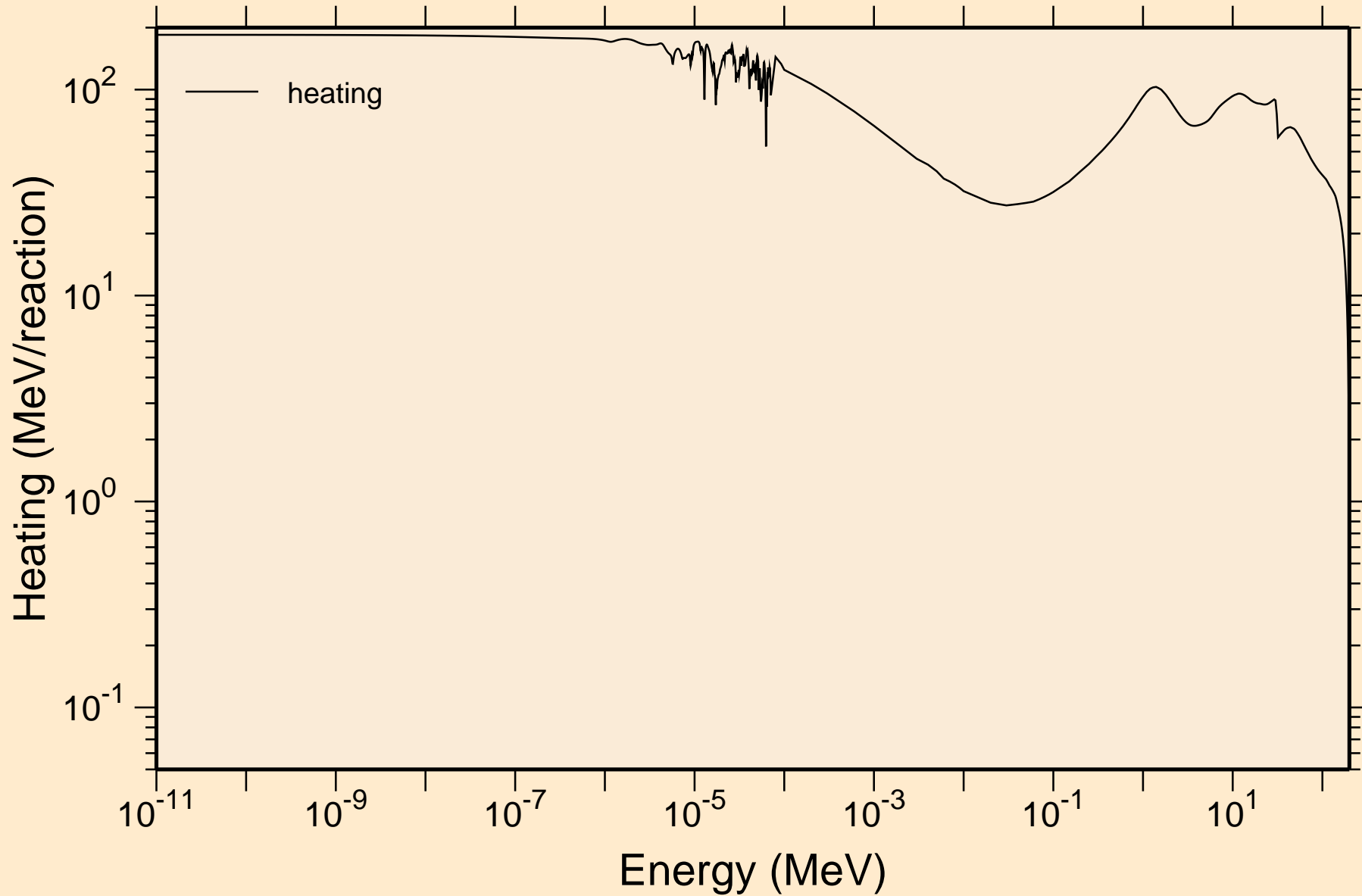

RF265 NEUTRON ACER TENDL-2021 LIBRARY; T=293.6K
Damage

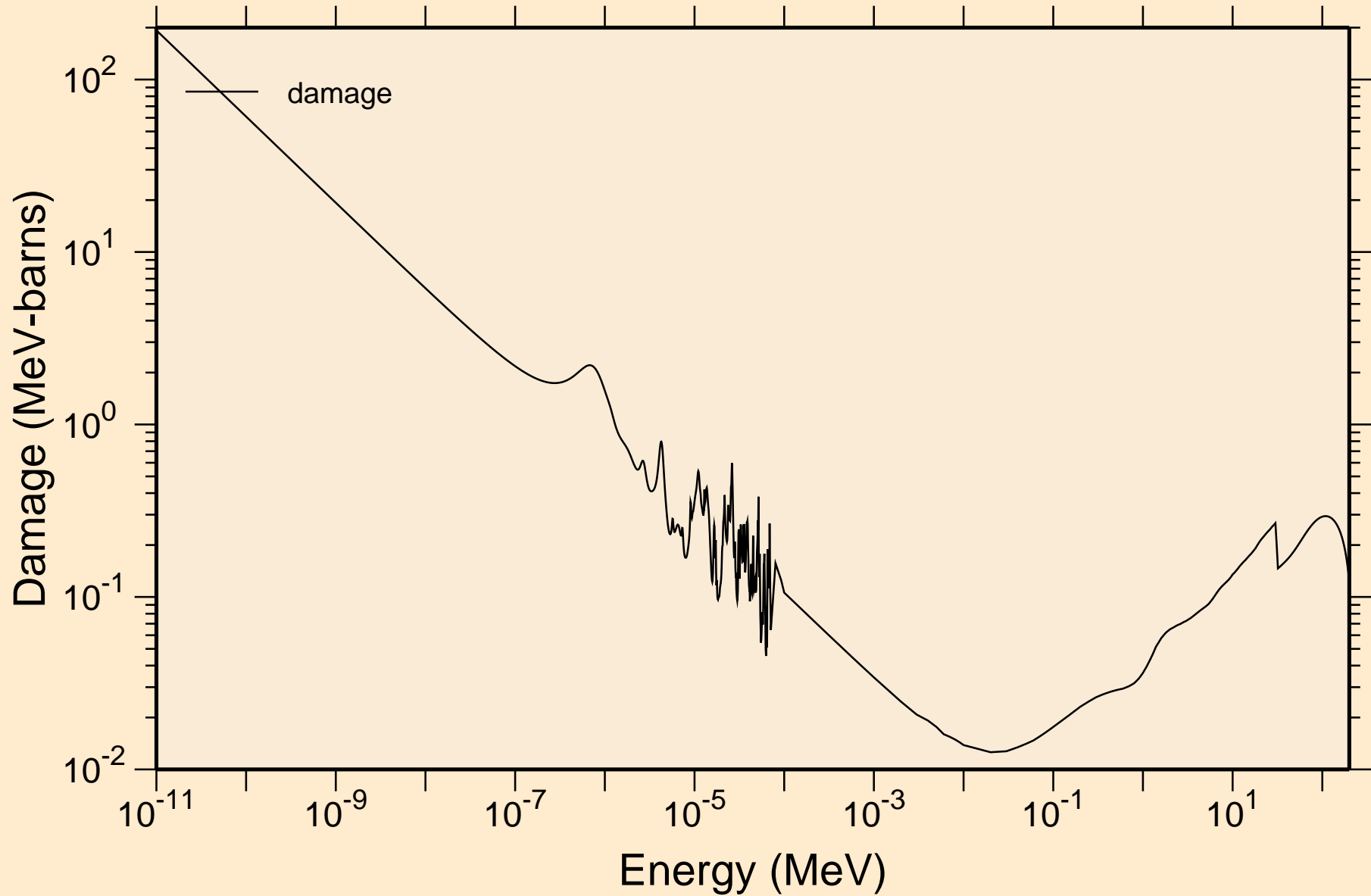

RF265 NEUTRON ACER TENDL-2021 LIBRARY; T=293.6K
Non-threshold reactions

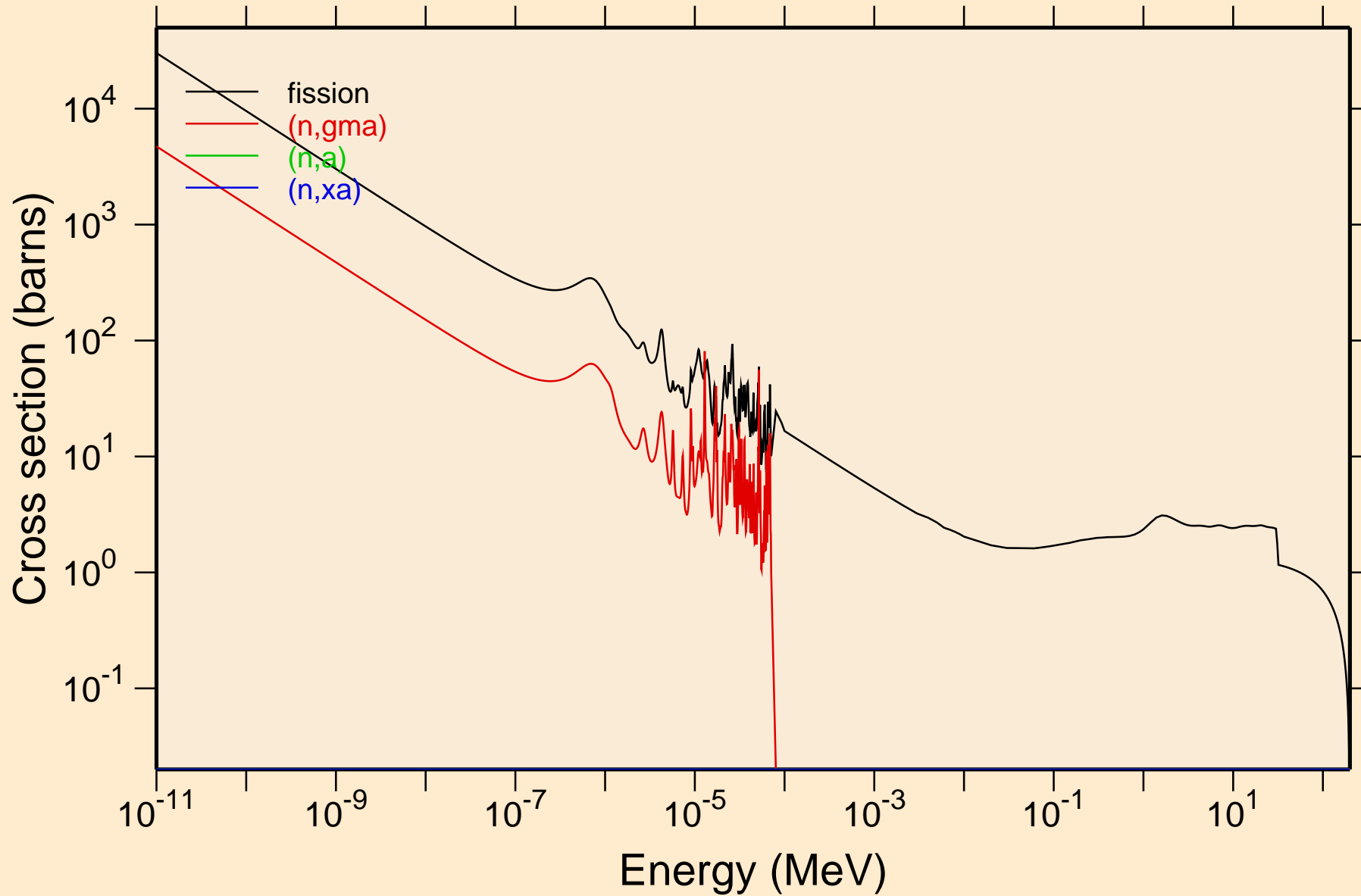

RF265 NEUTRON ACER TENDL-2021 LIBRARY; T=293.6K
Principal cross sections

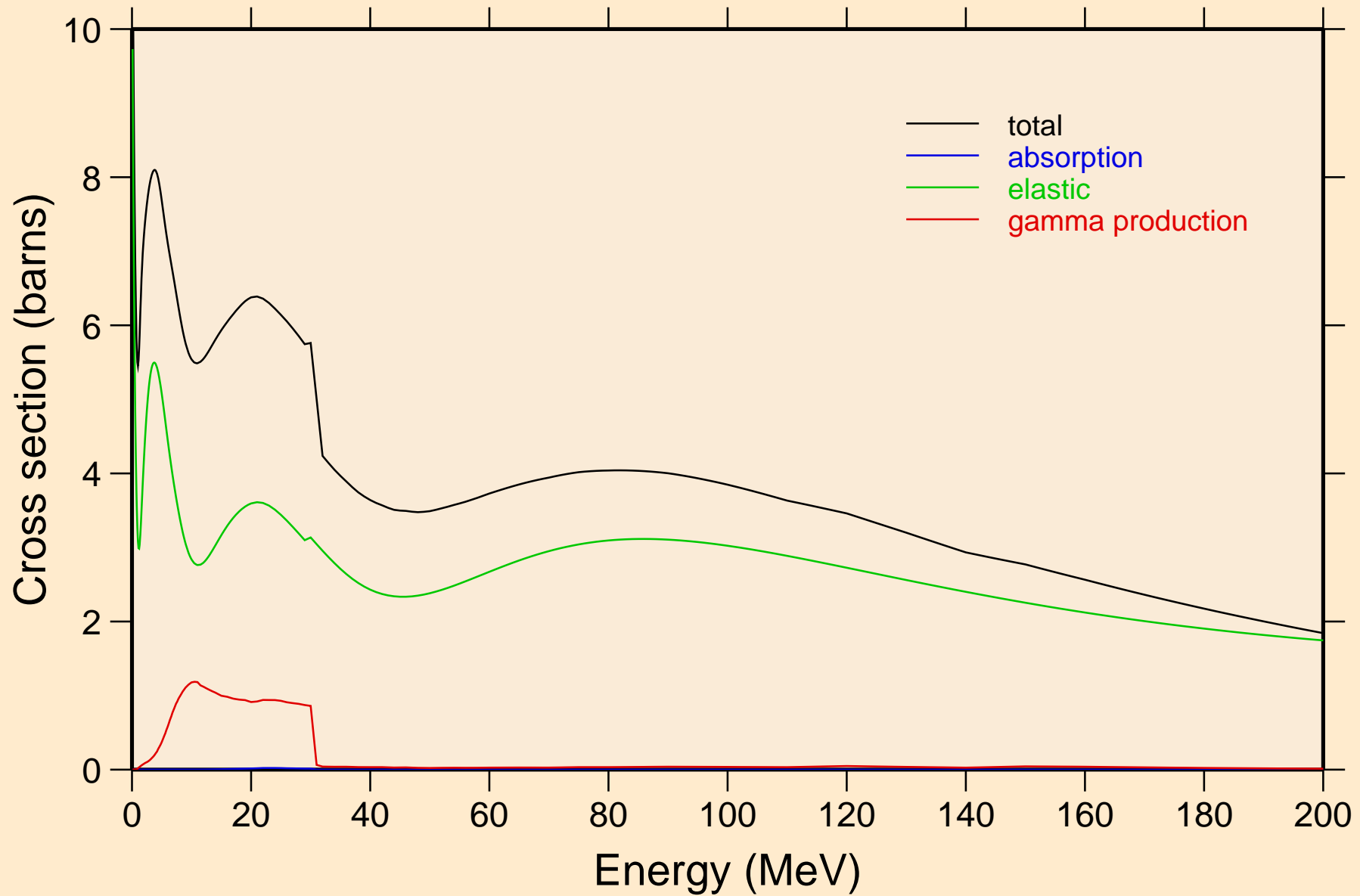

RF265 NEUTRON ACER TENDL-2021 LIBRARY; T=293.6K
Heating

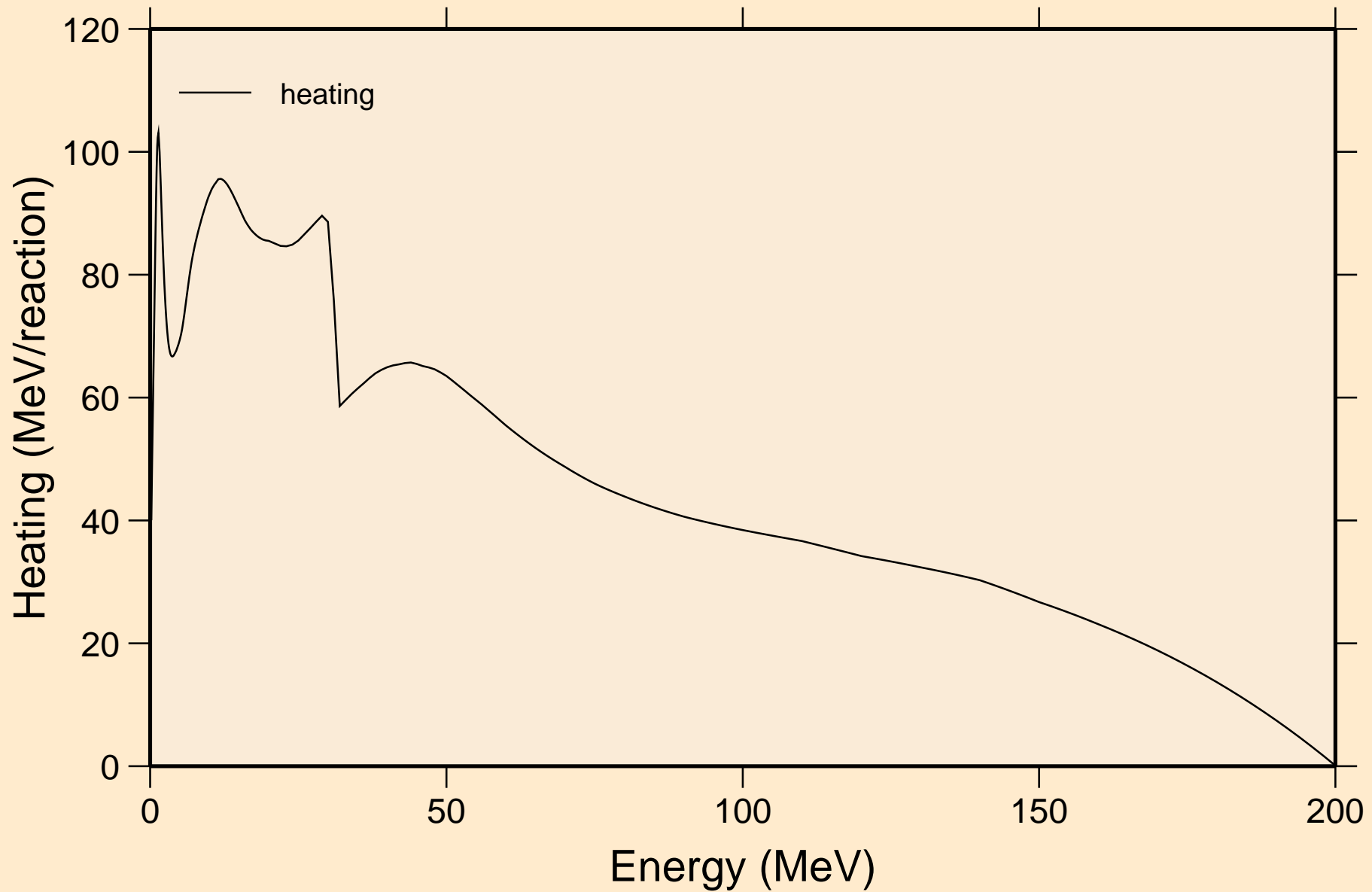

RF265 NEUTRON ACER TENDL-2021 LIBRARY; T=293.6K
Damage

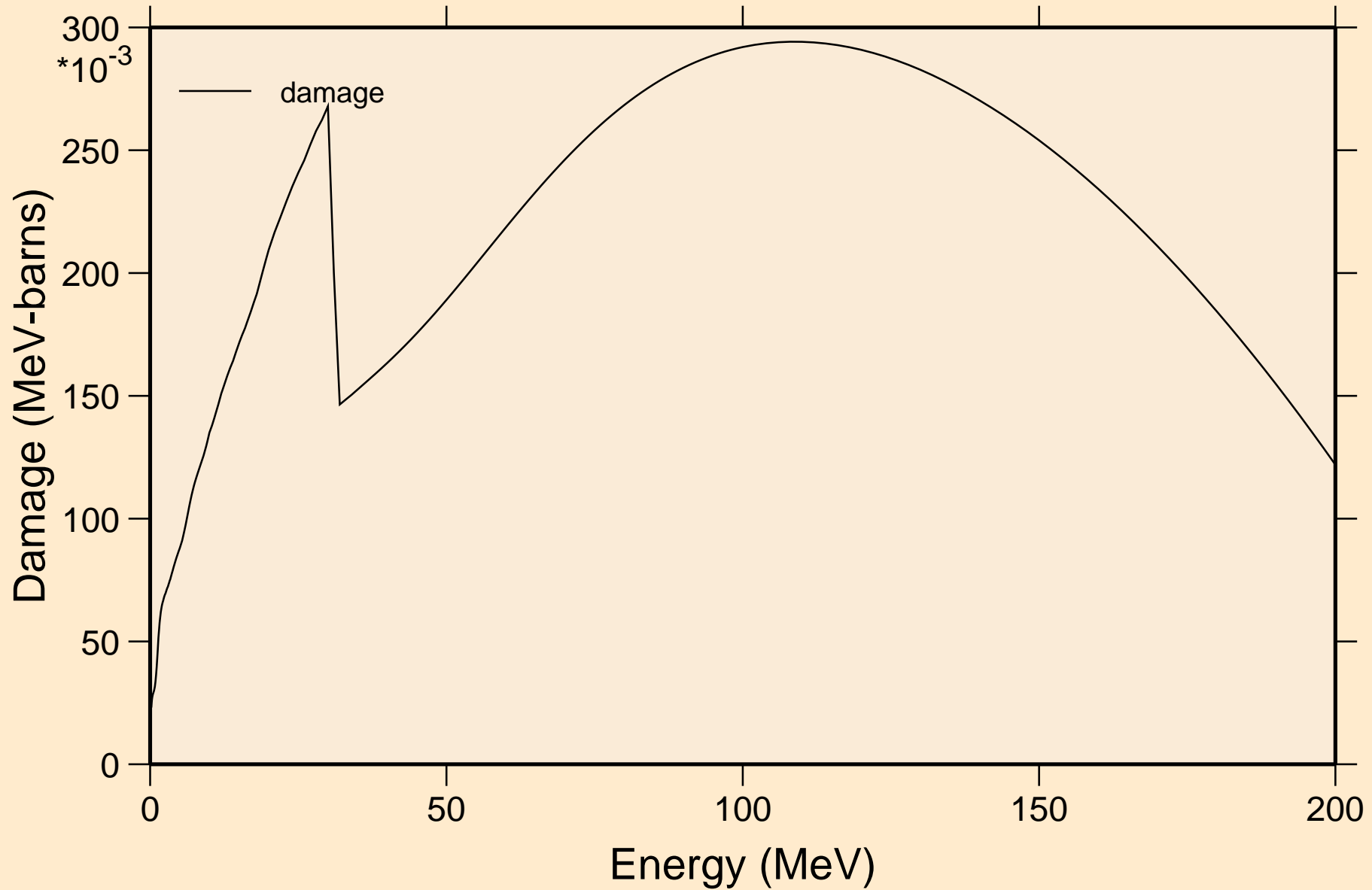

RF265 NEUTRON ACER TENDL-2021 LIBRARY; T=293.6K
Non-threshold reactions

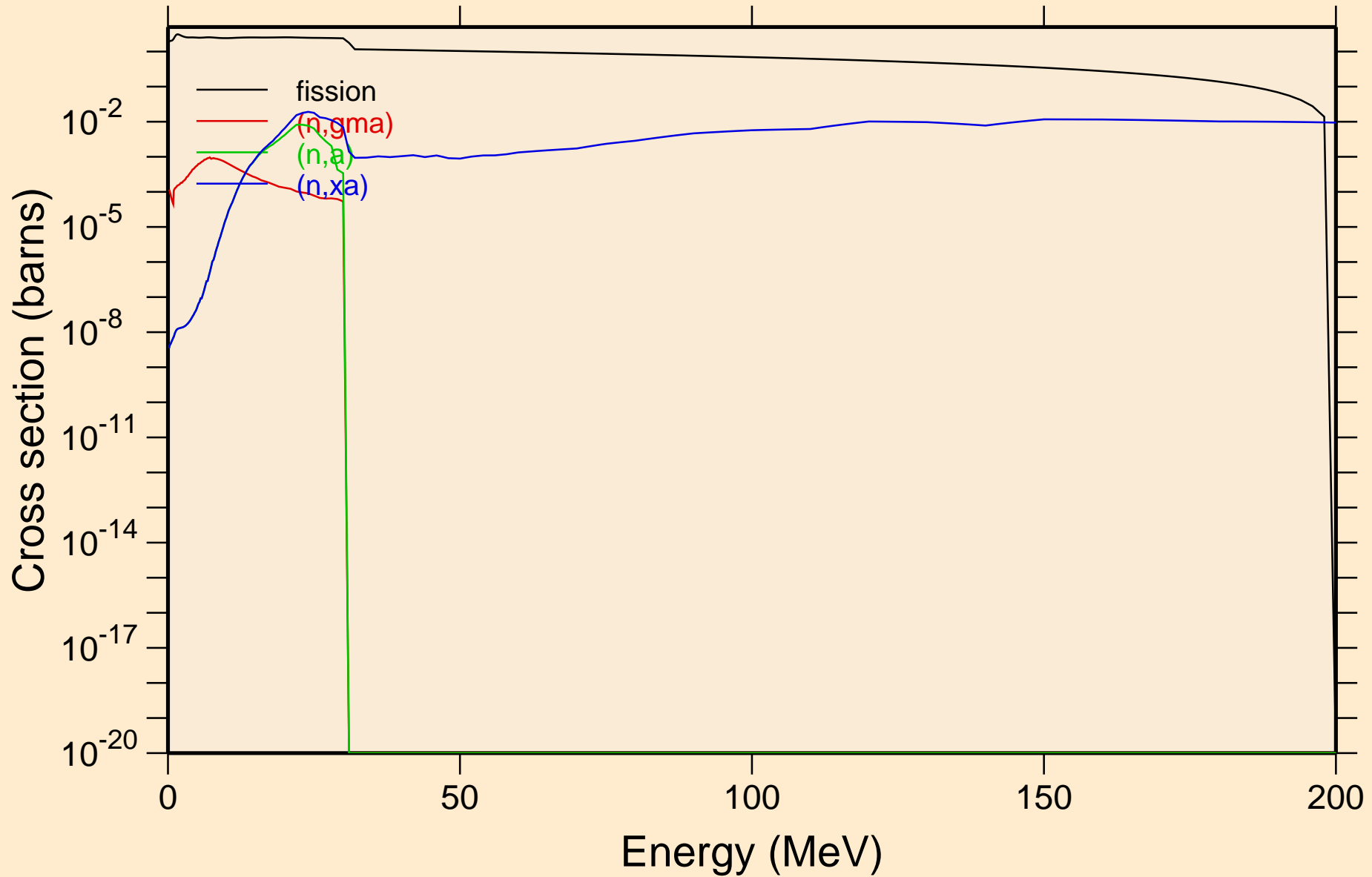

RF265 NEUTRON ACER TENDL-2021 LIBRARY; T=293.6K
Inelastic levels

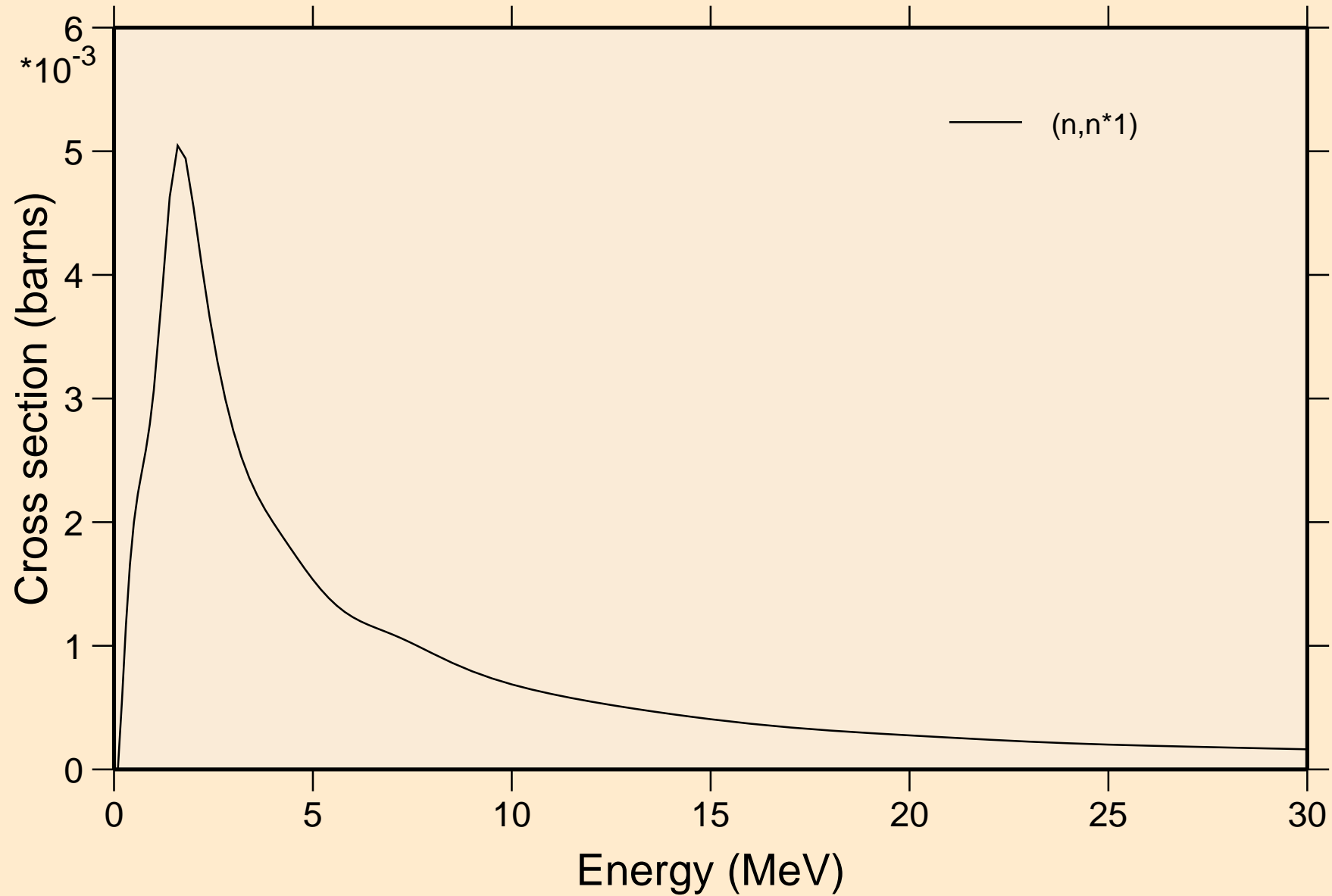

RF265 NEUTRON ACER TENDL-2021 LIBRARY; T=293.6K

Threshold reactions

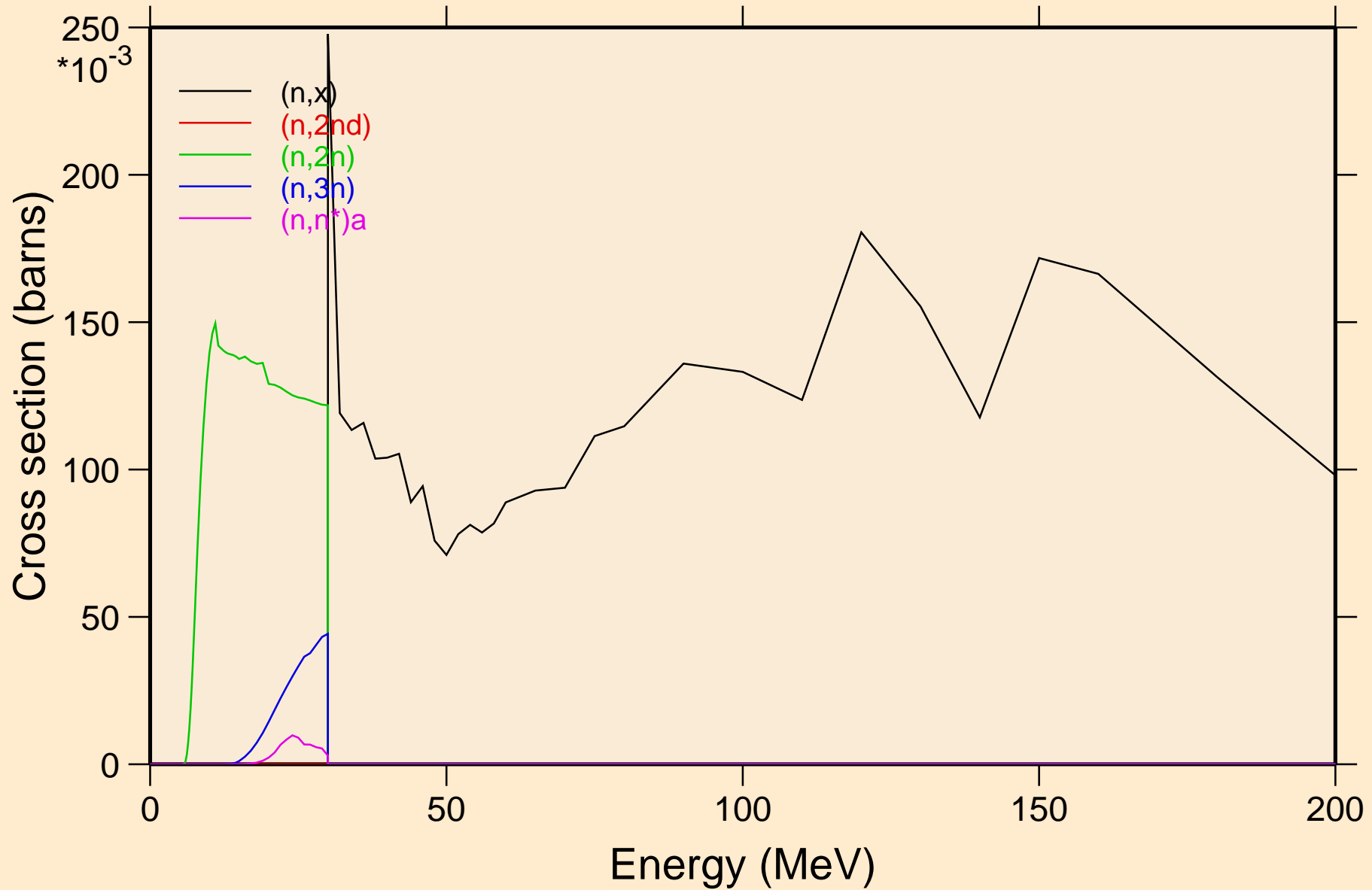

RF265 NEUTRON ACER TENDL-2021 LIBRARY; T=293.6K
Threshold reactions

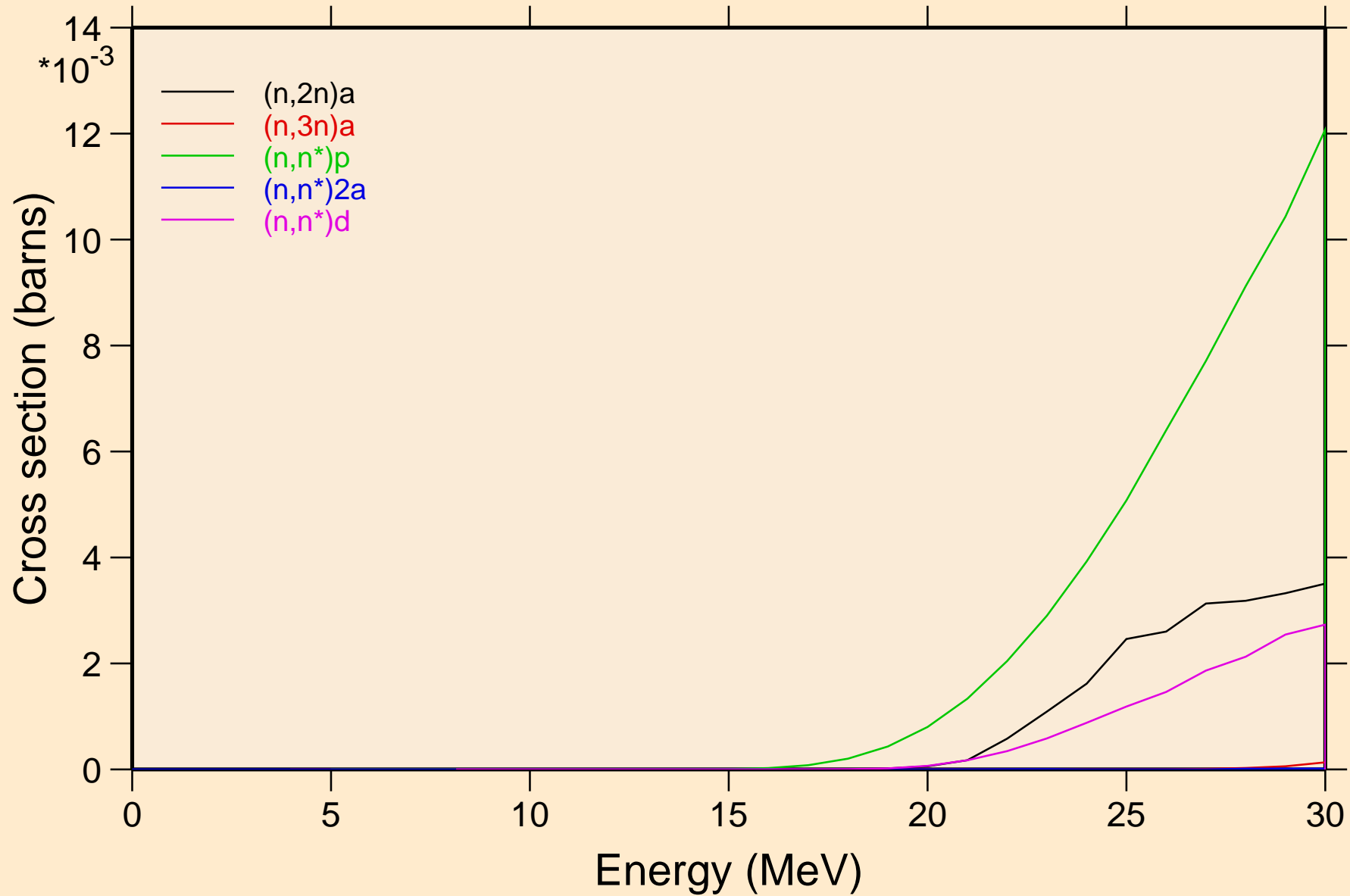

RF265 NEUTRON ACER TENDL-2021 LIBRARY; T=293.6K
Threshold reactions

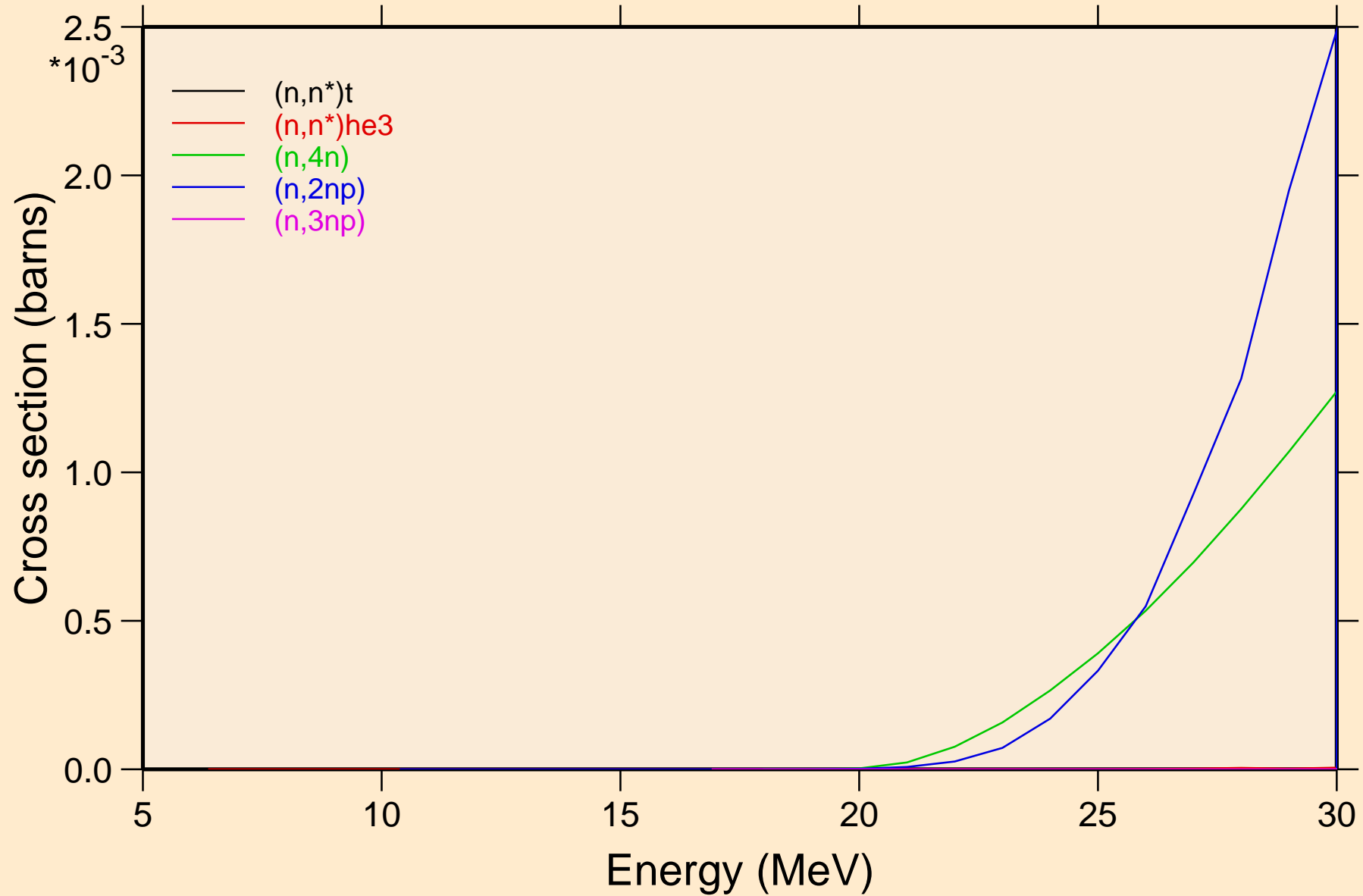

RF265 NEUTRON ACER TENDL-2021 LIBRARY; T=293.6K
Threshold reactions

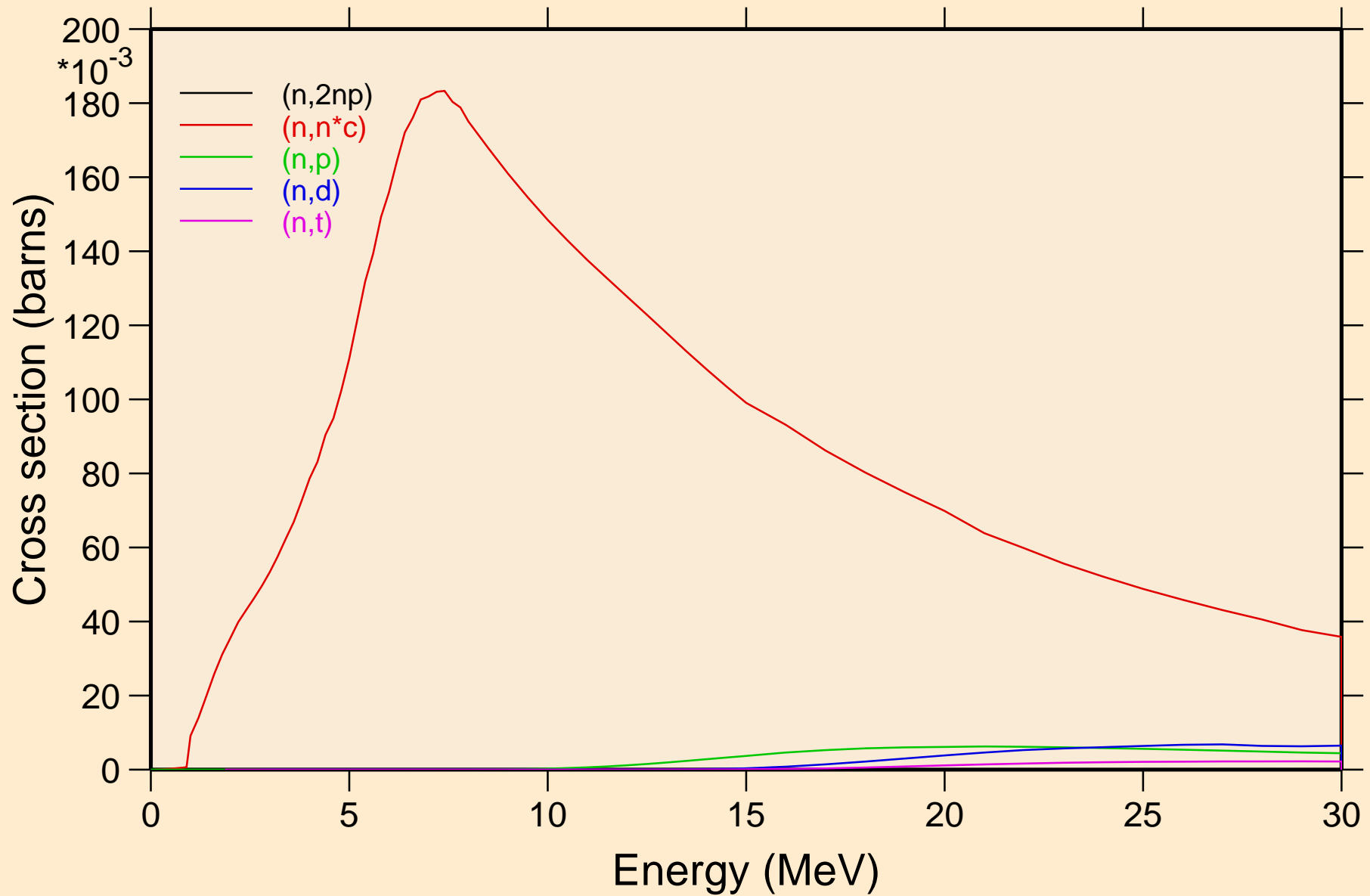

RF265 NEUTRON ACER TENDL-2021 LIBRARY; T=293.6K
Threshold reactions

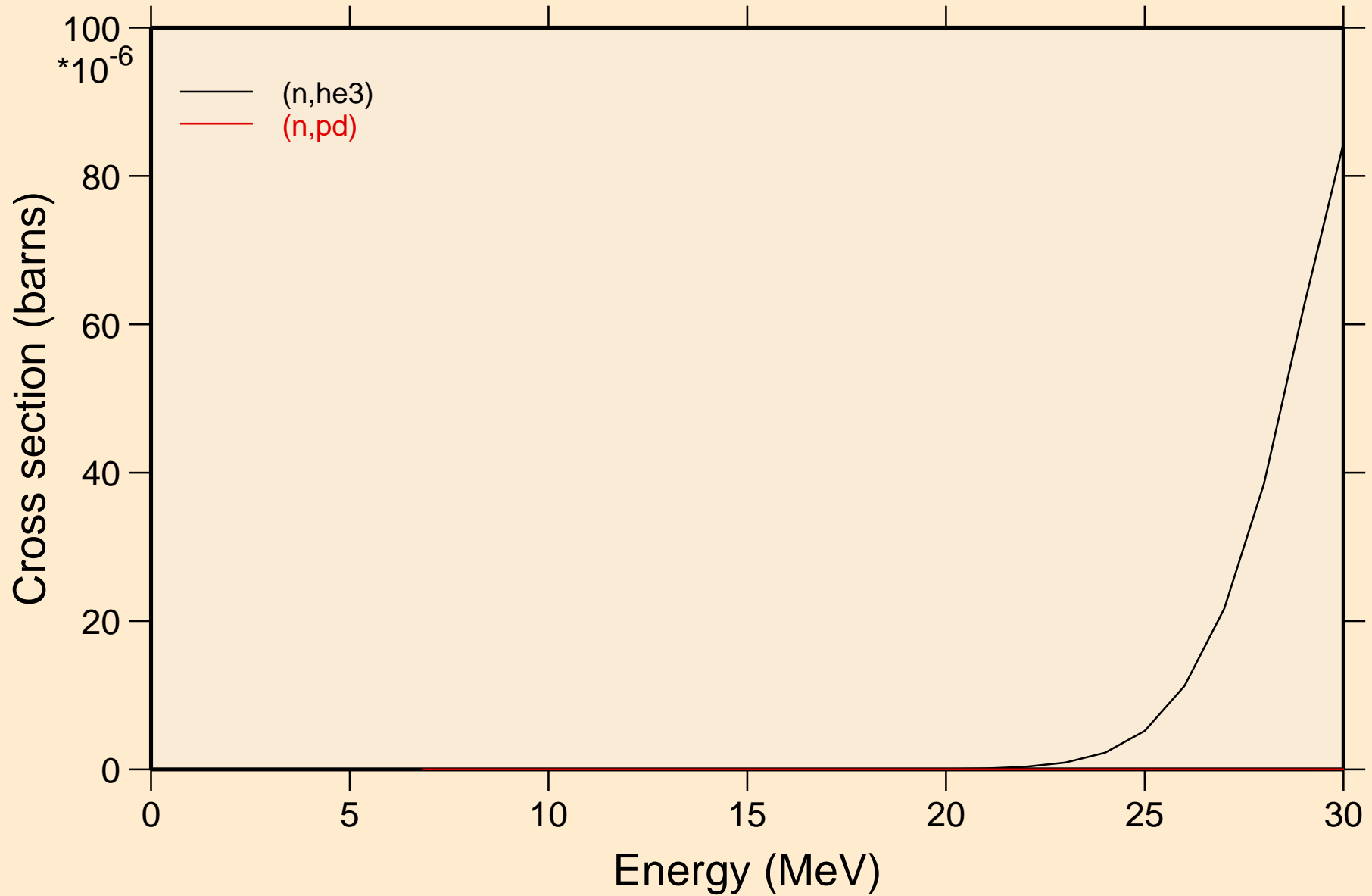

RF265 NEUTRON ACER TENDL-2021 LIBRARY; T=293.6K

Threshold reactions

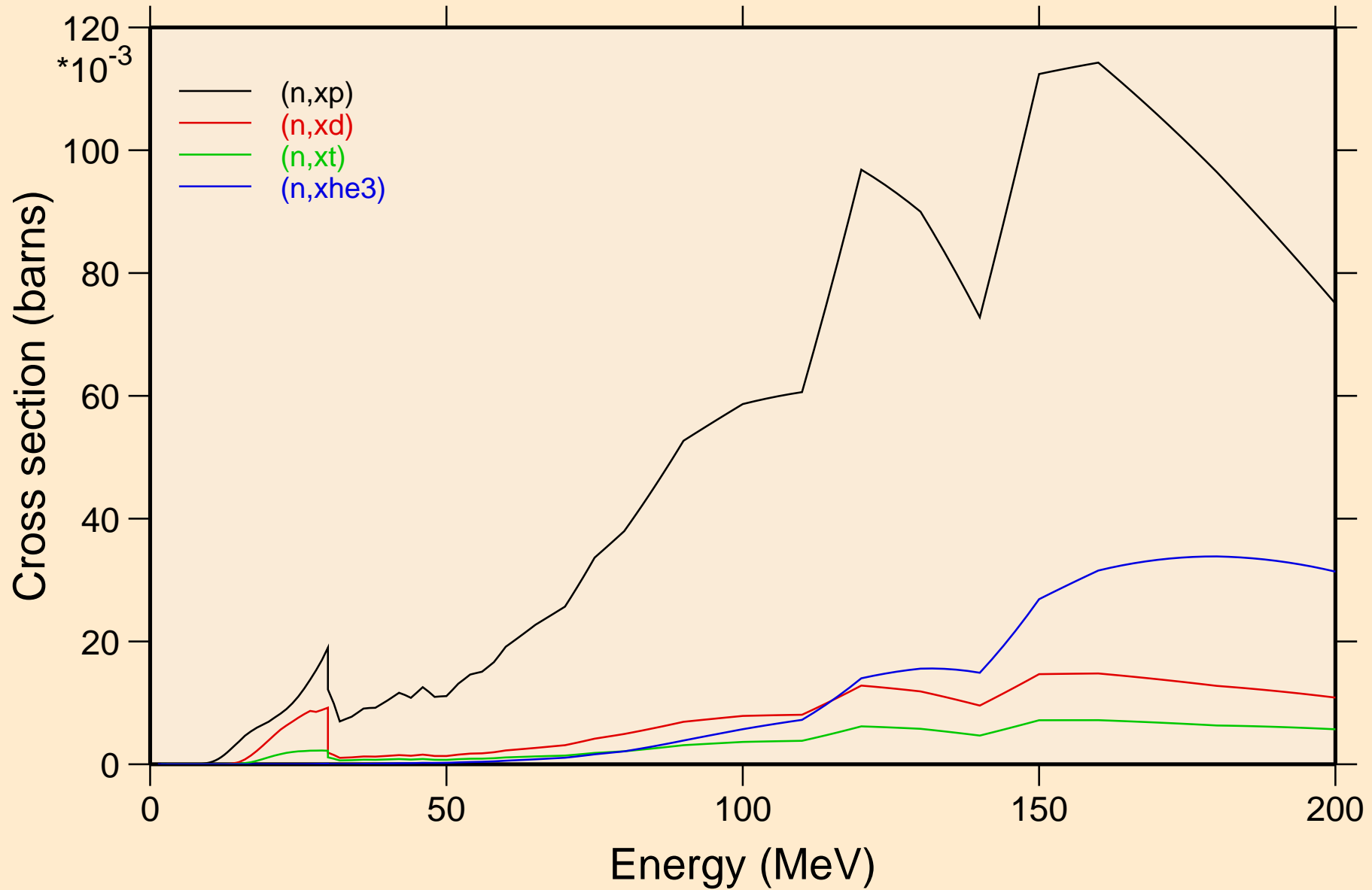

RF265 NEUTRON ACER TENDL-2021 LIBRARY; T=293.6K
angular distribution for elastic

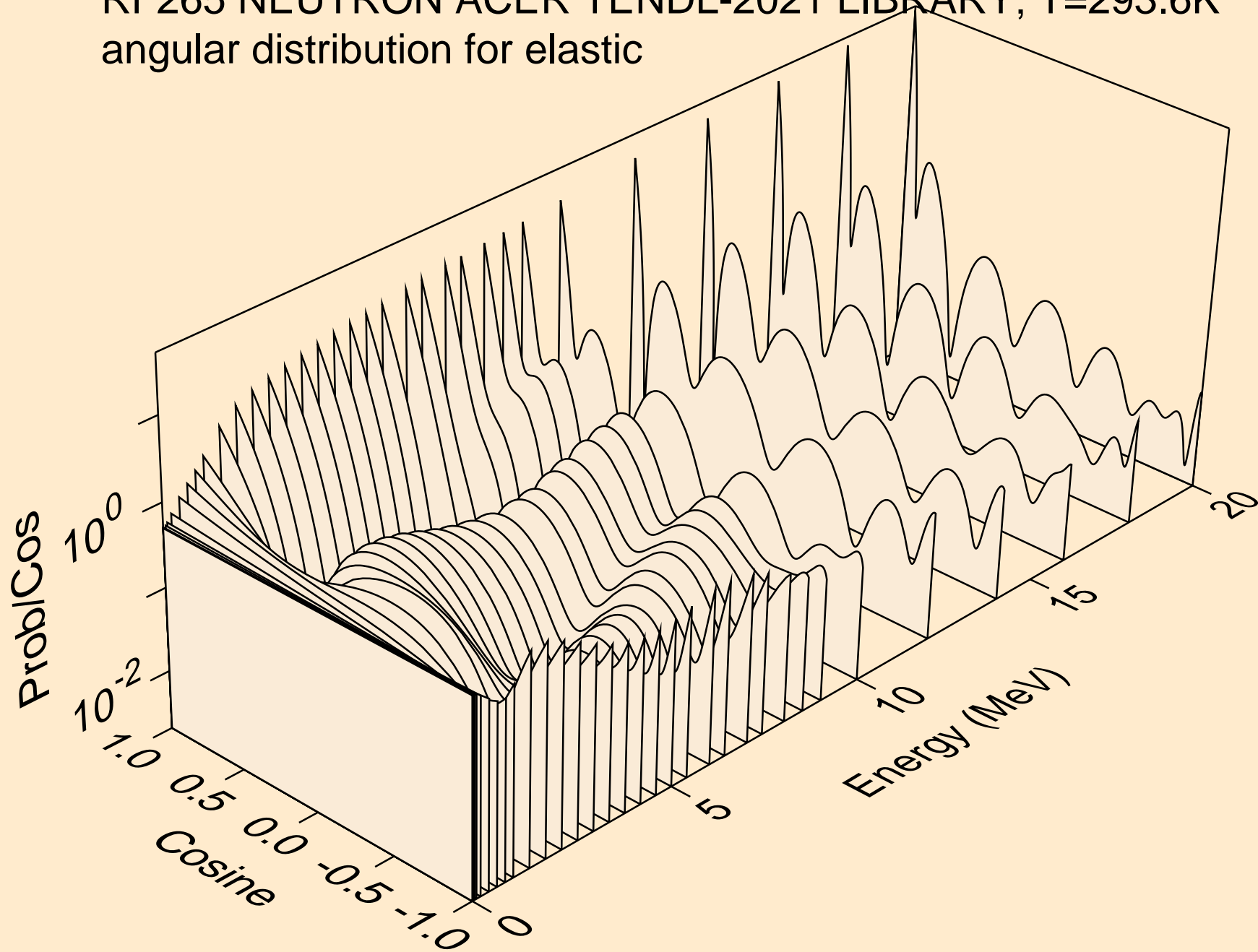

RF265 NEUTRON ACER TENDL-2021 LIBRARY; T=293.6K
angular distribution for elastic

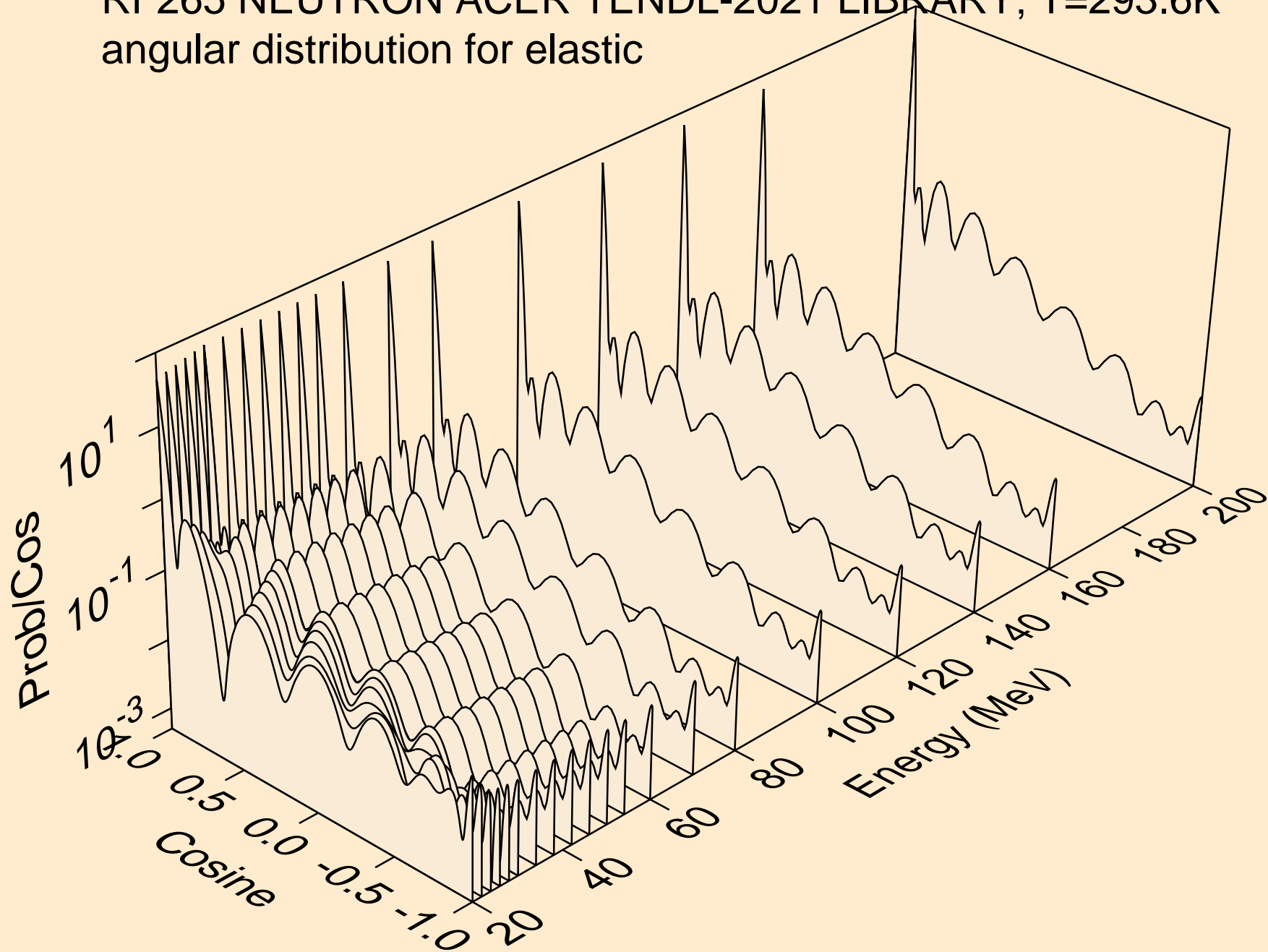

RF265 NEUTRON ACER TENDL-2021 LIBRARY; T=293.6K
angular distribution for (n,n*1)

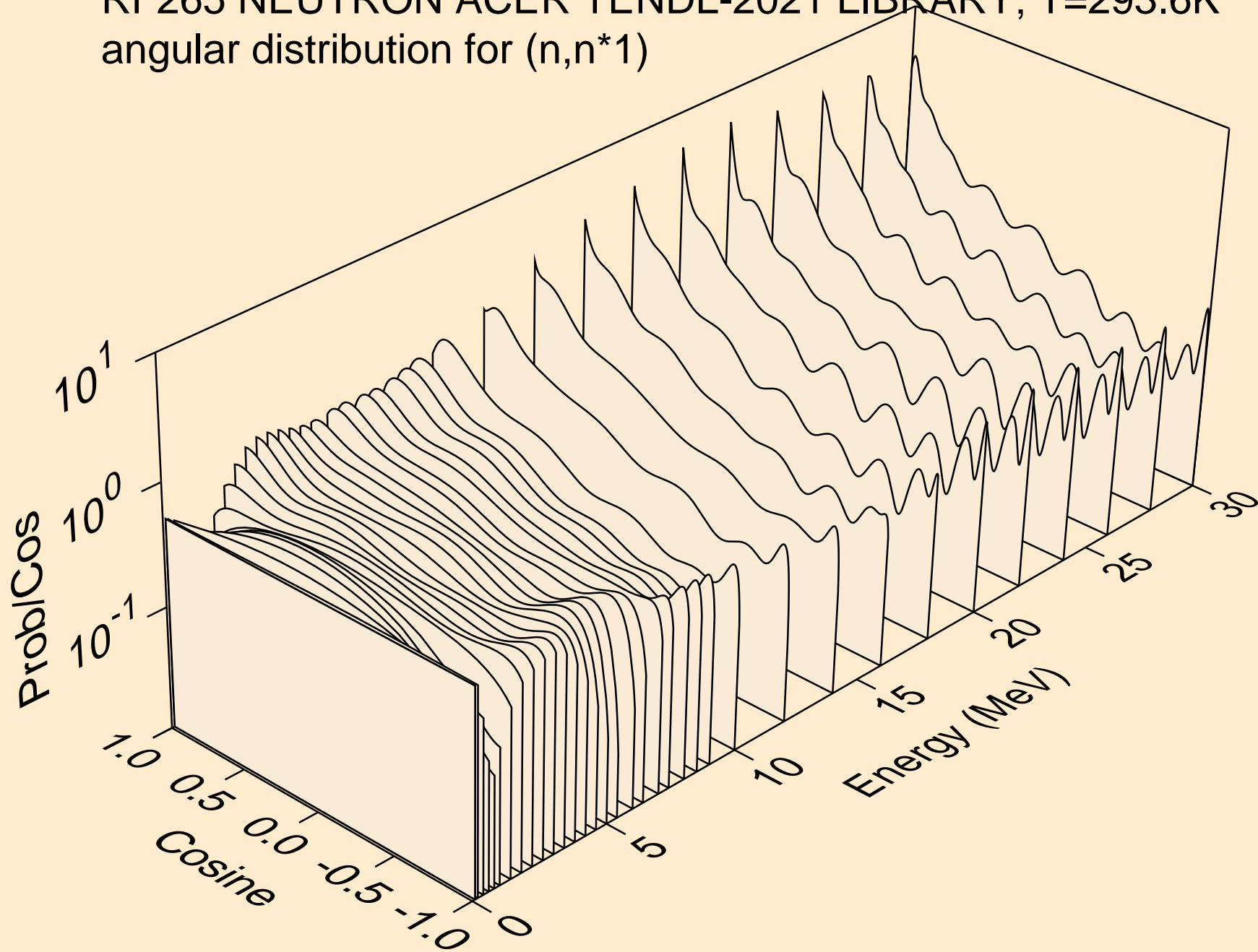

RF265 NEUTRON ACER TENDL-2021 LIBRARY; T=293.6K
Total fission nubar

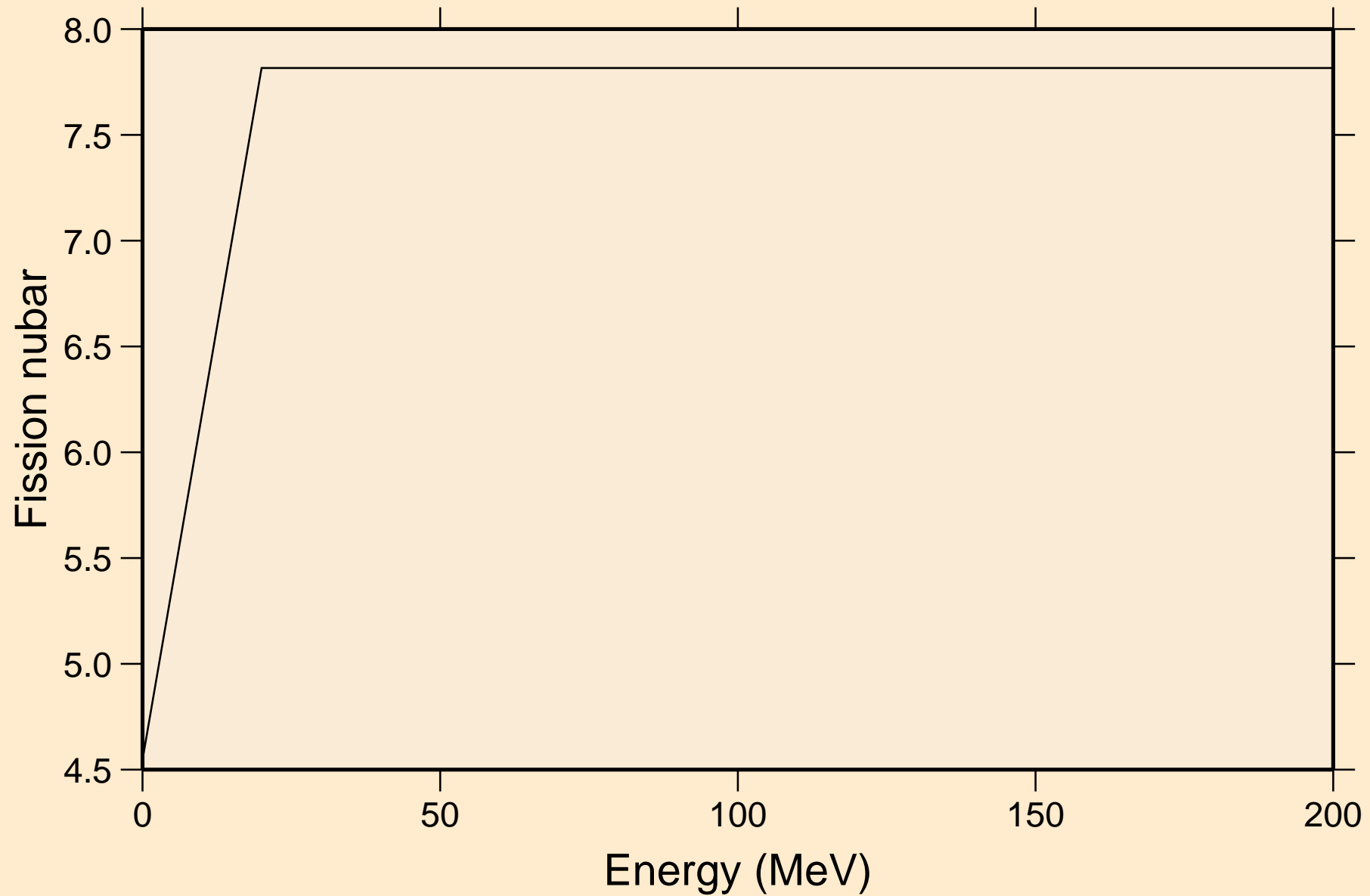

RF265 NEUTRON ACER TENDL-2021 LIBRARY; T=293.6K
Neutron emission for (n,x)

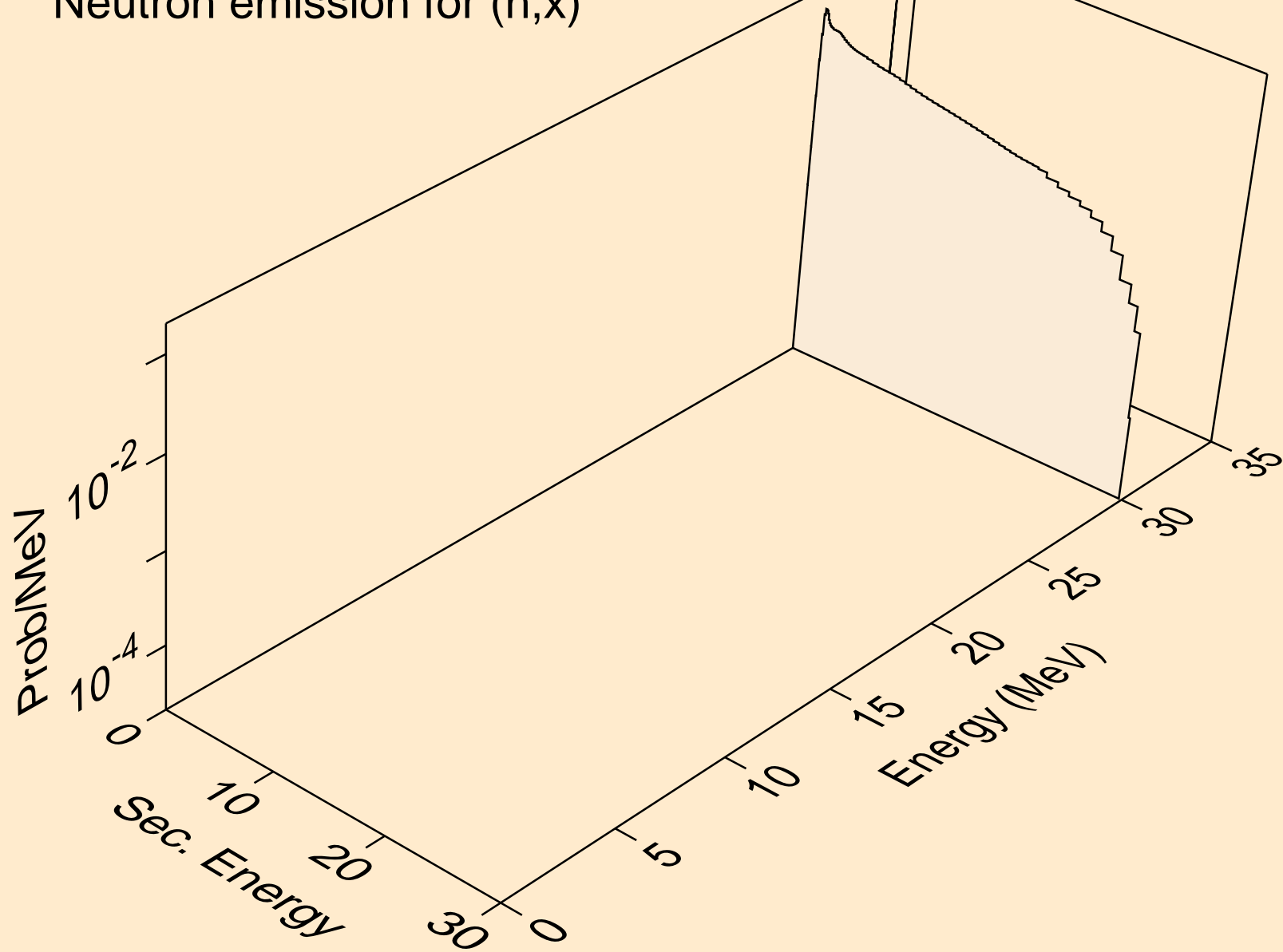

RF265 NEUTRON ACER TENDL-2021 LIBRARY; T=293.6K
Neutron emission for (n,2nd)

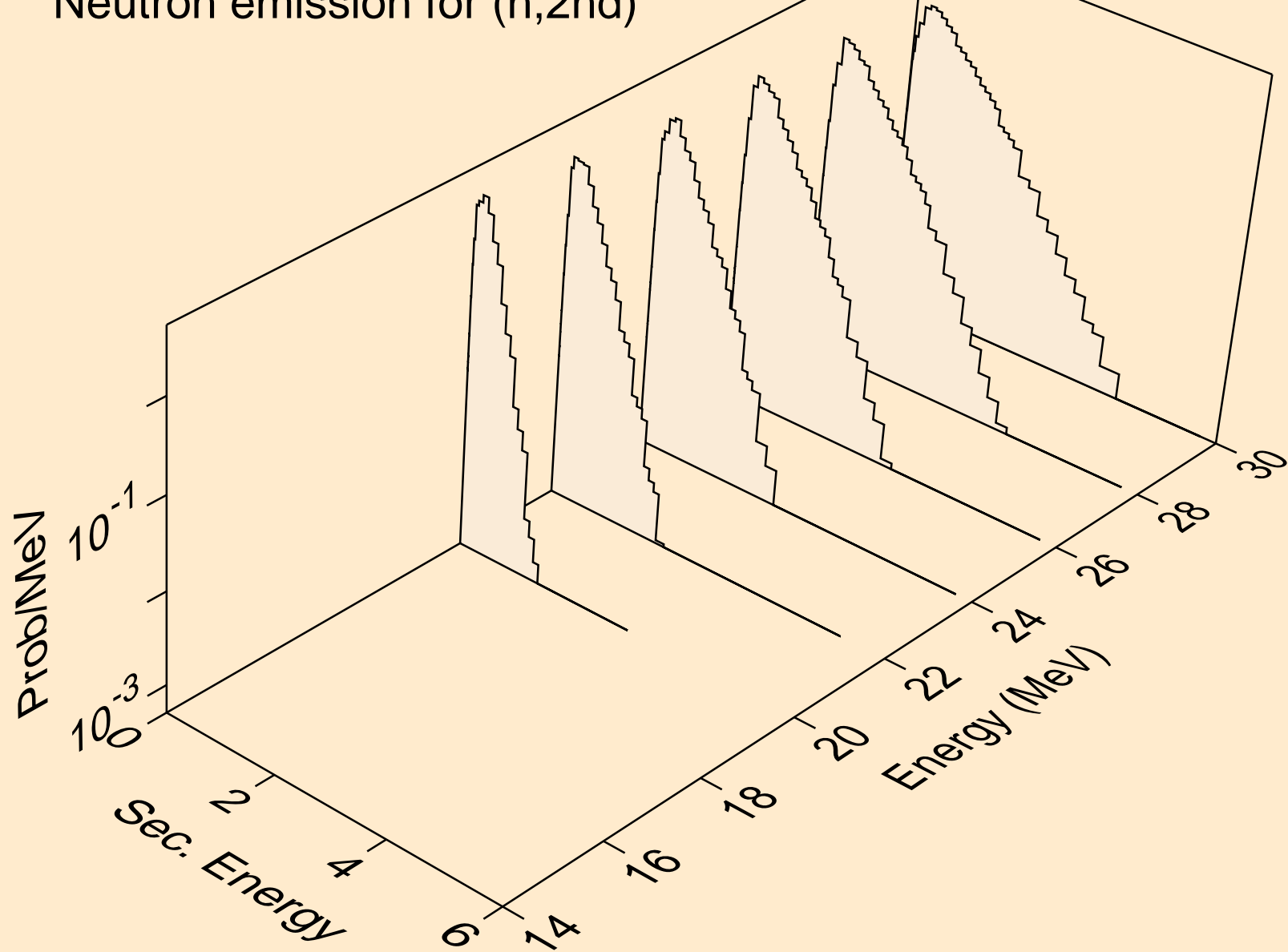

RF265 NEUTRON ACER TENDL-2021 LIBRARY; T=293.6K
Neutron emission for (n,2n)

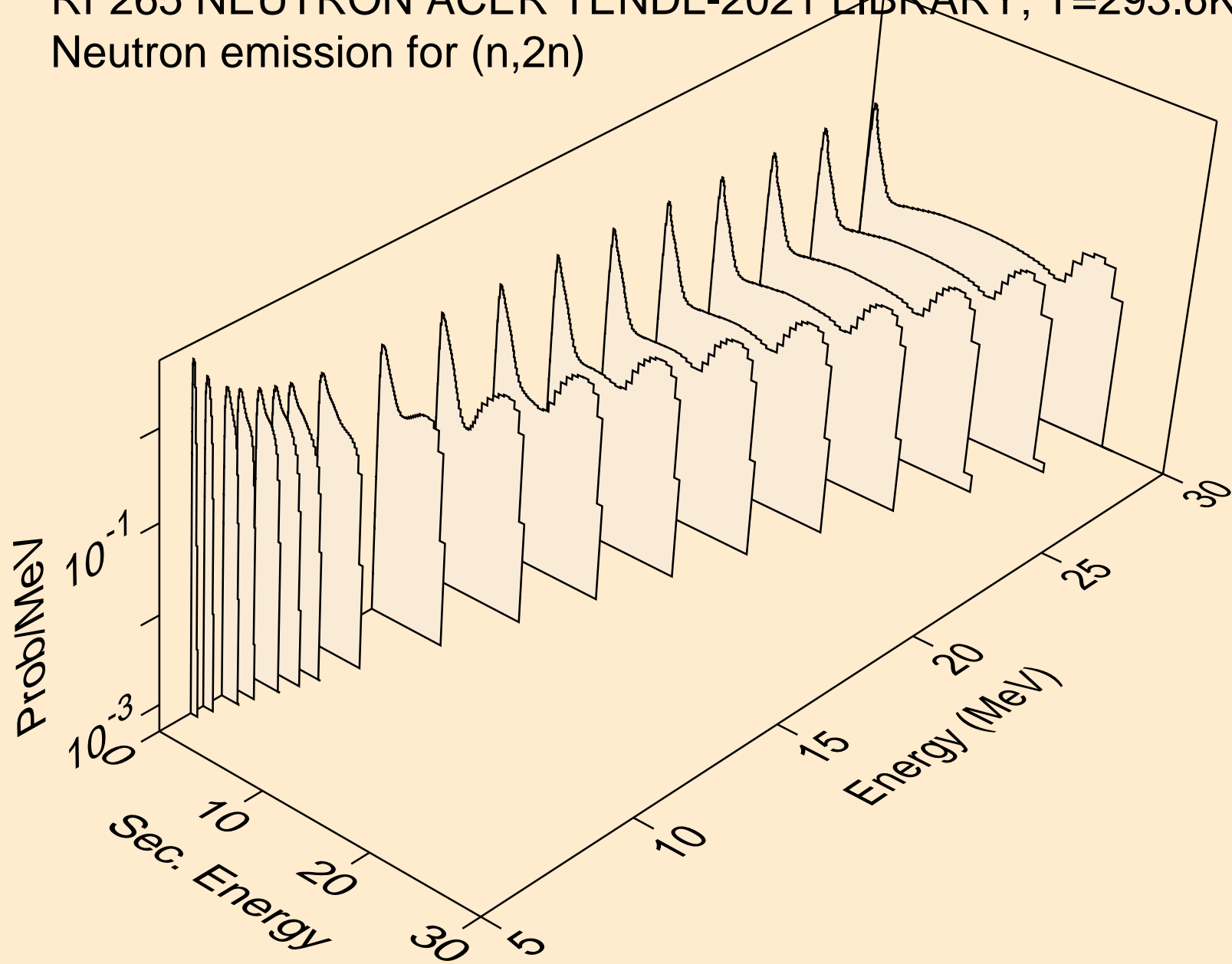

RF265 NEUTRON ACER TENDL-2021 LIBRARY; T=293.6K
Neutron emission for (n,3n)

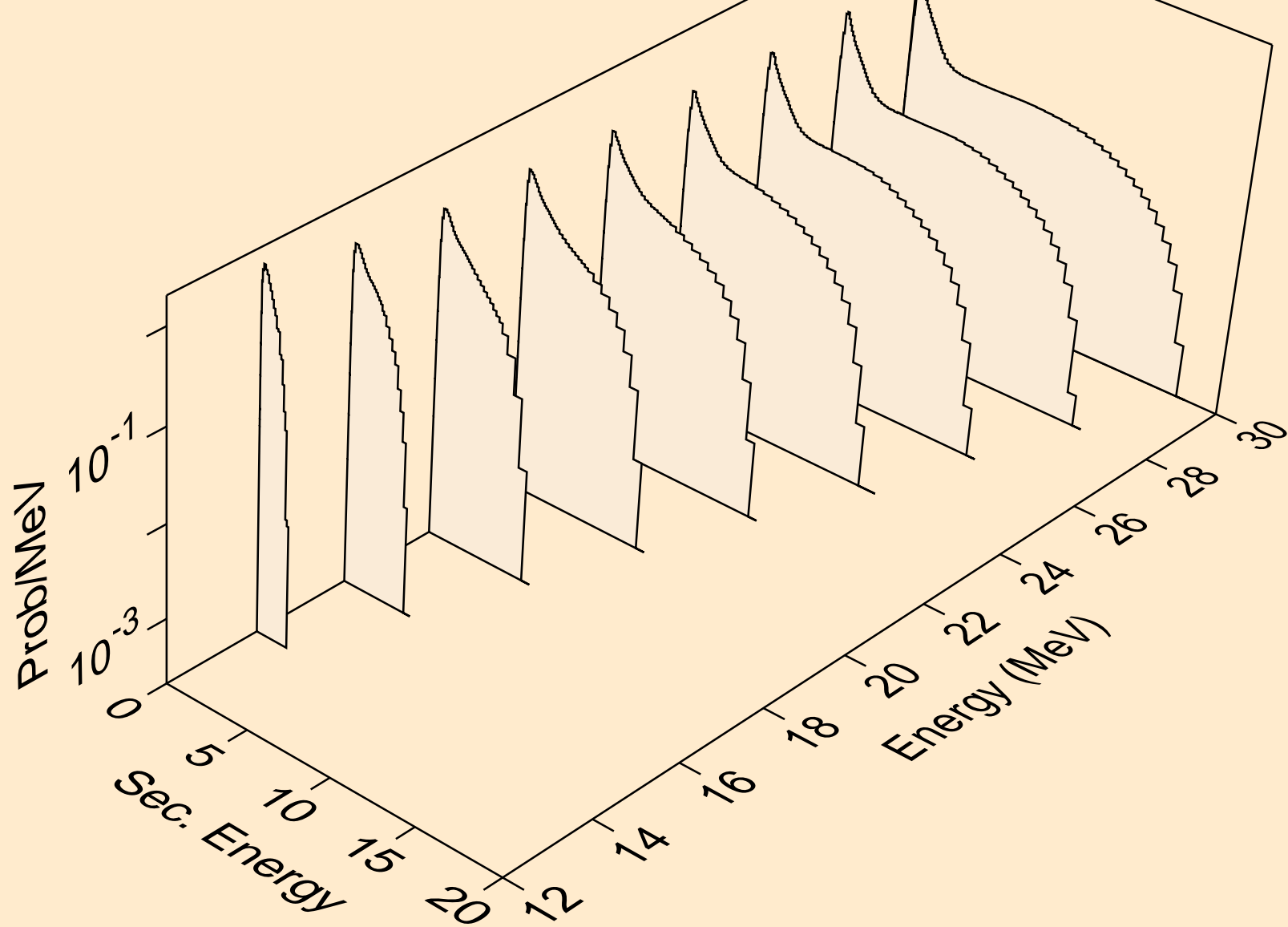

RF265 NEUTRON ACER TENDL-2021 LIBRARY; T=293.6K
Neutron emission for fission

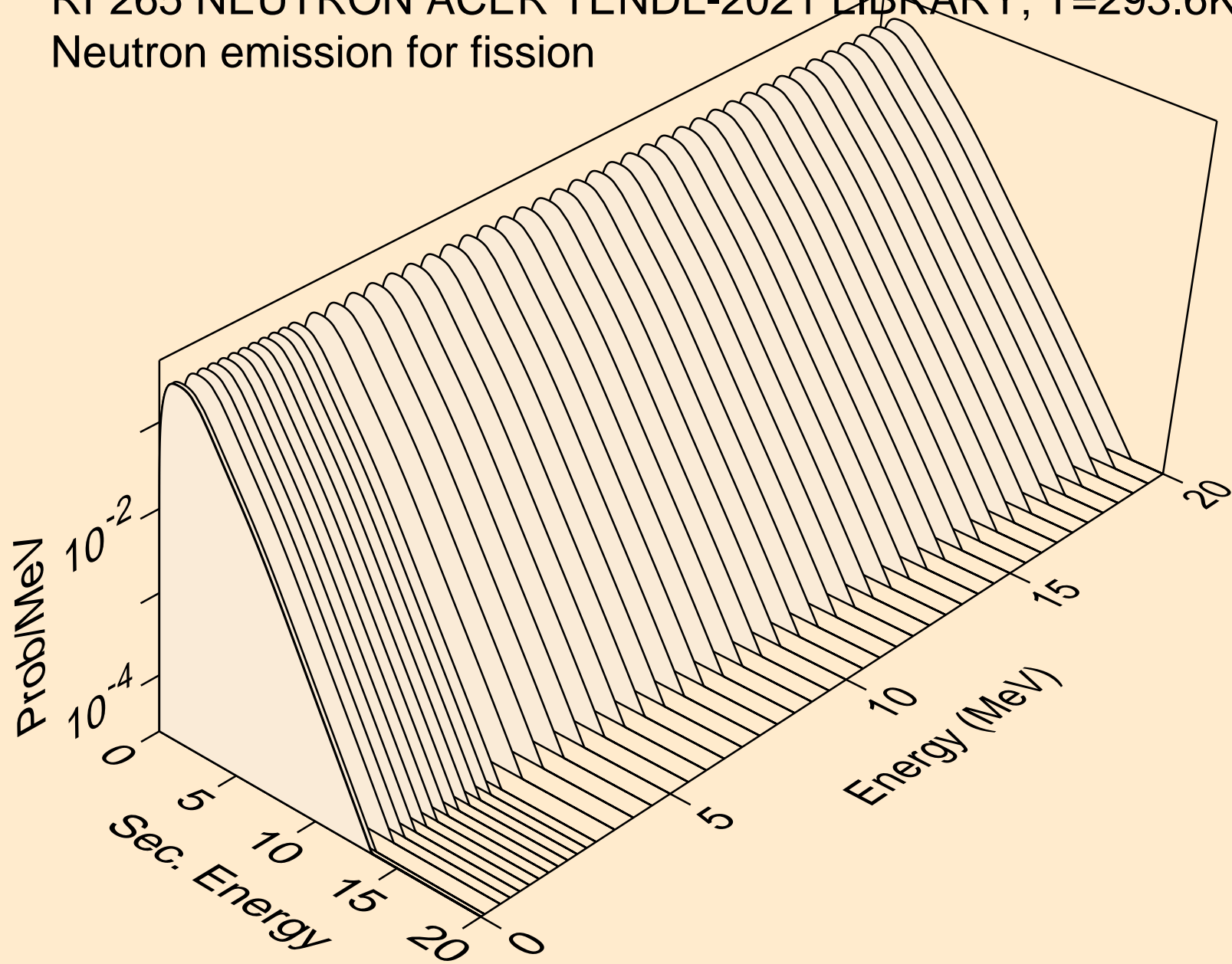

RF265 NEUTRON ACER TENDL-2021 LIBRARY; T=293.6K
Neutron emission for (n,n*)a

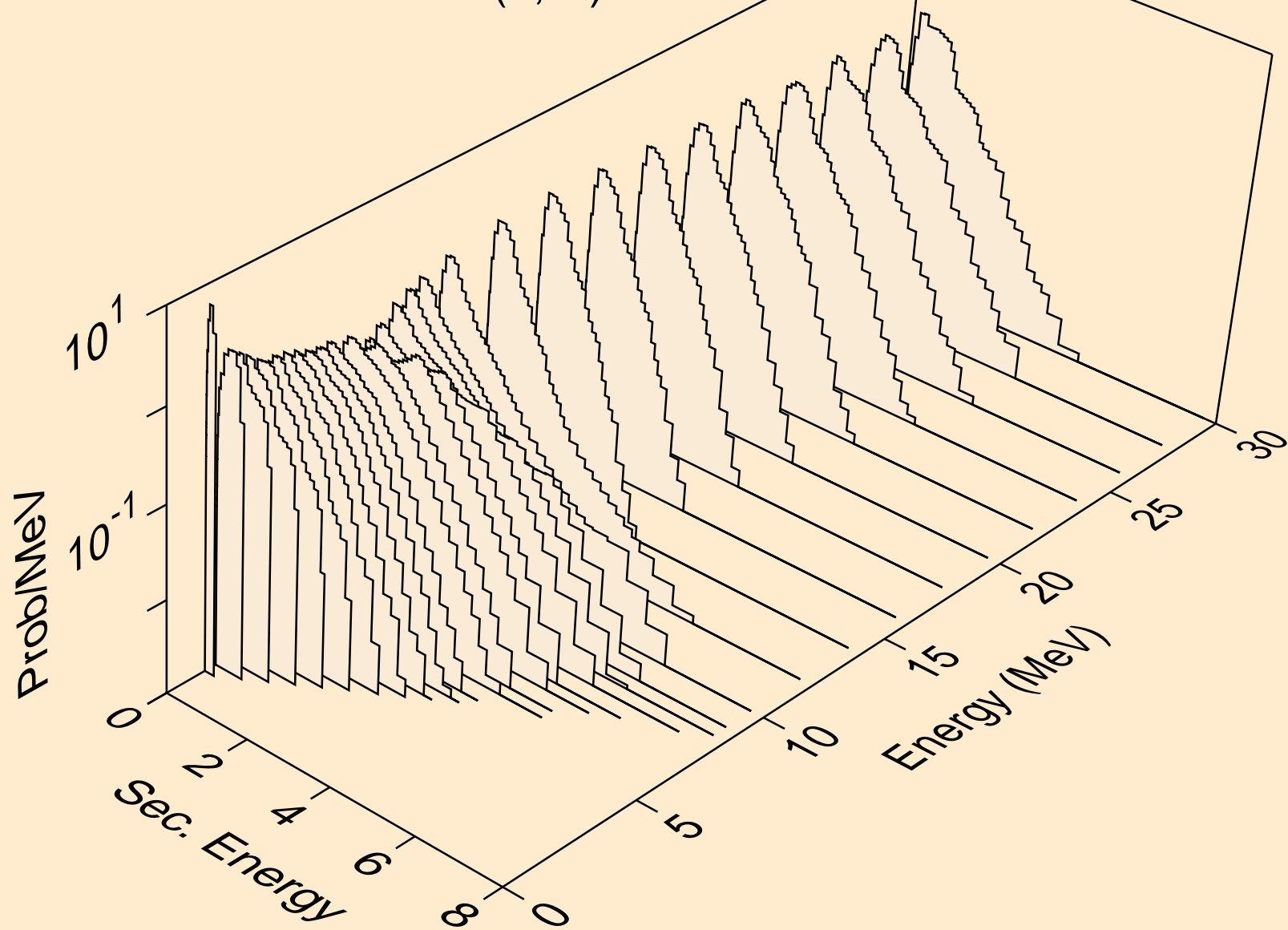

RF265 NEUTRON ACER TENDL-2021 LIBRARY; T=293.6K
Neutron emission for (n,2n)_a

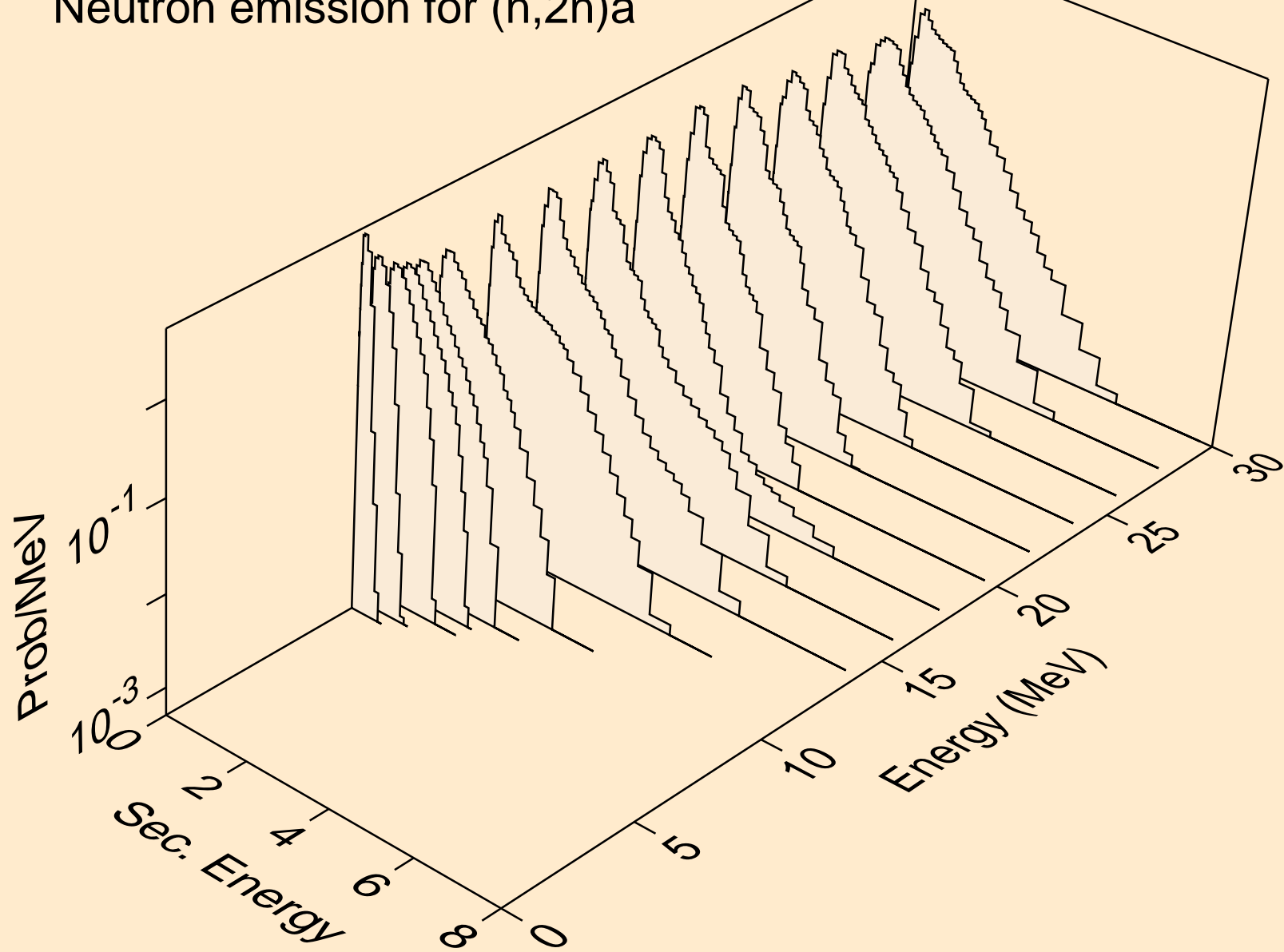

RF265 NEUTRON ACER TENDL-2021 LIBRARY; T=293.6K
Neutron emission for (n,3n)a

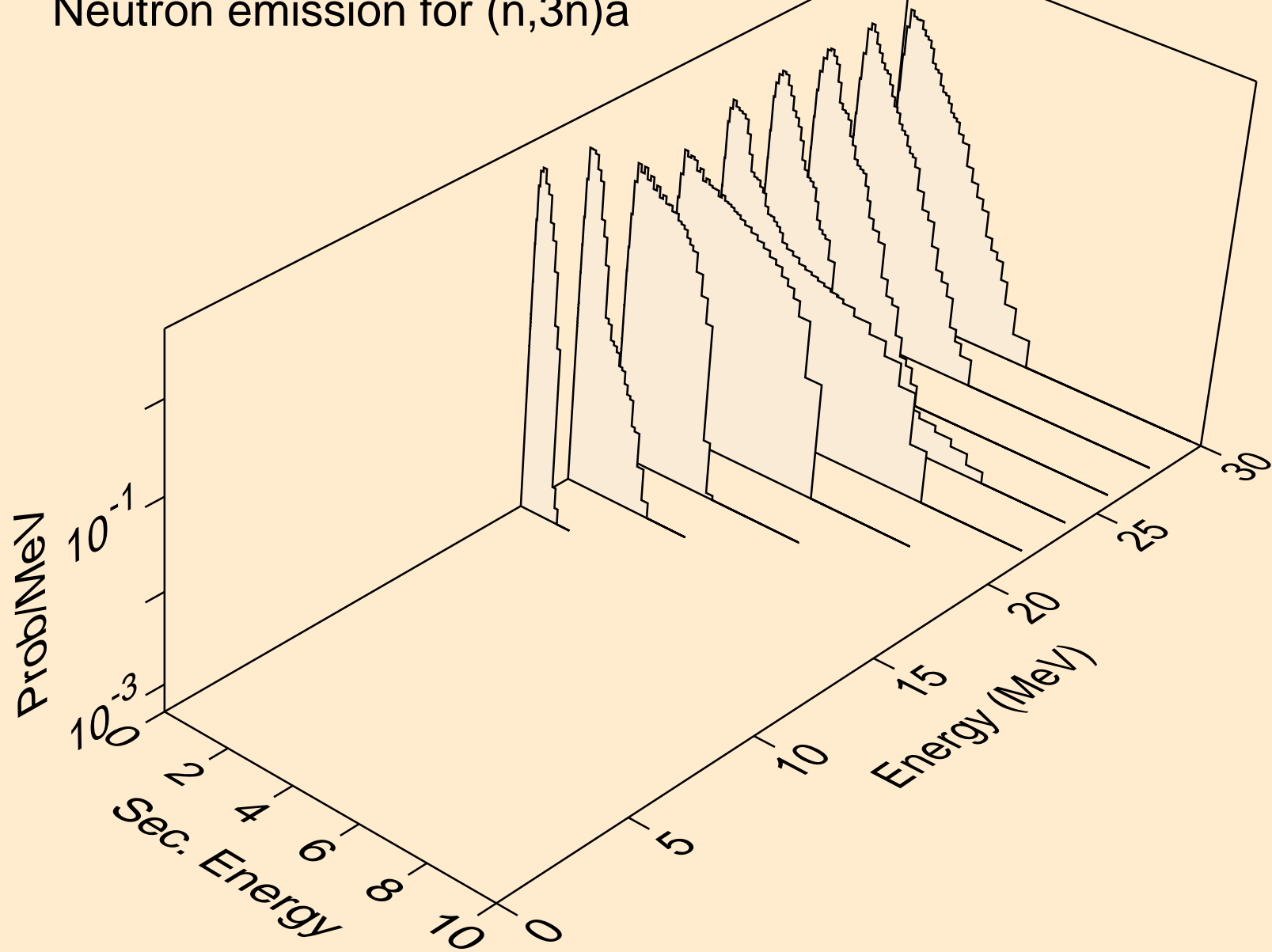

RF265 NEUTRON ACER TENDL-2021 LIBRARY; T=293.6K
Neutron emission for (n,n*)p

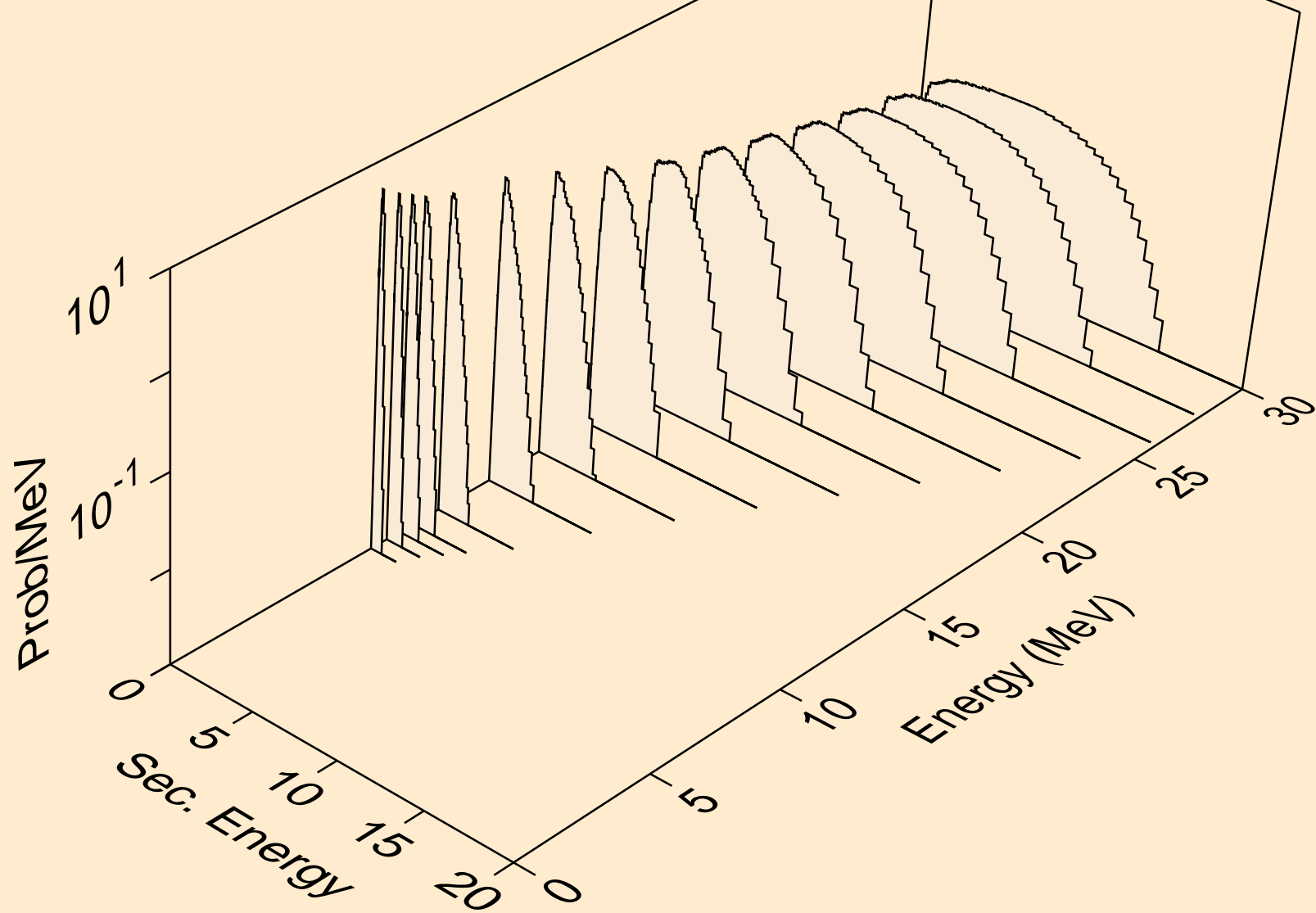

RF265 NEUTRON ACER TENDL-2021 LIBRARY; T=293.6K
Neutron emission for (n,n*)2a

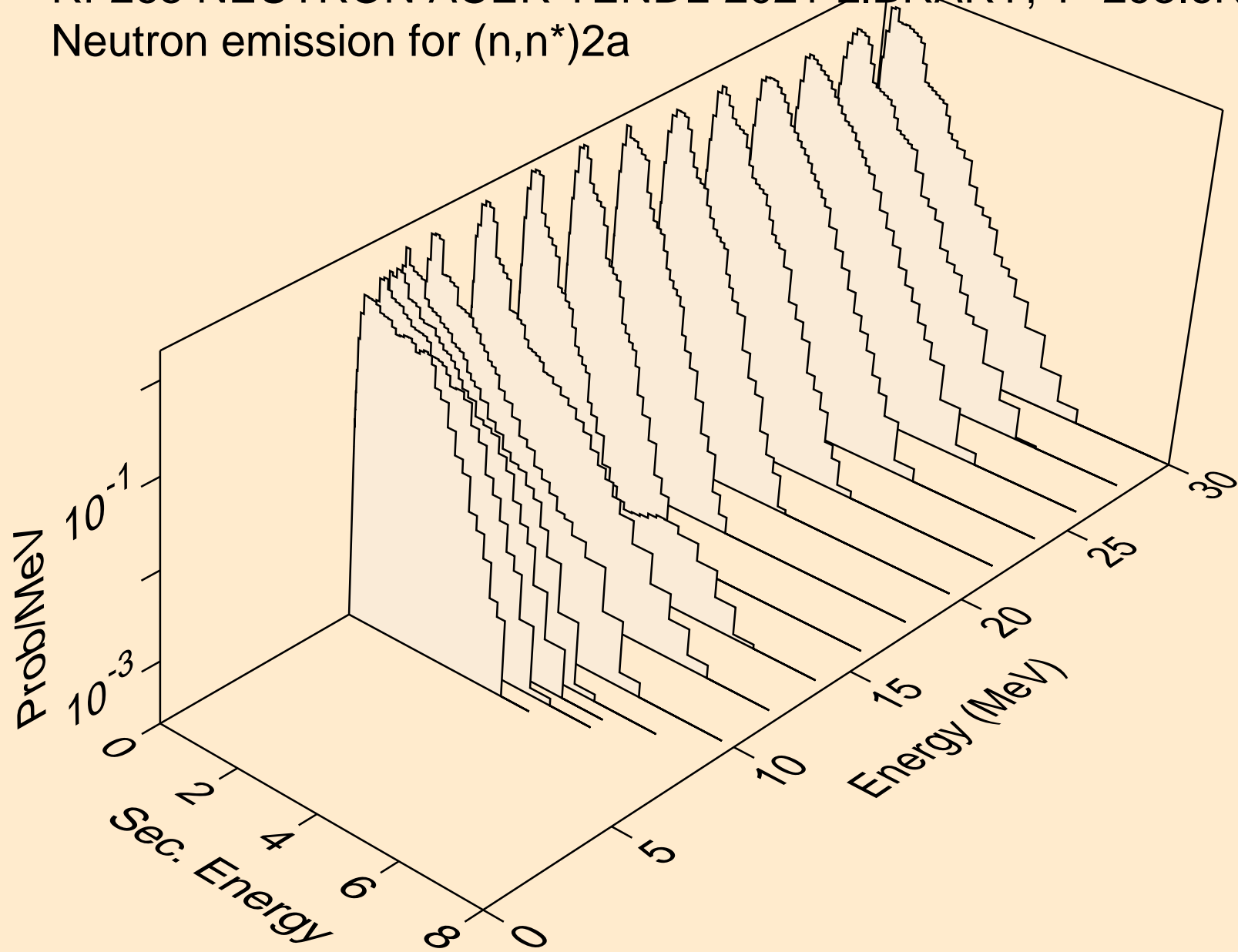

RF265 NEUTRON ACER TENDL-2021 LIBRARY; T=293.6K
Neutron emission for (n,n*)d

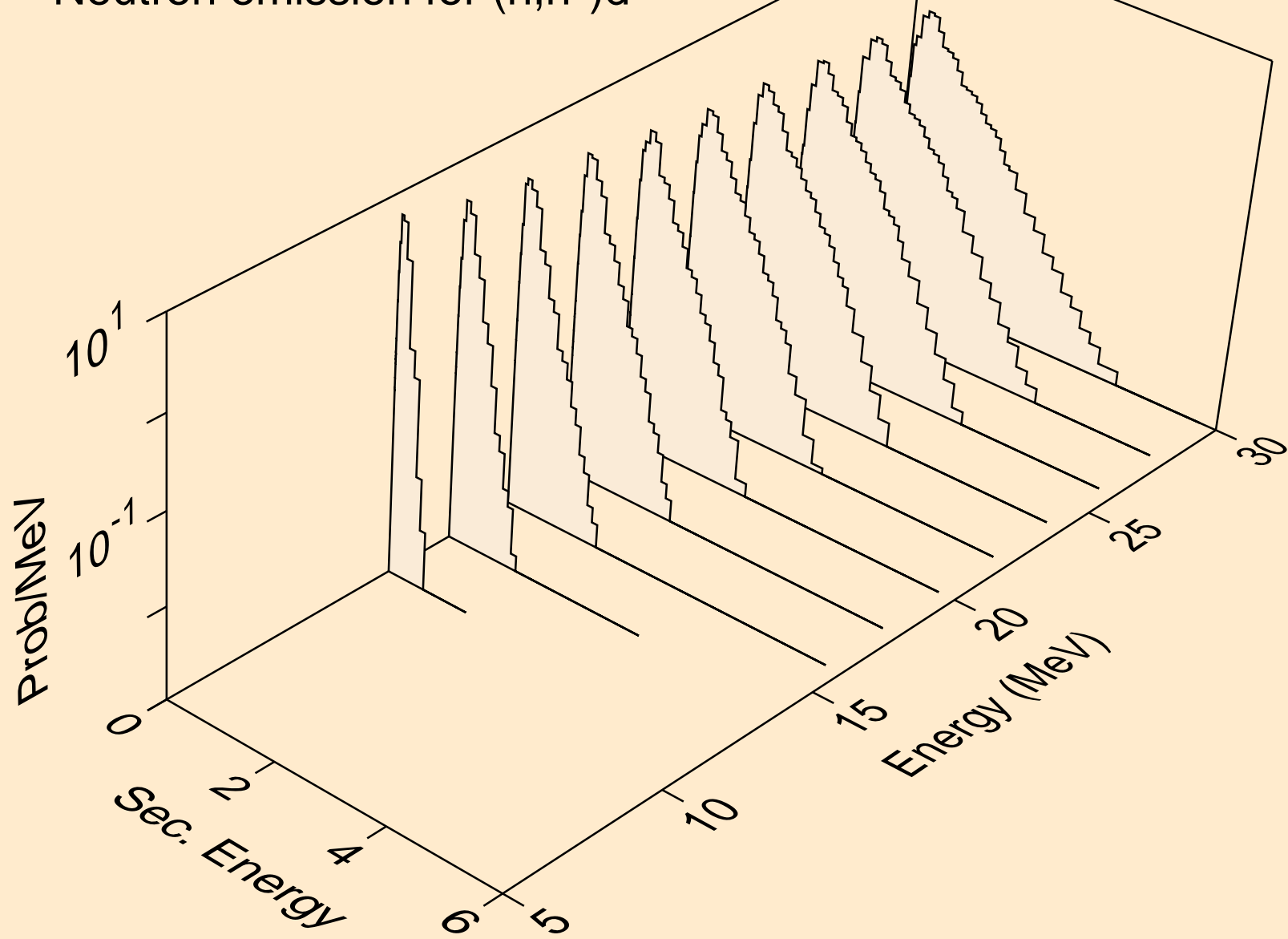

RF265 NEUTRON ACER TENDL-2021 LIBRARY; T=293.6K
Neutron emission for (n,n*)t

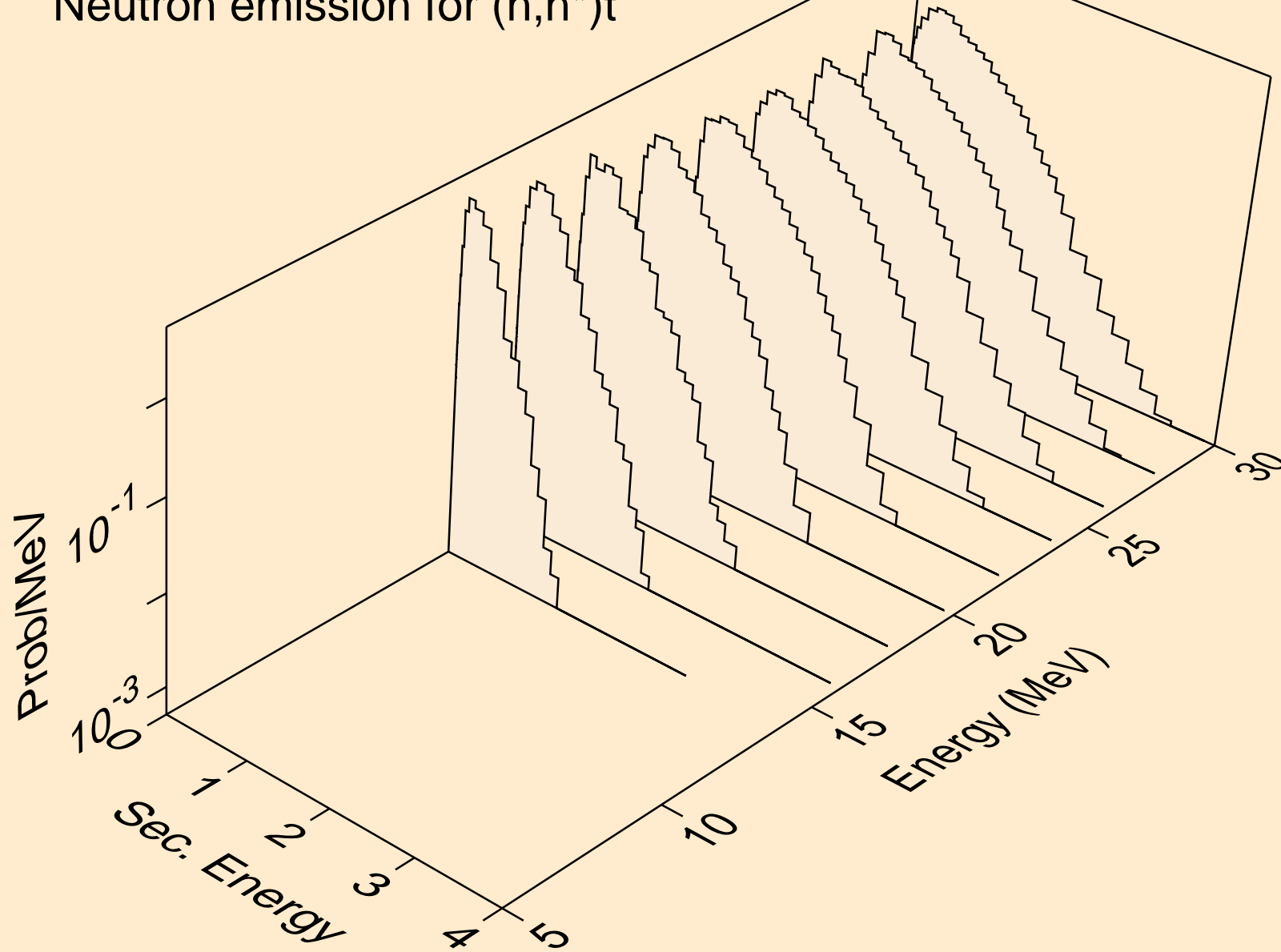

RF265 NEUTRON ACER TENDL-2021 LIBRARY; T=293.6K
Neutron emission for (n,n*)he3

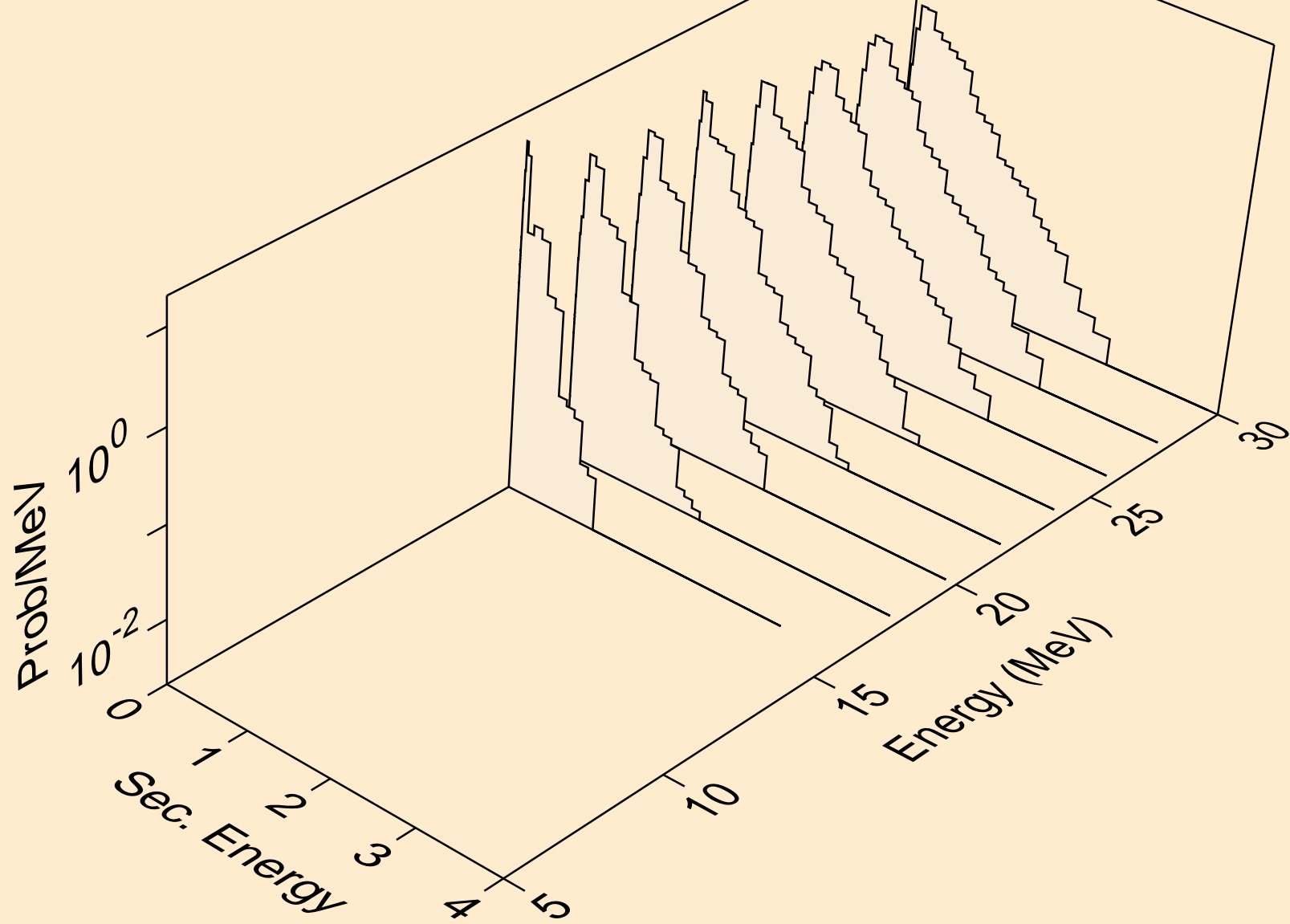

RF265 NEUTRON ACER TENDL-2021 LIBRARY; T=293.6K
Neutron emission for (n,4n)

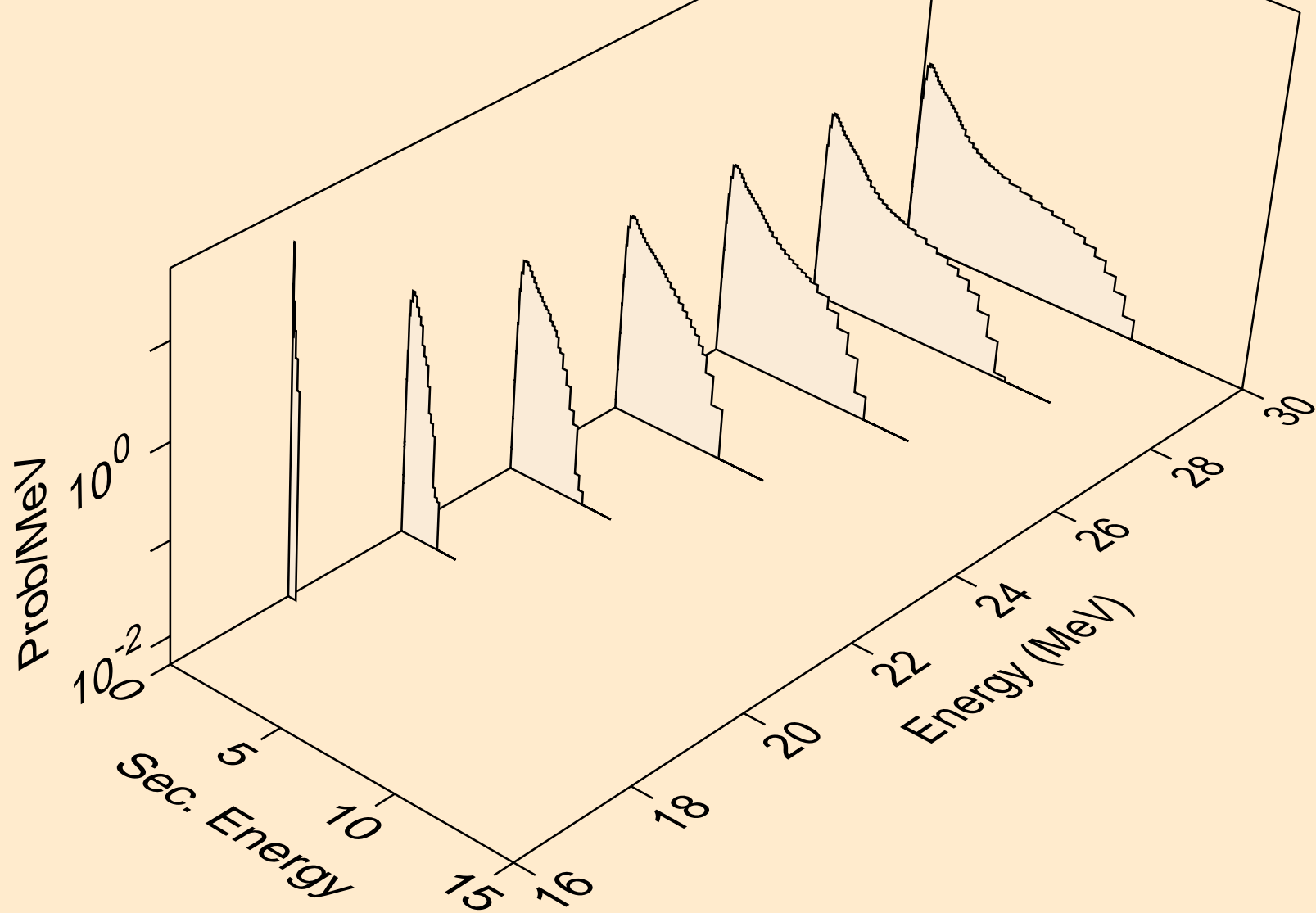

RF265 NEUTRON ACER TENDL-2021 LIBRARY; T=293.6K
Neutron emission for (n,2np)

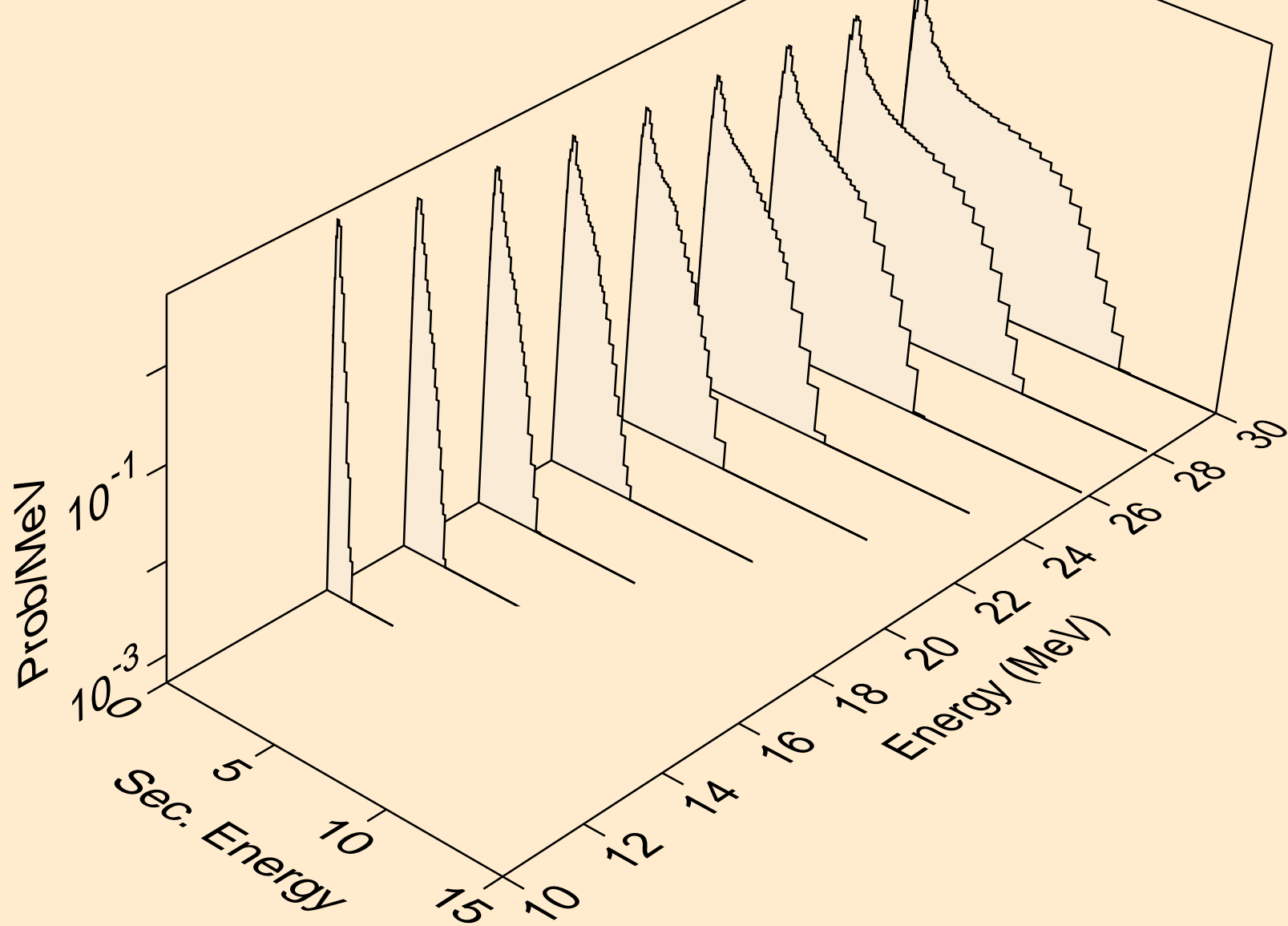

RF265 NEUTRON ACER TENDL-2021 LIBRARY; T=293.6K
Neutron emission for (n,3np)

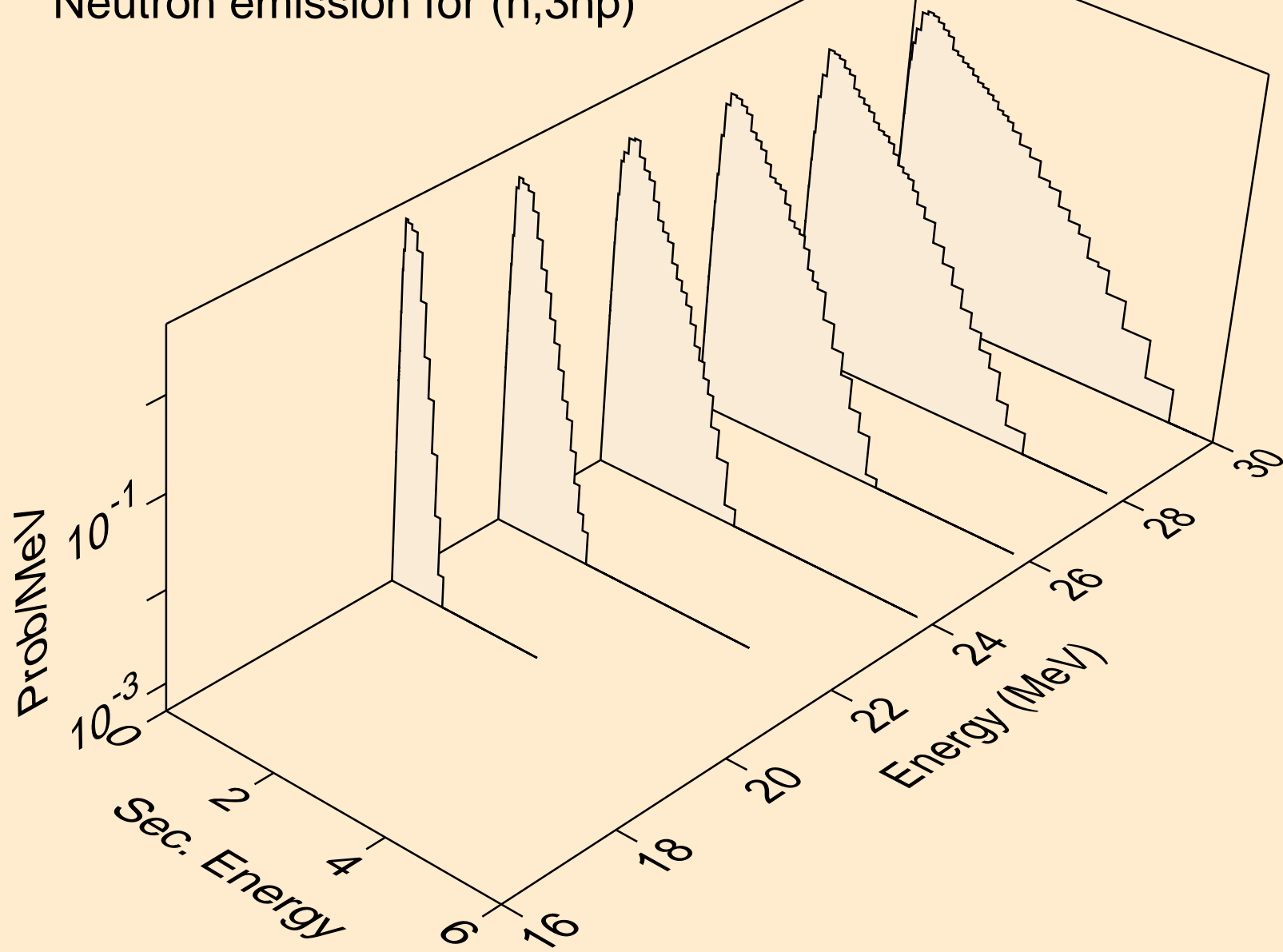

RF265 NEUTRON ACER TENDL-2021 LIBRARY; T=293.6K
Neutron emission for (n,2np)

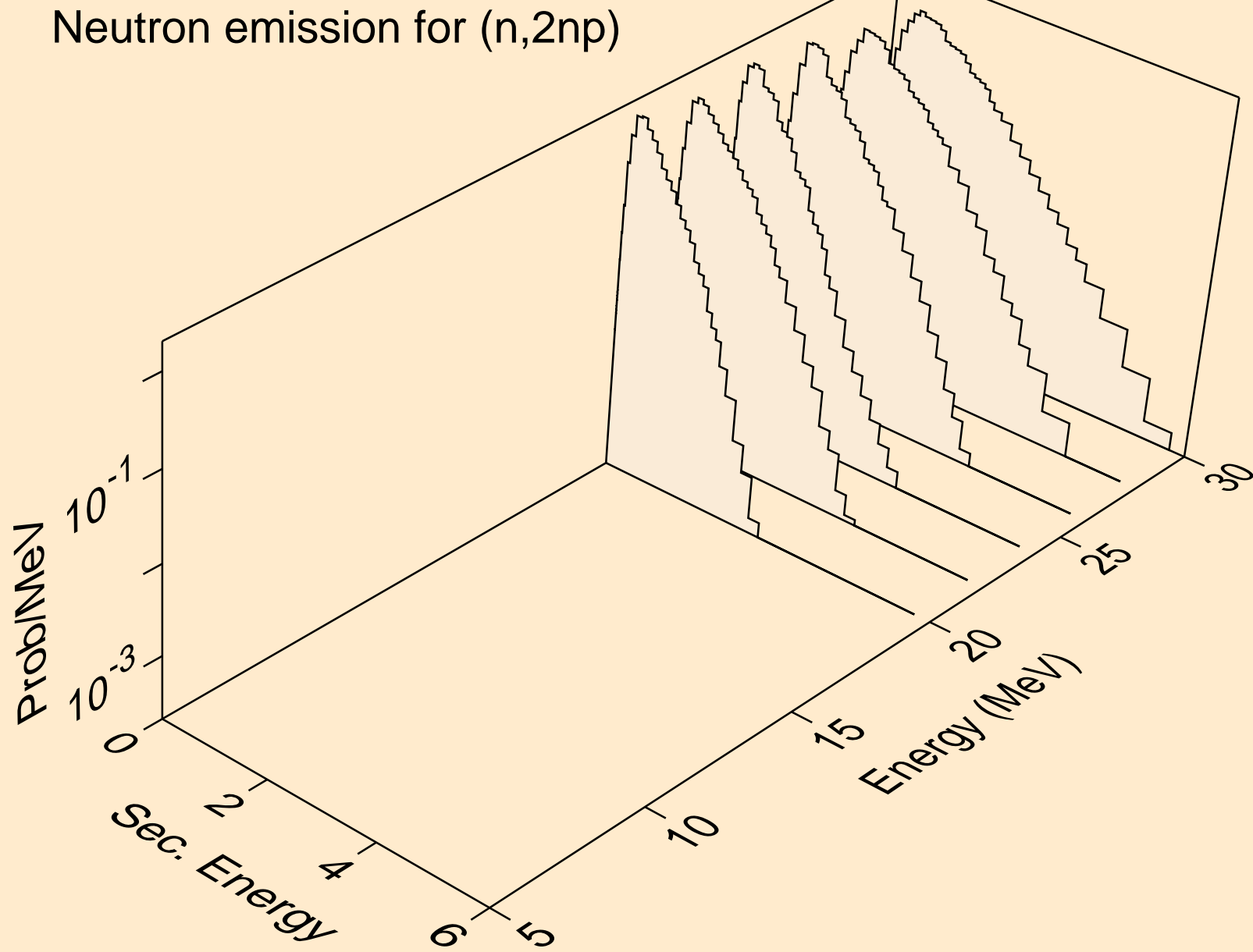

RF265 NEUTRON ACER TENDL-2021 LIBRARY; T=293.6K
Neutron emission for (n,n*c)

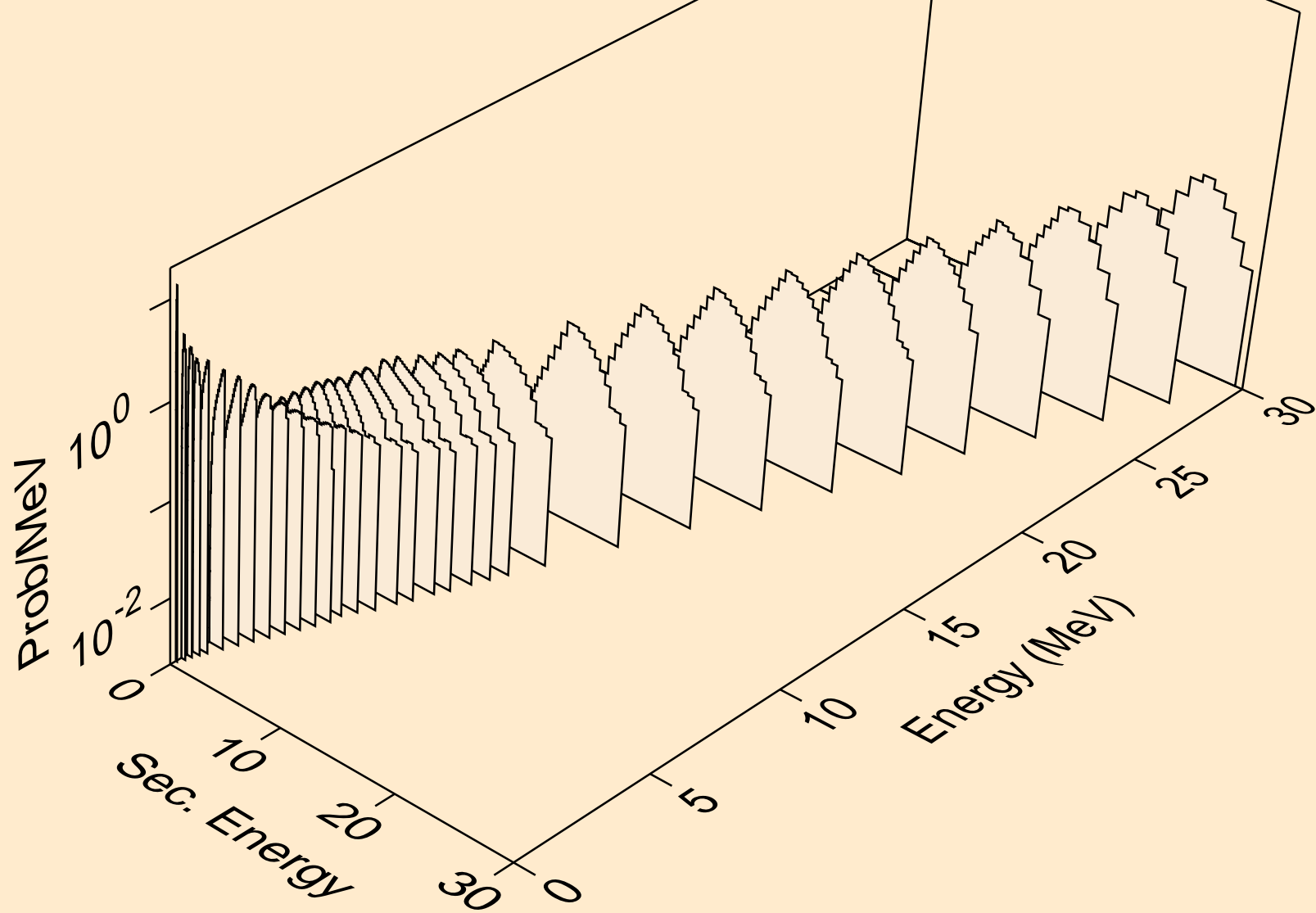

RF265 NEUTRON ACER TENDL-2021 LIBRARY; T=293.6K

Delayed nubar

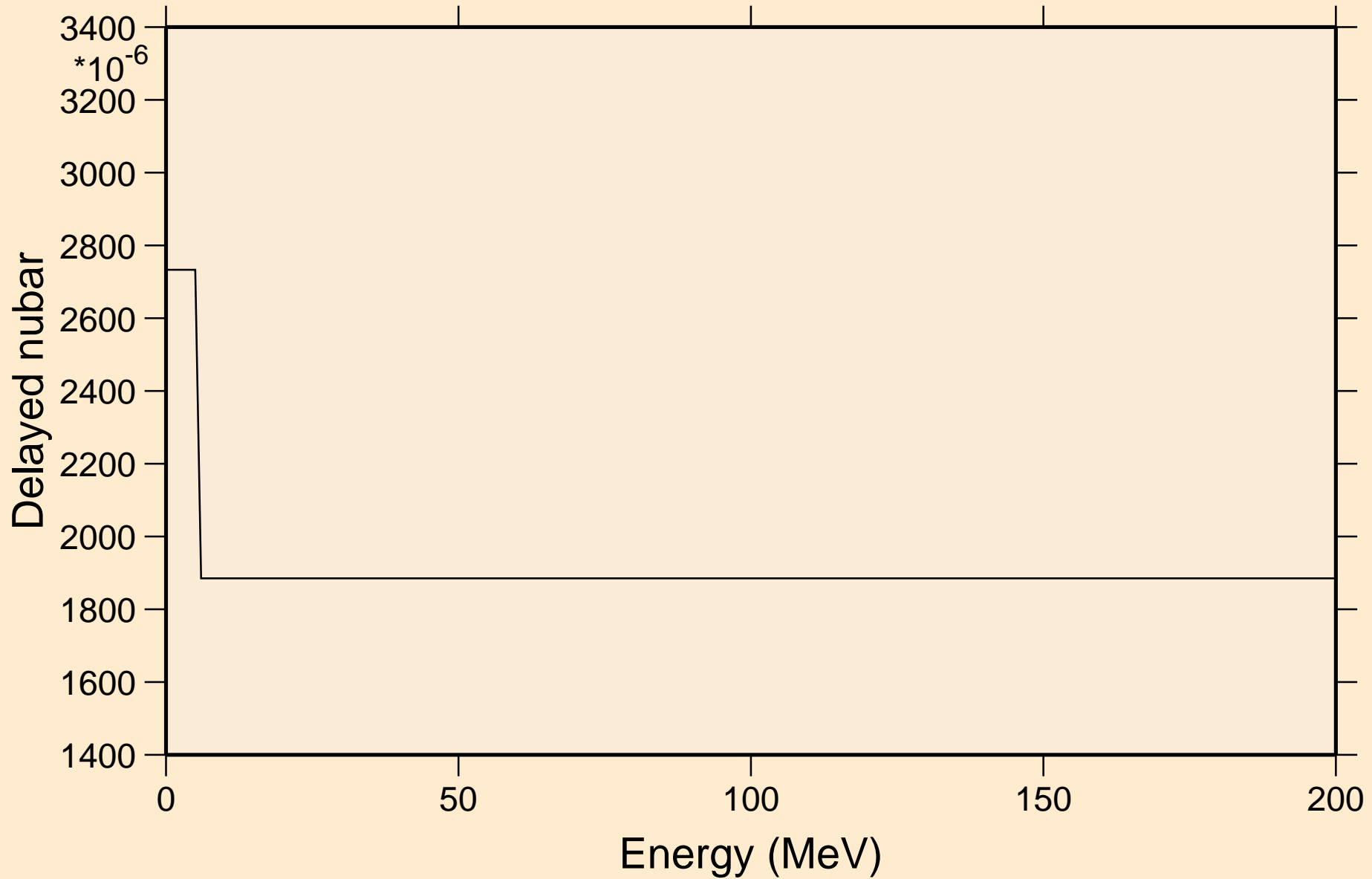

RF265 NEUTRON ACER TENDL-2021 LIBRARY; T=293.6K

Delayed neutron spectra

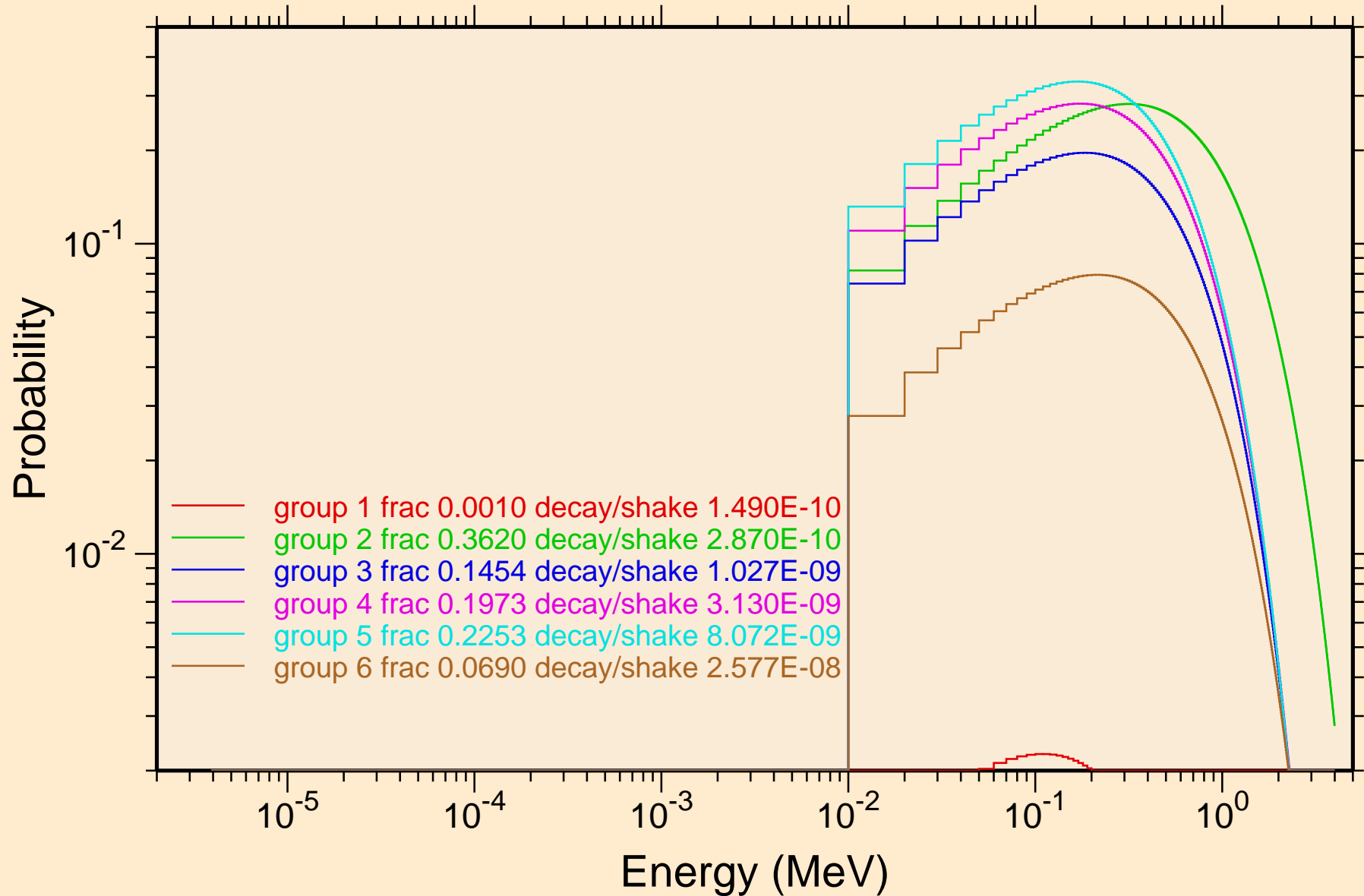

RF265 NEUTRON ACER TENDL-2021 LIBRARY; T=293.6K
Photon emission for (n,x)

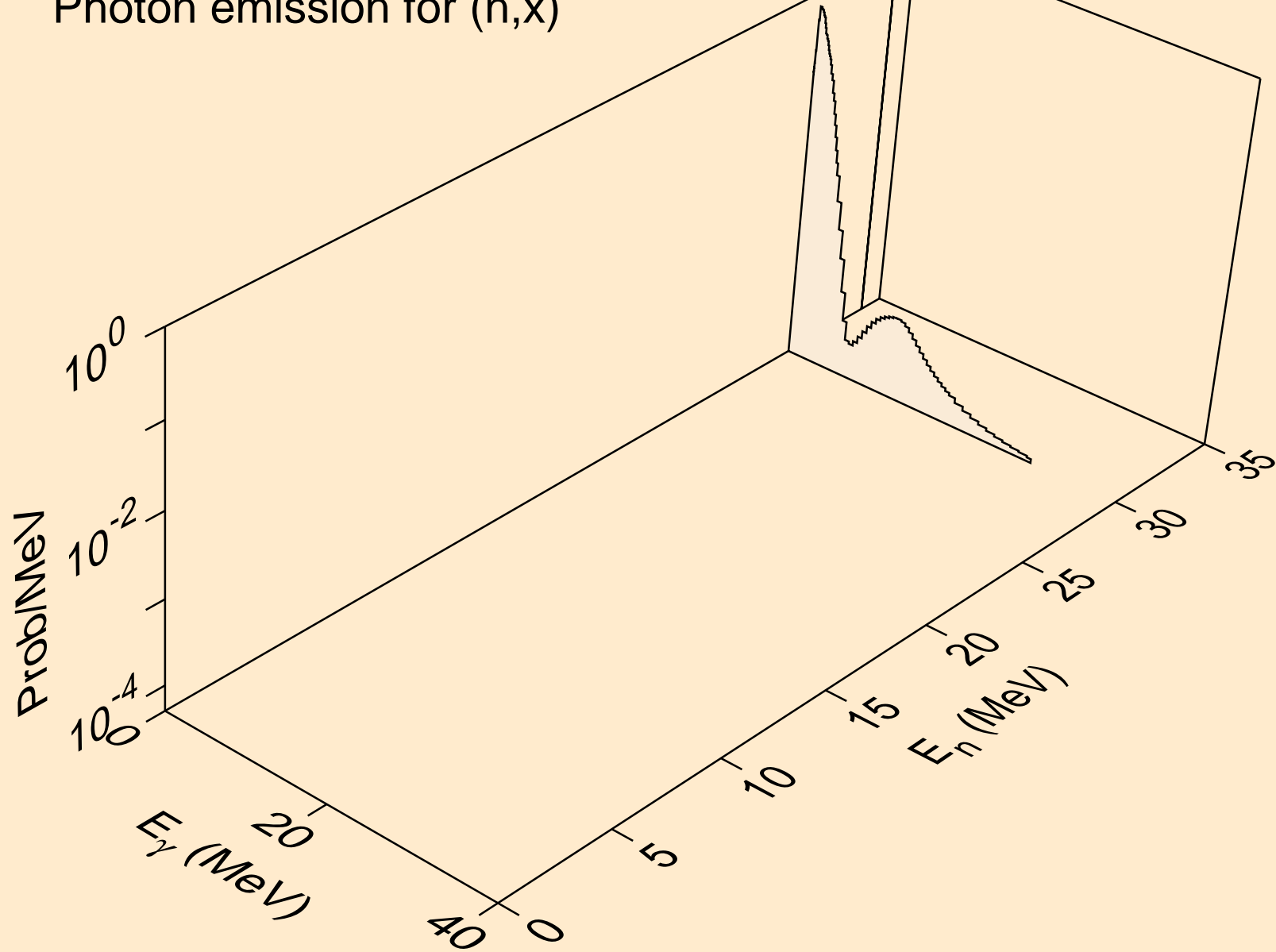

RF265 NEUTRON ACER TENDL-2021 LIBRARY; T=293.6K
Photon emission for (n,2nd)

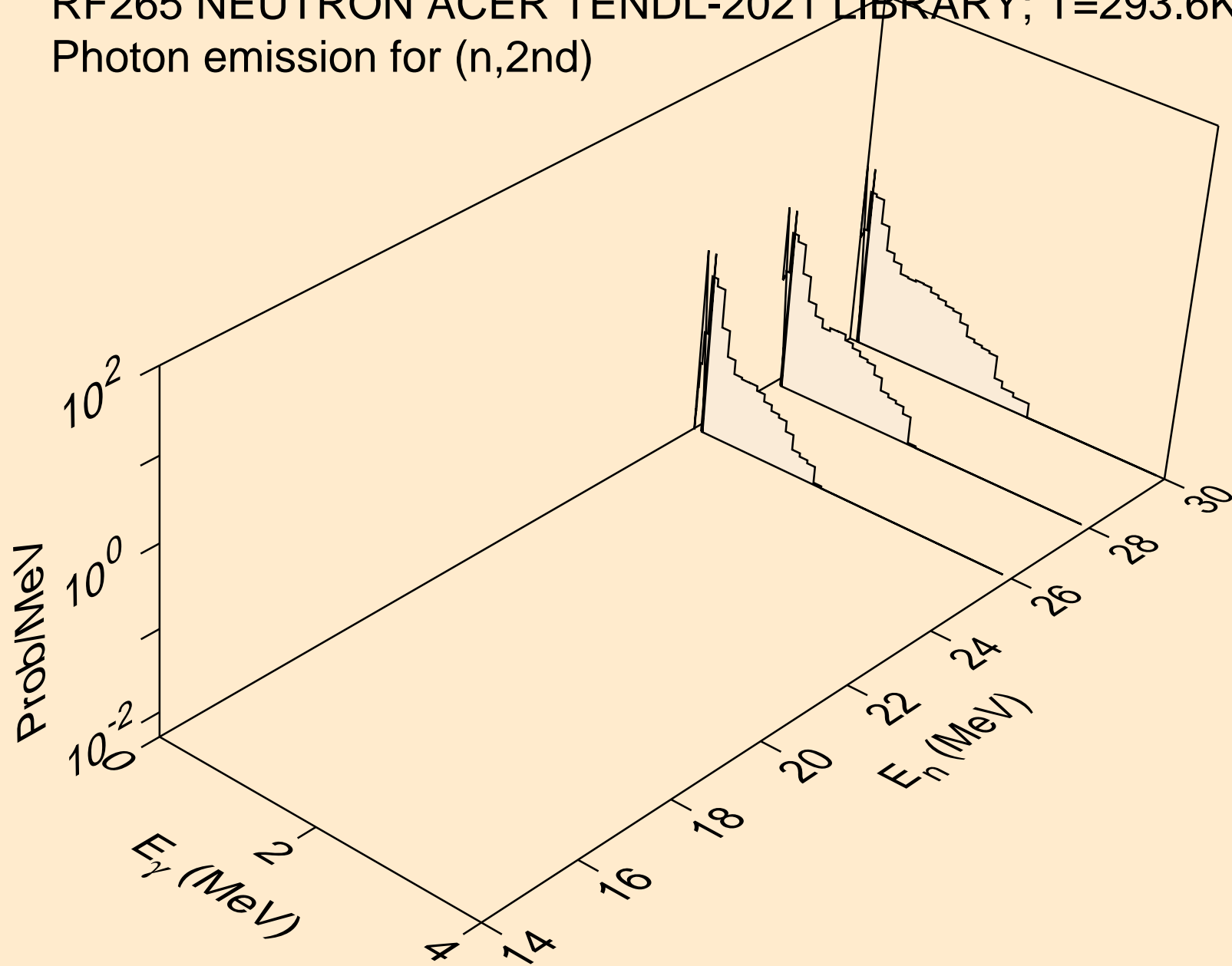

RF265 NEUTRON ACER TENDL-2021 LIBRARY; T=293.6K
Photon emission for (n,2n)

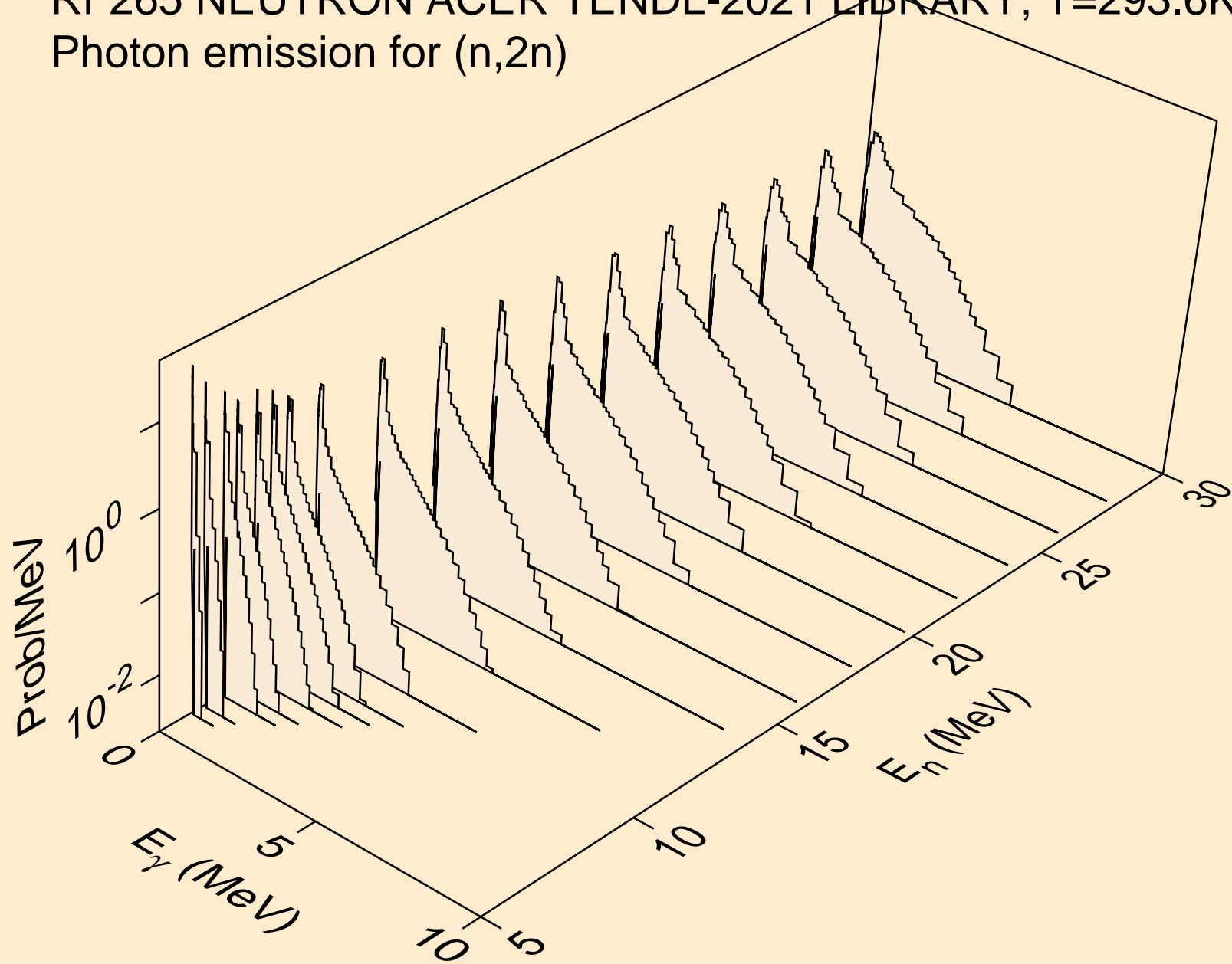

RF265 NEUTRON ACER TENDL-2021 LIBRARY; T=293.6K
Photon emission for (n,3n)

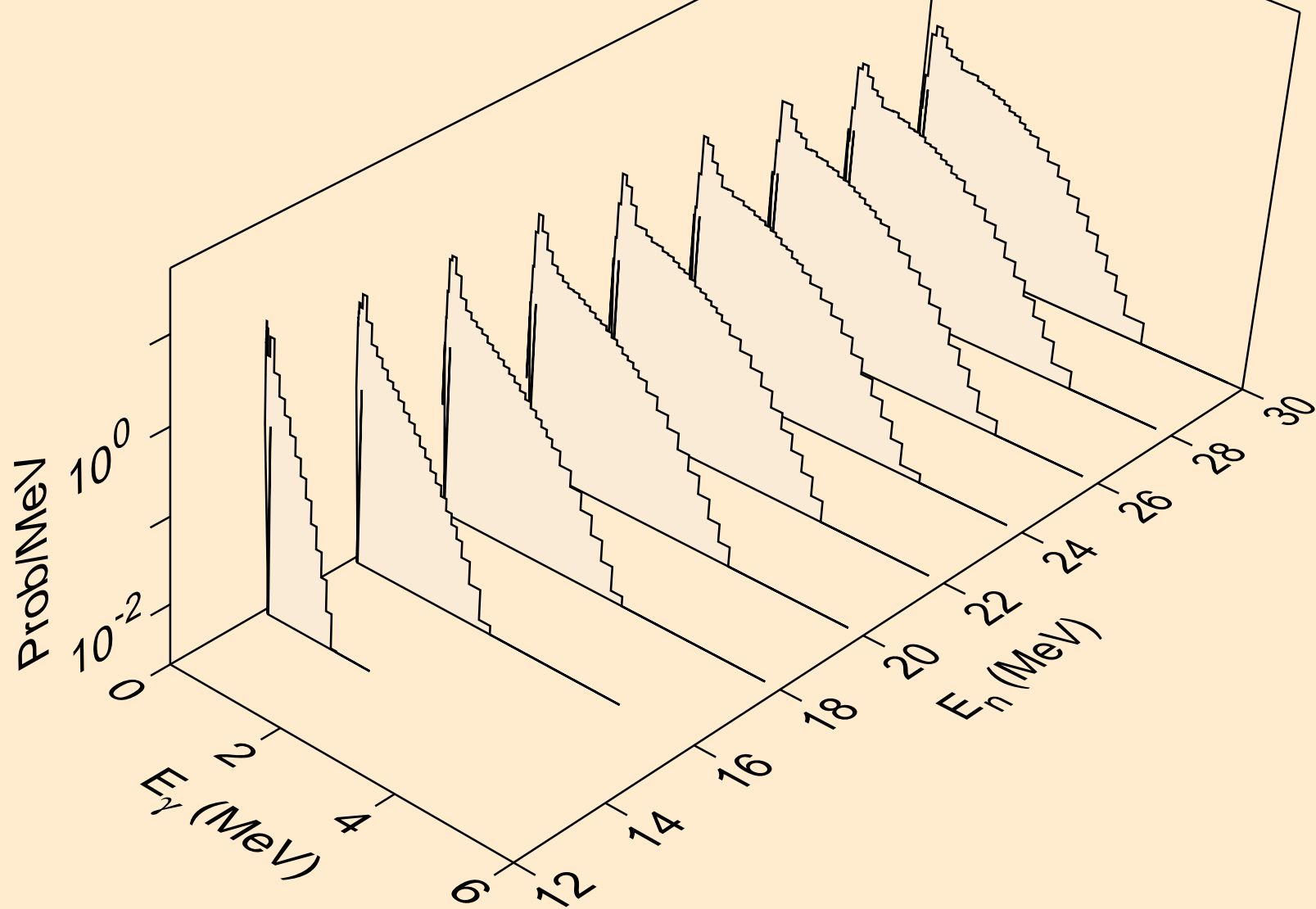

RF265 NEUTRON ACER TENDL-2021 LIBRARY; T=293.6K
Photon emission for (n,n*)a

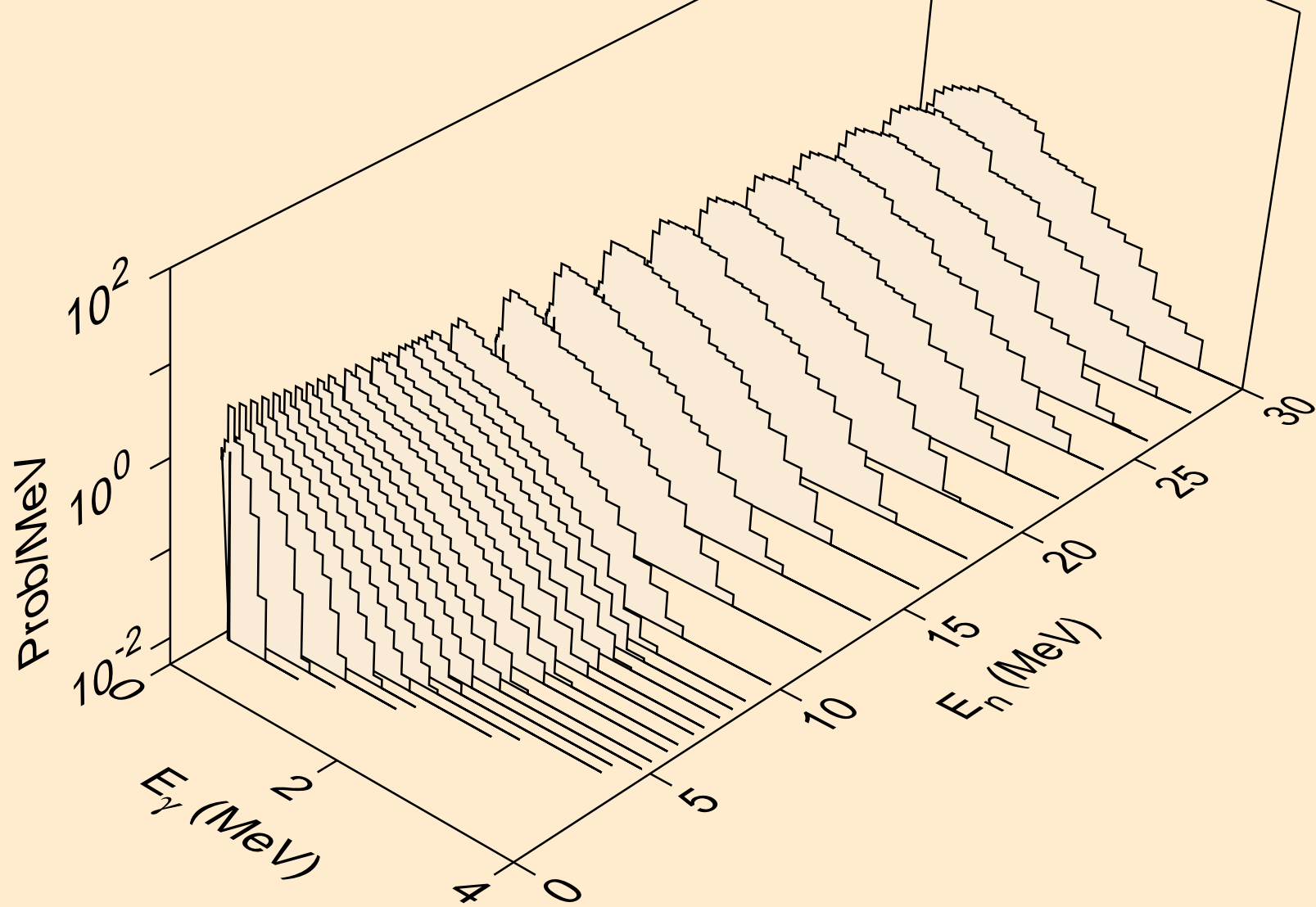

RF265 NEUTRON ACER TENDL-2021 LIBRARY; T=293.6K
Photon emission for (n,2n)a

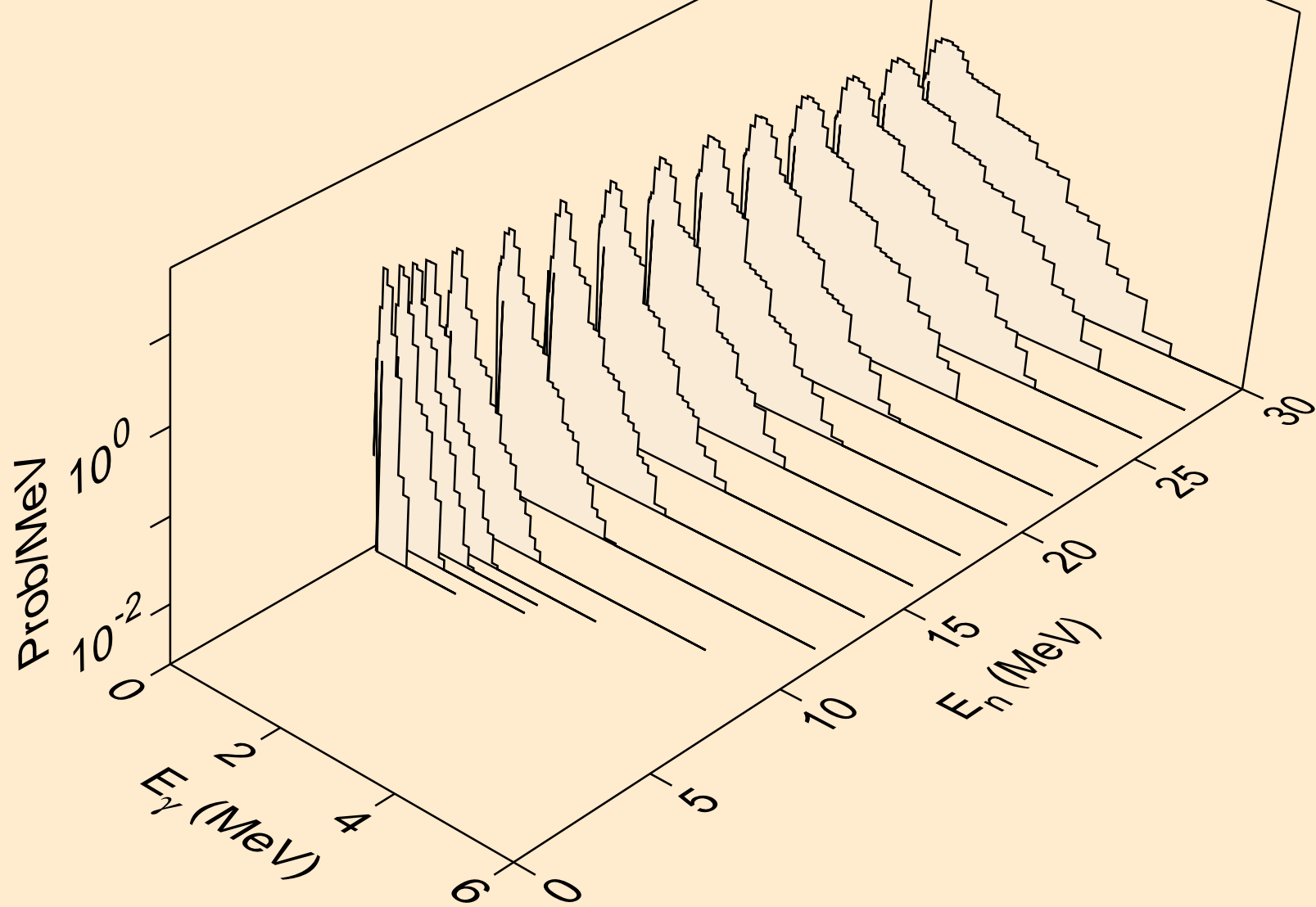

RF265 NEUTRON ACER TENDL-2021 LIBRARY; T=293.6K
Photon emission for (n,3n)a

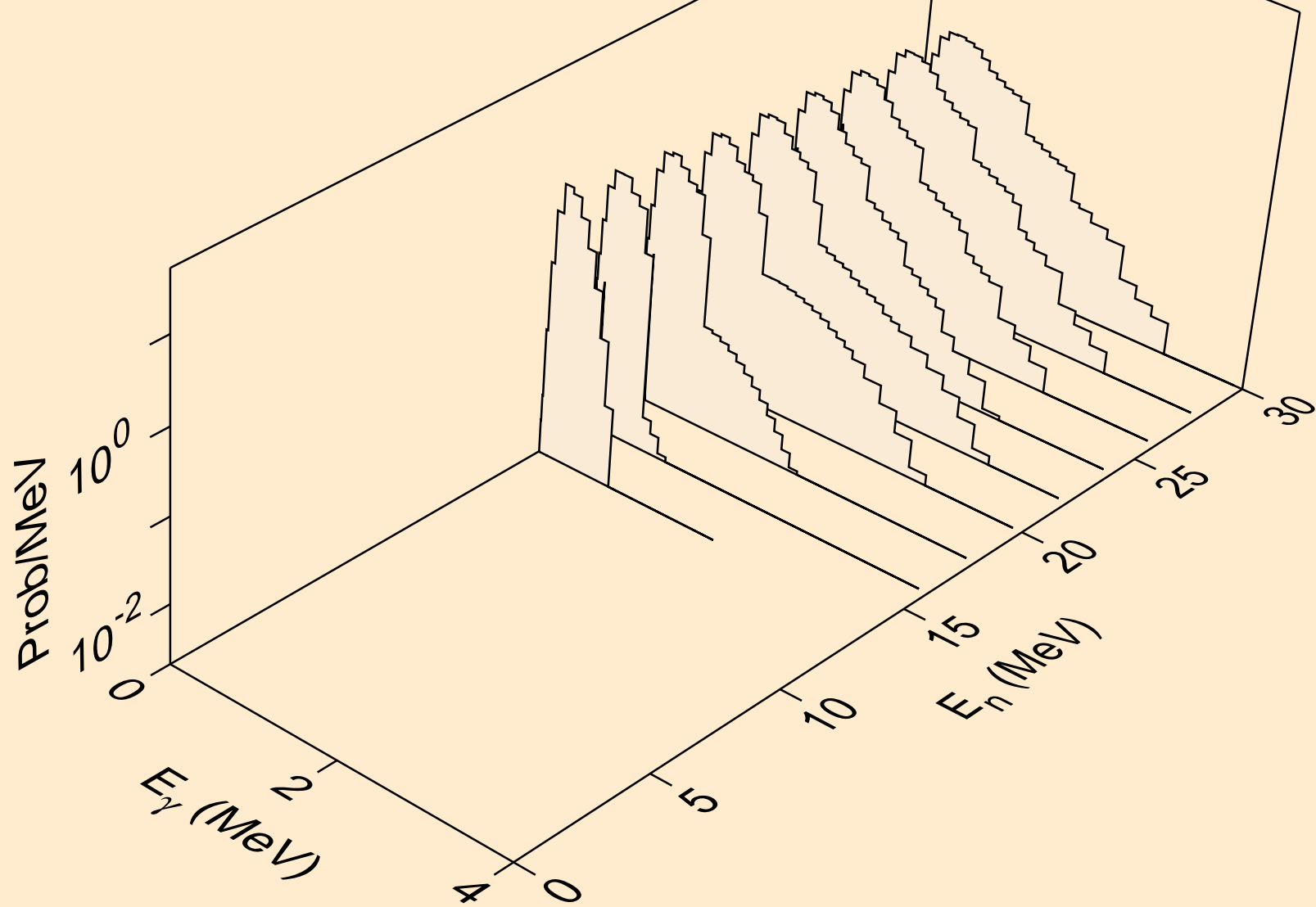

RF265 NEUTRON ACER TENDL-2021 LIBRARY; T=293.6K
Photon emission for (n,n*)p

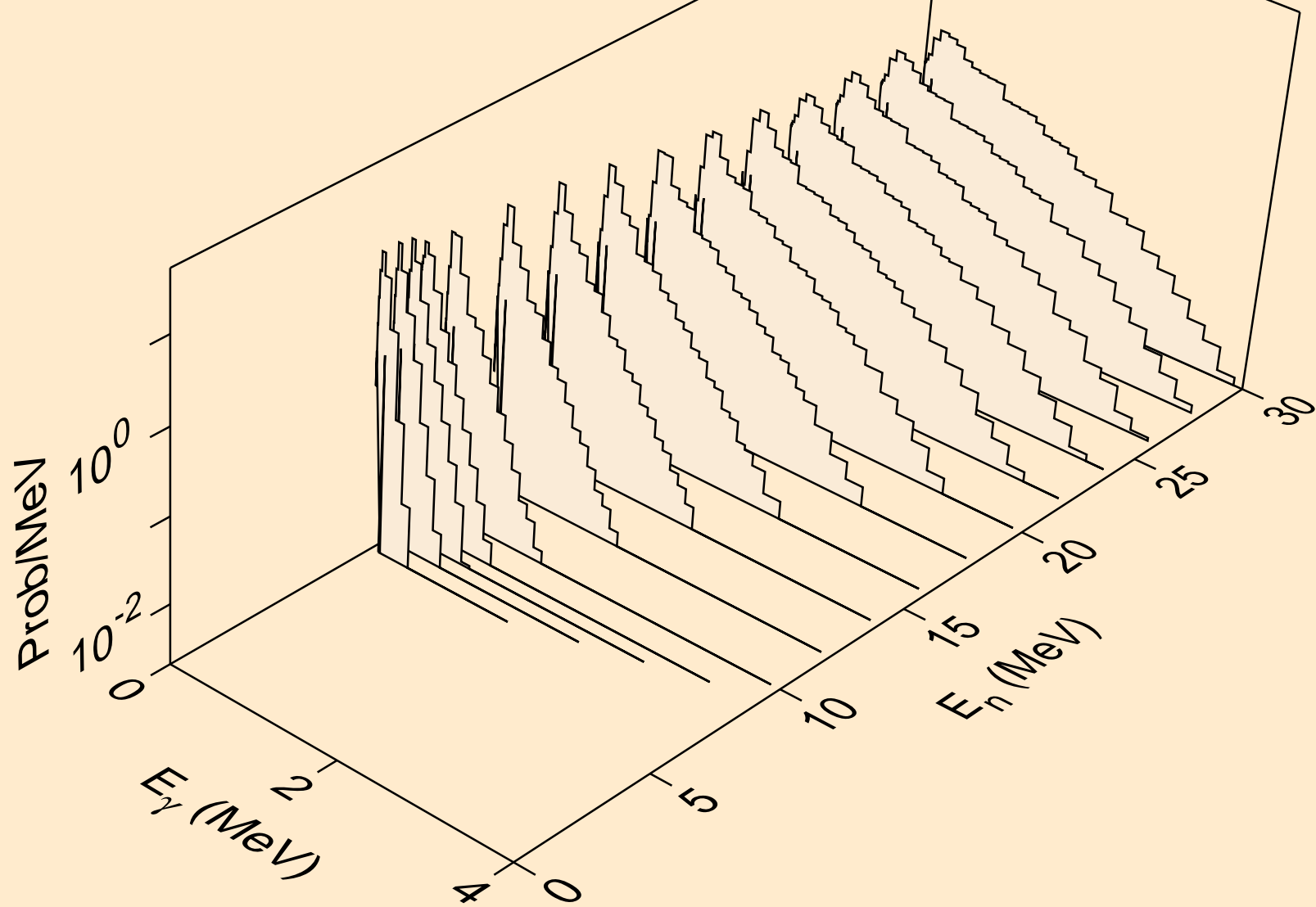

RF265 NEUTRON ACER TENDL-2021 LIBRARY; T=293.6K
Photon emission for (n,n*)2a

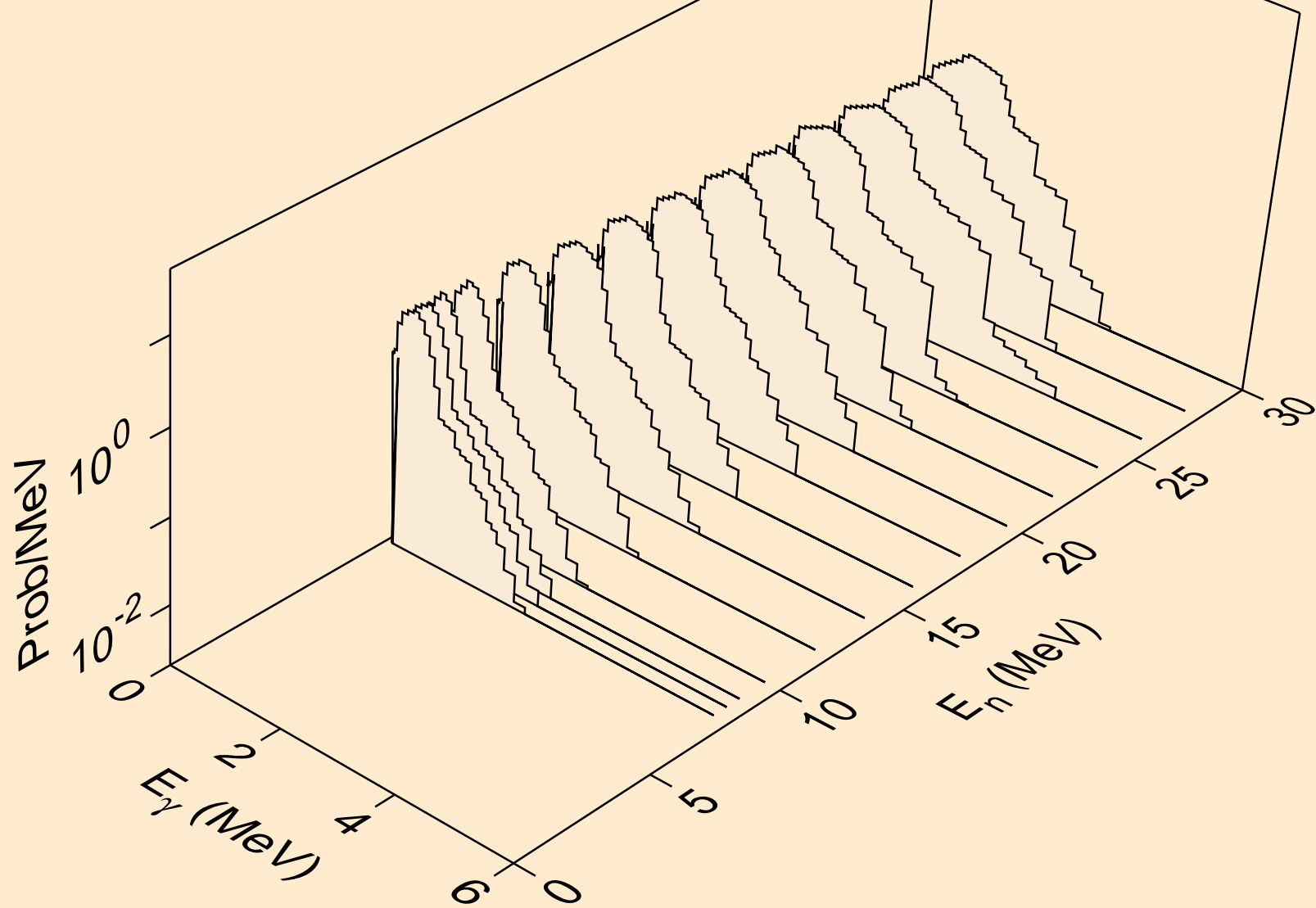

RF265 NEUTRON ACER TENDL-2021 LIBRARY; T=293.6K
Photon emission for (n,n*)d

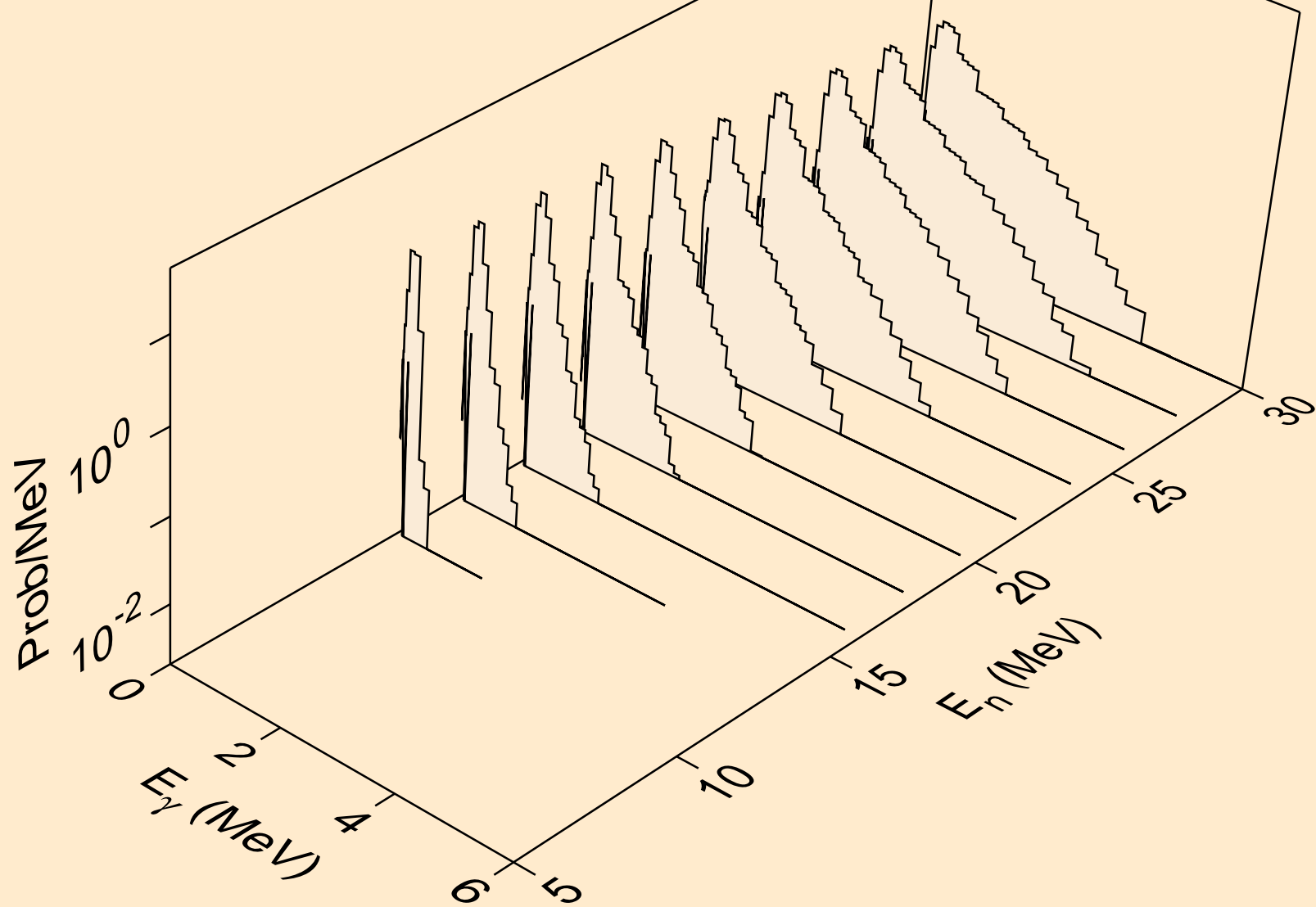

RF265 NEUTRON ACER TENDL-2021 LIBRARY; T=293.6K
Photon emission for (n,n*)t

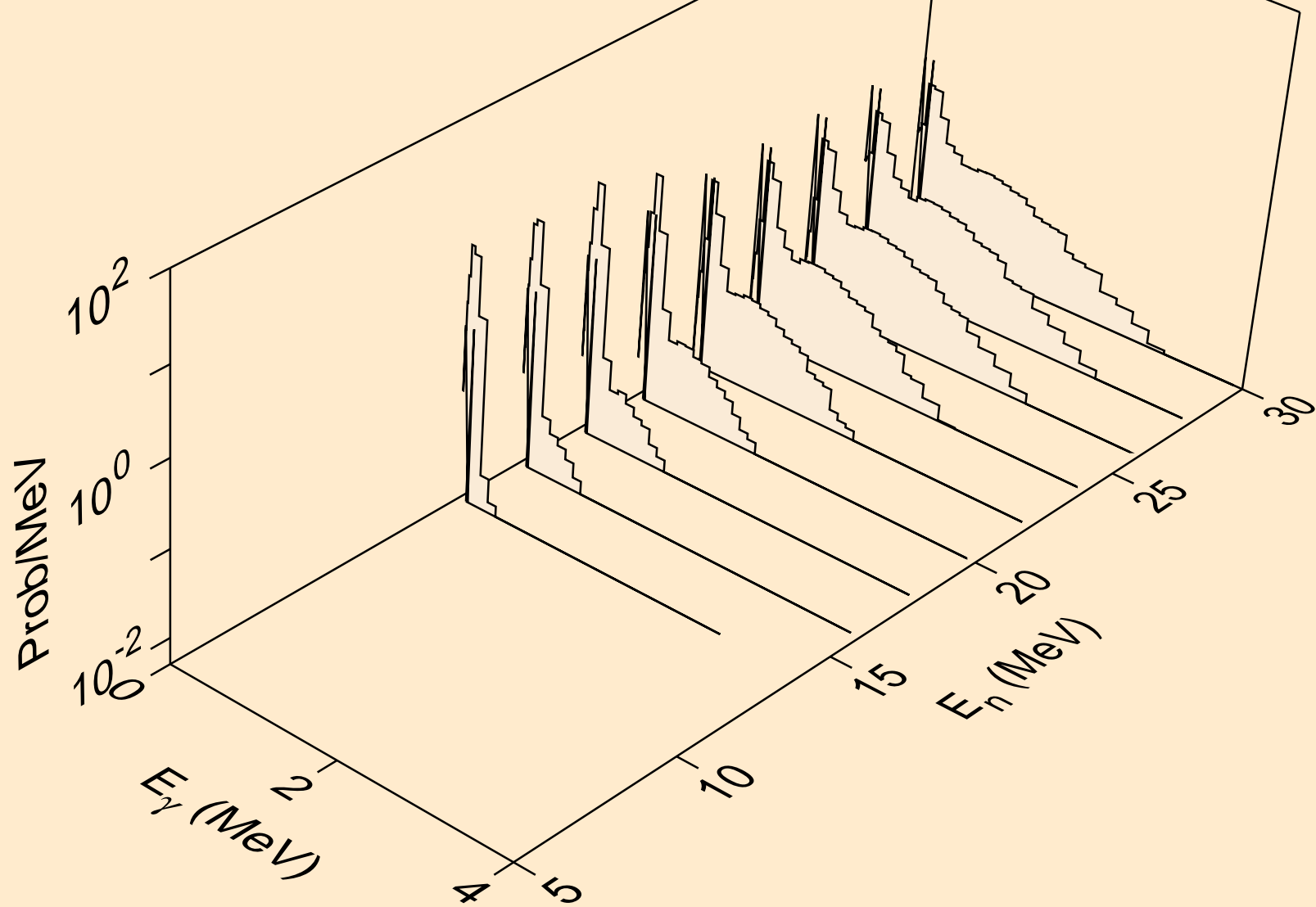

RF265 NEUTRON ACER TENDL-2021 LIBRARY; T=293.6K
Photon emission for (n,n*)he3

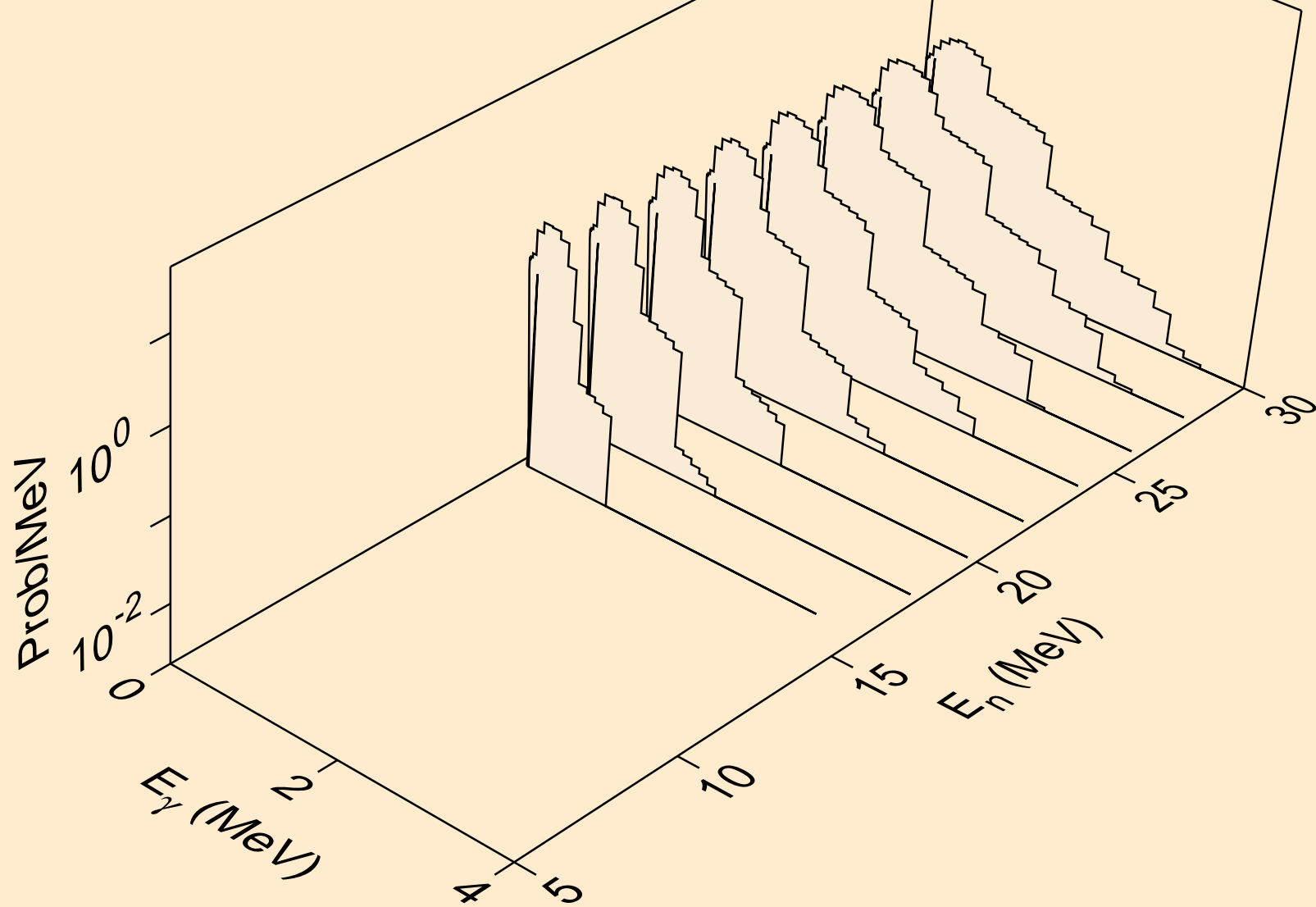

RF265 NEUTRON ACER TENDL-2021 LIBRARY; T=293.6K
Photon emission for (n,4n)

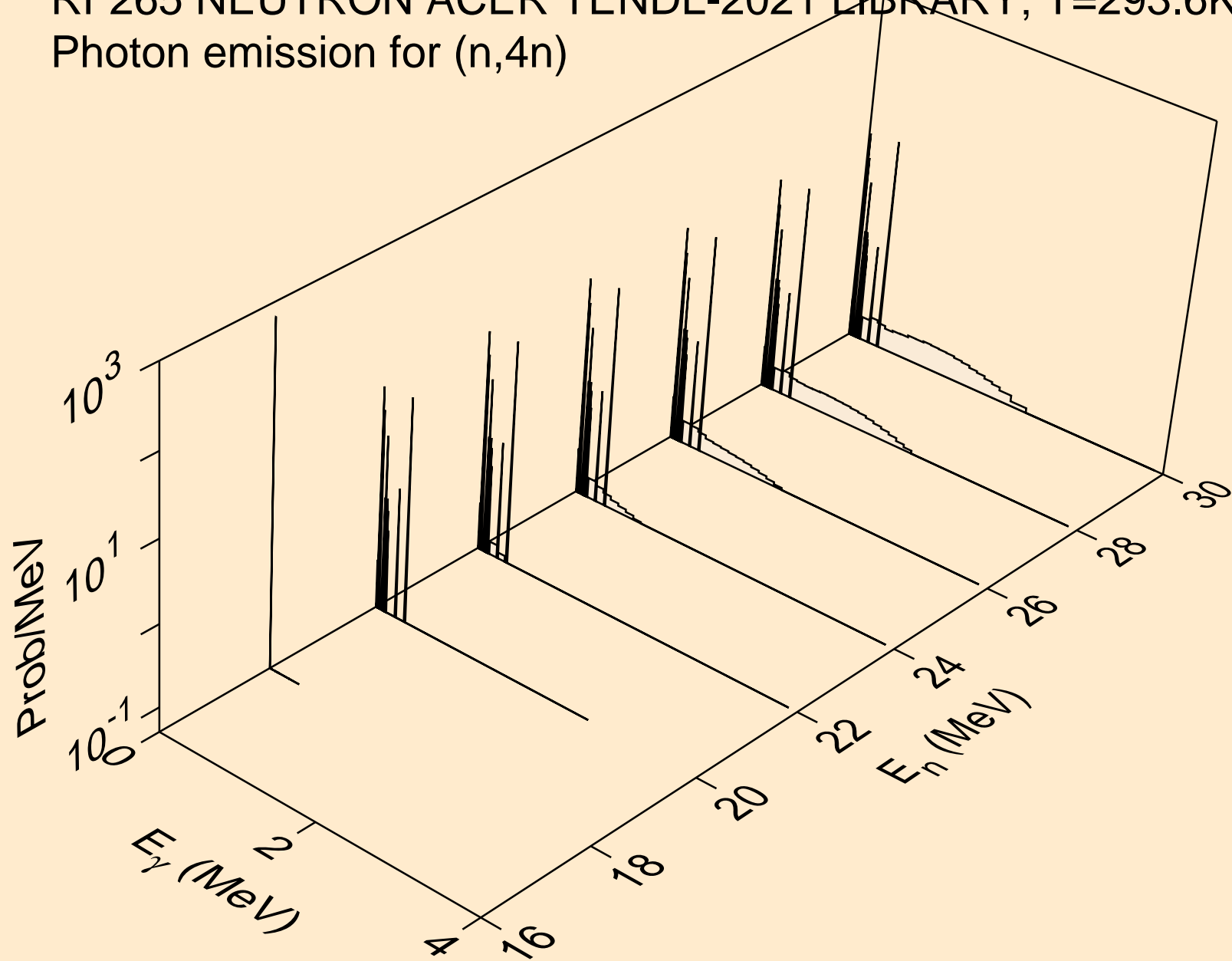

RF265 NEUTRON ACER TENDL-2021 LIBRARY; T=293.6K
Photon emission for (n,2np)

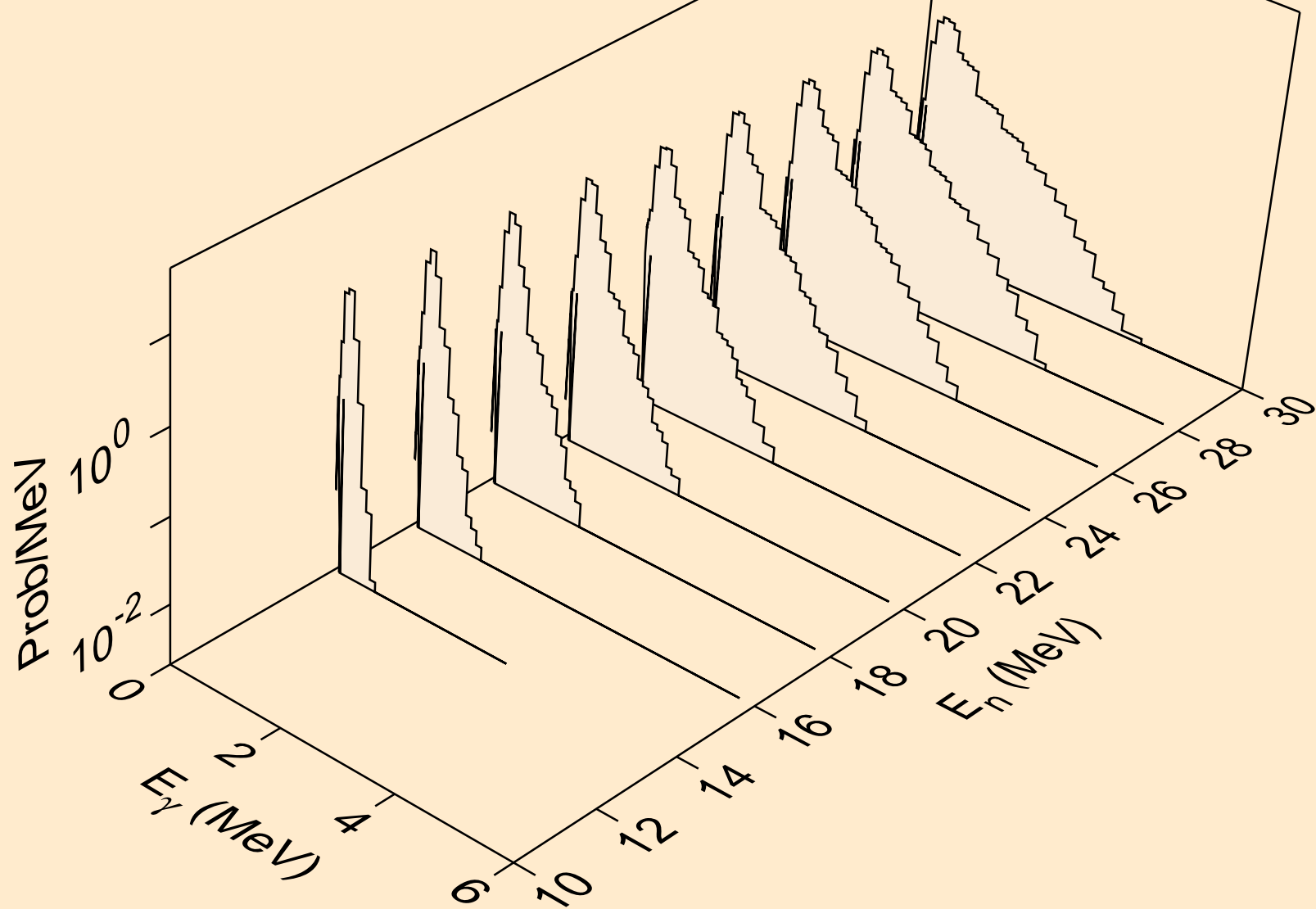

RF265 NEUTRON ACER TENDL-2021 LIBRARY; T=293.6K
Photon emission for (n,3np)

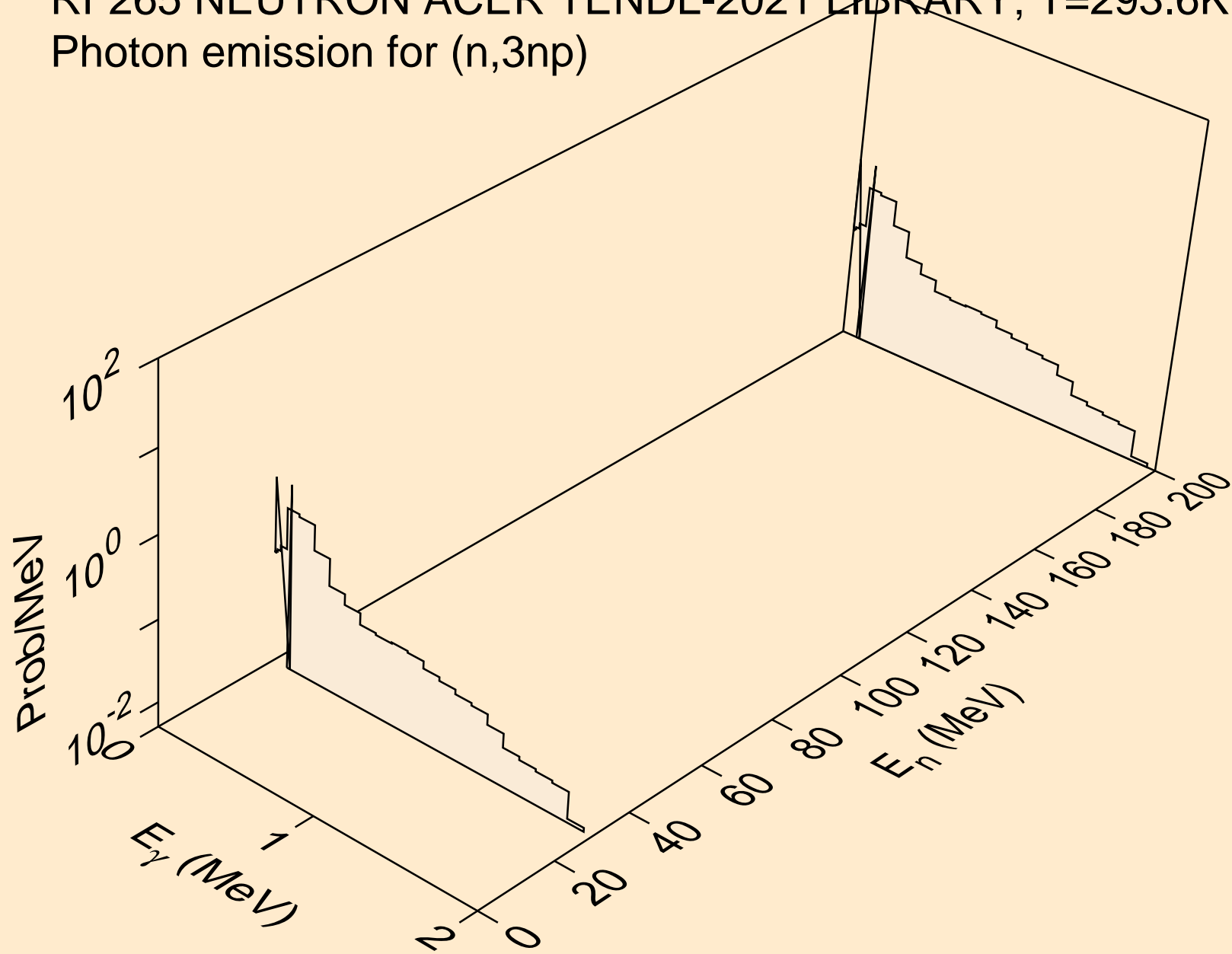

RF265 NEUTRON ACER TENDL-2021 LIBRARY; T=293.6K
Photon emission for (n,2np)

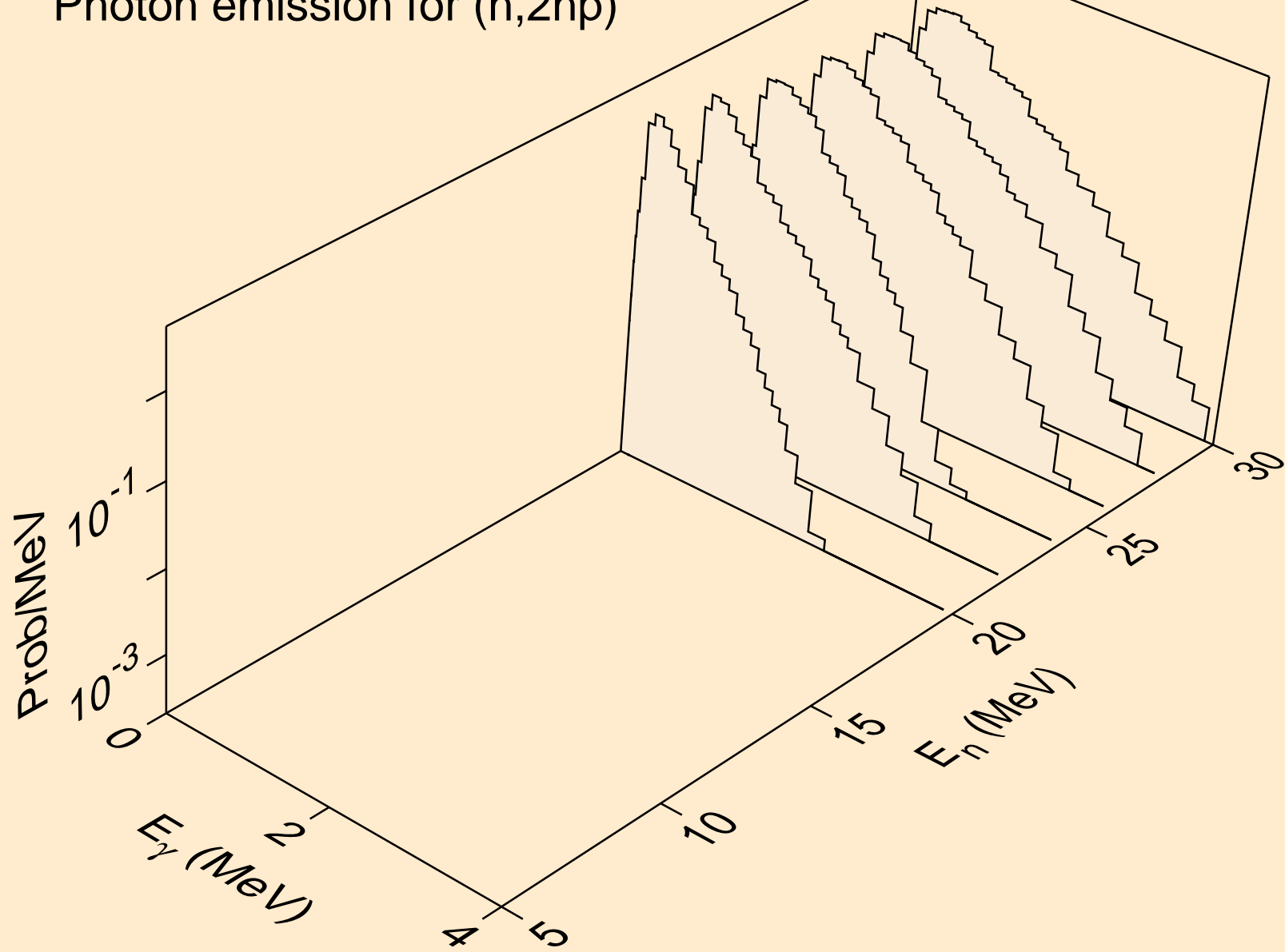

RF265 NEUTRON ACER TENDL-2021 LIBRARY; T=293.6K
Photon emission for (n,n*c)

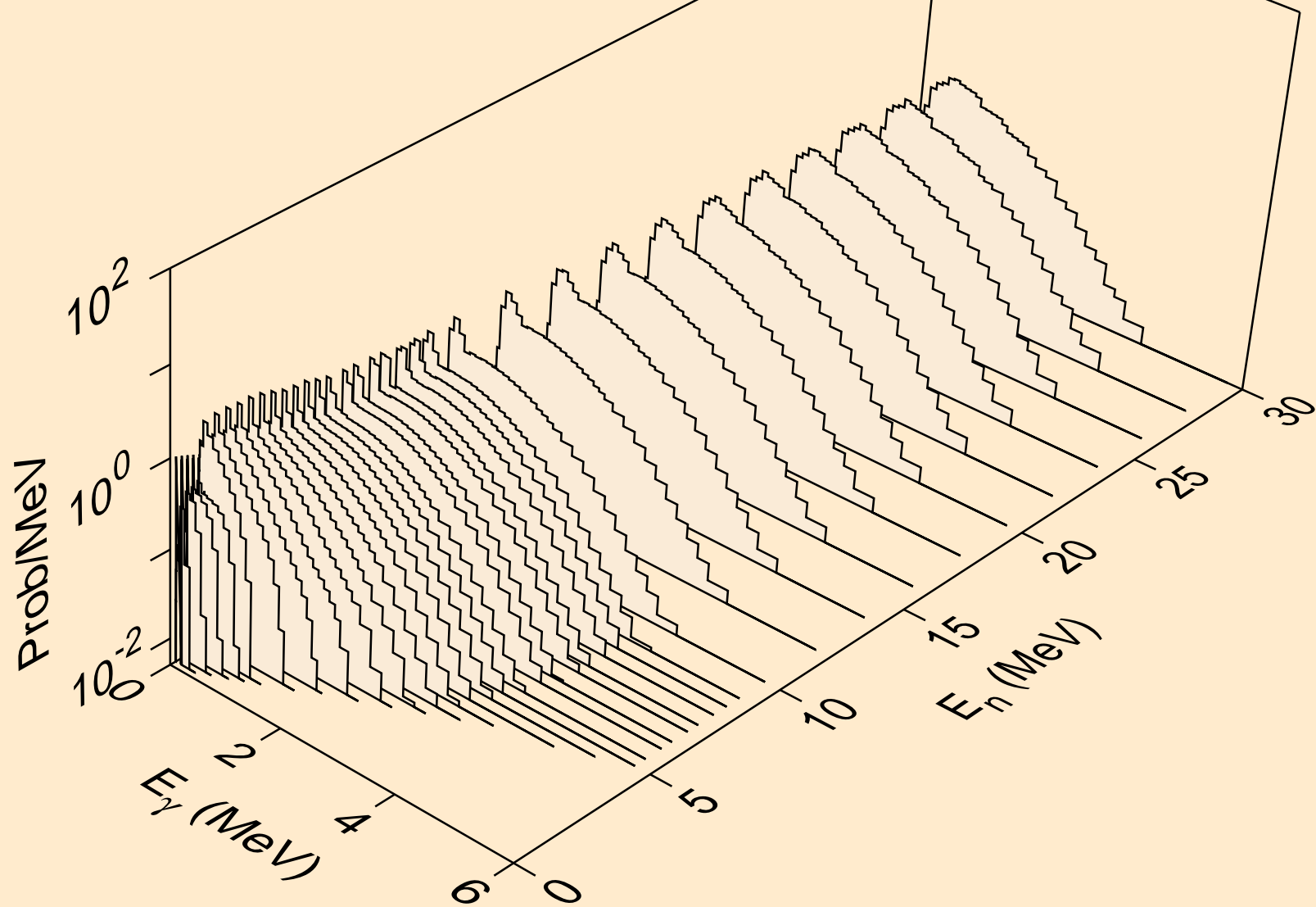

RF265 NEUTRON ACER TENDL-2021 LIBRARY; T=293.6K
Photon emission for (n,gma)

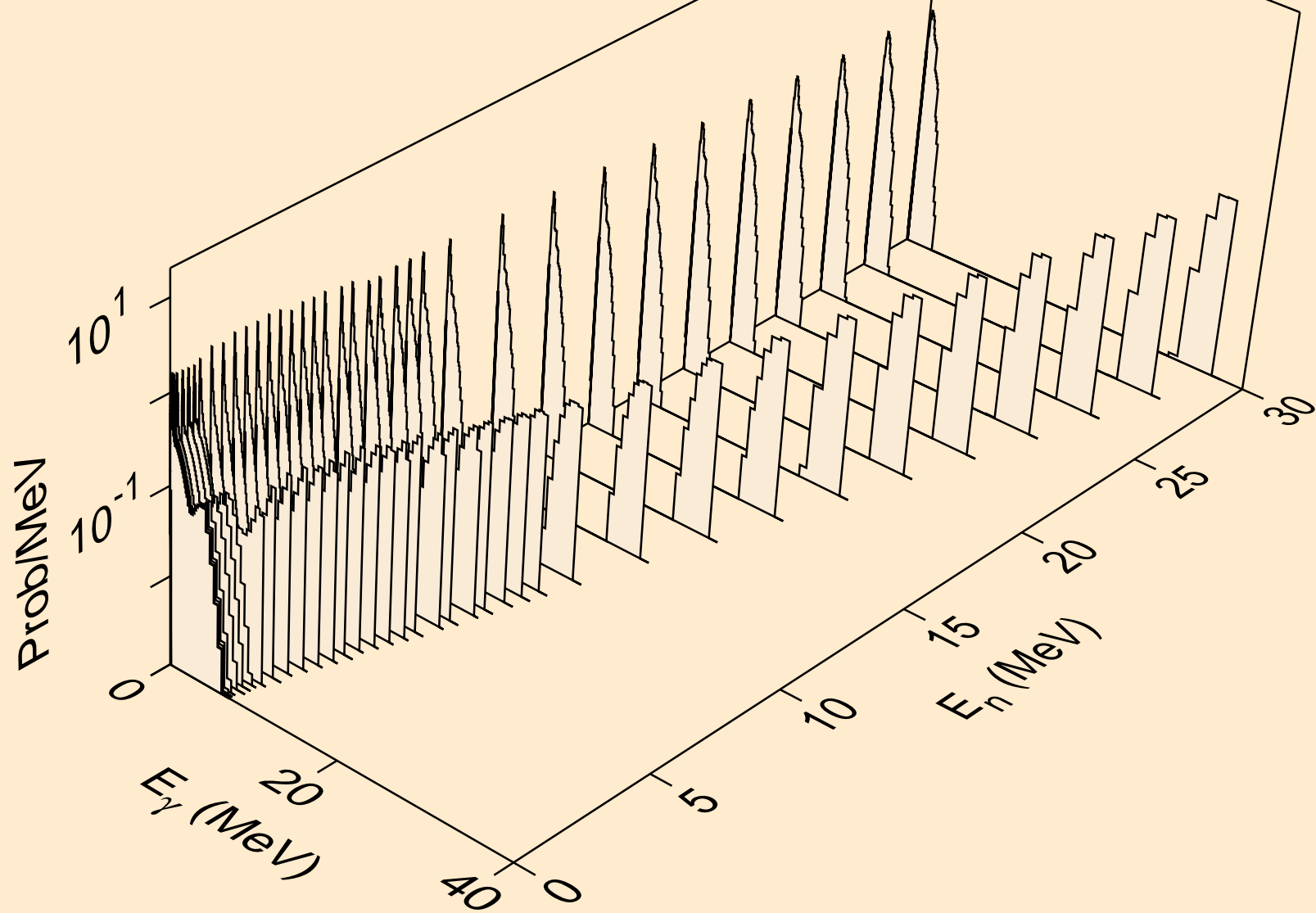

RF265 NEUTRON ACER TENDL-2021 LIBRARY; T=293.6K
Photon emission for (n,p)

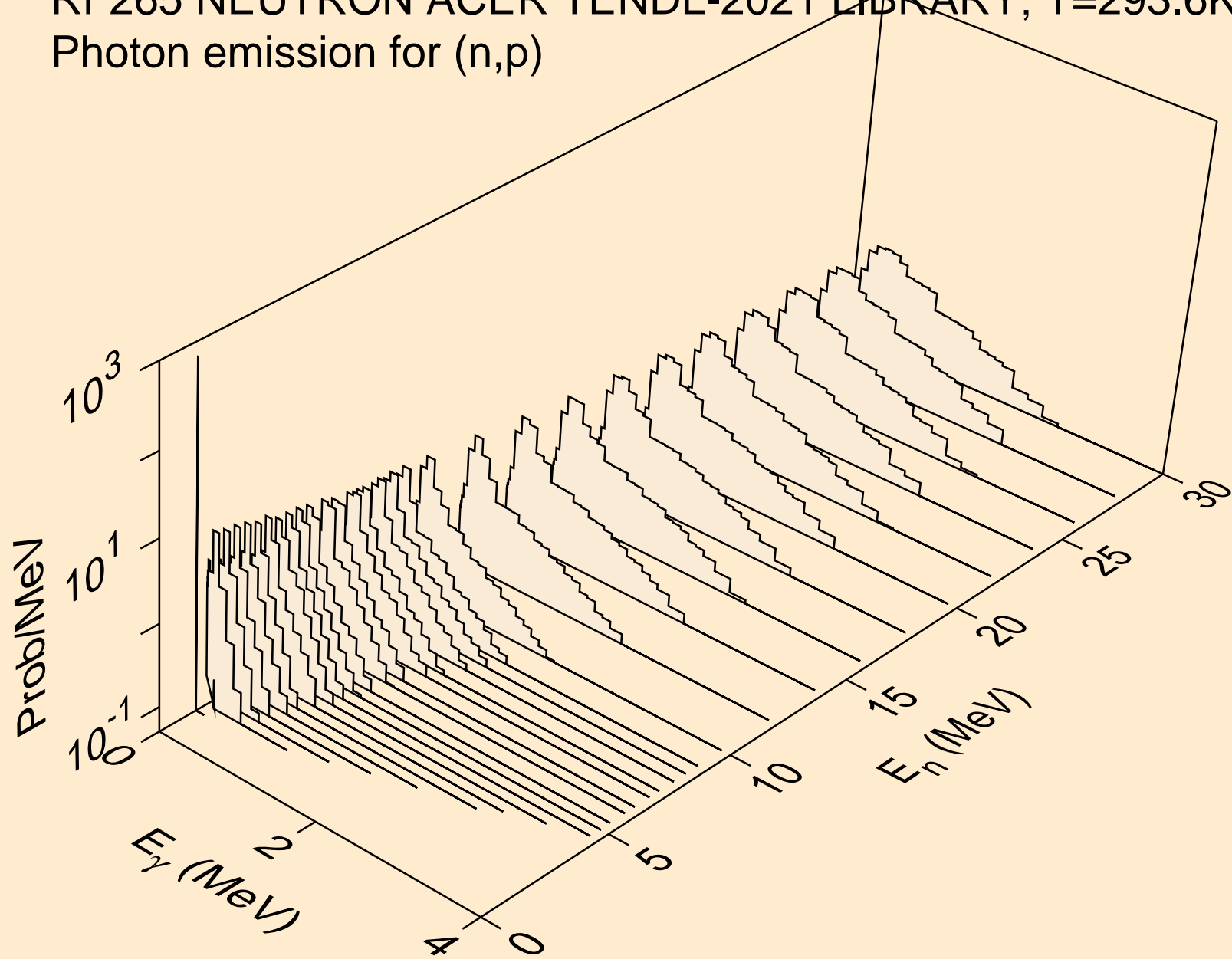

RF265 NEUTRON ACER TENDL-2021 LIBRARY; T=293.6K
Photon emission for (n,d)

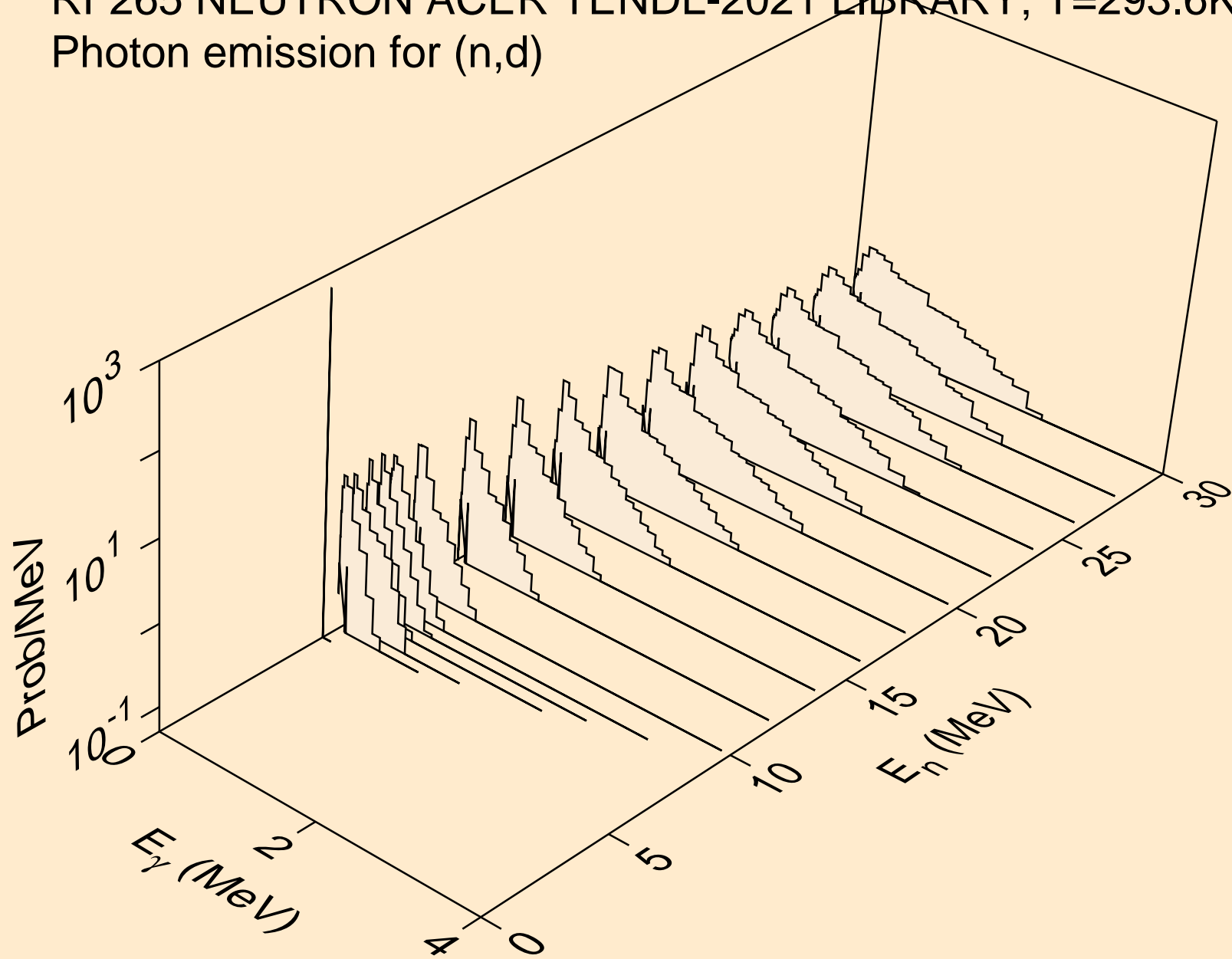

RF265 NEUTRON ACER TENDL-2021 LIBRARY; T=293.6K
Photon emission for (n,t)

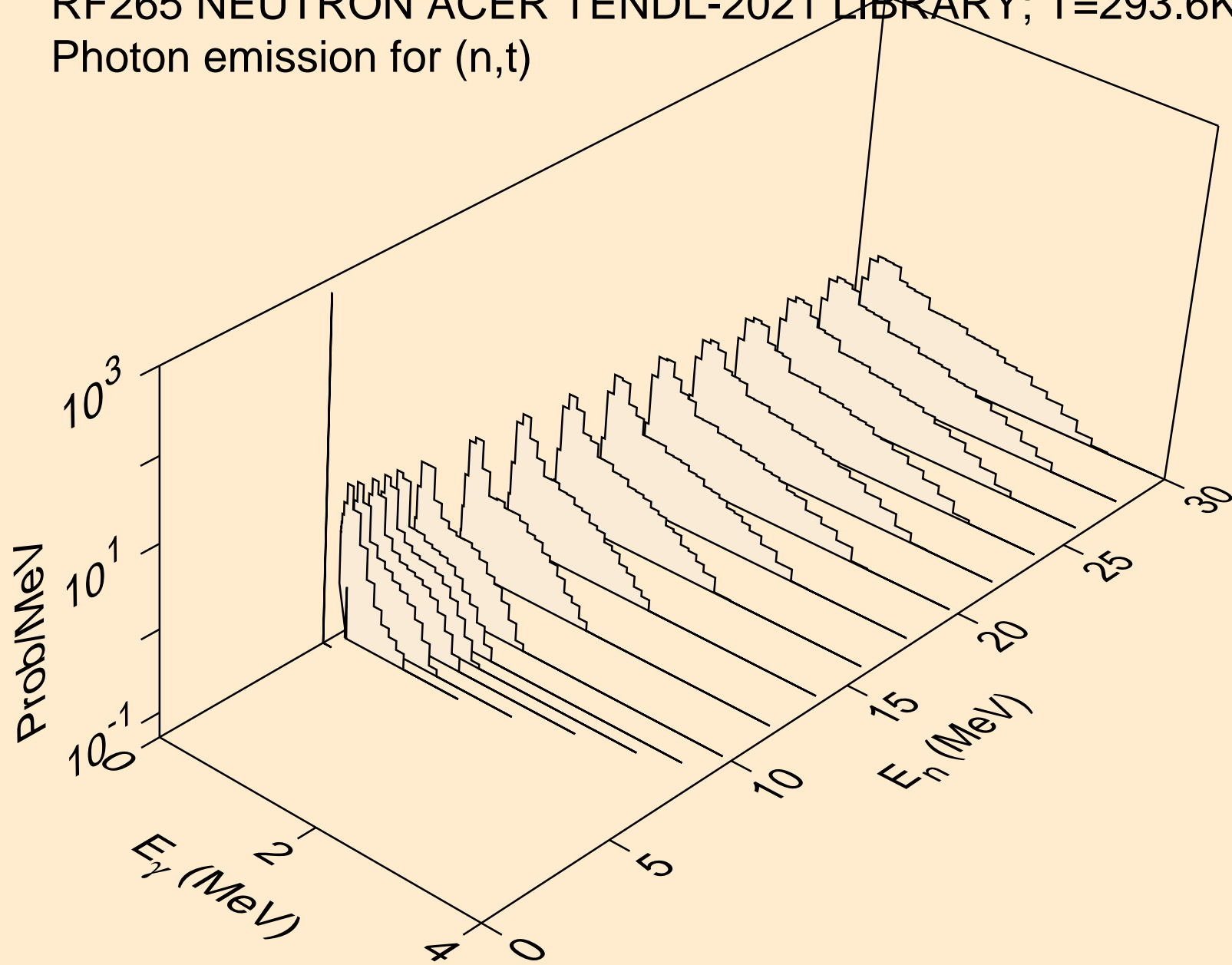

RF265 NEUTRON ACER TENDL-2021 LIBRARY; T=293.6K
Photon emission for (n,he3)

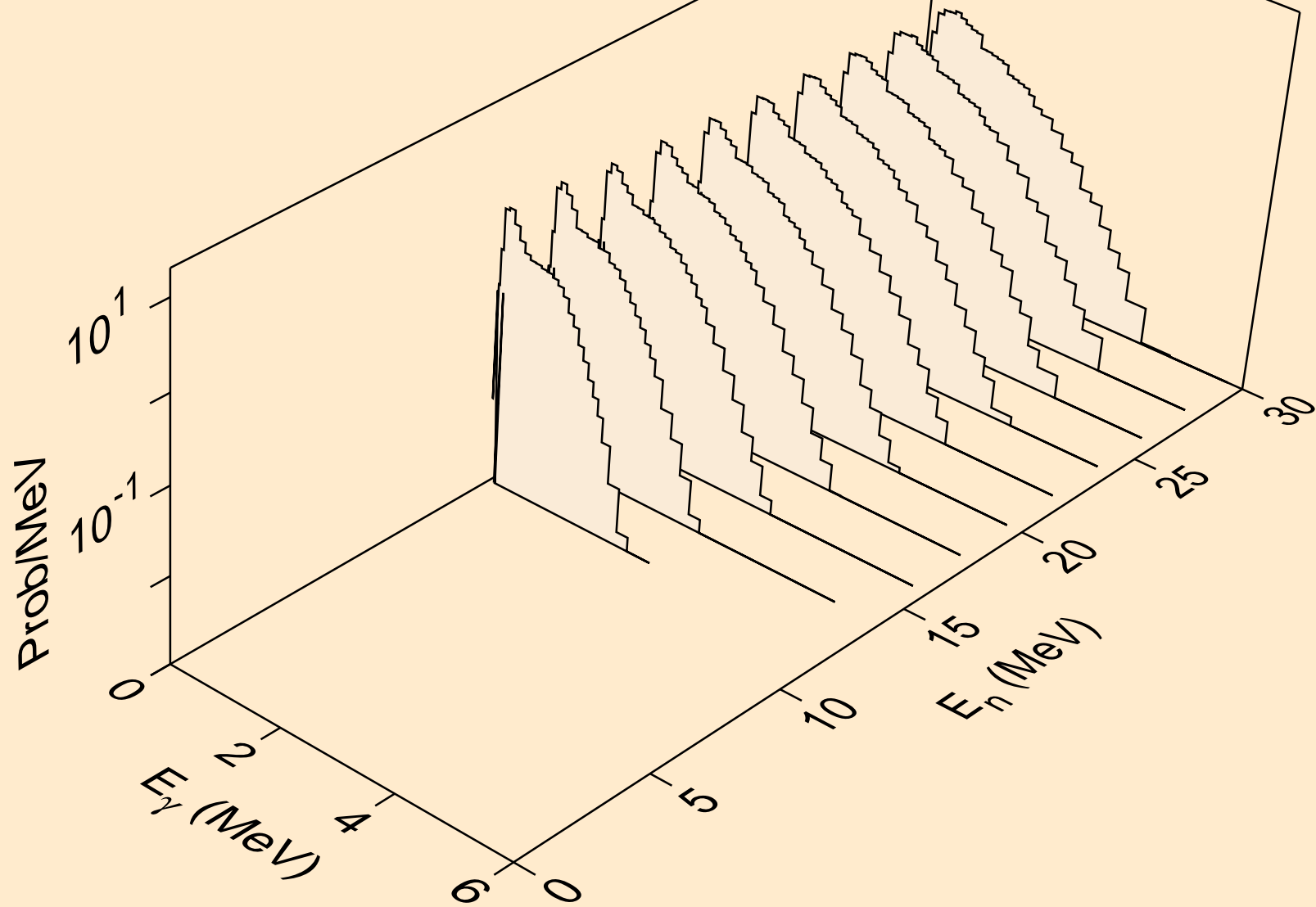

RF265 NEUTRON ACER TENDL-2021 LIBRARY; T=293.6K
Photon emission for (n,a)

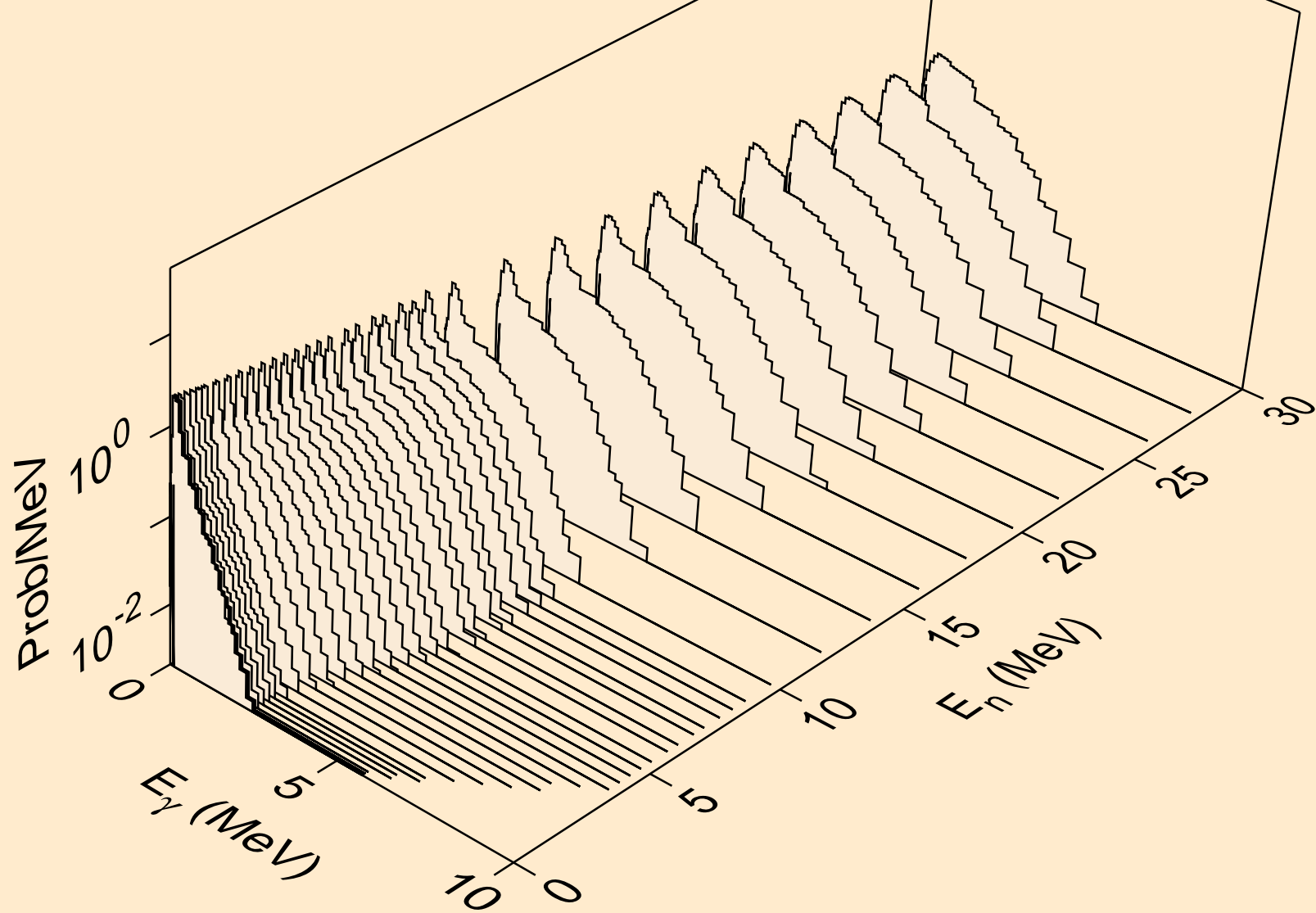

RF265 NEUTRON ACER TENDL-2021 LIBRARY; T=293.6K
Photon emission for (n,pd)

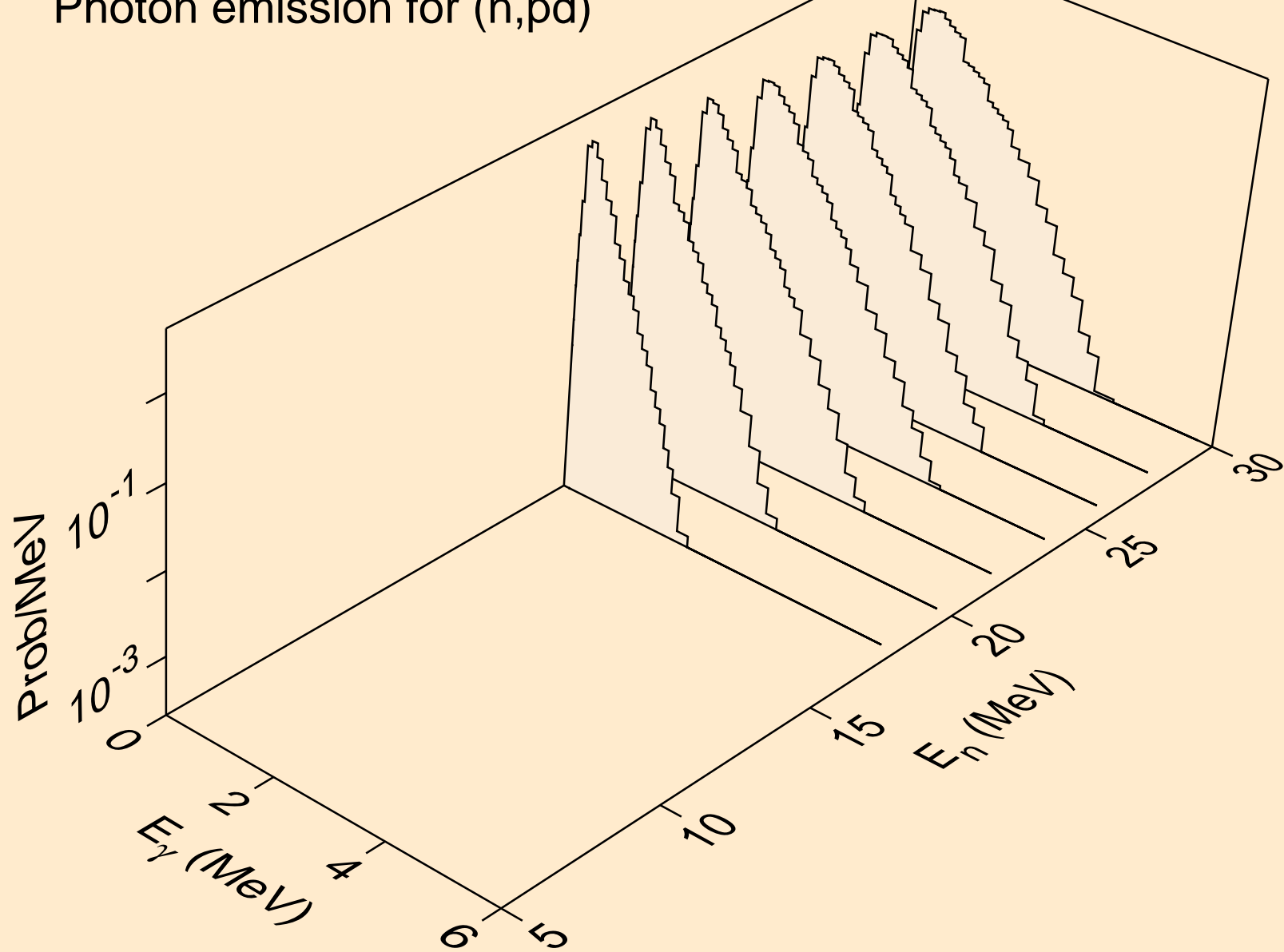

RF265 NEUTRON ACER TENDL-2021 LIBRARY; T=293.6K
thermal capture photon spectrum

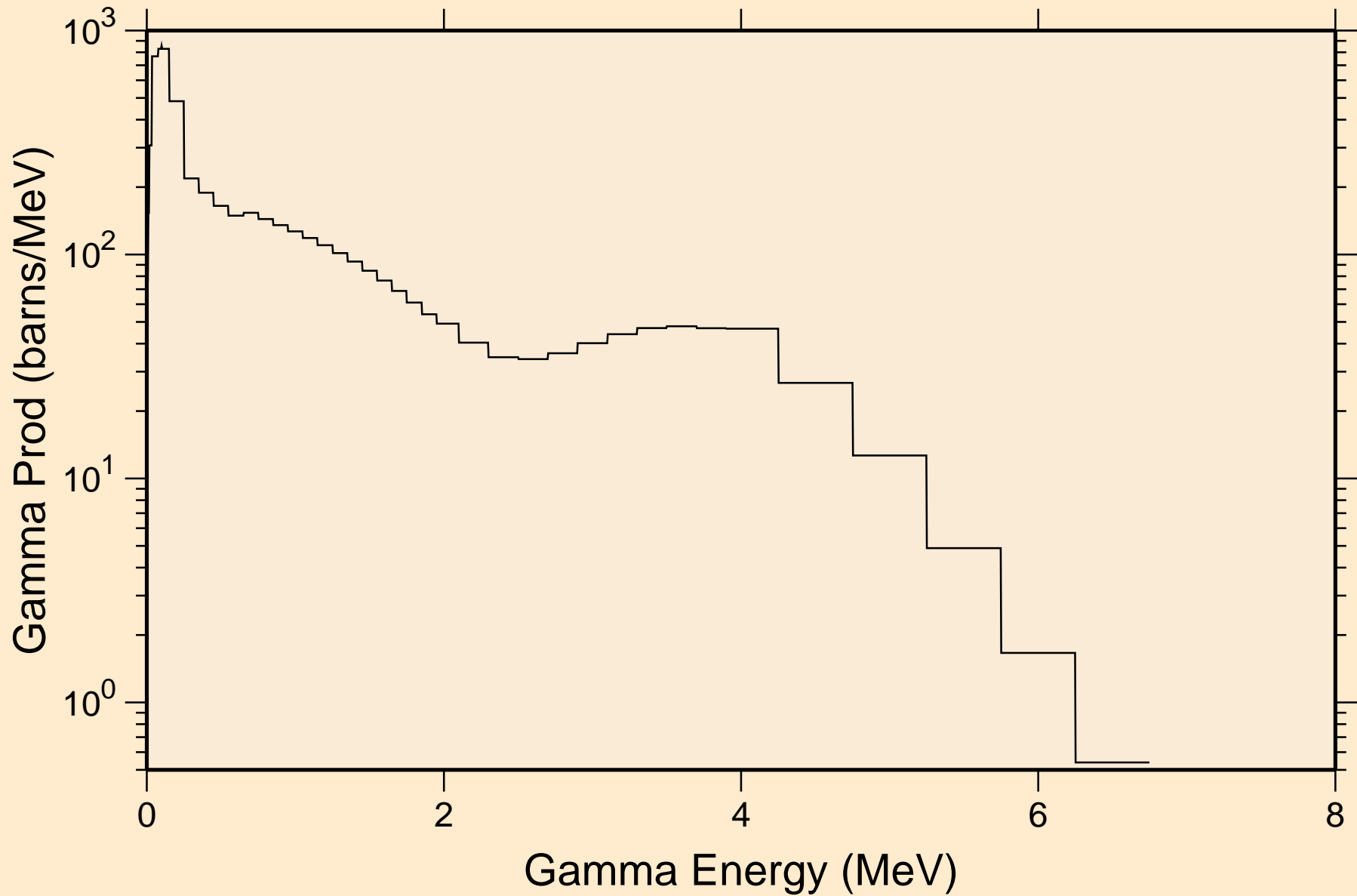

RF265 NEUTRON ACER TENDL-2021 LIBRARY; T=293.6K
14 MeV photon spectrum

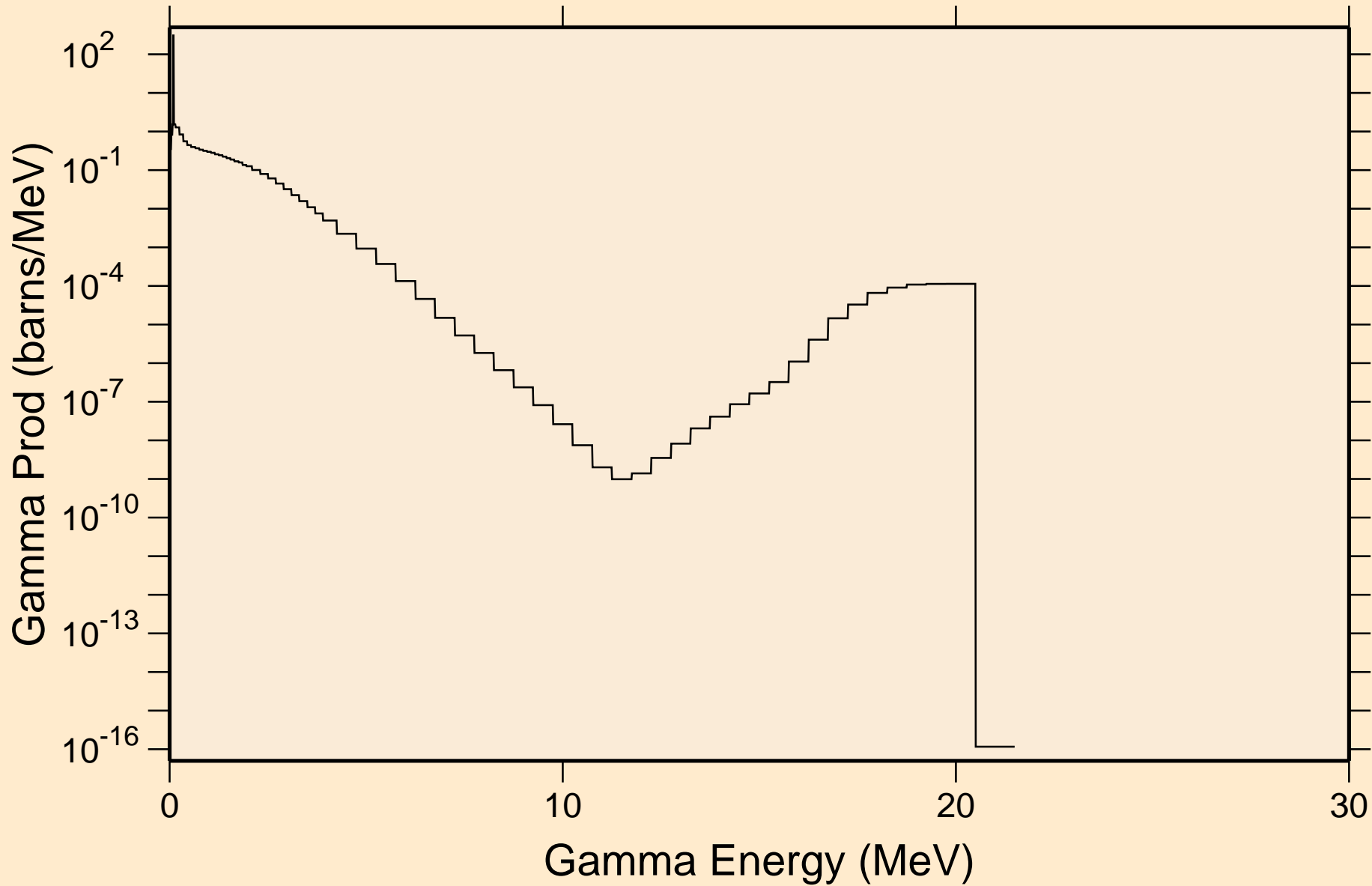

RF265 NEUTRON ACER TENDL-2021 LIBRARY; T=293.6K

Particle heating contributions

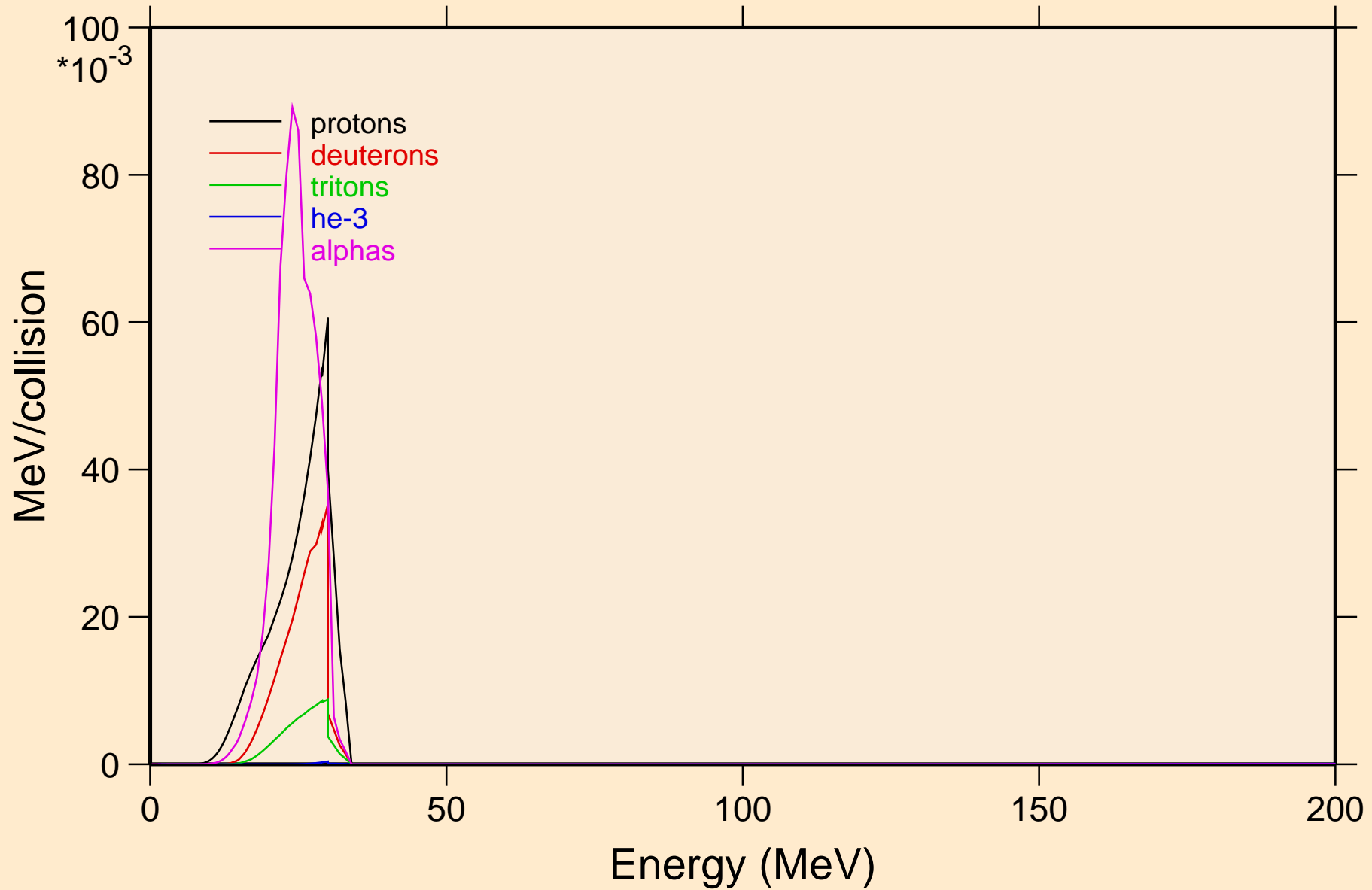

RF265 NEUTRON ACER TENDL-2021 LIBRARY; T=293.6K
Recoil Heating

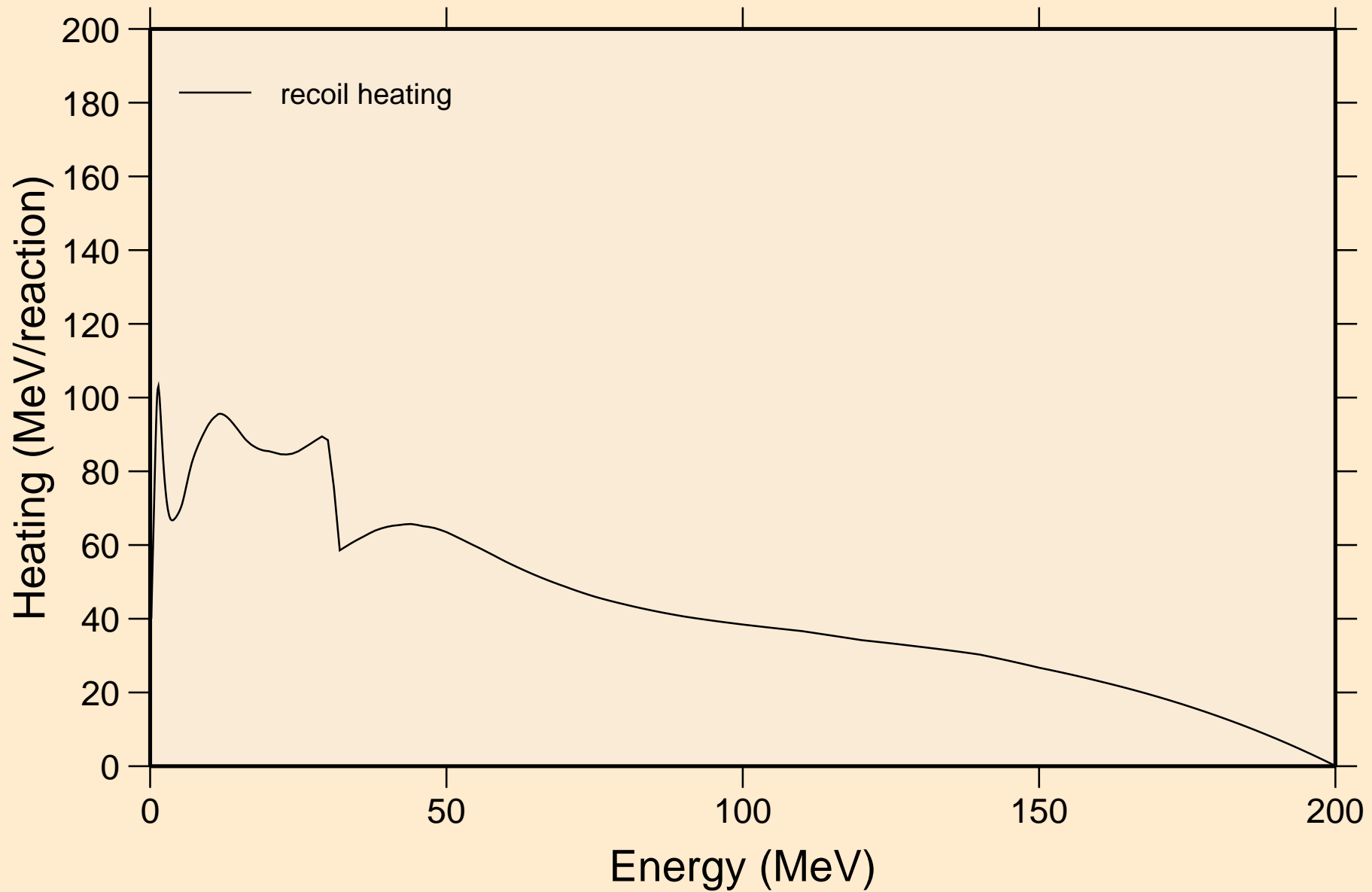

RF265 NEUTRON ACER TENDL-2021 LIBRARY; T=293.6K

Particle production cross sections

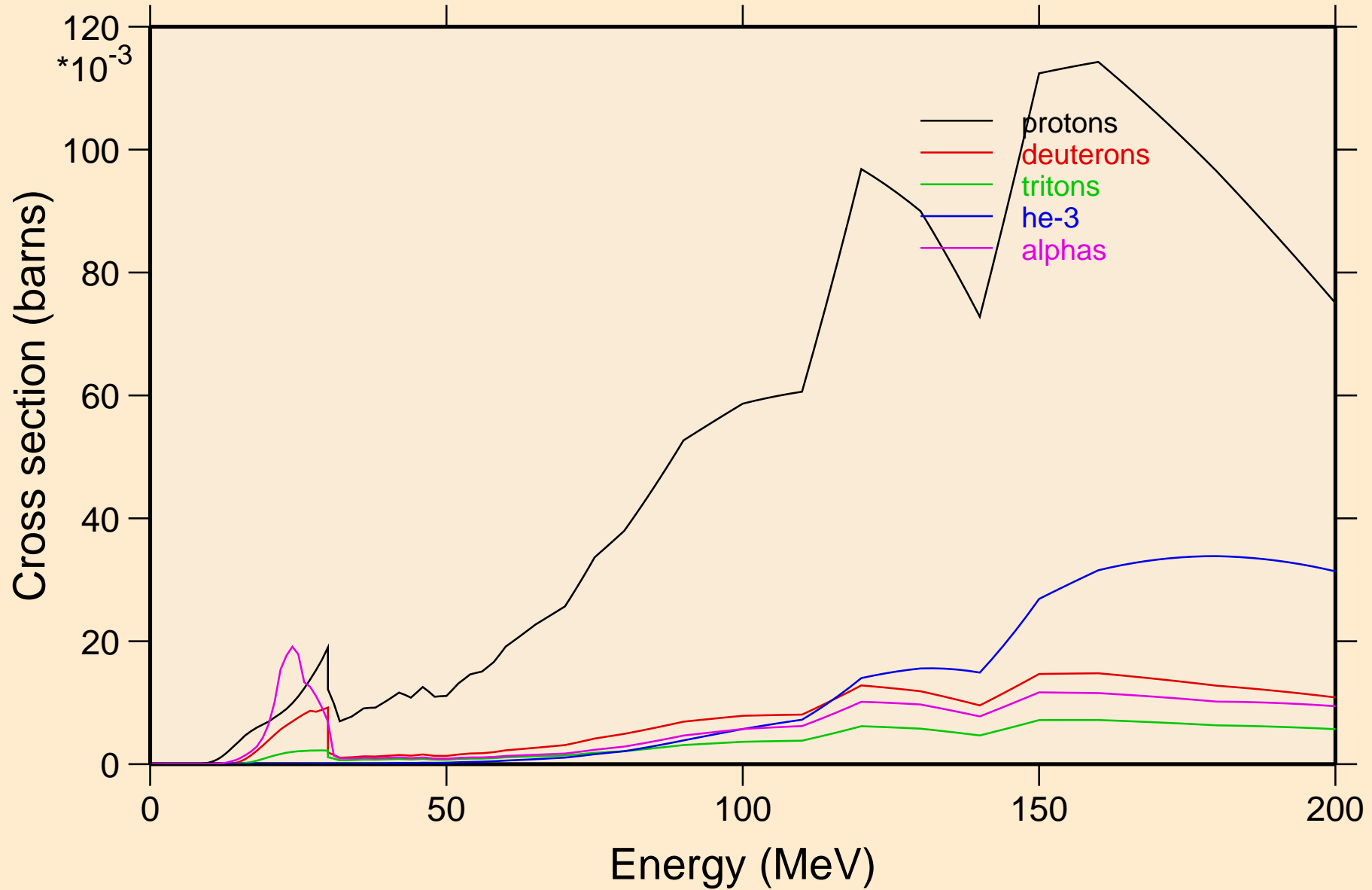

RF265 NEUTRON ACER TENDL-2021 LIBRARY; T=293.6K
protons from (n,x)

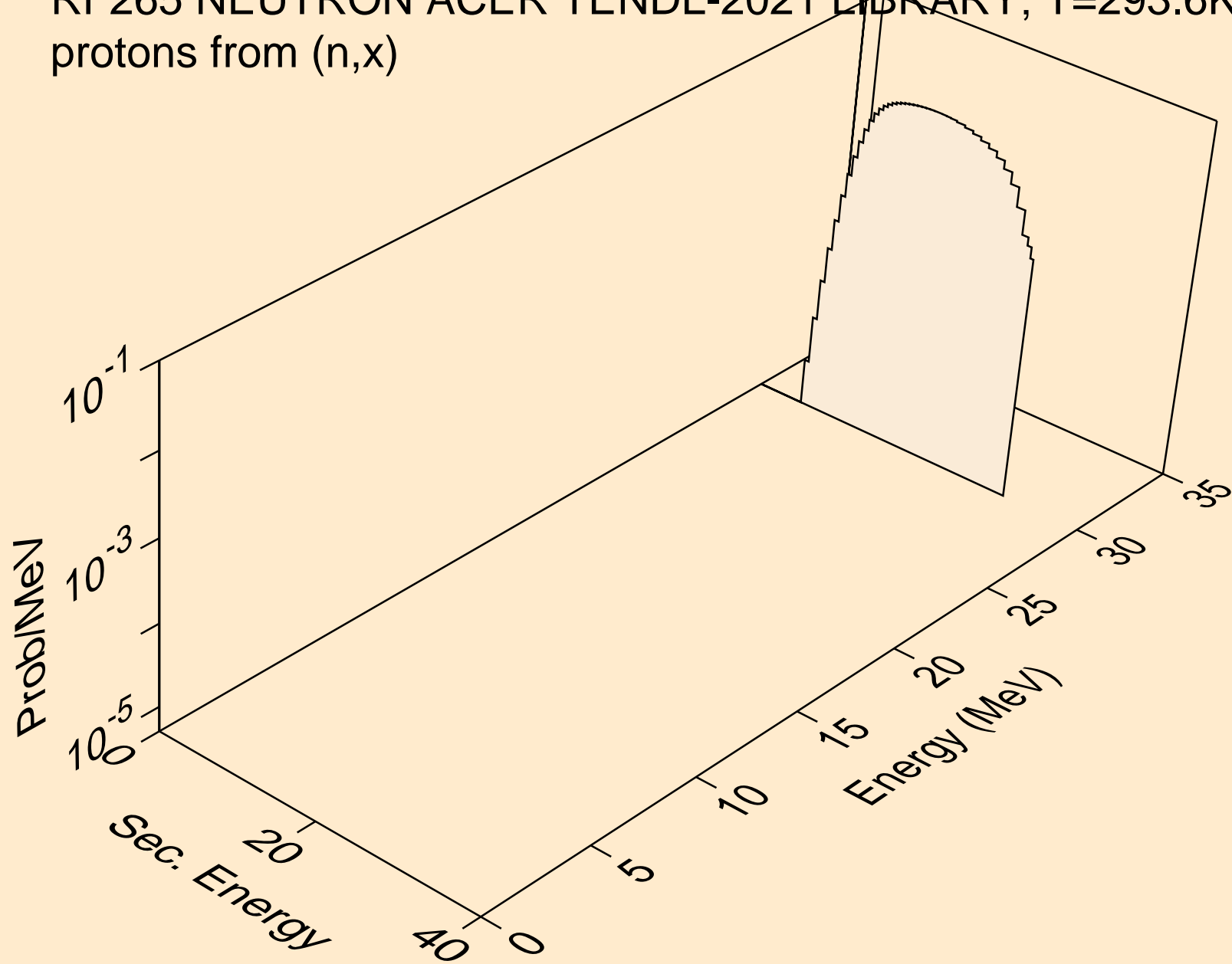

RF265 NEUTRON ACER TENDL-2021 LIBRARY; T=293.6K
protons from (n,n*)p

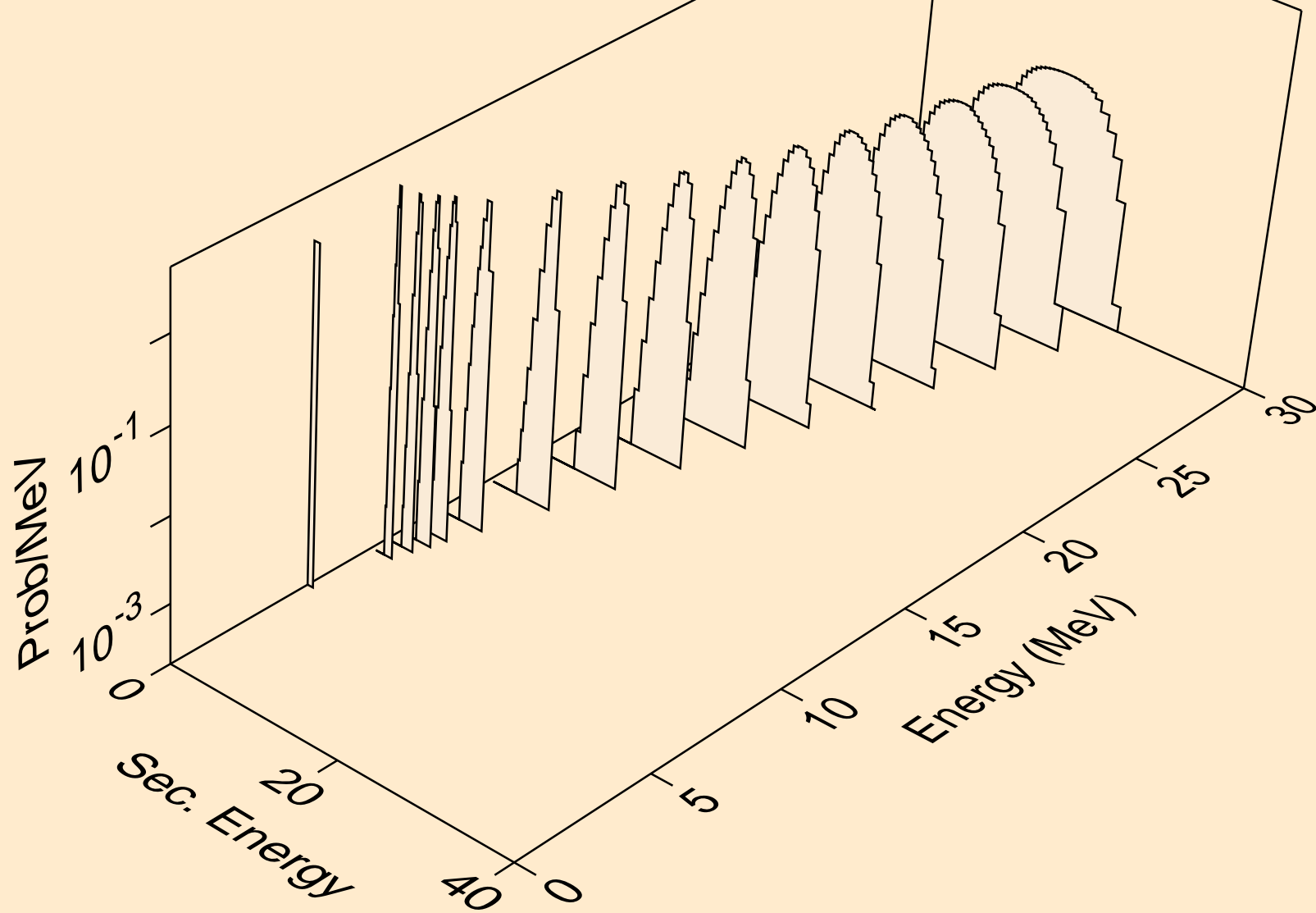

RF265 NEUTRON ACER TENDL-2021 LIBRARY; T=293.6K
protons from (n,2np)

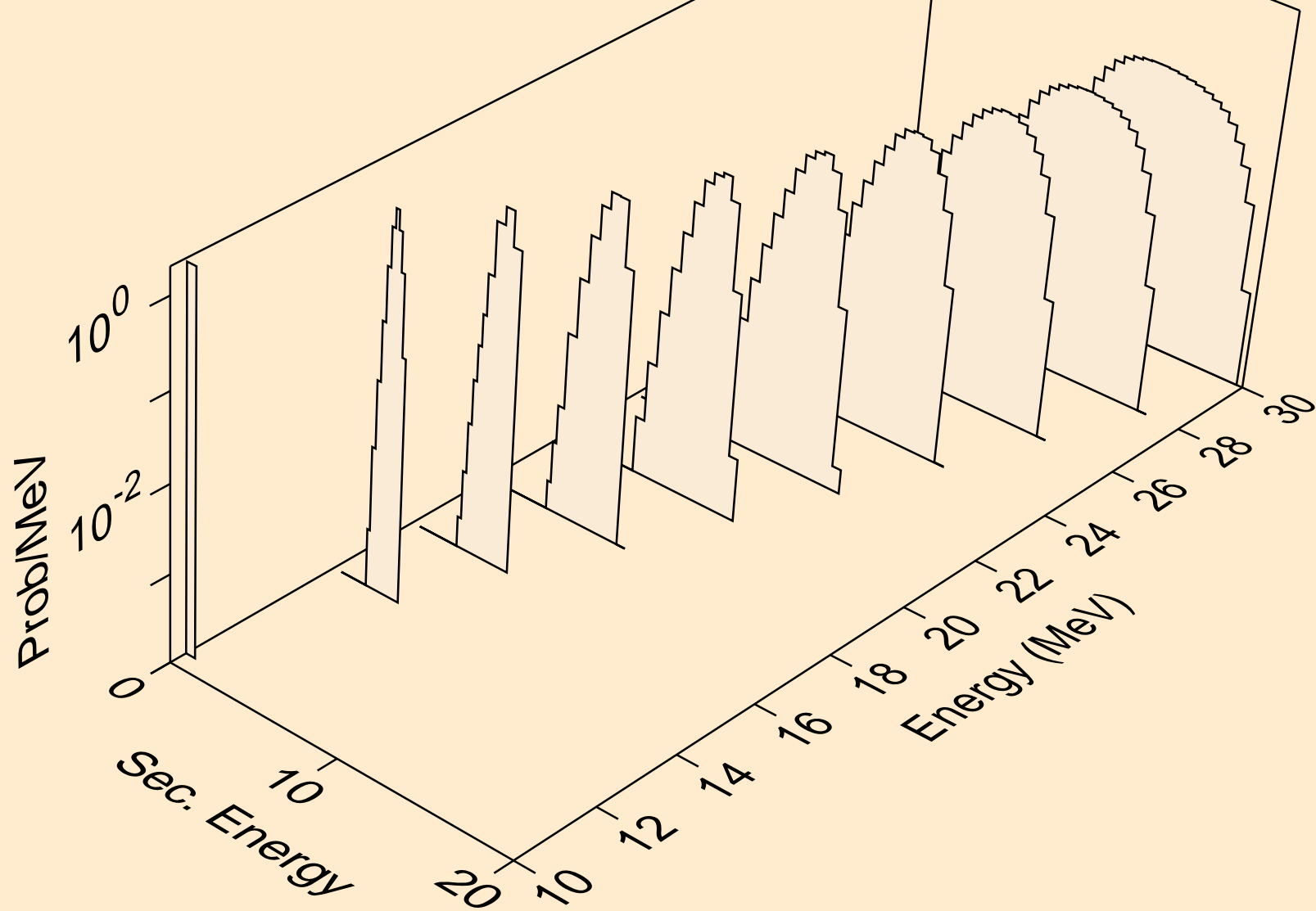

RF265 NEUTRON ACER TENDL-2021 LIBRARY; T=293.6K
protons from (n,3np)

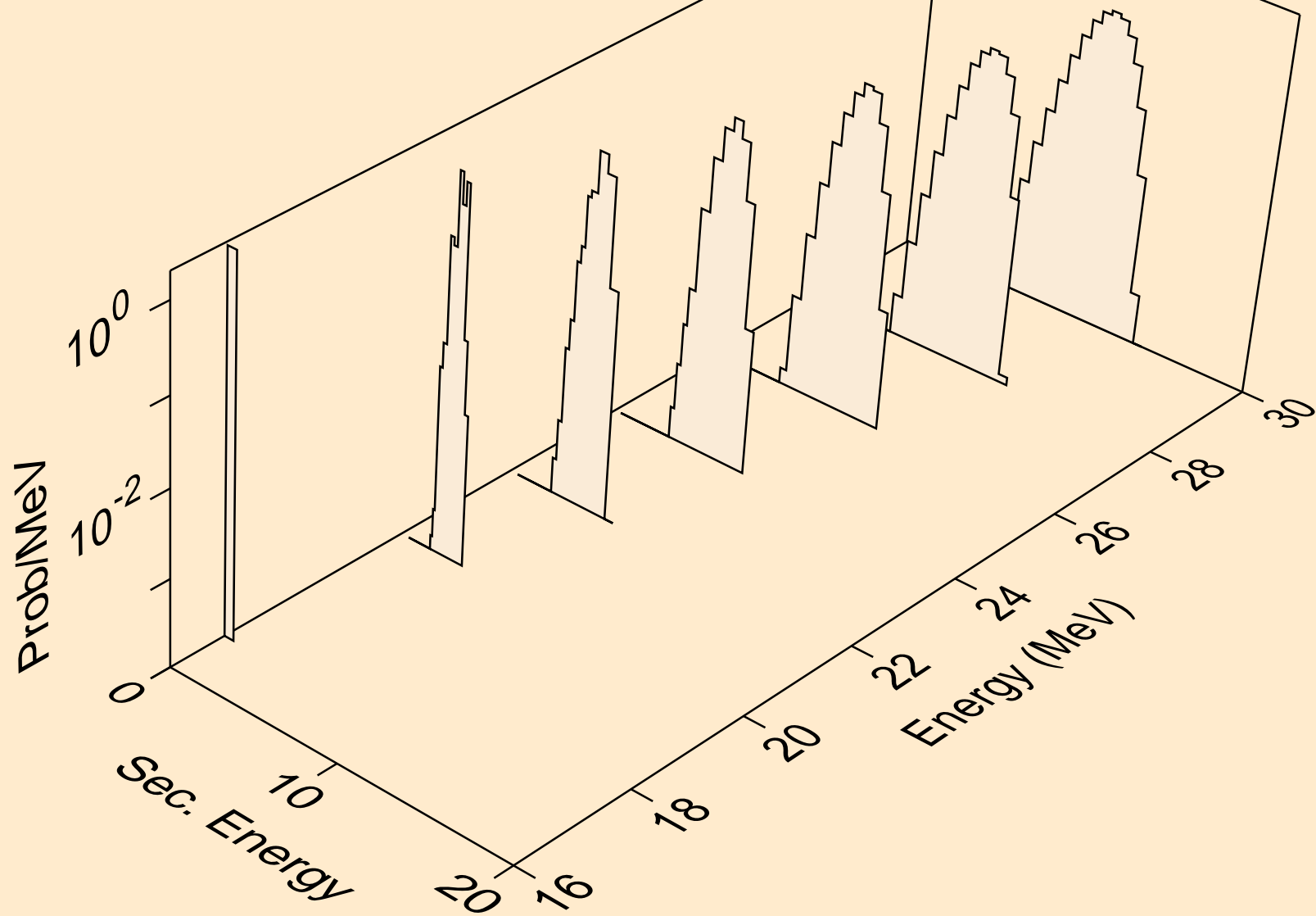

RF265 NEUTRON ACER TENDL-2021 LIBRARY; T=293.6K
protons from (n,2np)

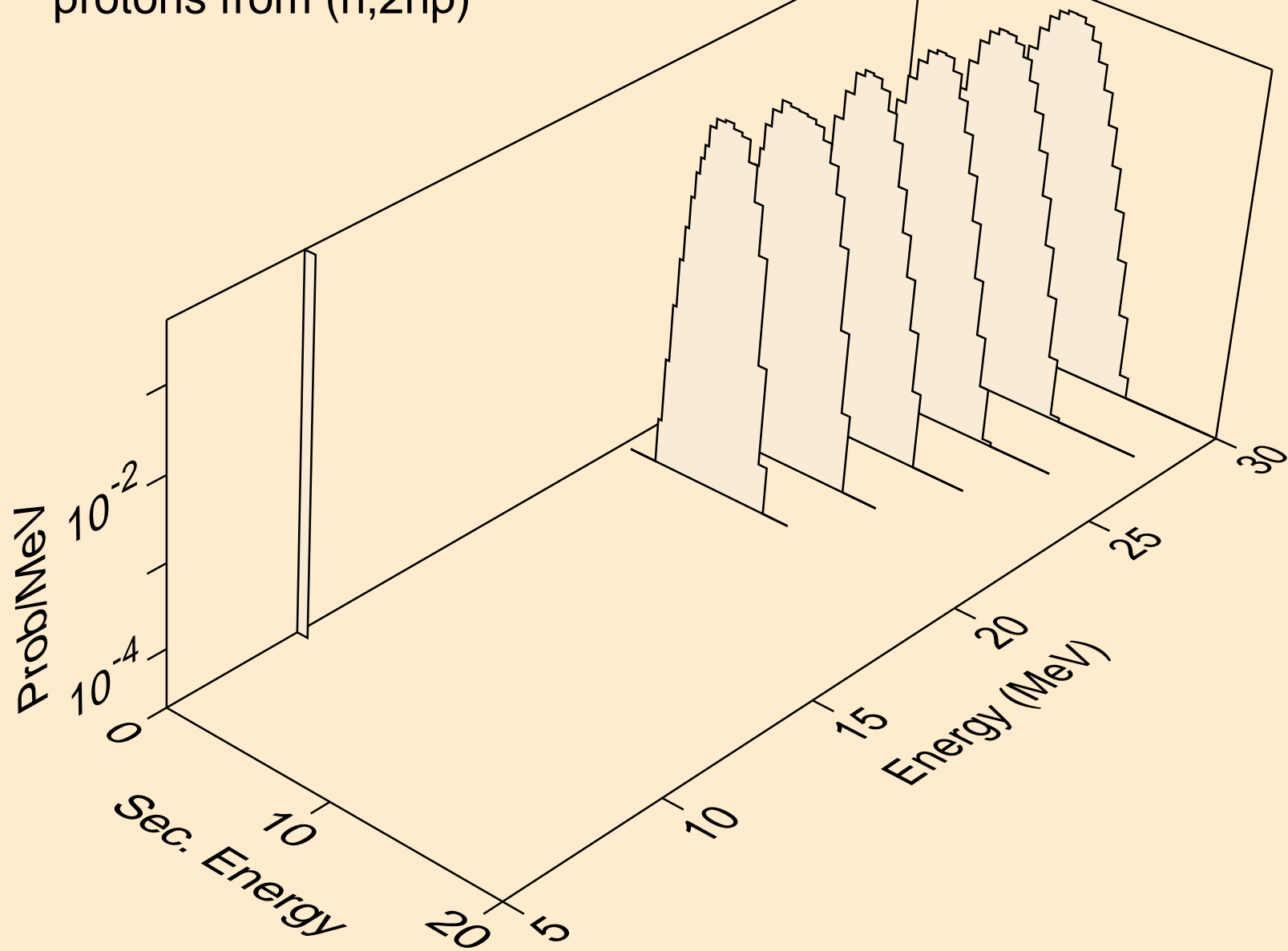

RF265 NEUTRON ACER TENDL-2021 LIBRARY; T=293.6K
protons from (n,p)

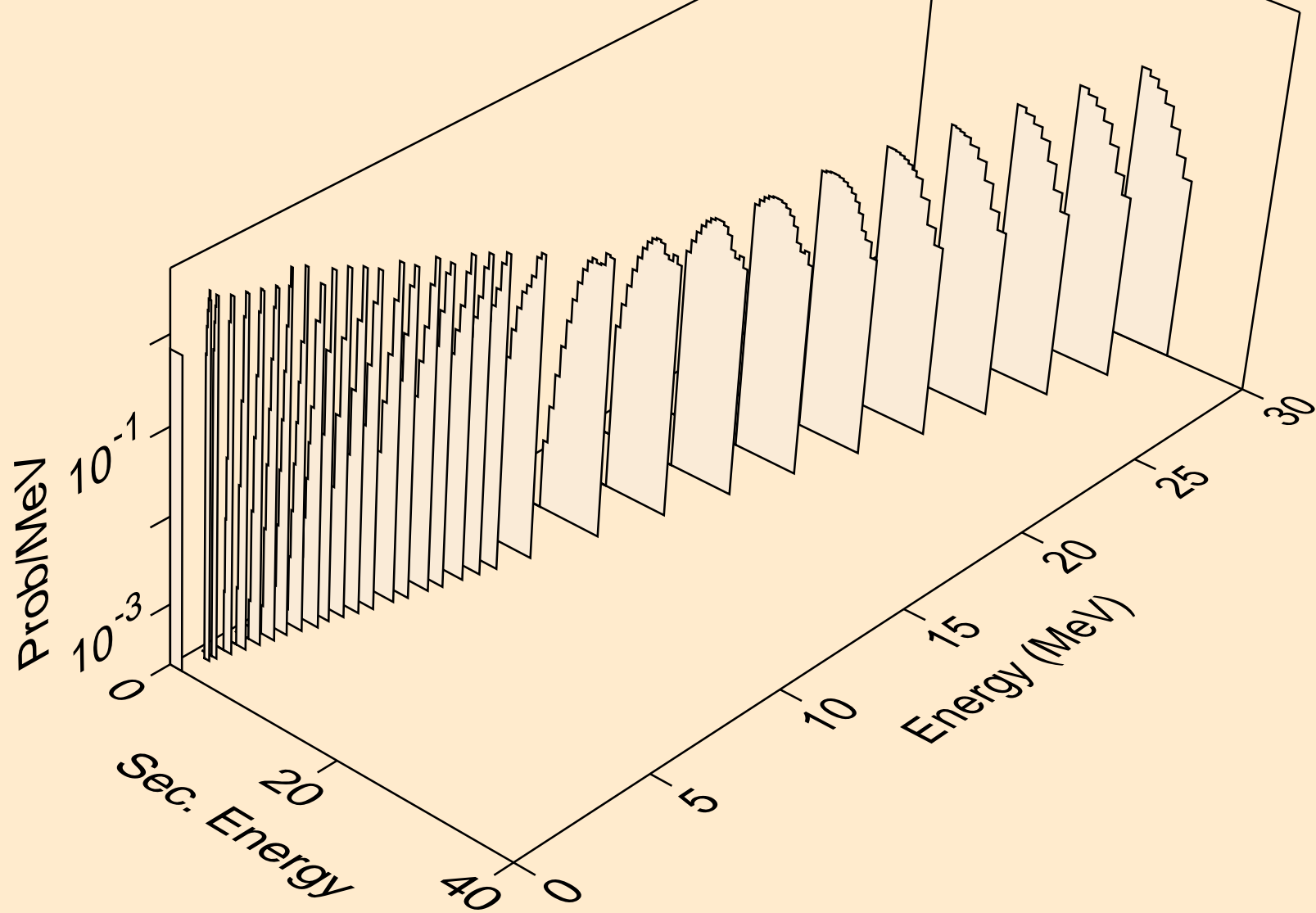

RF265 NEUTRON ACER TENDL-2021 LIBRARY; T=293.6K
protons from (n,pd)

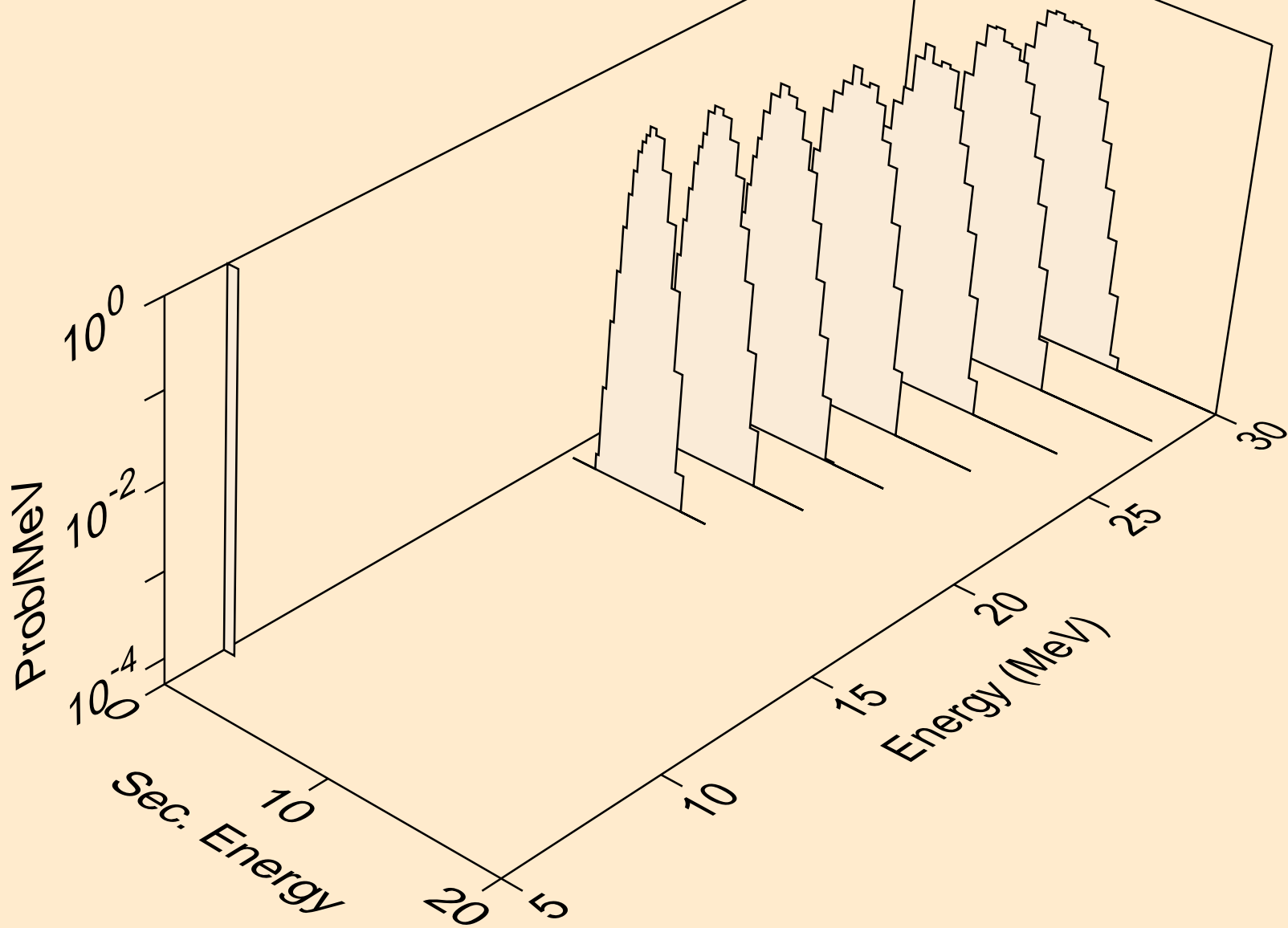

RF265 NEUTRON ACER TENDL-2021 LIBRARY; T=293.6K
deuterons from (n,x)

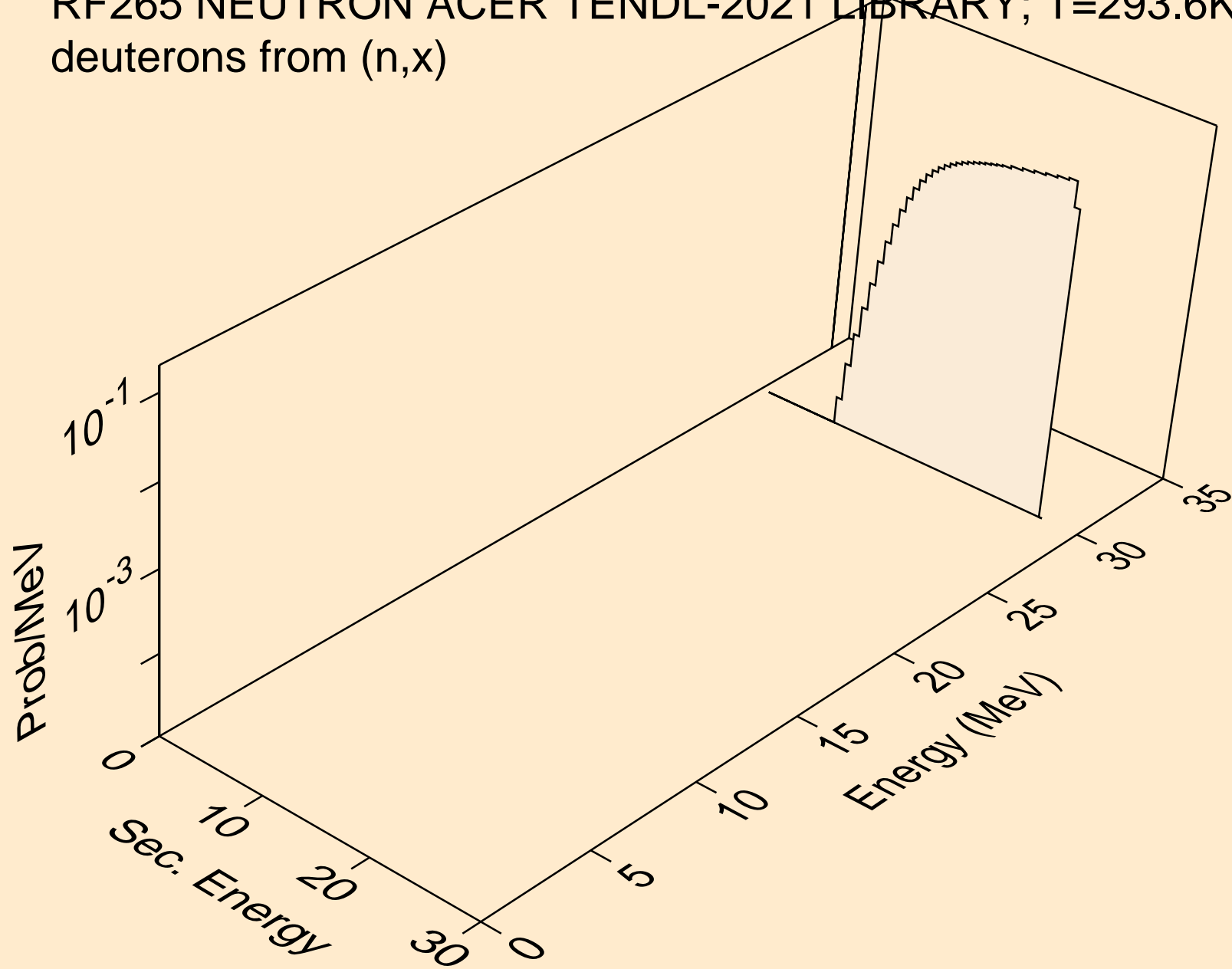

RF265 NEUTRON ACER TENDL-2021 LIBRARY; T=293.6K
deuterons from (n,2nd)

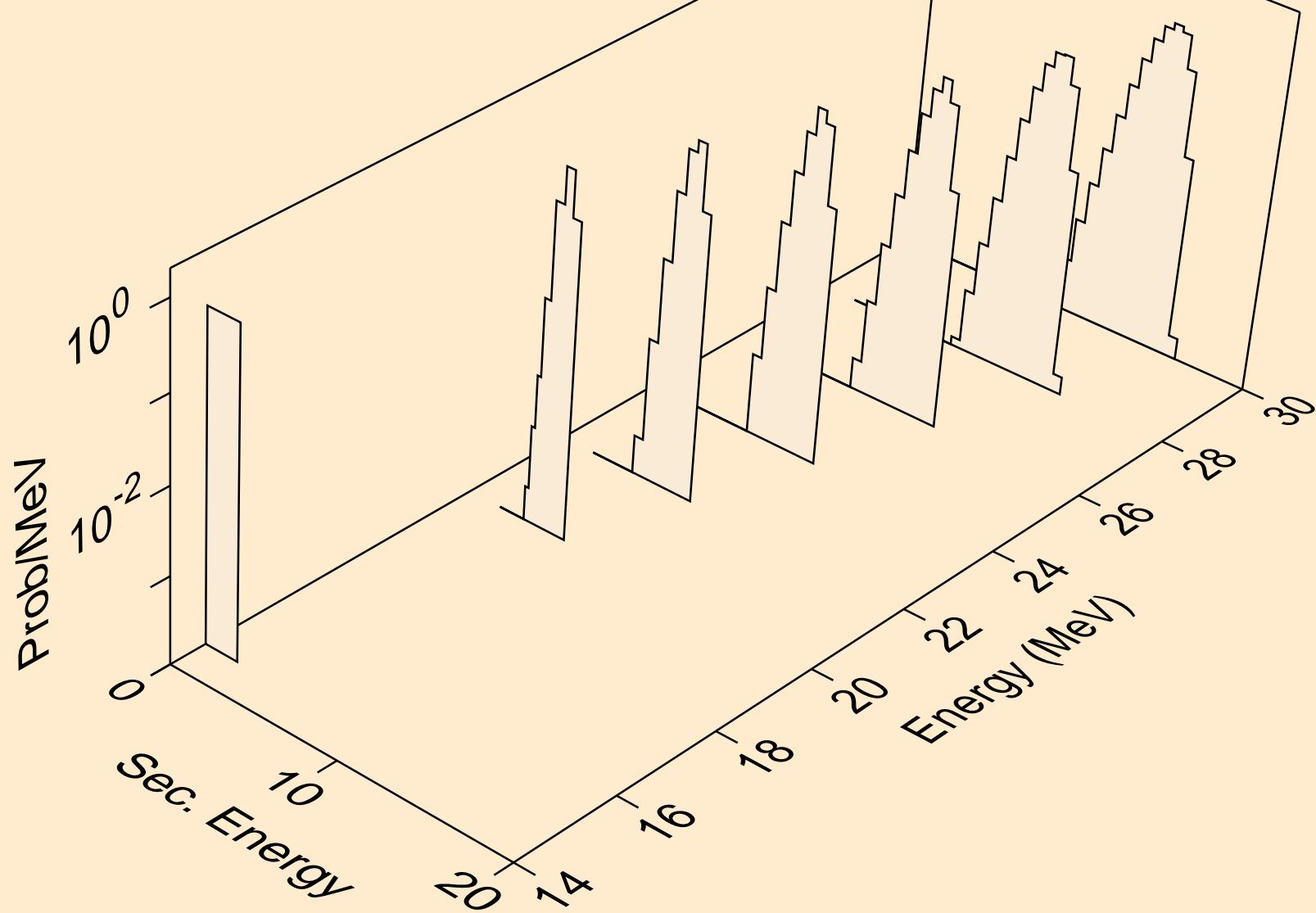

RF265 NEUTRON ACER TENDL-2021 LIBRARY; T=293.6K
deuterons from (n,n*)d

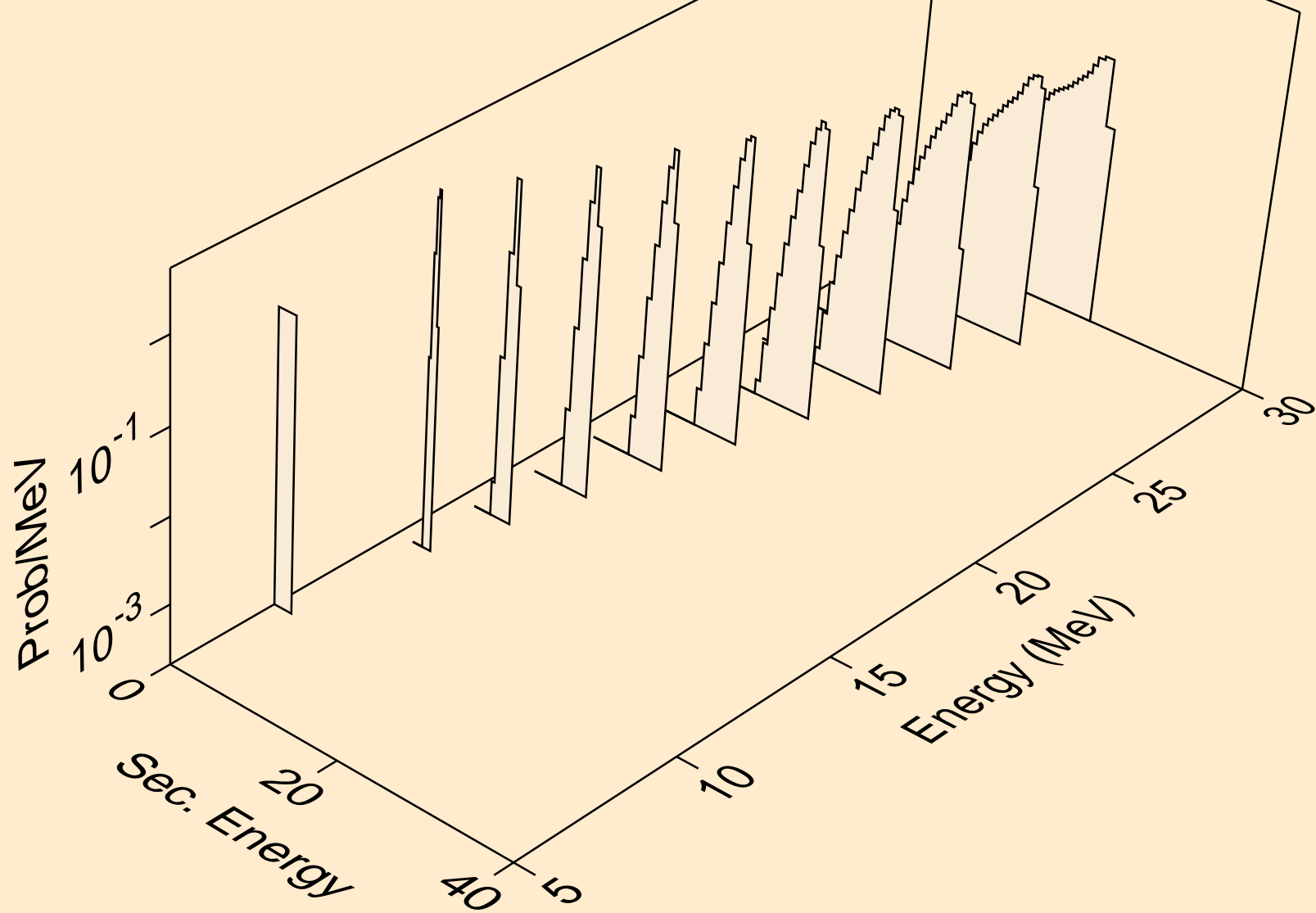

RF265 NEUTRON ACER TENDL-2021 LIBRARY; T=293.6K
deuterons from (n,d)

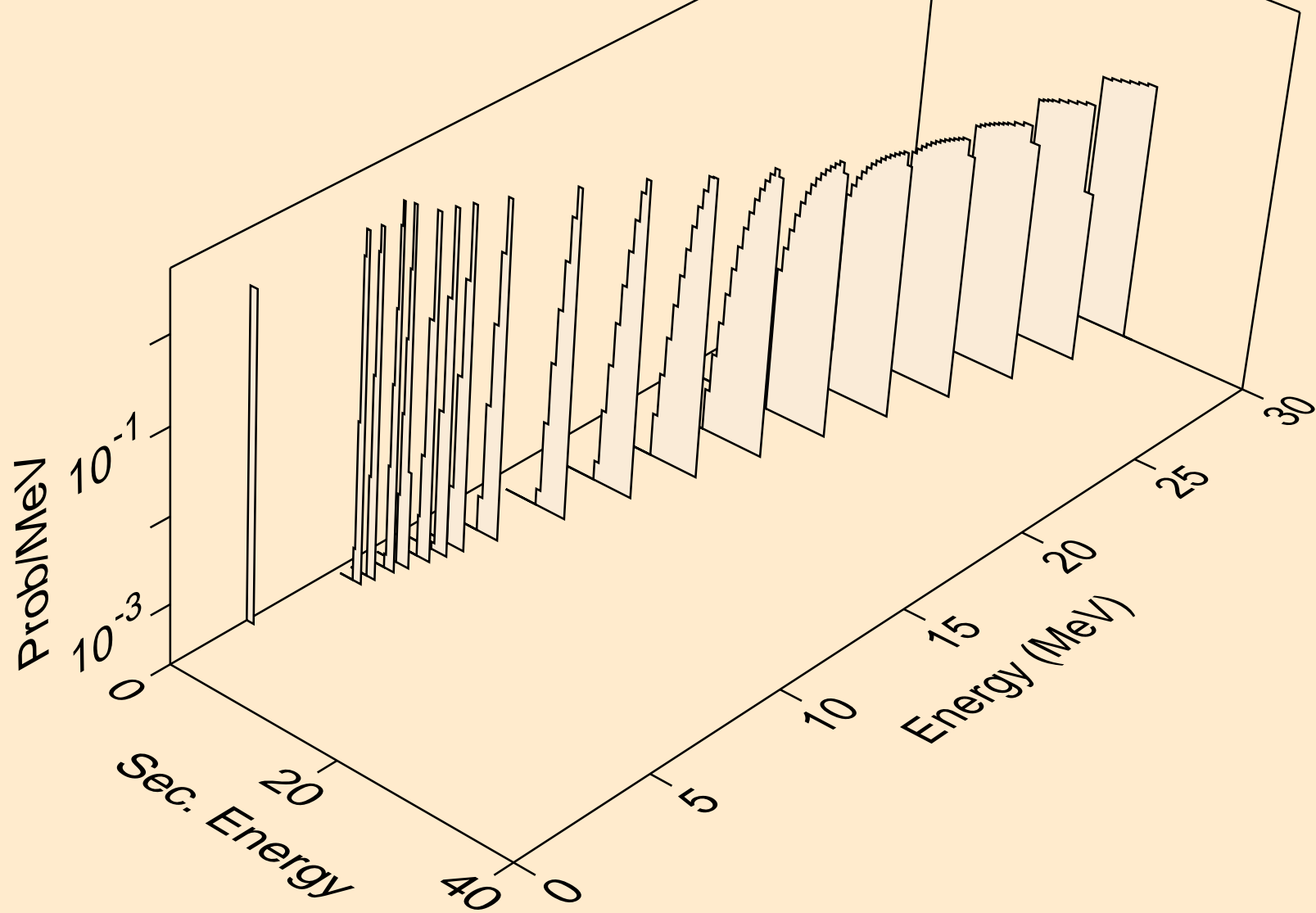

RF265 NEUTRON ACER TENDL-2021 LIBRARY; T=293.6K
deuterons from (n,pd)

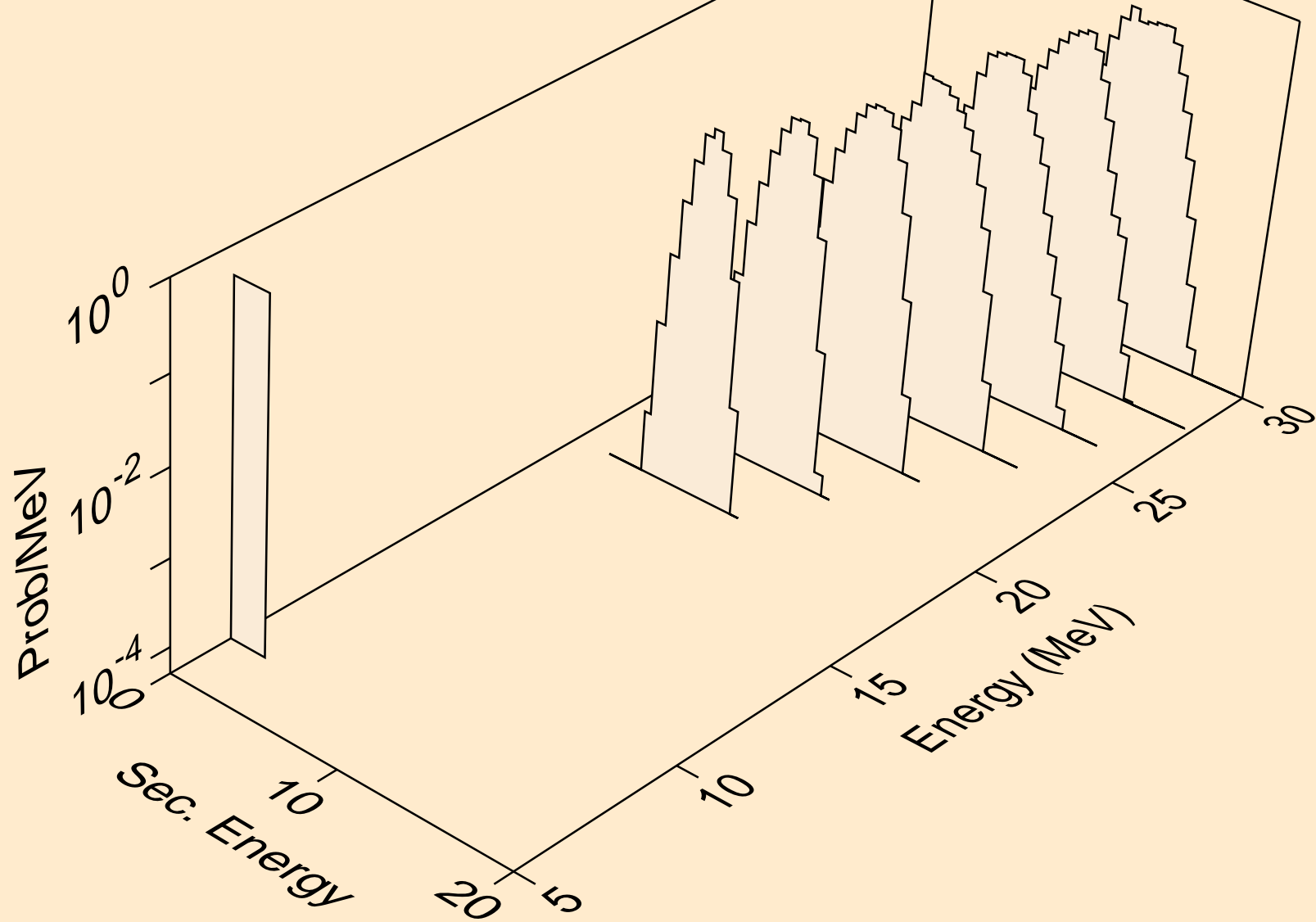

RF265 NEUTRON ACER TENDL-2021 LIBRARY; T=293.6K
tritons from (n,x)

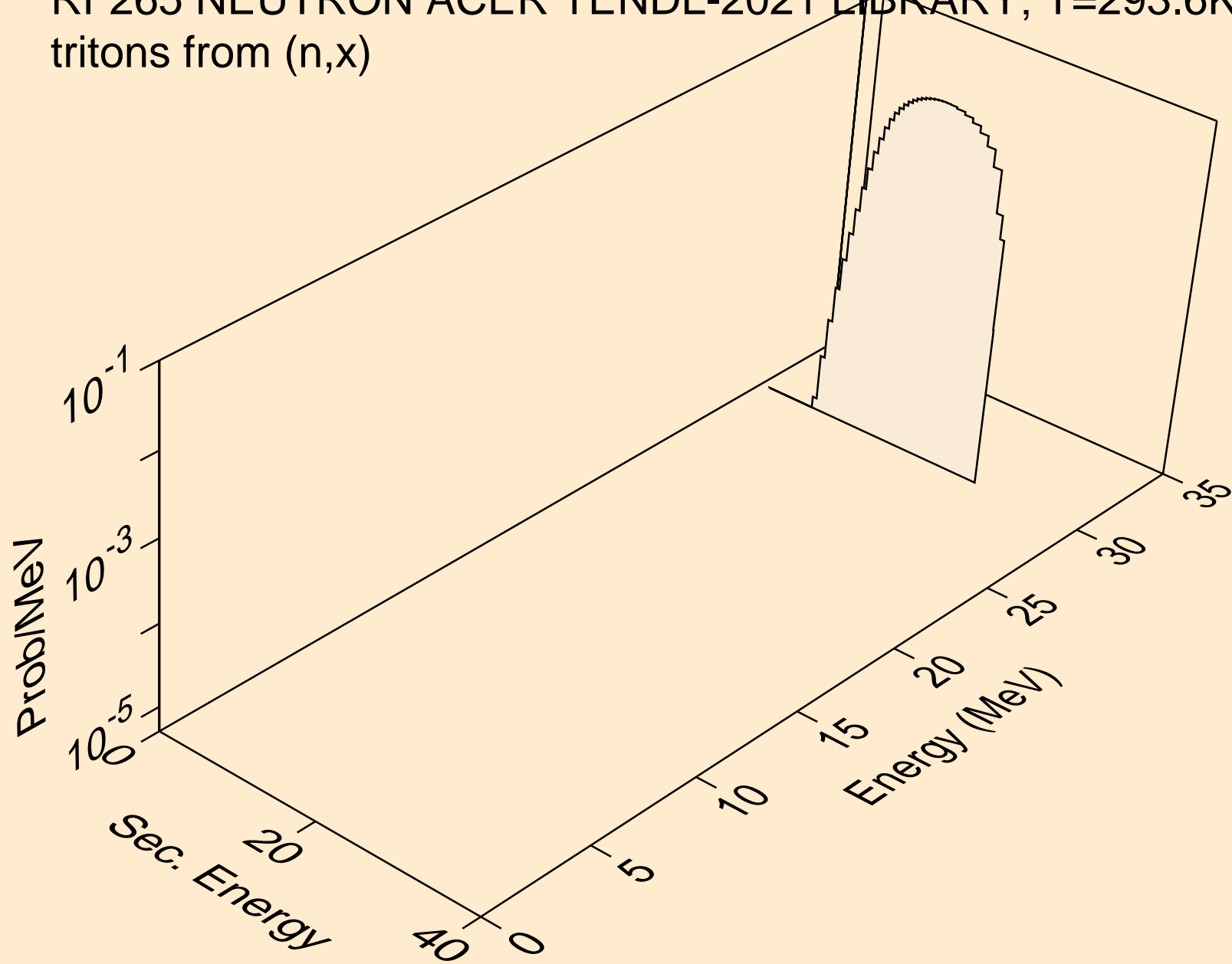

RF265 NEUTRON ACER TENDL-2021 LIBRARY; T=293.6K
tritons from (n,n*)t

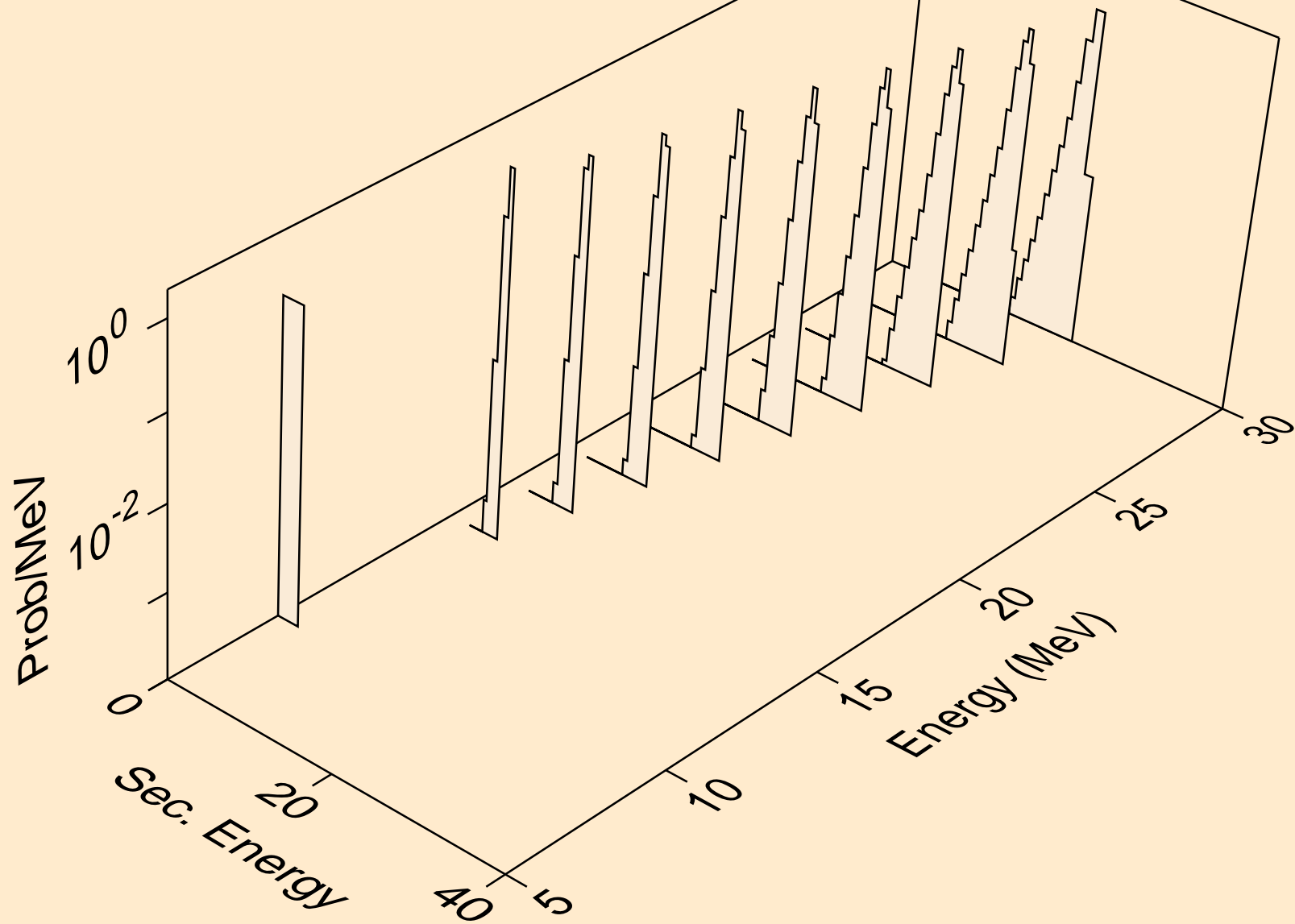

RF265 NEUTRON ACER TENDL-2021 LIBRARY; T=293.6K
tritons from (n,t)

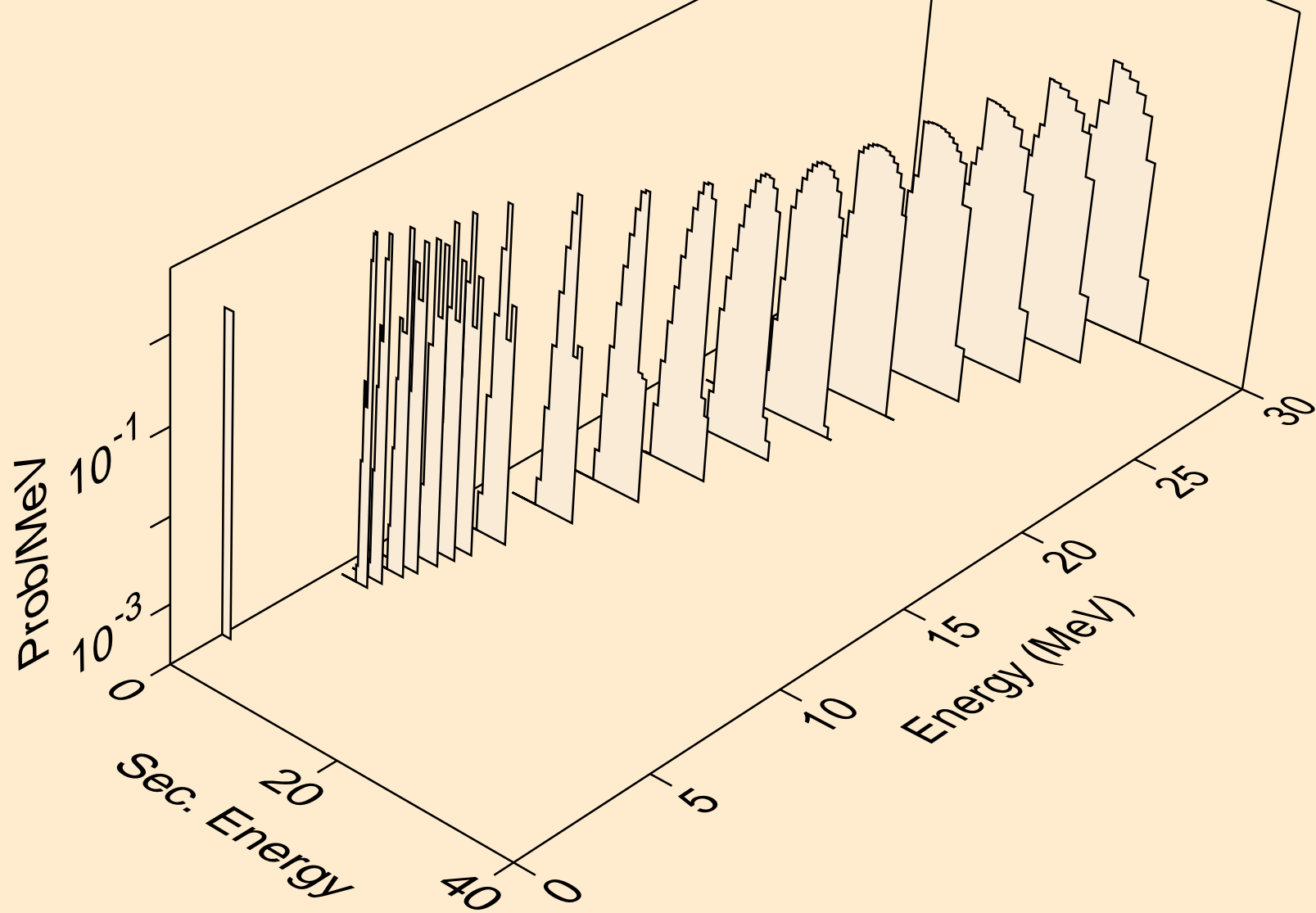

RF265 NEUTRON ACER TENDL-2021 LIBRARY; T=293.6K
he3s from (n,x)

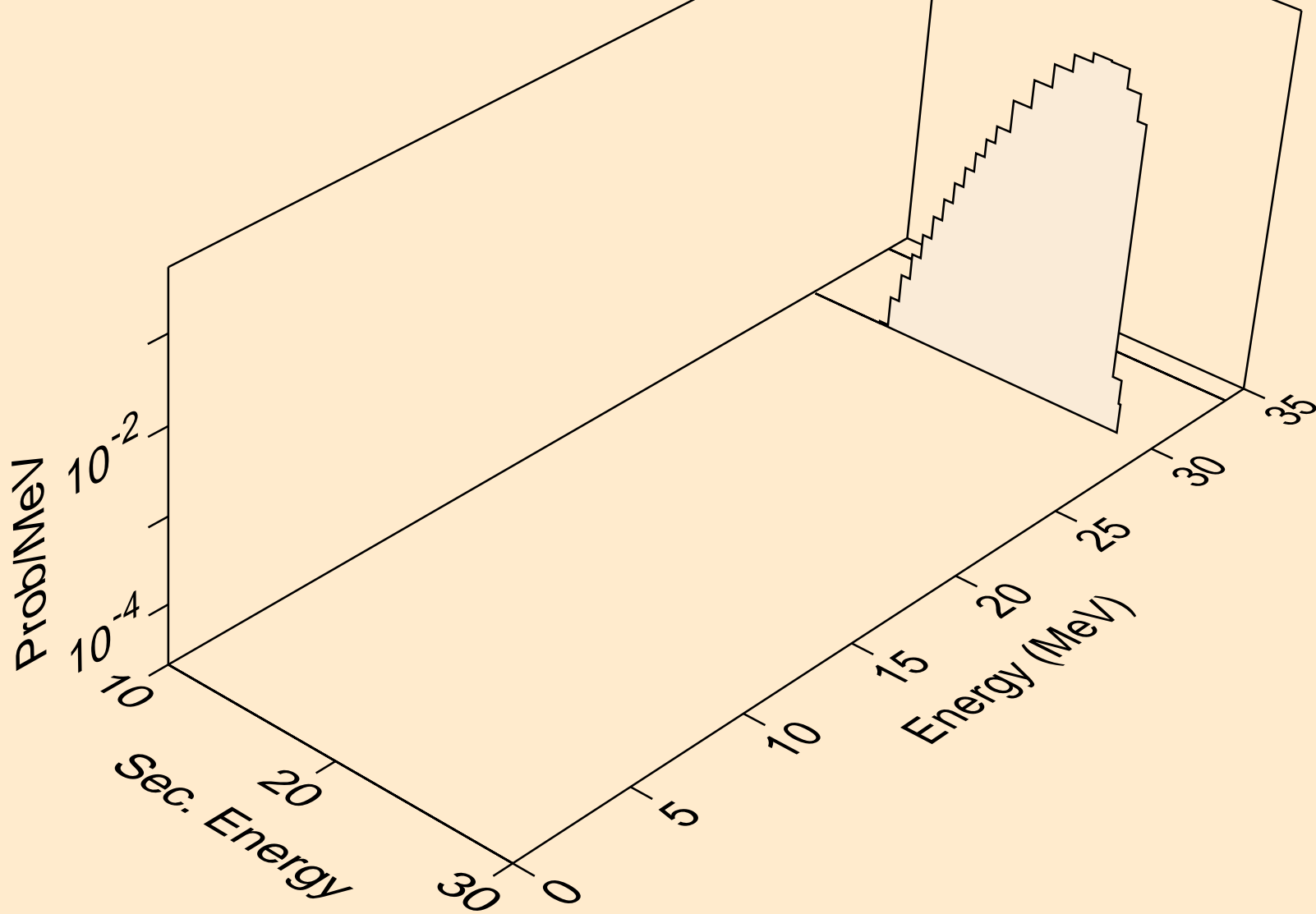

RF265 NEUTRON ACER TENDL-2021 LIBRARY; T=293.6K
he3s from (n,n*)he3

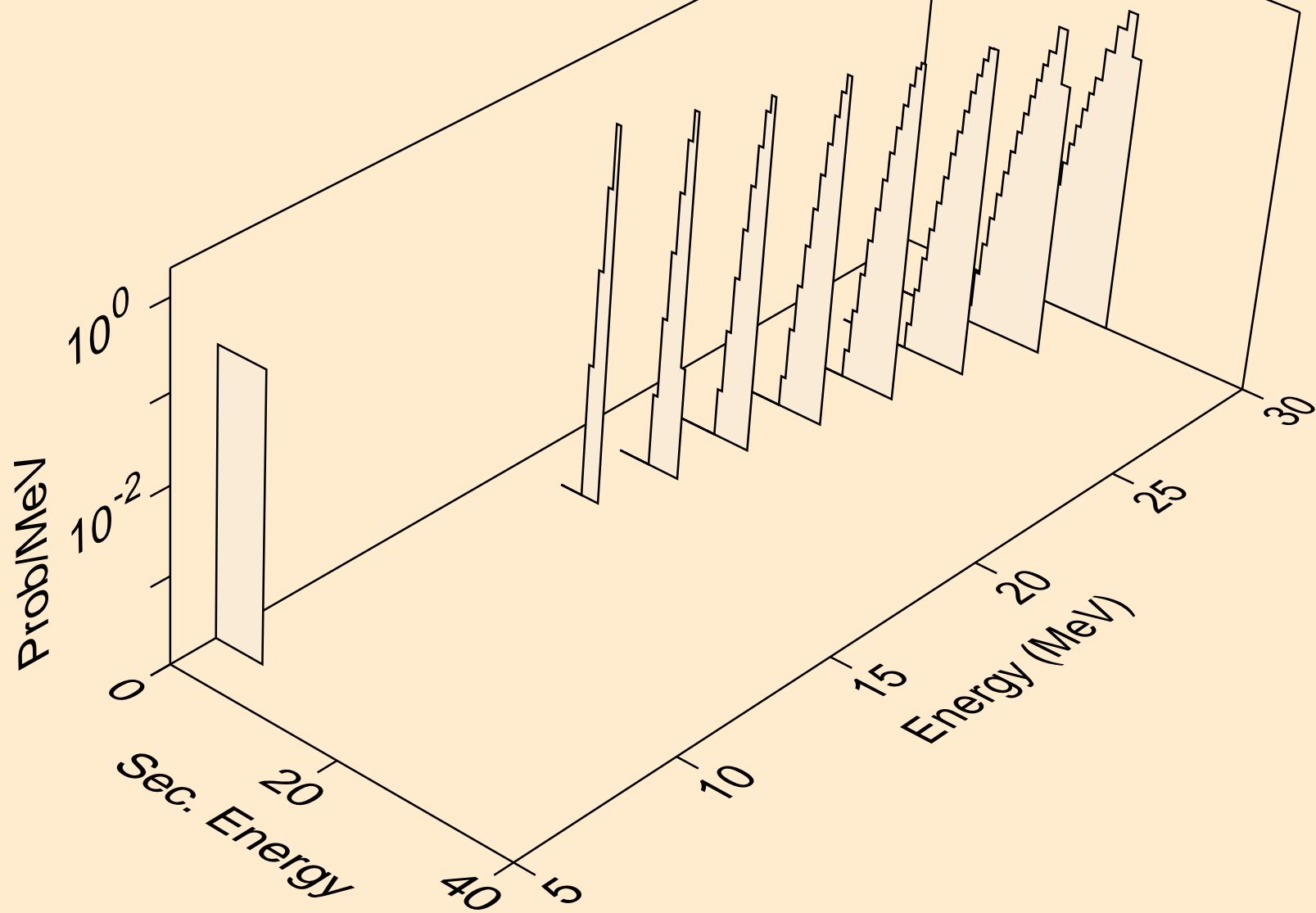

RF265 NEUTRON ACER TENDL-2021 LIBRARY; T=293.6K
he3s from (n,he3)

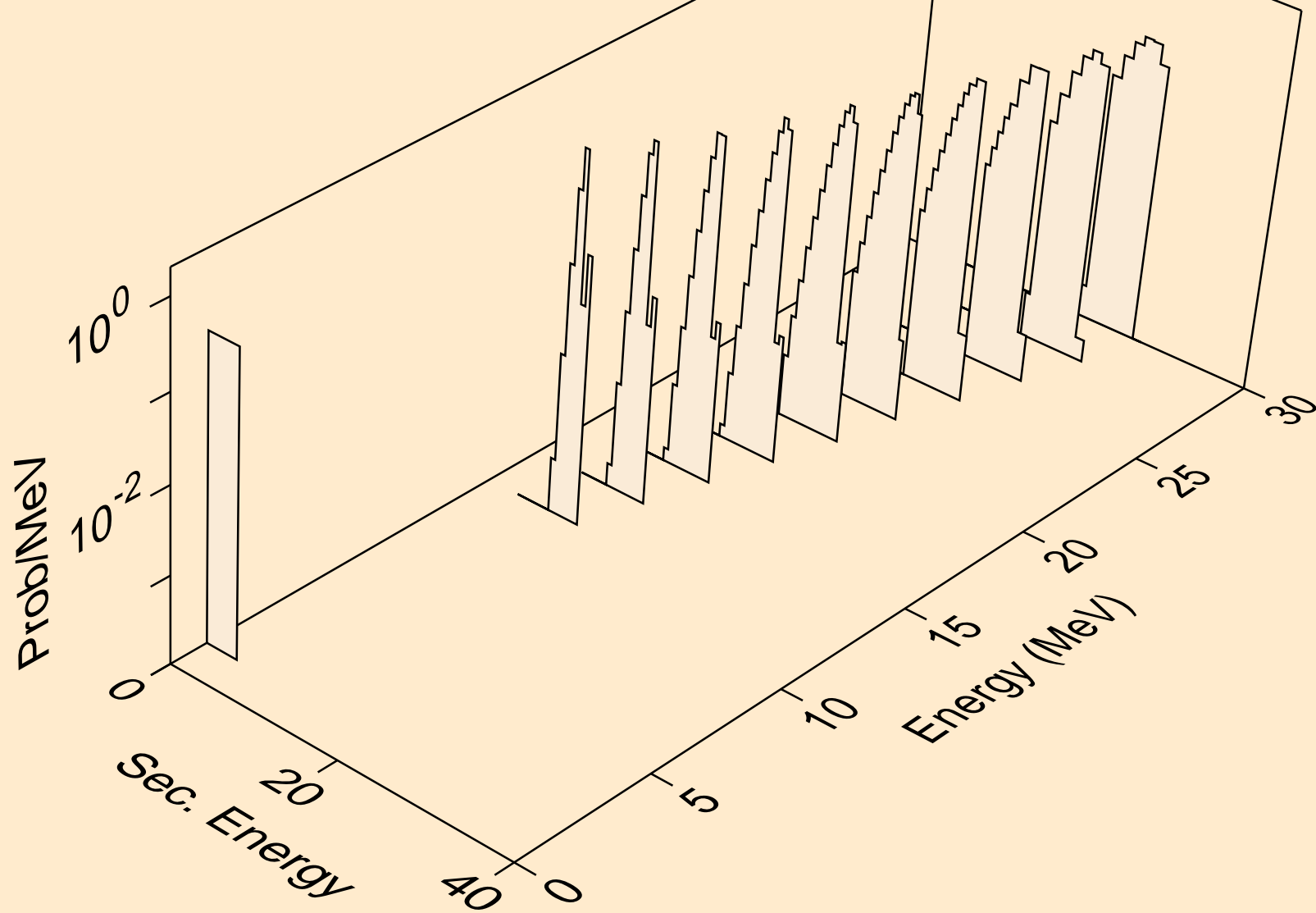

RF265 NEUTRON ACER TENDL-2021 LIBRARY; T=293.6K
alphas from (n,x)

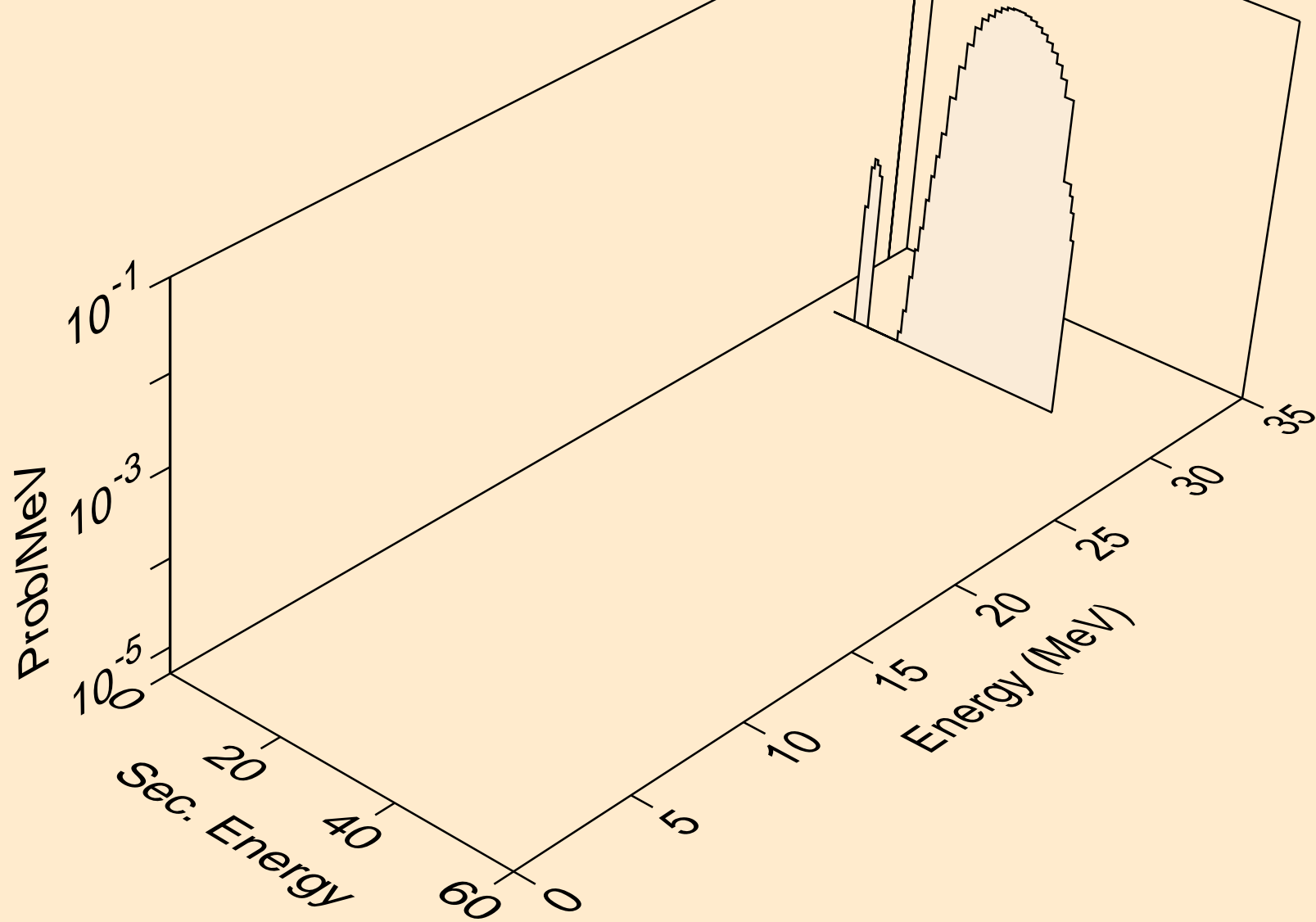

RF265 NEUTRON ACER TENDL-2021 LIBRARY; T=293.6K
alphas from (n,n*)a

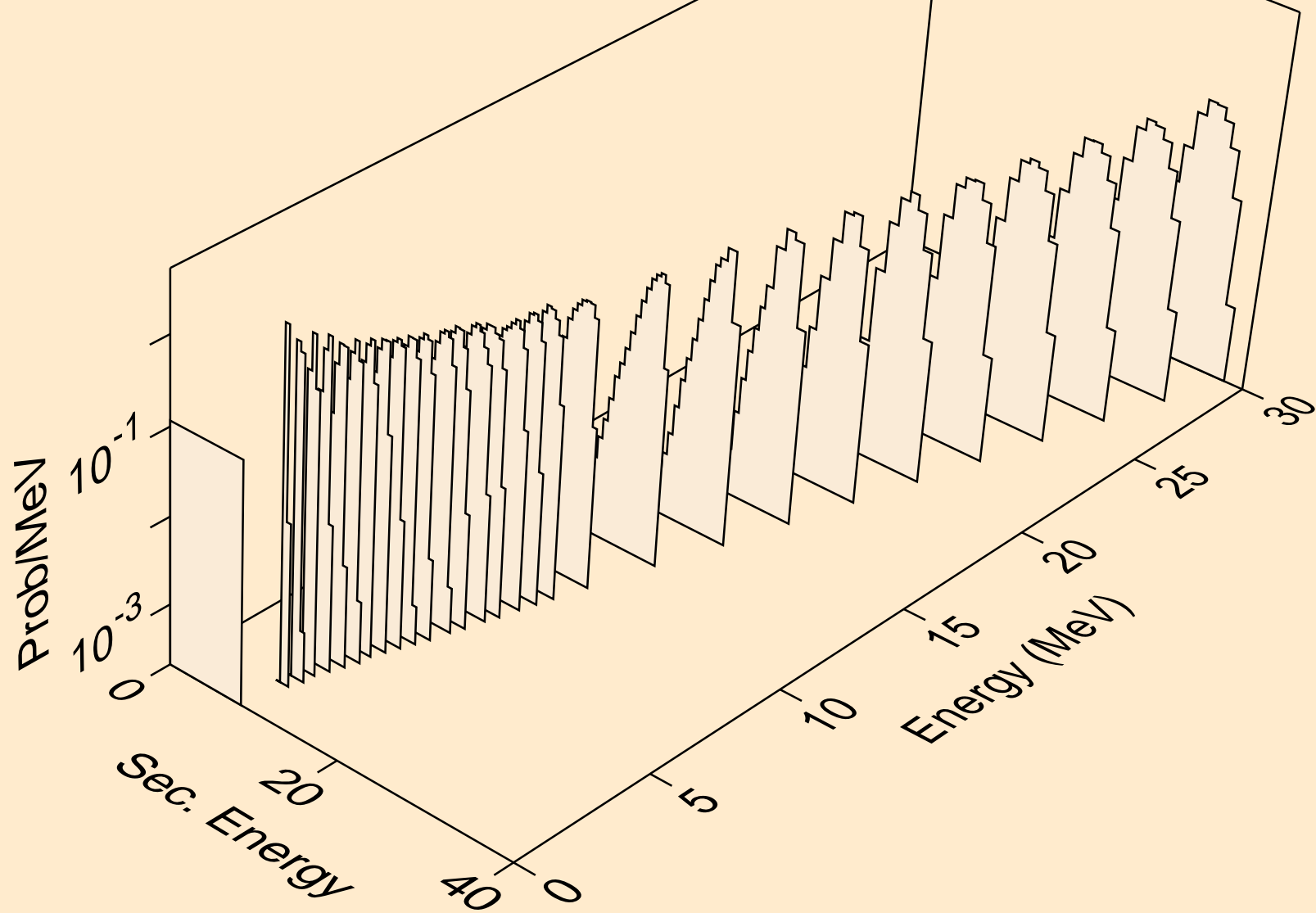

RF265 NEUTRON ACER TENDL-2021 LIBRARY; T=293.6K
alphas from (n,2n)a

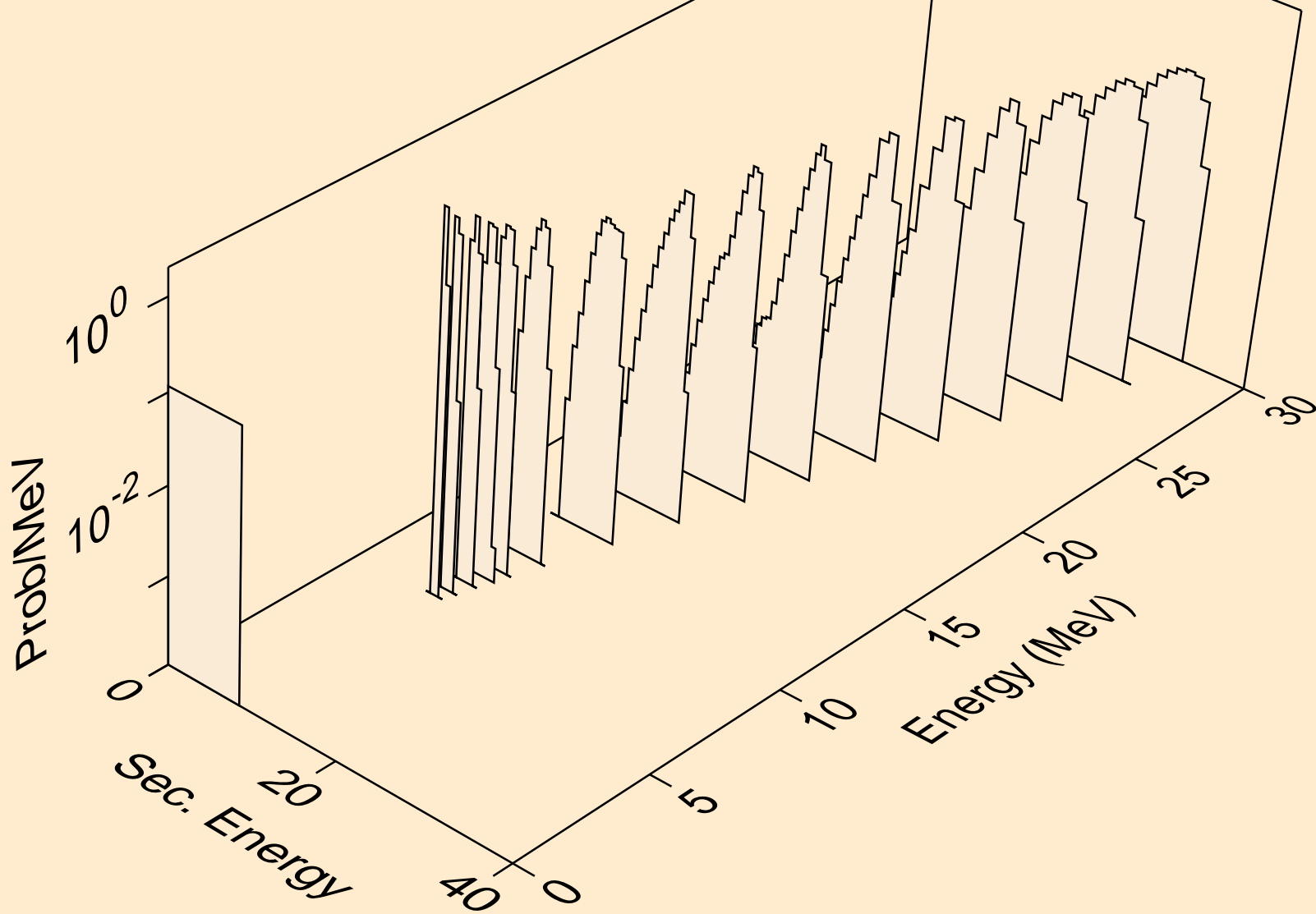

RF265 NEUTRON ACER TENDL-2021 LIBRARY; T=293.6K
alphas from (n,3n)a

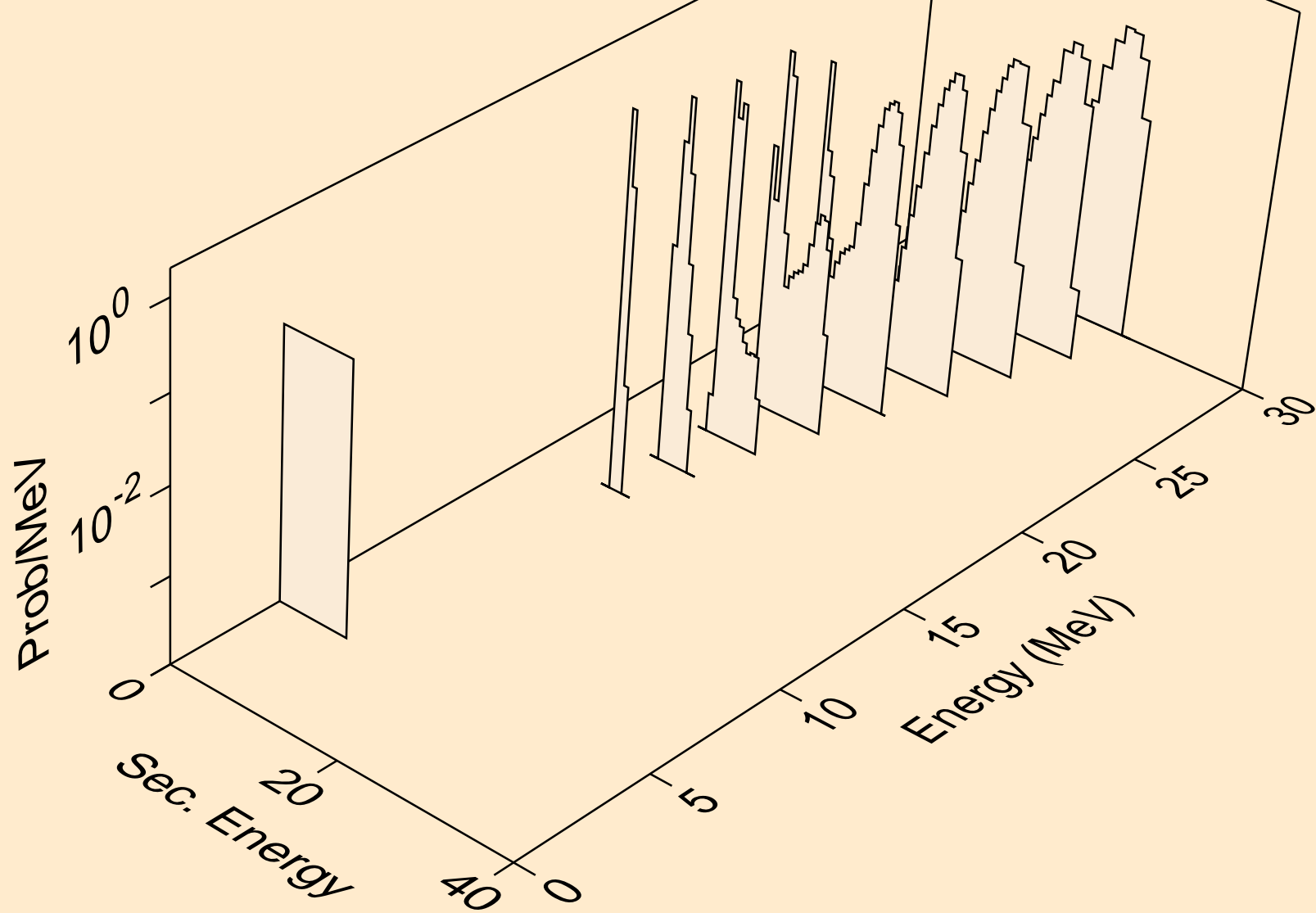

RF265 NEUTRON ACER TENDL-2021 LIBRARY; T=293.6K
alphas from (n,n*)2a

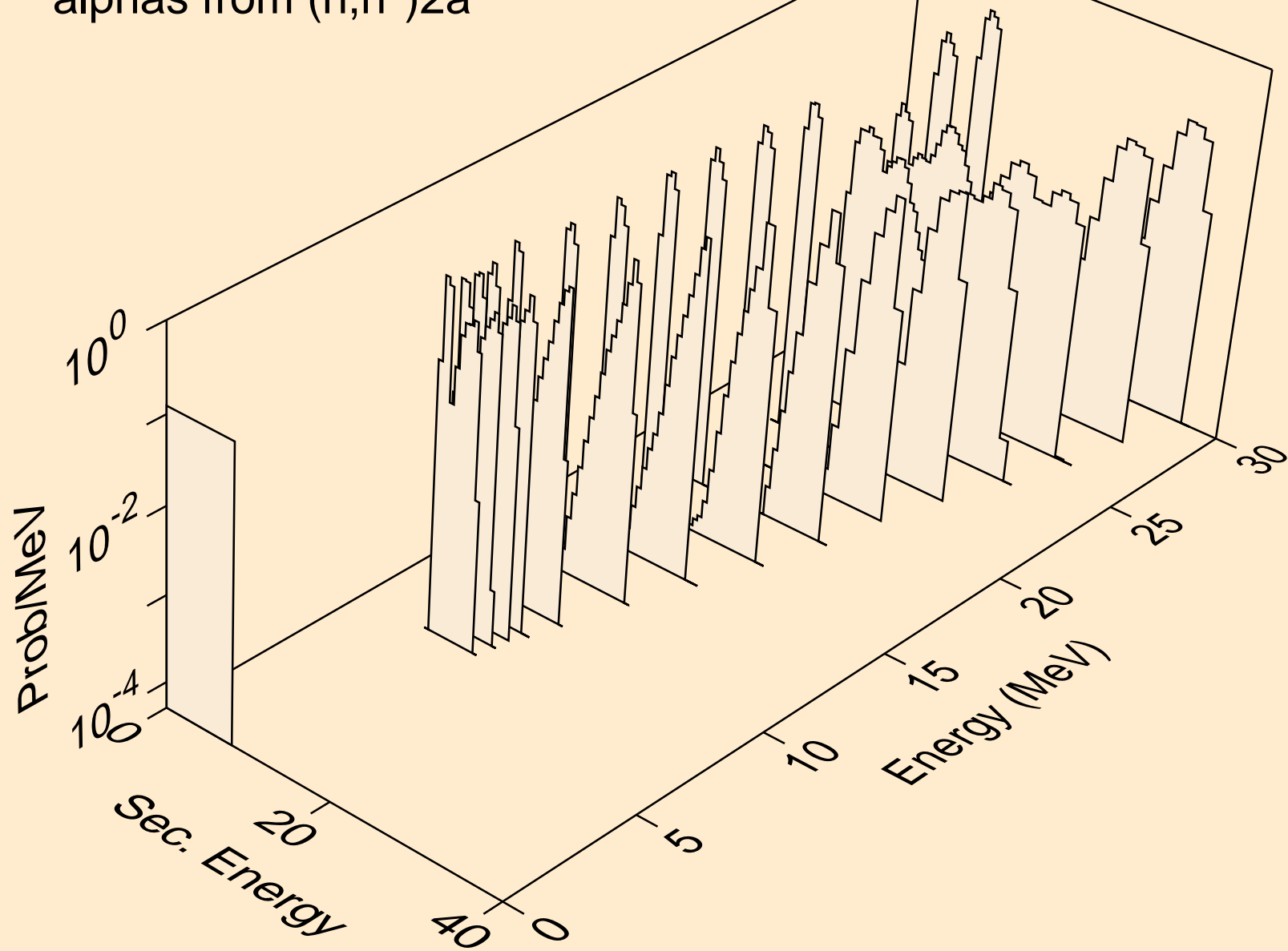

RF265 NEUTRON ACER TENDL-2021 LIBRARY; T=293.6K
alphas from (n,a)

