

RF266 NEUTRON ACER TENDL-2021 LIBRARY; T=293.6K

Principal cross sections

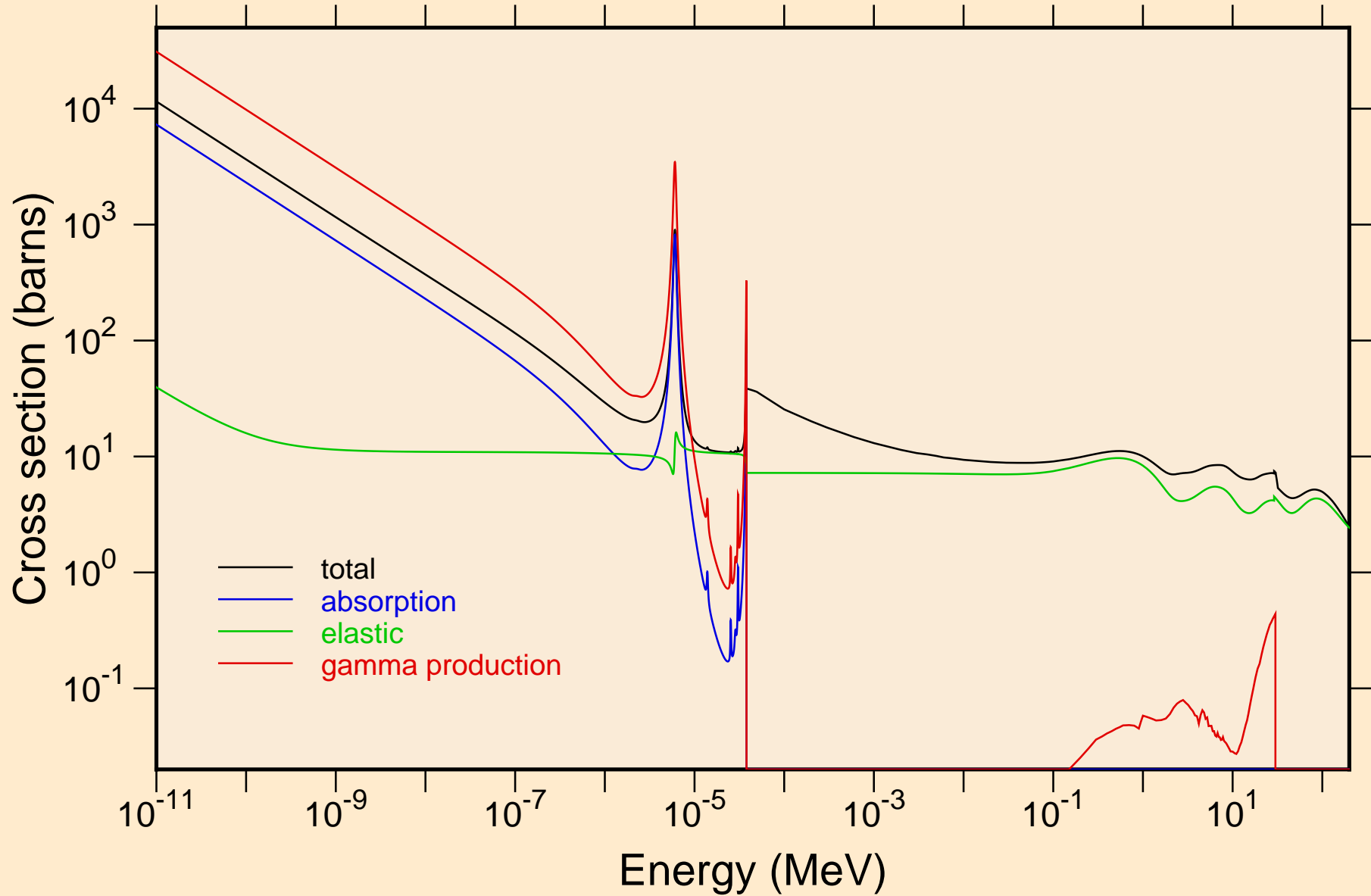

RF266 NEUTRON ACER TENDL-2021 LIBRARY; T=293.6K
Heating

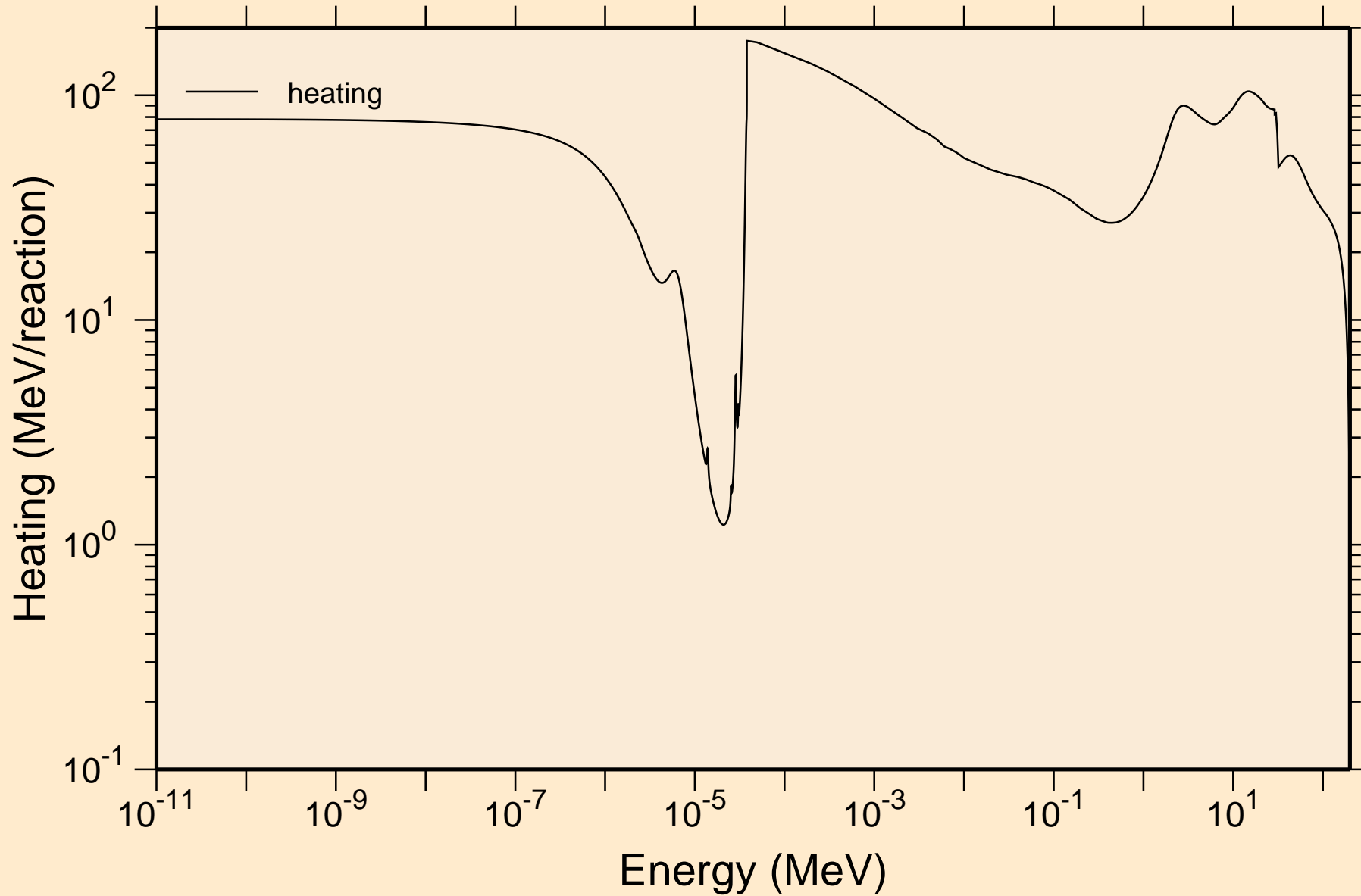

RF266 NEUTRON ACER TENDL-2021 LIBRARY; T=293.6K
Damage

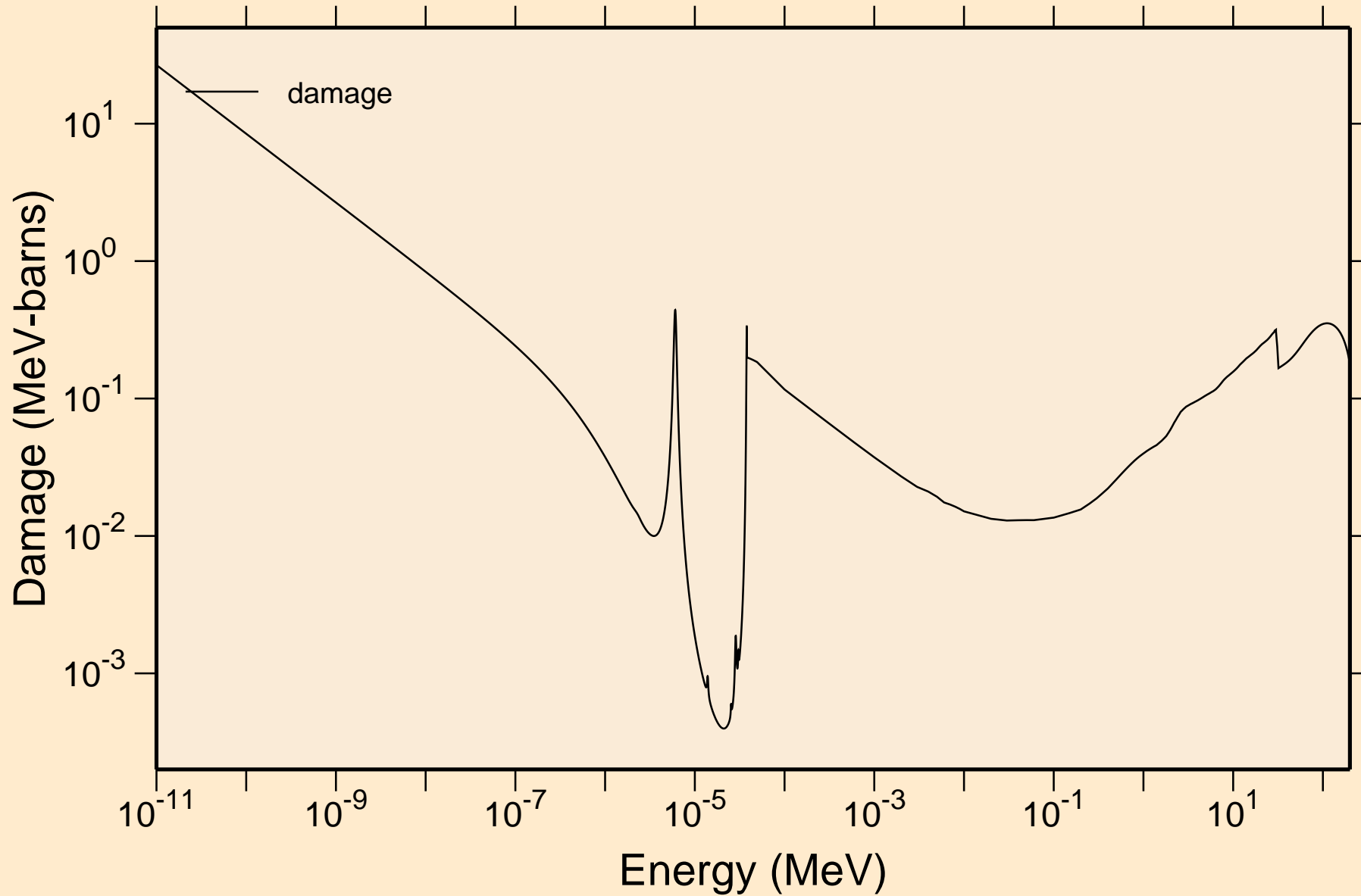

RF266 NEUTRON ACER TENDL-2021 LIBRARY; T=293.6K
Non-threshold reactions

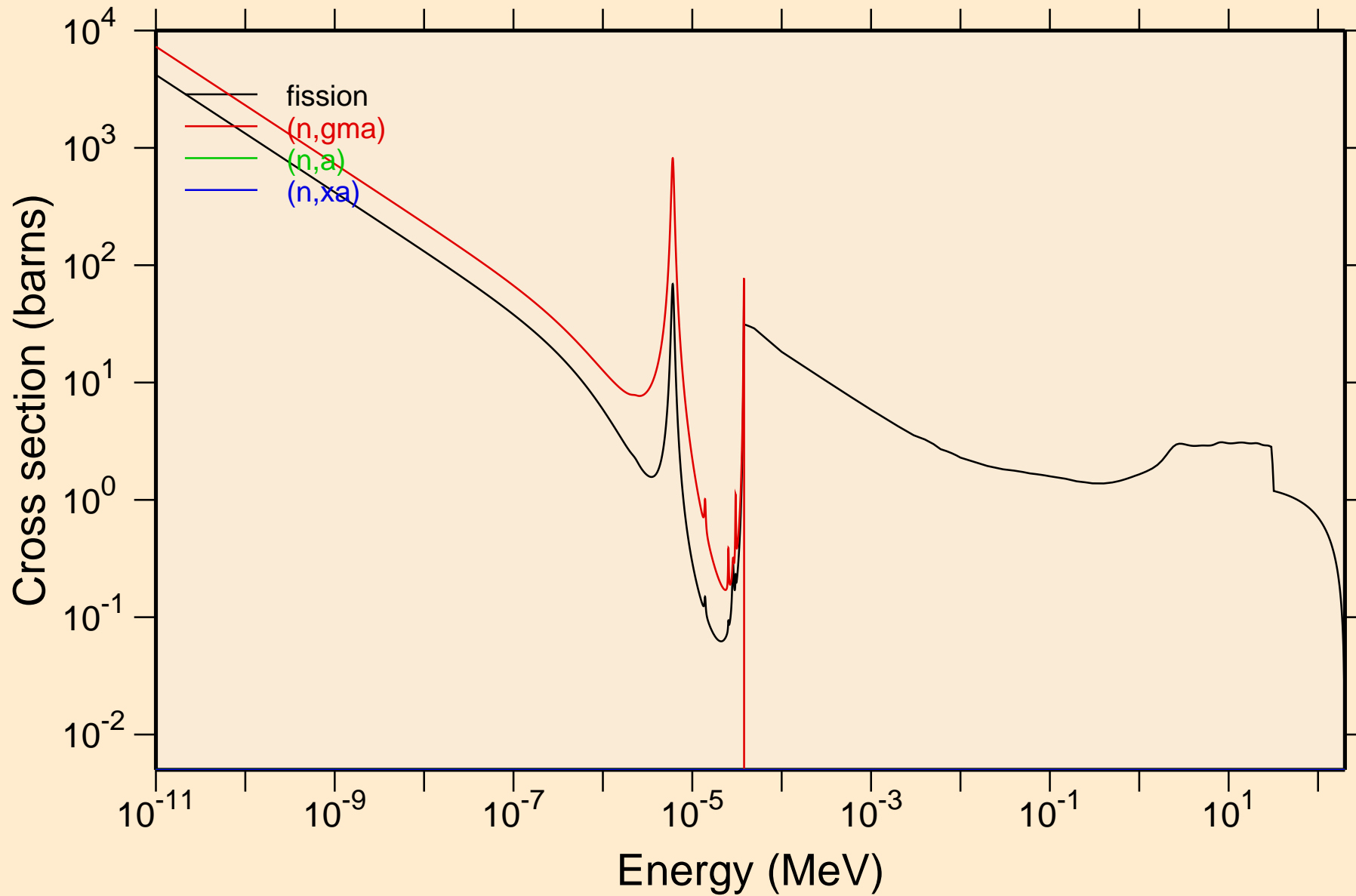

RF266 NEUTRON ACER TENDL-2021 LIBRARY; T=293.6K
Principal cross sections

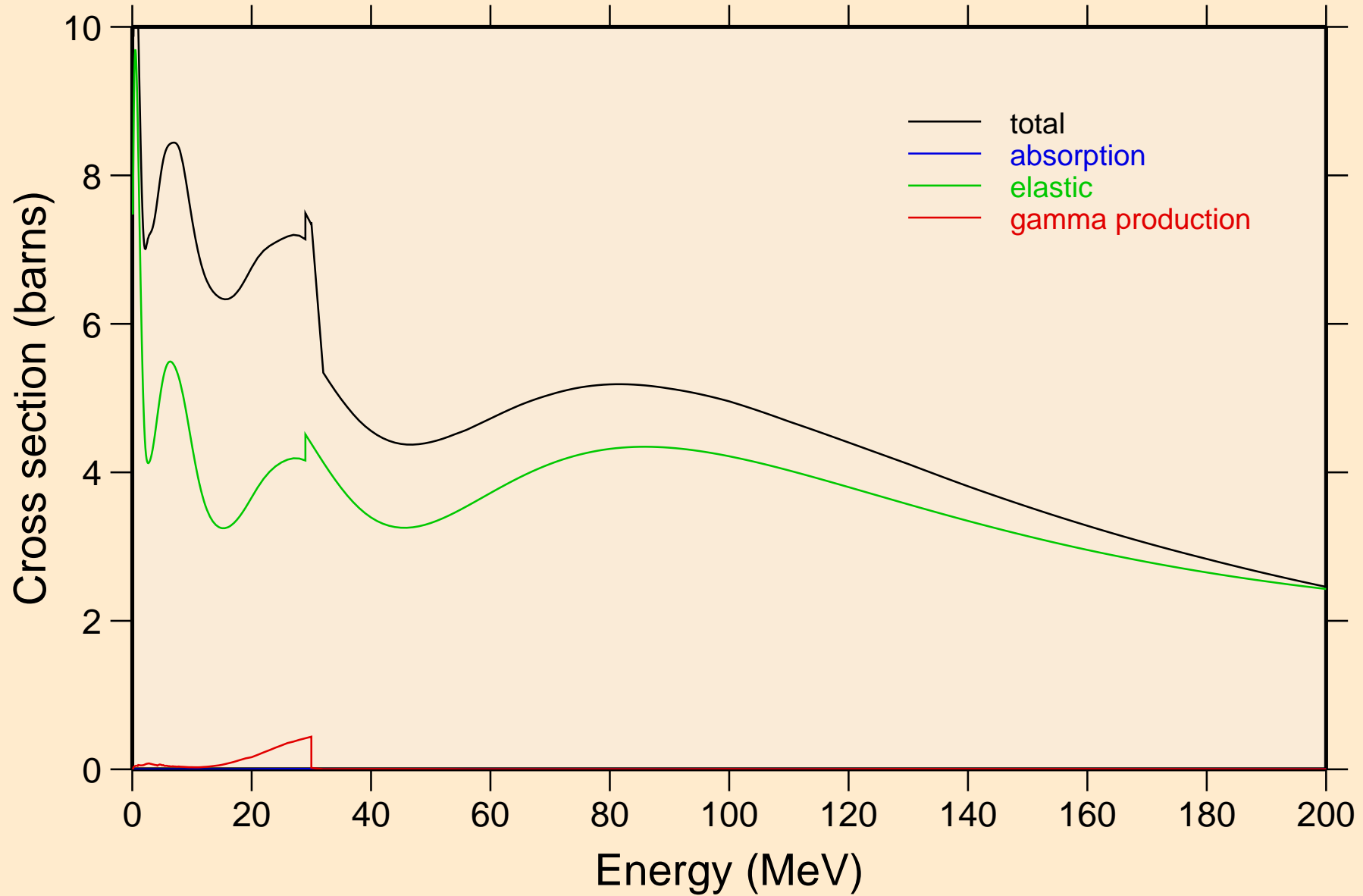

RF266 NEUTRON ACER TENDL-2021 LIBRARY; T=293.6K
Heating

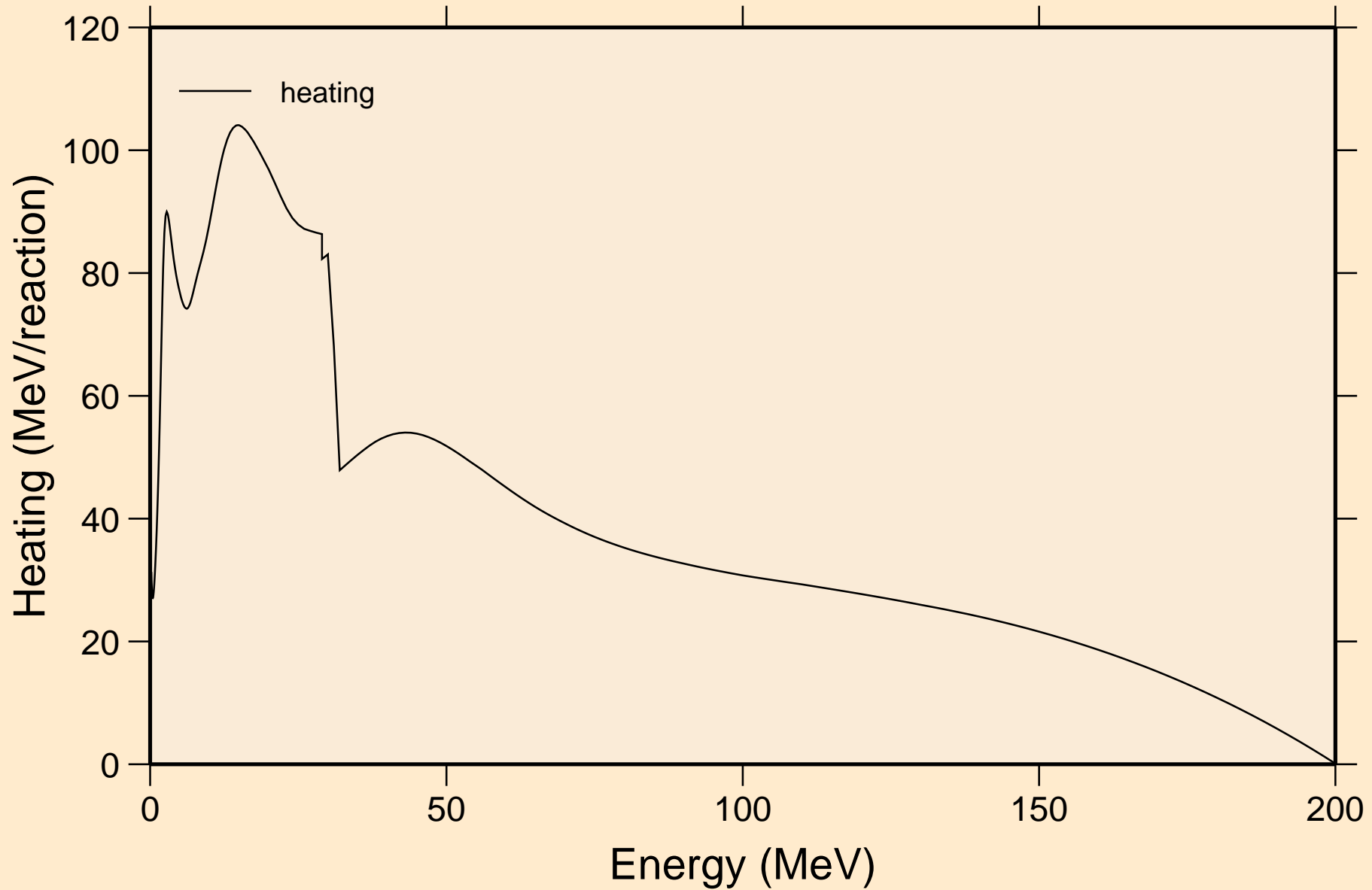

RF266 NEUTRON ACER TENDL-2021 LIBRARY; T=293.6K
Damage

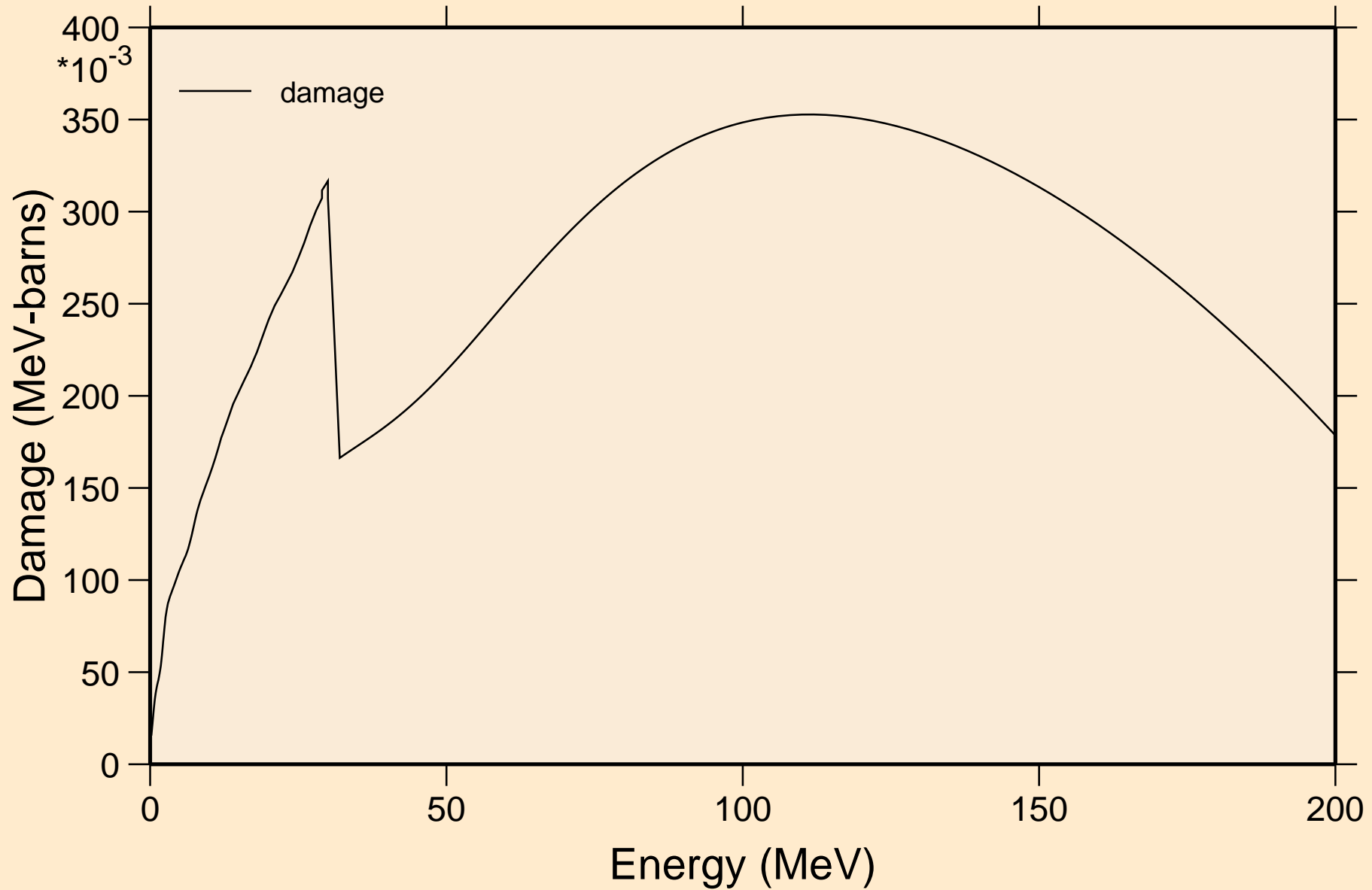

RF266 NEUTRON ACER TENDL-2021 LIBRARY; T=293.6K
Non-threshold reactions

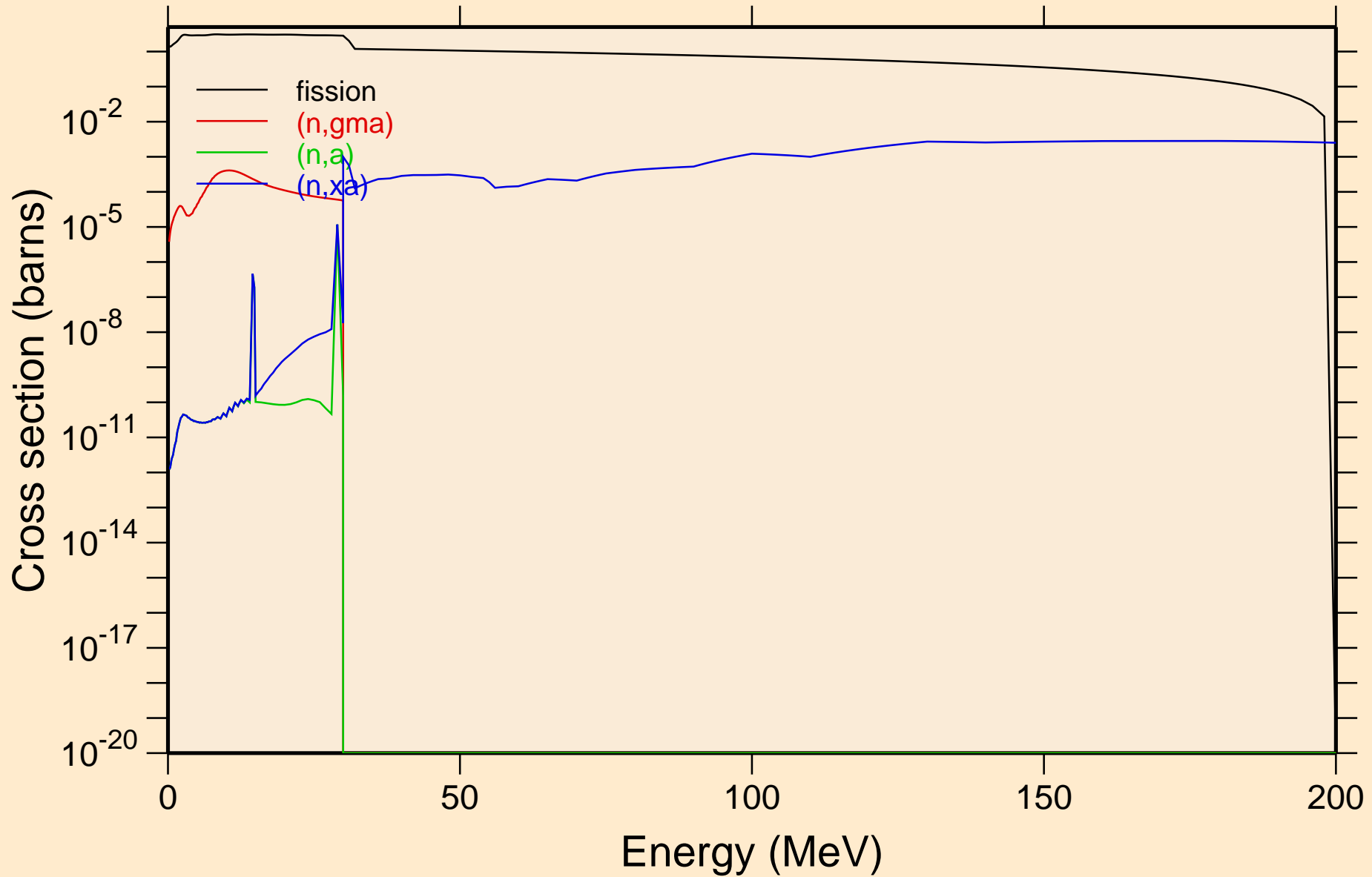

RF266 NEUTRON ACER TENDL-2021 LIBRARY; T=293.6K
Inelastic levels

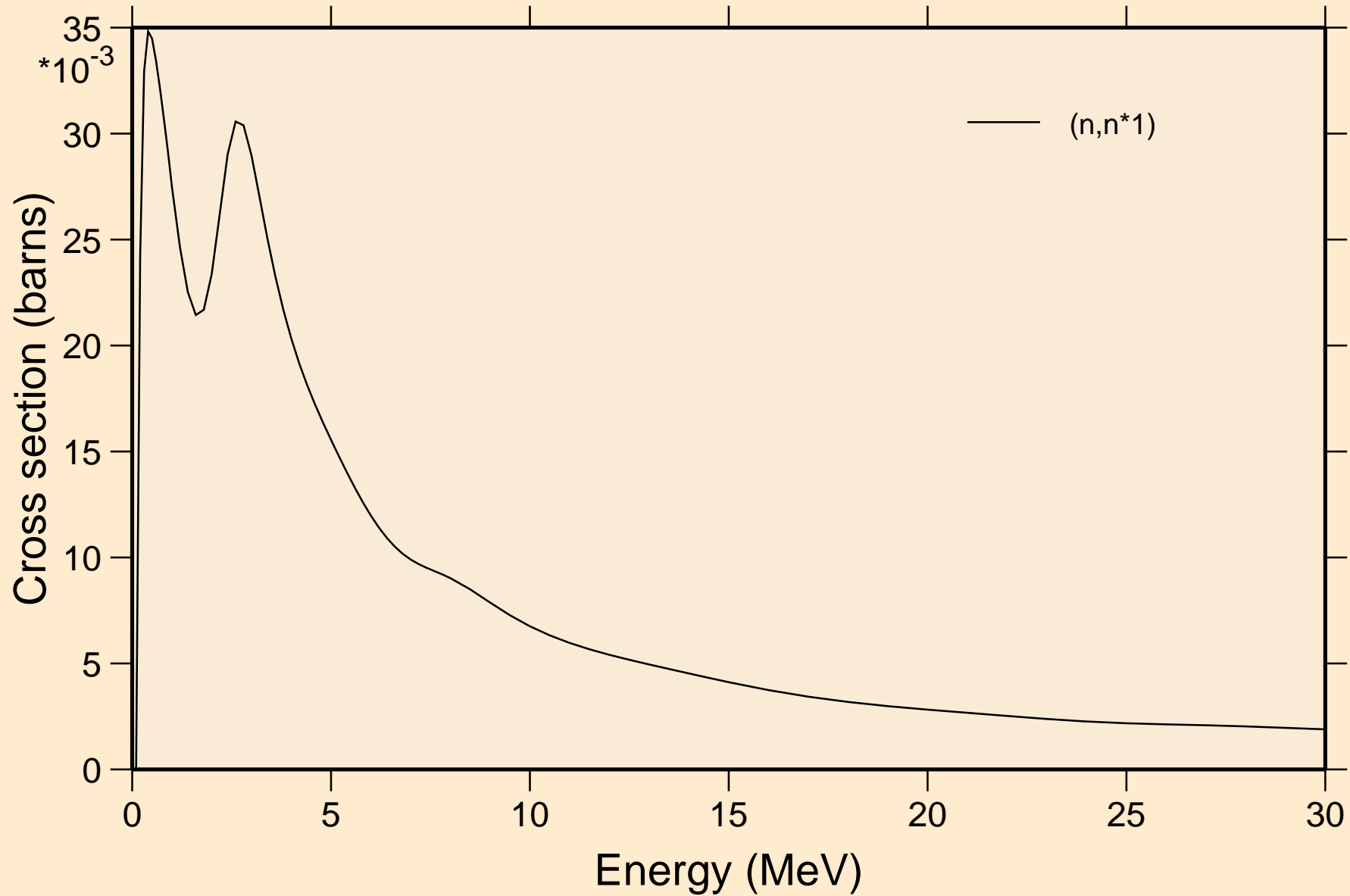

RF266 NEUTRON ACER TENDL-2021 LIBRARY; T=293.6K
Threshold reactions

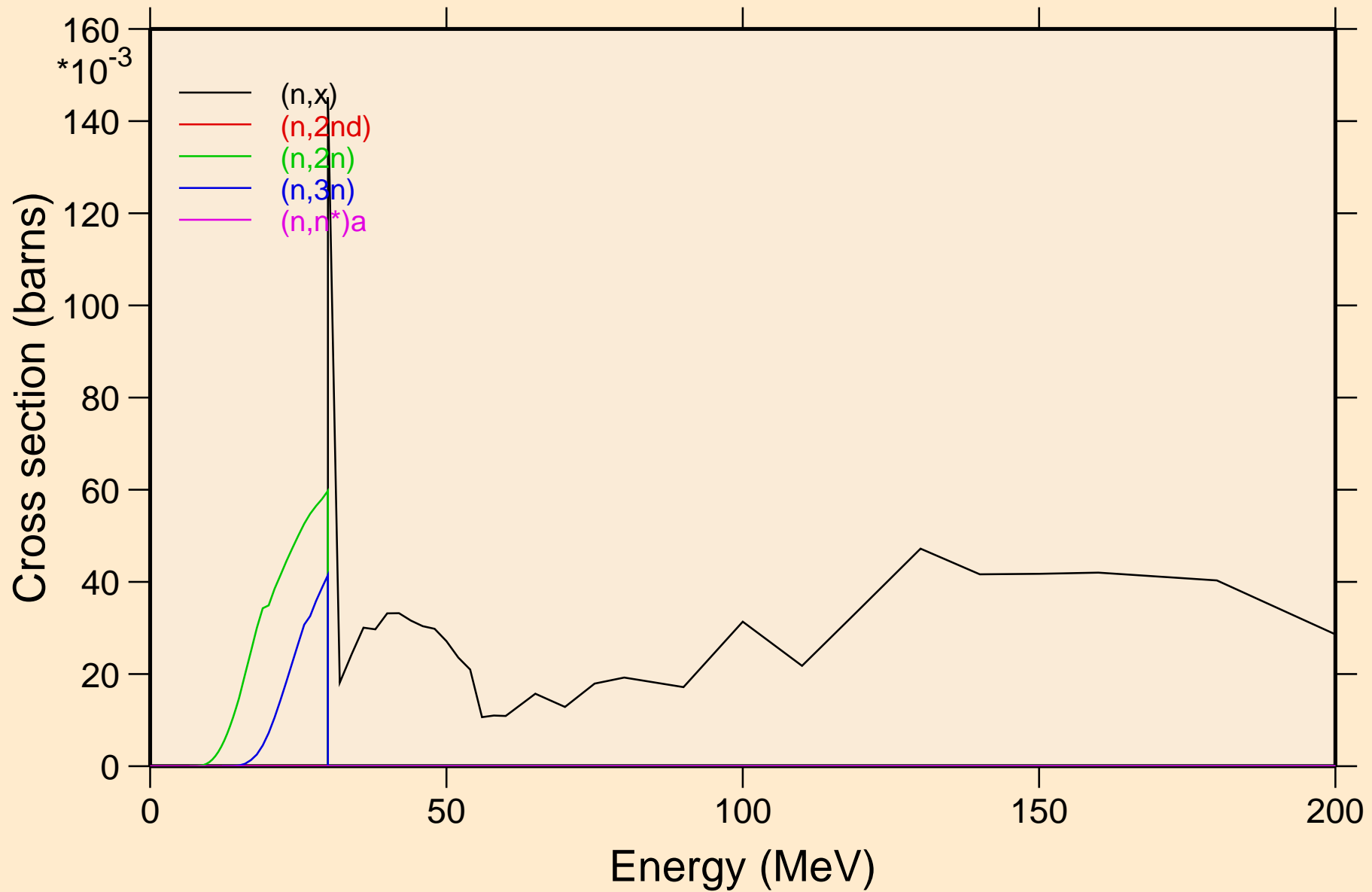

RF266 NEUTRON ACER TENDL-2021 LIBRARY; T=293.6K
Threshold reactions

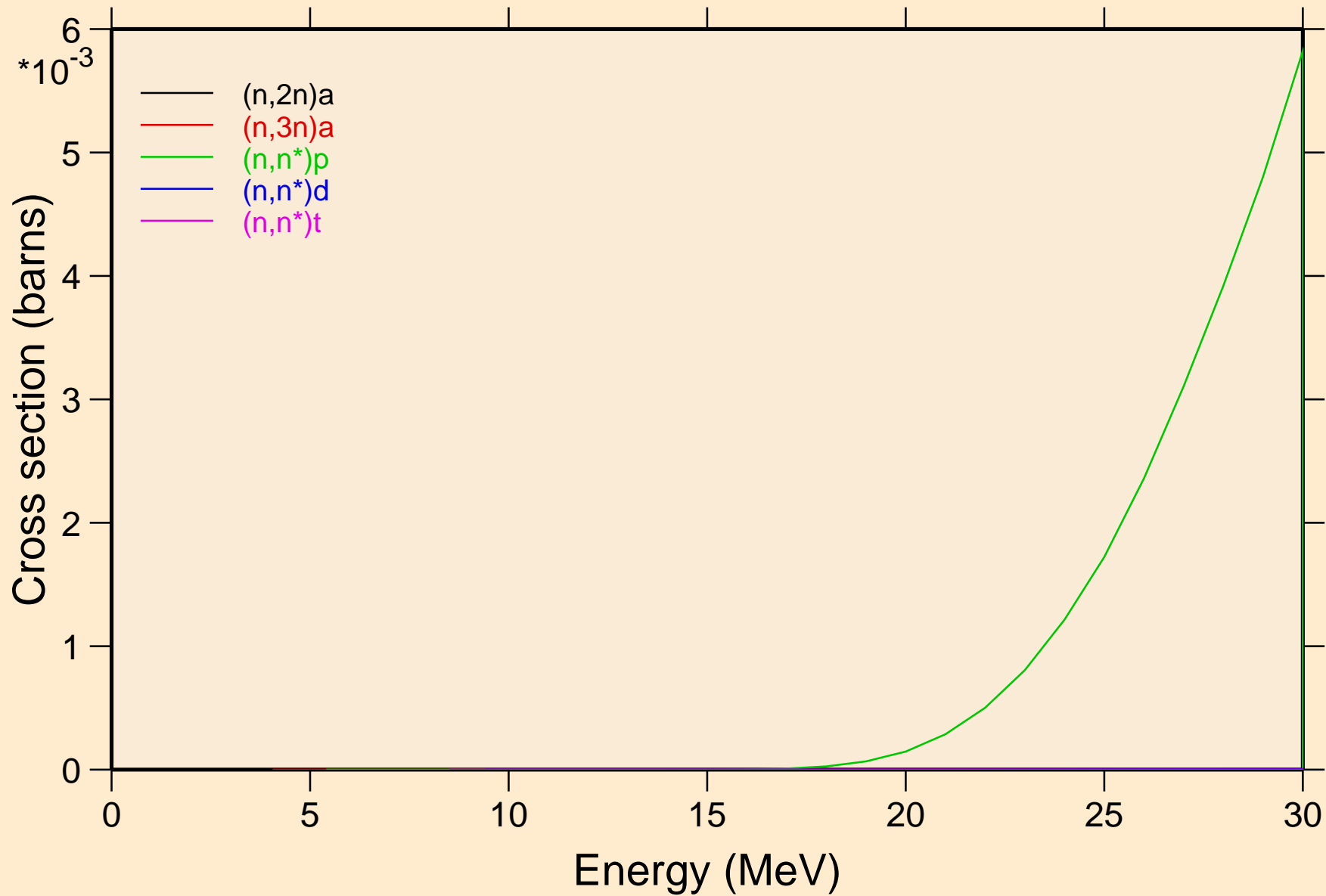

RF266 NEUTRON ACER TENDL-2021 LIBRARY; T=293.6K
Threshold reactions

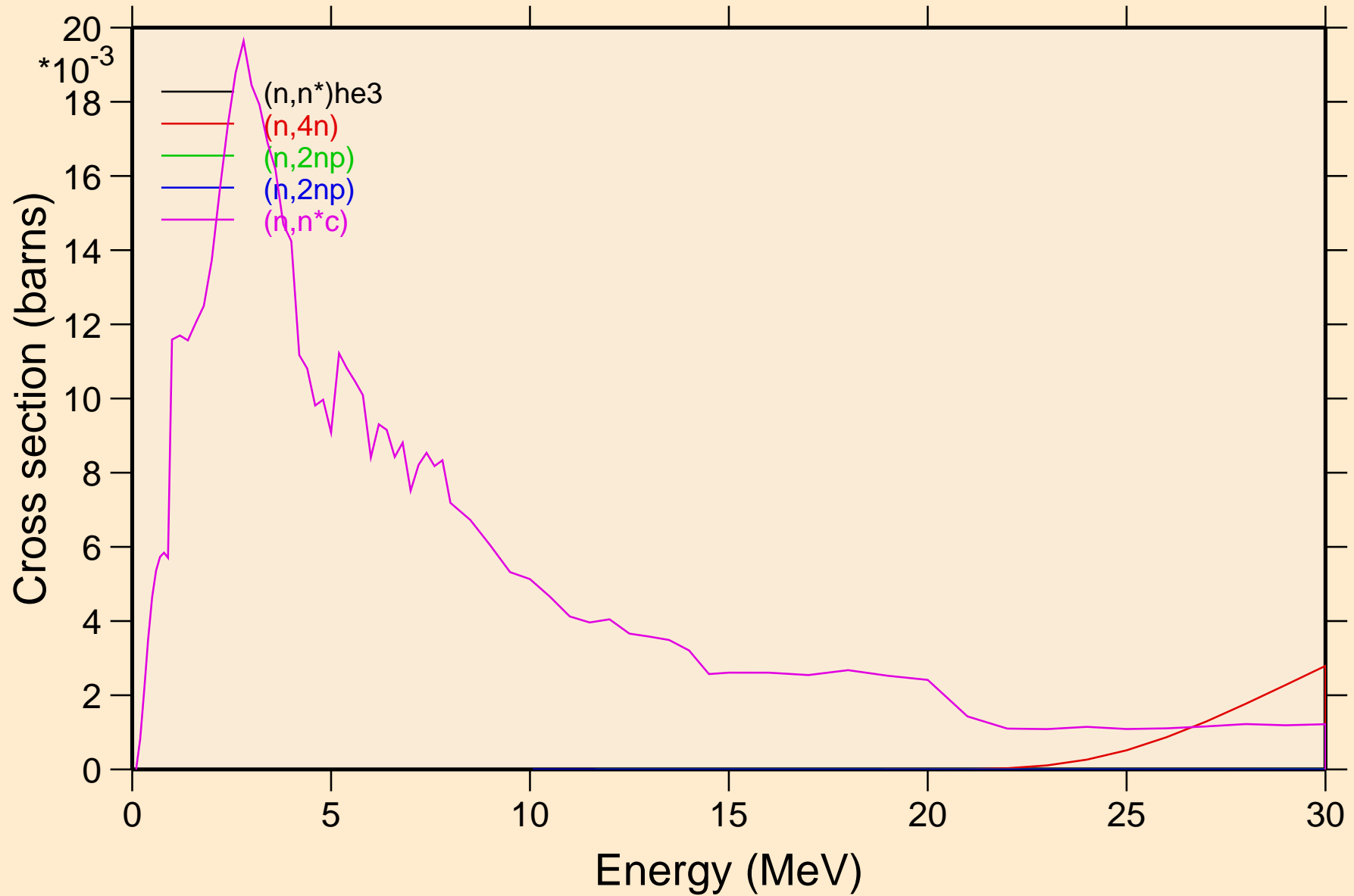

RF266 NEUTRON ACER TENDL-2021 LIBRARY; T=293.6K
Threshold reactions

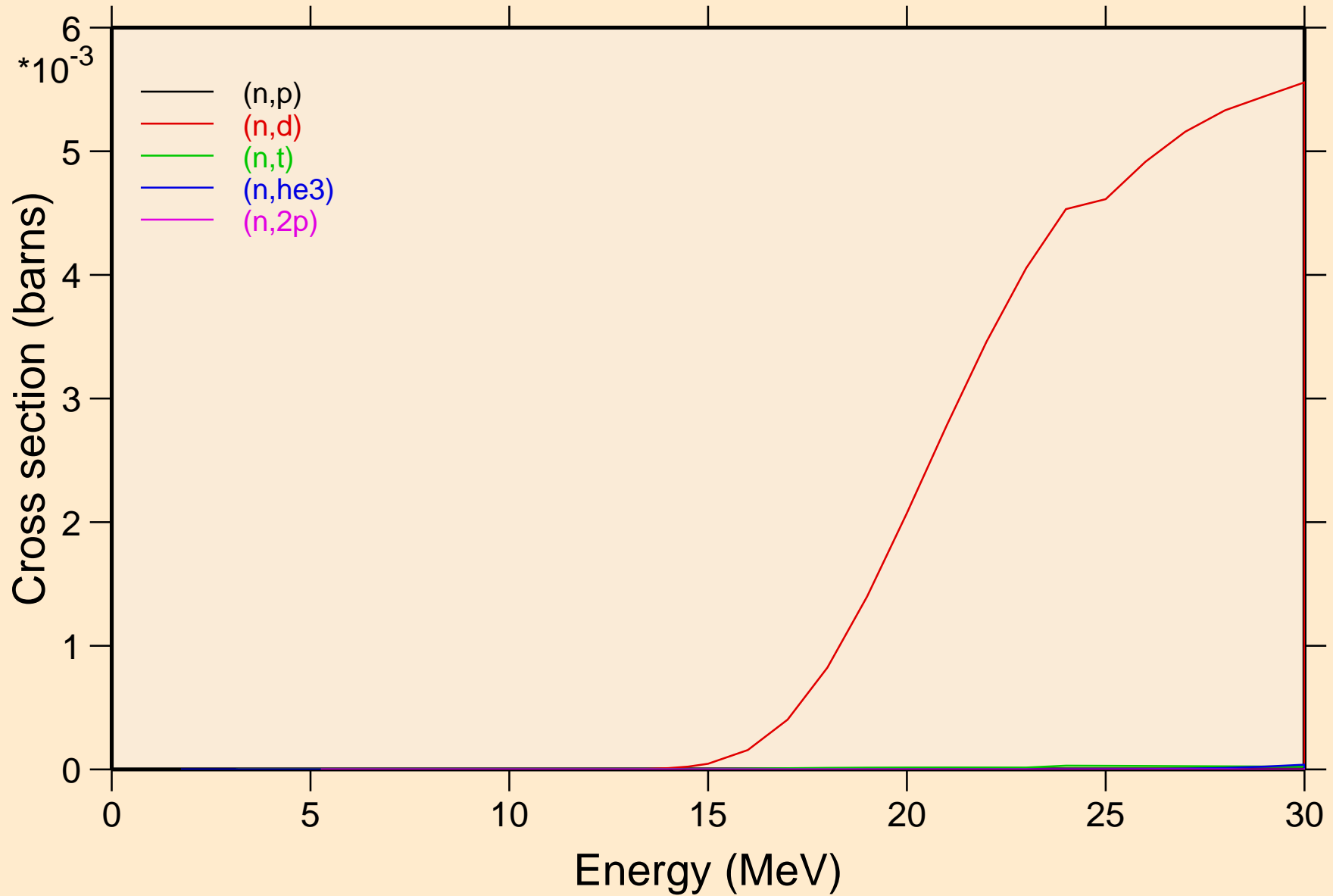

RF266 NEUTRON ACER TENDL-2021 LIBRARY; T=293.6K
Threshold reactions

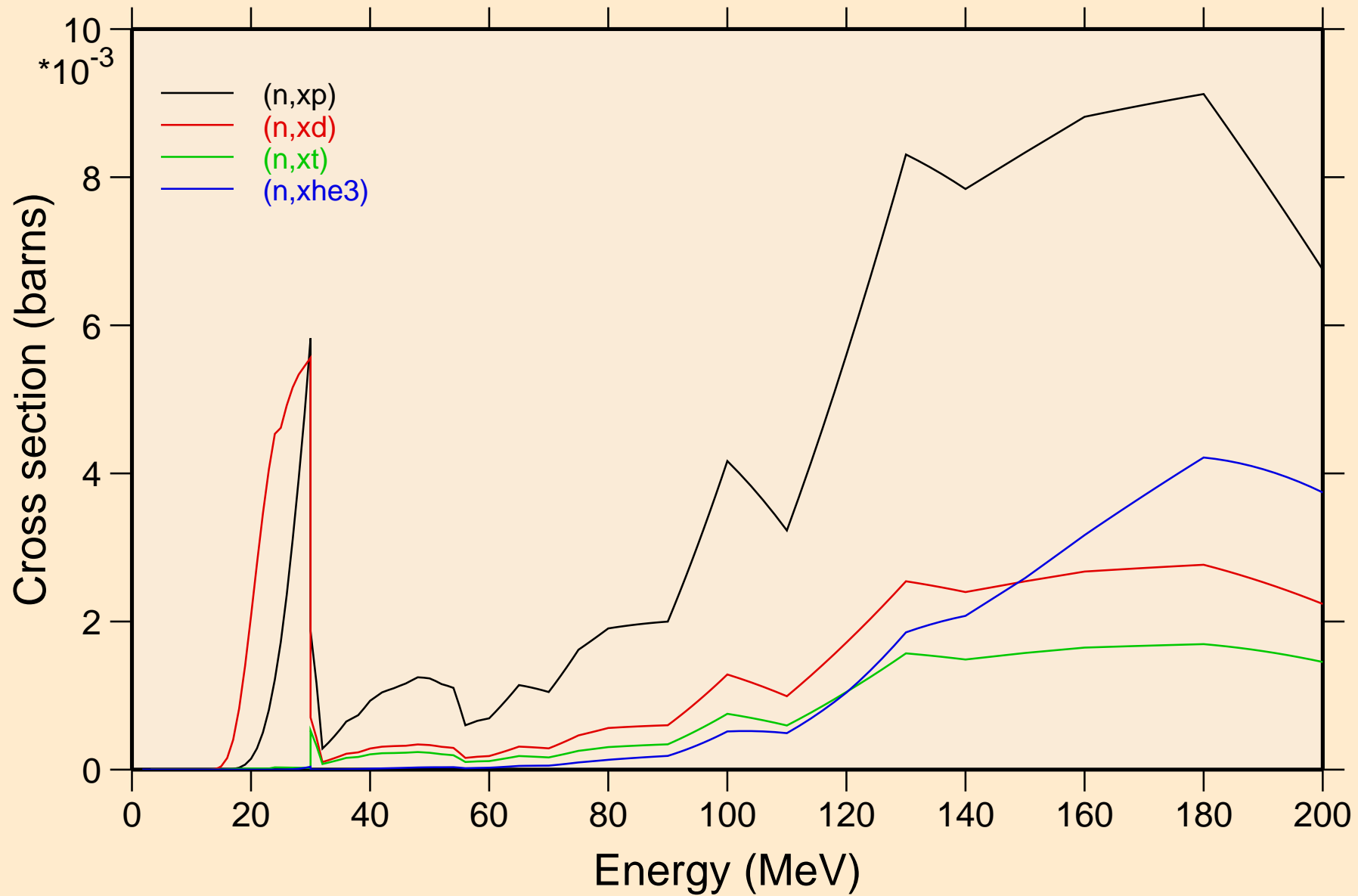

RF266 NEUTRON ACER TENDL-2021 LIBRARY; T=293.6K
angular distribution for elastic

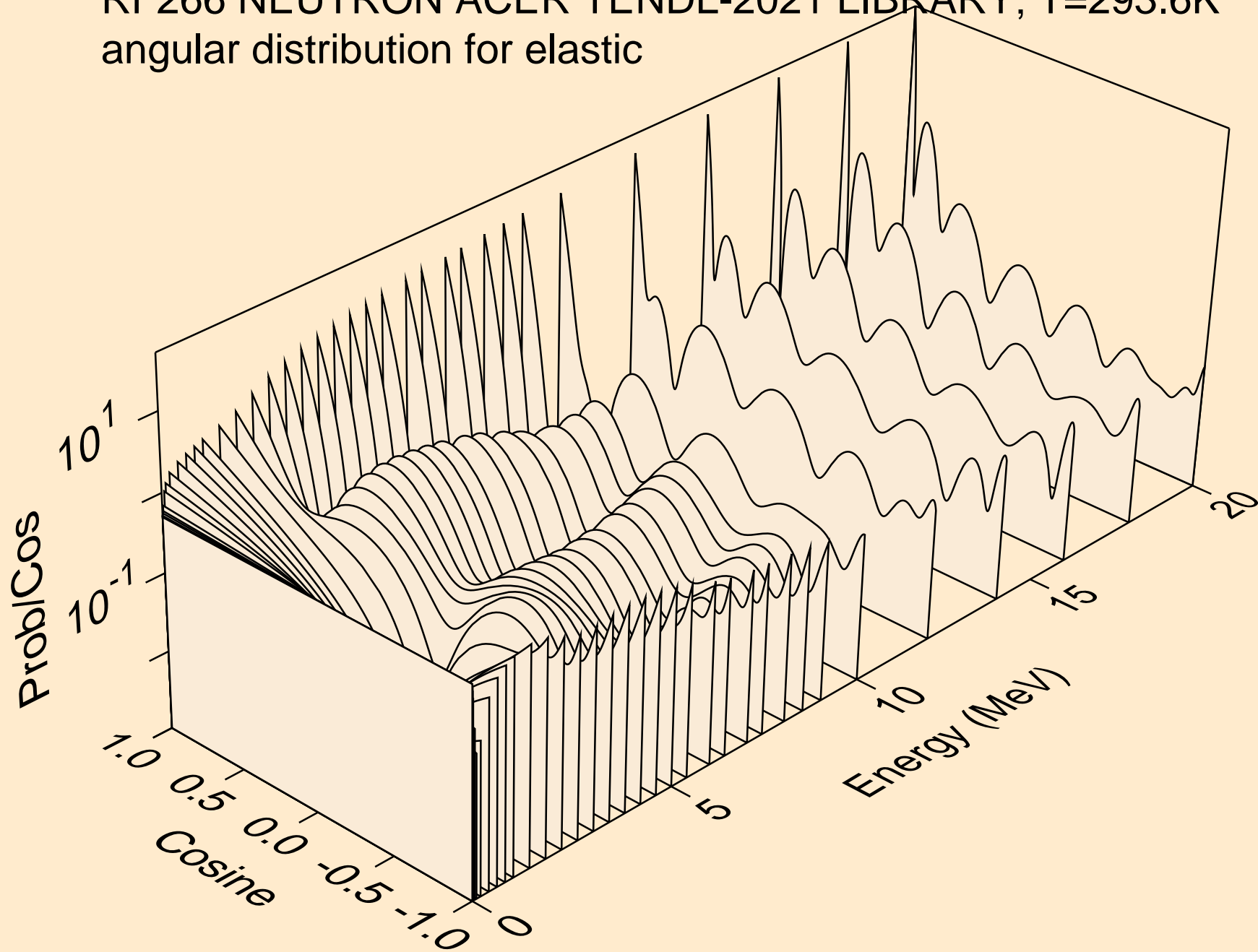

RF266 NEUTRON ACER TENDL-2021 LIBRARY; T=293.6K
angular distribution for elastic

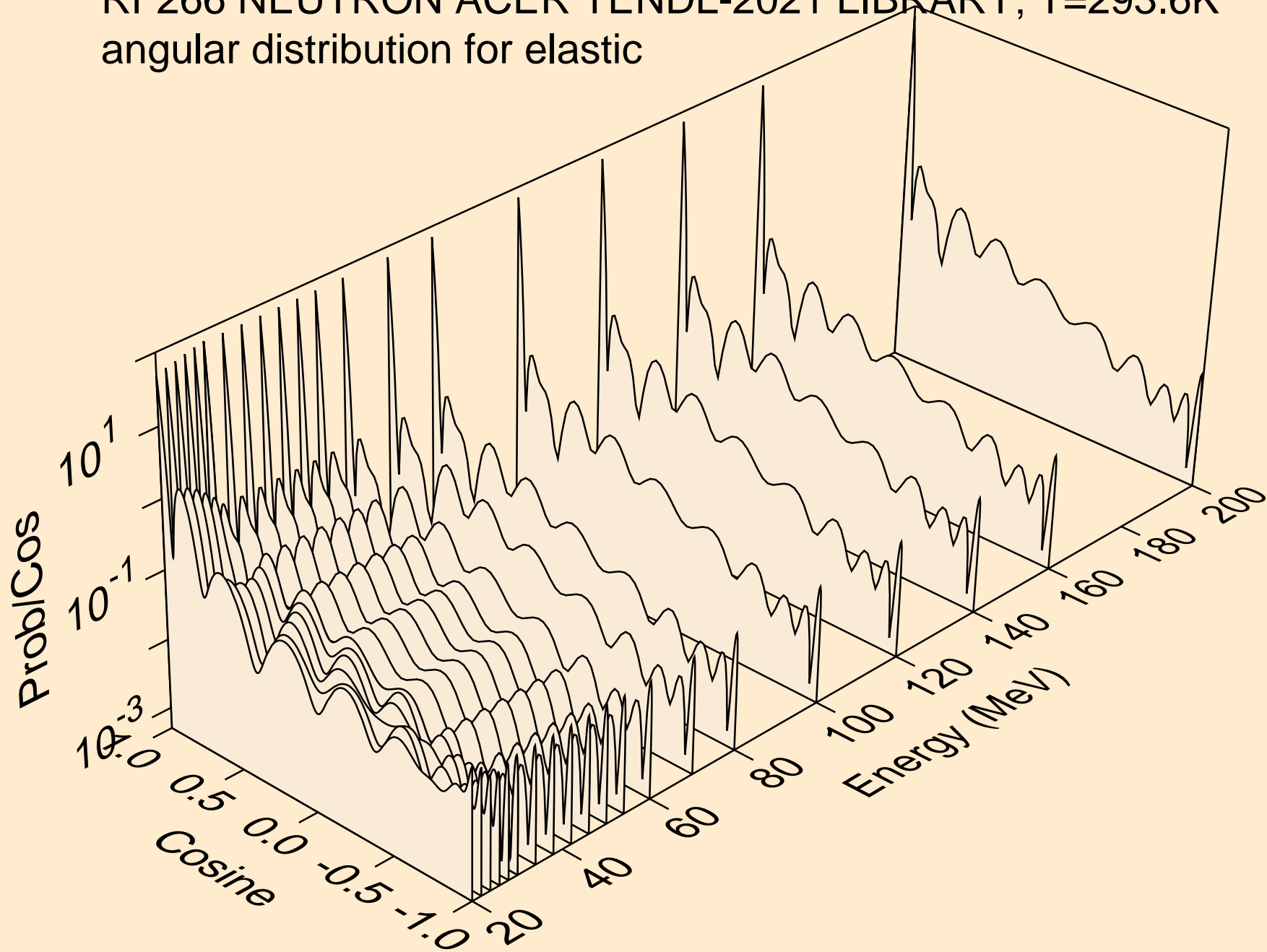

RF266 NEUTRON ACER TENDL-2021 LIBRARY; T=293.6K
angular distribution for (n,n*1)

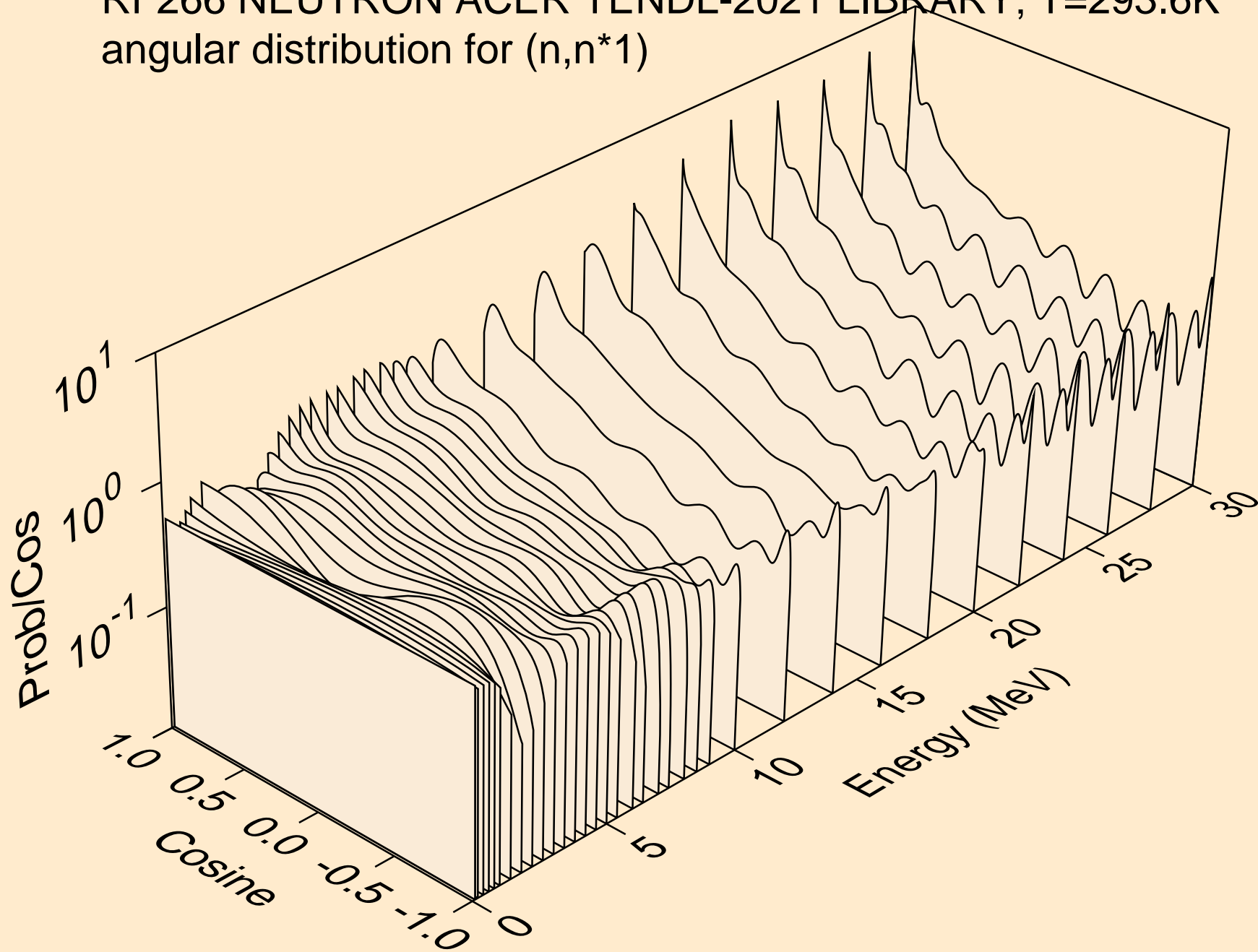

RF266 NEUTRON ACER TENDL-2021 LIBRARY; T=293.6K
Total fission nubar

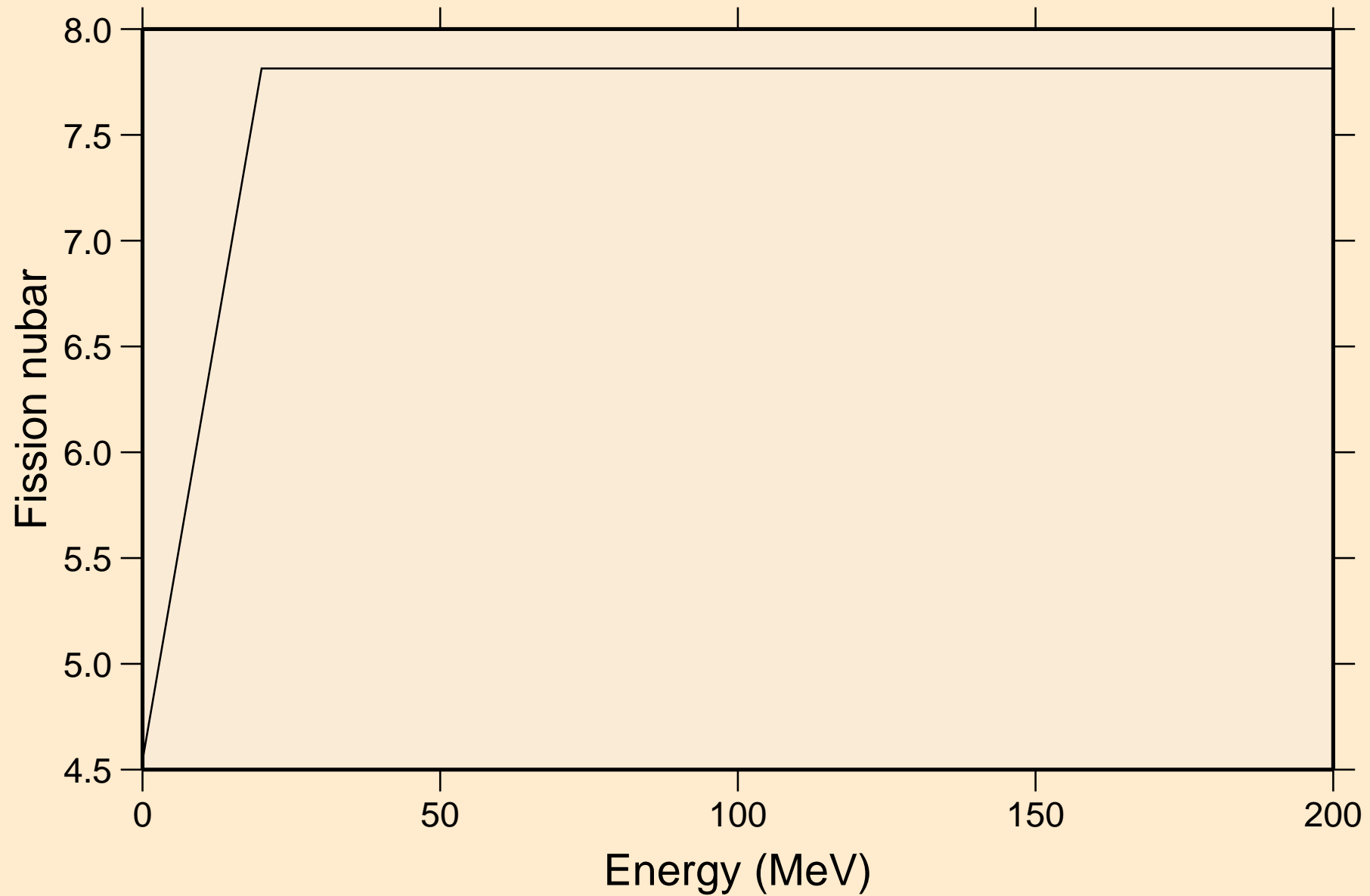

RF266 NEUTRON ACER TENDL-2021 LIBRARY; T=293.6K
Neutron emission for (n,x)

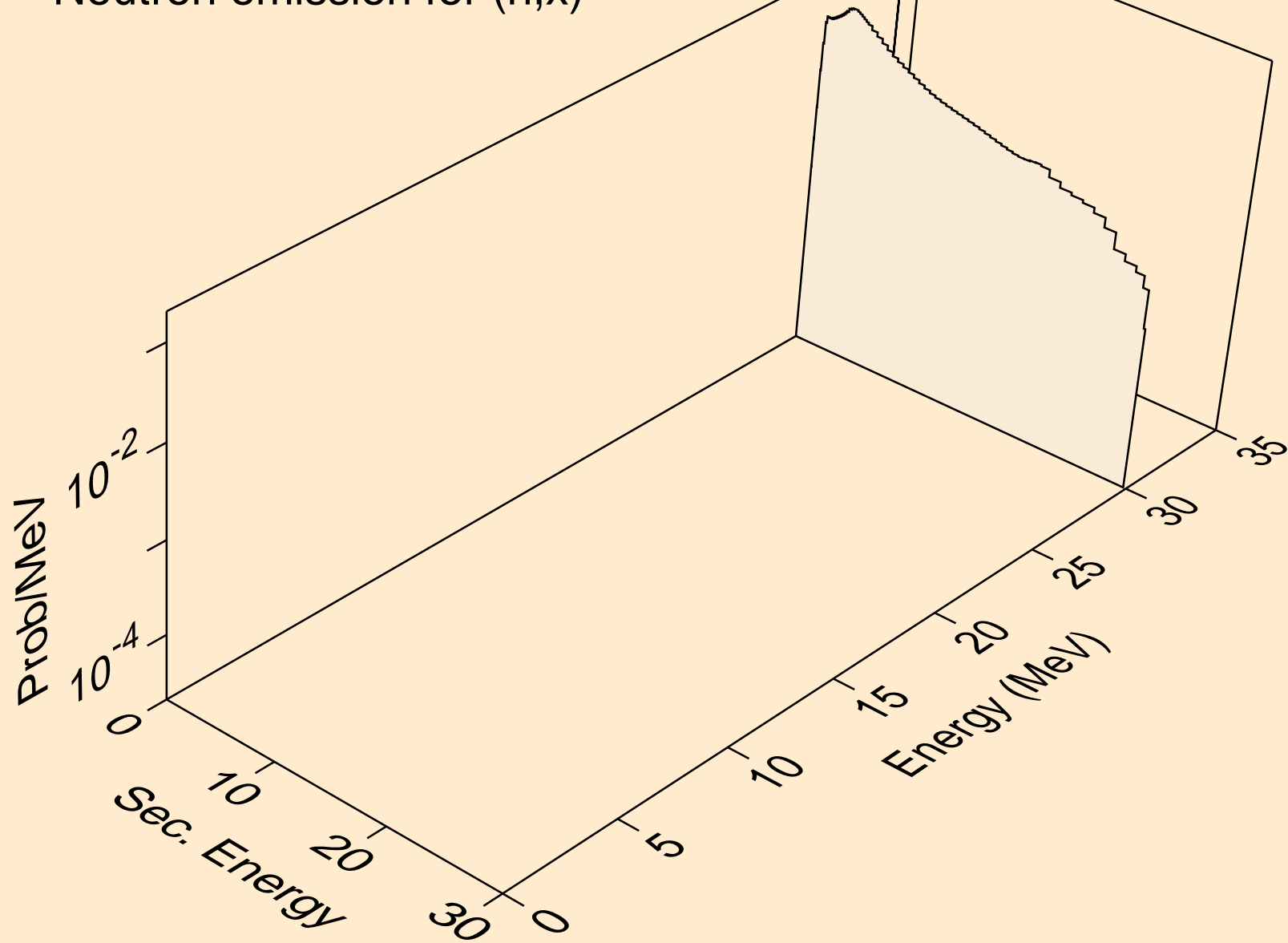

RF266 NEUTRON ACER TENDL-2021 LIBRARY; T=293.6K
Neutron emission for (n,2nd)

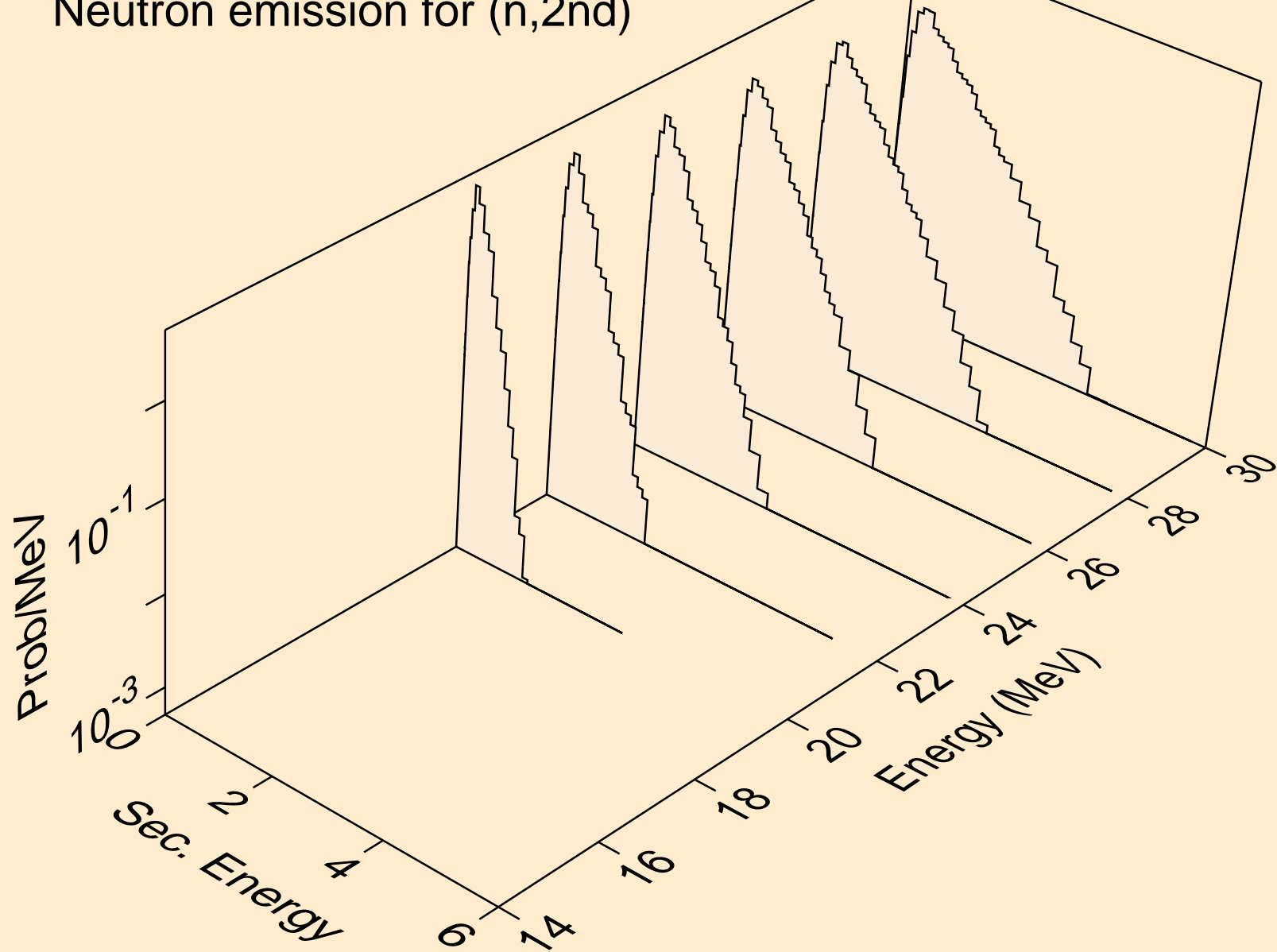

RF266 NEUTRON ACER TENDL-2021 LIBRARY; T=293.6K
Neutron emission for (n,2n)

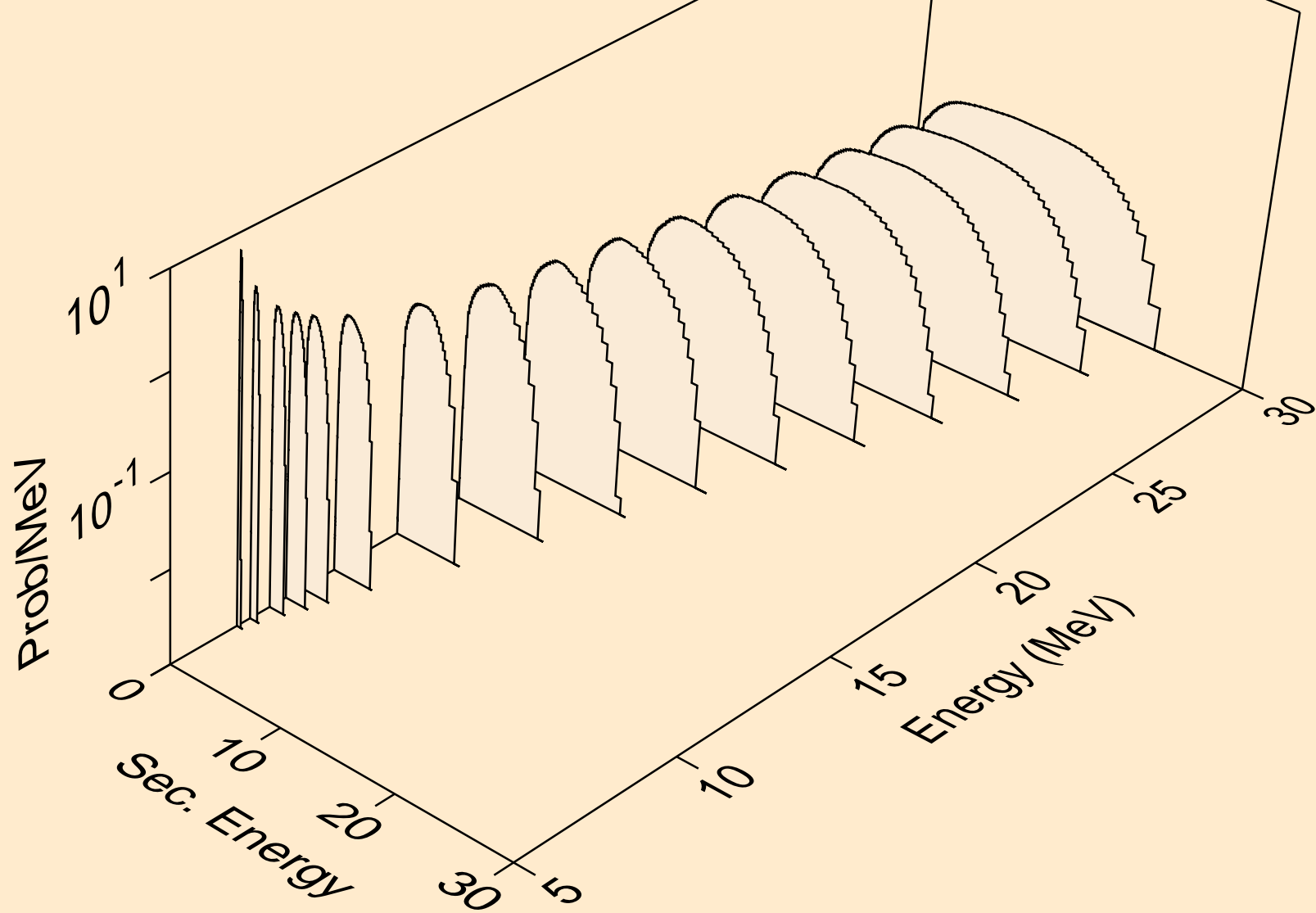

RF266 NEUTRON ACER TENDL-2021 LIBRARY; T=293.6K
Neutron emission for (n,3n)

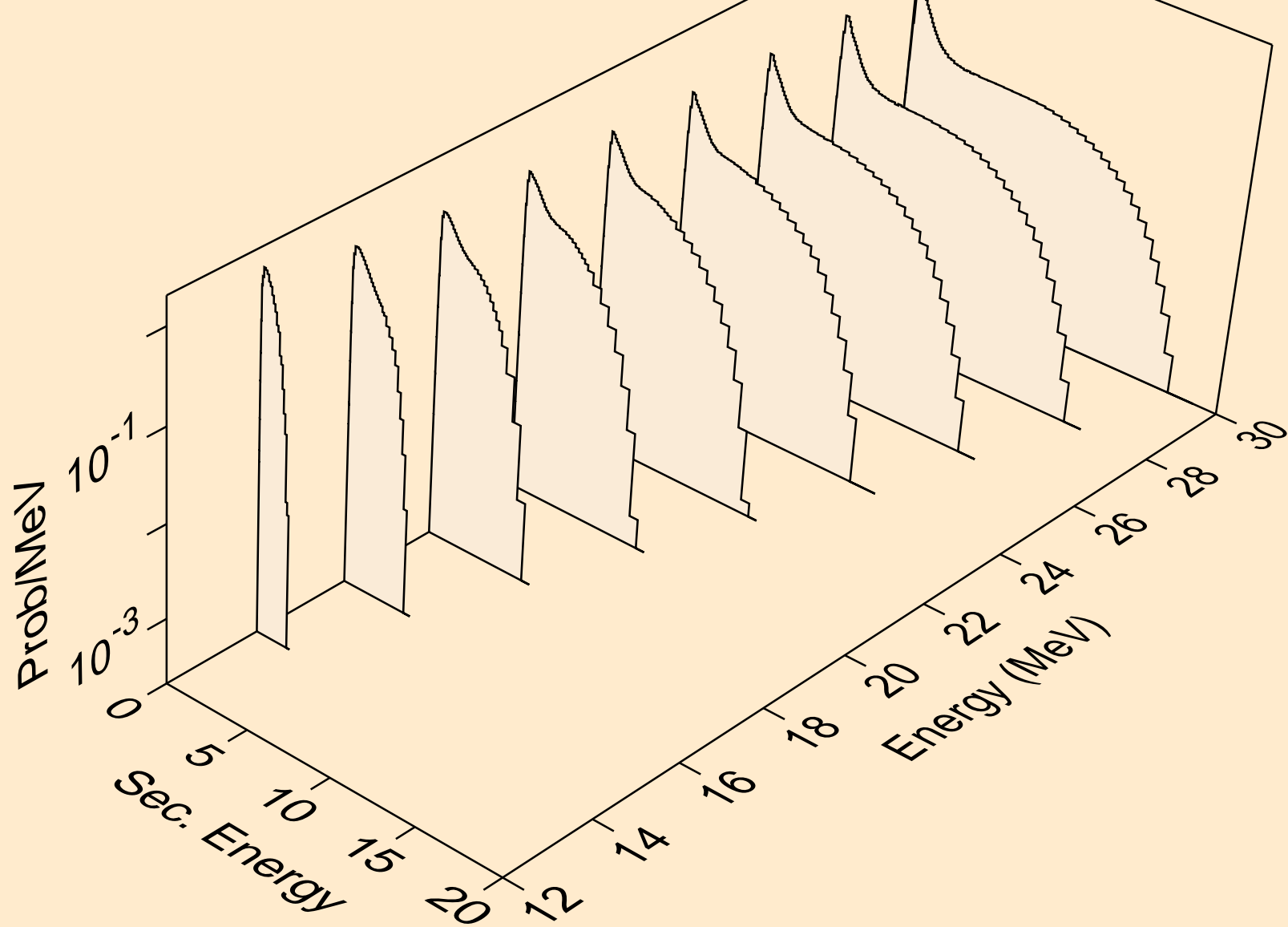

RF266 NEUTRON ACER TENDL-2021 LIBRARY; T=293.6K
Neutron emission for fission

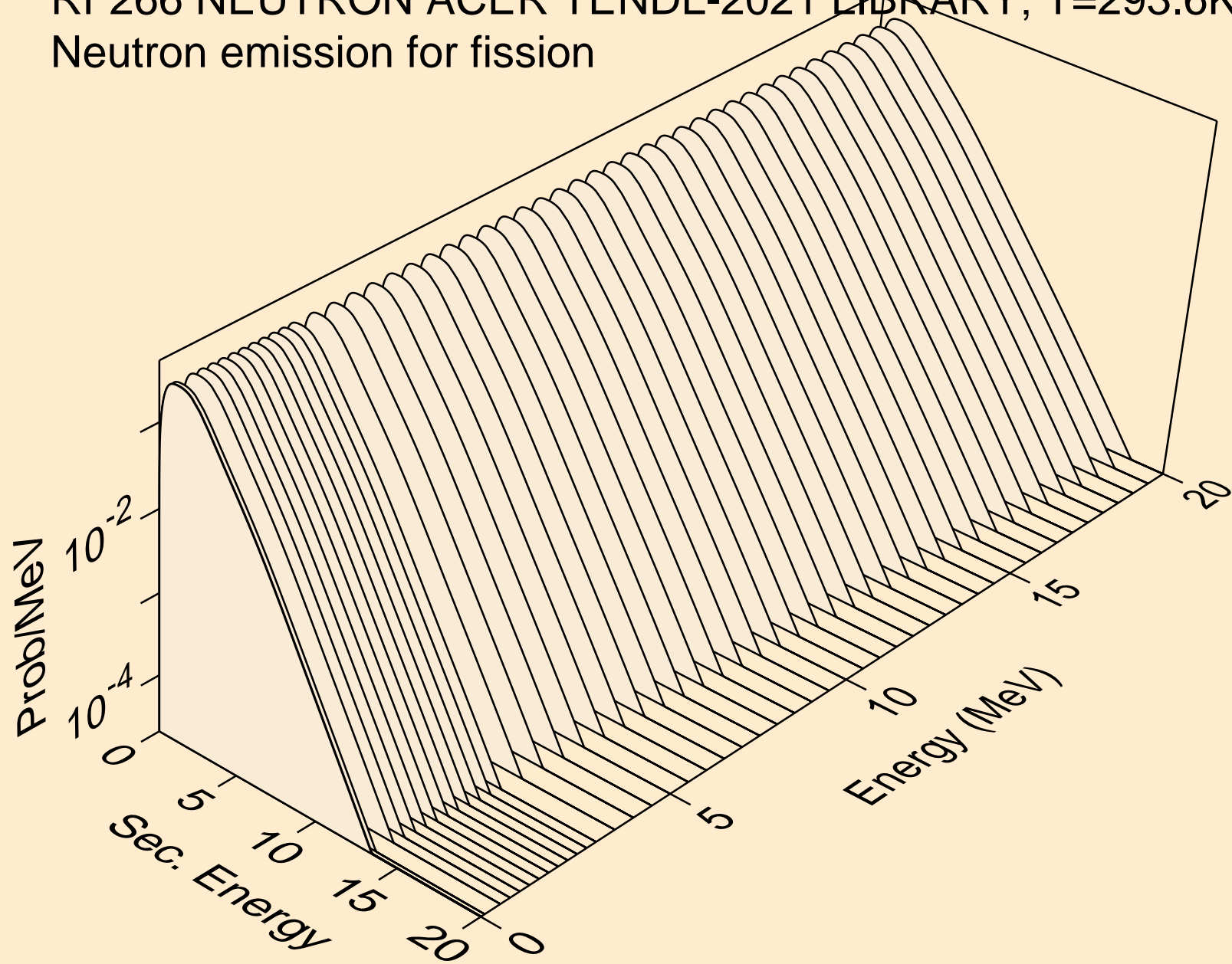

RF266 NEUTRON ACER TENDL-2021 LIBRARY; T=293.6K
Neutron emission for (n,n*)a

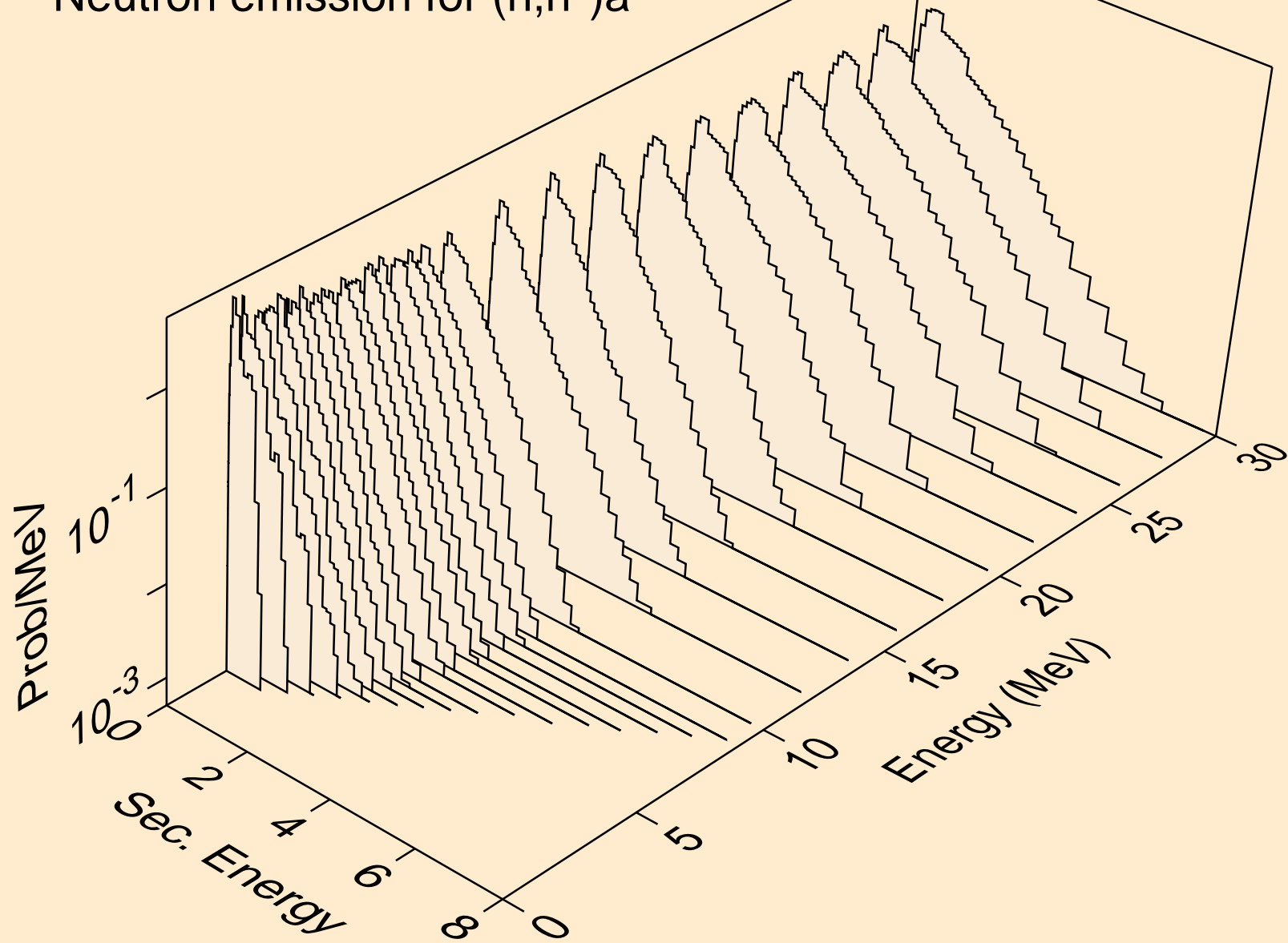

RF266 NEUTRON ACER TENDL-2021 LIBRARY; T=293.6K
Neutron emission for (n,2n)_a

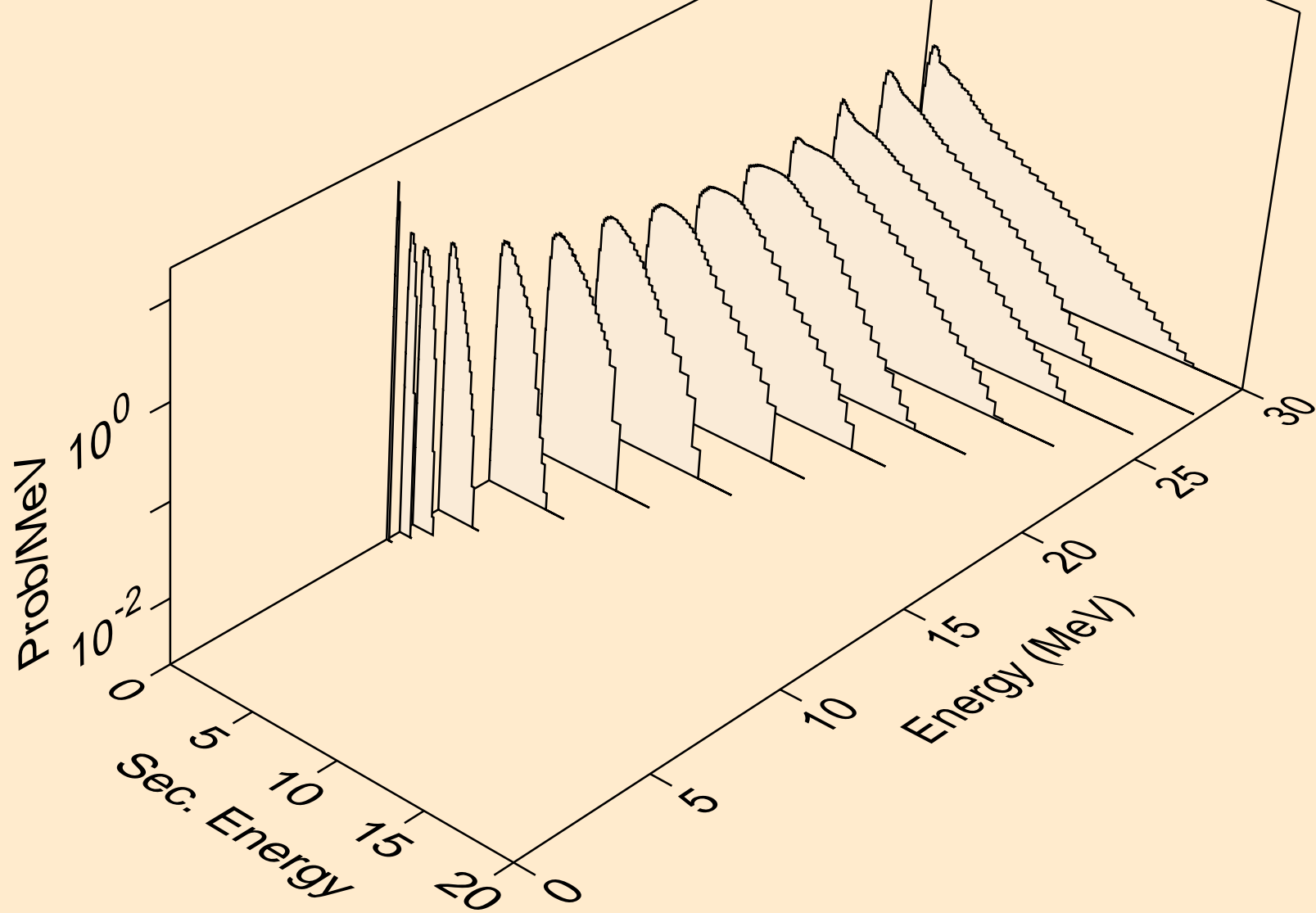

RF266 NEUTRON ACER TENDL-2021 LIBRARY; T=293.6K
Neutron emission for (n,3n)a

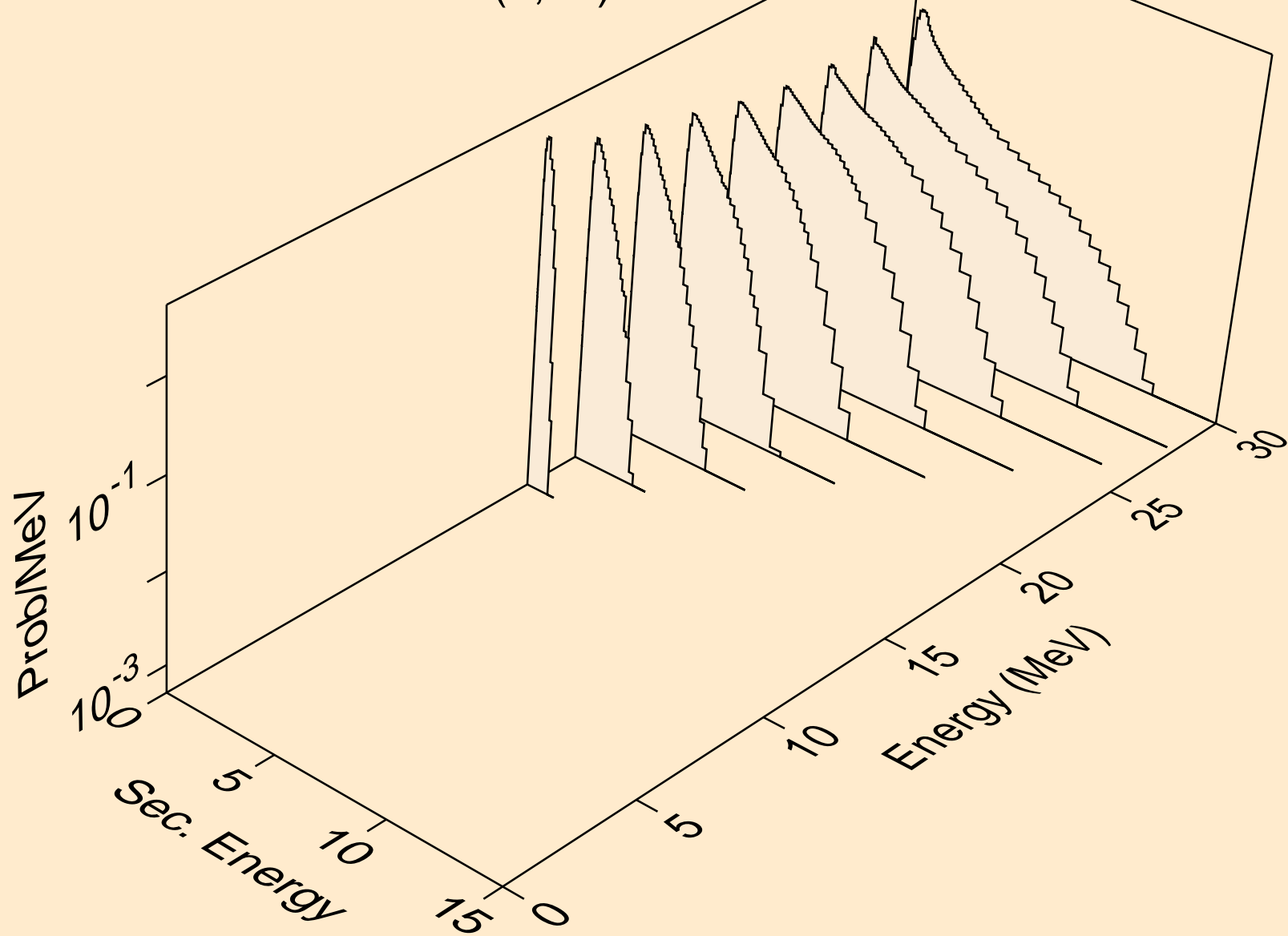

RF266 NEUTRON ACER TENDL-2021 LIBRARY; T=293.6K
Neutron emission for (n,n*)p

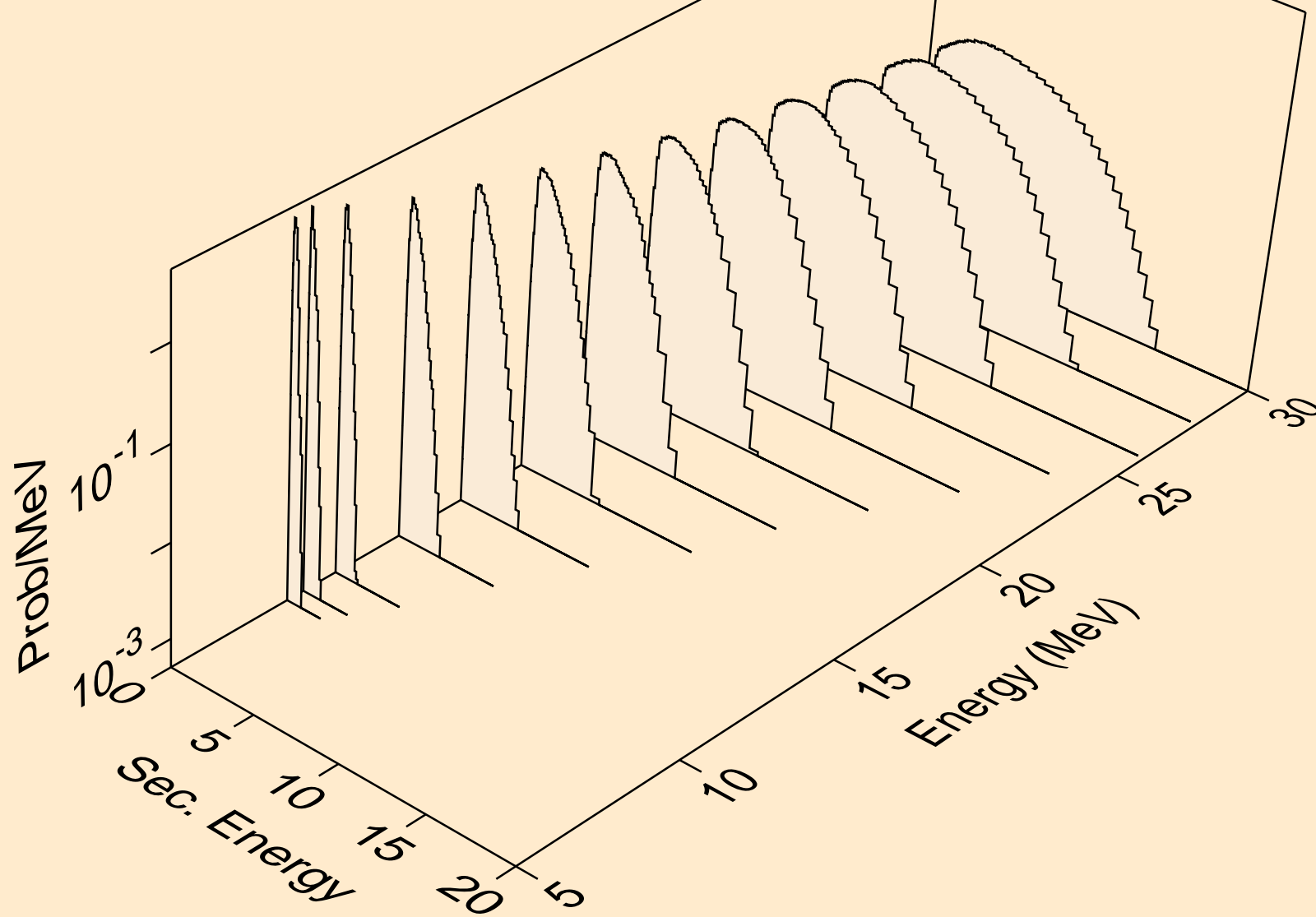

RF266 NEUTRON ACER TENDL-2021 LIBRARY; T=293.6K
Neutron emission for (n,n*)d

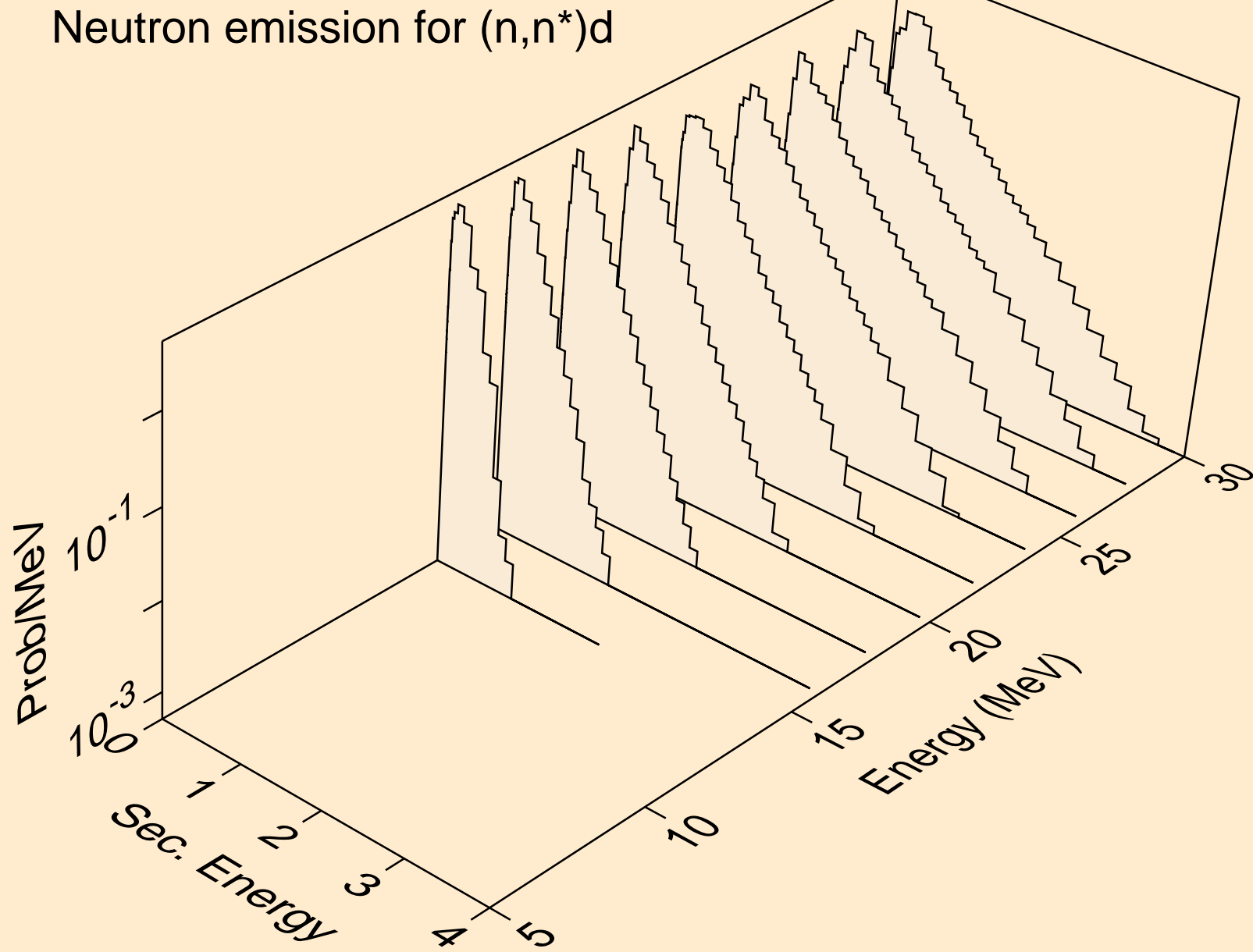

RF266 NEUTRON ACER TENDL-2021 LIBRARY; T=293.6K
Neutron emission for (n,n*)t

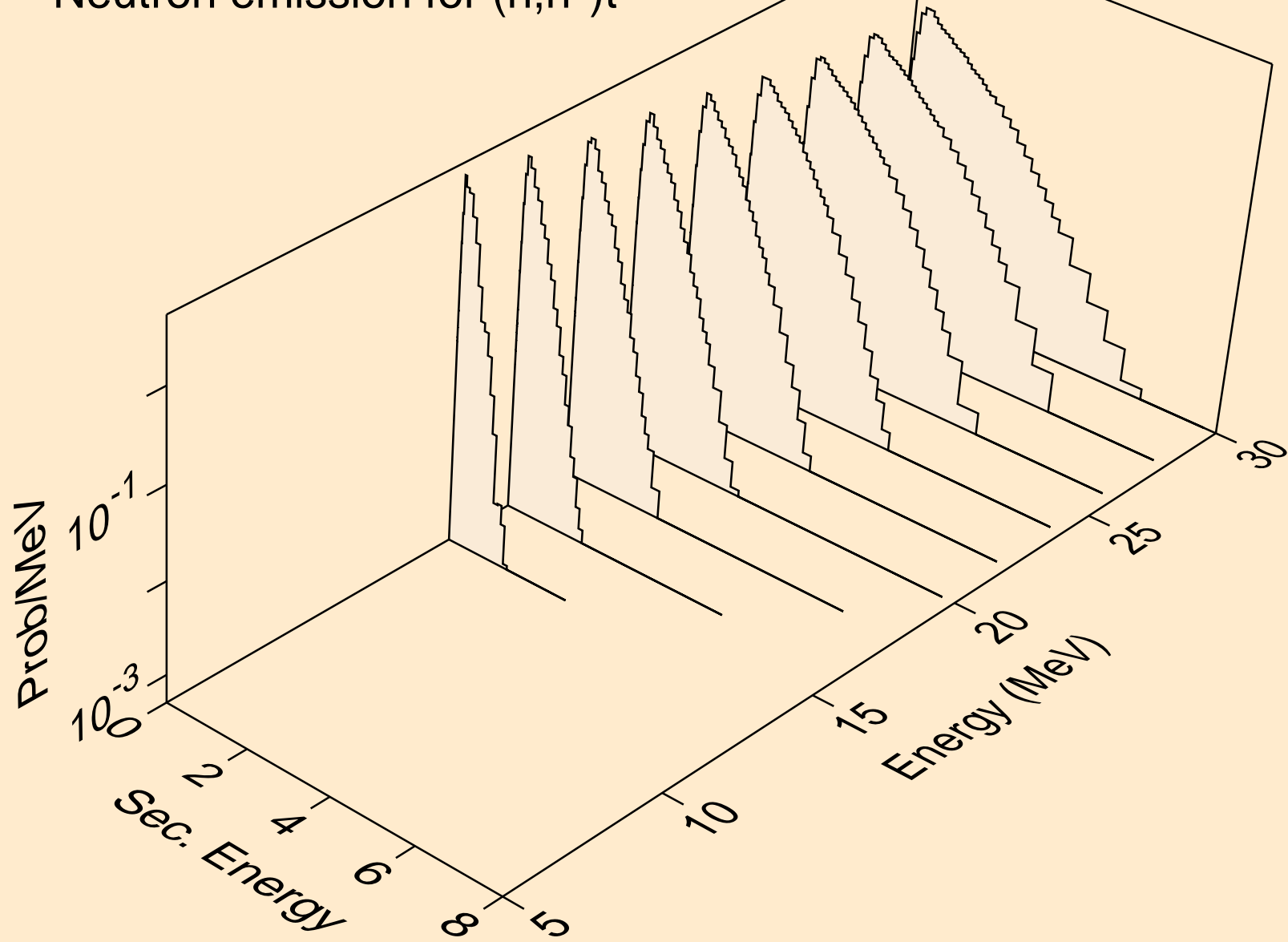

RF266 NEUTRON ACER TENDL-2021 LIBRARY; T=293.6K
Neutron emission for (n,n*)he3

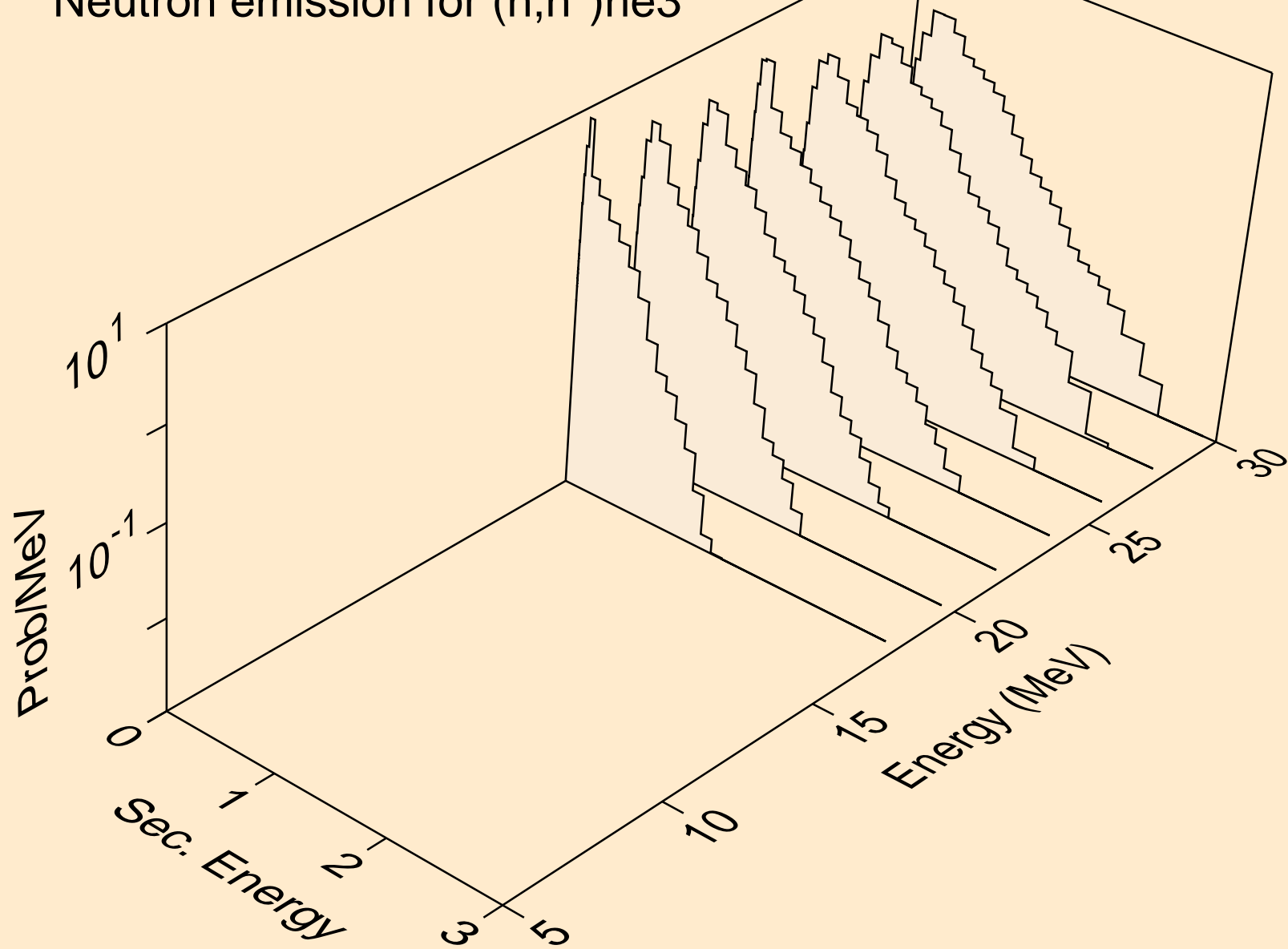

RF266 NEUTRON ACER TENDL-2021 LIBRARY; T=293.6K
Neutron emission for (n,4n)

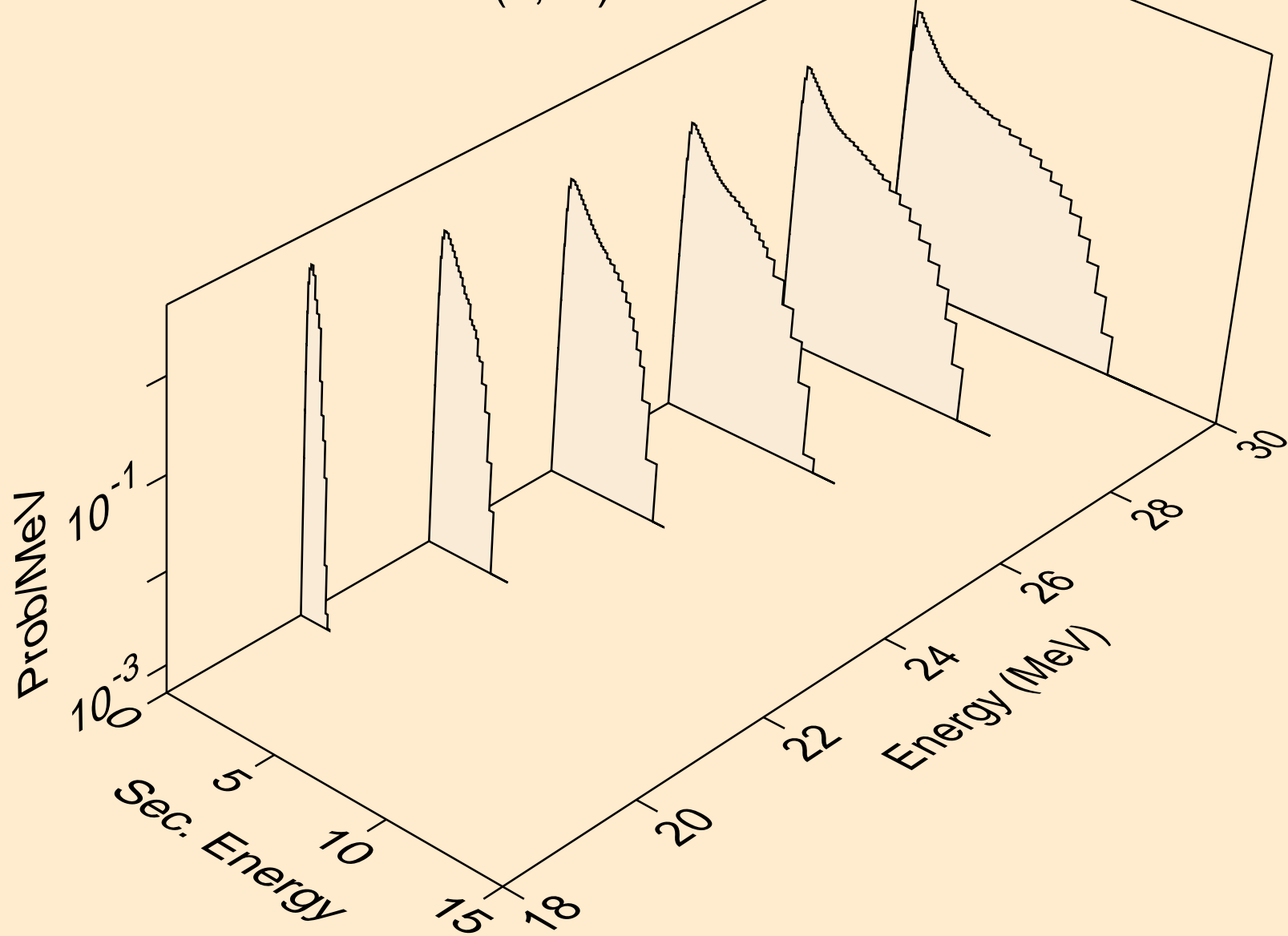

RF266 NEUTRON ACER TENDL-2021 LIBRARY; T=293.6K
Neutron emission for (n,2np)

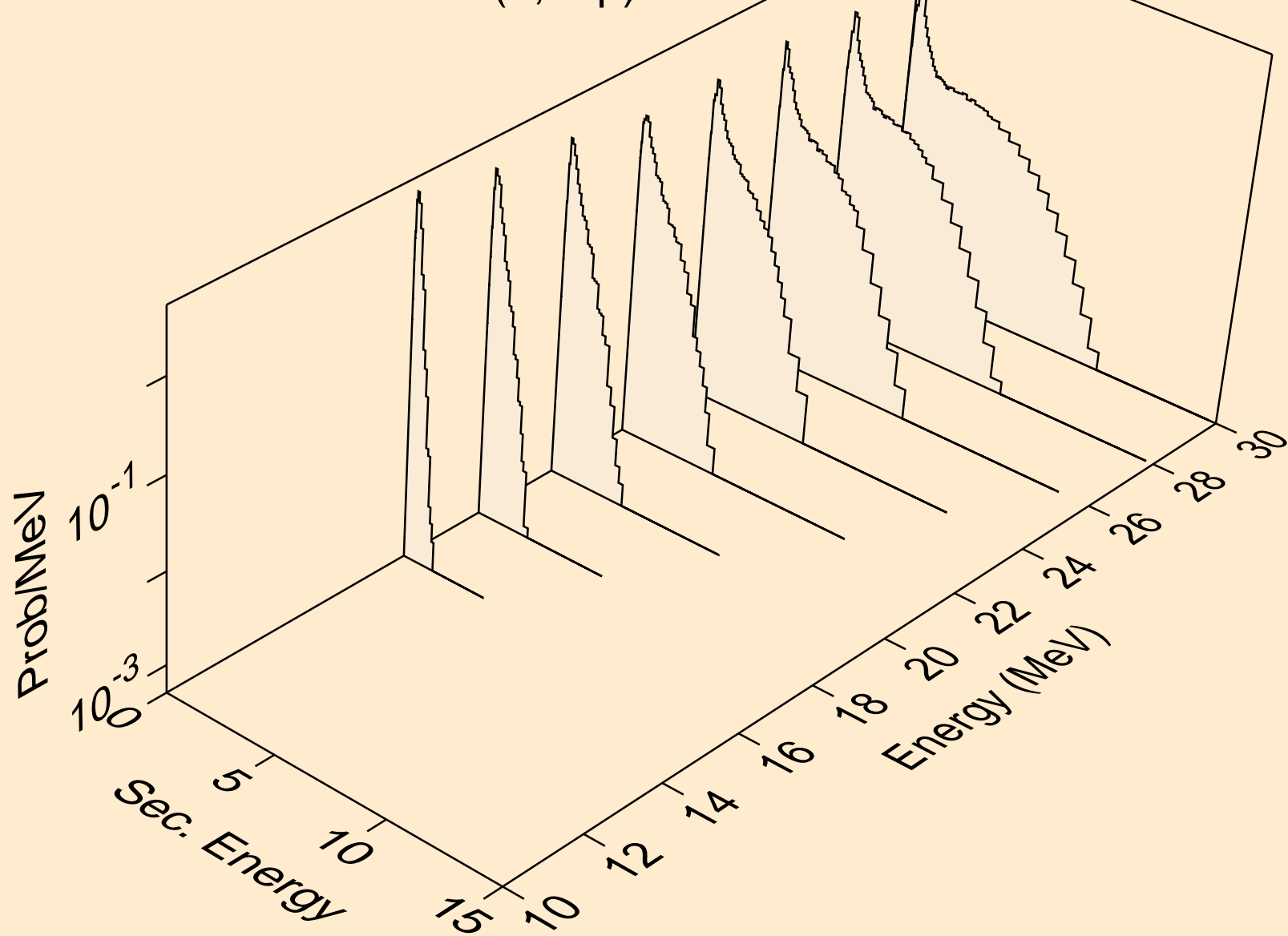

RF266 NEUTRON ACER TENDL-2021 LIBRARY; T=293.6K
Neutron emission for (n,2np)

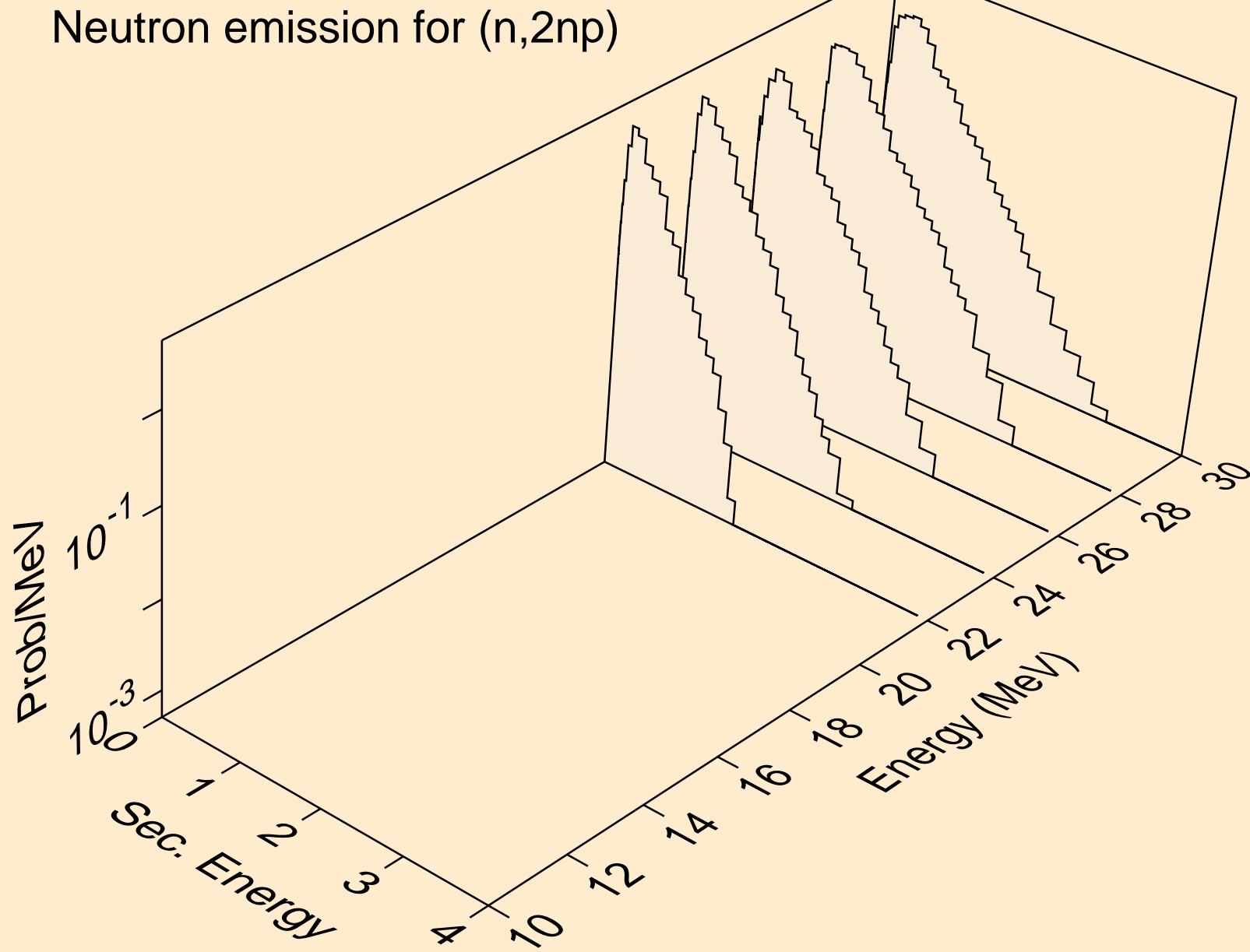

RF266 NEUTRON ACER TENDL-2021 LIBRARY; T=293.6K
Neutron emission for (n,n*c)

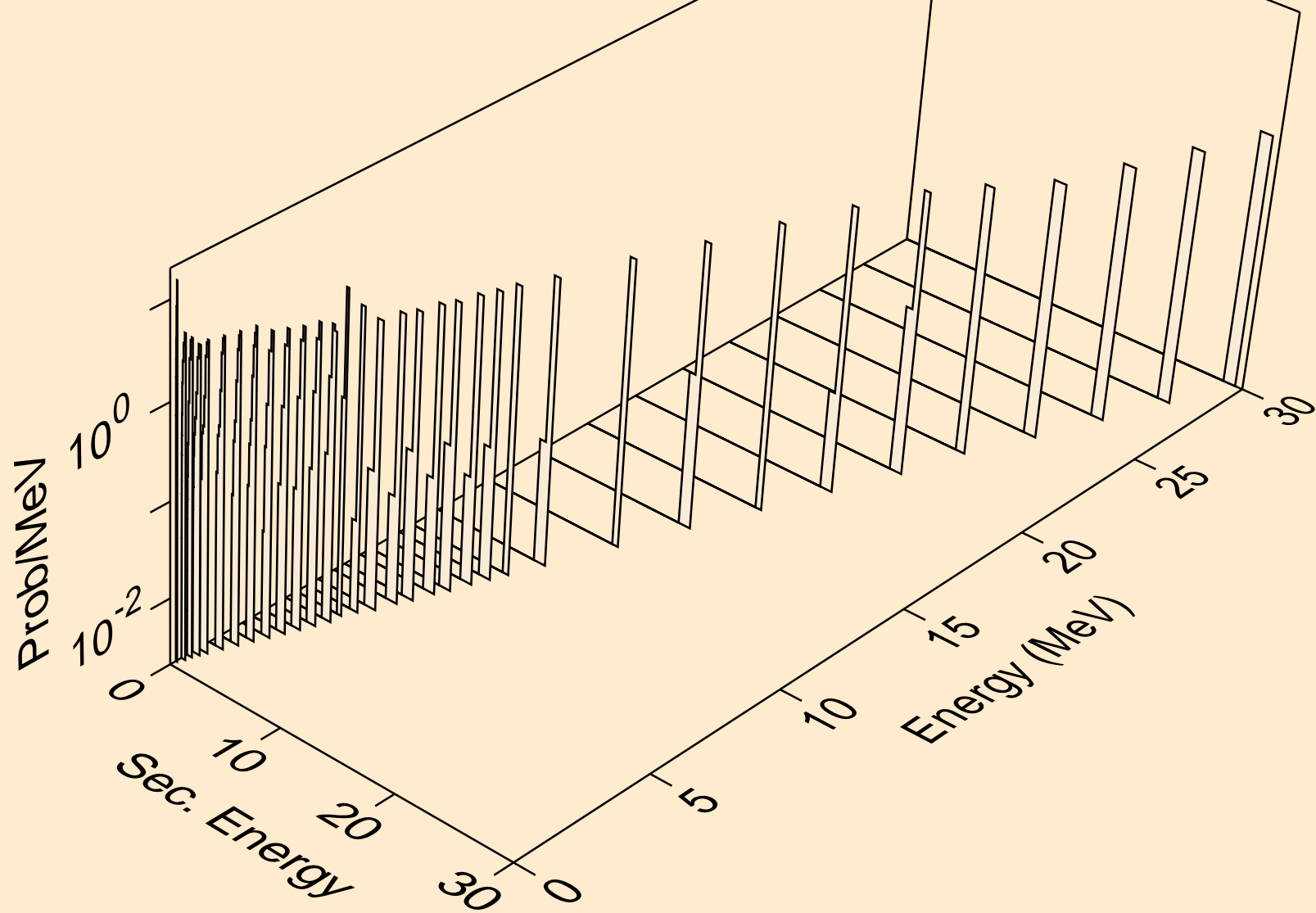

RF266 NEUTRON ACER TENDL-2021 LIBRARY; T=293.6K
Delayed nubar

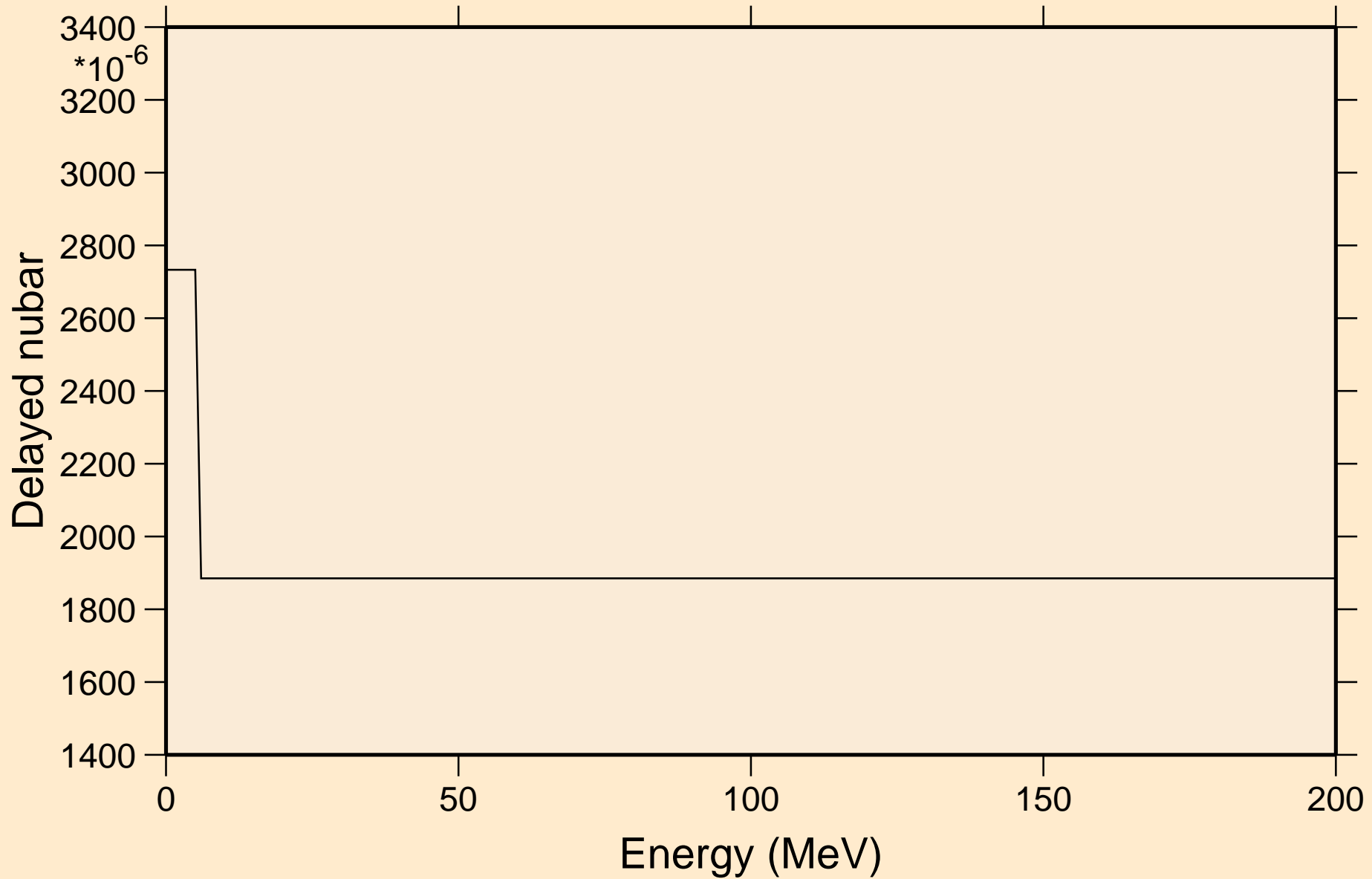

RF266 NEUTRON ACER TENDL-2021 LIBRARY; T=293.6K

Delayed neutron spectra

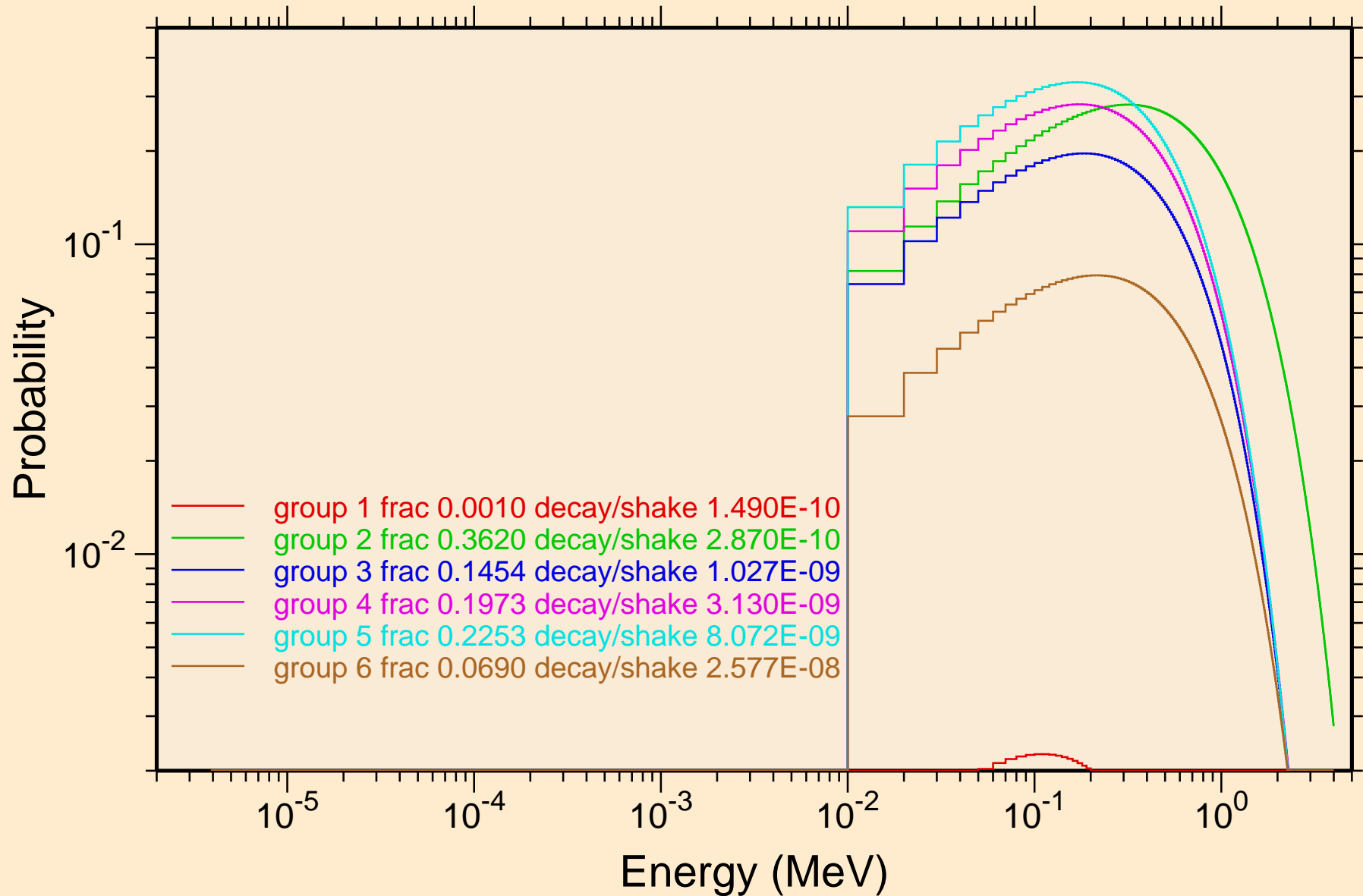

RF266 NEUTRON ACER TENDL-2021 LIBRARY; T=293.6K
Photon emission for (n,x)

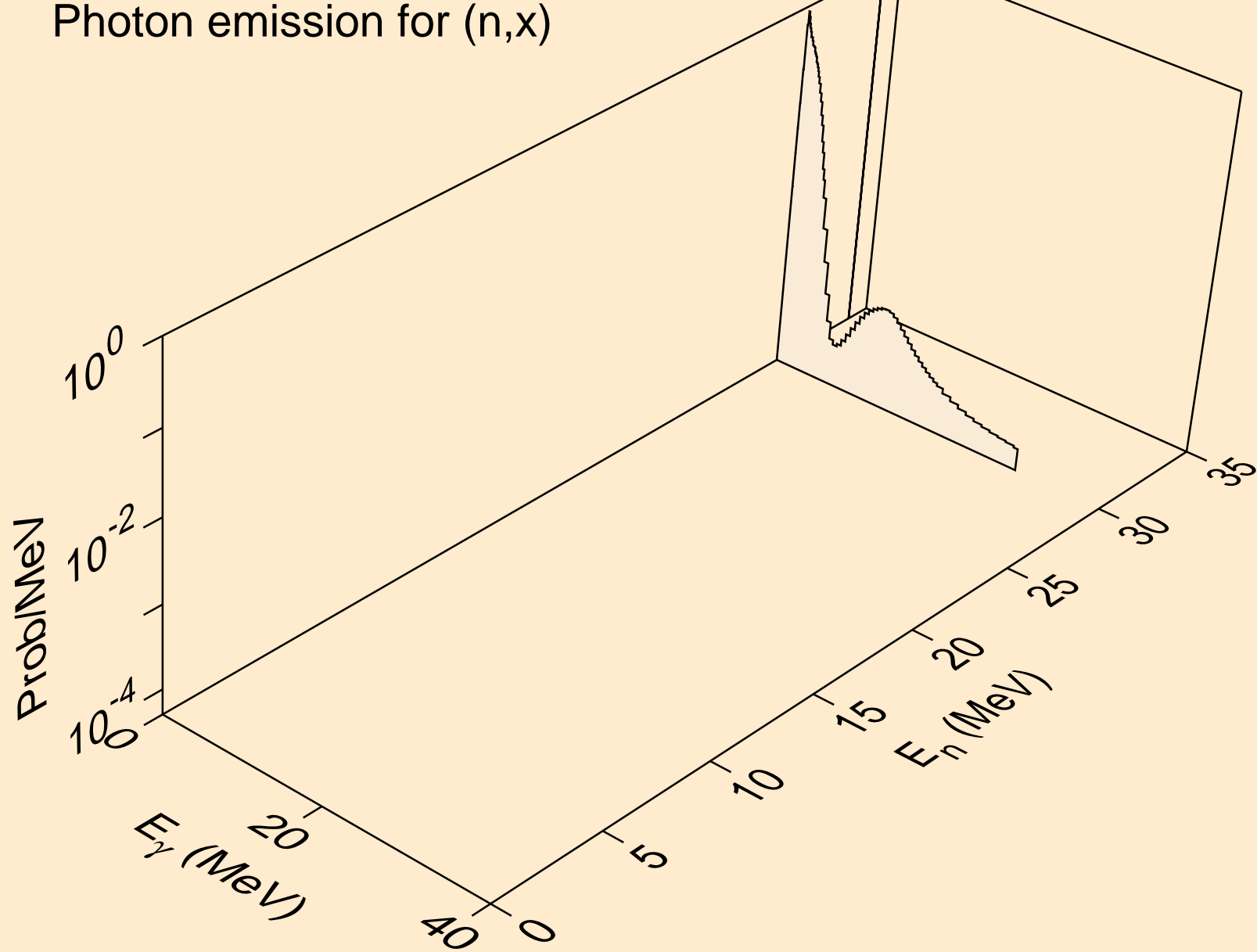

RF266 NEUTRON ACER TENDL-2021 LIBRARY; T=293.6K
Photon emission for (n,2nd)

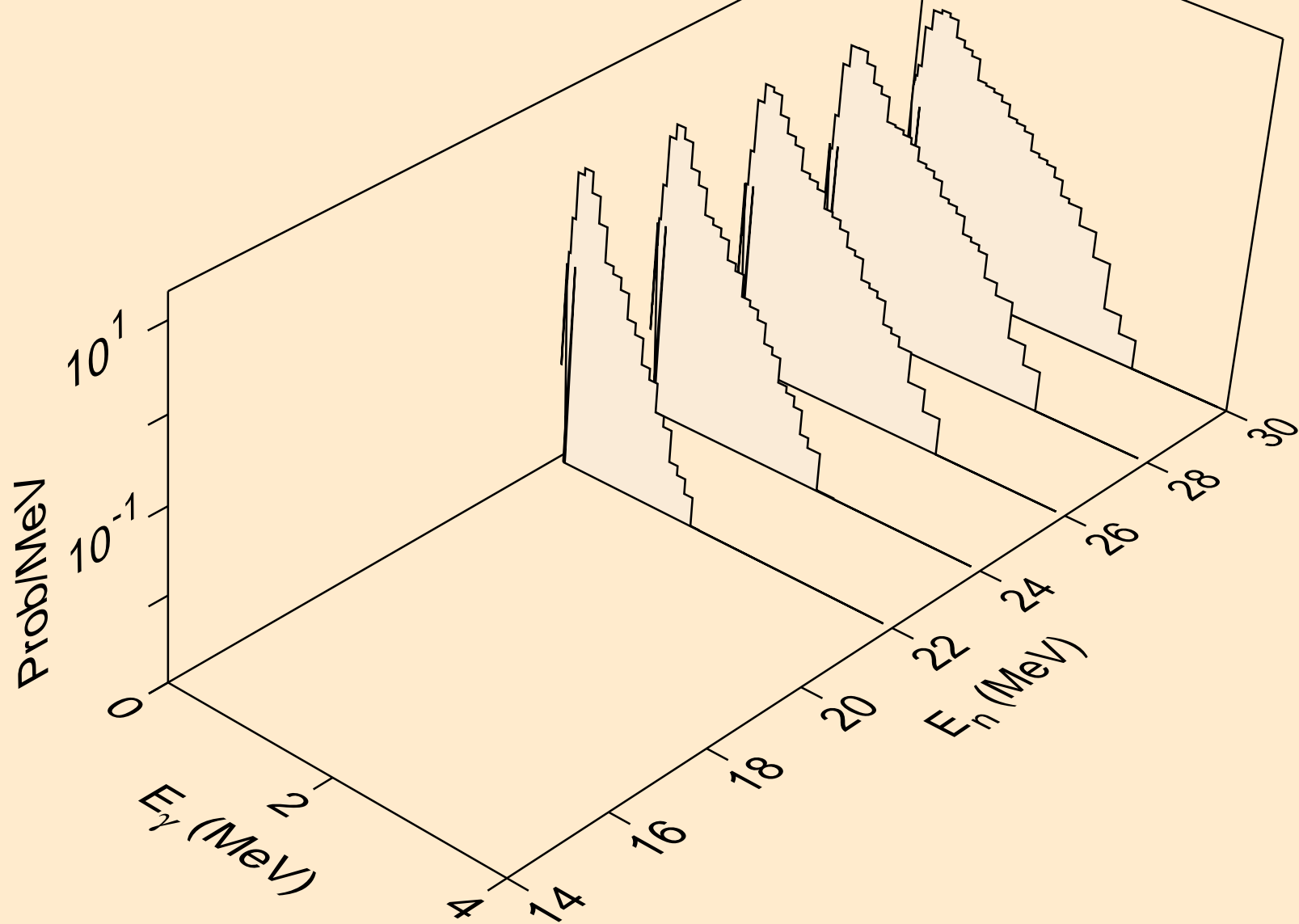

RF266 NEUTRON ACER TENDL-2021 LIBRARY; T=293.6K
Photon emission for (n,2n)

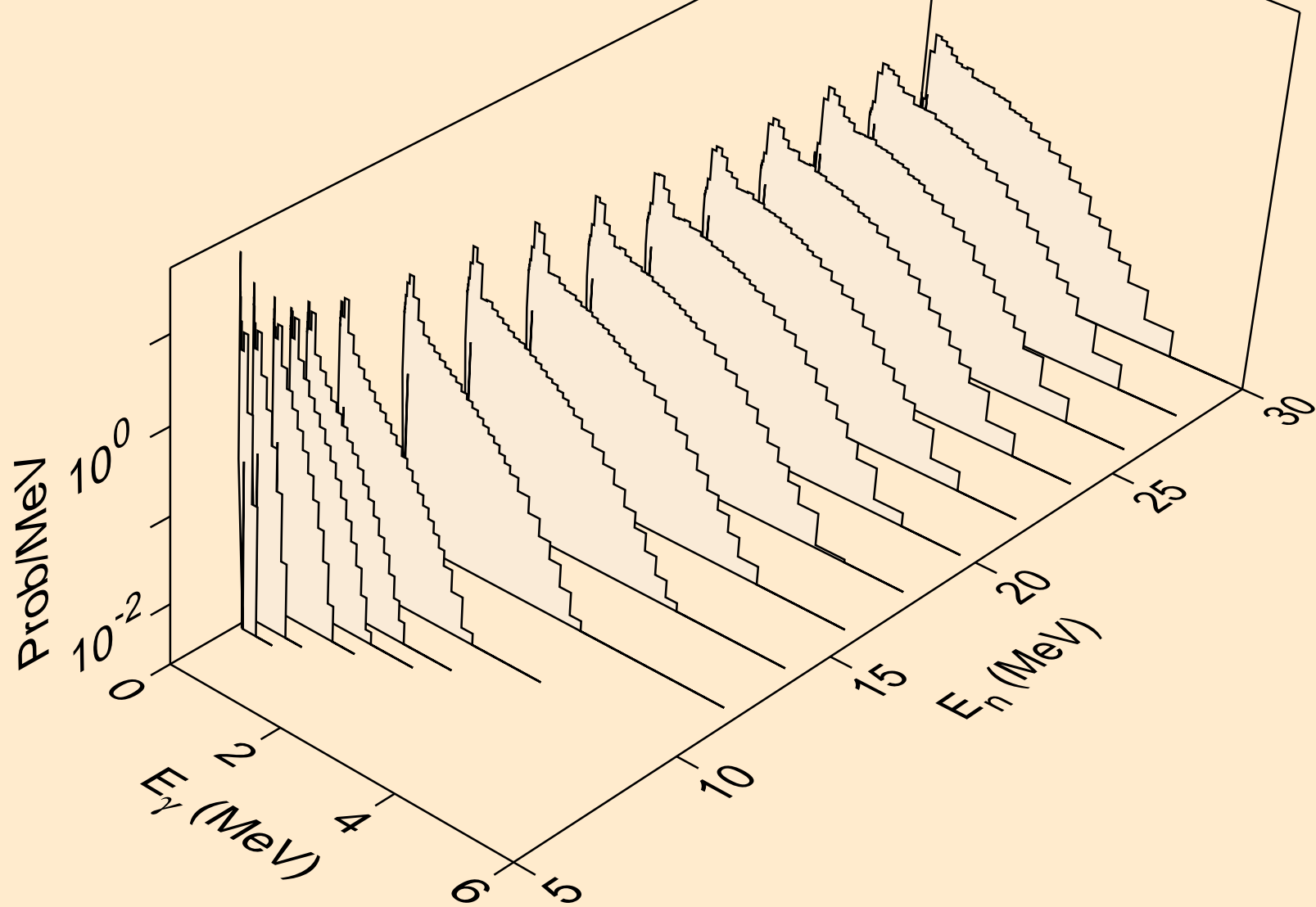

RF266 NEUTRON ACER TENDL-2021 LIBRARY; T=293.6K
Photon emission for (n,3n)

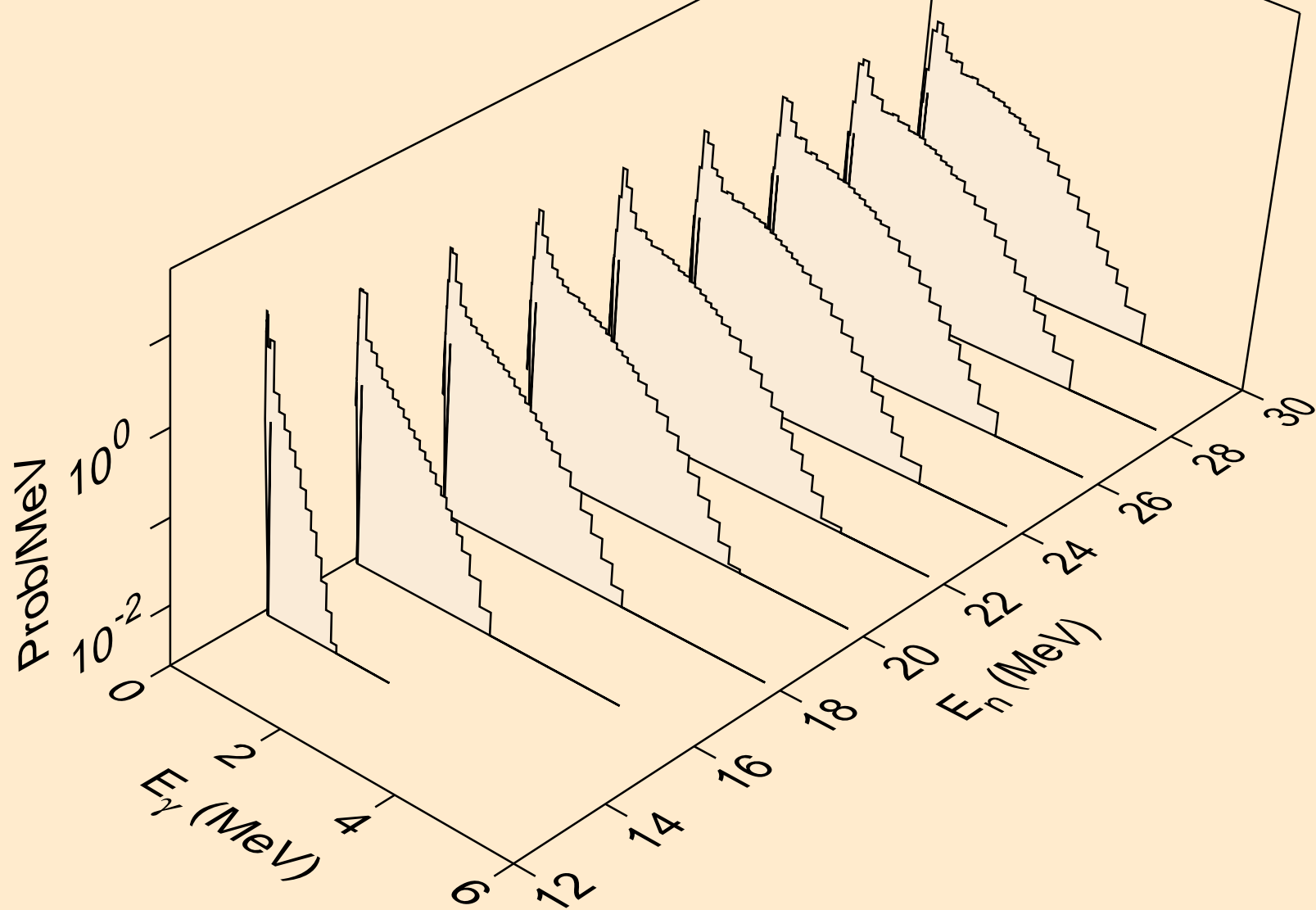

RF266 NEUTRON ACER TENDL-2021 LIBRARY; T=293.6K
Photon emission for (n,n*)a

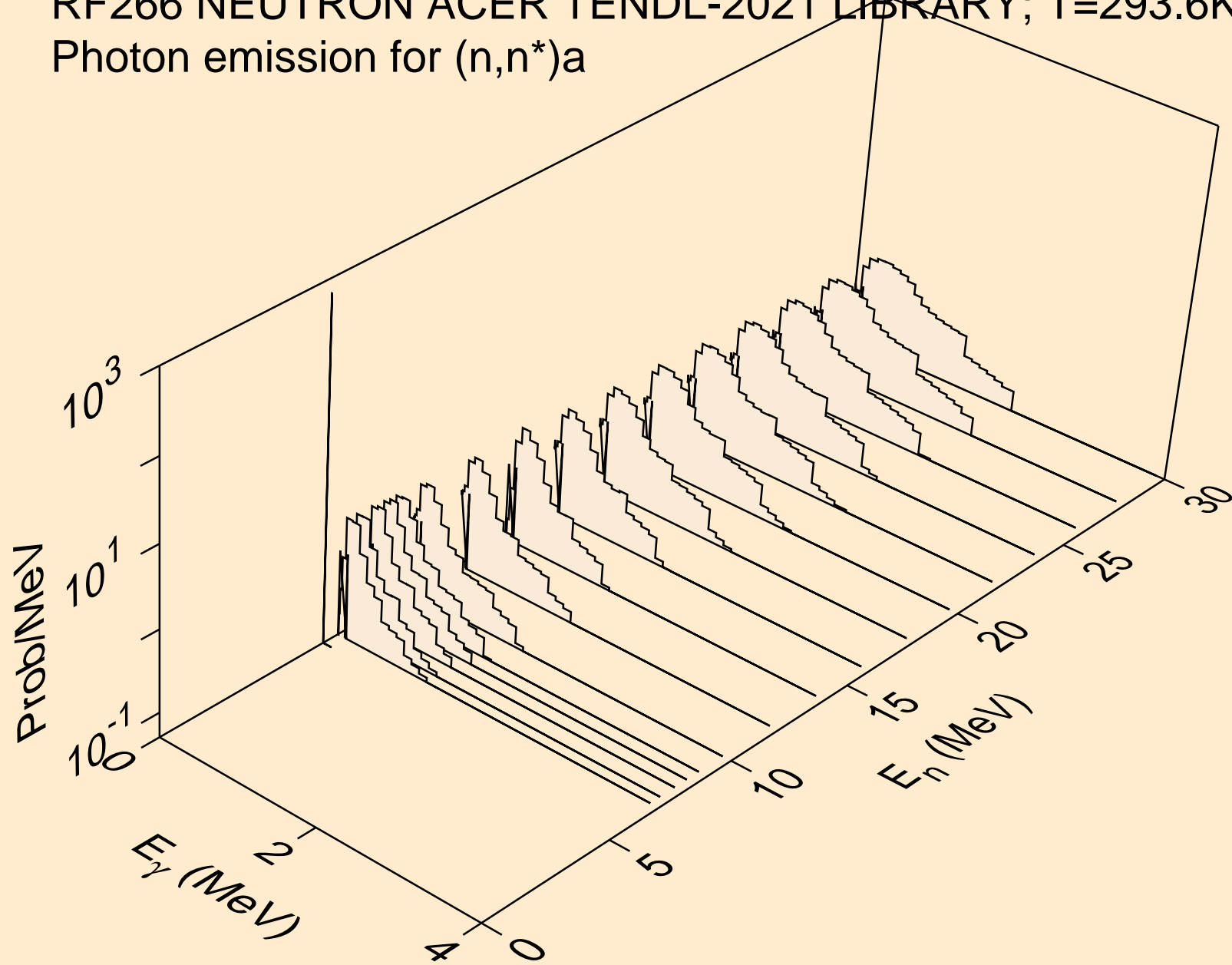

RF266 NEUTRON ACER TENDL-2021 LIBRARY; T=293.6K
Photon emission for (n,2n)a

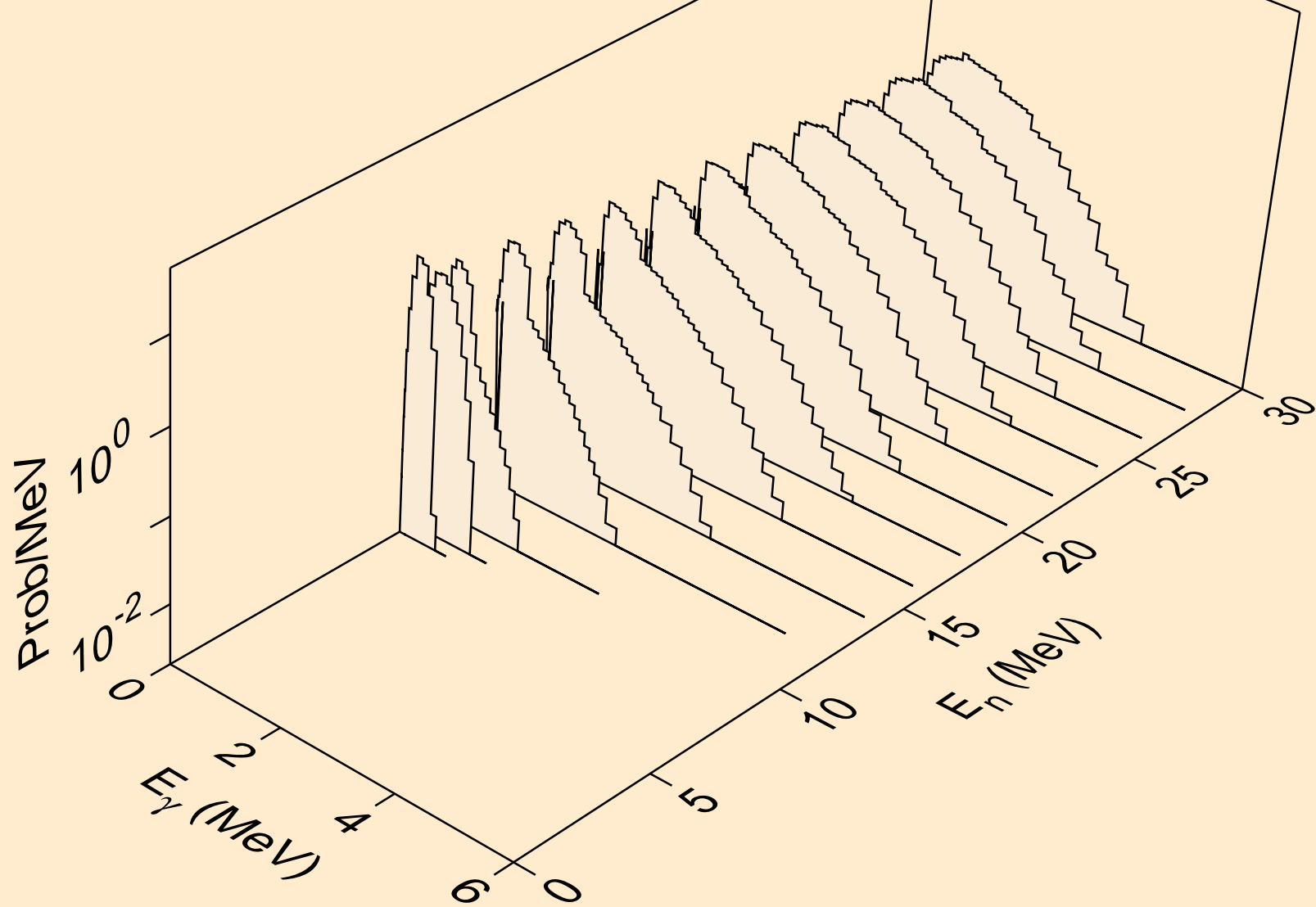

RF266 NEUTRON ACER TENDL-2021 LIBRARY; T=293.6K
Photon emission for (n,3n)a

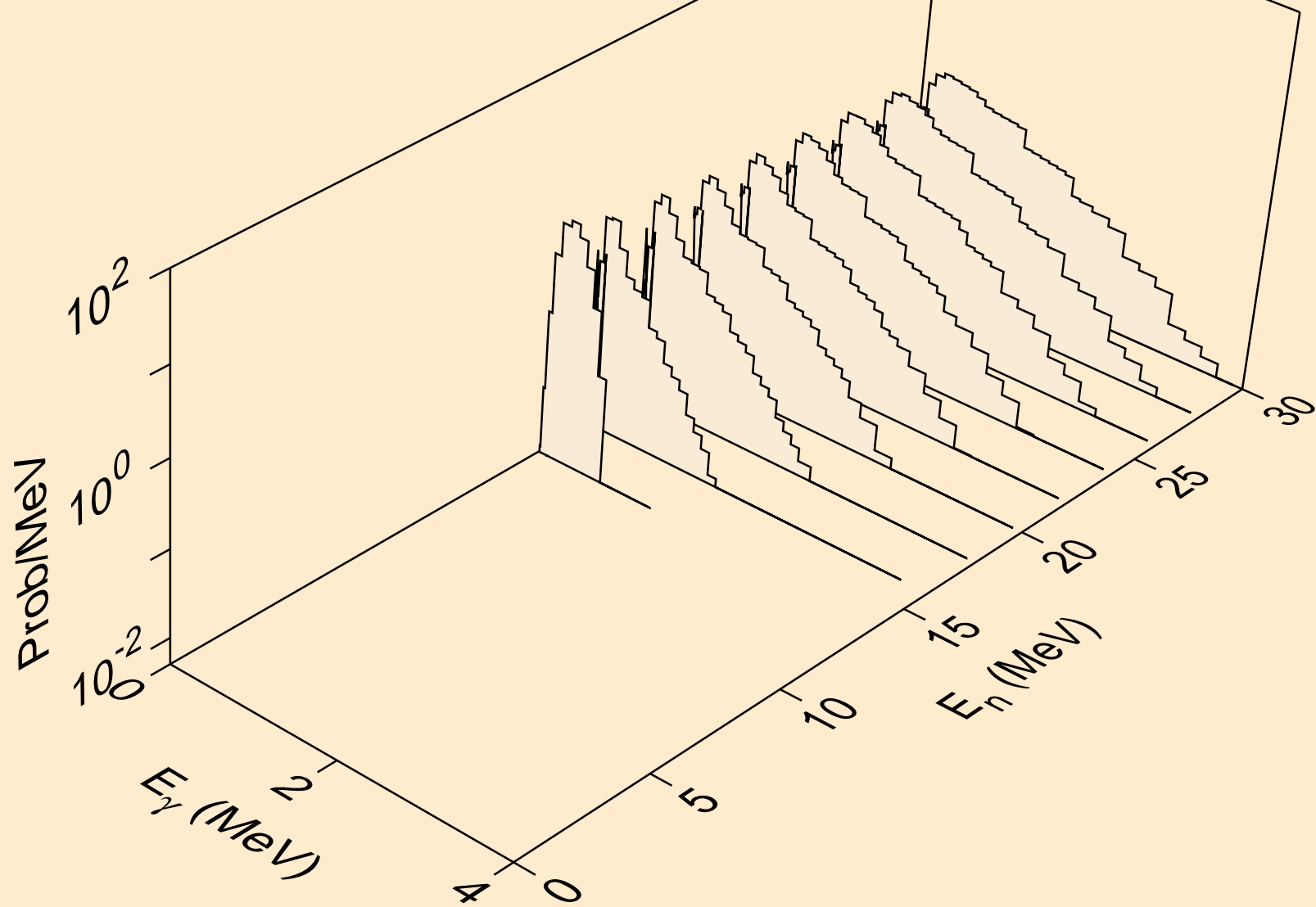

RF266 NEUTRON ACER TENDL-2021 LIBRARY; T=293.6K
Photon emission for (n,n*)p

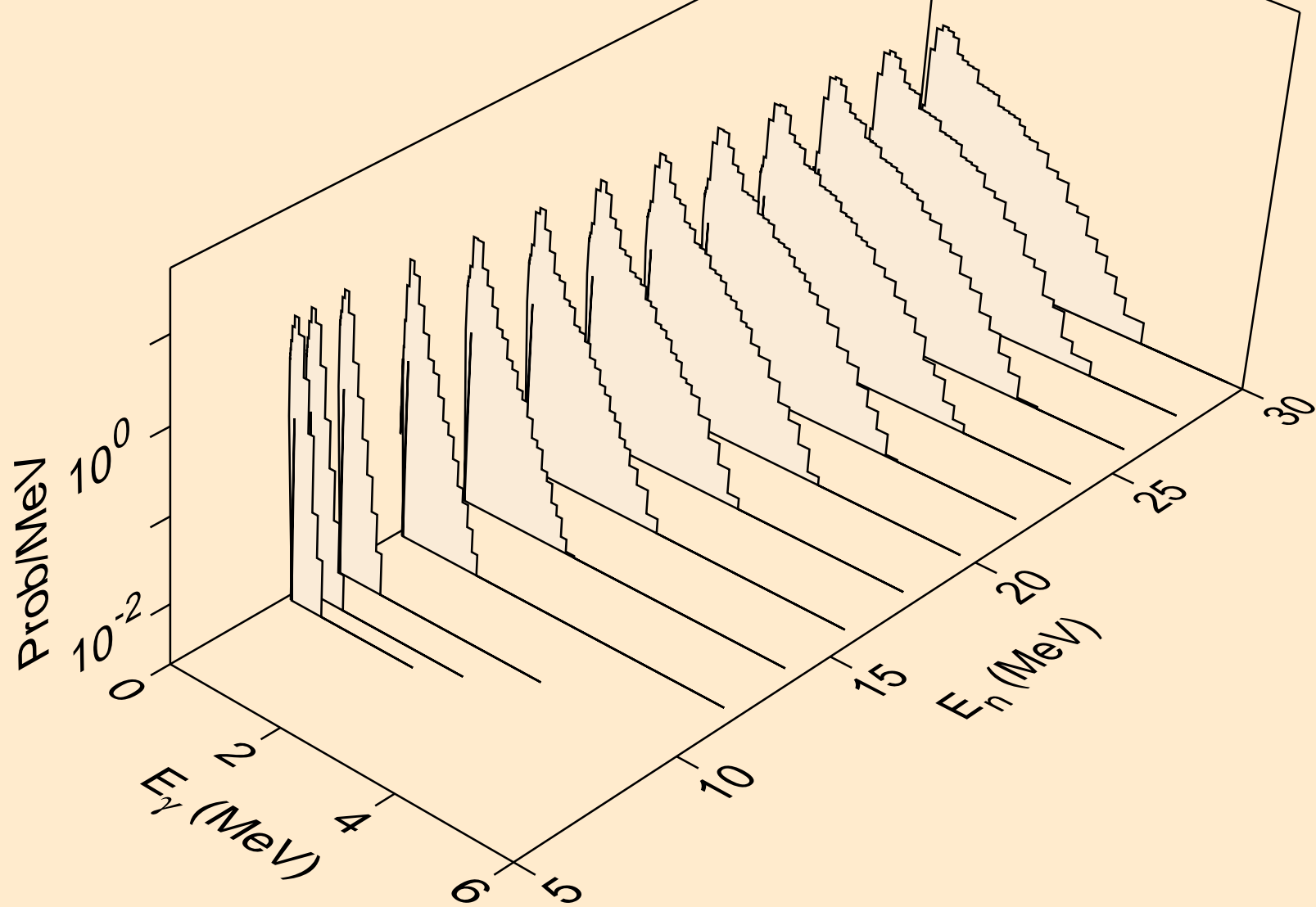

RF266 NEUTRON ACER TENDL-2021 LIBRARY; T=293.6K
Photon emission for (n,n*)d

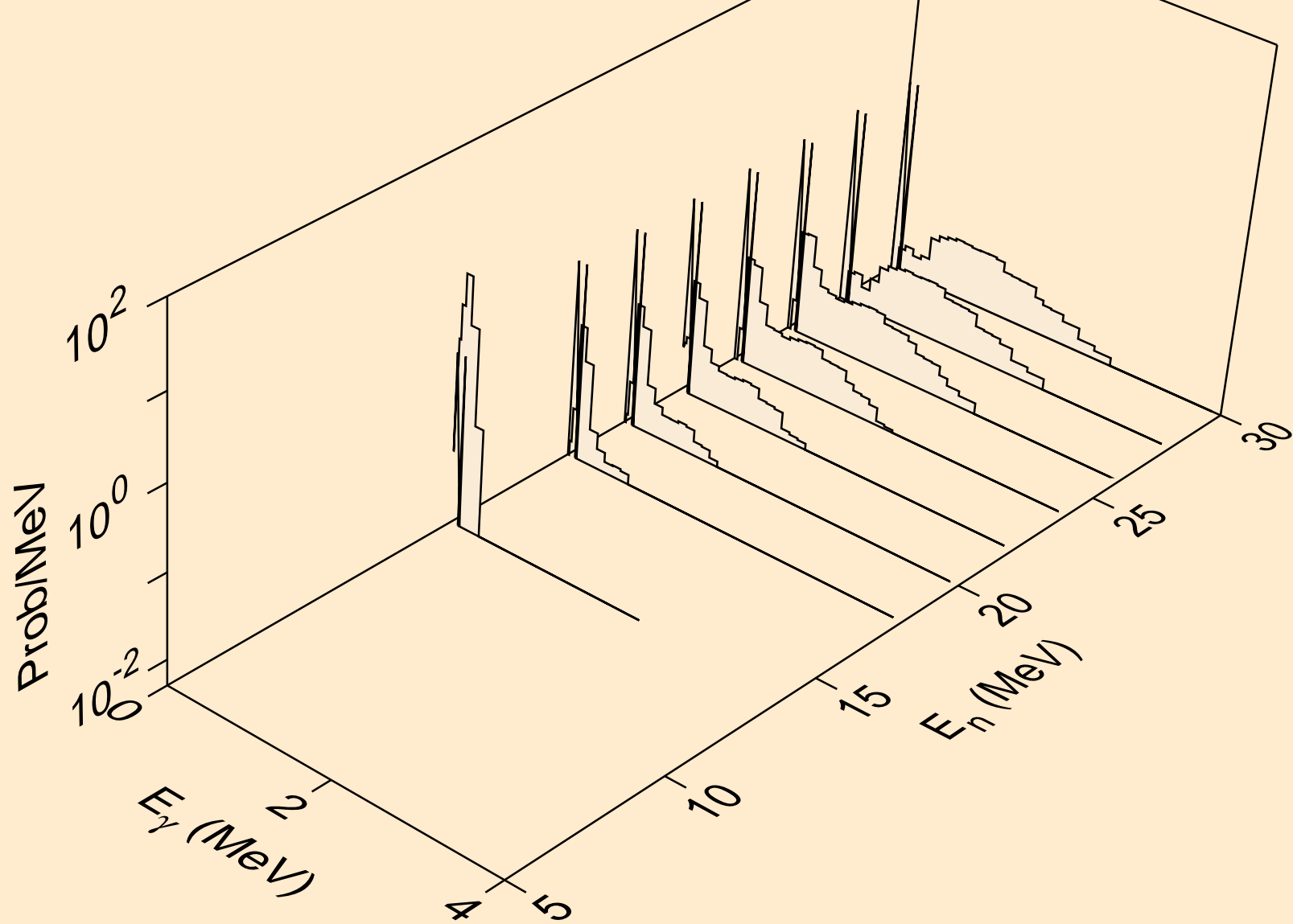

RF266 NEUTRON ACER TENDL-2021 LIBRARY; T=293.6K
Photon emission for (n,n*)t

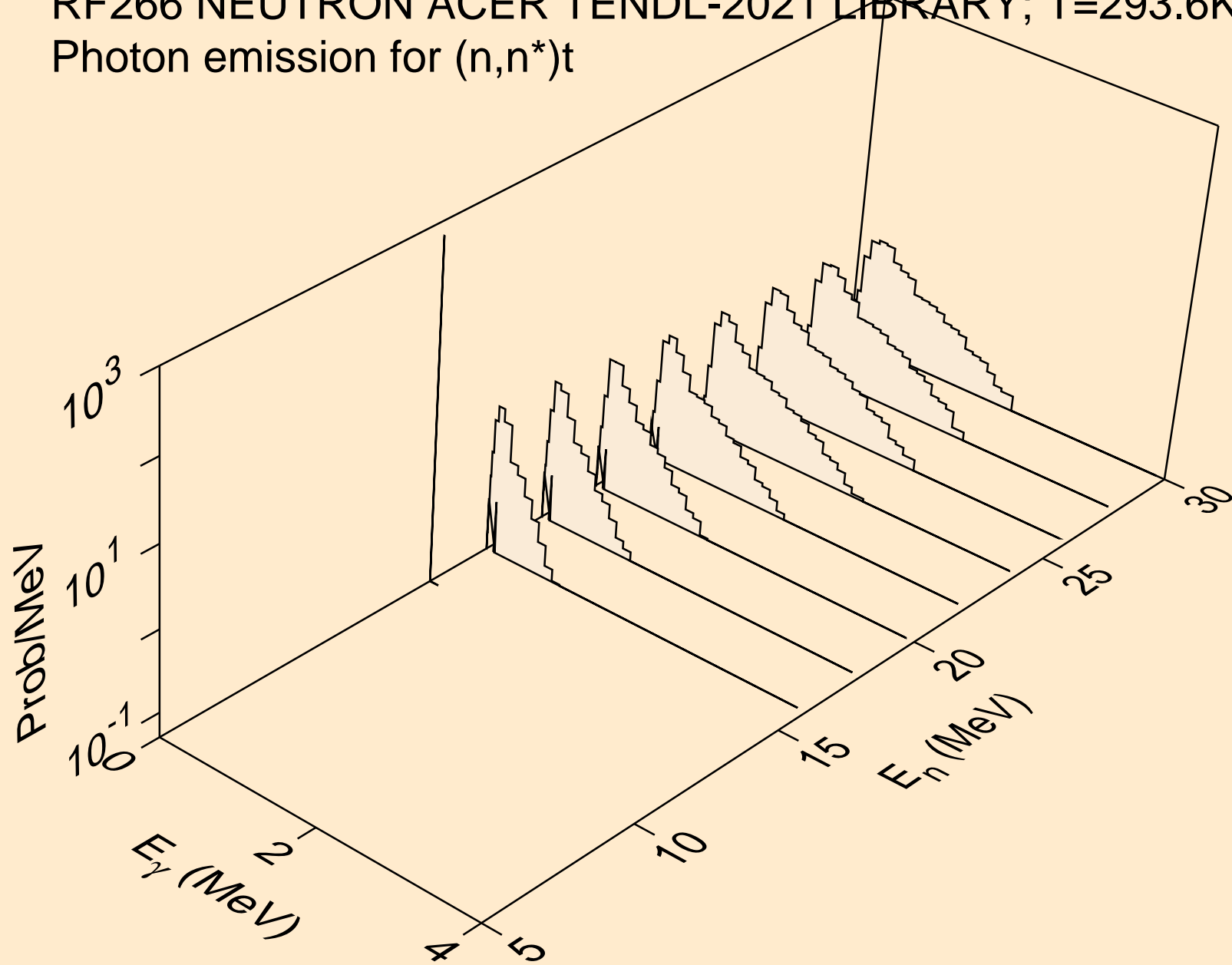

RF266 NEUTRON ACER TENDL-2021 LIBRARY; T=293.6K
Photon emission for (n,n*)he3

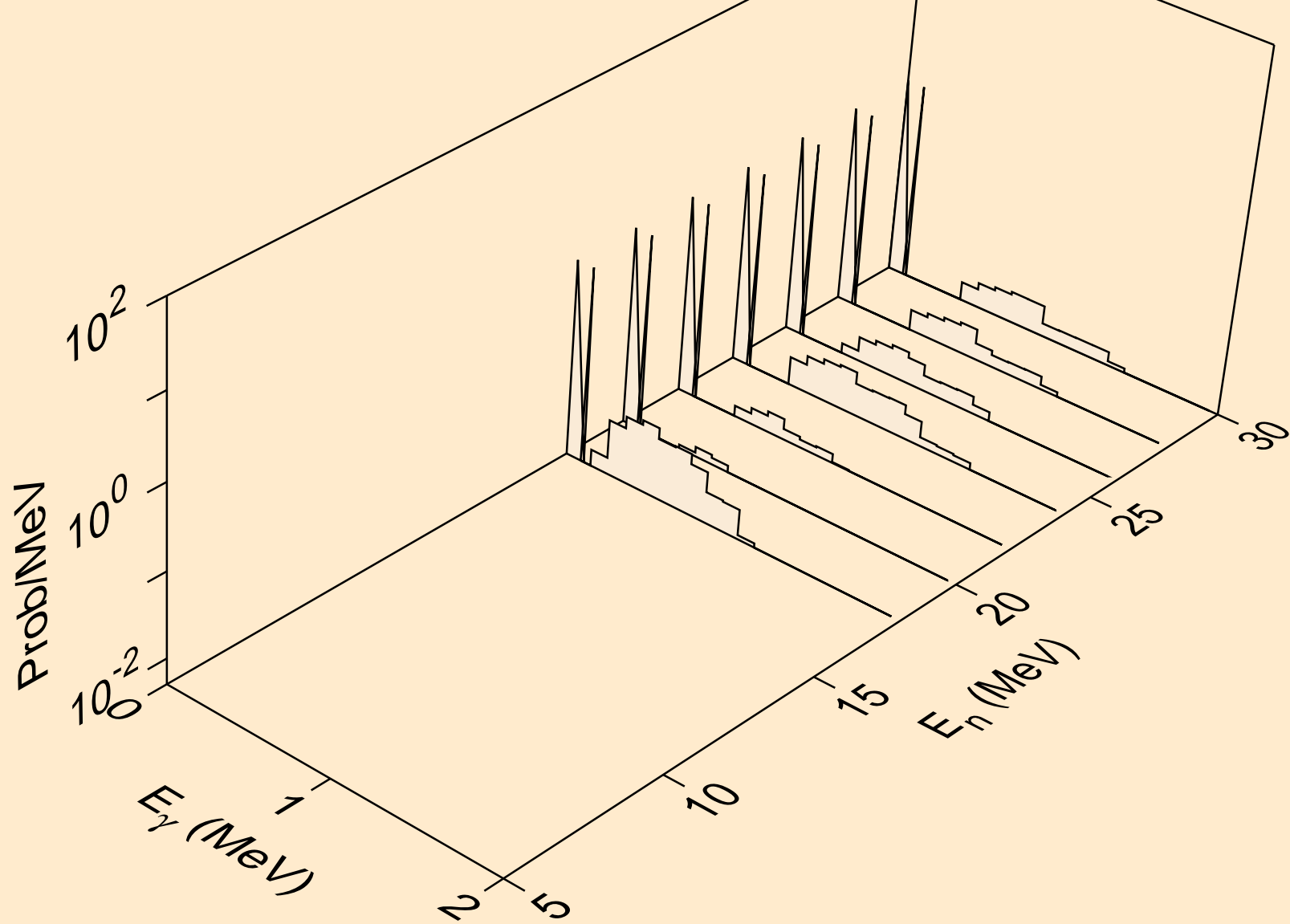

RF266 NEUTRON ACER TENDL-2021 LIBRARY; T=293.6K
Photon emission for (n,4n)

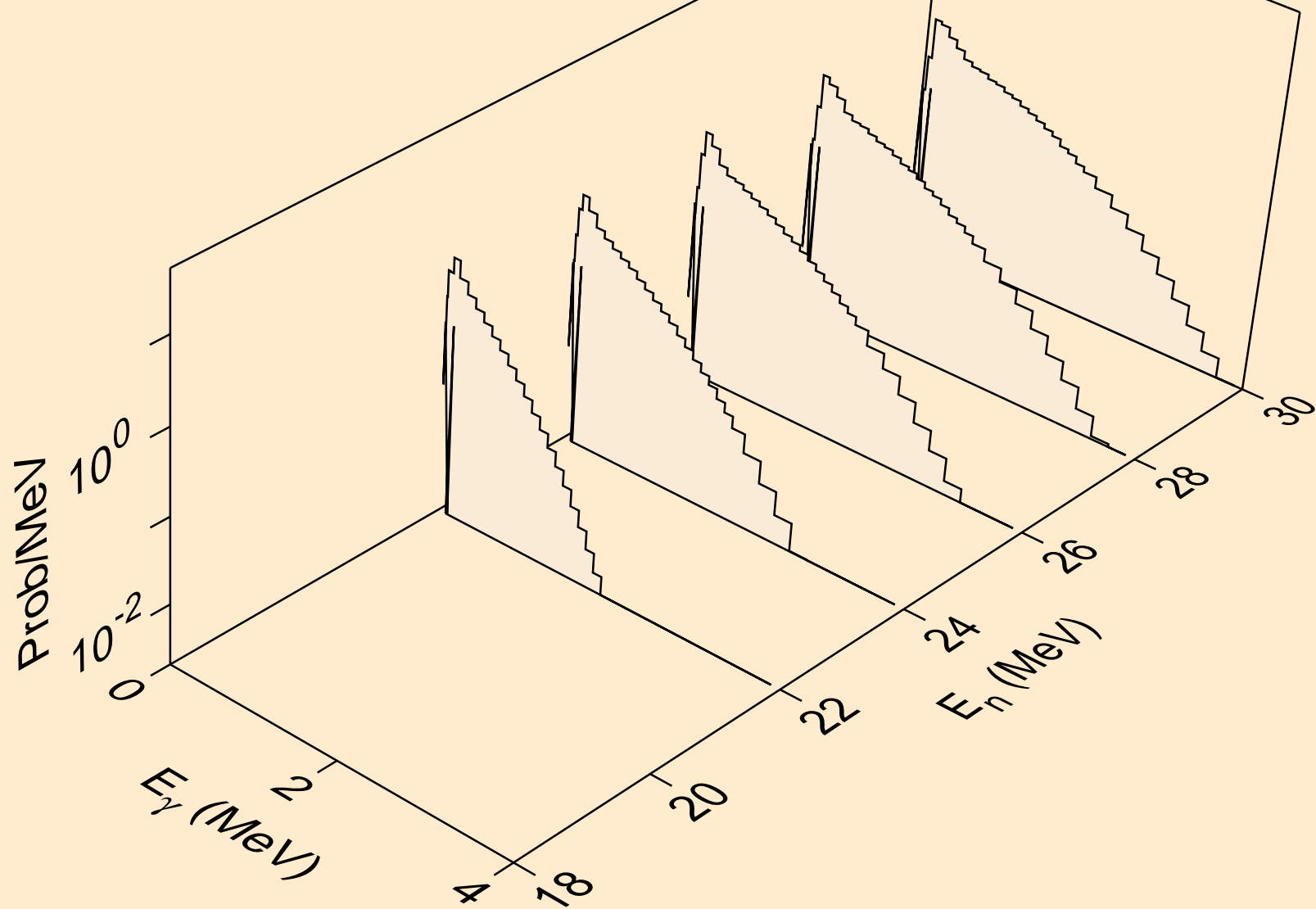

RF266 NEUTRON ACER TENDL-2021 LIBRARY; T=293.6K
Photon emission for (n,2np)

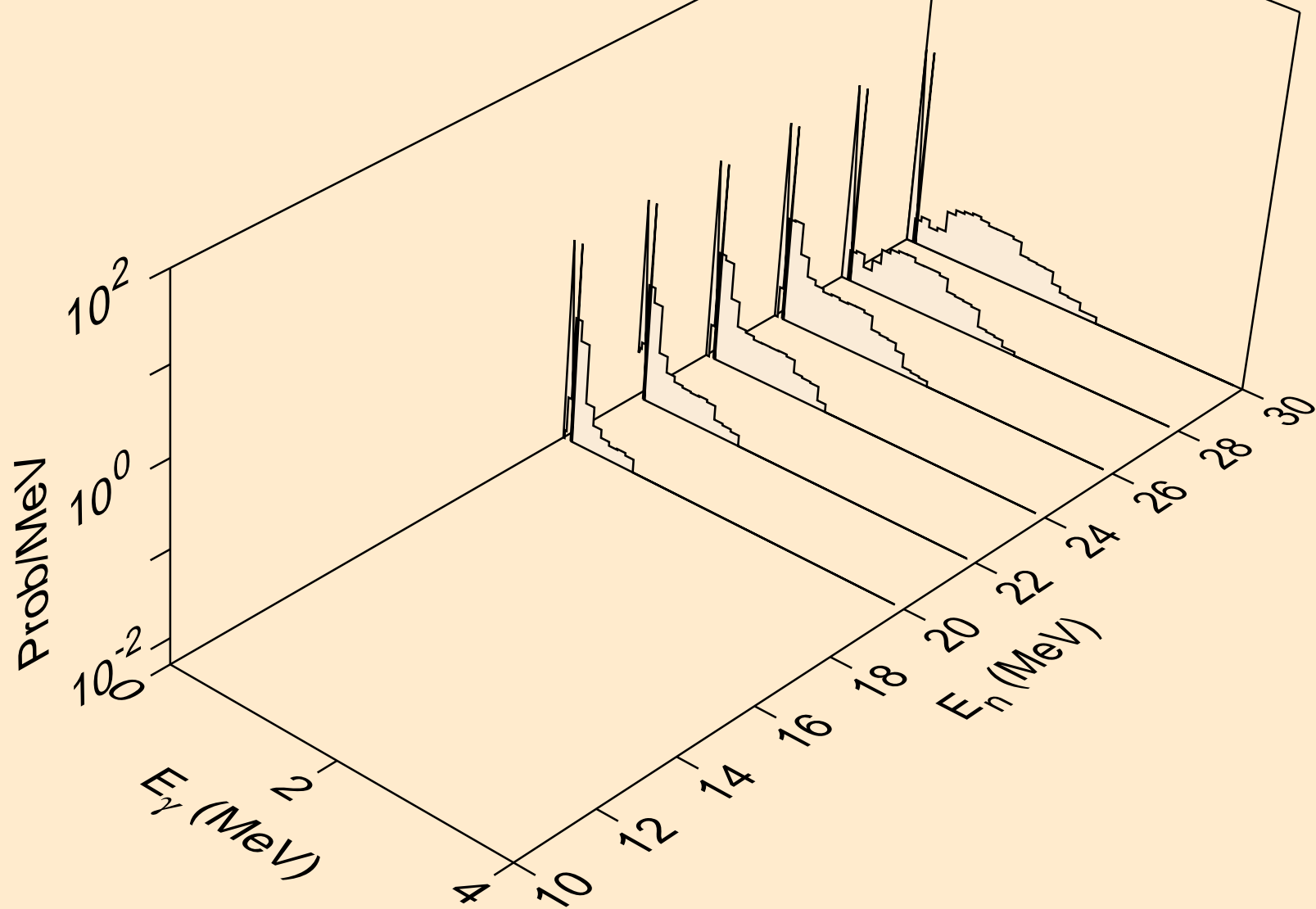

RF266 NEUTRON ACER TENDL-2021 LIBRARY; T=293.6K
Photon emission for (n,2np)

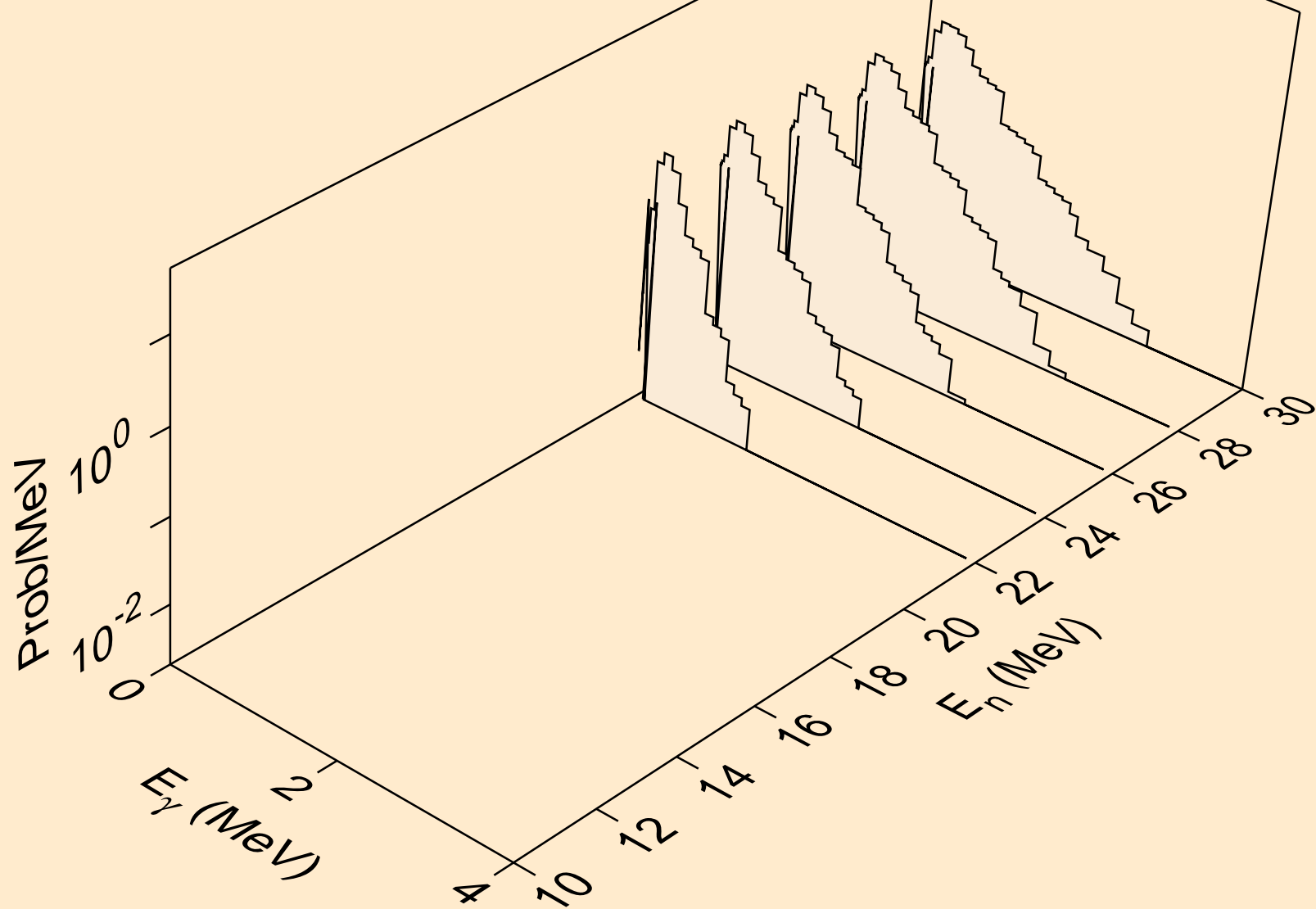

RF266 NEUTRON ACER TENDL-2021 LIBRARY; T=293.6K
Photon emission for (n,n*c)

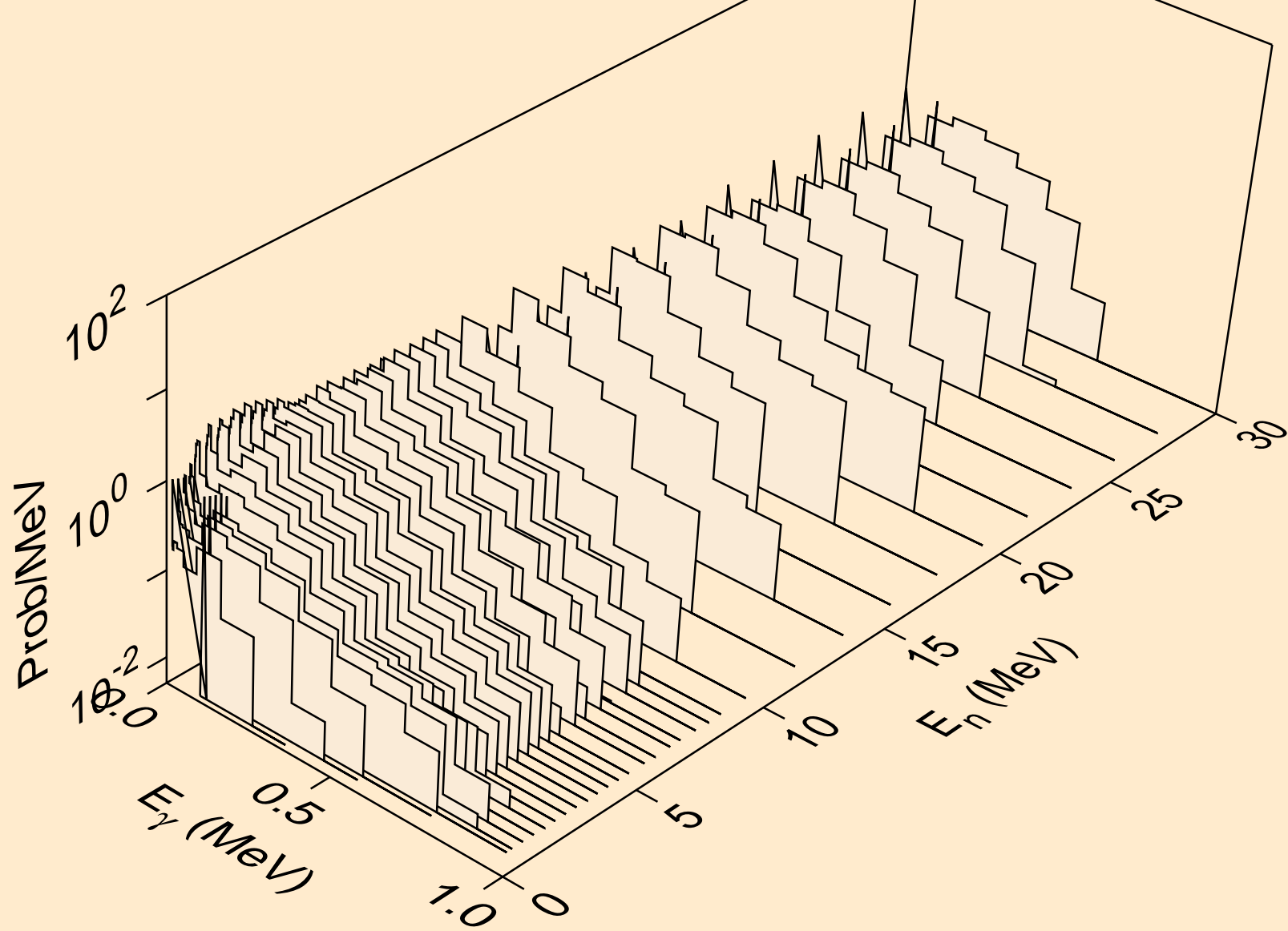

RF266 NEUTRON ACER TENDL-2021 LIBRARY; T=293.6K
Photon emission for (n,gma)

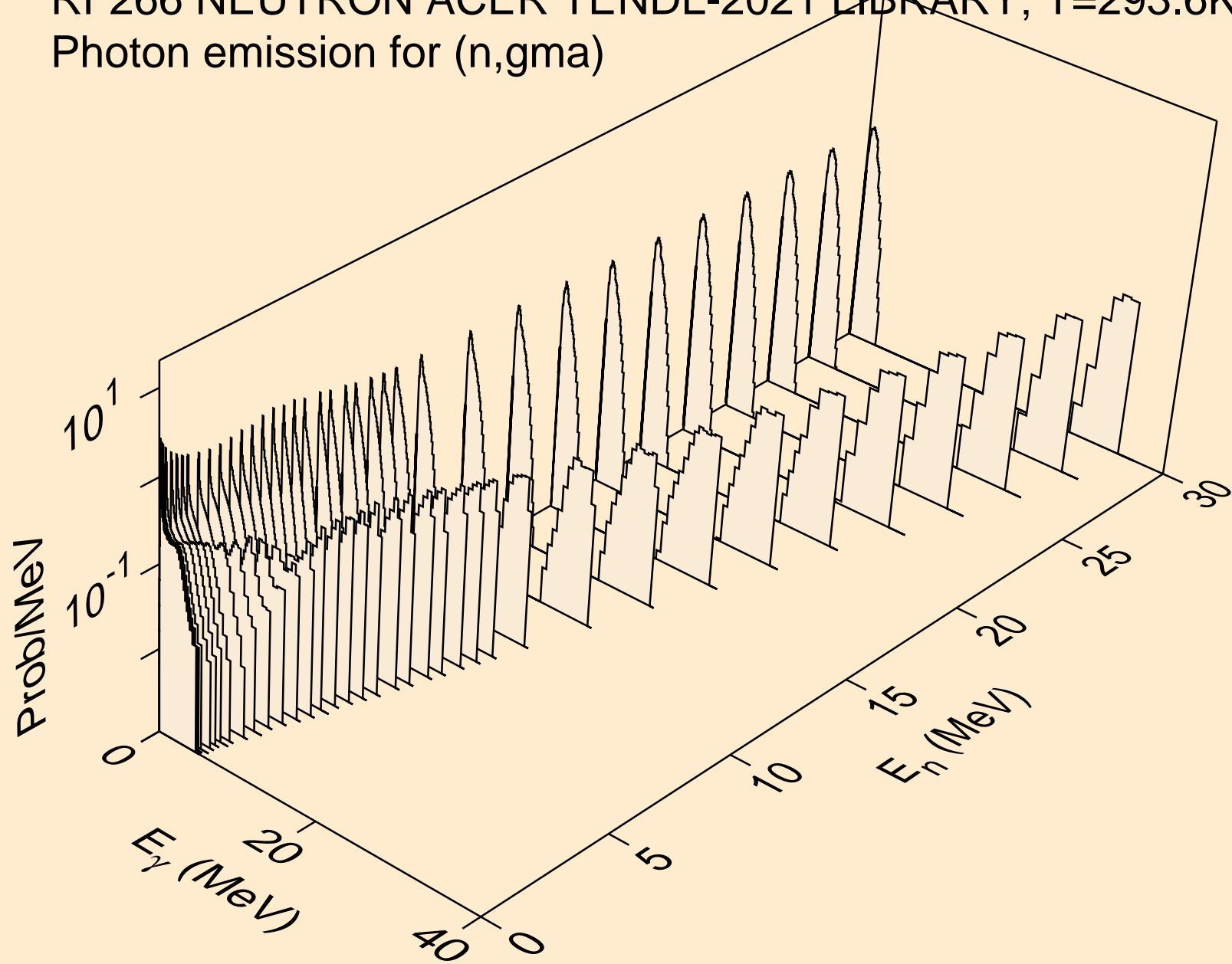

RF266 NEUTRON ACER TENDL-2021 LIBRARY; T=293.6K
Photon emission for (n,p)

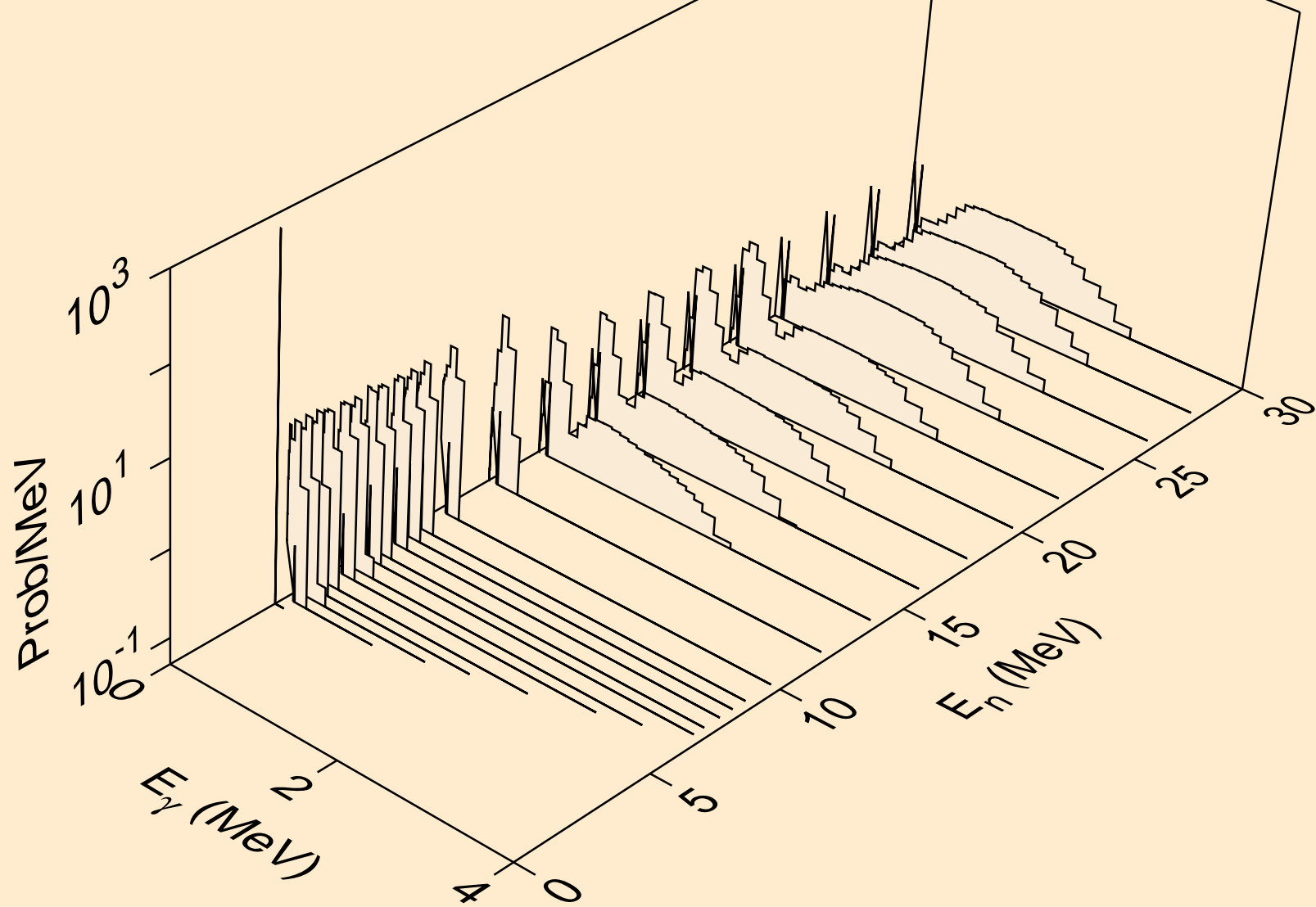

RF266 NEUTRON ACER TENDL-2021 LIBRARY; T=293.6K
Photon emission for (n,d)

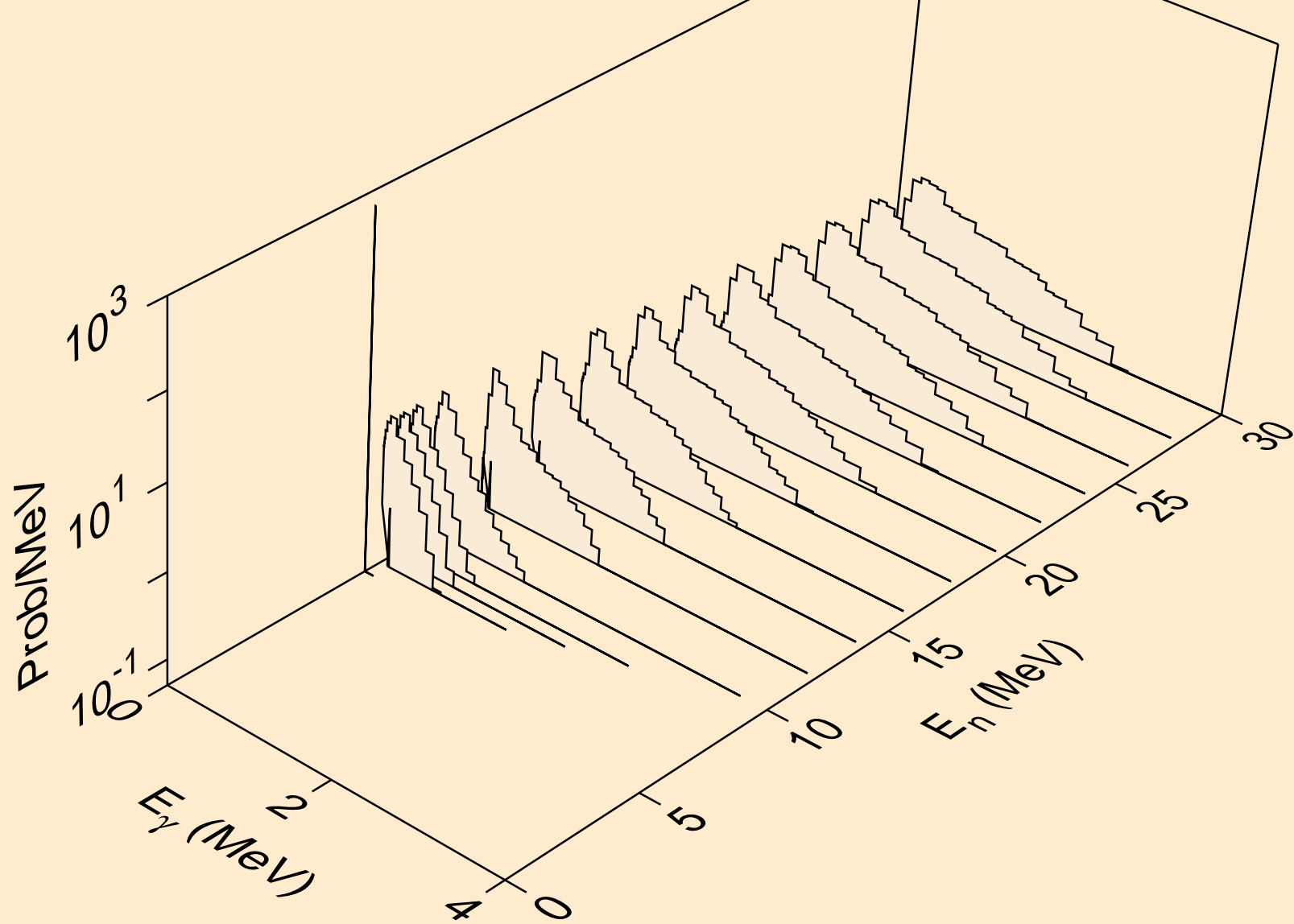

RF266 NEUTRON ACER TENDL-2021 LIBRARY; T=293.6K
Photon emission for (n,t)

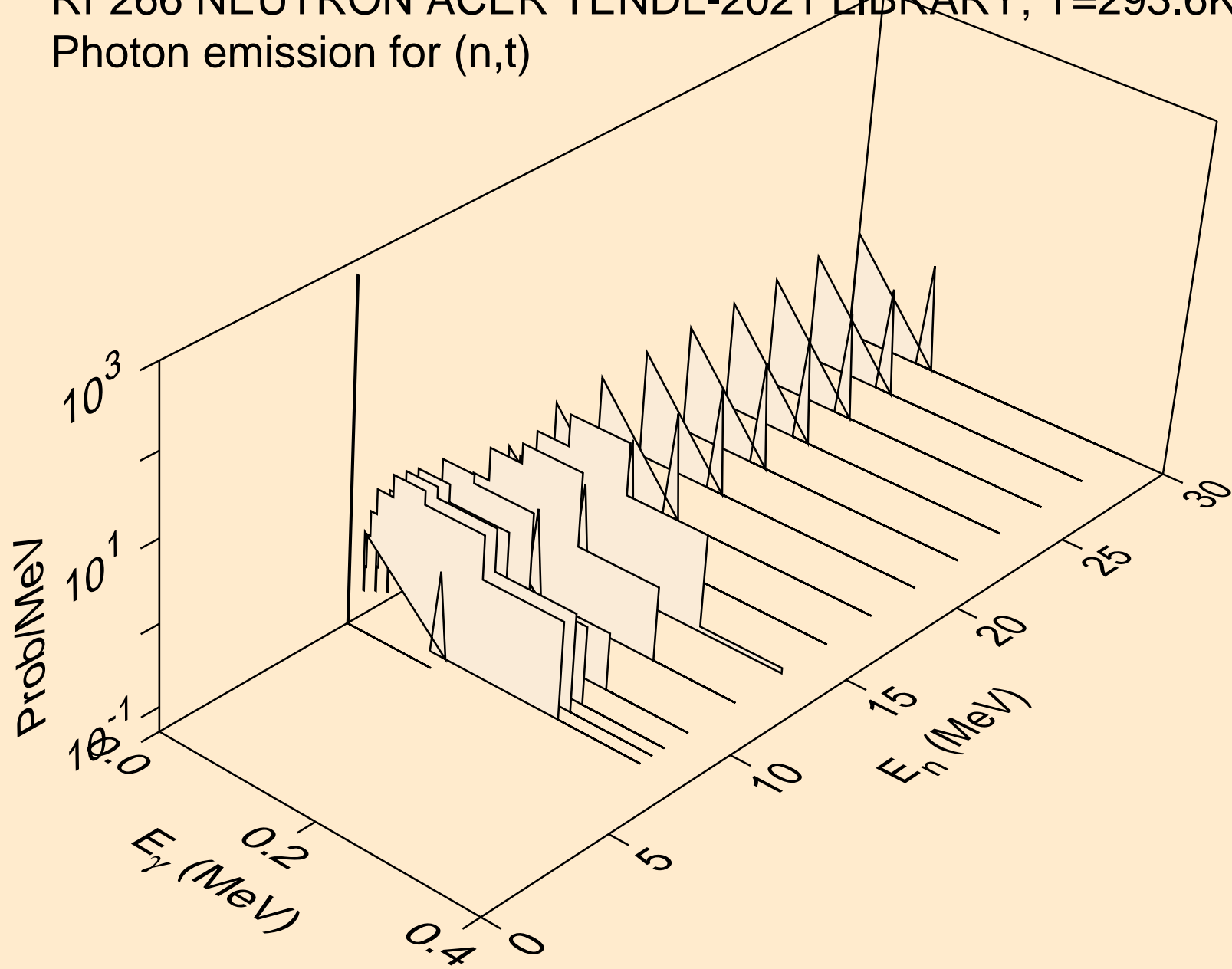

RF266 NEUTRON ACER TENDL-2021 LIBRARY; T=293.6K
Photon emission for (n,he3)

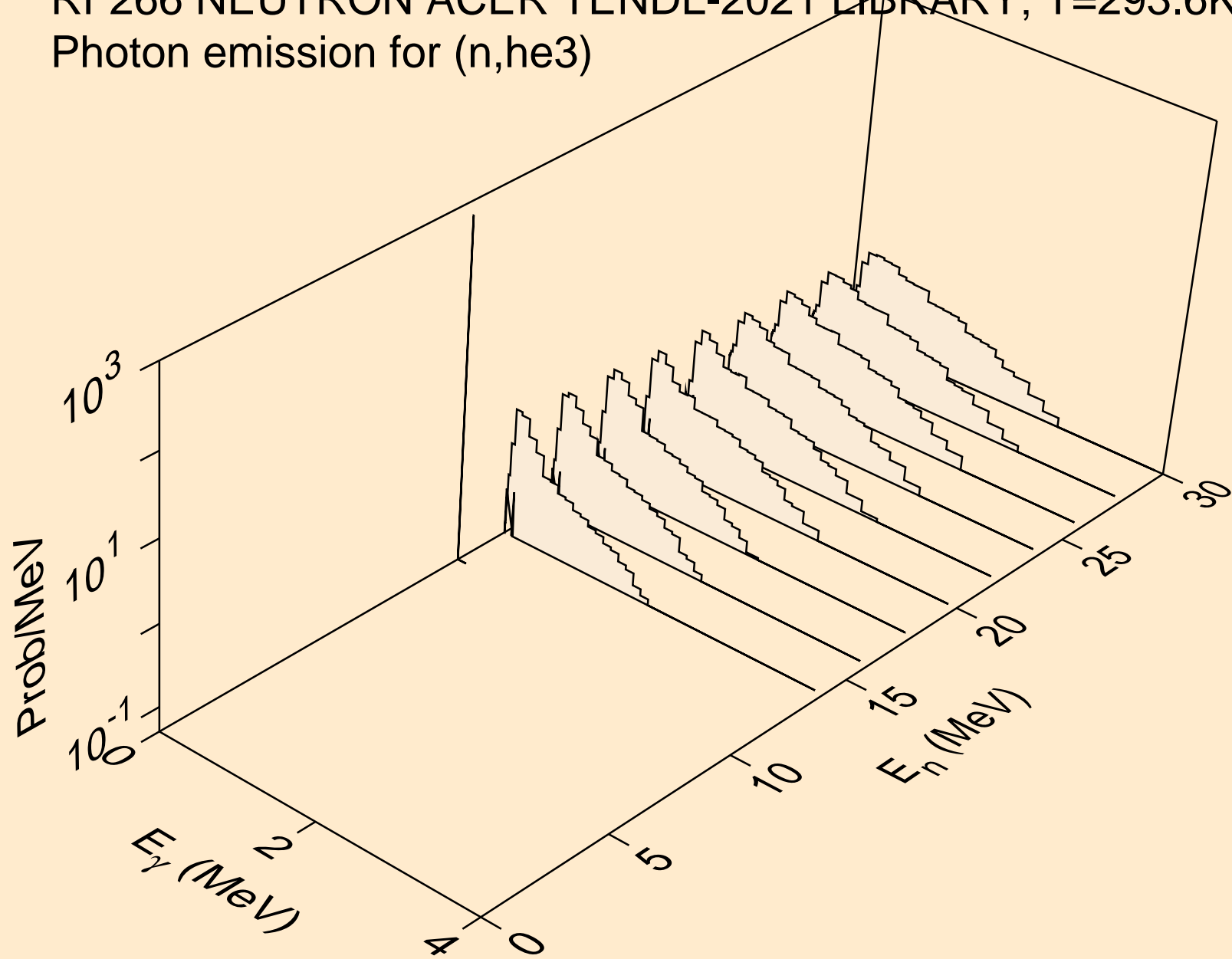

RF266 NEUTRON ACER TENDL-2021 LIBRARY; T=293.6K
Photon emission for (n,a)

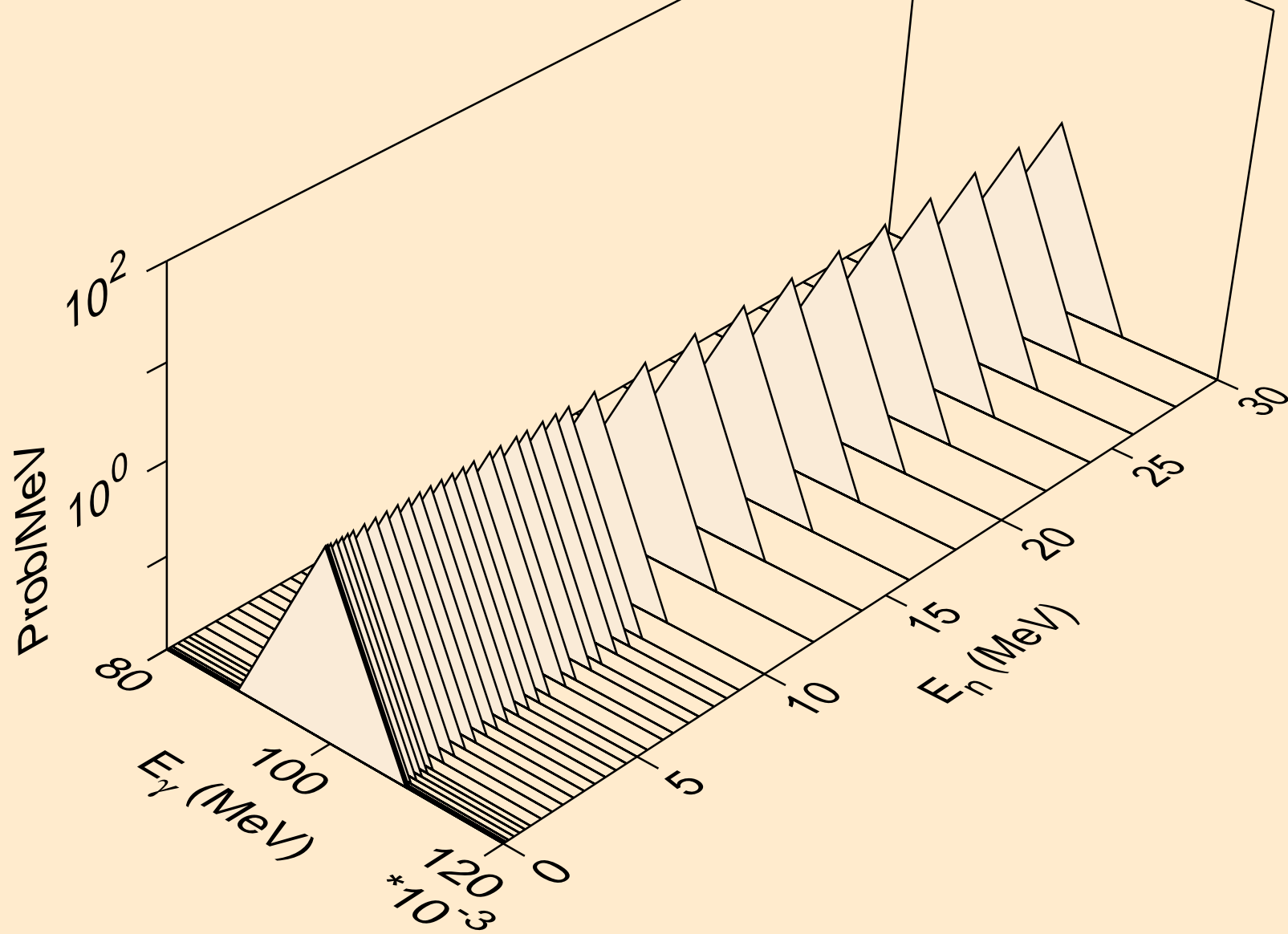

RF266 NEUTRON ACER TENDL-2021 LIBRARY; T=293.6K
Photon emission for (n,2p)

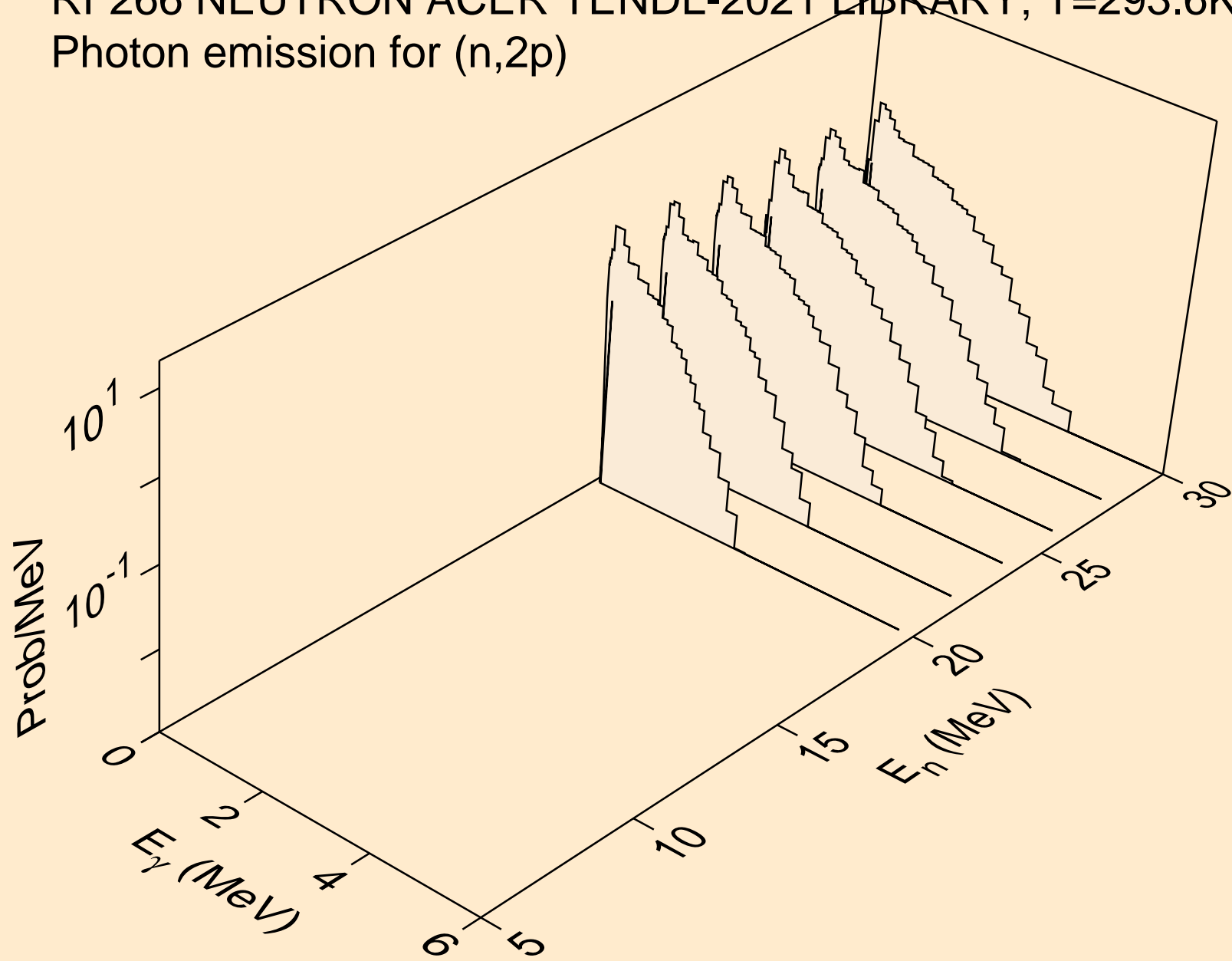

RF266 NEUTRON ACER TENDL-2021 LIBRARY; T=293.6K
thermal capture photon spectrum

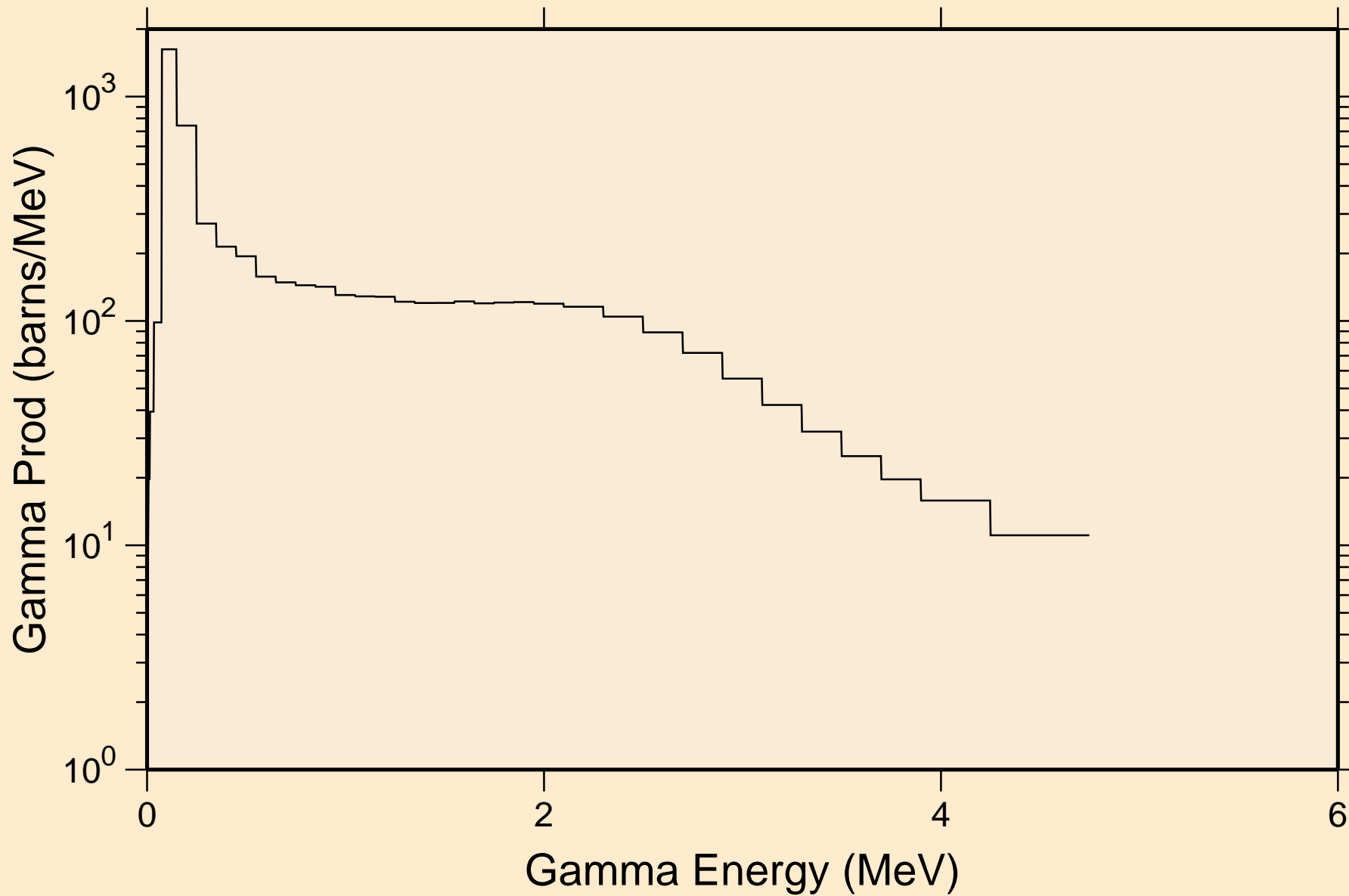

RF266 NEUTRON ACER TENDL-2021 LIBRARY; T=293.6K
14 MeV photon spectrum

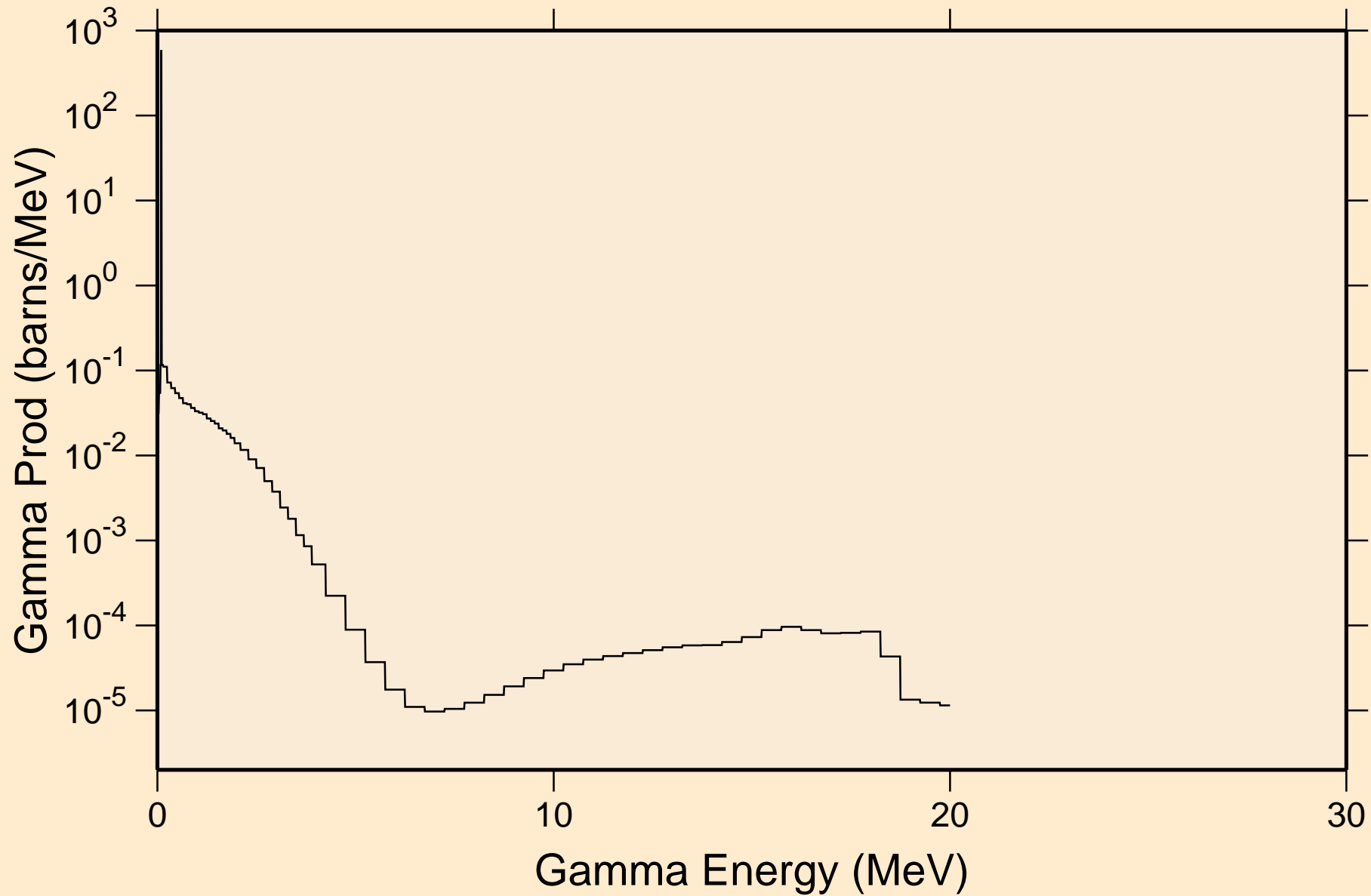

RF266 NEUTRON ACER TENDL-2021 LIBRARY; T=293.6K

Particle heating contributions

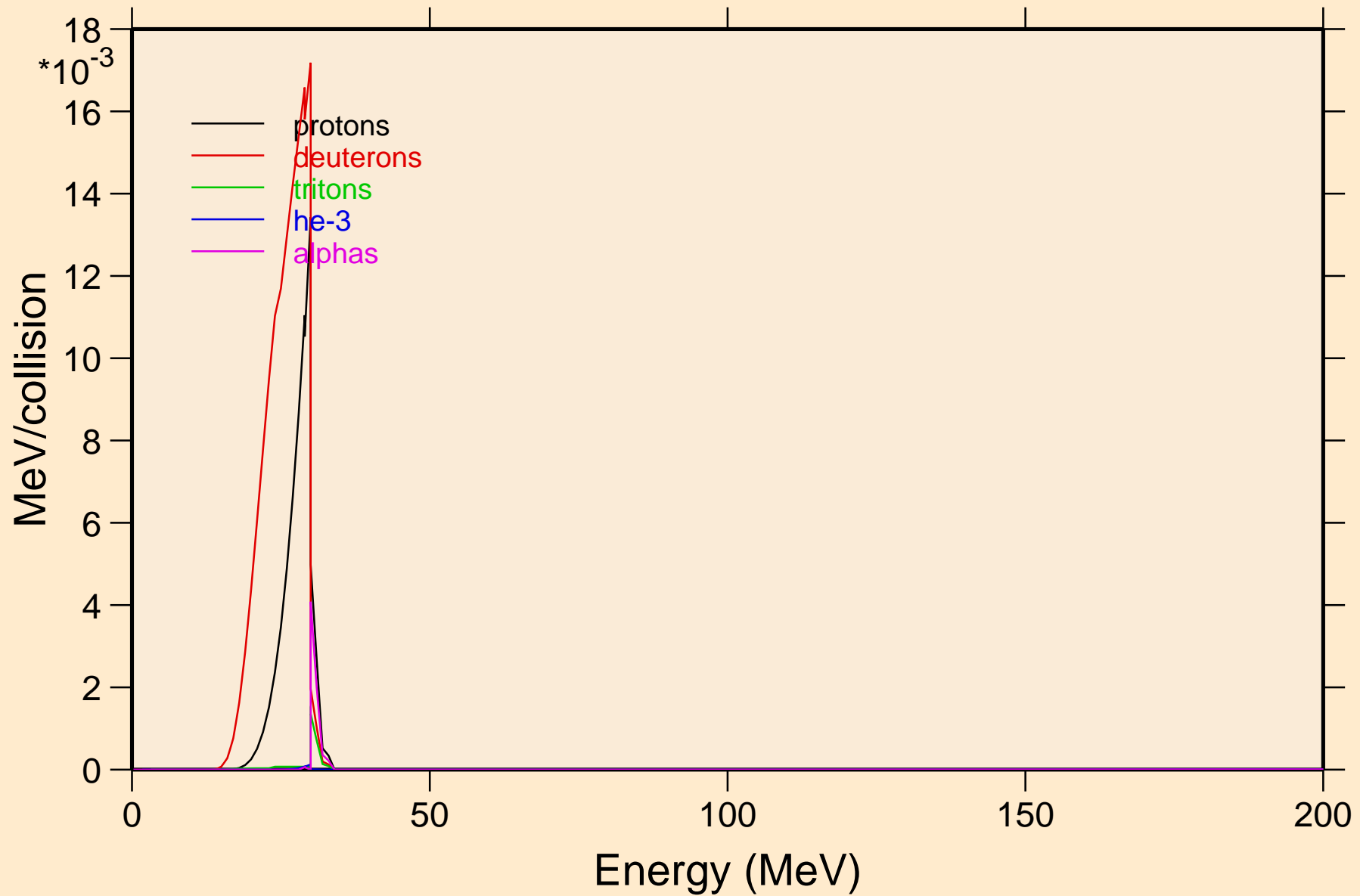

RF266 NEUTRON ACER TENDL-2021 LIBRARY; T=293.6K
Recoil Heating

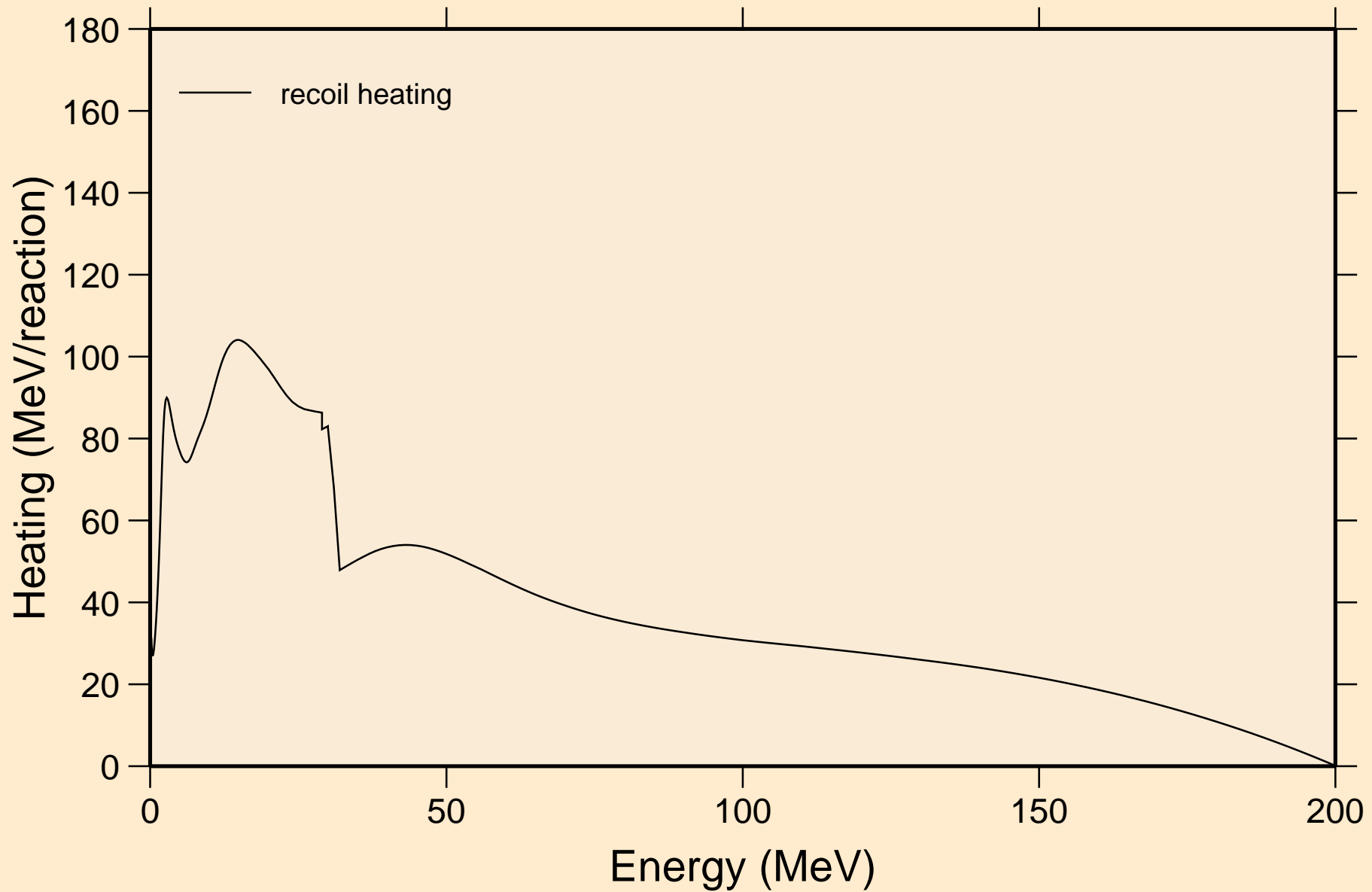

RF266 NEUTRON ACER TENDL-2021 LIBRARY; T=293.6K
Particle production cross sections

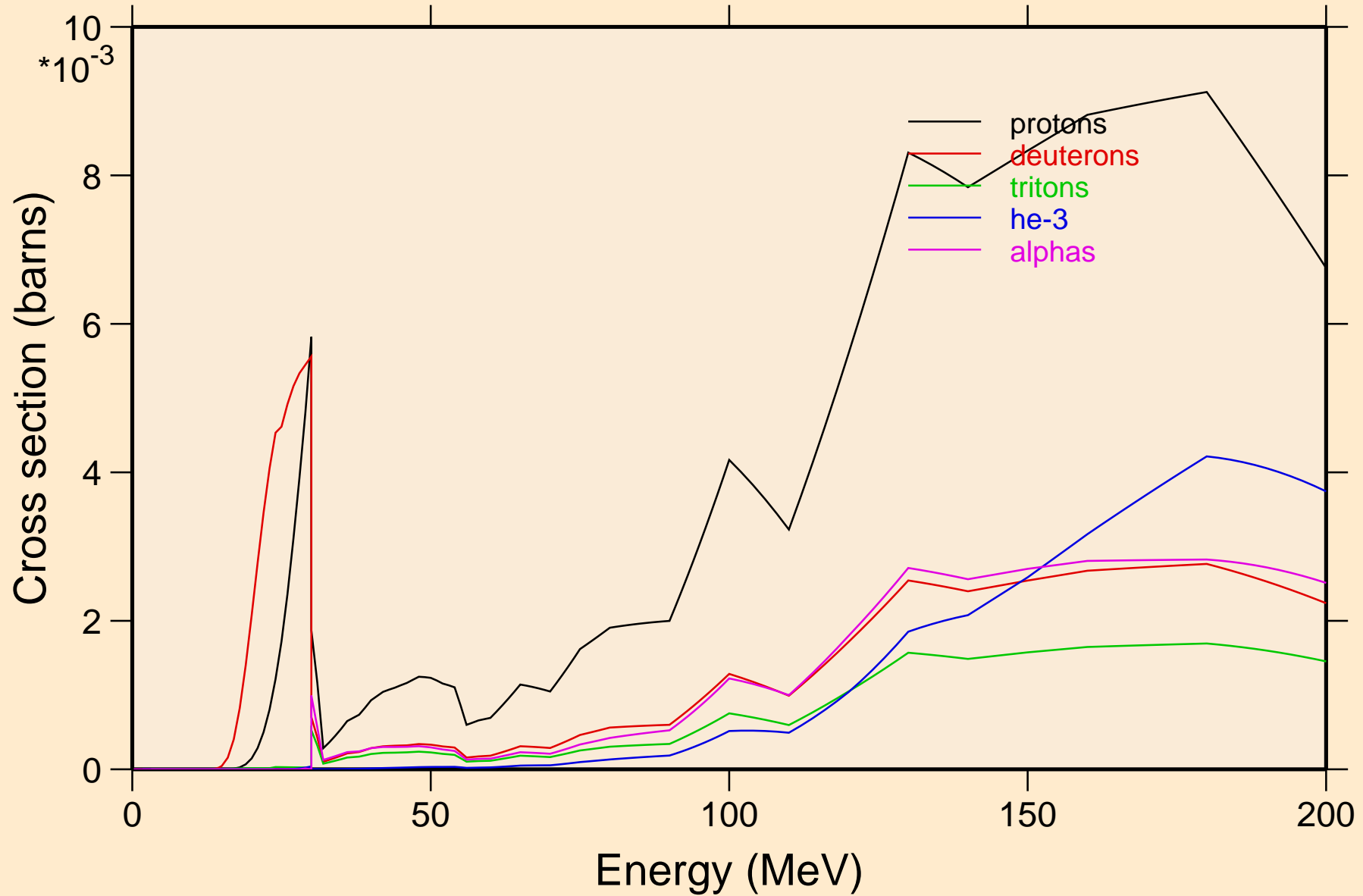

RF266 NEUTRON ACER TENDL-2021 LIBRARY; T=293.6K
protons from (n,x)

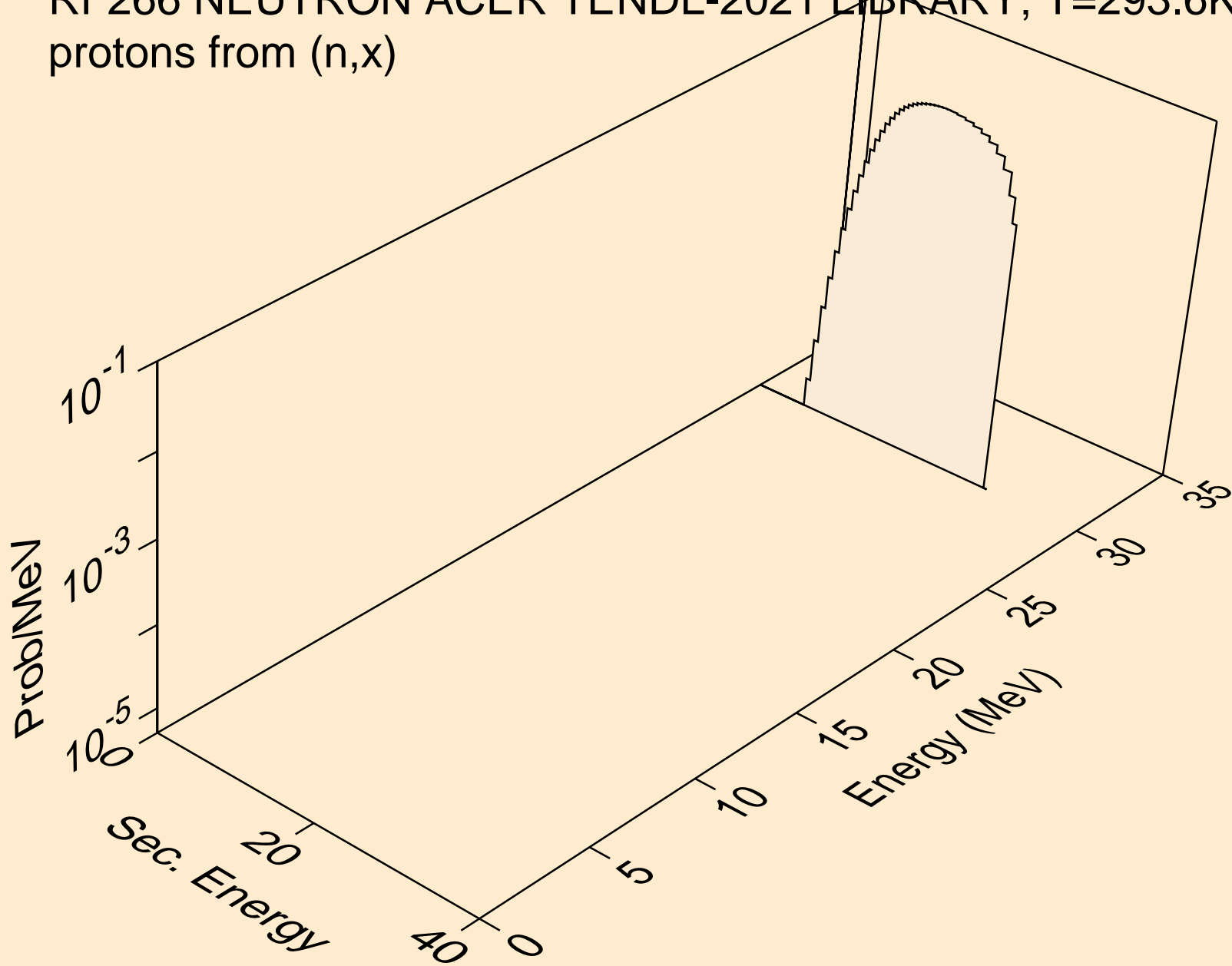

RF266 NEUTRON ACER TENDL-2021 LIBRARY; T=293.6K
protons from (n,n*)p

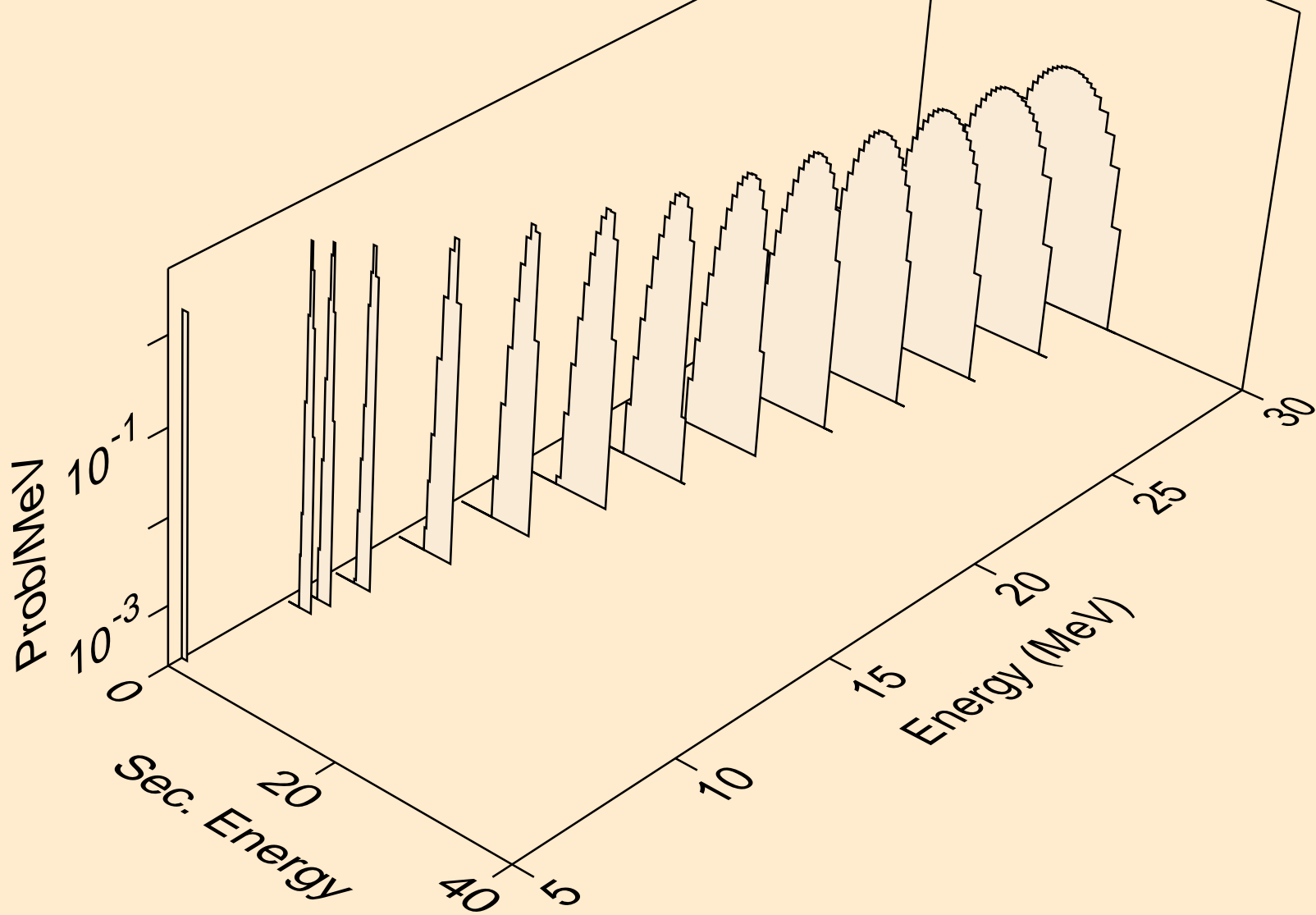

RF266 NEUTRON ACER TENDL-2021 LIBRARY; T=293.6K
protons from (n,2np)

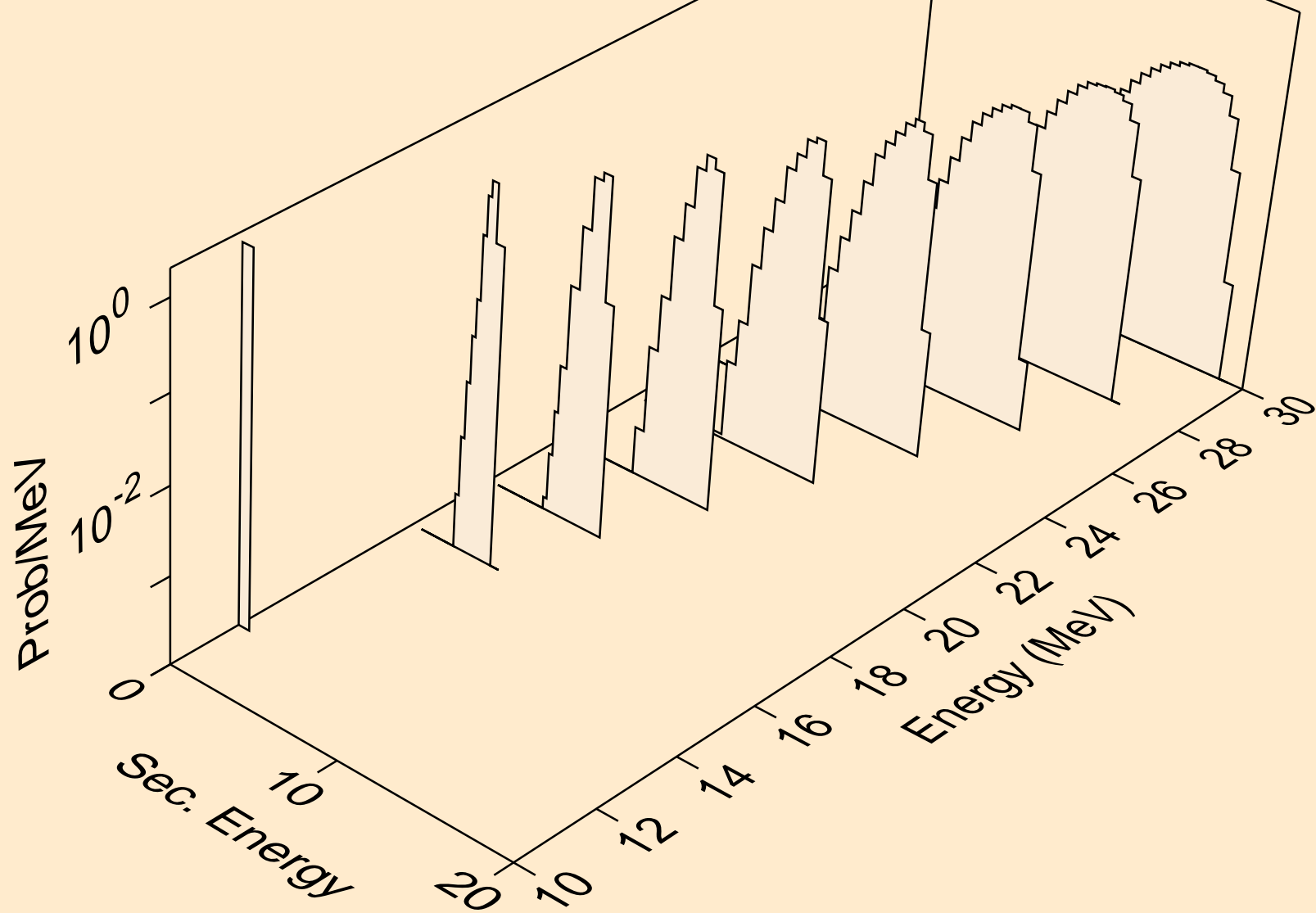

RF266 NEUTRON ACER TENDL-2021 LIBRARY; T=293.6K
protons from (n,2np)

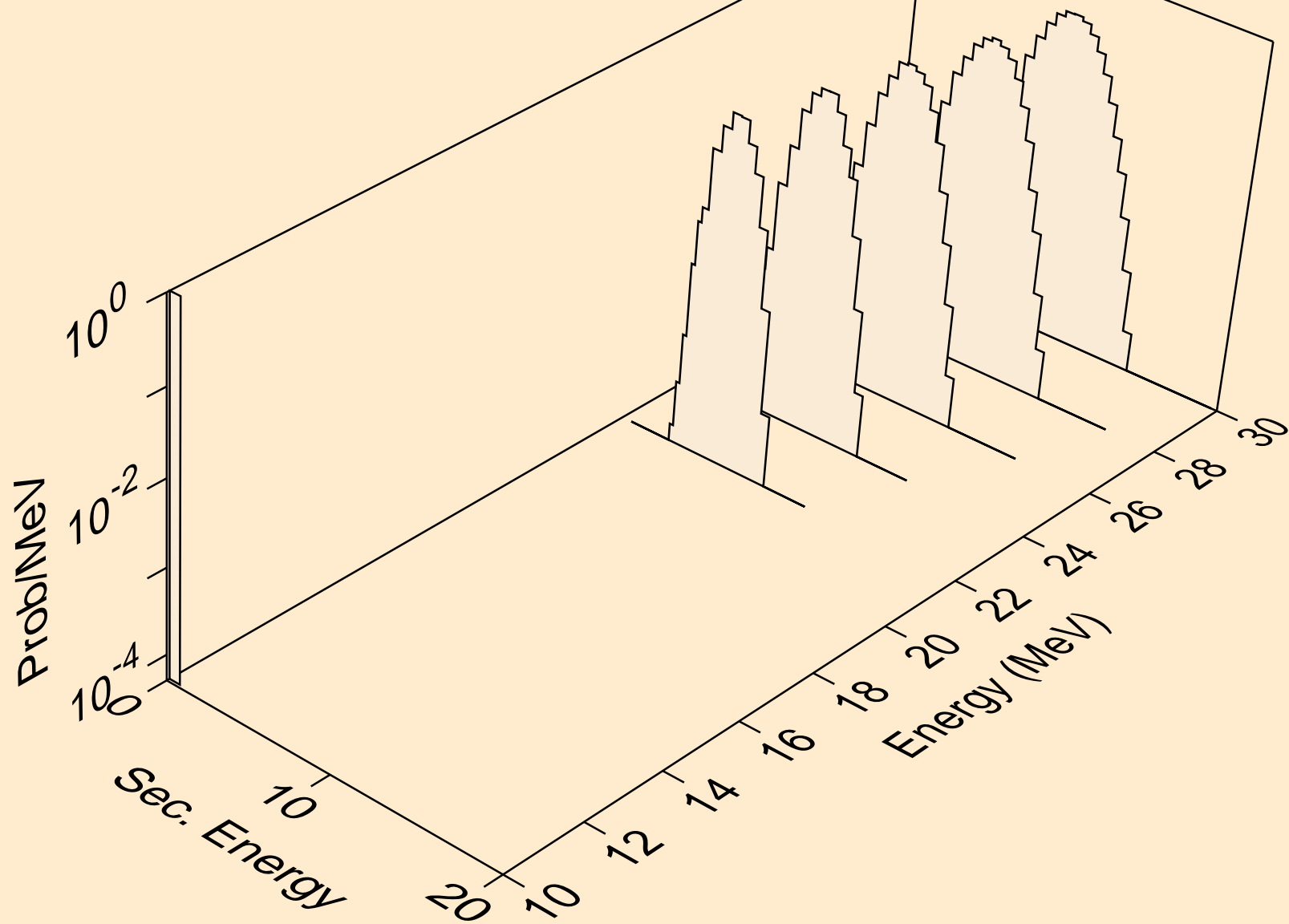

RF266 NEUTRON ACER TENDL-2021 LIBRARY; T=293.6K
protons from (n,p)

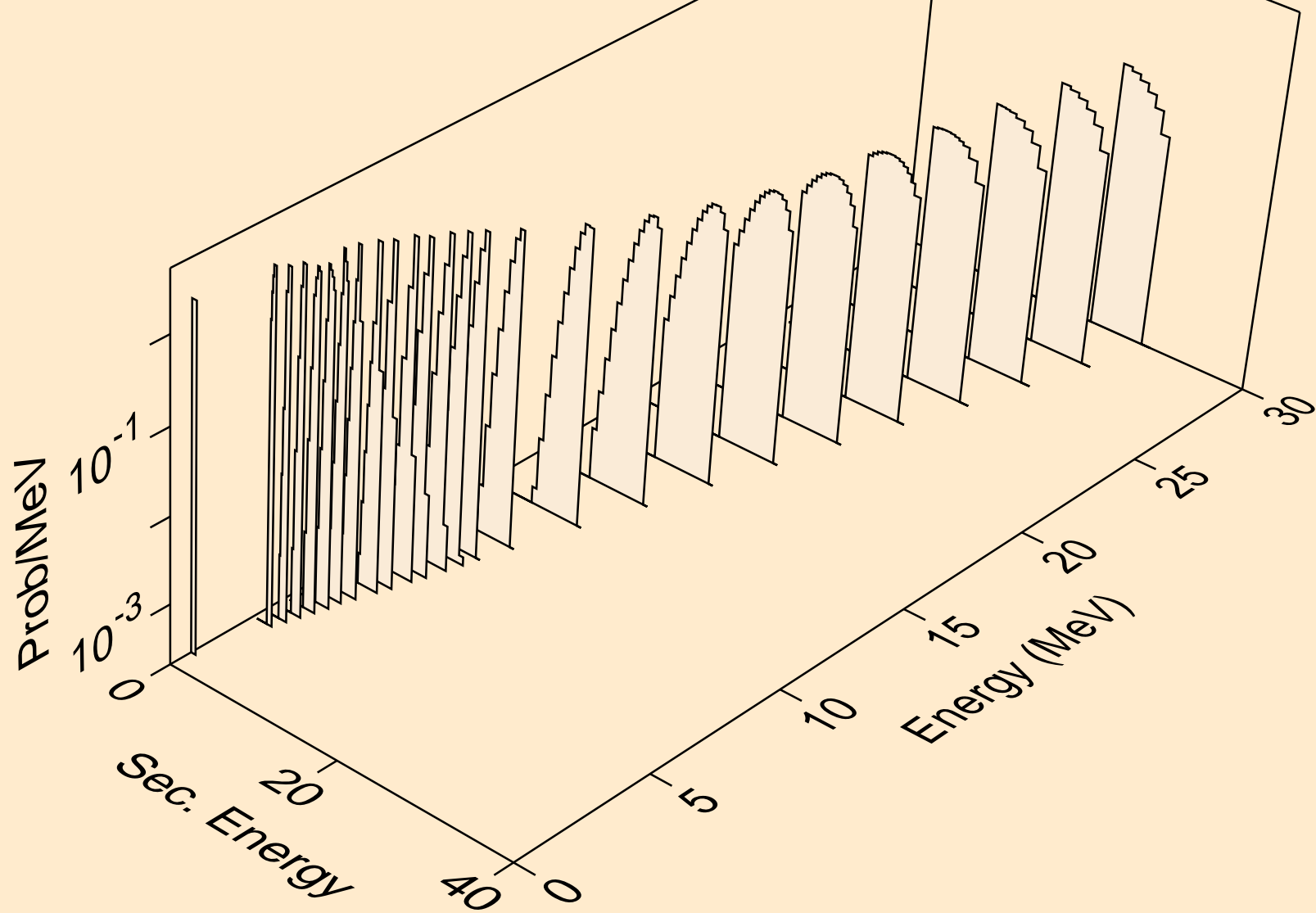

RF266 NEUTRON ACER TENDL-2021 LIBRARY; T=293.6K
protons from (n,2p)

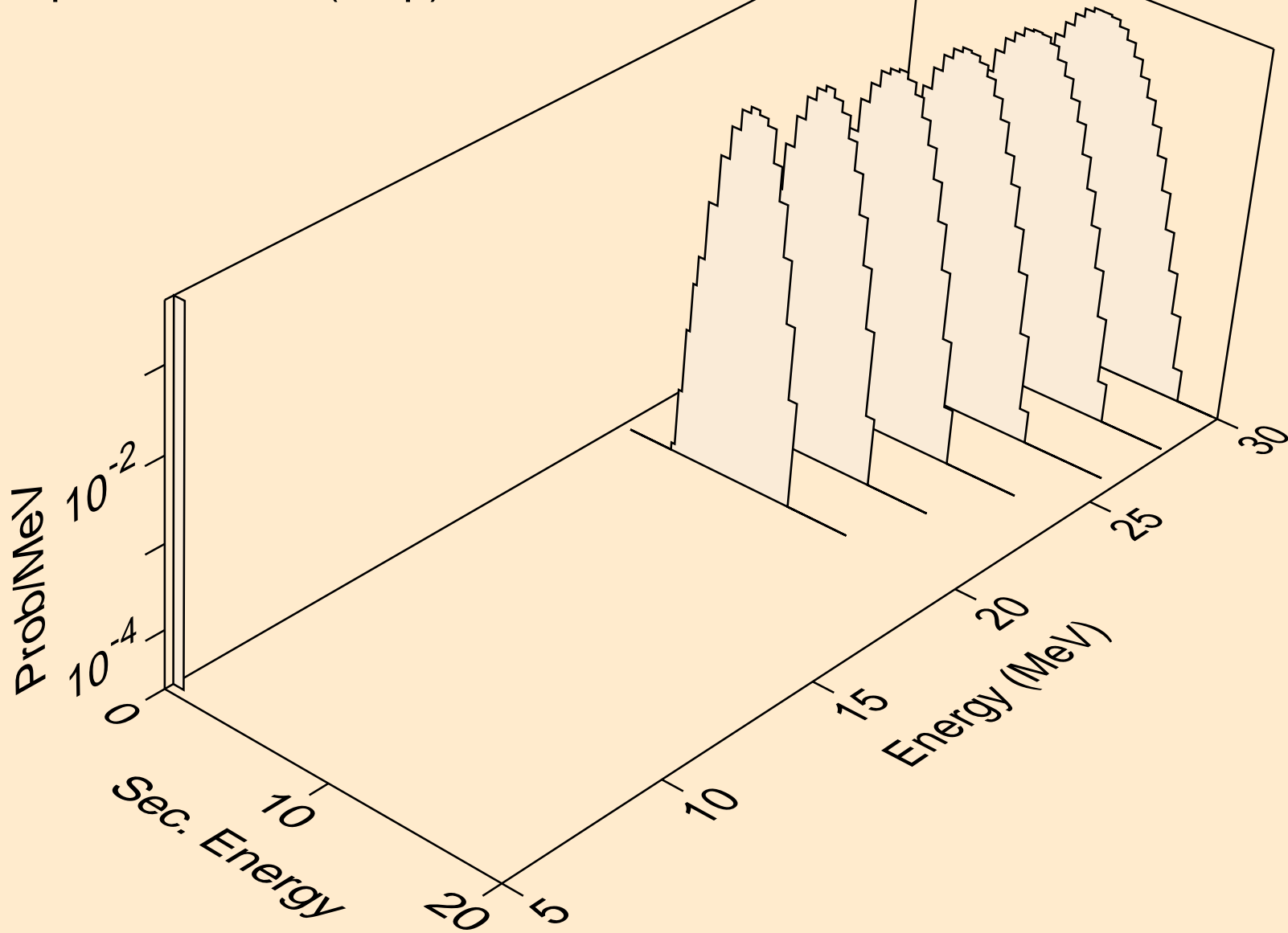

RF266 NEUTRON ACER TENDL-2021 LIBRARY; T=293.6K
deuterons from (n,x)

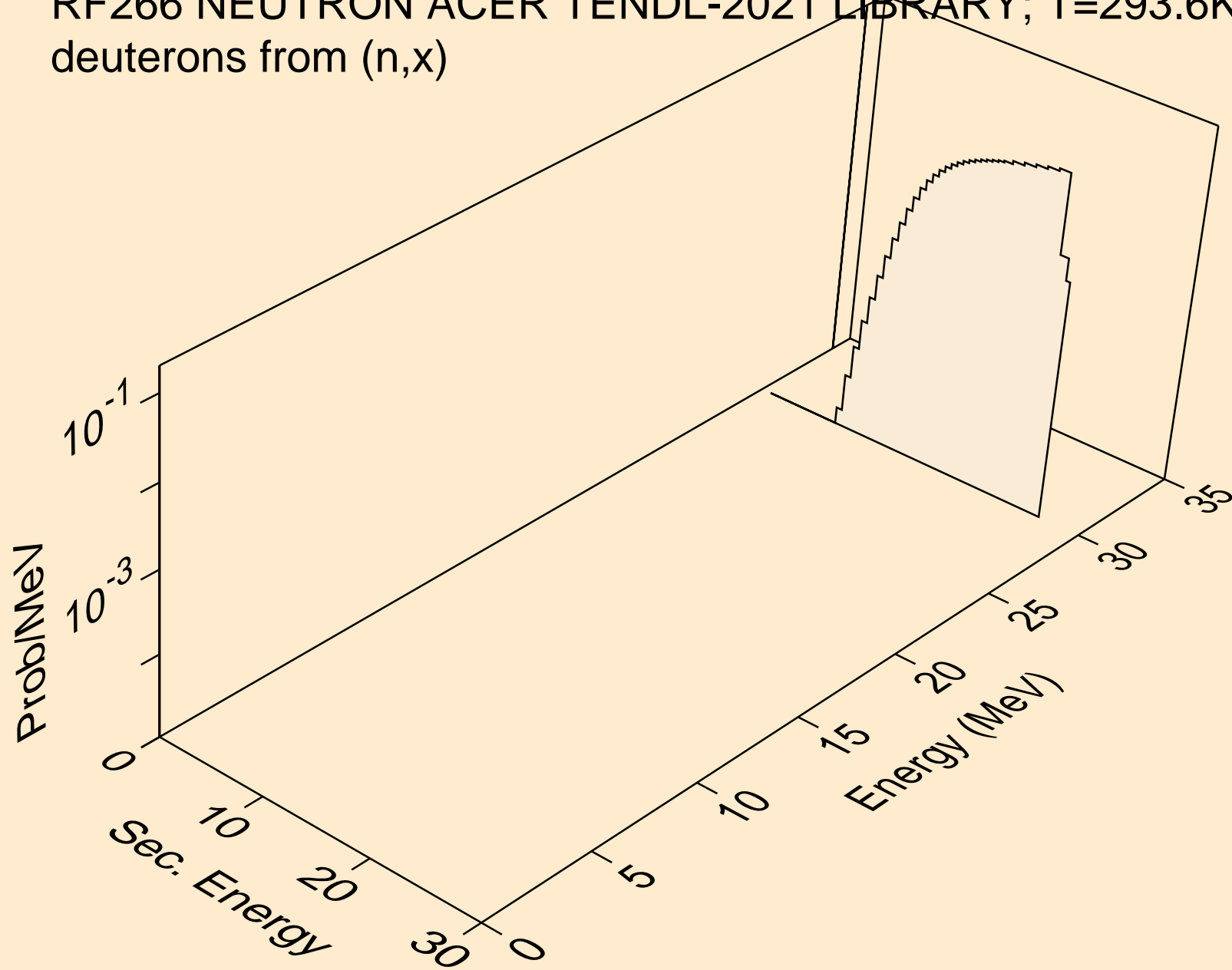

RF266 NEUTRON ACER TENDL-2021 LIBRARY; T=293.6K
deuterons from (n,2nd)

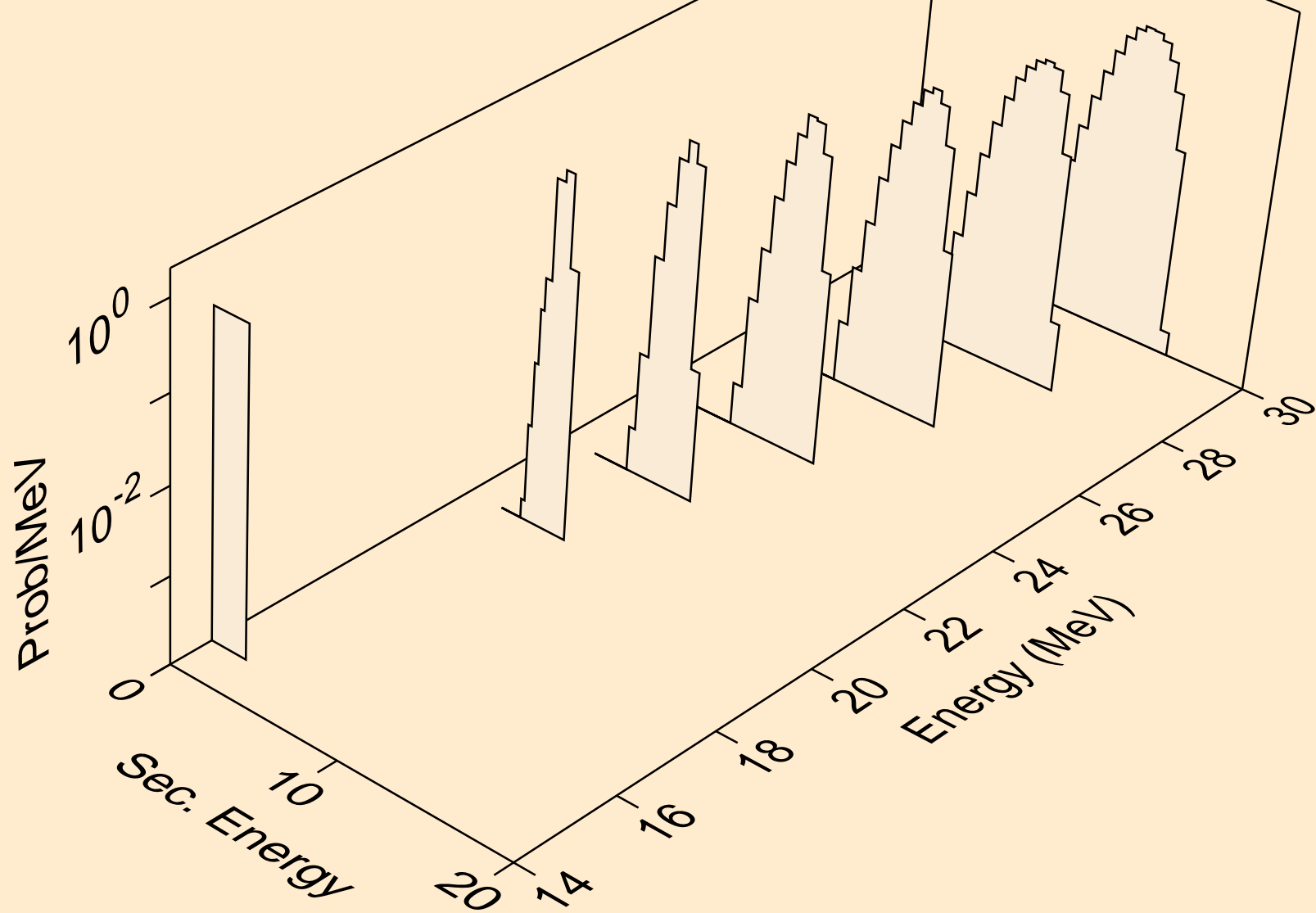

RF266 NEUTRON ACER TENDL-2021 LIBRARY; T=293.6K
deuterons from (n,n*)d

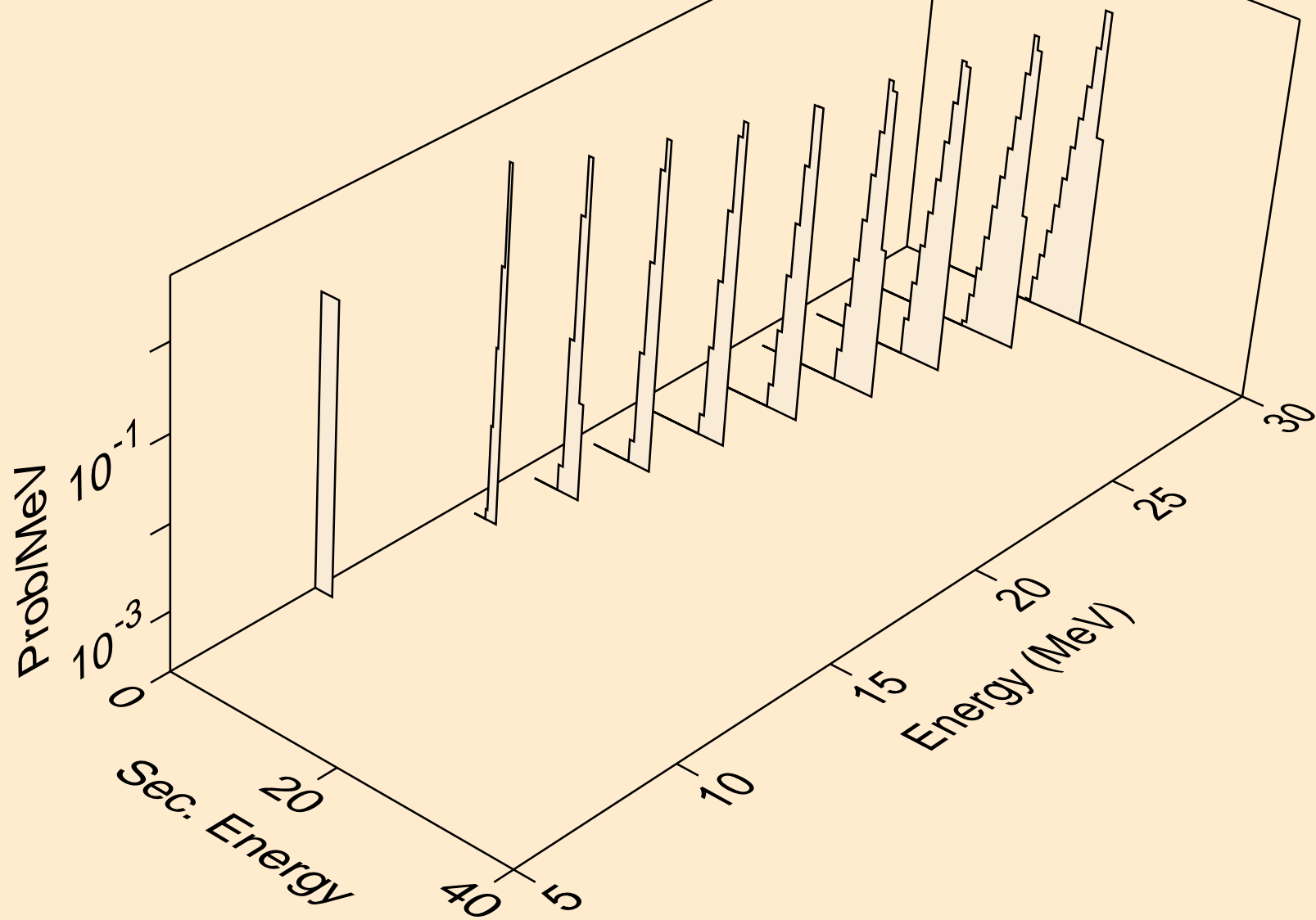

RF266 NEUTRON ACER TENDL-2021 LIBRARY; T=293.6K
deuterons from (n,d)

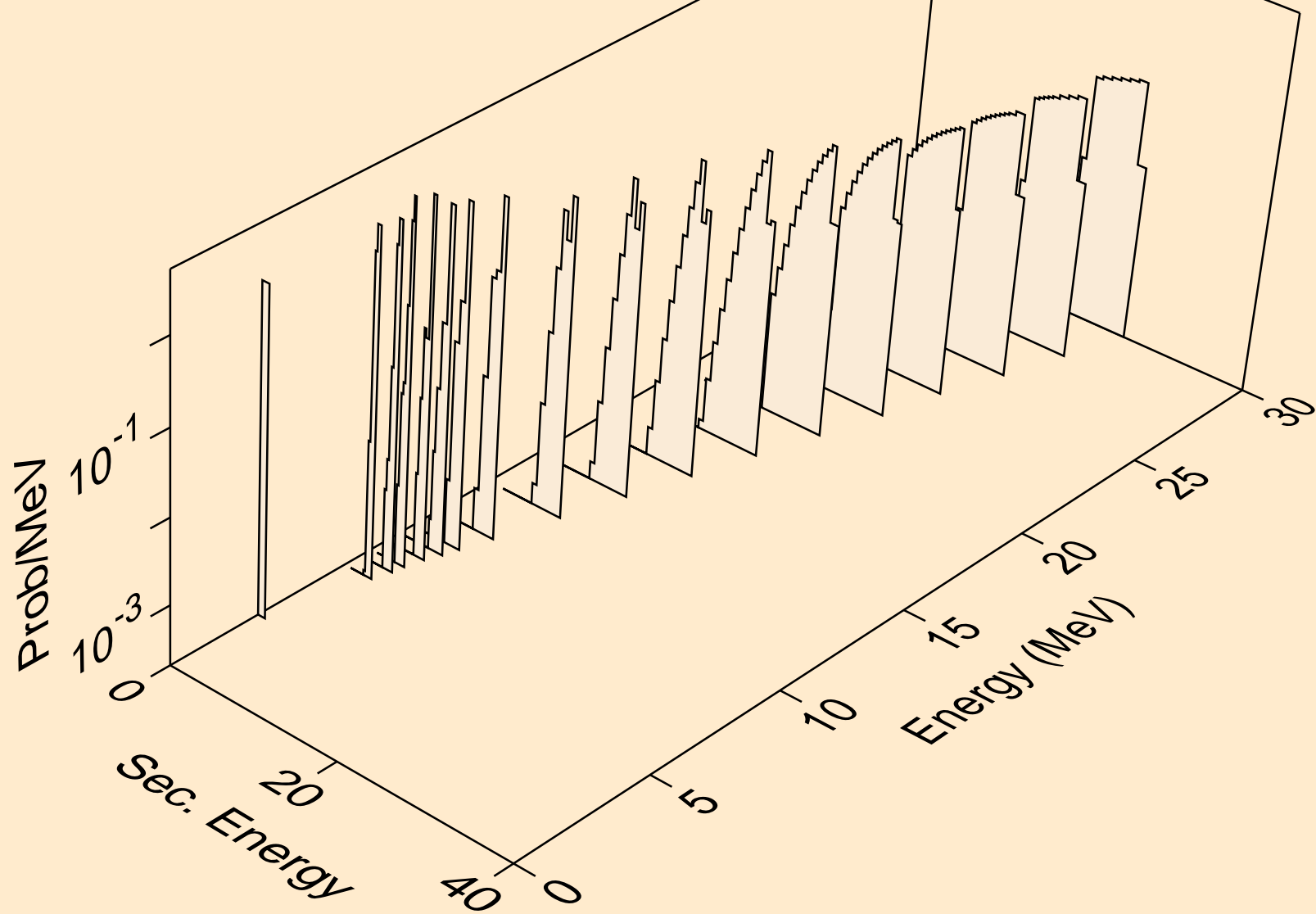

RF266 NEUTRON ACER TENDL-2021 LIBRARY; T=293.6K
tritons from (n,x)

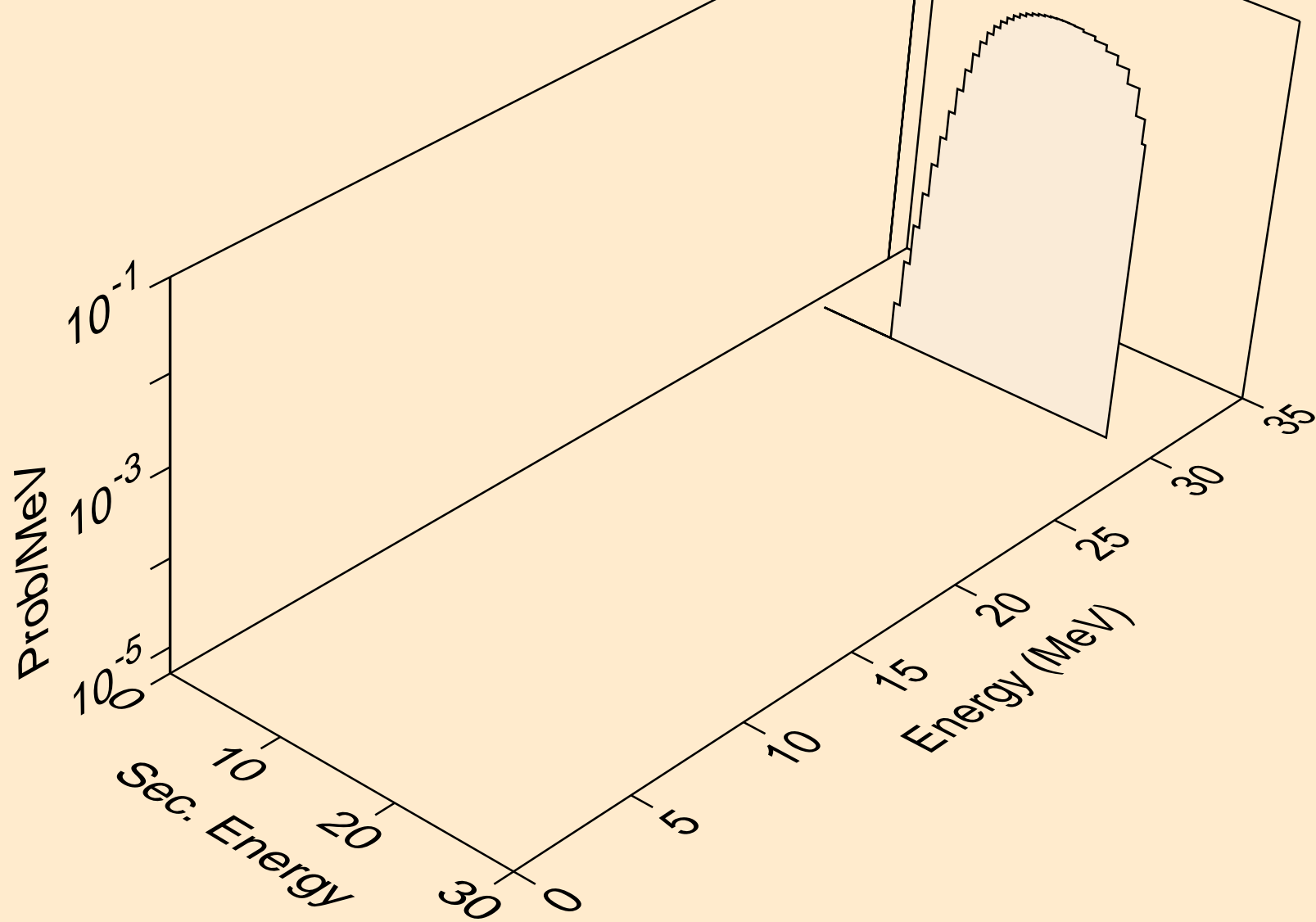

RF266 NEUTRON ACER TENDL-2021 LIBRARY; T=293.6K
tritons from (n,n*)t

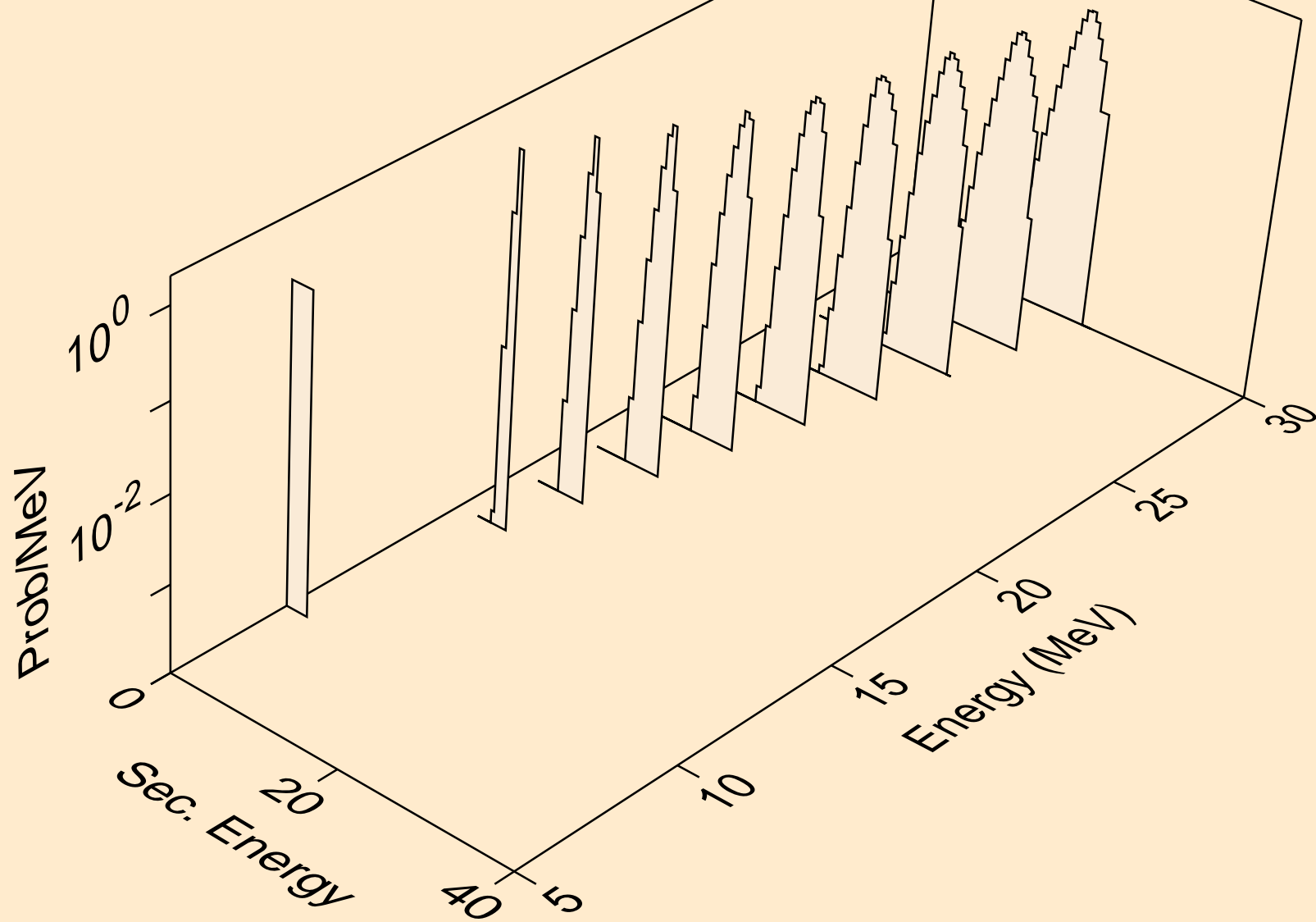

RF266 NEUTRON ACER TENDL-2021 LIBRARY; T=293.6K
tritons from (n,t)

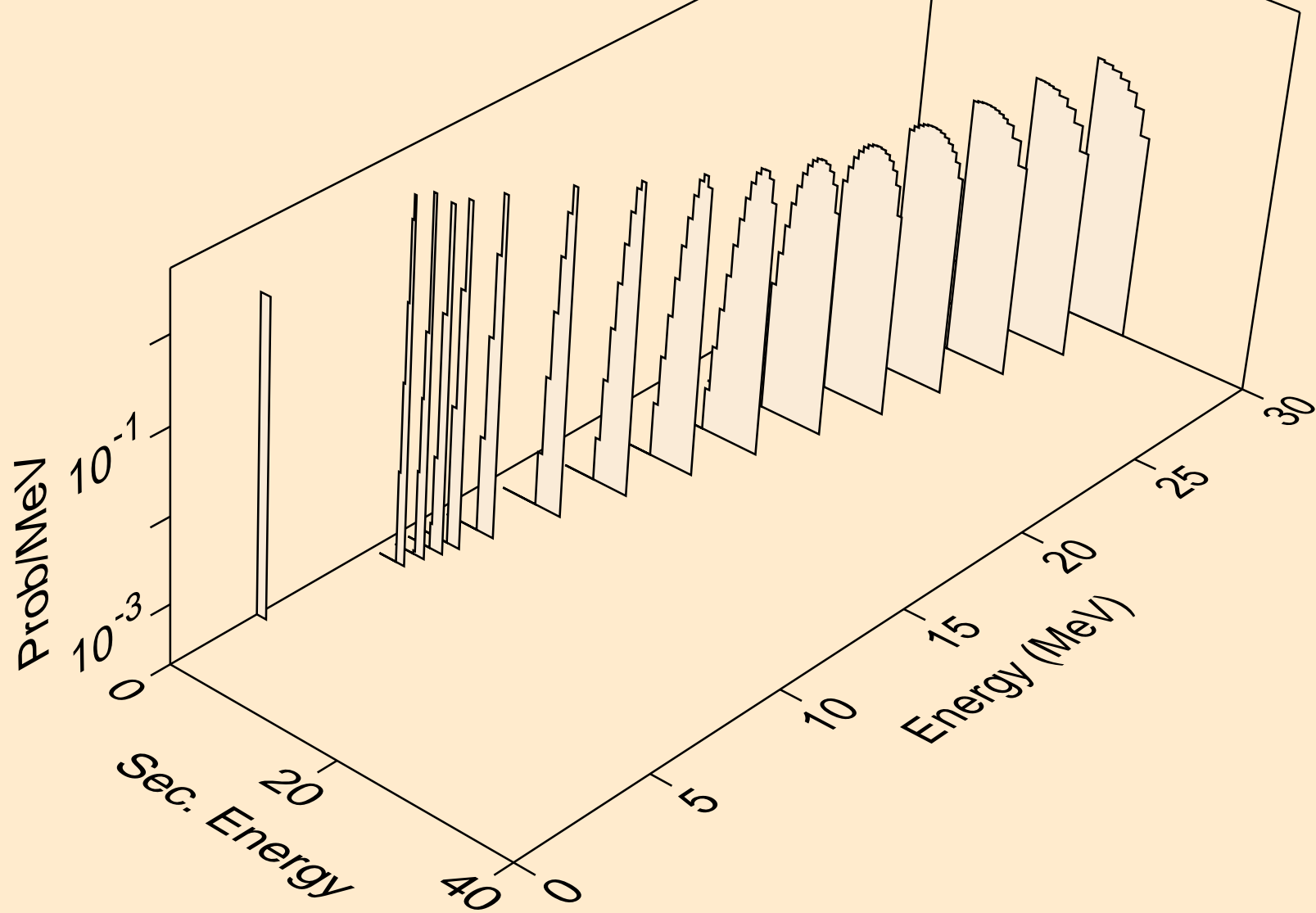

RF266 NEUTRON ACER TENDL-2021 LIBRARY; T=293.6K
he3s from (n,x)

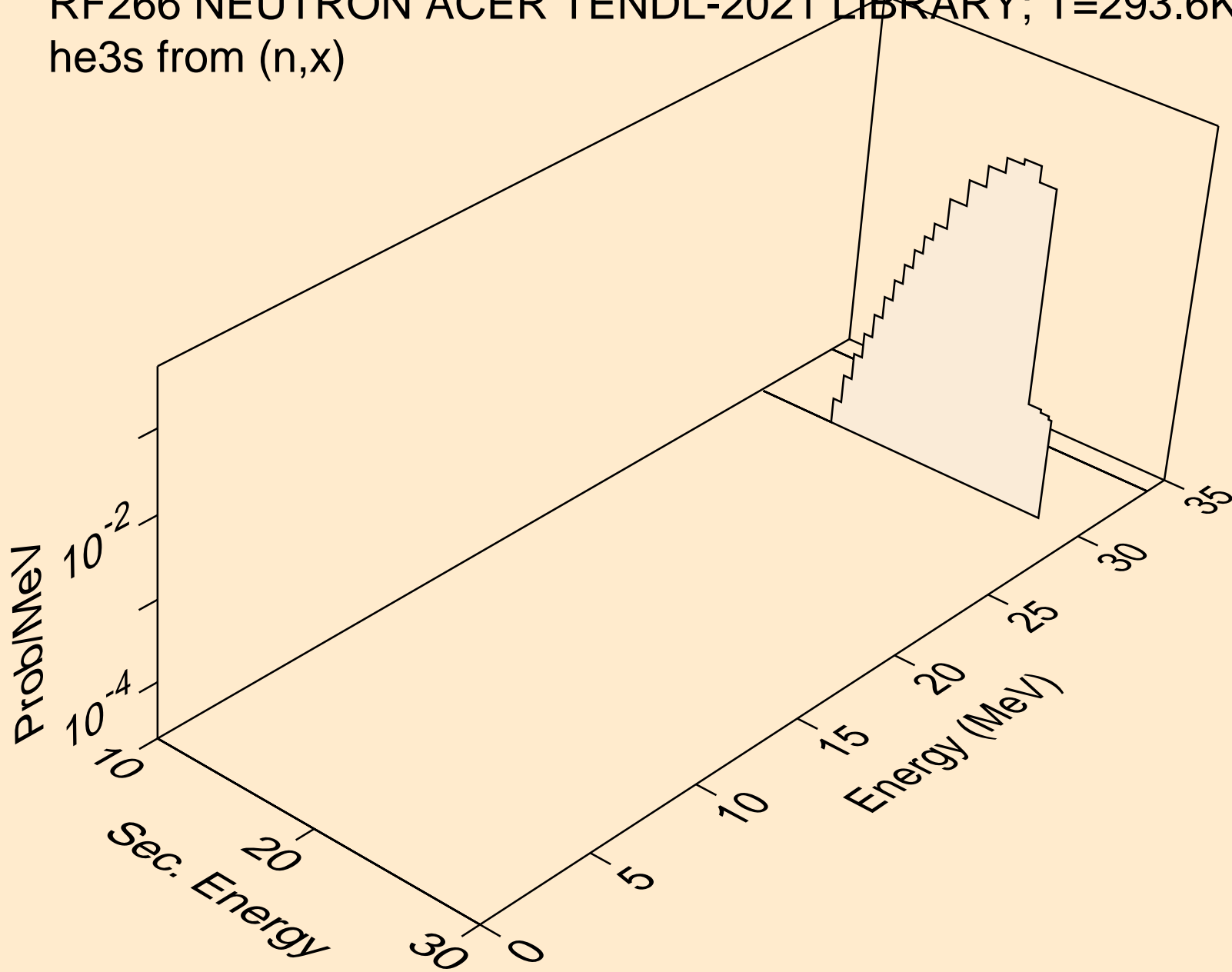

RF266 NEUTRON ACER TENDL-2021 LIBRARY; T=293.6K
he3s from (n,n*)he3

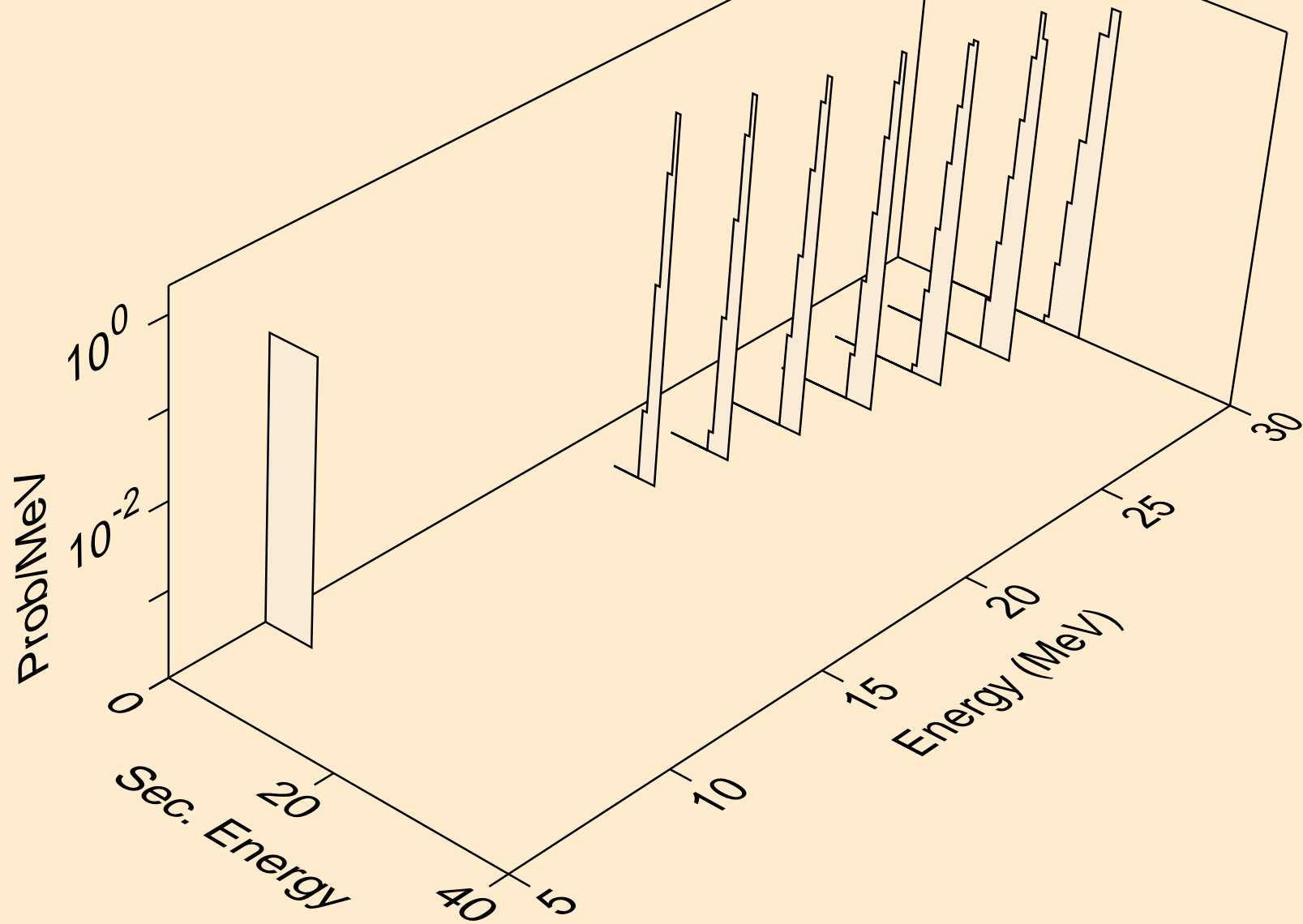

RF266 NEUTRON ACER TENDL-2021 LIBRARY; T=293.6K
he3s from (n,he3)

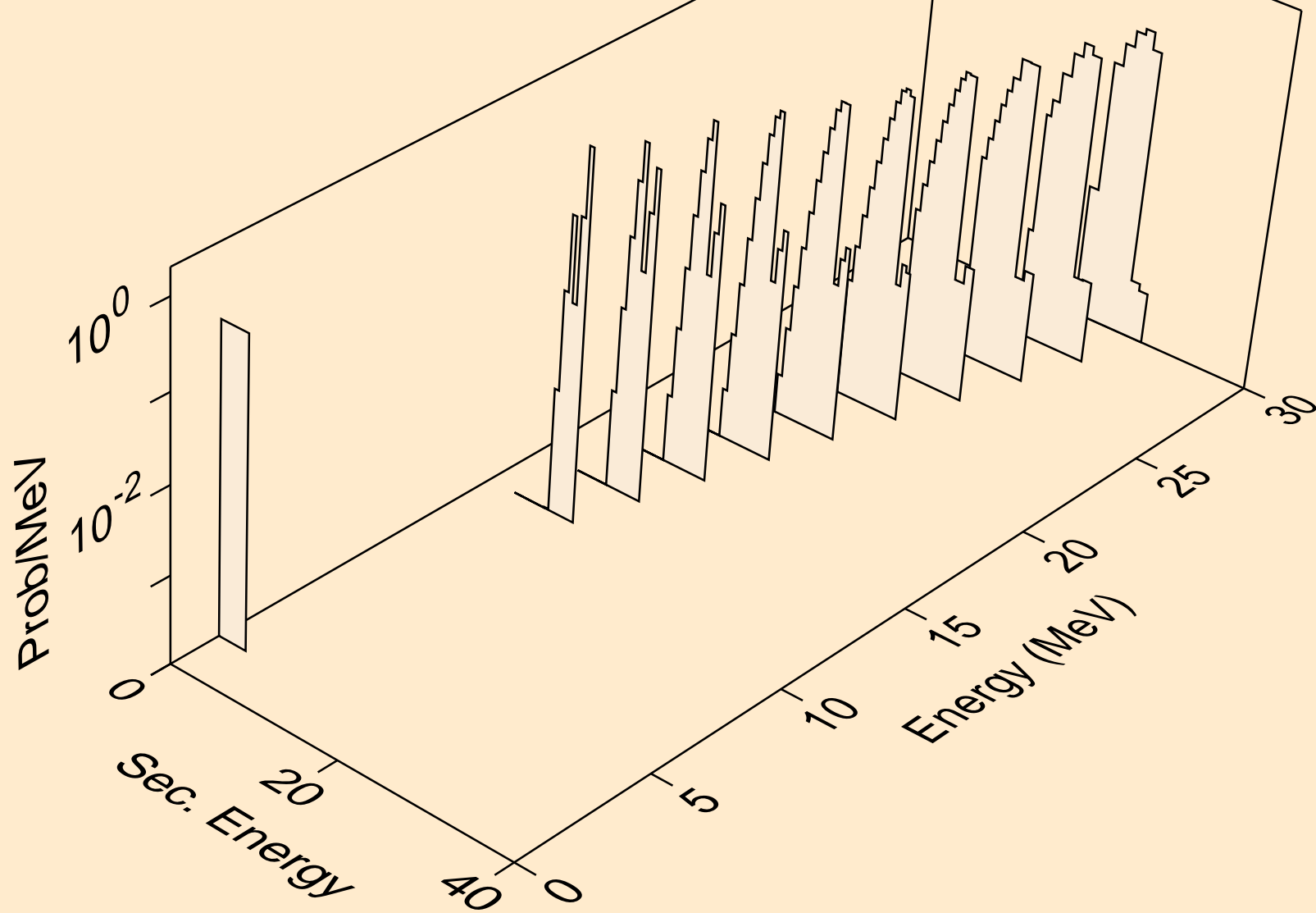

RF266 NEUTRON ACER TENDL-2021 LIBRARY; T=293.6K
alphas from (n,x)

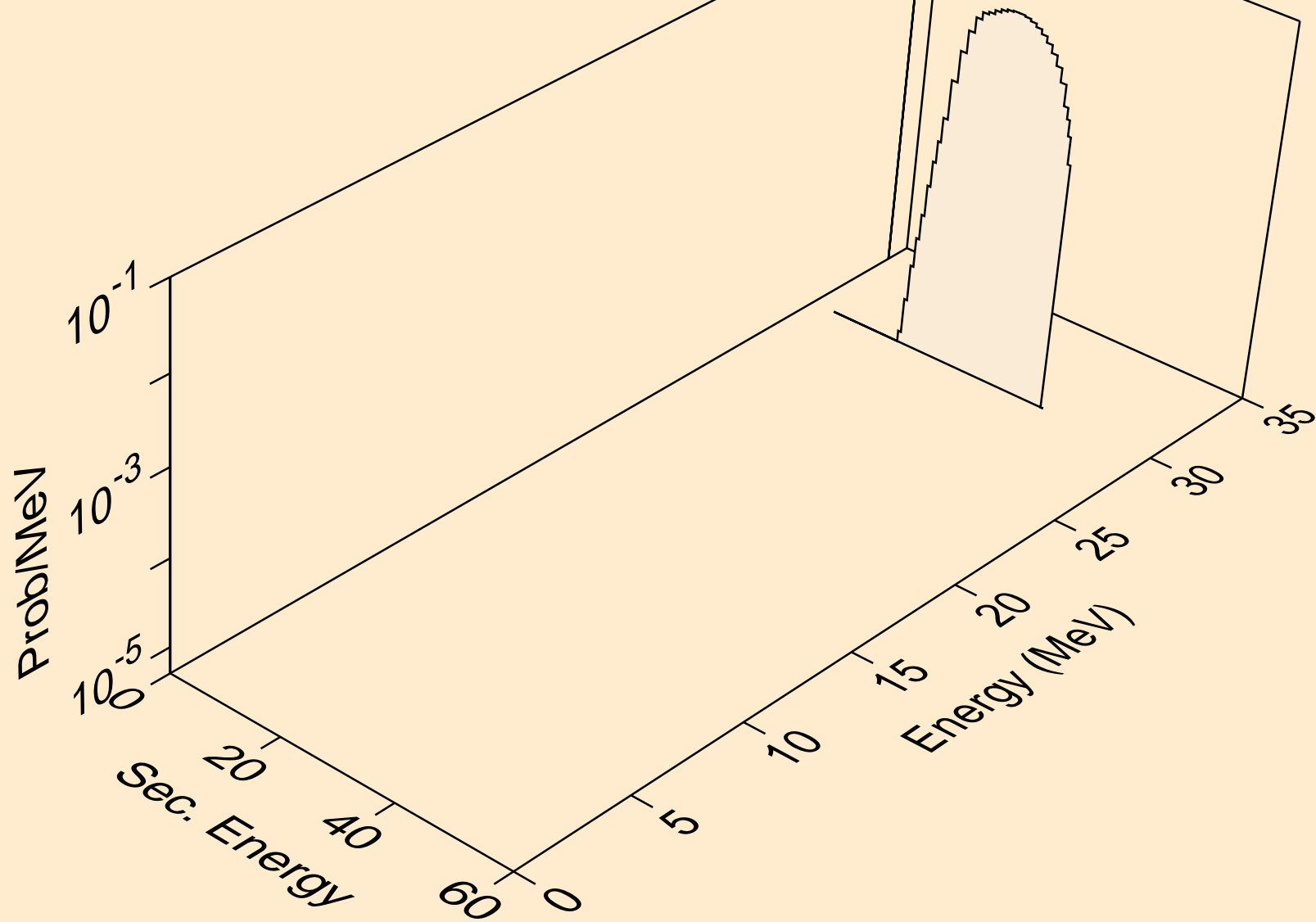

RF266 NEUTRON ACER TENDL-2021 LIBRARY; T=293.6K
alphas from (n,n*)a

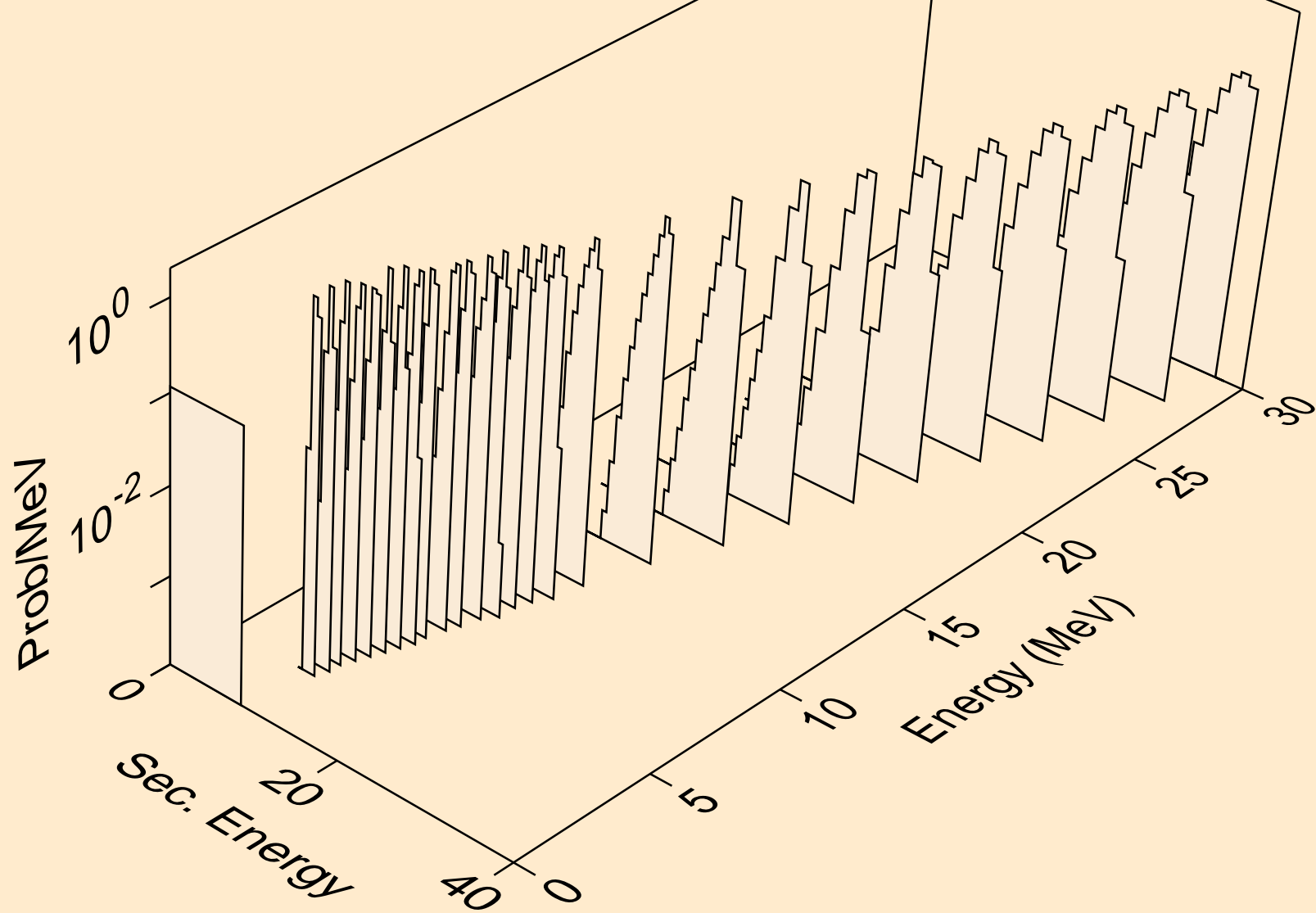

RF266 NEUTRON ACER TENDL-2021 LIBRARY; T=293.6K
alphas from (n,2n)a

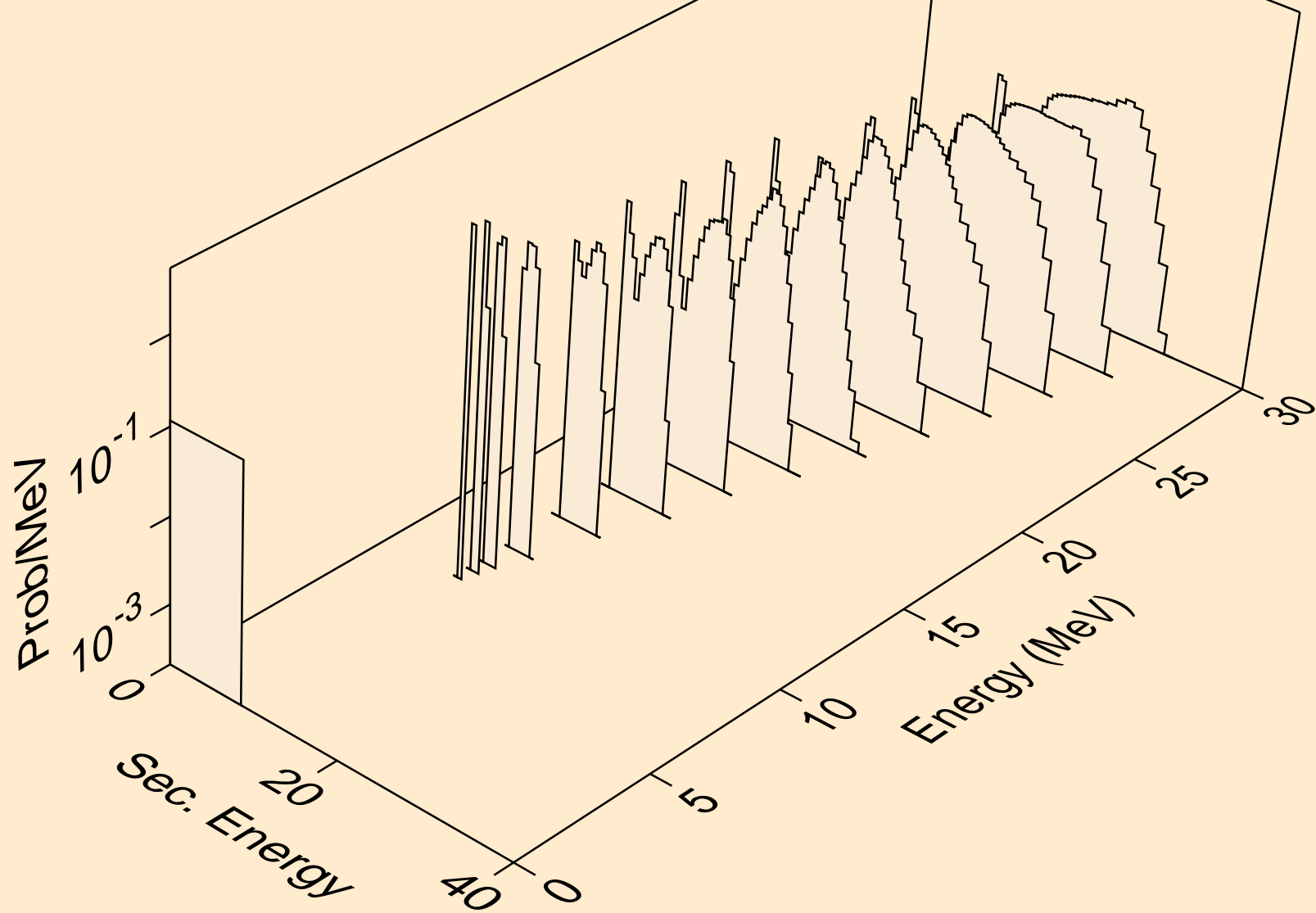

RF266 NEUTRON ACER TENDL-2021 LIBRARY; T=293.6K
alphas from (n,3n)a

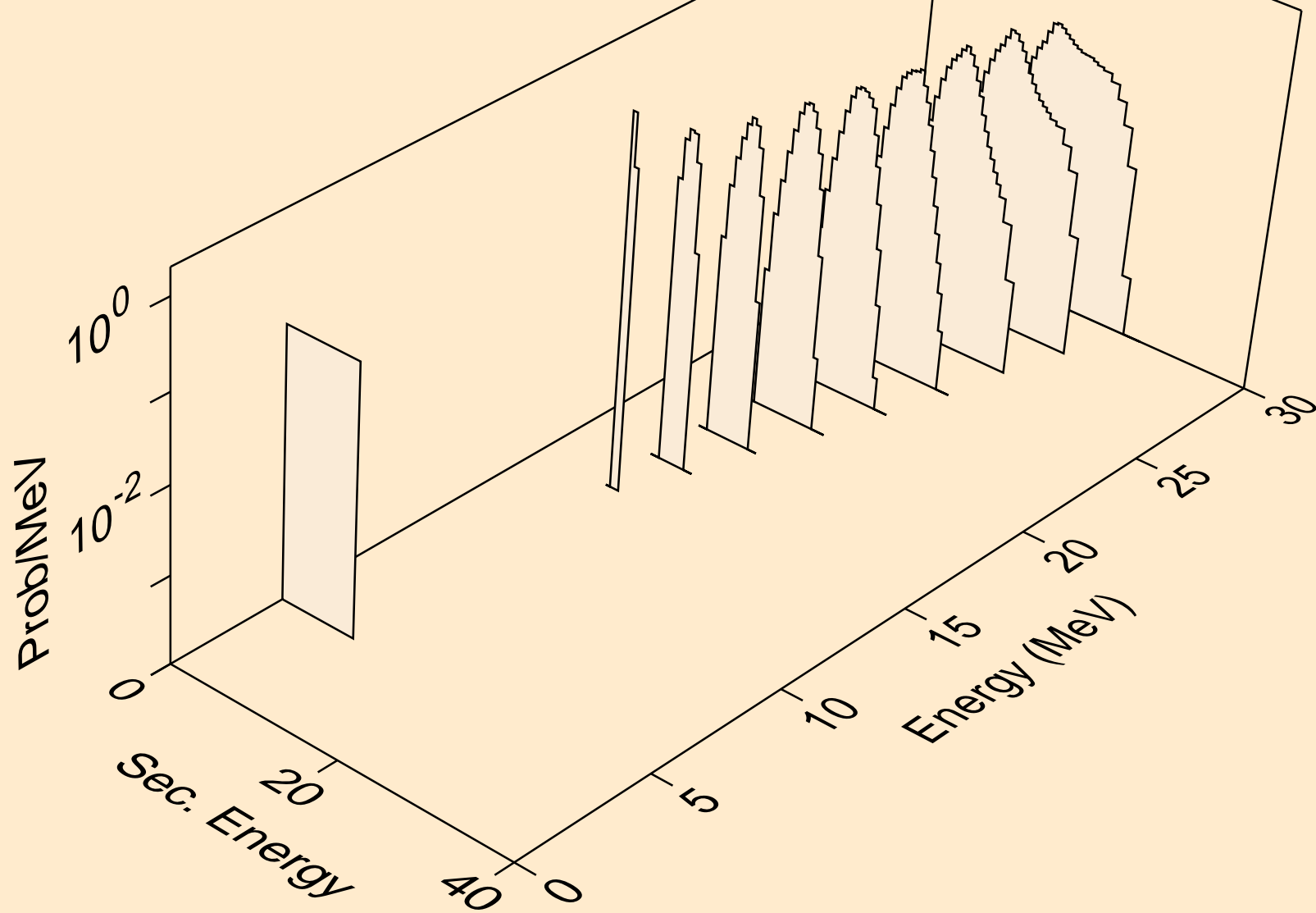

RF266 NEUTRON ACER TENDL-2021 LIBRARY; T=293.6K
alphas from (n,a)

