

RN201 NEUTRON ACER TENDL-2021 LIBRARY; T=293.6K

Principal cross sections

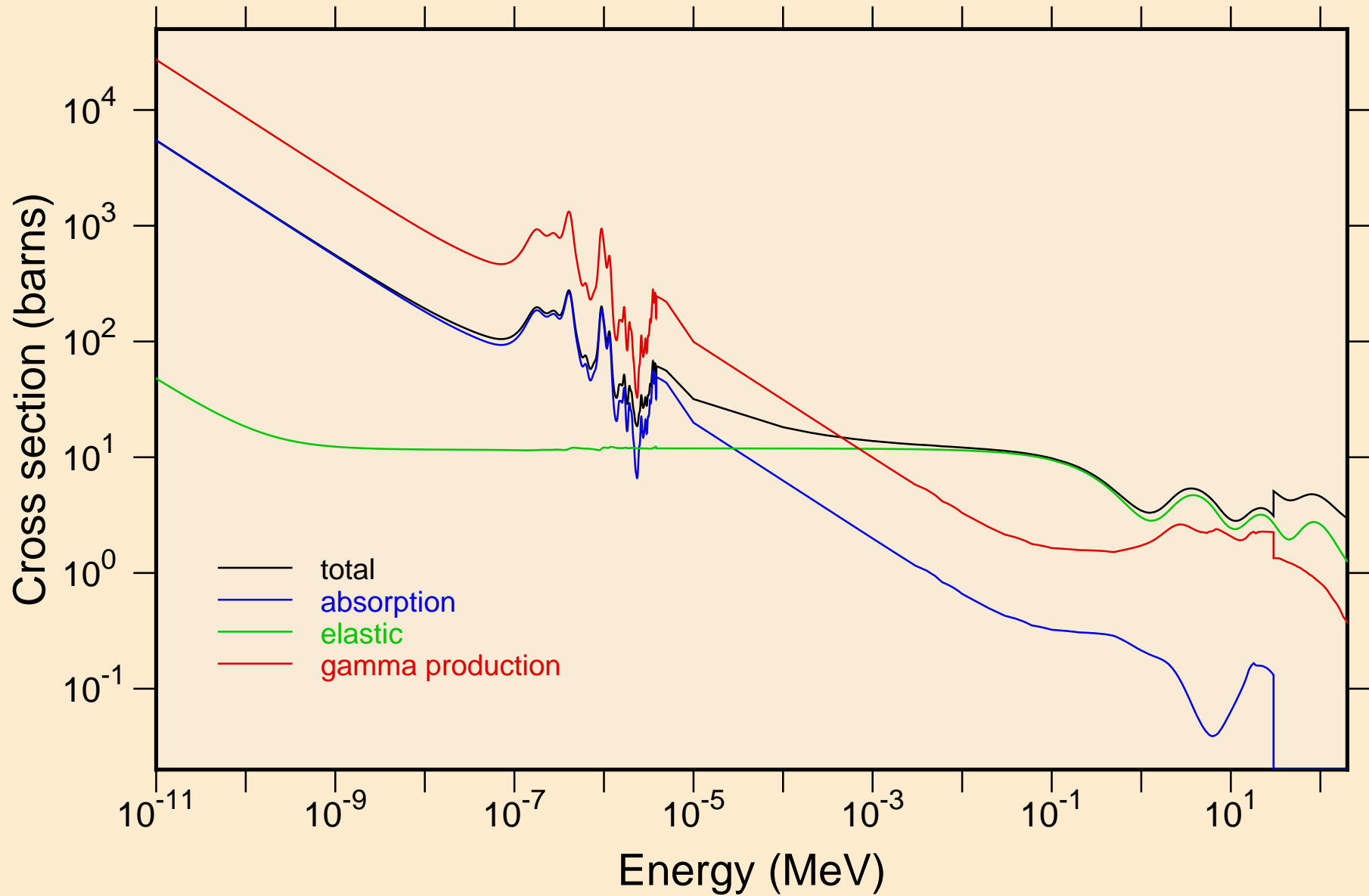

RN201 NEUTRON ACER TENDL-2021 LIBRARY; T=293.6K
resonance total cross section

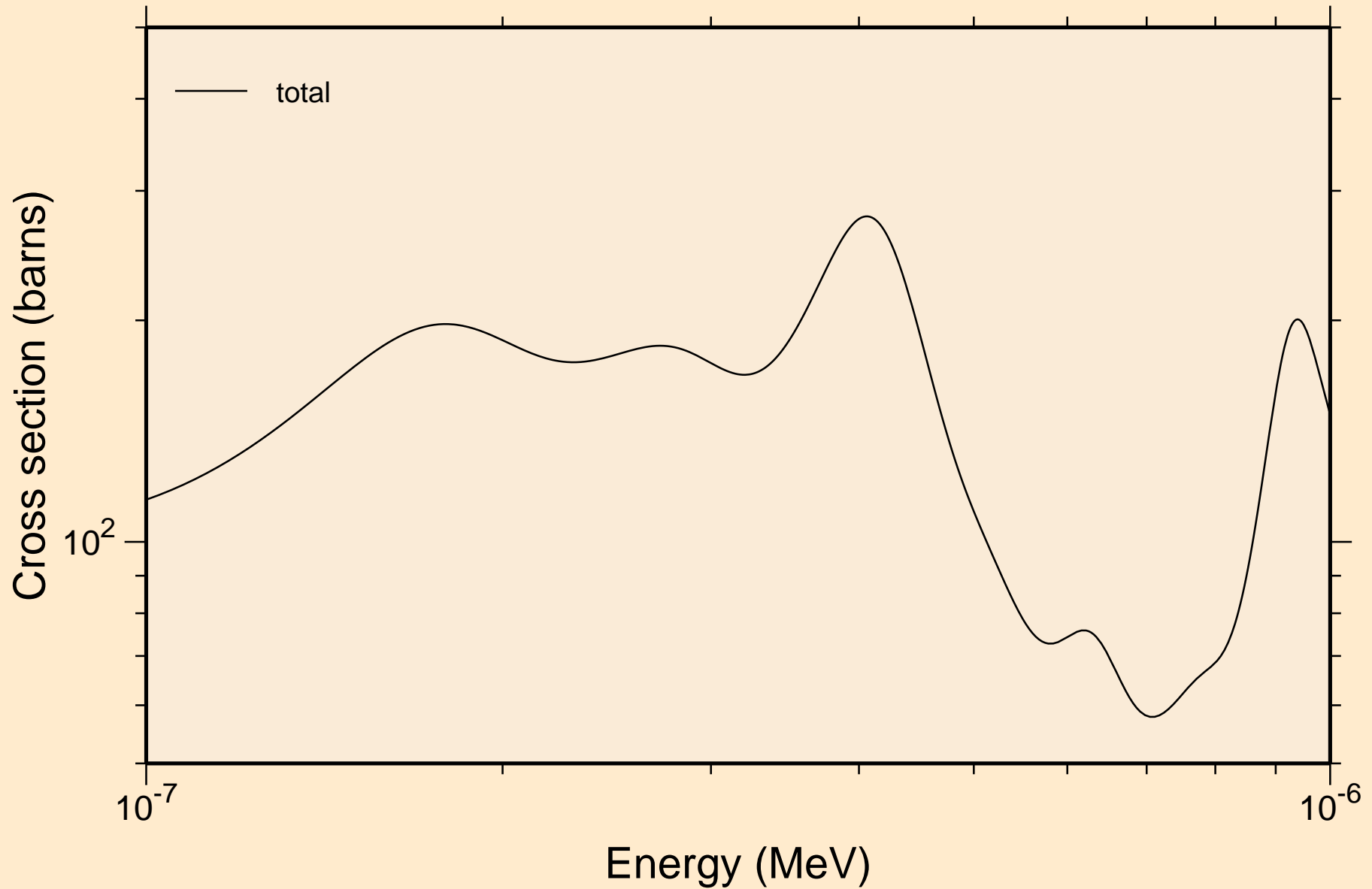

RN201 NEUTRON ACER TENDL-2021 LIBRARY; T=293.6K
resonance total cross section

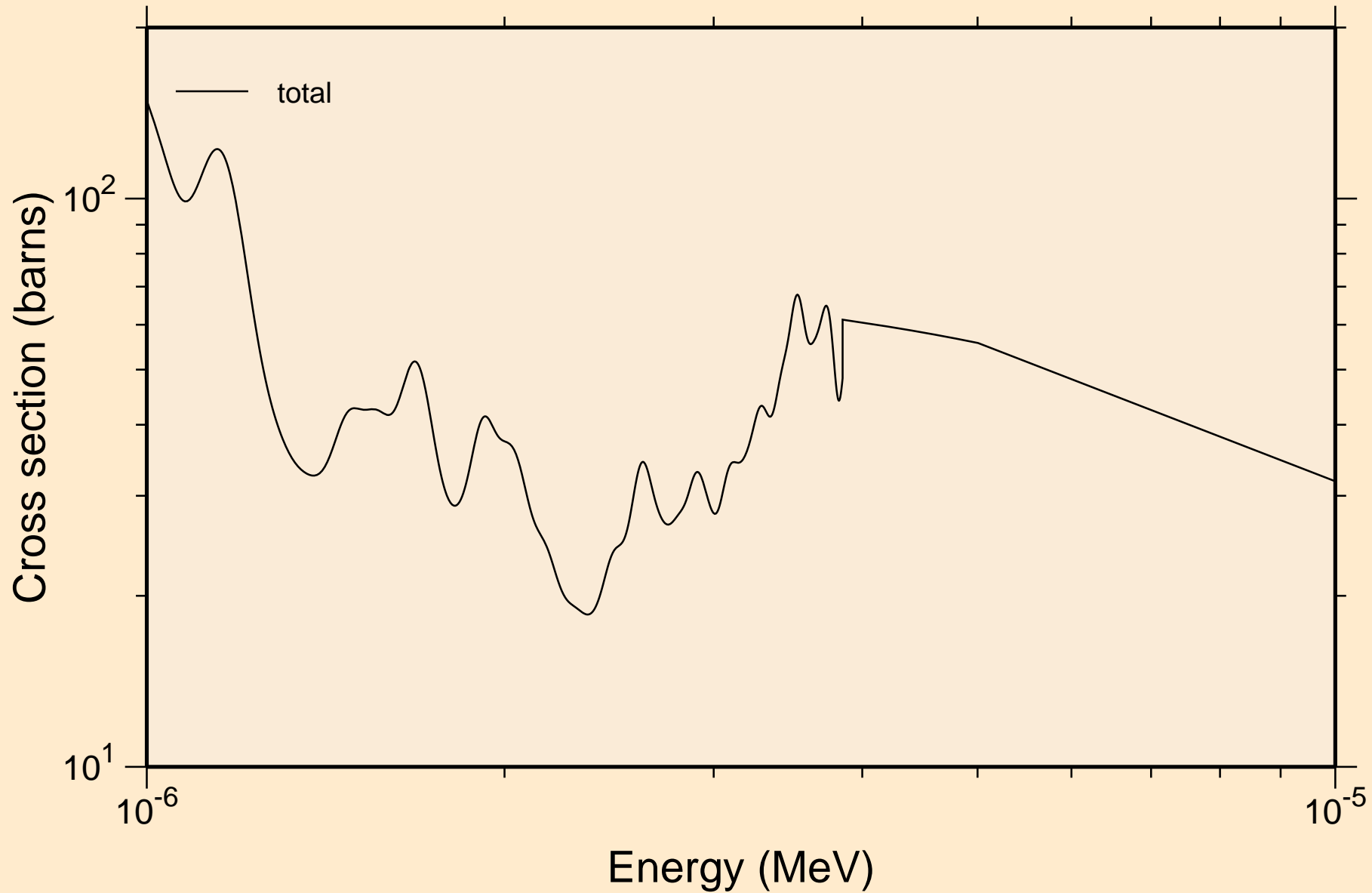

RN201 NEUTRON ACER TENDL-2021 LIBRARY; T=293.6K
resonance total cross section

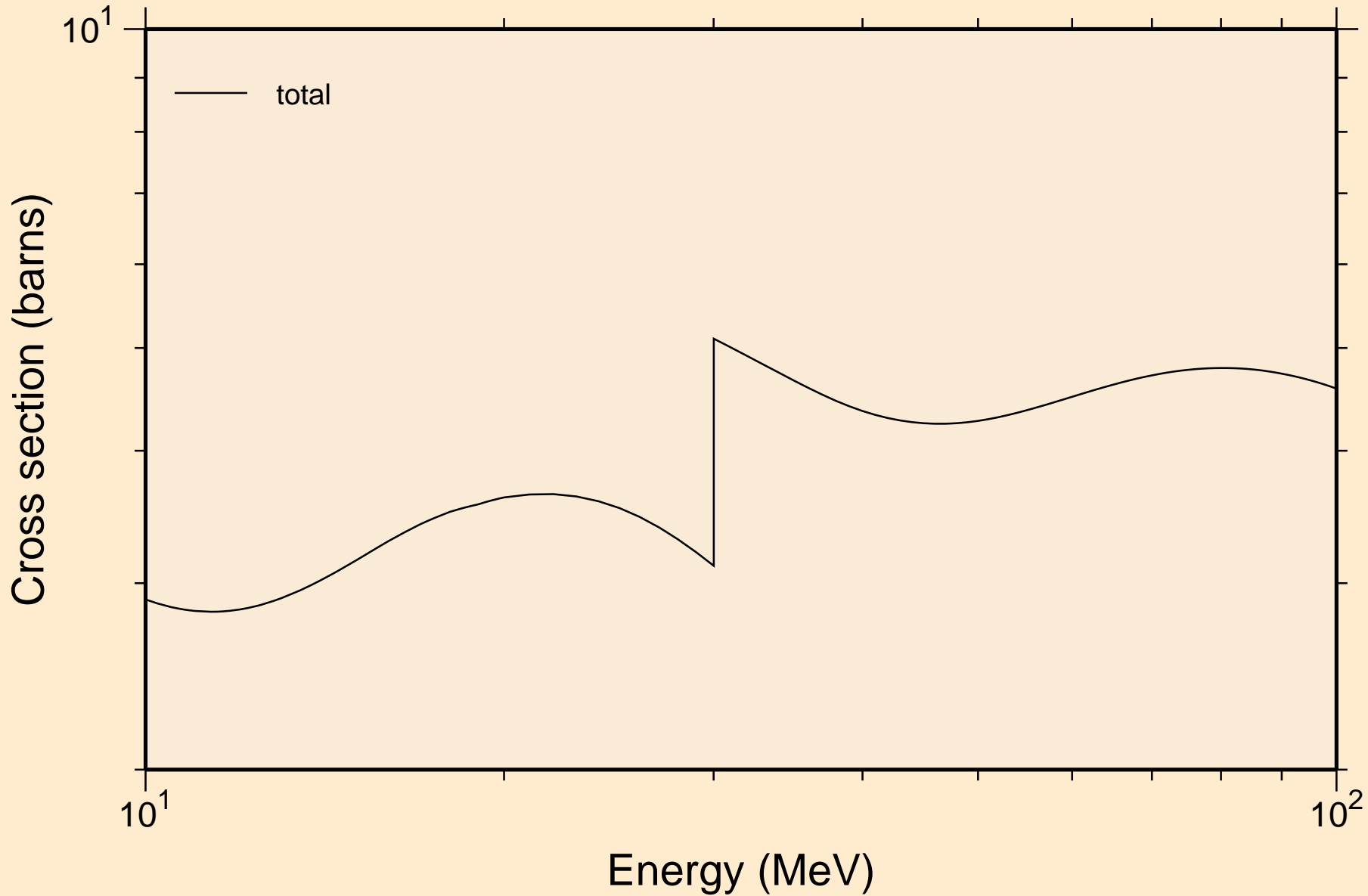

RN201 NEUTRON ACER TENDL-2021 LIBRARY; T=293.6K
resonance absorption cross sections

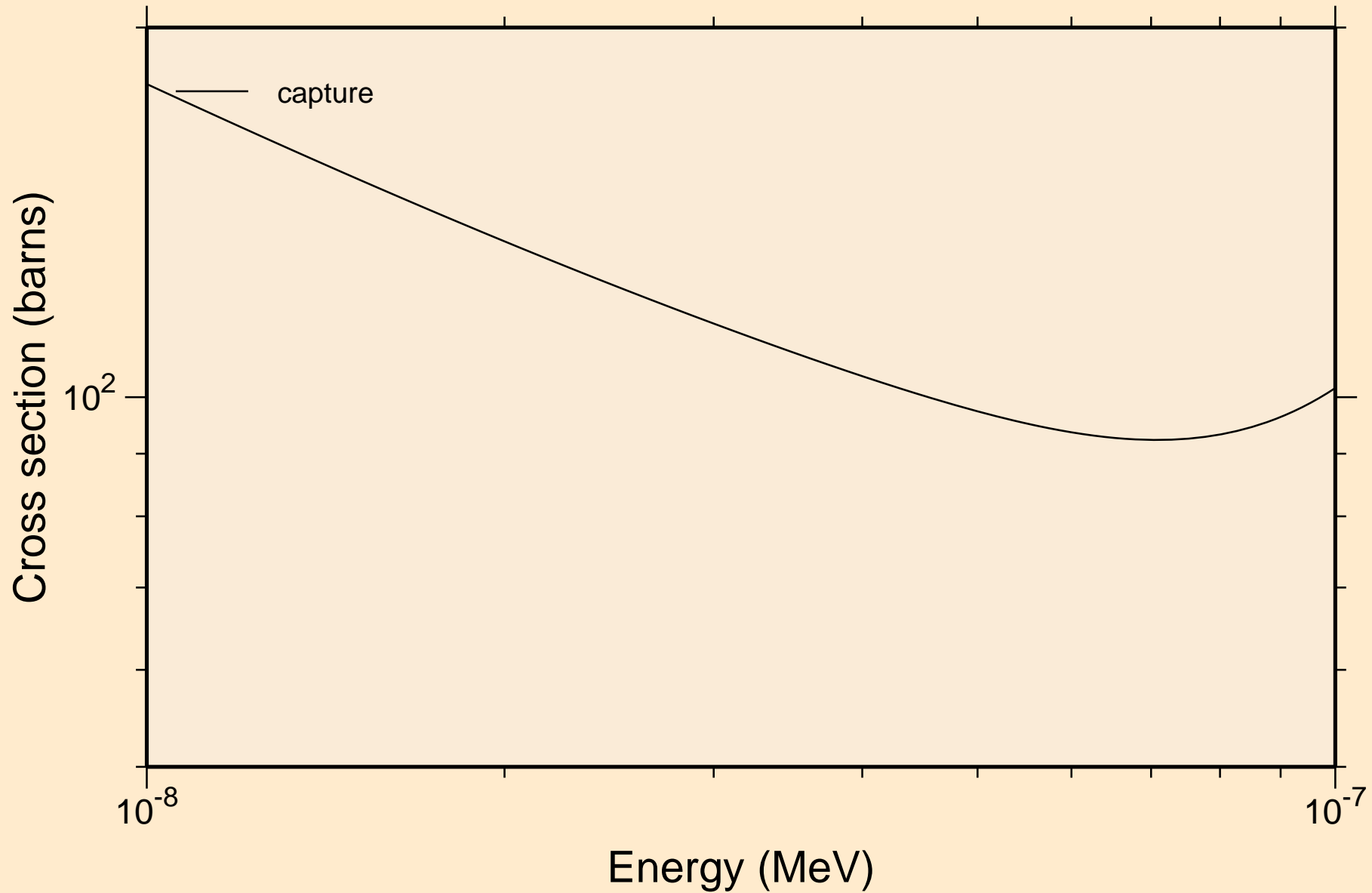

RN201 NEUTRON ACER TENDL-2021 LIBRARY; T=293.6K
resonance absorption cross sections

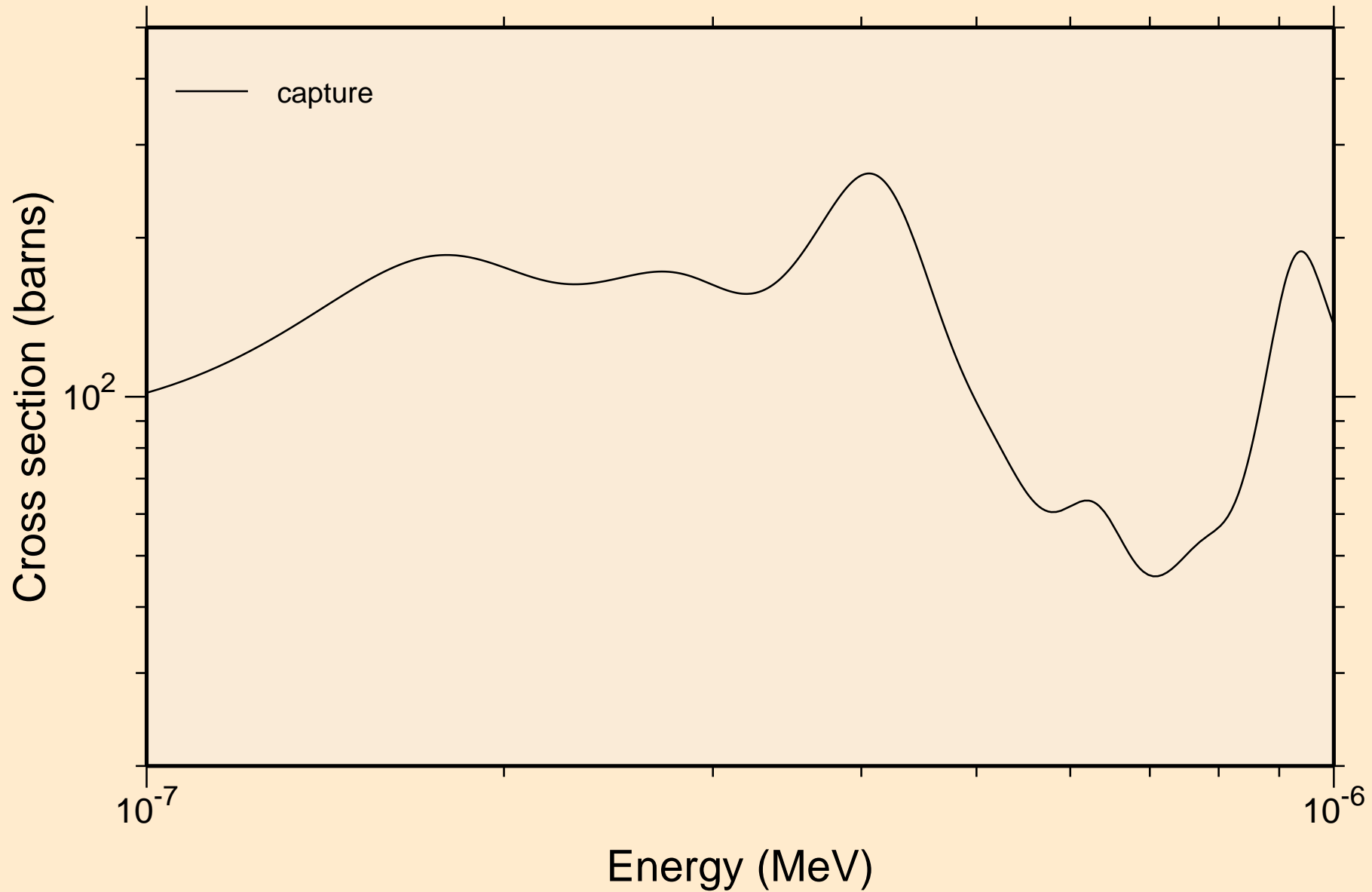

RN201 NEUTRON ACER TENDL-2021 LIBRARY; T=293.6K
resonance absorption cross sections

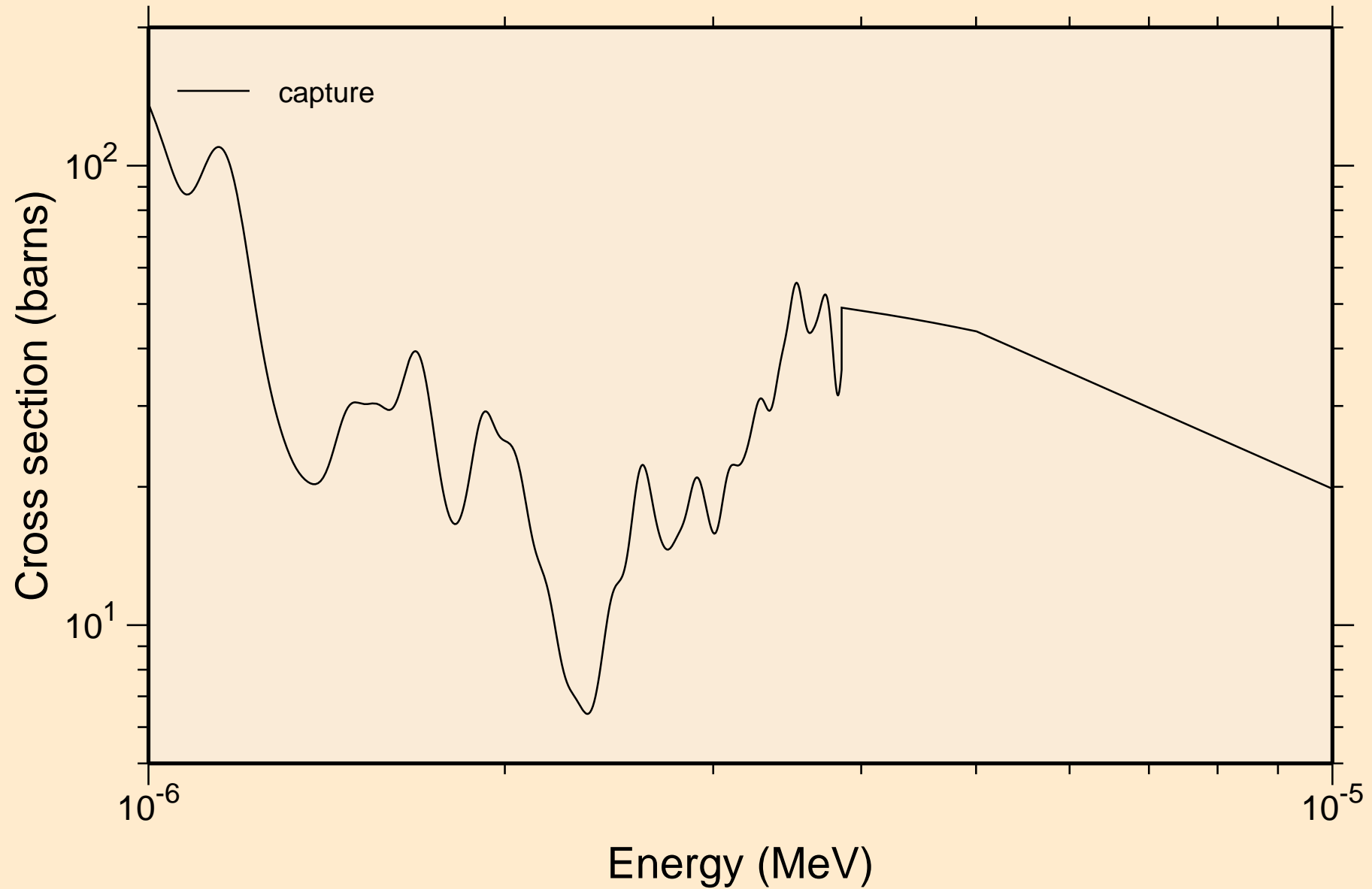

RN201 NEUTRON ACER TENDL-2021 LIBRARY; T=293.6K
resonance absorption cross sections

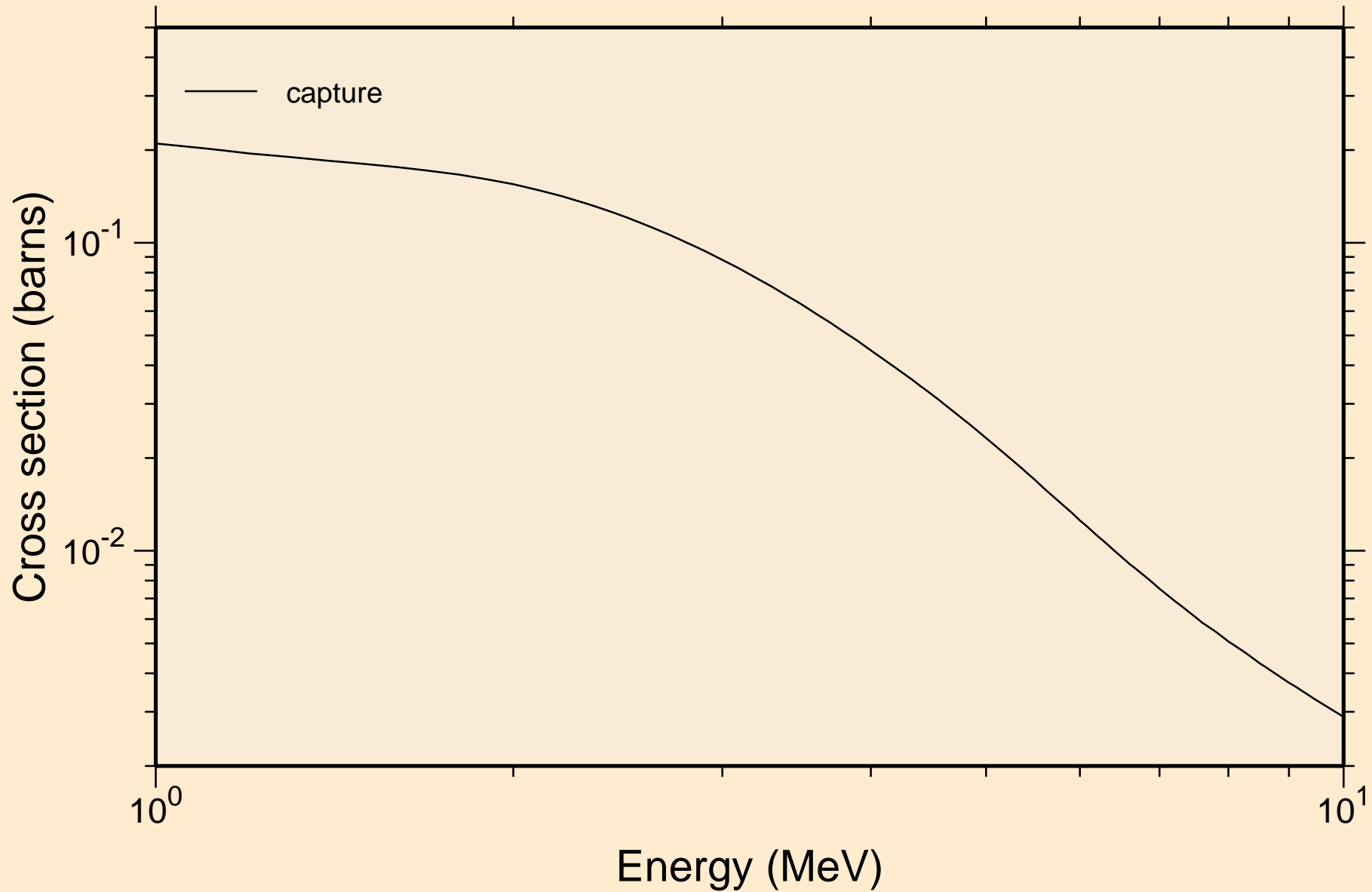

RN201 NEUTRON ACER TENDL-2021 LIBRARY; T=293.6K
Heating

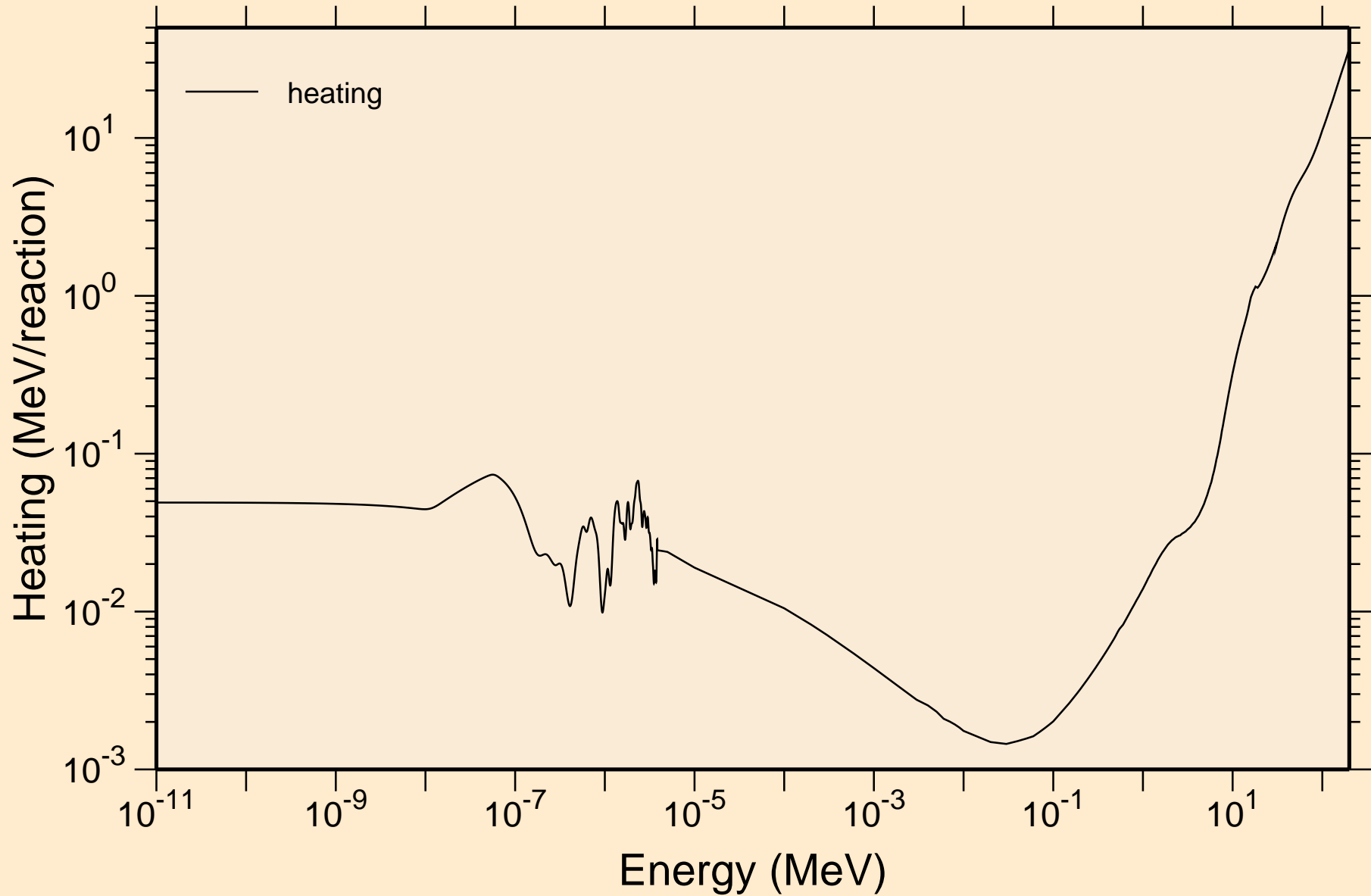

RN201 NEUTRON ACER TENDL-2021 LIBRARY; T=293.6K
Damage

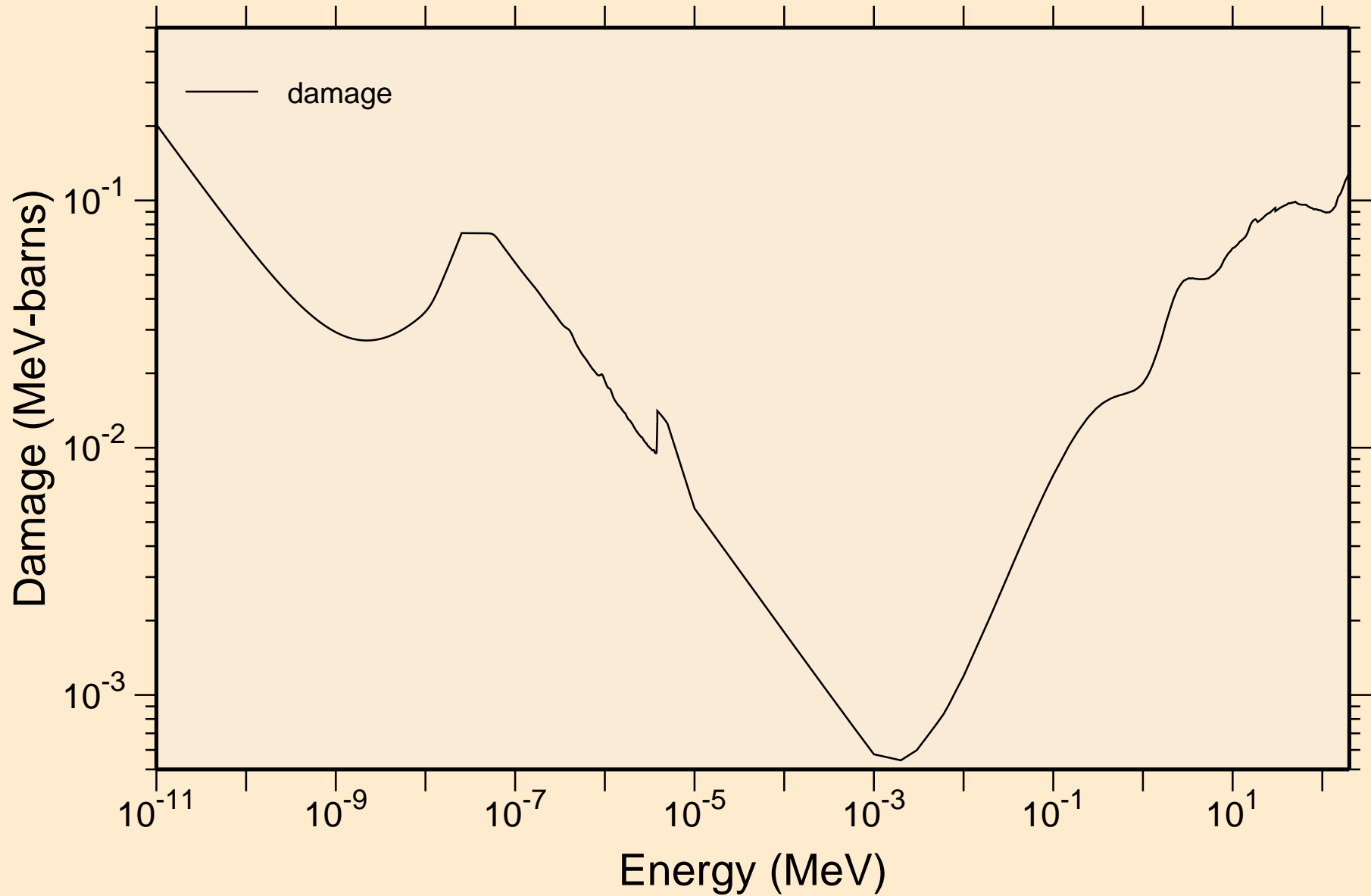

RN201 NEUTRON ACER TENDL-2021 LIBRARY; T=293.6K
Non-threshold reactions

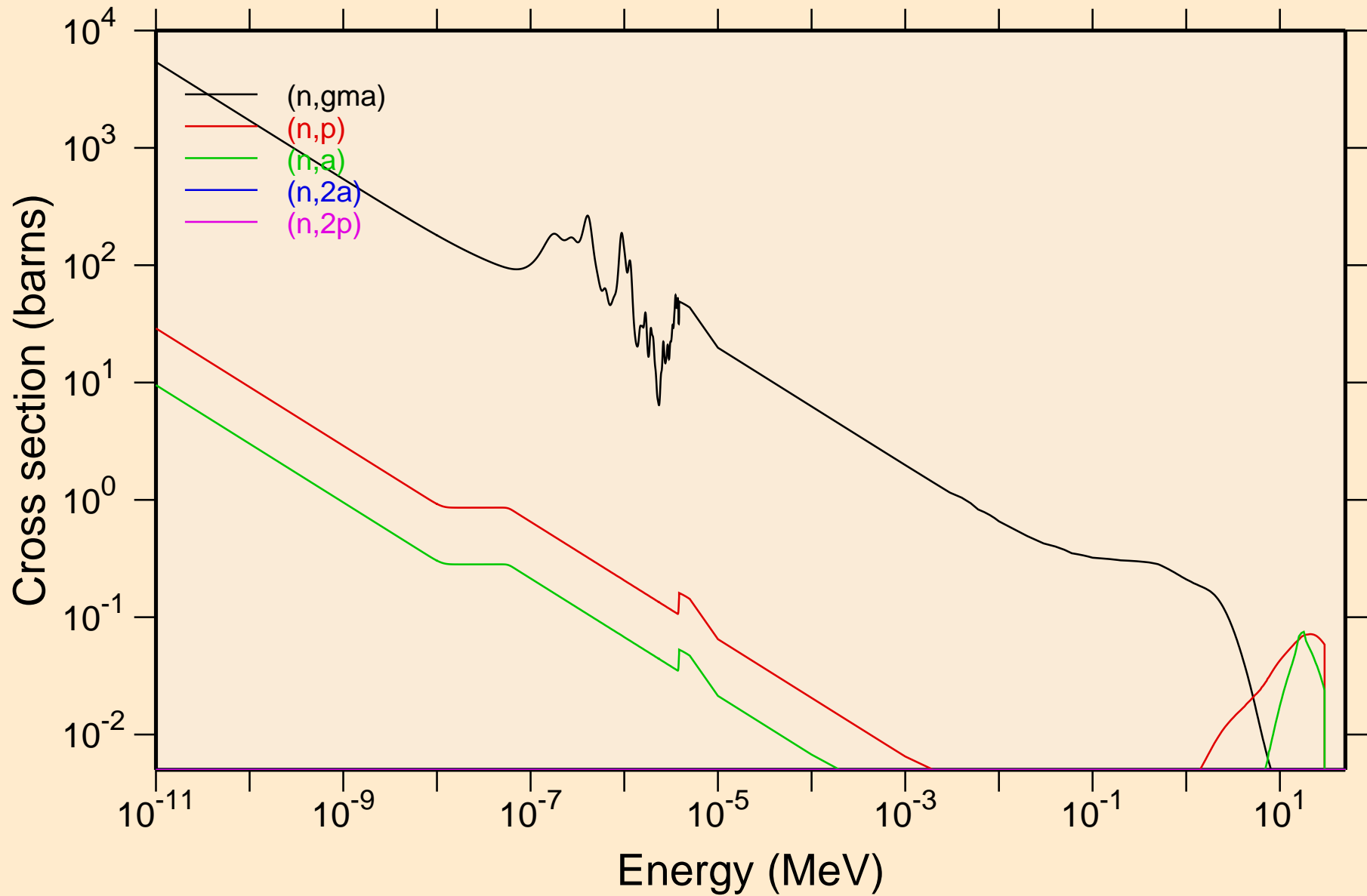

RN201 NEUTRON ACER TENDL-2021 LIBRARY; T=293.6K
Non-threshold reactions

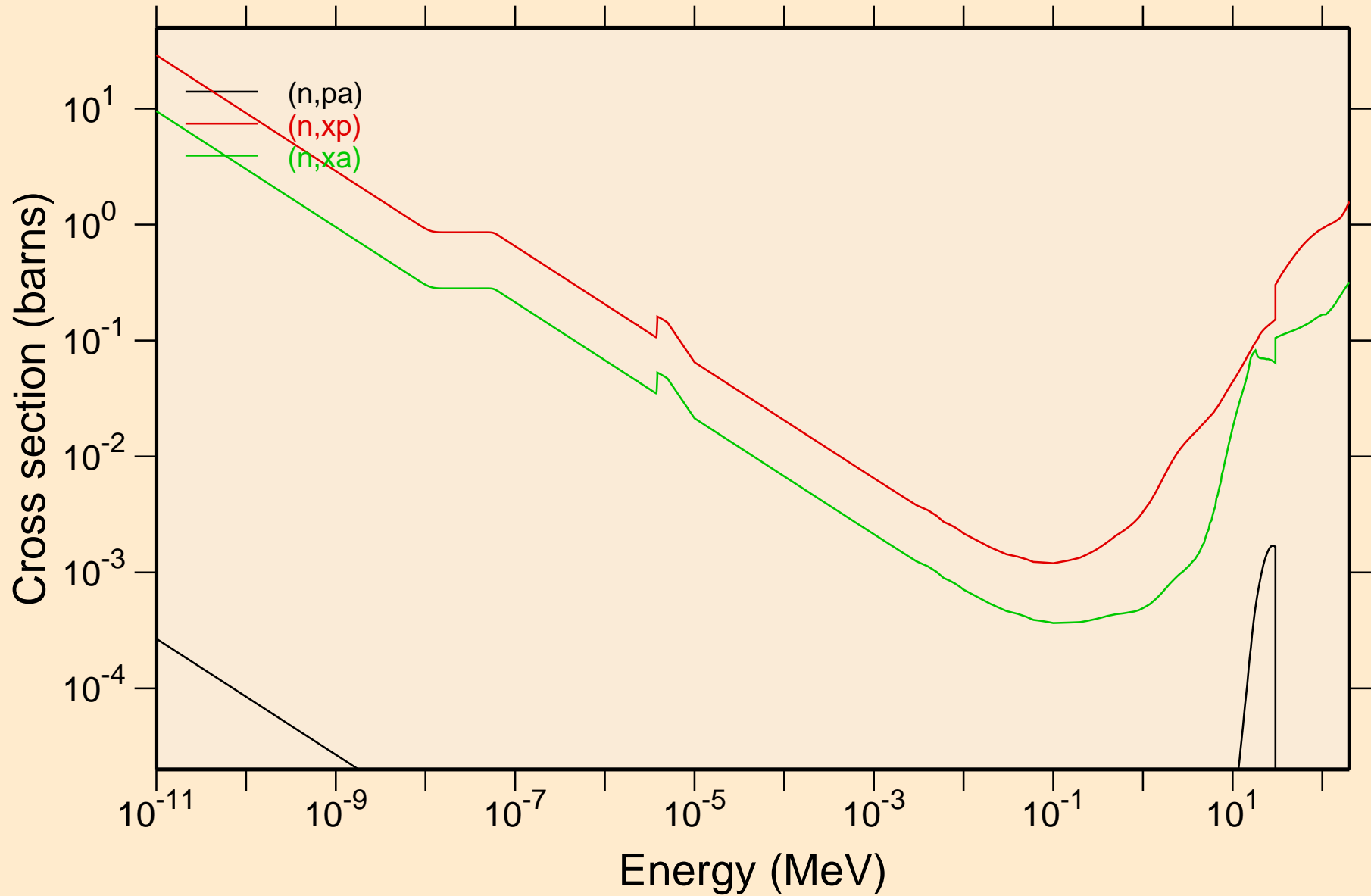

RN201 NEUTRON ACER TENDL-2021 LIBRARY; T=293.6K
Principal cross sections

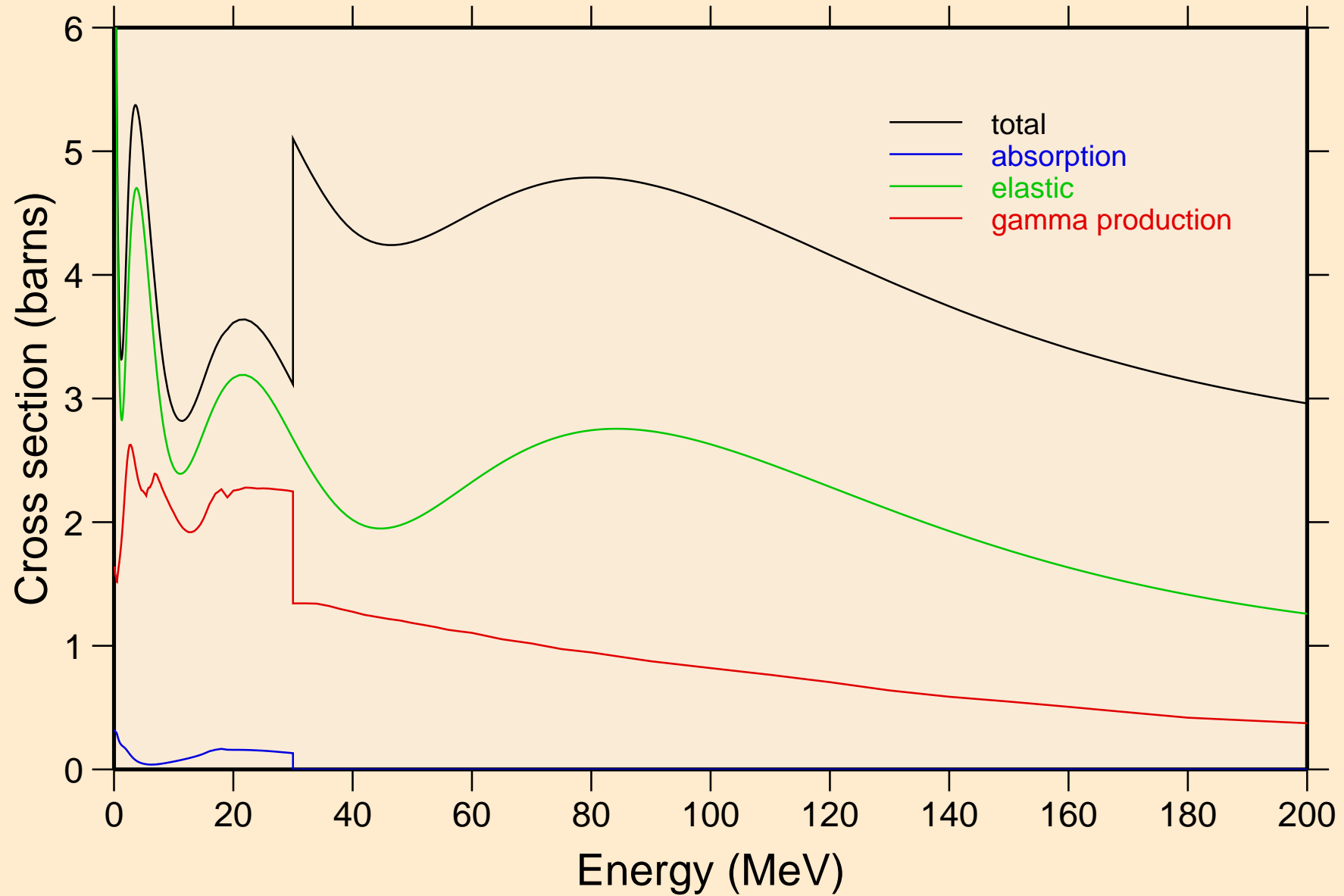

RN201 NEUTRON ACER TENDL-2021 LIBRARY; T=293.6K
Heating

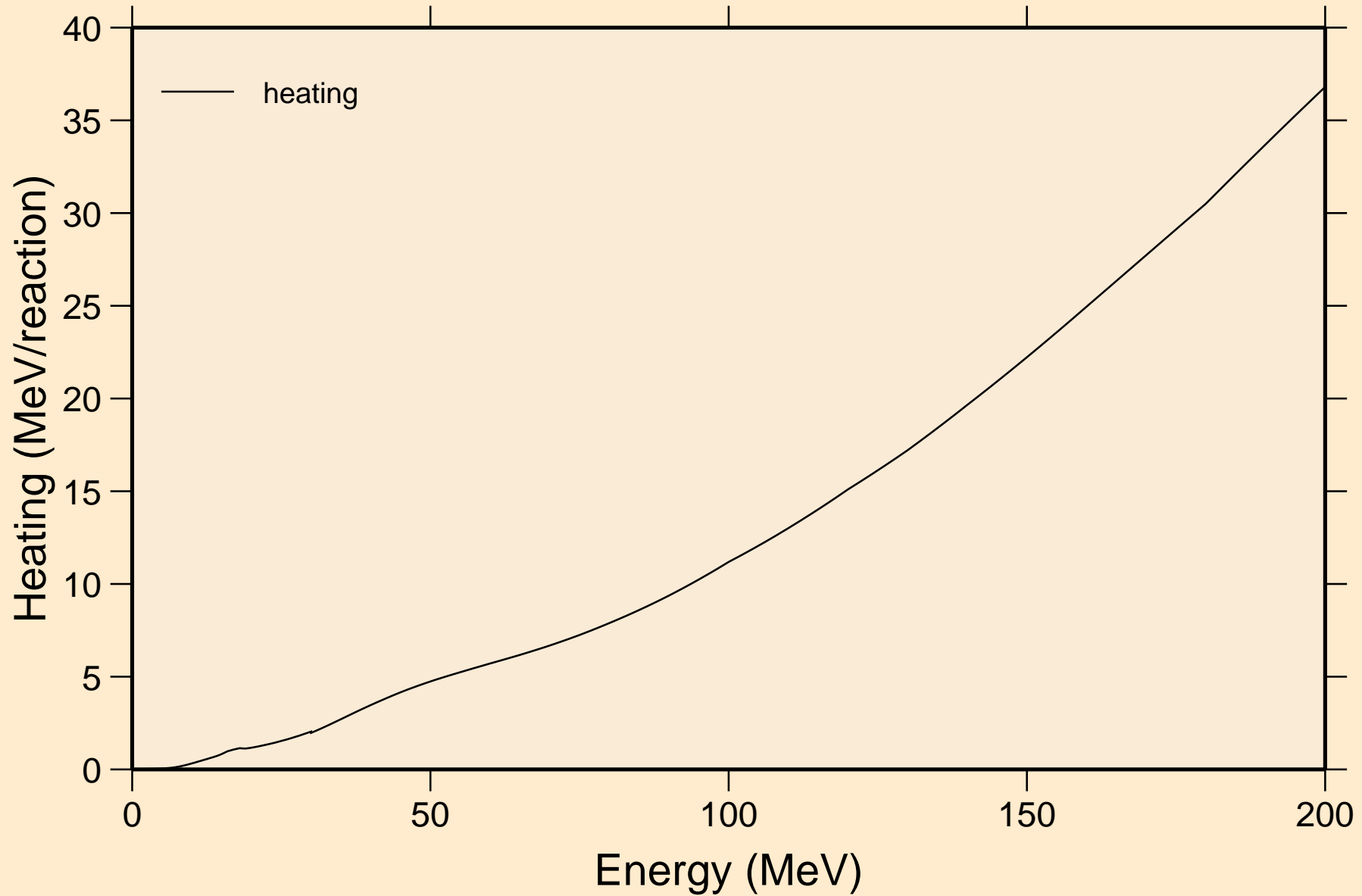

RN201 NEUTRON ACER TENDL-2021 LIBRARY; T=293.6K
Damage

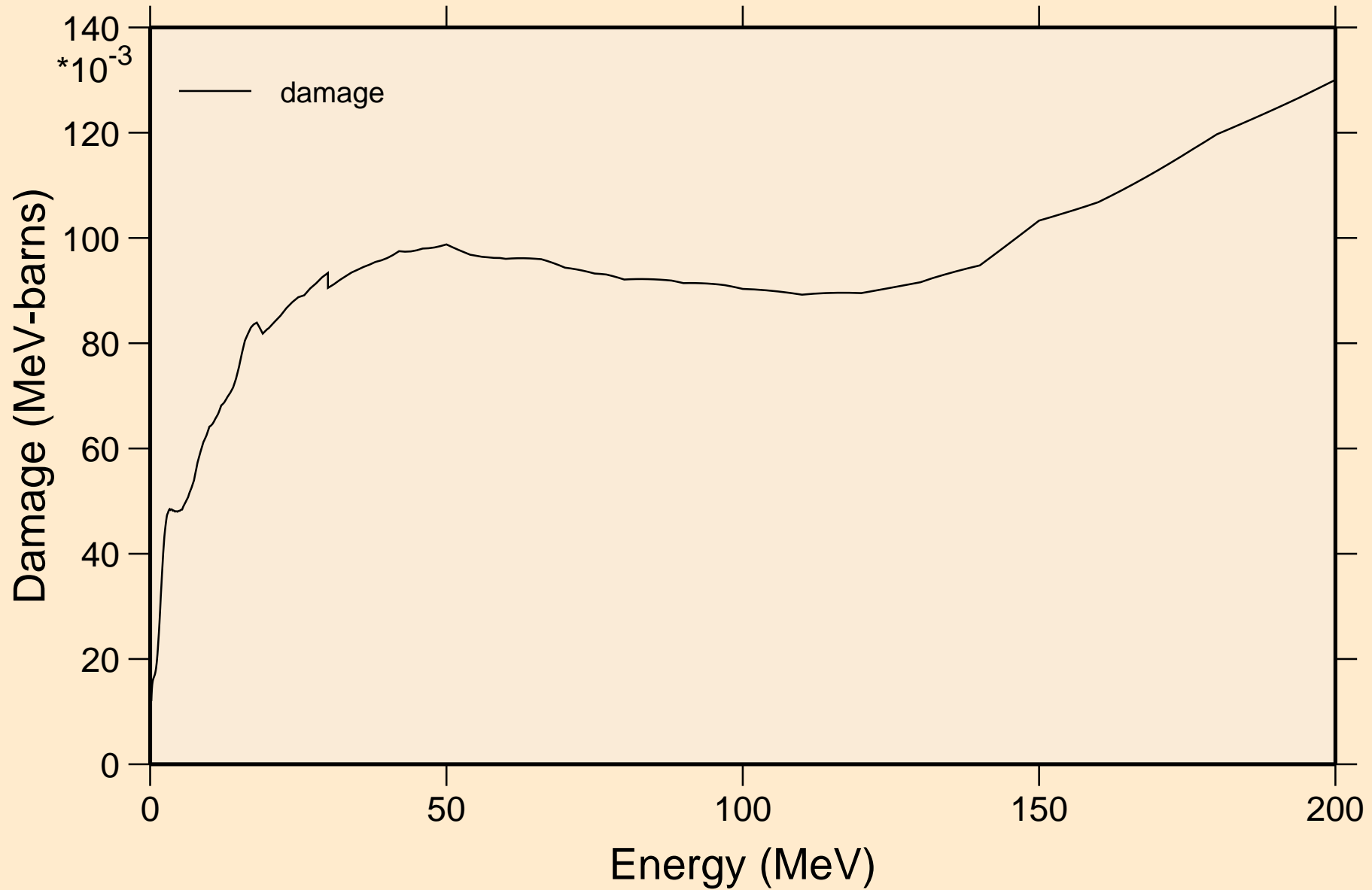

RN201 NEUTRON ACER TENDL-2021 LIBRARY; T=293.6K
Non-threshold reactions

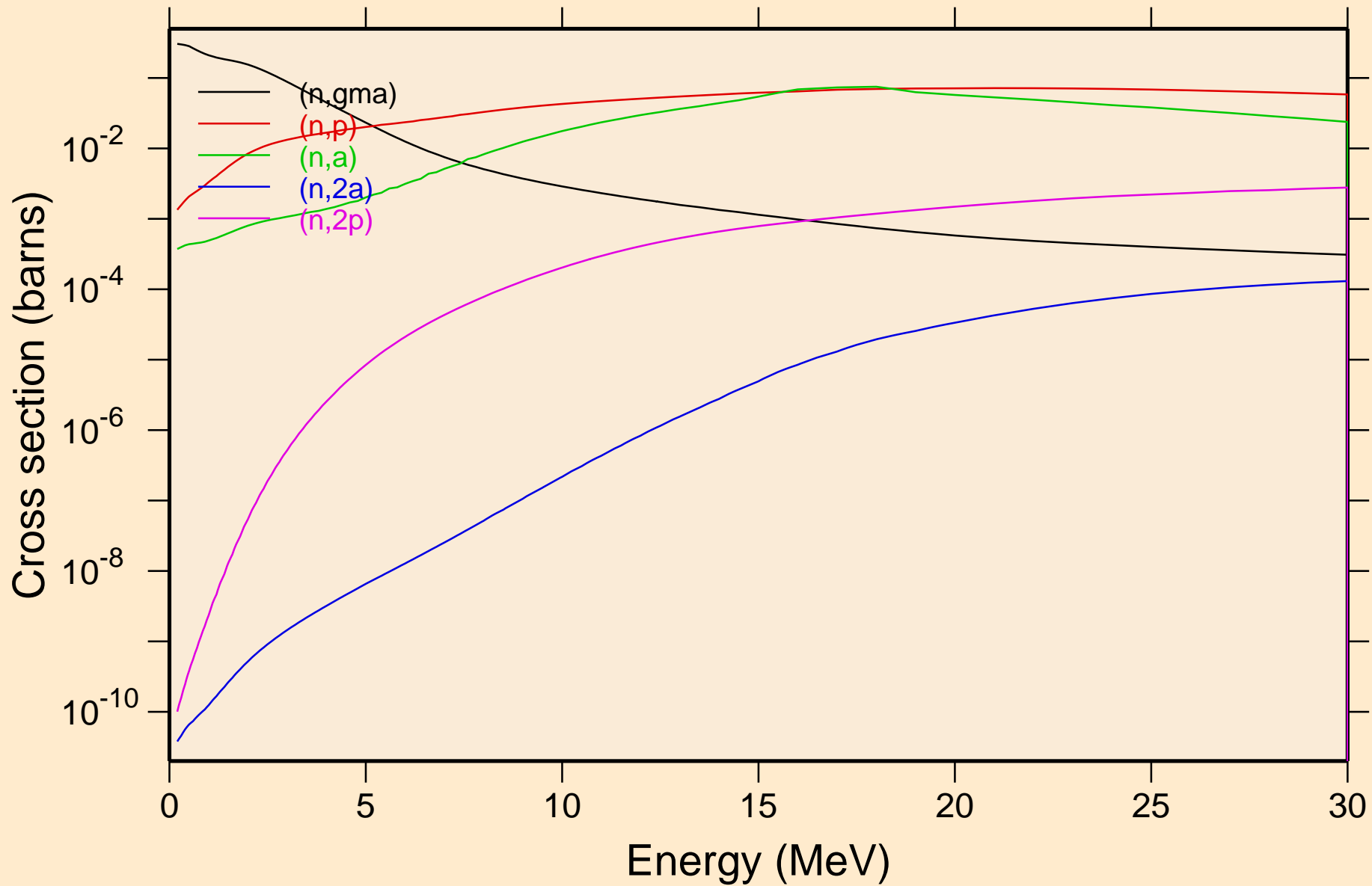

RN201 NEUTRON ACER TENDL-2021 LIBRARY; T=293.6K
Non-threshold reactions

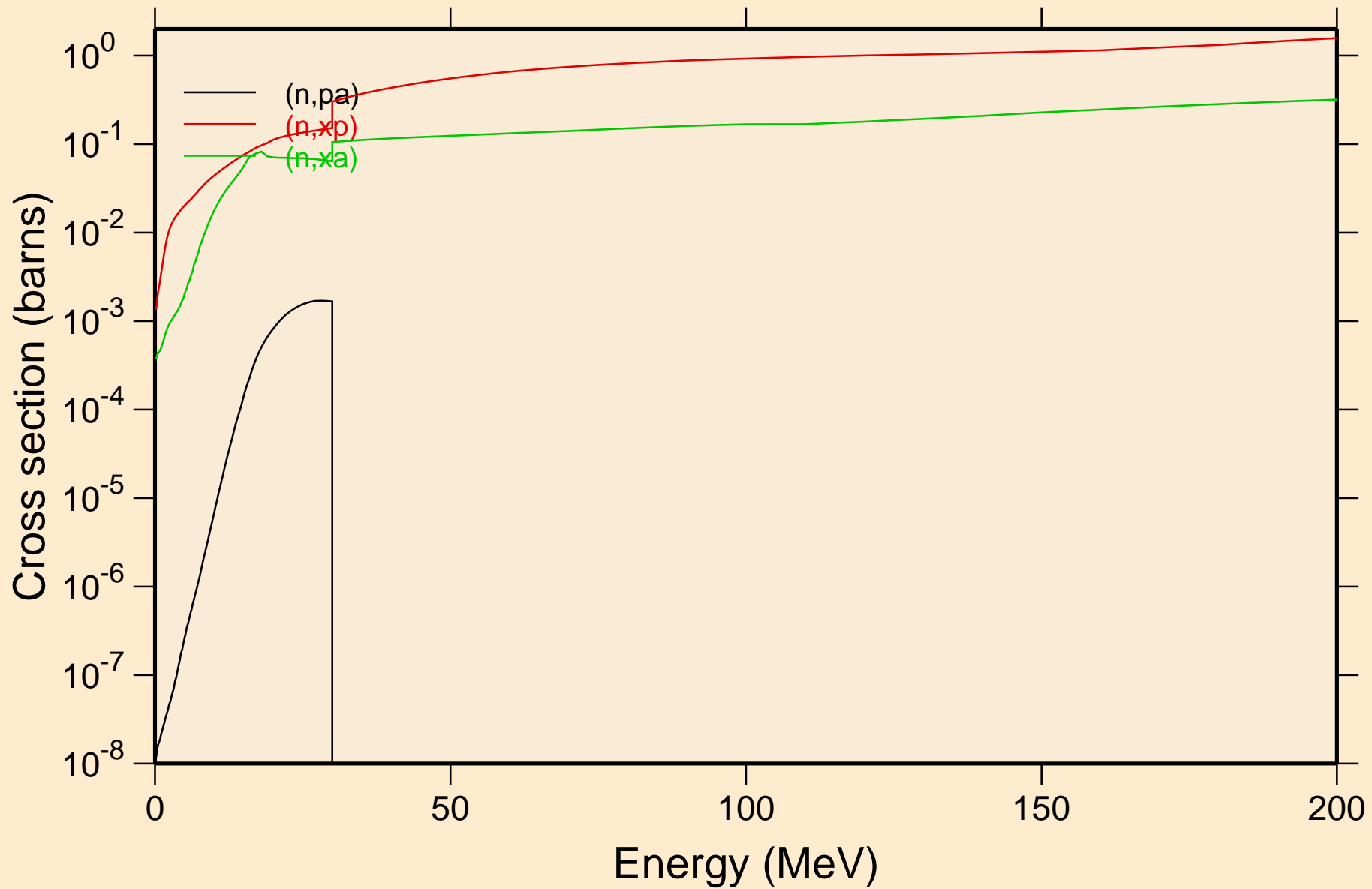

RN201 NEUTRON ACER TENDL-2021 LIBRARY; T=293.6K
Inelastic levels

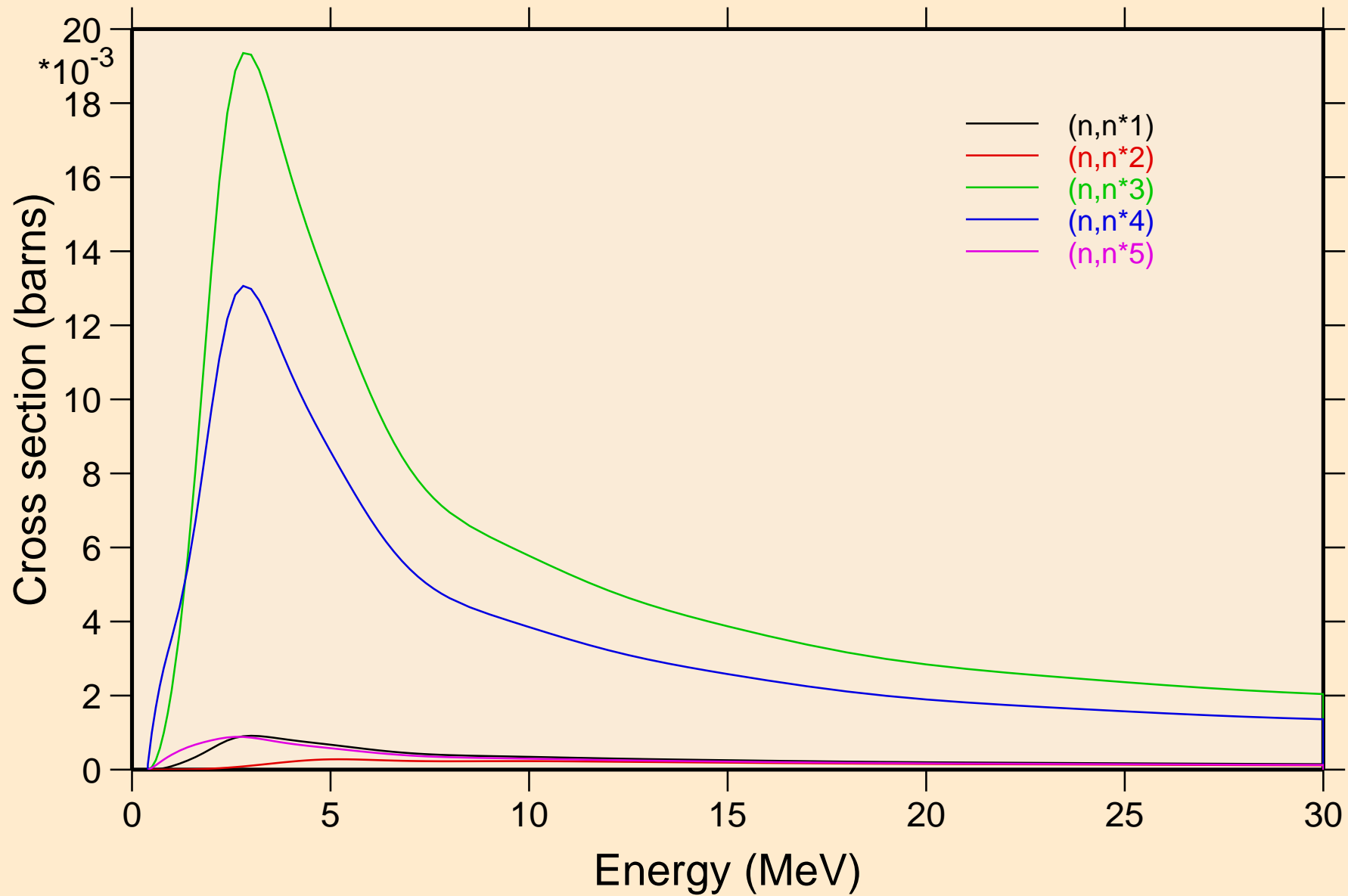

RN201 NEUTRON ACER TENDL-2021 LIBRARY; T=293.6K
Inelastic levels

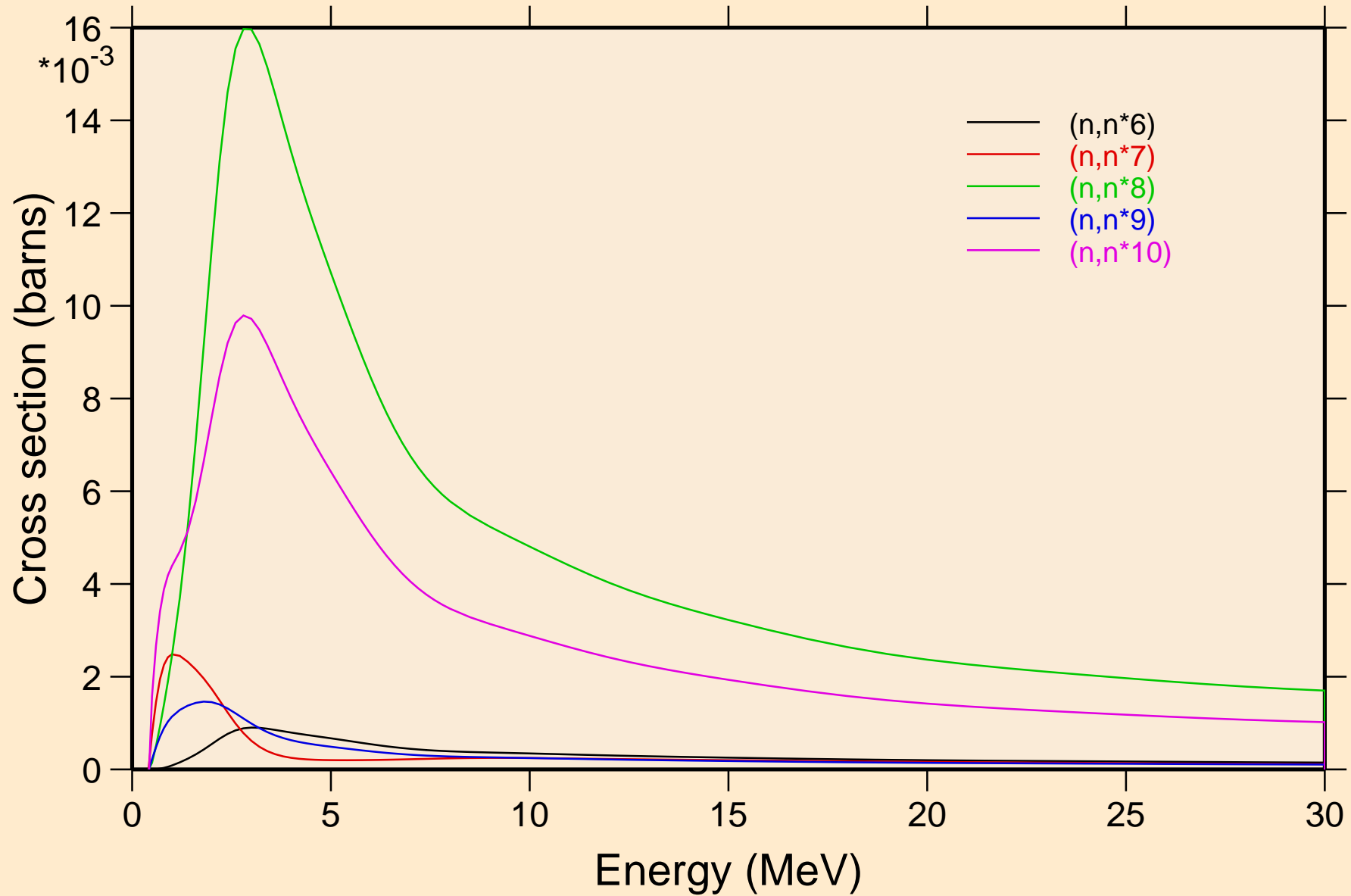

RN201 NEUTRON ACER TENDL-2021 LIBRARY; T=293.6K
Inelastic levels

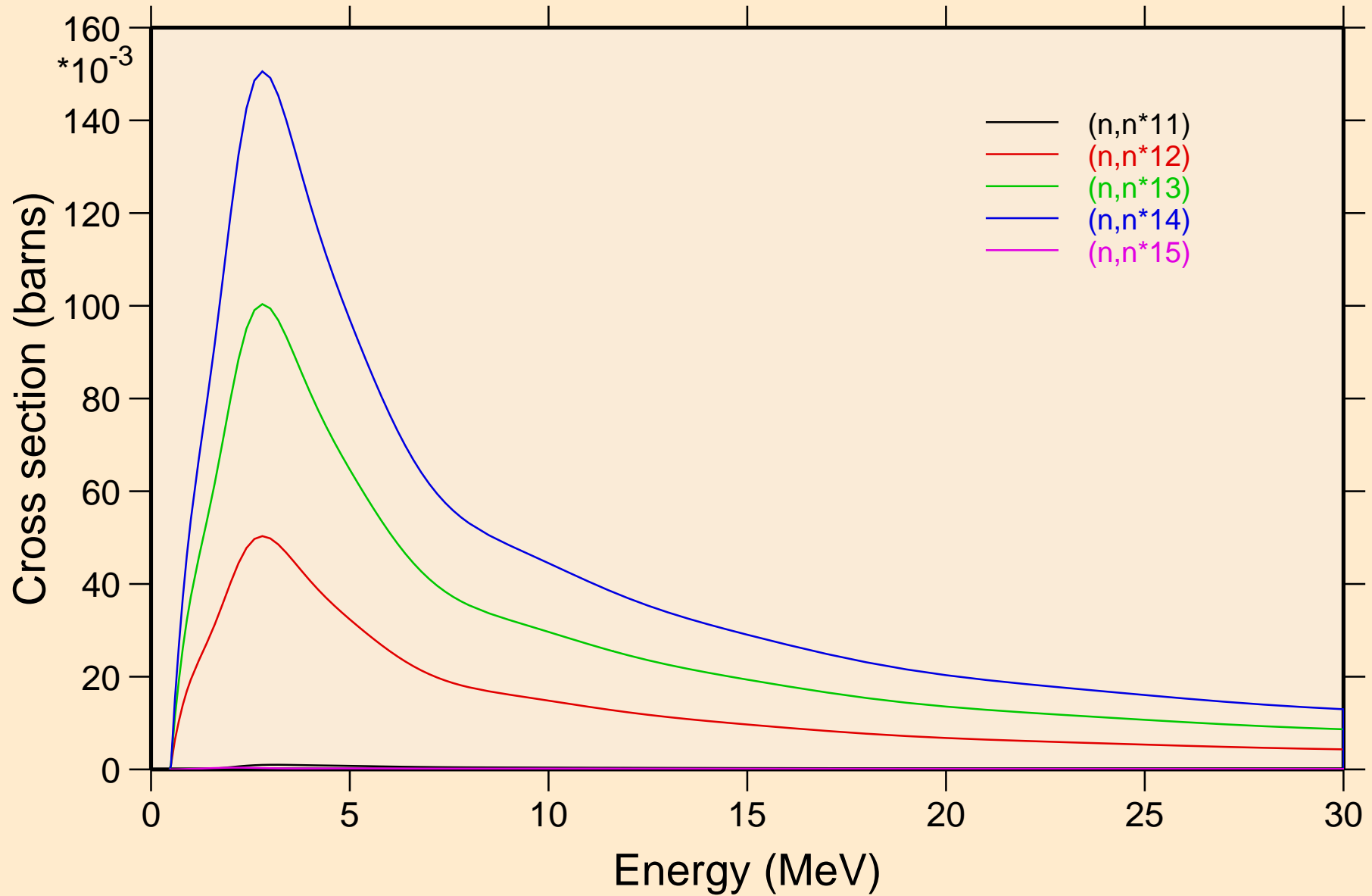

RN201 NEUTRON ACER TENDL-2021 LIBRARY; T=293.6K
Inelastic levels

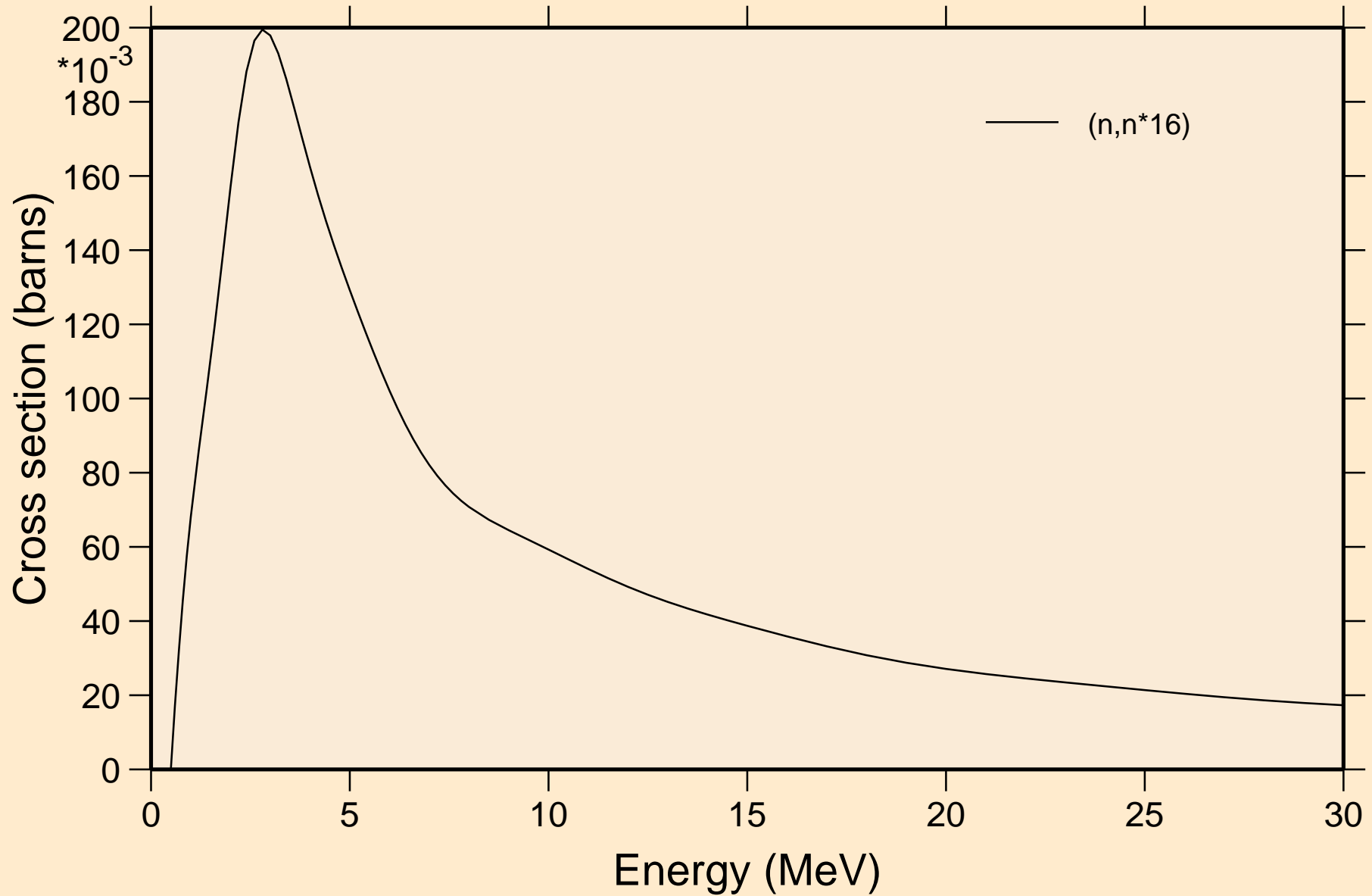

RN201 NEUTRON ACER TENDL-2021 LIBRARY; T=293.6K
Threshold reactions

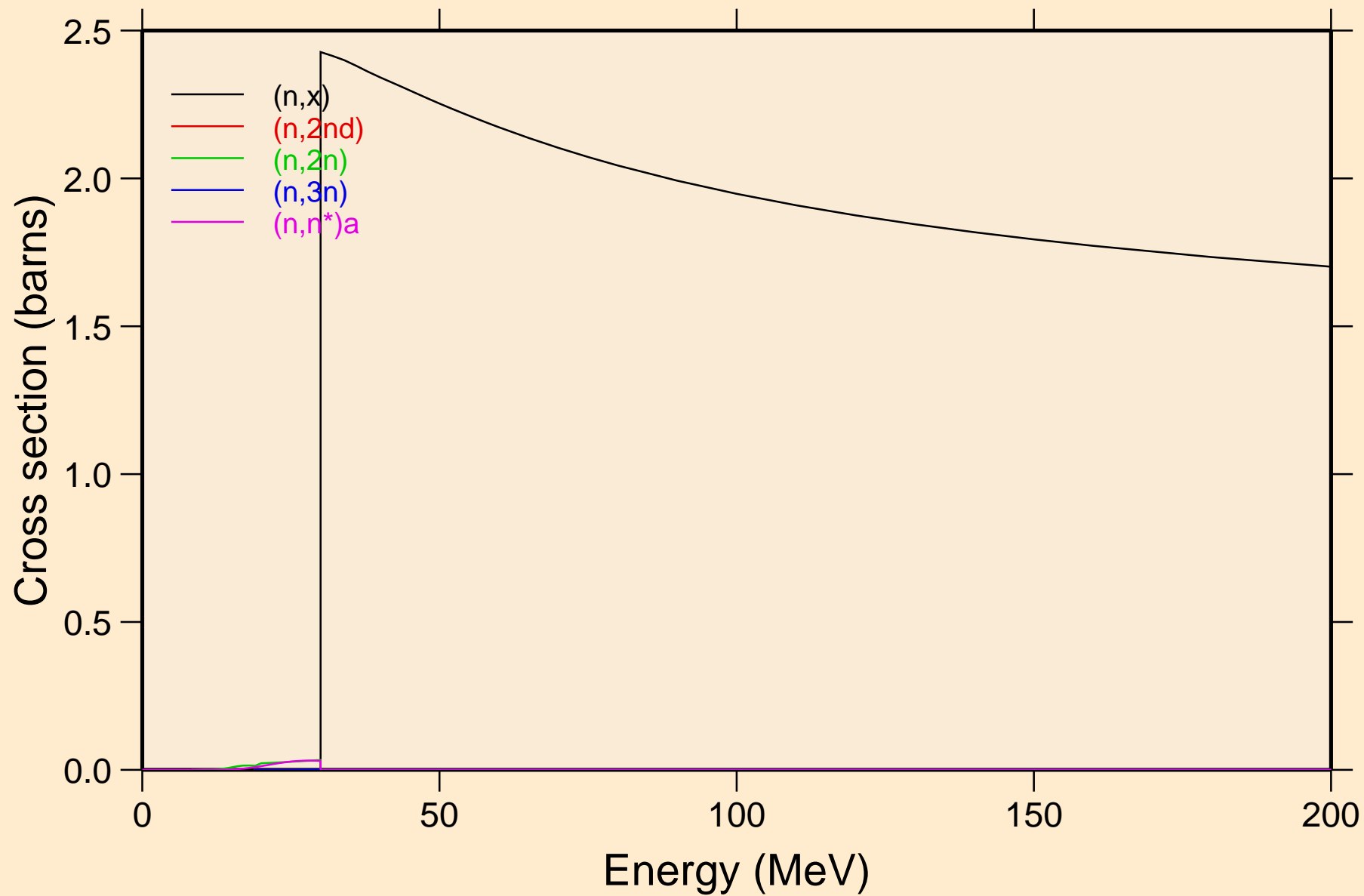

RN201 NEUTRON ACER TENDL-2021 LIBRARY; T=293.6K
Threshold reactions

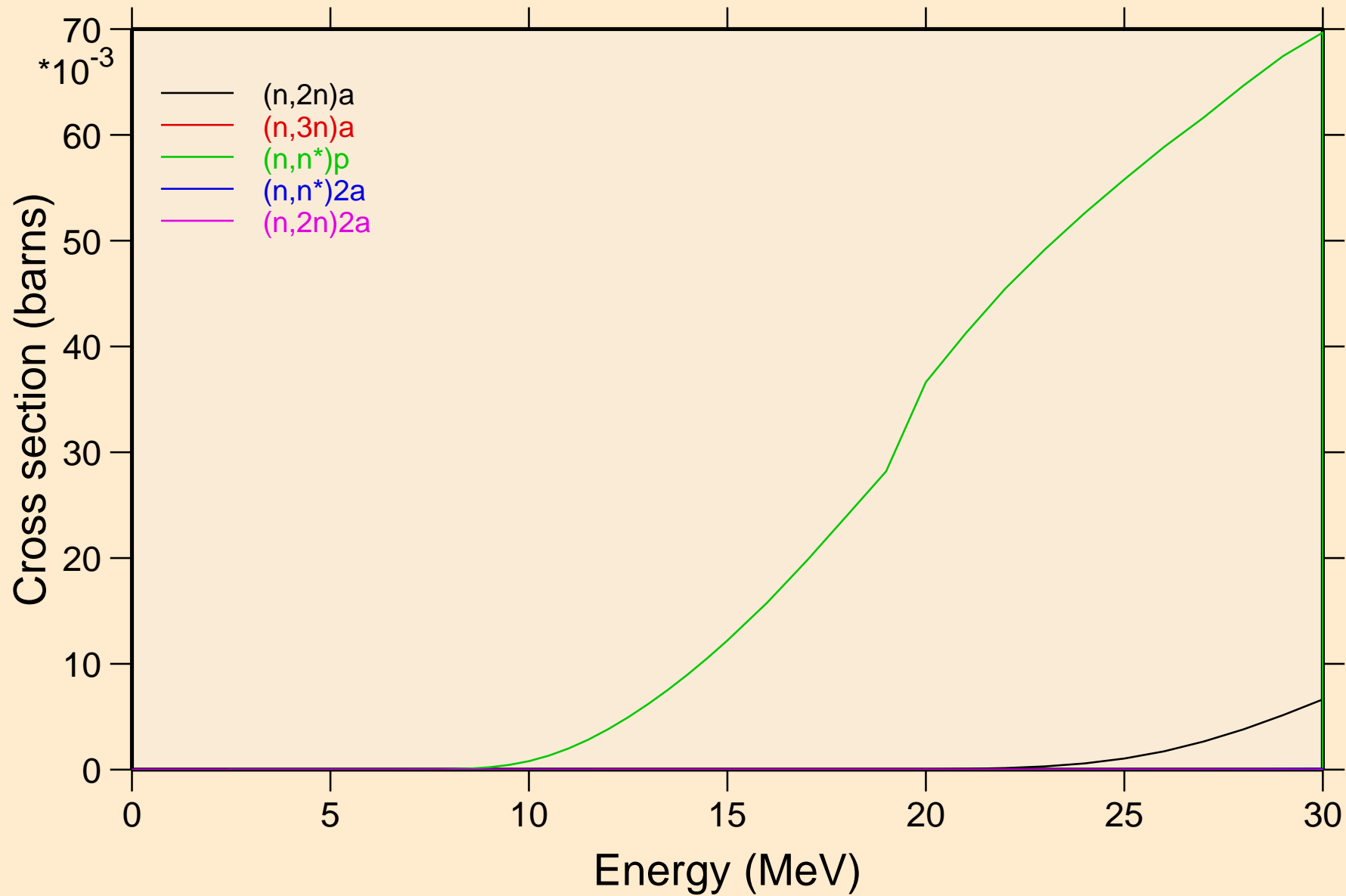

RN201 NEUTRON ACER TENDL-2021 LIBRARY; T=293.6K
Threshold reactions

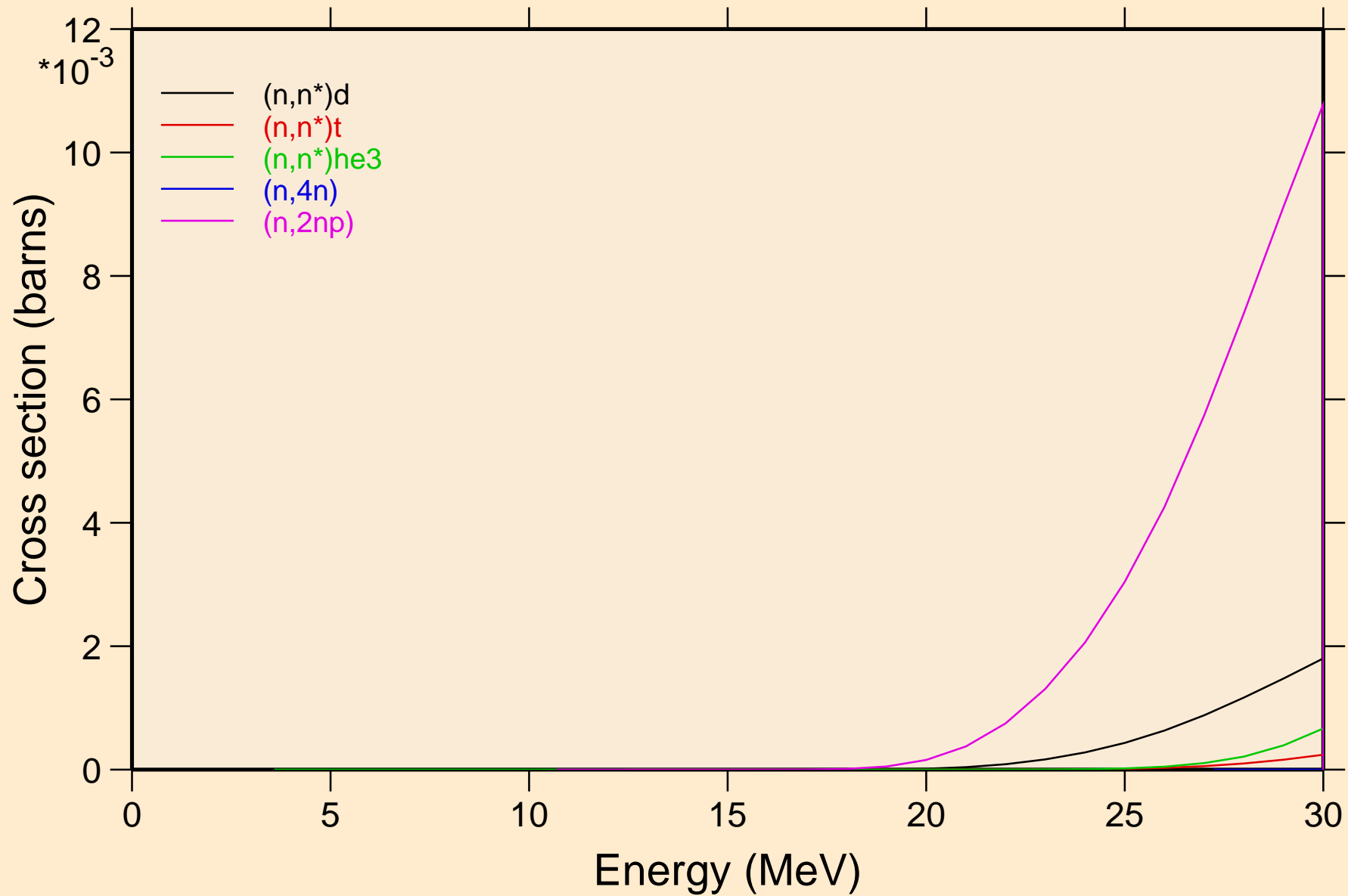

RN201 NEUTRON ACER TENDL-2021 LIBRARY; T=293.6K

Threshold reactions

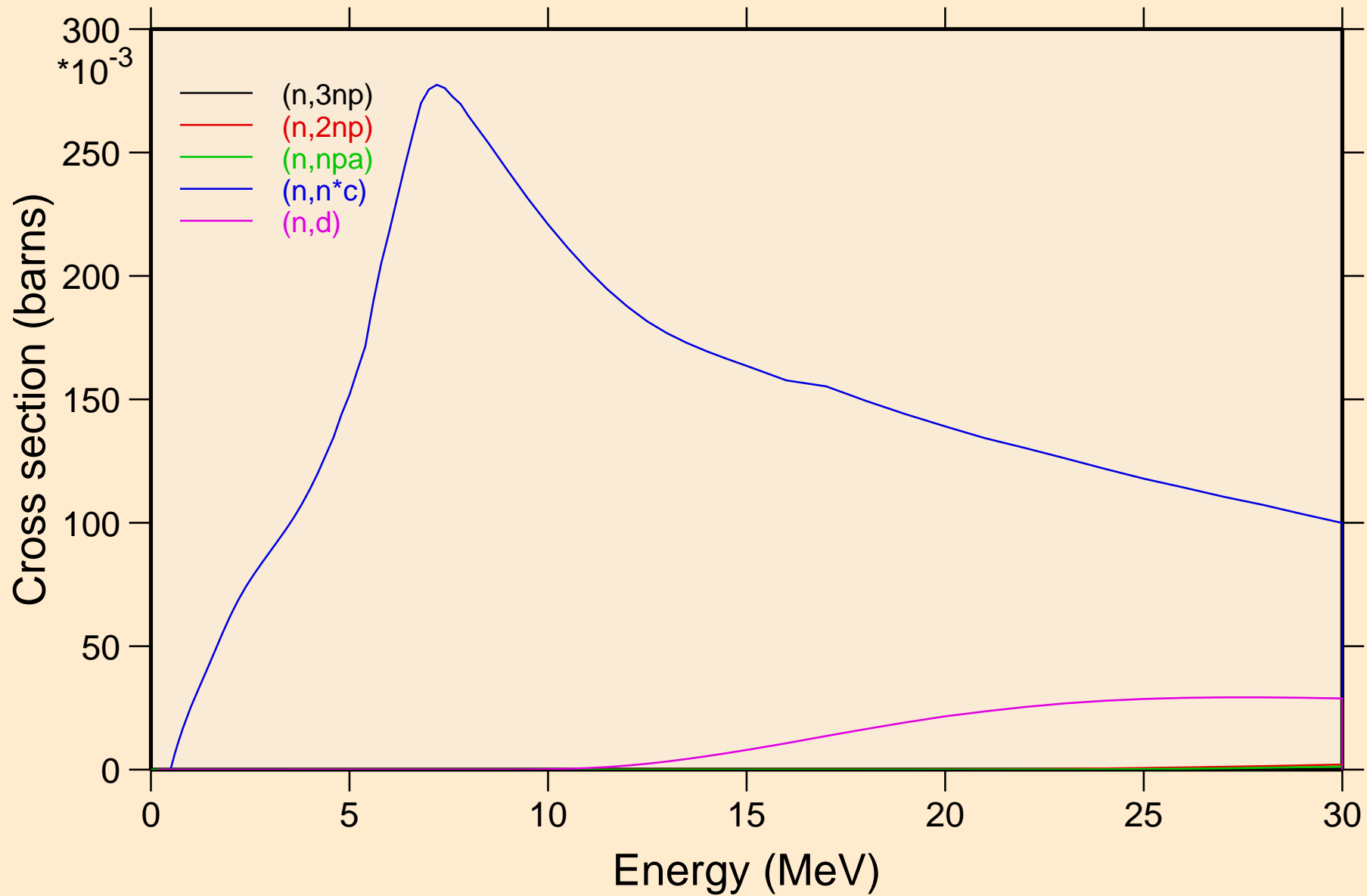

RN201 NEUTRON ACER TENDL-2021 LIBRARY; T=293.6K
Threshold reactions

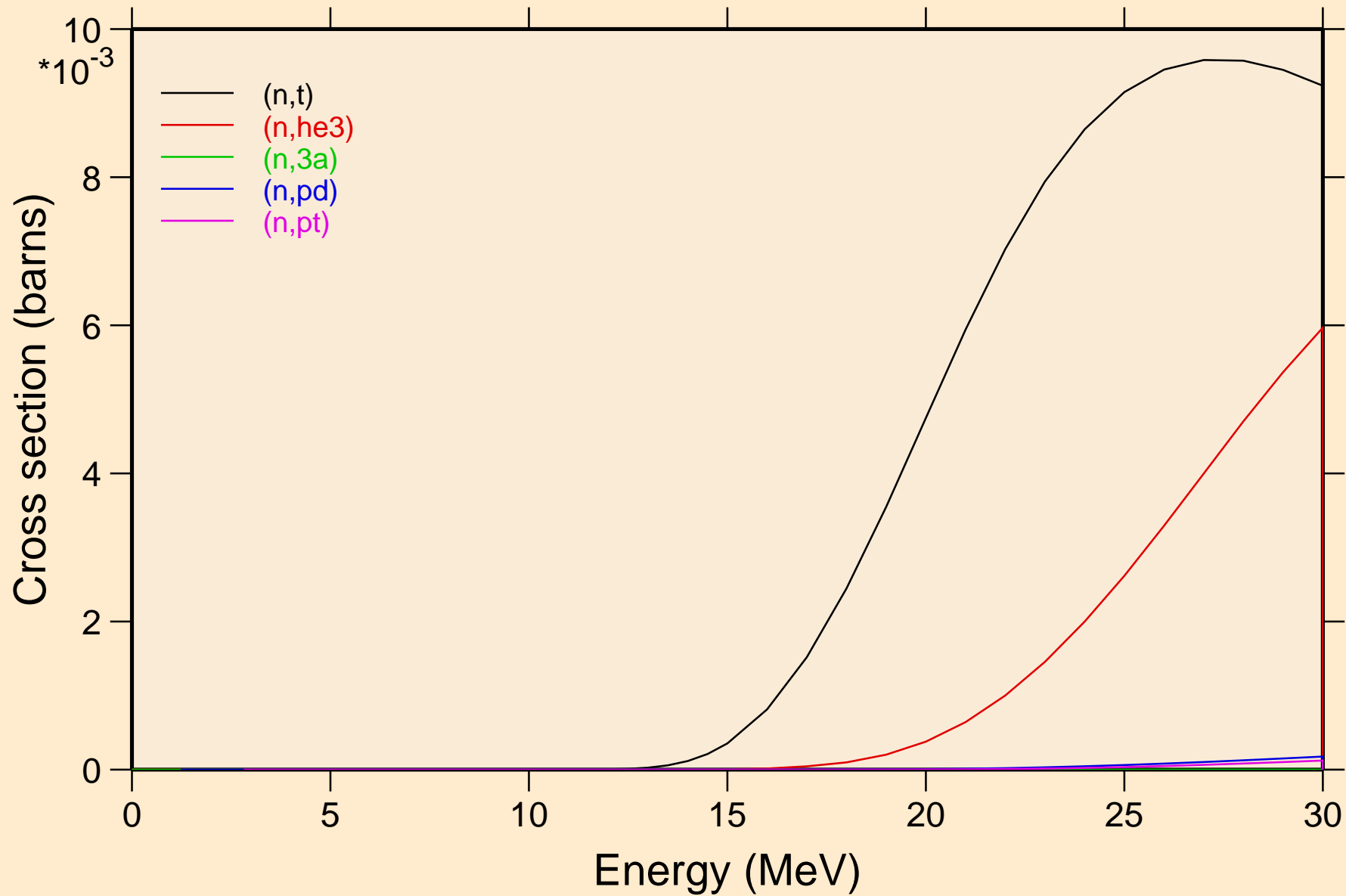

RN201 NEUTRON ACER TENDL-2021 LIBRARY; T=293.6K
Threshold reactions

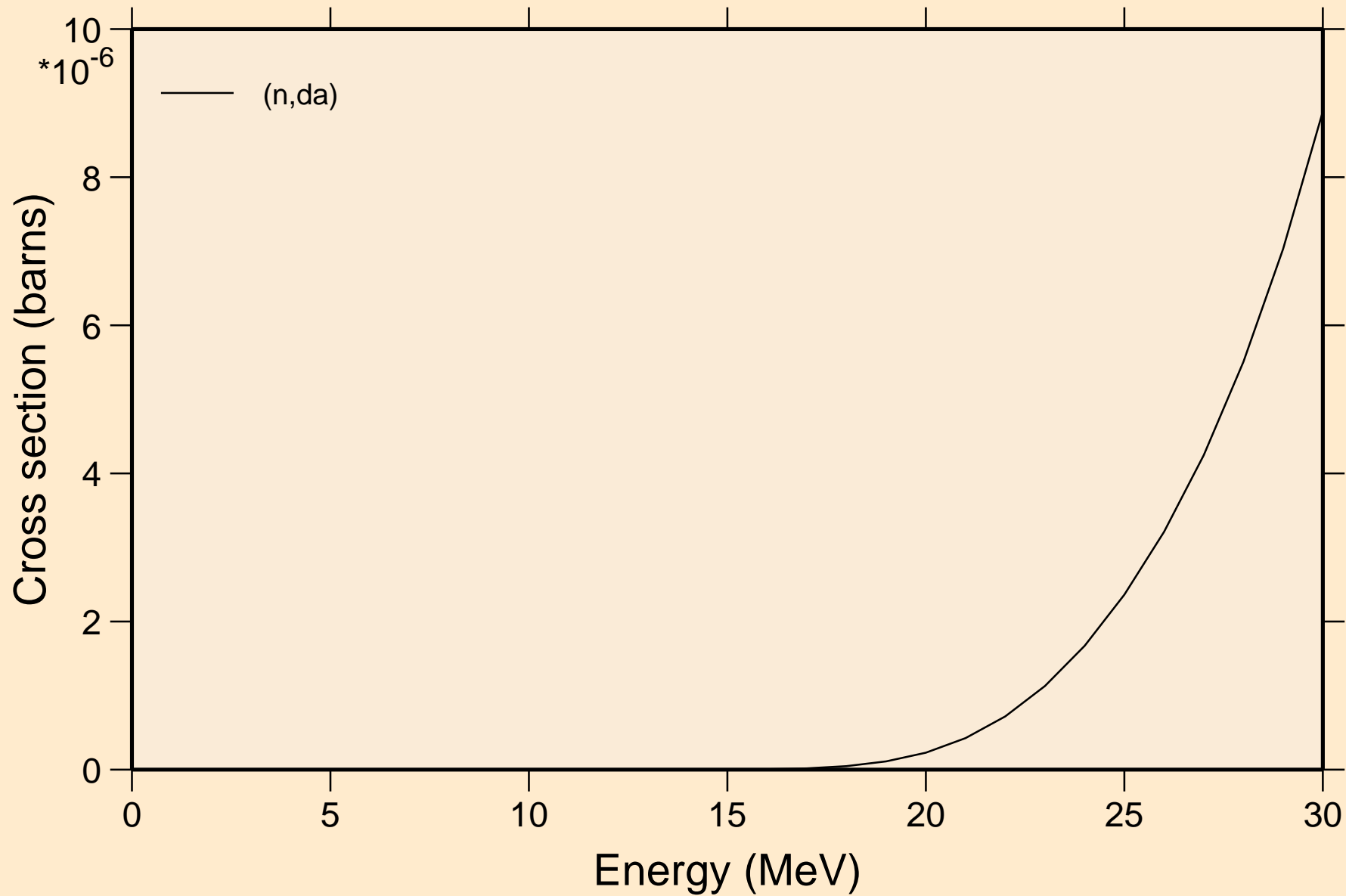

RN201 NEUTRON ACER TENDL-2021 LIBRARY; T=293.6K
Threshold reactions

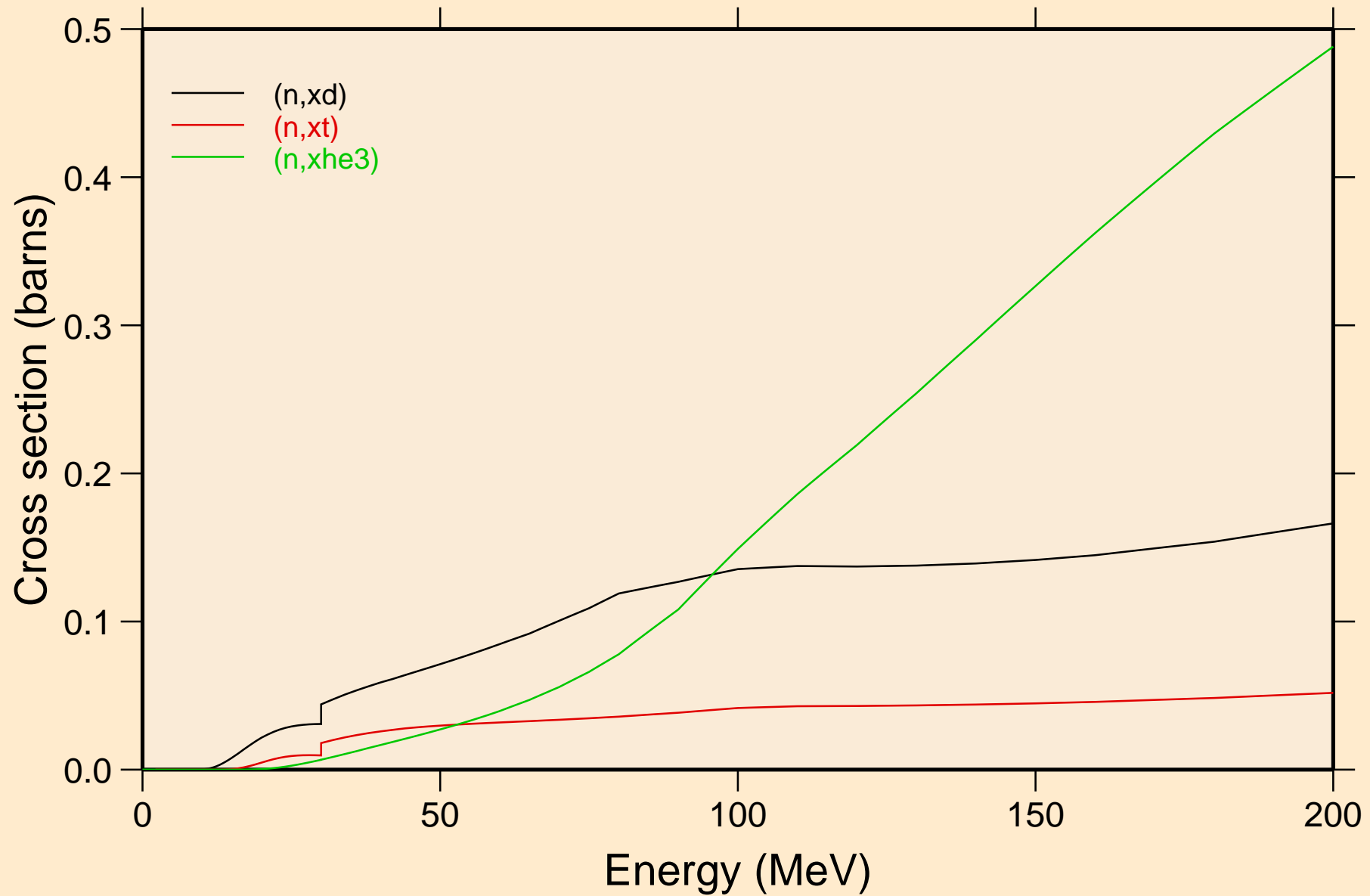

RN201 NEUTRON ACER TENDL-2021 LIBRARY; T=293.6K
angular distribution for elastic

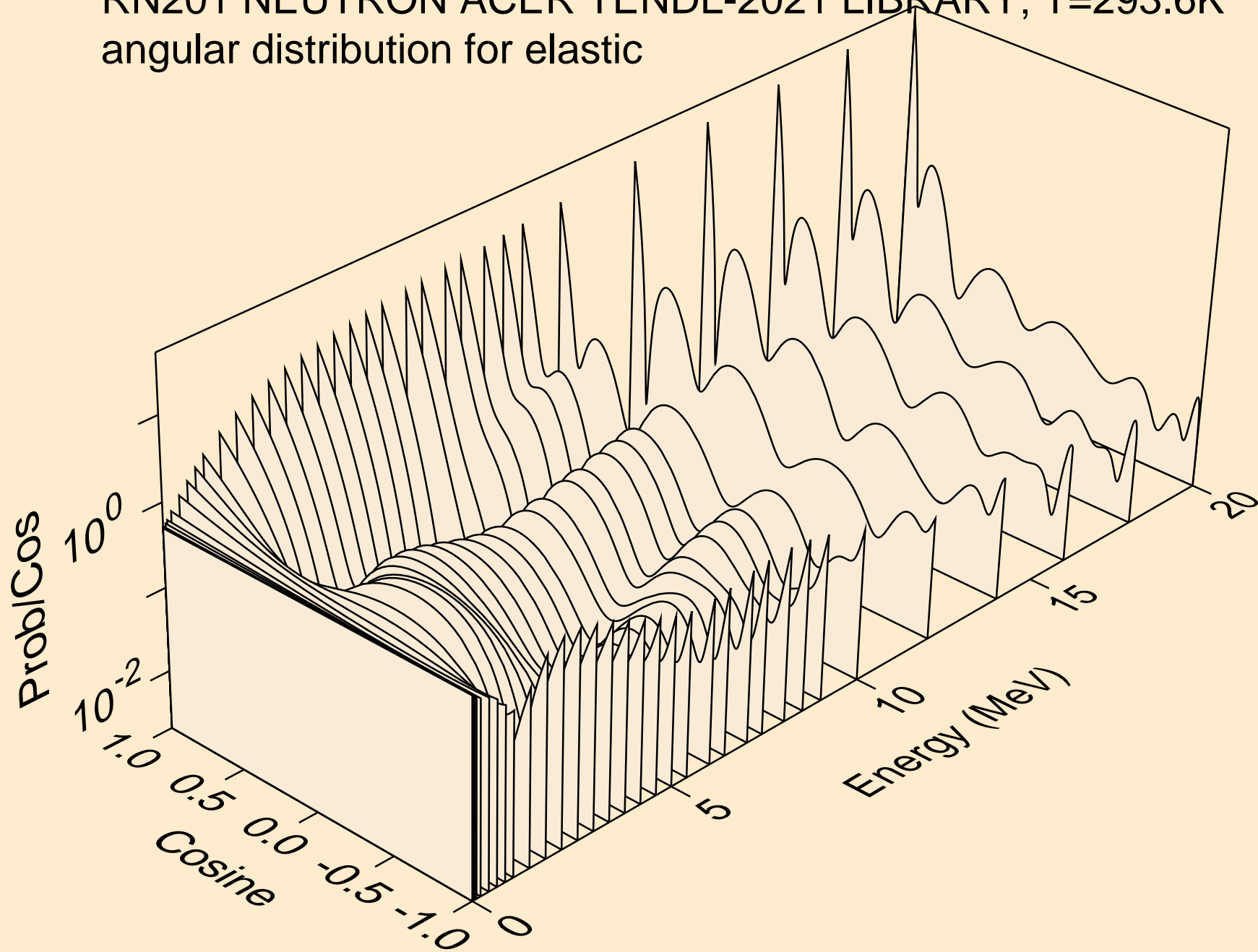

RN201 NEUTRON ACER TENDL-2021 LIBRARY; T=293.6K
angular distribution for elastic

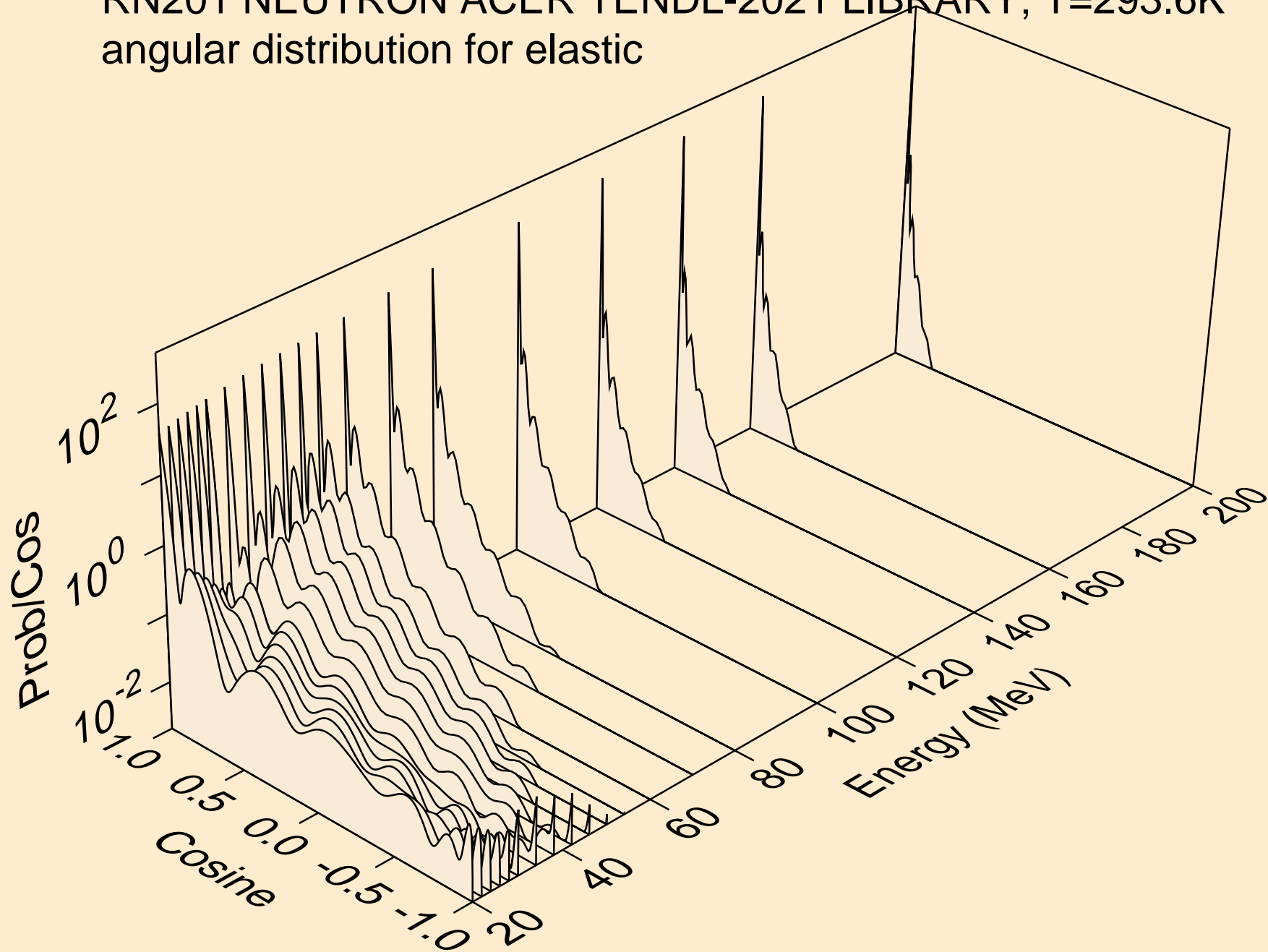

RN201 NEUTRON ACER TENDL-2021 LIBRARY; T=293.6K
angular distribution for (n,n*1)

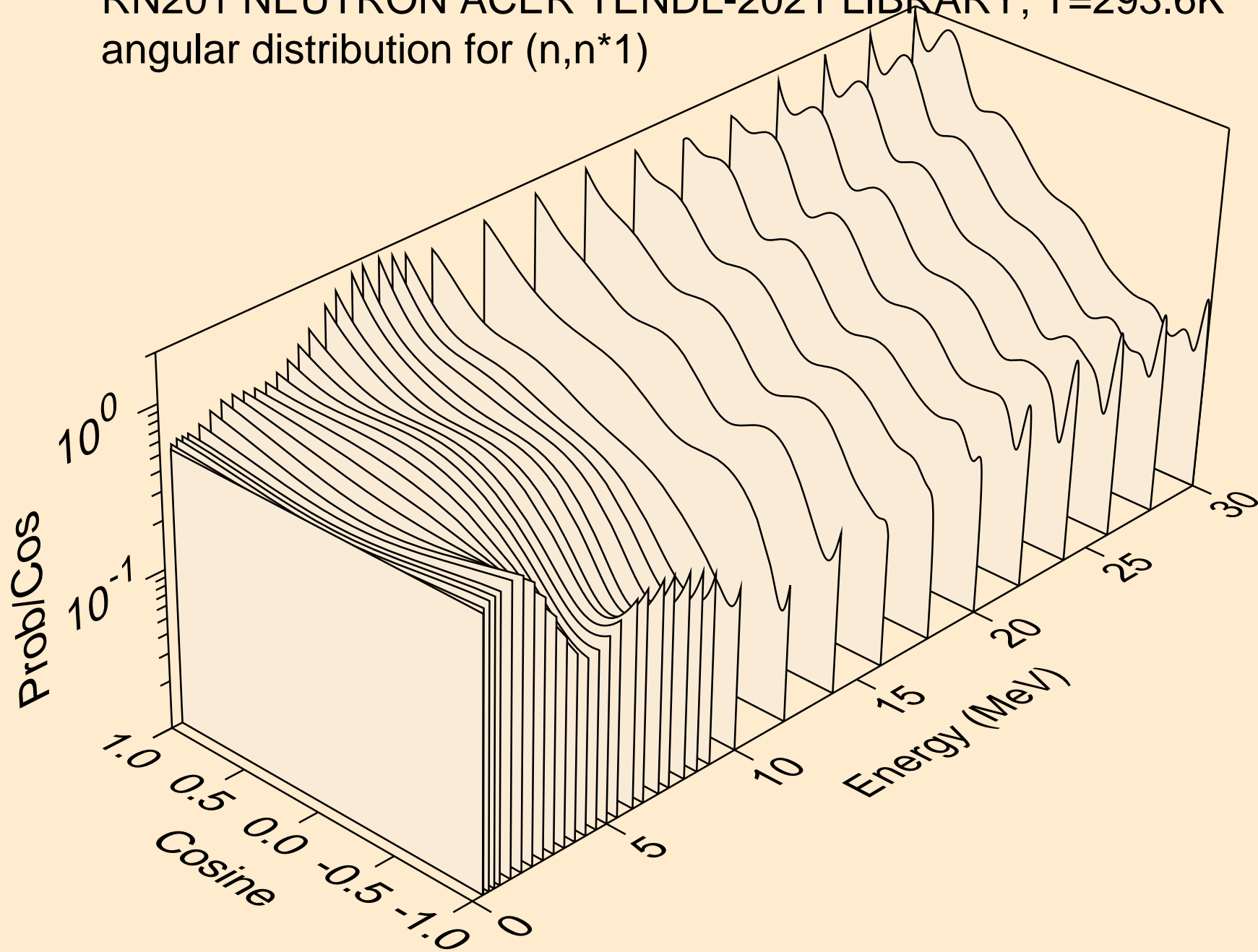

RN201 NEUTRON ACER TENDL-2021 LIBRARY; T=293.6K
angular distribution for (n,n*2)

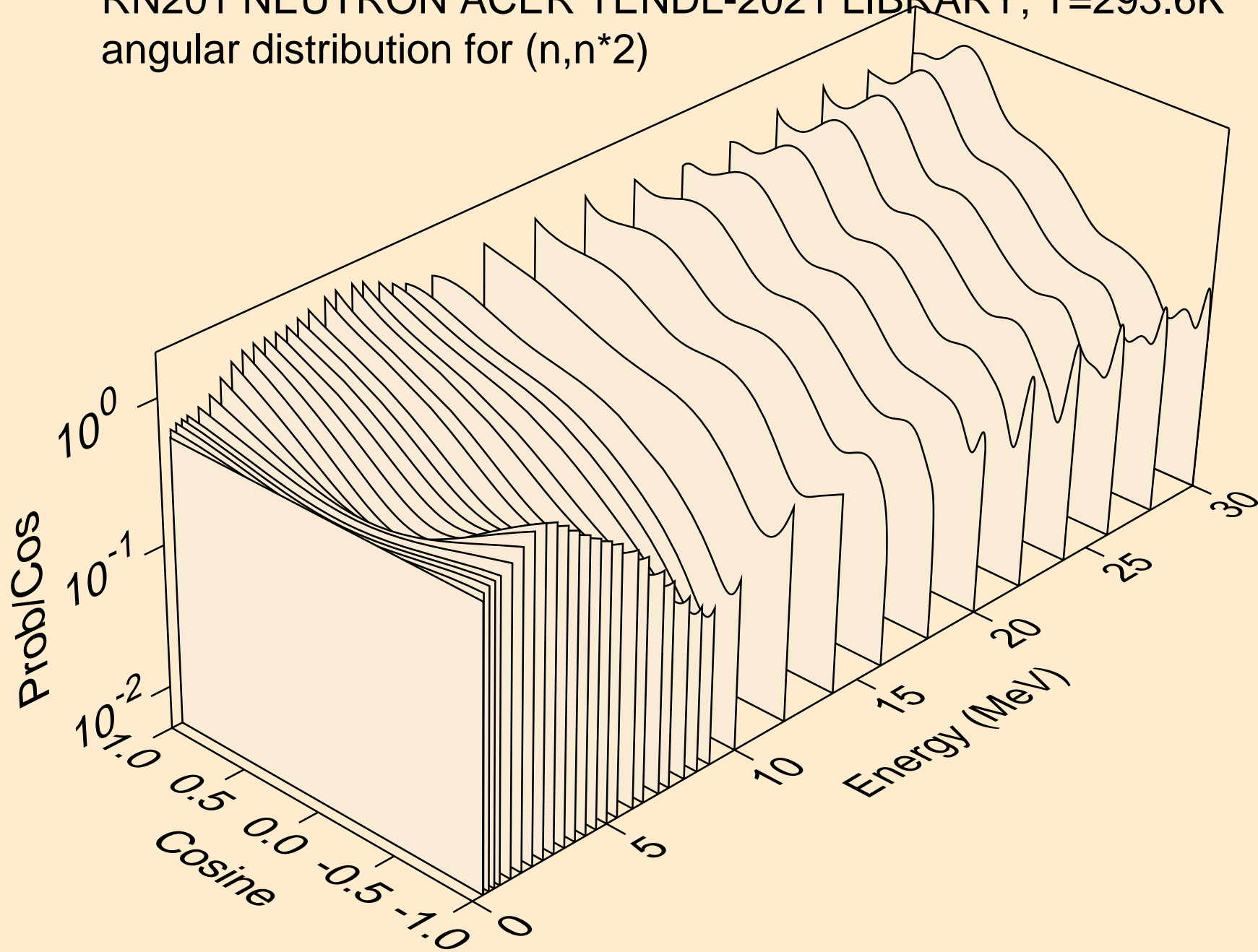

RN201 NEUTRON ACER TENDL-2021 LIBRARY; T=293.6K
angular distribution for (n,n*3)

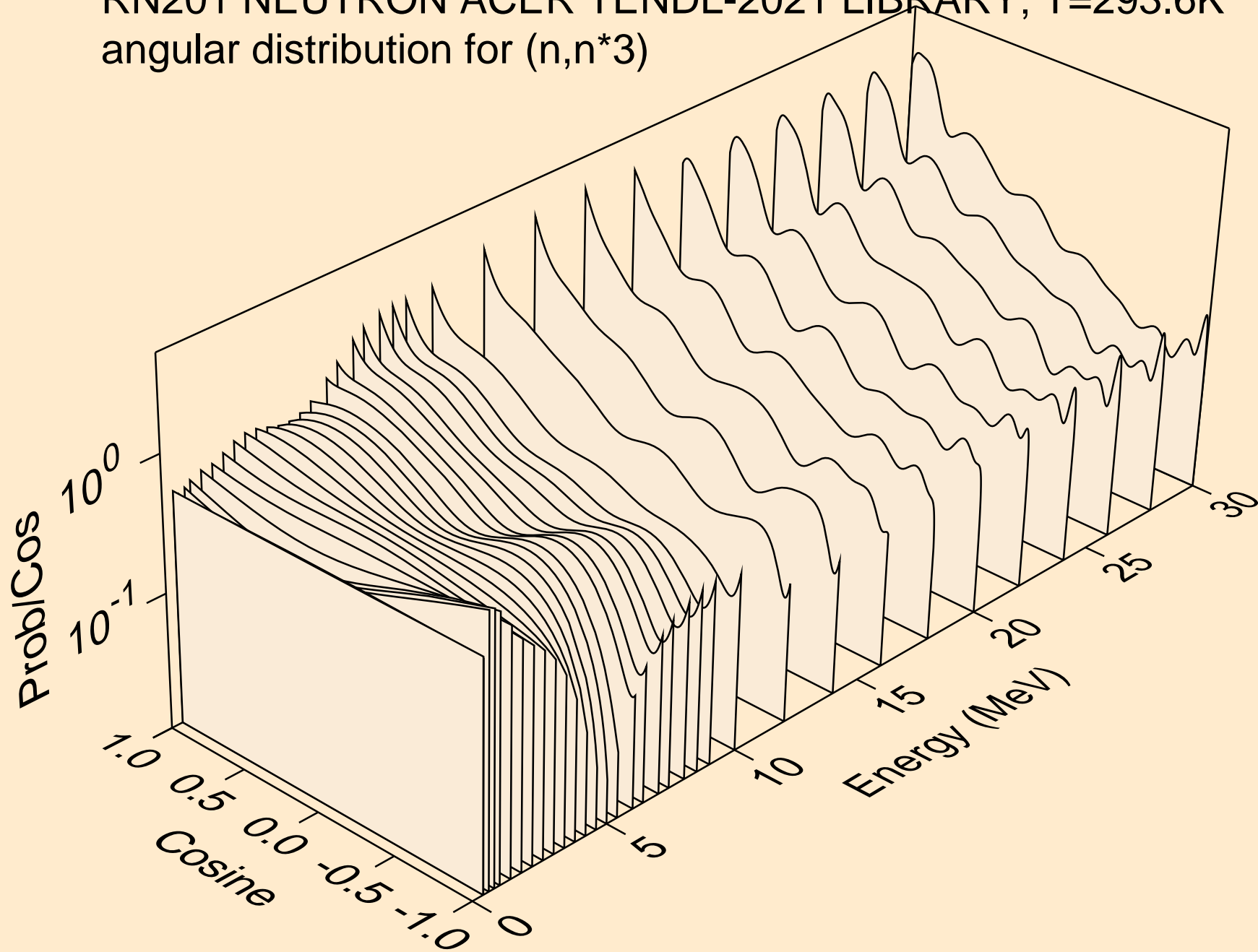

RN201 NEUTRON ACER TENDL-2021 LIBRARY; T=293.6K
angular distribution for (n,n*4)

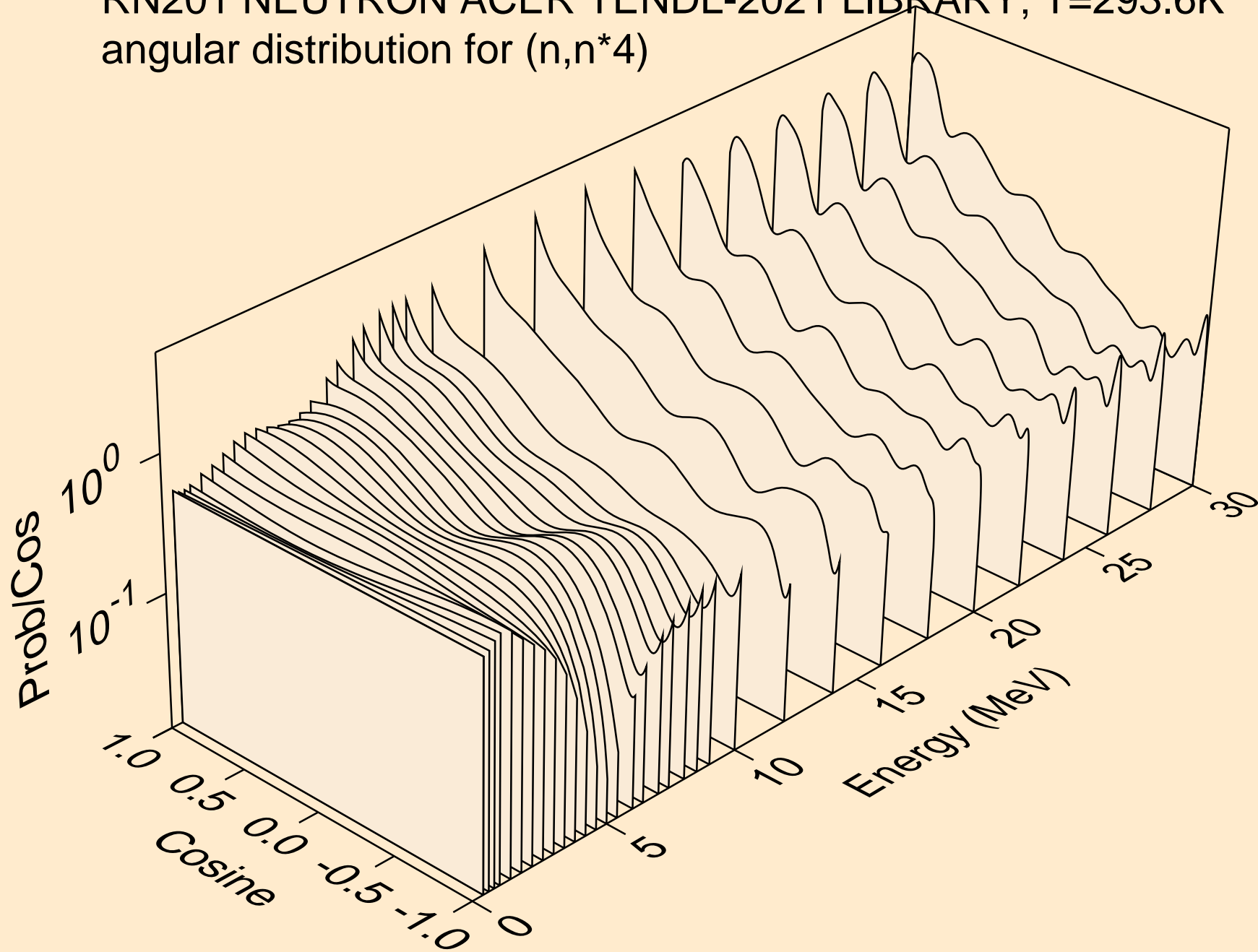

RN201 NEUTRON ACER TENDL-2021 LIBRARY; T=293.6K
angular distribution for (n,n*5)

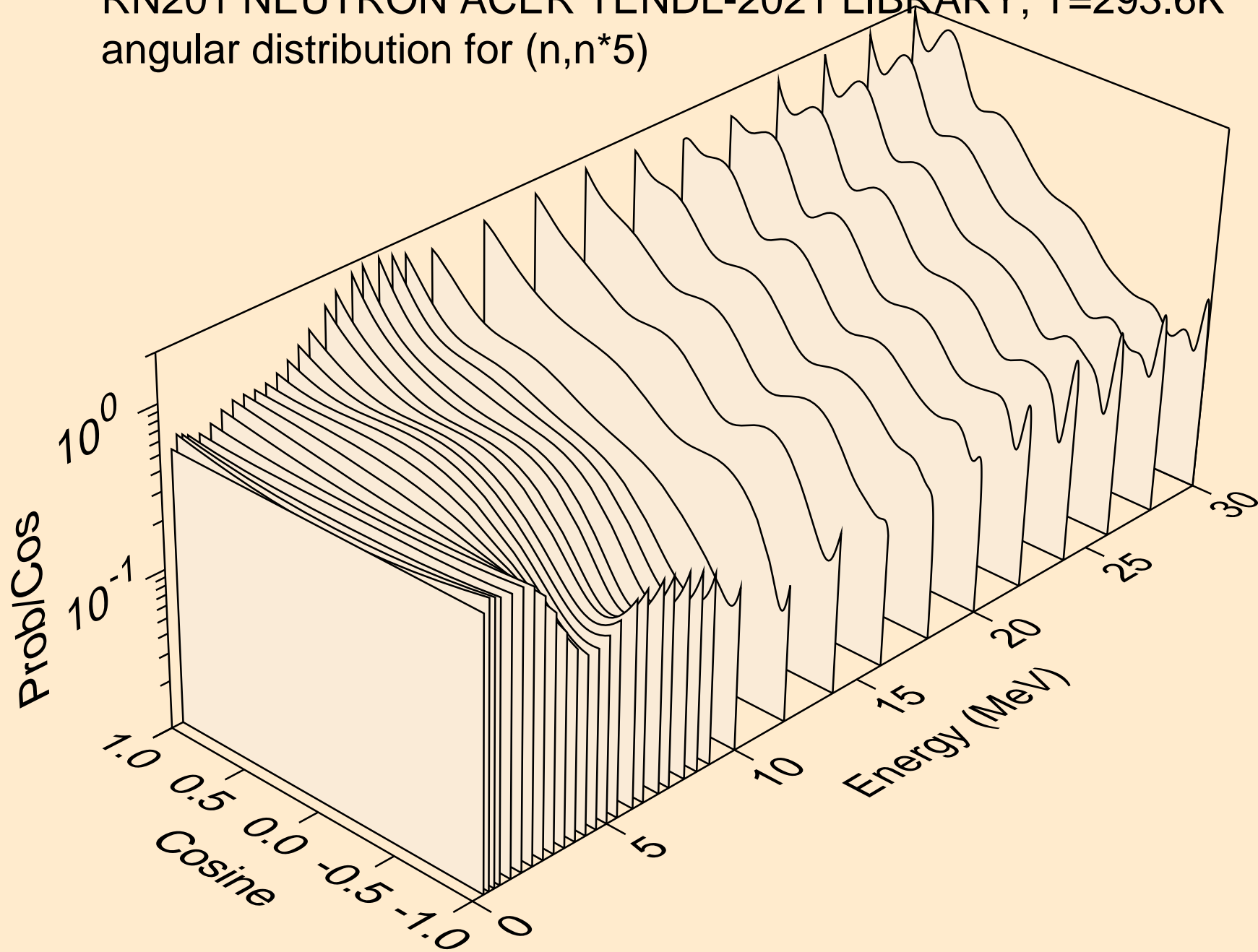

RN201 NEUTRON ACER TENDL-2021 LIBRARY; T=293.6K
angular distribution for (n,n*6)

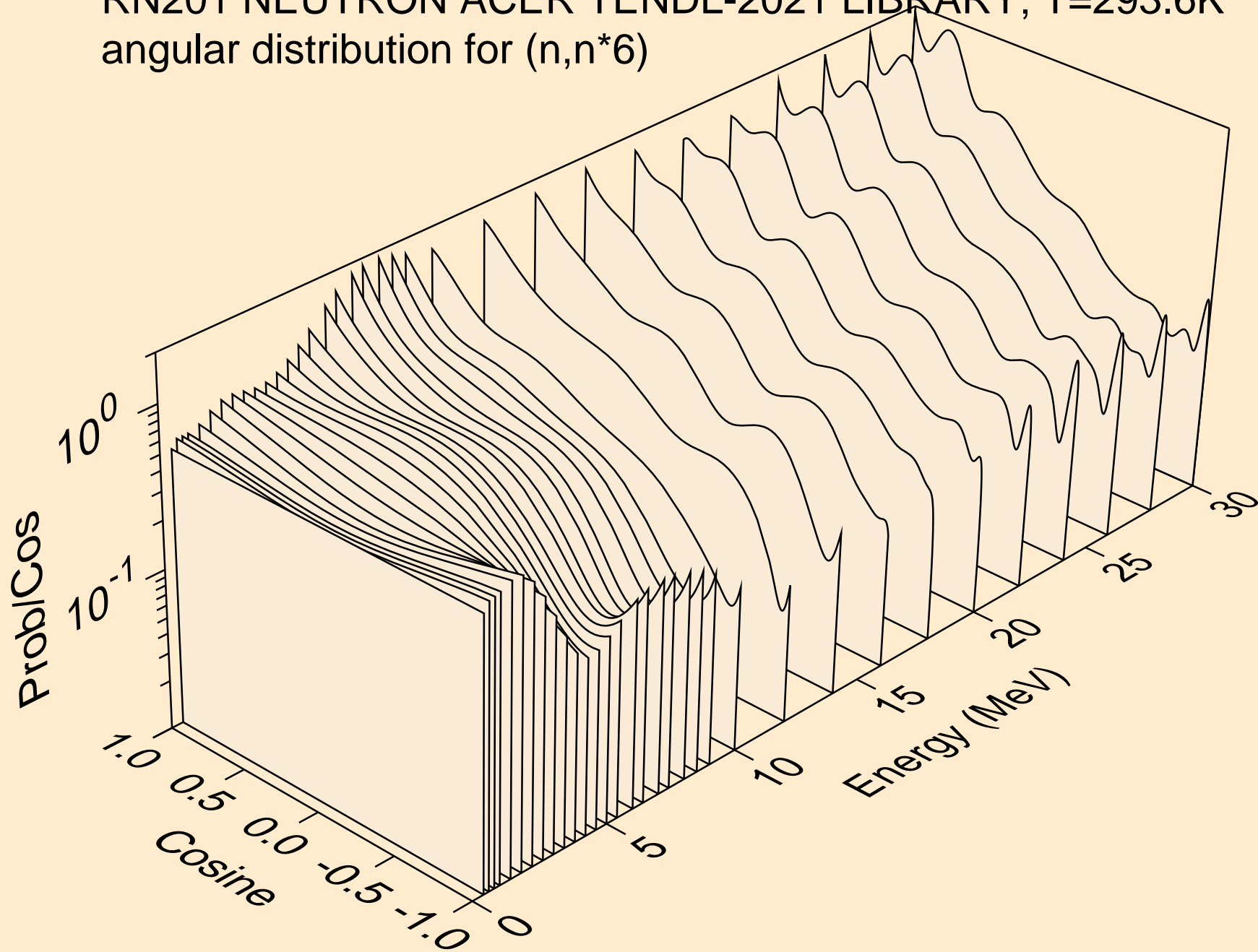

RN201 NEUTRON ACER TENDL-2021 LIBRARY; T=293.6K
angular distribution for (n,n*7)

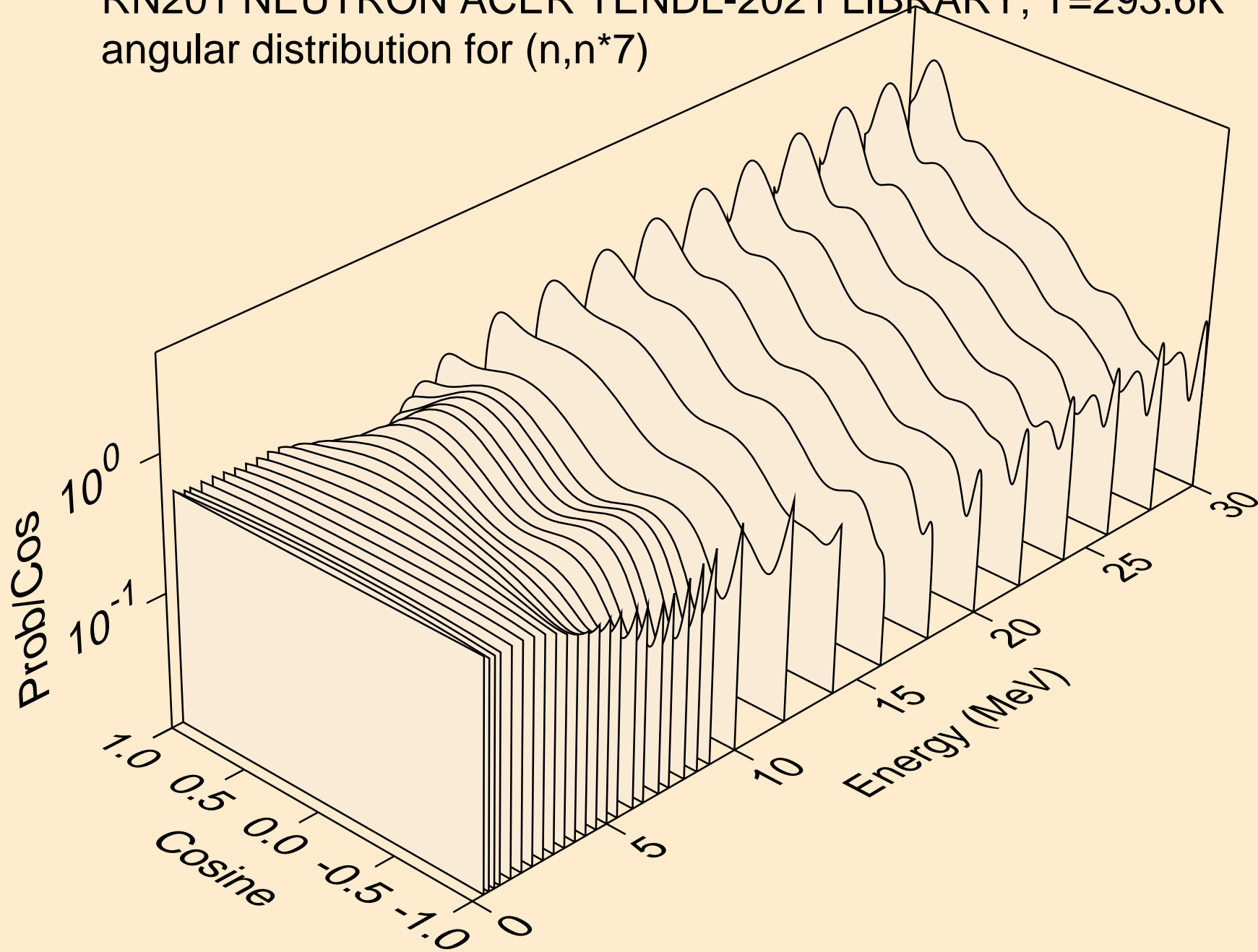

RN201 NEUTRON ACER TENDL-2021 LIBRARY; T=293.6K
angular distribution for (n,n*8)

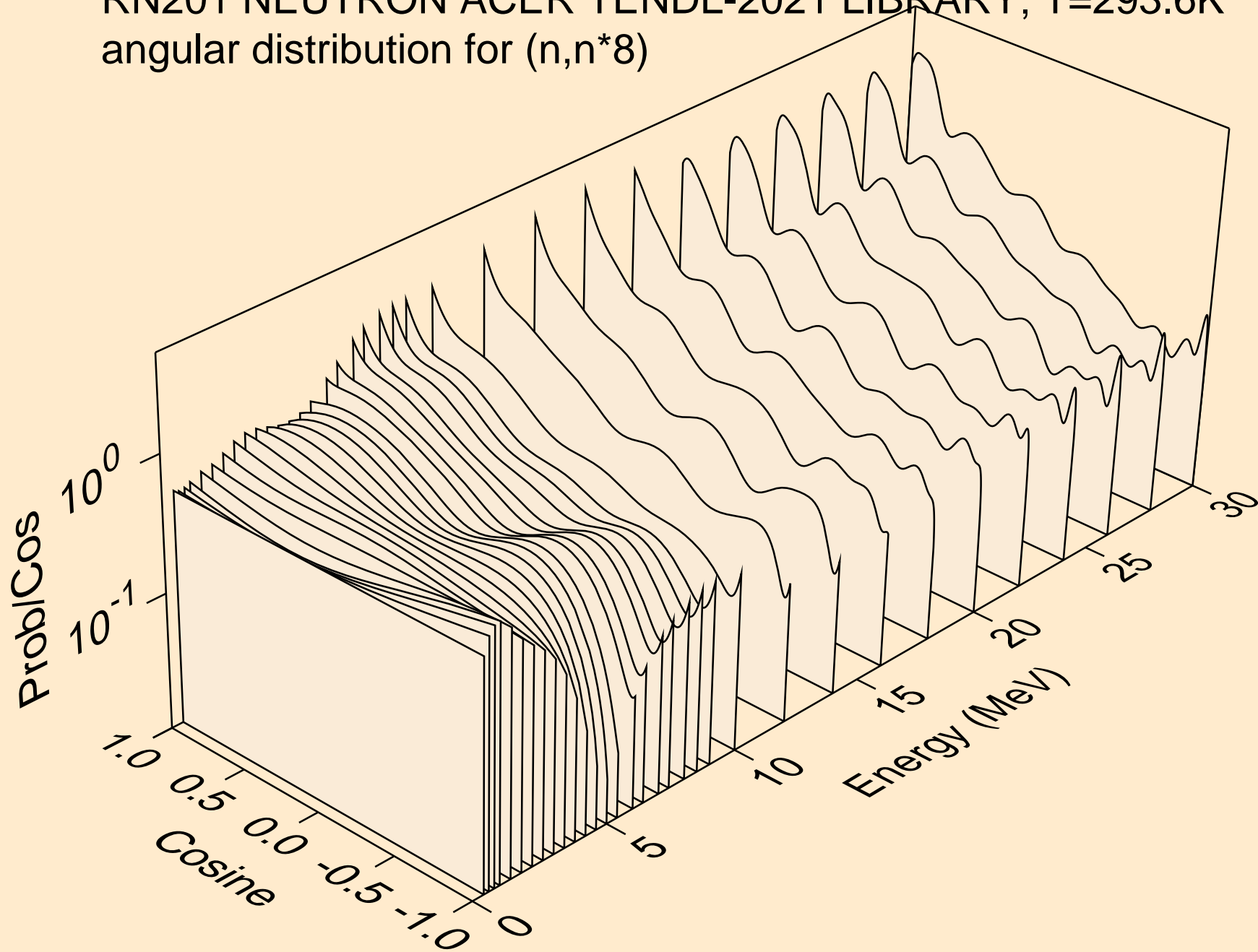

RN201 NEUTRON ACER TENDL-2021 LIBRARY; T=293.6K
angular distribution for (n,n*9)

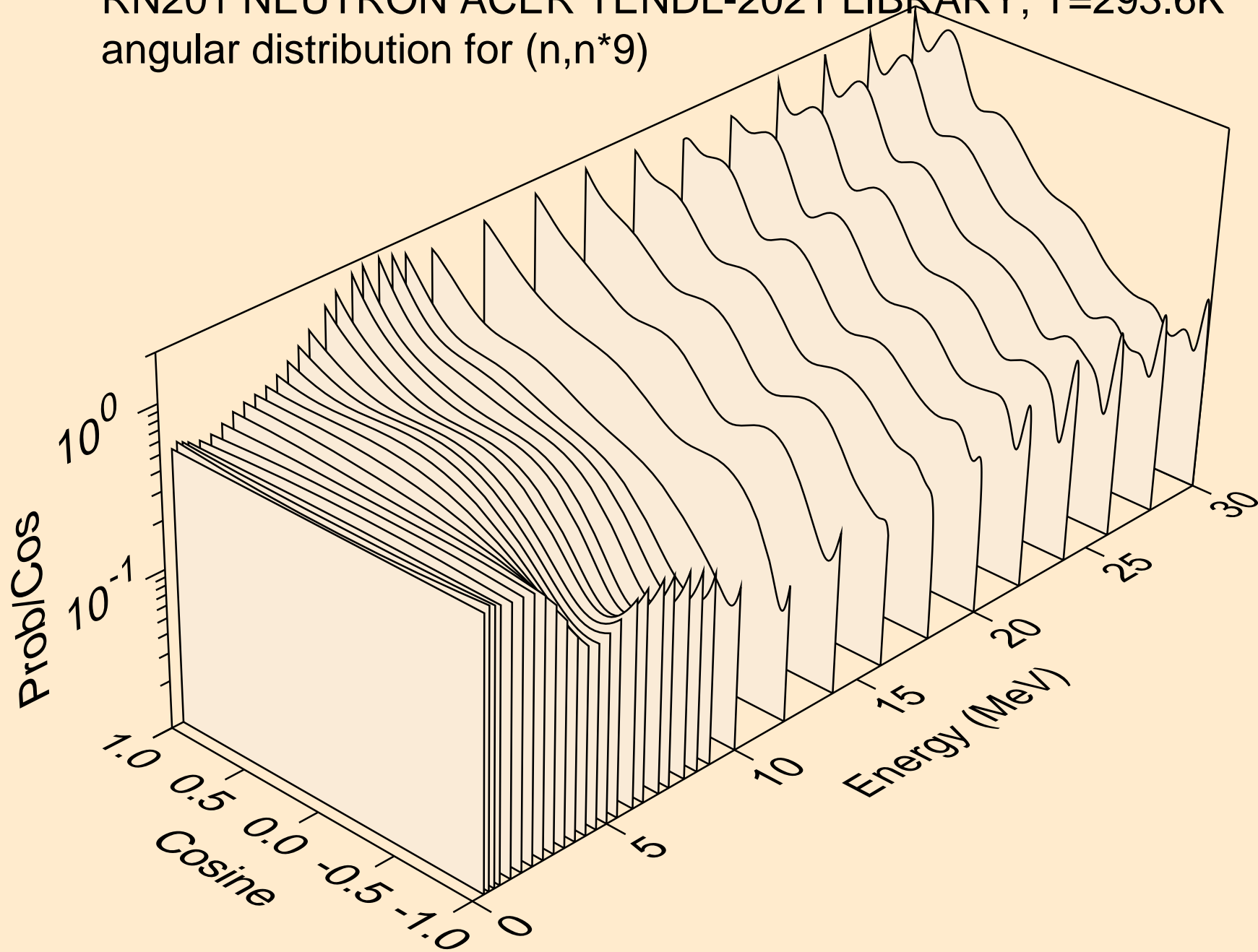

RN201 NEUTRON ACER TENDL-2021 LIBRARY; T=293.6K
angular distribution for (n,n*10)

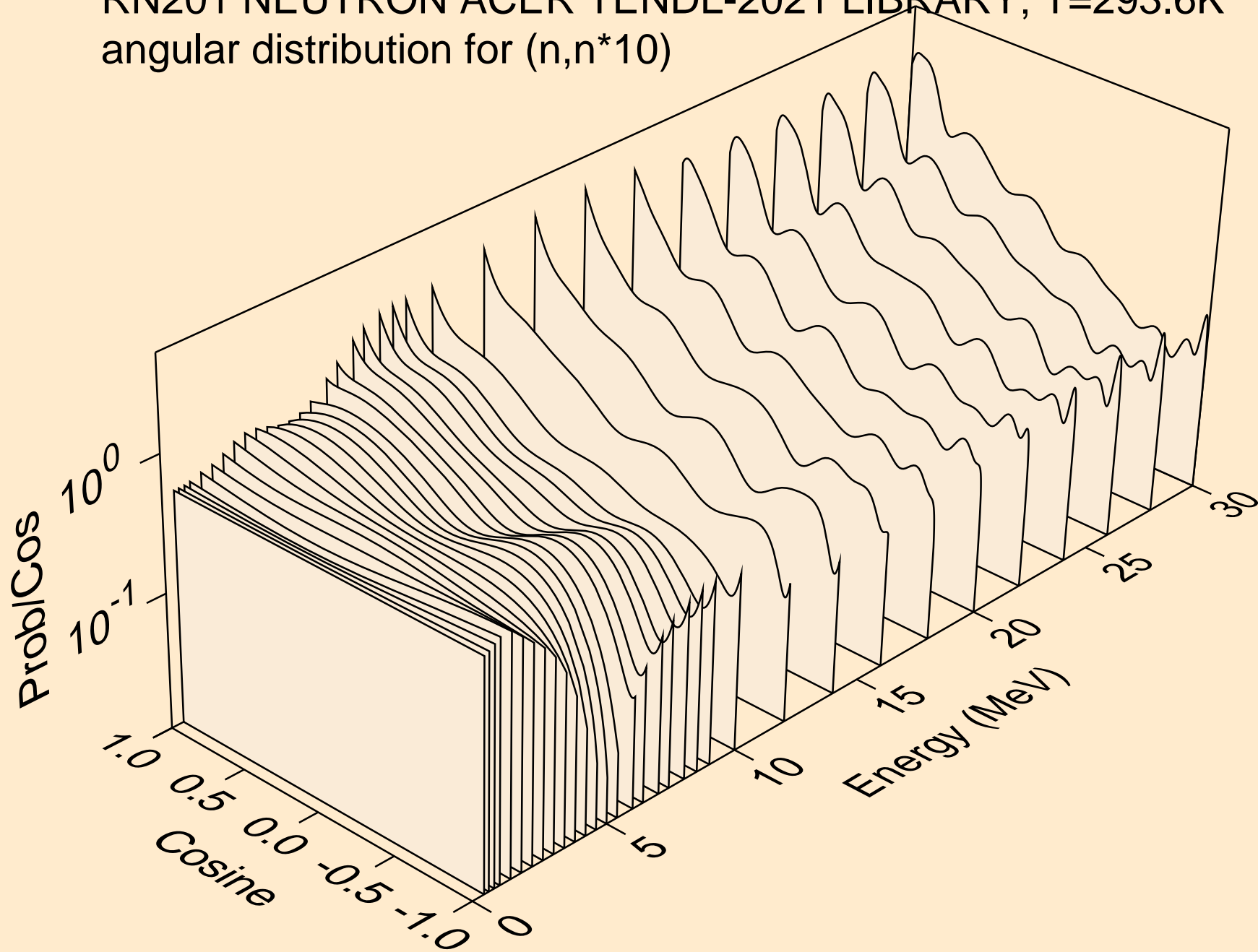

RN201 NEUTRON ACER TENDL-2021 LIBRARY; T=293.6K
angular distribution for (n,n*11)

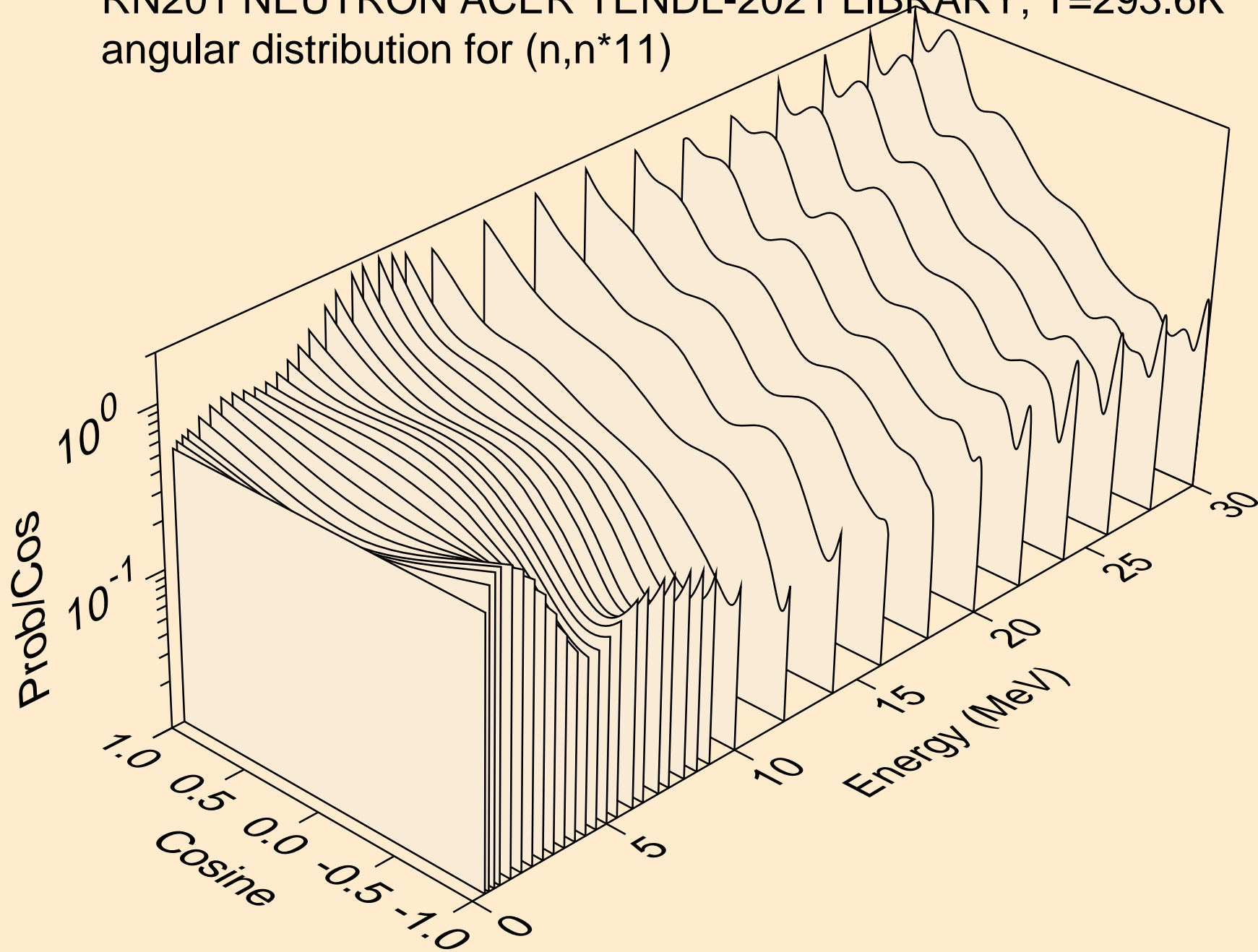

RN201 NEUTRON ACER TENDL-2021 LIBRARY; T=293.6K
angular distribution for (n,n*12)

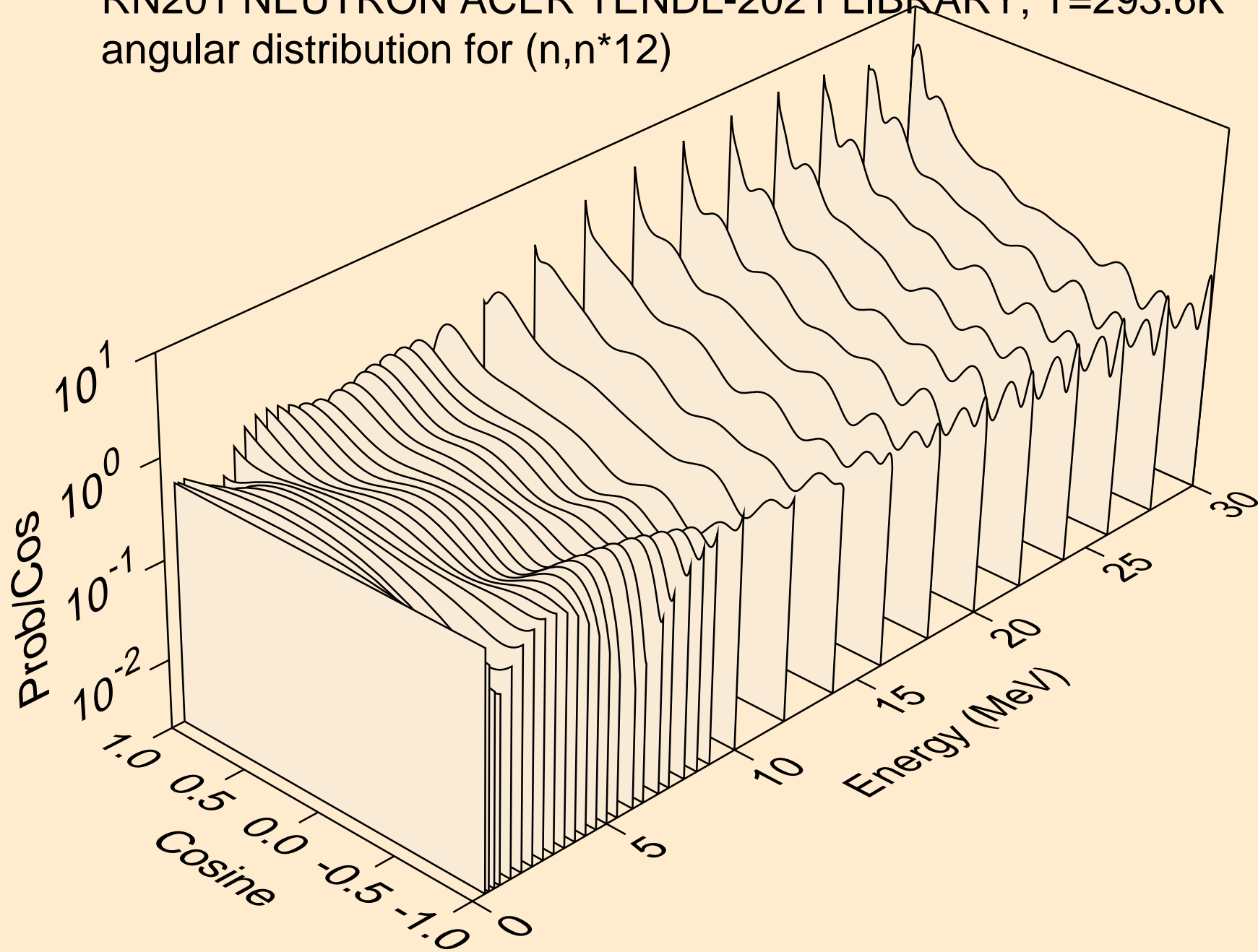

RN201 NEUTRON ACER TENDL-2021 LIBRARY; T=293.6K
angular distribution for (n,n*13)

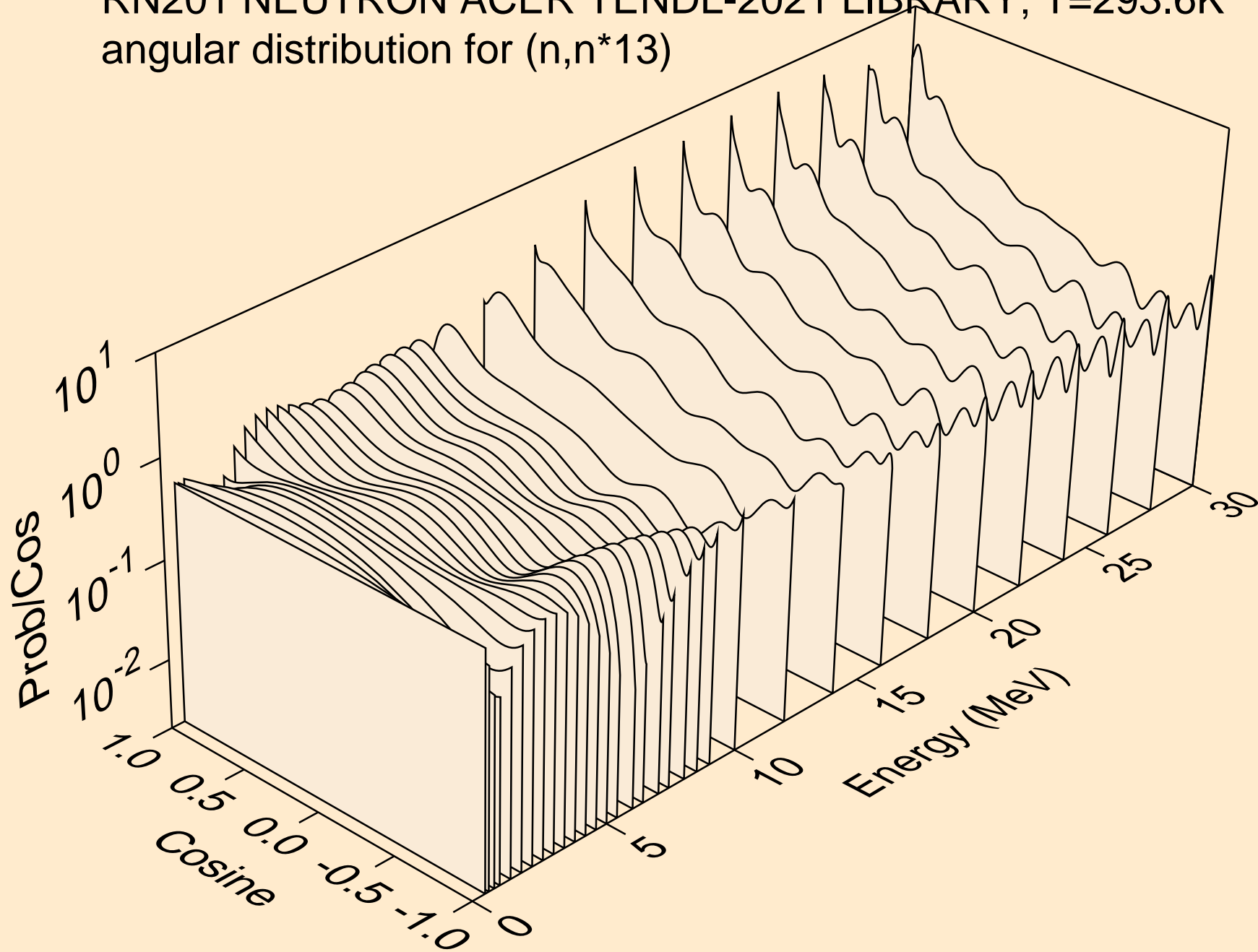

RN201 NEUTRON ACER TENDL-2021 LIBRARY; T=293.6K
angular distribution for (n,n*14)

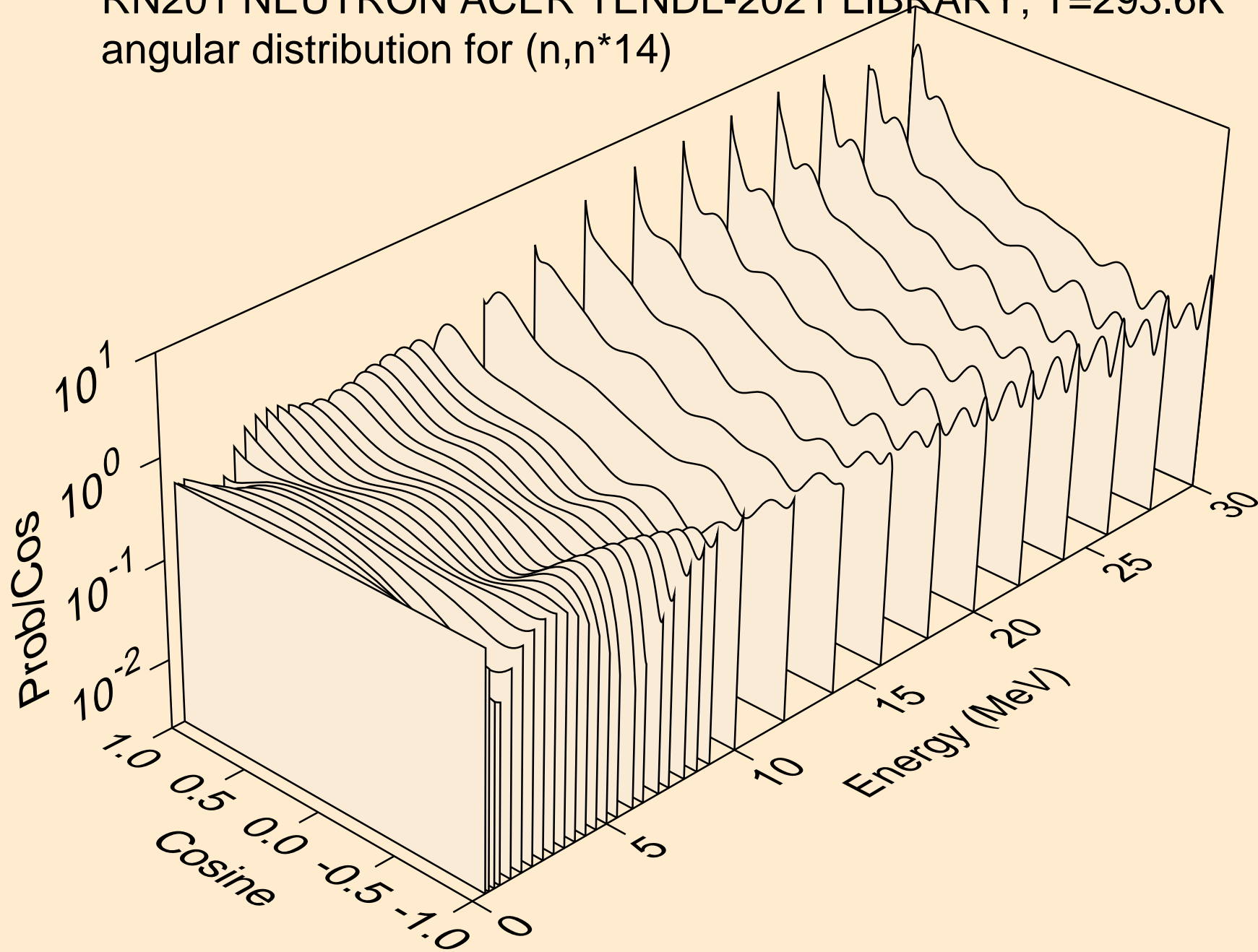

RN201 NEUTRON ACER TENDL-2021 LIBRARY; T=293.6K
angular distribution for (n,n*15)

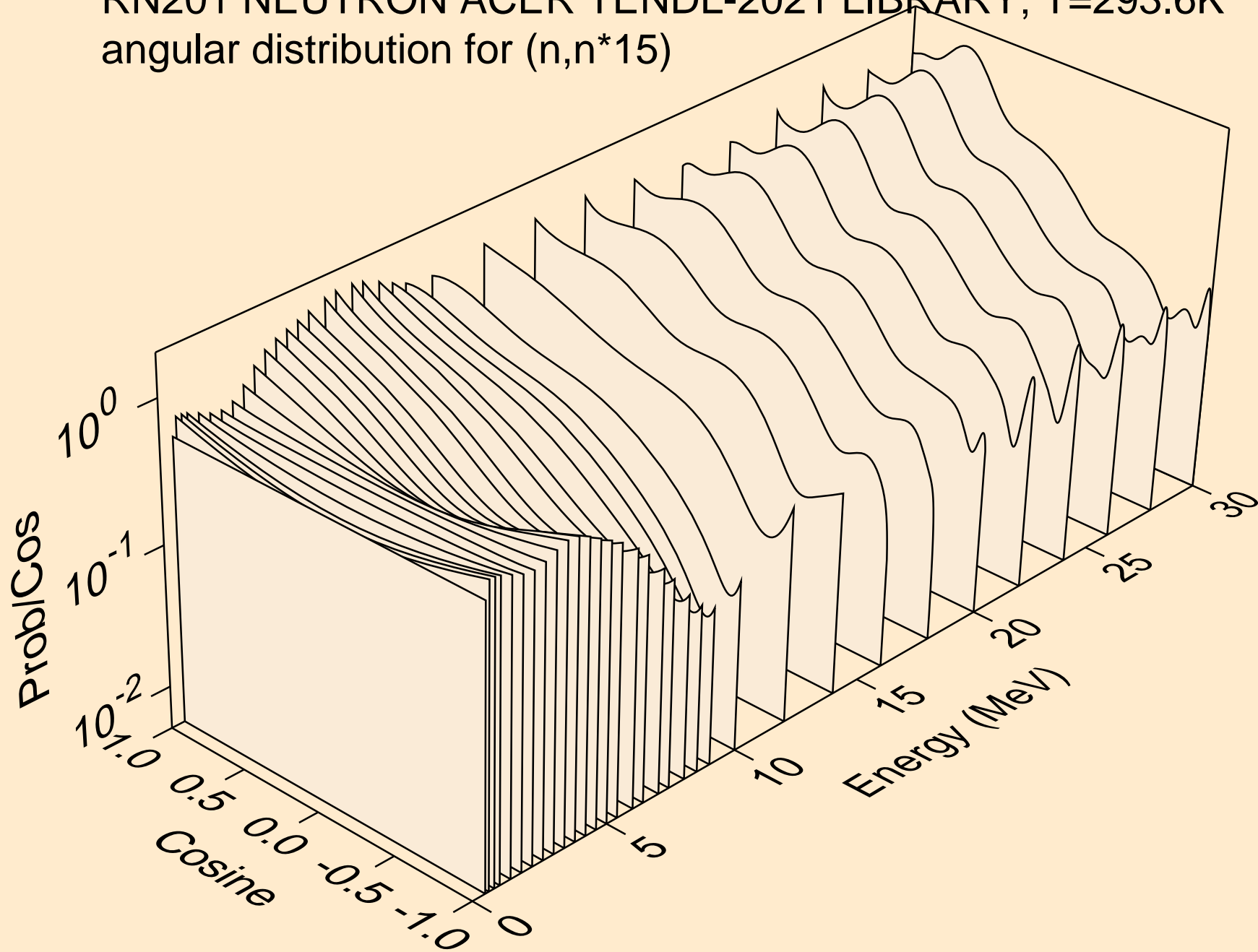

RN201 NEUTRON ACER TENDL-2021 LIBRARY; T=293.6K
angular distribution for (n,n*16)

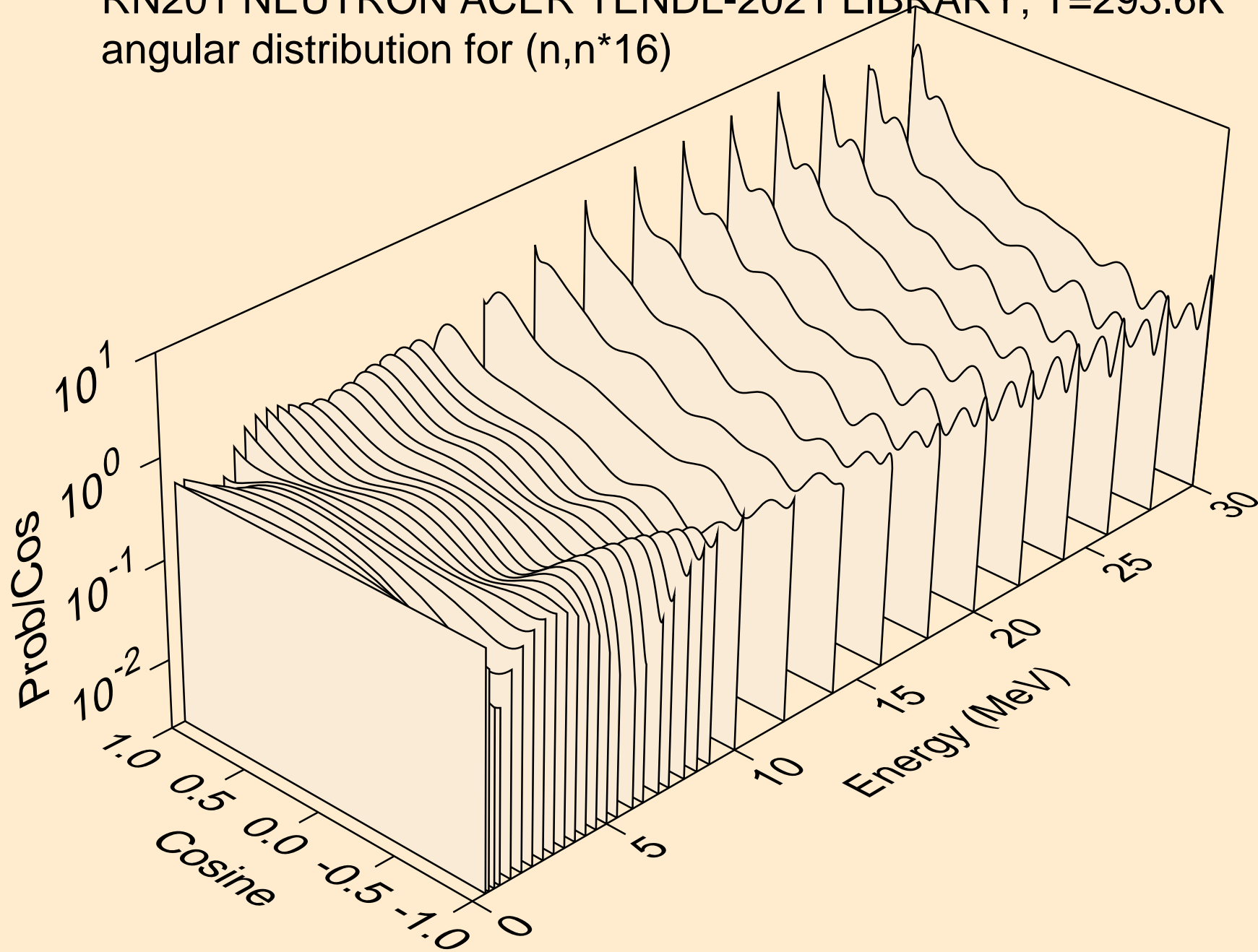

RN201 NEUTRON ACER TENDL-2021 LIBRARY; T=293.6K
Neutron emission for (n,x)

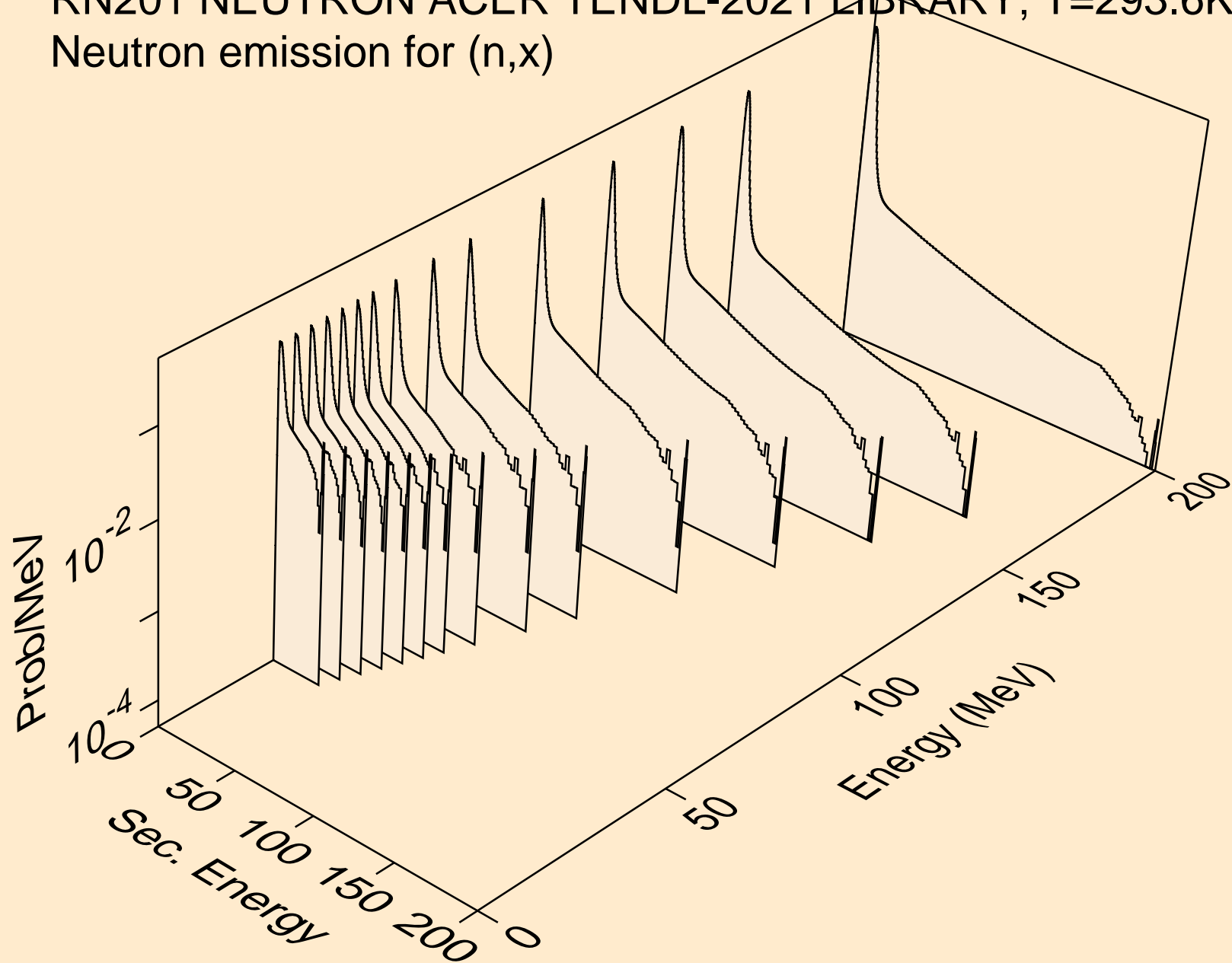

RN201 NEUTRON ACER TENDL-2021 LIBRARY; T=293.6K
Neutron emission for (n,2nd)

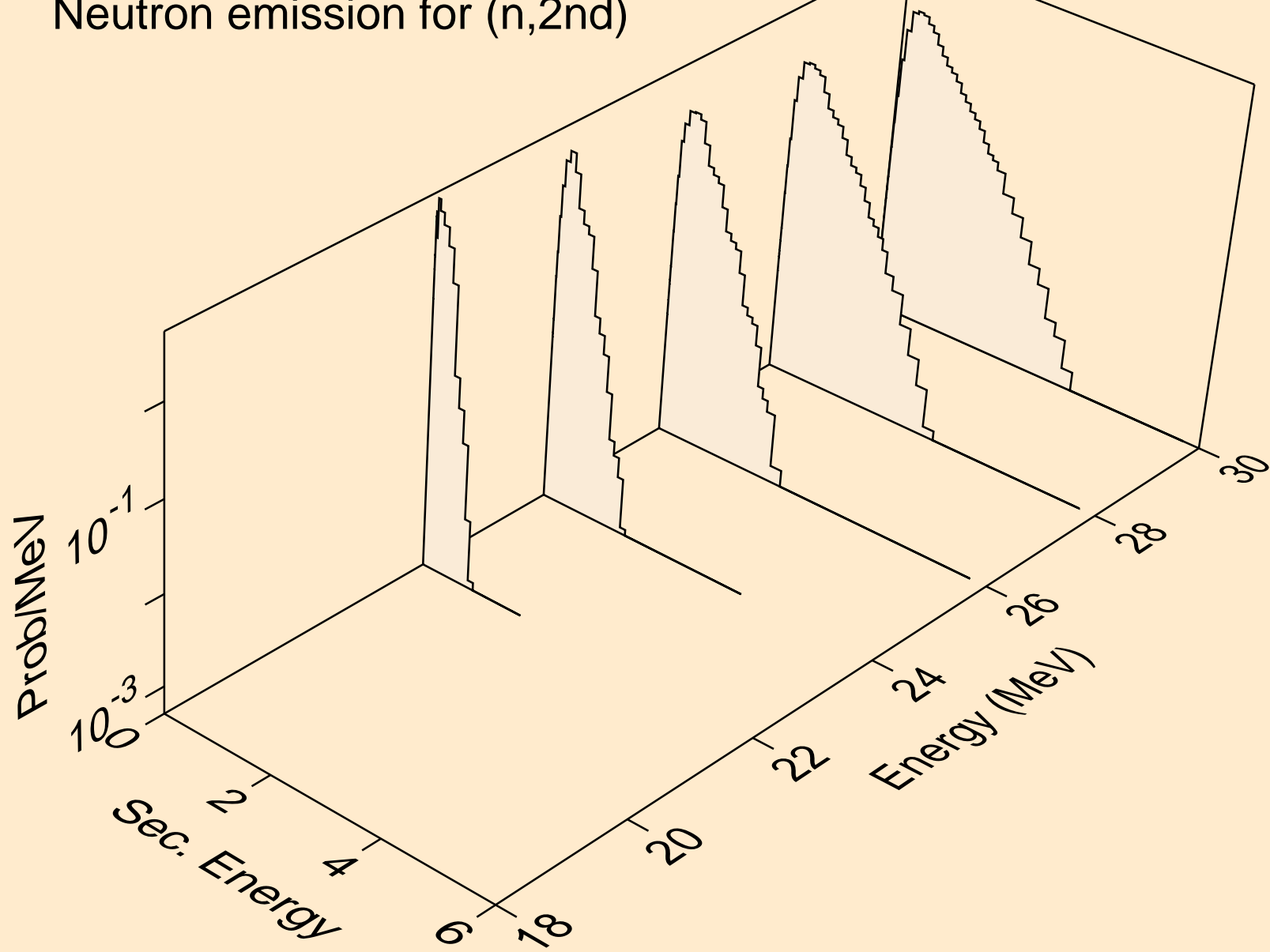

RN201 NEUTRON ACER TENDL-2021 LIBRARY; T=293.6K
Neutron emission for (n,2n)

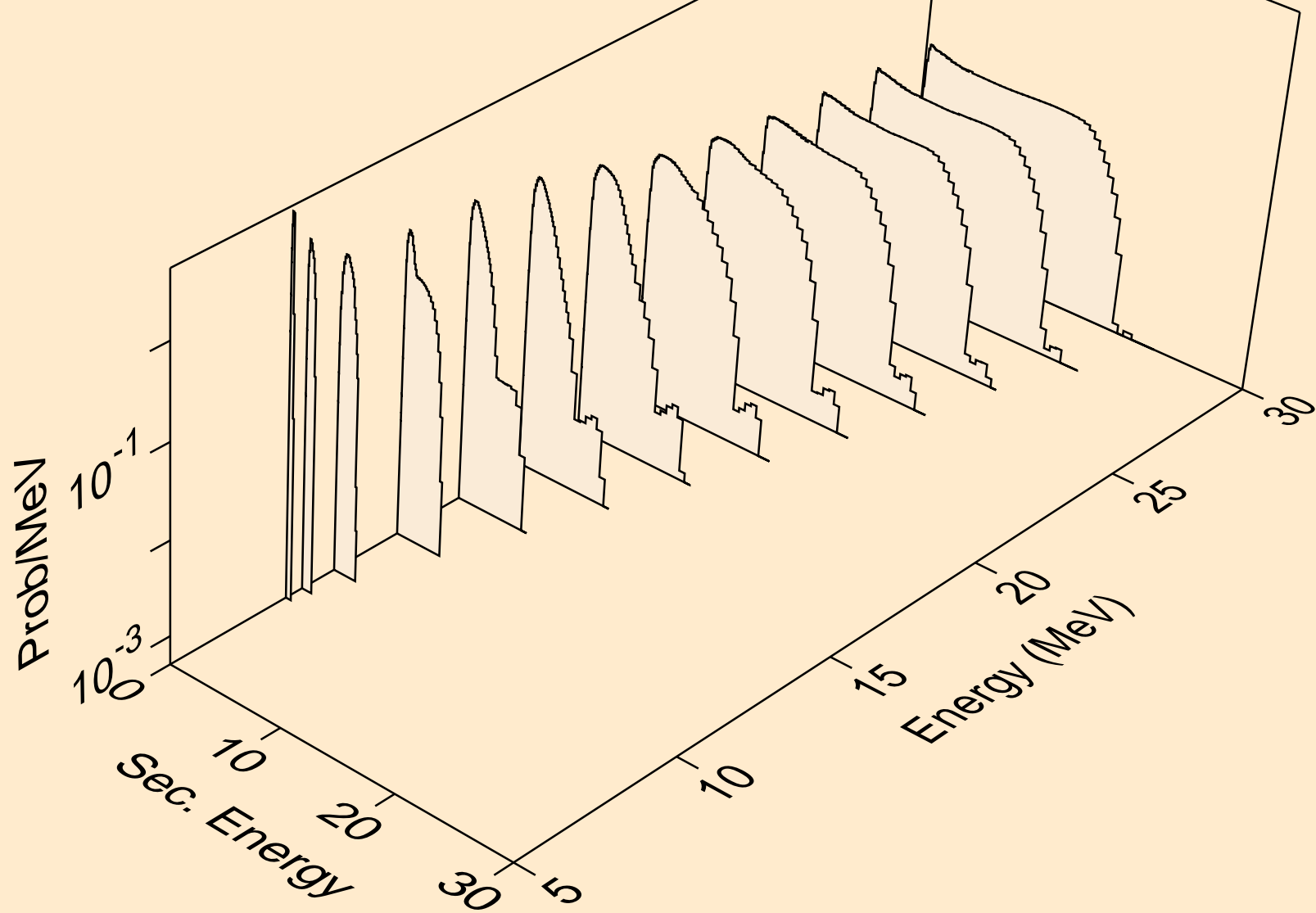

RN201 NEUTRON ACER TENDL-2021 LIBRARY; T=293.6K
Neutron emission for (n,3n)

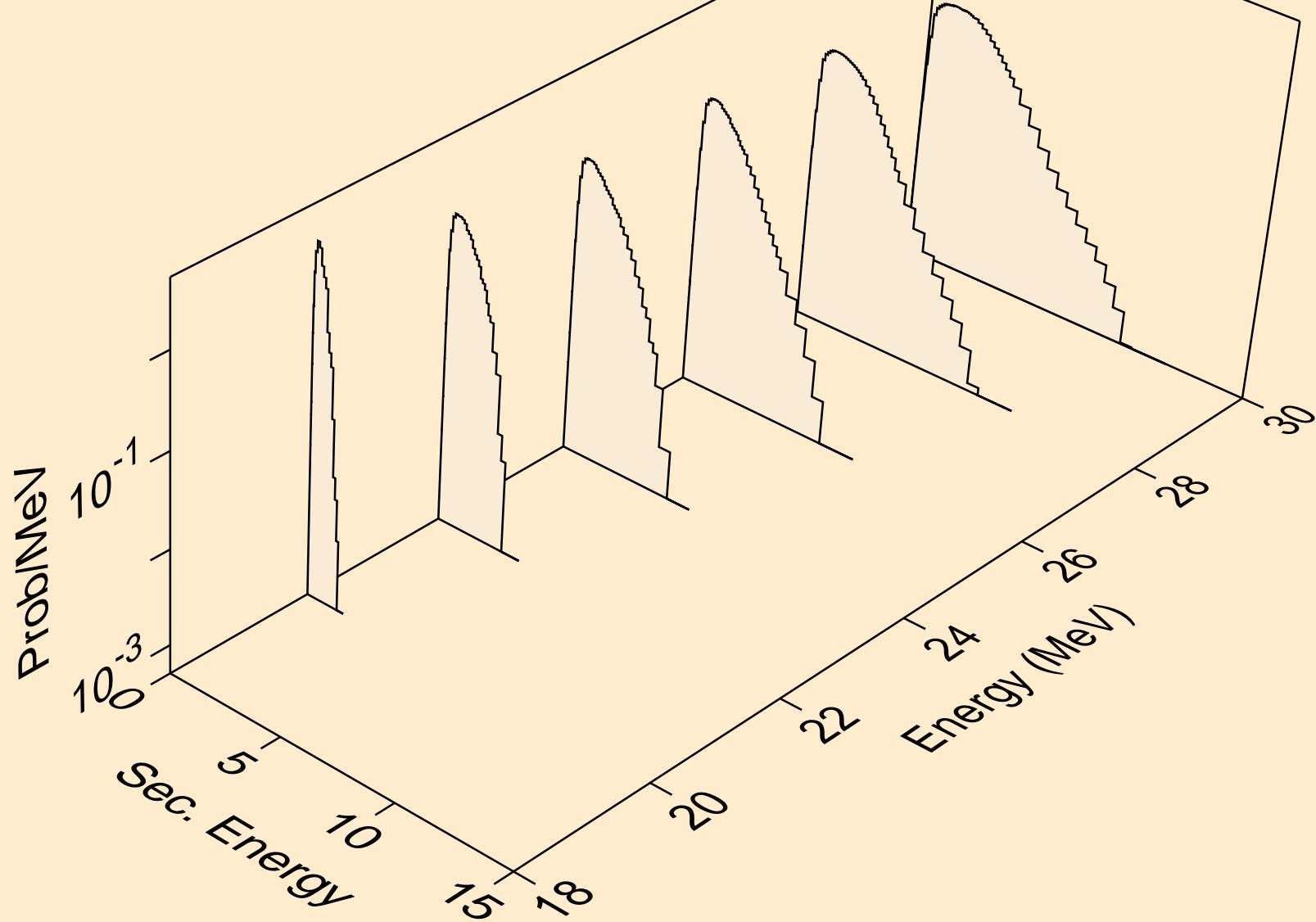

RN201 NEUTRON ACER TENDL-2021 LIBRARY; T=293.6K
Neutron emission for (n,n*)a

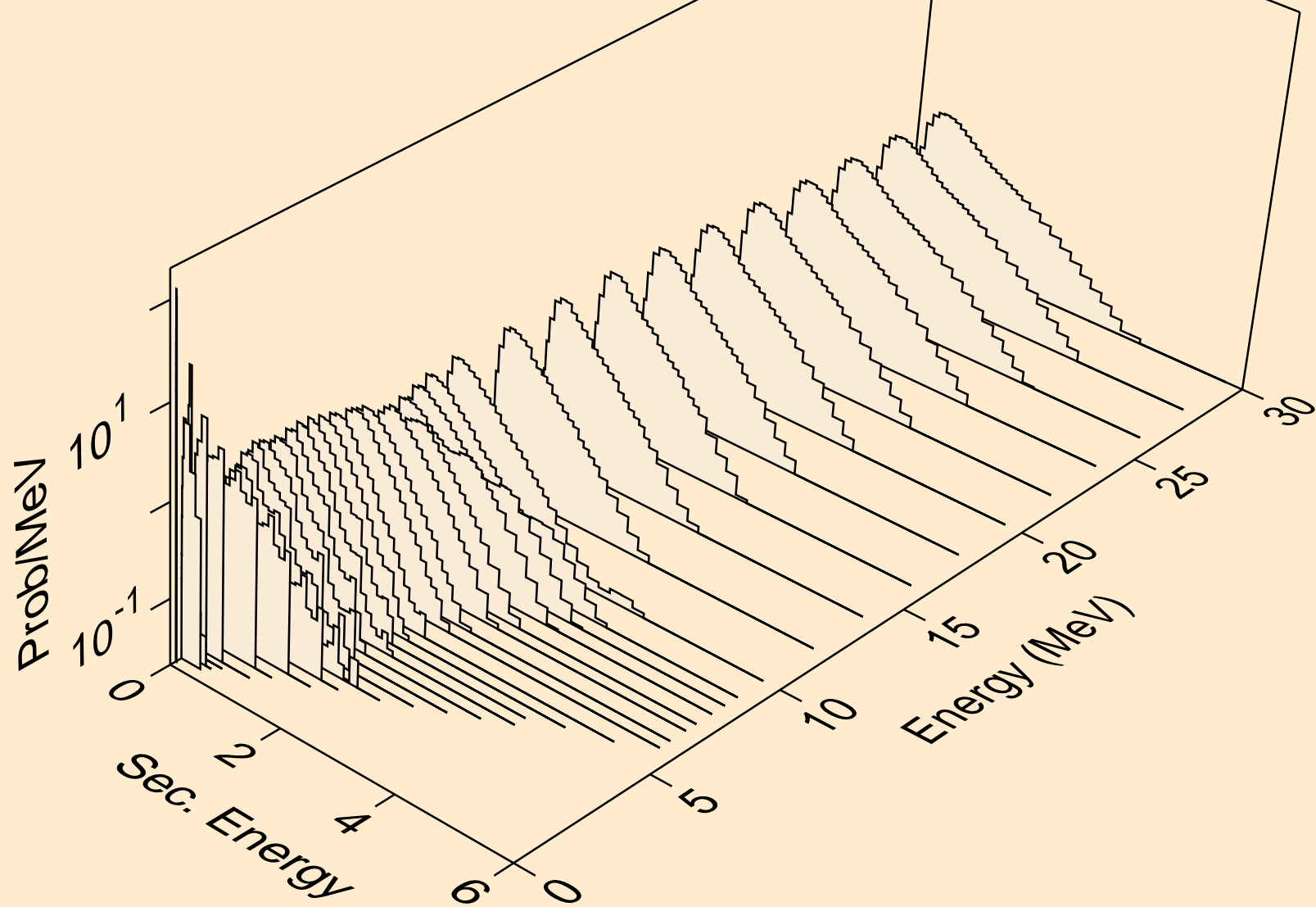

RN201 NEUTRON ACER TENDL-2021 LIBRARY; T=293.6K
Neutron emission for (n,2n)a

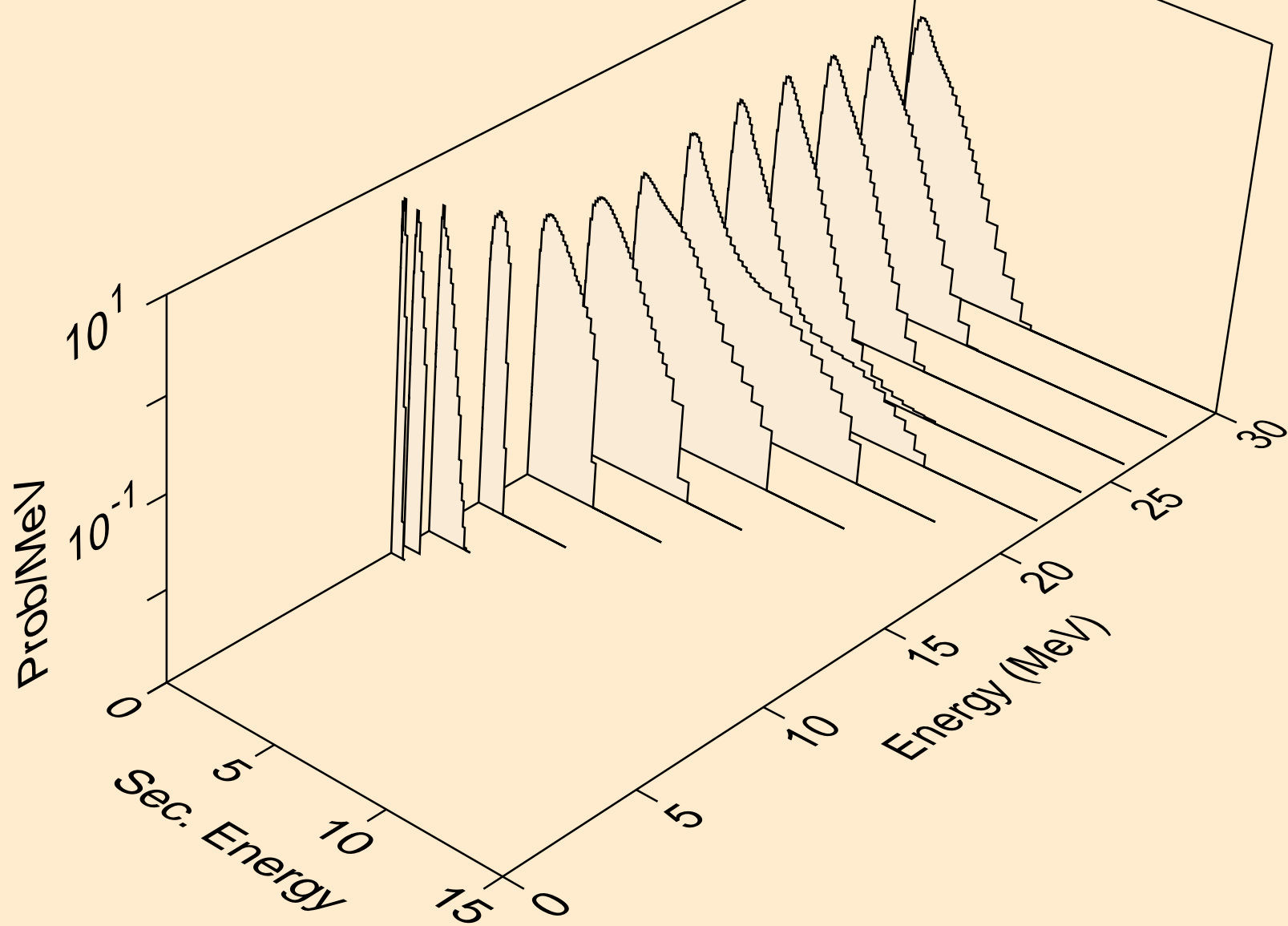

RN201 NEUTRON ACER TENDL-2021 LIBRARY; T=293.6K
Neutron emission for (n,3n)a

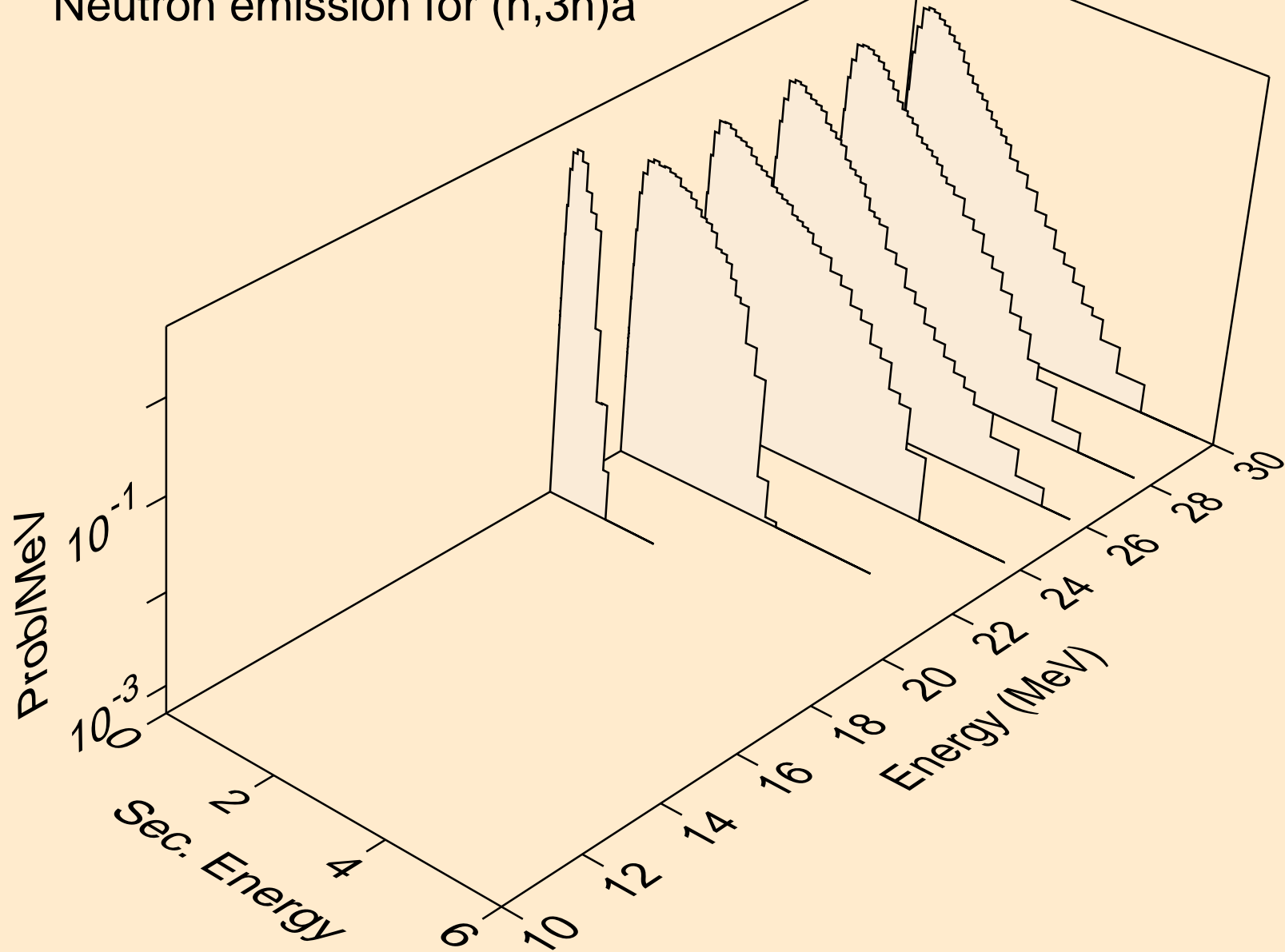

RN201 NEUTRON ACER TENDL-2021 LIBRARY; T=293.6K
Neutron emission for (n,n*)p

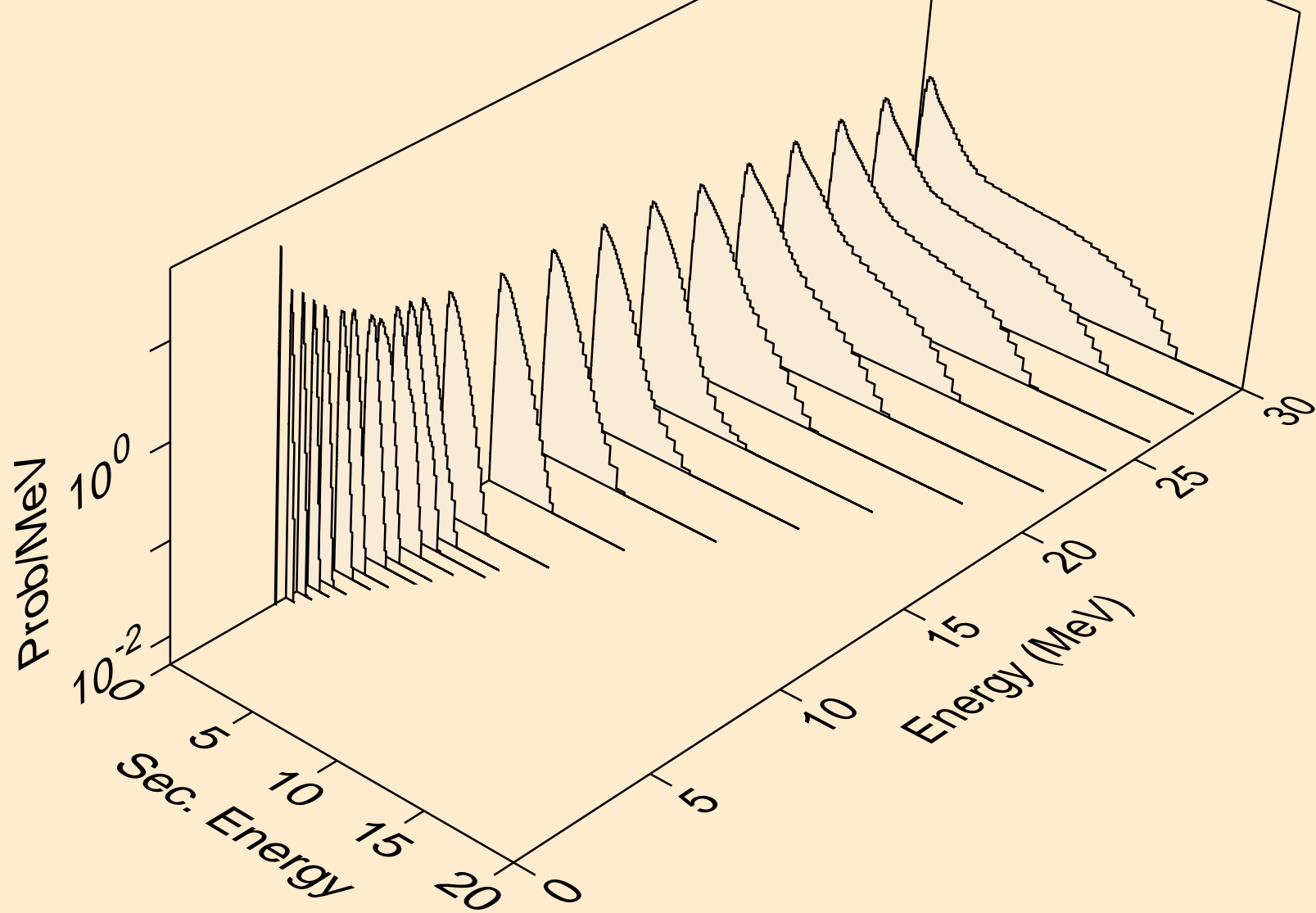

RN201 NEUTRON ACER TENDL-2021 LIBRARY; T=293.6K
Neutron emission for (n,n*)2a

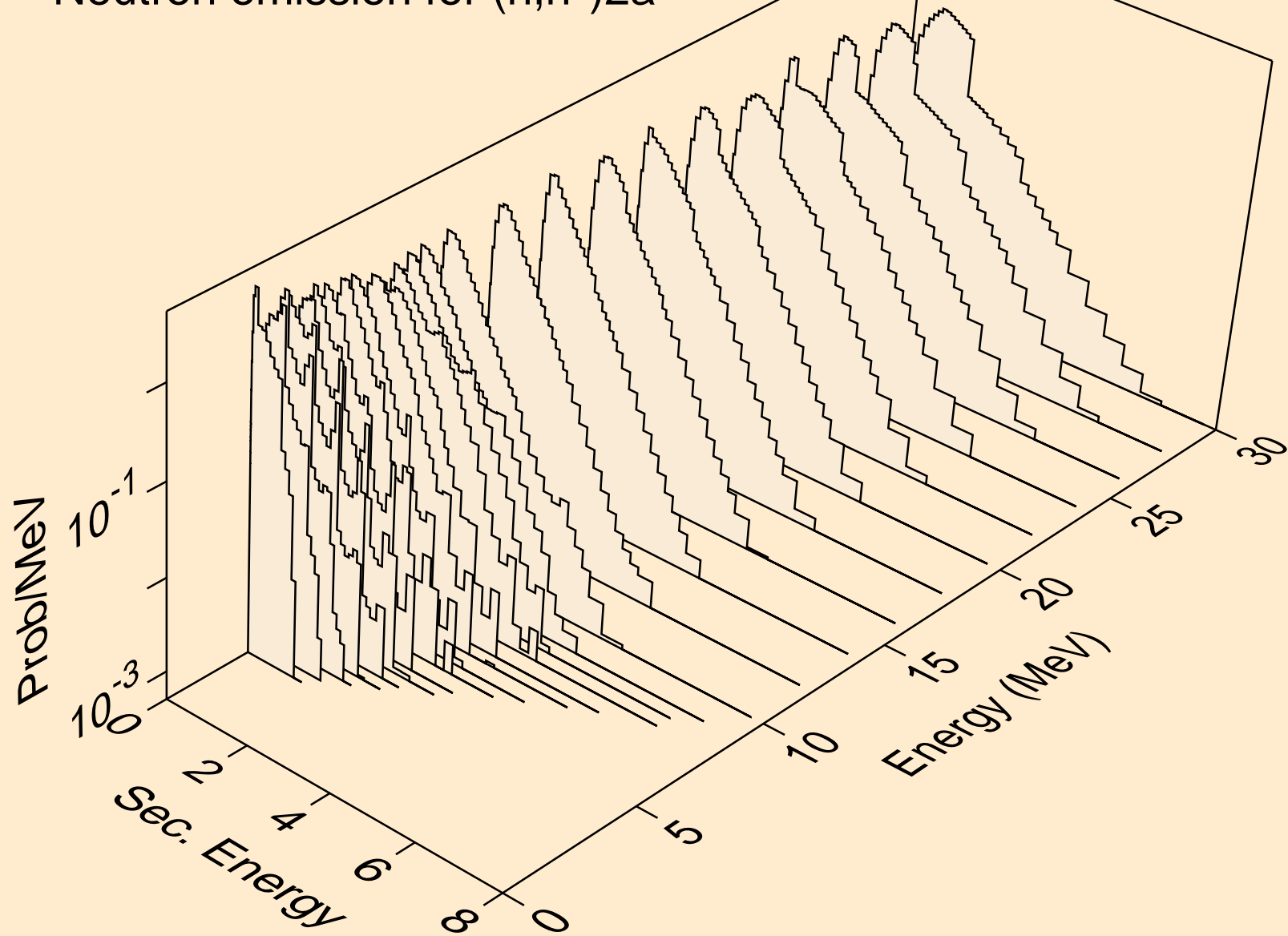

RN201 NEUTRON ACER TENDL-2021 LIBRARY; T=293.6K
Neutron emission for (n,2n)2a

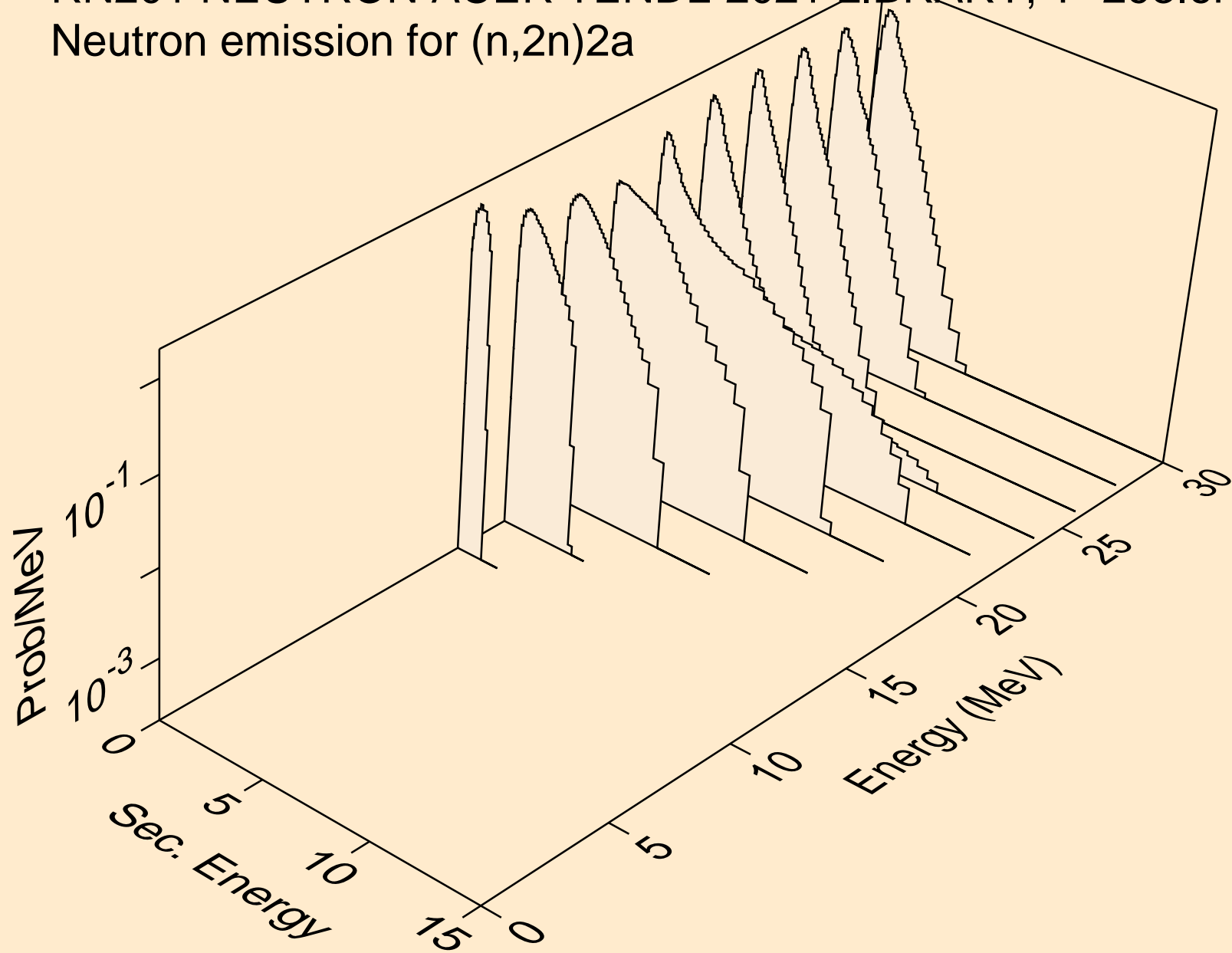

RN201 NEUTRON ACER TENDL-2021 LIBRARY; T=293.6K
Neutron emission for (n,n*)d

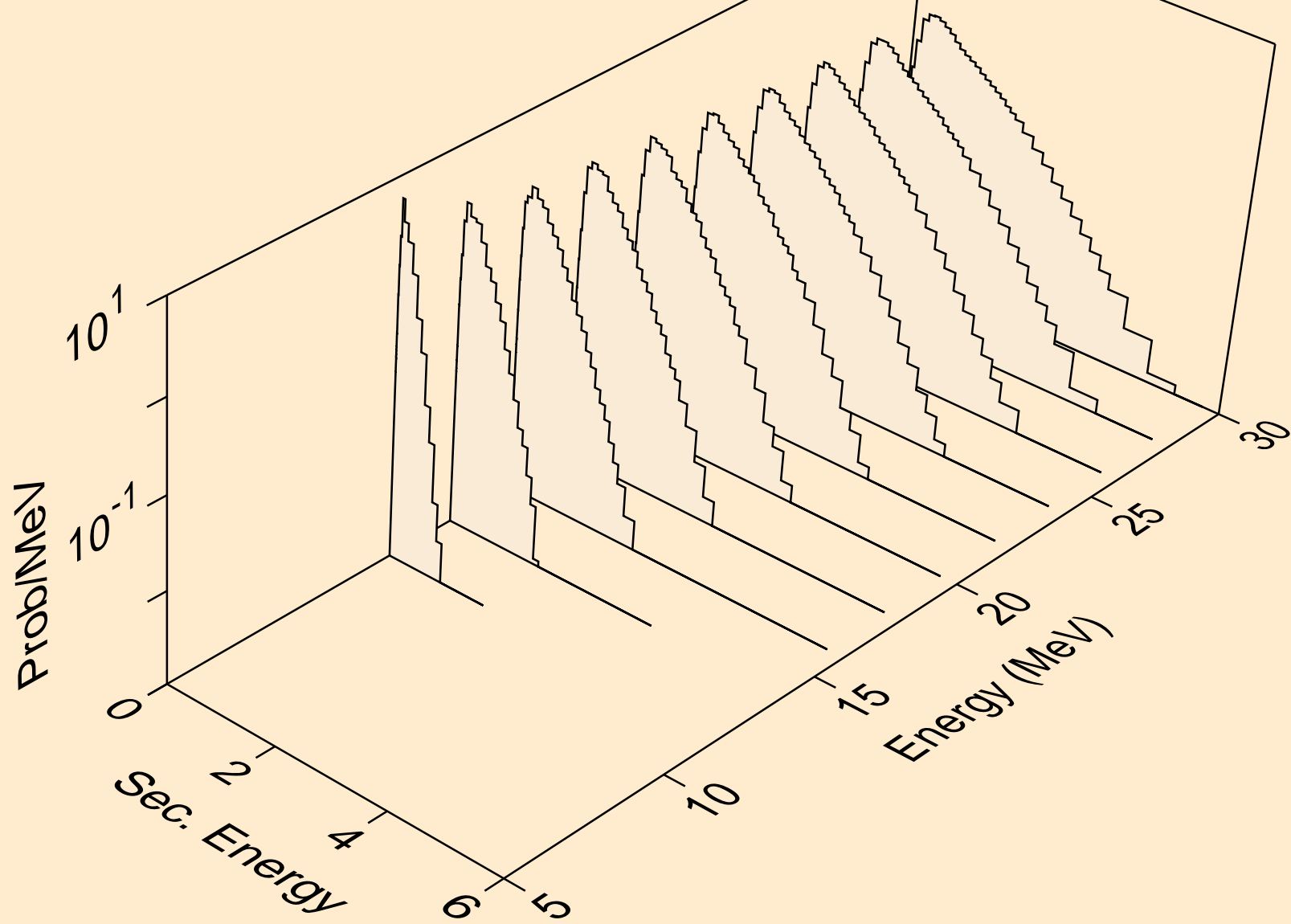

RN201 NEUTRON ACER TENDL-2021 LIBRARY; T=293.6K
Neutron emission for (n,n*)t

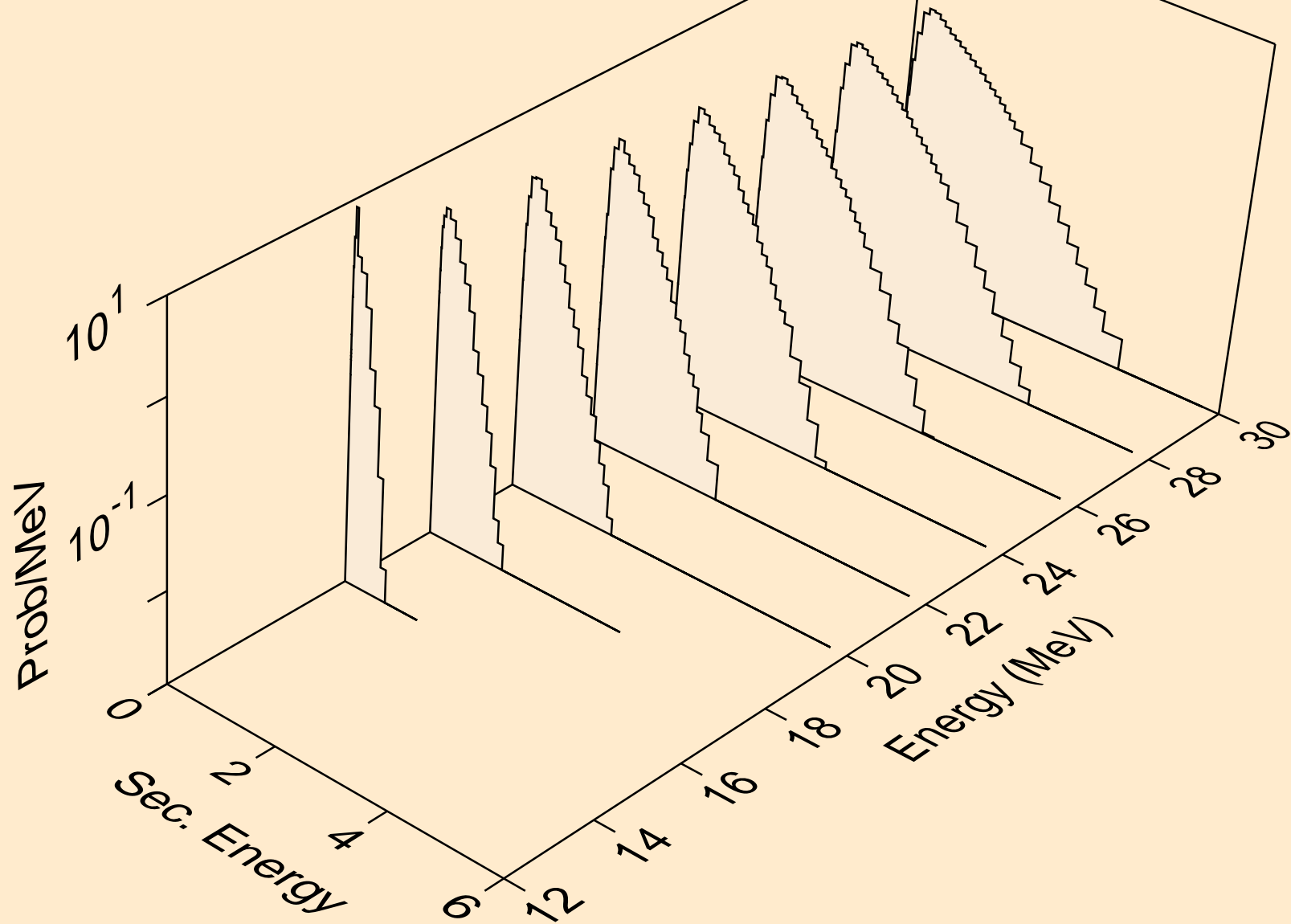

RN201 NEUTRON ACER TENDL-2021 LIBRARY; T=293.6K
Neutron emission for (n,n*)he3

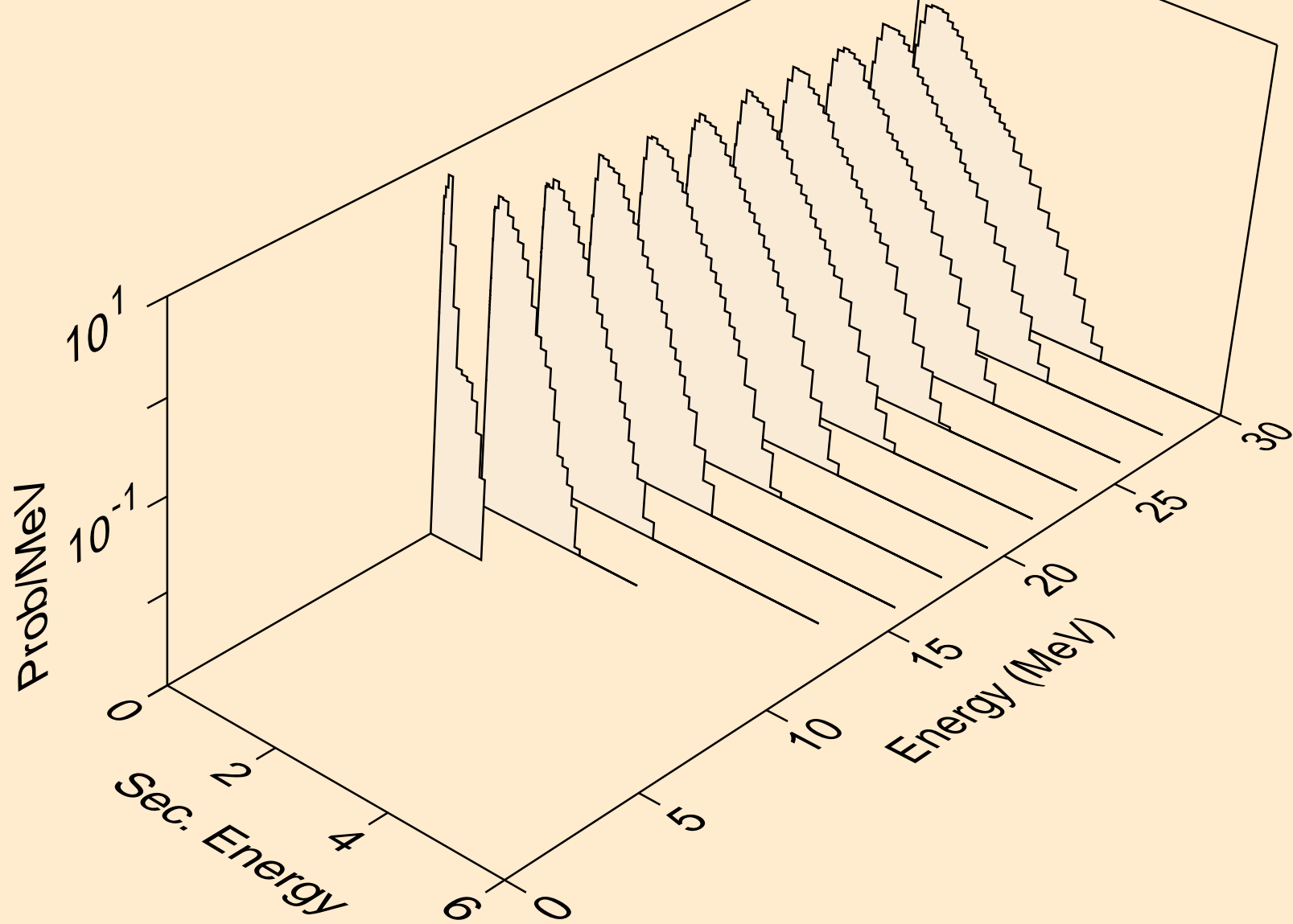

RN201 NEUTRON ACER TENDL-2021 LIBRARY; T=293.6K
Neutron emission for (n,4n)

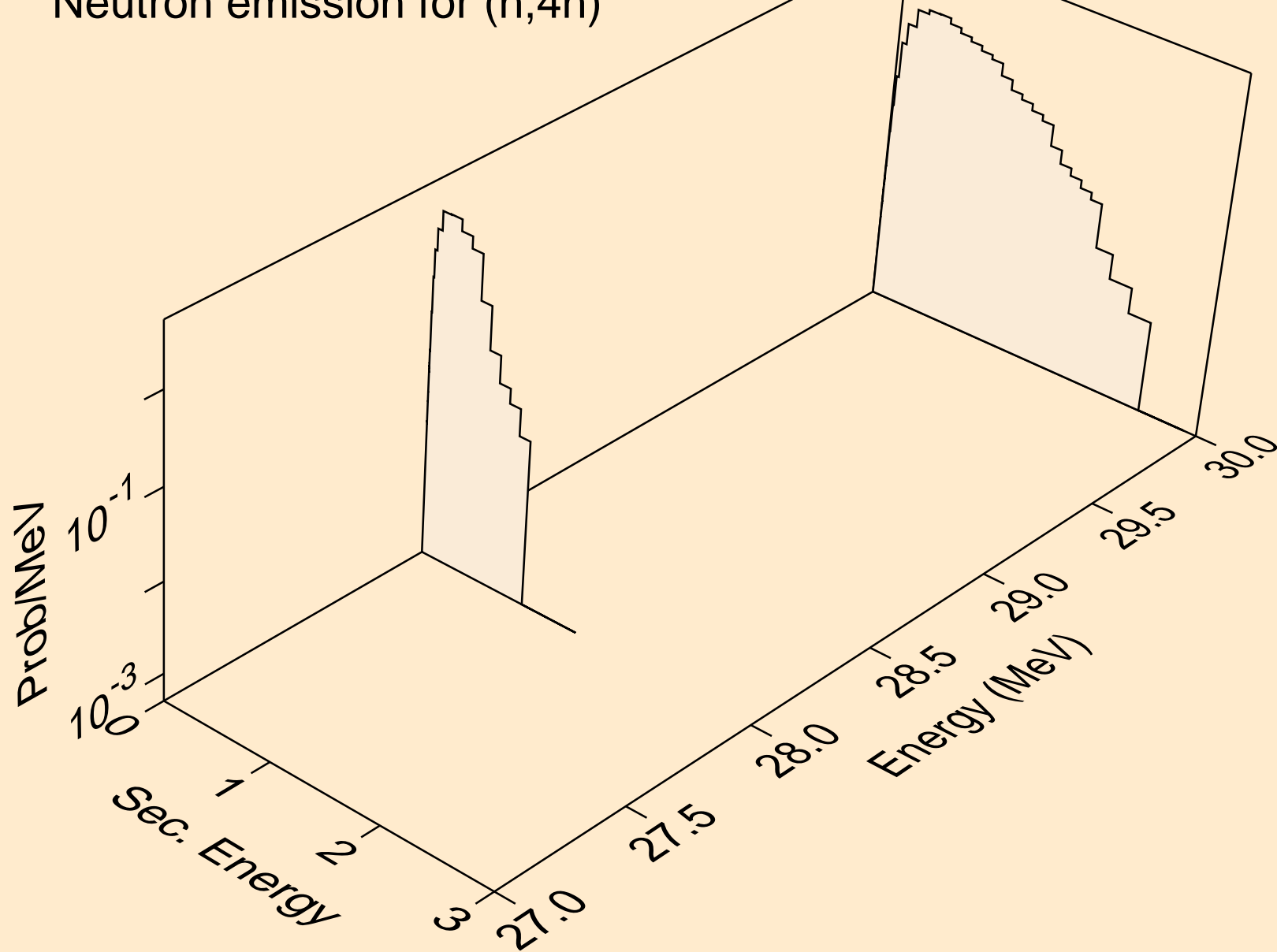

RN201 NEUTRON ACER TENDL-2021 LIBRARY; T=293.6K
Neutron emission for (n,2np)

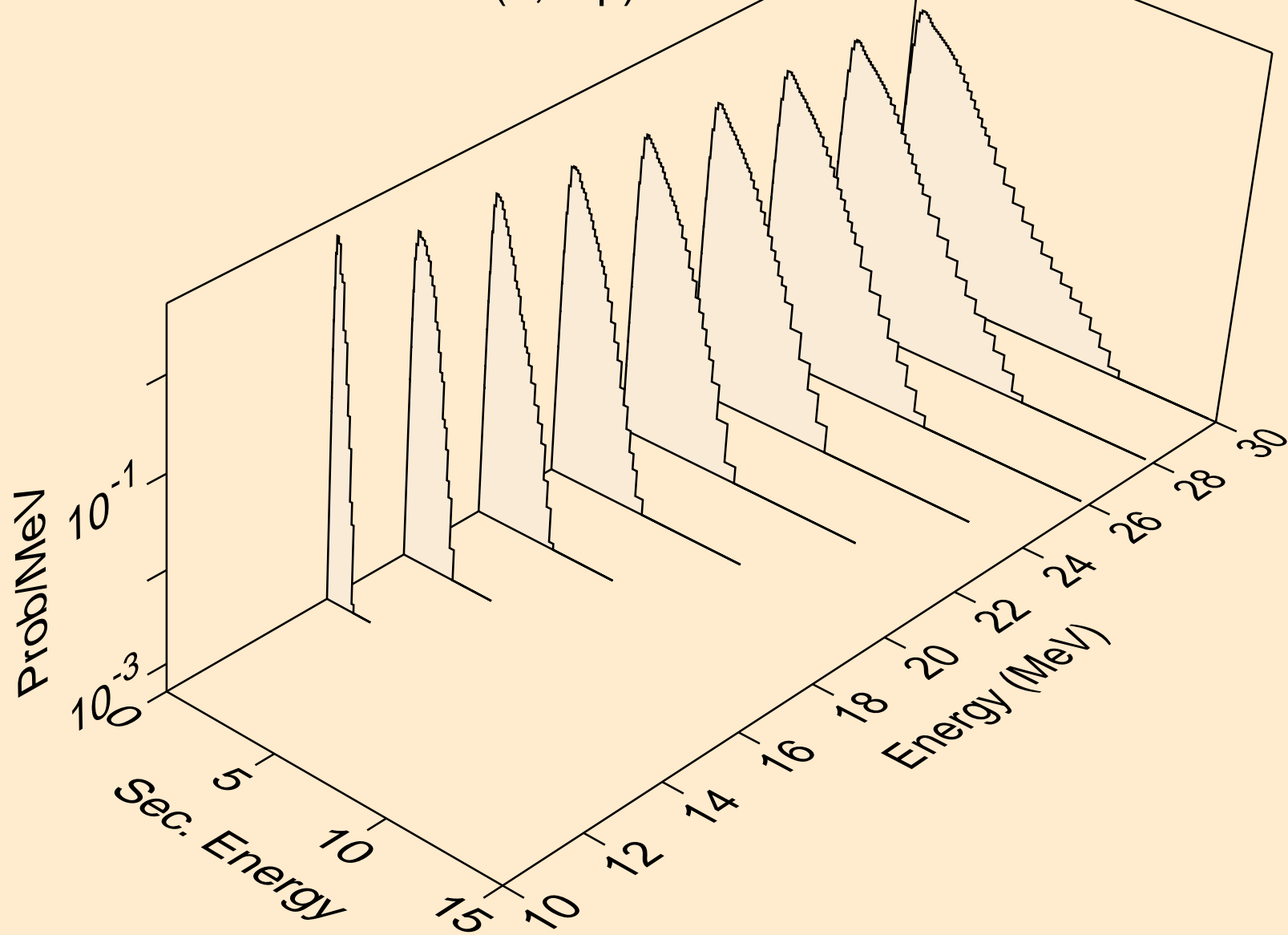

RN201 NEUTRON ACER TENDL-2021 LIBRARY; T=293.6K
Neutron emission for (n,3np)

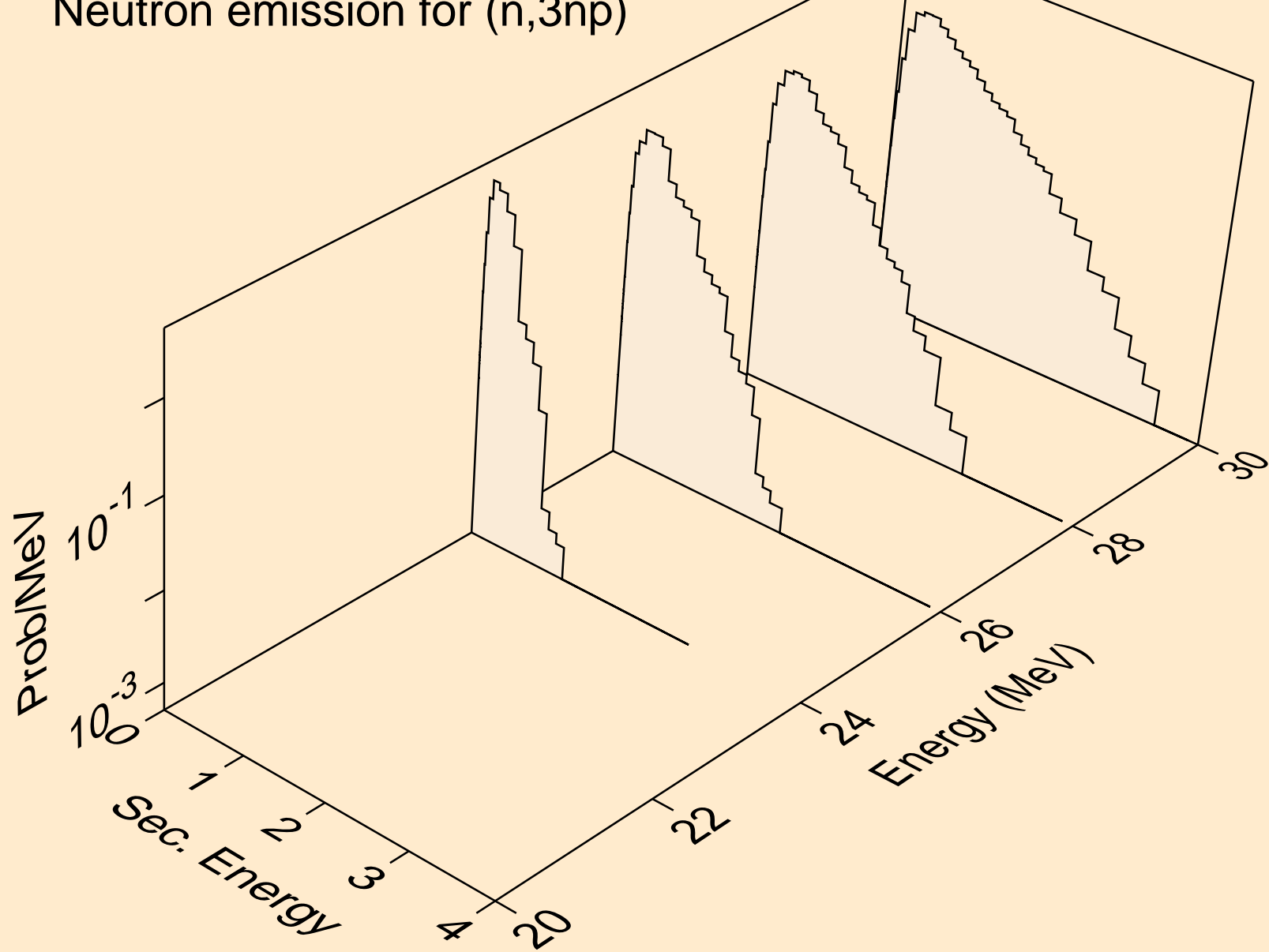

RN201 NEUTRON ACER TENDL-2021 LIBRARY; T=293.6K
Neutron emission for (n,2np)

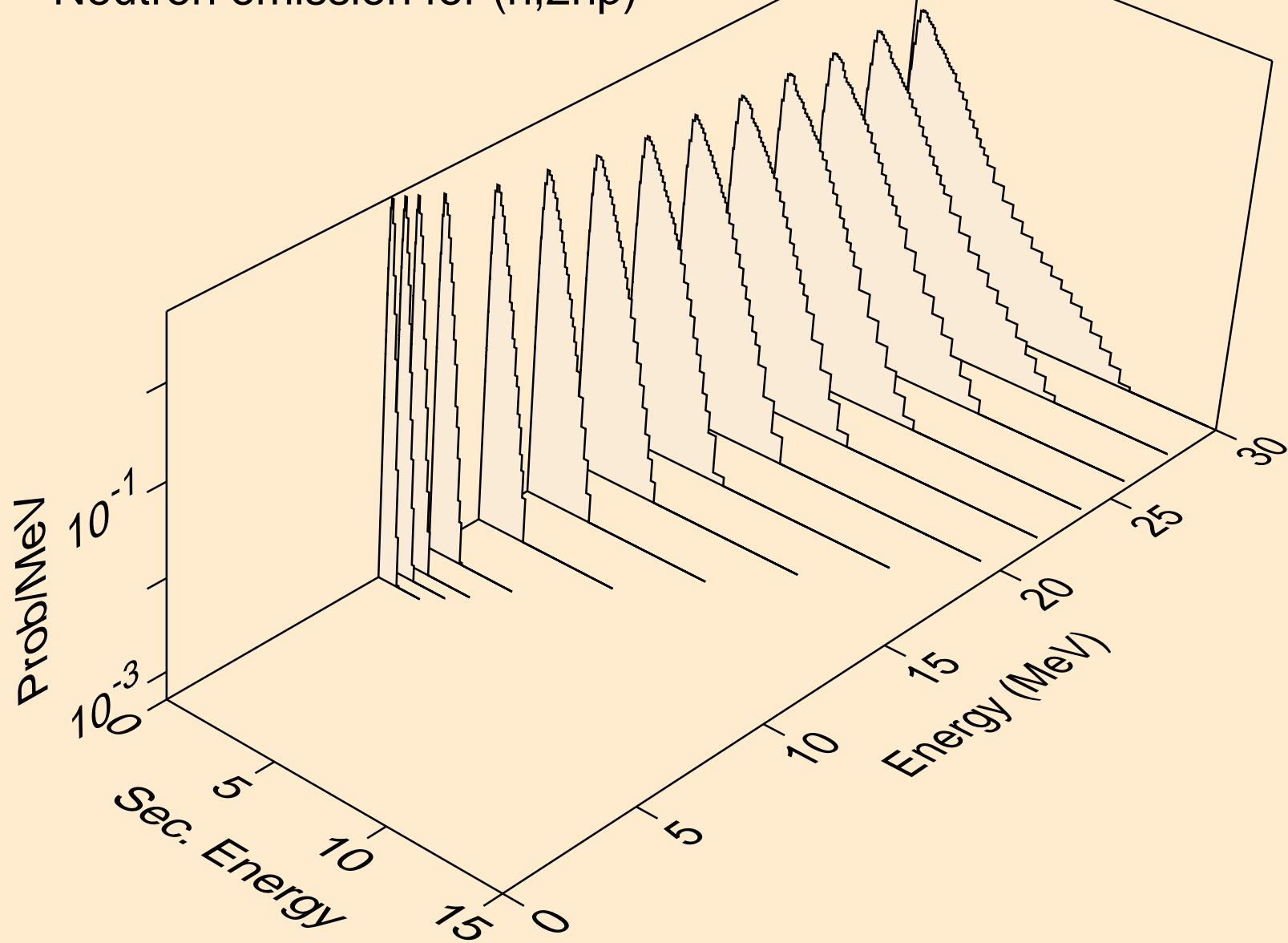

RN201 NEUTRON ACER TENDL-2021 LIBRARY; T=293.6K
Neutron emission for (n,npa)

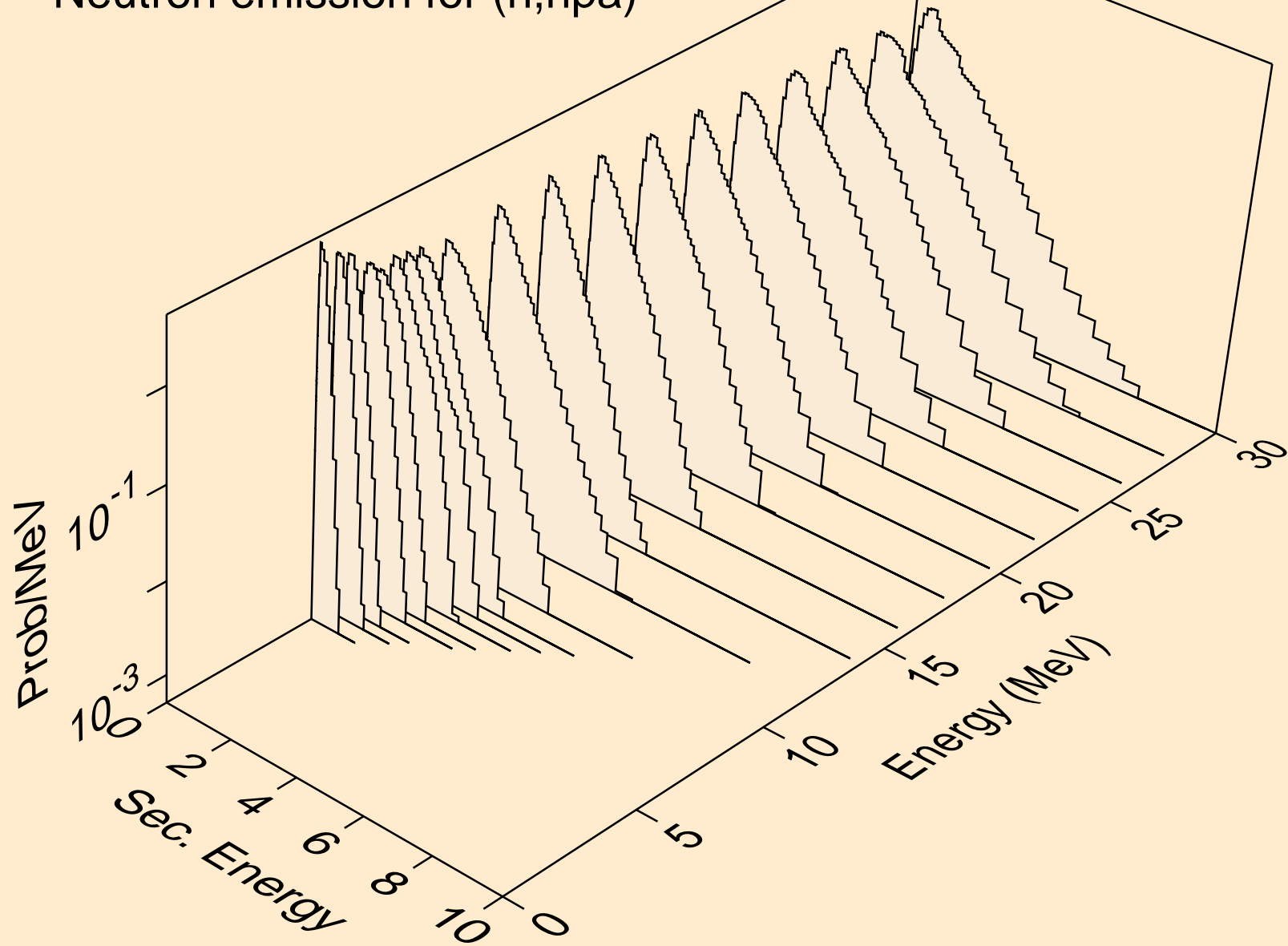

RN201 NEUTRON ACER TENDL-2021 LIBRARY; T=293.6K
Neutron emission for (n,n*c)

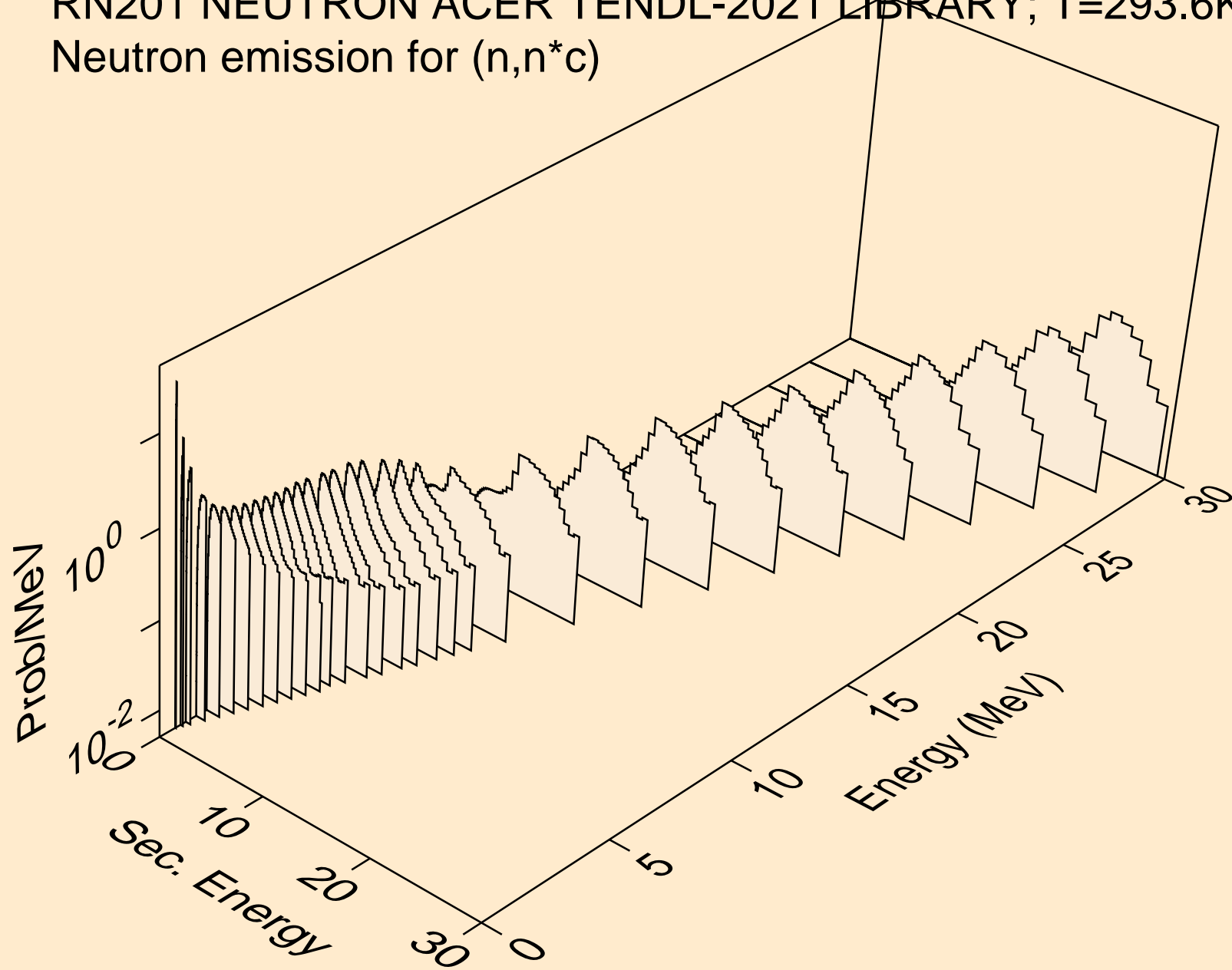

RN201 NEUTRON ACER TENDL-2021 LIBRARY; T=293.6K
Photon emission for (n,x)

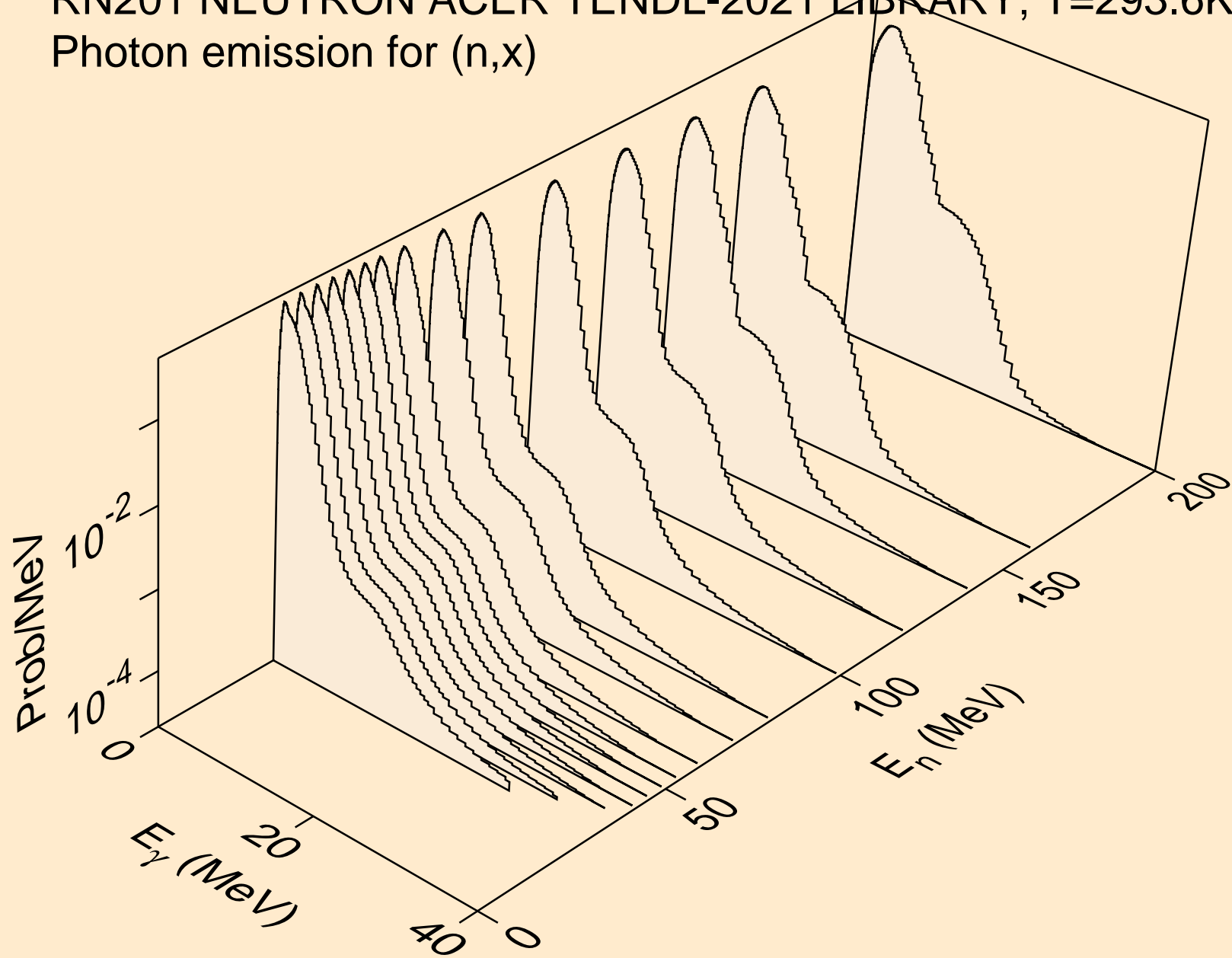

RN201 NEUTRON ACER TENDL-2021 LIBRARY; T=293.6K
Photon emission for (n,2nd)

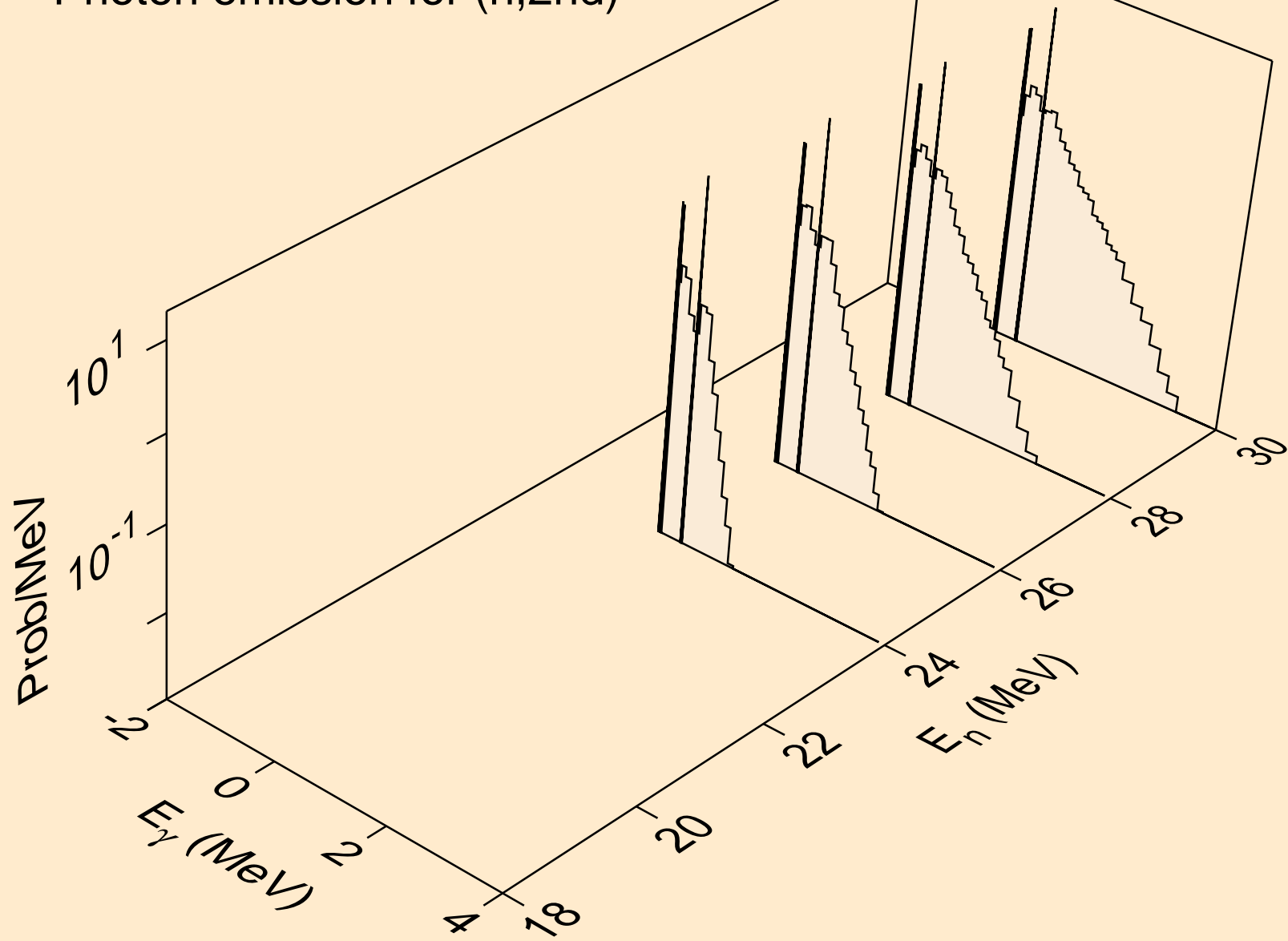

RN201 NEUTRON ACER TENDL-2021 LIBRARY; T=293.6K
Photon emission for (n,2n)

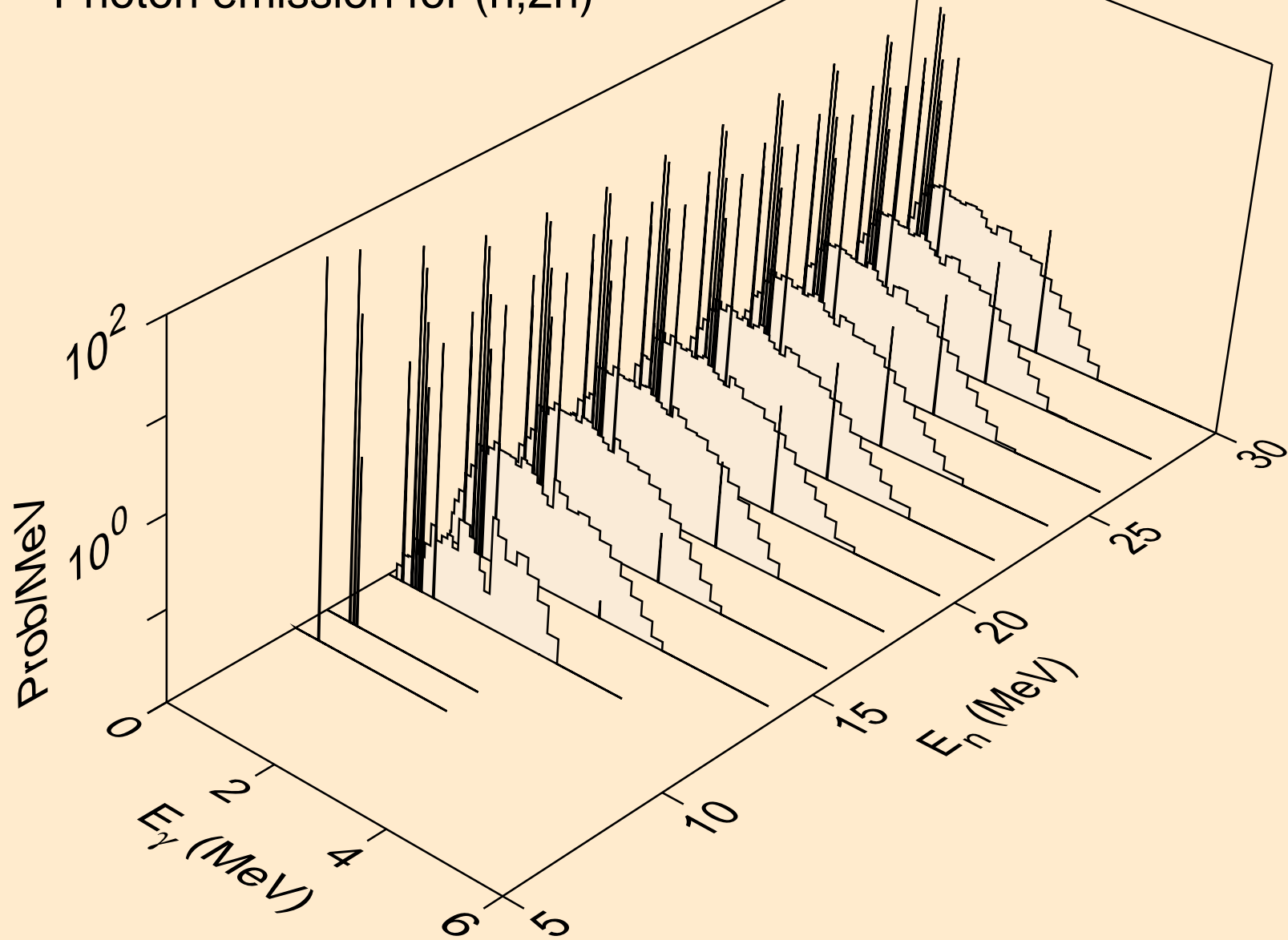

RN201 NEUTRON ACER TENDL-2021 LIBRARY; T=293.6K
Photon emission for (n,3n)

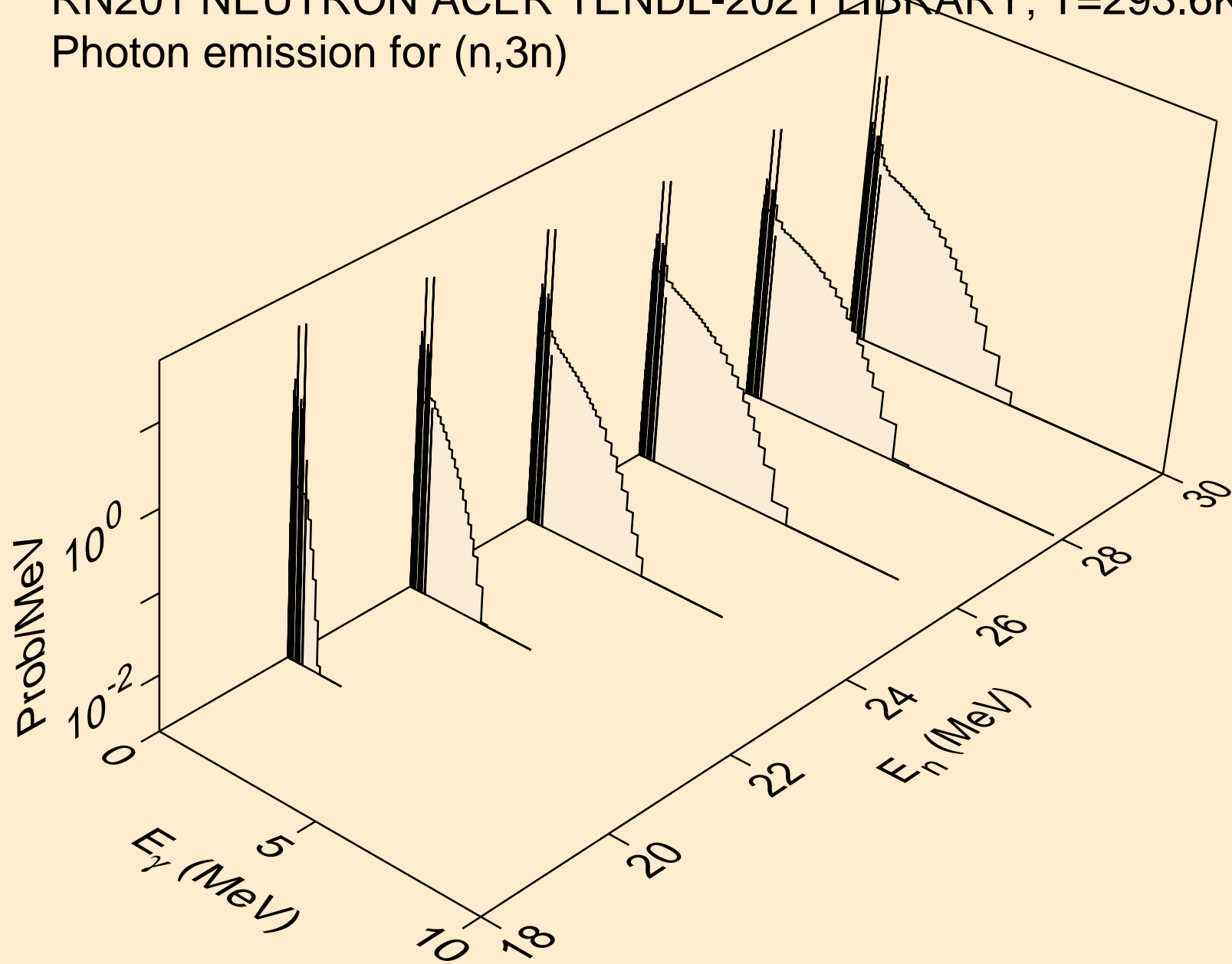

RN201 NEUTRON ACER TENDL-2021 LIBRARY; T=293.6K
Photon emission for (n,n*)a

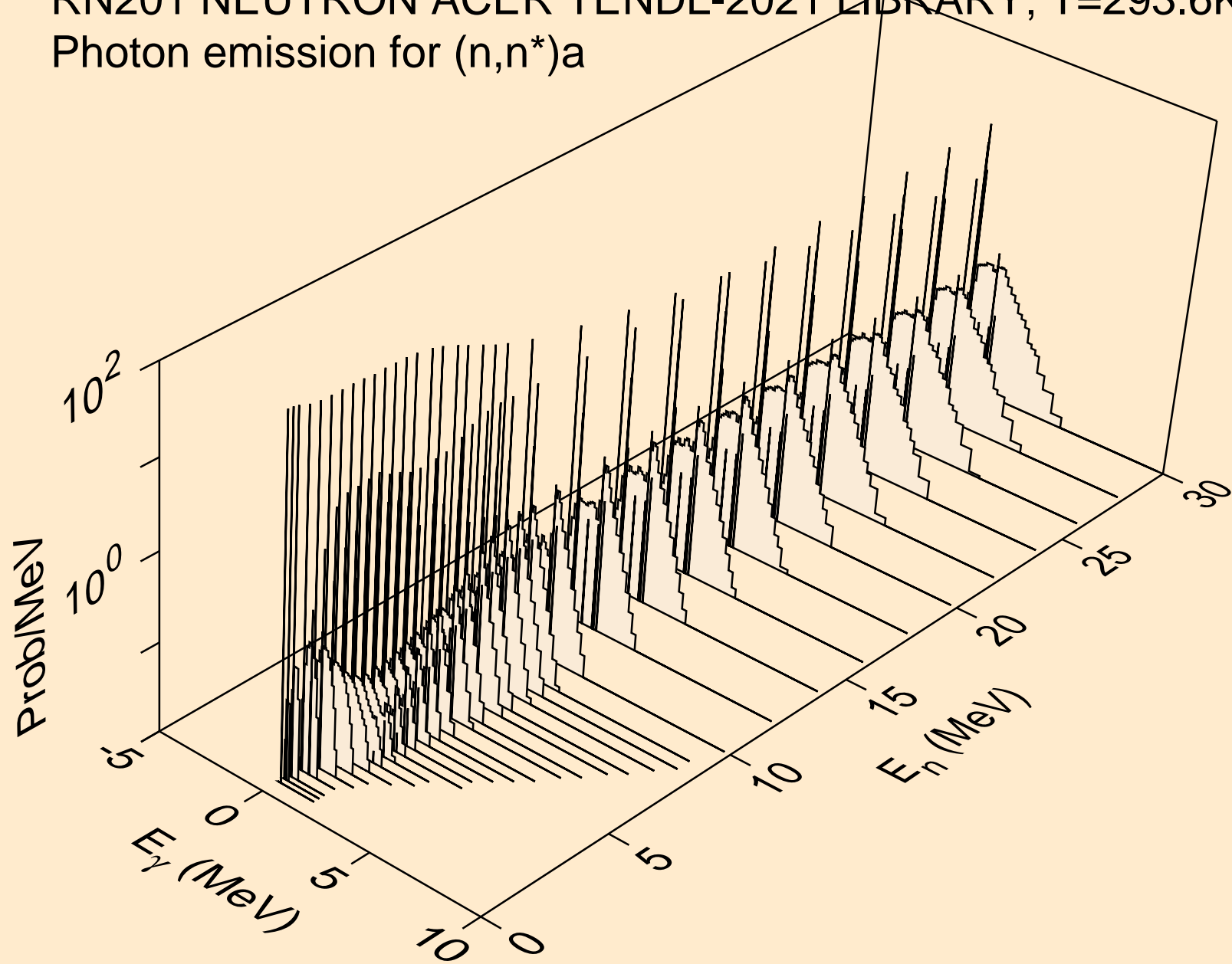

RN201 NEUTRON ACER TENDL-2021 LIBRARY; T=293.6K
Photon emission for (n,2n)a

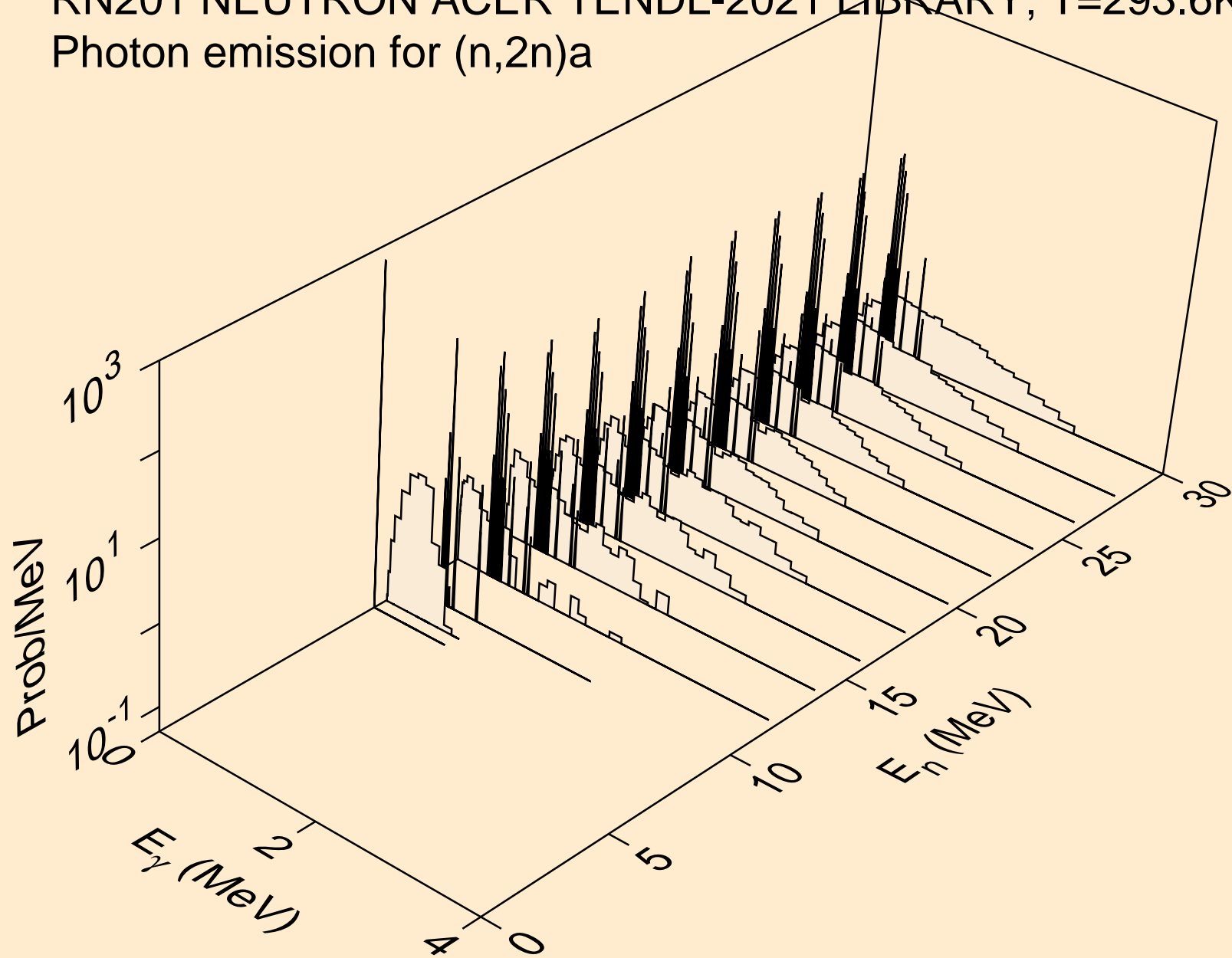

RN201 NEUTRON ACER TENDL-2021 LIBRARY; T=293.6K
Photon emission for (n,3n)a

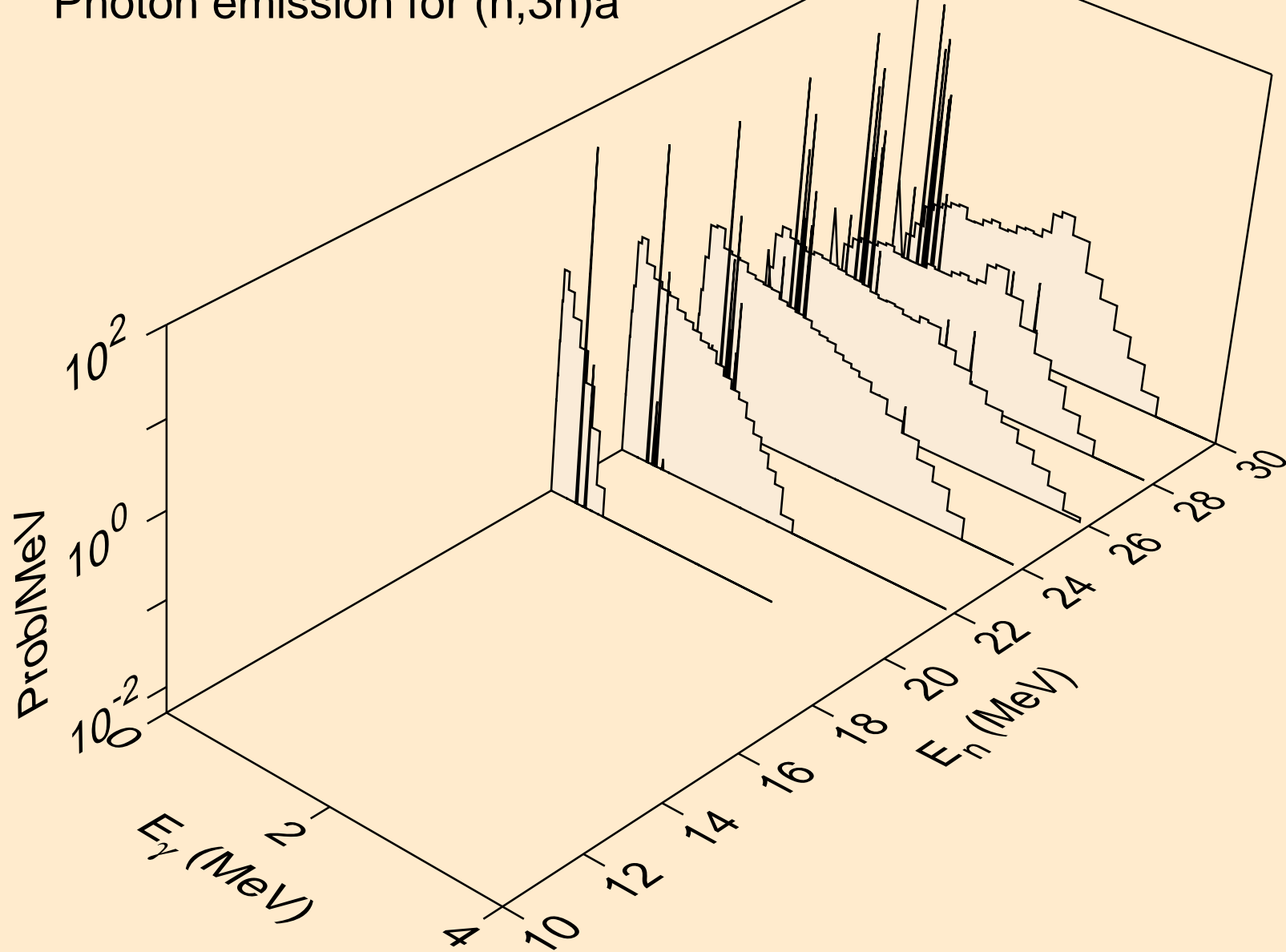

RN201 NEUTRON ACER TENDL-2021 LIBRARY; T=293.6K
Photon emission for (n,n*)p

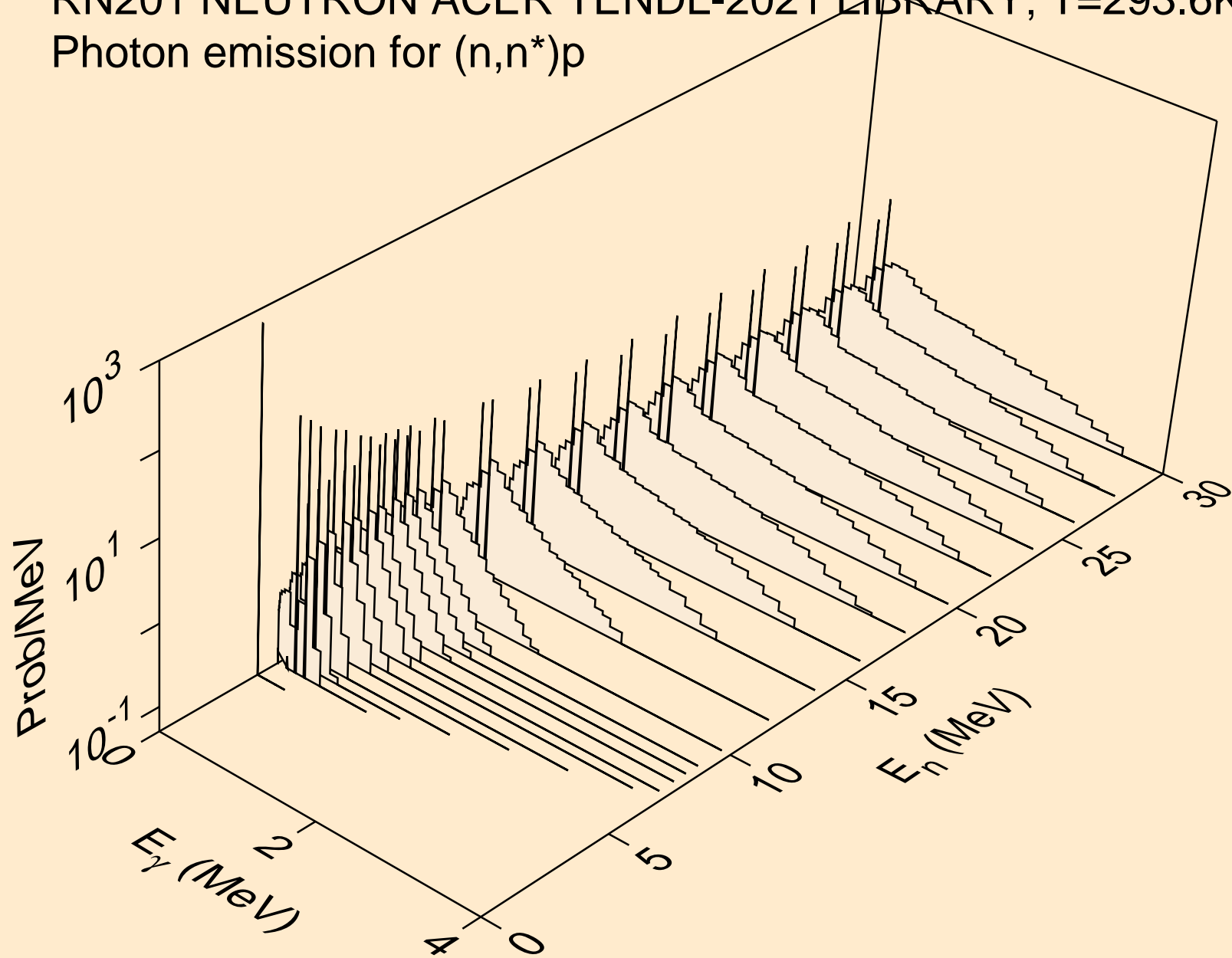

RN201 NEUTRON ACER TENDL-2021 LIBRARY; T=293.6K
Photon emission for (n,n*)2a

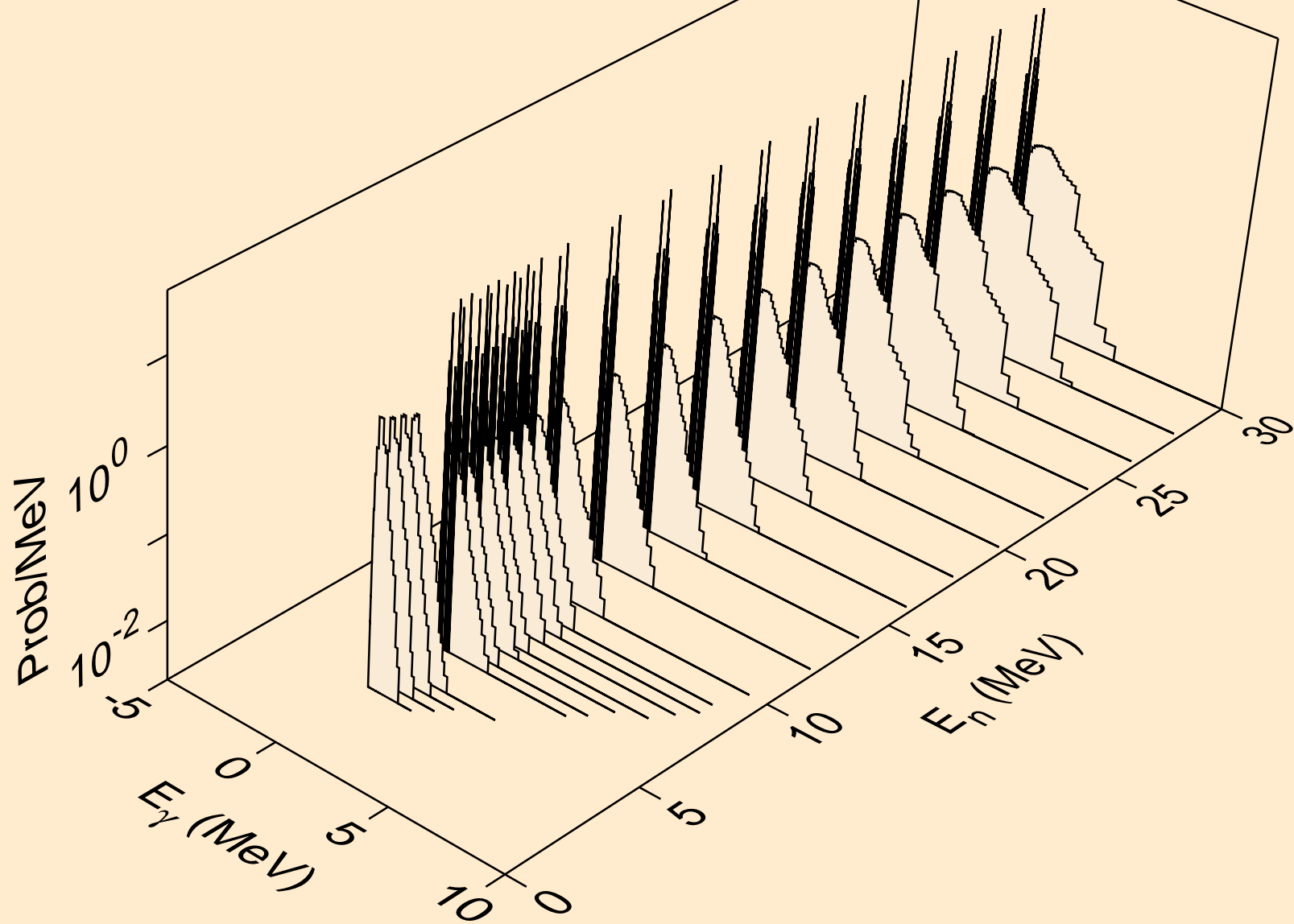

RN201 NEUTRON ACER TENDL-2021 LIBRARY; T=293.6K
Photon emission for (n,2n)2a

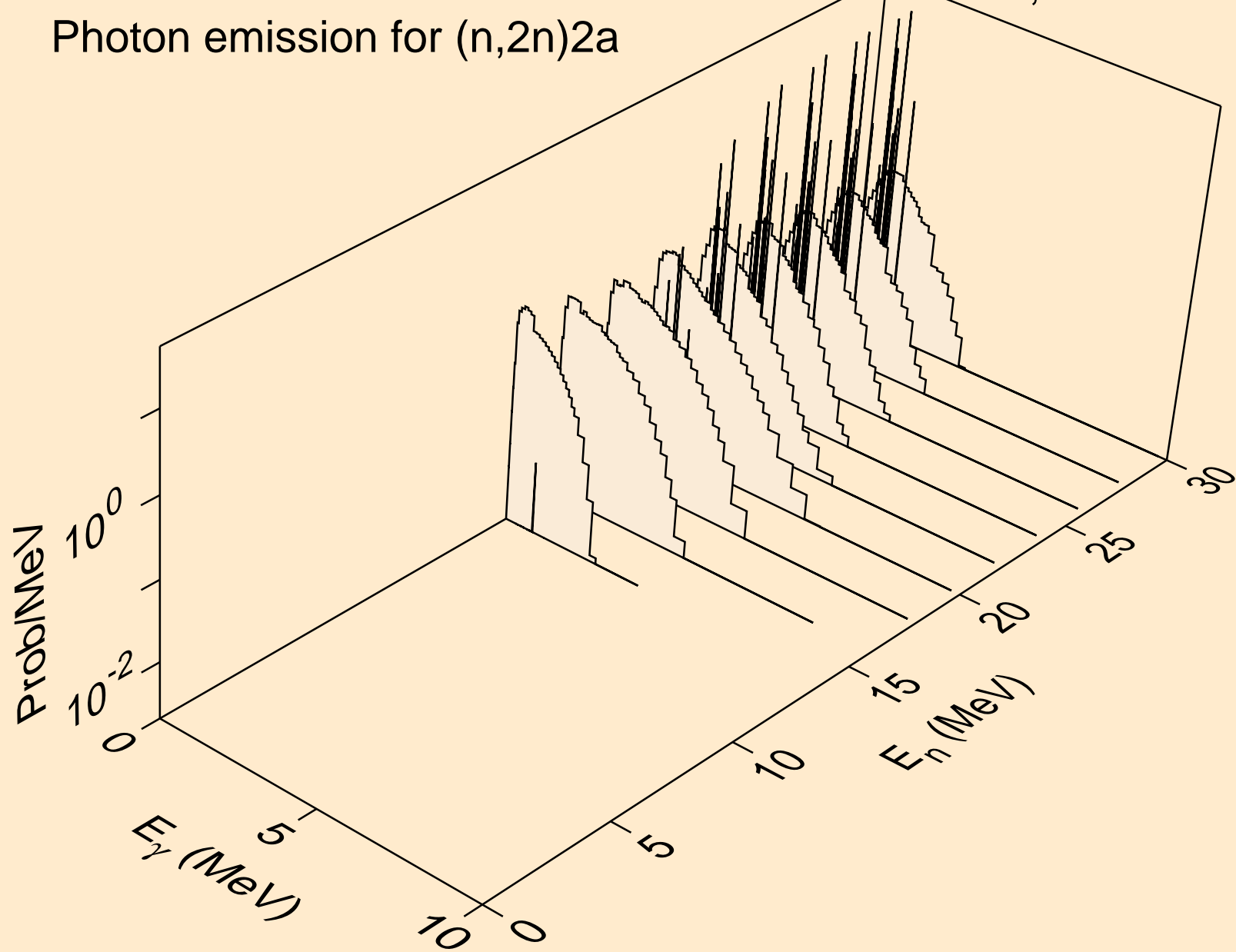

RN201 NEUTRON ACER TENDL-2021 LIBRARY; T=293.6K
Photon emission for (n,n*)d

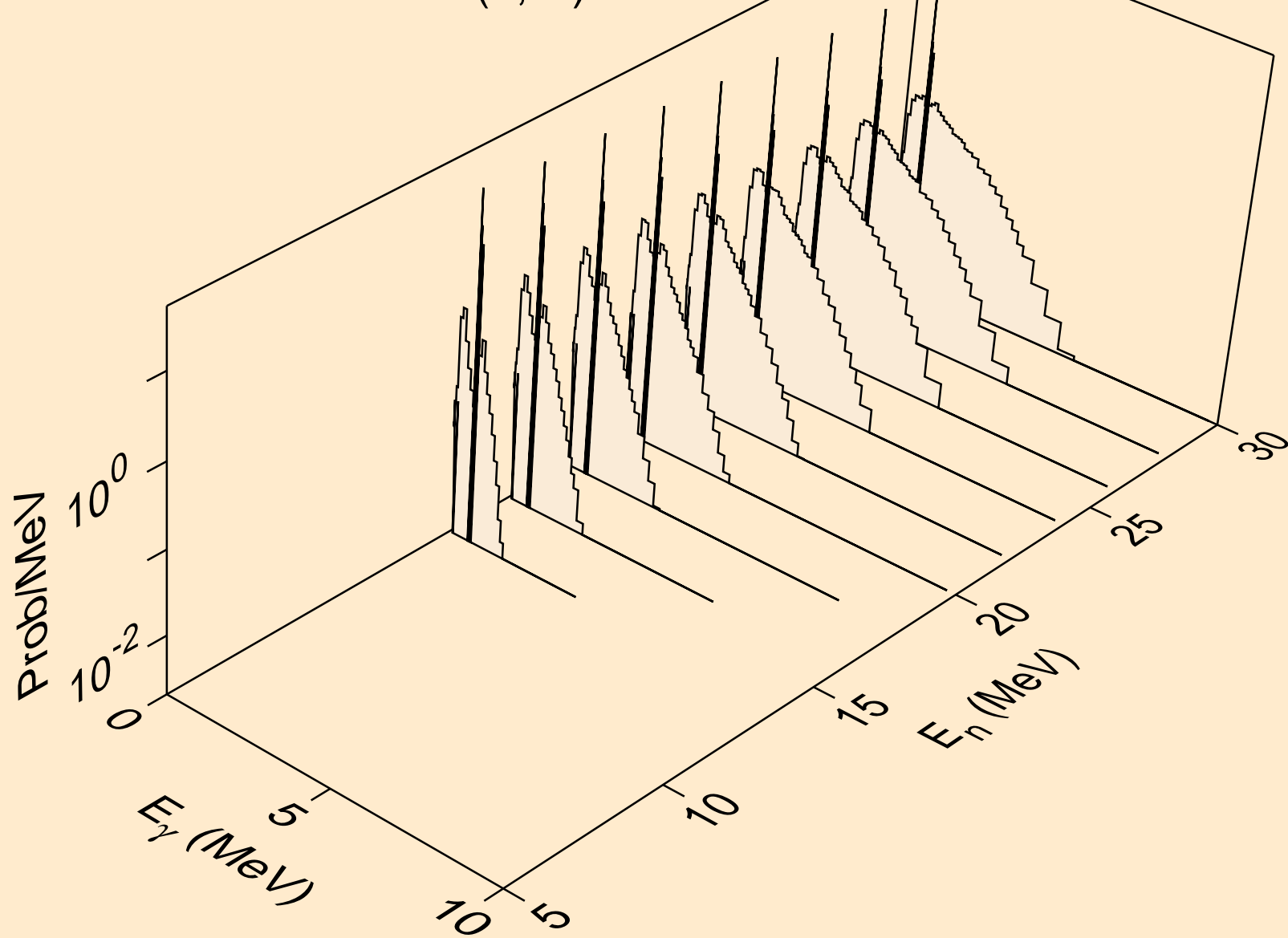

RN201 NEUTRON ACER TENDL-2021 LIBRARY; T=293.6K
Photon emission for (n,n*)t

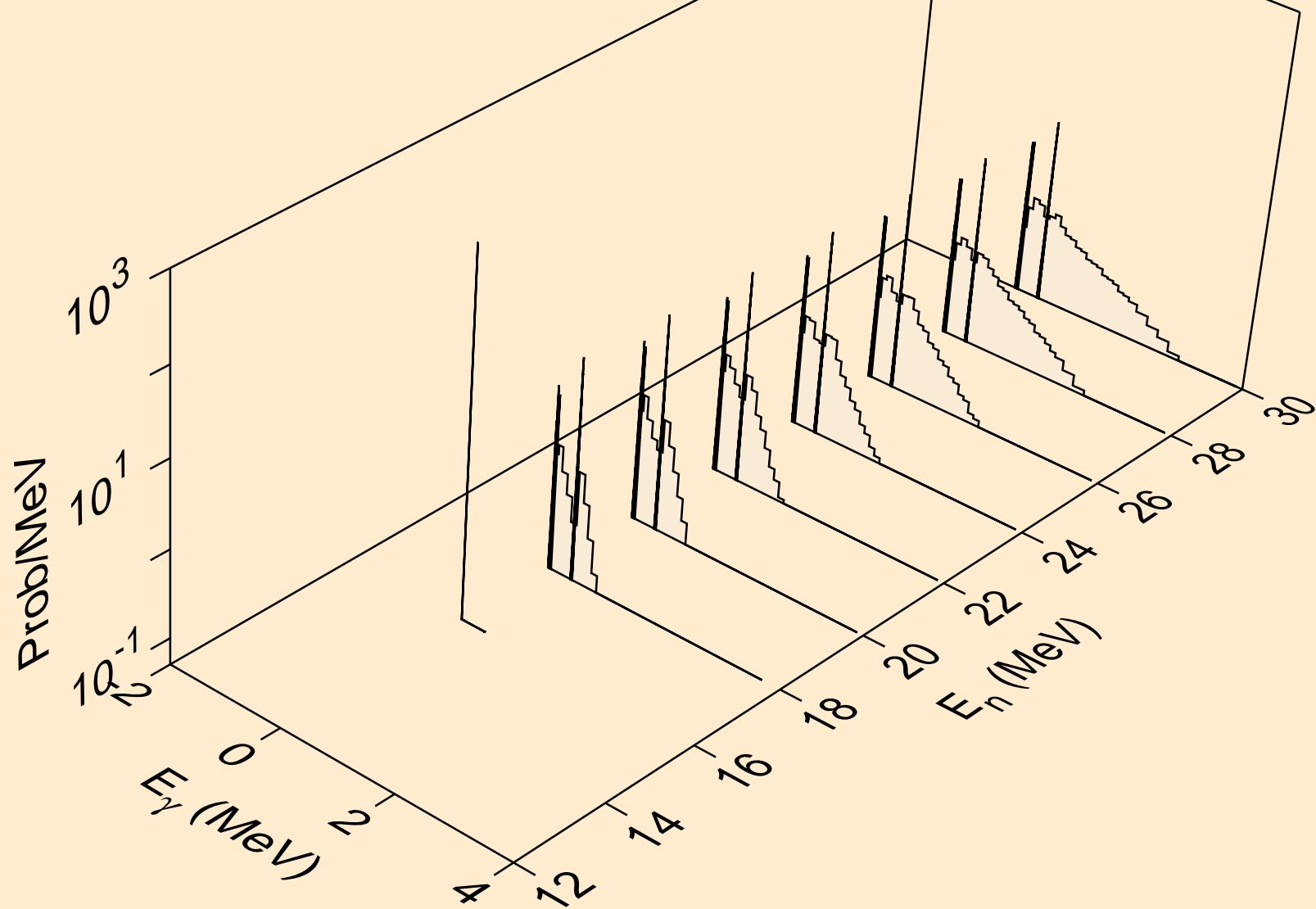

RN201 NEUTRON ACER TENDL-2021 LIBRARY; T=293.6K
Photon emission for (n,n*)he3

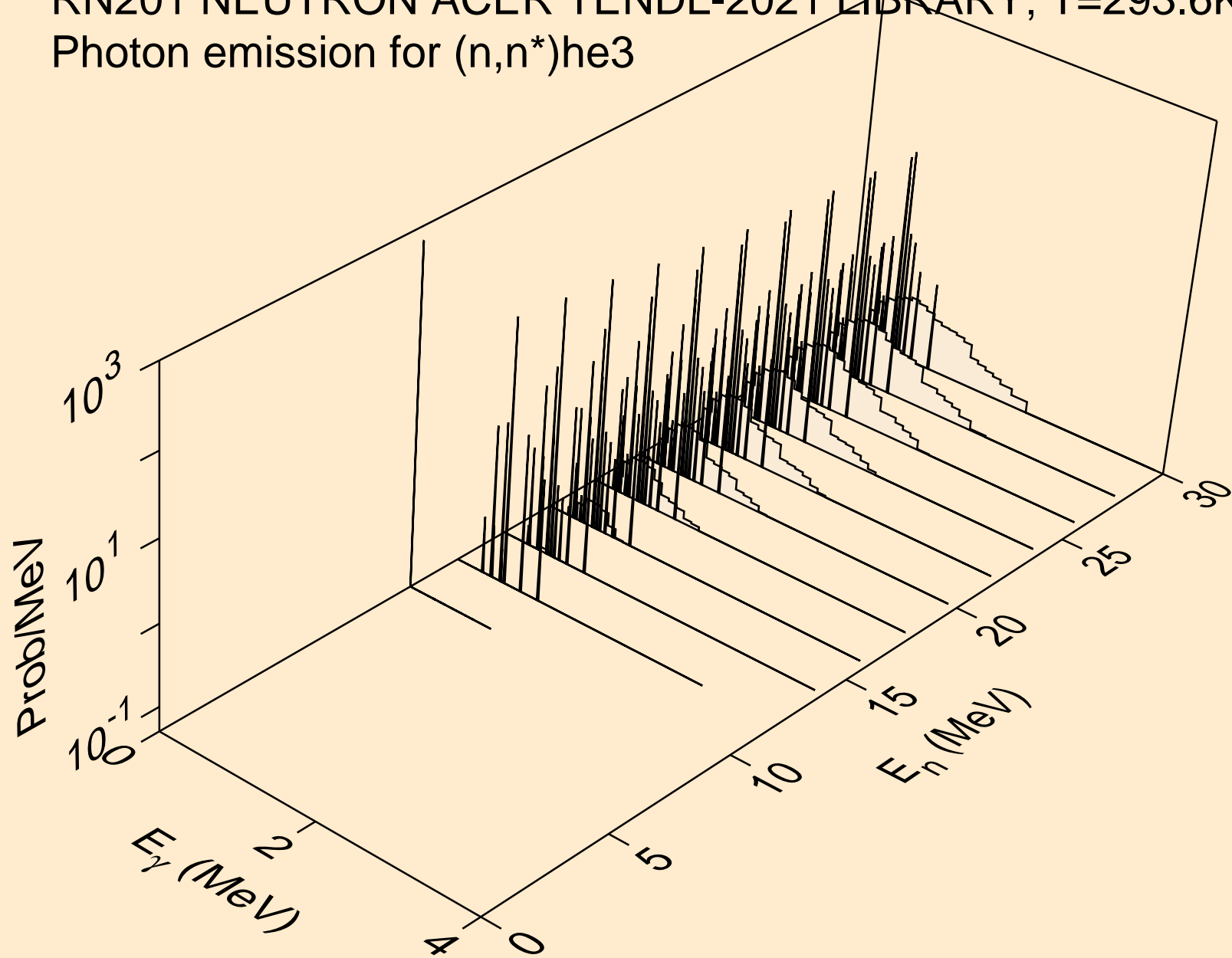

RN201 NEUTRON ACER TENDL-2021 LIBRARY; T=293.6K
Photon emission for (n,4n)

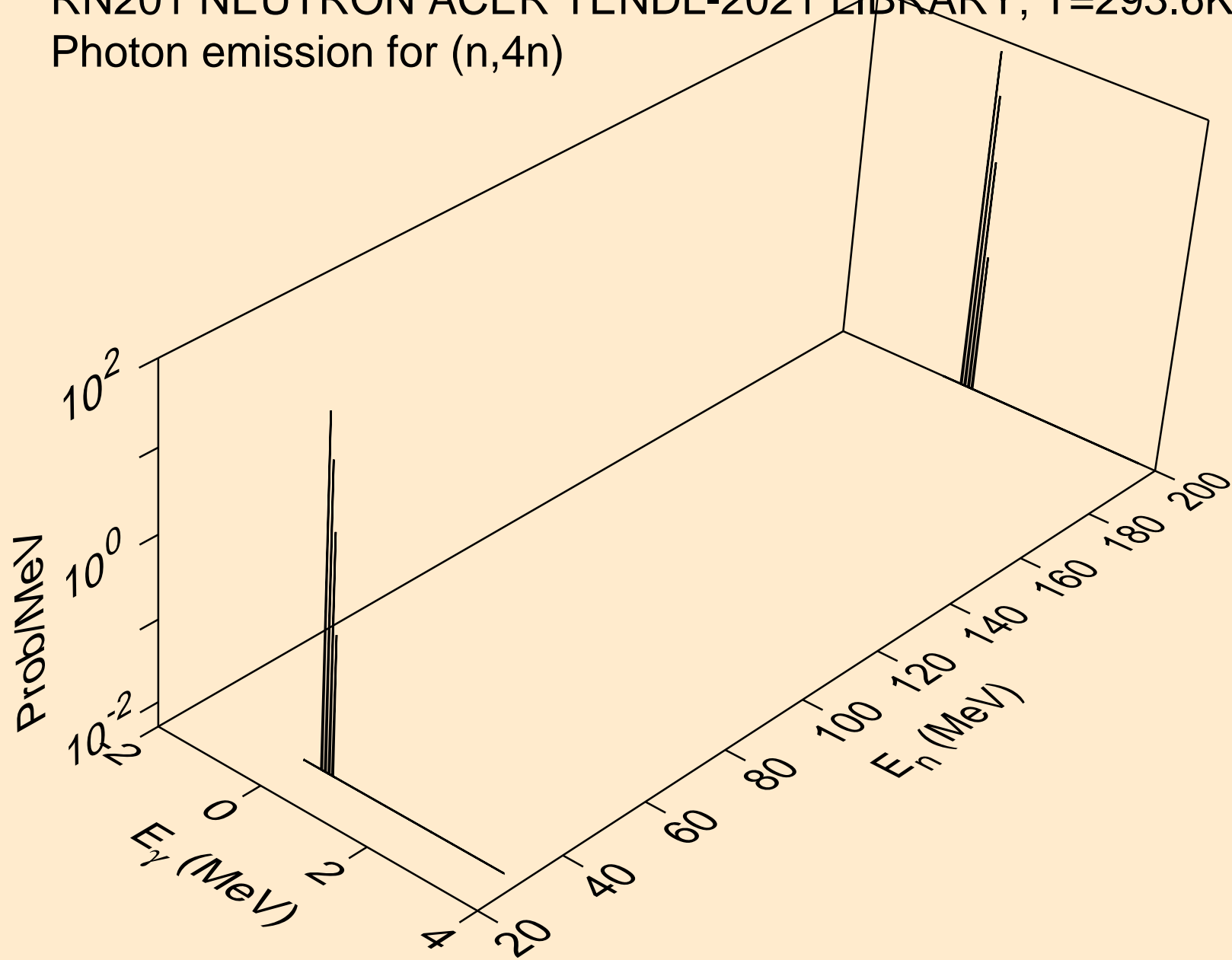

RN201 NEUTRON ACER TENDL-2021 LIBRARY; T=293.6K
Photon emission for (n,2np)

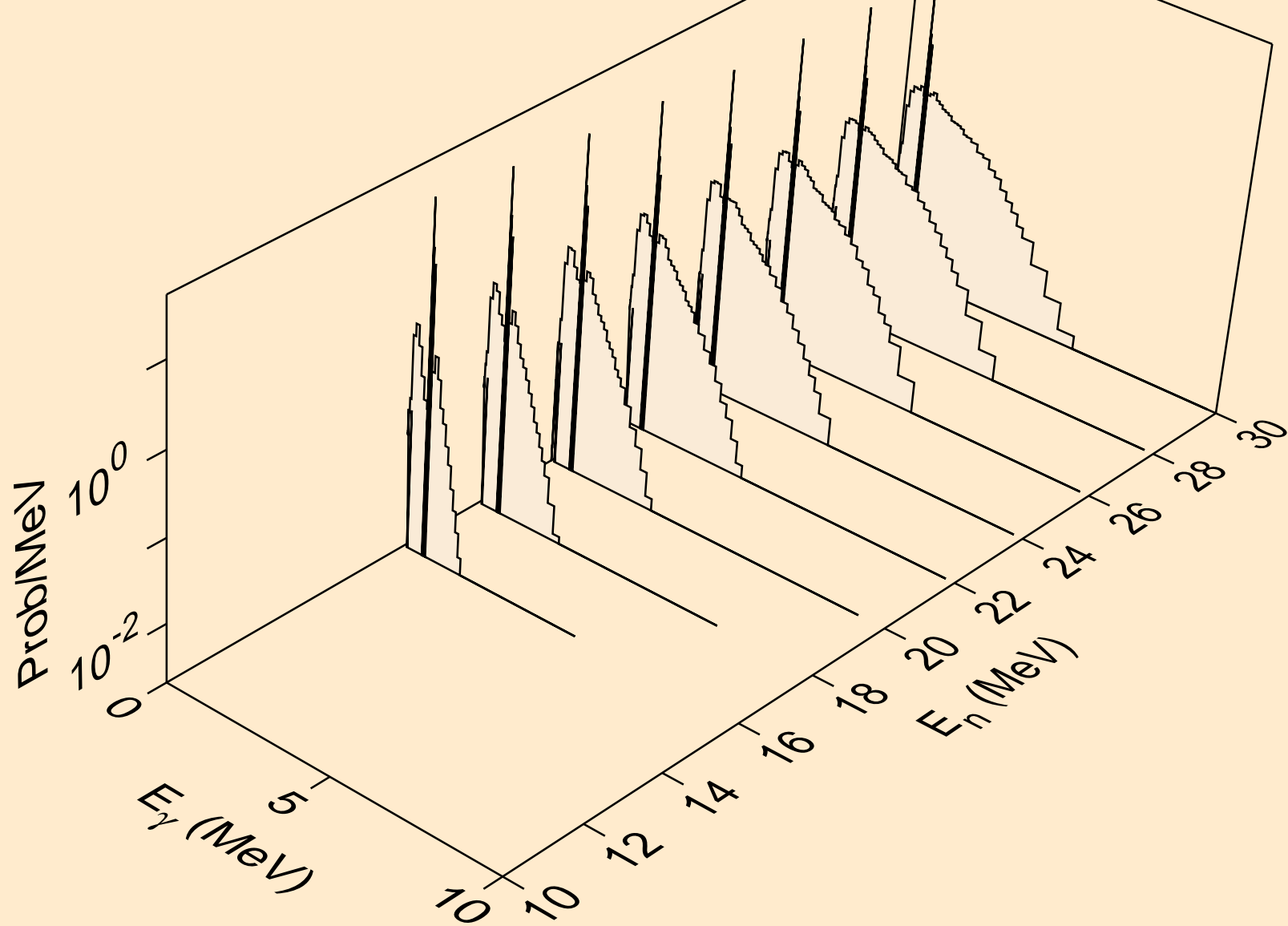

RN201 NEUTRON ACER TENDL-2021 LIBRARY; T=293.6K
Photon emission for (n,3np)

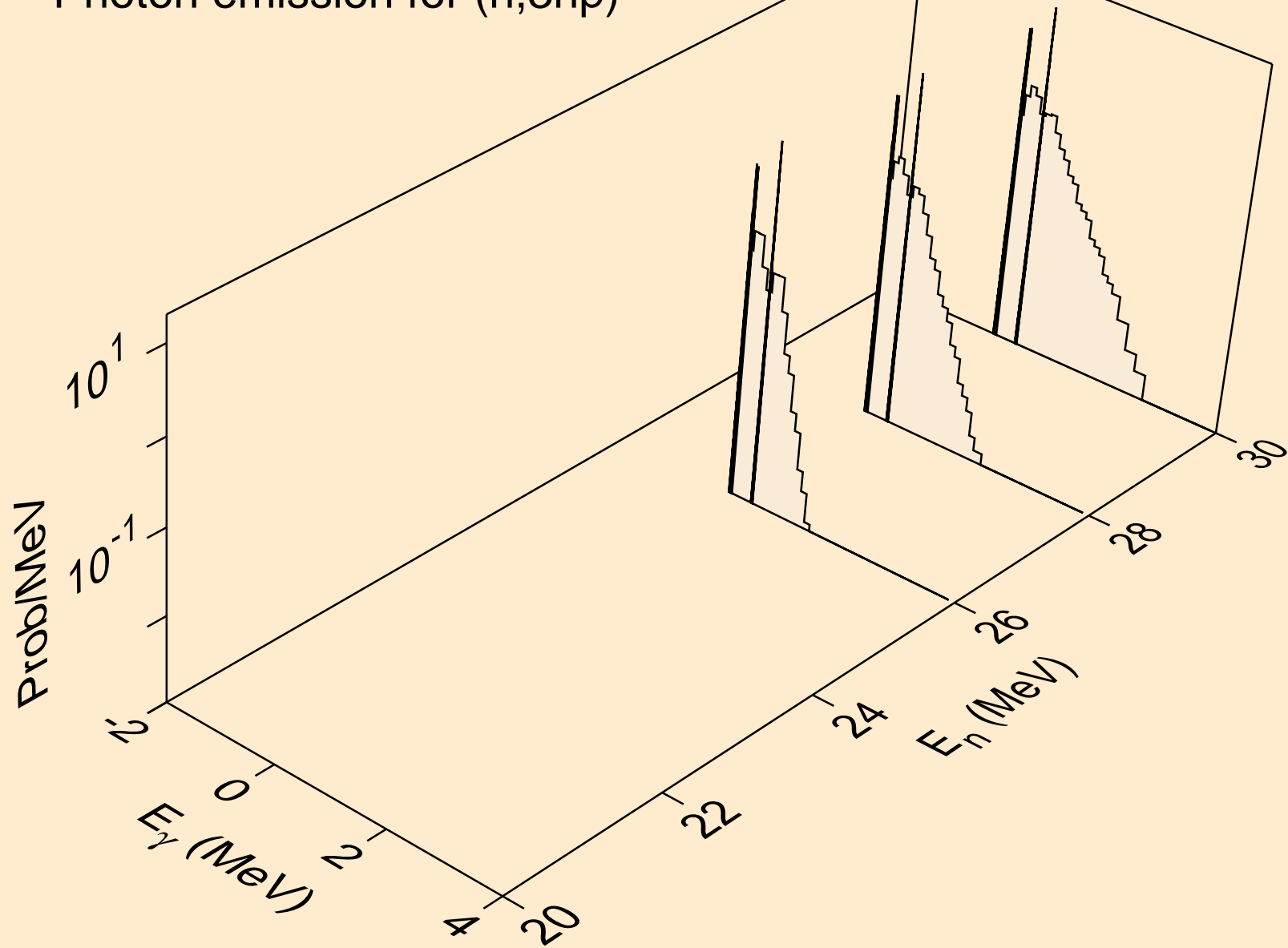

RN201 NEUTRON ACER TENDL-2021 LIBRARY; T=293.6K
Photon emission for (n,2np)

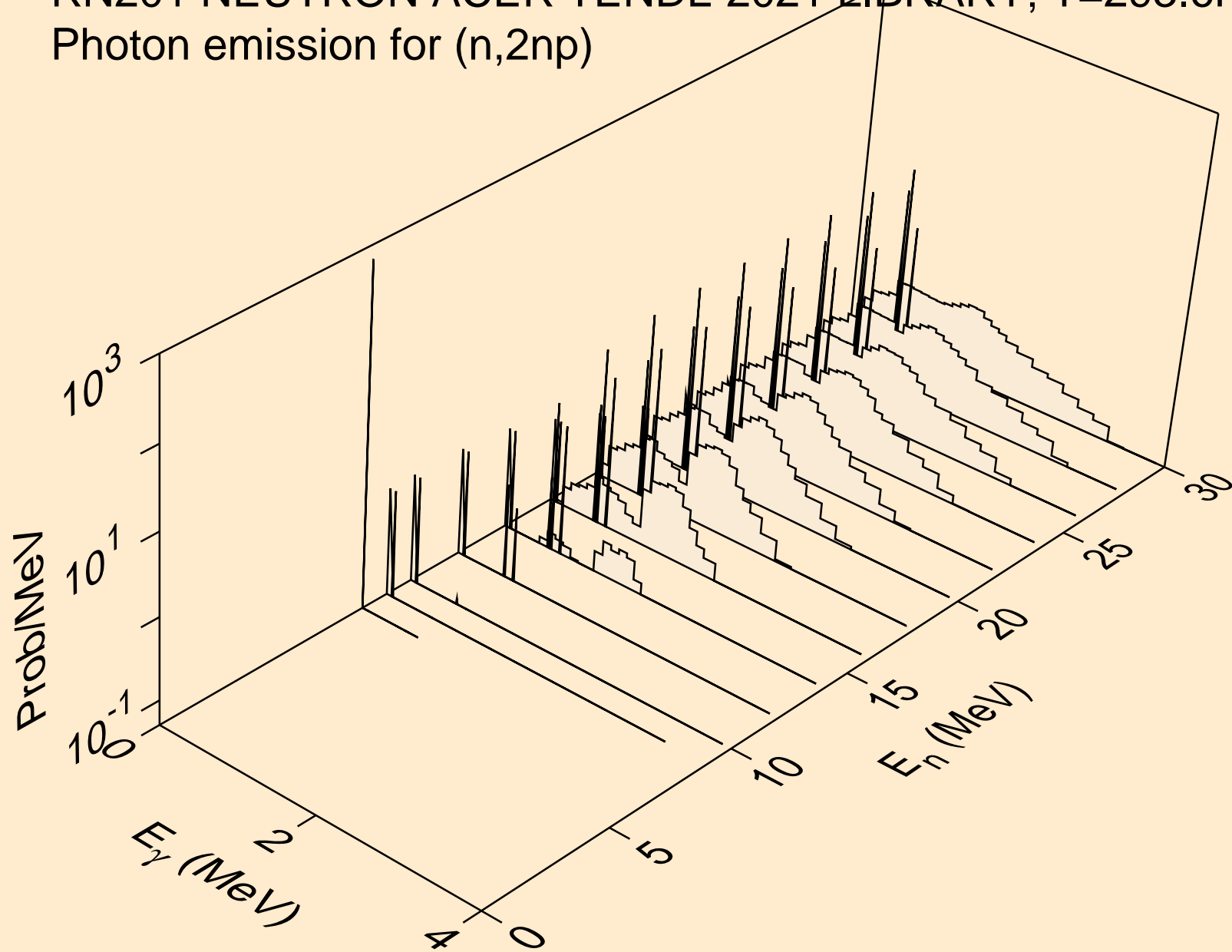

RN201 NEUTRON ACER TENDL-2021 LIBRARY; T=293.6K
Photon emission for (n,npa)

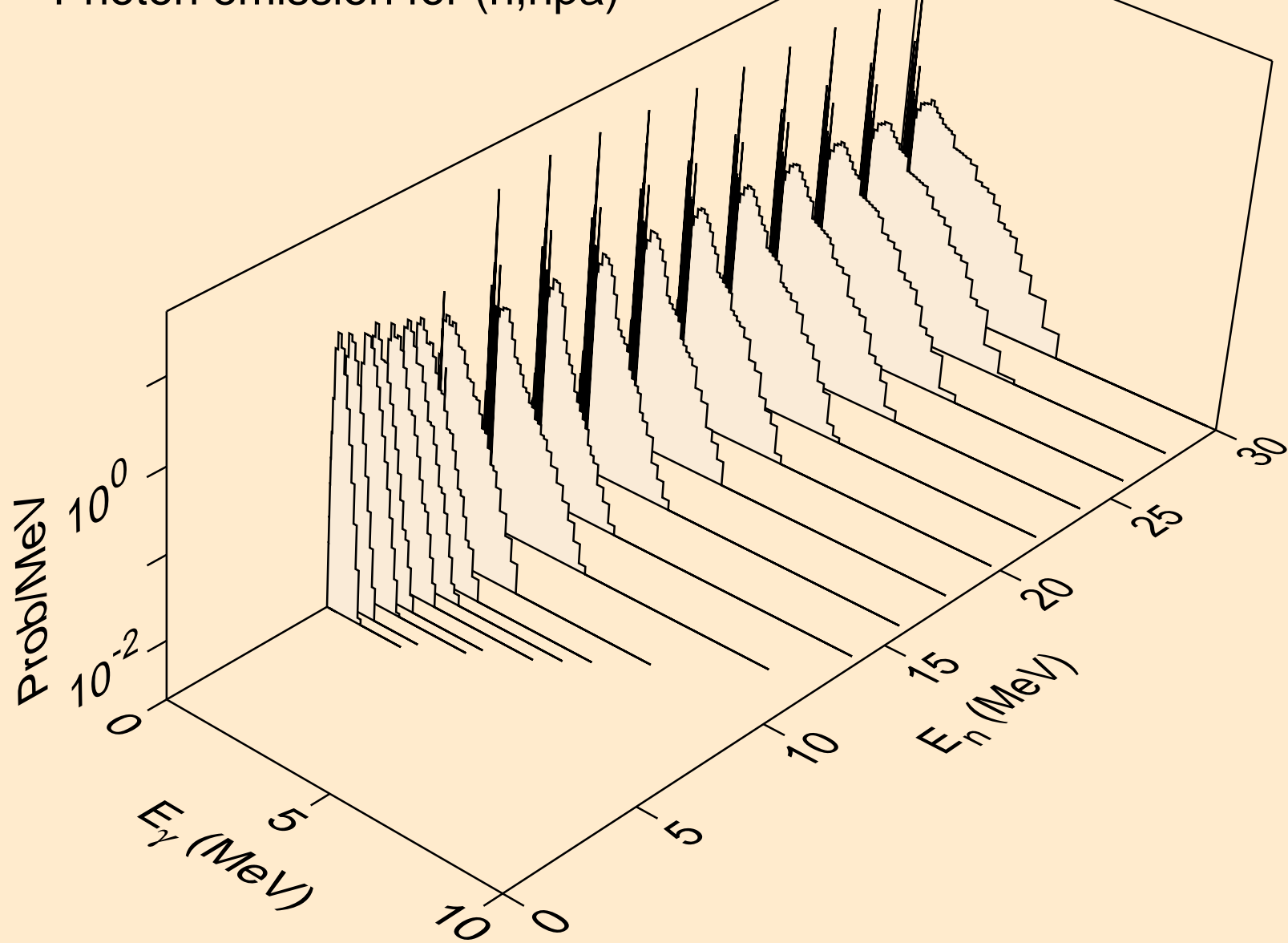

RN201 NEUTRON ACER TENDL-2021 LIBRARY; T=293.6K
Photon emission for (n,n*c)

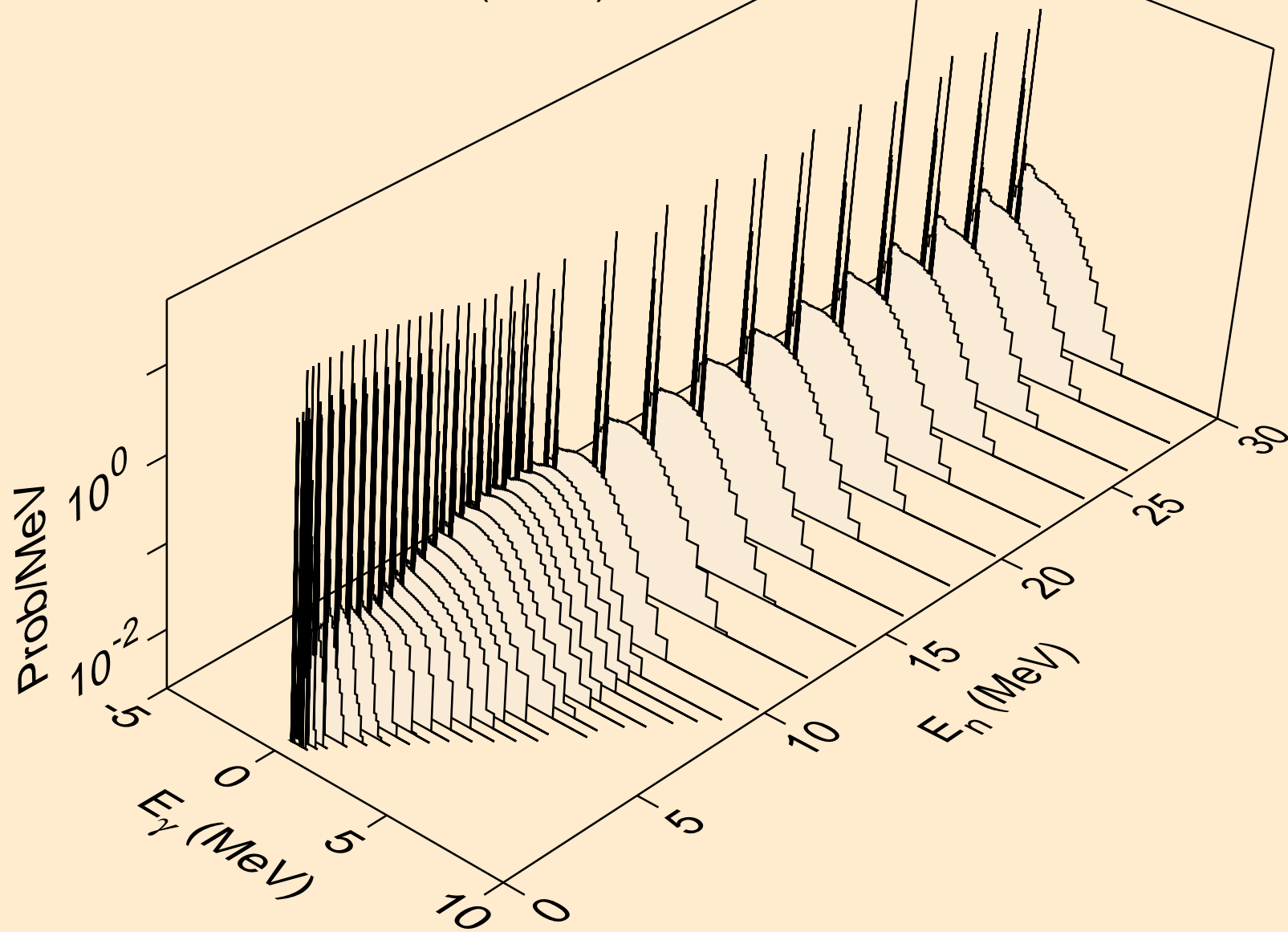

RN201 NEUTRON ACER TENDL-2021 LIBRARY; T=293.6K
Photon emission for (n,gma)

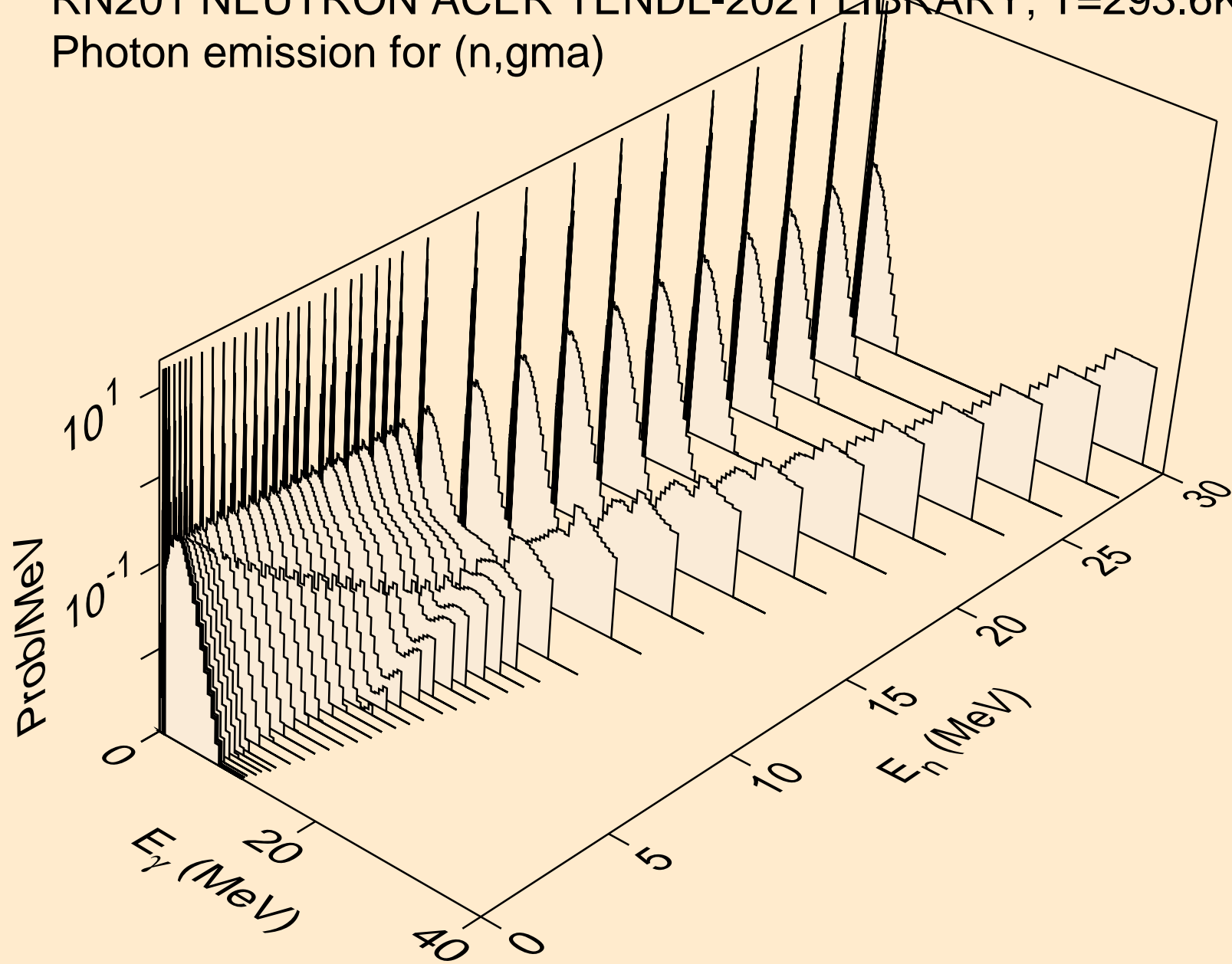

RN201 NEUTRON ACER TENDL-2021 LIBRARY; T=293.6K
Photon emission for (n,p)

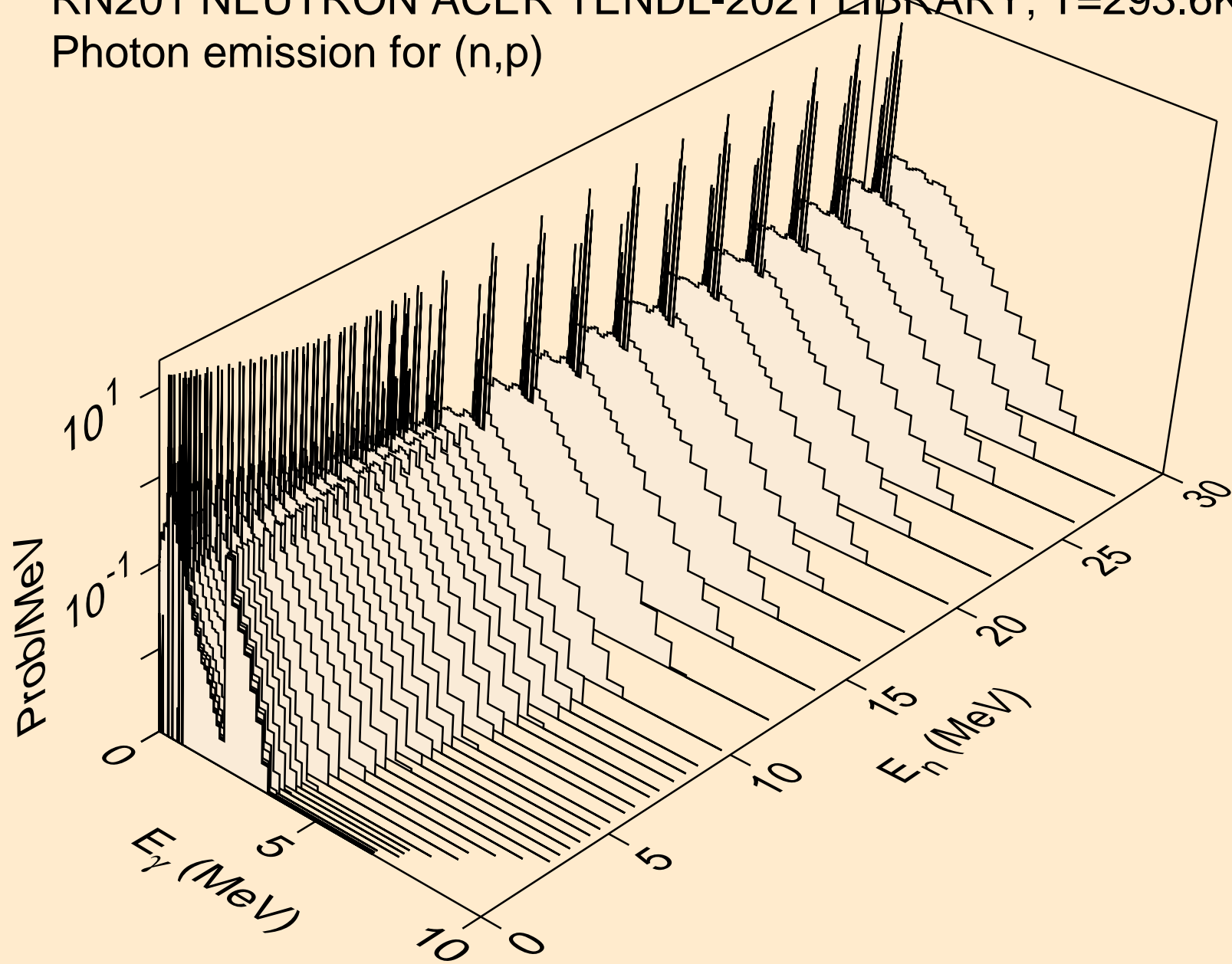

RN201 NEUTRON ACER TENDL-2021 LIBRARY; T=293.6K
Photon emission for (n,d)

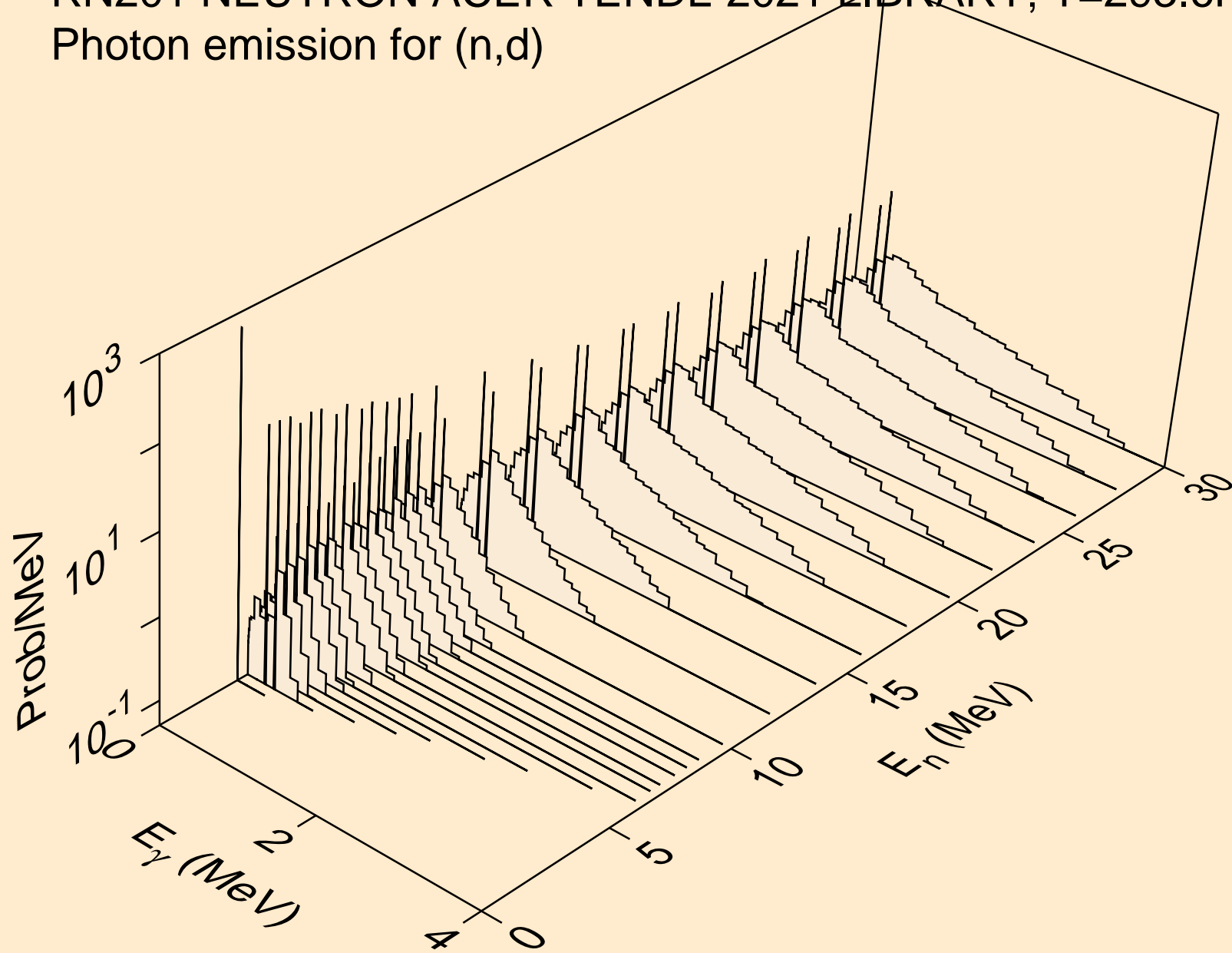

RN201 NEUTRON ACER TENDL-2021 LIBRARY; T=293.6K
Photon emission for (n,t)

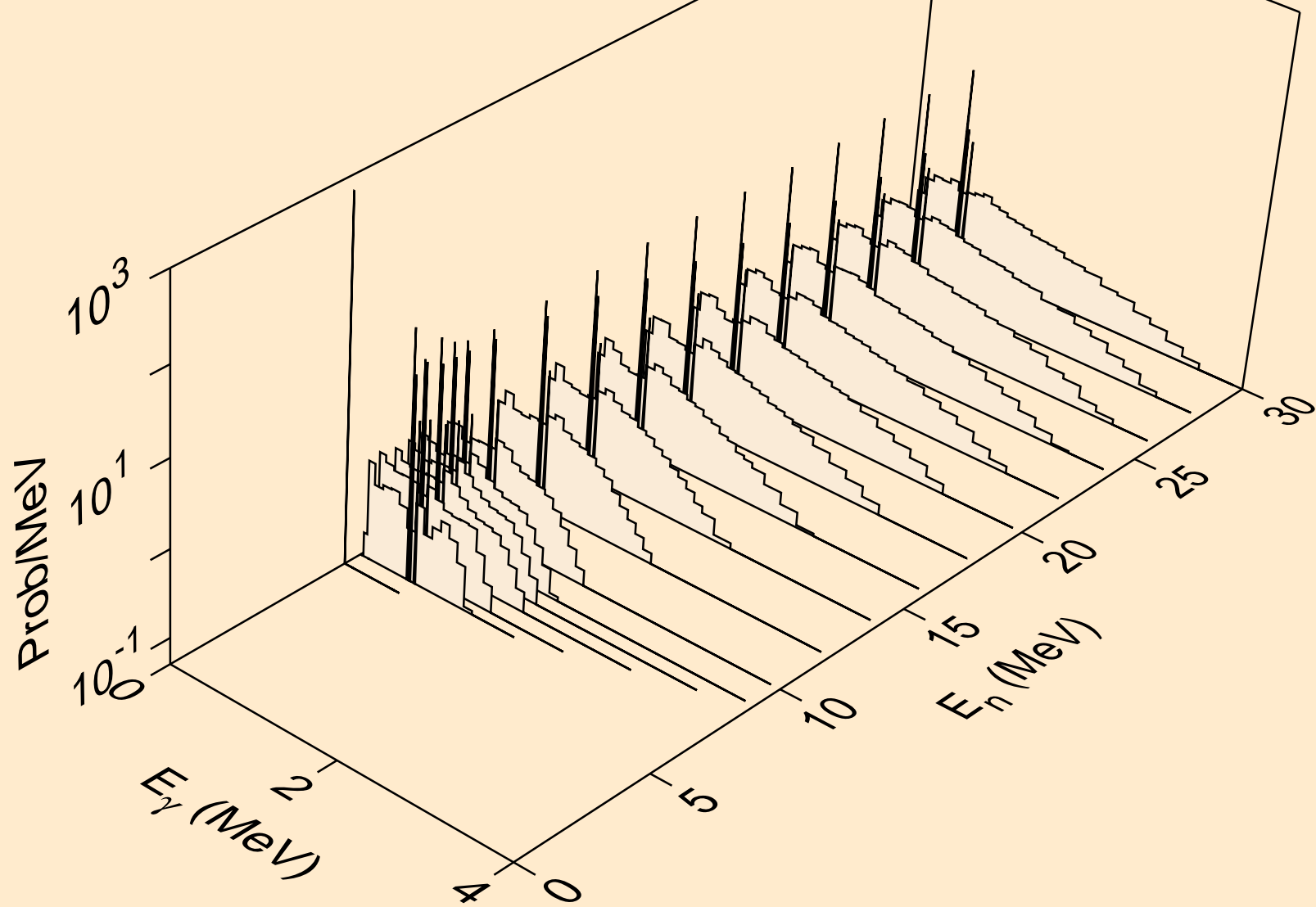

RN201 NEUTRON ACER TENDL-2021 LIBRARY; T=293.6K
Photon emission for (n,he3)

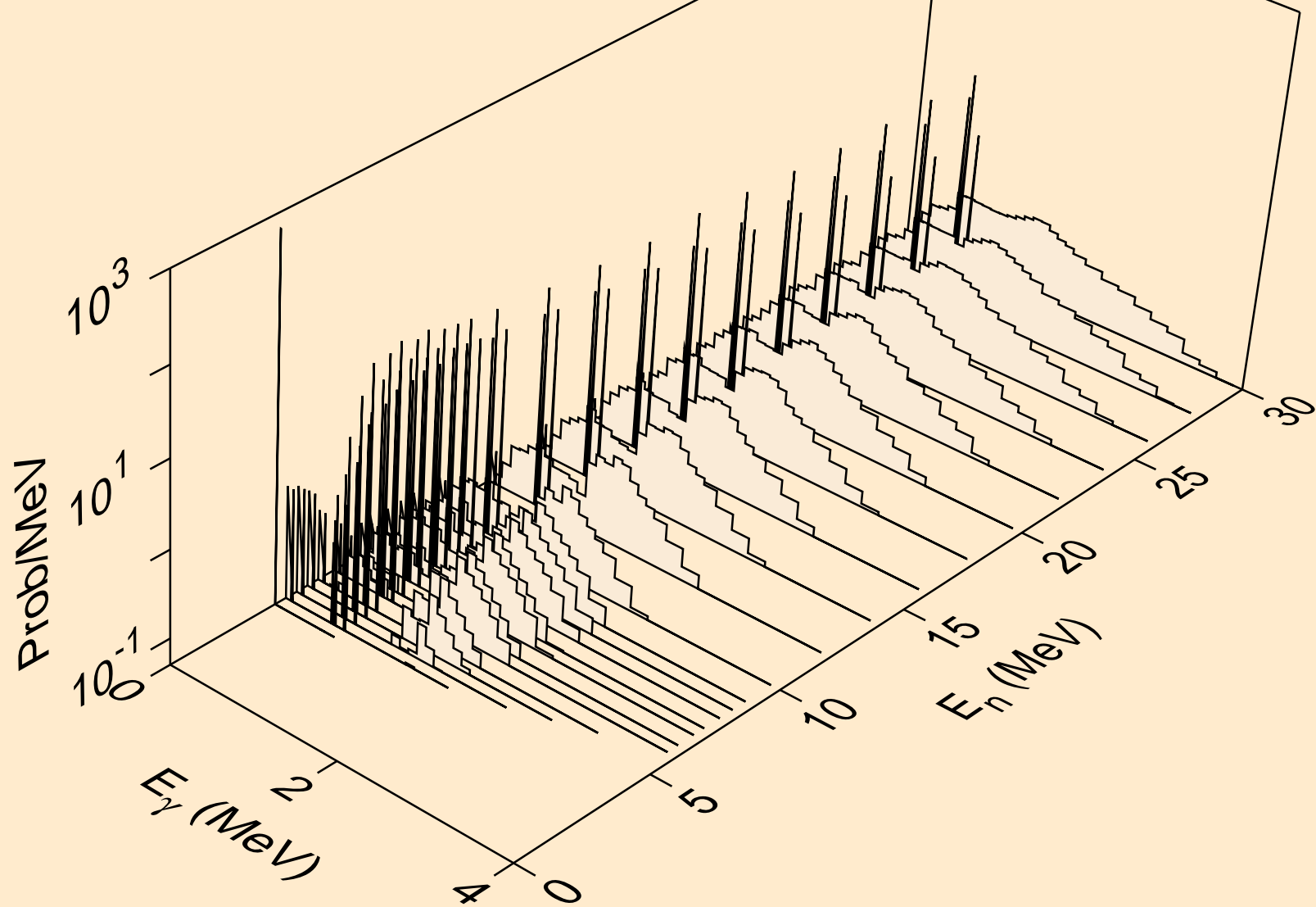

RN201 NEUTRON ACER TENDL-2021 LIBRARY; T=293.6K
Photon emission for (n,a)

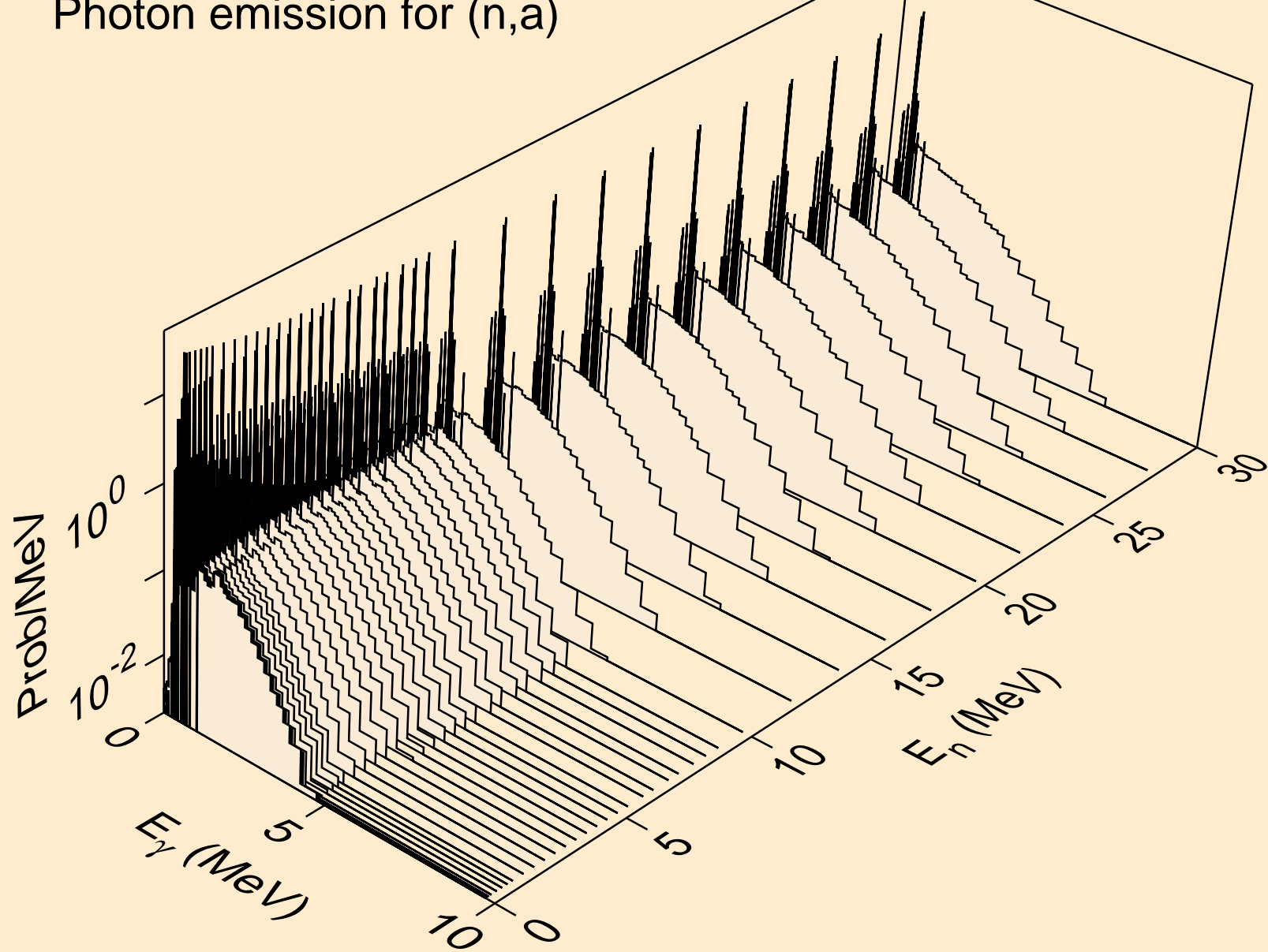

RN201 NEUTRON ACER TENDL-2021 LIBRARY; T=293.6K
Photon emission for (n,2a)

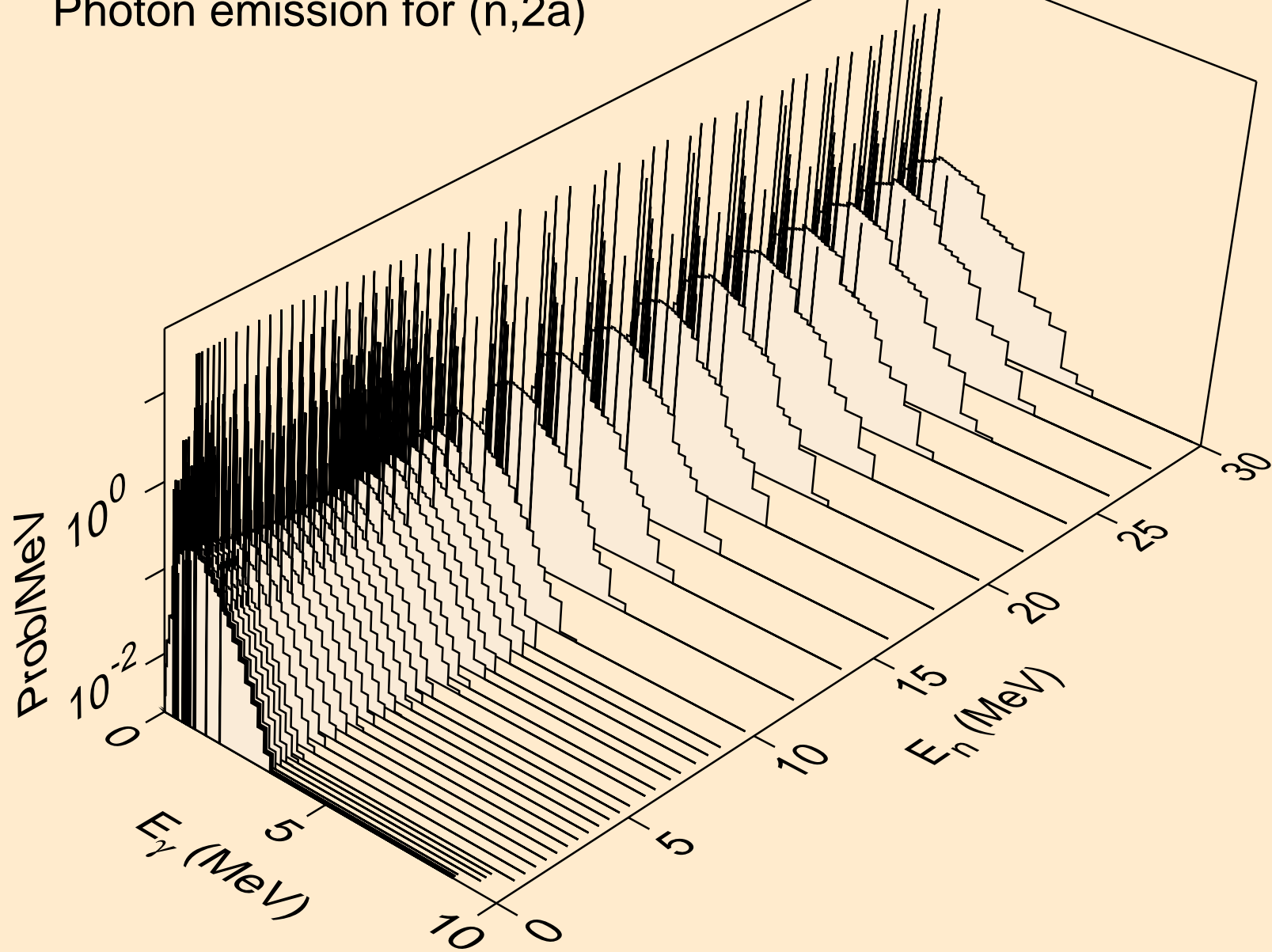

RN201 NEUTRON ACER TENDL-2021 LIBRARY; T=293.6K
Photon emission for (n,3a)

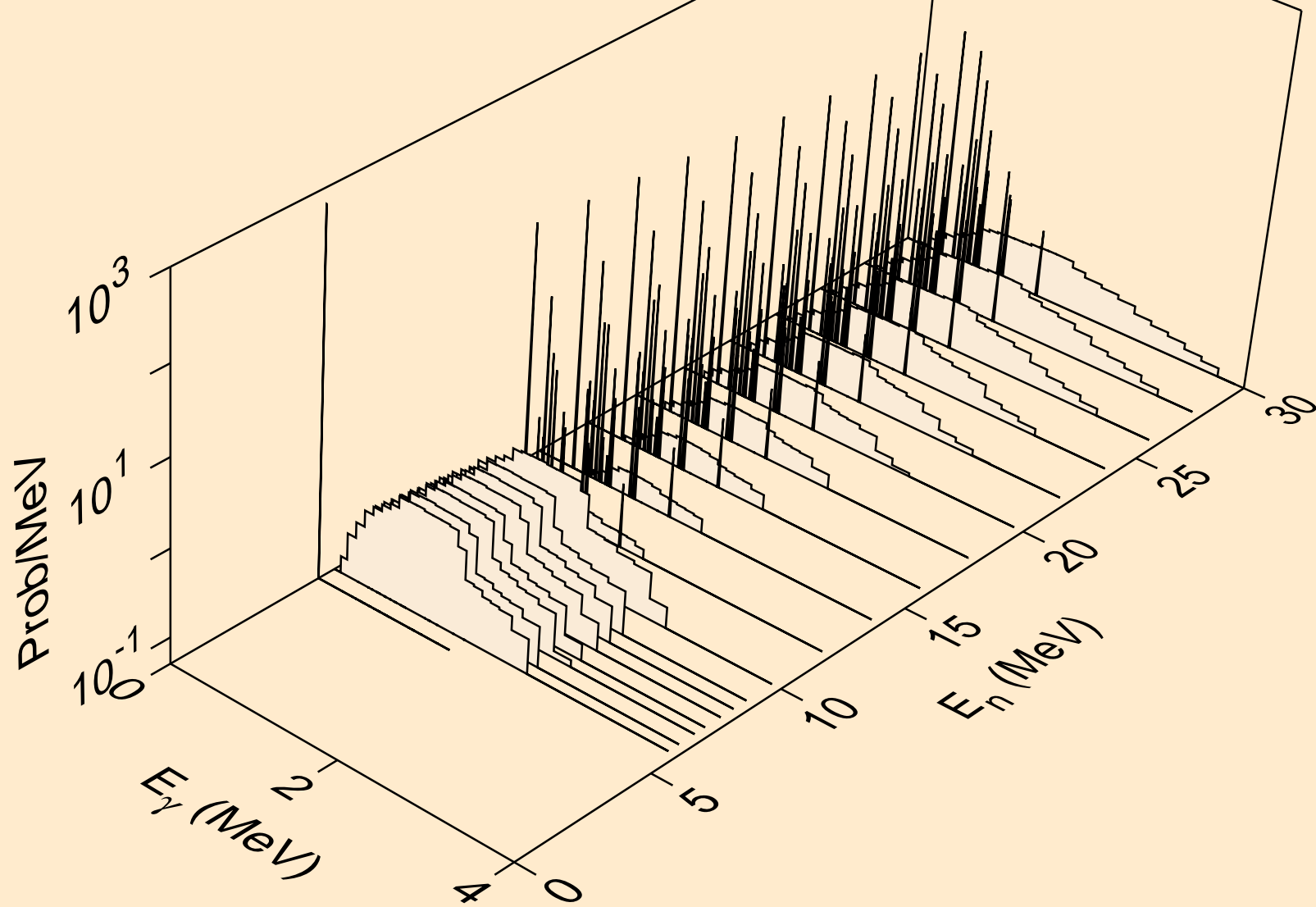

RN201 NEUTRON ACER TENDL-2021 LIBRARY; T=293.6K
Photon emission for (n,2p)

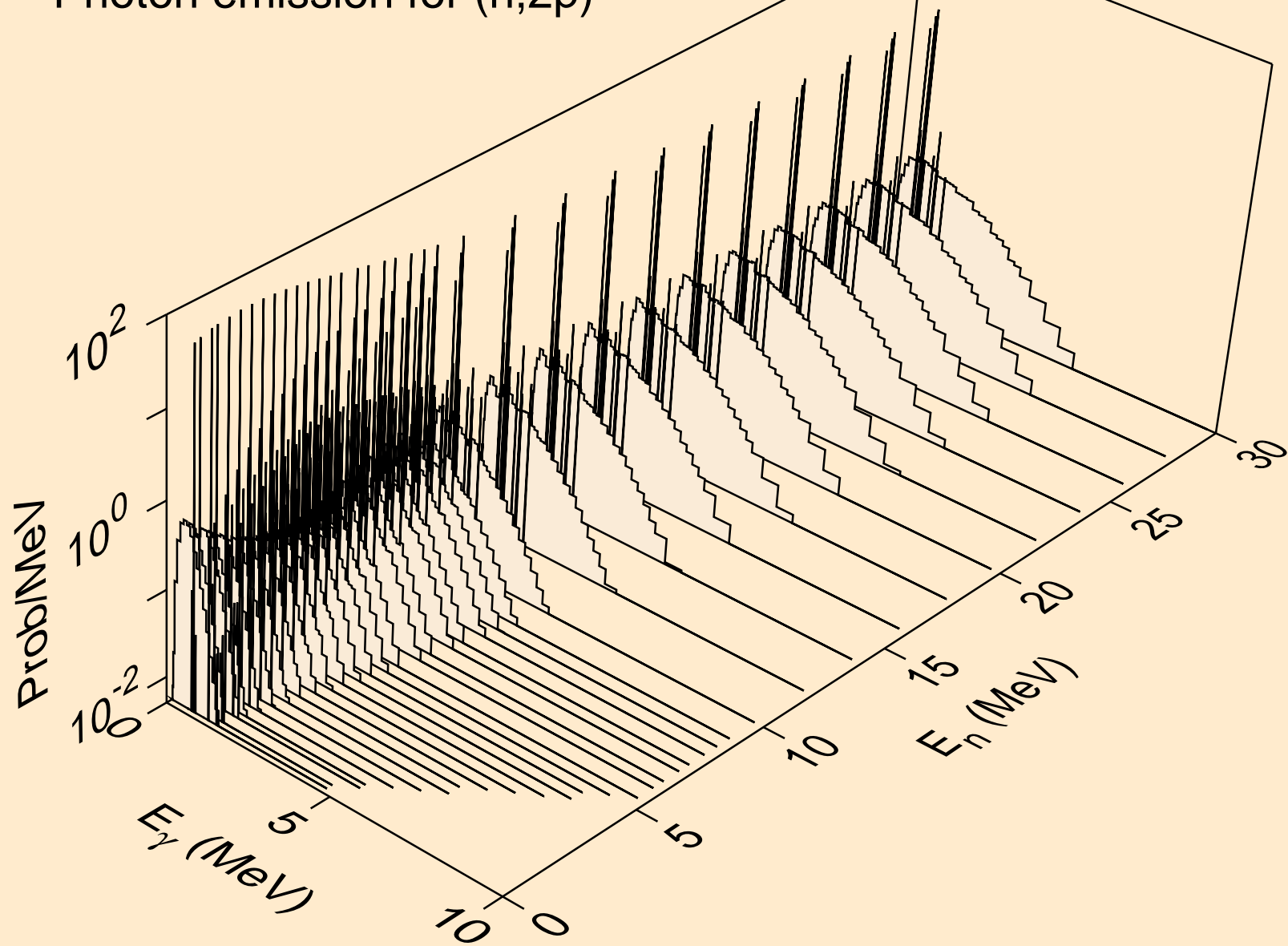

RN201 NEUTRON ACER TENDL-2021 LIBRARY; T=293.6K
Photon emission for (n,p α)

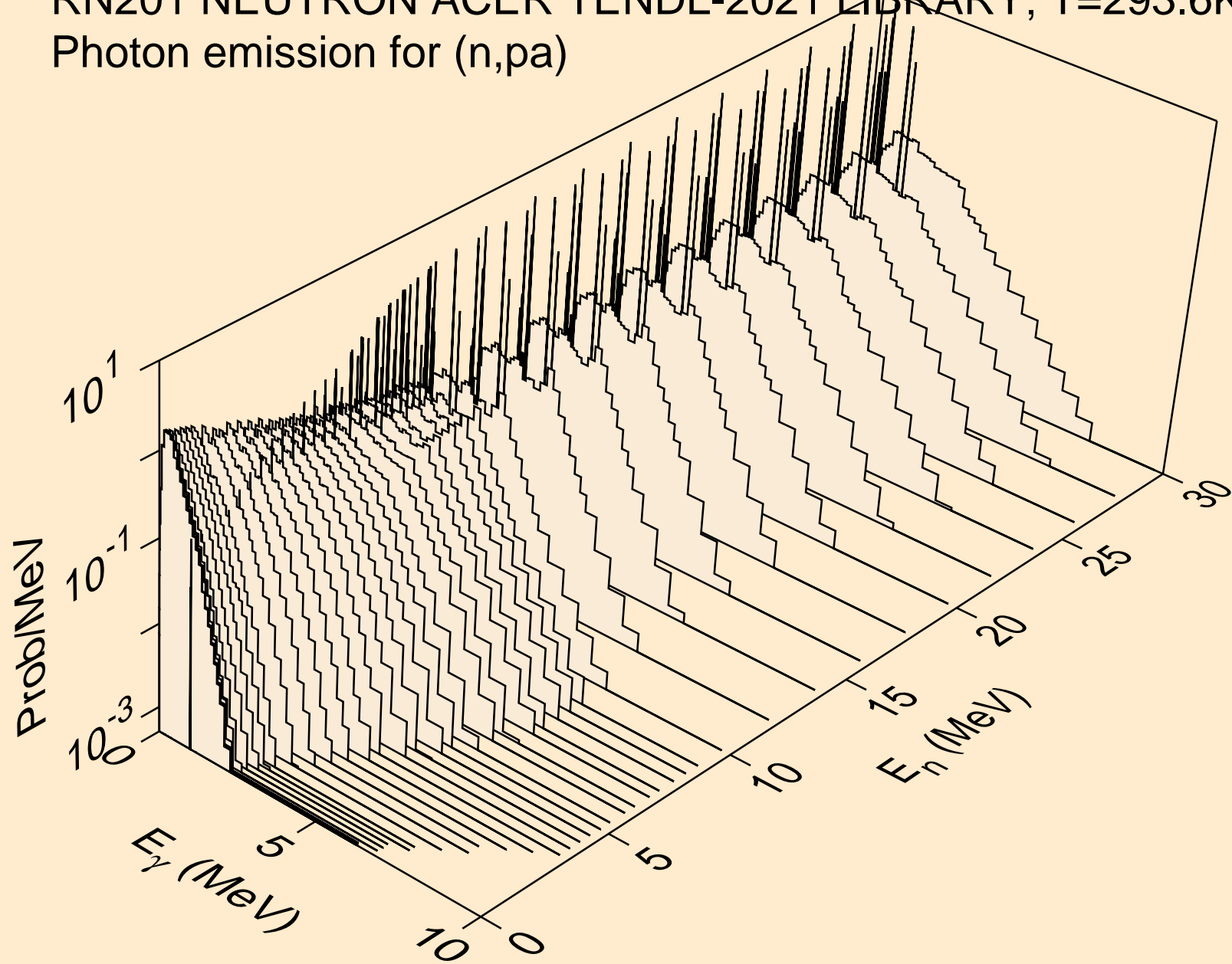

RN201 NEUTRON ACER TENDL-2021 LIBRARY; T=293.6K
Photon emission for (n,pd)

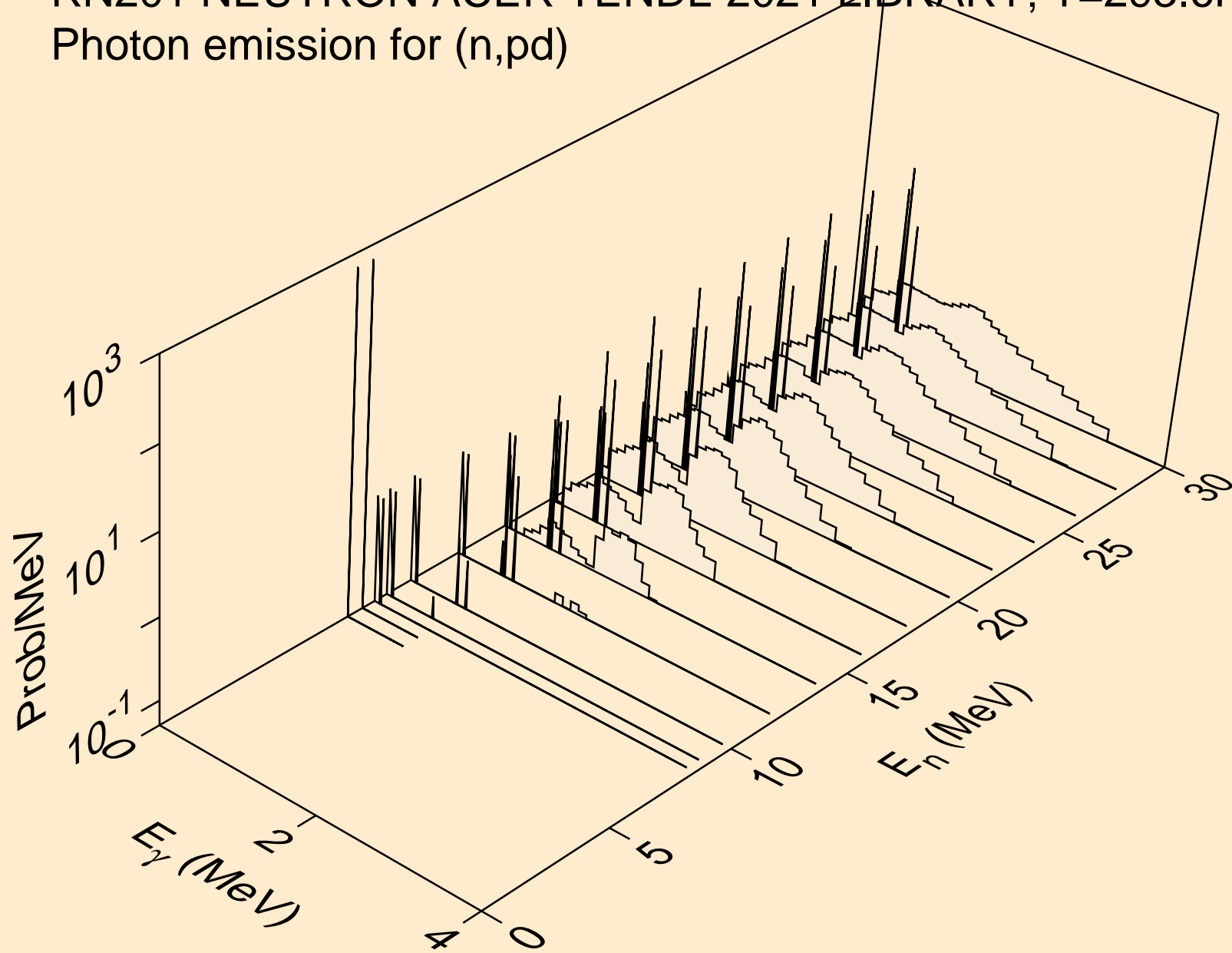

RN201 NEUTRON ACER TENDL-2021 LIBRARY; T=293.6K
Photon emission for (n,pt)

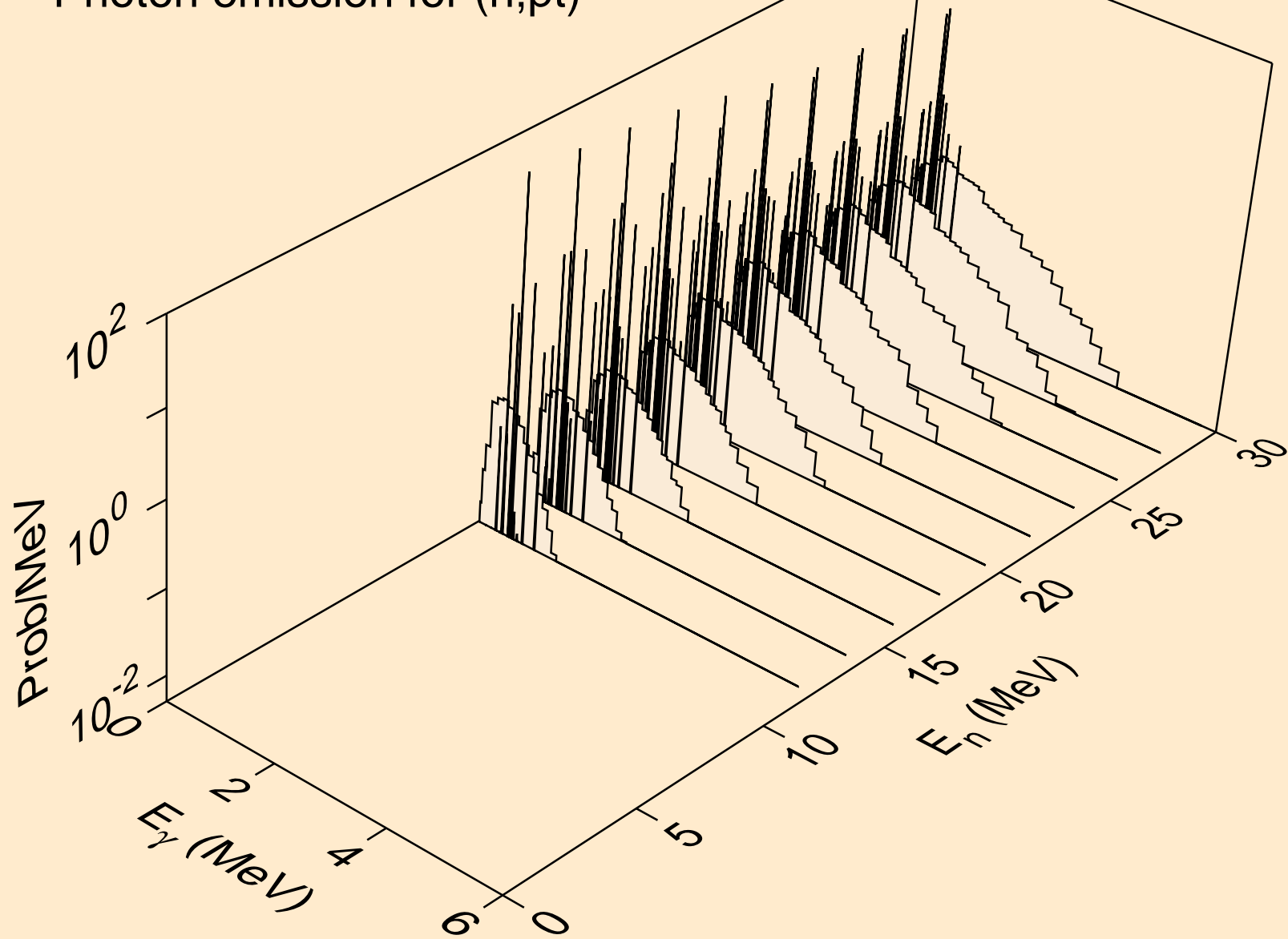

RN201 NEUTRON ACER TENDL-2021 LIBRARY; T=293.6K
Photon emission for (n,da)

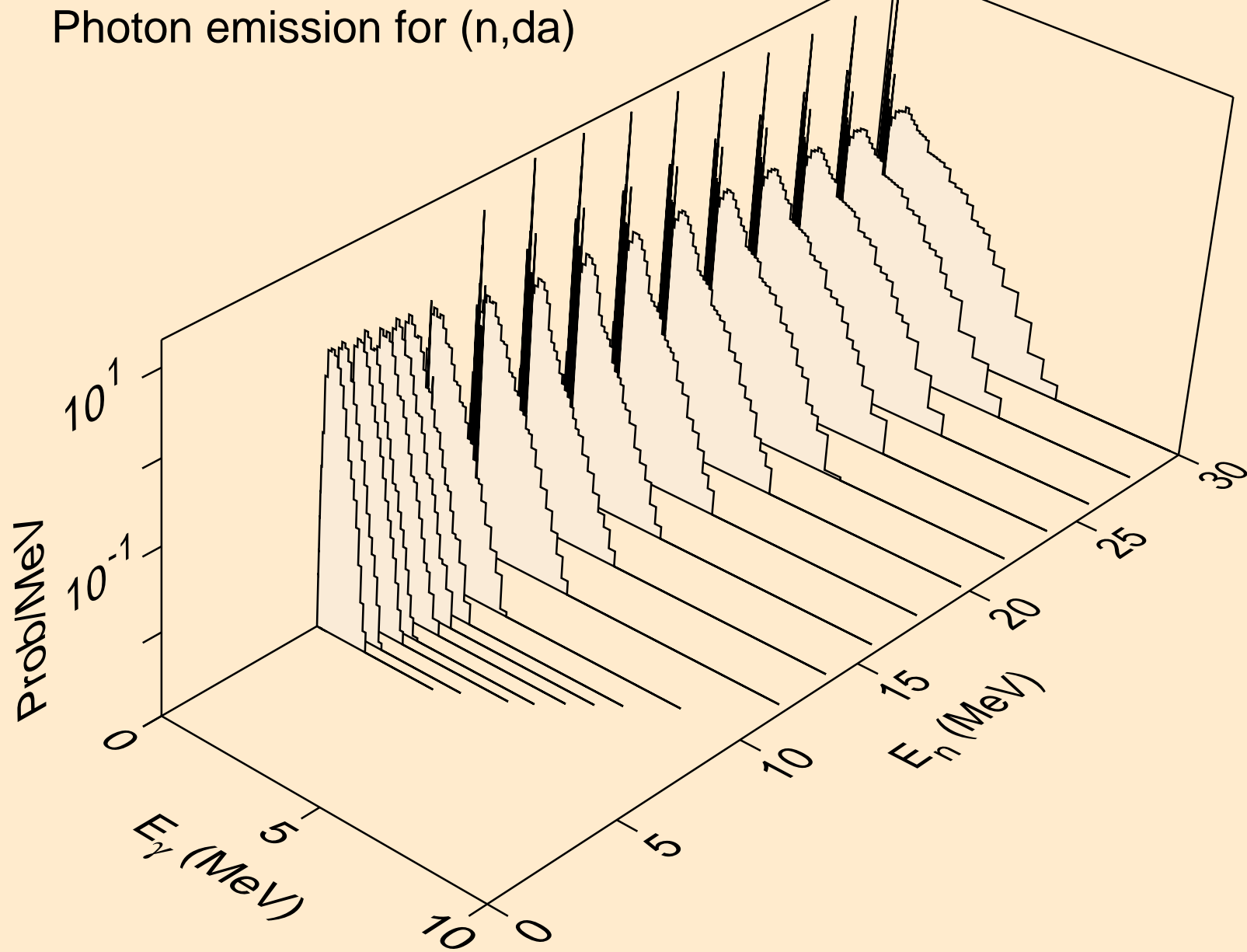

RN201 NEUTRON ACER TENDL-2021 LIBRARY; T=293.6K
thermal capture photon spectrum

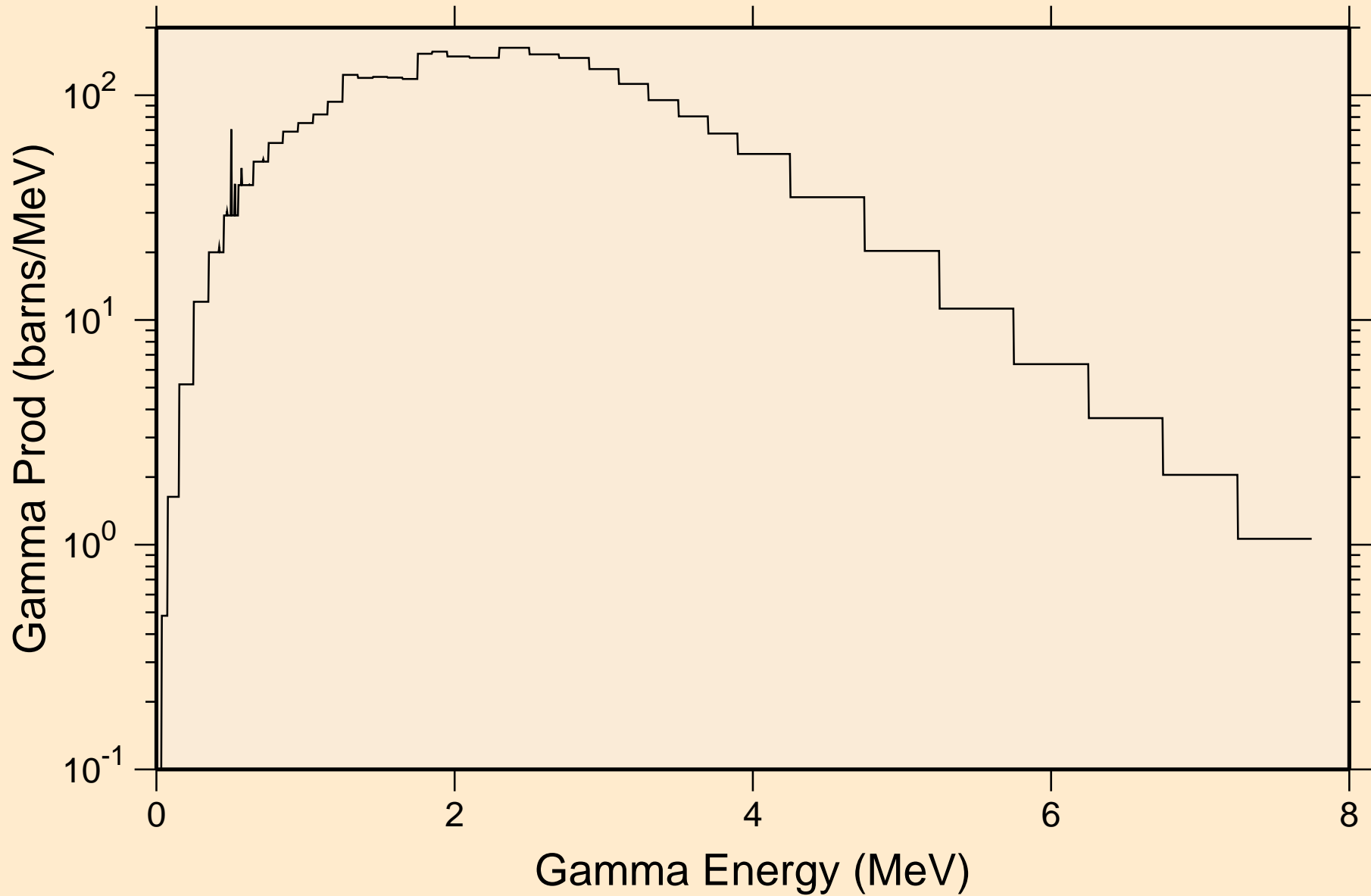

RN201 NEUTRON ACER TENDL-2021 LIBRARY; T=293.6K
14 MeV photon spectrum

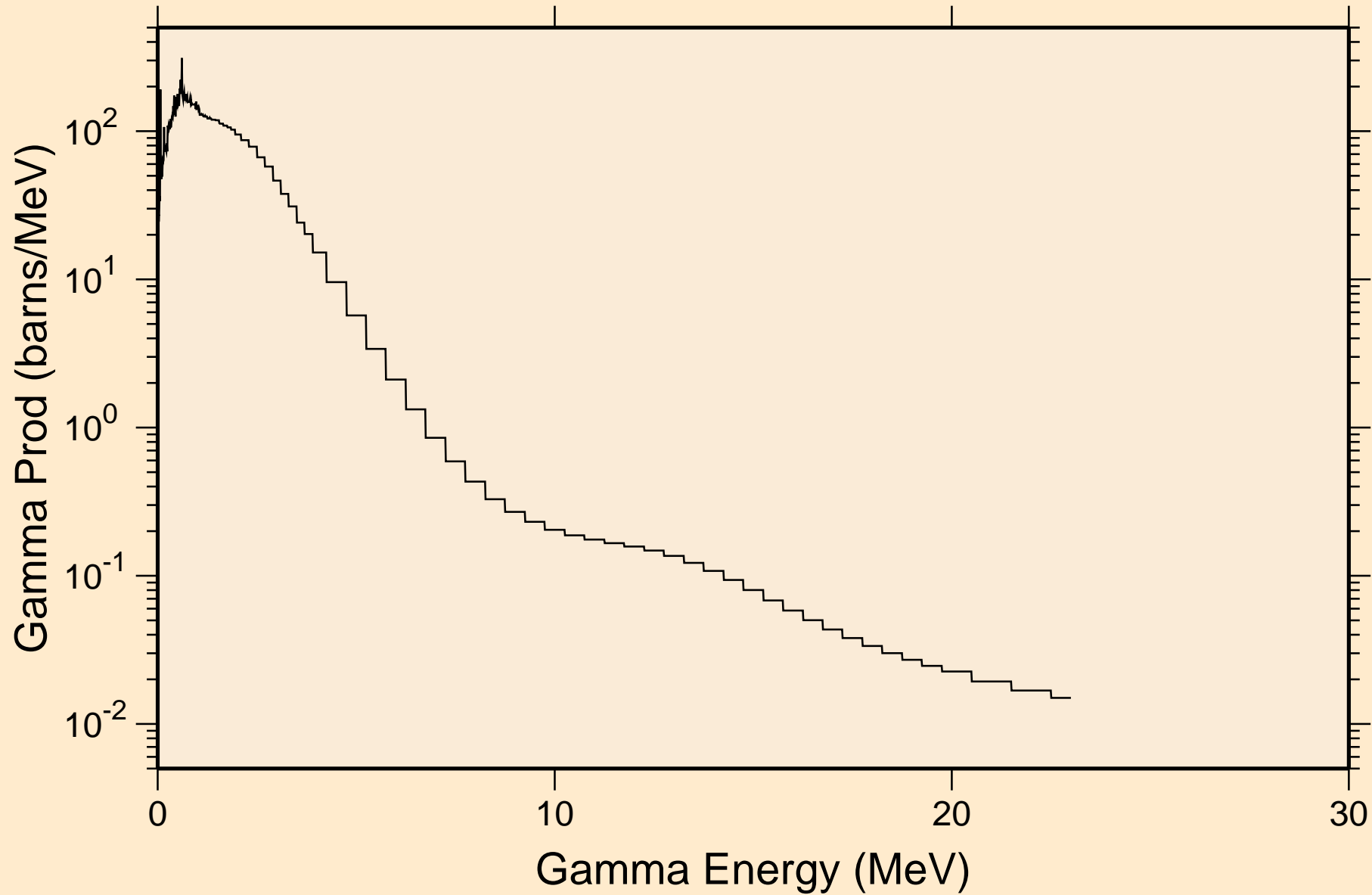

RN201 NEUTRON ACER TENDL-2021 LIBRARY; T=293.6K
Particle heating contributions

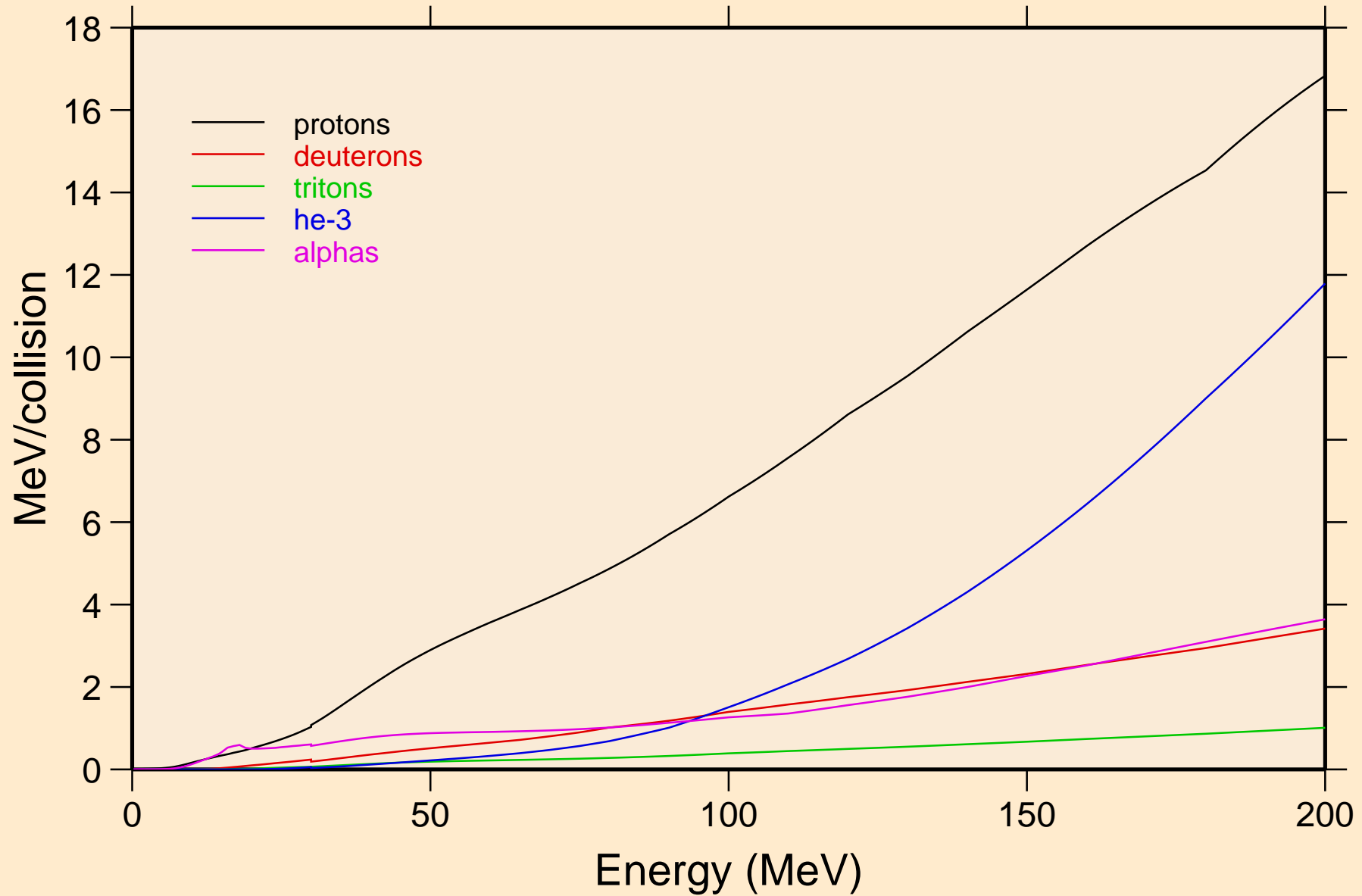

RN201 NEUTRON ACER TENDL-2021 LIBRARY; T=293.6K
Recoil Heating

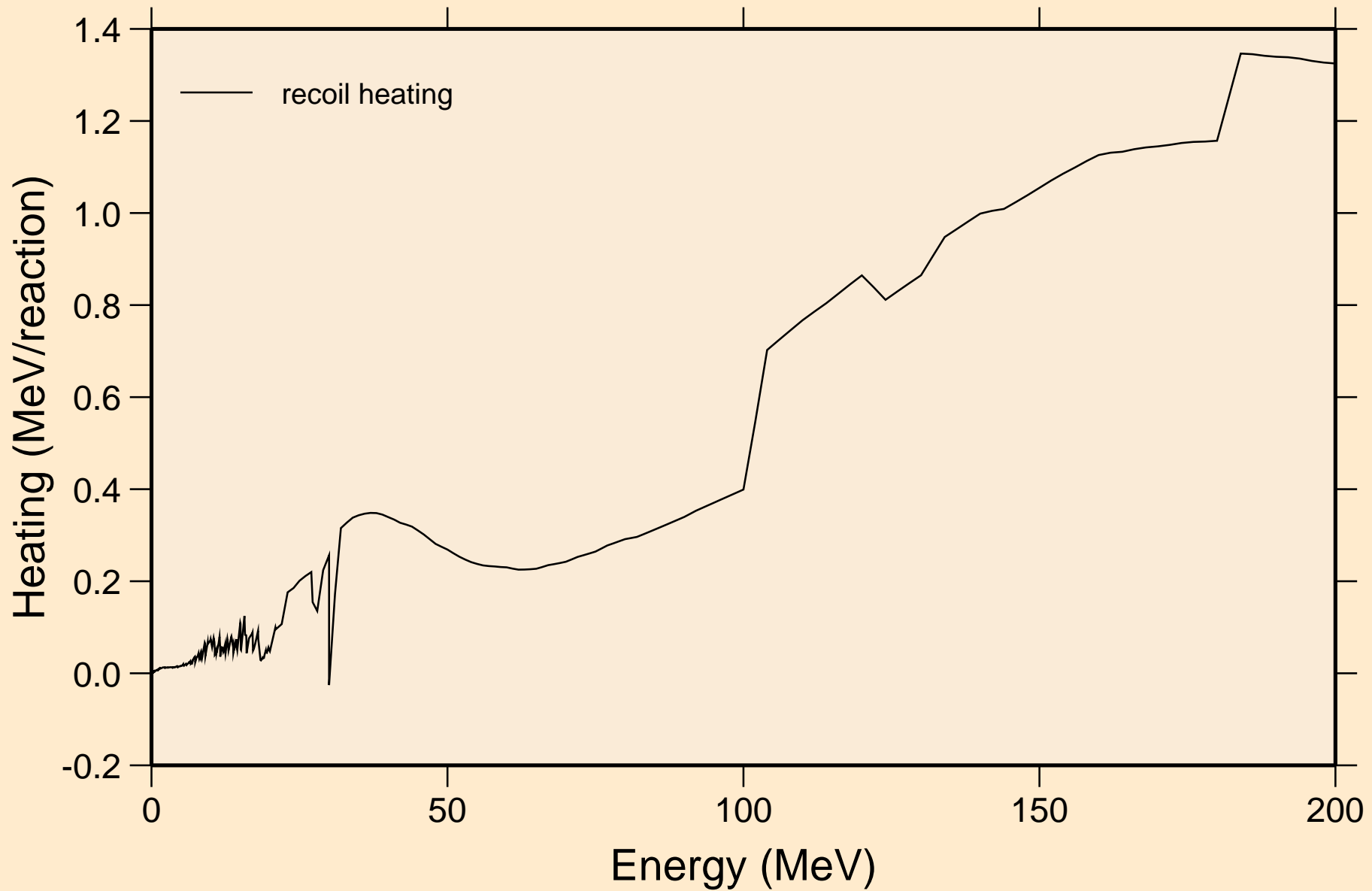

RN201 NEUTRON ACER TENDL-2021 LIBRARY; T=293.6K
Particle production cross sections

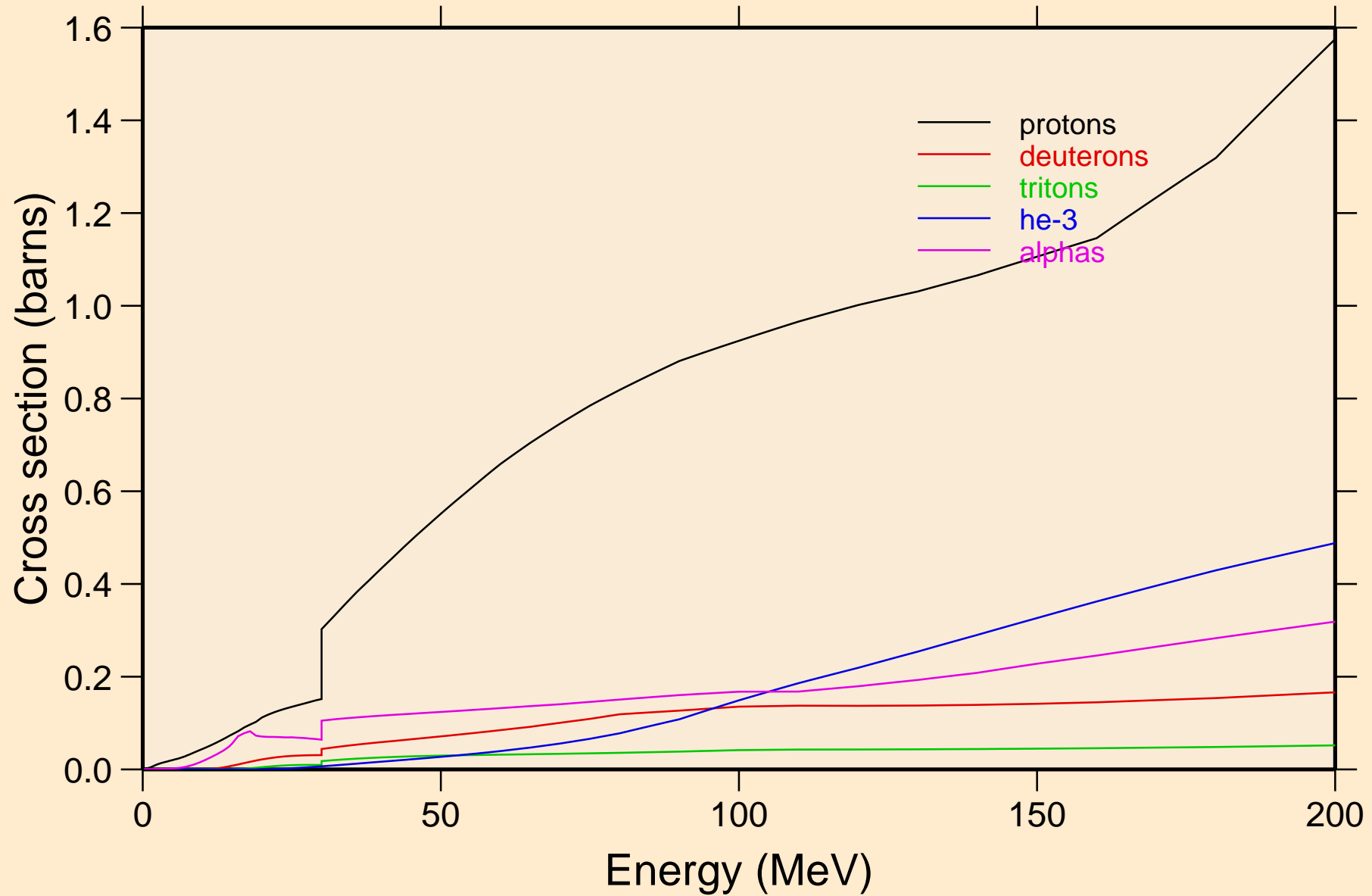

RN201 NEUTRON ACER TENDL-2021 LIBRARY; T=293.6K
protons from (n,x)

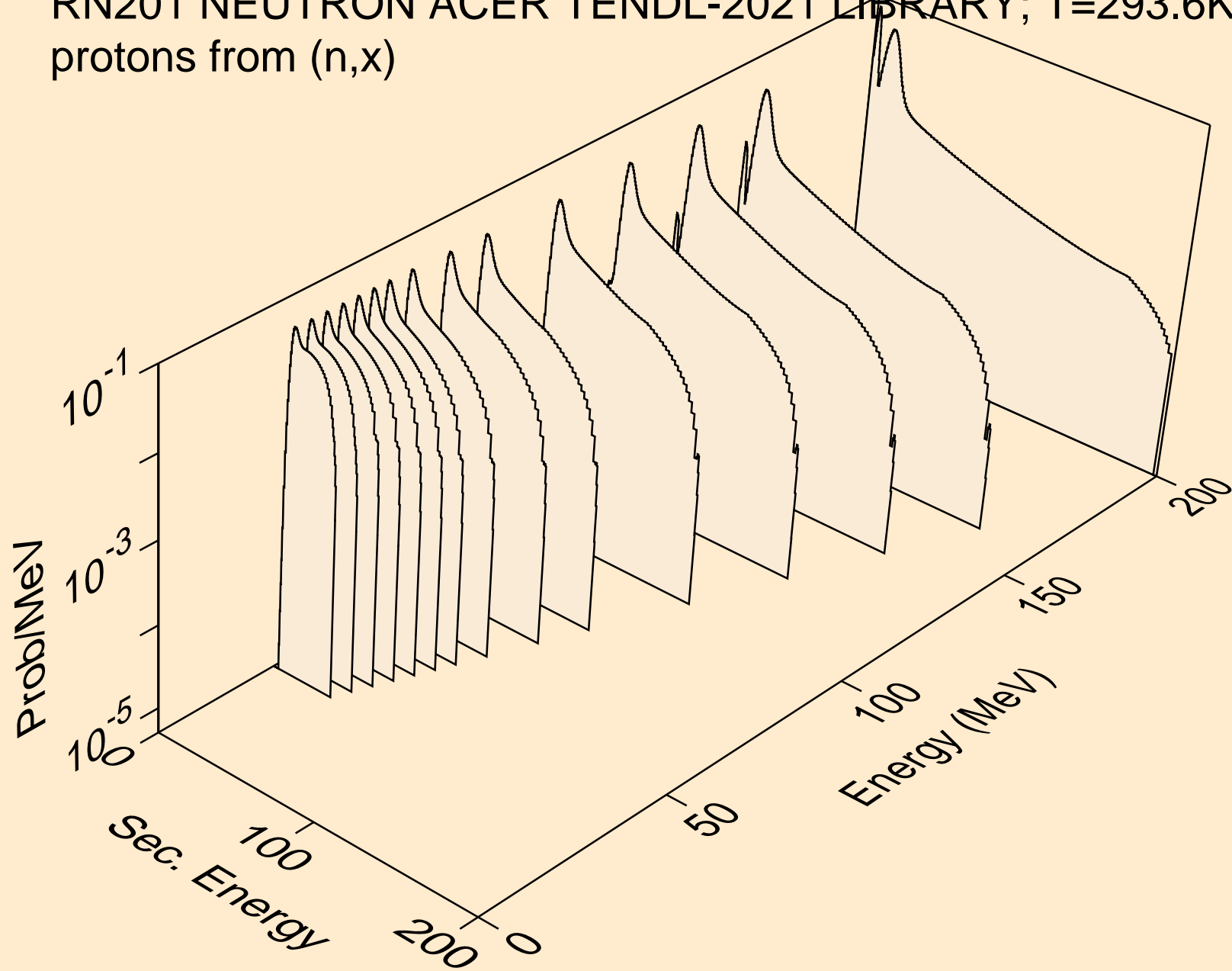

RN201 NEUTRON ACER TENDL-2021 LIBRARY; T=293.6K
protons from (n,n*)p

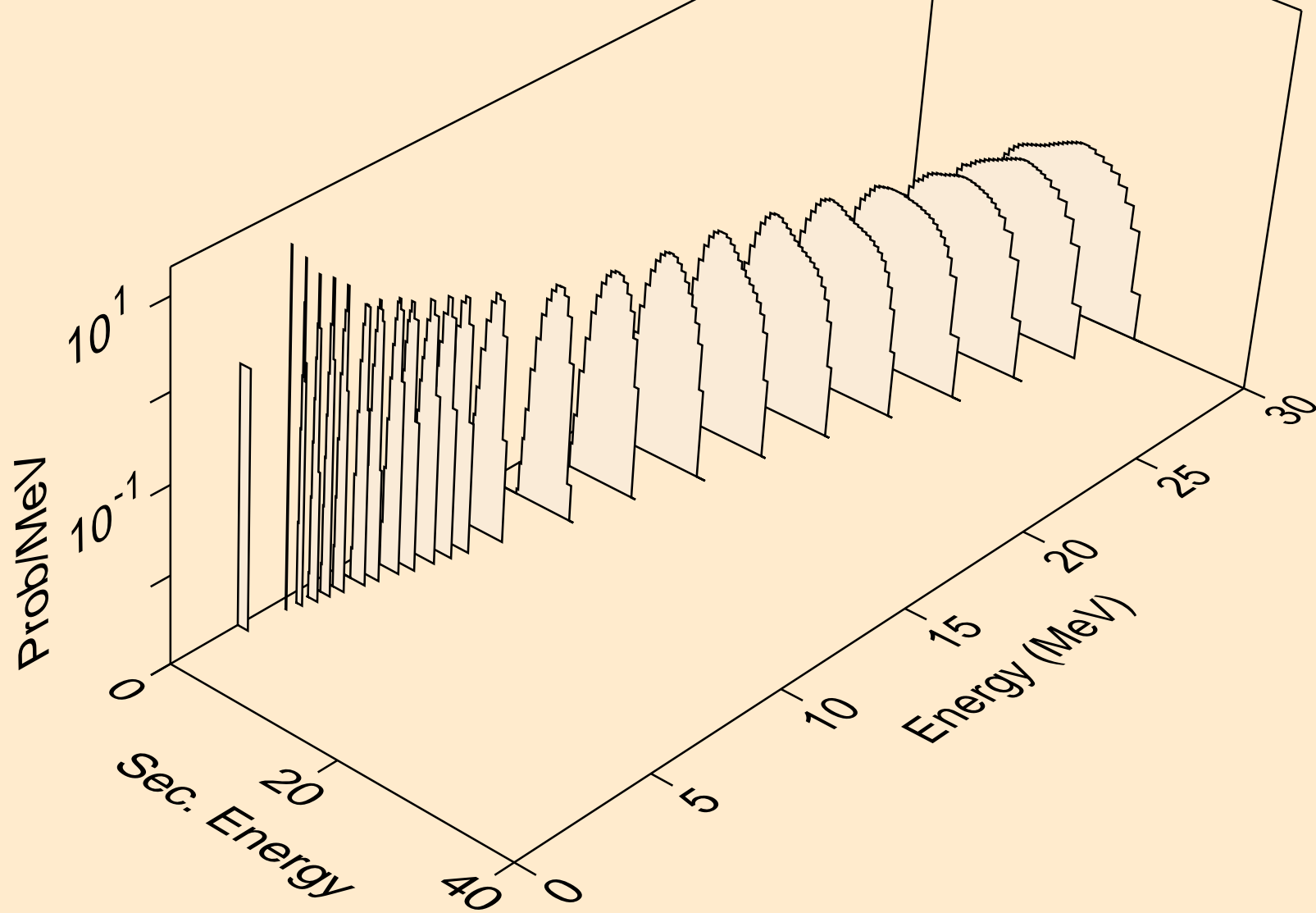

RN201 NEUTRON ACER TENDL-2021 LIBRARY; T=293.6K
protons from (n,2np)

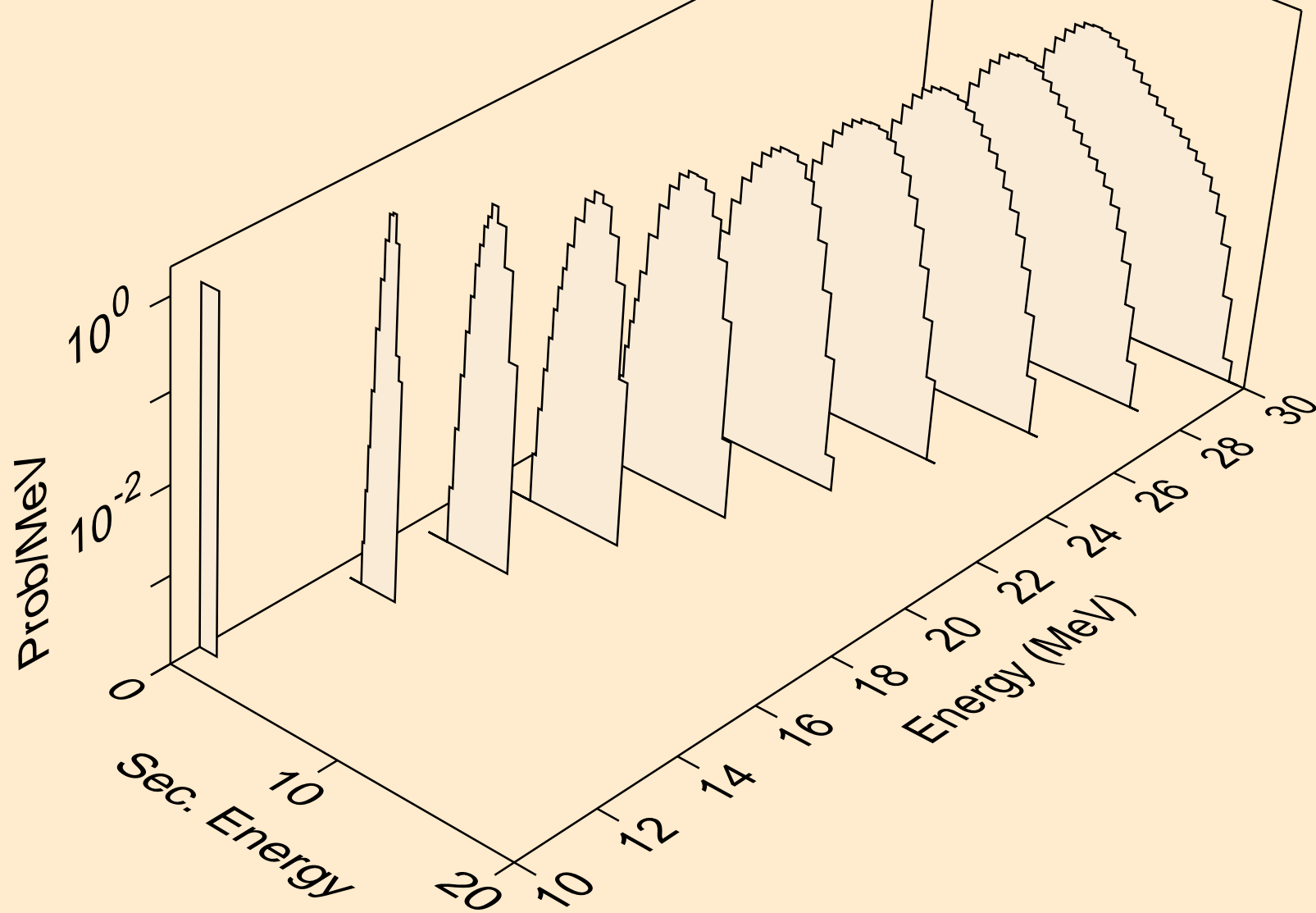

RN201 NEUTRON ACER TENDL-2021 LIBRARY; T=293.6K
protons from (n,3np)

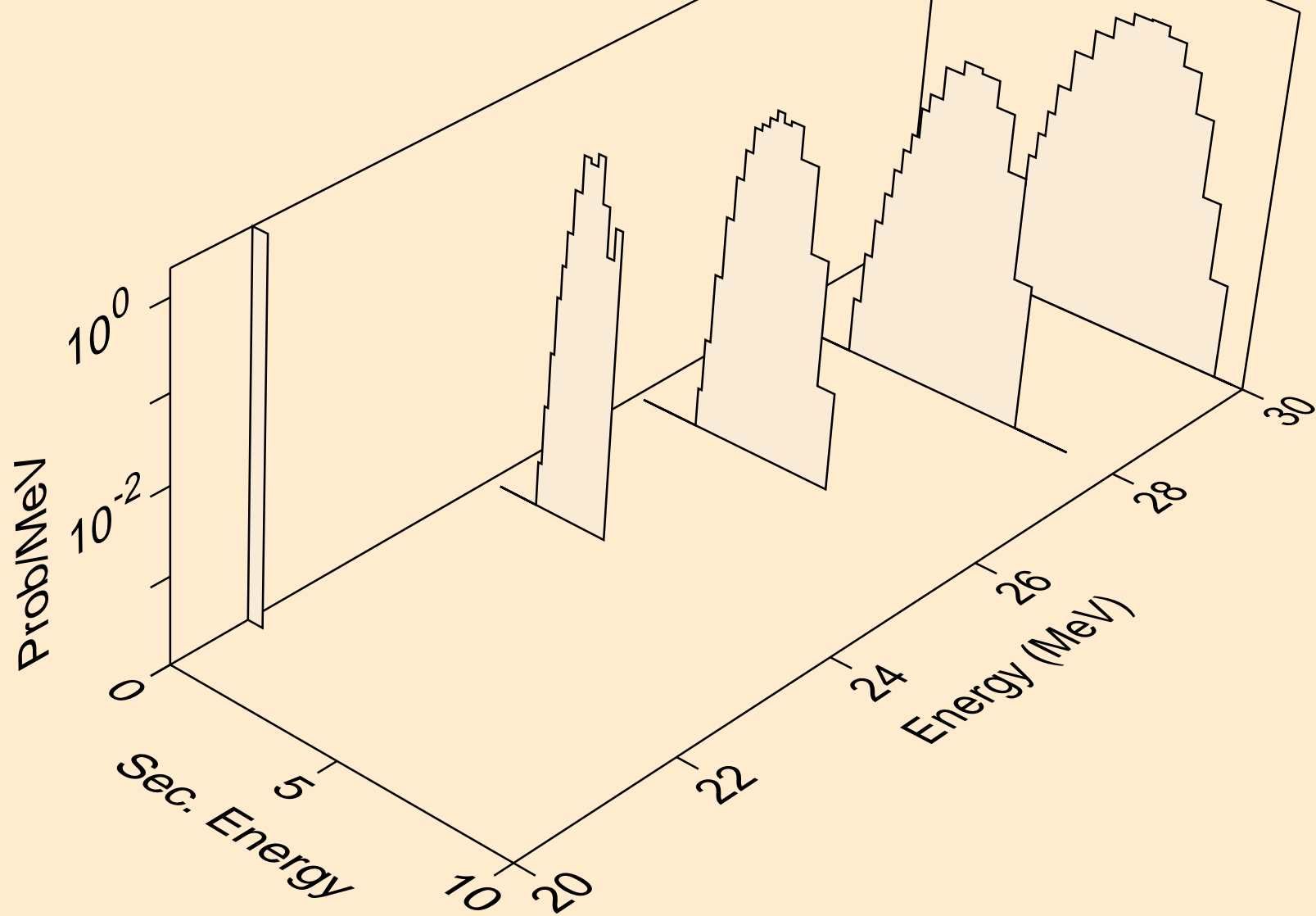

RN201 NEUTRON ACER TENDL-2021 LIBRARY; T=293.6K
protons from (n,2np)

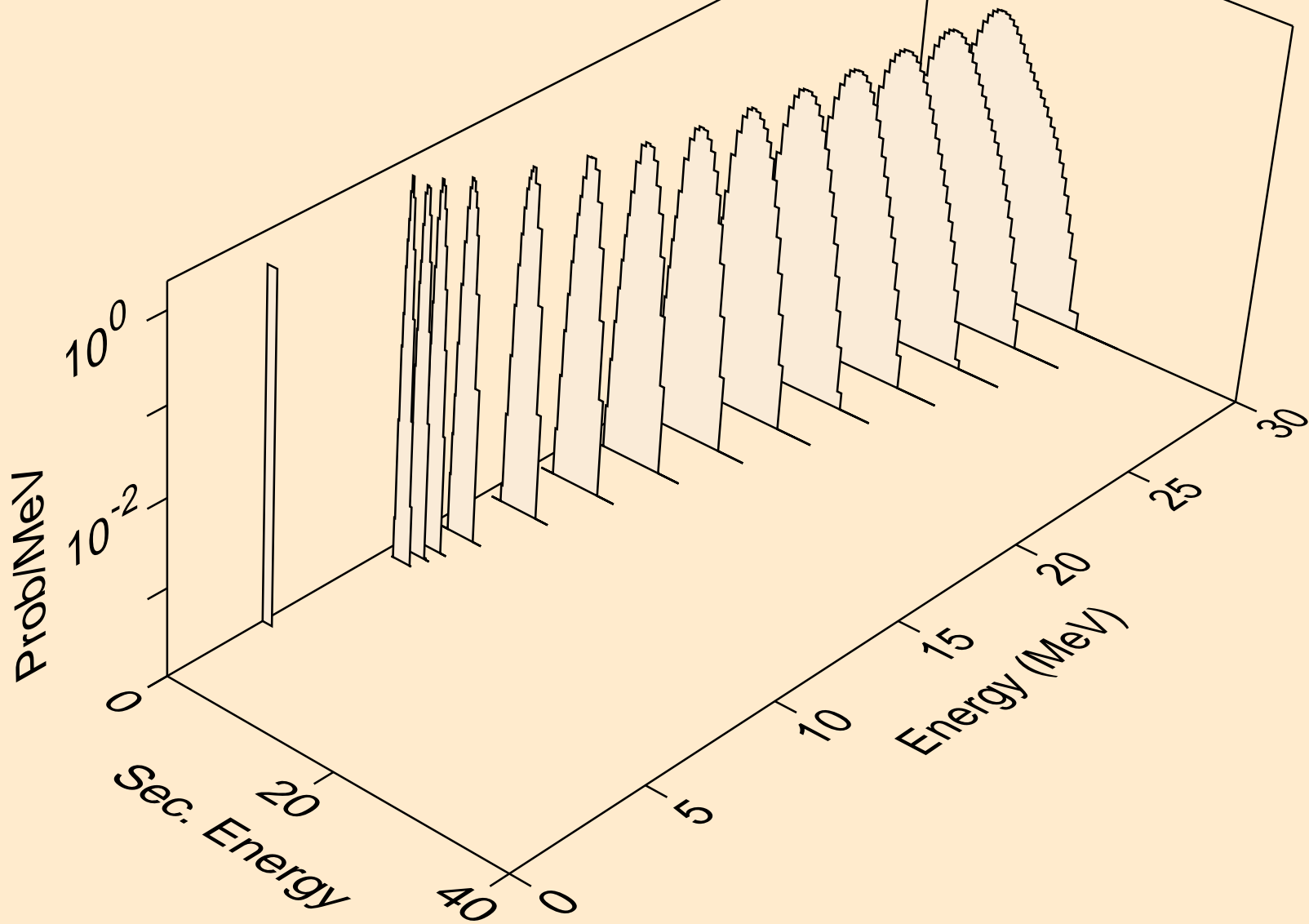

RN201 NEUTRON ACER TENDL-2021 LIBRARY; T=293.6K
protons from (n,npa)

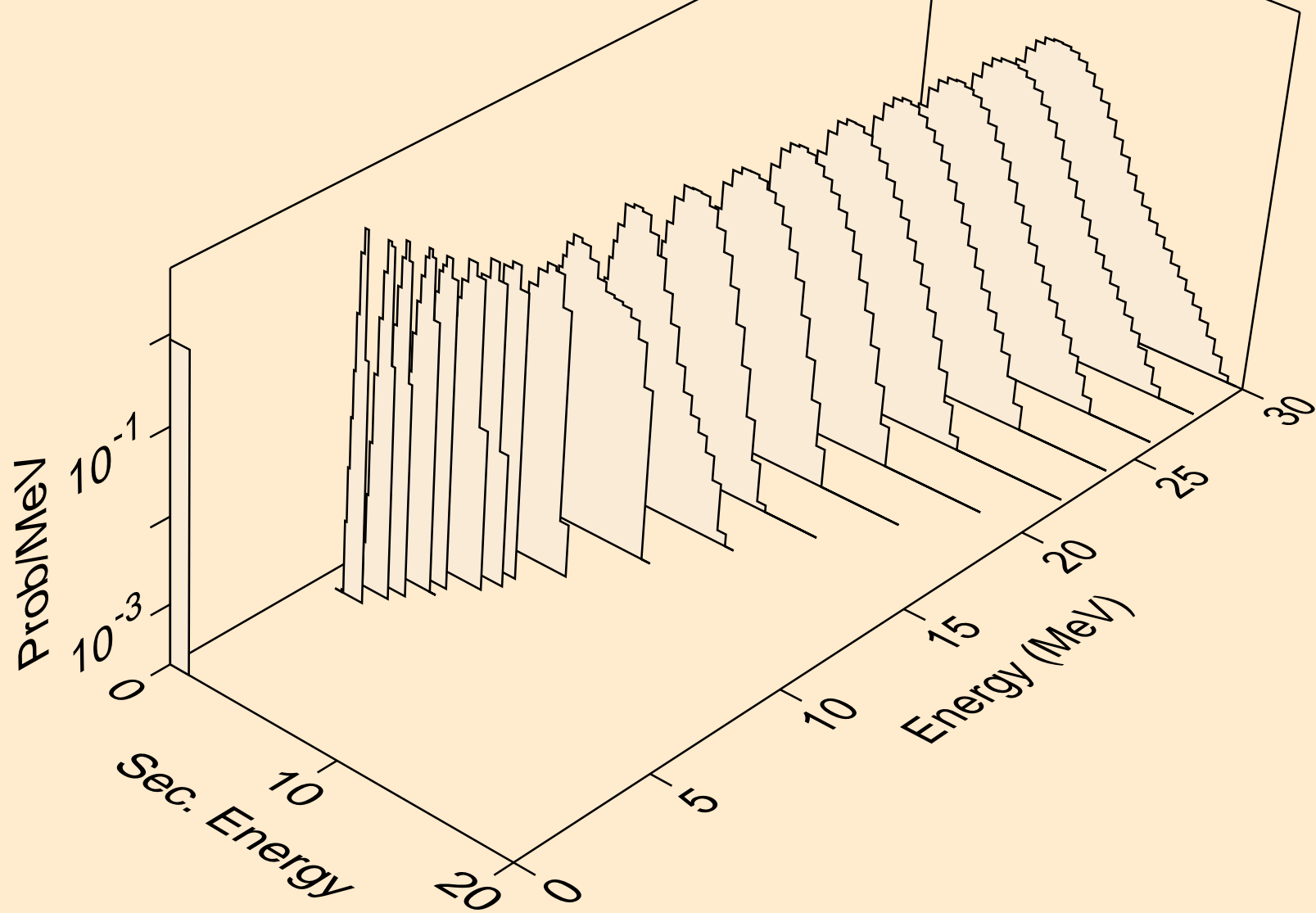

RN201 NEUTRON ACER TENDL-2021 LIBRARY; T=293.6K
protons from (n,p)

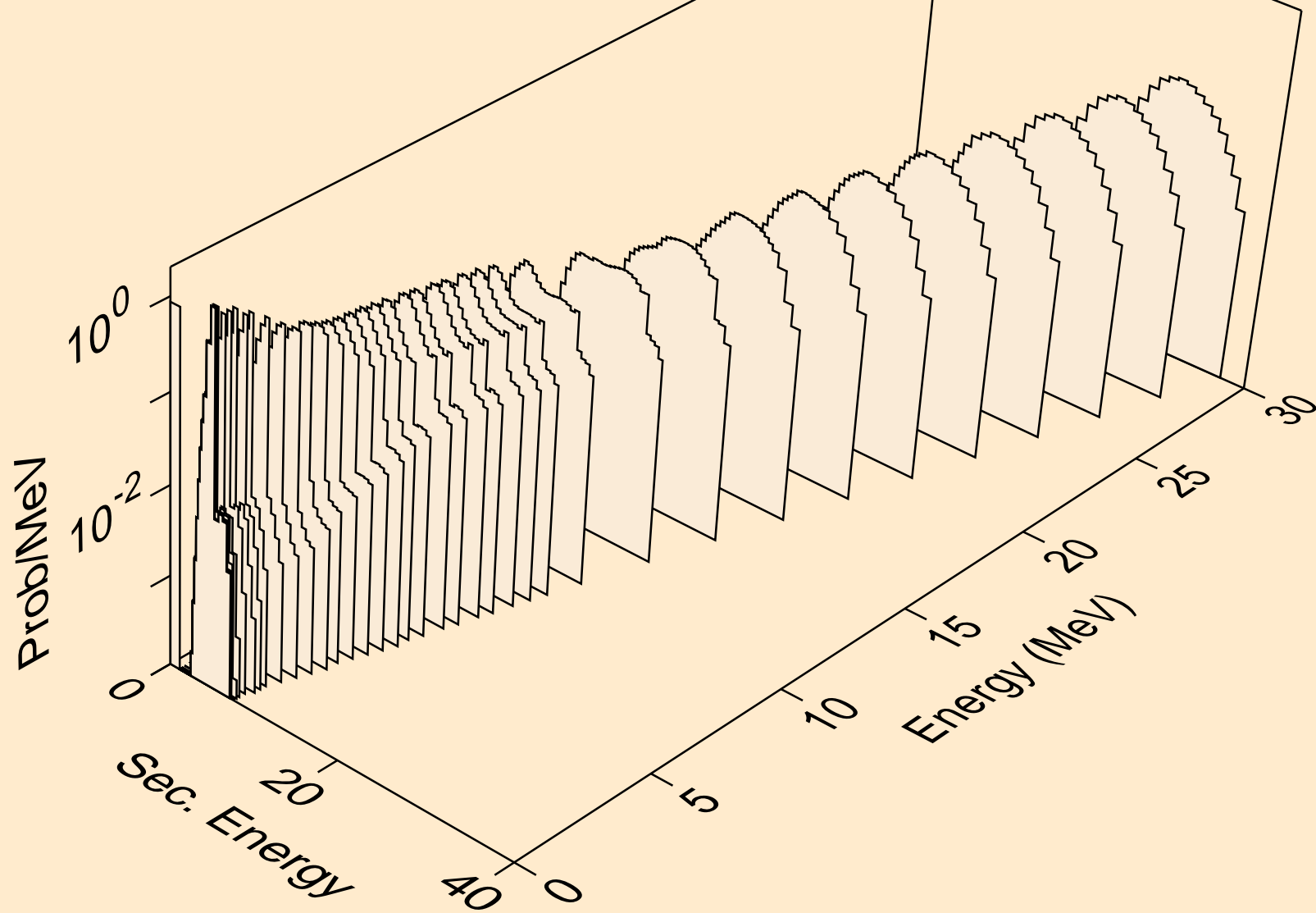

RN201 NEUTRON ACER TENDL-2021 LIBRARY; T=293.6K
protons from (n,2p)

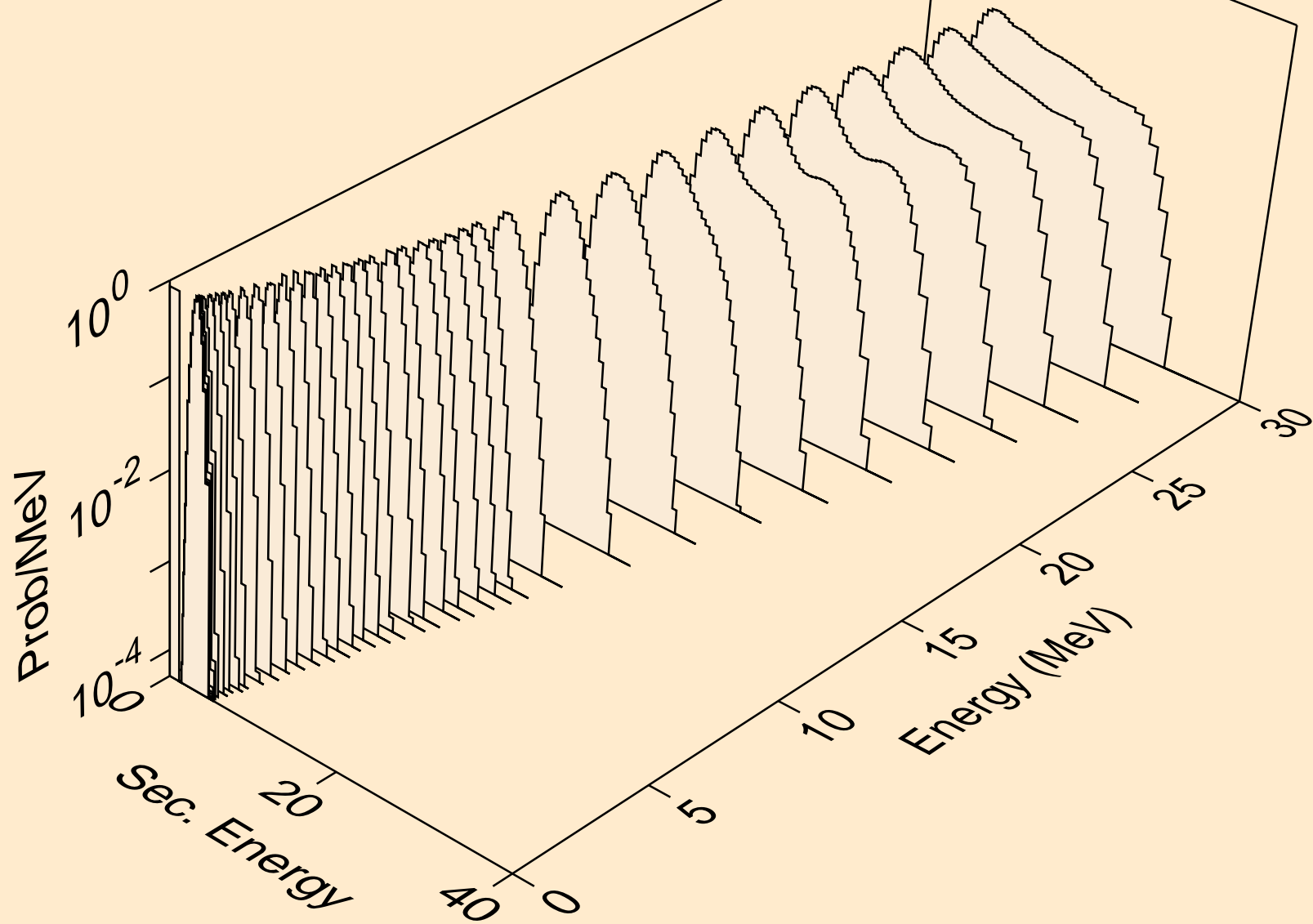

RN201 NEUTRON ACER TENDL-2021 LIBRARY; T=293.6K
protons from (n,p)

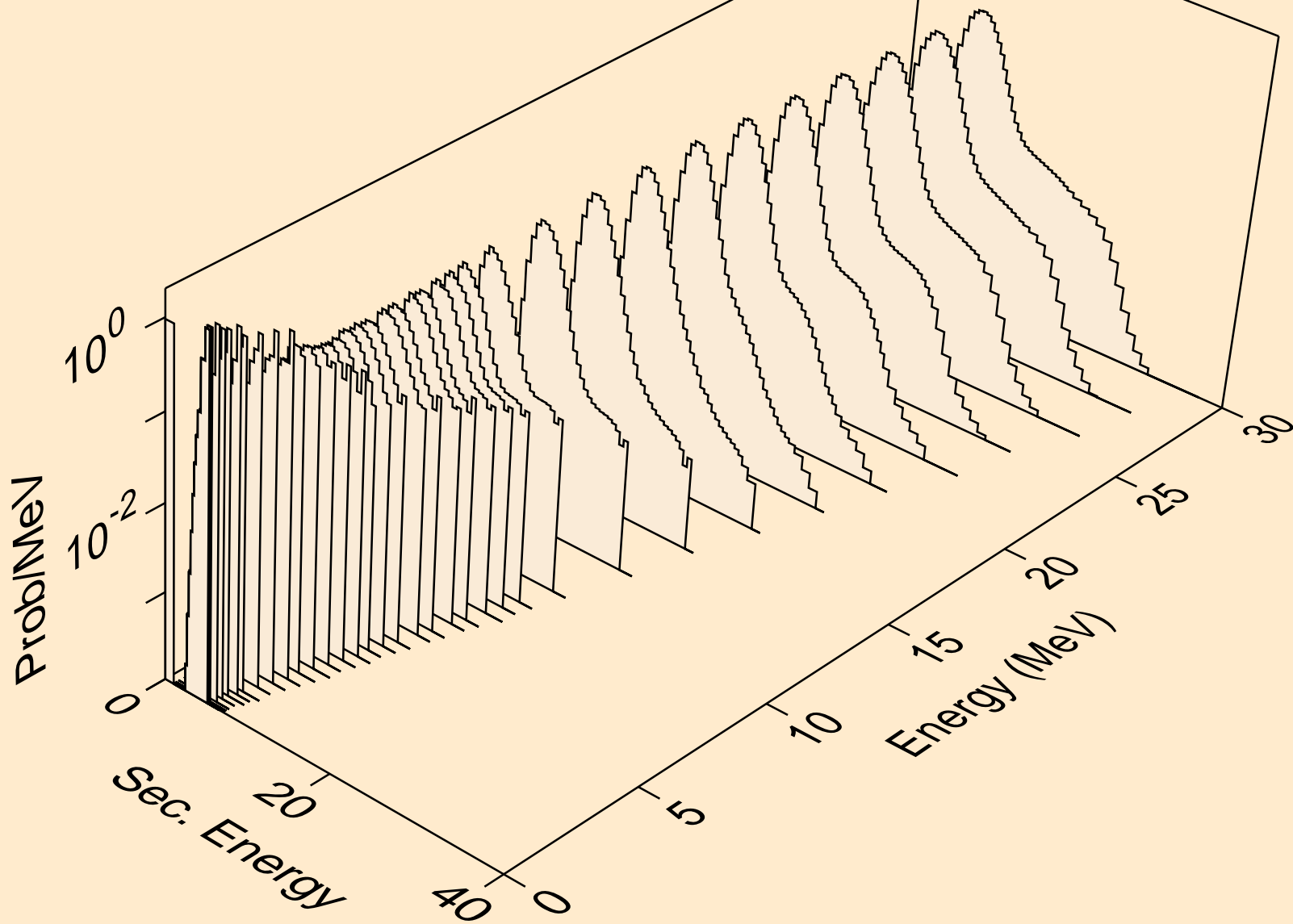

RN201 NEUTRON ACER TENDL-2021 LIBRARY; T=293.6K
protons from (n,pd)

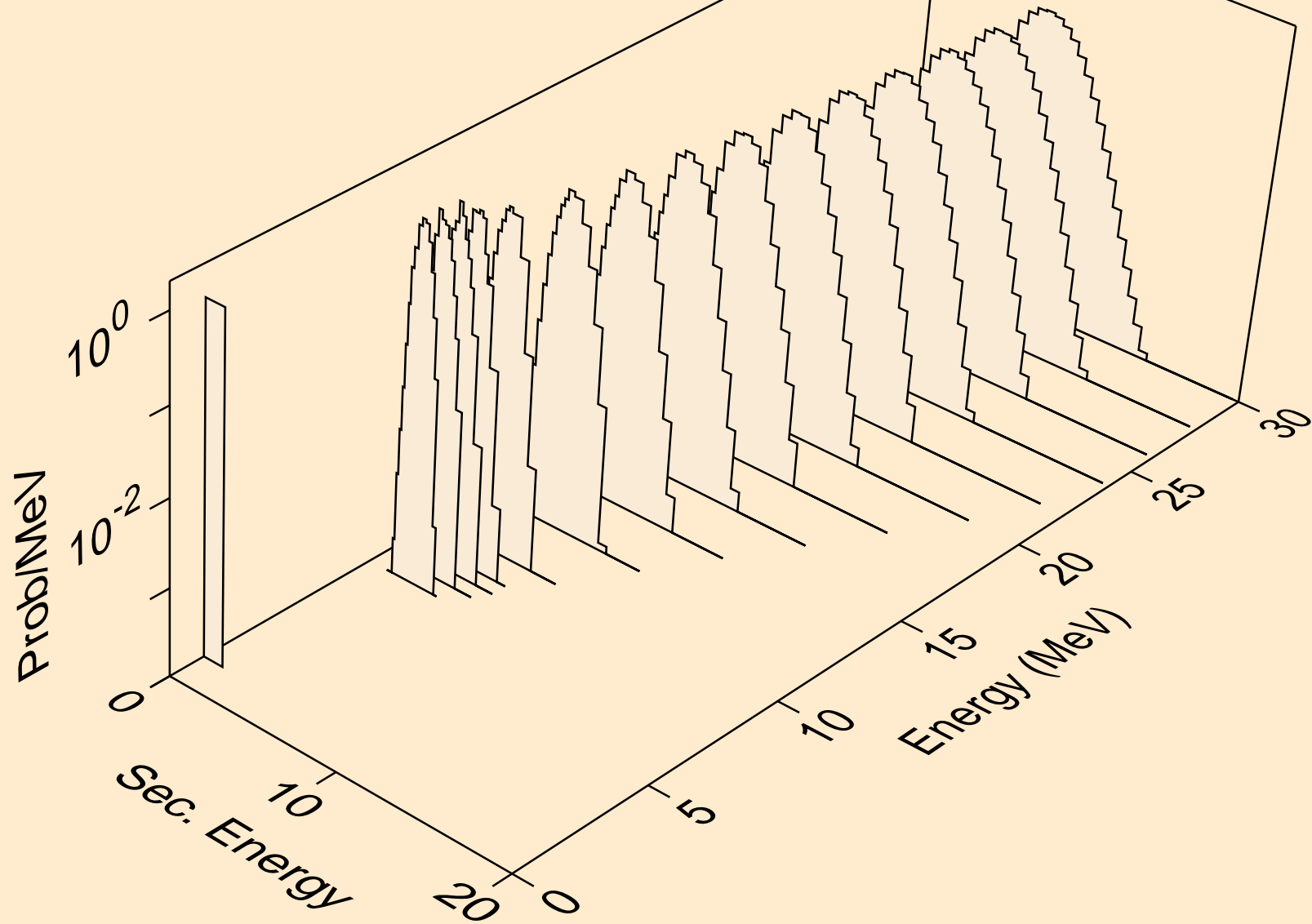

RN201 NEUTRON ACER TENDL-2021 LIBRARY; T=293.6K
protons from (n,pt)

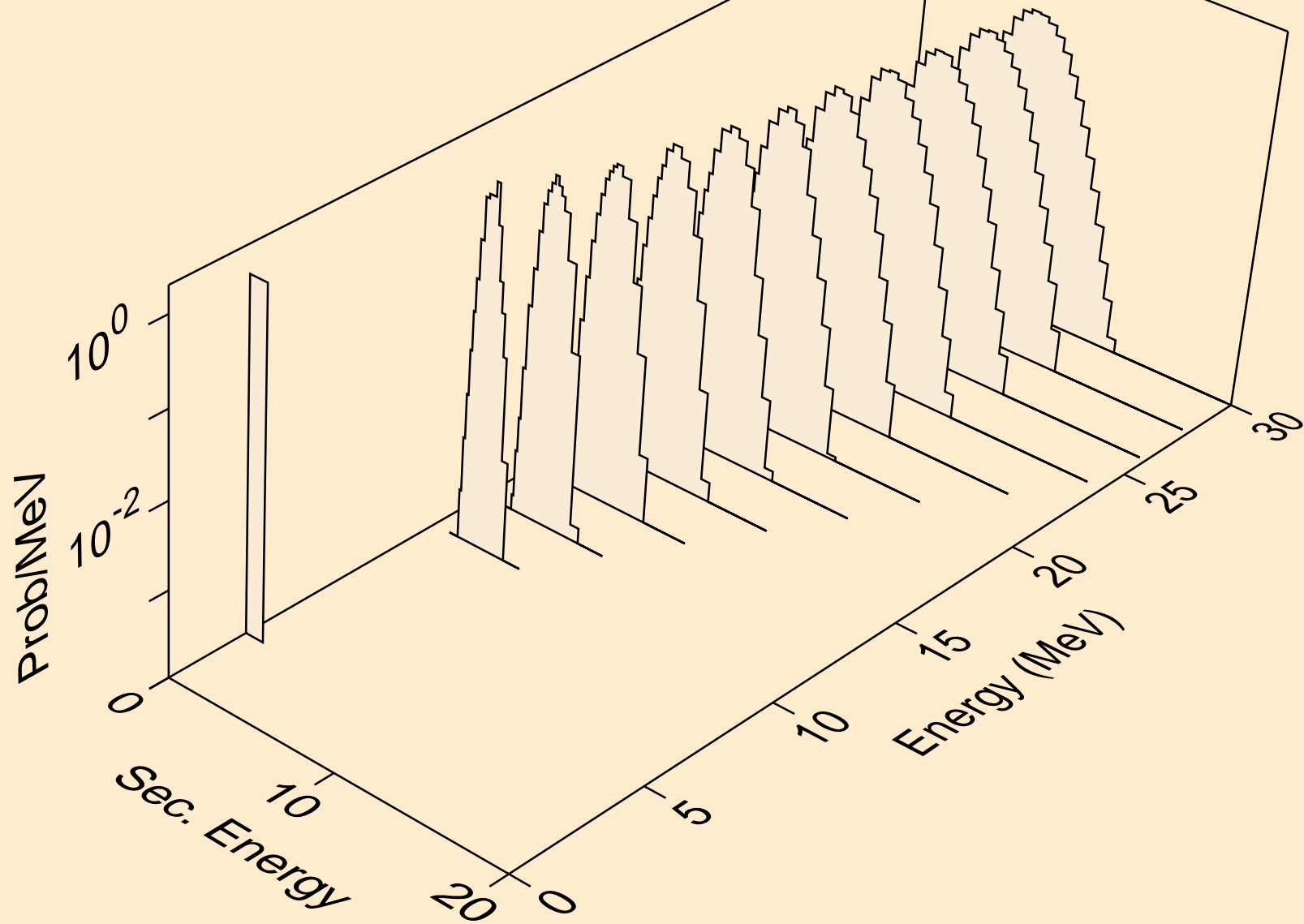

RN201 NEUTRON ACER TENDL-2021 LIBRARY; T=293.6K
deuterons from (n,x)

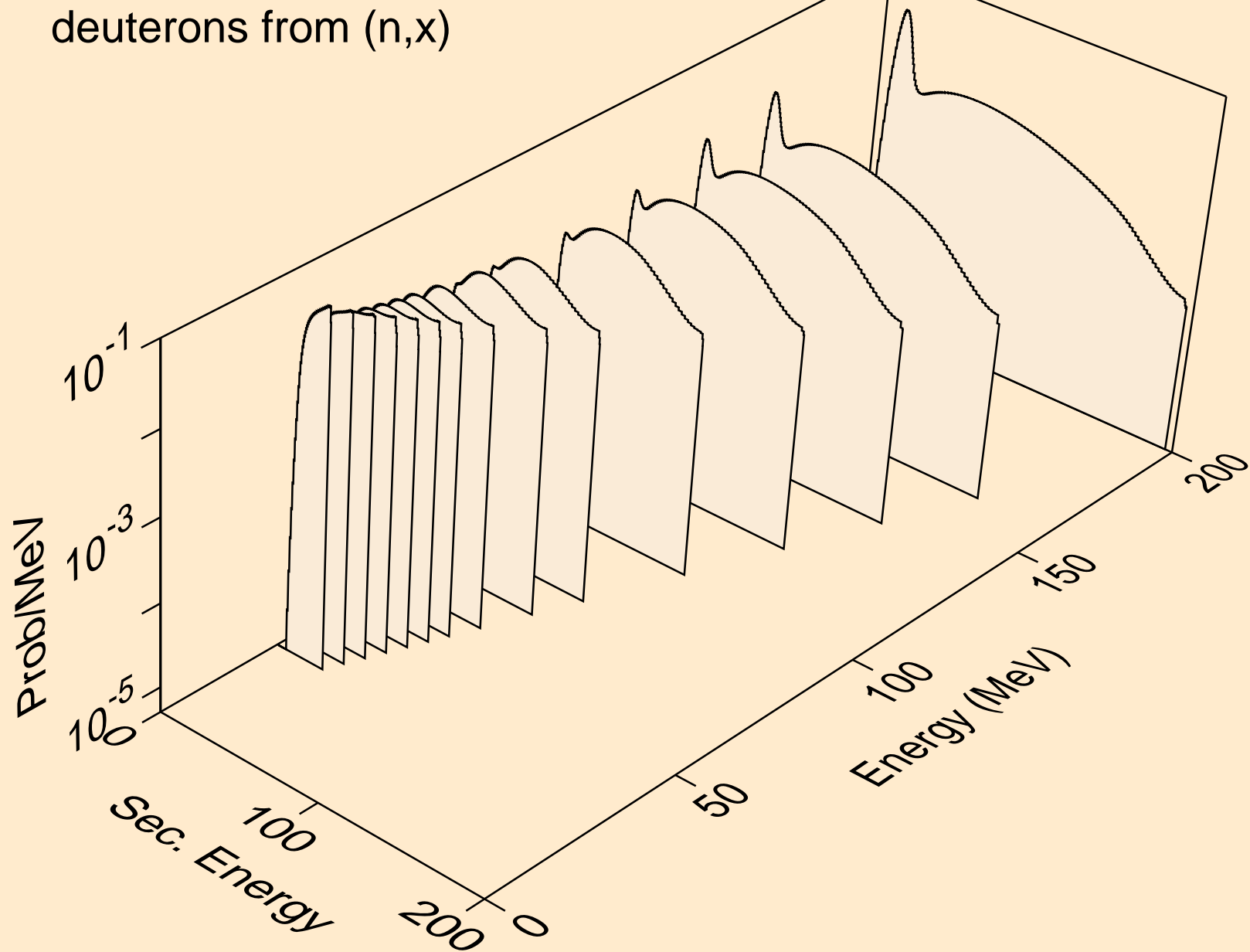

RN201 NEUTRON ACER TENDL-2021 LIBRARY; T=293.6K
deuterons from (n,2nd)

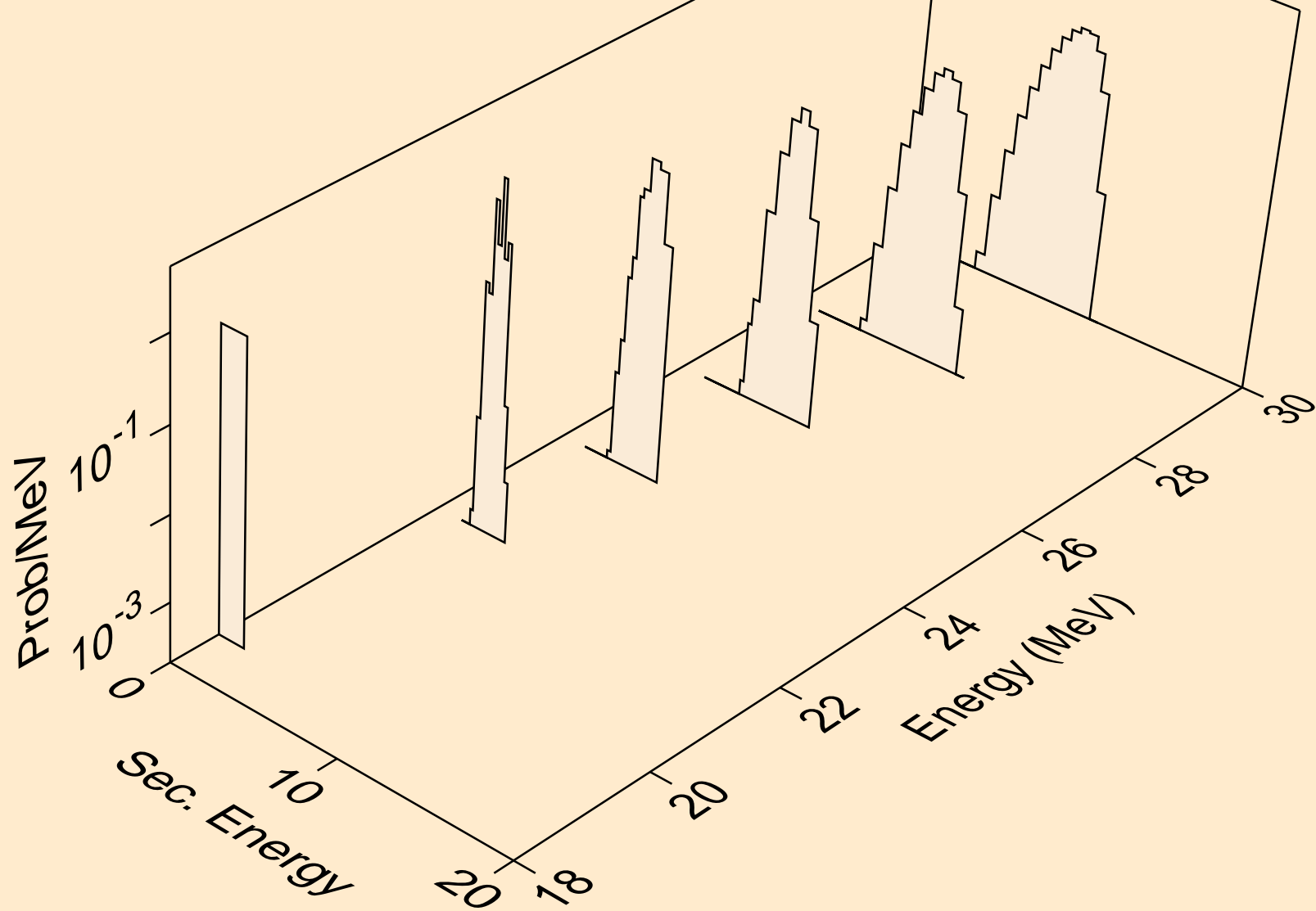

RN201 NEUTRON ACER TENDL-2021 LIBRARY; T=293.6K
deuterons from (n,n*)d

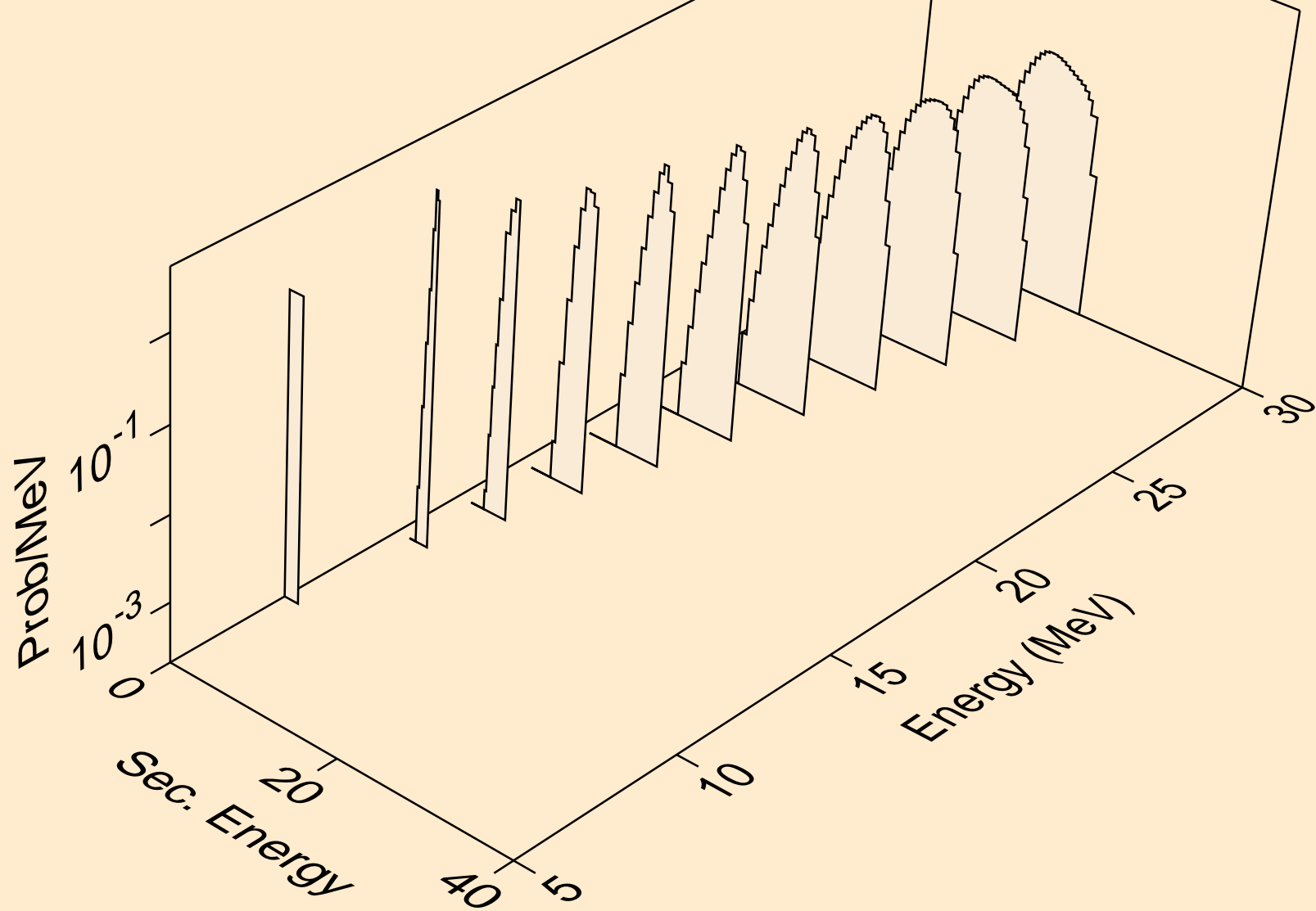

RN201 NEUTRON ACER TENDL-2021 LIBRARY; T=293.6K
deuterons from (n,d)

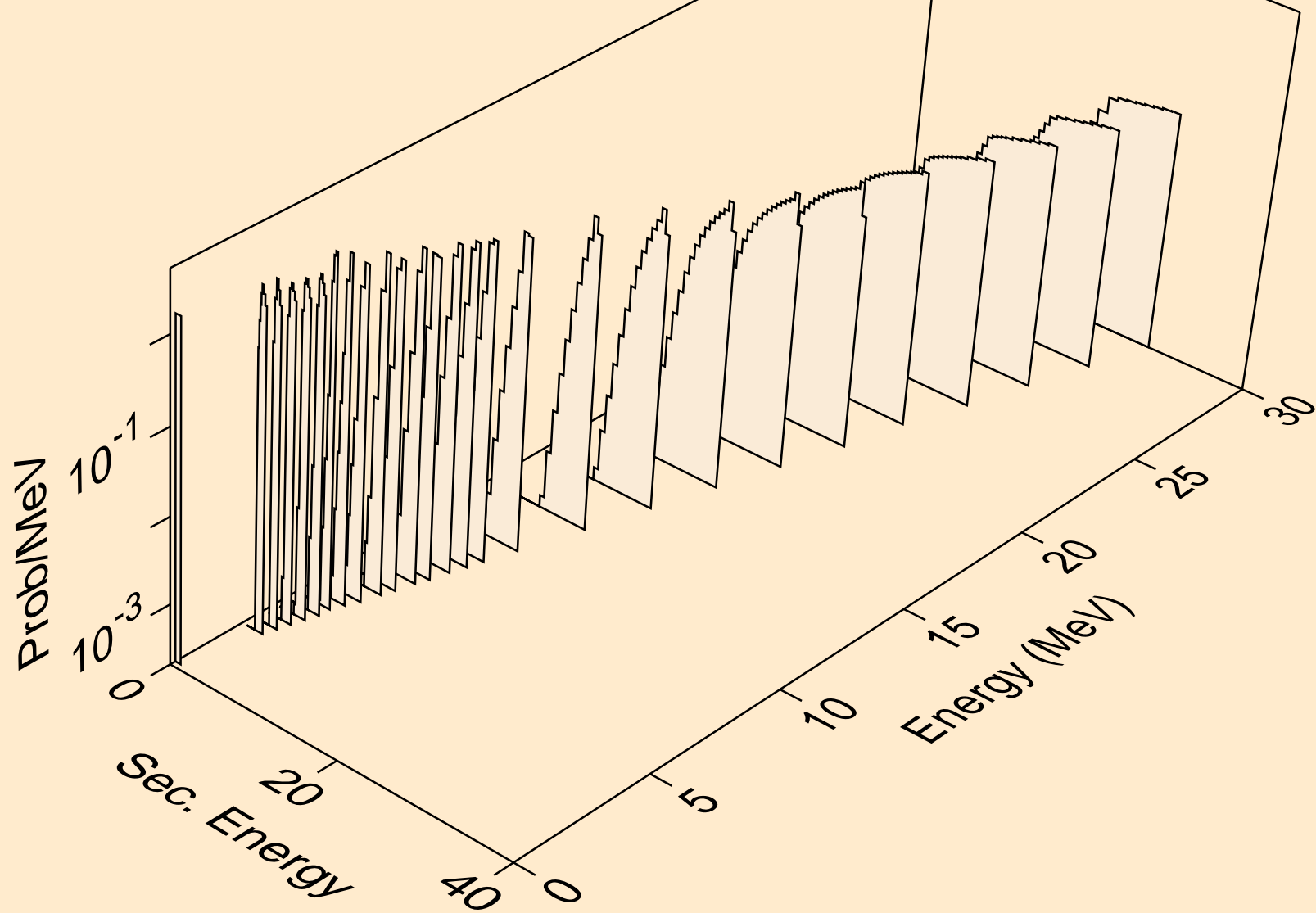

RN201 NEUTRON ACER TENDL-2021 LIBRARY; T=293.6K
deuterons from (n,pd)

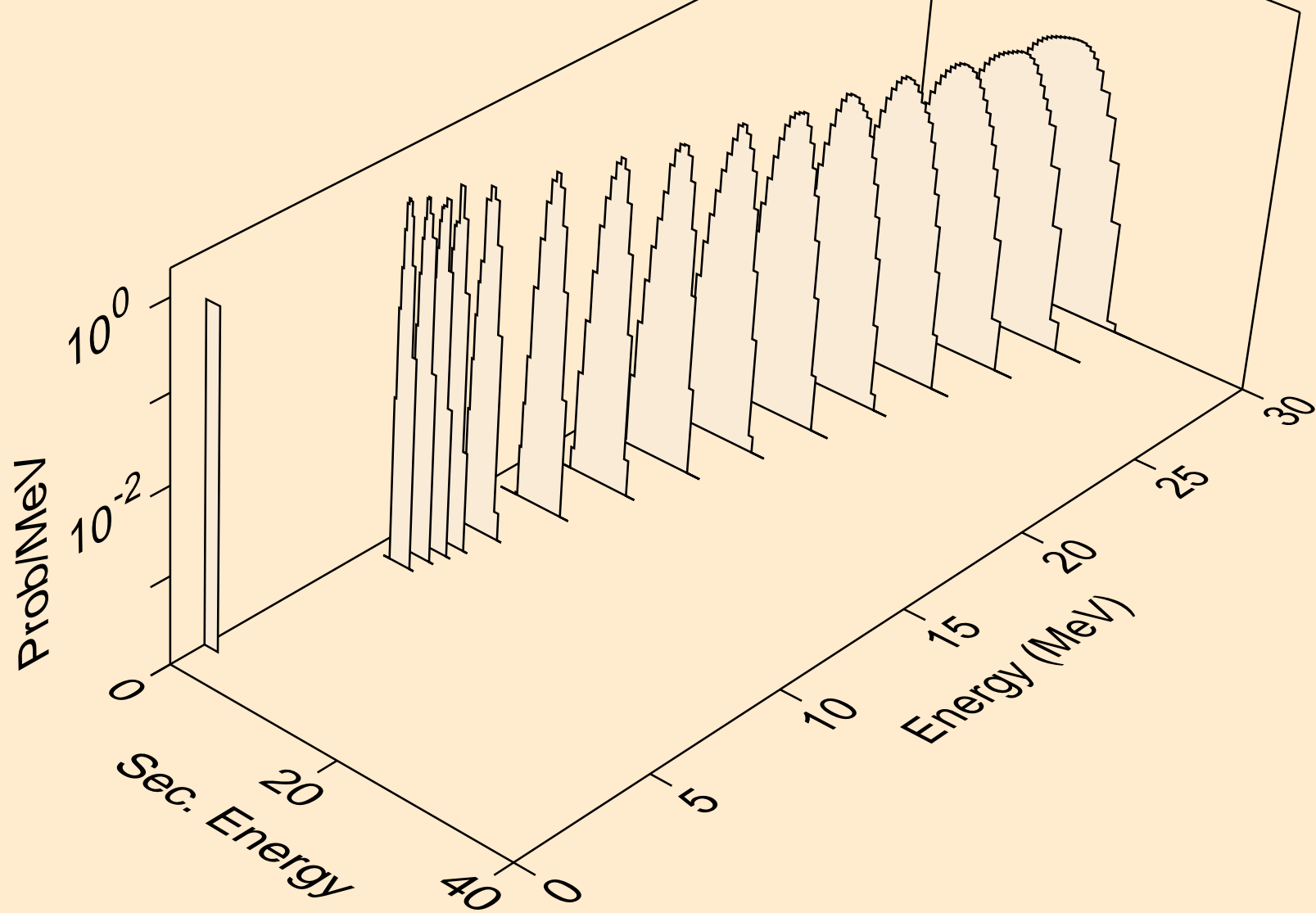

RN201 NEUTRON ACER TENDL-2021 LIBRARY; T=293.6K
deuterons from (n,da)

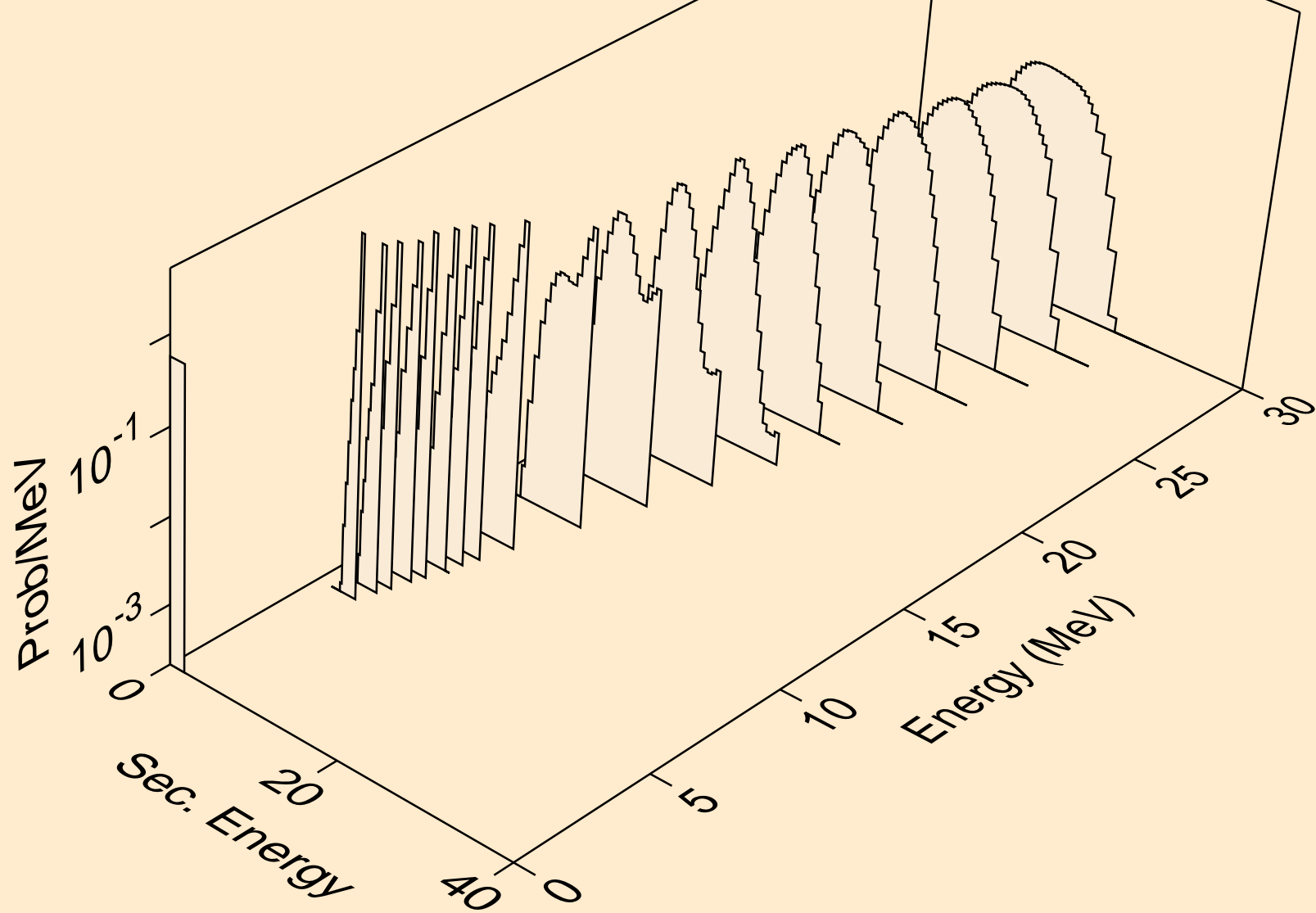

RN201 NEUTRON ACER TENDL-2021 LIBRARY; T=293.6K
tritons from (n,x)

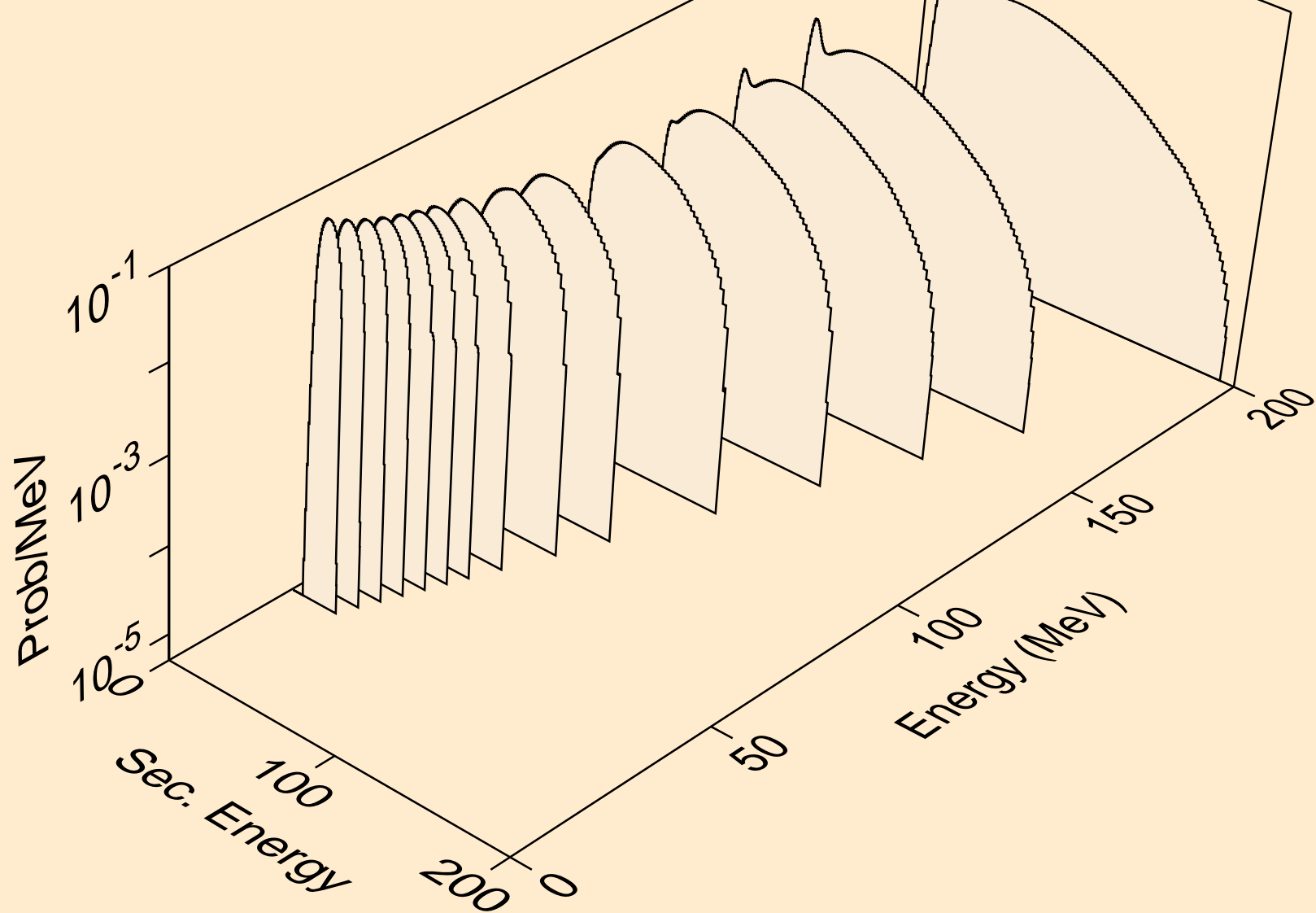

RN201 NEUTRON ACER TENDL-2021 LIBRARY; T=293.6K
tritons from (n,n*)t

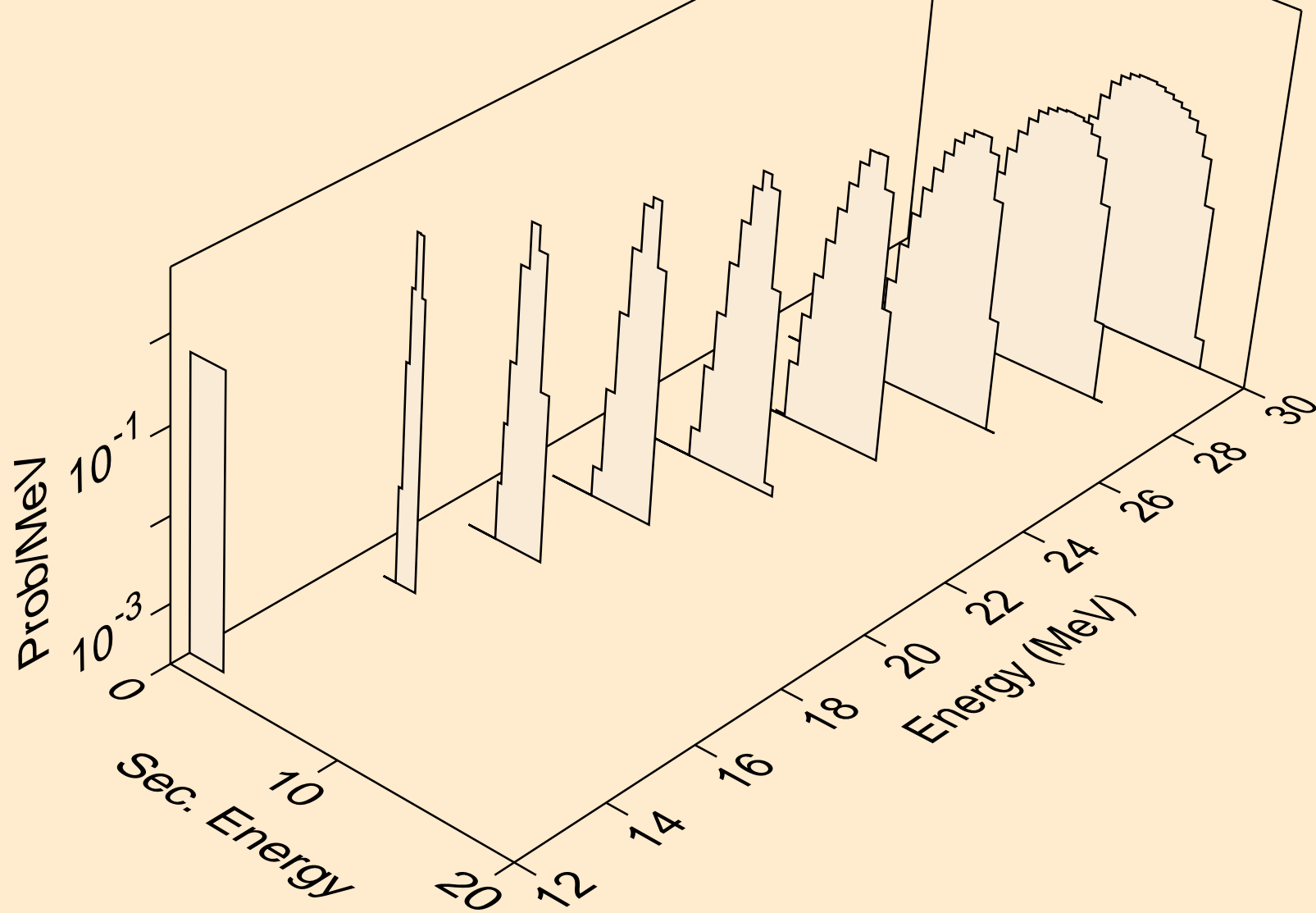

RN201 NEUTRON ACER TENDL-2021 LIBRARY; T=293.6K
tritons from (n,t)

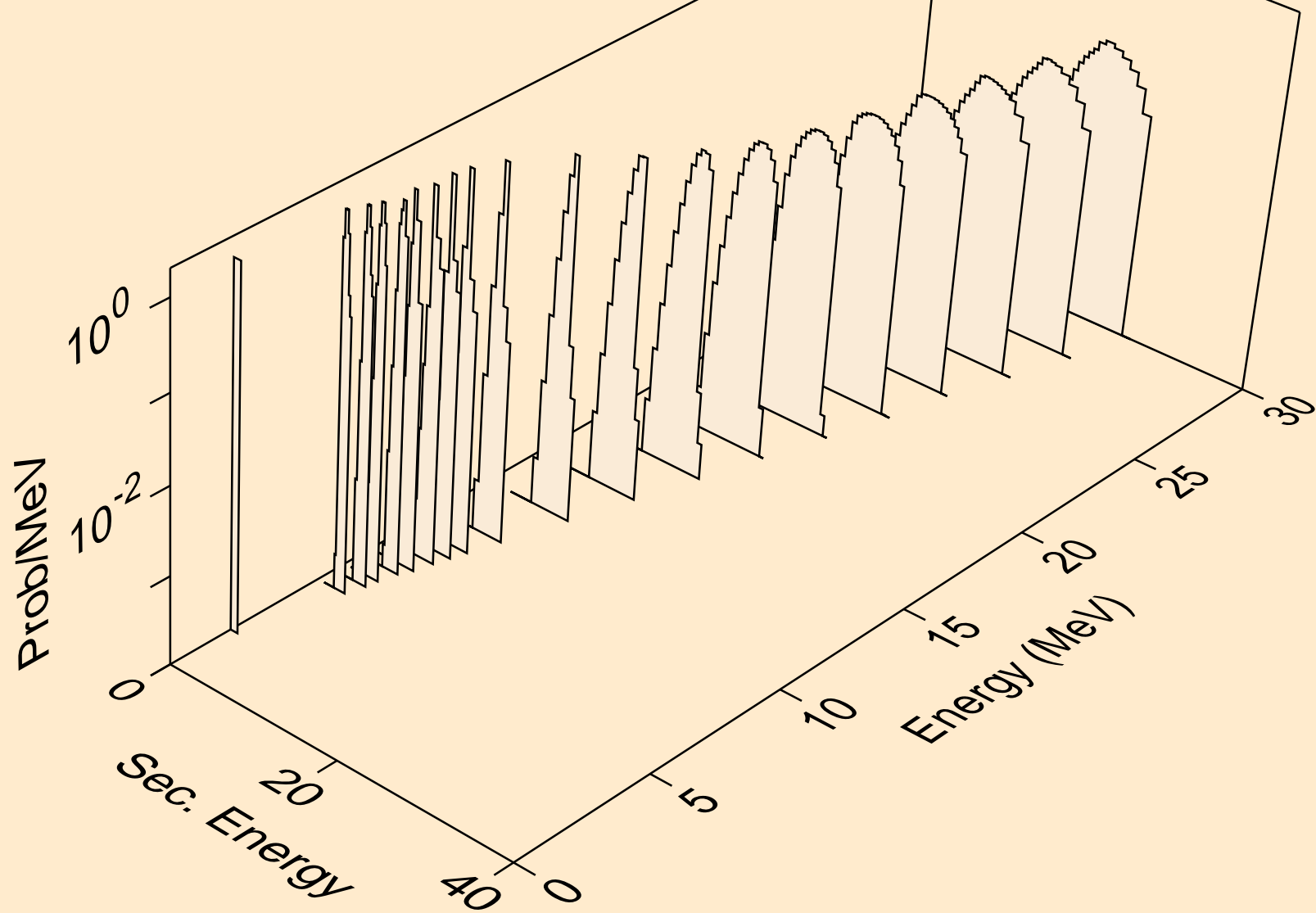

RN201 NEUTRON ACER TENDL-2021 LIBRARY; T=293.6K
tritons from (n,pt)

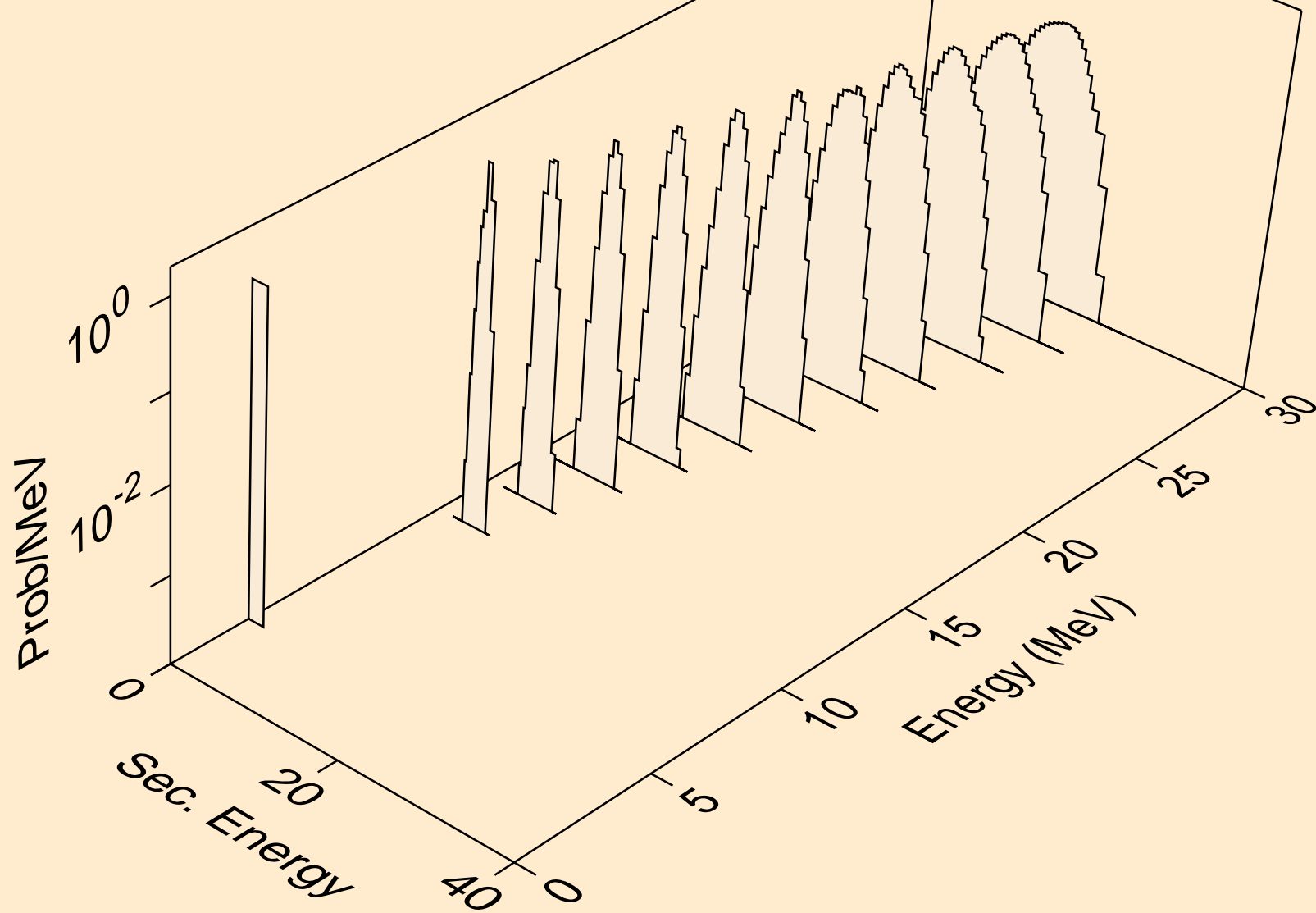

RN201 NEUTRON ACER TENDL-2021 LIBRARY; T=293.6K
he3s from (n,x)

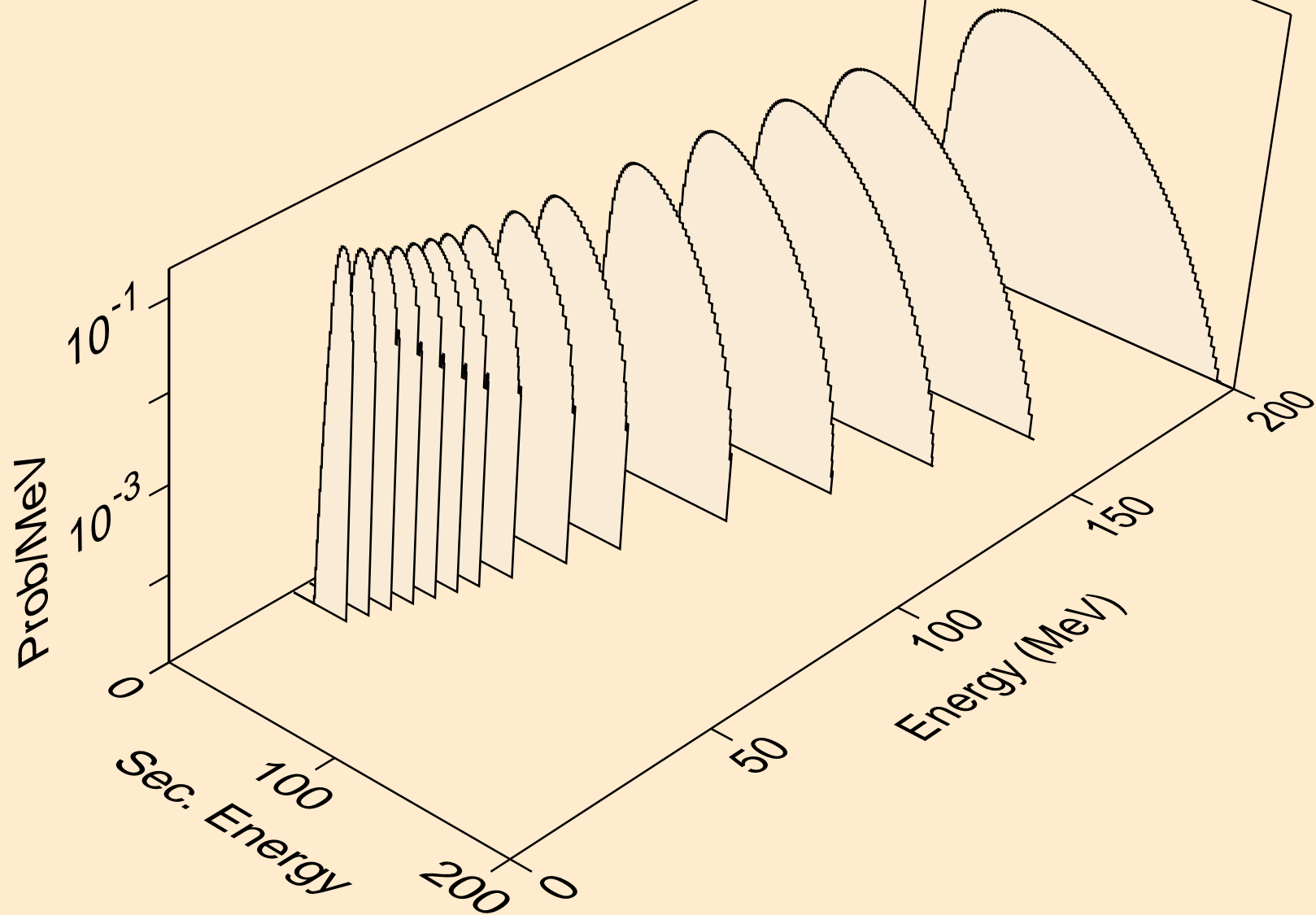

RN201 NEUTRON ACER TENDL-2021 LIBRARY; T=293.6K
he3s from (n,n*)he3

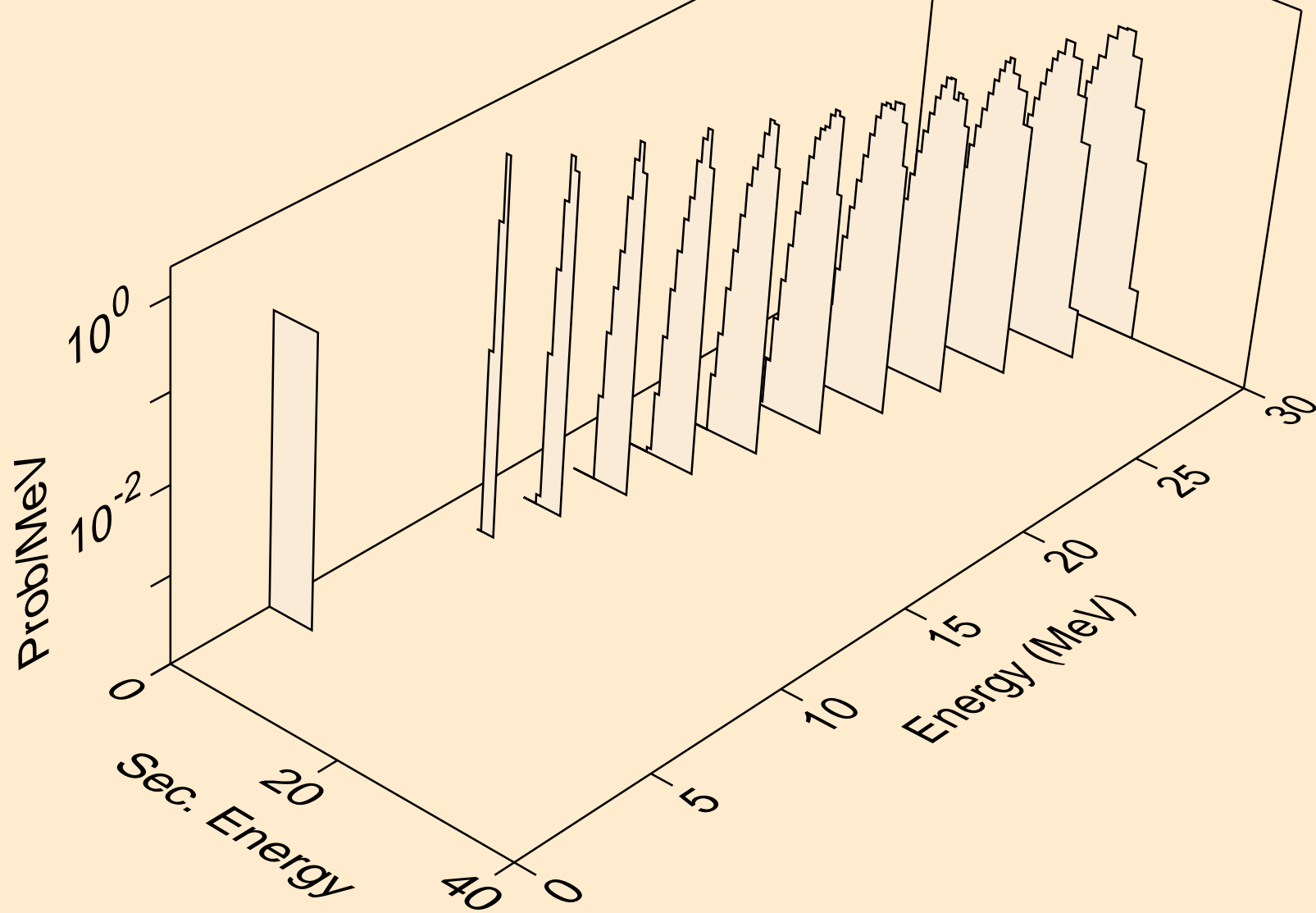

RN201 NEUTRON ACER TENDL-2021 LIBRARY; T=293.6K
he3s from (n,he3)

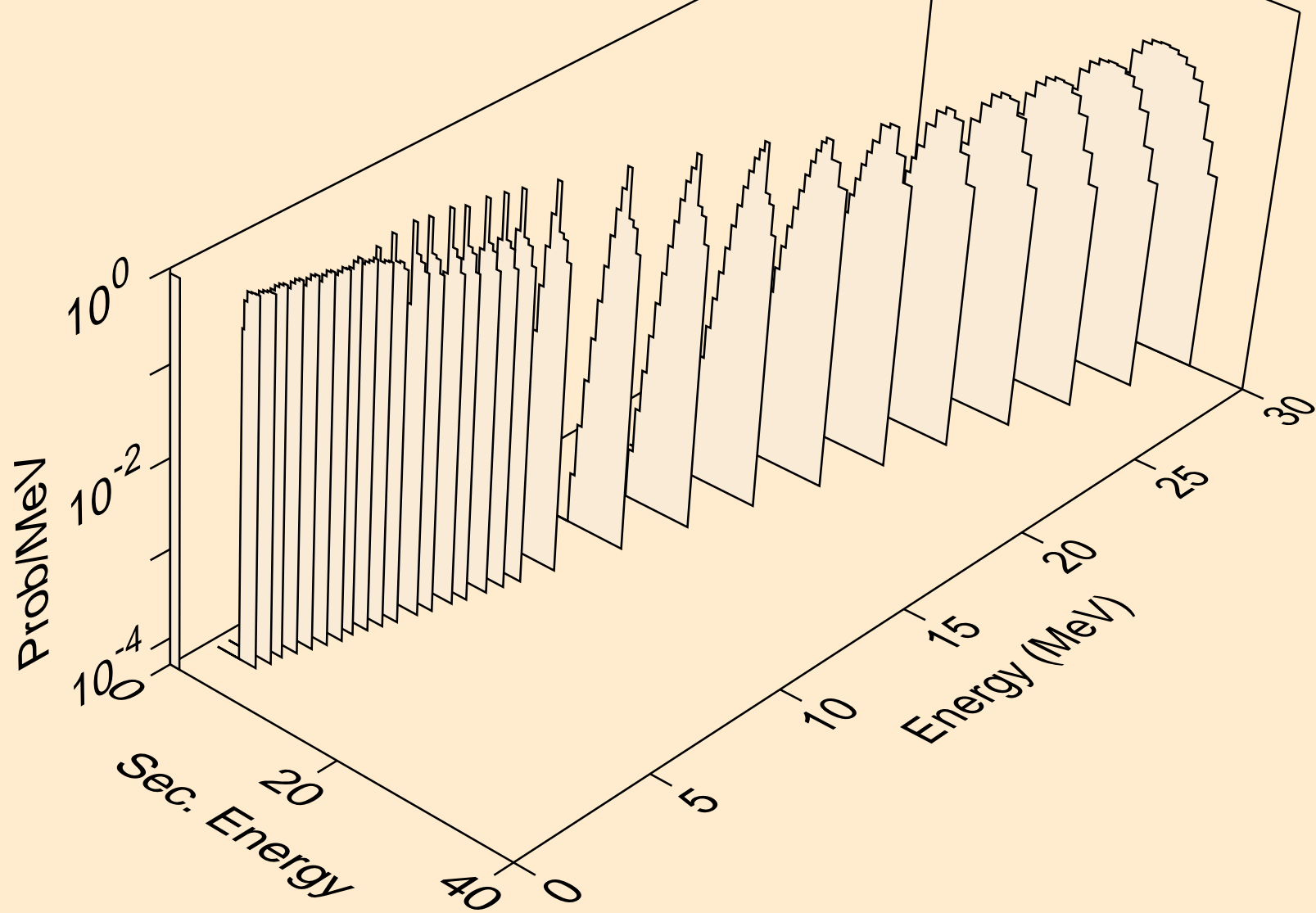

RN201 NEUTRON ACER TENDL-2021 LIBRARY; T=293.6K
alphas from (n,x)

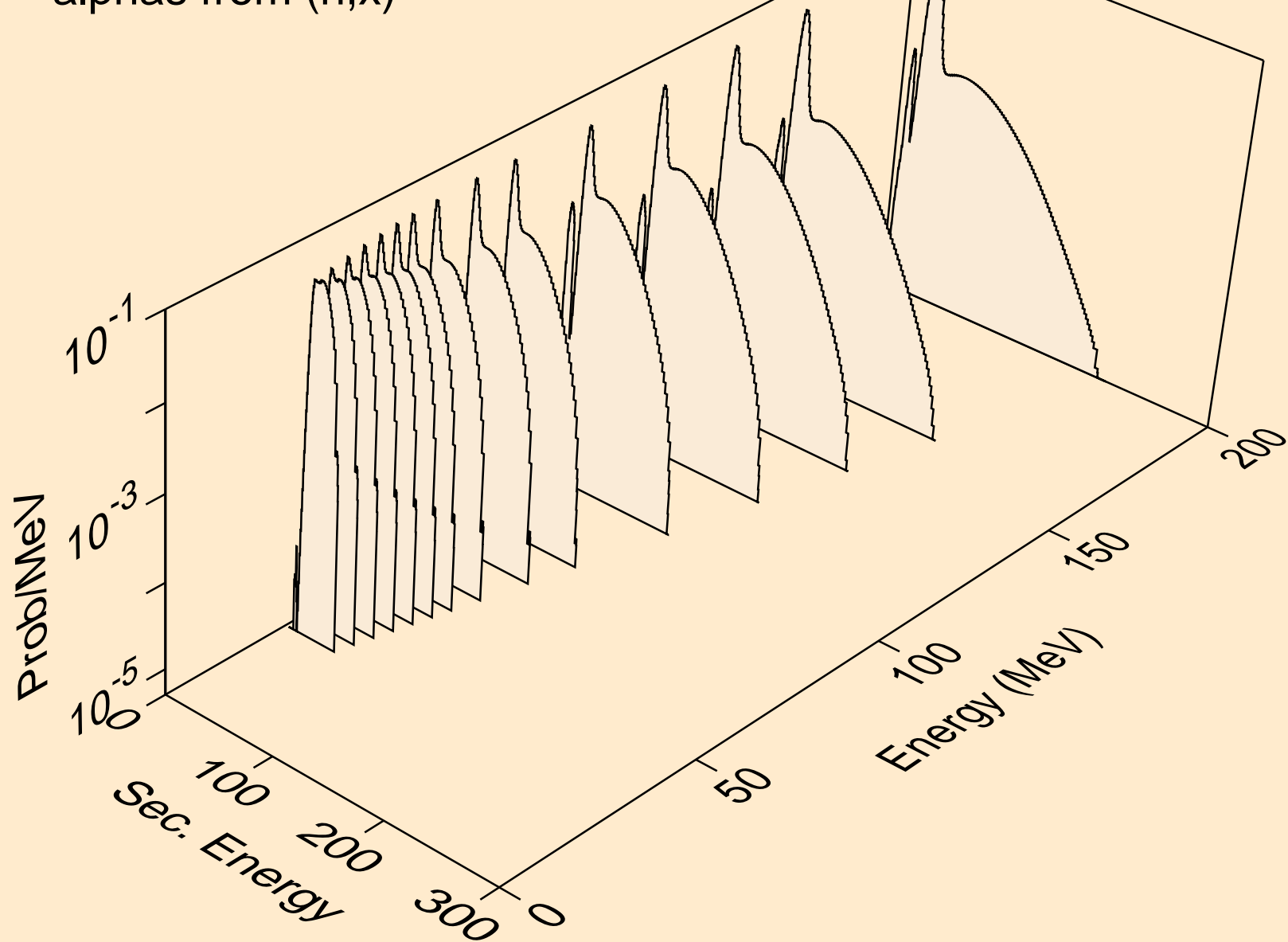

RN201 NEUTRON ACER TENDL-2021 LIBRARY; T=293.6K
alphas from (n,n*)a

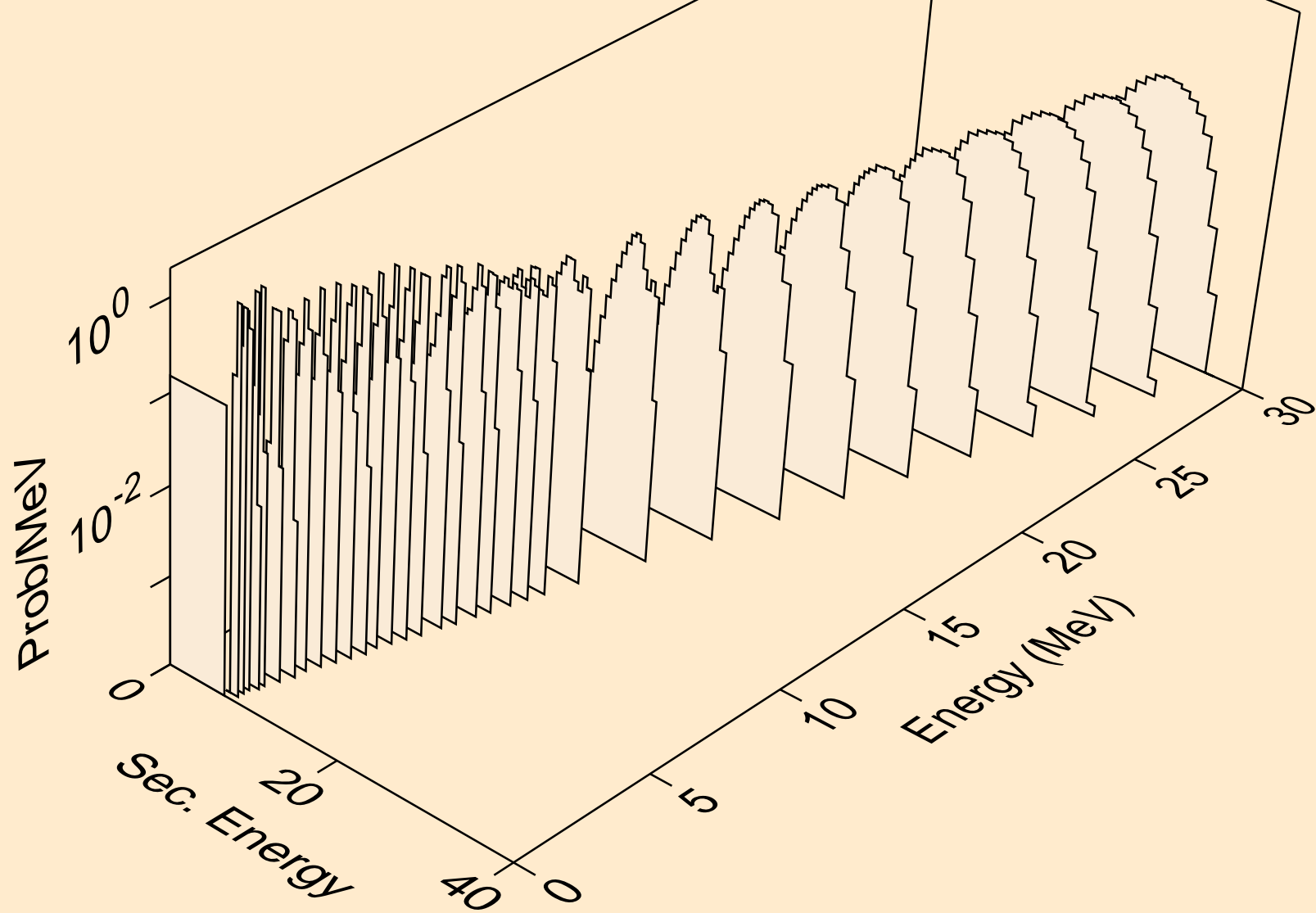

RN201 NEUTRON ACER TENDL-2021 LIBRARY; T=293.6K
alphas from (n,2n)a

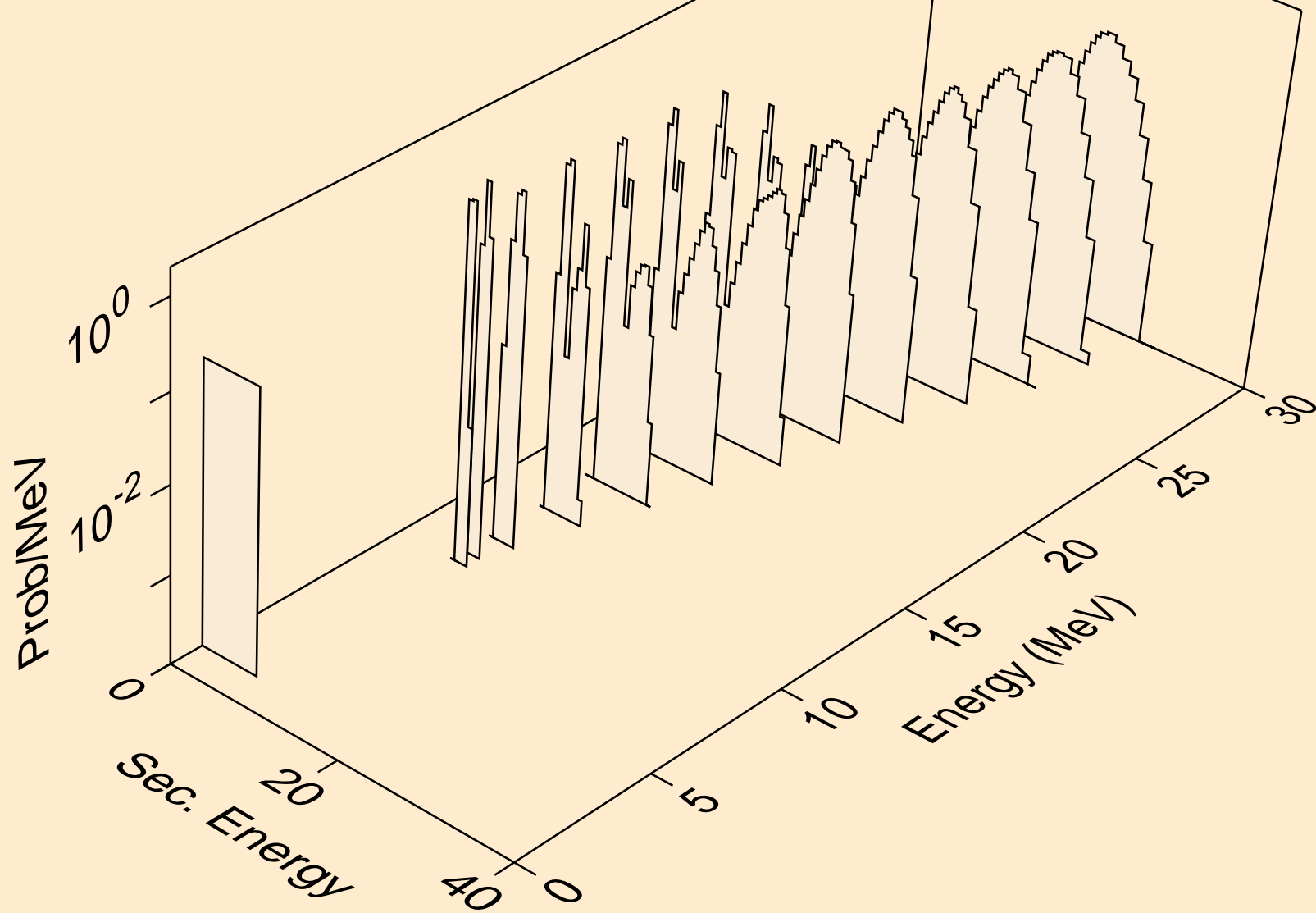

RN201 NEUTRON ACER TENDL-2021 LIBRARY; T=293.6K
alphas from (n,3n)a

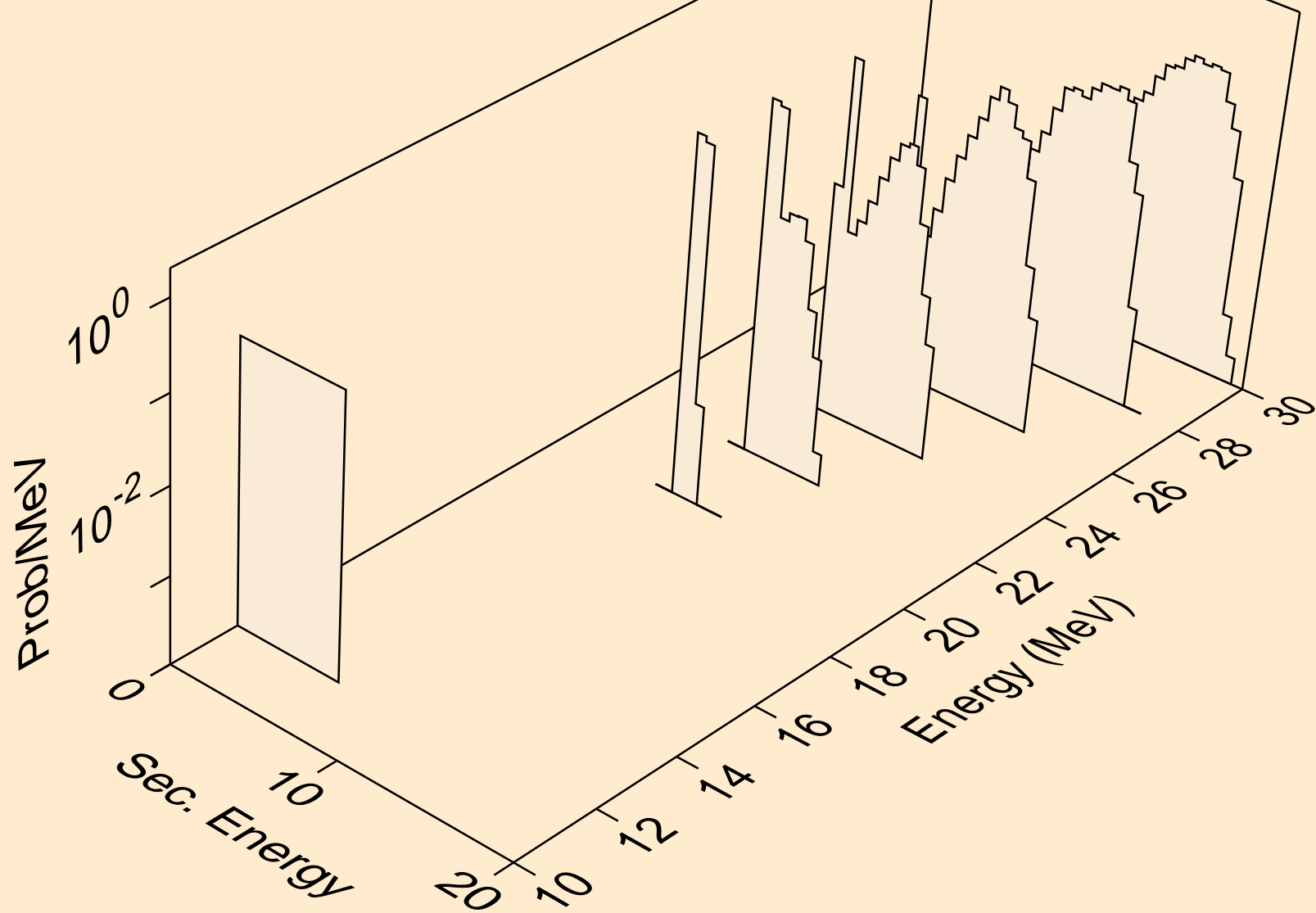

RN201 NEUTRON ACER TENDL-2021 LIBRARY; T=293.6K
alphas from (n,n*)2a

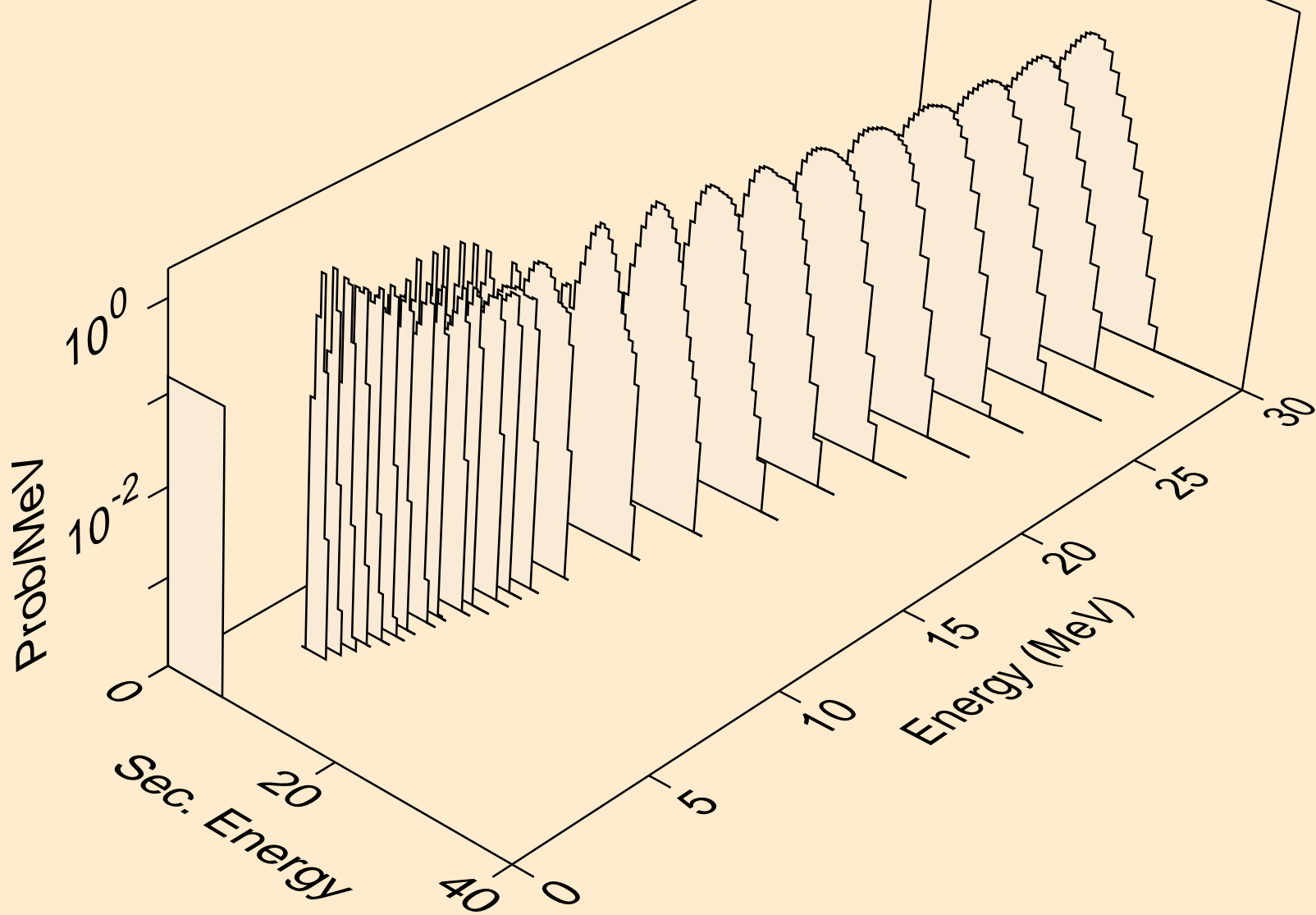

RN201 NEUTRON ACER TENDL-2021 LIBRARY; T=293.6K
alphas from (n,2n)2a

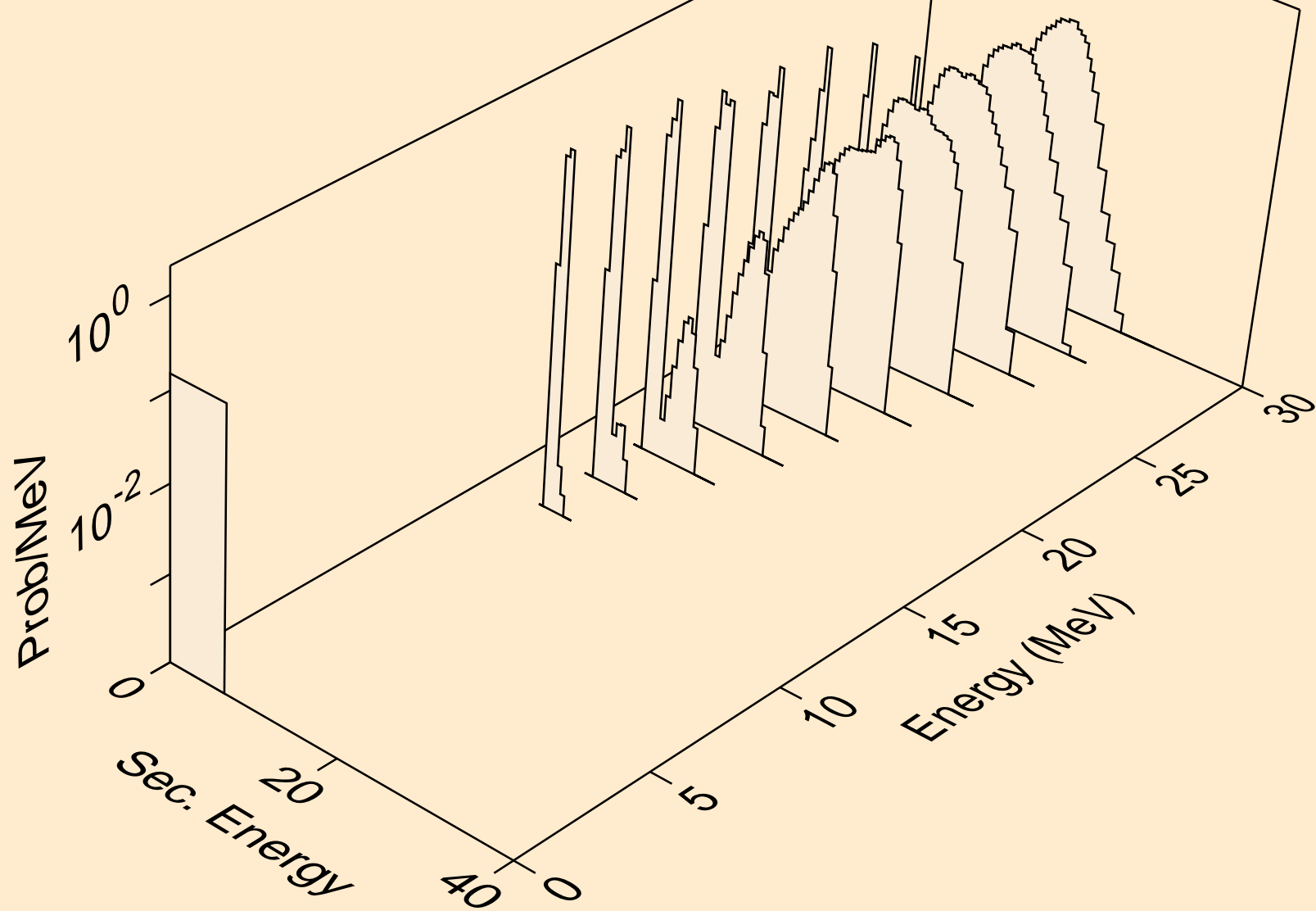

RN201 NEUTRON ACER TENDL-2021 LIBRARY; T=293.6K
alphas from (n,npa)

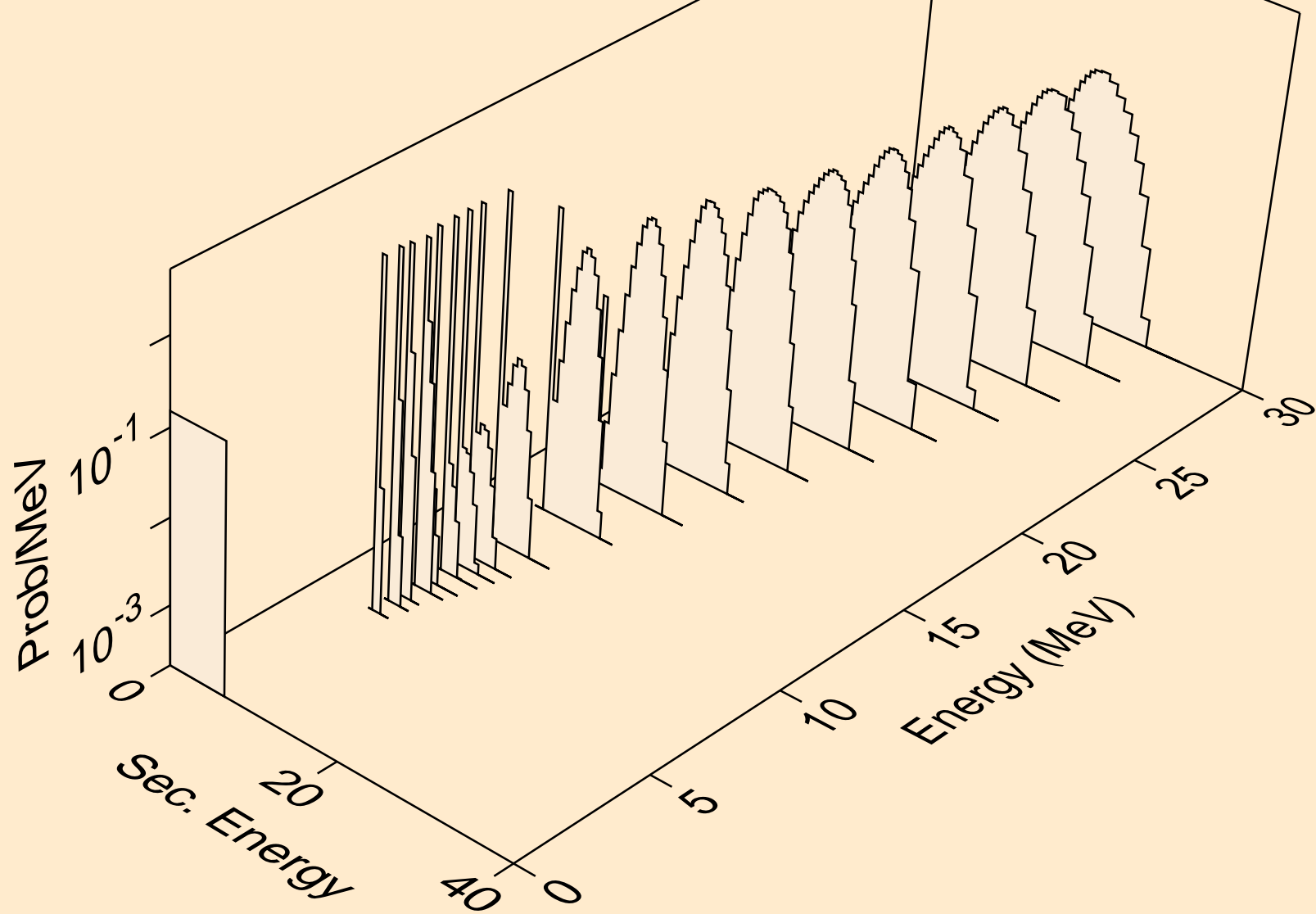

RN201 NEUTRON ACER TENDL-2021 LIBRARY; T=293.6K
alphas from (n,a)

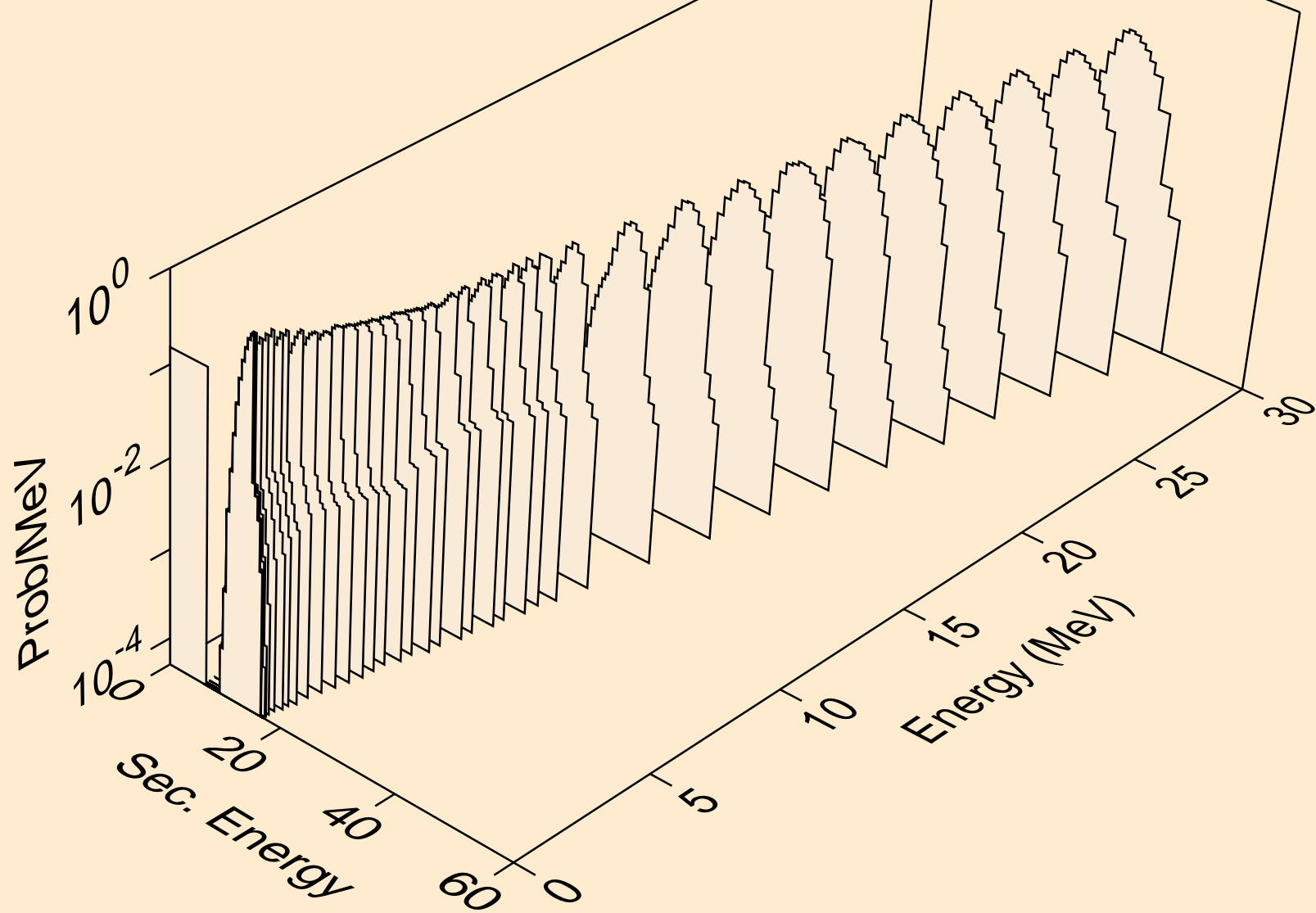

RN201 NEUTRON ACER TENDL-2021 LIBRARY; T=293.6K
alphas from (n,2a)

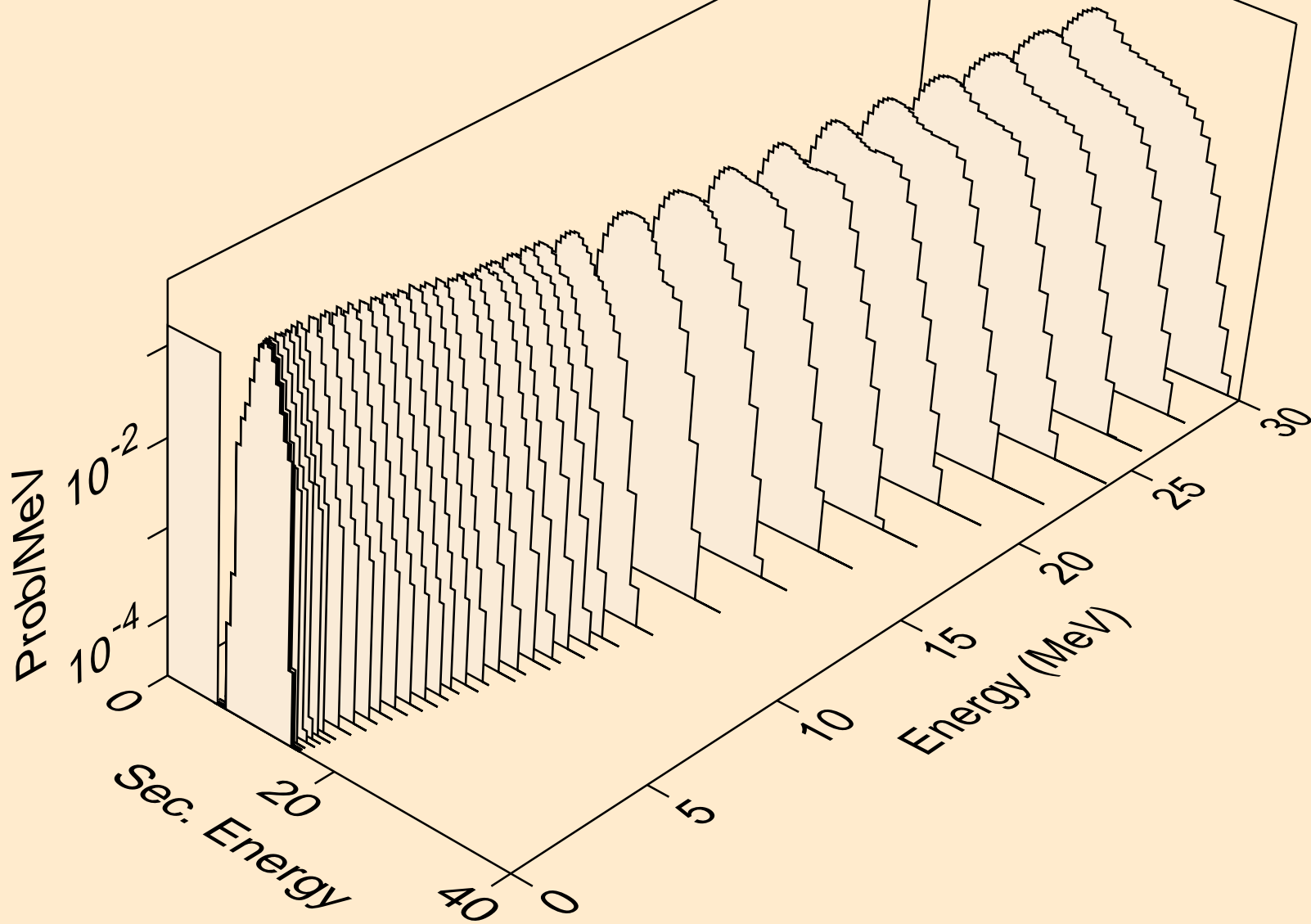

RN201 NEUTRON ACER TENDL-2021 LIBRARY; T=293.6K
alphas from (n,3a)

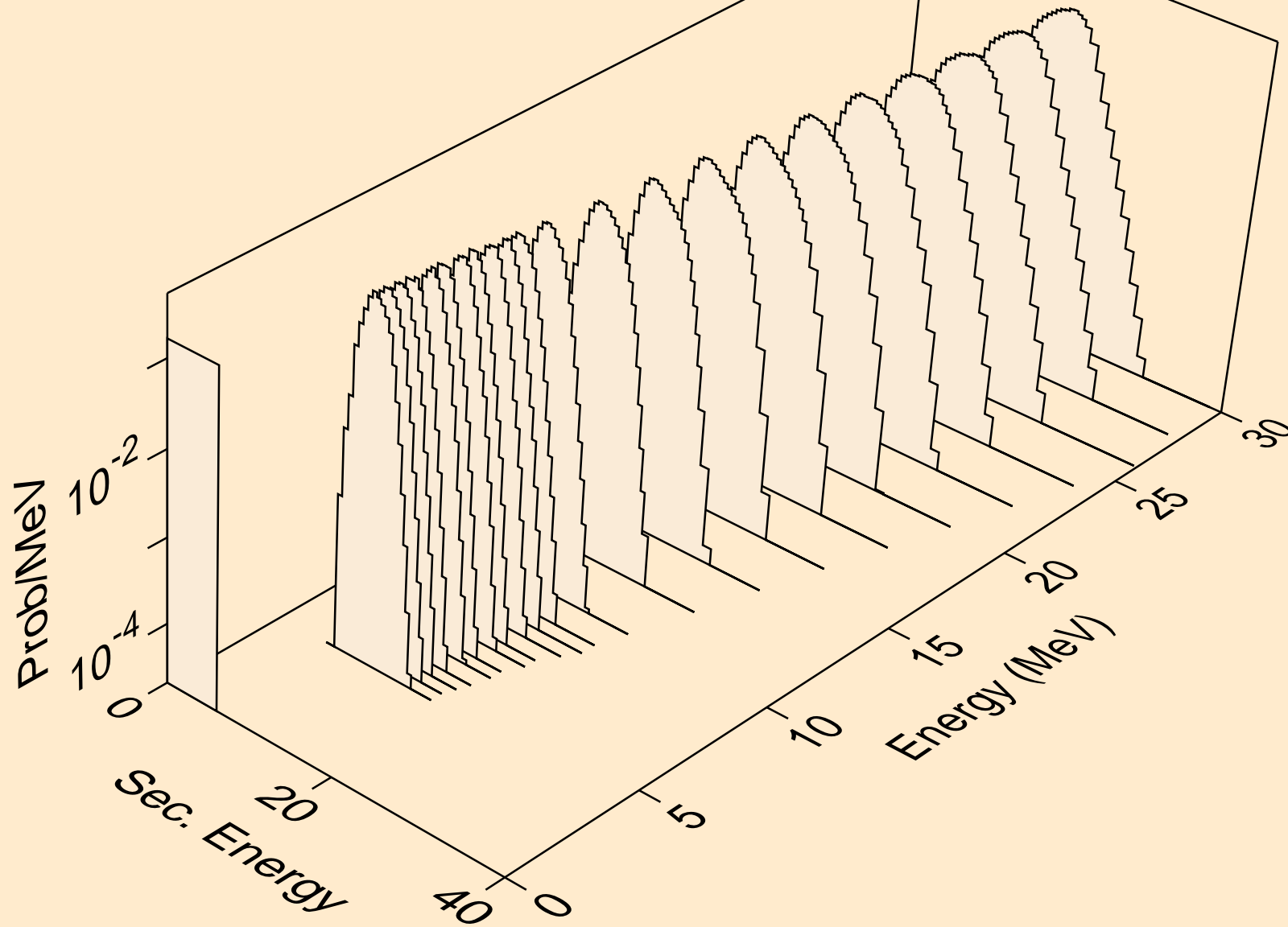

RN201 NEUTRON ACER TENDL-2021 LIBRARY; T=293.6K
alphas from (n,pa)

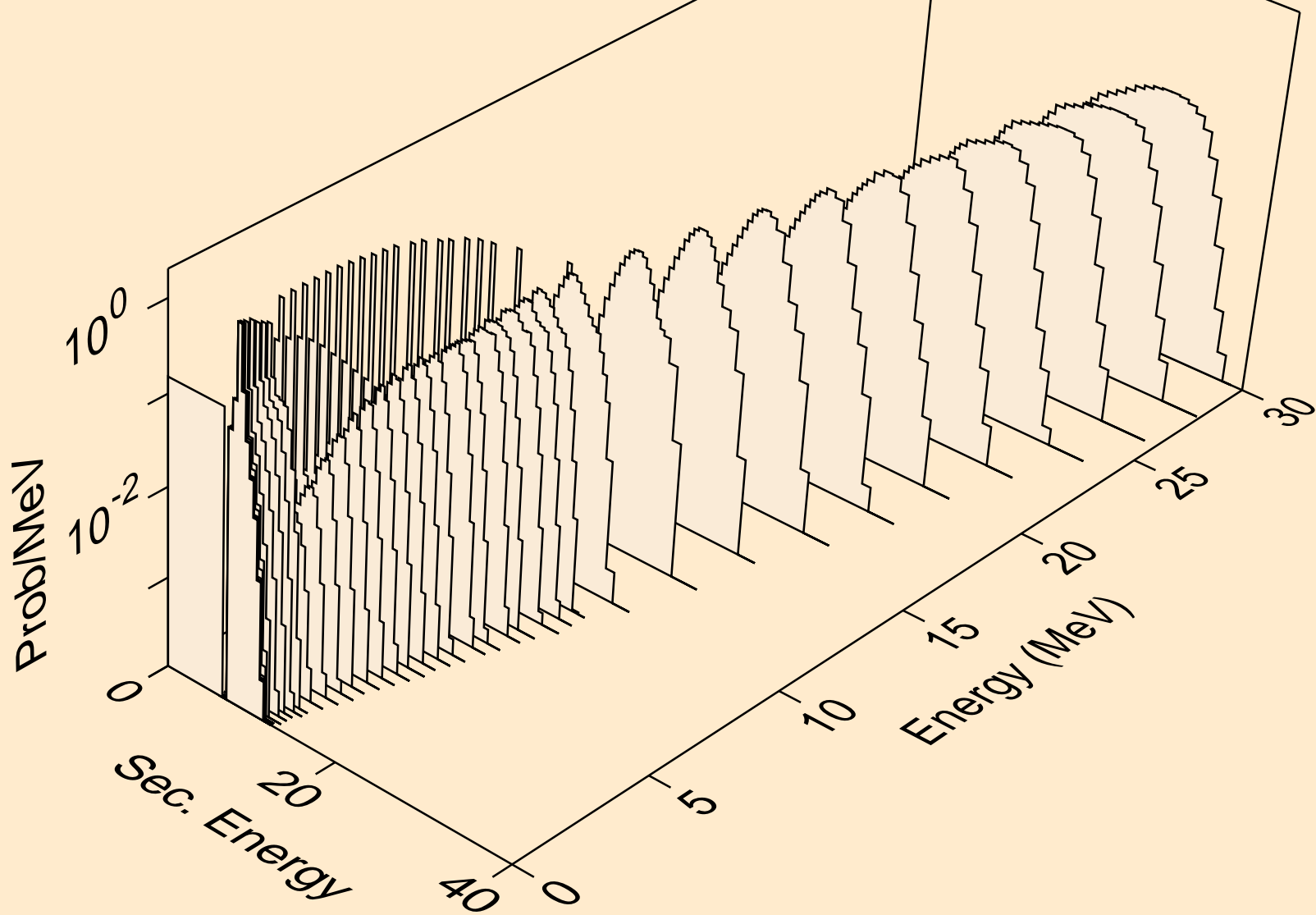

RN201 NEUTRON ACER TENDL-2021 LIBRARY; T=293.6K
alphas from (n,da)

