

RU096 NEUTRON ACER TENDL-2021 LIBRARY; T=293.6K
Principal cross sections

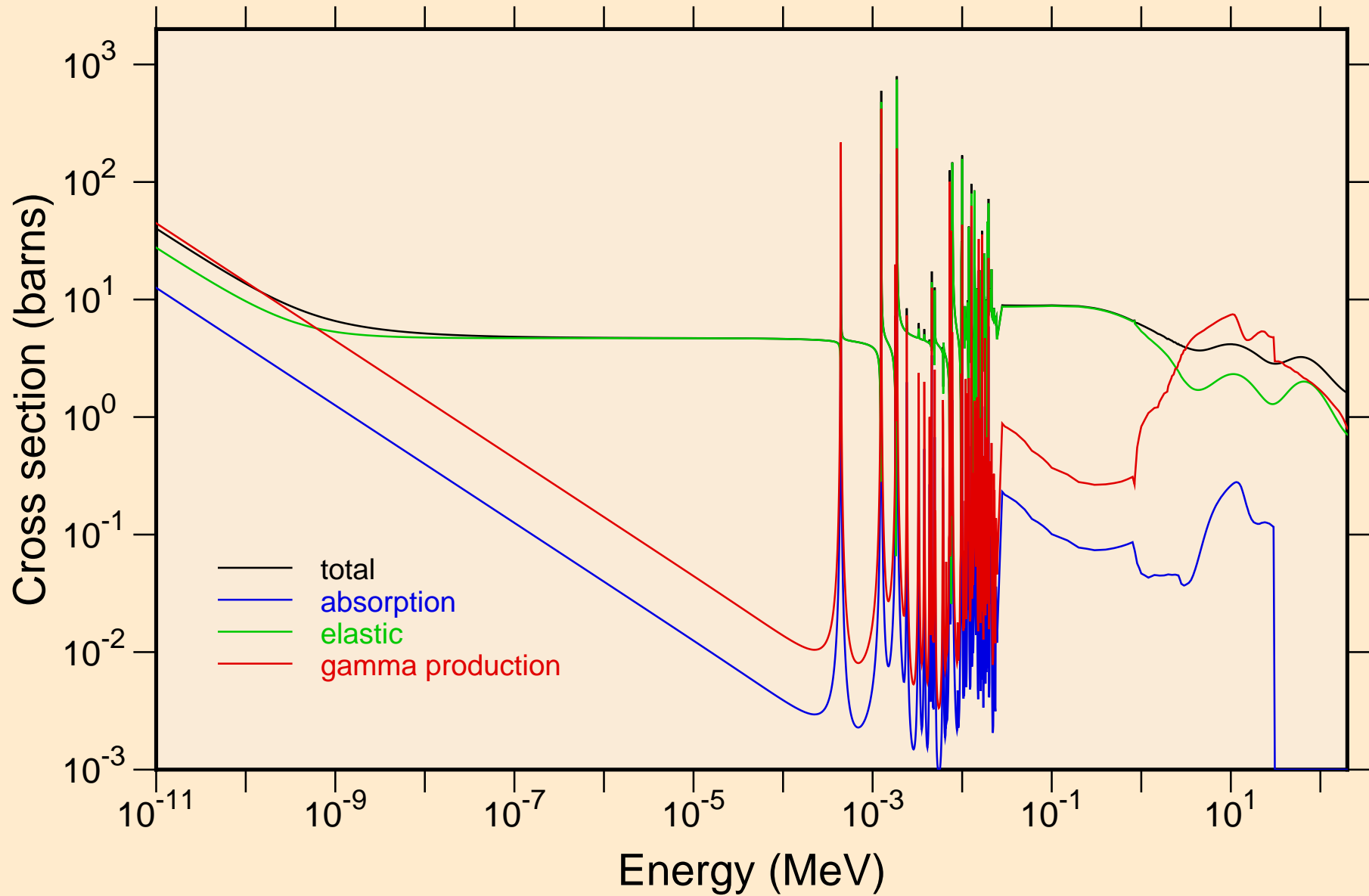

RU096 NEUTRON ACER TENDL-2021 LIBRARY; T=293.6K
resonance total cross section

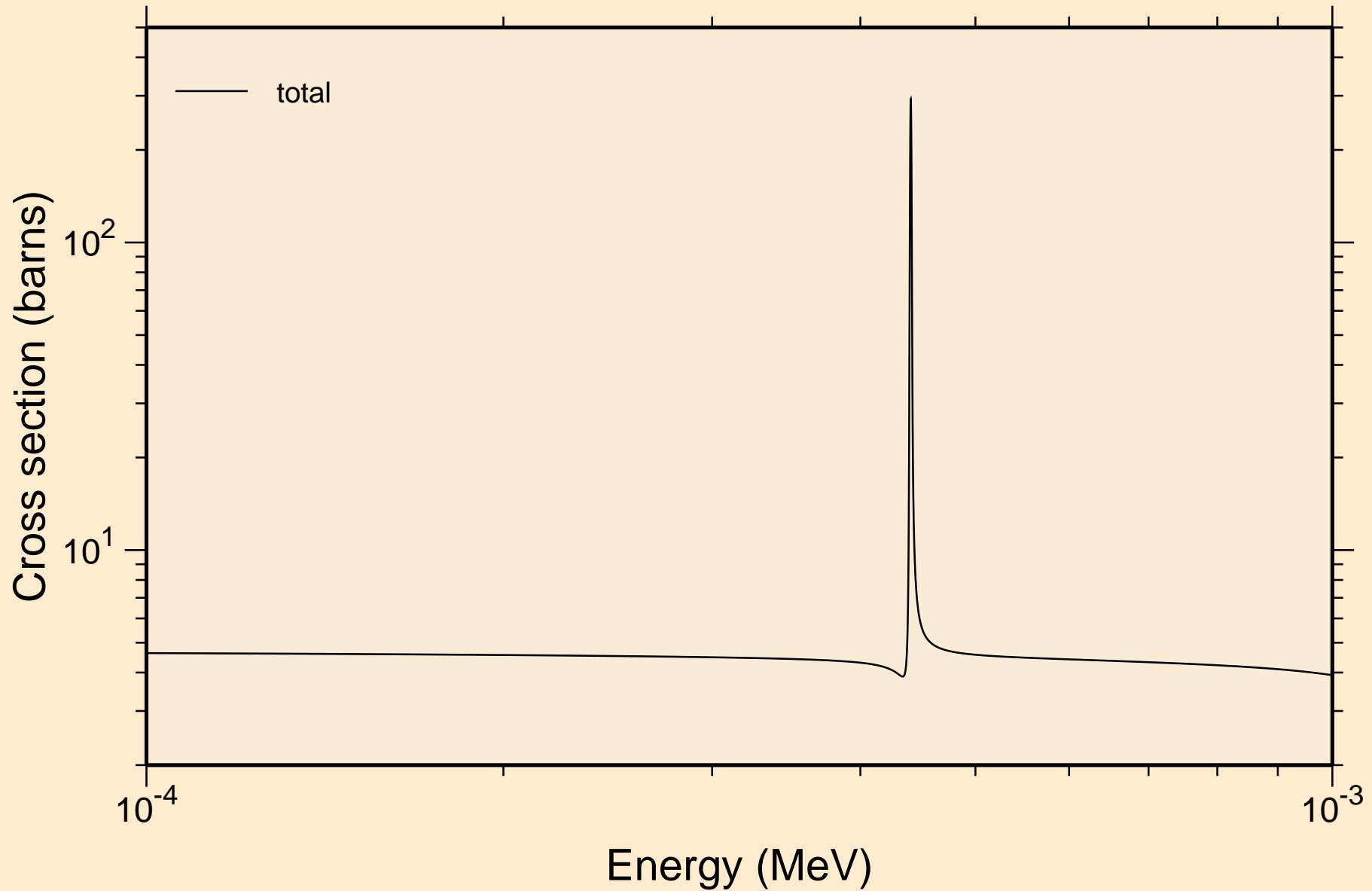

RU096 NEUTRON ACER TENDL-2021 LIBRARY; T=293.6K
resonance total cross section

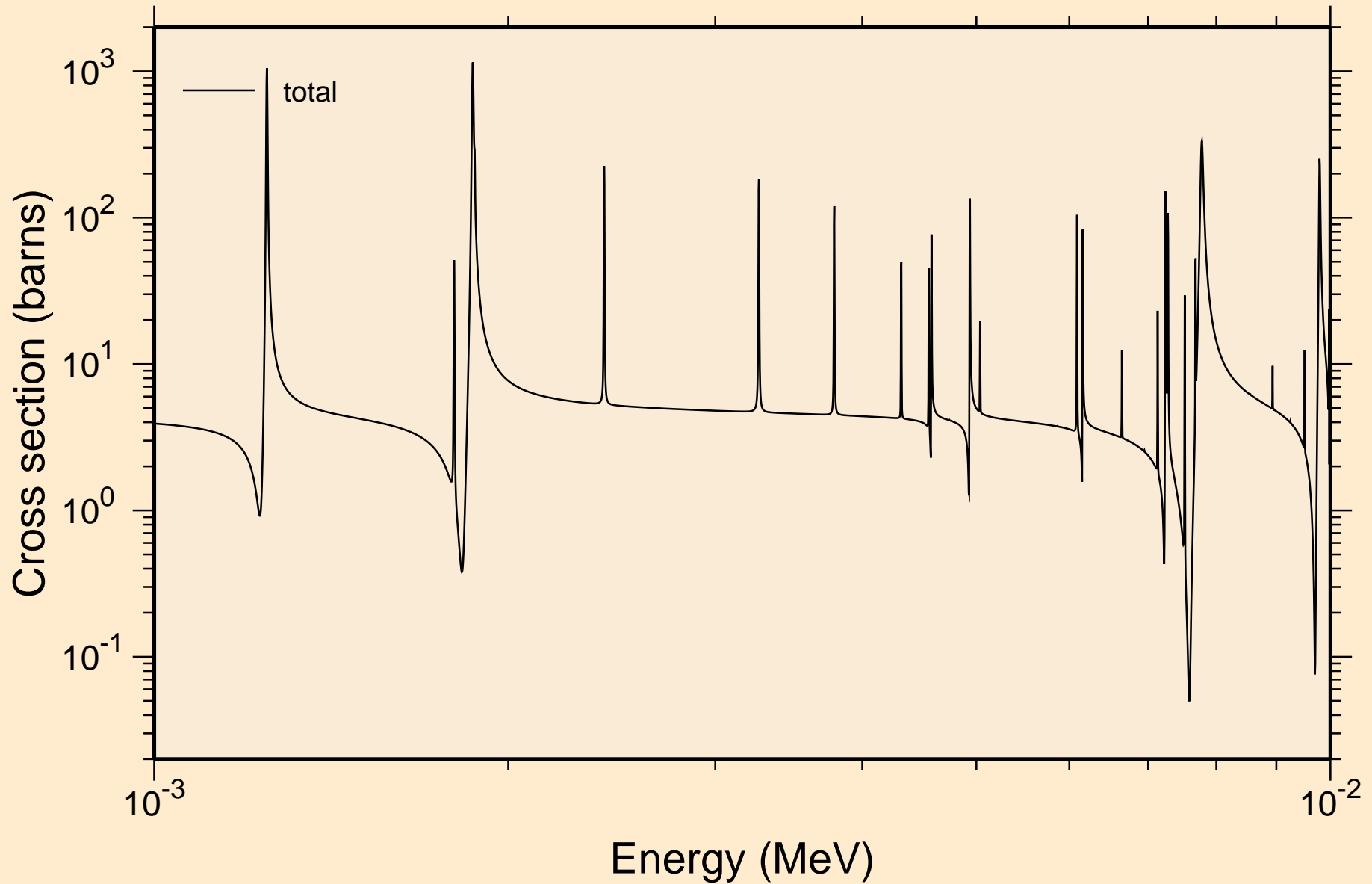

RU096 NEUTRON ACER TENDL-2021 LIBRARY; T=293.6K
resonance total cross section

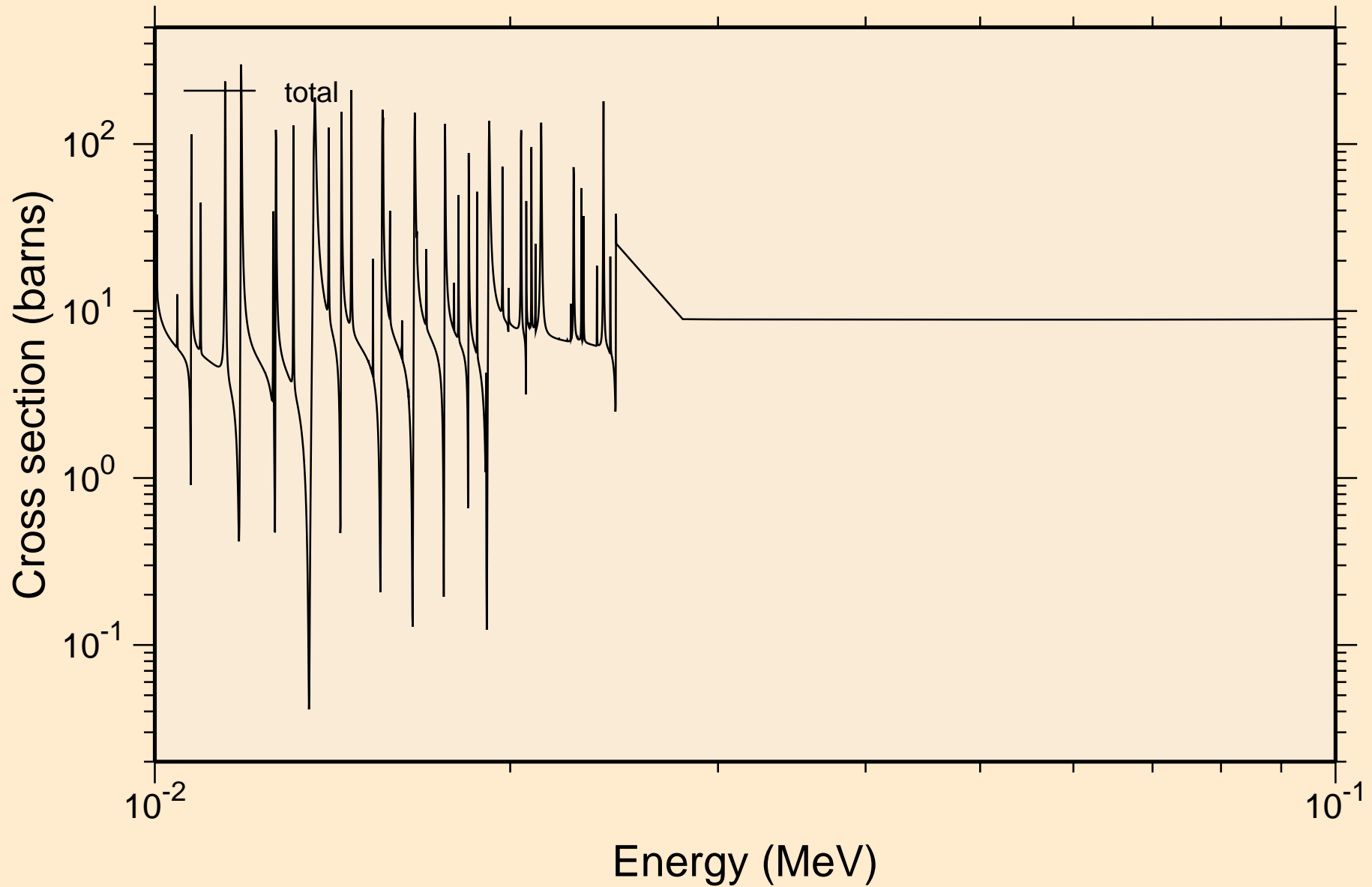

RU096 NEUTRON ACER TENDL-2021 LIBRARY; T=293.6K
resonance total cross section

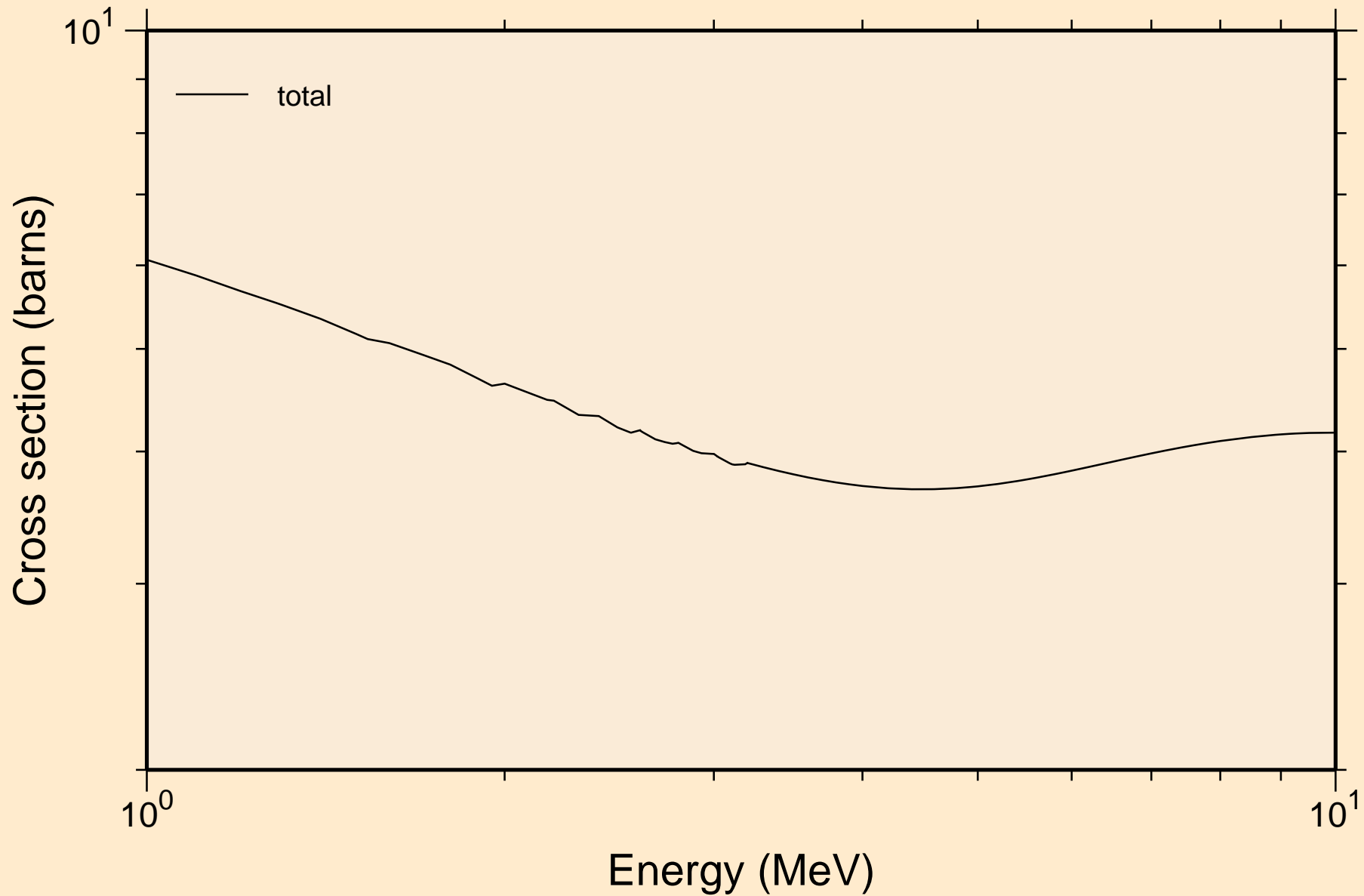

RU096 NEUTRON ACER TENDL-2021 LIBRARY; T=293.6K
resonance absorption cross sections

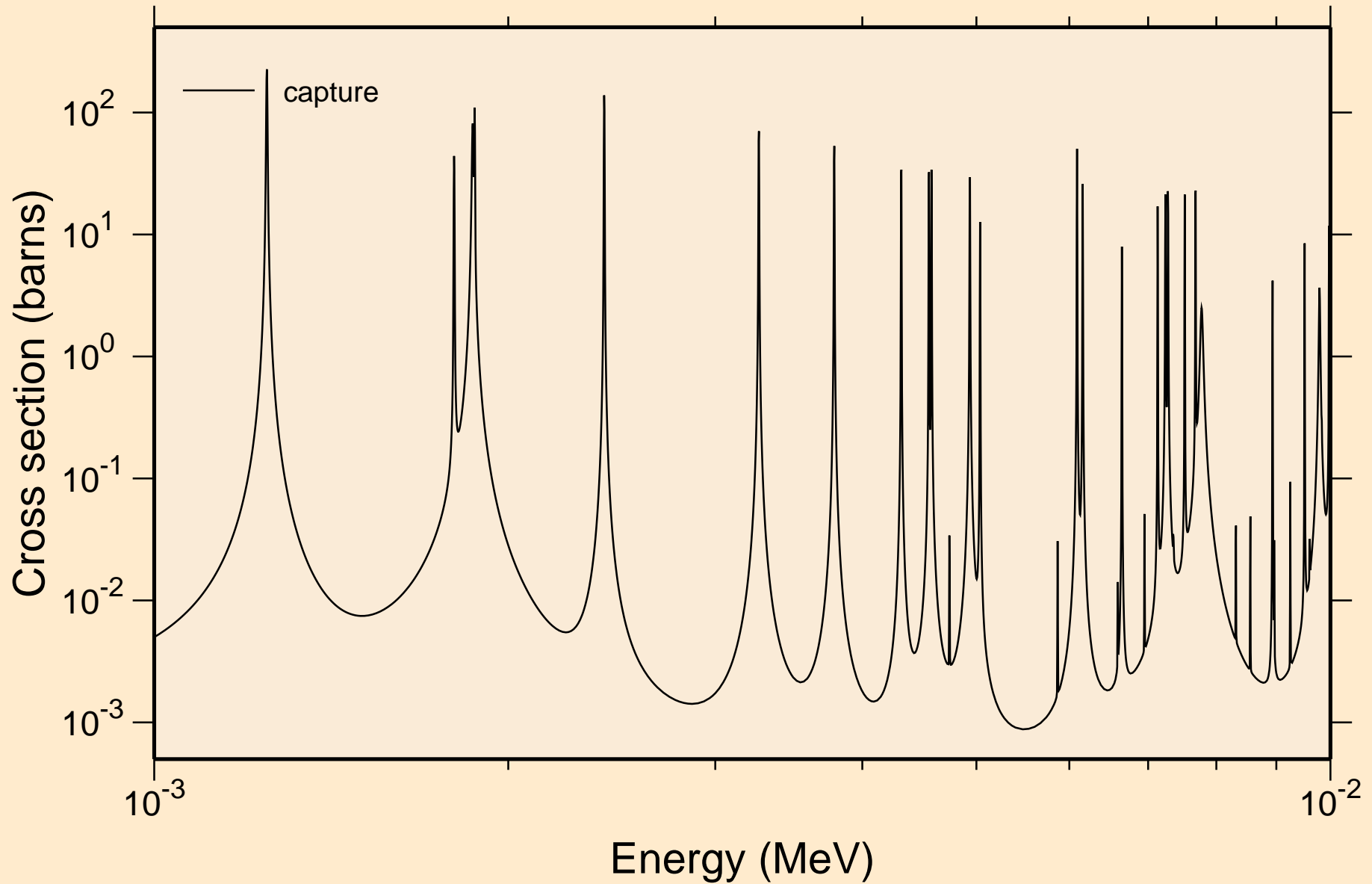

RU096 NEUTRON ACER TENDL-2021 LIBRARY; T=293.6K
resonance absorption cross sections

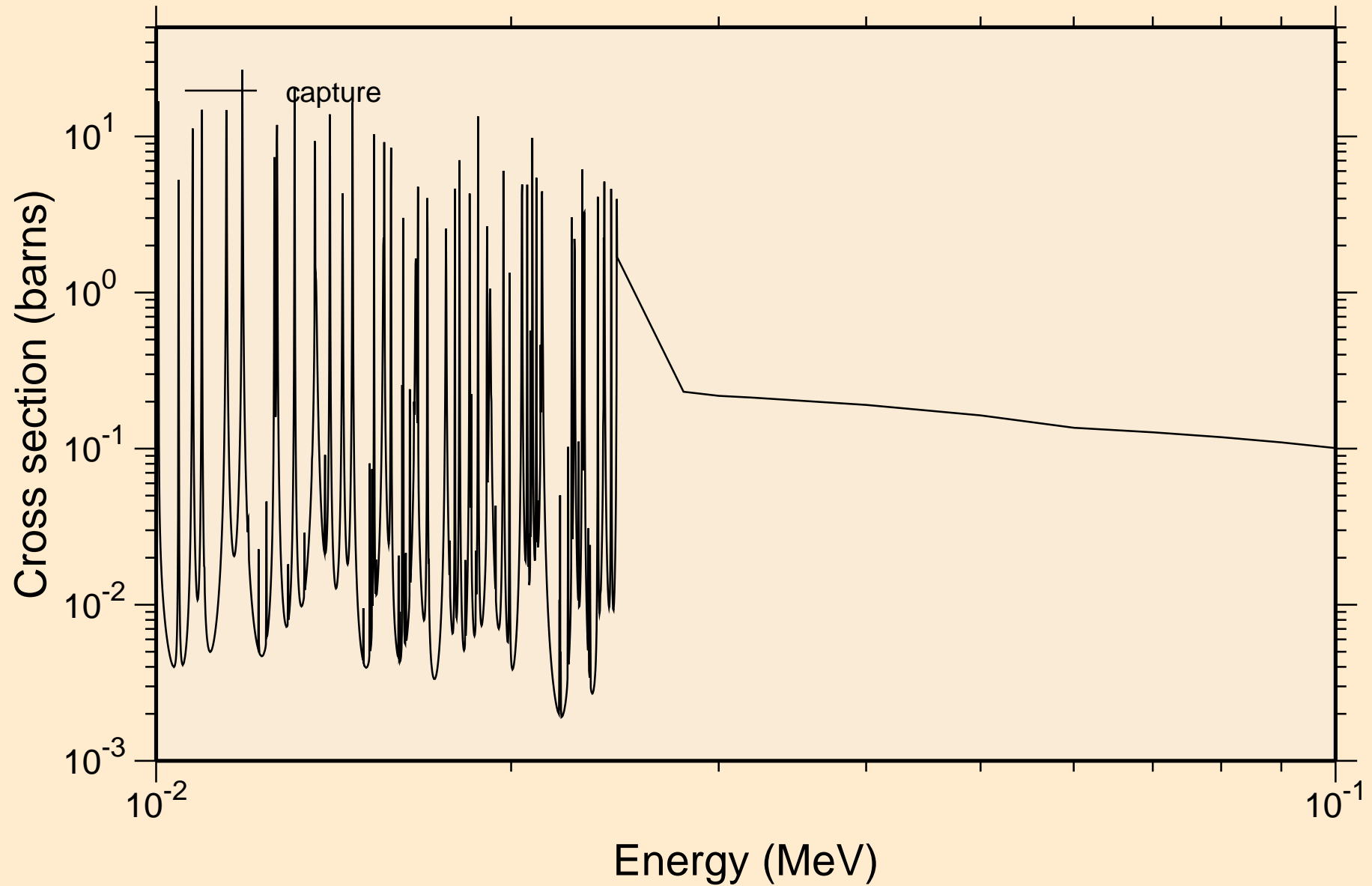

RU096 NEUTRON ACER TENDL-2021 LIBRARY; T=293.6K
resonance absorption cross sections

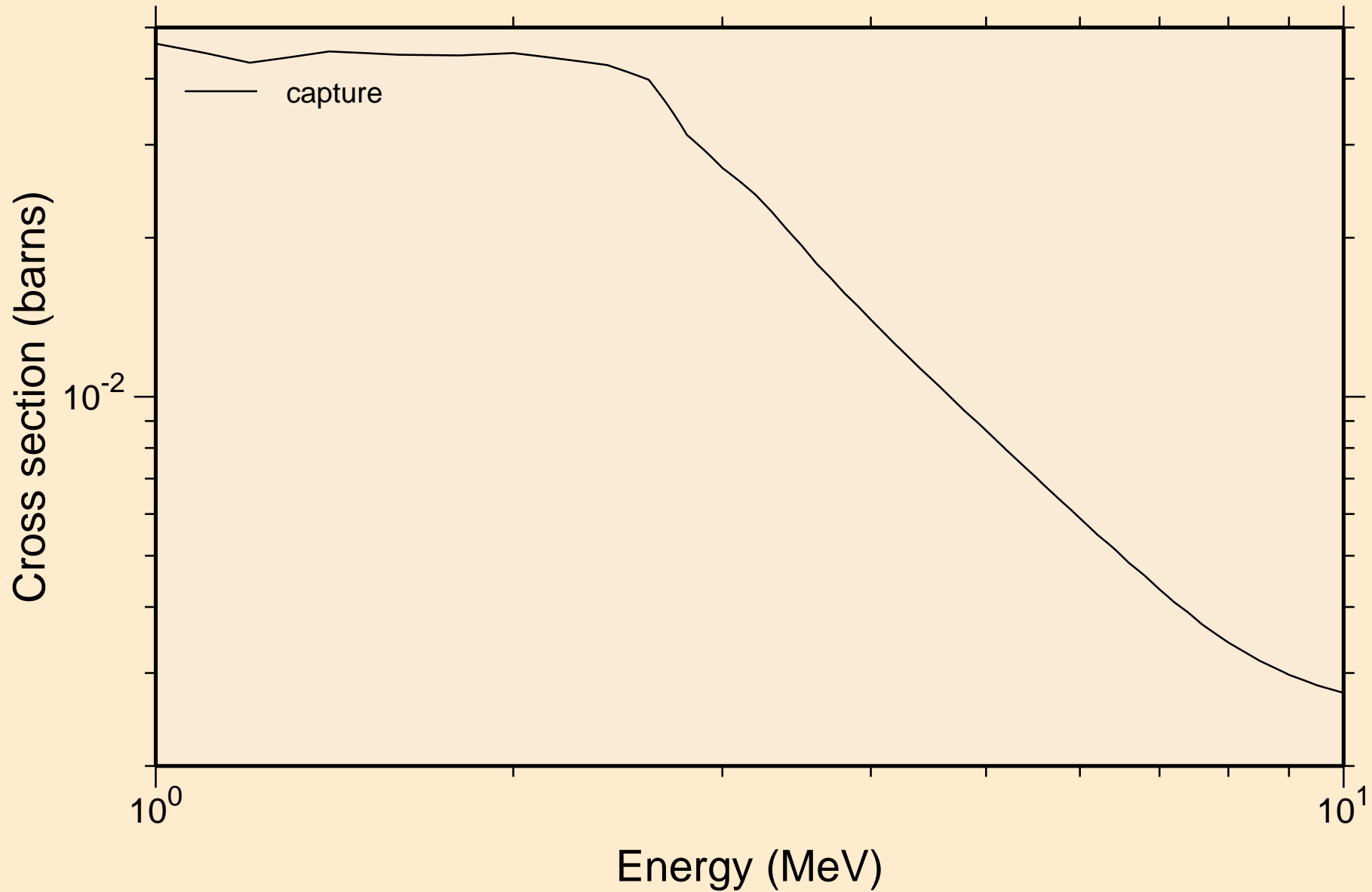

RU096 NEUTRON ACER TENDL-2021 LIBRARY; T=293.6K
Heating

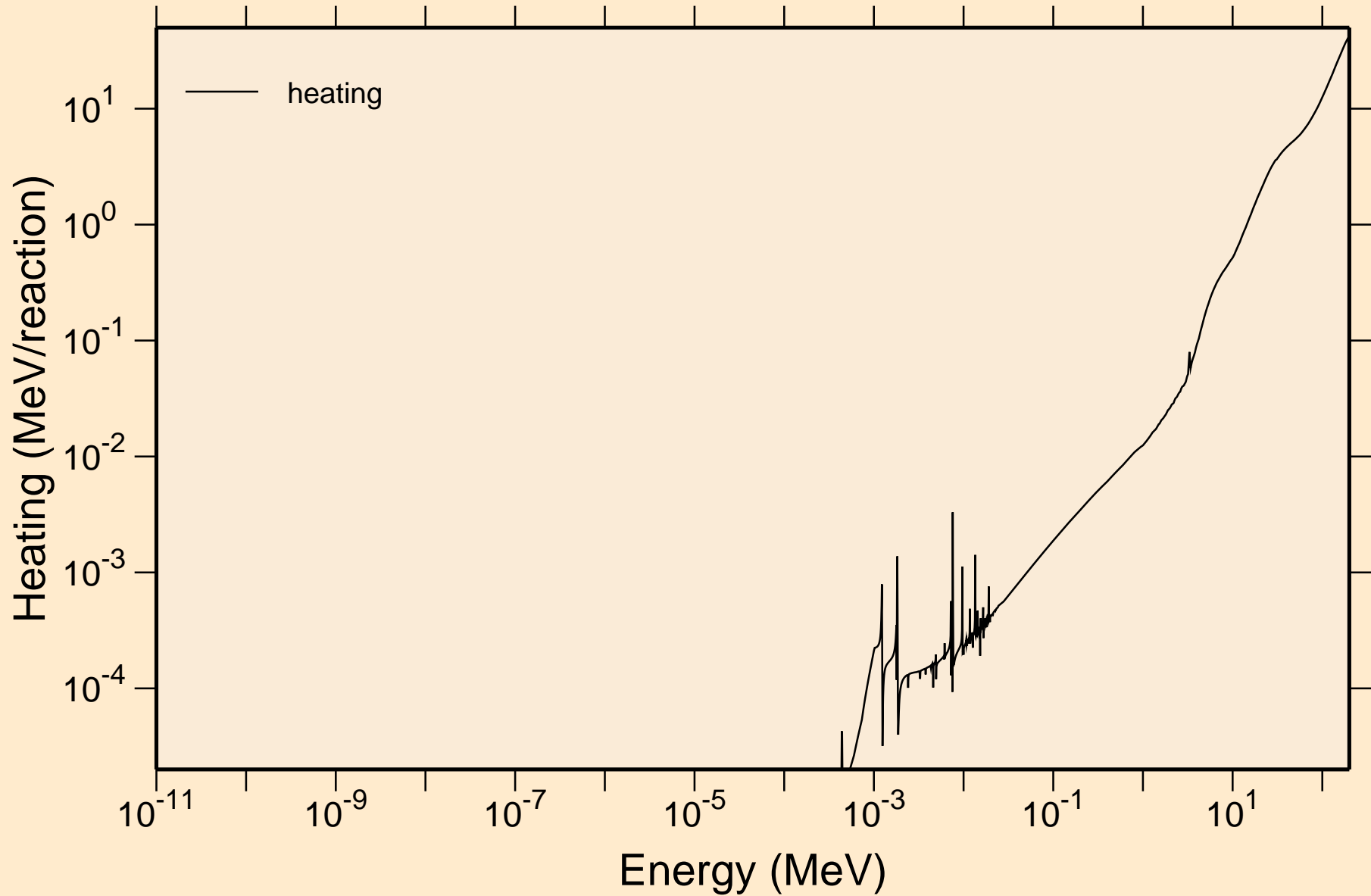

RU096 NEUTRON ACER TENDL-2021 LIBRARY; T=293.6K
Damage

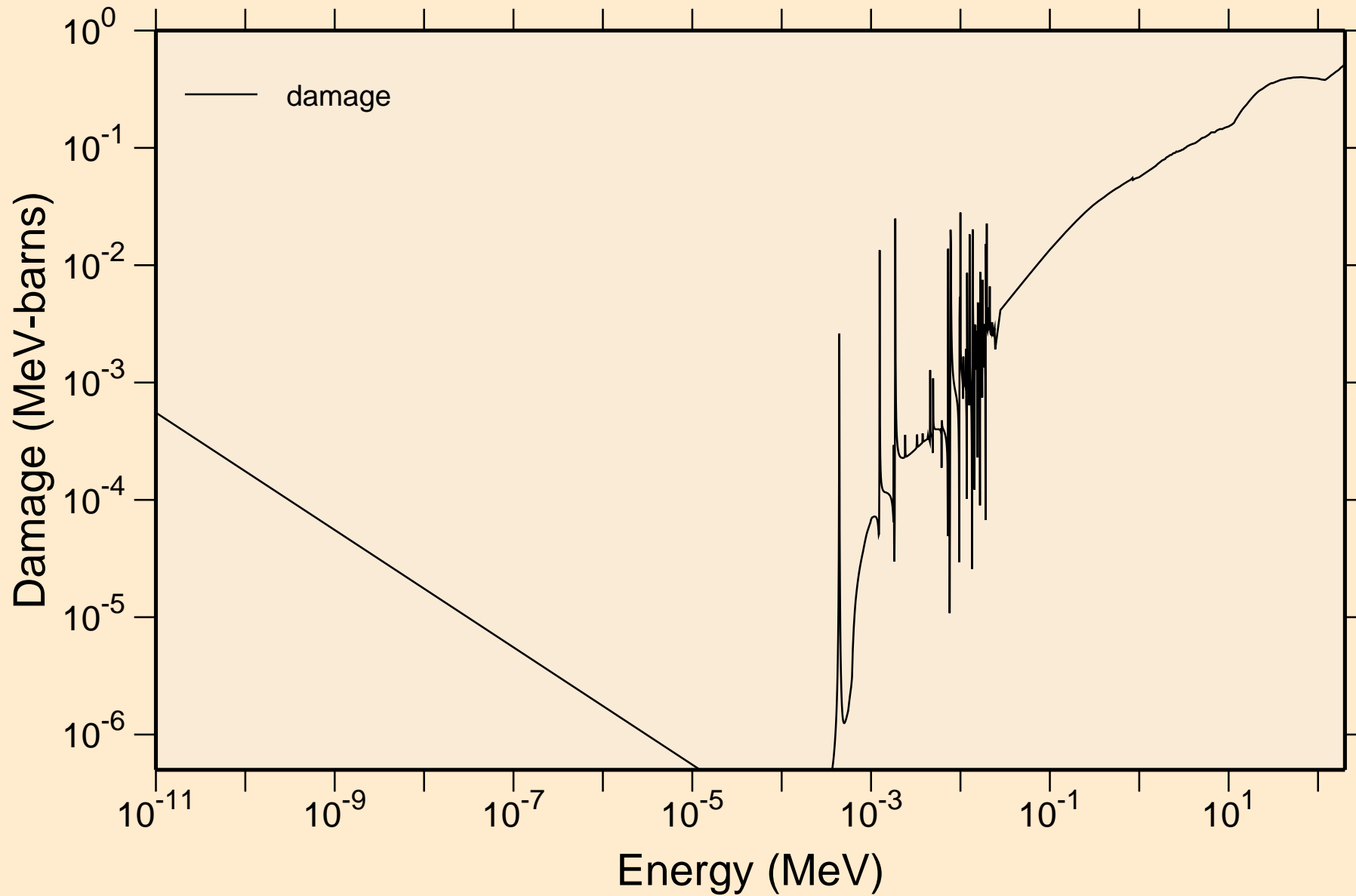

RU096 NEUTRON ACER TENDL-2021 LIBRARY; T=293.6K
Non-threshold reactions

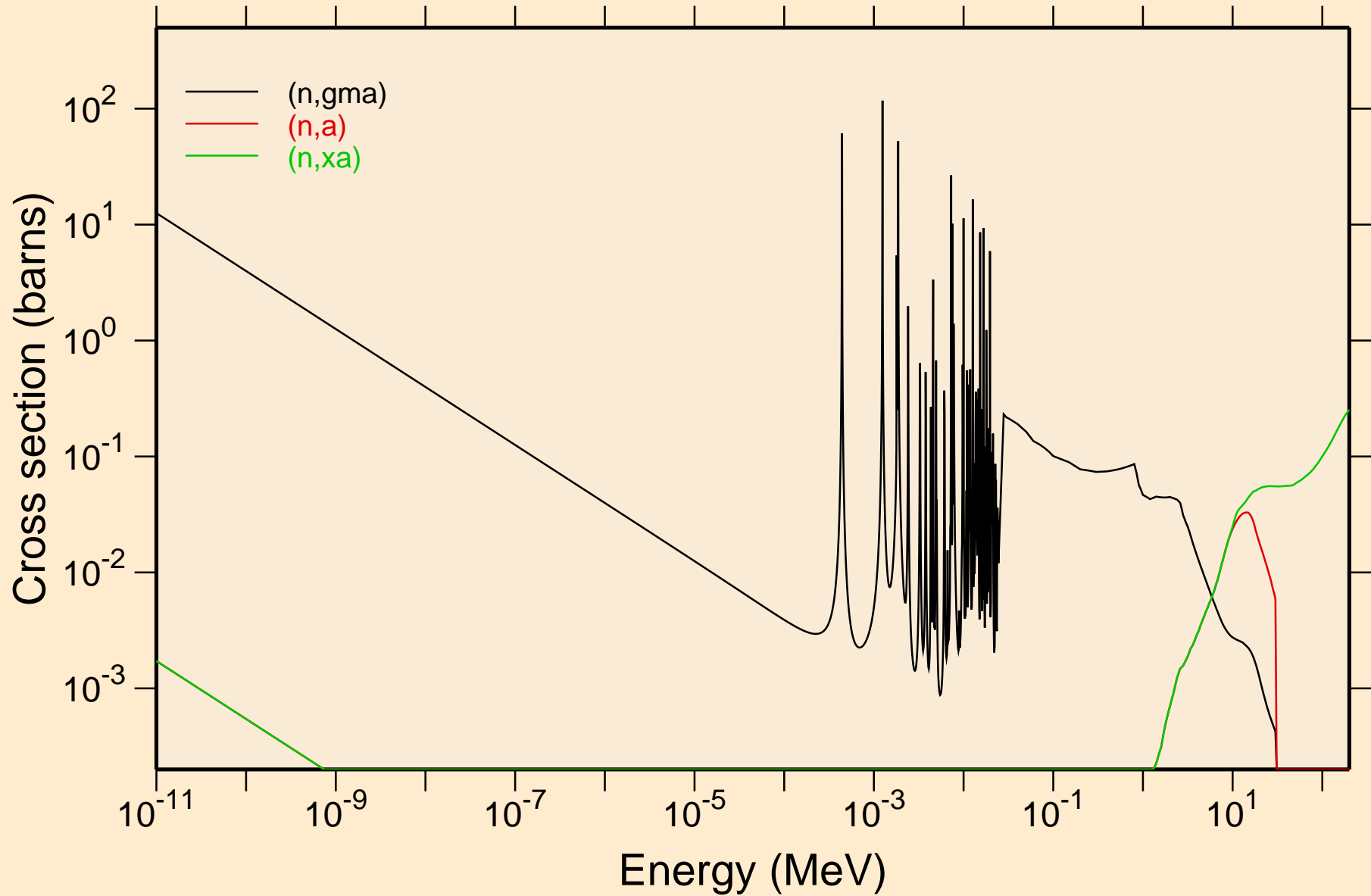

RU096 NEUTRON ACER TENDL-2021 LIBRARY; T=293.6K
Principal cross sections

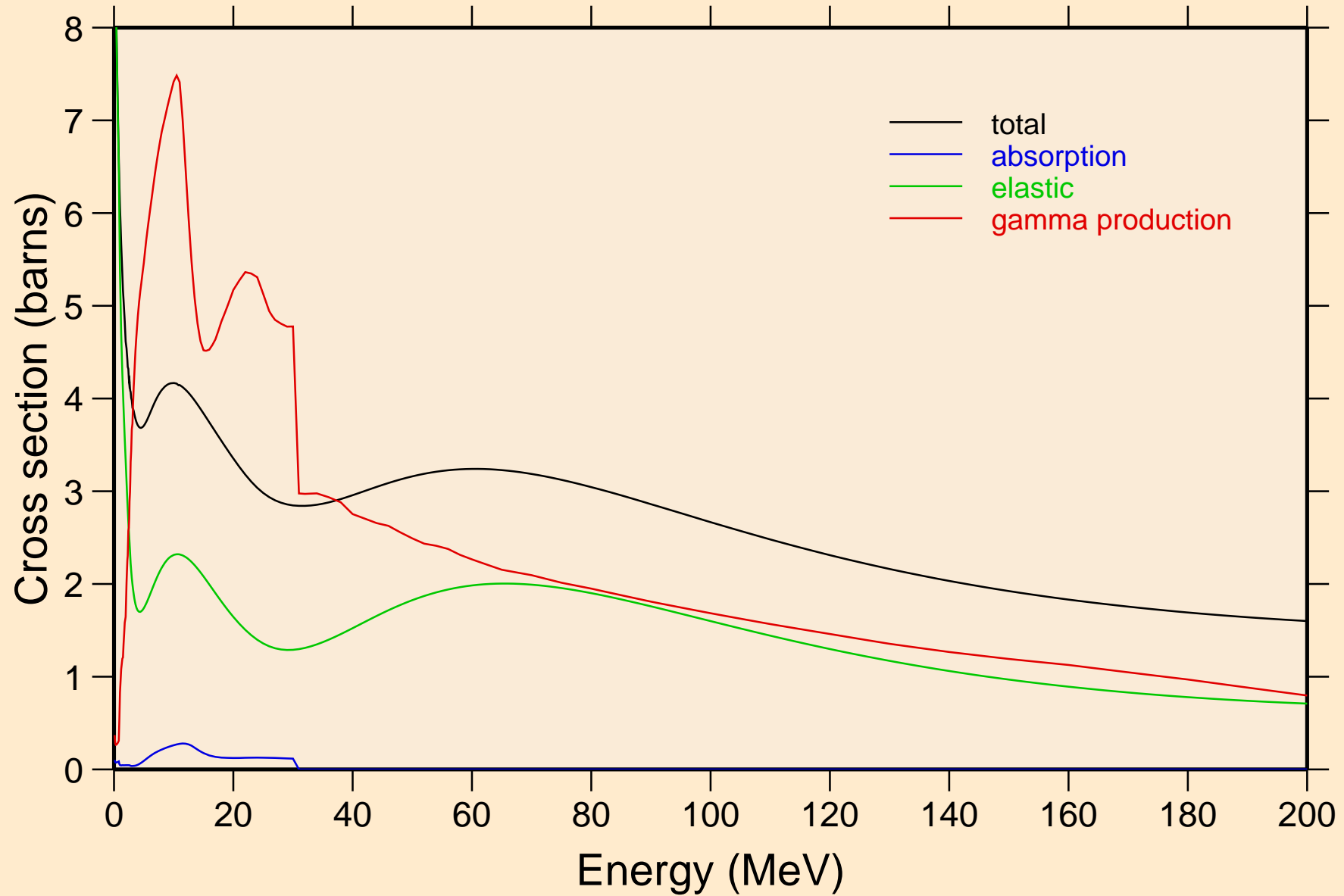

RU096 NEUTRON ACER TENDL-2021 LIBRARY; T=293.6K
Heating

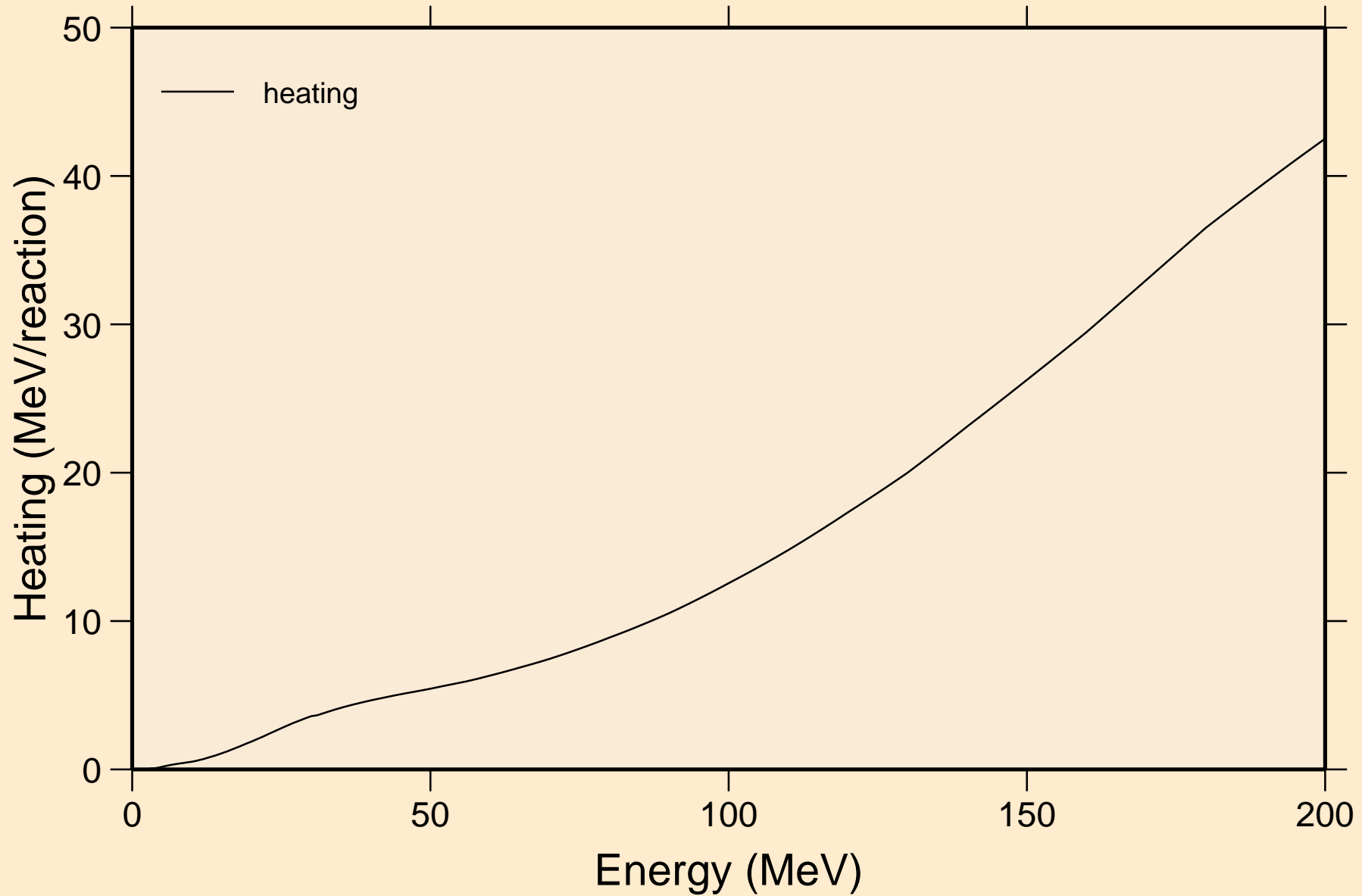

RU096 NEUTRON ACER TENDL-2021 LIBRARY; T=293.6K
Damage

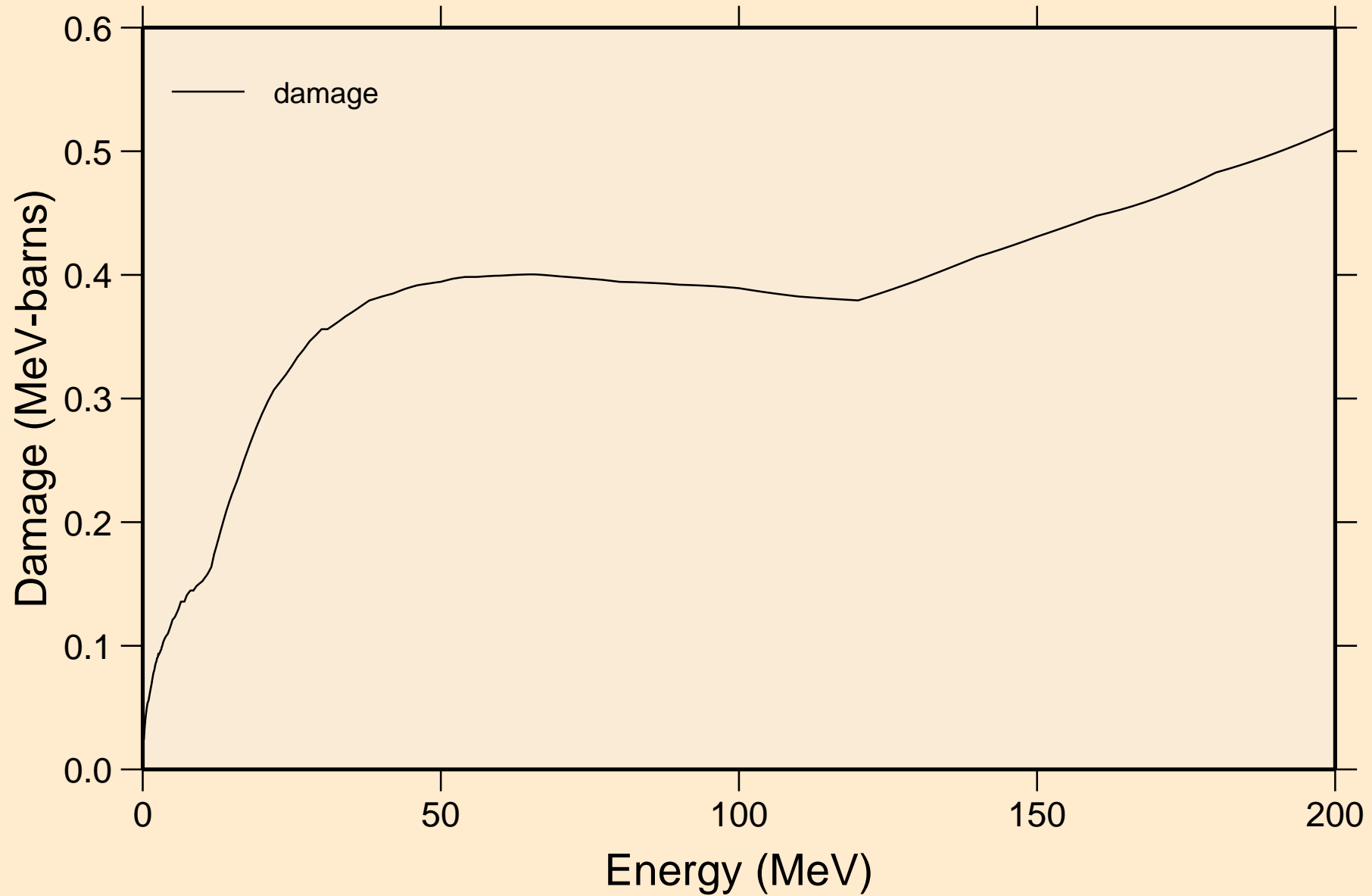

RU096 NEUTRON ACER TENDL-2021 LIBRARY; T=293.6K
Non-threshold reactions

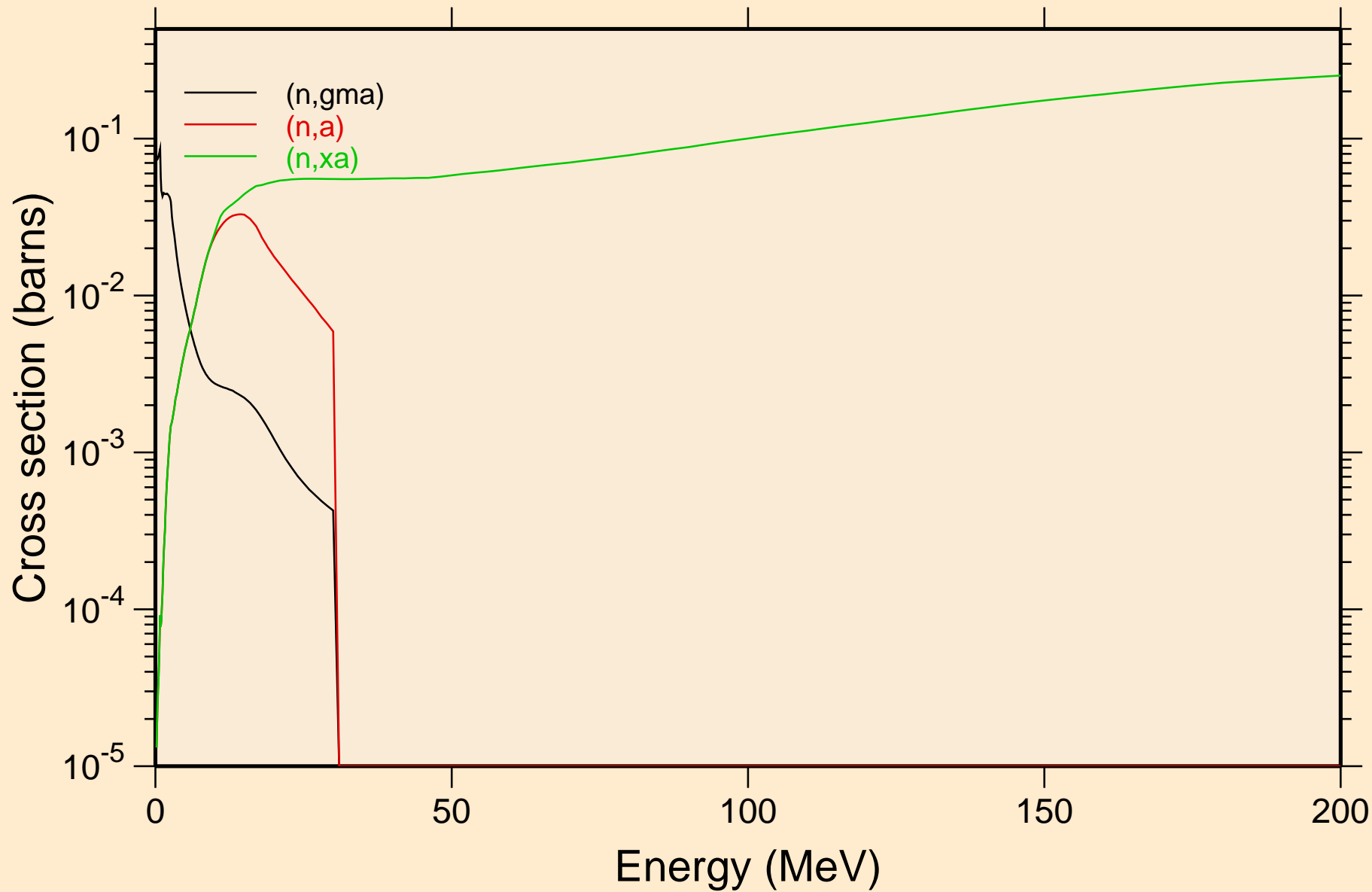

RU096 NEUTRON ACER TENDL-2021 LIBRARY; T=293.6K
Inelastic levels

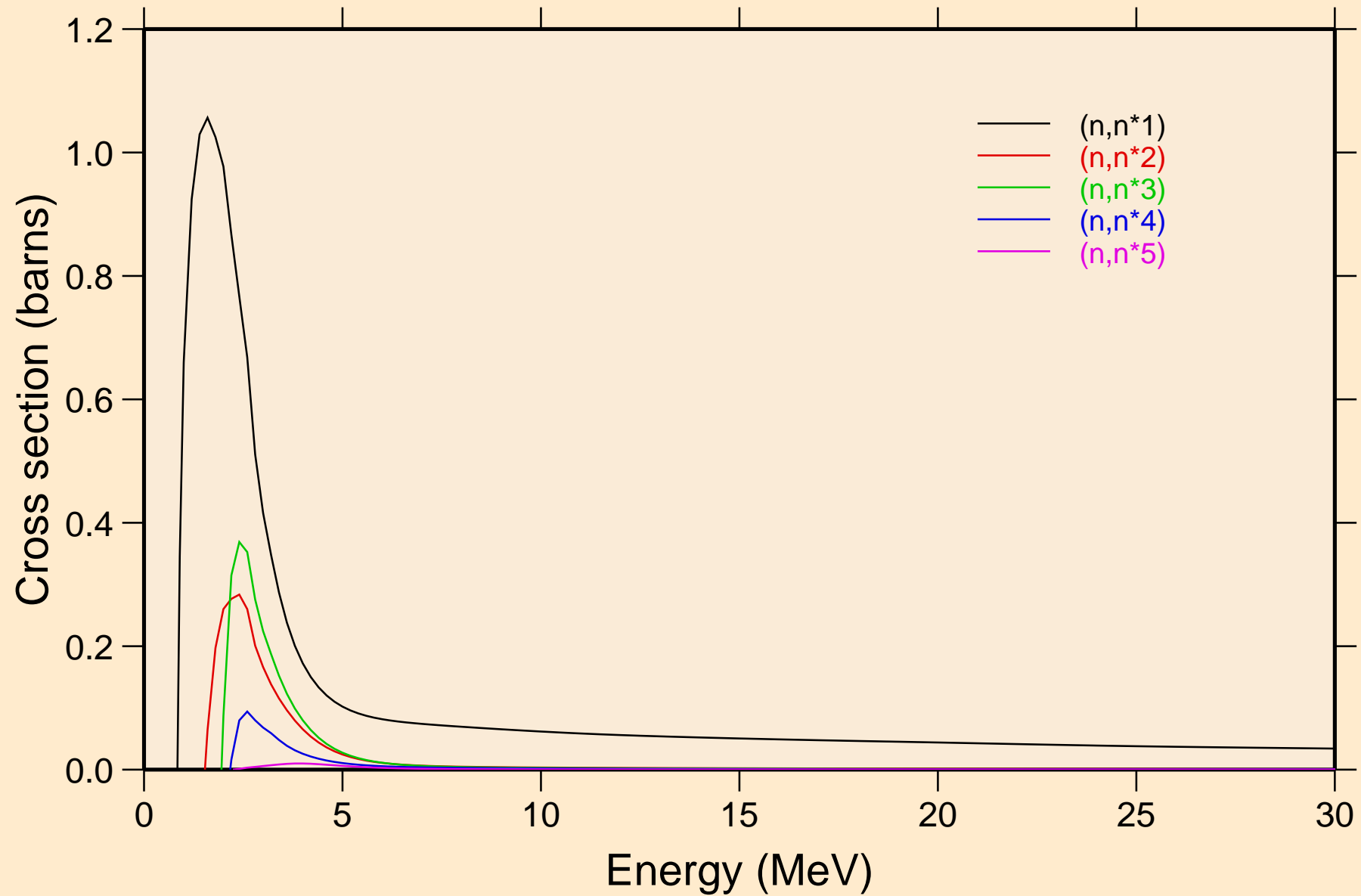

RU096 NEUTRON ACER TENDL-2021 LIBRARY; T=293.6K
Inelastic levels

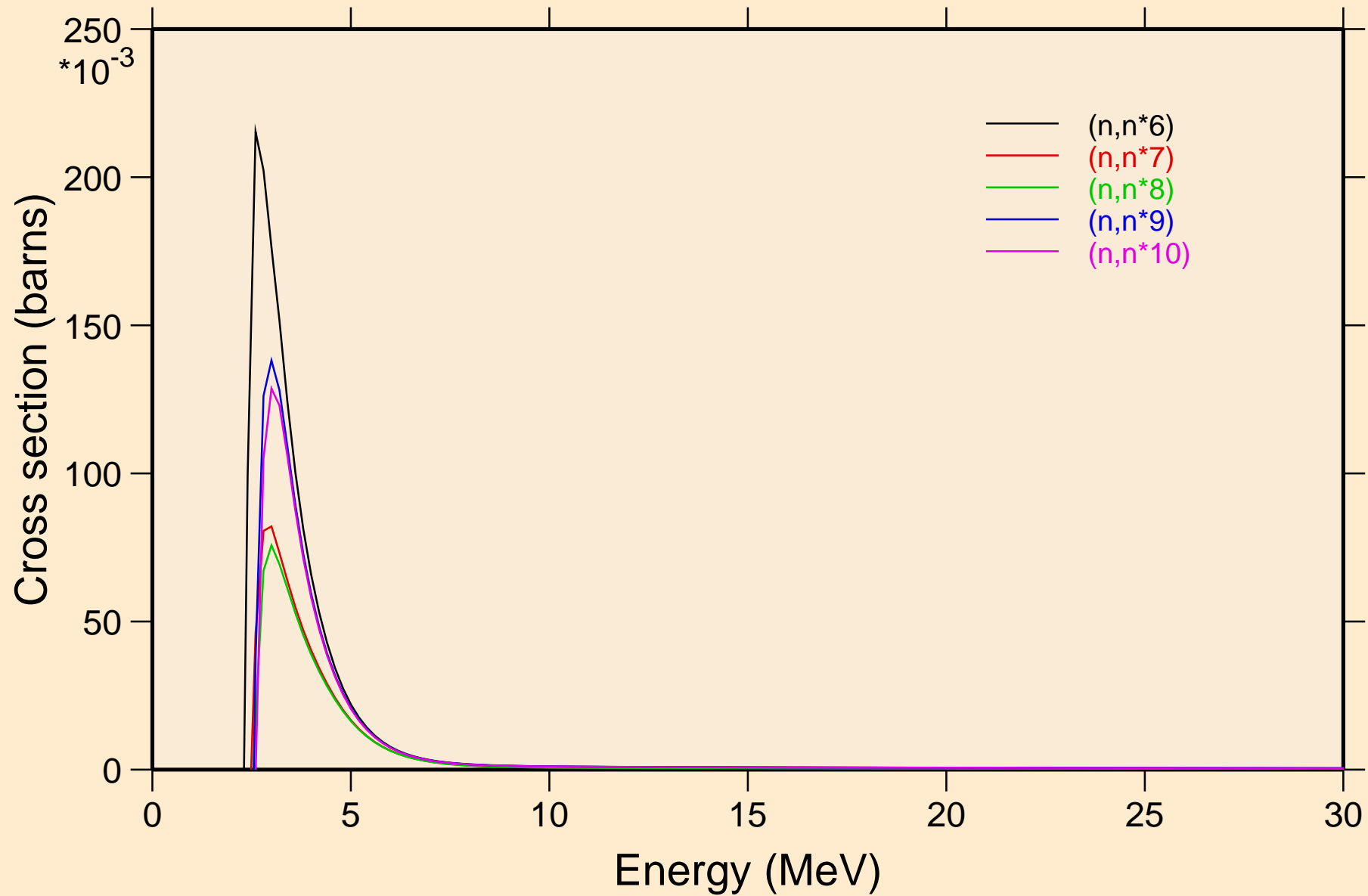

RU096 NEUTRON ACER TENDL-2021 LIBRARY; T=293.6K
Inelastic levels

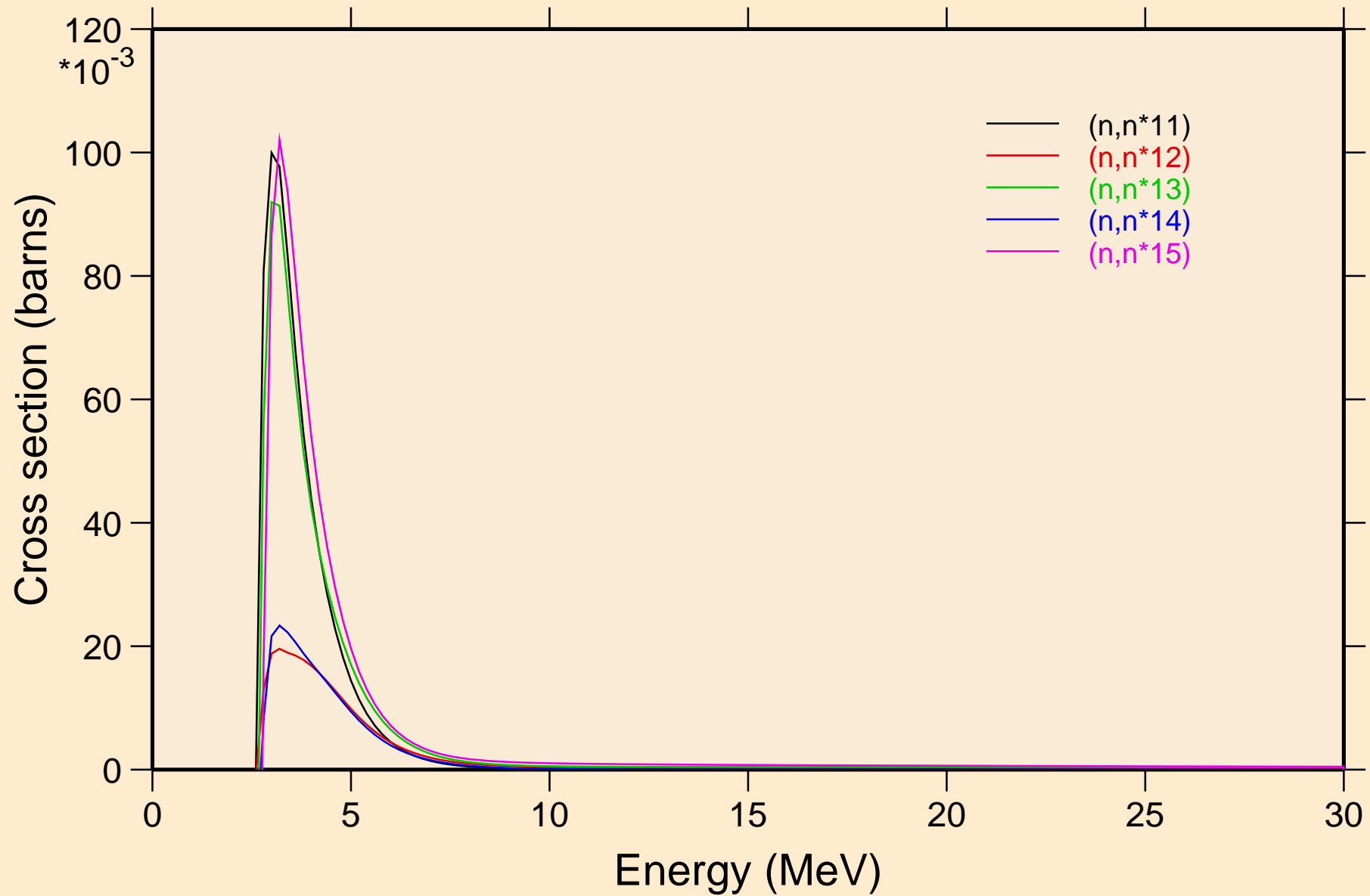

RU096 NEUTRON ACER TENDL-2021 LIBRARY; T=293.6K
Inelastic levels

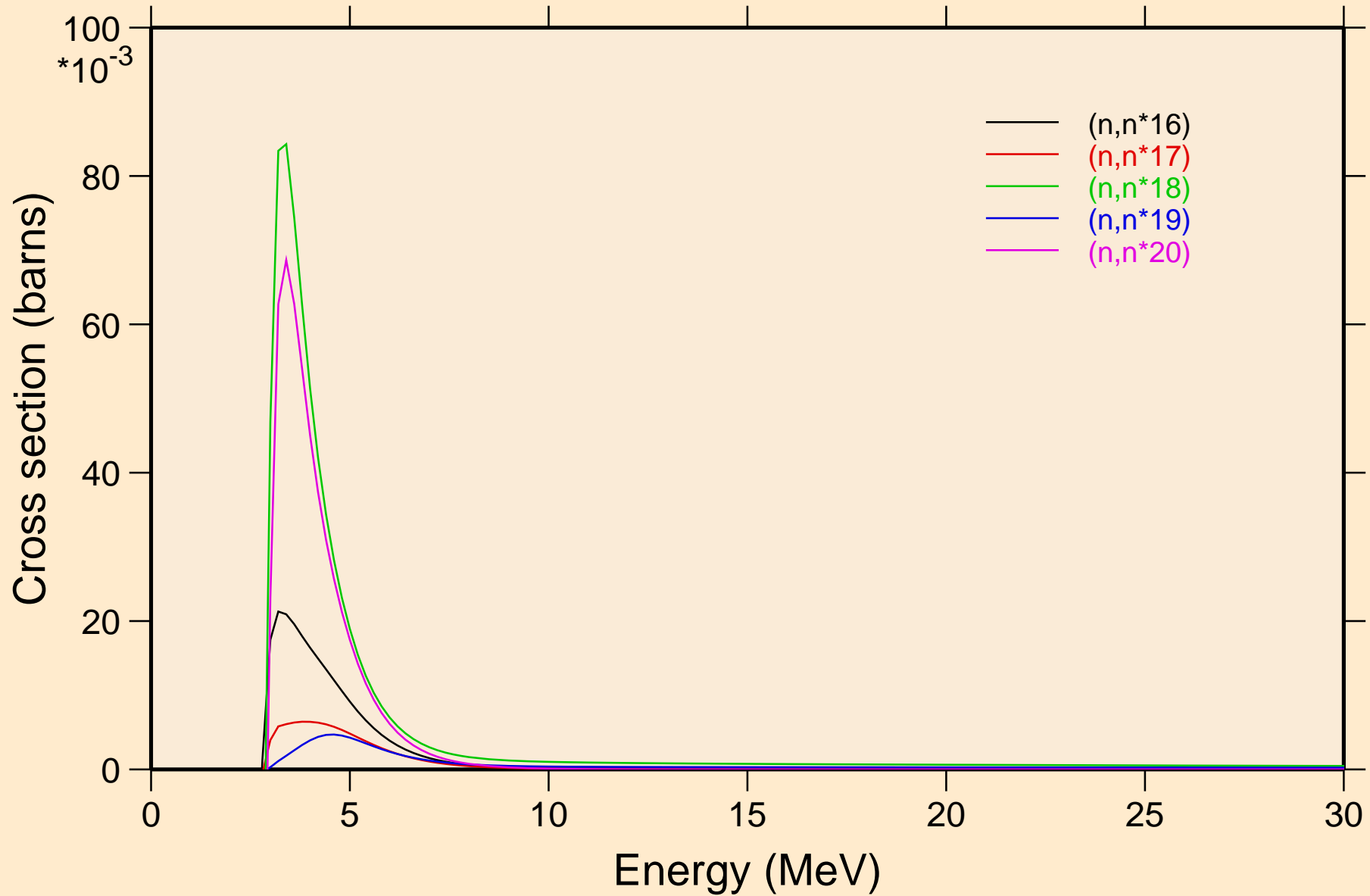

RU096 NEUTRON ACER TENDL-2021 LIBRARY; T=293.6K
Inelastic levels

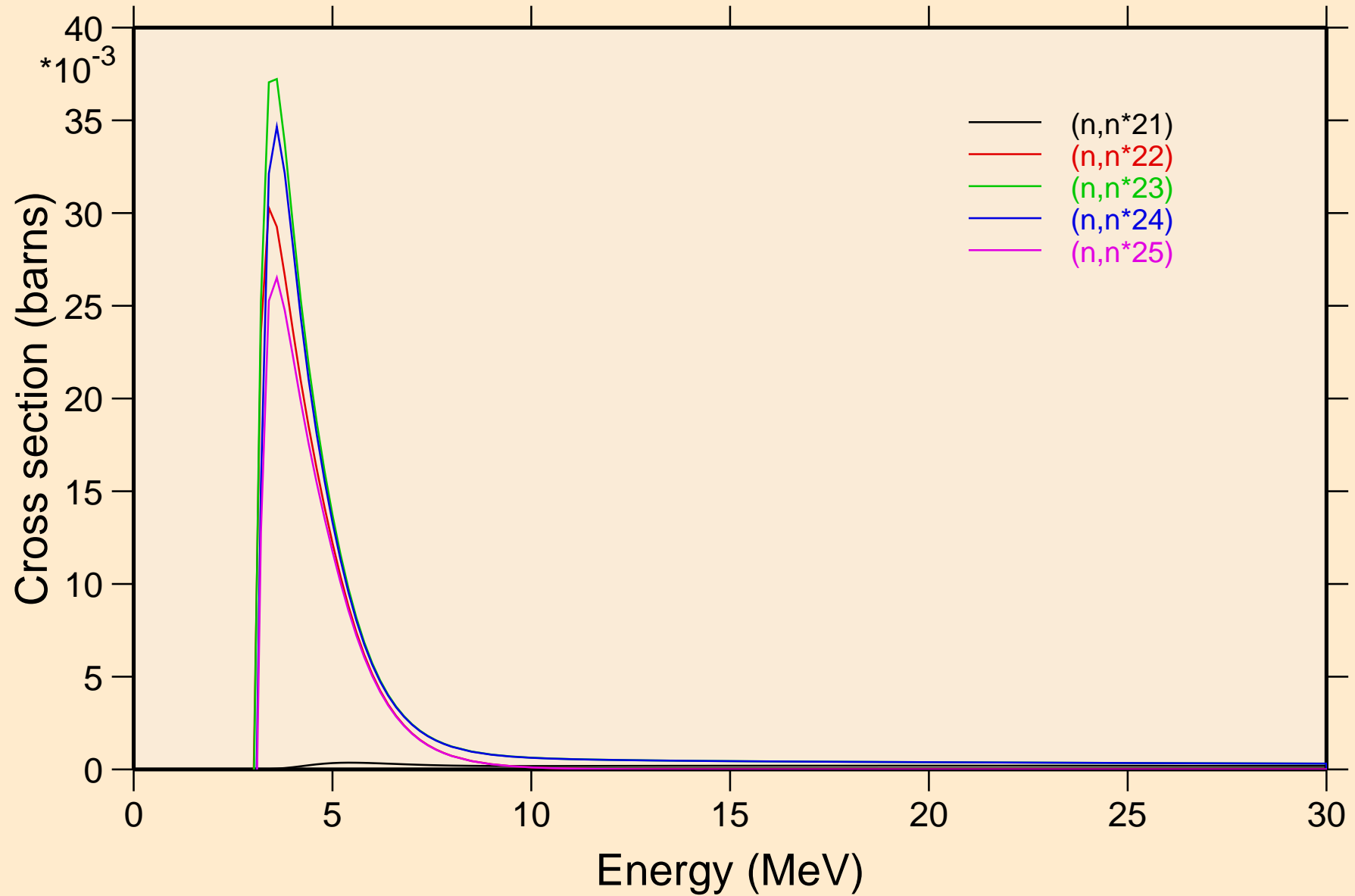

RU096 NEUTRON ACER TENDL-2021 LIBRARY; T=293.6K
Inelastic levels

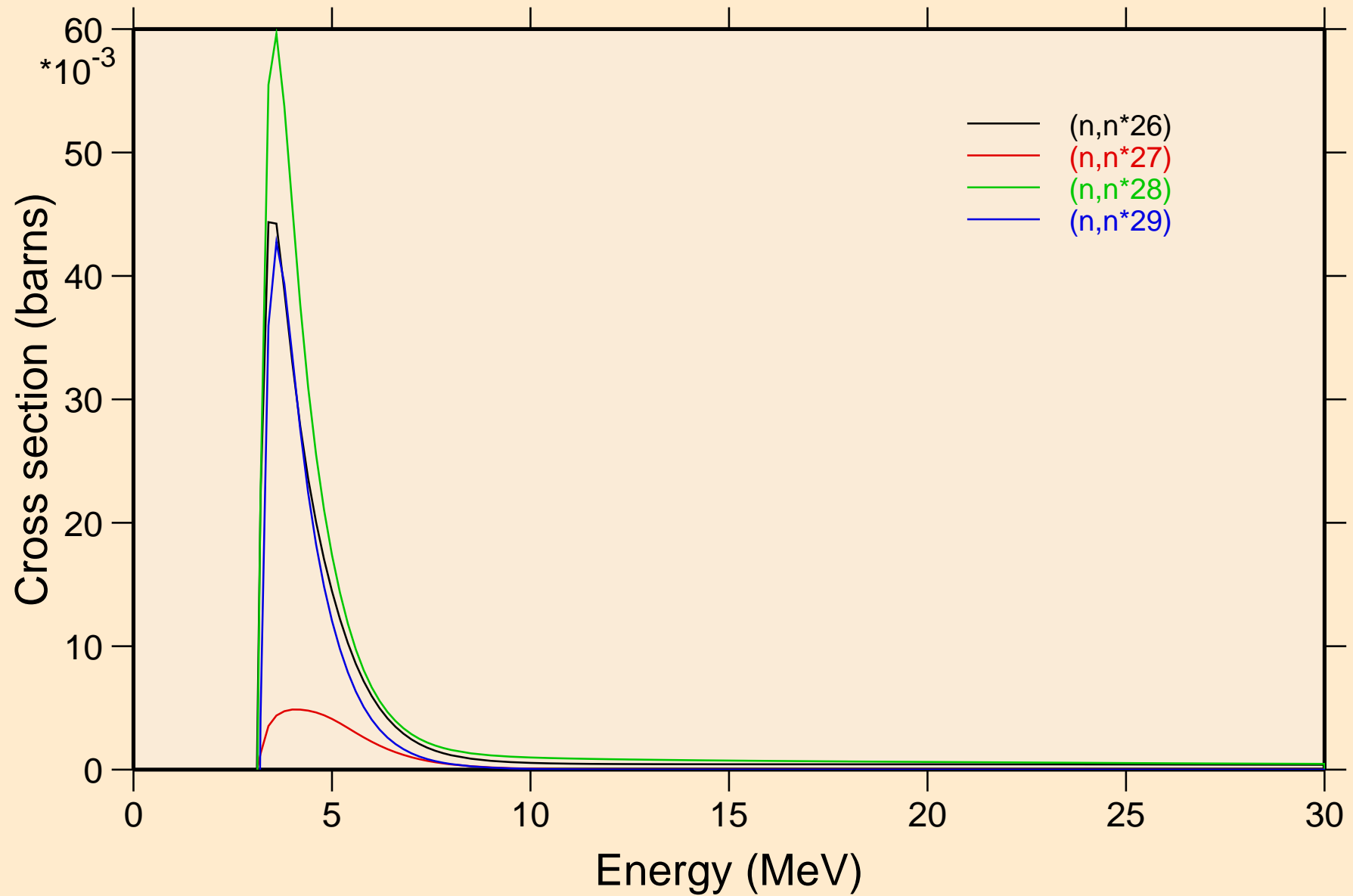

RU096 NEUTRON ACER TENDL-2021 LIBRARY; T=293.6K
Threshold reactions

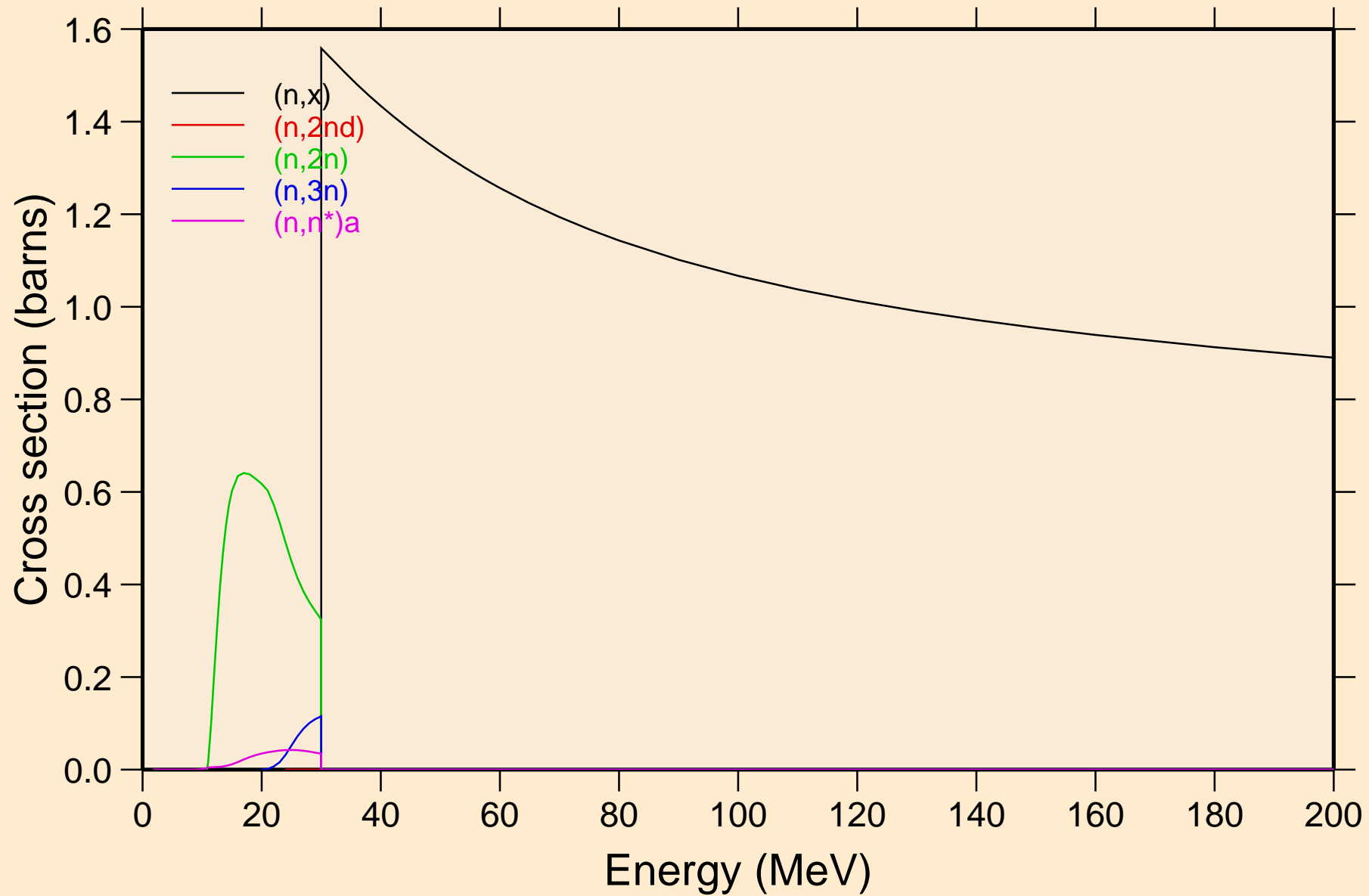

RU096 NEUTRON ACER TENDL-2021 LIBRARY; T=293.6K
Threshold reactions

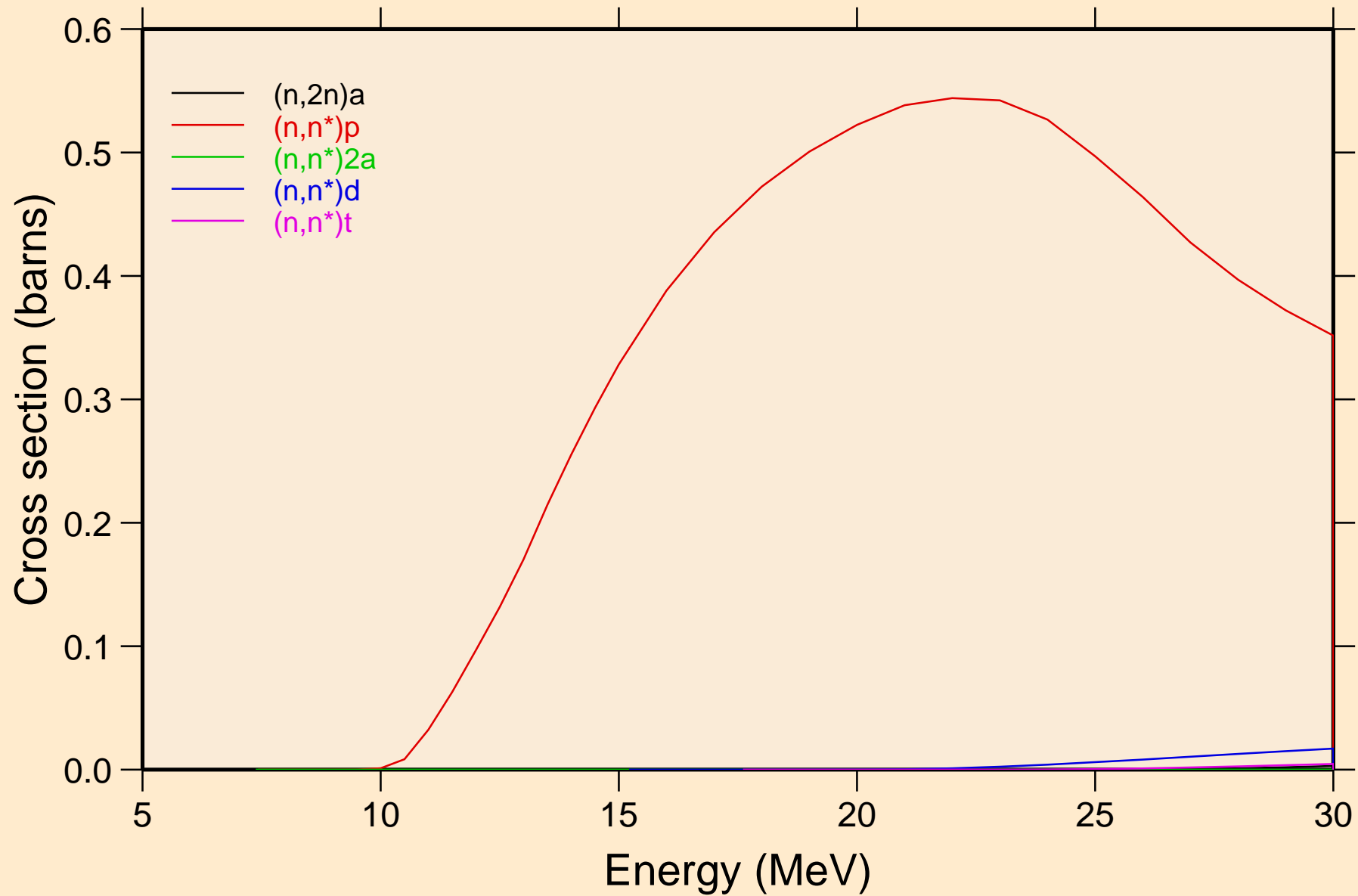

RU096 NEUTRON ACER TENDL-2021 LIBRARY; T=293.6K
Threshold reactions

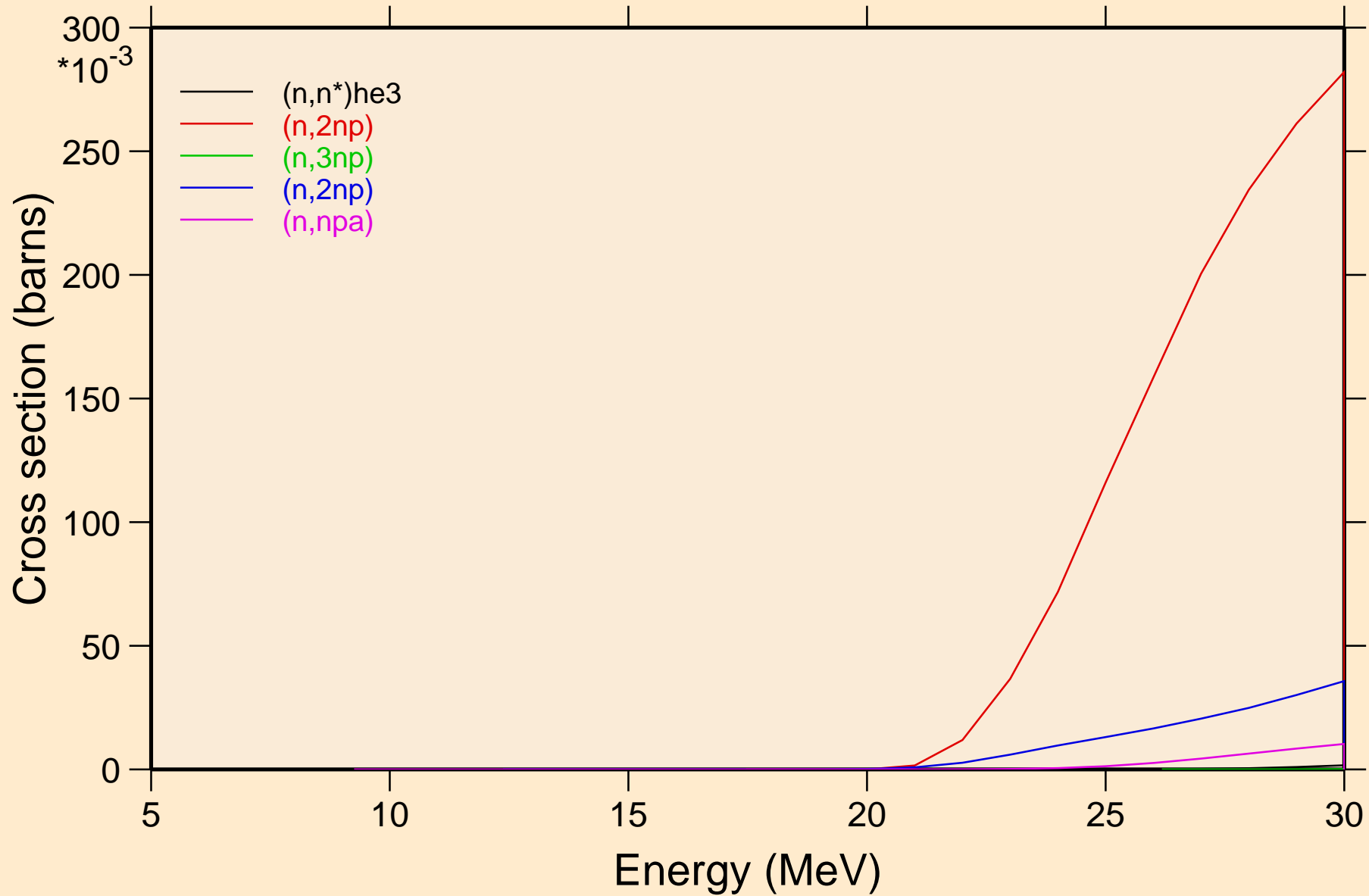

RU096 NEUTRON ACER TENDL-2021 LIBRARY; T=293.6K
Threshold reactions

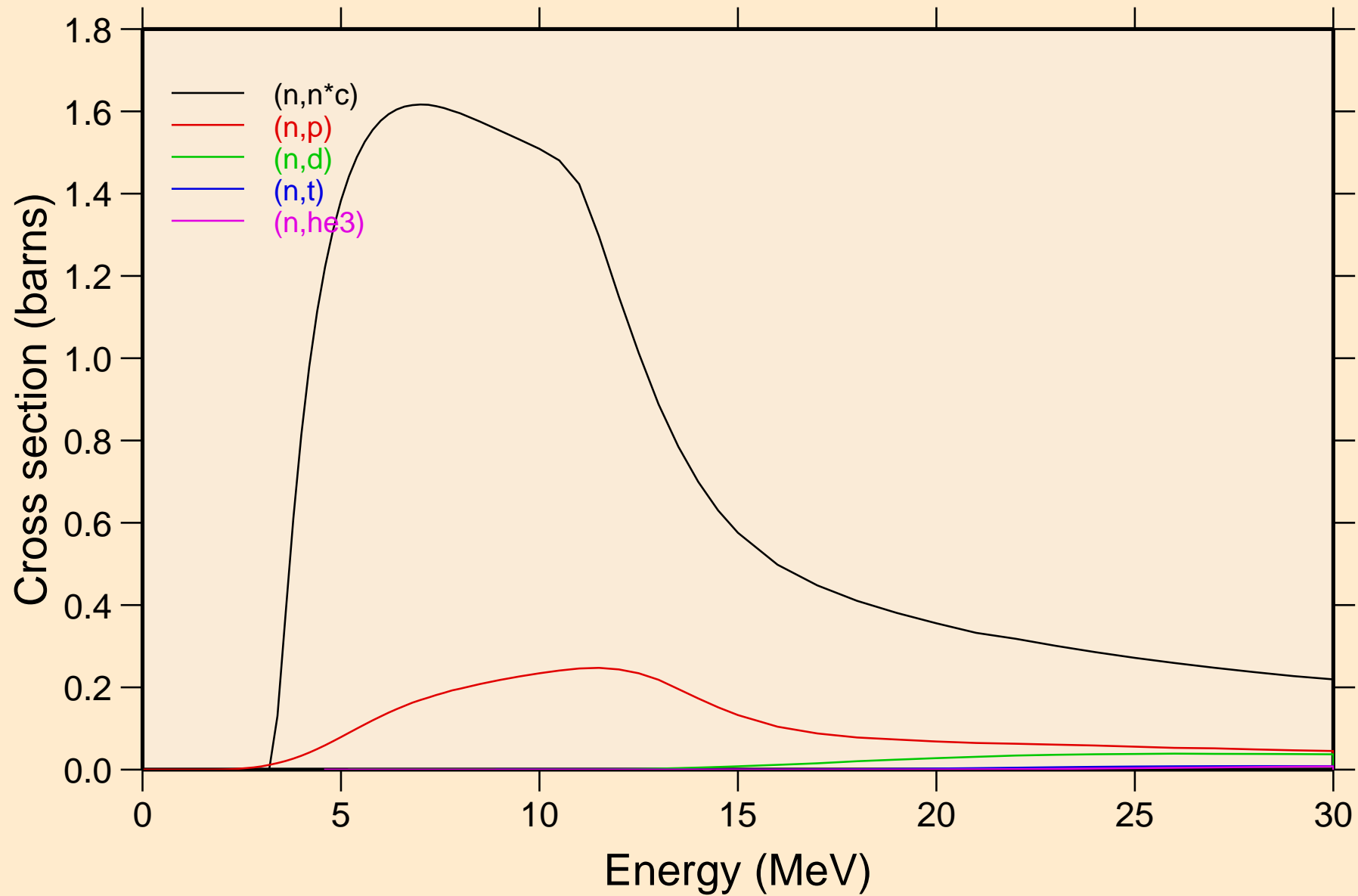

RU096 NEUTRON ACER TENDL-2021 LIBRARY; T=293.6K
Threshold reactions

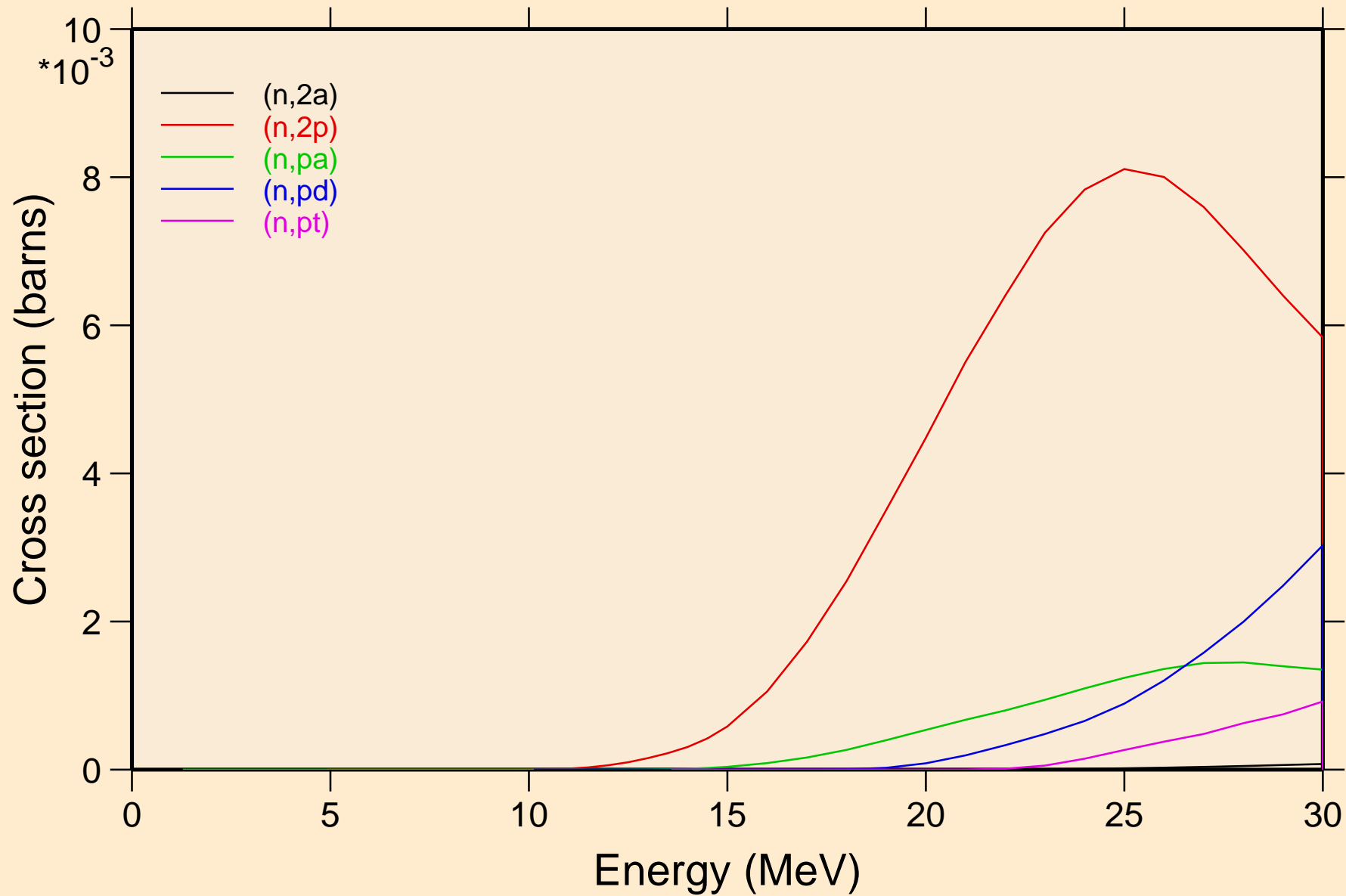

RU096 NEUTRON ACER TENDL-2021 LIBRARY; T=293.6K
Threshold reactions

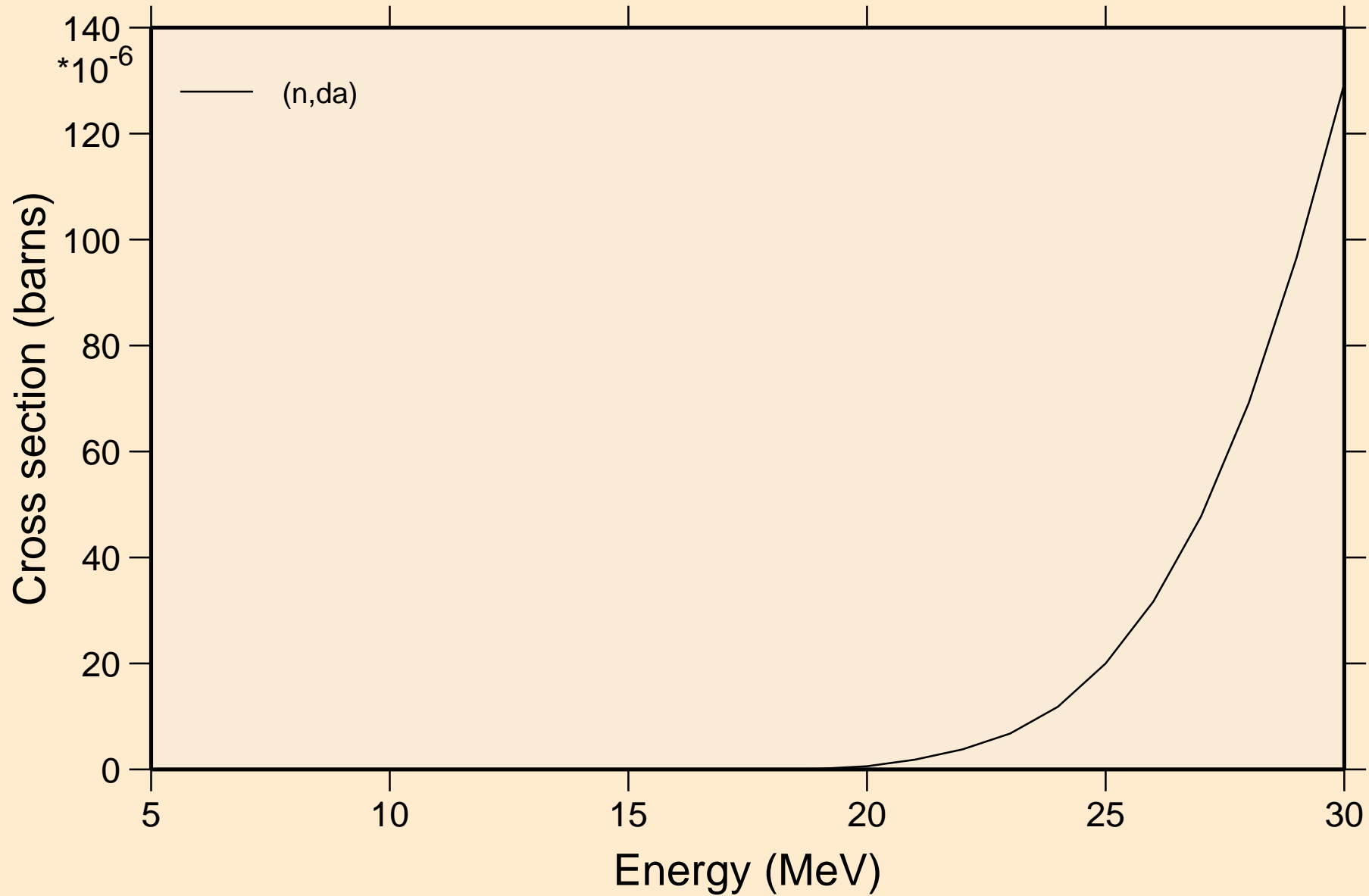

RU096 NEUTRON ACER TENDL-2021 LIBRARY; T=293.6K
Threshold reactions

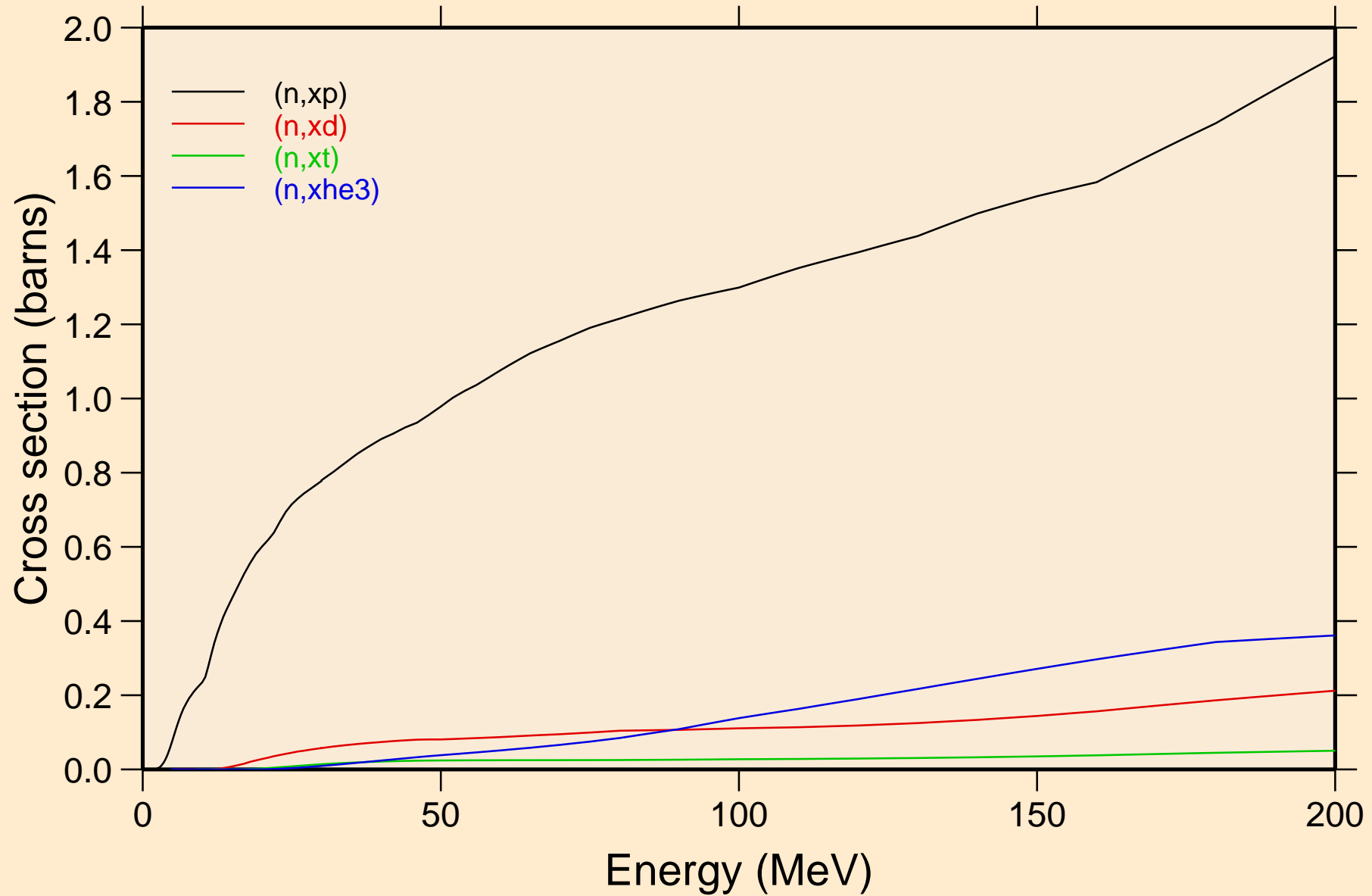

RU096 NEUTRON ACER TENDL-2021 LIBRARY; T=293.6K
angular distribution for elastic

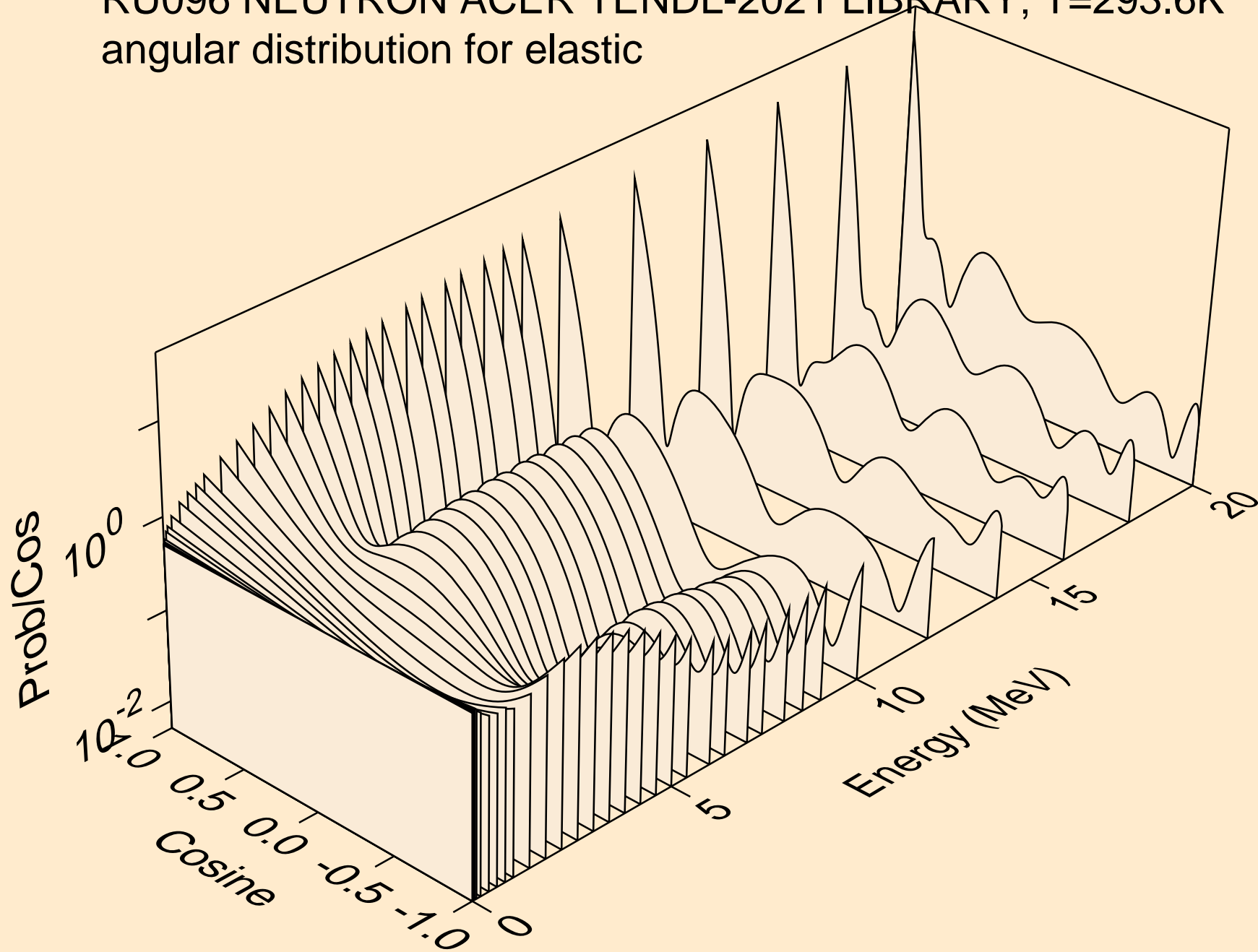

RU096 NEUTRON ACER TENDL-2021 LIBRARY; T=293.6K
angular distribution for elastic

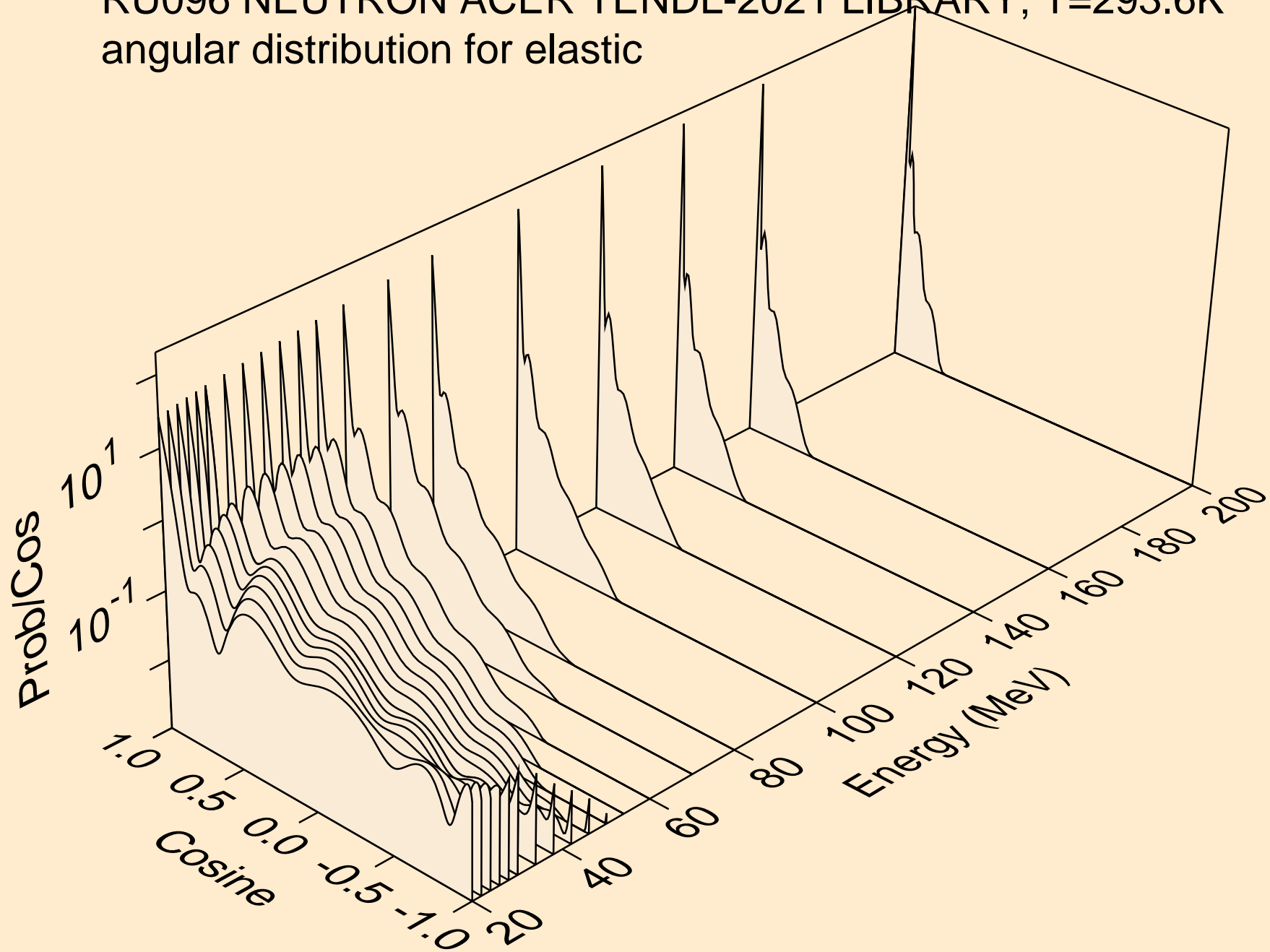

RU096 NEUTRON ACER TENDL-2021 LIBRARY; T=293.6K
angular distribution for (n,n*1)

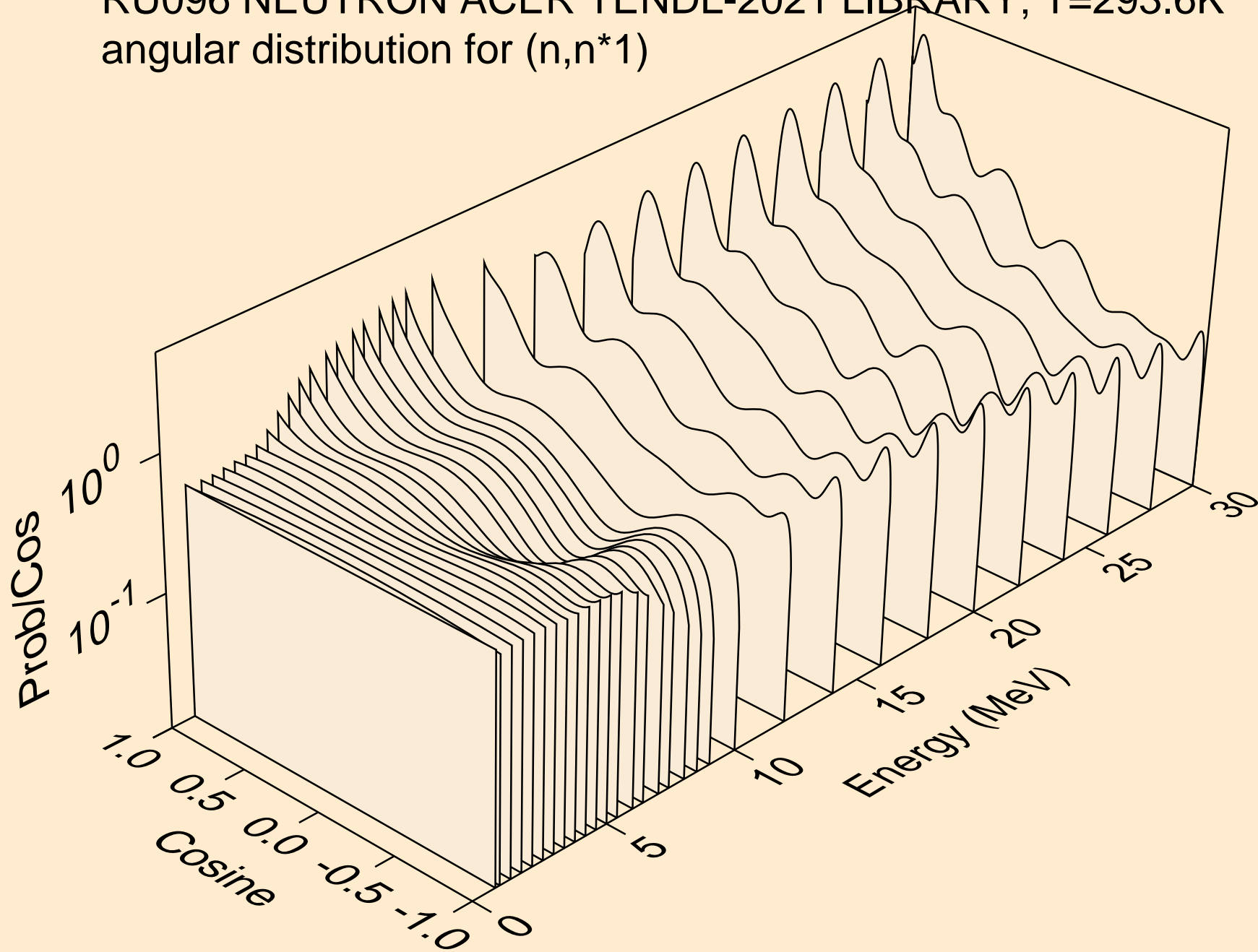

RU096 NEUTRON ACER TENDL-2021 LIBRARY; T=293.6K
angular distribution for (n,n*2)

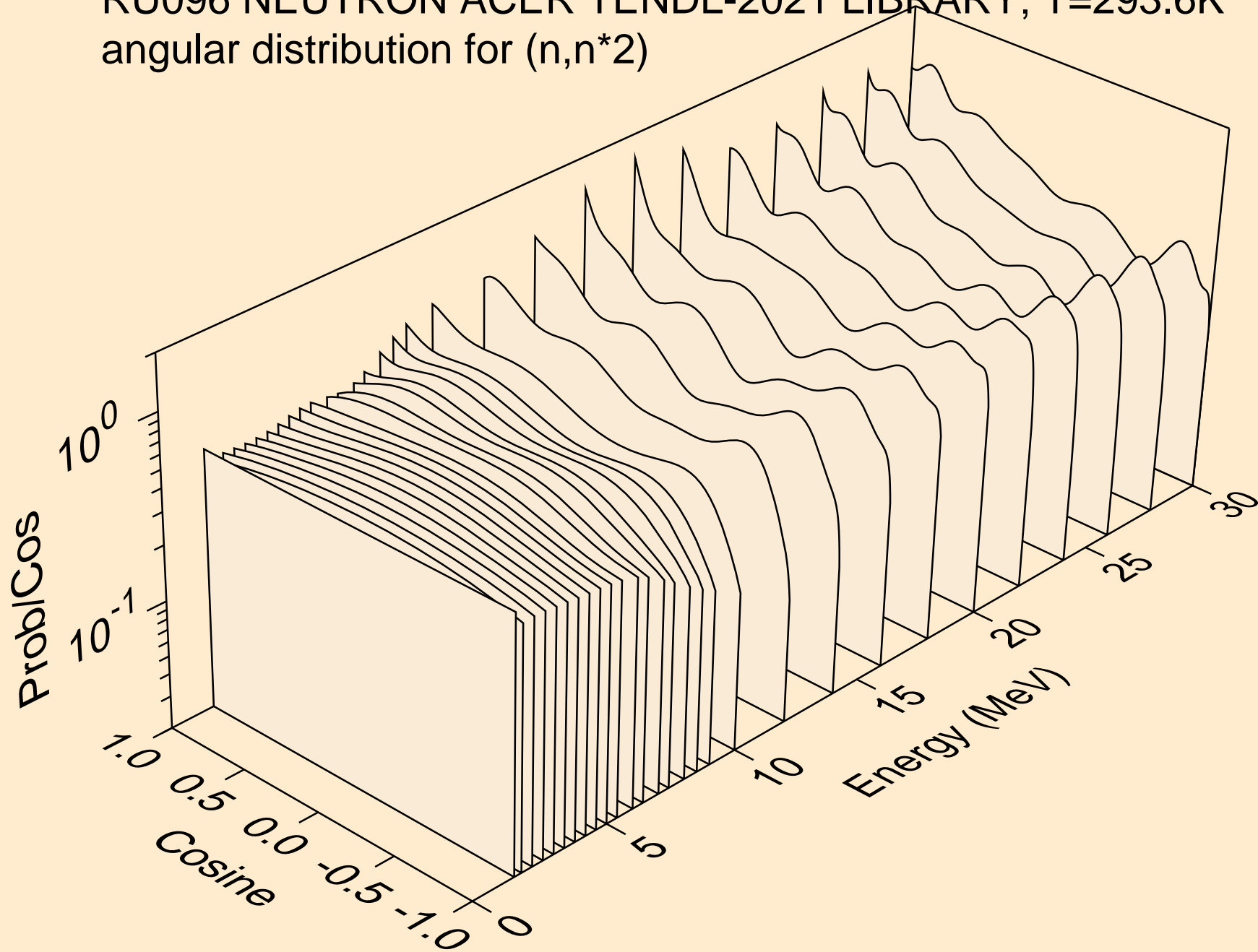

RU096 NEUTRON ACER TENDL-2021 LIBRARY; T=293.6K
angular distribution for (n,n*3)

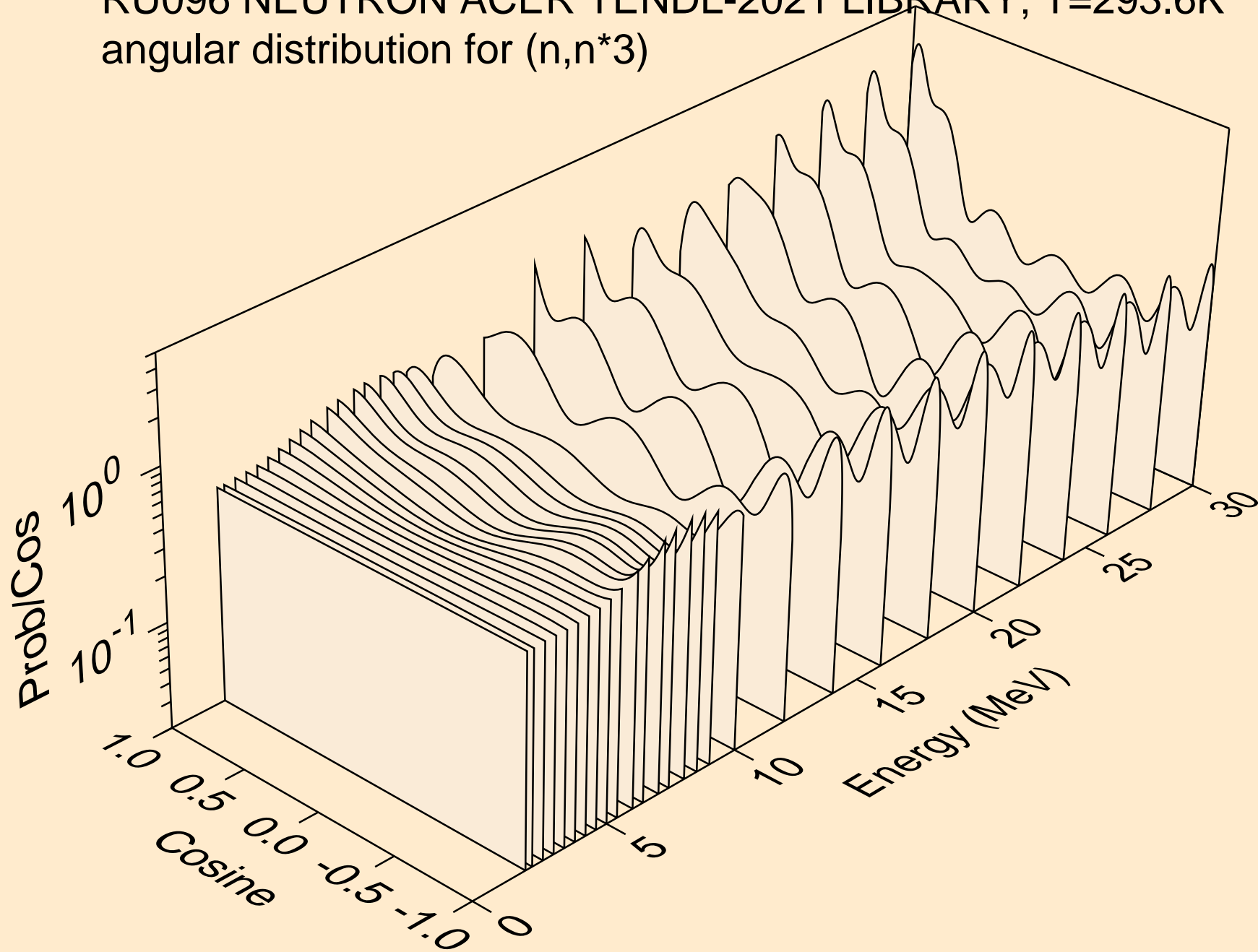

RU096 NEUTRON ACER TENDL-2021 LIBRARY; T=293.6K
angular distribution for (n,n*4)

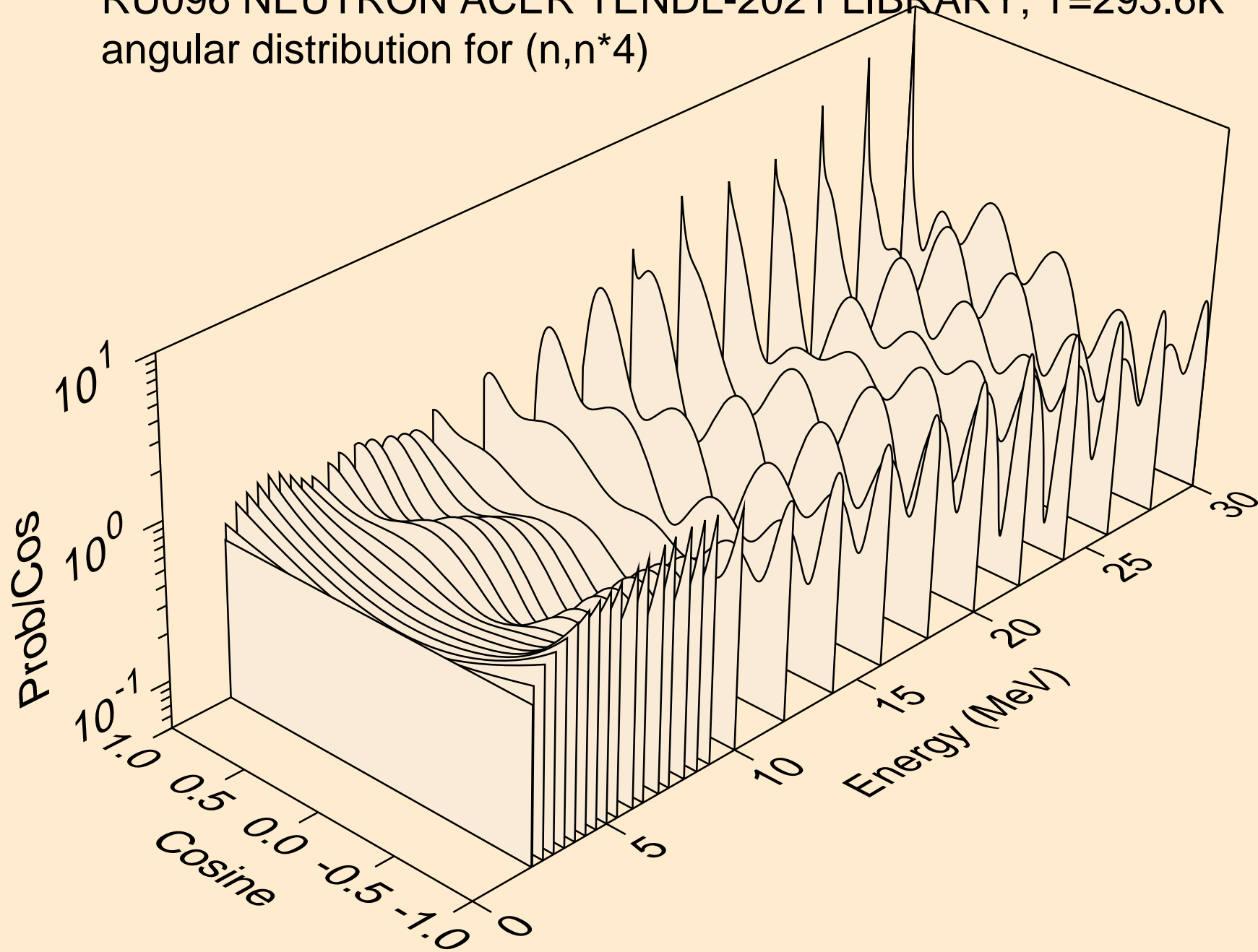

RU096 NEUTRON ACER TENDL-2021 LIBRARY; T=293.6K
angular distribution for (n,n*5)

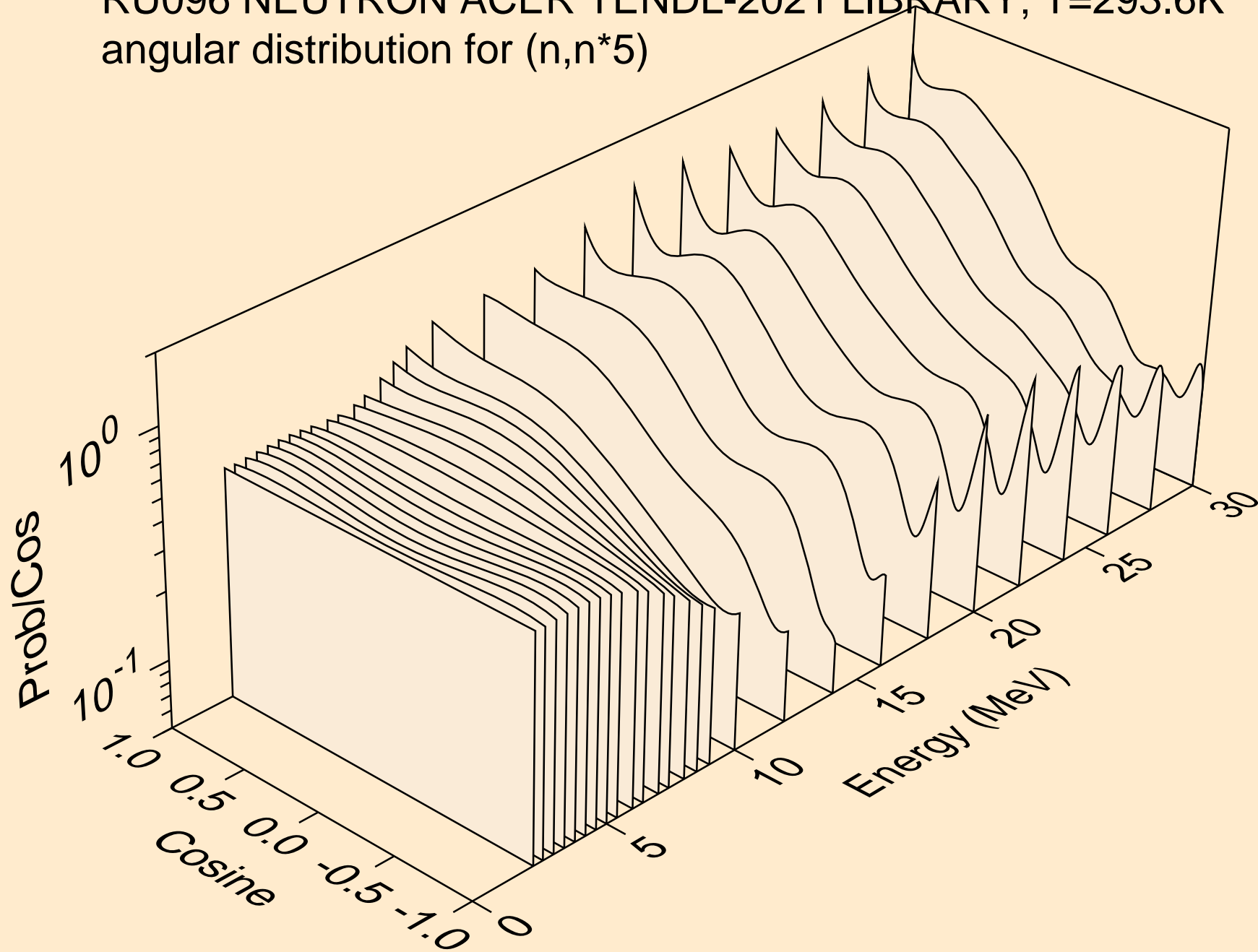

RU096 NEUTRON ACER TENDL-2021 LIBRARY; T=293.6K
angular distribution for (n,n*6)

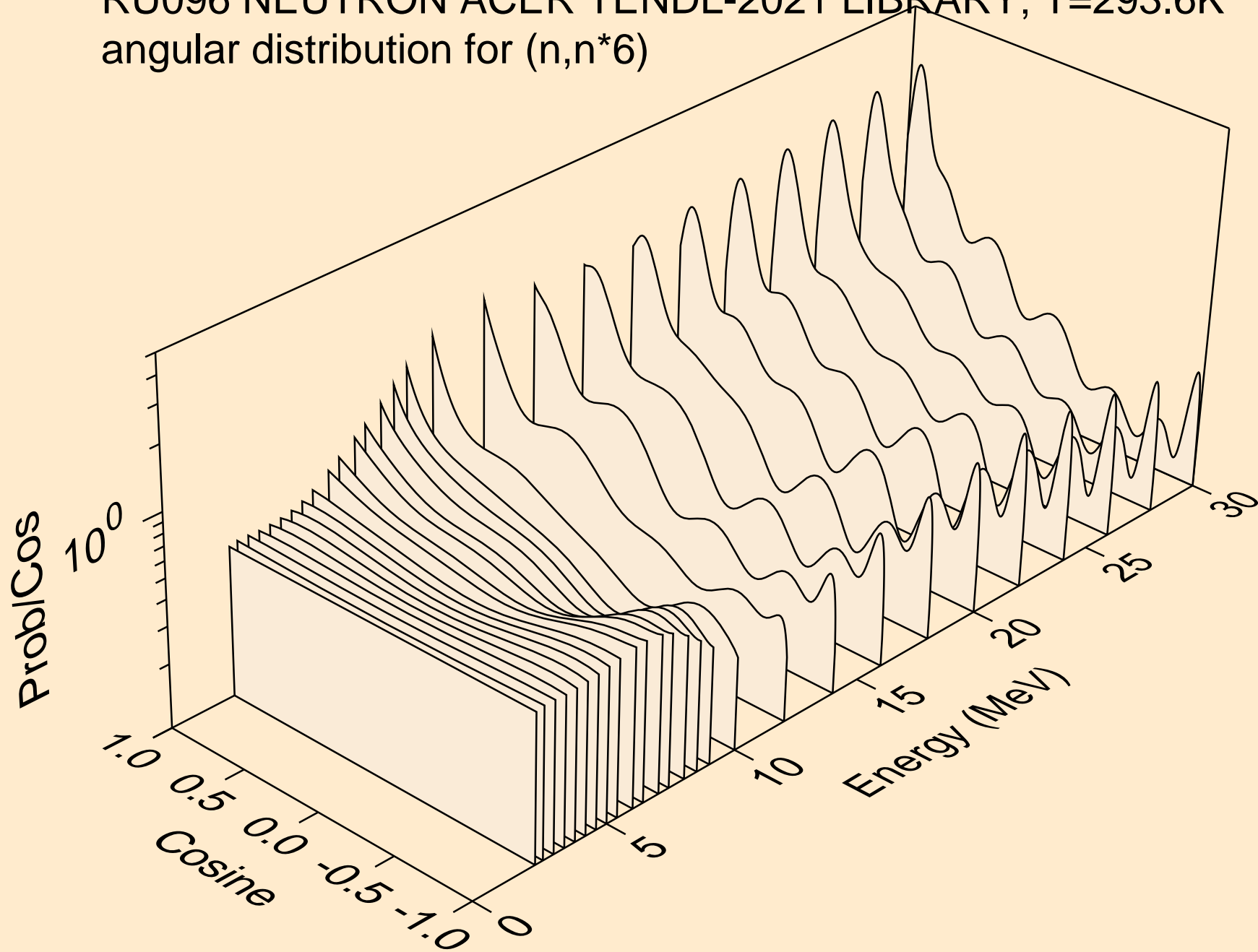

RU096 NEUTRON ACER TENDL-2021 LIBRARY; T=293.6K
angular distribution for (n,n*7)

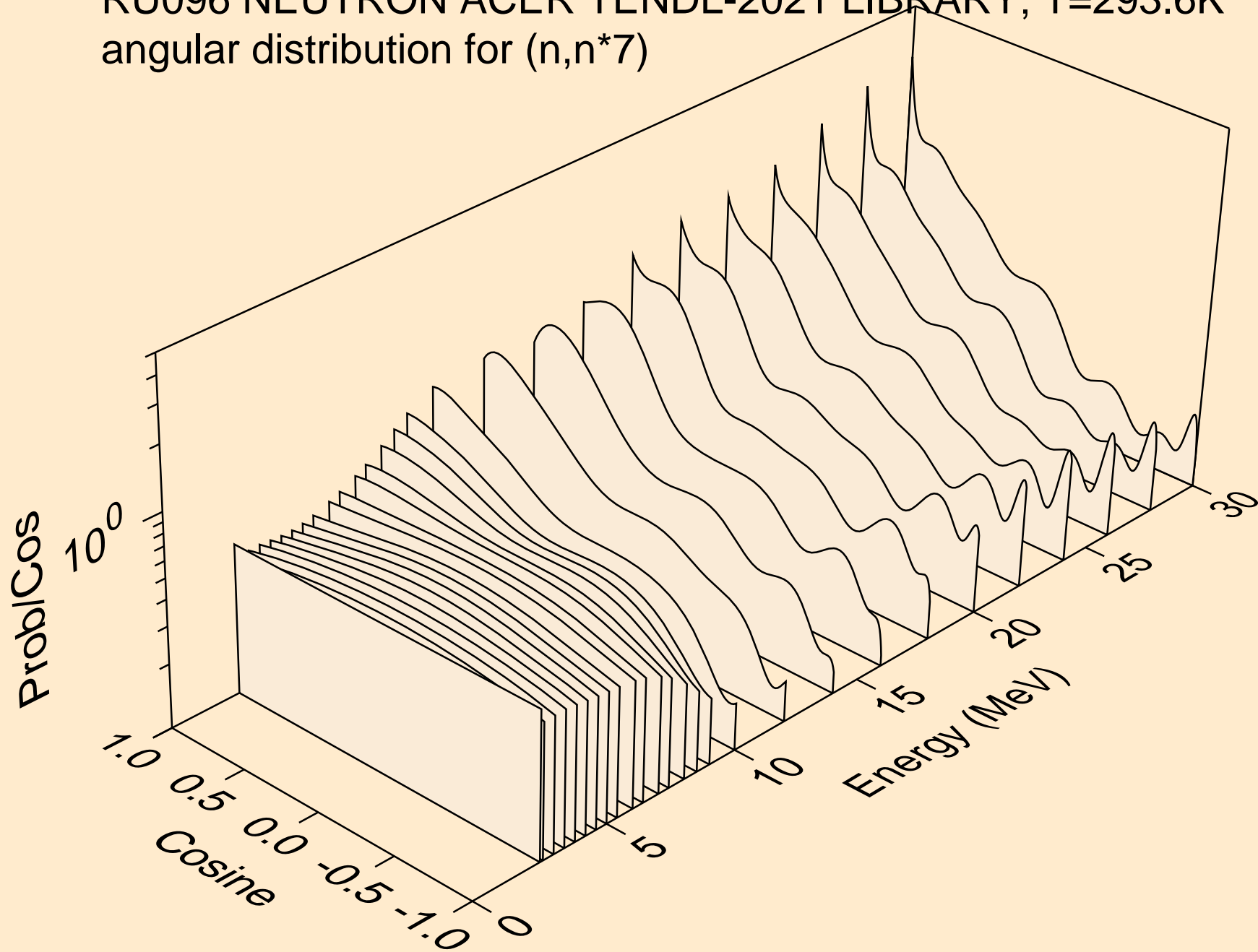

RU096 NEUTRON ACER TENDL-2021 LIBRARY; T=293.6K
angular distribution for (n,n*8)

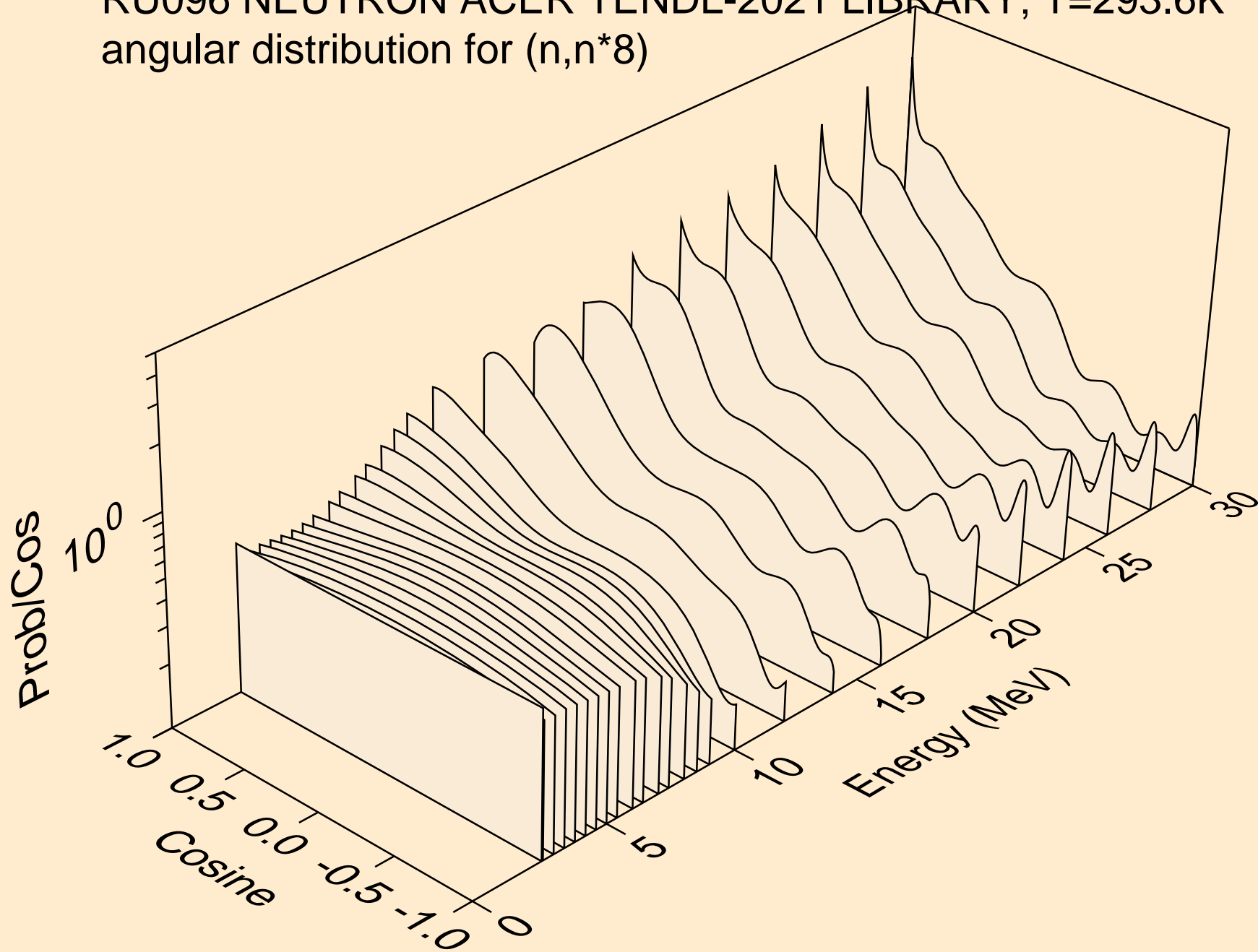

RU096 NEUTRON ACER TENDL-2021 LIBRARY; T=293.6K
angular distribution for (n,n*9)

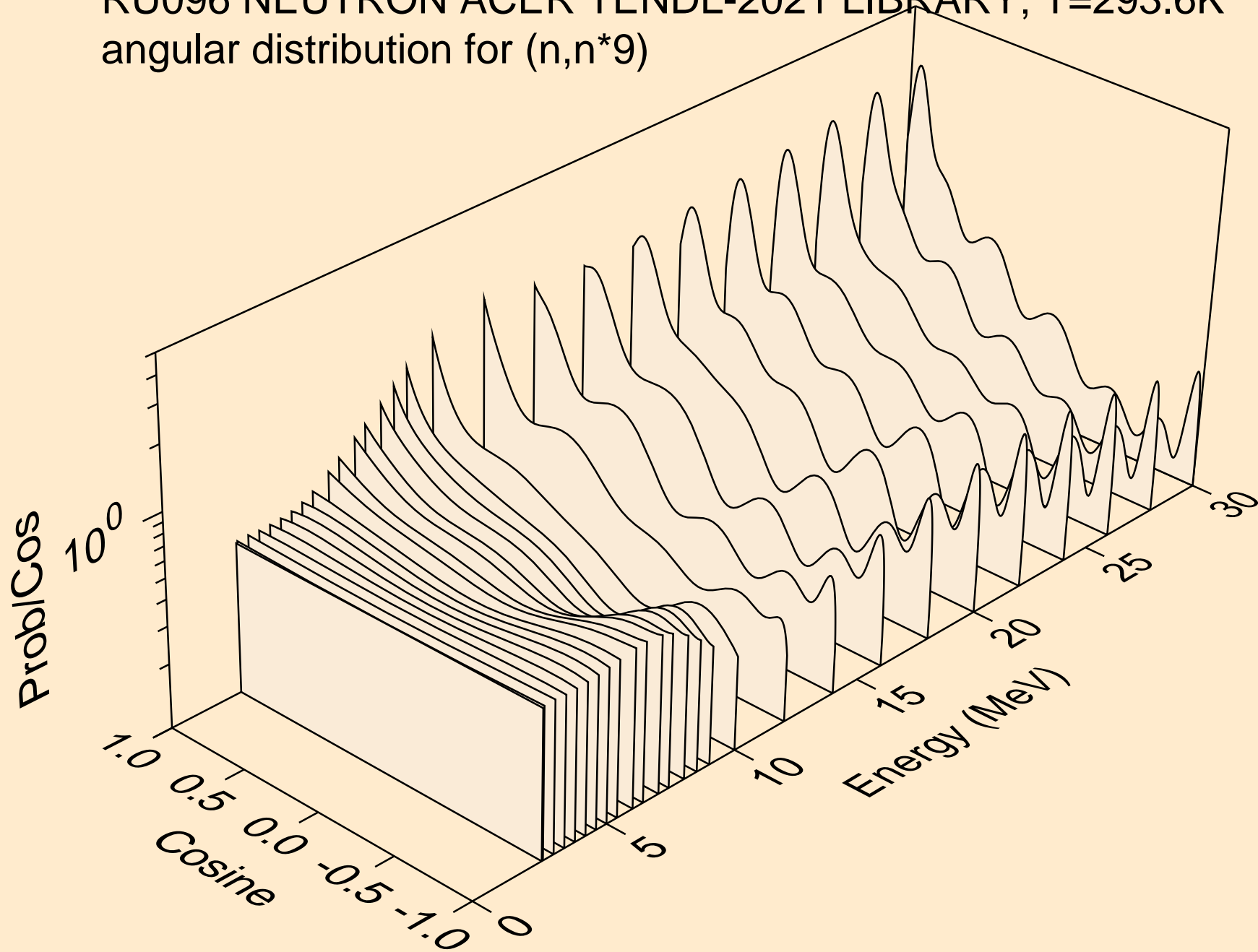

RU096 NEUTRON ACER TENDL-2021 LIBRARY; T=293.6K
angular distribution for (n,n*10)

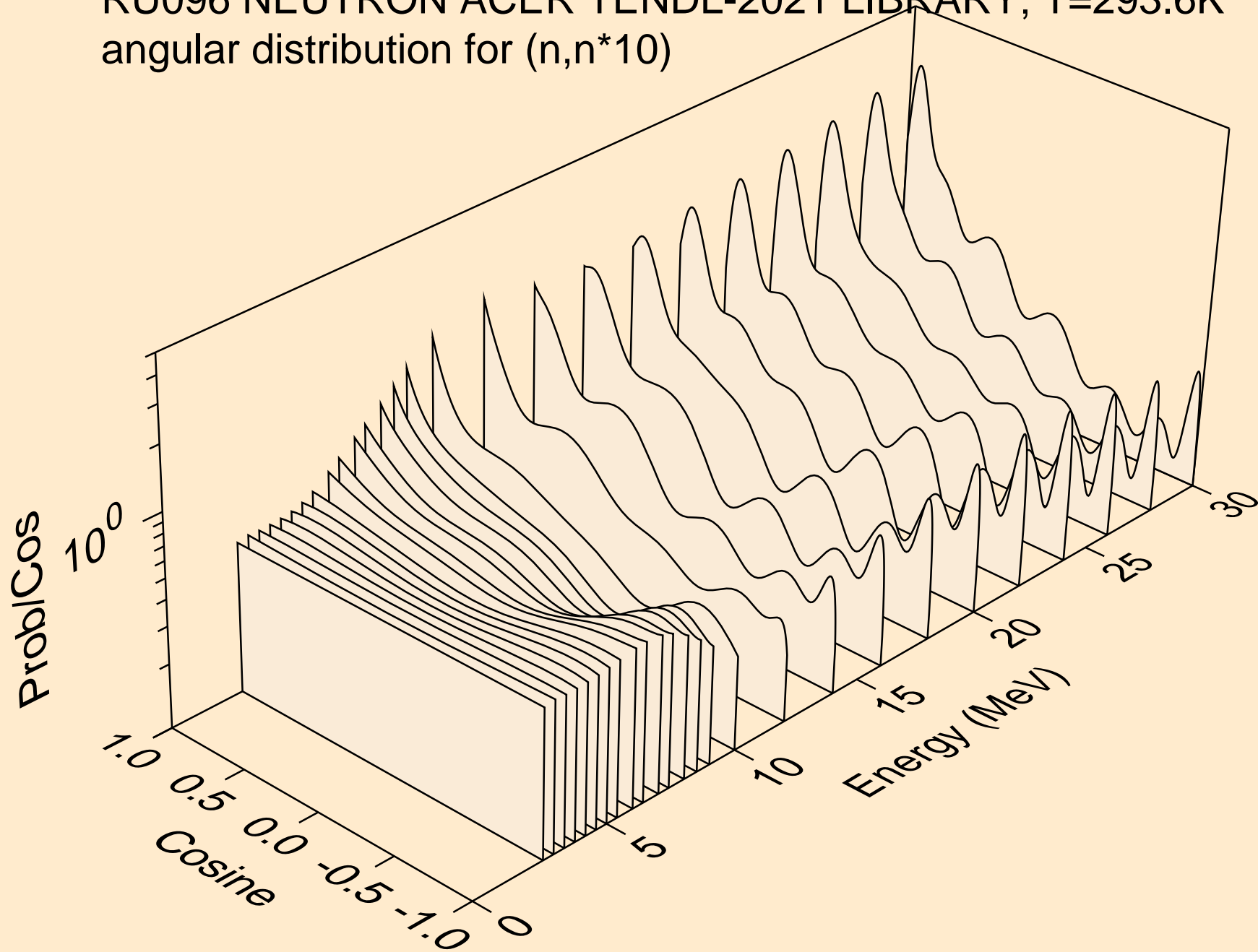

RU096 NEUTRON ACER TENDL-2021 LIBRARY; T=293.6K
angular distribution for (n,n*11)

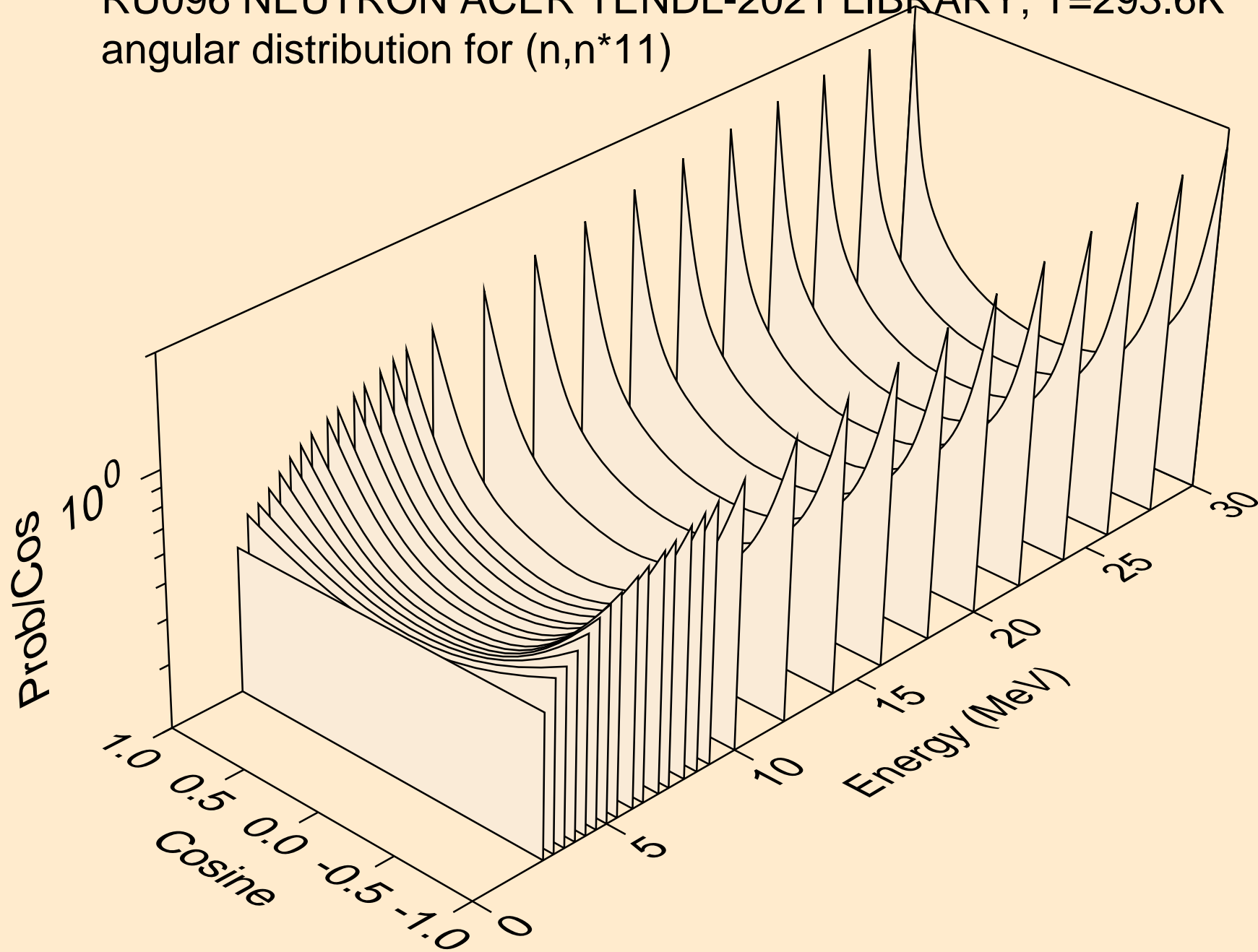

RU096 NEUTRON ACER TENDL-2021 LIBRARY; T=293.6K
angular distribution for (n,n*12)

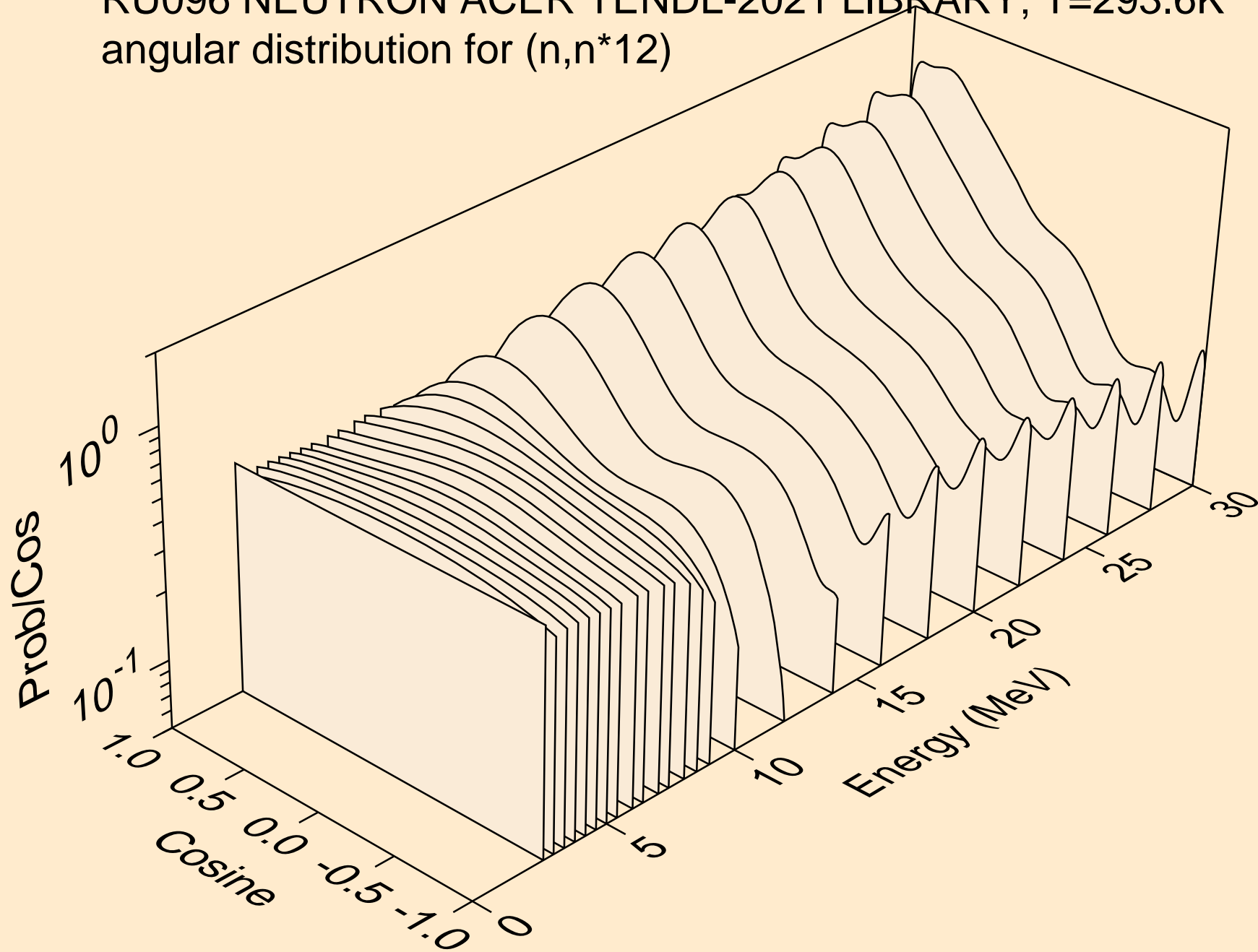

RU096 NEUTRON ACER TENDL-2021 LIBRARY; T=293.6K
angular distribution for (n,n*13)

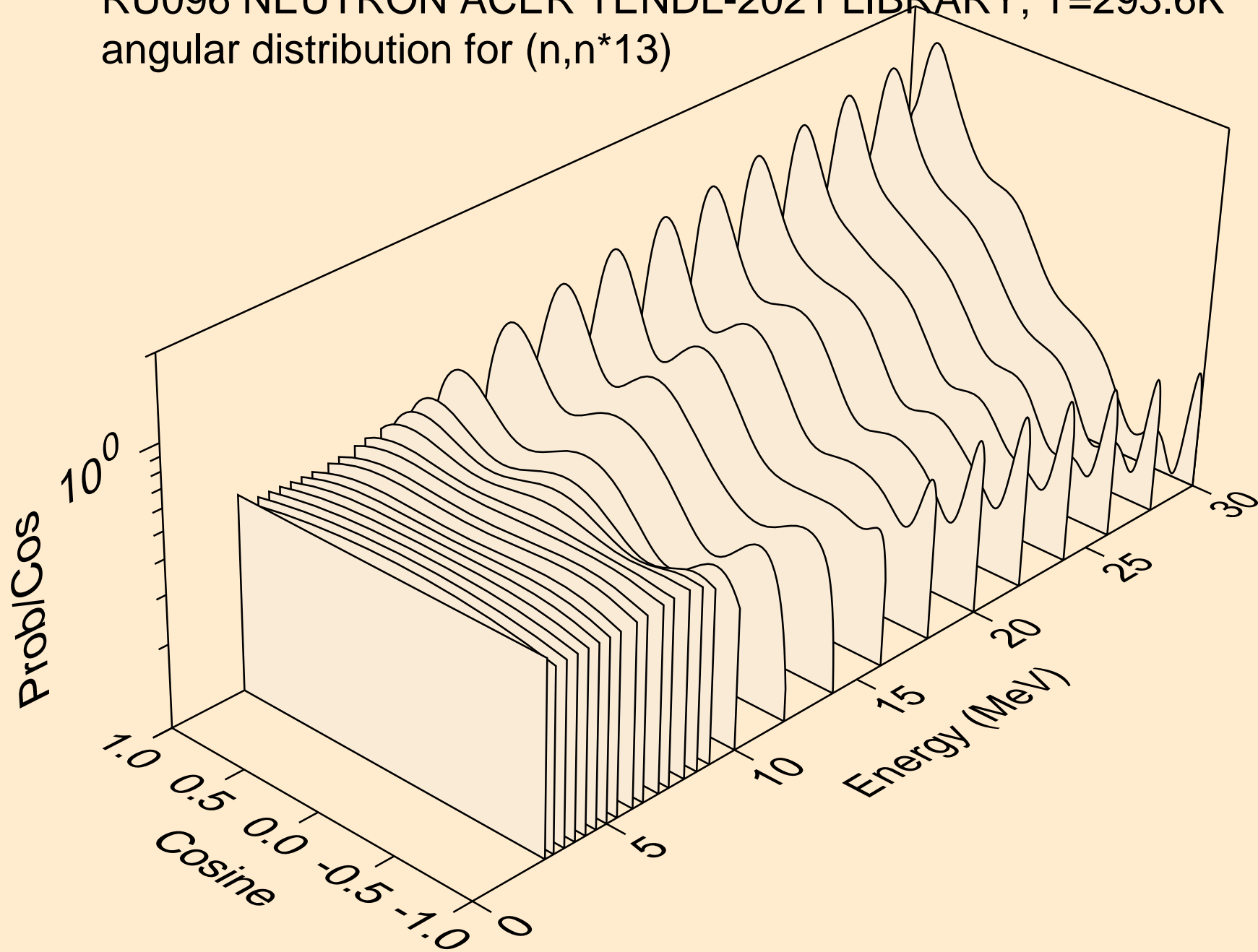

RU096 NEUTRON ACER TENDL-2021 LIBRARY; T=293.6K
angular distribution for (n,n*14)

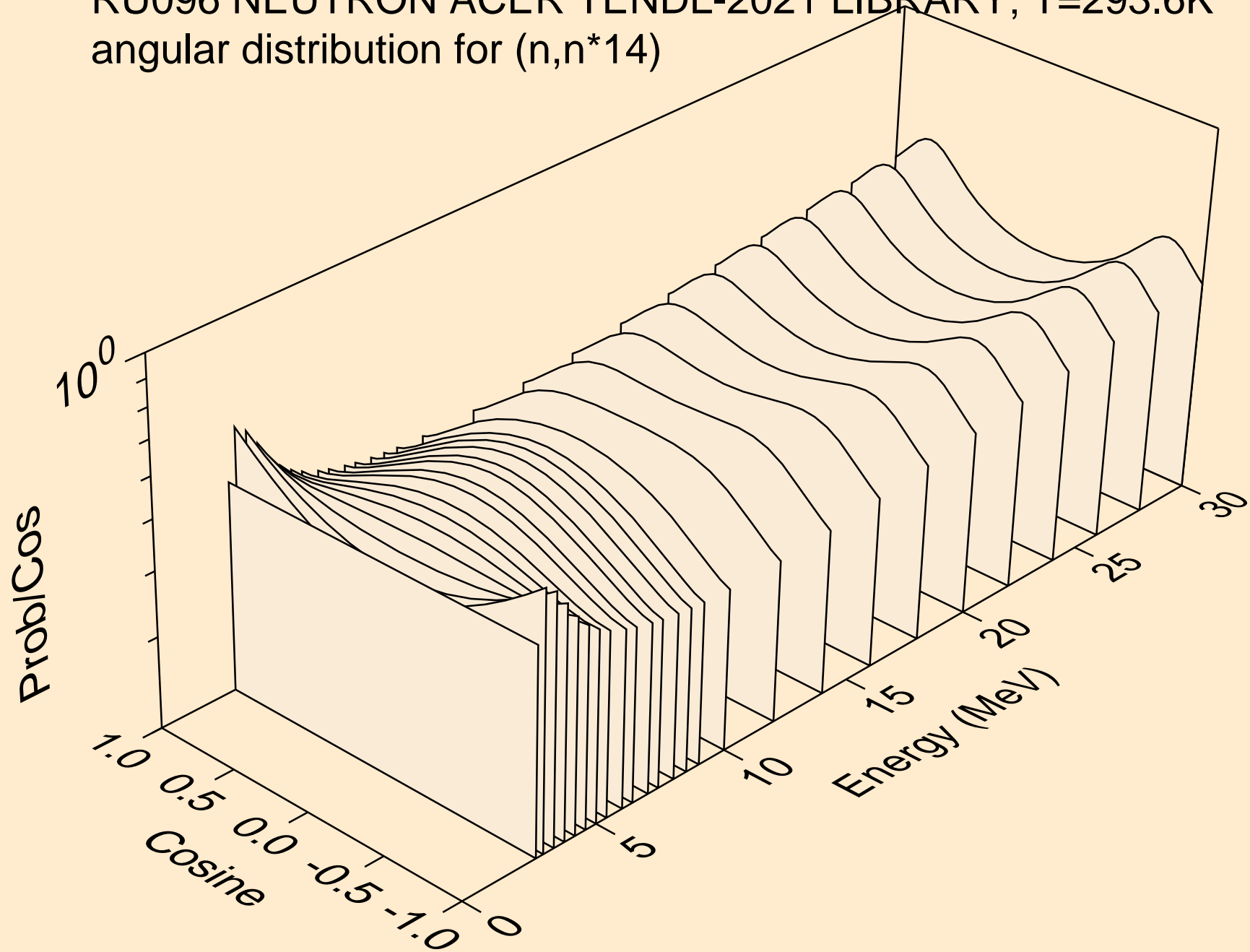

RU096 NEUTRON ACER TENDL-2021 LIBRARY; T=293.6K
angular distribution for (n,n*15)

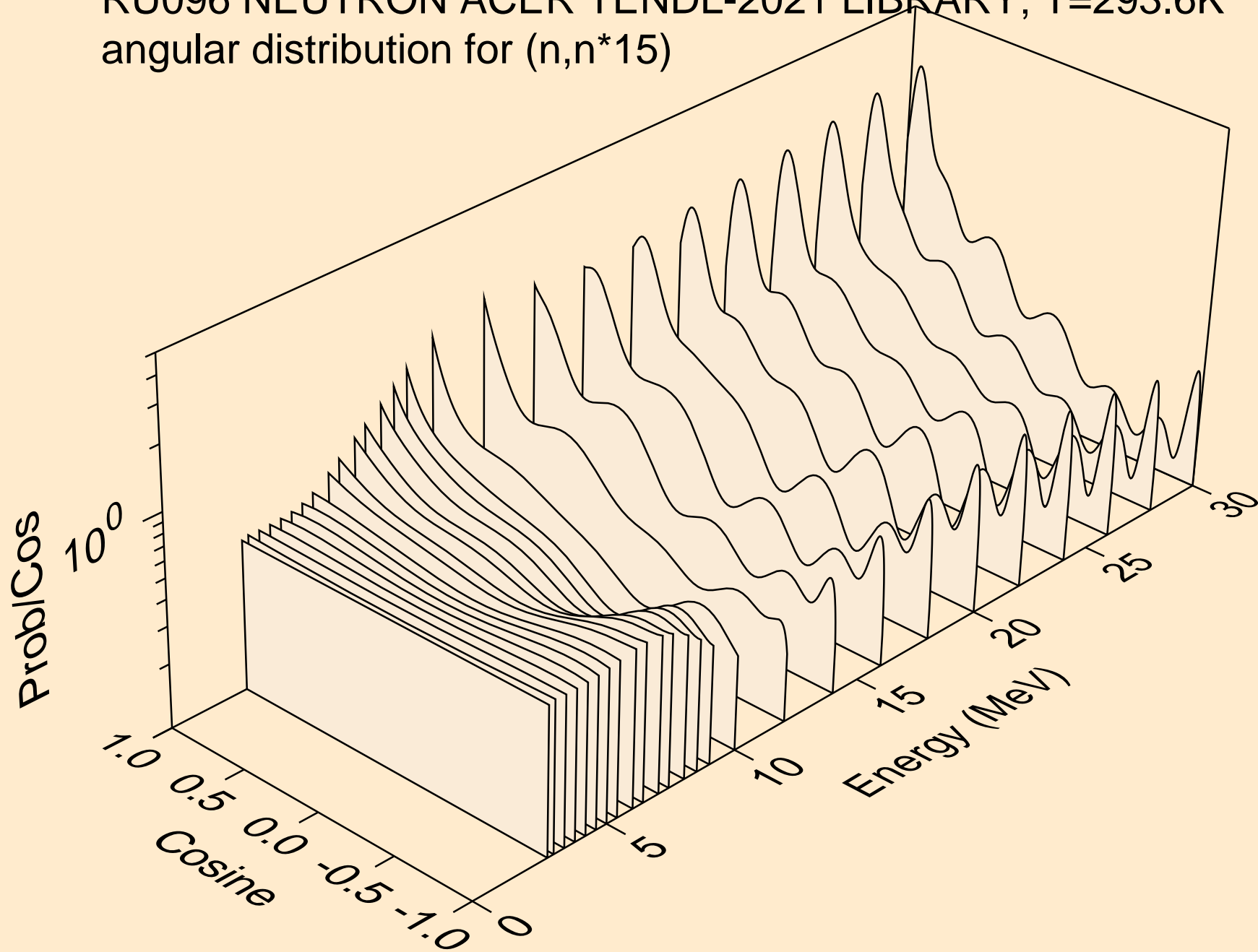

RU096 NEUTRON ACER TENDL-2021 LIBRARY; T=293.6K
angular distribution for (n,n*16)

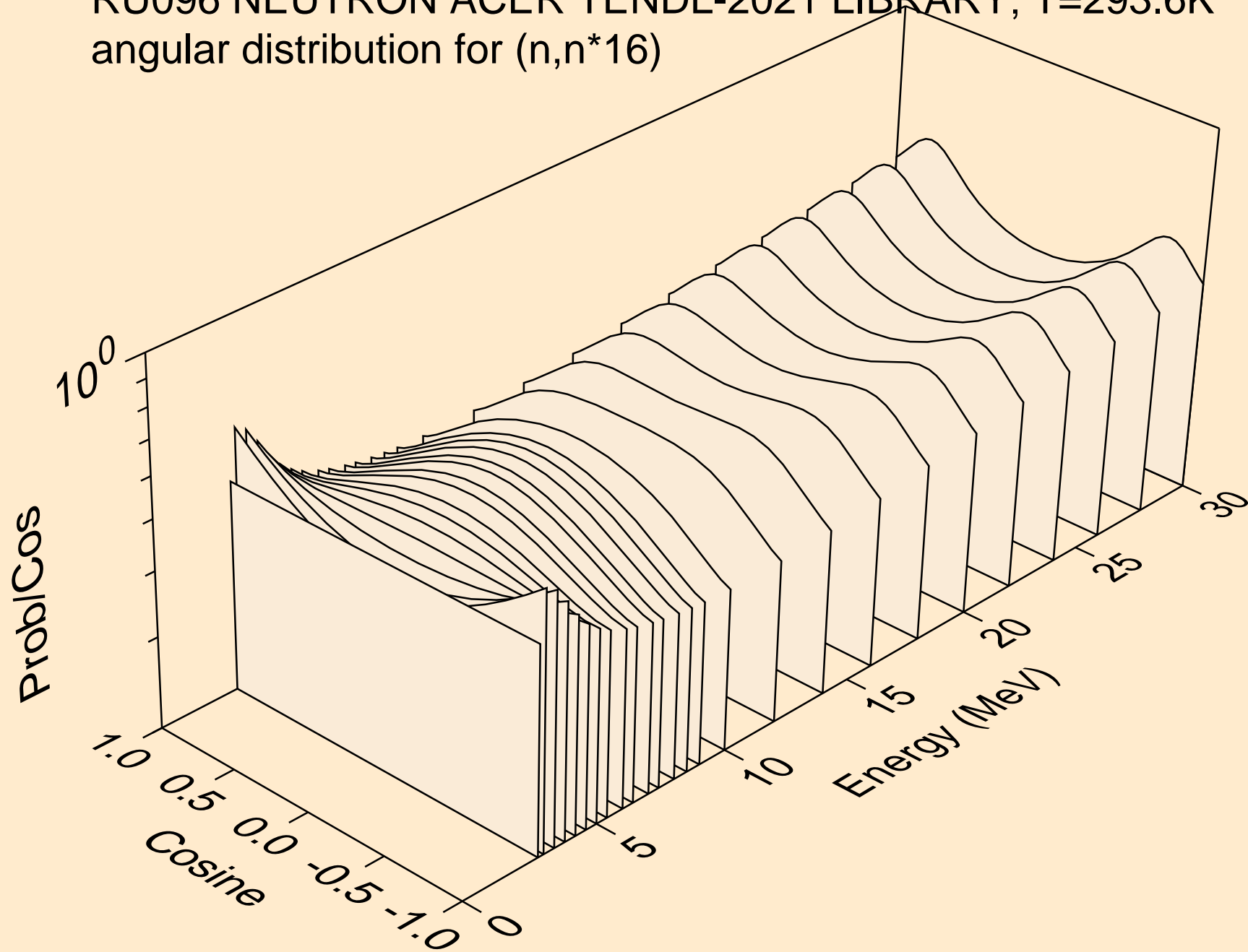

RU096 NEUTRON ACER TENDL-2021 LIBRARY; T=293.6K
angular distribution for (n,n*17)

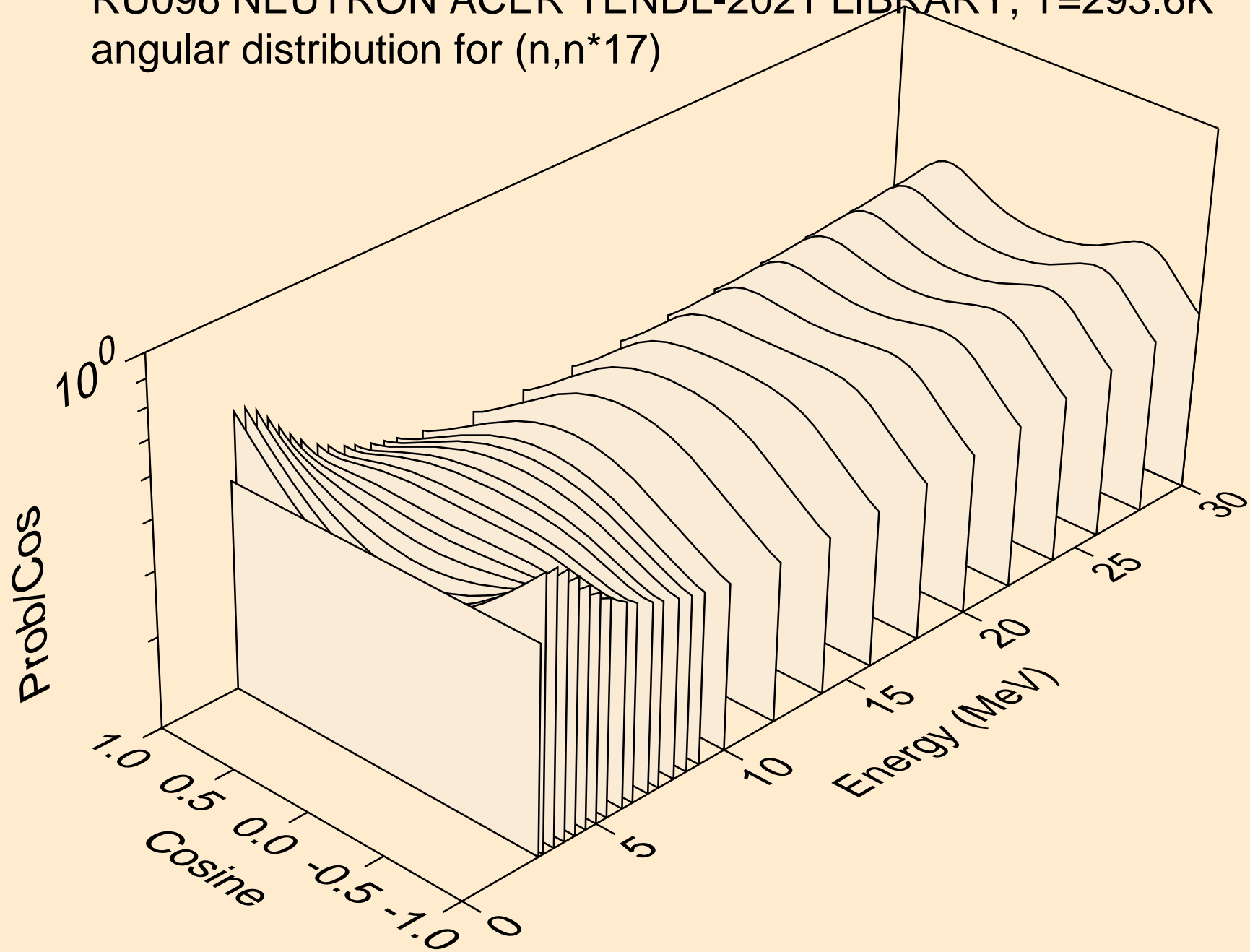

RU096 NEUTRON ACER TENDL-2021 LIBRARY; T=293.6K
angular distribution for (n,n*18)

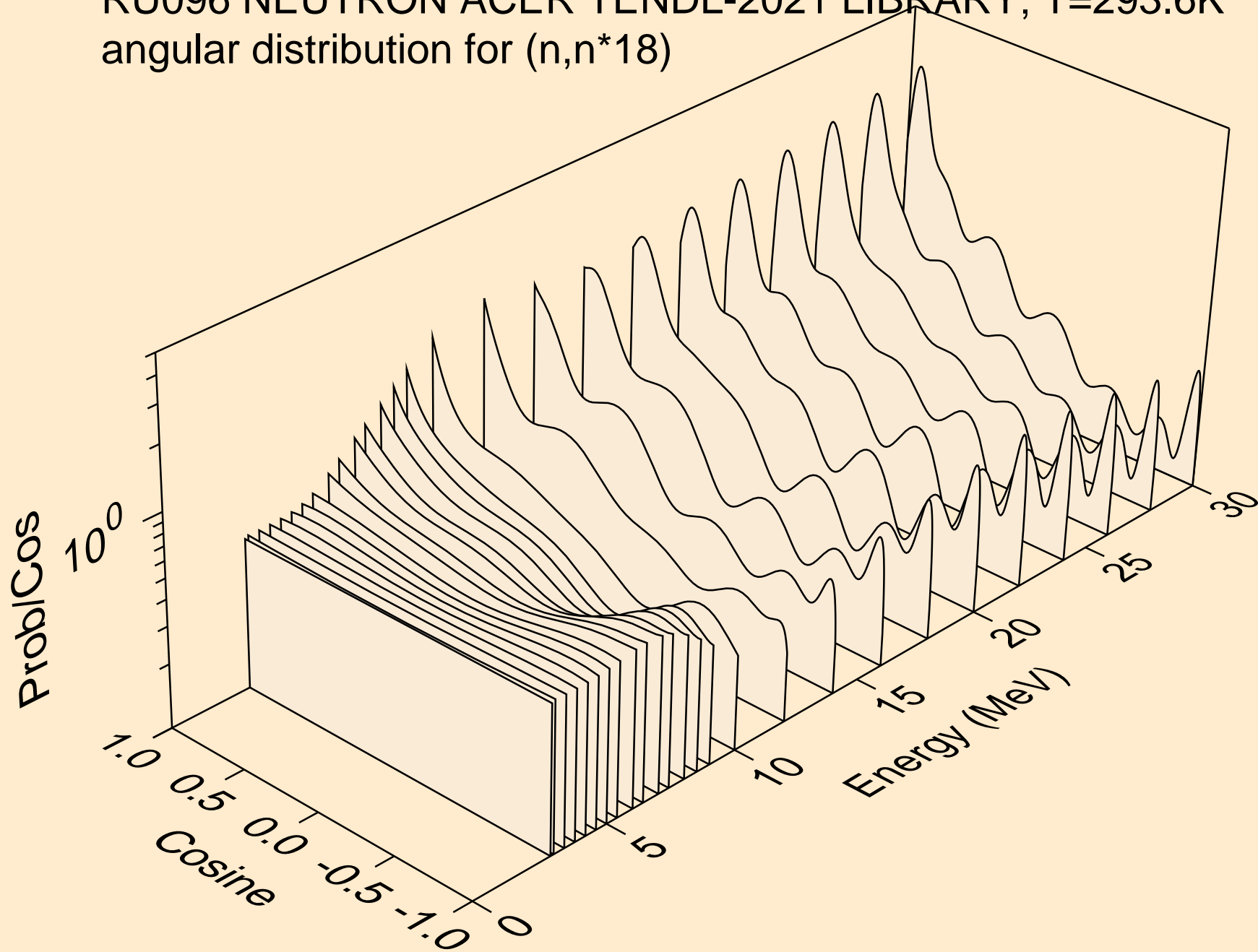

RU096 NEUTRON ACER TENDL-2021 LIBRARY; T=293.6K
angular distribution for (n,n*19)

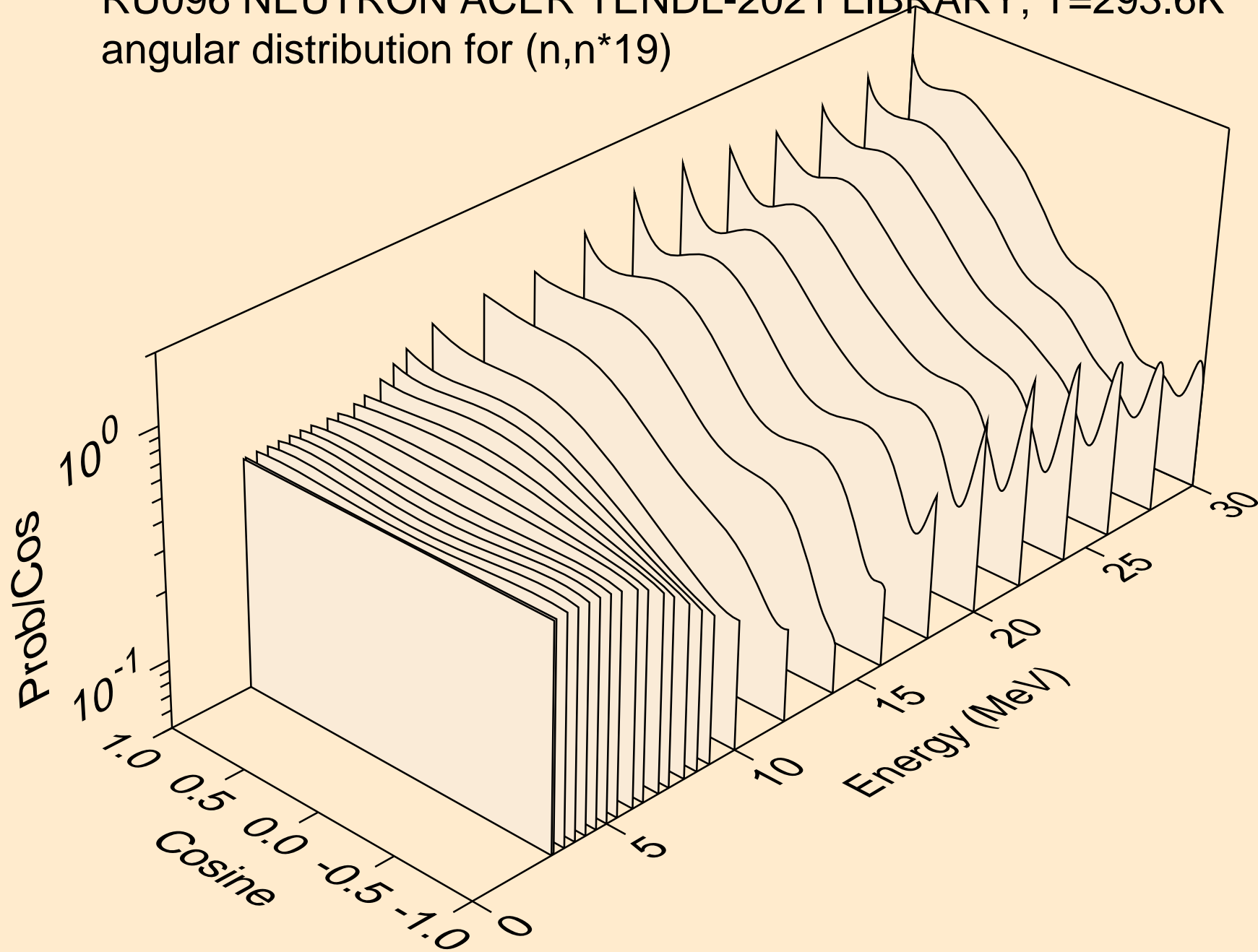

RU096 NEUTRON ACER TENDL-2021 LIBRARY; T=293.6K
angular distribution for (n,n*20)

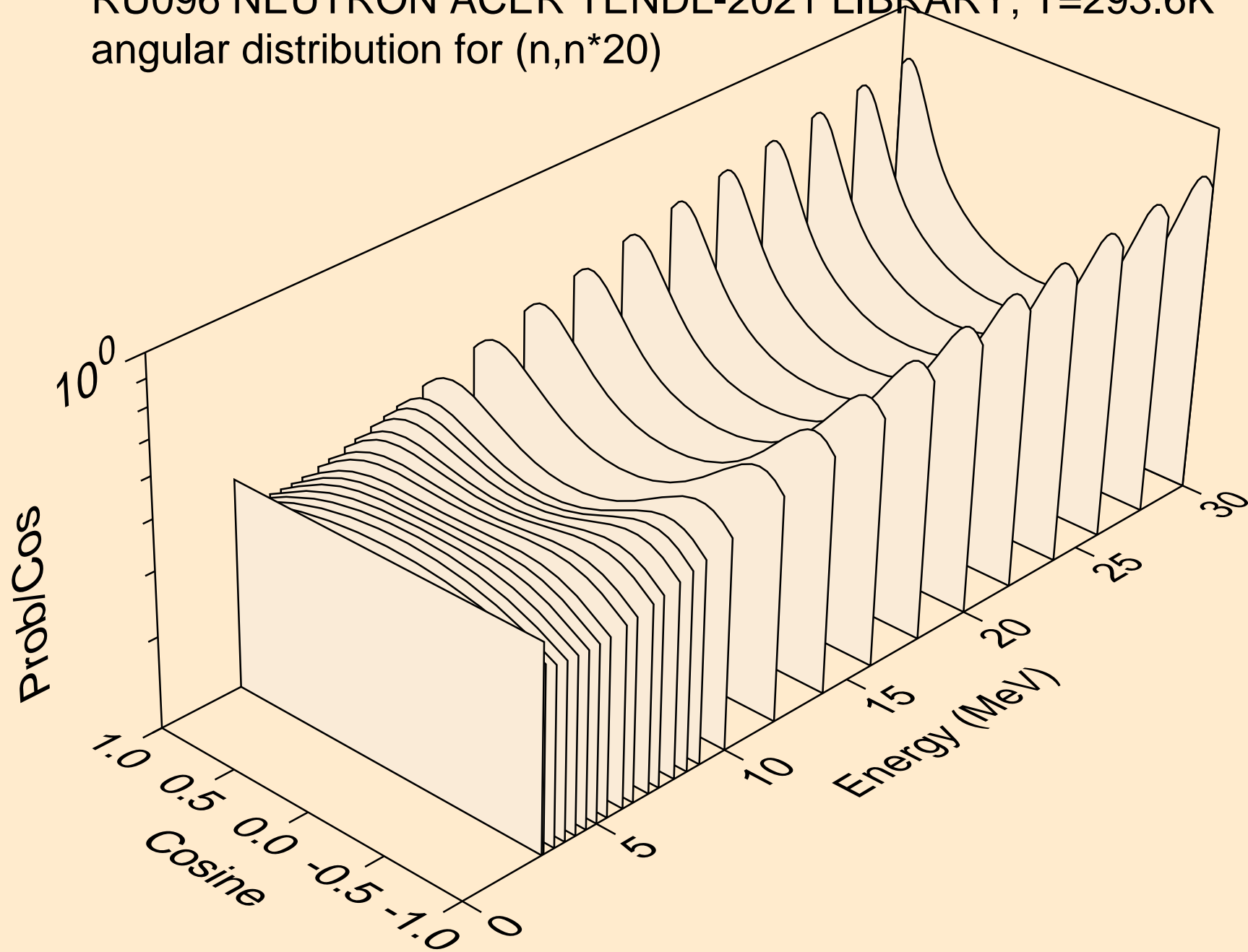

RU096 NEUTRON ACER TENDL-2021 LIBRARY; T=293.6K
angular distribution for (n,n*21)

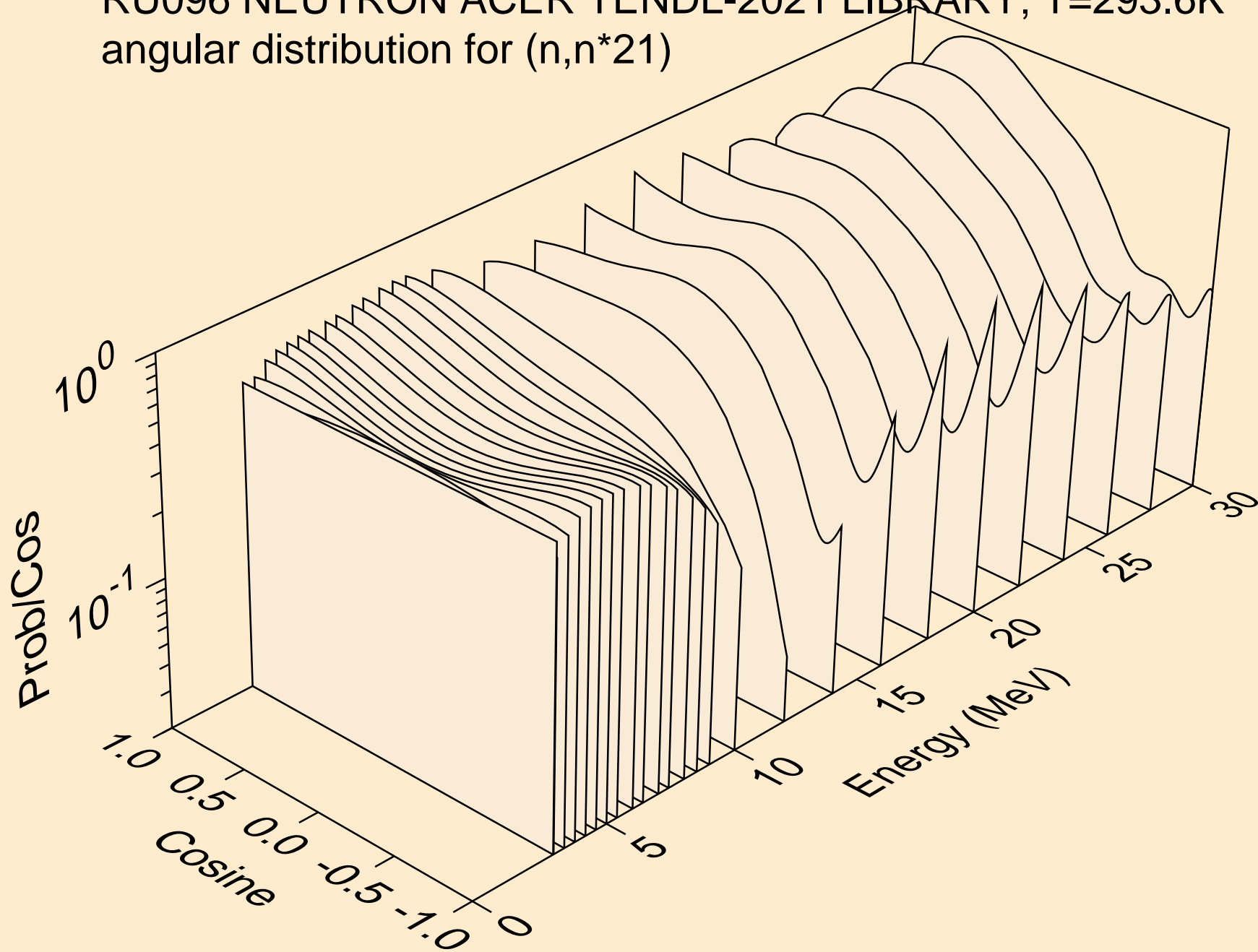

RU096 NEUTRON ACER TENDL-2021 LIBRARY; T=293.6K
angular distribution for (n,n*22)

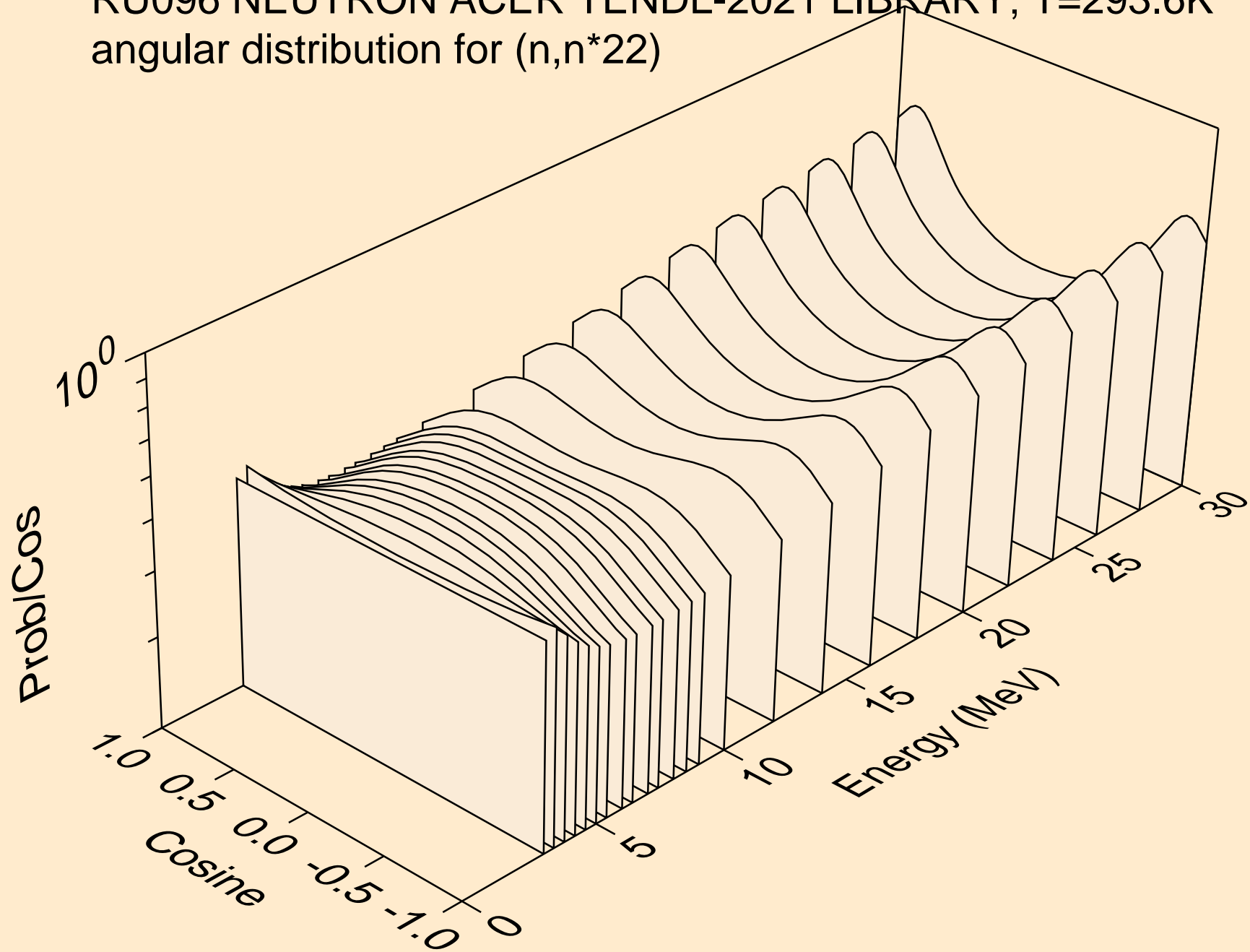

RU096 NEUTRON ACER TENDL-2021 LIBRARY; T=293.6K
angular distribution for (n,n*23)

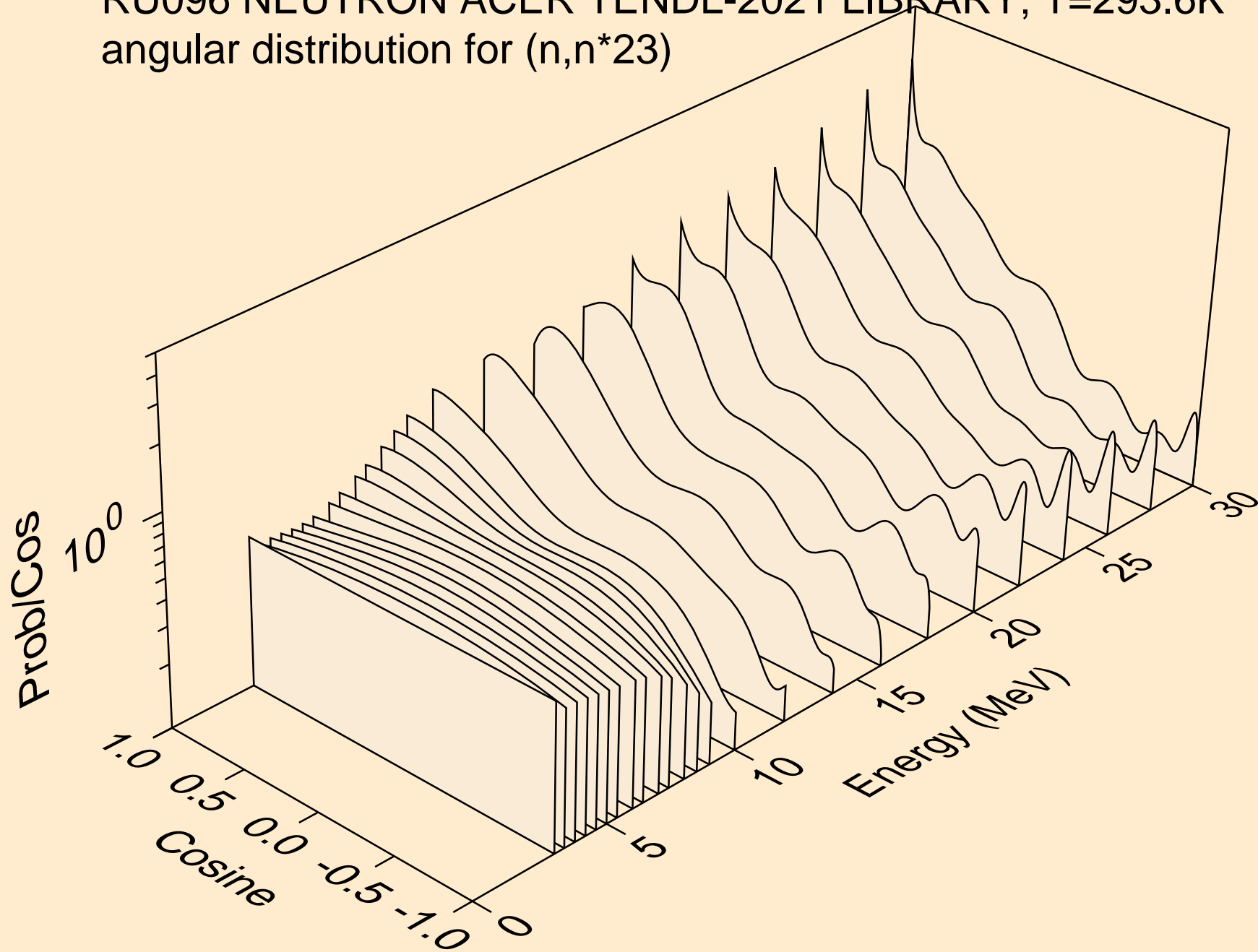

RU096 NEUTRON ACER TENDL-2021 LIBRARY; T=293.6K
angular distribution for (n,n*24)

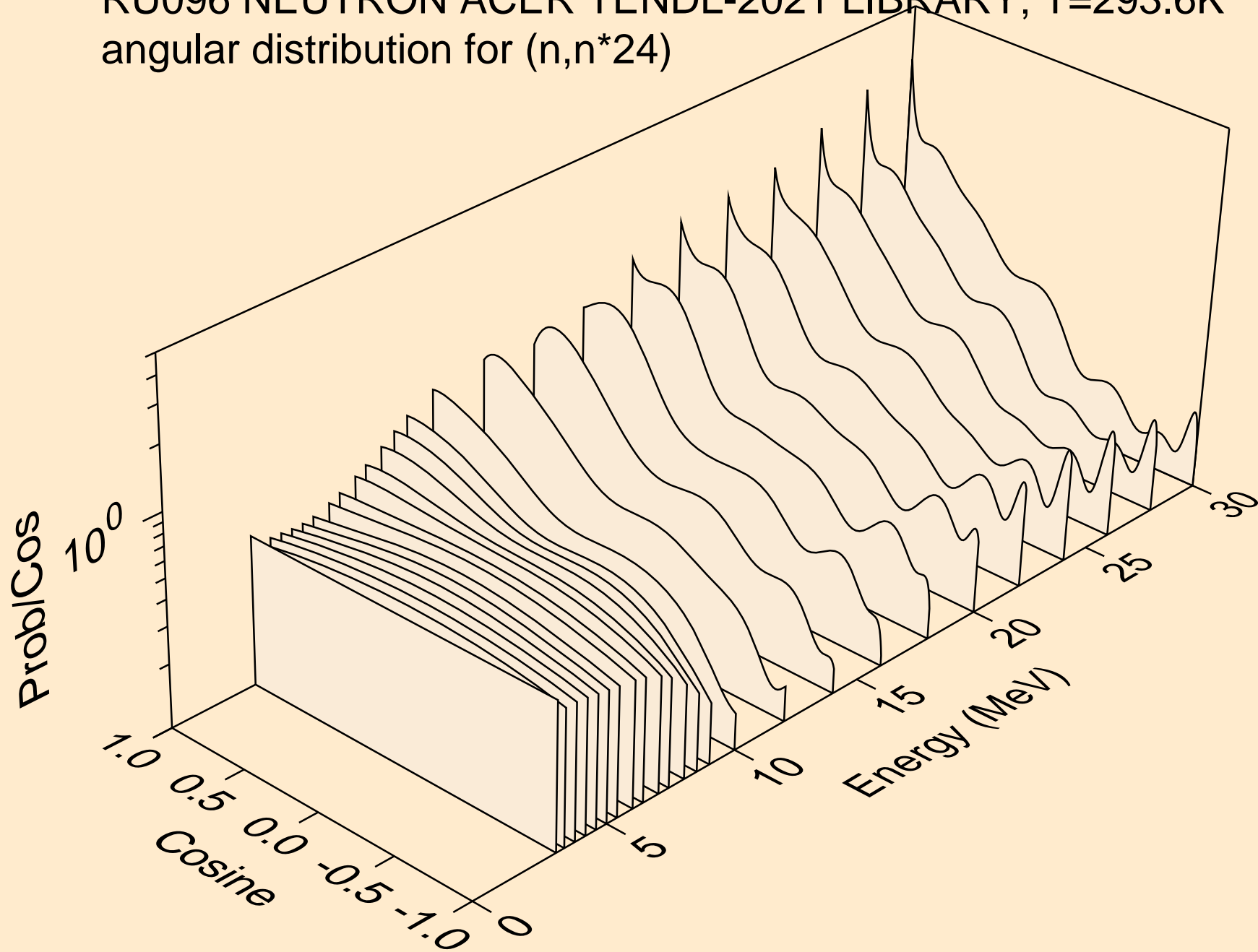

RU096 NEUTRON ACER TENDL-2021 LIBRARY; T=293.6K
angular distribution for (n,n*25)

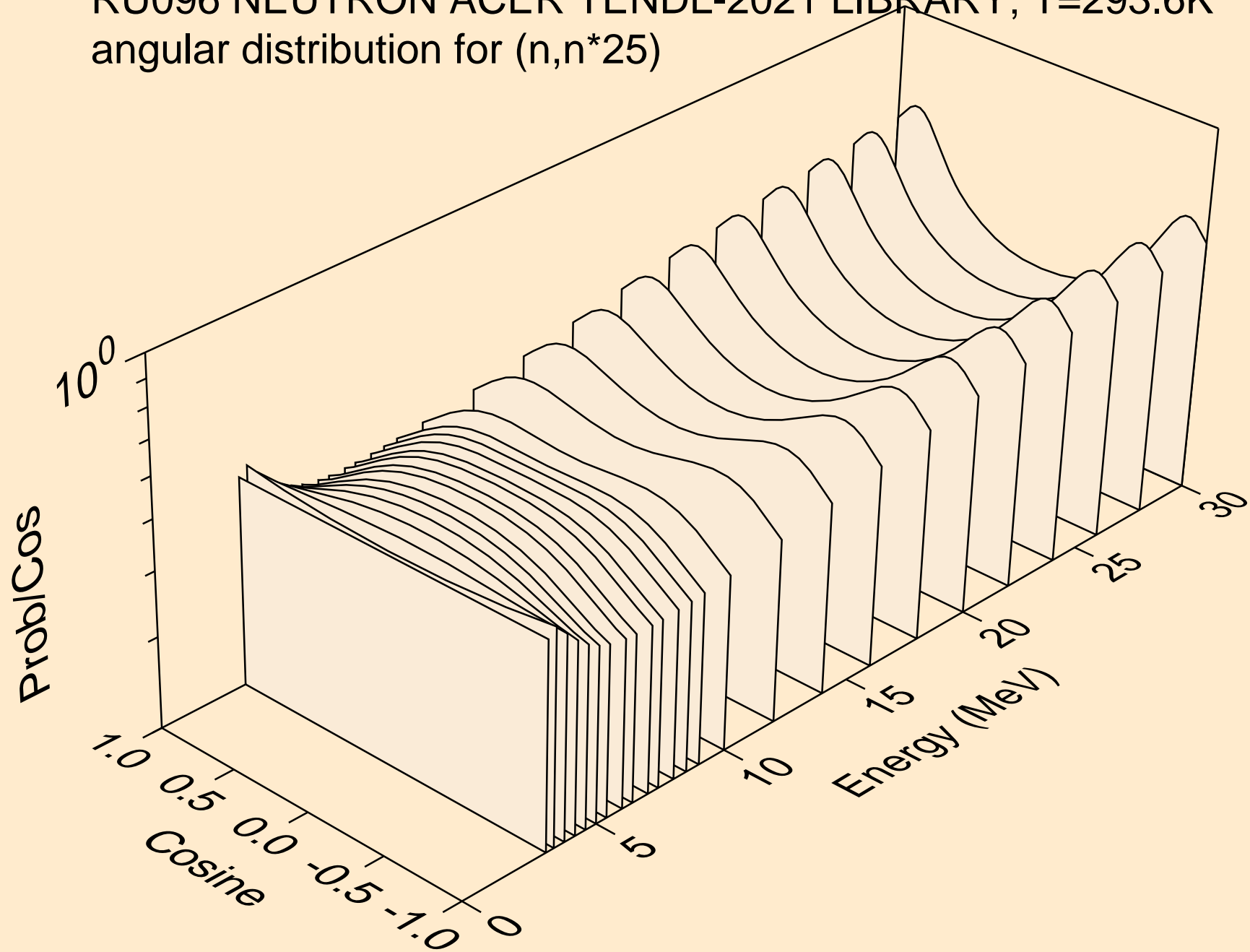

RU096 NEUTRON ACER TENDL-2021 LIBRARY; T=293.6K
angular distribution for (n,n*26)

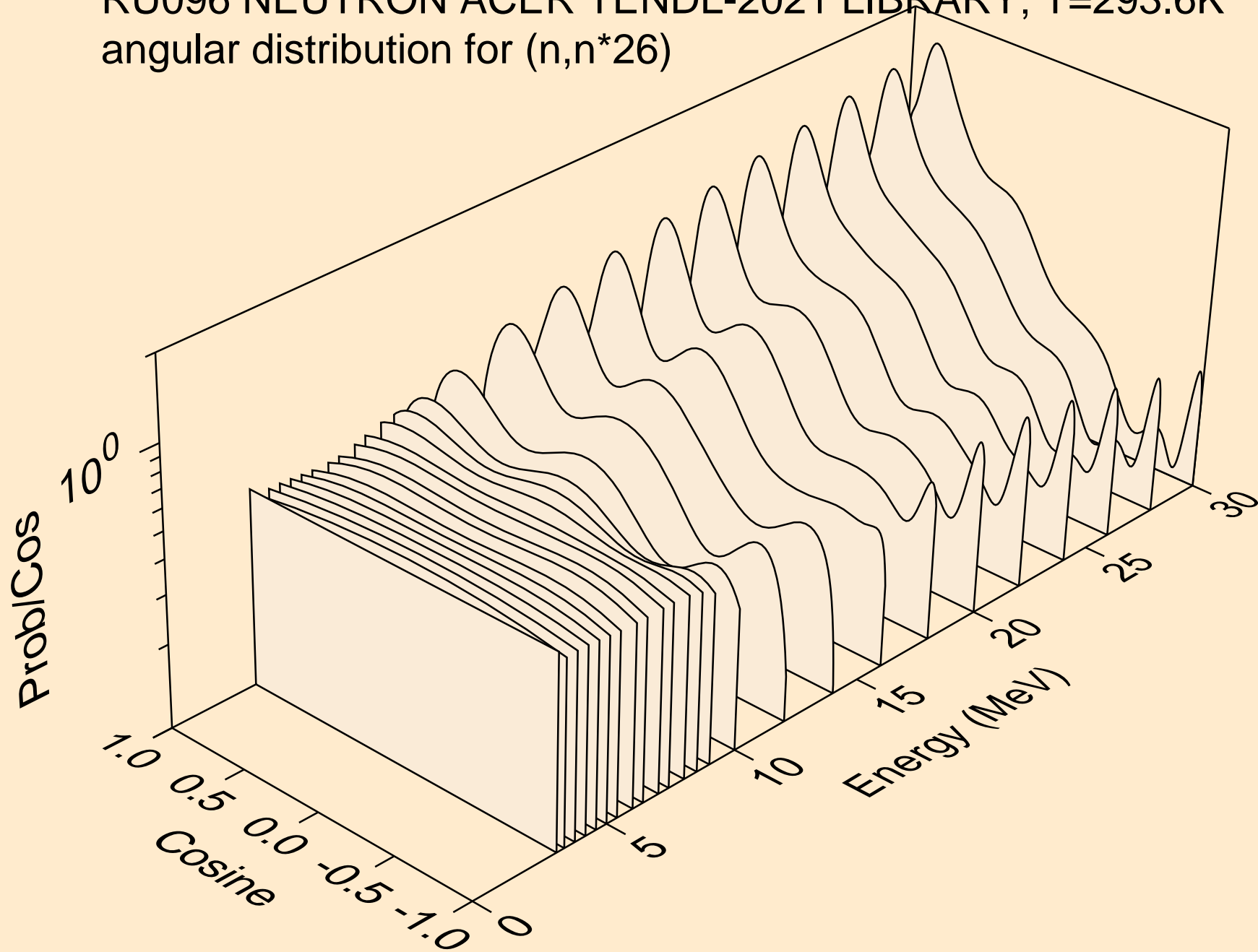

RU096 NEUTRON ACER TENDL-2021 LIBRARY; T=293.6K
angular distribution for (n,n*27)

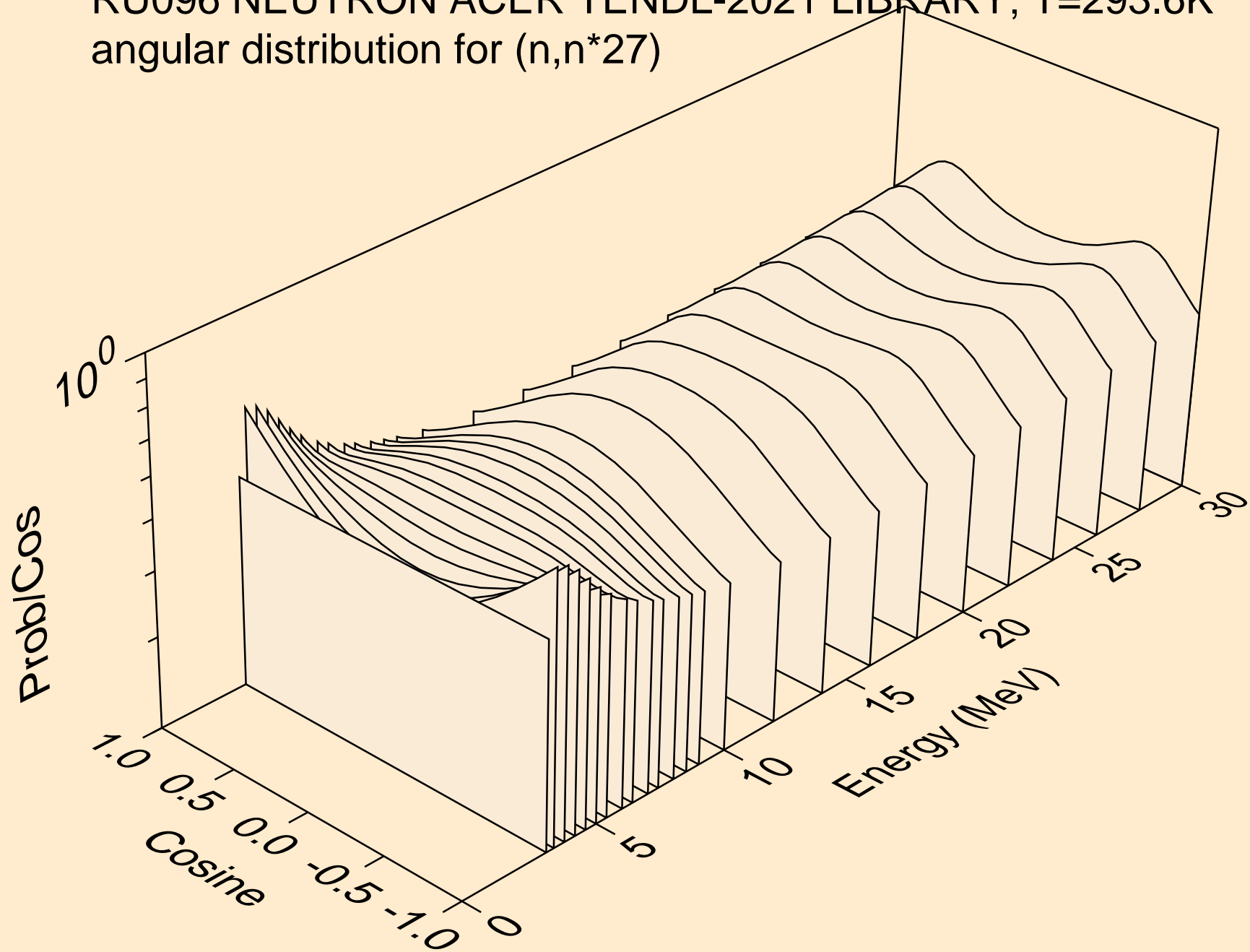

RU096 NEUTRON ACER TENDL-2021 LIBRARY; T=293.6K
angular distribution for (n,n*28)

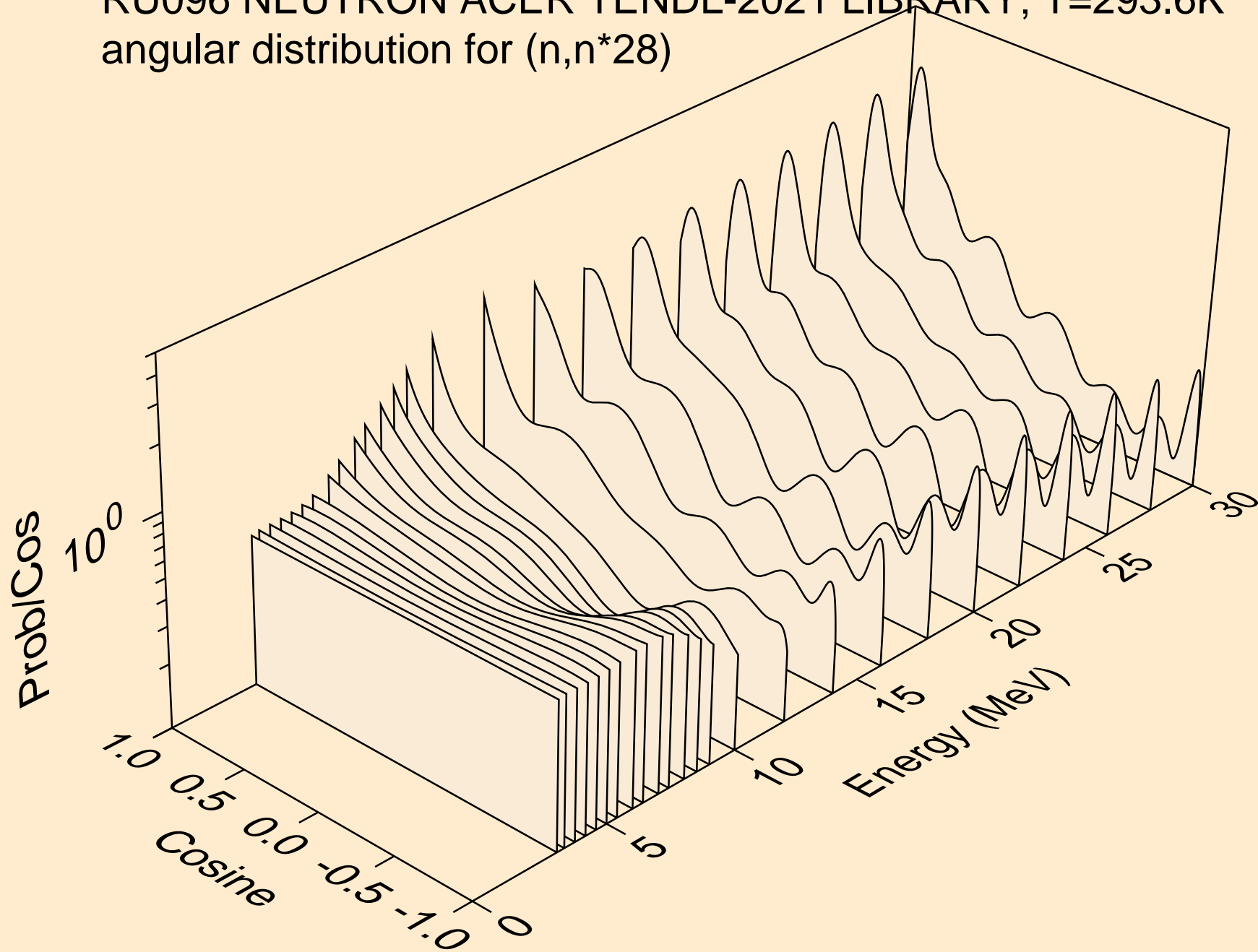

RU096 NEUTRON ACER TENDL-2021 LIBRARY; T=293.6K
angular distribution for (n,n*29)

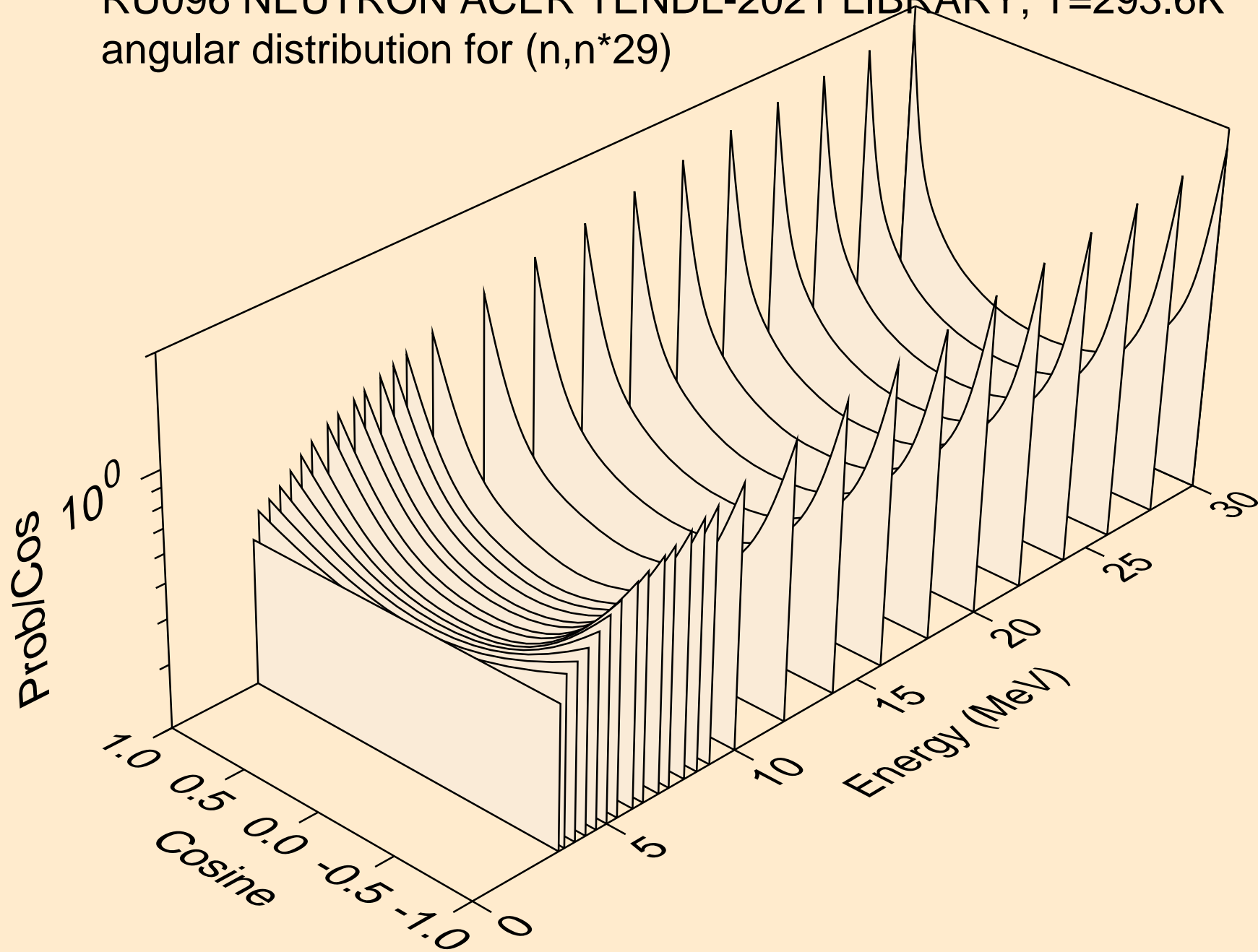

RU096 NEUTRON ACER TENDL-2021 LIBRARY; T=293.6K
Neutron emission for (n,x)

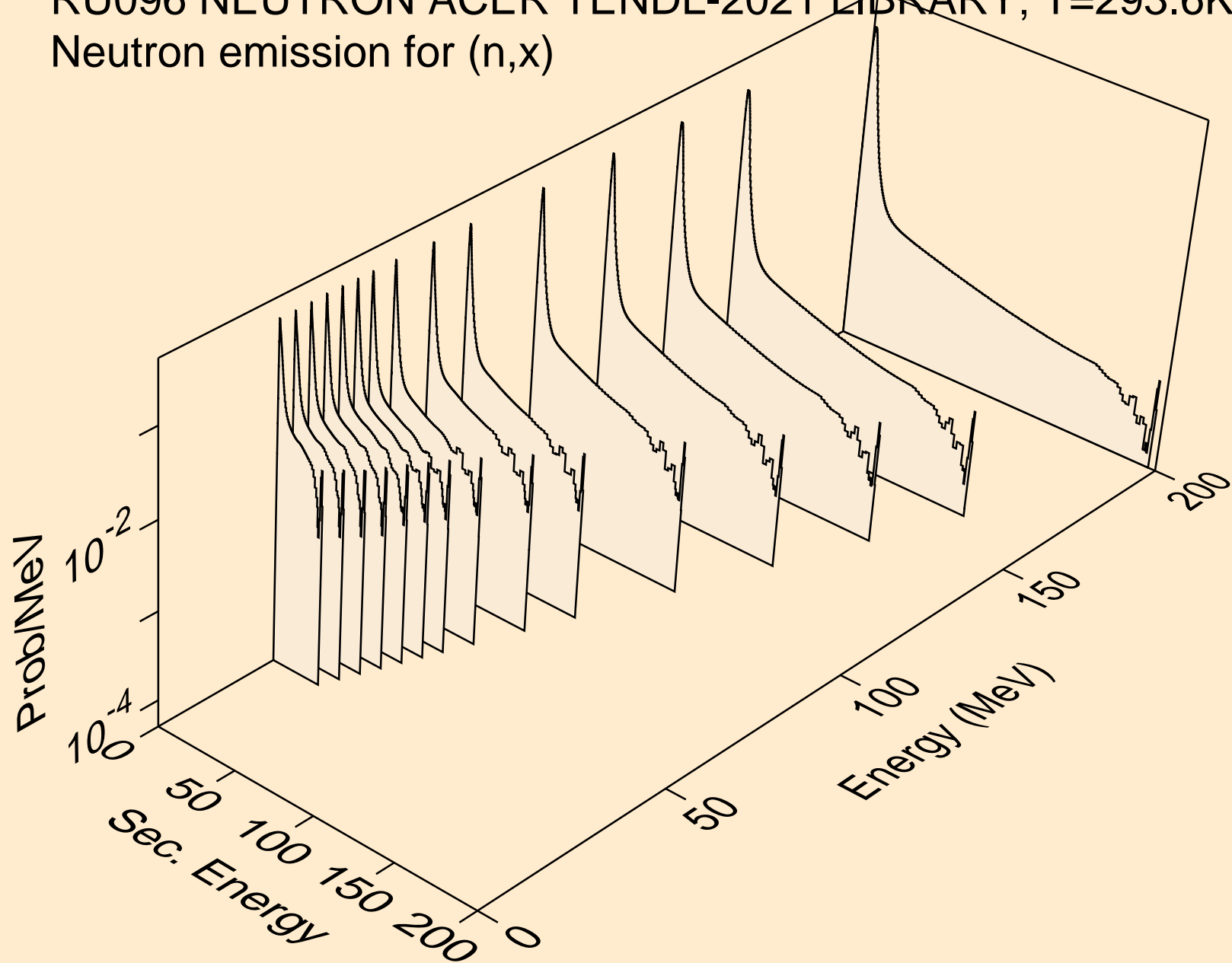

RU096 NEUTRON ACER TENDL-2021 LIBRARY; T=293.6K
Neutron emission for (n,2nd)

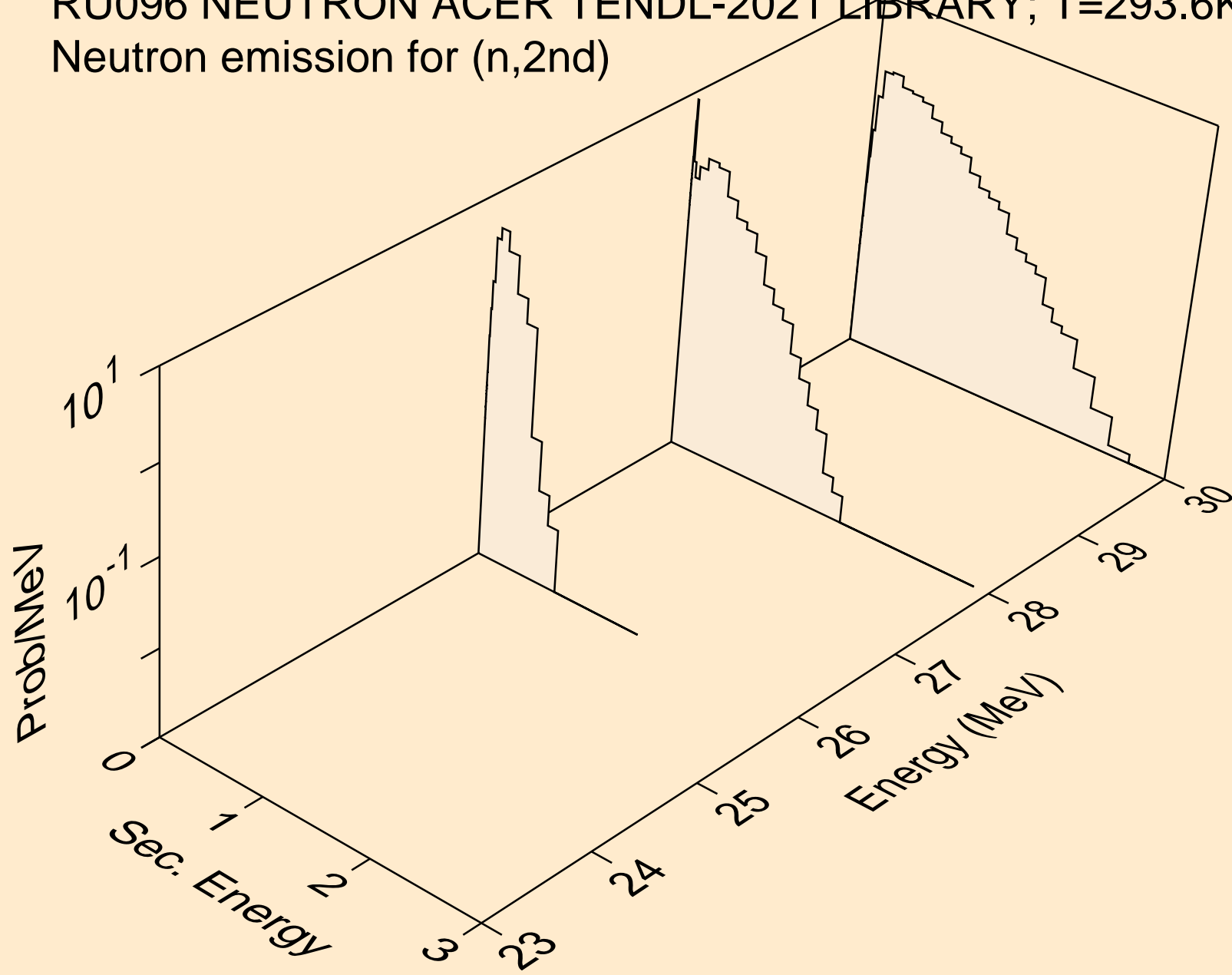

RU096 NEUTRON ACER TENDL-2021 LIBRARY; T=293.6K
Neutron emission for (n,2n)

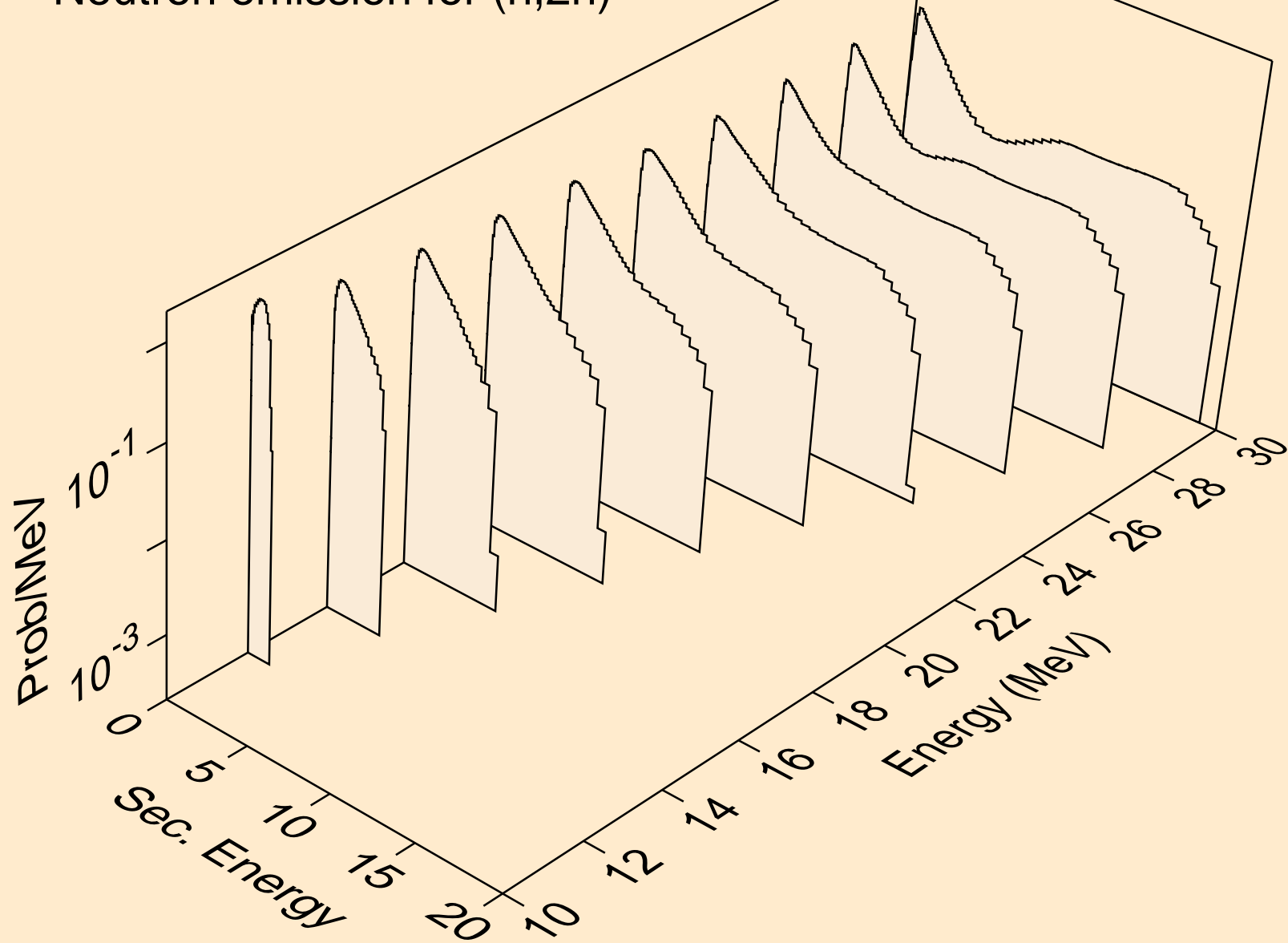

RU096 NEUTRON ACER TENDL-2021 LIBRARY; T=293.6K
Neutron emission for (n,3n)

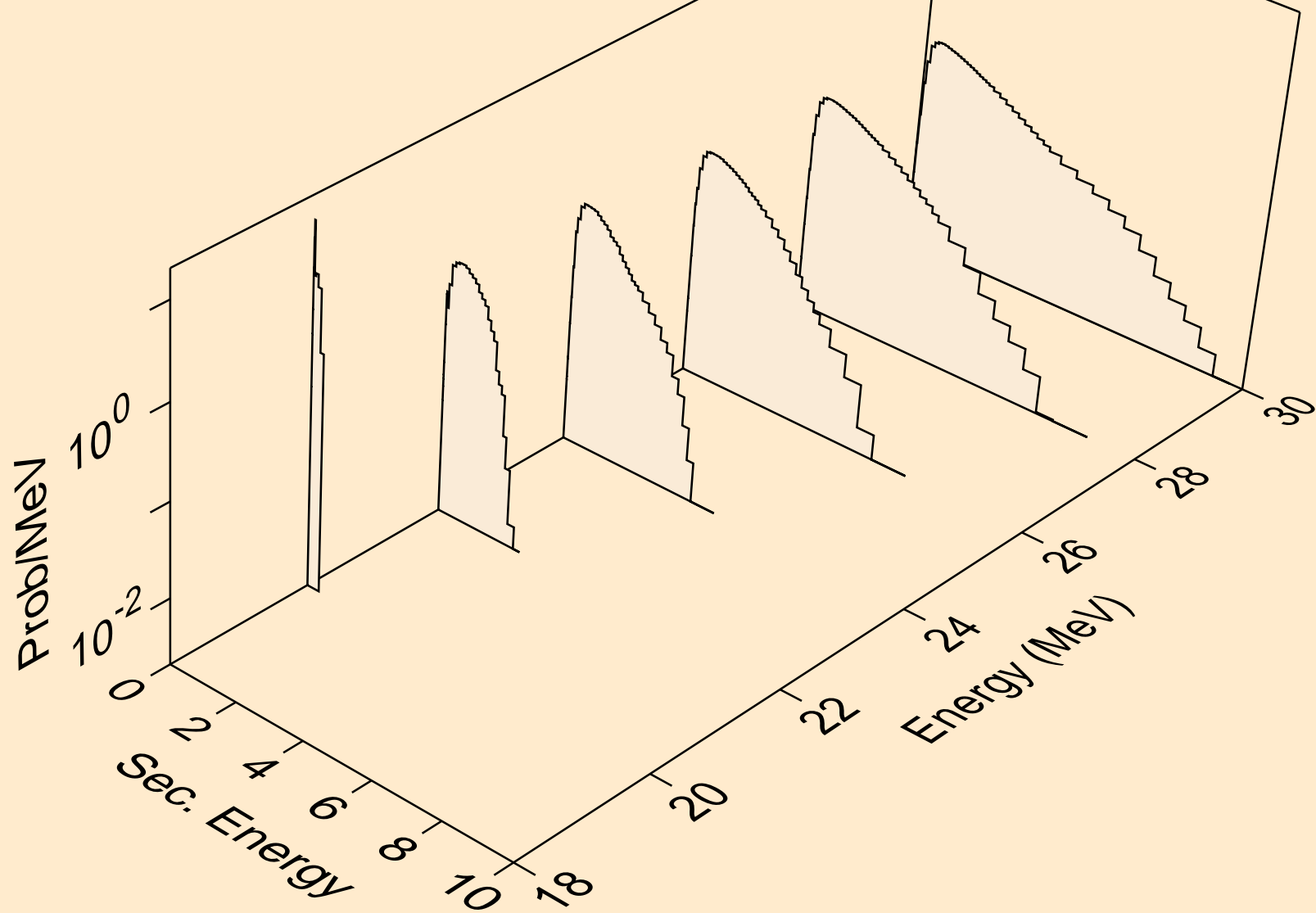

RU096 NEUTRON ACER TENDL-2021 LIBRARY; T=293.6K
Neutron emission for (n,n*)a

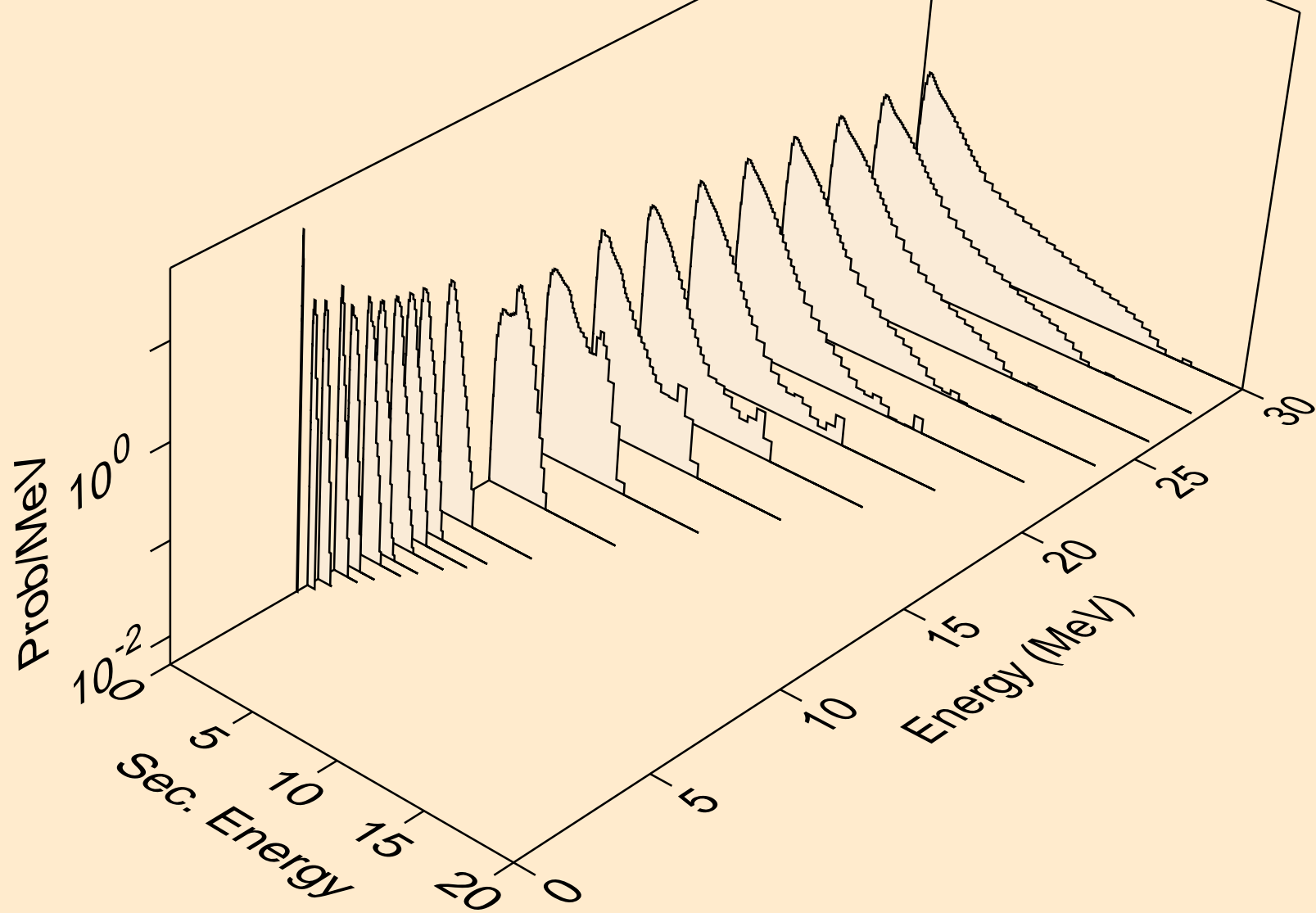

RU096 NEUTRON ACER TENDL-2021 LIBRARY; T=293.6K
Neutron emission for (n,2n)_a

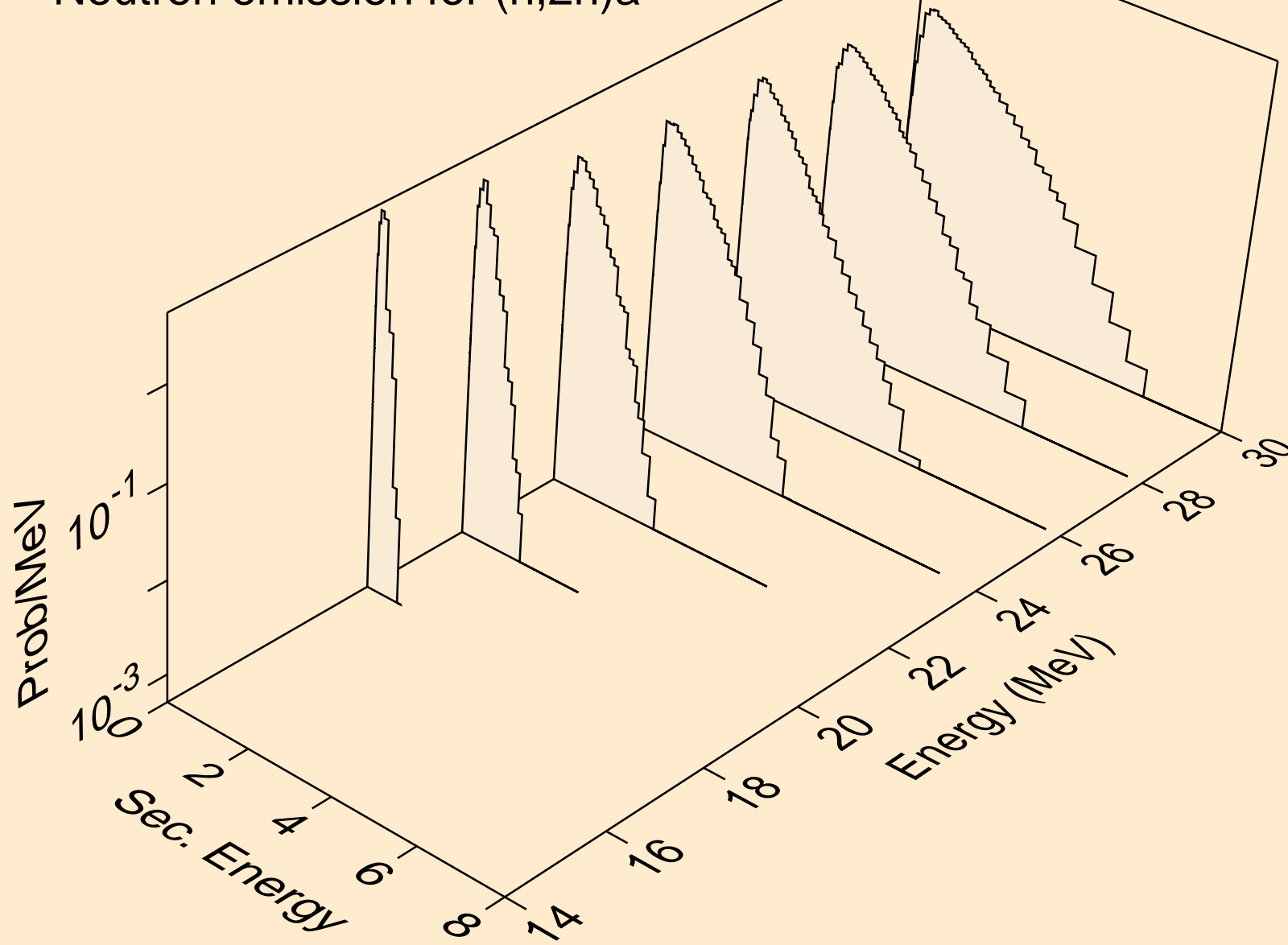

RU096 NEUTRON ACER TENDL-2021 LIBRARY; T=293.6K
Neutron emission for (n,n*)p

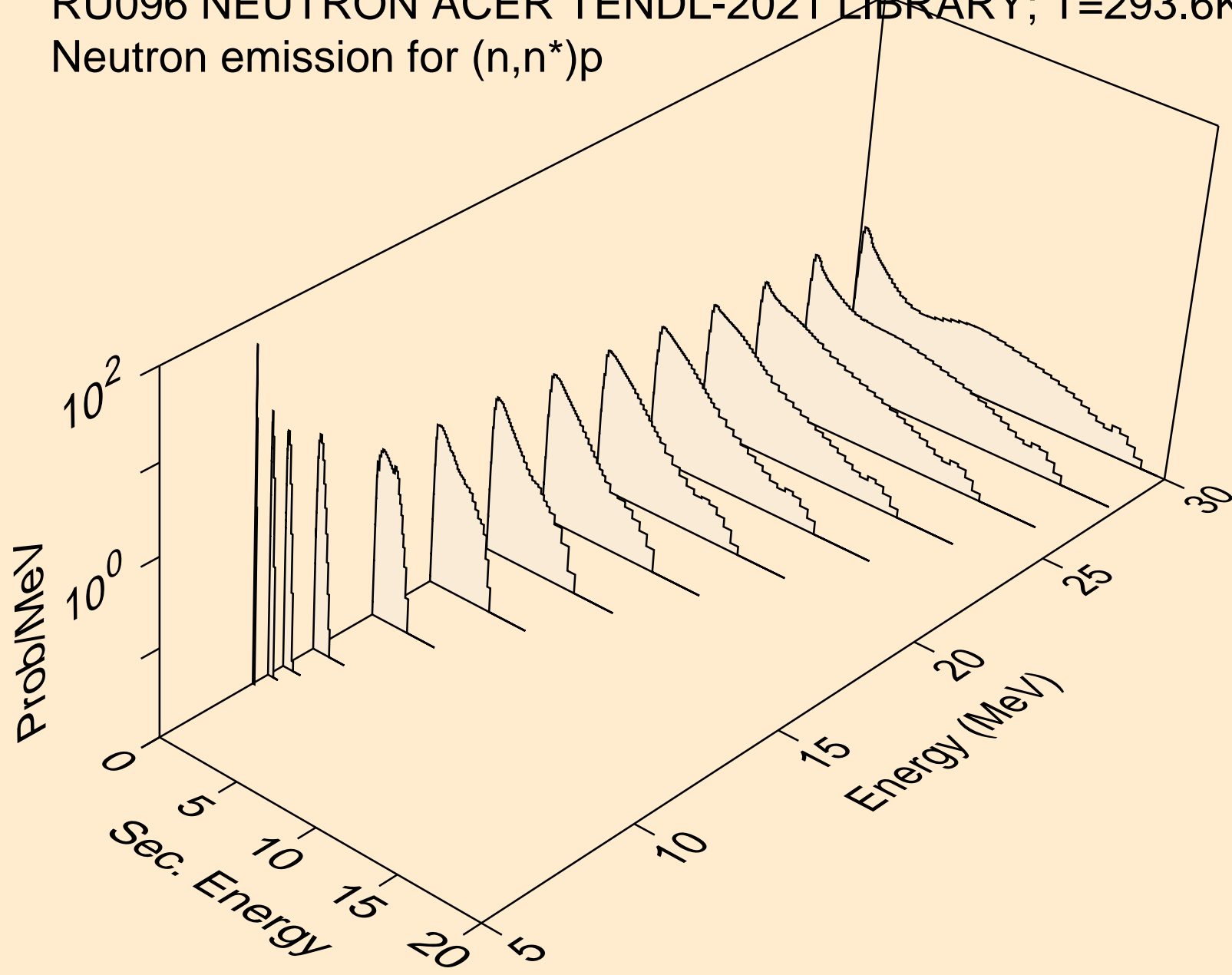

RU096 NEUTRON ACER TENDL-2021 LIBRARY; T=293.6K
Neutron emission for (n,n*)2a

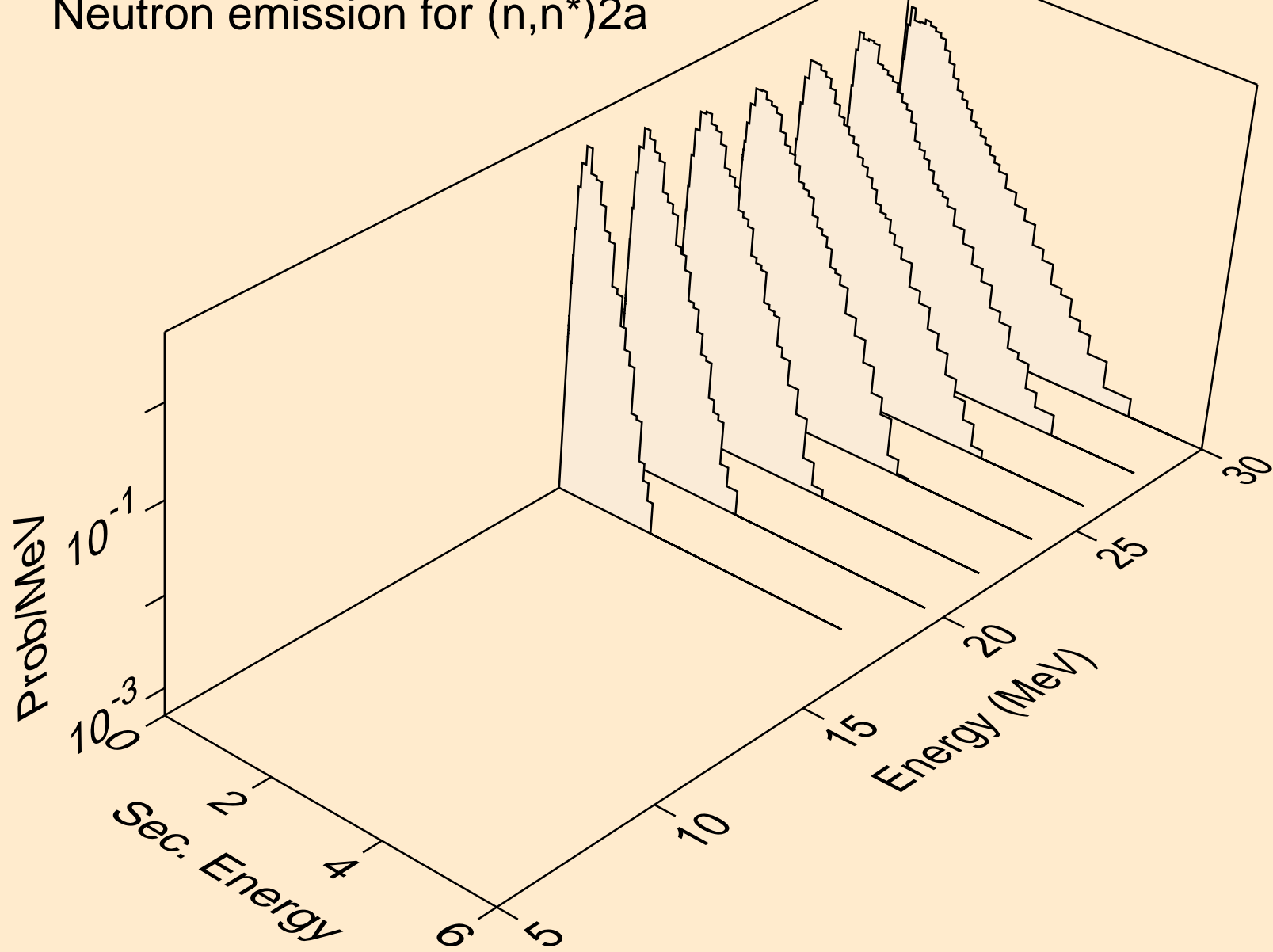

RU096 NEUTRON ACER TENDL-2021 LIBRARY; T=293.6K
Neutron emission for (n,n*)d

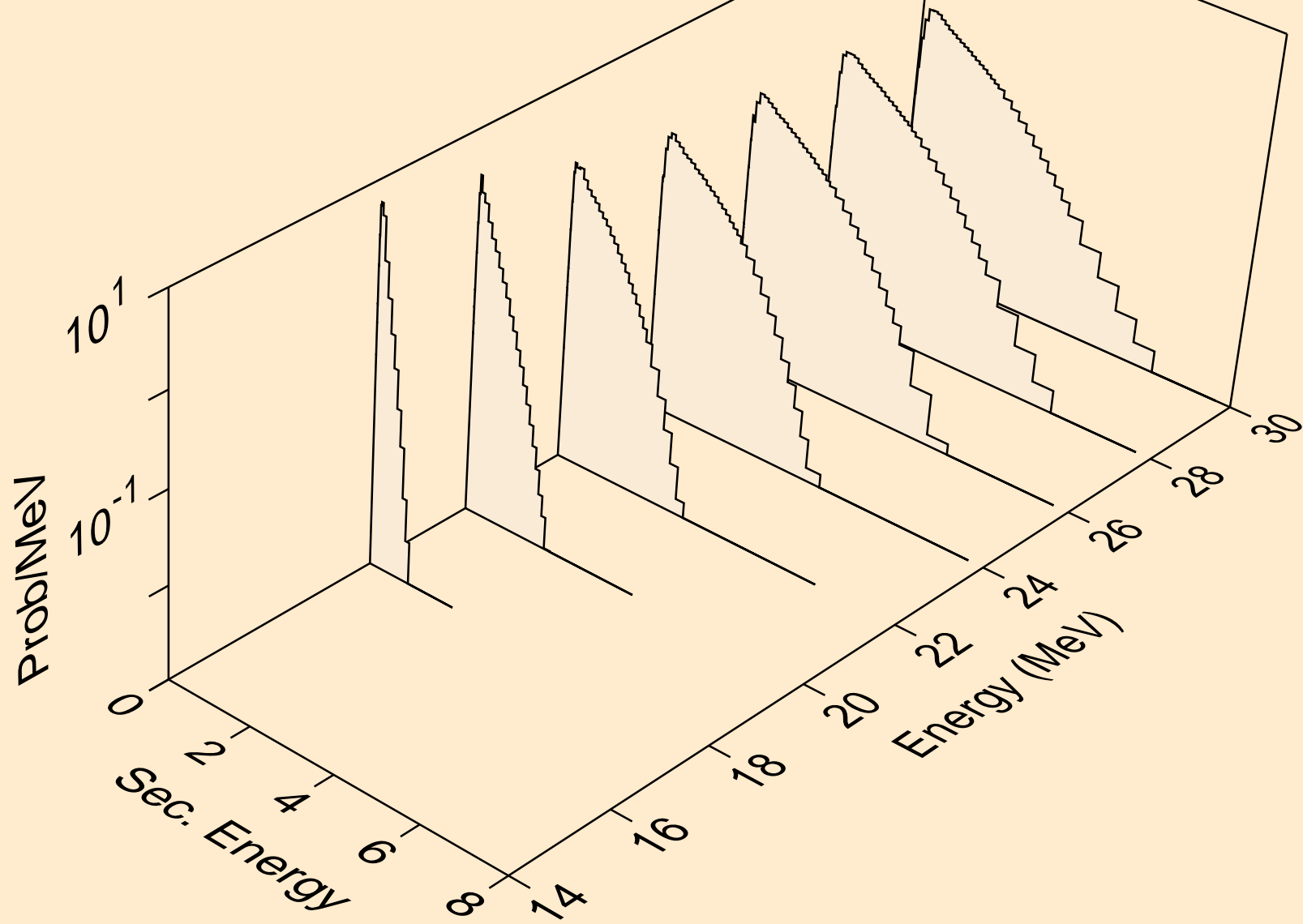

RU096 NEUTRON ACER TENDL-2021 LIBRARY; T=293.6K
Neutron emission for (n,n*)t

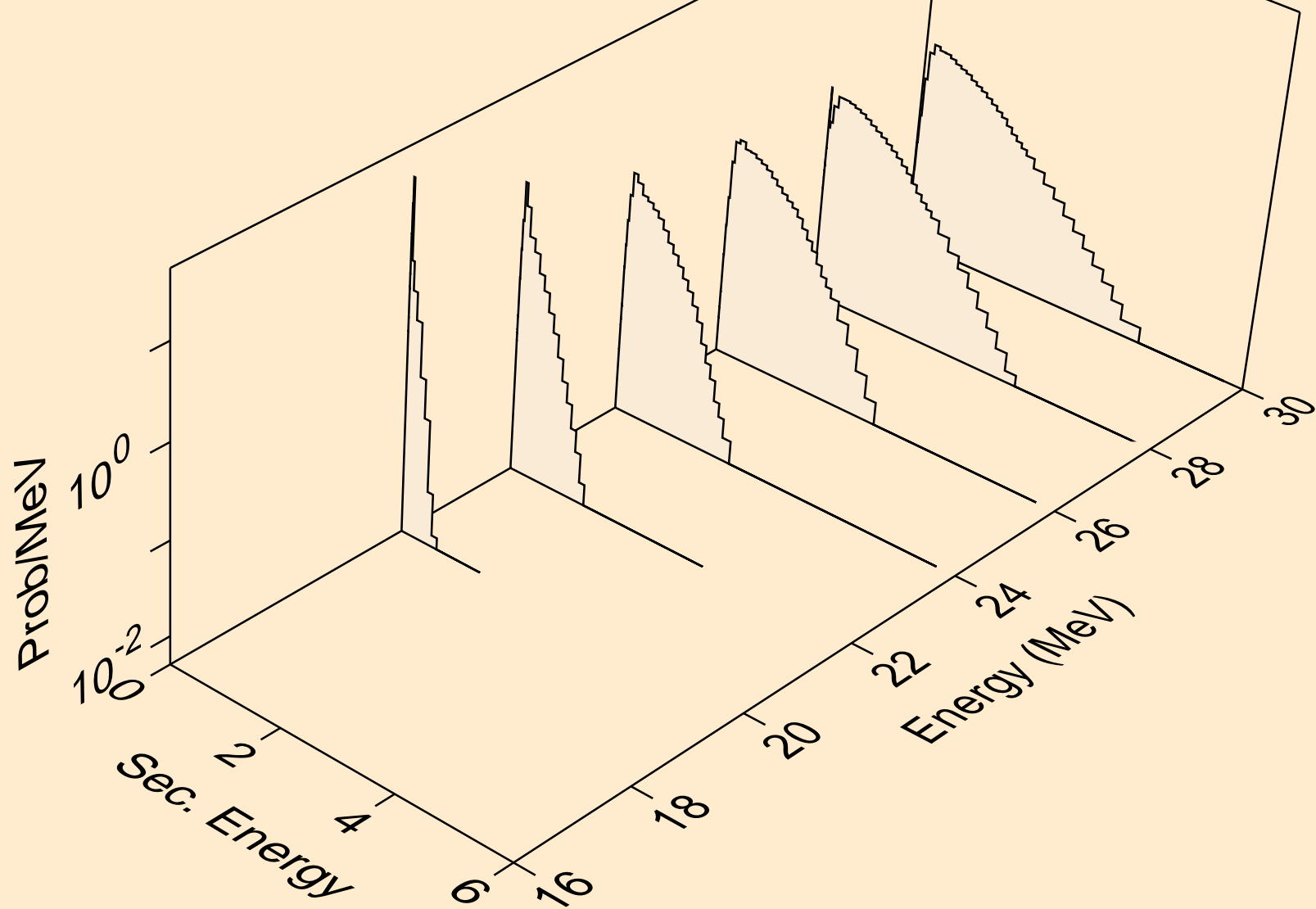

RU096 NEUTRON ACER TENDL-2021 LIBRARY; T=293.6K
Neutron emission for (n,n*)he3

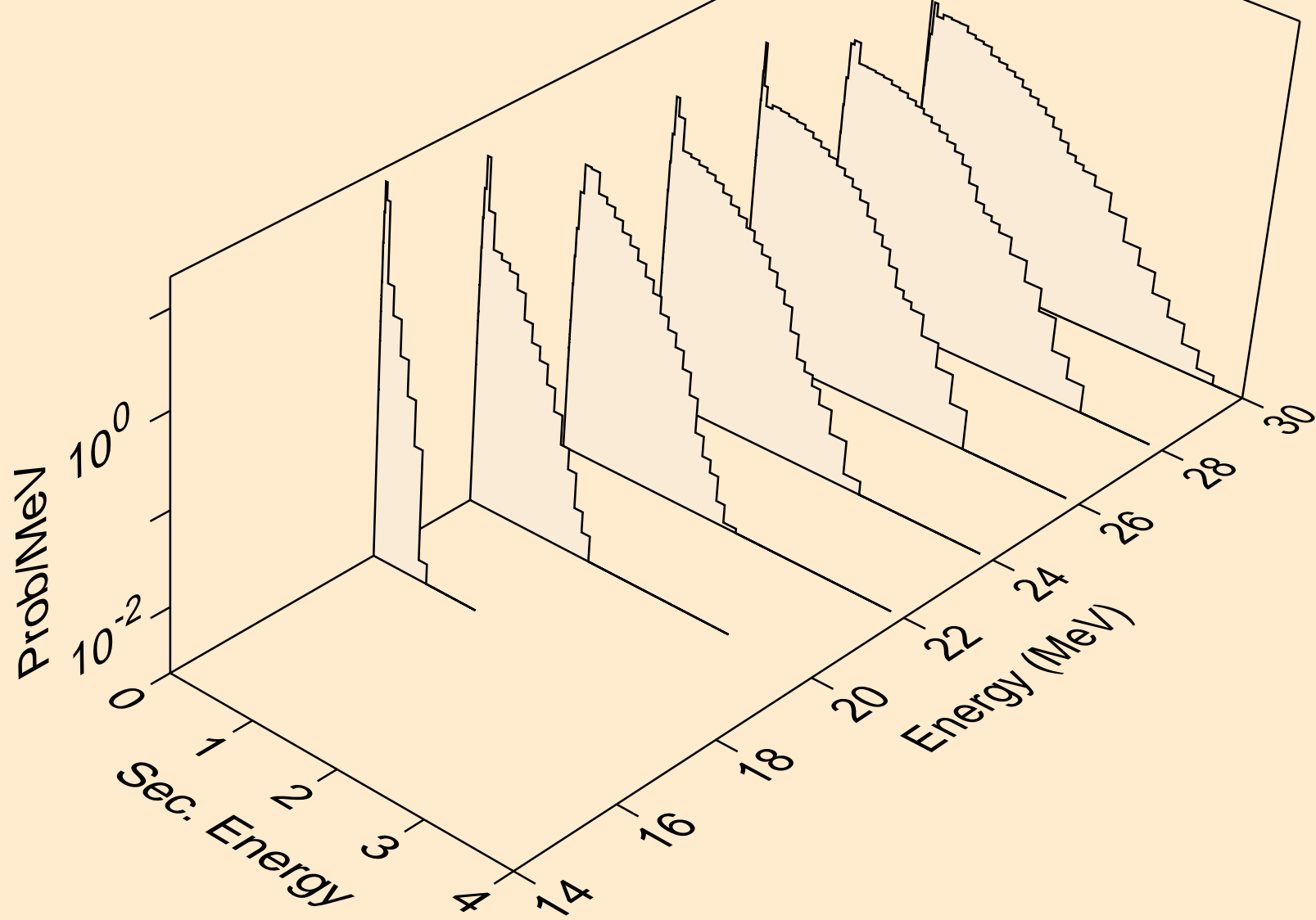

RU096 NEUTRON ACER TENDL-2021 LIBRARY; T=293.6K
Neutron emission for (n,2np)

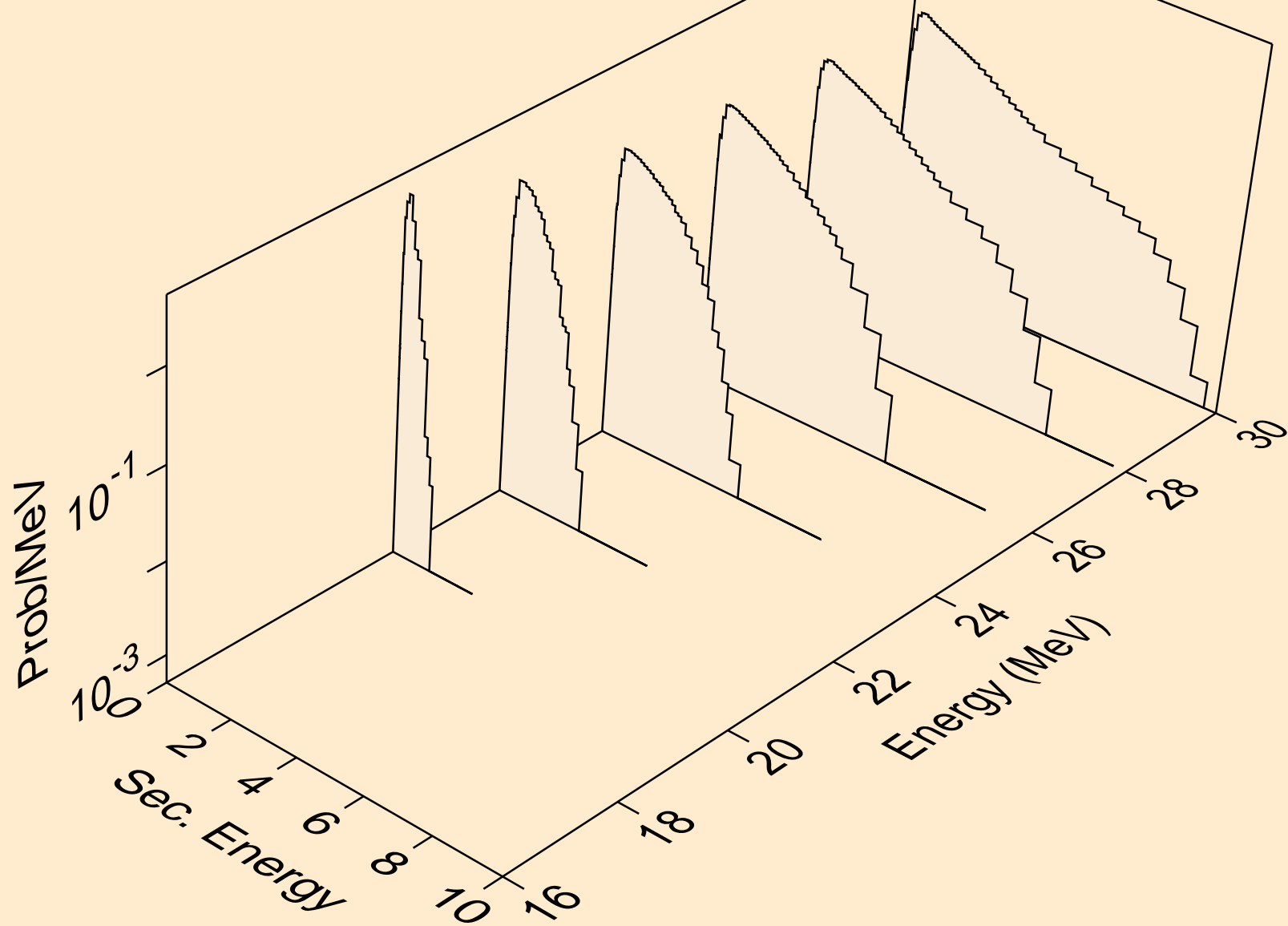

RU096 NEUTRON ACER TENDL-2021 LIBRARY; T=293.6K
Neutron emission for (n,3np)

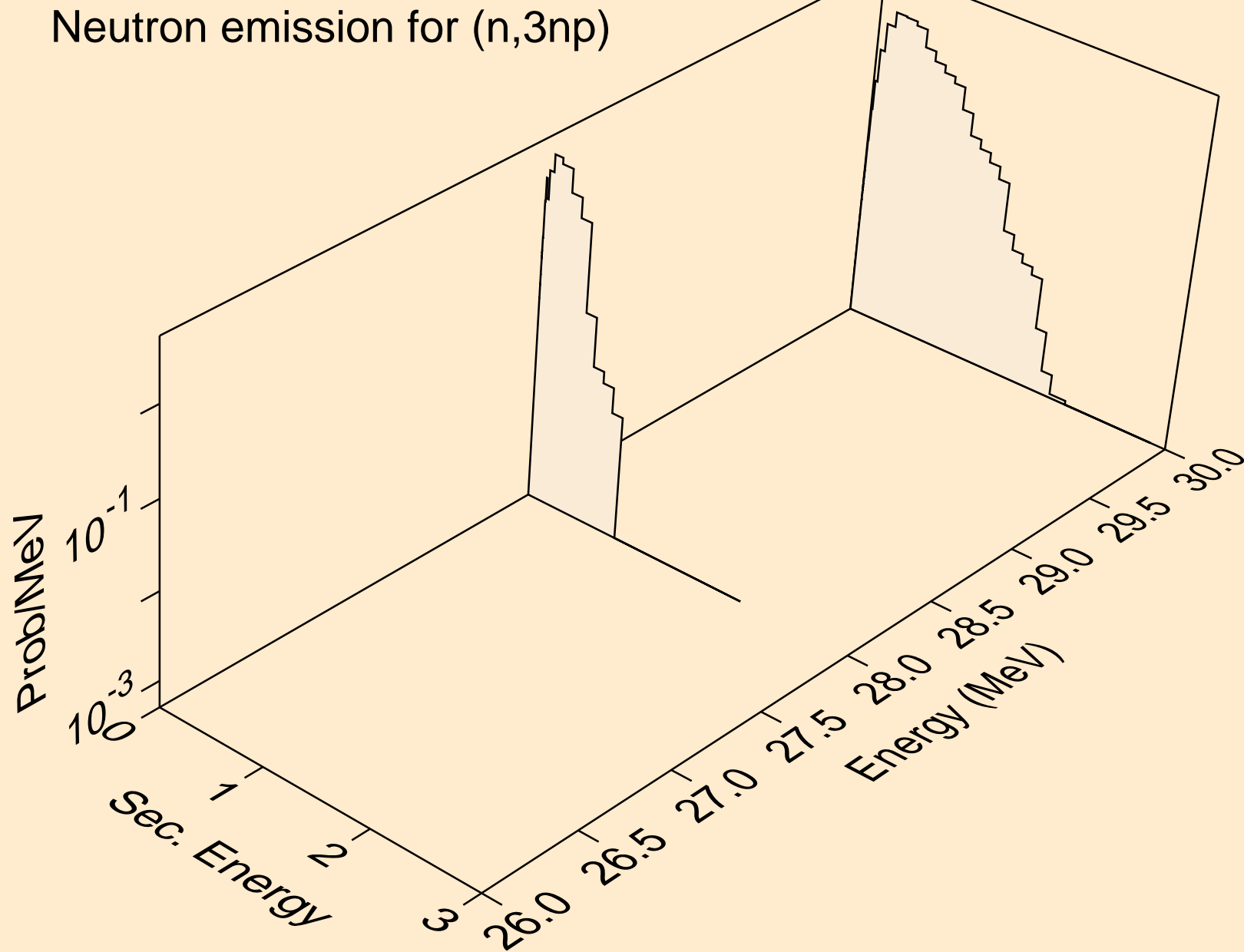

RU096 NEUTRON ACER TENDL-2021 LIBRARY; T=293.6K
Neutron emission for (n,2np)

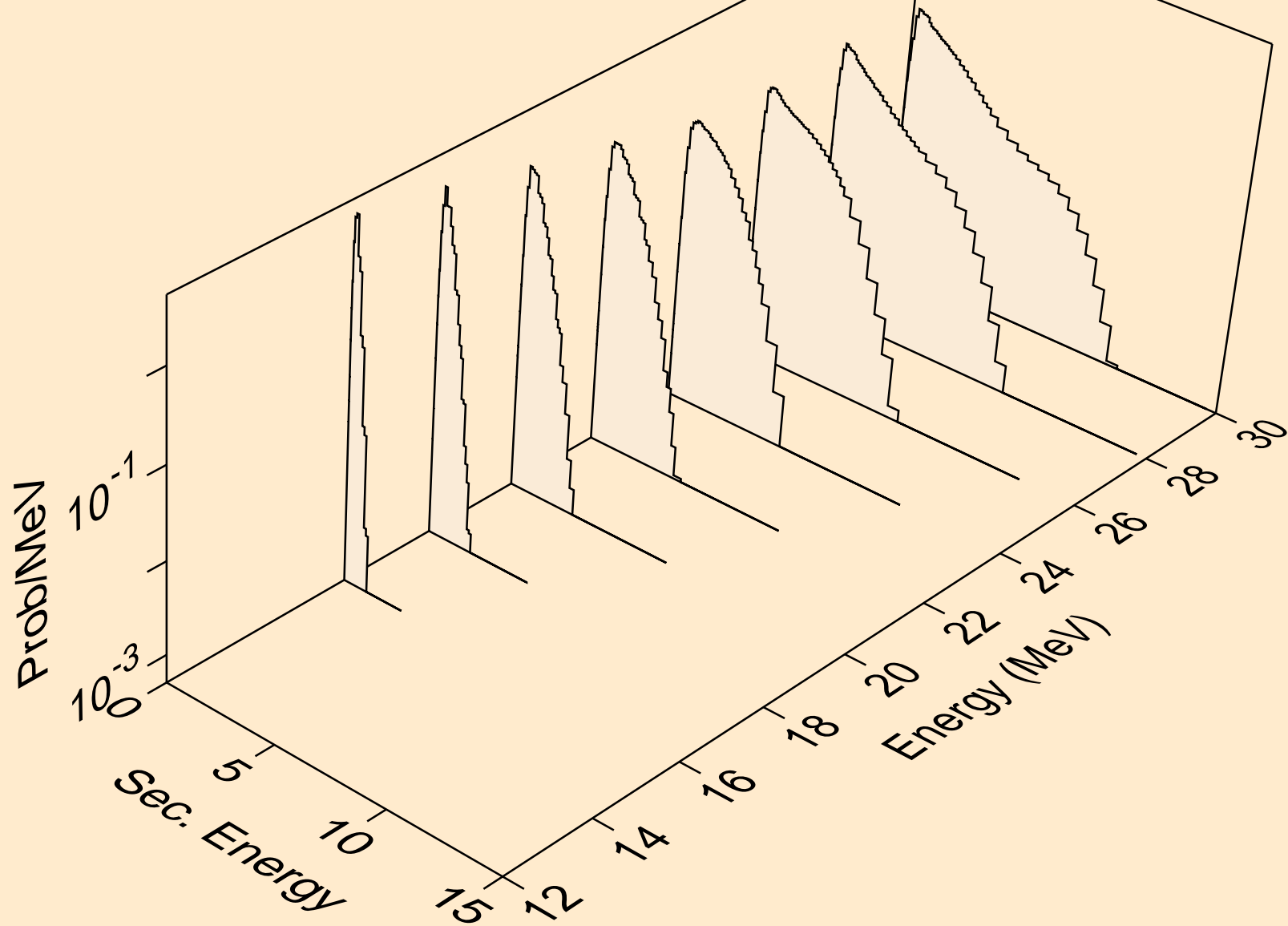

RU096 NEUTRON ACER TENDL-2021 LIBRARY; T=293.6K
Neutron emission for (n,npa)

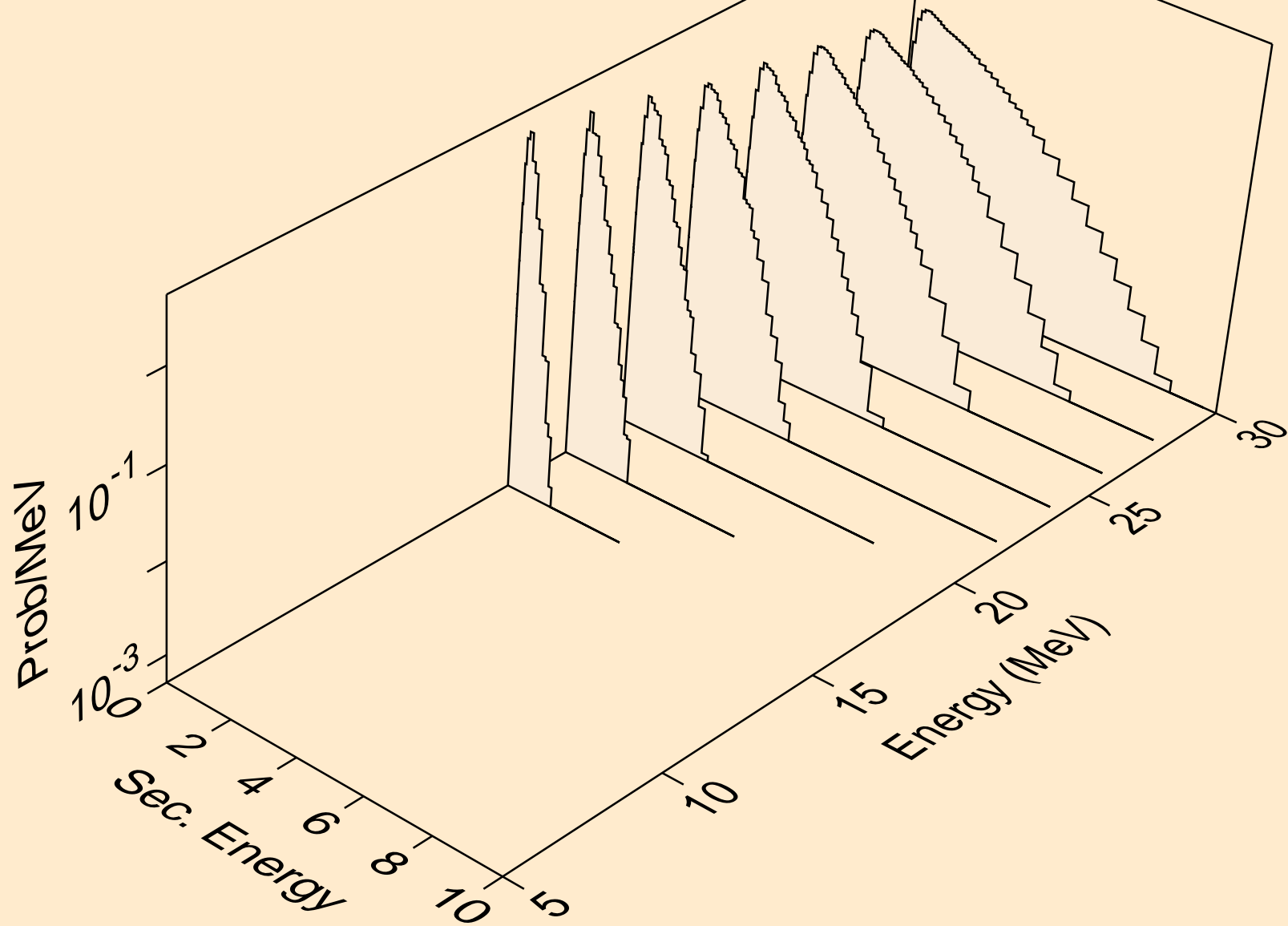

RU096 NEUTRON ACER TENDL-2021 LIBRARY; T=293.6K
Neutron emission for (n,n*c)

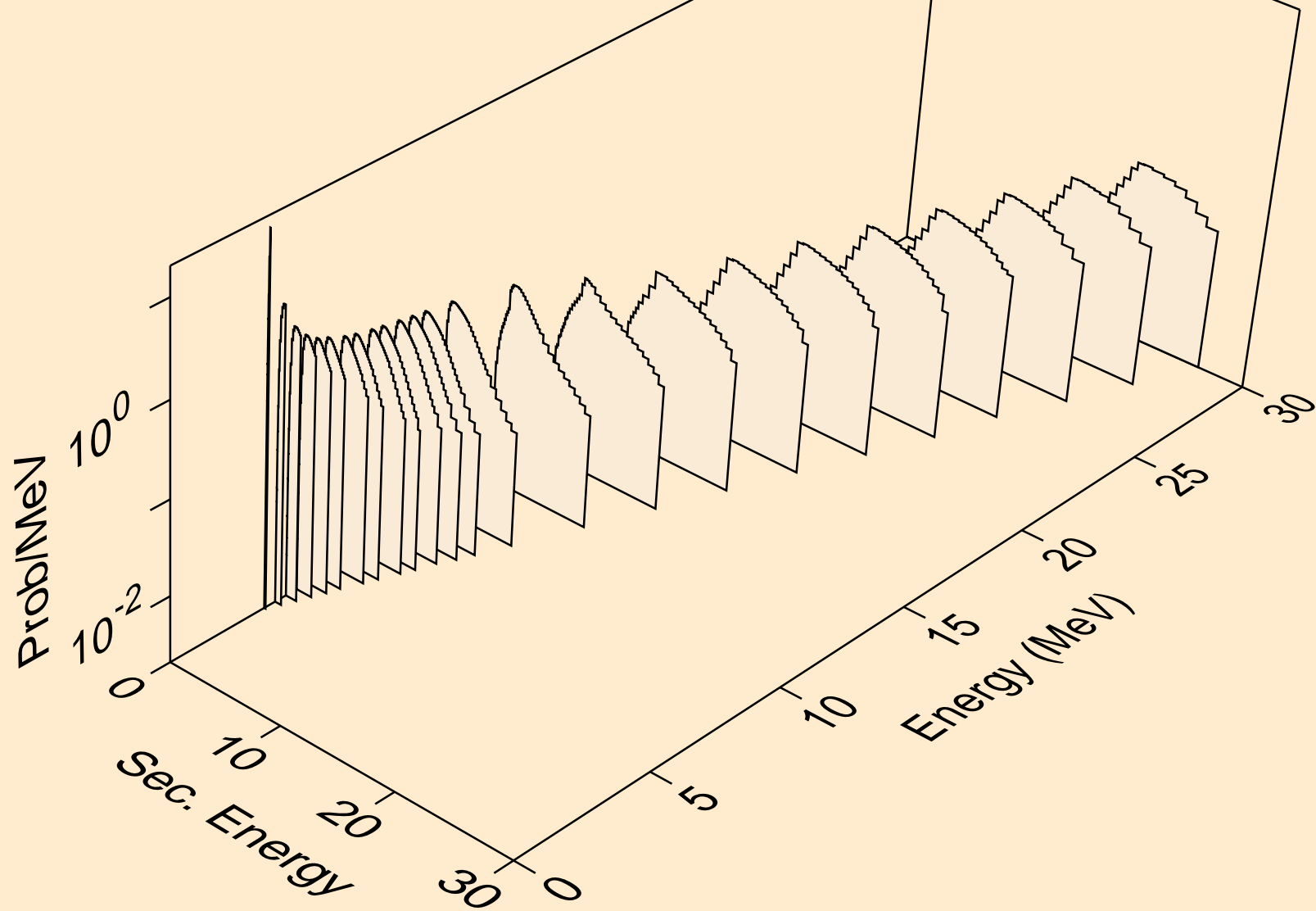

RU096 NEUTRON ACER TENDL-2021 LIBRARY; T=293.6K
Photon emission for (n,x)

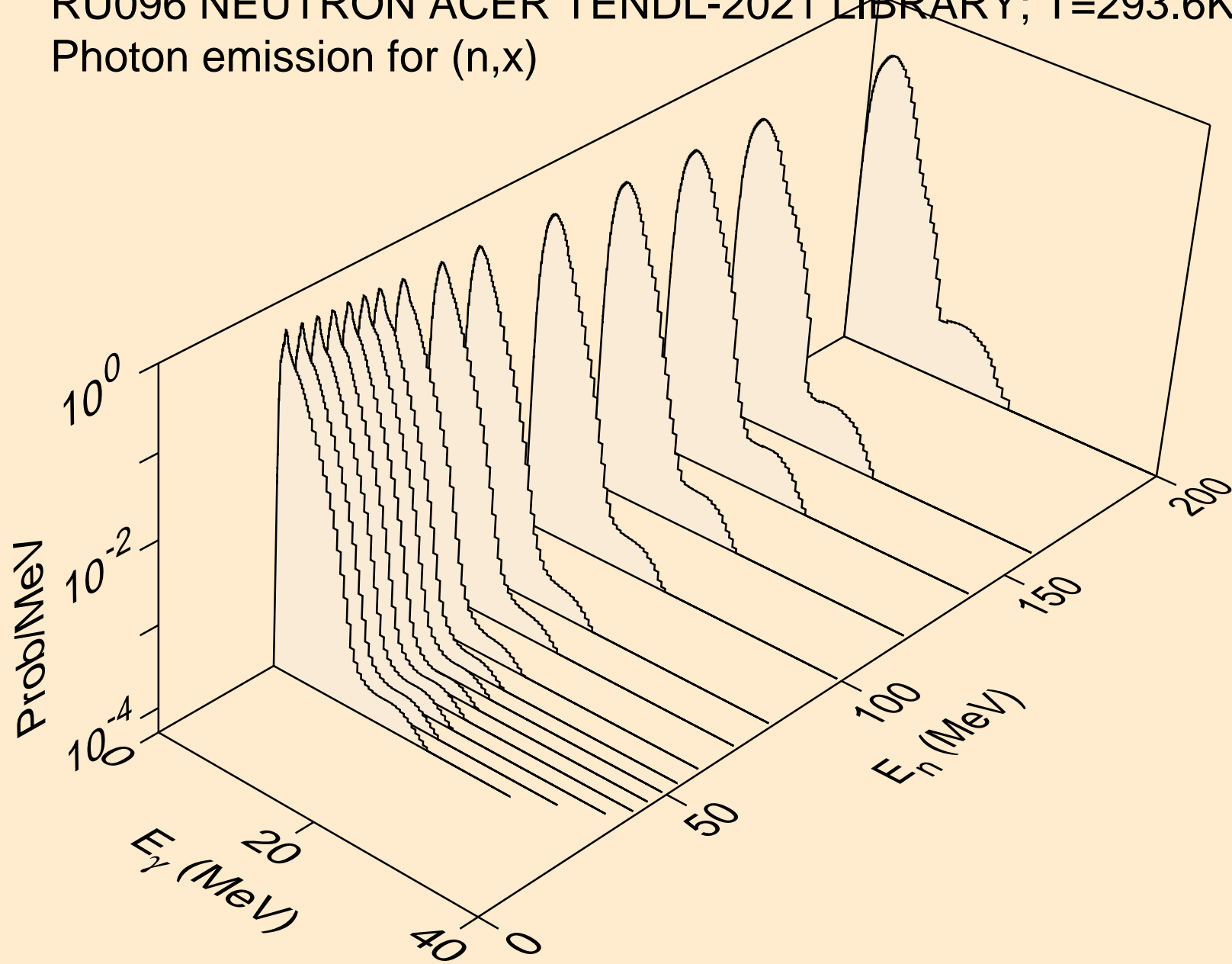

RU096 NEUTRON ACER TENDL-2021 LIBRARY; T=293.6K
Photon emission for (n,2nd)

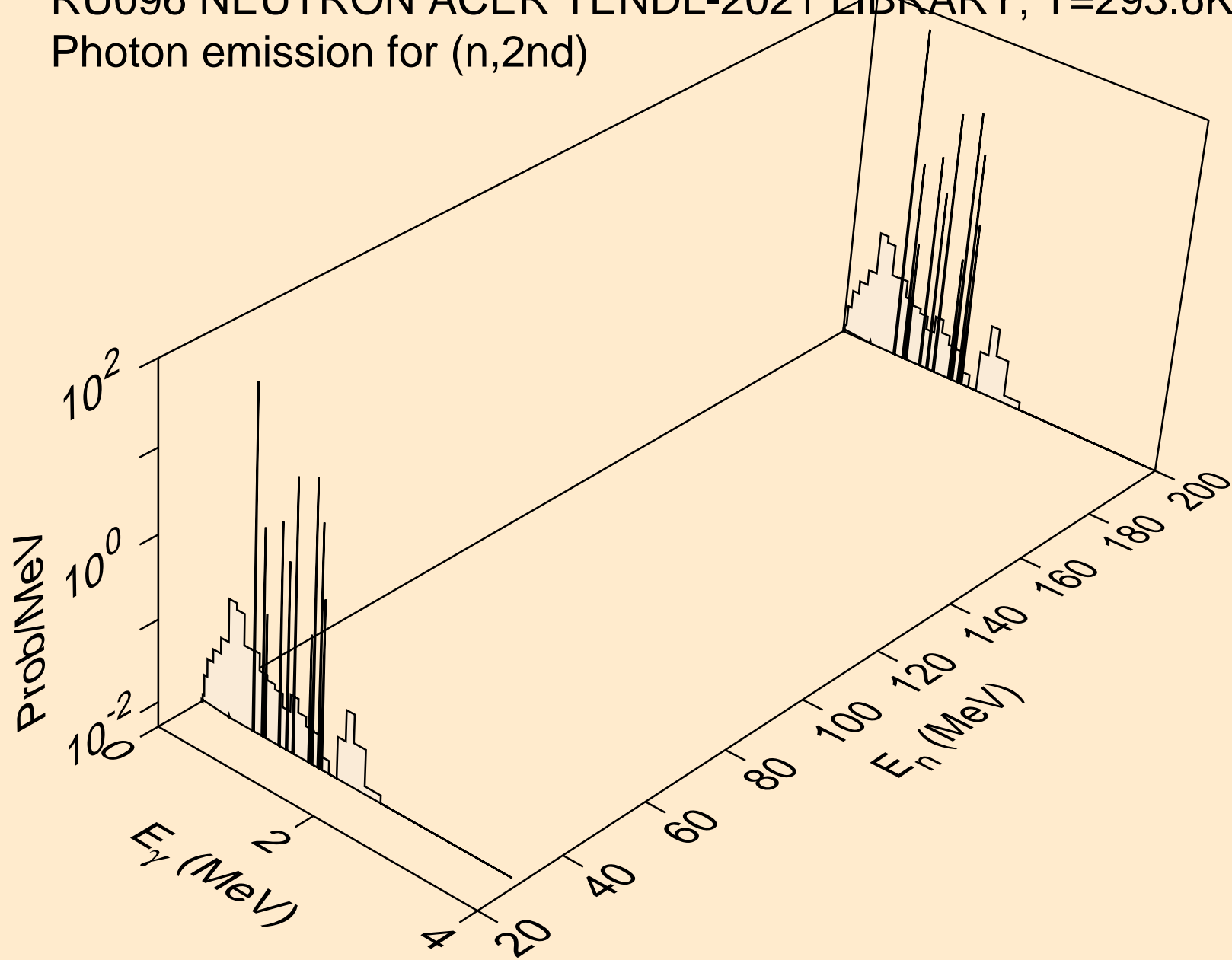

RU096 NEUTRON ACER TENDL-2021 LIBRARY; T=293.6K
Photon emission for (n,2n)

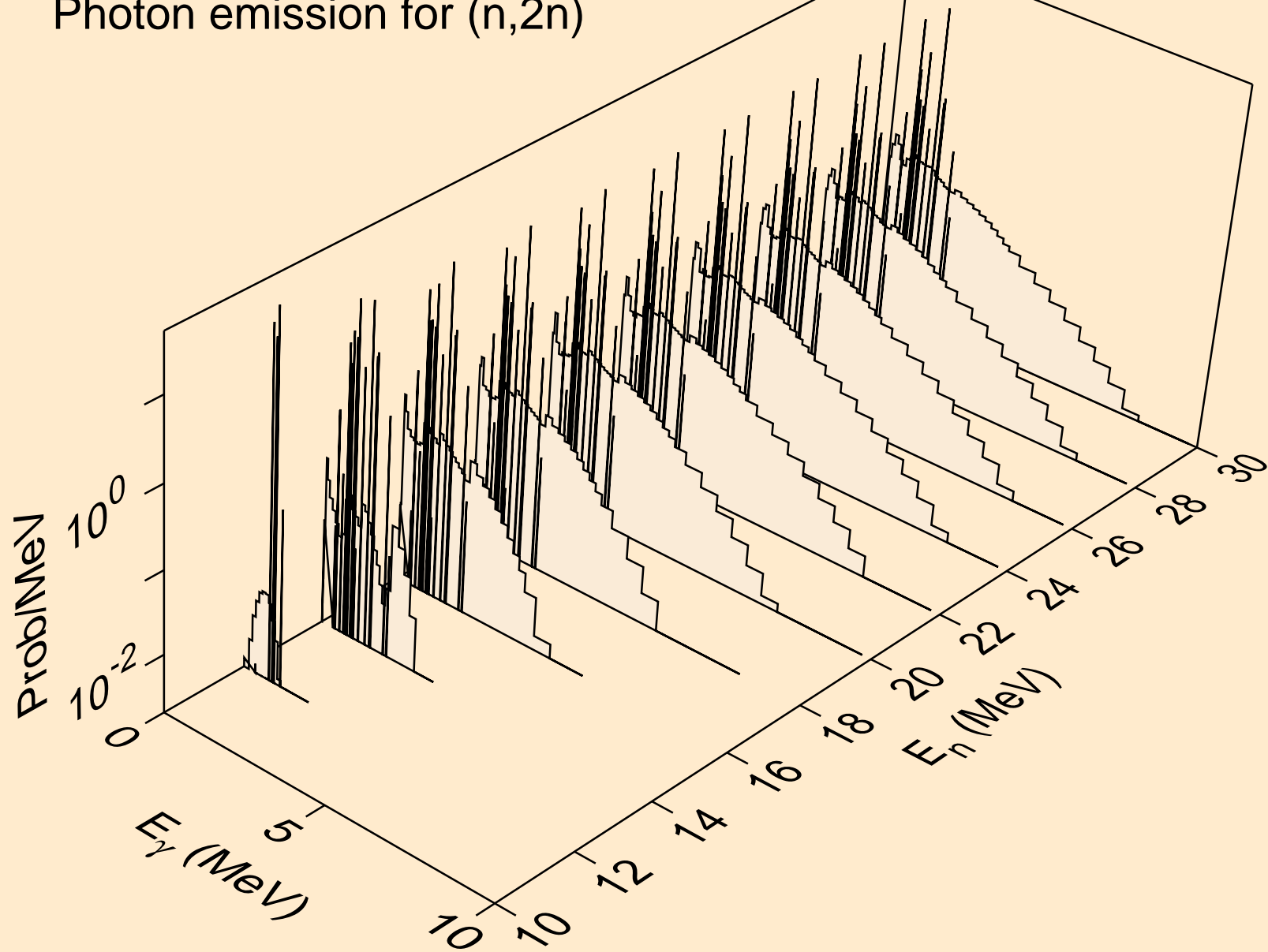

RU096 NEUTRON ACER TENDL-2021 LIBRARY; T=293.6K
Photon emission for (n,3n)

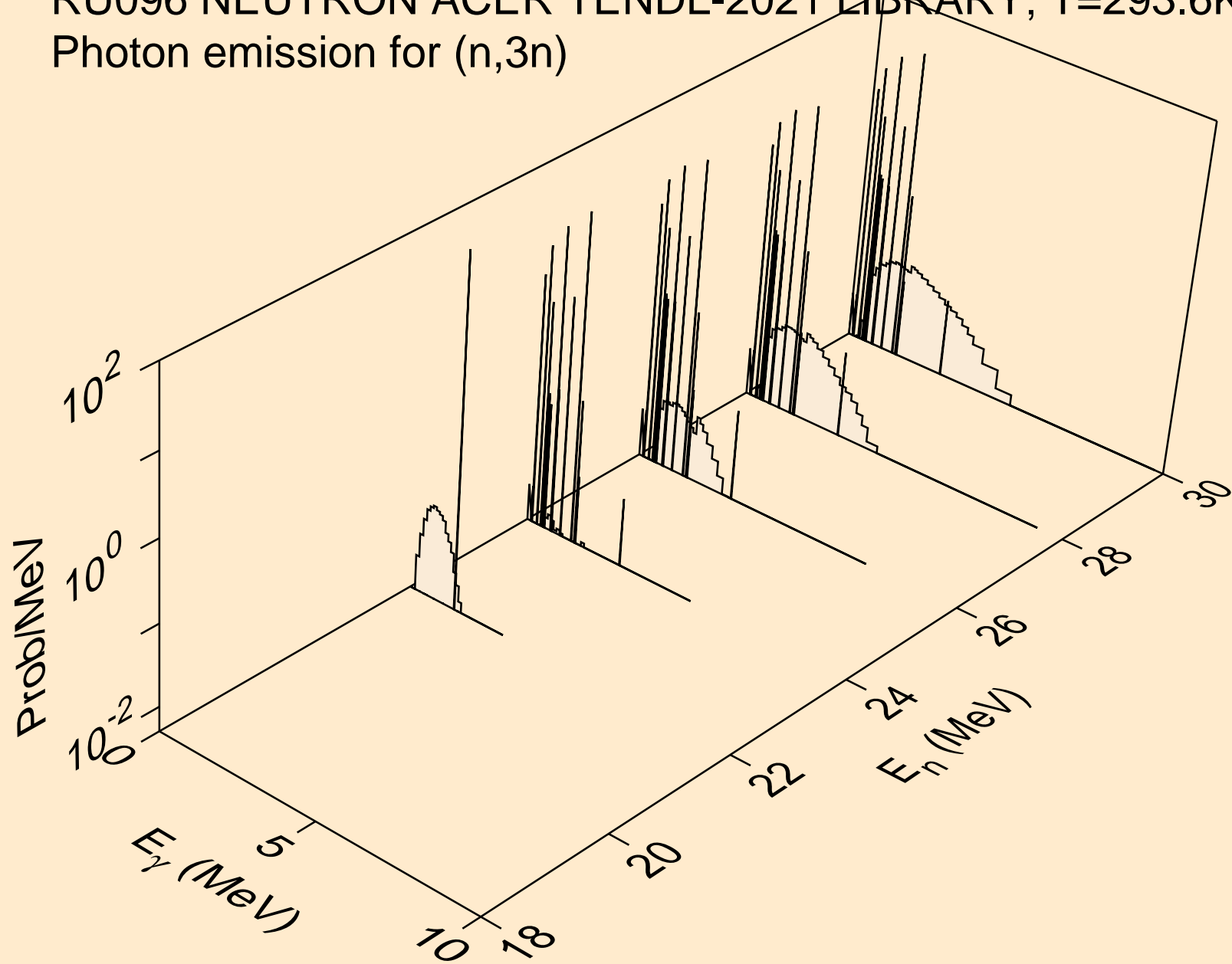

RU096 NEUTRON ACER TENDL-2021 LIBRARY; T=293.6K
Photon emission for (n,n*)a

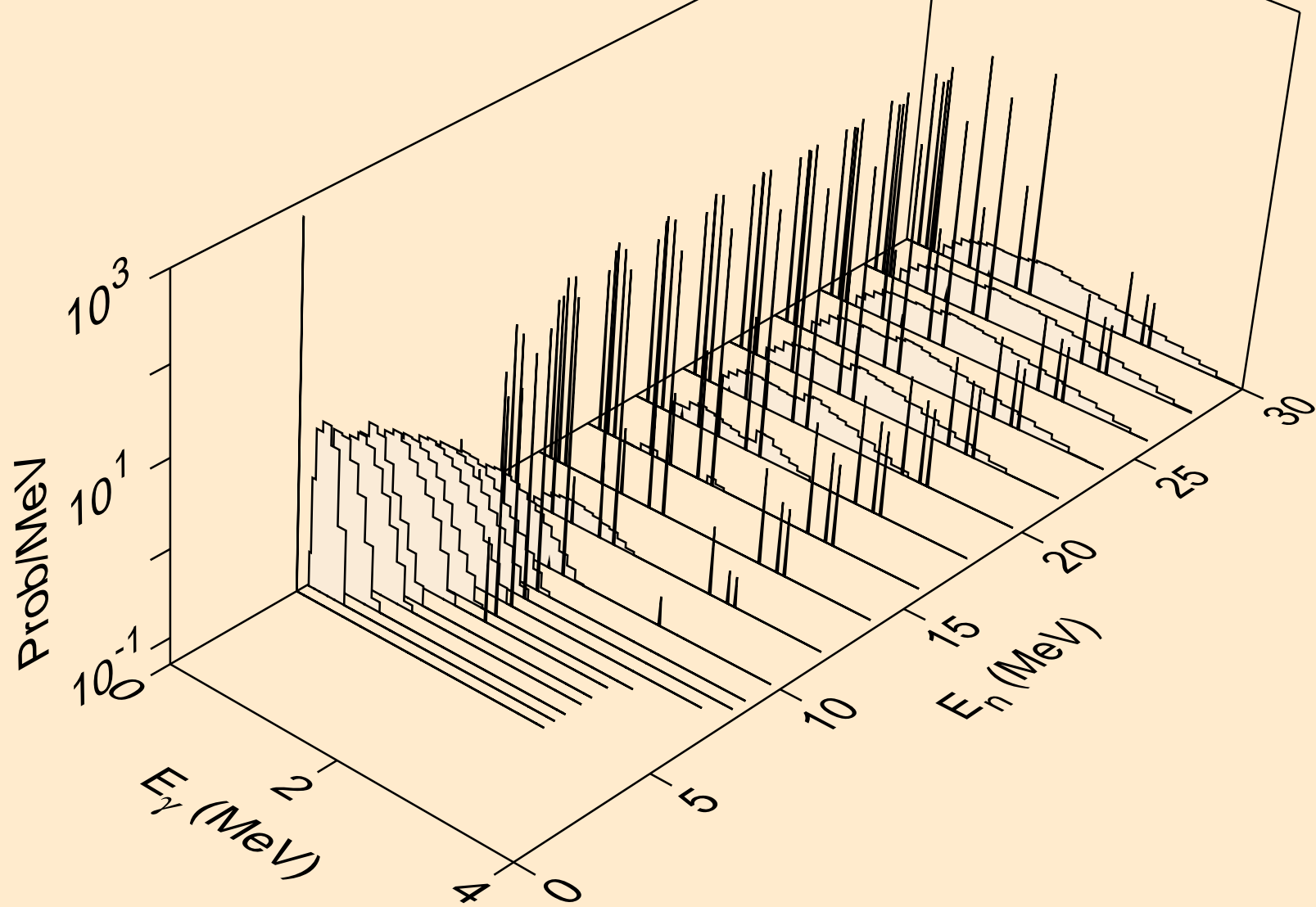

RU096 NEUTRON ACER TENDL-2021 LIBRARY; T=293.6K
Photon emission for (n,2n)a

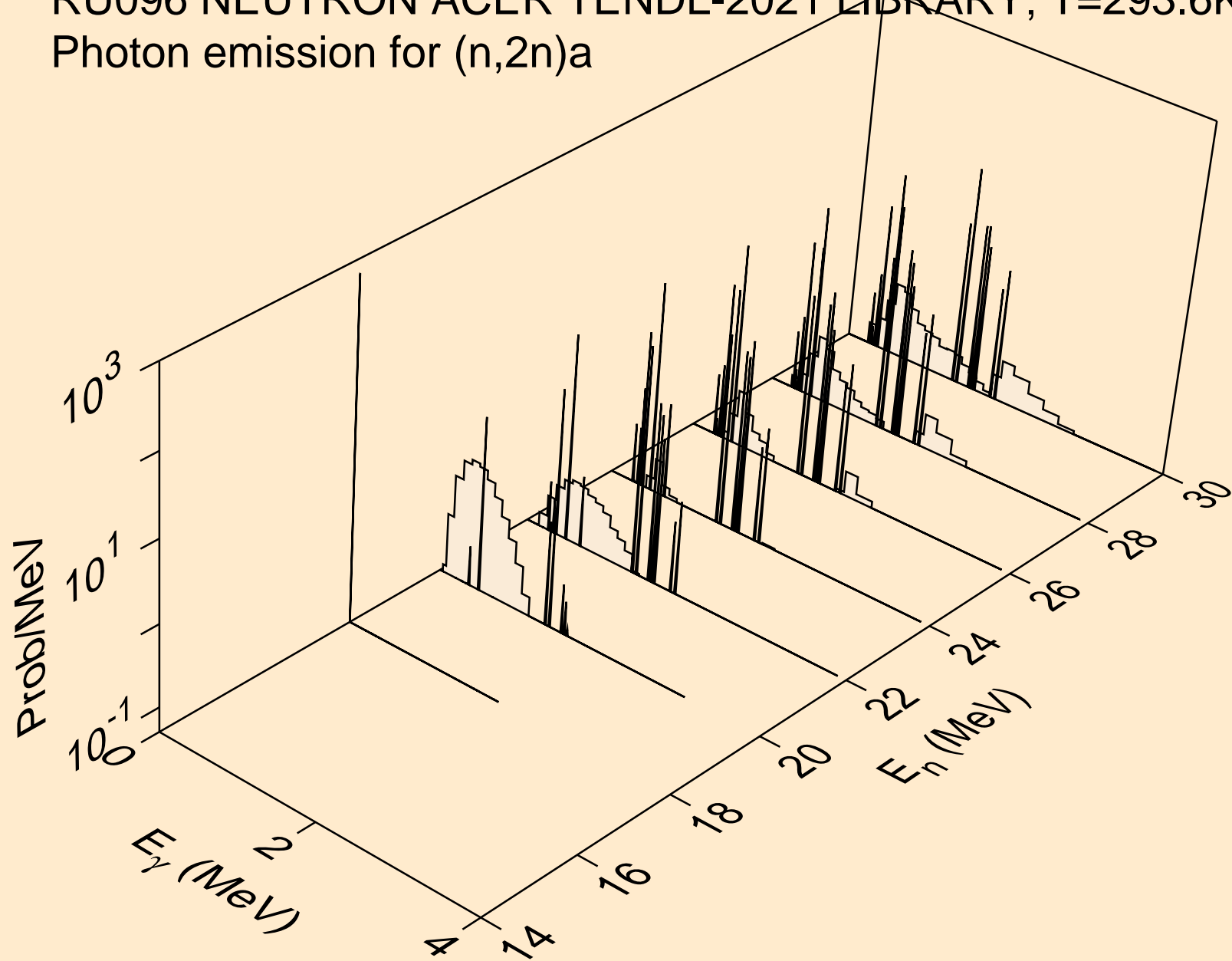

RU096 NEUTRON ACER TENDL-2021 LIBRARY; T=293.6K
Photon emission for (n,n*)p

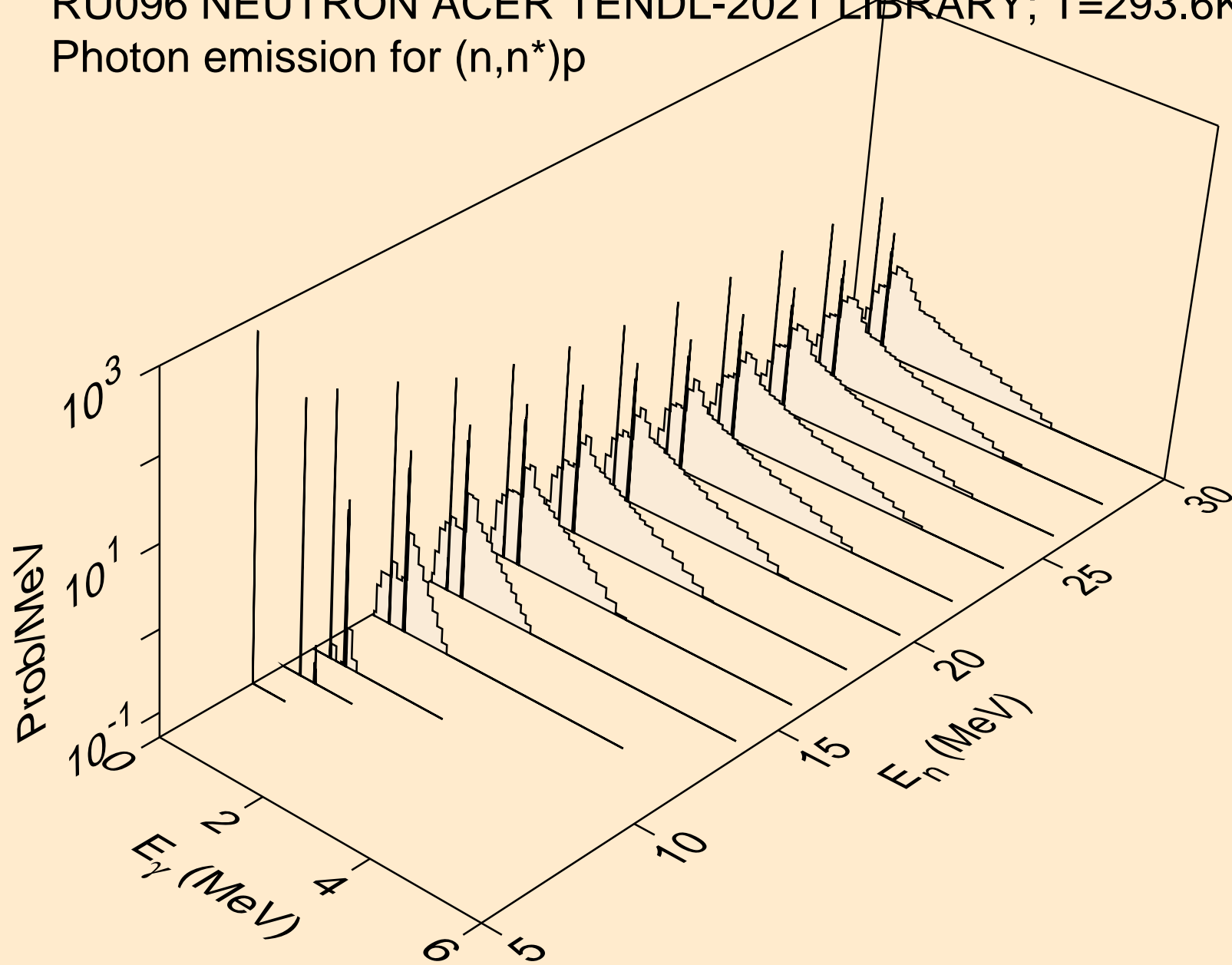

RU096 NEUTRON ACER TENDL-2021 LIBRARY; T=293.6K
Photon emission for (n,n*)2a

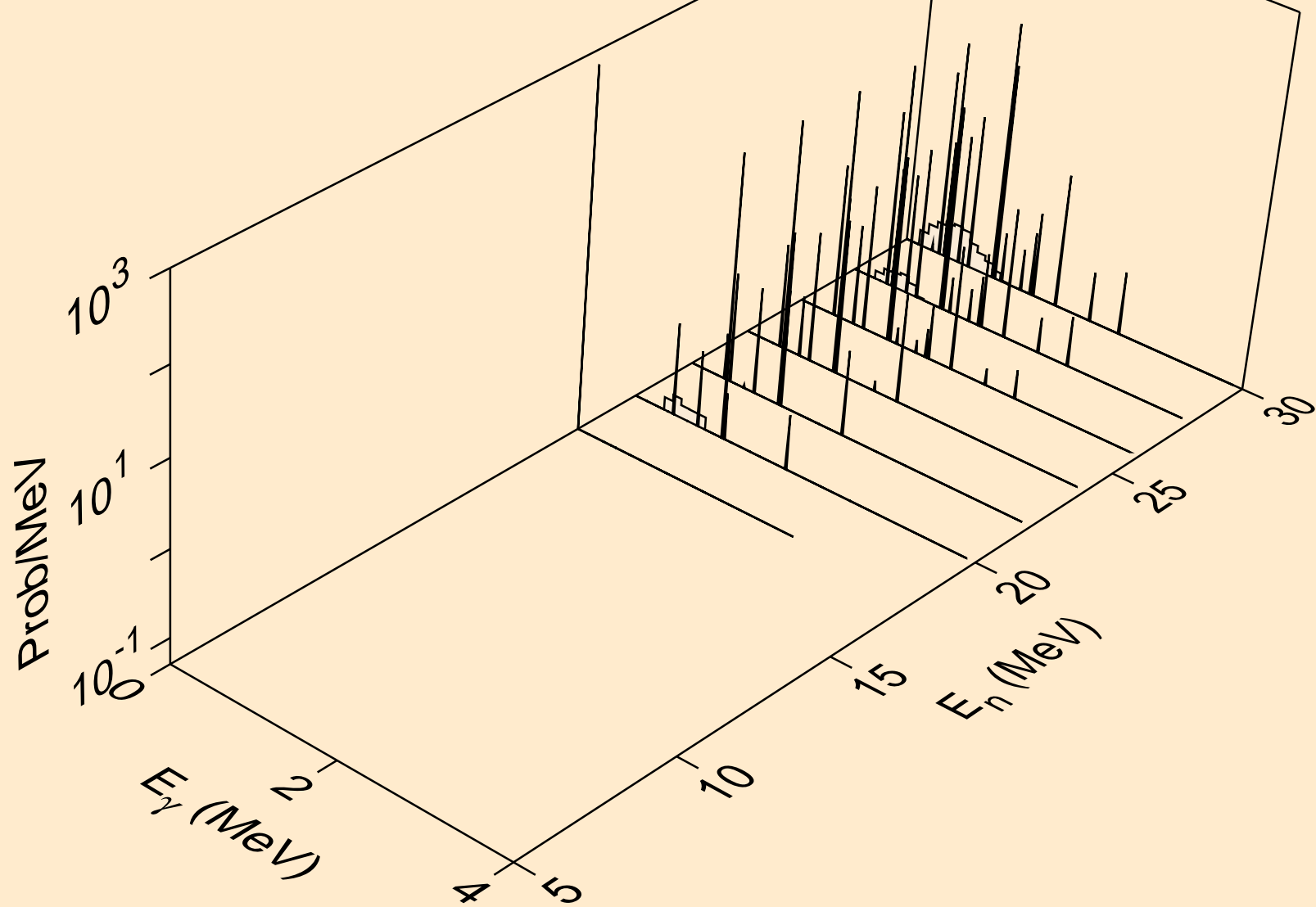

RU096 NEUTRON ACER TENDL-2021 LIBRARY; T=293.6K
Photon emission for (n,n*)d

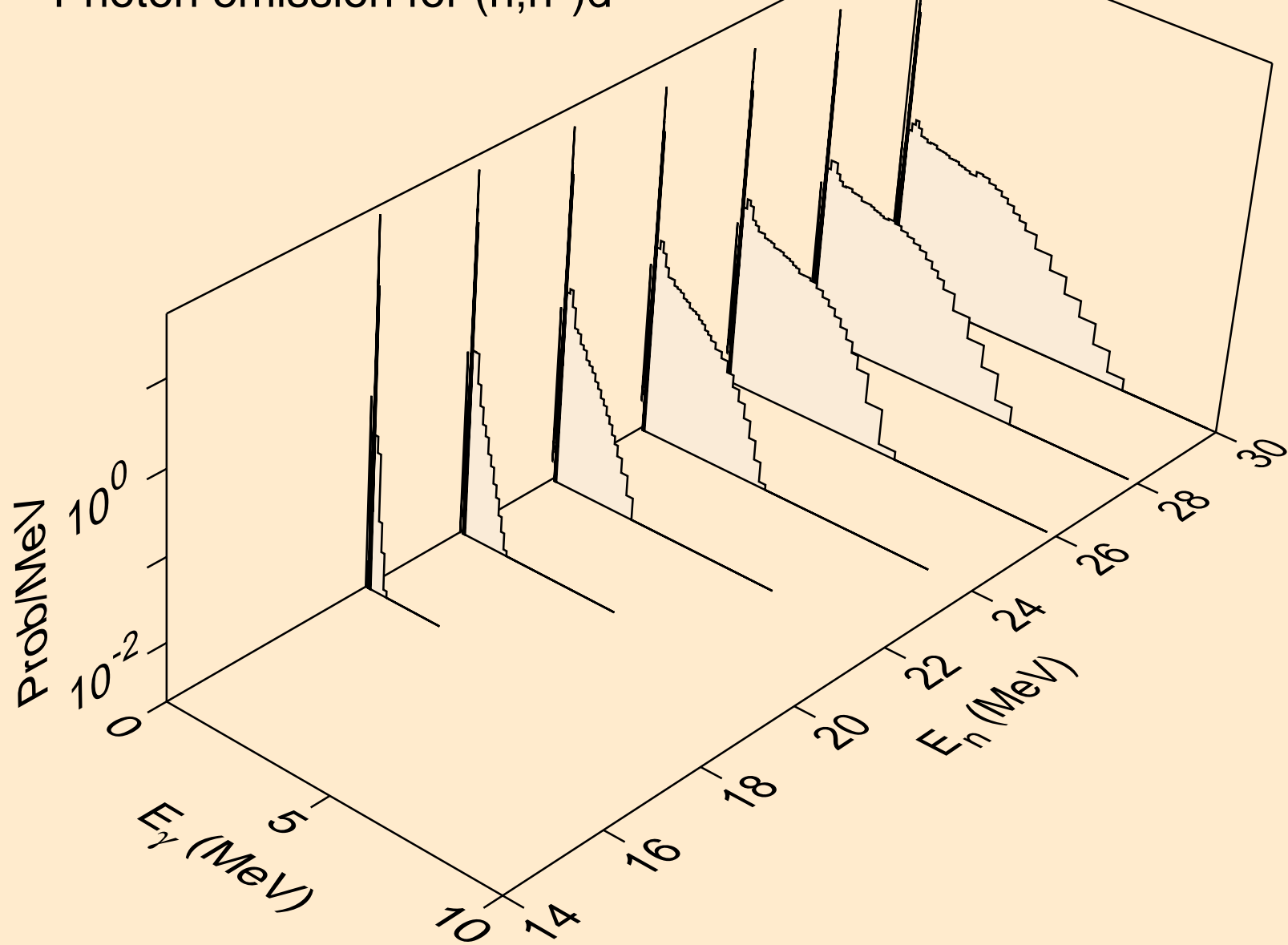

RU096 NEUTRON ACER TENDL-2021 LIBRARY; T=293.6K
Photon emission for (n,n*)t

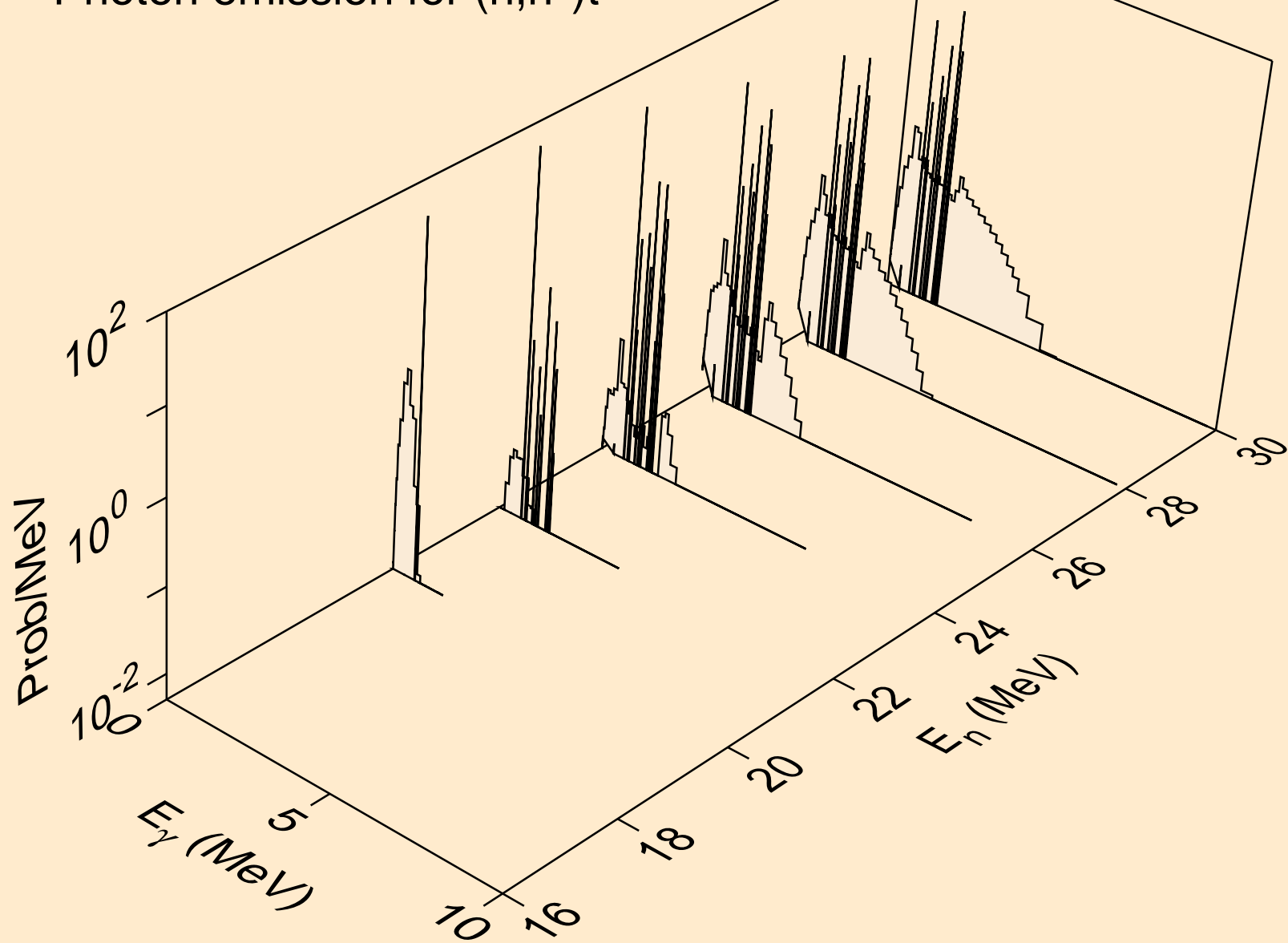

RU096 NEUTRON ACER TENDL-2021 LIBRARY; T=293.6K
Photon emission for (n,n*)he3

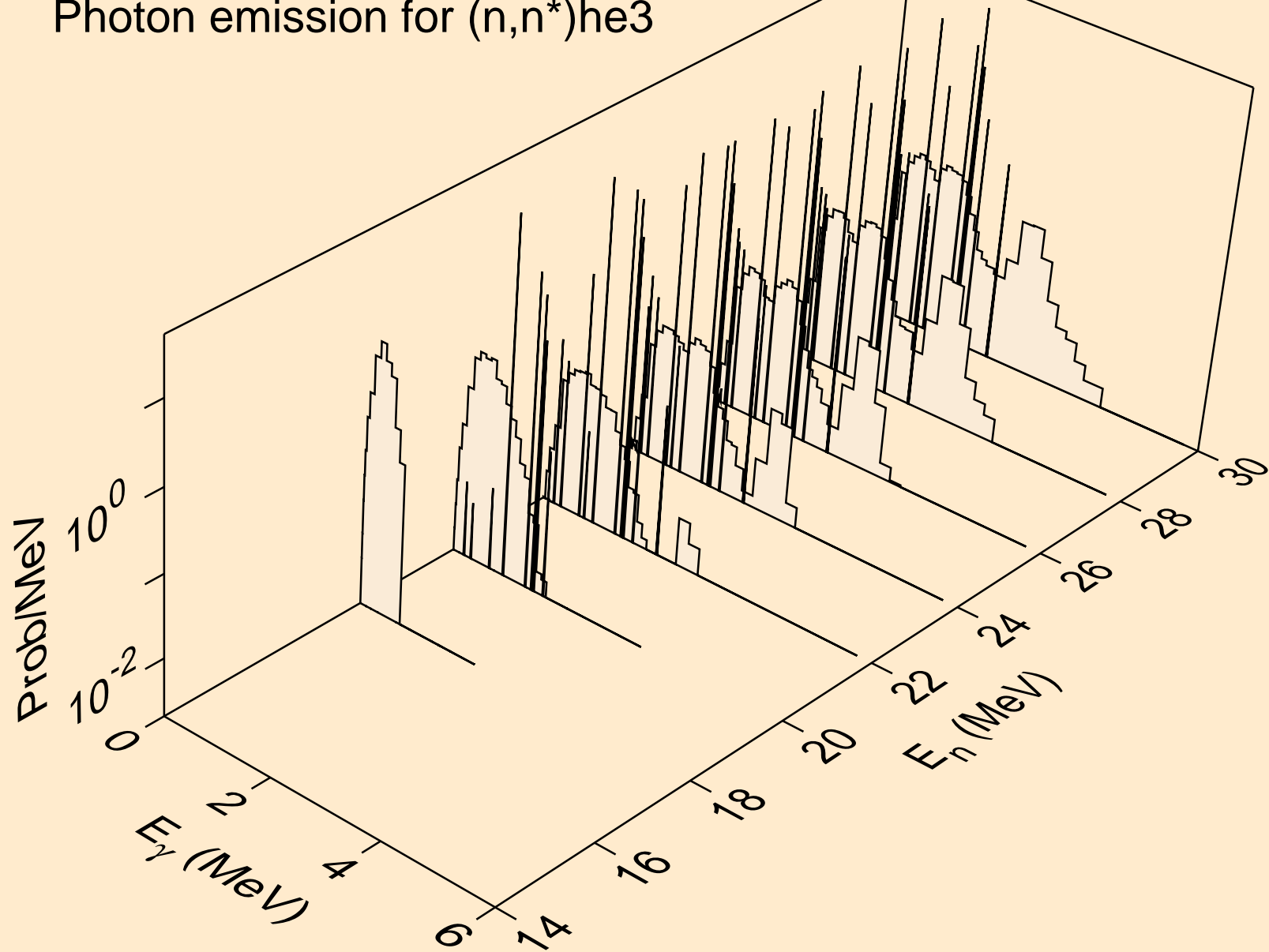

RU096 NEUTRON ACER TENDL-2021 LIBRARY; T=293.6K
Photon emission for (n,2np)

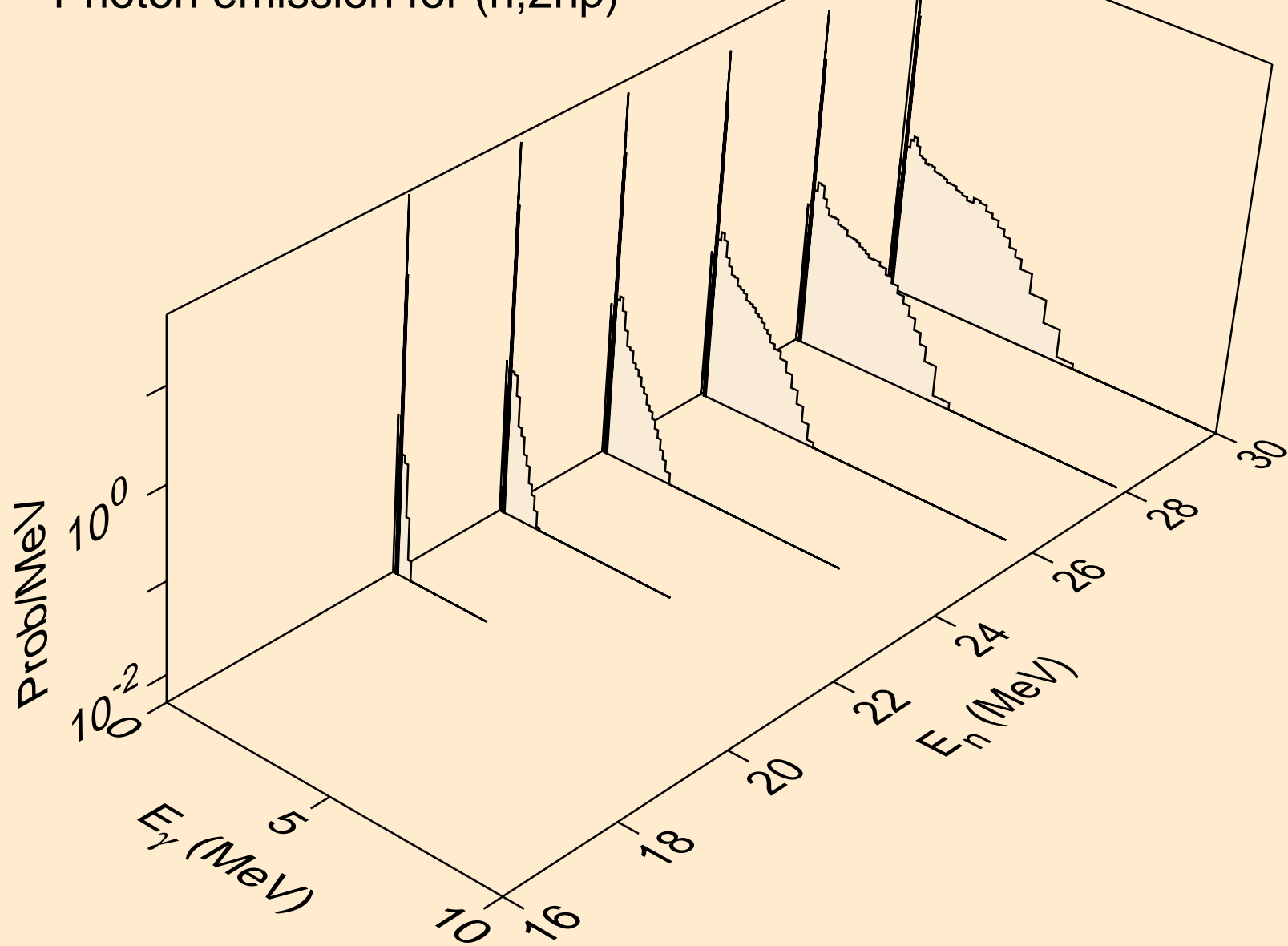

RU096 NEUTRON ACER TENDL-2021 LIBRARY; T=293.6K
Photon emission for (n,3np)

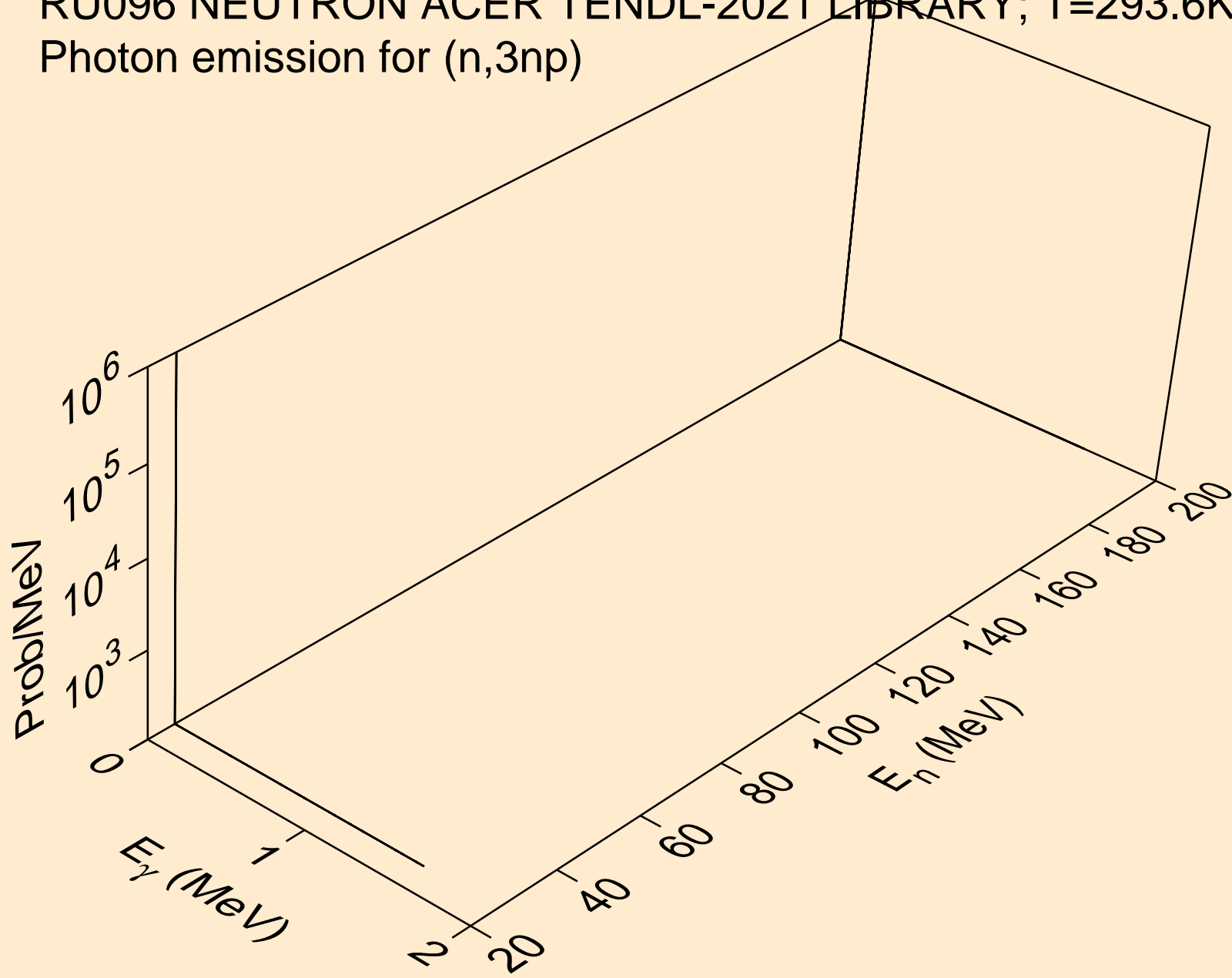

RU096 NEUTRON ACER TENDL-2021 LIBRARY; T=293.6K
Photon emission for (n,2np)

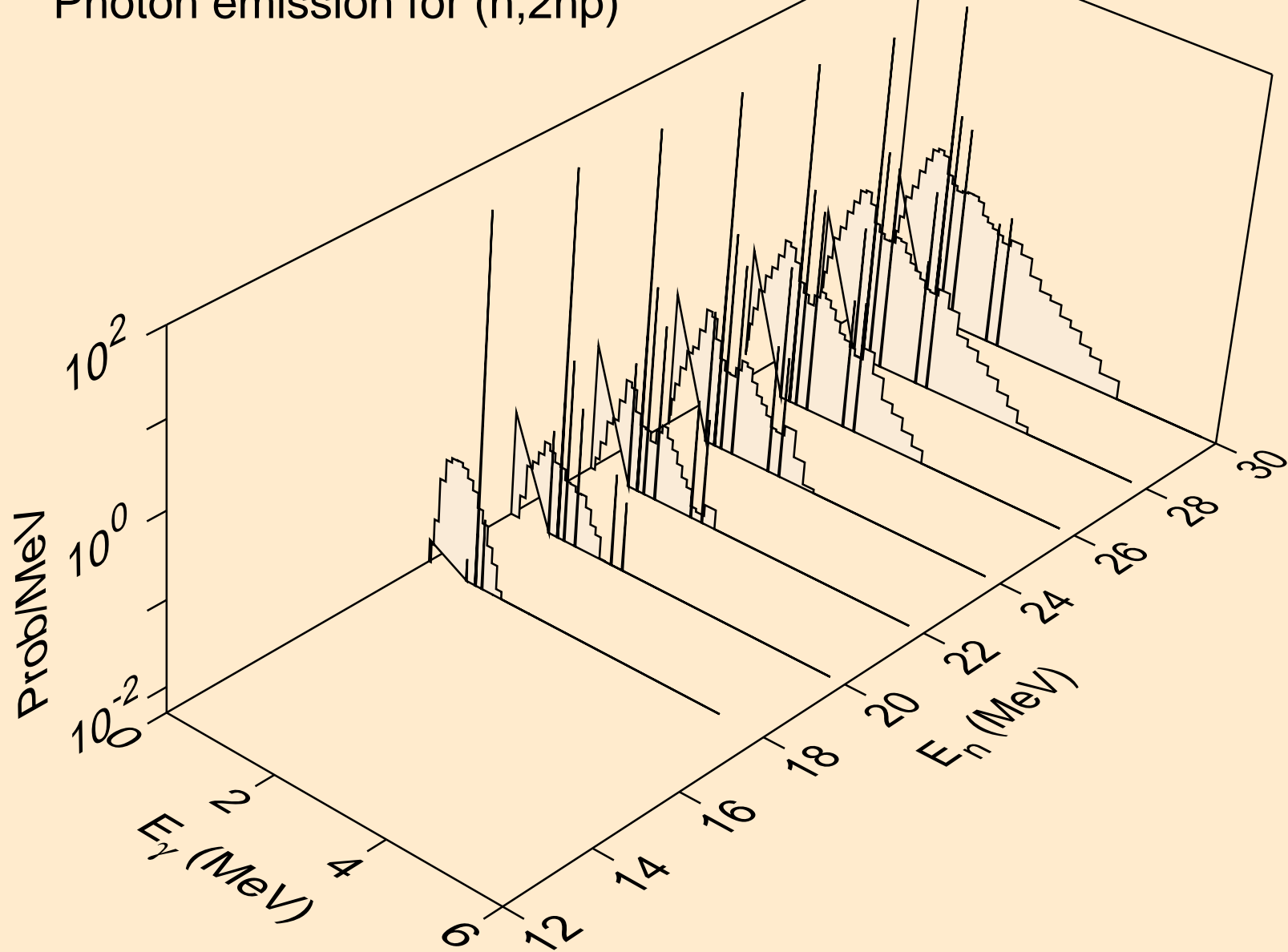

RU096 NEUTRON ACER TENDL-2021 LIBRARY; T=293.6K
Photon emission for (n,npa)

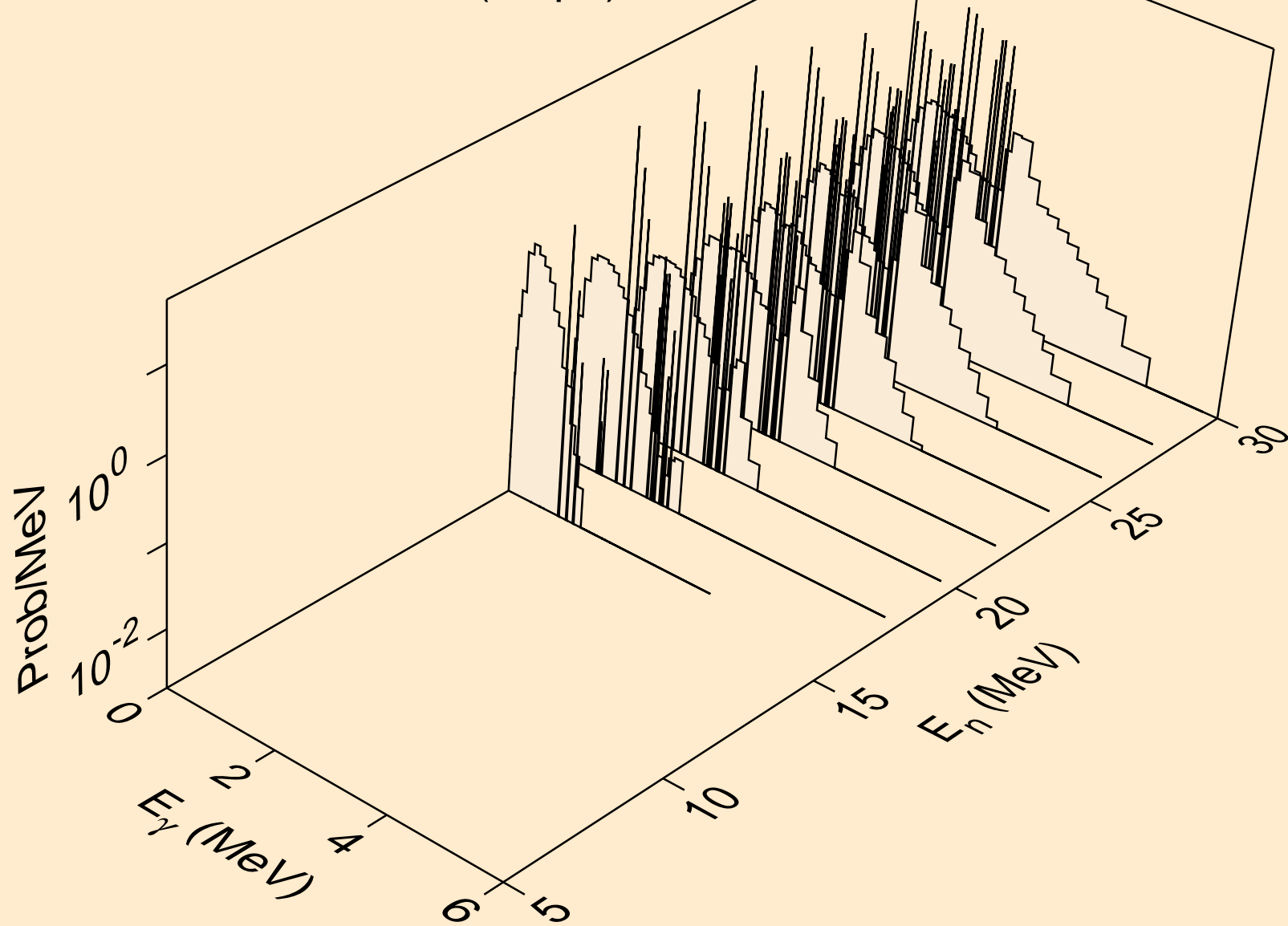

RU096 NEUTRON ACER TENDL-2021 LIBRARY; T=293.6K
Photon emission for (n,n*c)

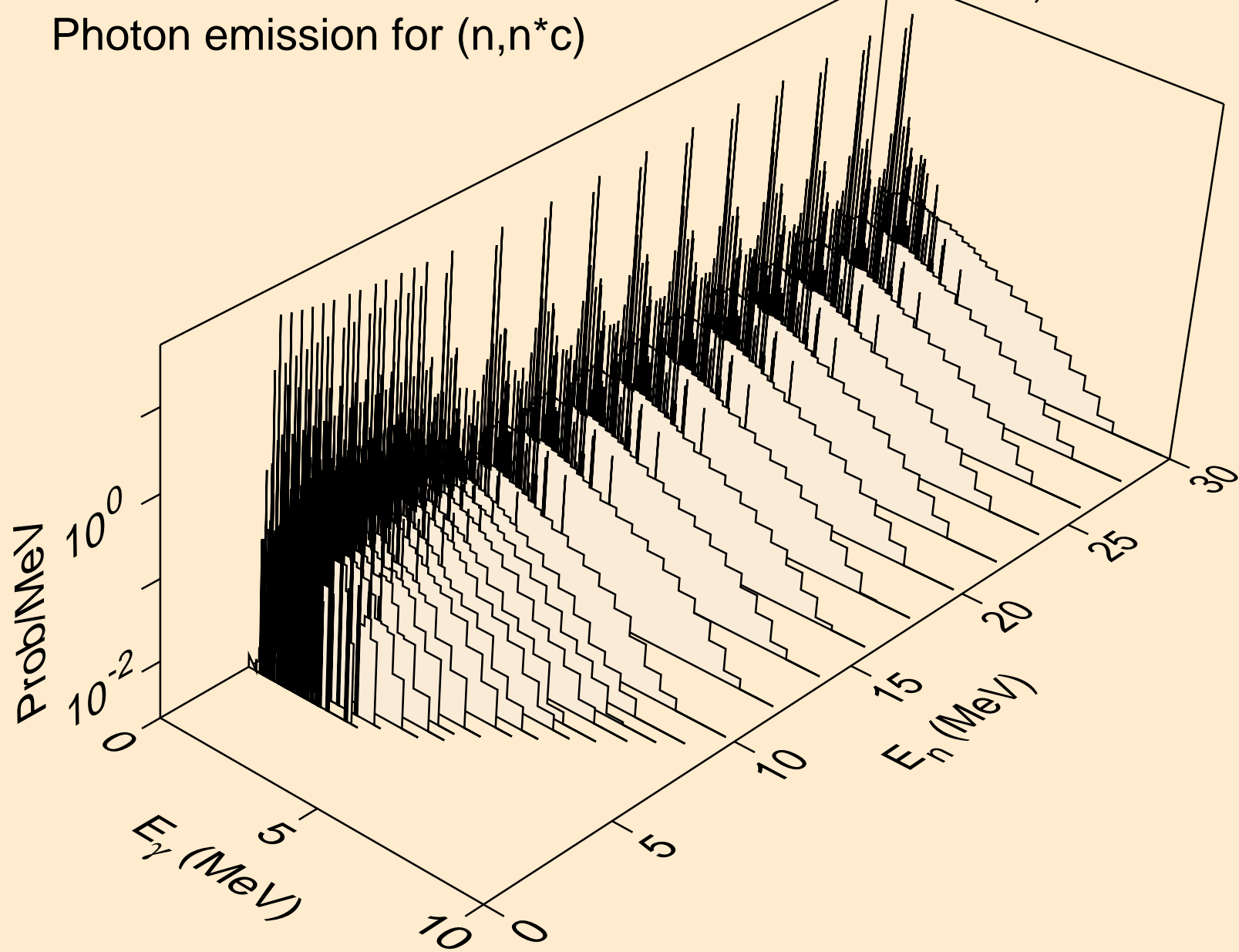

RU096 NEUTRON ACER TENDL-2021 LIBRARY; T=293.6K
Photon emission for (n,gma)

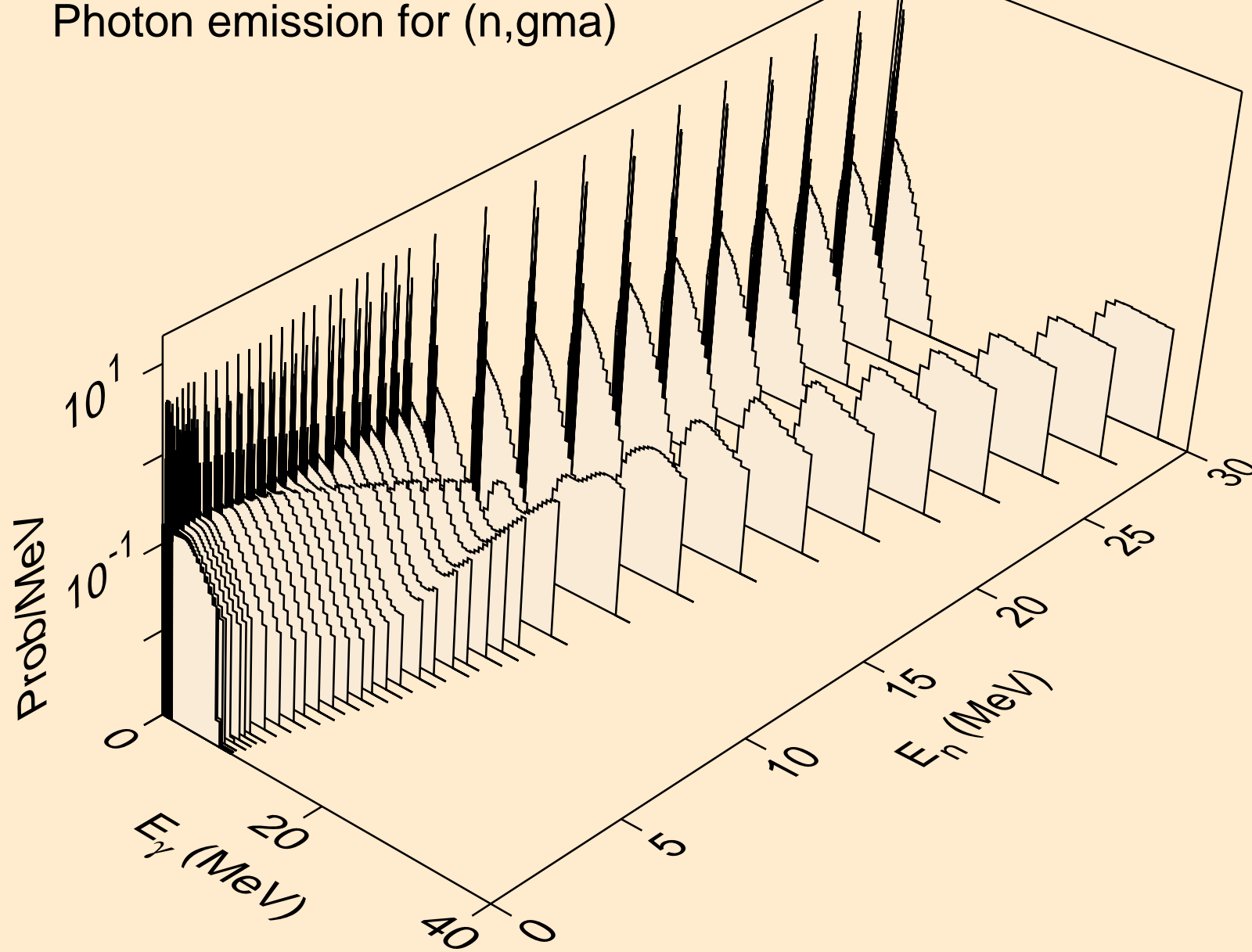

RU096 NEUTRON ACER TENDL-2021 LIBRARY; T=293.6K
Photon emission for (n,p)

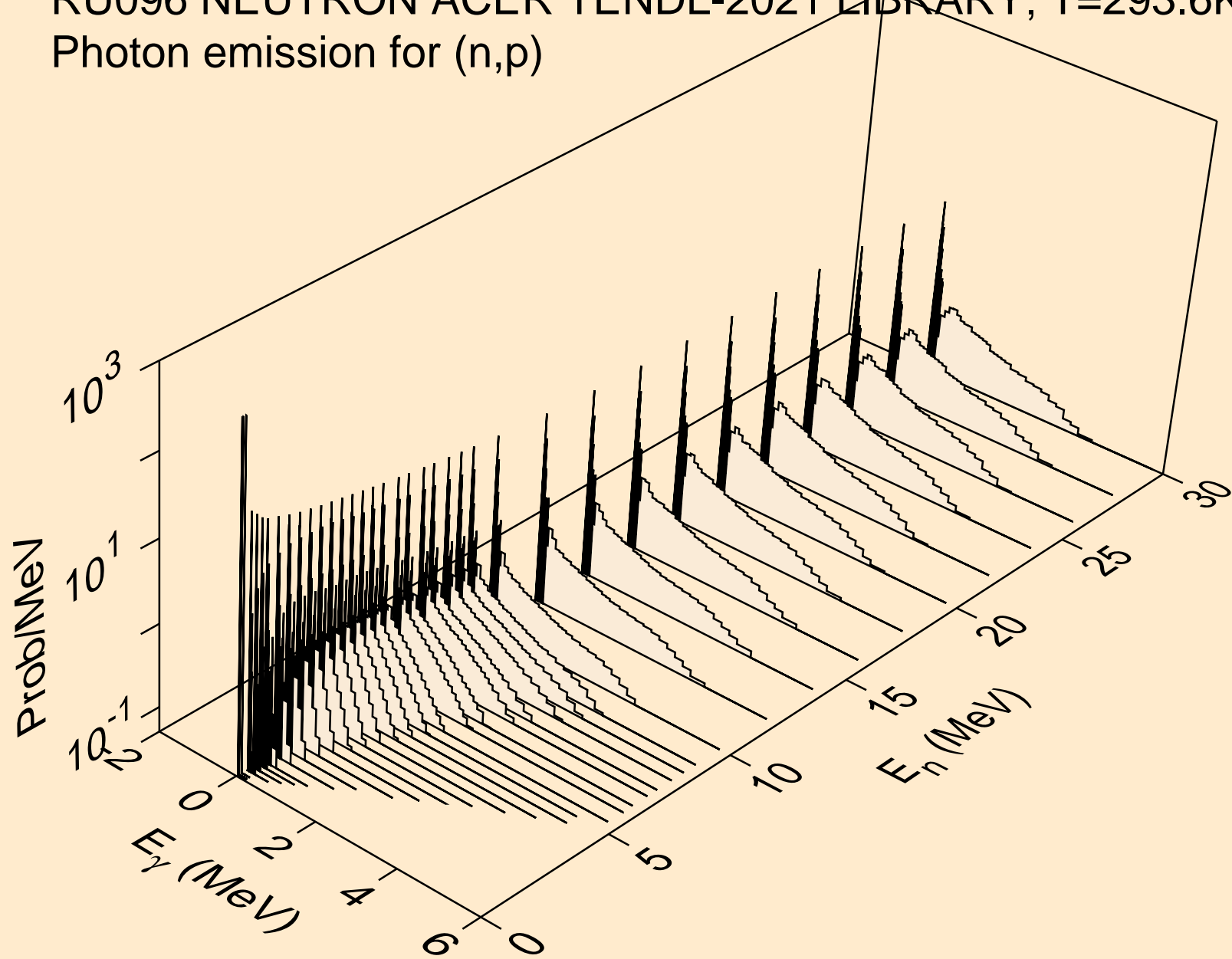

RU096 NEUTRON ACER TENDL-2021 LIBRARY; T=293.6K
Photon emission for (n,d)

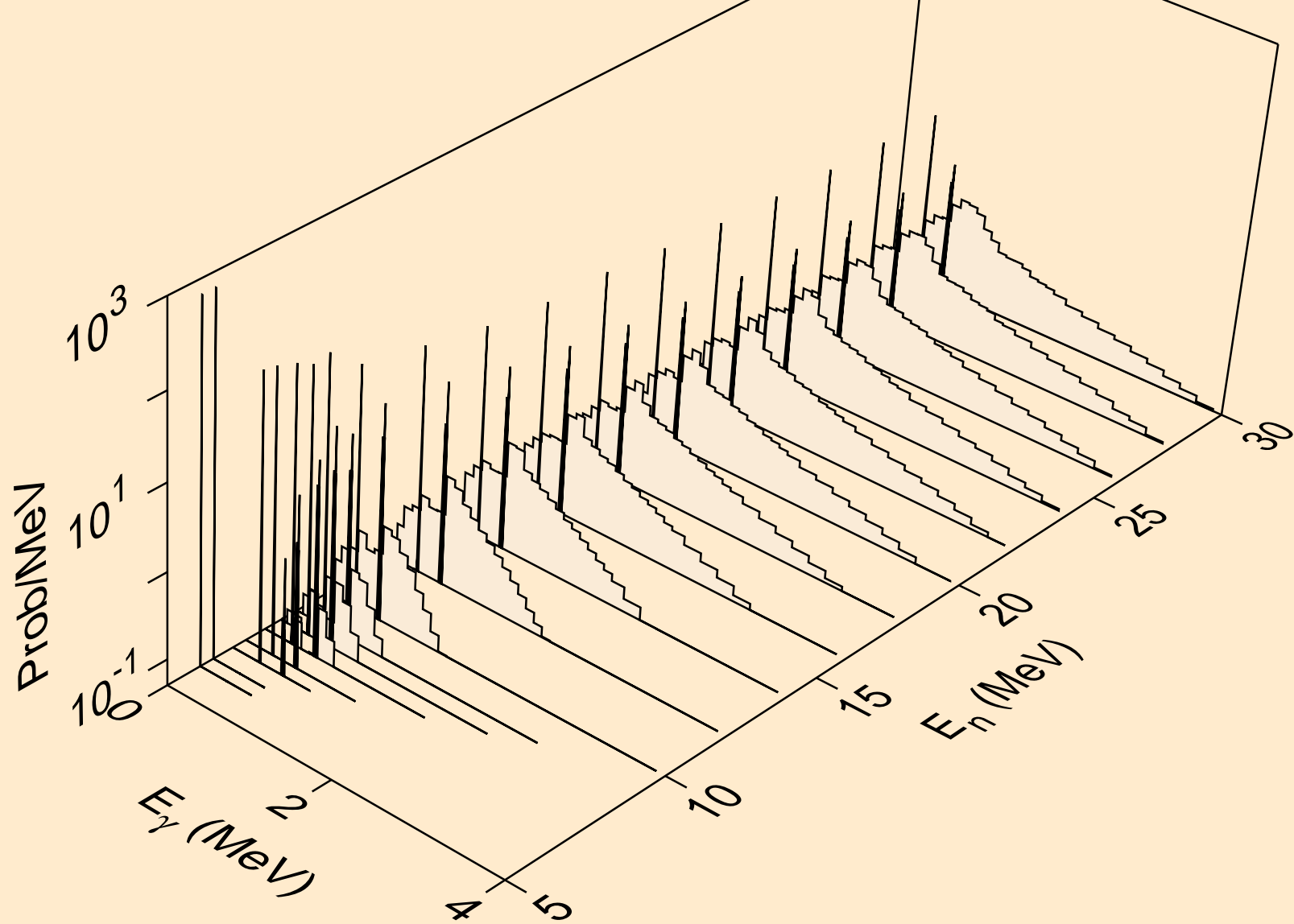

RU096 NEUTRON ACER TENDL-2021 LIBRARY; T=293.6K
Photon emission for (n,t)

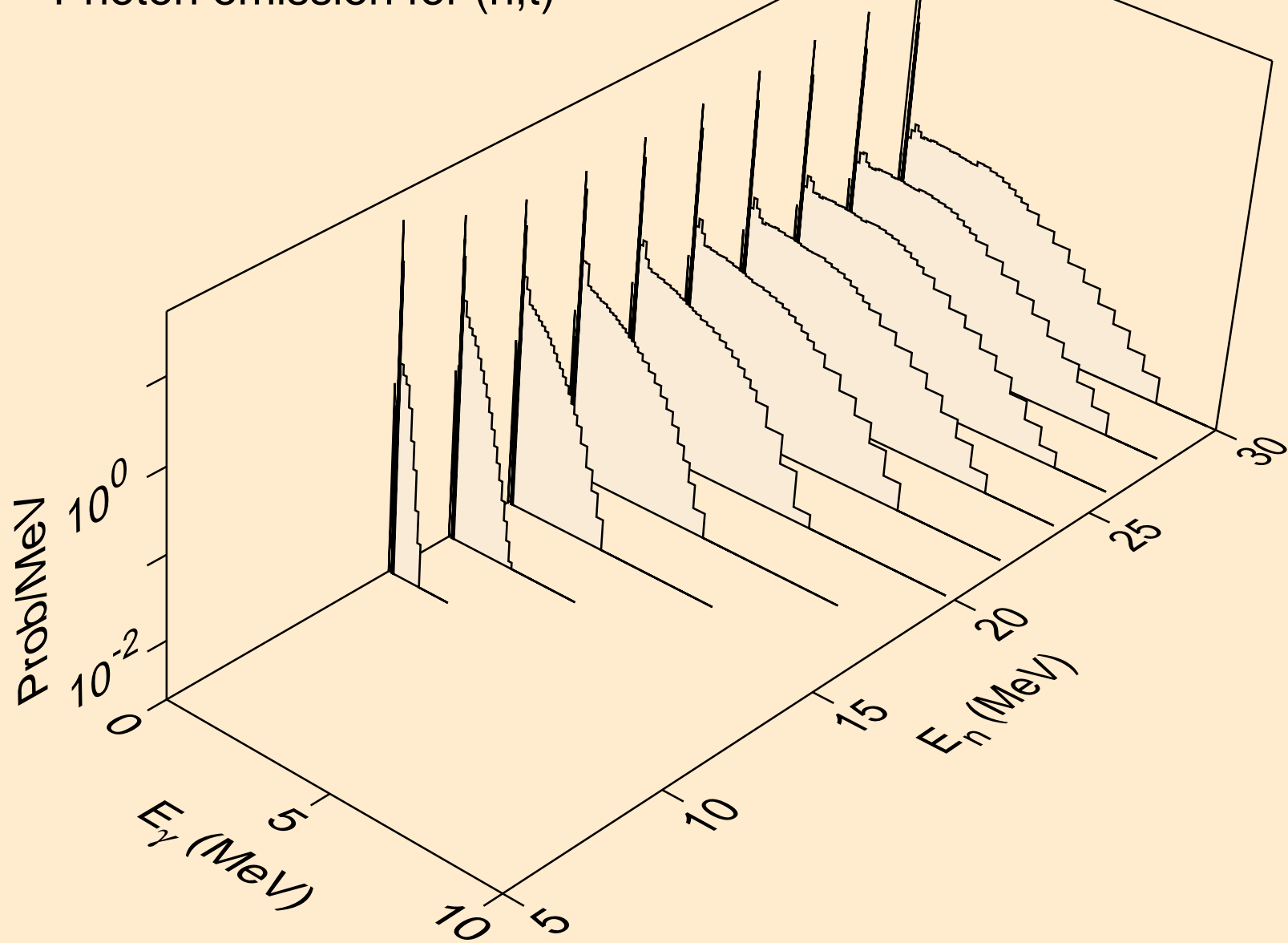

RU096 NEUTRON ACER TENDL-2021 LIBRARY; T=293.6K
Photon emission for (n,he3)

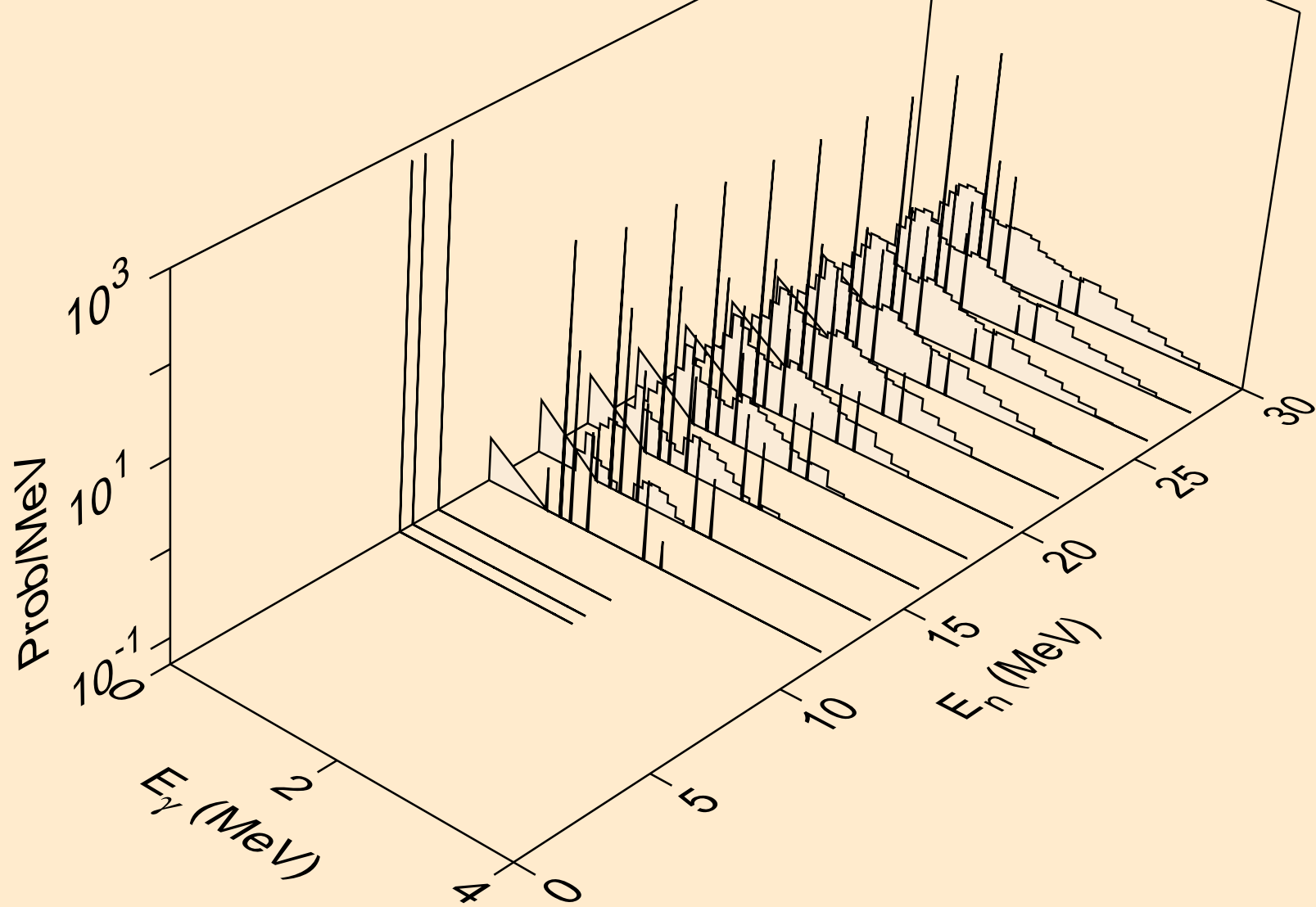

RU096 NEUTRON ACER TENDL-2021 LIBRARY; T=293.6K
Photon emission for (n,a)

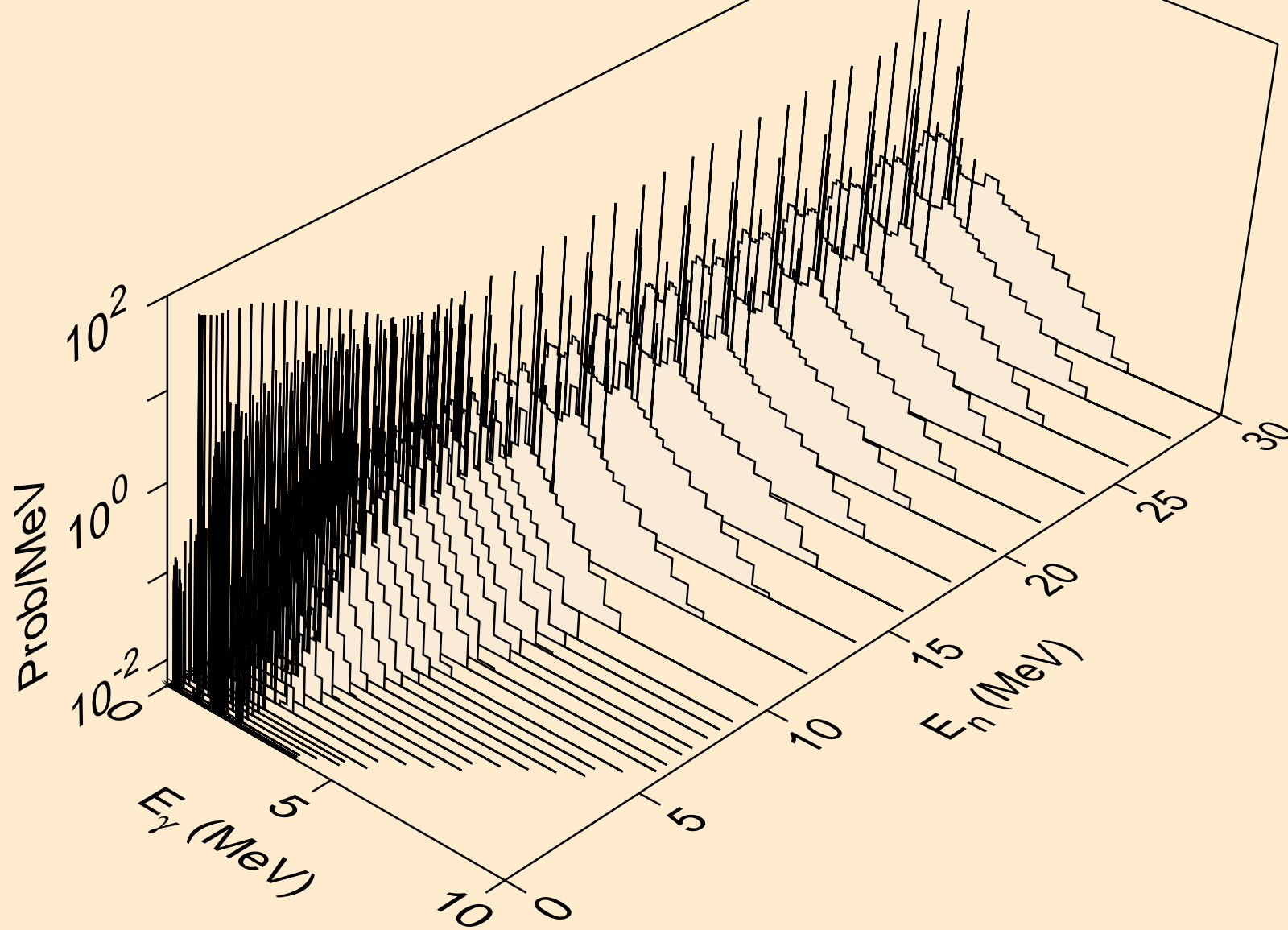

RU096 NEUTRON ACER TENDL-2021 LIBRARY; T=293.6K
Photon emission for (n,2a)

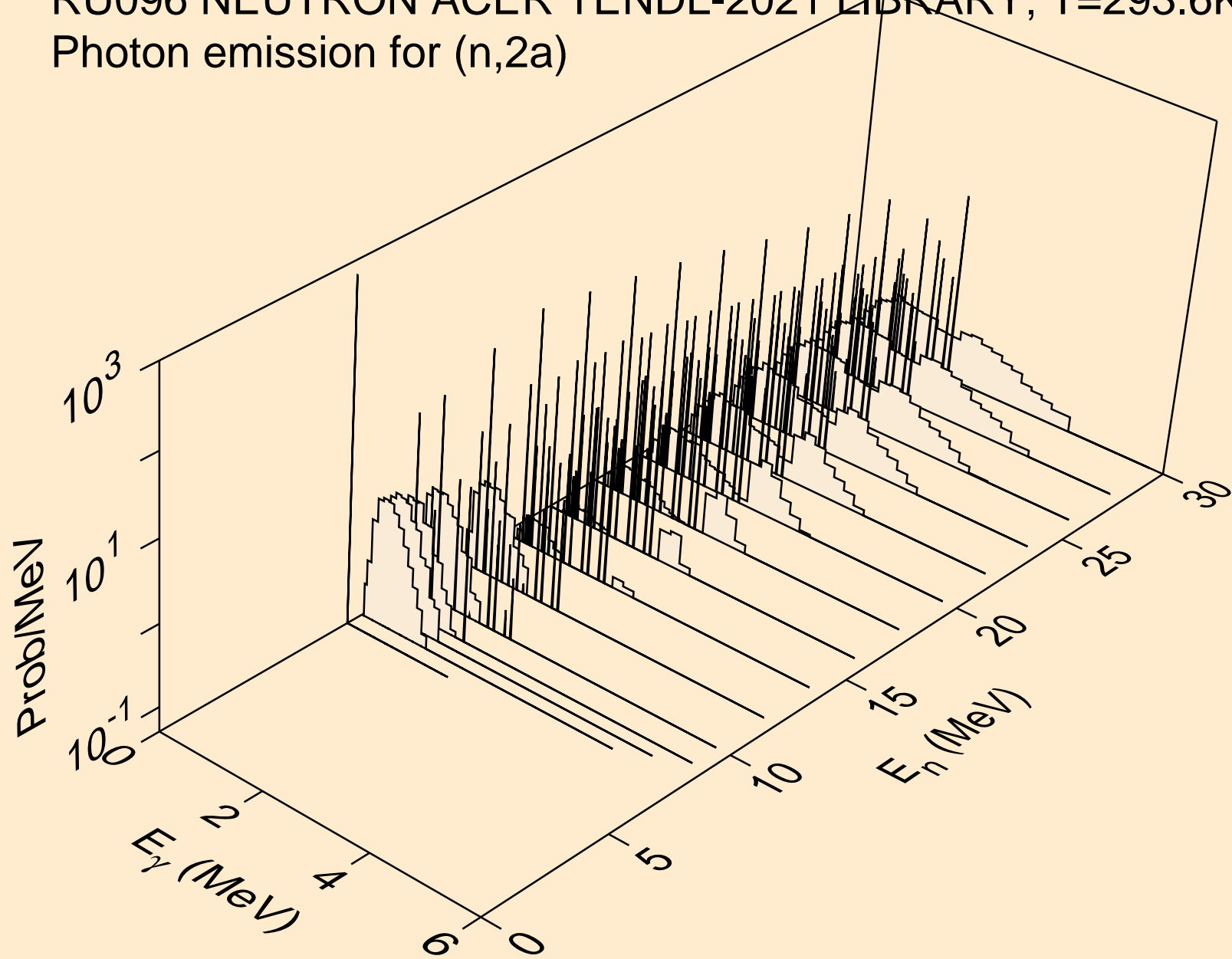

RU096 NEUTRON ACER TENDL-2021 LIBRARY; T=293.6K
Photon emission for (n,2p)

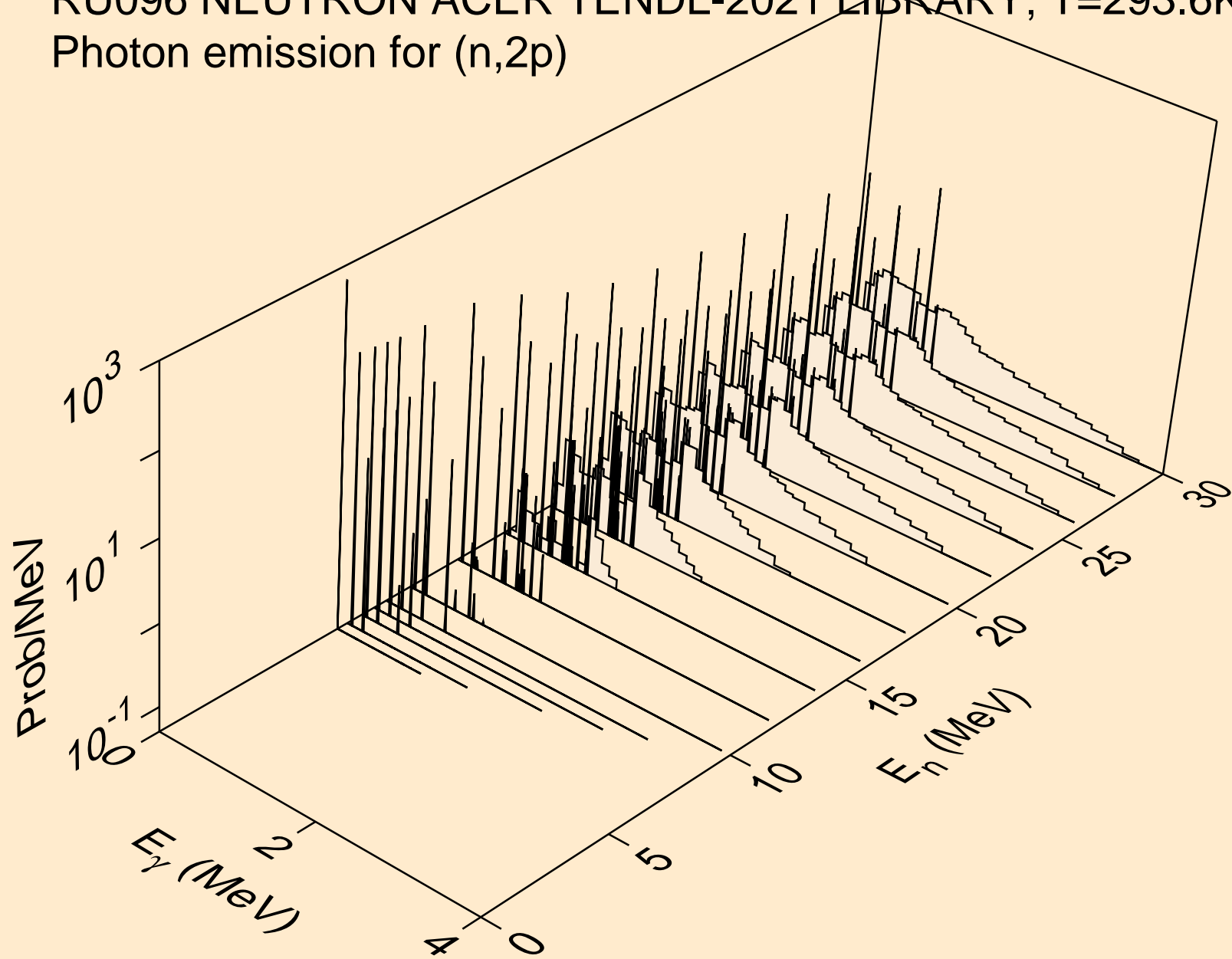

RU096 NEUTRON ACER TENDL-2021 LIBRARY; T=293.6K
Photon emission for (n,p)

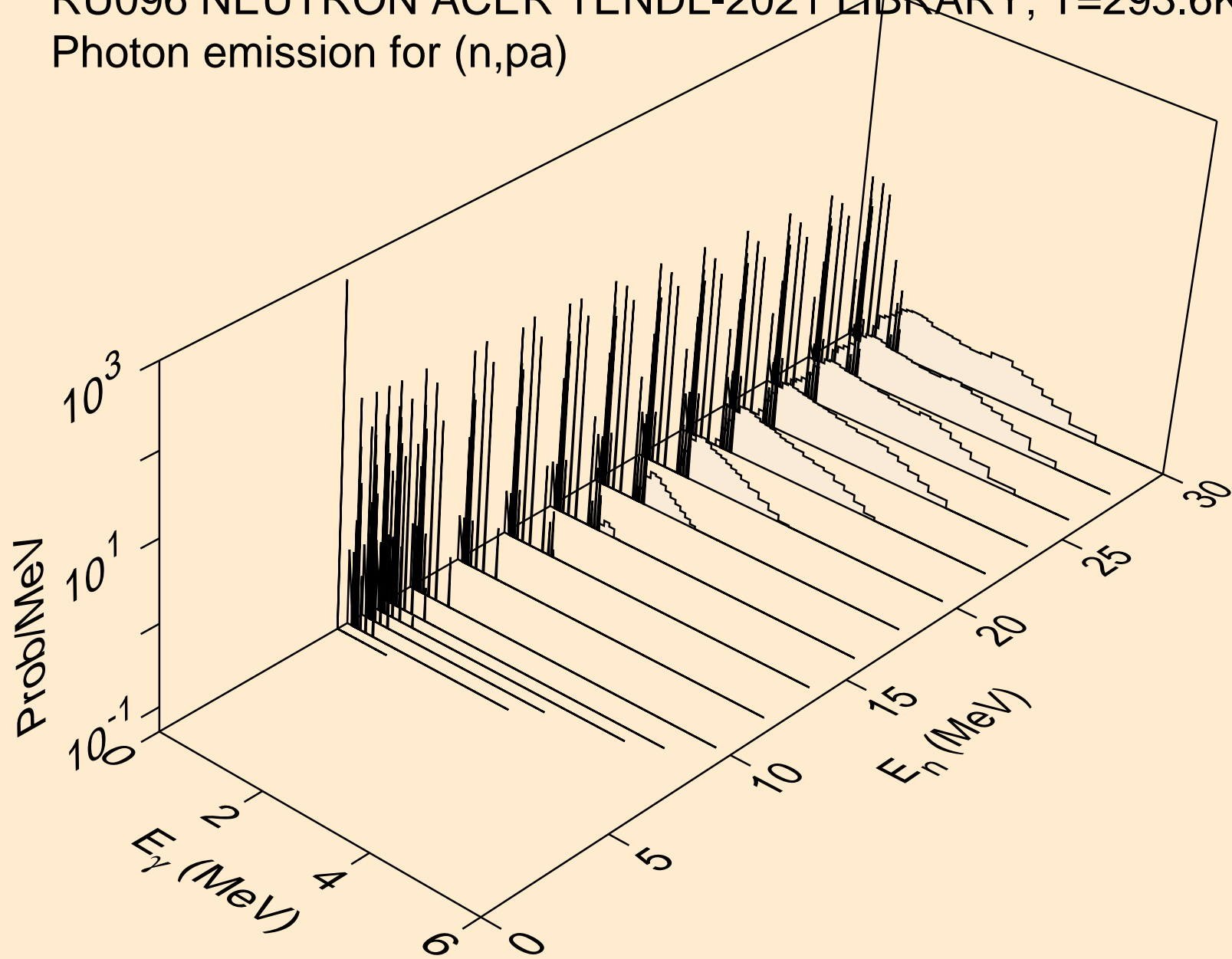

RU096 NEUTRON ACER TENDL-2021 LIBRARY; T=293.6K
Photon emission for (n,pd)

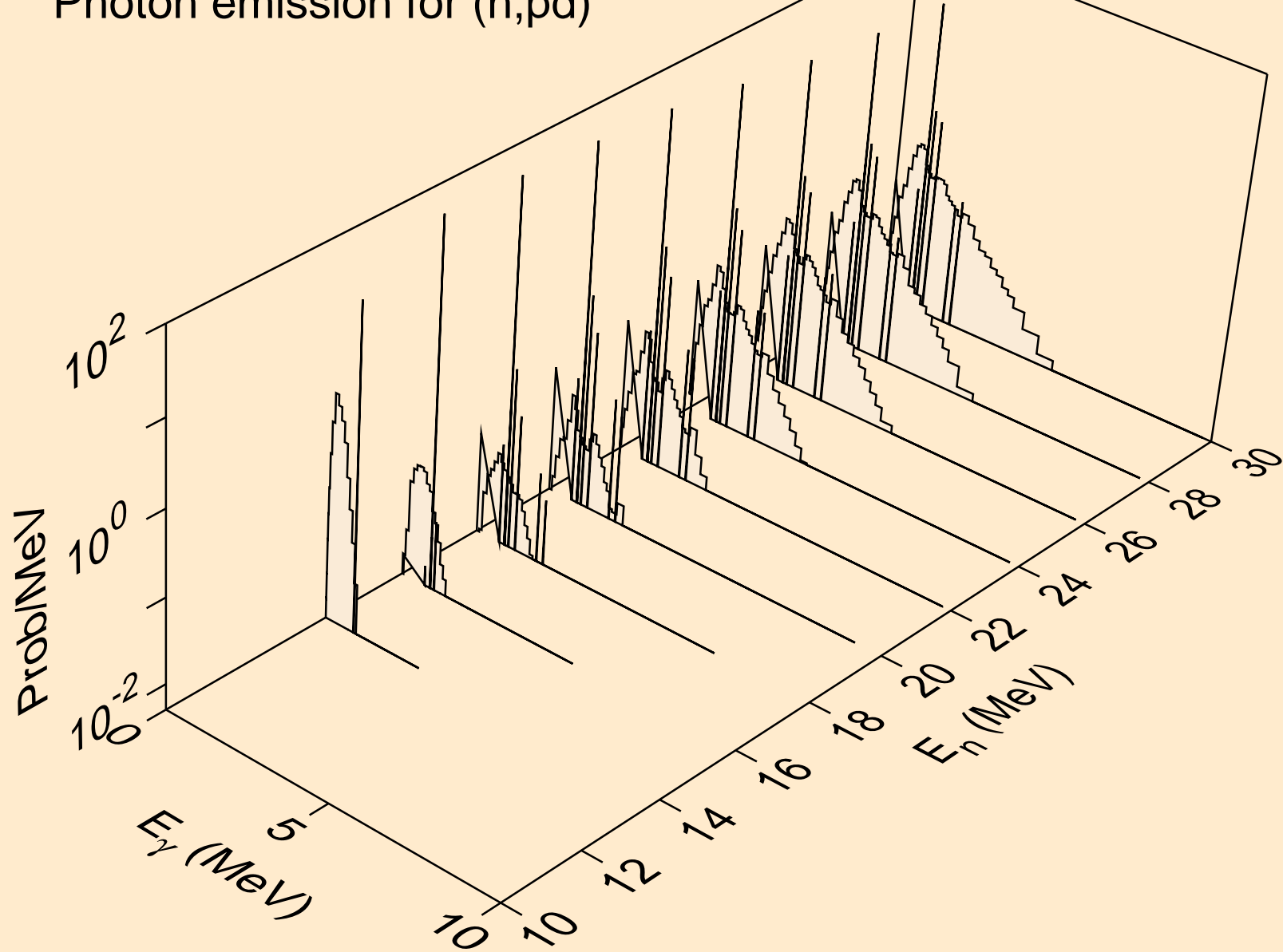

RU096 NEUTRON ACER TENDL-2021 LIBRARY; T=293.6K
Photon emission for (n,pt)

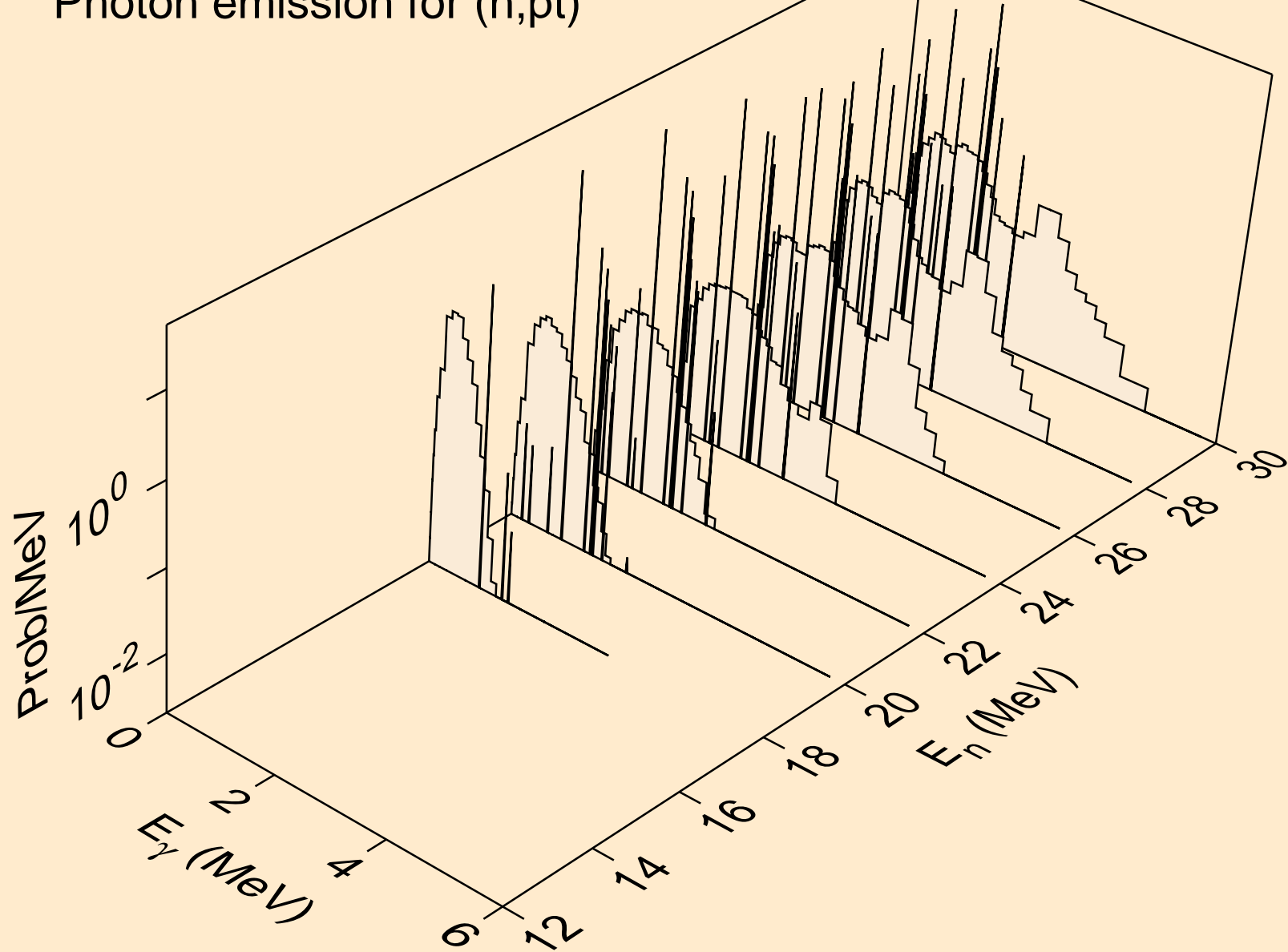

RU096 NEUTRON ACER TENDL-2021 LIBRARY; T=293.6K
Photon emission for (n,da)

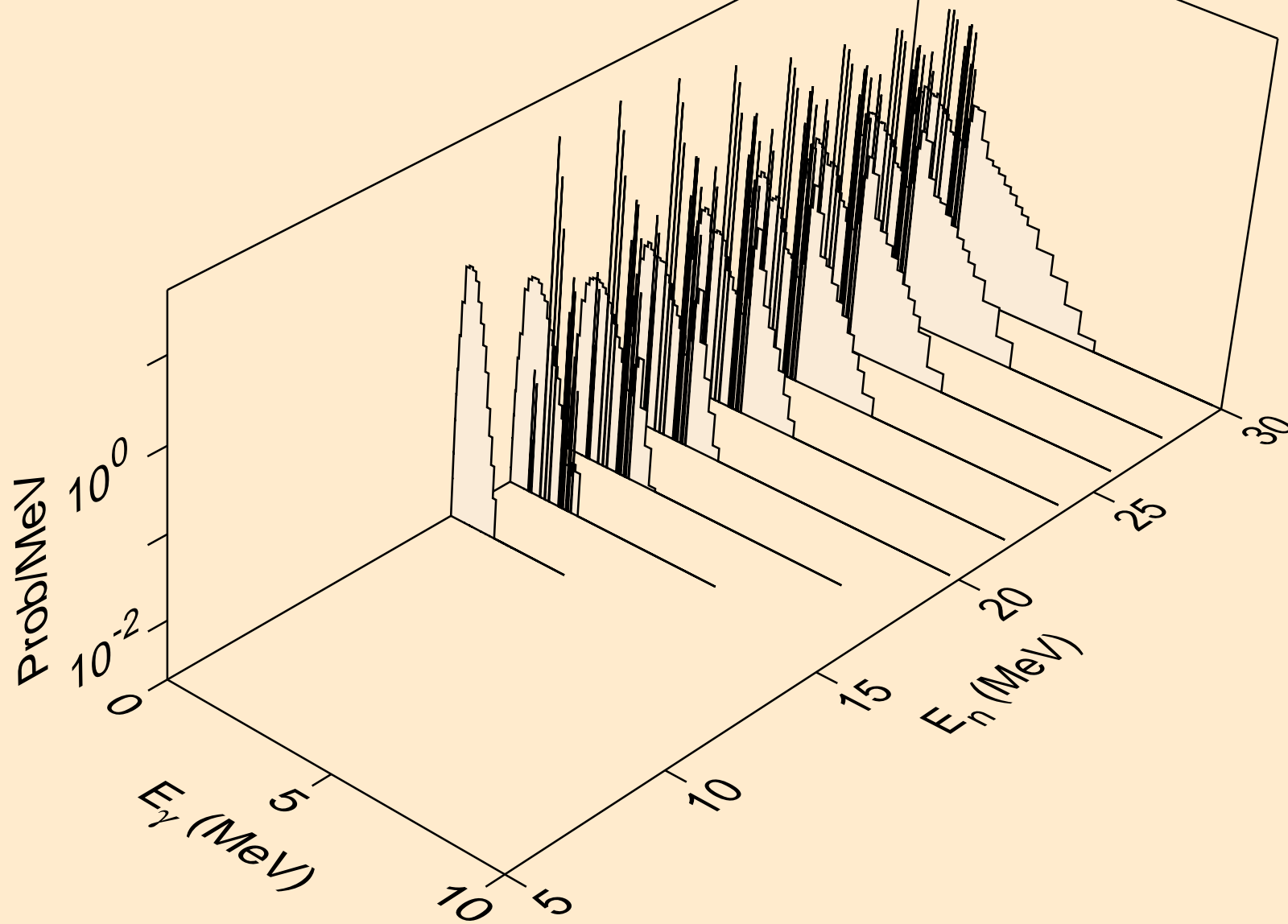

RU096 NEUTRON ACER TENDL-2021 LIBRARY; T=293.6K
thermal capture photon spectrum

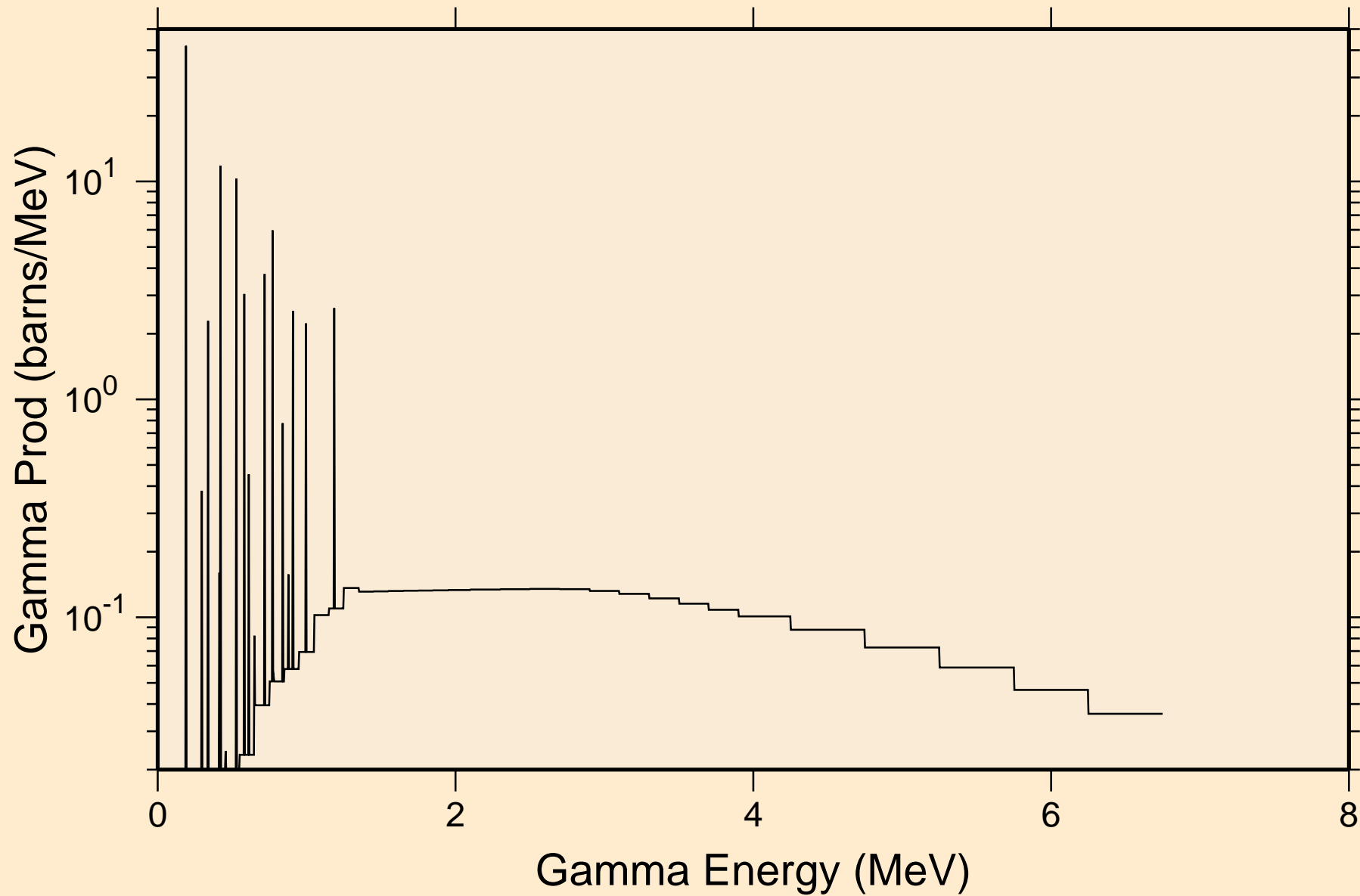

RU096 NEUTRON ACER TENDL-2021 LIBRARY; T=293.6K
14 MeV photon spectrum

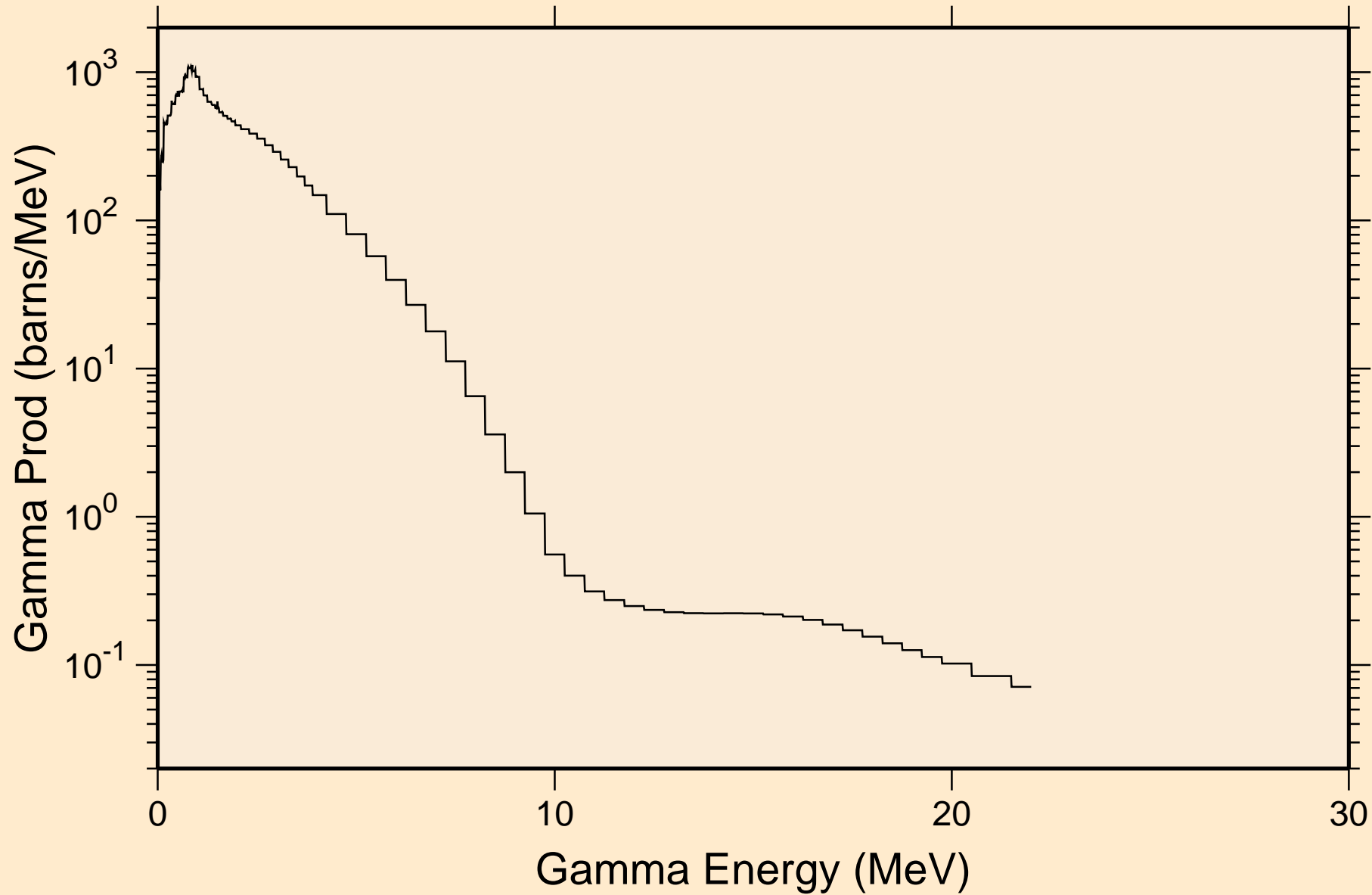

RU096 NEUTRON ACER TENDL-2021 LIBRARY; T=293.6K
Particle heating contributions

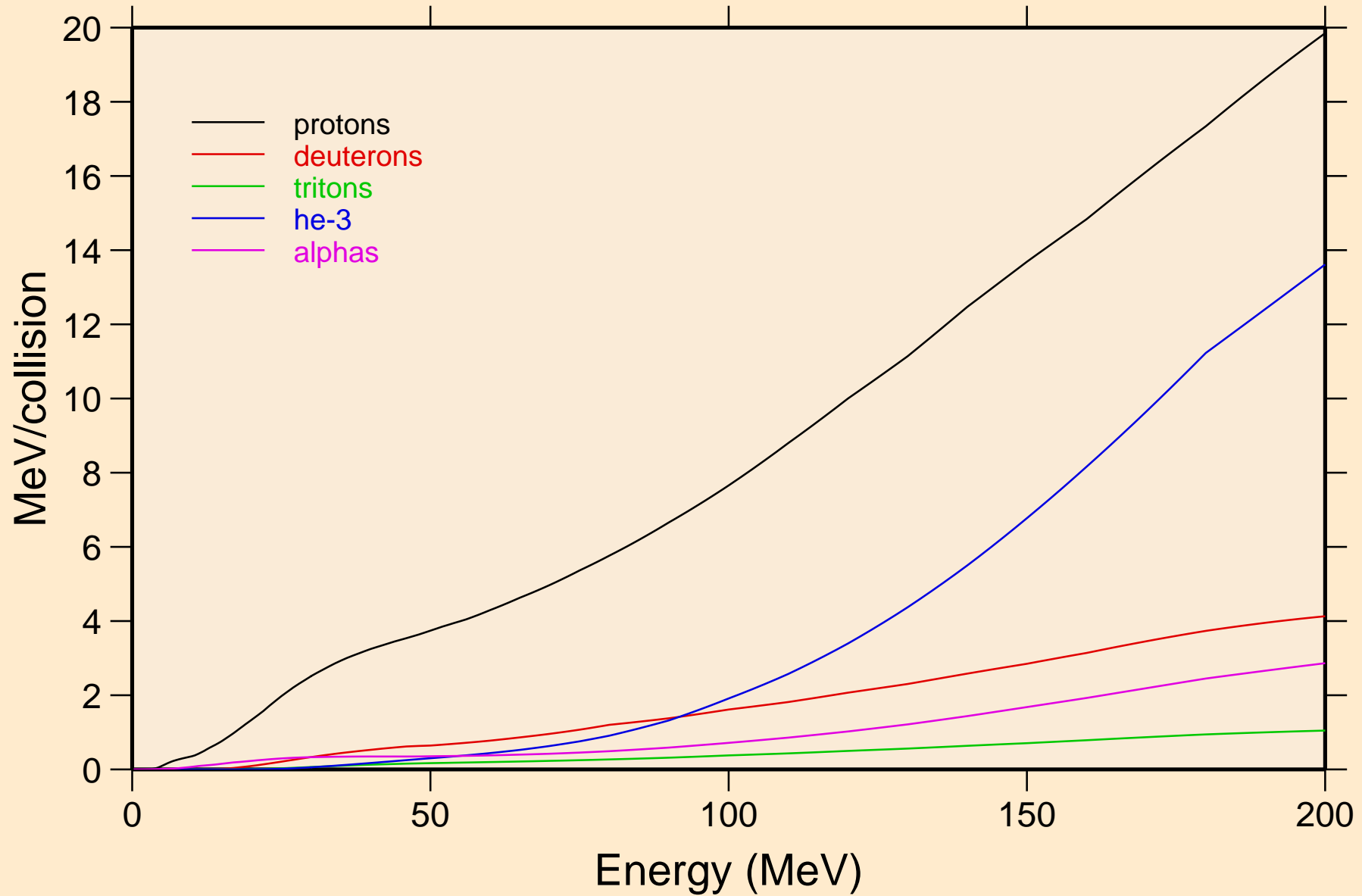

RU096 NEUTRON ACER TENDL-2021 LIBRARY; T=293.6K
Recoil Heating

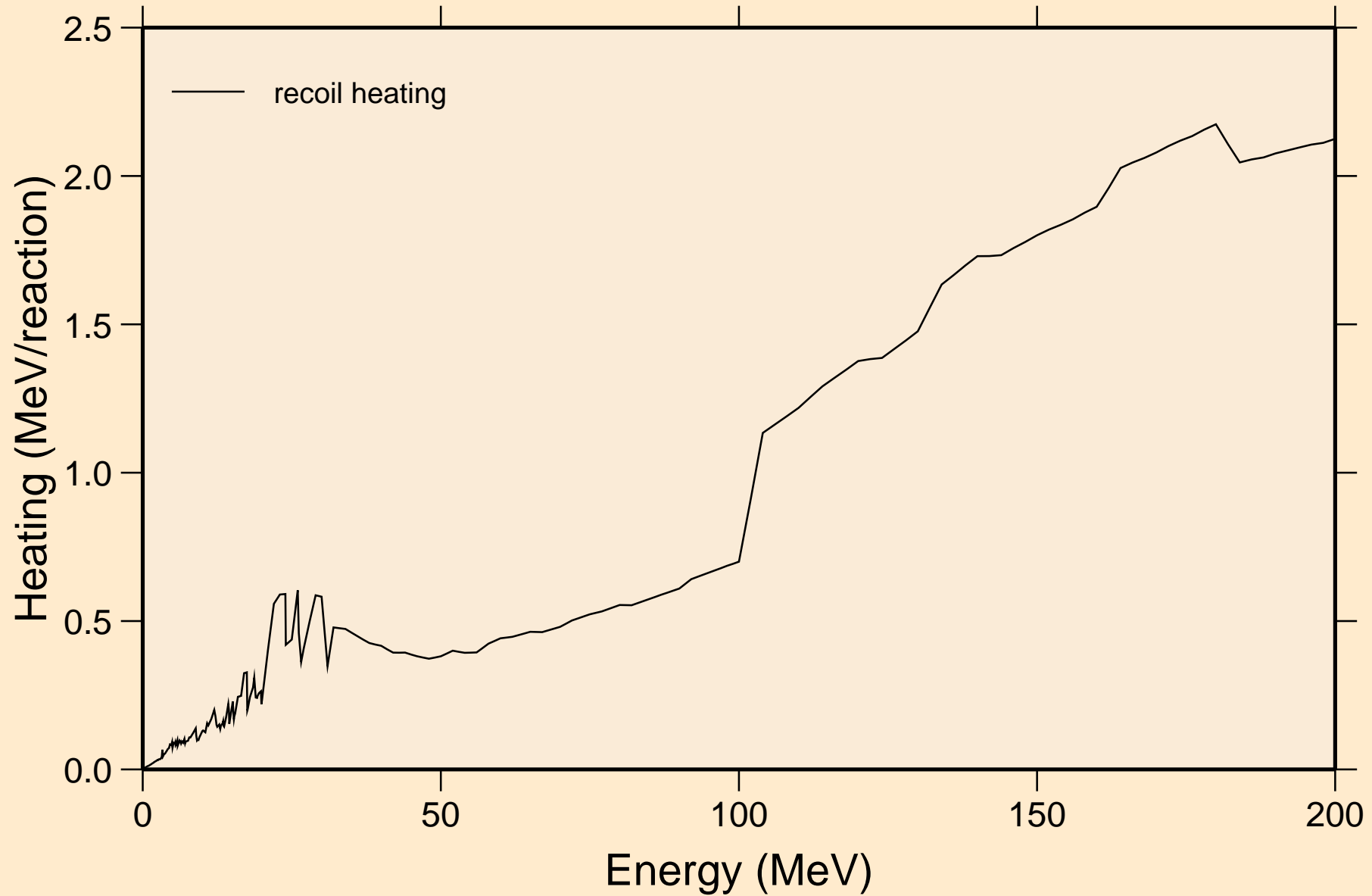

RU096 NEUTRON ACER TENDL-2021 LIBRARY; T=293.6K
Particle production cross sections

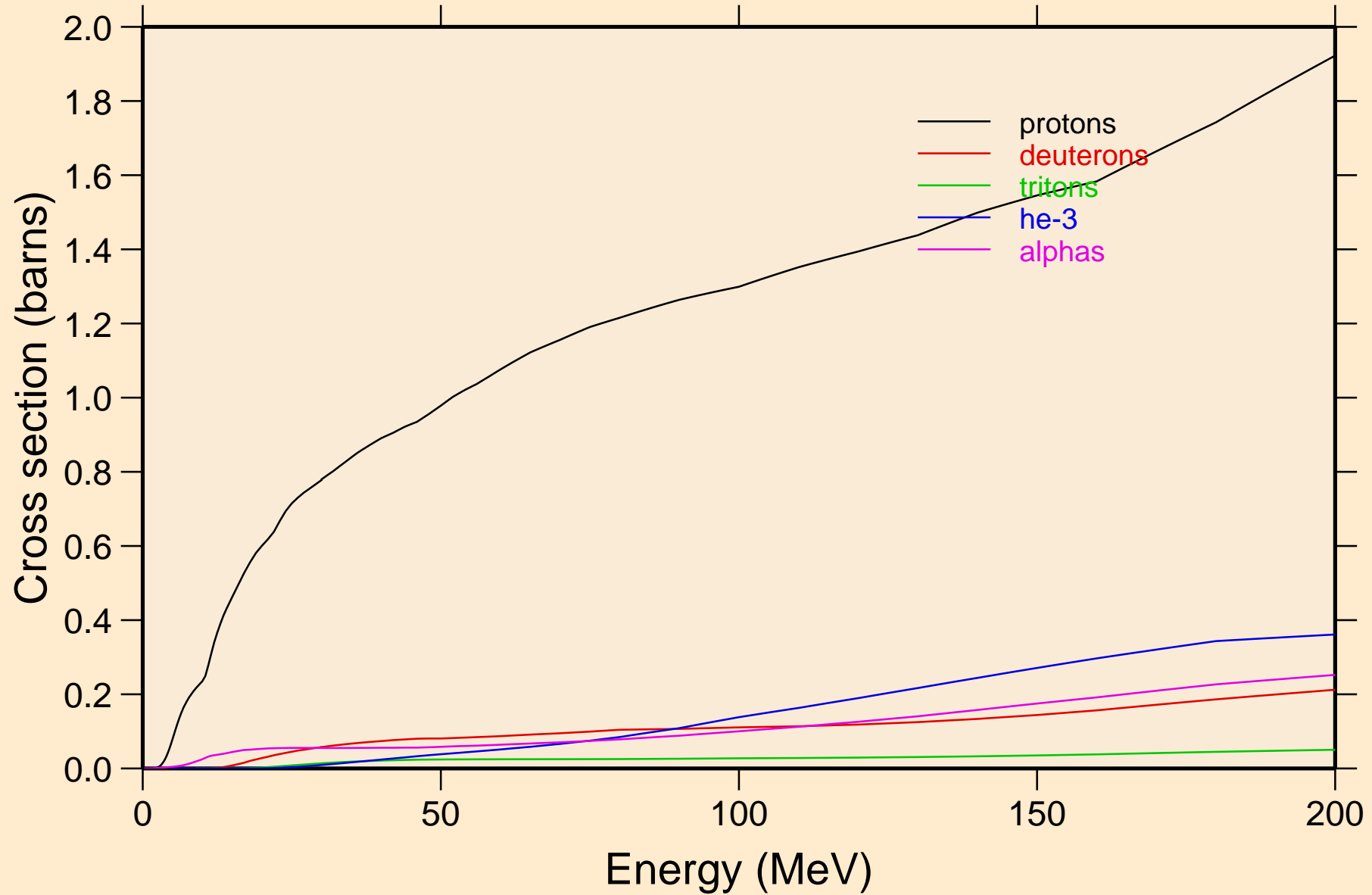

RU096 NEUTRON ACER TENDL-2021 LIBRARY; T=293.6K
protons from (n,x)

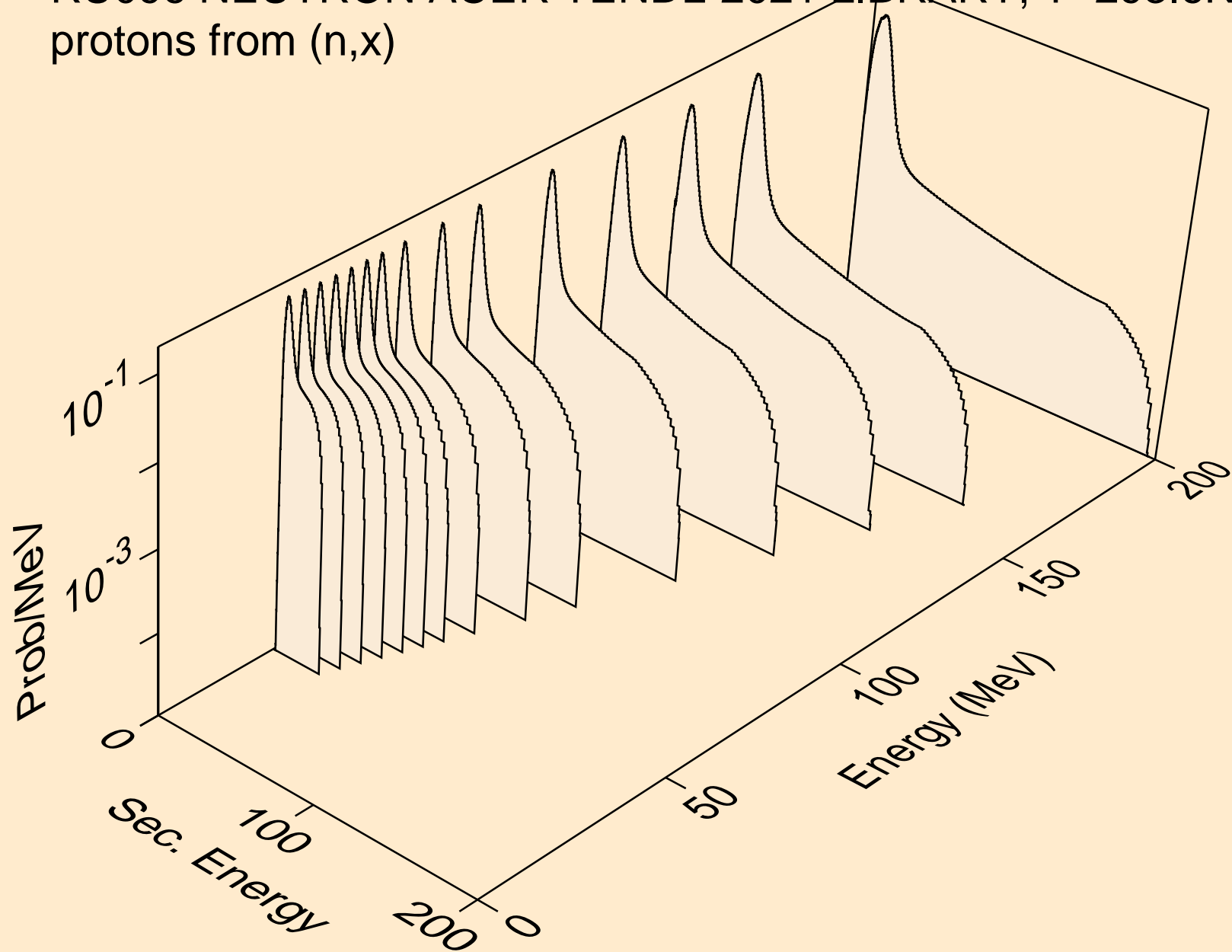

RU096 NEUTRON ACER TENDL-2021 LIBRARY; T=293.6K
protons from (n,n*)p

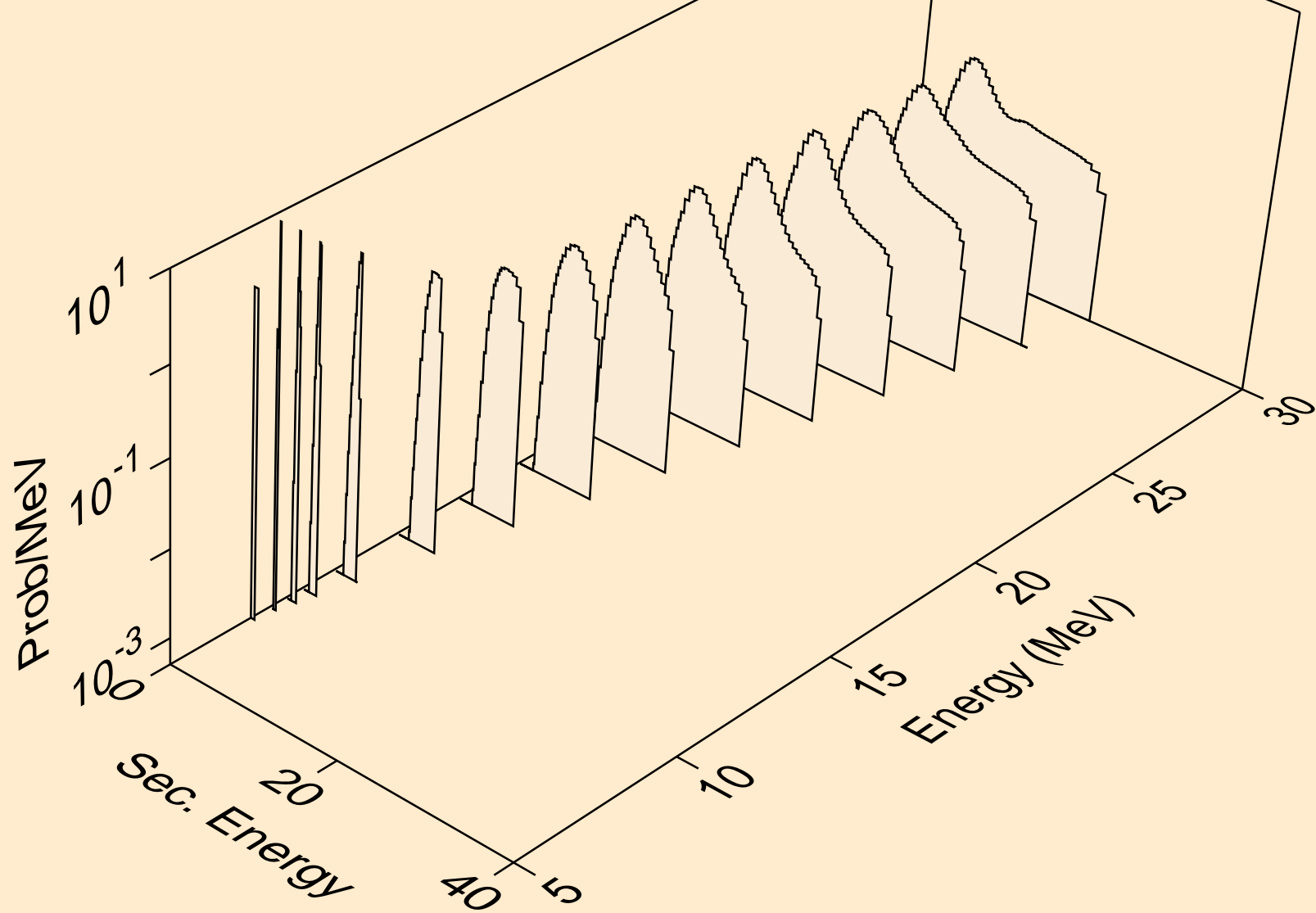

RU096 NEUTRON ACER TENDL-2021 LIBRARY; T=293.6K
protons from (n,2np)

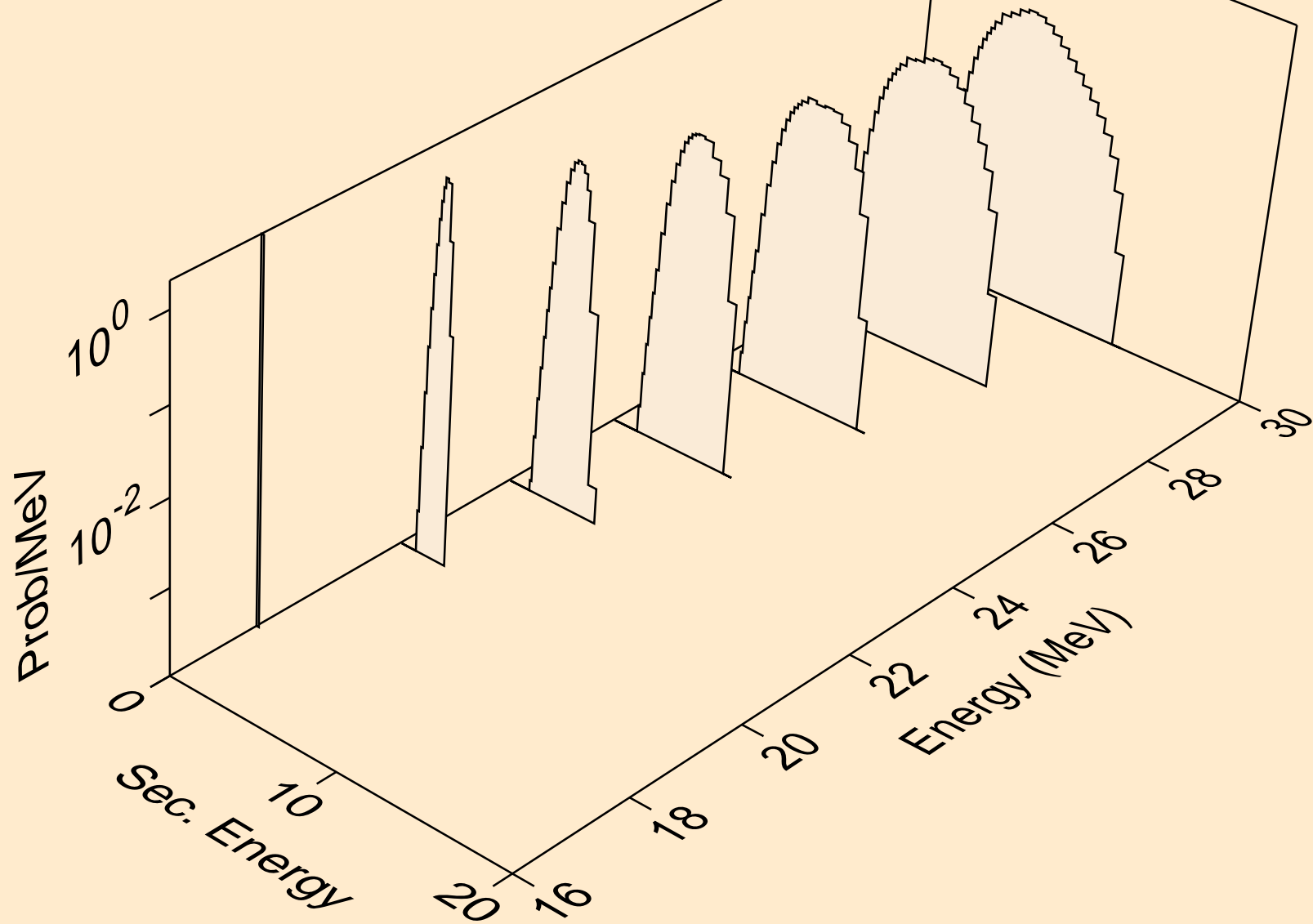

RU096 NEUTRON ACER TENDL-2021 LIBRARY; T=293.6K
protons from (n,3np)

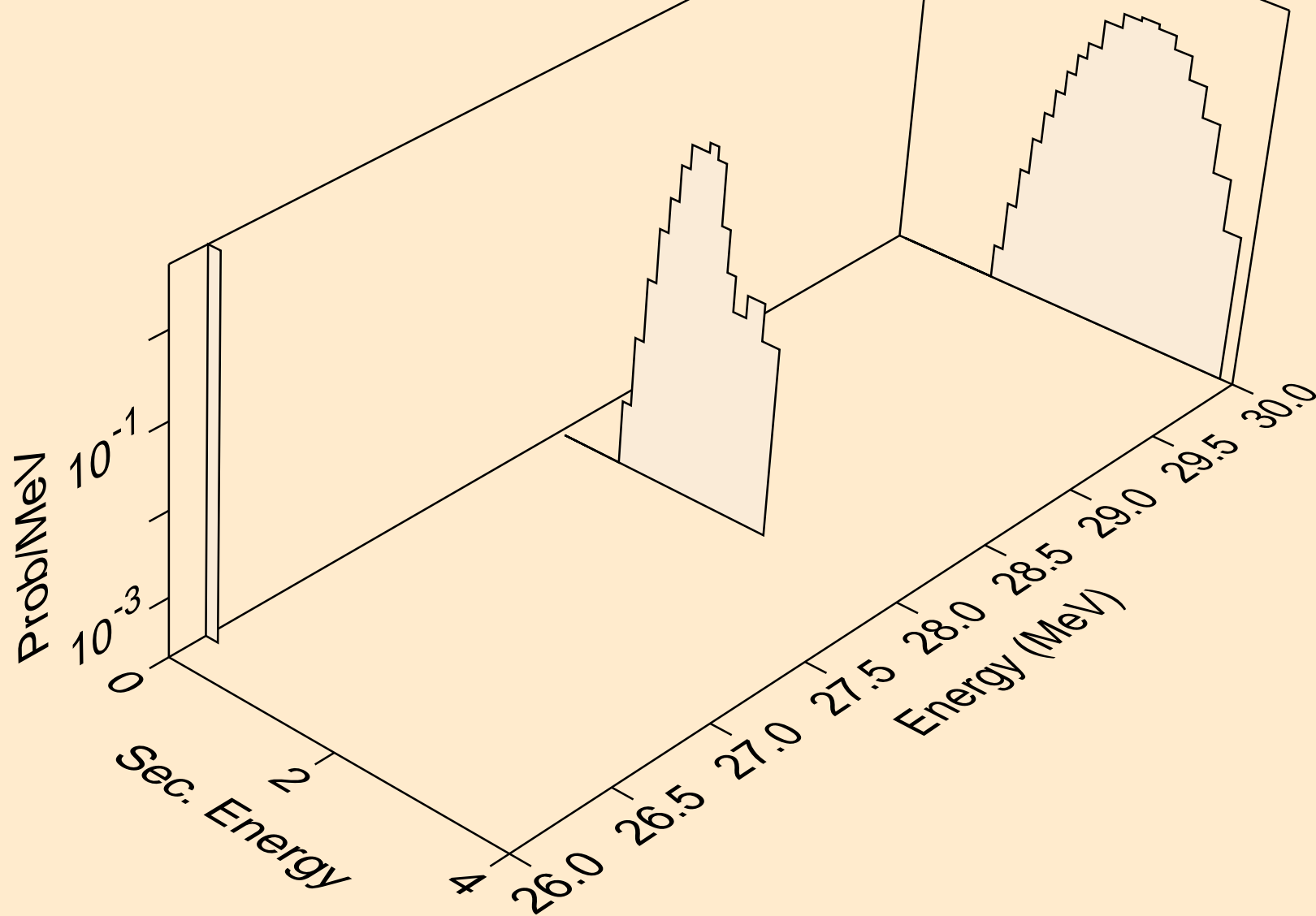

RU096 NEUTRON ACER TENDL-2021 LIBRARY; T=293.6K
protons from (n,2np)

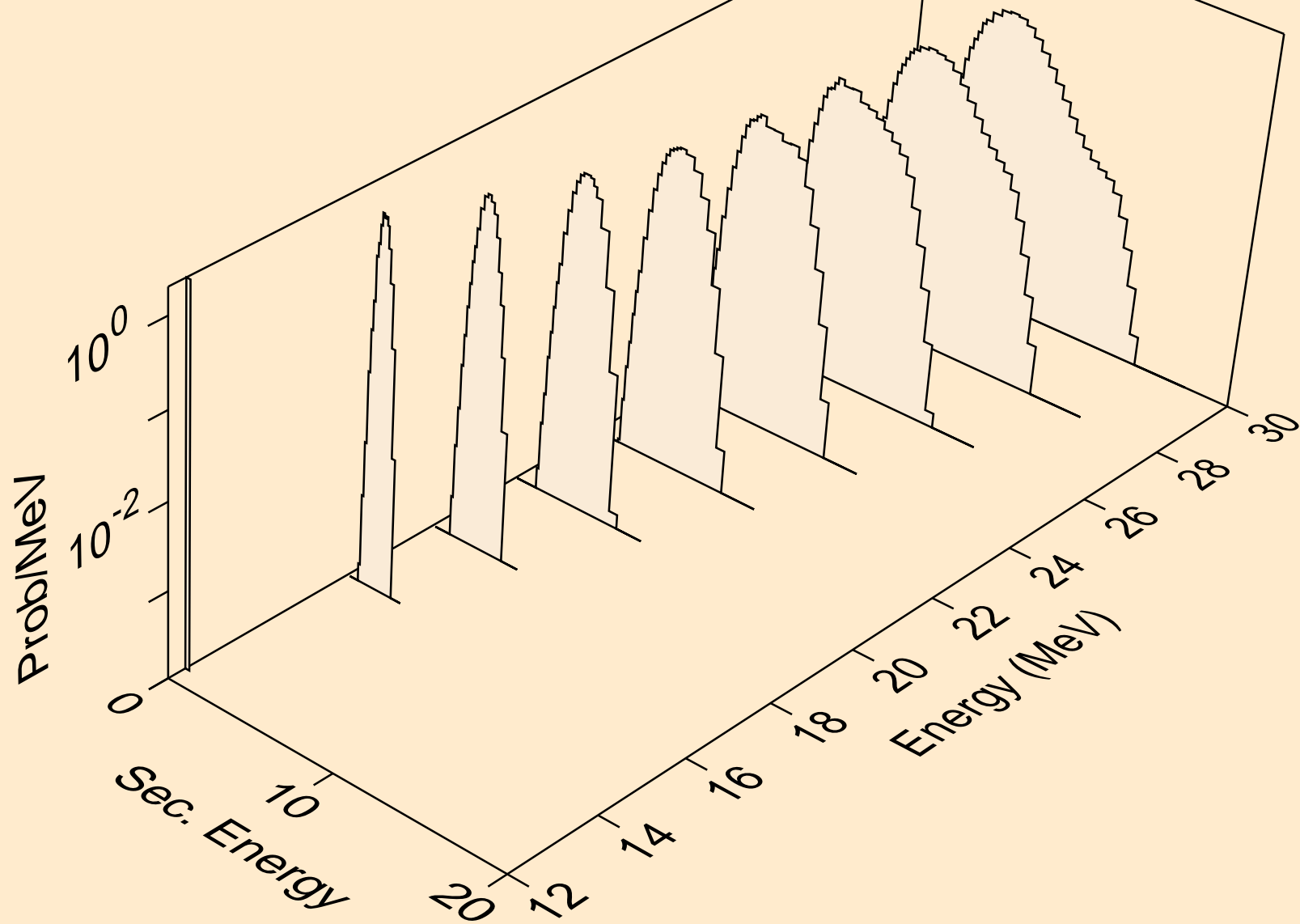

RU096 NEUTRON ACER TENDL-2021 LIBRARY; T=293.6K
protons from (n,npa)

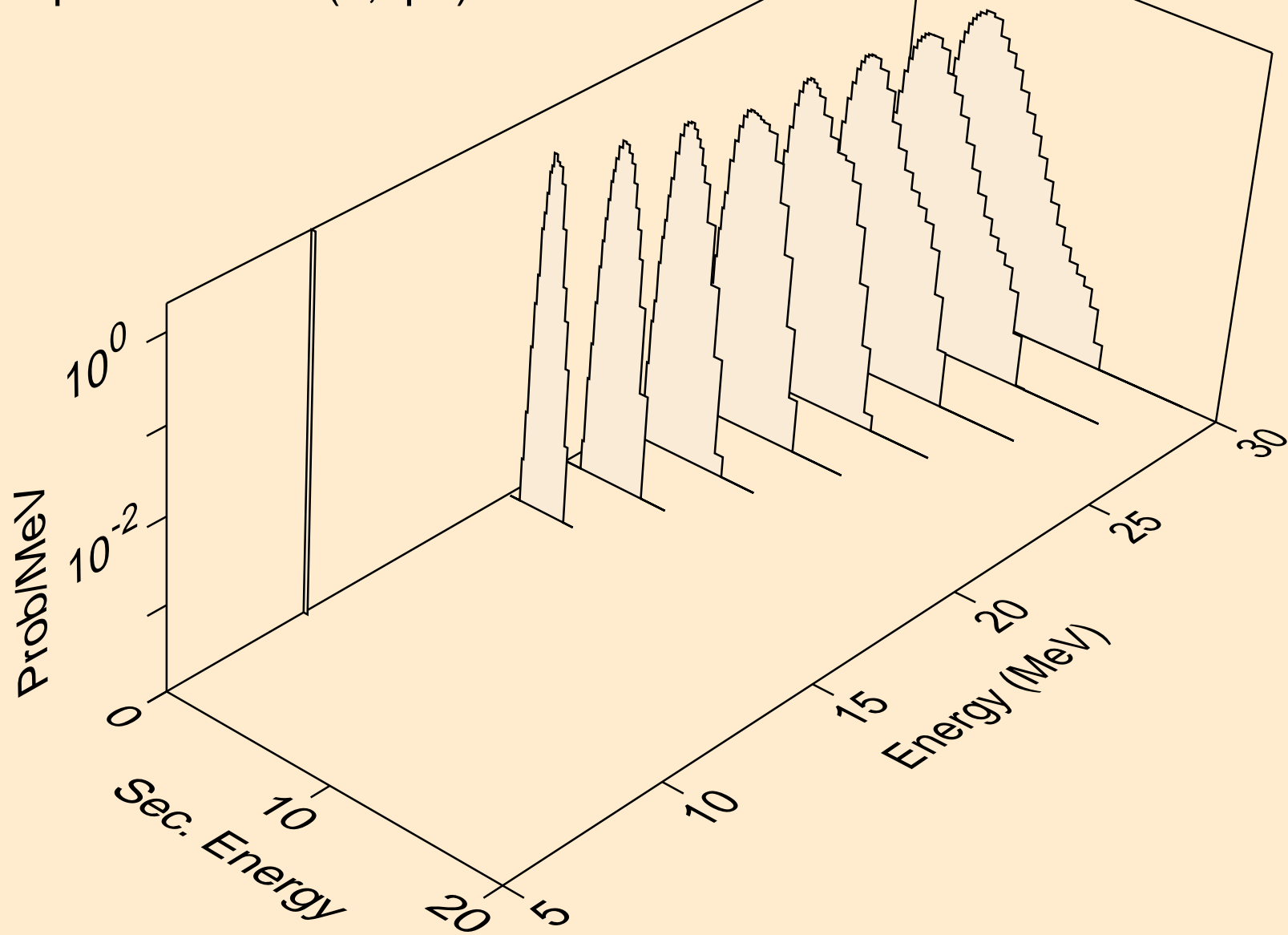

RU096 NEUTRON ACER TENDL-2021 LIBRARY; T=293.6K
protons from (n,p)

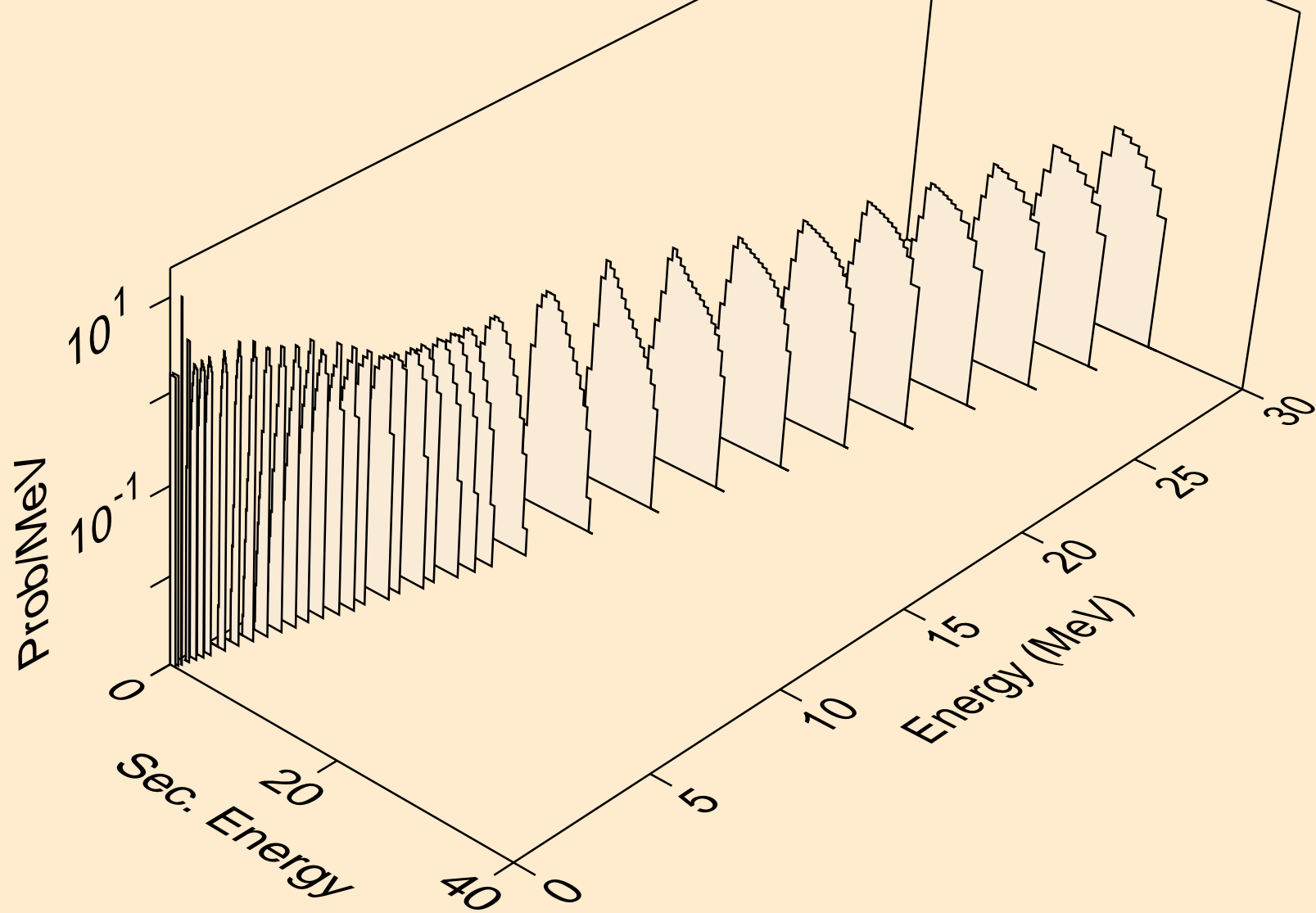

RU096 NEUTRON ACER TENDL-2021 LIBRARY; T=293.6K
protons from (n,2p)

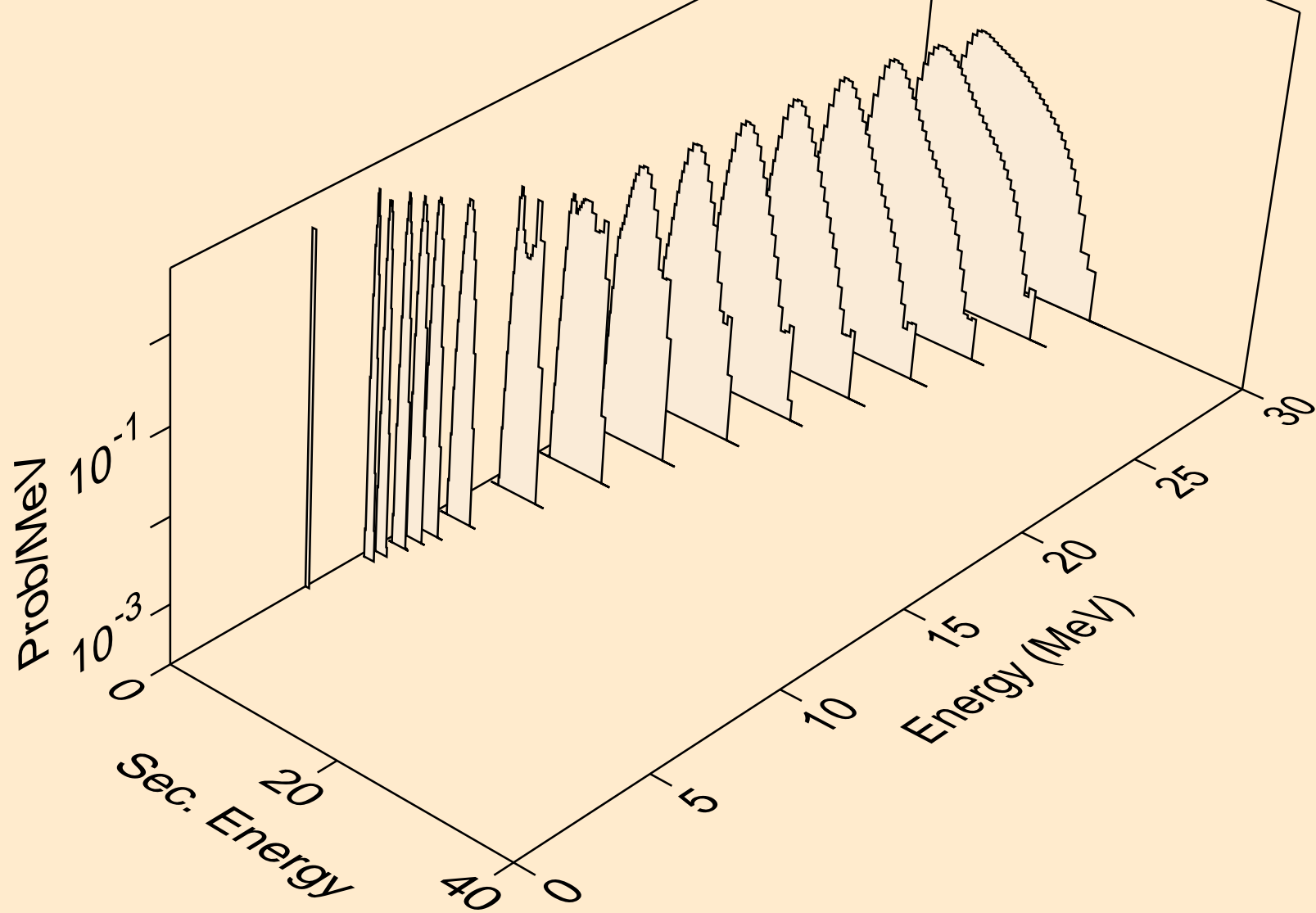

RU096 NEUTRON ACER TENDL-2021 LIBRARY; T=293.6K
protons from (n,p)

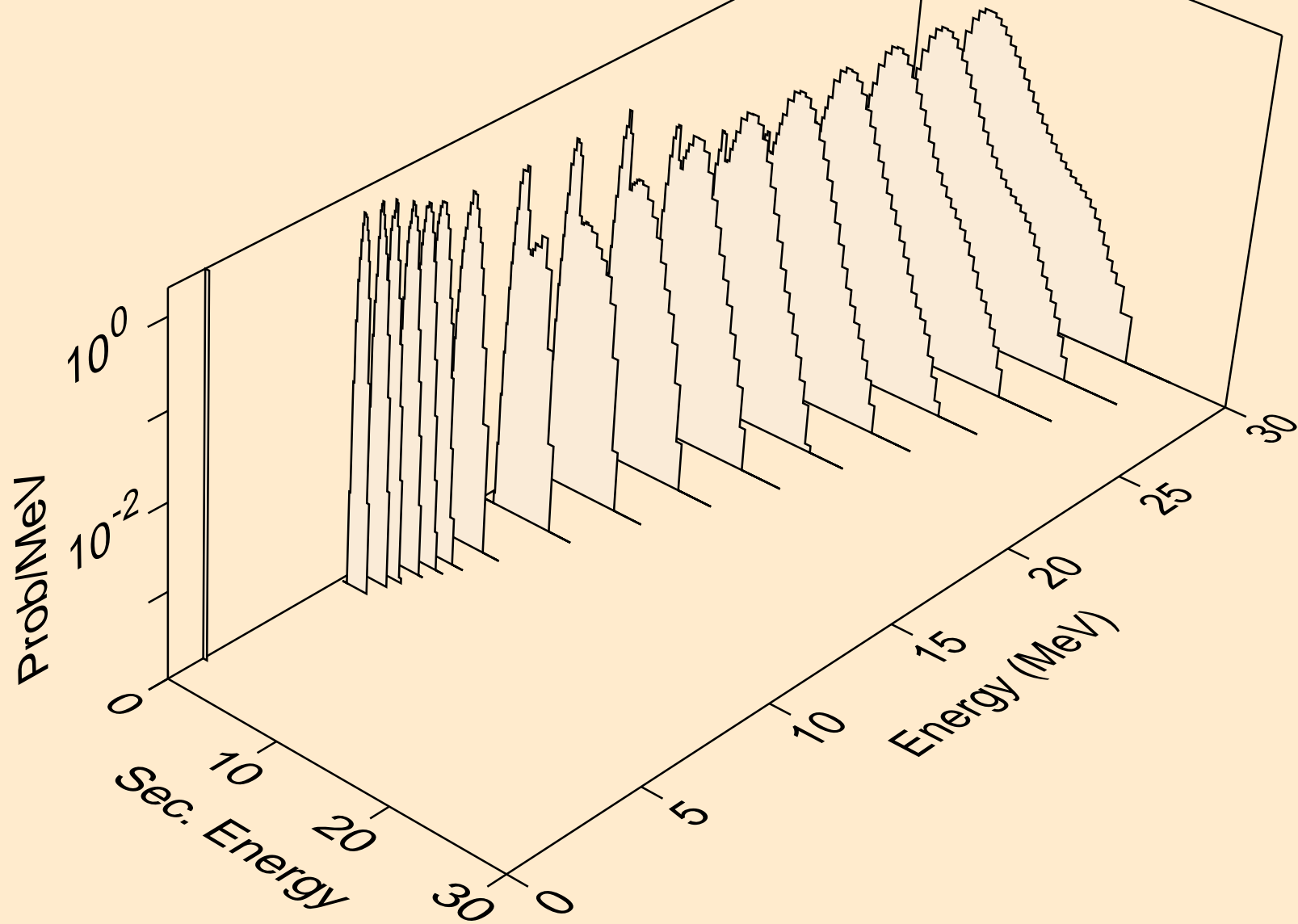

RU096 NEUTRON ACER TENDL-2021 LIBRARY; T=293.6K
protons from (n,pd)

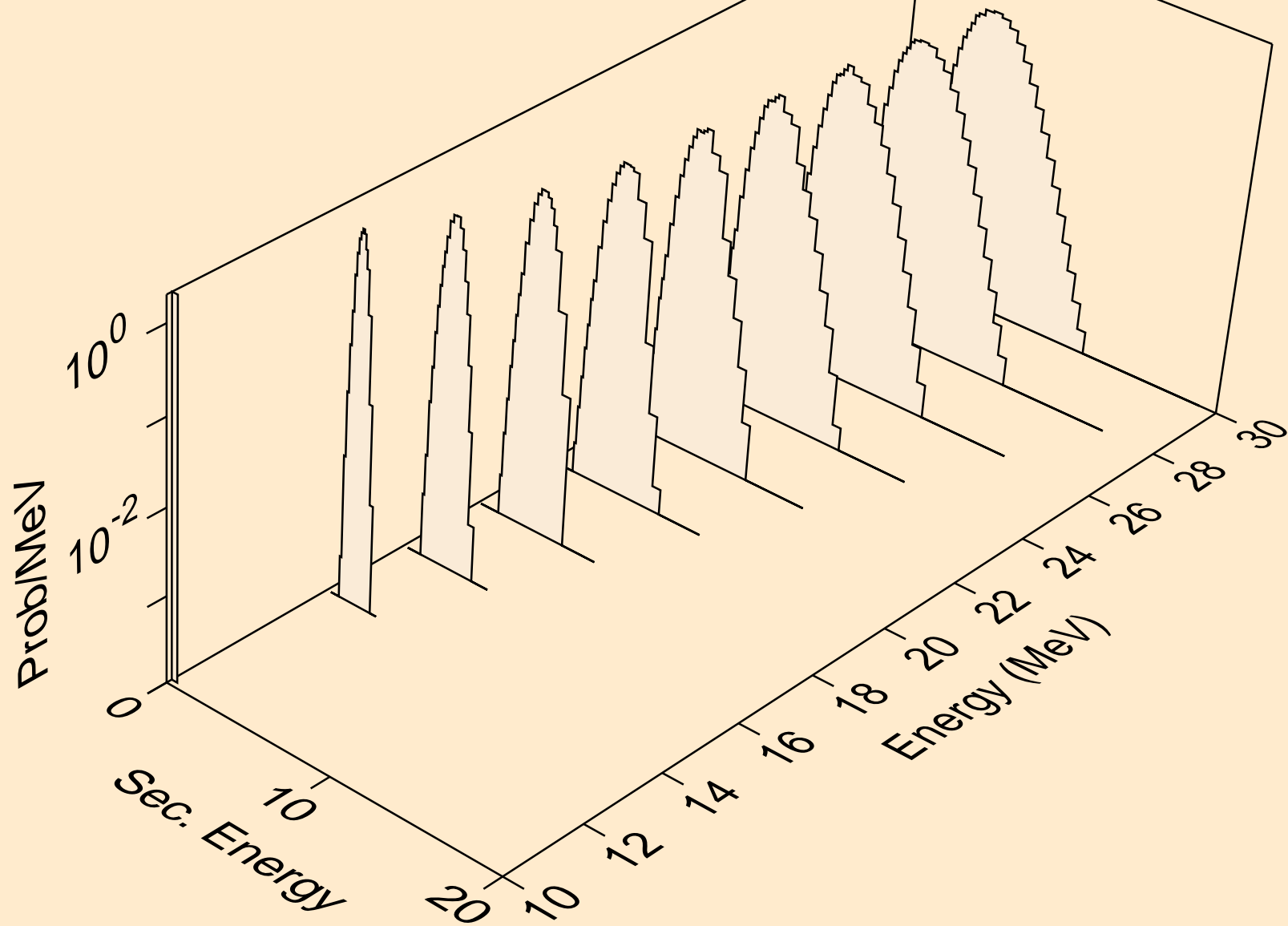

RU096 NEUTRON ACER TENDL-2021 LIBRARY; T=293.6K
protons from (n,pt)

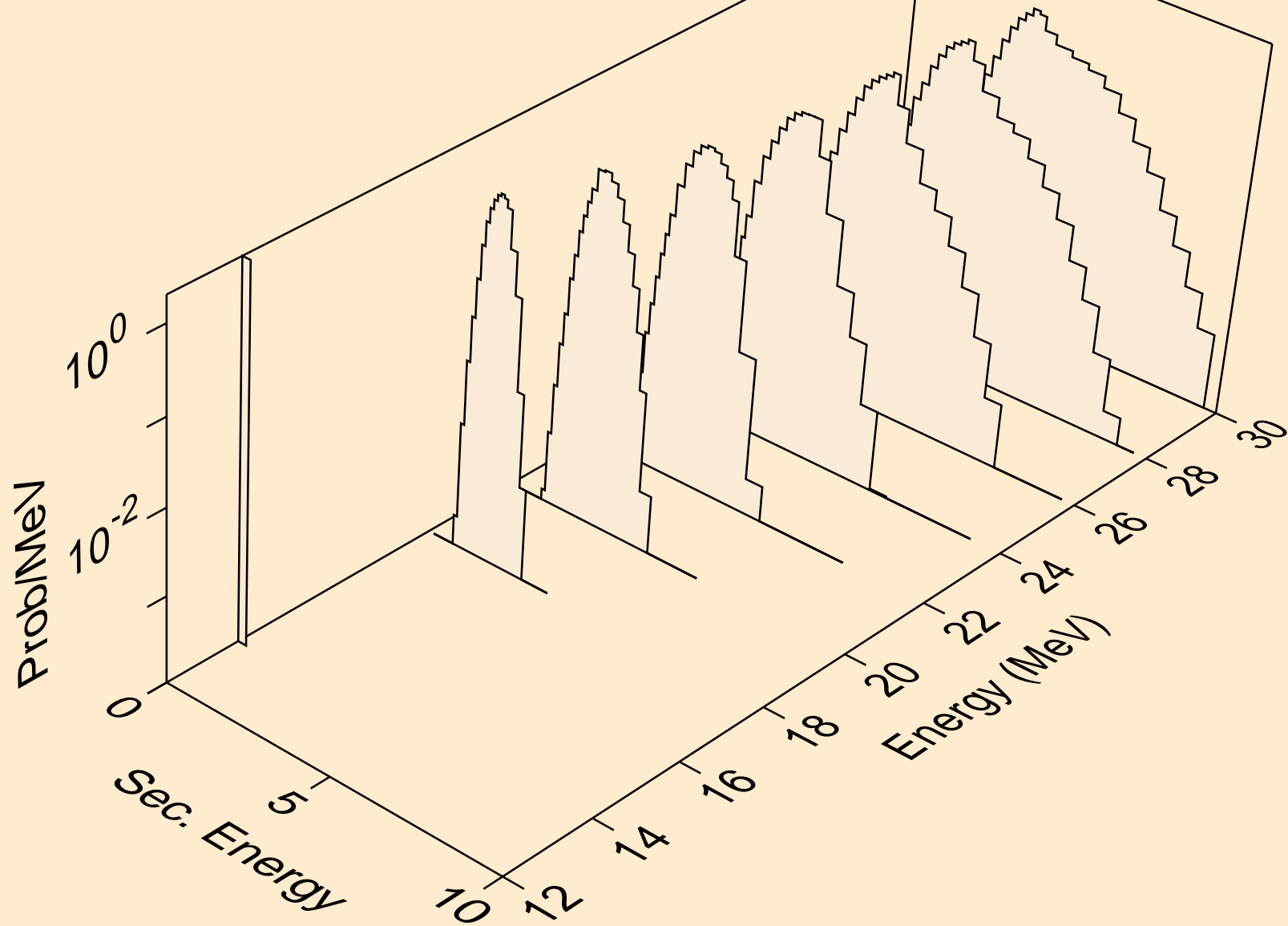

RU096 NEUTRON ACER TENDL-2021 LIBRARY; T=293.6K
deuterons from (n,x)

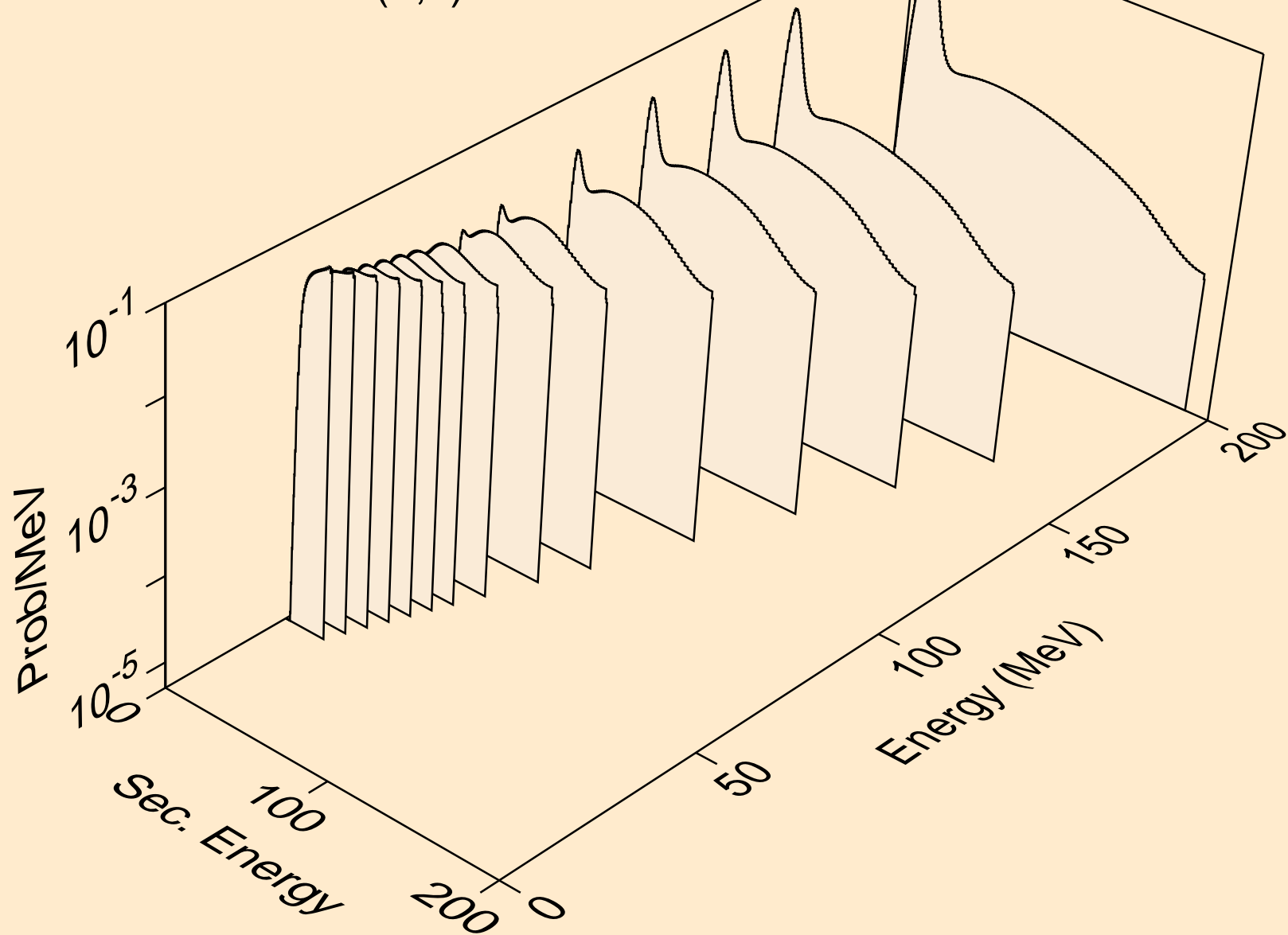

RU096 NEUTRON ACER TENDL-2021 LIBRARY; T=293.6K
deuterons from (n,2nd)

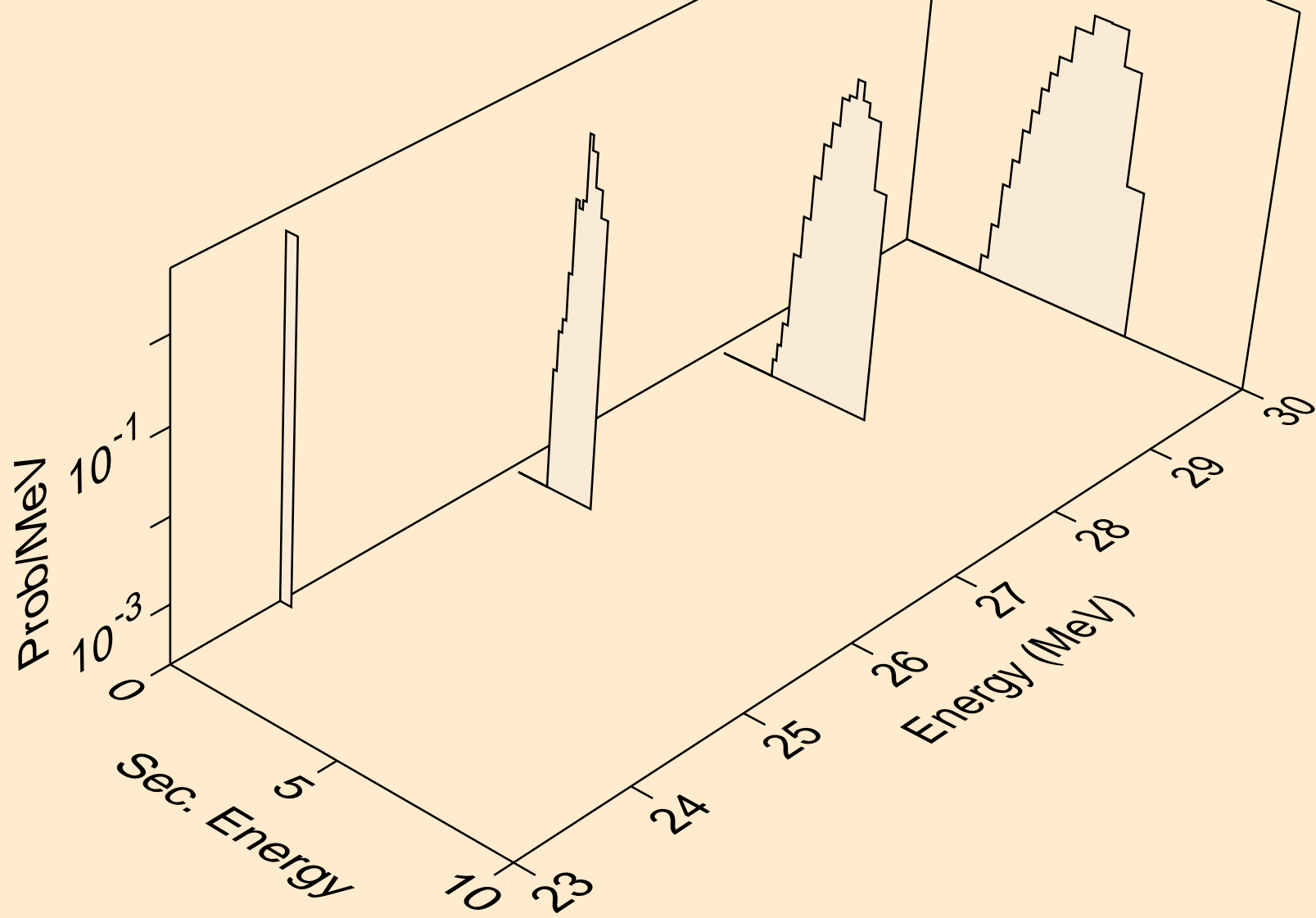

RU096 NEUTRON ACER TENDL-2021 LIBRARY; T=293.6K
deuterons from (n,n*)d

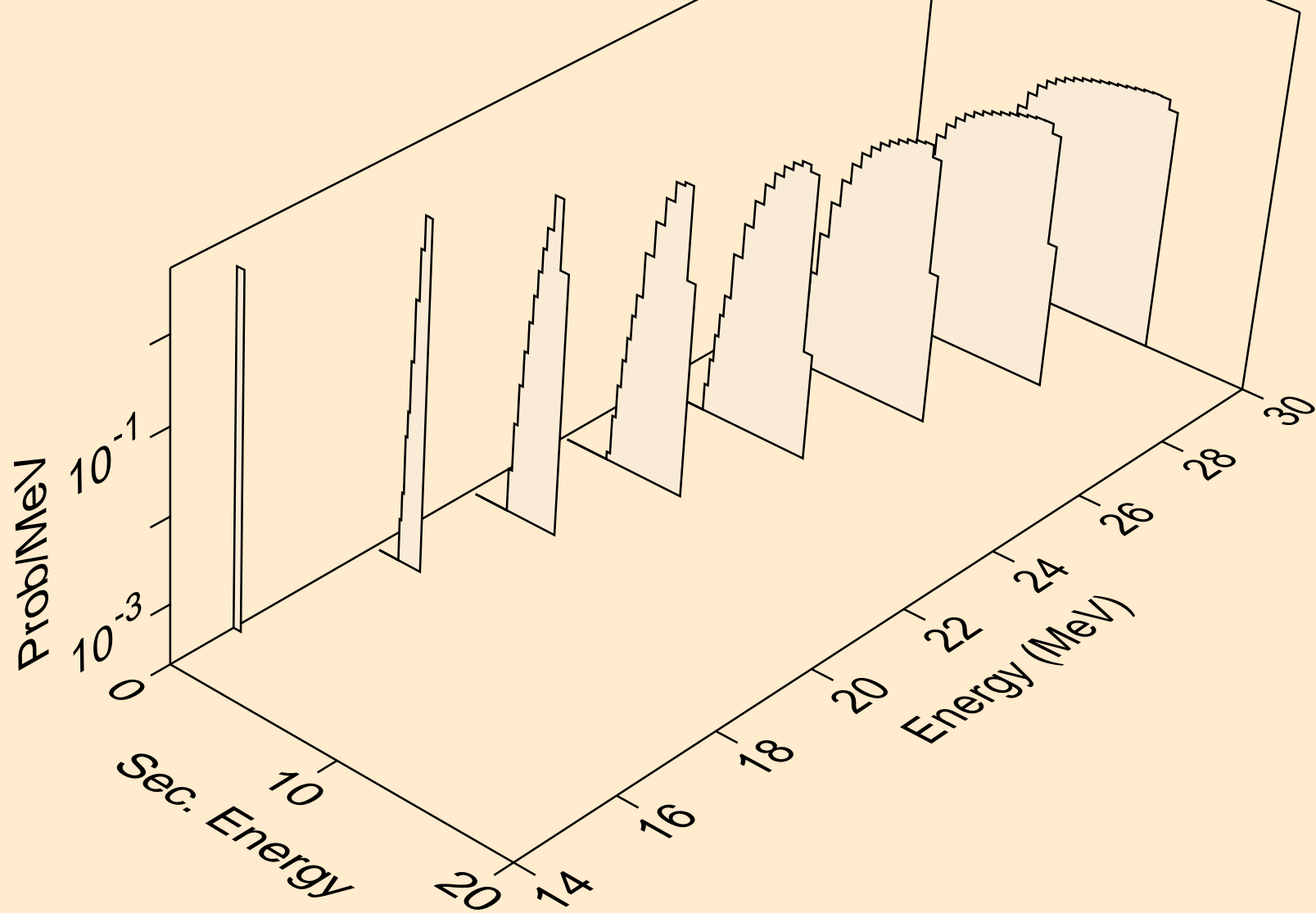

RU096 NEUTRON ACER TENDL-2021 LIBRARY; T=293.6K
deuterons from (n,d)

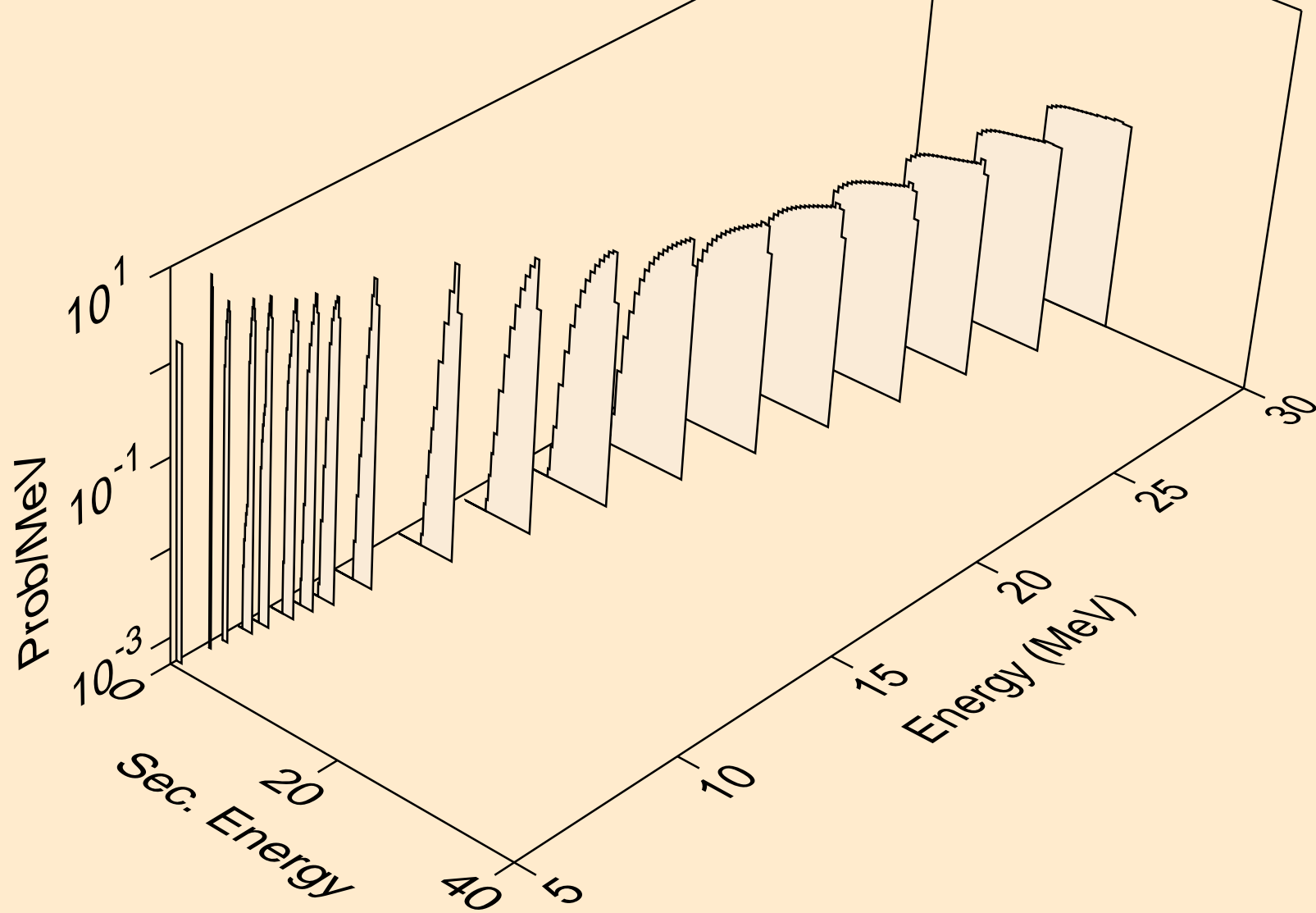

RU096 NEUTRON ACER TENDL-2021 LIBRARY; T=293.6K
deuterons from (n,pd)

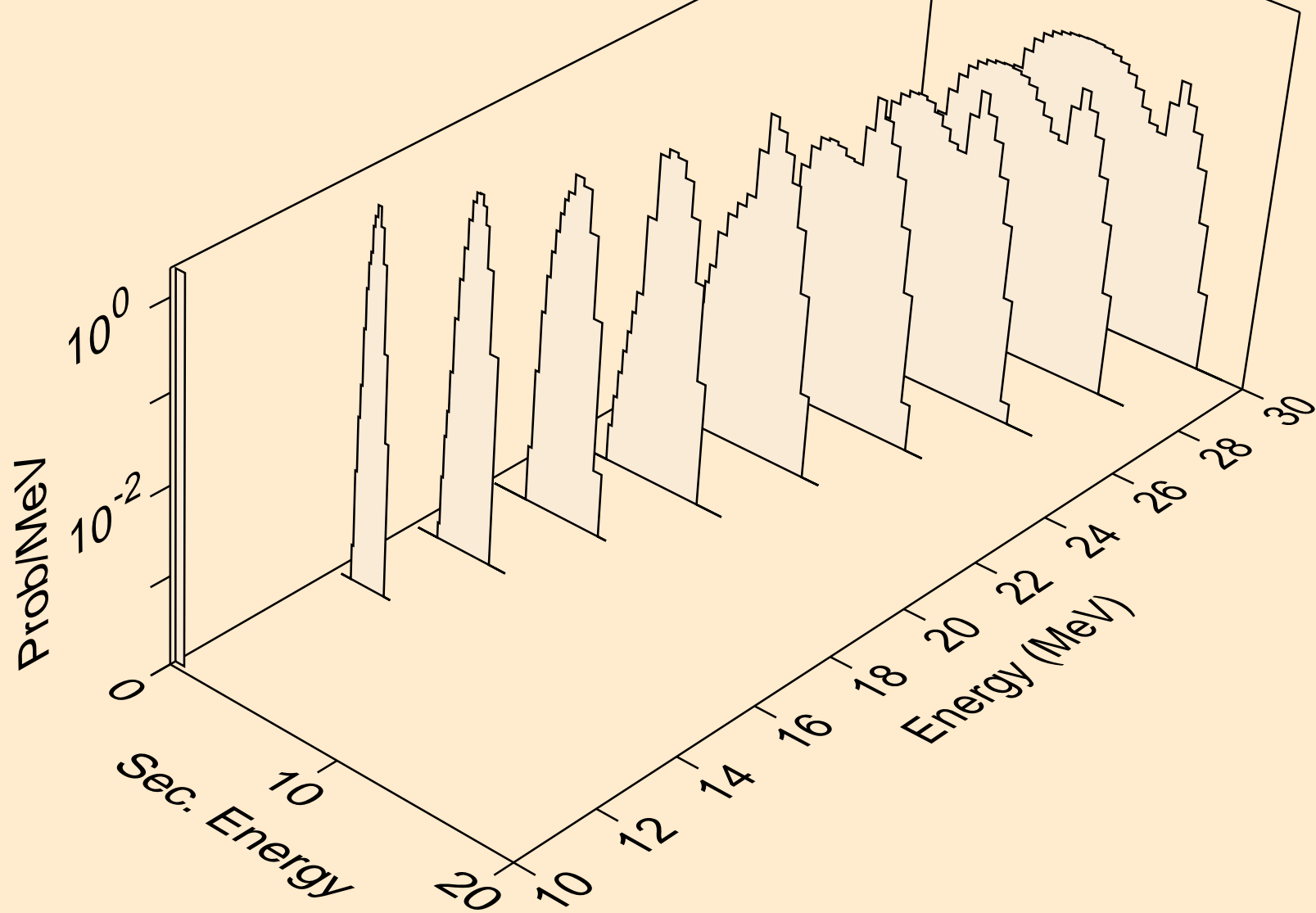

RU096 NEUTRON ACER TENDL-2021 LIBRARY; T=293.6K
deuterons from (n,da)

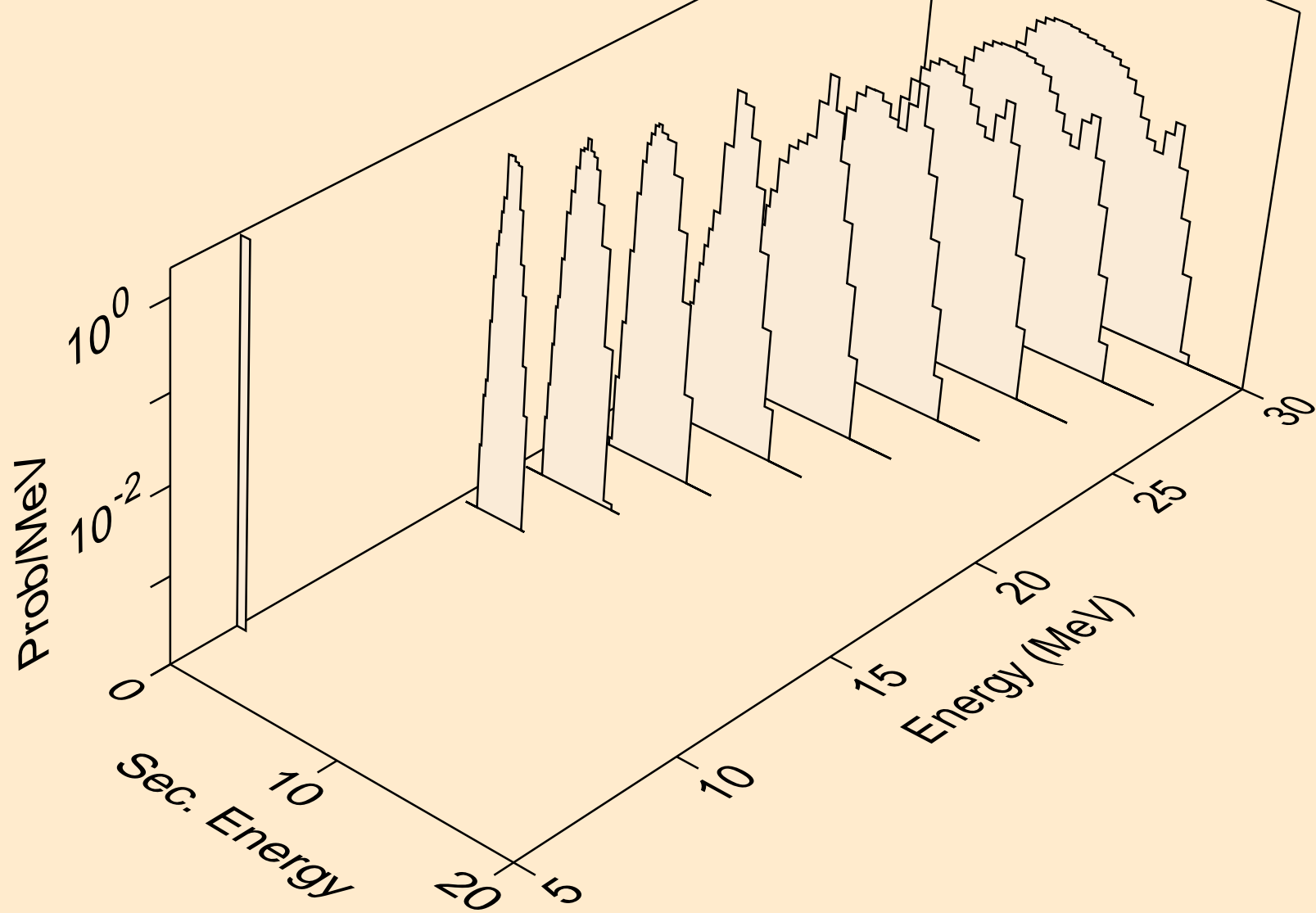

RU096 NEUTRON ACER TENDL-2021 LIBRARY; T=293.6K
tritons from (n,x)

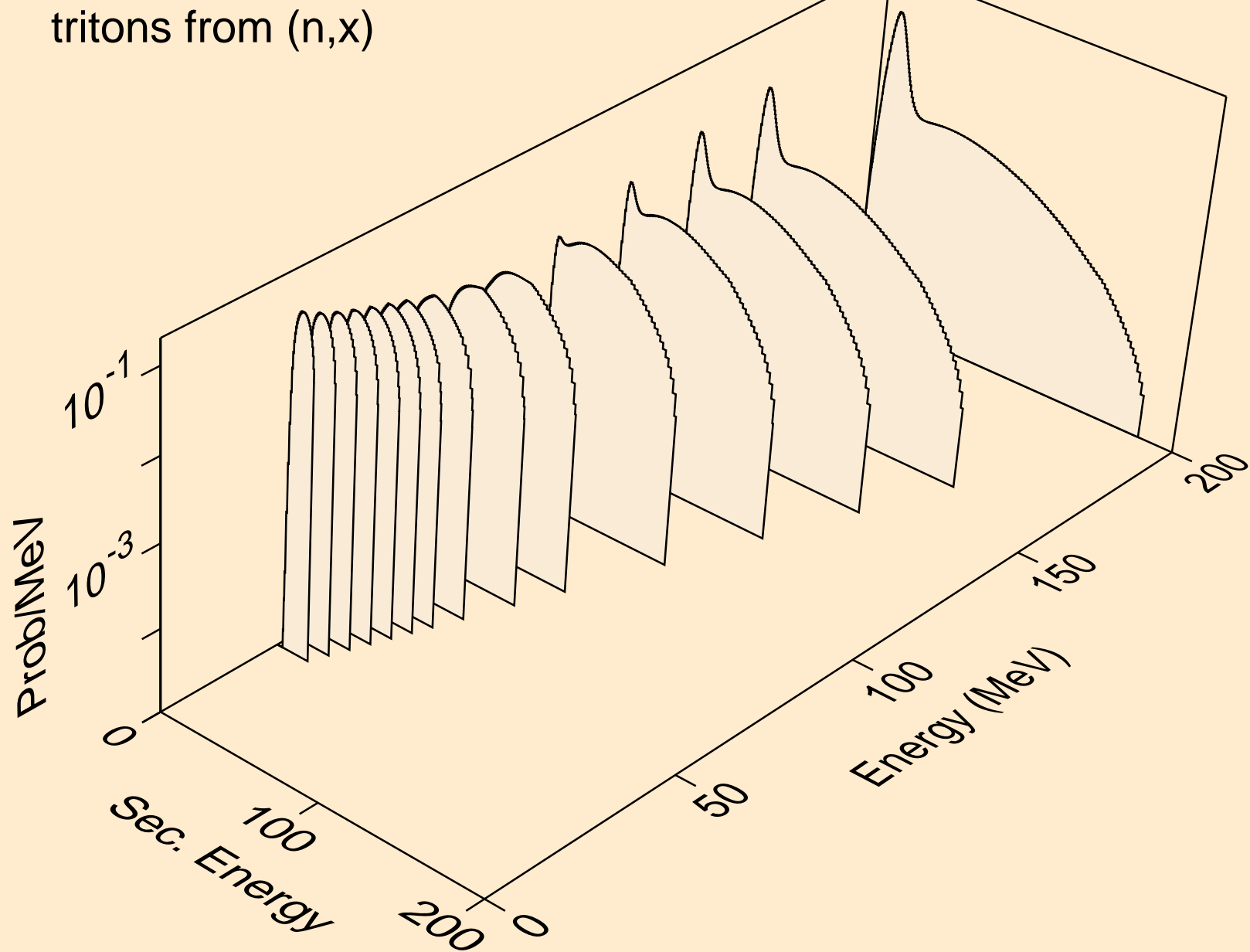

RU096 NEUTRON ACER TENDL-2021 LIBRARY; T=293.6K
tritons from (n,n*)t

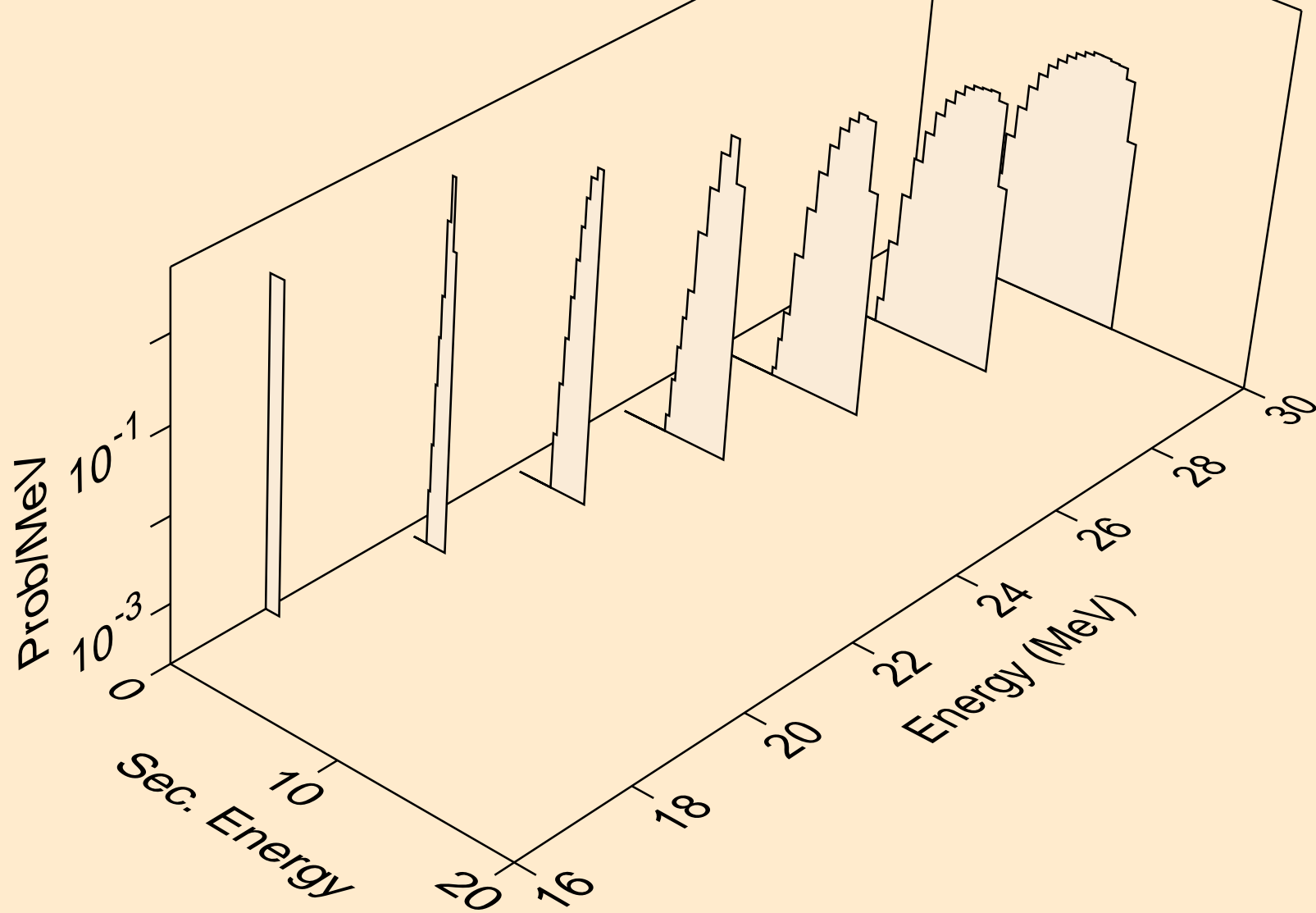

RU096 NEUTRON ACER TENDL-2021 LIBRARY; T=293.6K
tritons from (n,t)

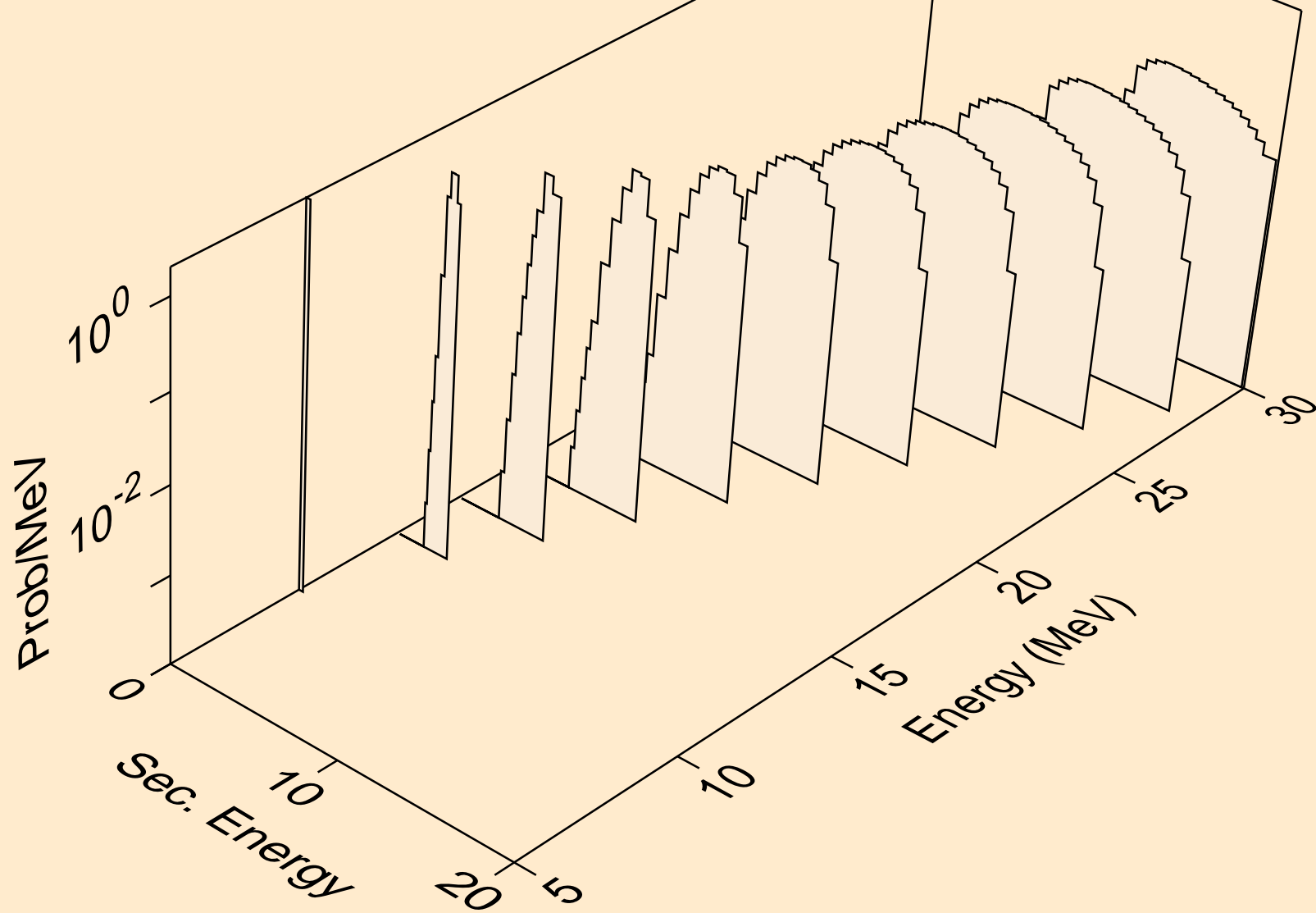

RU096 NEUTRON ACER TENDL-2021 LIBRARY; T=293.6K
tritons from (n,pt)

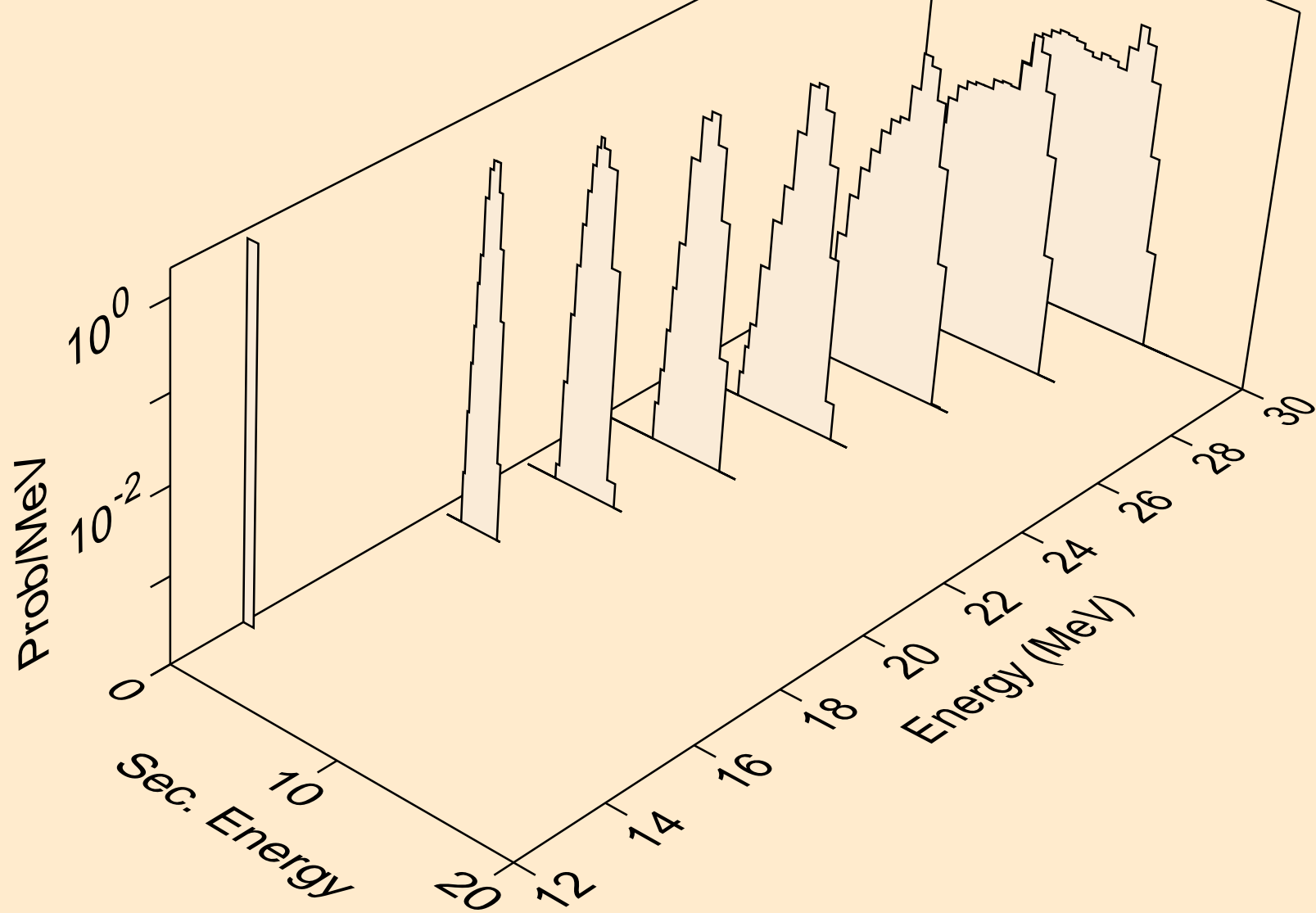

RU096 NEUTRON ACER TENDL-2021 LIBRARY; T=293.6K
he3s from (n,x)

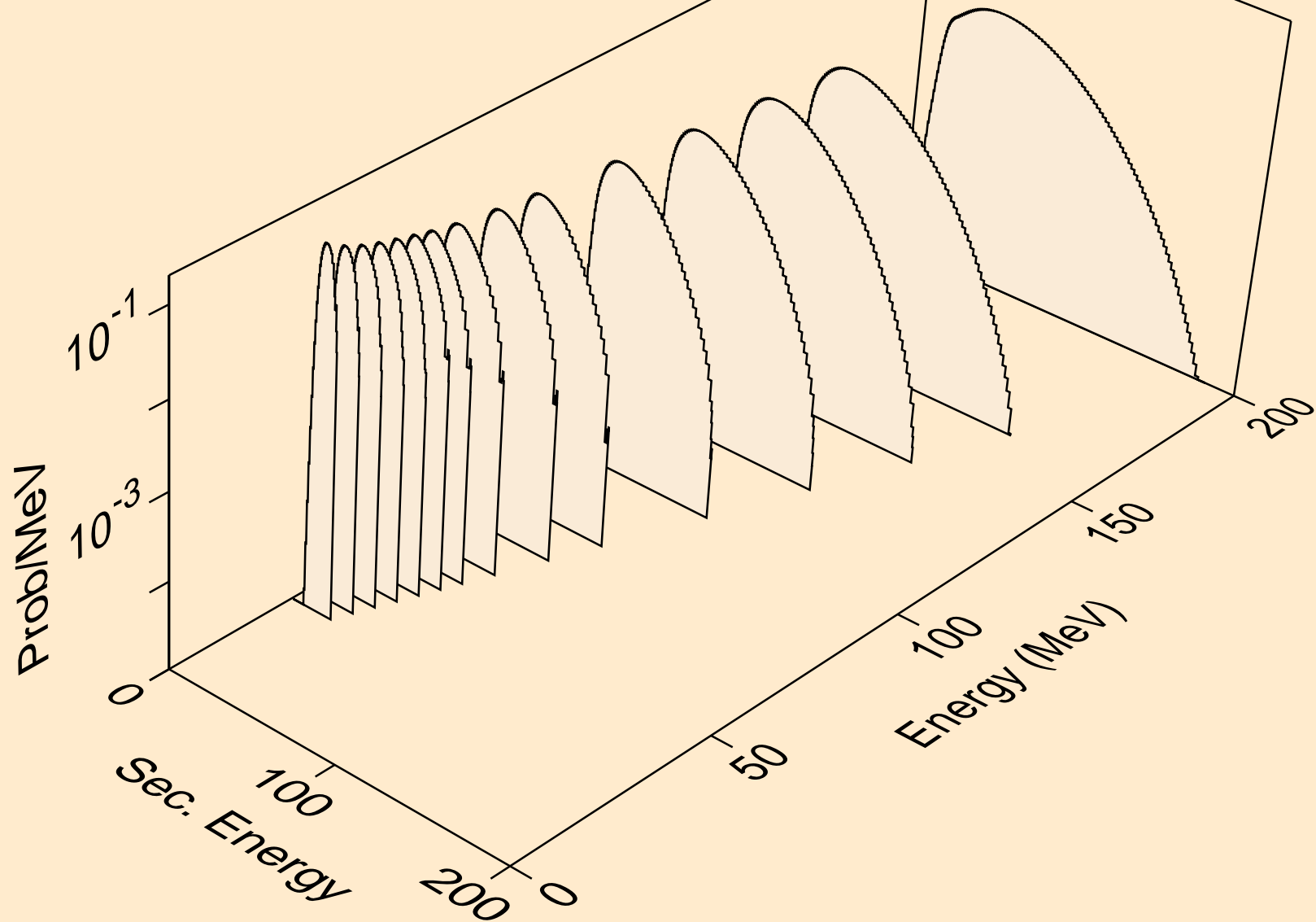

RU096 NEUTRON ACER TENDL-2021 LIBRARY; T=293.6K
he3s from (n,n*)he3

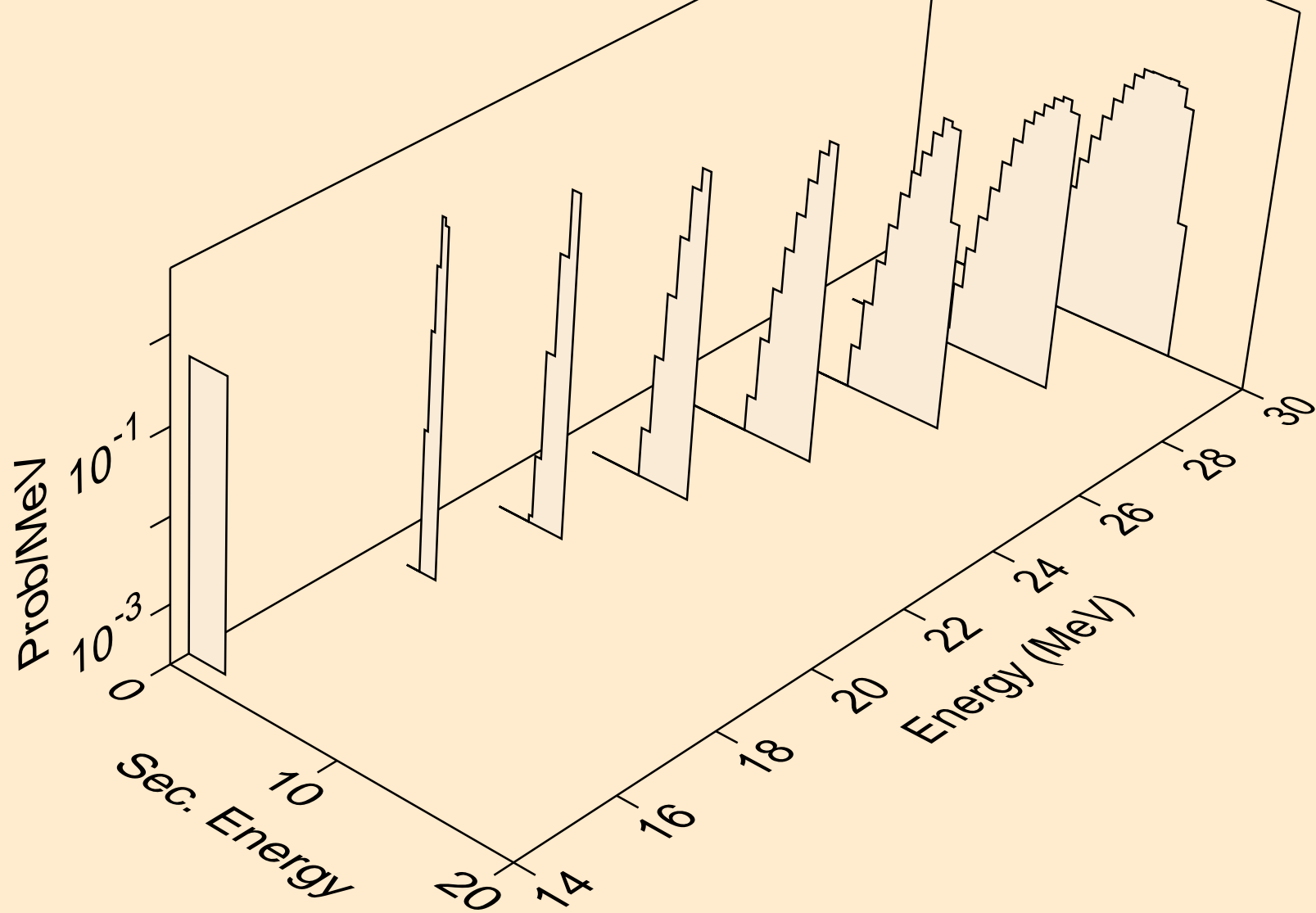

RU096 NEUTRON ACER TENDL-2021 LIBRARY; T=293.6K
he3s from (n,he3)

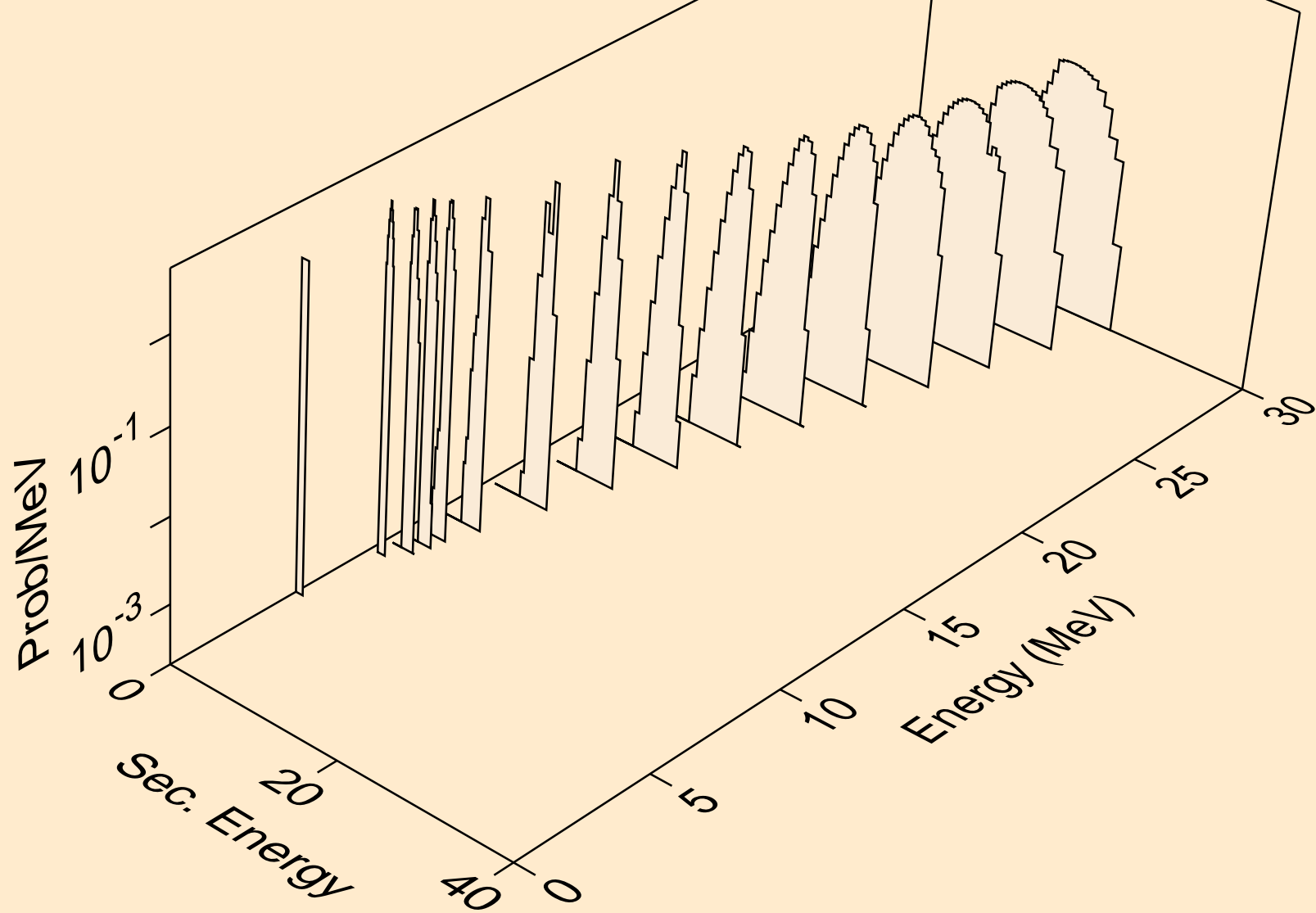

RU096 NEUTRON ACER TENDL-2021 LIBRARY; T=293.6K
alphas from (n,x)

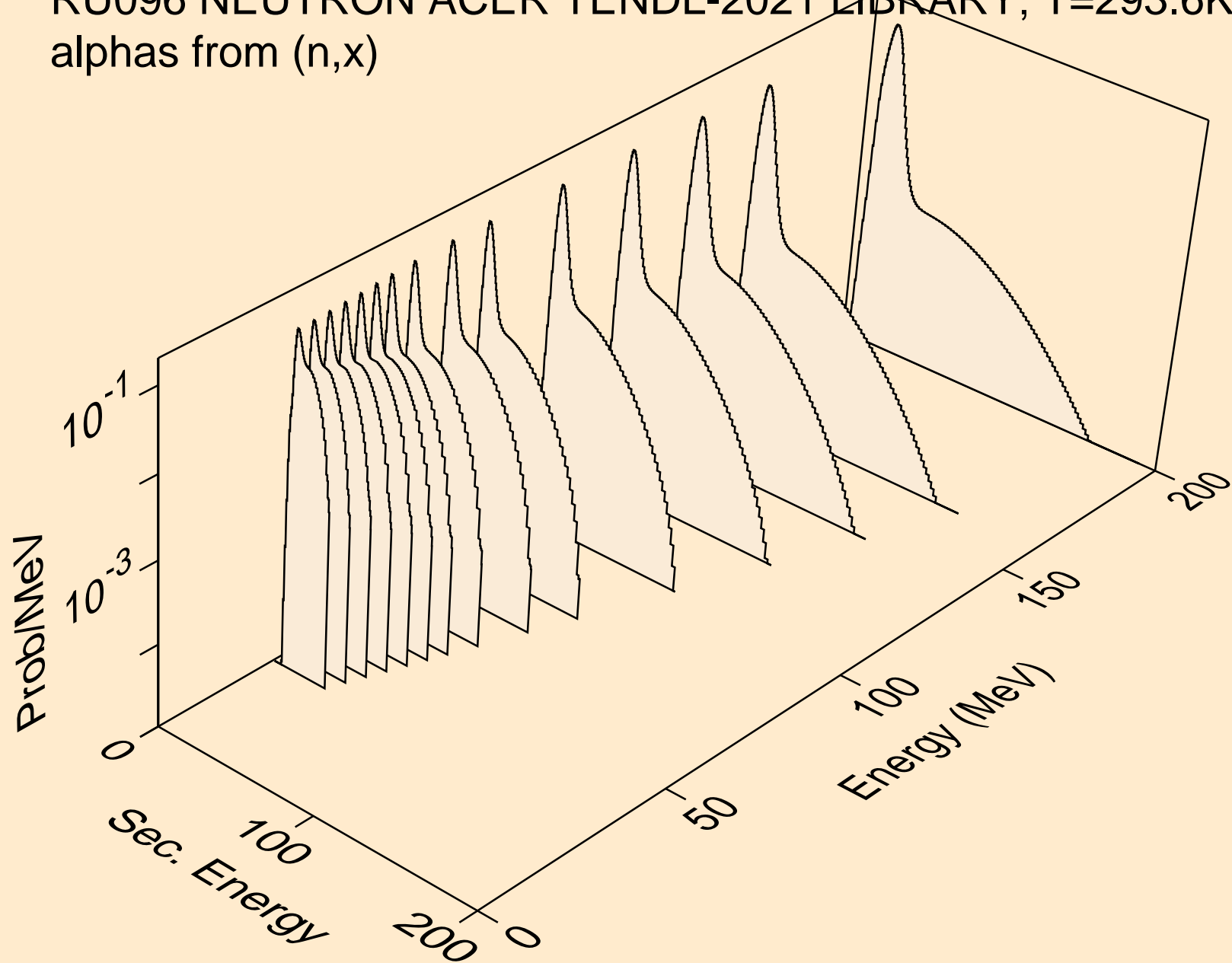

RU096 NEUTRON ACER TENDL-2021 LIBRARY; T=293.6K
alphas from (n,n*)a

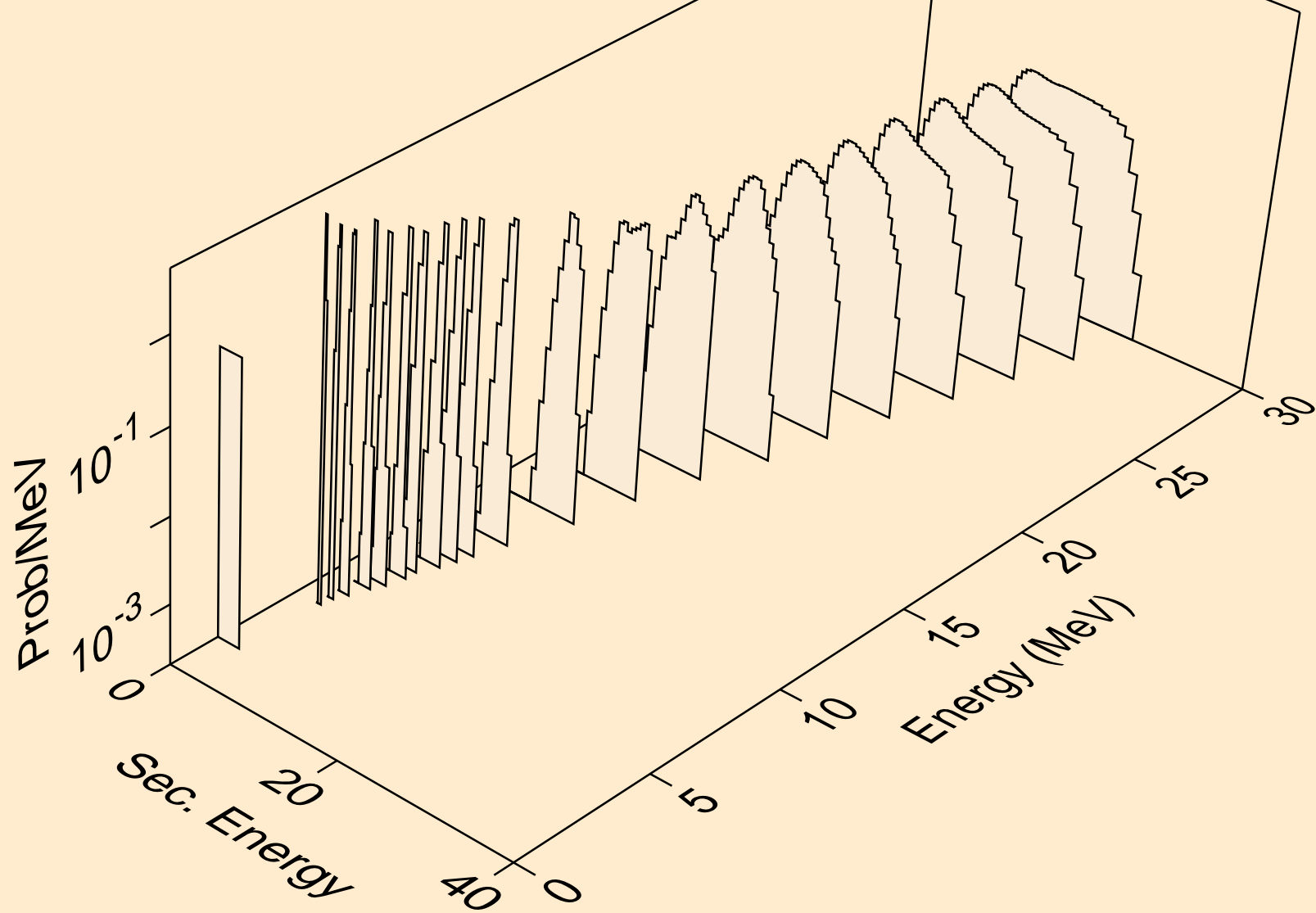

RU096 NEUTRON ACER TENDL-2021 LIBRARY; T=293.6K
alphas from (n,2n)a

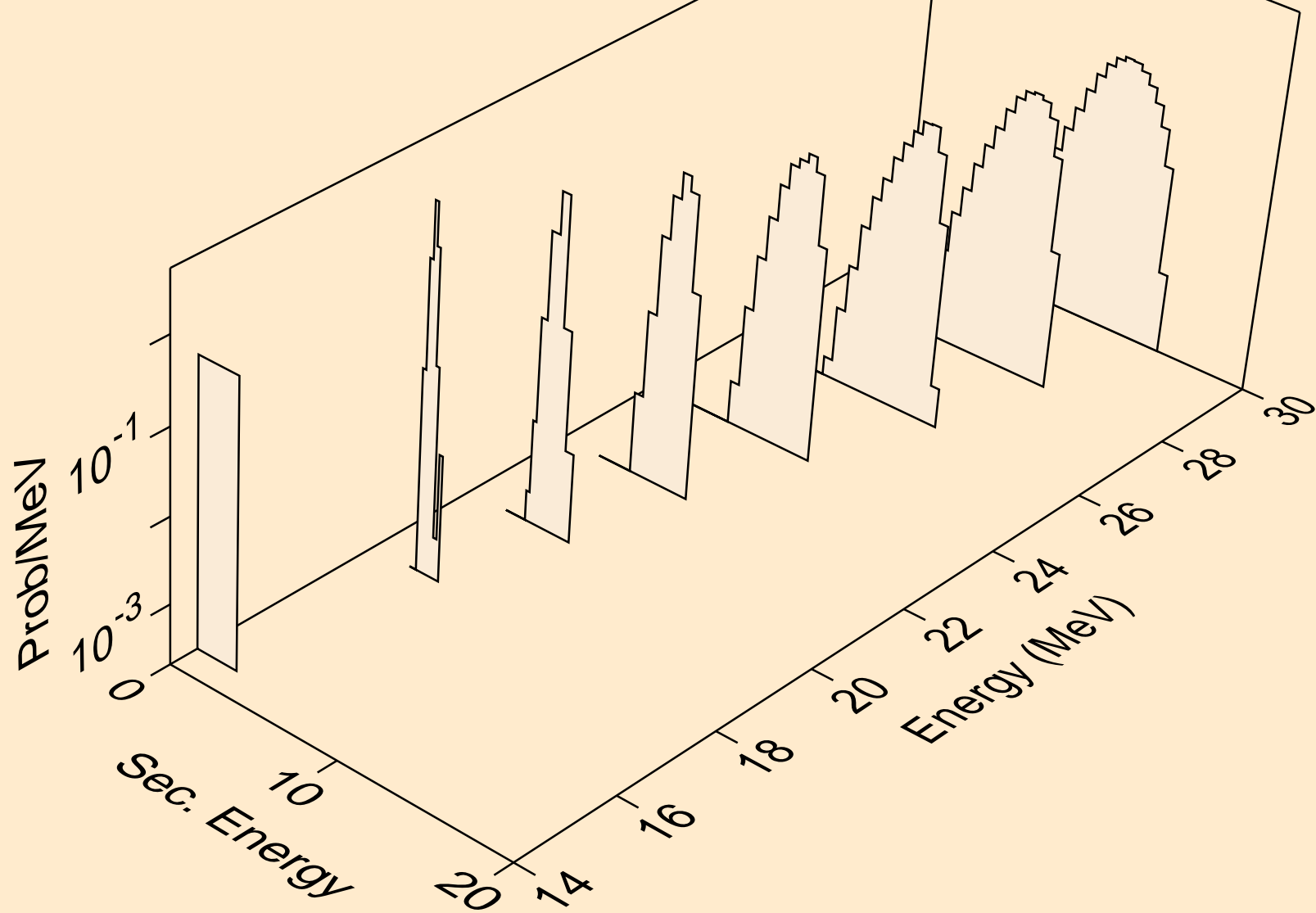

RU096 NEUTRON ACER TENDL-2021 LIBRARY; T=293.6K
alphas from (n,n*)2a

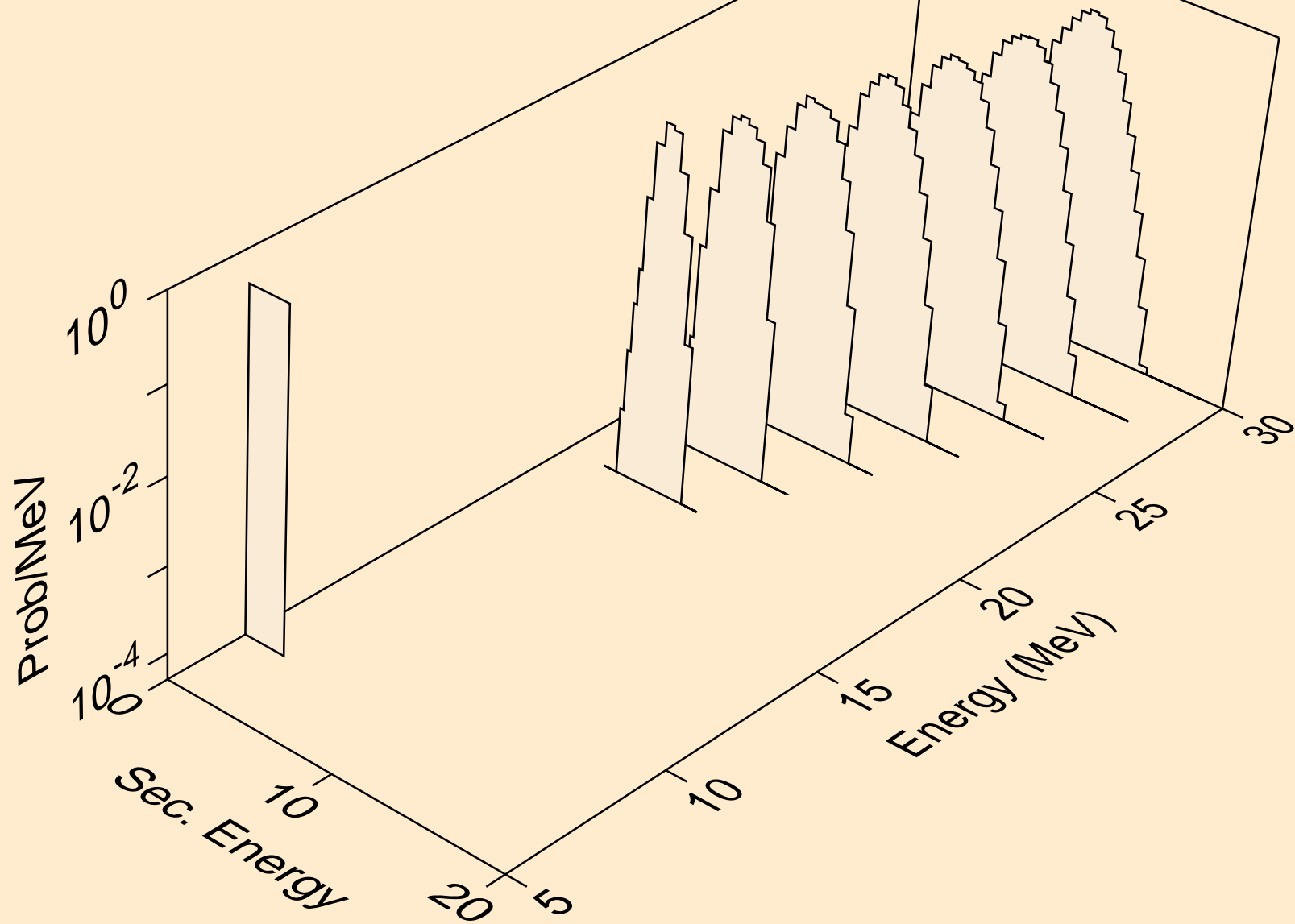

RU096 NEUTRON ACER TENDL-2021 LIBRARY; T=293.6K
alphas from (n,npa)

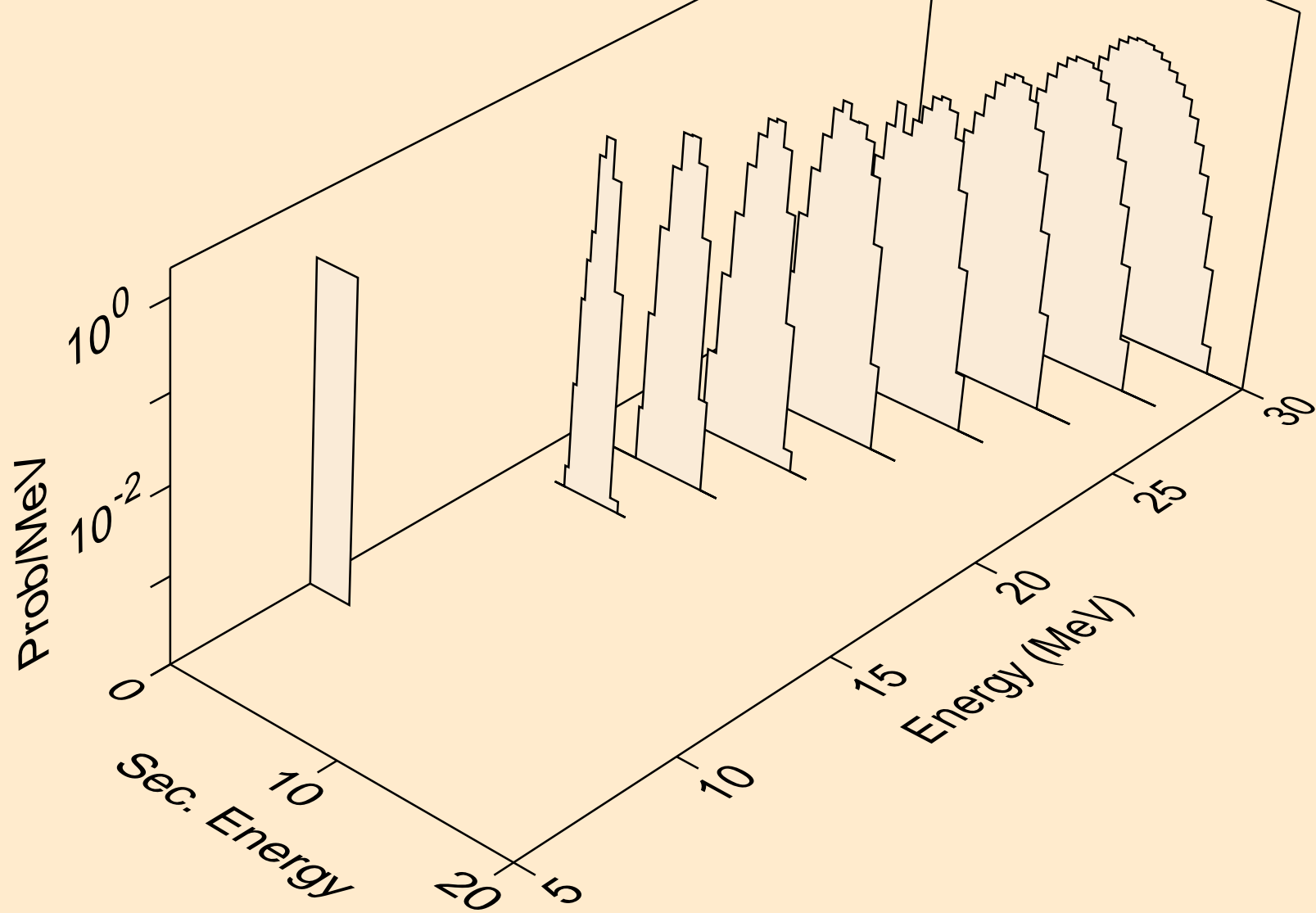

RU096 NEUTRON ACER TENDL-2021 LIBRARY; T=293.6K
alphas from (n,a)

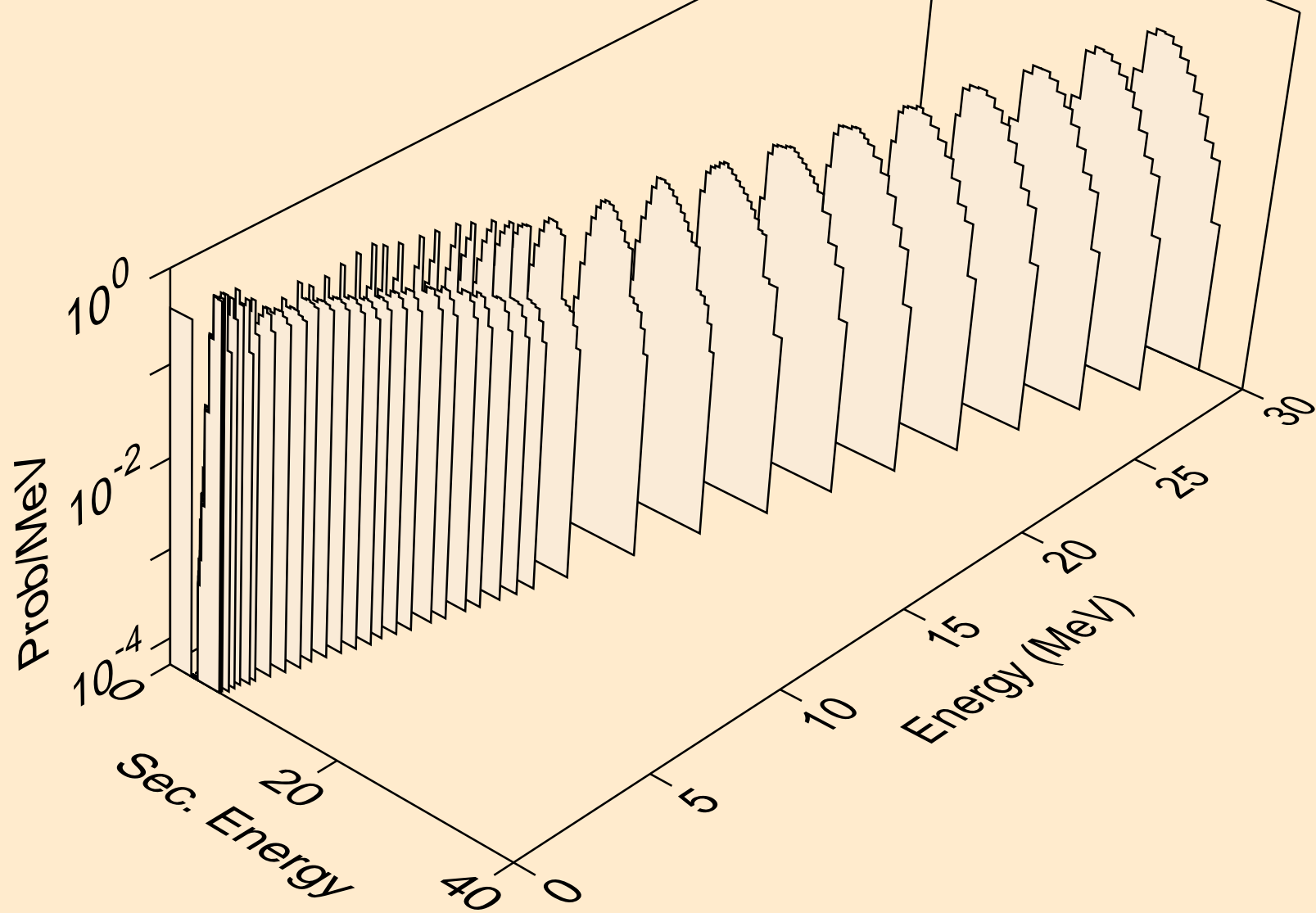

RU096 NEUTRON ACER TENDL-2021 LIBRARY; T=293.6K
alphas from (n,2a)

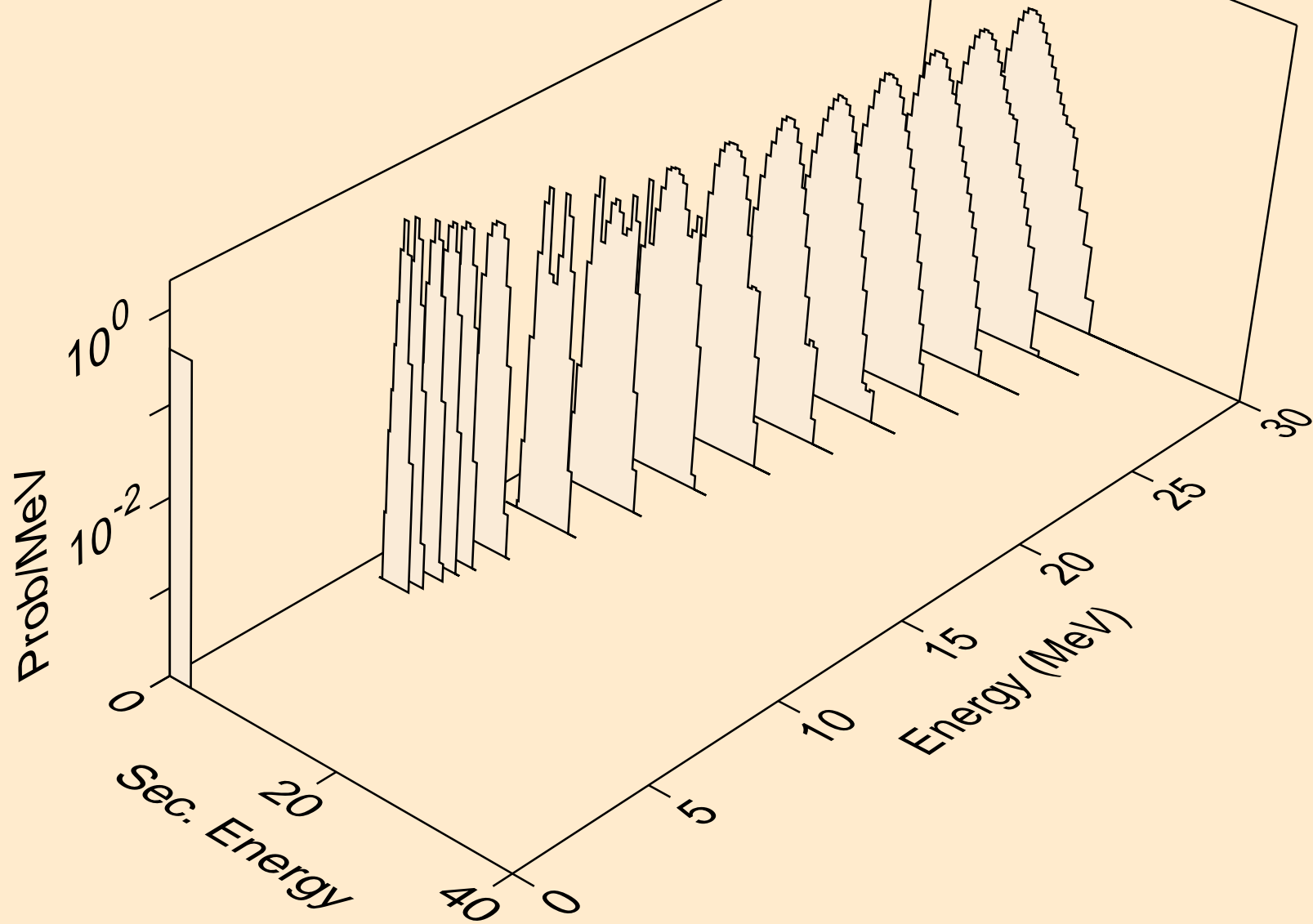

RU096 NEUTRON ACER TENDL-2021 LIBRARY; T=293.6K
alphas from (n,pa)

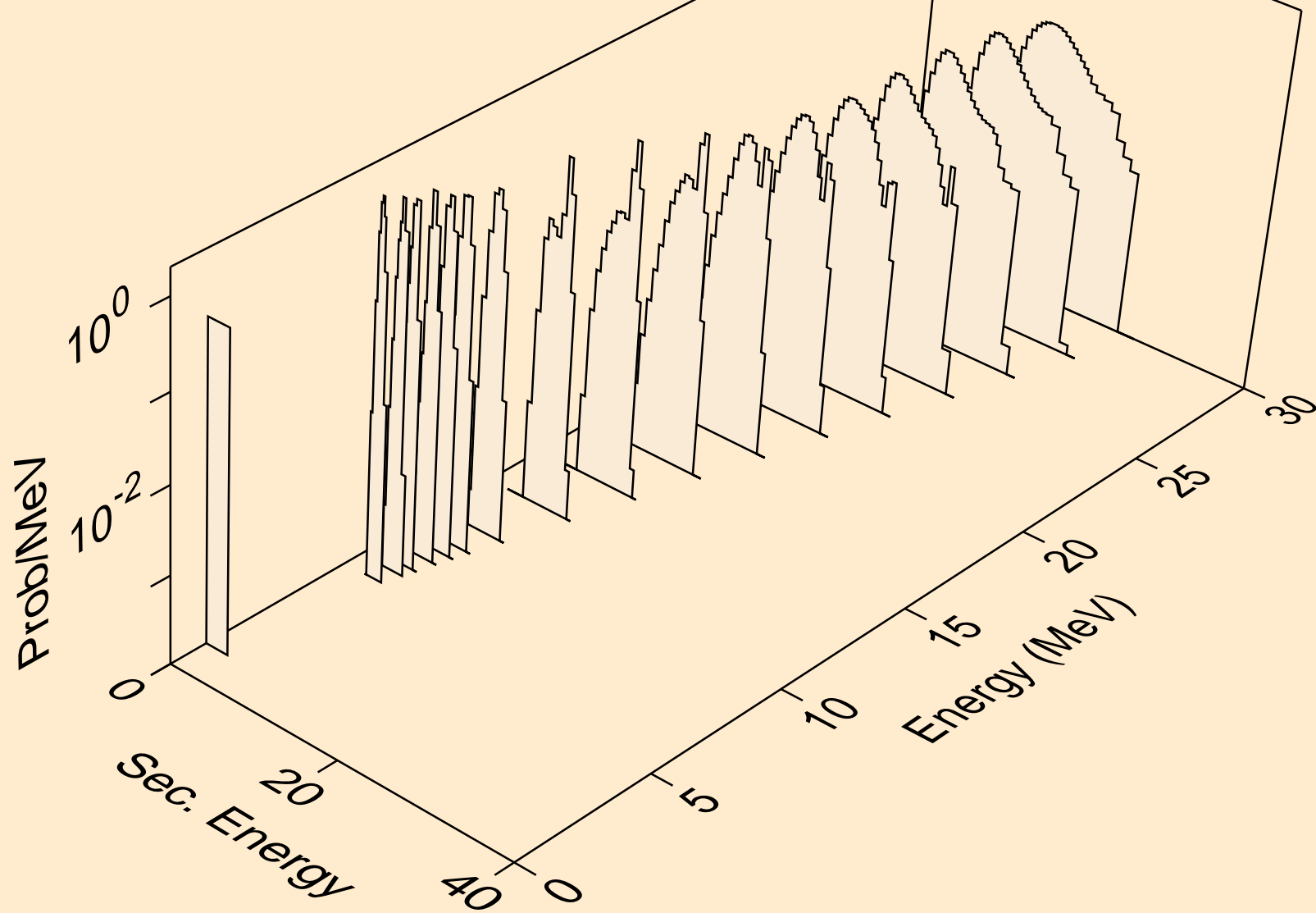

RU096 NEUTRON ACER TENDL-2021 LIBRARY; T=293.6K
alphas from (n,da)

