

S036 NEUTRON ACER TENDL-2021 LIBRARY; T=293.6K

Principal cross sections

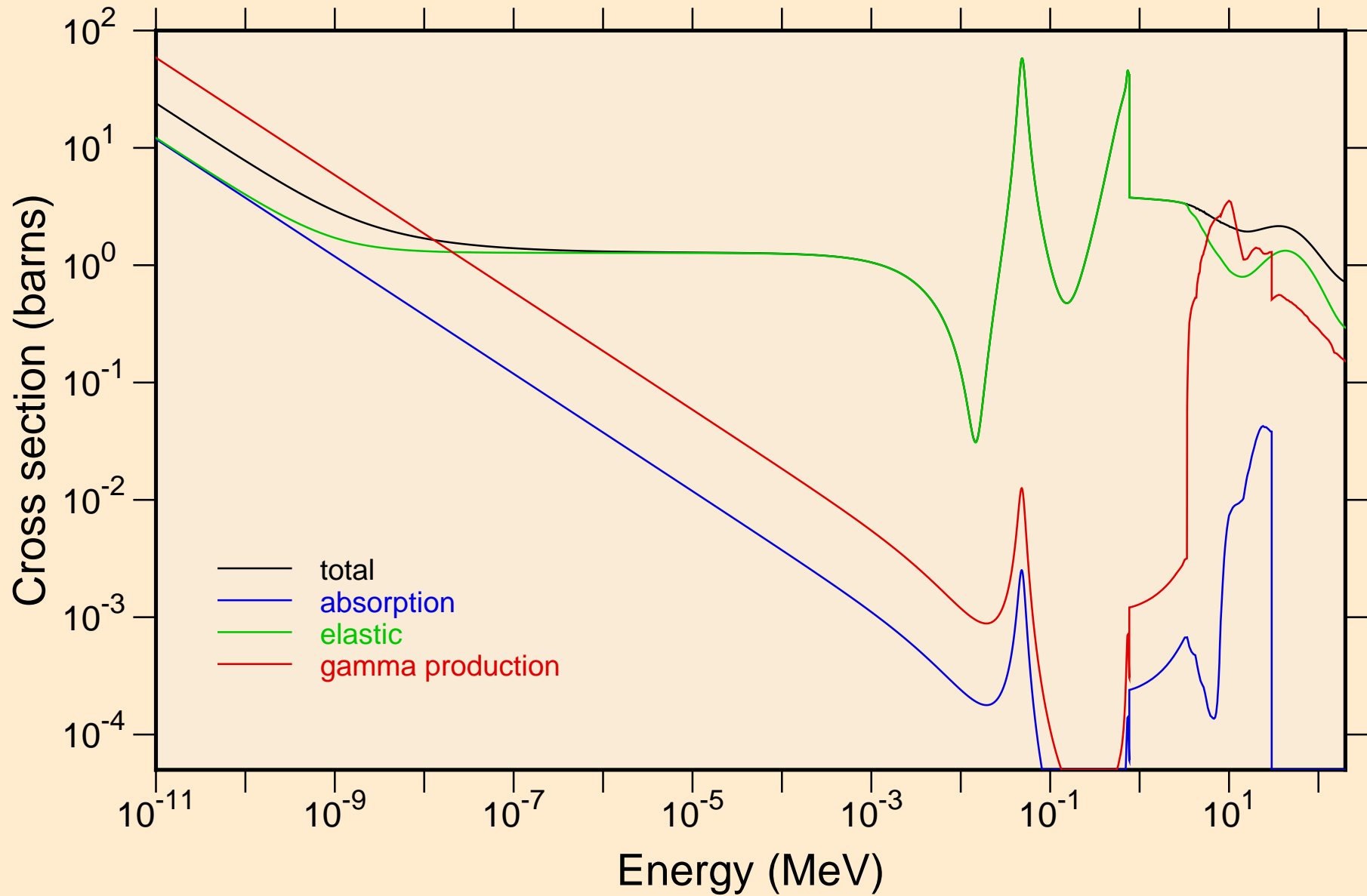

S036 NEUTRON ACER TENDL-2021 LIBRARY; T=293.6K
Heating

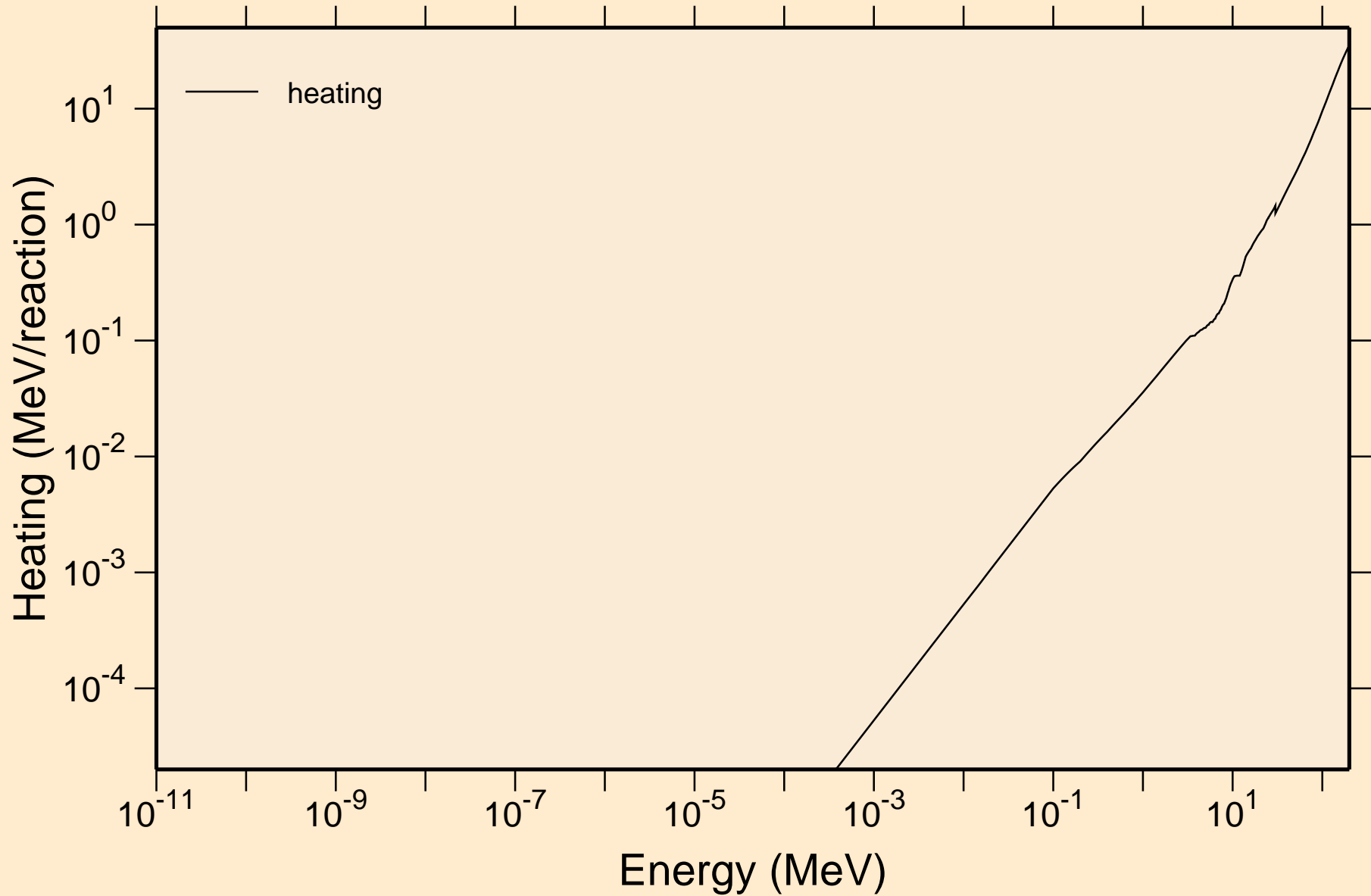

S036 NEUTRON ACER TENDL-2021 LIBRARY; T=293.6K
Damage

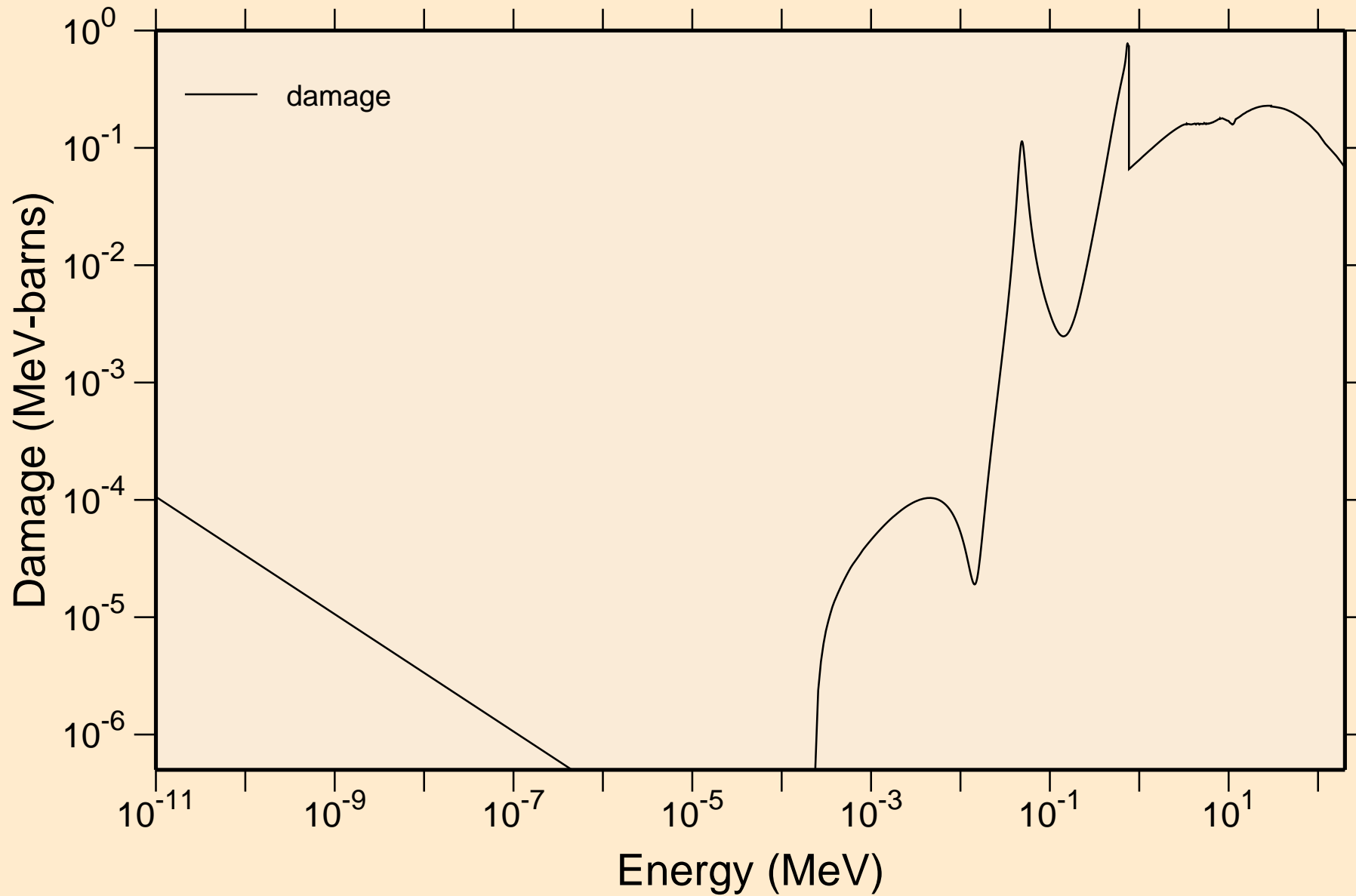

S036 NEUTRON ACER TENDL-2021 LIBRARY; T=293.6K
Non-threshold reactions

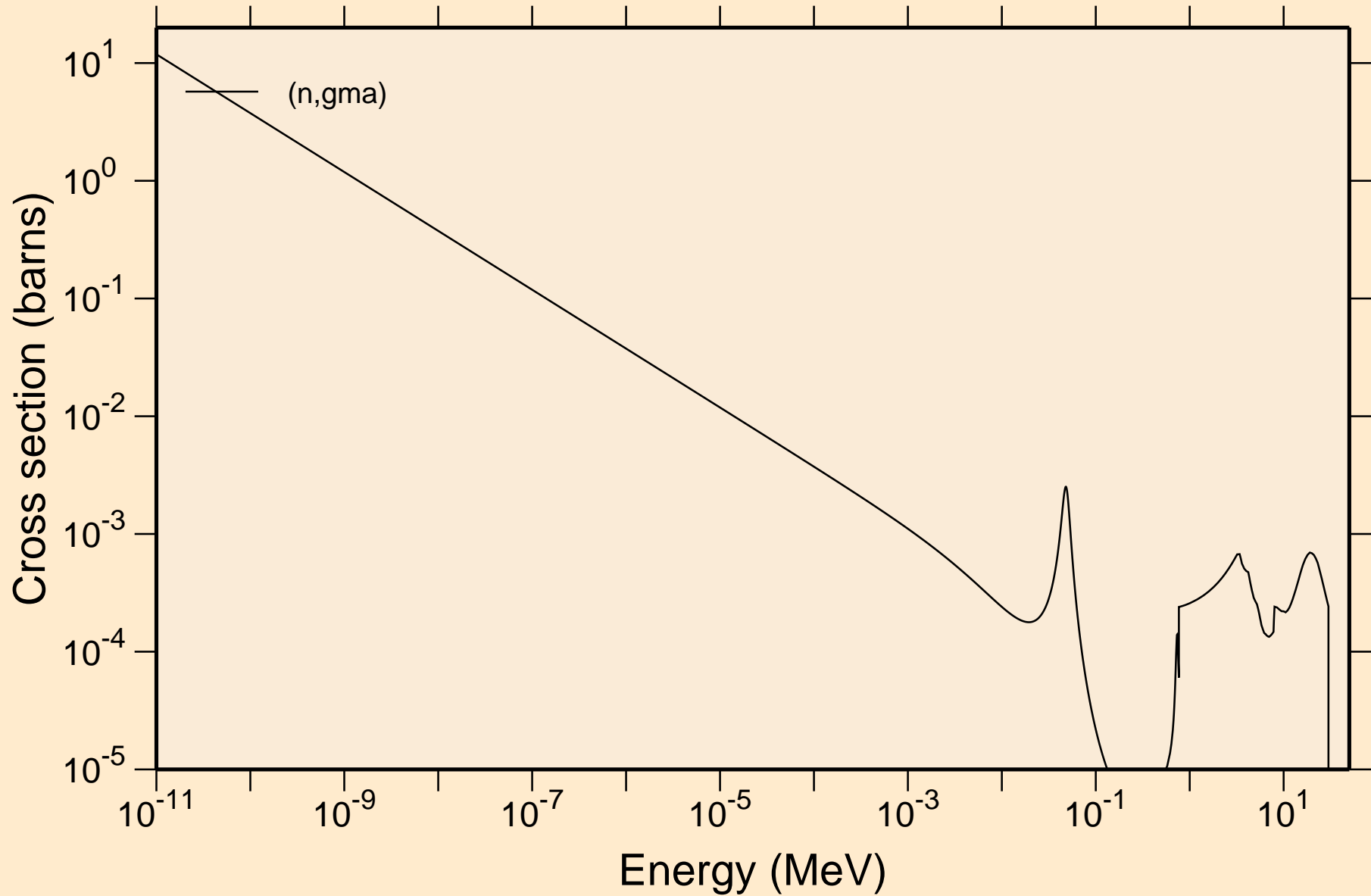

S036 NEUTRON ACER TENDL-2021 LIBRARY; T=293.6K

Principal cross sections

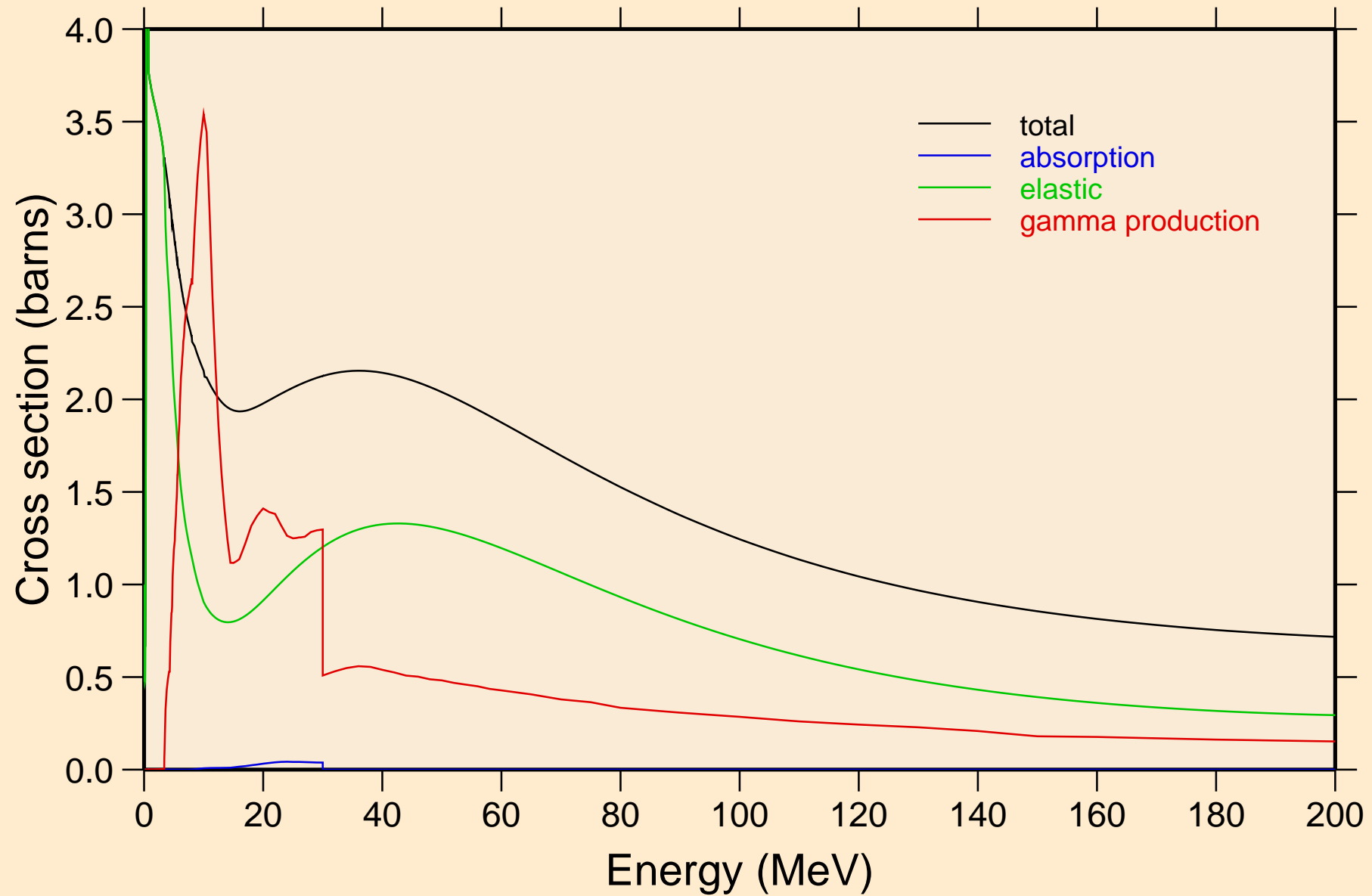

S036 NEUTRON ACER TENDL-2021 LIBRARY; T=293.6K

Heating

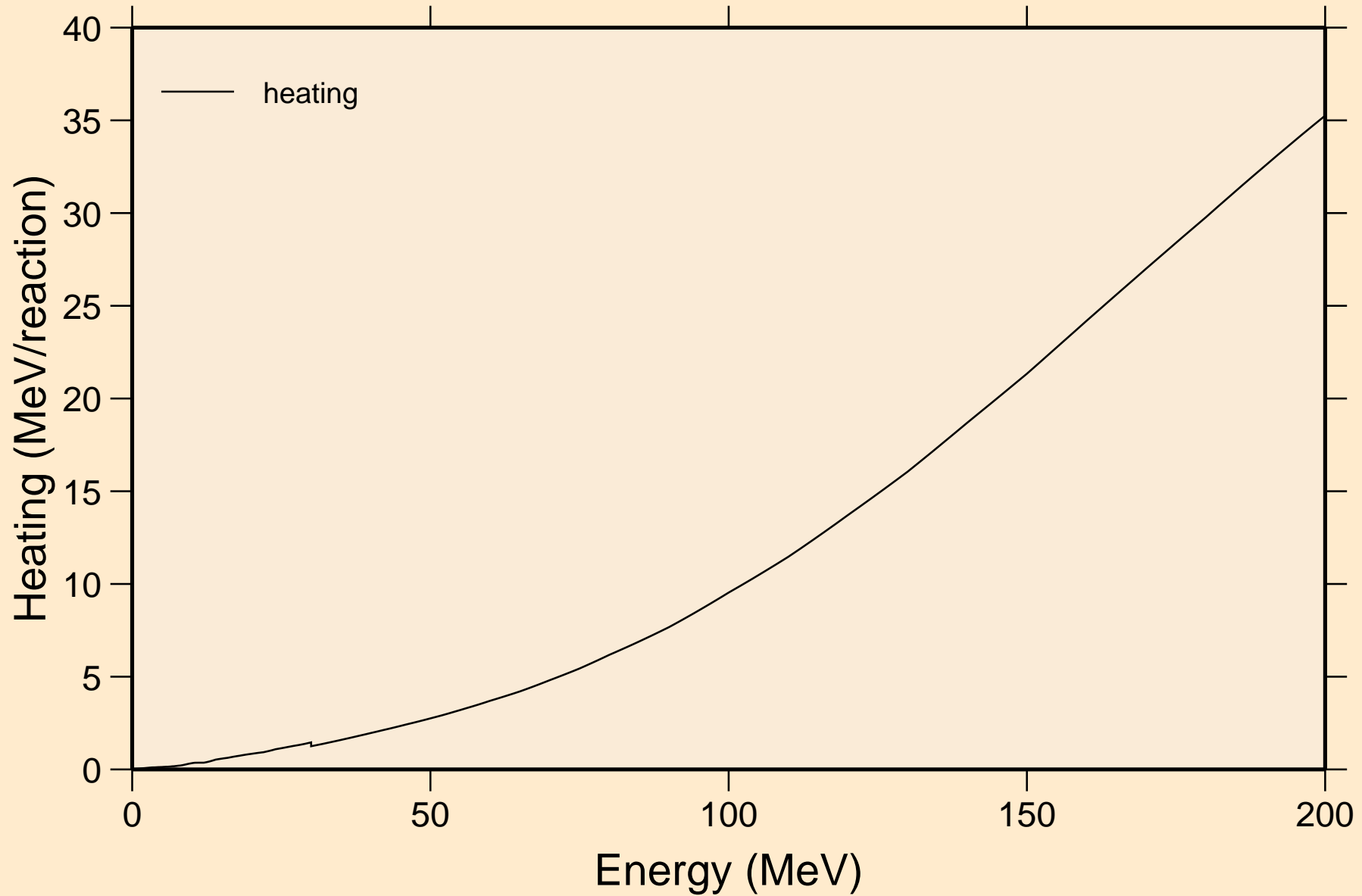

S036 NEUTRON ACER TENDL-2021 LIBRARY; T=293.6K

Damage

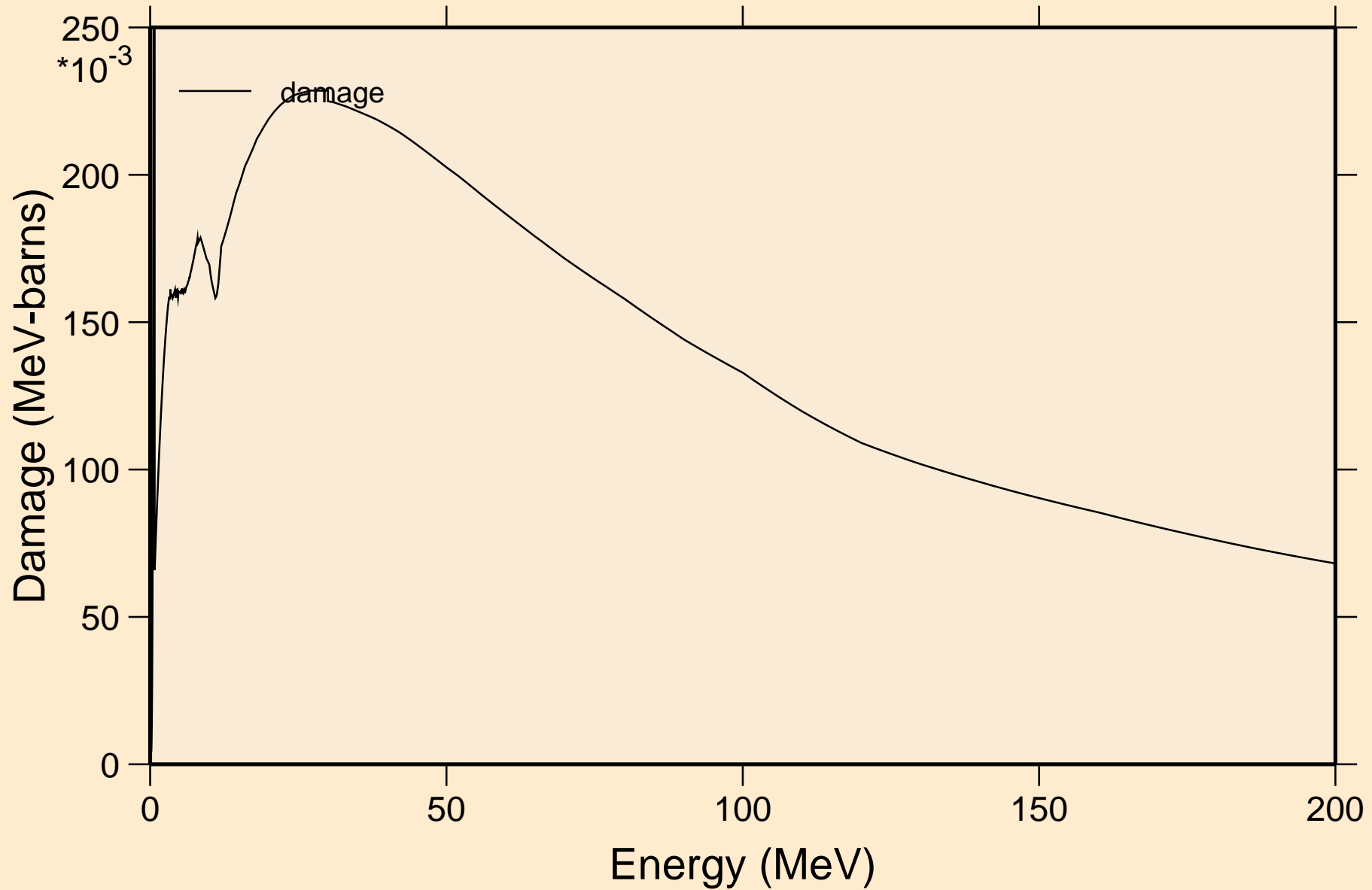

S036 NEUTRON ACER TENDL-2021 LIBRARY; T=293.6K
Non-threshold reactions

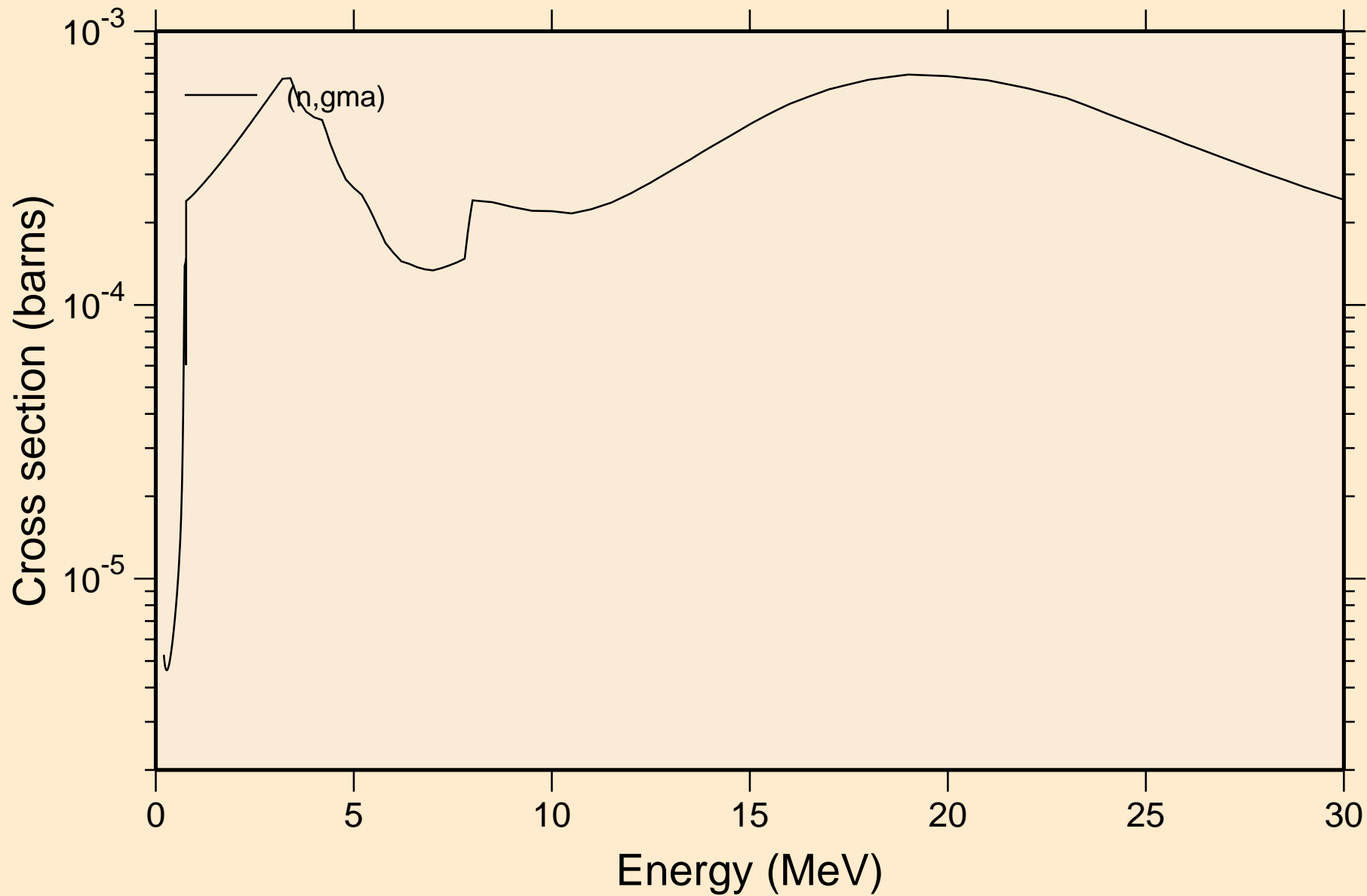

S036 NEUTRON ACER TENDL-2021 LIBRARY; T=293.6K
Inelastic levels

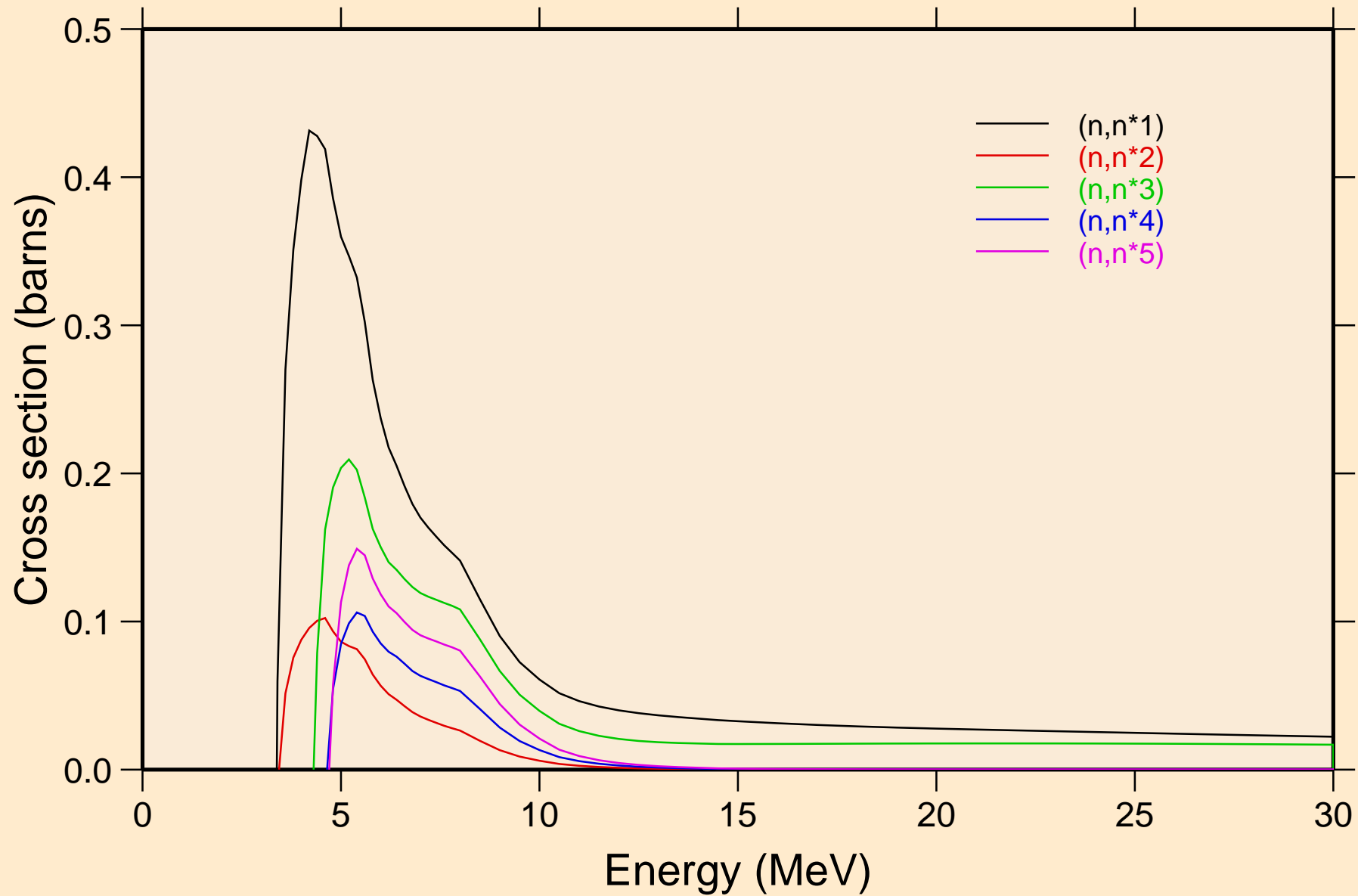

S036 NEUTRON ACER TENDL-2021 LIBRARY; T=293.6K
Inelastic levels

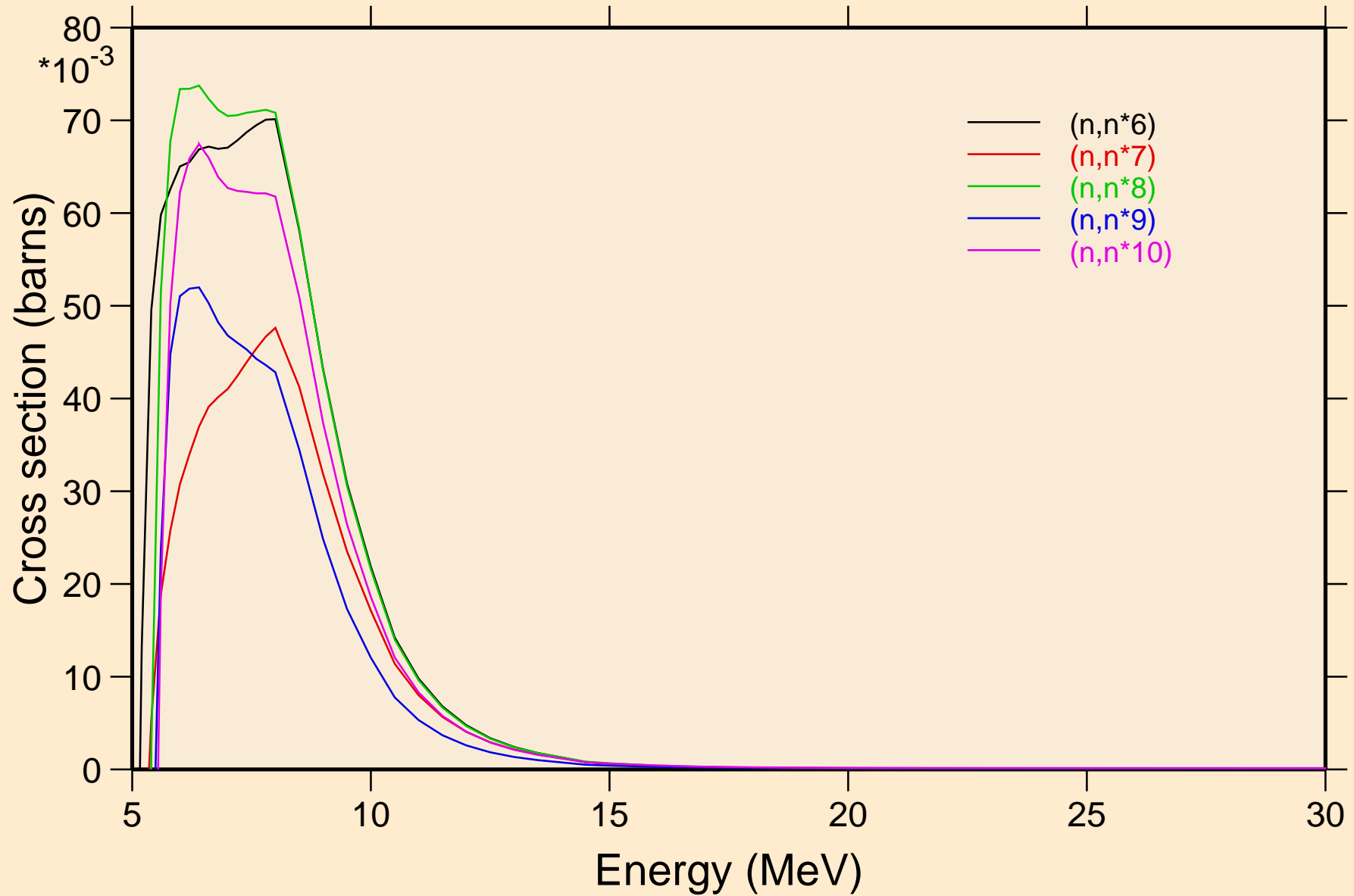

S036 NEUTRON ACER TENDL-2021 LIBRARY; T=293.6K
Inelastic levels

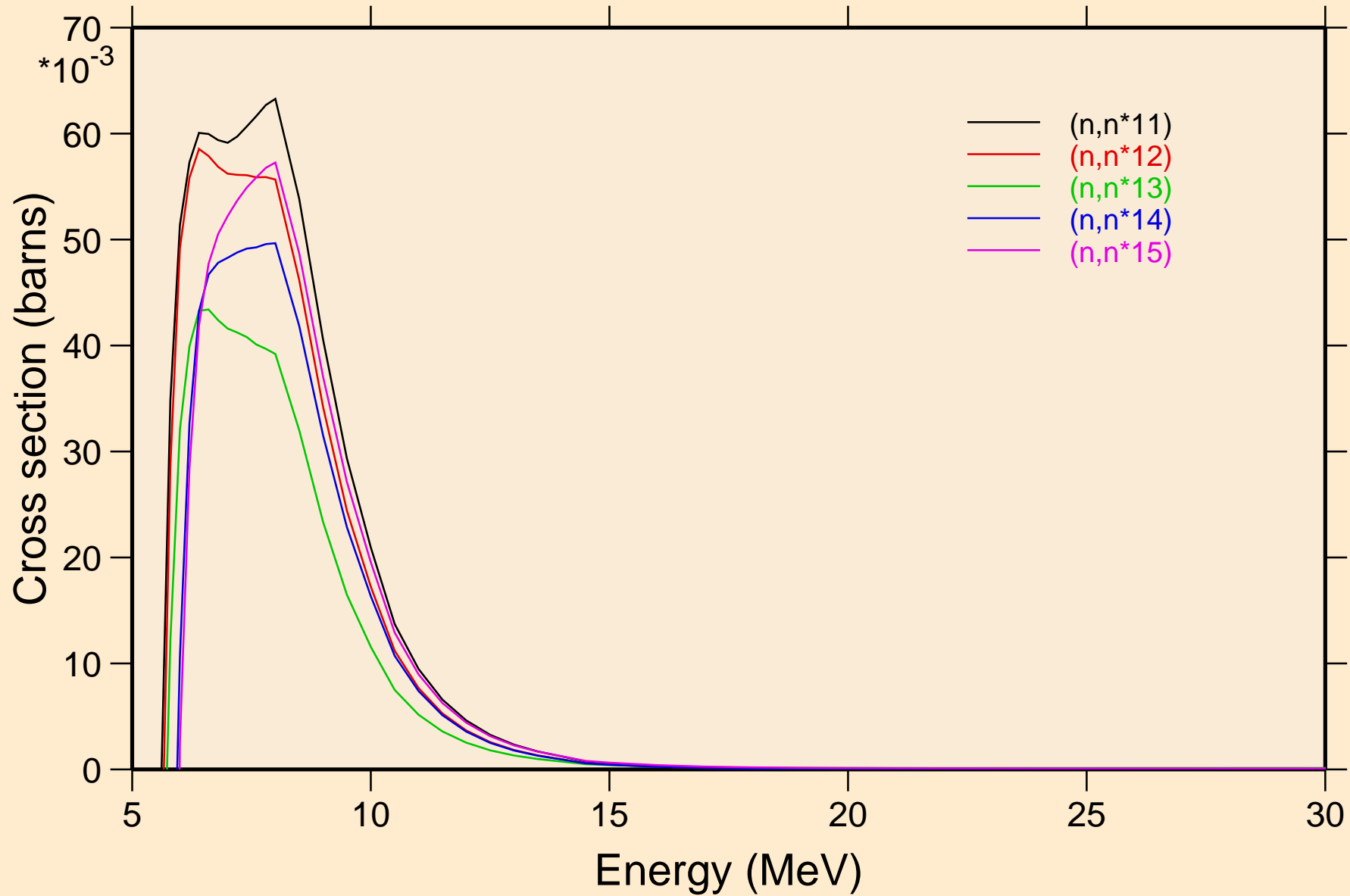

S036 NEUTRON ACER TENDL-2021 LIBRARY; T=293.6K
Inelastic levels

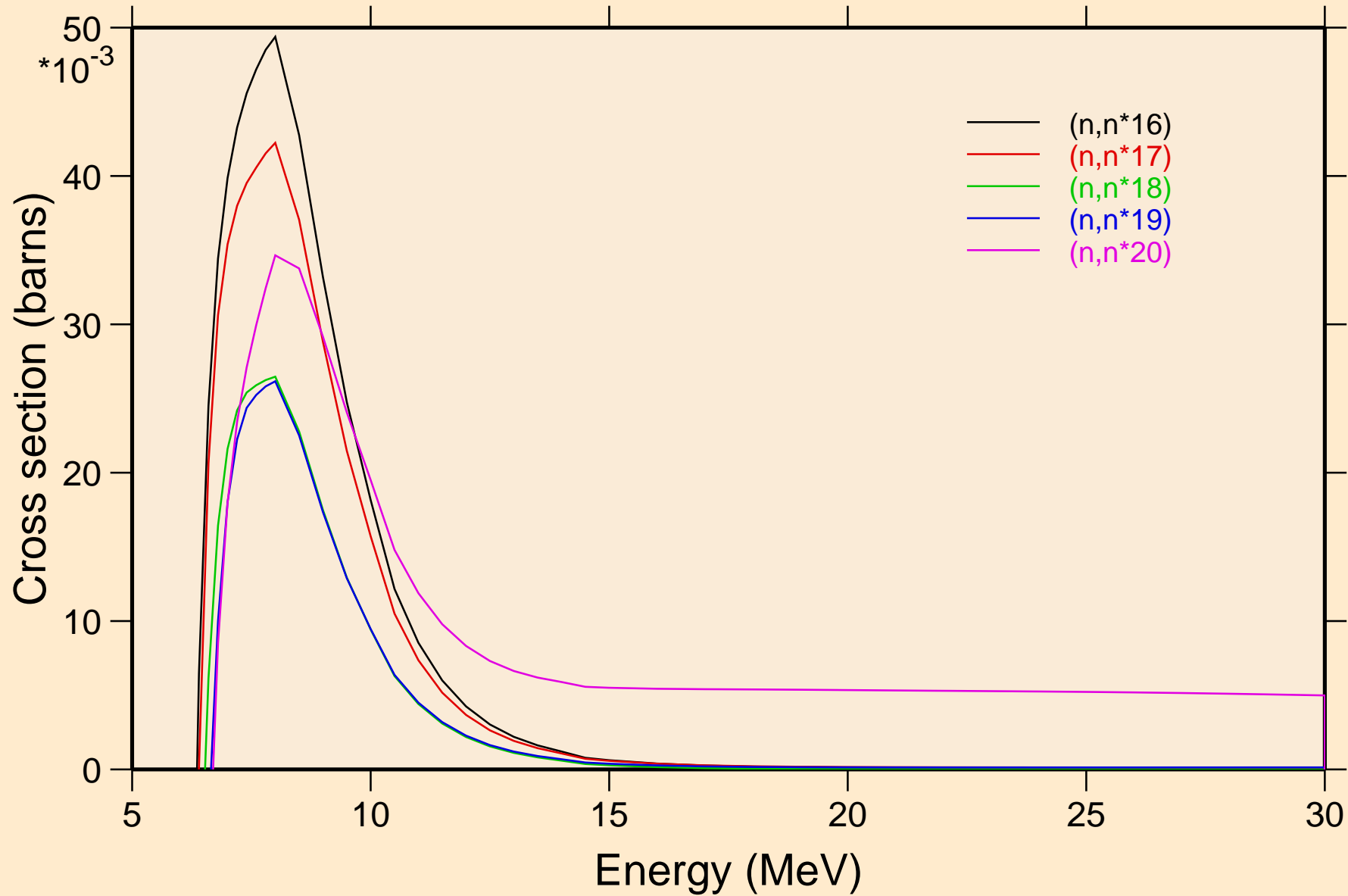

S036 NEUTRON ACER TENDL-2021 LIBRARY; T=293.6K
Inelastic levels

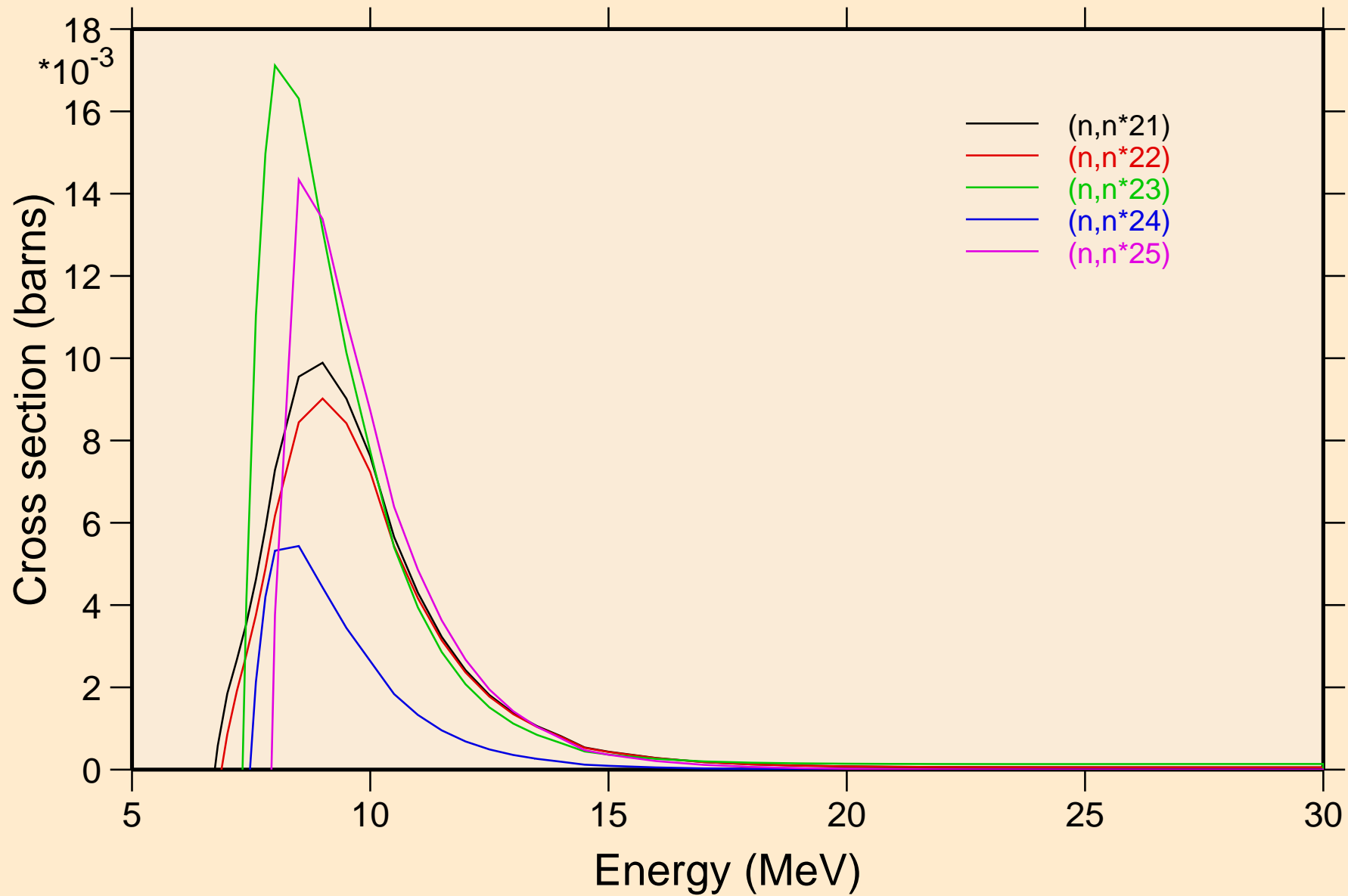

S036 NEUTRON ACER TENDL-2021 LIBRARY; T=293.6K
Inelastic levels

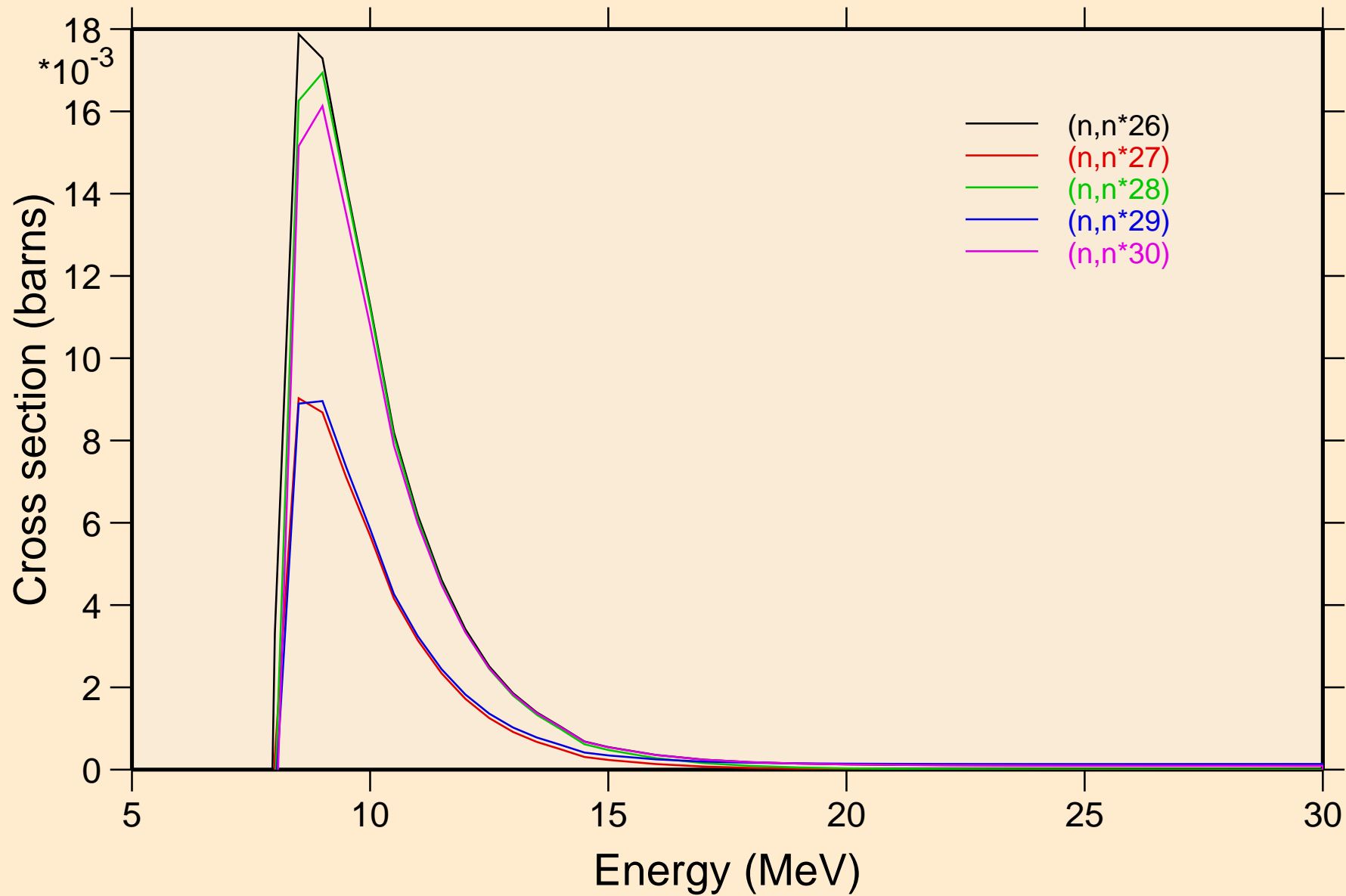

S036 NEUTRON ACER TENDL-2021 LIBRARY; T=293.6K
Threshold reactions

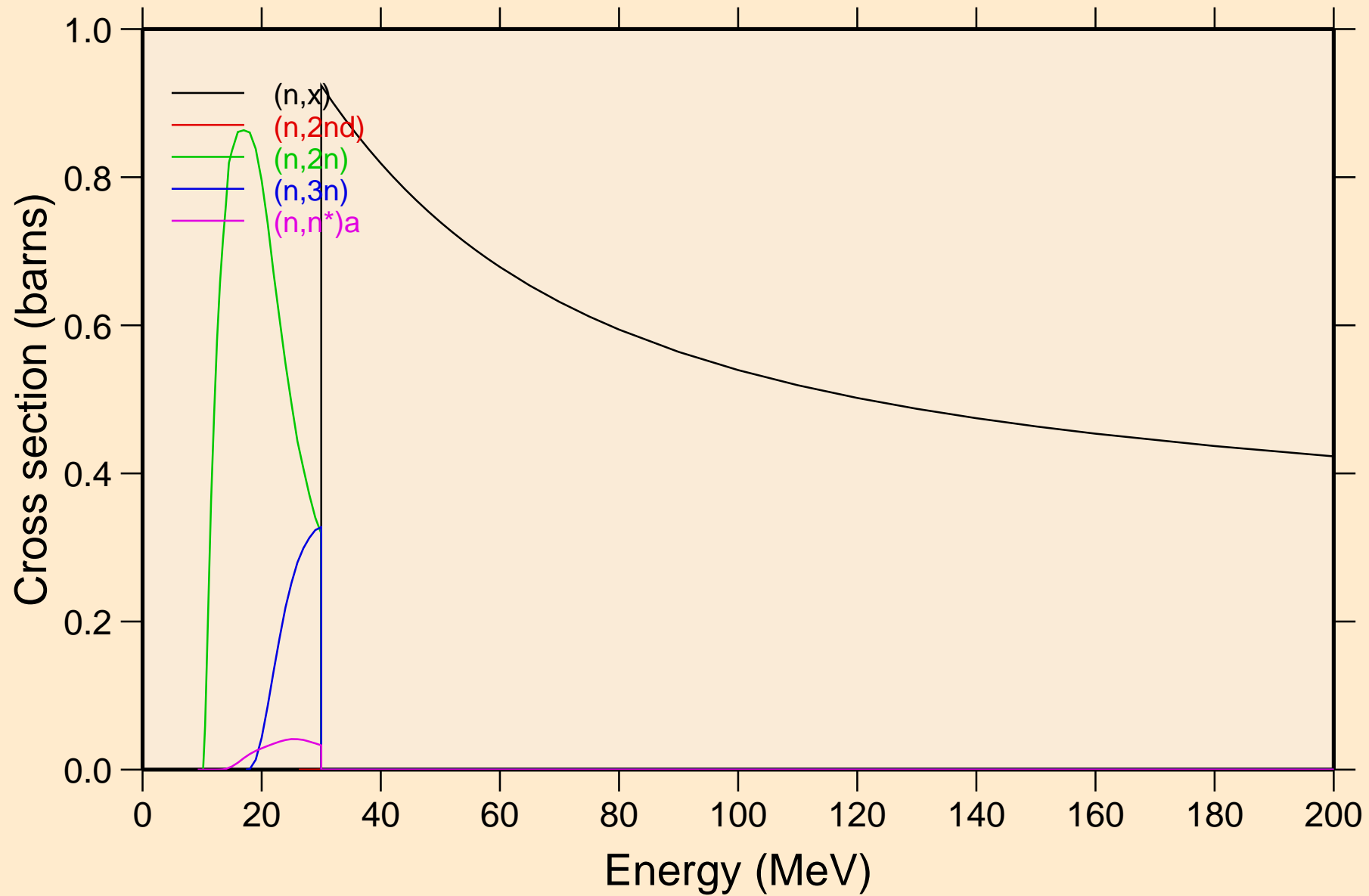

S036 NEUTRON ACER TENDL-2021 LIBRARY; T=293.6K

Threshold reactions

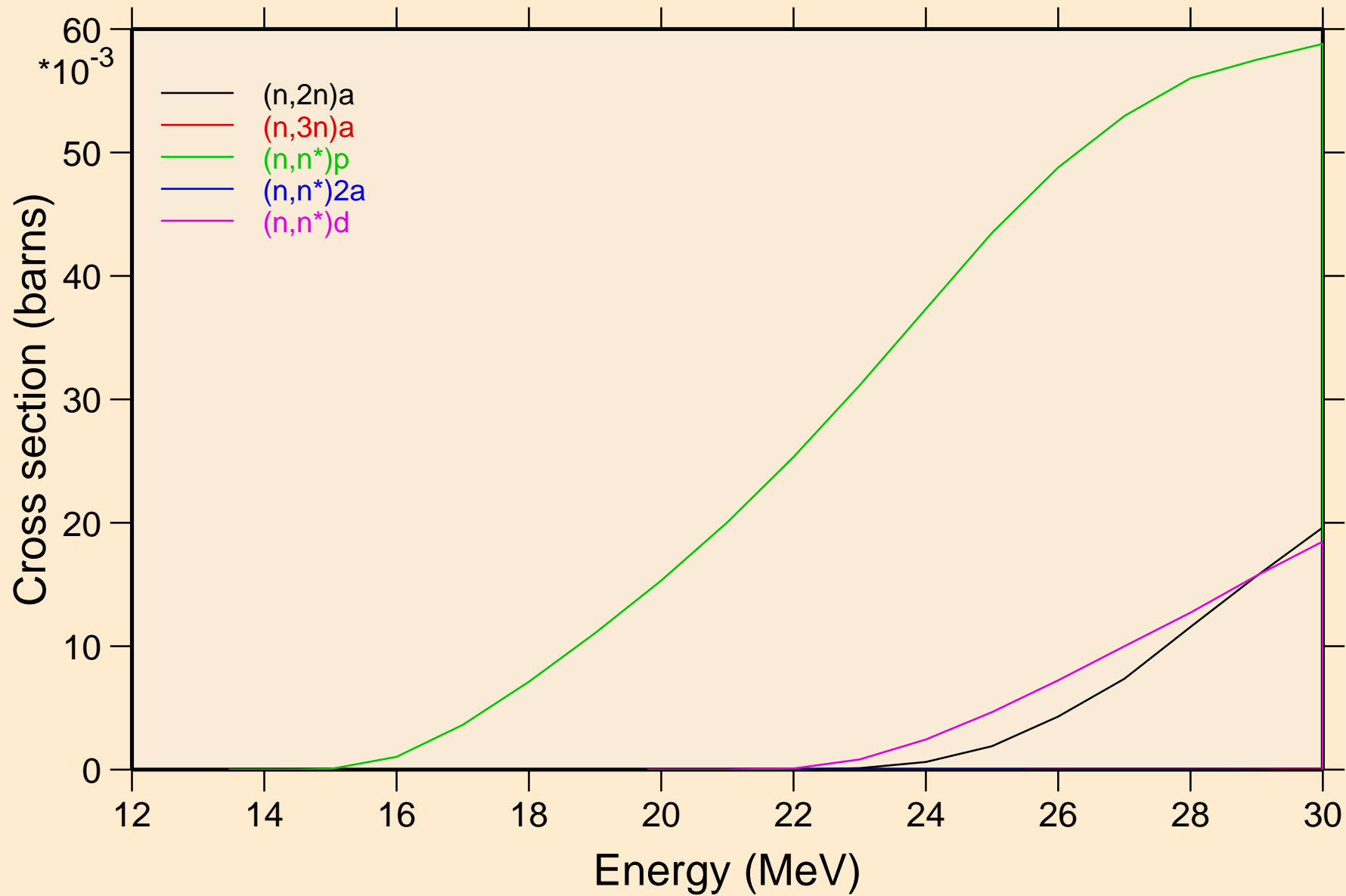

S036 NEUTRON ACER TENDL-2021 LIBRARY; T=293.6K
Threshold reactions

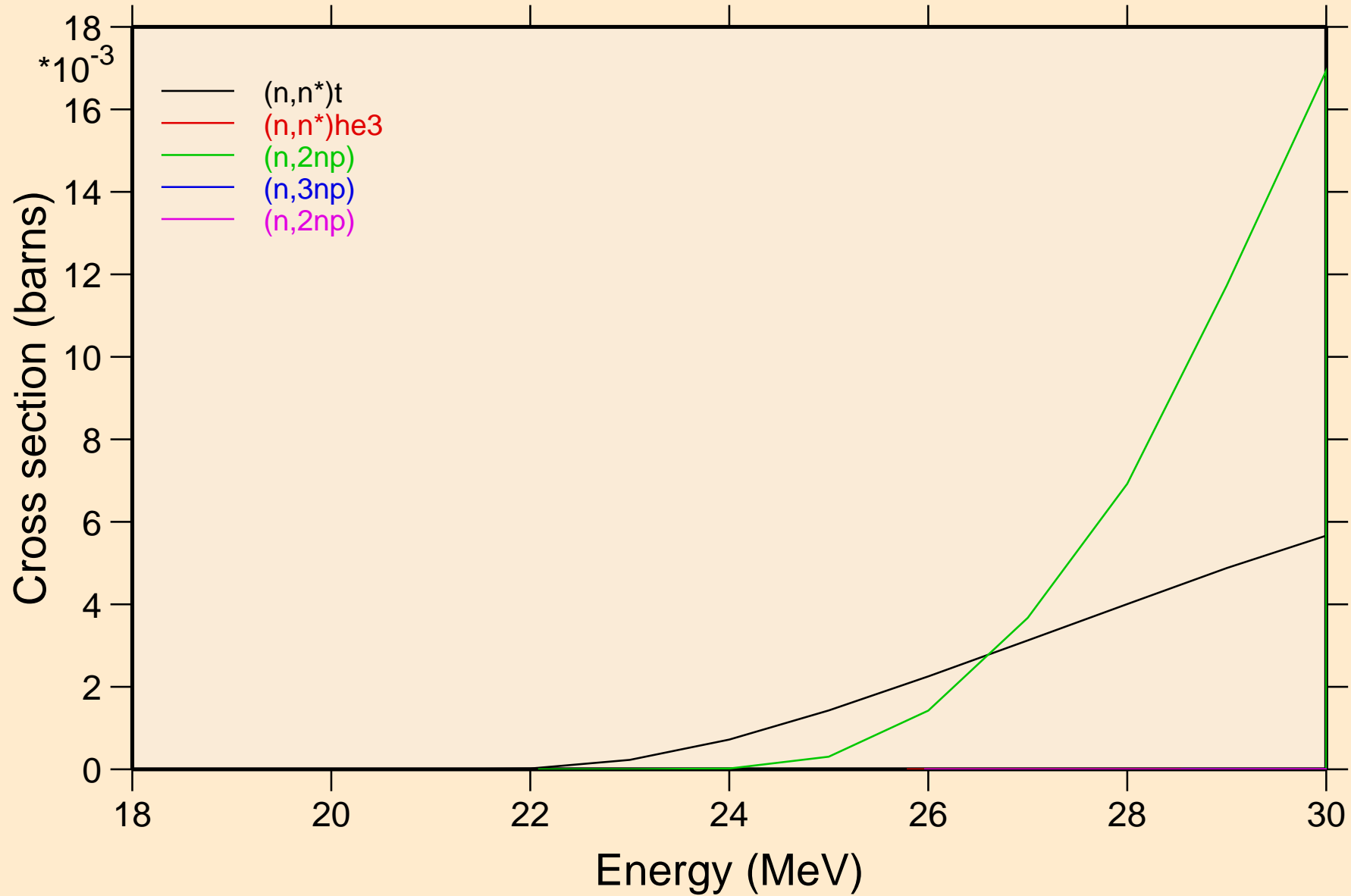

S036 NEUTRON ACER TENDL-2021 LIBRARY; T=293.6K

Threshold reactions

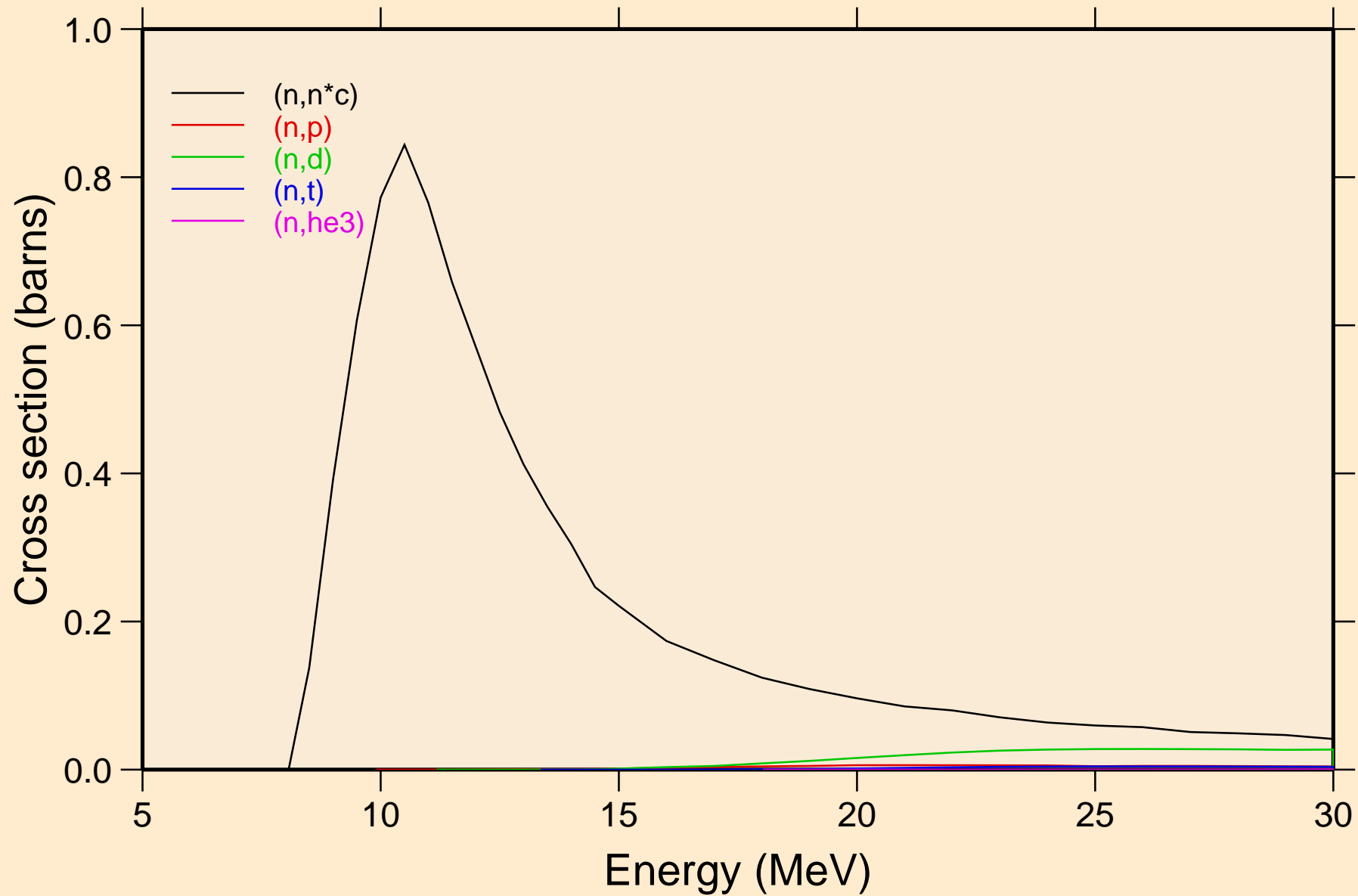

S036 NEUTRON ACER TENDL-2021 LIBRARY; T=293.6K
Threshold reactions

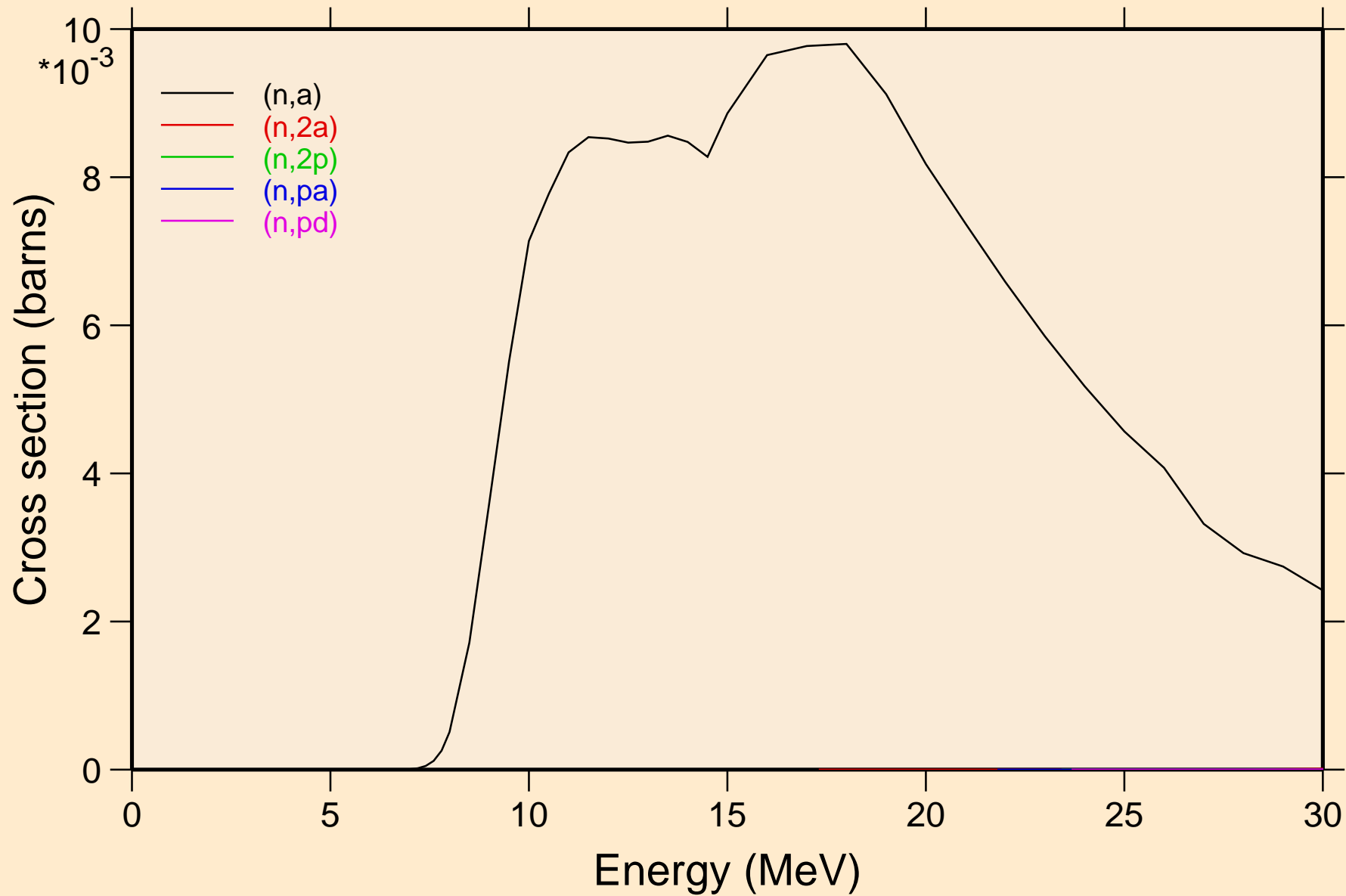

S036 NEUTRON ACER TENDL-2021 LIBRARY; T=293.6K
Threshold reactions

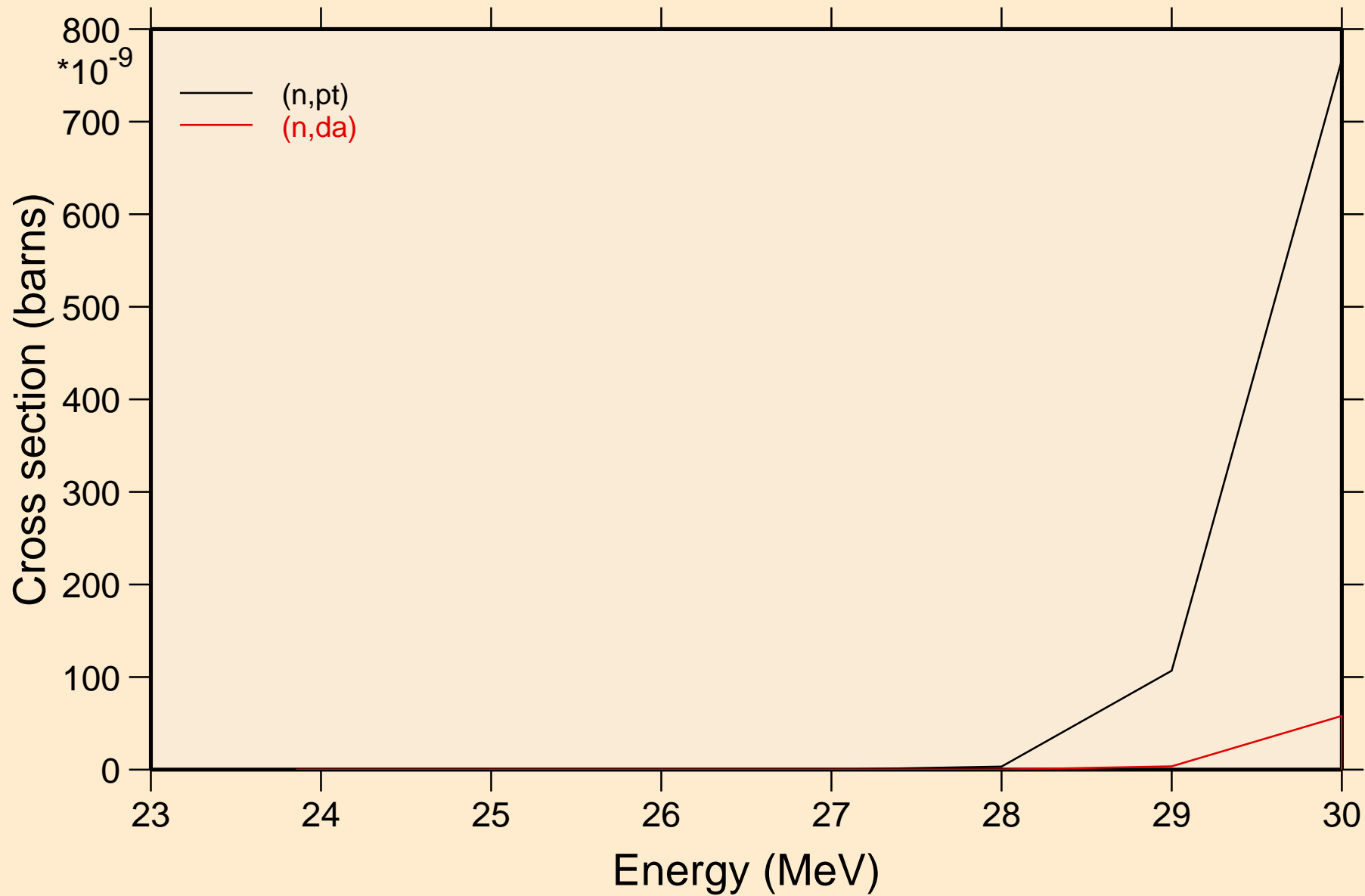

S036 NEUTRON ACER TENDL-2021 LIBRARY; T=293.6K
Threshold reactions

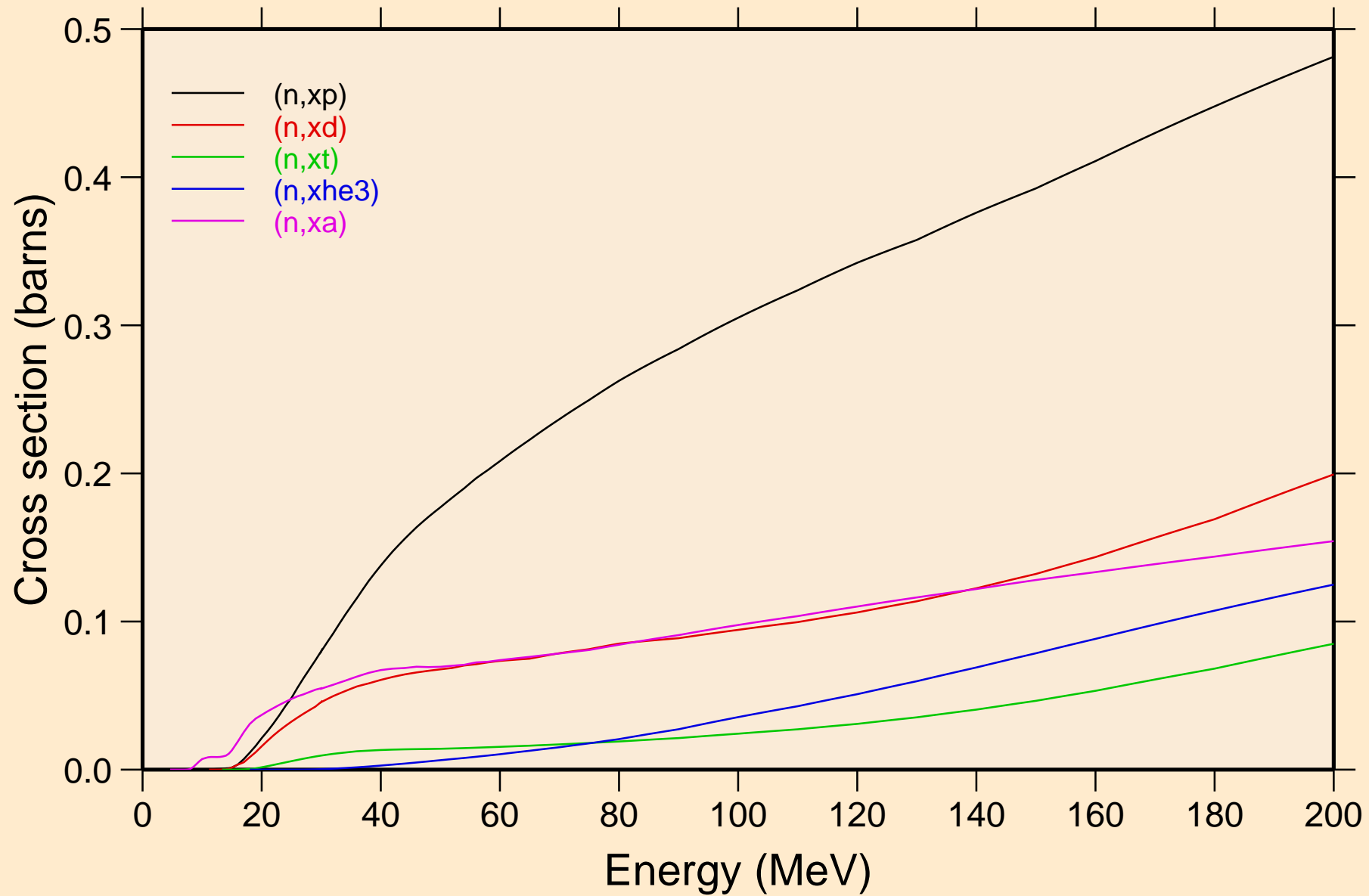

S036 NEUTRON ACER TENDL-2021 LIBRARY; T=293.6K
angular distribution for elastic

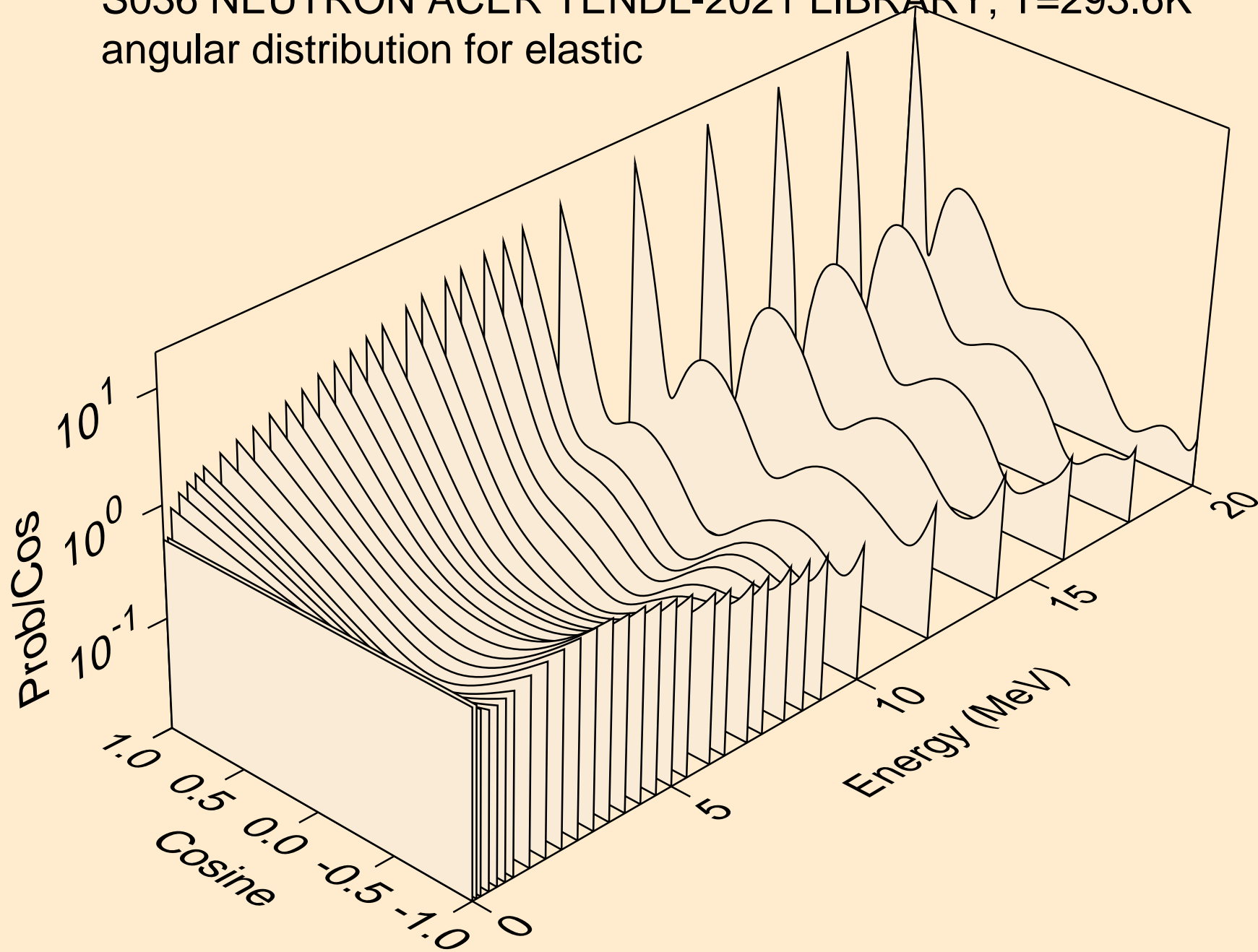

S036 NEUTRON ACER TENDL-2021 LIBRARY; T=293.6K
angular distribution for elastic

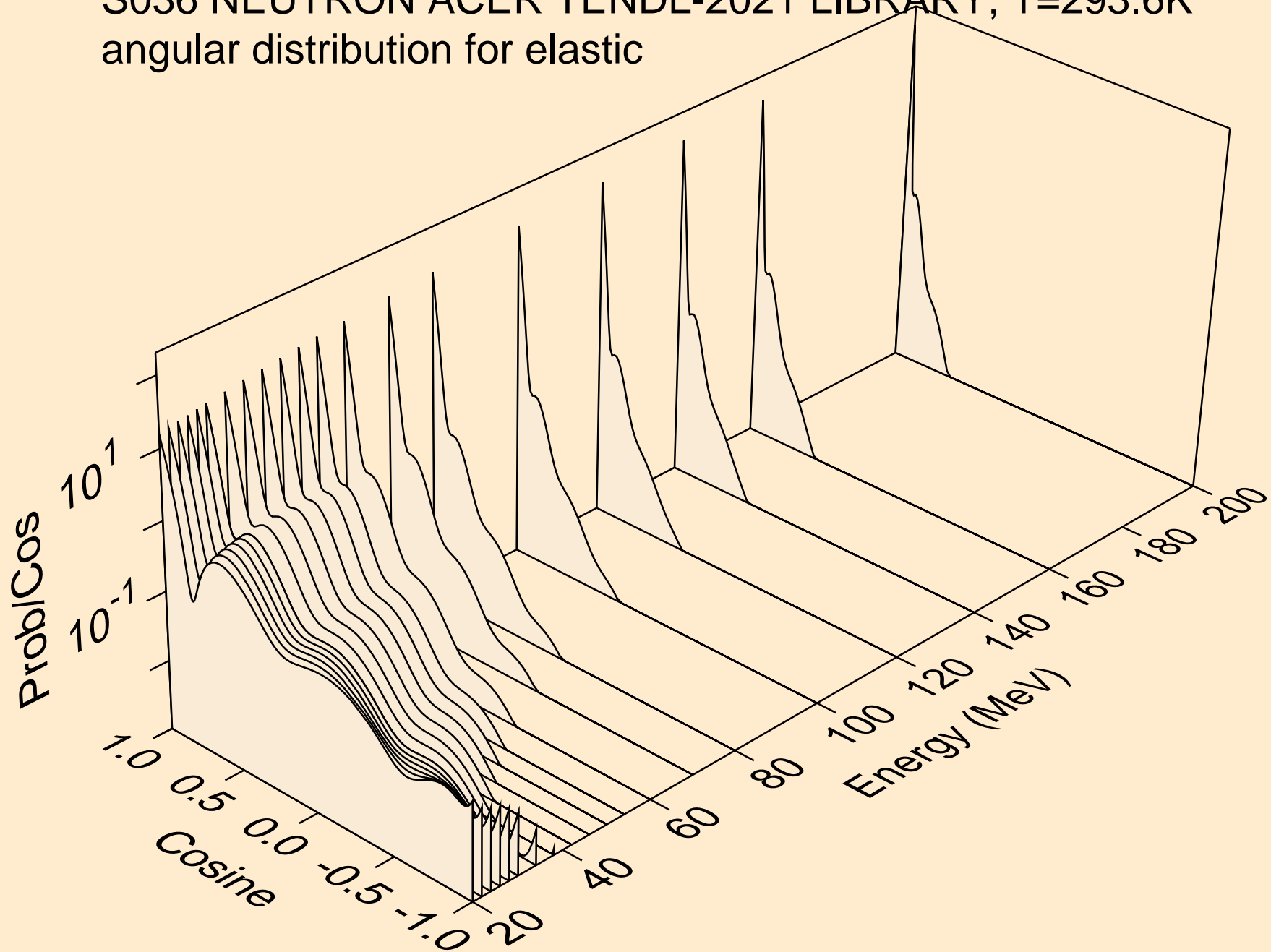

S036 NEUTRON ACER TENDL-2021 LIBRARY; T=293.6K
angular distribution for (n,n*1)

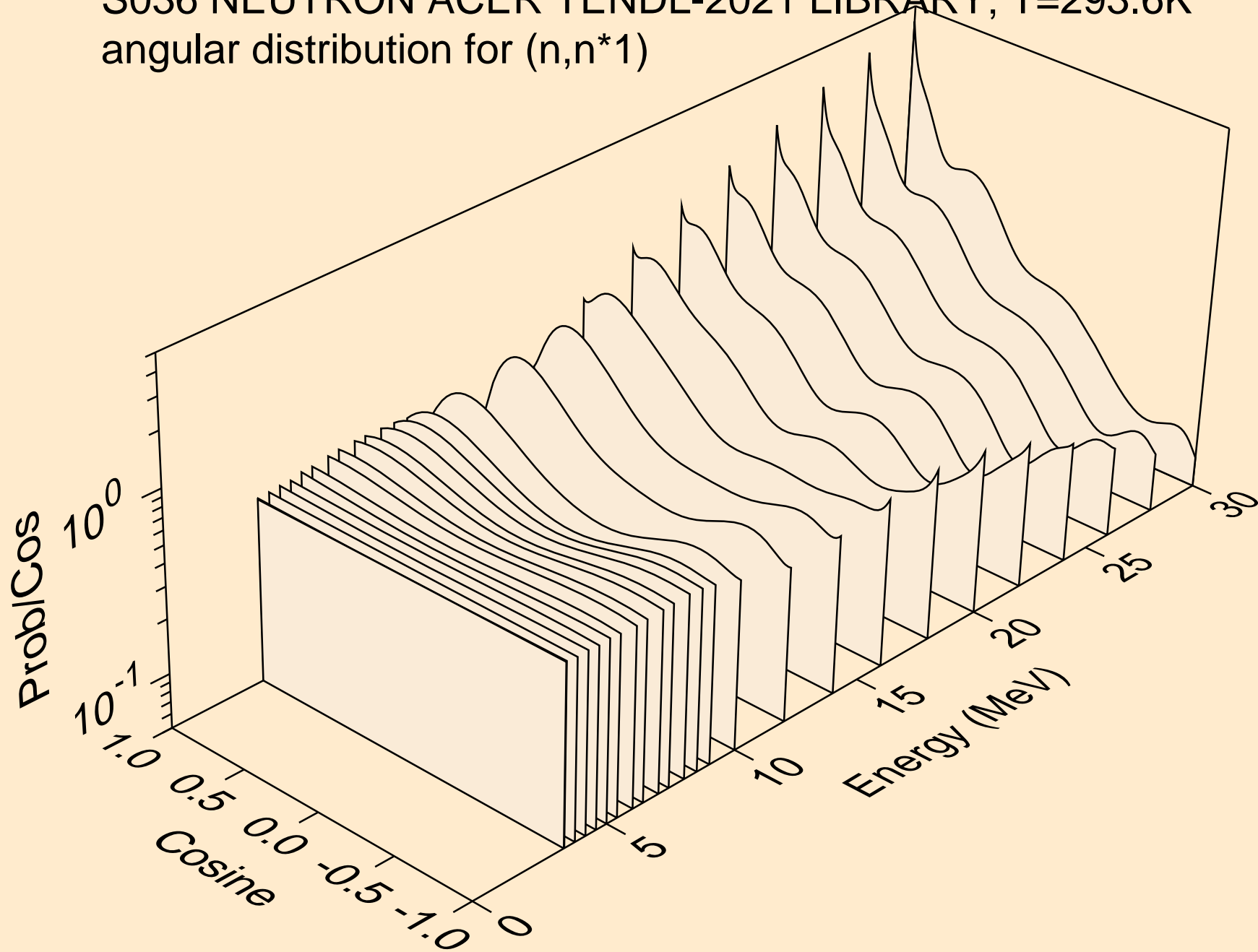

S036 NEUTRON ACER TENDL-2021 LIBRARY; T=293.6K
angular distribution for (n,n*2)

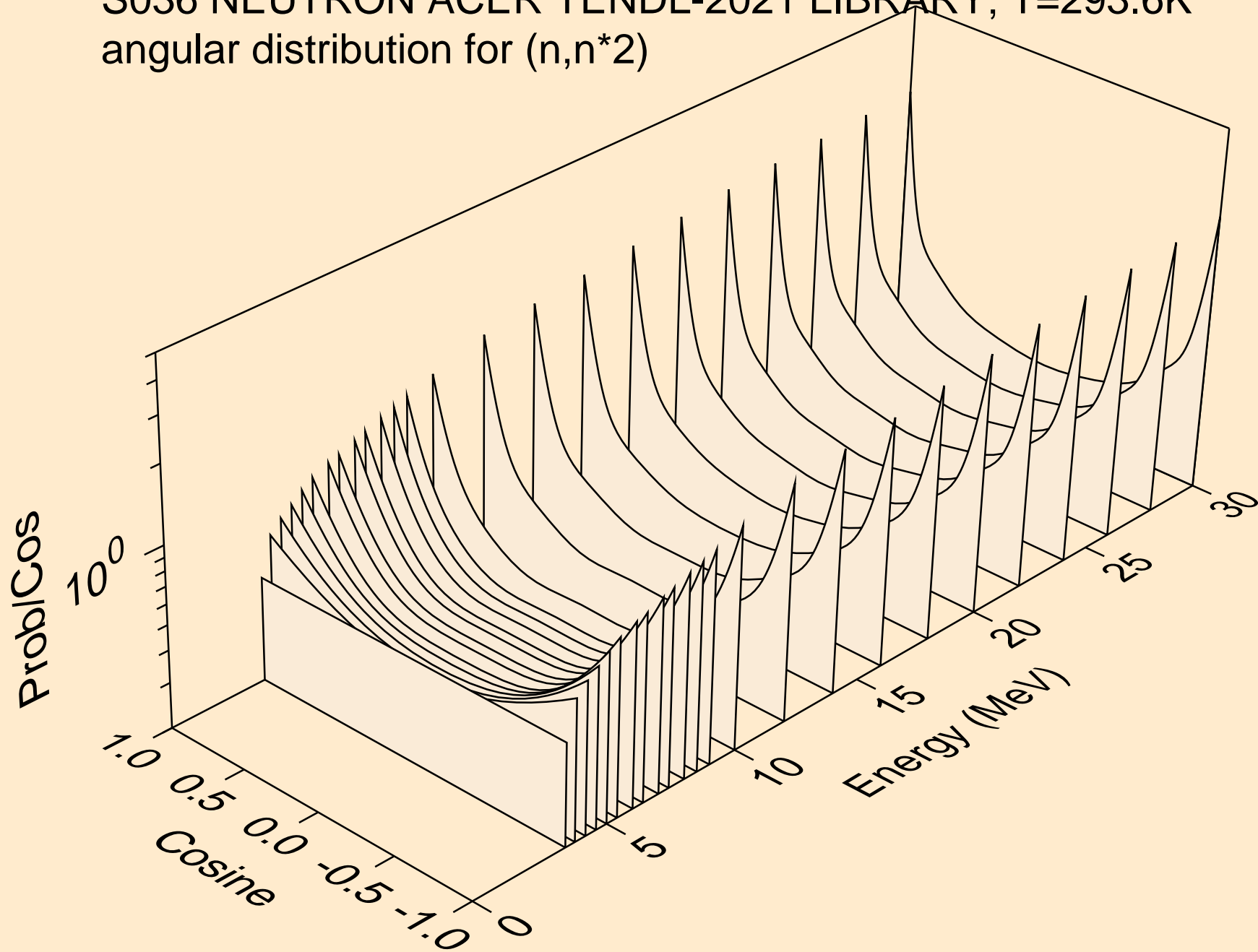

S036 NEUTRON ACER TENDL-2021 LIBRARY; T=293.6K
angular distribution for (n,n*3)

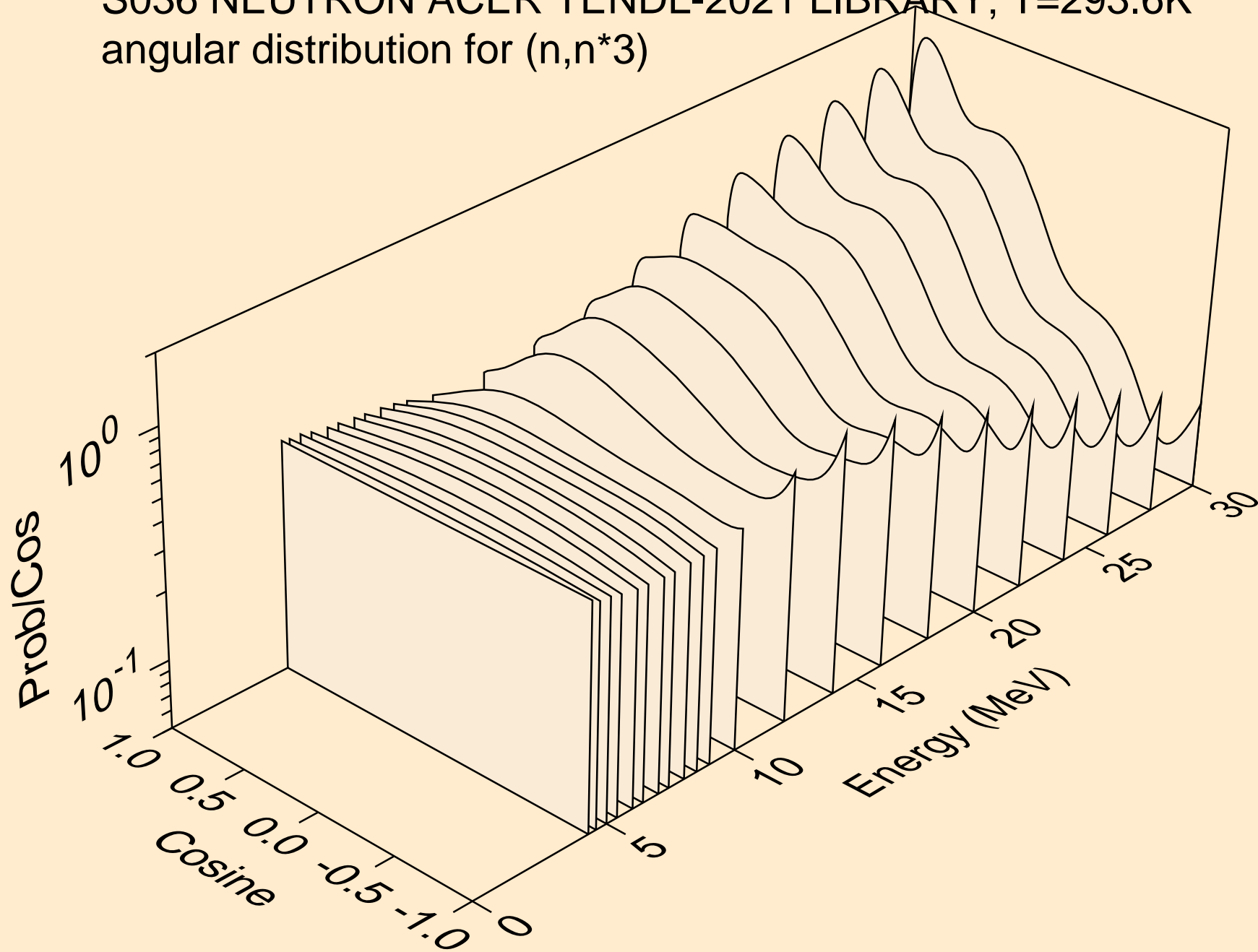

S036 NEUTRON ACER TENDL-2021 LIBRARY; T=293.6K
angular distribution for (n,n*4)

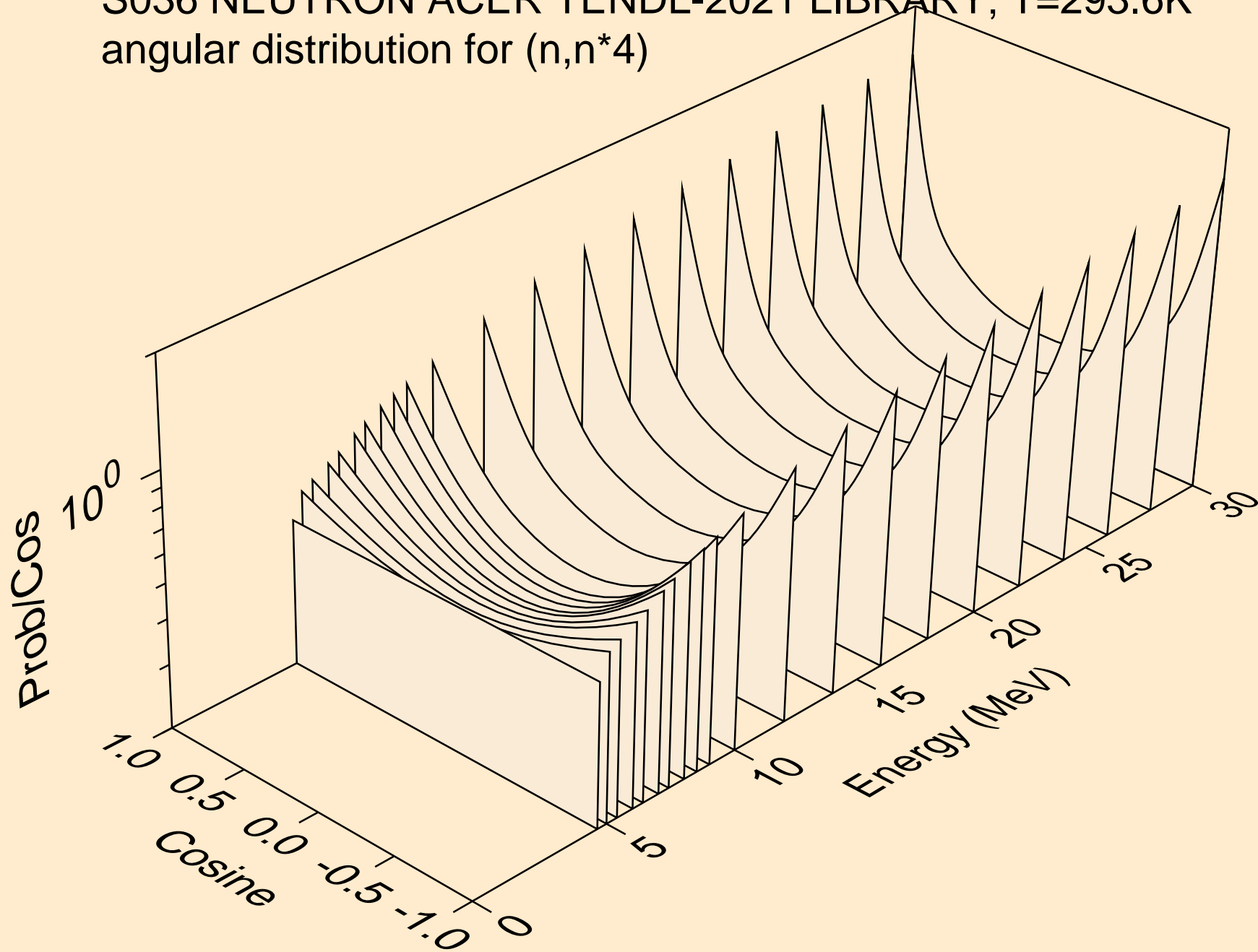

S036 NEUTRON ACER TENDL-2021 LIBRARY; T=293.6K
angular distribution for (n,n*5)

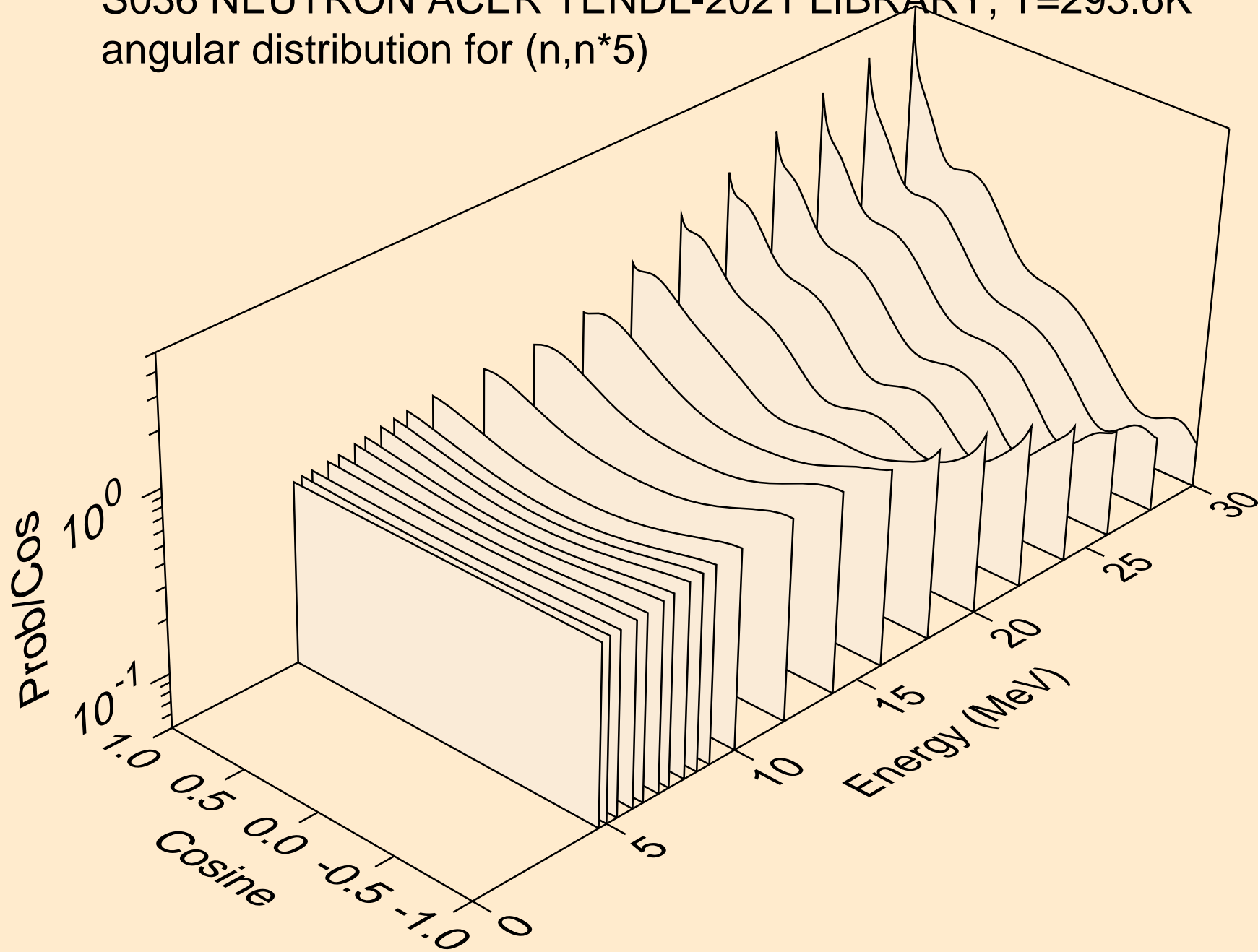

S036 NEUTRON ACER TENDL-2021 LIBRARY; T=293.6K
angular distribution for (n,n*6)

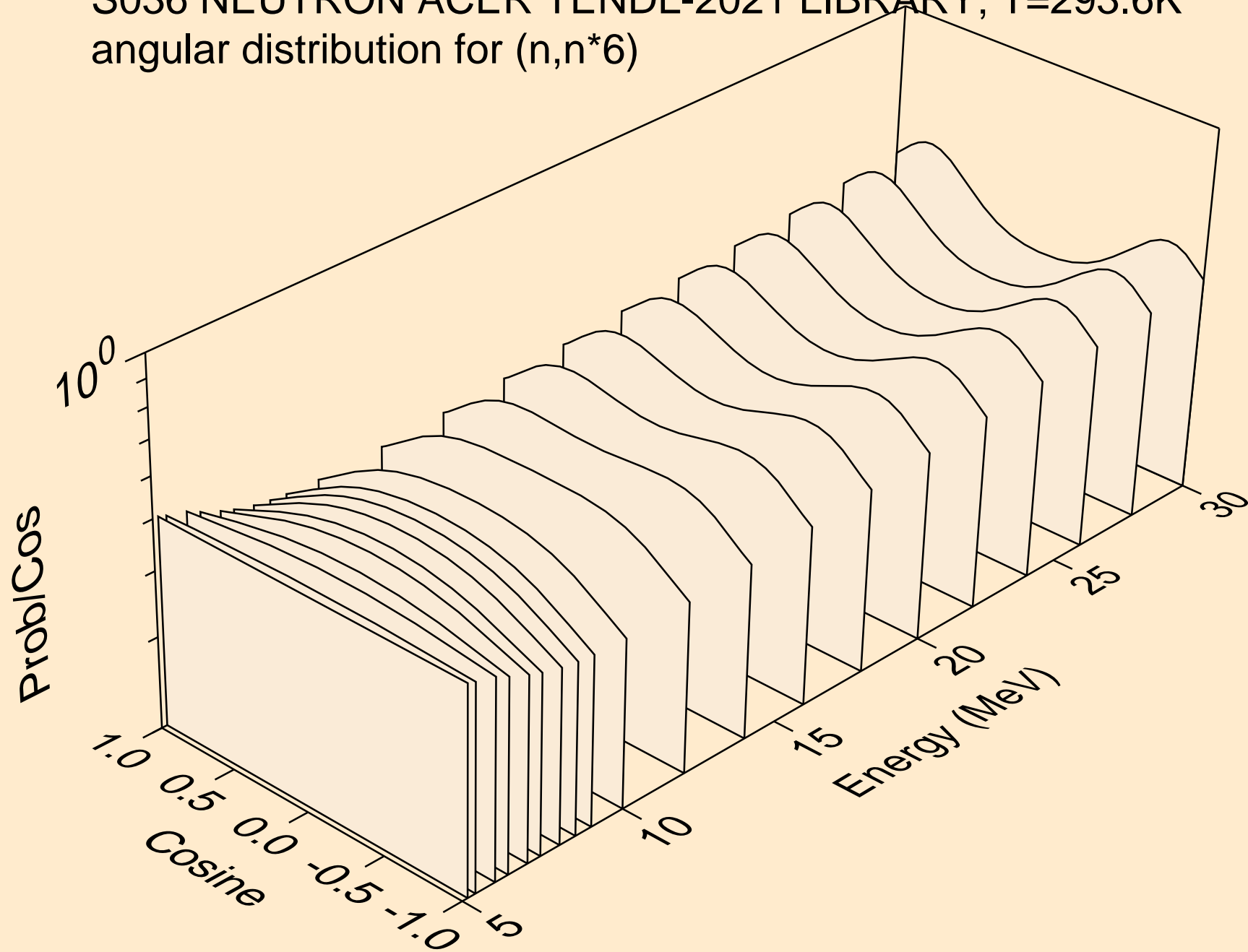

S036 NEUTRON ACER TENDL-2021 LIBRARY; T=293.6K
angular distribution for (n,n*7)

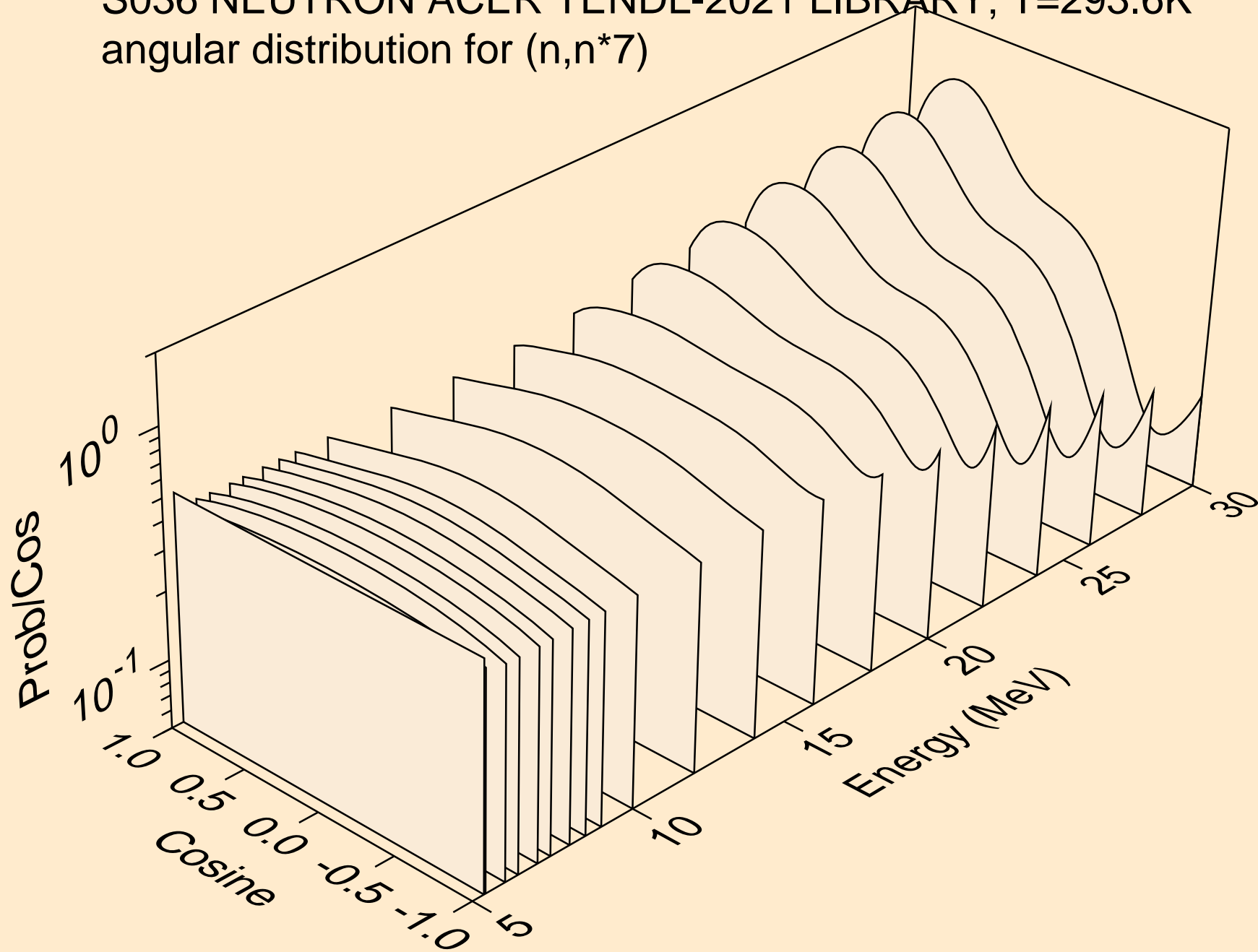

S036 NEUTRON ACER TENDL-2021 LIBRARY; T=293.6K
angular distribution for (n,n*8)

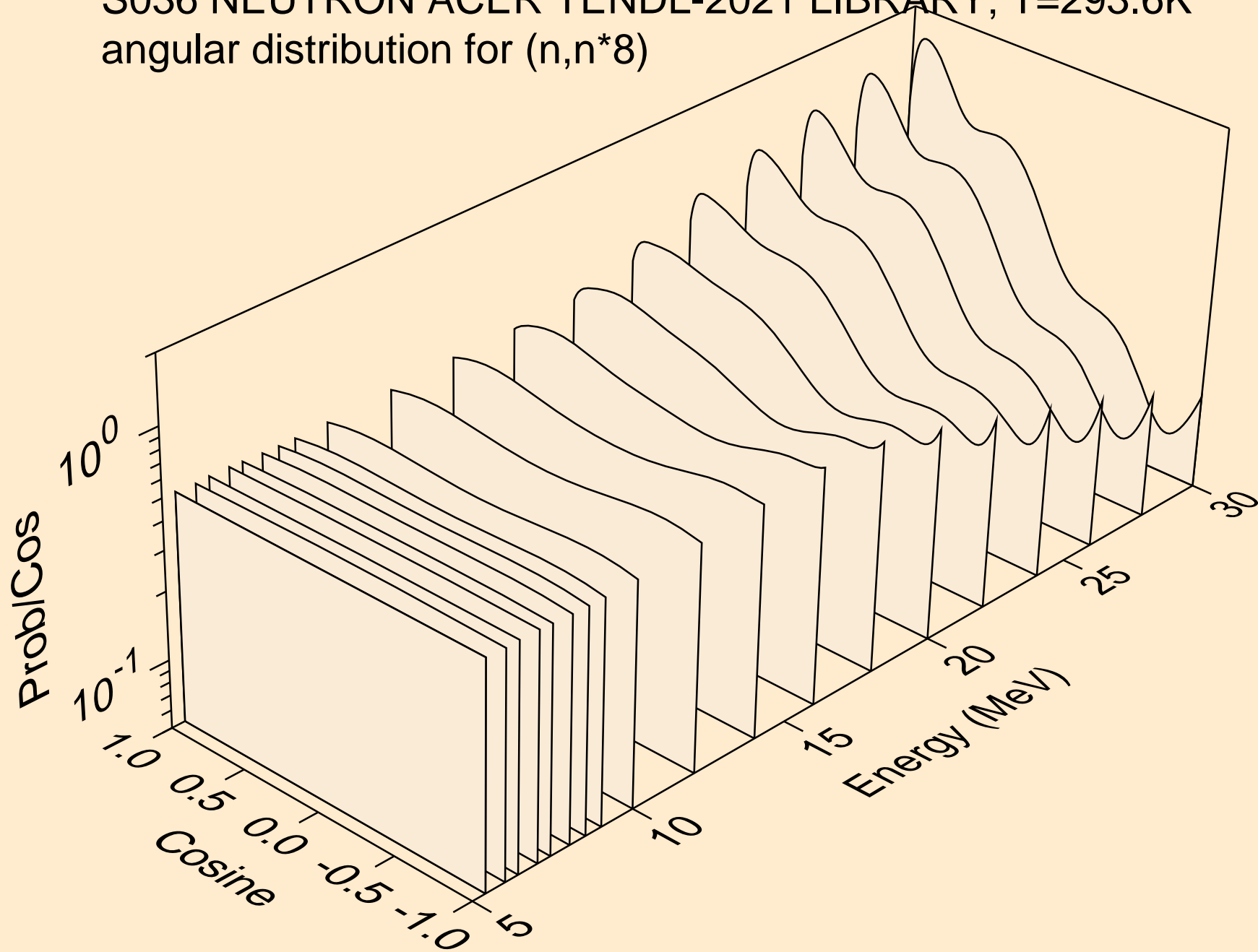

S036 NEUTRON ACER TENDL-2021 LIBRARY; T=293.6K
angular distribution for (n,n*9)

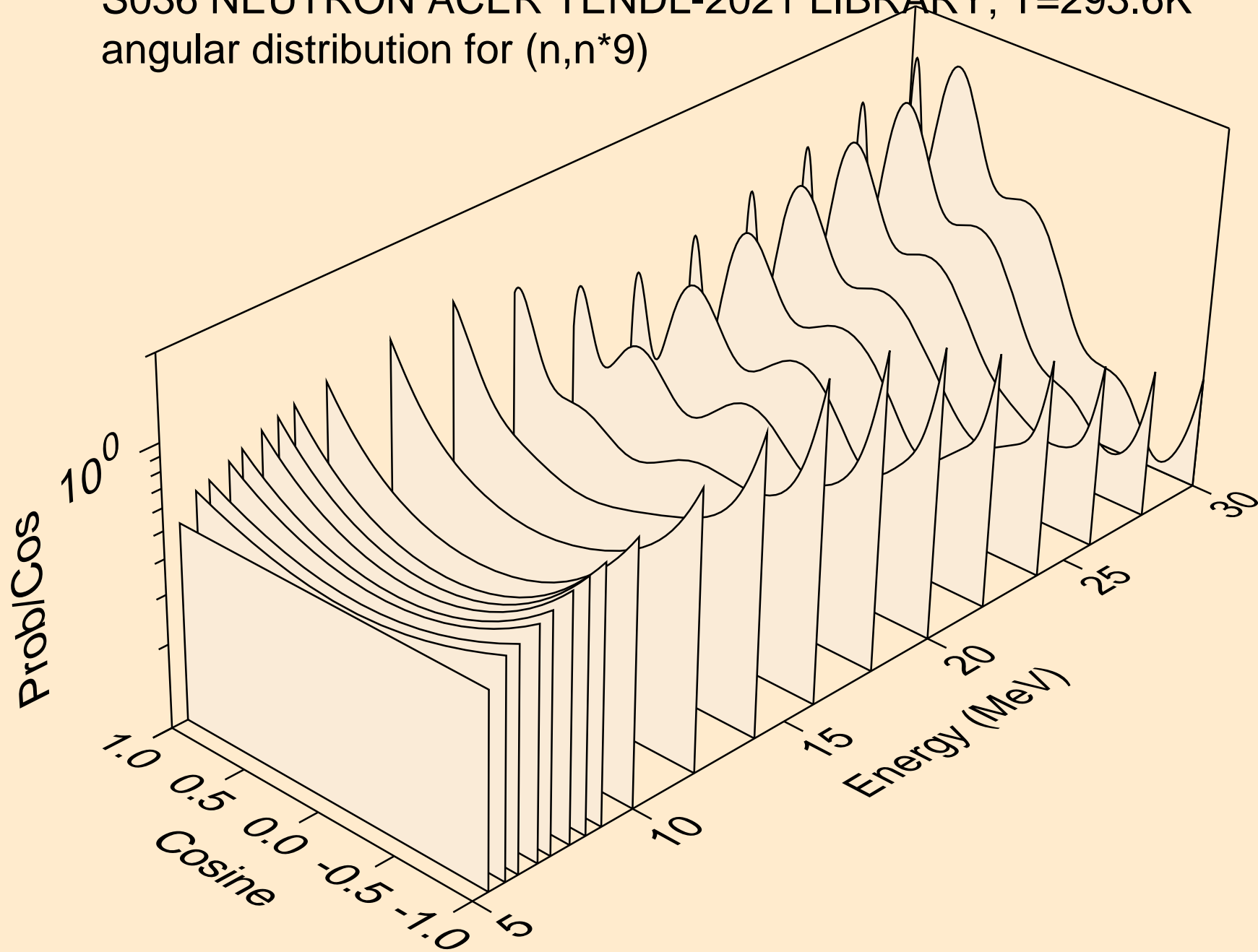

S036 NEUTRON ACER TENDL-2021 LIBRARY; T=293.6K
angular distribution for (n,n*10)

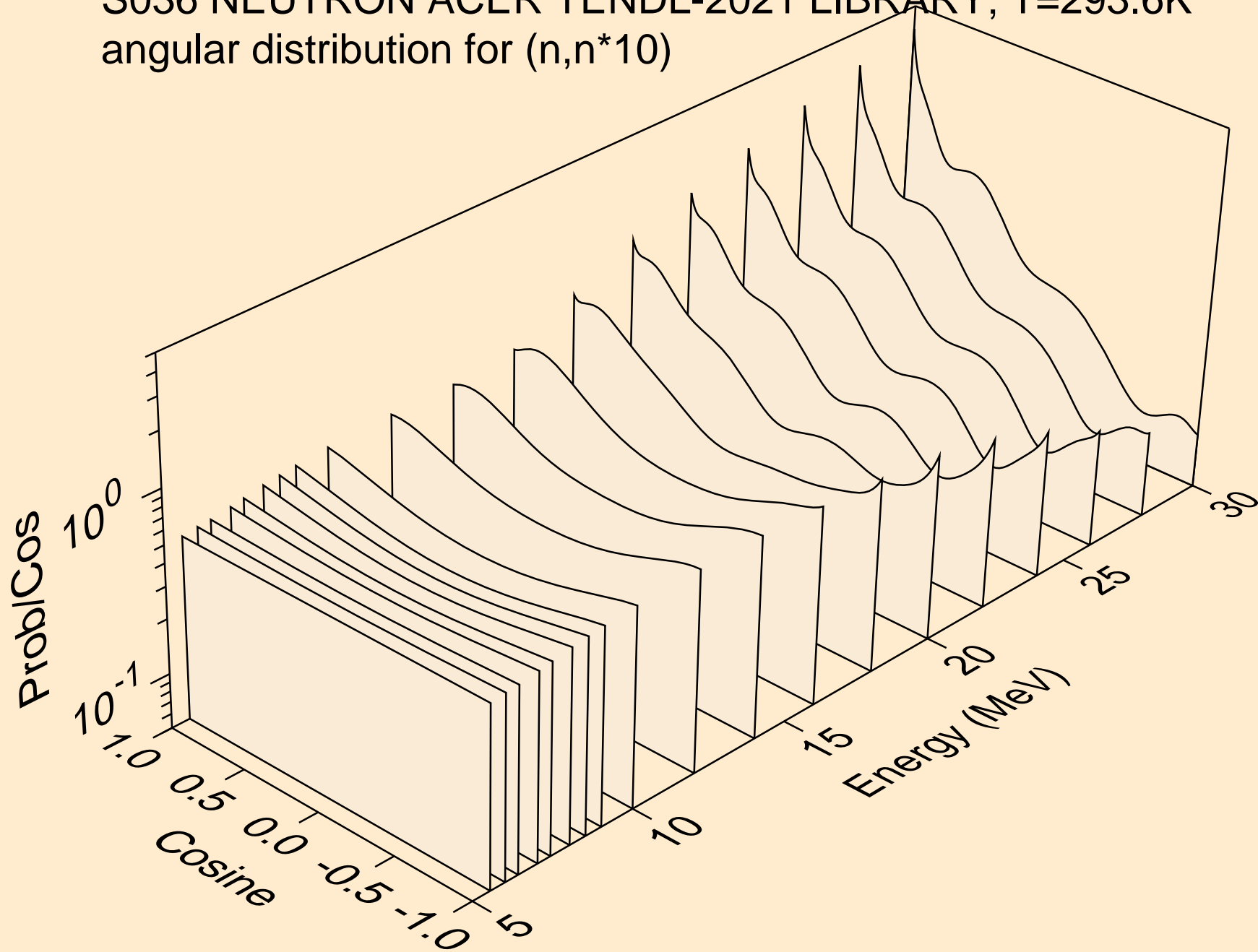

S036 NEUTRON ACER TENDL-2021 LIBRARY; T=293.6K
angular distribution for (n,n*11)

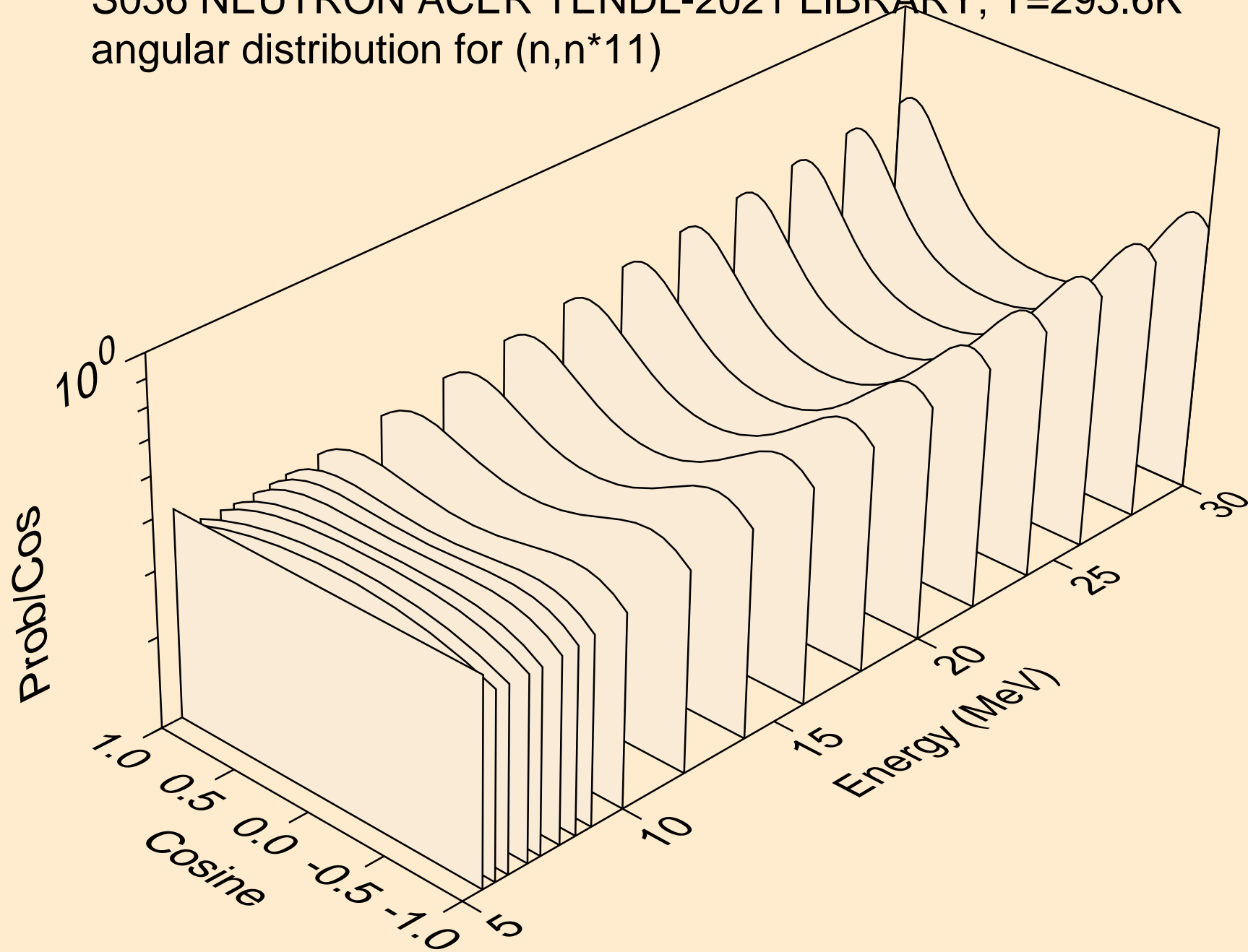

S036 NEUTRON ACER TENDL-2021 LIBRARY; T=293.6K
angular distribution for (n,n*12)

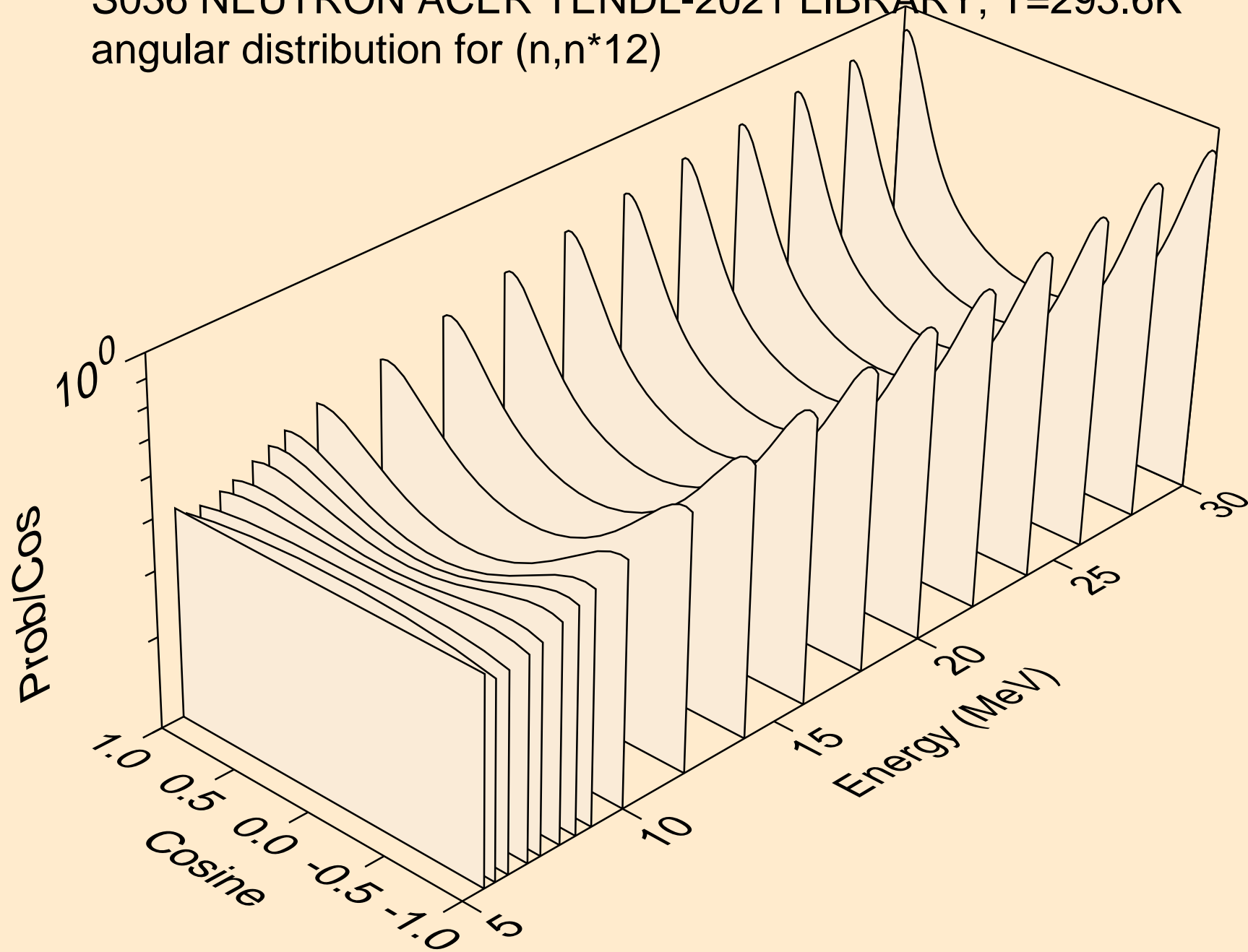

S036 NEUTRON ACER TENDL-2021 LIBRARY; T=293.6K
angular distribution for (n,n*13)

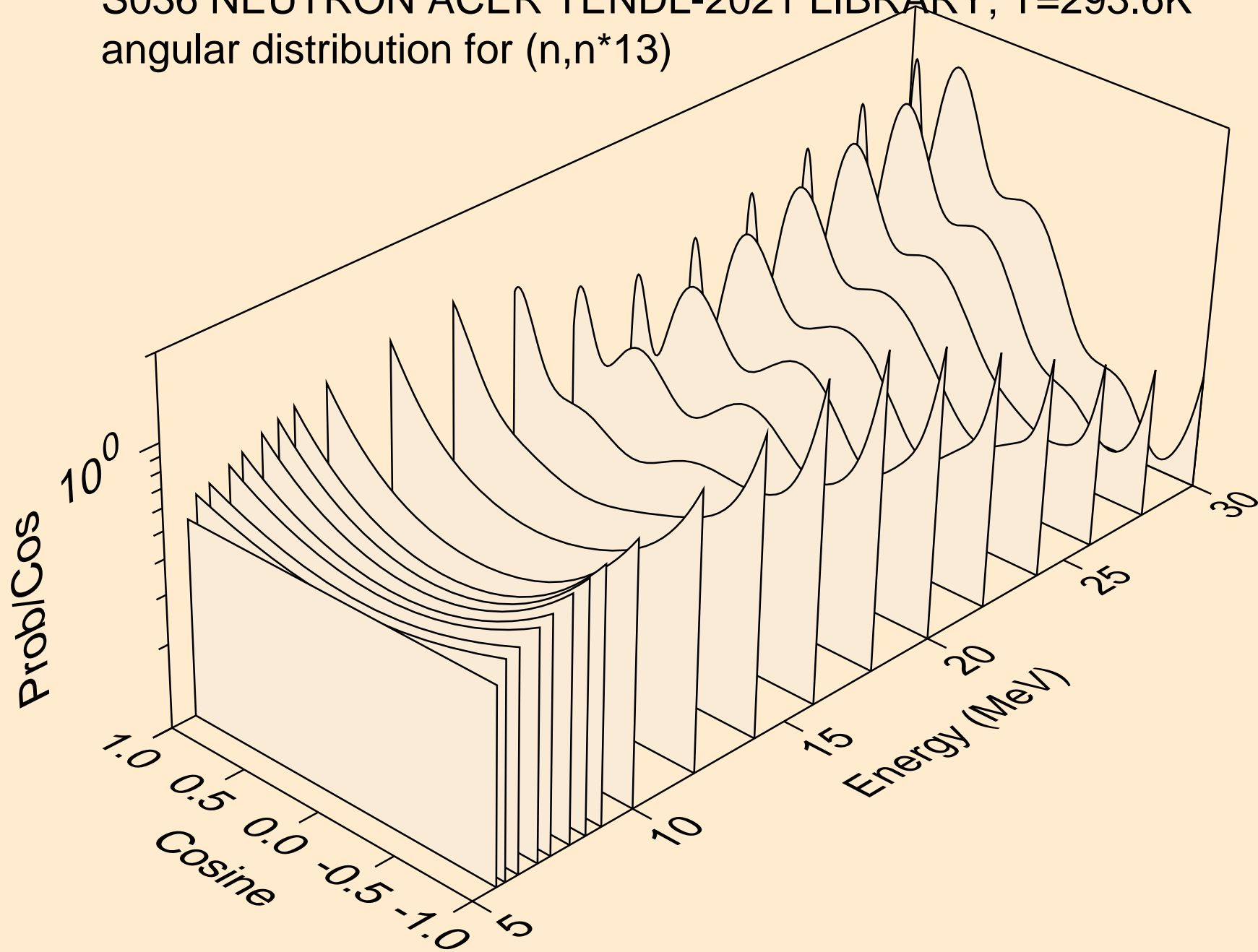

S036 NEUTRON ACER TENDL-2021 LIBRARY; T=293.6K
angular distribution for (n,n*14)

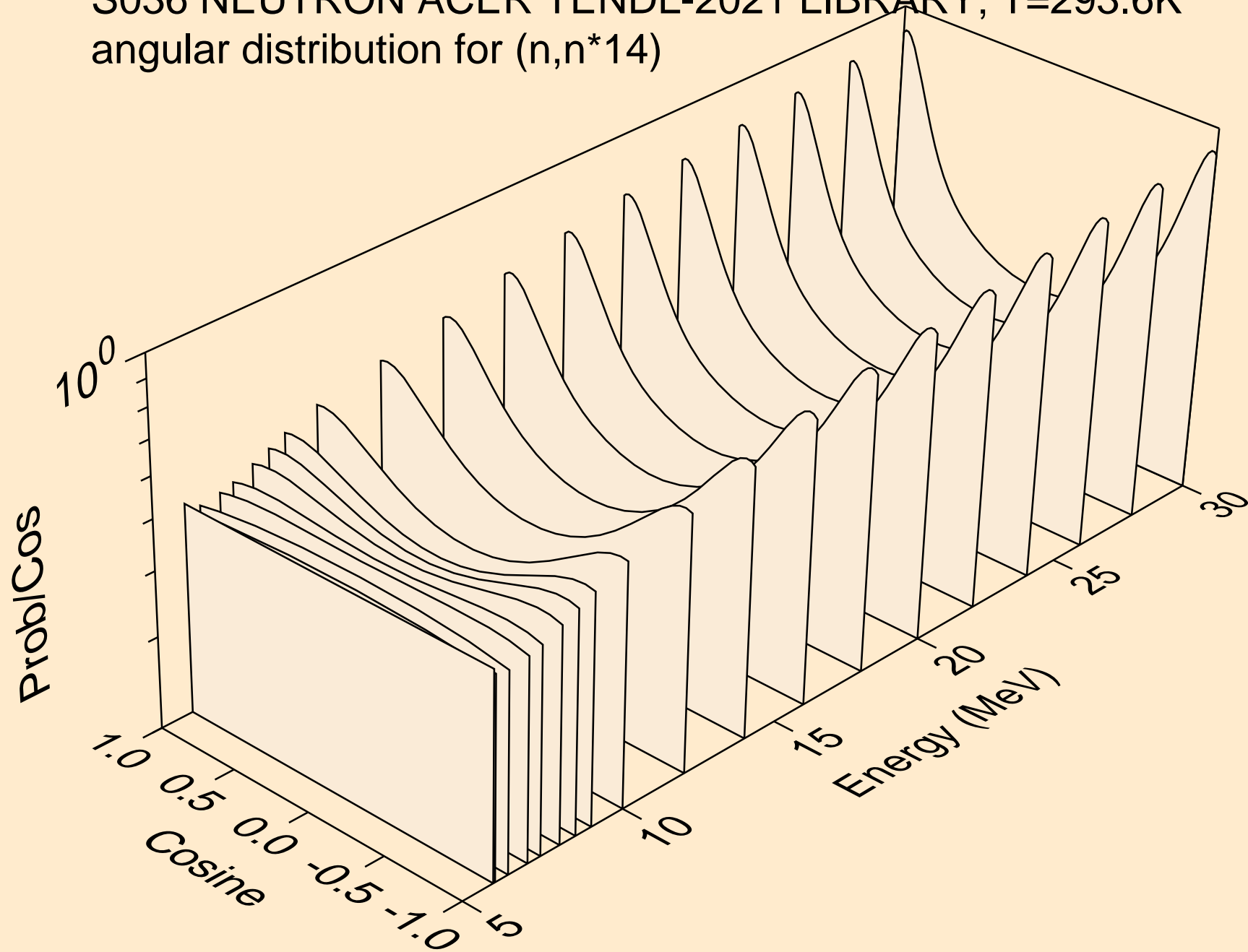

S036 NEUTRON ACER TENDL-2021 LIBRARY; T=293.6K
angular distribution for (n,n*15)

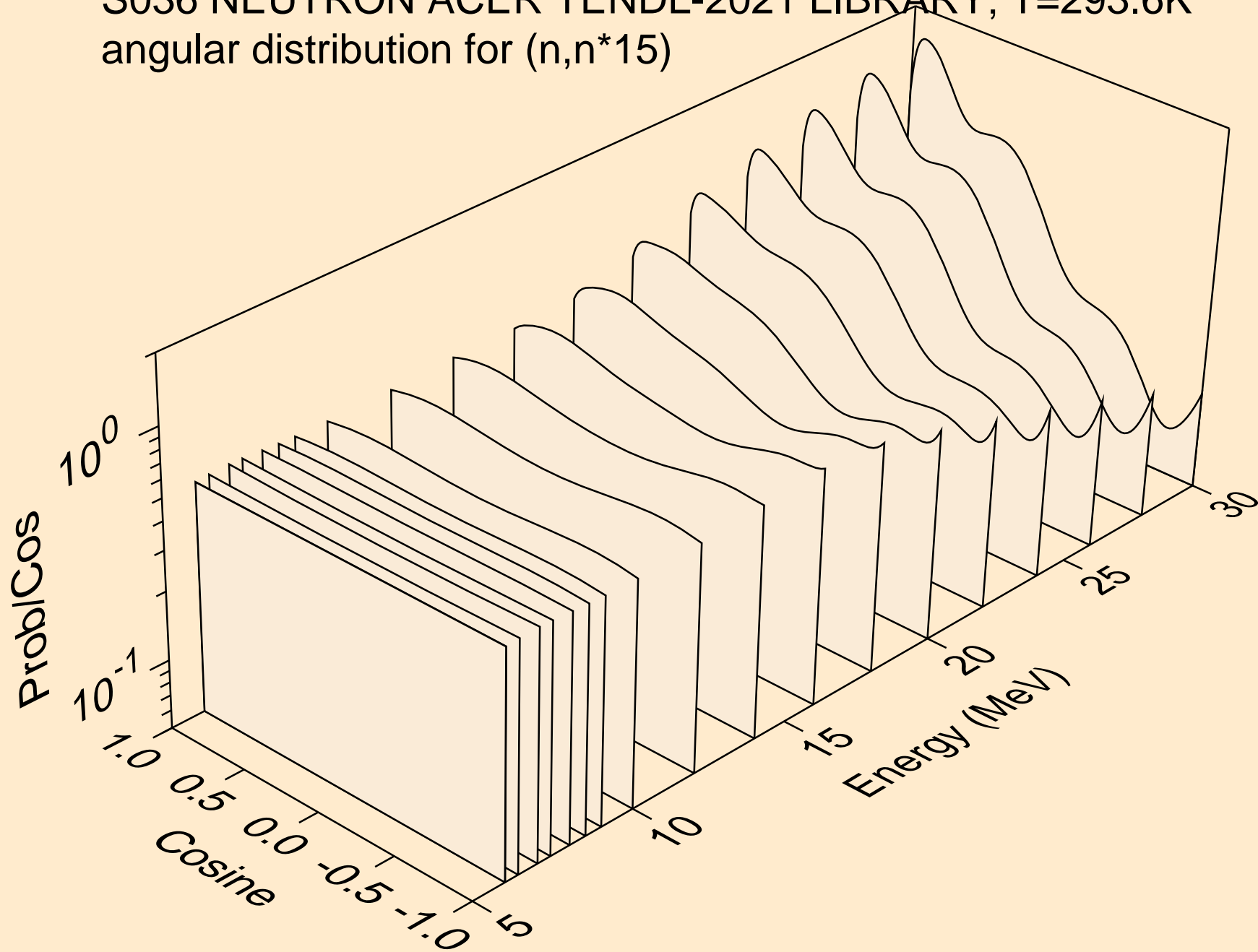

S036 NEUTRON ACER TENDL-2021 LIBRARY; T=293.6K
angular distribution for (n,n*16)

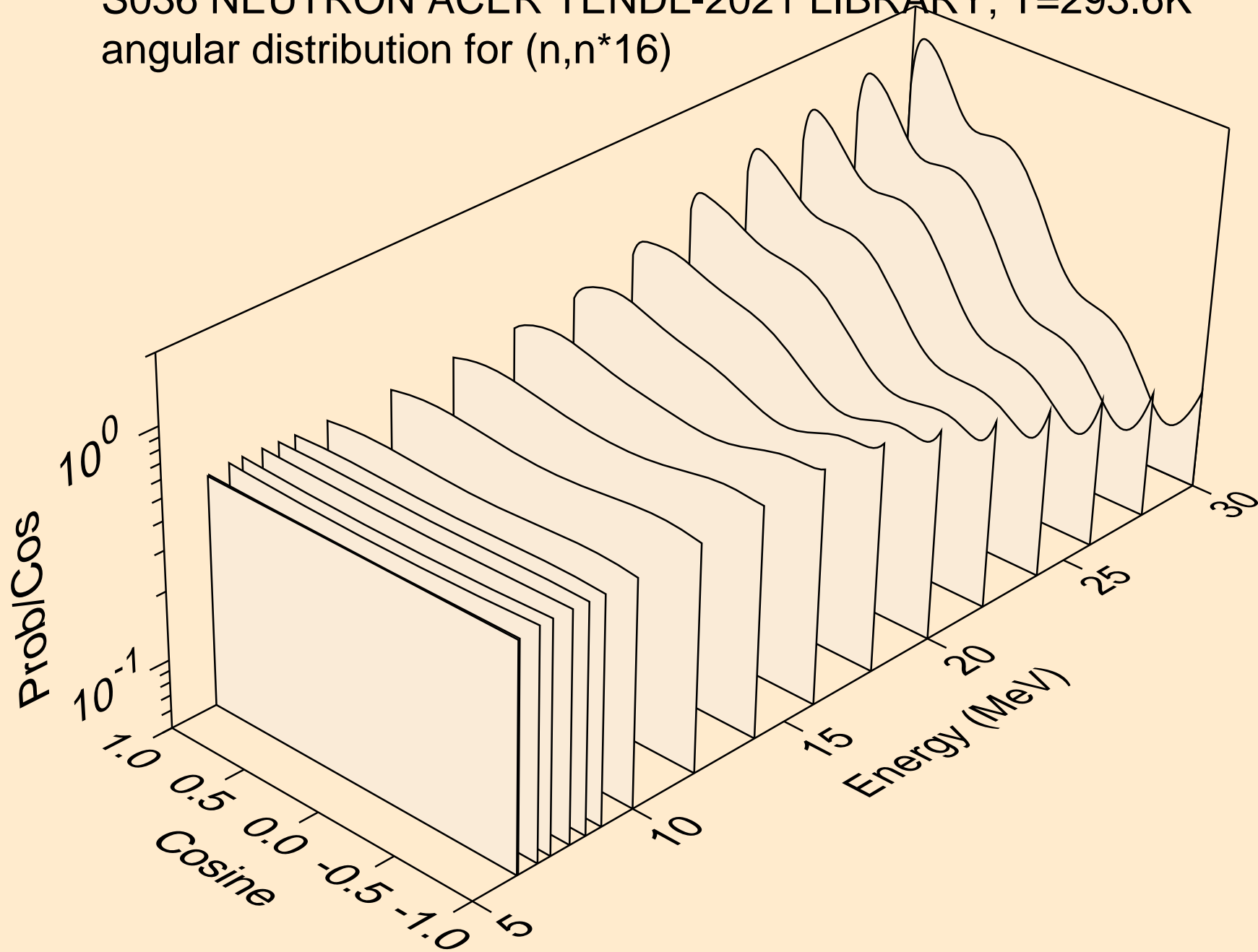

S036 NEUTRON ACER TENDL-2021 LIBRARY; T=293.6K
angular distribution for (n,n*17)

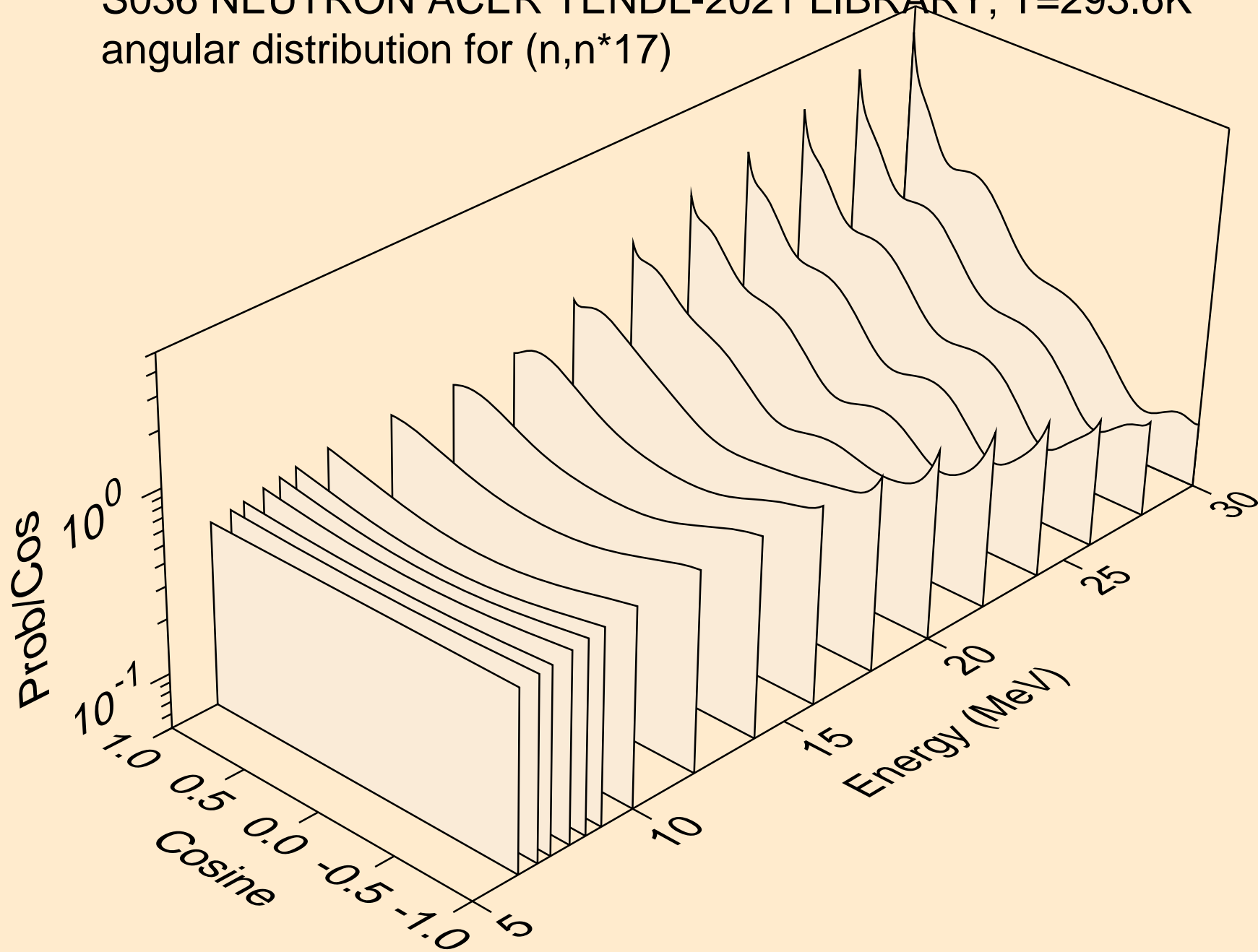

S036 NEUTRON ACER TENDL-2021 LIBRARY; T=293.6K
angular distribution for (n,n*18)

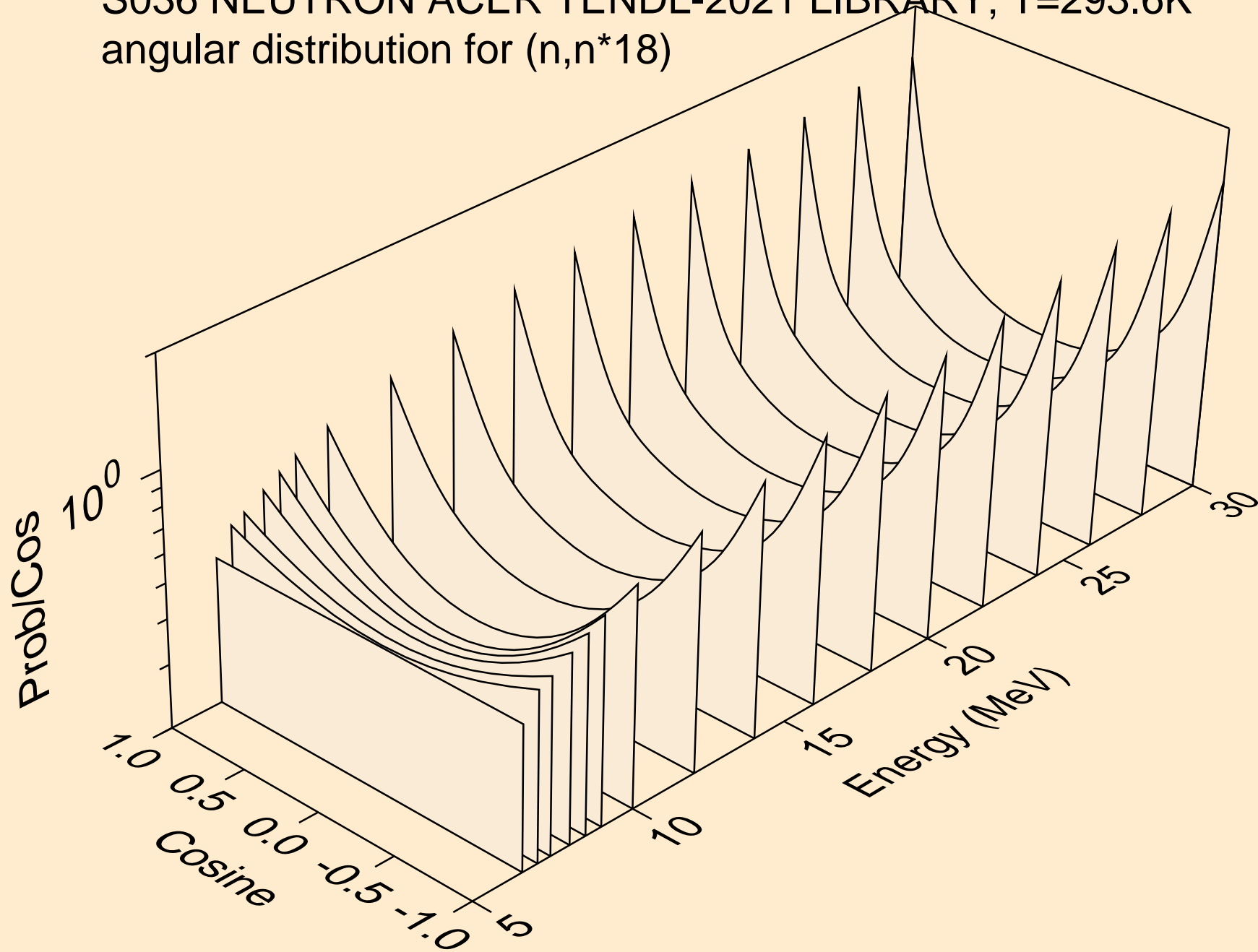

S036 NEUTRON ACER TENDL-2021 LIBRARY; T=293.6K
angular distribution for (n,n*19)

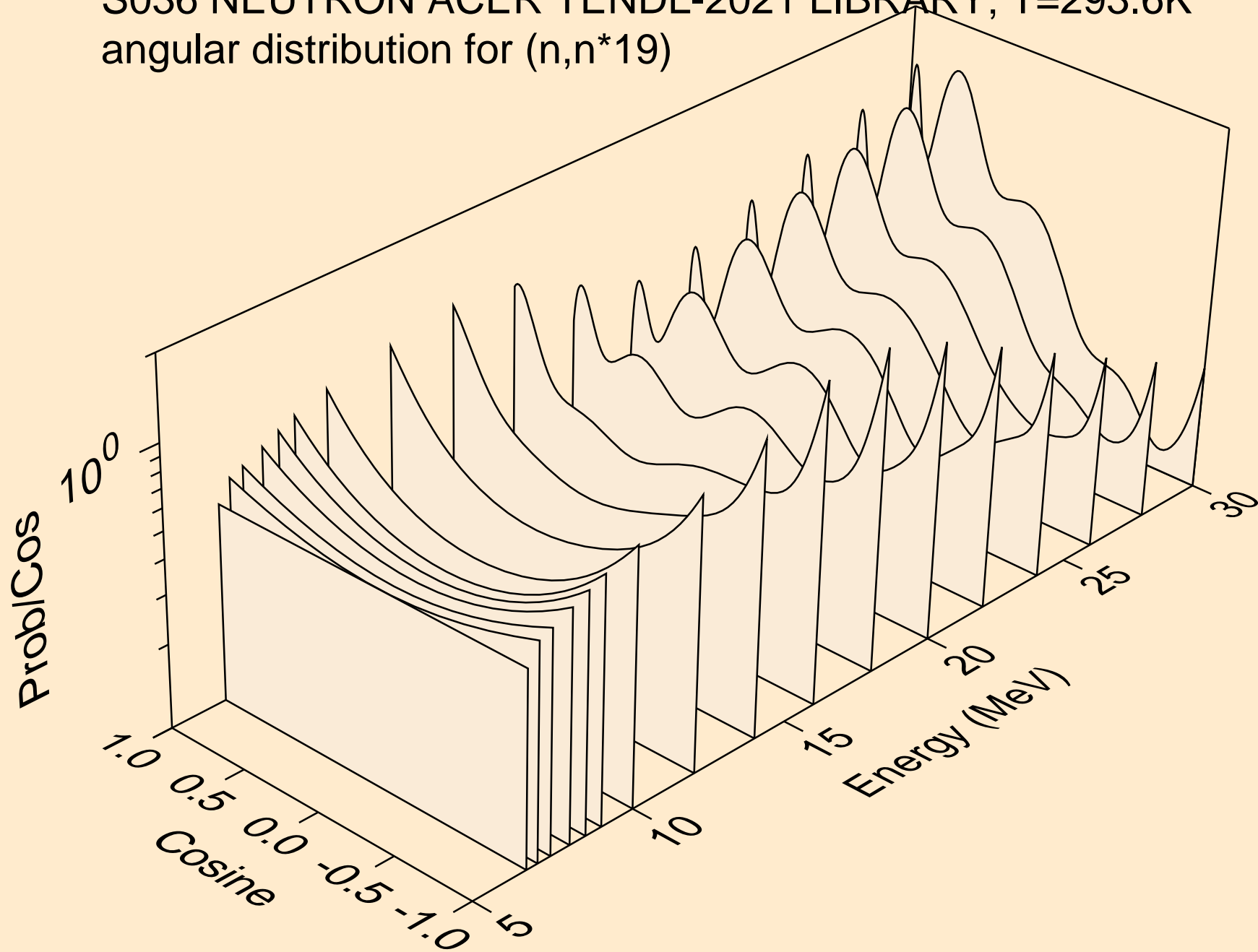

S036 NEUTRON ACER TENDL-2021 LIBRARY; T=293.6K
angular distribution for (n,n*20)

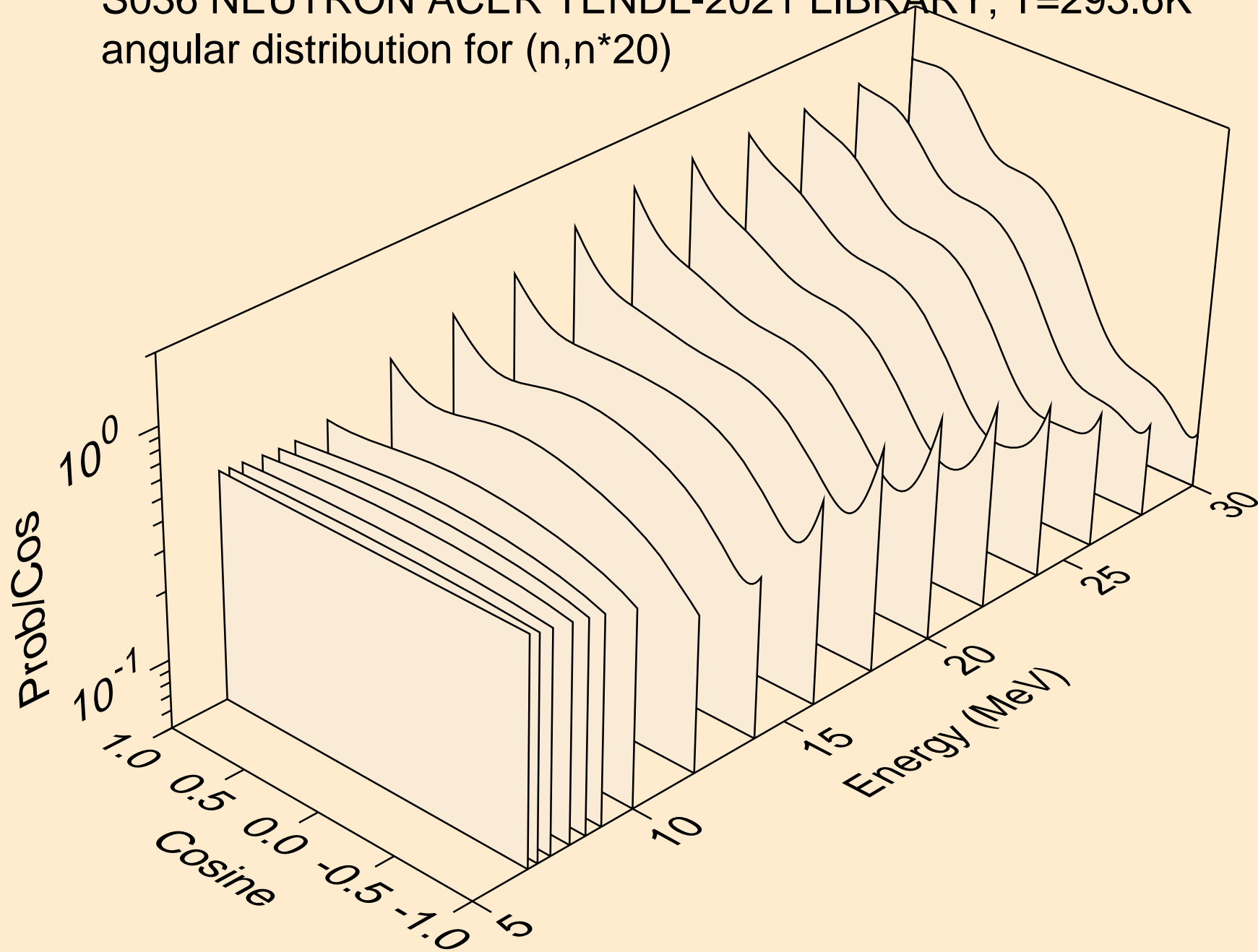

S036 NEUTRON ACER TENDL-2021 LIBRARY; T=293.6K
angular distribution for (n,n*21)

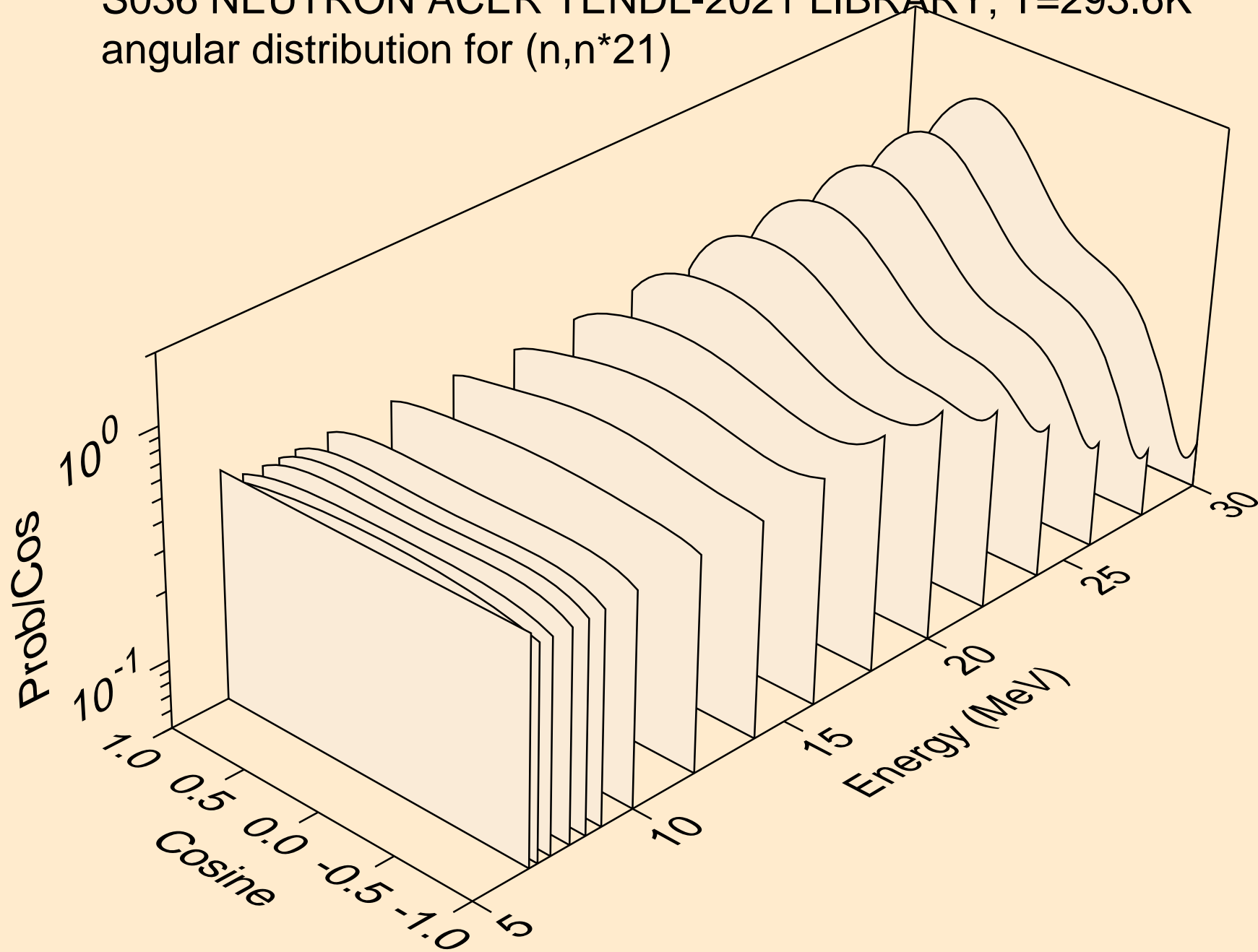

S036 NEUTRON ACER TENDL-2021 LIBRARY; T=293.6K
angular distribution for (n,n*22)

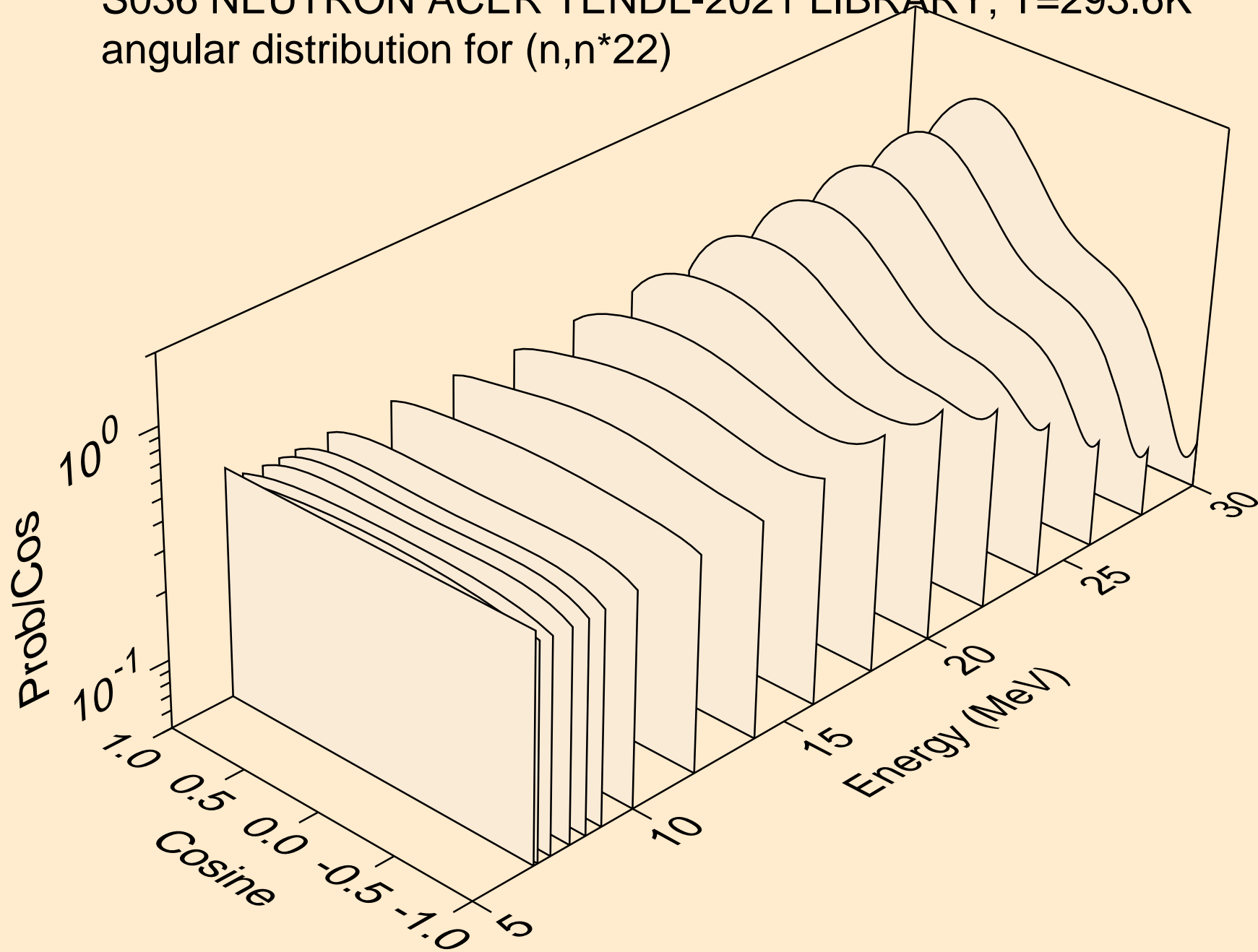

S036 NEUTRON ACER TENDL-2021 LIBRARY; T=293.6K
angular distribution for (n,n*23)

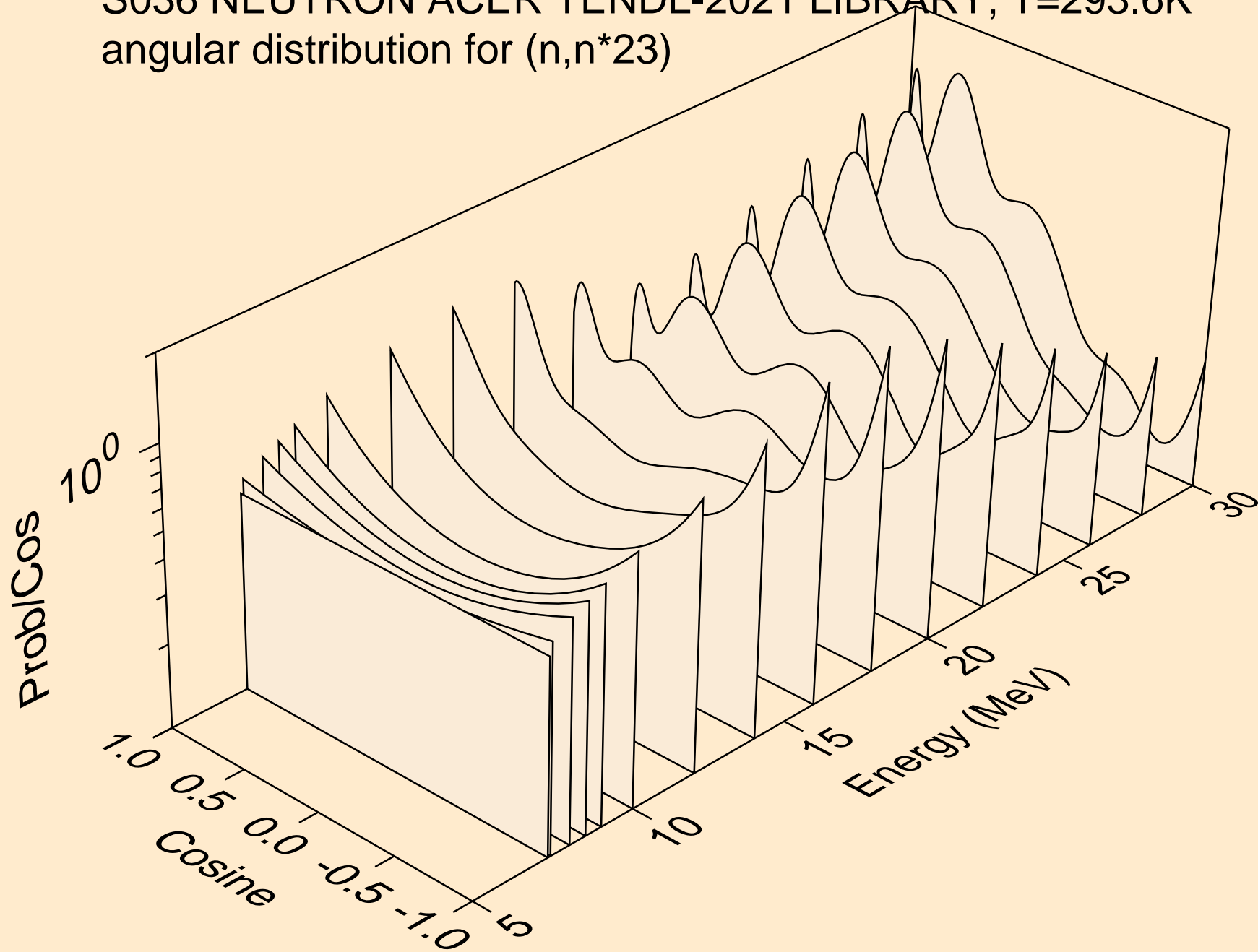

S036 NEUTRON ACER TENDL-2021 LIBRARY; T=293.6K
angular distribution for (n,n*24)

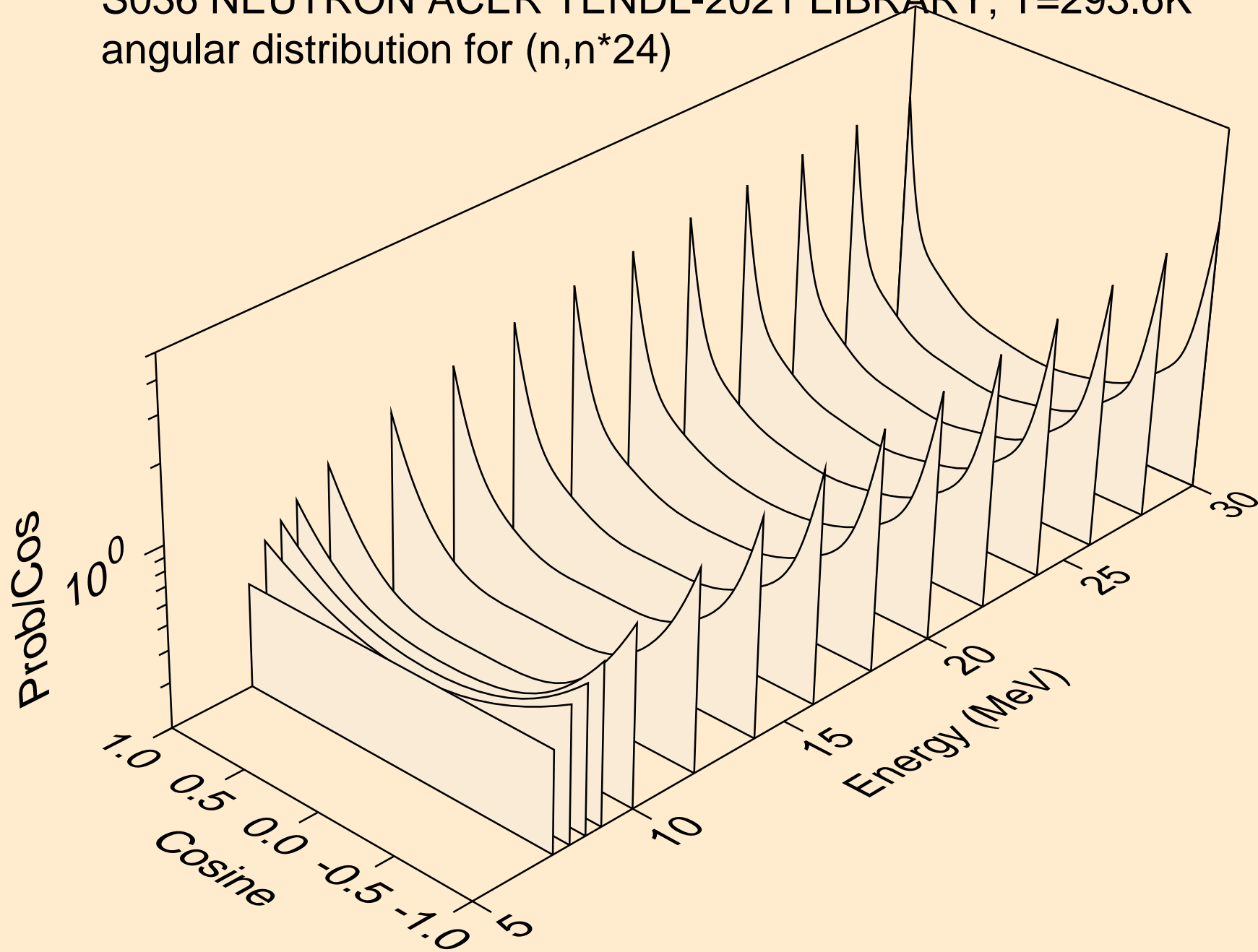

S036 NEUTRON ACER TENDL-2021 LIBRARY; T=293.6K
angular distribution for (n,n*25)

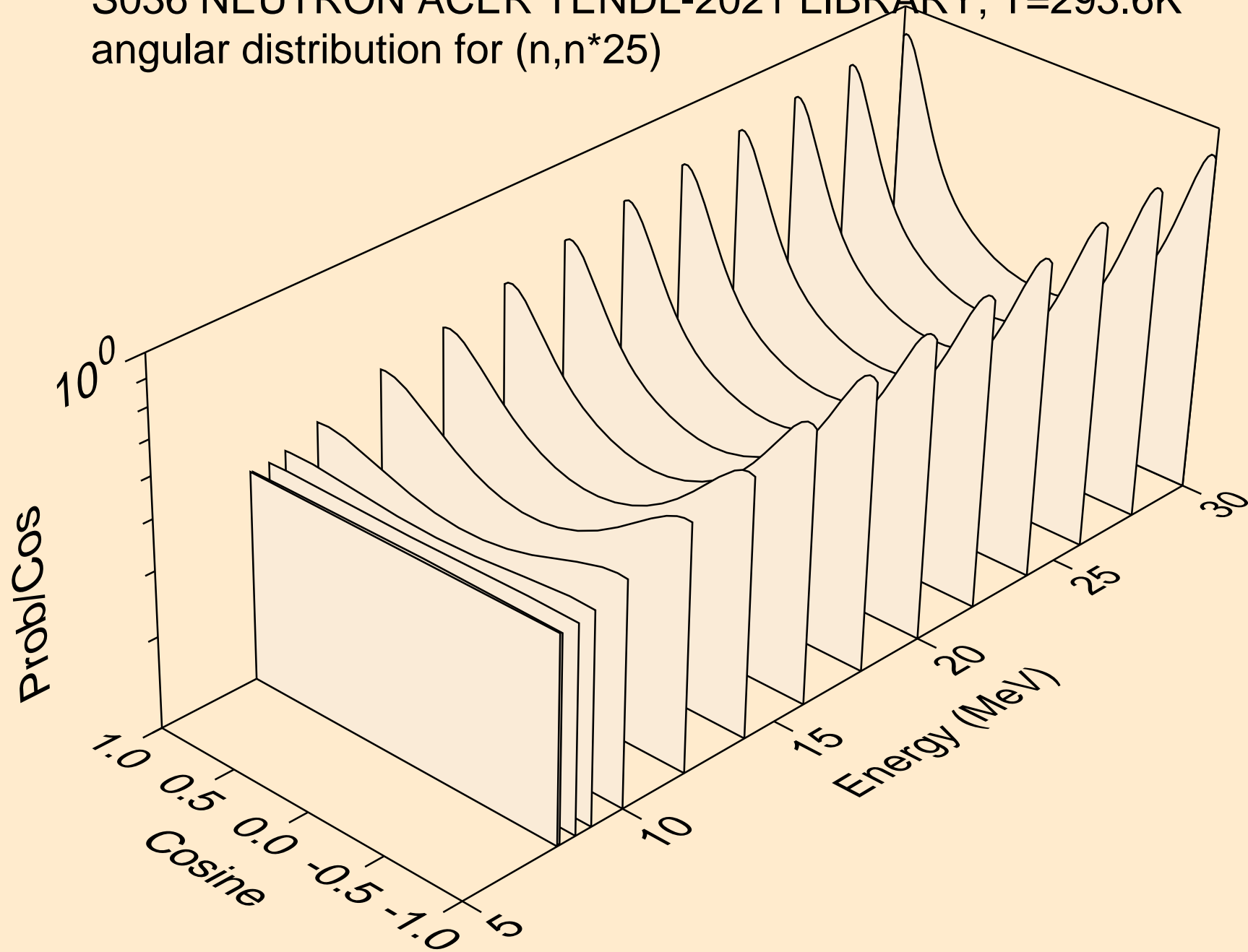

S036 NEUTRON ACER TENDL-2021 LIBRARY; T=293.6K
angular distribution for (n,n*26)

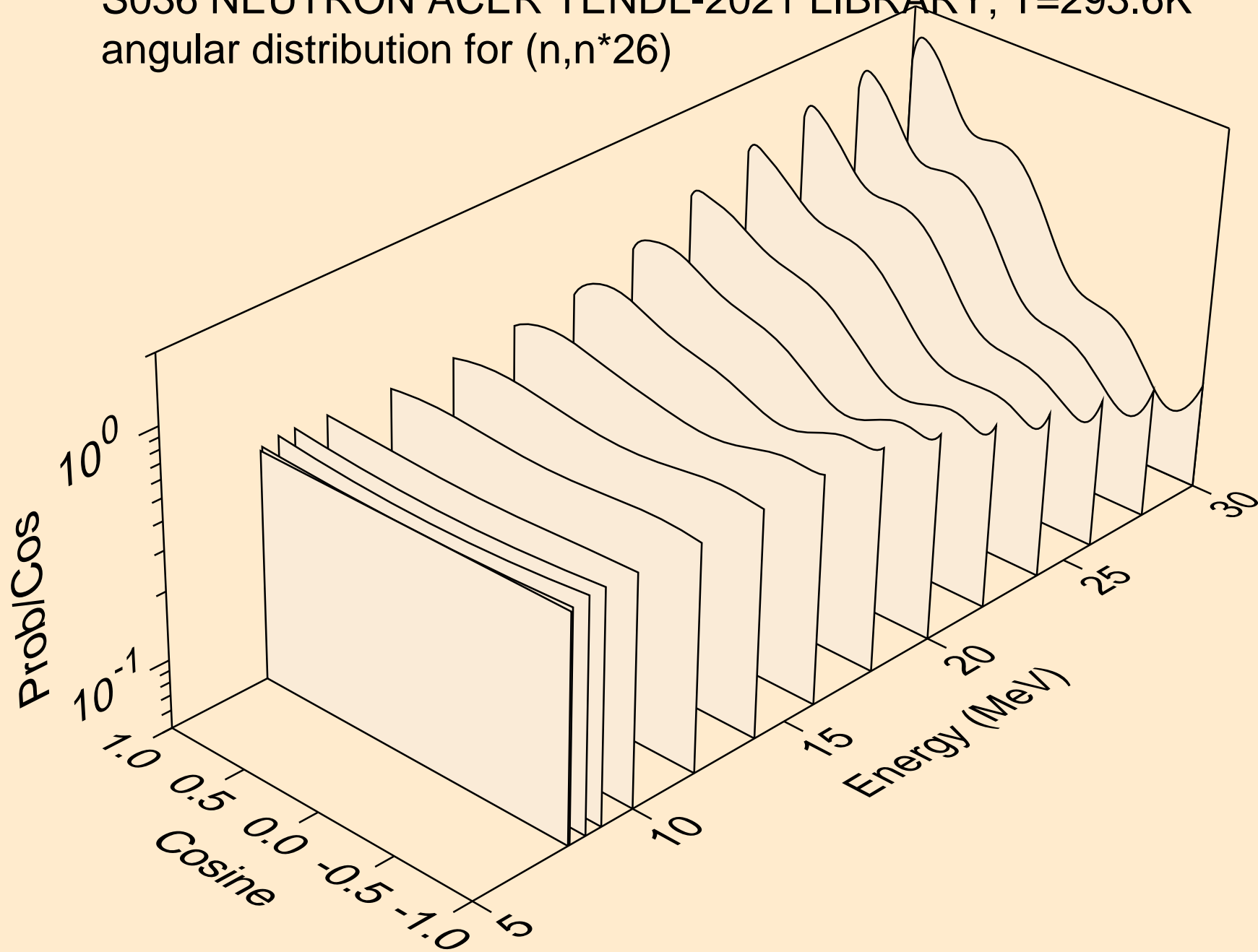

S036 NEUTRON ACER TENDL-2021 LIBRARY; T=293.6K
angular distribution for (n,n*27)

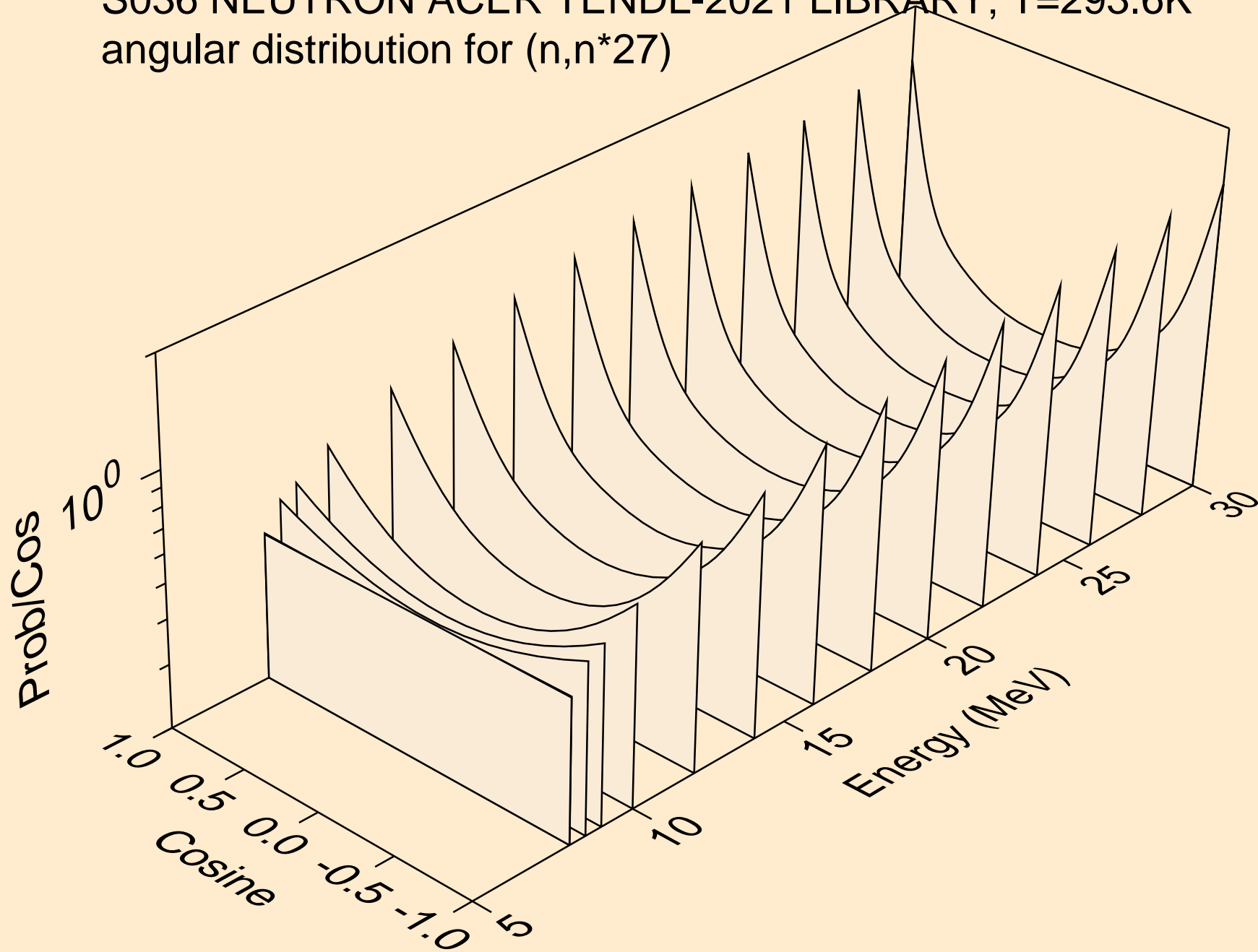

S036 NEUTRON ACER TENDL-2021 LIBRARY; T=293.6K
angular distribution for (n,n*28)

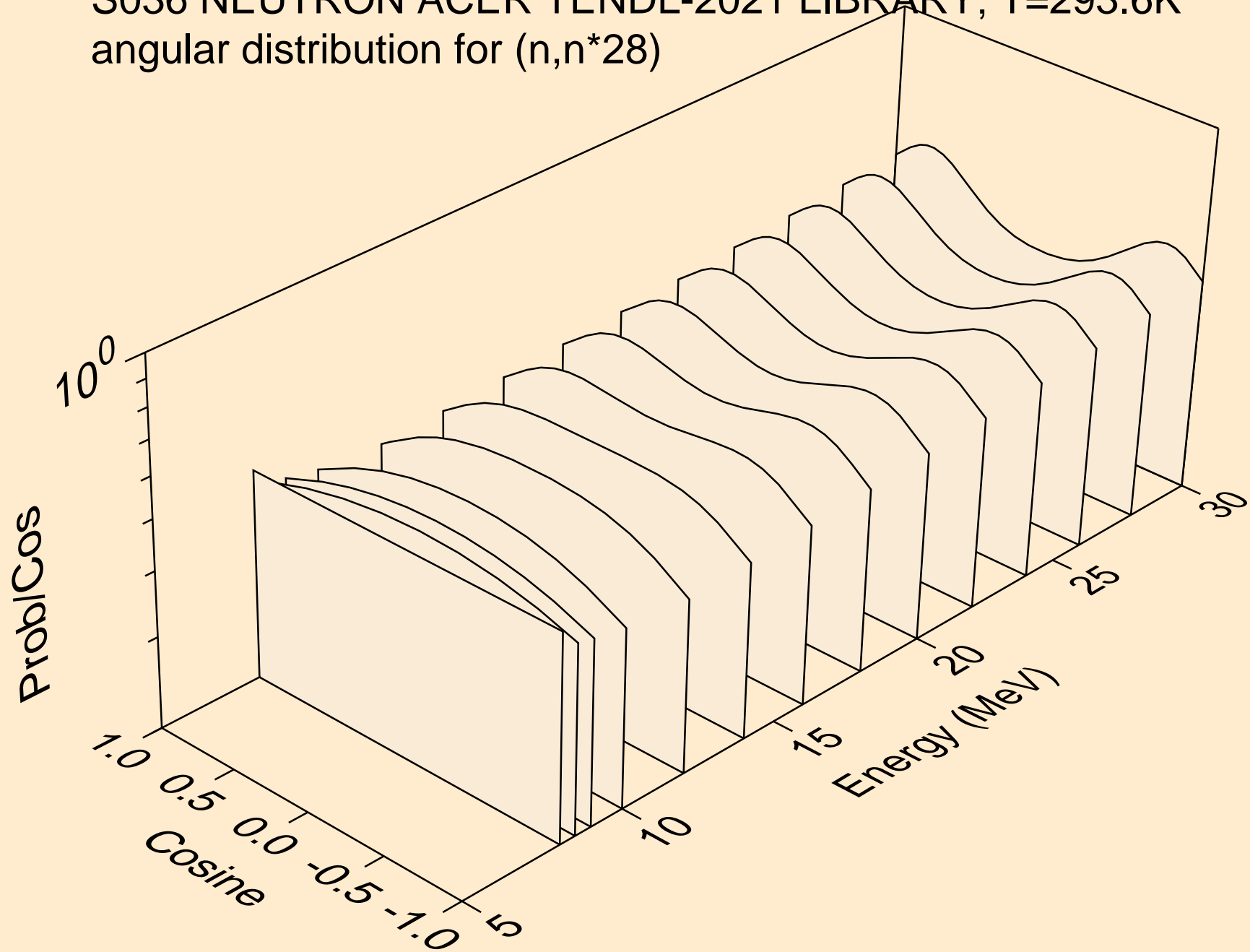

S036 NEUTRON ACER TENDL-2021 LIBRARY; T=293.6K
angular distribution for (n,n*29)

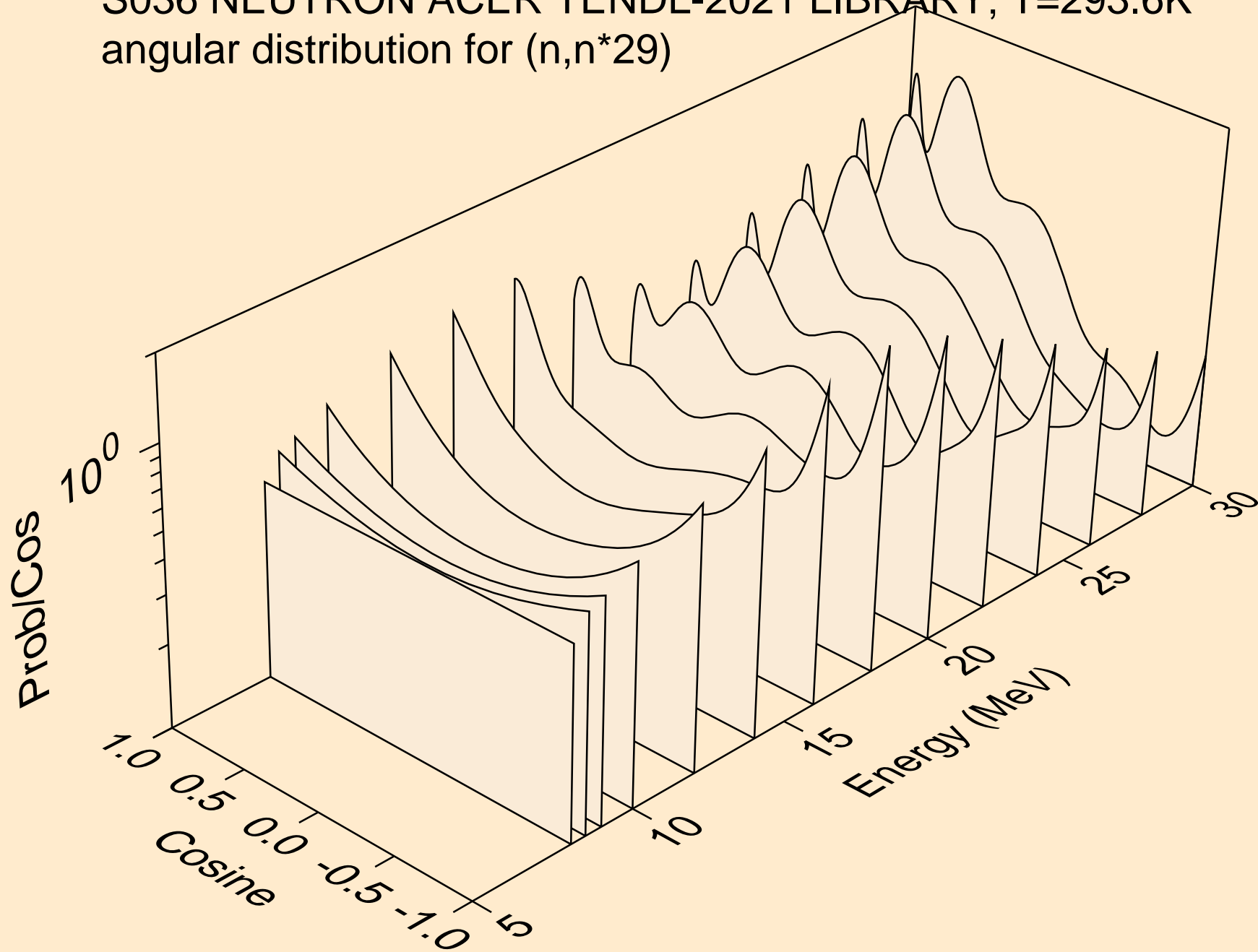

S036 NEUTRON ACER TENDL-2021 LIBRARY; T=293.6K
angular distribution for (n,n*30)

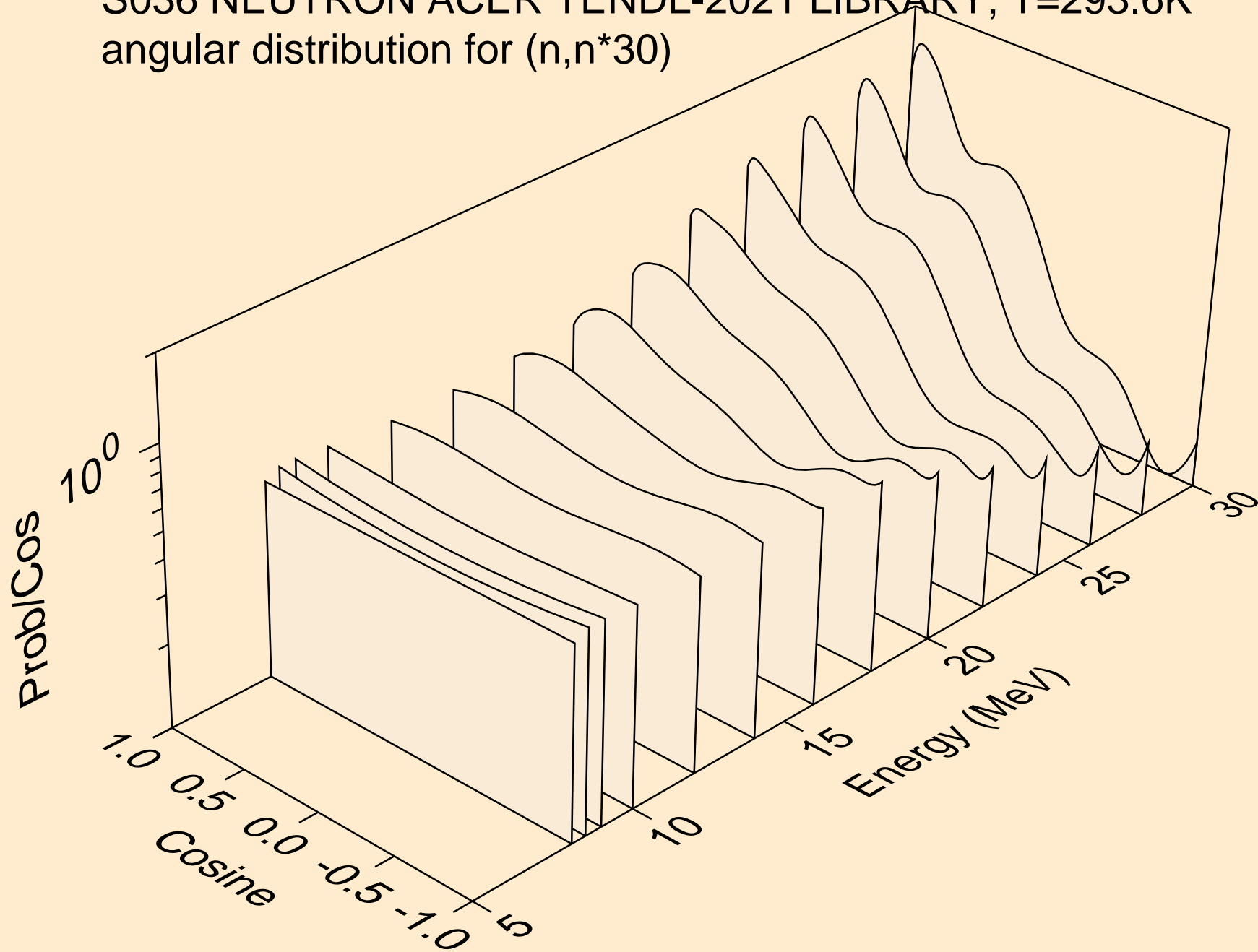

S036 NEUTRON ACER TENDL-2021 LIBRARY; T=293.6K
Neutron emission for (n,x)

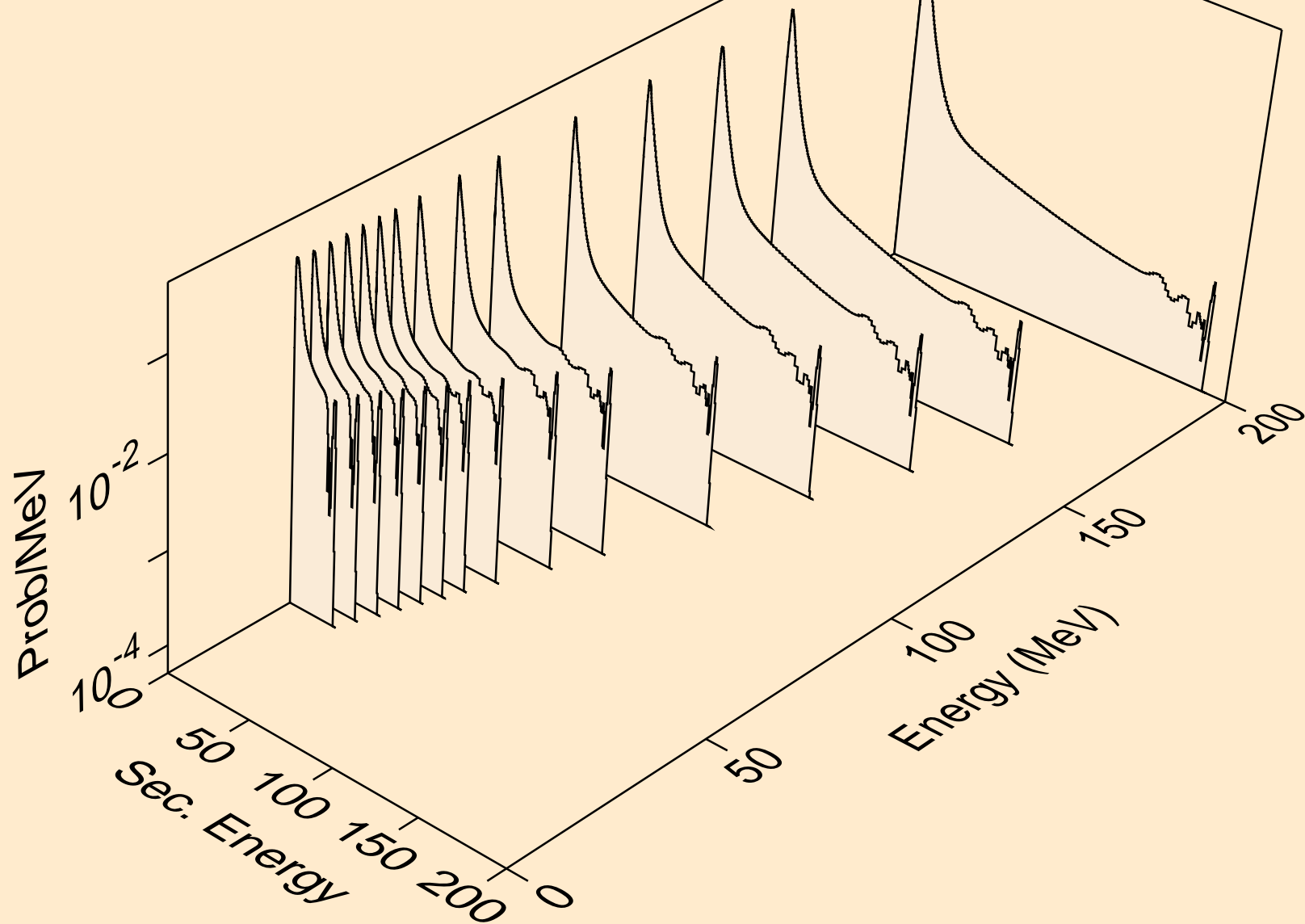

S036 NEUTRON ACER TENDL-2021 LIBRARY; T=293.6K
Neutron emission for (n,2nd)

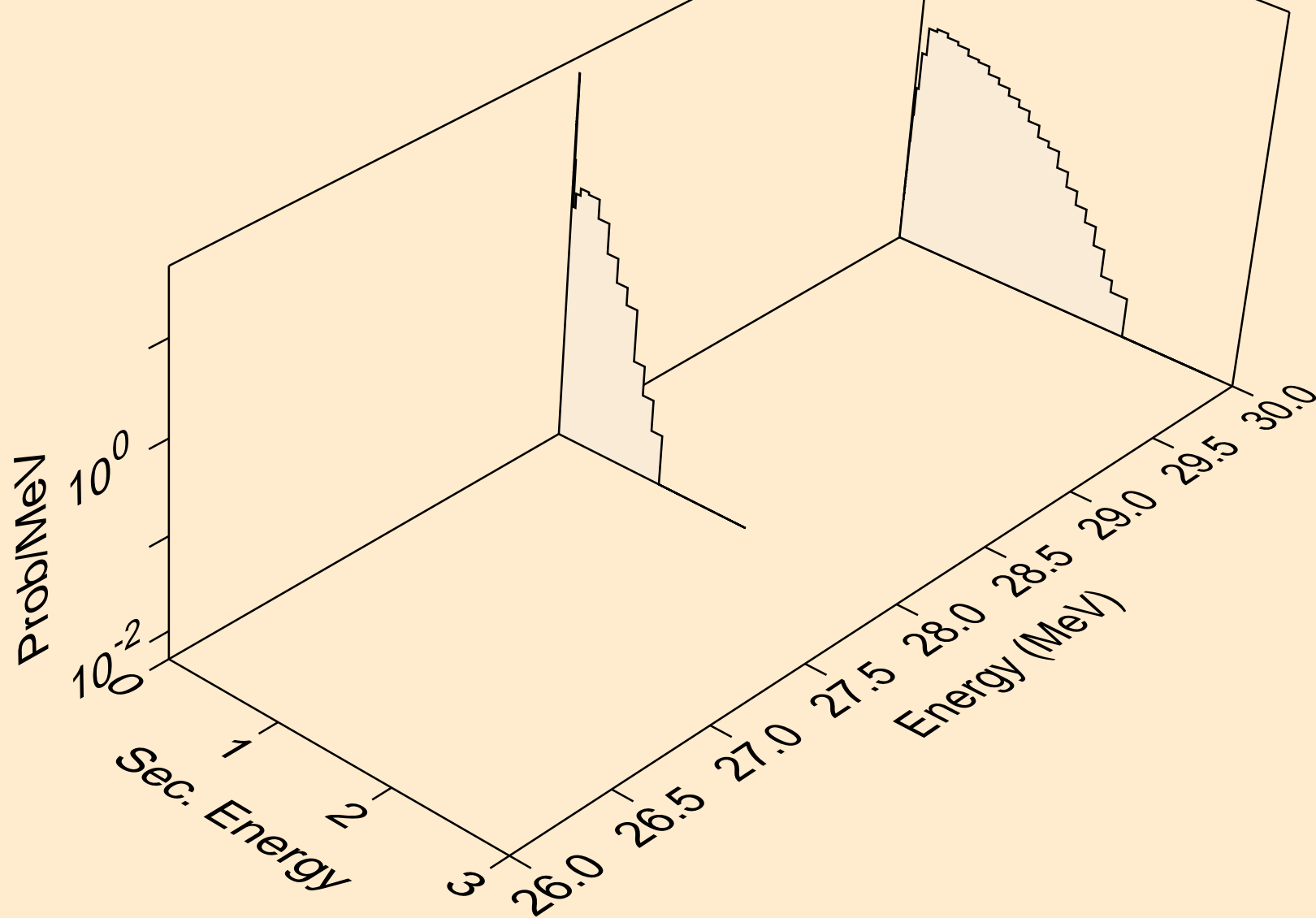

S036 NEUTRON ACER TENDL-2021 LIBRARY; T=293.6K
Neutron emission for (n,2n)

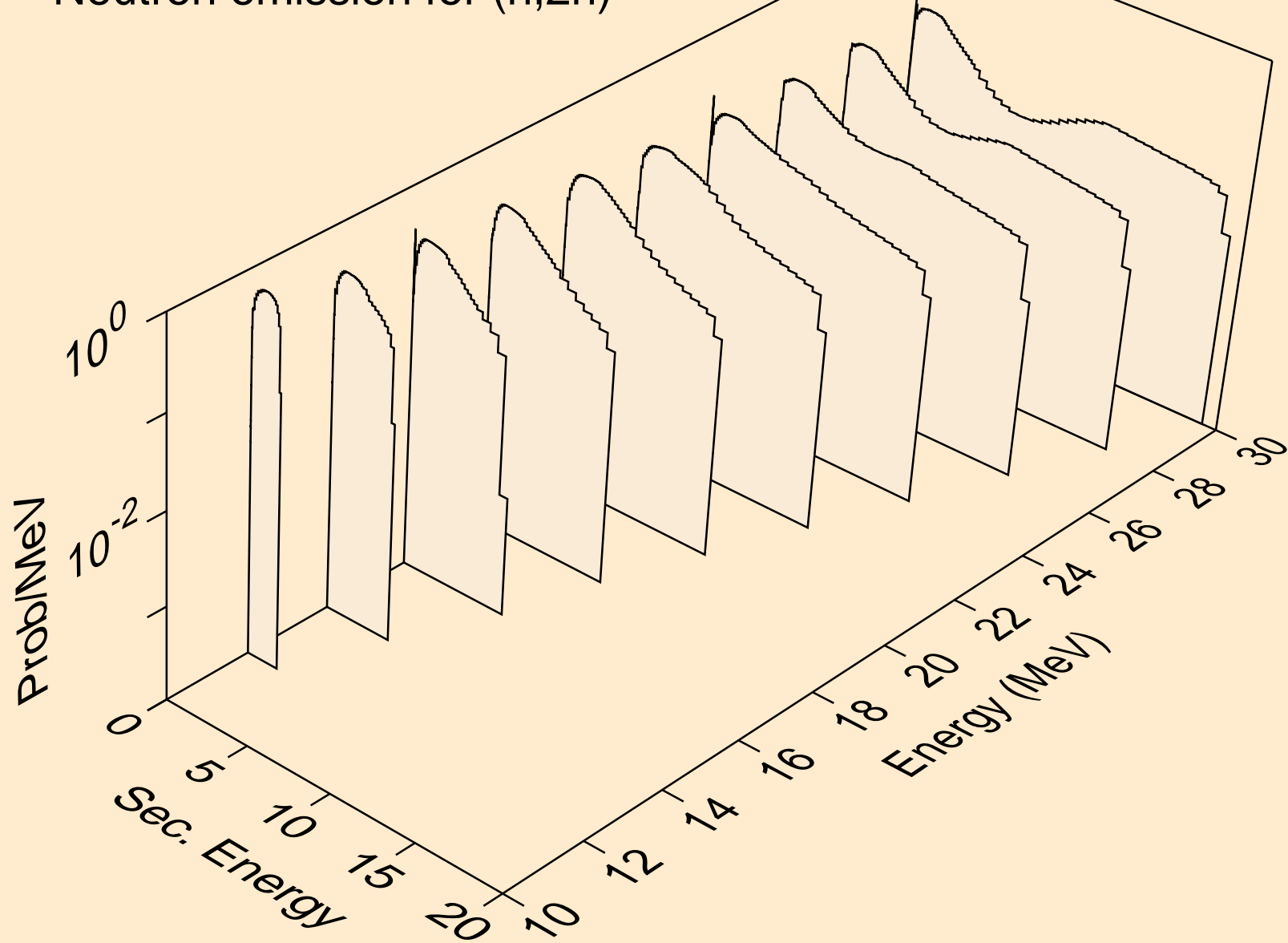

S036 NEUTRON ACER TENDL-2021 LIBRARY; T=293.6K
Neutron emission for (n,3n)

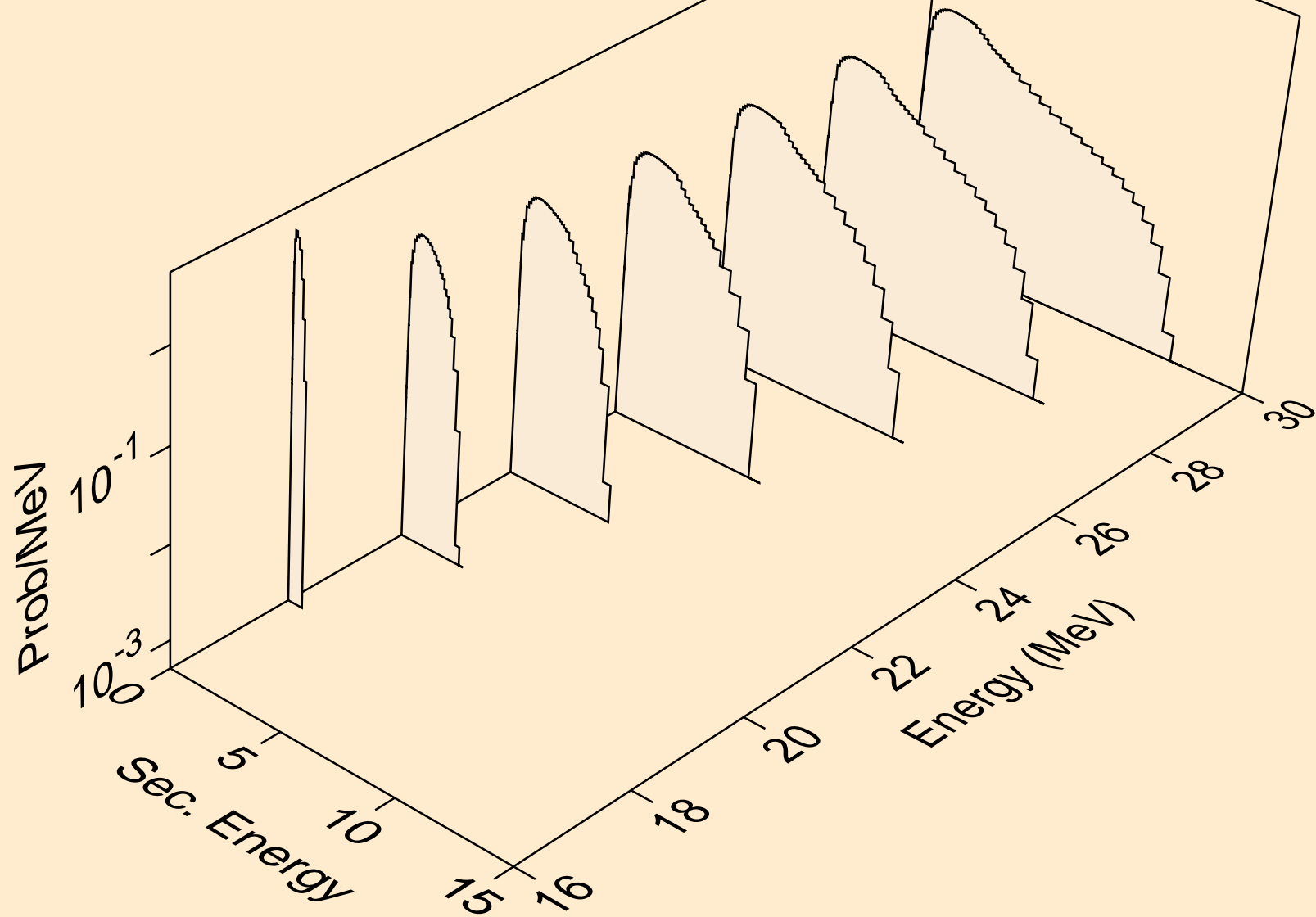

S036 NEUTRON ACER TENDL-2021 LIBRARY; T=293.6K
Neutron emission for (n,n*)a

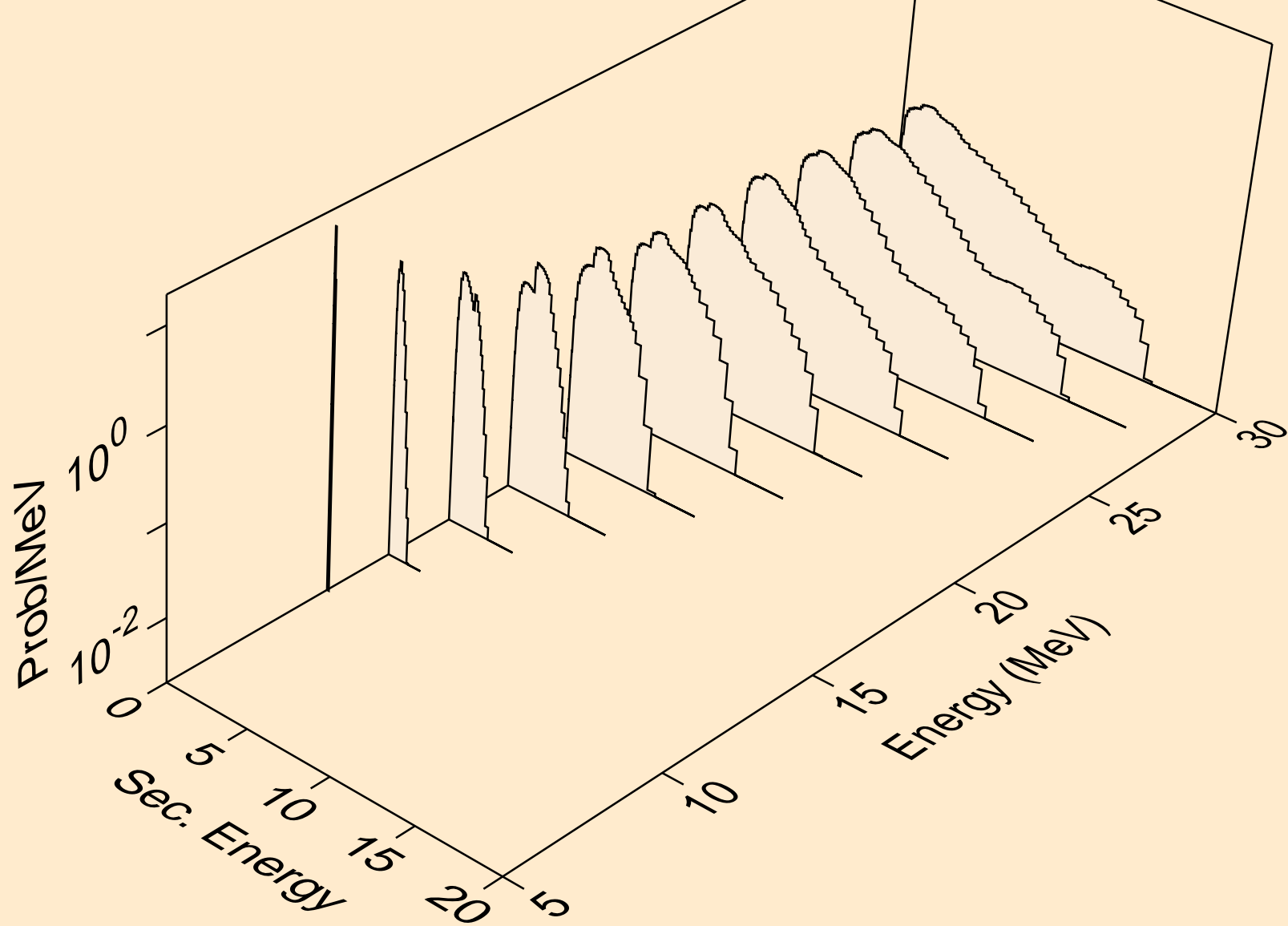

S036 NEUTRON ACER TENDL-2021 LIBRARY; T=293.6K
Neutron emission for (n,2n)a

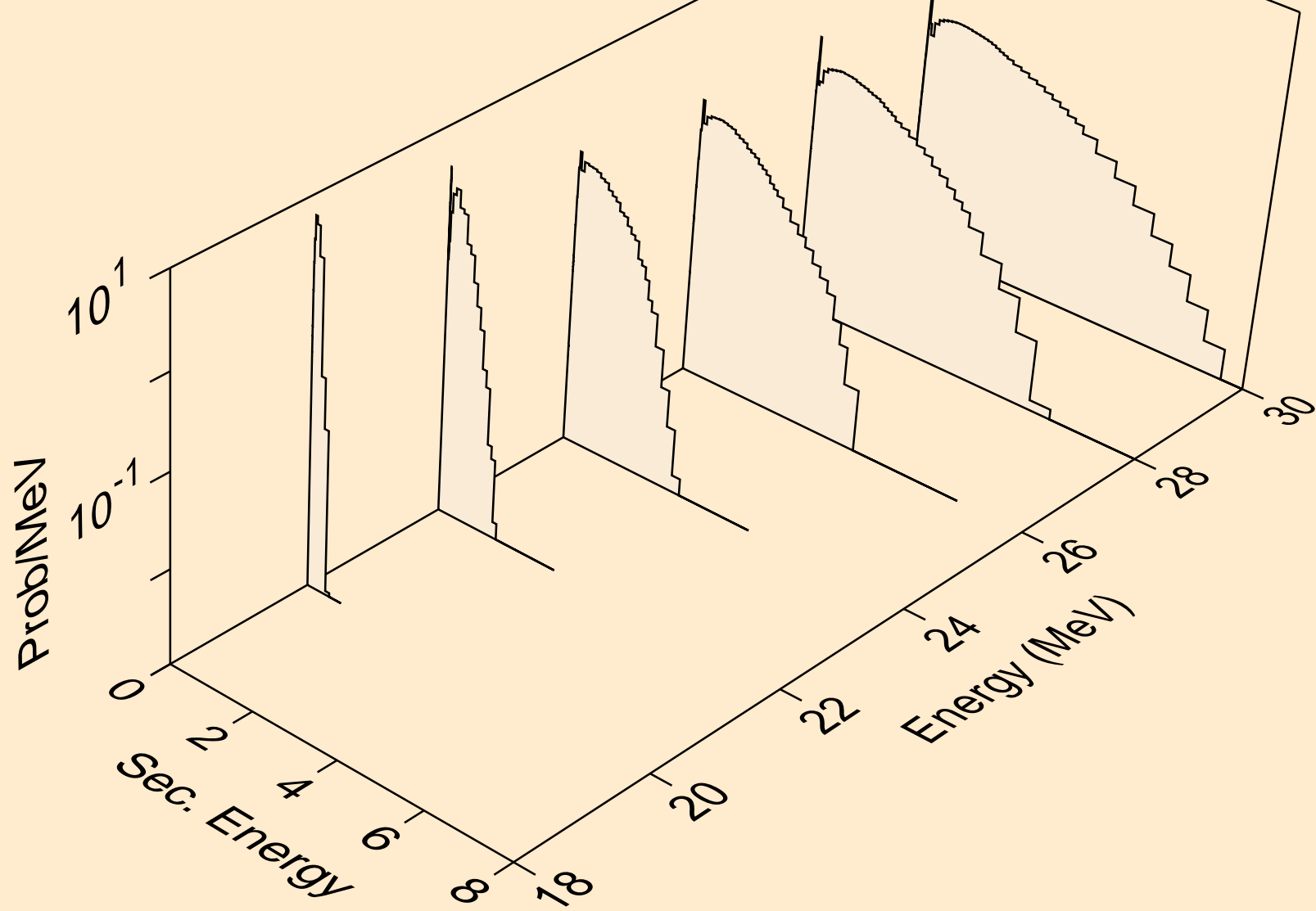

S036 NEUTRON ACER TENDL-2021 LIBRARY; T=293.6K
Neutron emission for (n,3n)a

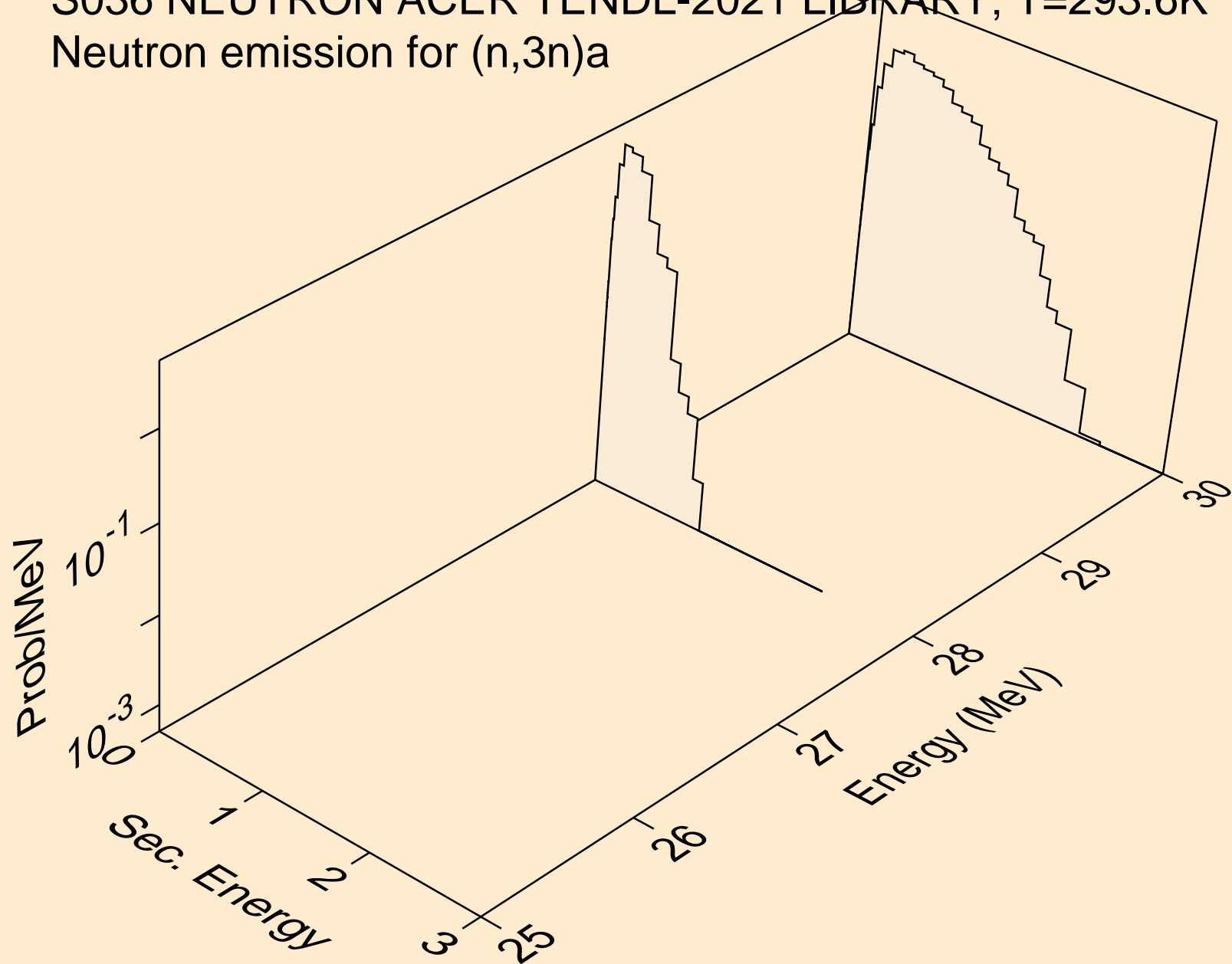

S036 NEUTRON ACER TENDL-2021 LIBRARY; T=293.6K
Neutron emission for (n,n*)p

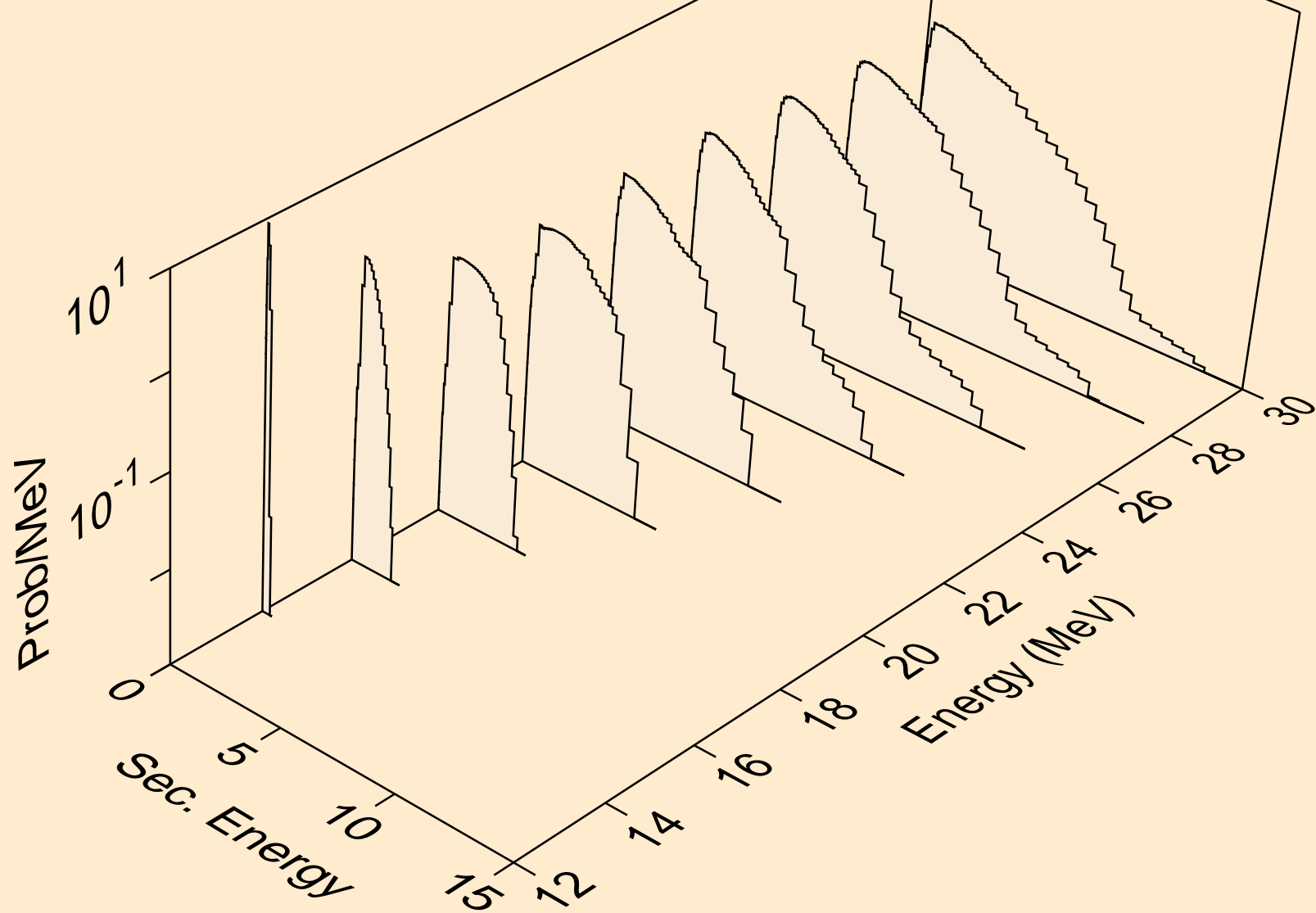

S036 NEUTRON ACER TENDL-2021 LIBRARY; T=293.6K
Neutron emission for (n,n*)2a

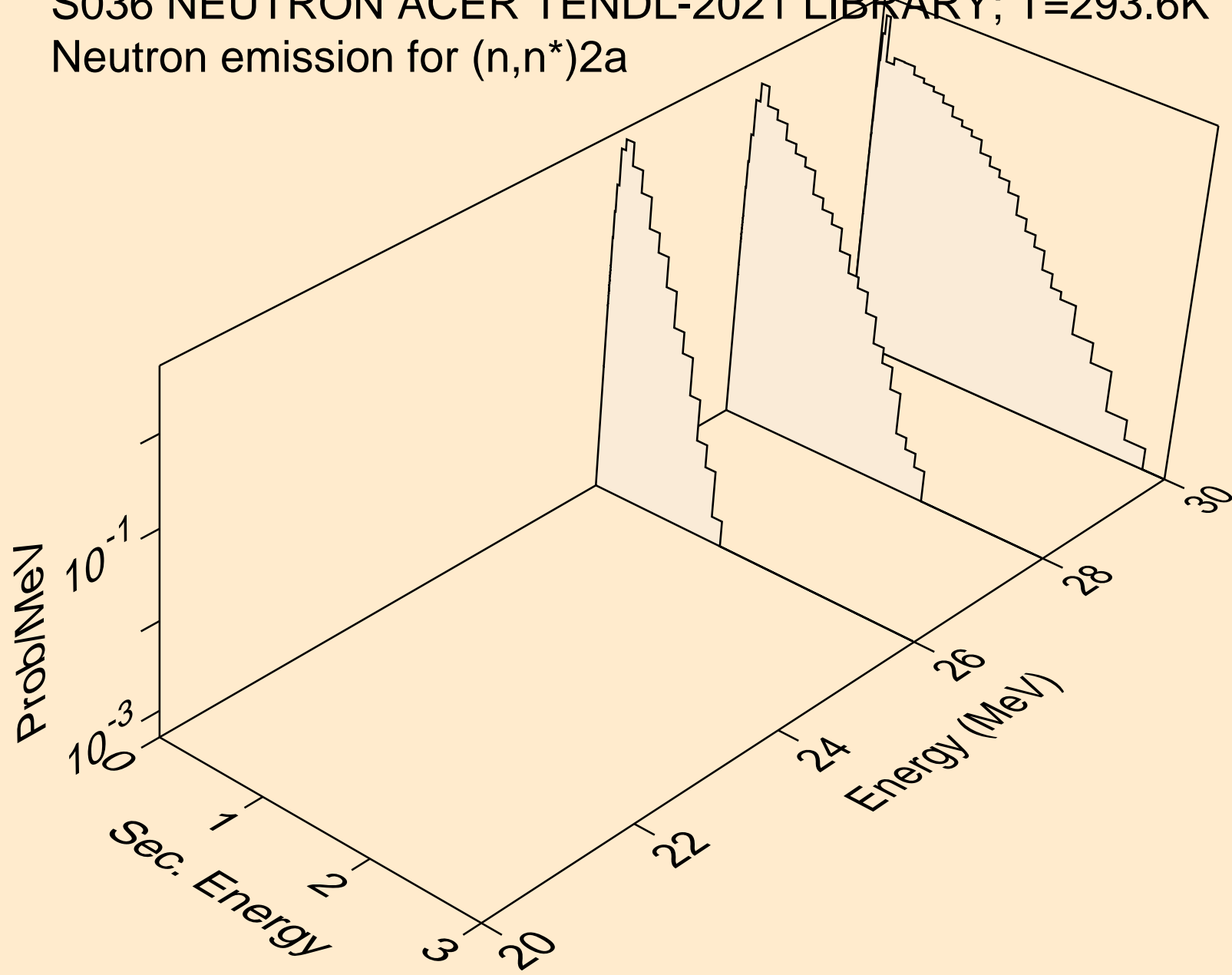

S036 NEUTRON ACER TENDL-2021 LIBRARY; T=293.6K
Neutron emission for (n,n*)d

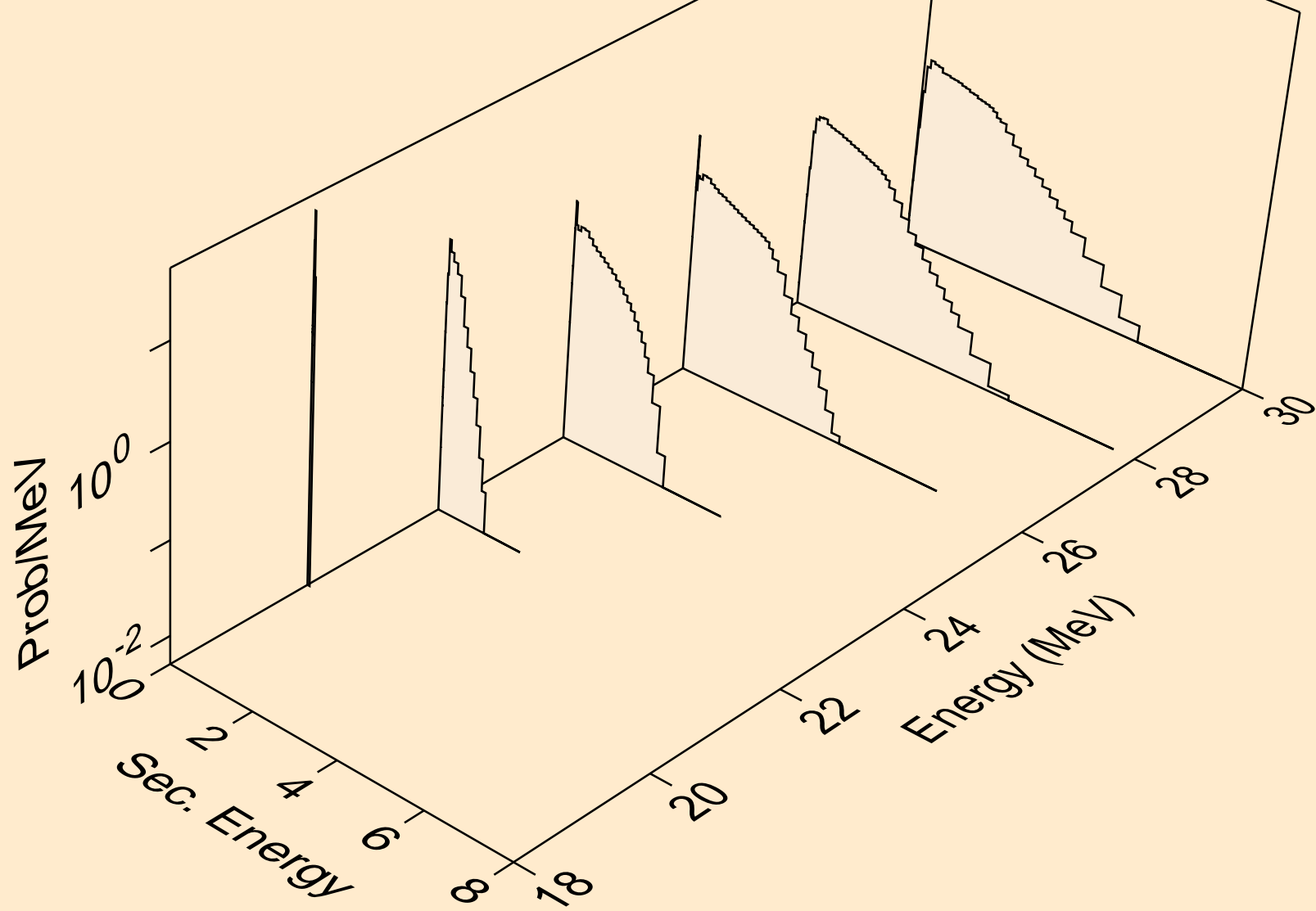

S036 NEUTRON ACER TENDL-2021 LIBRARY; T=293.6K
Neutron emission for (n,n*)t

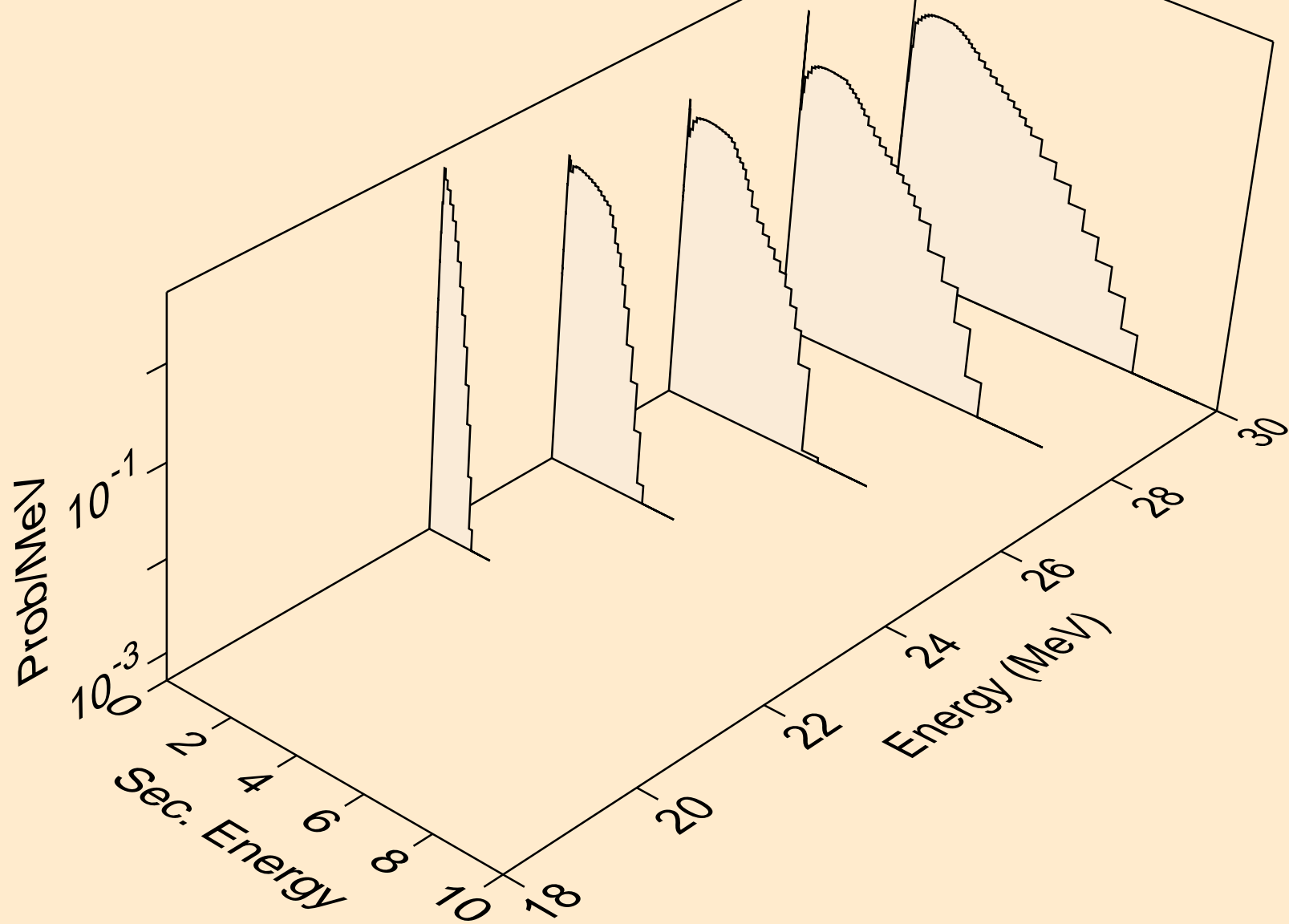

S036 NEUTRON ACER TENDL-2021 LIBRARY; T=293.6K
Neutron emission for (n,n*)he3

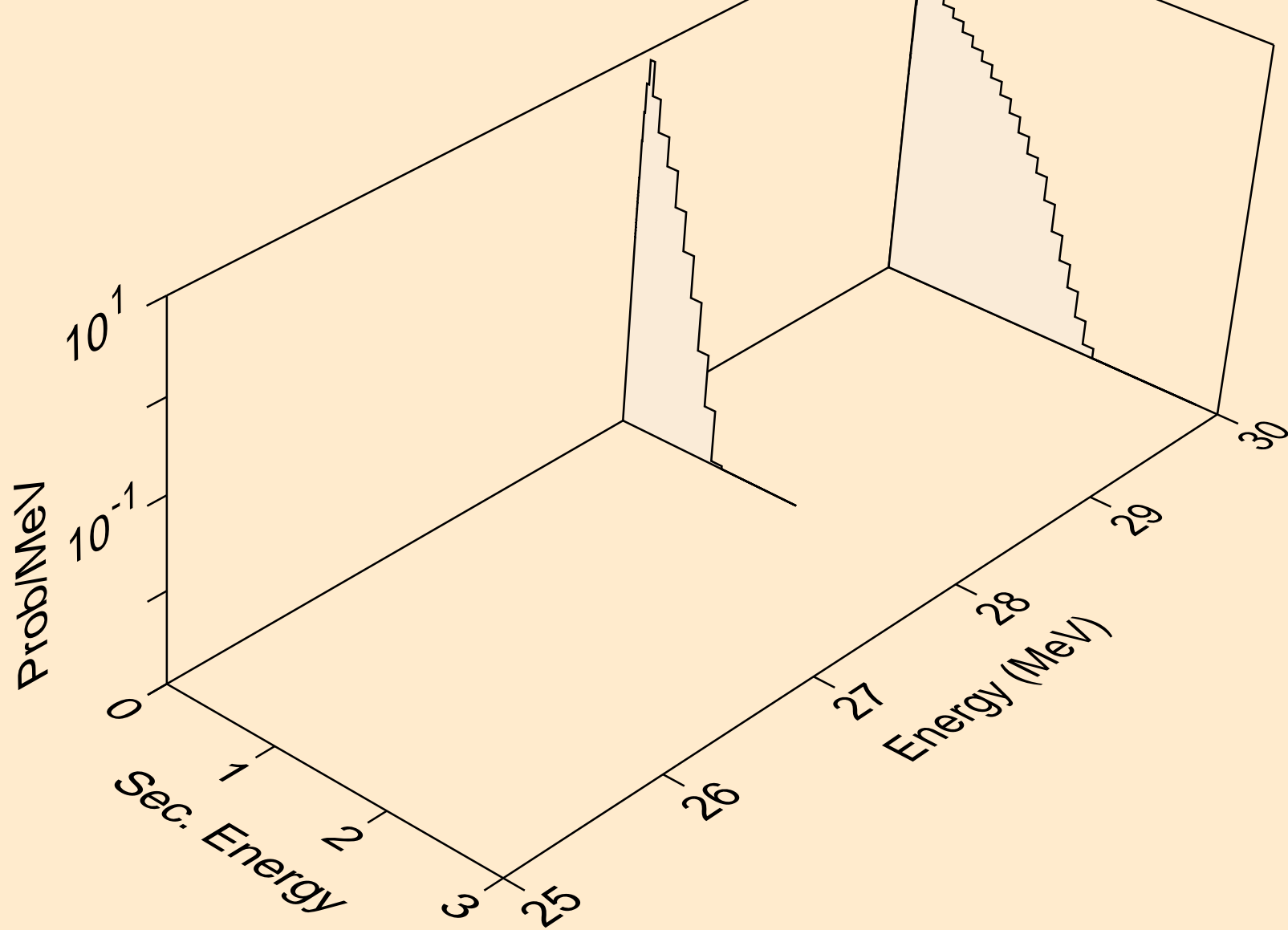

S036 NEUTRON ACER TENDL-2021 LIBRARY; T=293.6K
Neutron emission for (n,2np)

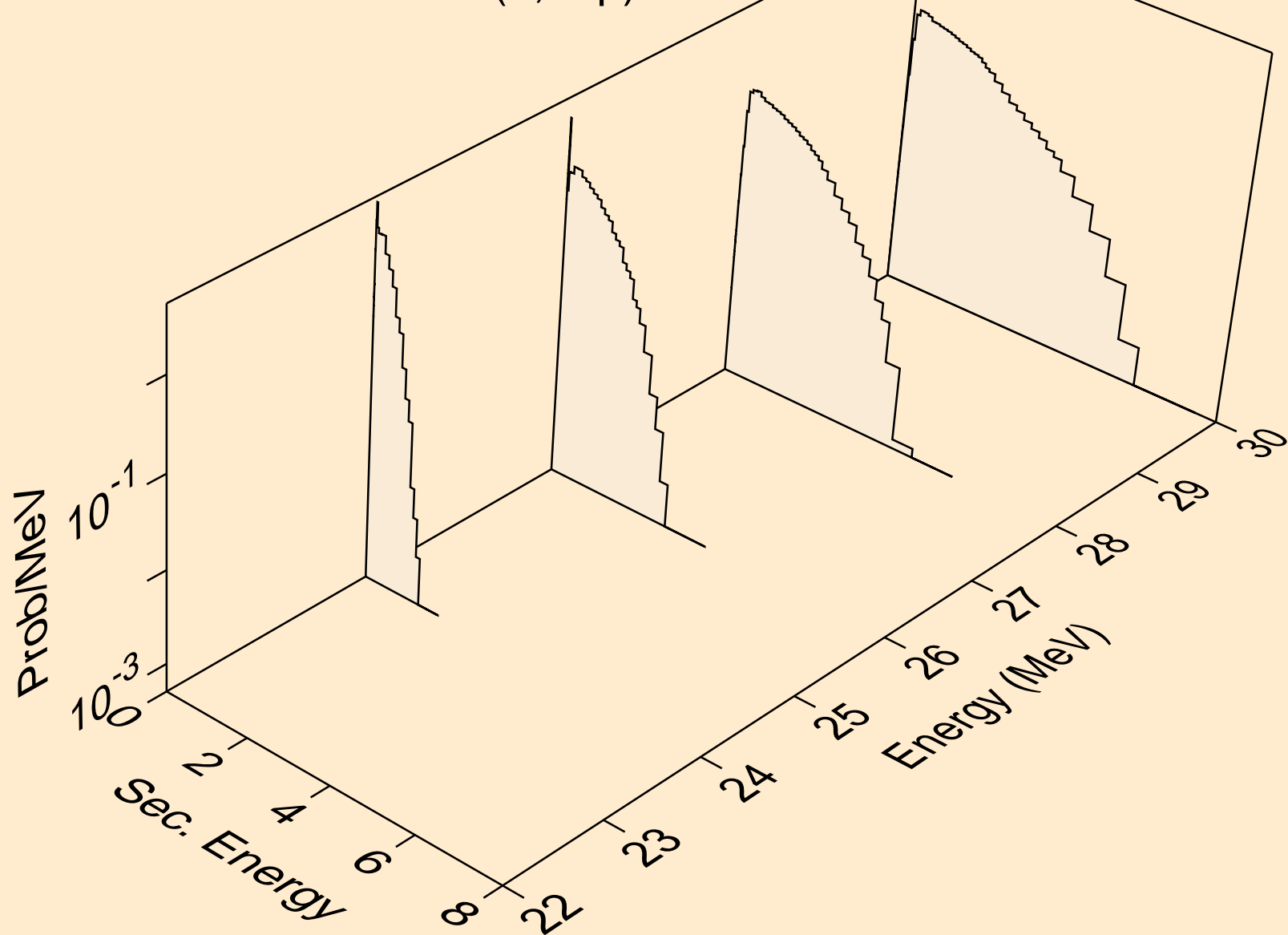

S036 NEUTRON ACER TENDL-2021 LIBRARY; T=293.6K
Neutron emission for (n,3np)

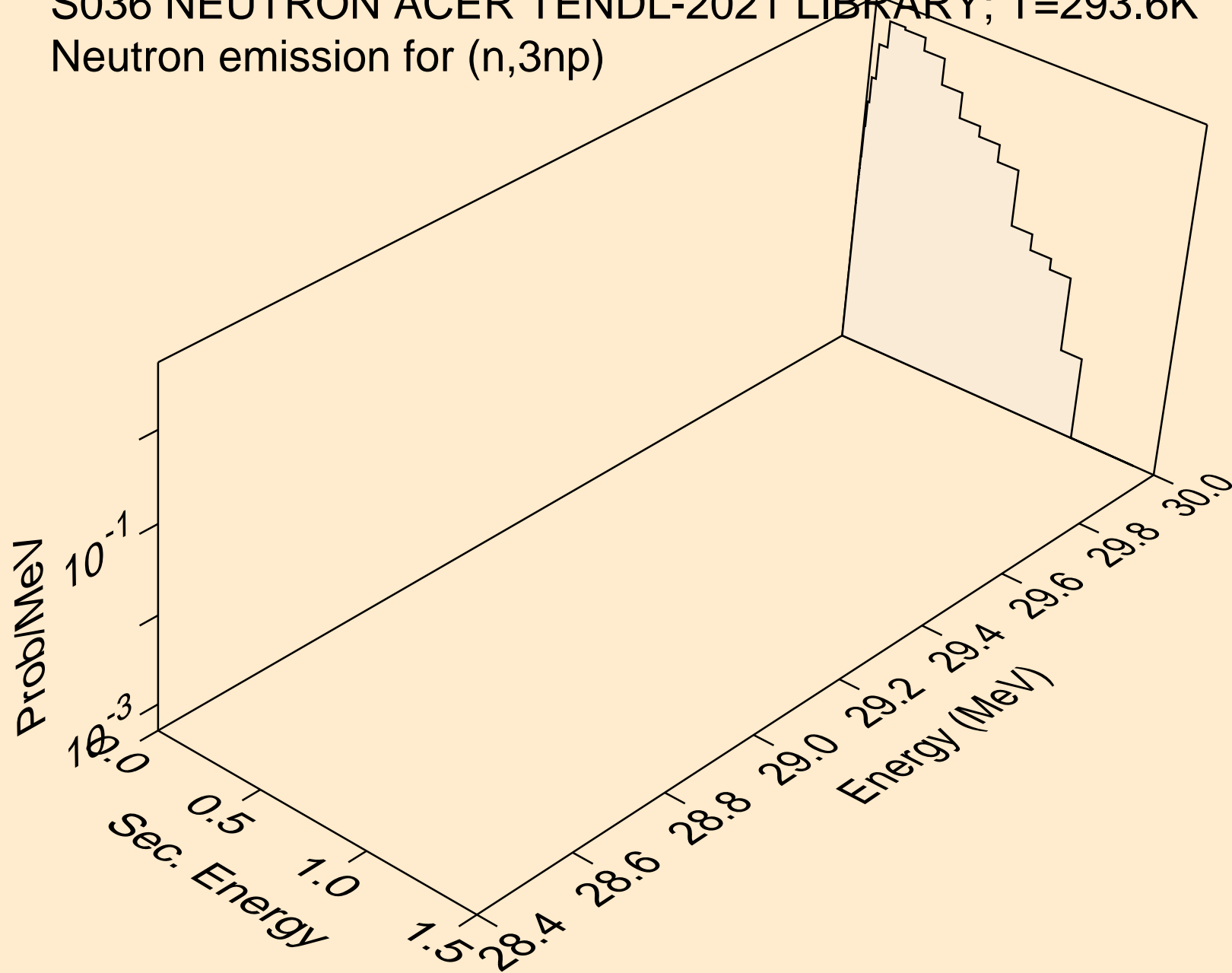

S036 NEUTRON ACER TENDL-2021 LIBRARY; T=293.6K
Neutron emission for (n,2np)

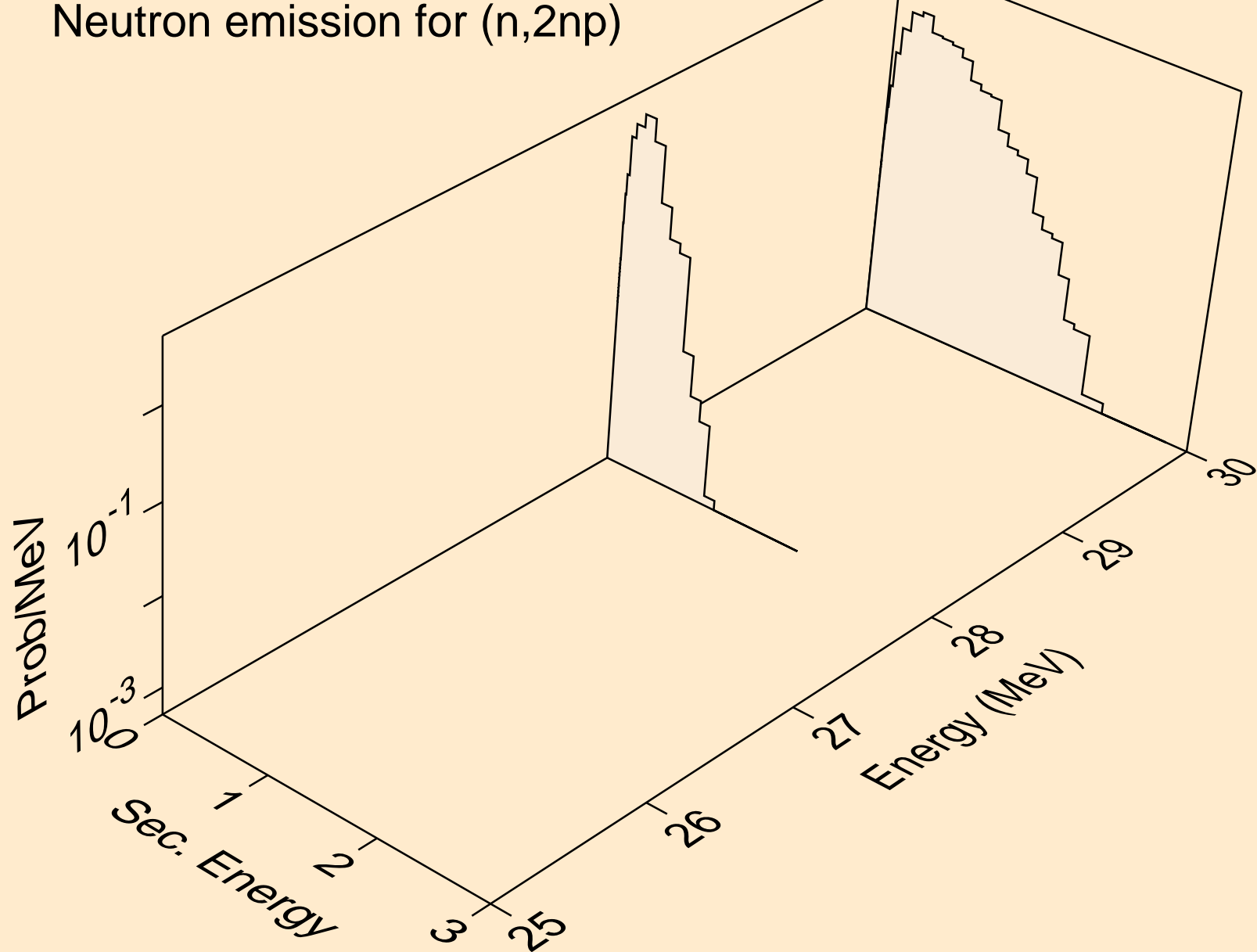

S036 NEUTRON ACER TENDL-2021 LIBRARY; T=293.6K
Neutron emission for (n,n*c)

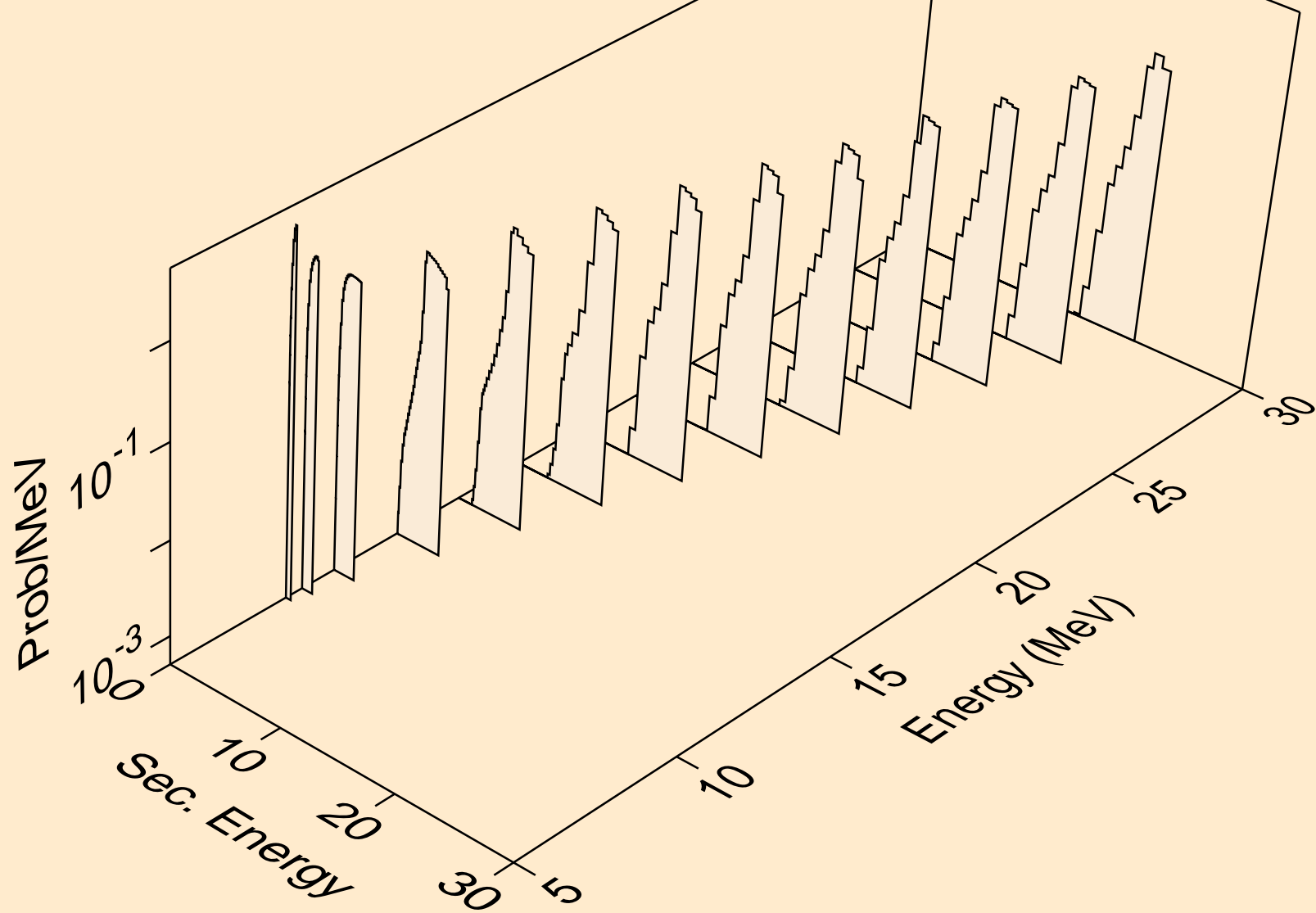

S036 NEUTRON ACER TENDL-2021 LIBRARY; T=293.6K
Photon emission for (n,x)

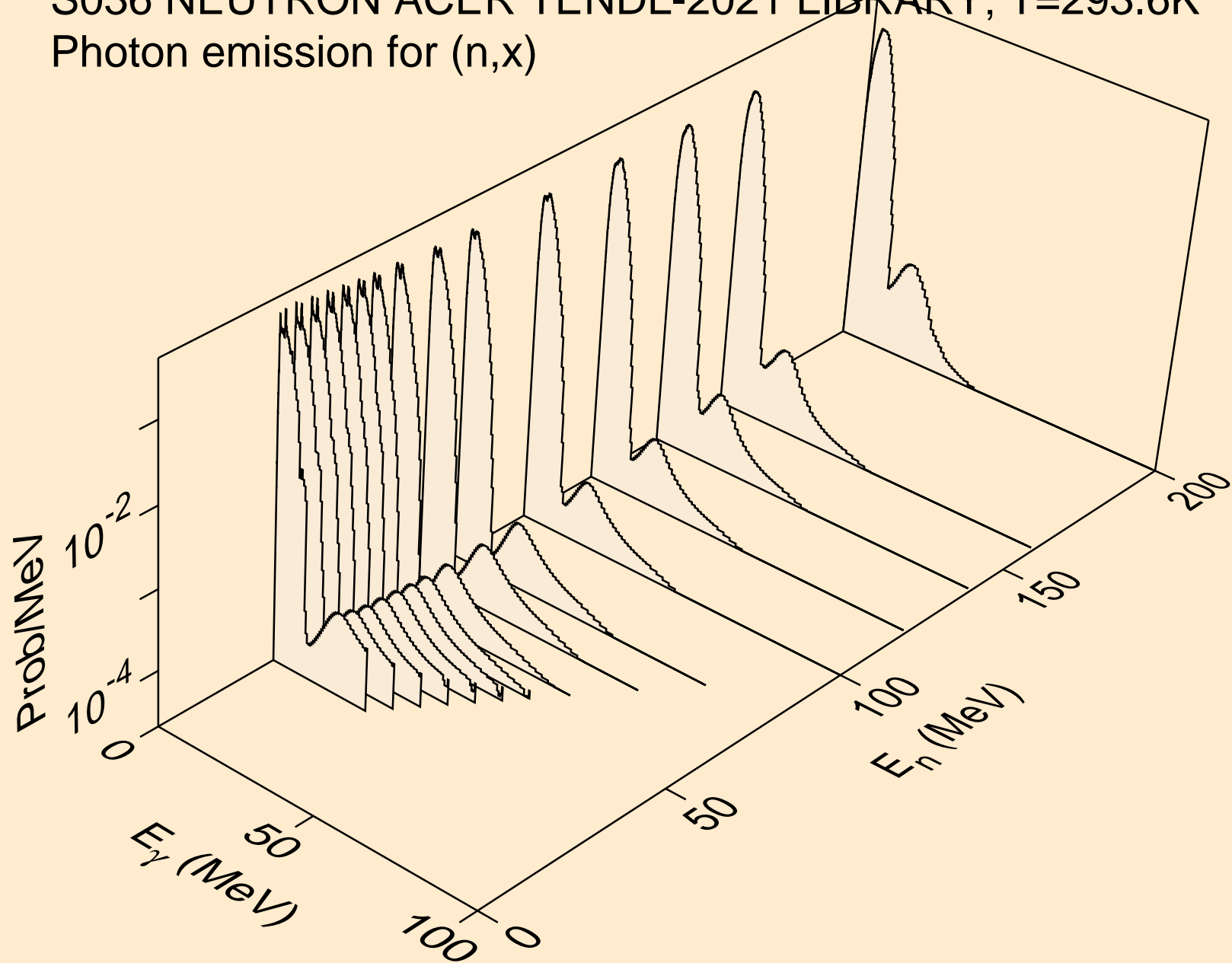

S036 NEUTRON ACER TENDL-2021 LIBRARY; T=293.6K
Photon emission for (n,2nd)

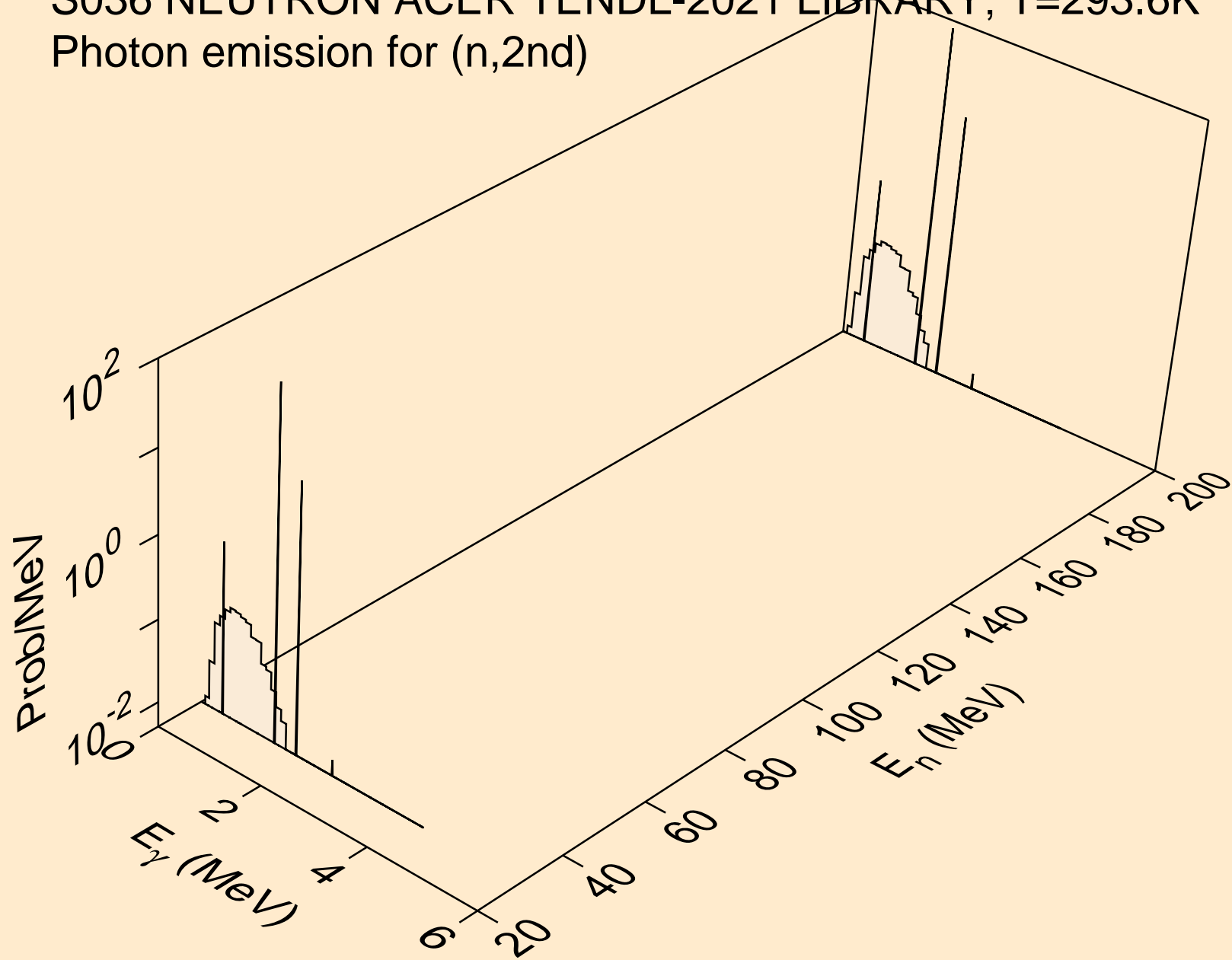

S036 NEUTRON ACER TENDL-2021 LIBRARY; T=293.6K
Photon emission for (n,2n)

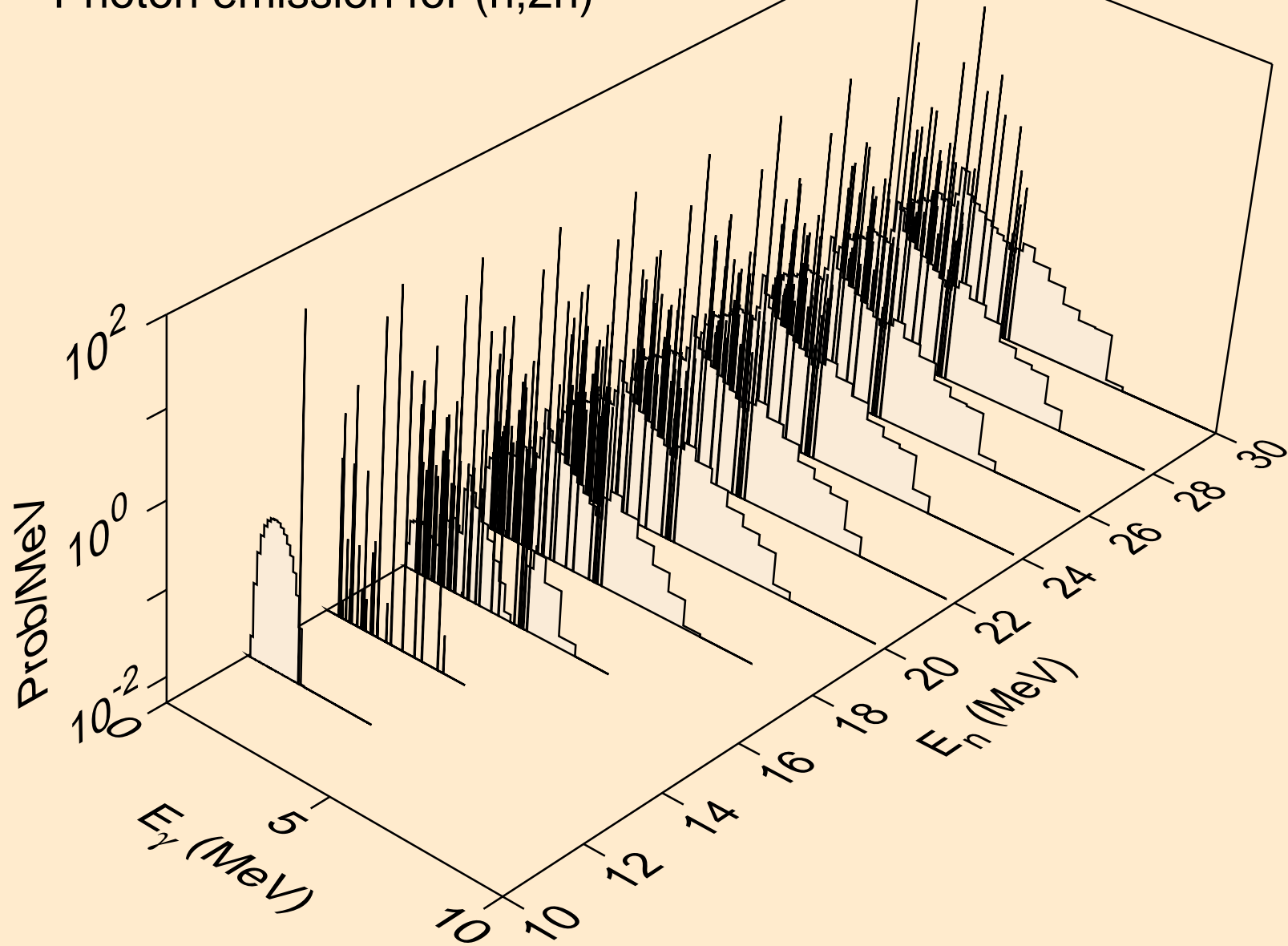

S036 NEUTRON ACER TENDL-2021 LIBRARY; T=293.6K
Photon emission for (n,3n)

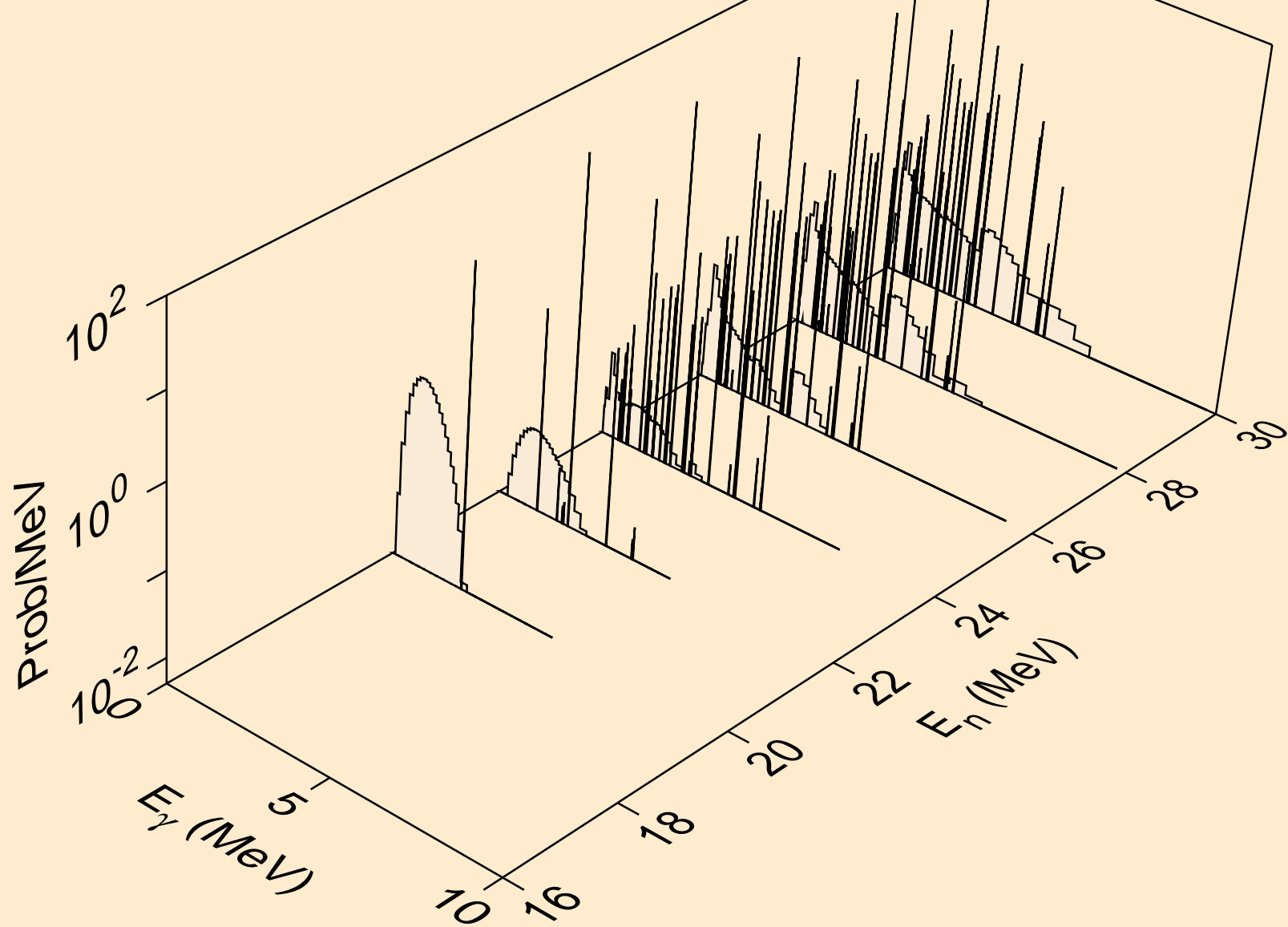

S036 NEUTRON ACER TENDL-2021 LIBRARY; T=293.6K
Photon emission for (n,n*)a

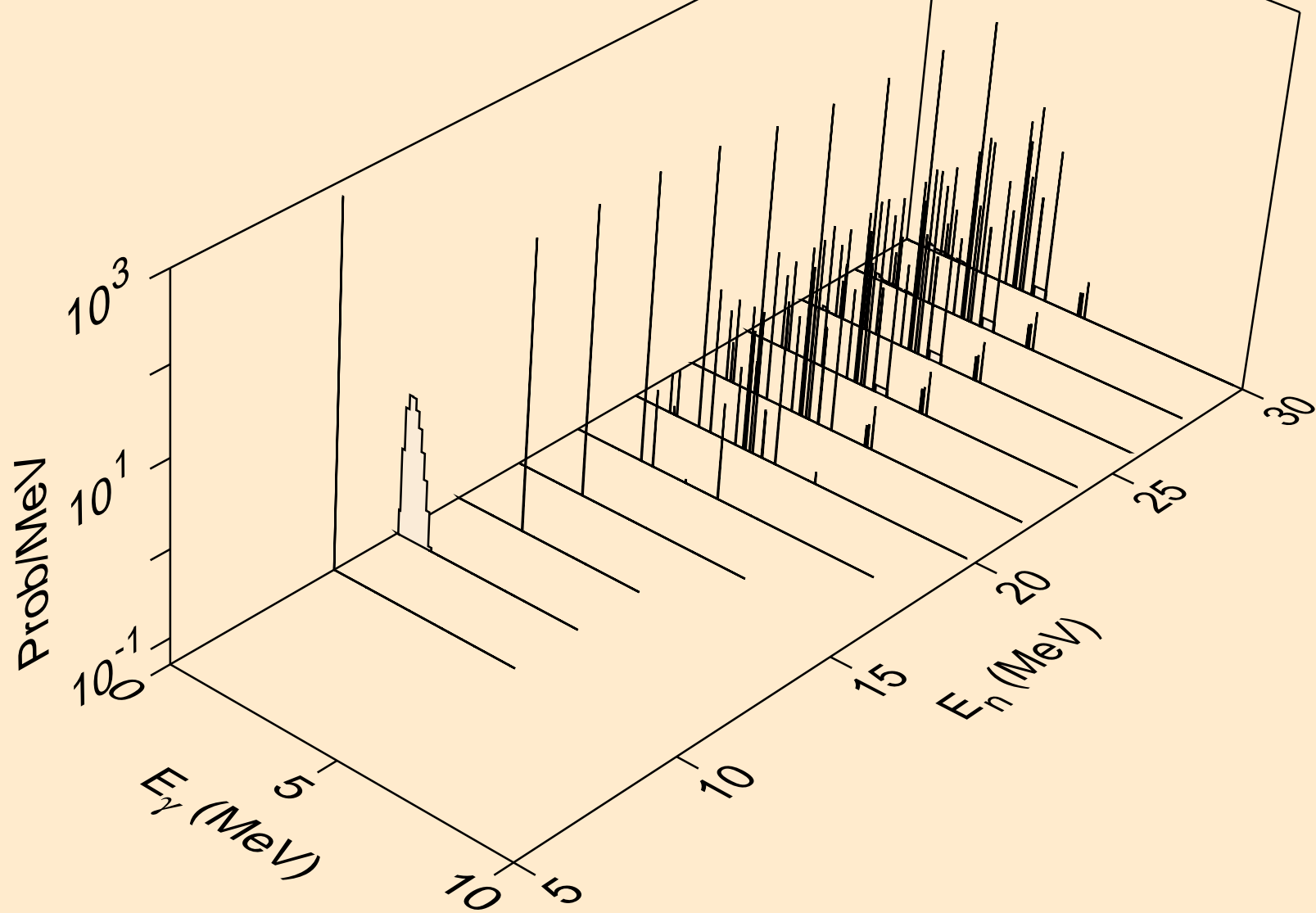

S036 NEUTRON ACER TENDL-2021 LIBRARY; T=293.6K
Photon emission for (n,2n)a

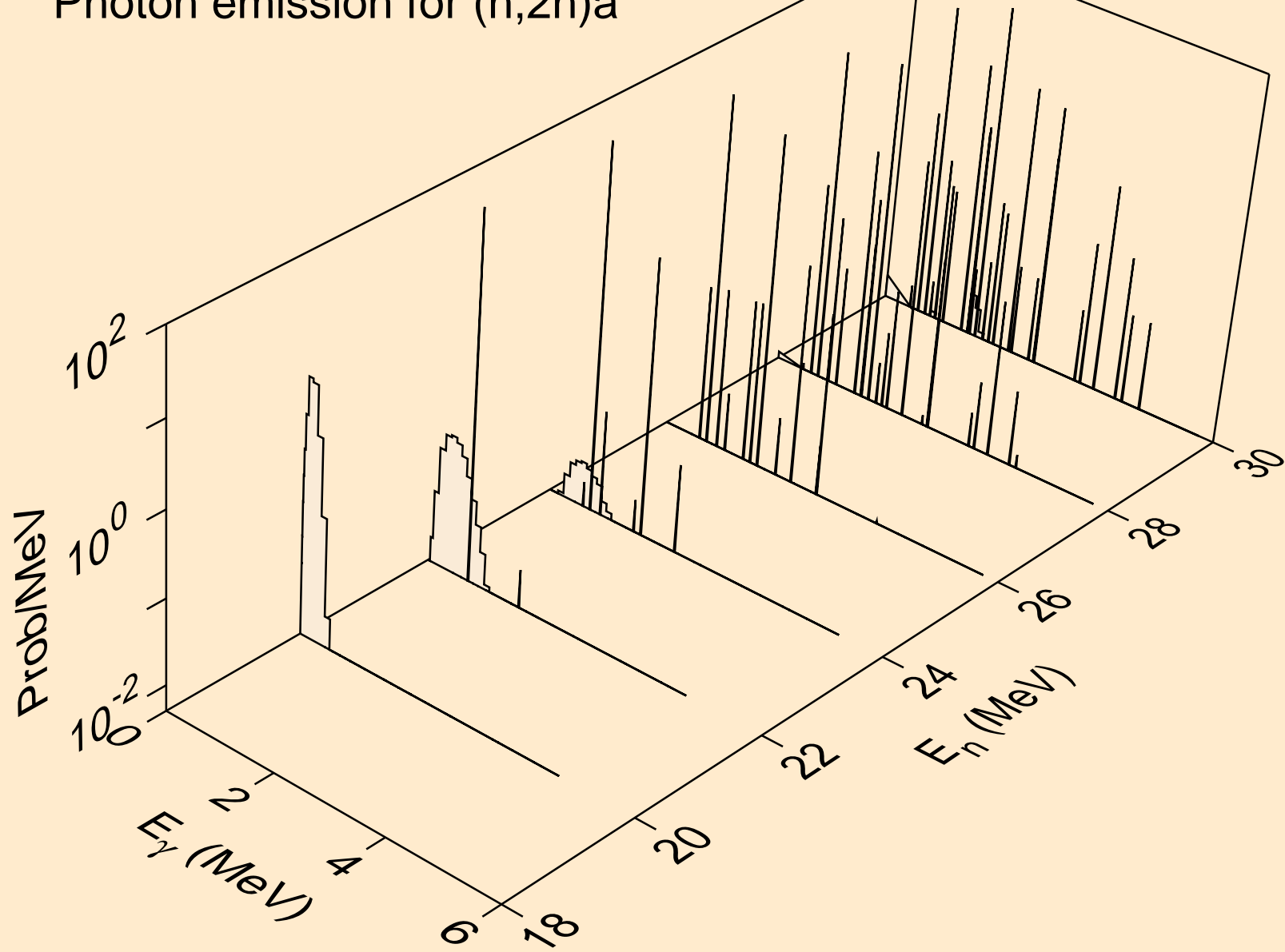

S036 NEUTRON ACER TENDL-2021 LIBRARY; T=293.6K
Photon emission for (n,3n)a

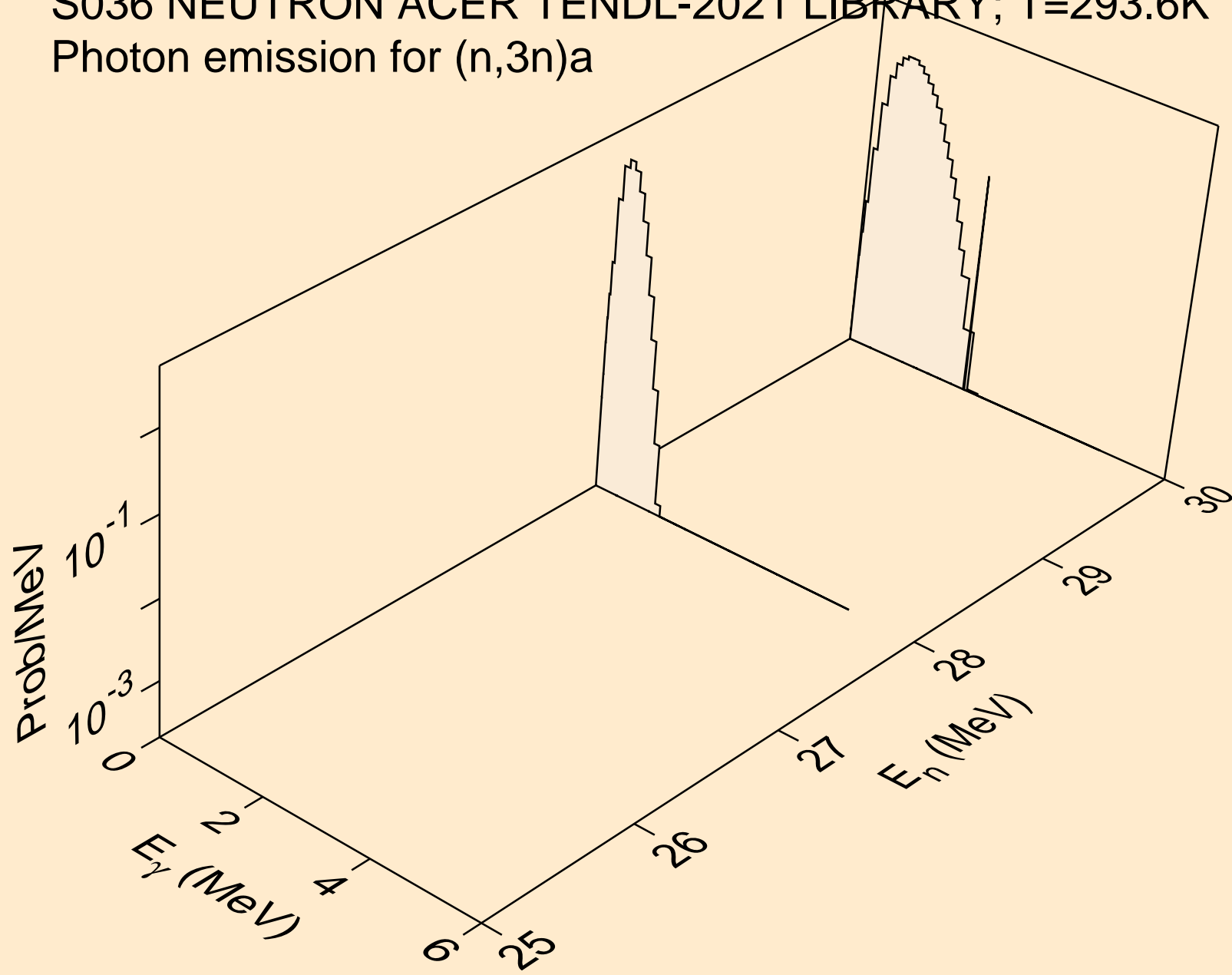

S036 NEUTRON ACER TENDL-2021 LIBRARY; T=293.6K
Photon emission for (n,n*)p

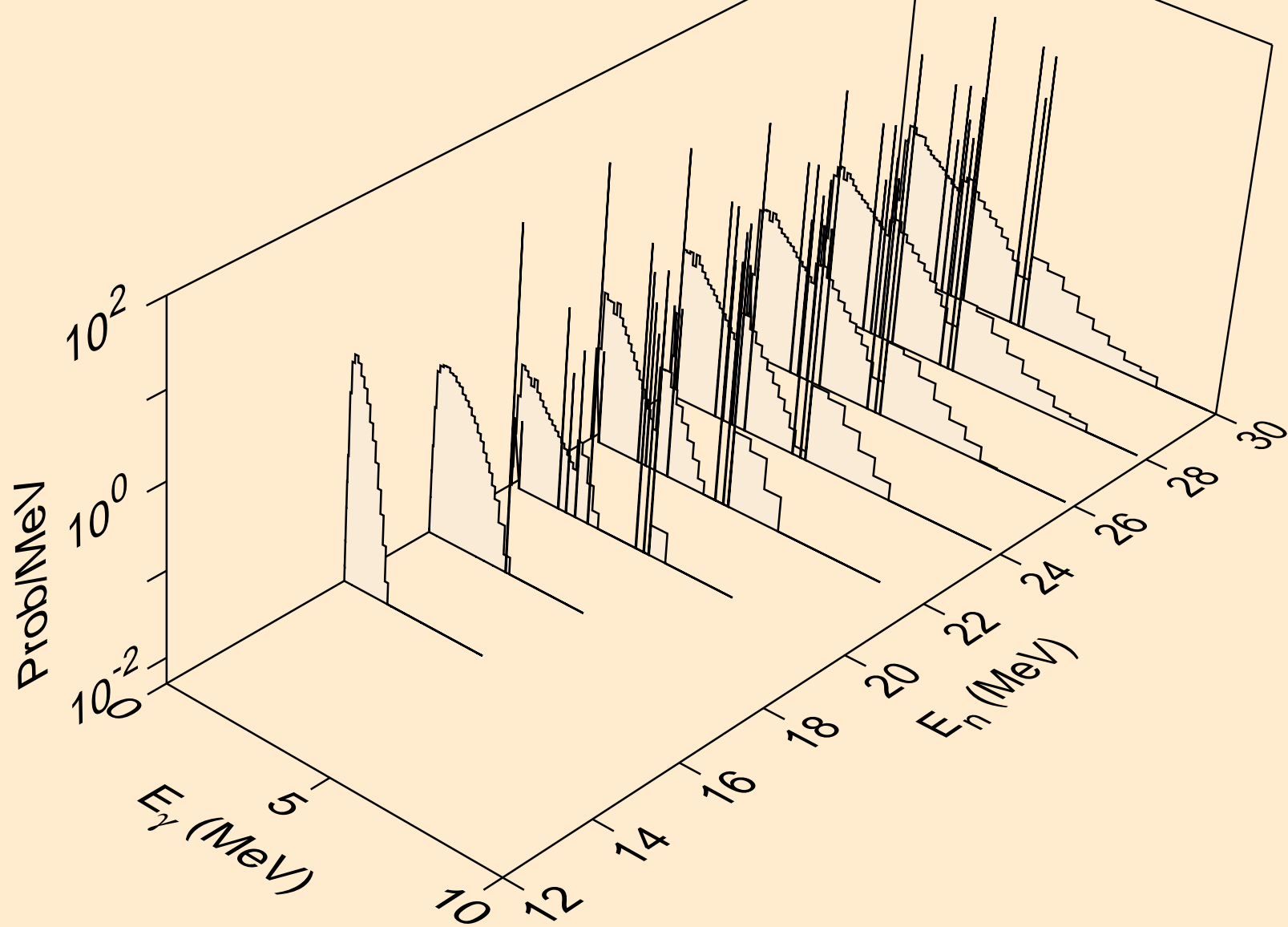

S036 NEUTRON ACER TENDL-2021 LIBRARY; T=293.6K
Photon emission for (n,n*)2a

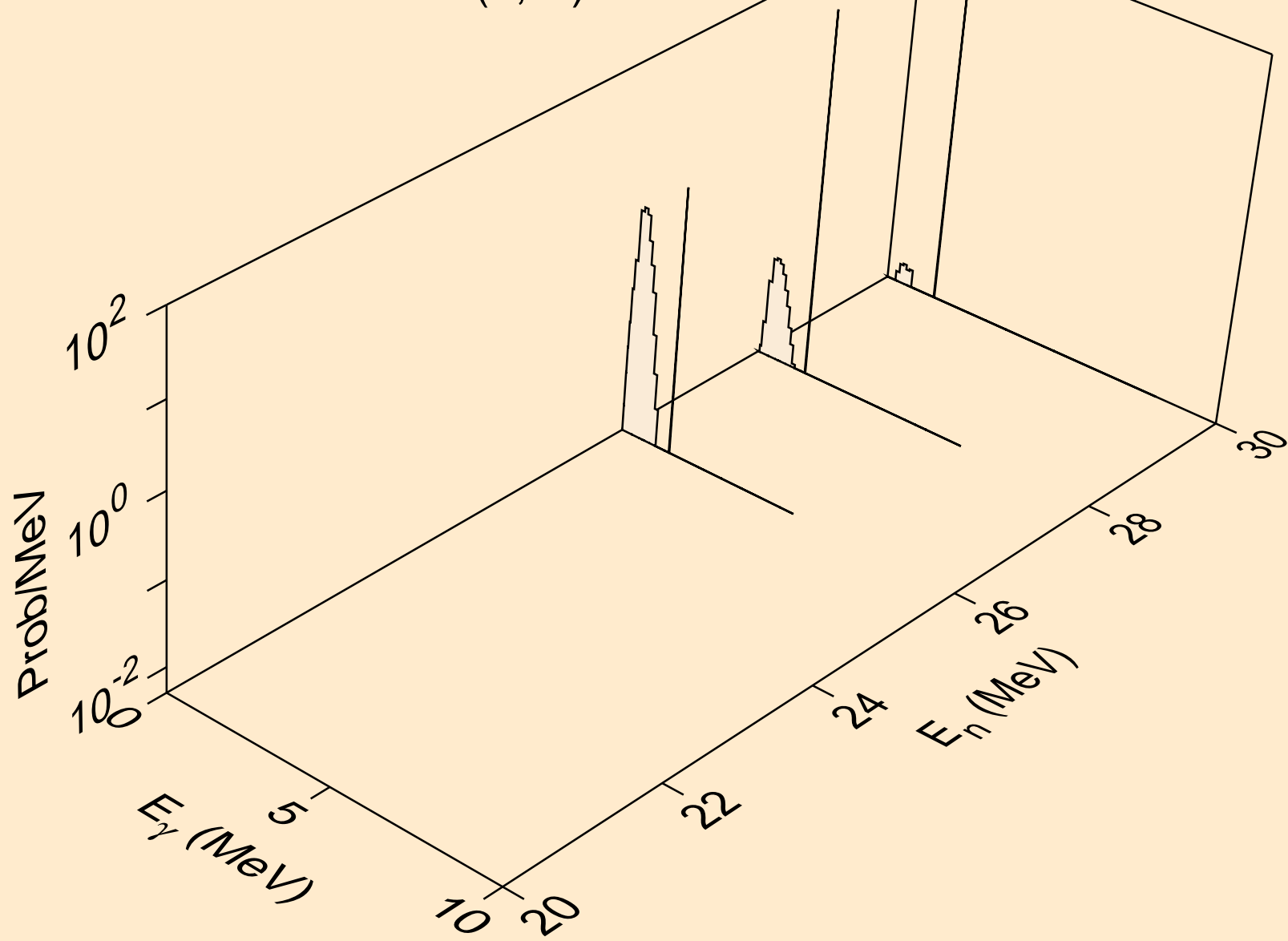

S036 NEUTRON ACER TENDL-2021 LIBRARY; T=293.6K
Photon emission for (n,n*)d

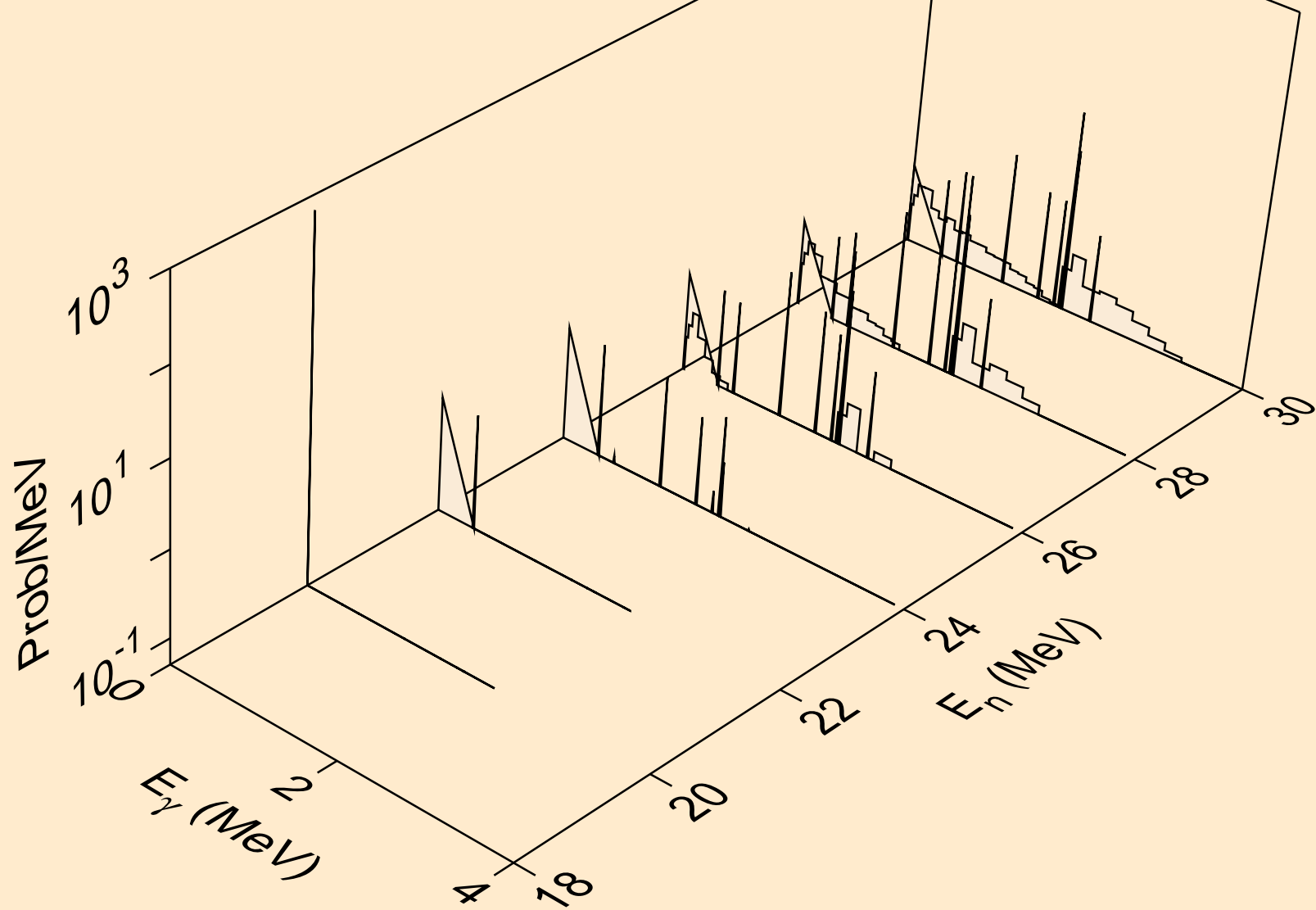

S036 NEUTRON ACER TENDL-2021 LIBRARY; T=293.6K
Photon emission for (n,n*)t

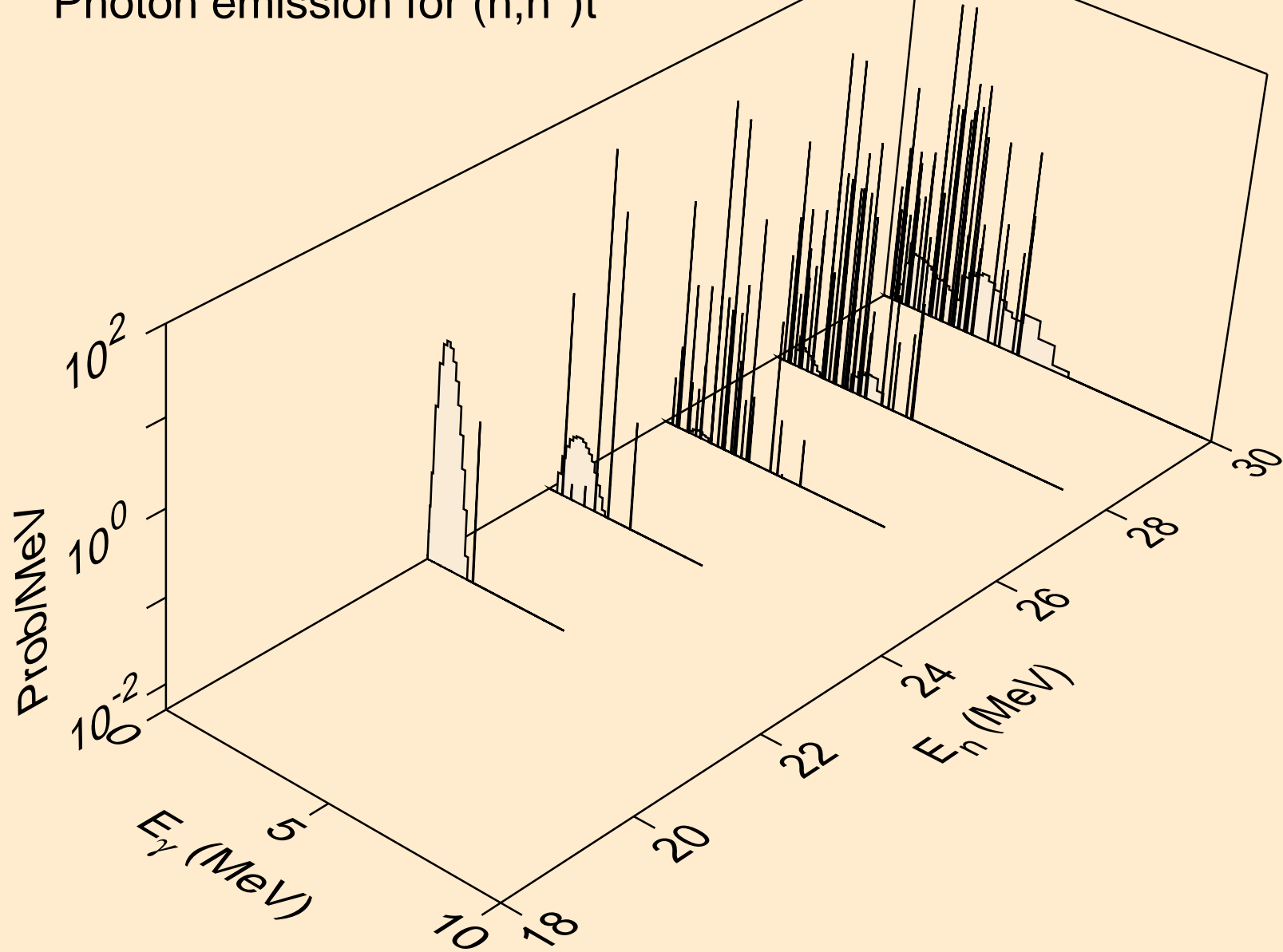

S036 NEUTRON ACER TENDL-2021 LIBRARY; T=293.6K
Photon emission for (n,n*)he3

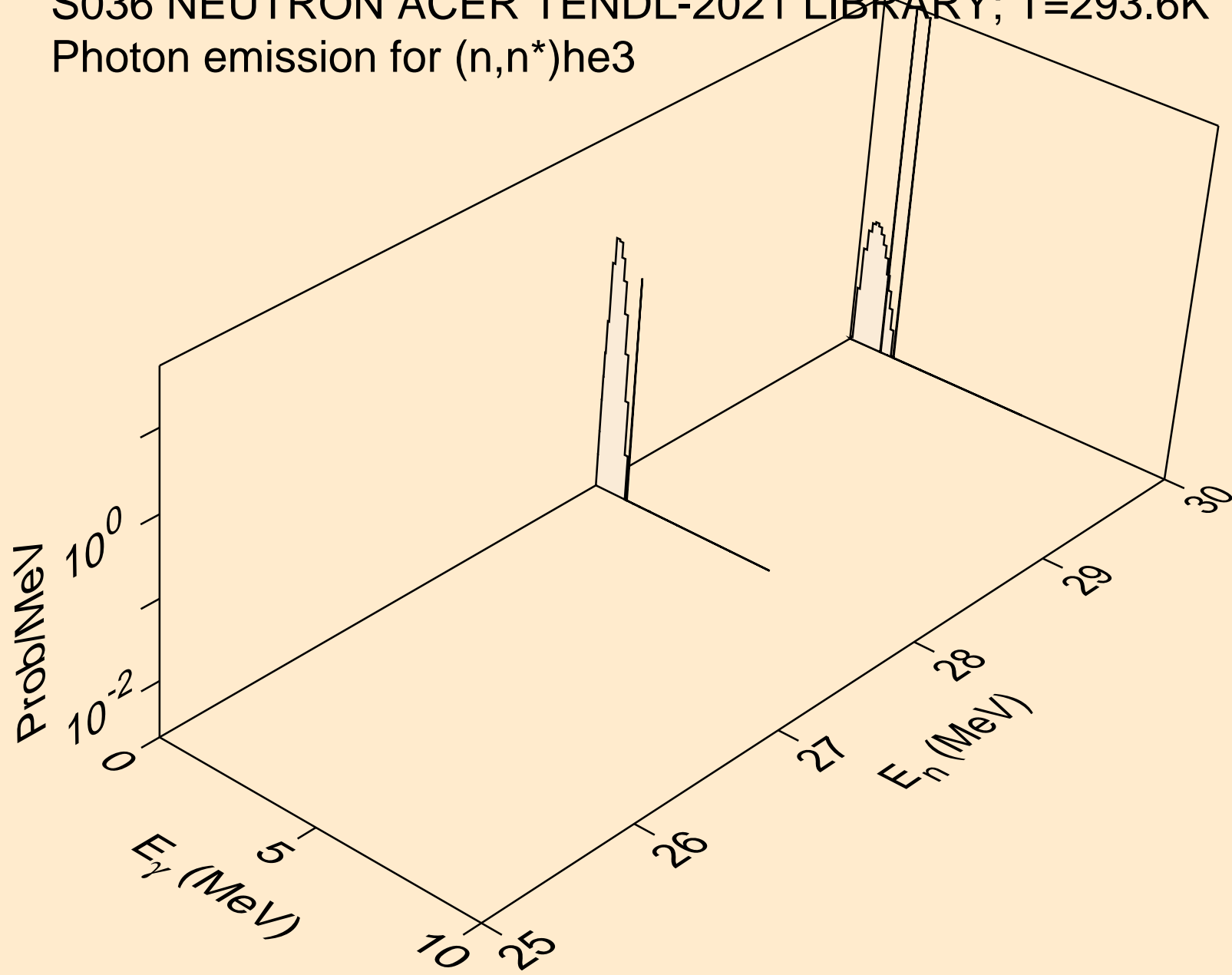

S036 NEUTRON ACER TENDL-2021 LIBRARY; T=293.6K
Photon emission for (n,2np)

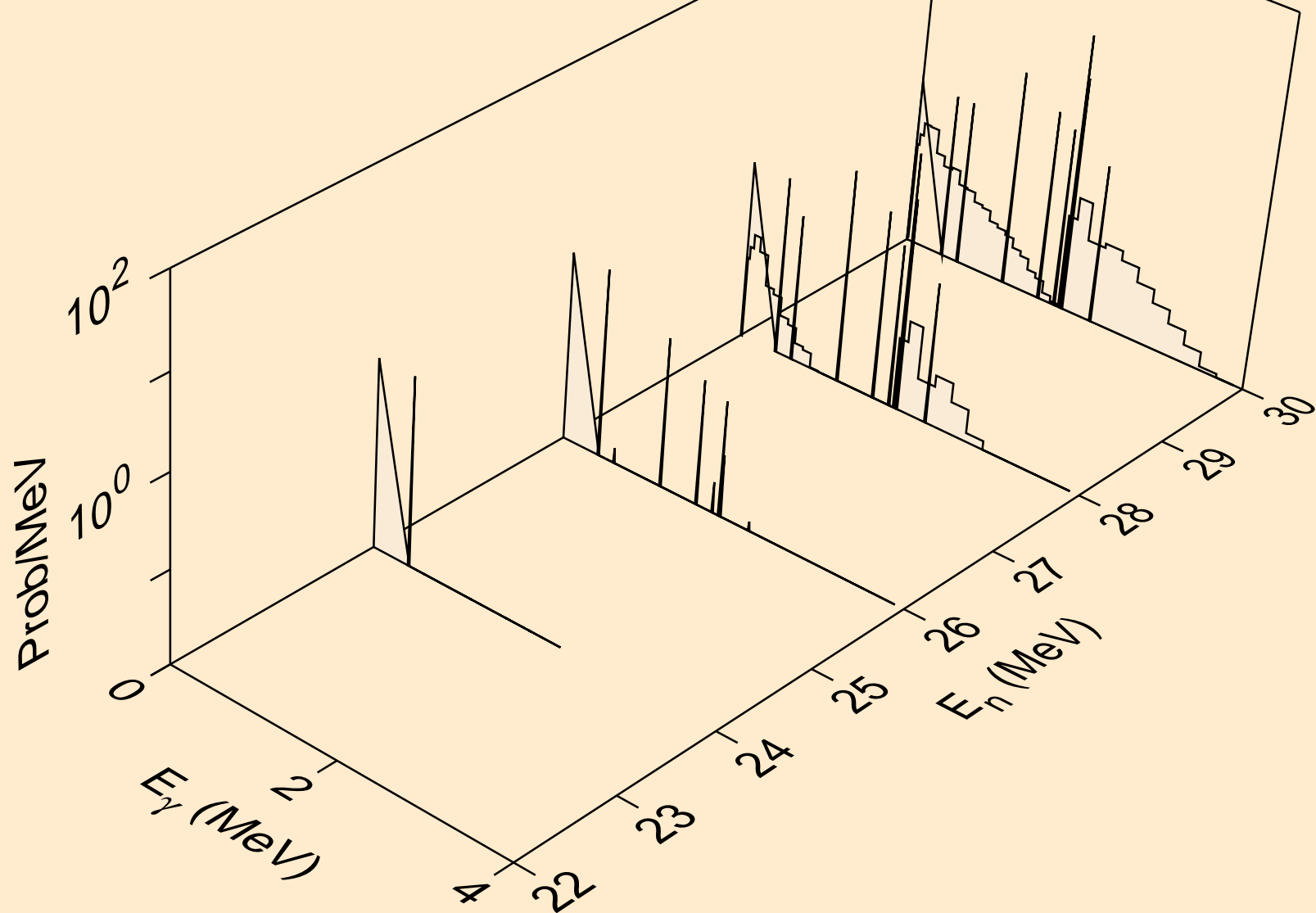

S036 NEUTRON ACER TENDL-2021 LIBRARY; T=293.6K
Photon emission for (n,3np)

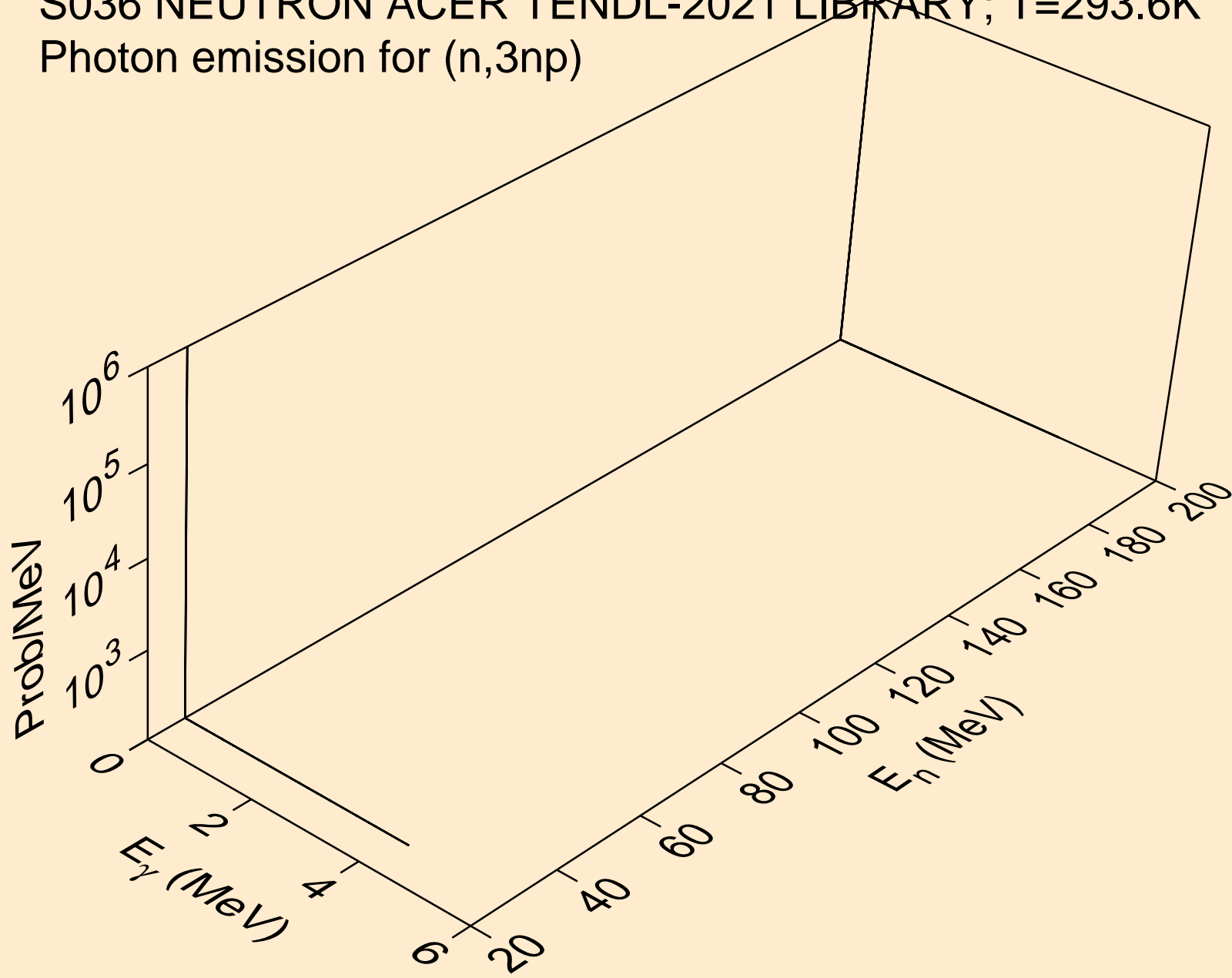

S036 NEUTRON ACER TENDL-2021 LIBRARY; T=293.6K
Photon emission for (n,2np)

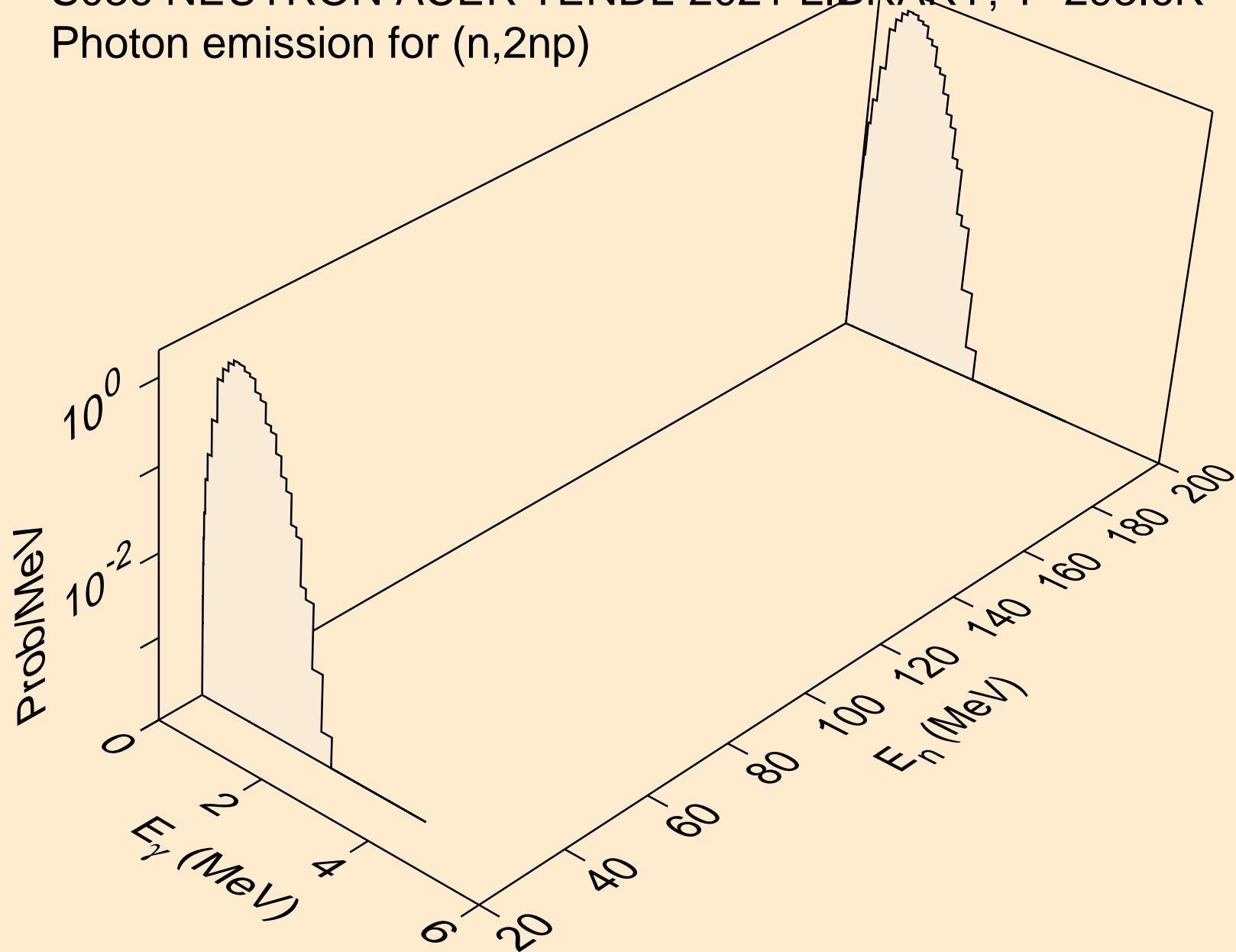

S036 NEUTRON ACER TENDL-2021 LIBRARY; T=293.6K
Photon emission for (n,n*c)

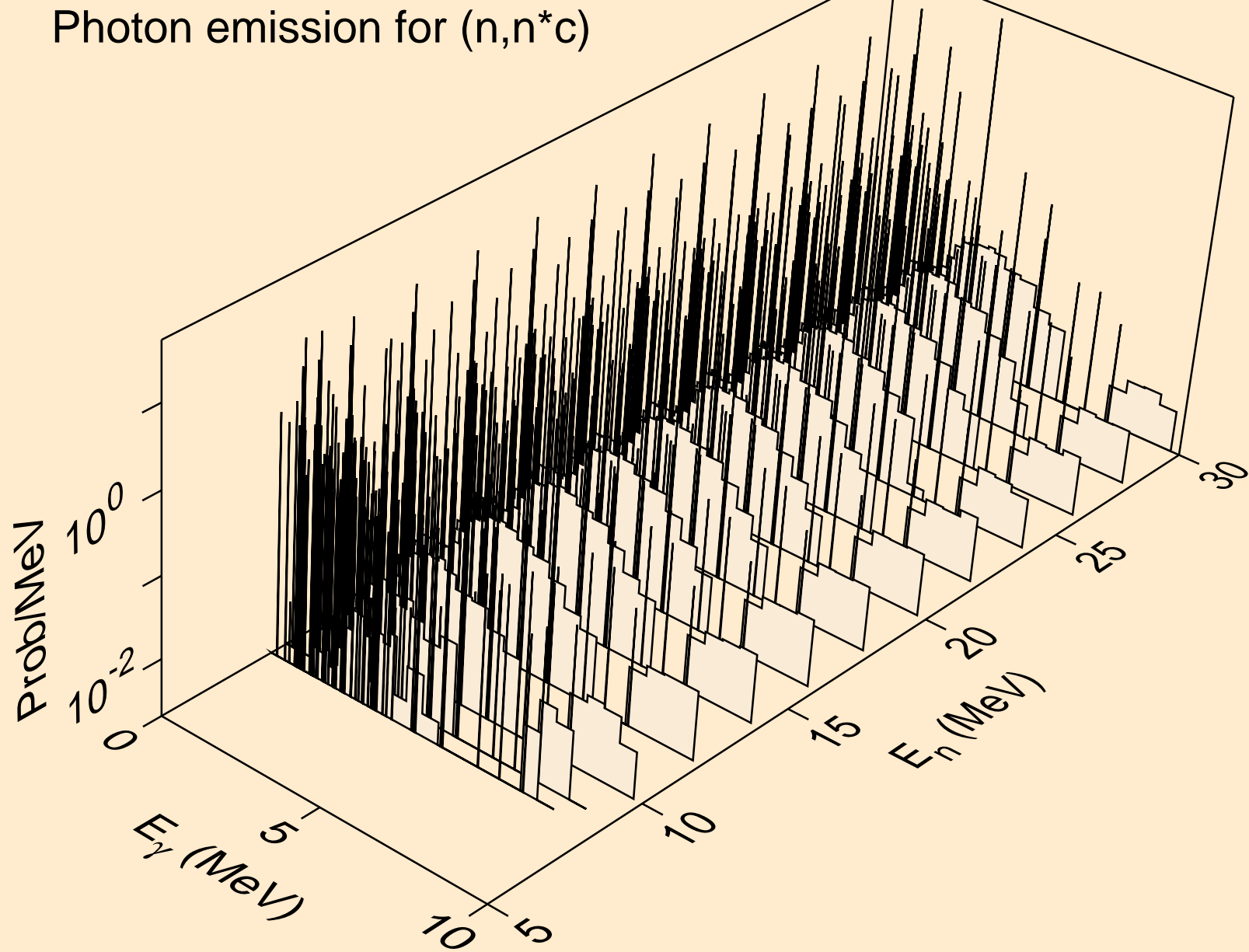

S036 NEUTRON ACER TENDL-2021 LIBRARY; T=293.6K
Photon emission for (n,gma)

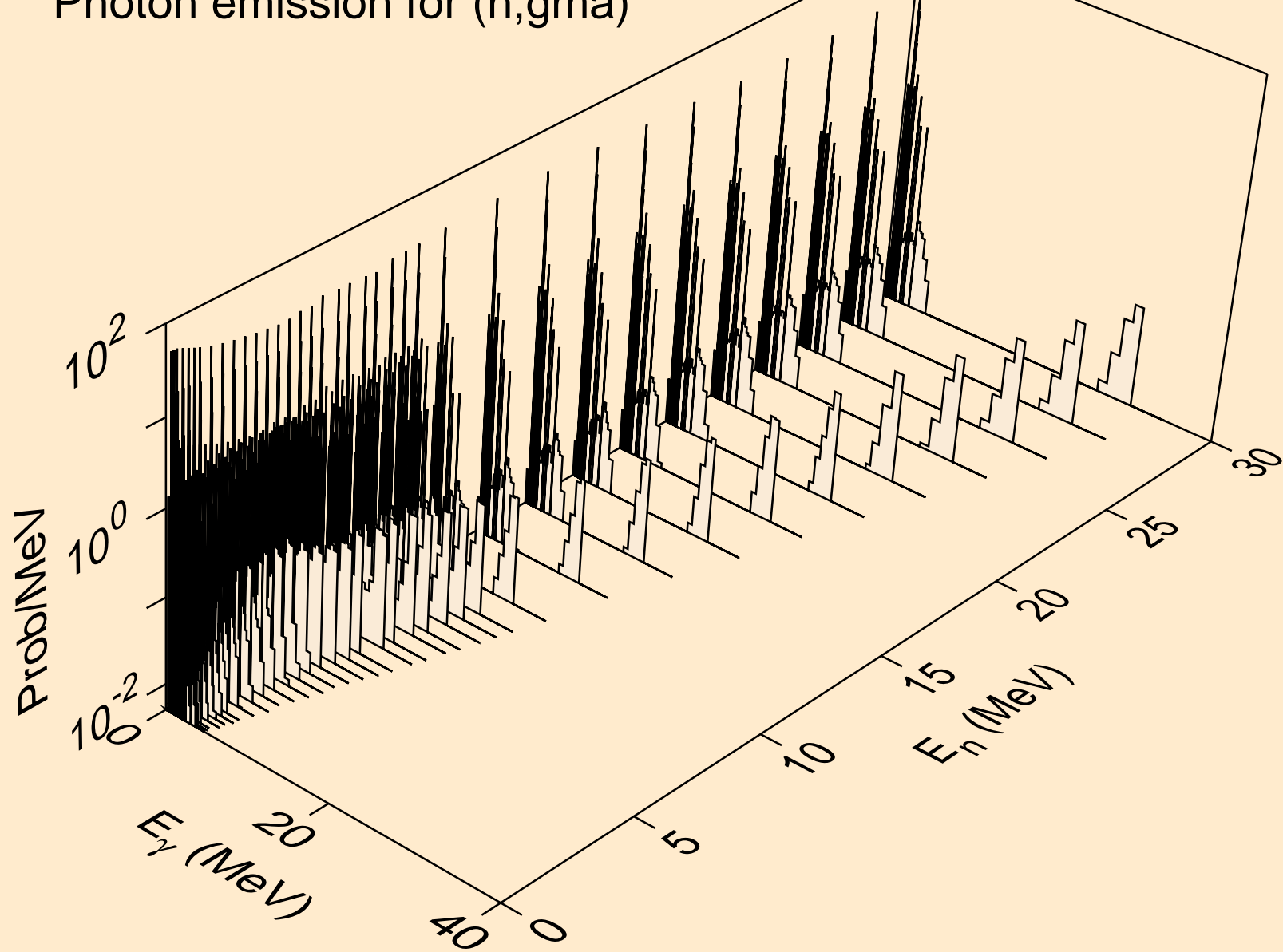

S036 NEUTRON ACER TENDL-2021 LIBRARY; T=293.6K
Photon emission for (n,p)

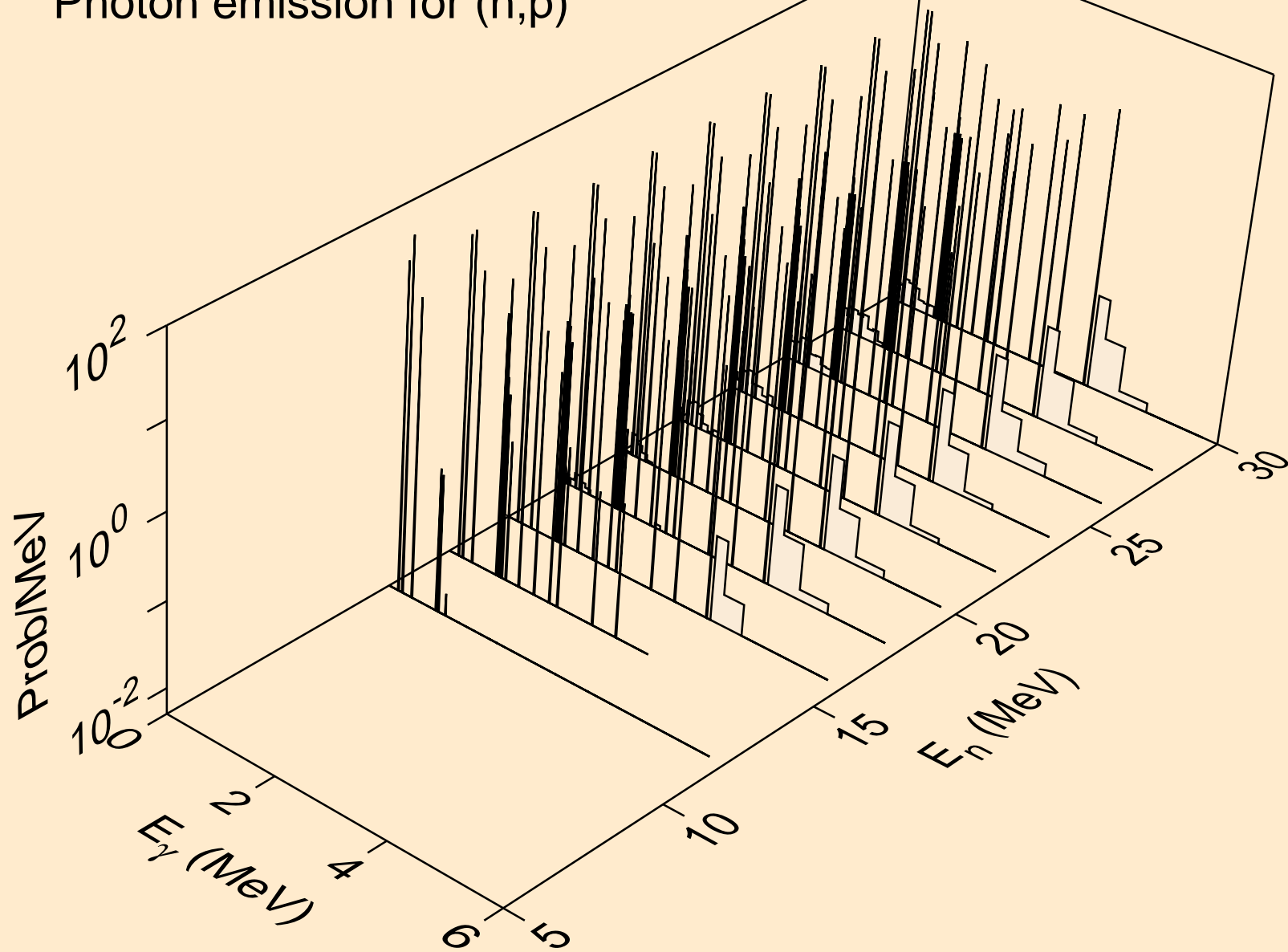

S036 NEUTRON ACER TENDL-2021 LIBRARY; T=293.6K
Photon emission for (n,d)

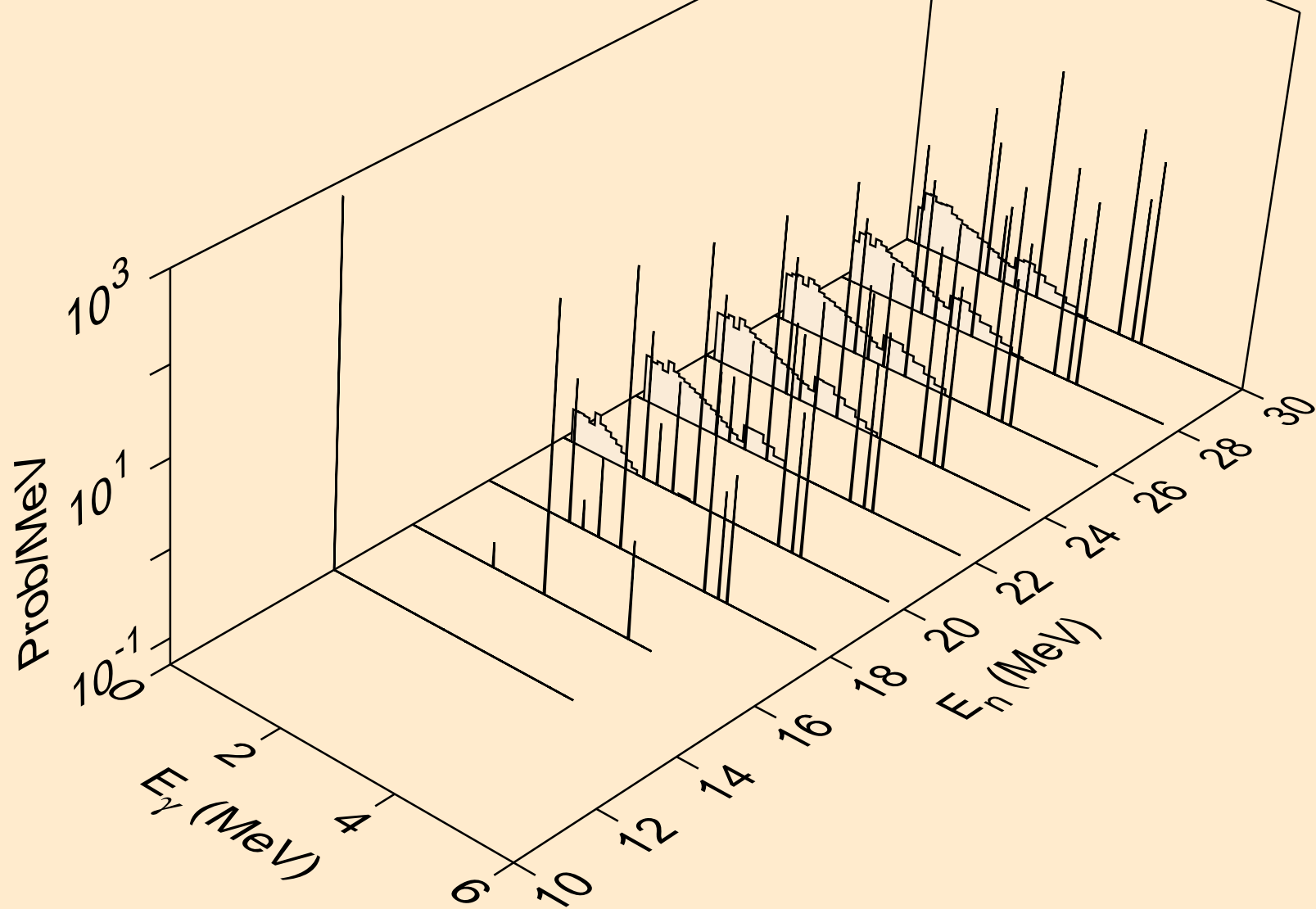

S036 NEUTRON ACER TENDL-2021 LIBRARY; T=293.6K
Photon emission for (n,t)

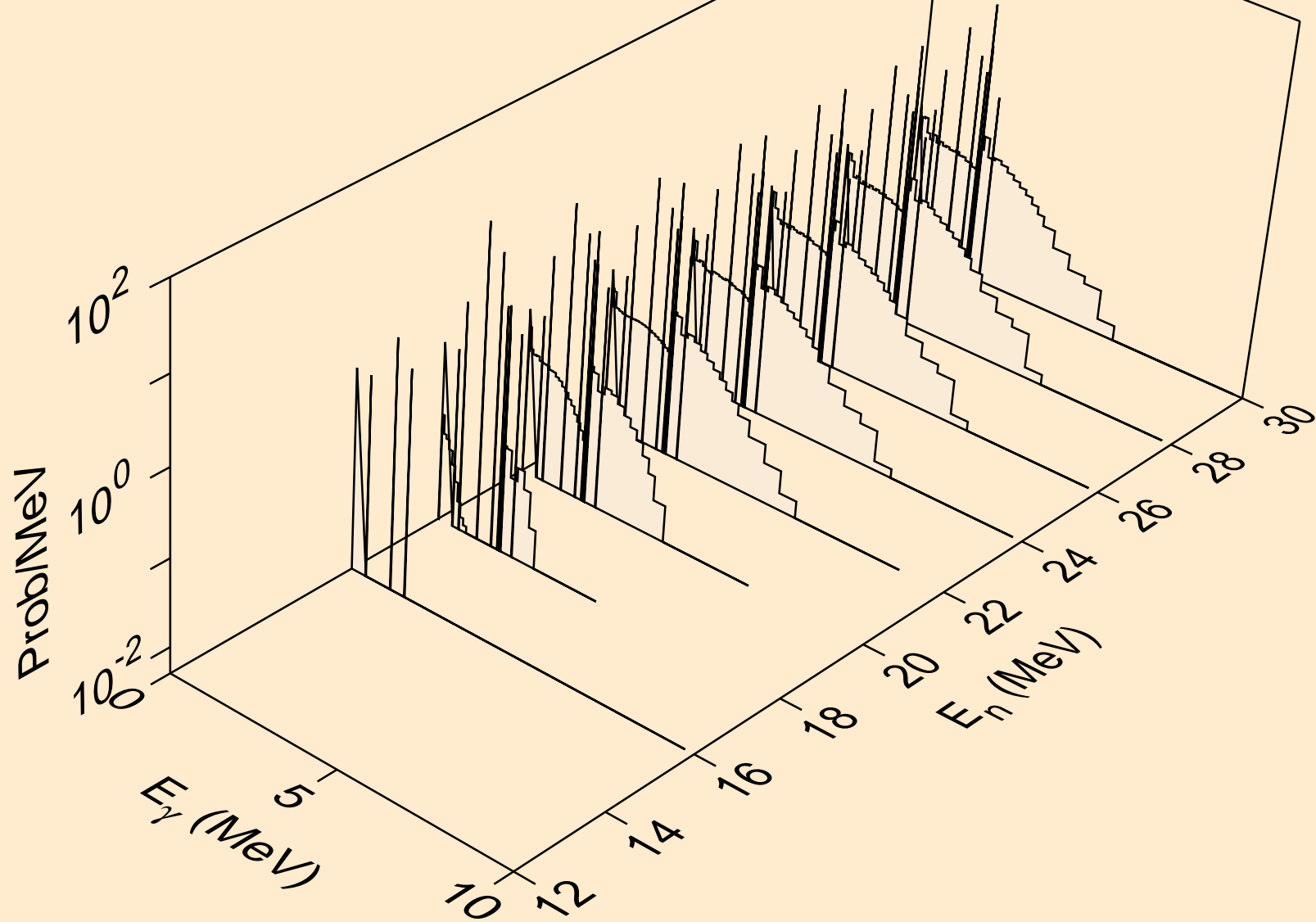

S036 NEUTRON ACER TENDL-2021 LIBRARY; T=293.6K
Photon emission for (n,he3)

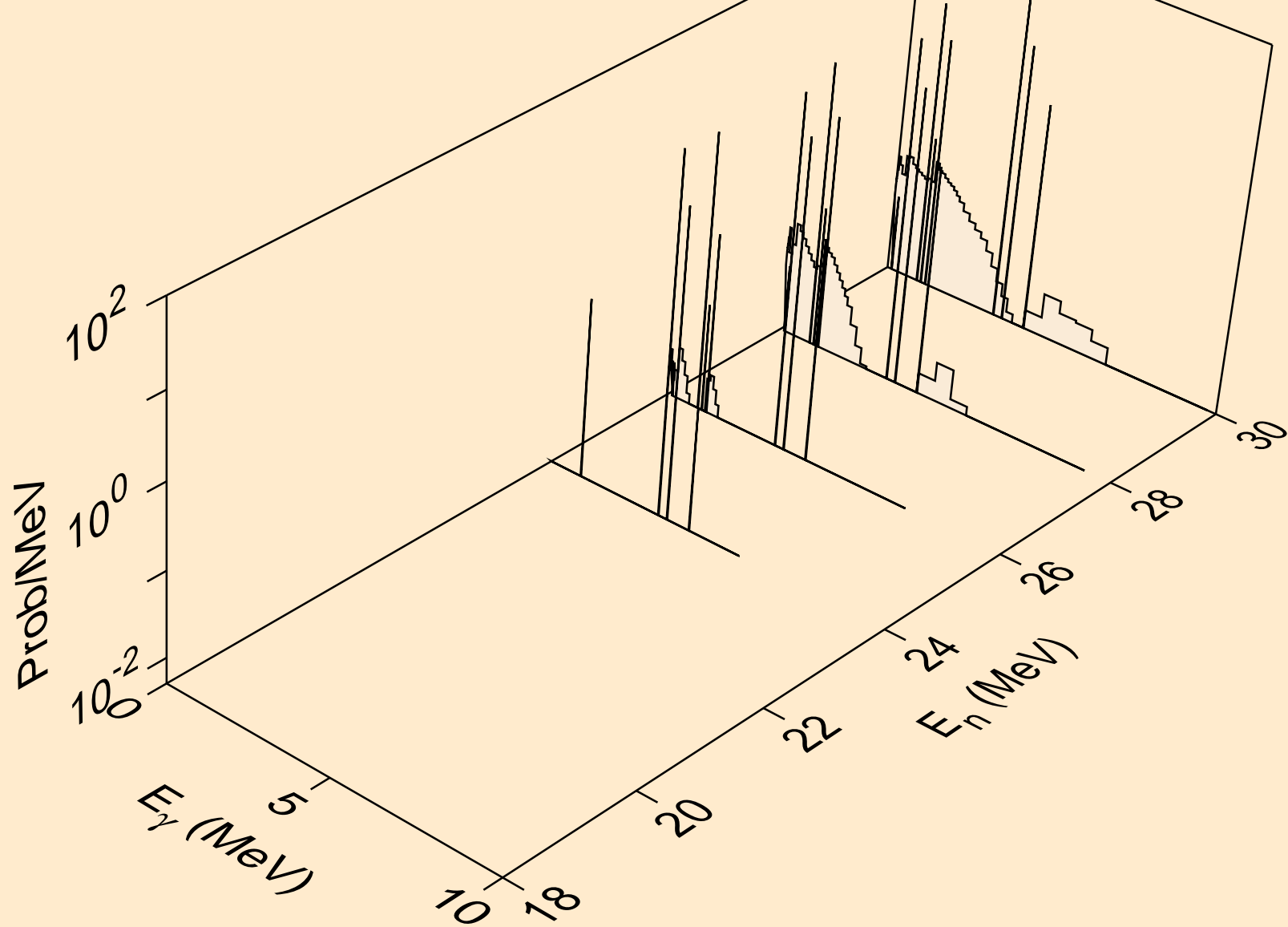

S036 NEUTRON ACER TENDL-2021 LIBRARY; T=293.6K
Photon emission for (n,a)

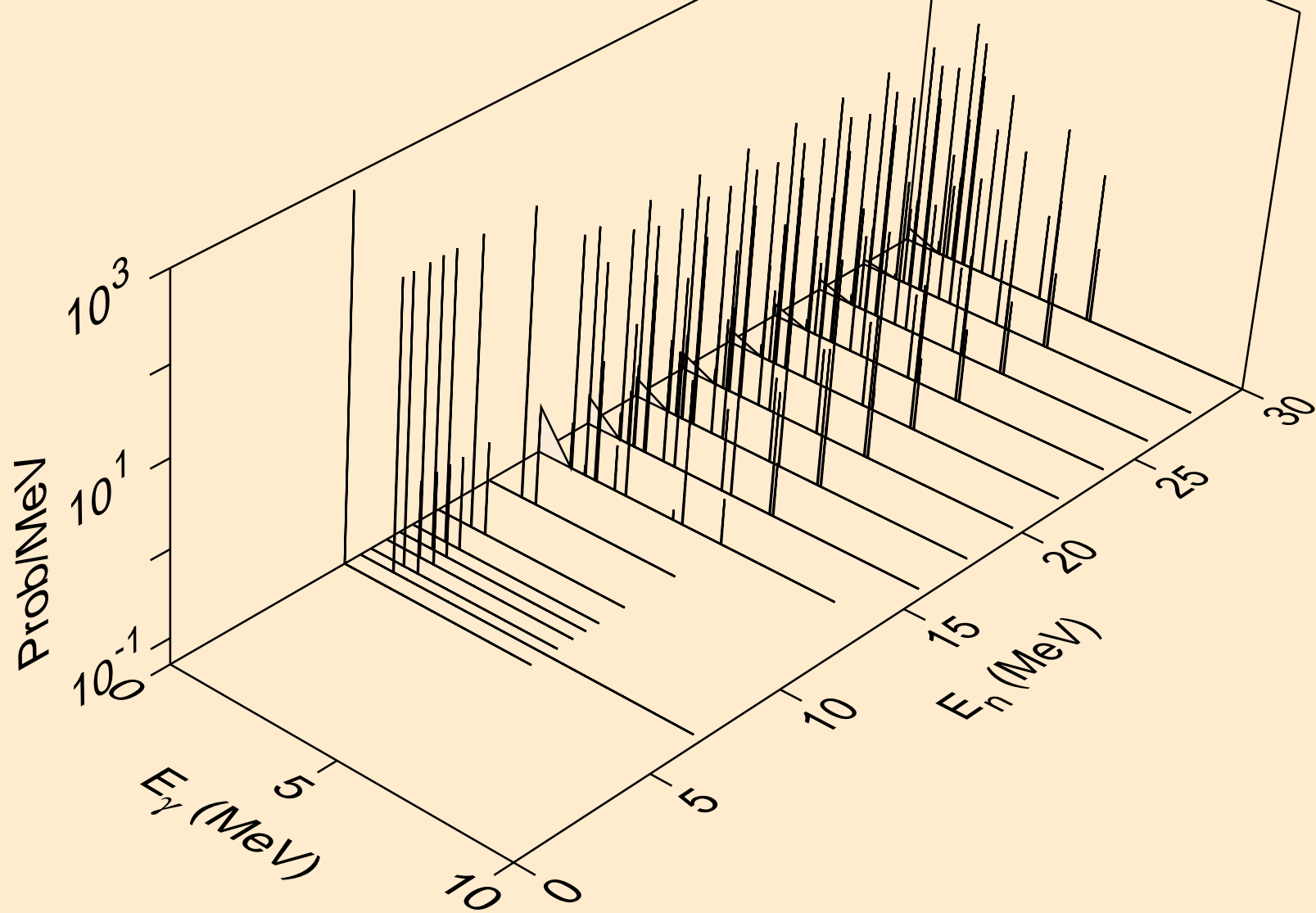

S036 NEUTRON ACER TENDL-2021 LIBRARY; T=293.6K
Photon emission for (n,2a)

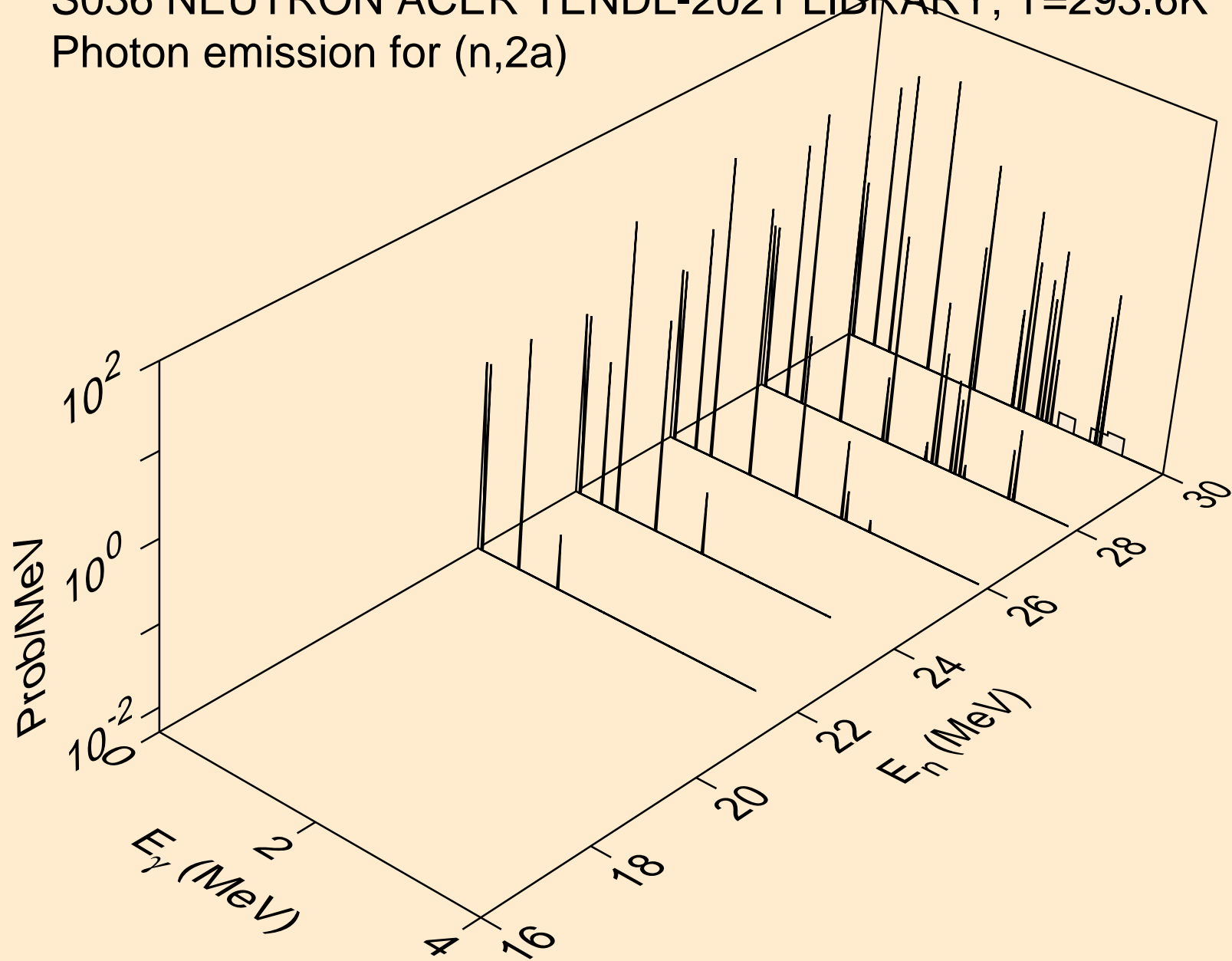

S036 NEUTRON ACER TENDL-2021 LIBRARY; T=293.6K
Photon emission for (n,2p)

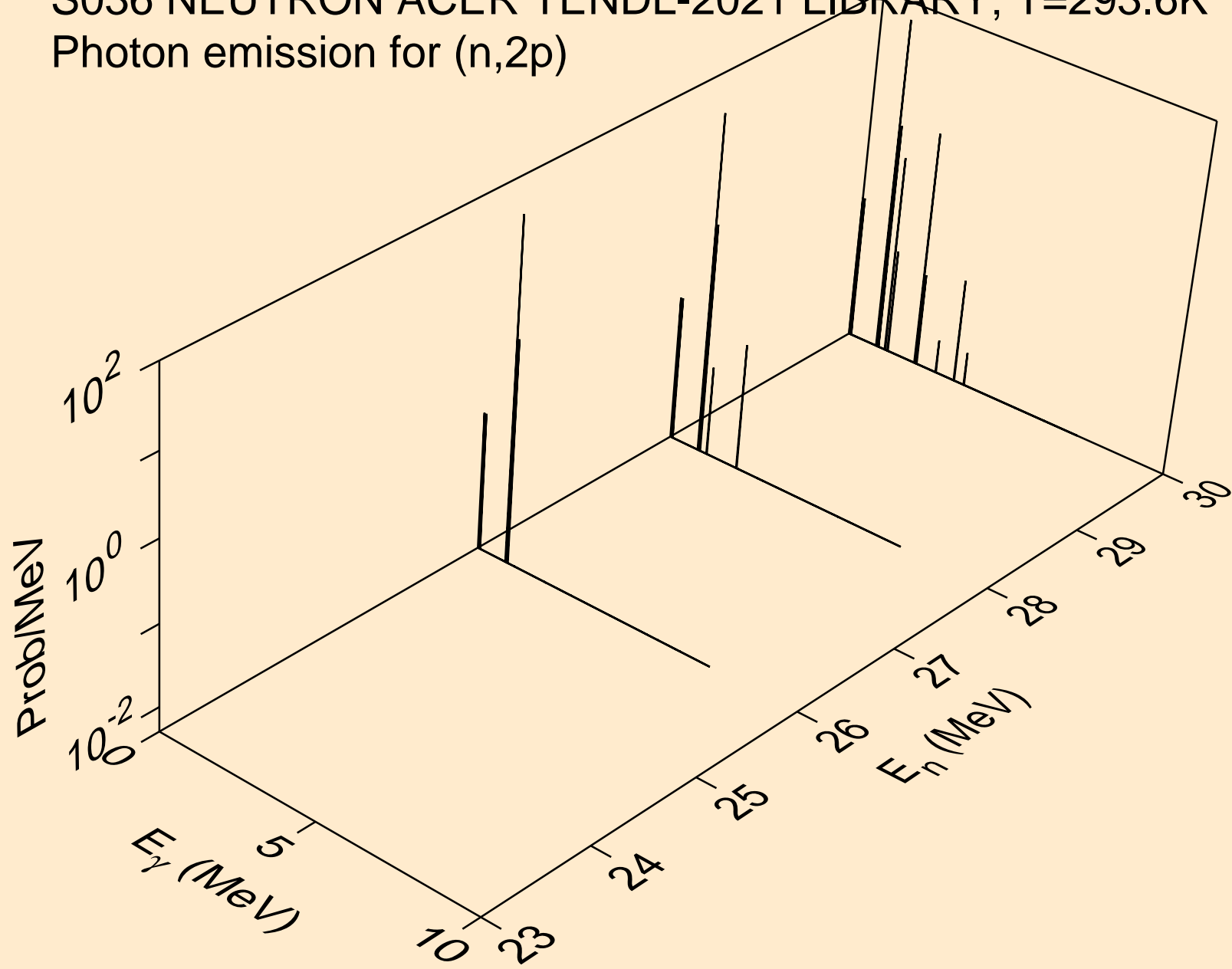

S036 NEUTRON ACER TENDL-2021 LIBRARY; T=293.6K
Photon emission for (n,p)

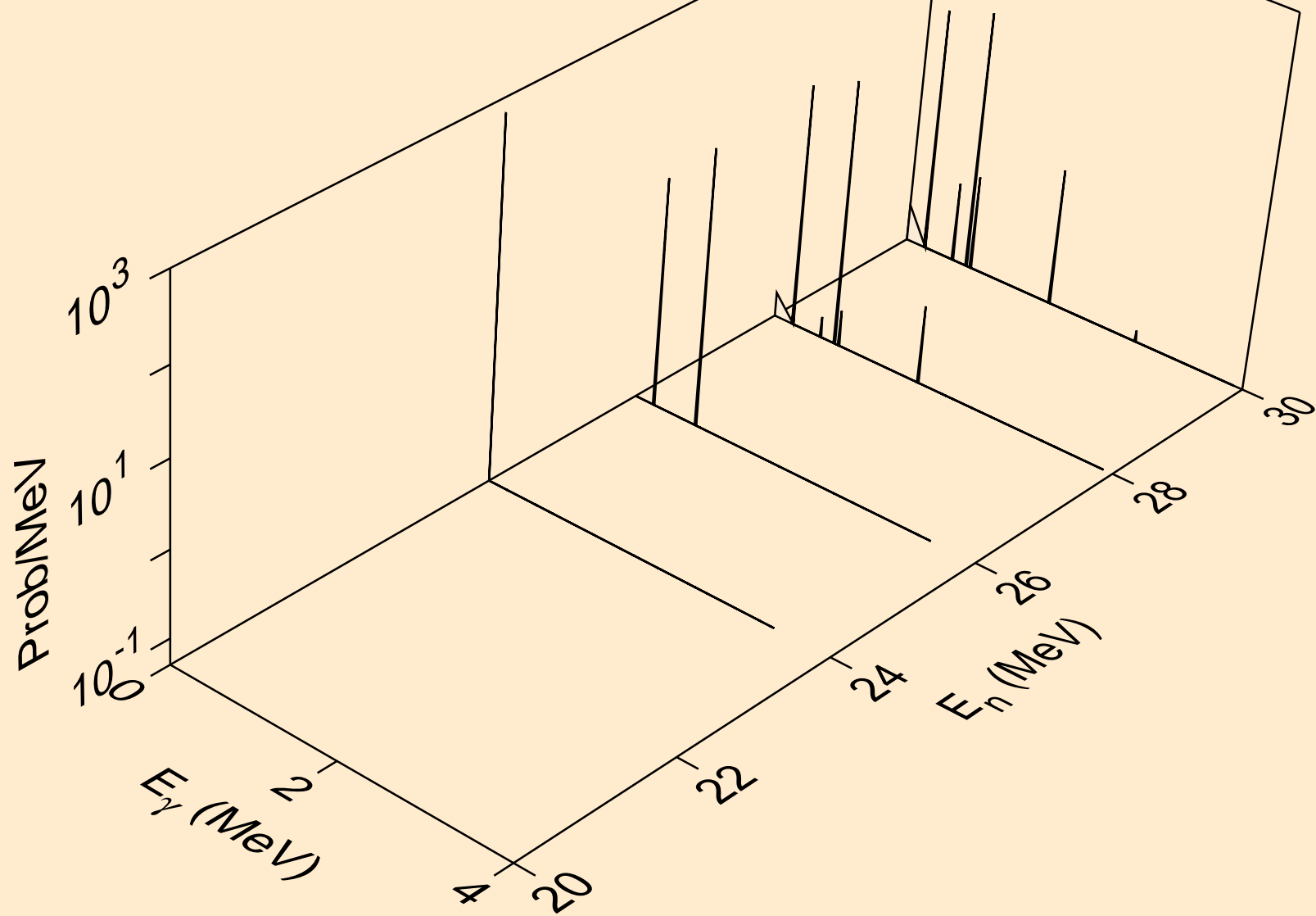

S036 NEUTRON ACER TENDL-2021 LIBRARY; T=293.6K
Photon emission for (n,pd)

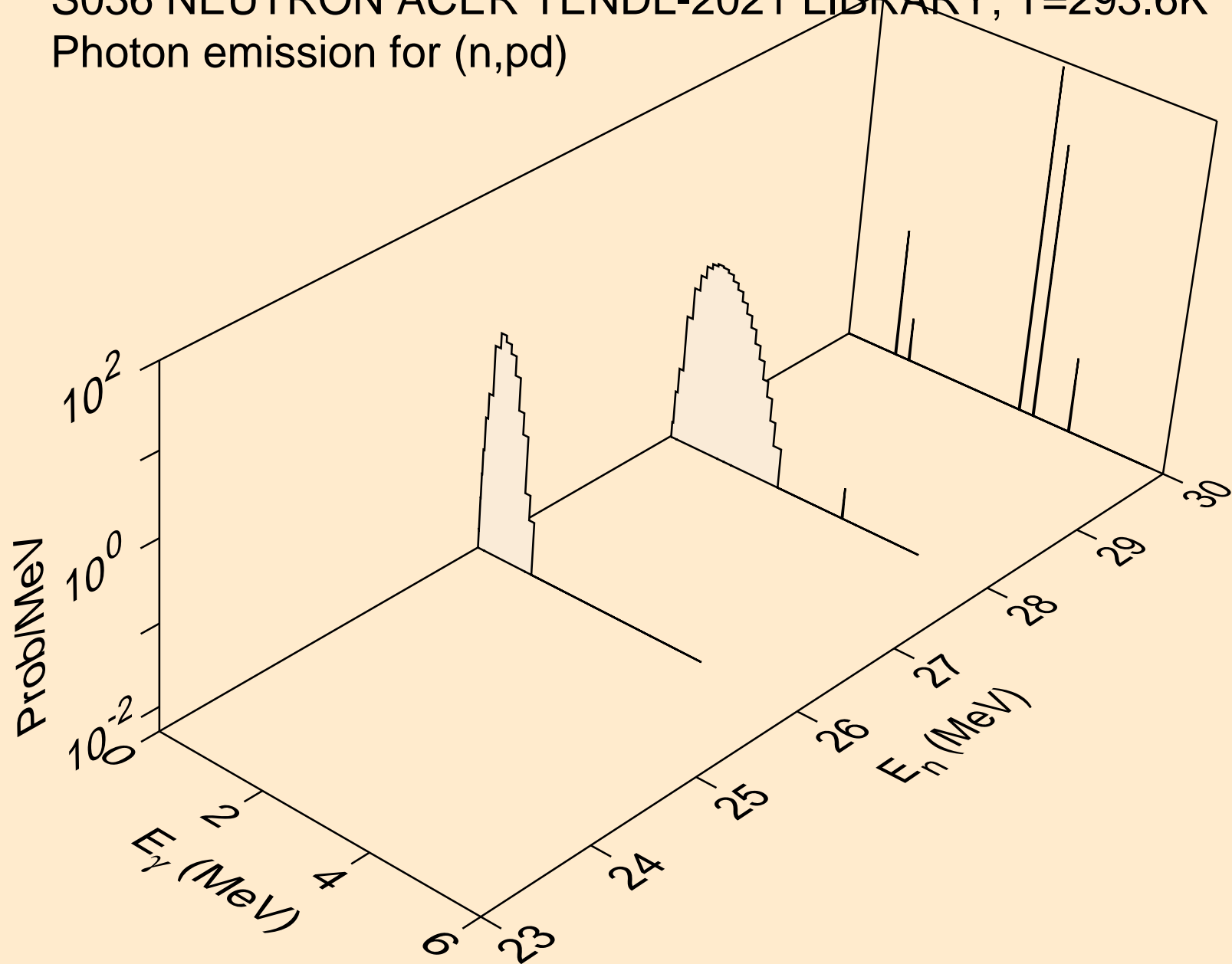

S036 NEUTRON ACER TENDL-2021 LIBRARY; T=293.6K
Photon emission for (n,pt)

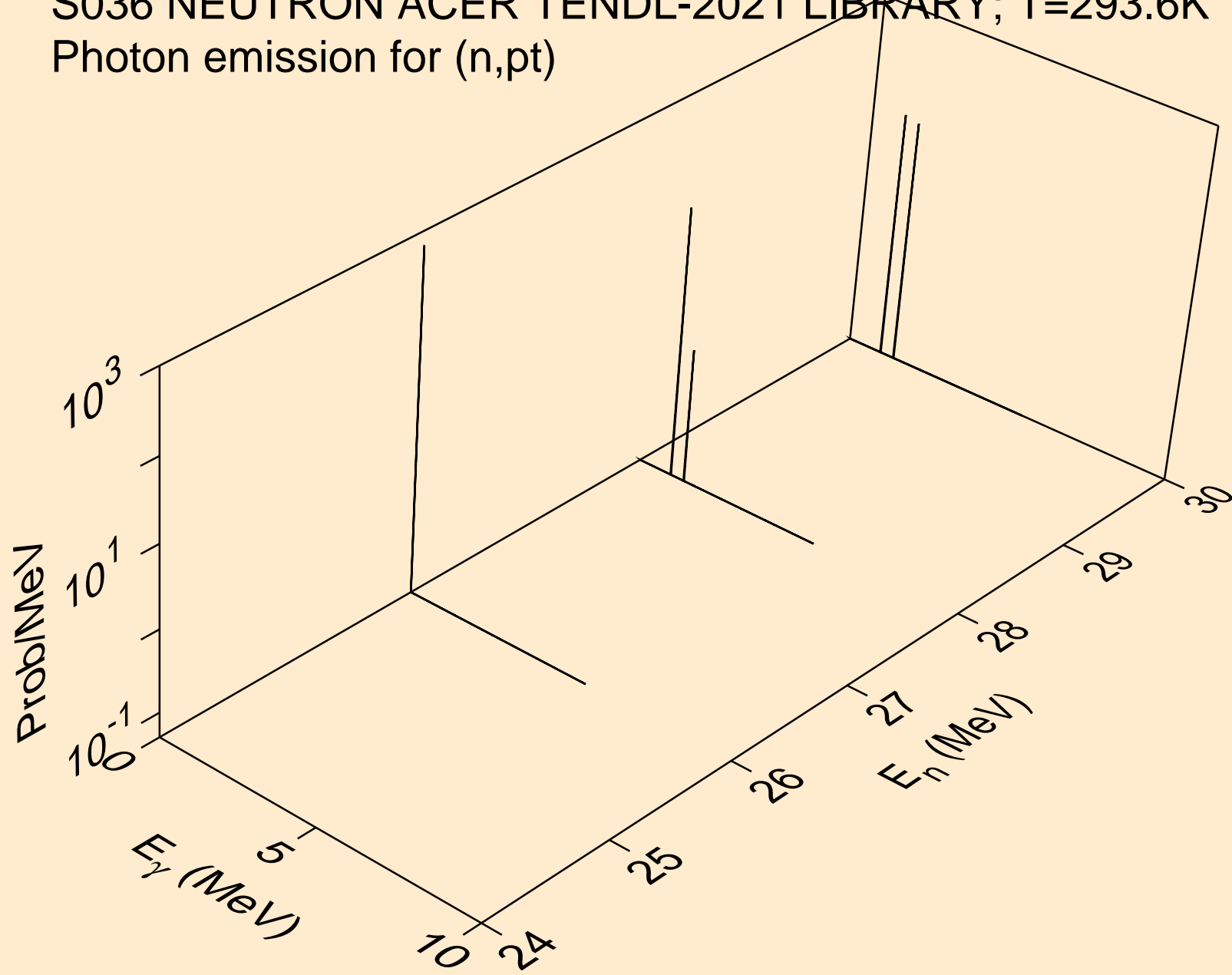

S036 NEUTRON ACER TENDL-2021 LIBRARY; T=293.6K
Photon emission for (n,da)

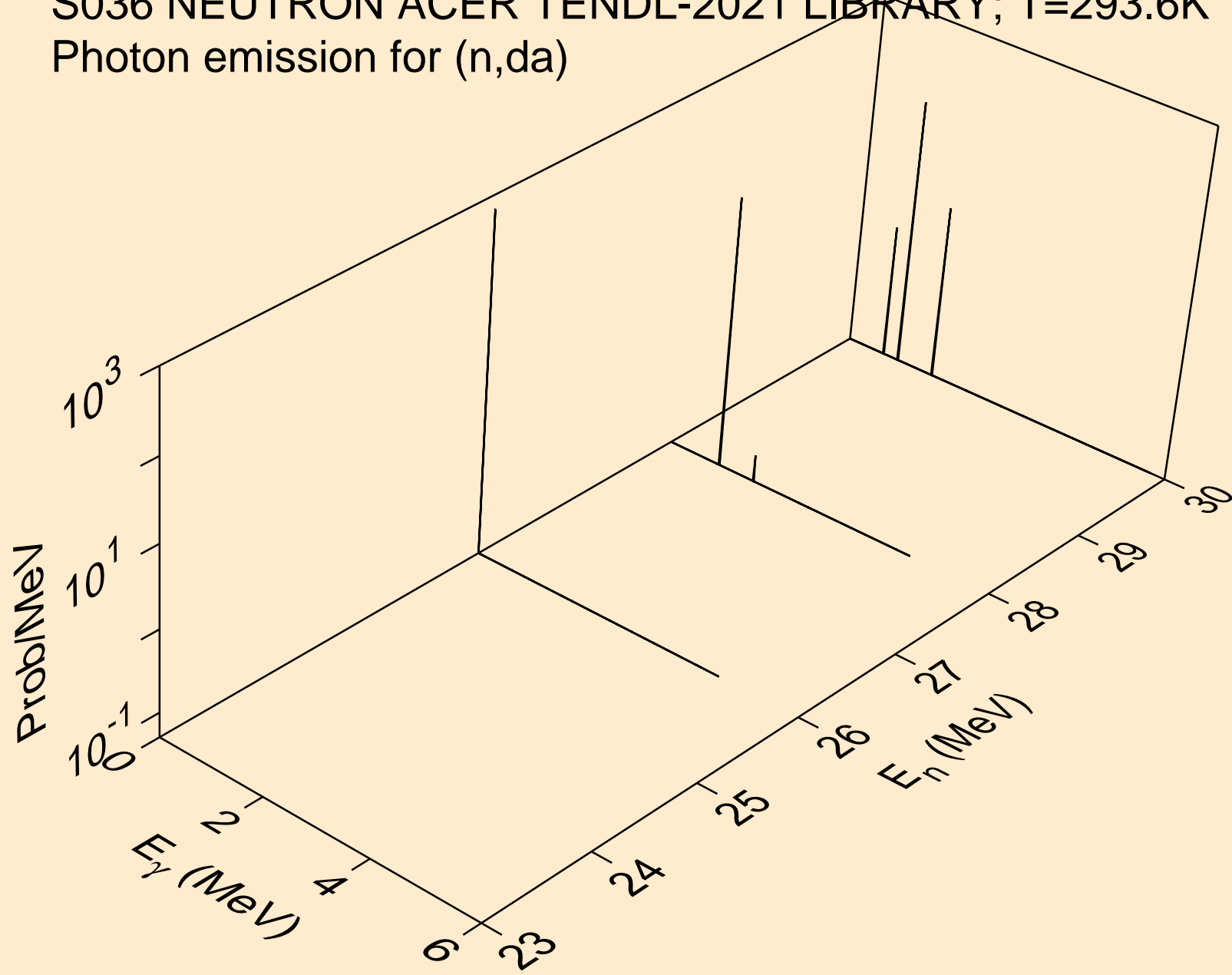

S036 NEUTRON ACER TENDL-2021 LIBRARY; T=293.6K
thermal capture photon spectrum

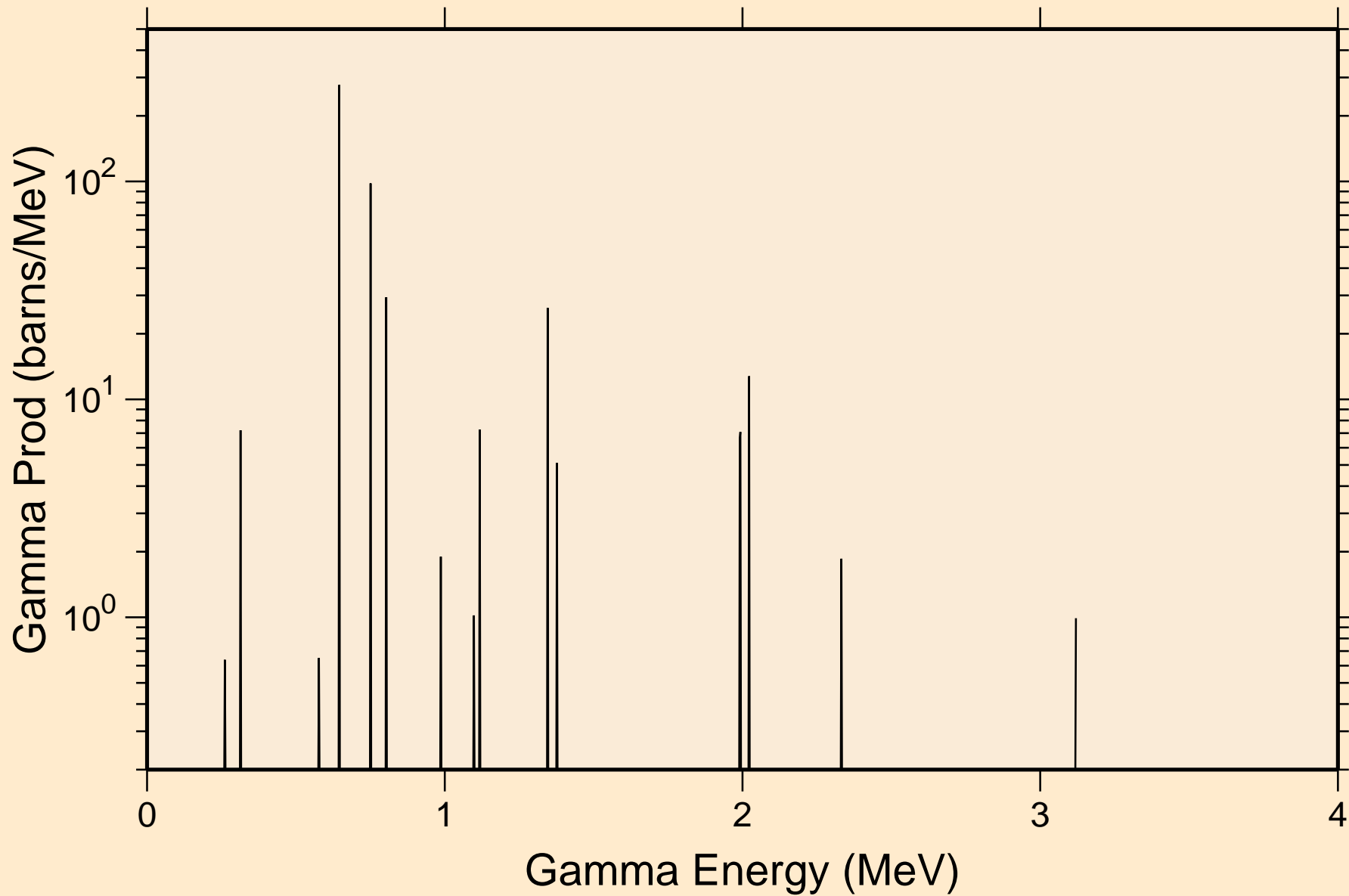

S036 NEUTRON ACER TENDL-2021 LIBRARY; T=293.6K
14 MeV photon spectrum

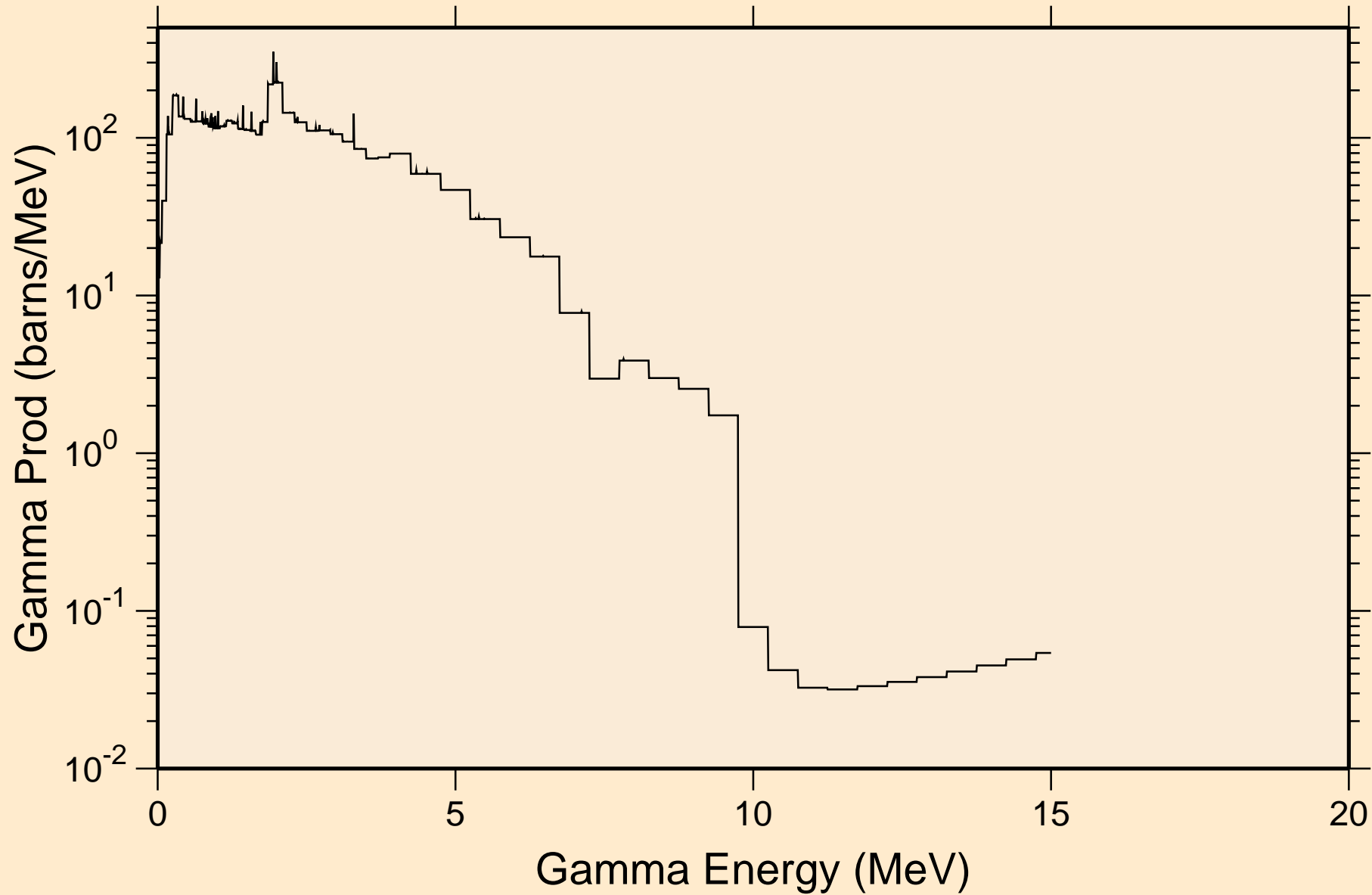

S036 NEUTRON ACER TENDL-2021 LIBRARY; T=293.6K
Particle heating contributions

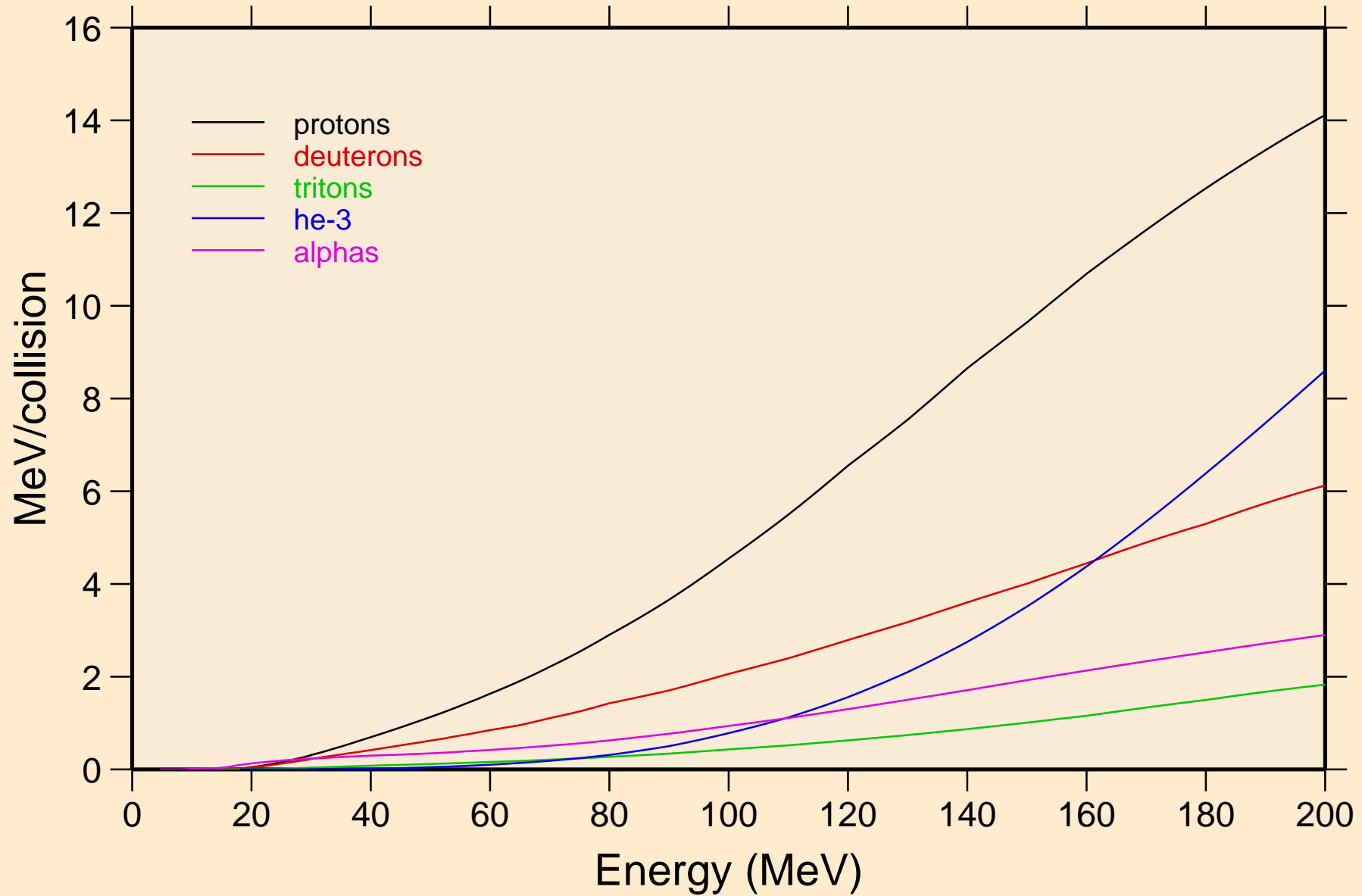

S036 NEUTRON ACER TENDL-2021 LIBRARY; T=293.6K
Recoil Heating

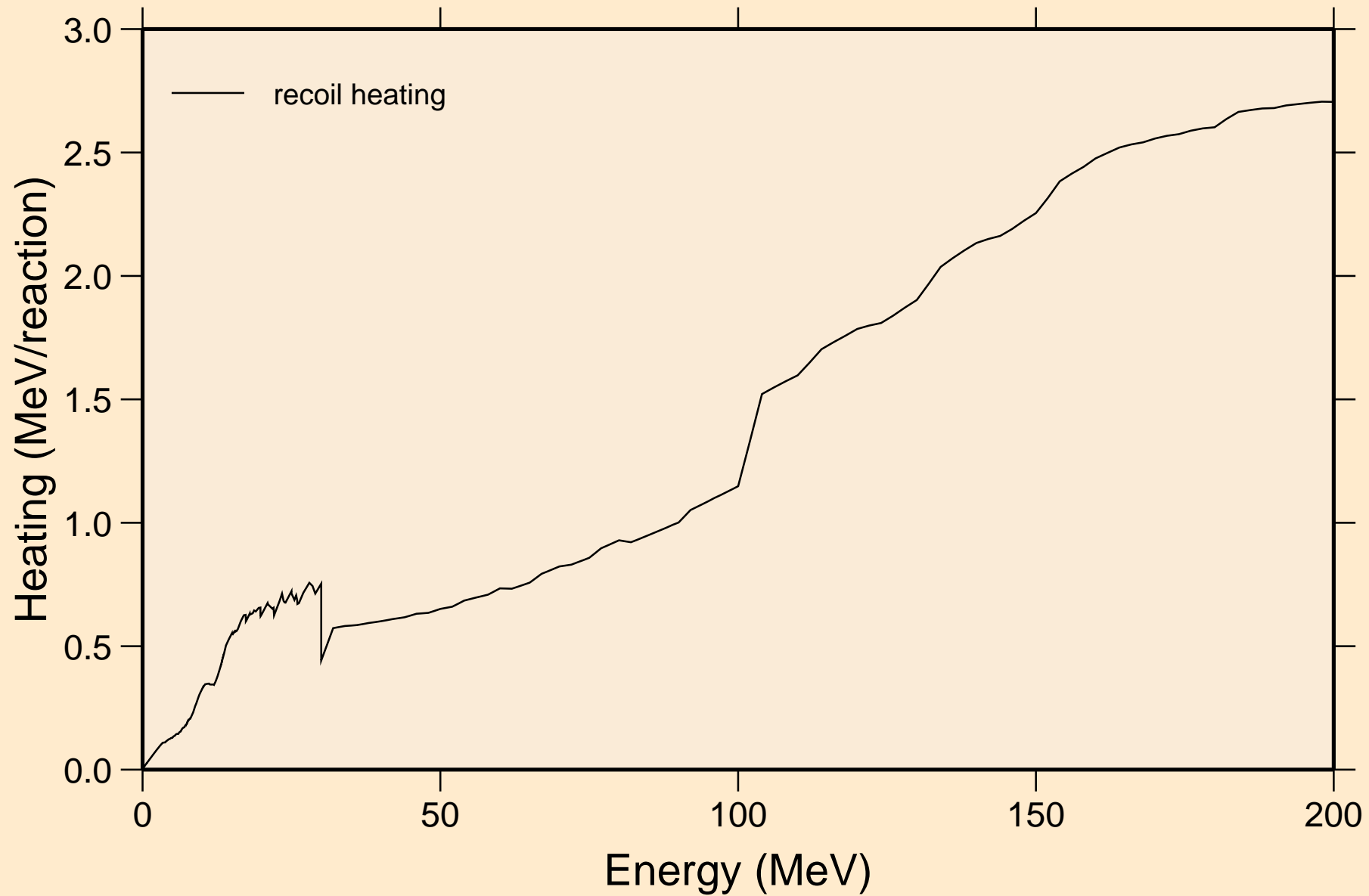

S036 NEUTRON ACER TENDL-2021 LIBRARY; T=293.6K
Particle production cross sections

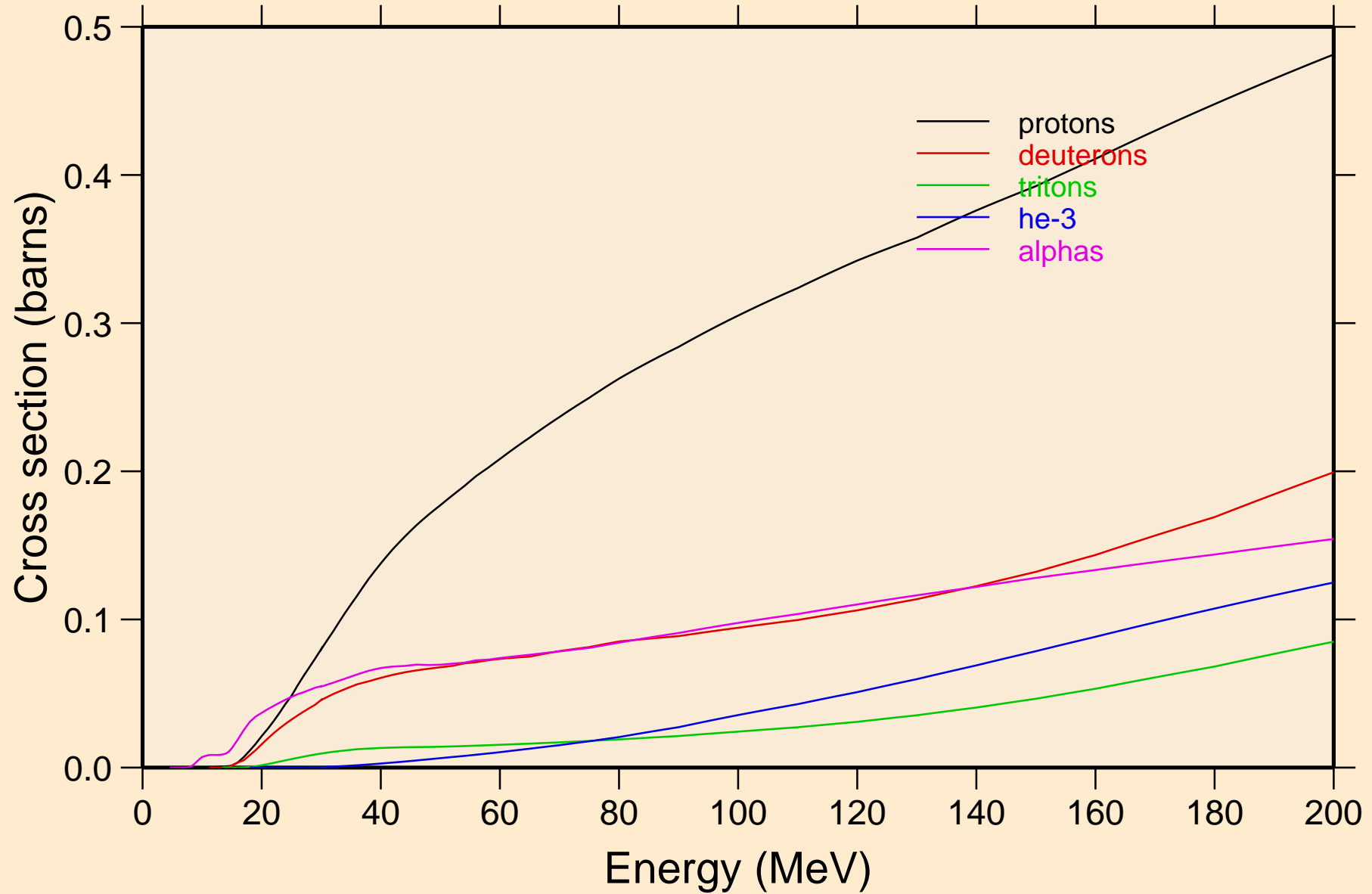

S036 NEUTRON ACER TENDL-2021 LIBRARY; T=293.6K
protons from (n,x)

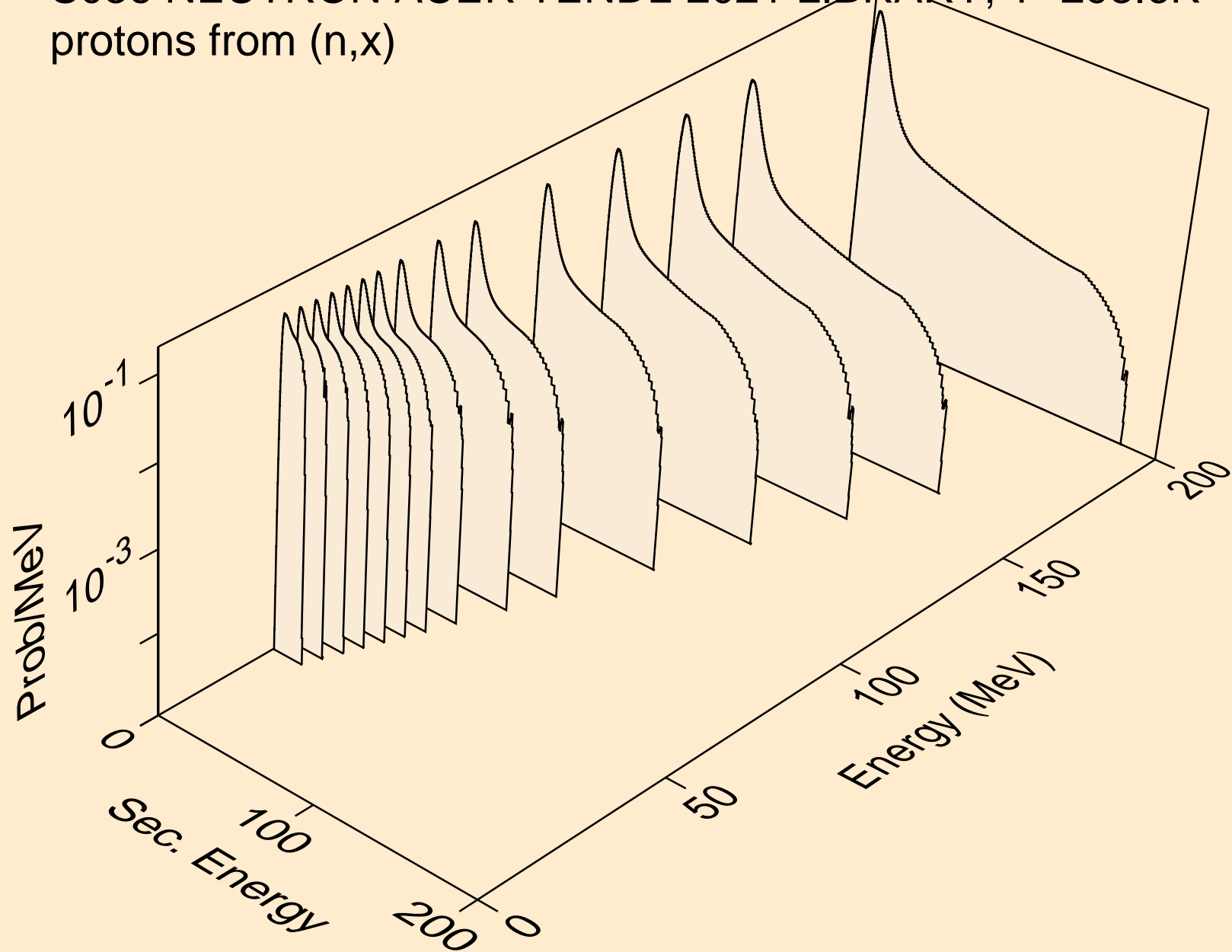

S036 NEUTRON ACER TENDL-2021 LIBRARY; T=293.6K
protons from (n,n*)p

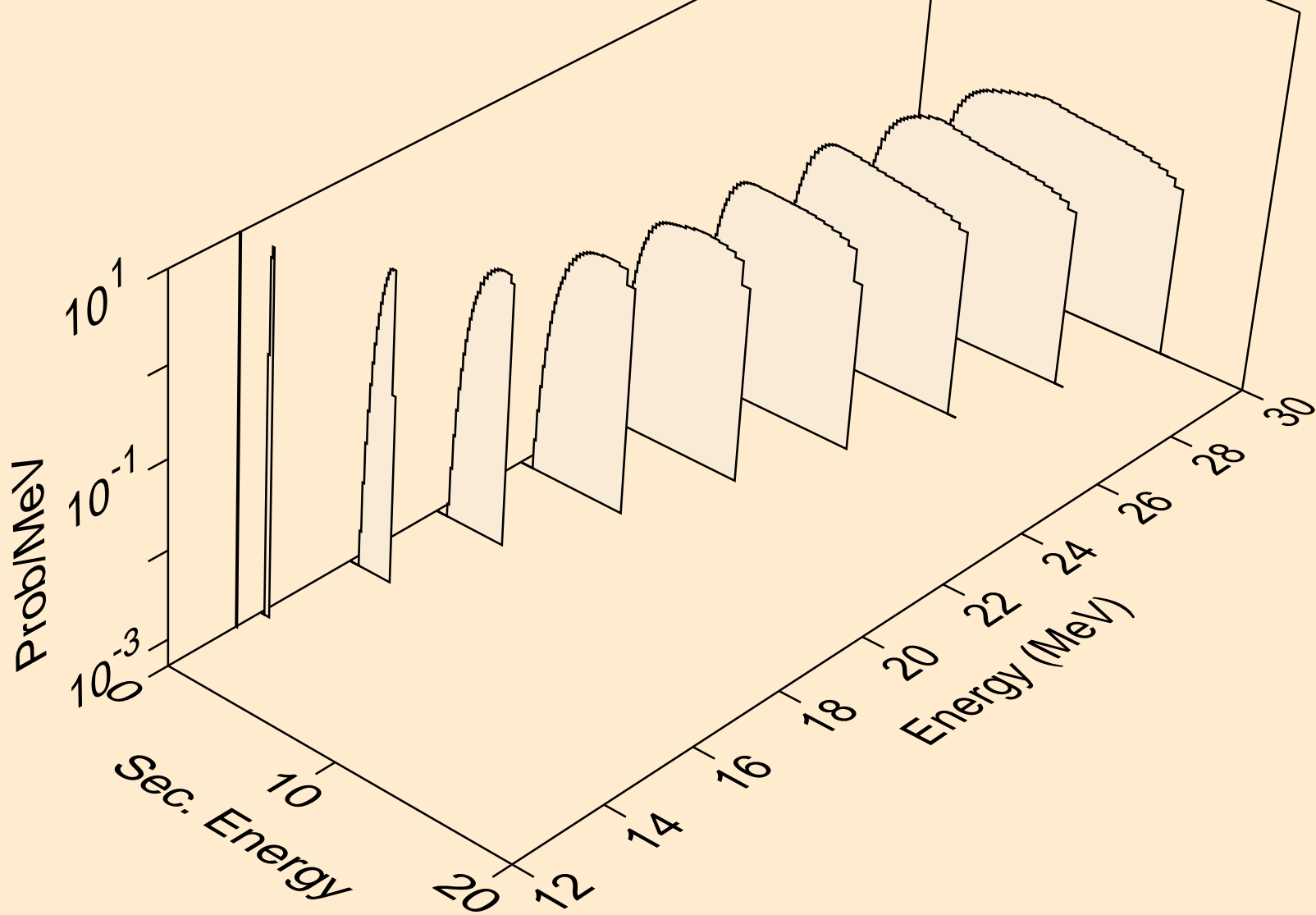

S036 NEUTRON ACER TENDL-2021 LIBRARY; T=293.6K
protons from (n,2np)

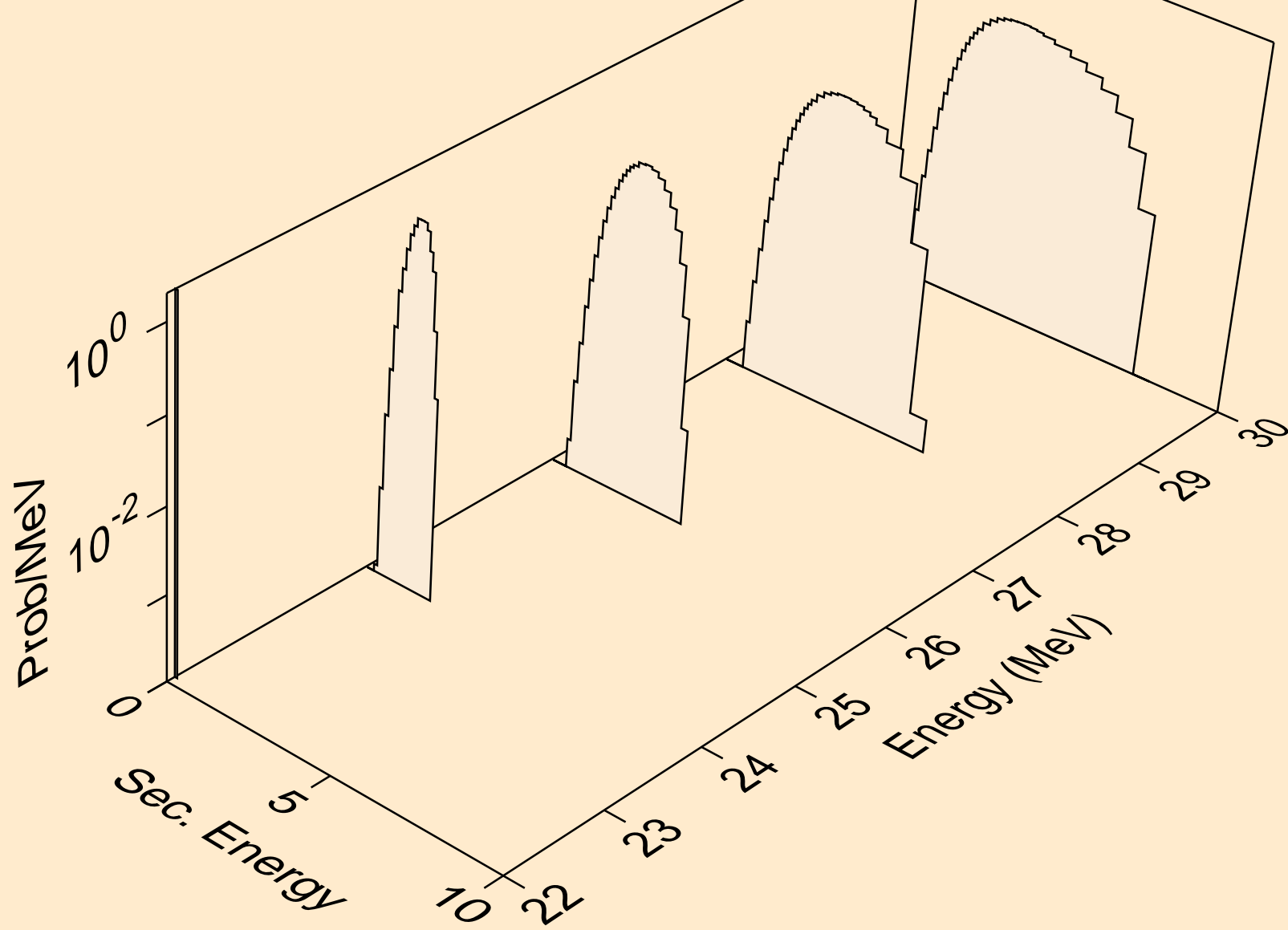

S036 NEUTRON ACER TENDL-2021 LIBRARY; T=293.6K
protons from (n,3np)

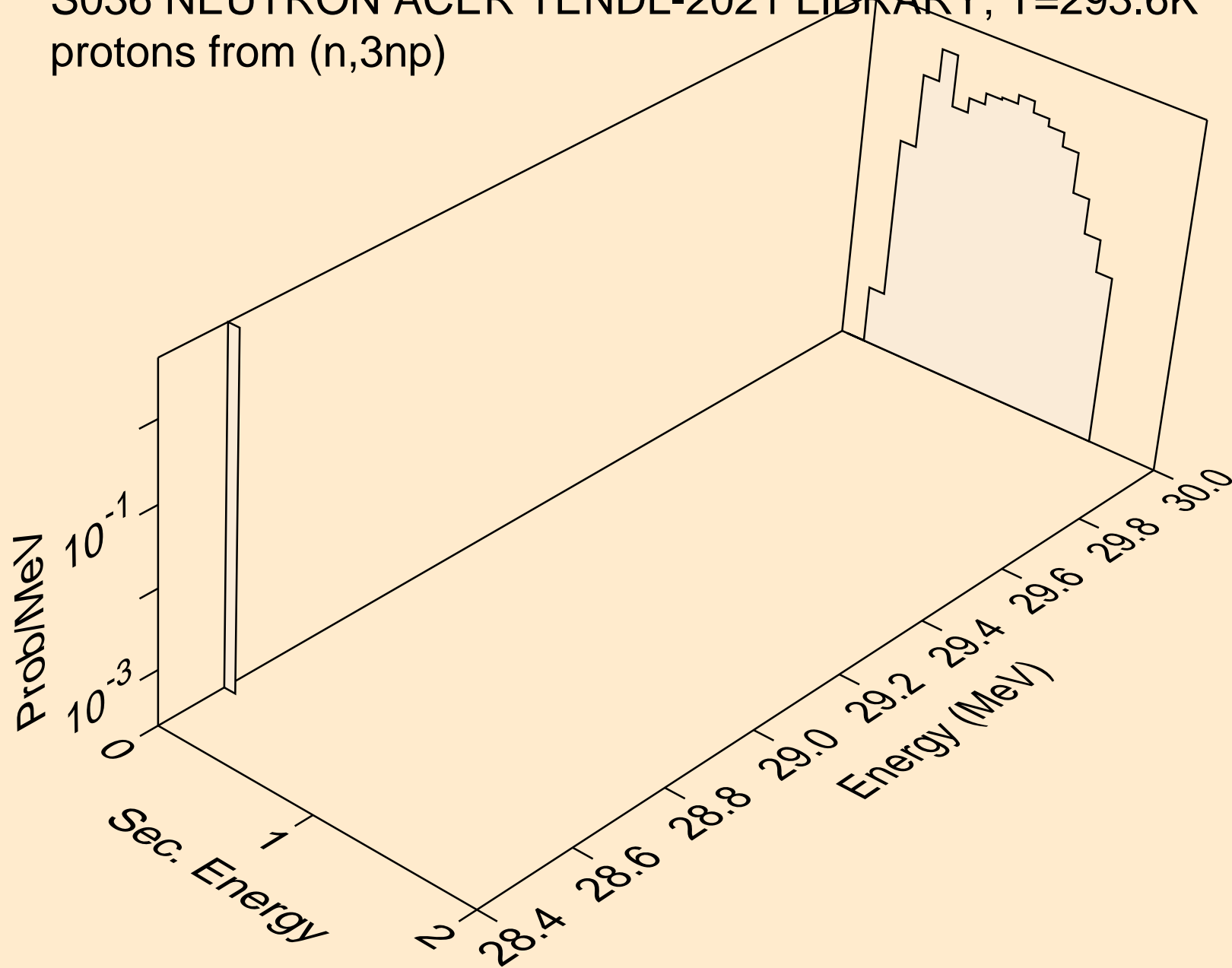

S036 NEUTRON ACER TENDL-2021 LIBRARY; T=293.6K
protons from (n,2np)

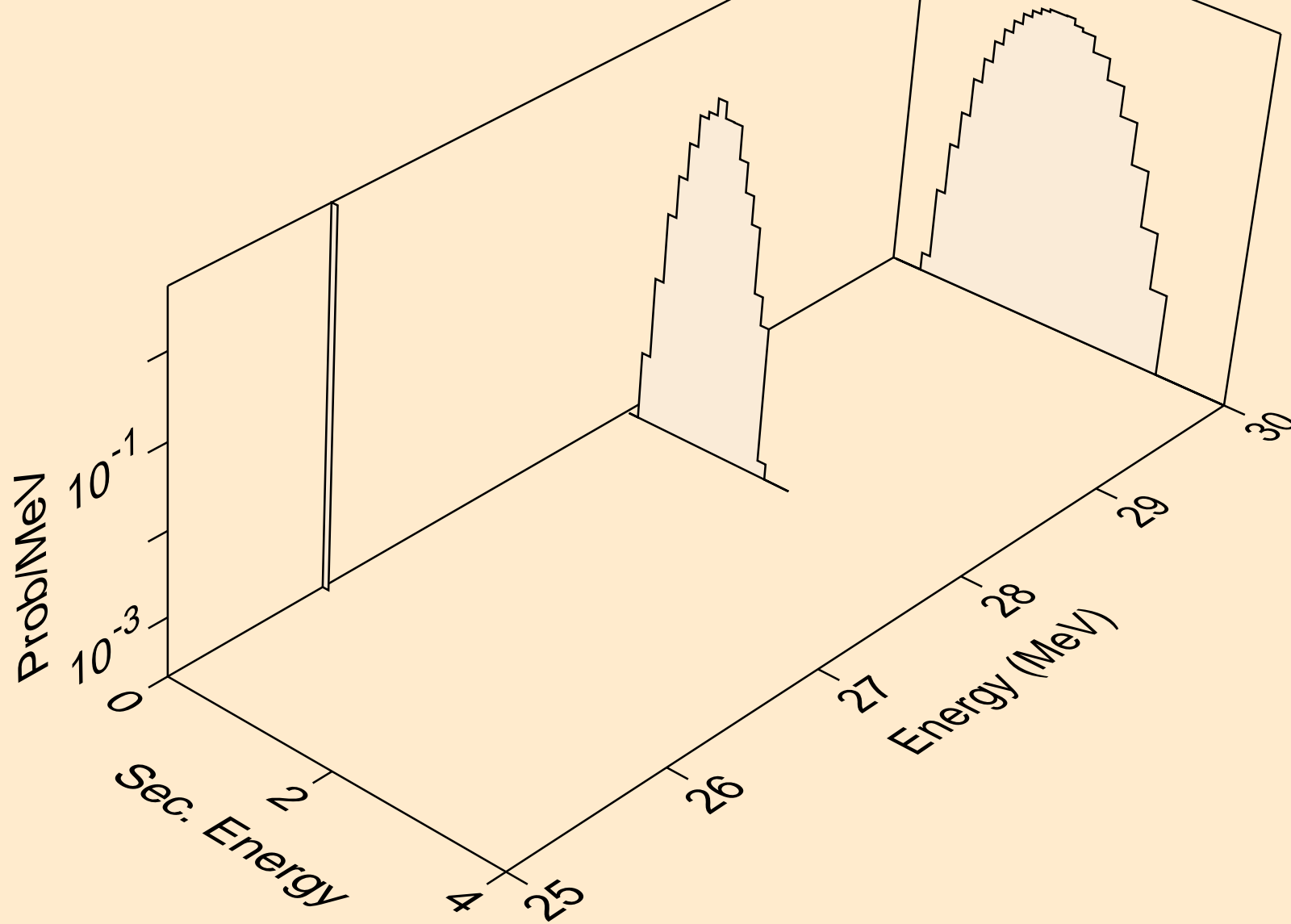

S036 NEUTRON ACER TENDL-2021 LIBRARY; T=293.6K
protons from (n,p)

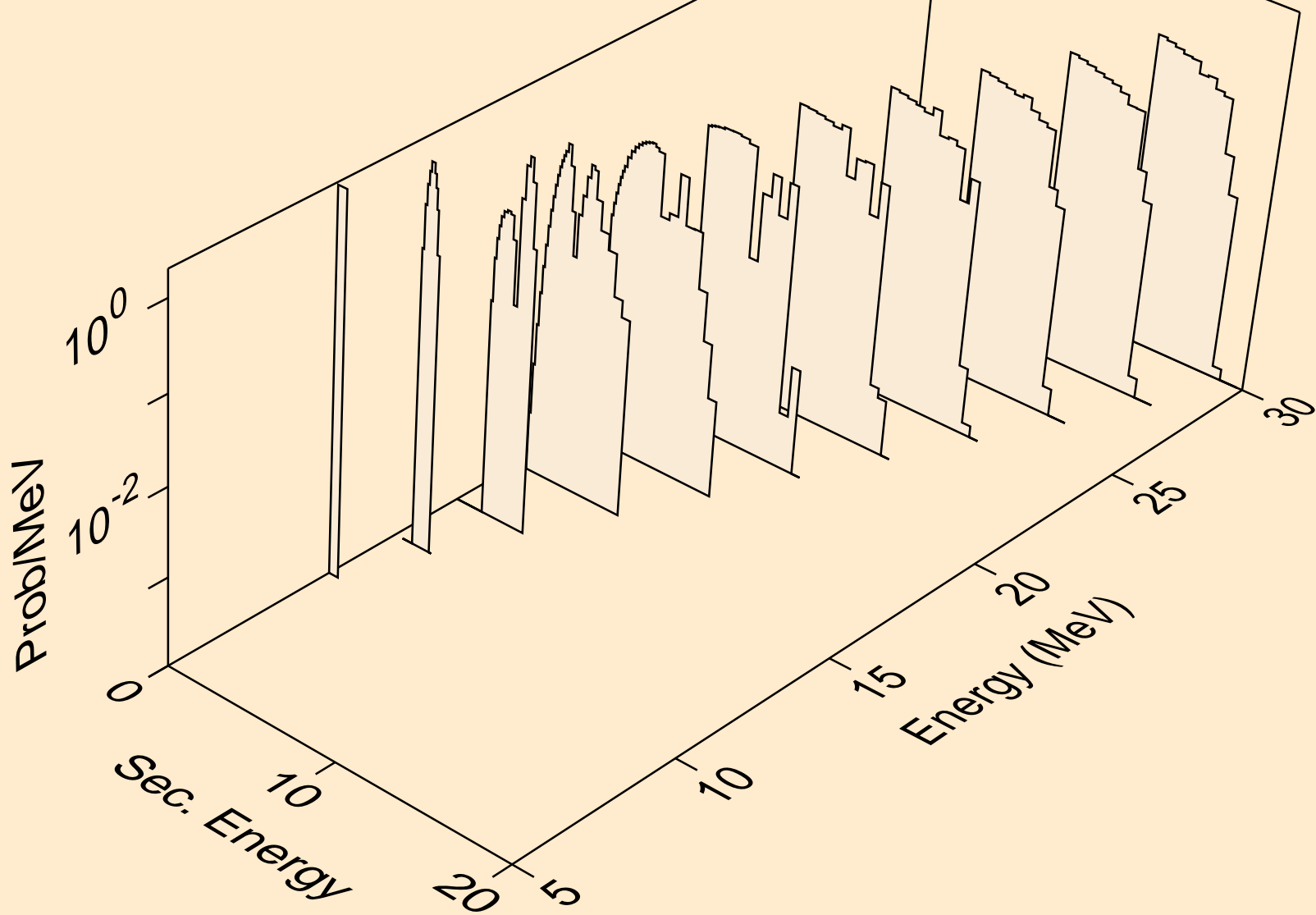

S036 NEUTRON ACER TENDL-2021 LIBRARY; T=293.6K
protons from (n,2p)

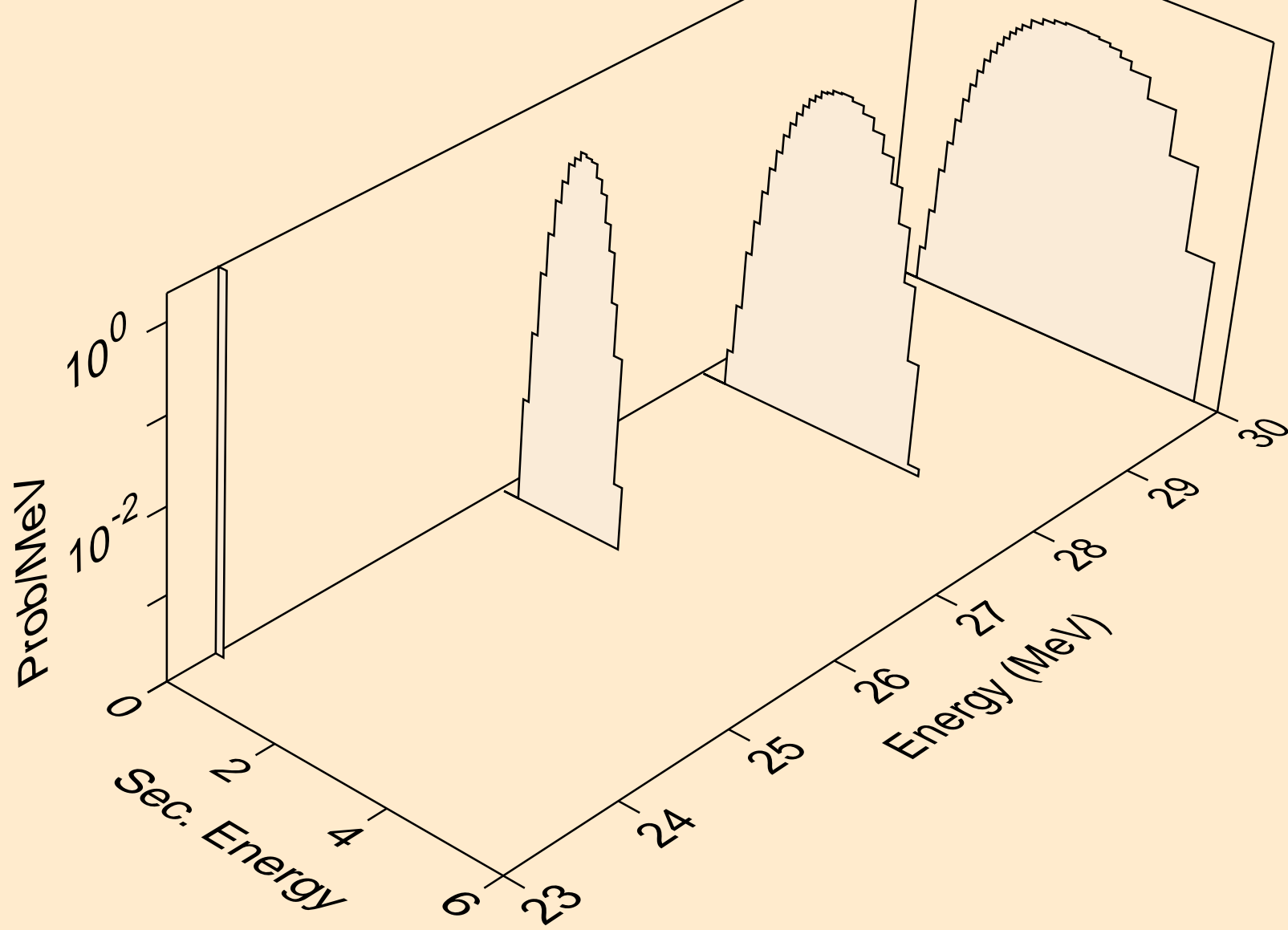

S036 NEUTRON ACER TENDL-2021 LIBRARY; T=293.6K
protons from (n,p)

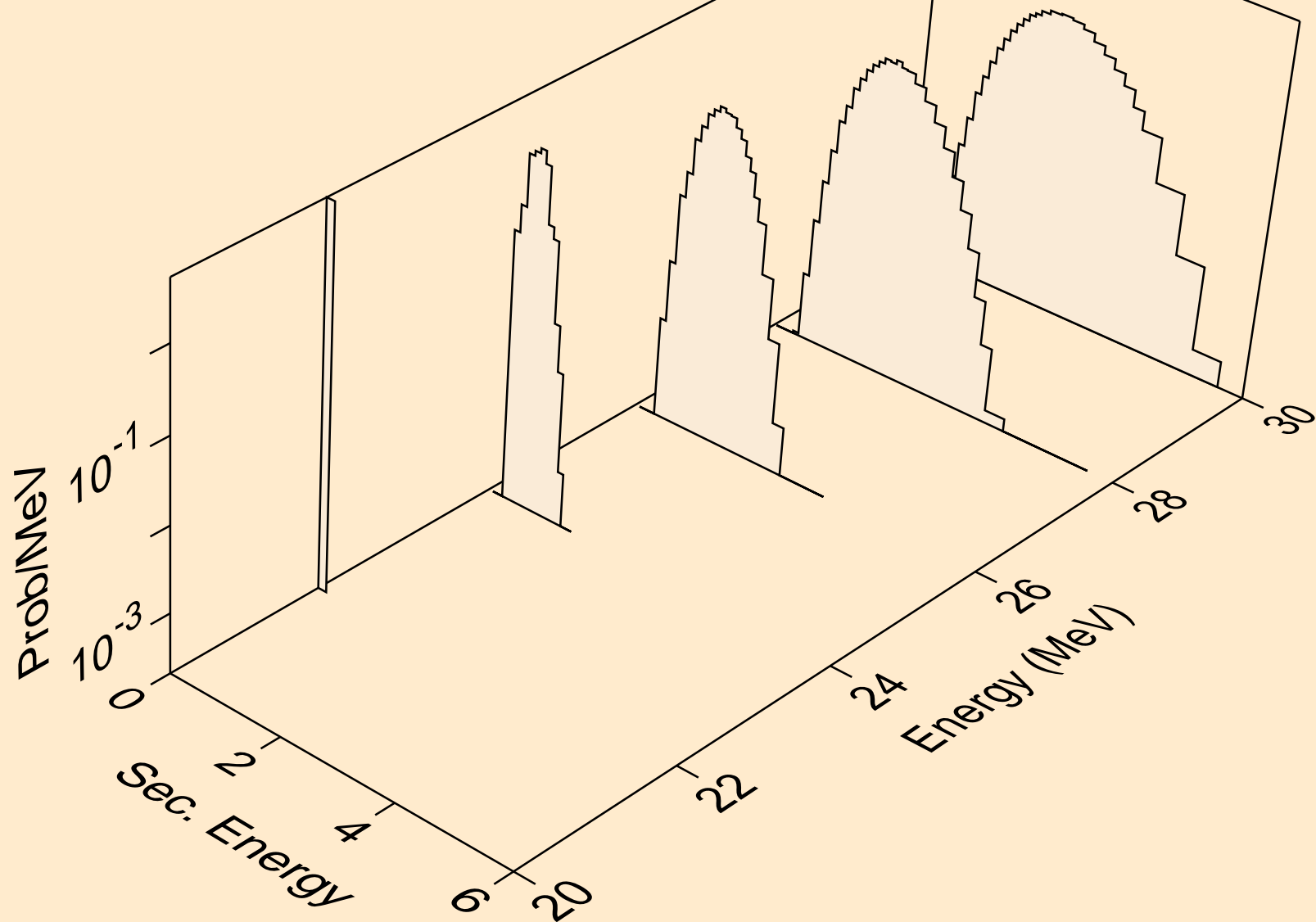

S036 NEUTRON ACER TENDL-2021 LIBRARY; T=293.6K
protons from (n,pd)

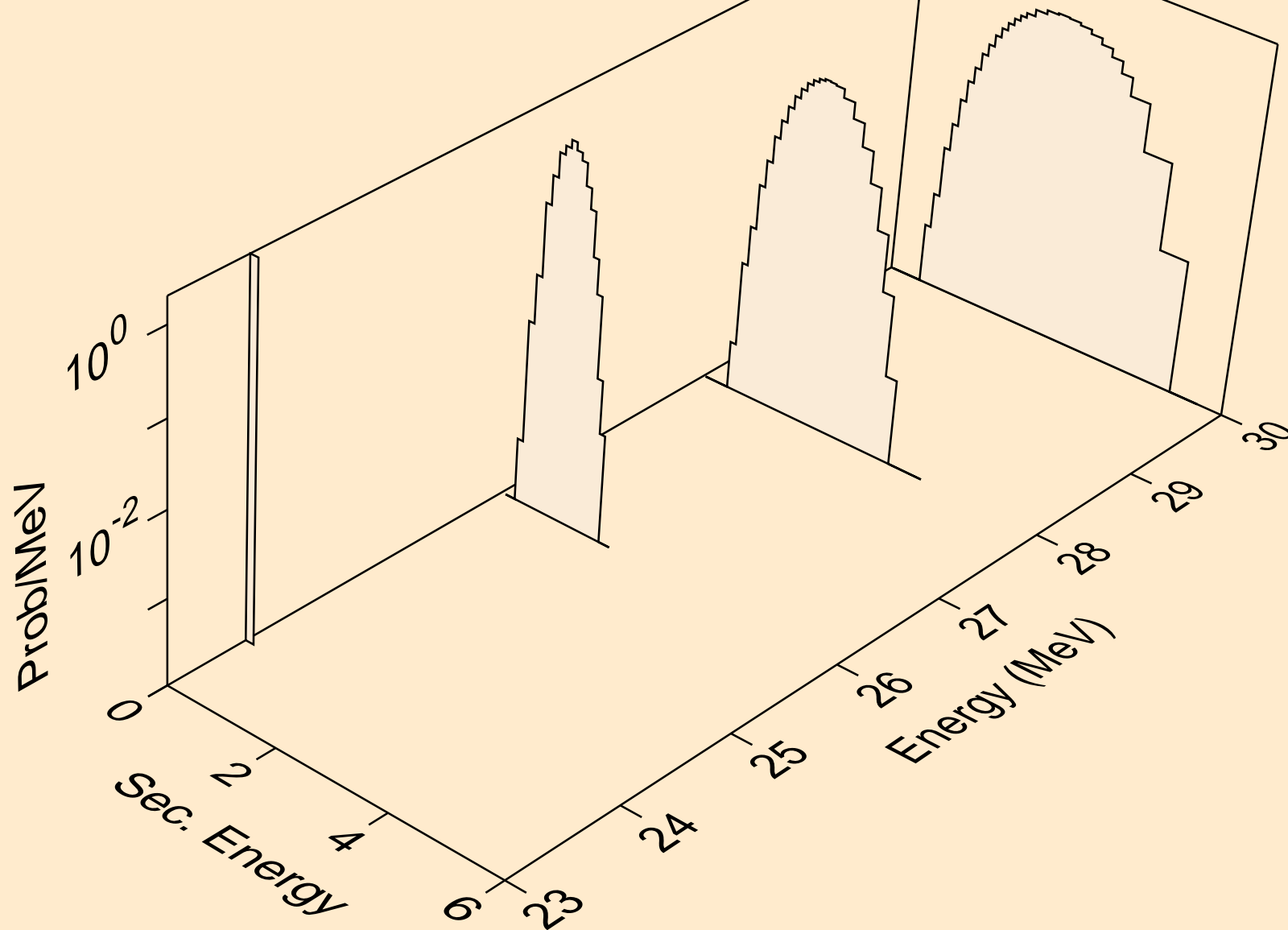

S036 NEUTRON ACER TENDL-2021 LIBRARY; T=293.6K
protons from (n,pt)

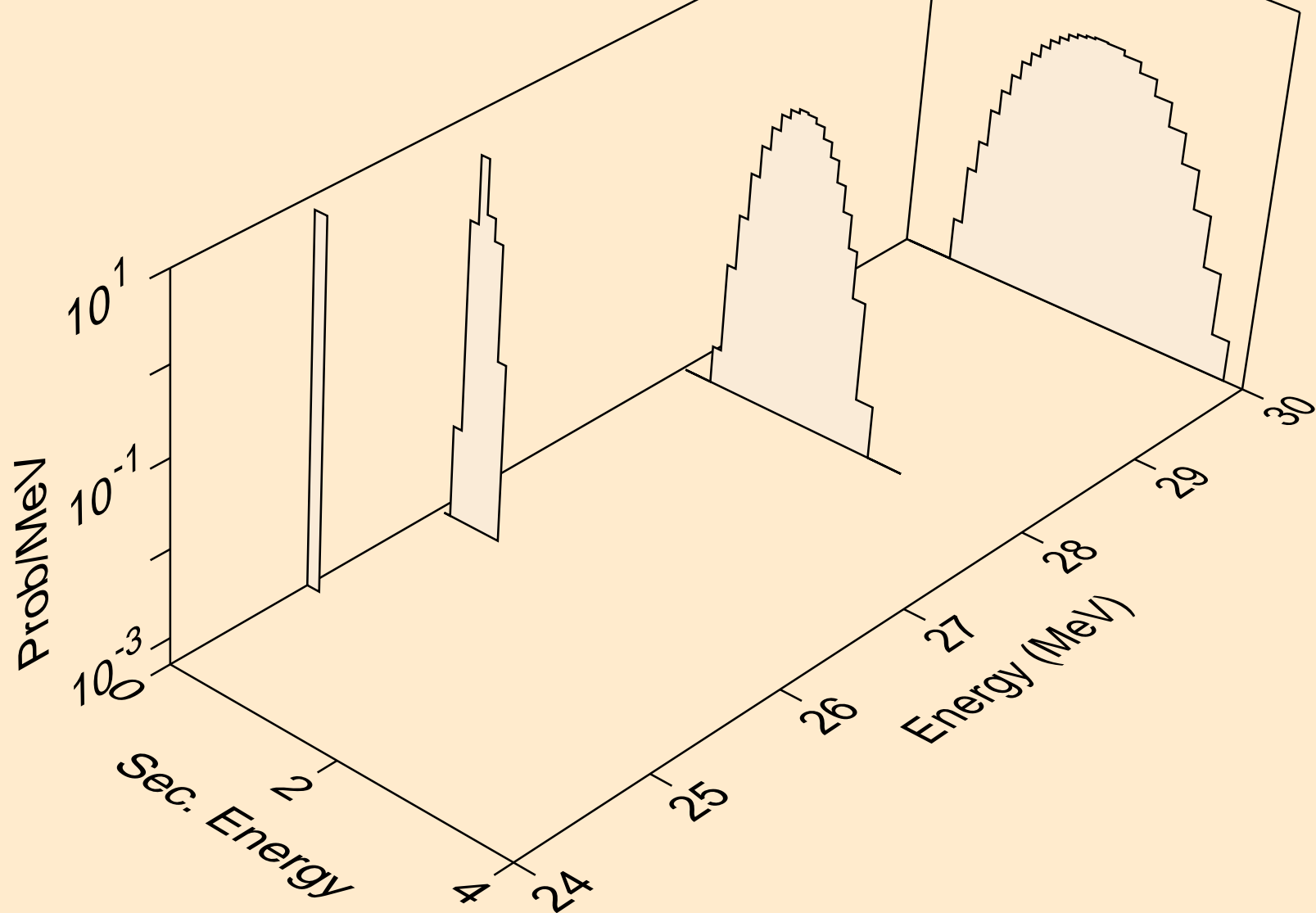

S036 NEUTRON ACER TENDL-2021 LIBRARY; T=293.6K
deuterons from (n,x)

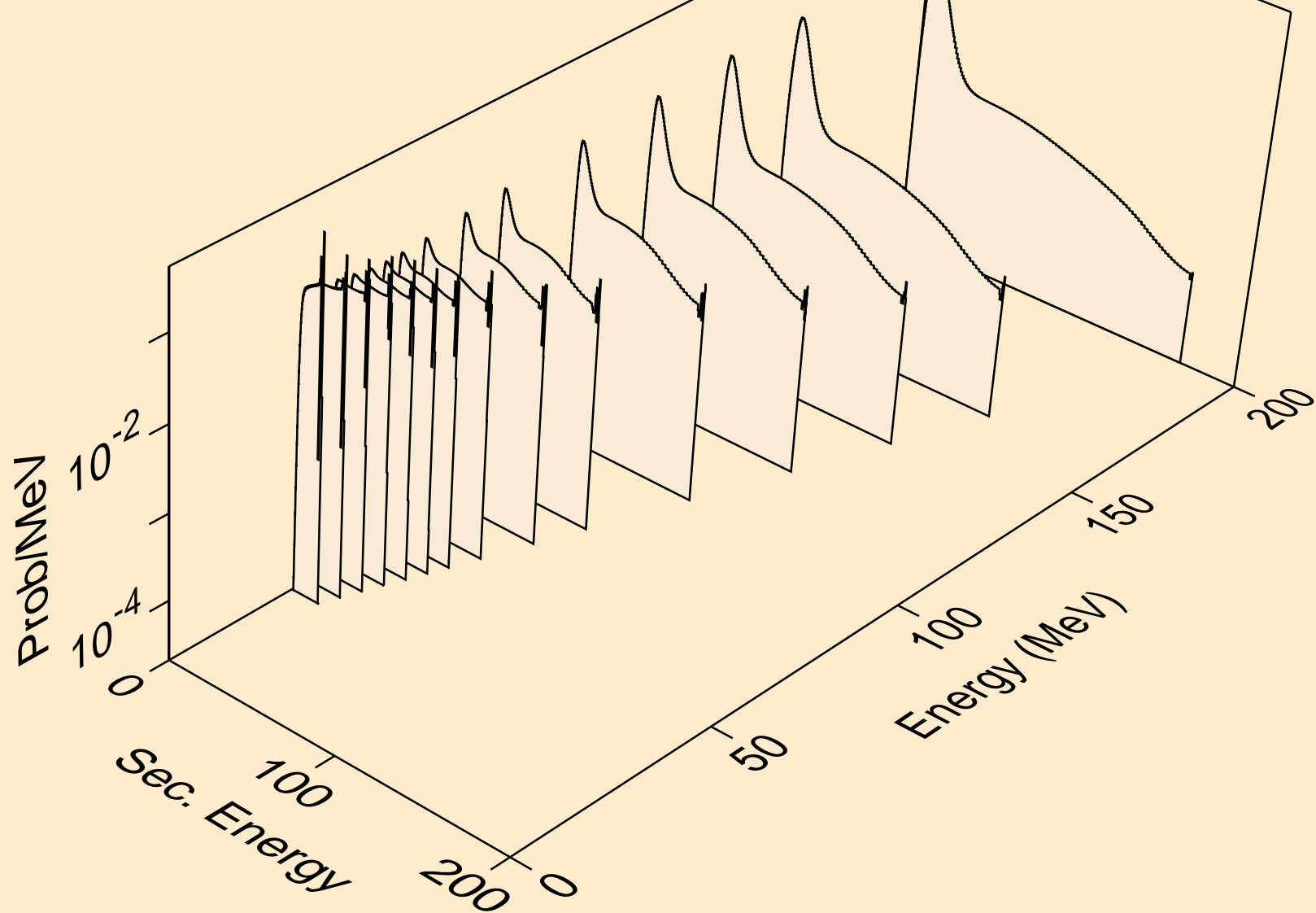

S036 NEUTRON ACER TENDL-2021 LIBRARY; T=293.6K
deuterons from (n,2nd)

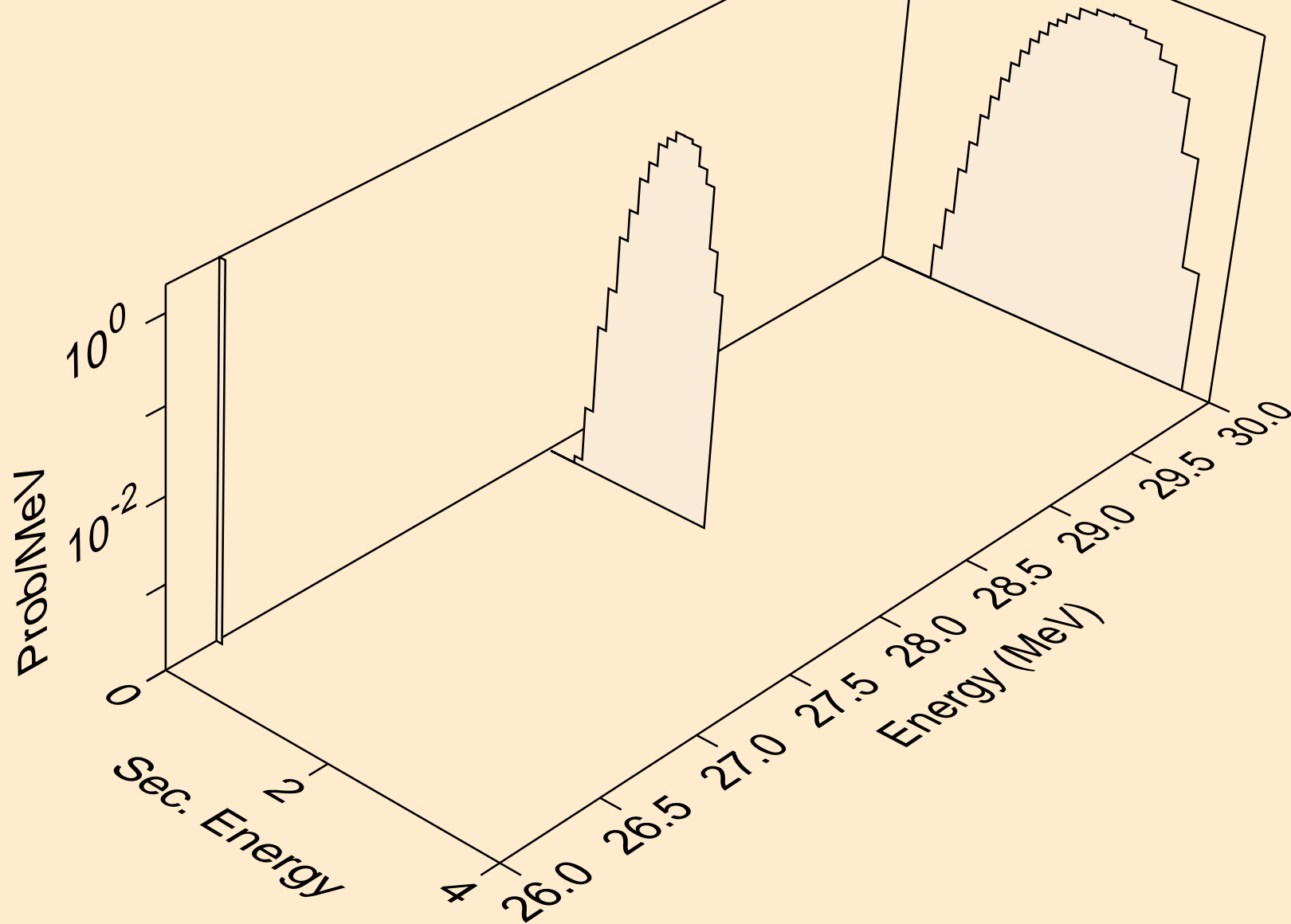

S036 NEUTRON ACER TENDL-2021 LIBRARY; T=293.6K
deuterons from (n,n*)d

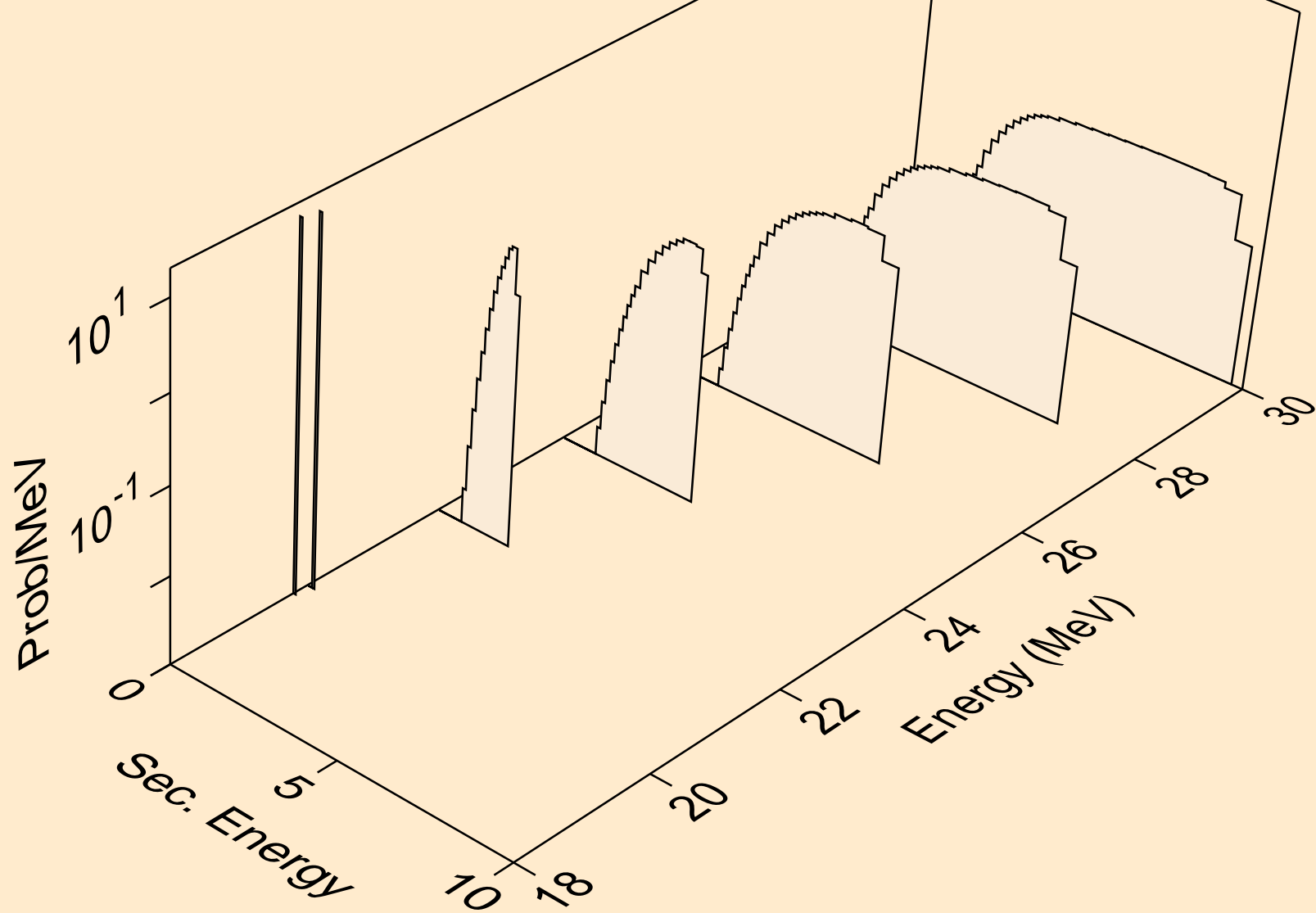

S036 NEUTRON ACER TENDL-2021 LIBRARY; T=293.6K
deuterons from (n,d)

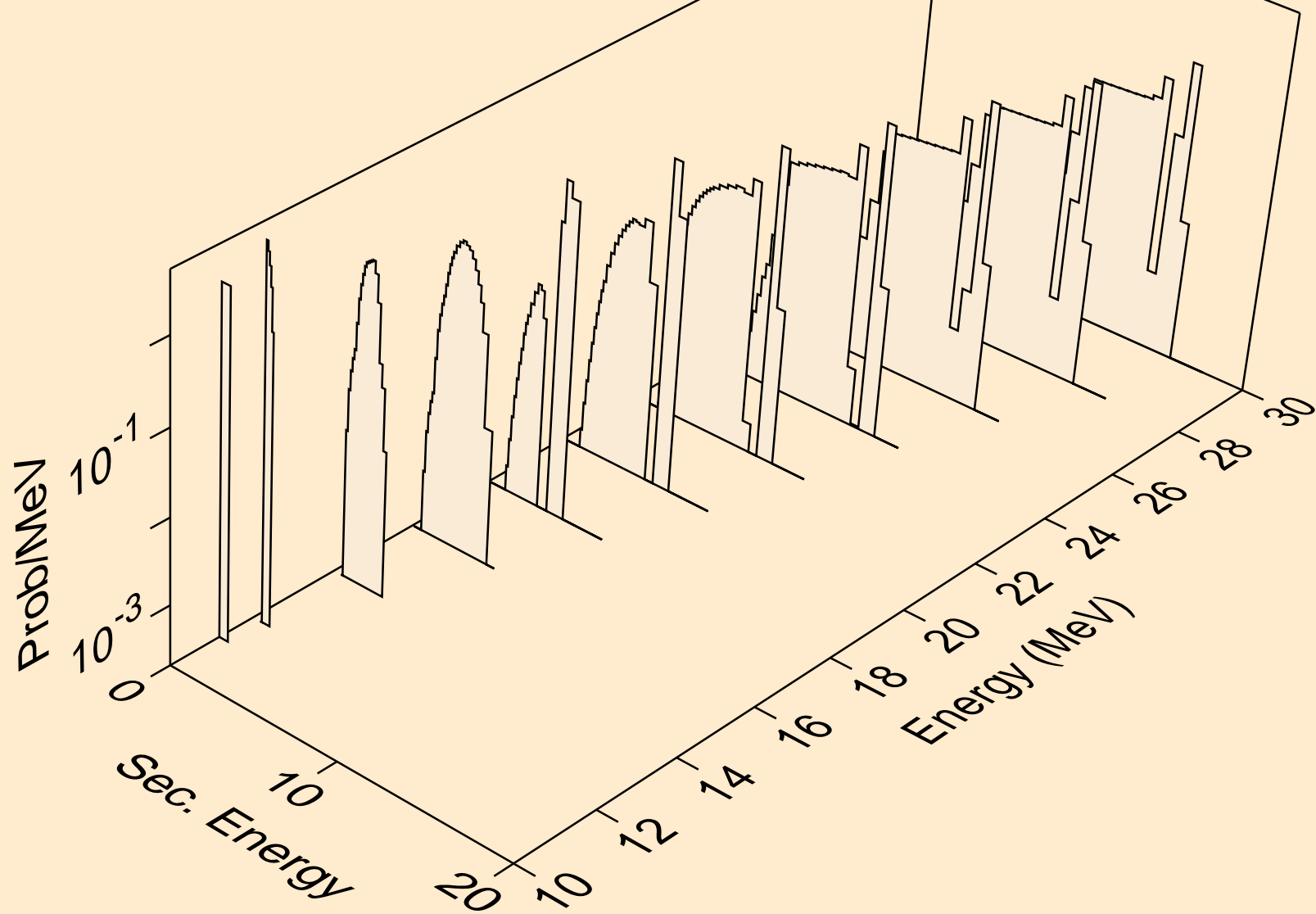

S036 NEUTRON ACER TENDL-2021 LIBRARY; T=293.6K
deuterons from (n,pd)

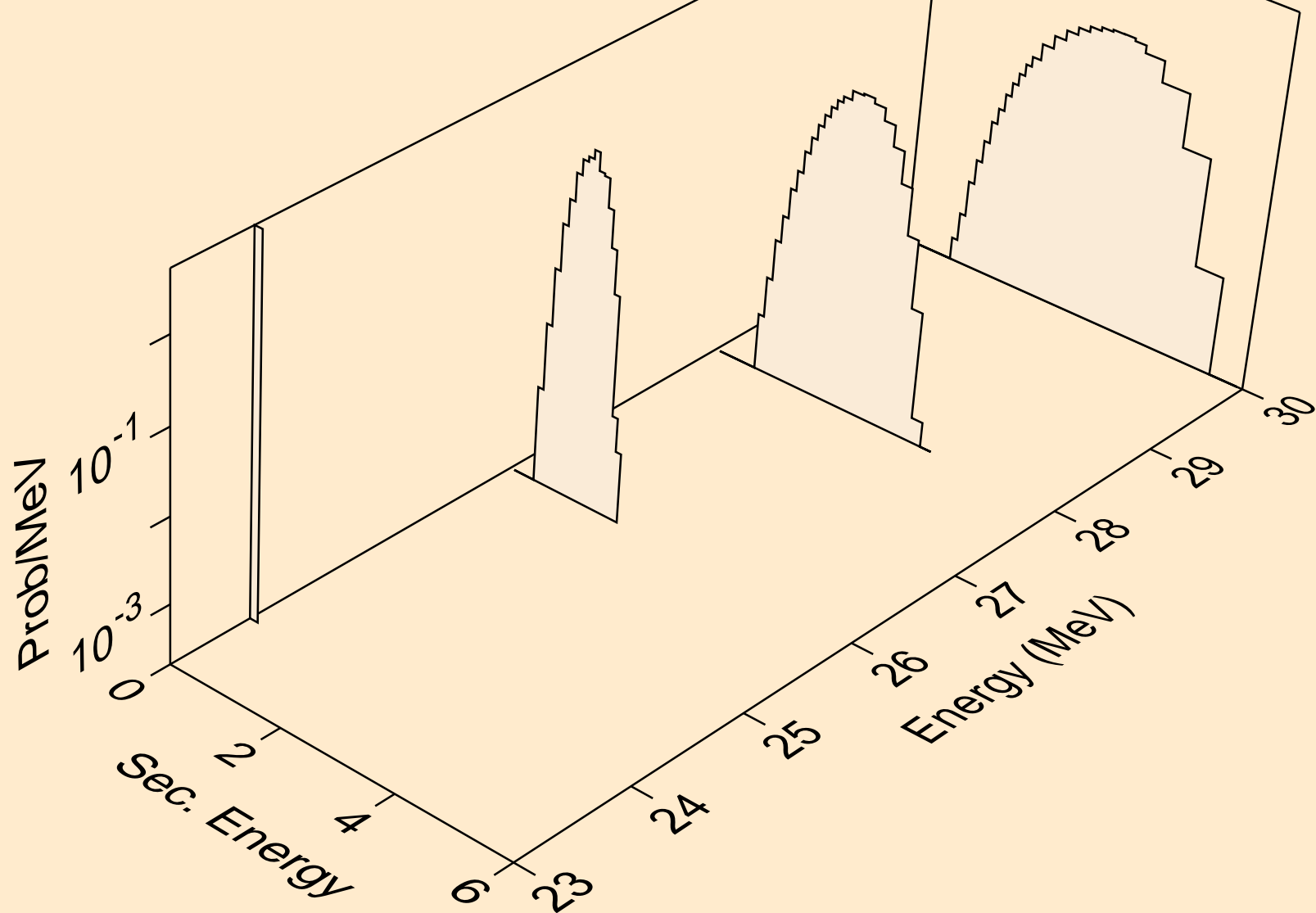

S036 NEUTRON ACER TENDL-2021 LIBRARY; T=293.6K
deuterons from (n,da)

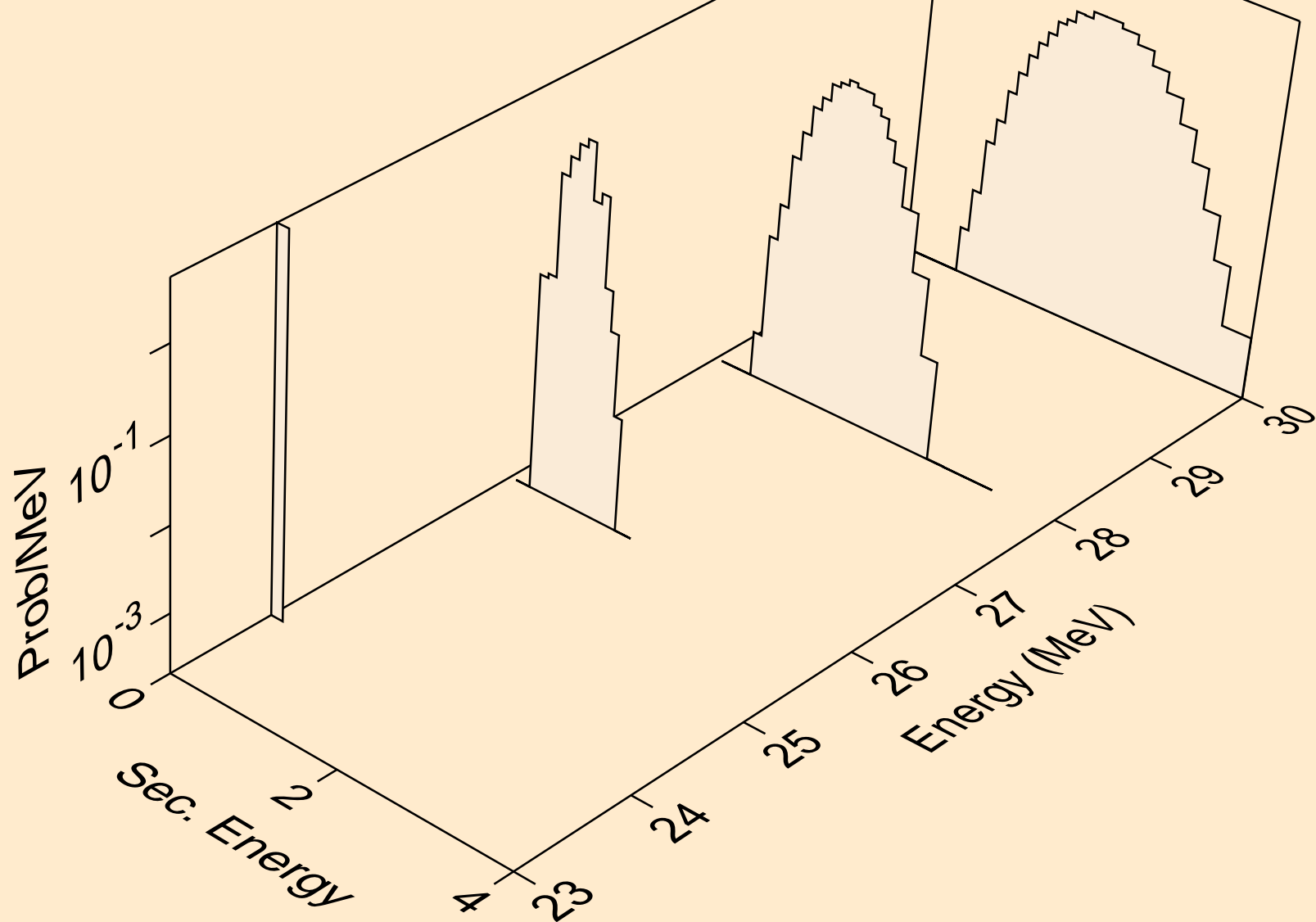

S036 NEUTRON ACER TENDL-2021 LIBRARY; T=293.6K
tritons from (n,x)

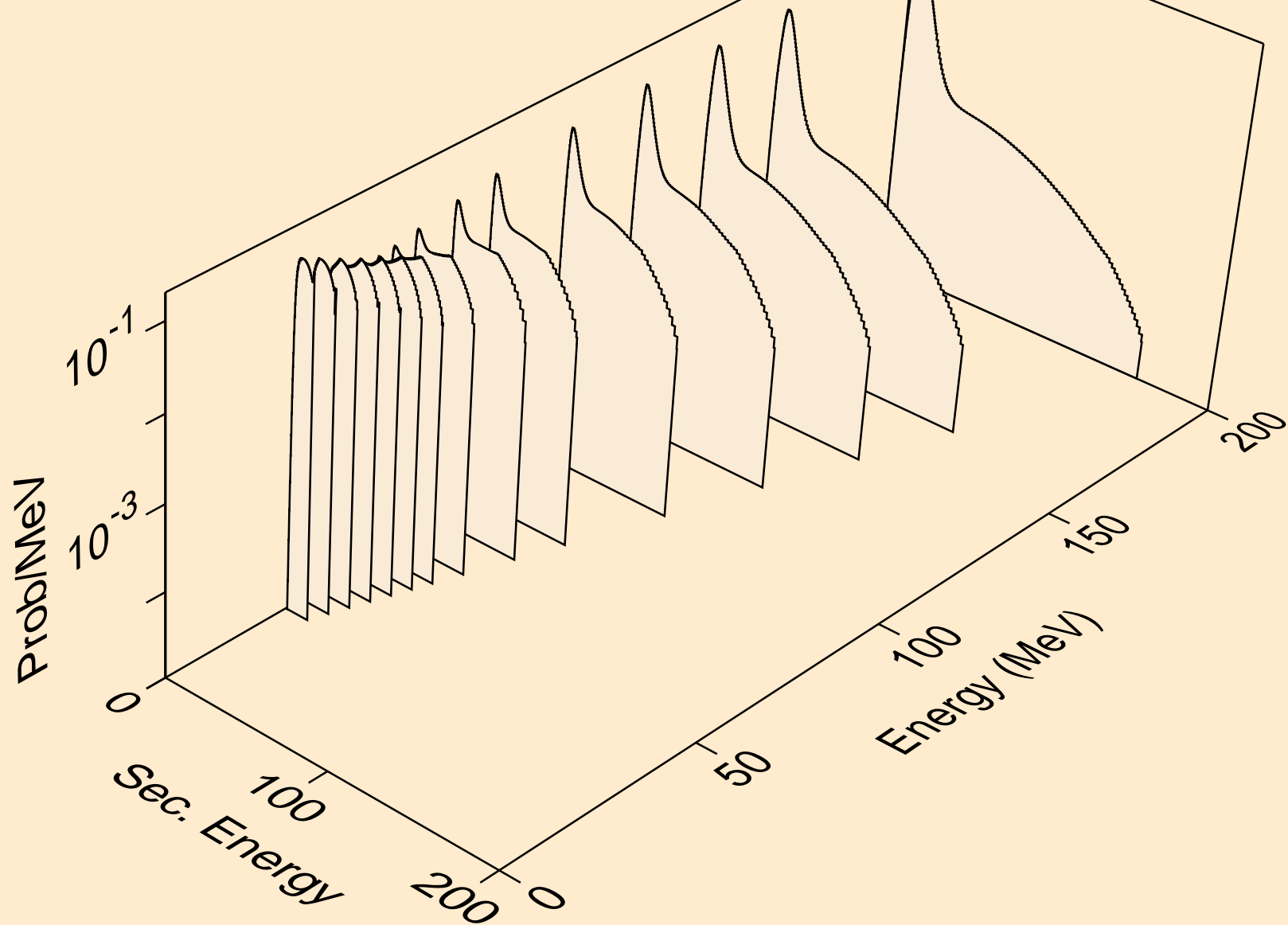

S036 NEUTRON ACER TENDL-2021 LIBRARY; T=293.6K
tritons from (n,n*)t

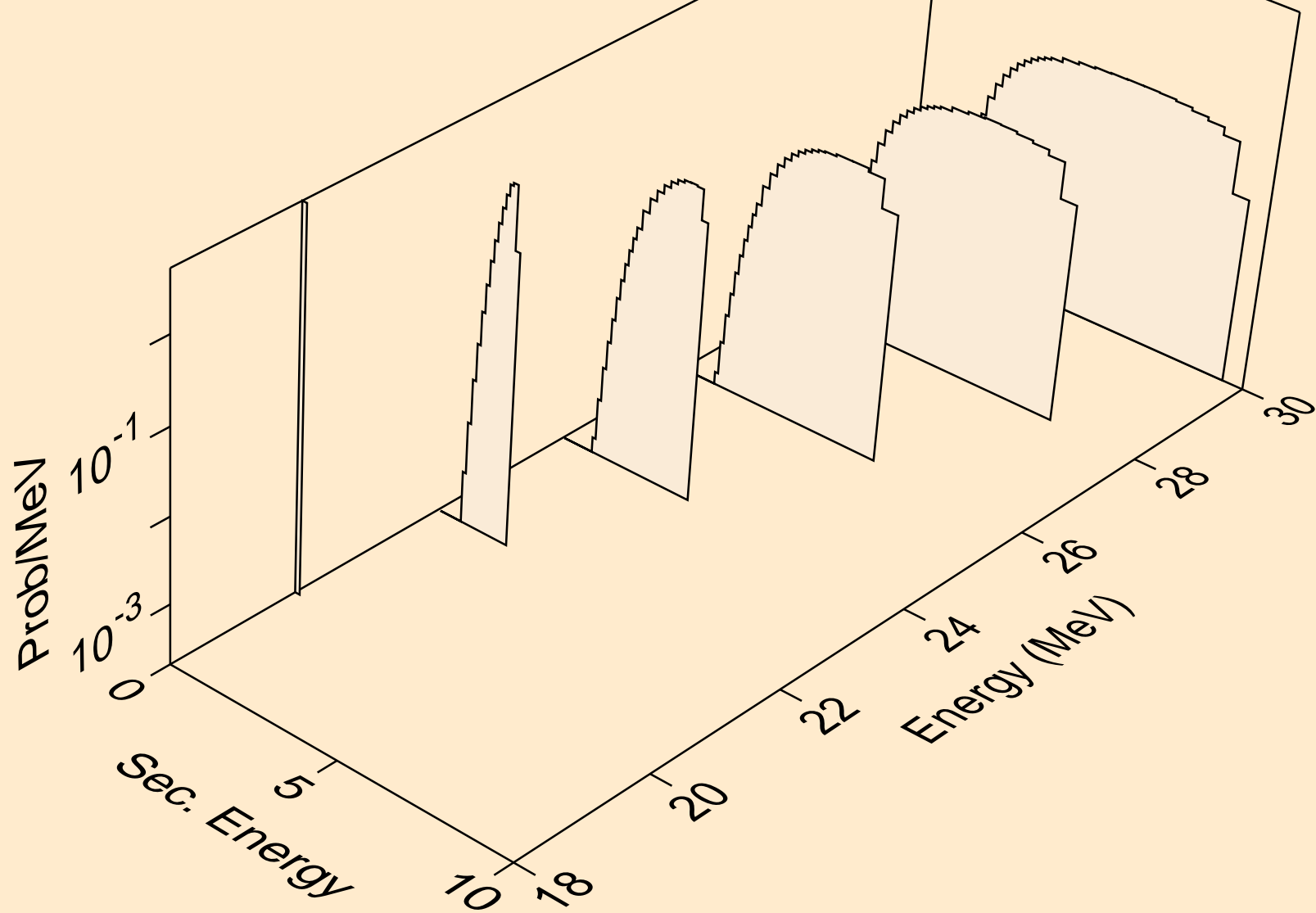

S036 NEUTRON ACER TENDL-2021 LIBRARY; T=293.6K
tritons from (n,t)

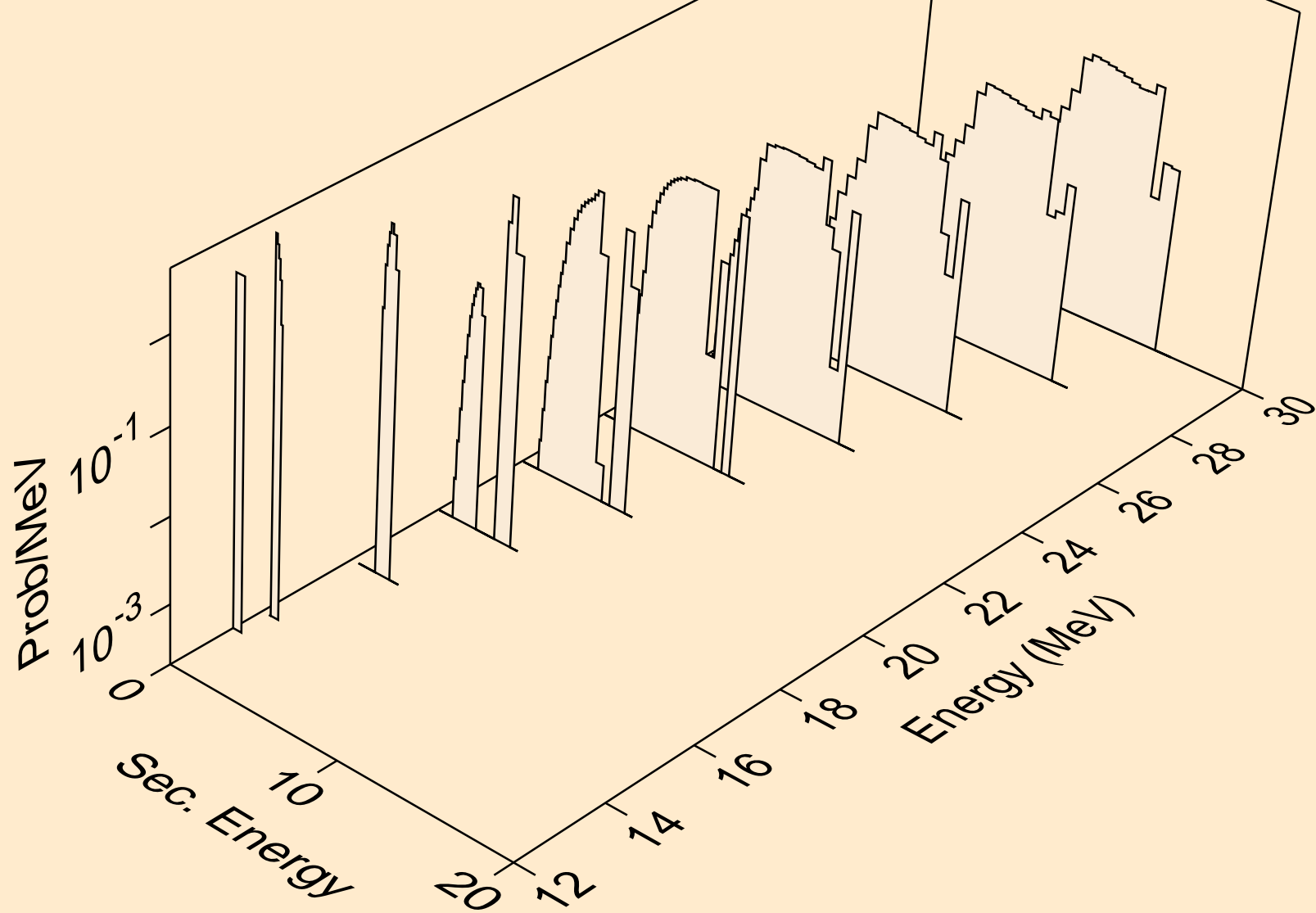

S036 NEUTRON ACER TENDL-2021 LIBRARY; T=293.6K
tritons from (n,pt)

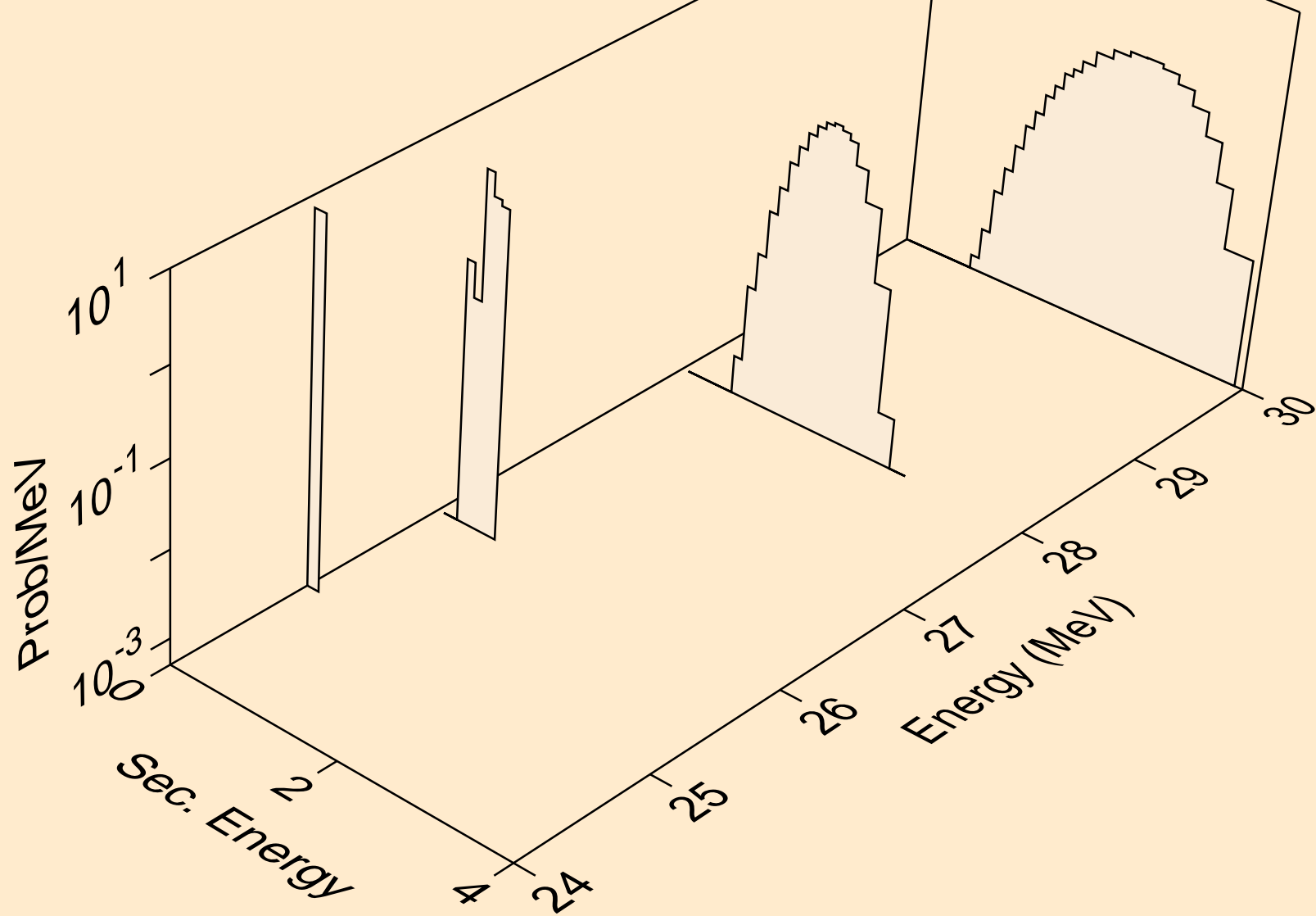

S036 NEUTRON ACER TENDL-2021 LIBRARY; T=293.6K
he3s from (n,x)

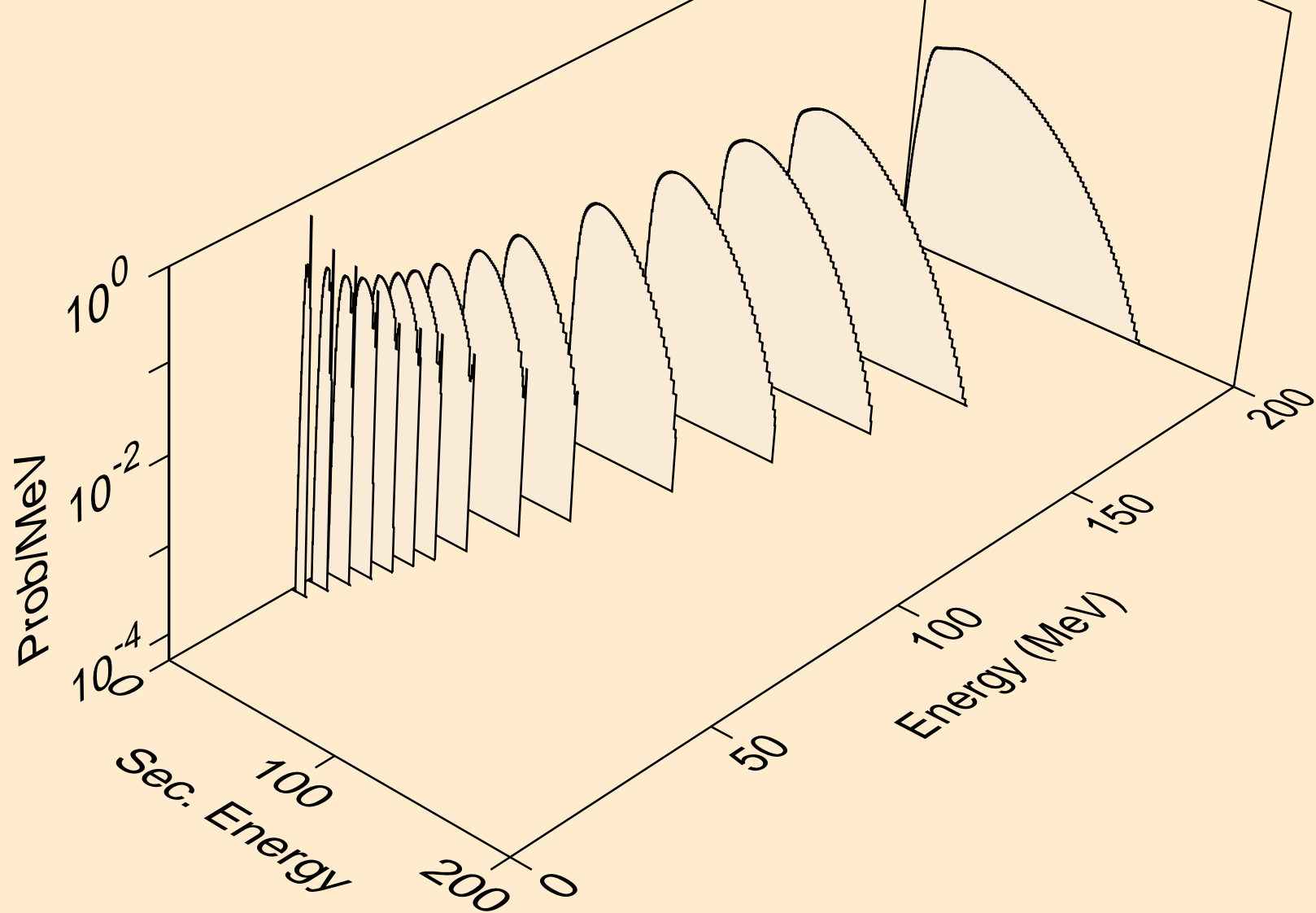

S036 NEUTRON ACER TENDL-2021 LIBRARY; T=293.6K
he3s from (n,n*)he3

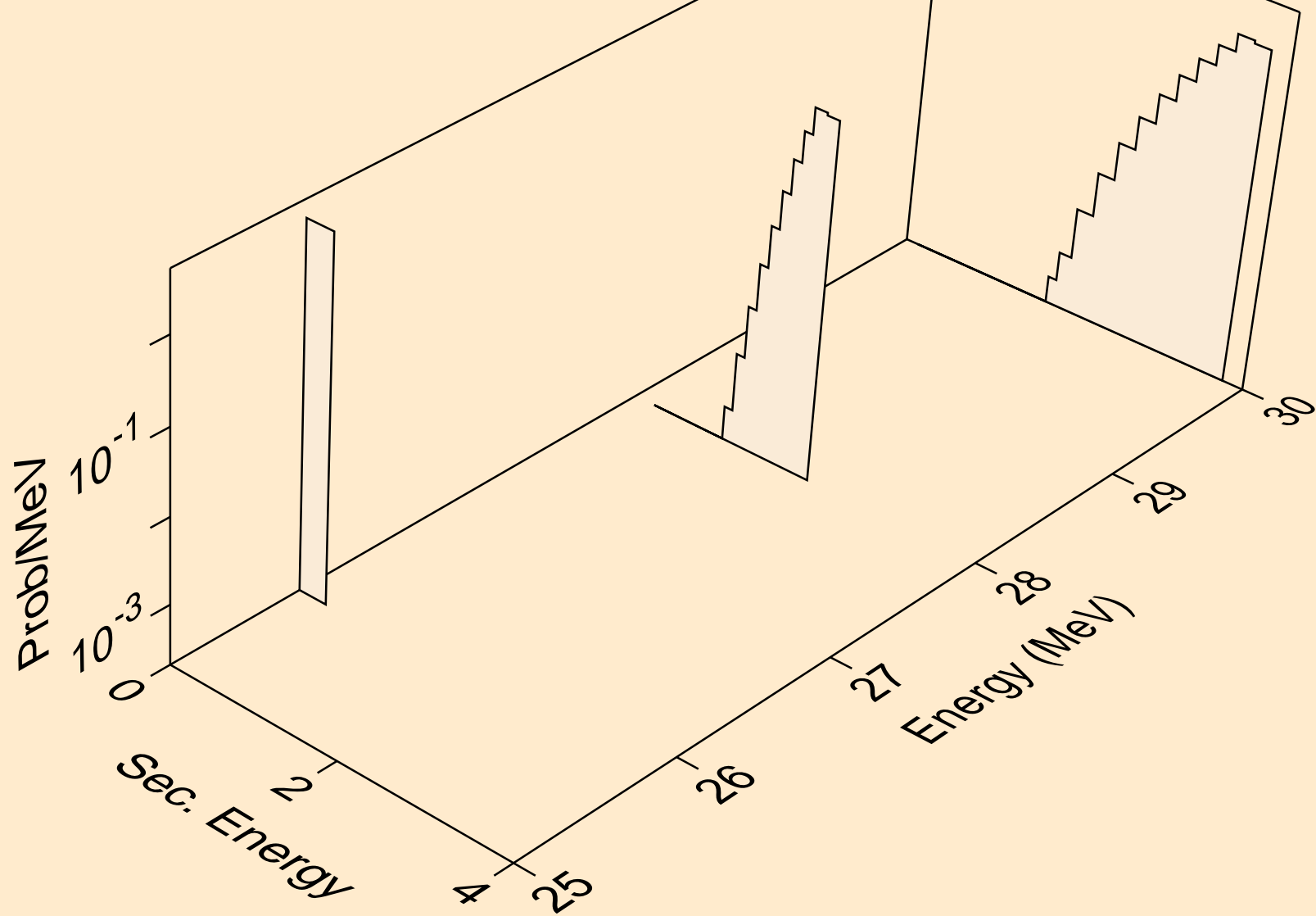

S036 NEUTRON ACER TENDL-2021 LIBRARY; T=293.6K
he3s from (n,he3)

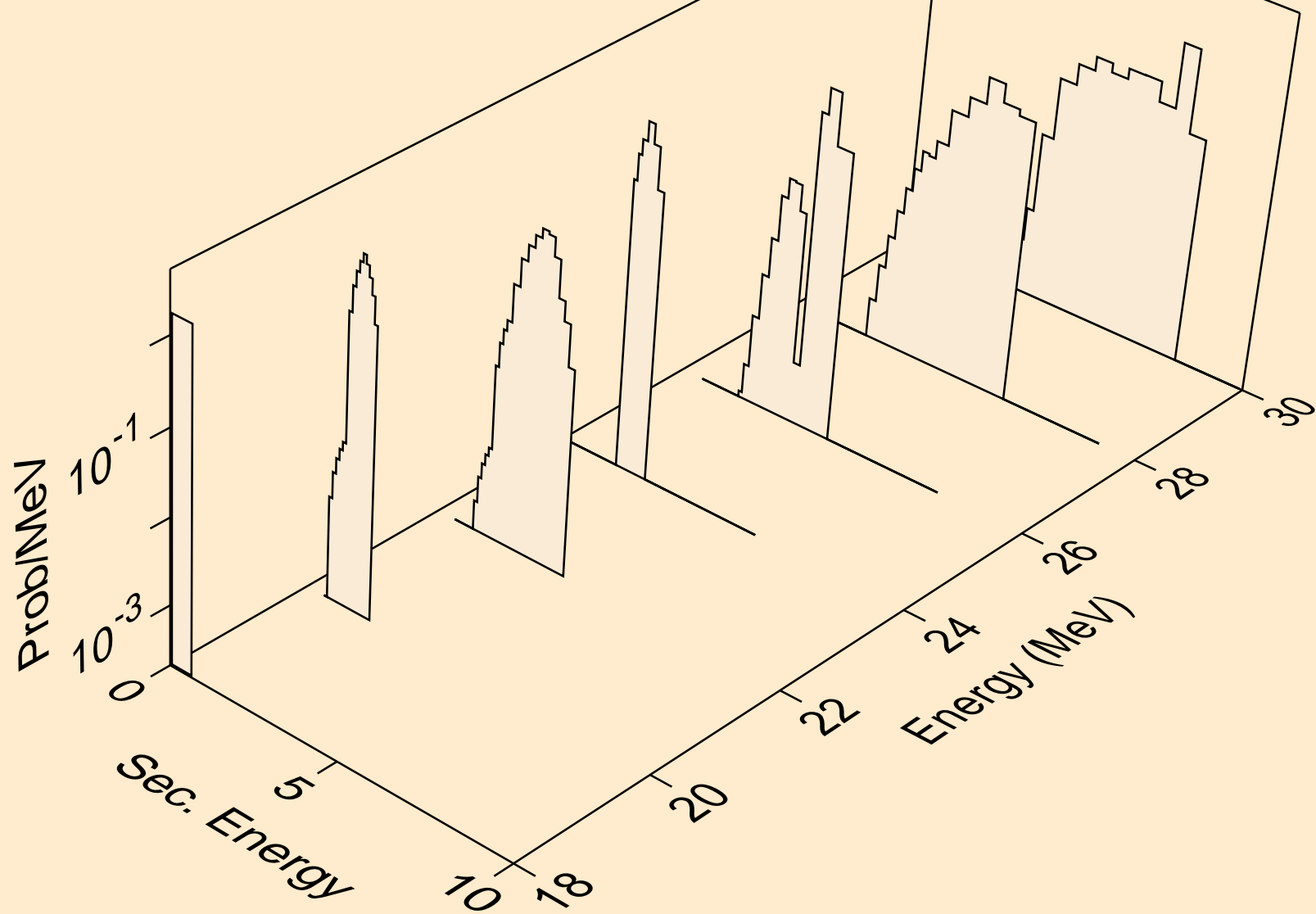

S036 NEUTRON ACER TENDL-2021 LIBRARY; T=293.6K
alphas from (n,x)

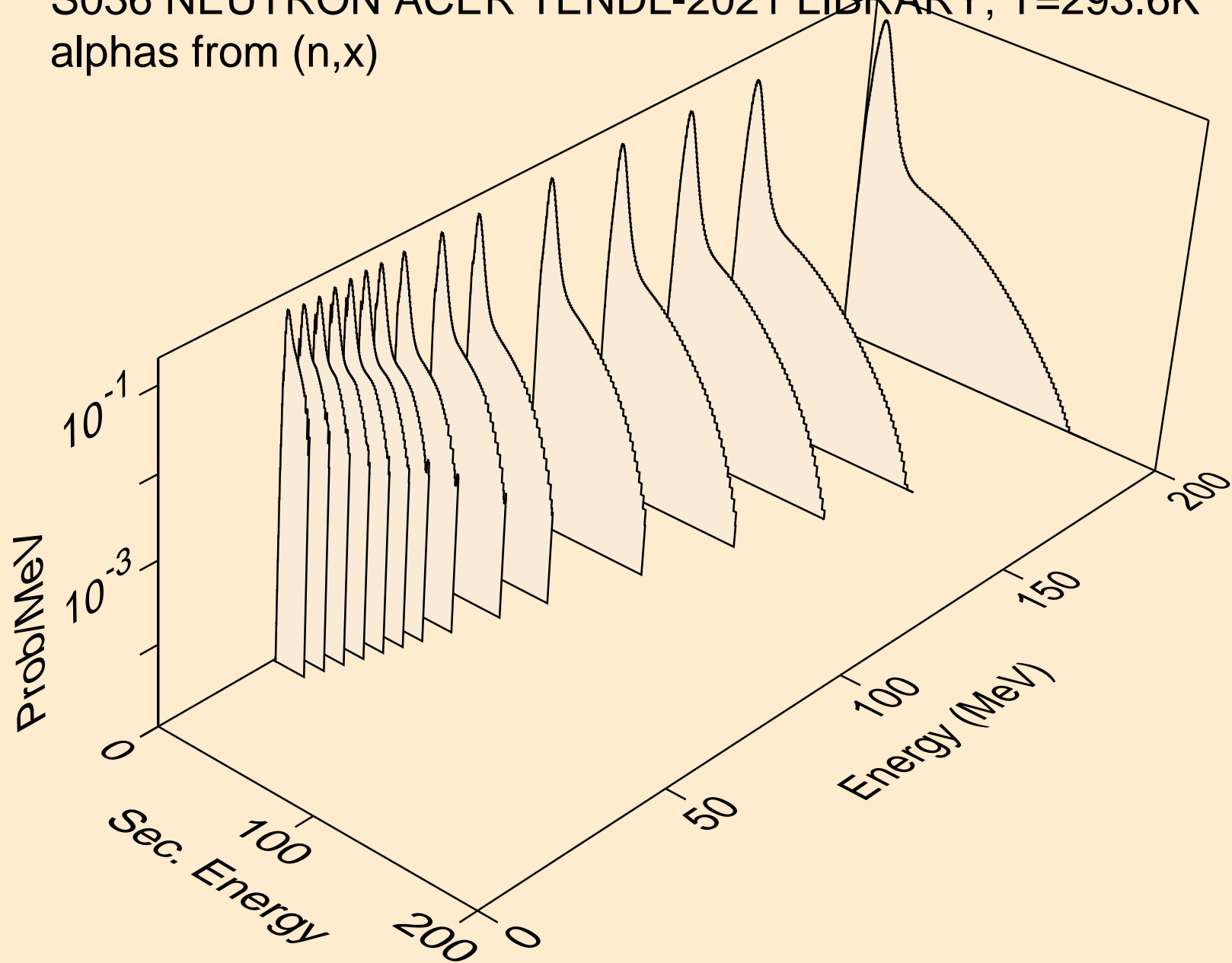

S036 NEUTRON ACER TENDL-2021 LIBRARY; T=293.6K
alphas from (n,n*)a

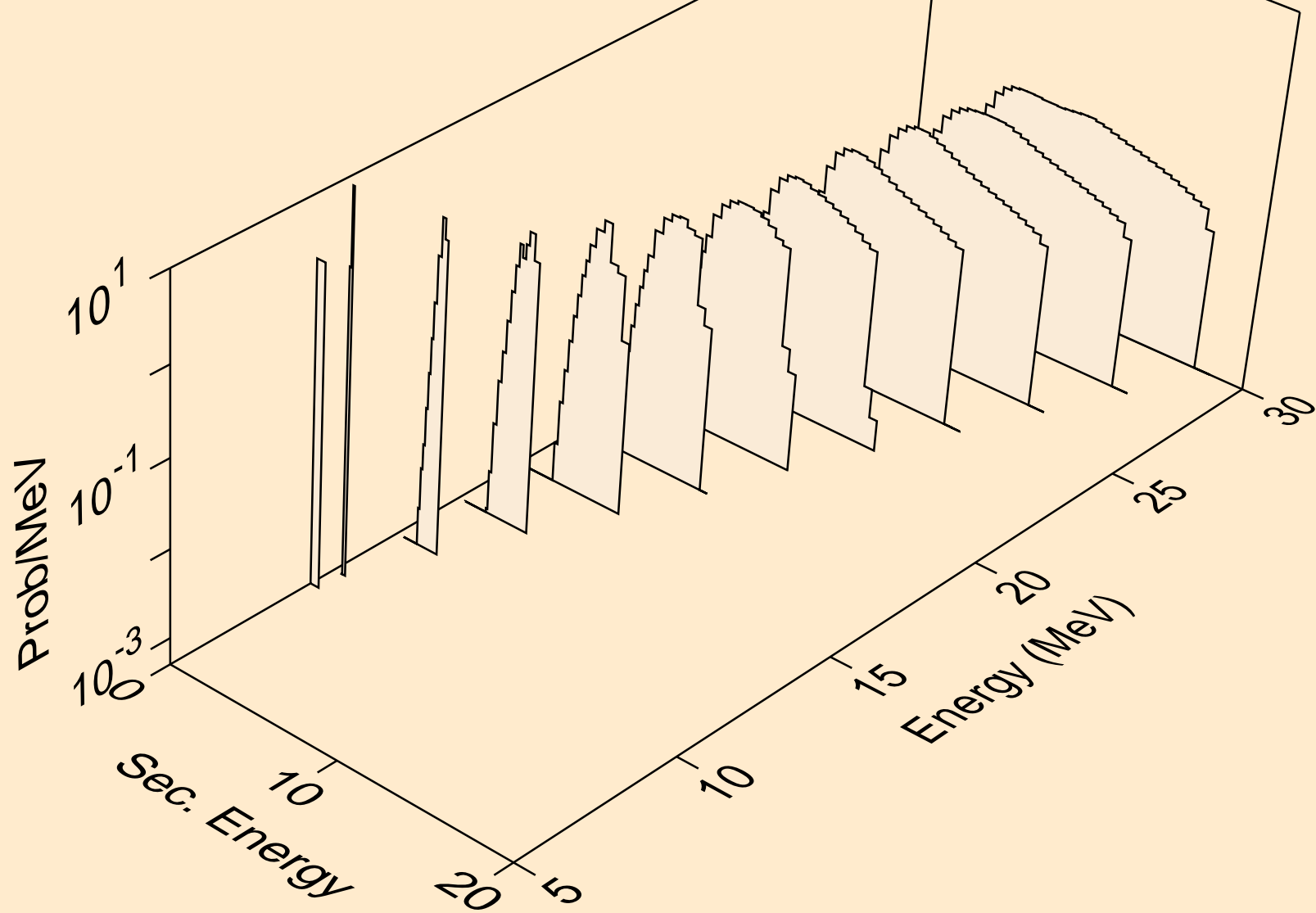

S036 NEUTRON ACER TENDL-2021 LIBRARY; T=293.6K
alphas from (n,2n)a

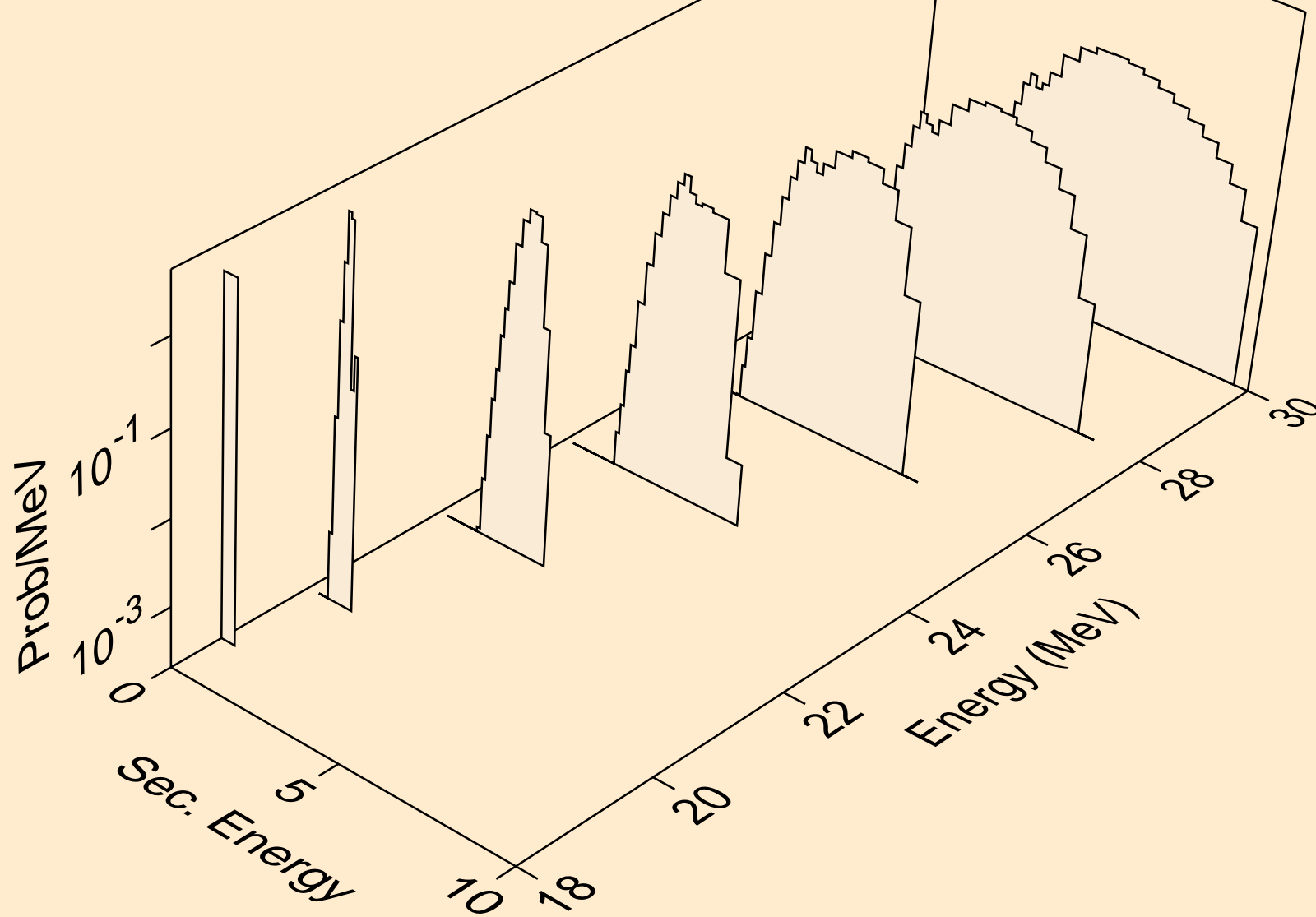

S036 NEUTRON ACER TENDL-2021 LIBRARY; T=293.6K
alphas from (n,3n)a

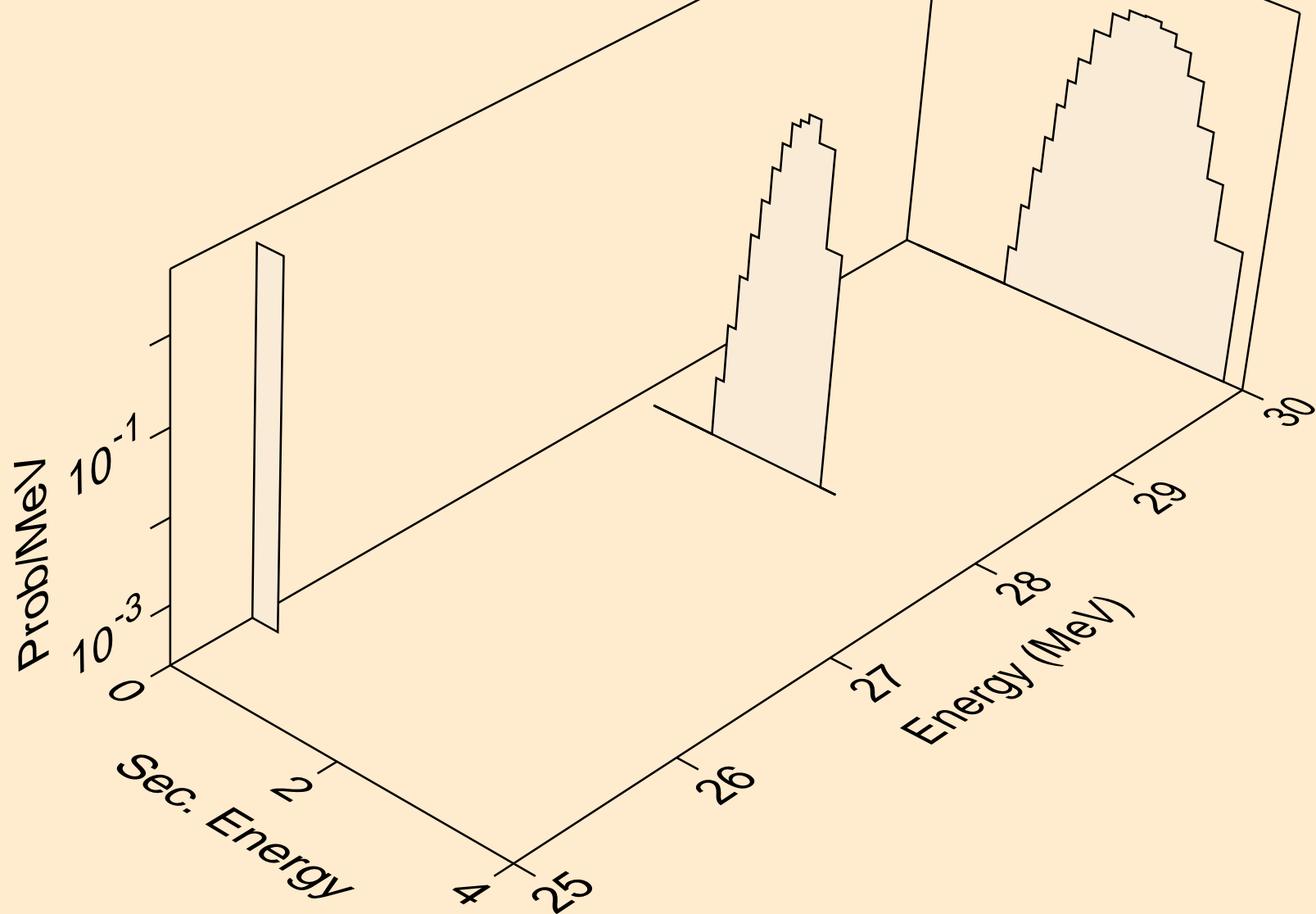

S036 NEUTRON ACER TENDL-2021 LIBRARY; T=293.6K
alphas from (n,n*)2a

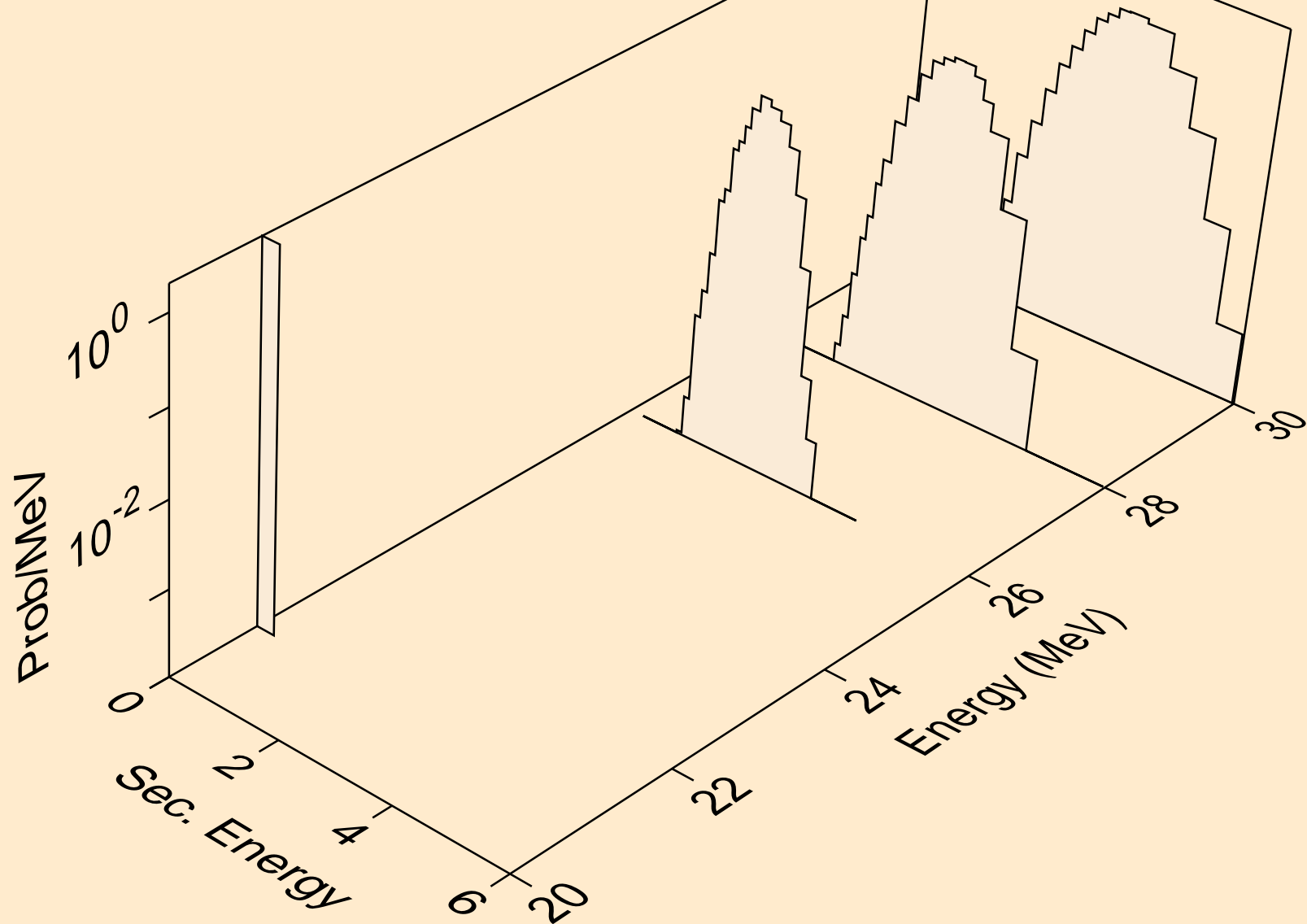

S036 NEUTRON ACER TENDL-2021 LIBRARY; T=293.6K
alphas from (n,a)

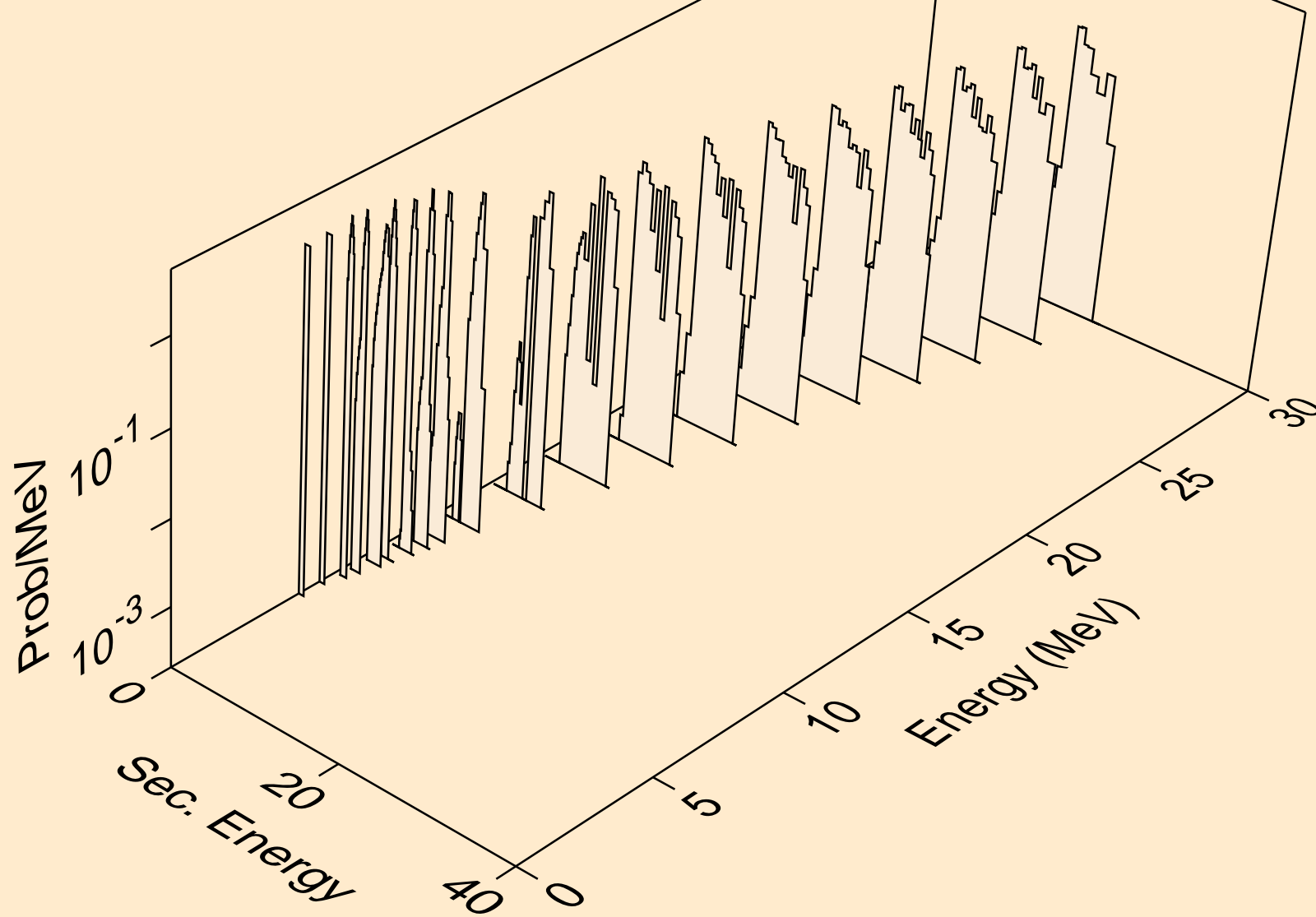

S036 NEUTRON ACER TENDL-2021 LIBRARY; T=293.6K
alphas from (n,2a)

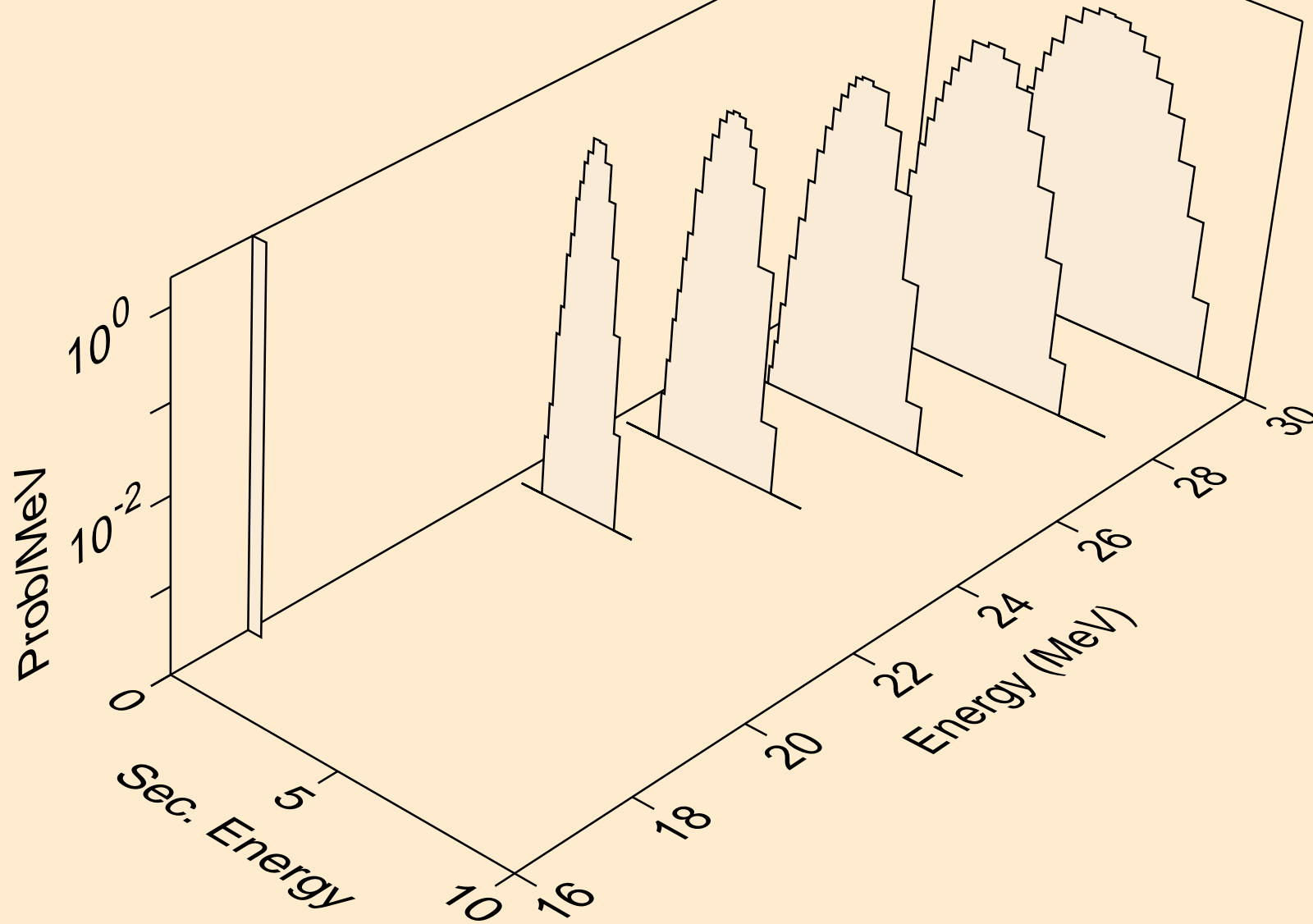

S036 NEUTRON ACER TENDL-2021 LIBRARY; T=293.6K
alphas from (n,pa)

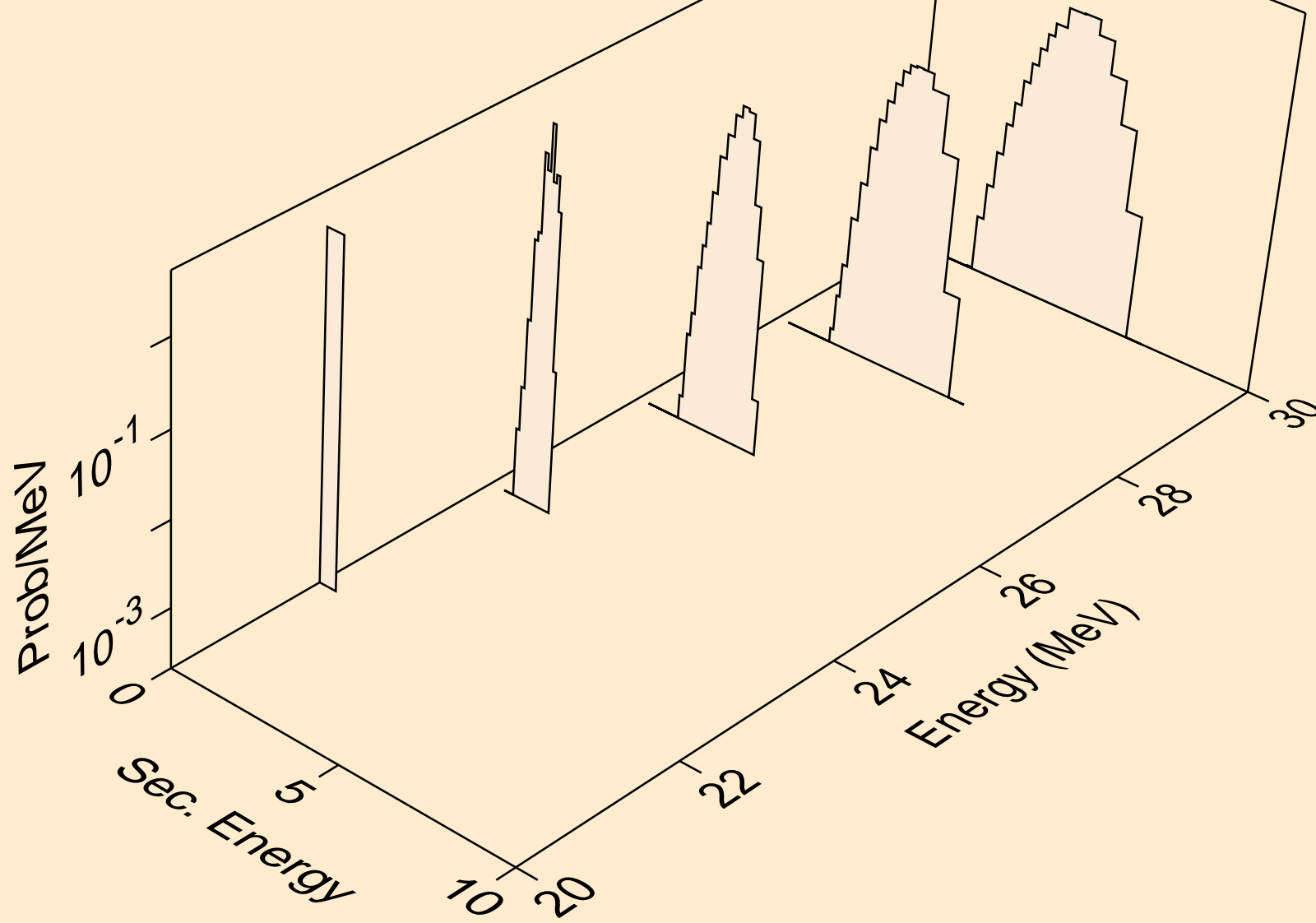

S036 NEUTRON ACER TENDL-2021 LIBRARY; T=293.6K
alphas from (n,da)

