

SB116 NEUTRON ACER TENDL-2021 LIBRARY; T=293.6K

Principal cross sections

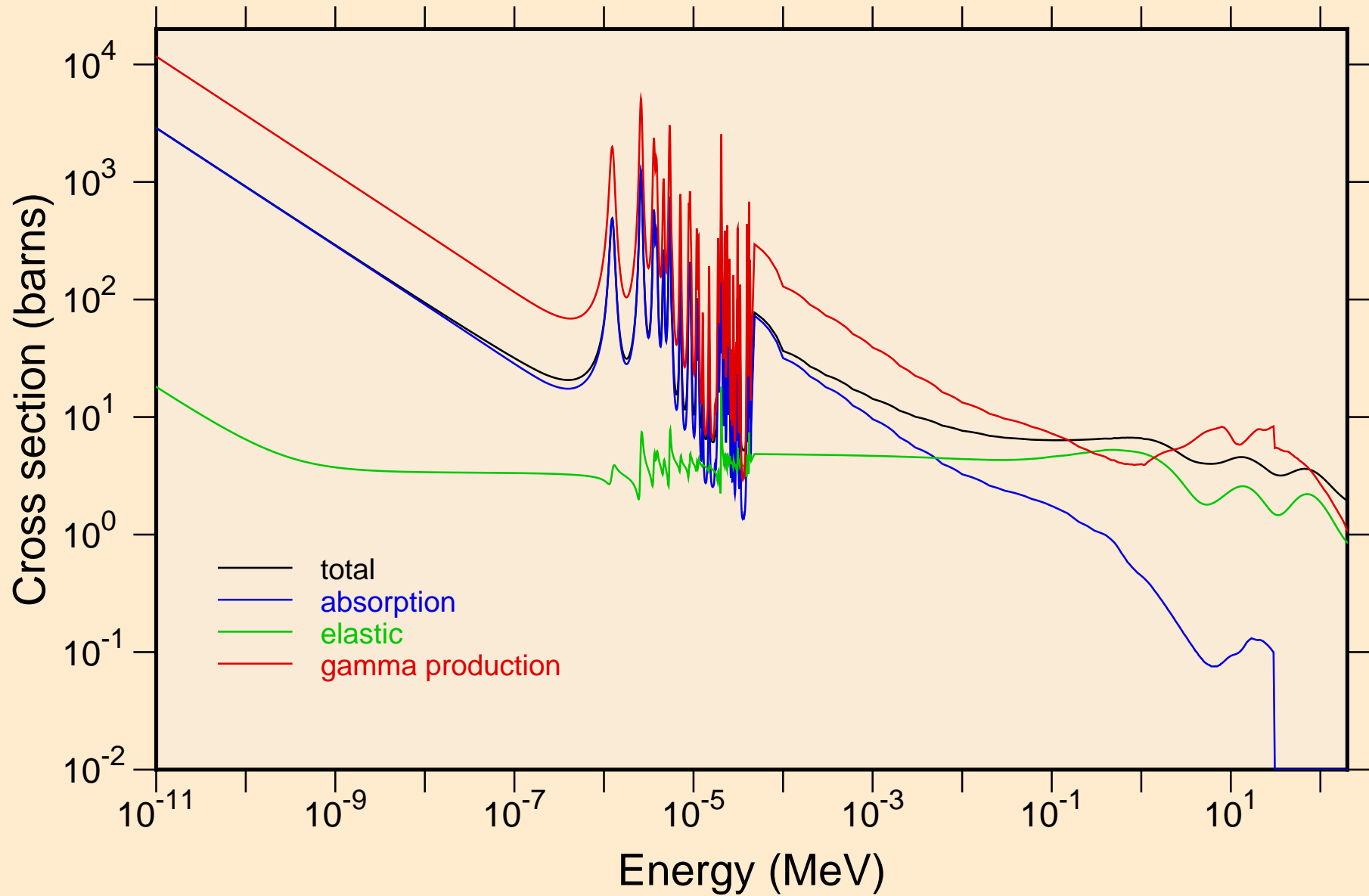

SB116 NEUTRON ACER TENDL-2021 LIBRARY; T=293.6K
resonance total cross section

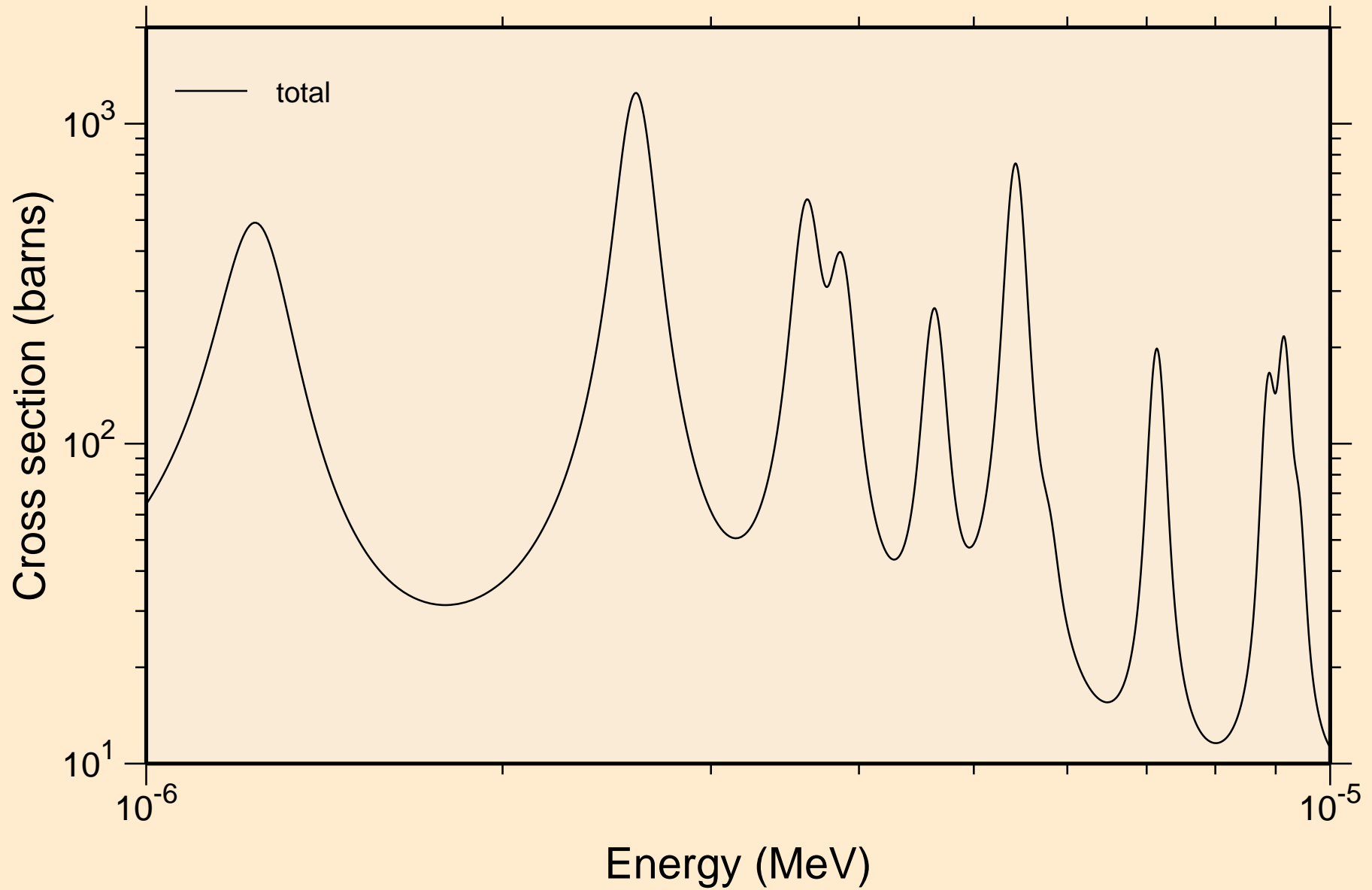

SB116 NEUTRON ACER TENDL-2021 LIBRARY; T=293.6K
resonance total cross section

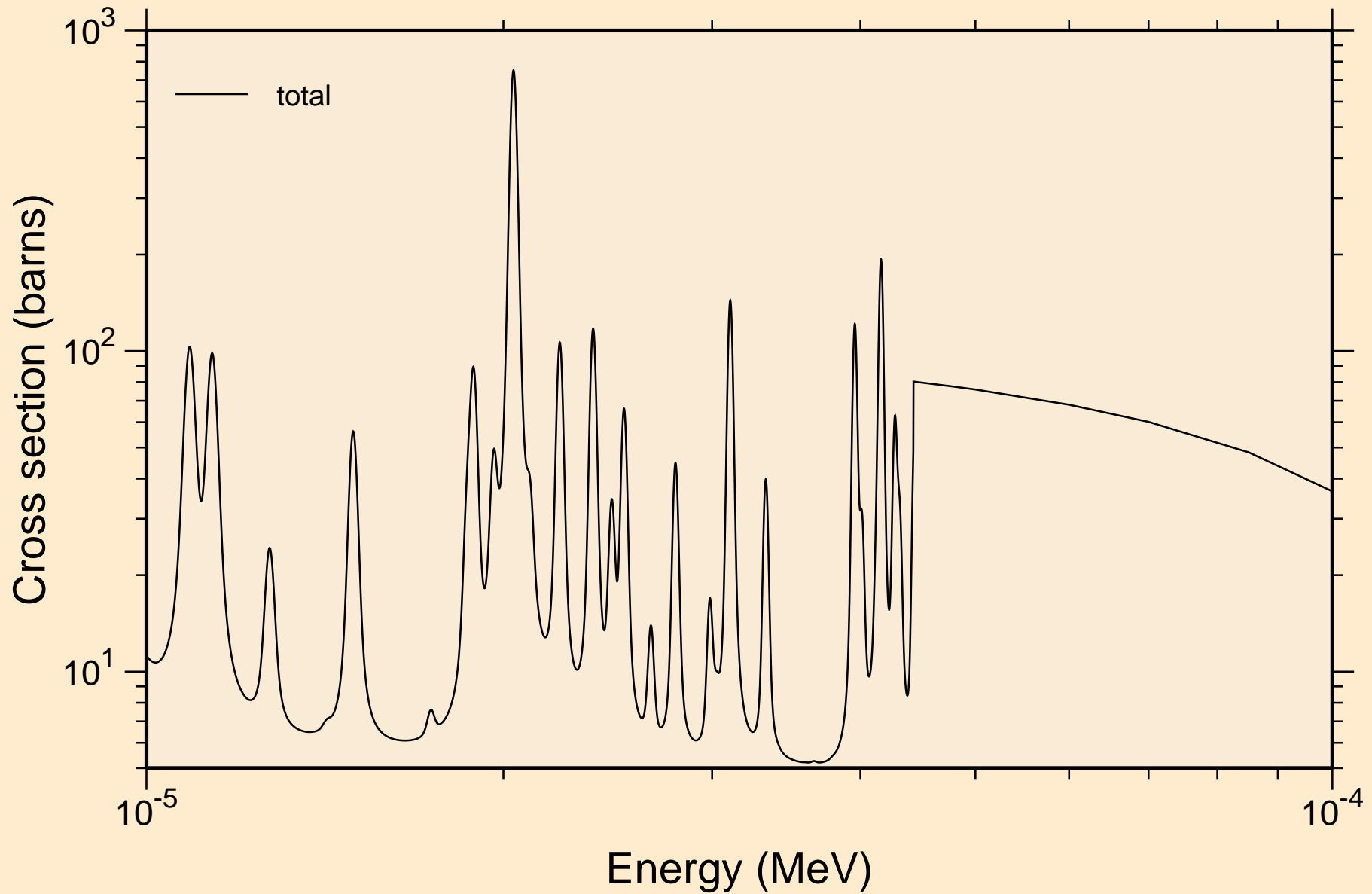

S¹¹⁶ NEUTRON ACER TENDL-2021 LIBRARY; T=293.6K
resonance total cross section

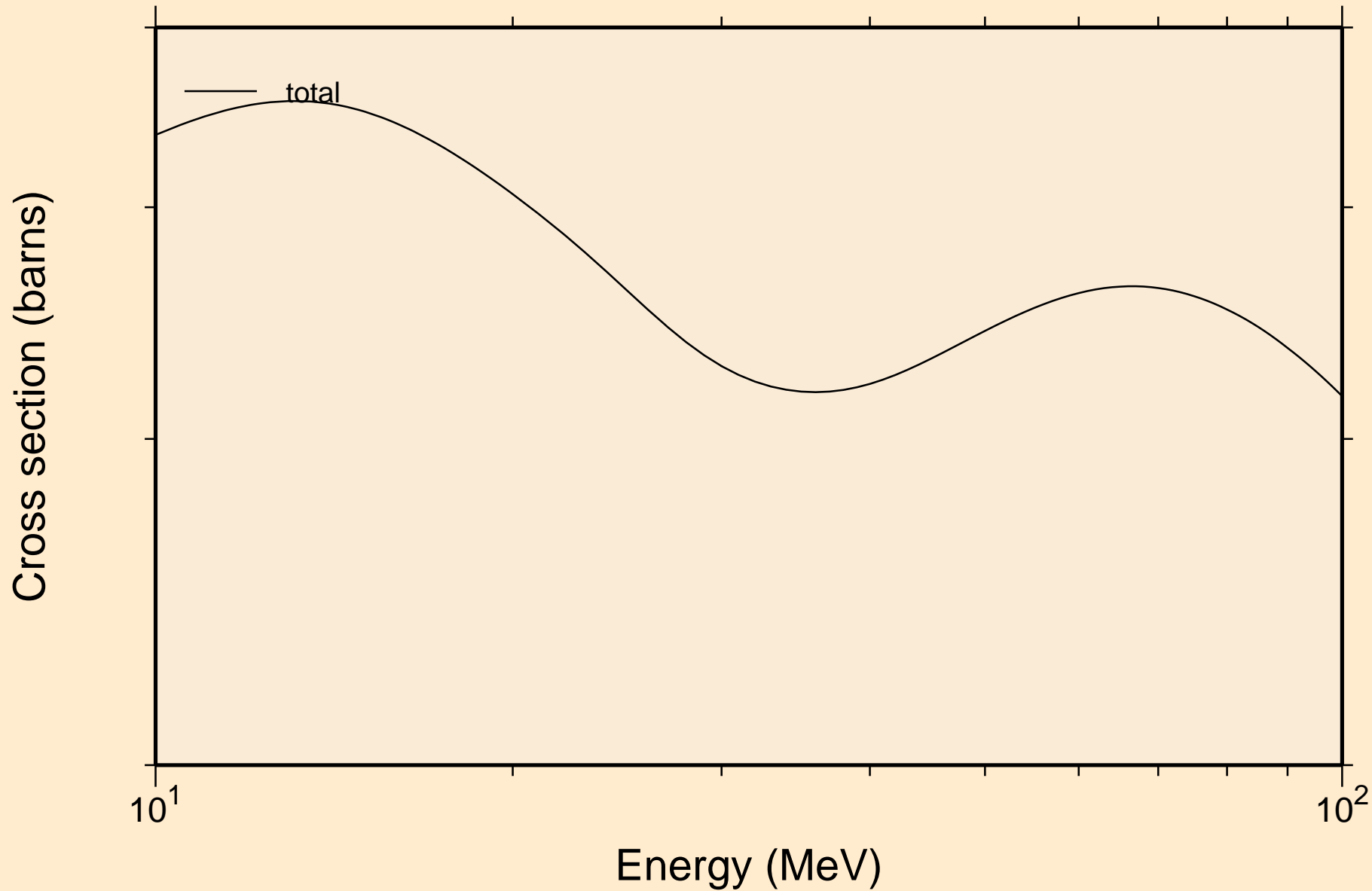

SB116 NEUTRON ACER TENDL-2021 LIBRARY; T=293.6K
resonance absorption cross sections

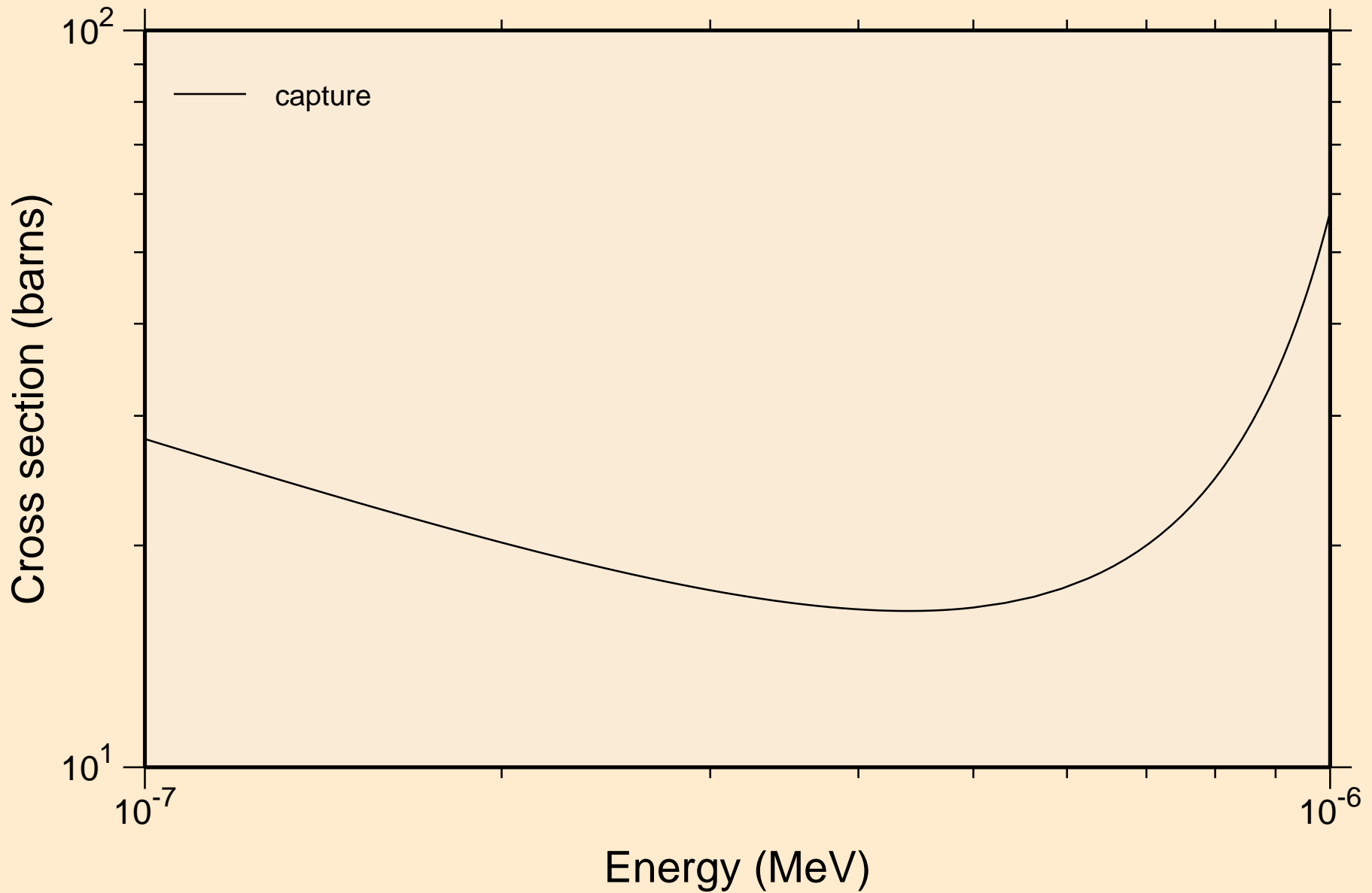

SB116 NEUTRON ACER TENDL-2021 LIBRARY; T=293.6K
resonance absorption cross sections

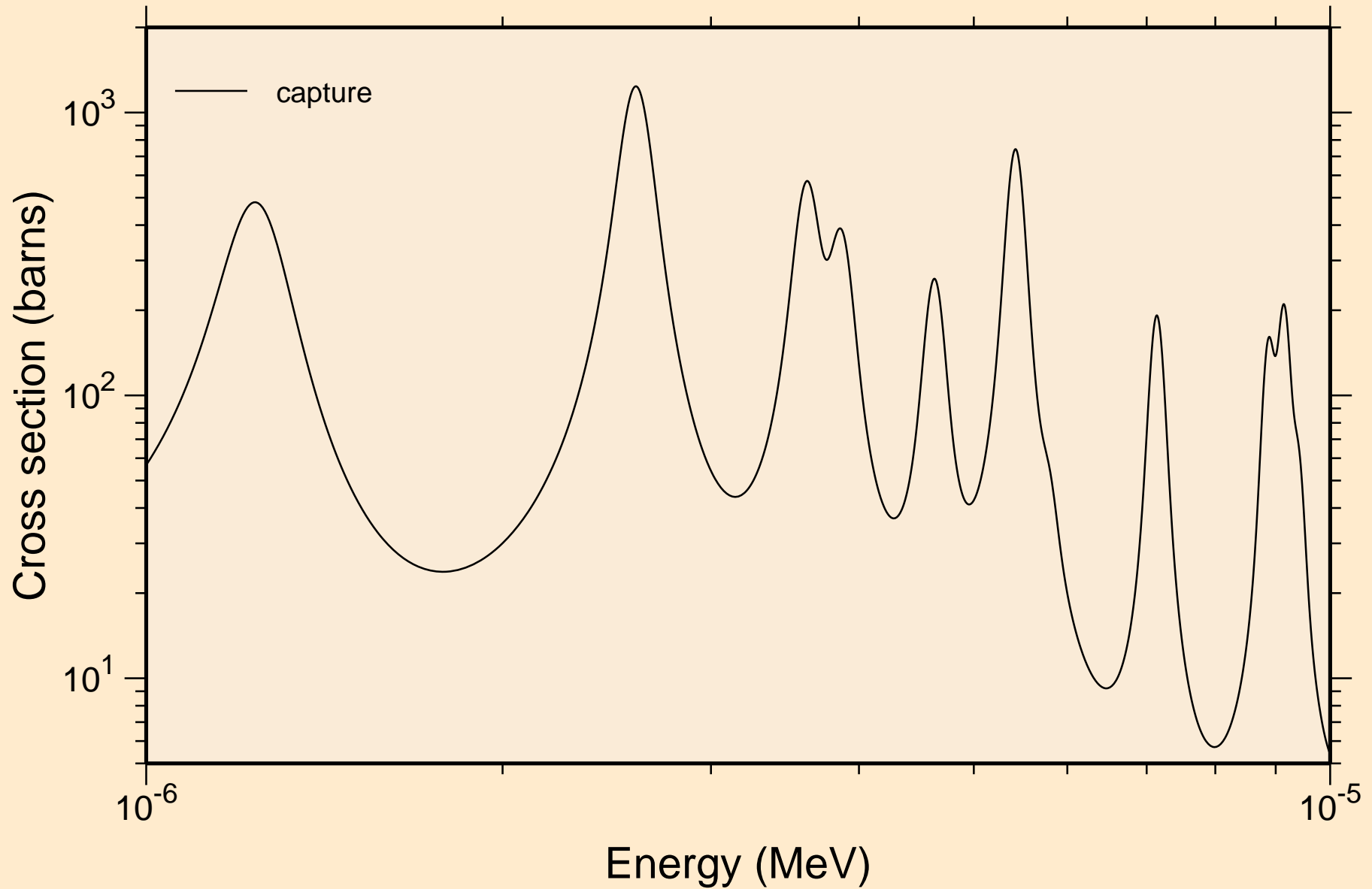

SB116 NEUTRON ACER TENDL-2021 LIBRARY; T=293.6K
resonance absorption cross sections

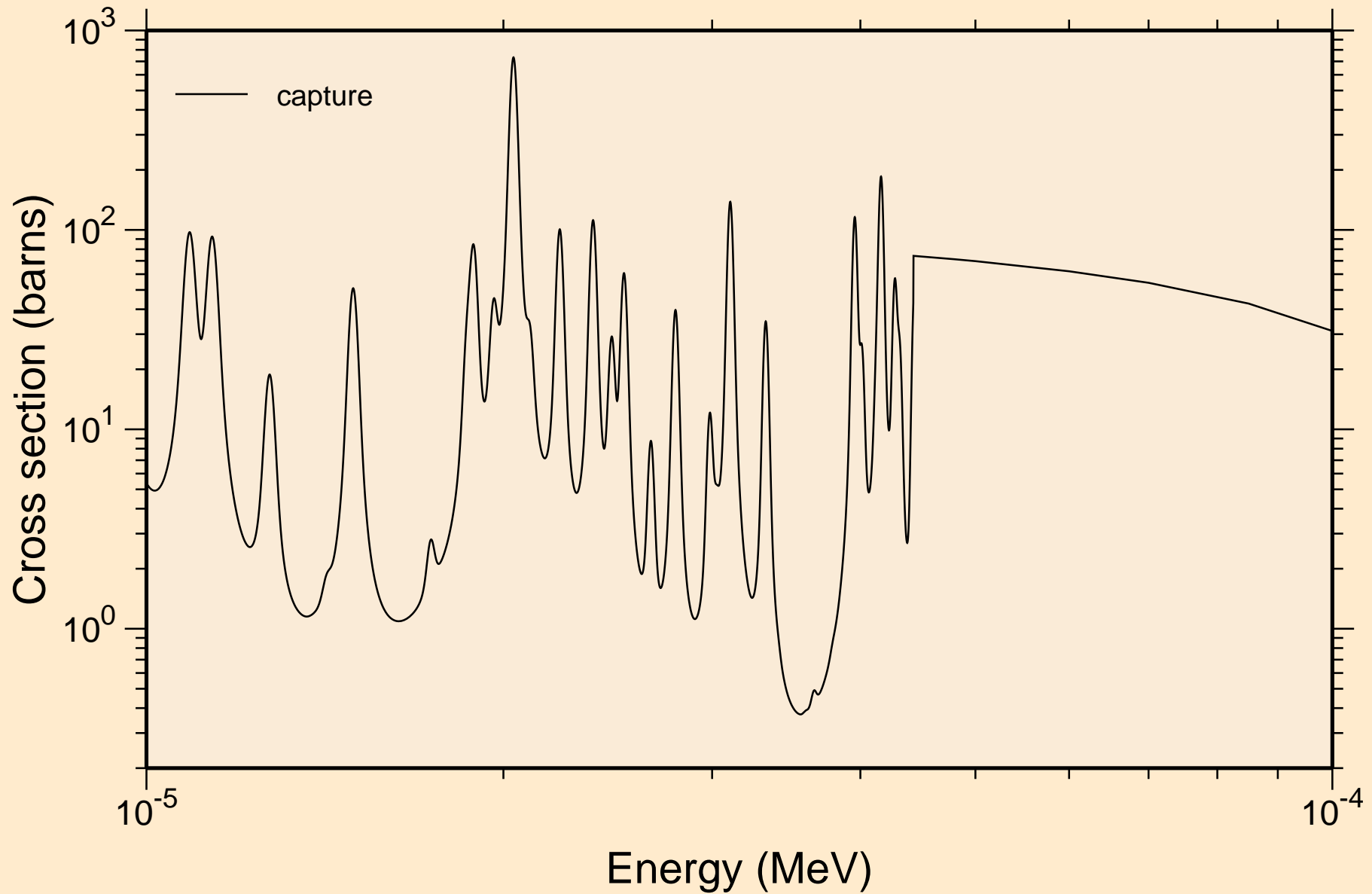

SB116 NEUTRON ACER TENDL-2021 LIBRARY; T=293.6K
resonance absorption cross sections

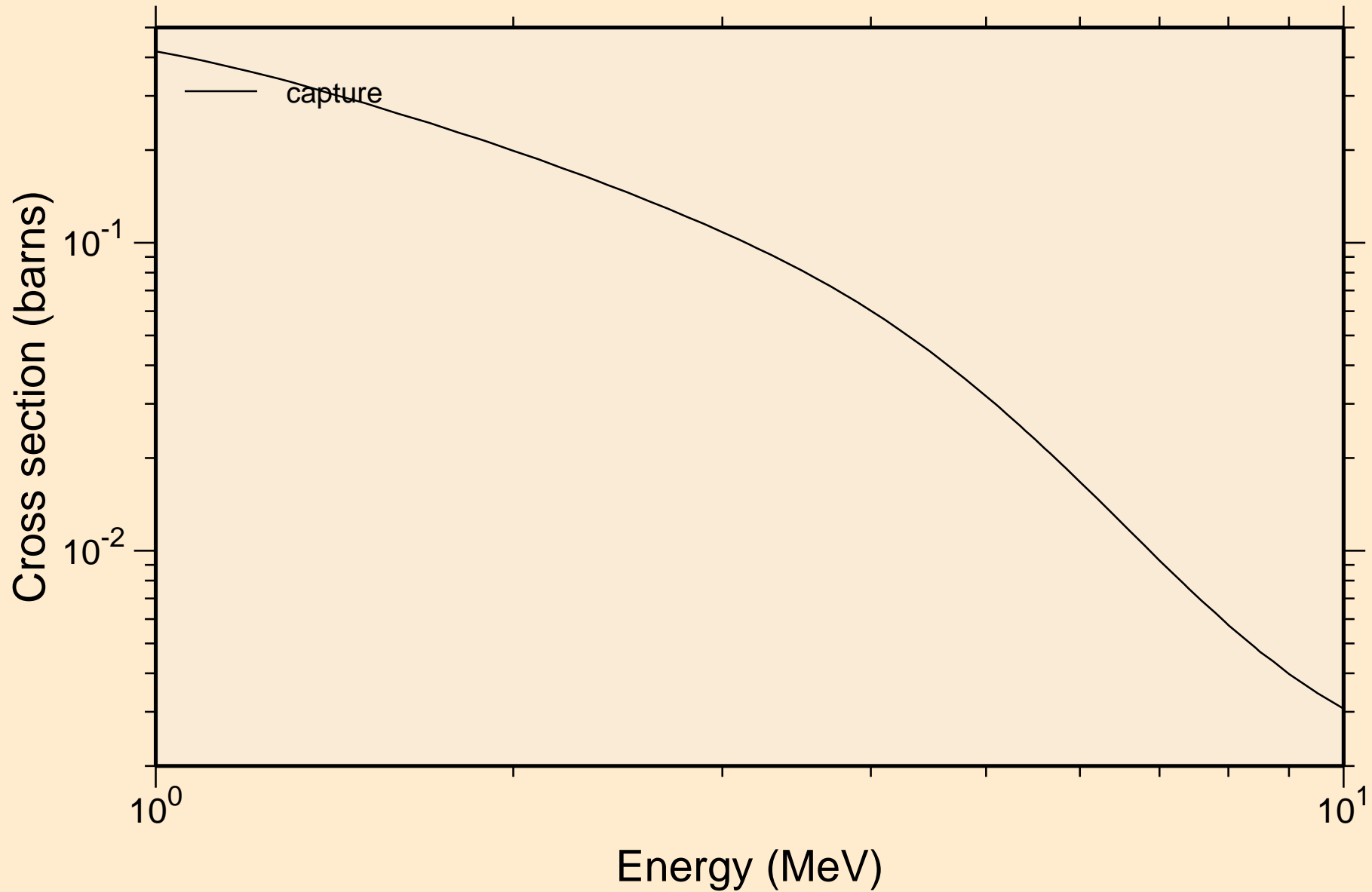

SB116 NEUTRON ACER TENDL-2021 LIBRARY; T=293.6K
Heating

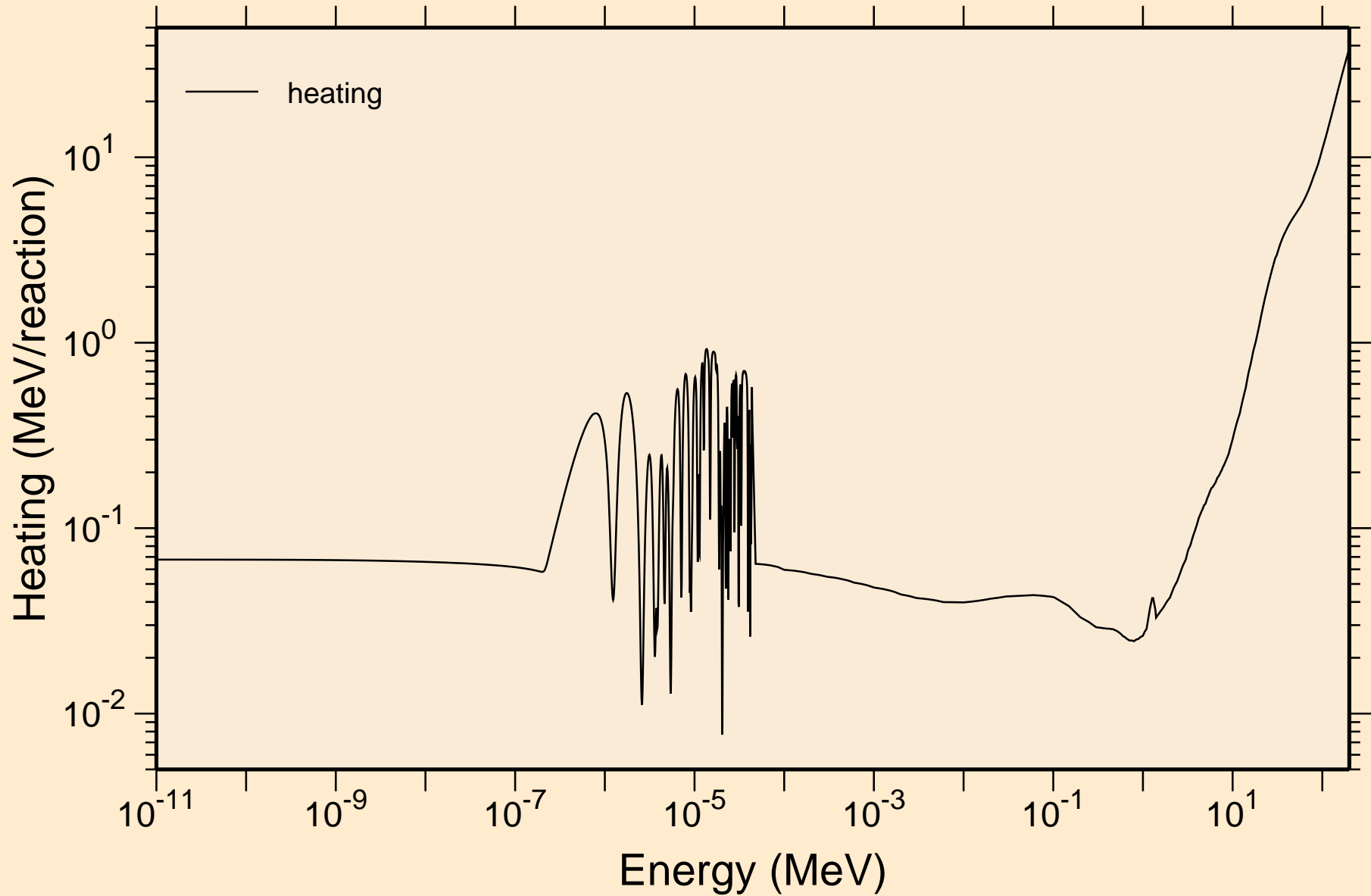

SB116 NEUTRON ACER TENDL-2021 LIBRARY; T=293.6K
Damage

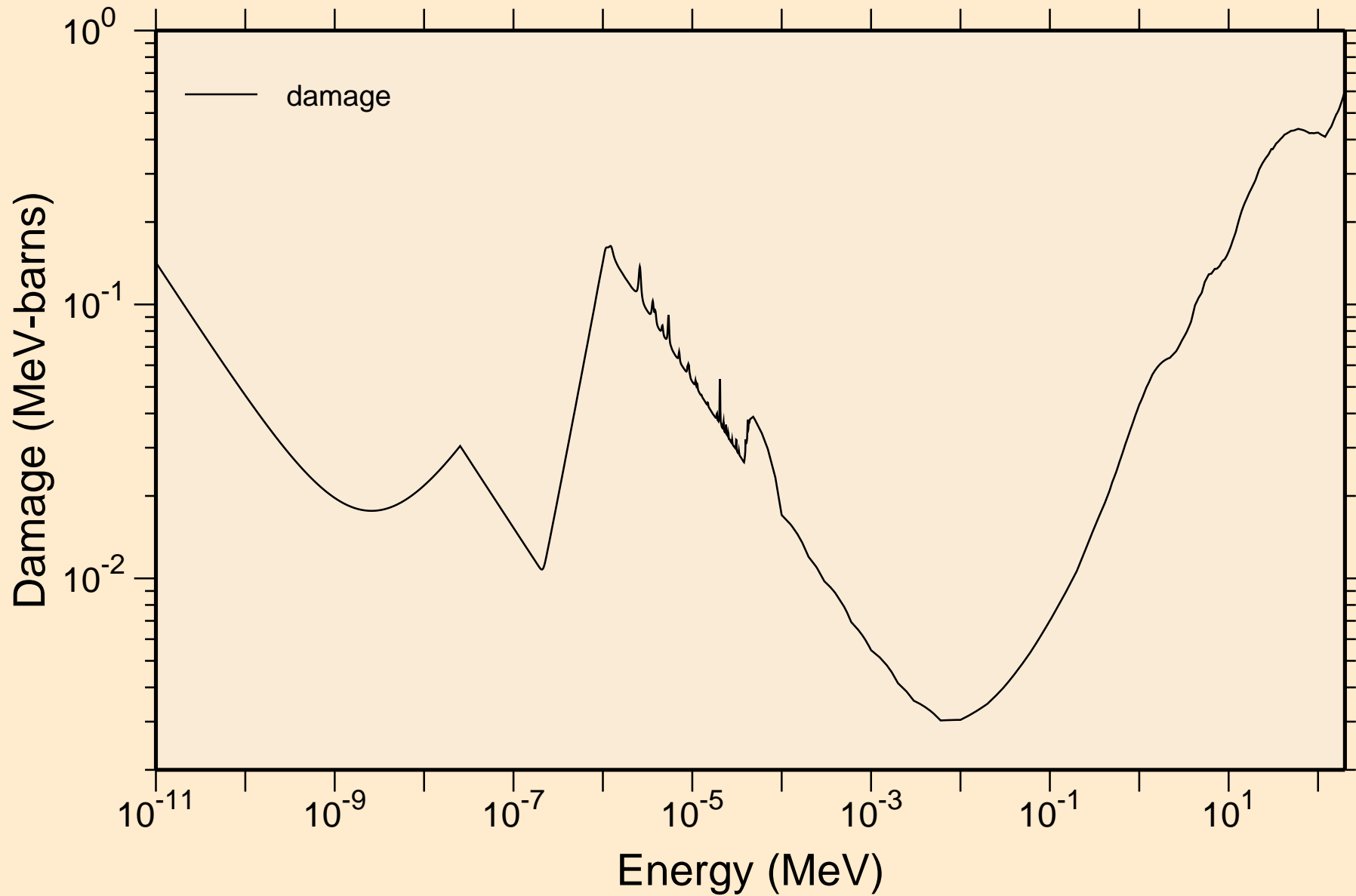

SB116 NEUTRON ACER TENDL-2021 LIBRARY; T=293.6K

Non-threshold reactions

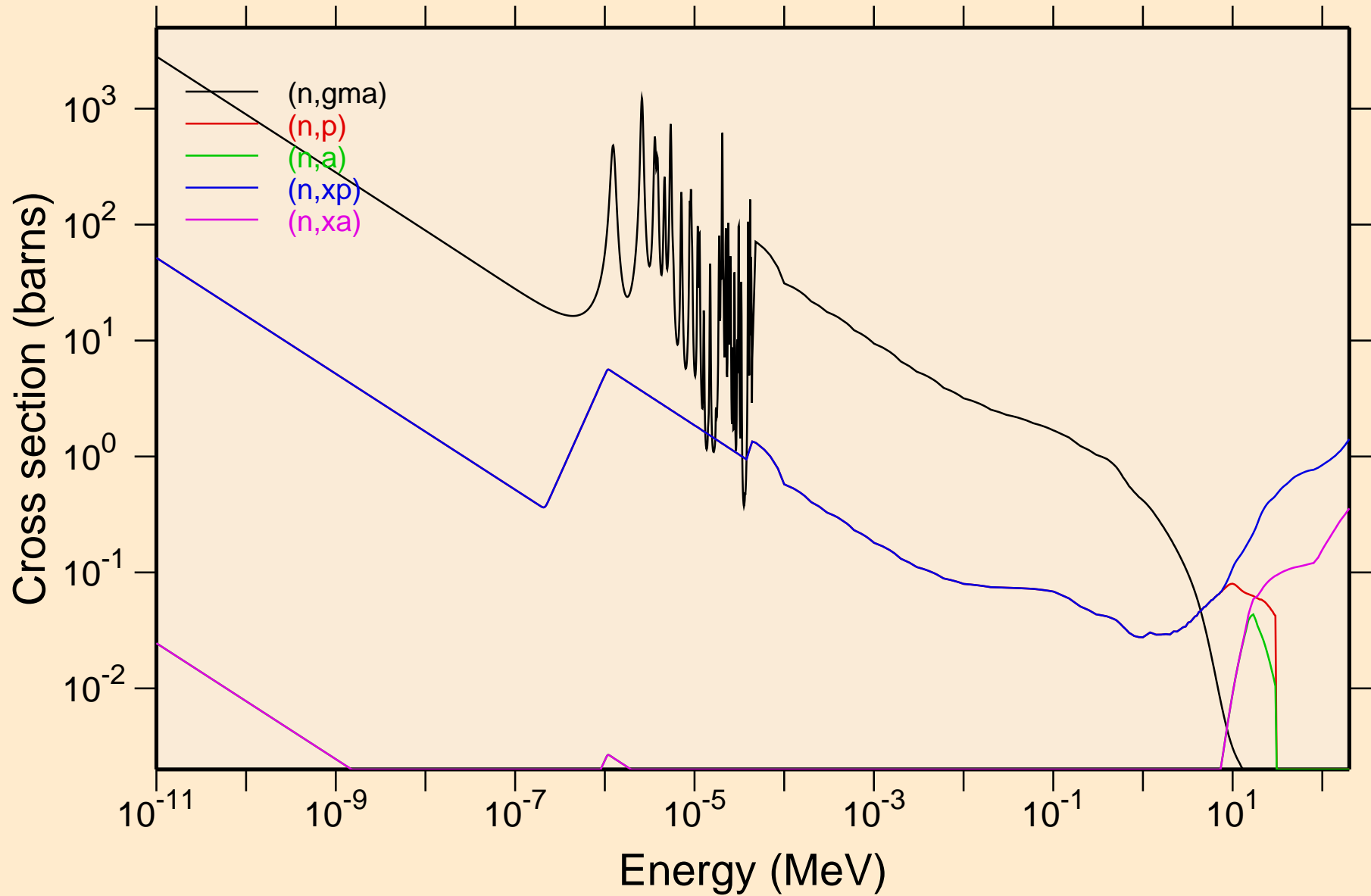

SB116 NEUTRON ACER TENDL-2021 LIBRARY; T=293.6K
Principal cross sections

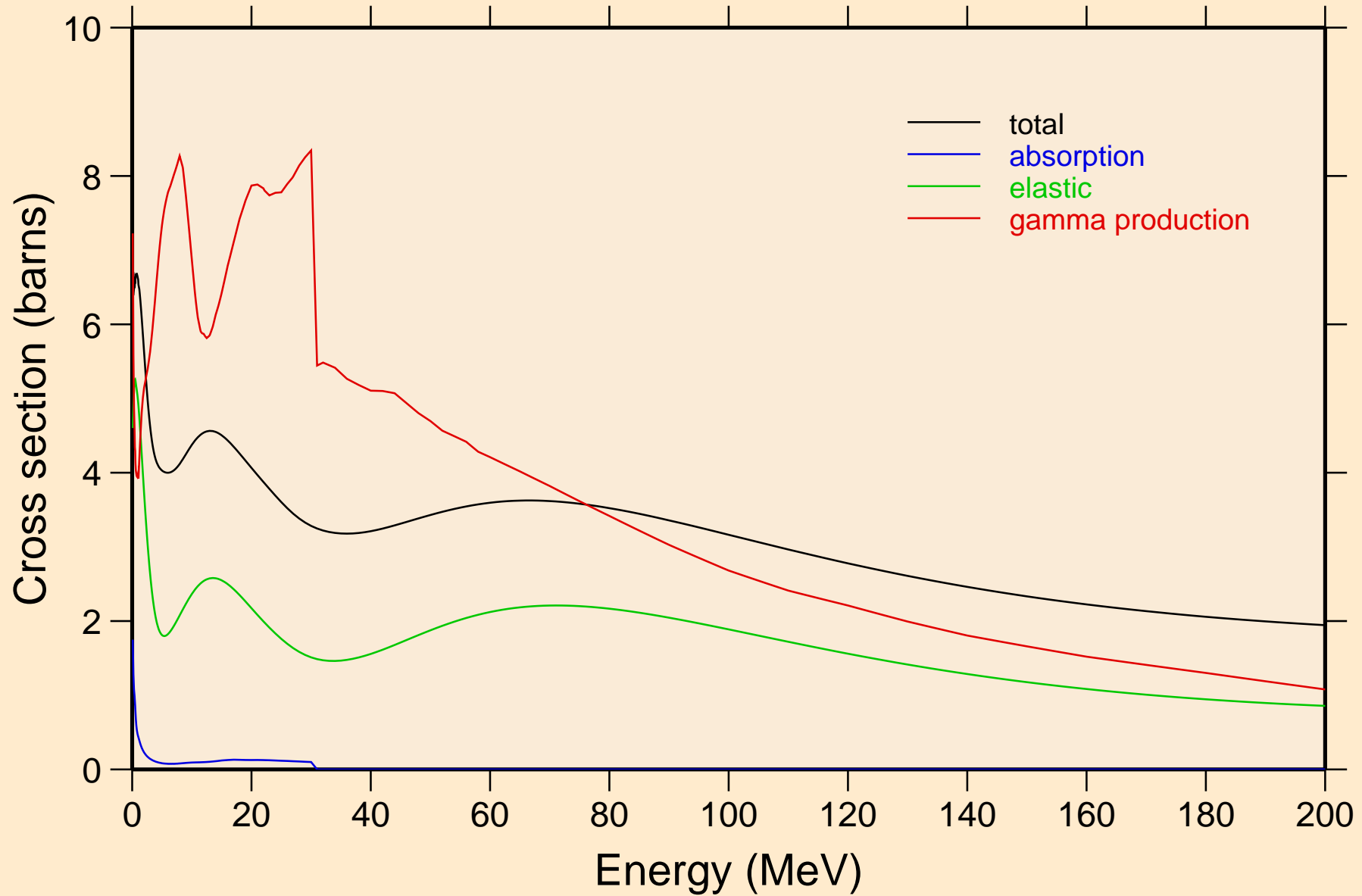

SB116 NEUTRON ACER TENDL-2021 LIBRARY; T=293.6K

Heating

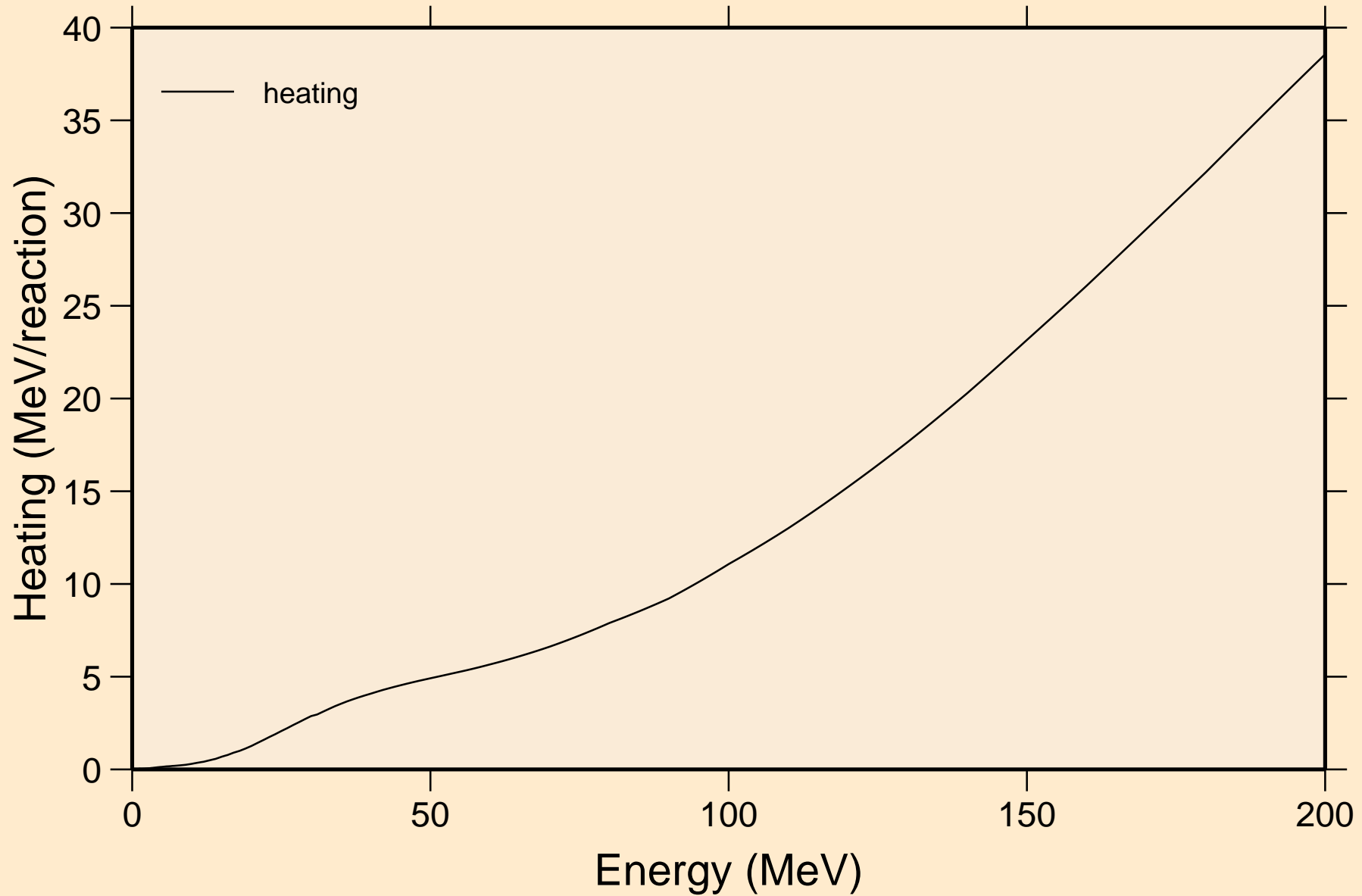

SB116 NEUTRON ACER TENDL-2021 LIBRARY; T=293.6K
Damage

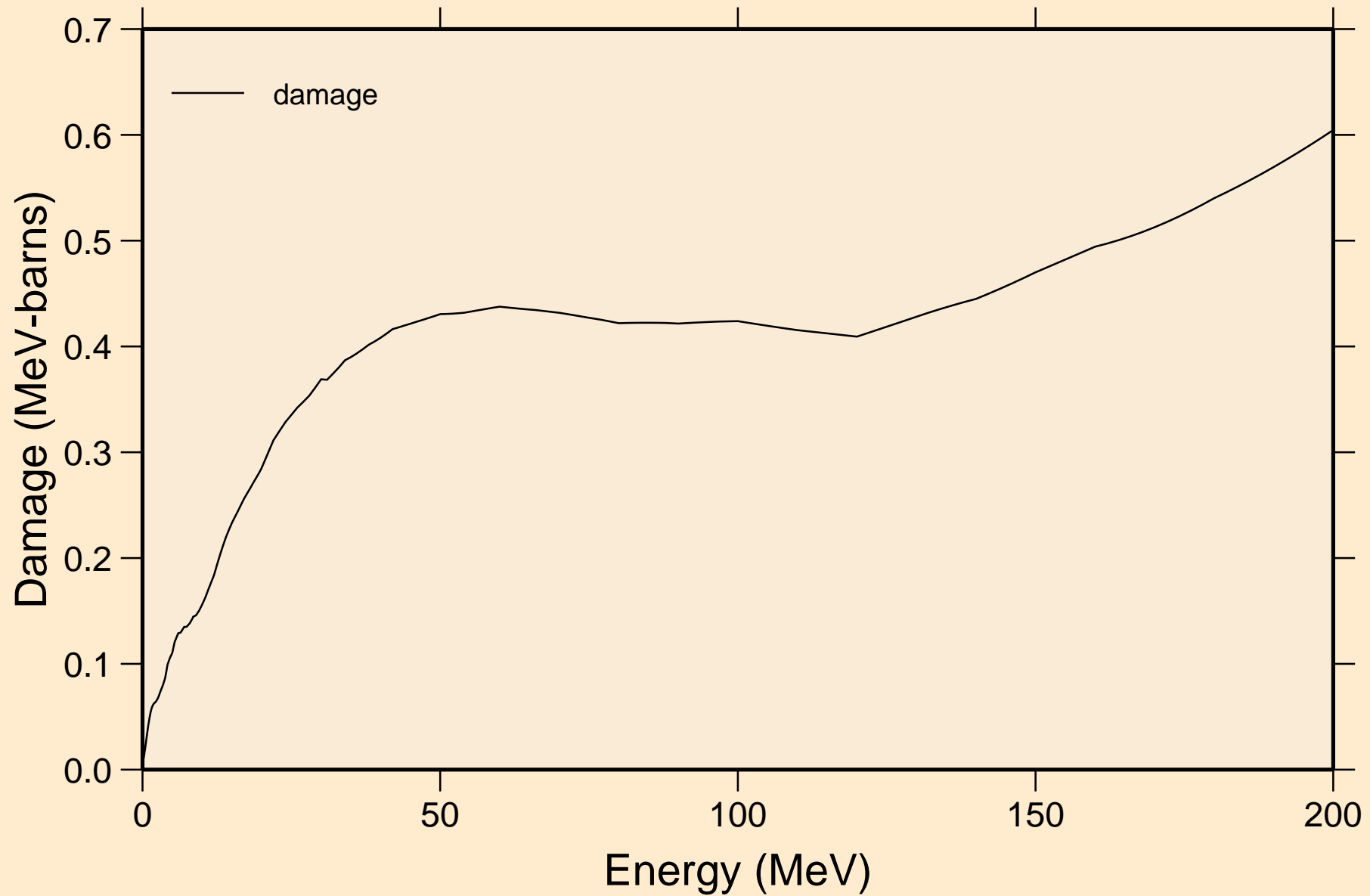

SB116 NEUTRON ACER TENDL-2021 LIBRARY; T=293.6K

Non-threshold reactions

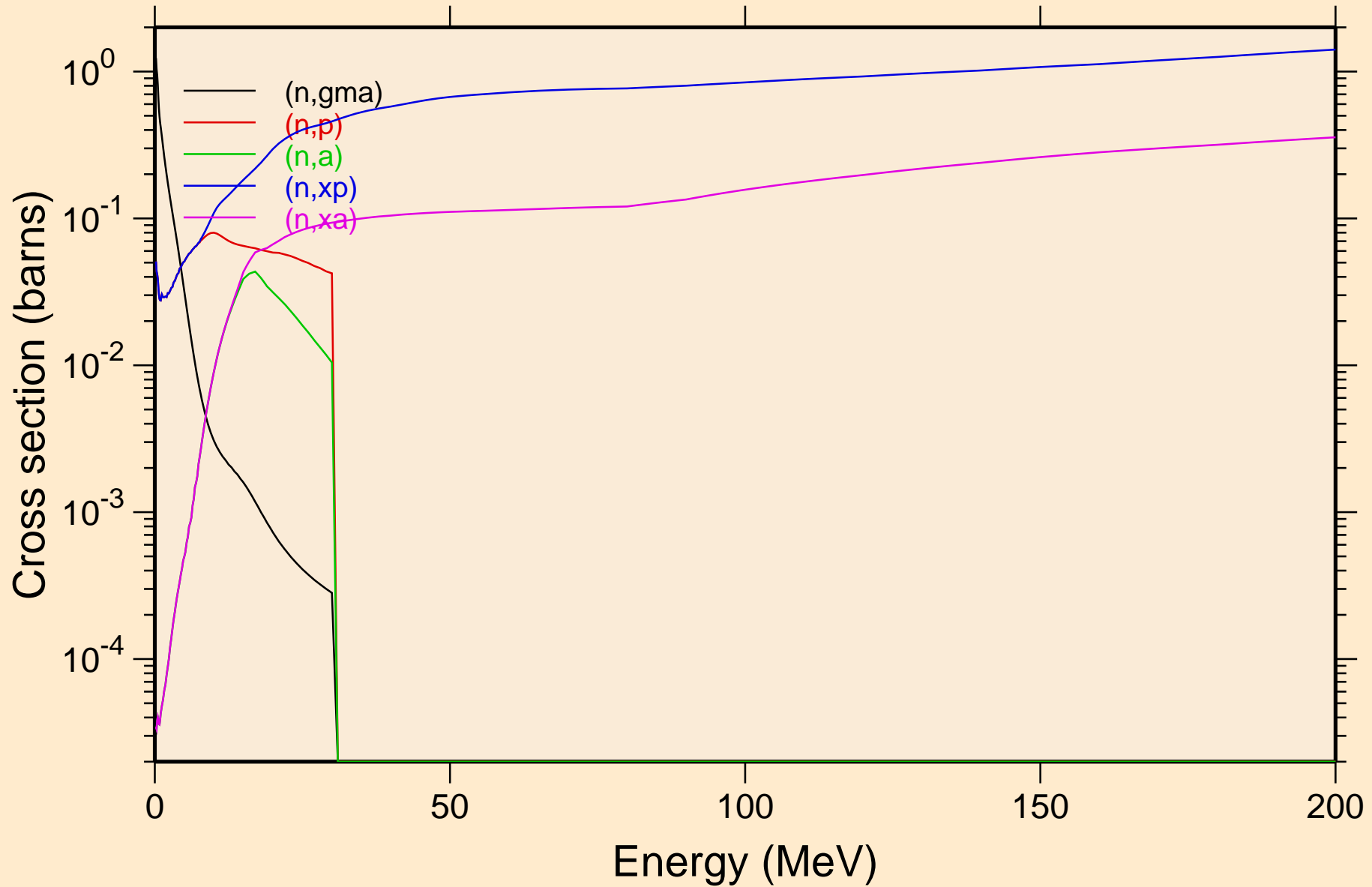

SB116 NEUTRON ACER TENDL-2021 LIBRARY; T=293.6K
Inelastic levels

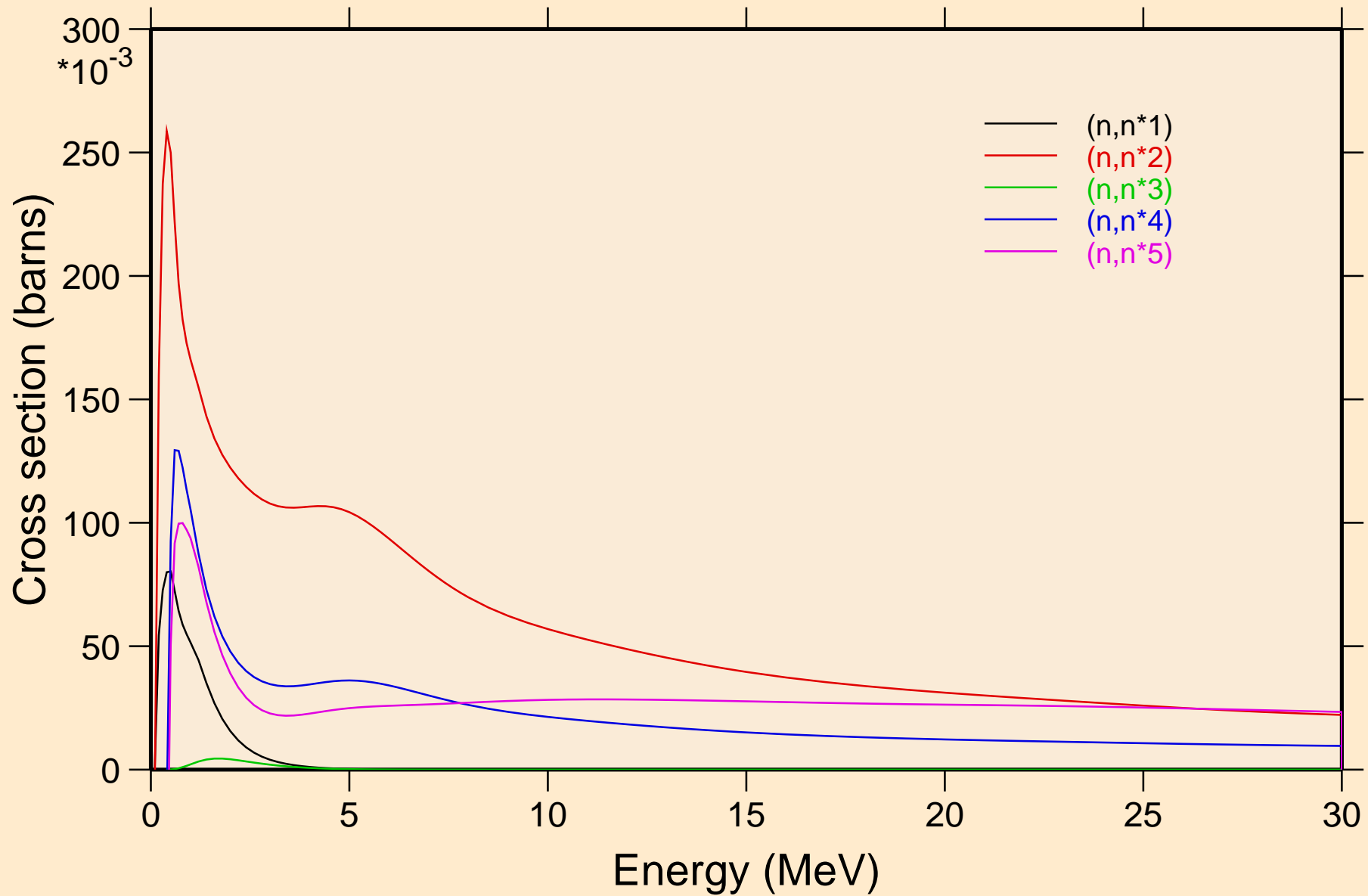

SB116 NEUTRON ACER TENDL-2021 LIBRARY; T=293.6K
Inelastic levels

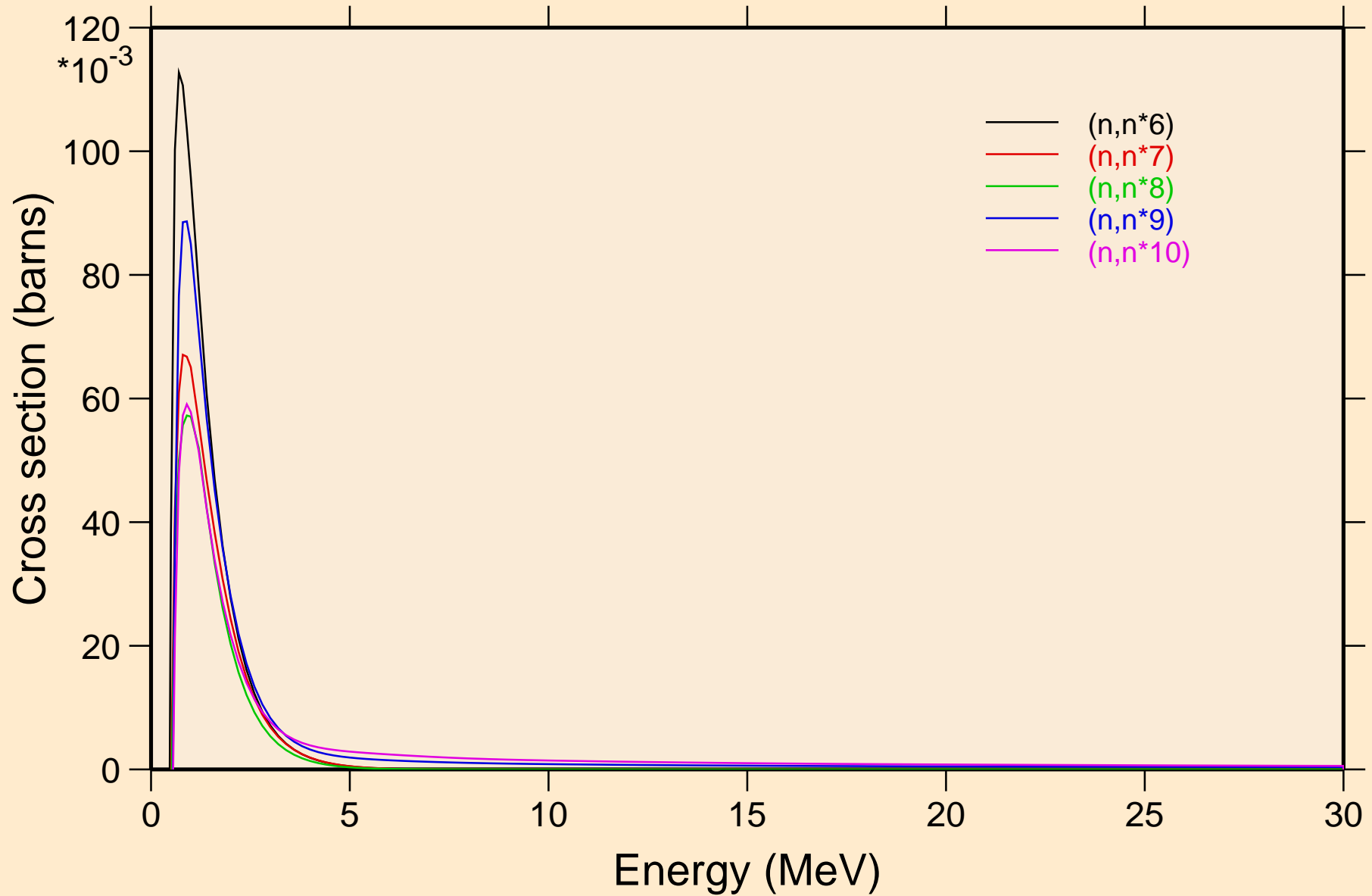

SB116 NEUTRON ACER TENDL-2021 LIBRARY; T=293.6K
Inelastic levels

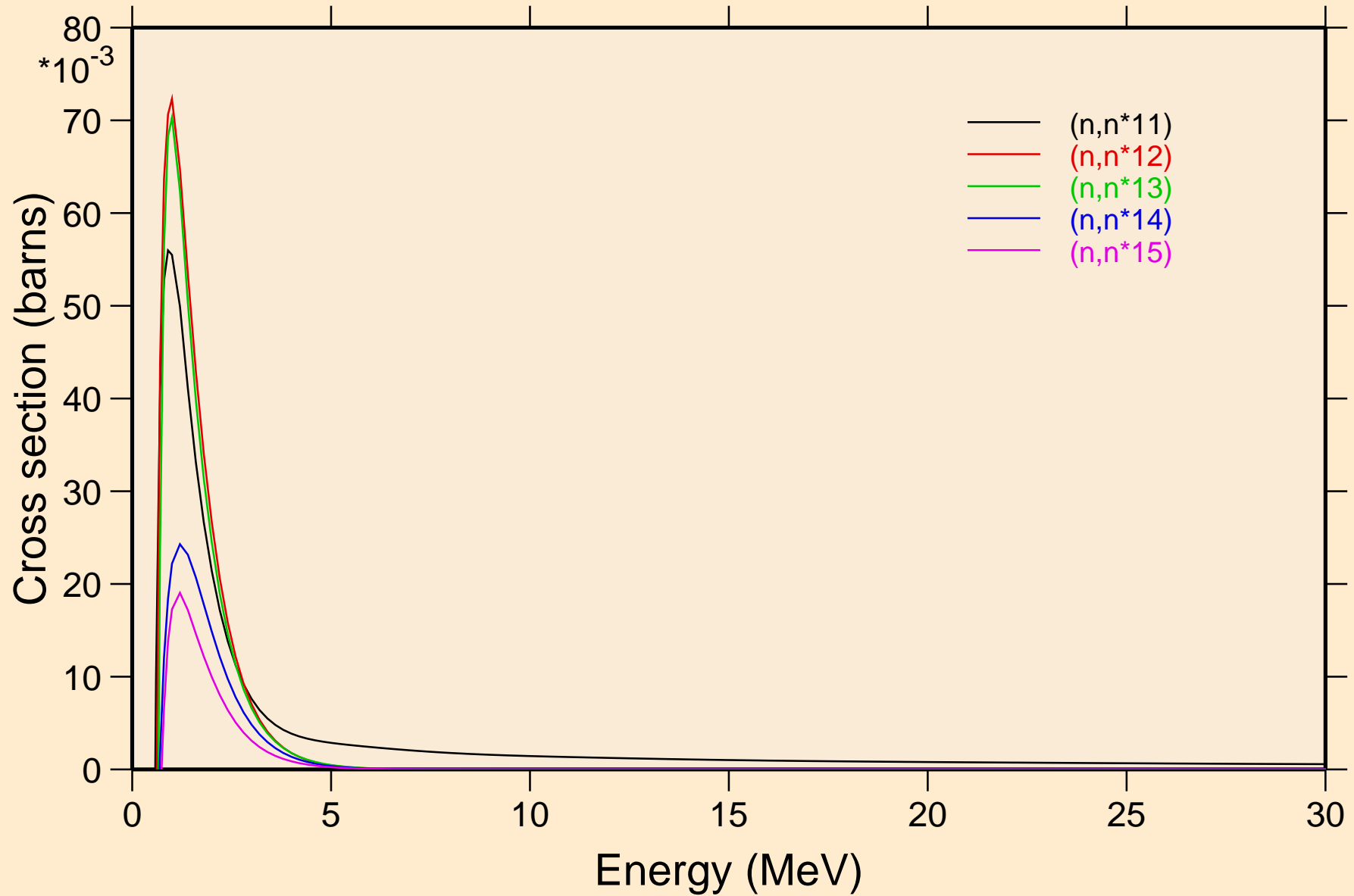

SB116 NEUTRON ACER TENDL-2021 LIBRARY; T=293.6K
Inelastic levels

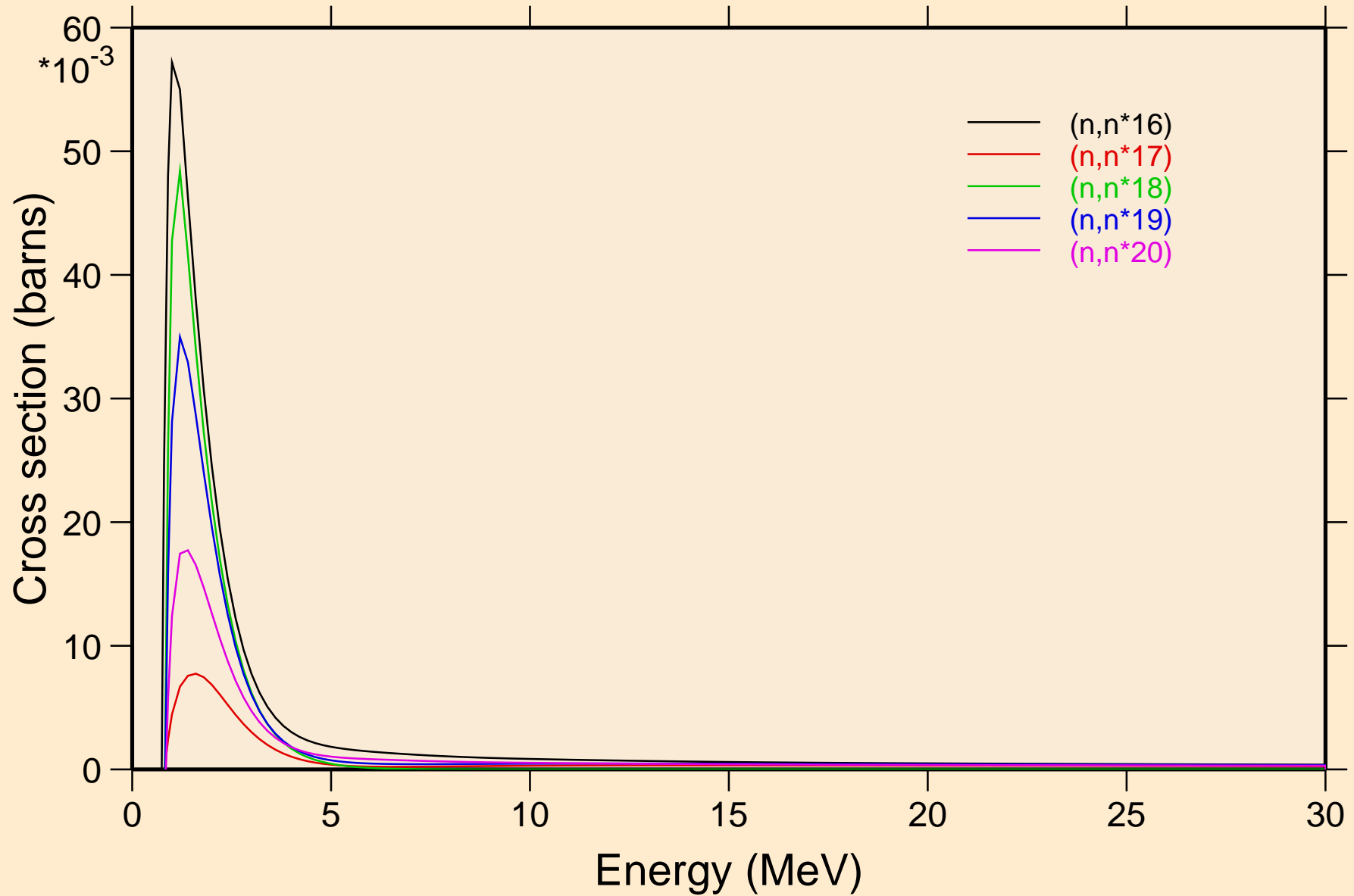

SB116 NEUTRON ACER TENDL-2021 LIBRARY; T=293.6K
Inelastic levels

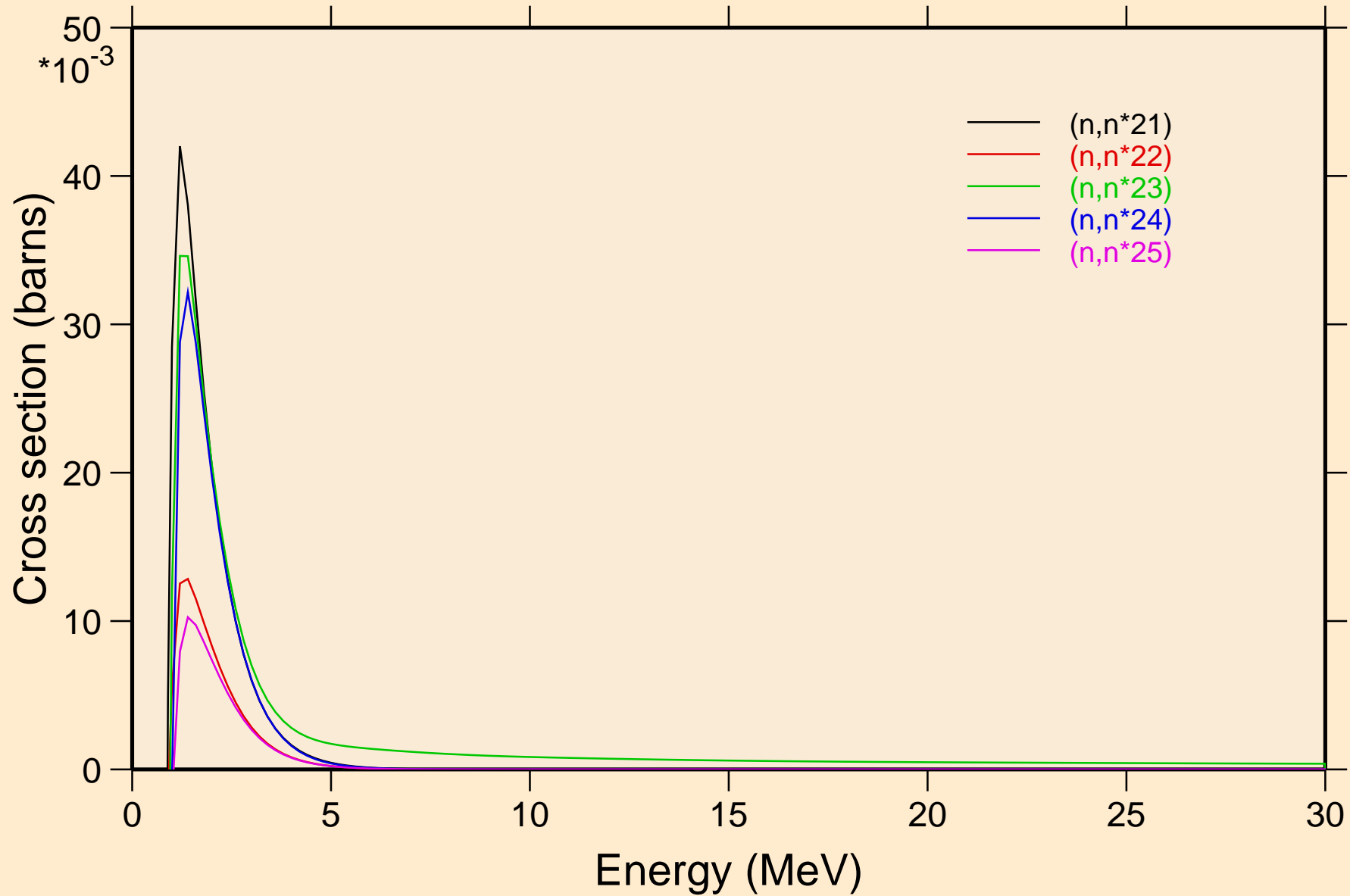

SB116 NEUTRON ACER TENDL-2021 LIBRARY; T=293.6K
Inelastic levels

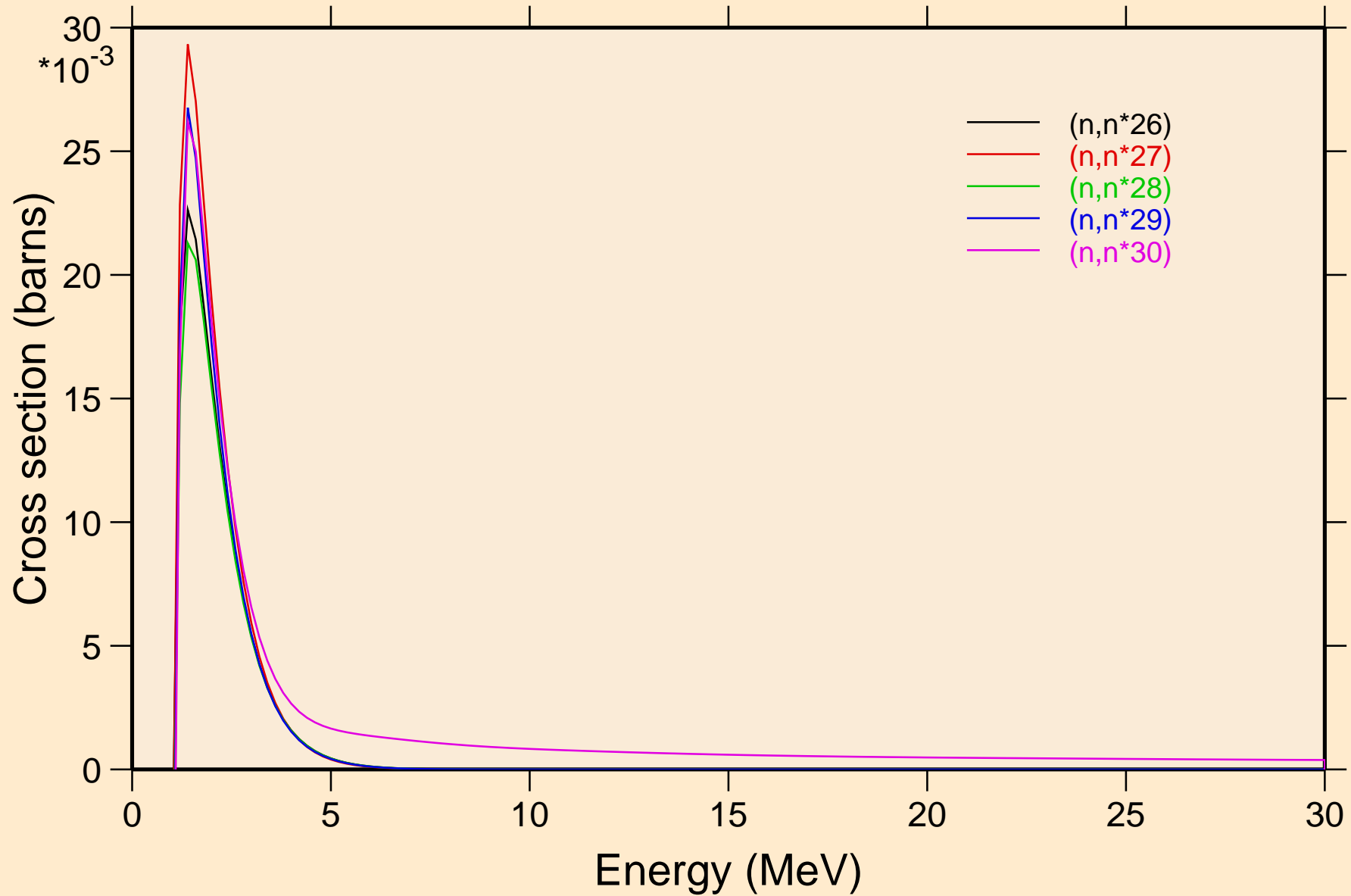

SB116 NEUTRON ACER TENDL-2021 LIBRARY; T=293.6K
Threshold reactions

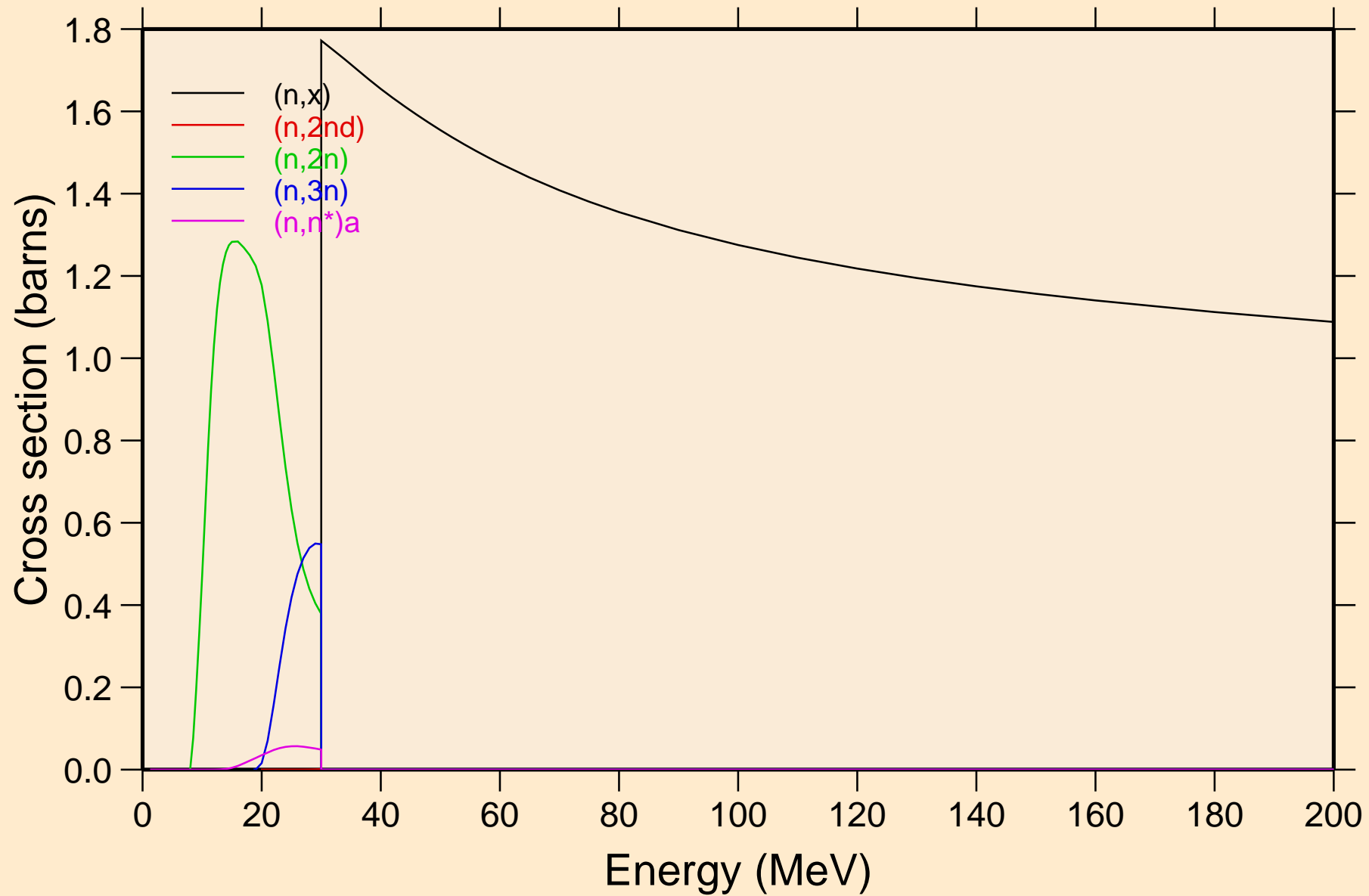

SB116 NEUTRON ACER TENDL-2021 LIBRARY; T=293.6K
Threshold reactions

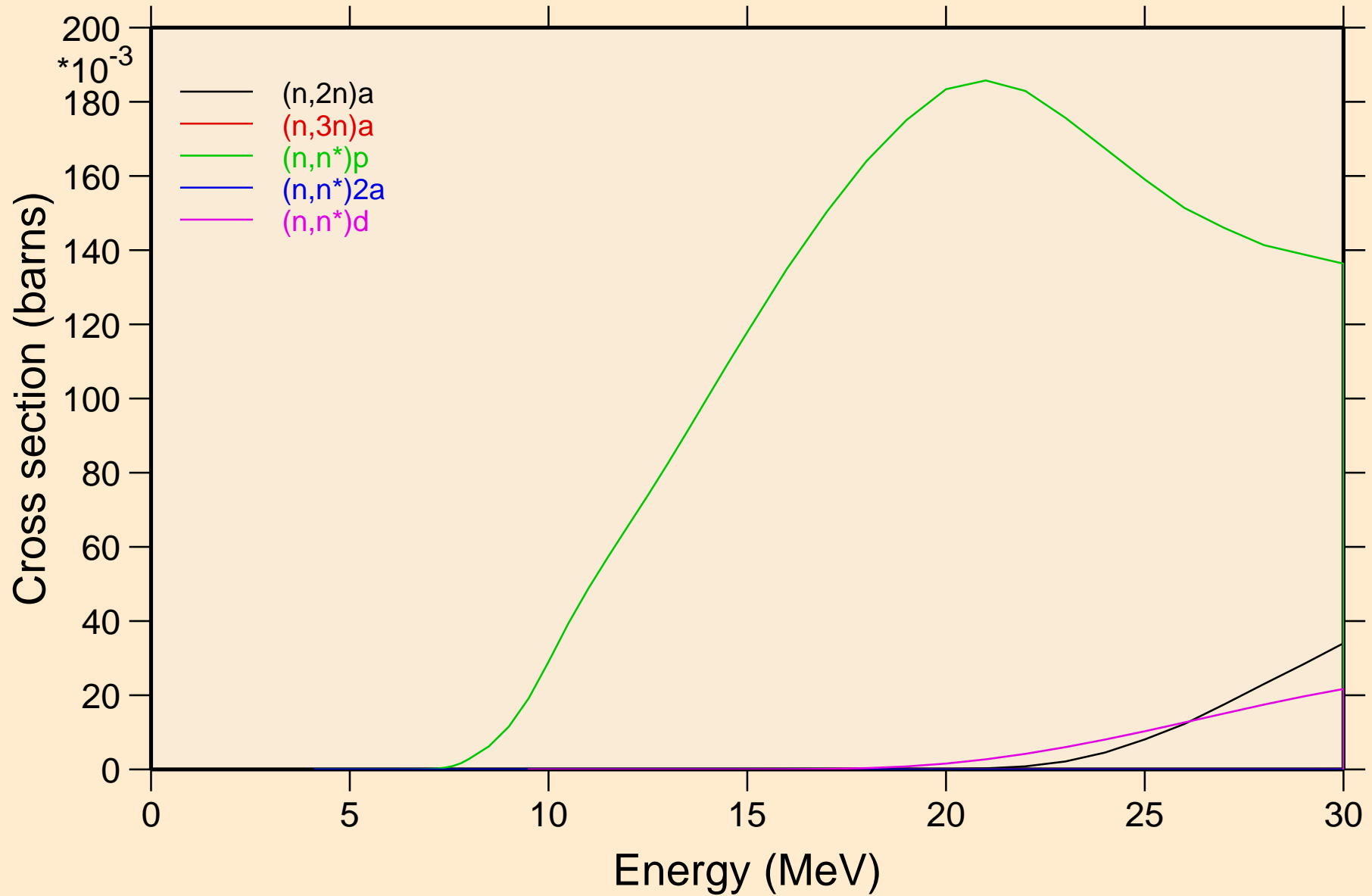

SB116 NEUTRON ACER TENDL-2021 LIBRARY; T=293.6K

Threshold reactions

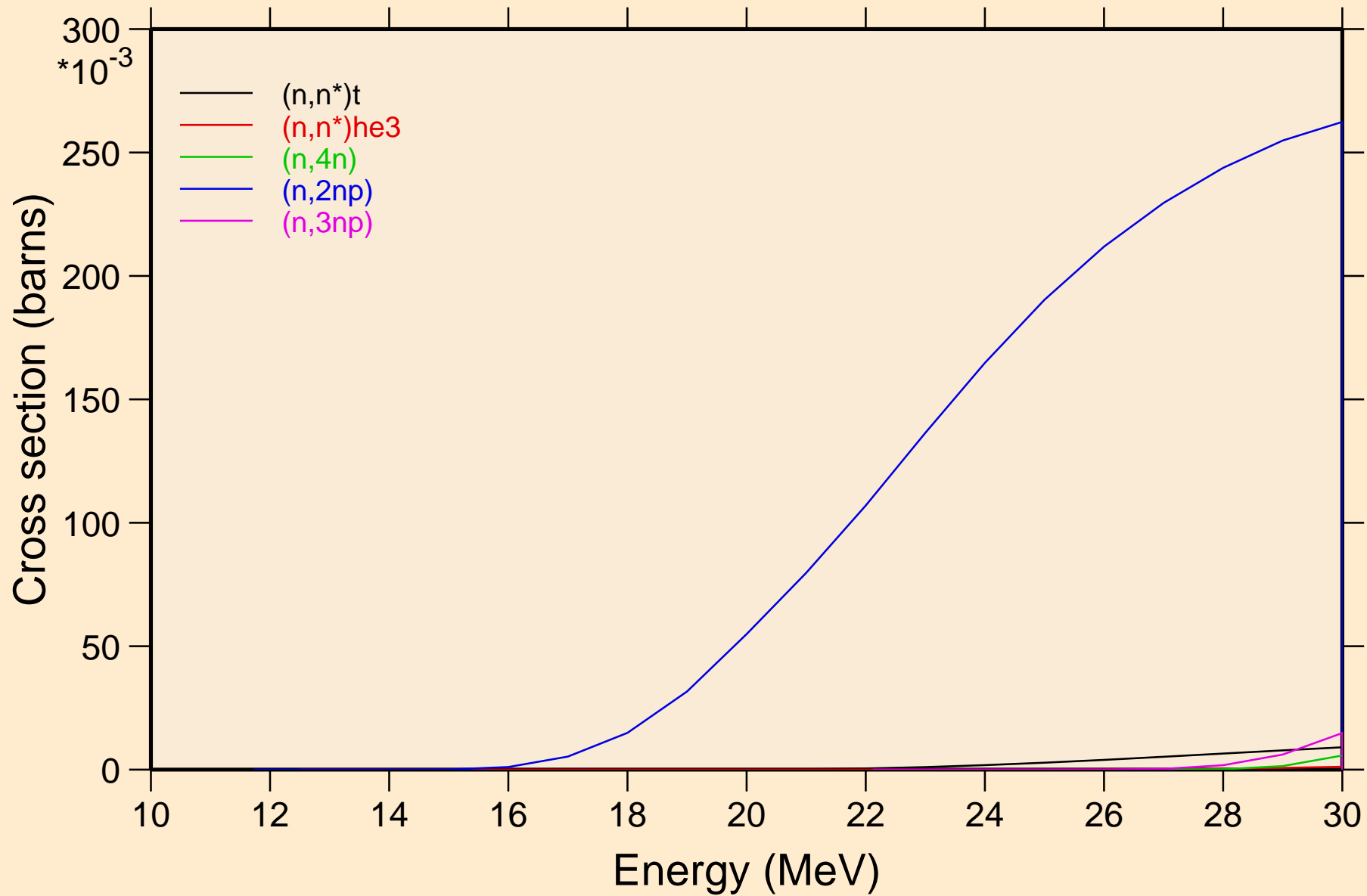

SB116 NEUTRON ACER TENDL-2021 LIBRARY; T=293.6K
Threshold reactions

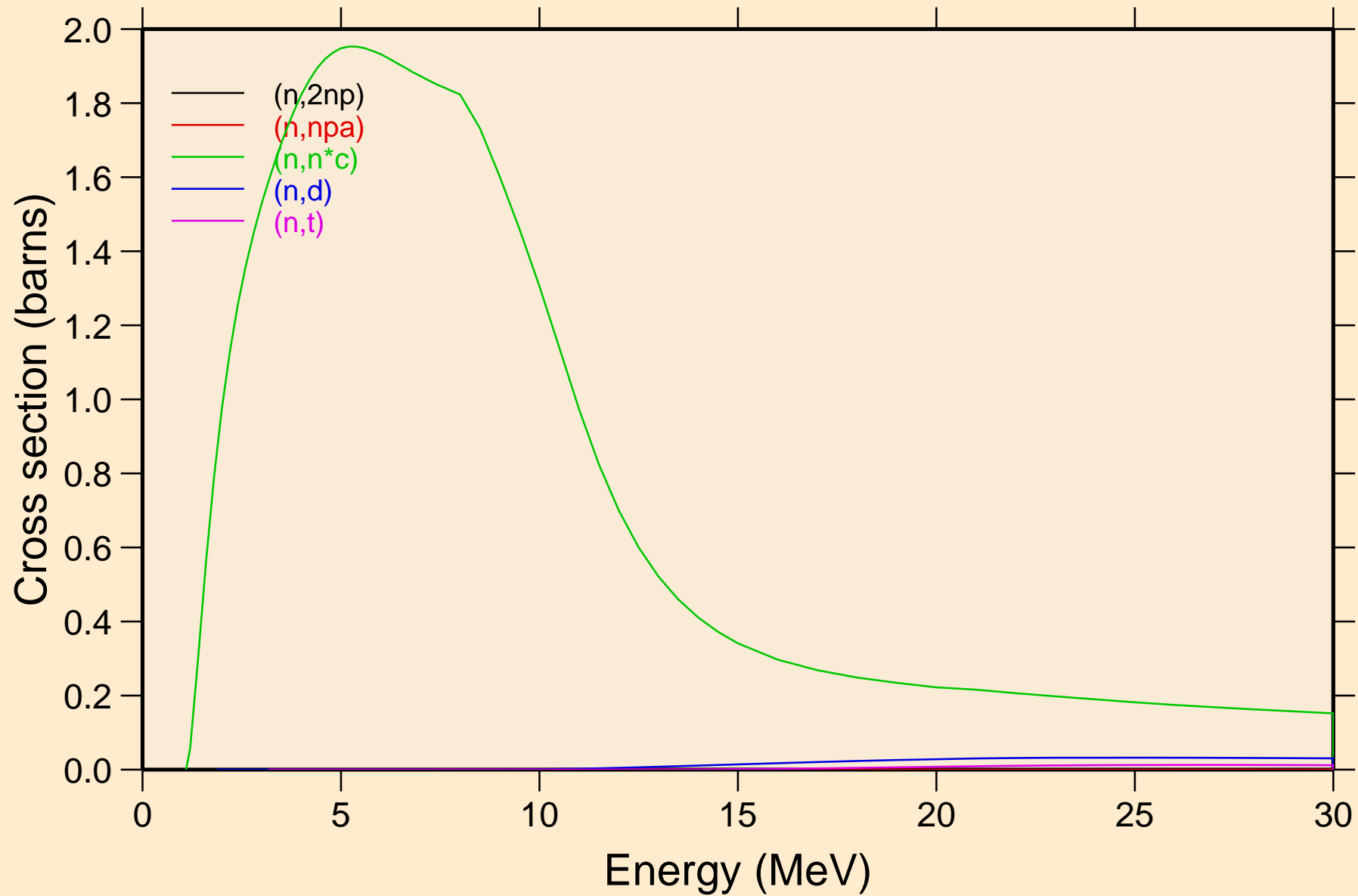

SB116 NEUTRON ACER TENDL-2021 LIBRARY; T=293.6K

Threshold reactions

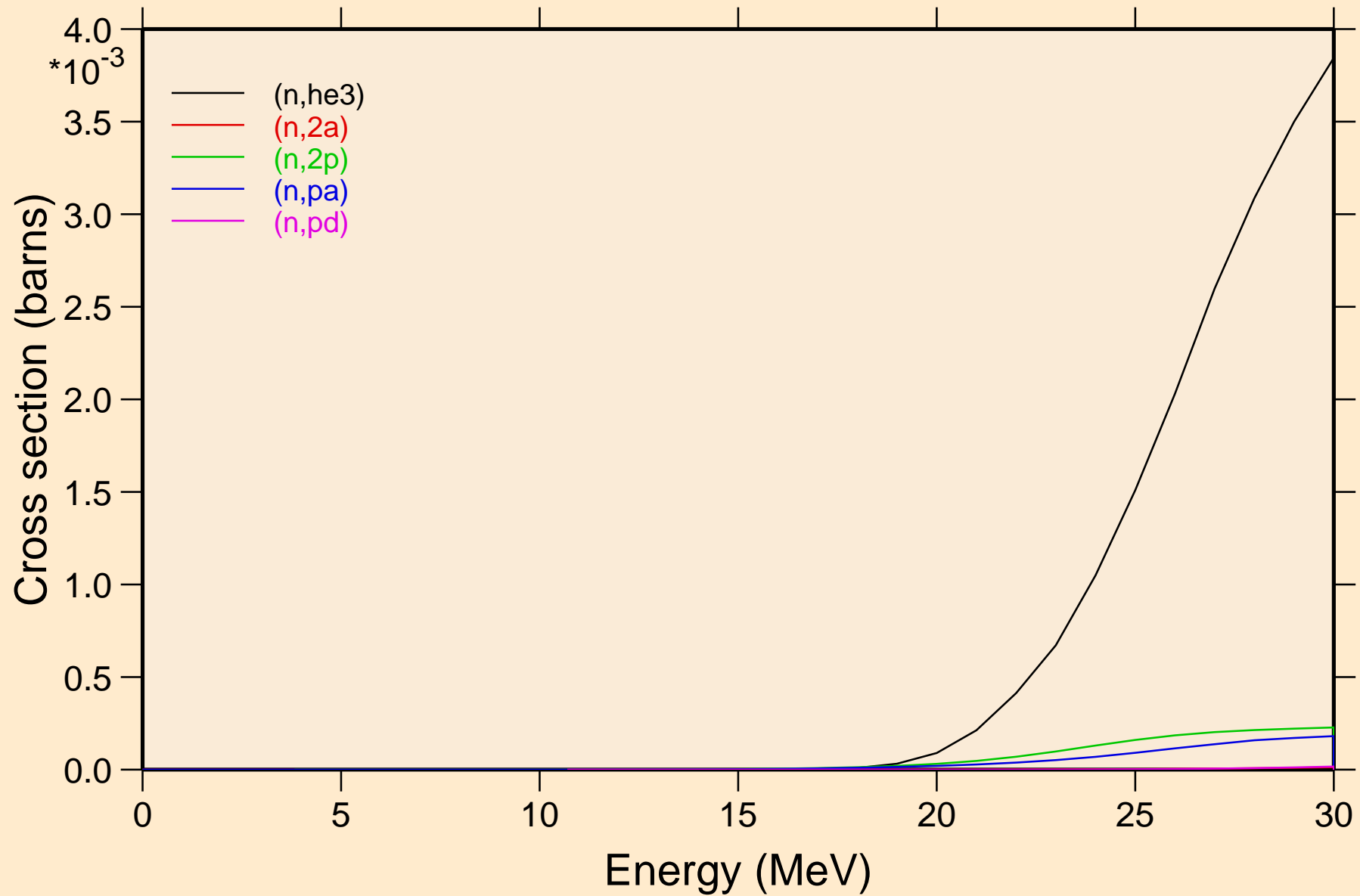

SB116 NEUTRON ACER TENDL-2021 LIBRARY; T=293.6K
Threshold reactions

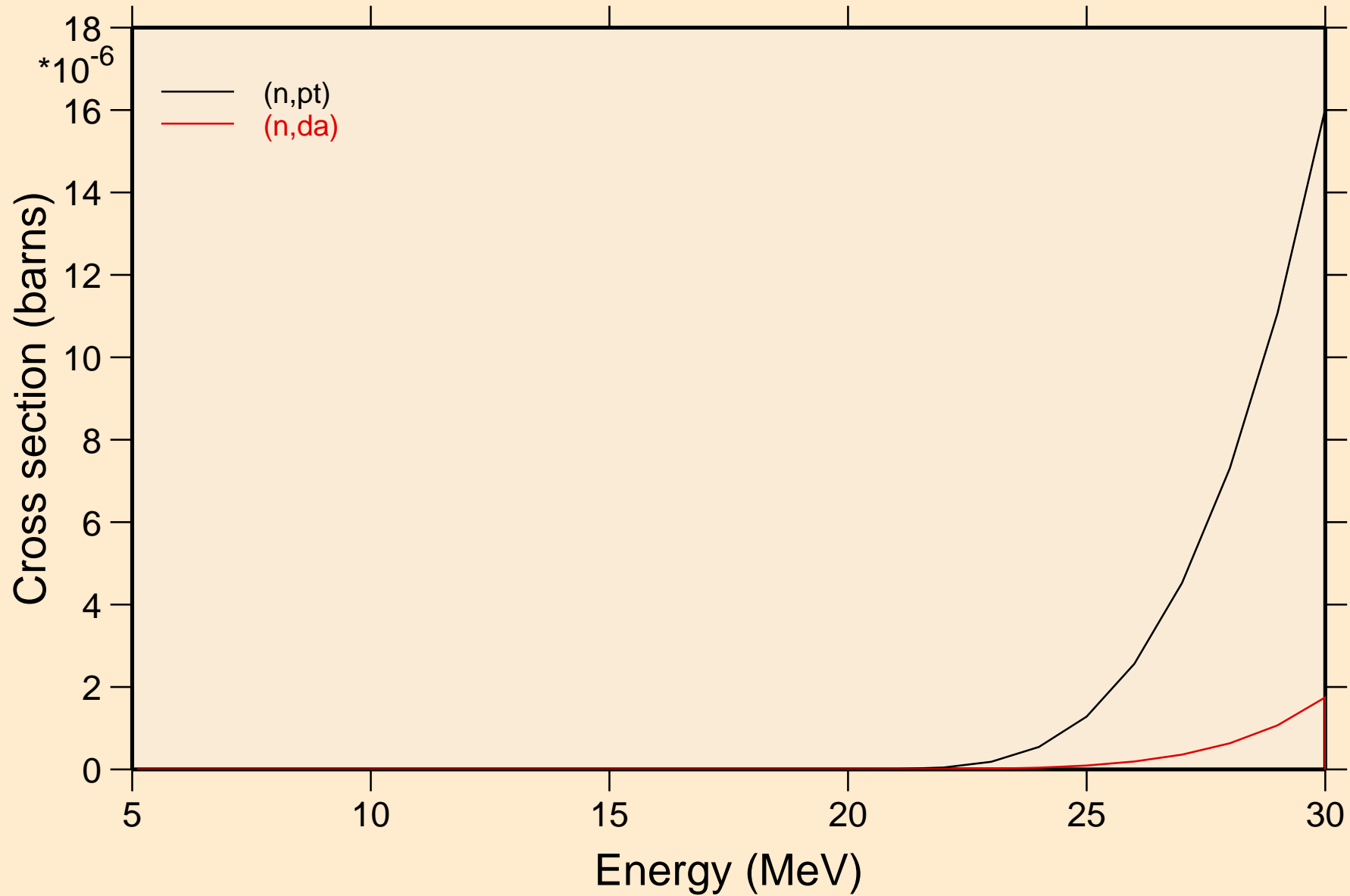

SB116 NEUTRON ACER TENDL-2021 LIBRARY; T=293.6K

Threshold reactions

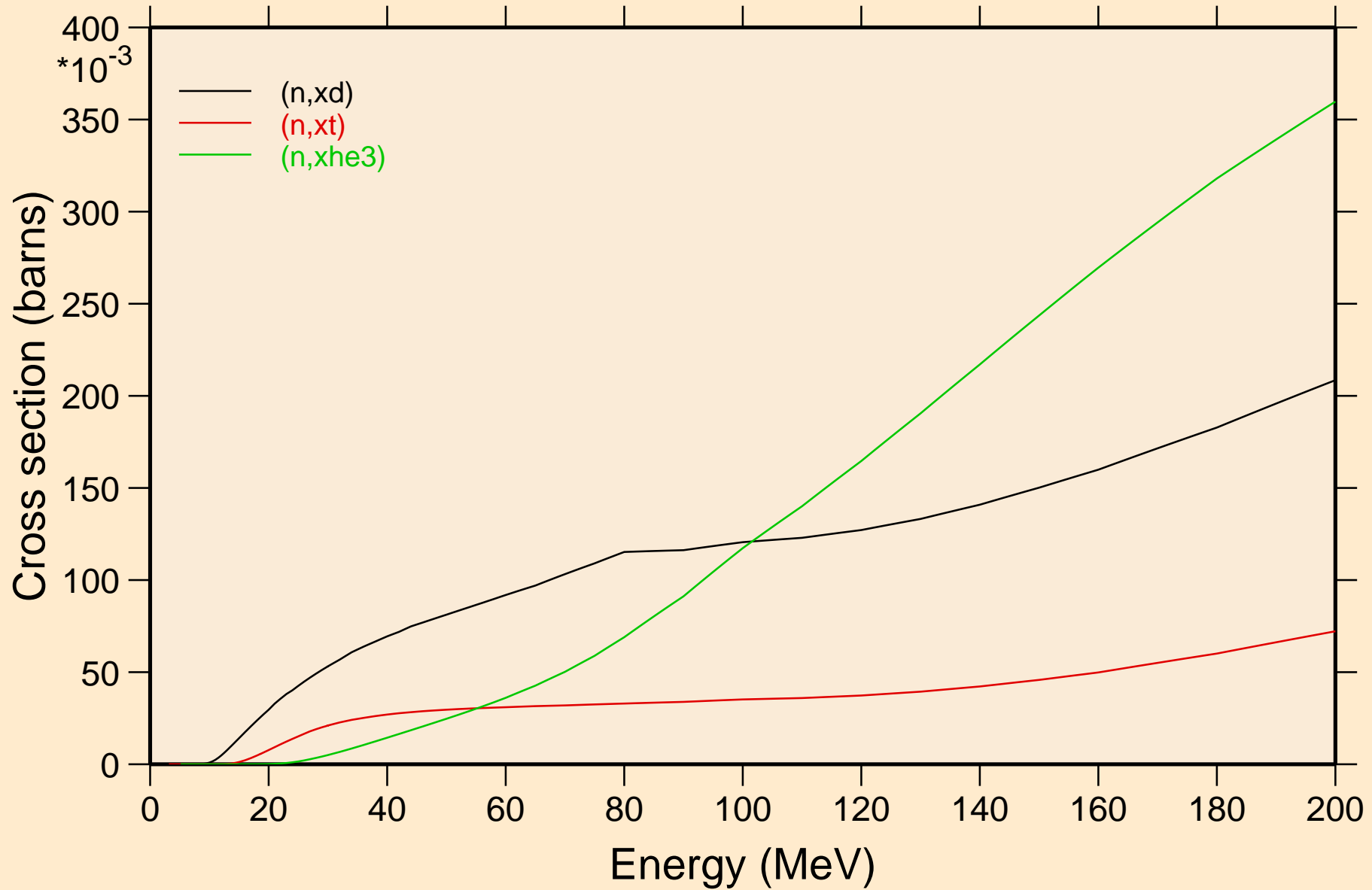

SB116 NEUTRON ACER TENDL-2021 LIBRARY; T=293.6K
angular distribution for elastic

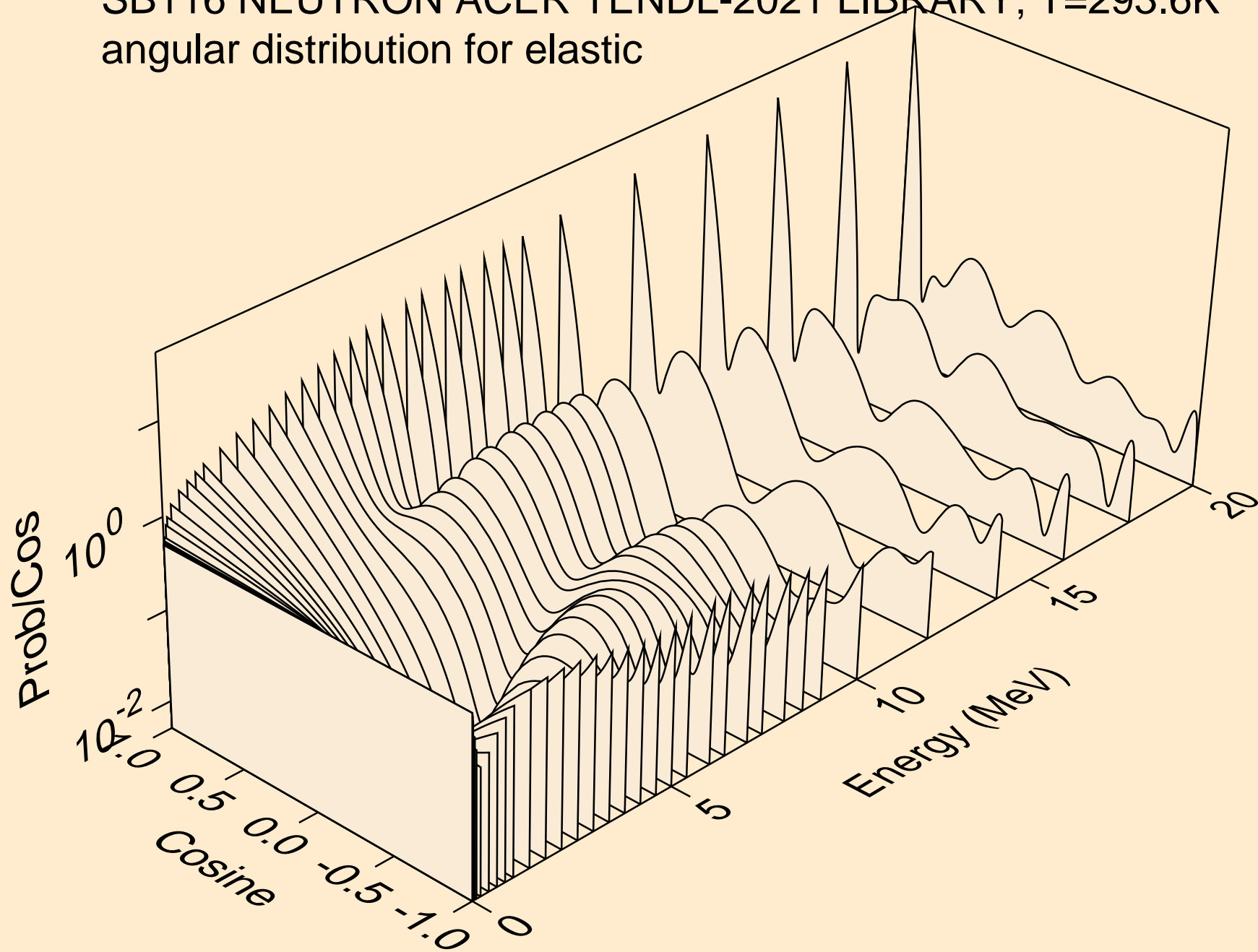

SB116 NEUTRON ACER TENDL-2021 LIBRARY; T=293.6K
angular distribution for elastic

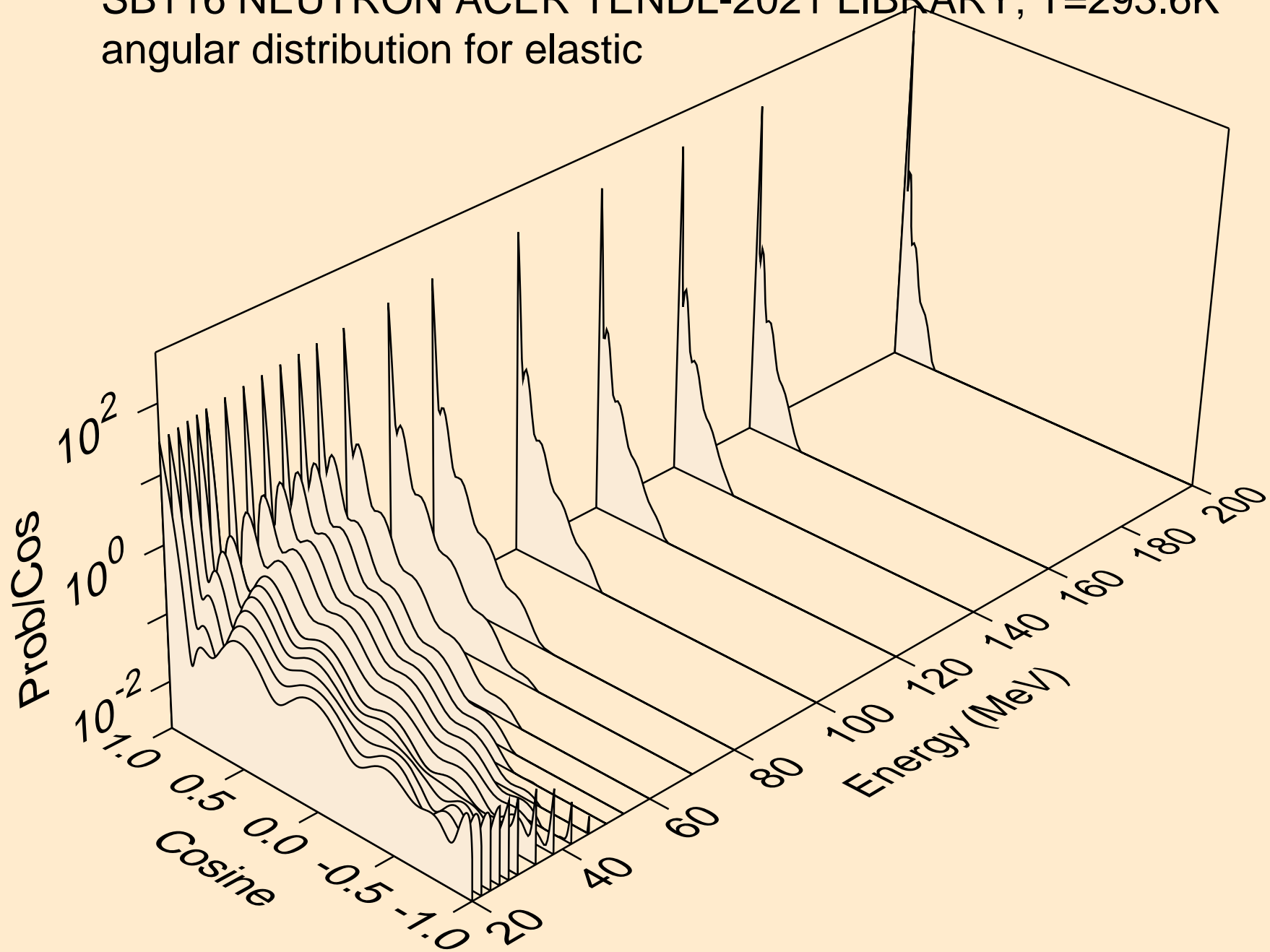

SB116 NEUTRON ACER TENDL-2021 LIBRARY; T=293.6K
angular distribution for (n,n*1)

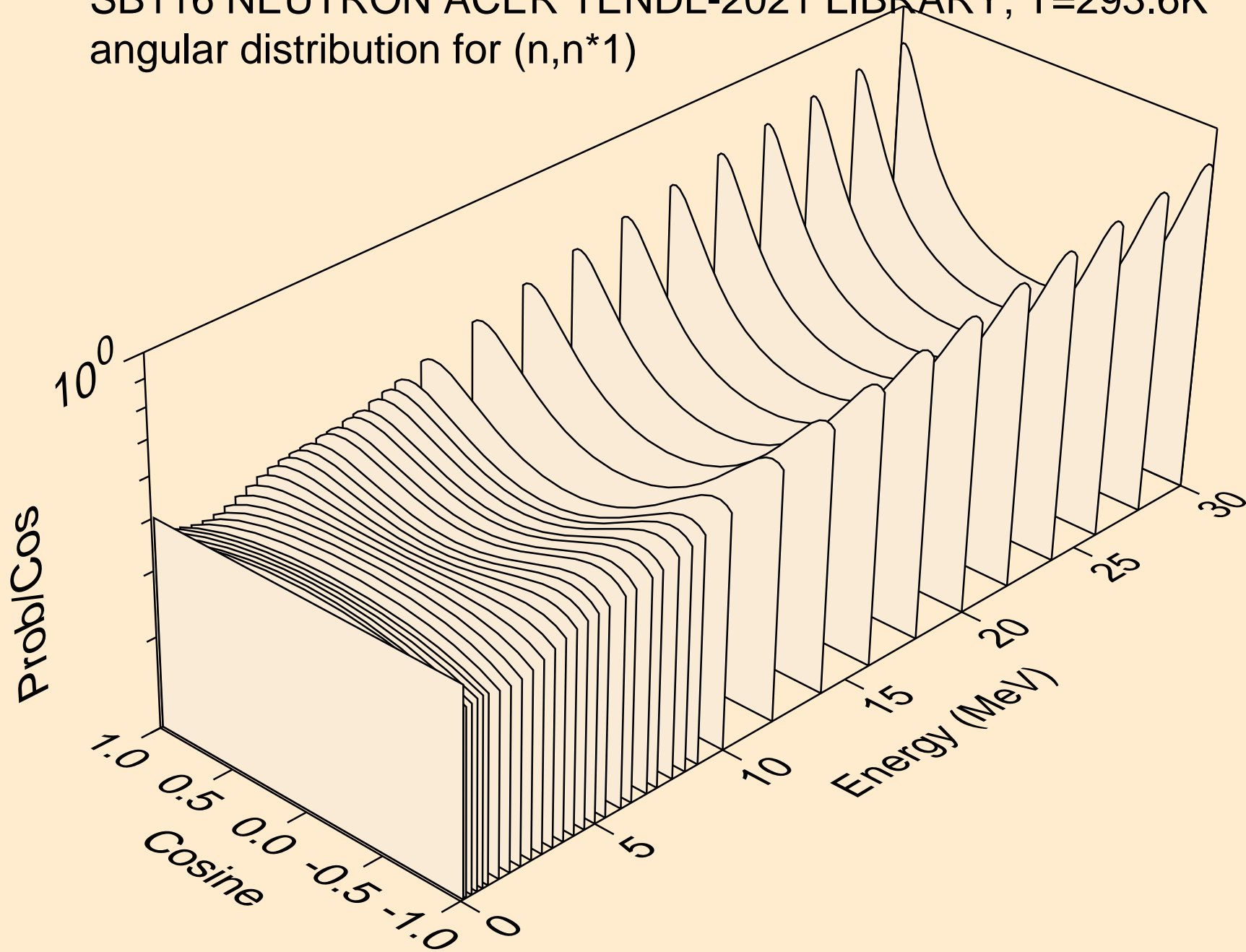

SB116 NEUTRON ACER TENDL-2021 LIBRARY; T=293.6K
angular distribution for (n,n*2)

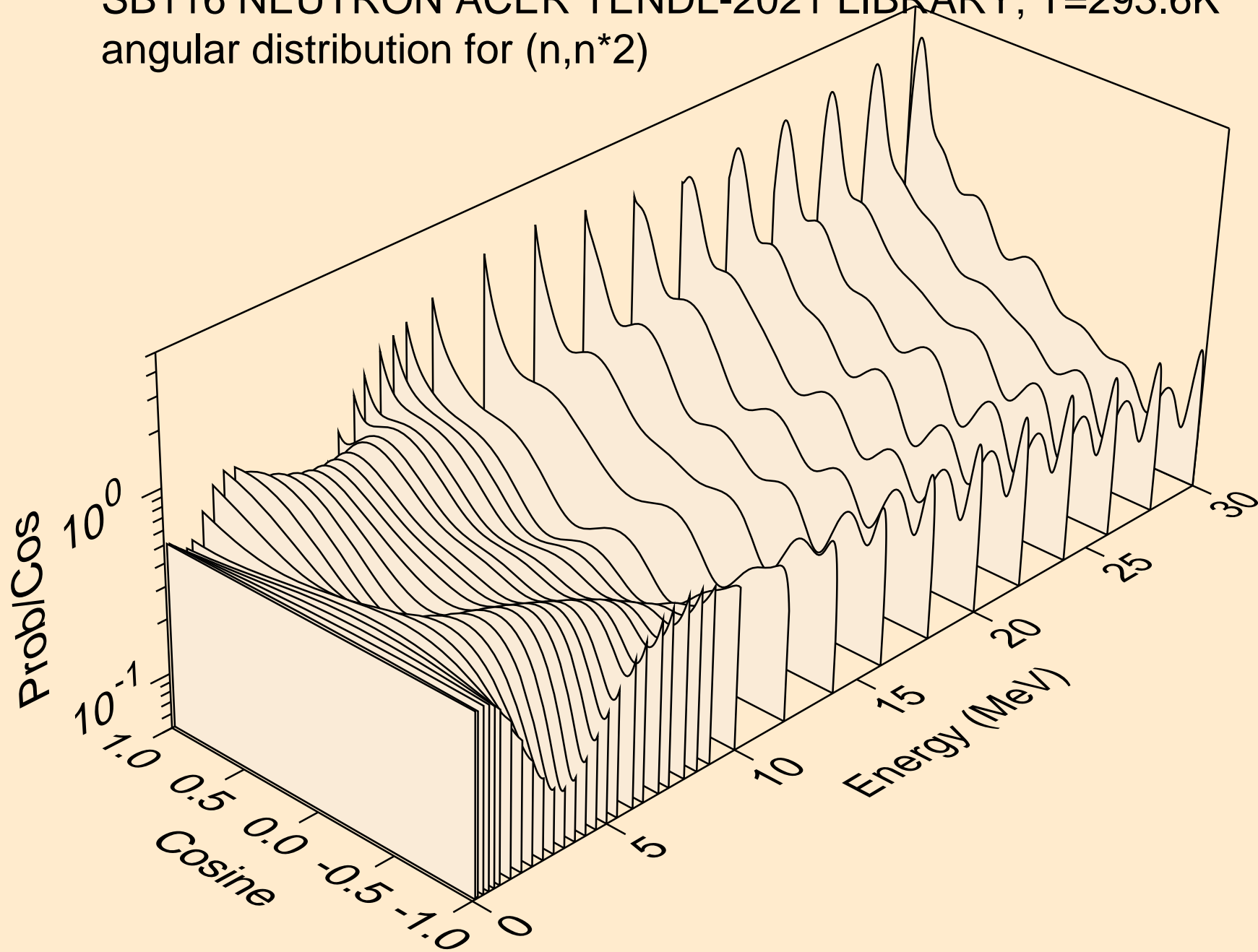

SB116 NEUTRON ACER TENDL-2021 LIBRARY; T=293.6K
angular distribution for (n,n*3)

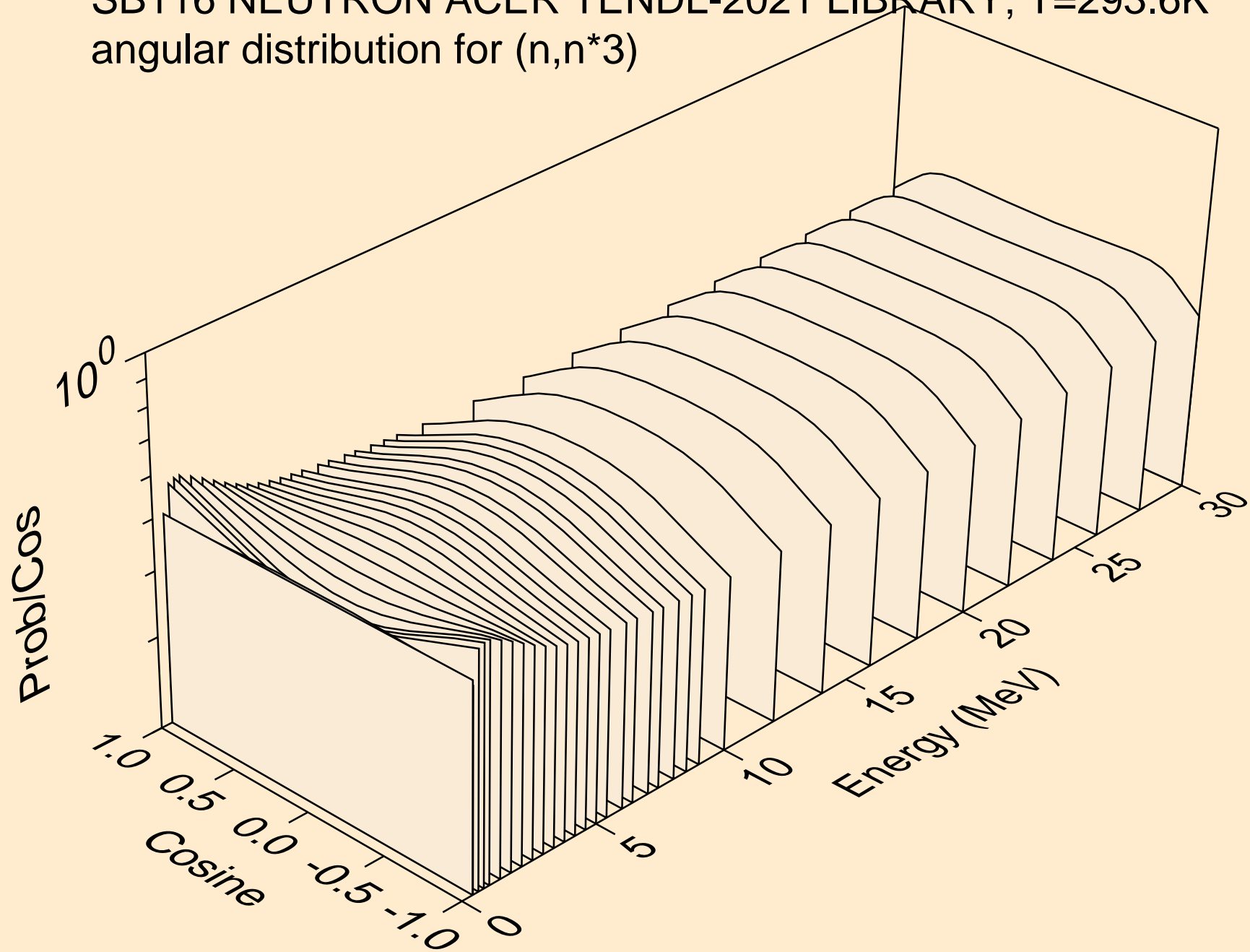

SB116 NEUTRON ACER TENDL-2021 LIBRARY; T=293.6K
angular distribution for (n,n*4)

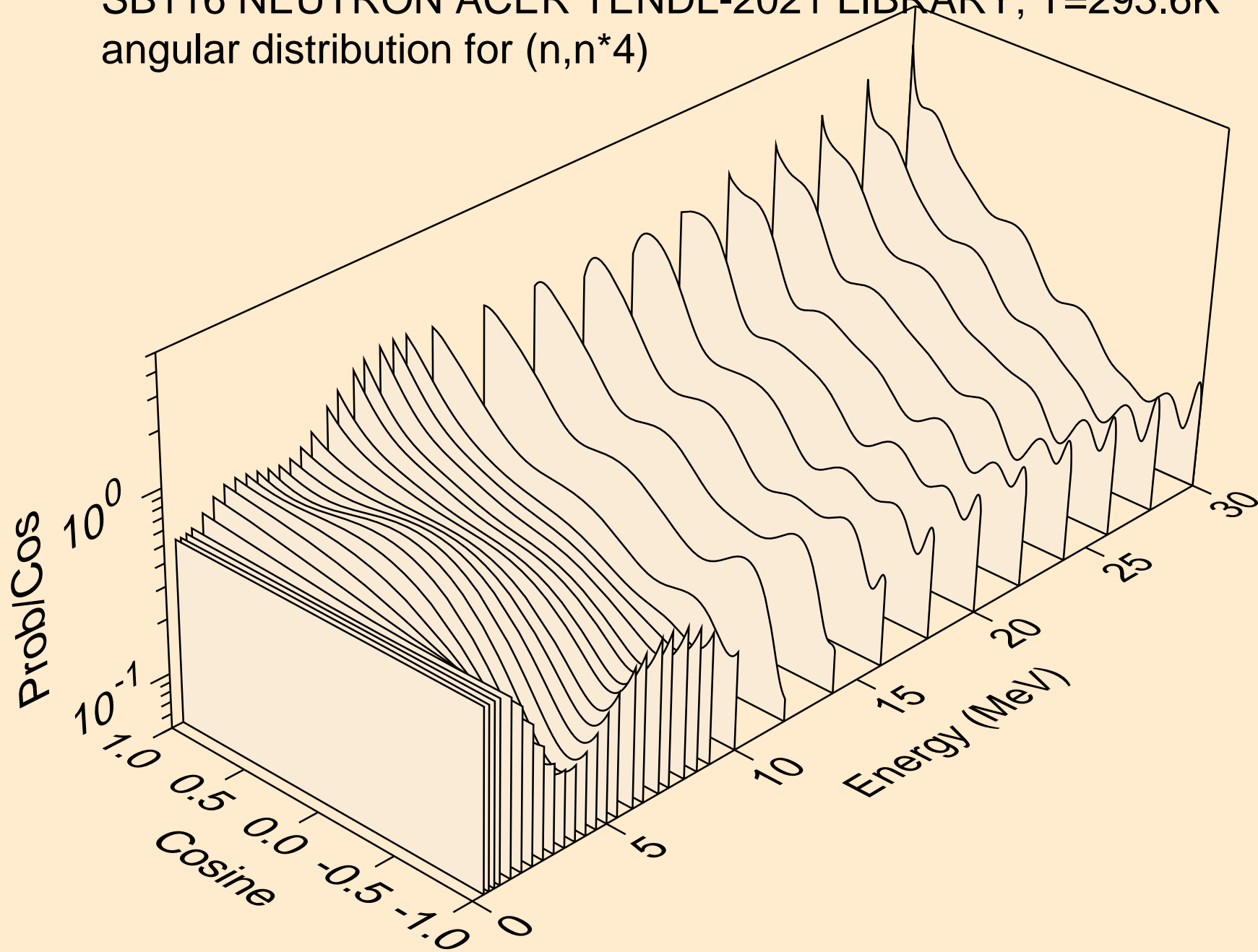

SB116 NEUTRON ACER TENDL-2021 LIBRARY; T=293.6K
angular distribution for (n,n*5)

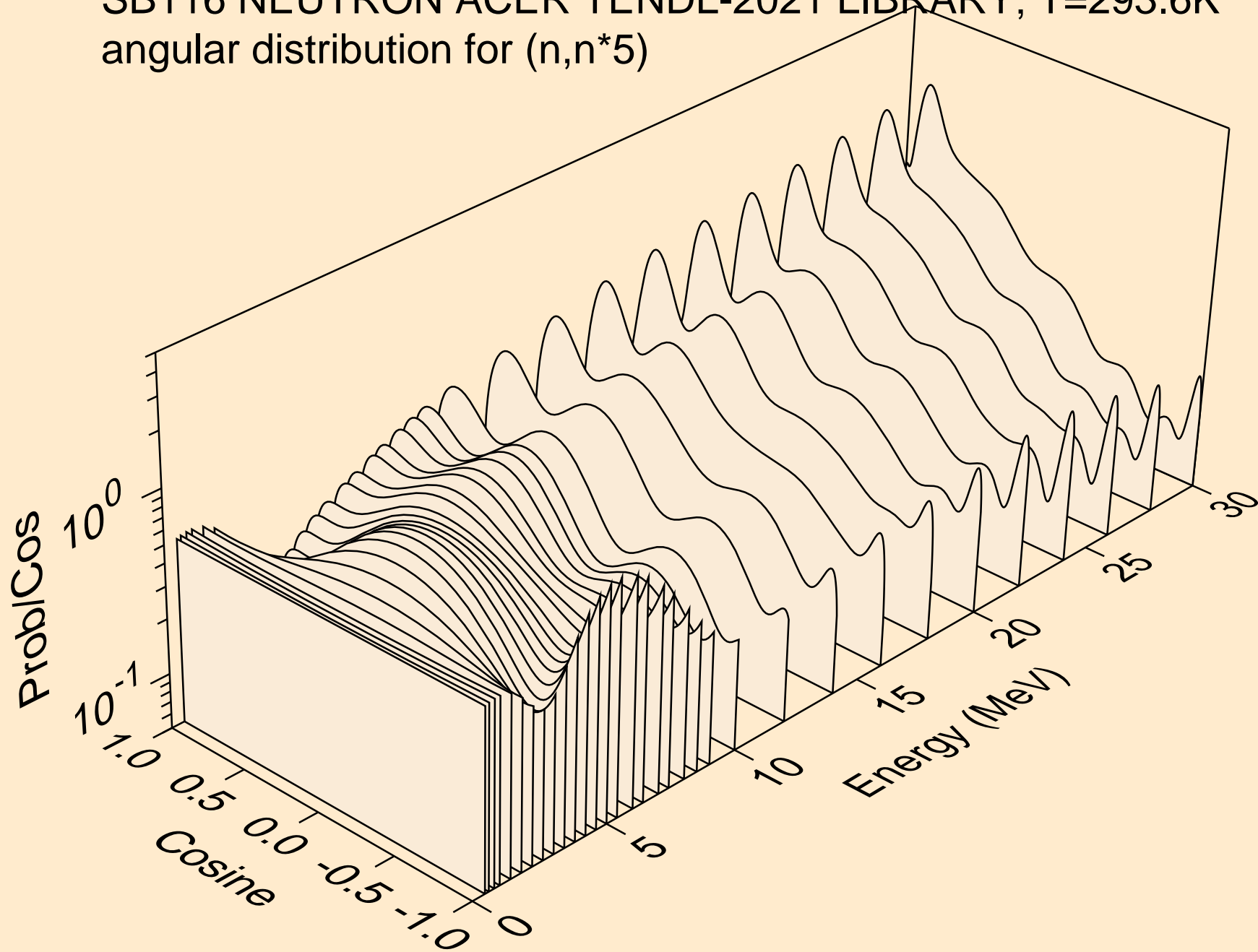

SB116 NEUTRON ACER TENDL-2021 LIBRARY; T=293.6K
angular distribution for (n,n*6)

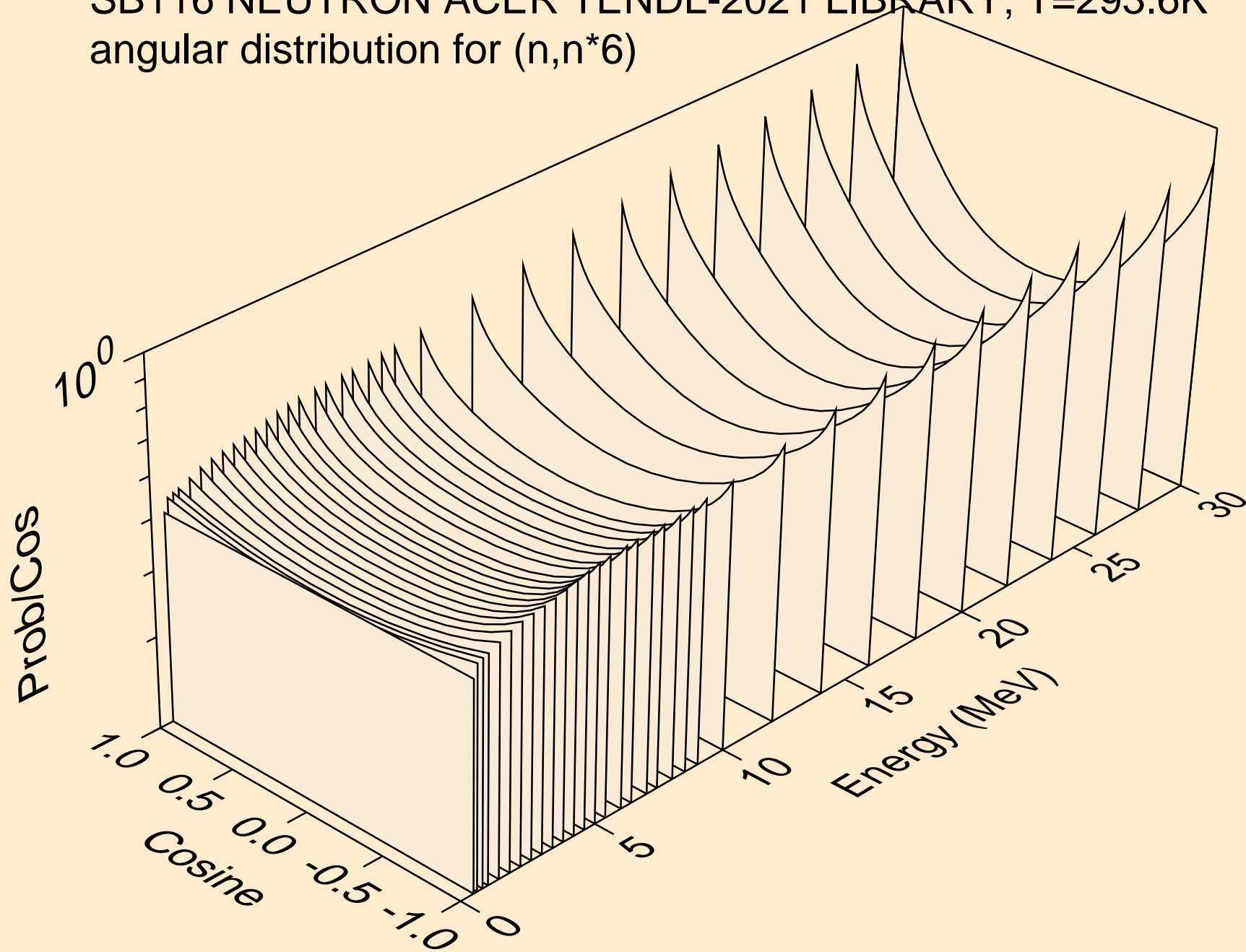

SB116 NEUTRON ACER TENDL-2021 LIBRARY; T=293.6K
angular distribution for (n,n*7)

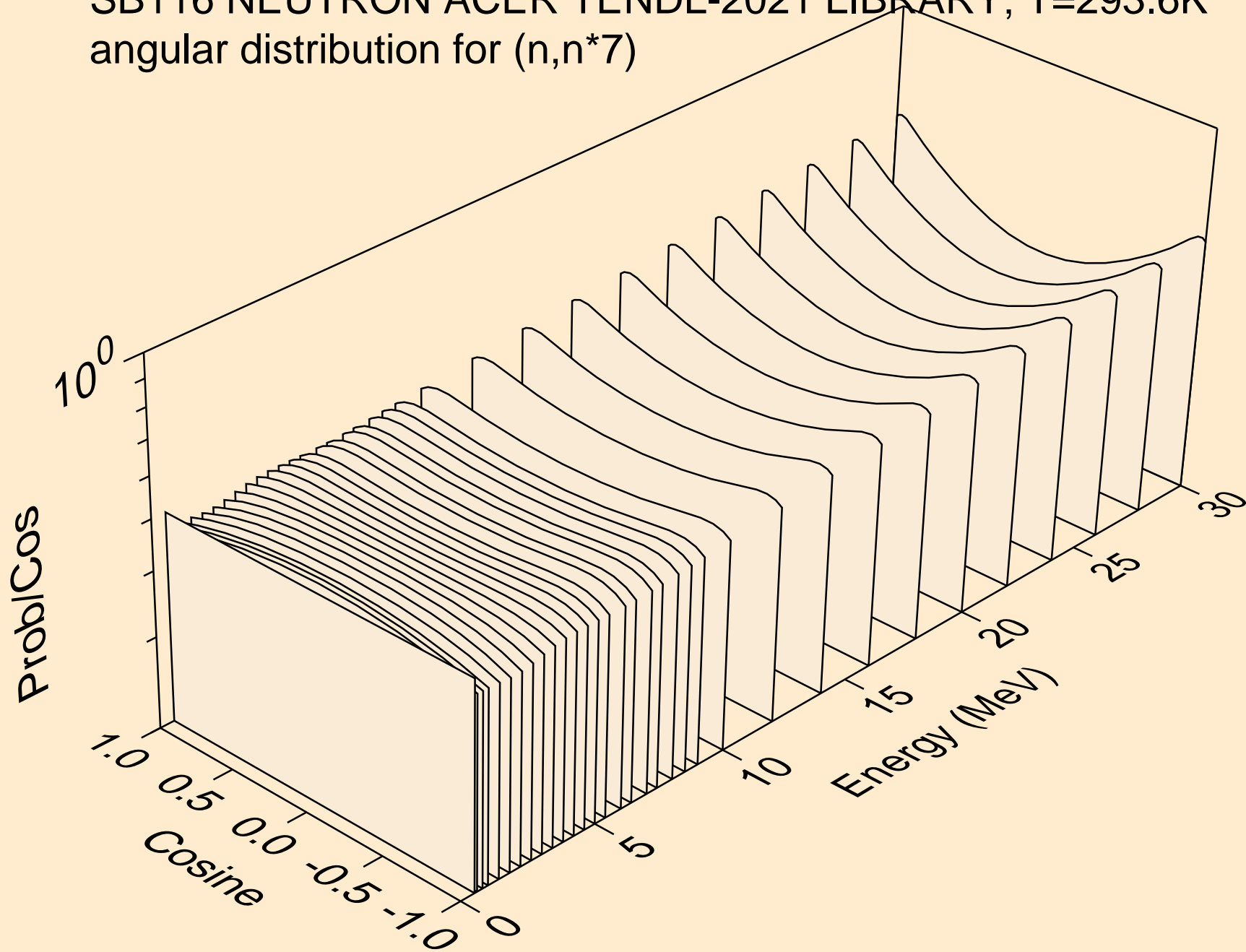

SB116 NEUTRON ACER TENDL-2021 LIBRARY; T=293.6K
angular distribution for (n,n*8)

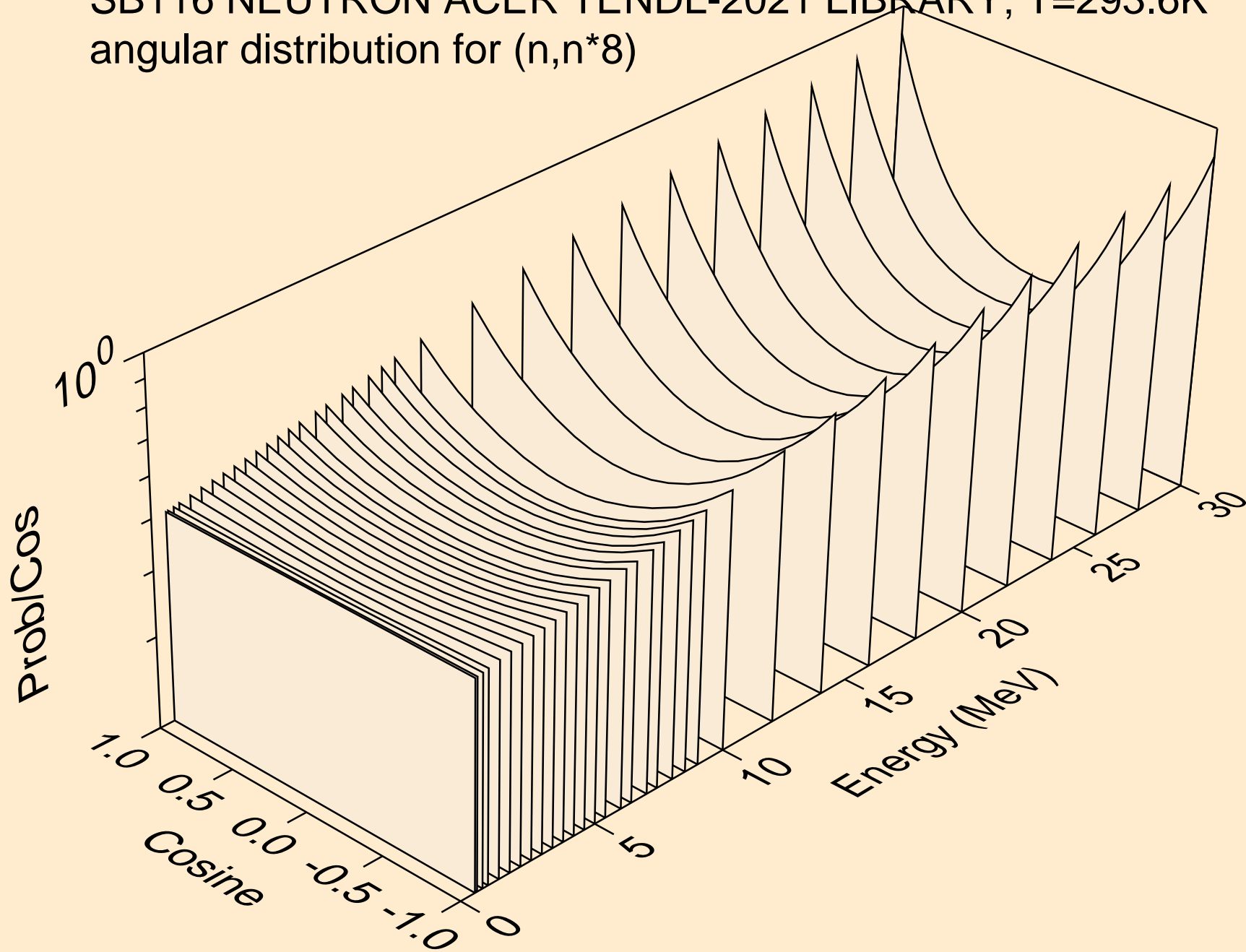

SB116 NEUTRON ACER TENDL-2021 LIBRARY; T=293.6K
angular distribution for (n,n*9)

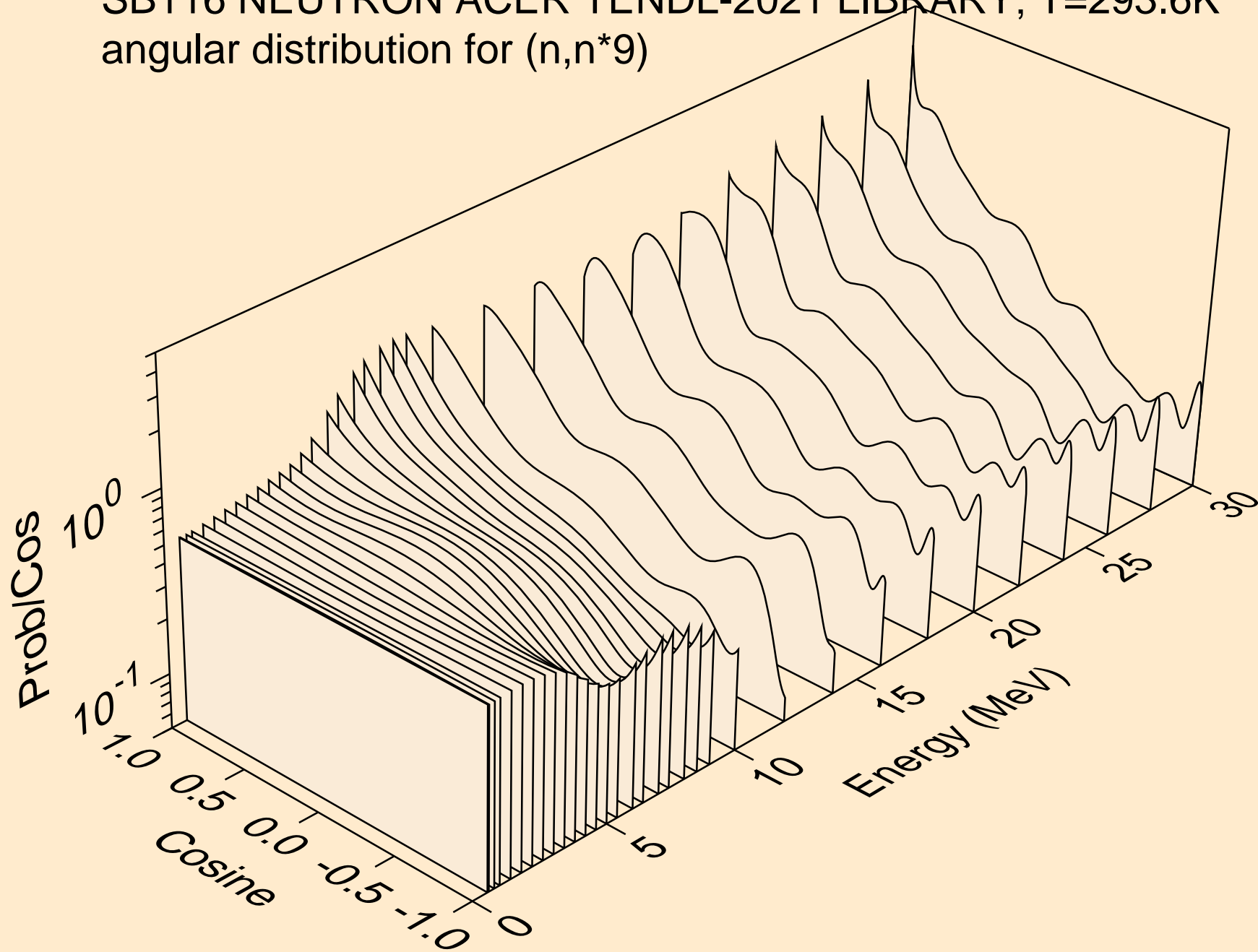

SB116 NEUTRON ACER TENDL-2021 LIBRARY; T=293.6K
angular distribution for (n,n*10)

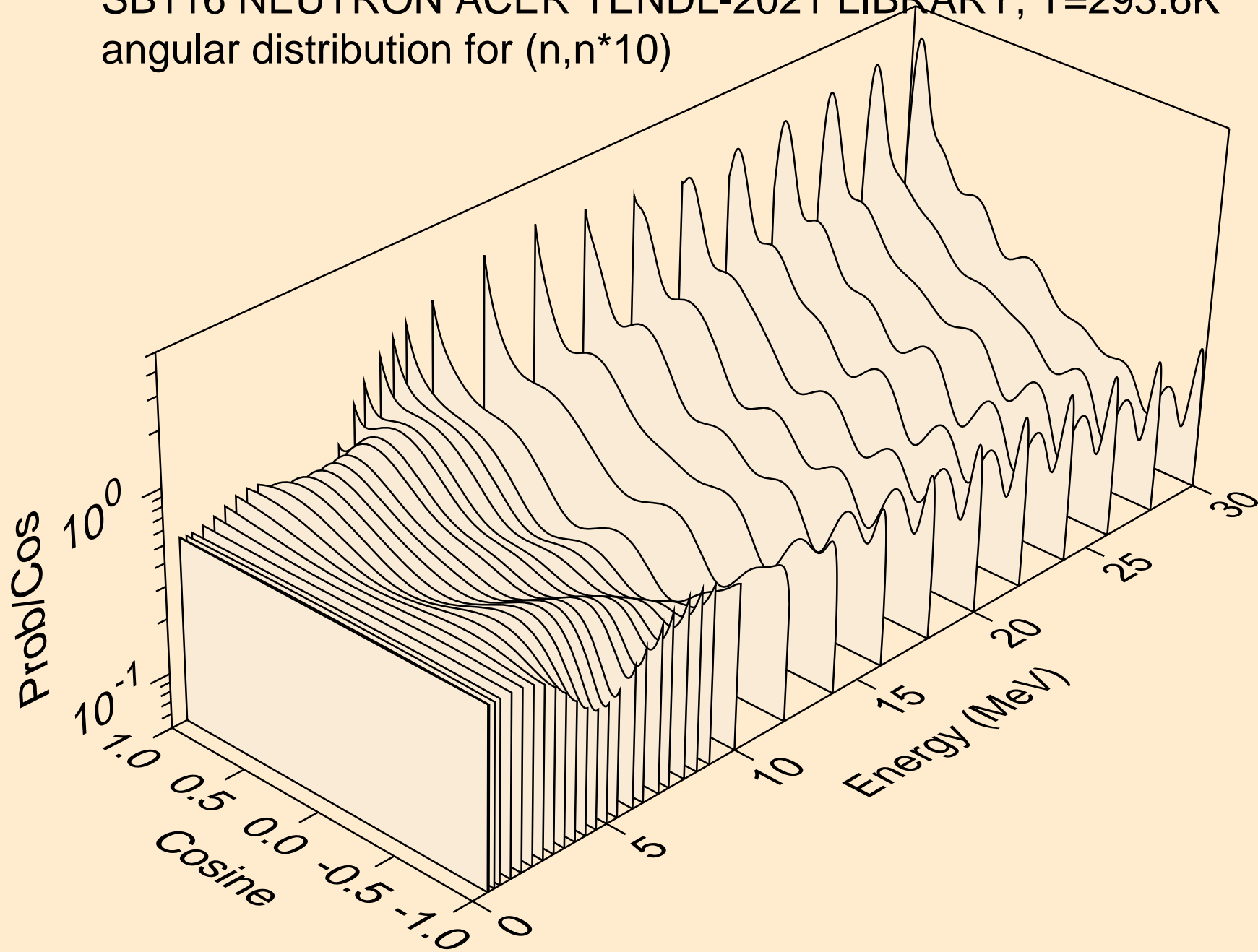

SB116 NEUTRON ACER TENDL-2021 LIBRARY; T=293.6K
angular distribution for (n,n*11)

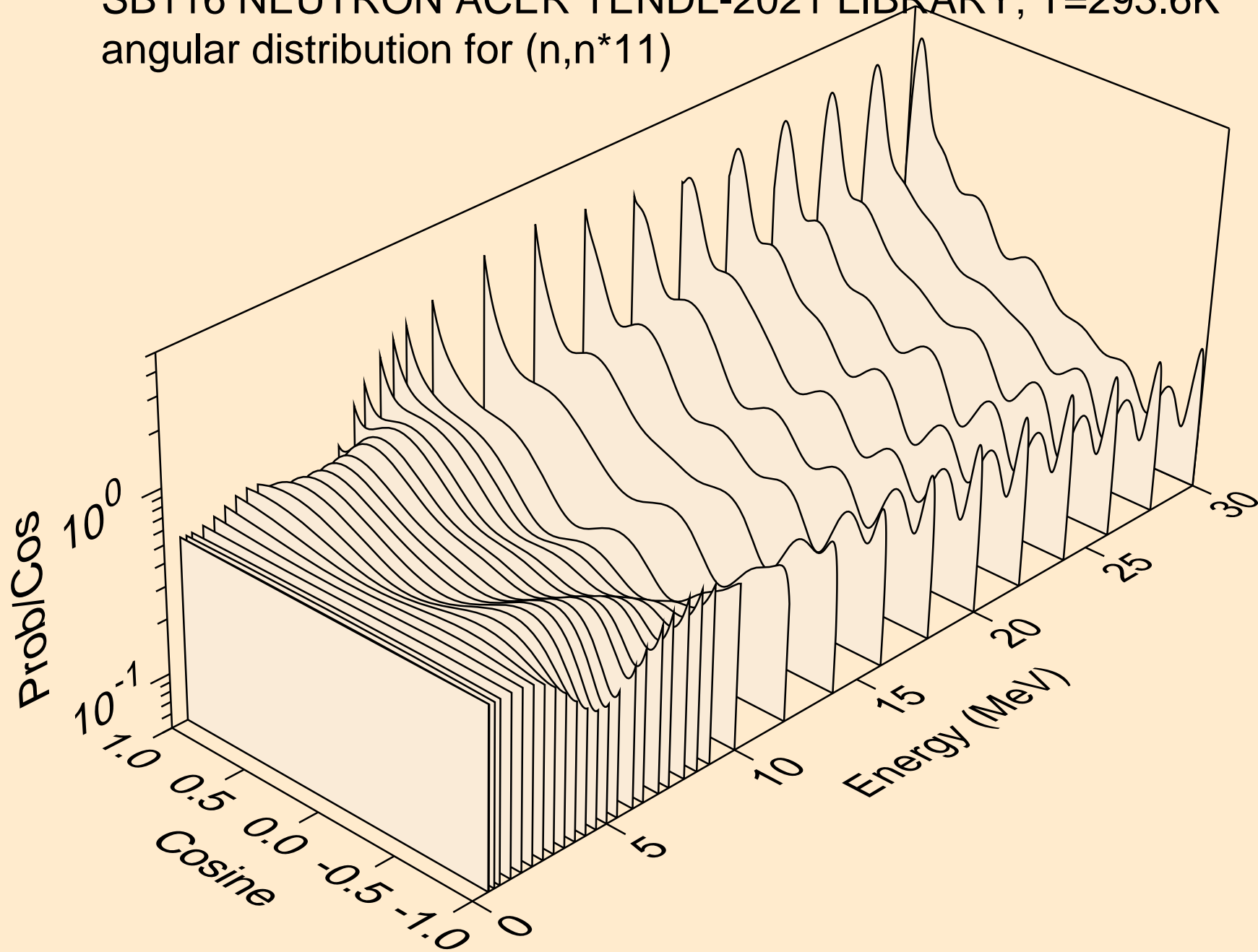

SB116 NEUTRON ACER TENDL-2021 LIBRARY; T=293.6K
angular distribution for (n,n*12)

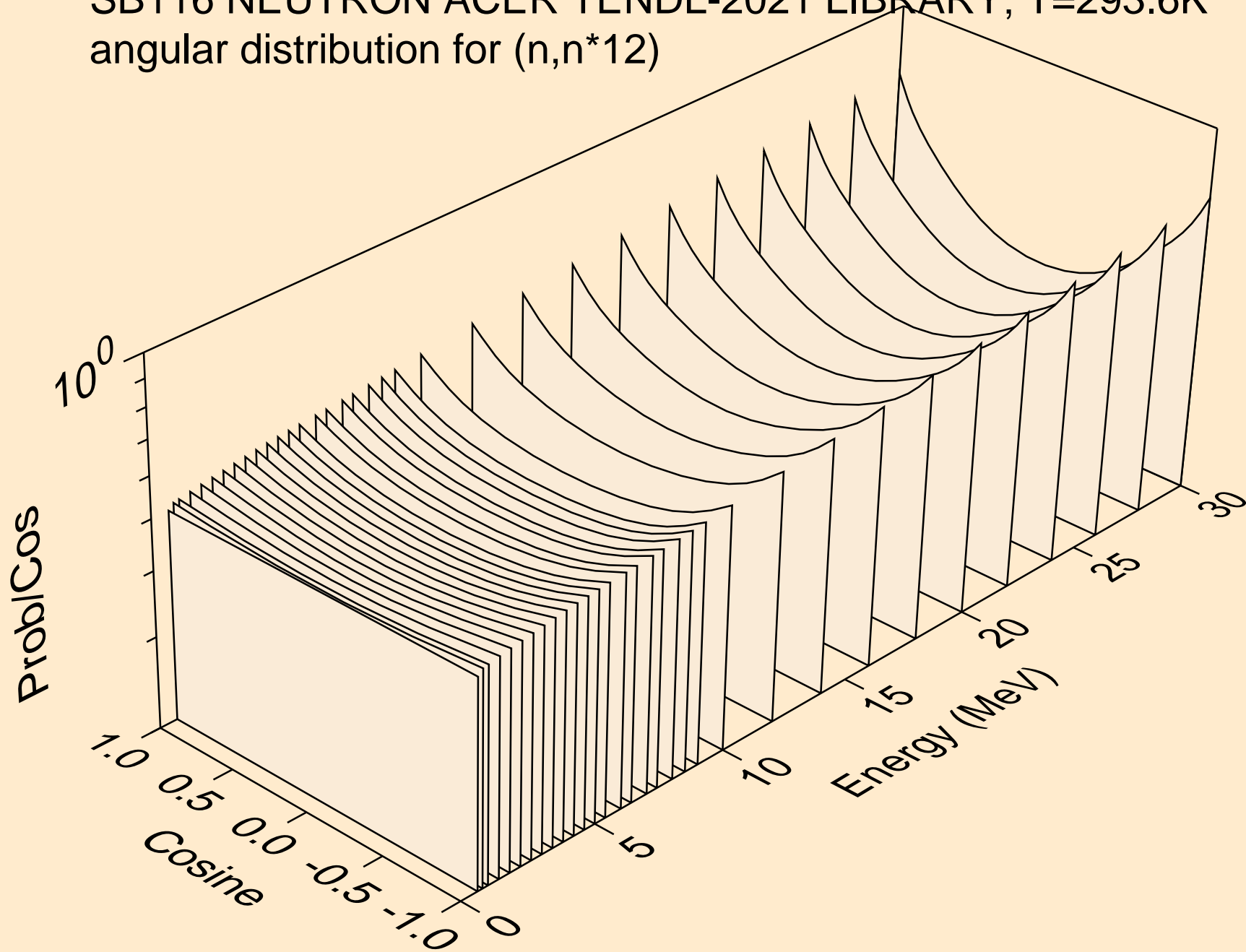

SB116 NEUTRON ACER TENDL-2021 LIBRARY; T=293.6K
angular distribution for (n,n*13)

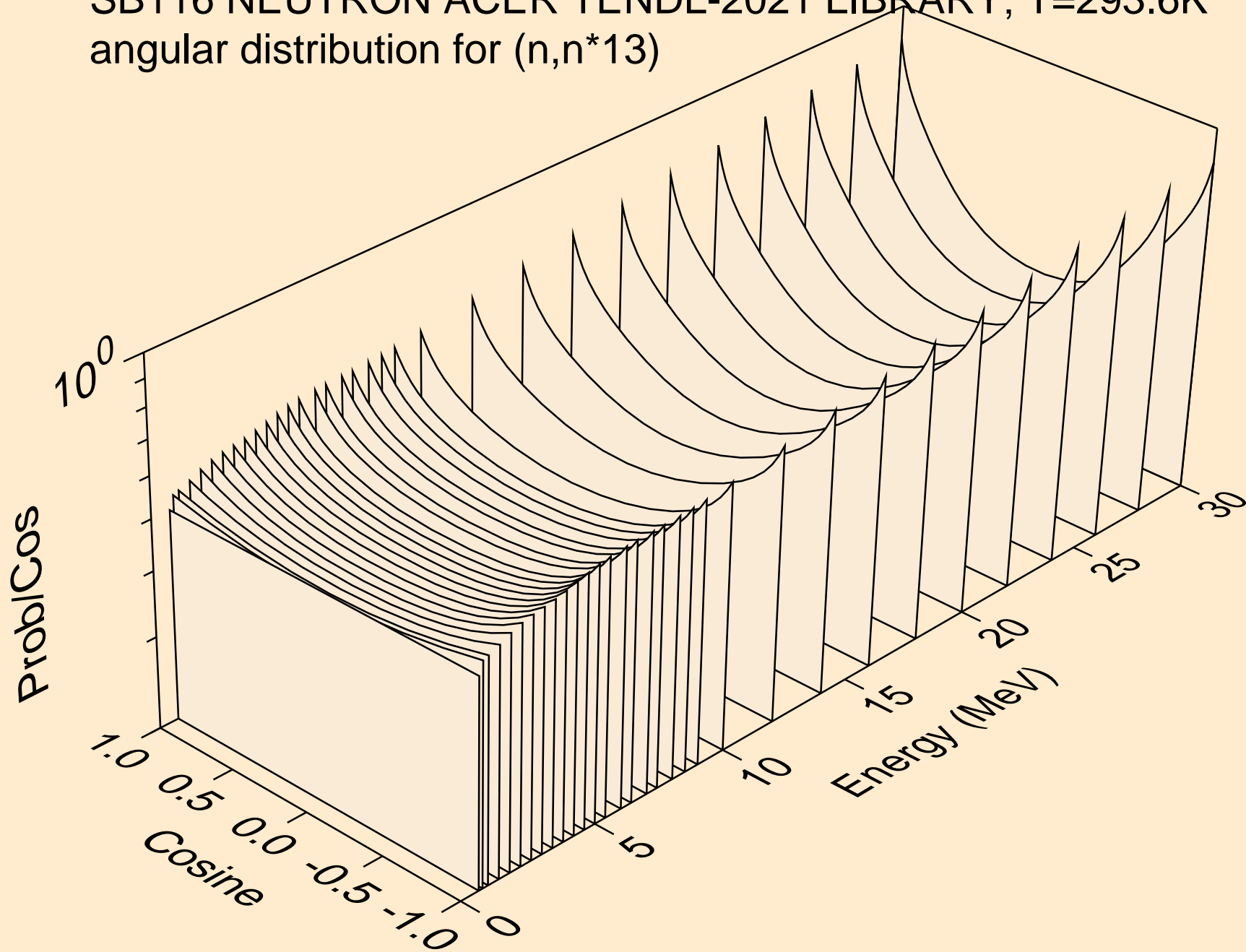

SB116 NEUTRON ACER TENDL-2021 LIBRARY; T=293.6K
angular distribution for (n,n*14)

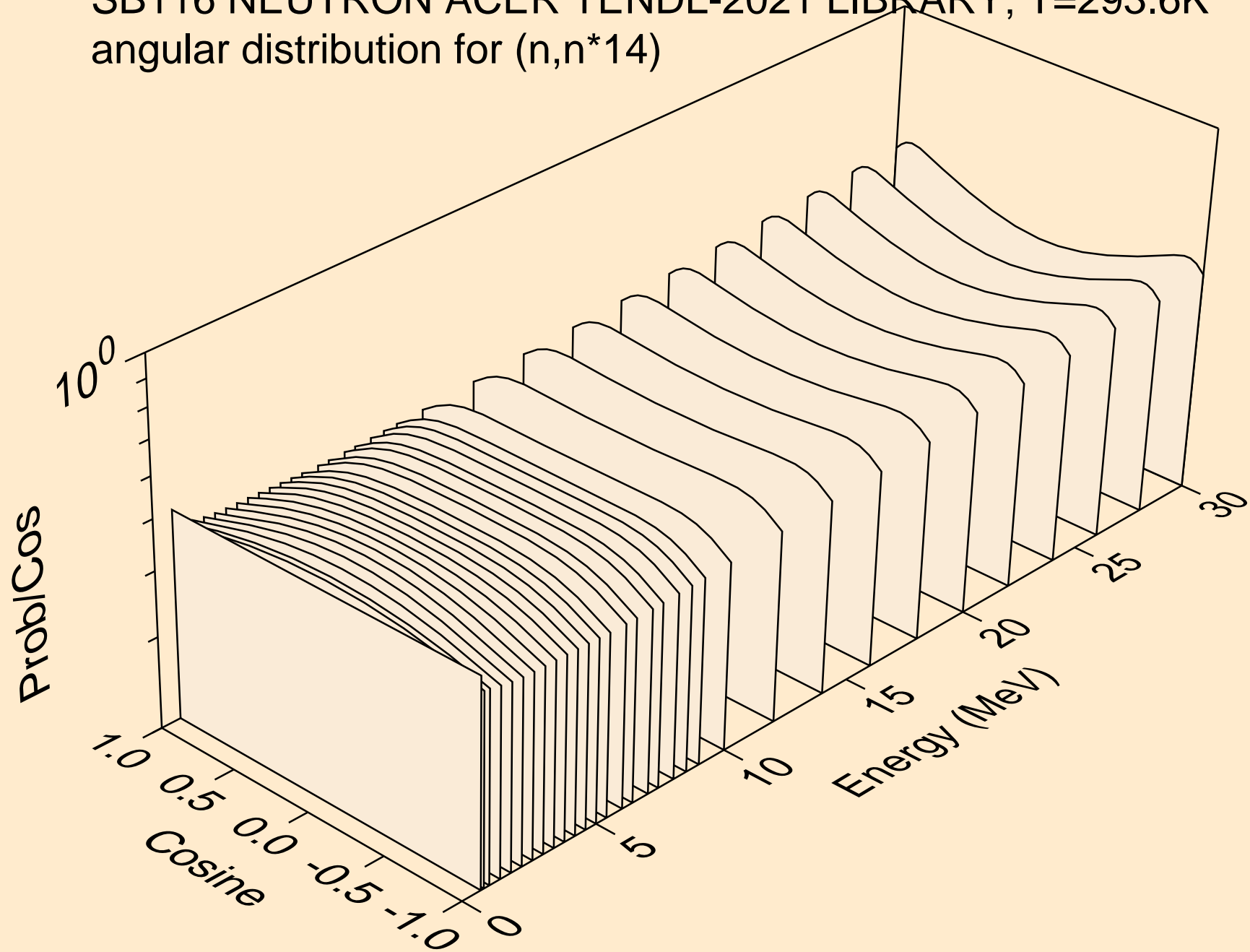

SB116 NEUTRON ACER TENDL-2021 LIBRARY; T=293.6K
angular distribution for (n,n*15)

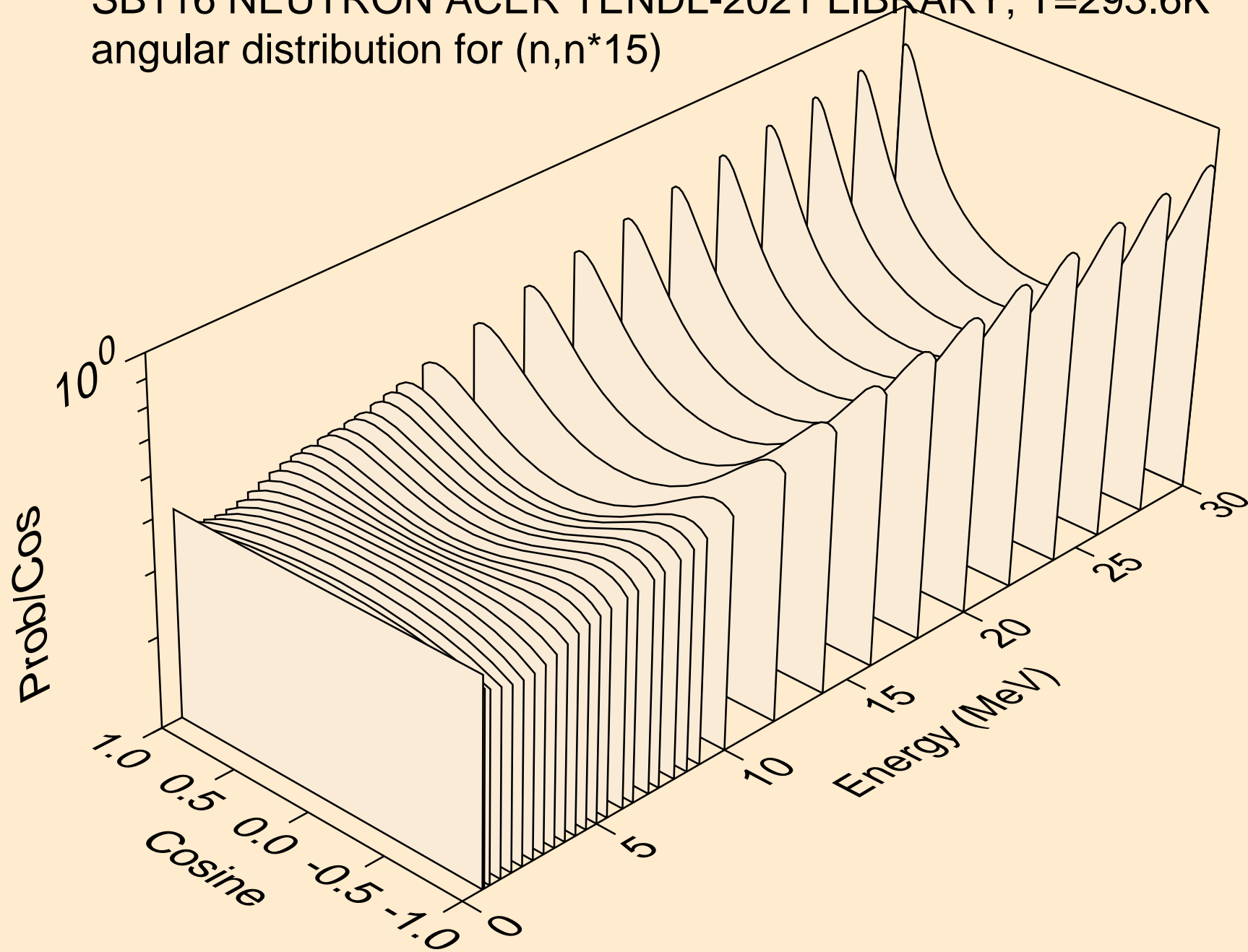

SB116 NEUTRON ACER TENDL-2021 LIBRARY; T=293.6K
angular distribution for (n,n*16)

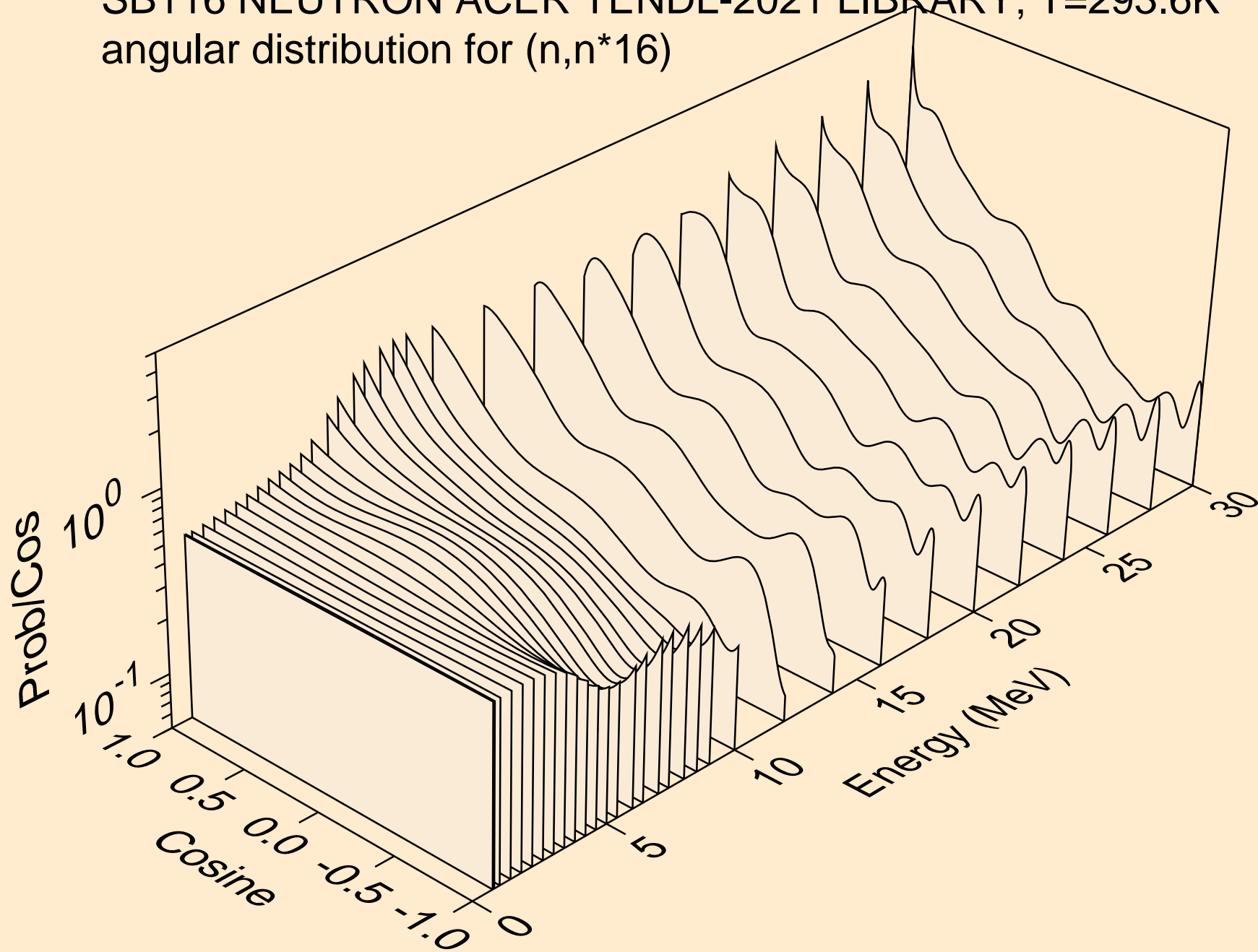

SB116 NEUTRON ACER TENDL-2021 LIBRARY; T=293.6K
angular distribution for (n,n*17)

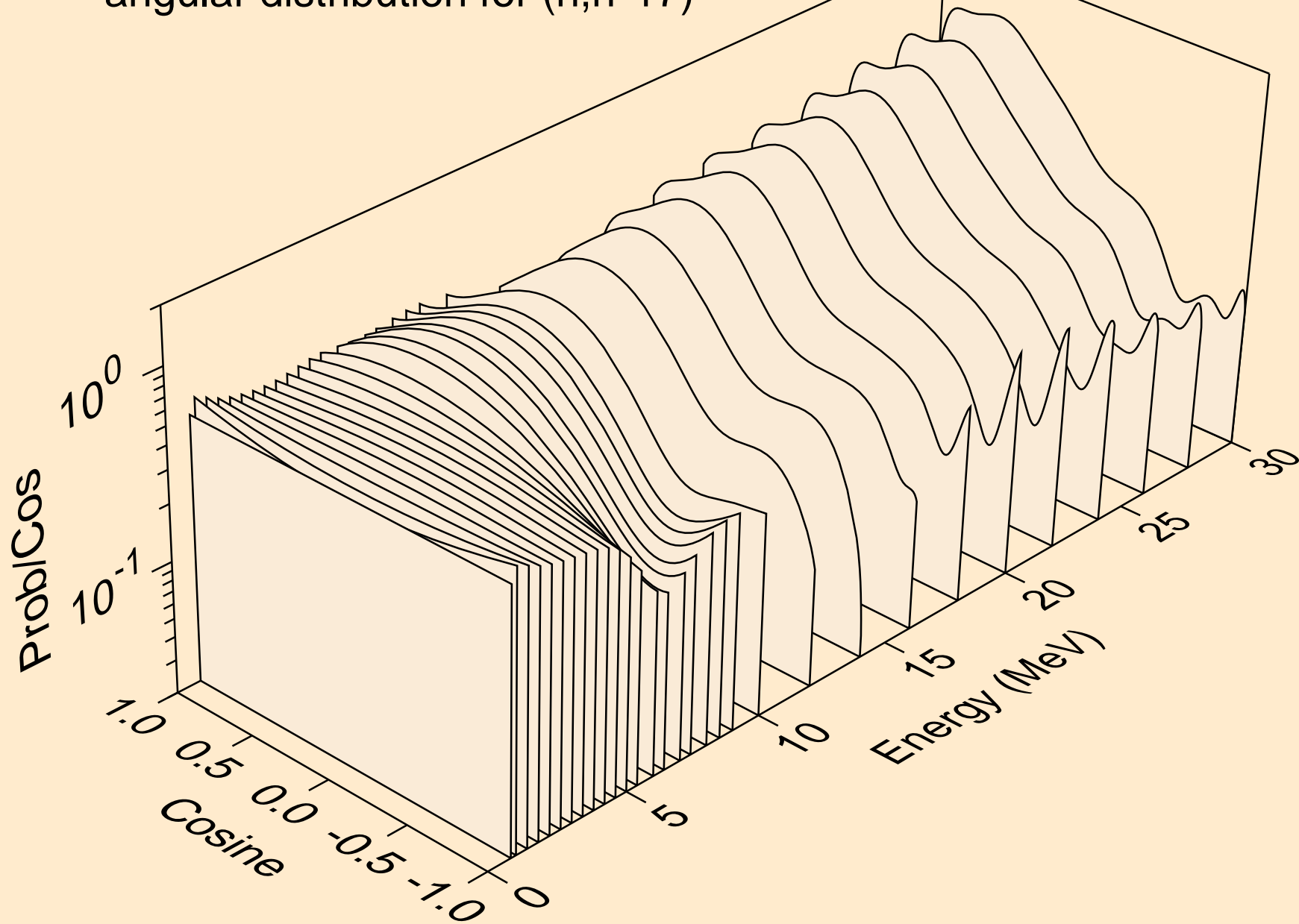

SB116 NEUTRON ACER TENDL-2021 LIBRARY; T=293.6K
angular distribution for (n,n*18)

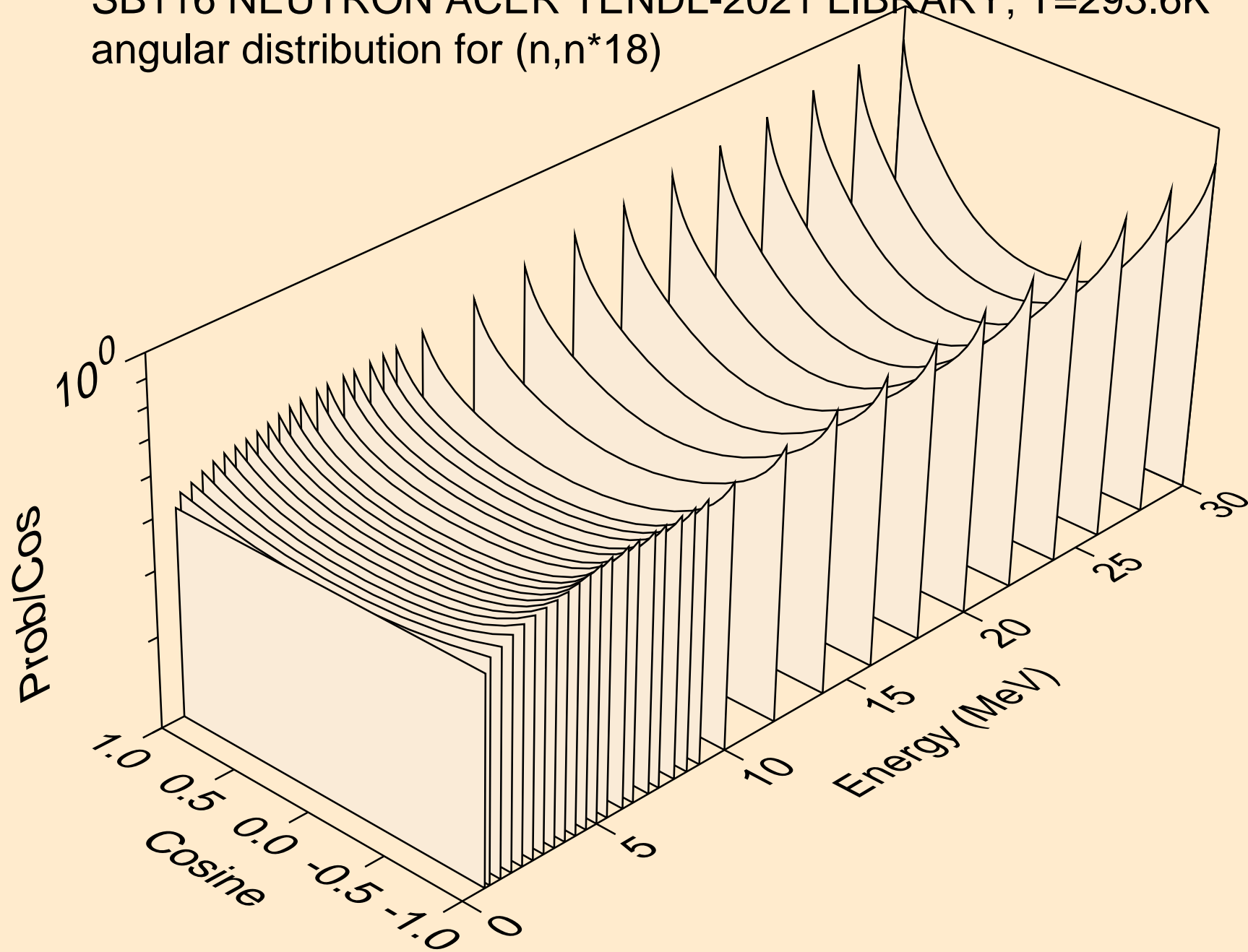

SB116 NEUTRON ACER TENDL-2021 LIBRARY; T=293.6K
angular distribution for (n,n*19)

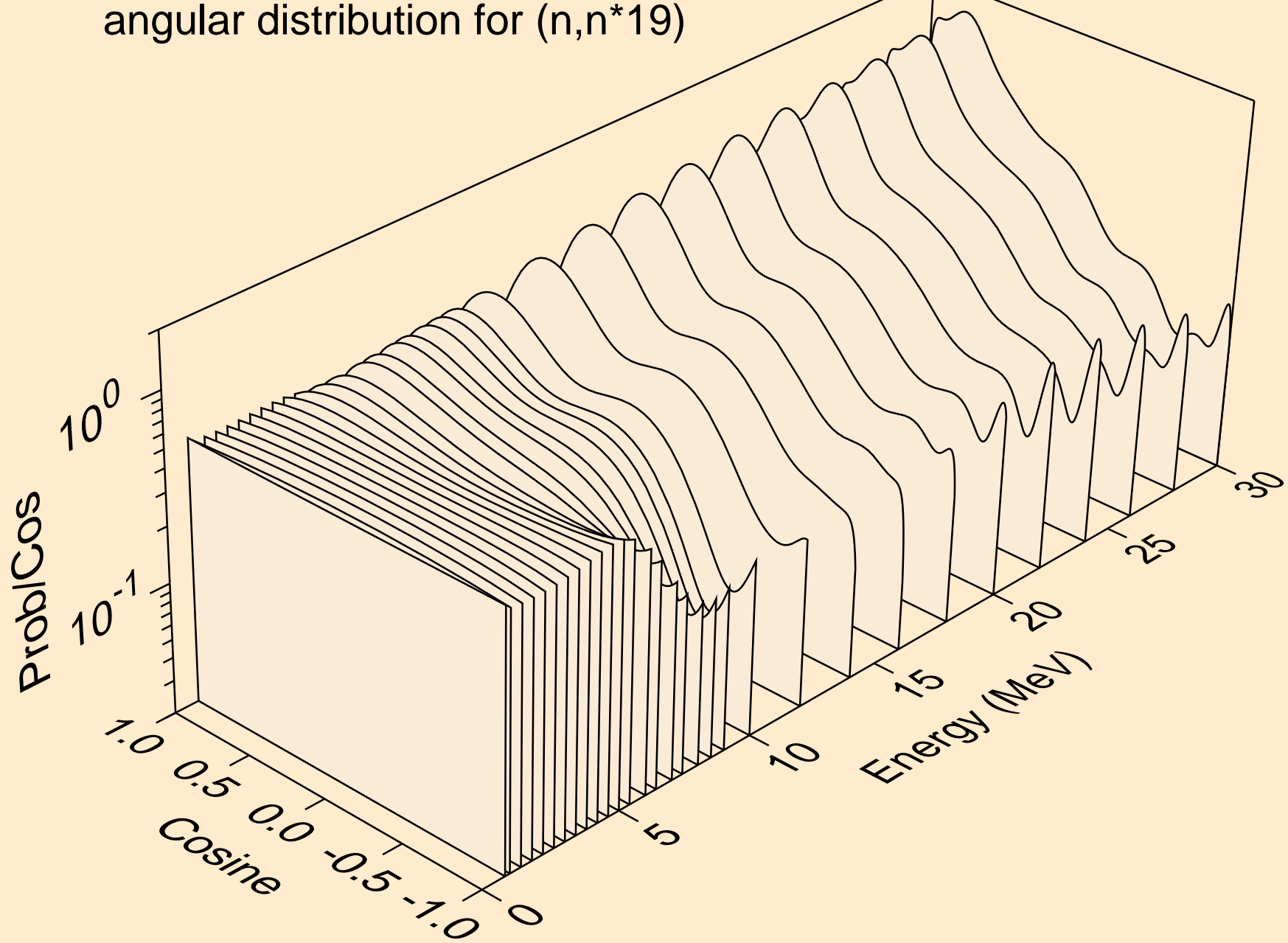

SB116 NEUTRON ACER TENDL-2021 LIBRARY; T=293.6K
angular distribution for (n,n*20)

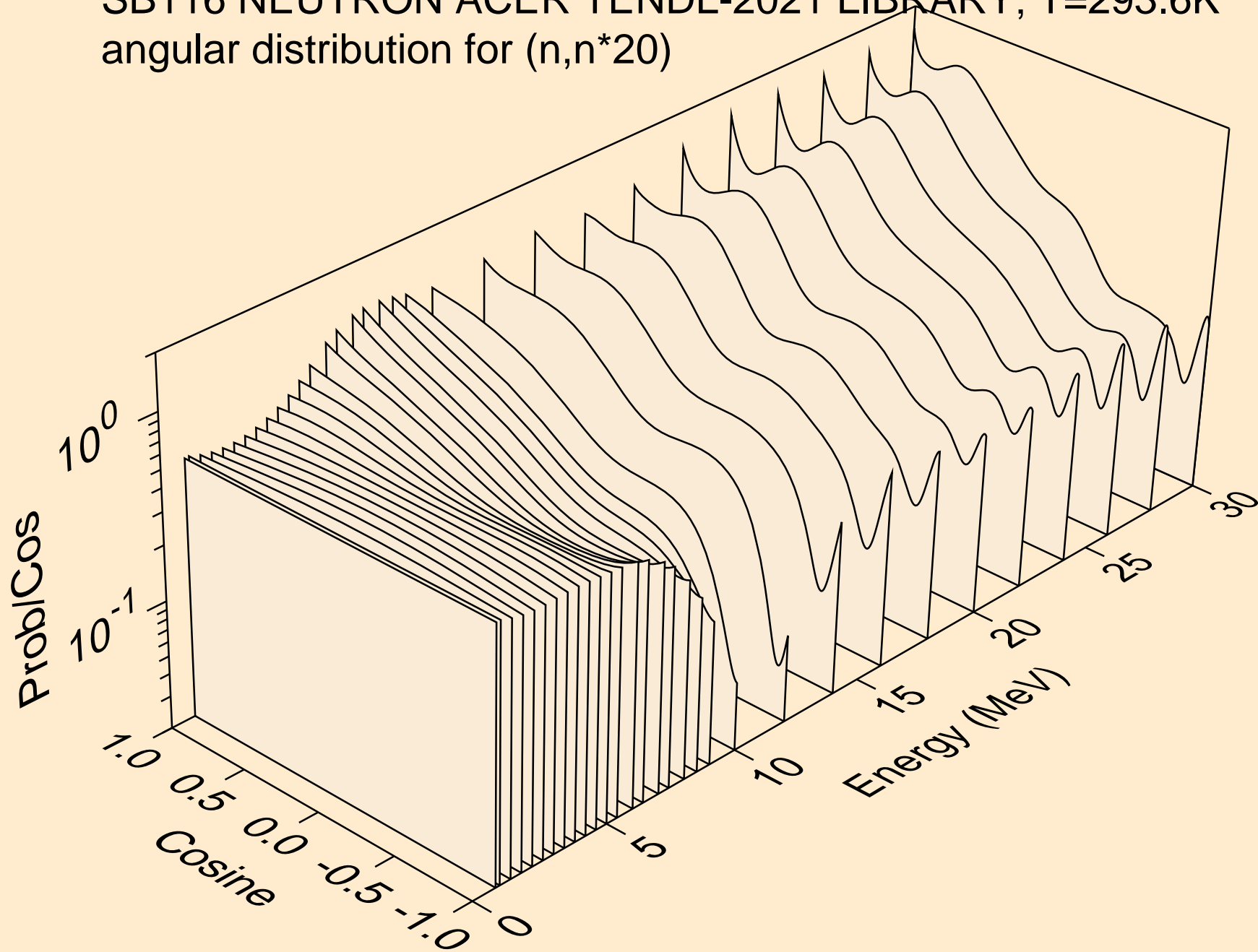

SB116 NEUTRON ACER TENDL-2021 LIBRARY; T=293.6K
angular distribution for (n,n*21)

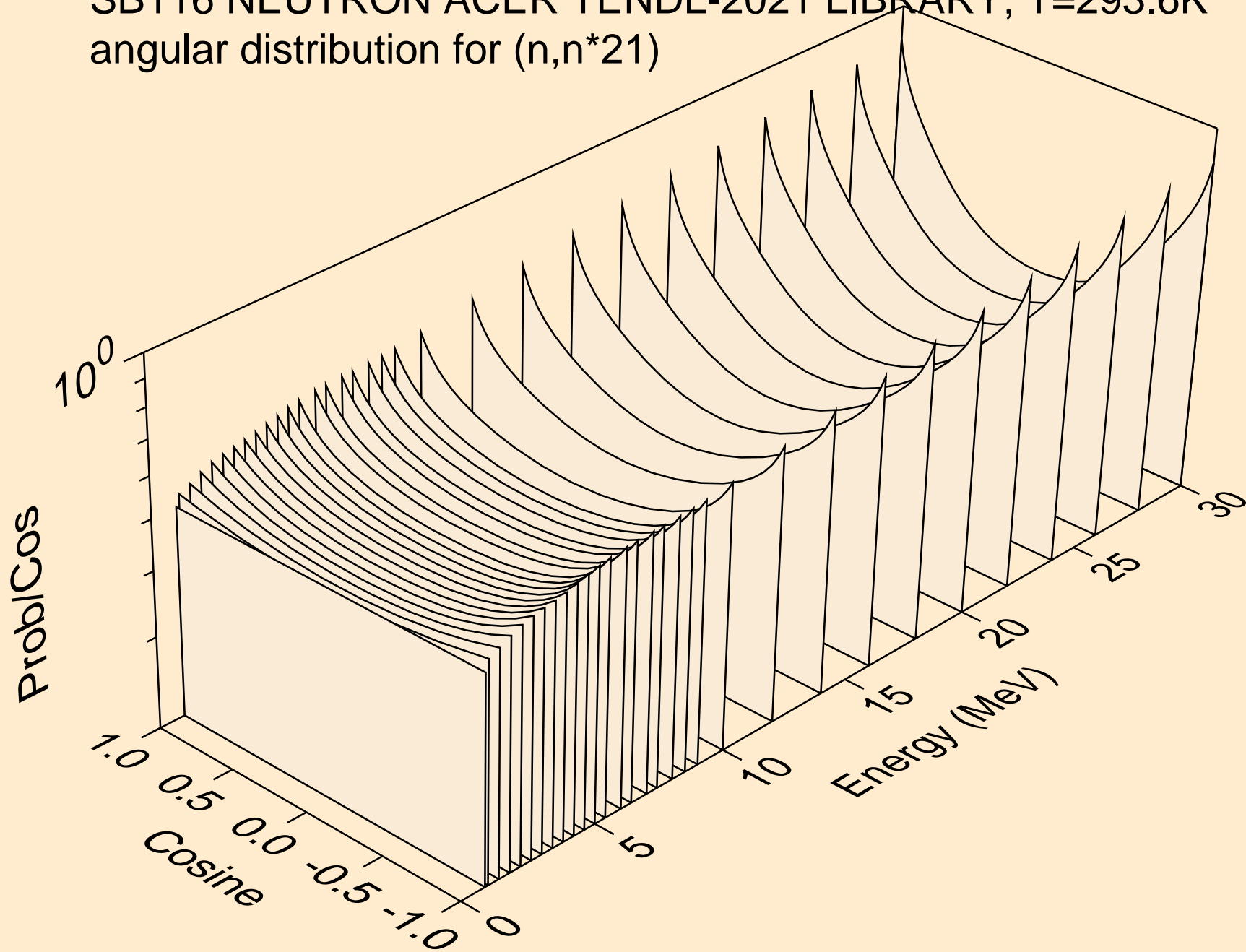

SB116 NEUTRON ACER TENDL-2021 LIBRARY; T=293.6K
angular distribution for (n,n*22)

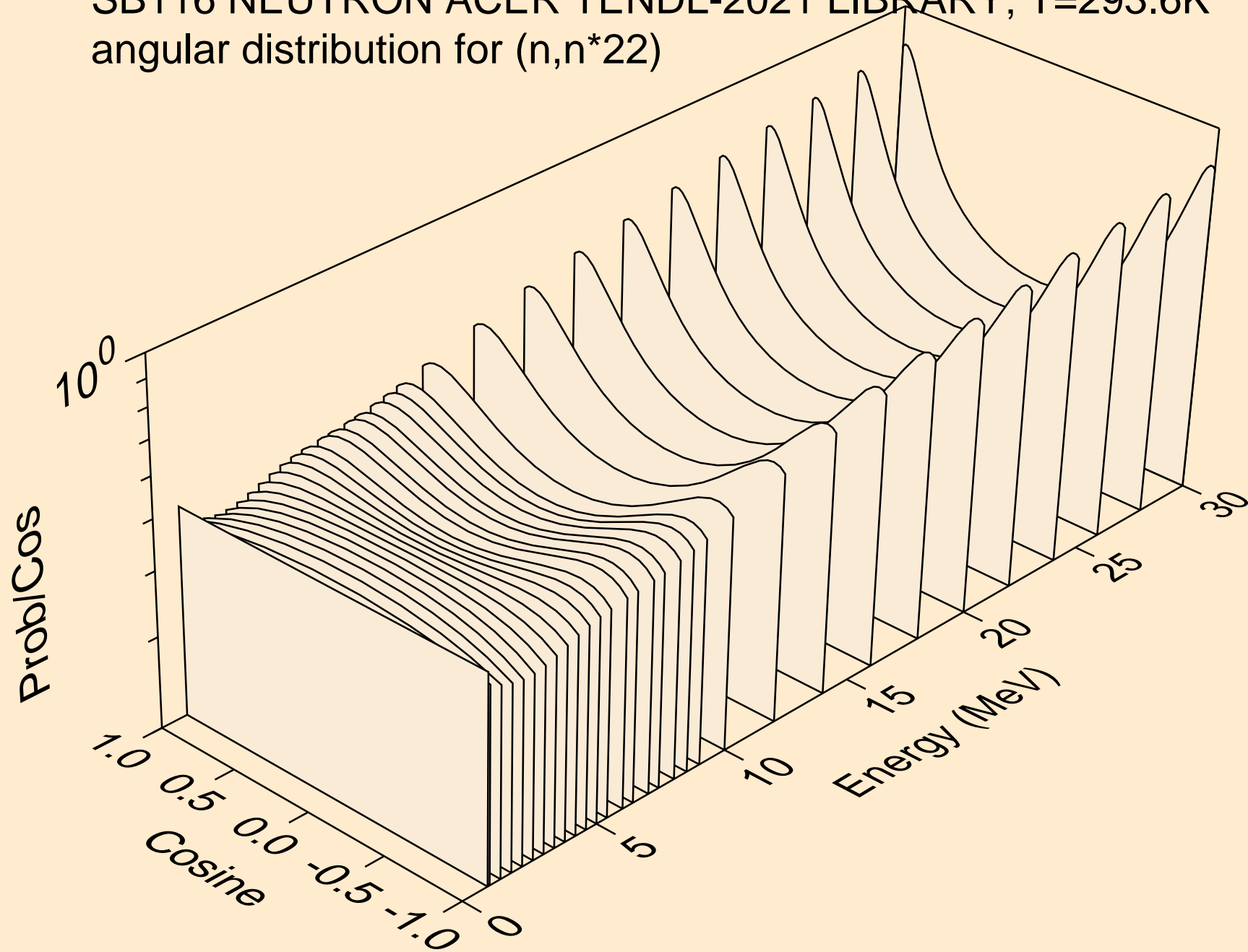

SB116 NEUTRON ACER TENDL-2021 LIBRARY; T=293.6K
angular distribution for (n,n*23)

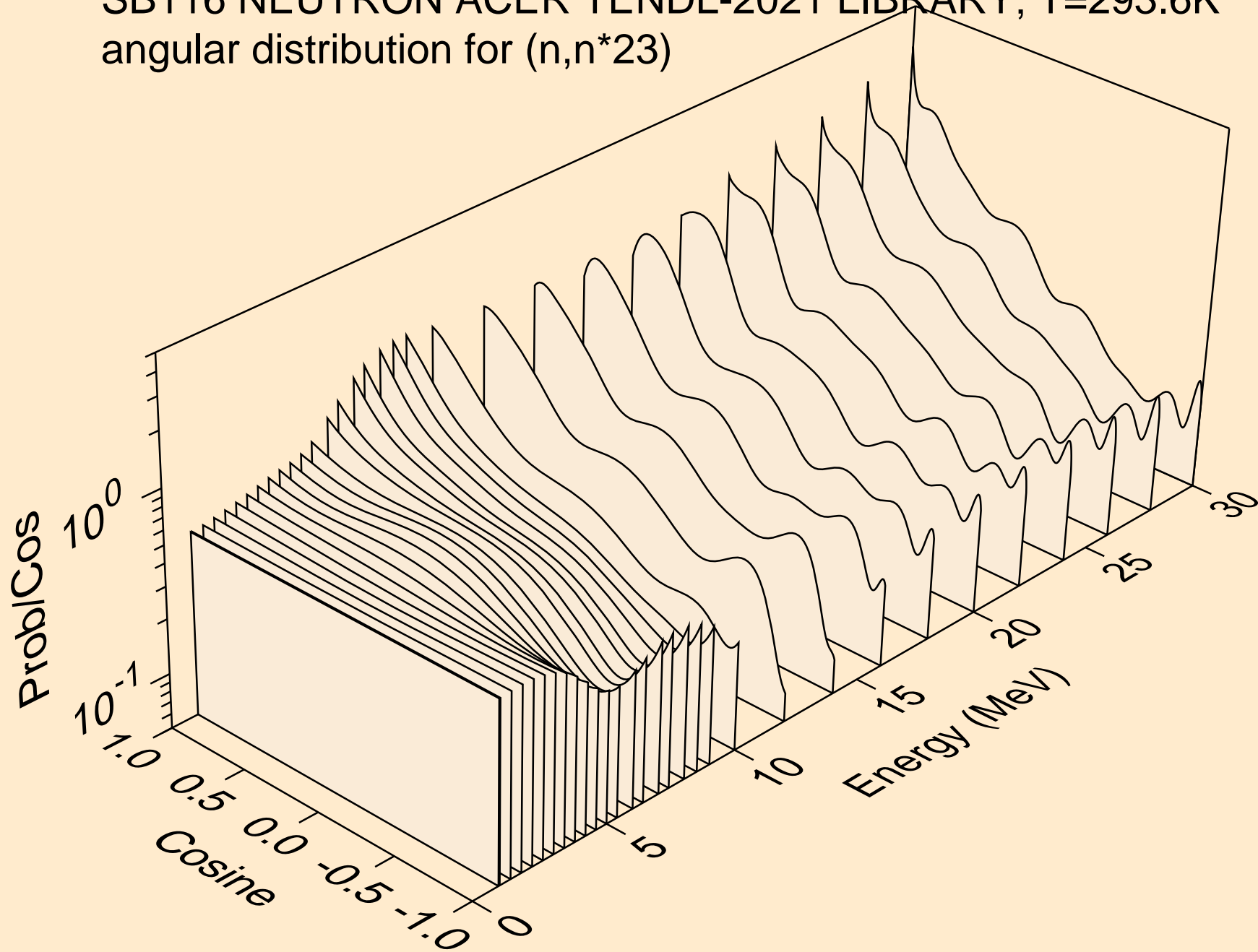

SB116 NEUTRON ACER TENDL-2021 LIBRARY; T=293.6K
angular distribution for (n,n*24)

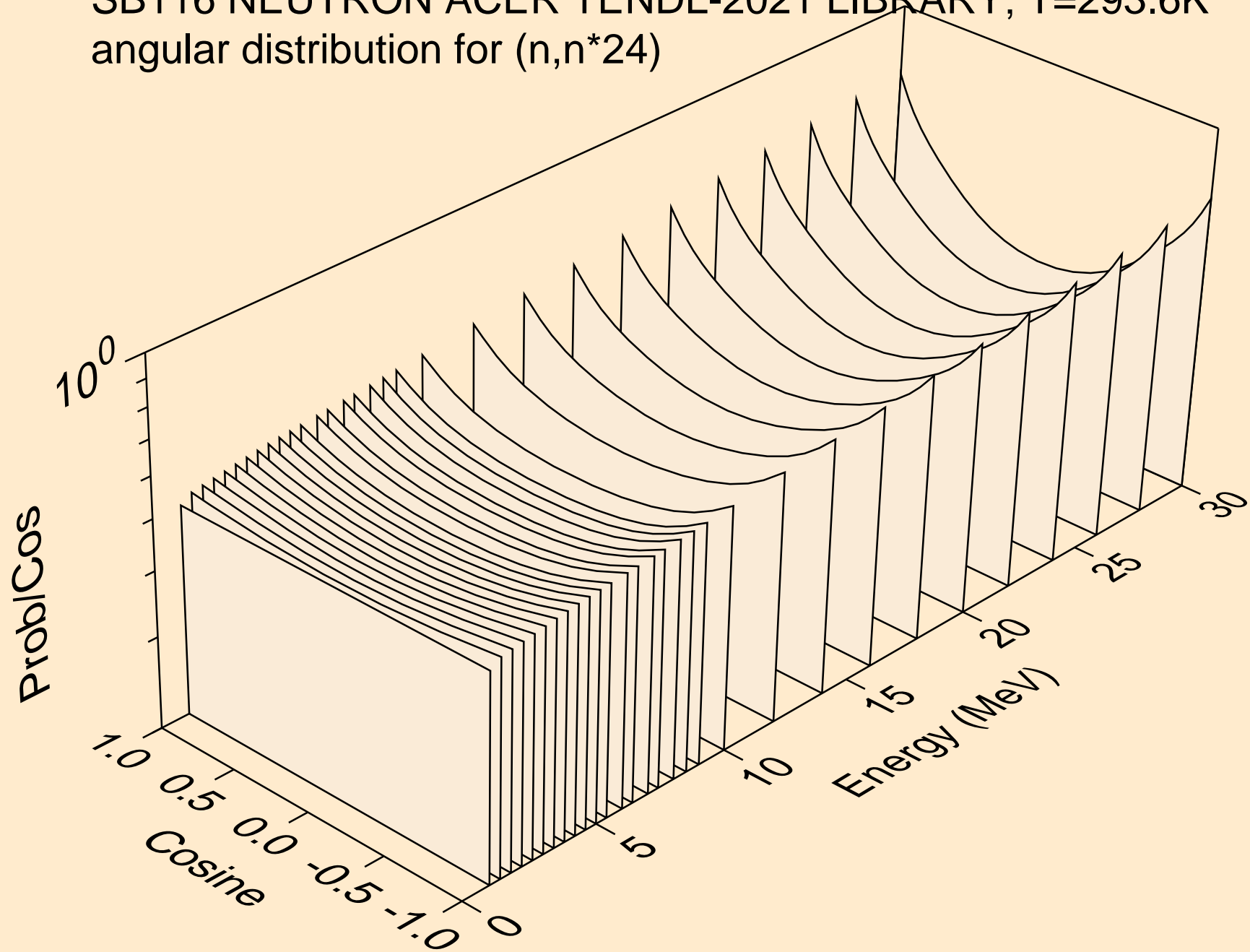

SB116 NEUTRON ACER TENDL-2021 LIBRARY; T=293.6K
angular distribution for (n,n*25)

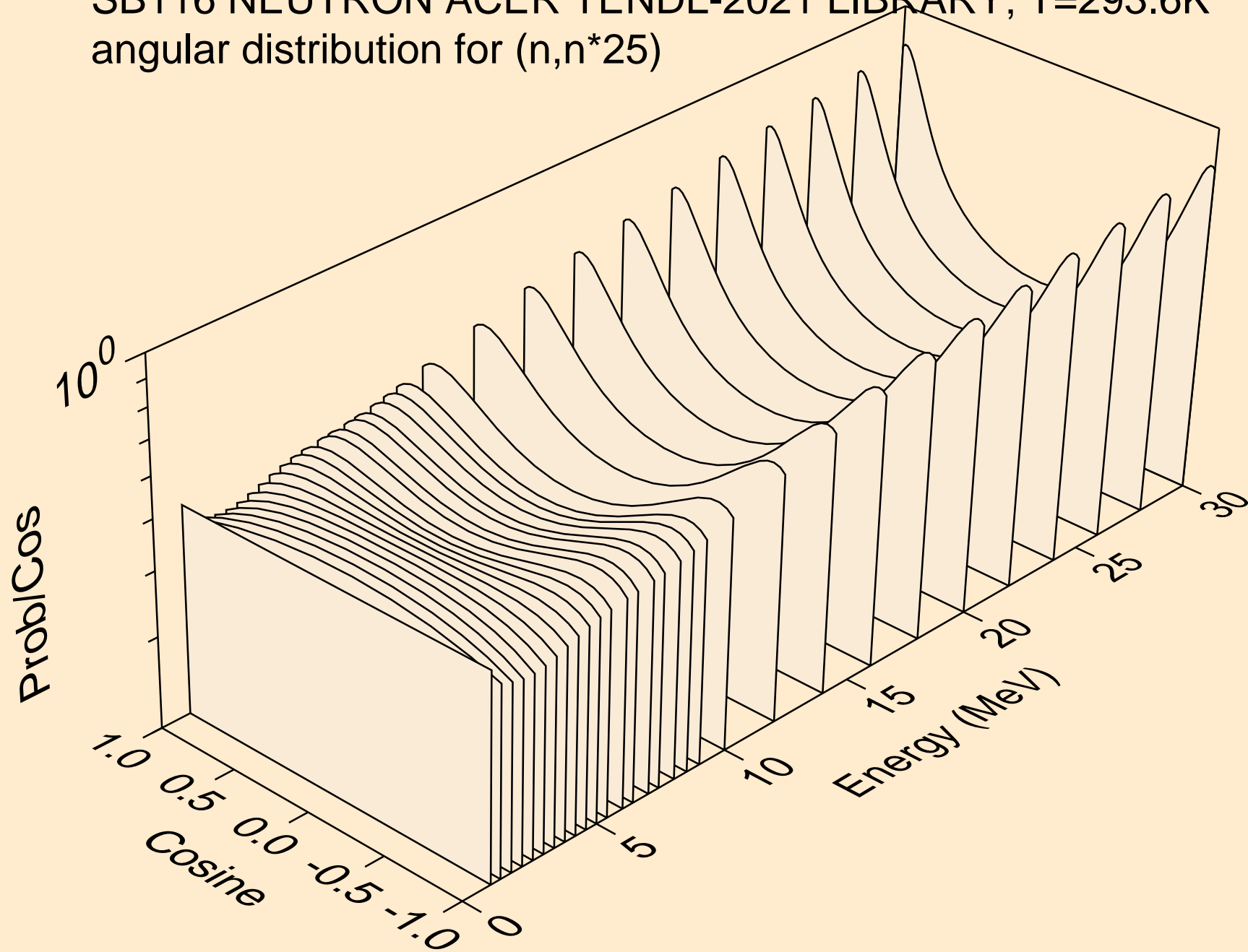

SB116 NEUTRON ACER TENDL-2021 LIBRARY; T=293.6K
angular distribution for (n,n*26)

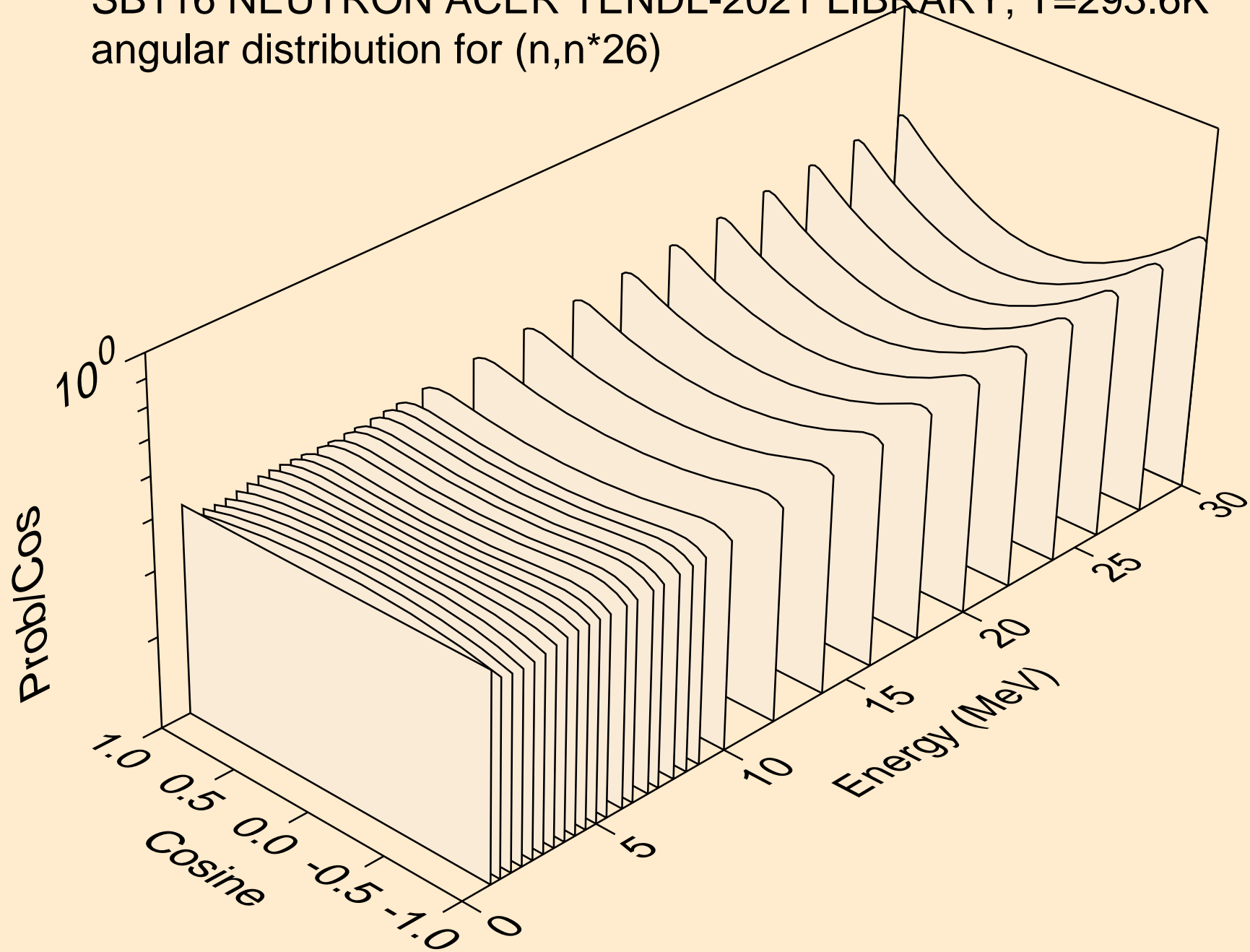

SB116 NEUTRON ACER TENDL-2021 LIBRARY; T=293.6K
angular distribution for (n,n*27)

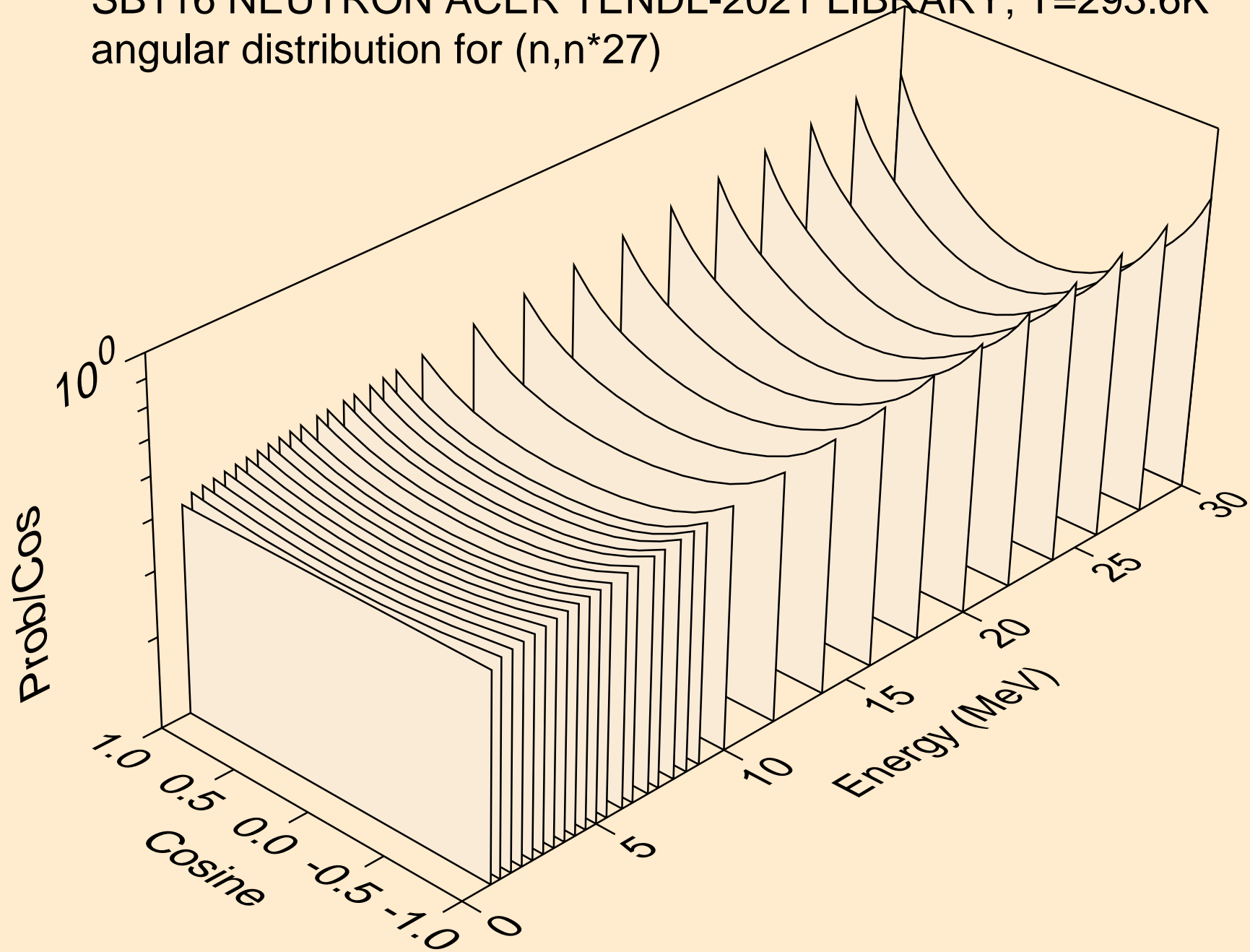

SB116 NEUTRON ACER TENDL-2021 LIBRARY; T=293.6K
angular distribution for (n,n*28)

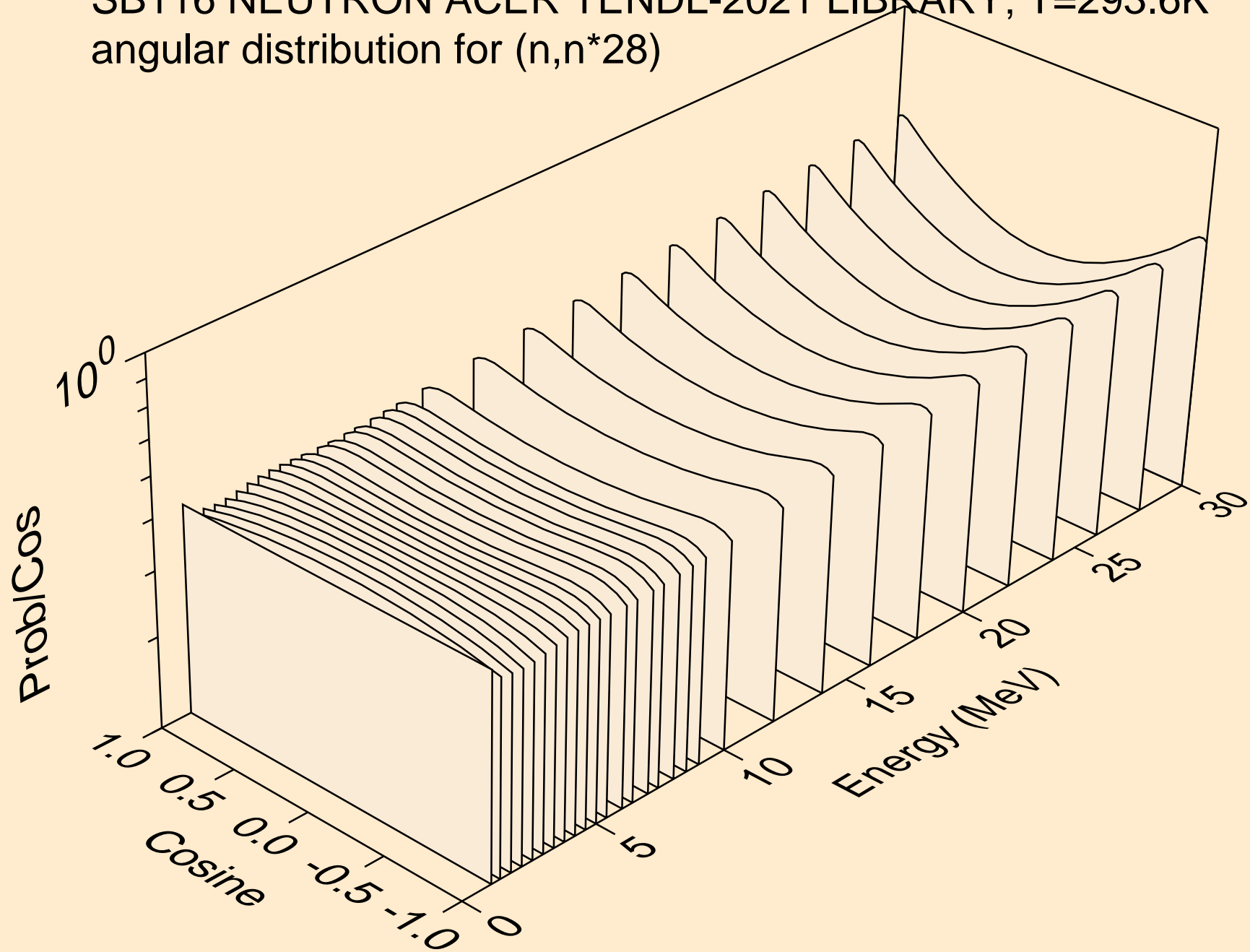

SB116 NEUTRON ACER TENDL-2021 LIBRARY; T=293.6K
angular distribution for (n,n*29)

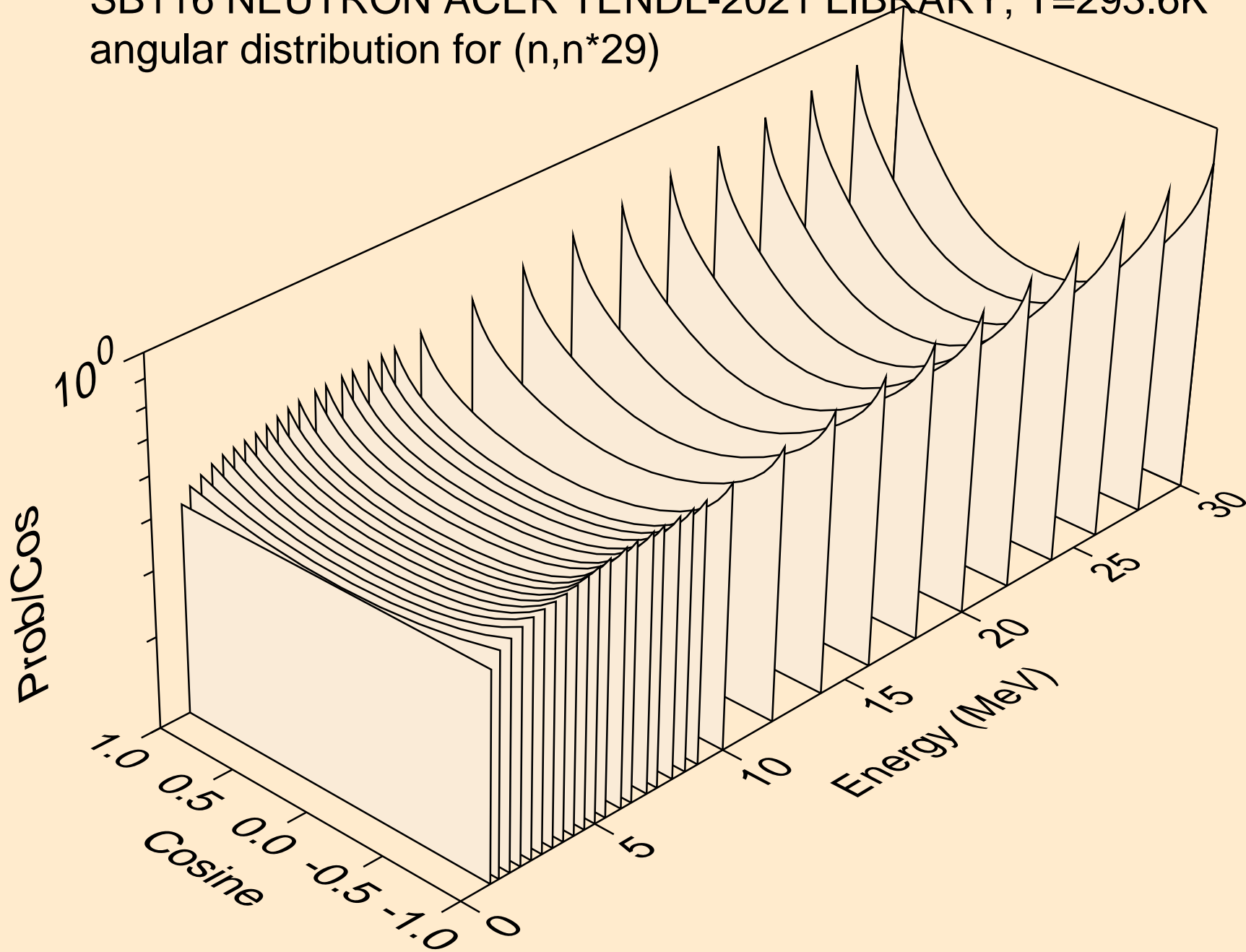

SB116 NEUTRON ACER TENDL-2021 LIBRARY; T=293.6K
angular distribution for (n,n*30)

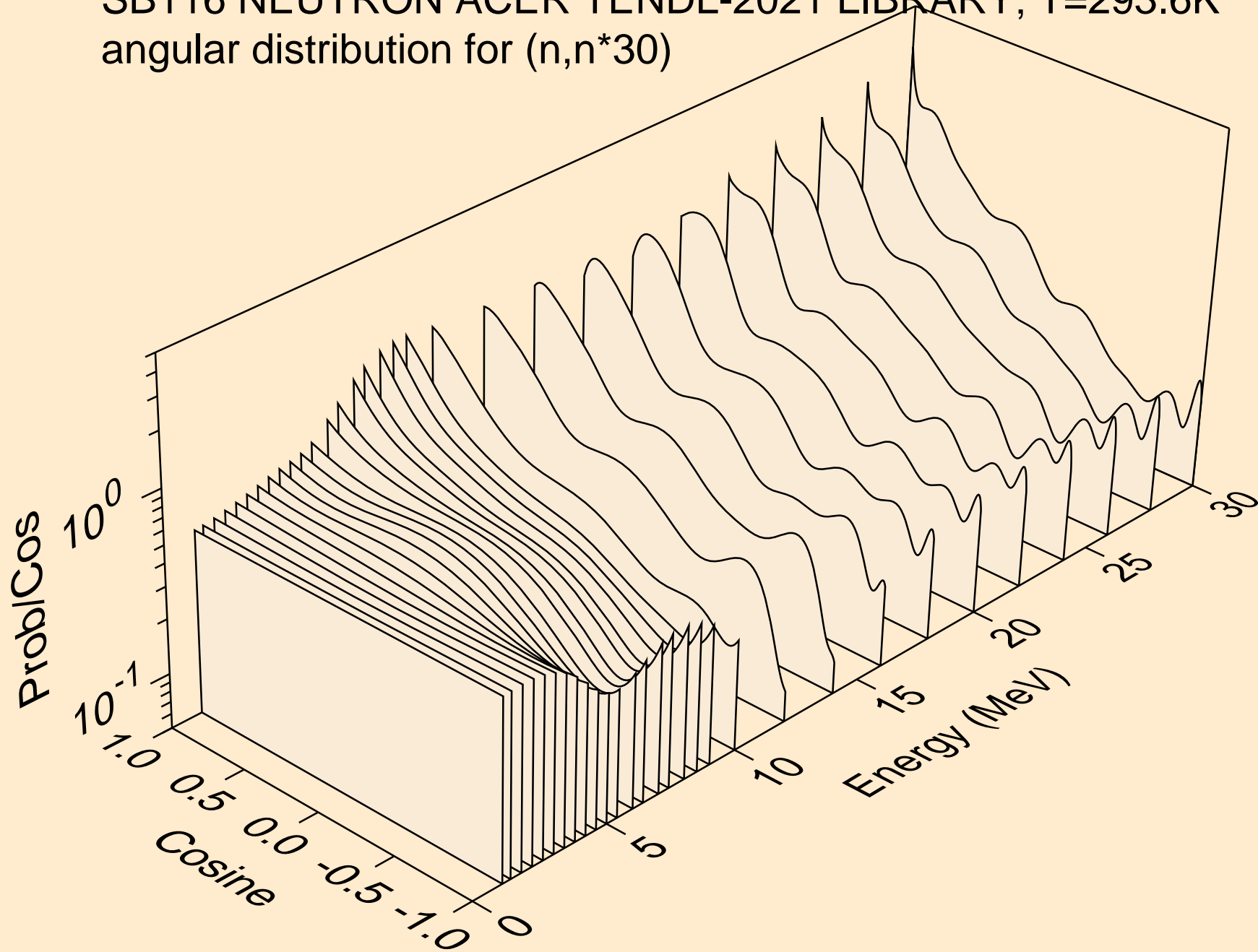

SB116 NEUTRON ACER TENDL-2021 LIBRARY; T=293.6K
Neutron emission for (n,x)

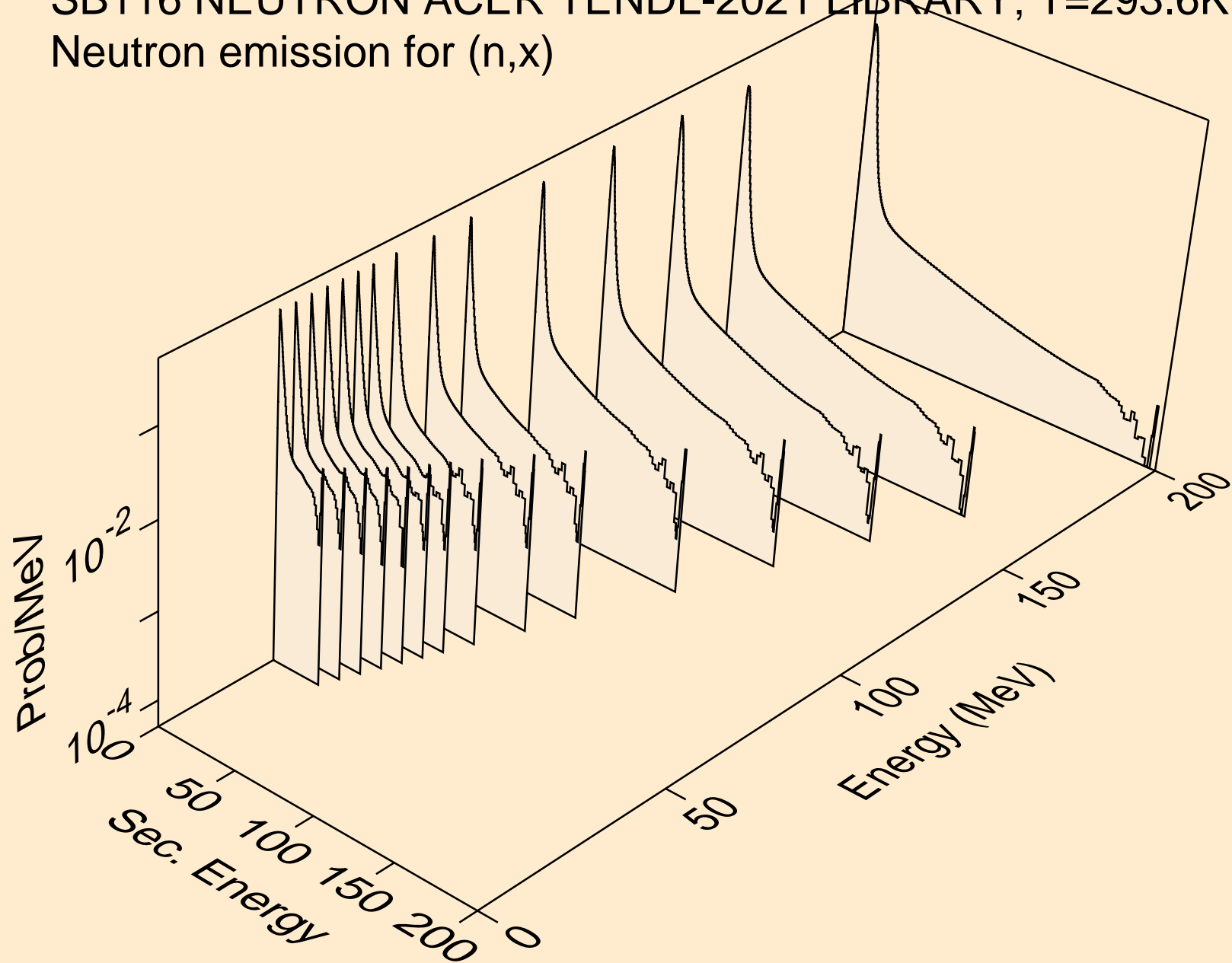

SB116 NEUTRON ACER TENDL-2021 LIBRARY; T=293.6K
Neutron emission for (n,2nd)

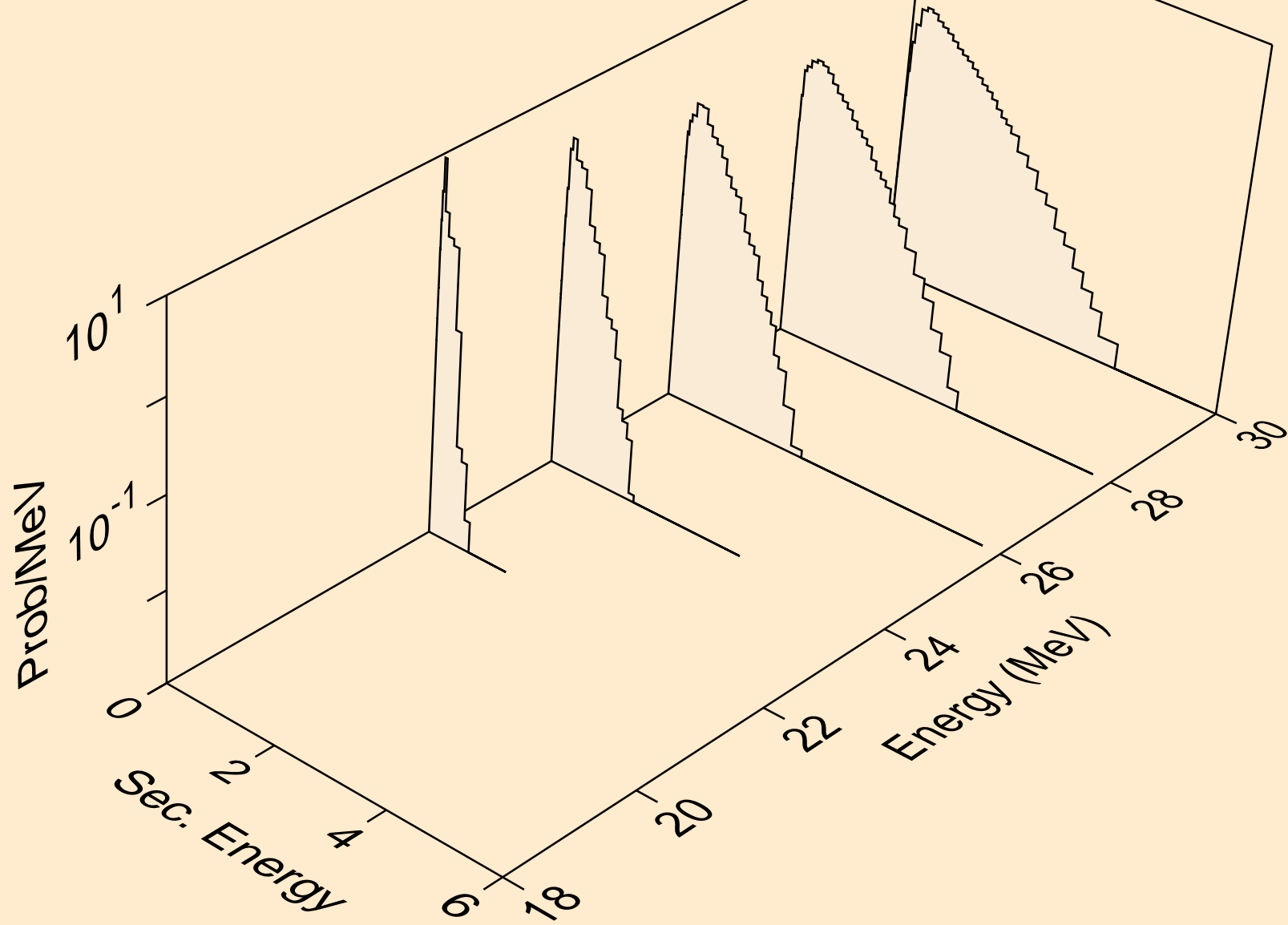

SB116 NEUTRON ACER TENDL-2021 LIBRARY; T=293.6K
Neutron emission for (n,2n)

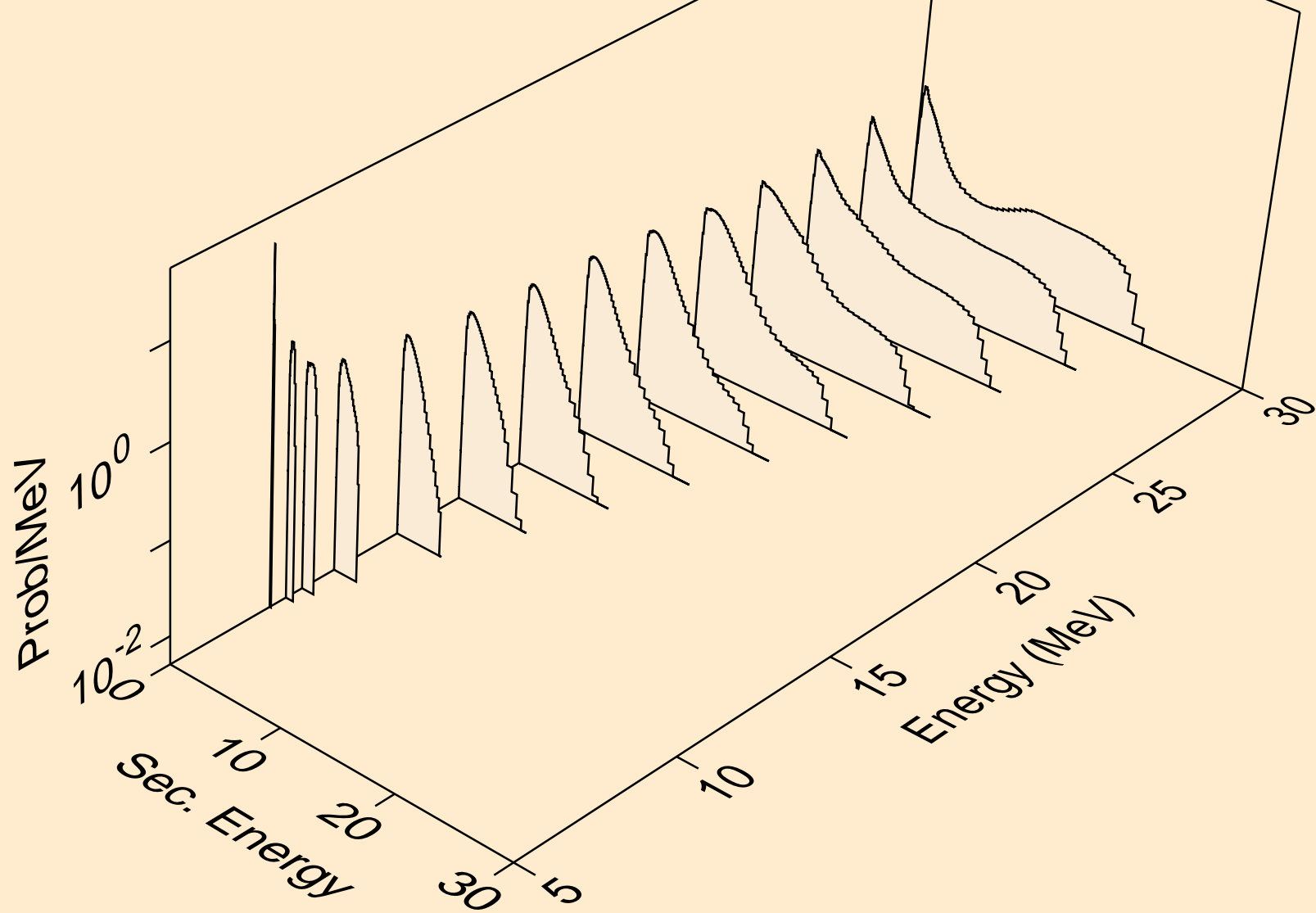

SB116 NEUTRON ACER TENDL-2021 LIBRARY; T=293.6K
Neutron emission for (n,3n)

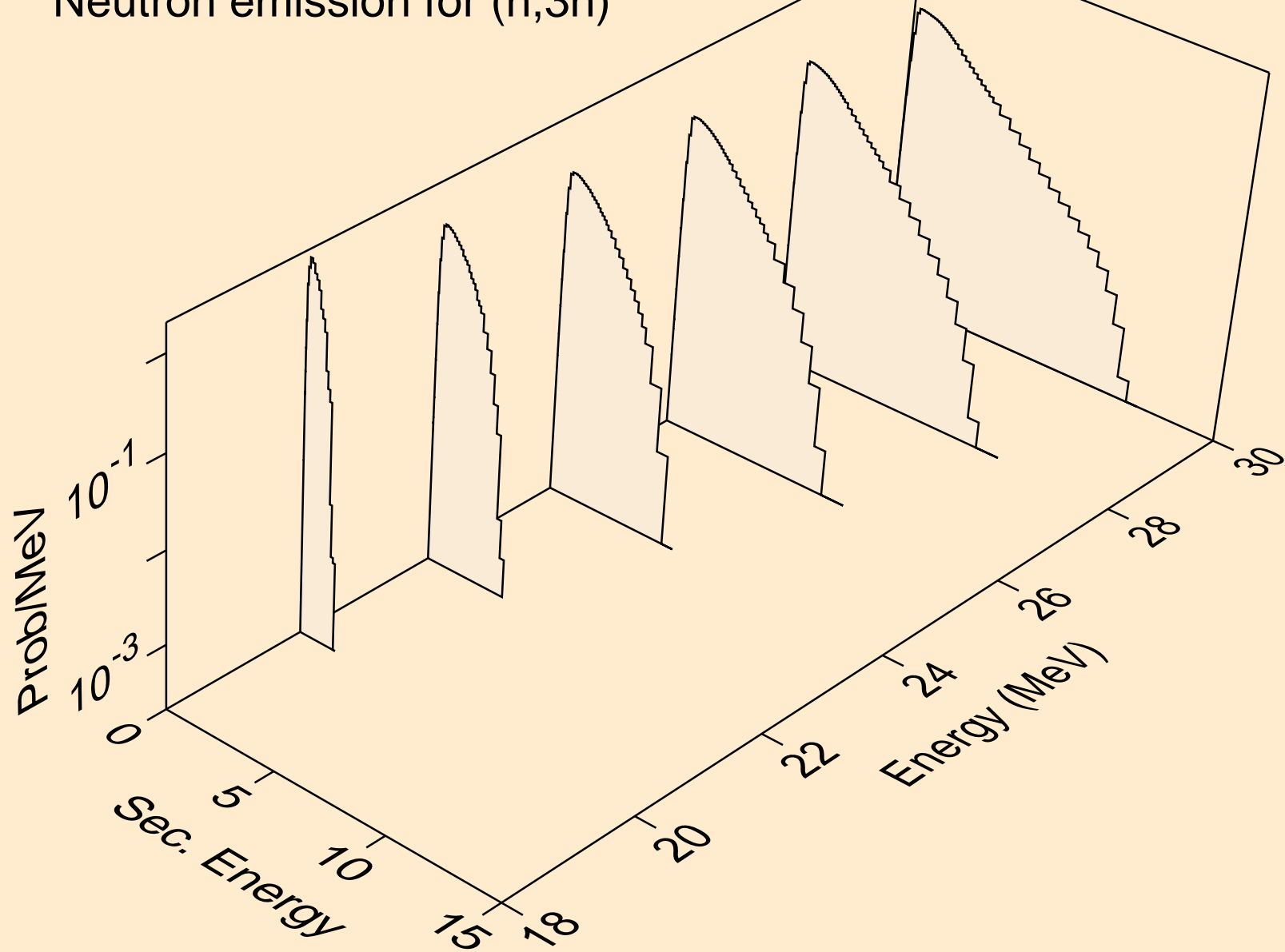

SB116 NEUTRON ACER TENDL-2021 LIBRARY; T=293.6K
Neutron emission for (n,n*)a

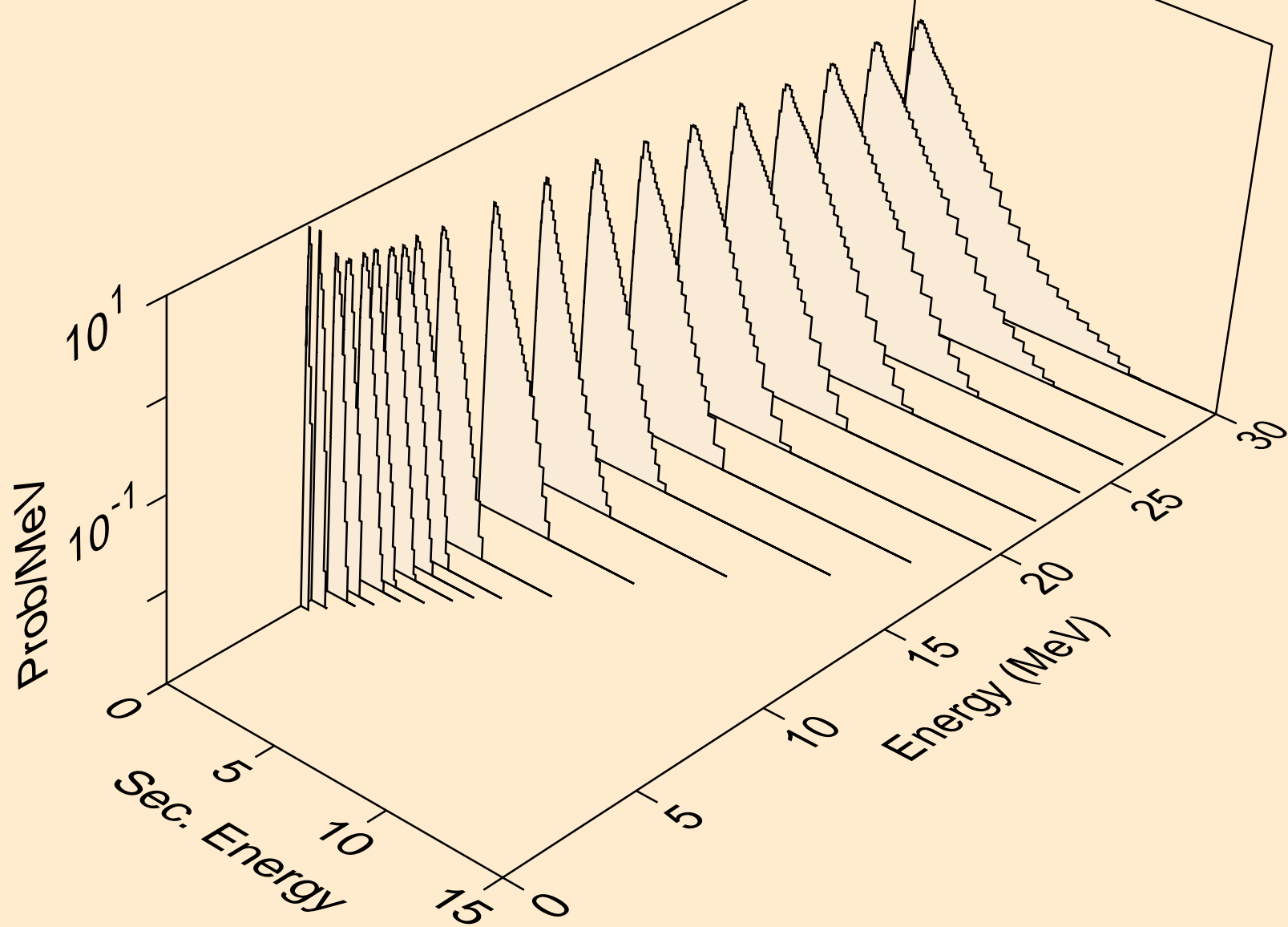

SB116 NEUTRON ACER TENDL-2021 LIBRARY; T=293.6K
Neutron emission for (n,2n)_a

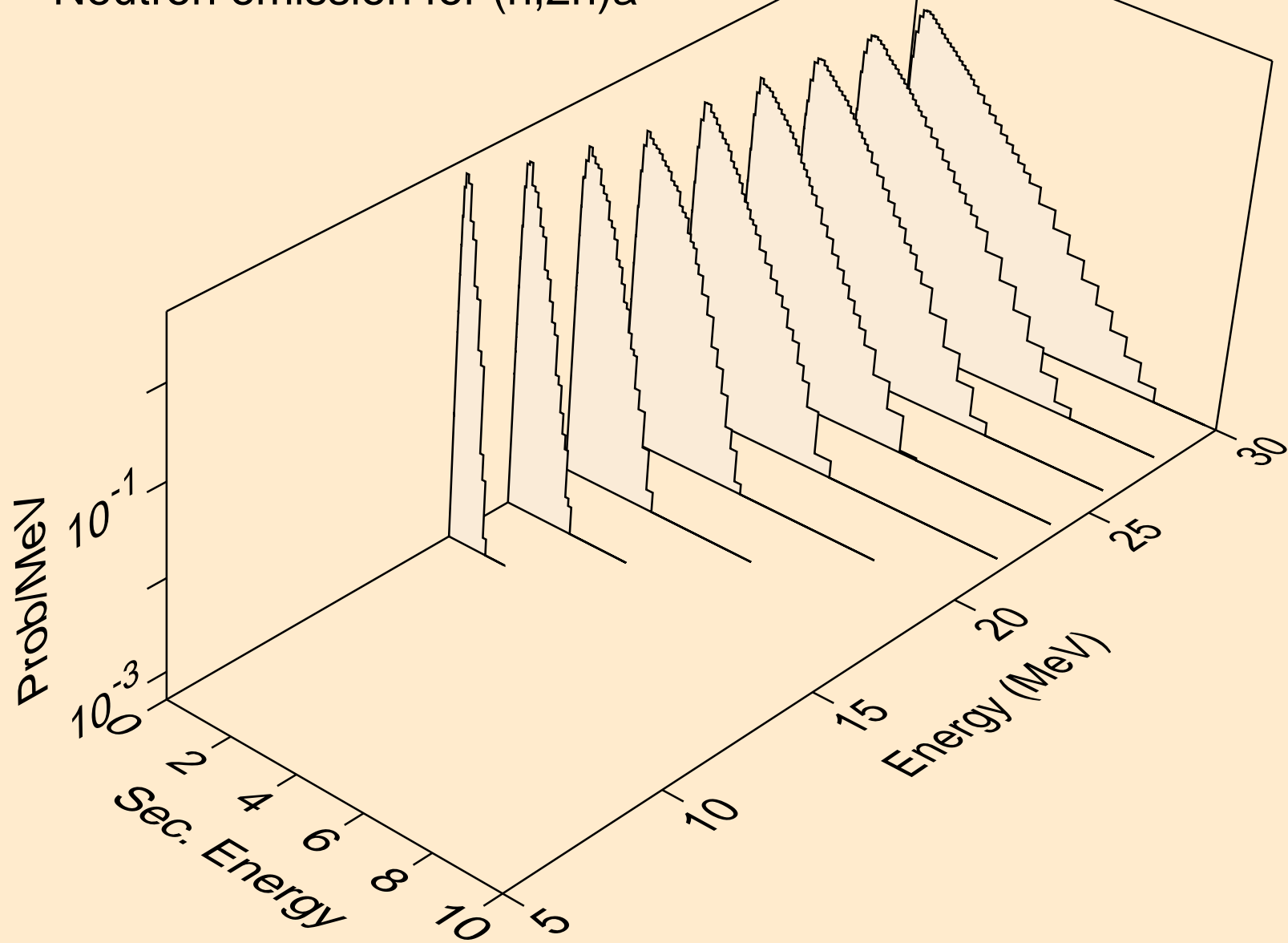

SB116 NEUTRON ACER TENDL-2021 LIBRARY; T=293.6K
Neutron emission for (n,3n)a

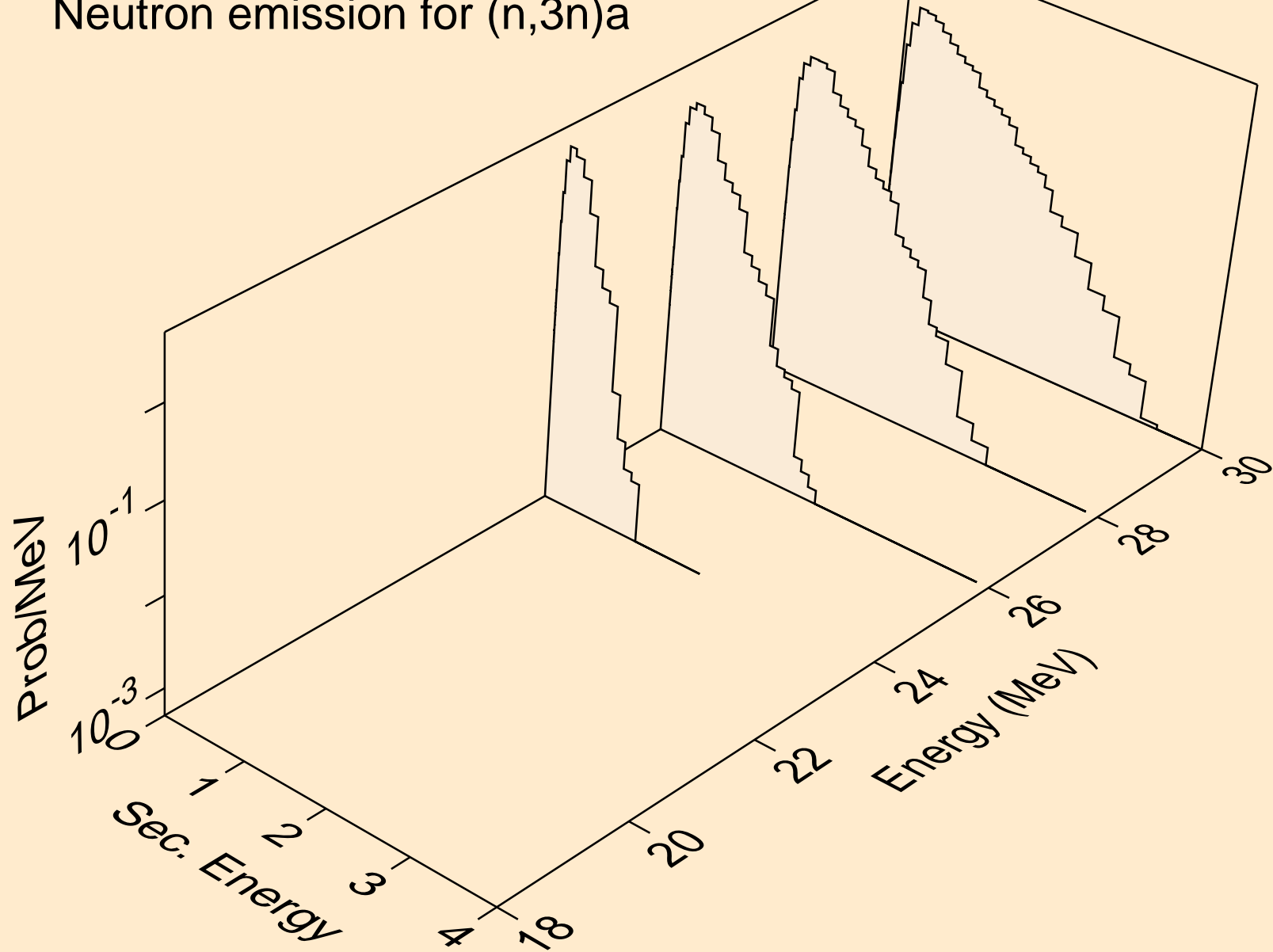

SB116 NEUTRON ACER TENDL-2021 LIBRARY; T=293.6K
Neutron emission for (n,n*)p

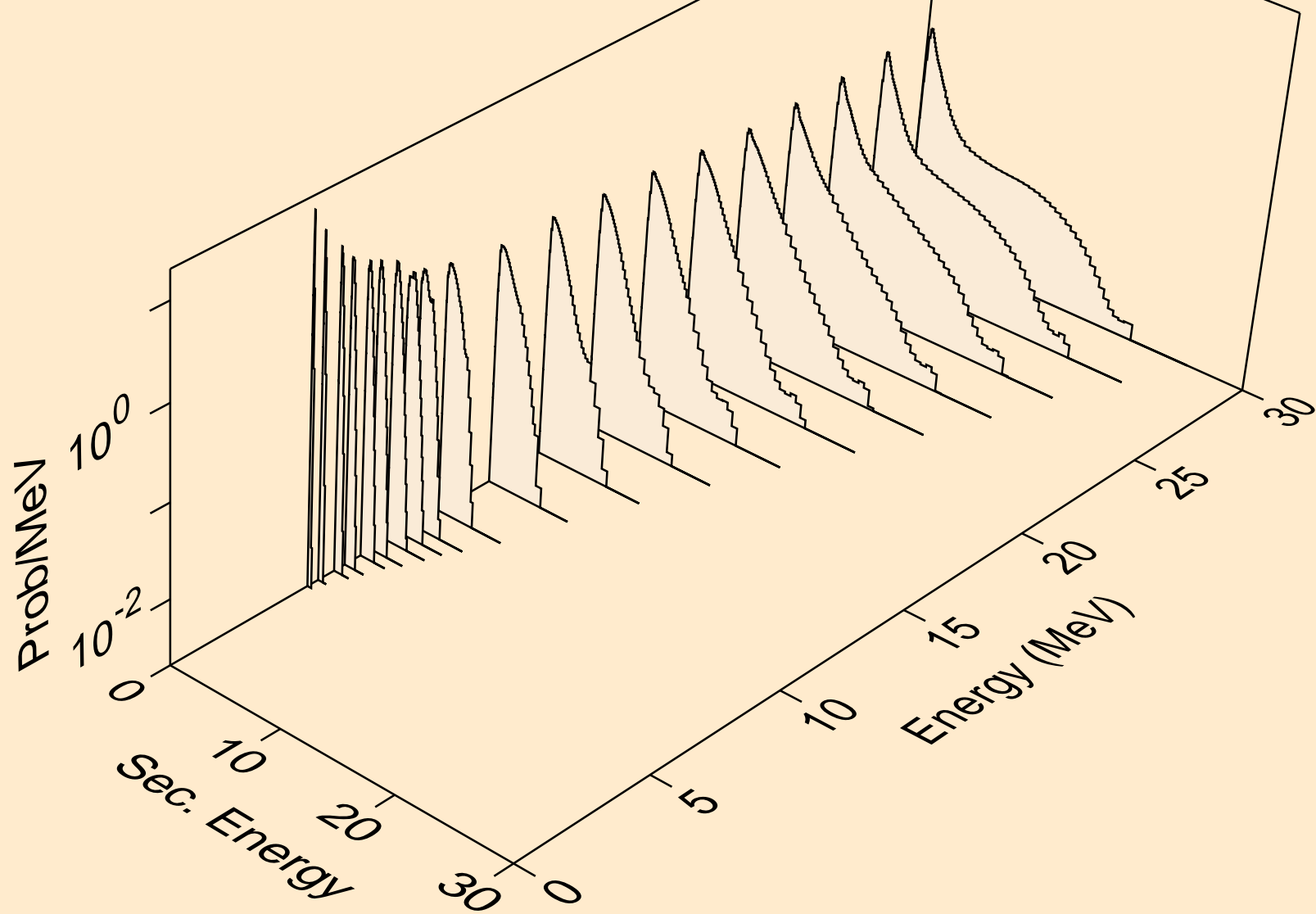

SB116 NEUTRON ACER TENDL-2021 LIBRARY; T=293.6K
Neutron emission for (n,n*)2a

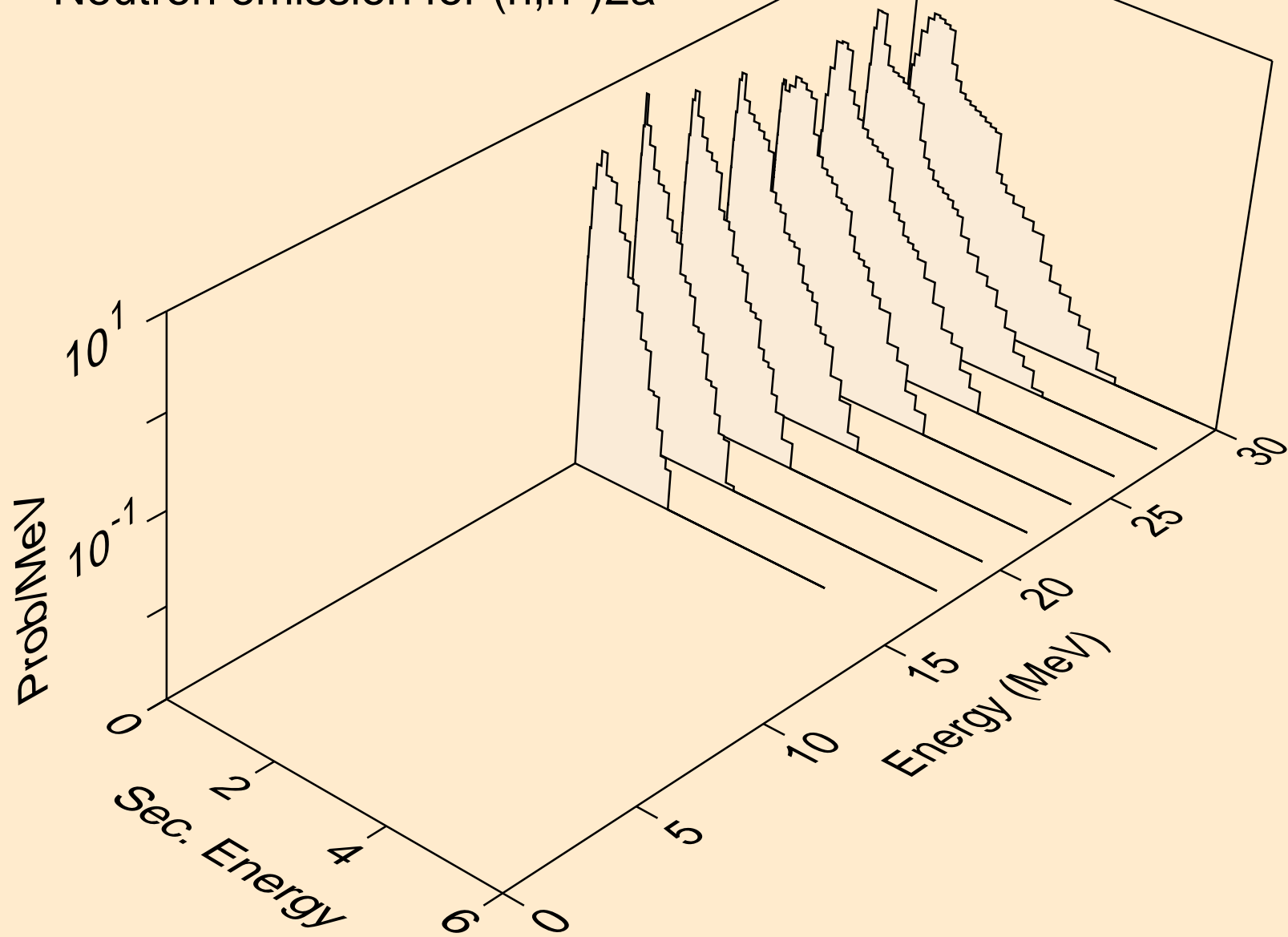

SB116 NEUTRON ACER TENDL-2021 LIBRARY; T=293.6K
Neutron emission for (n,n*)d

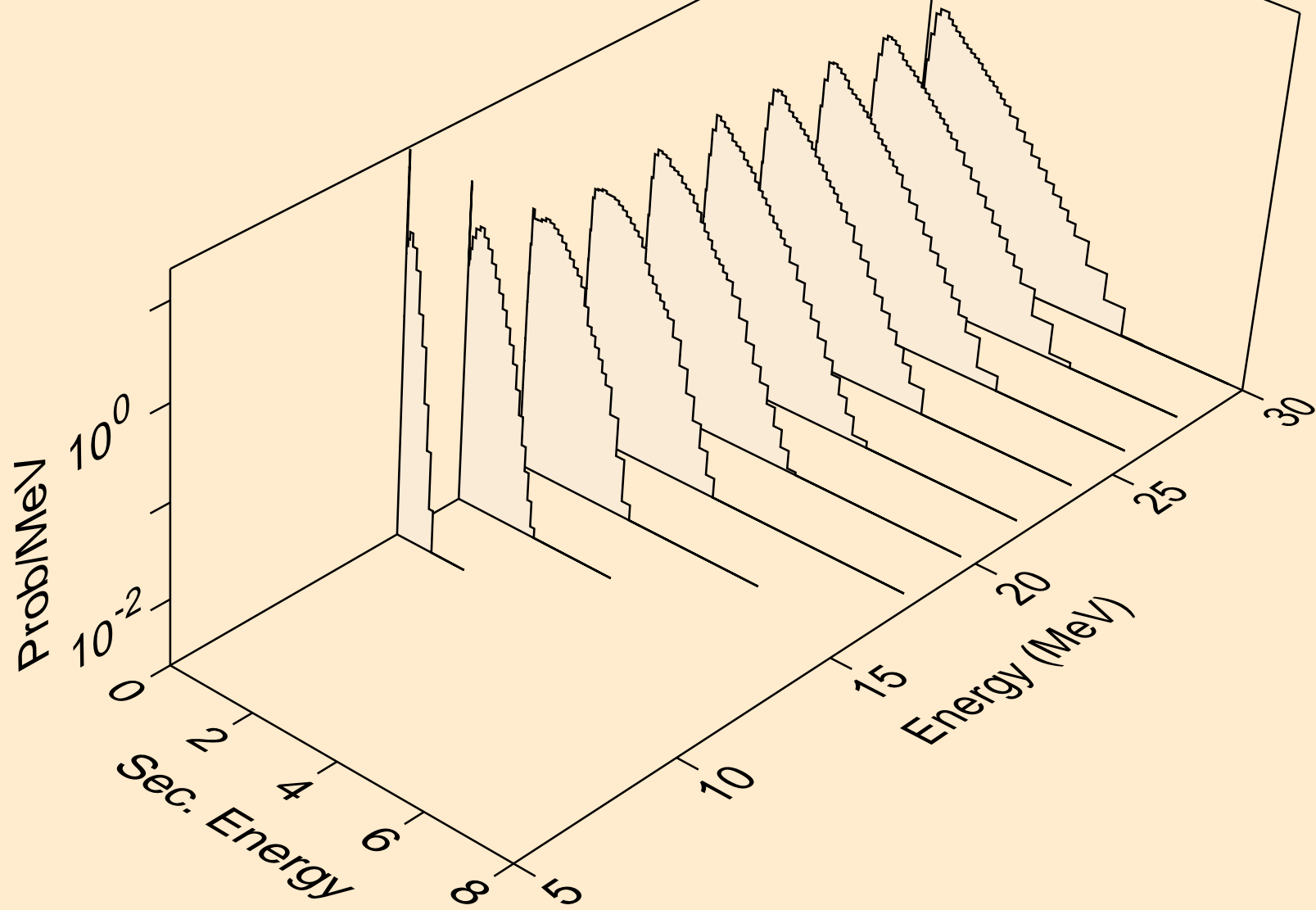

SB116 NEUTRON ACER TENDL-2021 LIBRARY; T=293.6K
Neutron emission for (n,n*)t

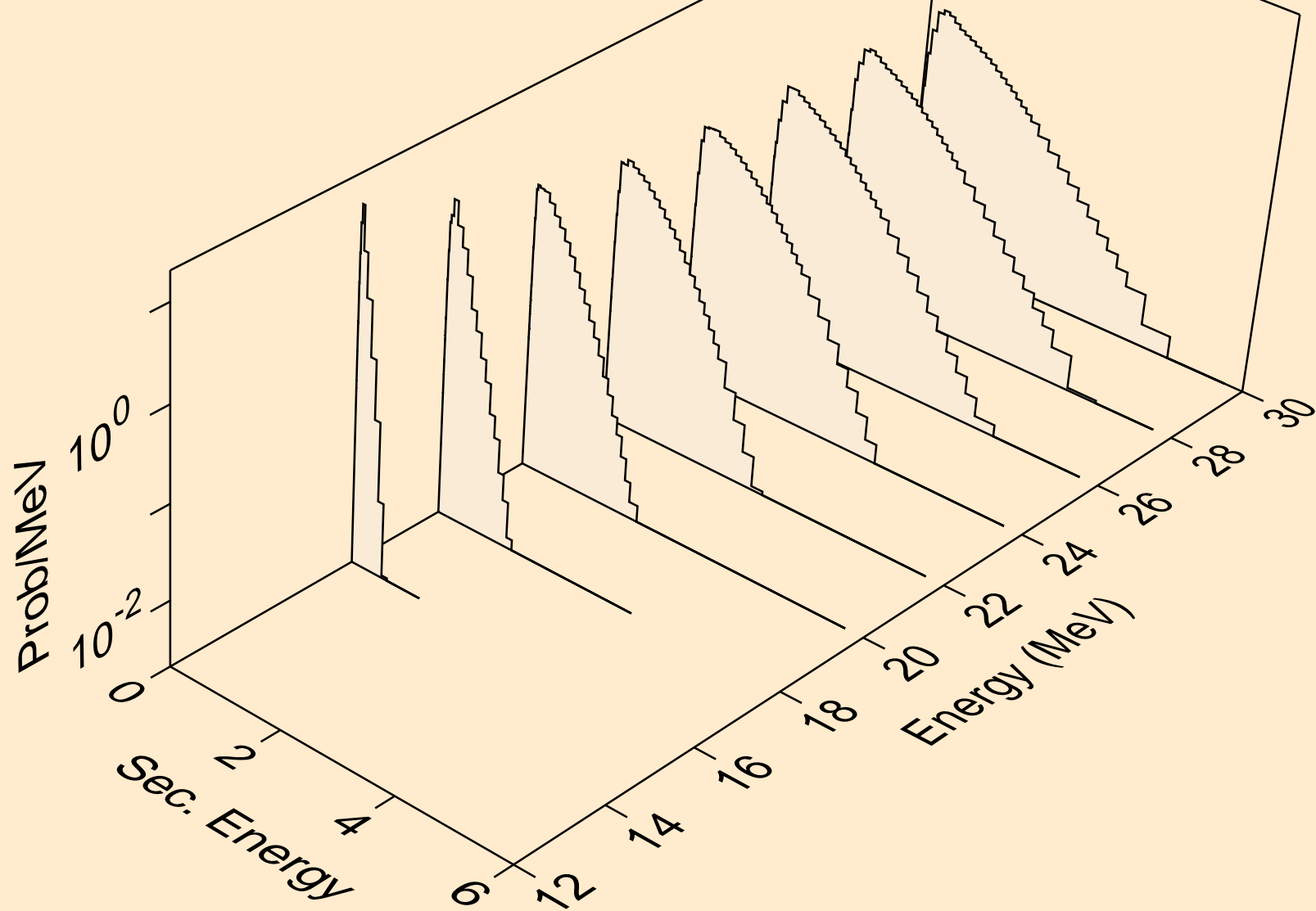

SB116 NEUTRON ACER TENDL-2021 LIBRARY; T=293.6K
Neutron emission for (n,n*)he3

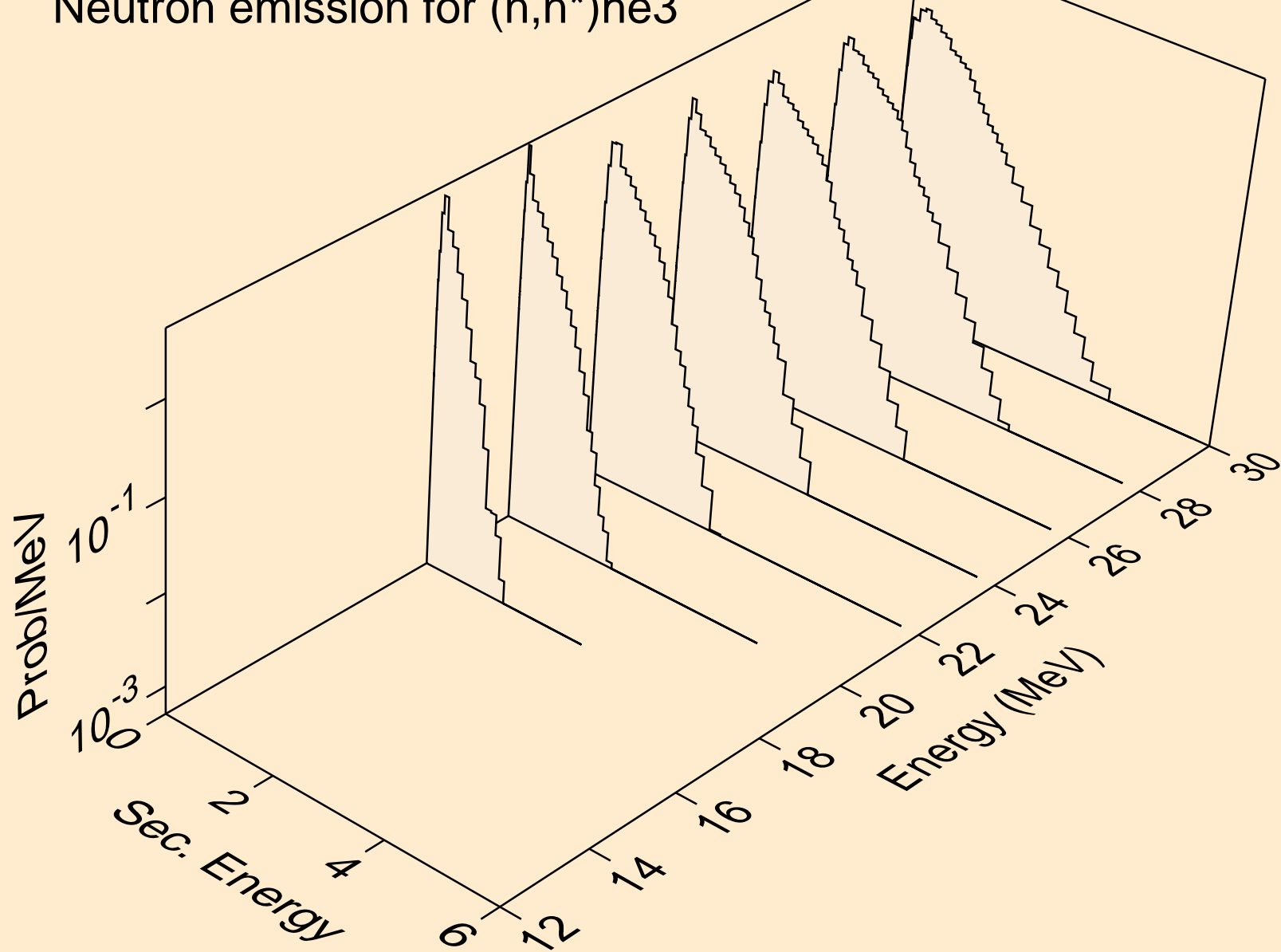

SB116 NEUTRON ACER TENDL-2021 LIBRARY; T=293.6K
Neutron emission for (n,4n)

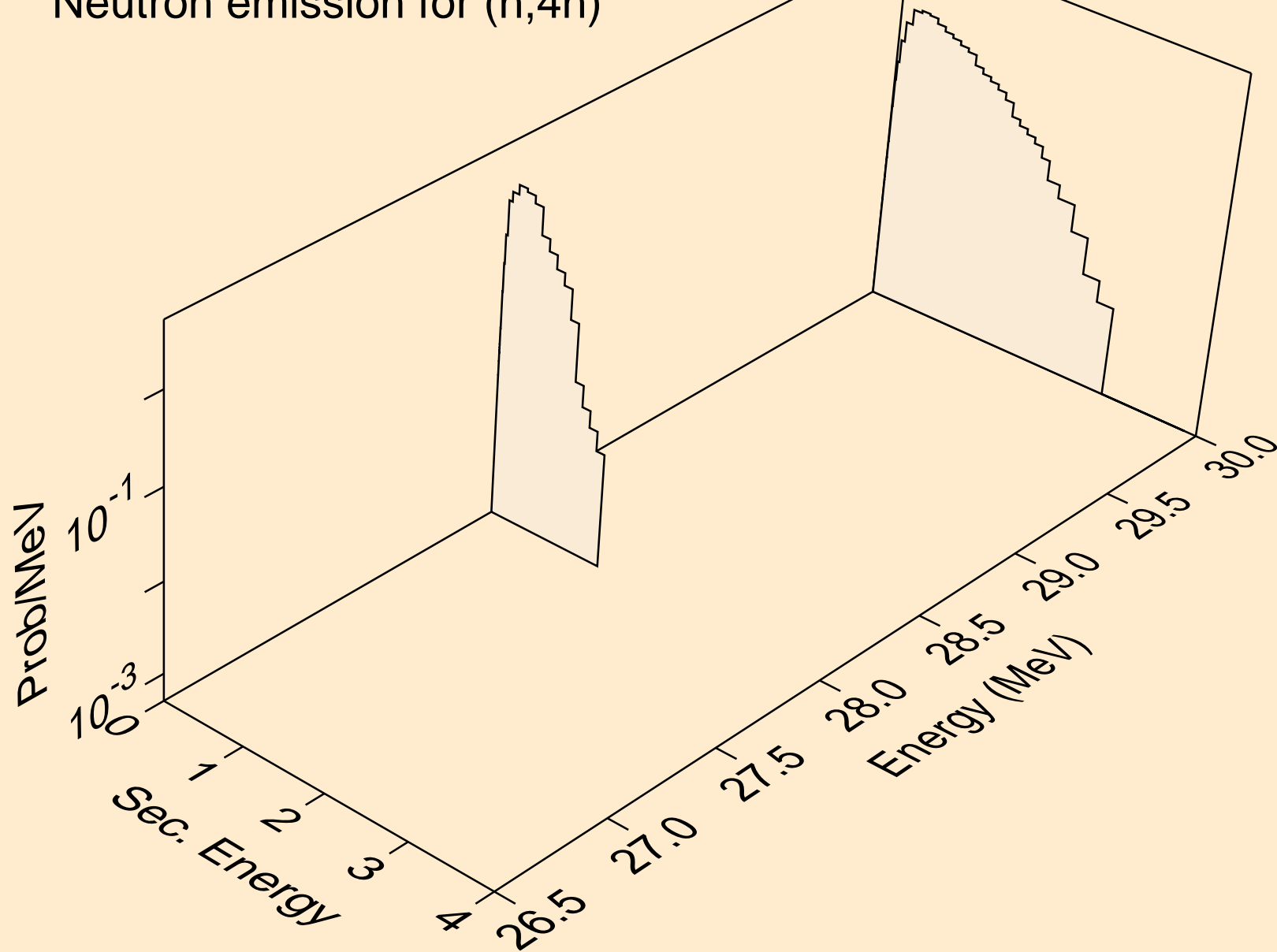

SB116 NEUTRON ACER TENDL-2021 LIBRARY; T=293.6K
Neutron emission for (n,2np)

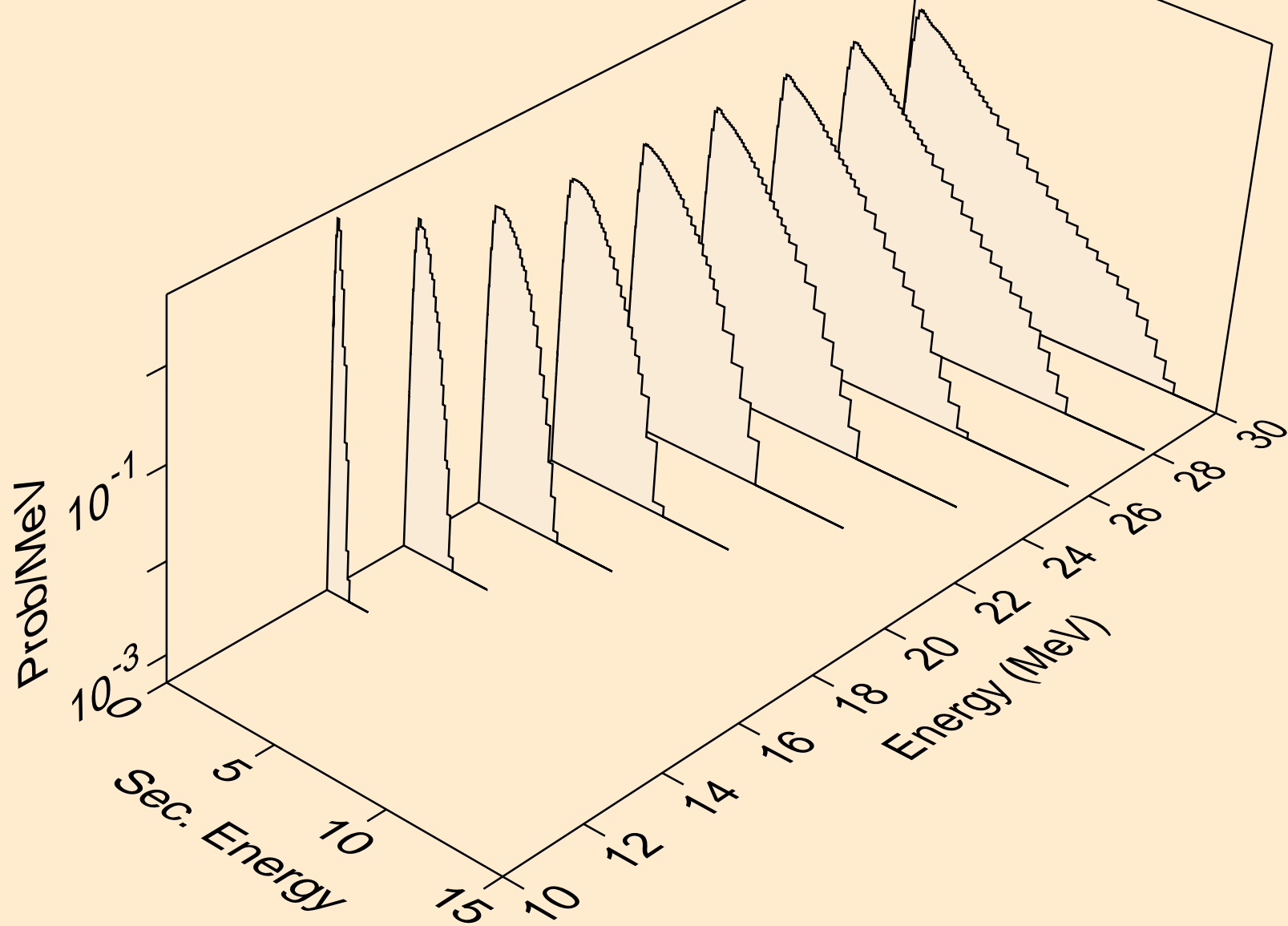

SB116 NEUTRON ACER TENDL-2021 LIBRARY; T=293.6K
Neutron emission for (n,3np)

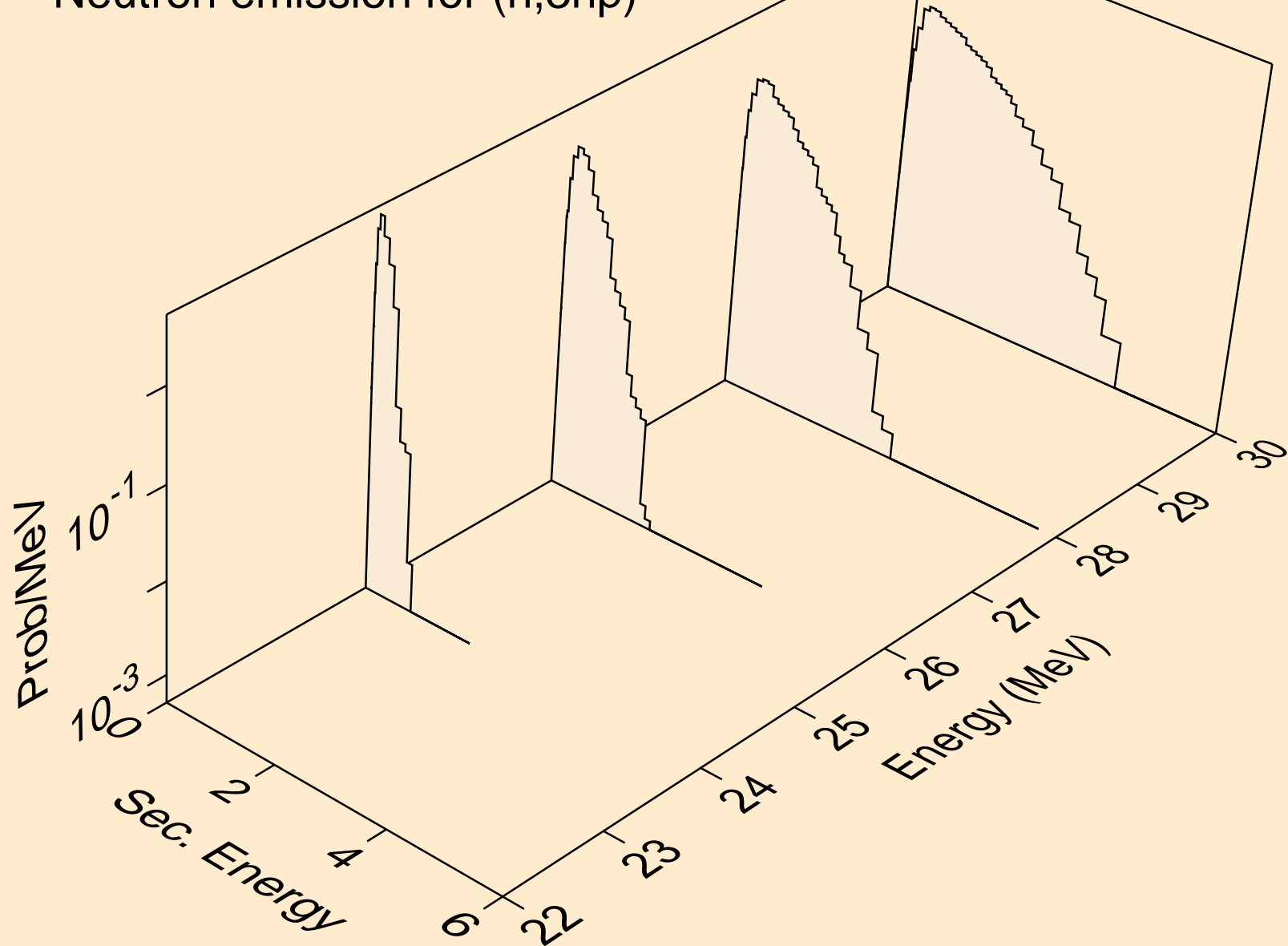

SB116 NEUTRON ACER TENDL-2021 LIBRARY; T=293.6K
Neutron emission for (n,2np)

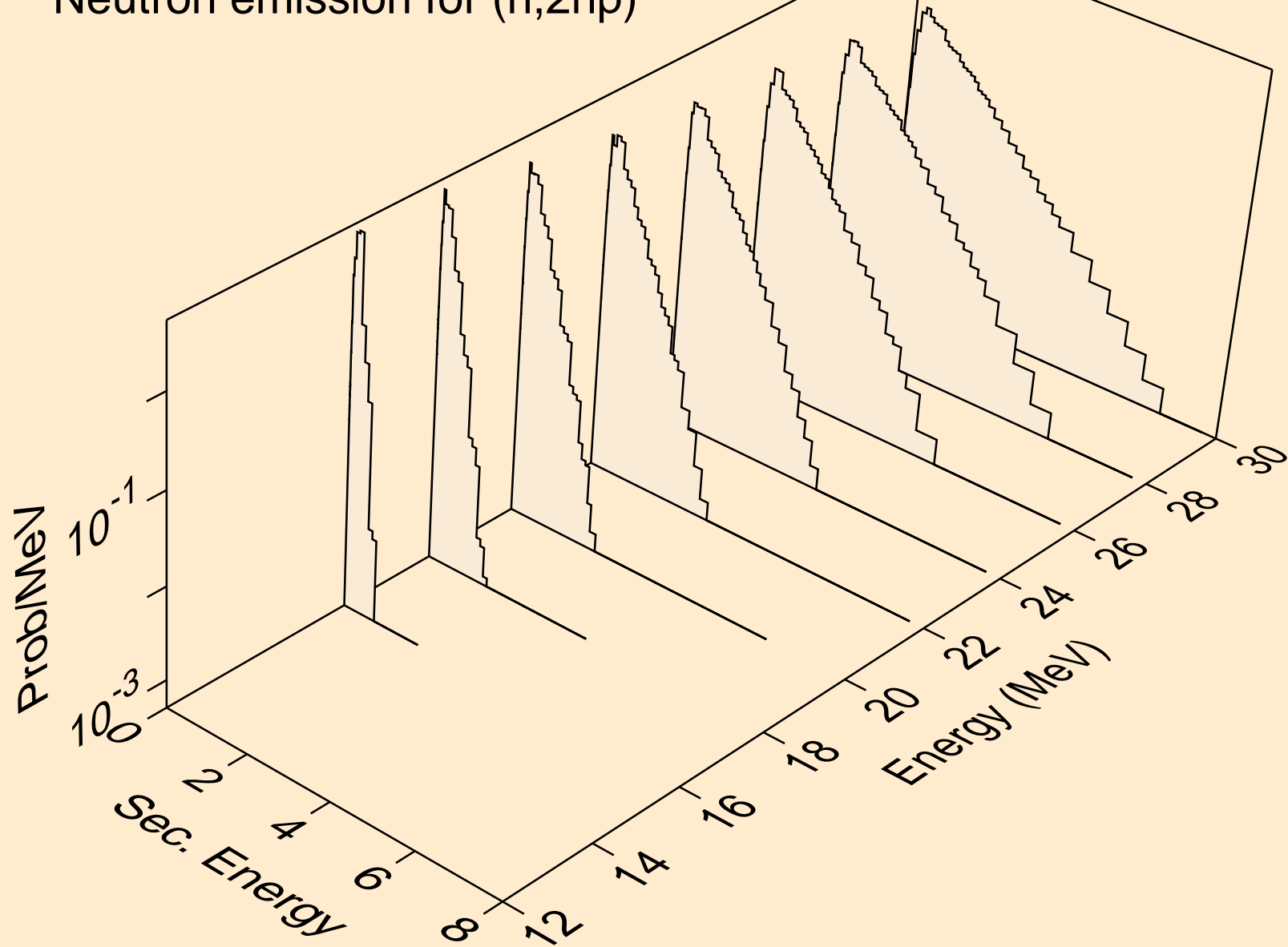

SB116 NEUTRON ACER TENDL-2021 LIBRARY; T=293.6K
Neutron emission for (n,npa)

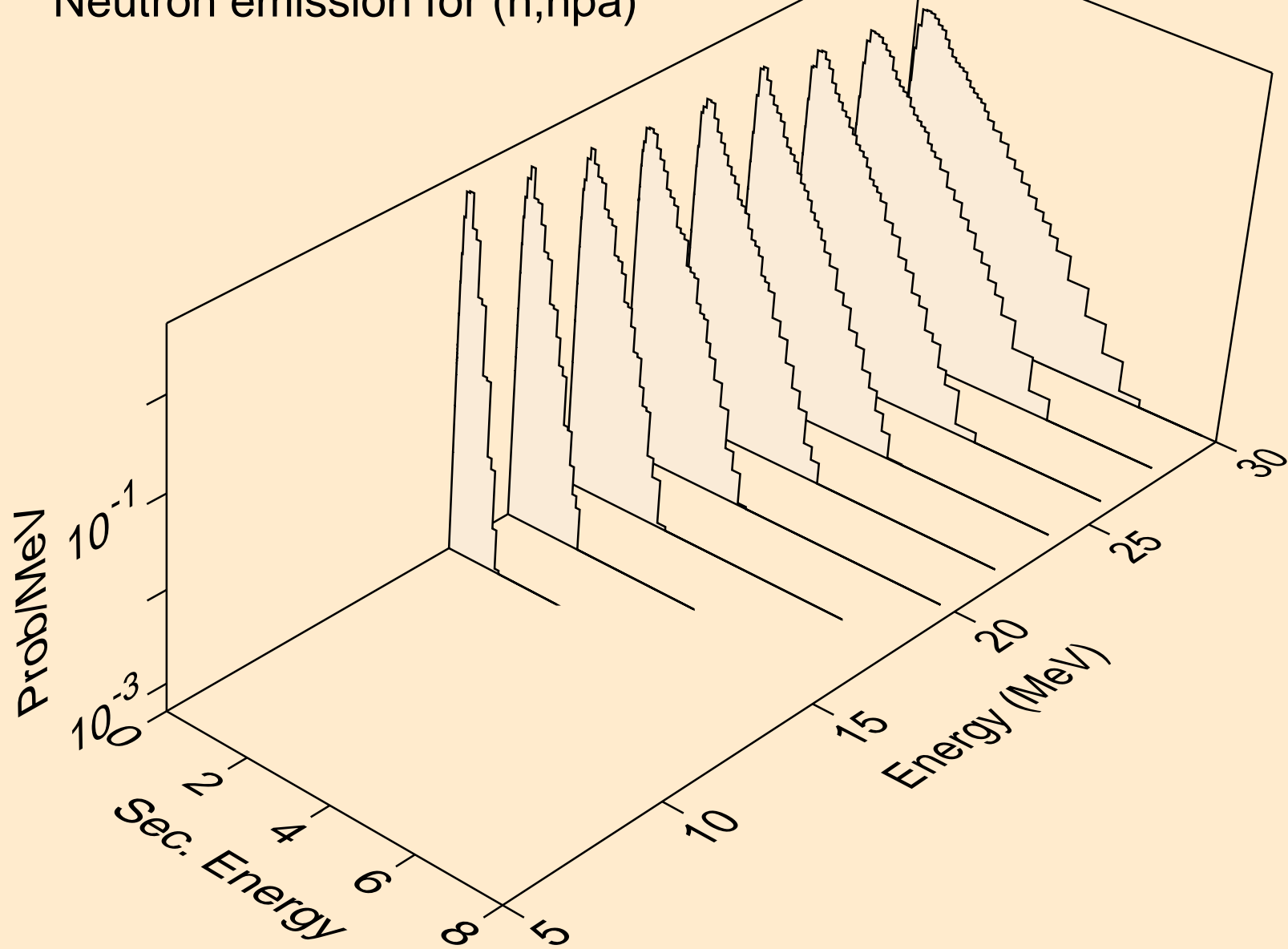

SB116 NEUTRON ACER TENDL-2021 LIBRARY; T=293.6K
Neutron emission for (n,n*c)

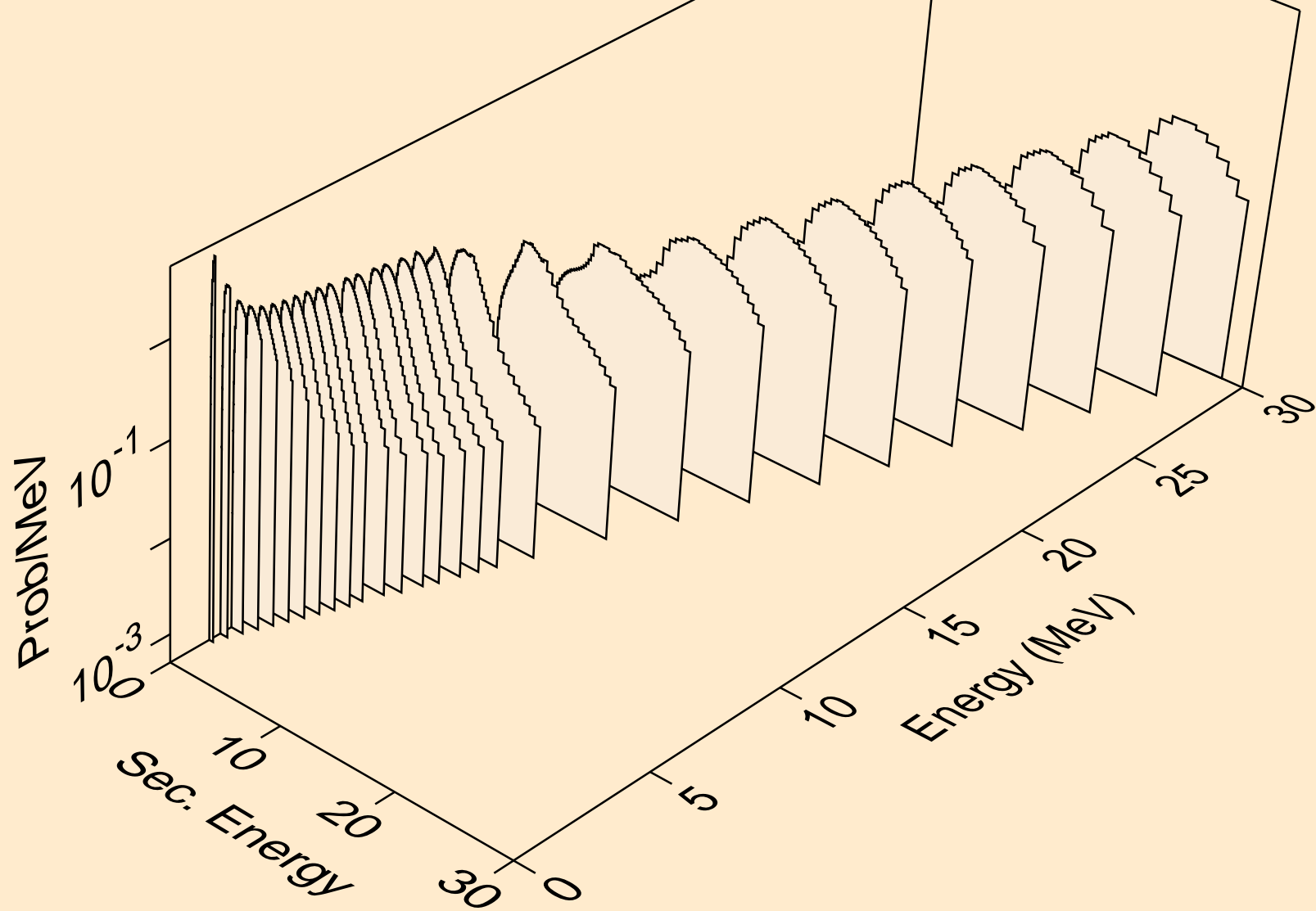

SB116 NEUTRON ACER TENDL-2021 LIBRARY; T=293.6K
Photon emission for (n,x)

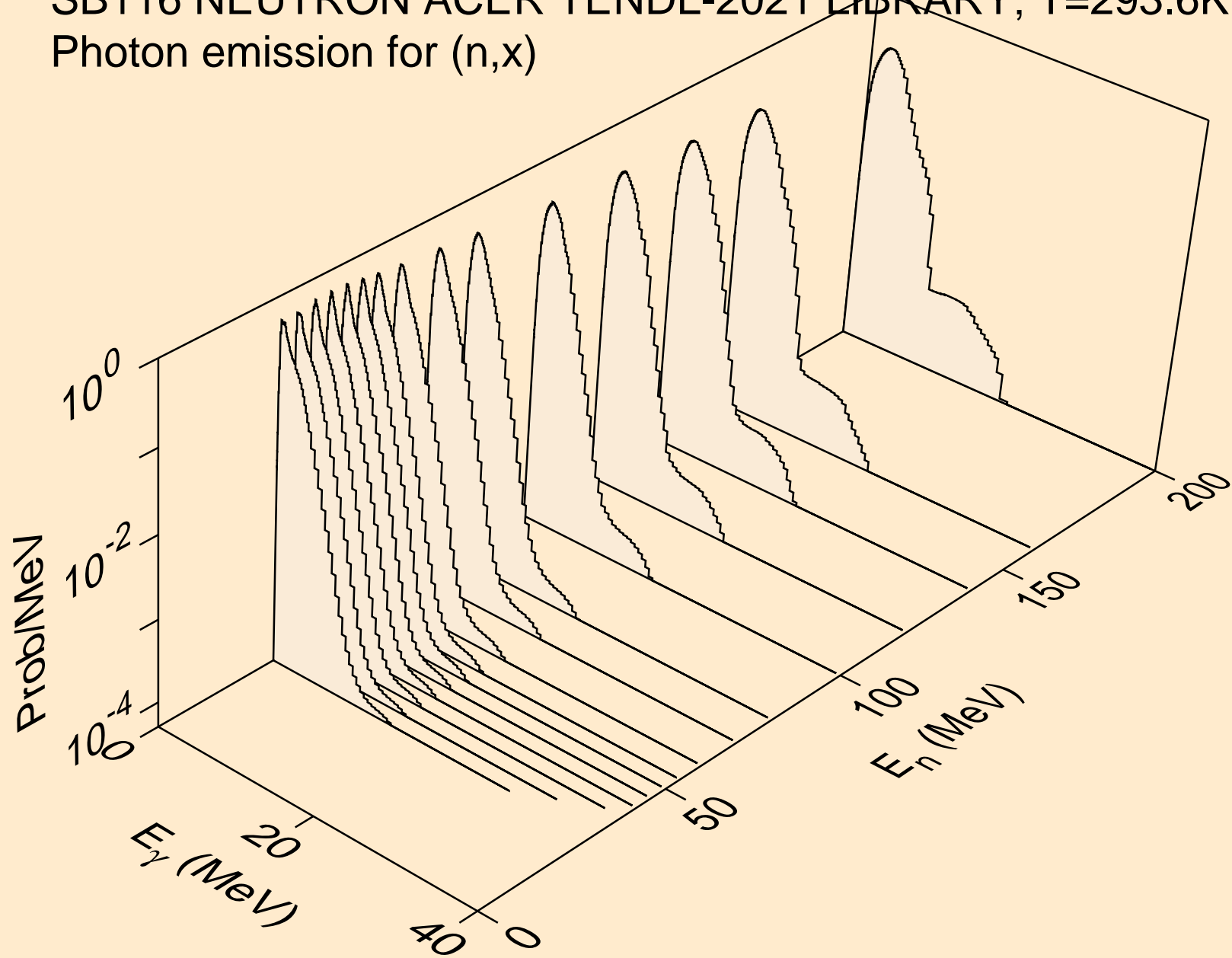

SB116 NEUTRON ACER TENDL-2021 LIBRARY; T=293.6K
Photon emission for (n,2nd)

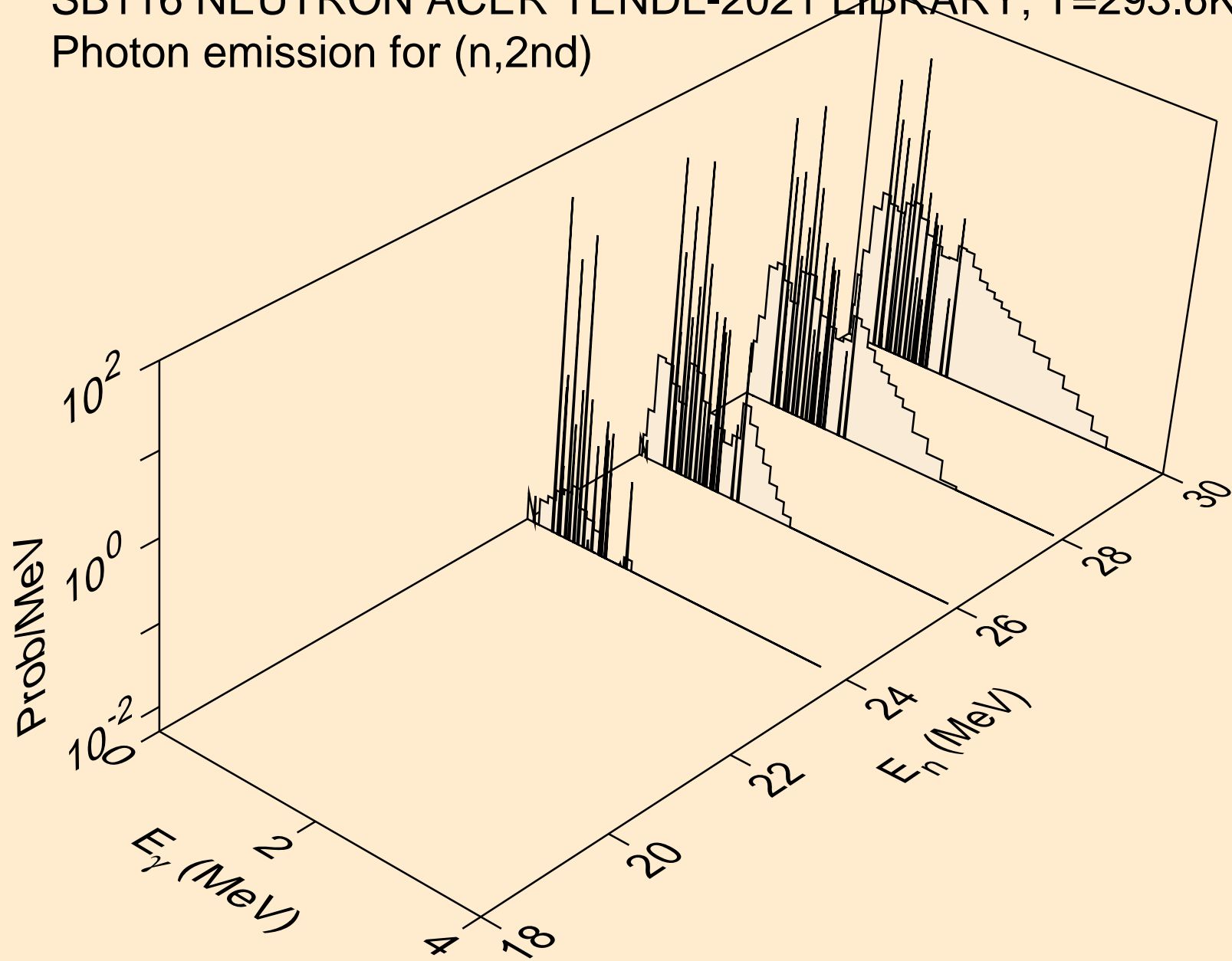

SB116 NEUTRON ACER TENDL-2021 LIBRARY; T=293.6K
Photon emission for (n,2n)

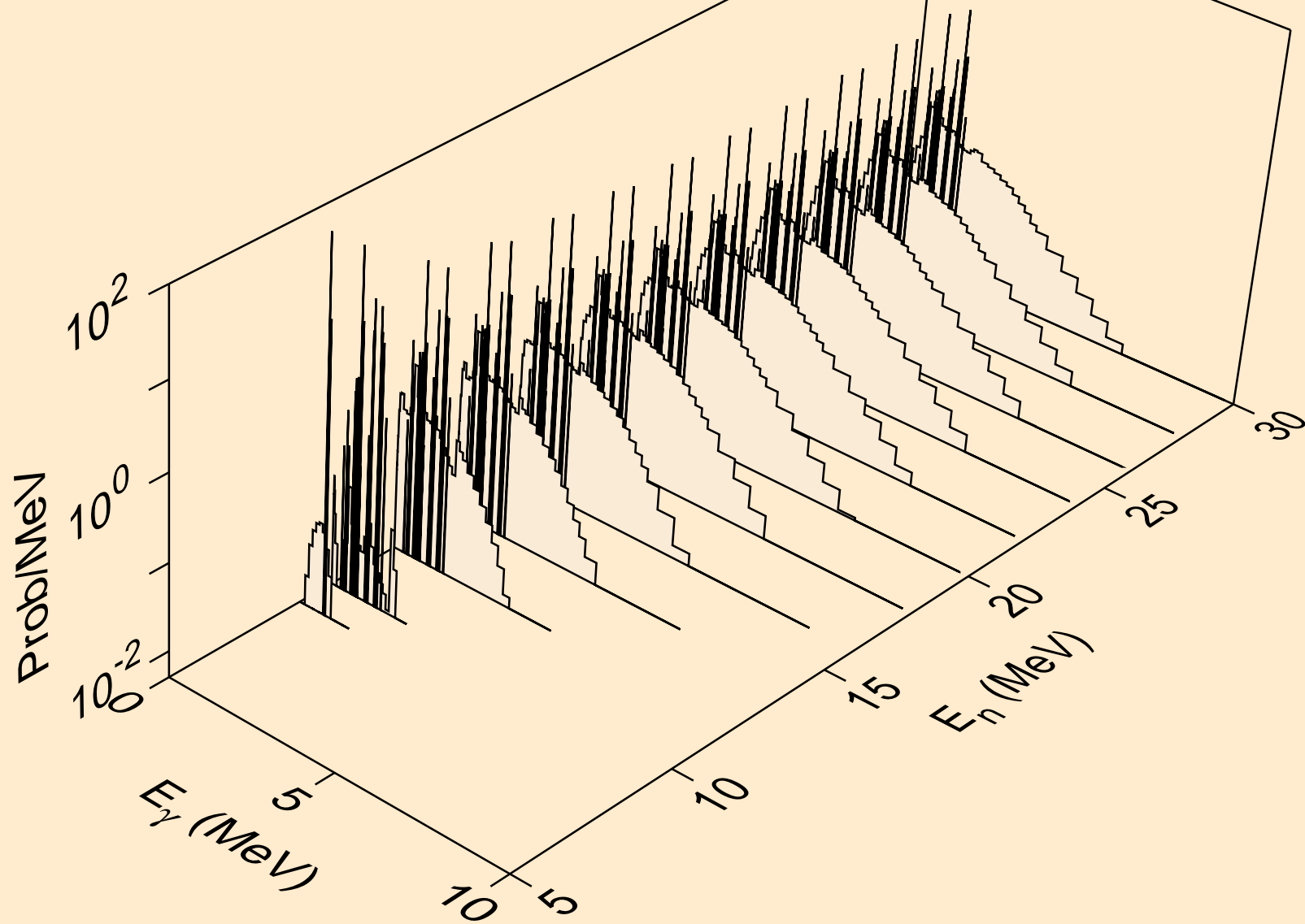

SB116 NEUTRON ACER TENDL-2021 LIBRARY; T=293.6K
Photon emission for (n,3n)

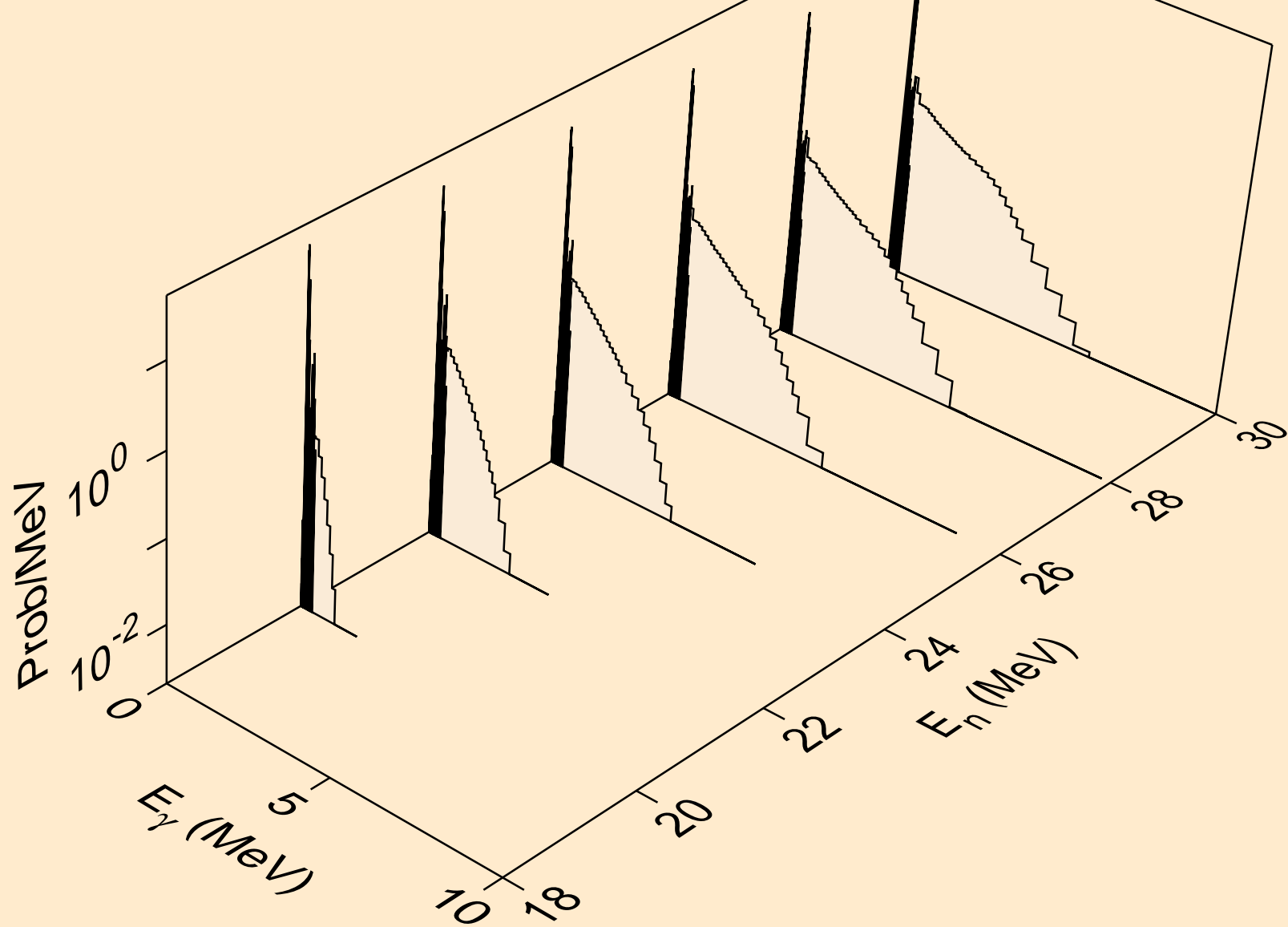

SB116 NEUTRON ACER TENDL-2021 LIBRARY; T=293.6K
Photon emission for (n,n*)a

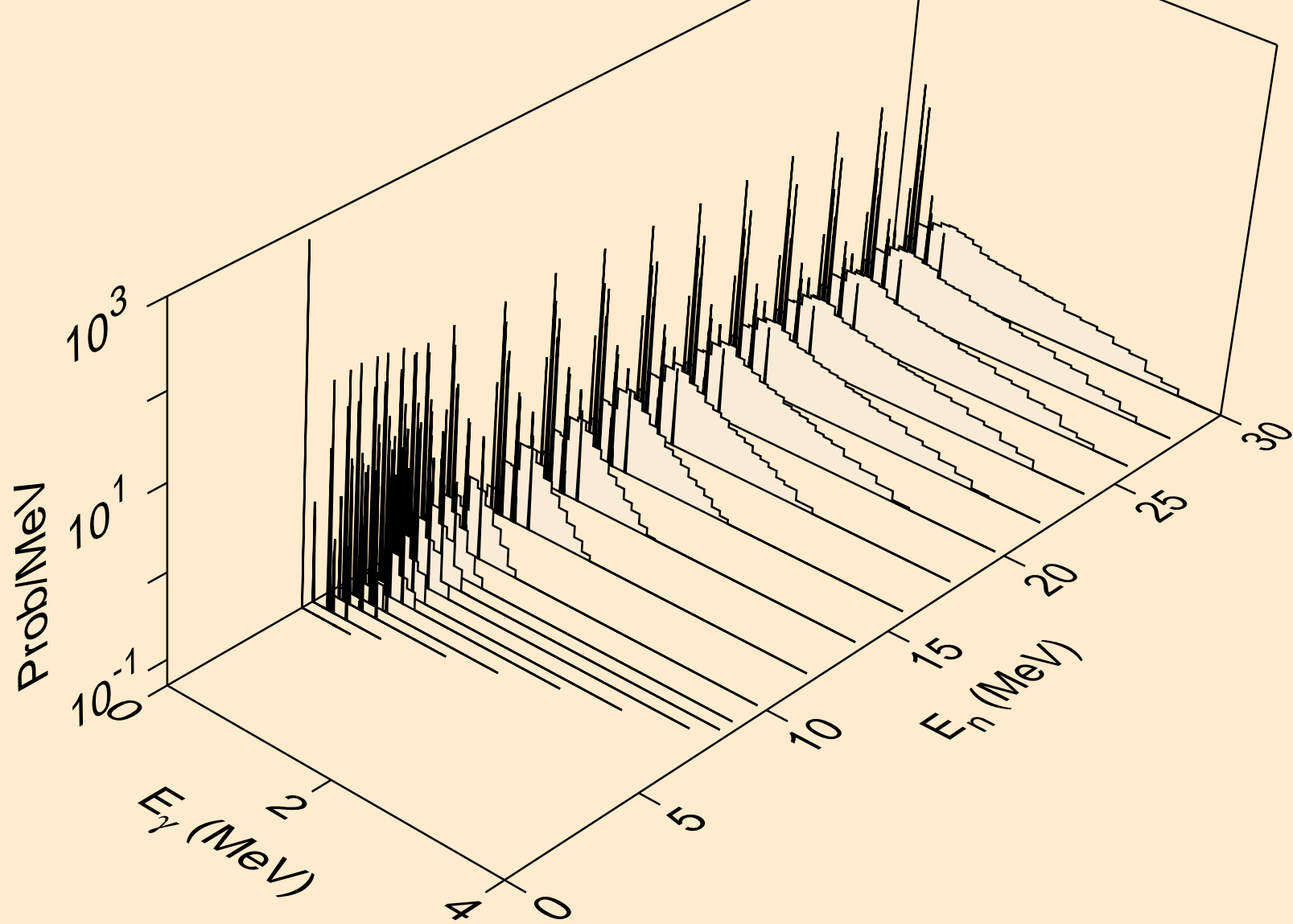

SB116 NEUTRON ACER TENDL-2021 LIBRARY; T=293.6K
Photon emission for (n,2n)a

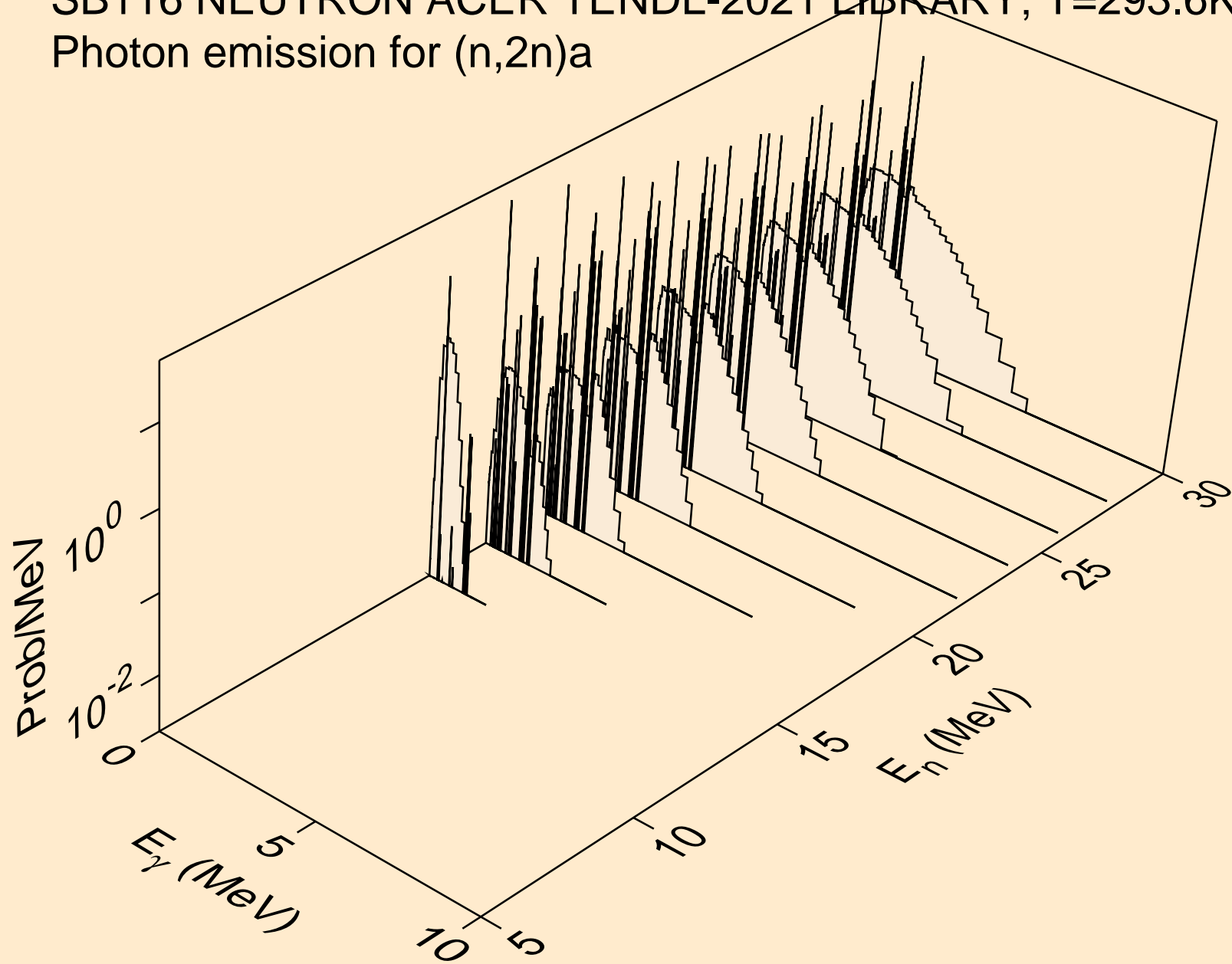

SB116 NEUTRON ACER TENDL-2021 LIBRARY; T=293.6K
Photon emission for (n,3n)a

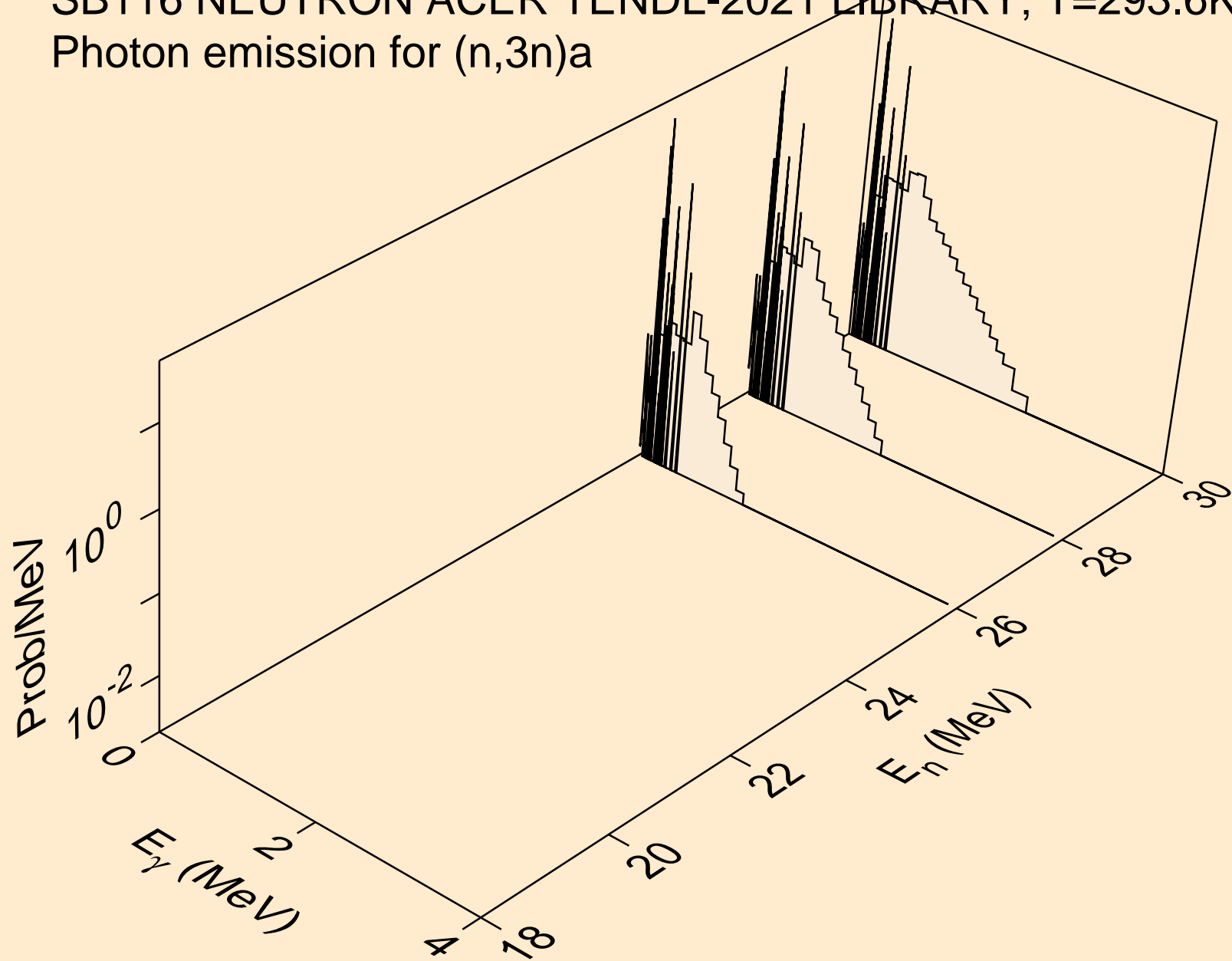

SB116 NEUTRON ACER TENDL-2021 LIBRARY; T=293.6K
Photon emission for (n,n*)p

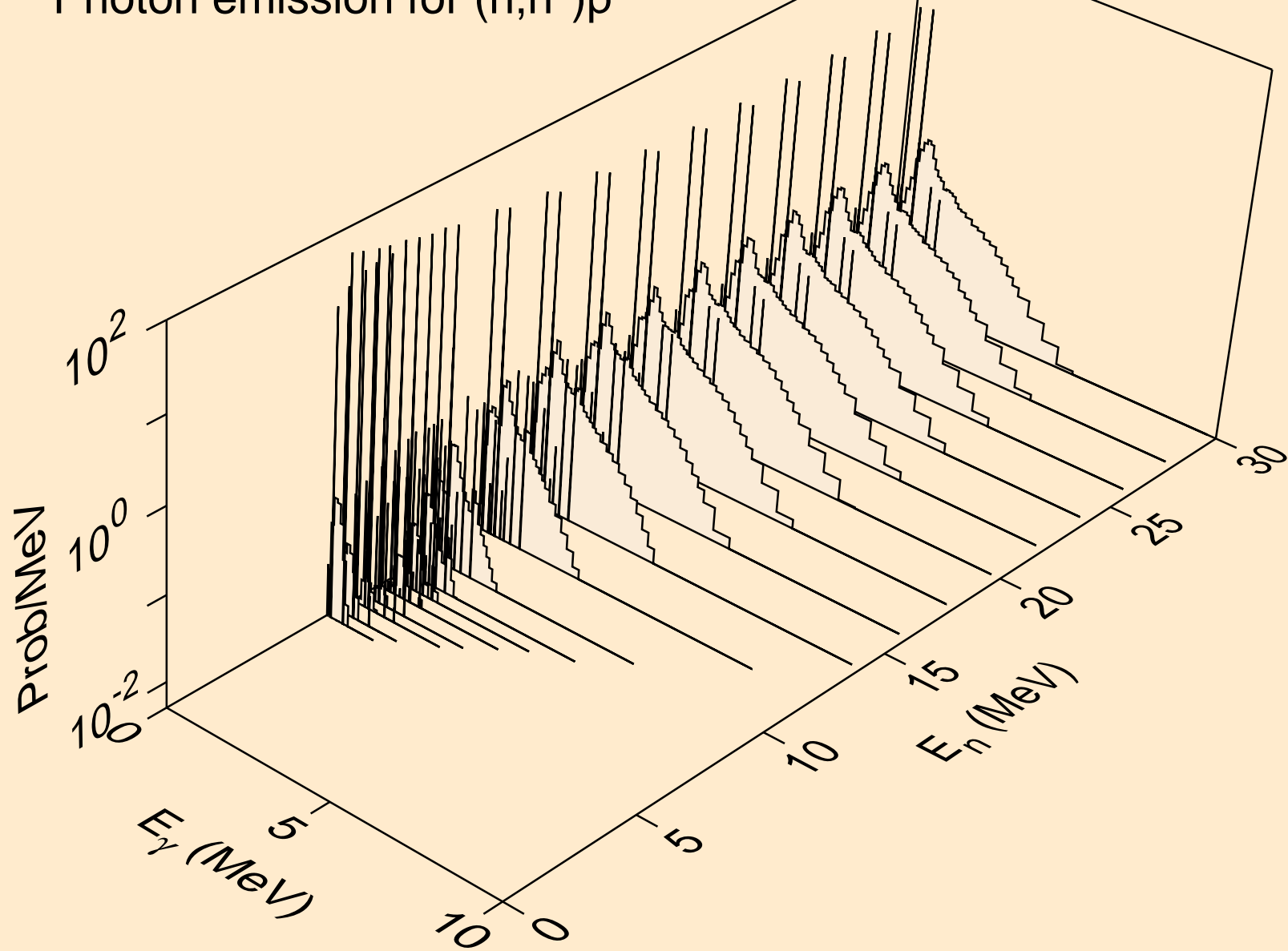

SB116 NEUTRON ACER TENDL-2021 LIBRARY; T=293.6K
Photon emission for (n,n*)2a

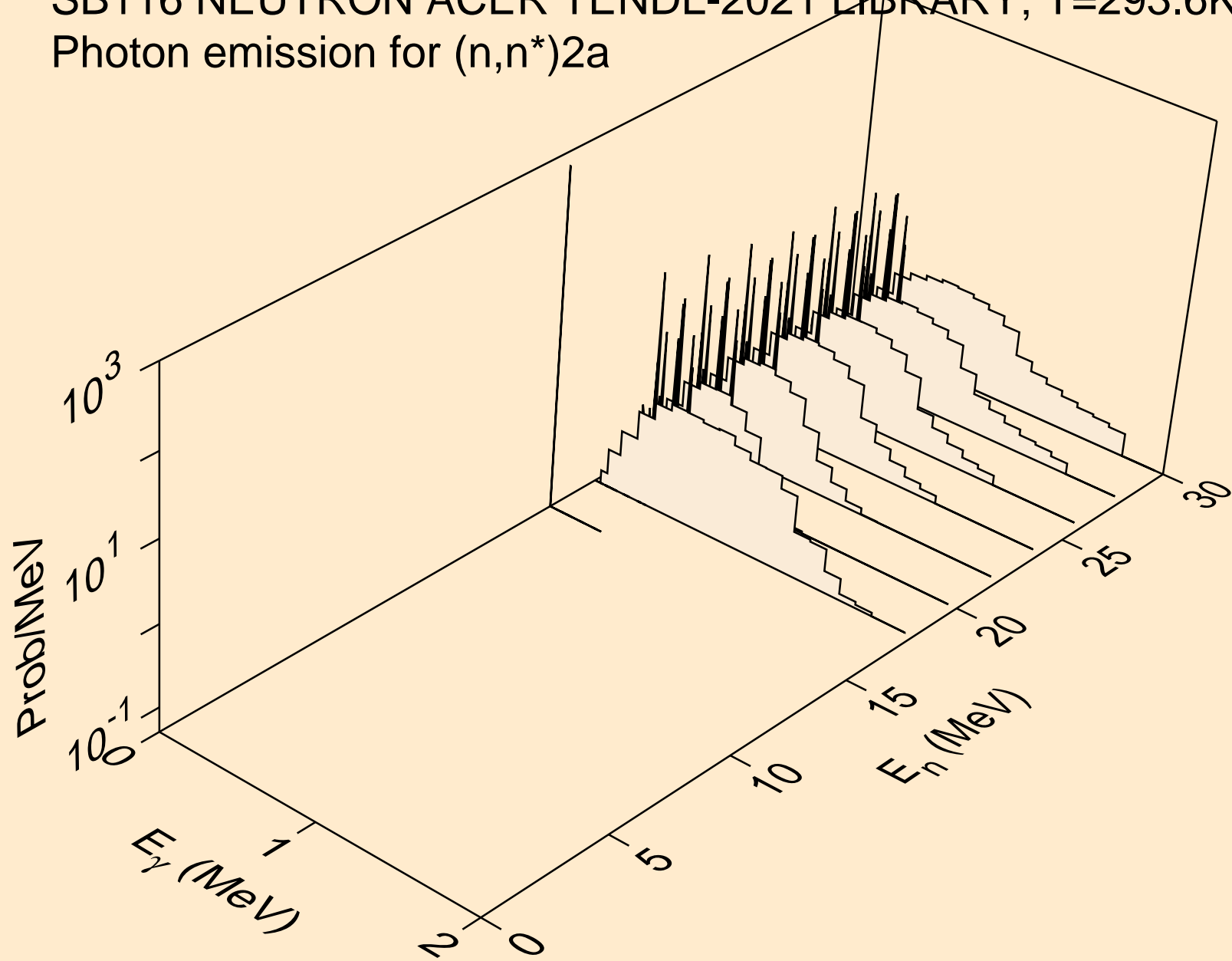

SB116 NEUTRON ACER TENDL-2021 LIBRARY; T=293.6K
Photon emission for (n,n*)d

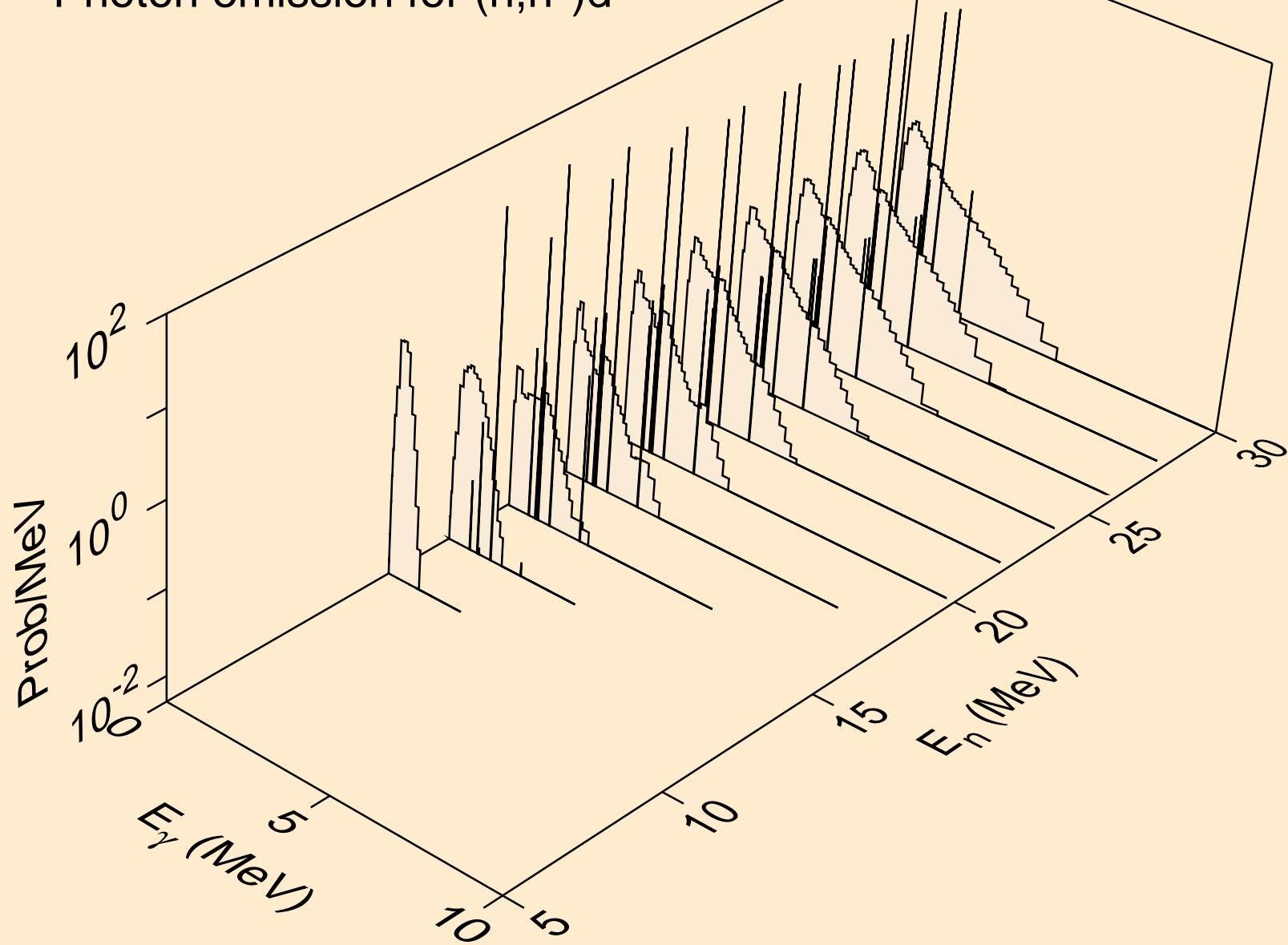

SB116 NEUTRON ACER TENDL-2021 LIBRARY; T=293.6K
Photon emission for (n,n*)t

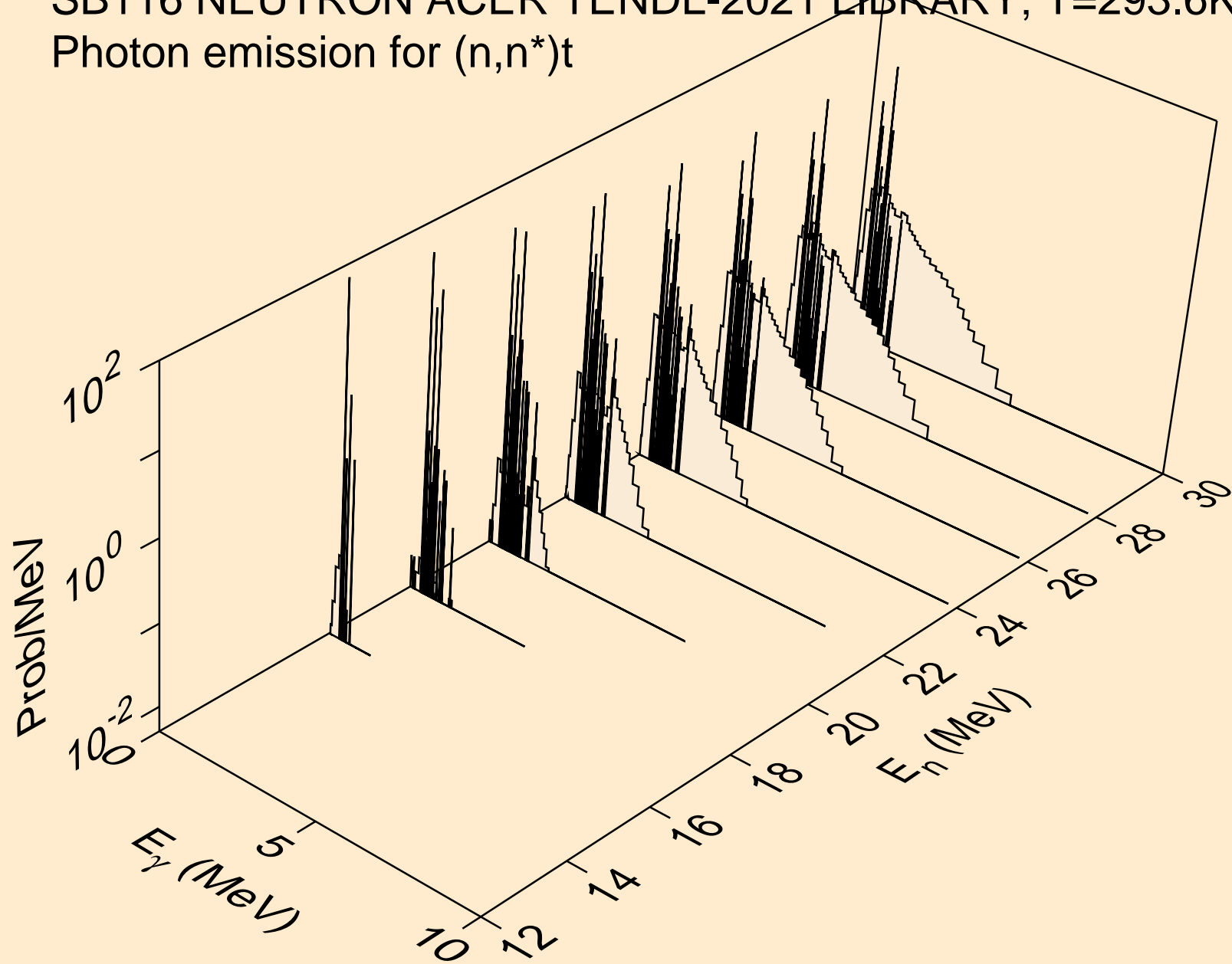

SB116 NEUTRON ACER TENDL-2021 LIBRARY; T=293.6K
Photon emission for (n,n*)he3

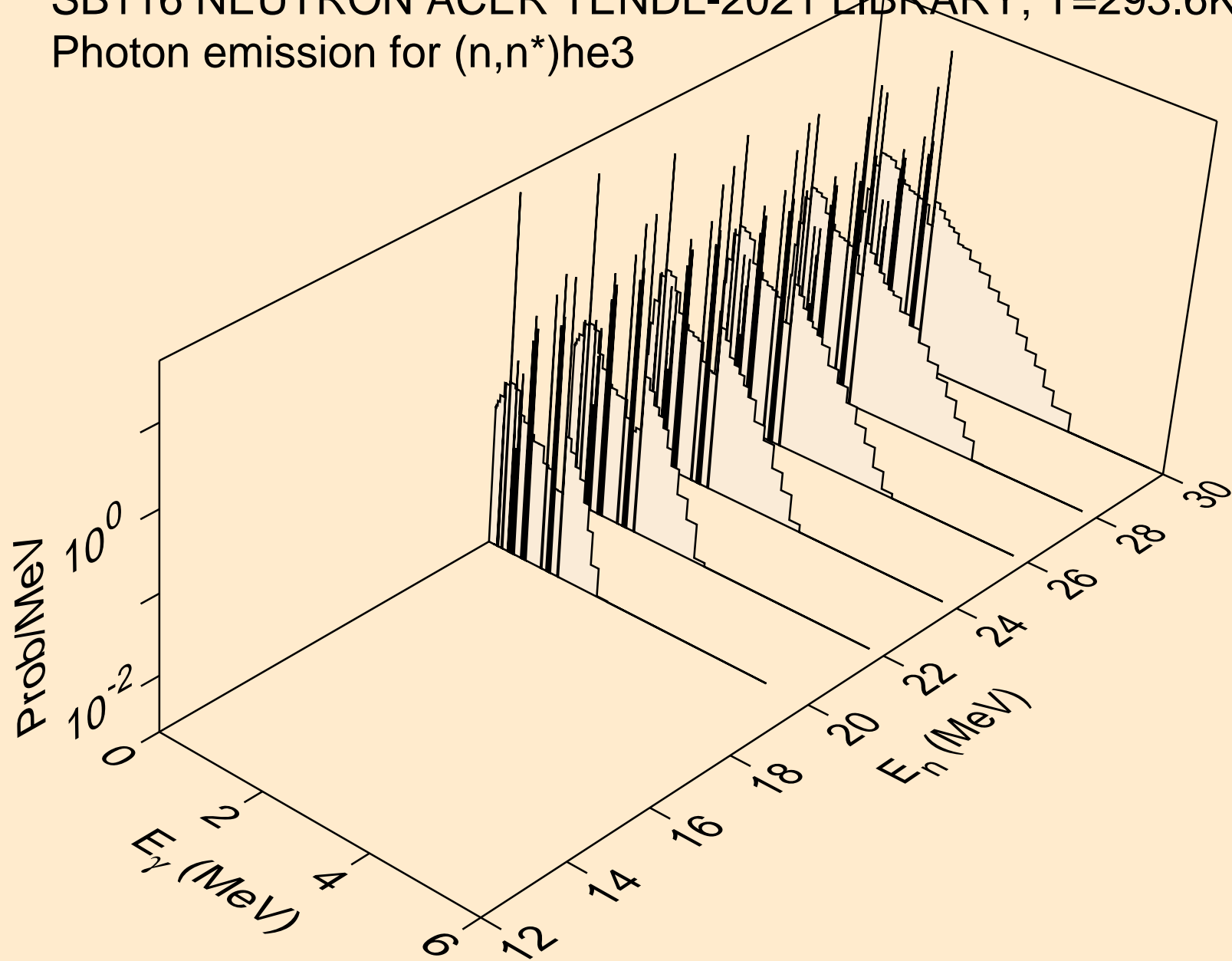

SB116 NEUTRON ACER TENDL-2021 LIBRARY; T=293.6K
Photon emission for (n,4n)

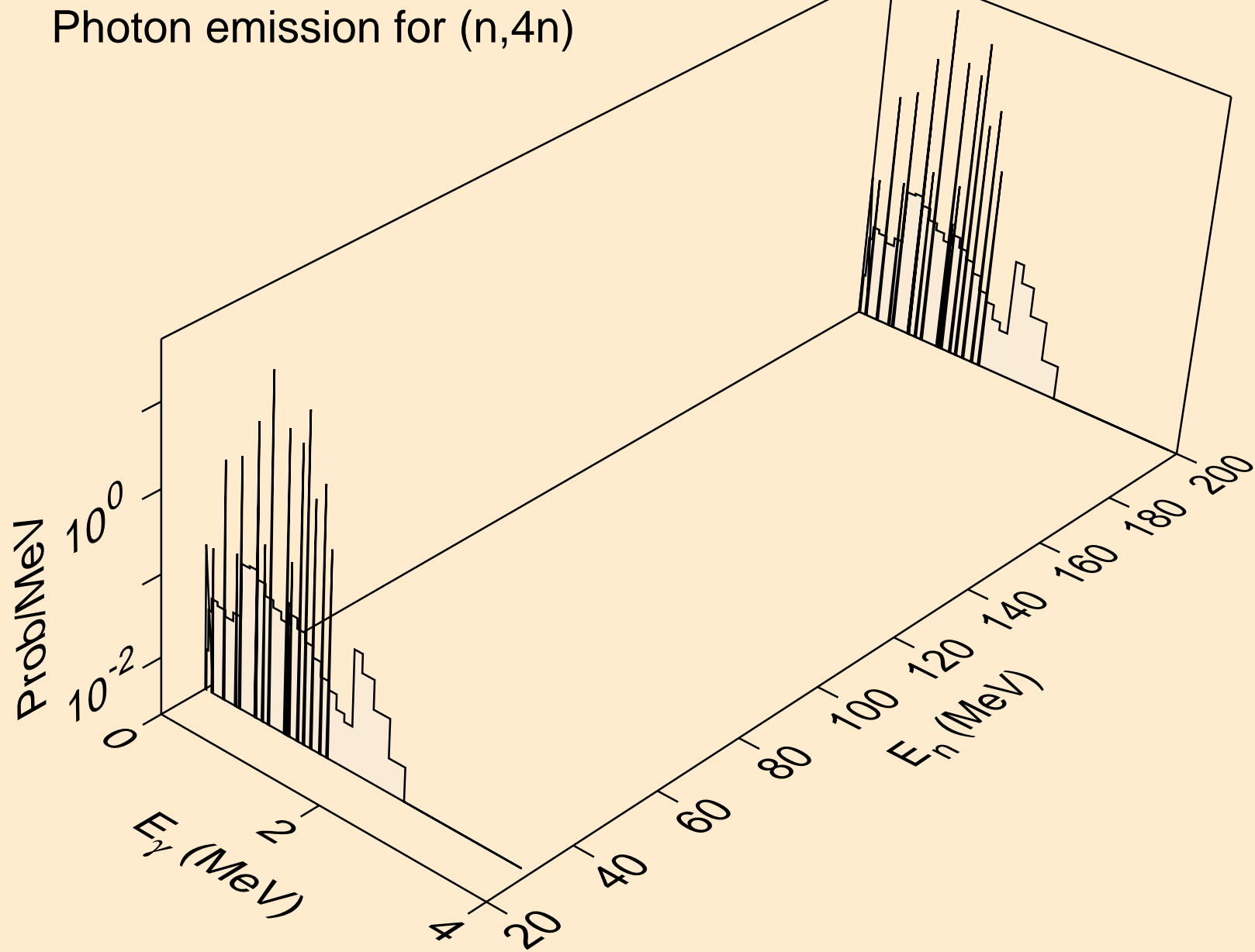

SB116 NEUTRON ACER TENDL-2021 LIBRARY; T=293.6K
Photon emission for (n,2np)

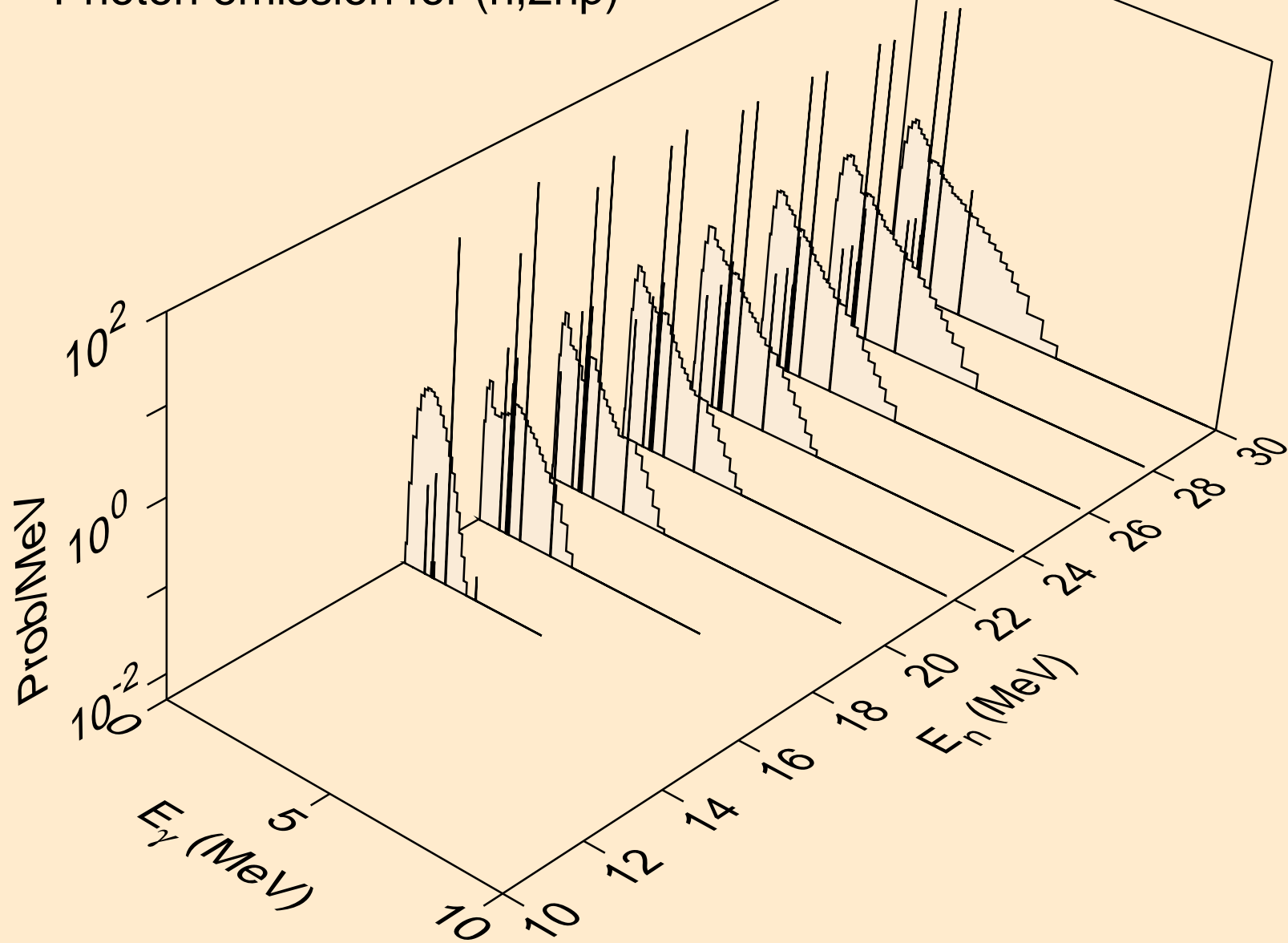

SB116 NEUTRON ACER TENDL-2021 LIBRARY; T=293.6K
Photon emission for (n,3np)

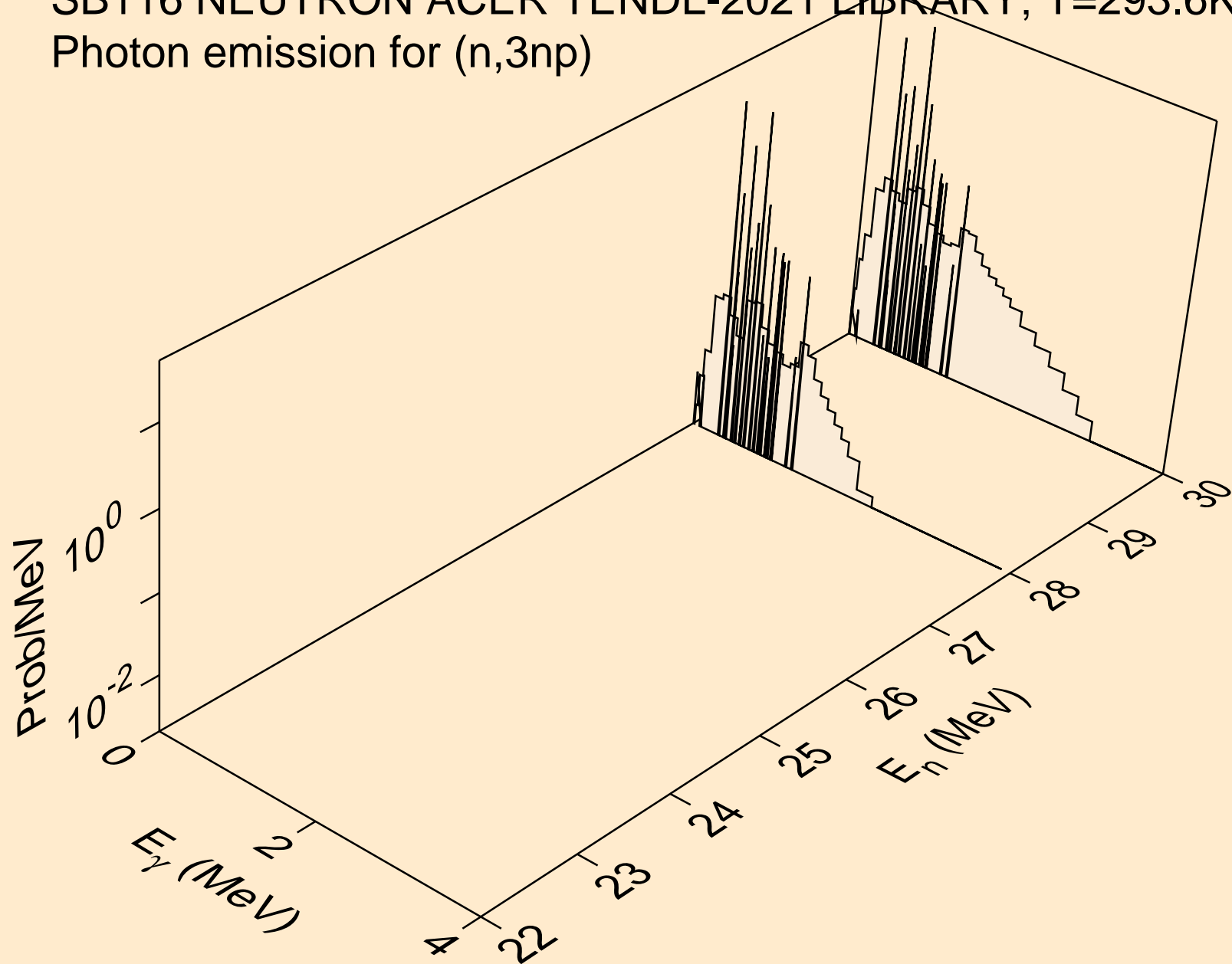

SB116 NEUTRON ACER TENDL-2021 LIBRARY; T=293.6K
Photon emission for (n,2np)

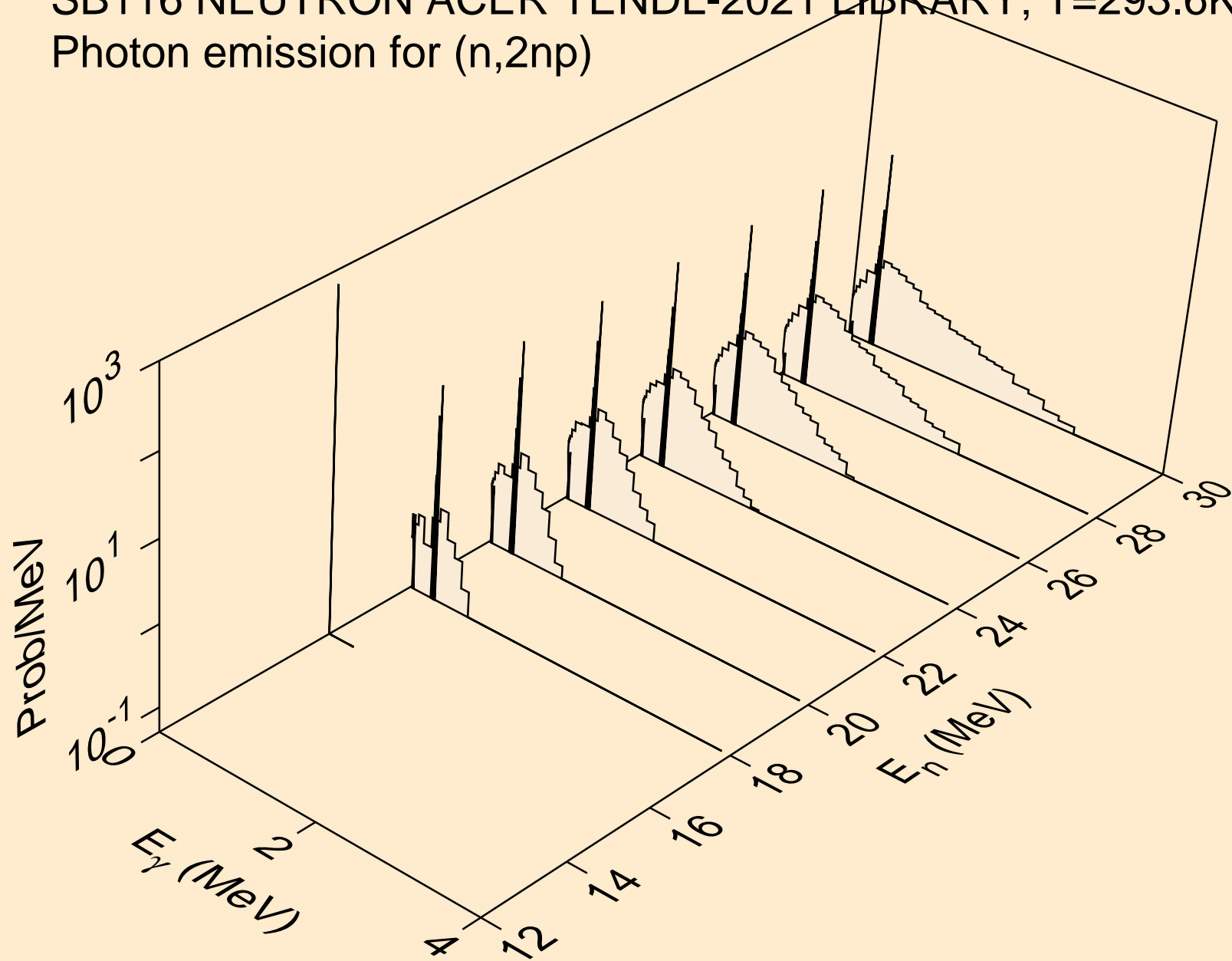

SB116 NEUTRON ACER TENDL-2021 LIBRARY; T=293.6K
Photon emission for (n,npa)

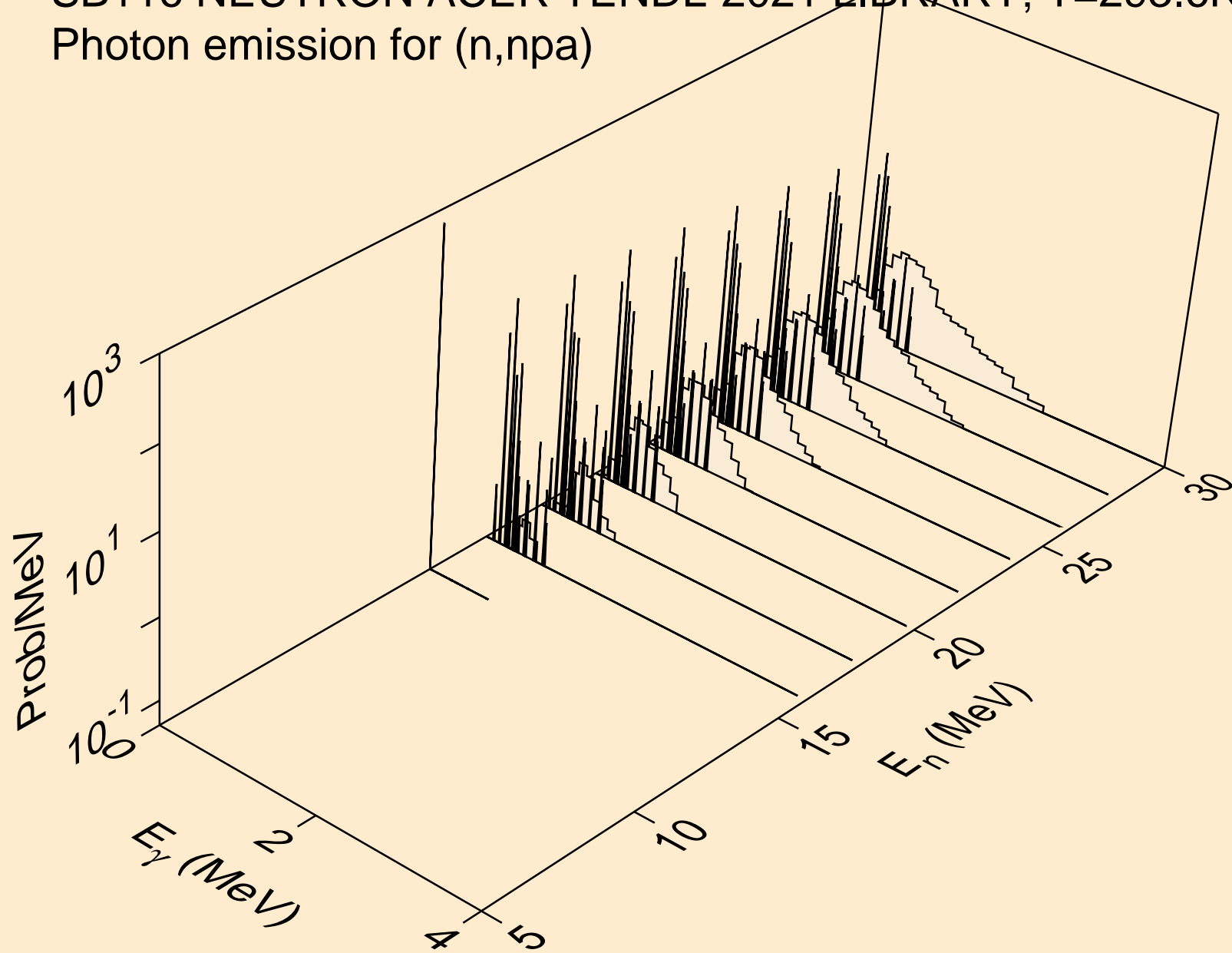

SB116 NEUTRON ACER TENDL-2021 LIBRARY; T=293.6K
Photon emission for (n,n*c)

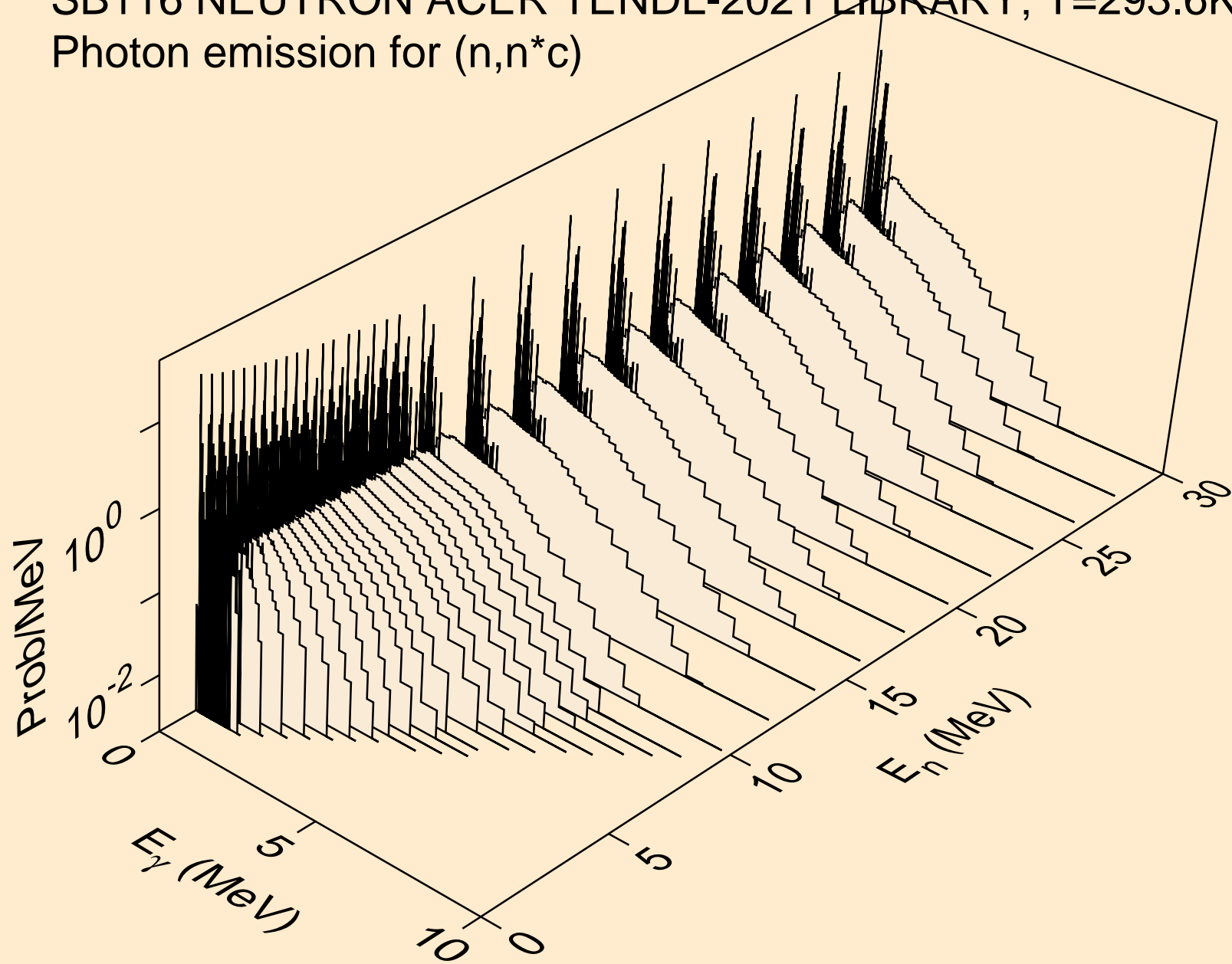

SB116 NEUTRON ACER TENDL-2021 LIBRARY; T=293.6K
Photon emission for (n,gma)

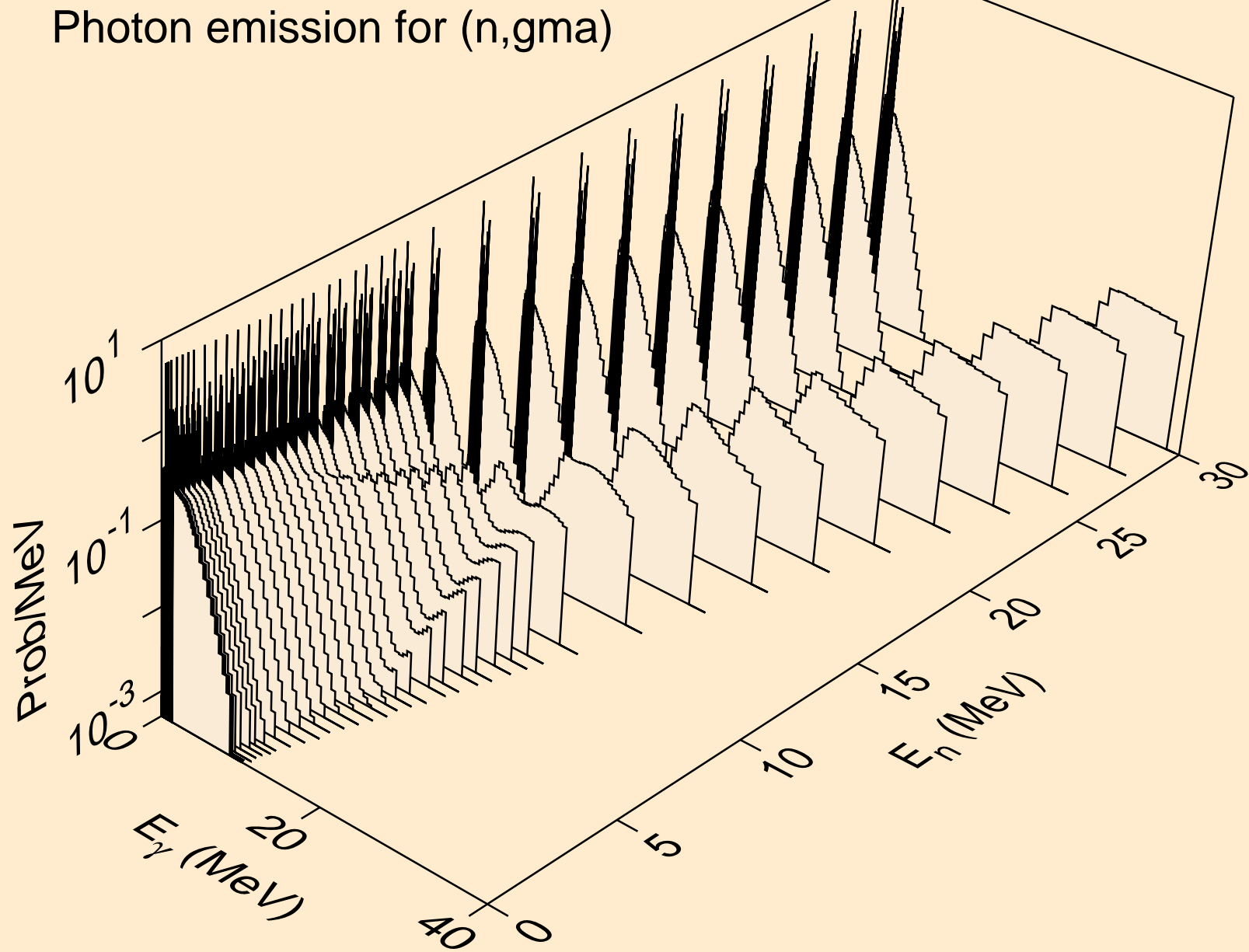

SB116 NEUTRON ACER TENDL-2021 LIBRARY; T=293.6K
Photon emission for (n,p)

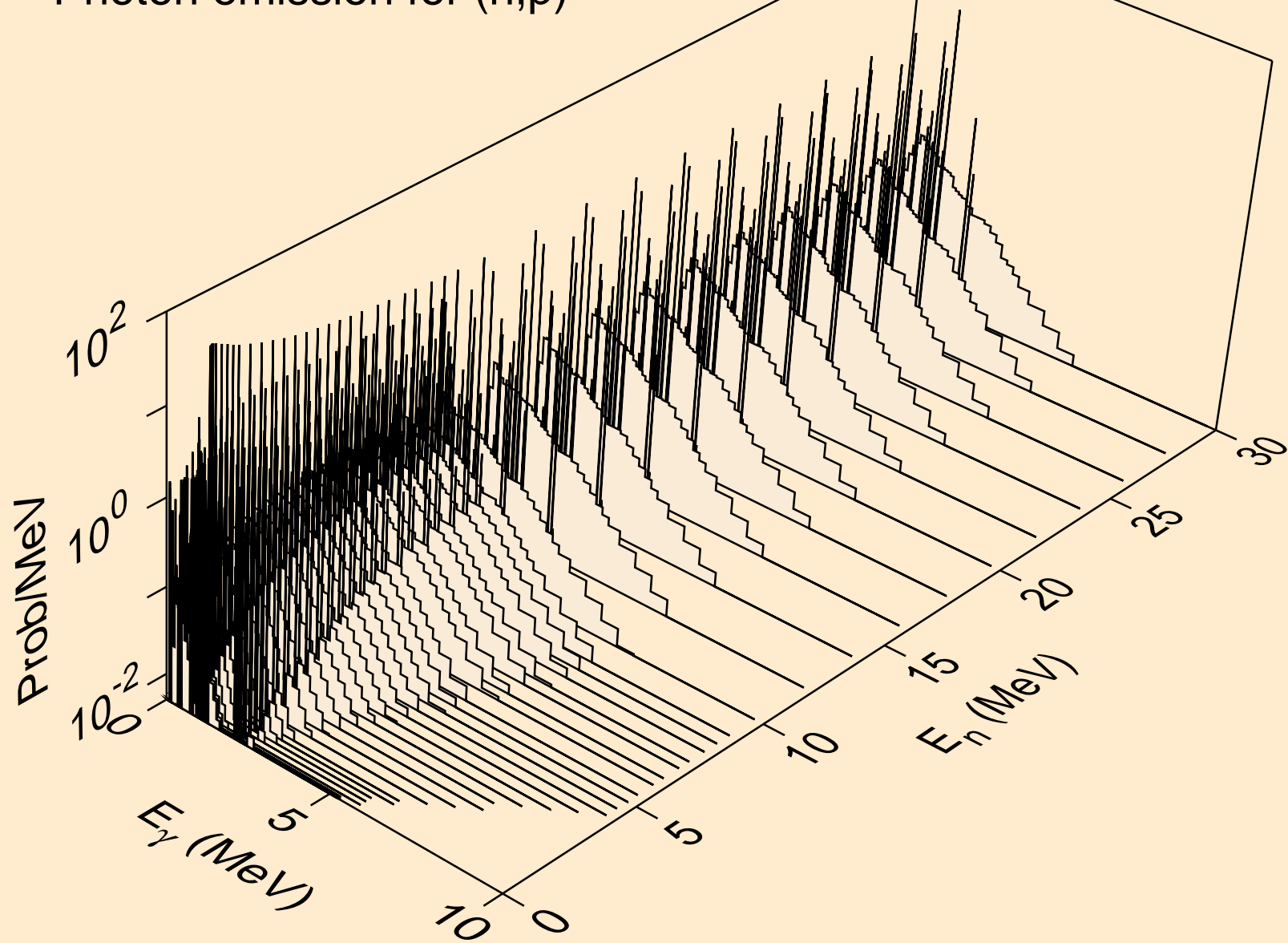

SB116 NEUTRON ACER TENDL-2021 LIBRARY; T=293.6K
Photon emission for (n,d)

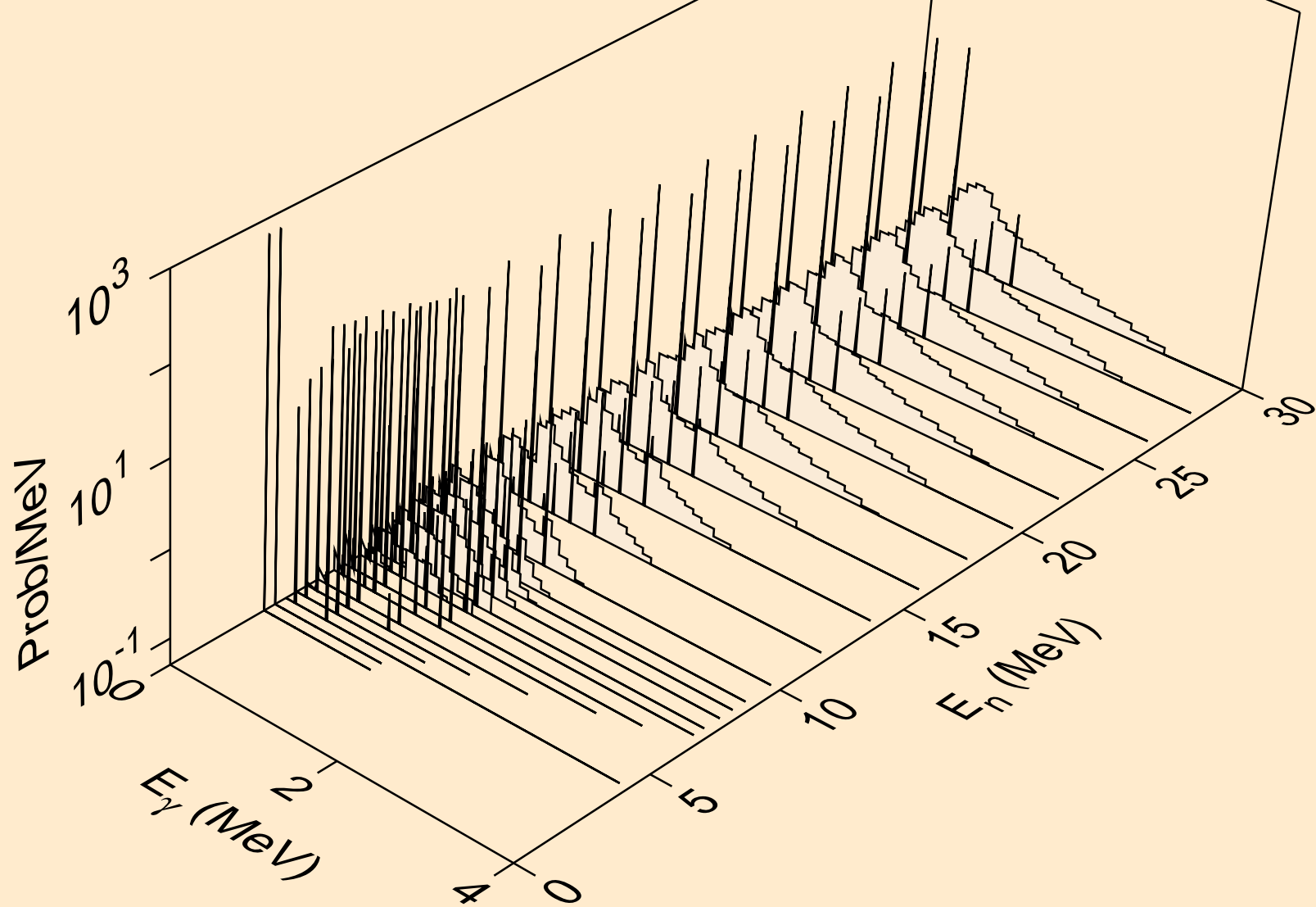

SB116 NEUTRON ACER TENDL-2021 LIBRARY; T=293.6K
Photon emission for (n,t)

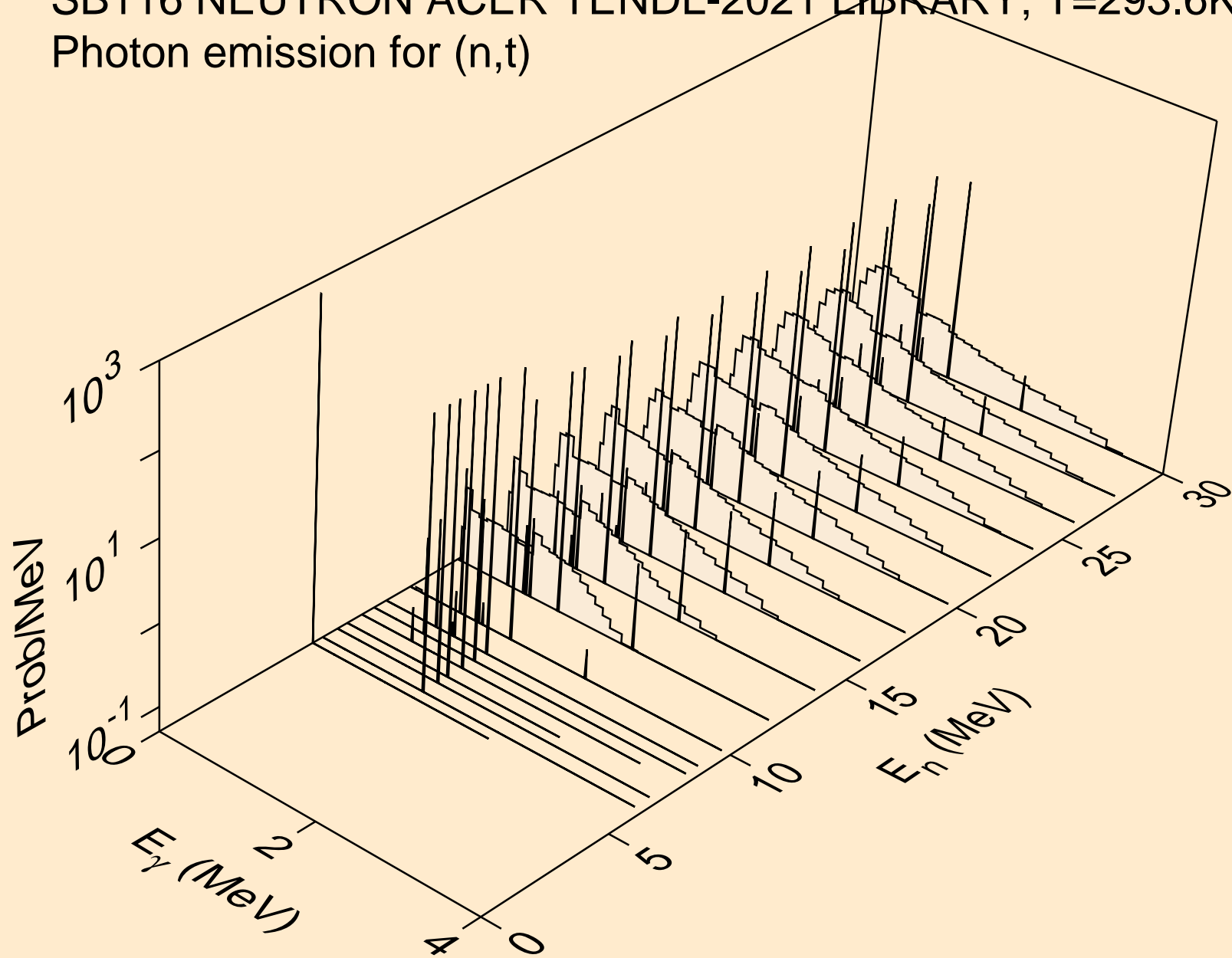

SB116 NEUTRON ACER TENDL-2021 LIBRARY; T=293.6K
Photon emission for (n,he3)

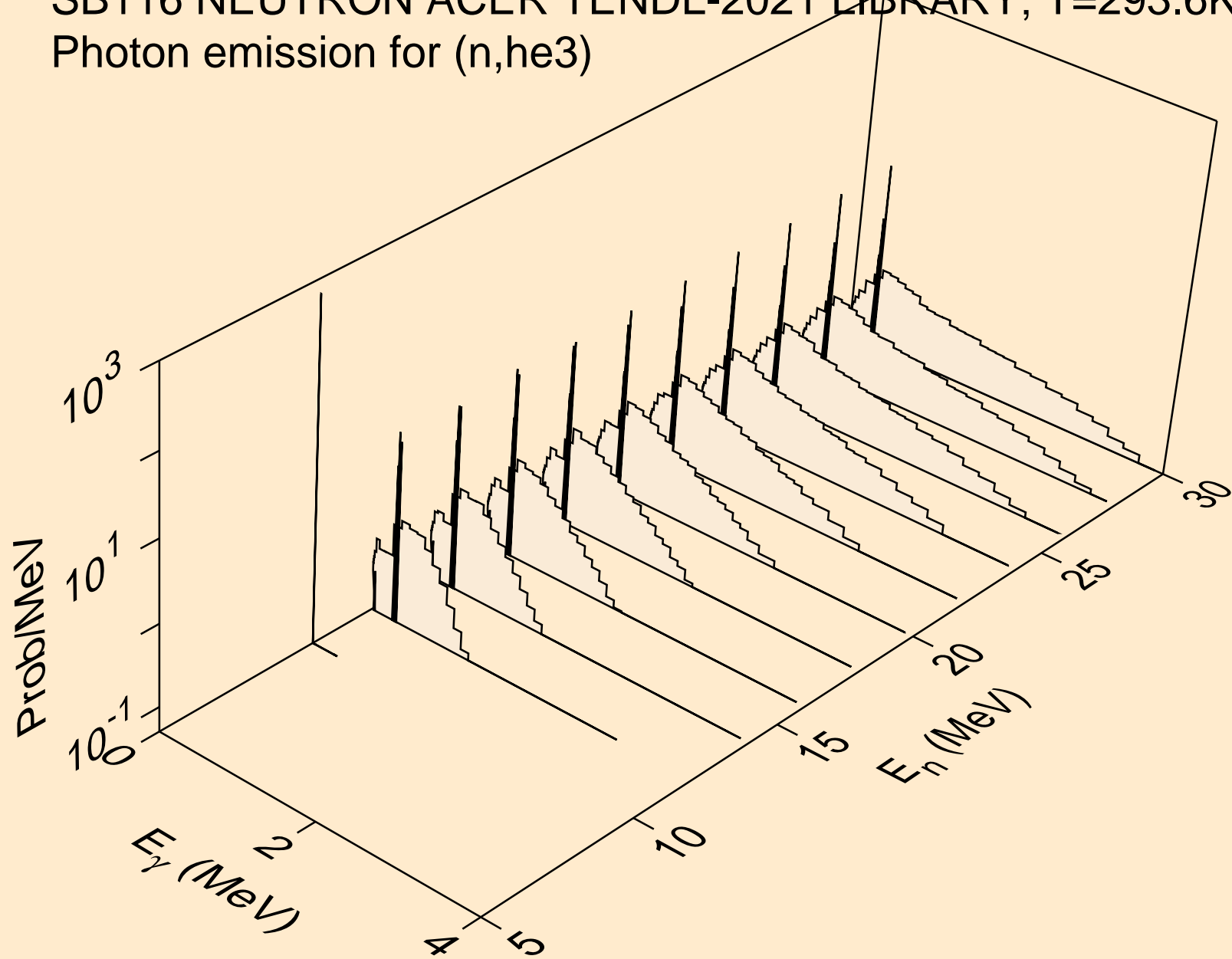

SB116 NEUTRON ACER TENDL-2021 LIBRARY; T=293.6K
Photon emission for (n,a)

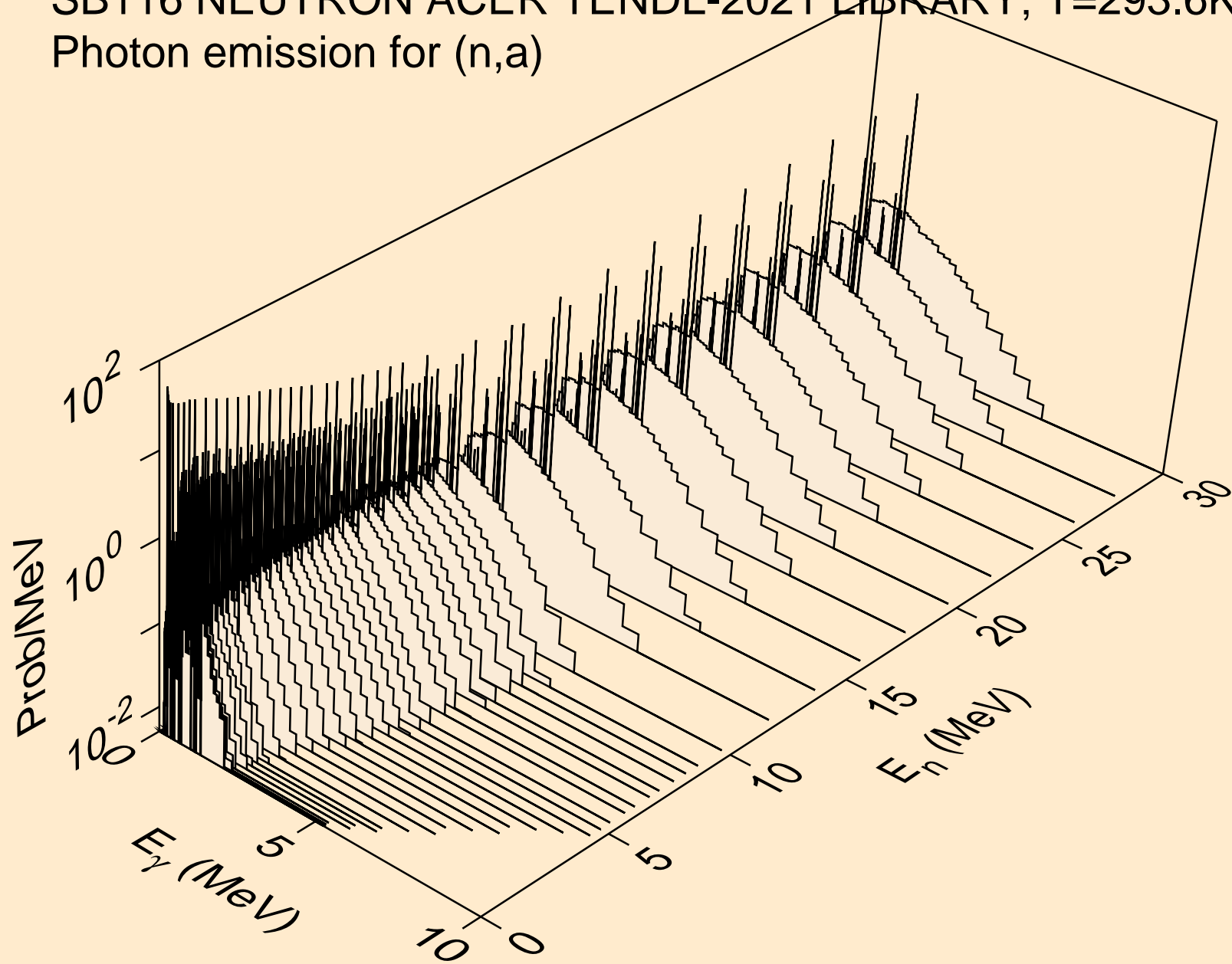

SB116 NEUTRON ACER TENDL-2021 LIBRARY; T=293.6K
Photon emission for (n,2a)

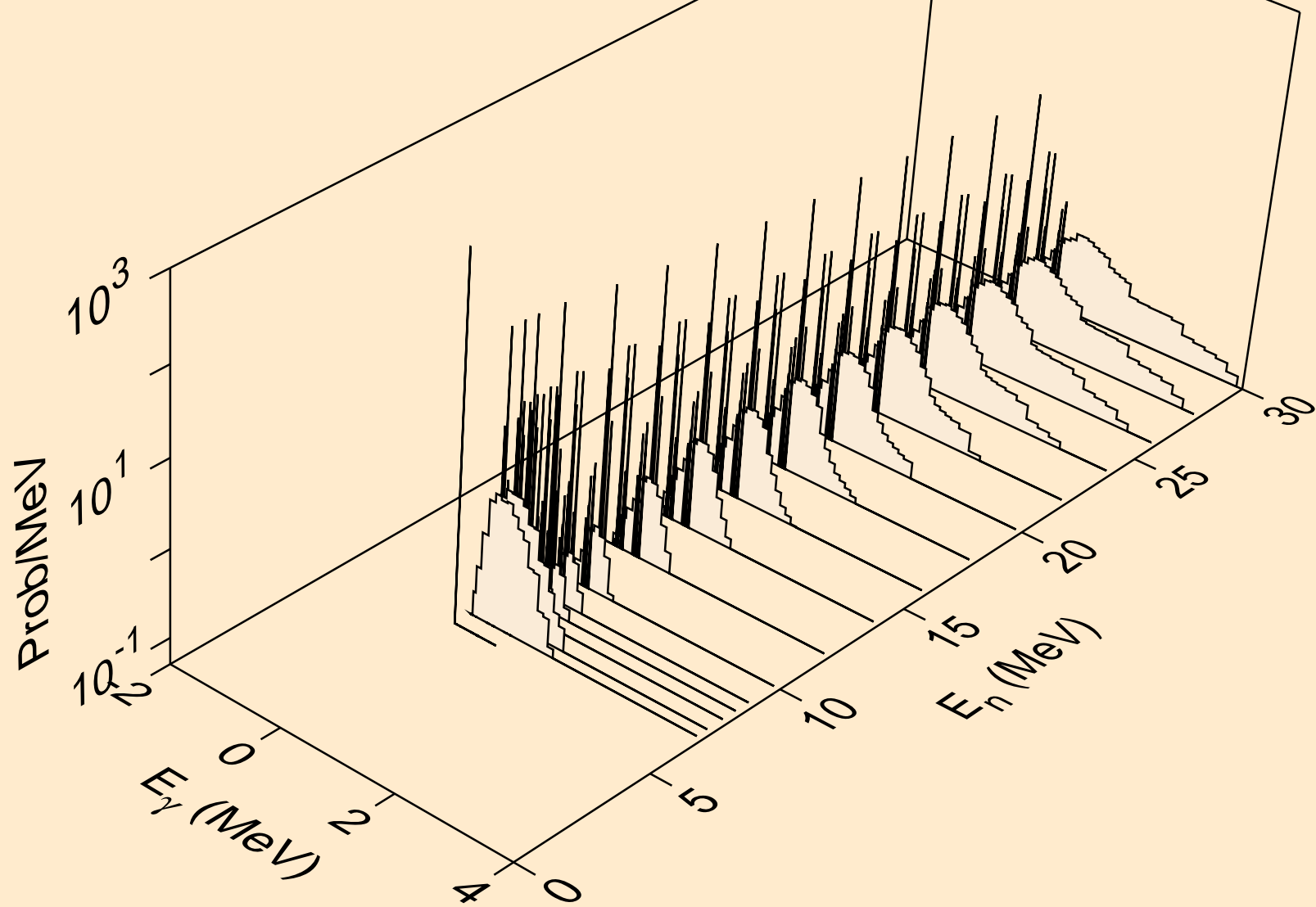

SB116 NEUTRON ACER TENDL-2021 LIBRARY; T=293.6K
Photon emission for (n,2p)

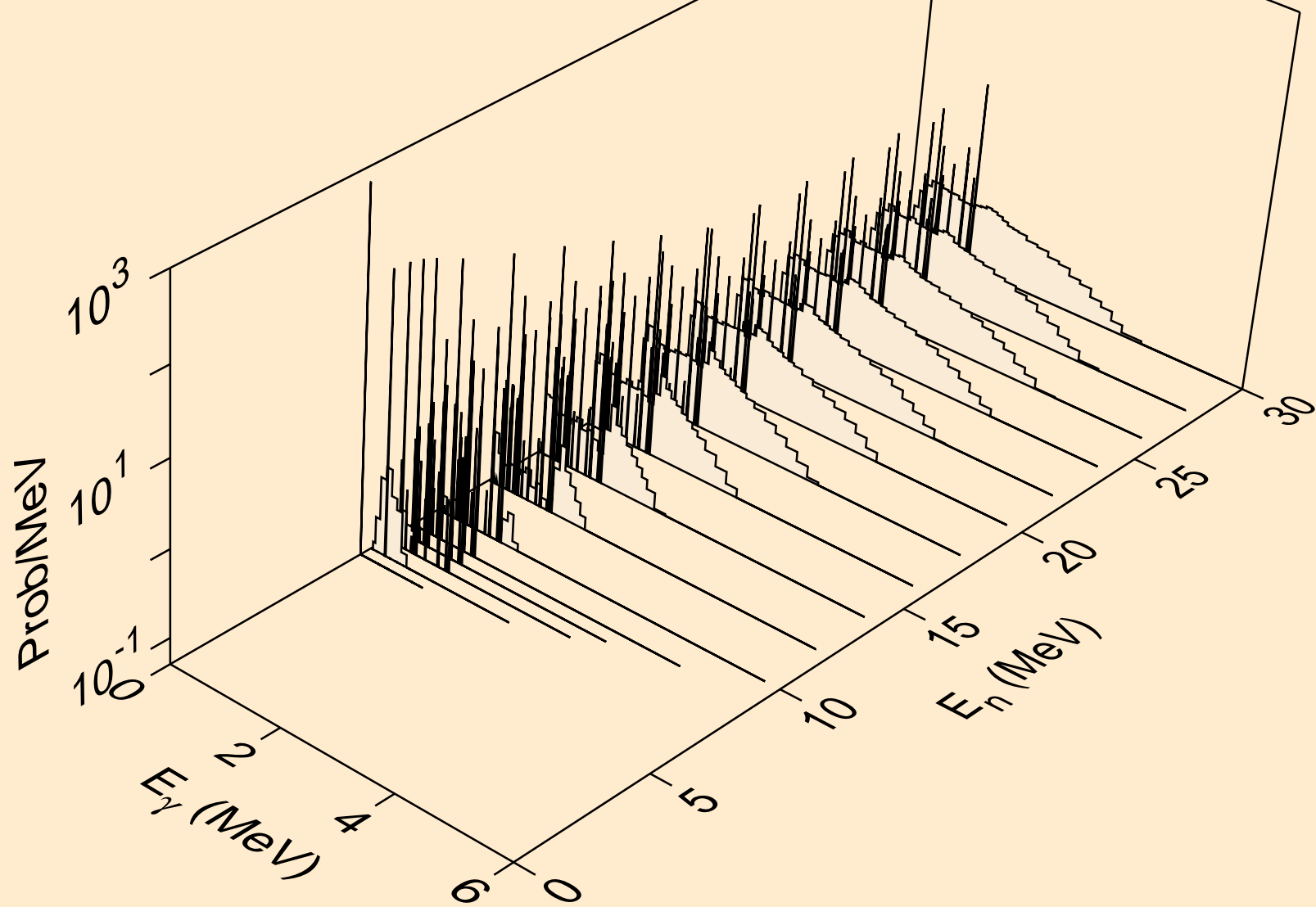

SB116 NEUTRON ACER TENDL-2021 LIBRARY; T=293.6K
Photon emission for (n,p)

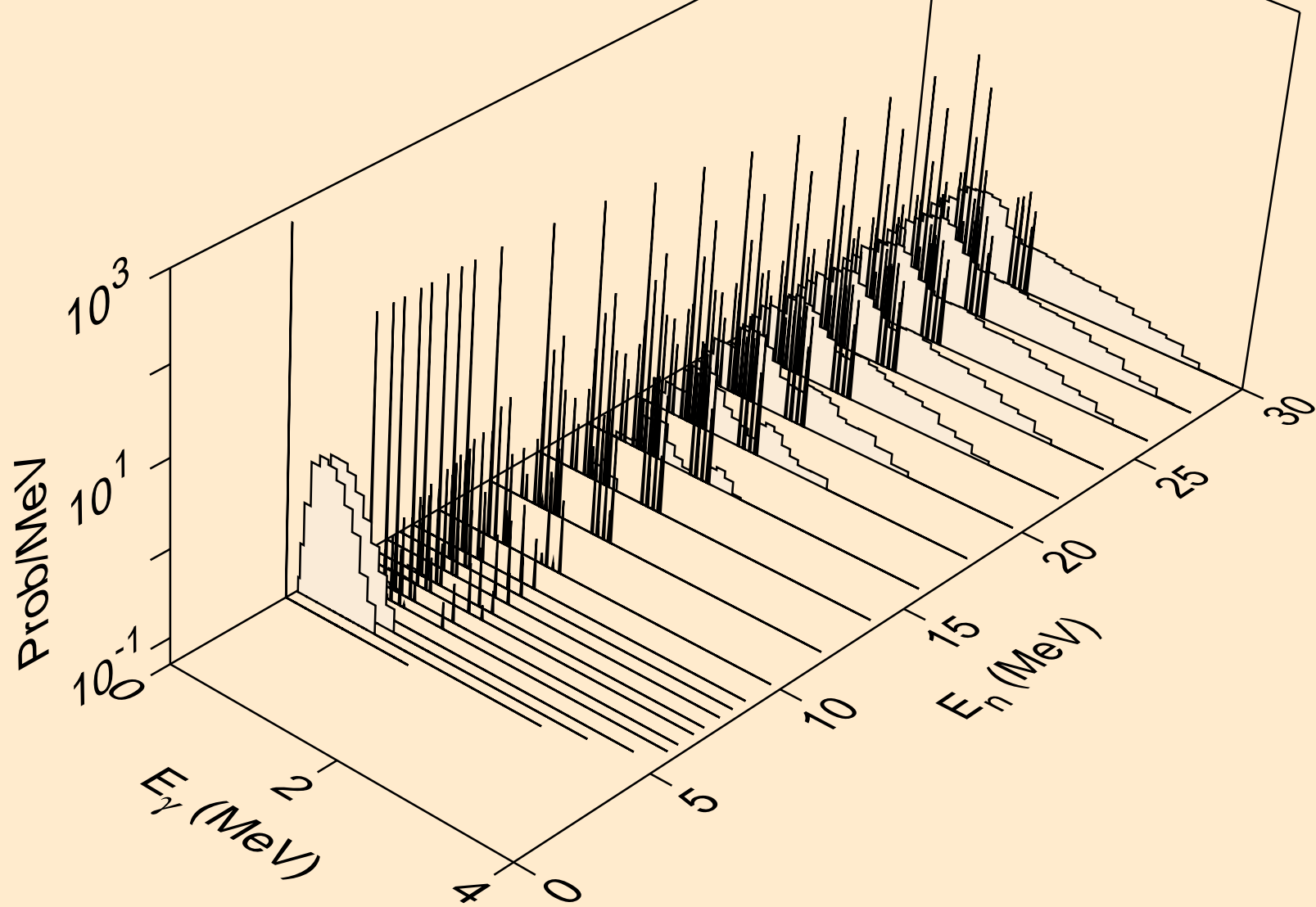

SB116 NEUTRON ACER TENDL-2021 LIBRARY; T=293.6K
Photon emission for (n,pd)

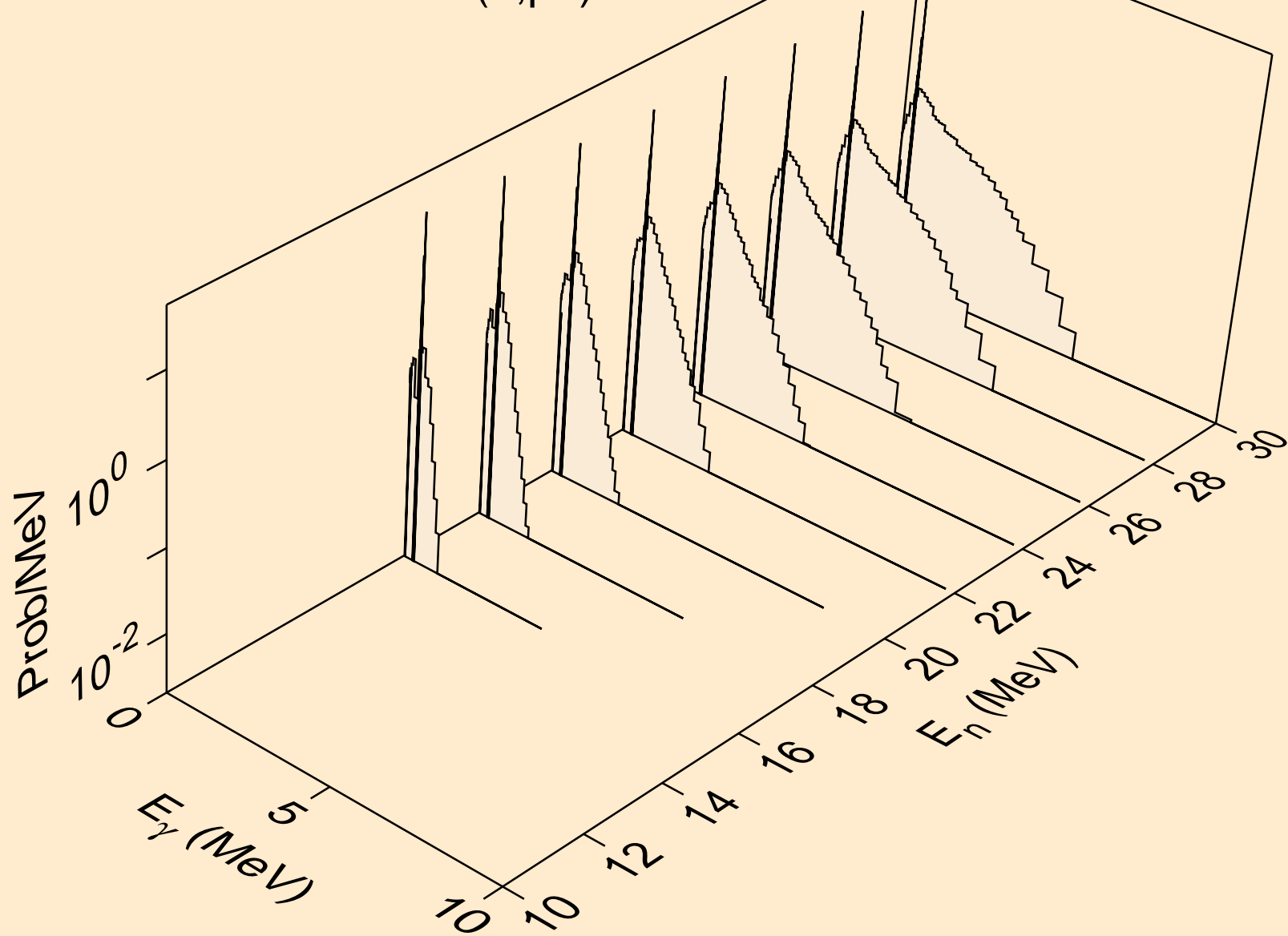

SB116 NEUTRON ACER TENDL-2021 LIBRARY; T=293.6K
Photon emission for (n,pt)

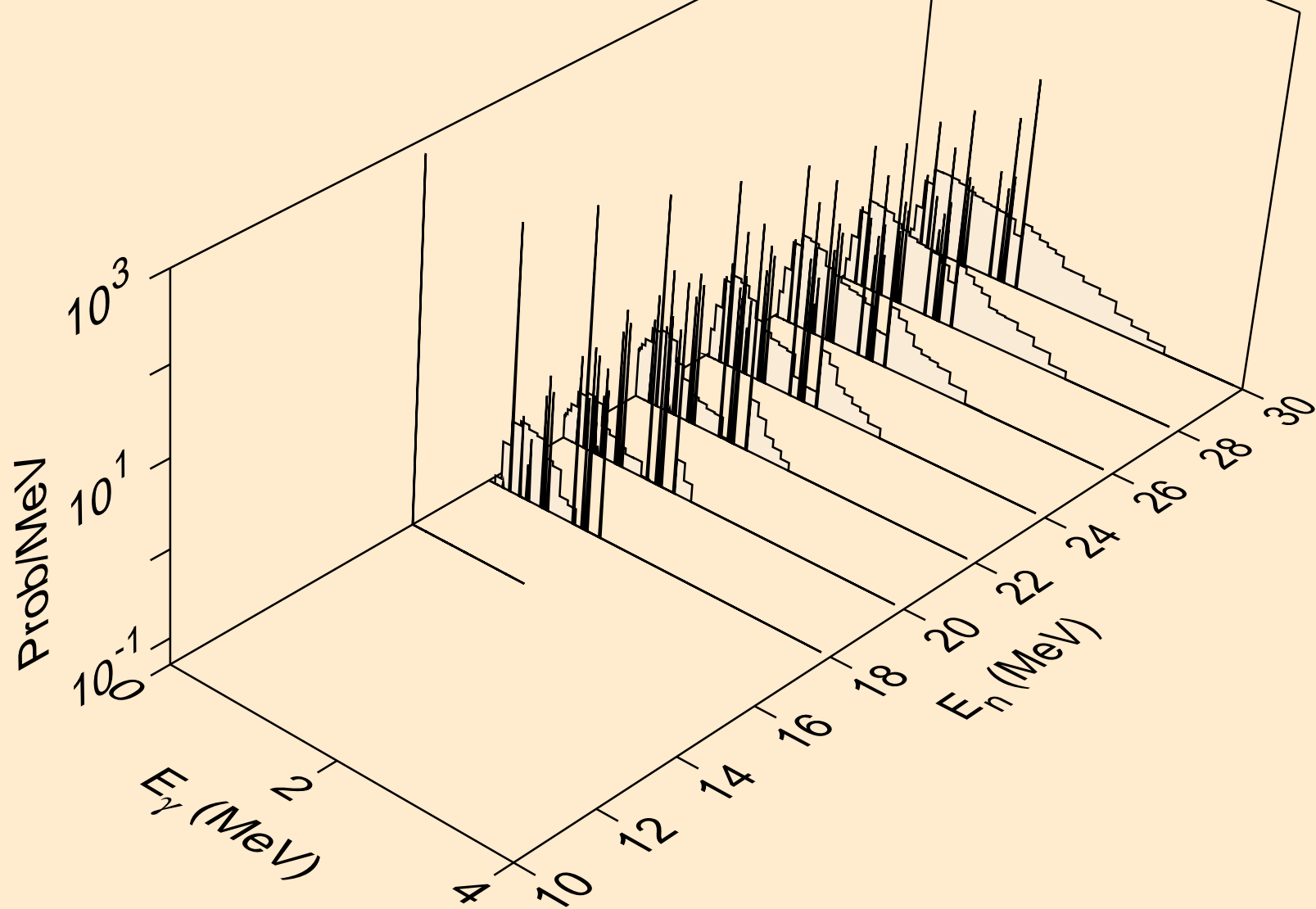

SB116 NEUTRON ACER TENDL-2021 LIBRARY; T=293.6K
Photon emission for (n,da)

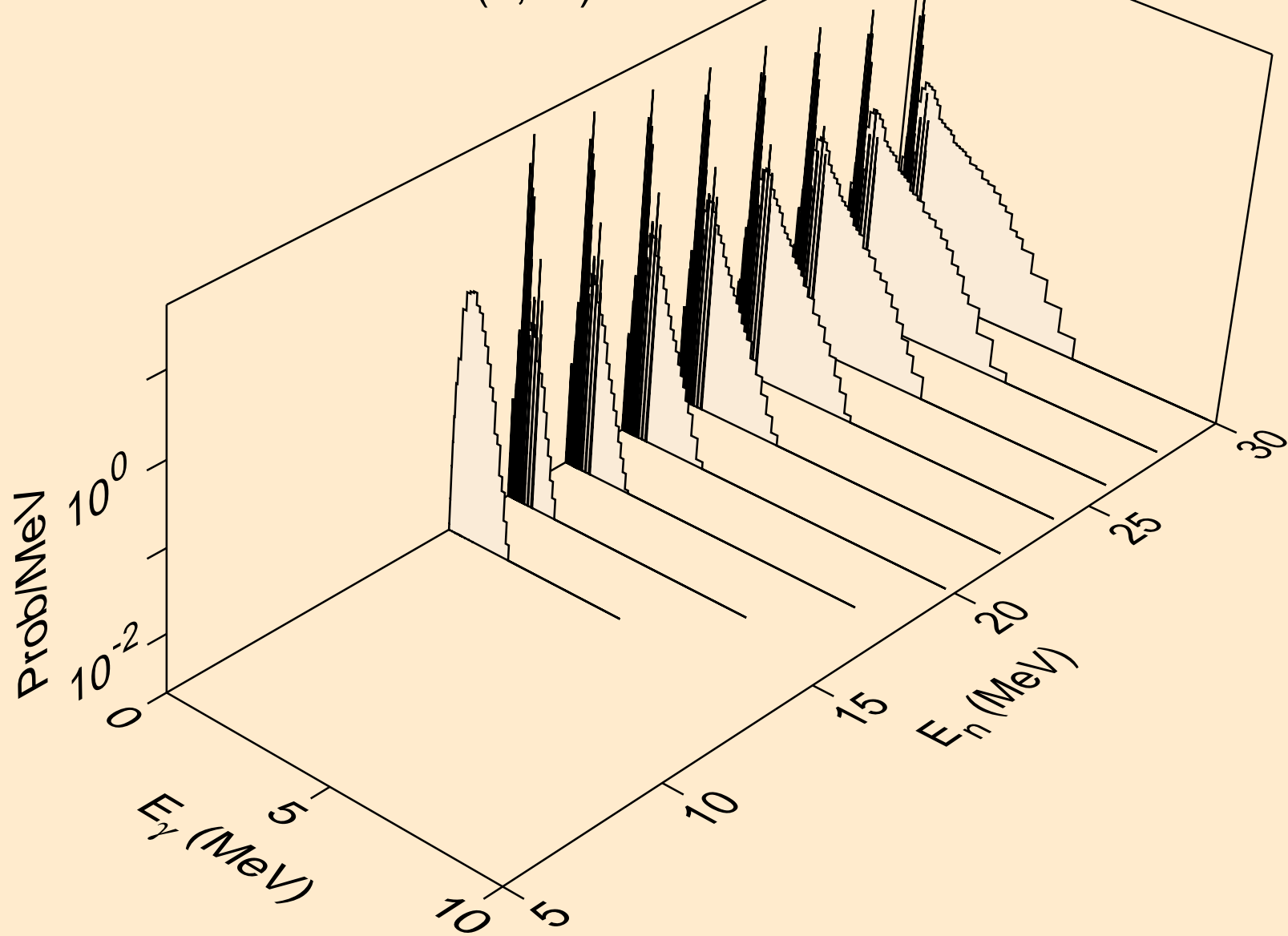

SB116 NEUTRON ACER TENDL-2021 LIBRARY; T=293.6K
thermal capture photon spectrum

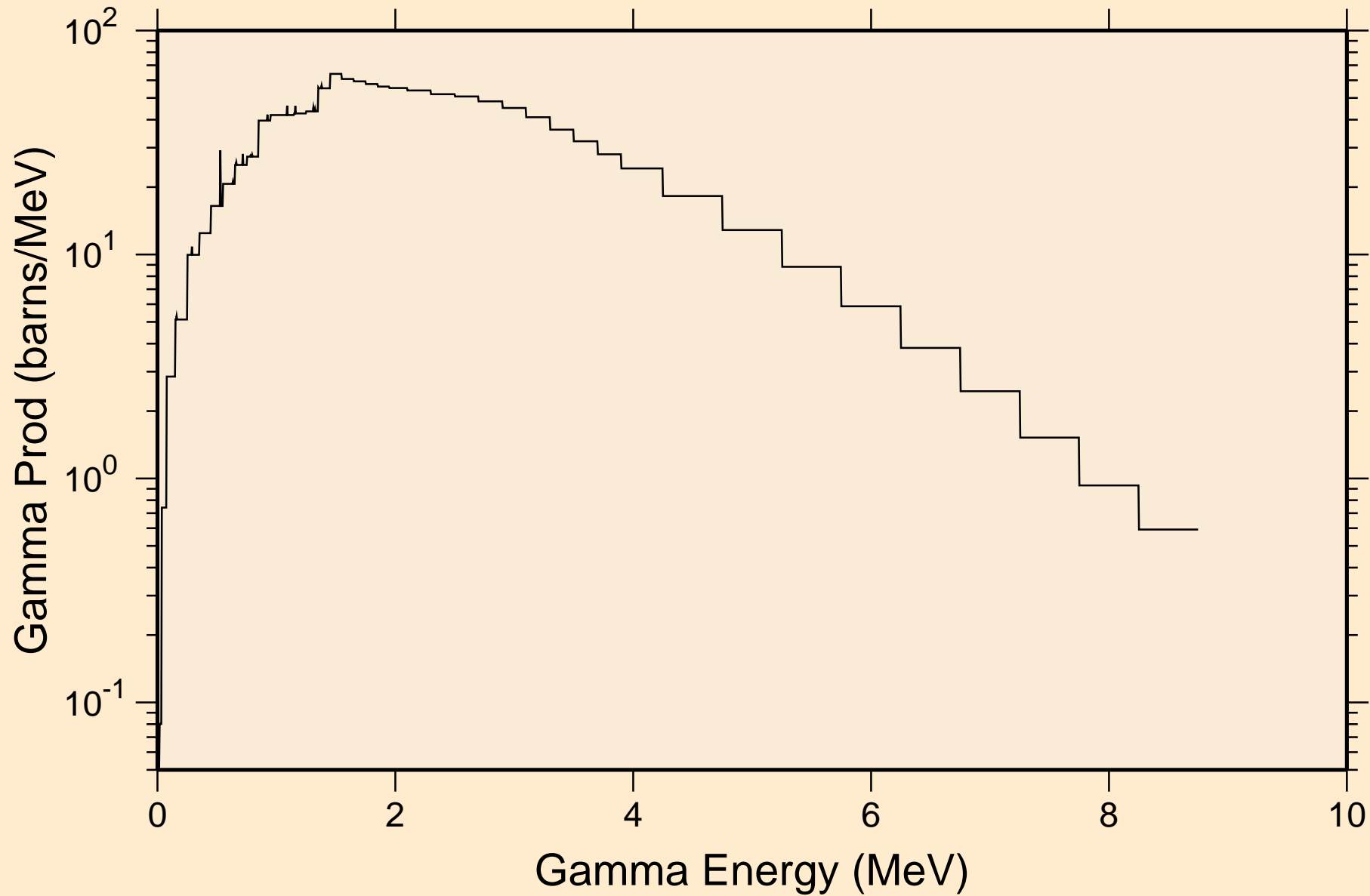

SB116 NEUTRON ACER TENDL-2021 LIBRARY; T=293.6K
14 MeV photon spectrum

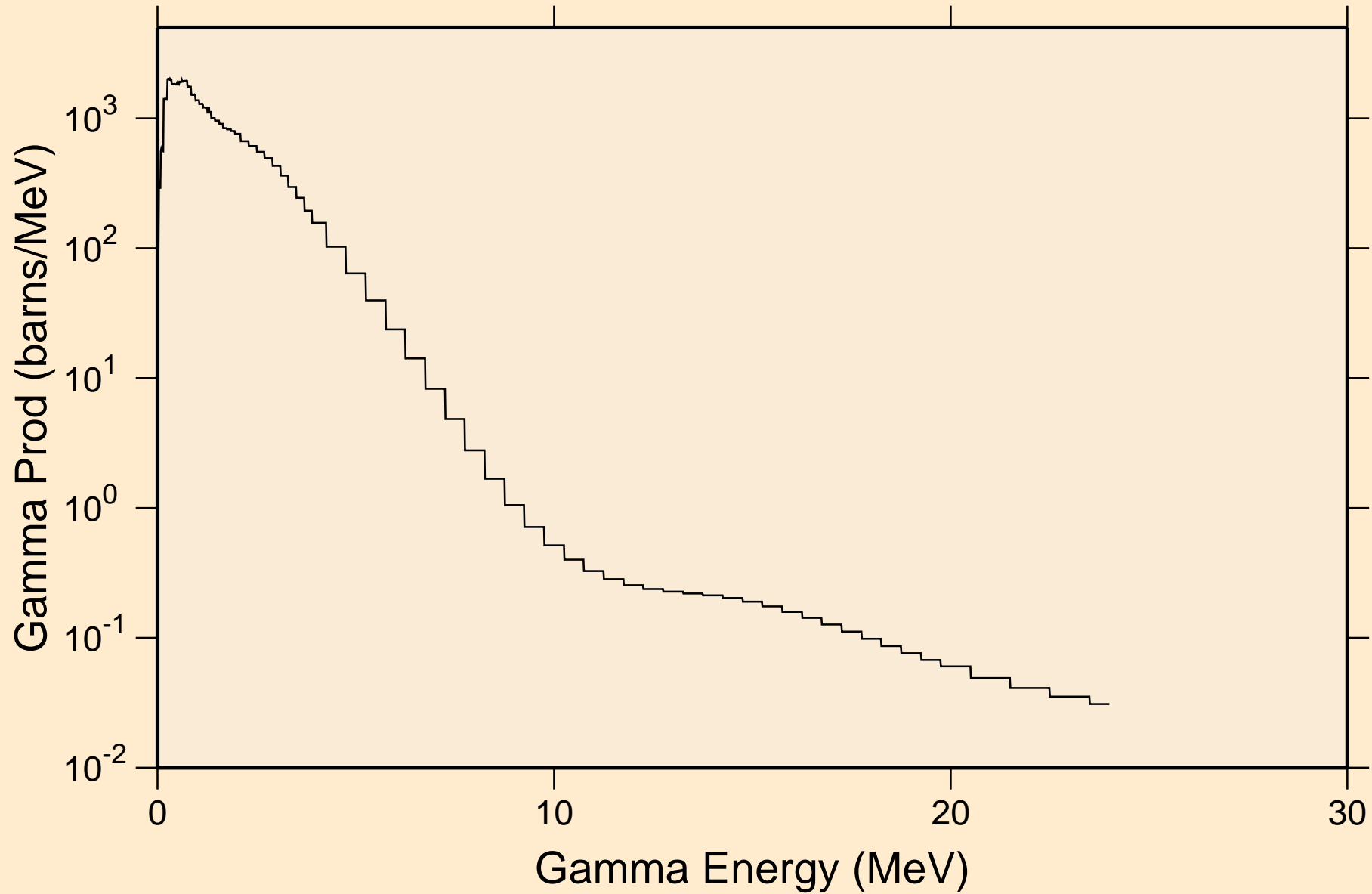

SB116 NEUTRON ACER TENDL-2021 LIBRARY; T=293.6K
Particle heating contributions

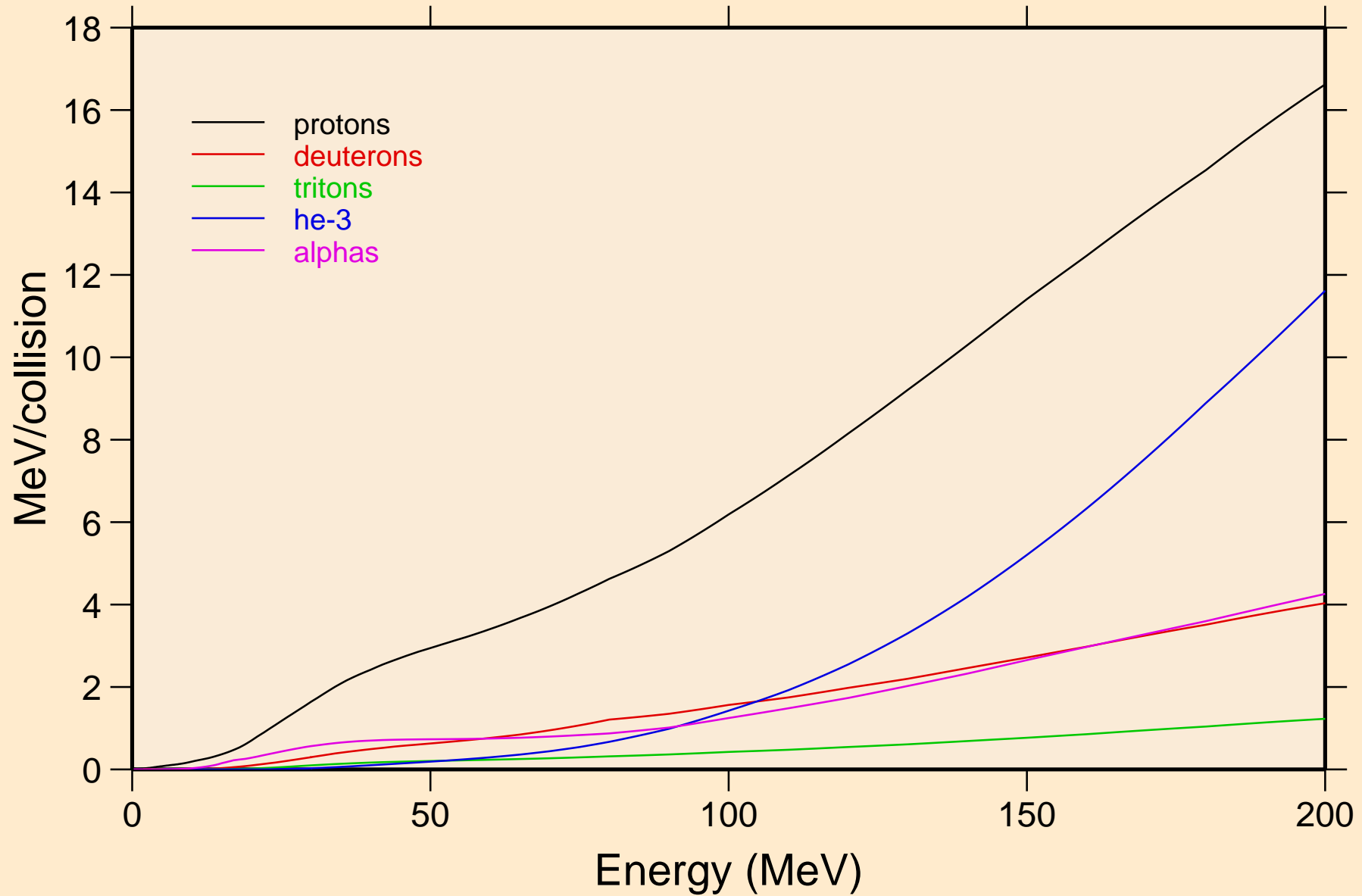

SB116 NEUTRON ACER TENDL-2021 LIBRARY; T=293.6K
Recoil Heating

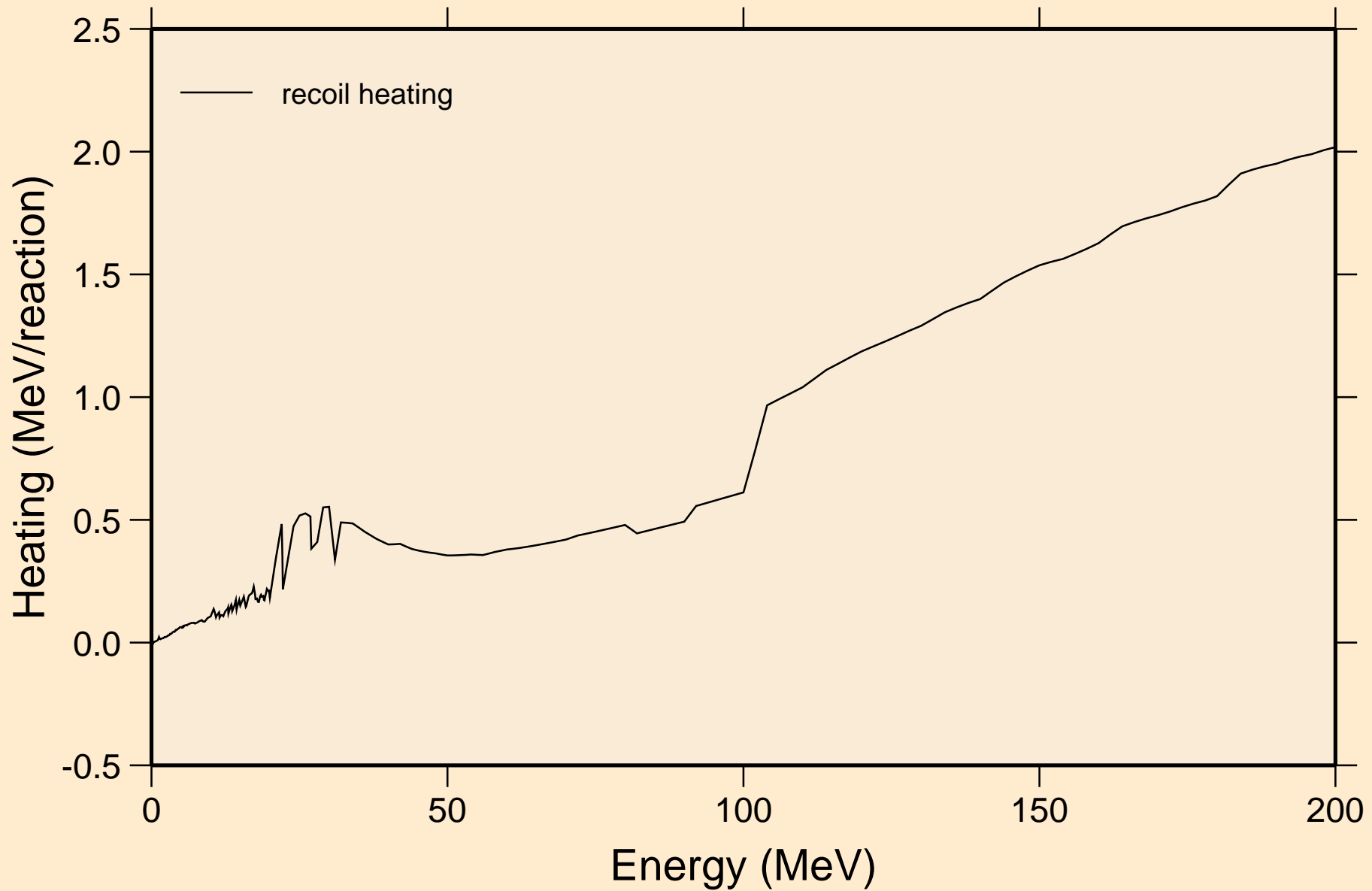

SB116 NEUTRON ACER TENDL-2021 LIBRARY; T=293.6K
Particle production cross sections

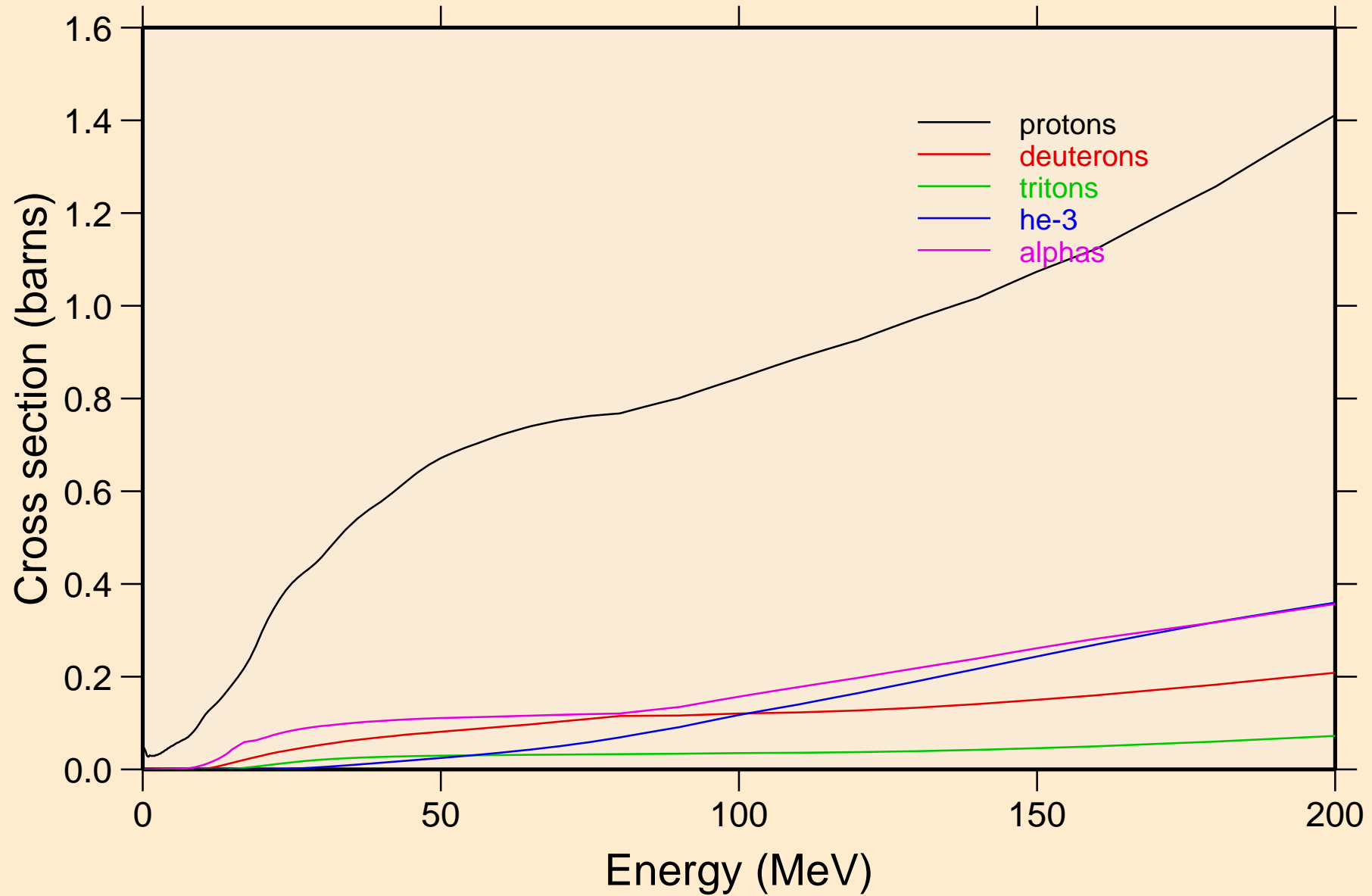

SB116 NEUTRON ACER TENDL-2021 LIBRARY; T=293.6K
protons from (n,x)

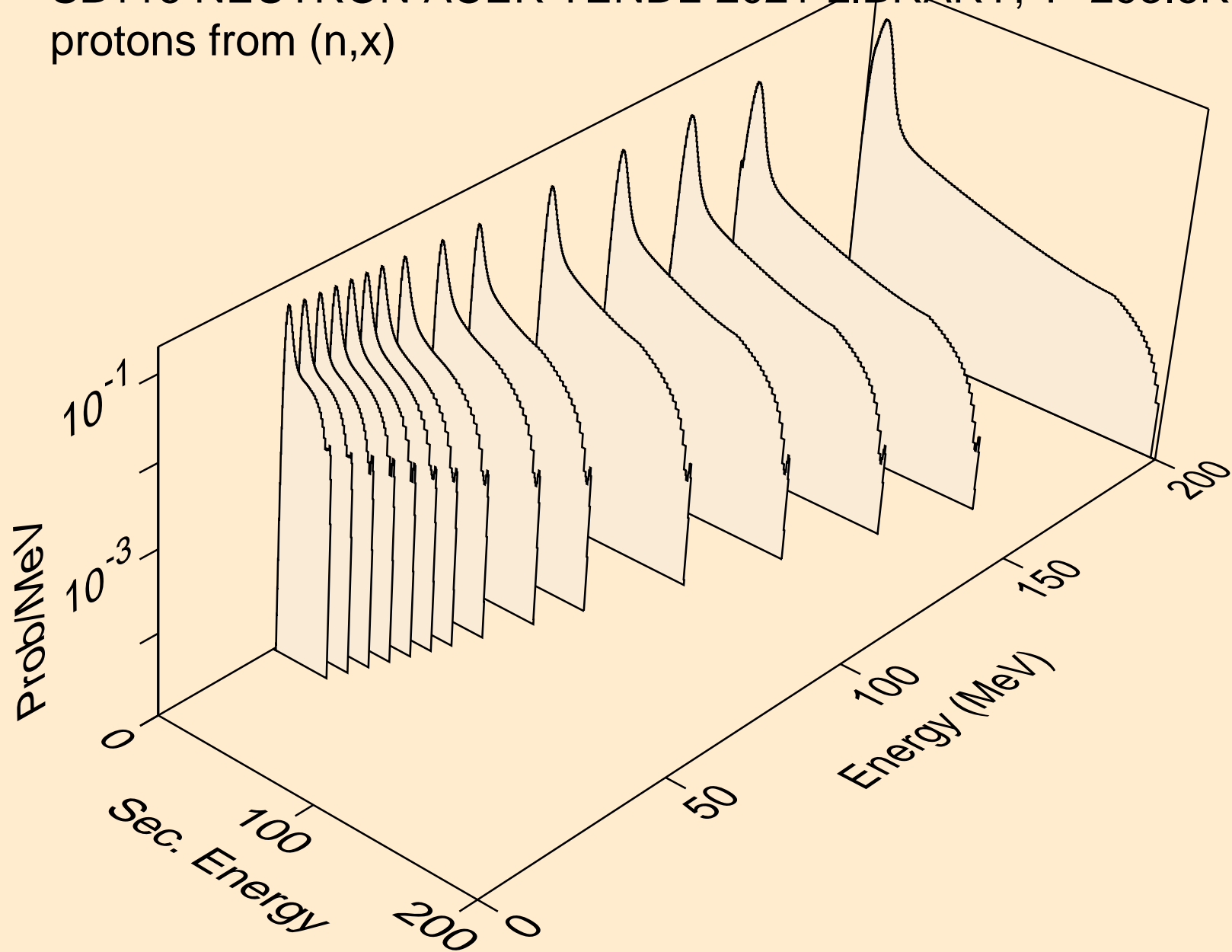

SB116 NEUTRON ACER TENDL-2021 LIBRARY; T=293.6K
protons from (n,n*)p

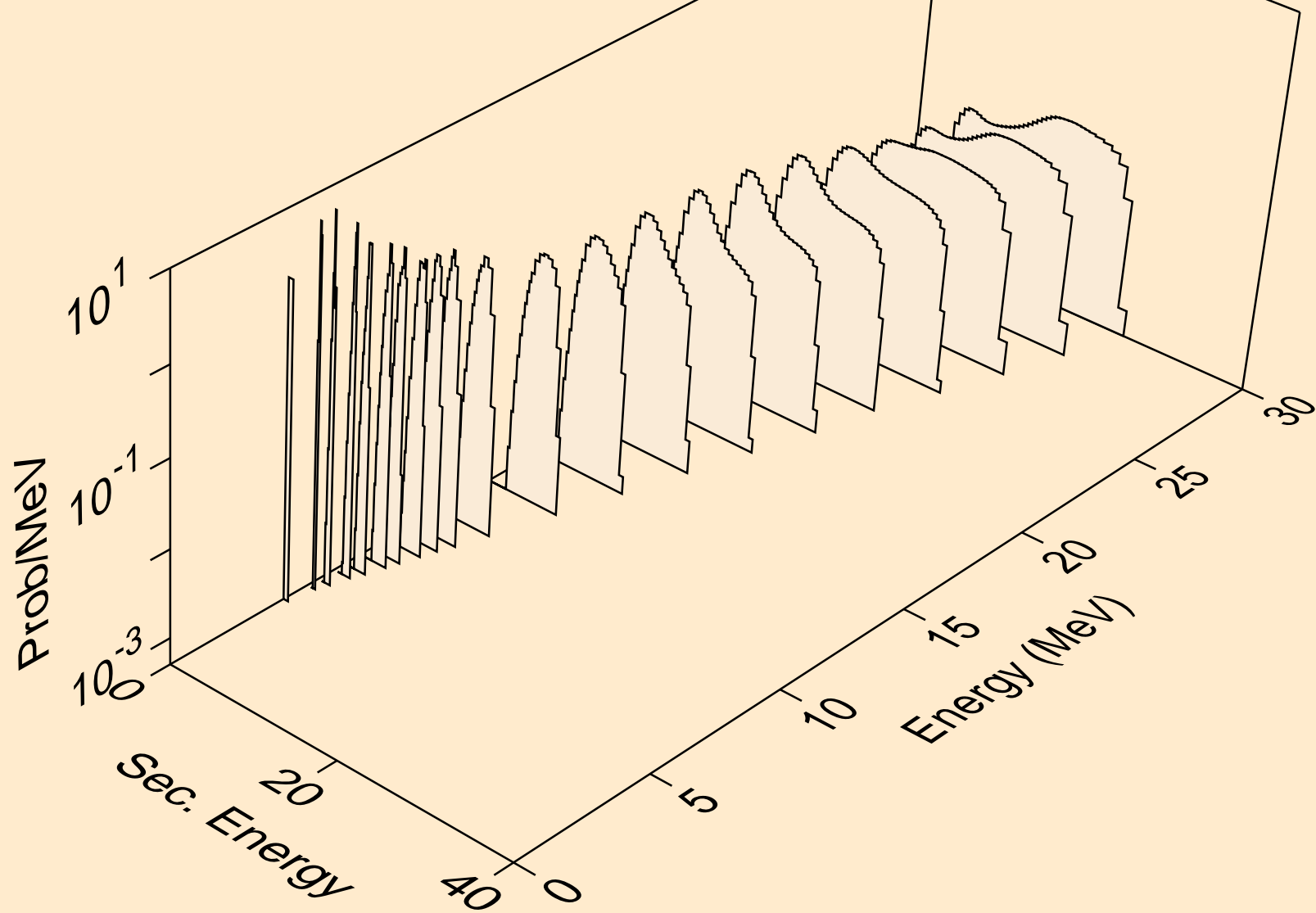

SB116 NEUTRON ACER TENDL-2021 LIBRARY; T=293.6K
protons from (n,2np)

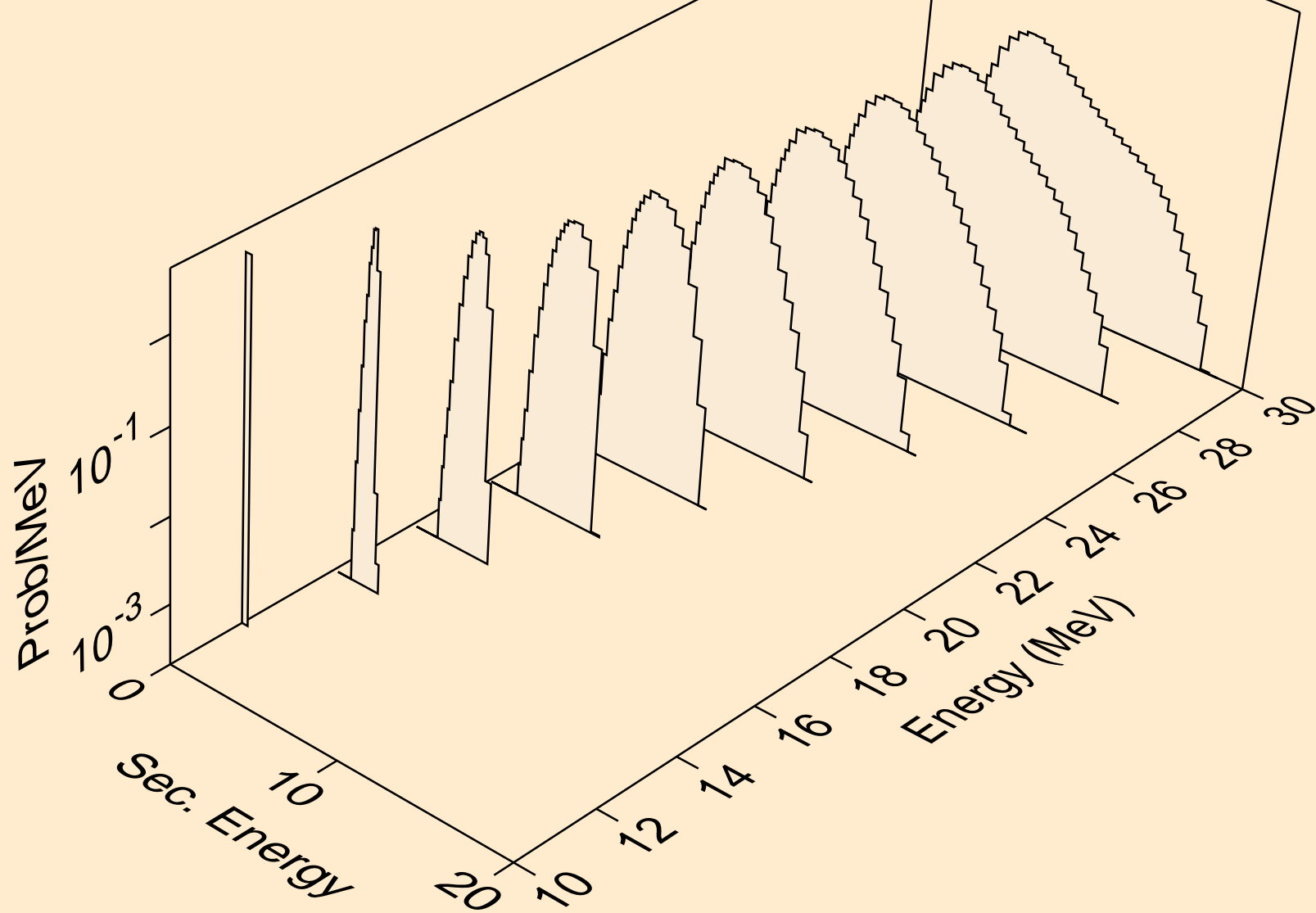

SB116 NEUTRON ACER TENDL-2021 LIBRARY; T=293.6K
protons from (n,3np)

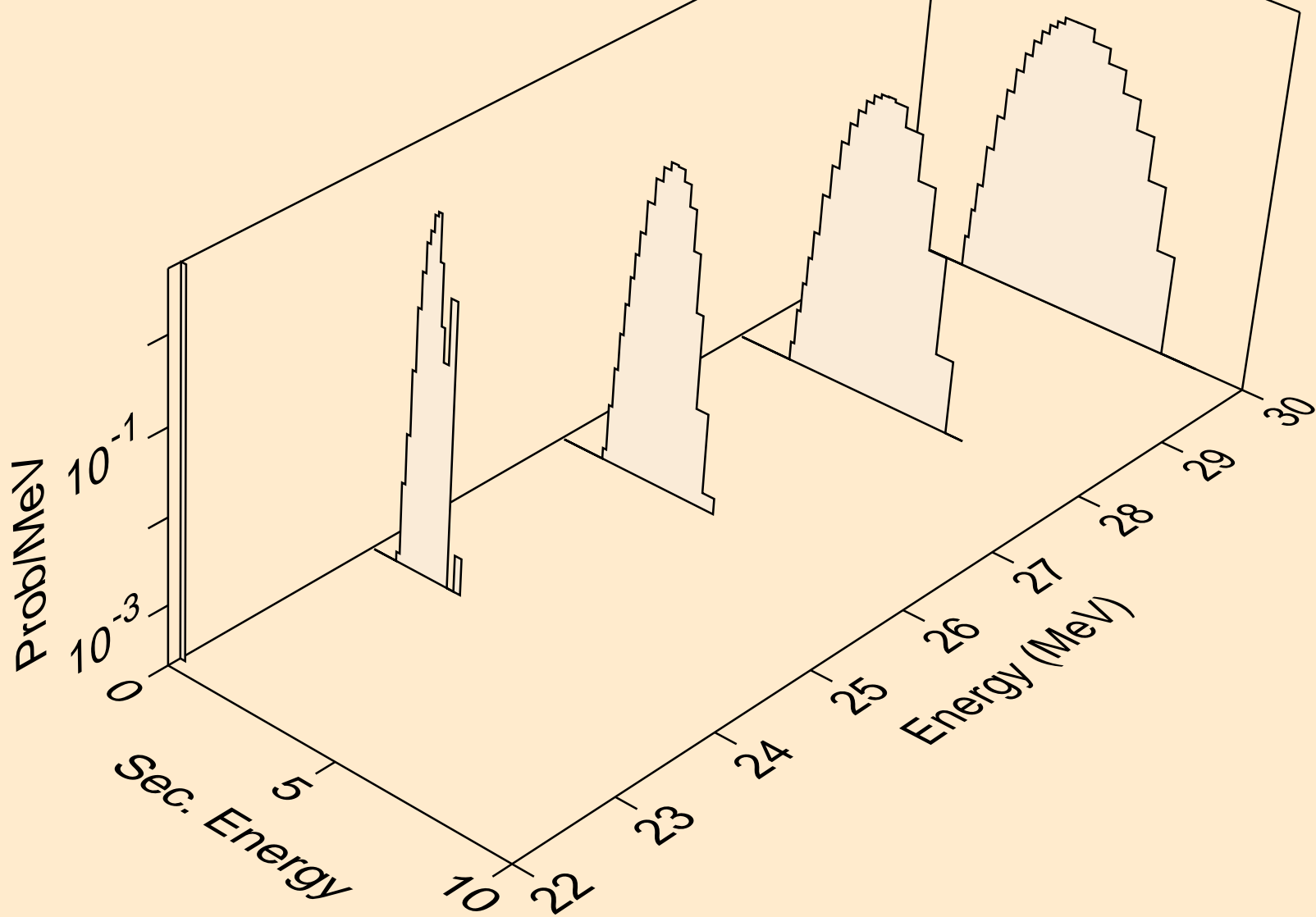

SB116 NEUTRON ACER TENDL-2021 LIBRARY; T=293.6K
protons from (n,2np)

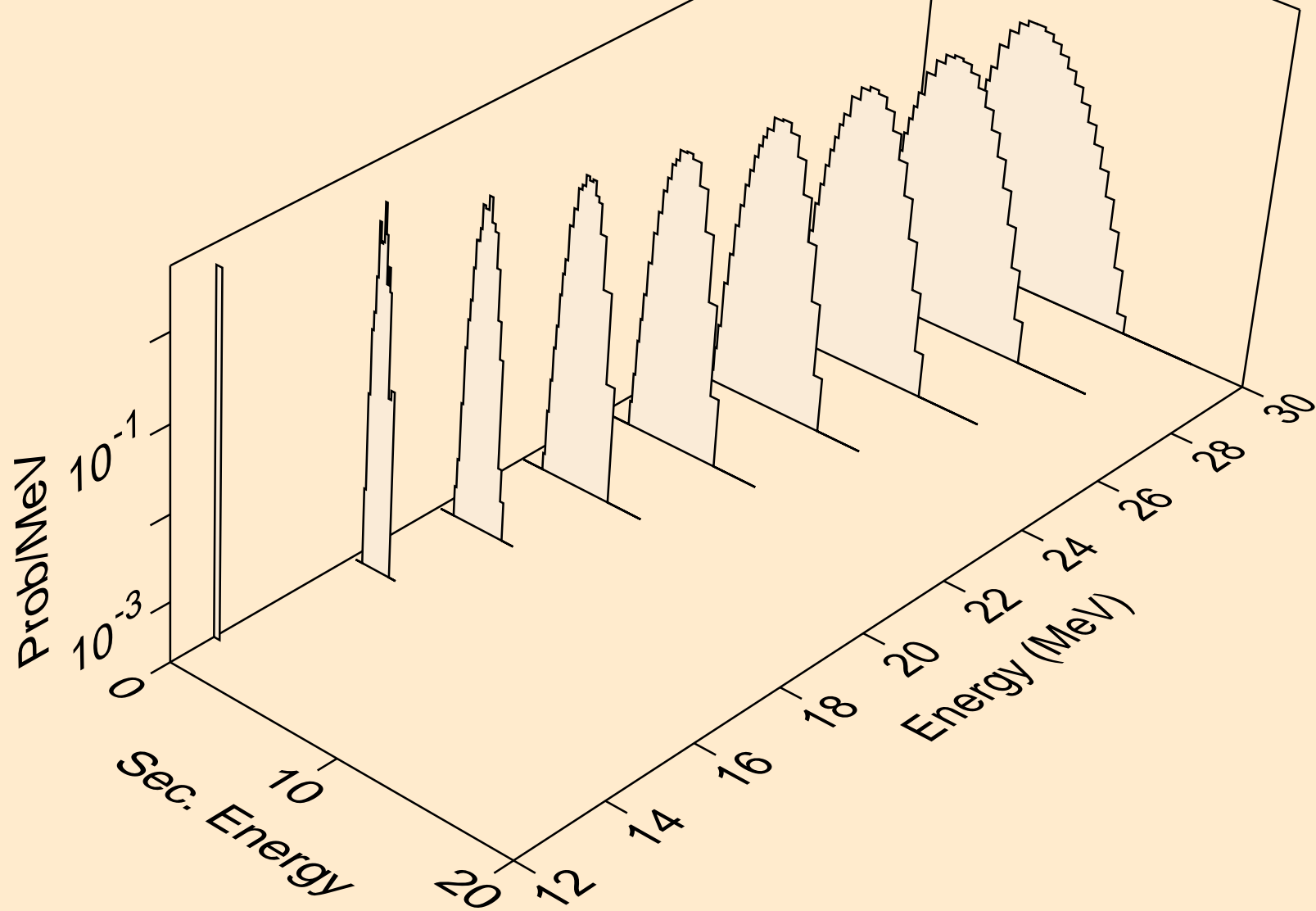

SB116 NEUTRON ACER TENDL-2021 LIBRARY; T=293.6K
protons from (n,npa)

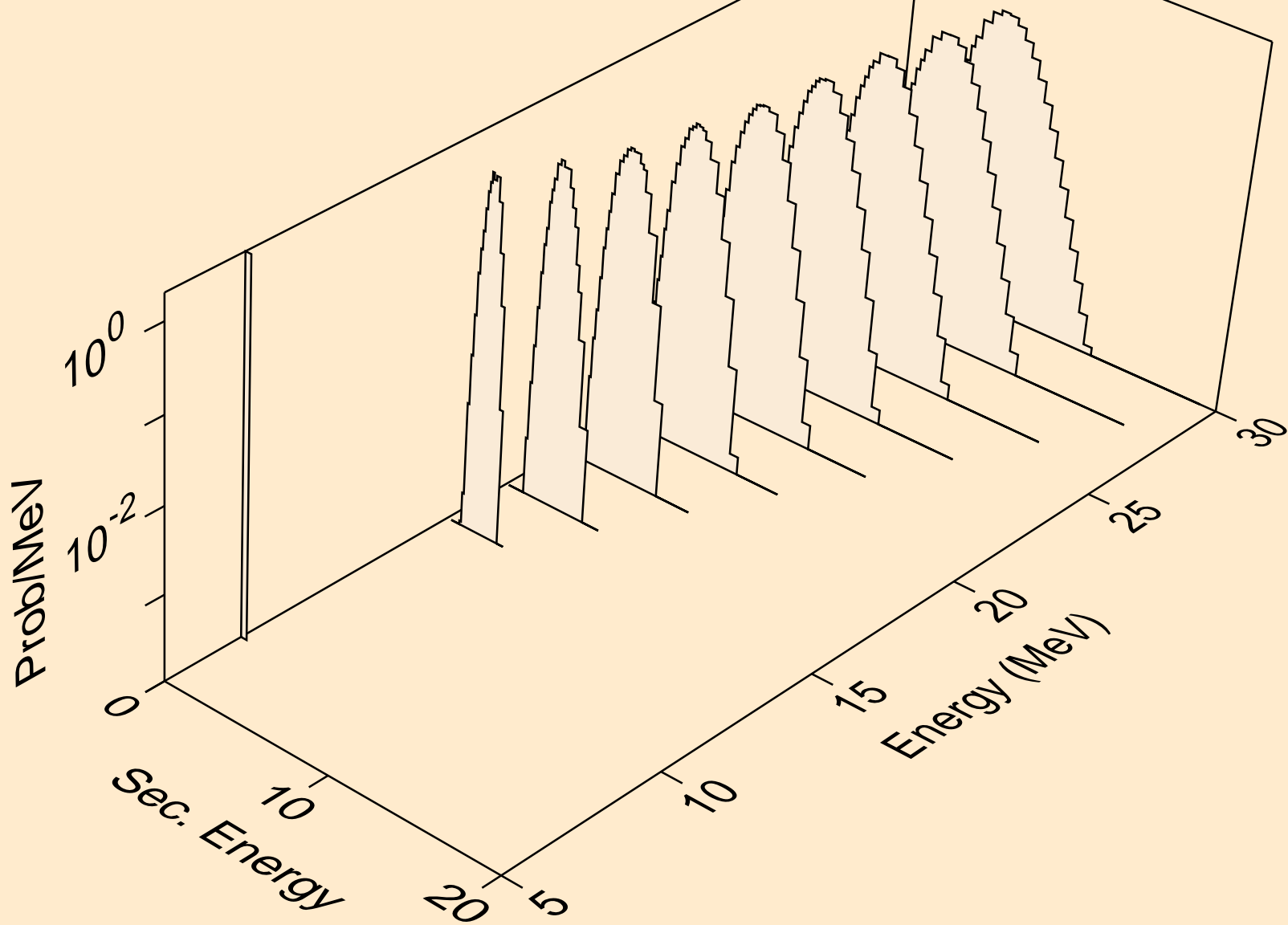

SB116 NEUTRON ACER TENDL-2021 LIBRARY; T=293.6K
protons from (n,p)

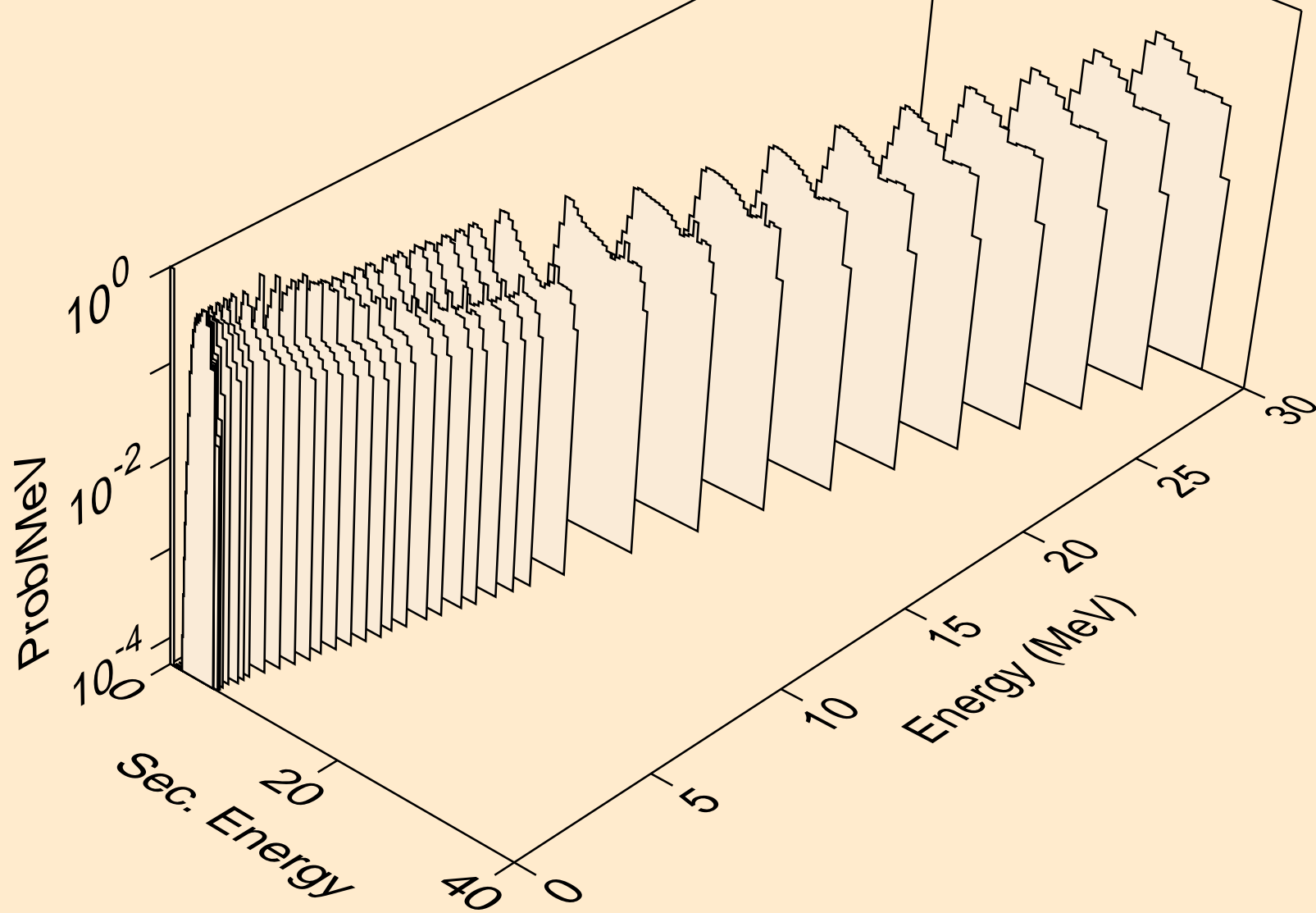

SB116 NEUTRON ACER TENDL-2021 LIBRARY; T=293.6K
protons from (n,2p)

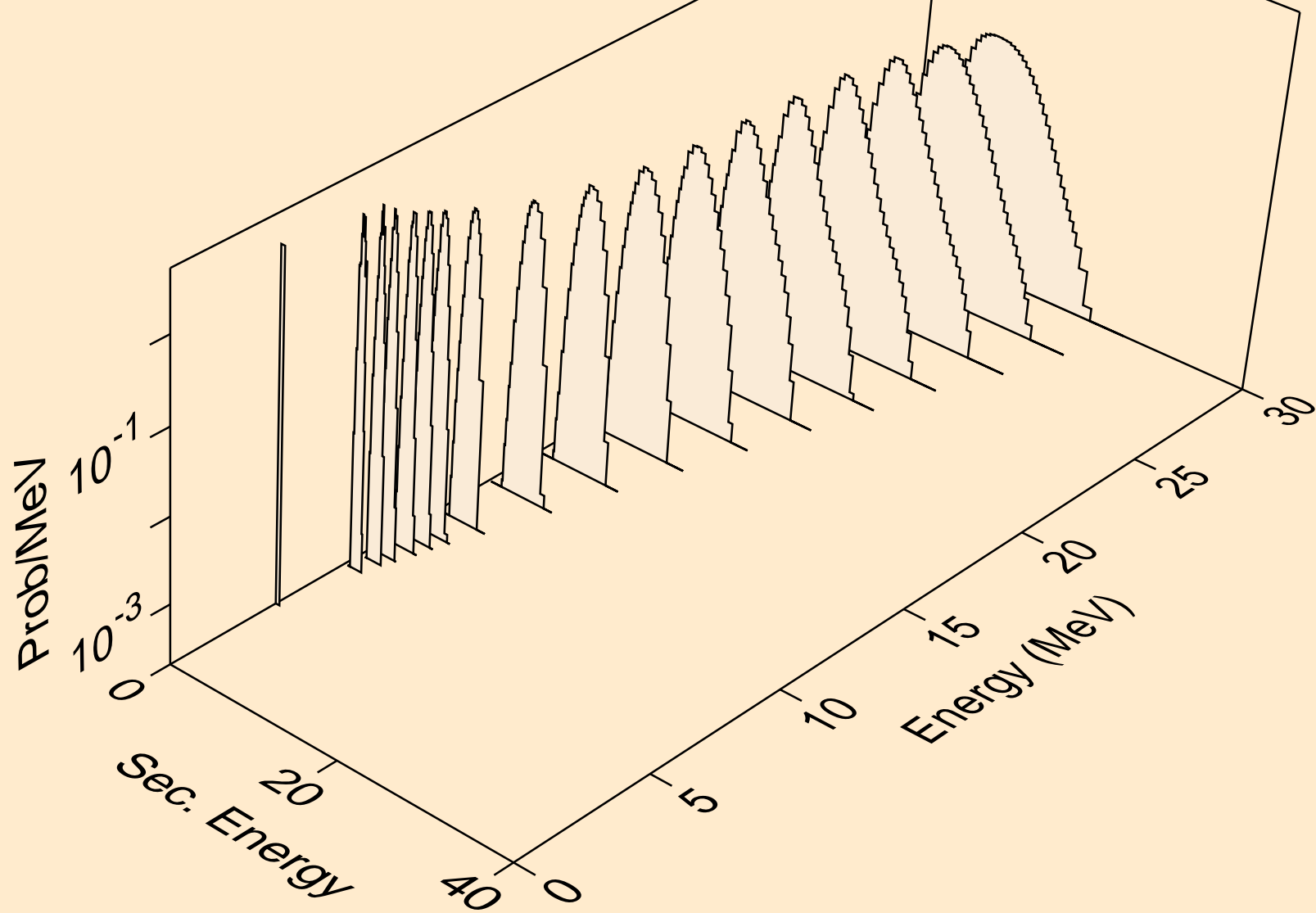

SB116 NEUTRON ACER TENDL-2021 LIBRARY; T=293.6K
protons from (n,p)

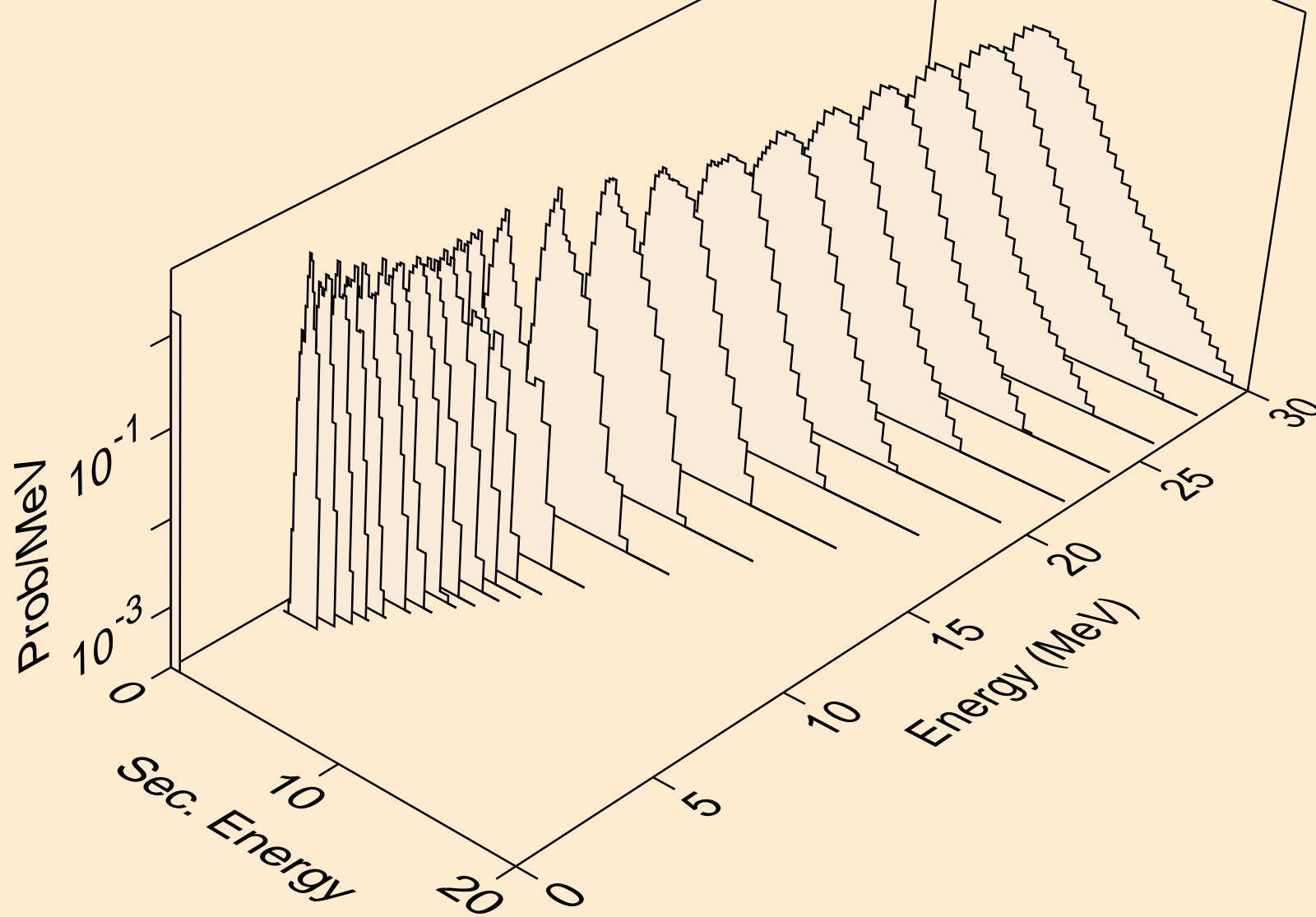

SB116 NEUTRON ACER TENDL-2021 LIBRARY; T=293.6K
protons from (n,pd)

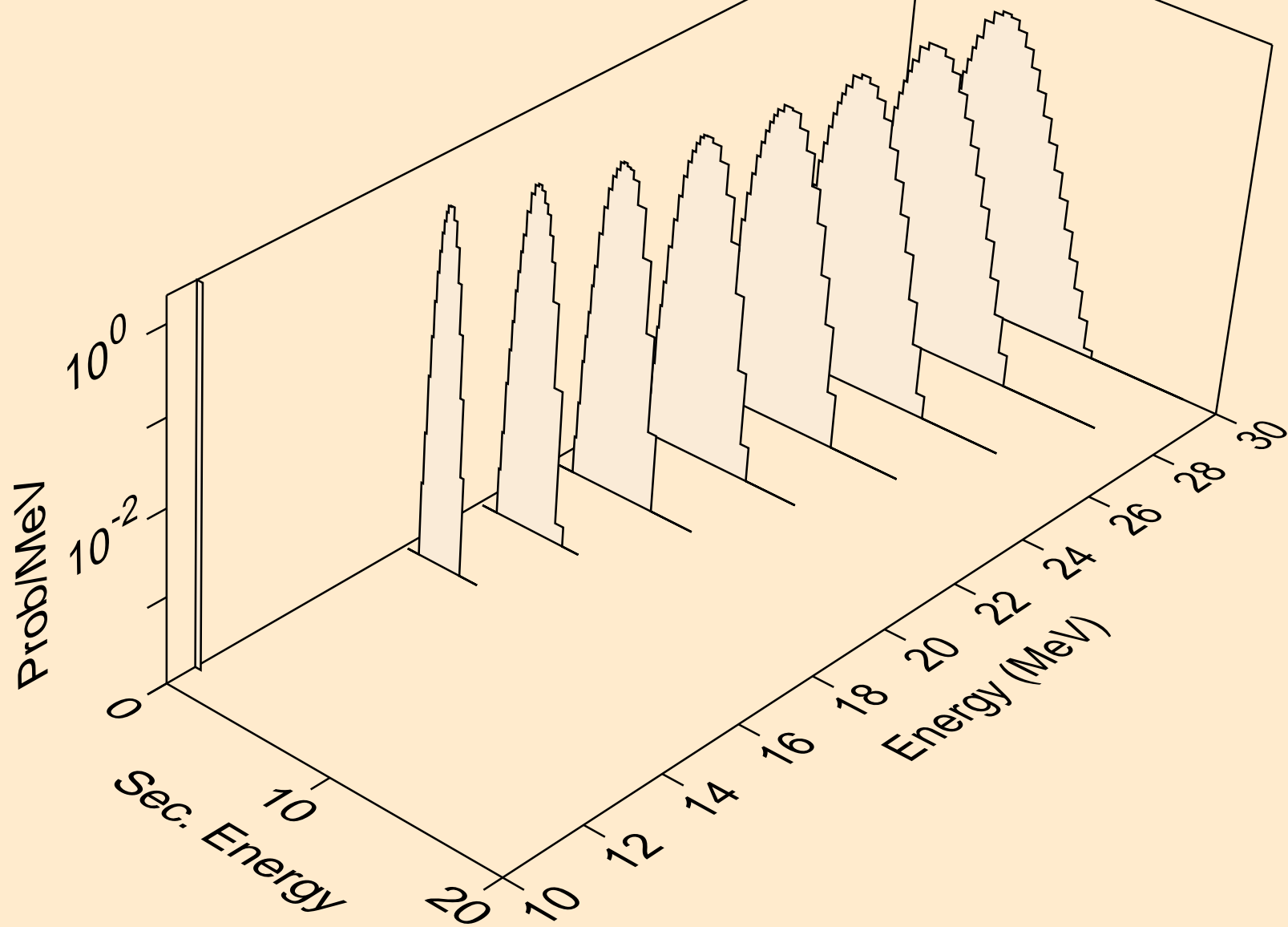

SB116 NEUTRON ACER TENDL-2021 LIBRARY; T=293.6K
protons from (n,pt)

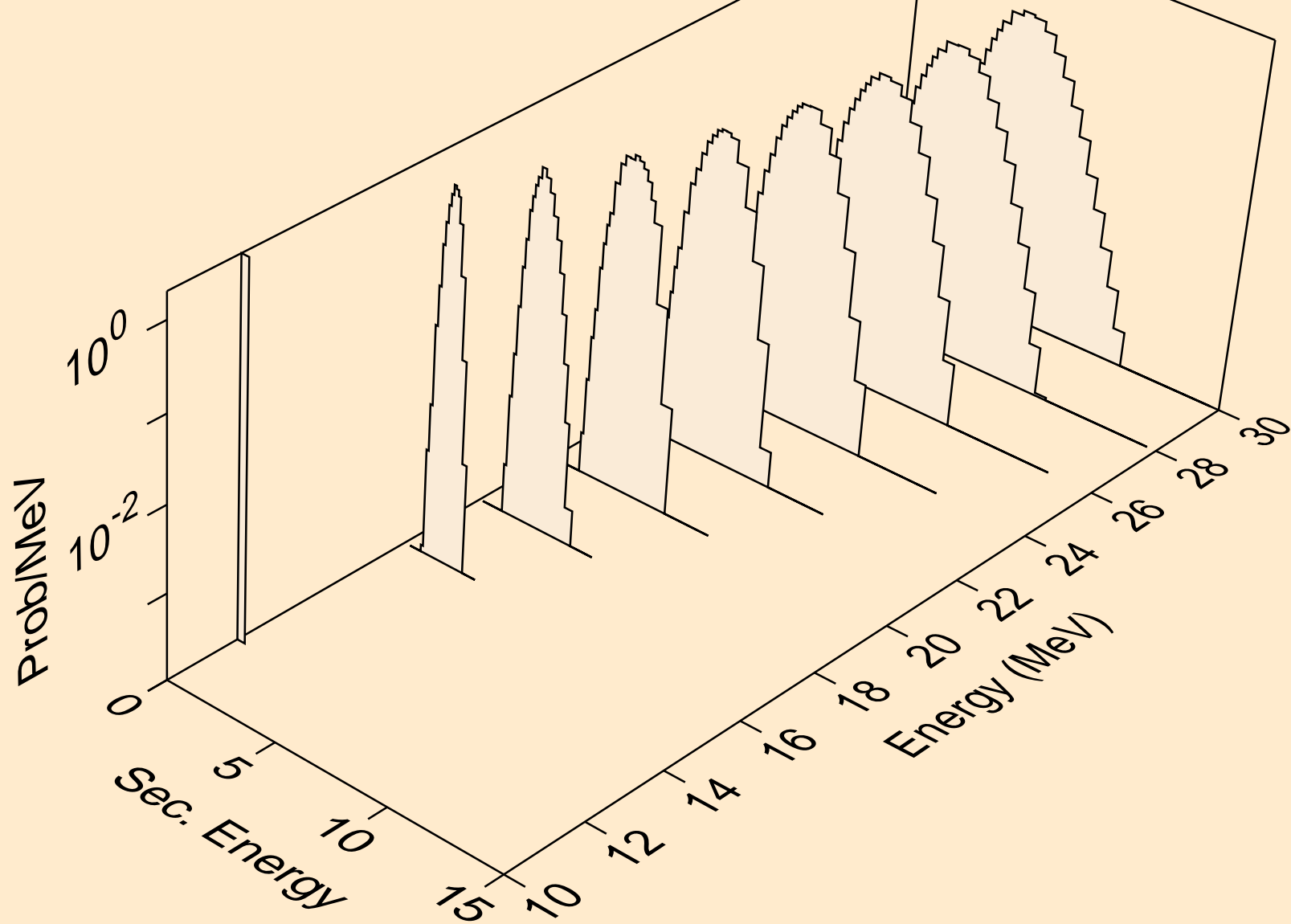

SB116 NEUTRON ACER TENDL-2021 LIBRARY; T=293.6K
deuterons from (n,x)

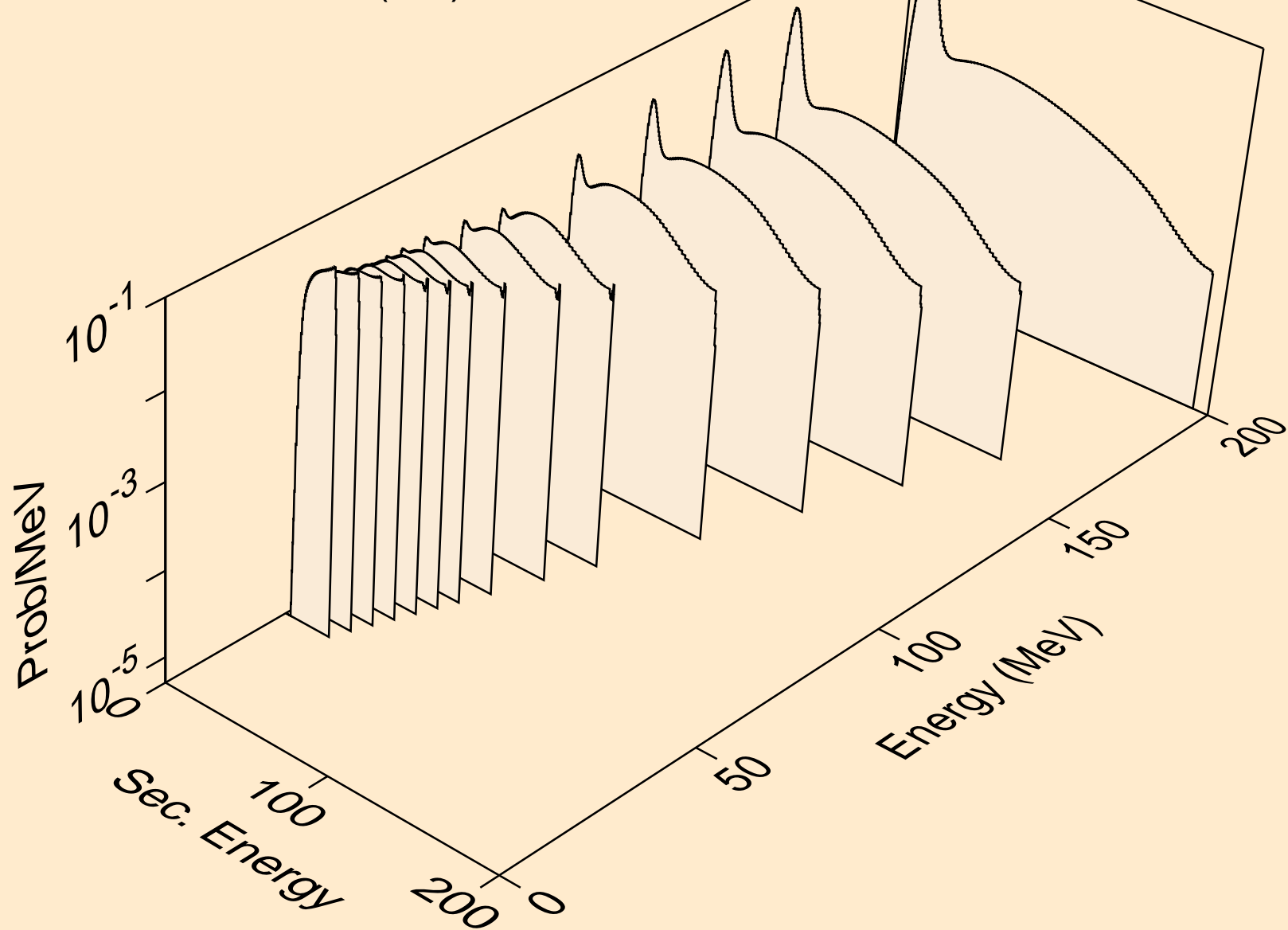

SB116 NEUTRON ACER TENDL-2021 LIBRARY; T=293.6K
deuterons from (n,2nd)

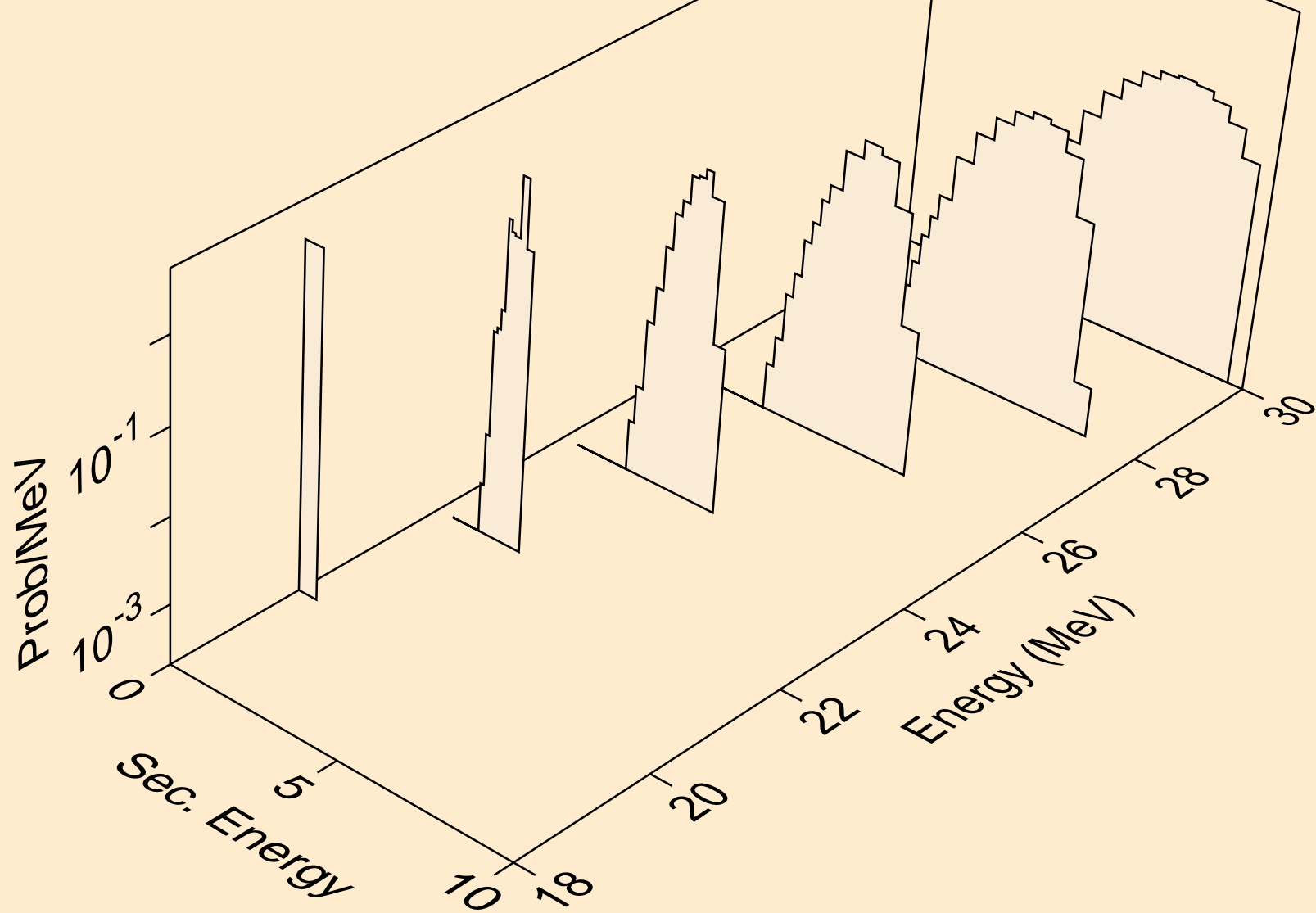

SB116 NEUTRON ACER TENDL-2021 LIBRARY; T=293.6K
deuterons from (n,n*)d

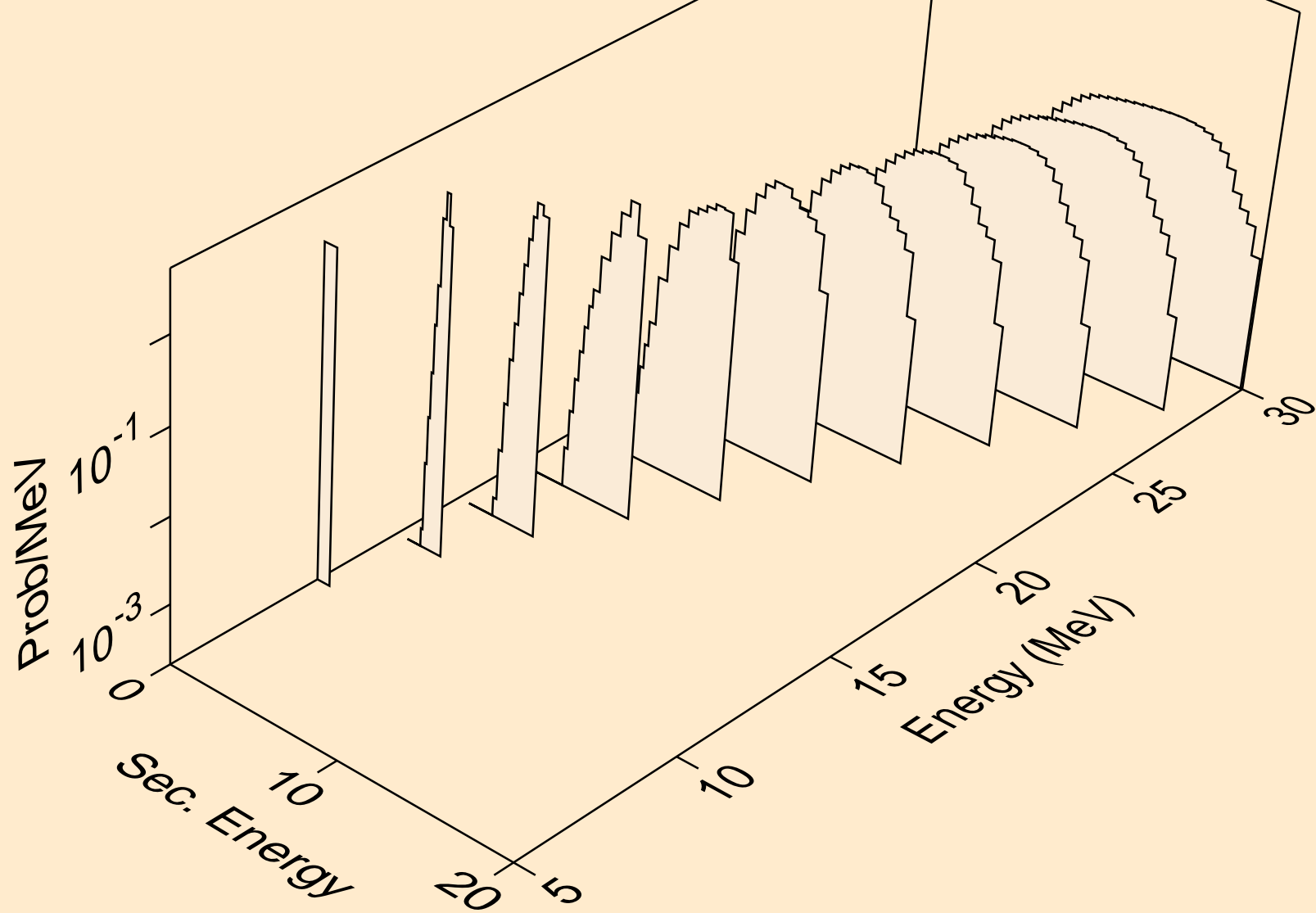

SB116 NEUTRON ACER TENDL-2021 LIBRARY; T=293.6K
deuterons from (n,d)

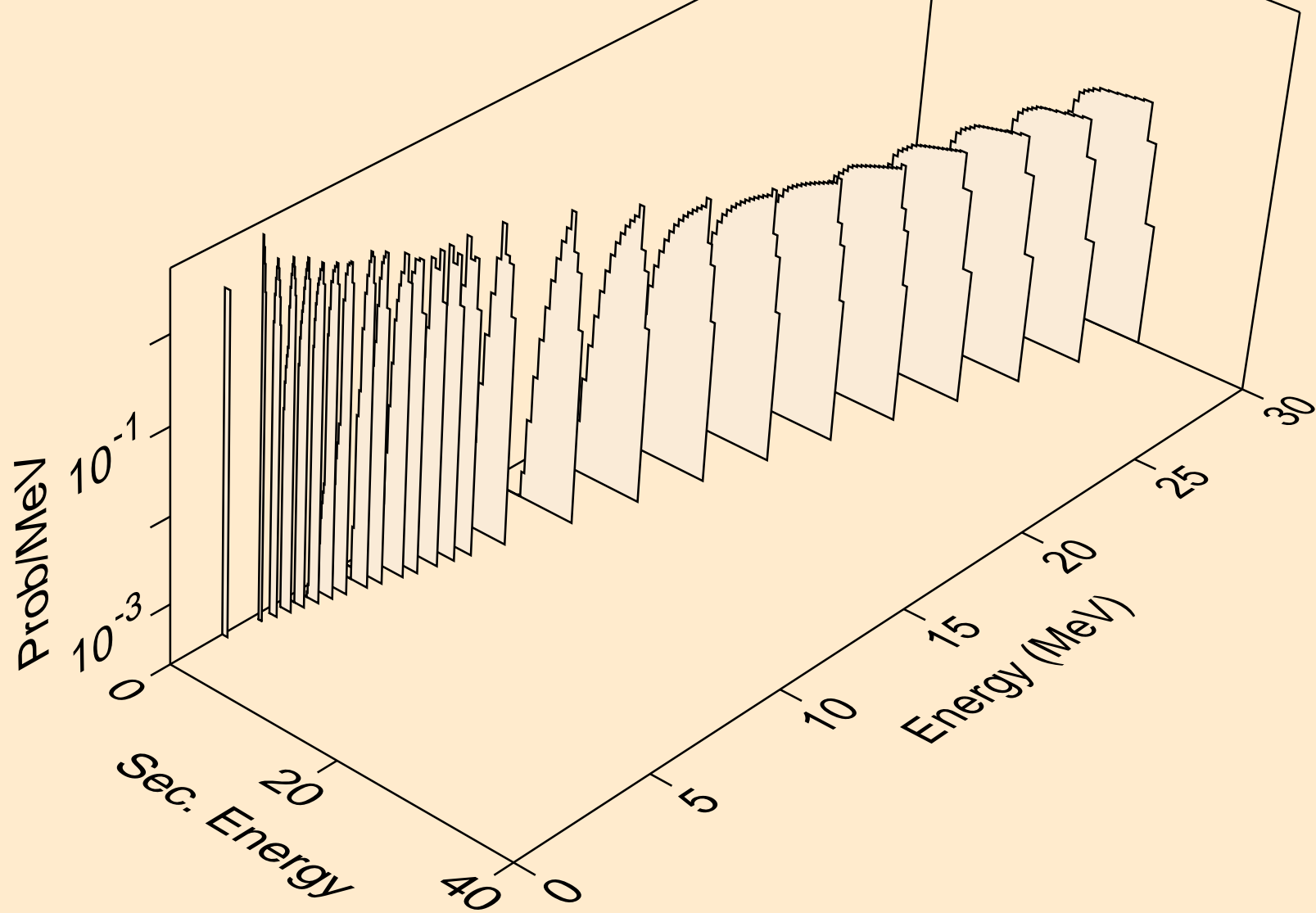

SB116 NEUTRON ACER TENDL-2021 LIBRARY; T=293.6K
deuterons from (n,pd)

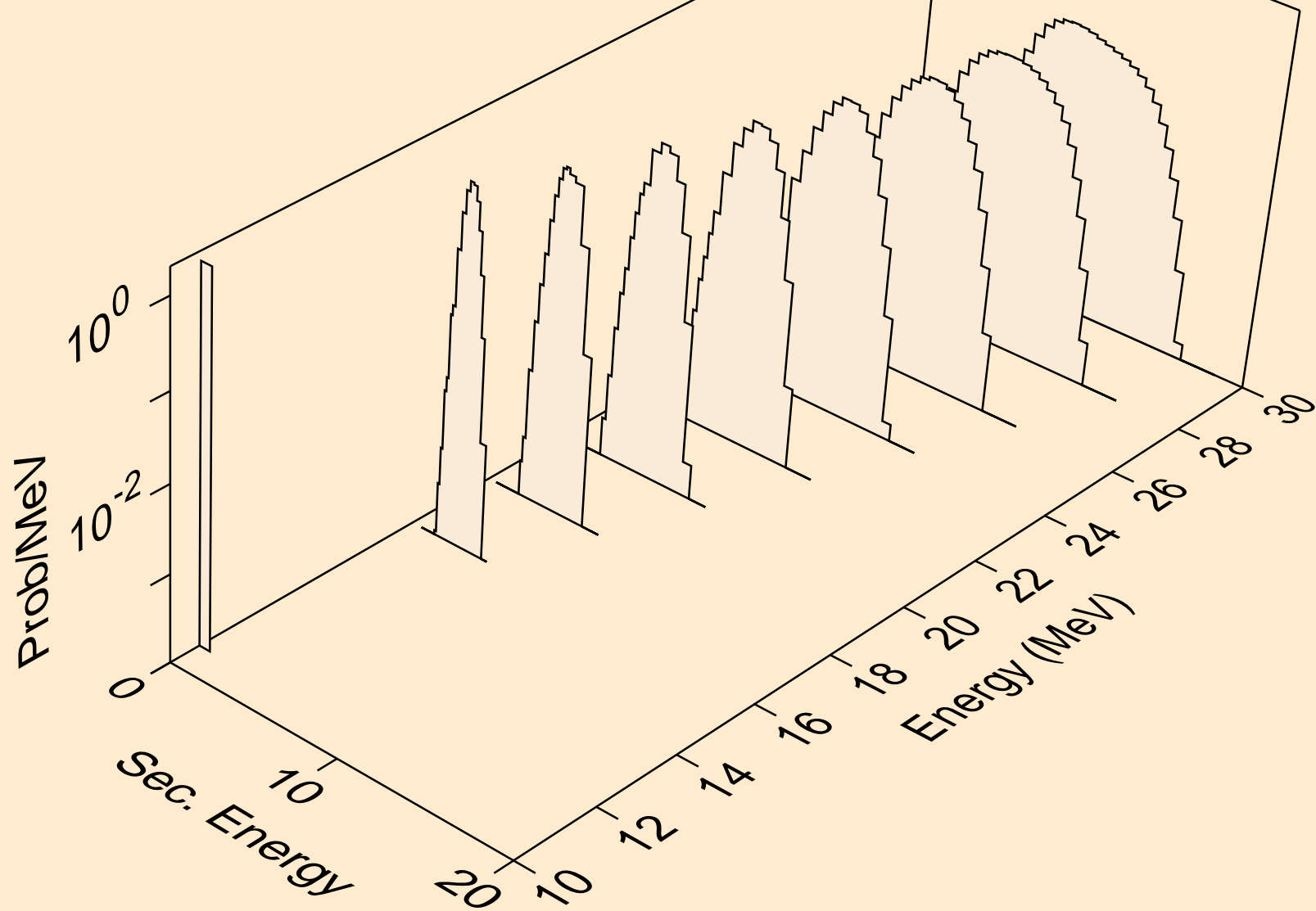

SB116 NEUTRON ACER TENDL-2021 LIBRARY; T=293.6K
deuterons from (n,da)

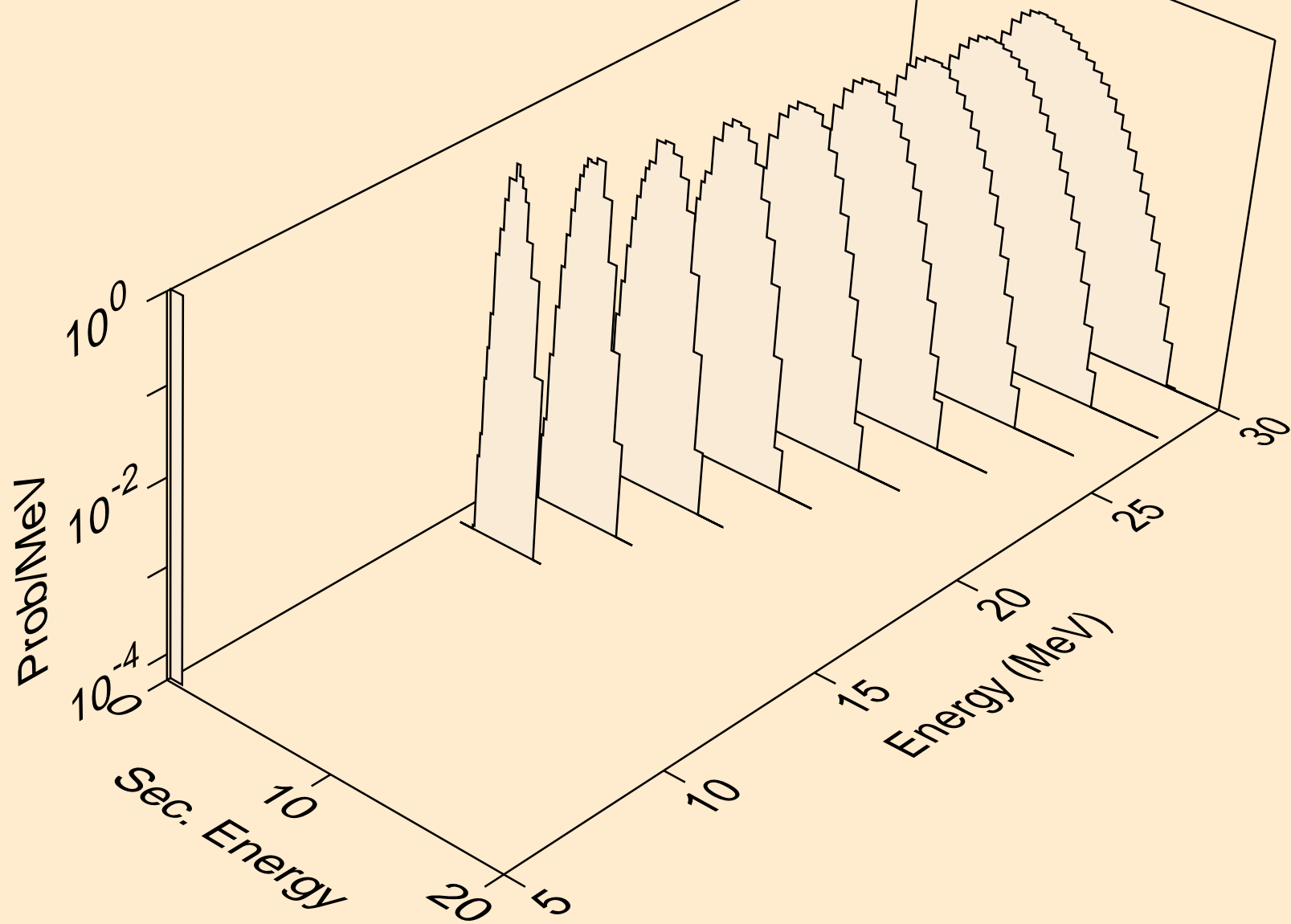

SB116 NEUTRON ACER TENDL-2021 LIBRARY; T=293.6K
tritons from (n,x)

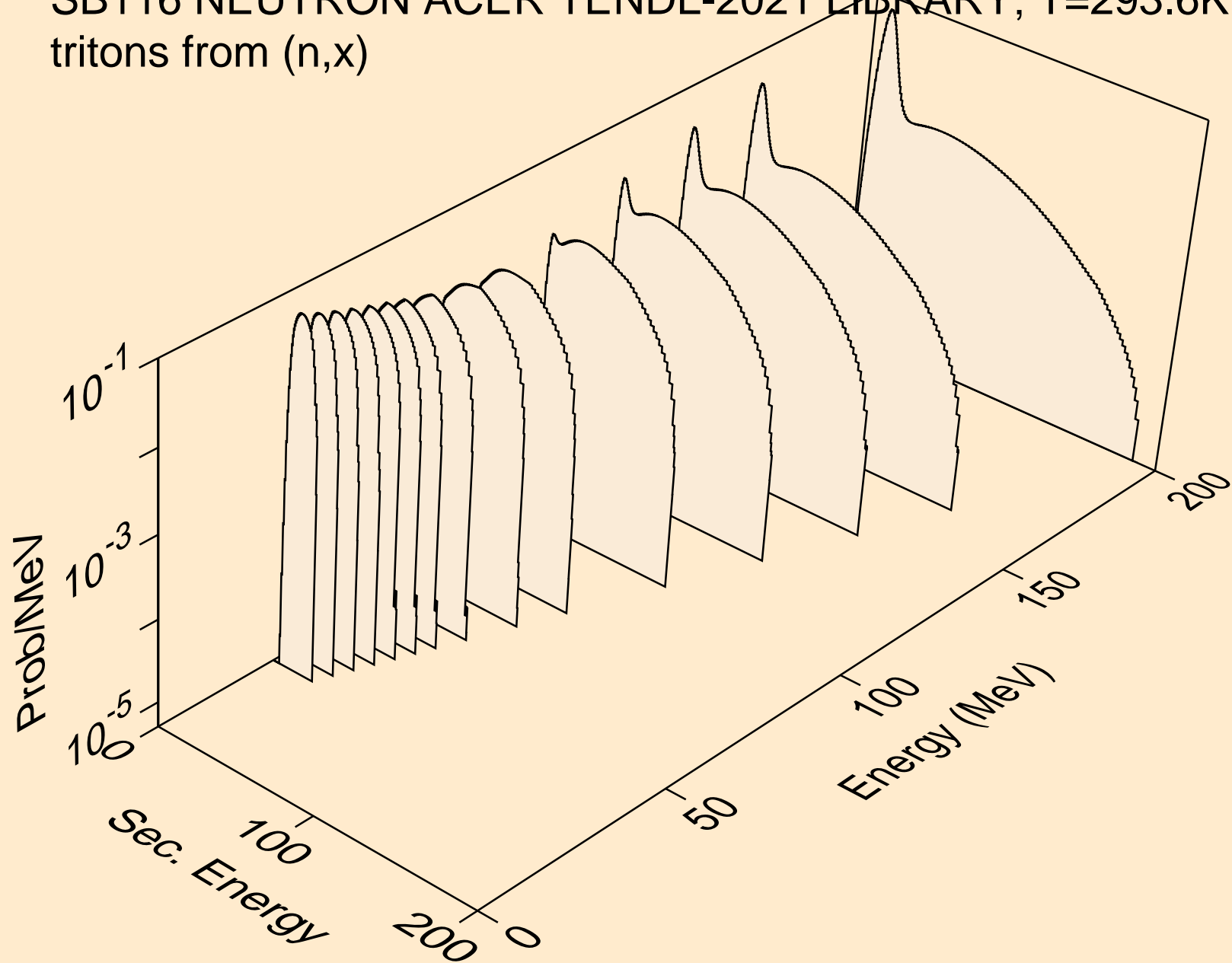

SB116 NEUTRON ACER TENDL-2021 LIBRARY; T=293.6K
tritons from (n,n*)t

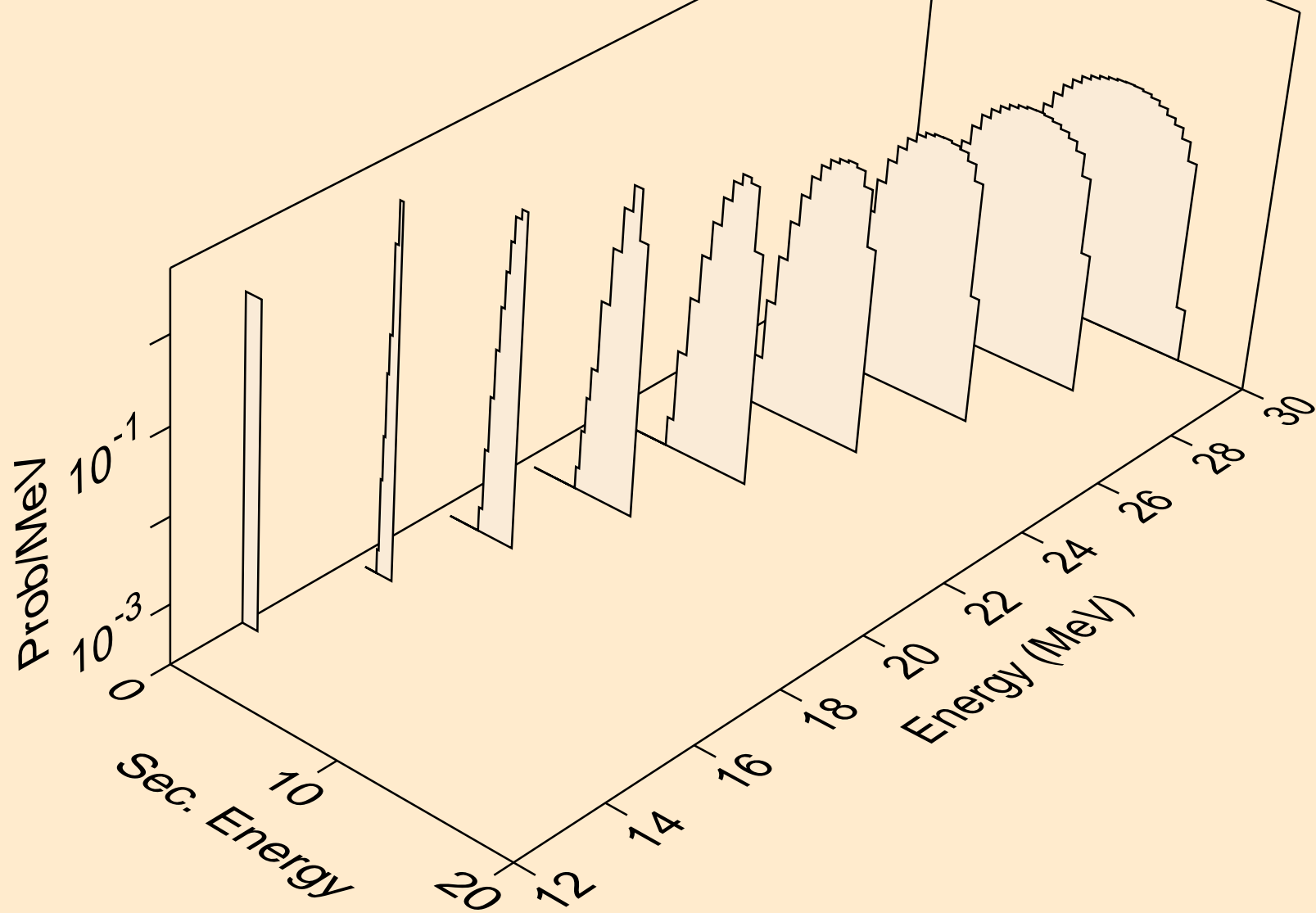

SB116 NEUTRON ACER TENDL-2021 LIBRARY; T=293.6K
tritons from (n,t)

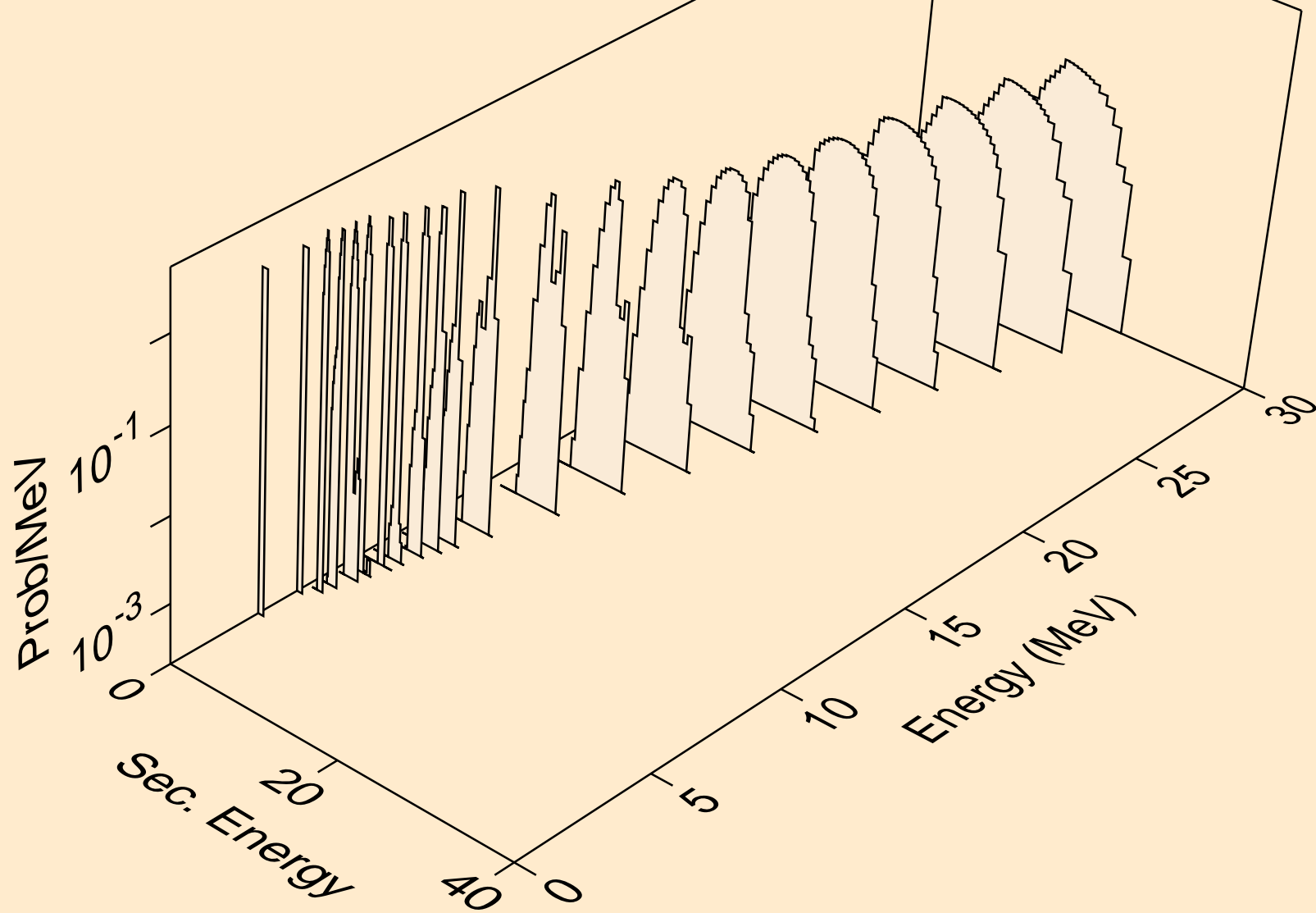

SB116 NEUTRON ACER TENDL-2021 LIBRARY; T=293.6K
tritons from (n,pt)

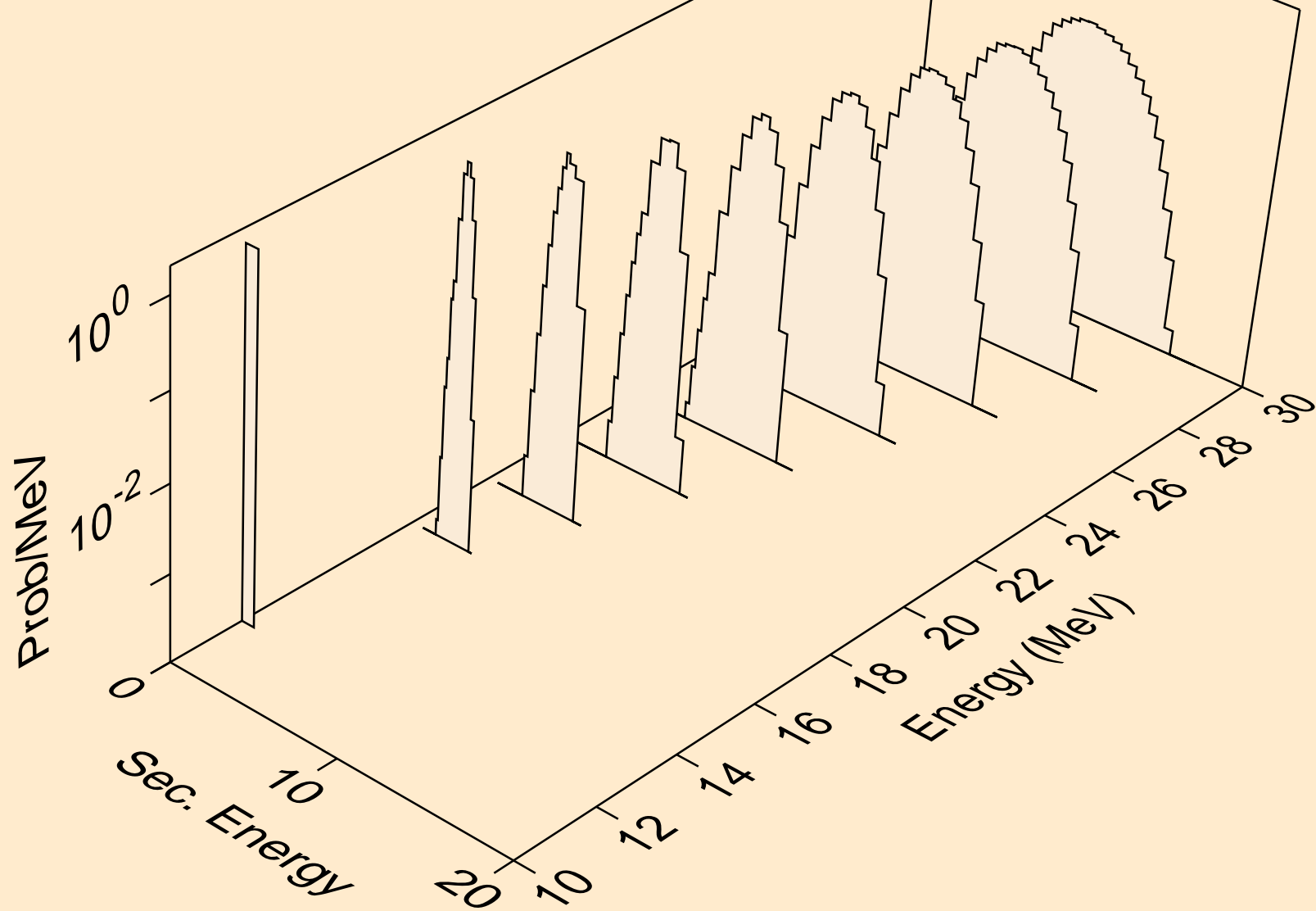

SB116 NEUTRON ACER TENDL-2021 LIBRARY; T=293.6K
he3s from (n,x)

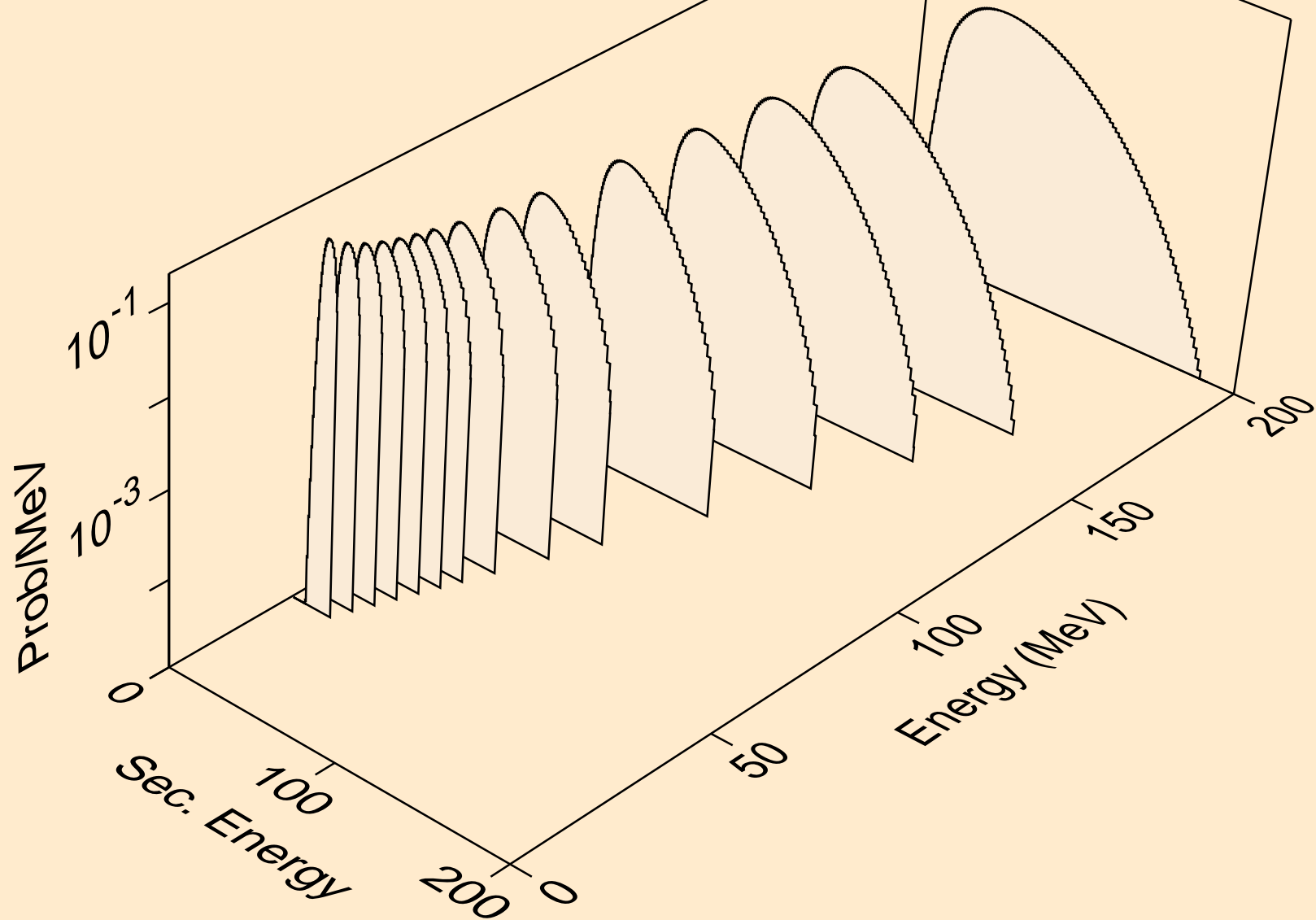

SB116 NEUTRON ACER TENDL-2021 LIBRARY; T=293.6K
he3s from (n,n*)he3

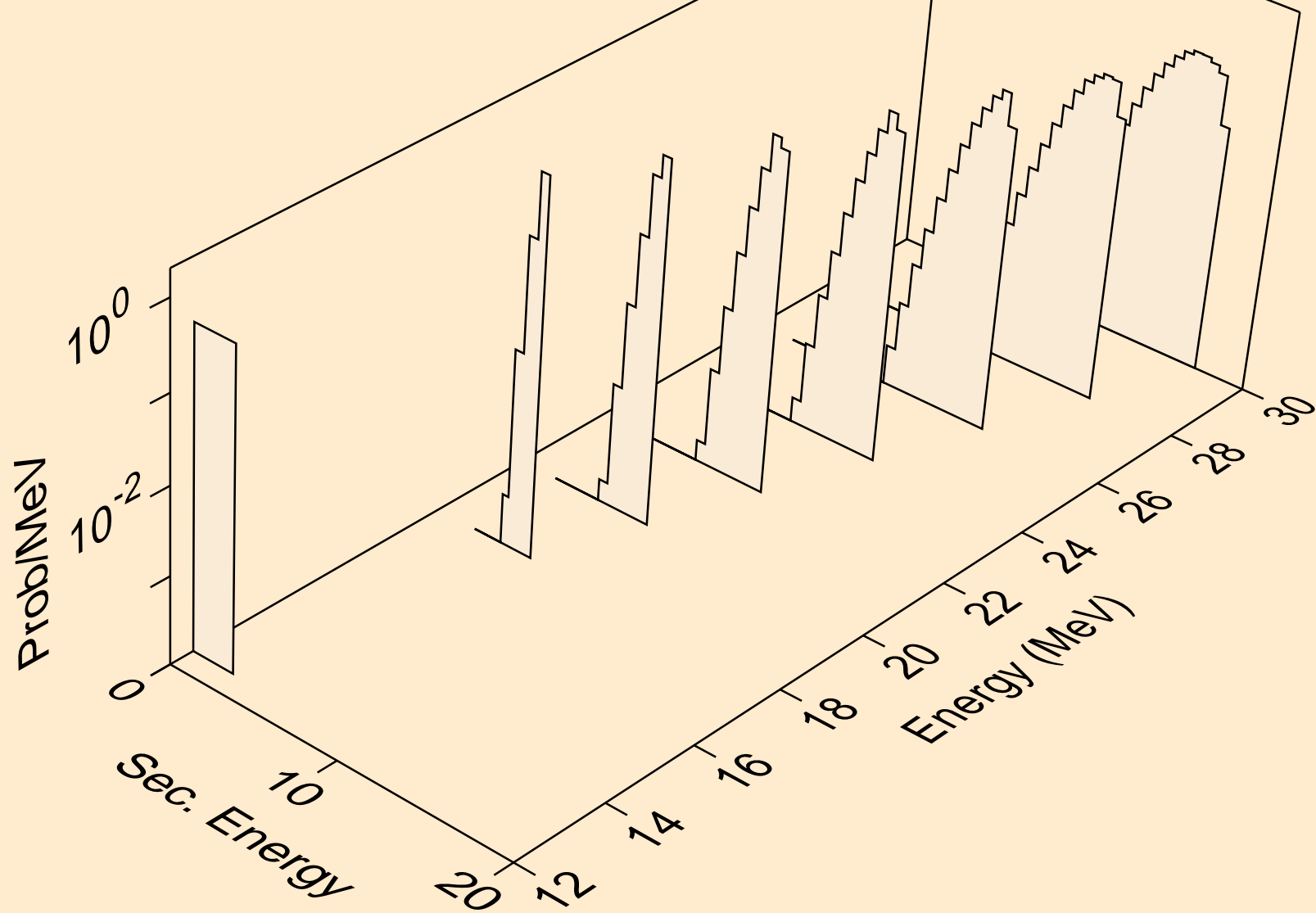

SB116 NEUTRON ACER TENDL-2021 LIBRARY; T=293.6K
he3s from (n,he3)

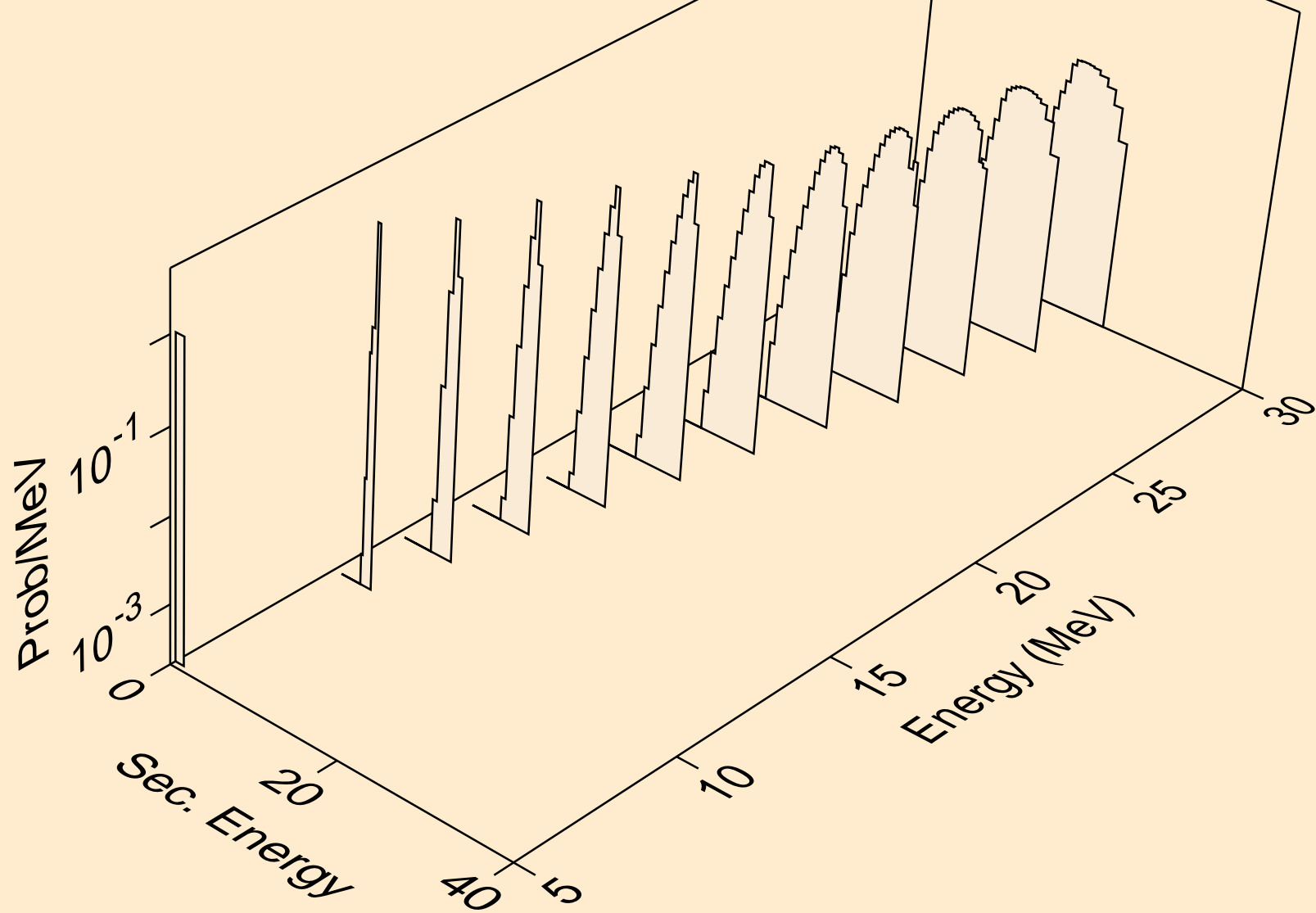

SB116 NEUTRON ACER TENDL-2021 LIBRARY; T=293.6K
alphas from (n,x)

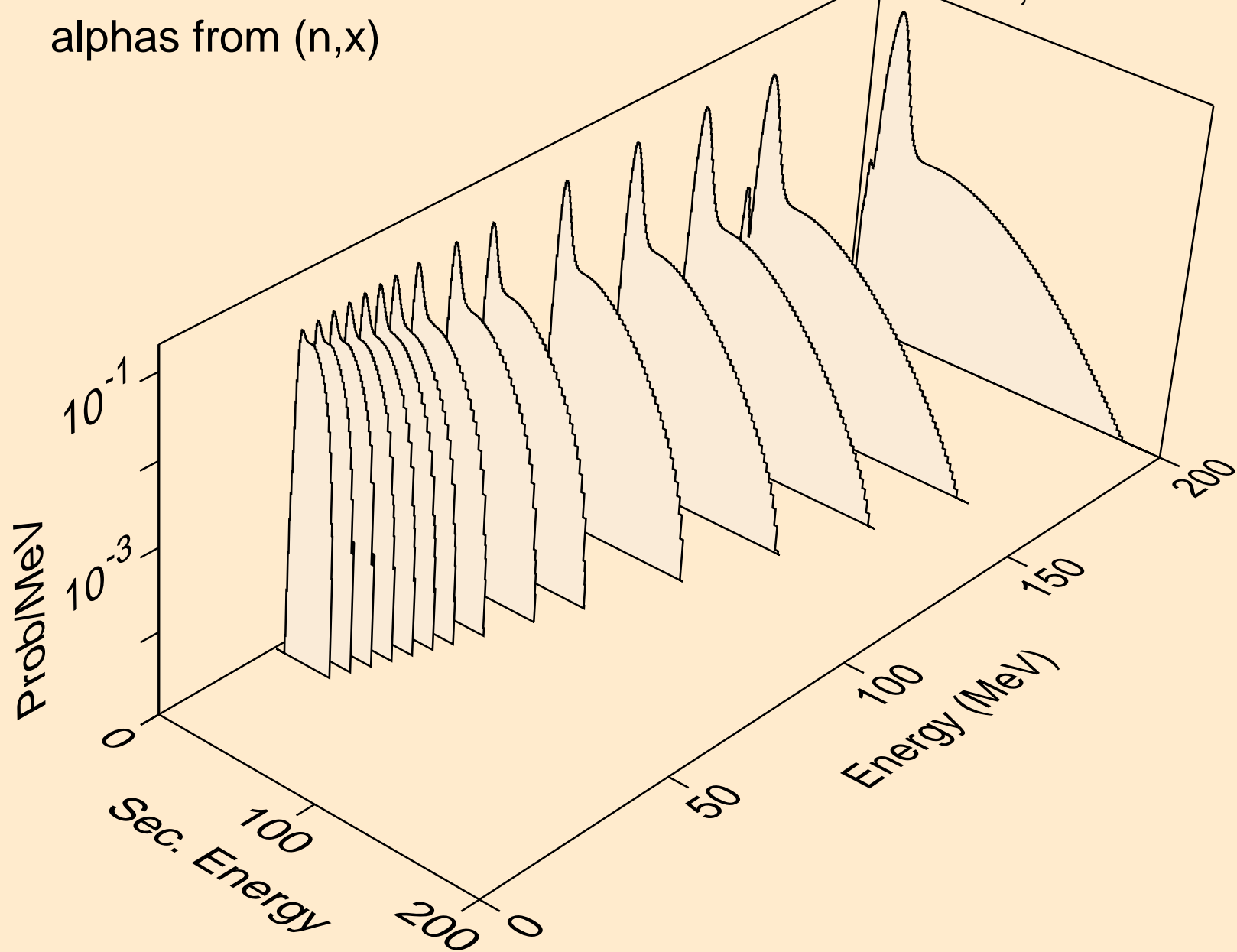

SB116 NEUTRON ACER TENDL-2021 LIBRARY; T=293.6K
alphas from (n,n*)a

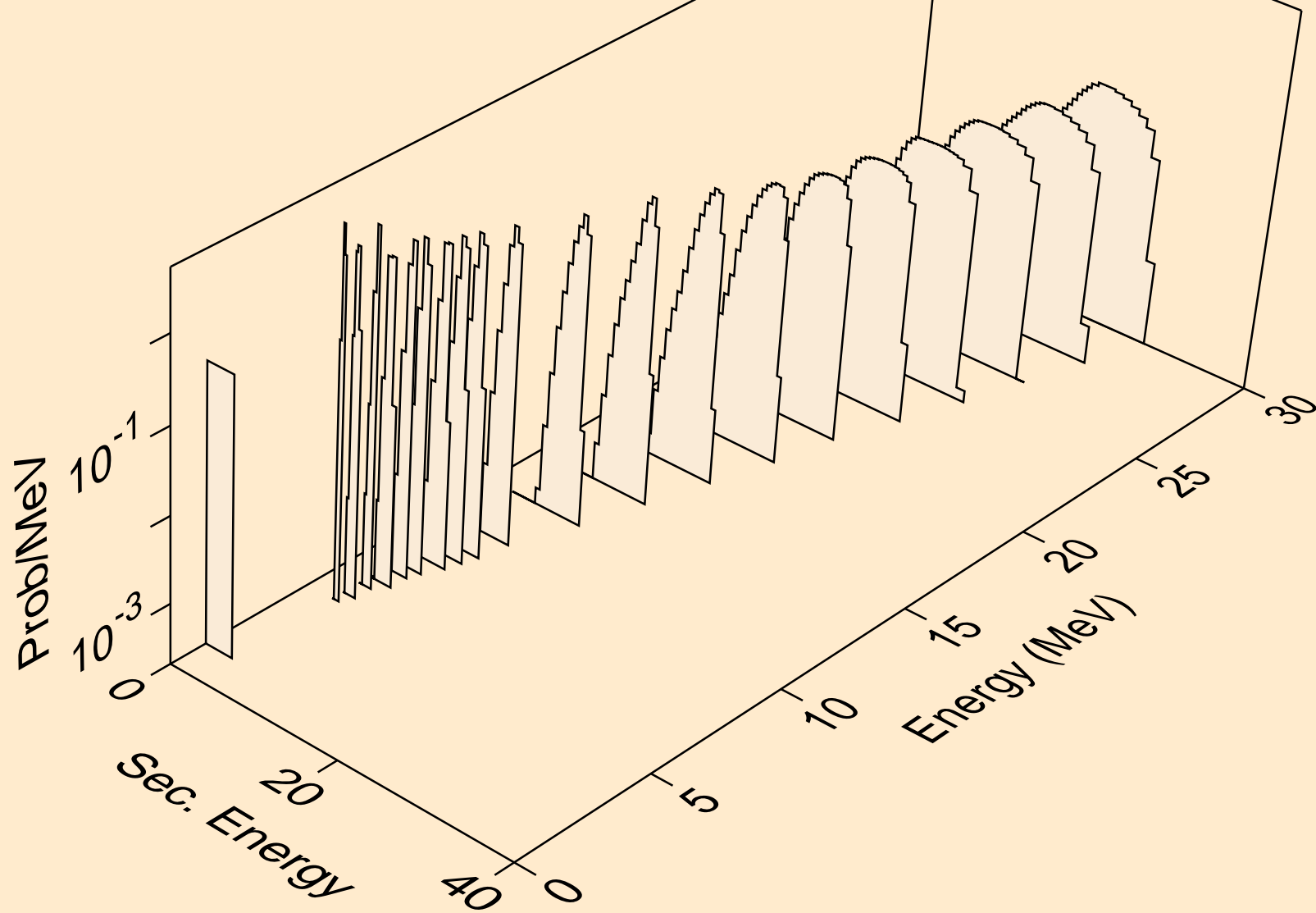

SB116 NEUTRON ACER TENDL-2021 LIBRARY; T=293.6K
alphas from (n,2n)a

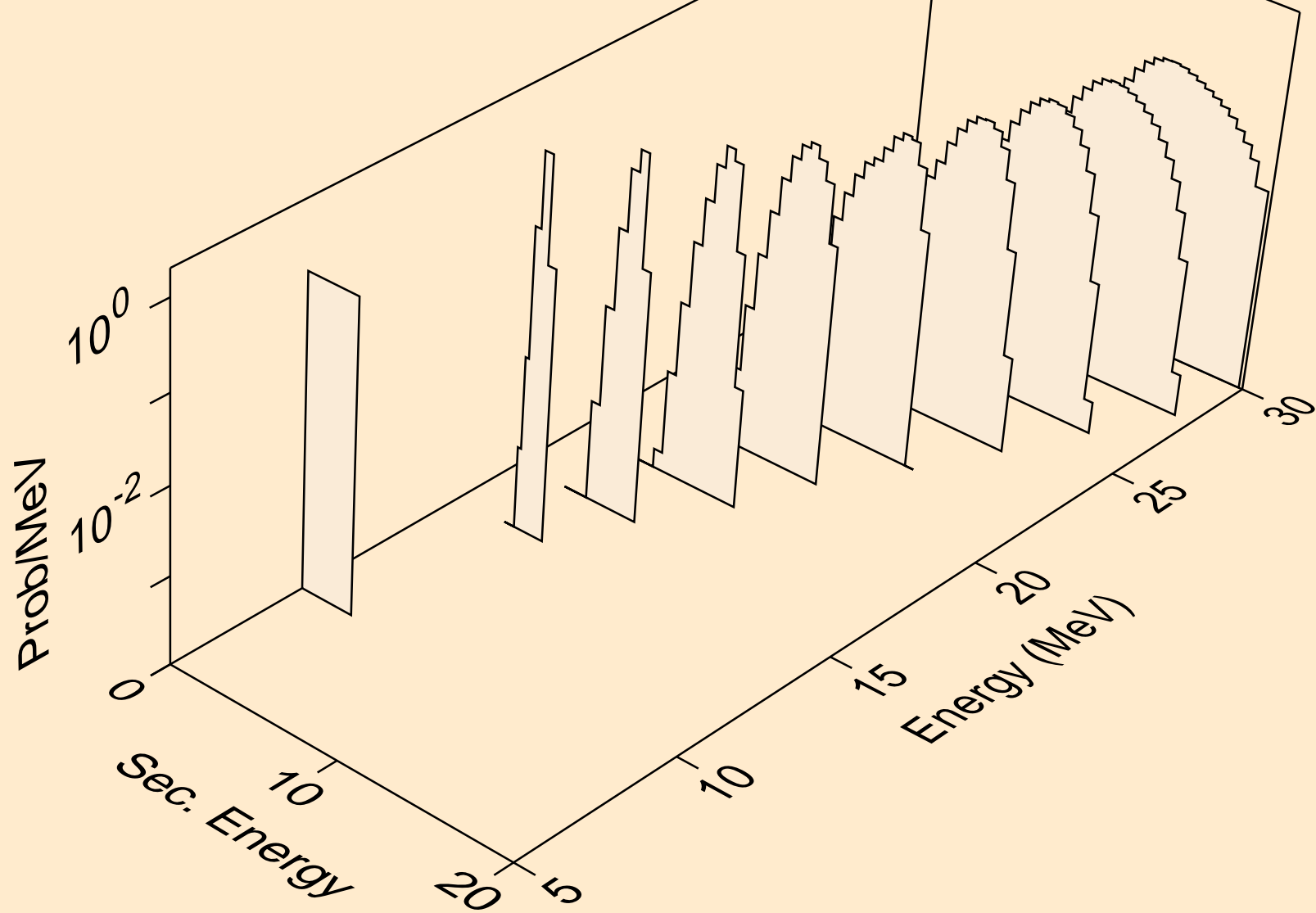

SB116 NEUTRON ACER TENDL-2021 LIBRARY; T=293.6K
alphas from (n,3n)a

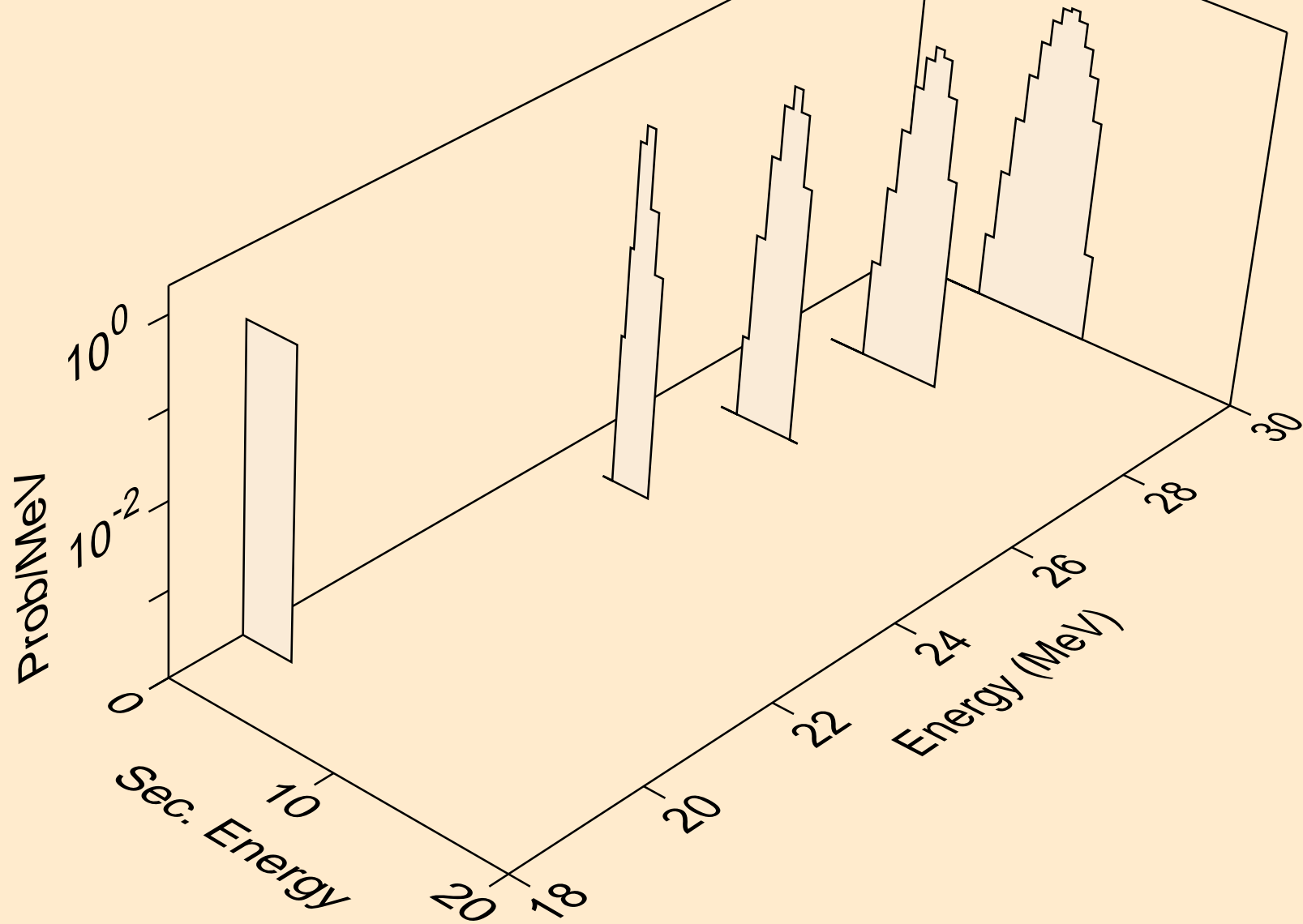

SB116 NEUTRON ACER TENDL-2021 LIBRARY; T=293.6K
alphas from (n,n*)2a

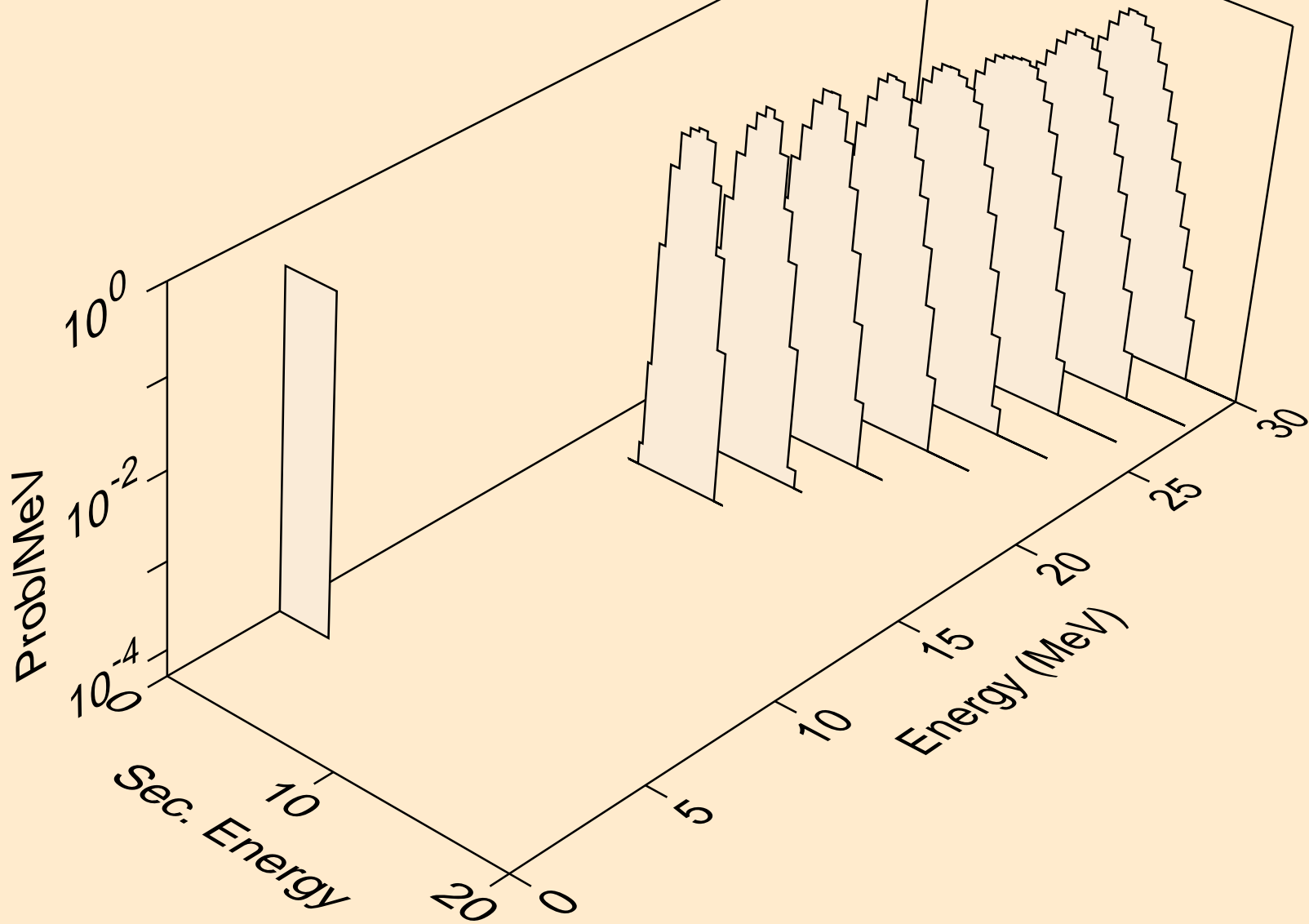

SB116 NEUTRON ACER TENDL-2021 LIBRARY; T=293.6K
alphas from (n,npa)

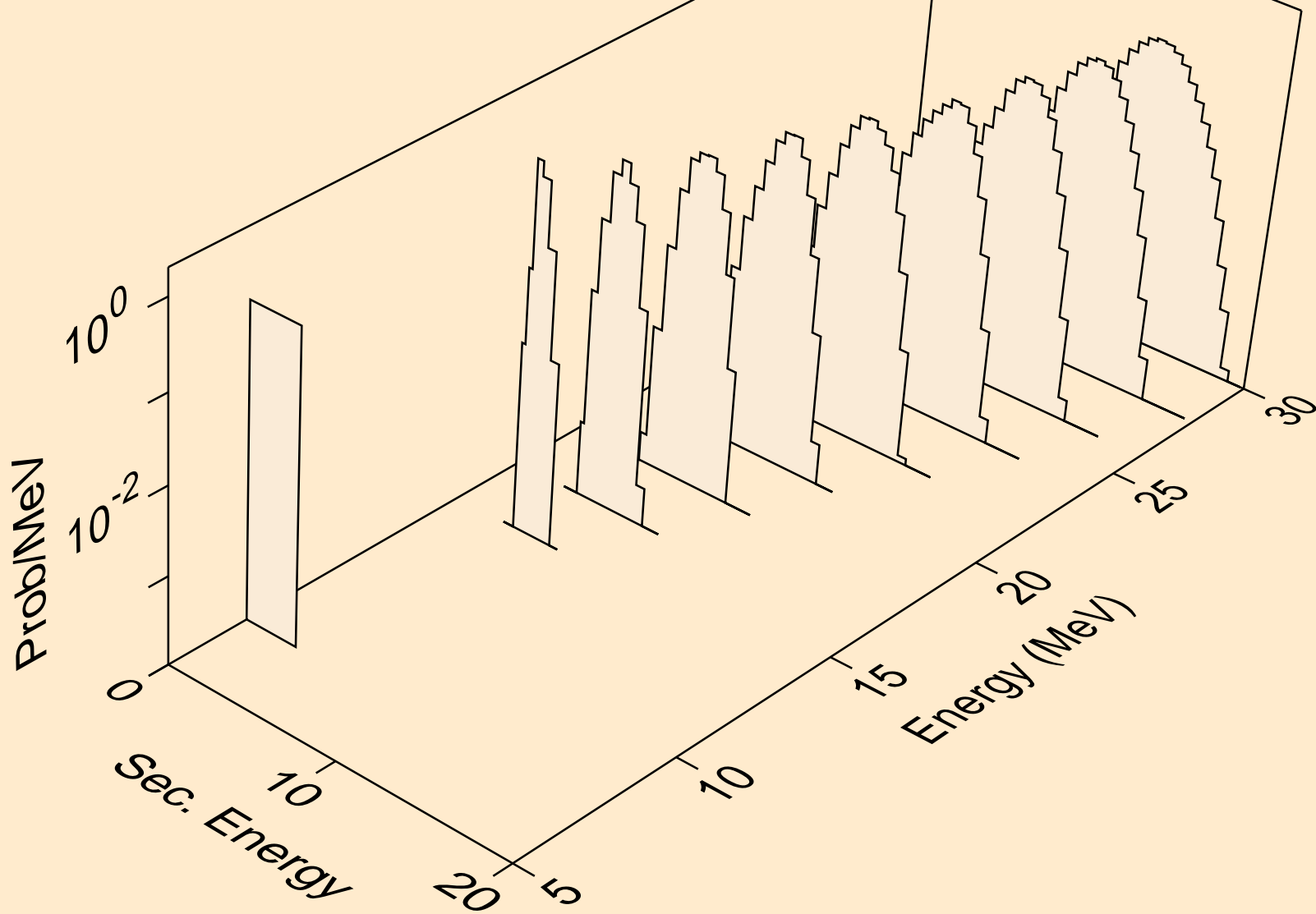

SB116 NEUTRON ACER TENDL-2021 LIBRARY; T=293.6K
alphas from (n,a)

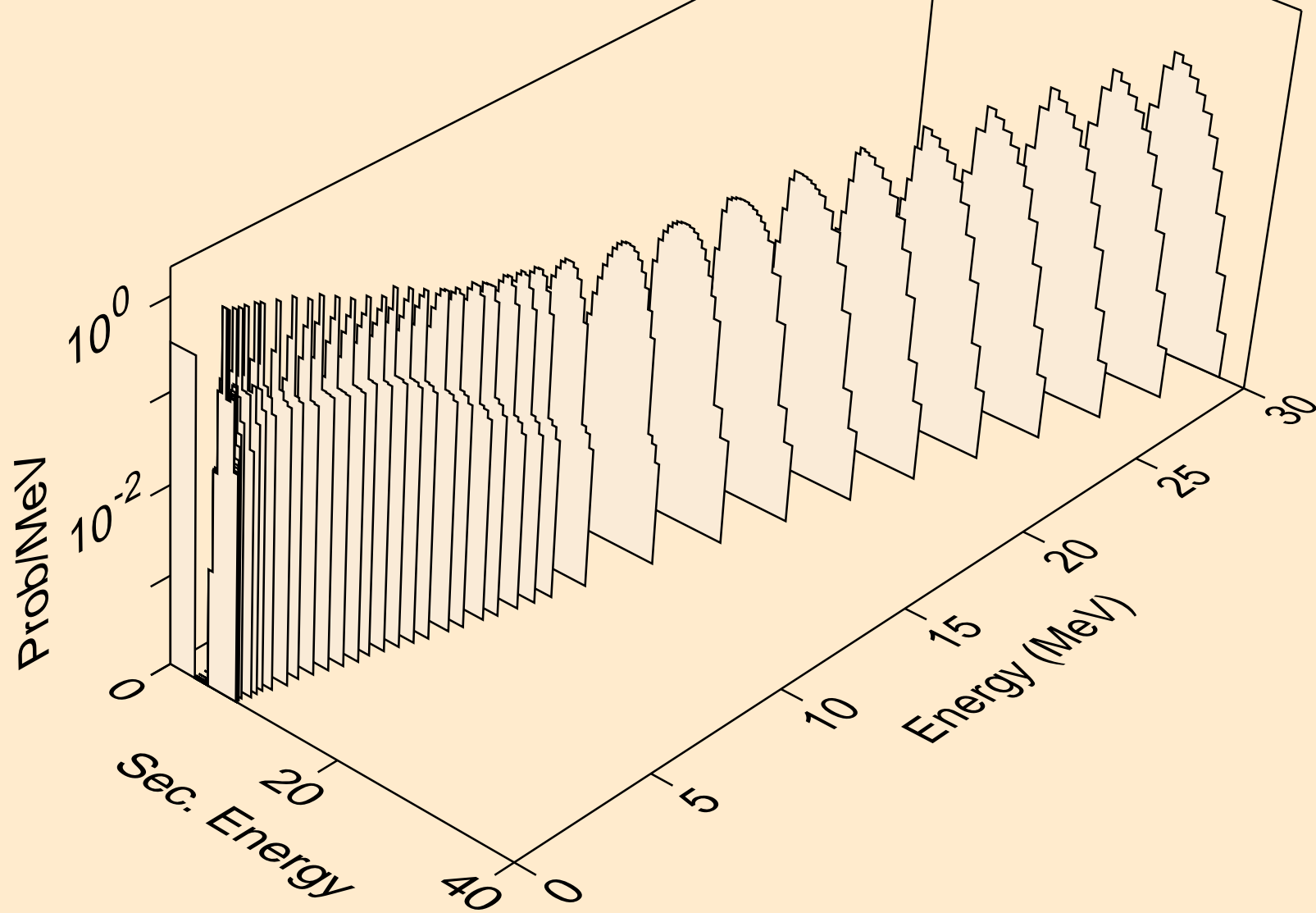

SB116 NEUTRON ACER TENDL-2021 LIBRARY; T=293.6K
alphas from (n,2a)

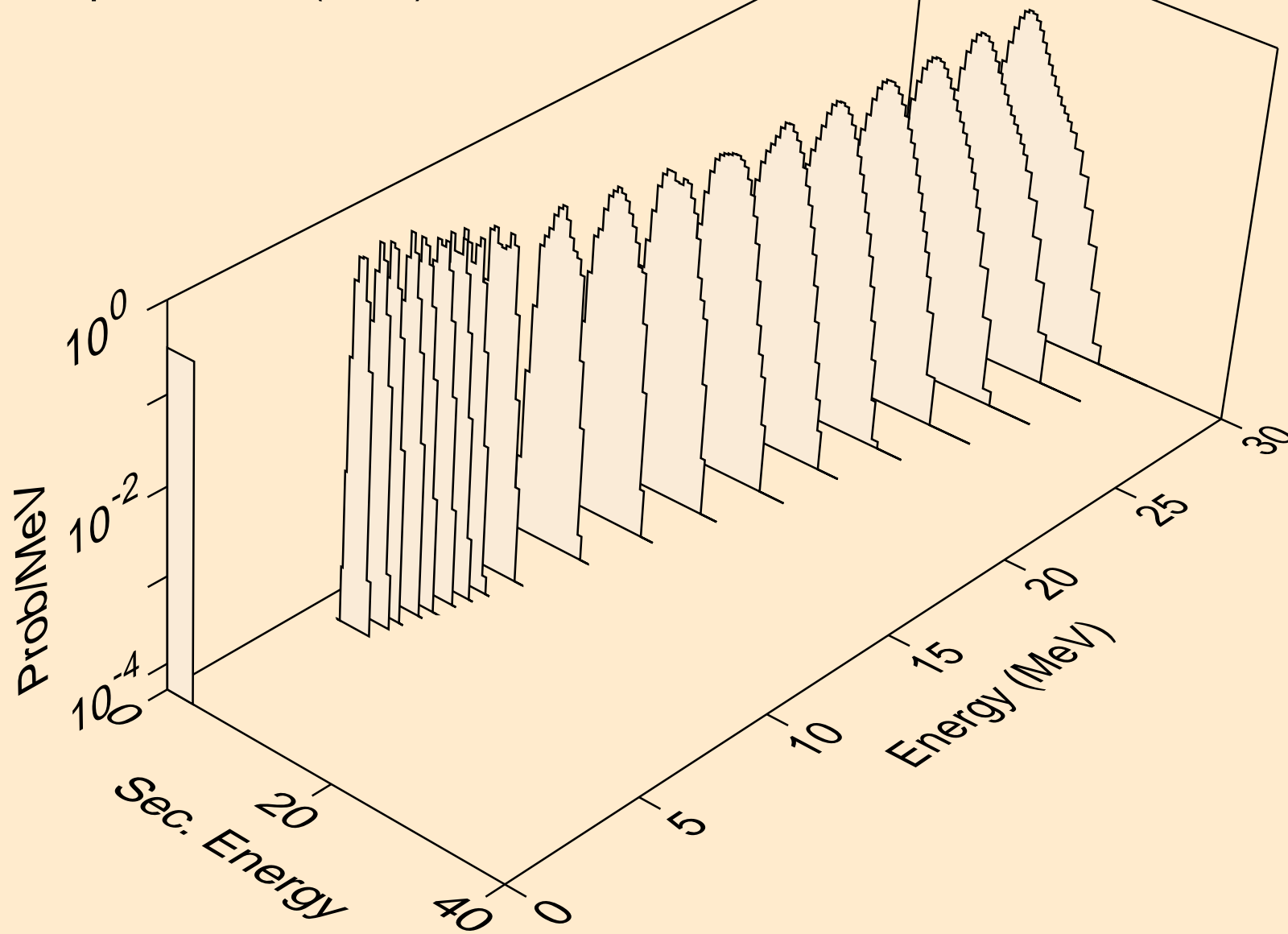

SB116 NEUTRON ACER TENDL-2021 LIBRARY; T=293.6K
alphas from (n,pa)

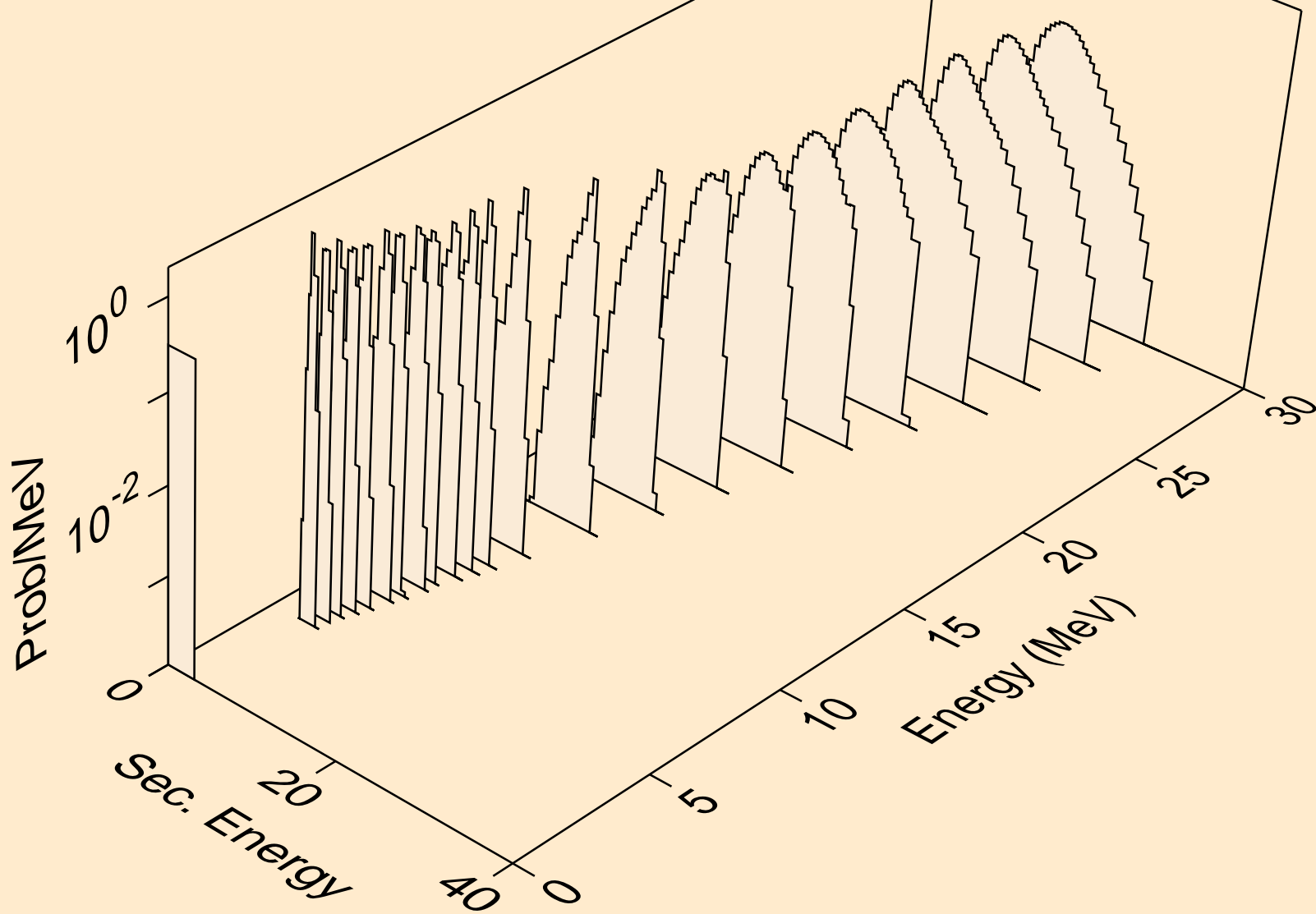

SB116 NEUTRON ACER TENDL-2021 LIBRARY; T=293.6K
alphas from (n,da)

