

SC042M NEUTRON ACER TENDL-2021 LIBRARY; T=293.6K
Principal cross sections

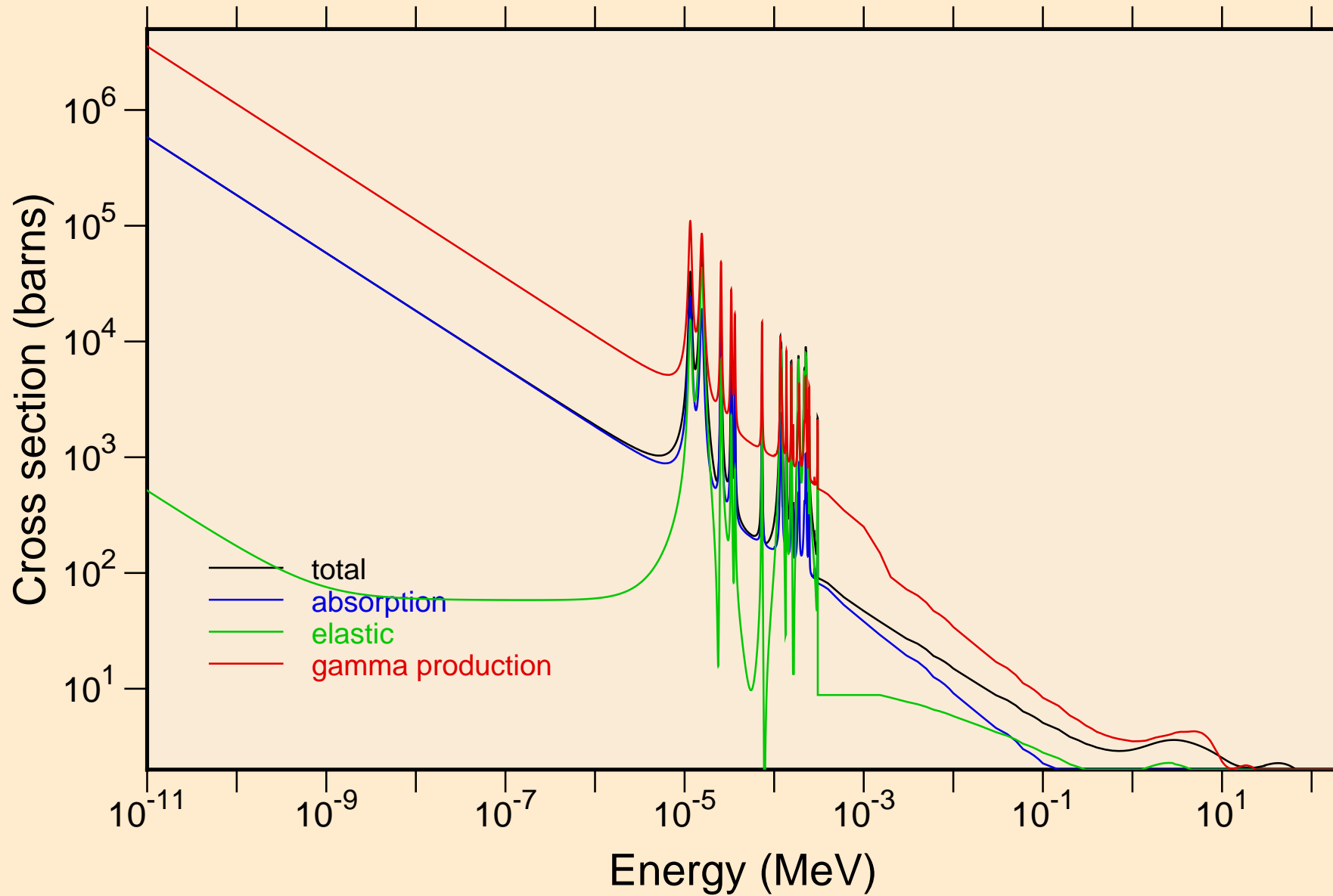

SC042M NEUTRON ACER TENDL-2021 LIBRARY; T=293.6K
resonance total cross section

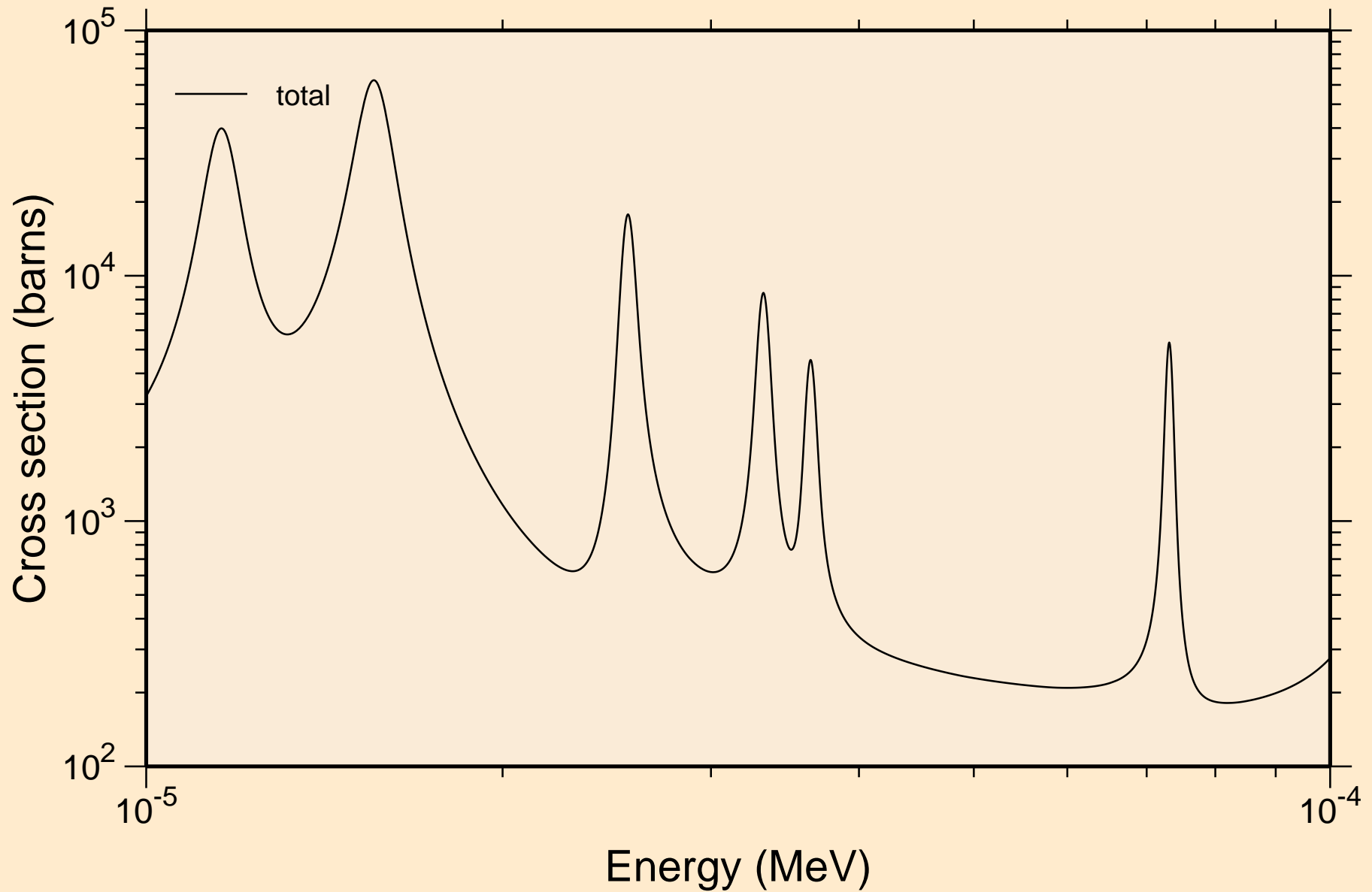

SC042M NEUTRON ACER TENDL-2021 LIBRARY; T=293.6K
resonance total cross section

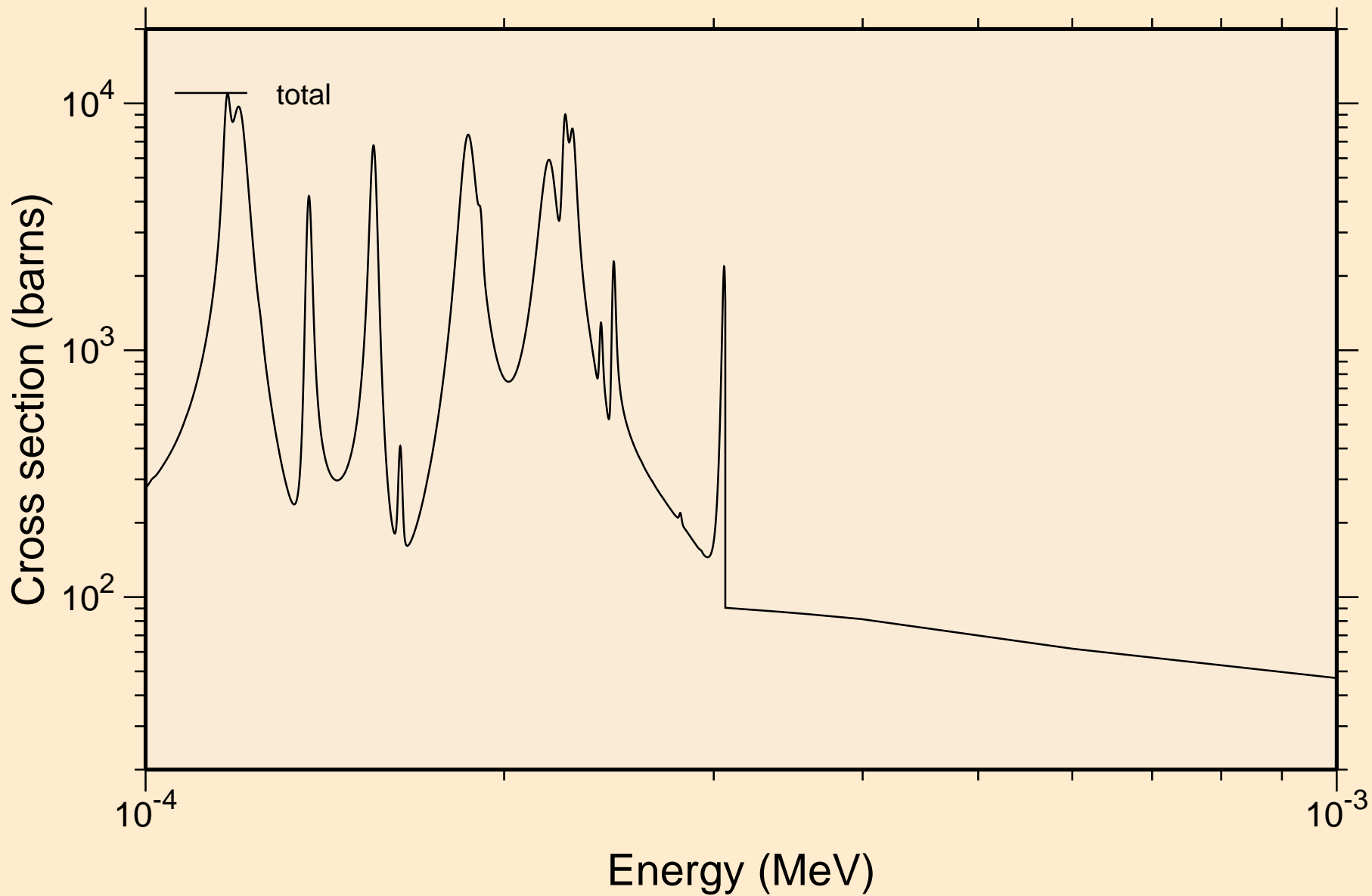

SC042M NEUTRON ACER TENDL-2021 LIBRARY; T=293.6K
resonance total cross section

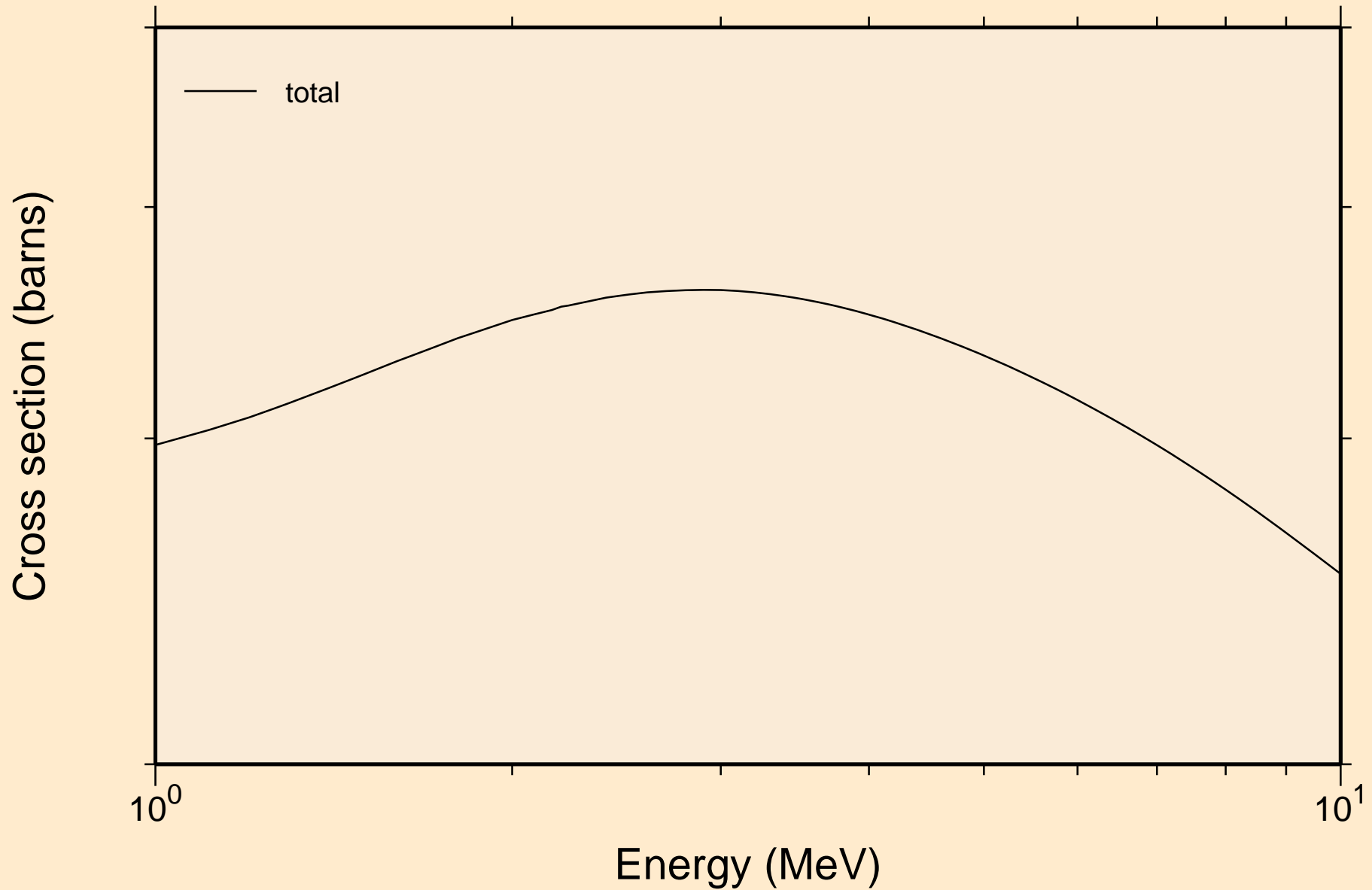

SC042M NEUTRON ACER TENDL-2021 LIBRARY; T=293.6K
resonance absorption cross sections

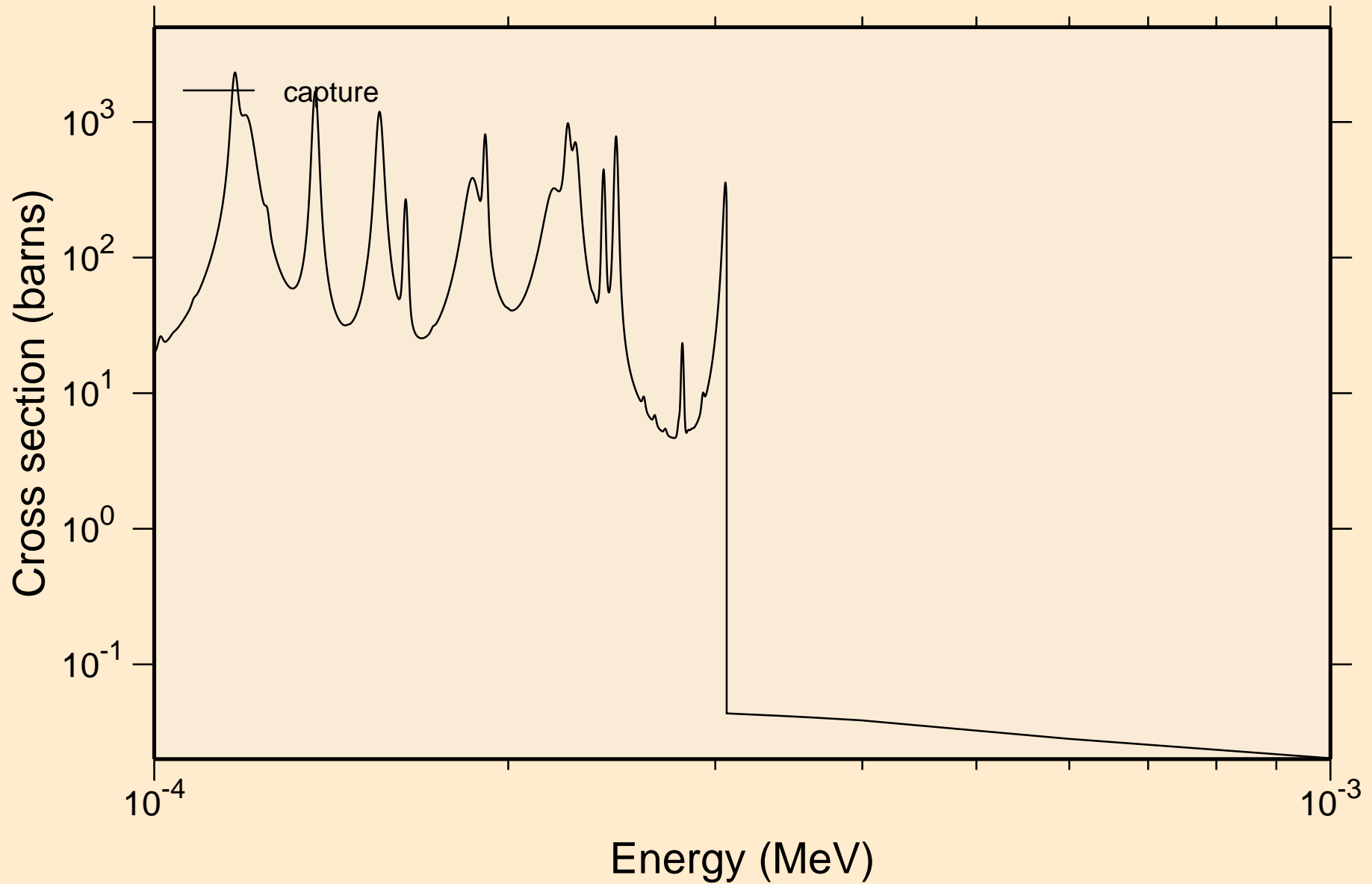

SC042M NEUTRON ACER TENDL-2021 LIBRARY; T=293.6K
resonance absorption cross sections

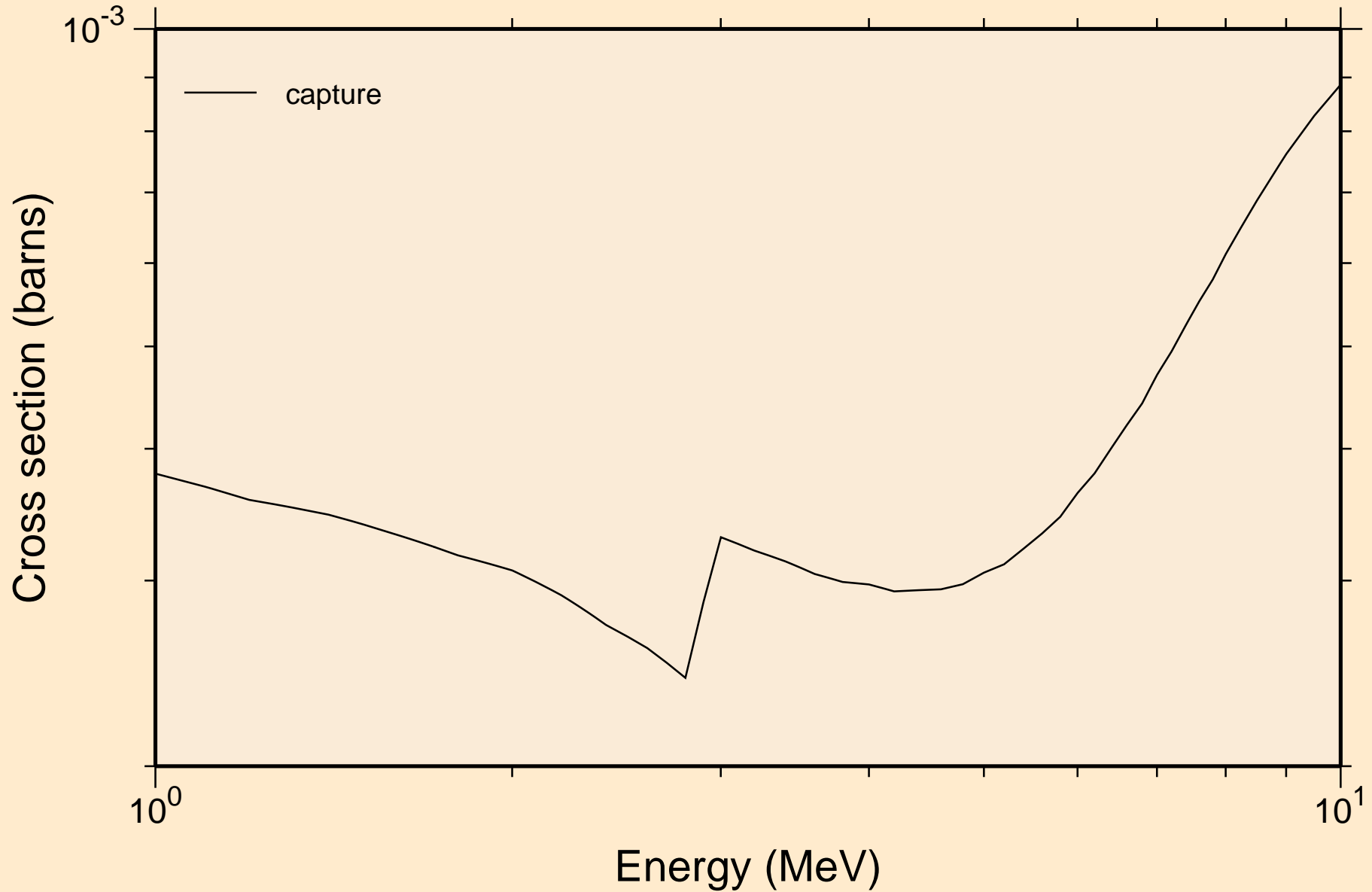

SC042M NEUTRON ACER TENDL-2021 LIBRARY; T=293.6K
Heating

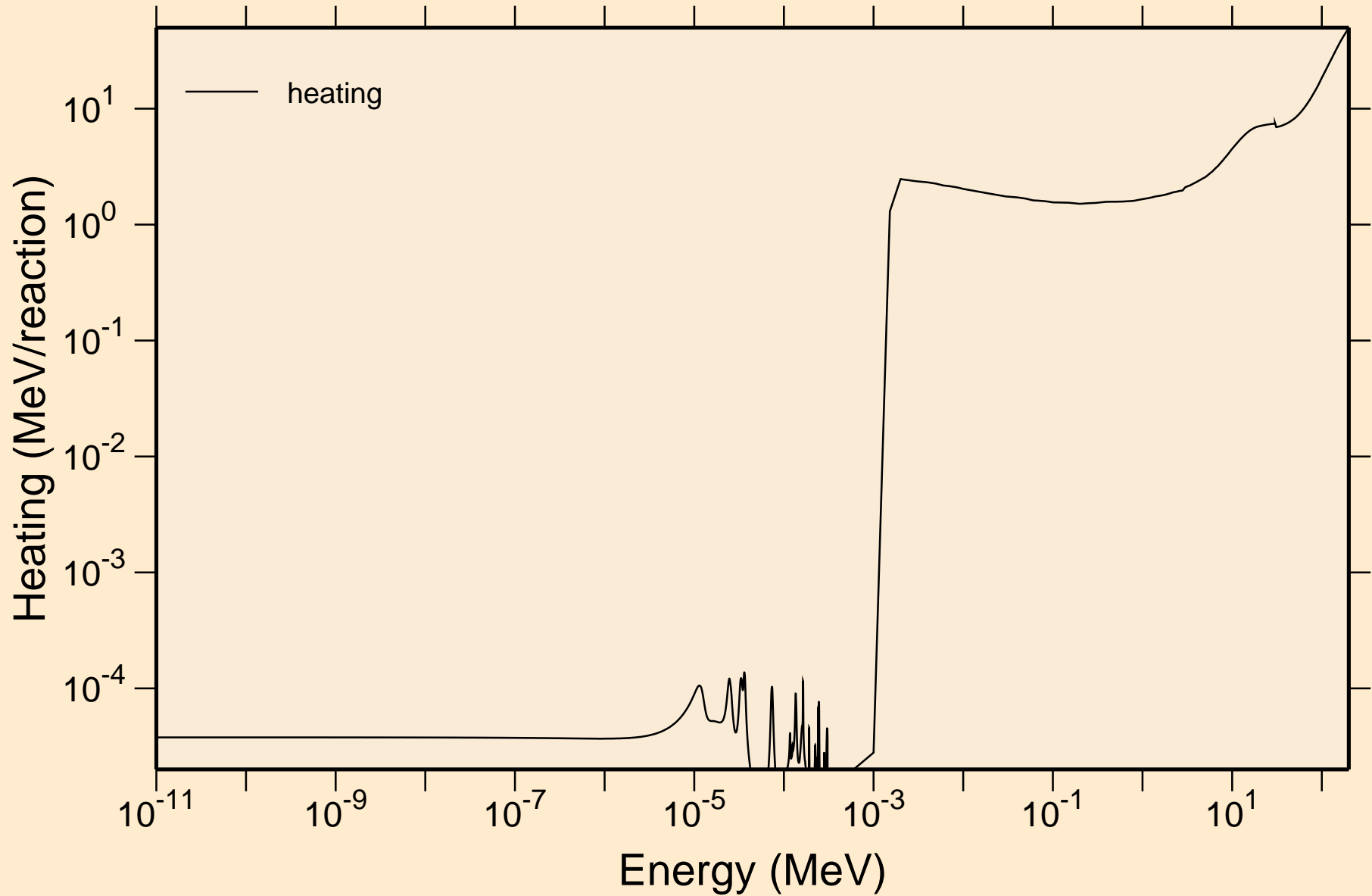

SC042M NEUTRON ACER TENDL-2021 LIBRARY; T=293.6K
Damage

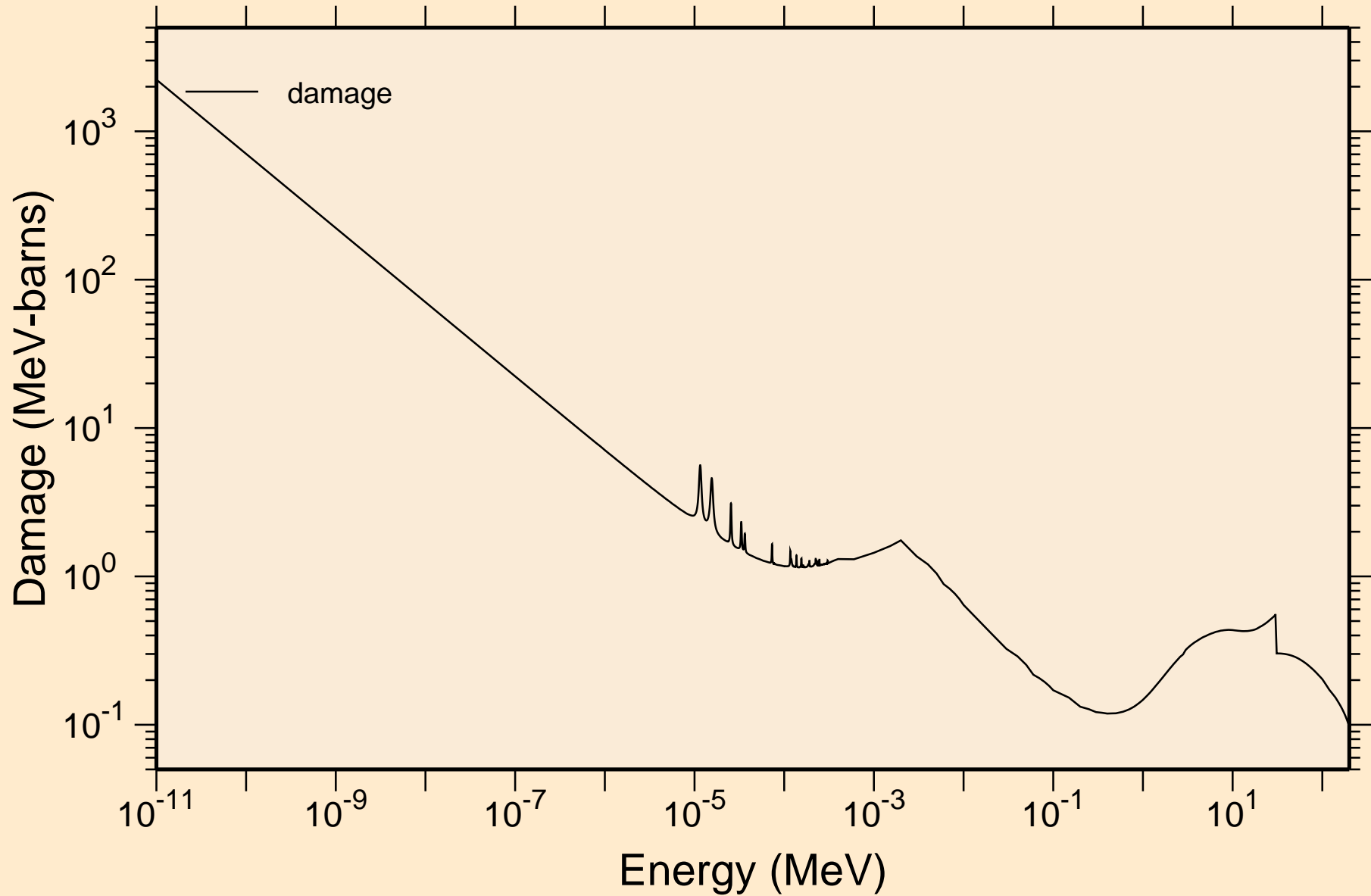

SC042M NEUTRON ACER TENDL-2021 LIBRARY; T=293.6K
Non-threshold reactions

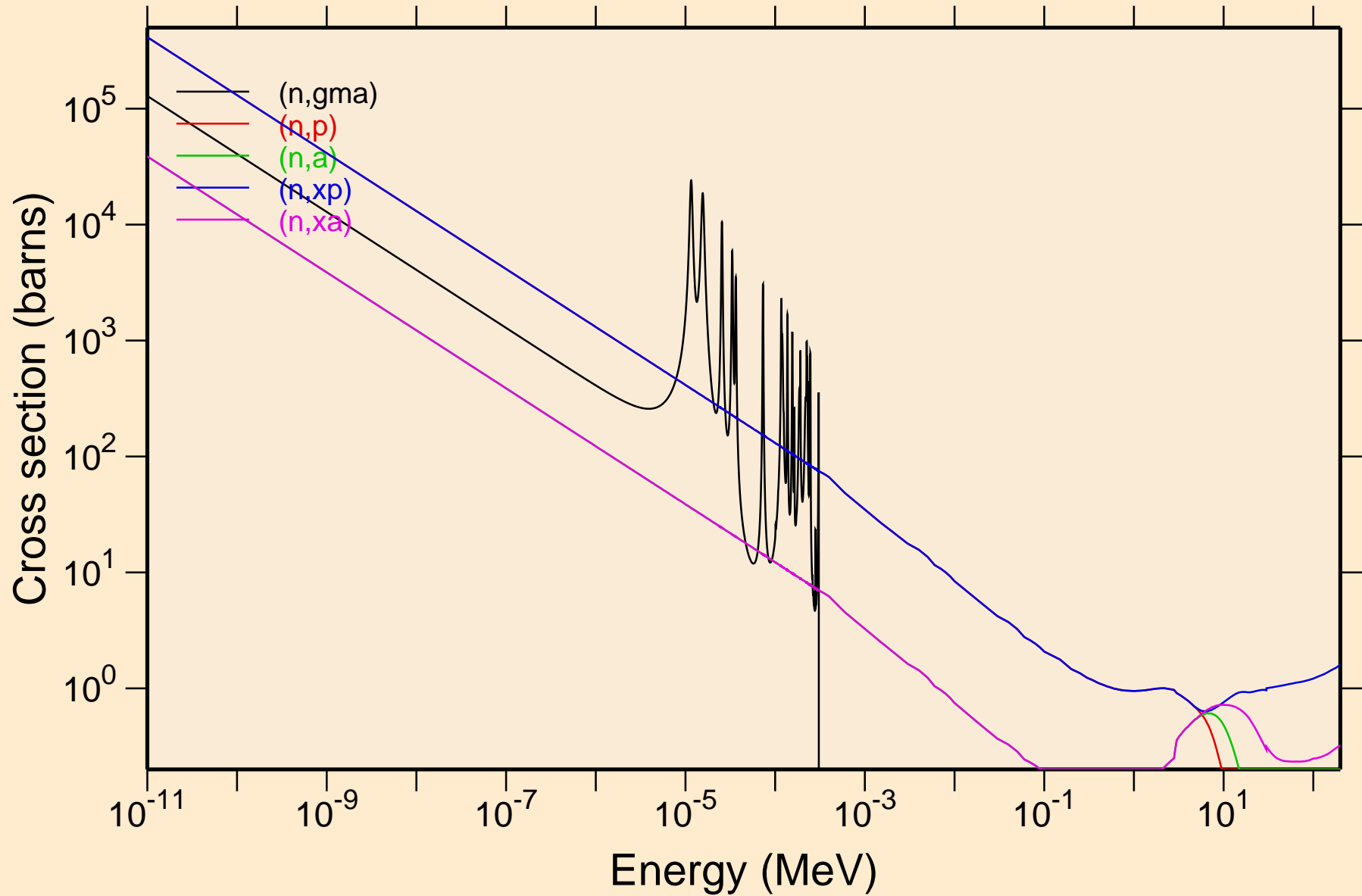

SC042M NEUTRON ACER TENDL-2021 LIBRARY; T=293.6K
Principal cross sections

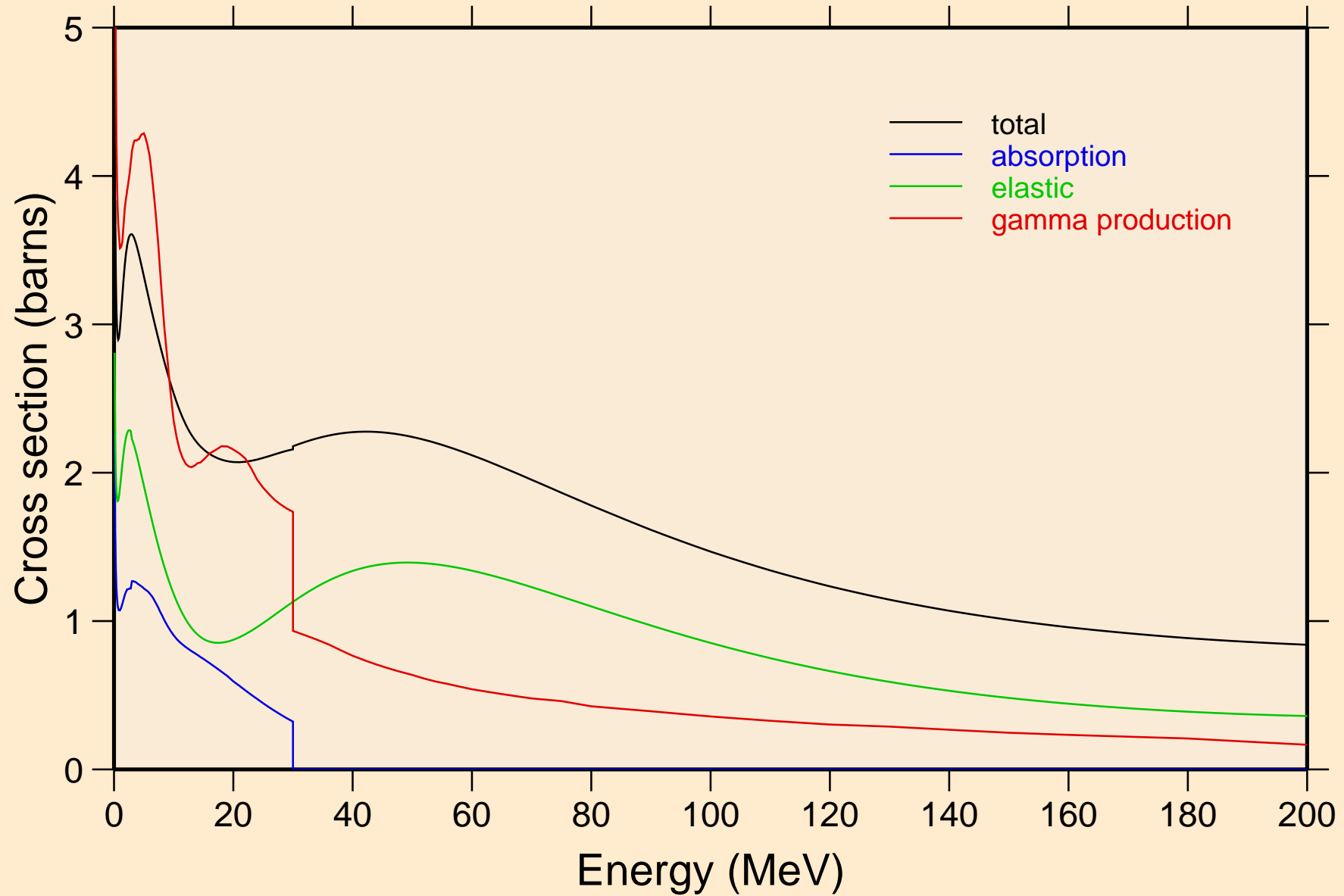

SC042M NEUTRON ACER TENDL-2021 LIBRARY; T=293.6K
Heating

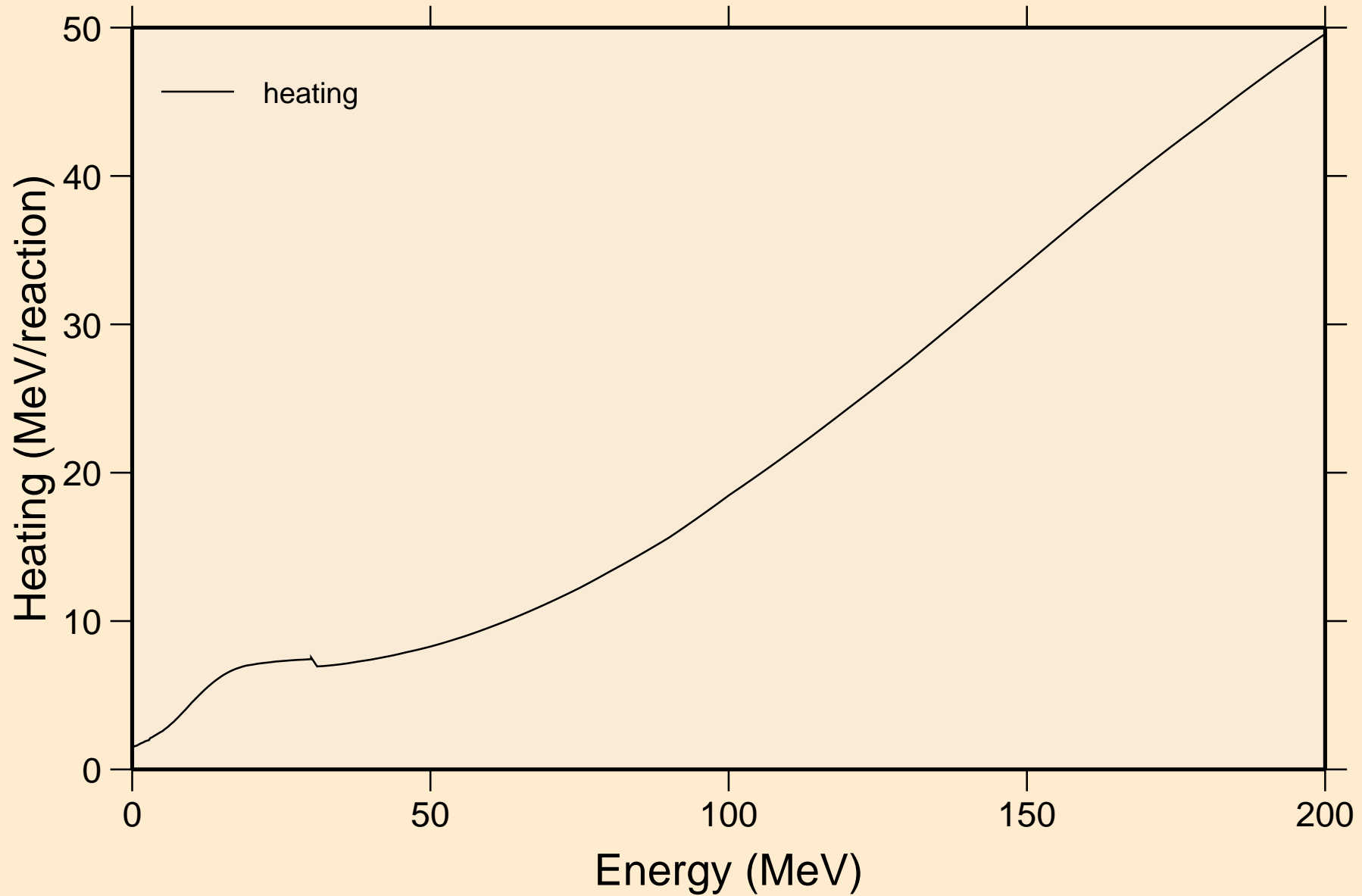

SC042M NEUTRON ACER TENDL-2021 LIBRARY; T=293.6K
Damage

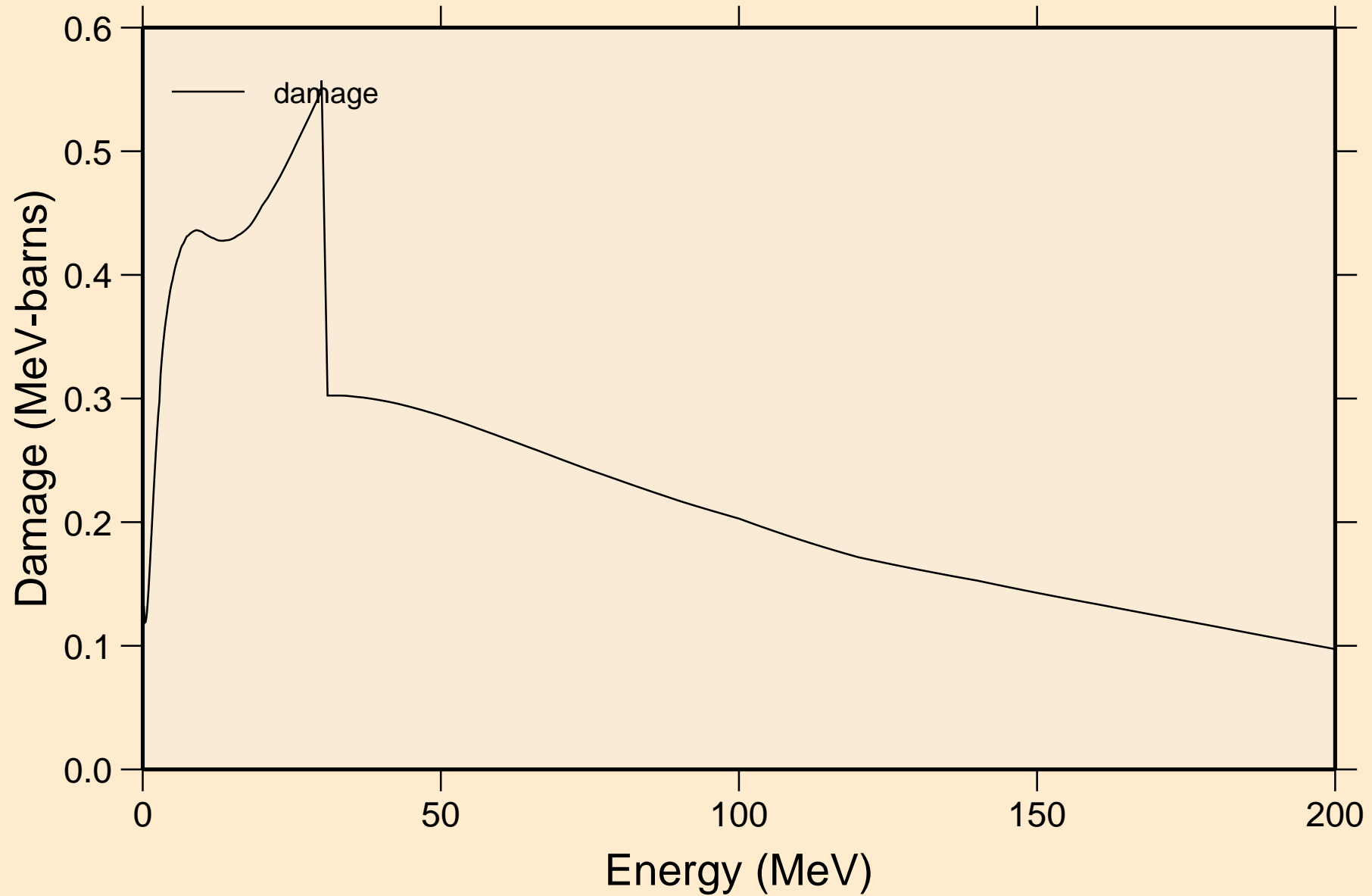

SC042M NEUTRON ACER TENDL-2021 LIBRARY; T=293.6K
Non-threshold reactions

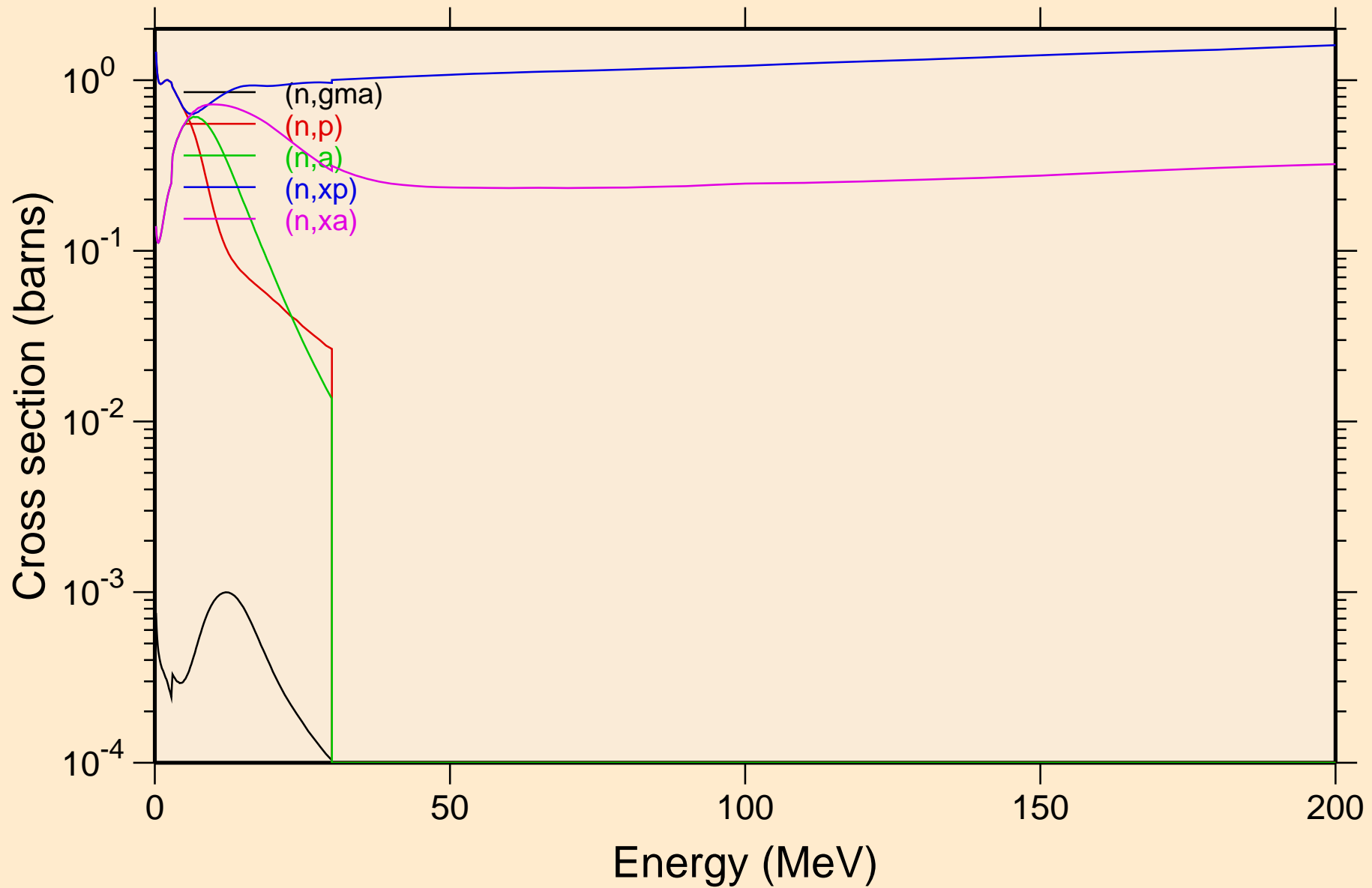

SC042M NEUTRON ACER TENDL-2021 LIBRARY; T=293.6K
Inelastic levels

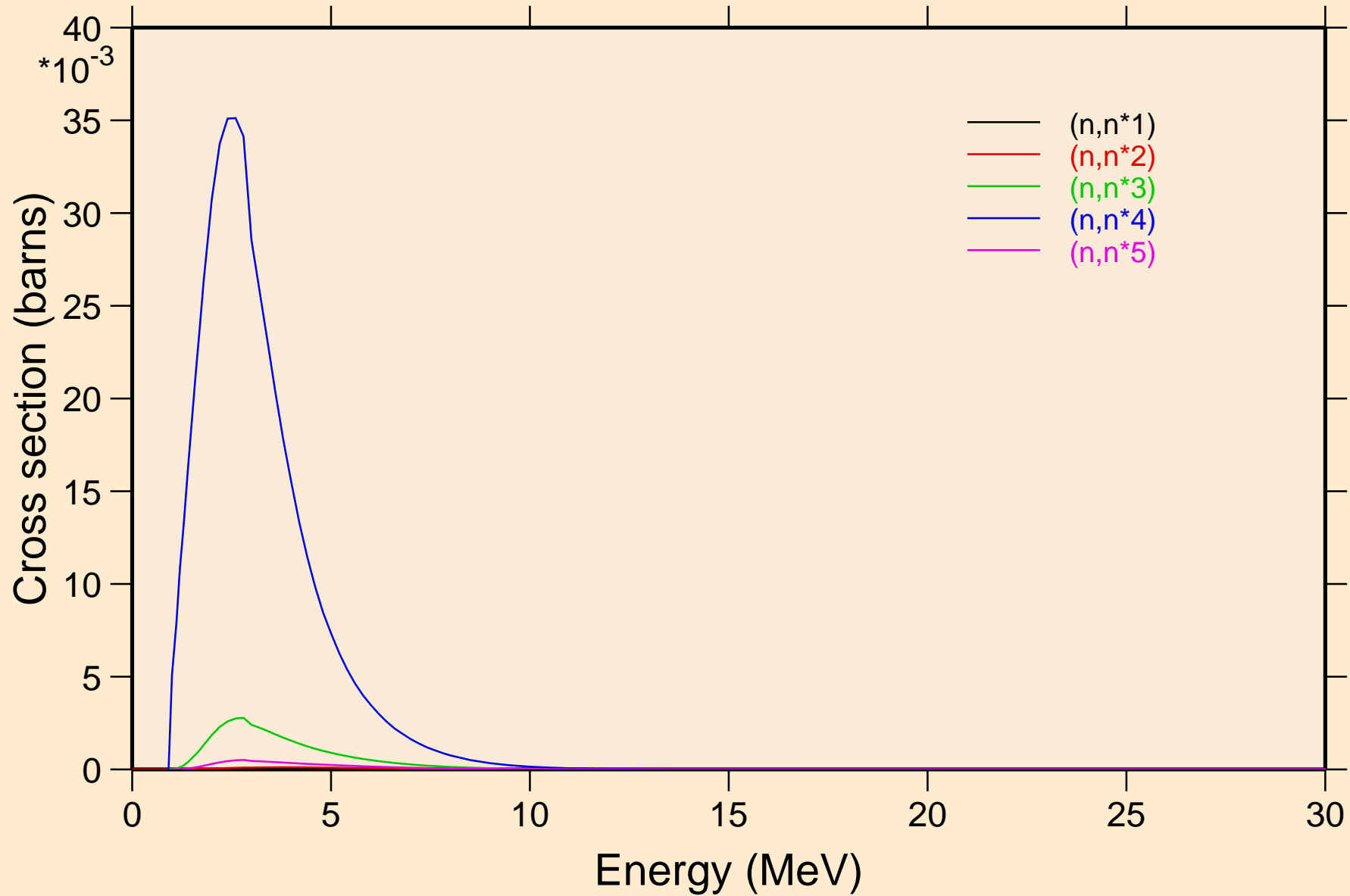

SC042M NEUTRON ACER TENDL-2021 LIBRARY; T=293.6K
Inelastic levels

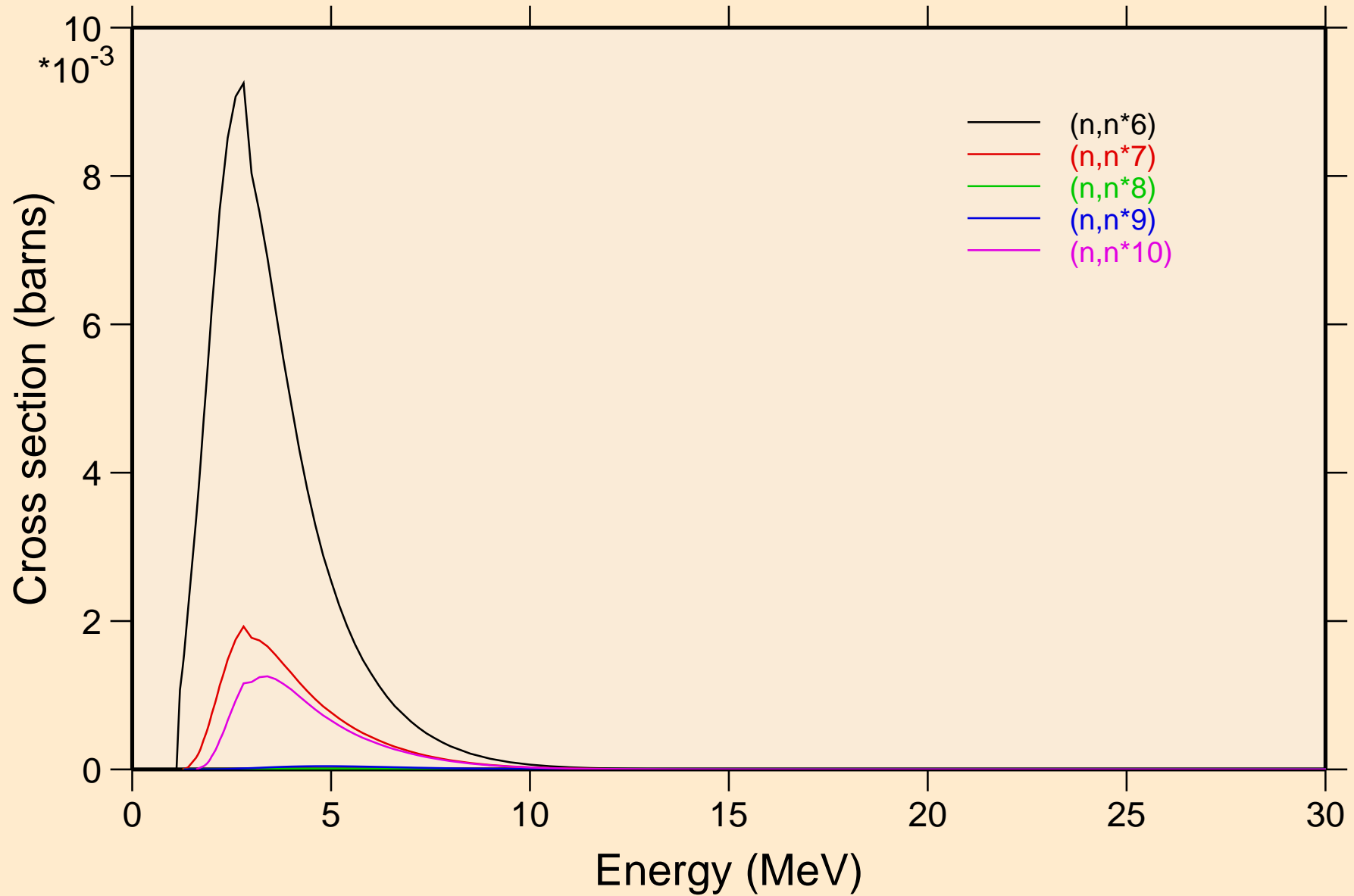

SC042M NEUTRON ACER TENDL-2021 LIBRARY; T=293.6K
Inelastic levels

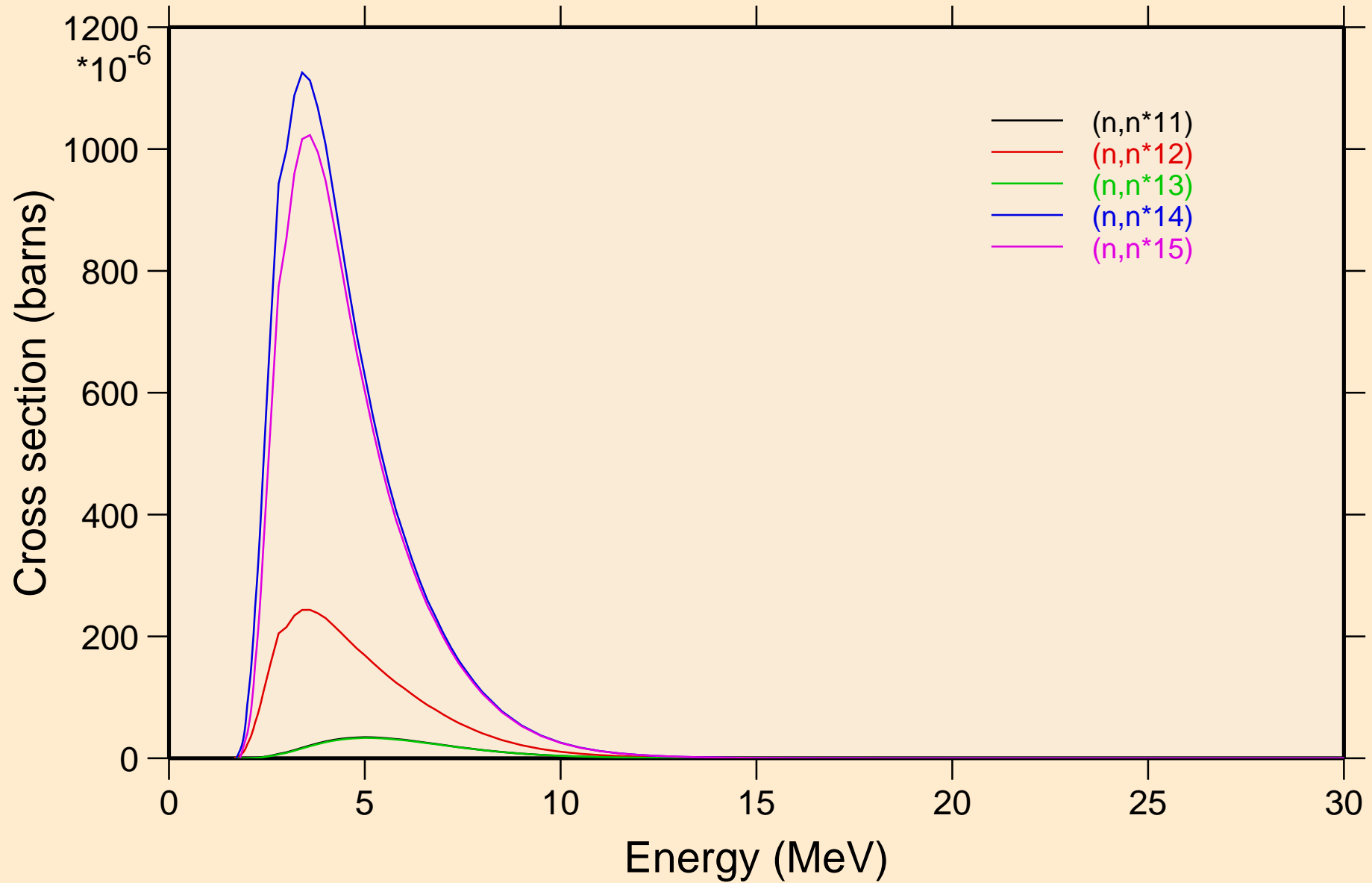

SC042M NEUTRON ACER TENDL-2021 LIBRARY; T=293.6K
Inelastic levels

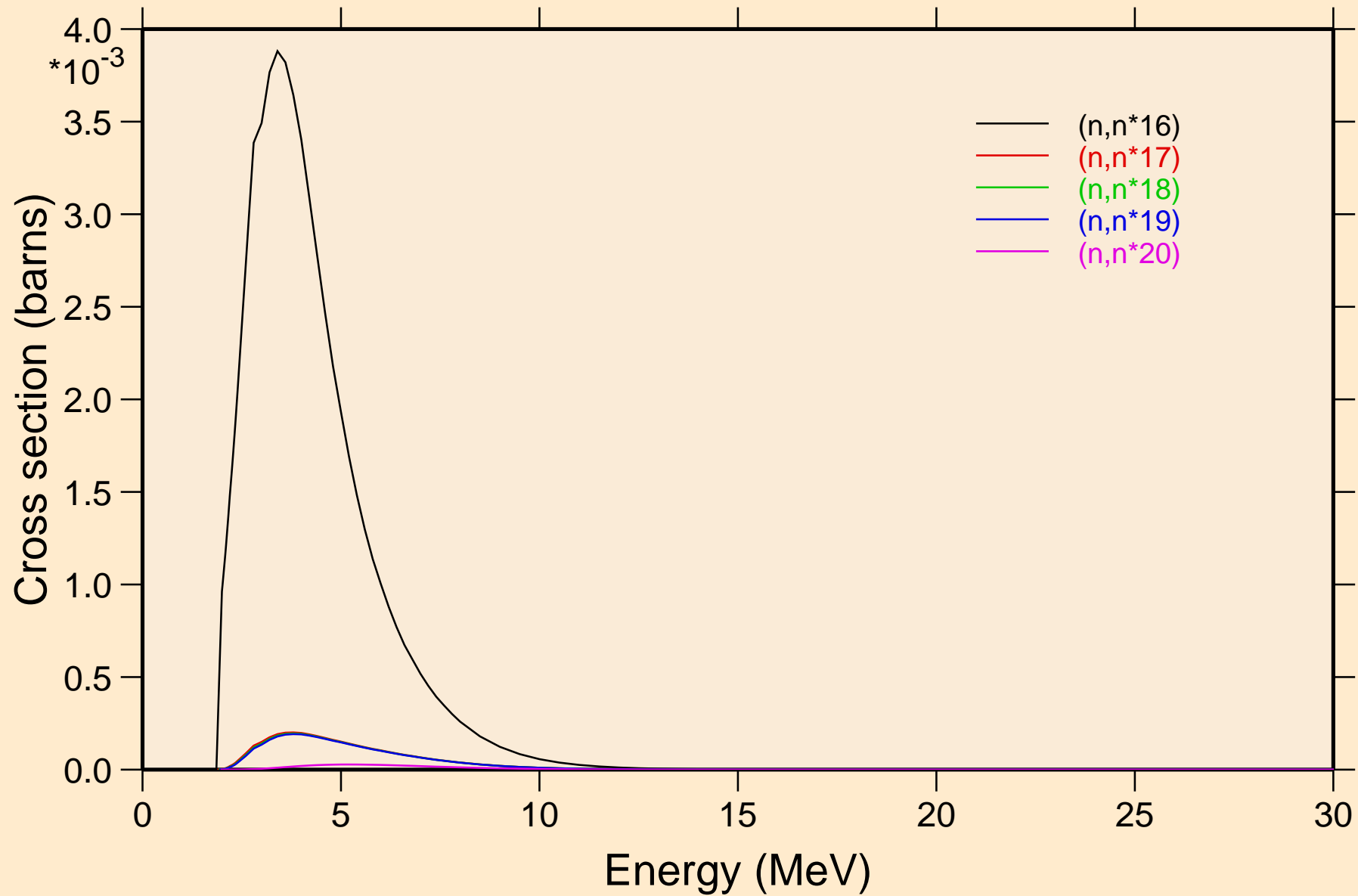

SC042M NEUTRON ACER TENDL-2021 LIBRARY; T=293.6K
Inelastic levels

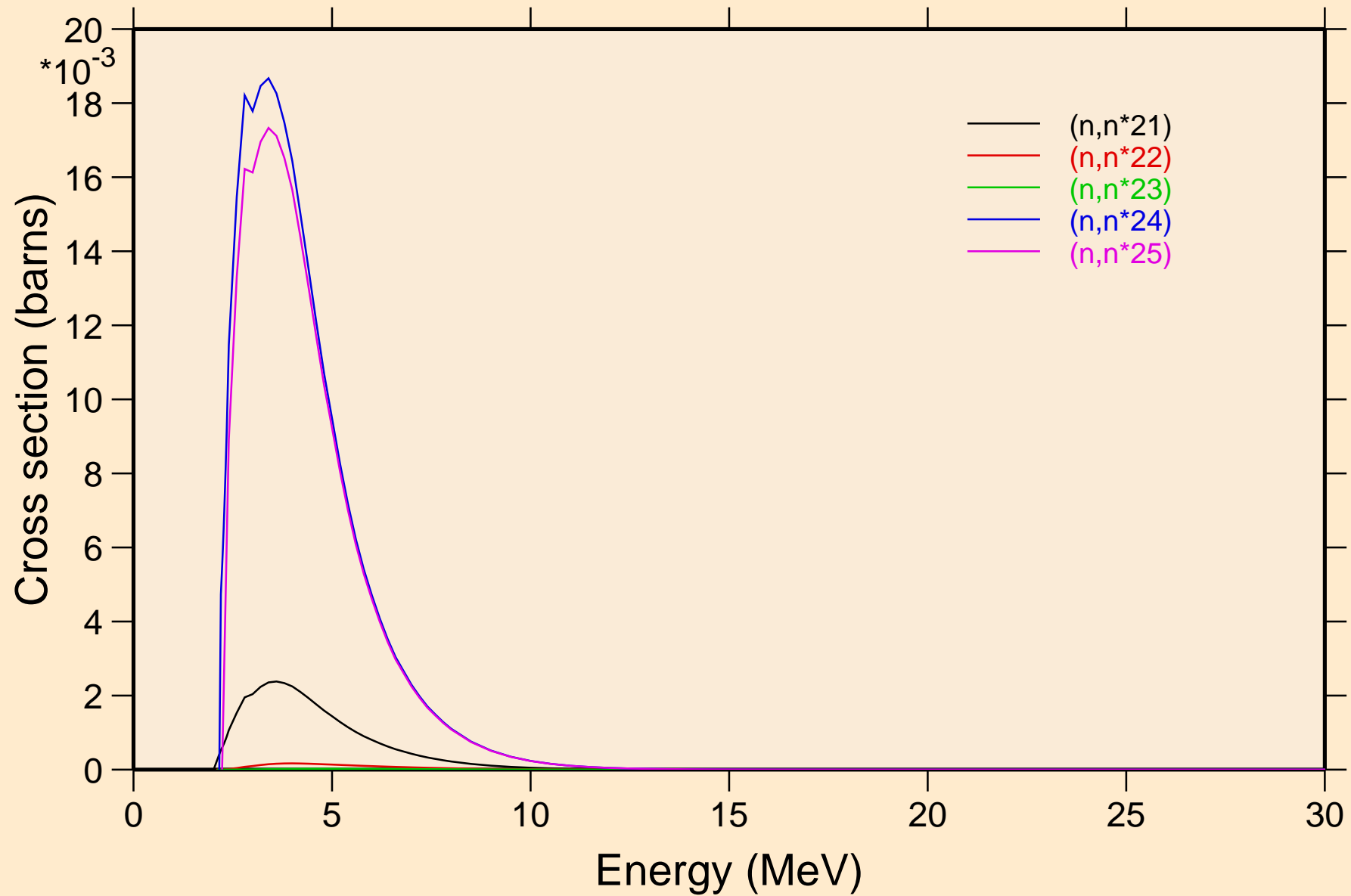

SC042M NEUTRON ACER TENDL-2021 LIBRARY; T=293.6K
Threshold reactions

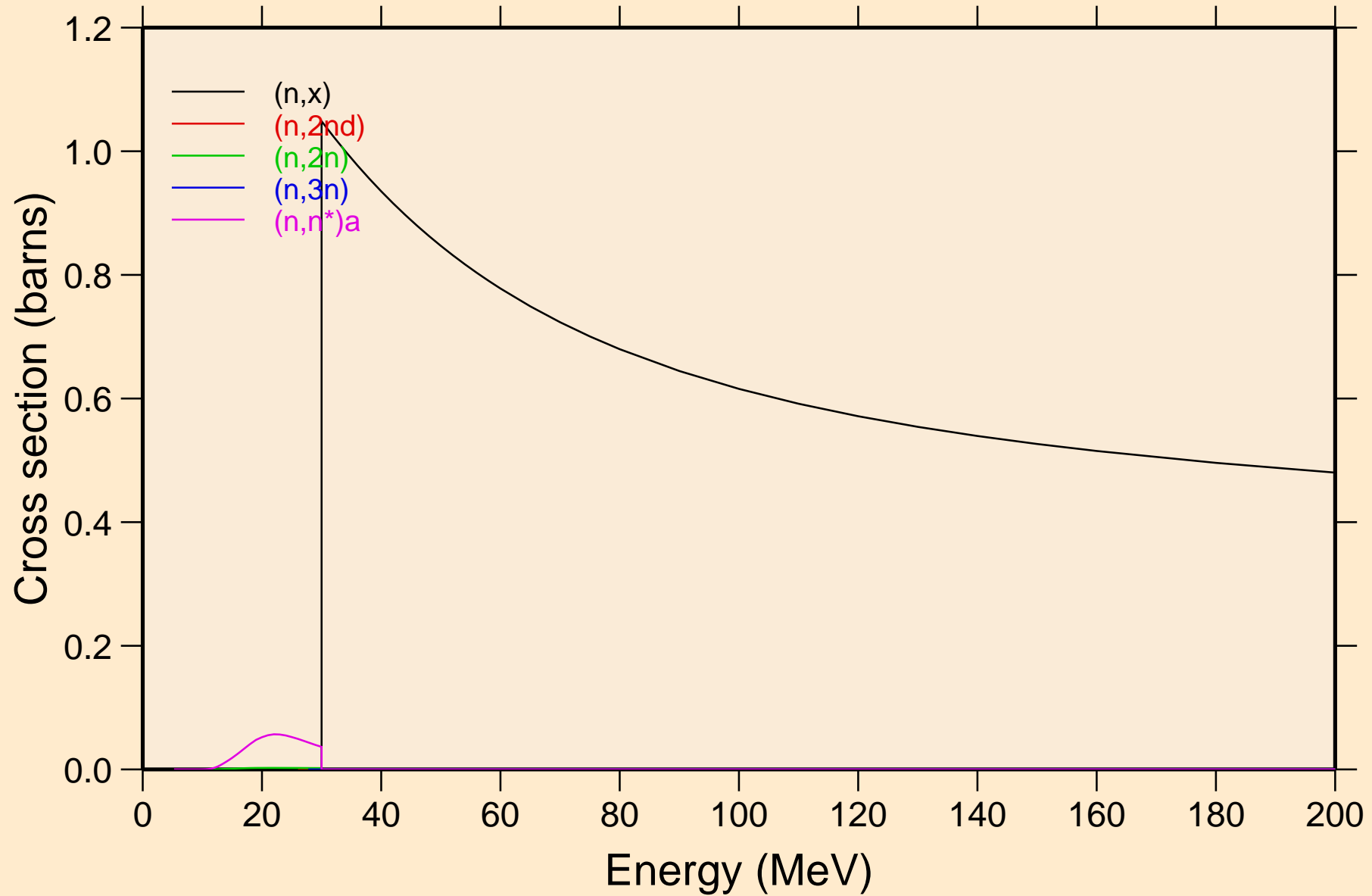

SC042M NEUTRON ACER TENDL-2021 LIBRARY; T=293.6K
Threshold reactions

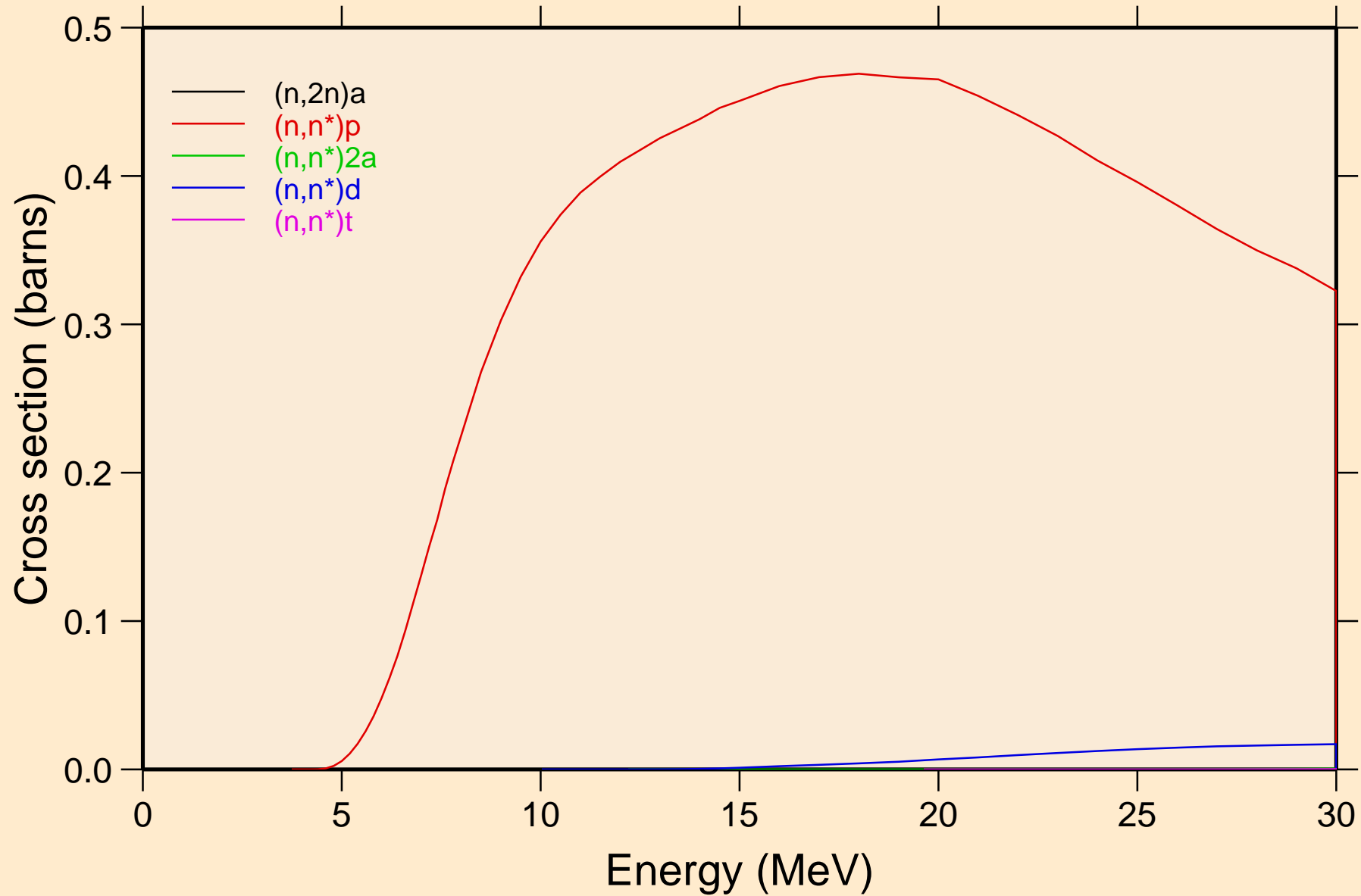

SC042M NEUTRON ACER TENDL-2021 LIBRARY; T=293.6K
Threshold reactions

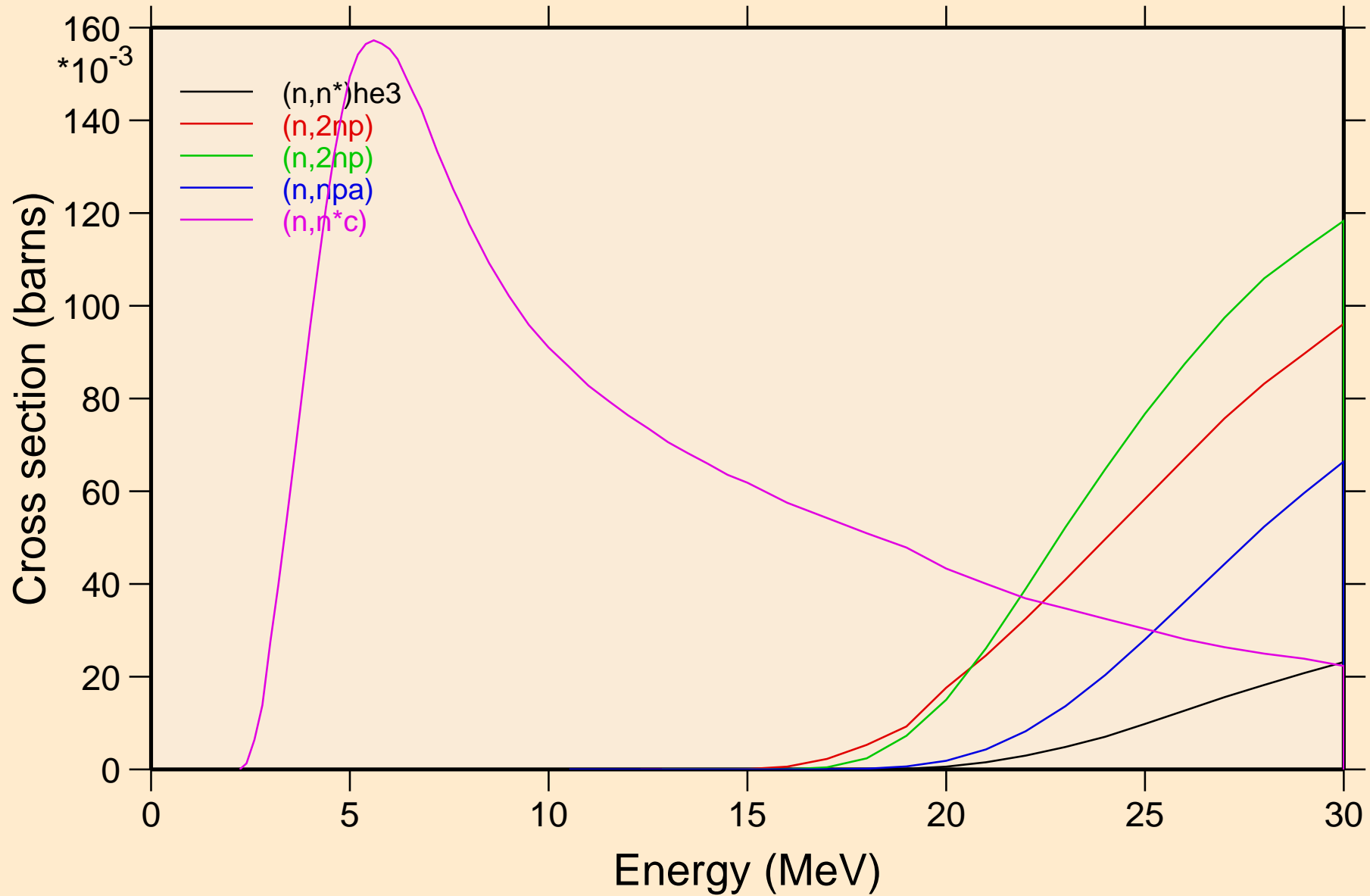

SC042M NEUTRON ACER TENDL-2021 LIBRARY; T=293.6K
Threshold reactions

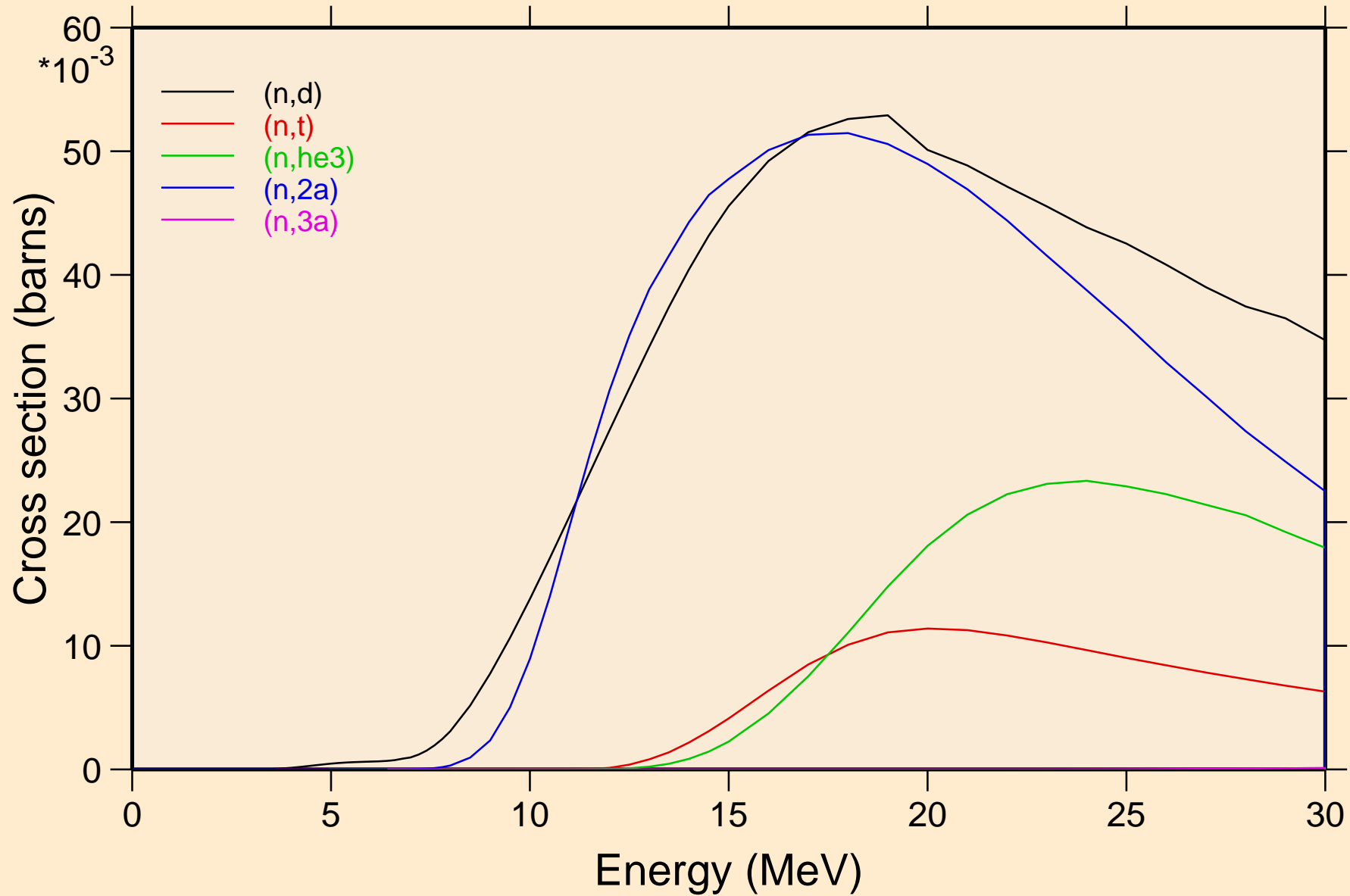

SC042M NEUTRON ACER TENDL-2021 LIBRARY; T=293.6K
Threshold reactions

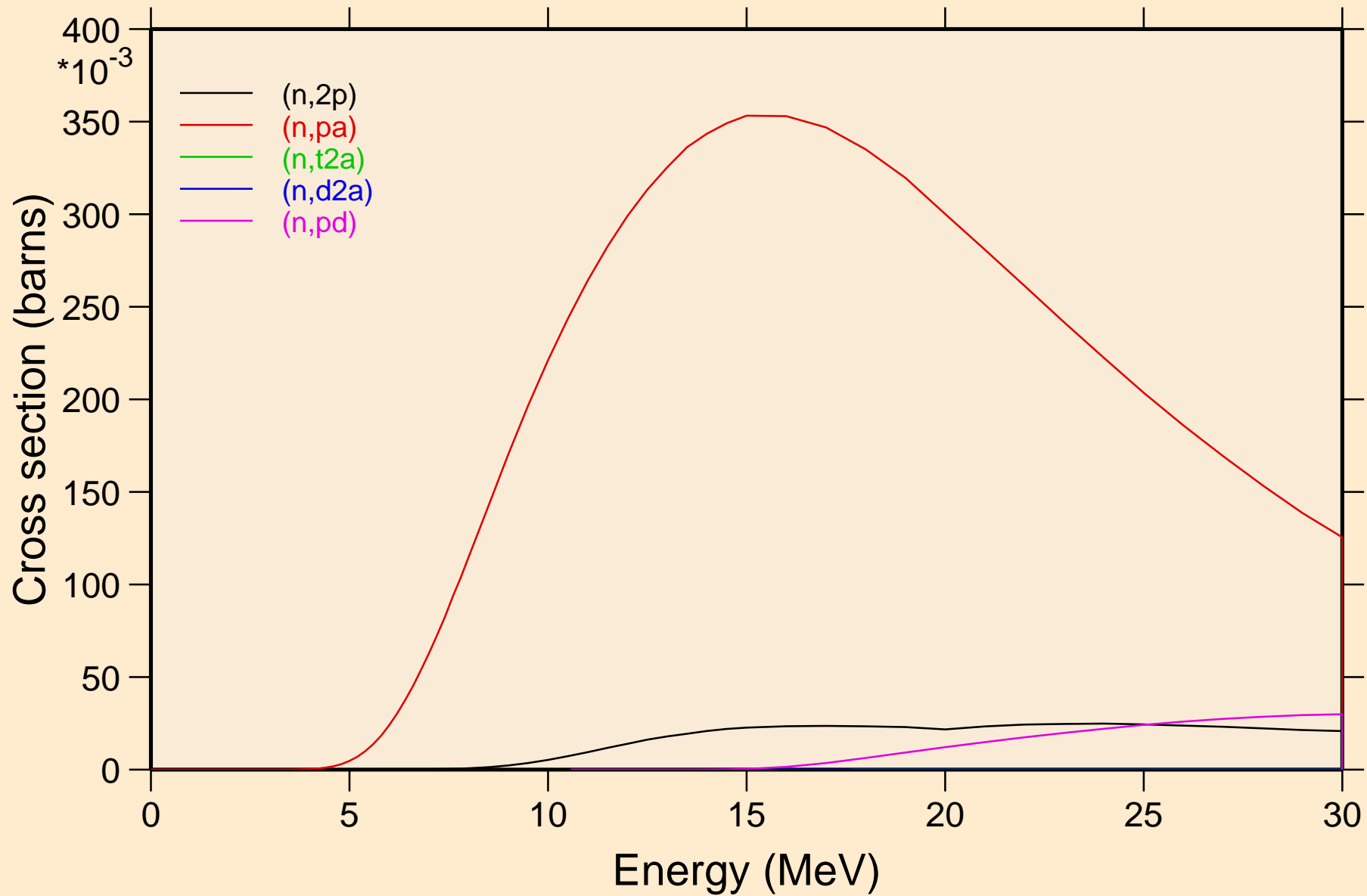

SC042M NEUTRON ACER TENDL-2021 LIBRARY; T=293.6K
Threshold reactions

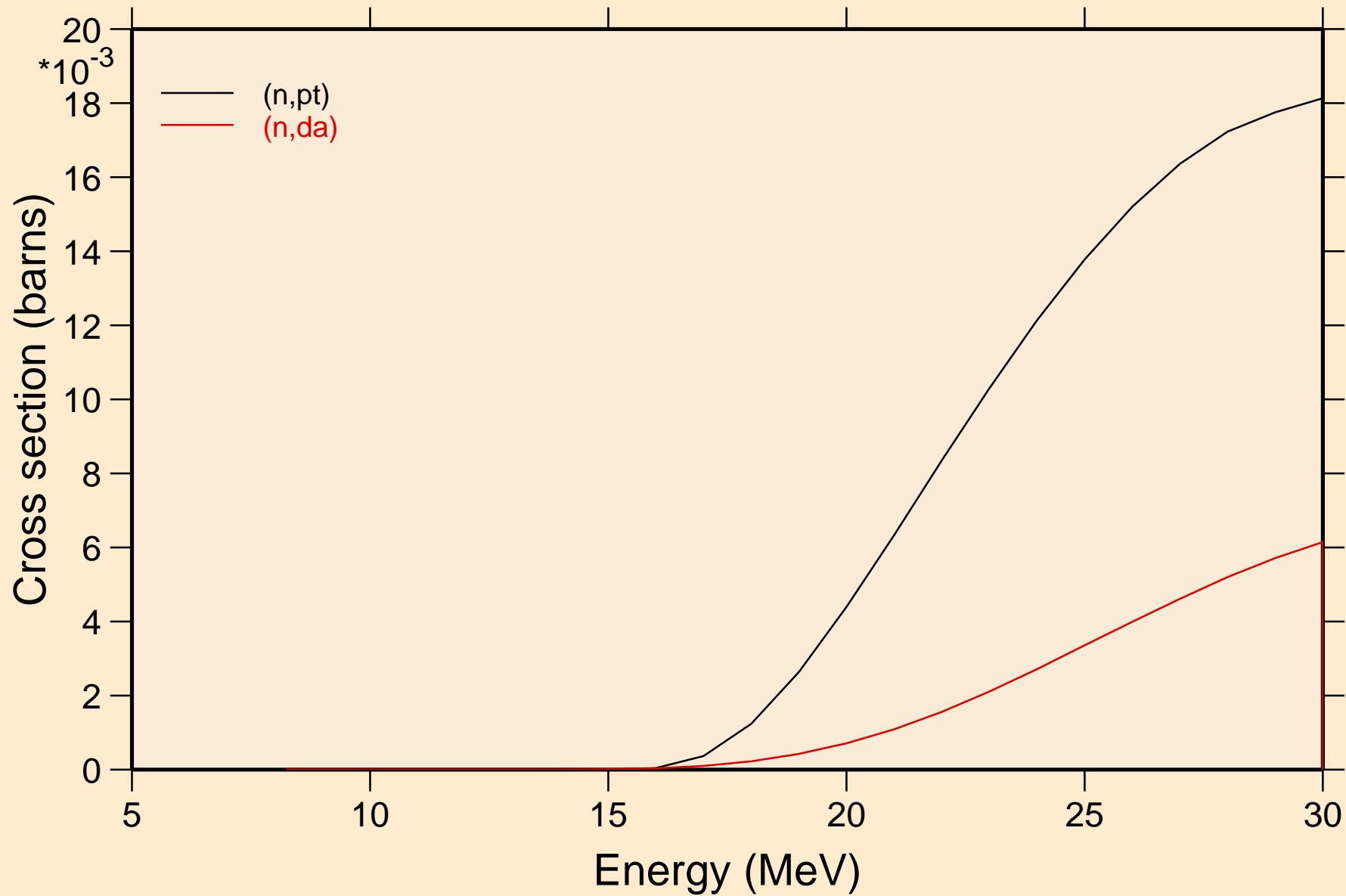

SC042M NEUTRON ACER TENDL-2021 LIBRARY; T=293.6K
Threshold reactions

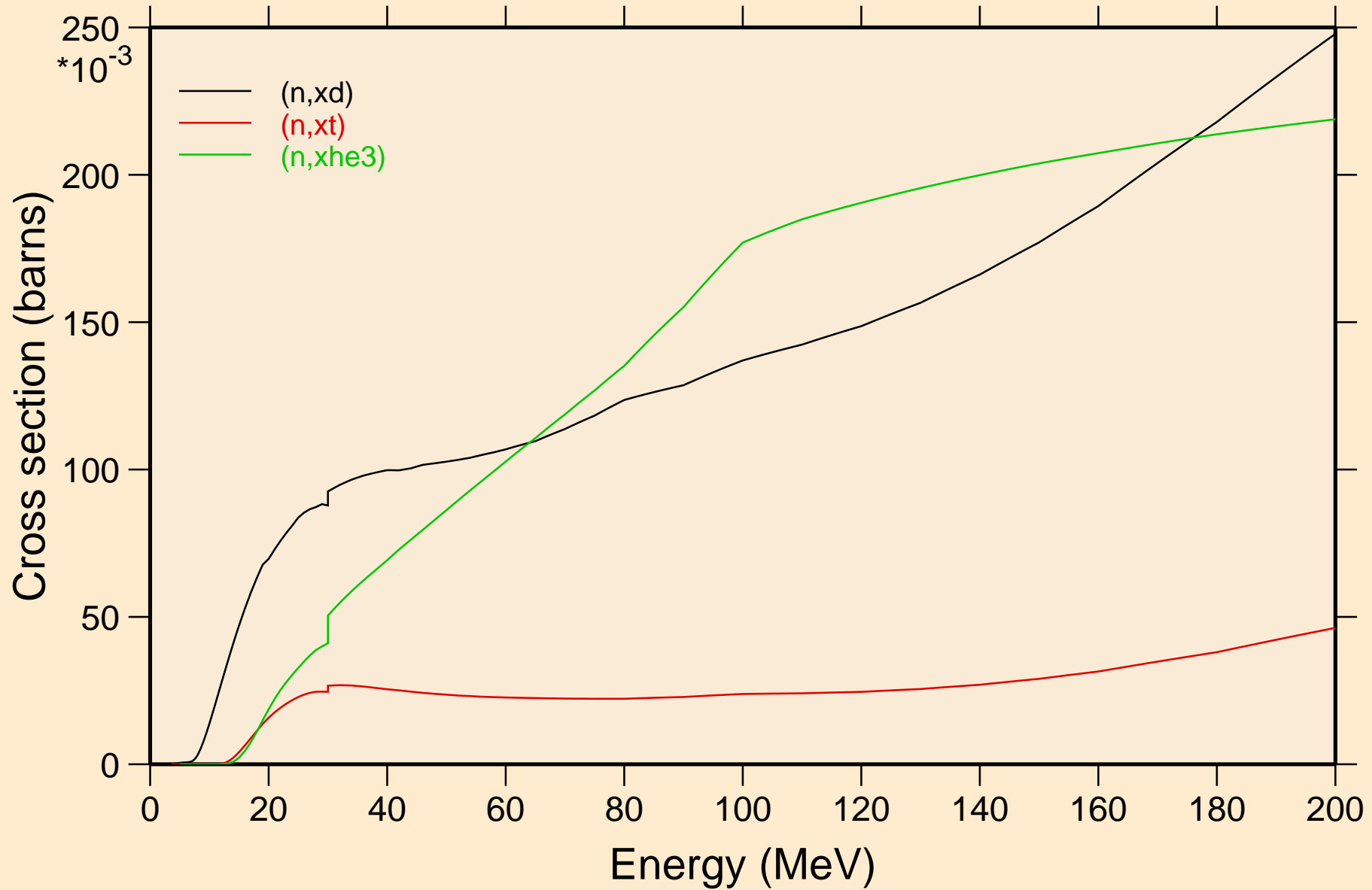

SC042M NEUTRON ACER TENDL-2021 LIBRARY; T=293.6K
angular distribution for elastic

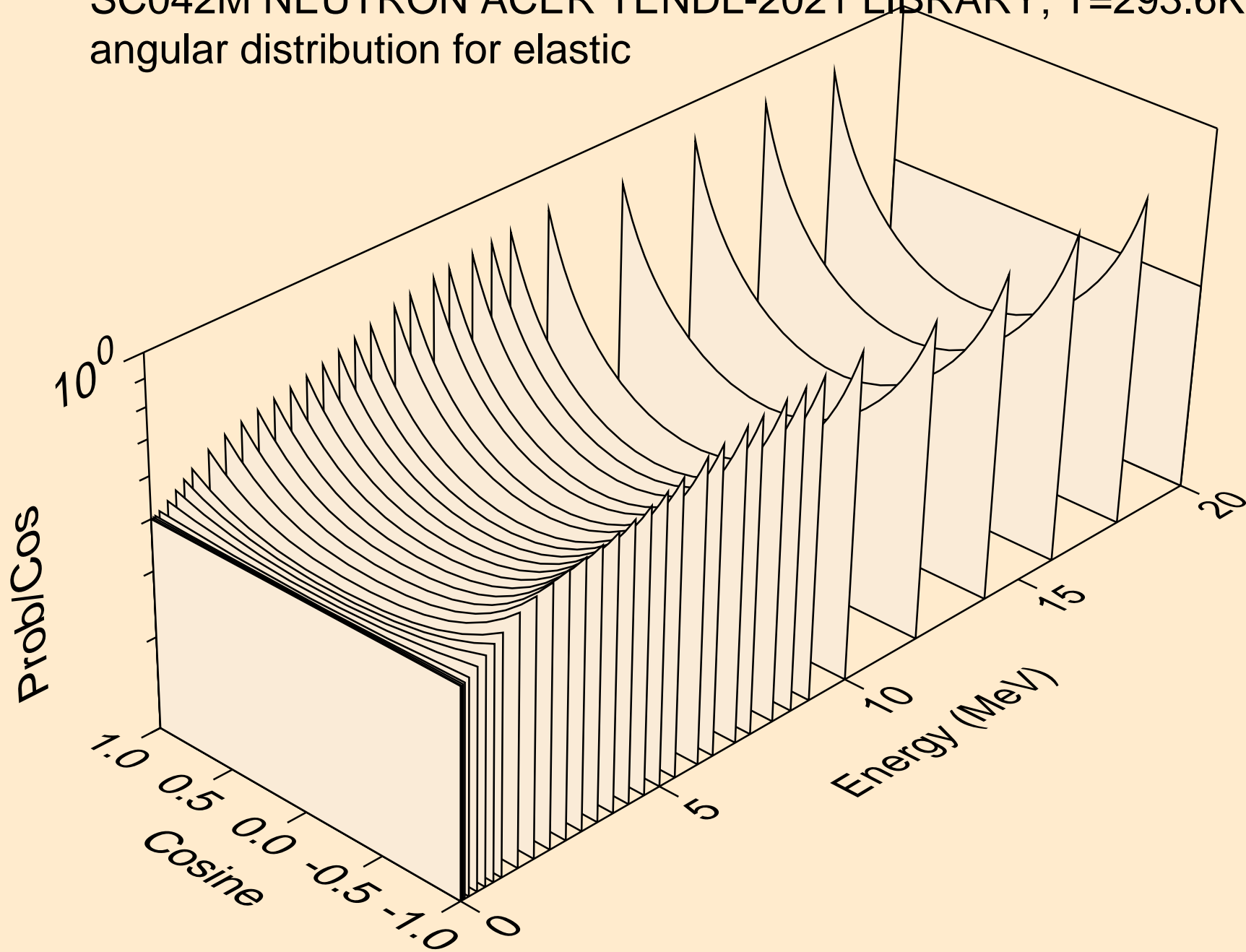

SC042M NEUTRON ACER TENDL-2021 LIBRARY; T=293.6K
angular distribution for elastic

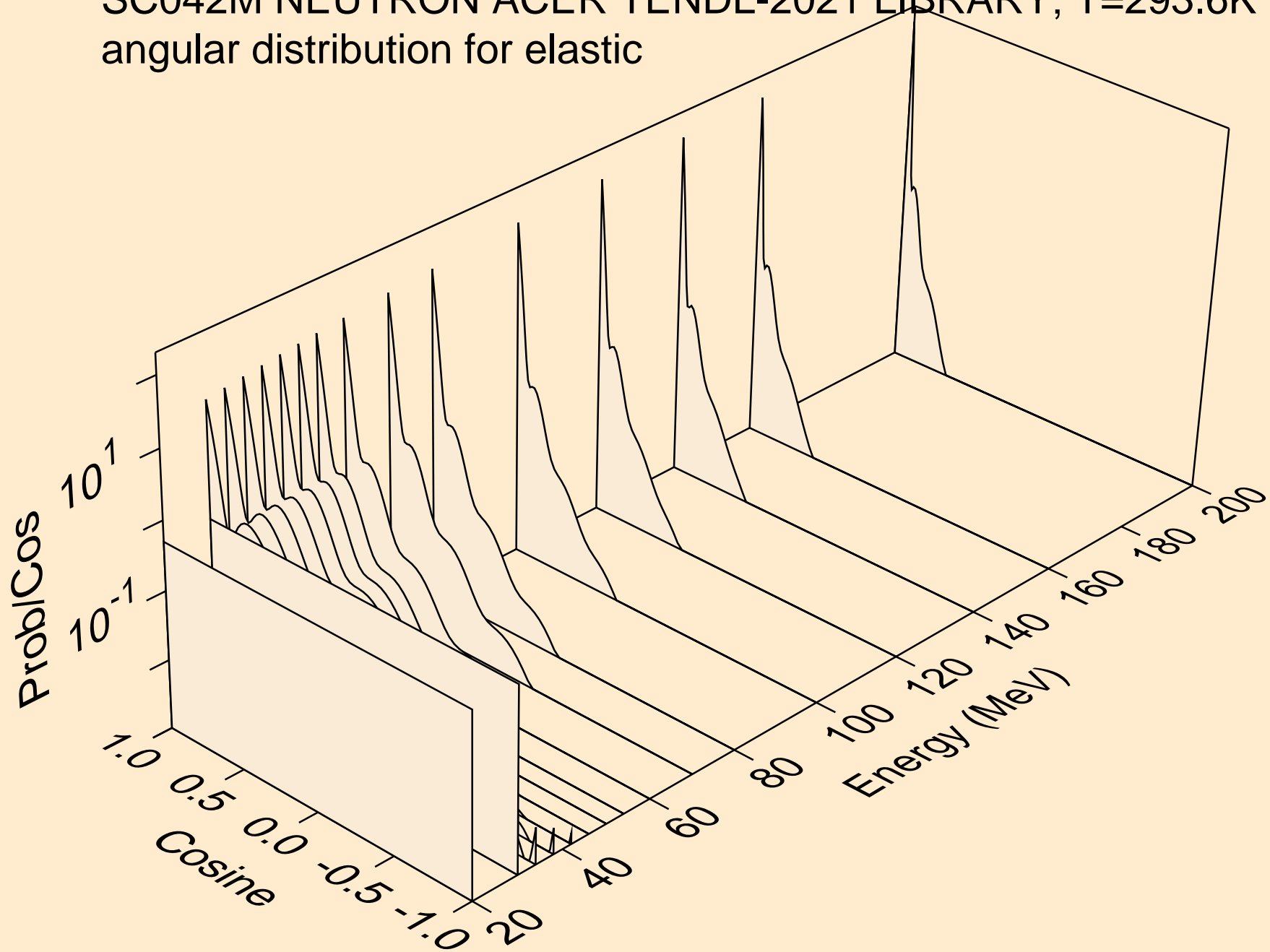

SC042M NEUTRON ACER TENDL-2021 LIBRARY; T=293.6K
angular distribution for (n,n*1)

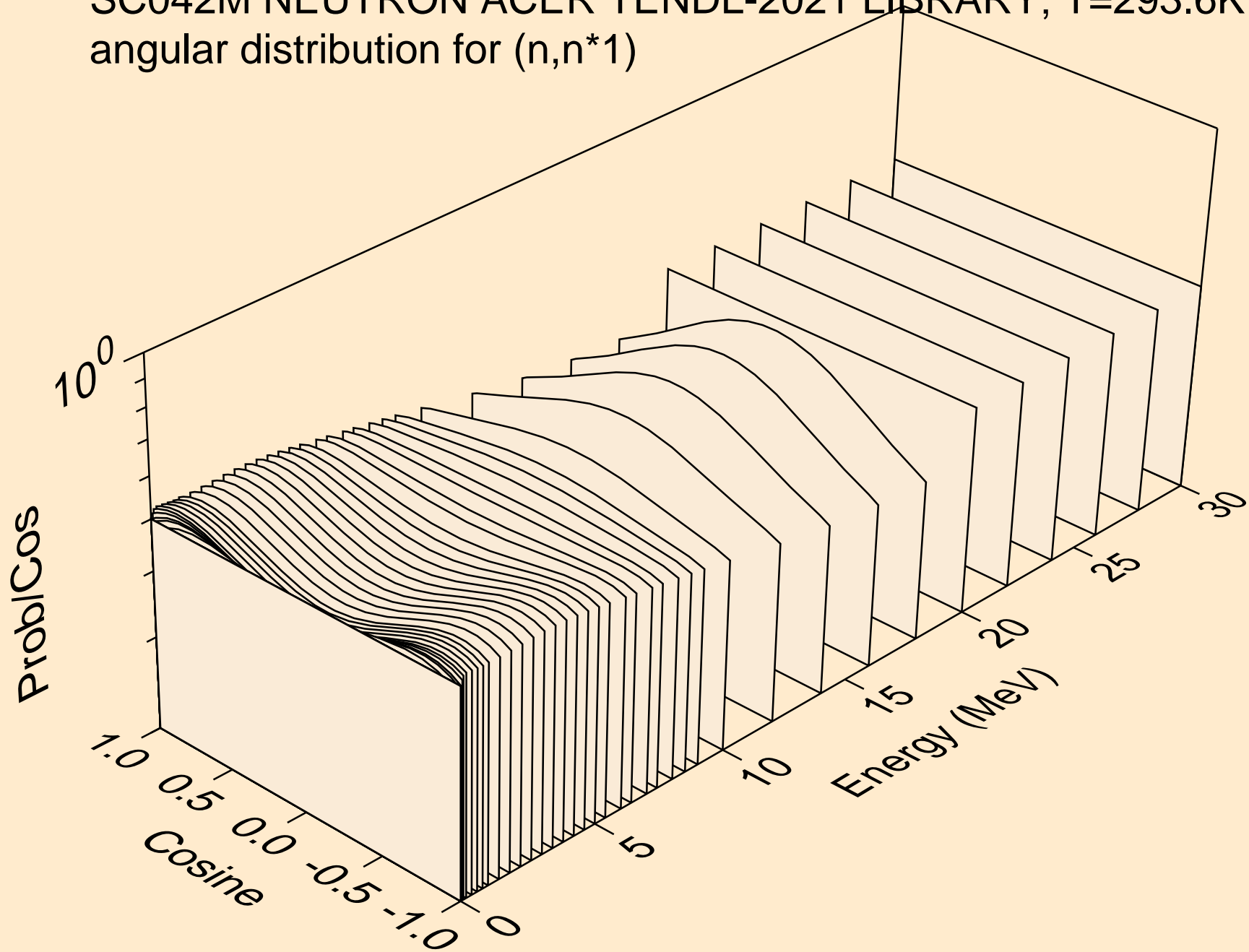

SC042M NEUTRON ACER TENDL-2021 LIBRARY; T=293.6K
angular distribution for (n,n*2)

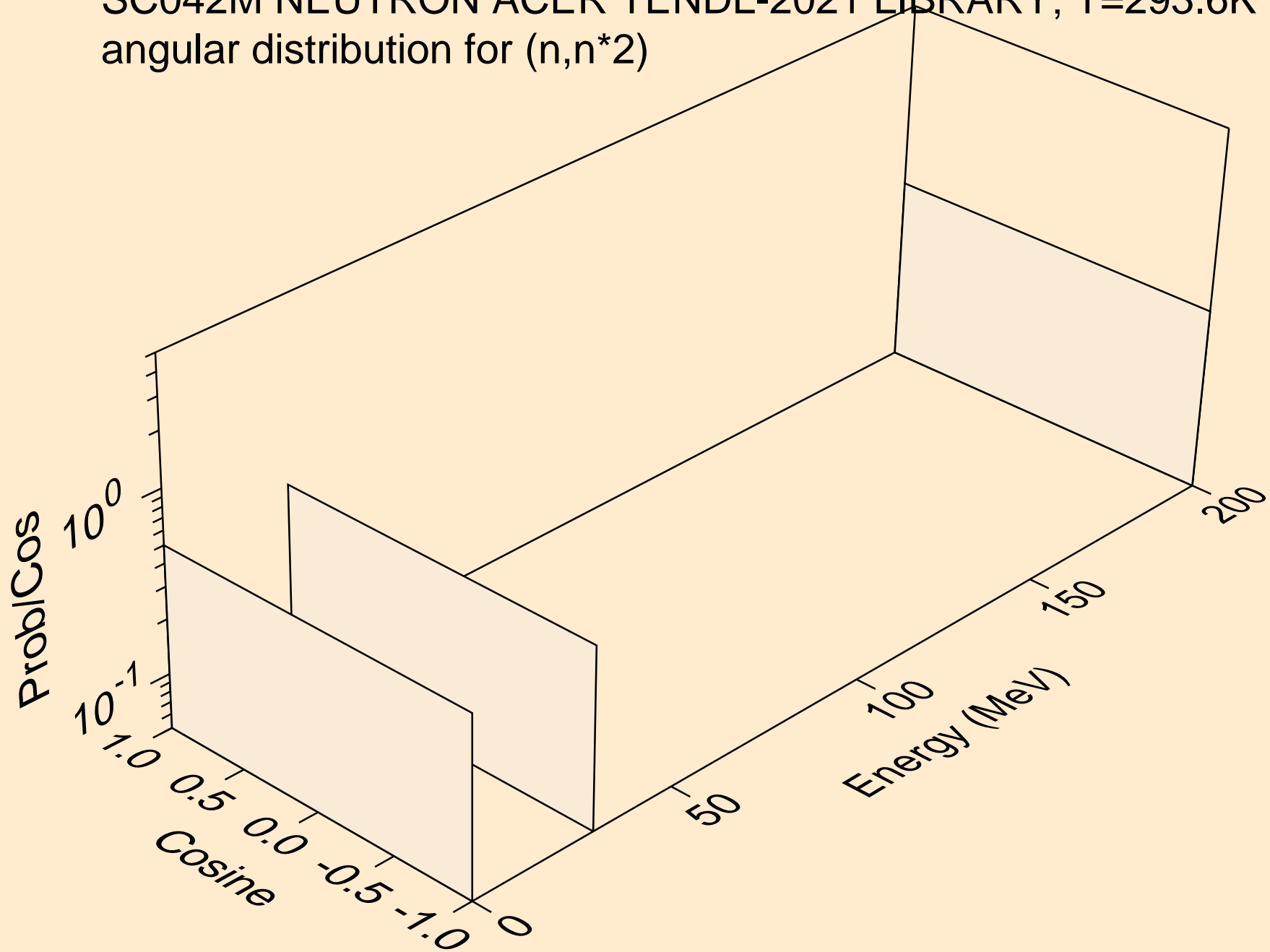

SC042M NEUTRON ACER TENDL-2021 LIBRARY; T=293.6K
angular distribution for (n,n*3)

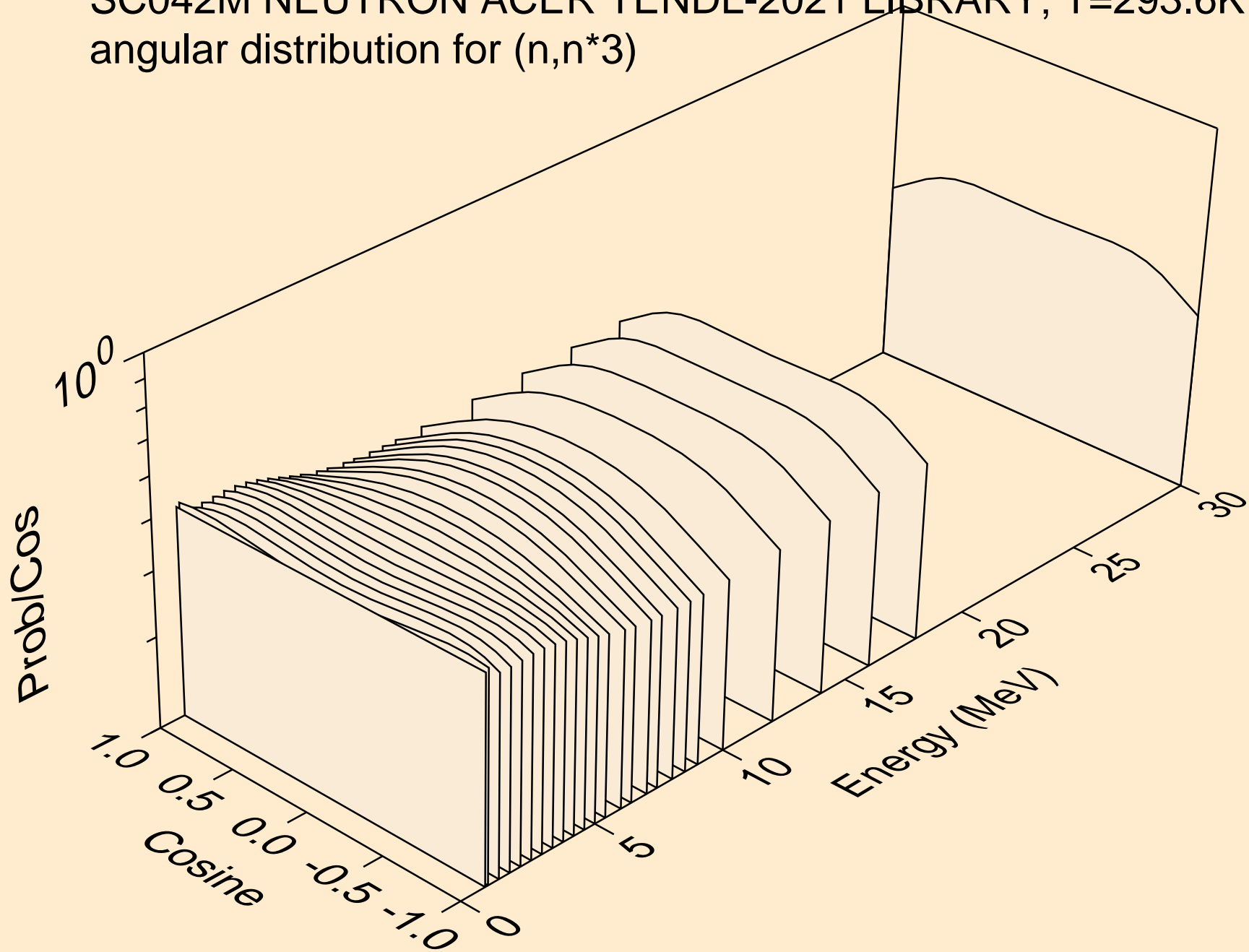

SC042M NEUTRON ACER TENDL-2021 LIBRARY; T=293.6K
angular distribution for (n,n*4)

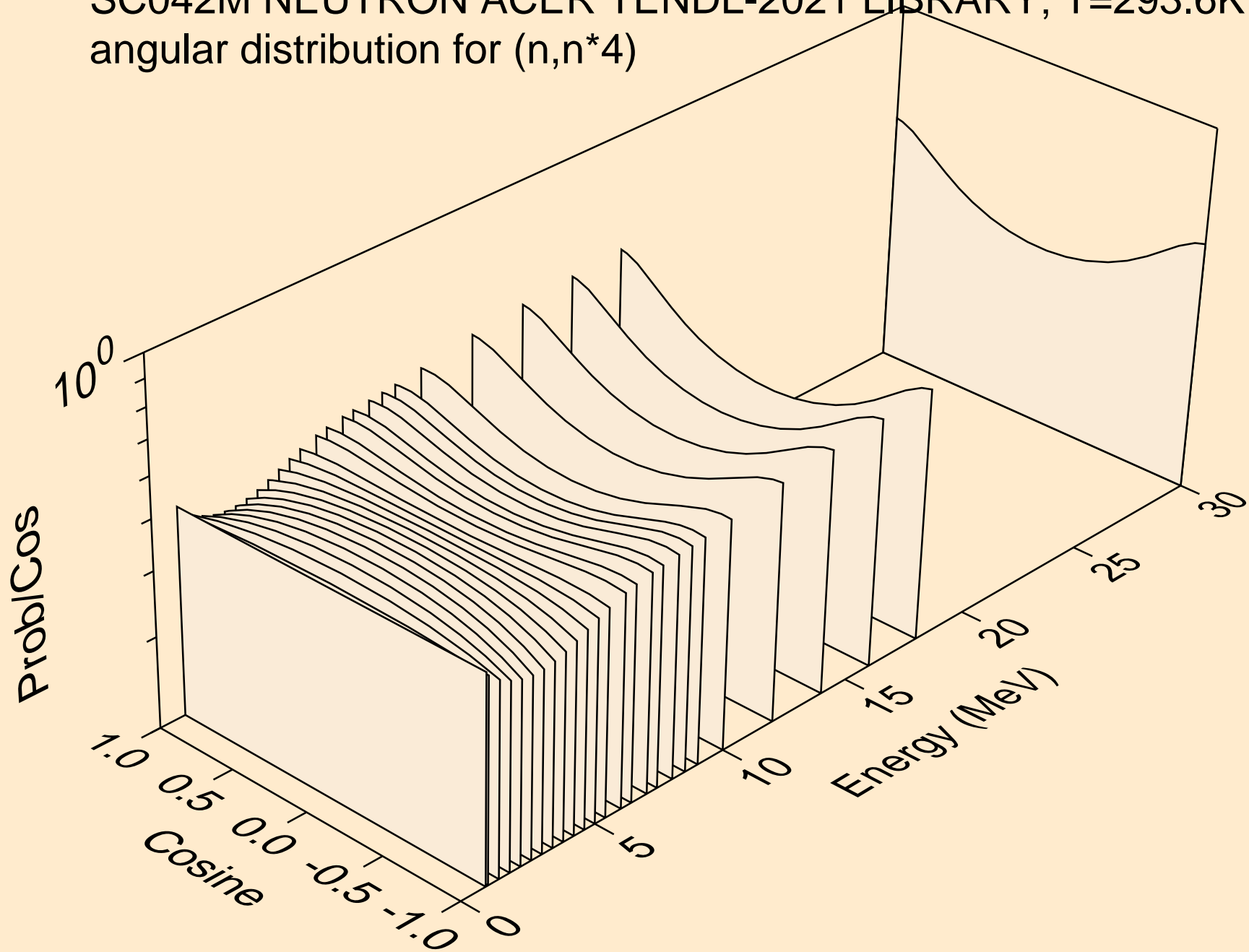

SC042M NEUTRON ACER TENDL-2021 LIBRARY; T=293.6K
angular distribution for (n,n*5)

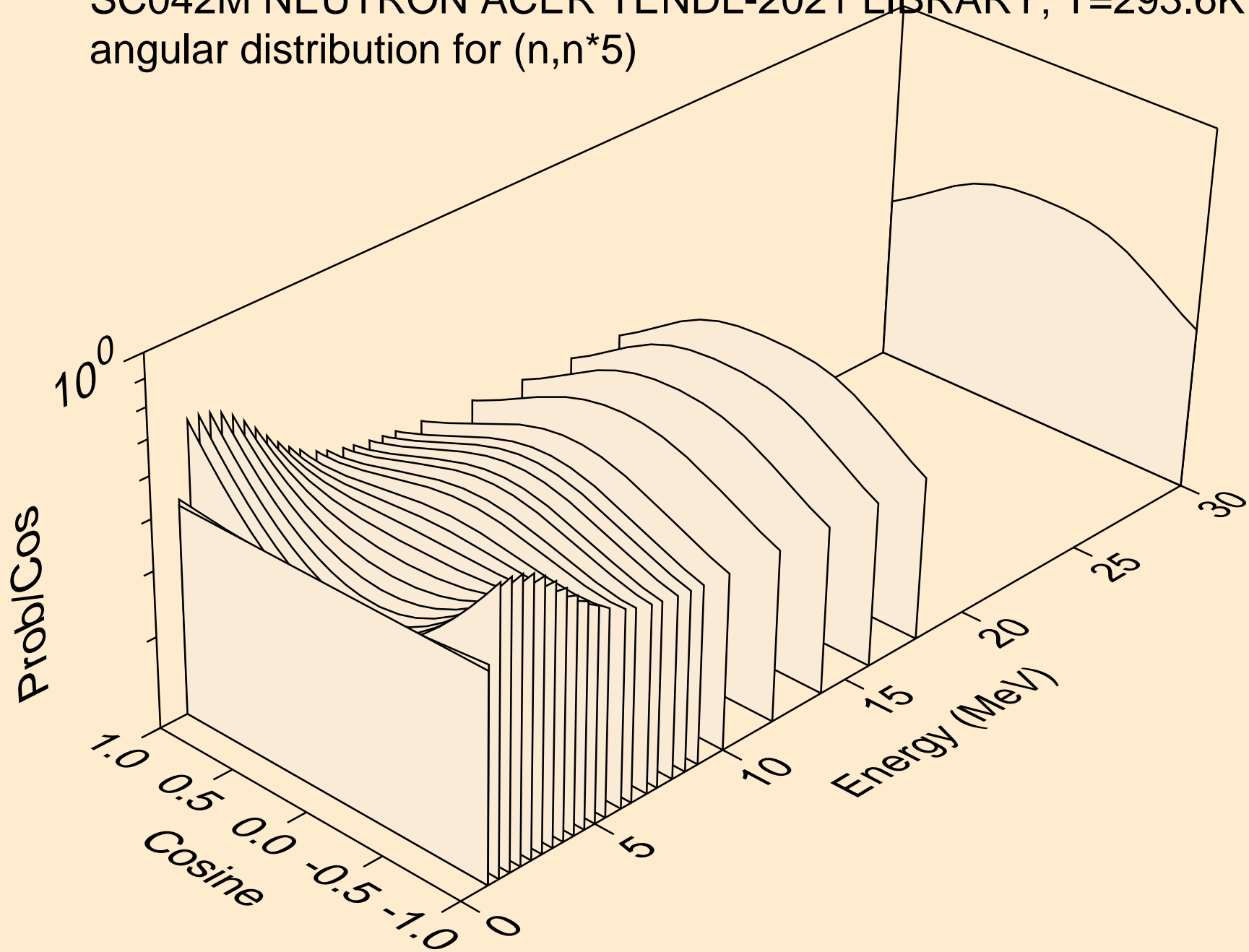

SC042M NEUTRON ACER TENDL-2021 LIBRARY; T=293.6K
angular distribution for (n,n*6)

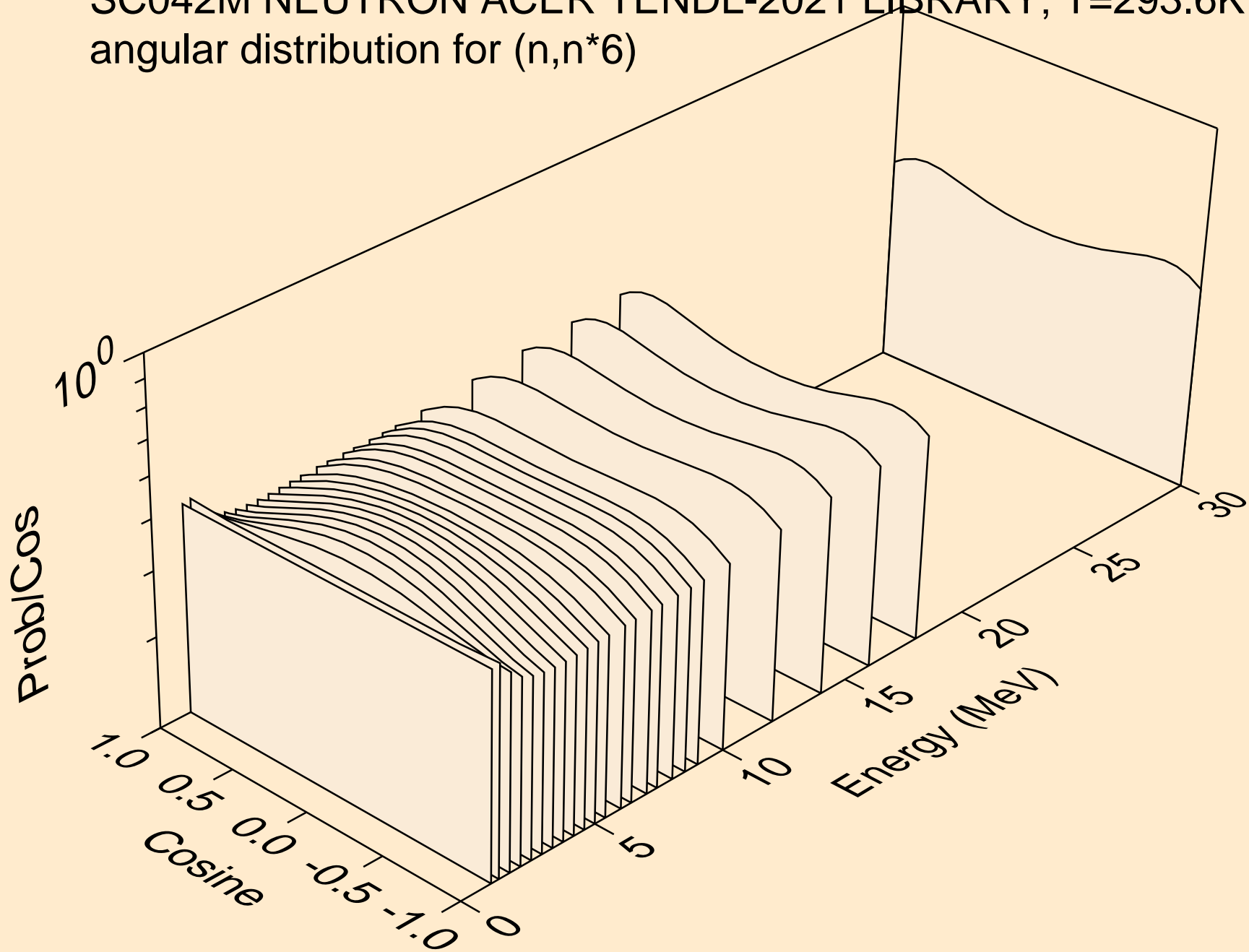

SC042M NEUTRON ACER TENDL-2021 LIBRARY; T=293.6K
angular distribution for (n,n*7)

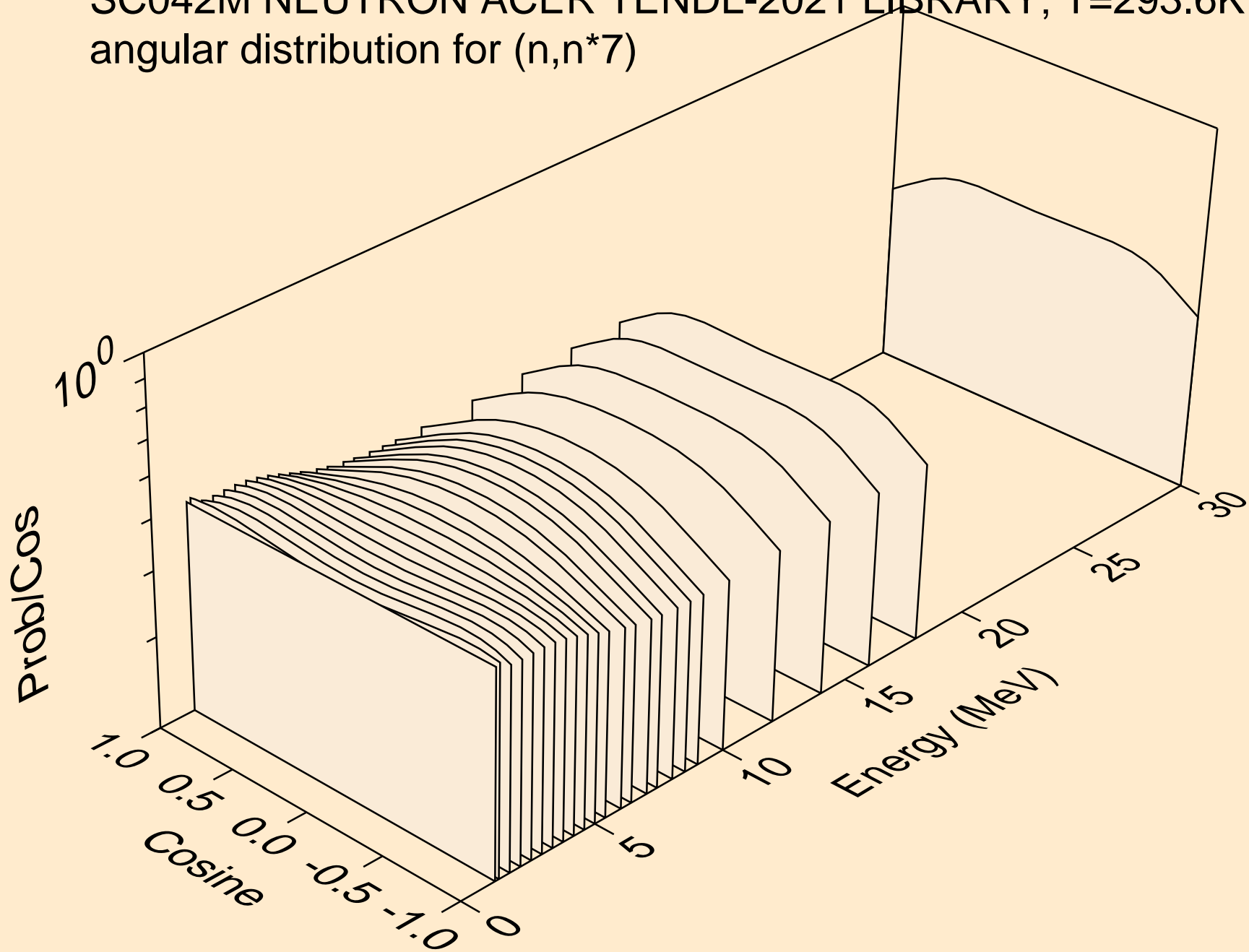

SC042M NEUTRON ACER TENDL-2021 LIBRARY; T=293.6K
angular distribution for (n,n*8)

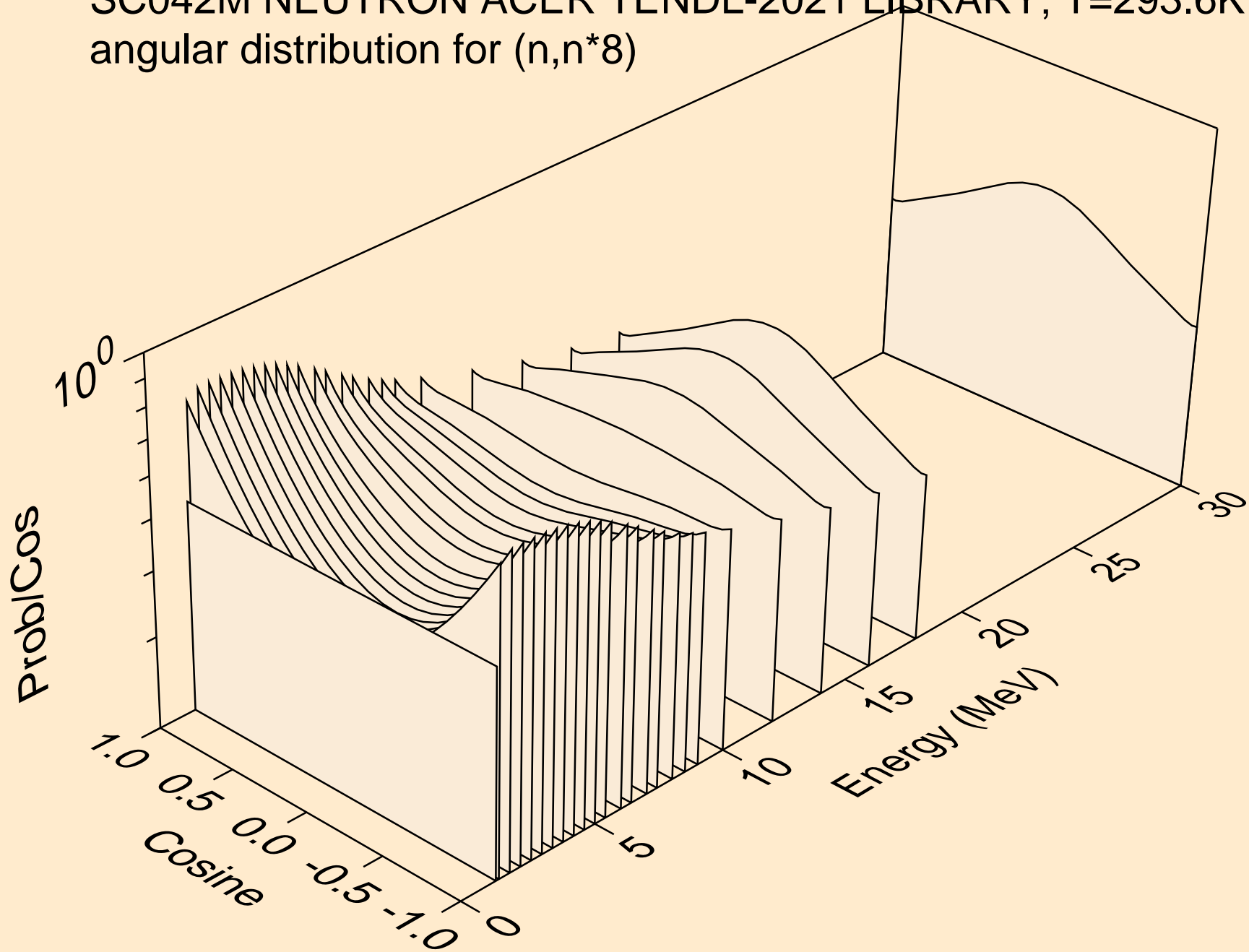

SC042M NEUTRON ACER TENDL-2021 LIBRARY; T=293.6K
angular distribution for (n,n*9)

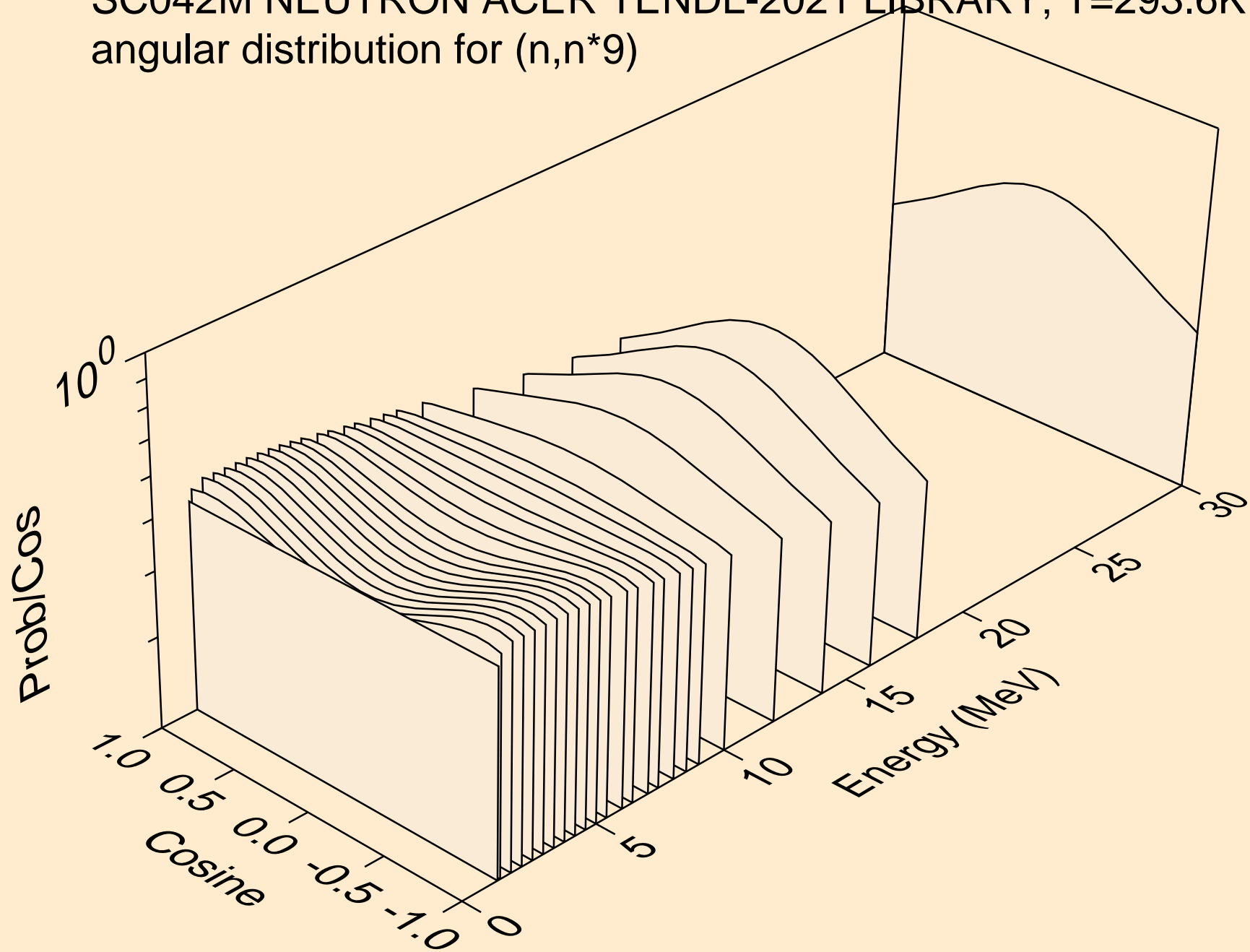

SC042M NEUTRON ACER TENDL-2021 LIBRARY; T=293.6K
angular distribution for (n,n*10)

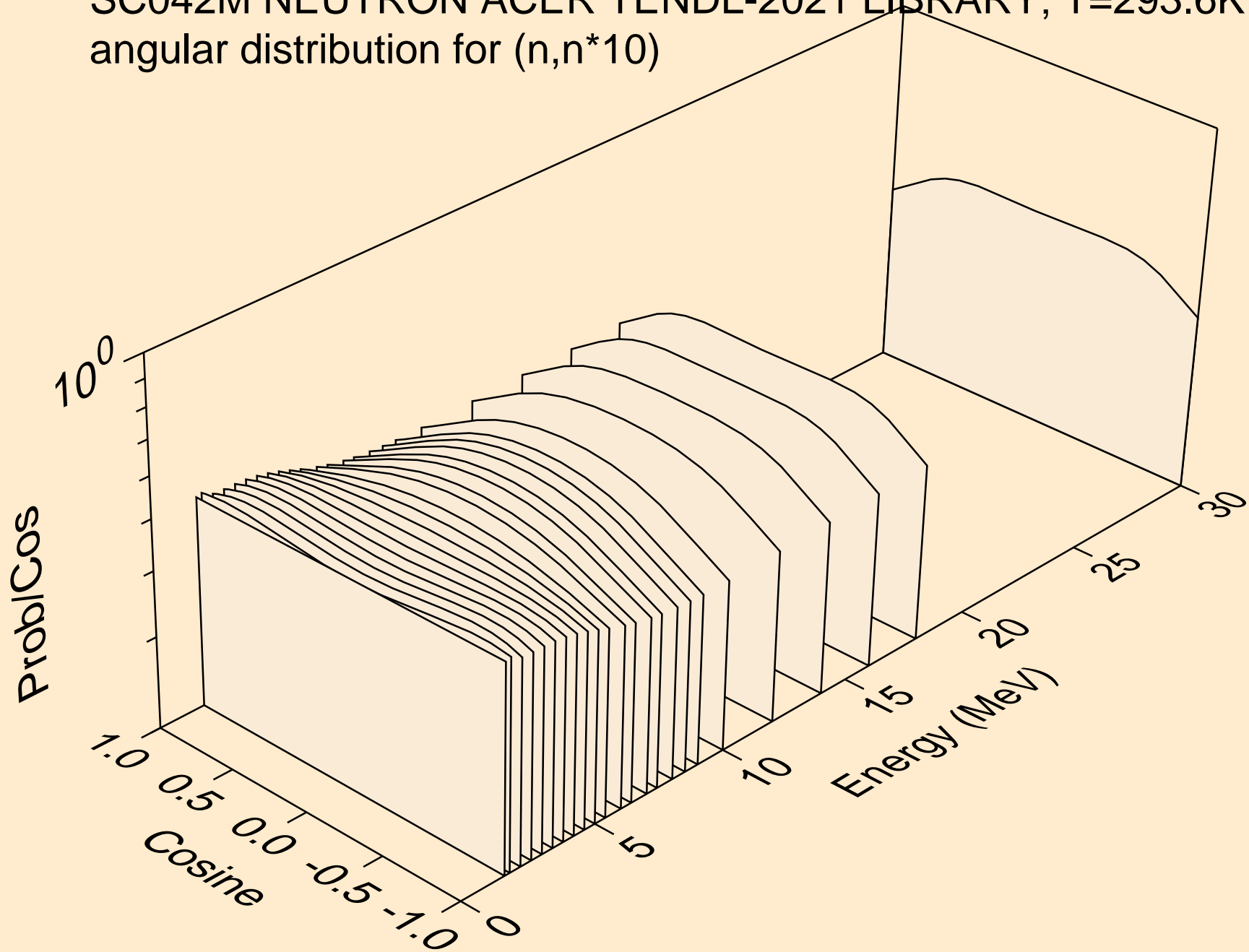

SC042M NEUTRON ACER TENDL-2021 LIBRARY; T=293.6K
angular distribution for (n,n*11)

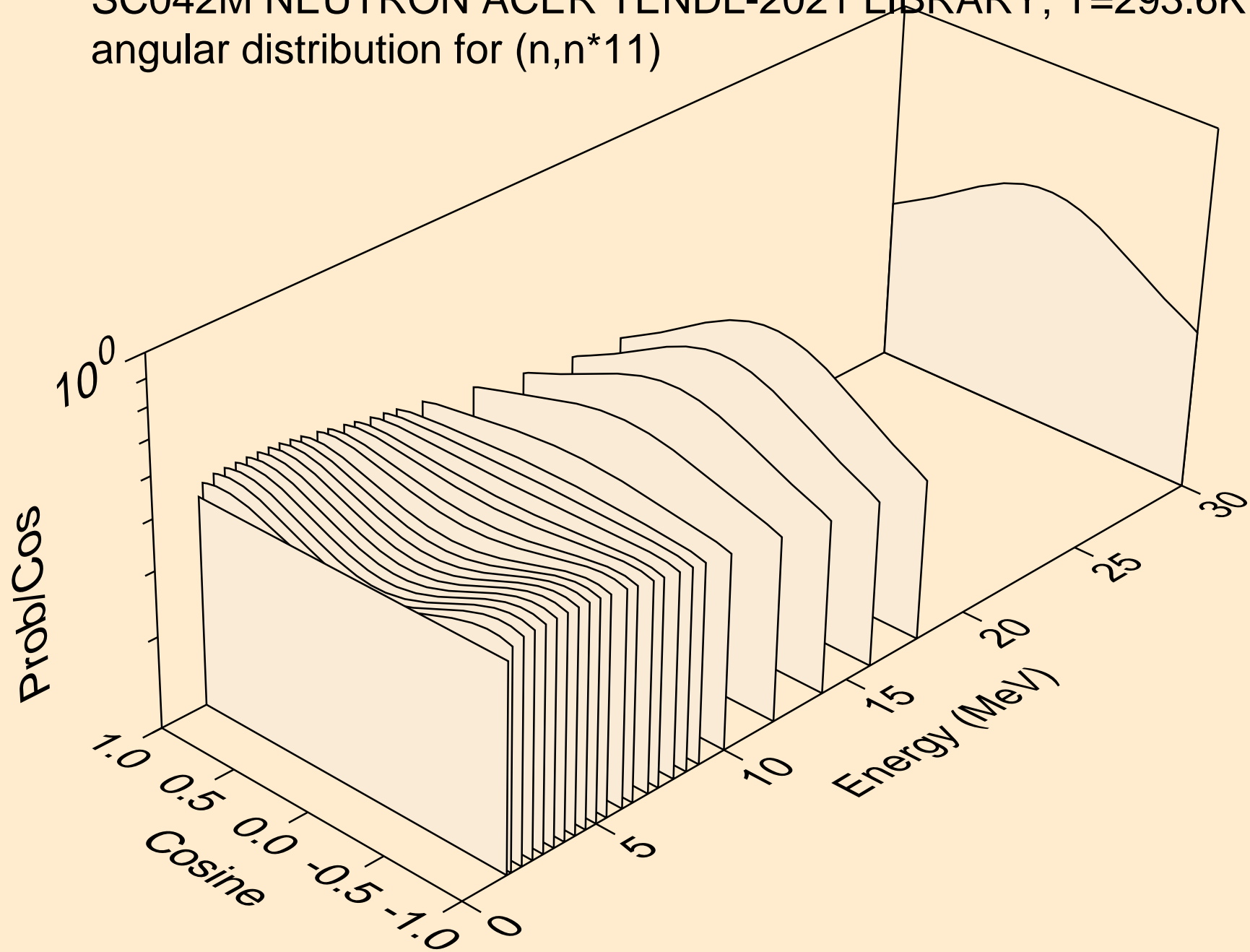

SC042M NEUTRON ACER TENDL-2021 LIBRARY; T=293.6K
angular distribution for (n,n*12)

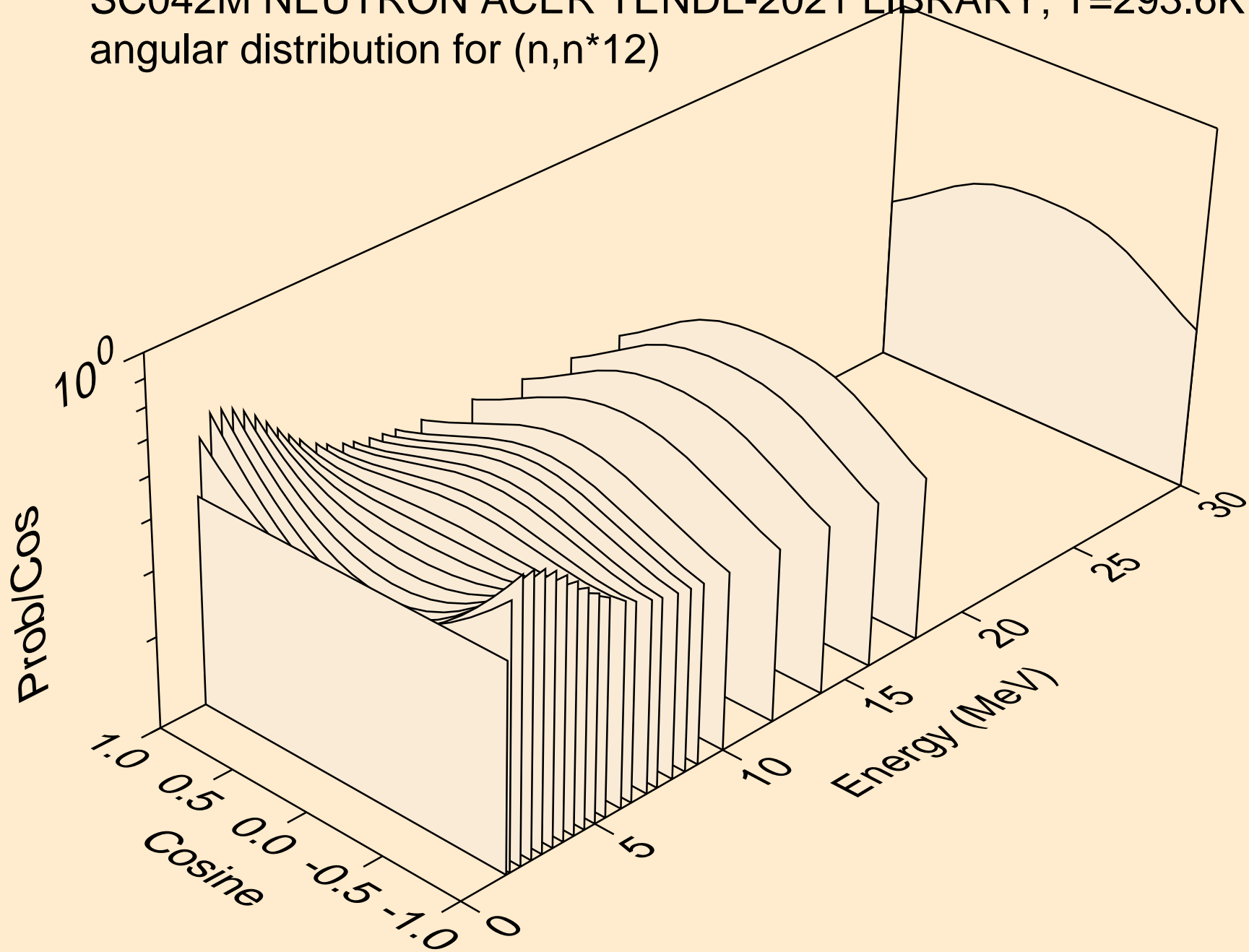

SC042M NEUTRON ACER TENDL-2021 LIBRARY; T=293.6K
angular distribution for (n,n*13)

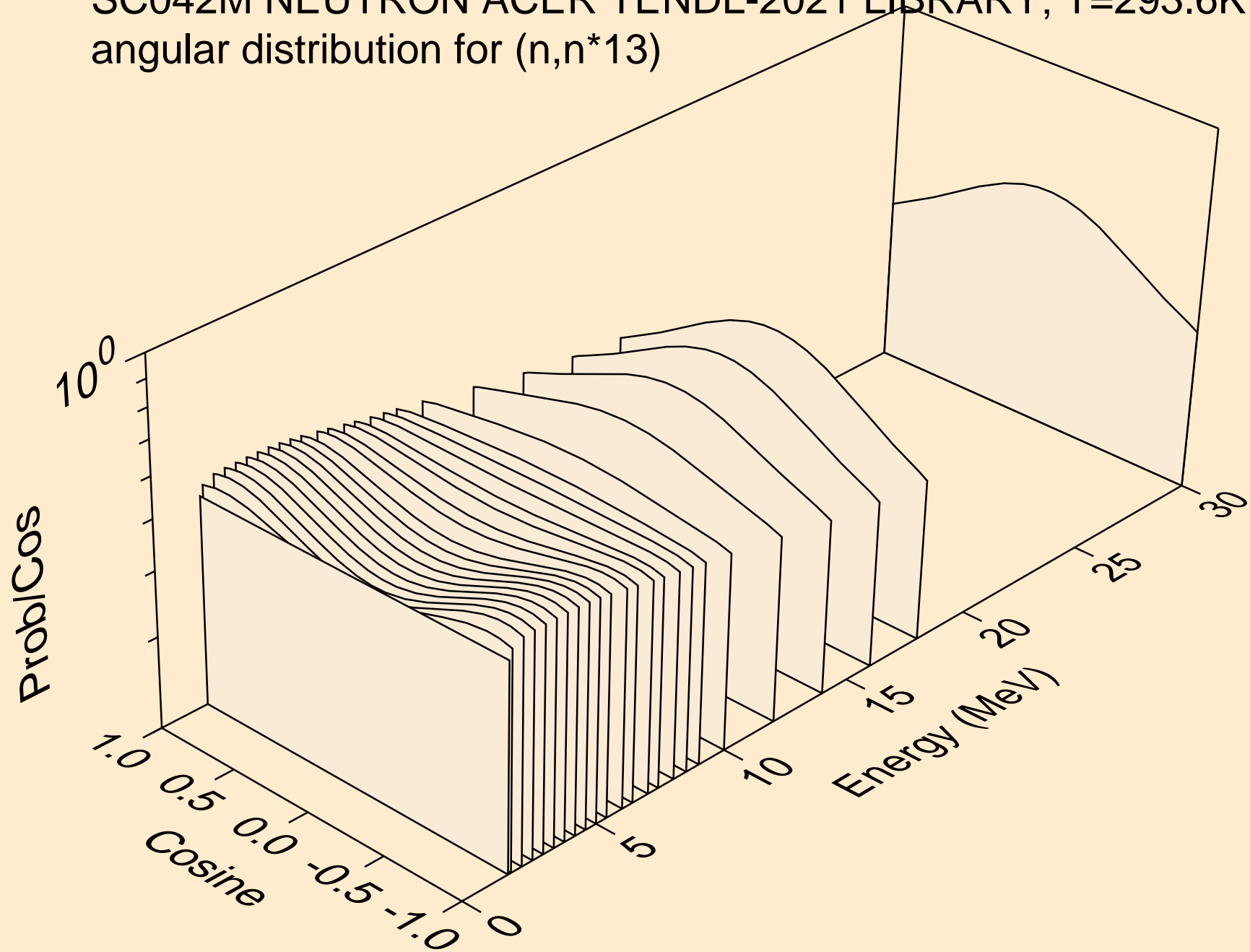

SC042M NEUTRON ACER TENDL-2021 LIBRARY; T=293.6K
angular distribution for (n,n*14)

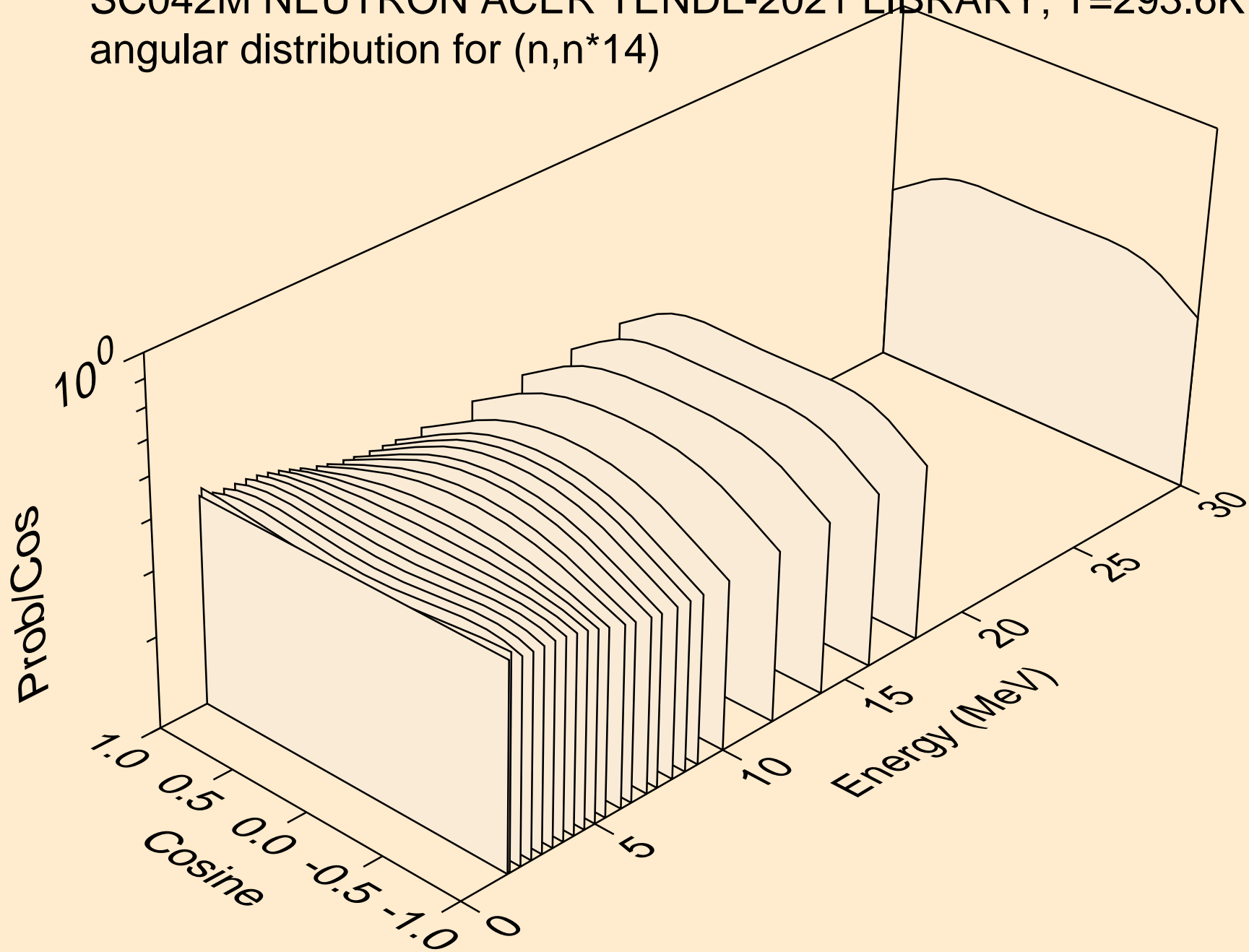

SC042M NEUTRON ACER TENDL-2021 LIBRARY; T=293.6K
angular distribution for (n,n*15)

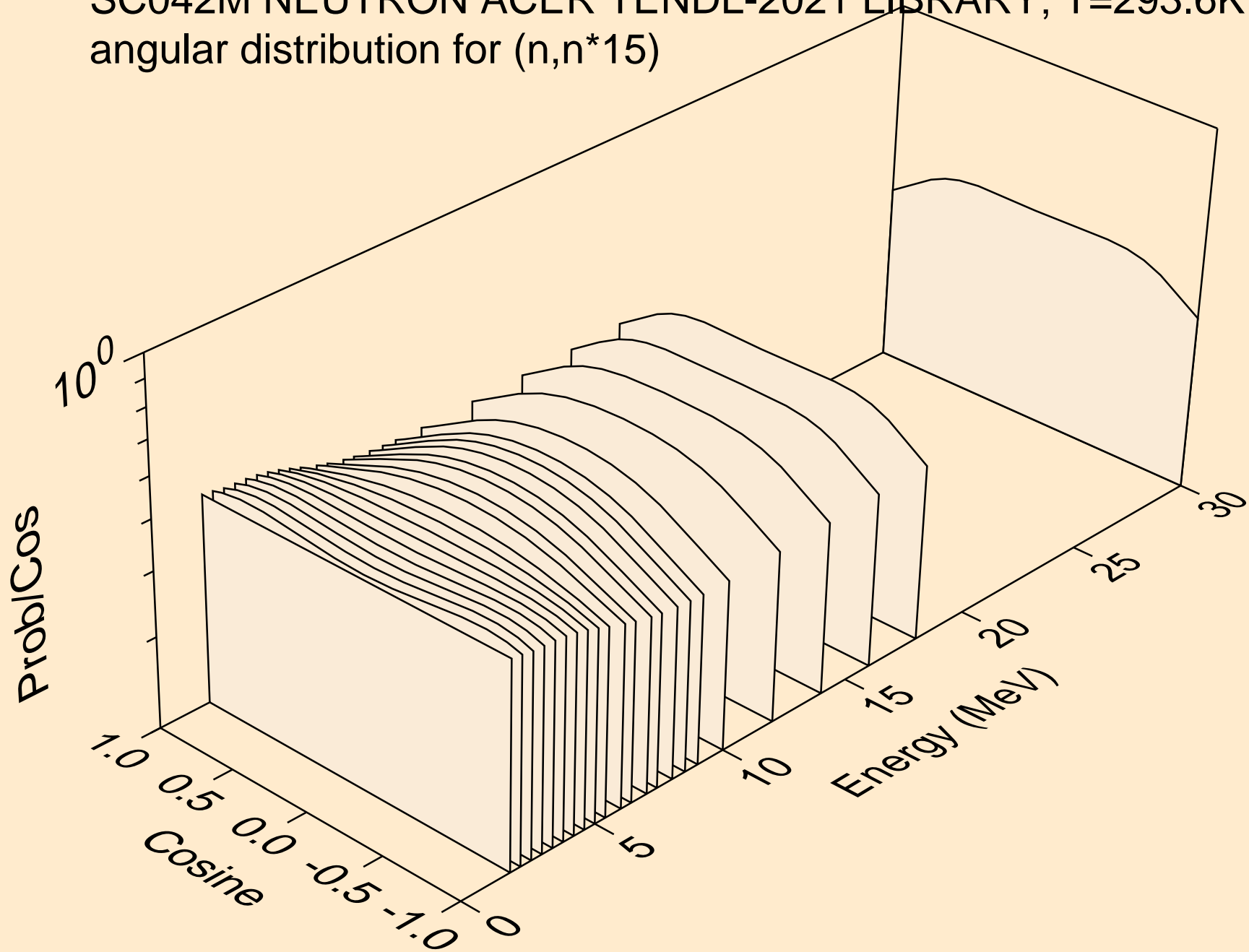

SC042M NEUTRON ACER TENDL-2021 LIBRARY; T=293.6K
angular distribution for (n,n*16)

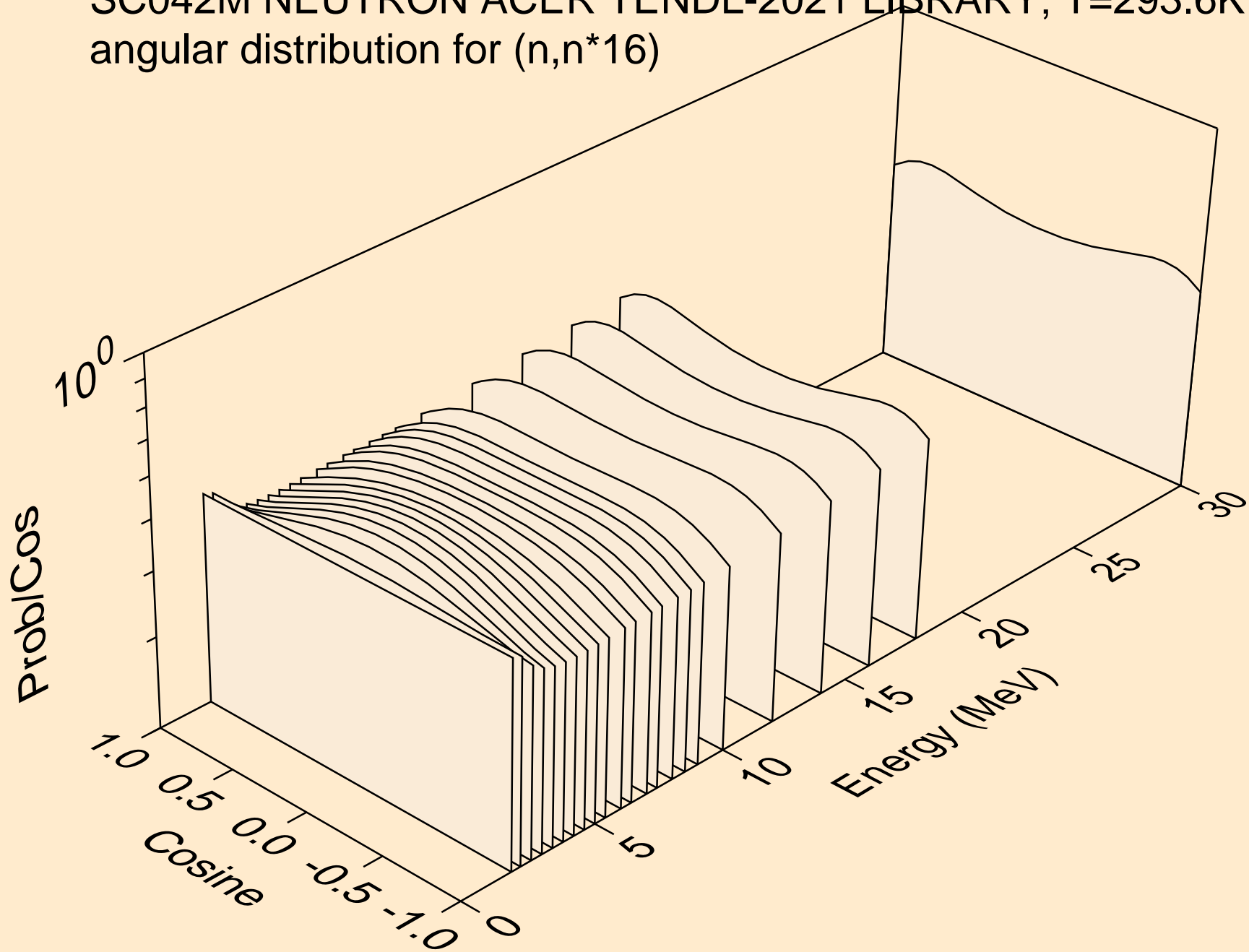

SC042M NEUTRON ACER TENDL-2021 LIBRARY; T=293.6K
angular distribution for (n,n*17)

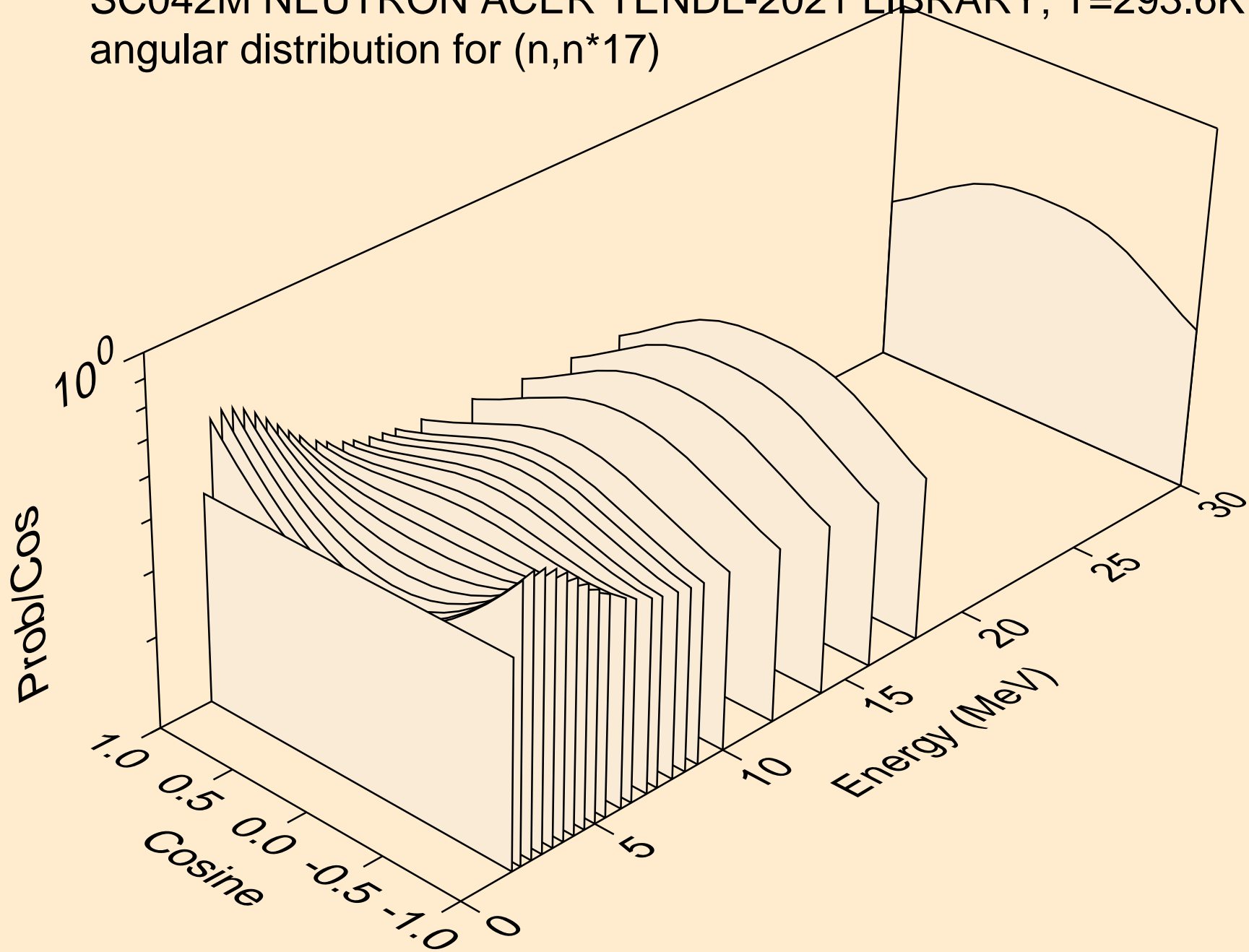

SC042M NEUTRON ACER TENDL-2021 LIBRARY; T=293.6K
angular distribution for (n,n*18)

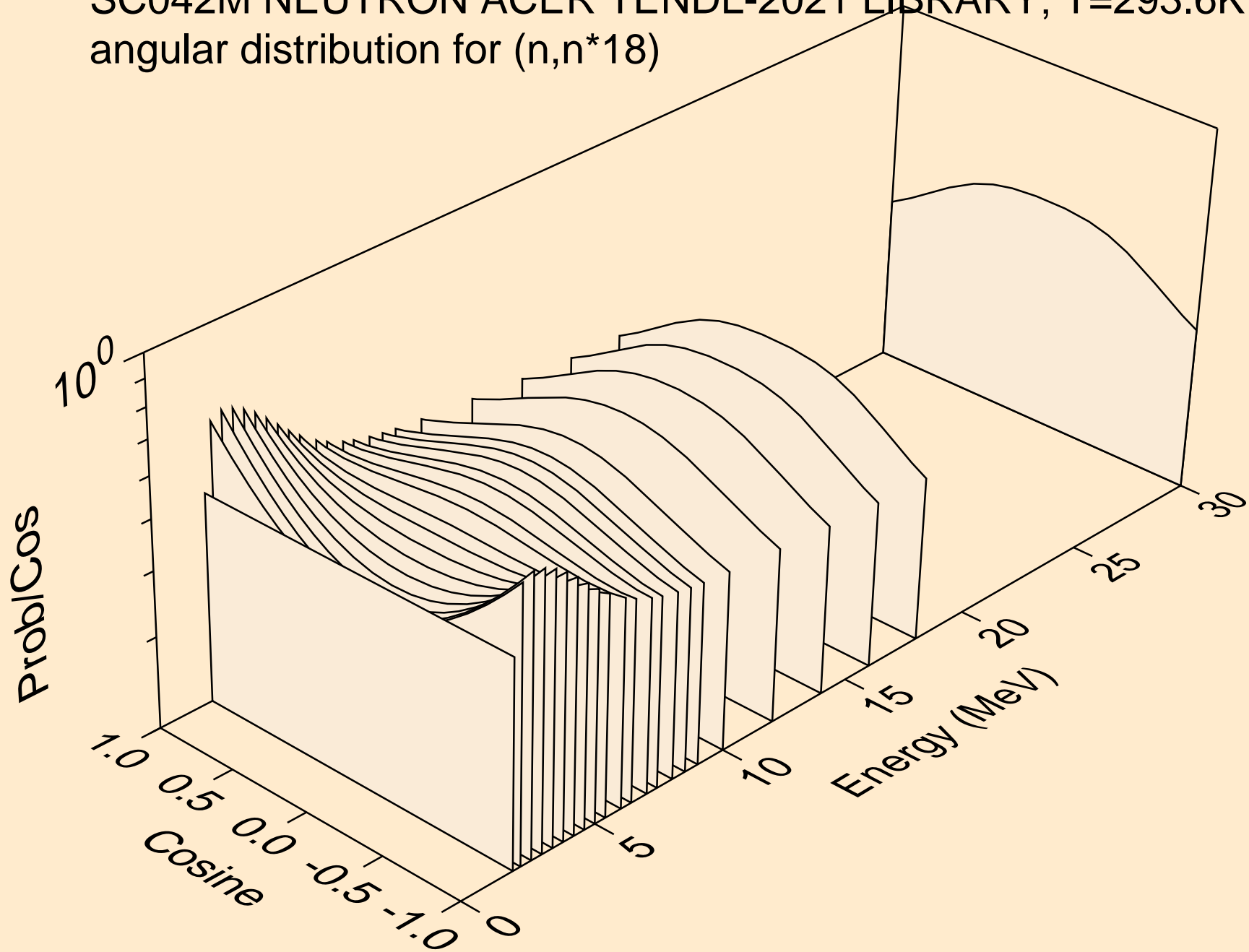

SC042M NEUTRON ACER TENDL-2021 LIBRARY; T=293.6K
angular distribution for (n,n*19)

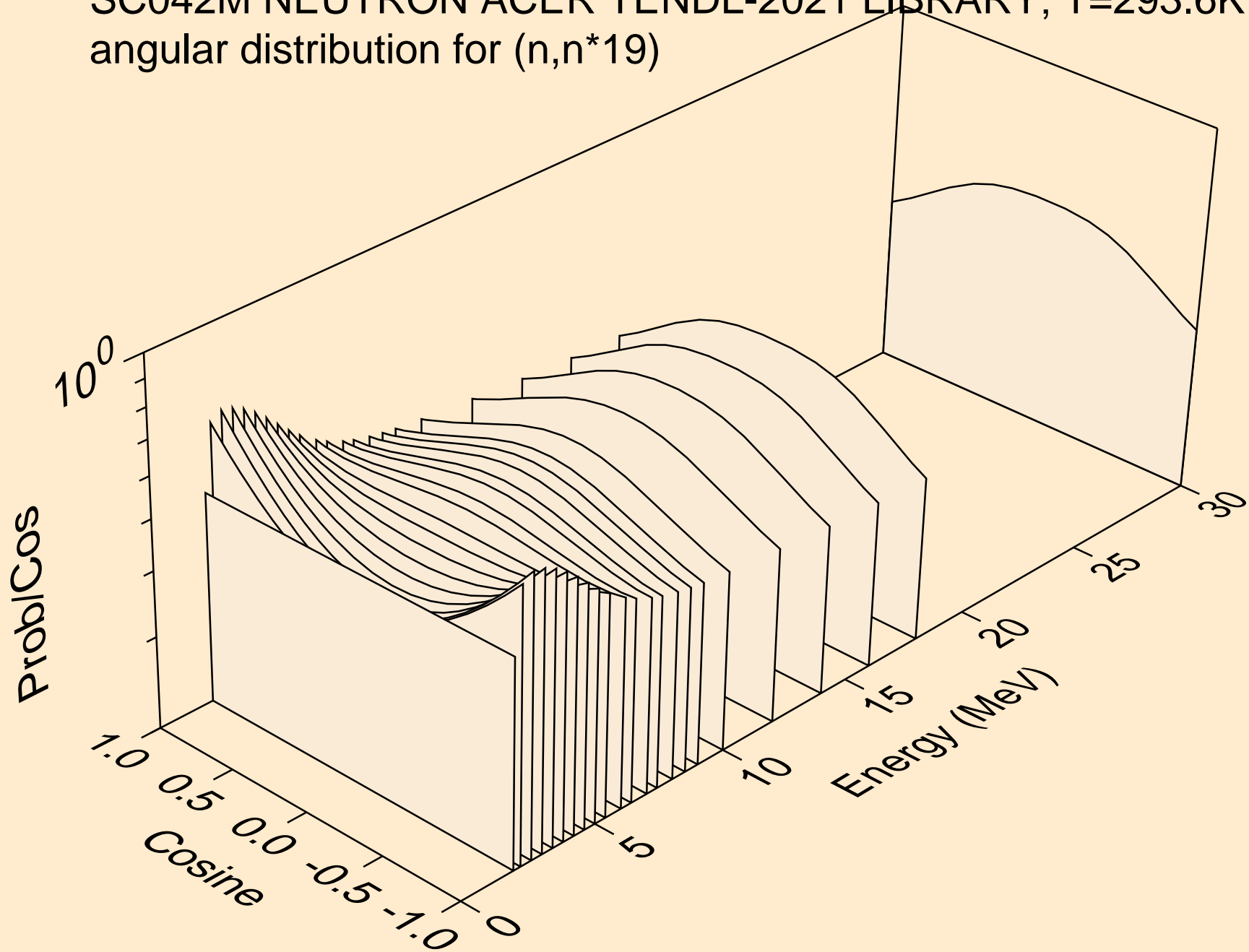

SC042M NEUTRON ACER TENDL-2021 LIBRARY; T=293.6K
angular distribution for (n,n*20)

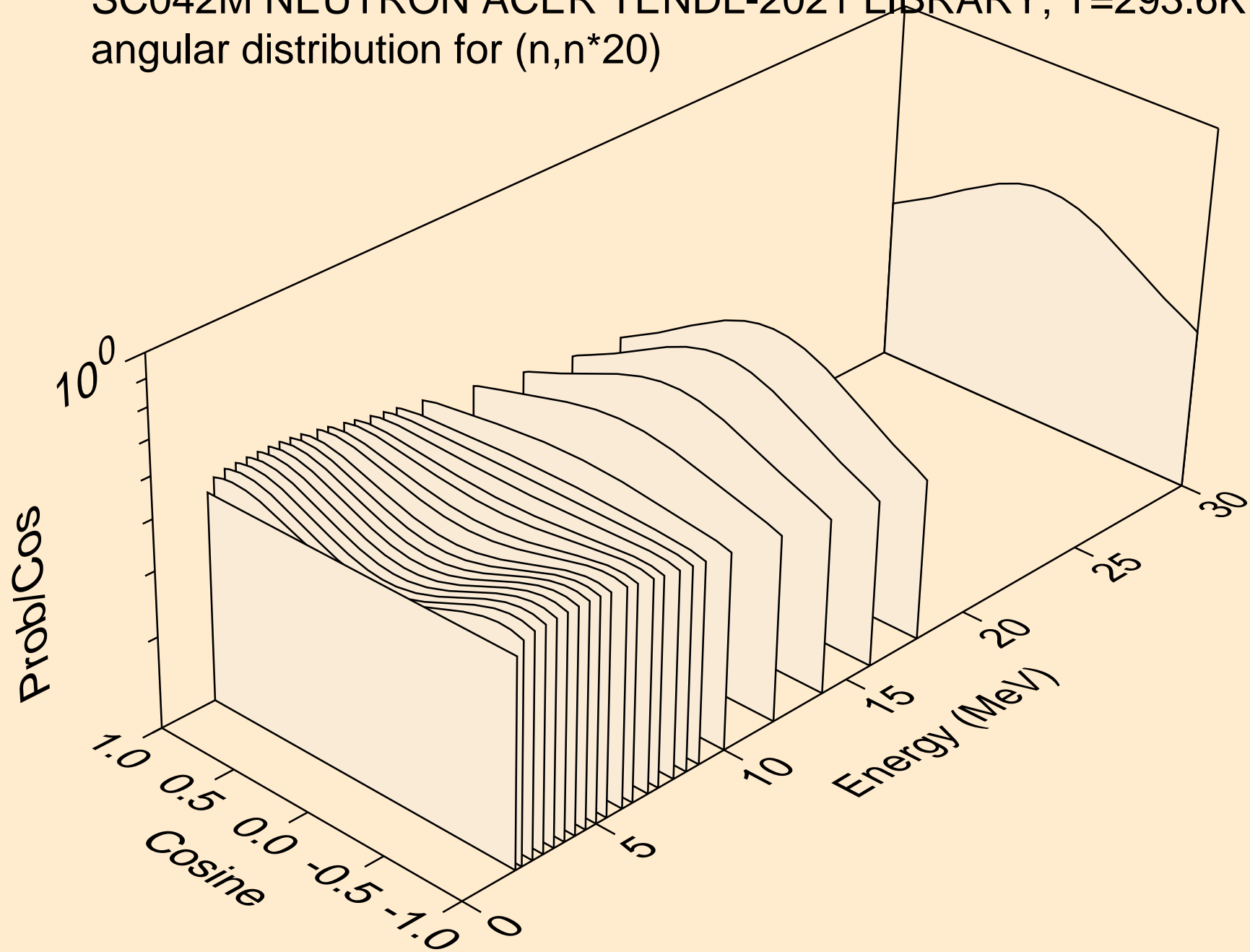

SC042M NEUTRON ACER TENDL-2021 LIBRARY; T=293.6K
angular distribution for (n,n*21)

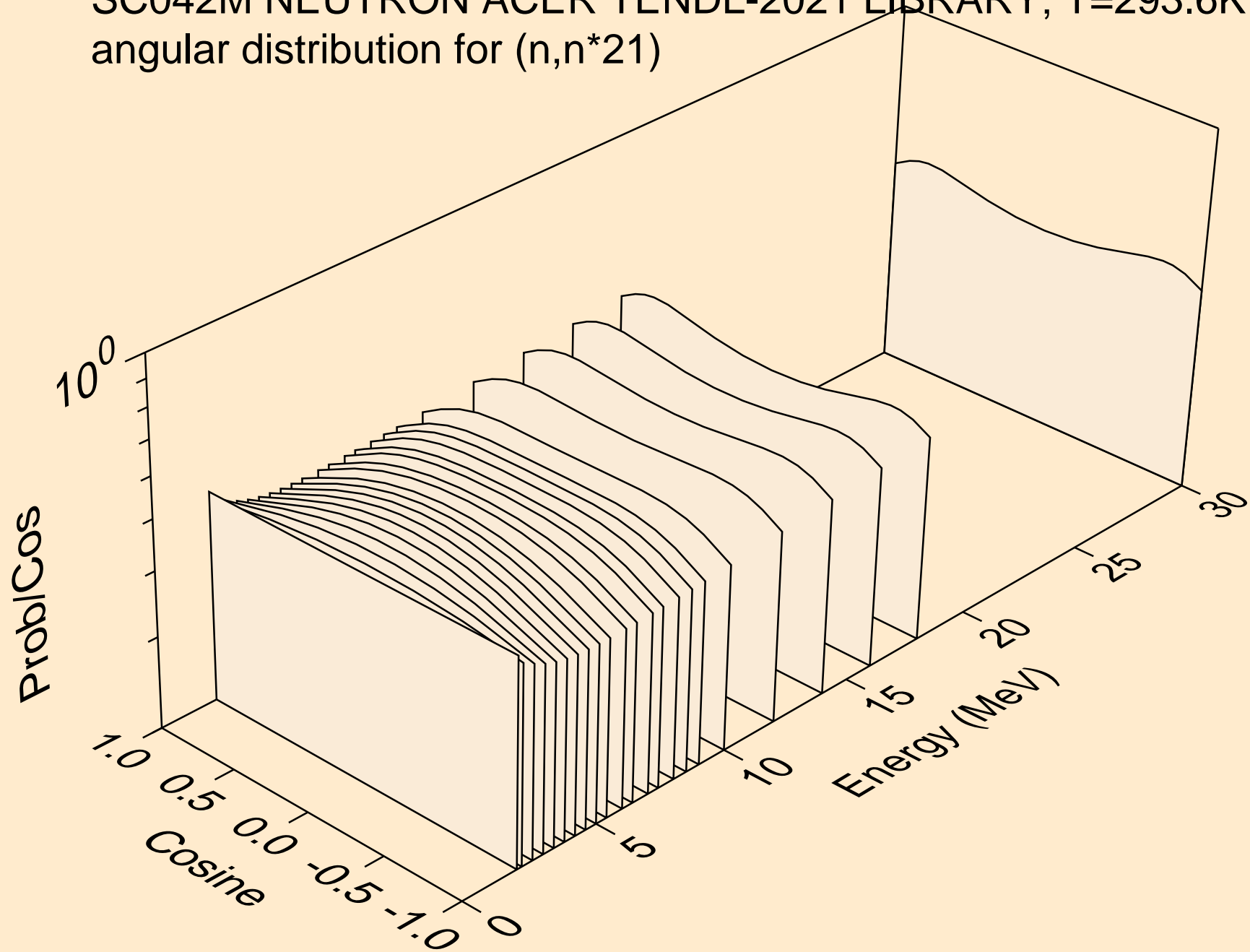

SC042M NEUTRON ACER TENDL-2021 LIBRARY; T=293.6K
angular distribution for (n,n*22)

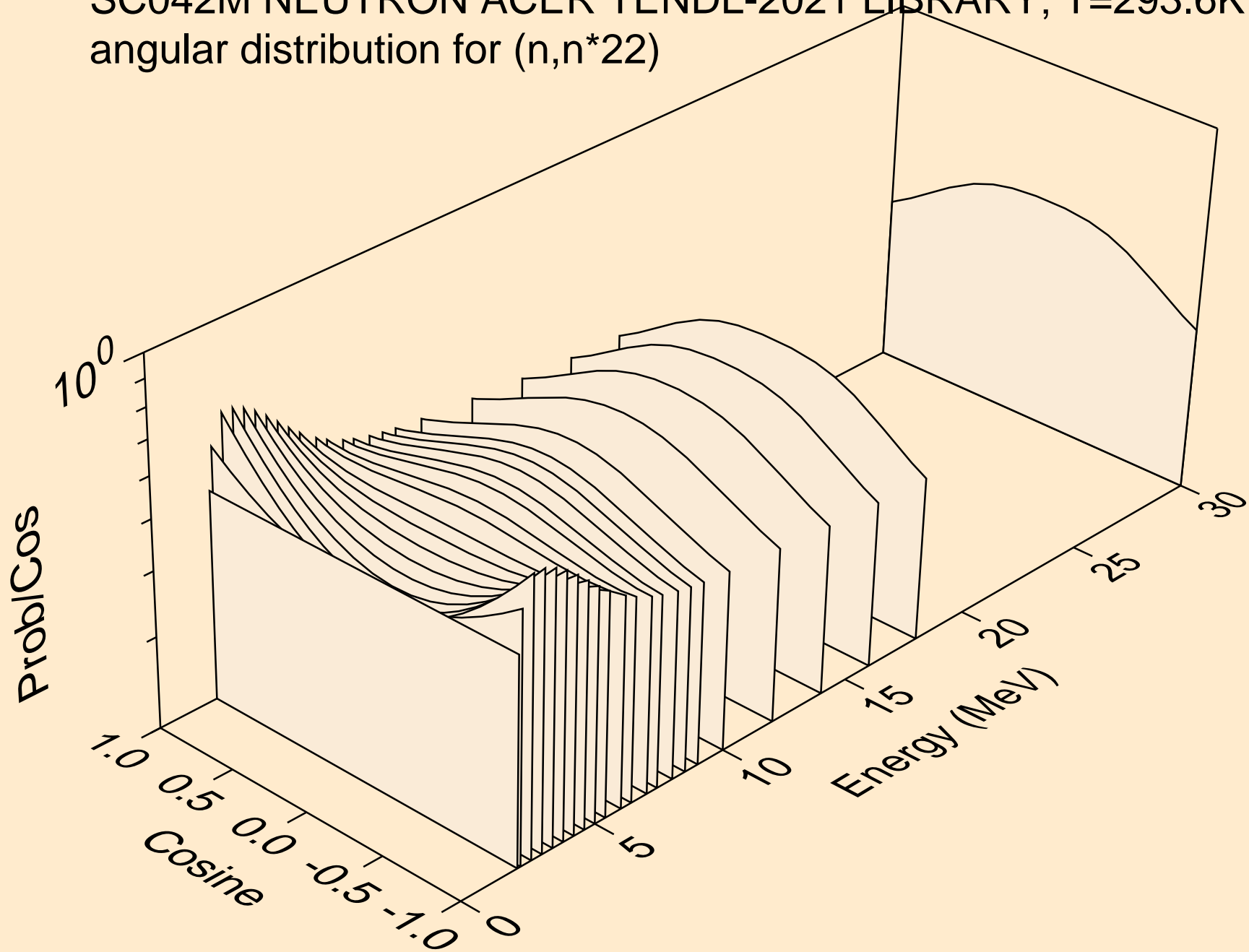

SC042M NEUTRON ACER TENDL-2021 LIBRARY; T=293.6K
angular distribution for (n,n*23)

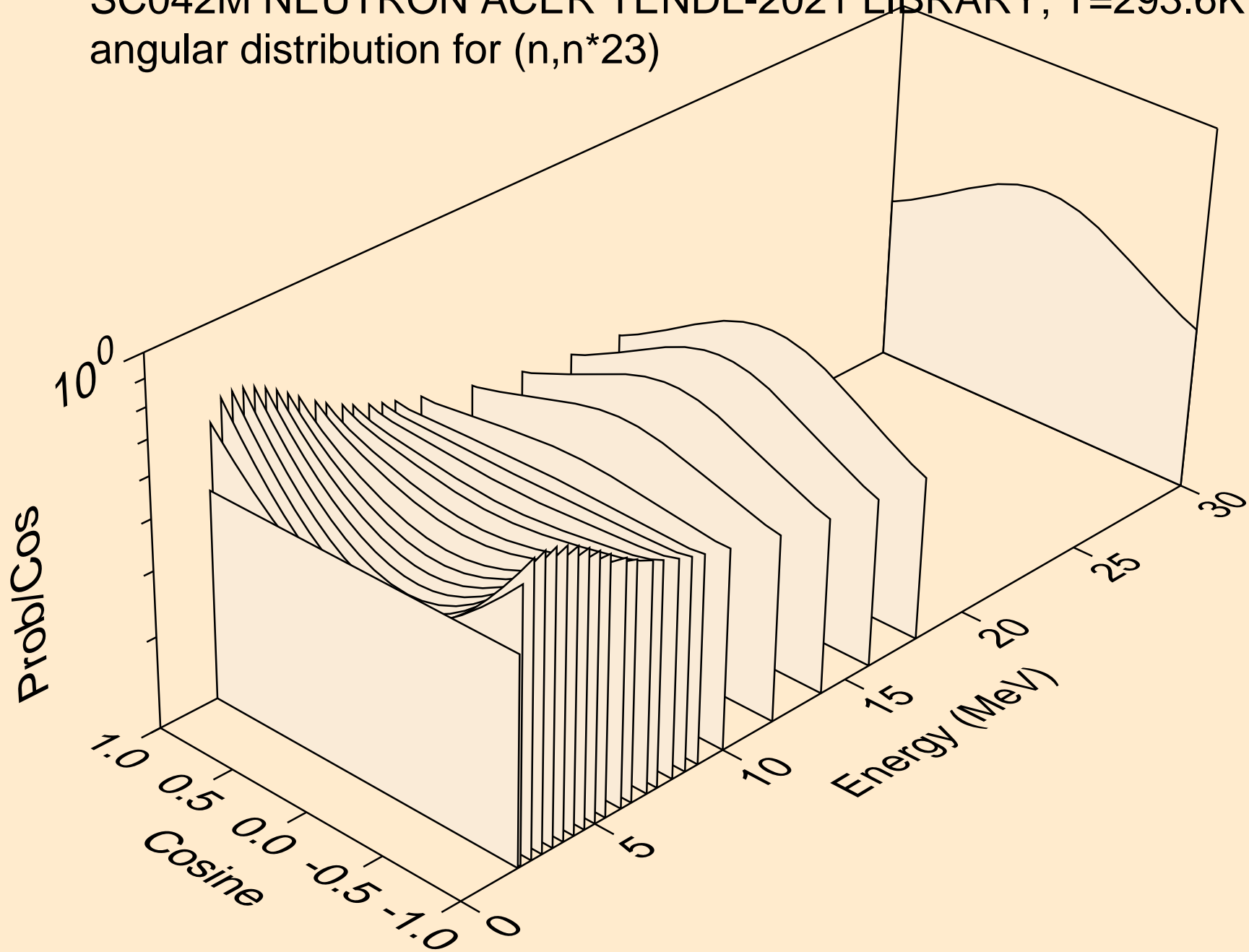

SC042M NEUTRON ACER TENDL-2021 LIBRARY; T=293.6K
angular distribution for (n,n*24)

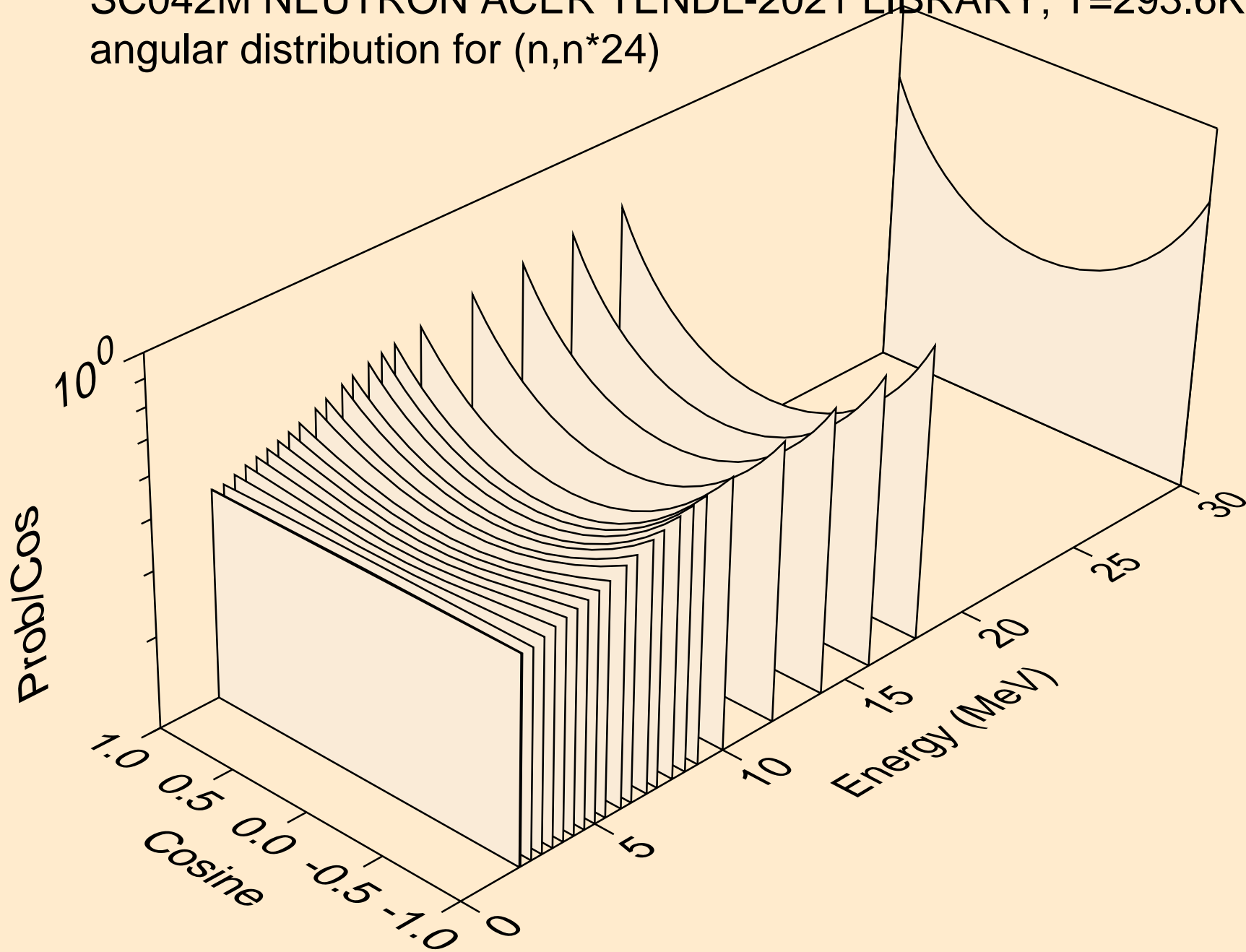

SC042M NEUTRON ACER TENDL-2021 LIBRARY; T=293.6K
angular distribution for (n,n*25)

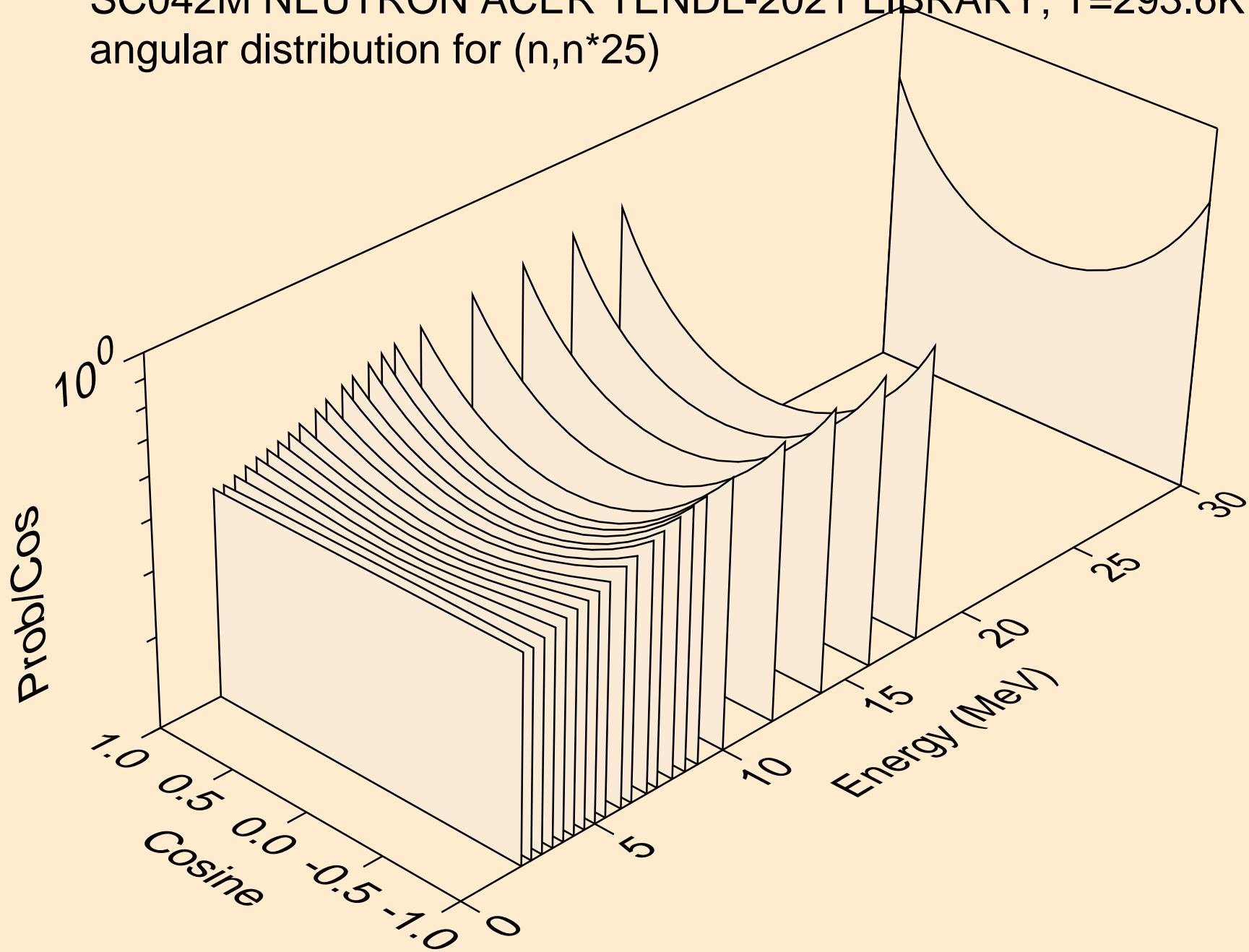

SC042M NEUTRON ACER TENDL-2021 LIBRARY; T=293.6K
Neutron emission for (n,x)

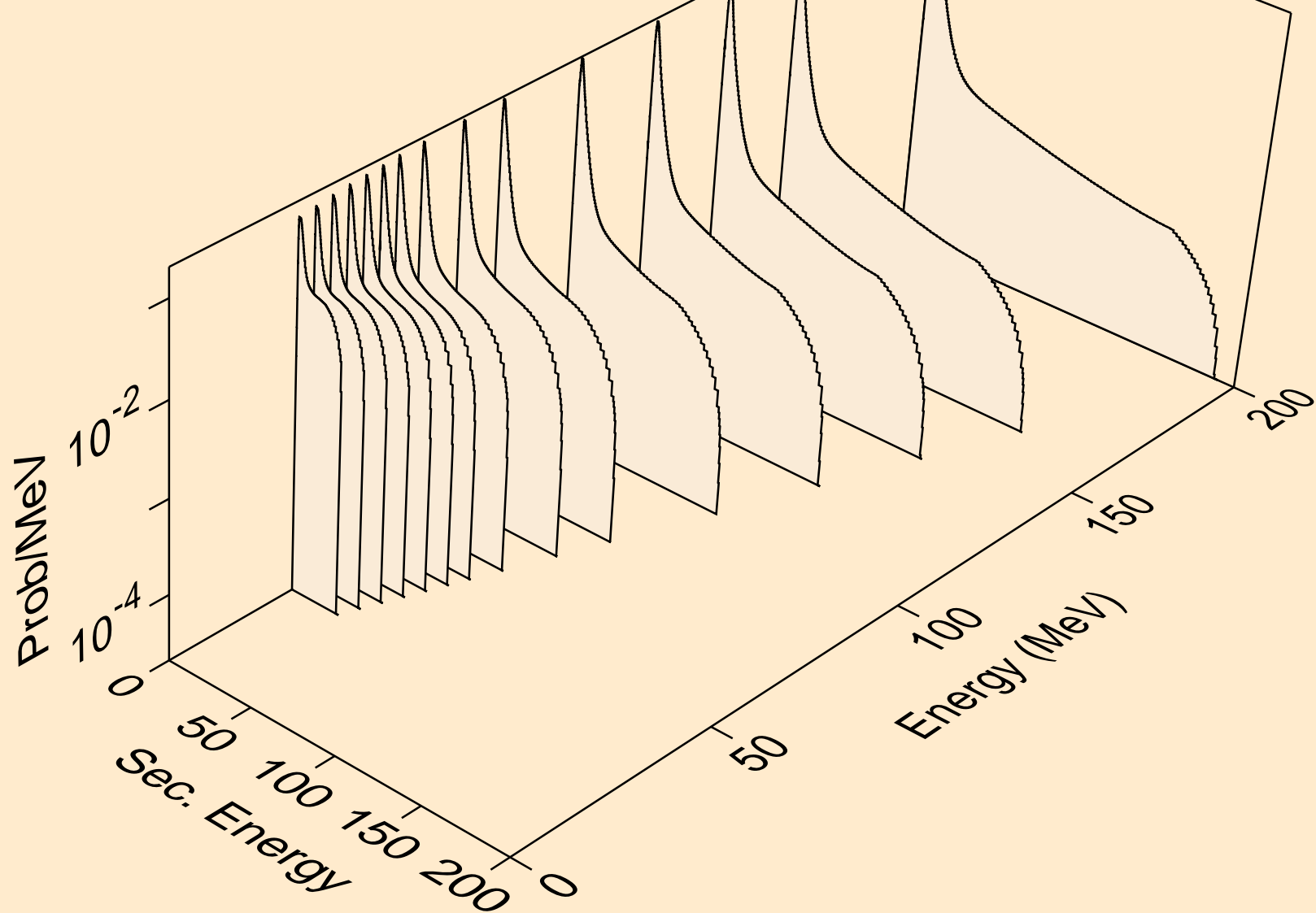

SC042M NEUTRON ACER TENDL-2021 LIBRARY; T=293.6K
Neutron emission for (n,2nd)

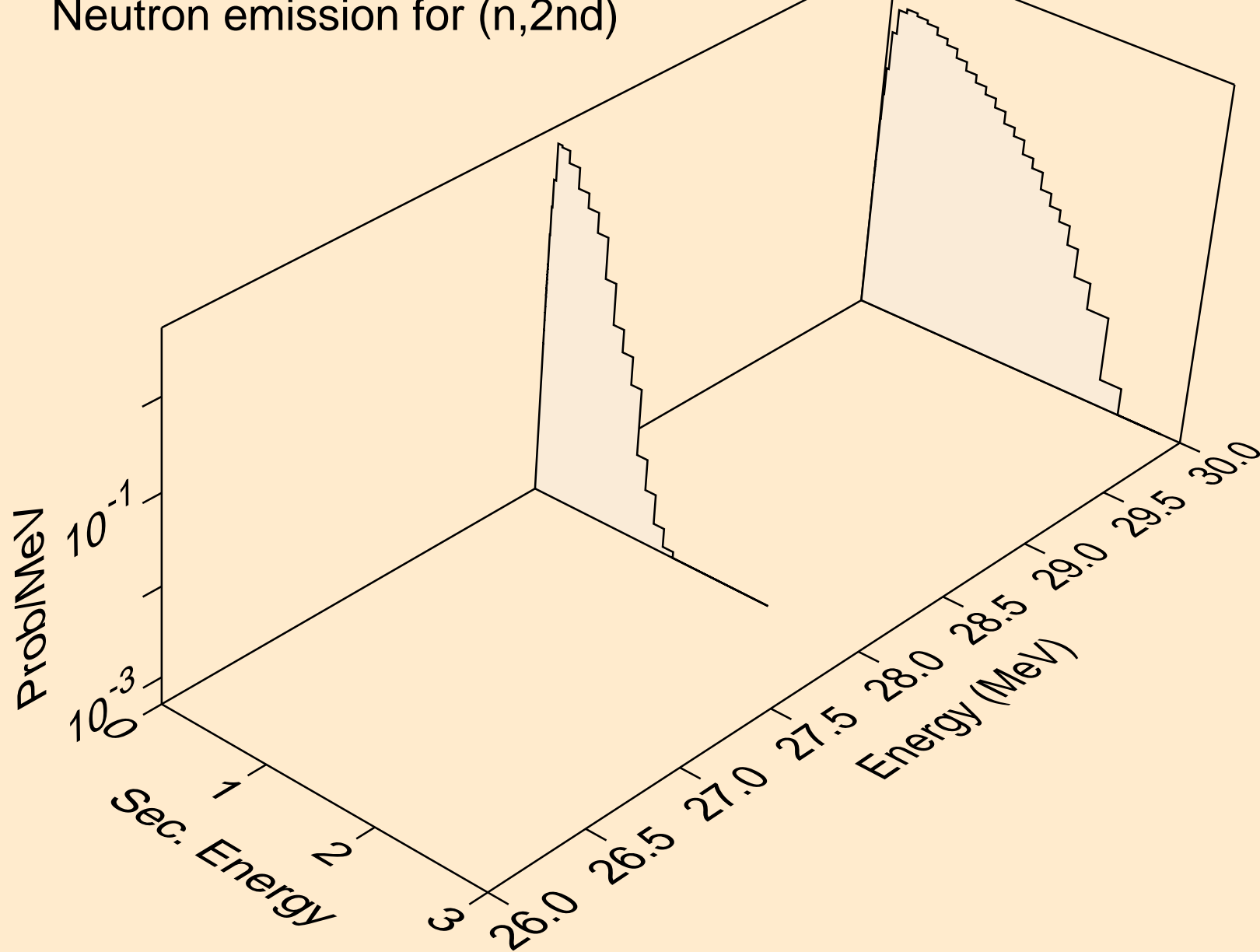

SC042M NEUTRON ACER TENDL-2021 LIBRARY; T=293.6K
Neutron emission for (n,2n)

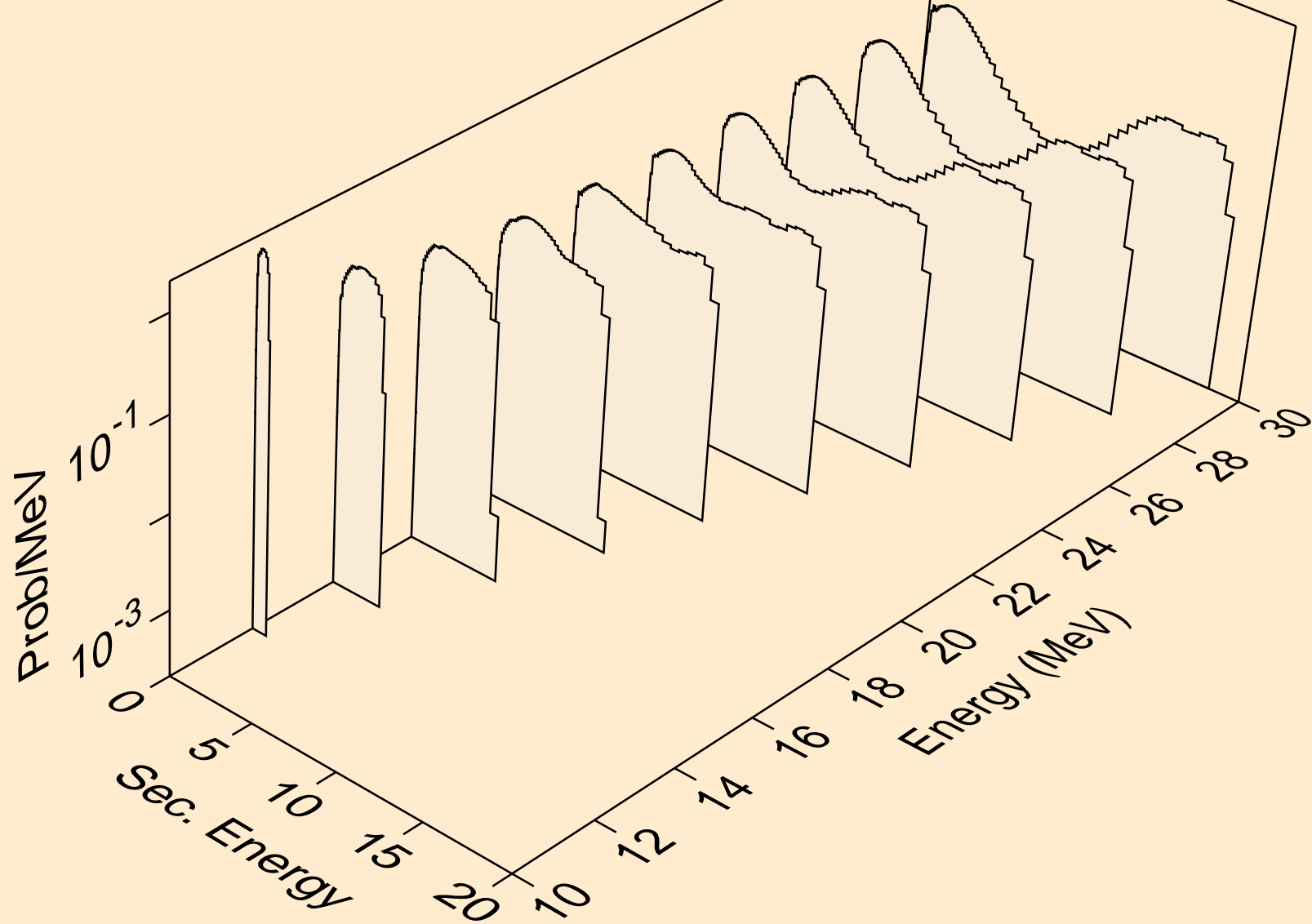

SC042M NEUTRON ACER TENDL-2021 LIBRARY; T=293.6K
Neutron emission for (n,3n)

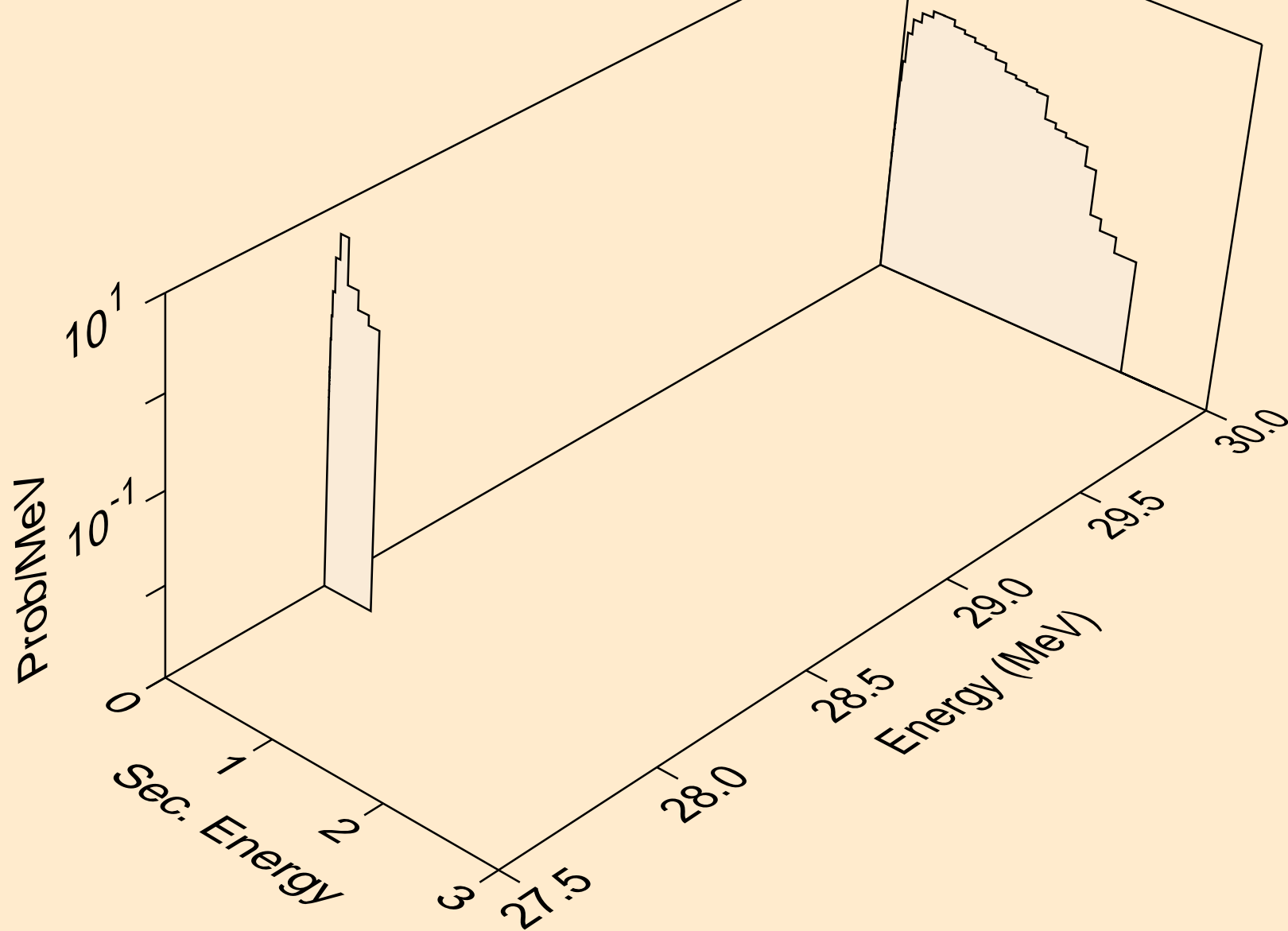

SC042M NEUTRON ACER TENDL-2021 LIBRARY; T=293.6K
Neutron emission for (n,n*)a

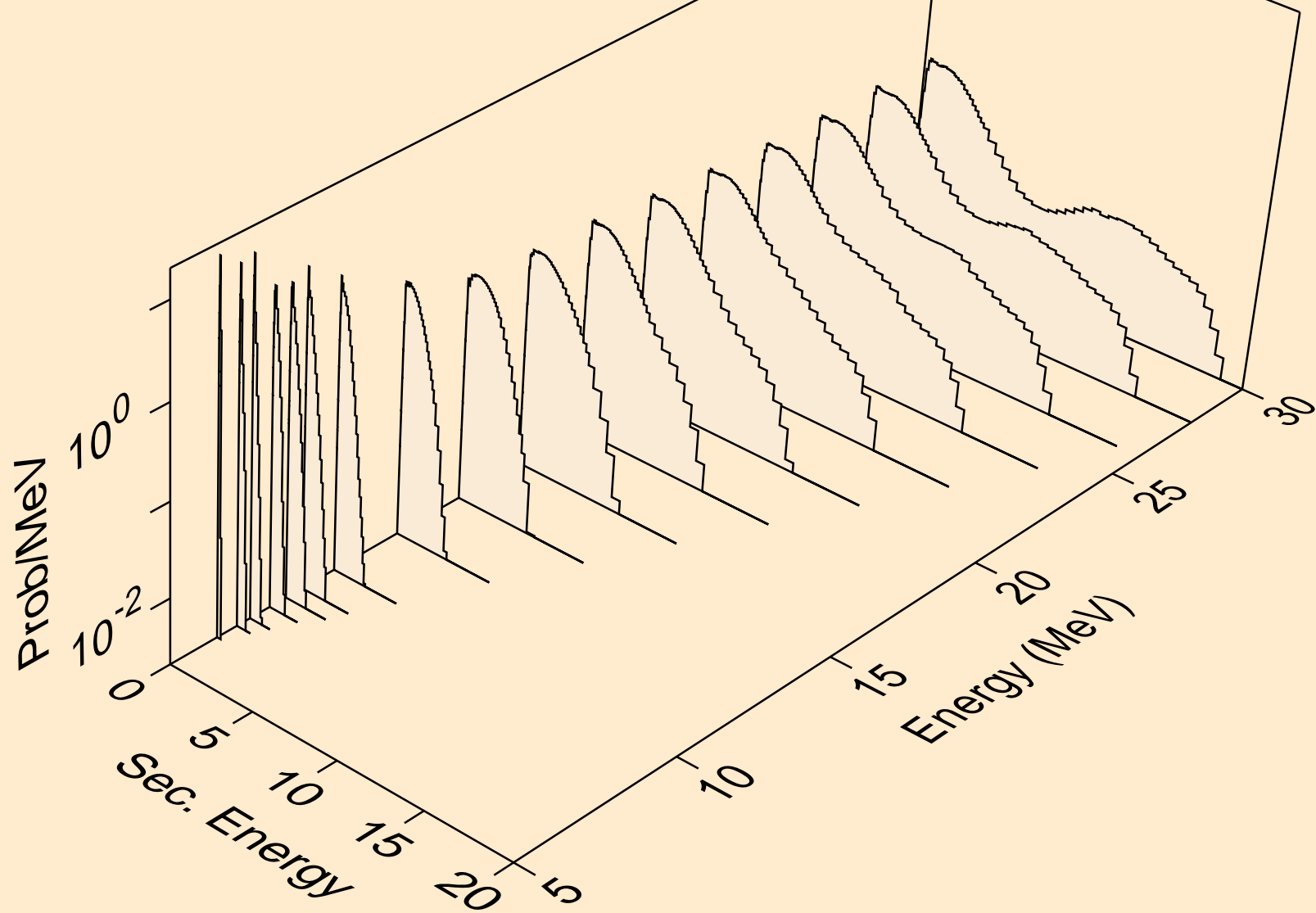

SC042M NEUTRON ACER TENDL-2021 LIBRARY; T=293.6K
Neutron emission for (n,2n)a

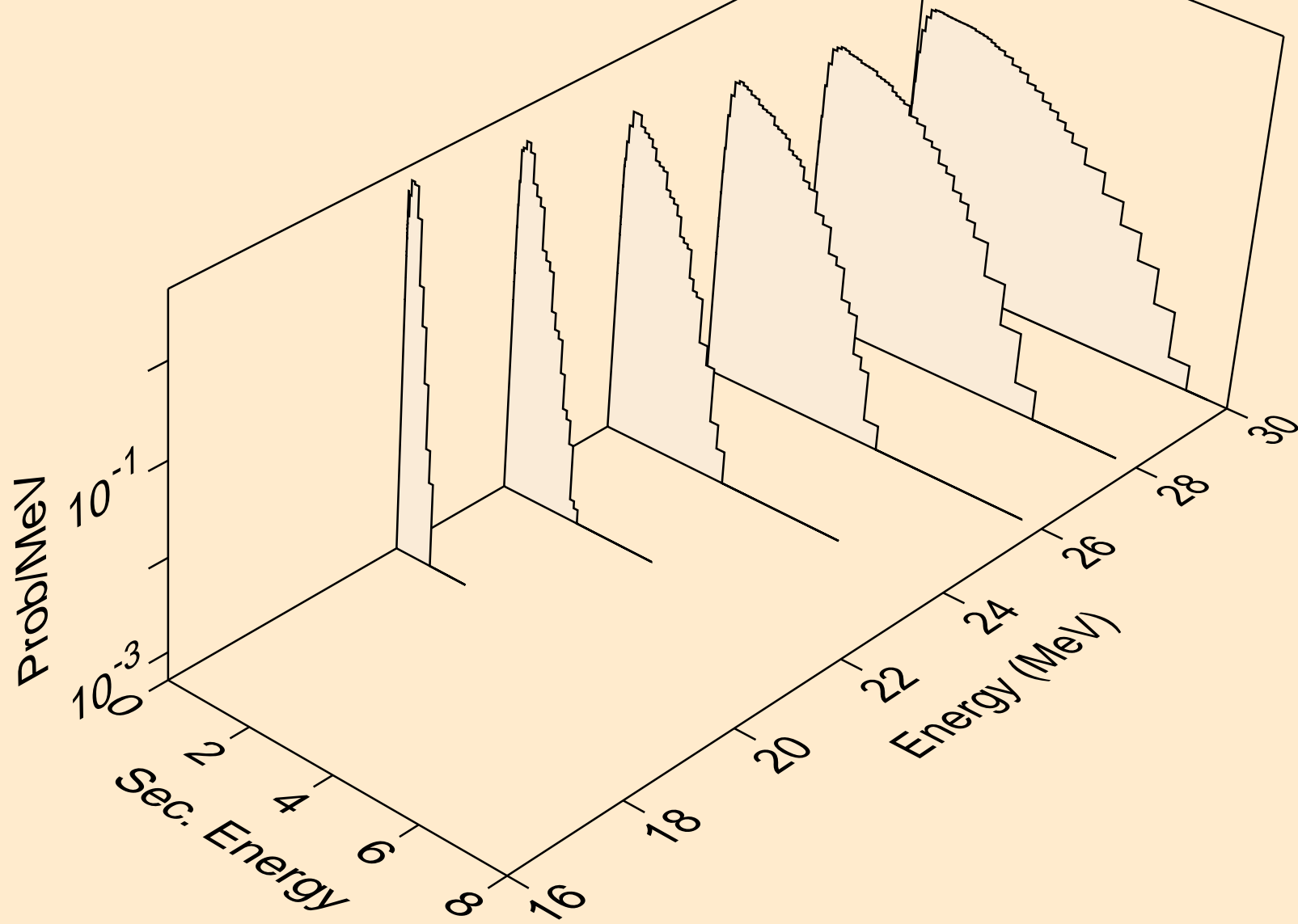

SC042M NEUTRON ACER TENDL-2021 LIBRARY; T=293.6K
Neutron emission for (n,n*)p

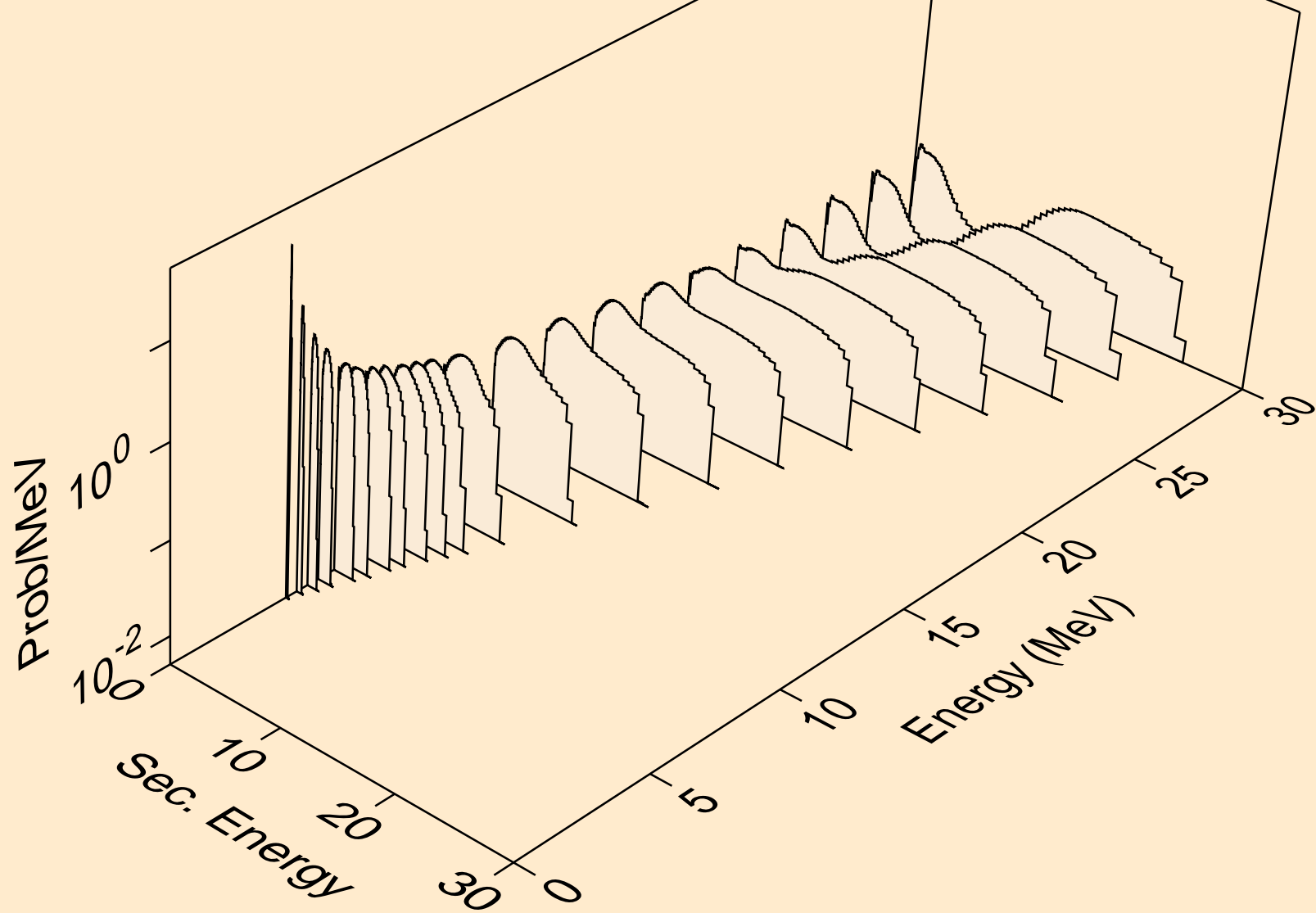

SC042M NEUTRON ACER TENDL-2021 LIBRARY; T=293.6K
Neutron emission for (n,n*)2a

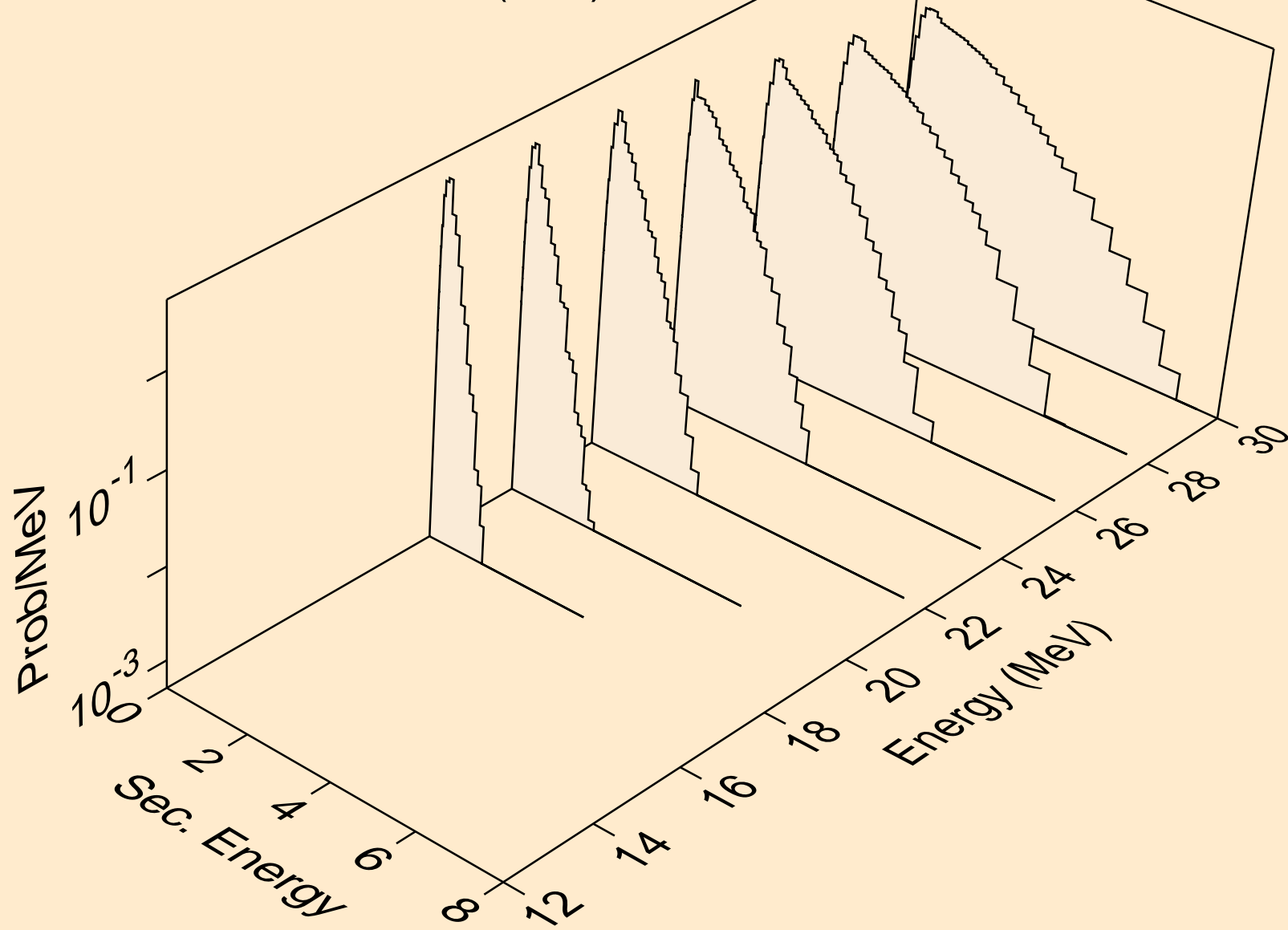

SC042M NEUTRON ACER TENDL-2021 LIBRARY; T=293.6K
Neutron emission for (n,n*)d

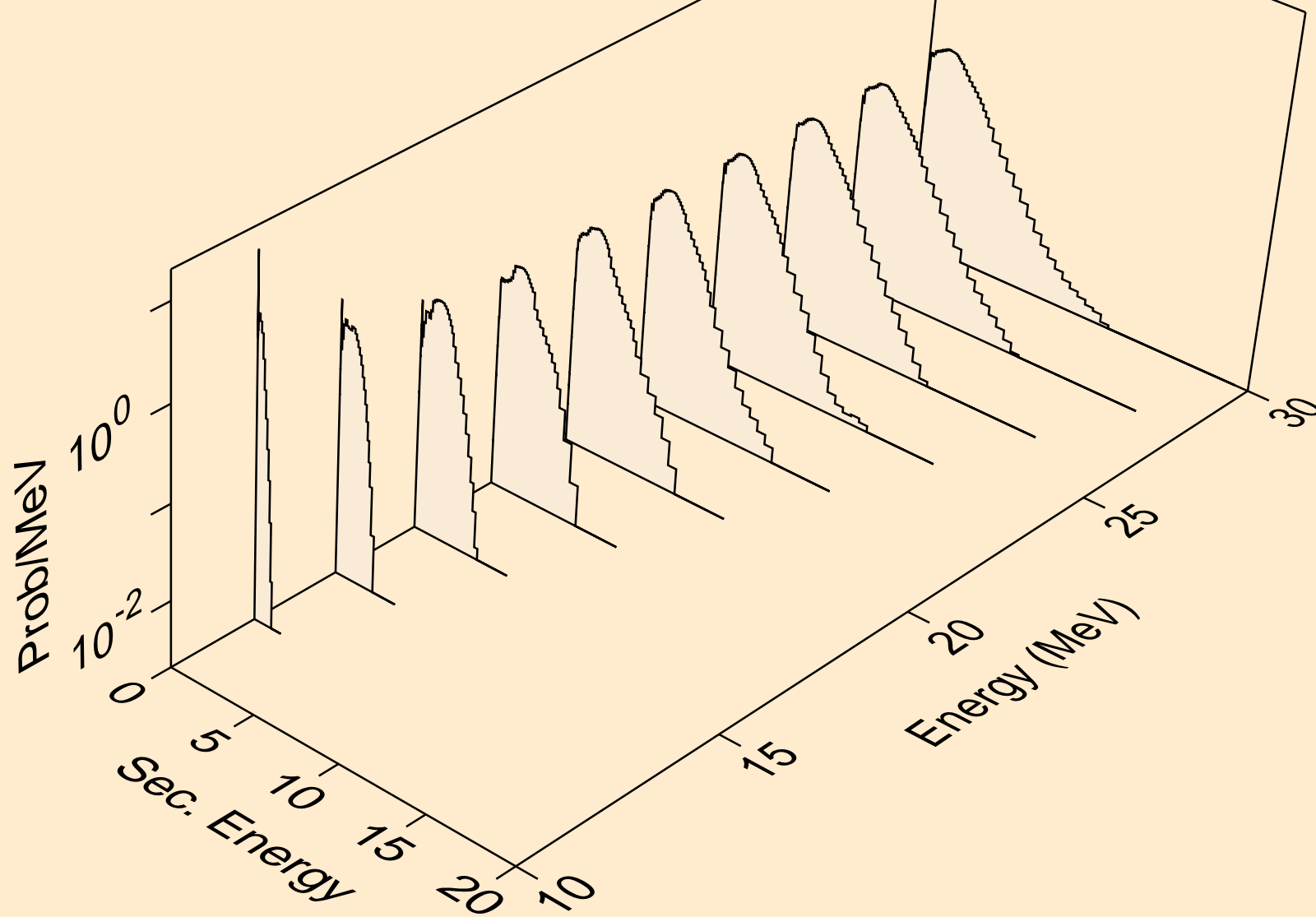

SC042M NEUTRON ACER TENDL-2021 LIBRARY; T=293.6K
Neutron emission for (n,n*)t

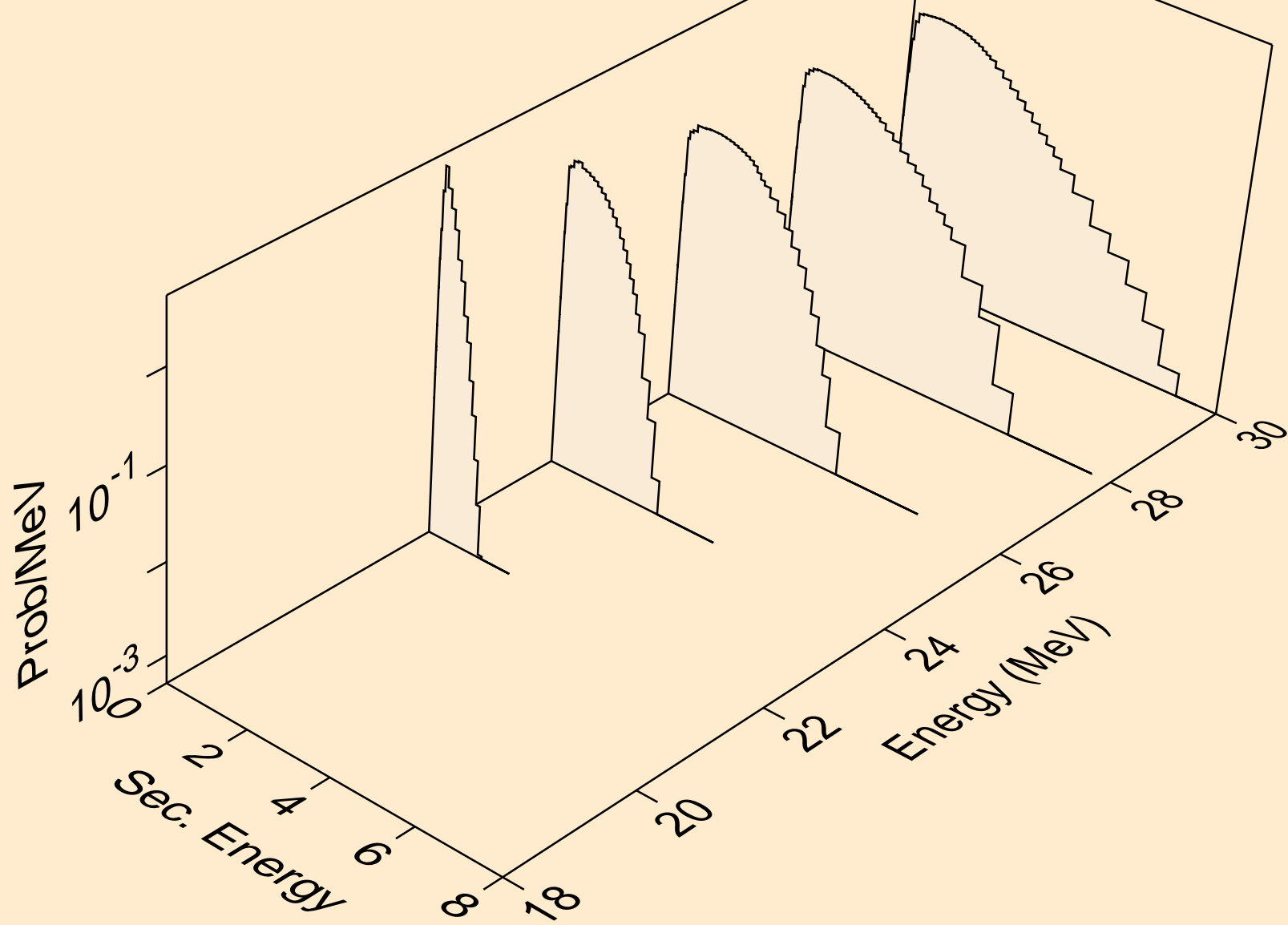

SC042M NEUTRON ACER TENDL-2021 LIBRARY; T=293.6K
Neutron emission for (n,n*)he3

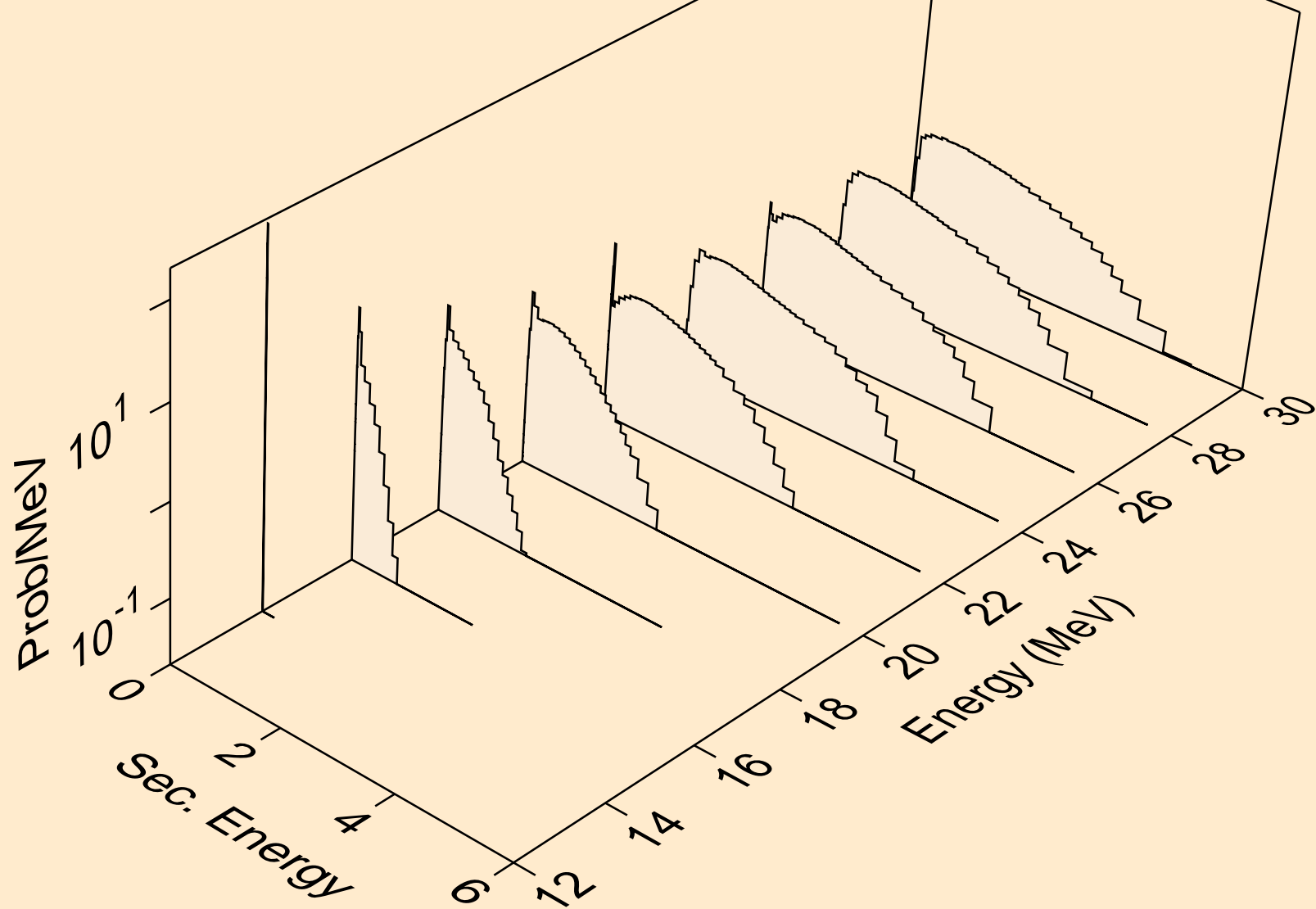

SC042M NEUTRON ACER TENDL-2021 LIBRARY; T=293.6K
Neutron emission for (n,2np)

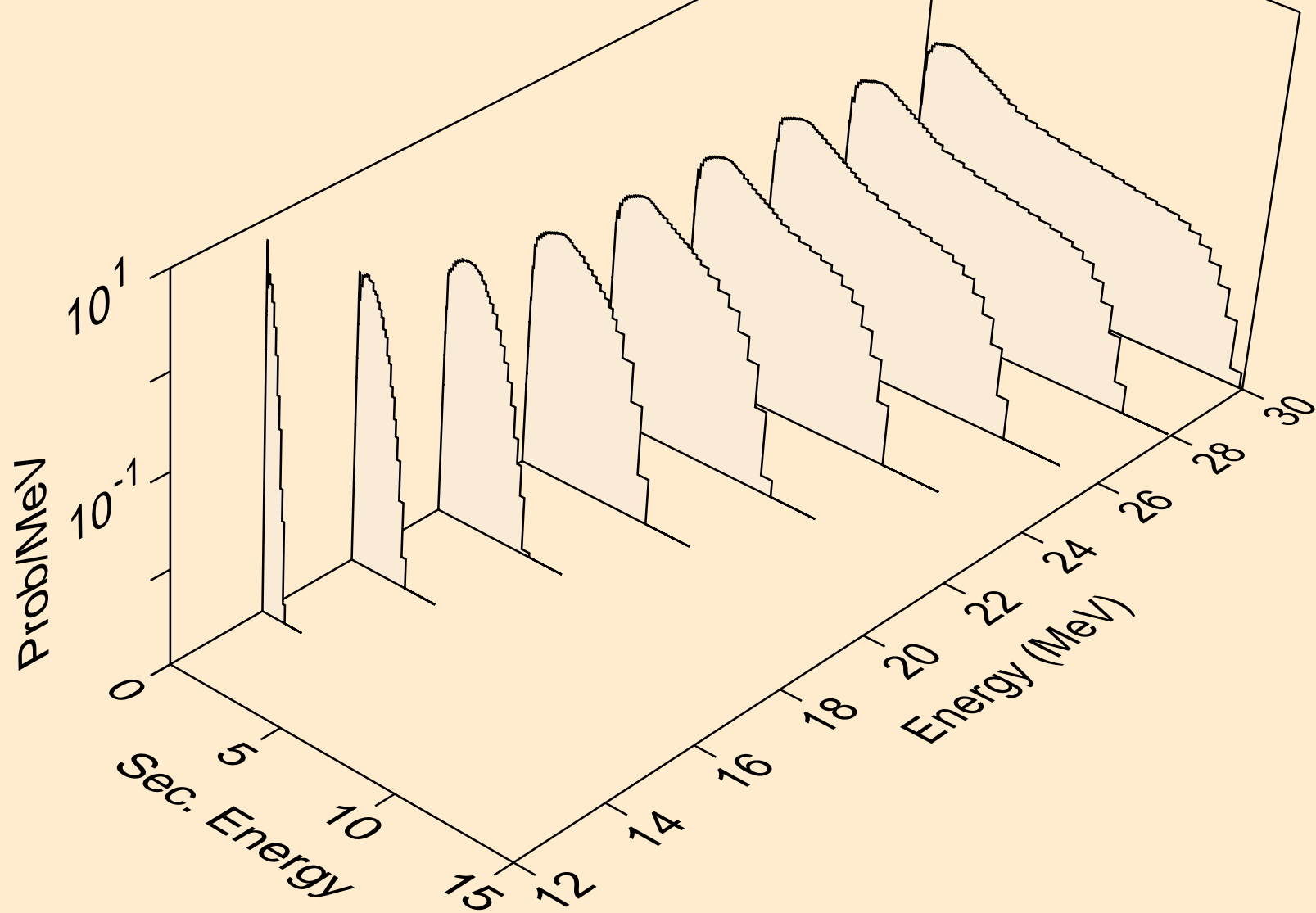

SC042M NEUTRON ACER TENDL-2021 LIBRARY; T=293.6K
Neutron emission for (n,2np)

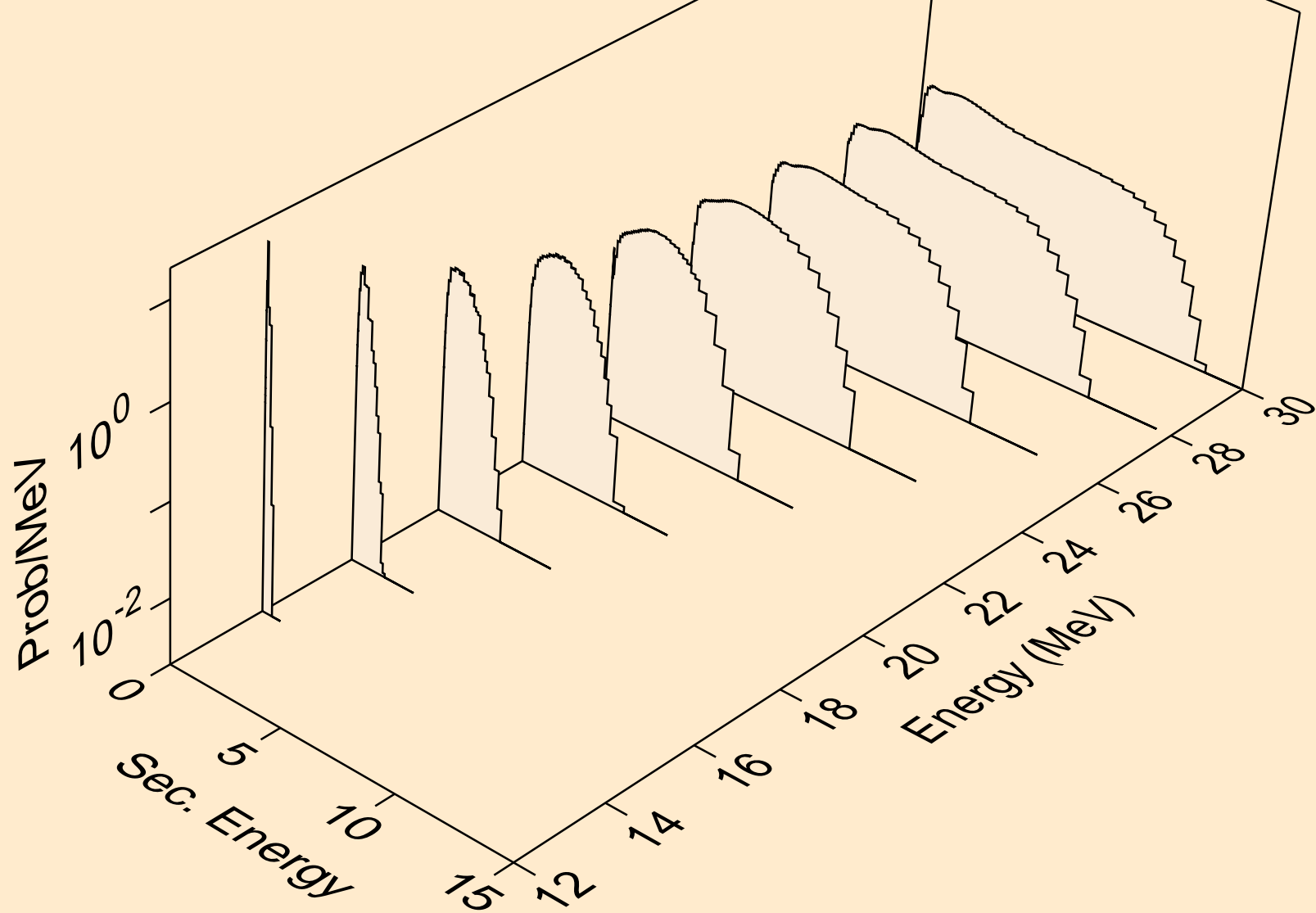

SC042M NEUTRON ACER TENDL-2021 LIBRARY; T=293.6K
Neutron emission for (n,npa)

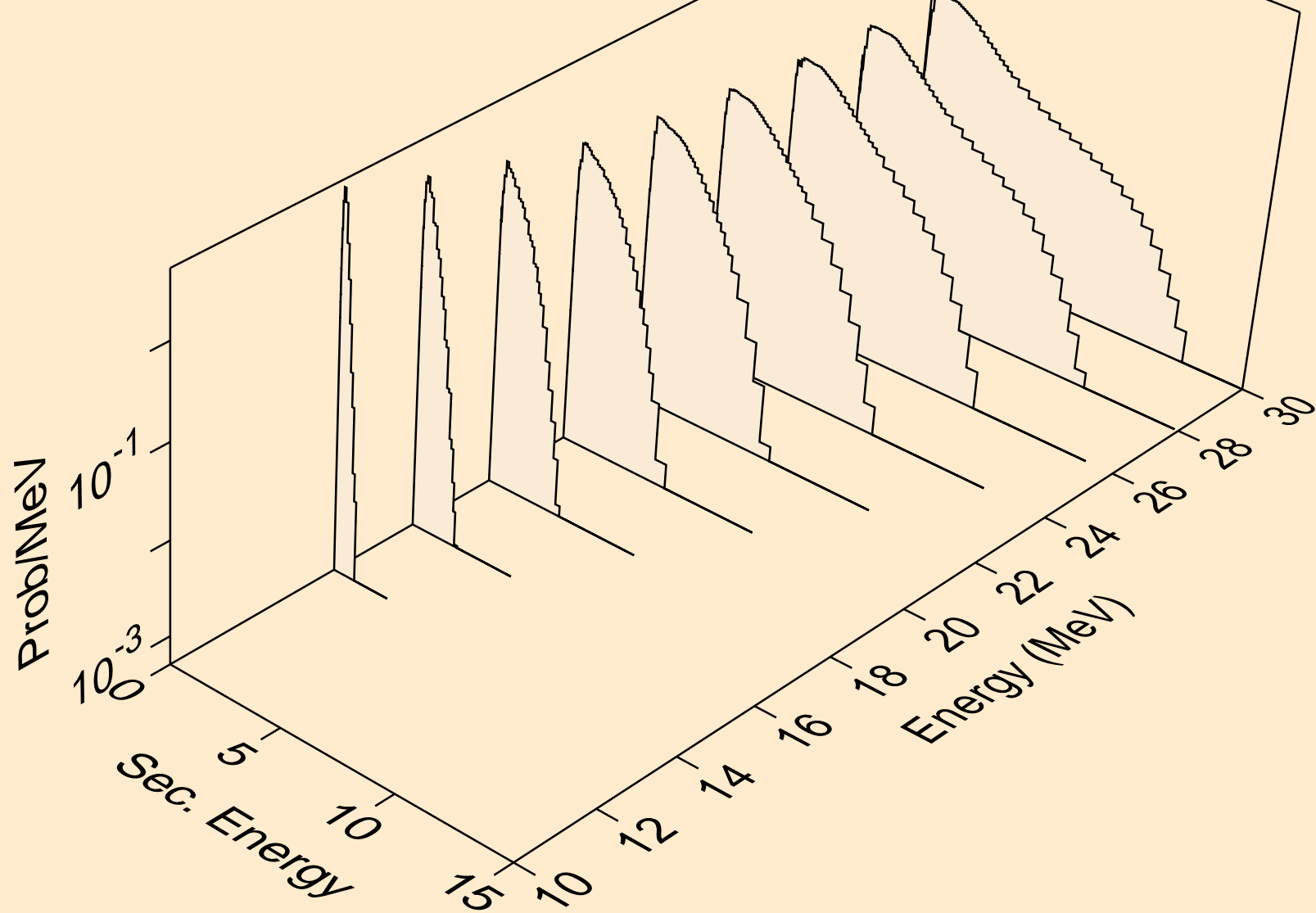

SC042M NEUTRON ACER TENDL-2021 LIBRARY; T=293.6K
Neutron emission for (n,n*c)

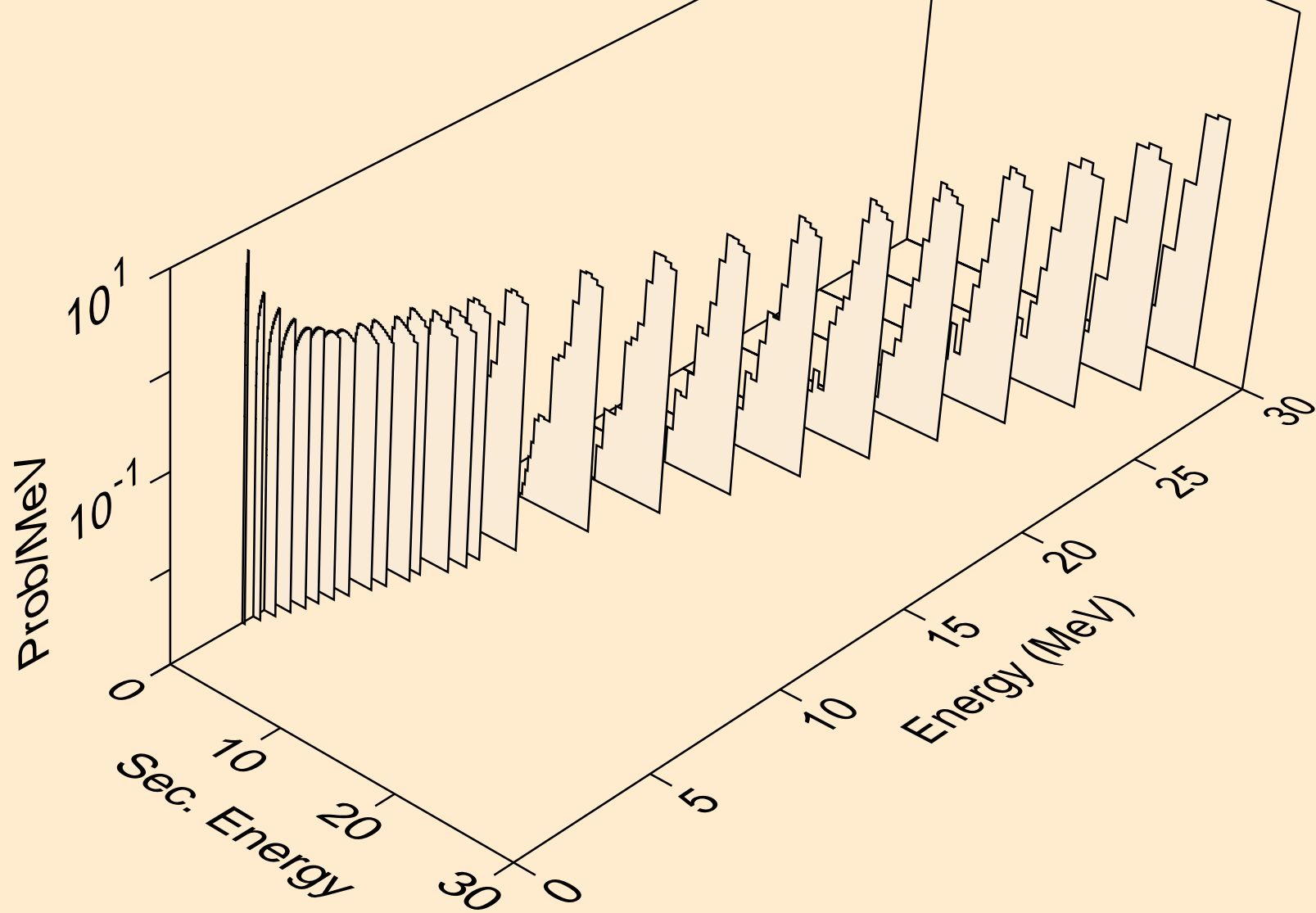

SC042M NEUTRON ACER TENDL-2021 LIBRARY; T=293.6K
Photon emission for (n,x)

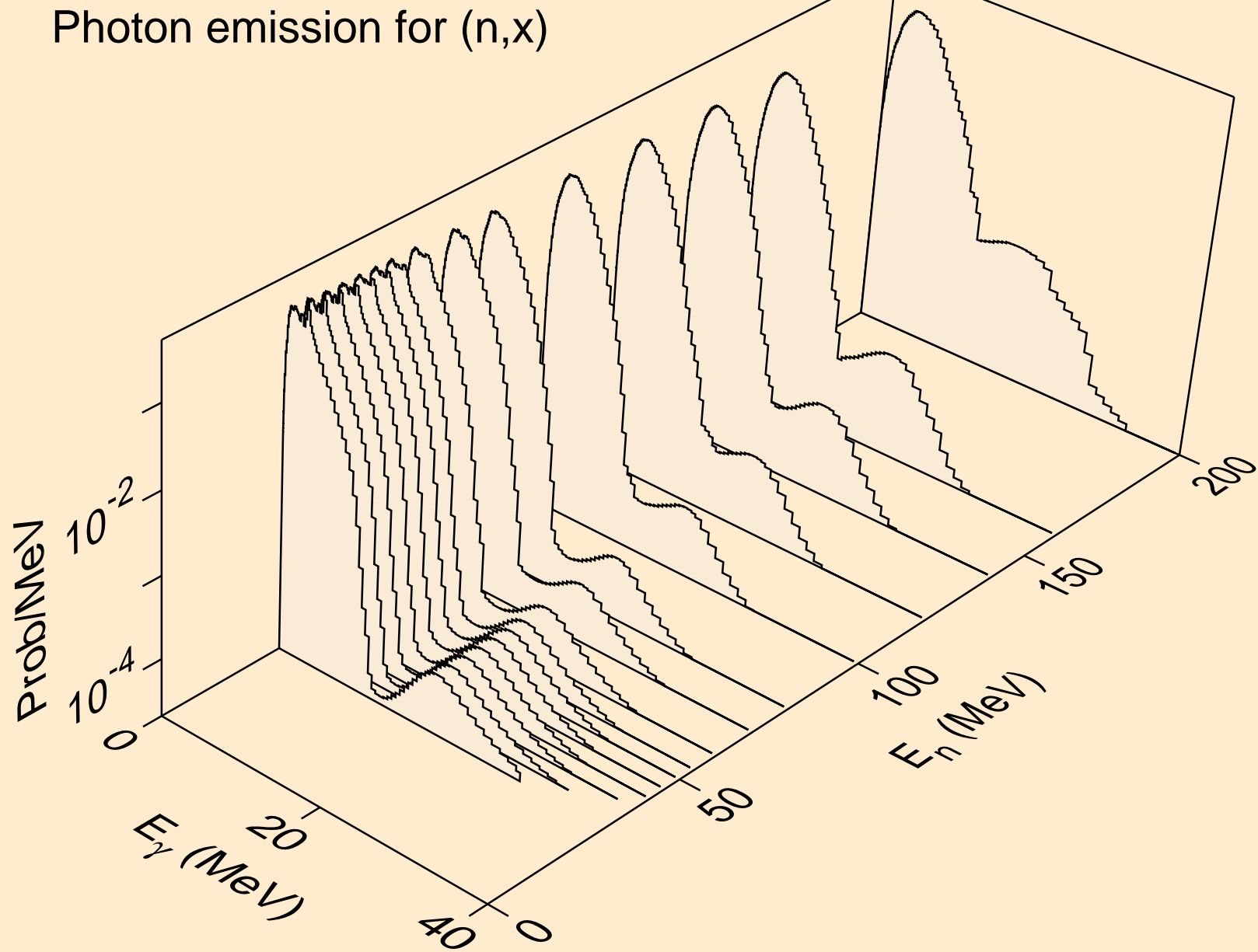

SC042M NEUTRON ACER TENDL-2021 LIBRARY; T=293.6K
Photon emission for (n,2nd)

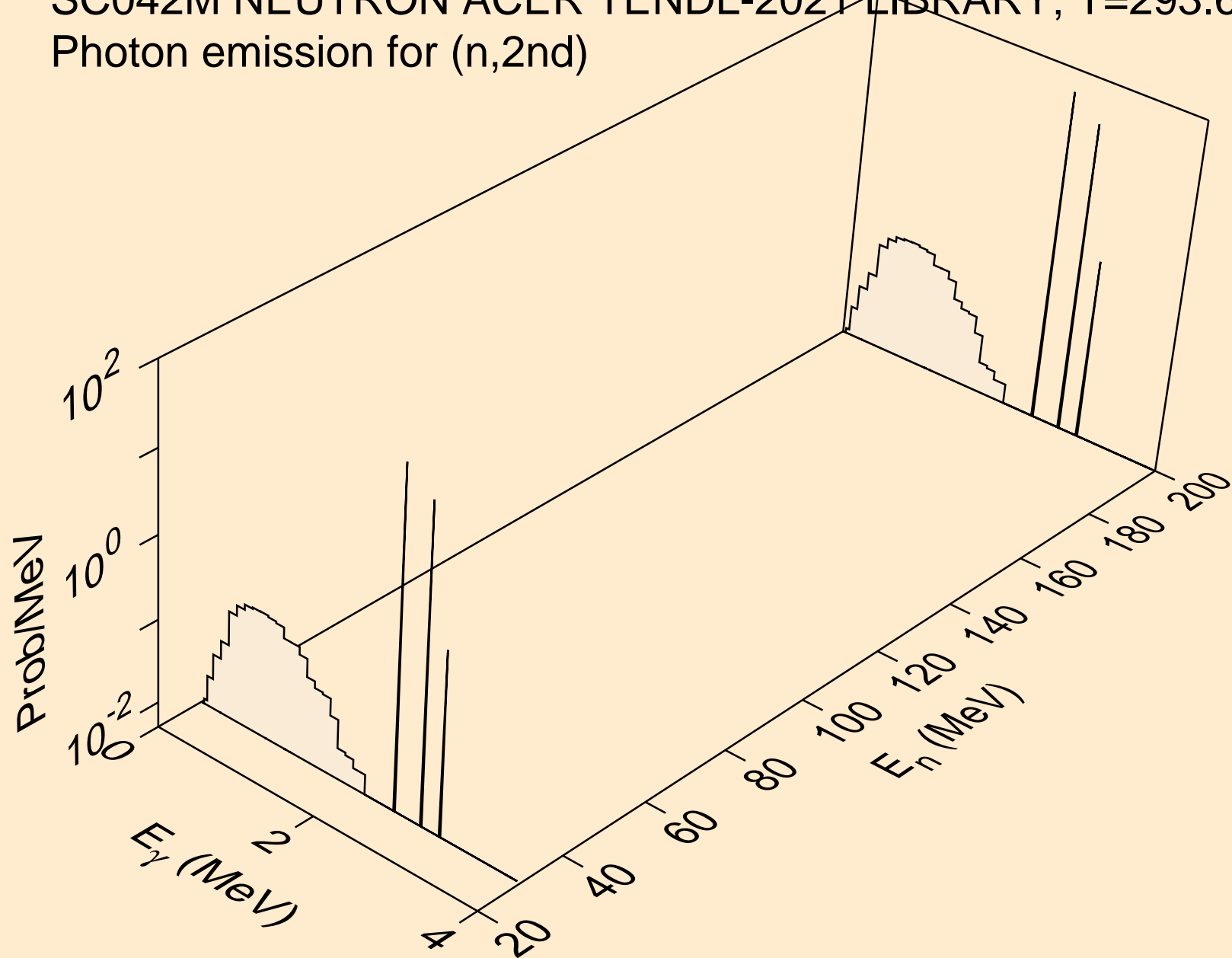

SC042M NEUTRON ACER TENDL-2021 LIBRARY; T=293.6K
Photon emission for (n,2n)

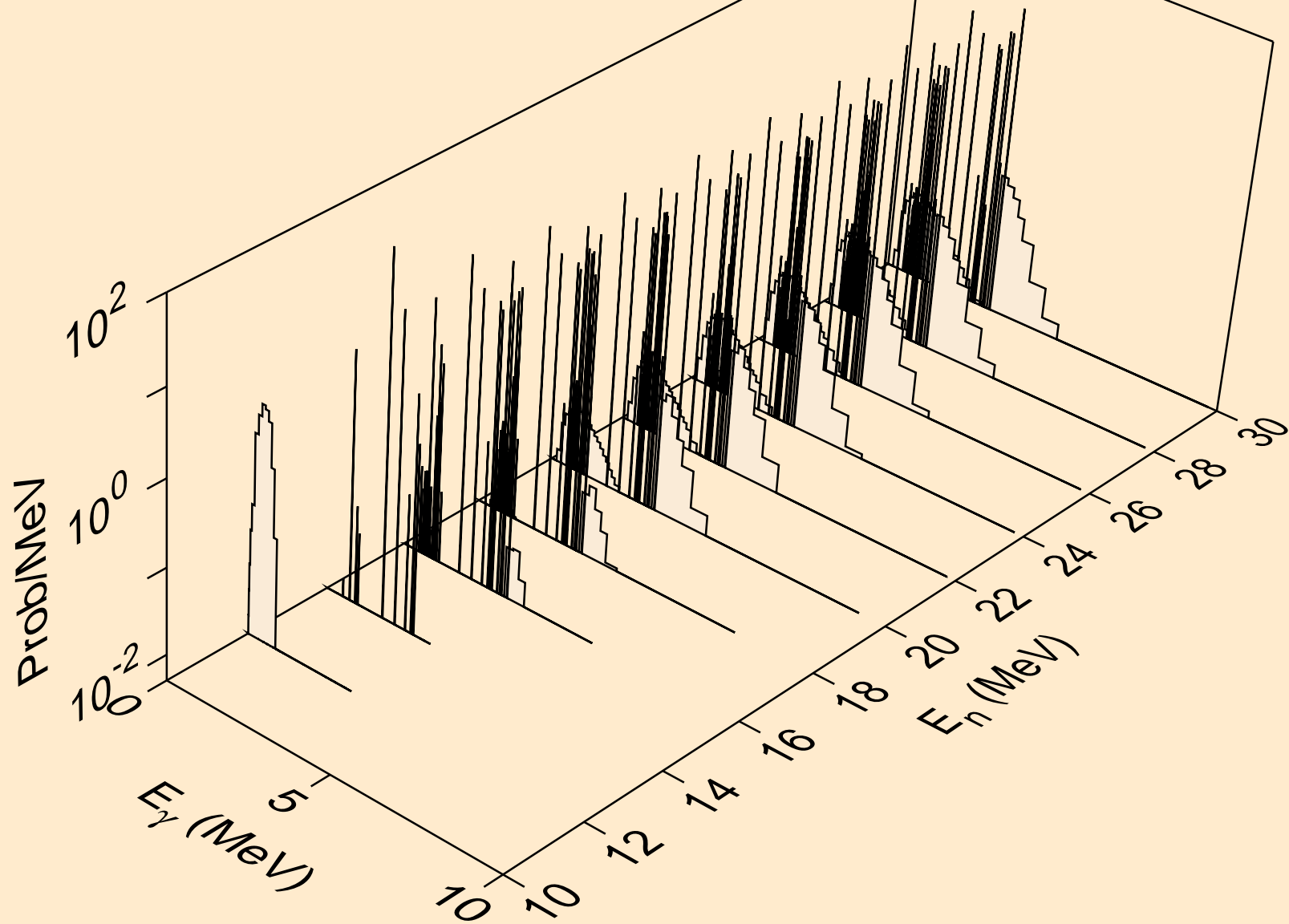

SC042M NEUTRON ACER TENDL-2021 LIBRARY; T=293.6K
Photon emission for (n,3n)

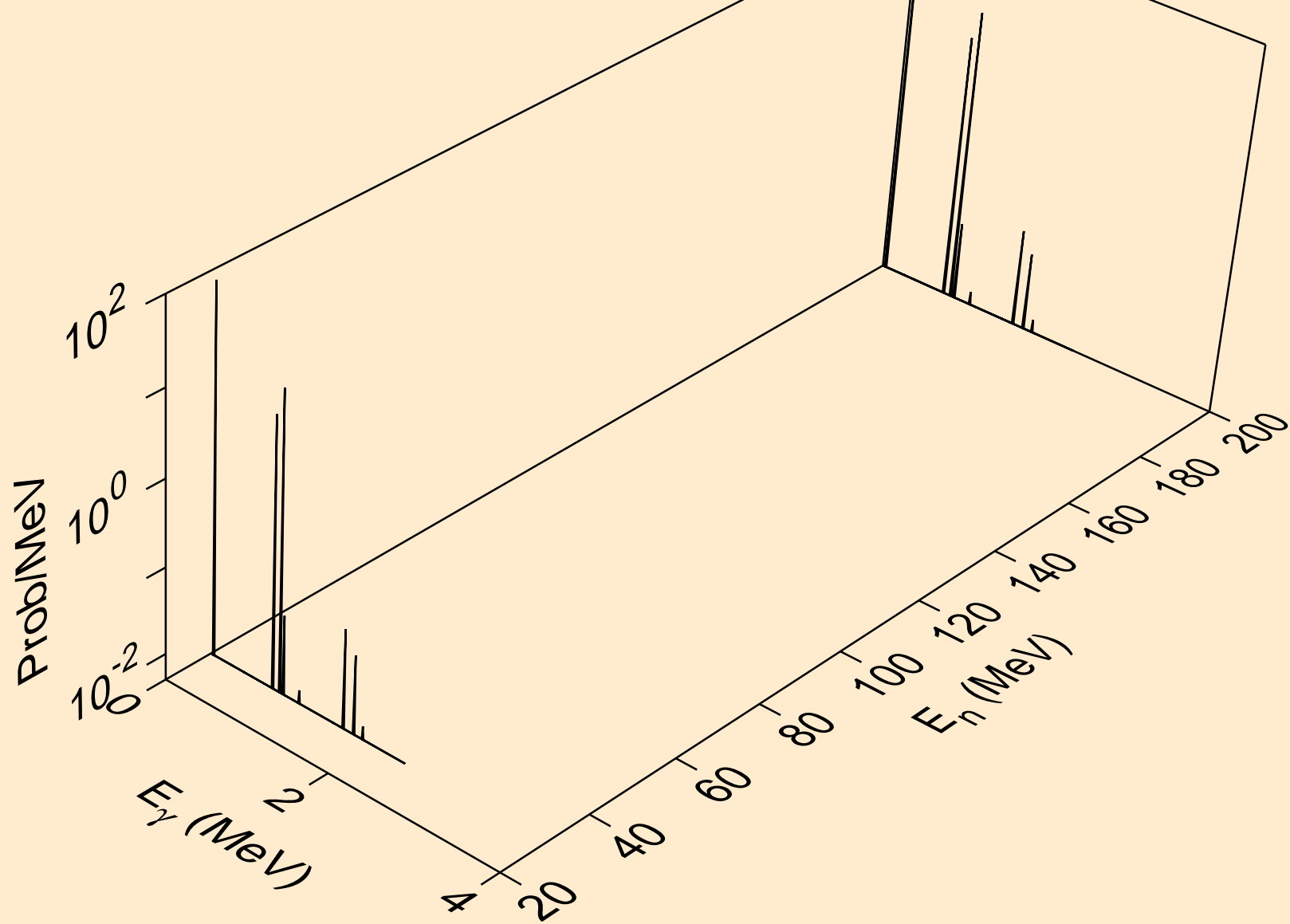

SC042M NEUTRON ACER TENDL-2021 LIBRARY; T=293.6K
Photon emission for (n,n*)a

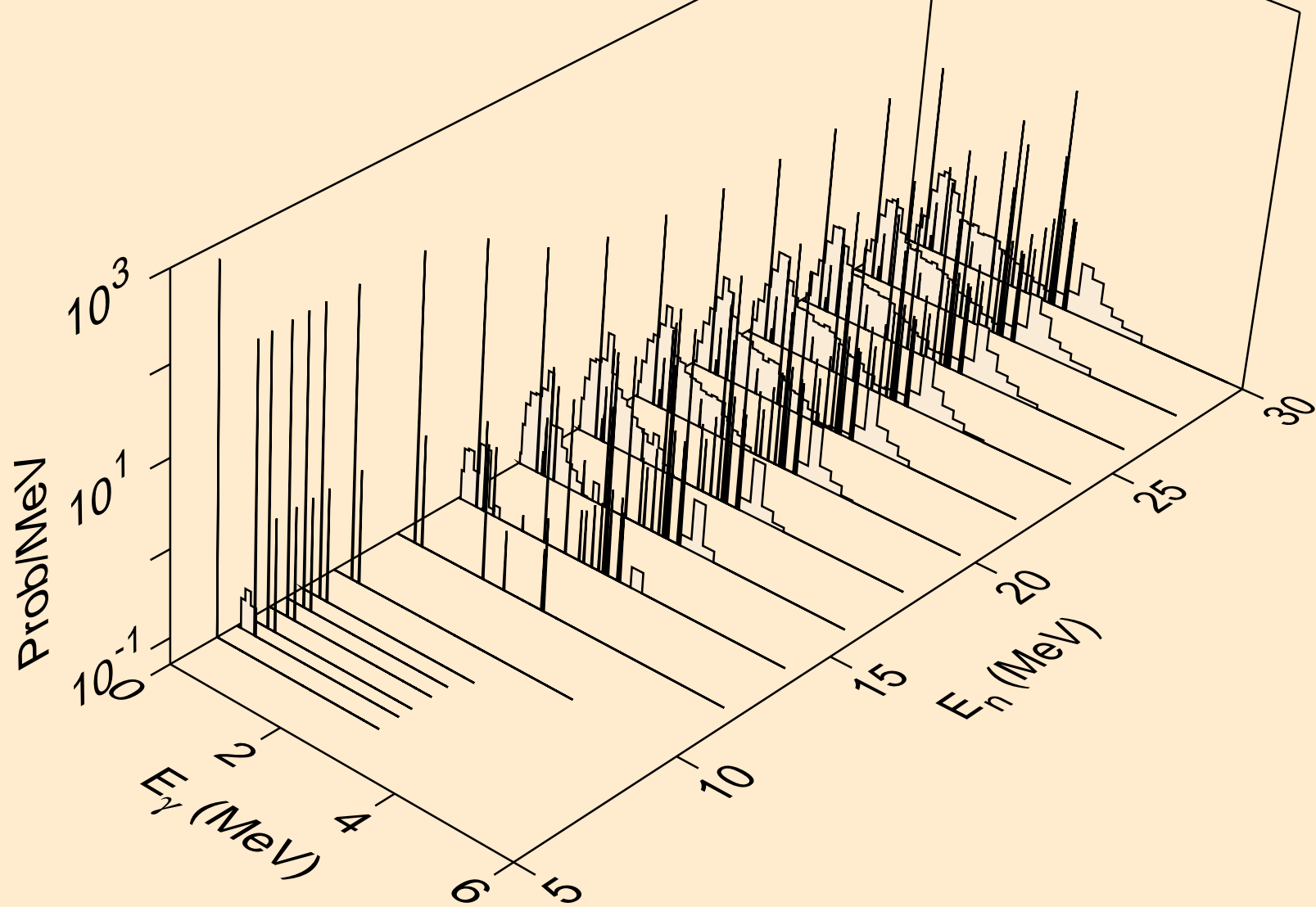

SC042M NEUTRON ACER TENDL-2021 LIBRARY; T=293.6K
Photon emission for (n,2n)a

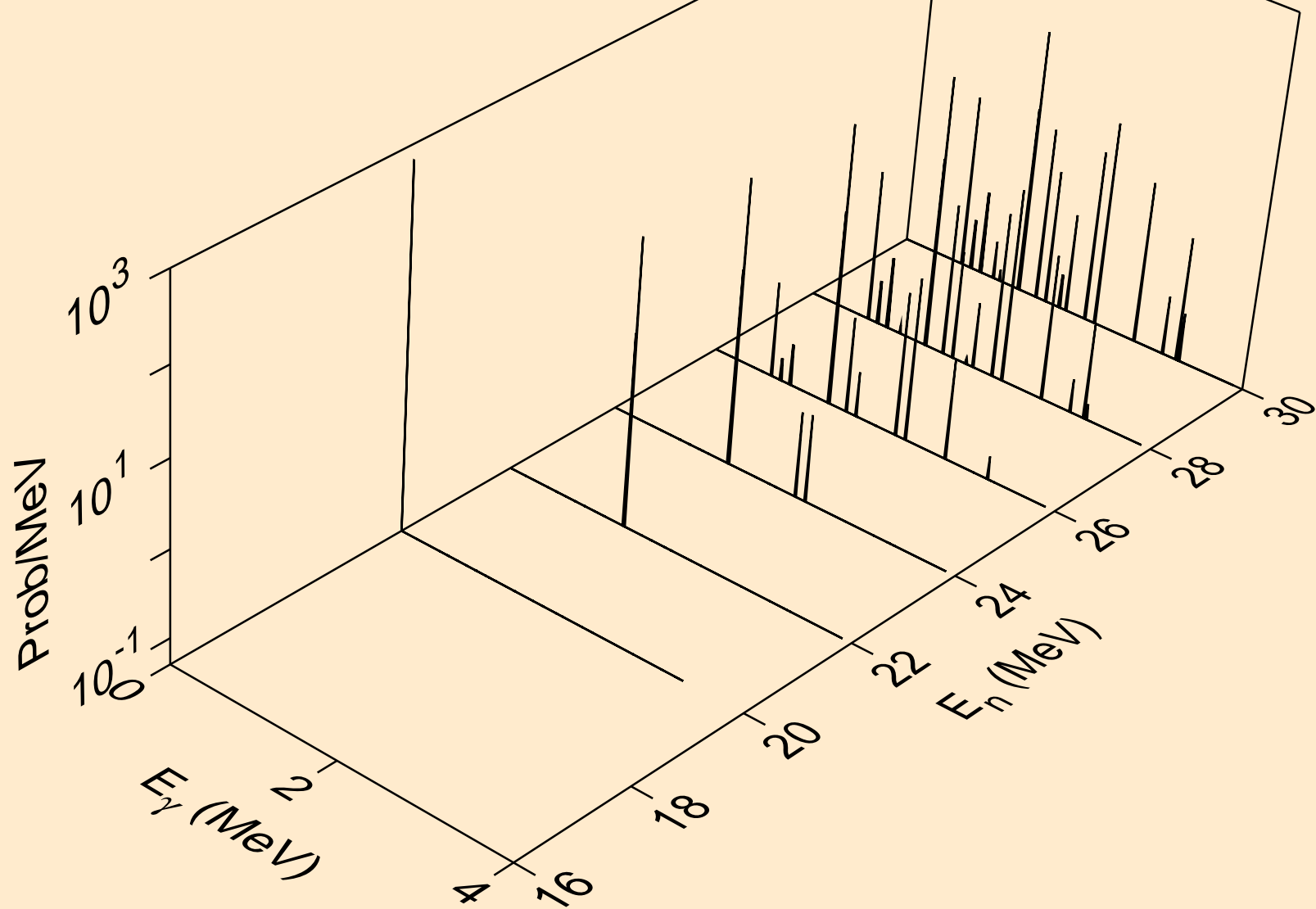

SC042M NEUTRON ACER TENDL-2021 LIBRARY; T=293.6K
Photon emission for (n,n*)p

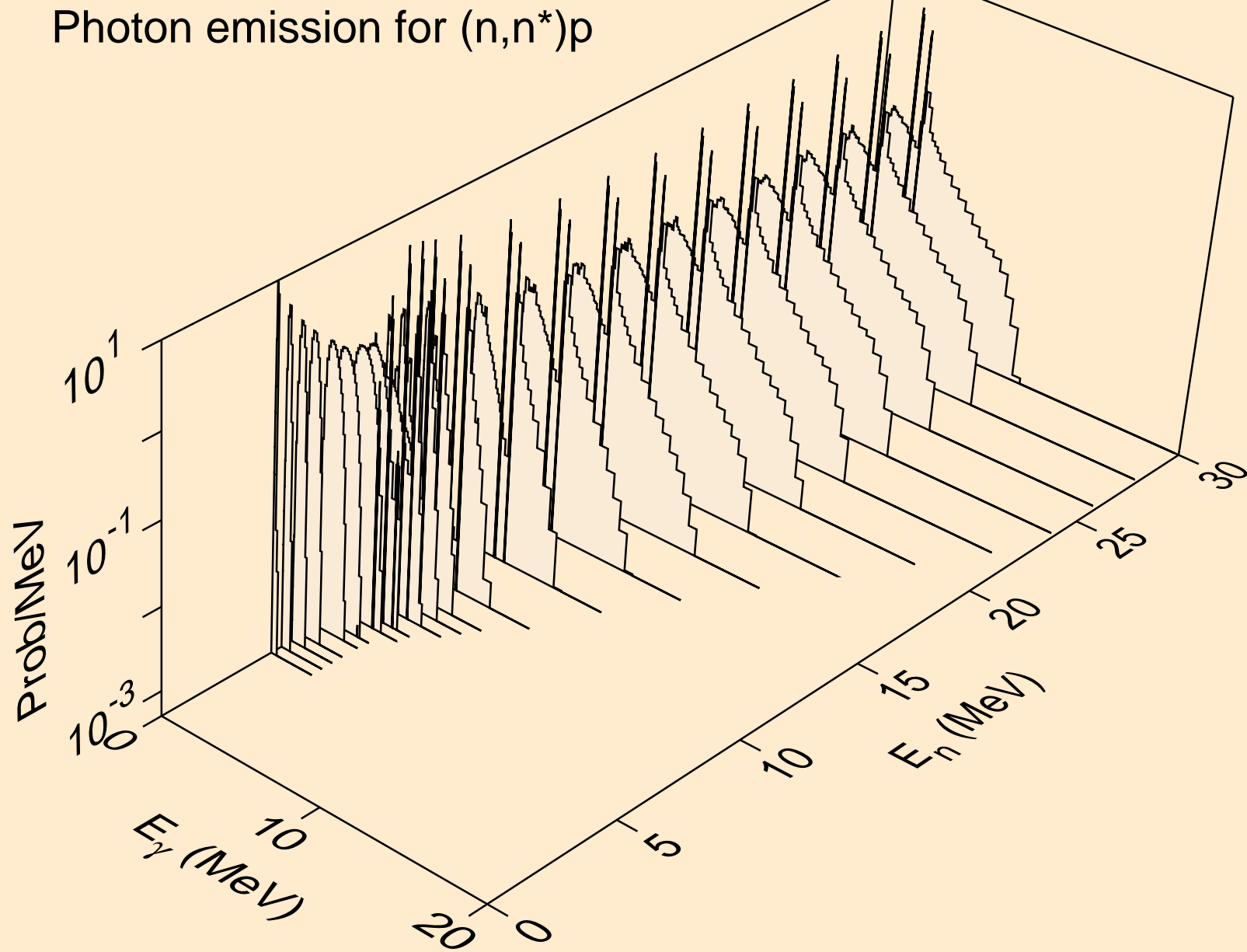

SC042M NEUTRON ACER TENDL-2021 LIBRARY; T=293.6K
Photon emission for (n,n*)2a

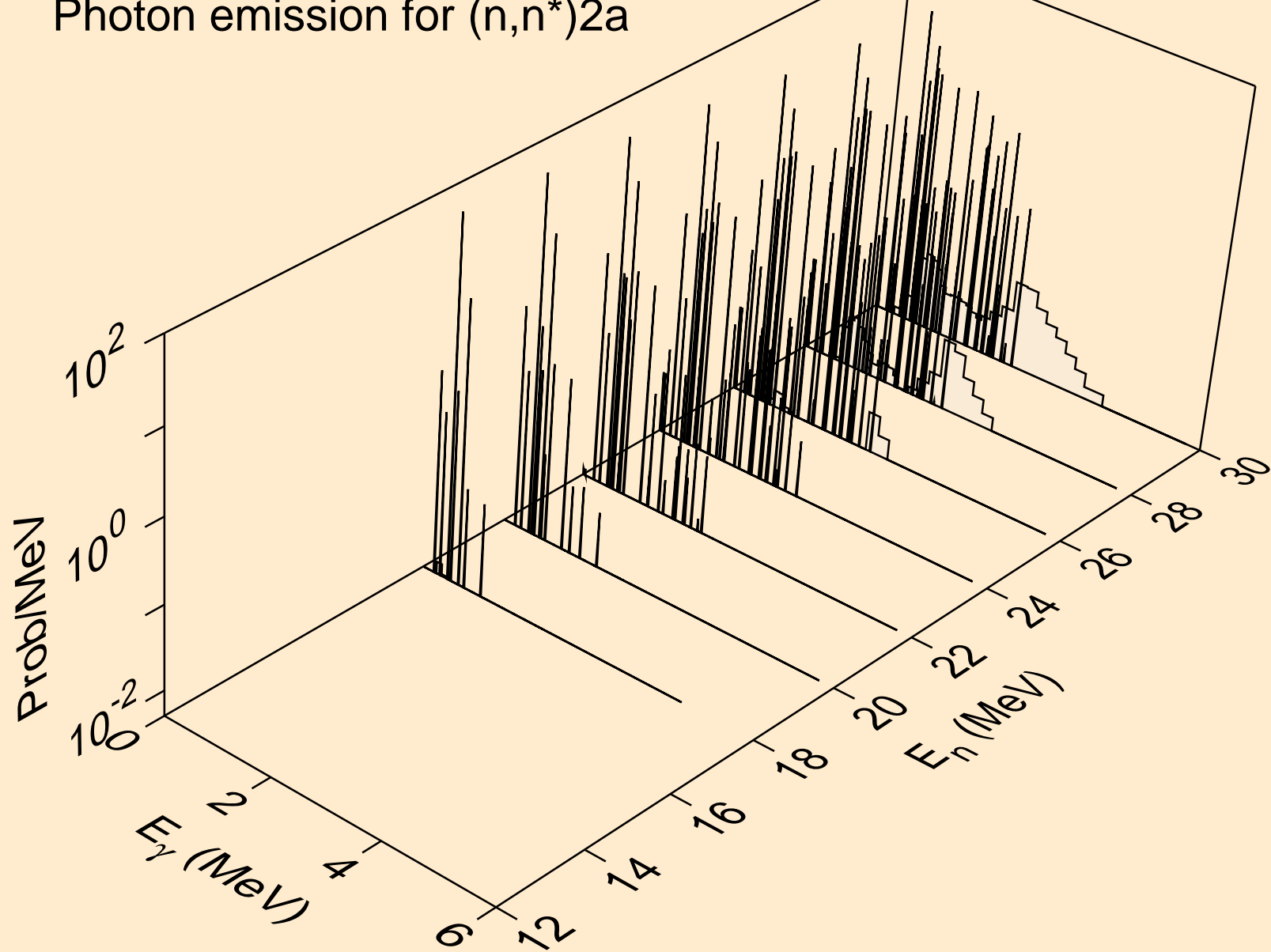

SC042M NEUTRON ACER TENDL-2021 LIBRARY; T=293.6K
Photon emission for (n,n*)d

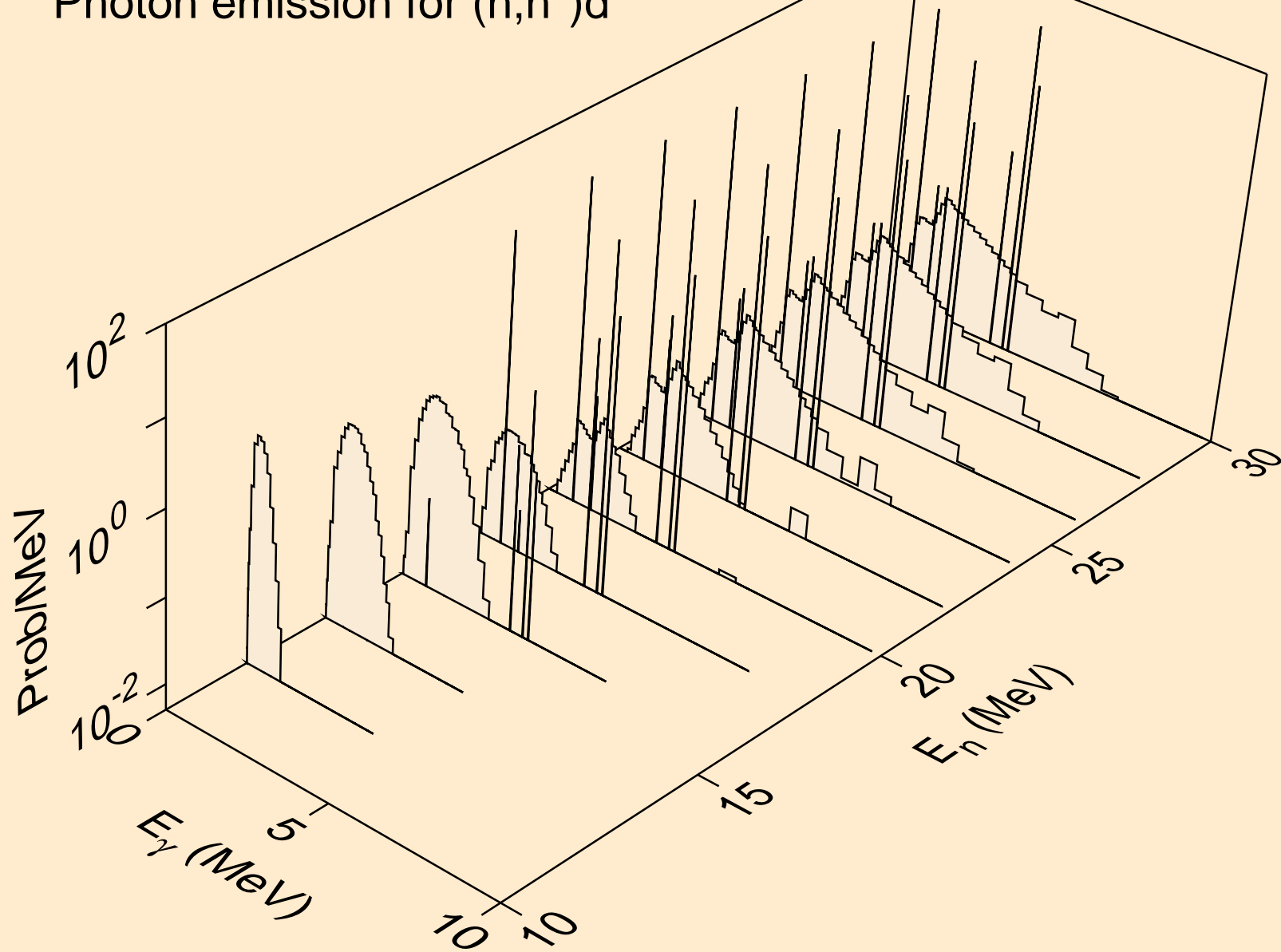

SC042M NEUTRON ACER TENDL-2021 LIBRARY; T=293.6K
Photon emission for (n,n*)t

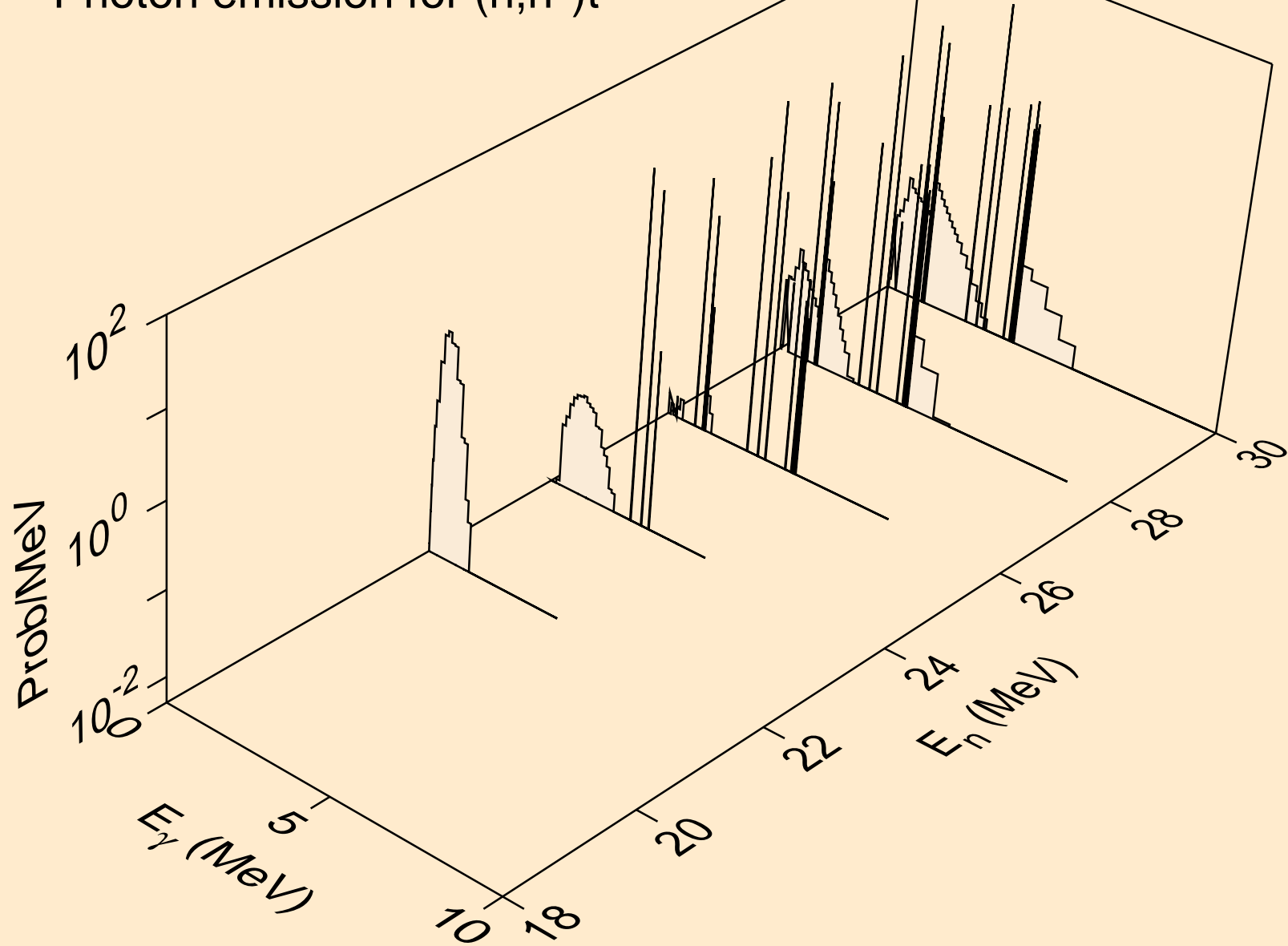

SC042M NEUTRON ACER TENDL-2021 LIBRARY; T=293.6K
Photon emission for (n,n*)he3

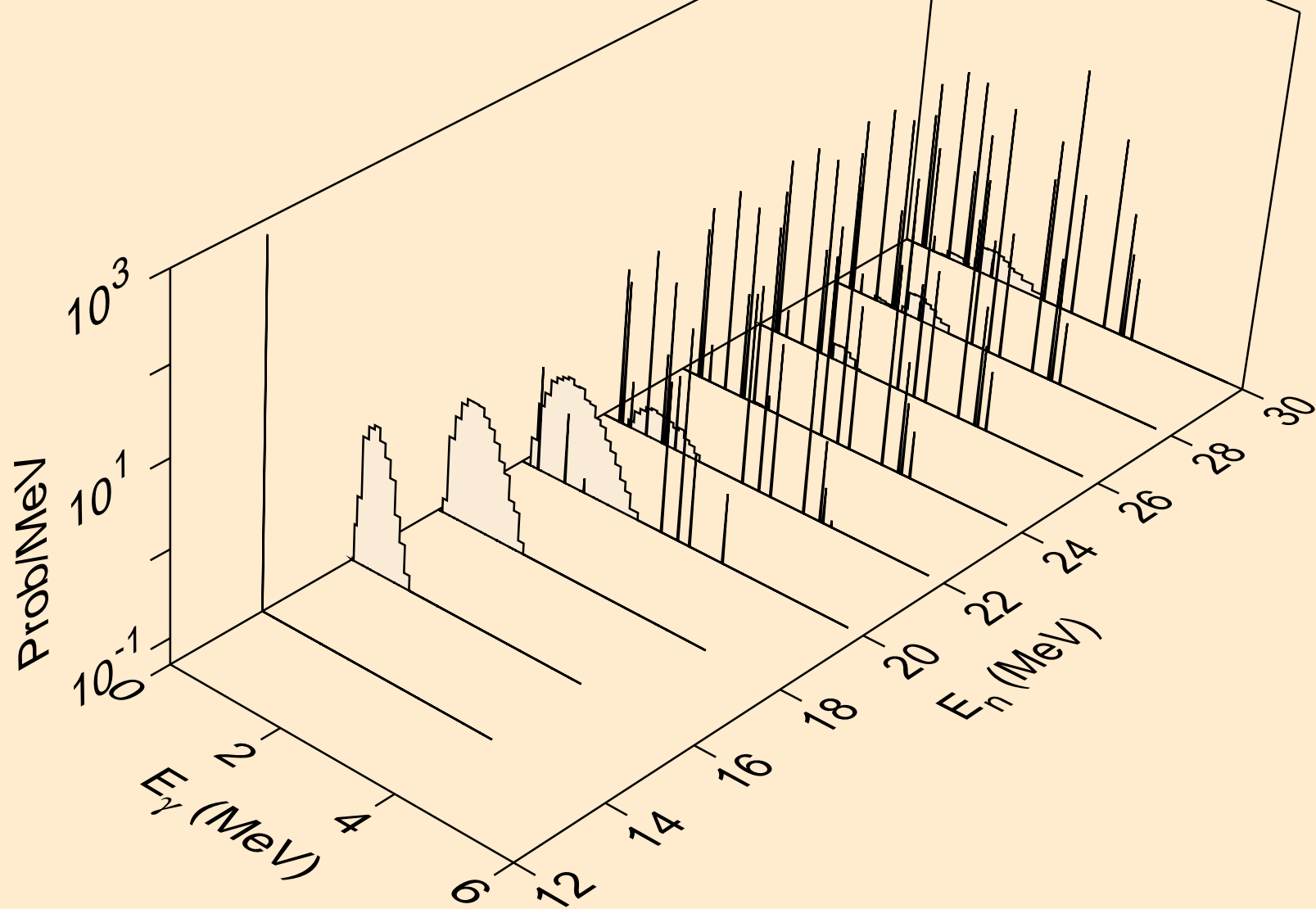

SC042M NEUTRON ACER TENDL-2021 LIBRARY; T=293.6K
Photon emission for (n,2np)

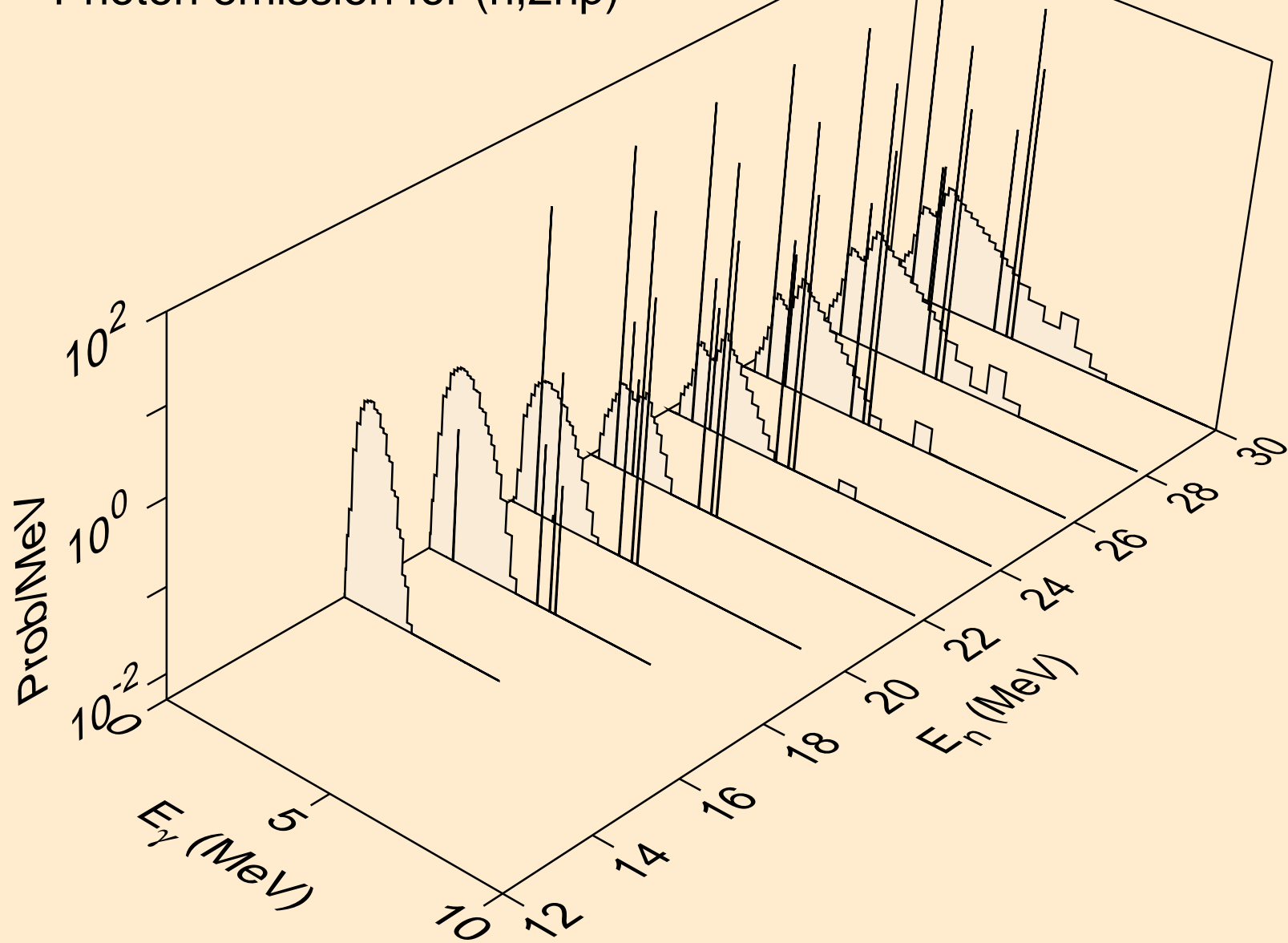

SC042M NEUTRON ACER TENDL-2021 LIBRARY; T=293.6K
Photon emission for (n,2np)

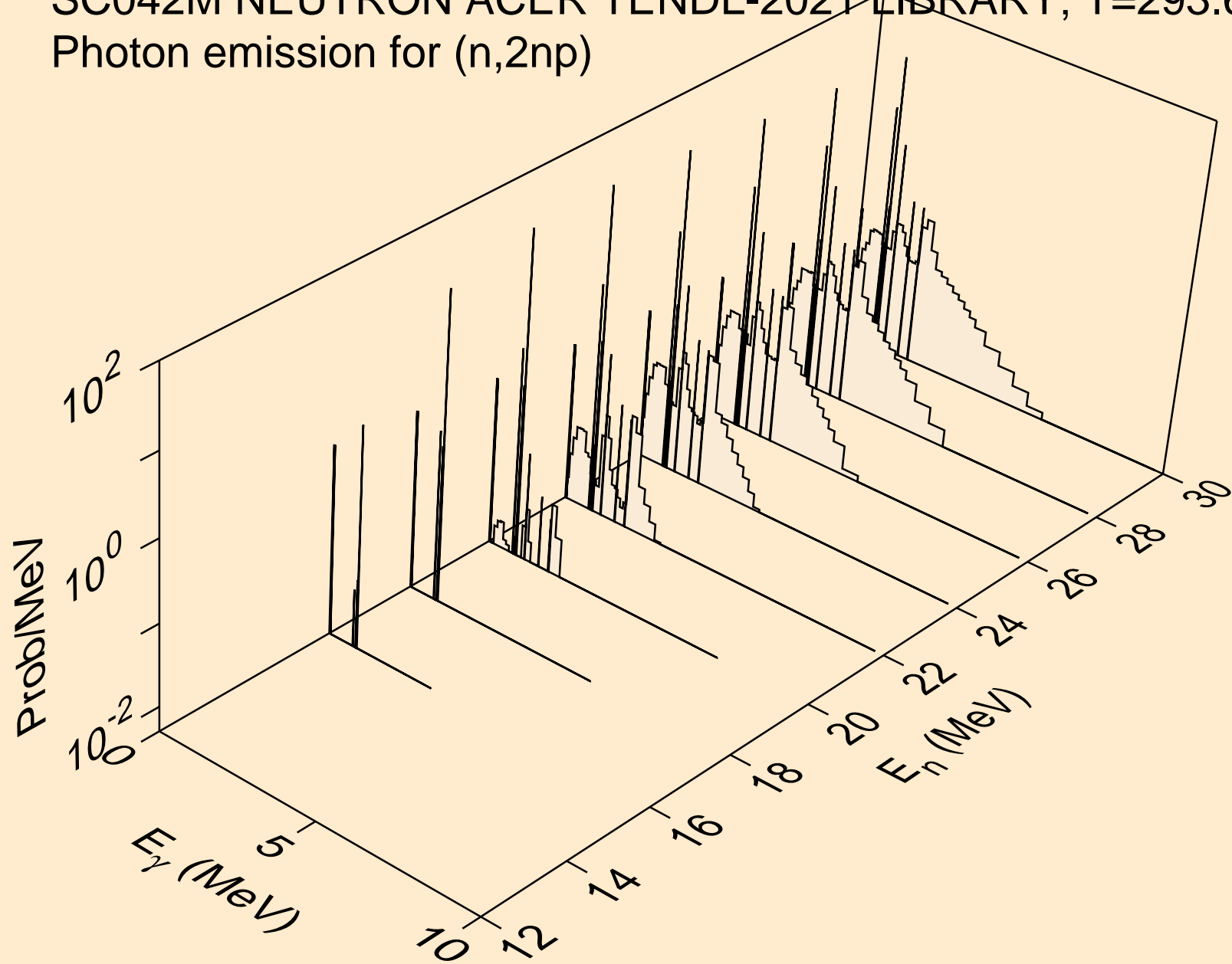

SC042M NEUTRON ACER TENDL-2021 LIBRARY; T=293.6K
Photon emission for (n,npa)

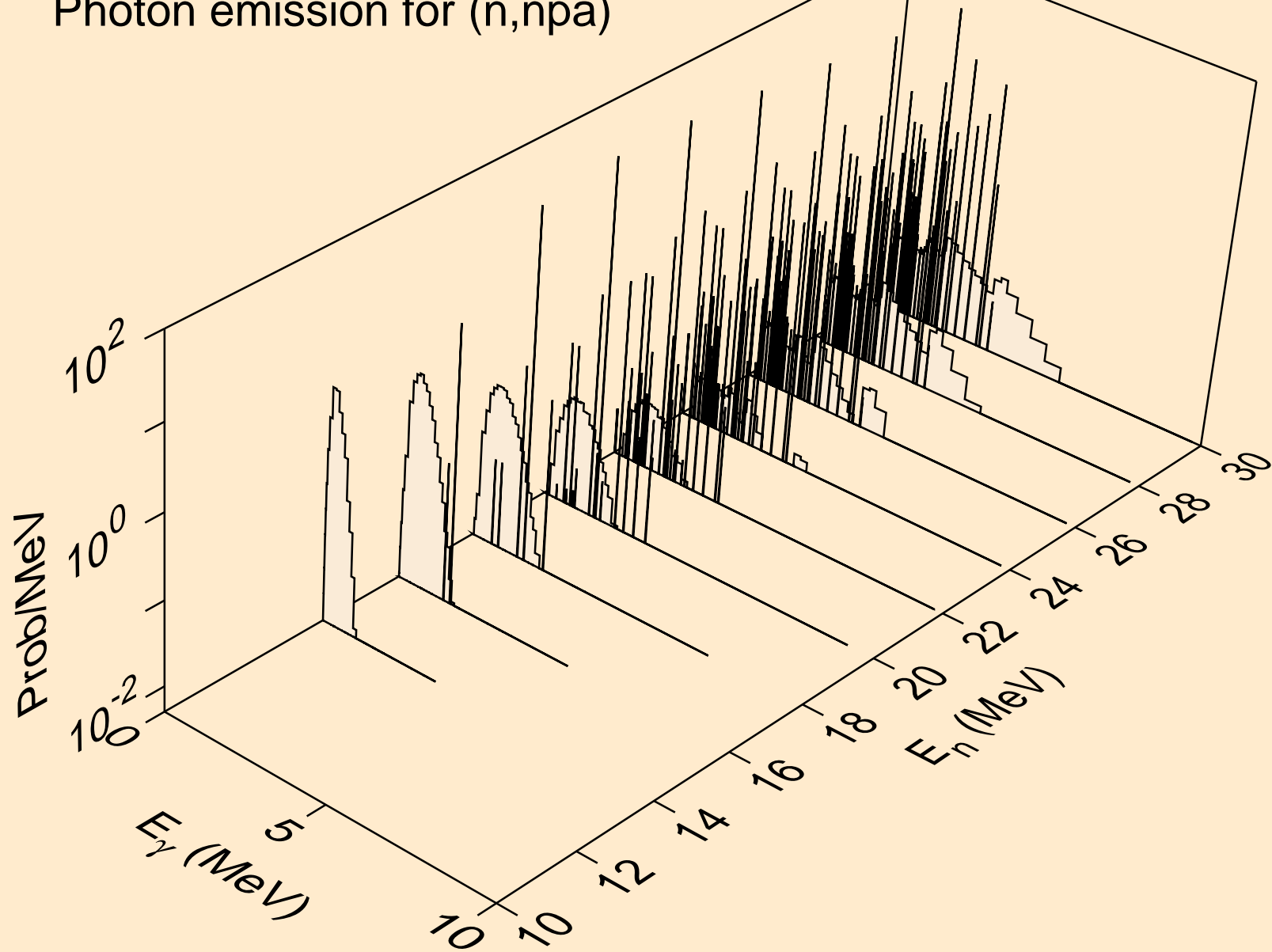

SC042M NEUTRON ACER TENDL-2021 LIBRARY; T=293.6K
Photon emission for (n,n*1)

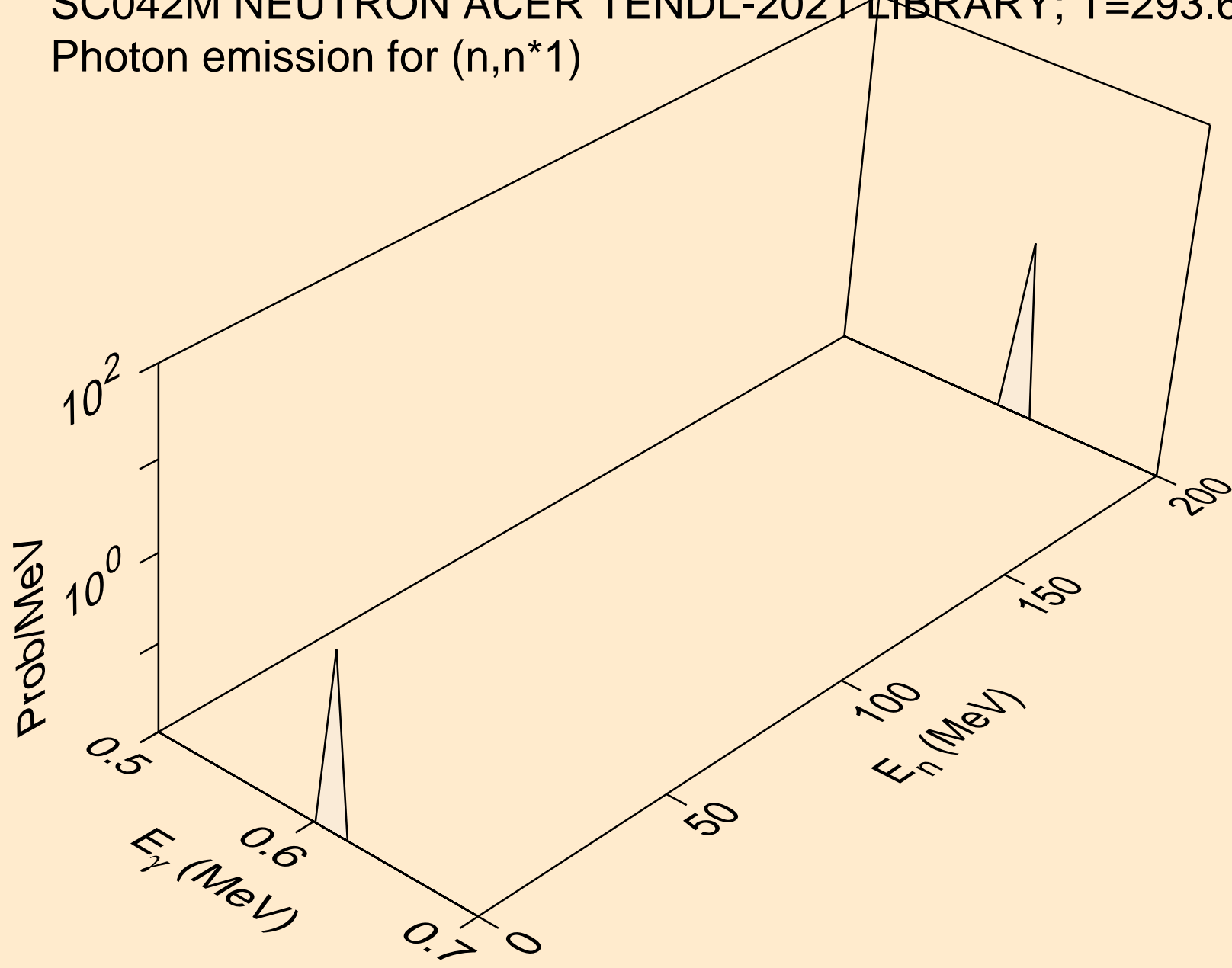

SC042M NEUTRON ACER TENDL-2021 LIBRARY; T=293.6K
Photon emission for (n,n*3)

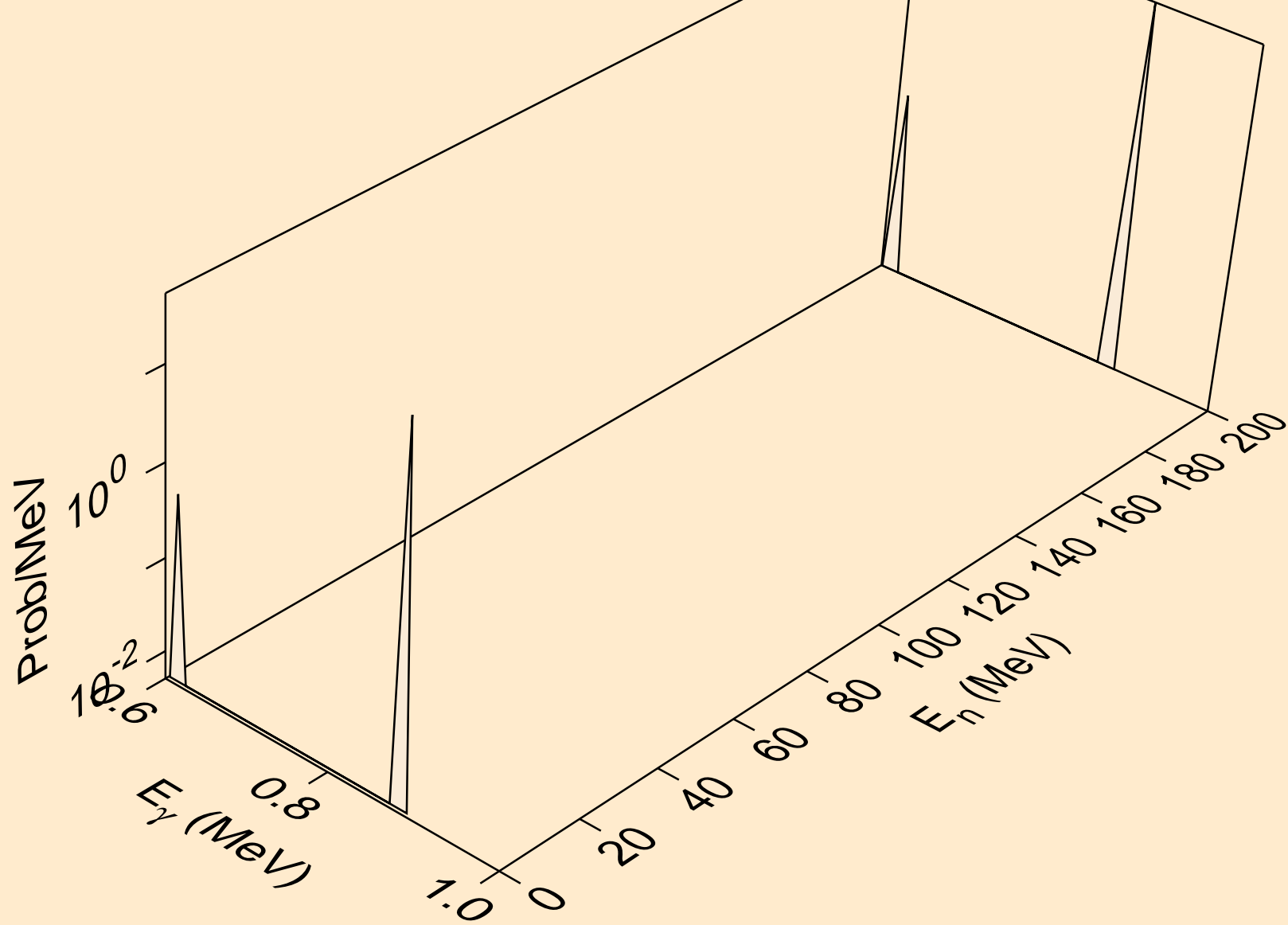

SC042M NEUTRON ACER TENDL-2021 LIBRARY; T=293.6K
Photon emission for (n,n*4)

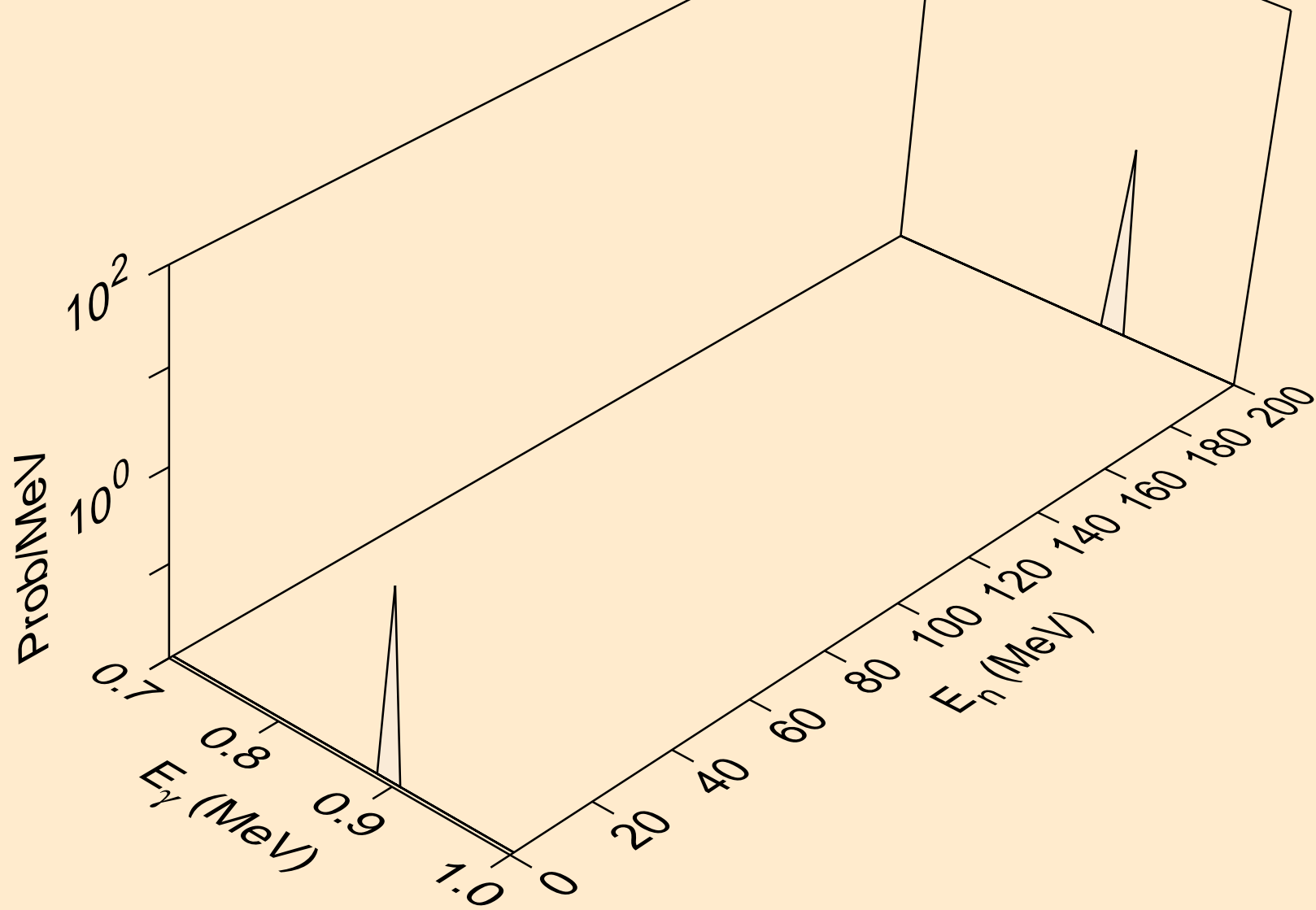

SC042M NEUTRON ACER TENDL-2021 LIBRARY; T=293.6K
Photon emission for (n,n*5)

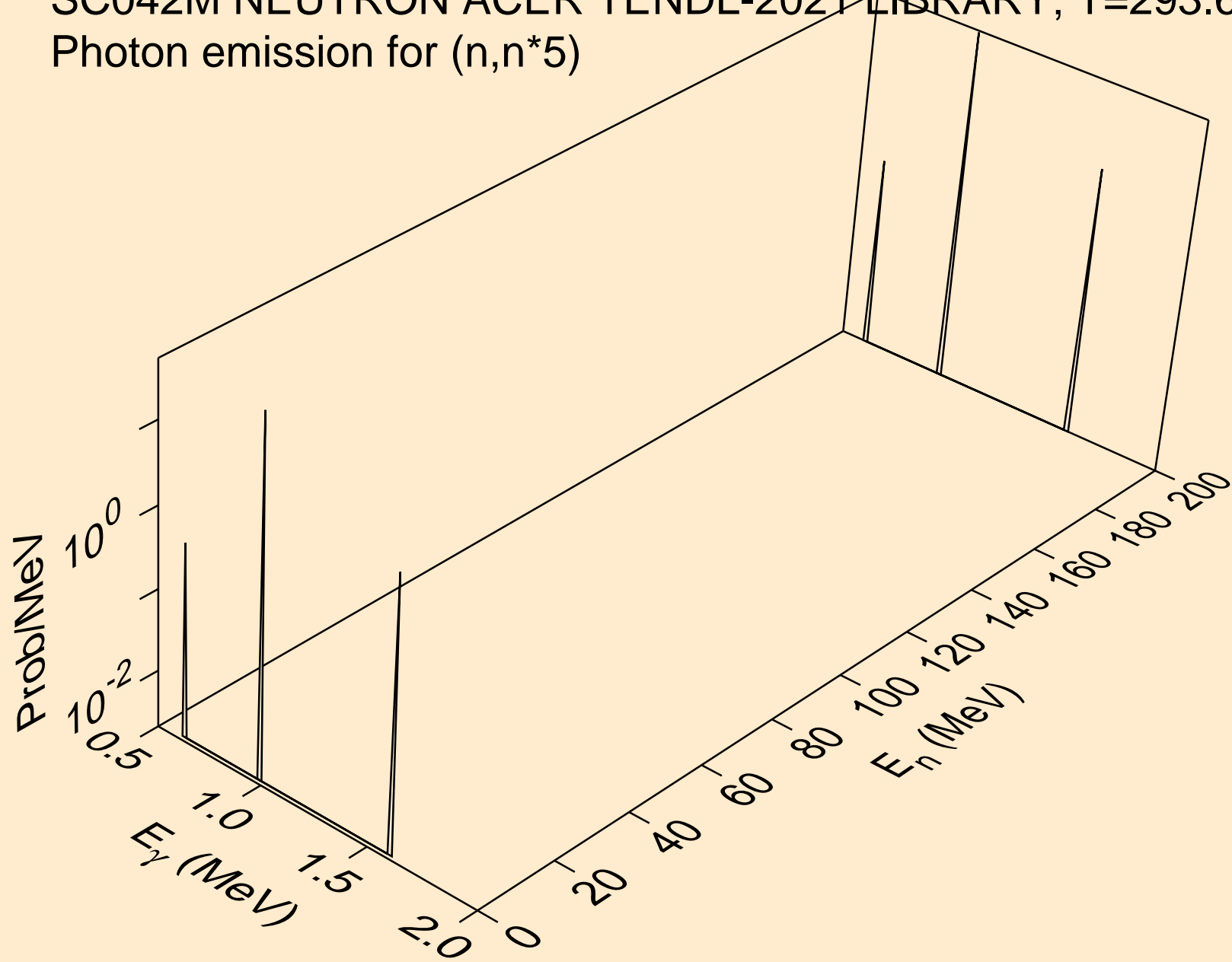

SC042M NEUTRON ACER TENDL-2021 LIBRARY; T=293.6K
Photon emission for (n,n*6)

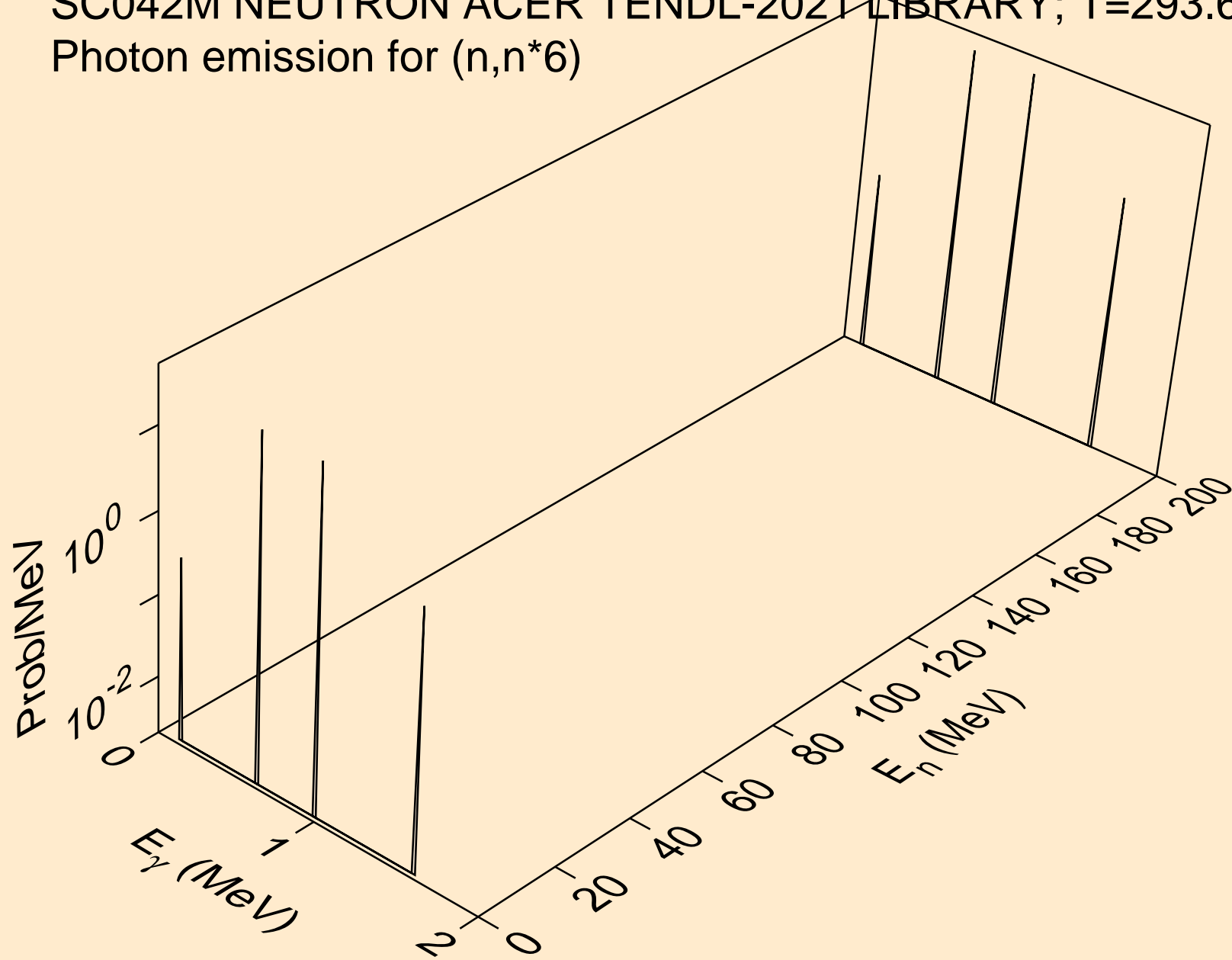

SC042M NEUTRON ACER TENDL-2021 LIBRARY; T=293.6K
Photon emission for (n,n*7)

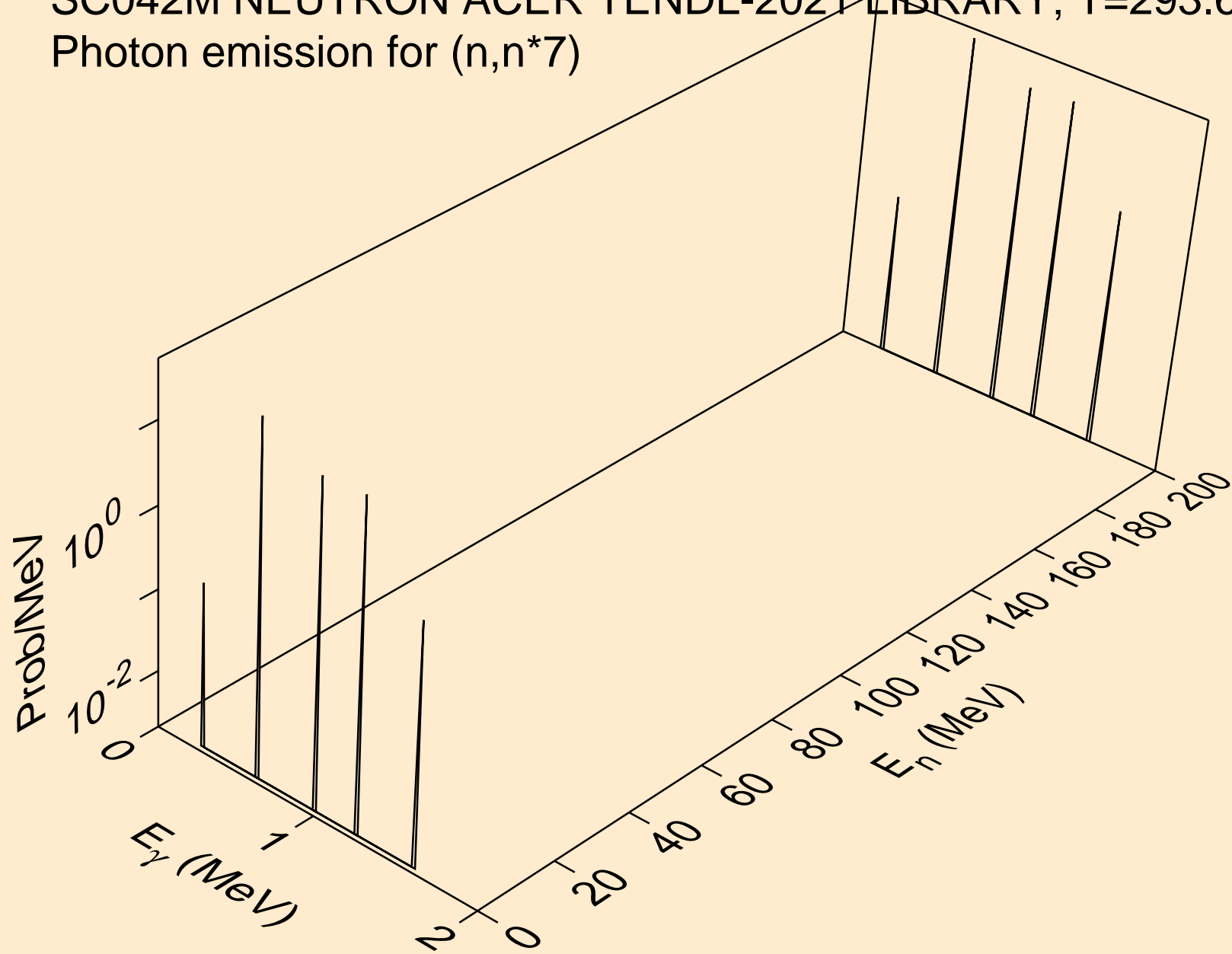

SC042M NEUTRON ACER TENDL-2021 LIBRARY; T=293.6K
Photon emission for (n,n*8)

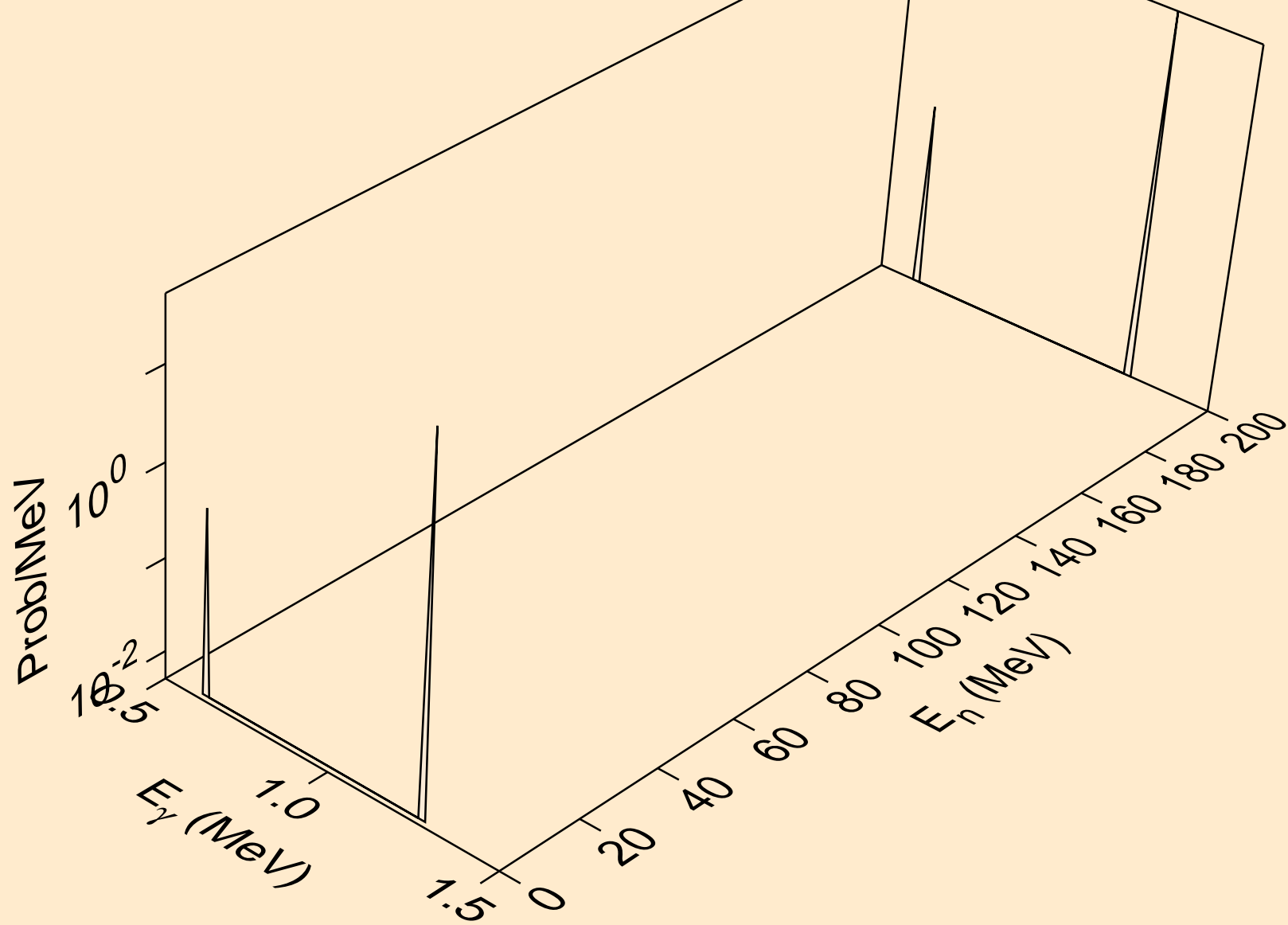

SC042M NEUTRON ACER TENDL-2021 LIBRARY; T=293.6K
Photon emission for (n,n*9)

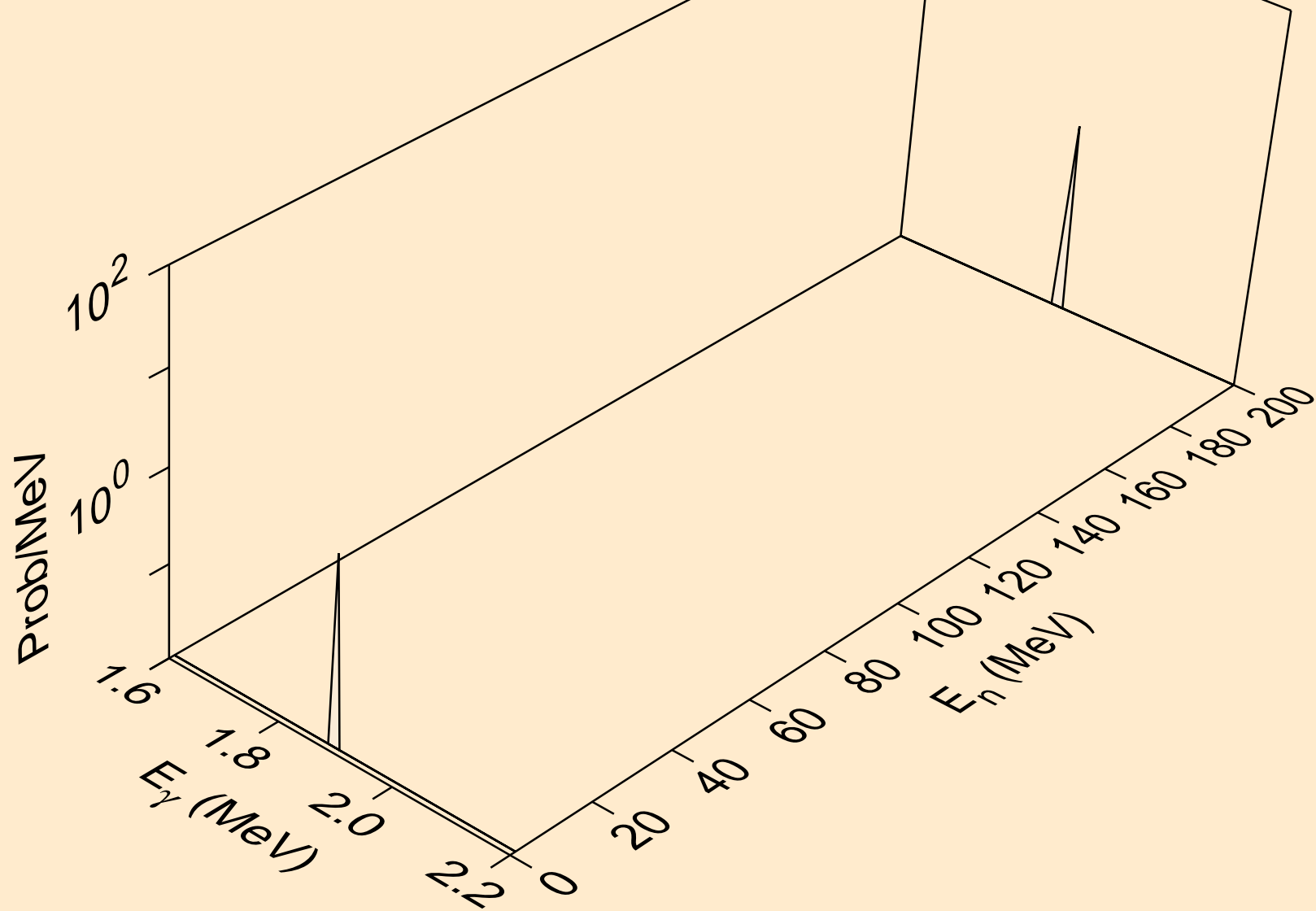

SC042M NEUTRON ACER TENDL-2021 LIBRARY; T=293.6K
Photon emission for (n,n*10)

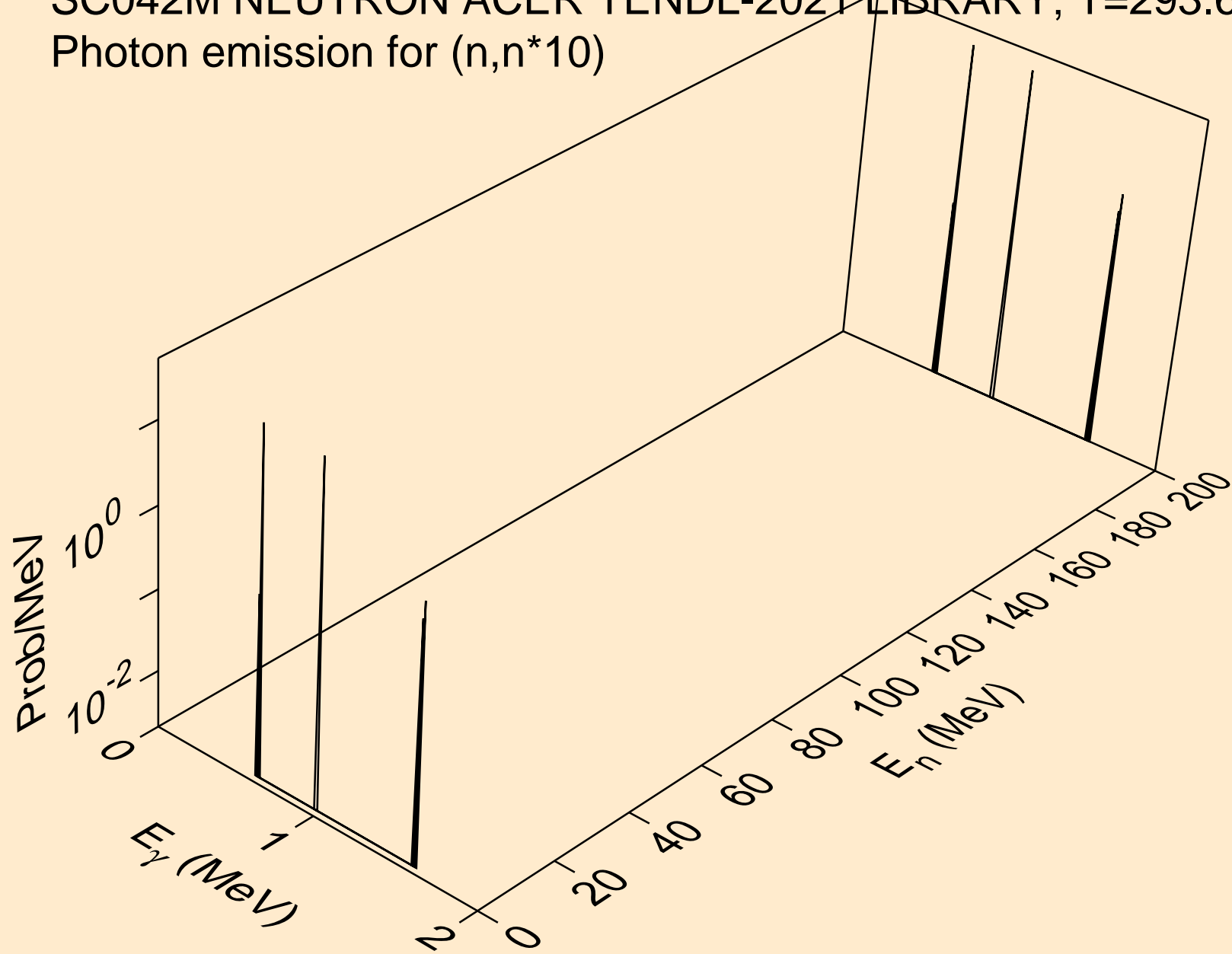

SC042M NEUTRON ACER TENDL-2021 LIBRARY; T=293.6K
Photon emission for (n,n*11)

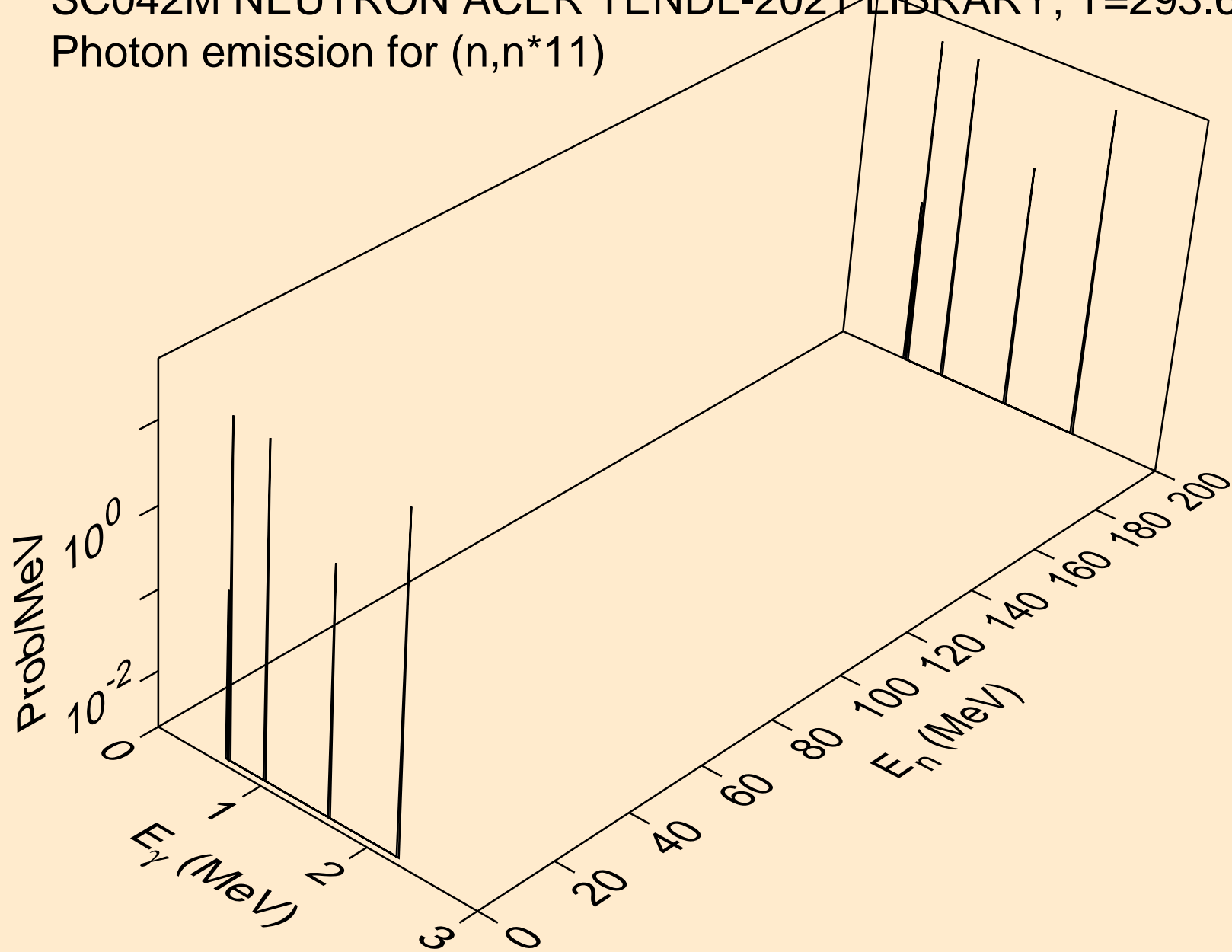

SC042M NEUTRON ACER TENDL-2021 LIBRARY; T=293.6K
Photon emission for (n,n*12)

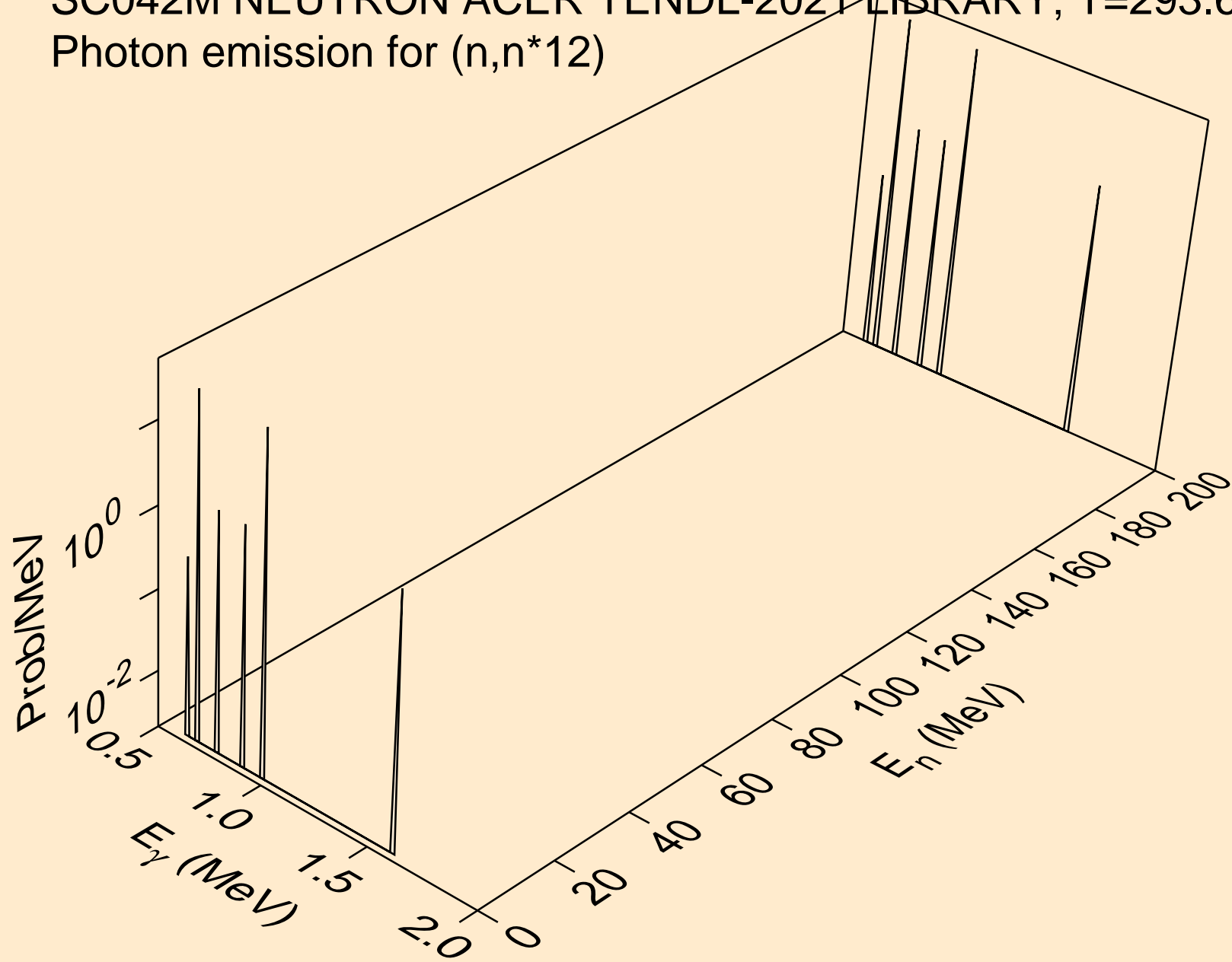

SC042M NEUTRON ACER TENDL-2021 LIBRARY; T=293.6K
Photon emission for (n,n*13)

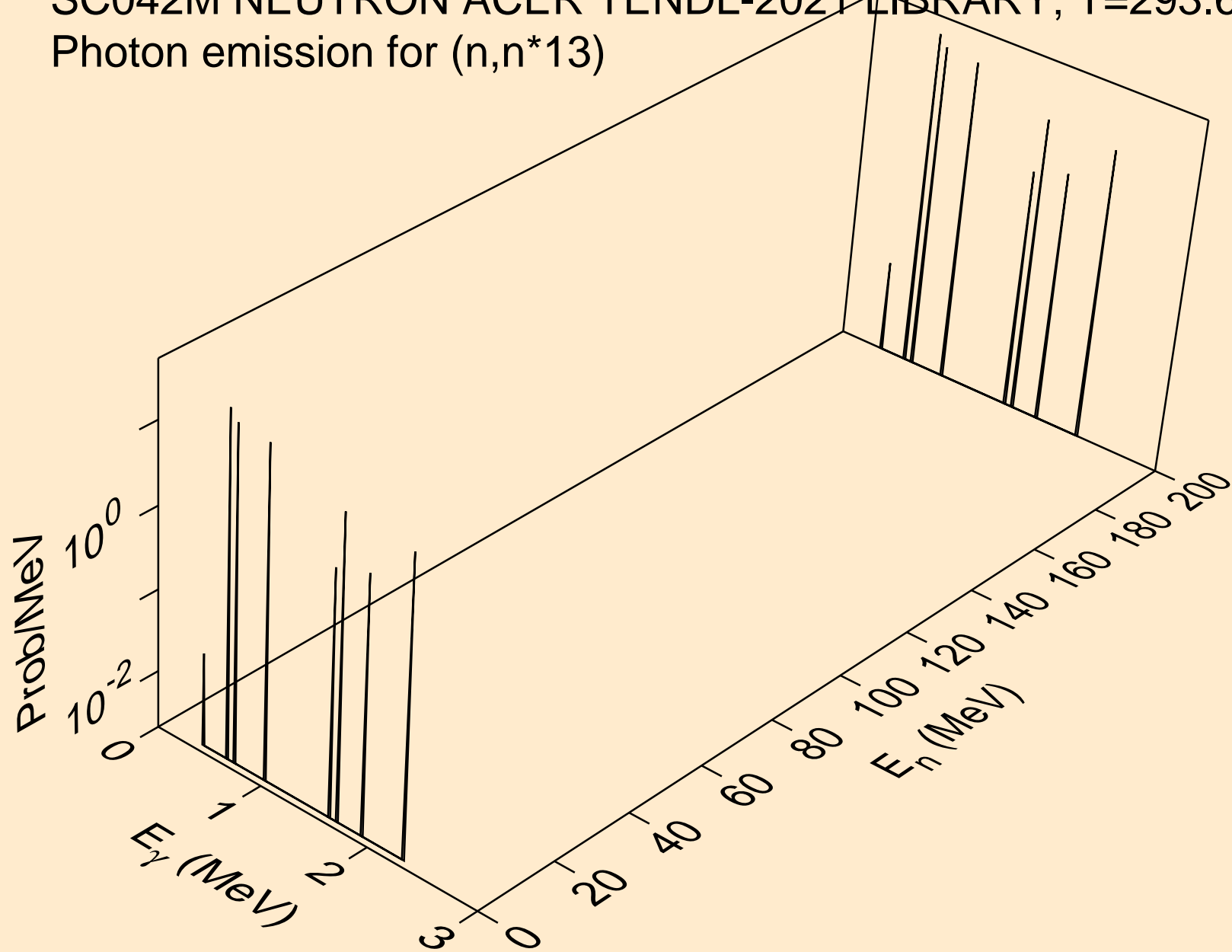

SC042M NEUTRON ACER TENDL-2021 LIBRARY; T=293.6K
Photon emission for (n,n*14)

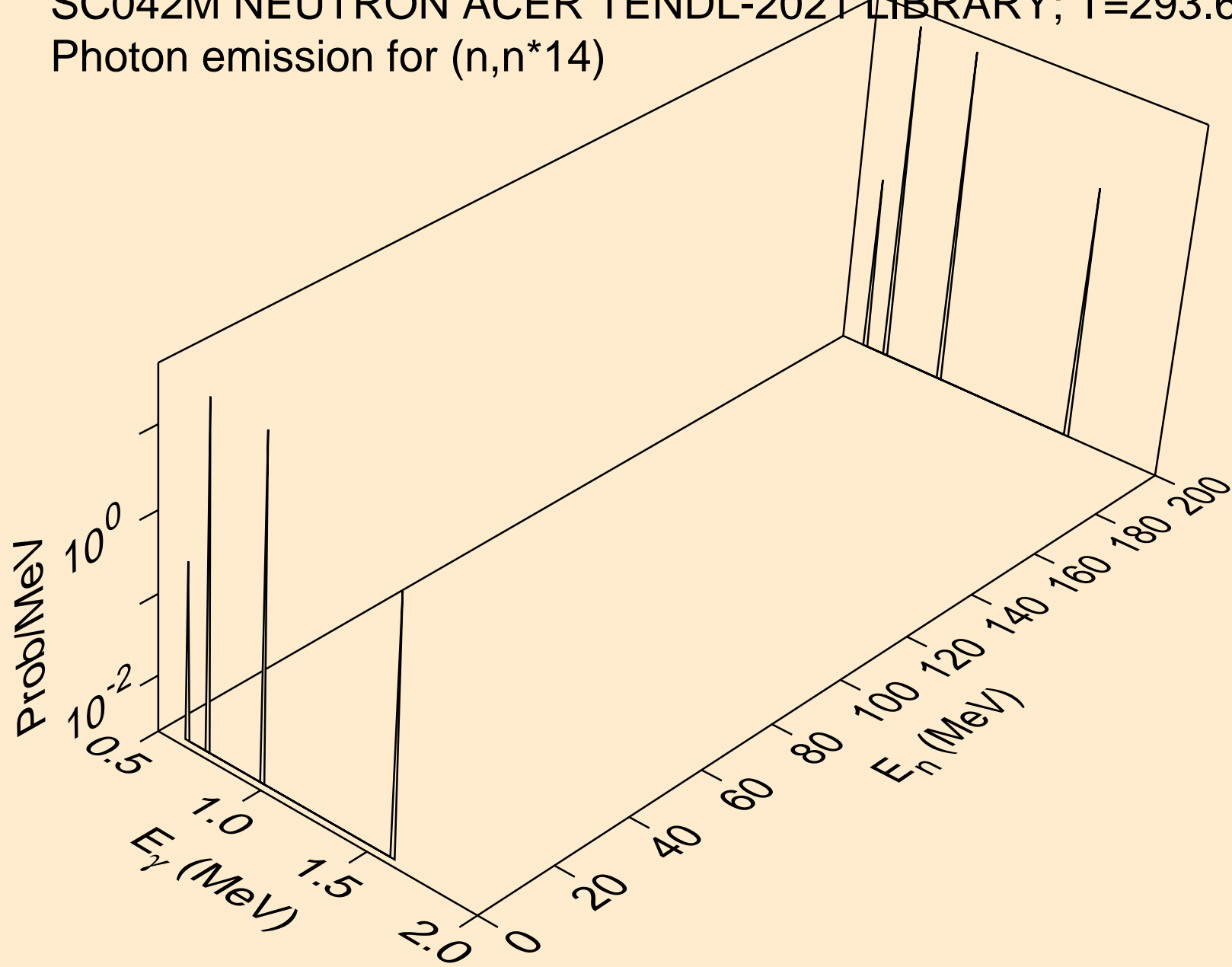

SC042M NEUTRON ACER TENDL-2021 LIBRARY; T=293.6K
Photon emission for (n,n*15)

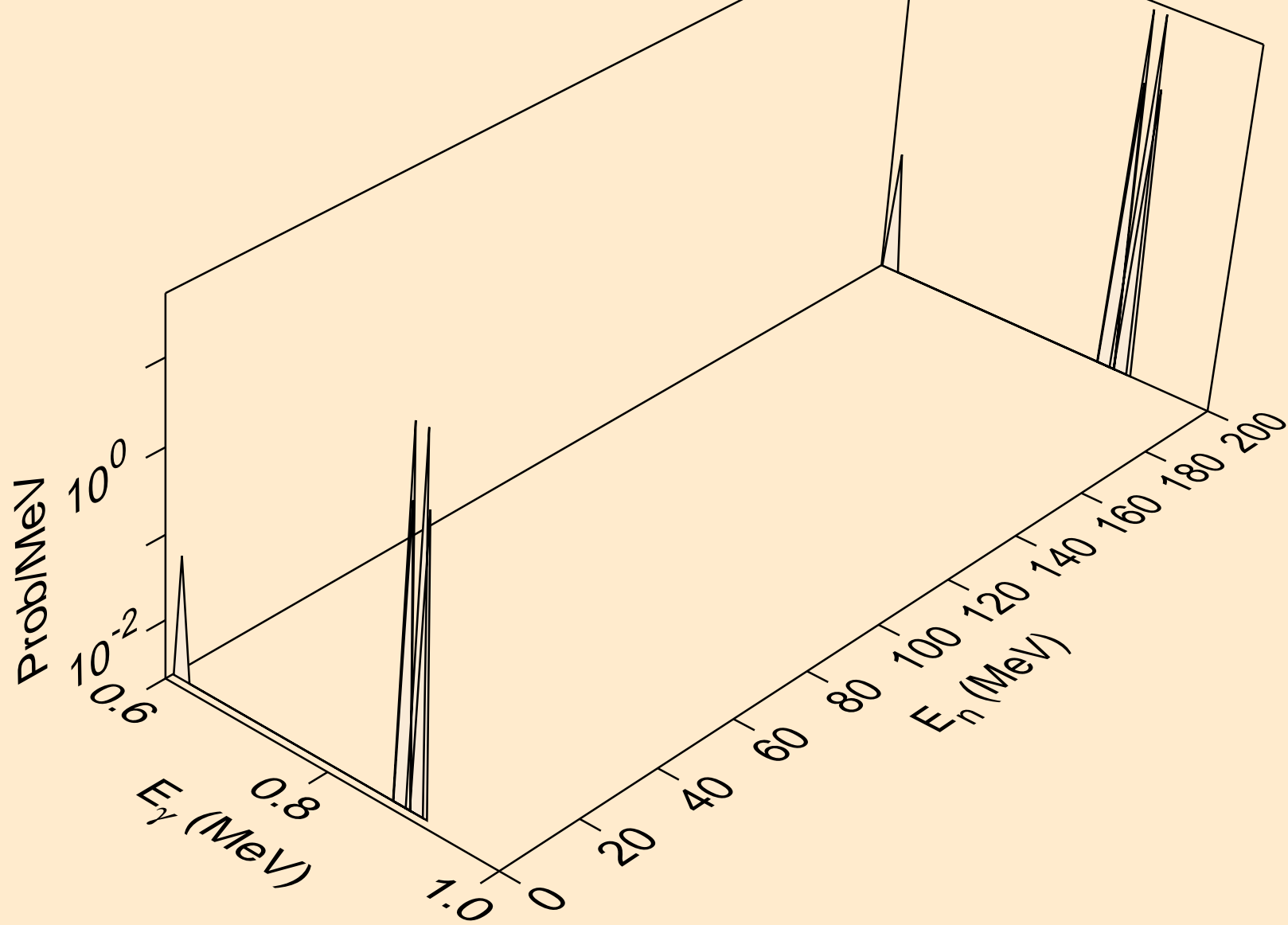

SC042M NEUTRON ACER TENDL-2021 LIBRARY; T=293.6K
Photon emission for (n,n*16)

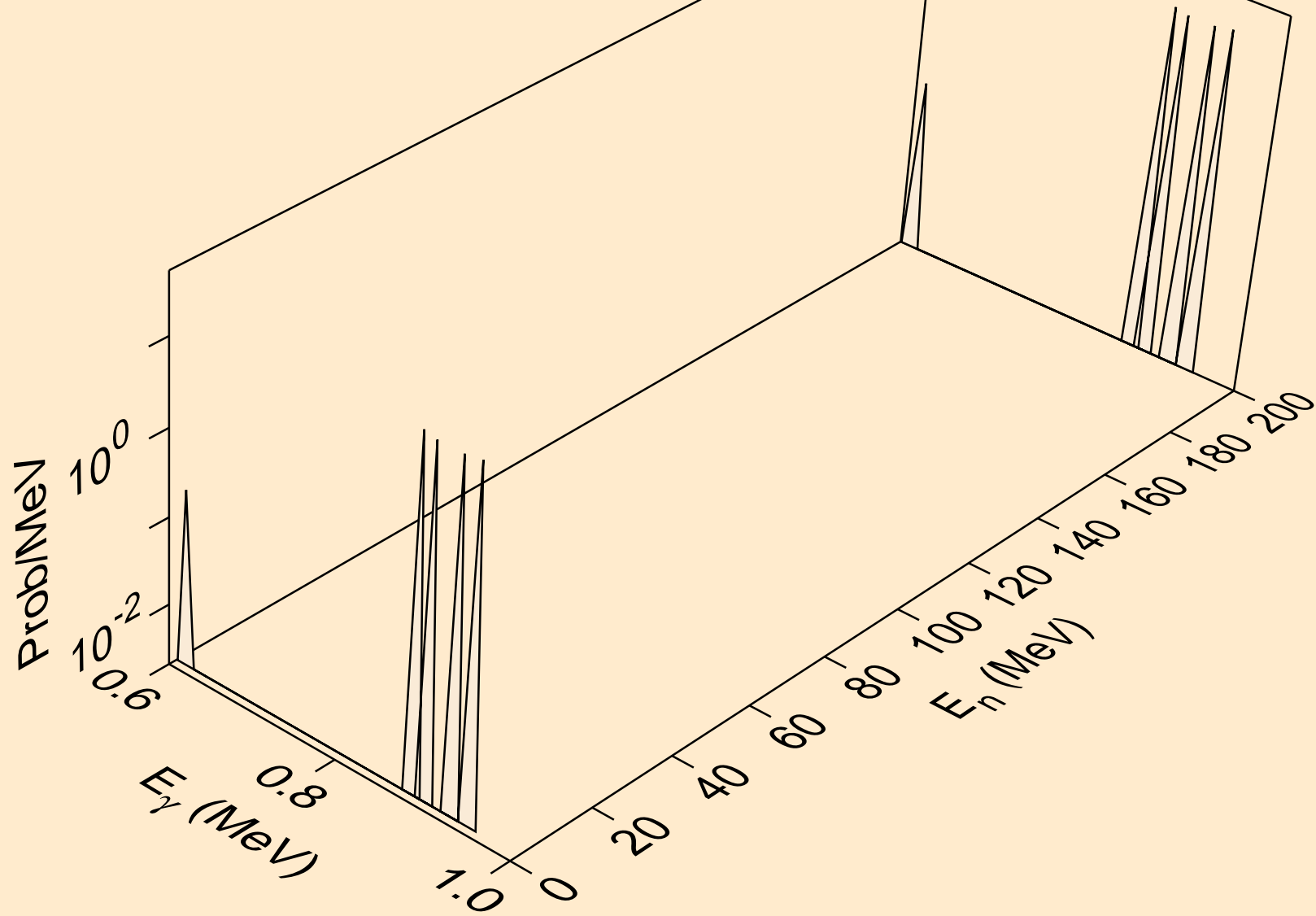

SC042M NEUTRON ACER TENDL-2021 LIBRARY; T=293.6K
Photon emission for (n,n*17)

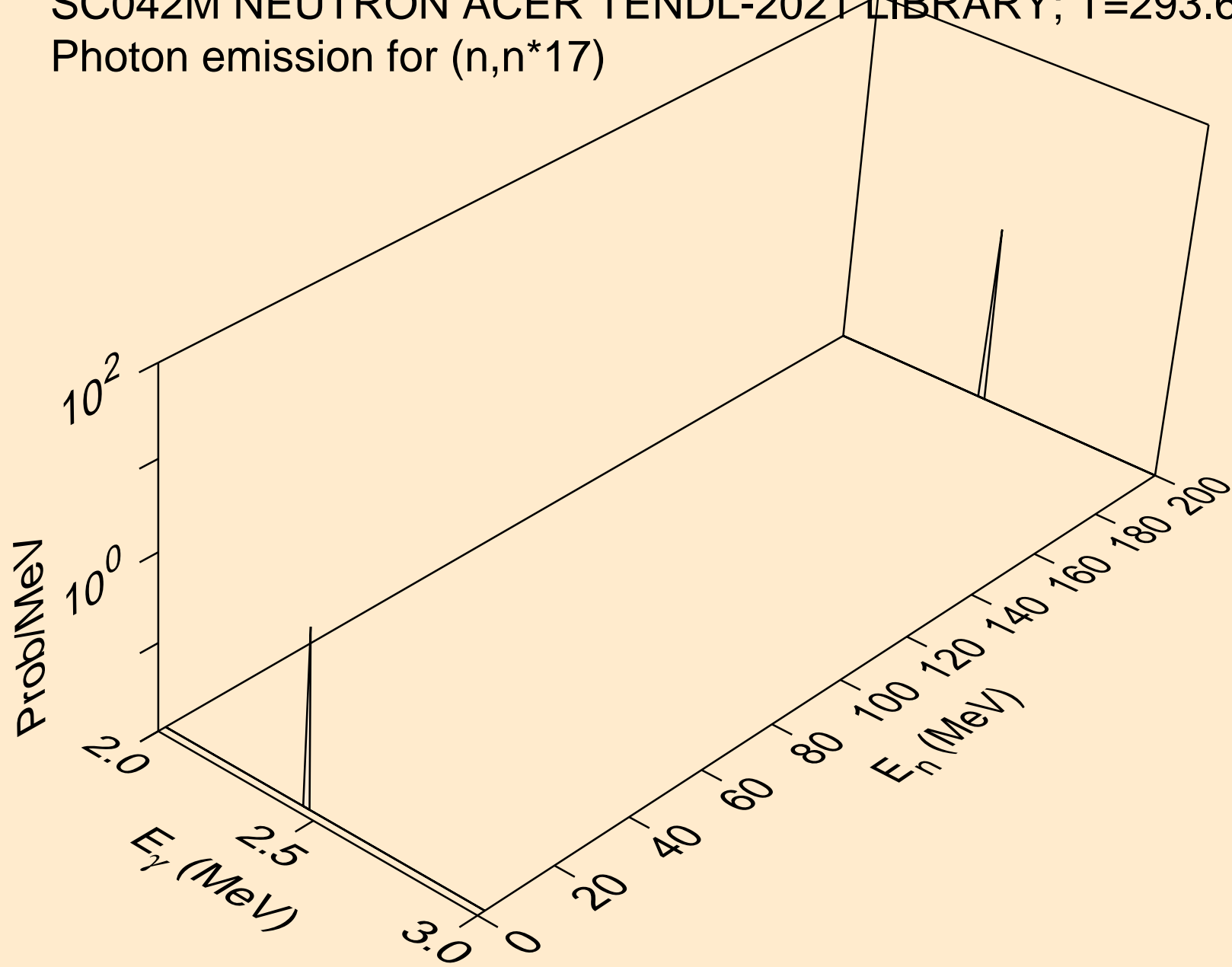

SC042M NEUTRON ACER TENDL-2021 LIBRARY; T=293.6K
Photon emission for (n,n*18)

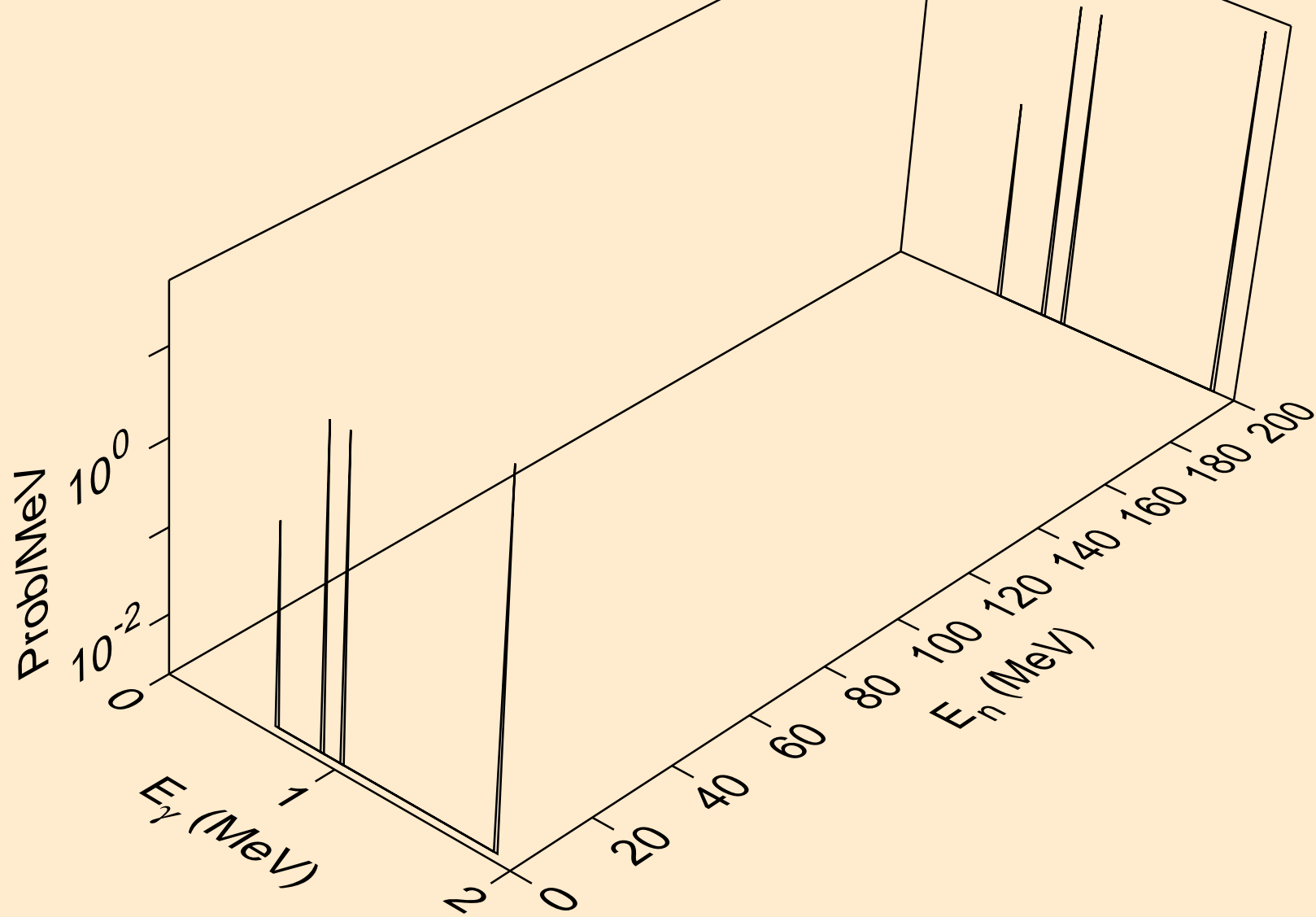

SC042M NEUTRON ACER TENDL-2021 LIBRARY; T=293.6K
Photon emission for (n,n*19)

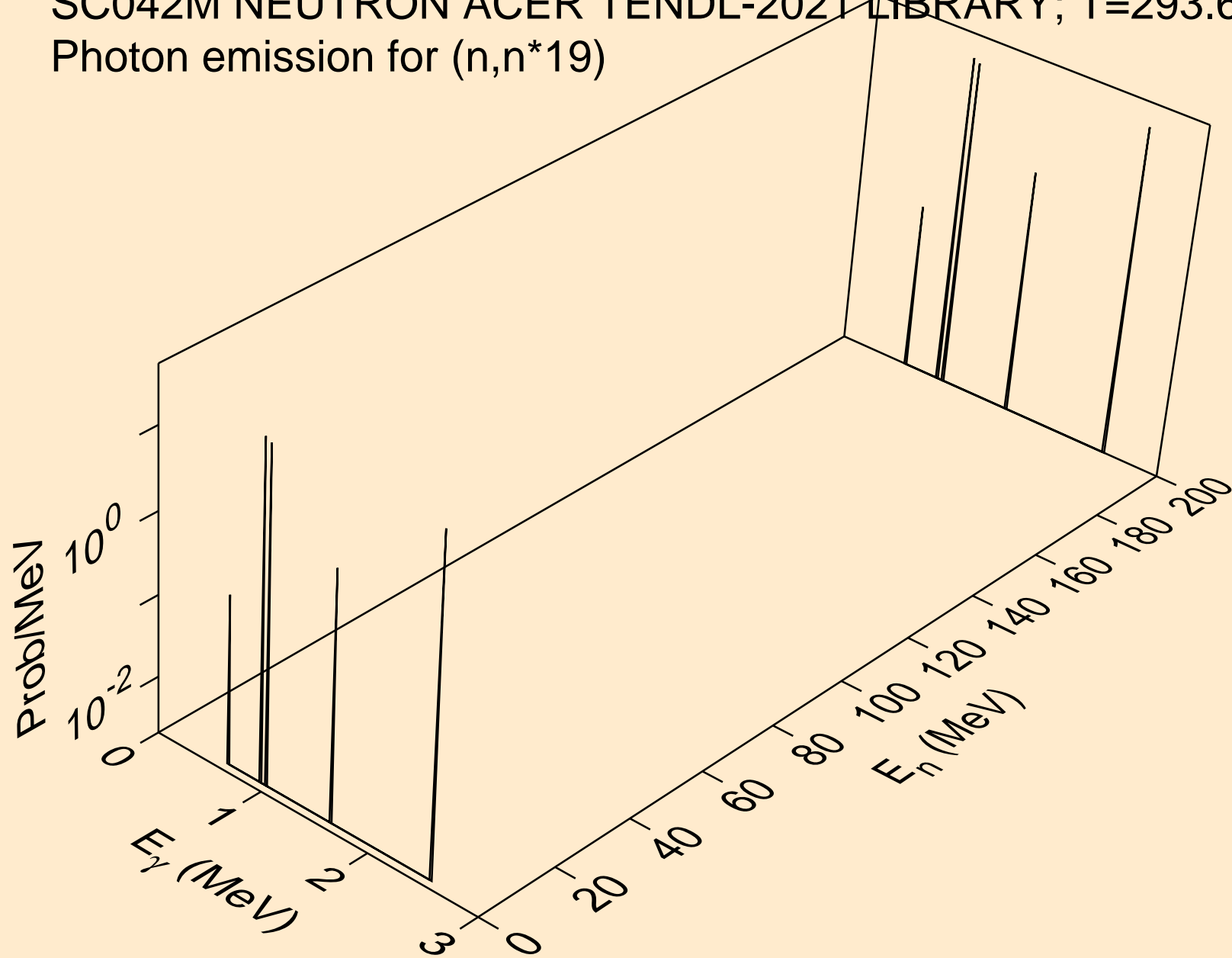

SC042M NEUTRON ACER TENDL-2021 LIBRARY; T=293.6K
Photon emission for (n,n*20)

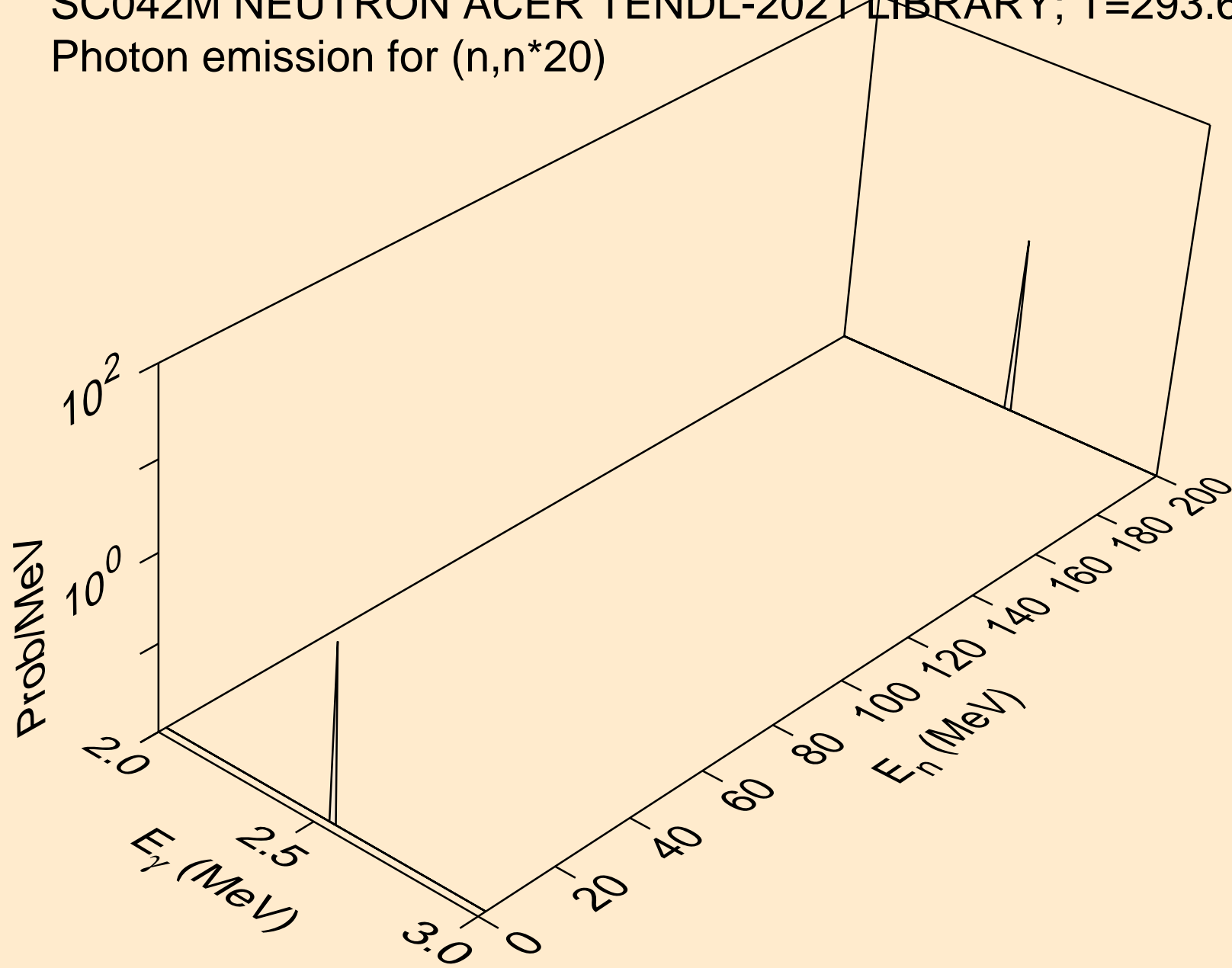

SC042M NEUTRON ACER TENDL-2021 LIBRARY; T=293.6K
Photon emission for (n,n*21)

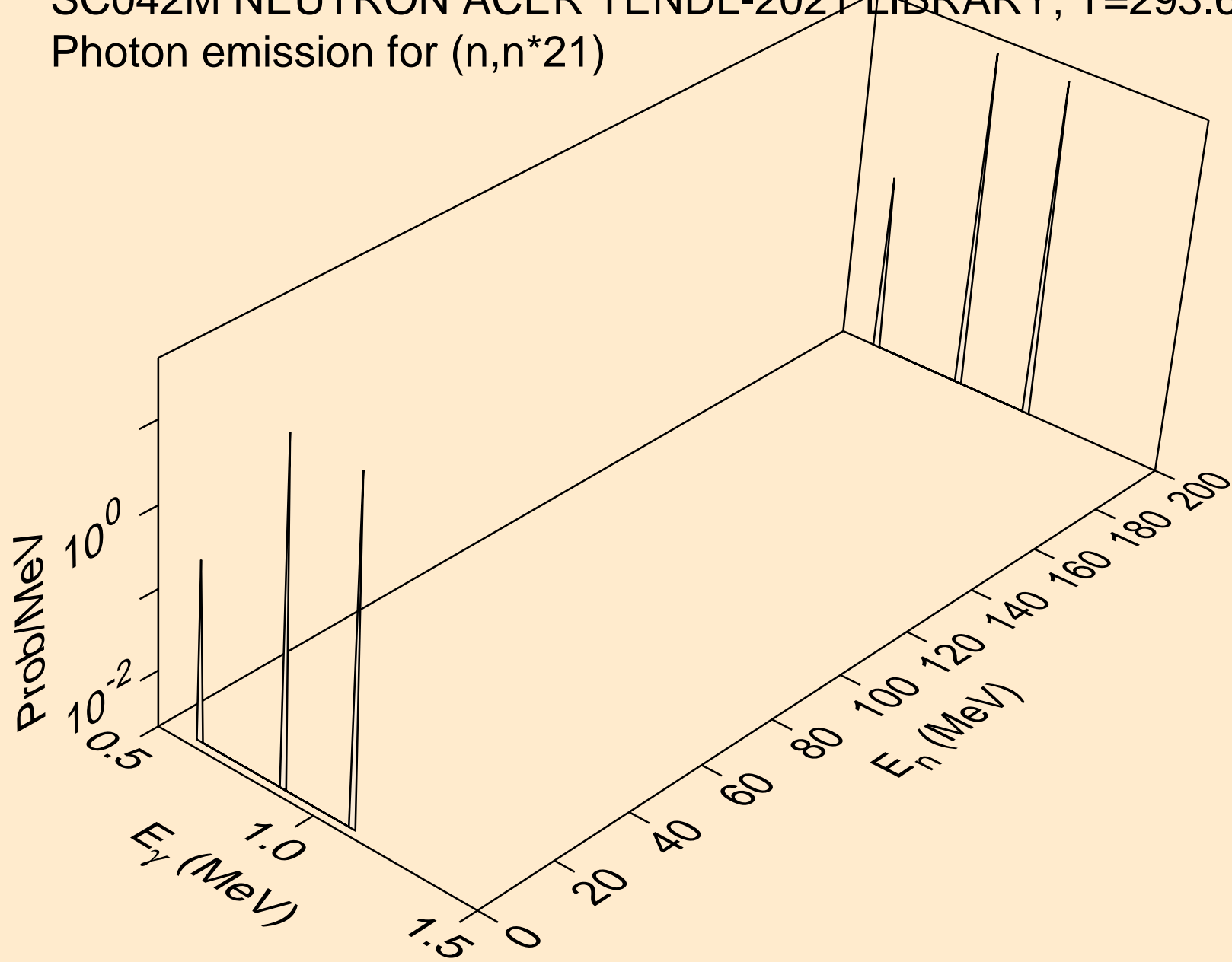

SC042M NEUTRON ACER TENDL-2021 LIBRARY; T=293.6K
Photon emission for (n,n*22)

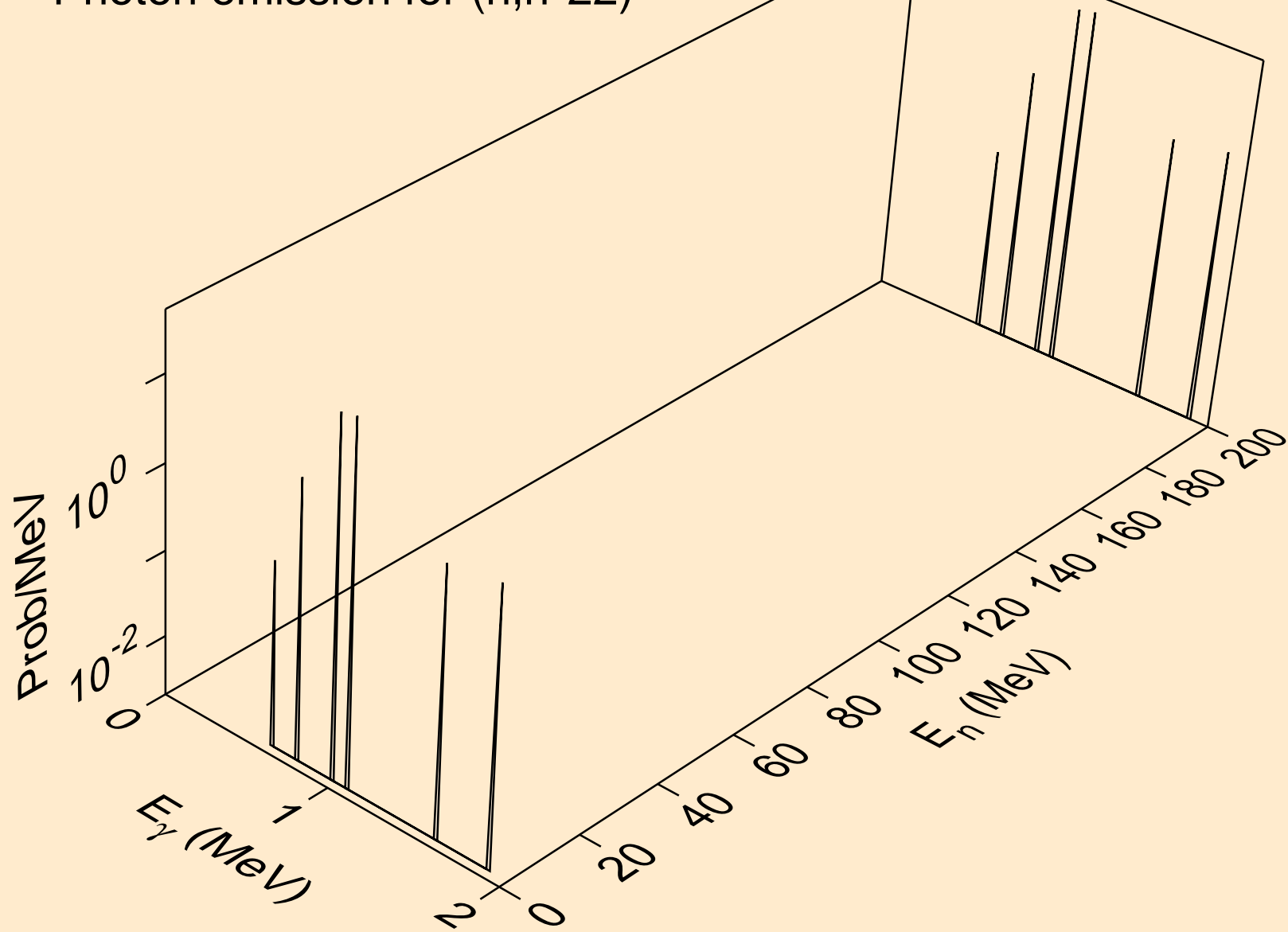

SC042M NEUTRON ACER TENDL-2021 LIBRARY; T=293.6K
Photon emission for (n,n*23)

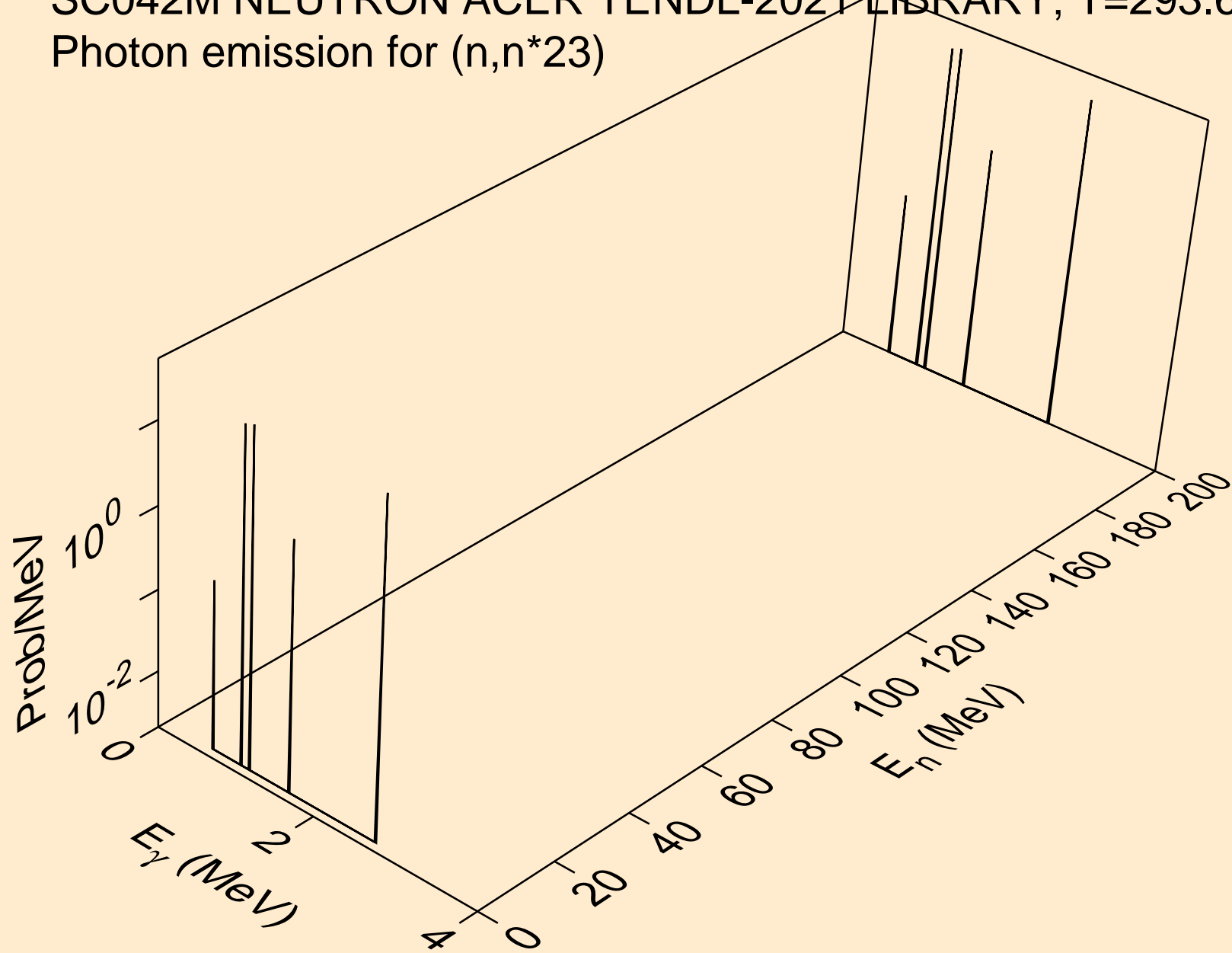

SC042M NEUTRON ACER TENDL-2021 LIBRARY; T=293.6K
Photon emission for (n,n*24)

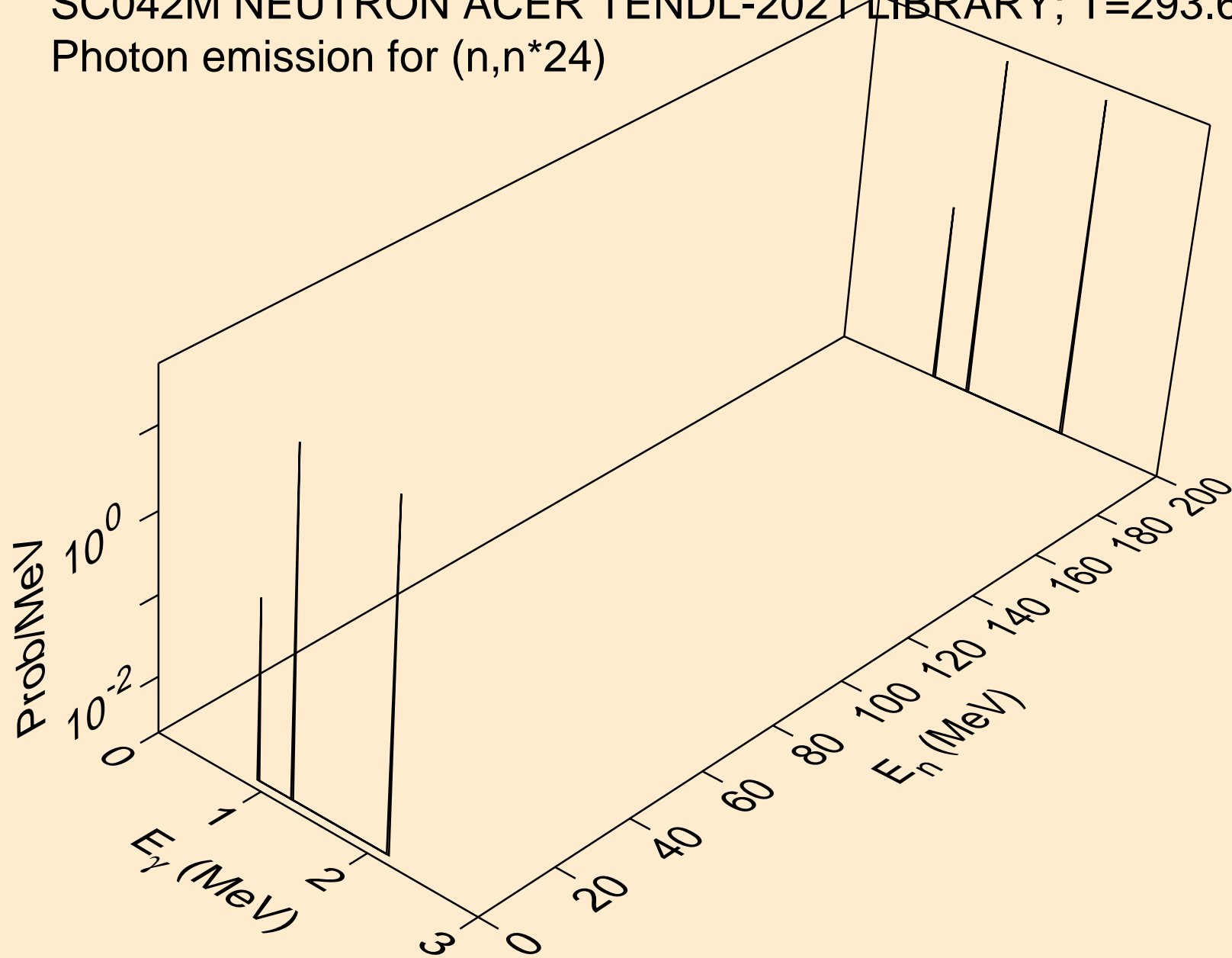

SC042M NEUTRON ACER TENDL-2021 LIBRARY; T=293.6K
Photon emission for (n,n*25)

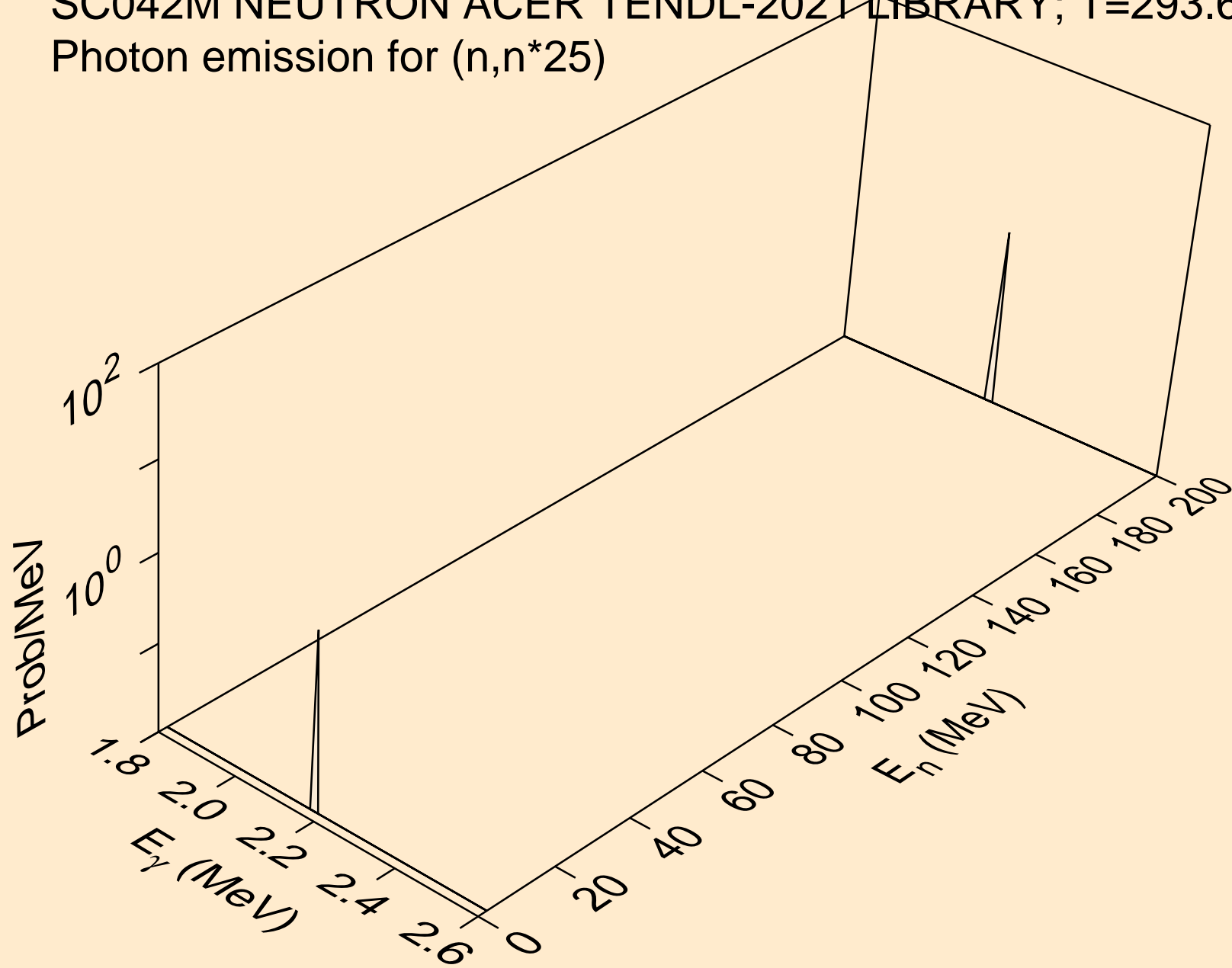

SC042M NEUTRON ACER TENDL-2021 LIBRARY; T=293.6K
Photon emission for (n,n*c)

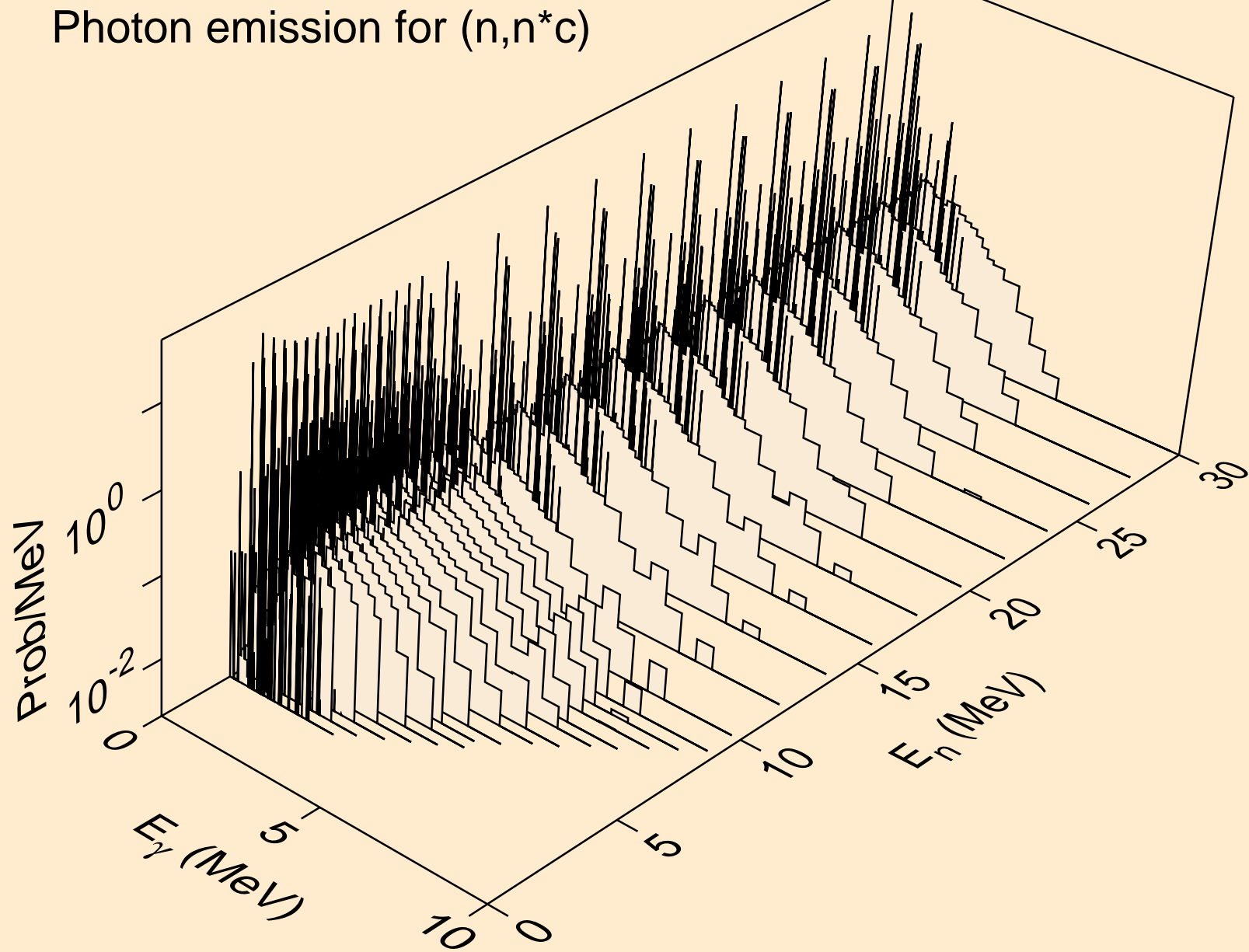

SC042M NEUTRON ACER TENDL-2021 LIBRARY; T=293.6K
Photon emission for (n,gma)

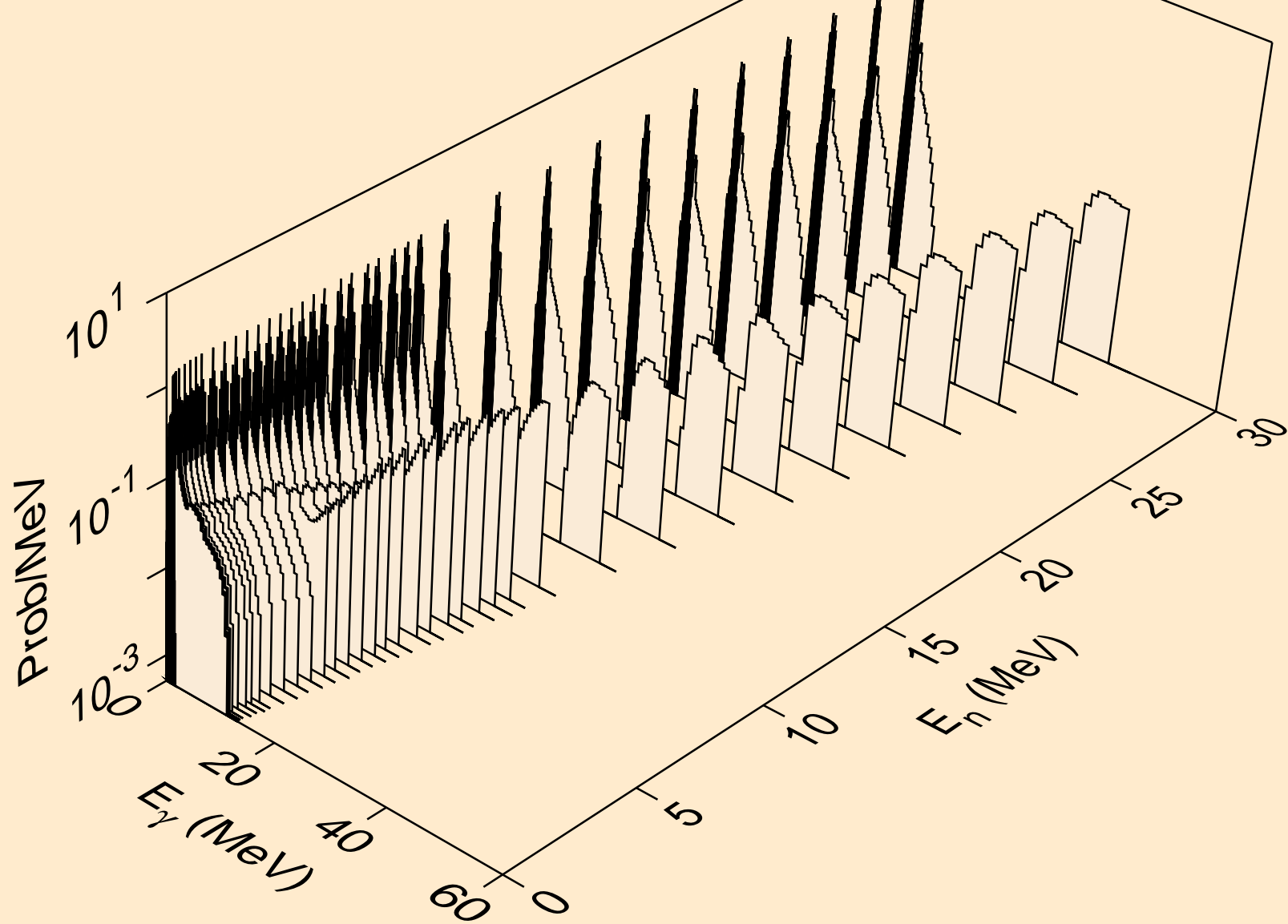

SC042M NEUTRON ACER TENDL-2021 LIBRARY; T=293.6K
Photon emission for (n,p)

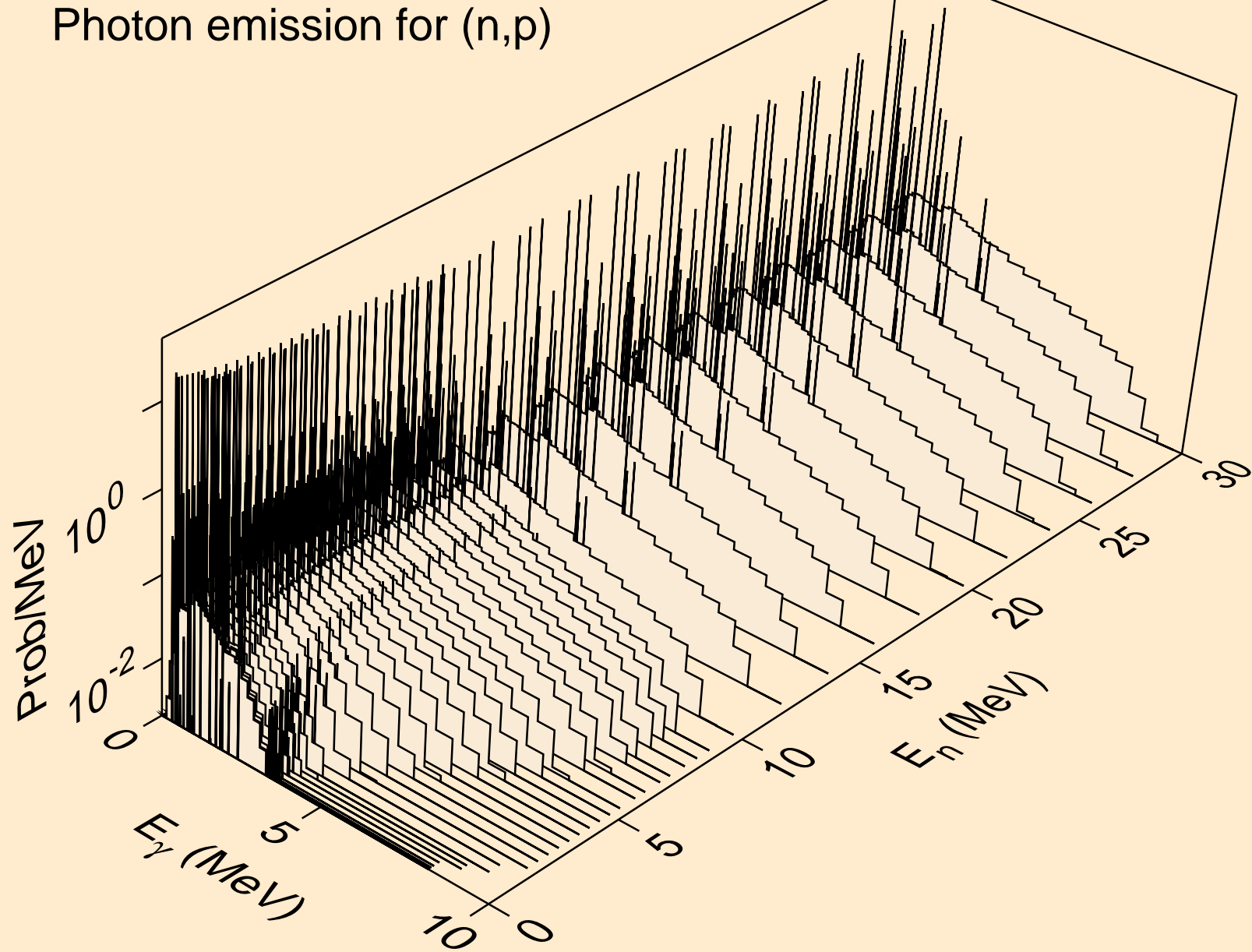

SC042M NEUTRON ACER TENDL-2021 LIBRARY; T=293.6K
Photon emission for (n,d)

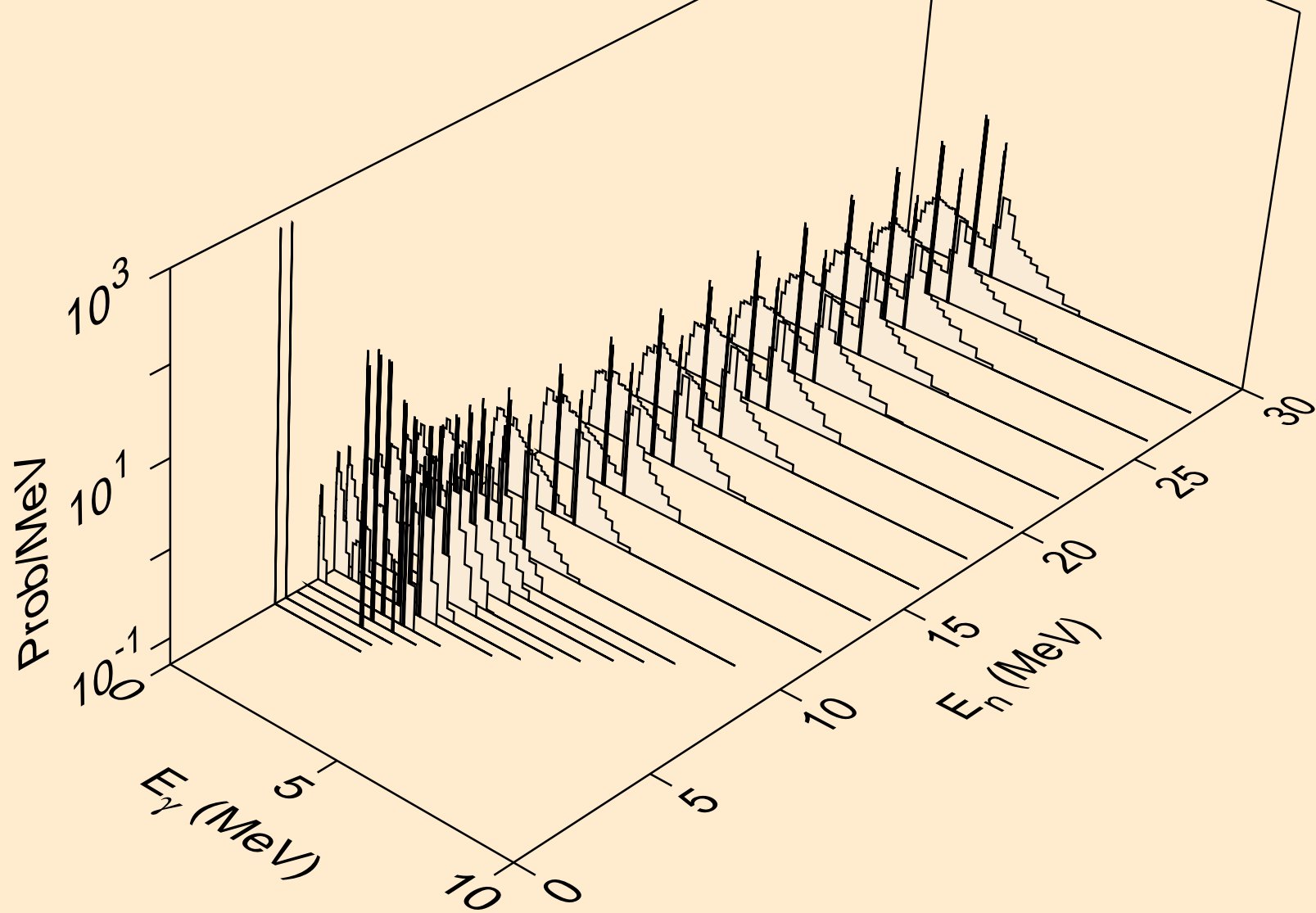

SC042M NEUTRON ACER TENDL-2021 LIBRARY; T=293.6K
Photon emission for (n,t)

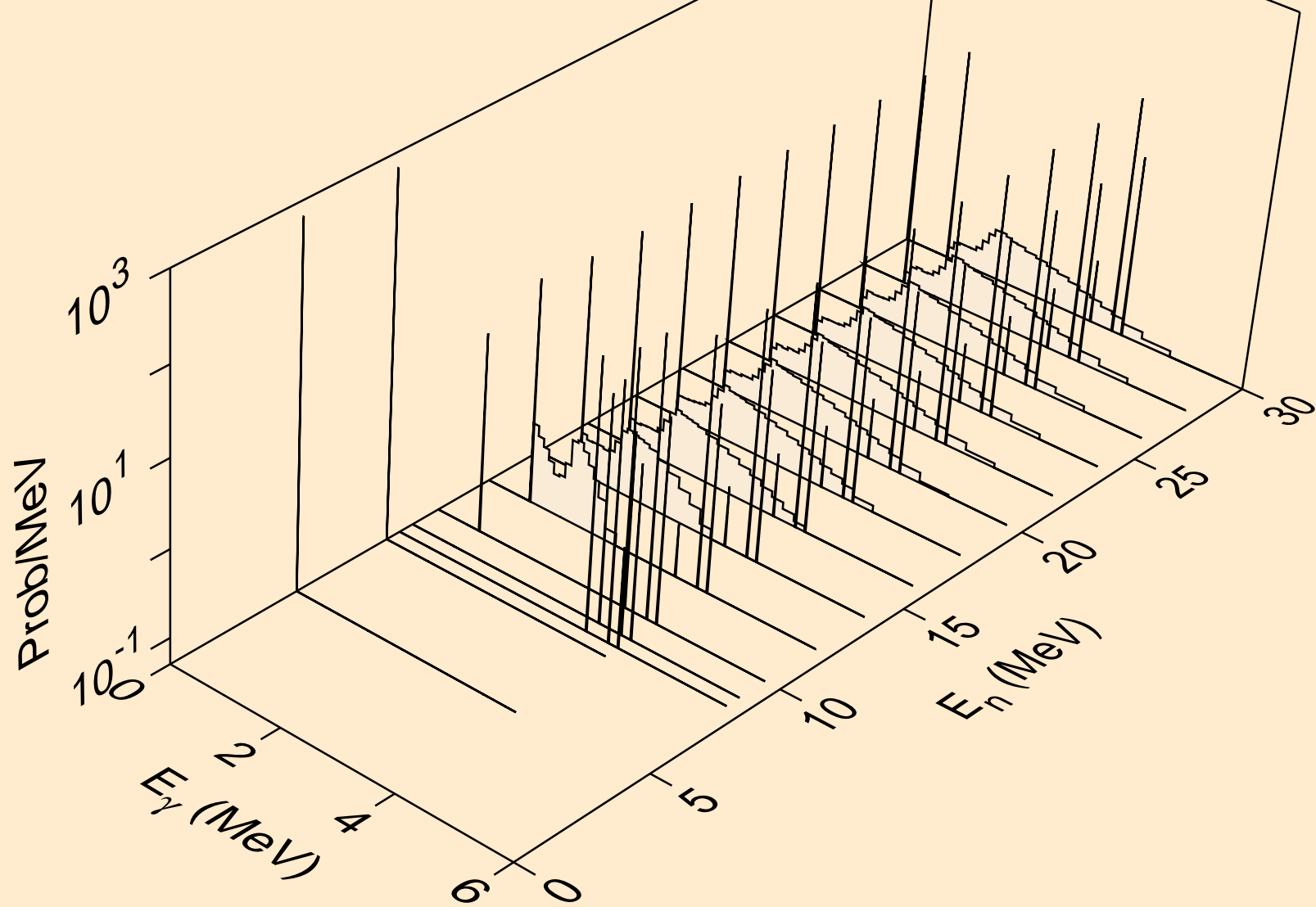

SC042M NEUTRON ACER TENDL-2021 LIBRARY; T=293.6K
Photon emission for (n,he3)

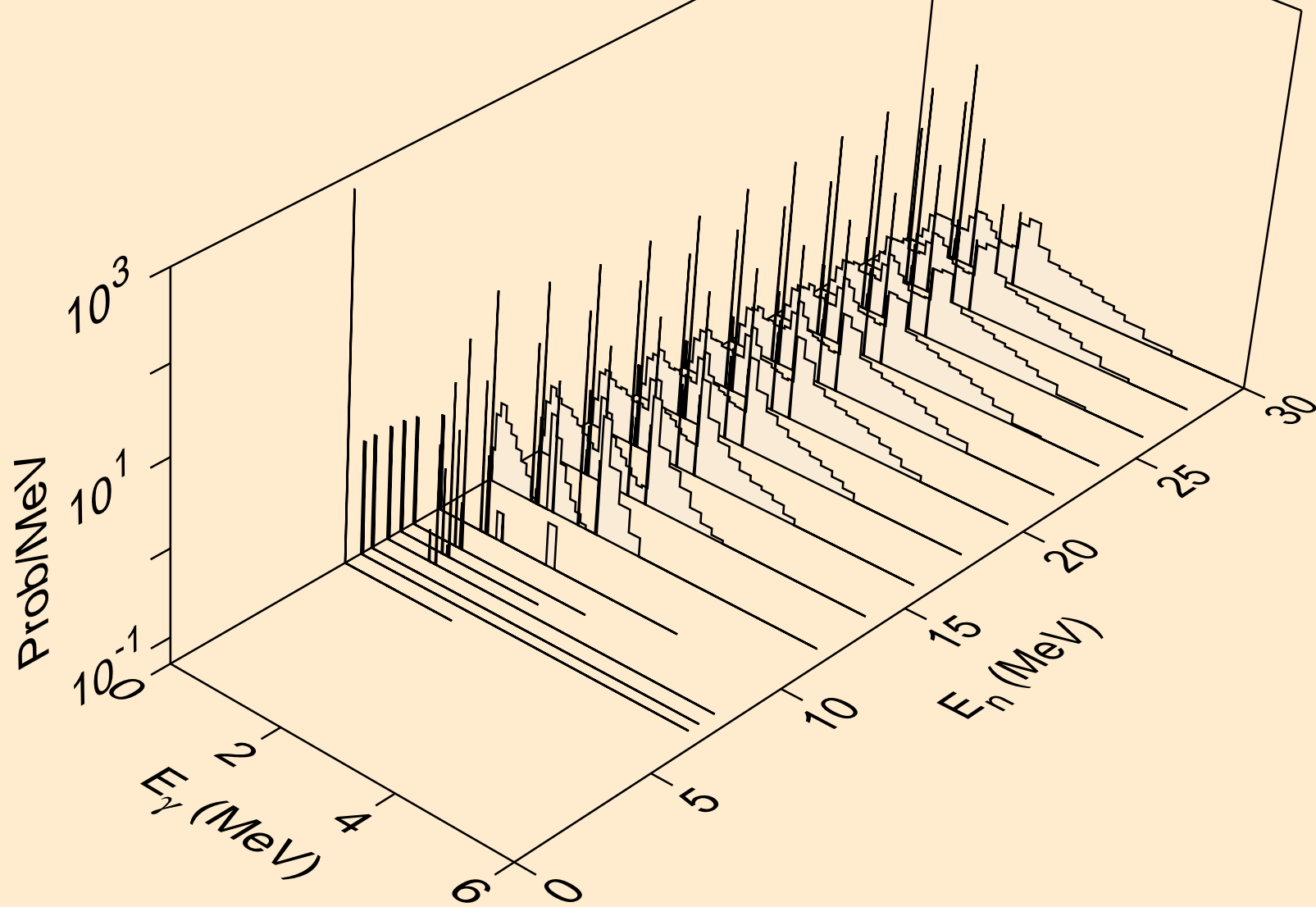

SC042M NEUTRON ACER TENDL-2021 LIBRARY; T=293.6K
Photon emission for (n,a)

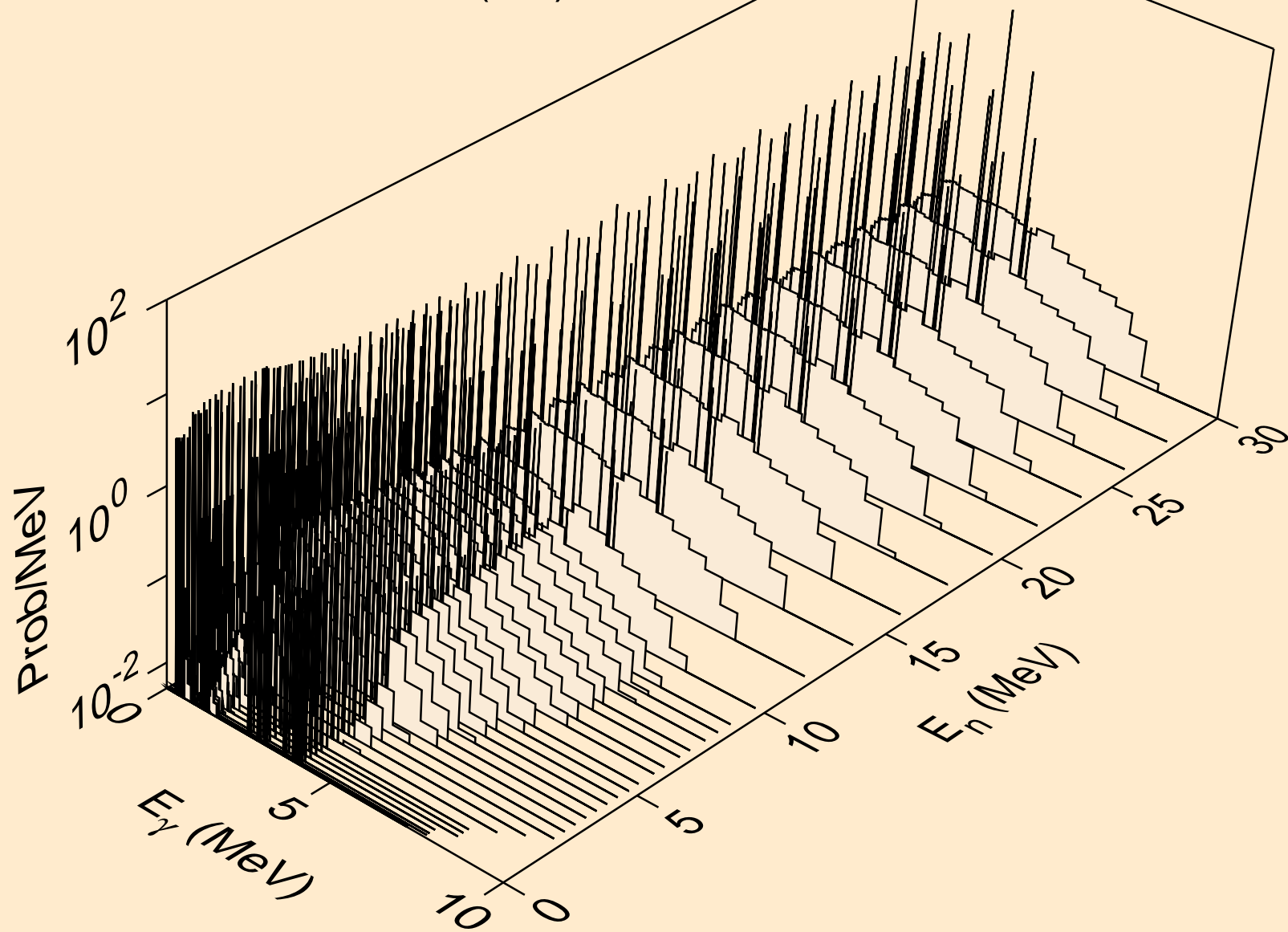

SC042M NEUTRON ACER TENDL-2021 LIBRARY; T=293.6K
Photon emission for (n,2a)

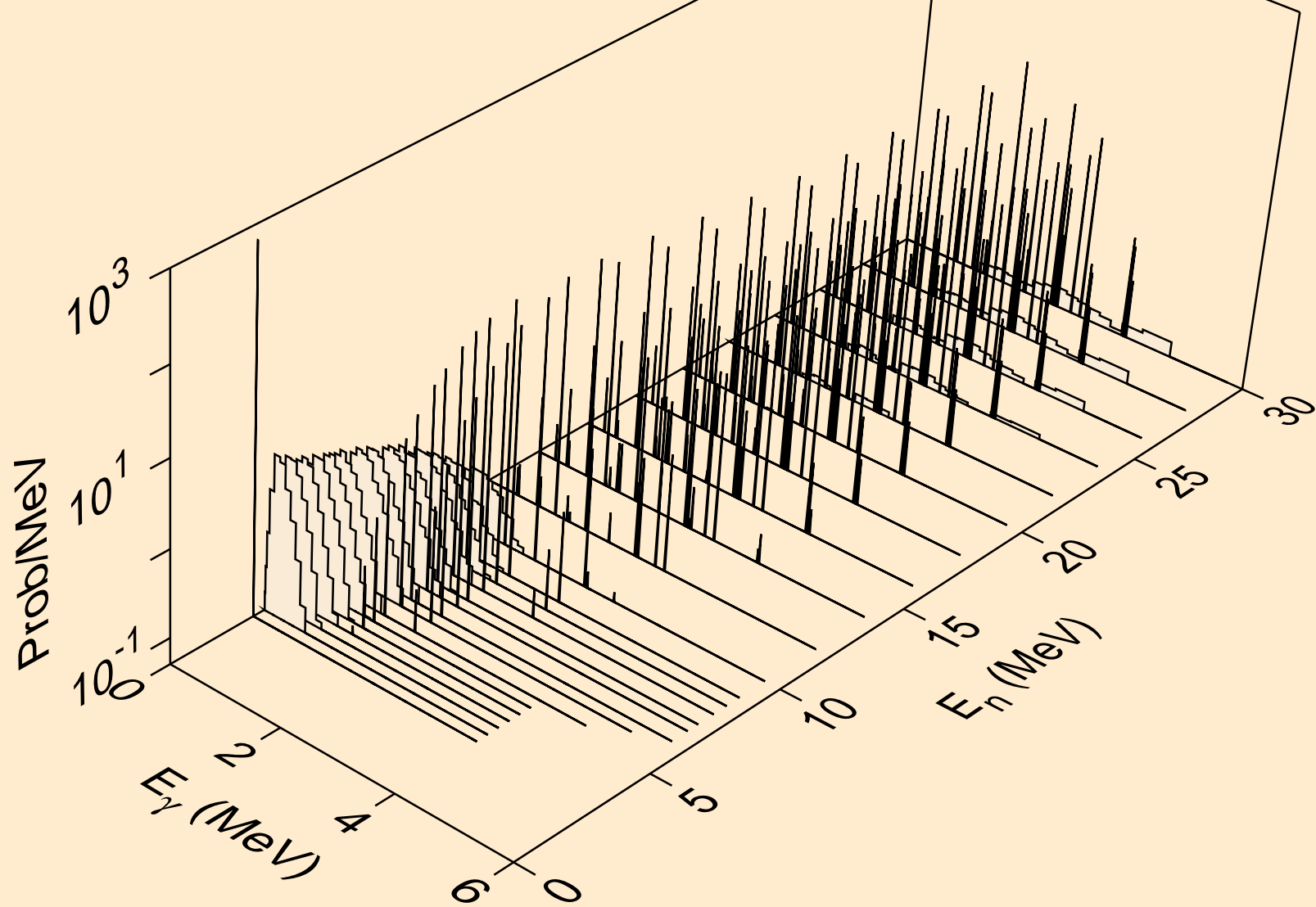

SC042M NEUTRON ACER TENDL-2021 LIBRARY; T=293.6K
Photon emission for (n,3a)

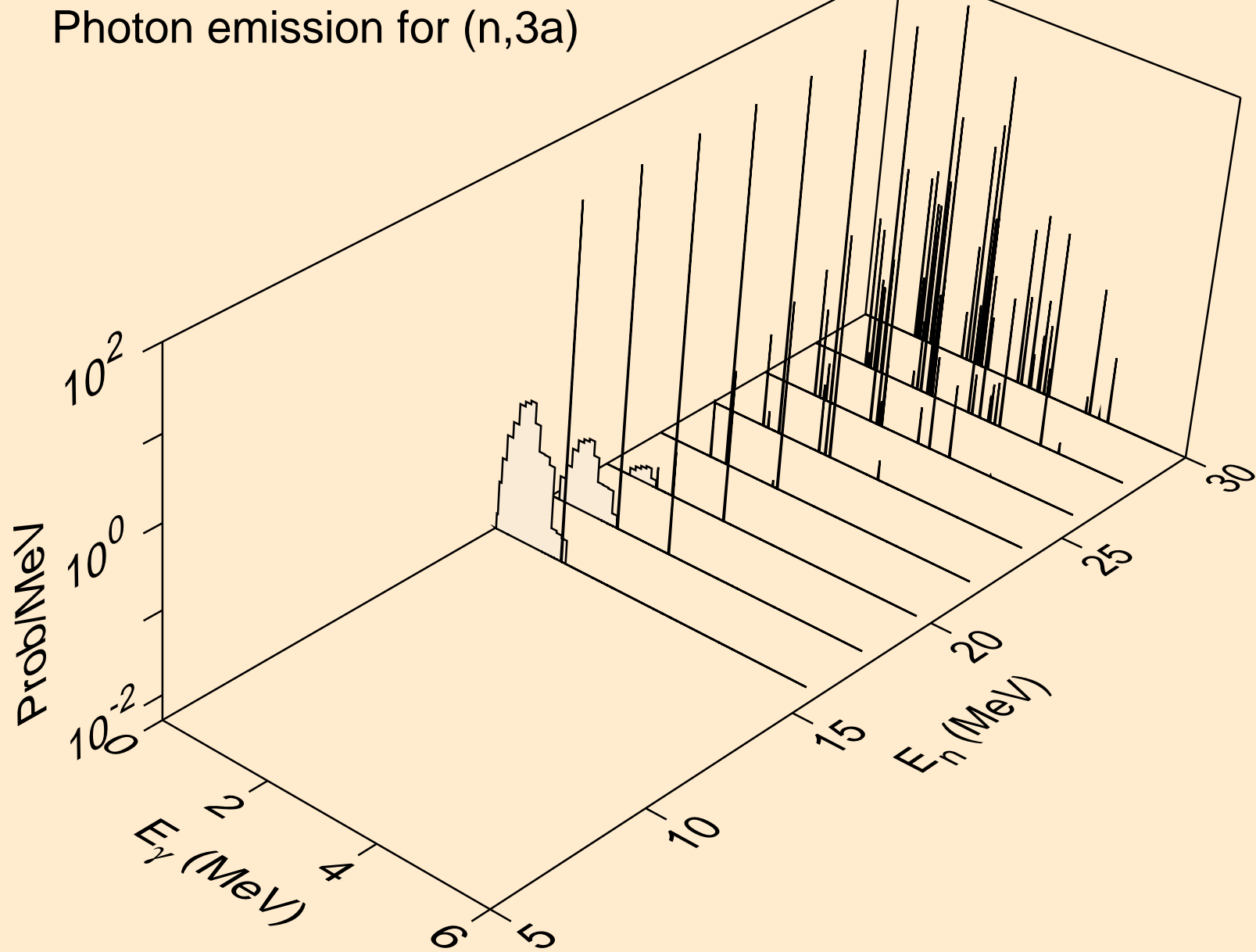

SC042M NEUTRON ACER TENDL-2021 LIBRARY; T=293.6K
Photon emission for (n,2p)

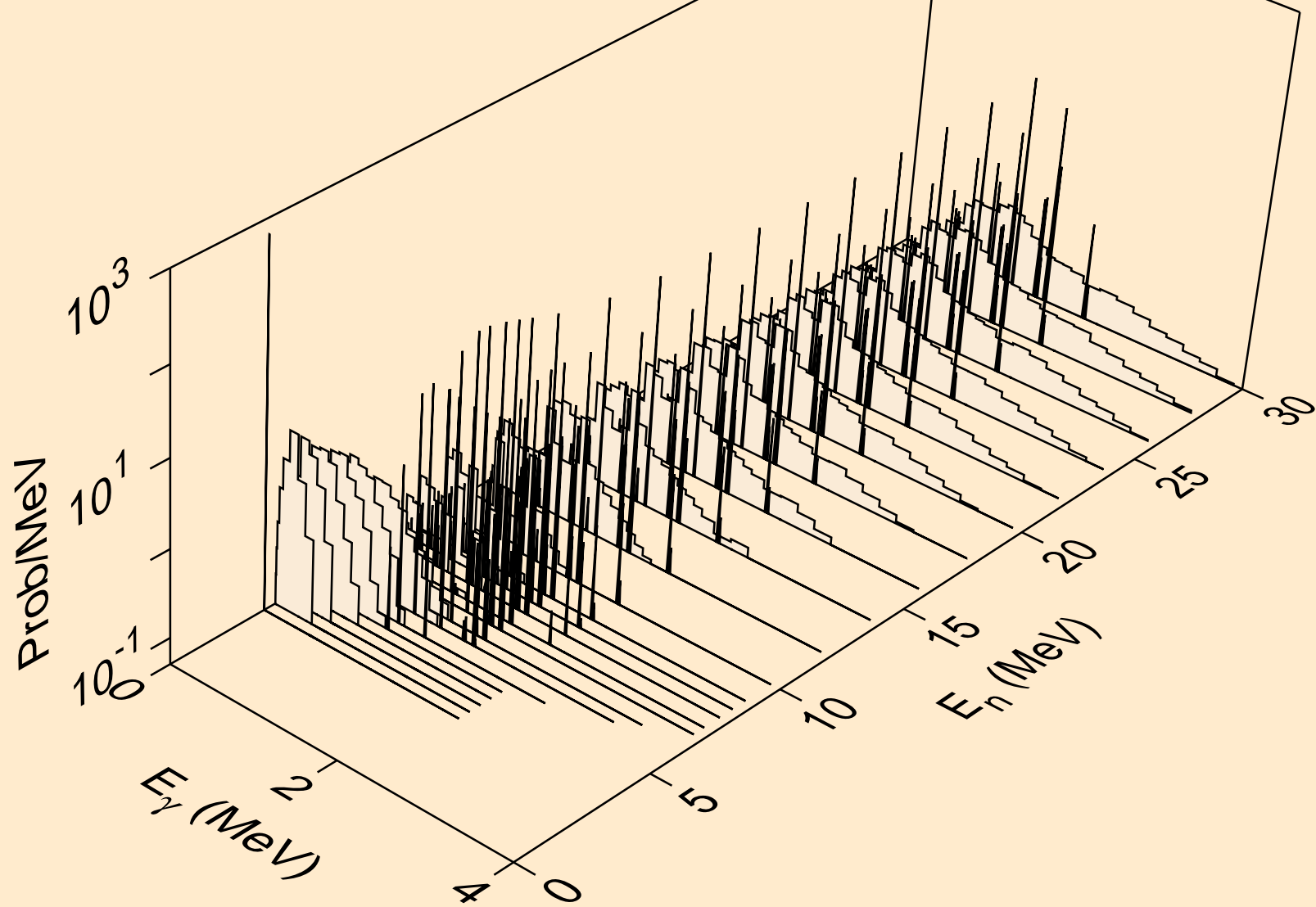

SC042M NEUTRON ACER TENDL-2021 LIBRARY; T=293.6K
Photon emission for (n,p)

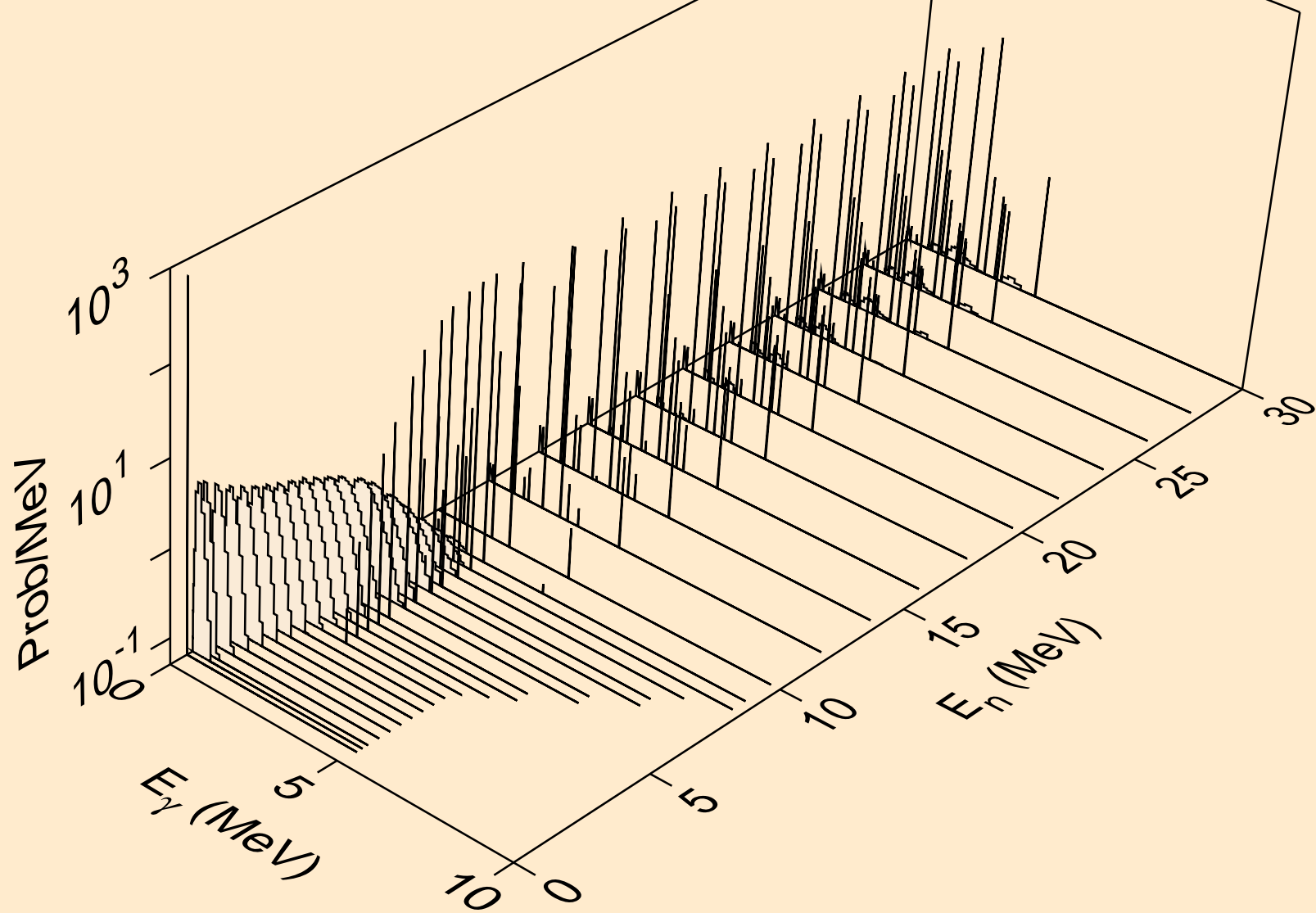

SC042M NEUTRON ACER TENDL-2021 LIBRARY; T=293.6K
Photon emission for (n,t2a)

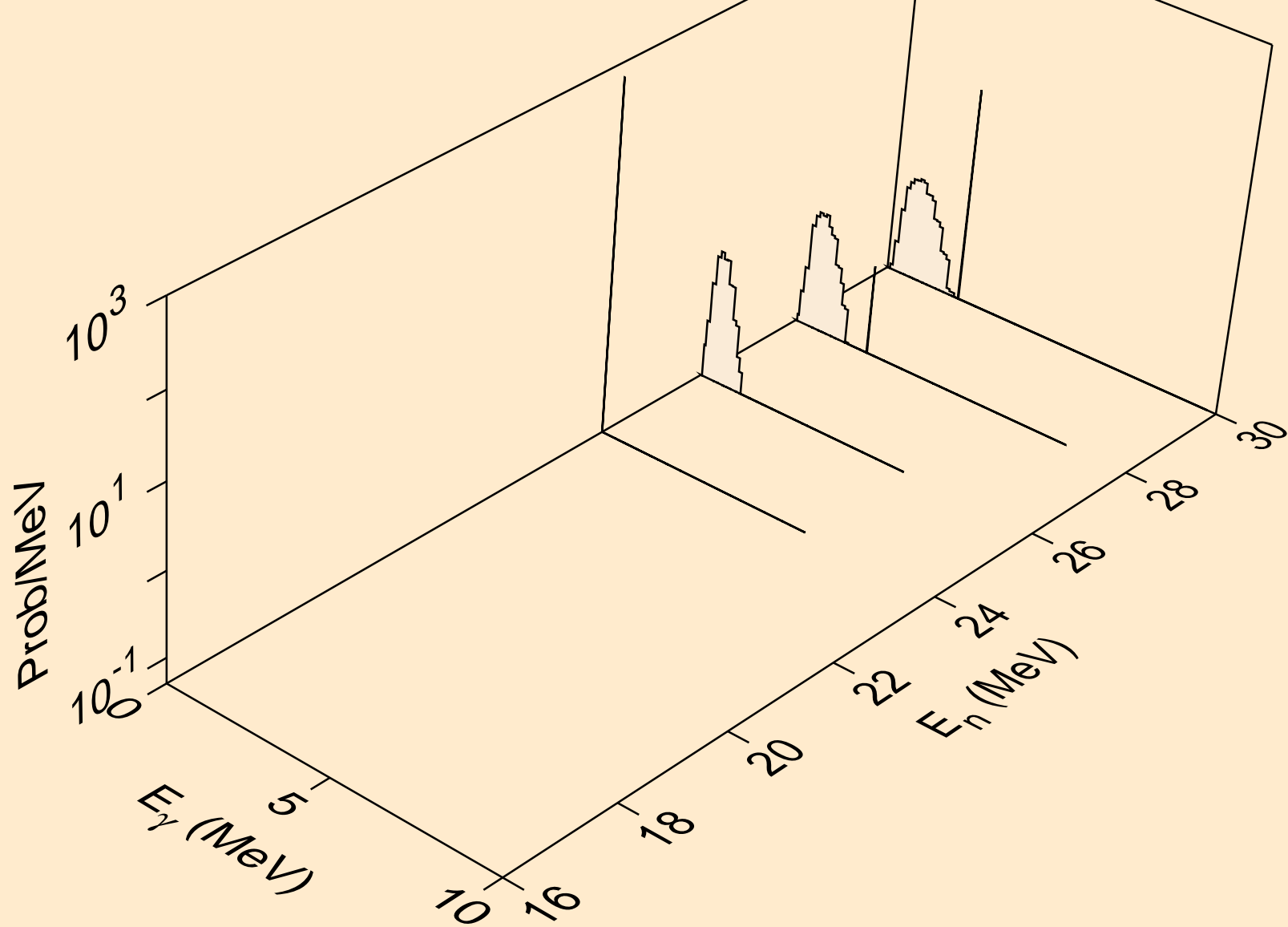

SC042M NEUTRON ACER TENDL-2021 LIBRARY; T=293.6K
Photon emission for (n,d2a)

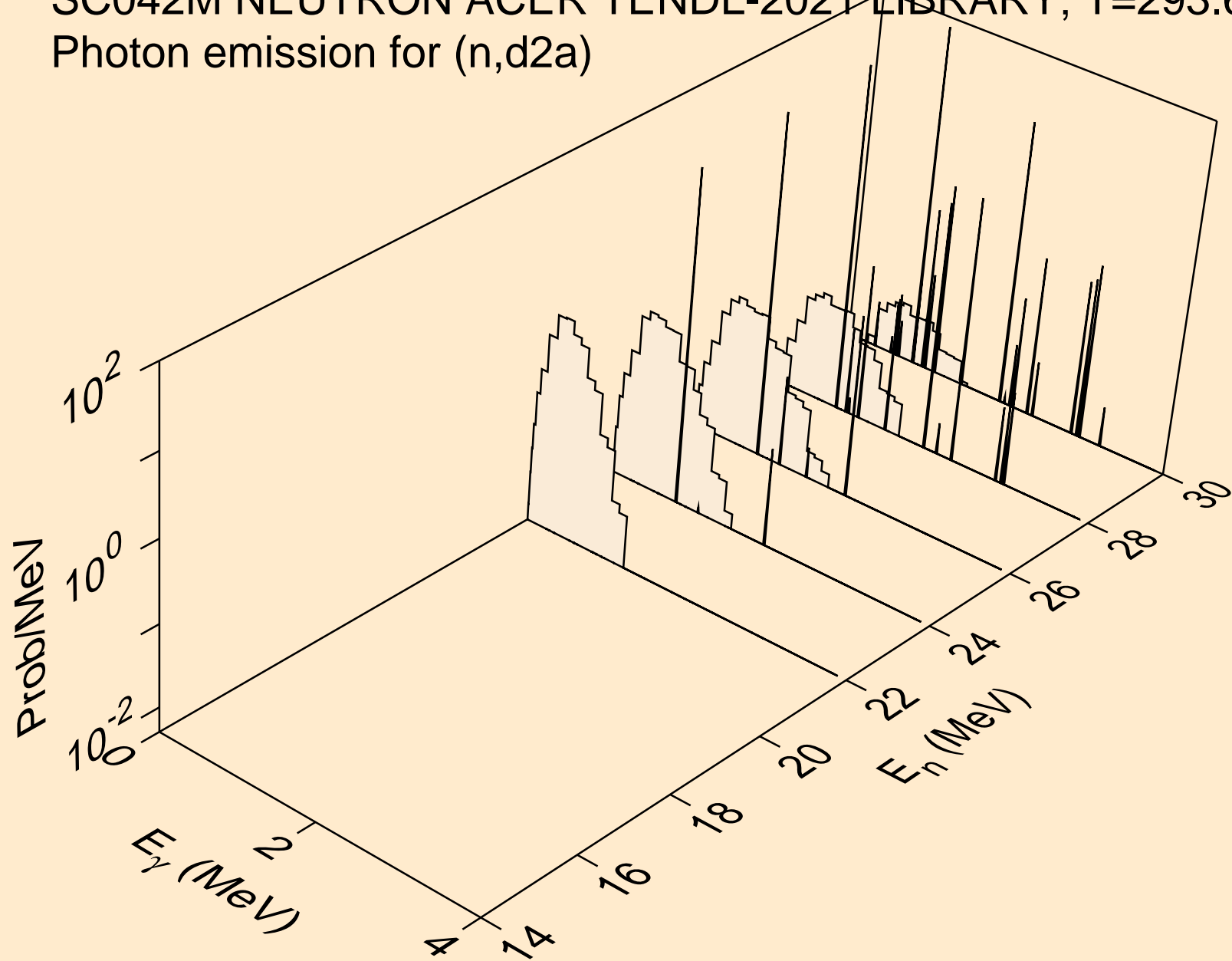

SC042M NEUTRON ACER TENDL-2021 LIBRARY; T=293.6K
Photon emission for (n,pd)

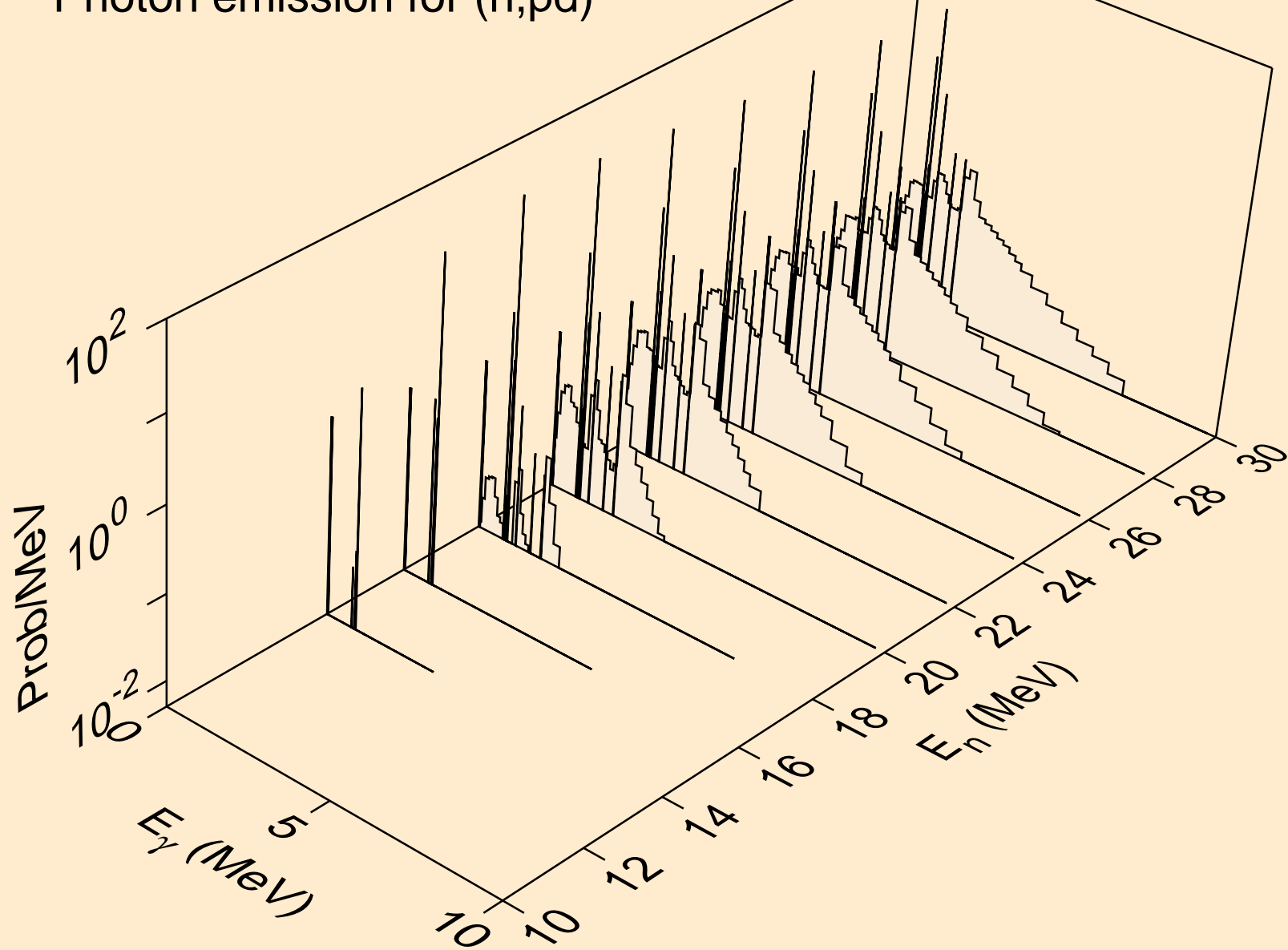

SC042M NEUTRON ACER TENDL-2021 LIBRARY; T=293.6K
Photon emission for (n,pt)

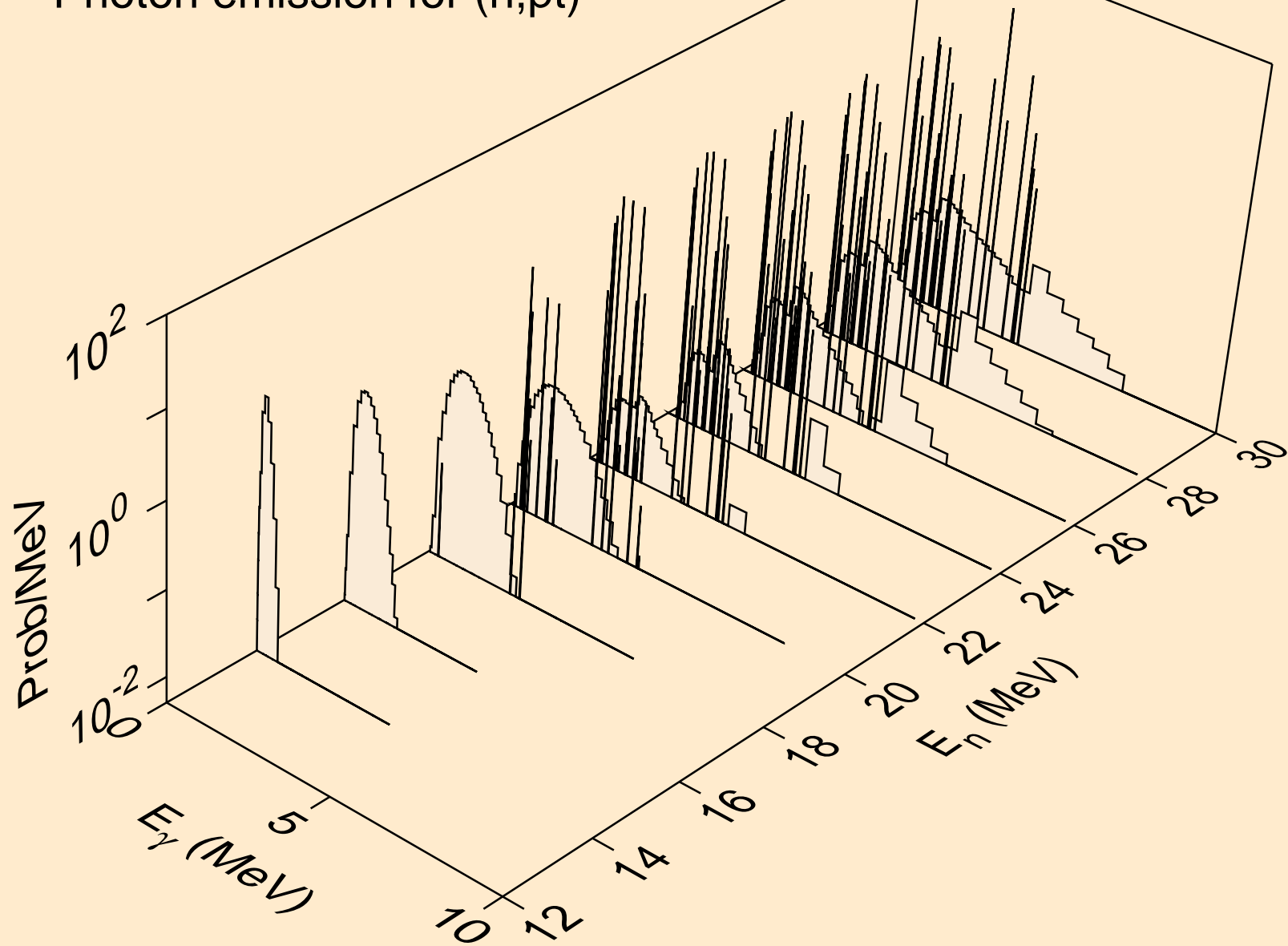

SC042M NEUTRON ACER TENDL-2021 LIBRARY; T=293.6K
Photon emission for (n,da)

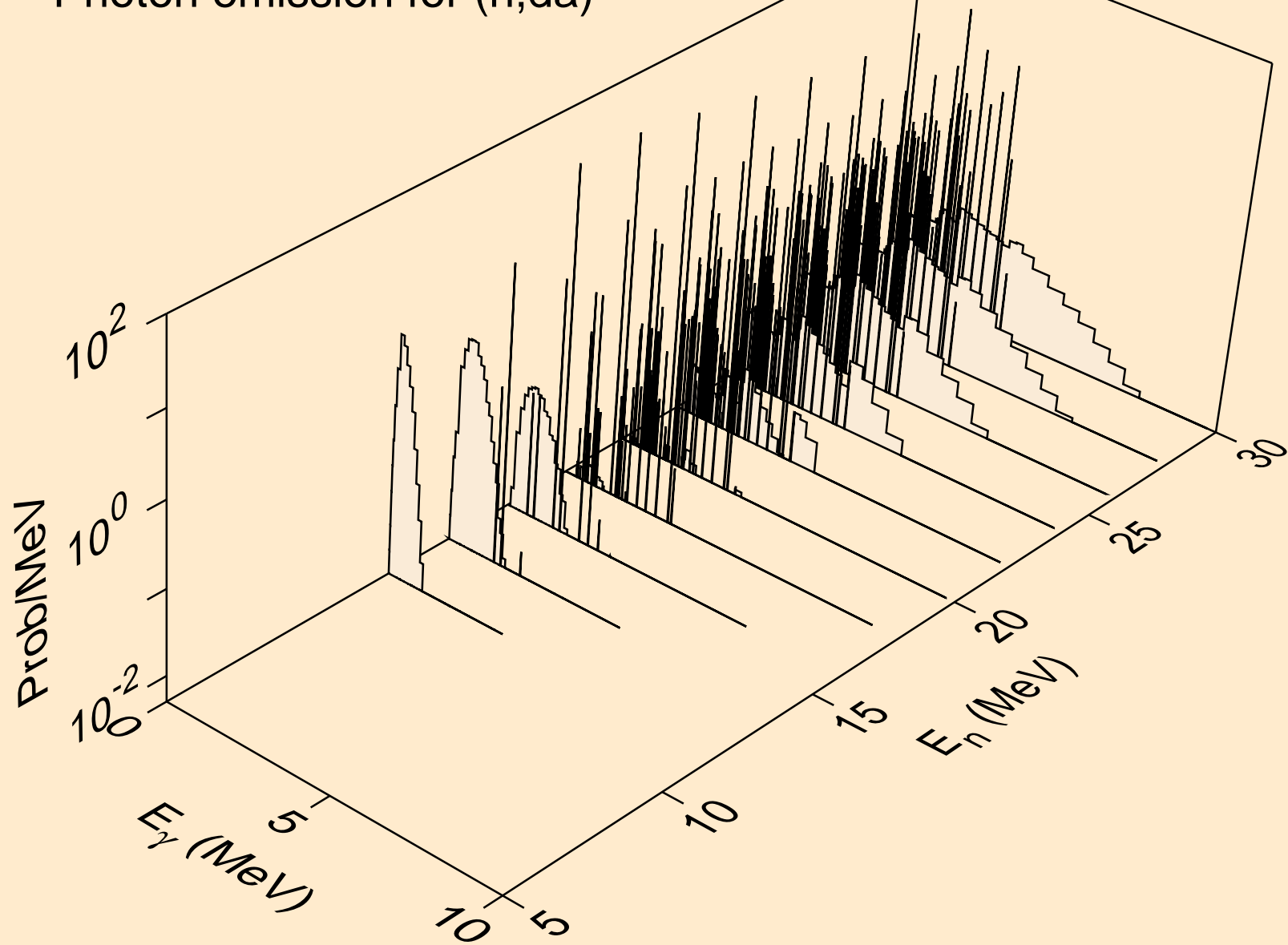

SC042M NEUTRON ACER TENDL-2021 LIBRARY; T=293.6K
thermal capture photon spectrum

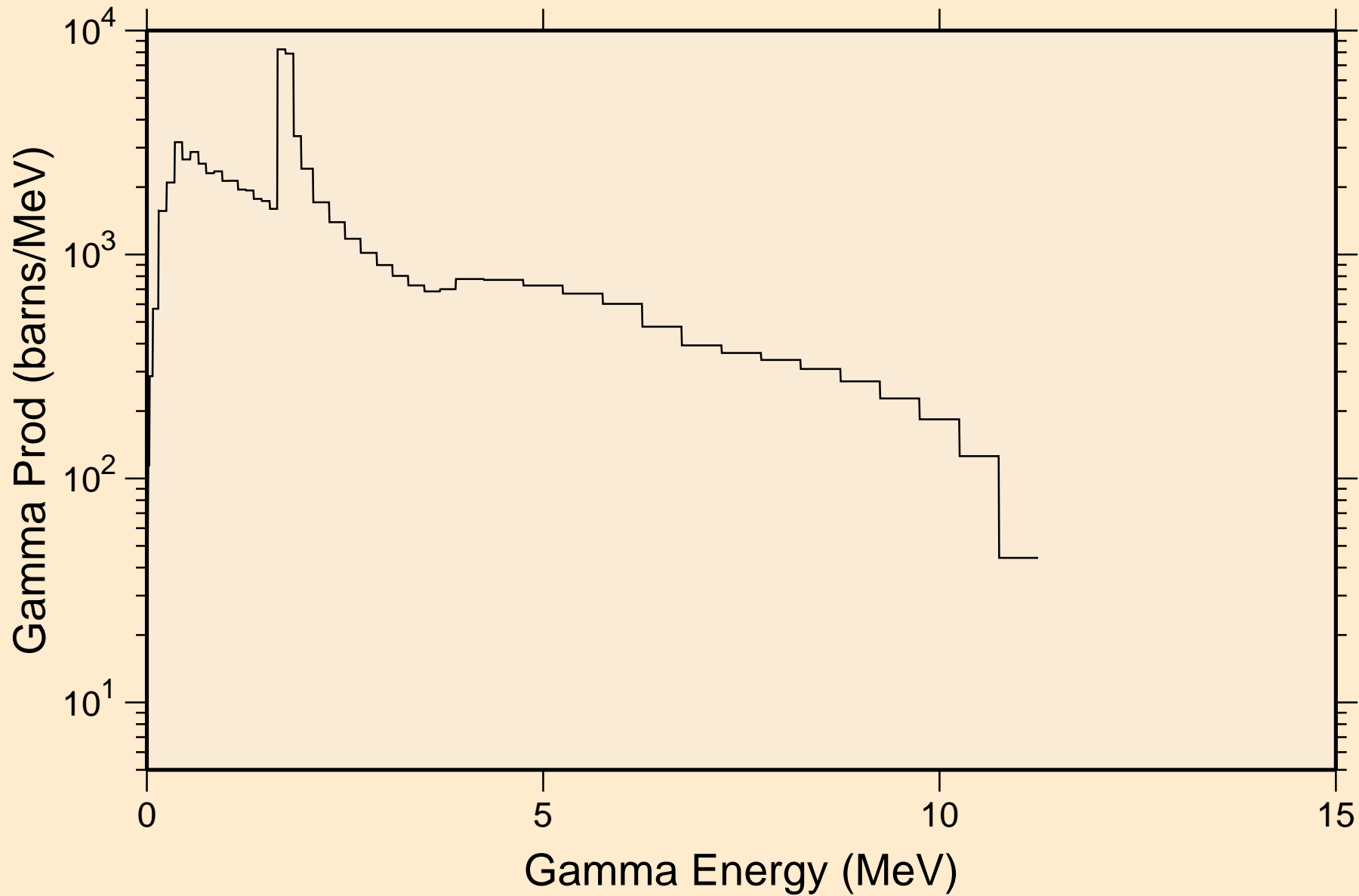

SC042M NEUTRON ACER TENDL-2021 LIBRARY; T=293.6K
14 MeV photon spectrum

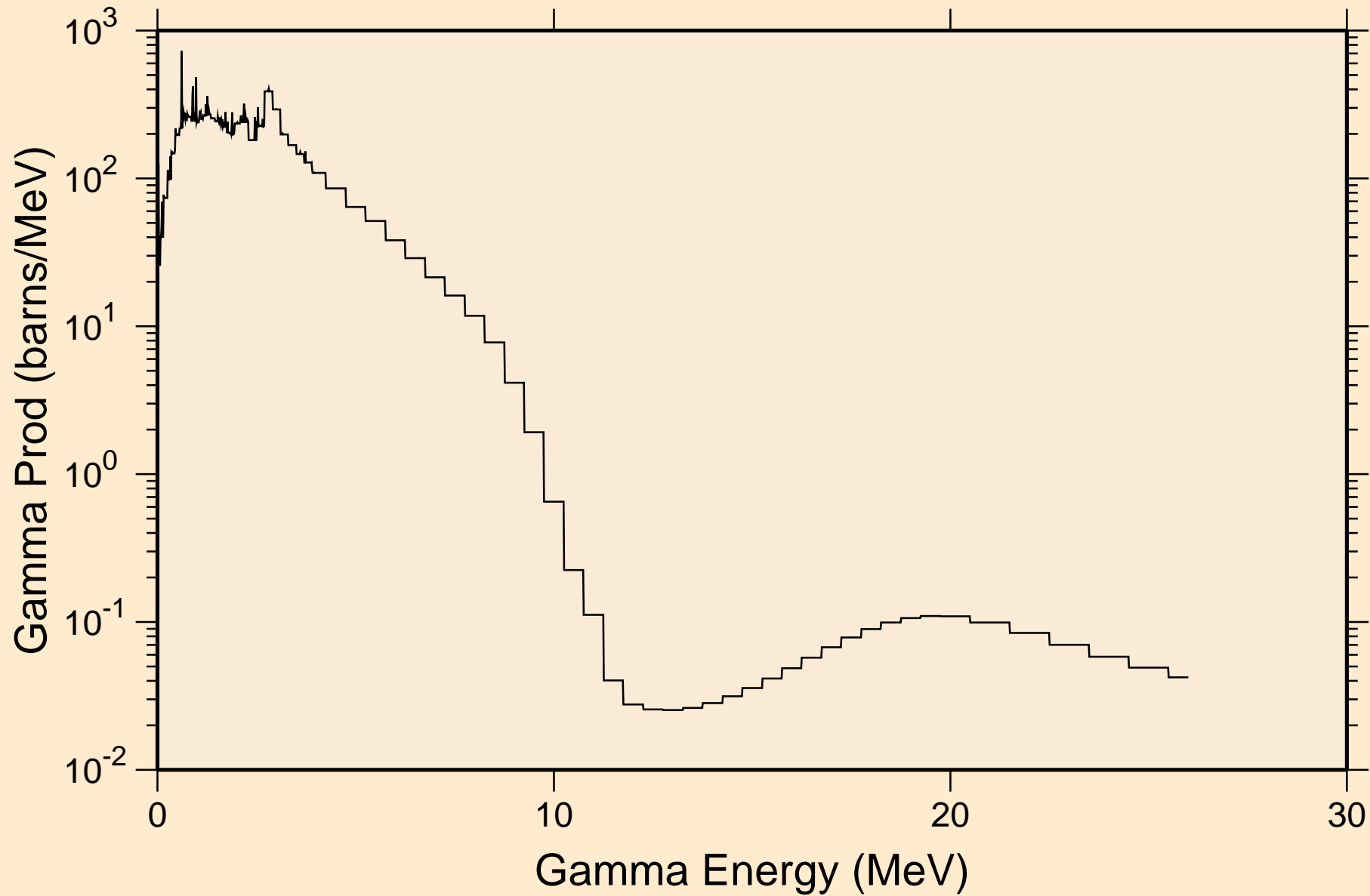

SC042M NEUTRON ACER TENDL-2021 LIBRARY; T=293.6K

Particle heating contributions

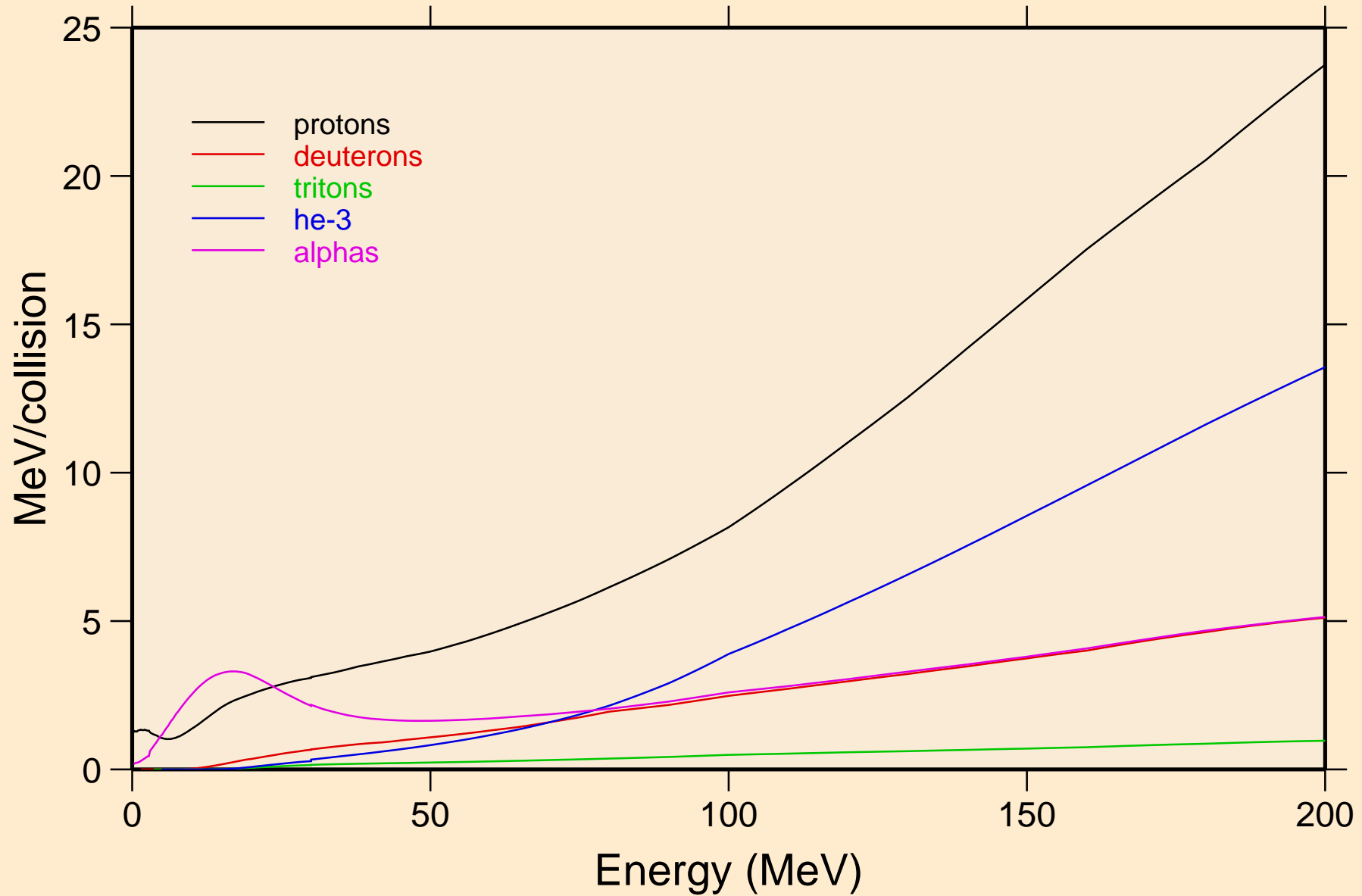

SC042M NEUTRON ACER TENDL-2021 LIBRARY; T=293.6K Recoil Heating

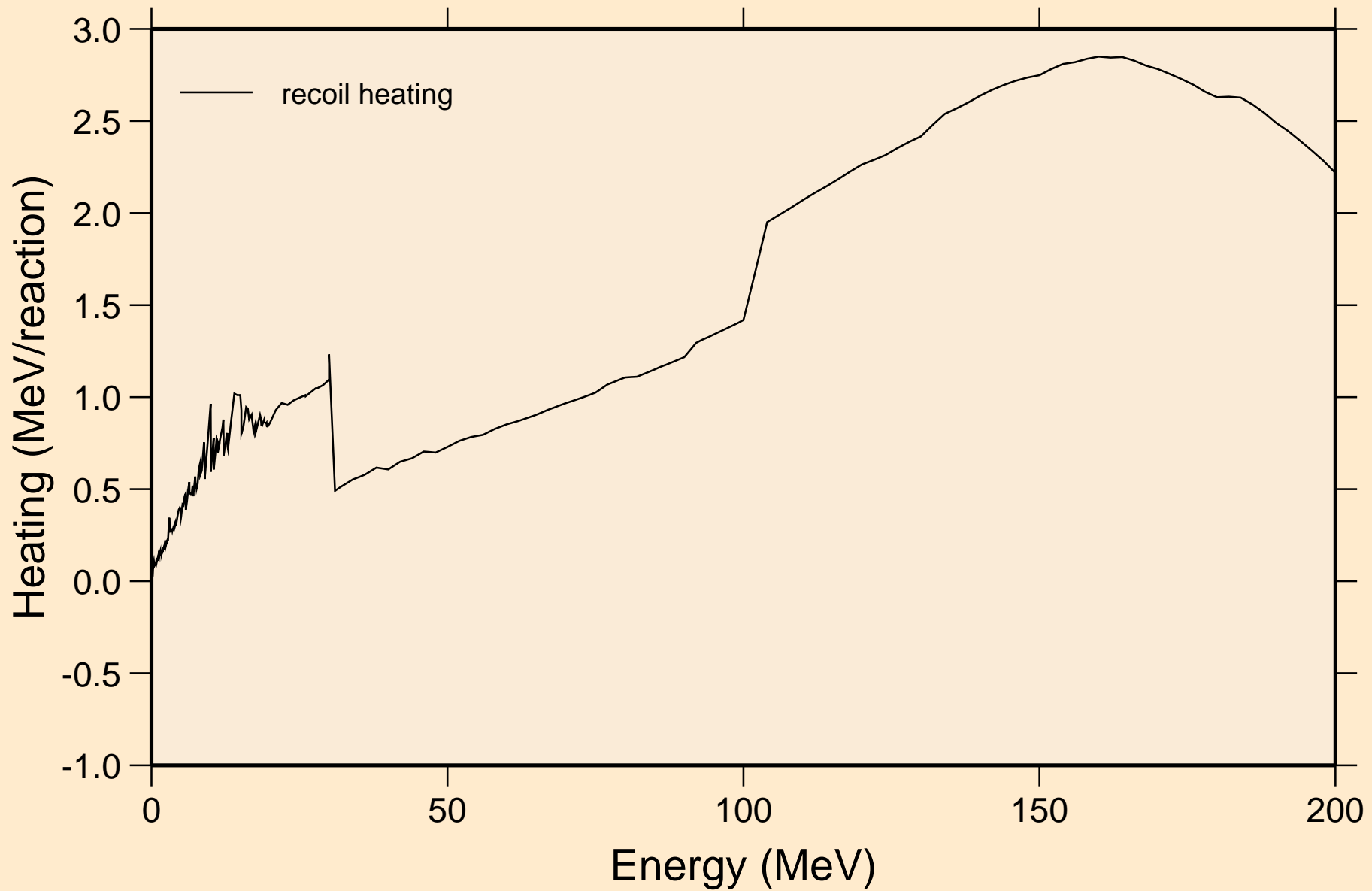

SC042M NEUTRON ACER TENDL-2021 LIBRARY; T=293.6K
Particle production cross sections

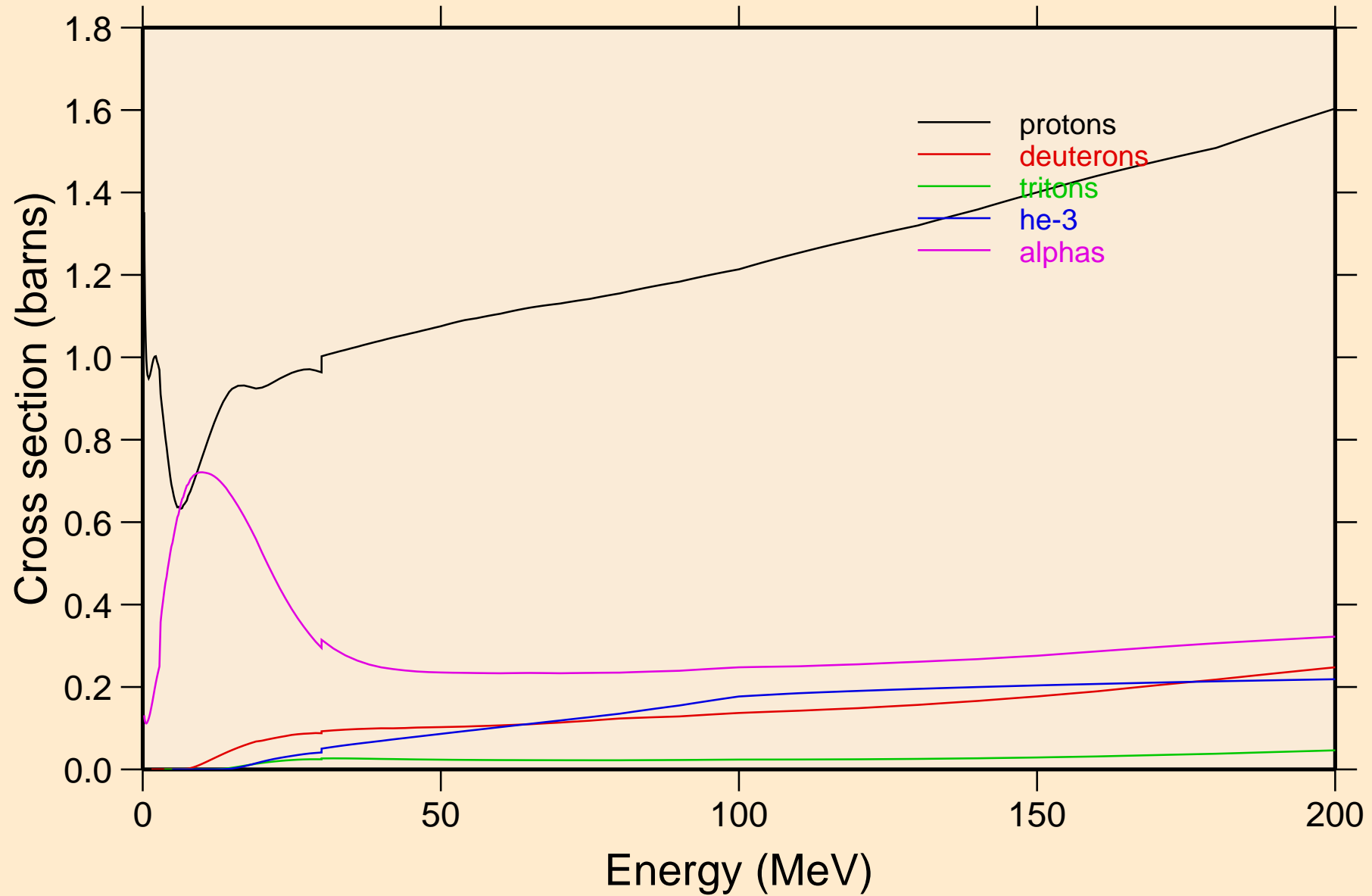

SC042M NEUTRON ACER TENDL-2021 LIBRARY; T=293.6K
protons from (n,x)

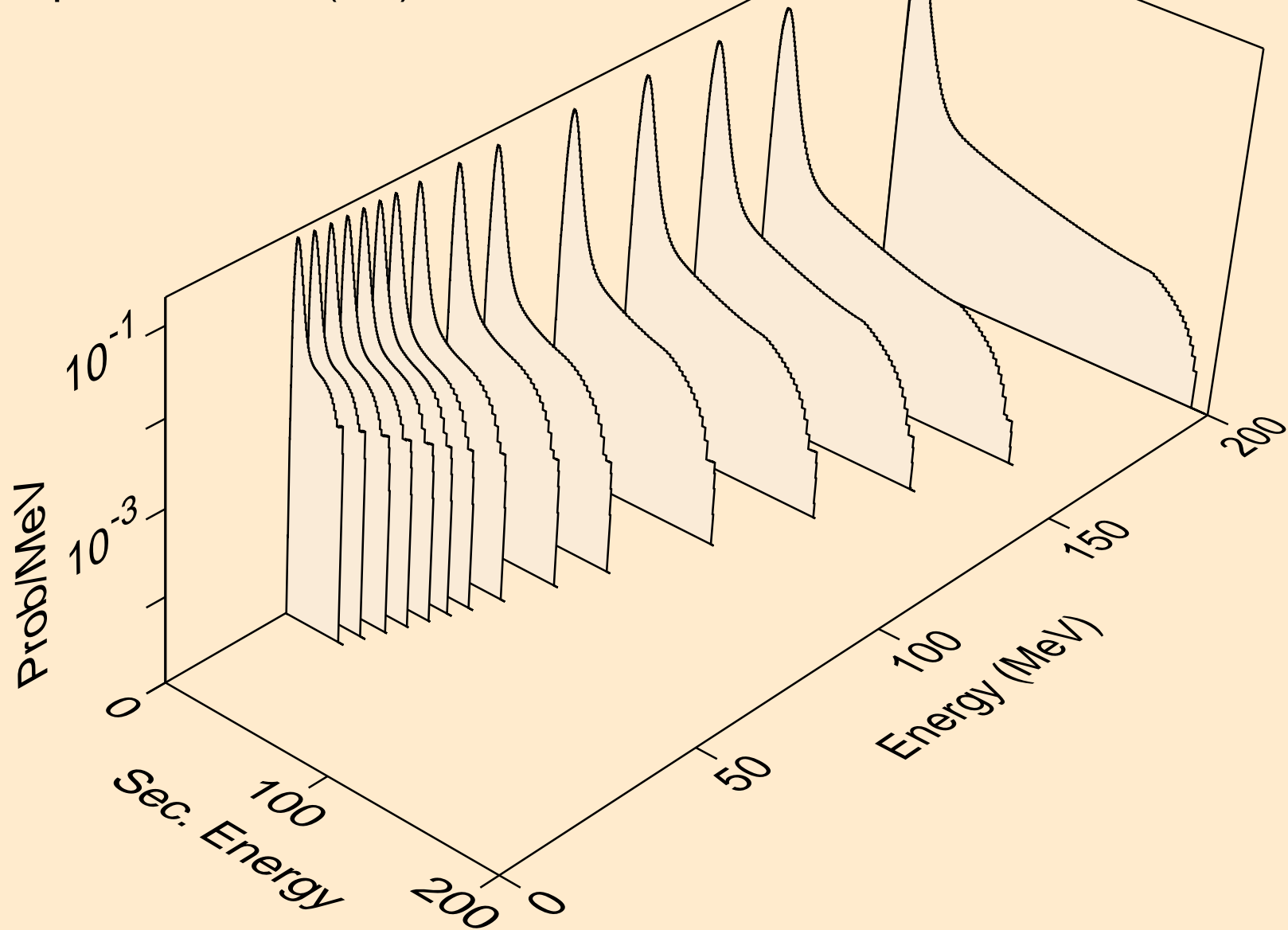

SC042M NEUTRON ACER TENDL-2021 LIBRARY; T=293.6K
protons from (n,n*)p

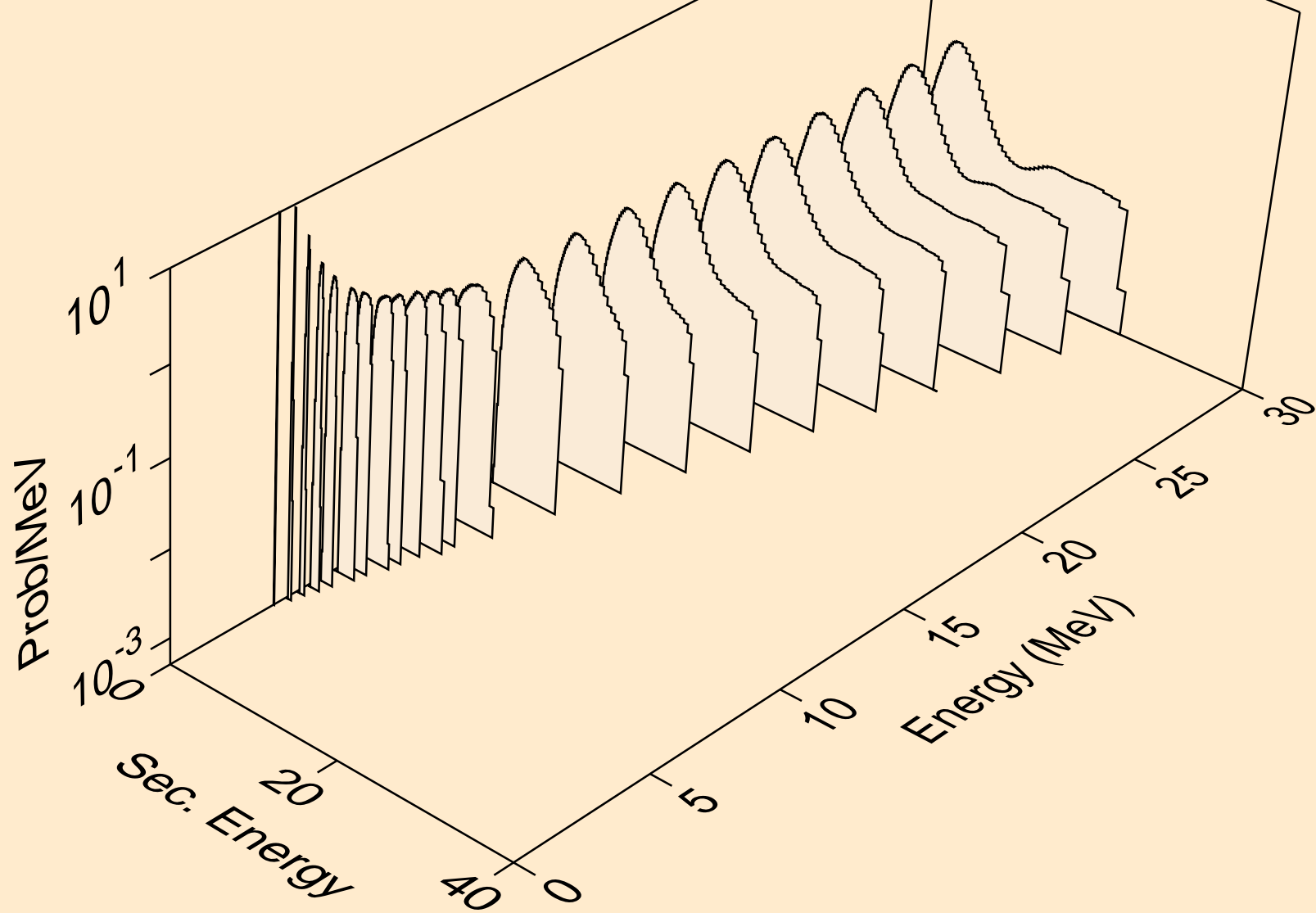

SC042M NEUTRON ACER TENDL-2021 LIBRARY; T=293.6K
protons from (n,2np)

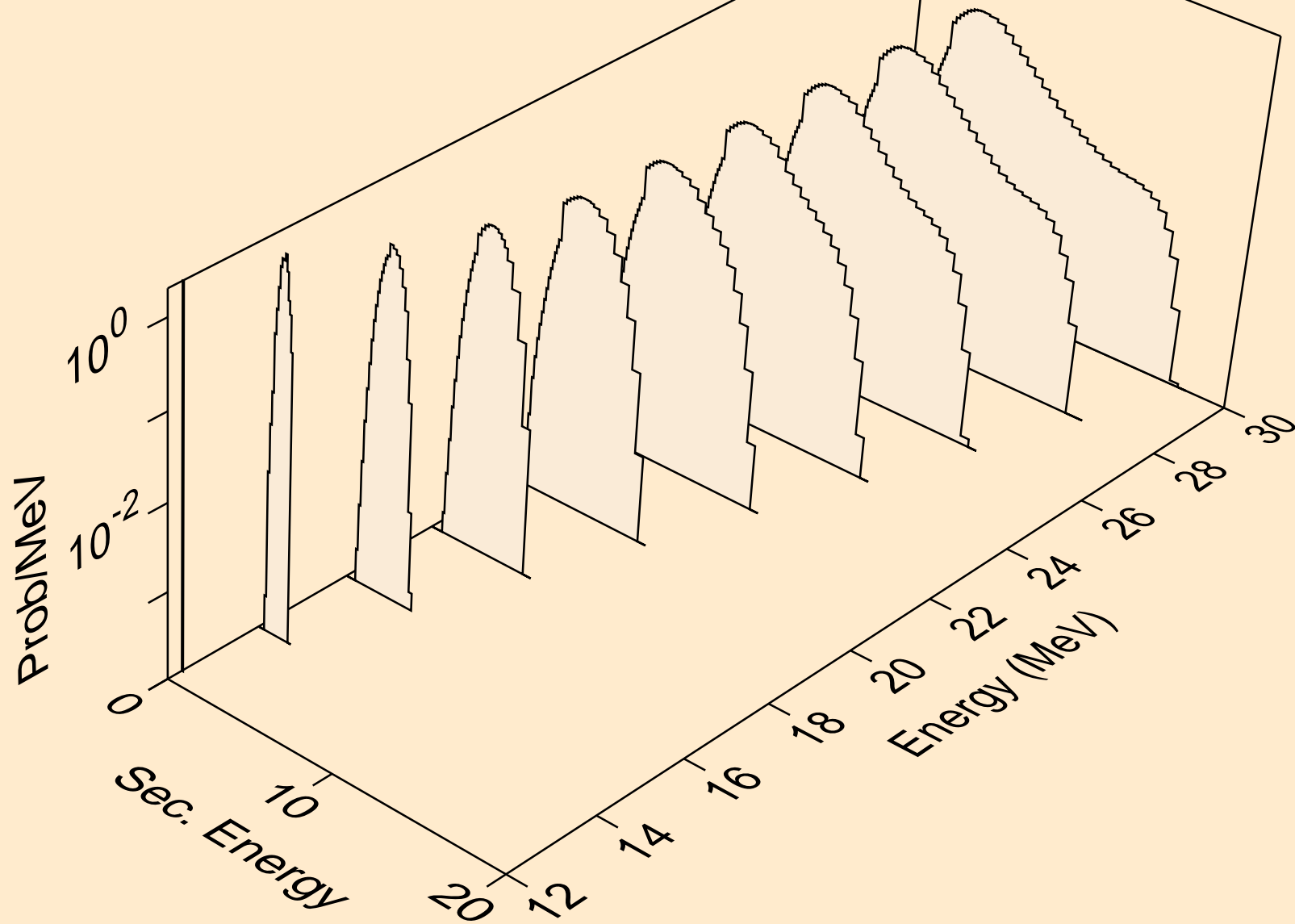

SC042M NEUTRON ACER TENDL-2021 LIBRARY; T=293.6K
protons from (n,2np)

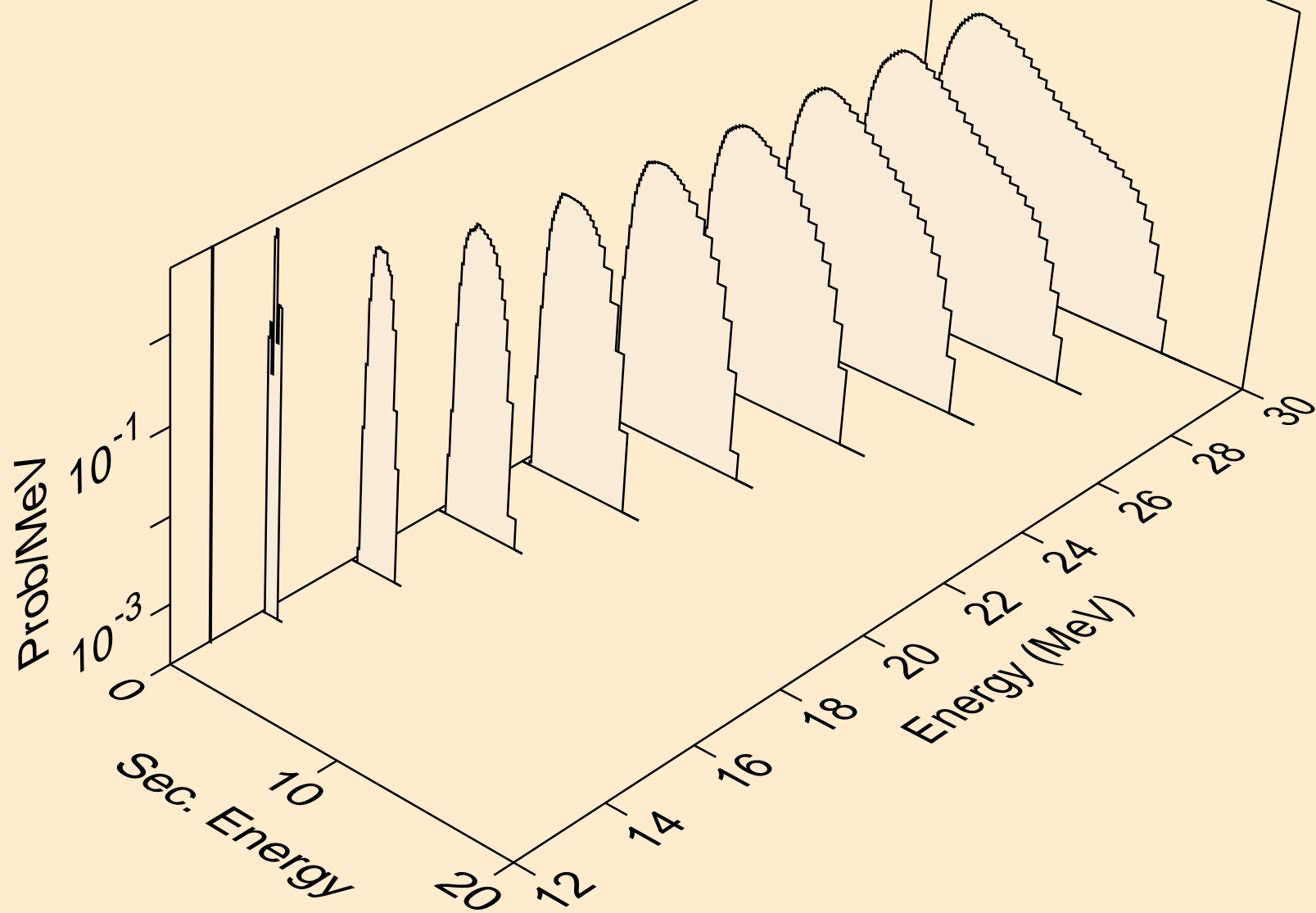

SC042M NEUTRON ACER TENDL-2021 LIBRARY; T=293.6K
protons from (n,npa)

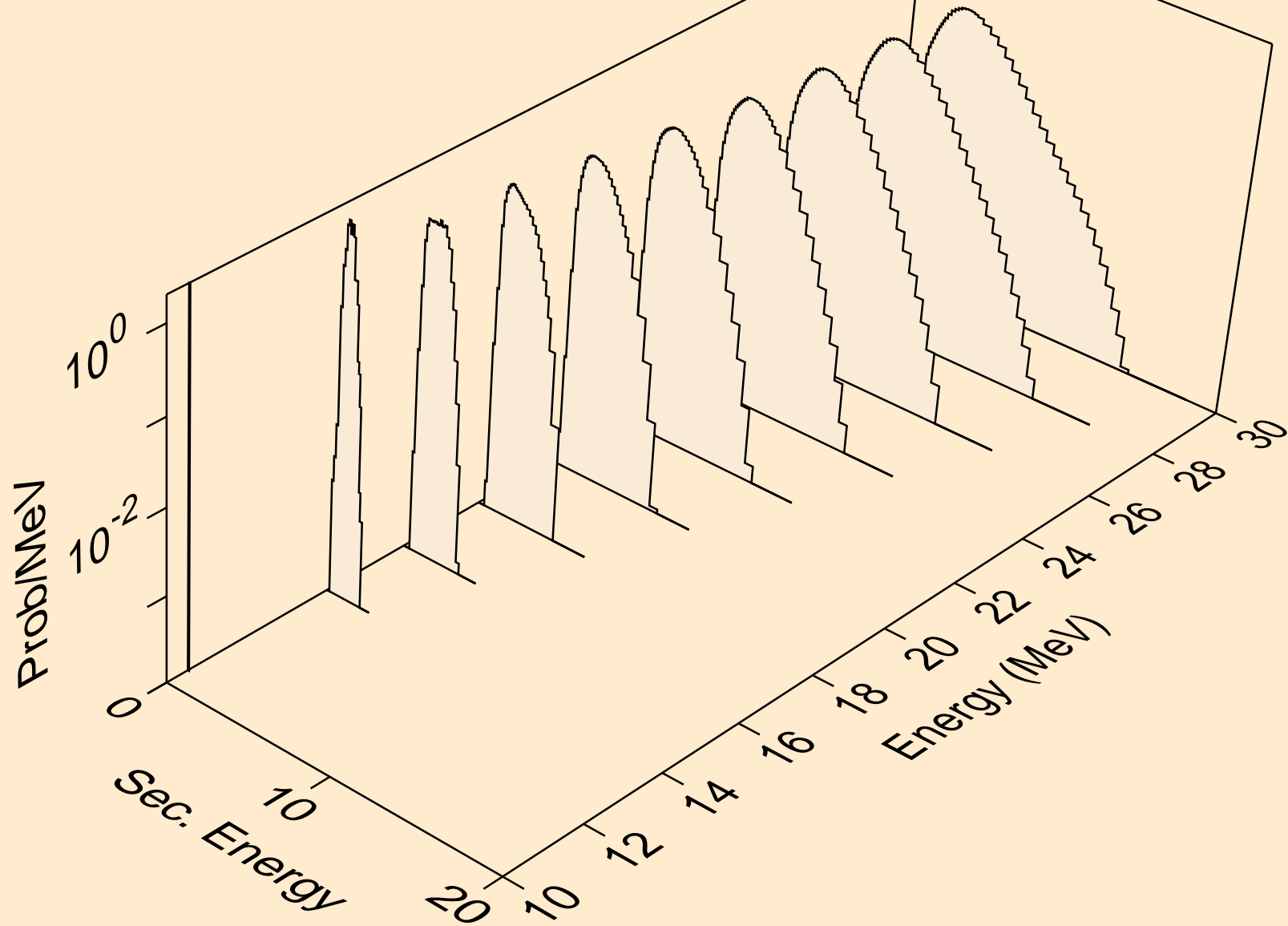

SC042M NEUTRON ACER TENDL-2021 LIBRARY; T=293.6K
protons from (n,p)

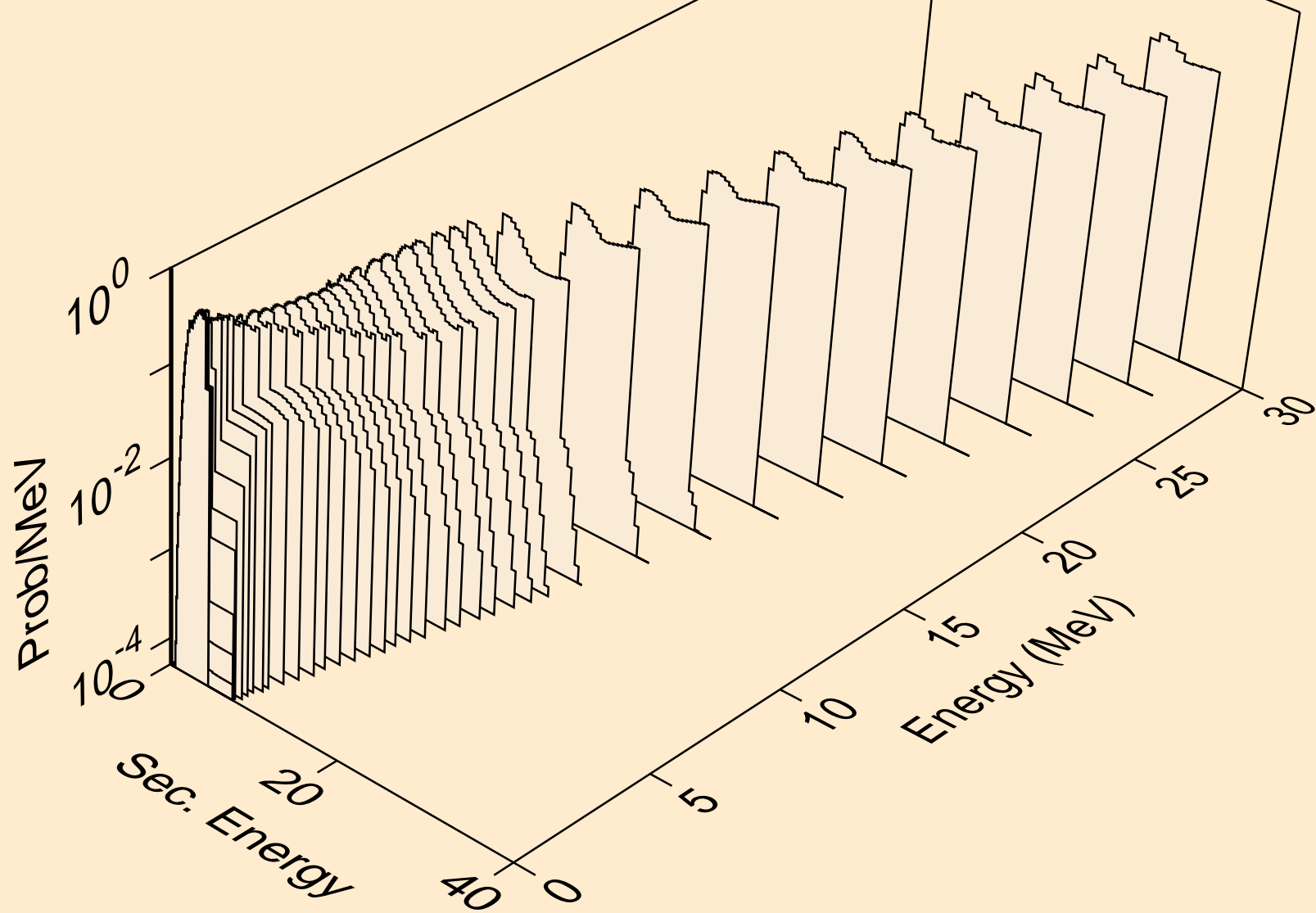

SC042M NEUTRON ACER TENDL-2021 LIBRARY; T=293.6K
protons from (n,2p)

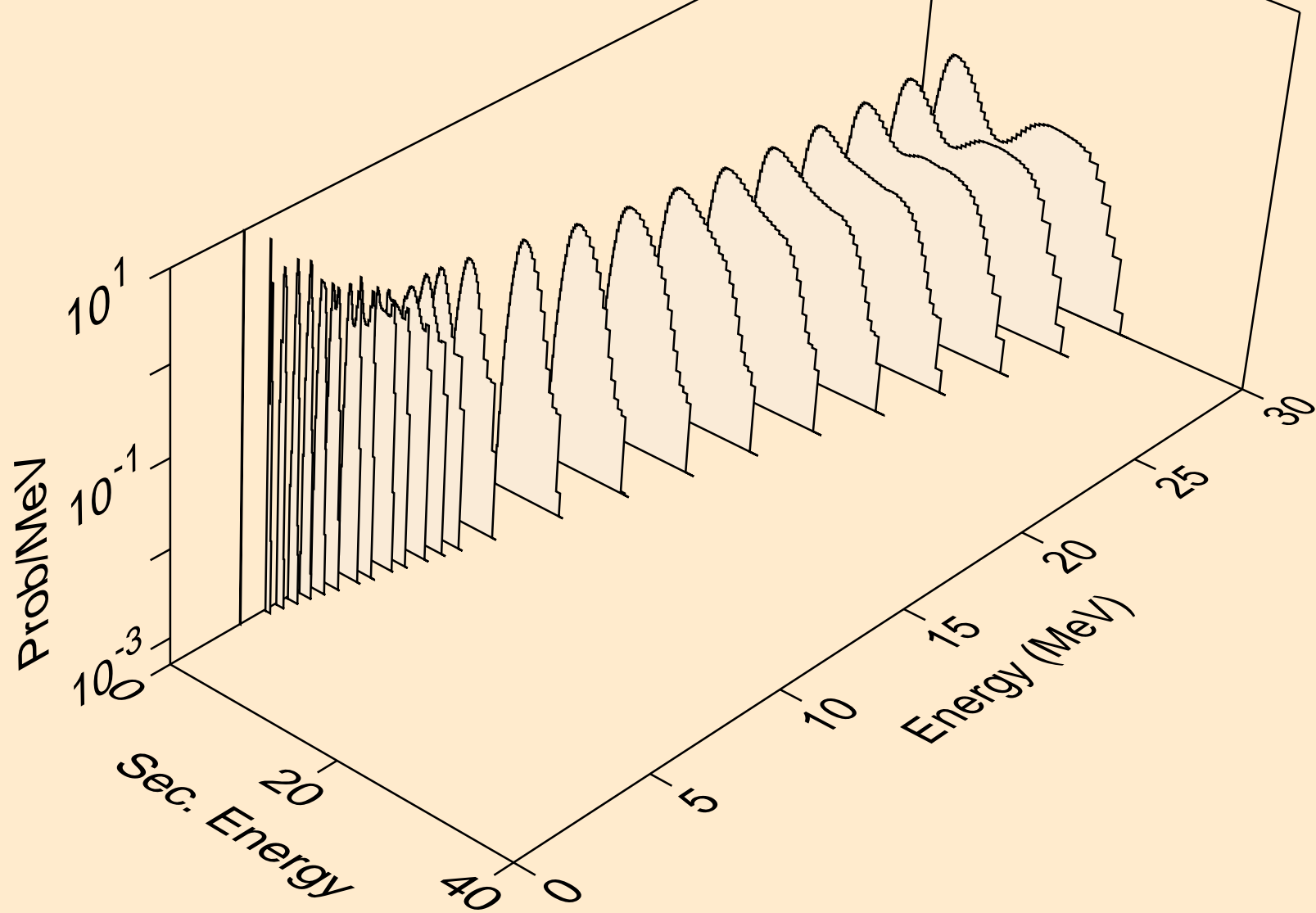

SC042M NEUTRON ACER TENDL-2021 LIBRARY; T=293.6K
protons from (n,p)

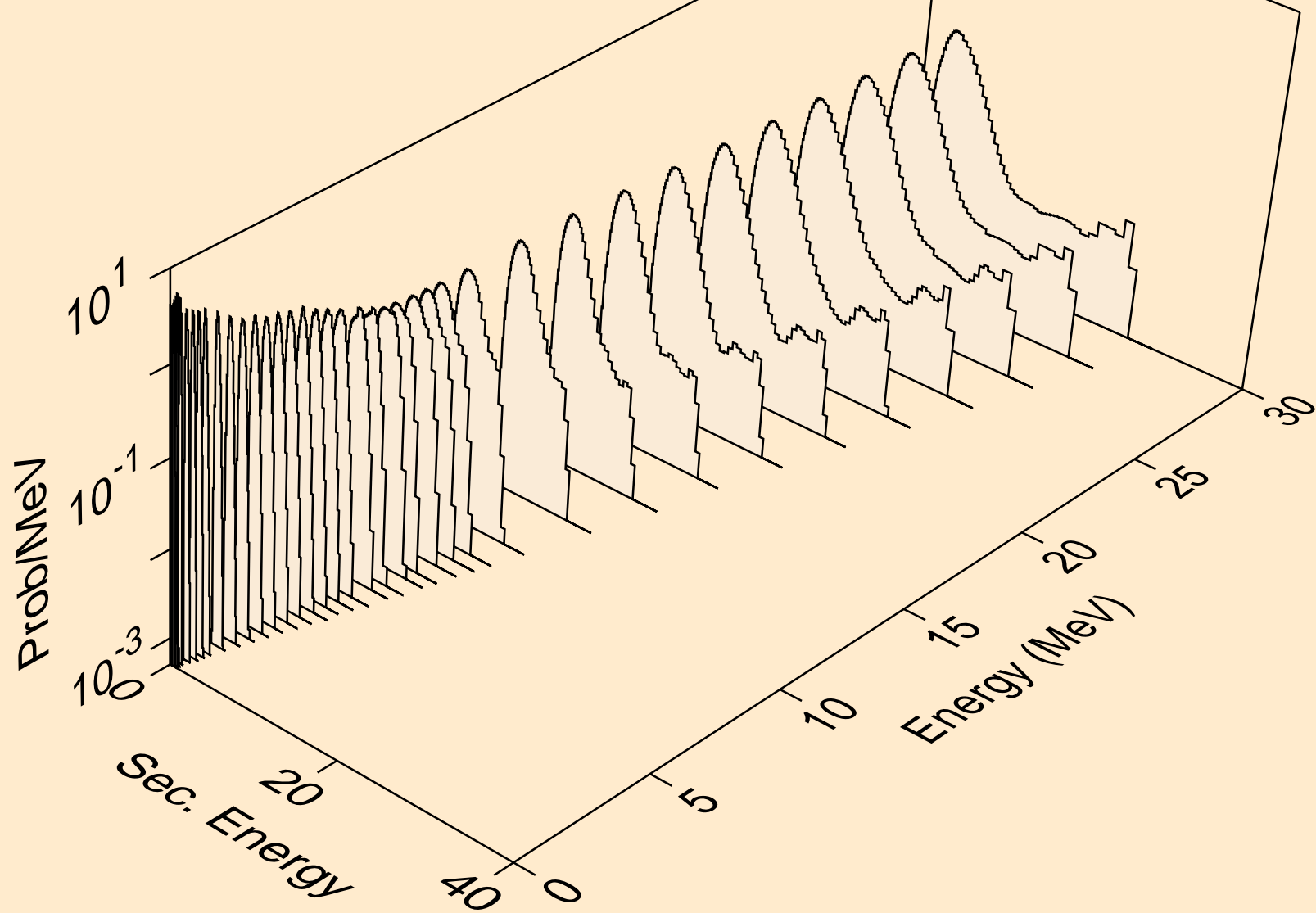

SC042M NEUTRON ACER TENDL-2021 LIBRARY; T=293.6K
protons from (n,pd)

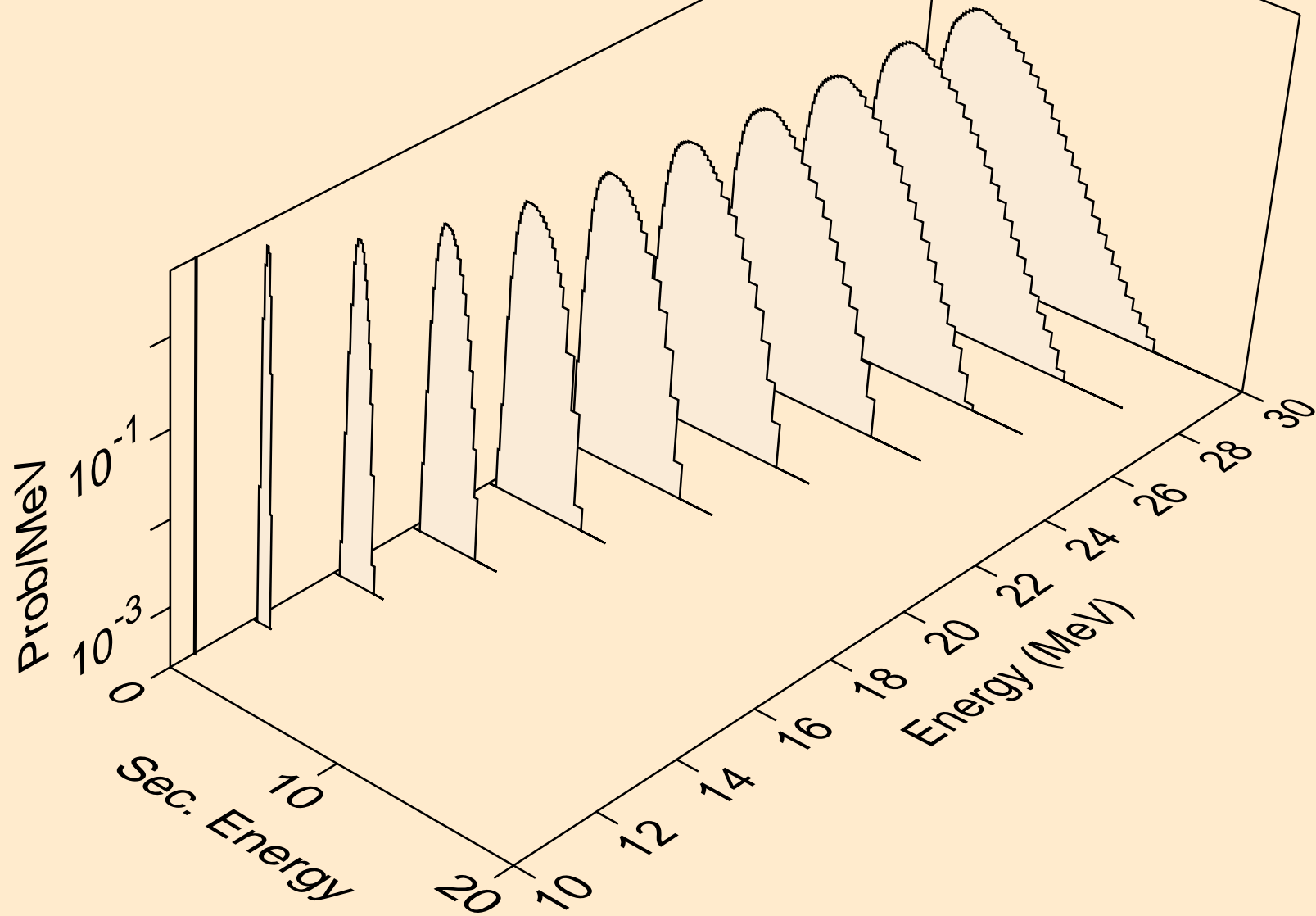

SC042M NEUTRON ACER TENDL-2021 LIBRARY; T=293.6K
protons from (n,pt)

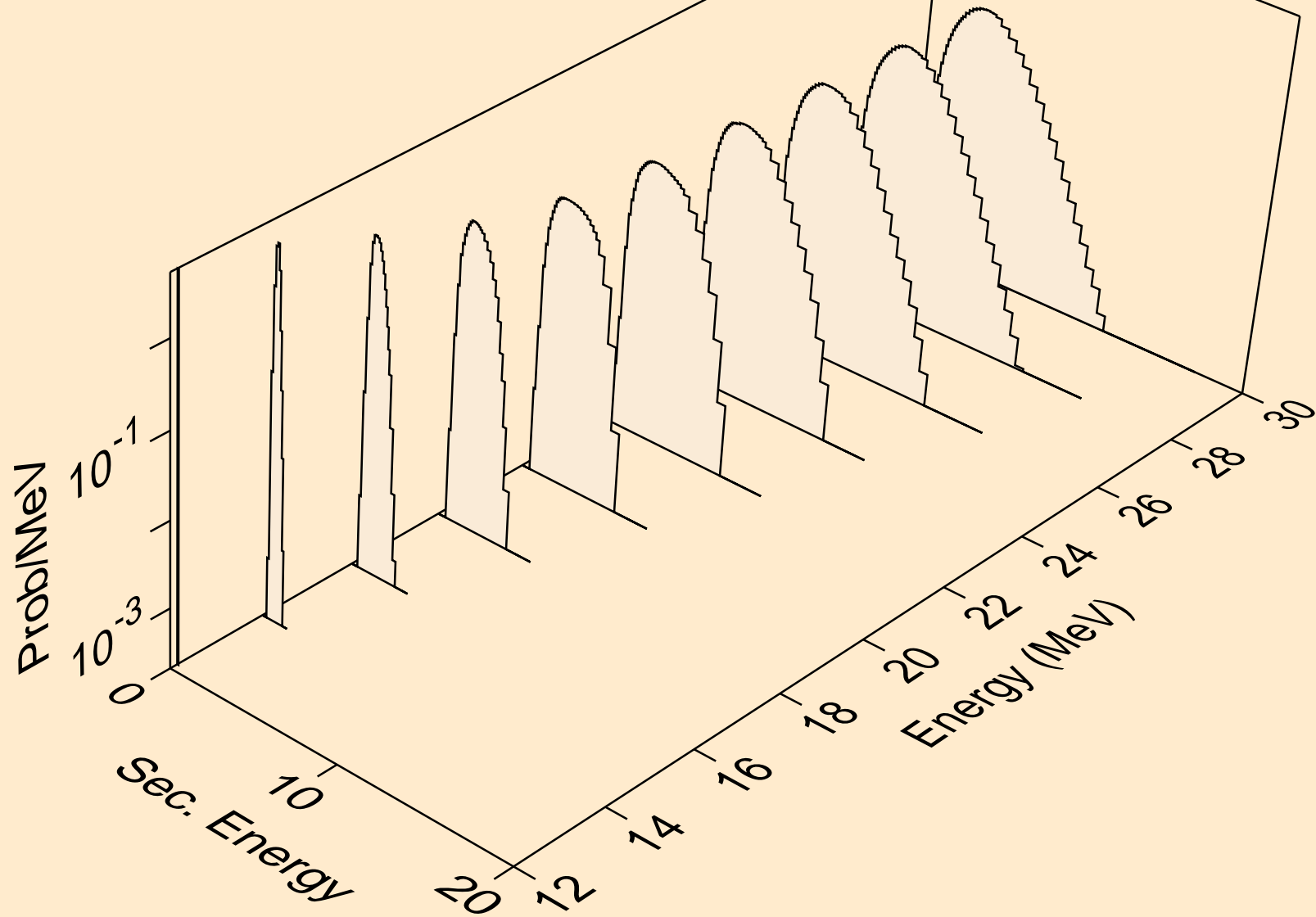

SC042M NEUTRON ACER TENDL-2021 LIBRARY; T=293.6K
deuterons from (n,x)

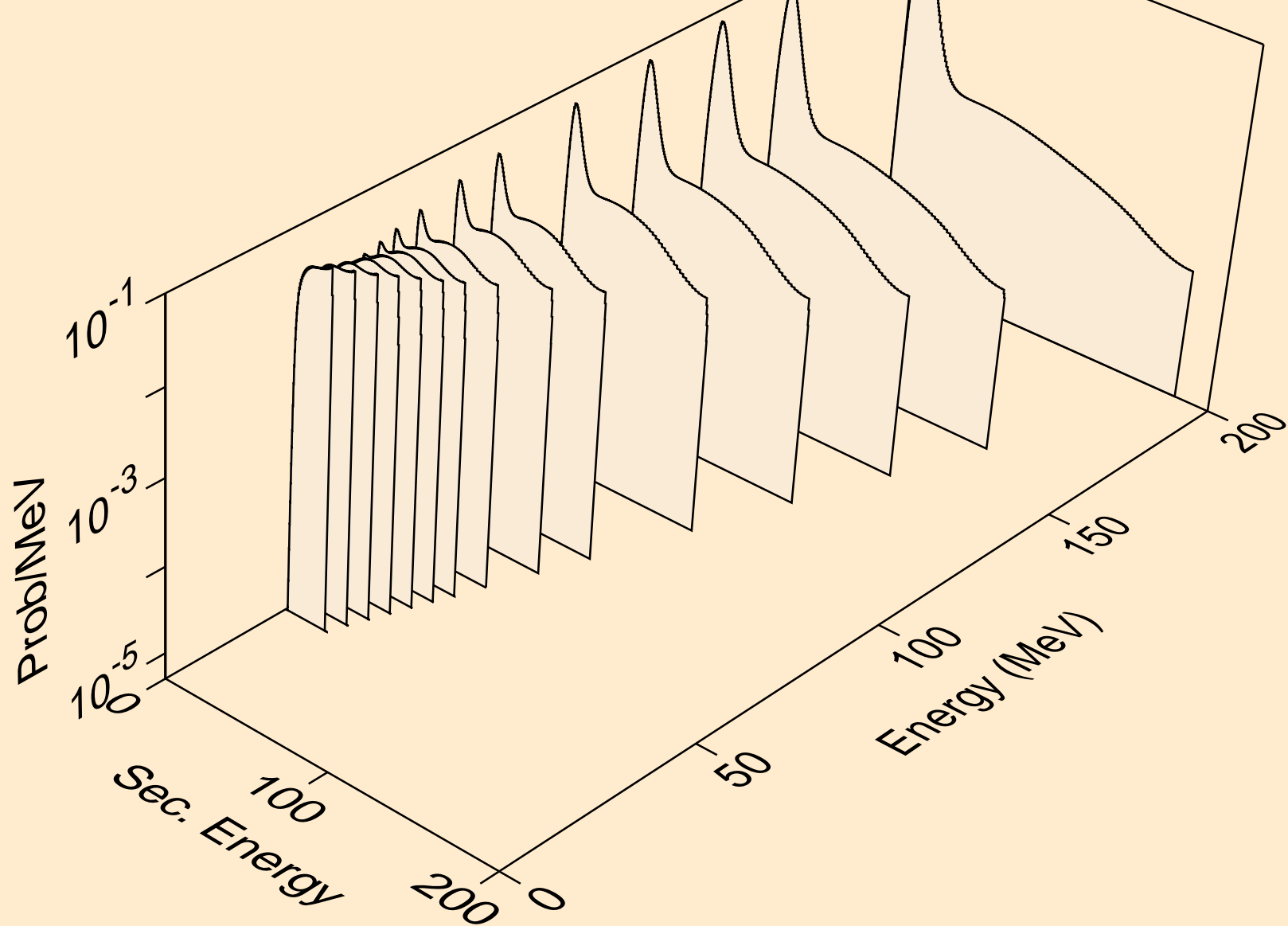

SC042M NEUTRON ACER TENDL-2021 LIBRARY; T=293.6K
deuterons from (n,2nd)

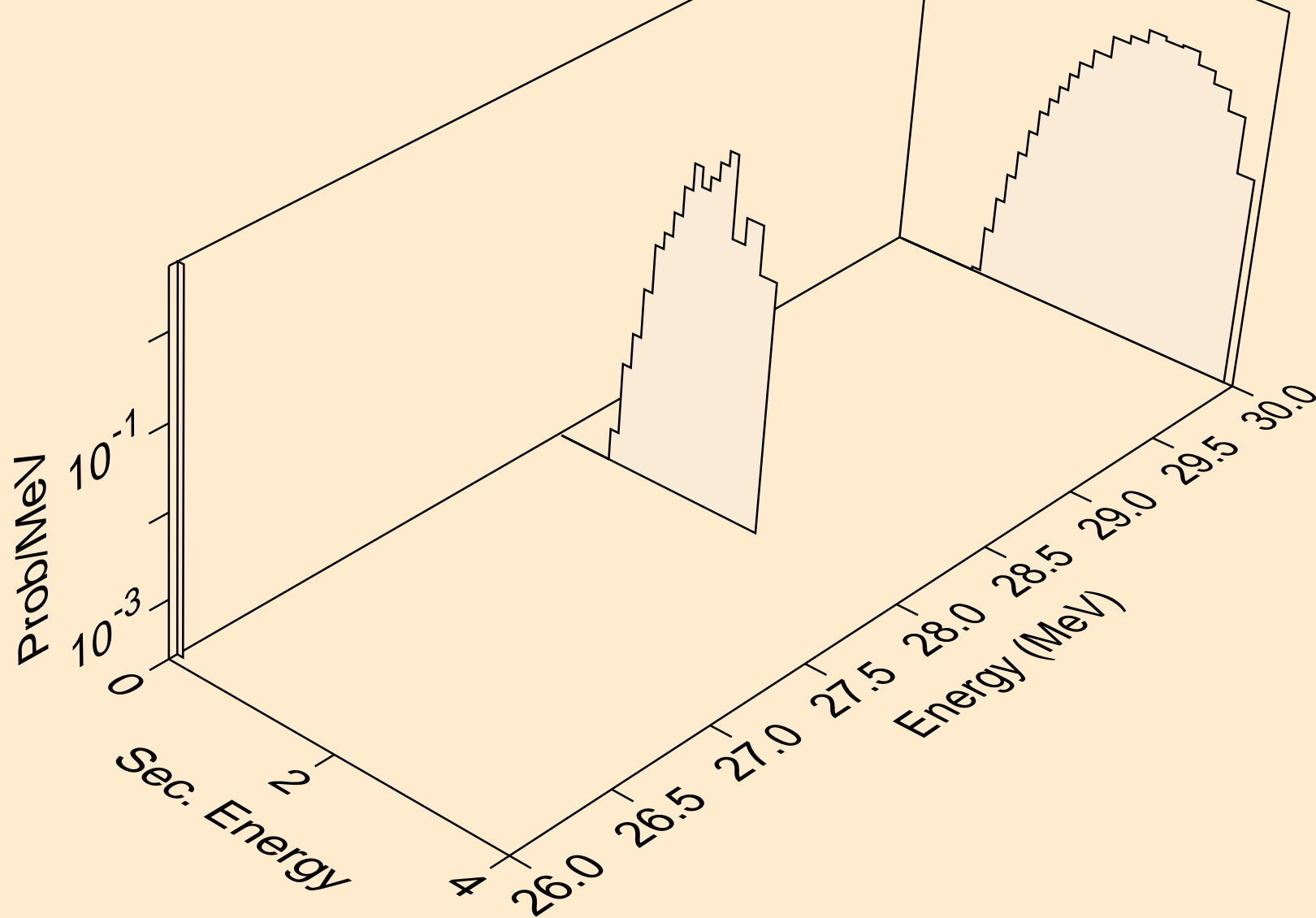

SC042M NEUTRON ACER TENDL-2021 LIBRARY; T=293.6K
deuterons from (n,n*)d

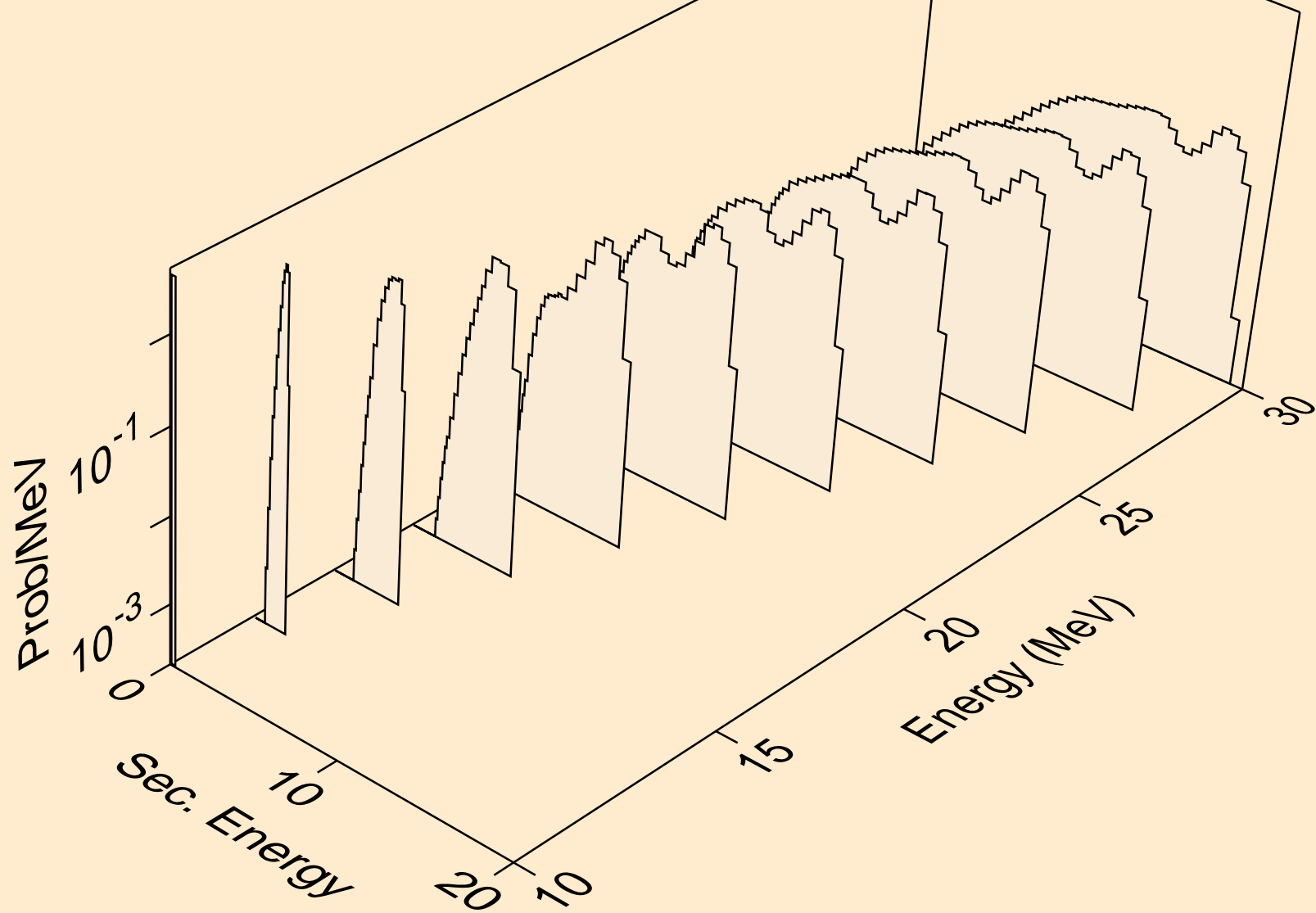

SC042M NEUTRON ACER TENDL-2021 LIBRARY; T=293.6K
deuterons from (n,d)

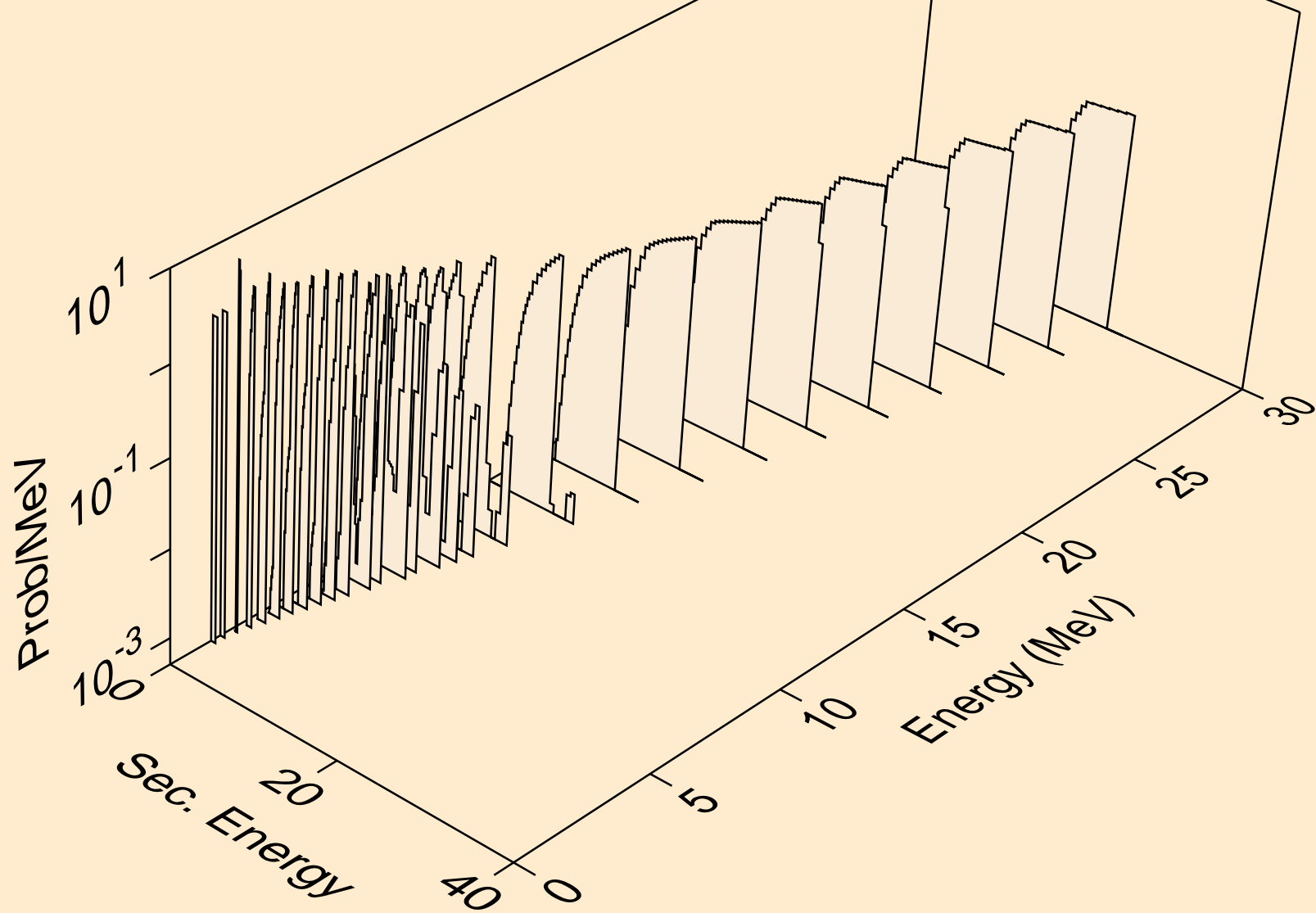

SC042M NEUTRON ACER TENDL-2021 LIBRARY; T=293.6K
deuterons from (n,d2a)

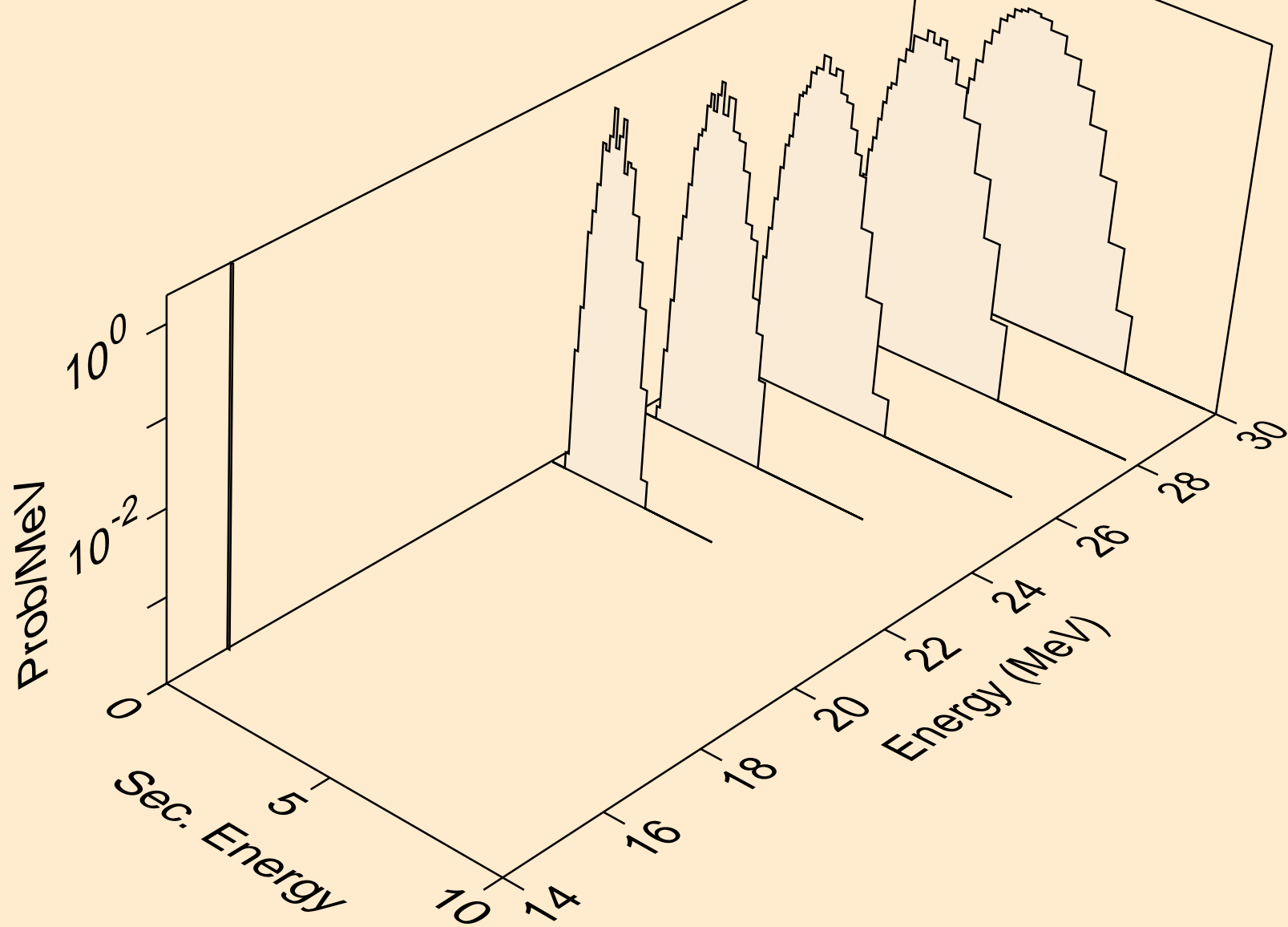

SC042M NEUTRON ACER TENDL-2021 LIBRARY; T=293.6K
deuterons from (n,pd)

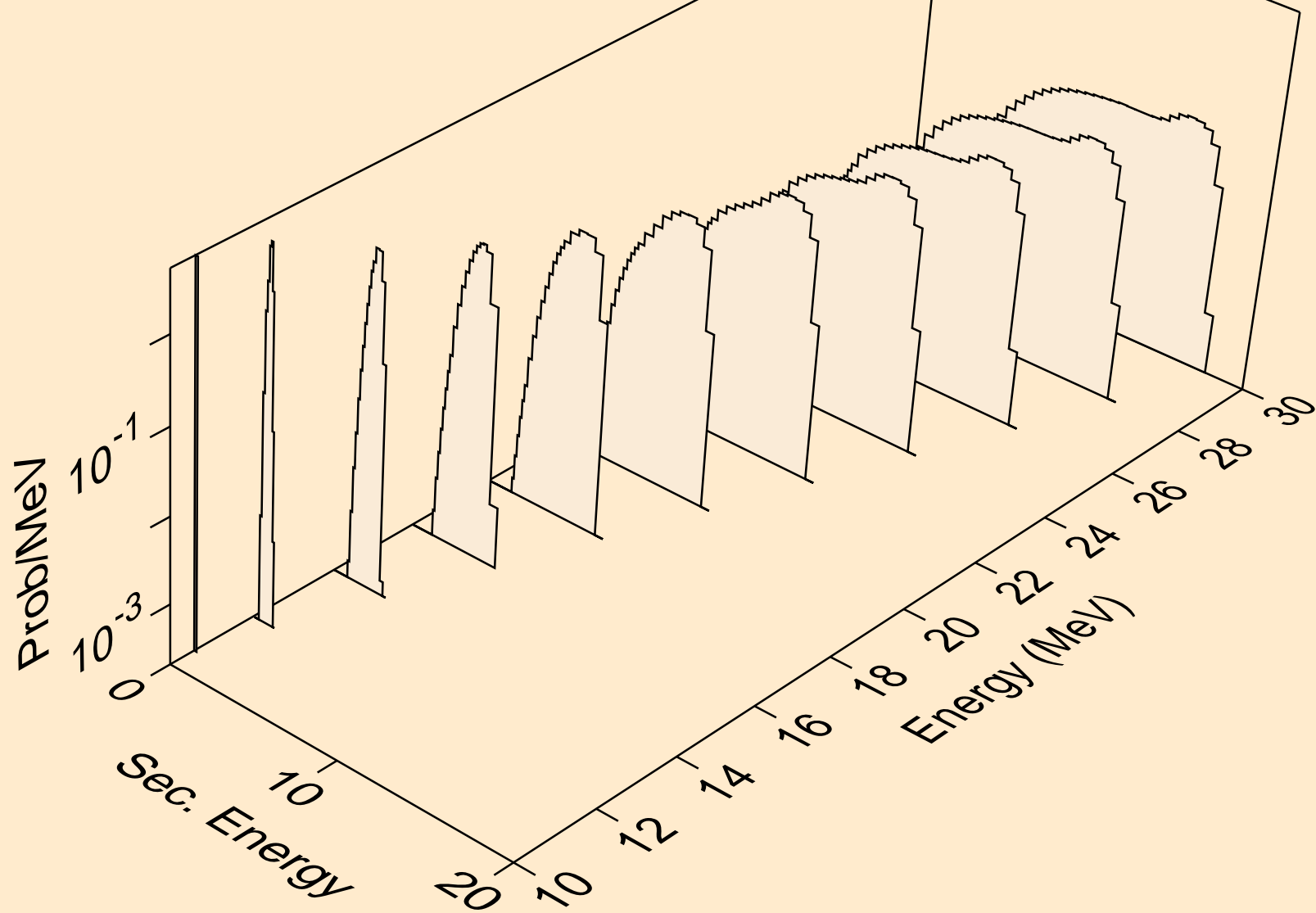

SC042M NEUTRON ACER TENDL-2021 LIBRARY; T=293.6K
deuterons from (n,da)

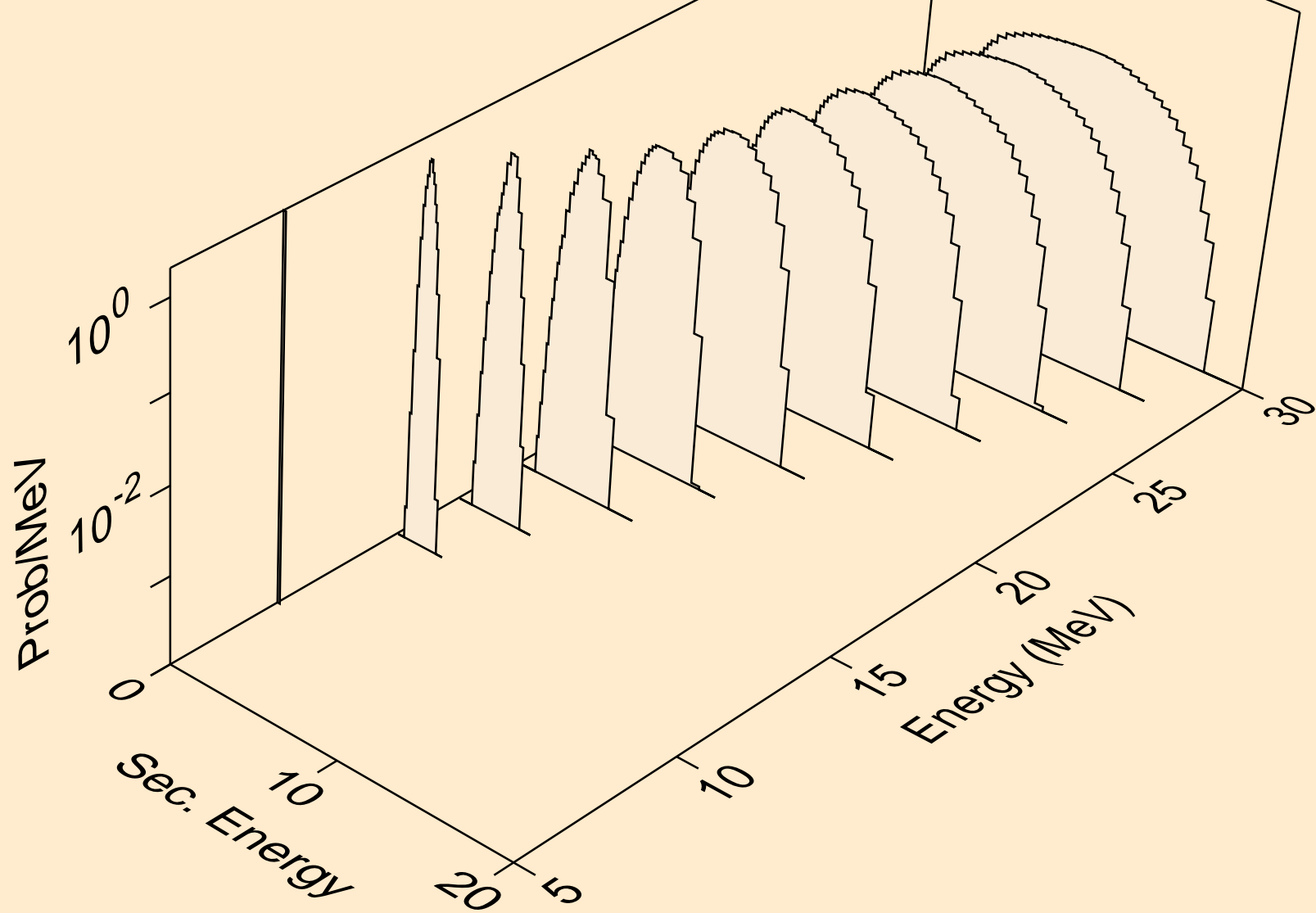

SC042M NEUTRON ACER TENDL-2021 LIBRARY; T=293.6K
tritons from (n,x)

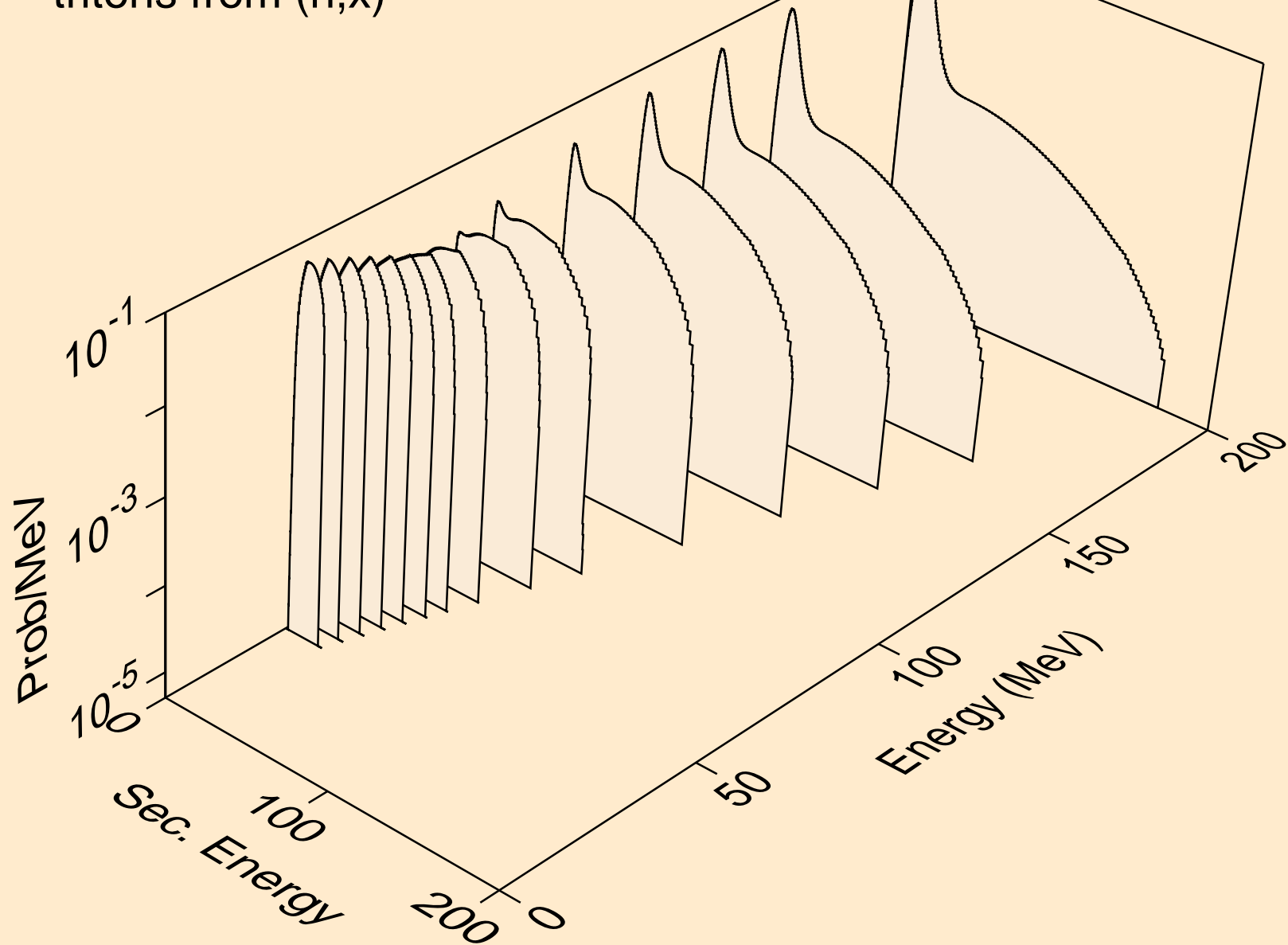

SC042M NEUTRON ACER TENDL-2021 LIBRARY; T=293.6K
tritons from (n,n*)t

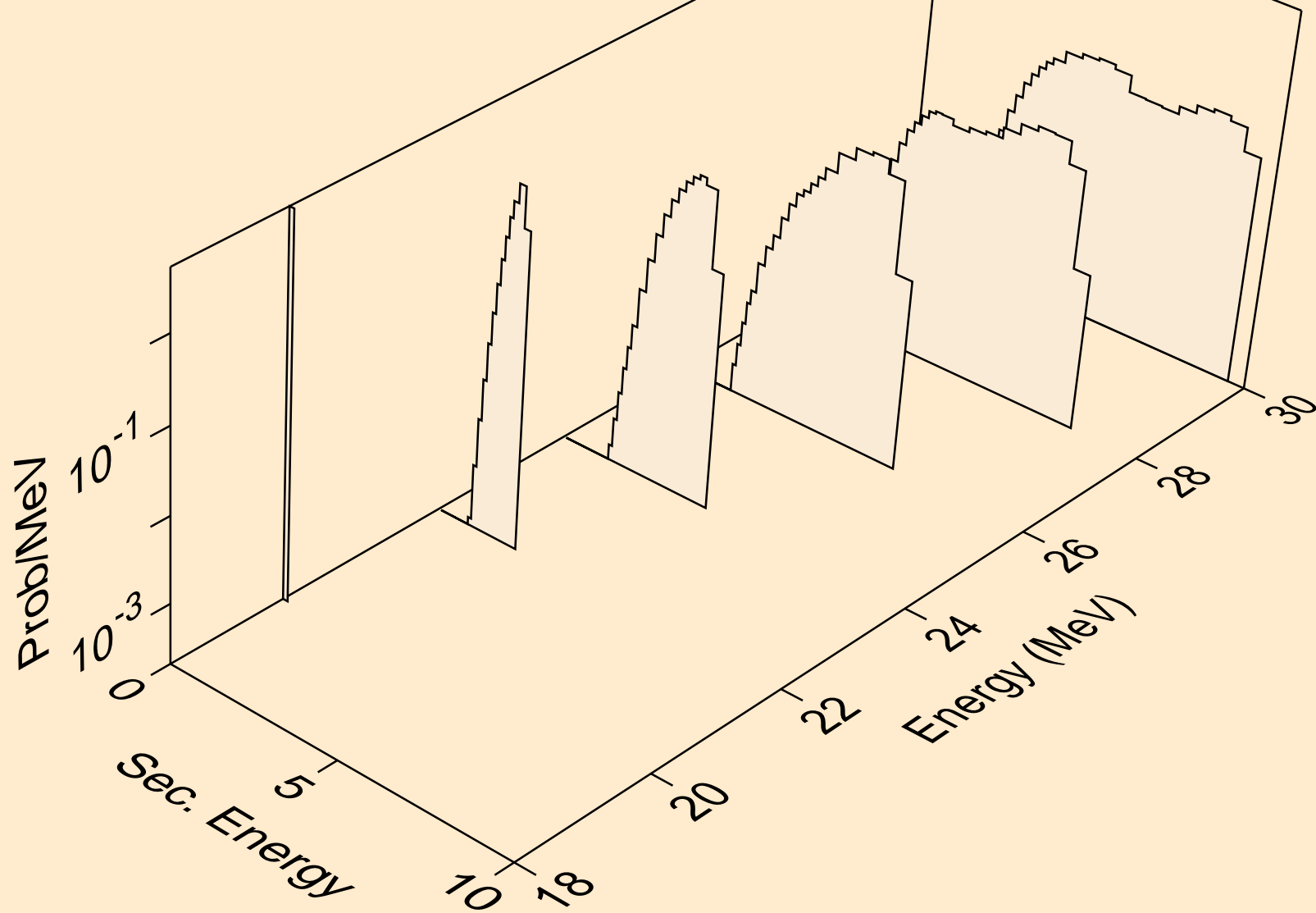

SC042M NEUTRON ACER TENDL-2021 LIBRARY; T=293.6K
tritons from (n,t)

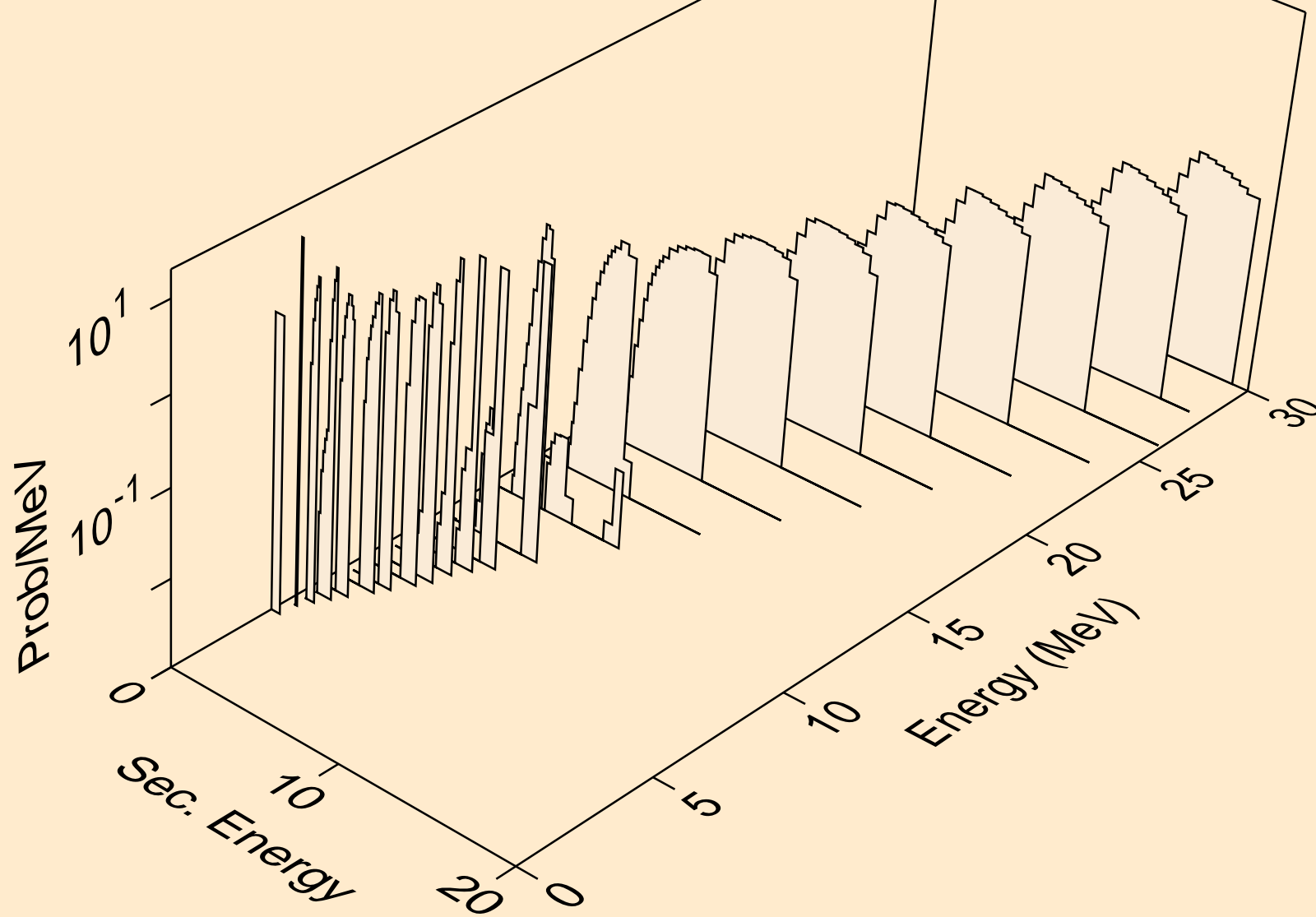

SC042M NEUTRON ACER TENDL-2021 LIBRARY; T=293.6K
tritons from (n,t2a)

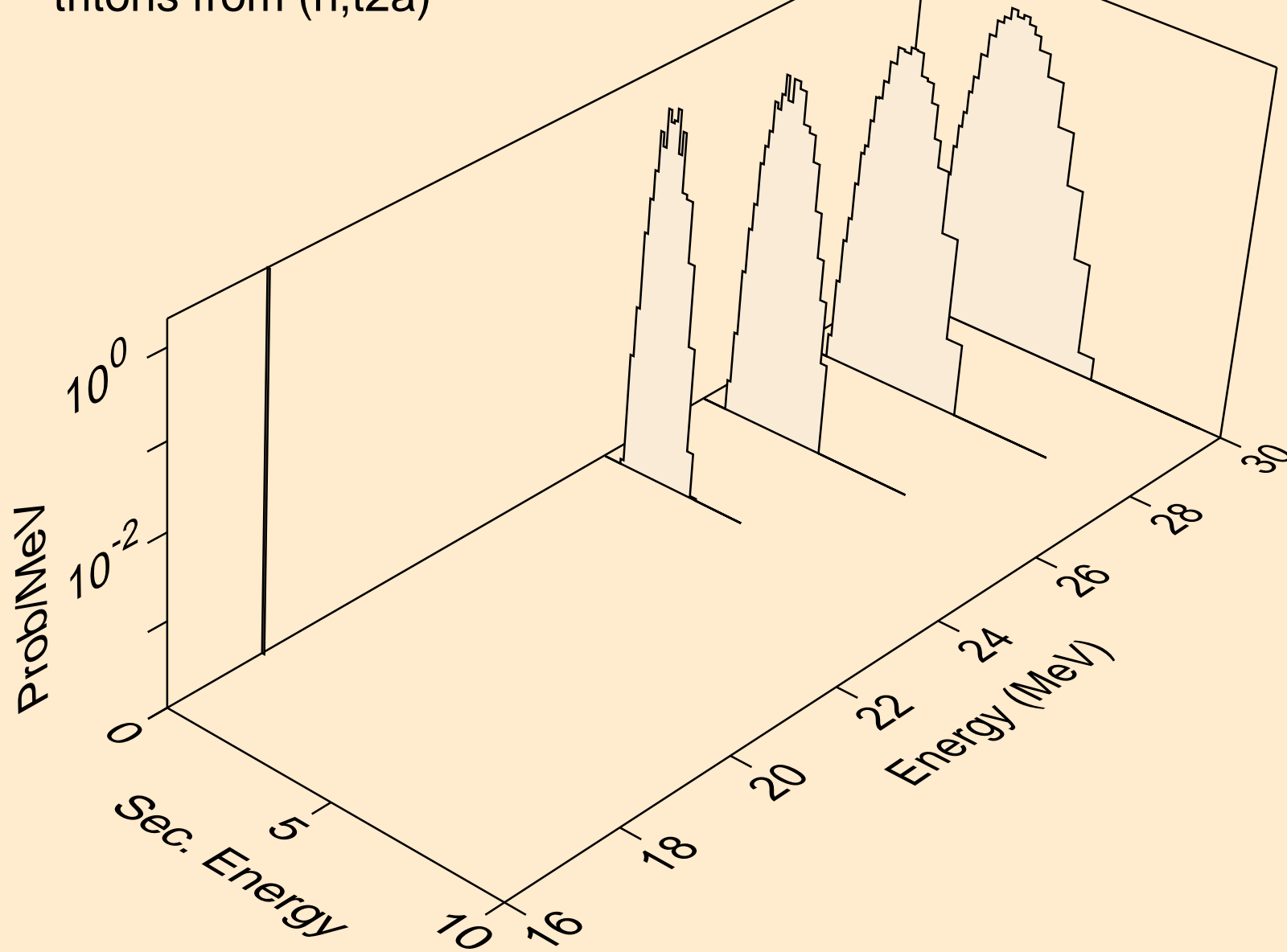

SC042M NEUTRON ACER TENDL-2021 LIBRARY; T=293.6K
tritons from (n,pt)

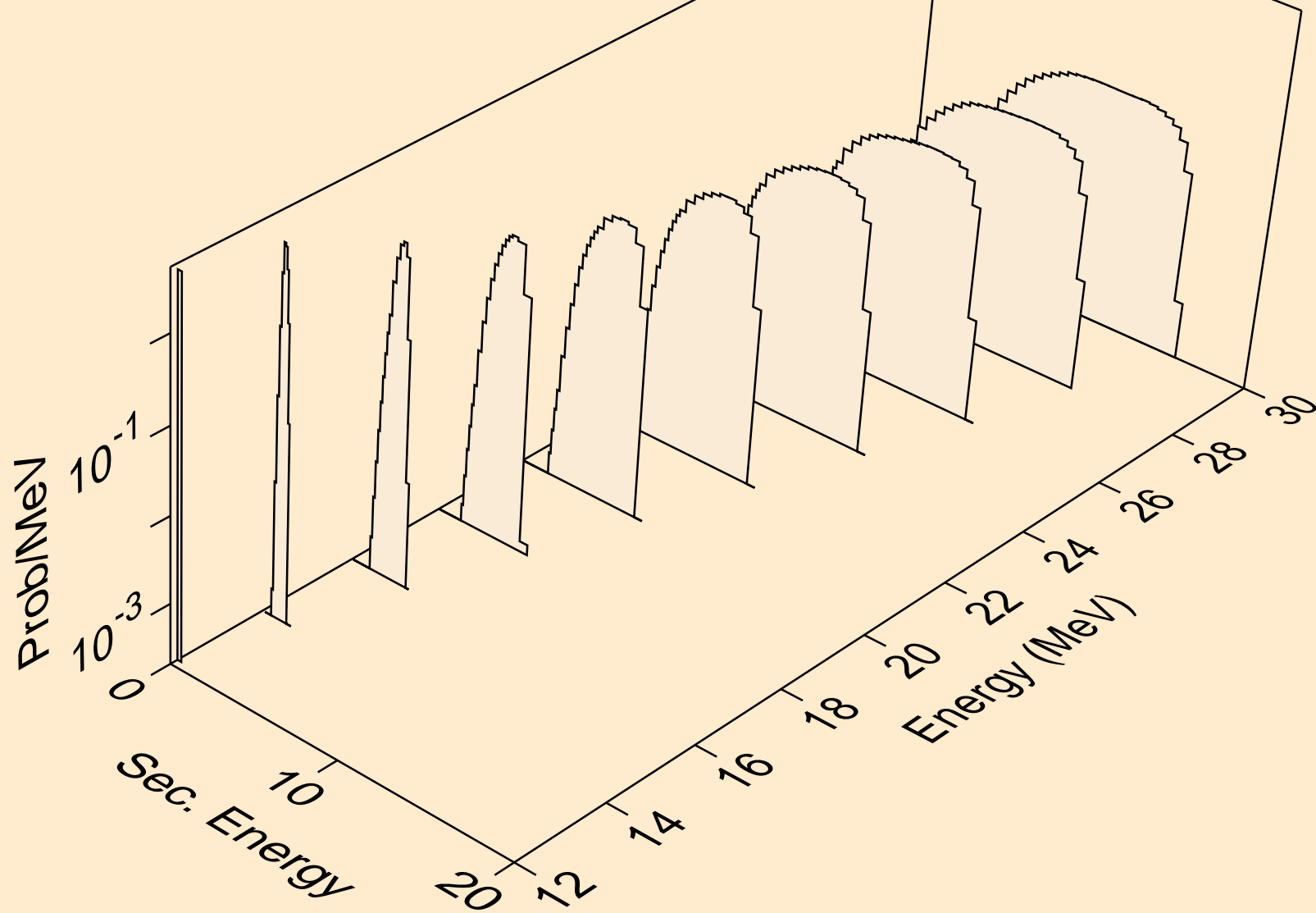

SC042M NEUTRON ACER TENDL-2021 LIBRARY; T=293.6K
he3s from (n,x)

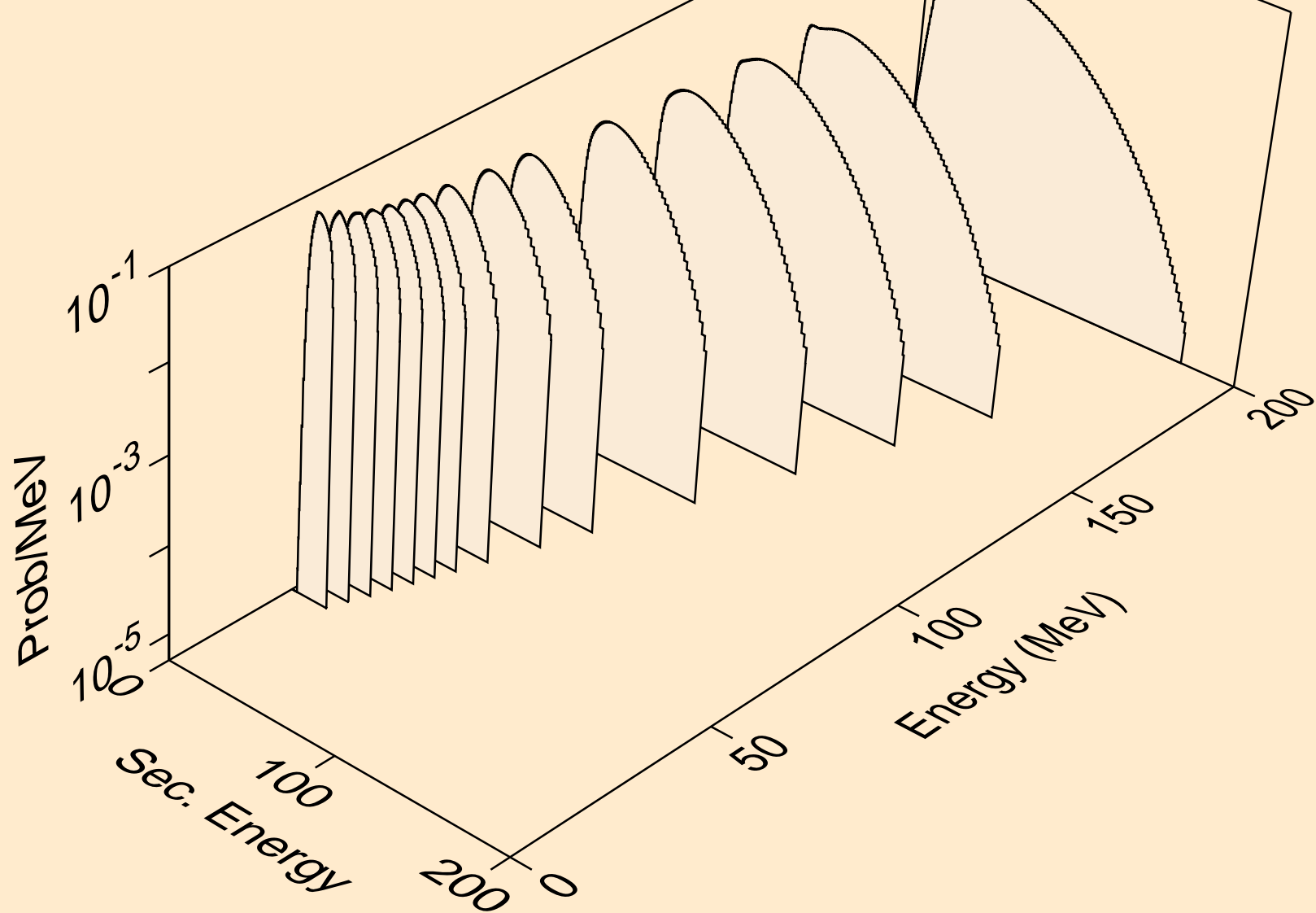

SC042M NEUTRON ACER TENDL-2021 LIBRARY; T=293.6K
he3s from (n,n*)he3

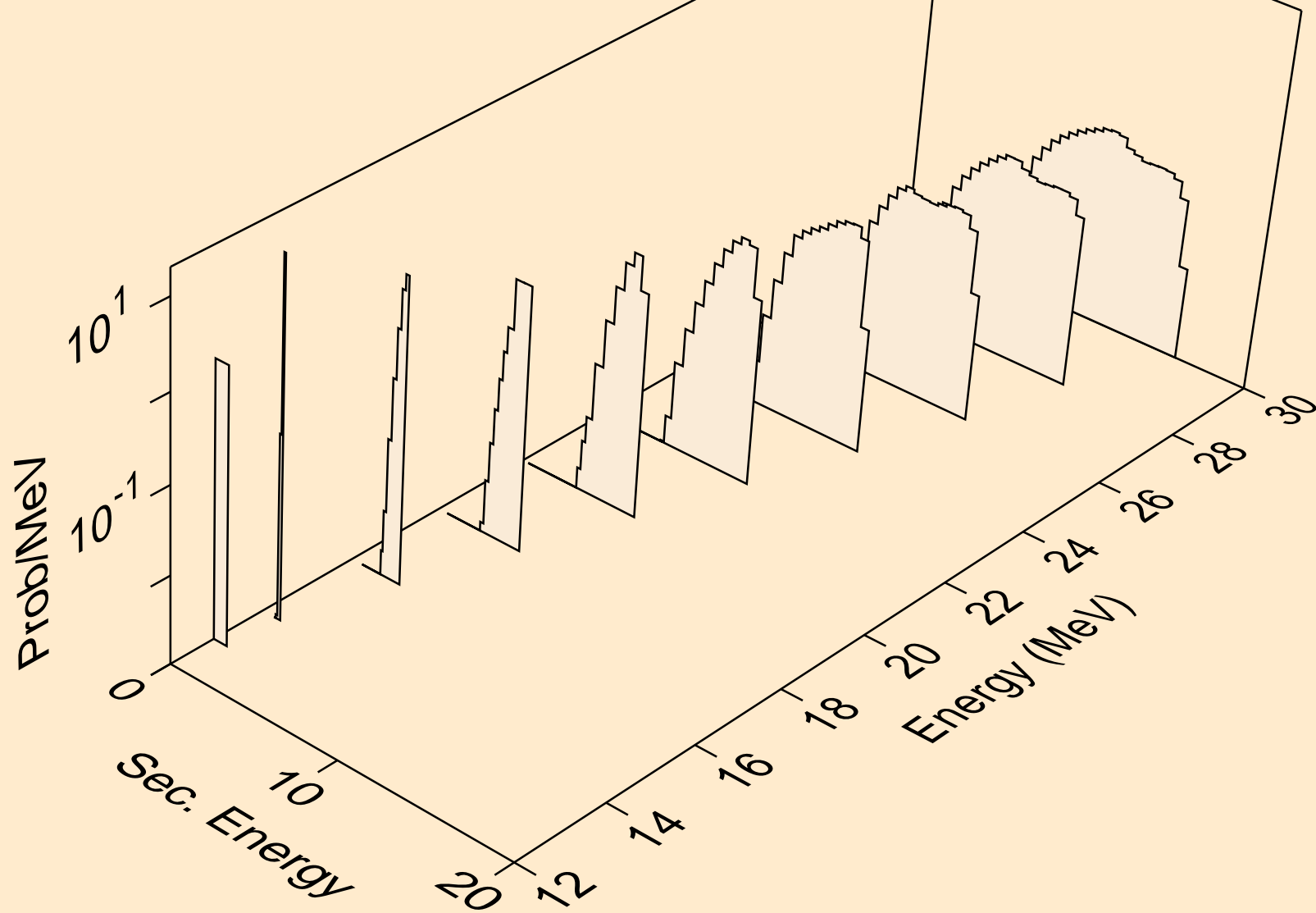

SC042M NEUTRON ACER TENDL-2021 LIBRARY; T=293.6K
he3s from (n,he3)

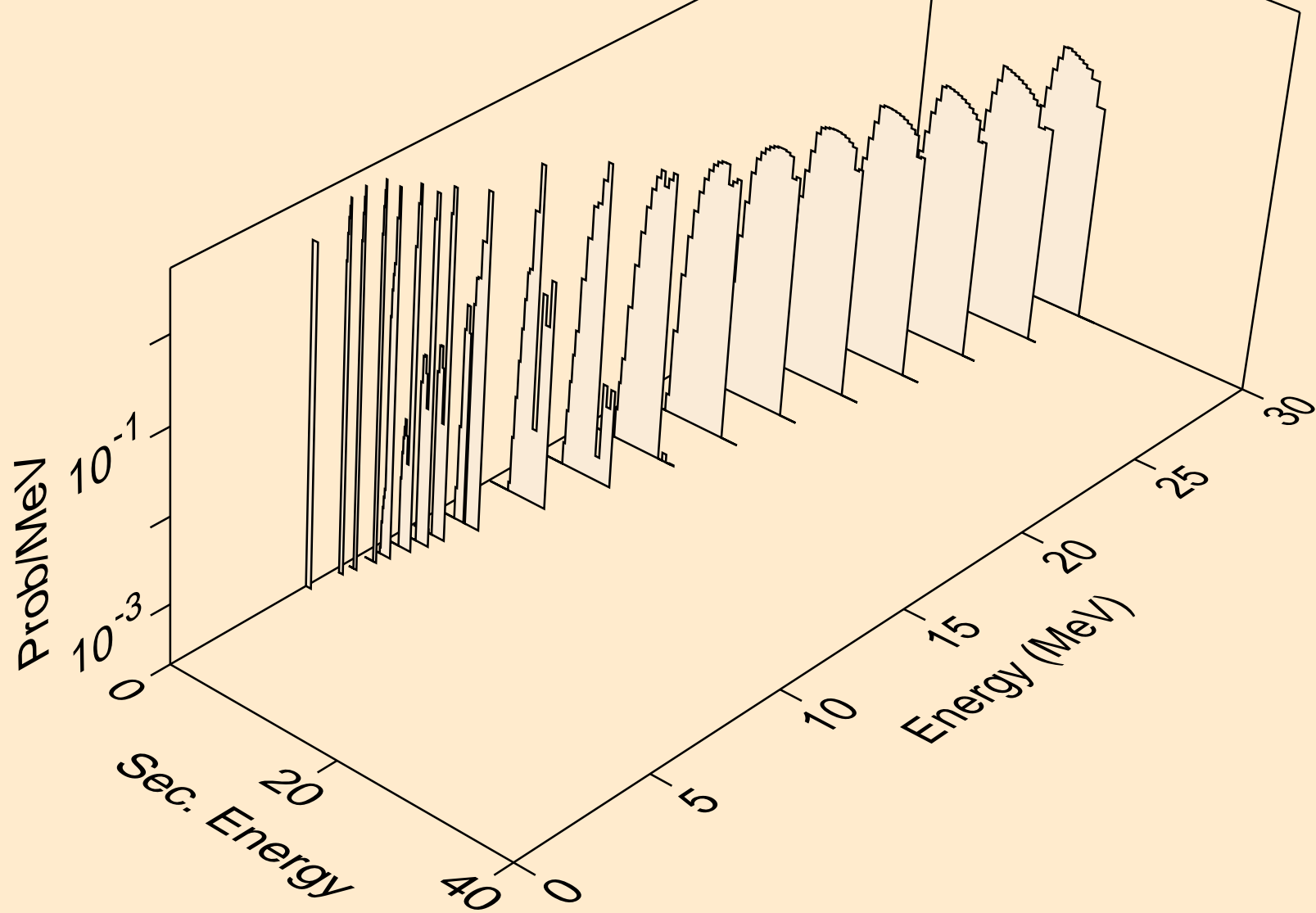

SC042M NEUTRON ACER TENDL-2021 LIBRARY; T=293.6K
alphas from (n,x)

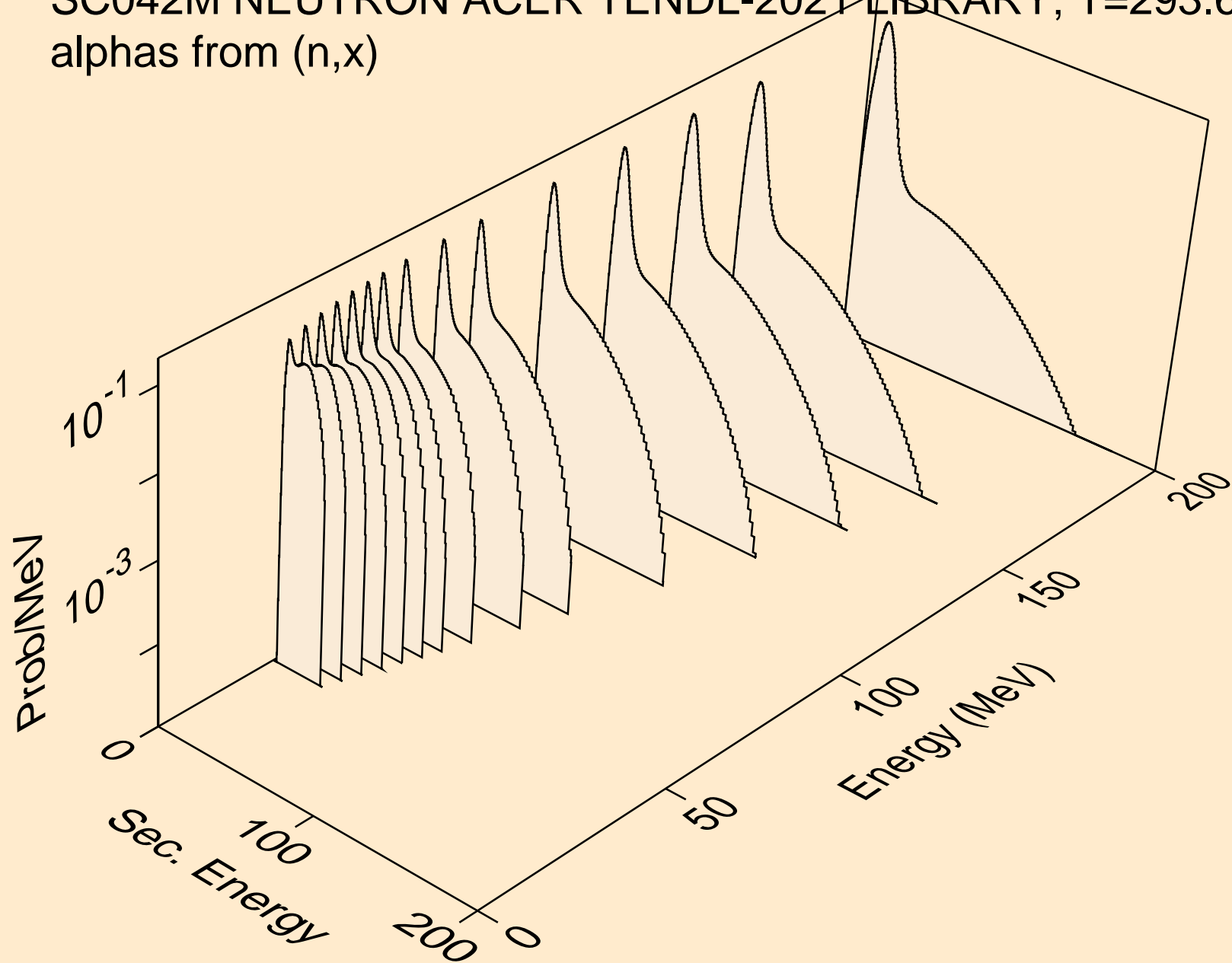

SC042M NEUTRON ACER TENDL-2021 LIBRARY; T=293.6K
alphas from (n,n*)a

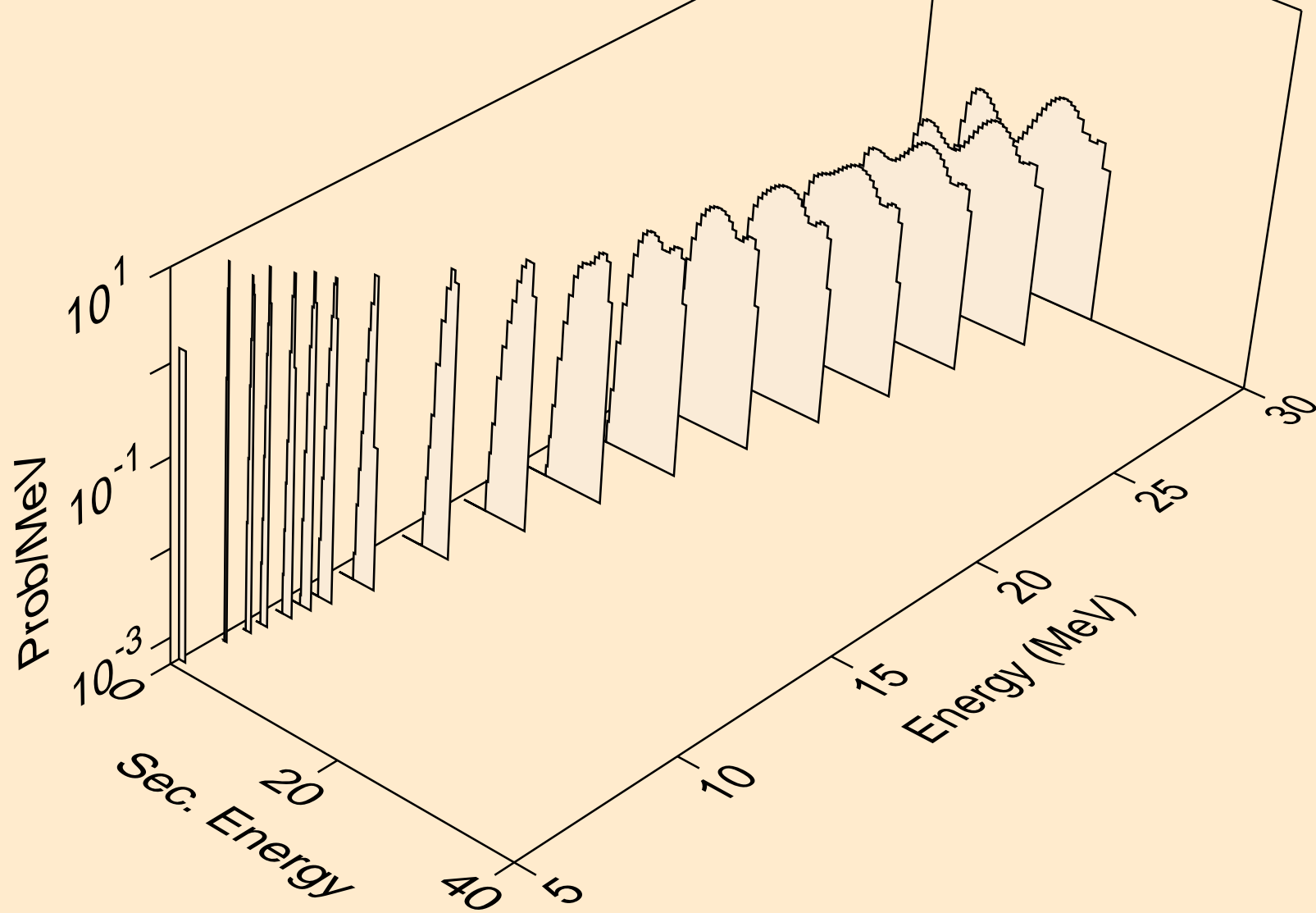

SC042M NEUTRON ACER TENDL-2021 LIBRARY; T=293.6K
alphas from (n,2n)a

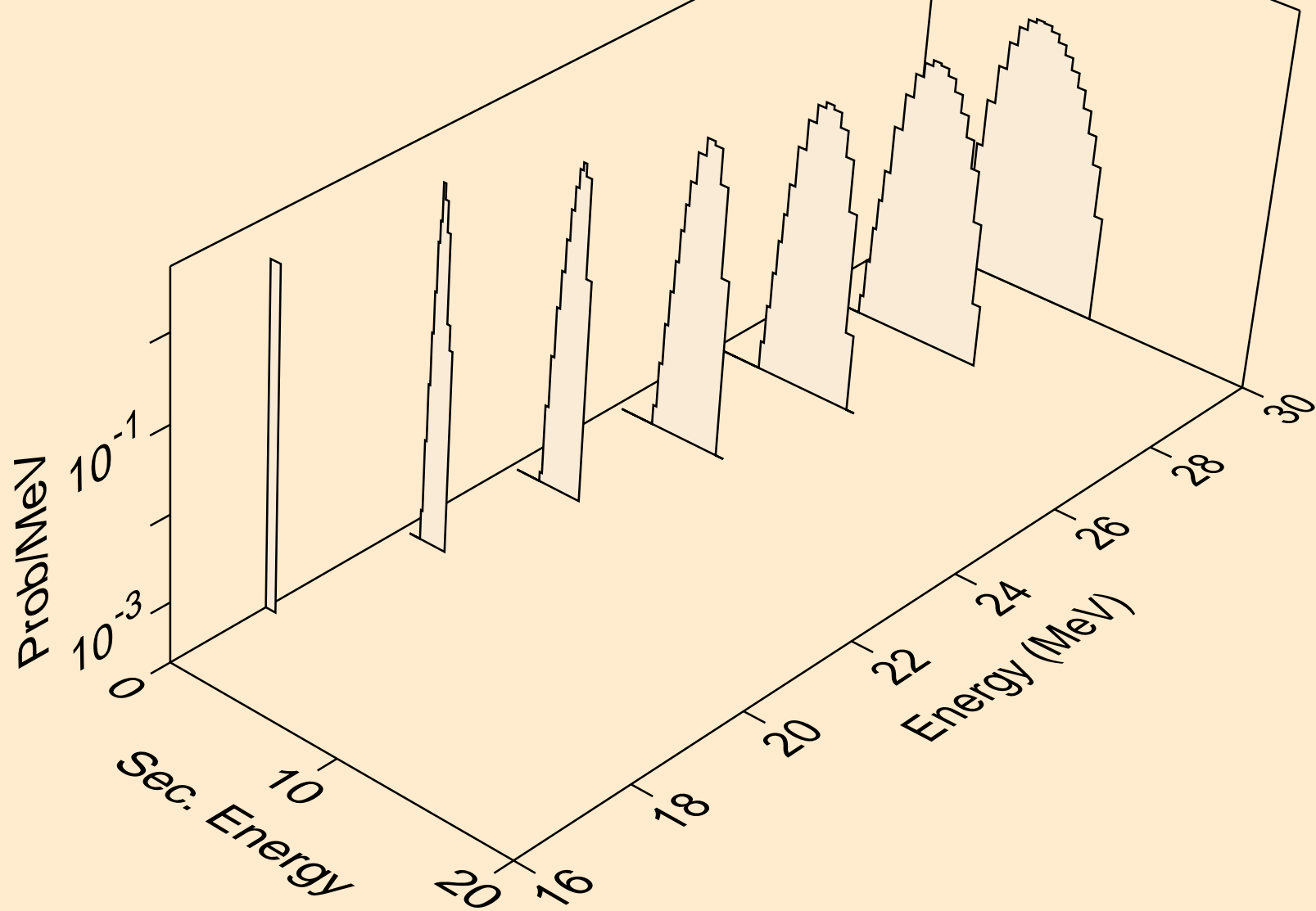

SC042M NEUTRON ACER TENDL-2021 LIBRARY; T=293.6K
alphas from (n,n*)2a

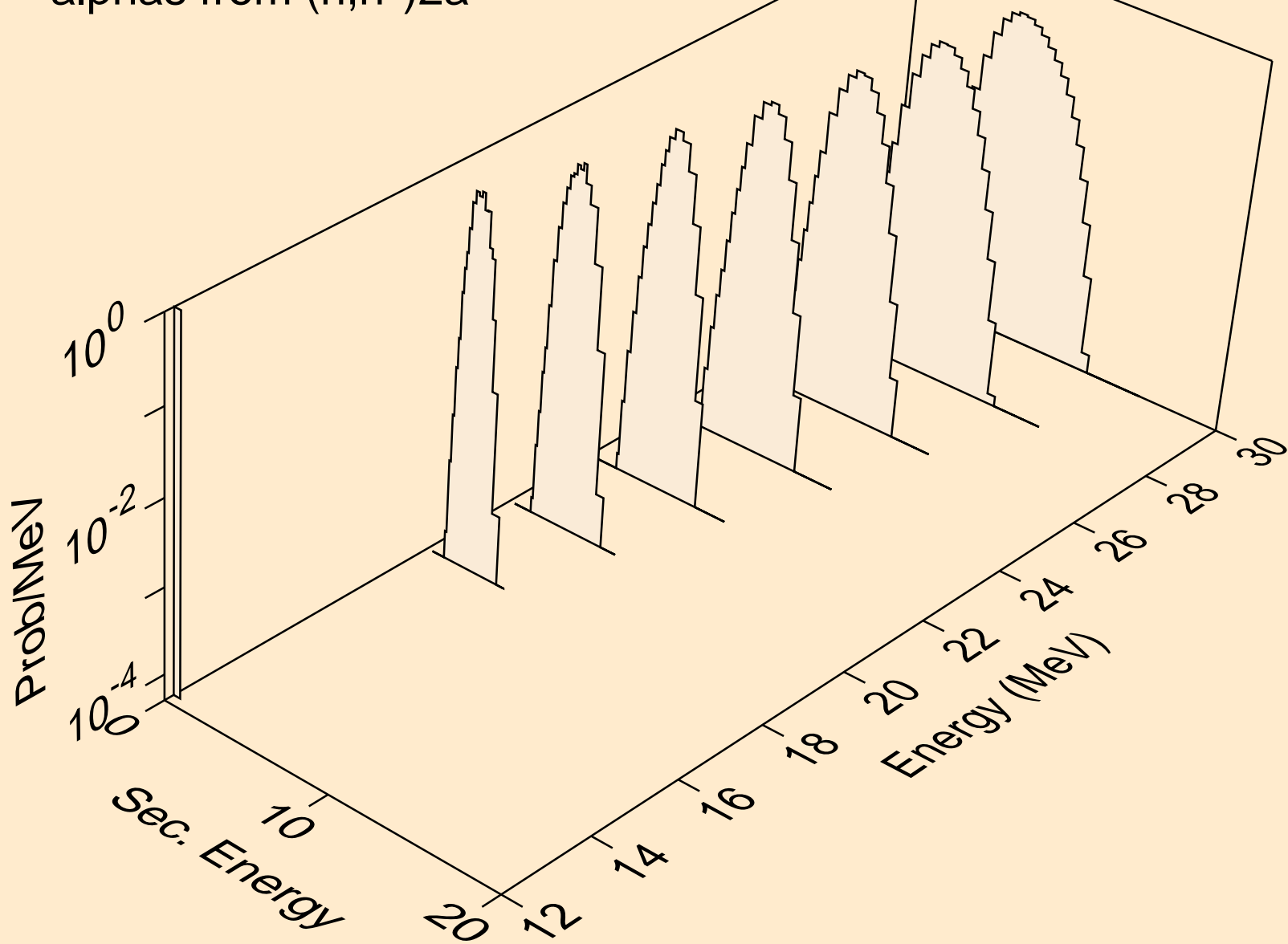

SC042M NEUTRON ACER TENDL-2021 LIBRARY; T=293.6K
alphas from (n,npa)

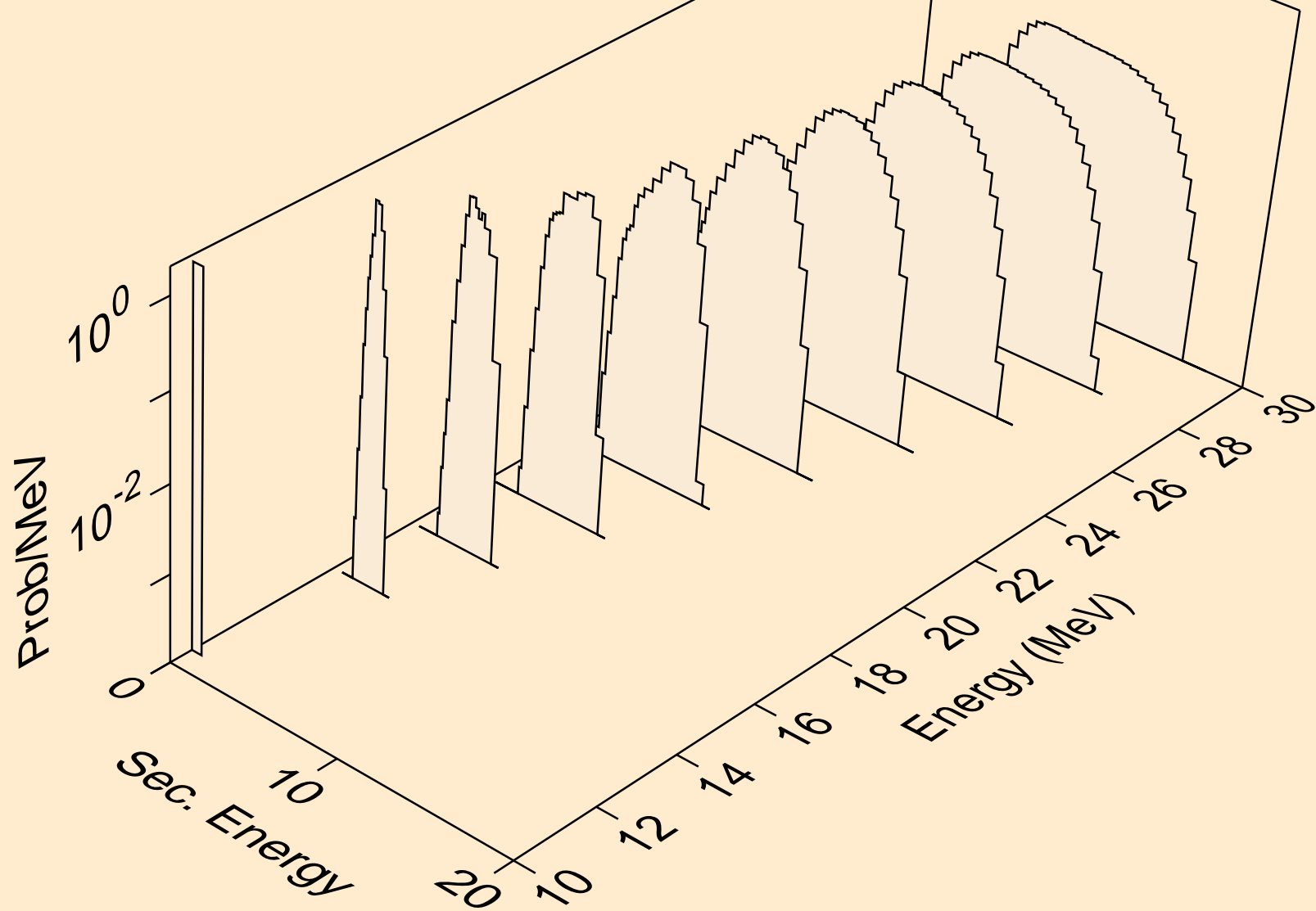

SC042M NEUTRON ACER TENDL-2021 LIBRARY; T=293.6K
alphas from (n,a)

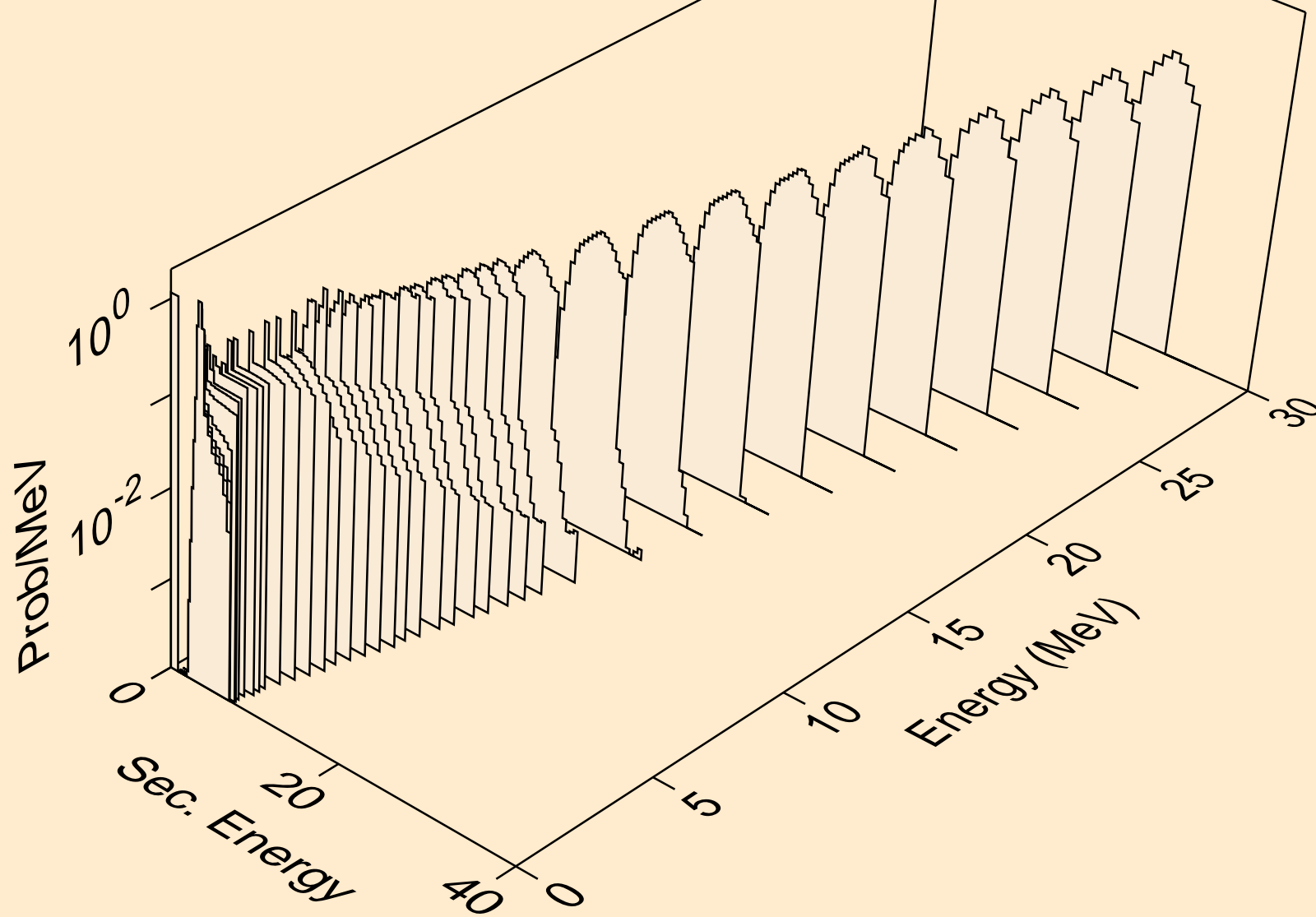

SC042M NEUTRON ACER TENDL-2021 LIBRARY; T=293.6K
alphas from (n,2a)

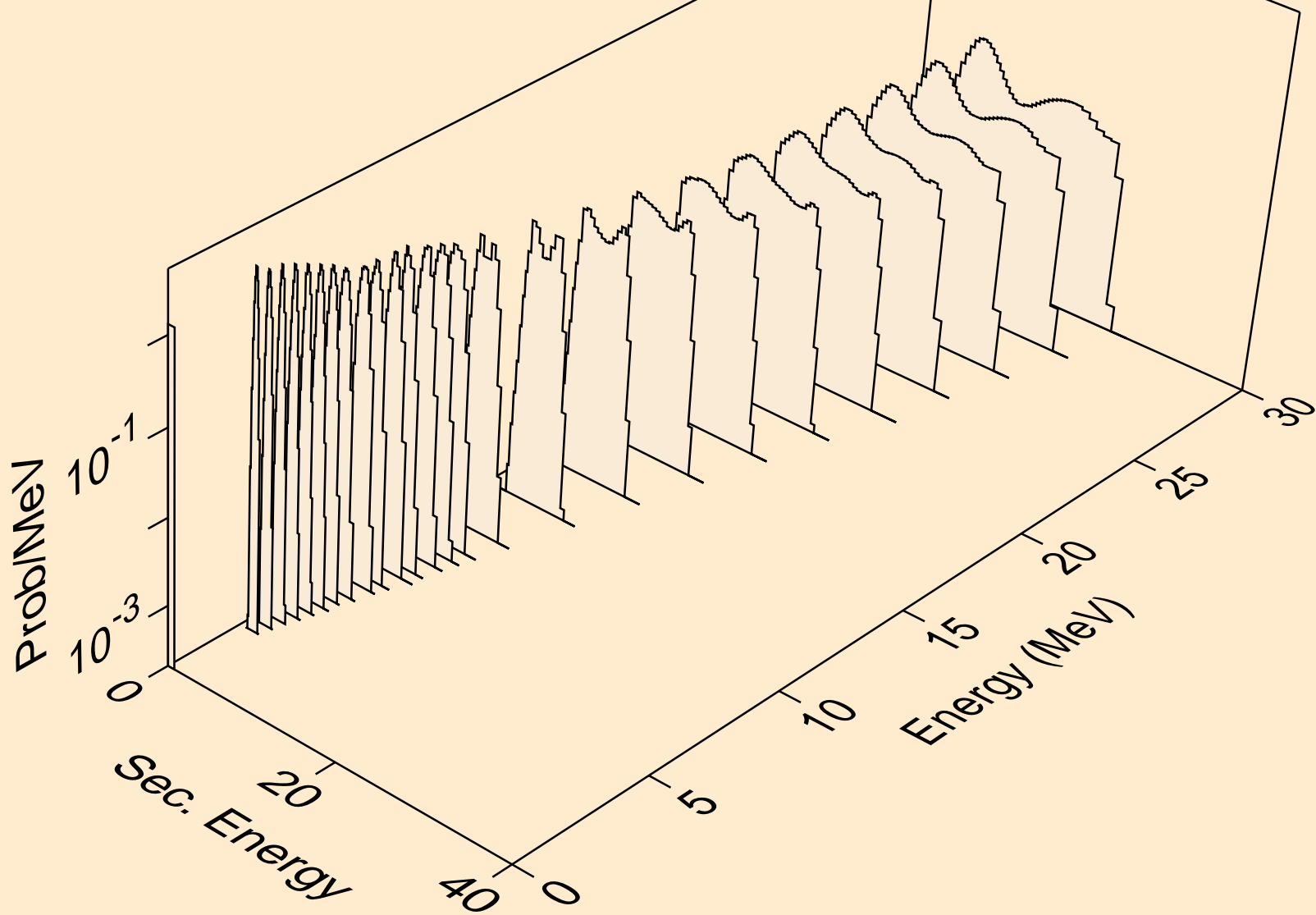

SC042M NEUTRON ACER TENDL-2021 LIBRARY; T=293.6K
alphas from (n,3a)

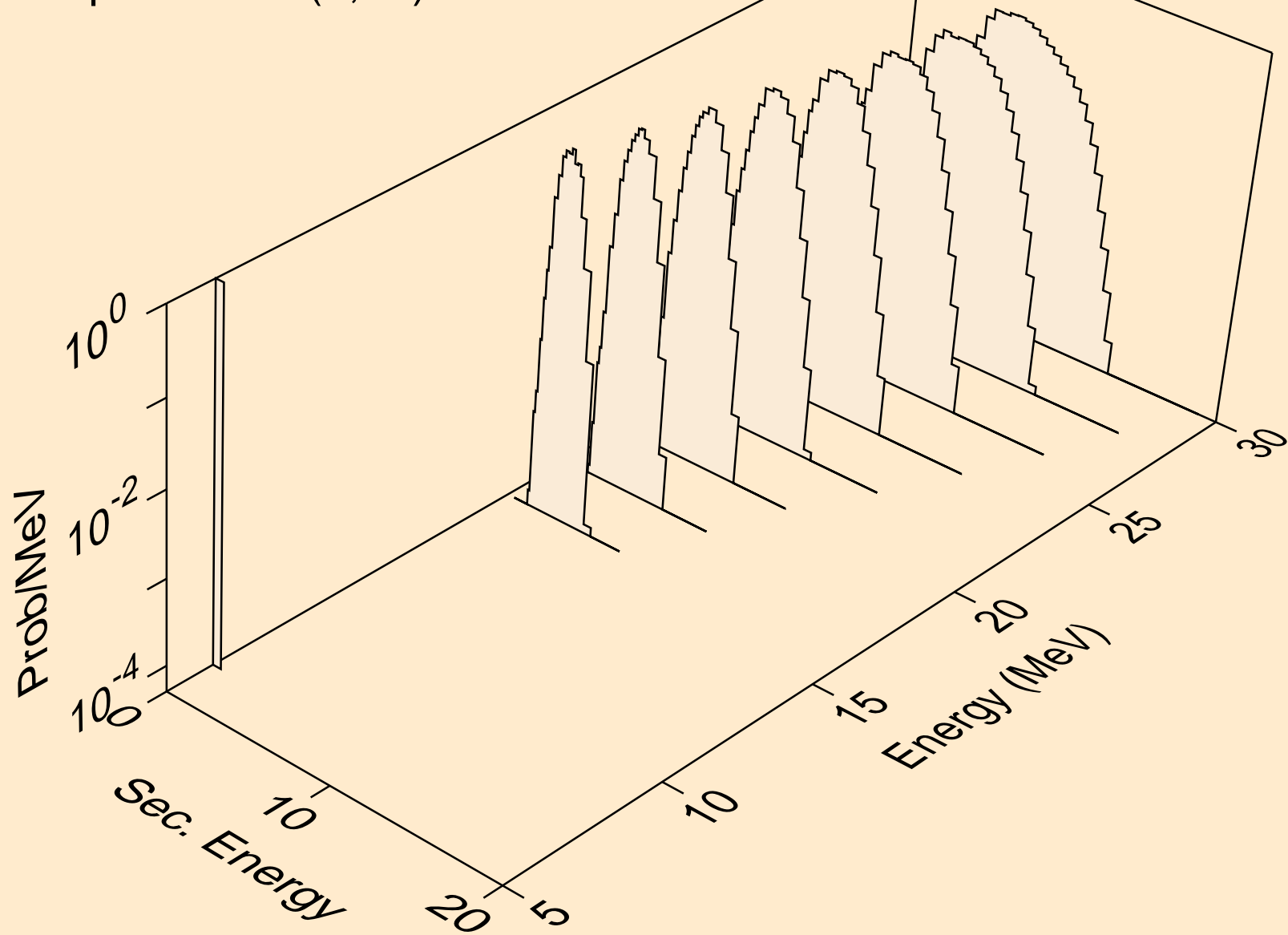

SC042M NEUTRON ACER TENDL-2021 LIBRARY; T=293.6K
alphas from (n,pa)

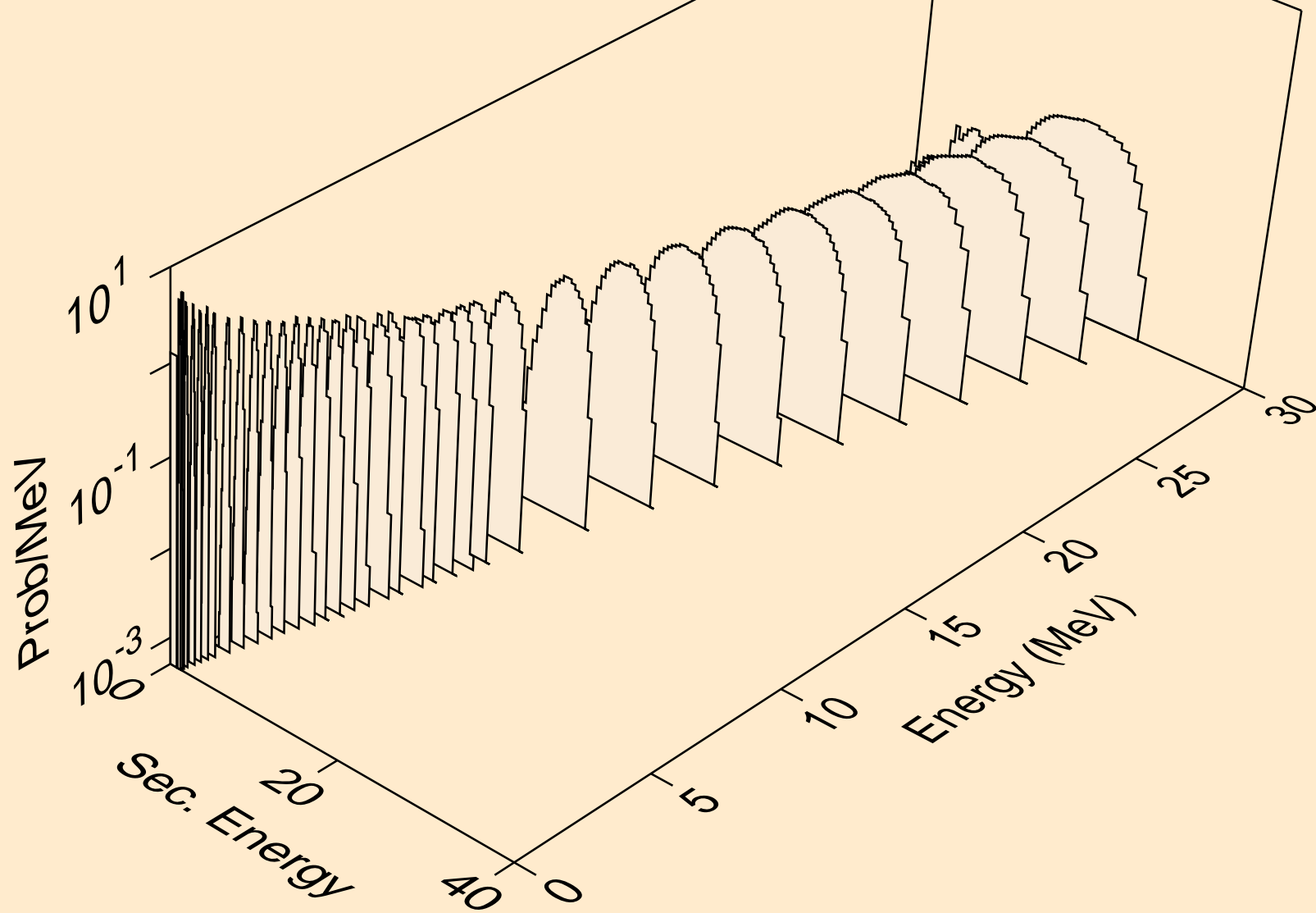

SC042M NEUTRON ACER TENDL-2021 LIBRARY; T=293.6K
alphas from (n,t2a)

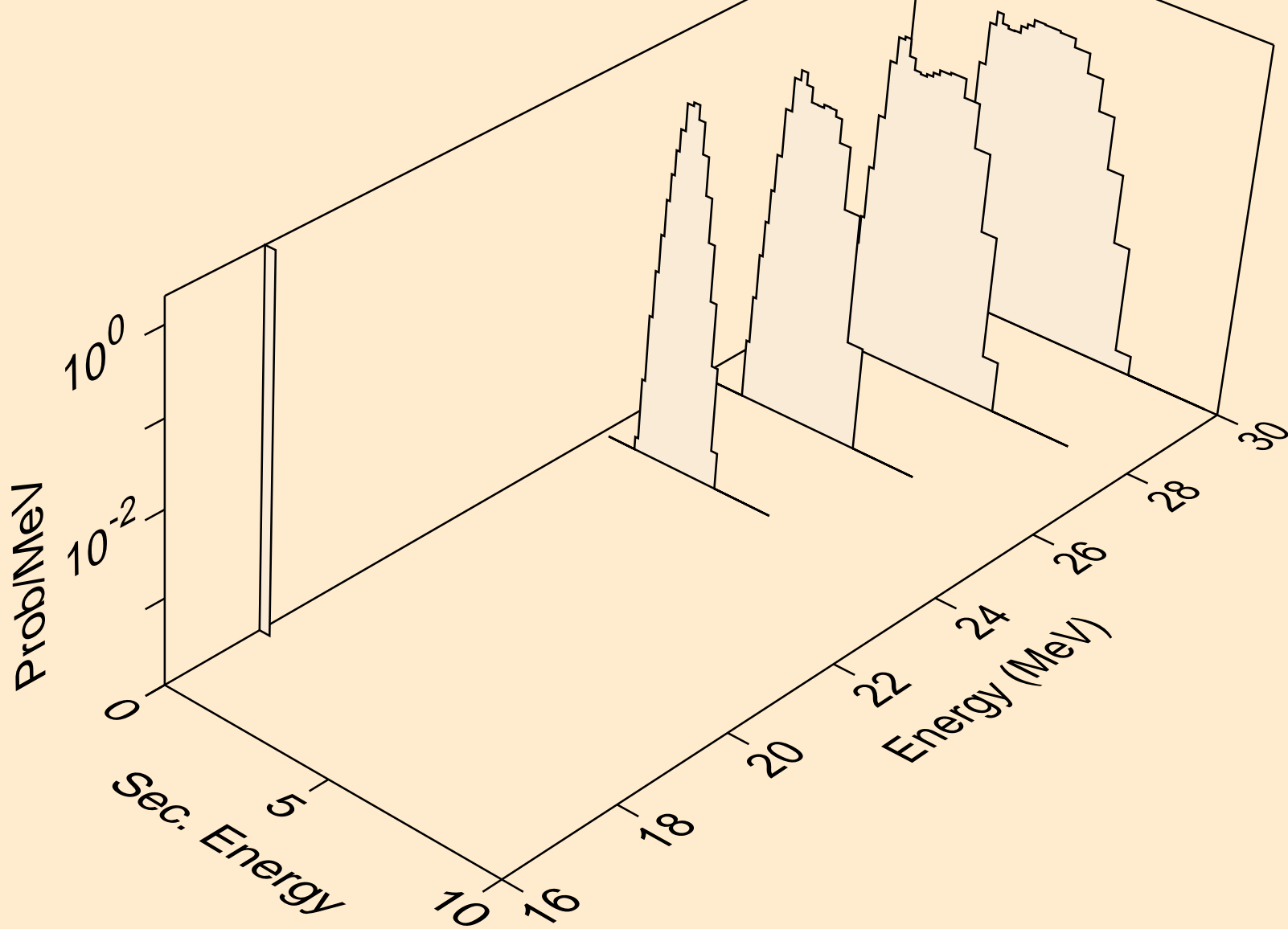

SC042M NEUTRON ACER TENDL-2021 LIBRARY; T=293.6K
alphas from (n,d2a)

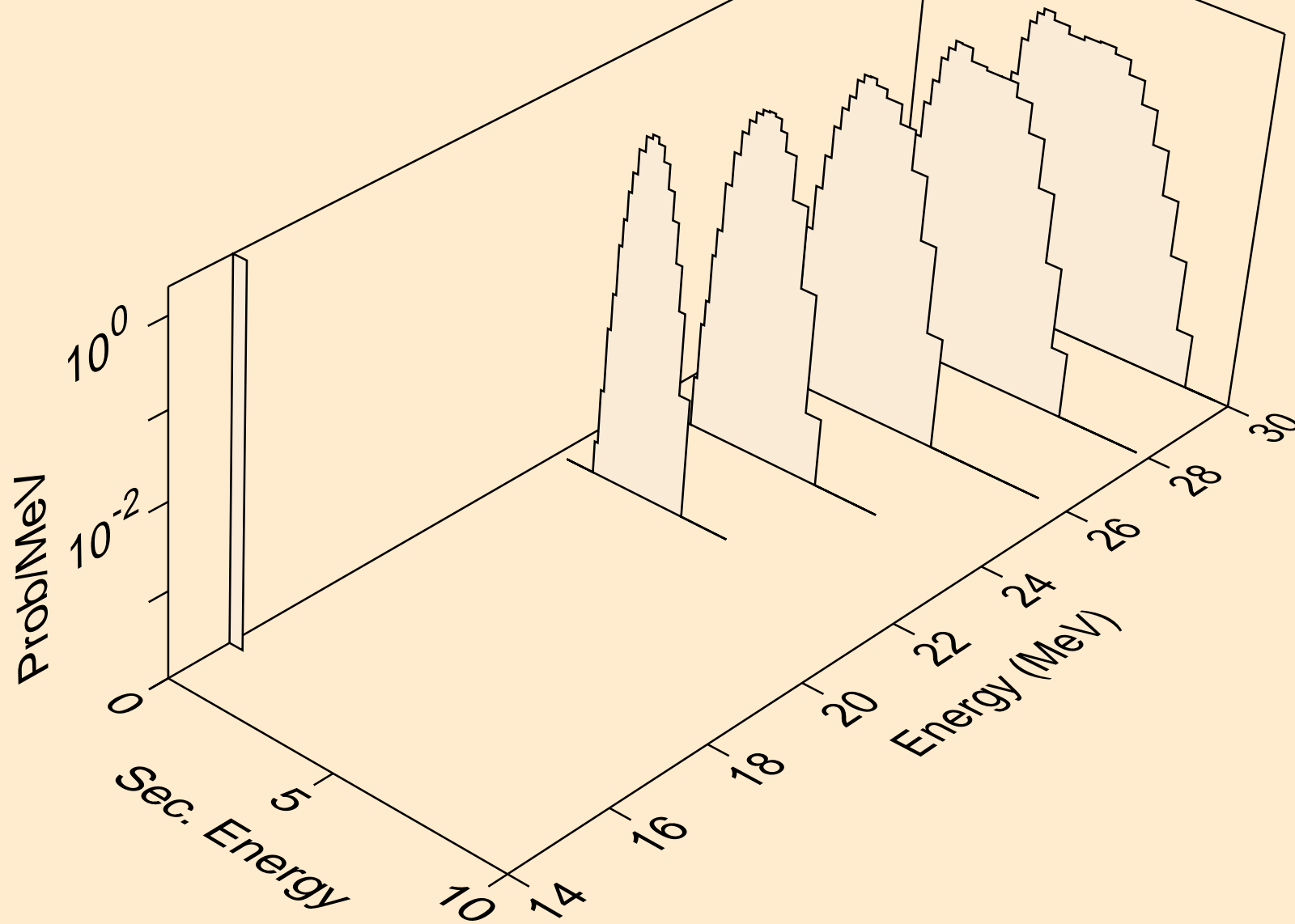

SC042M NEUTRON ACER TENDL-2021 LIBRARY; T=293.6K
alphas from (n,da)

