

SC046M NEUTRON ACER TENDL-2021 LIBRARY; T=293.6K
Principal cross sections

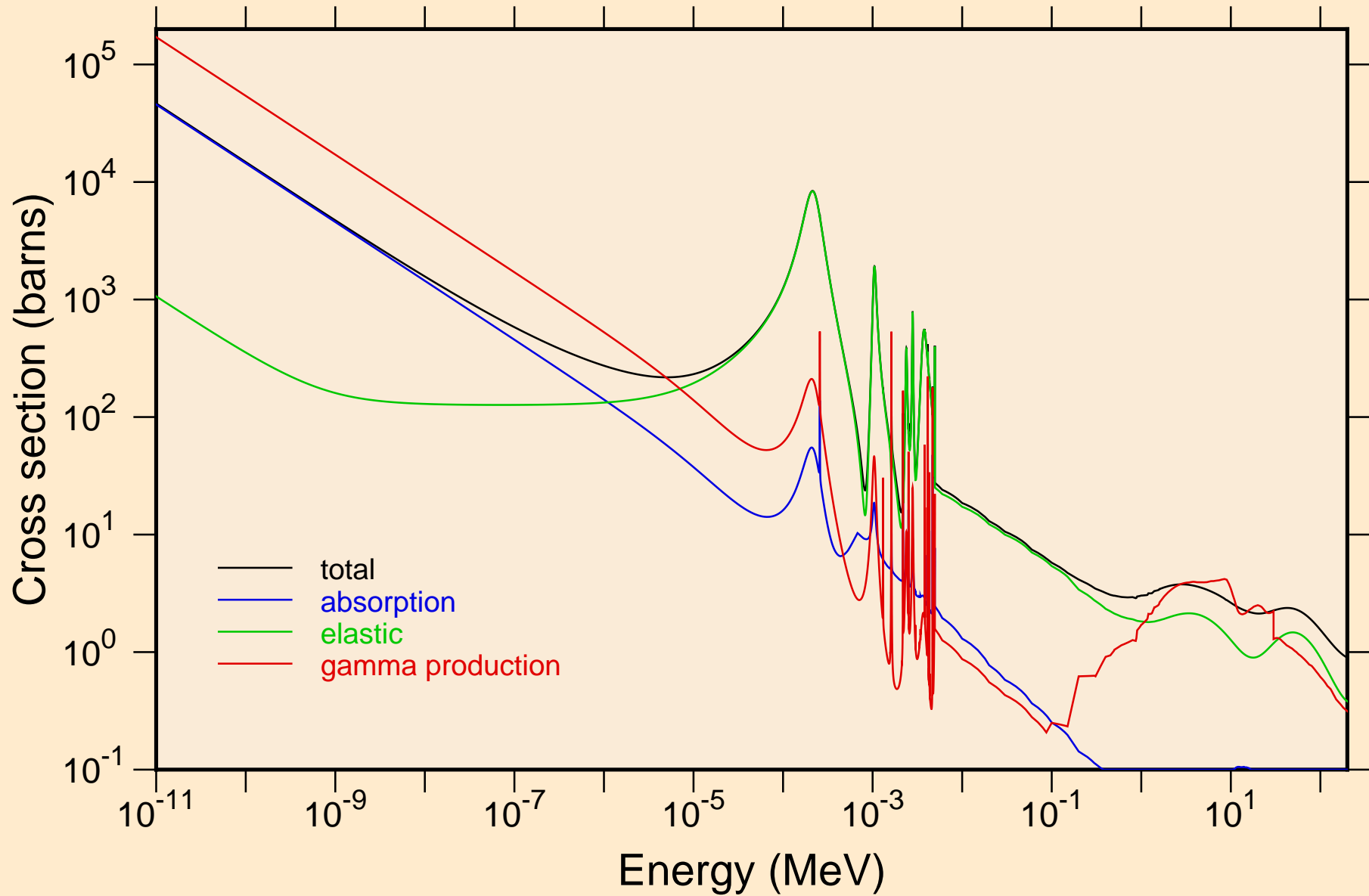

SC046M NEUTRON ACER TENDL-2021 LIBRARY; T=293.6K
resonance total cross section

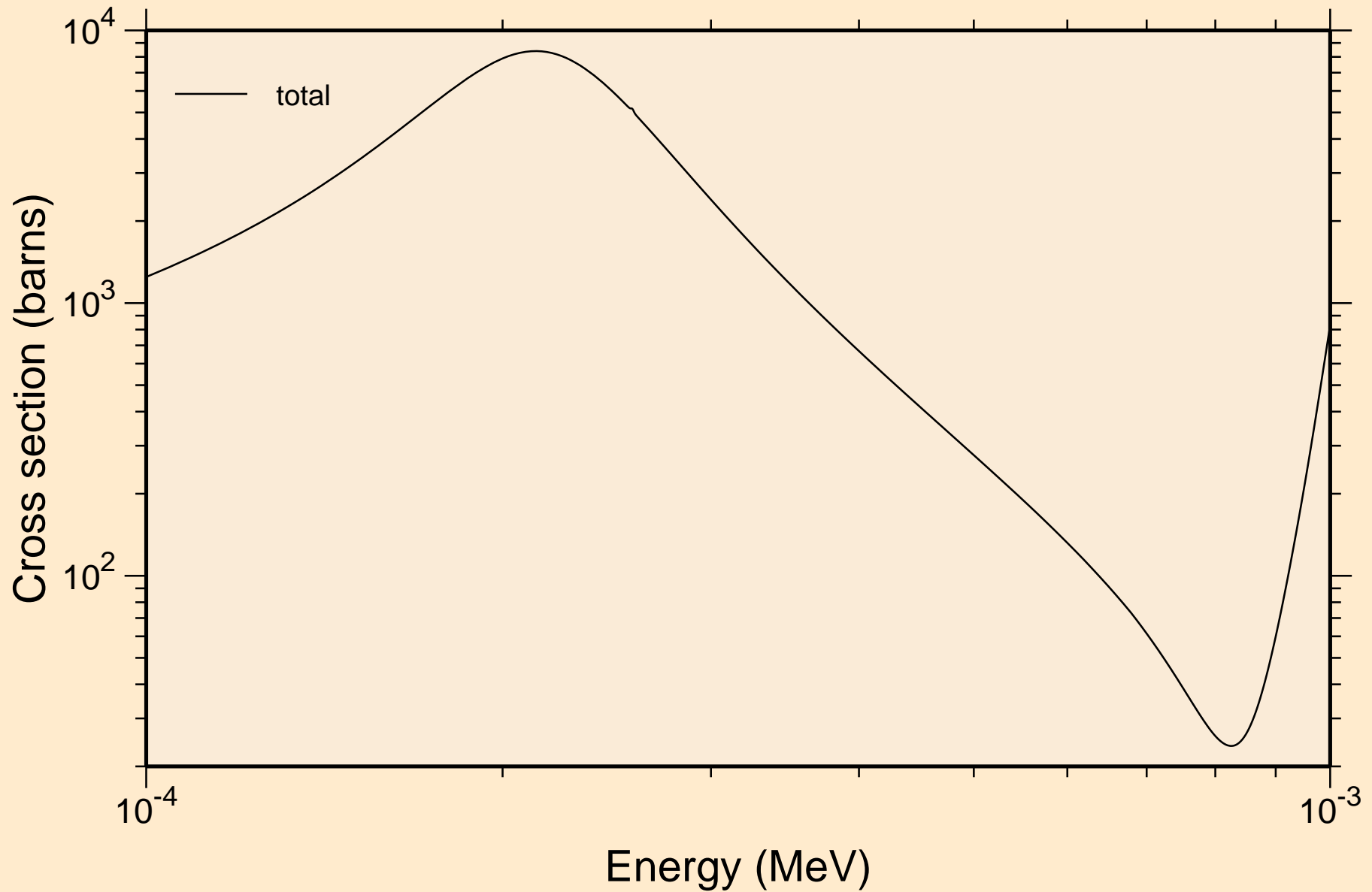

SC046M NEUTRON ACER TENDL-2021 LIBRARY; T=293.6K
resonance total cross section

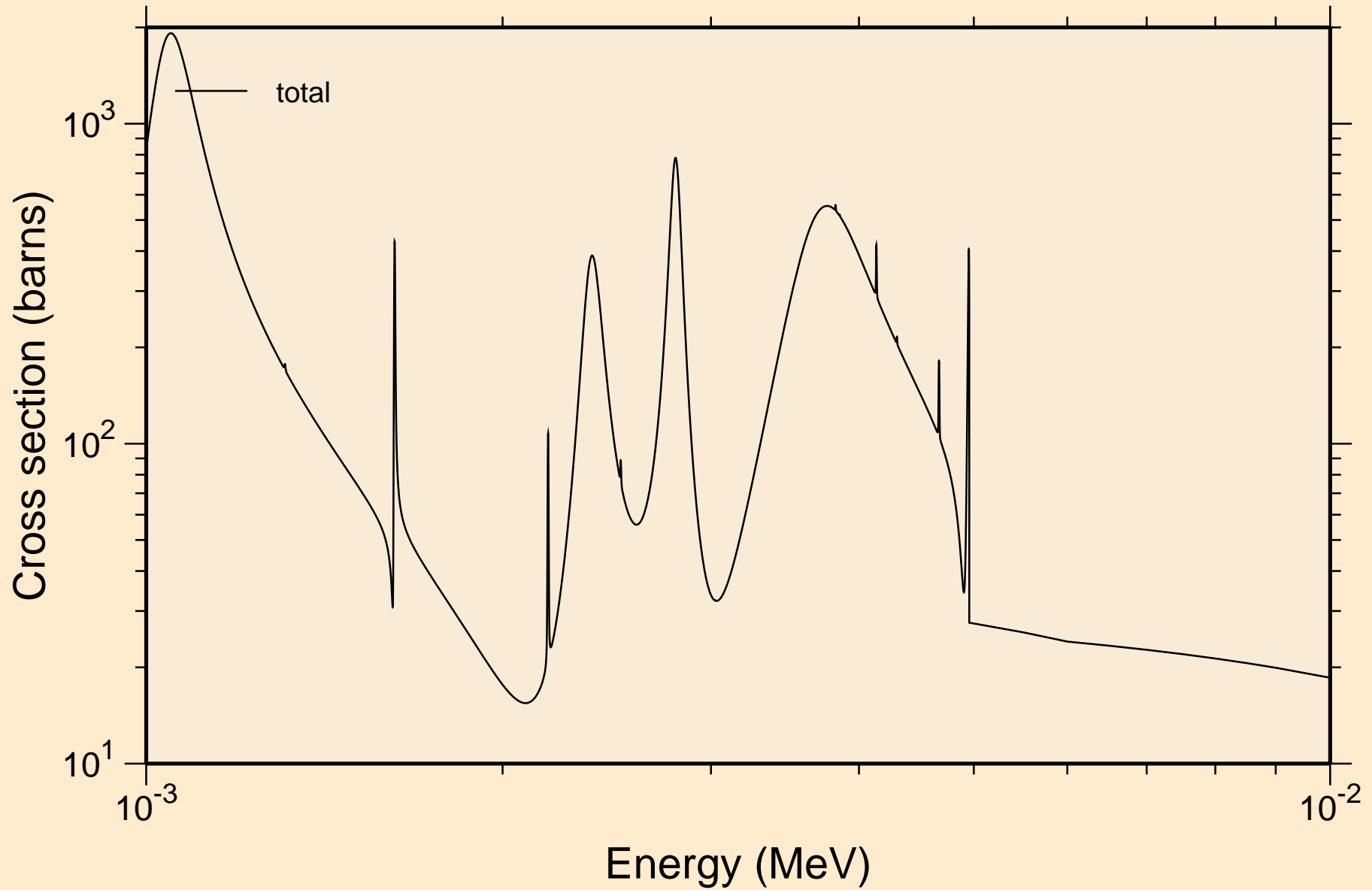

SC046M NEUTRON ACER TENDL-2021 LIBRARY; T=293.6K
resonance total cross section

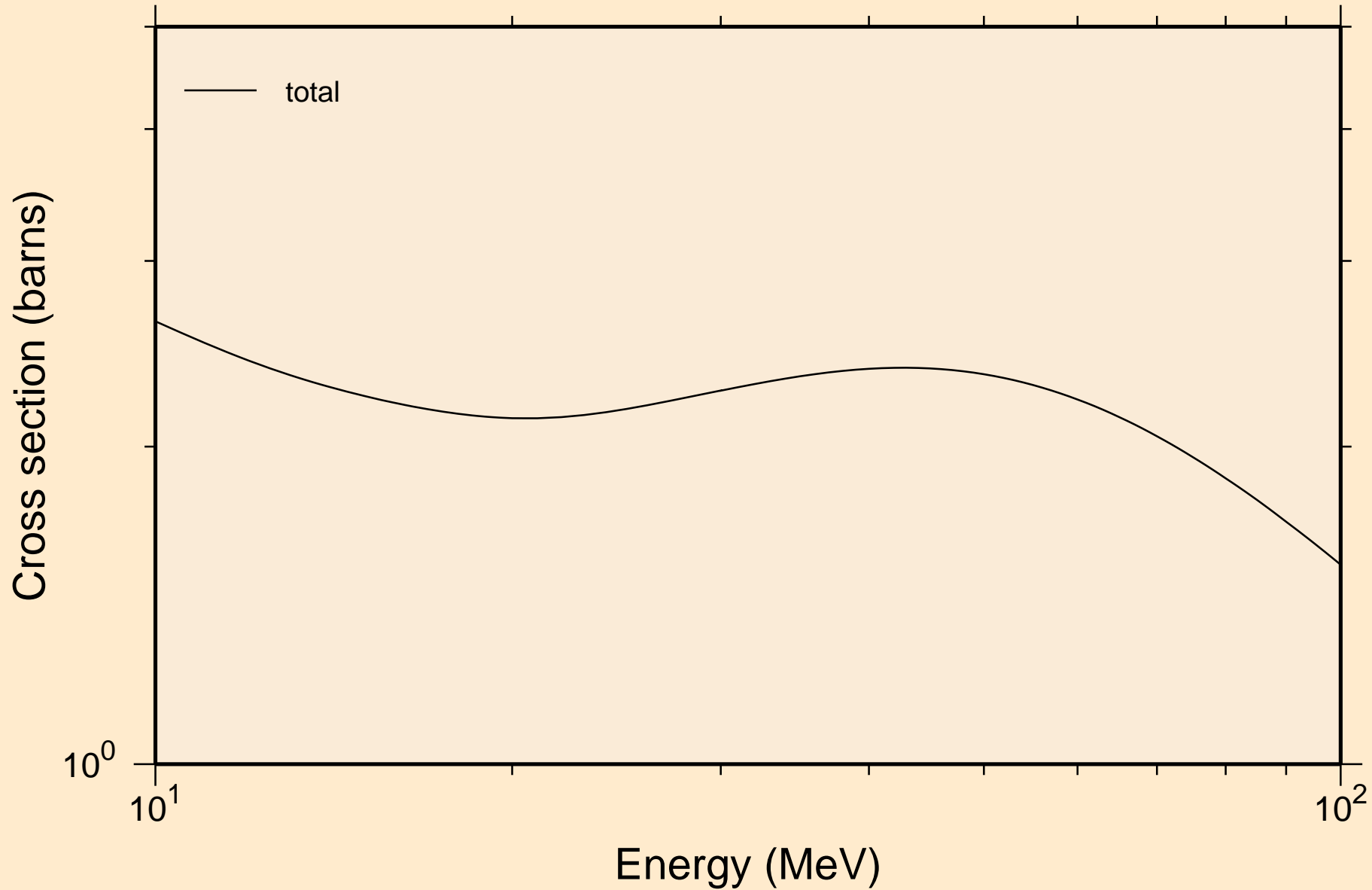

SC046M NEUTRON ACER TENDL-2021 LIBRARY; T=293.6K
resonance absorption cross sections

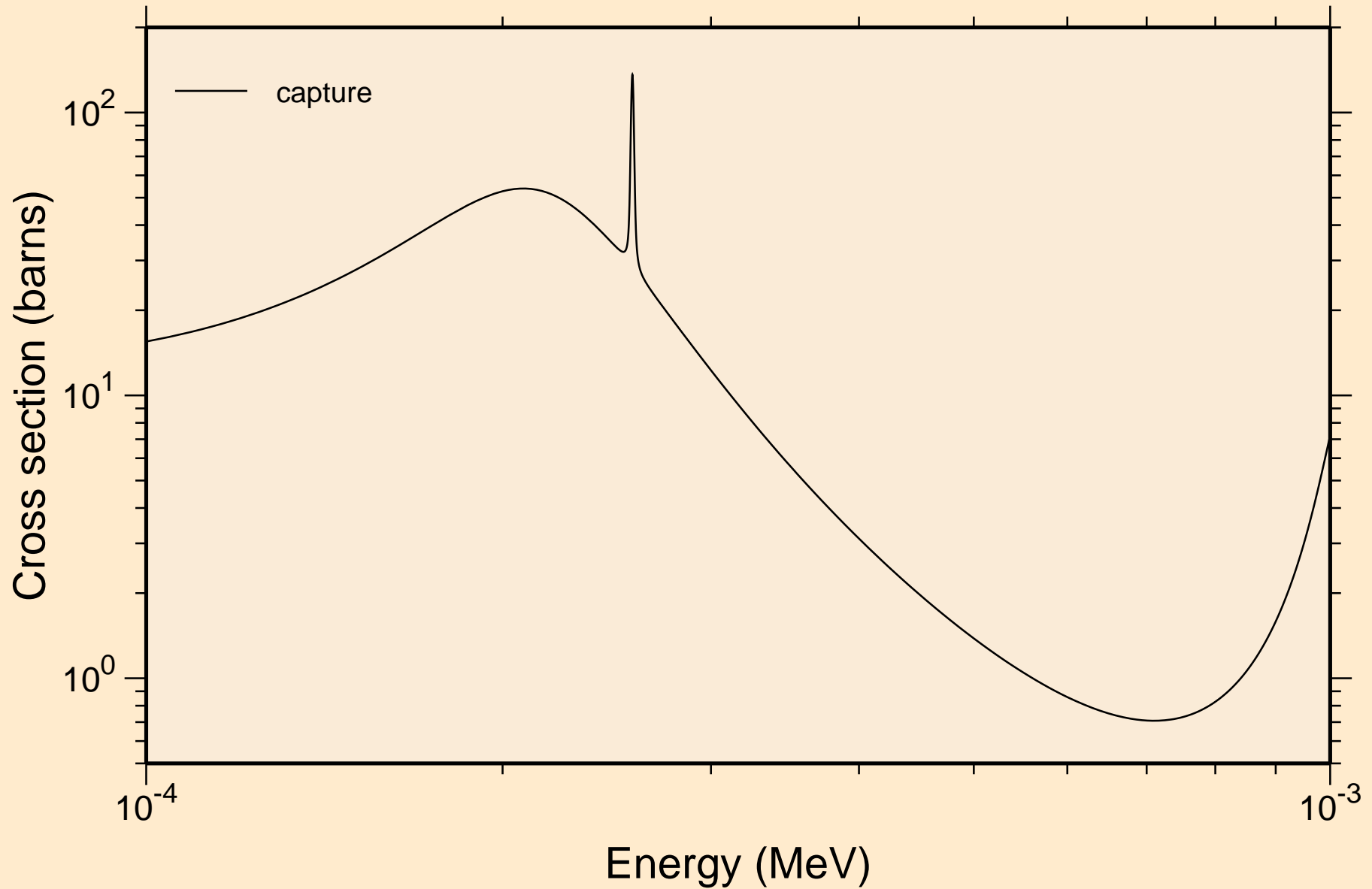

SC046M NEUTRON ACER TENDL-2021 LIBRARY; T=293.6K
resonance absorption cross sections

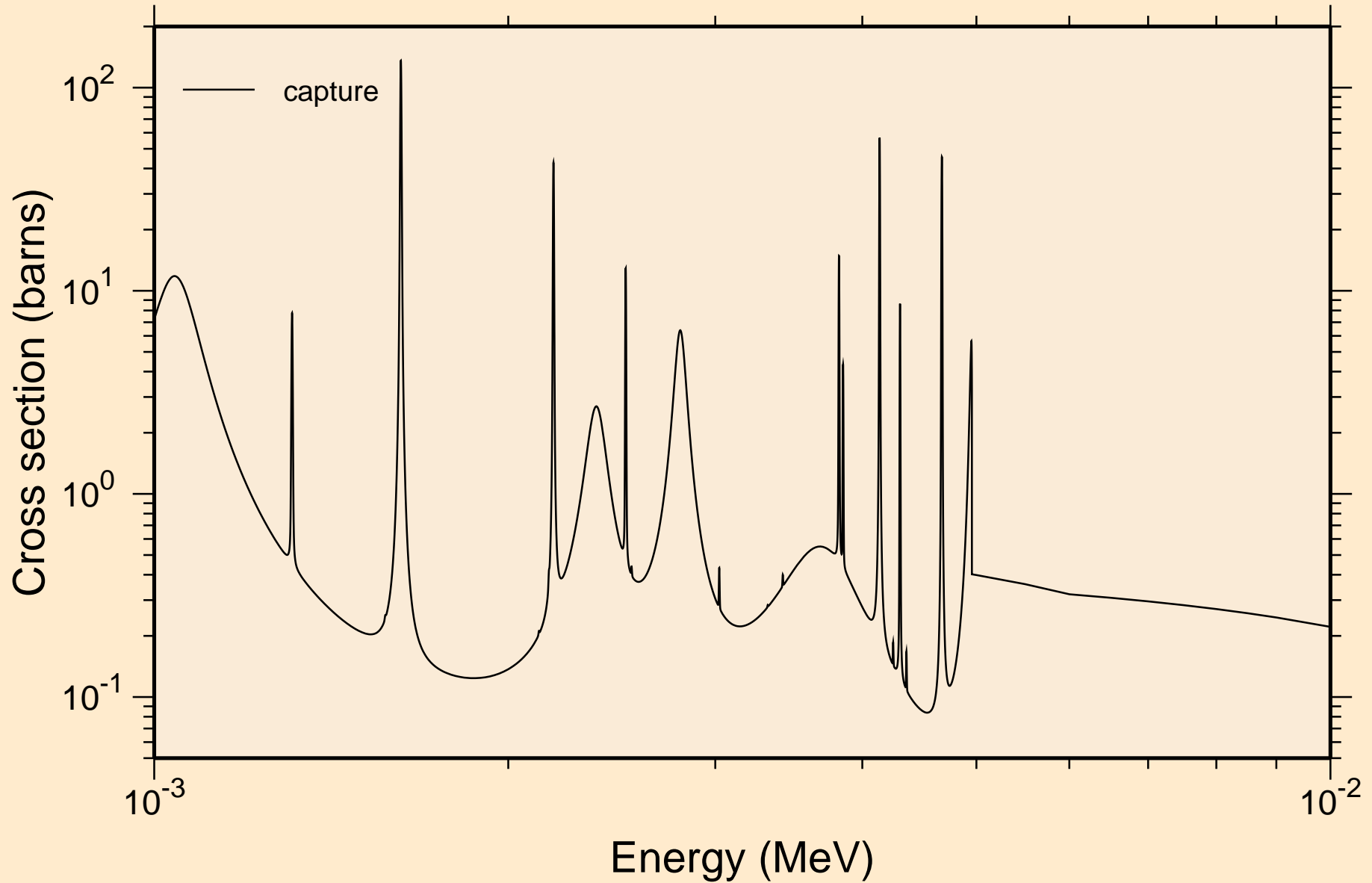

SC046M NEUTRON ACER TENDL-2021 LIBRARY; T=293.6K
resonance absorption cross sections

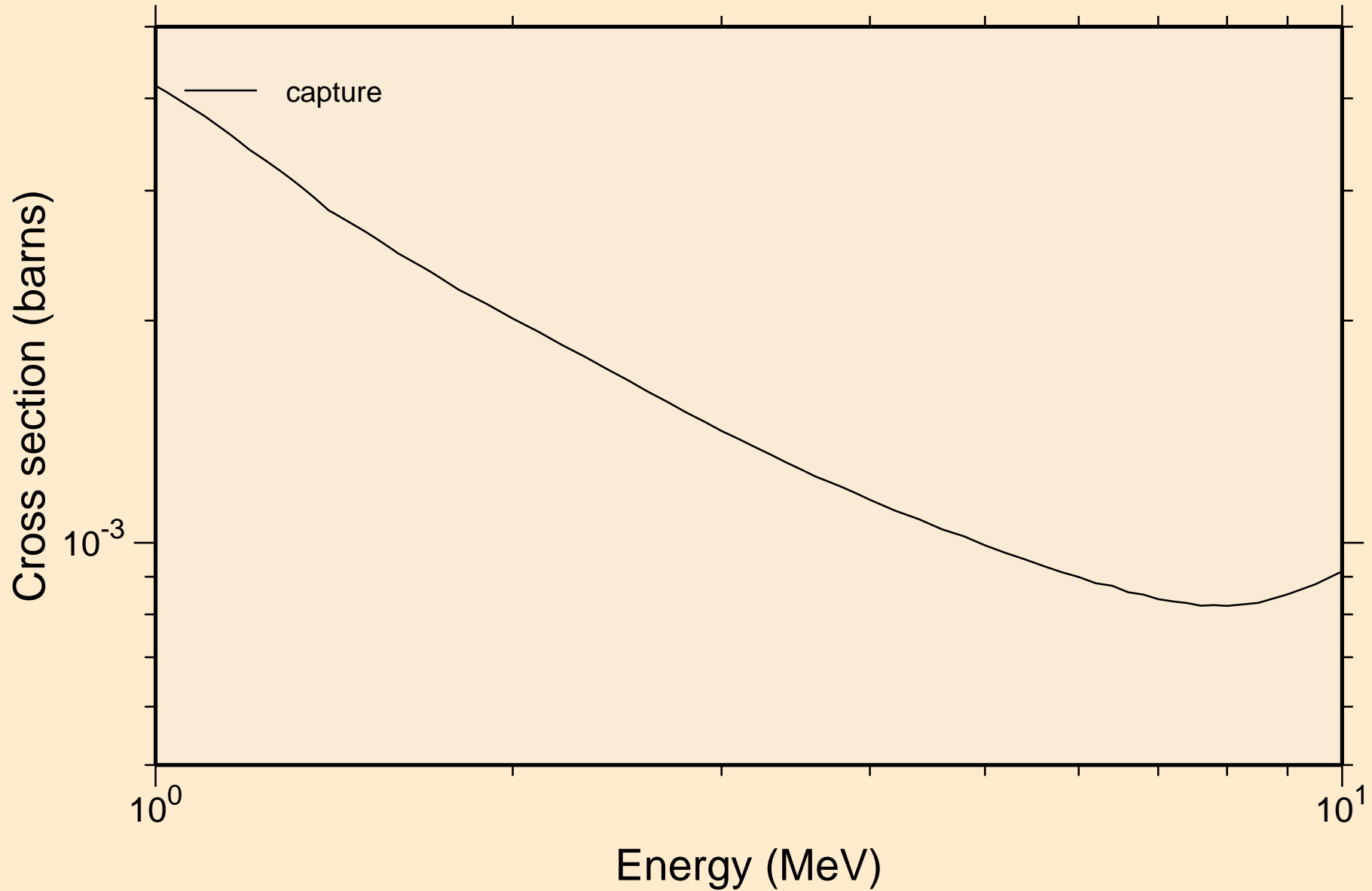

SC046M NEUTRON ACER TENDL-2021 LIBRARY; T=293.6K
Heating

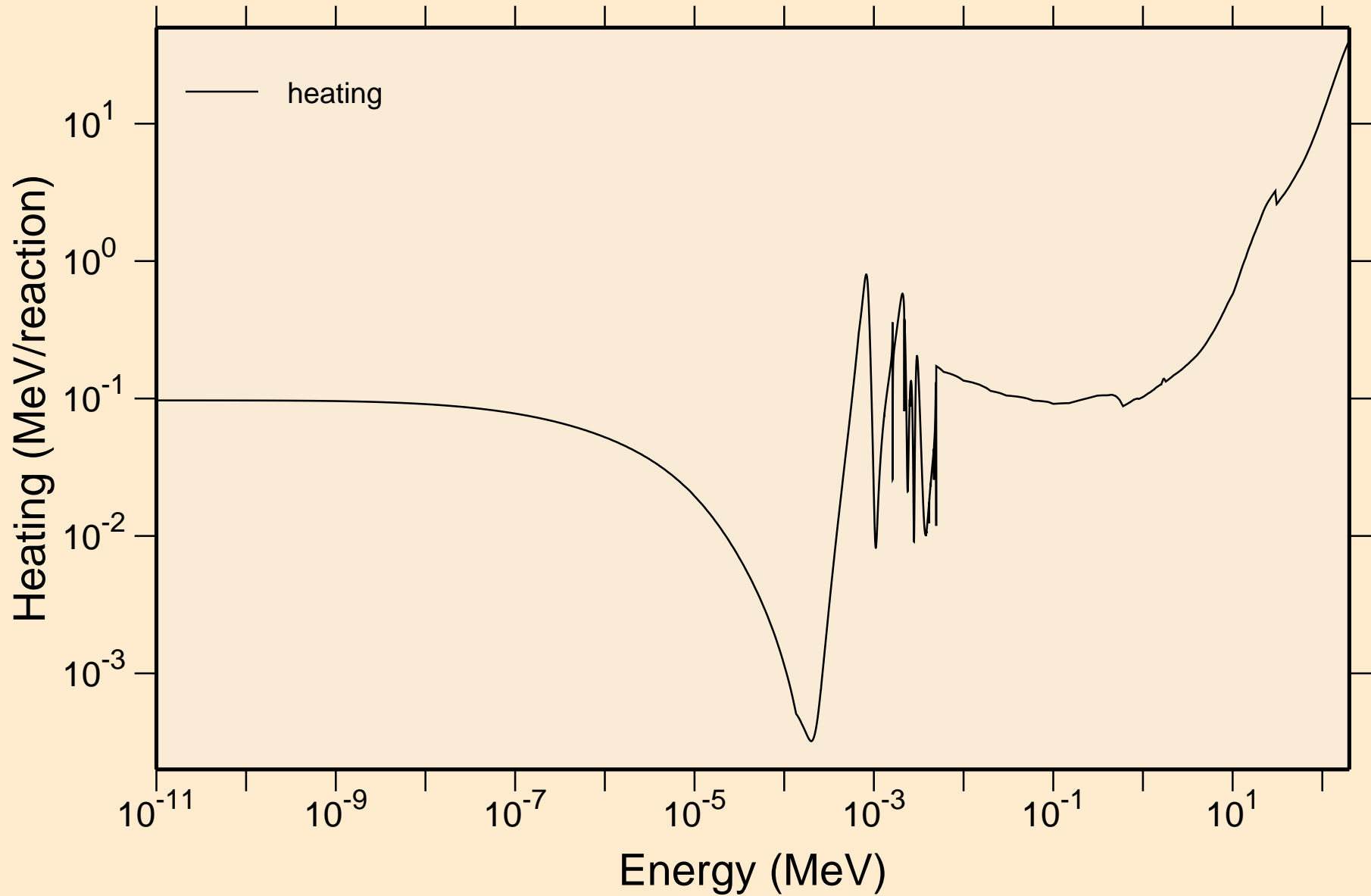

SC046M NEUTRON ACER TENDL-2021 LIBRARY; T=293.6K Damage

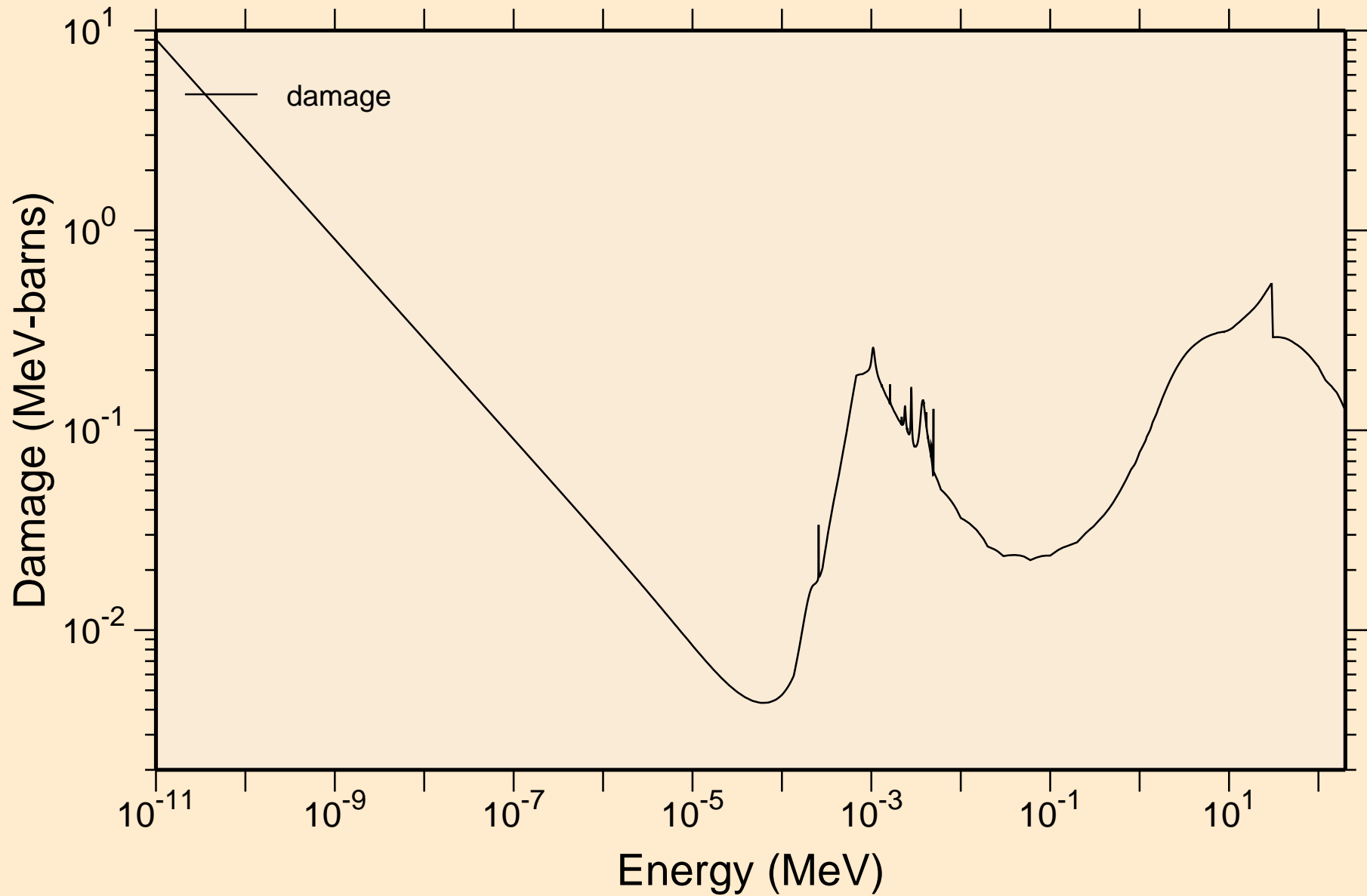

SC046M NEUTRON ACER TENDL-2021 LIBRARY; T=293.6K
Non-threshold reactions

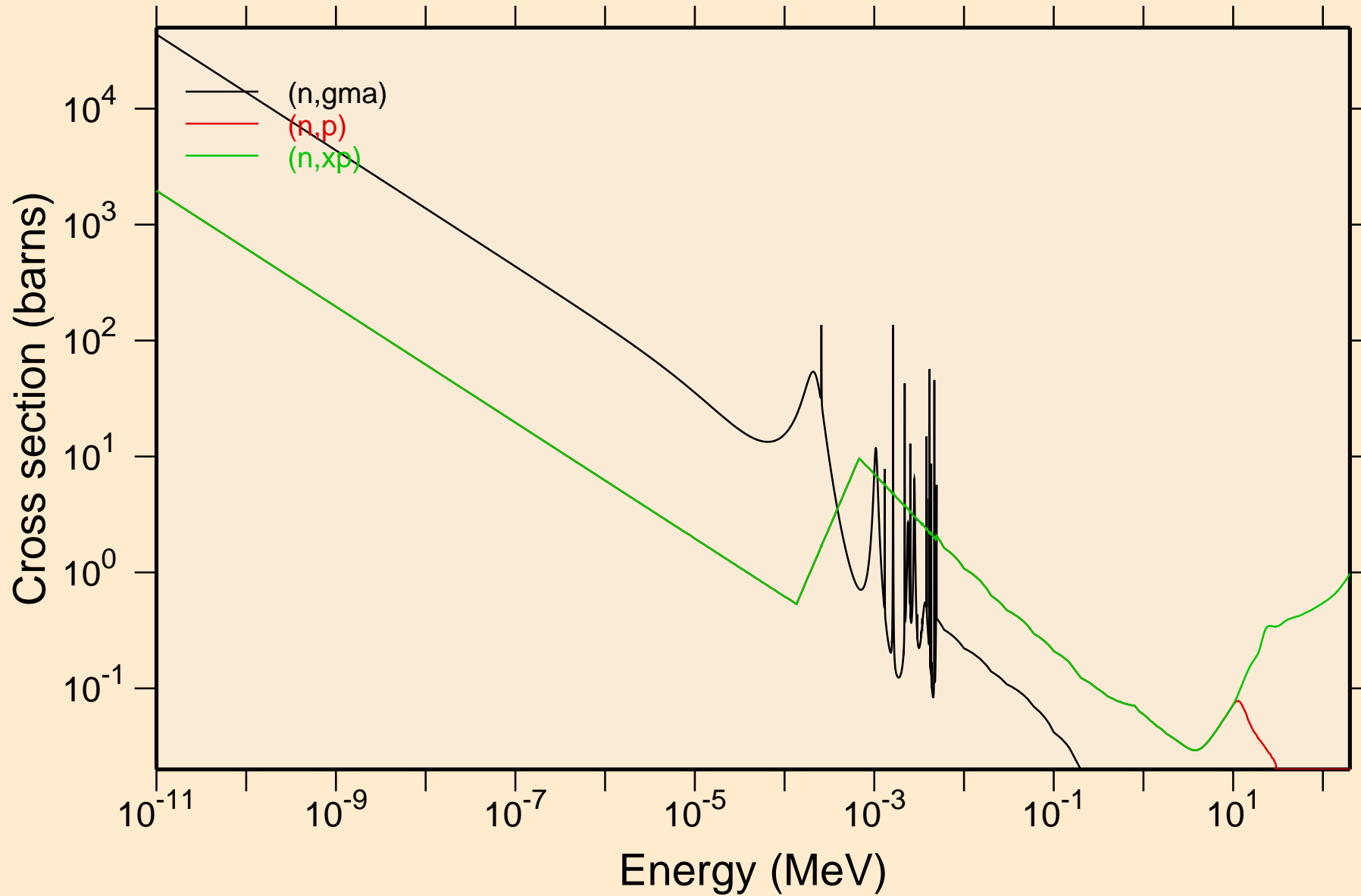

SC046M NEUTRON ACER TENDL-2021 LIBRARY; T=293.6K
Principal cross sections

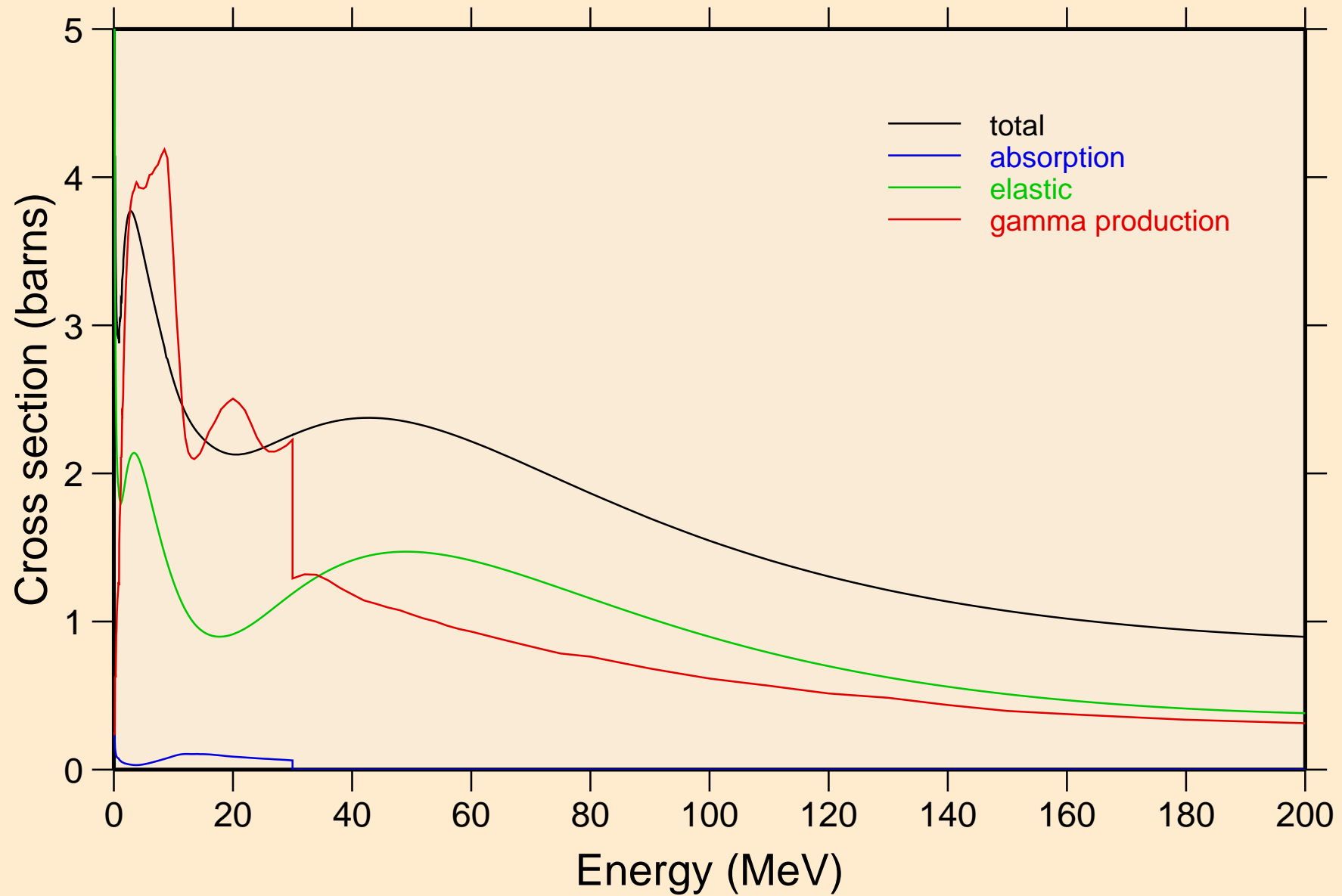

SC046M NEUTRON ACER TENDL-2021 LIBRARY; T=293.6K
Heating

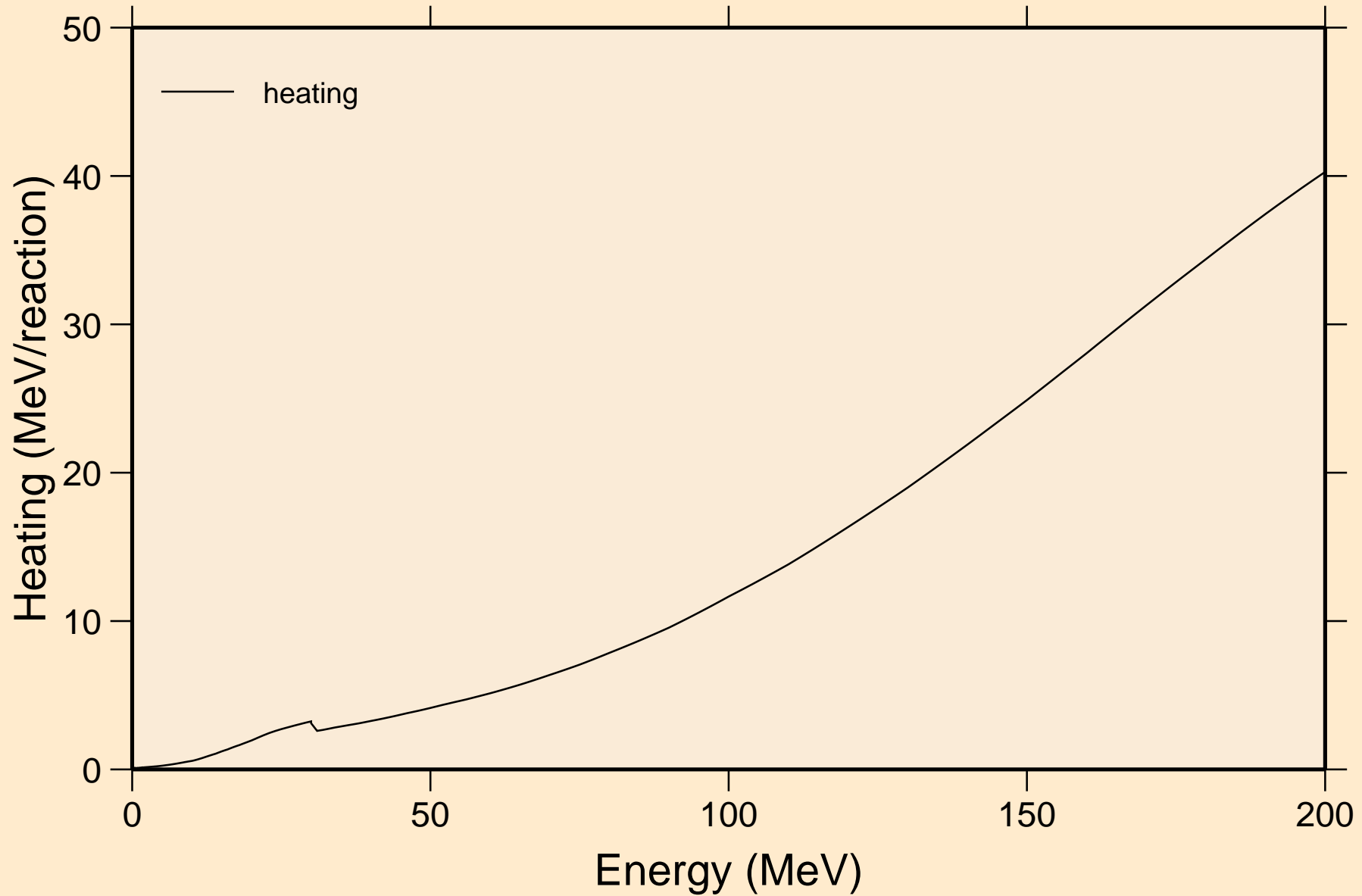

SC046M NEUTRON ACER TENDL-2021 LIBRARY; T=293.6K
Damage

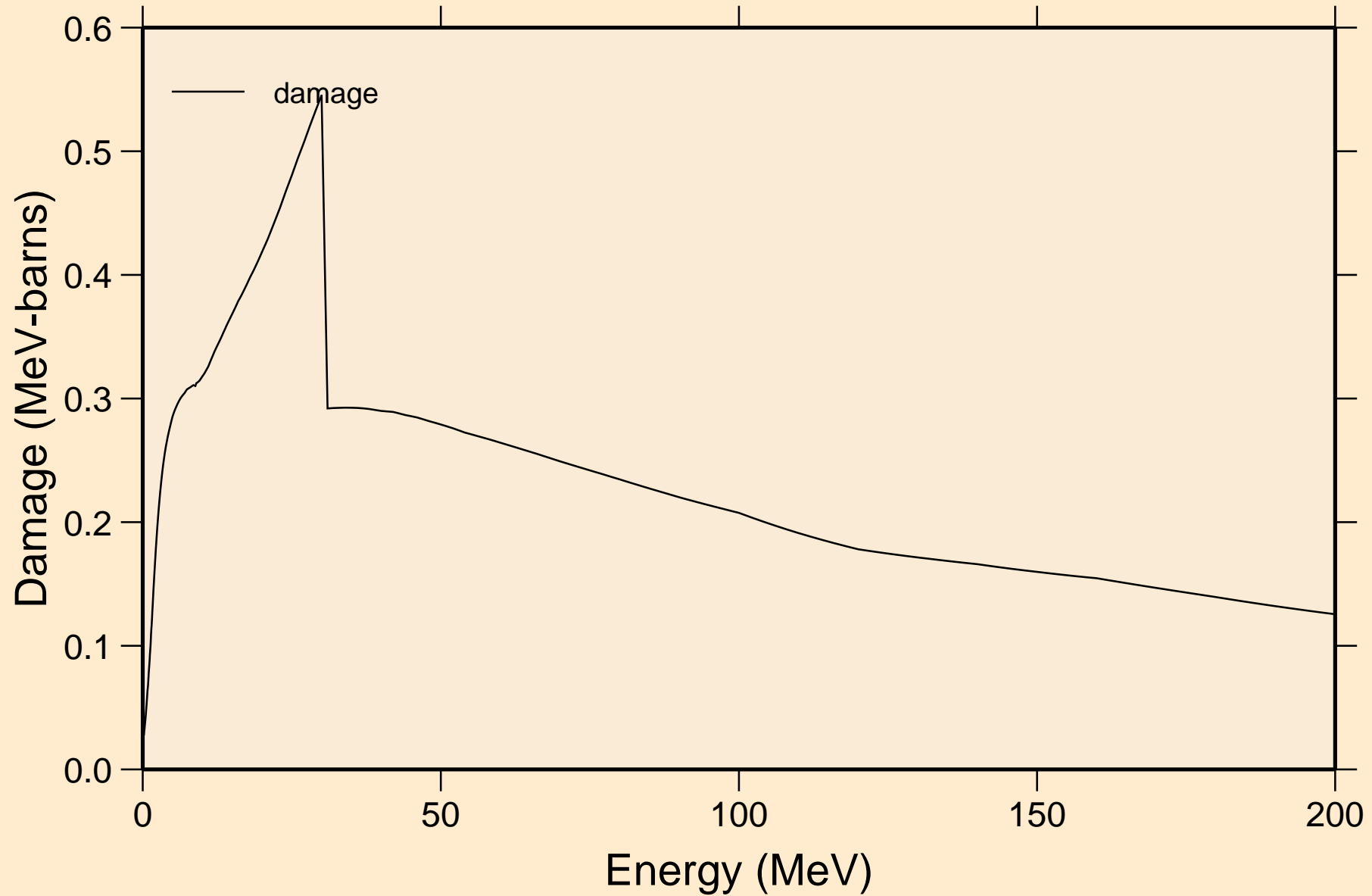

SC046M NEUTRON ACER TENDL-2021 LIBRARY; T=293.6K
Non-threshold reactions

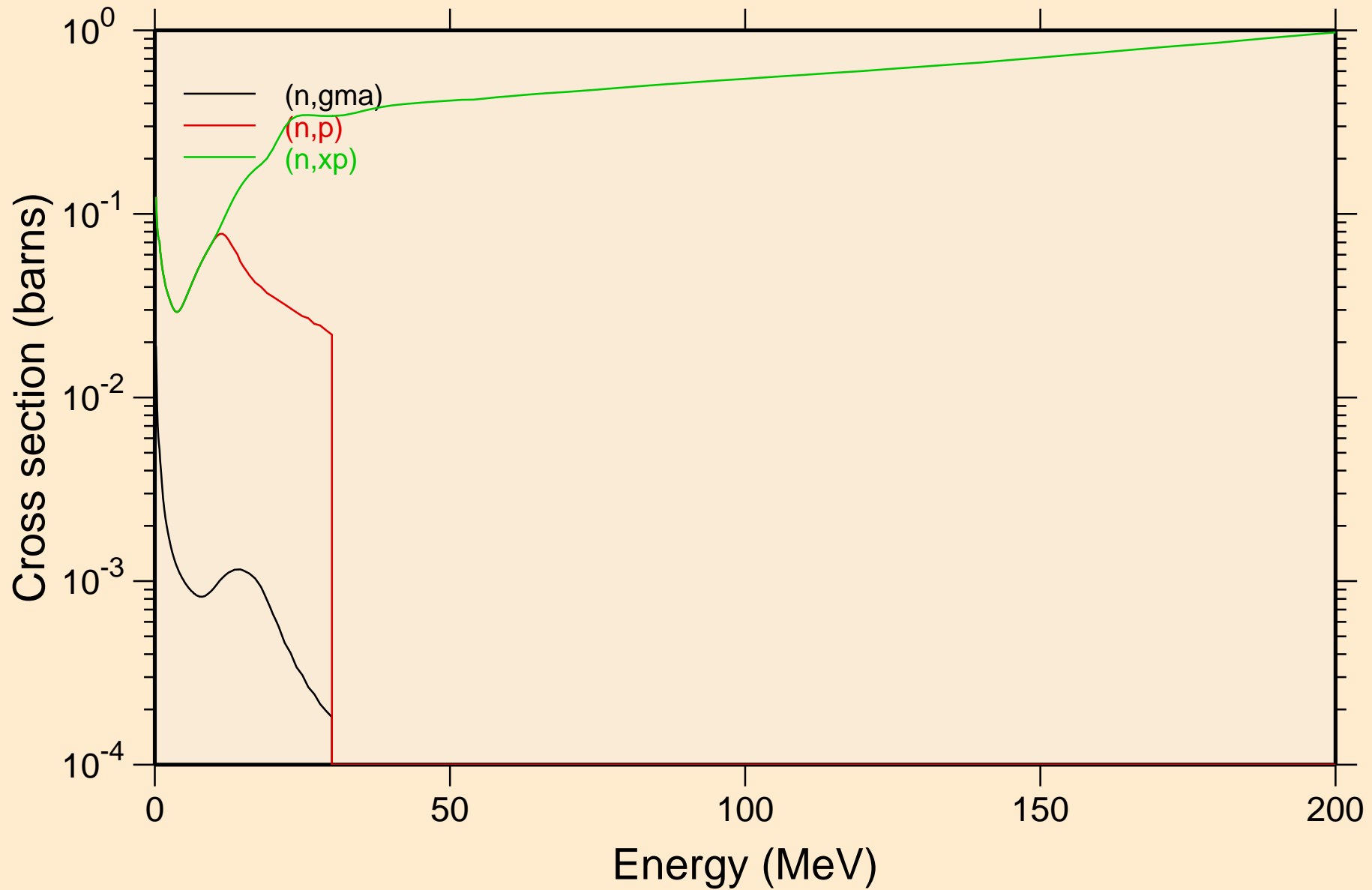

SC046M NEUTRON ACER TENDL-2021 LIBRARY; T=293.6K
Inelastic levels

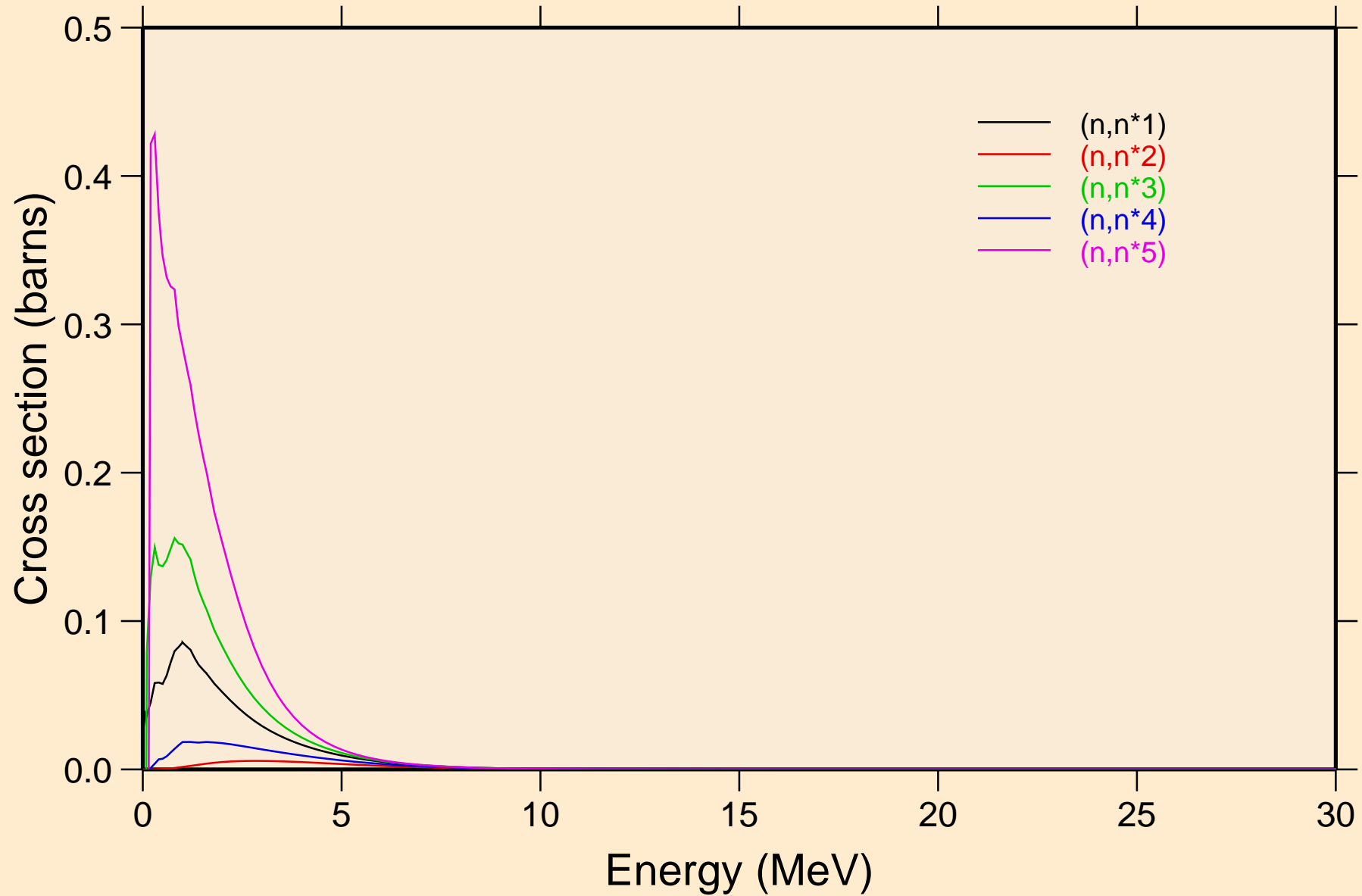

SC046M NEUTRON ACER TENDL-2021 LIBRARY; T=293.6K
Inelastic levels

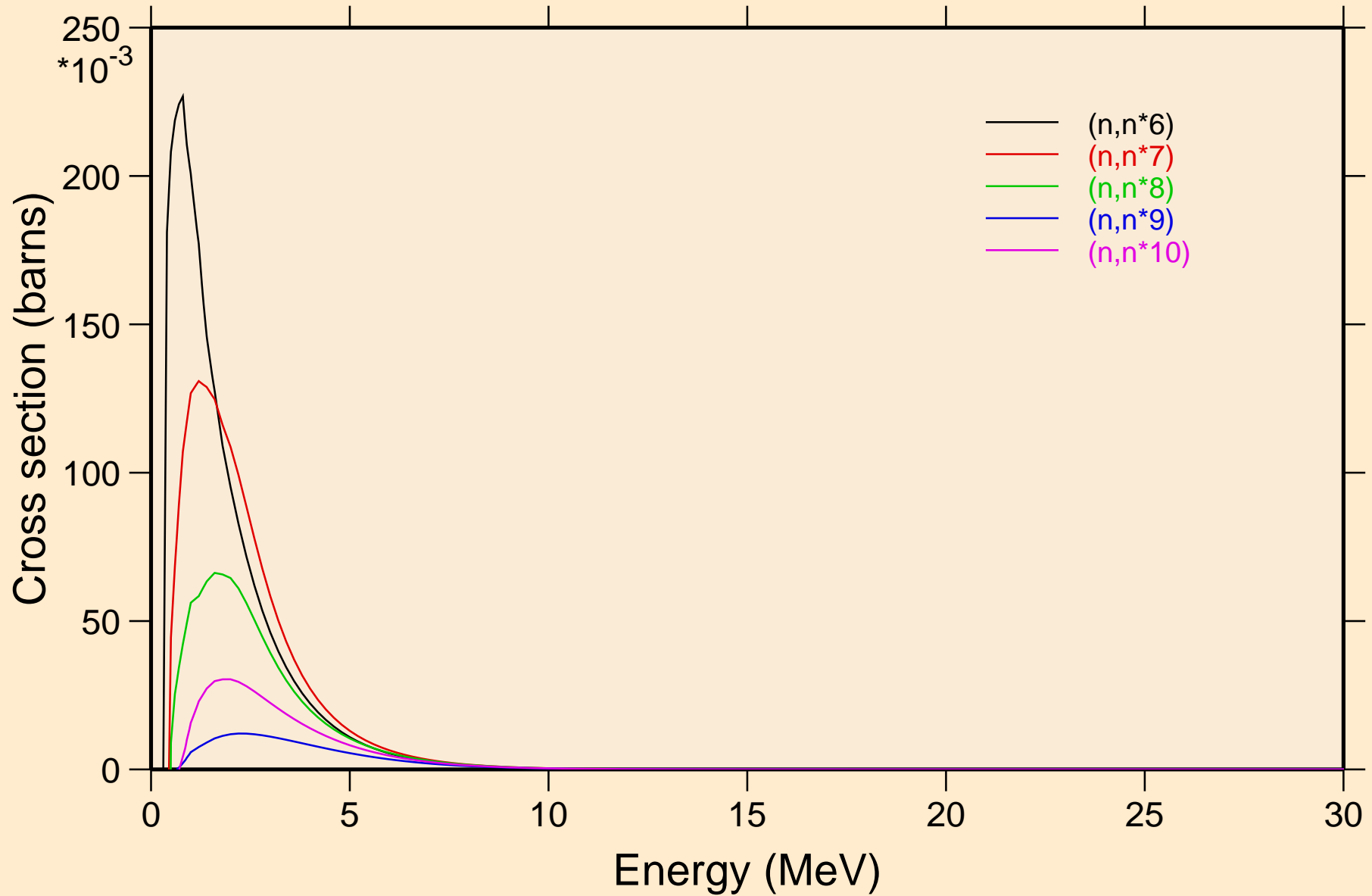

SC046M NEUTRON ACER TENDL-2021 LIBRARY; T=293.6K
Inelastic levels

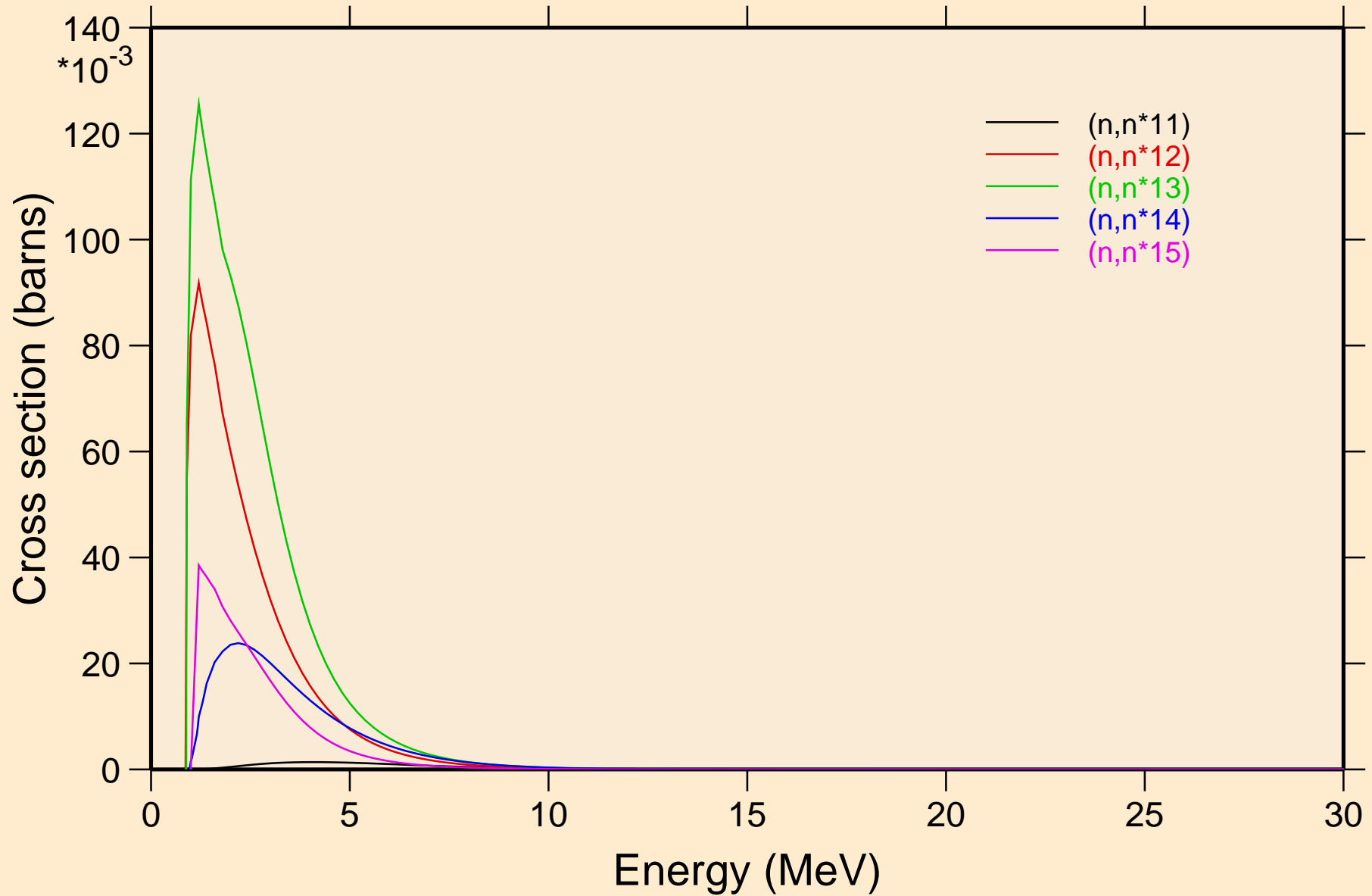

SC046M NEUTRON ACER TENDL-2021 LIBRARY; T=293.6K
Inelastic levels

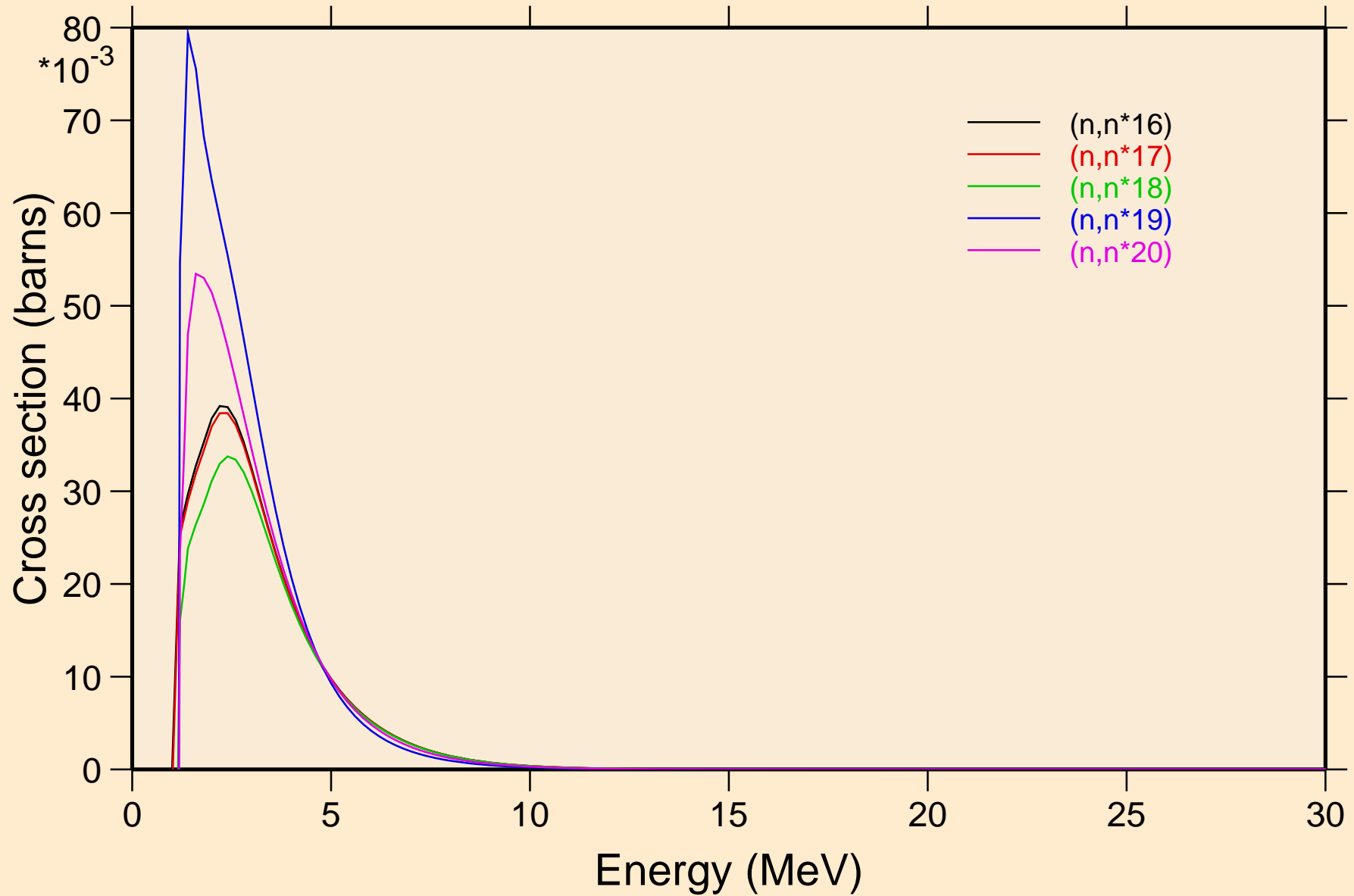

SC046M NEUTRON ACER TENDL-2021 LIBRARY; T=293.6K
Inelastic levels

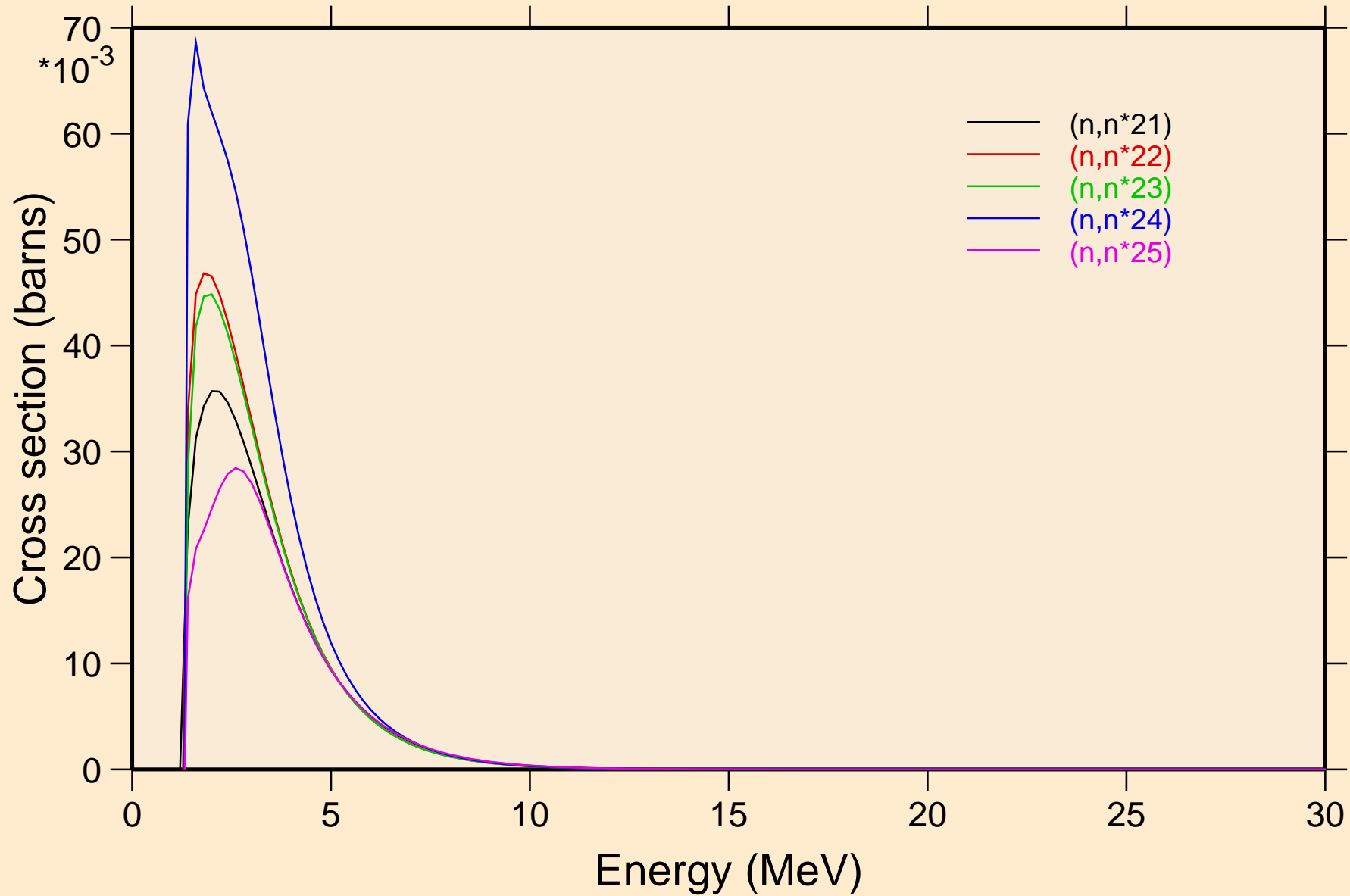

SC046M NEUTRON ACER TENDL-2021 LIBRARY; T=293.6K
Inelastic levels

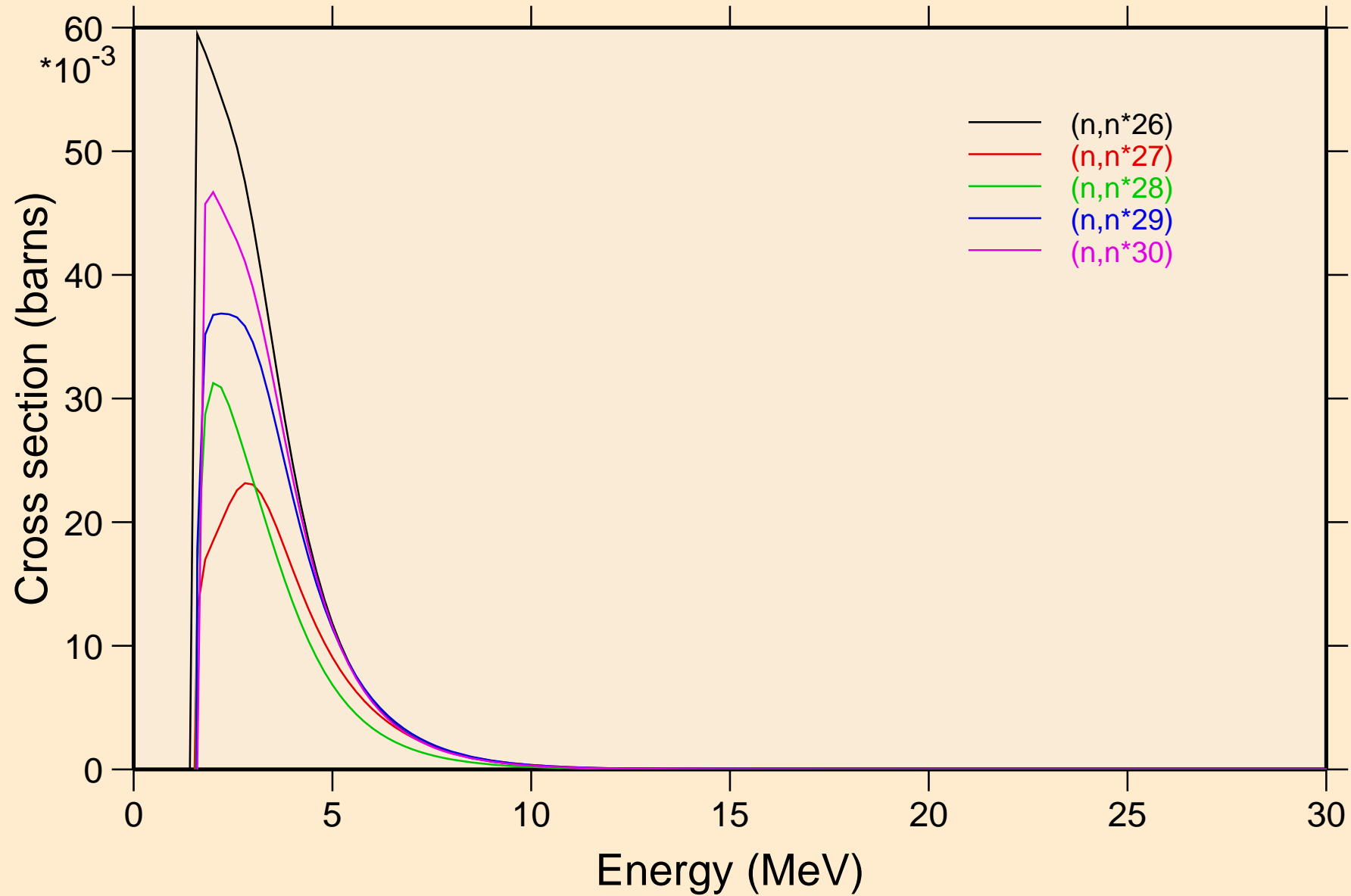

SC046M NEUTRON ACER TENDL-2021 LIBRARY; T=293.6K
Threshold reactions

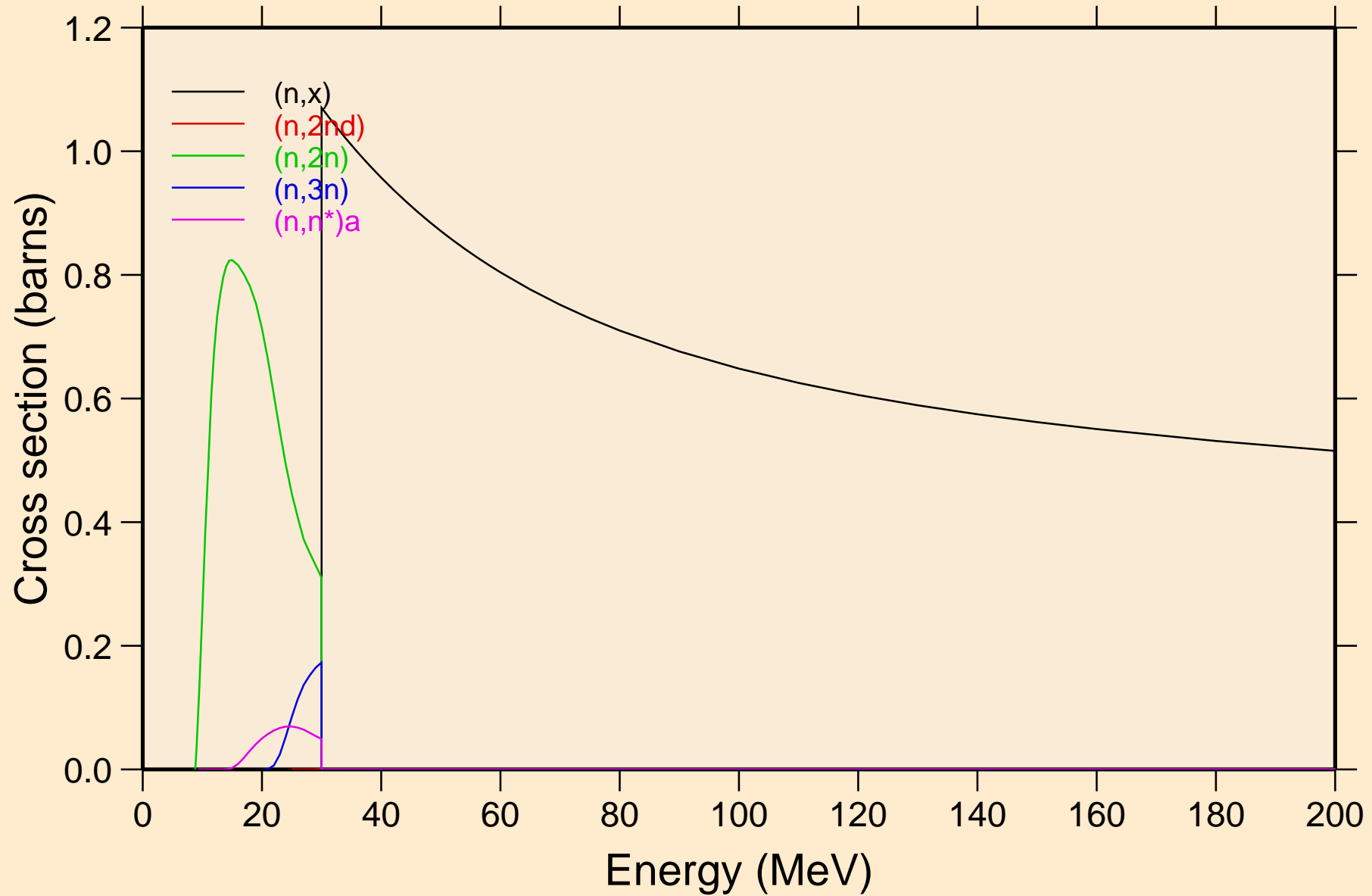

SC046M NEUTRON ACER TENDL-2021 LIBRARY; T=293.6K
Threshold reactions

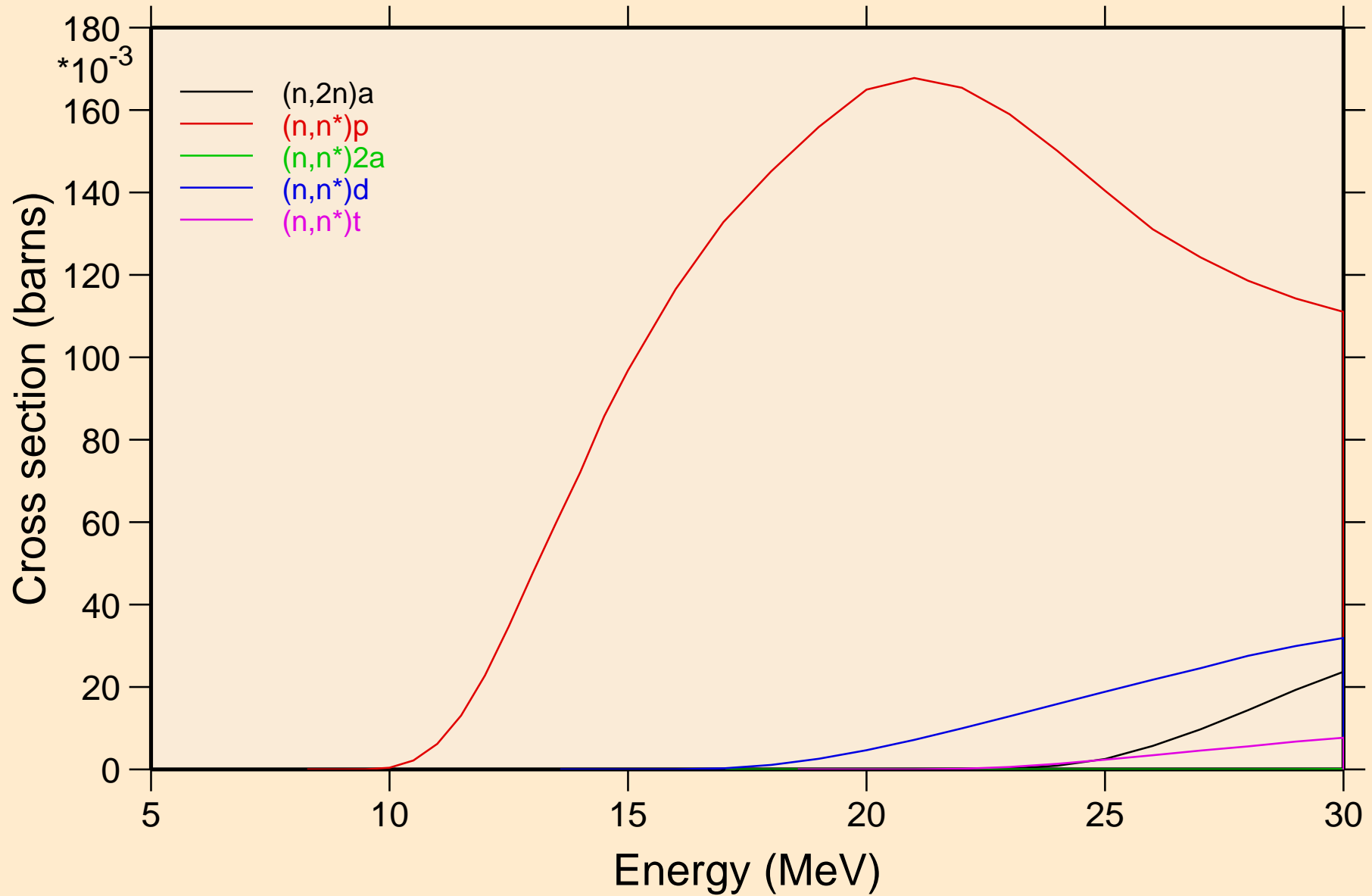

SC046M NEUTRON ACER TENDL-2021 LIBRARY; T=293.6K
Threshold reactions

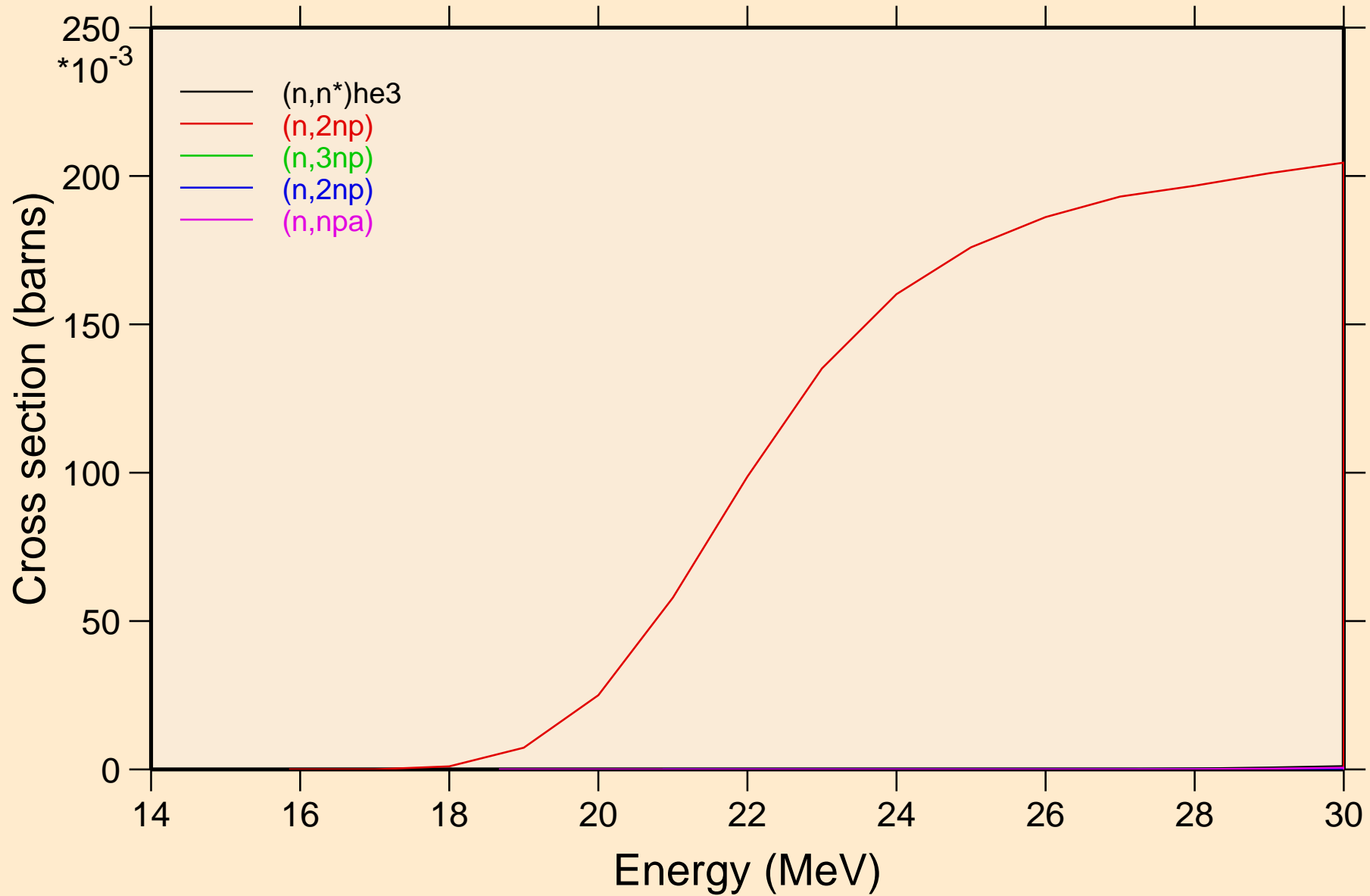

SC046M NEUTRON ACER TENDL-2021 LIBRARY; T=293.6K
Threshold reactions

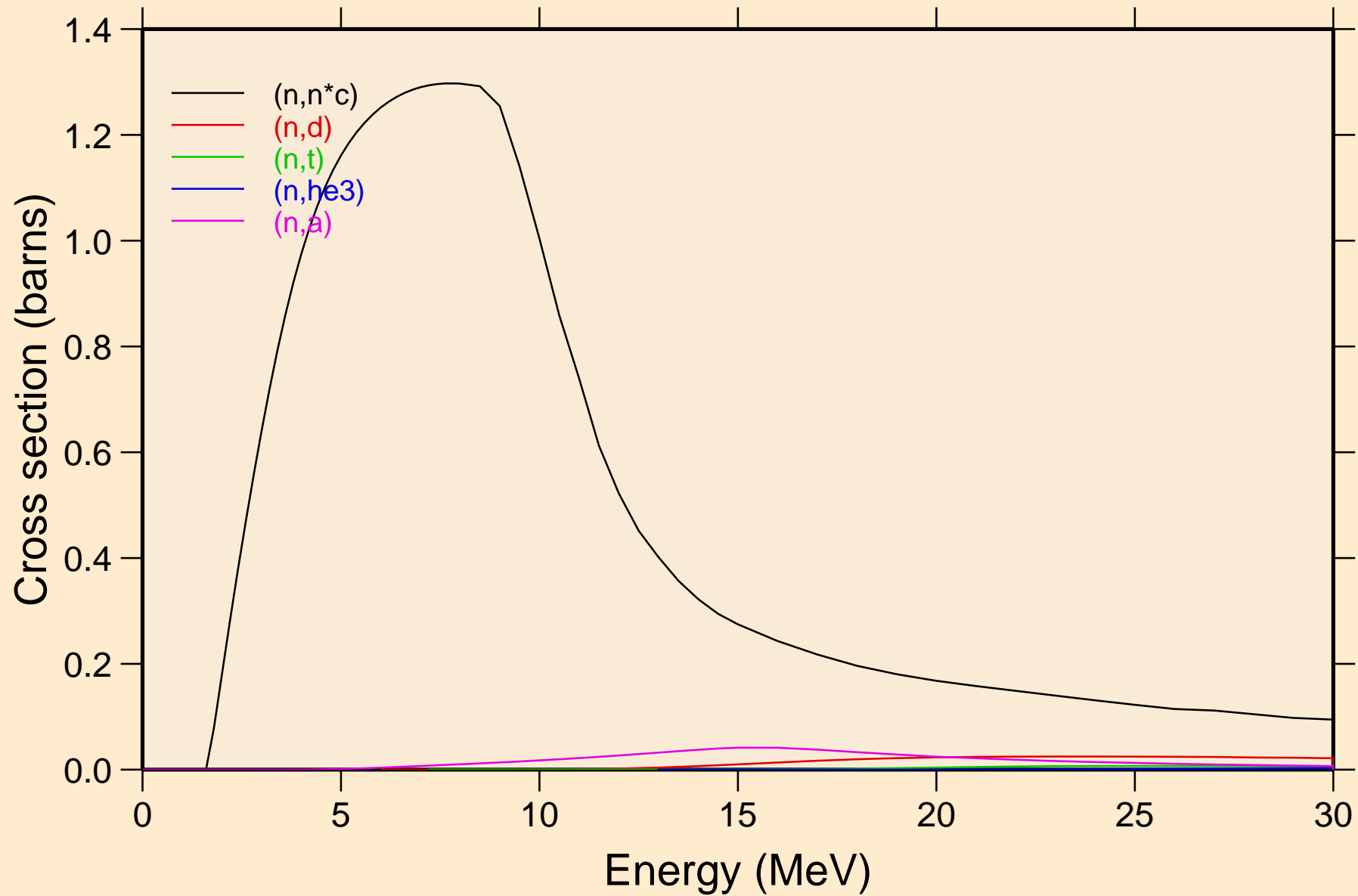

SC046M NEUTRON ACER TENDL-2021 LIBRARY; T=293.6K
Threshold reactions

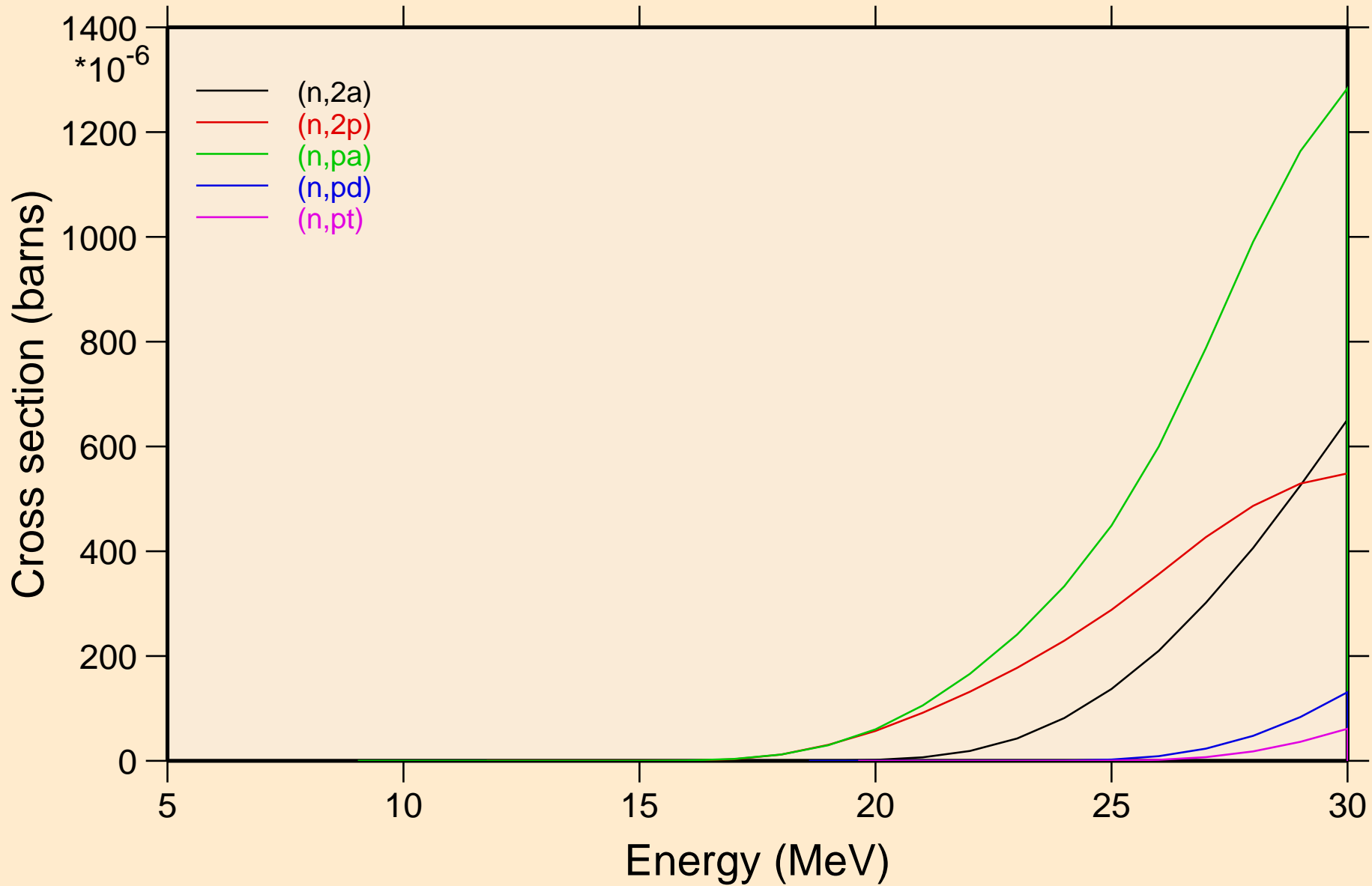

SC046M NEUTRON ACER TENDL-2021 LIBRARY; T=293.6K
Threshold reactions

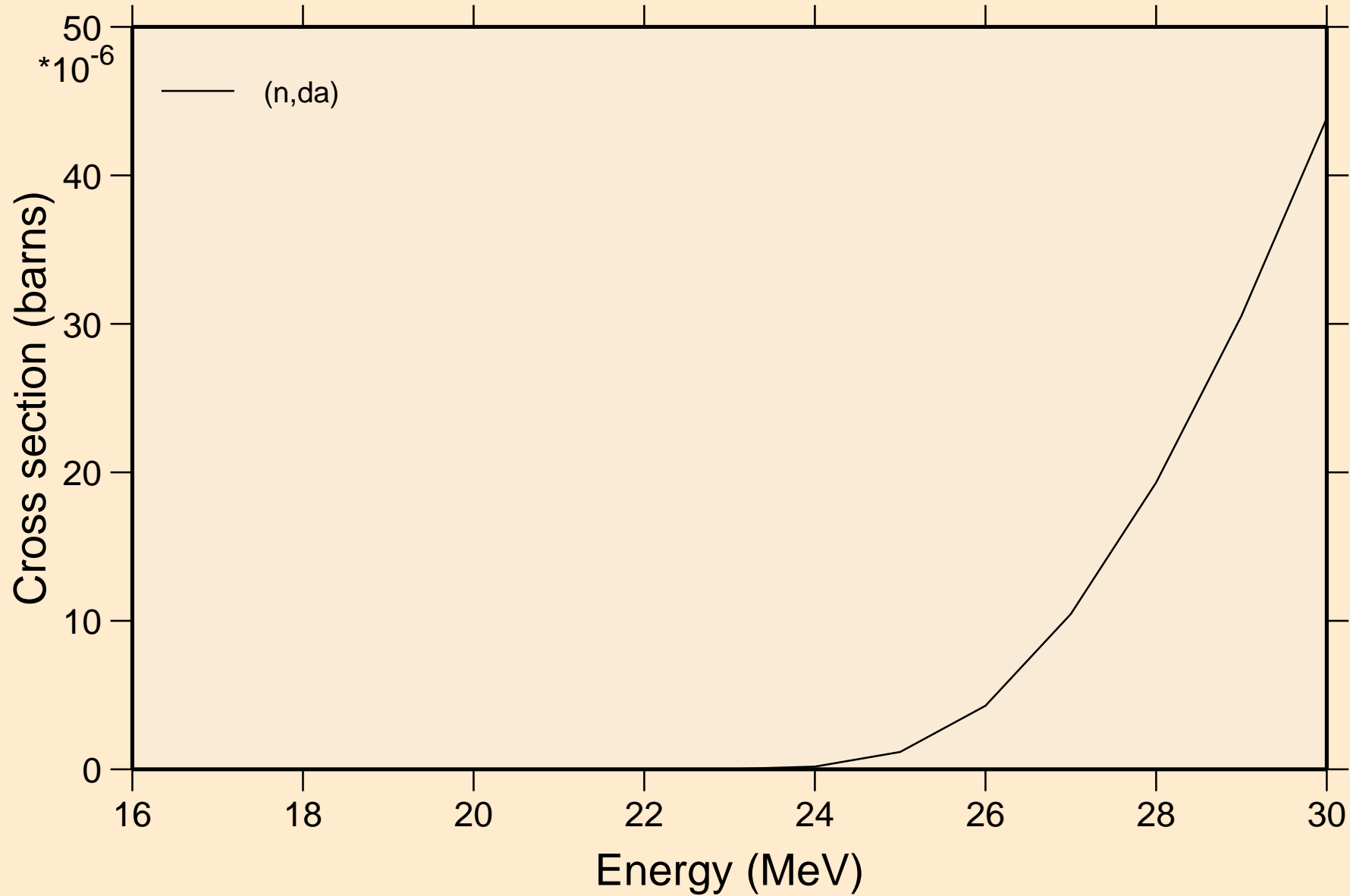

SC046M NEUTRON ACER TENDL-2021 LIBRARY; T=293.6K
Threshold reactions

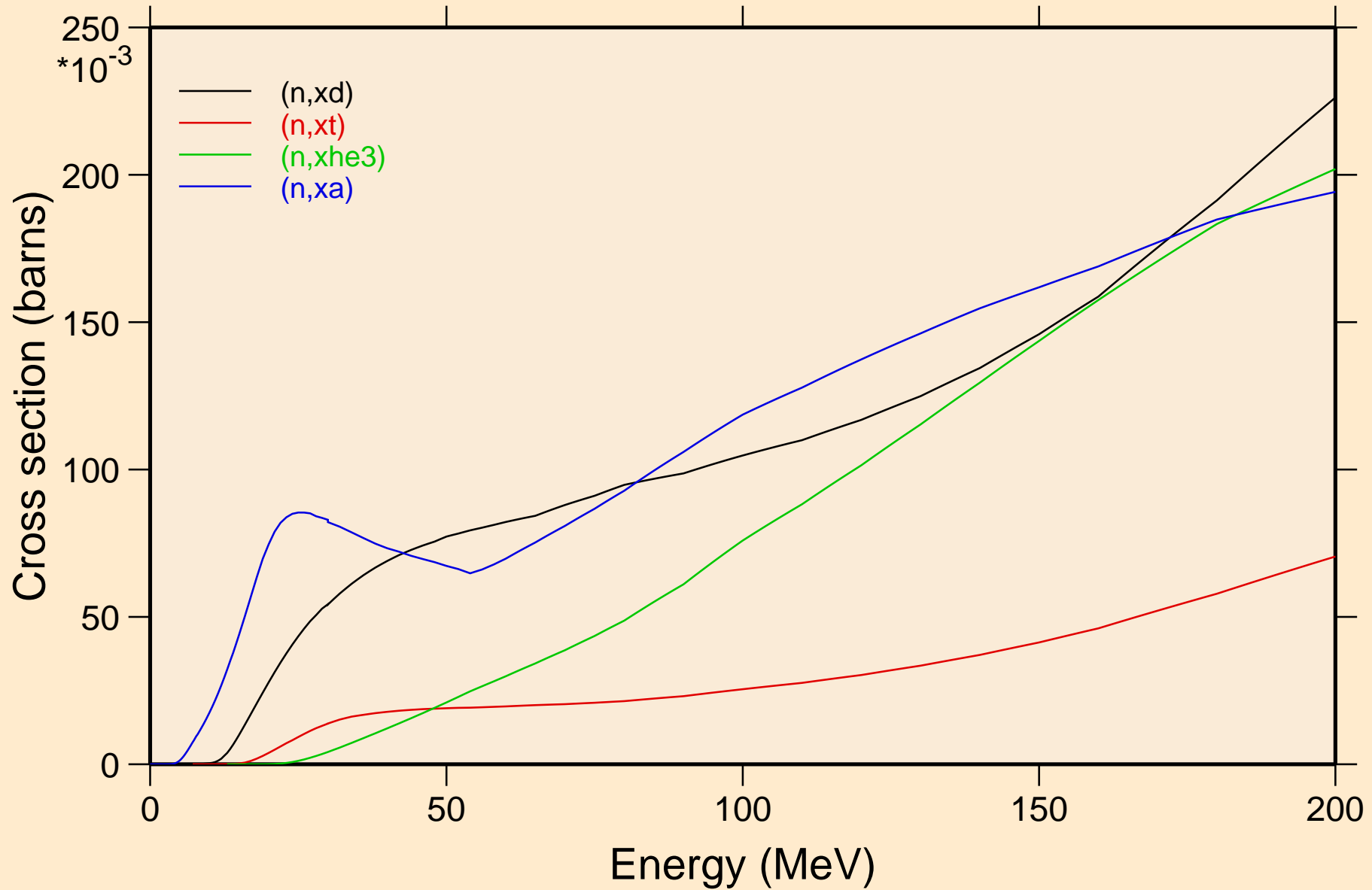

SC046M NEUTRON ACER TENDL-2021 LIBRARY; T=293.6K
angular distribution for elastic

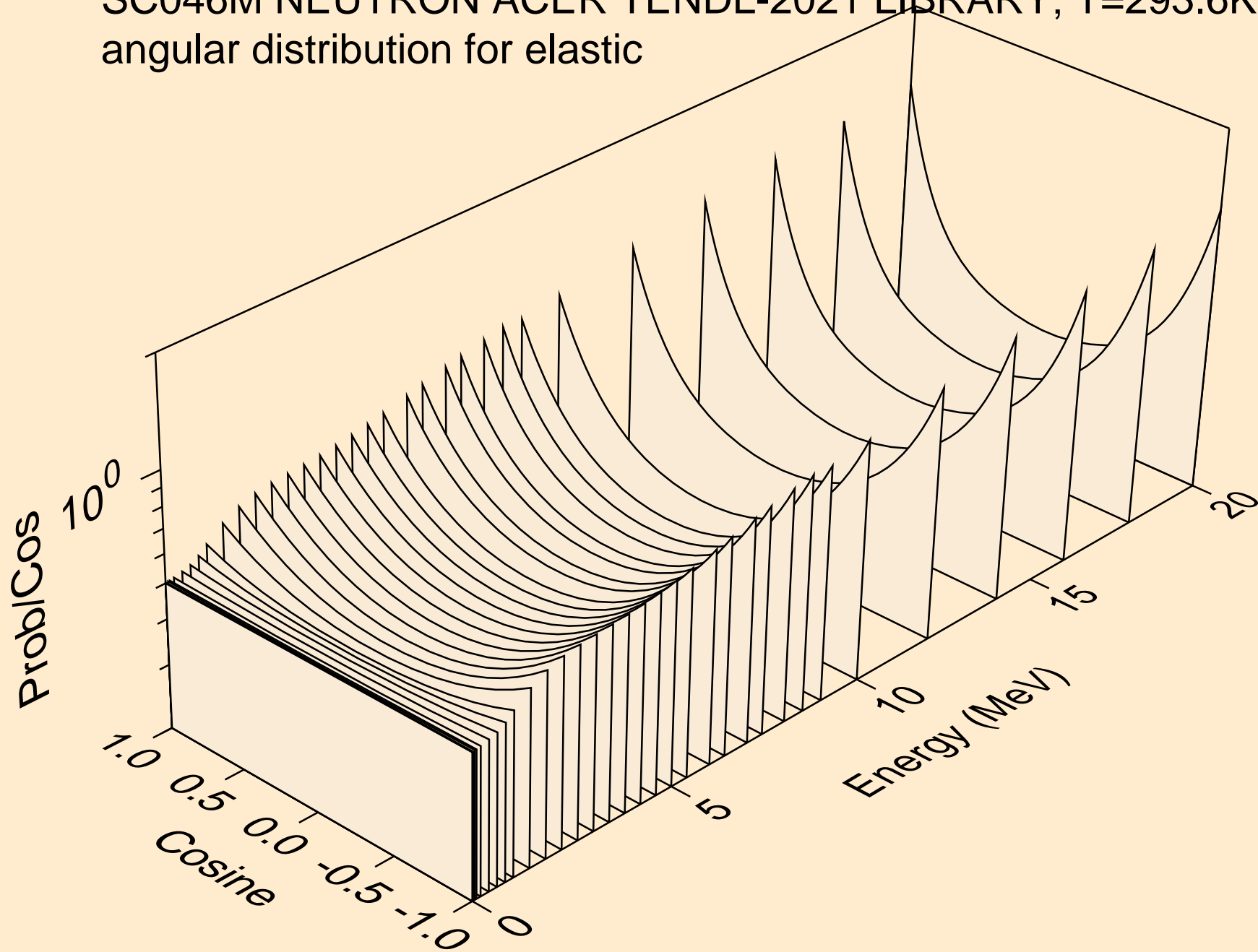

SC046M NEUTRON ACER TENDL-2021 LIBRARY; T=293.6K
angular distribution for elastic

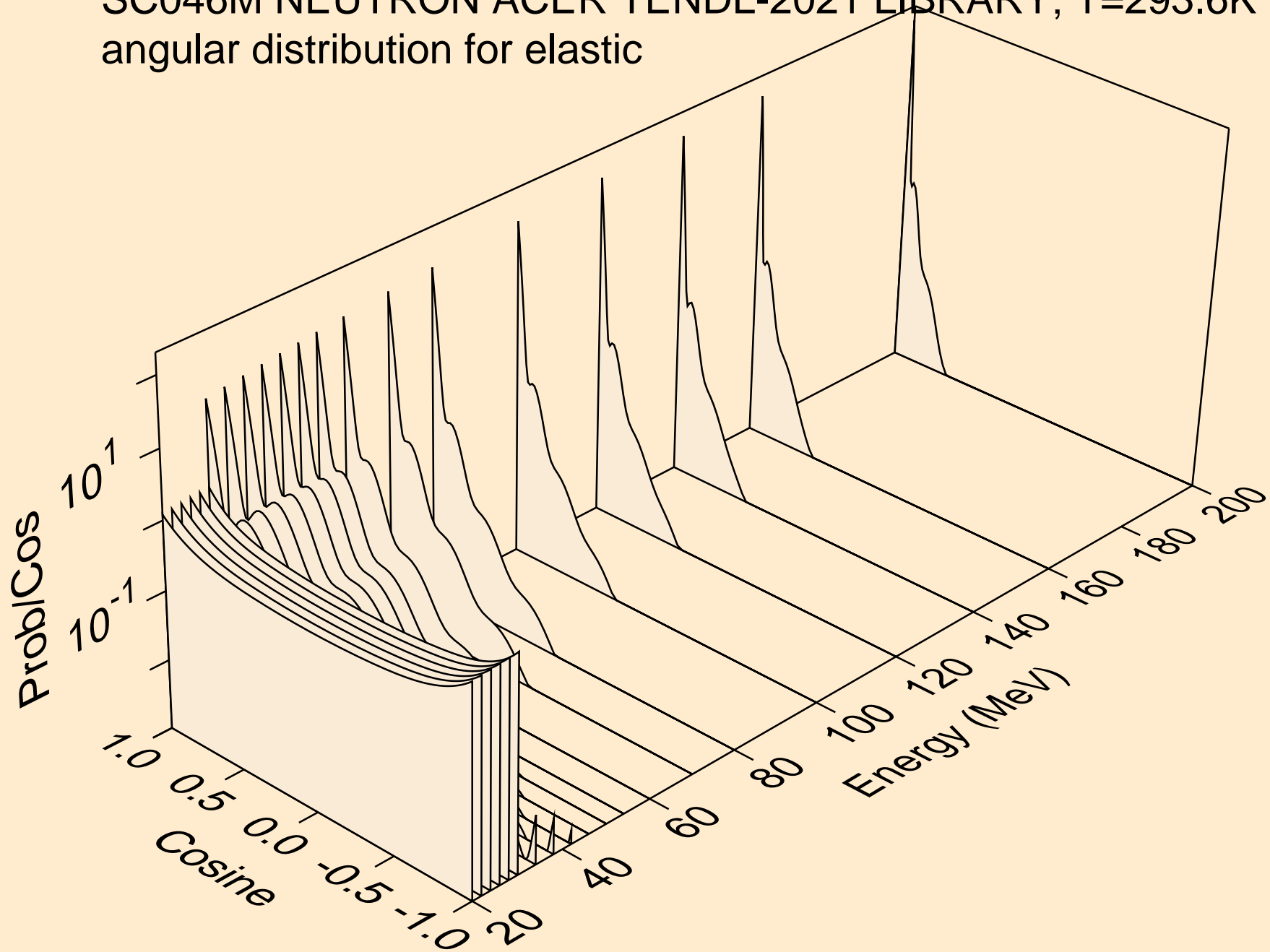

SC046M NEUTRON ACER TENDL-2021 LIBRARY; T=293.6K
angular distribution for (n,n*1)

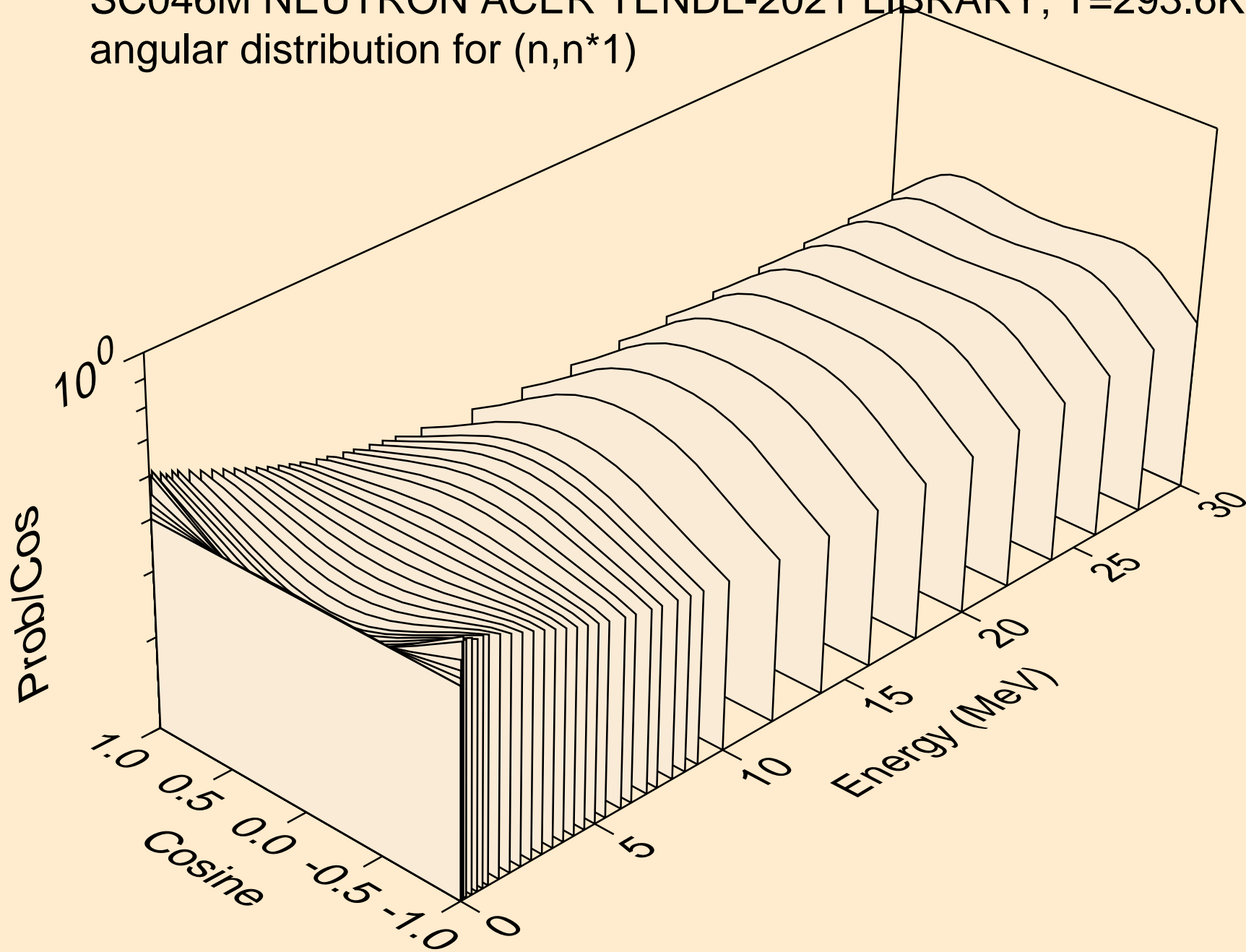

SC046M NEUTRON ACER TENDL-2021 LIBRARY; T=293.6K
angular distribution for (n,n*2)

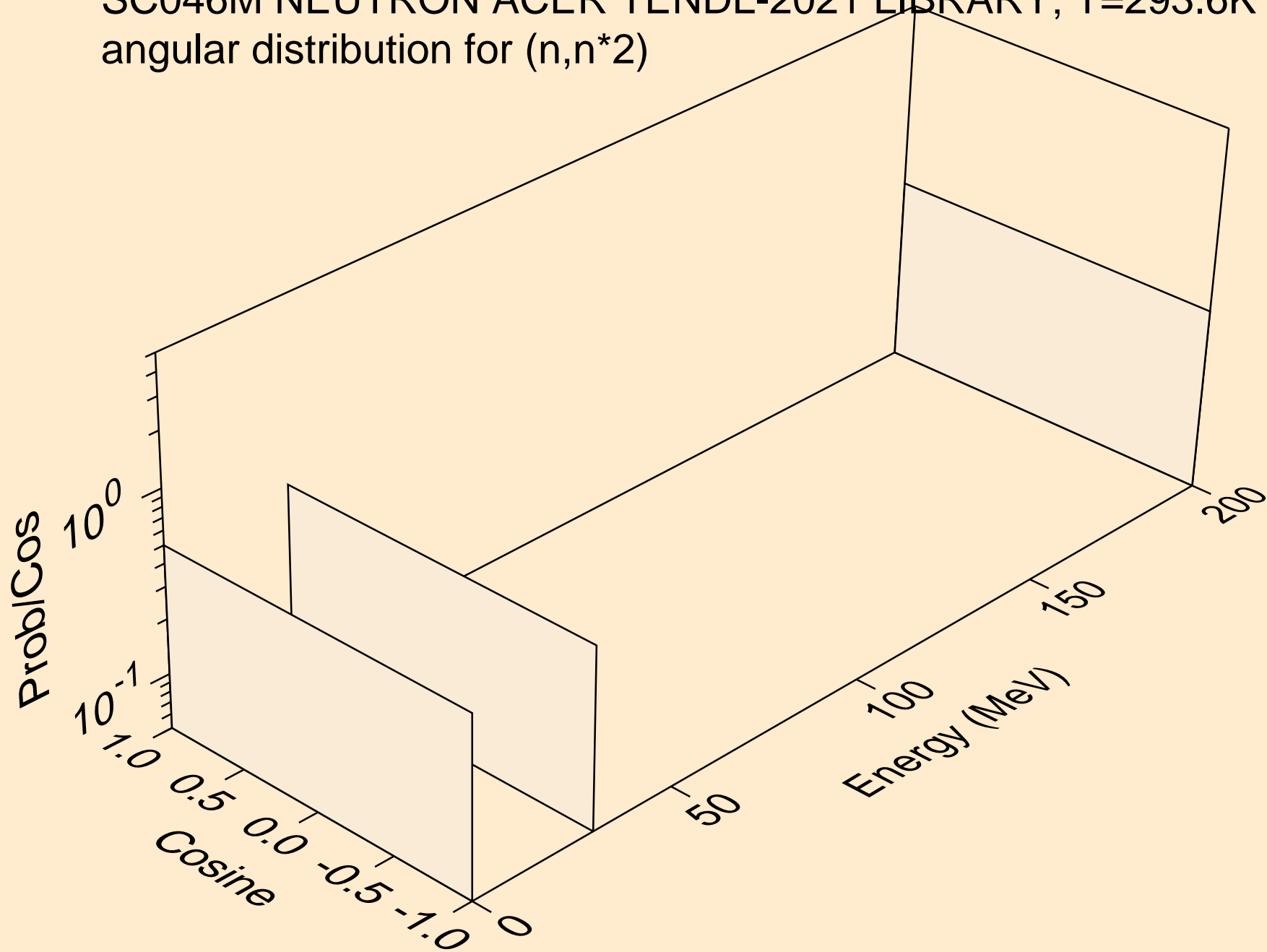

SC046M NEUTRON ACER TENDL-2021 LIBRARY; T=293.6K
angular distribution for (n,n*3)

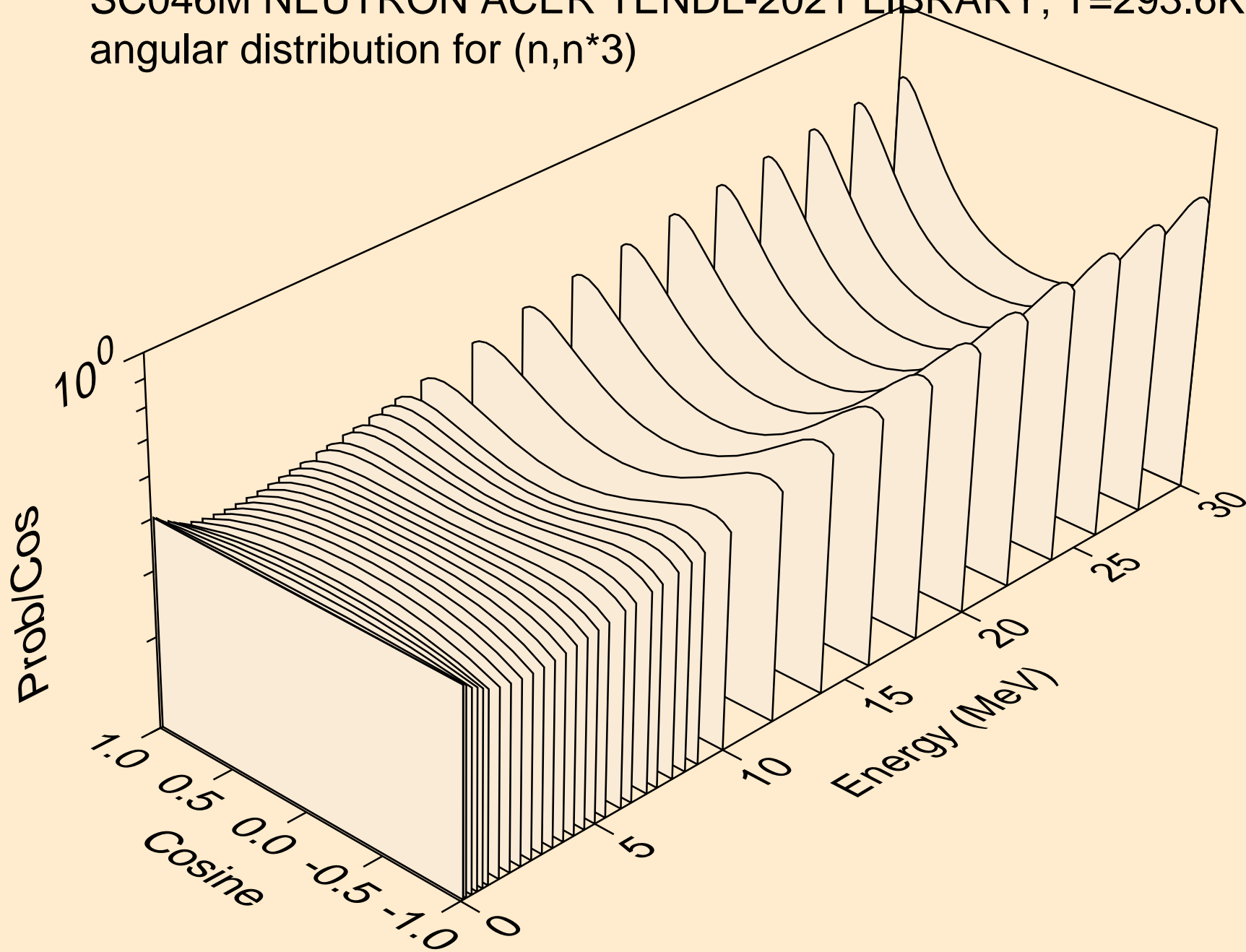

SC046M NEUTRON ACER TENDL-2021 LIBRARY; T=293.6K
angular distribution for (n,n*4)

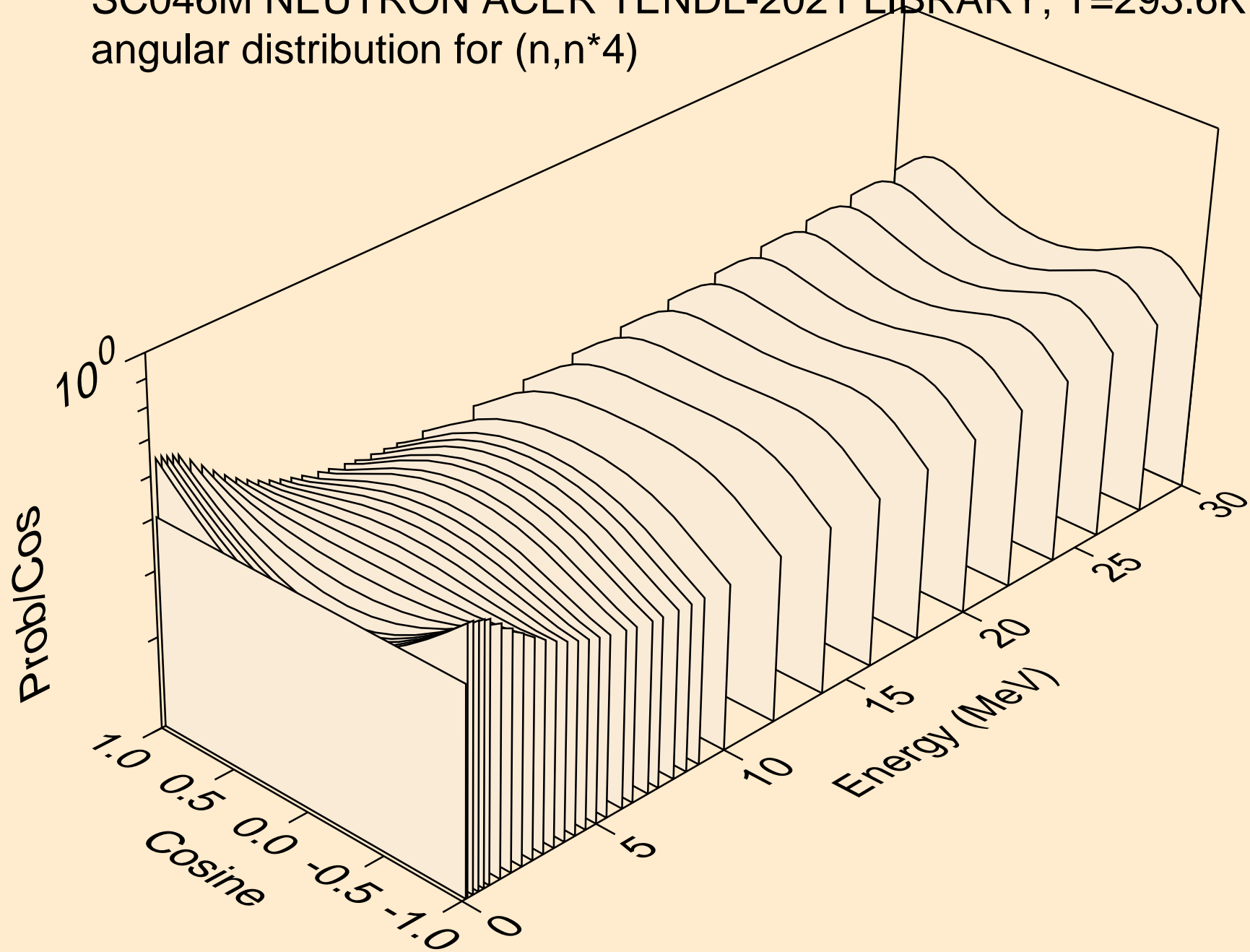

SC046M NEUTRON ACER TENDL-2021 LIBRARY; T=293.6K
angular distribution for (n,n*5)

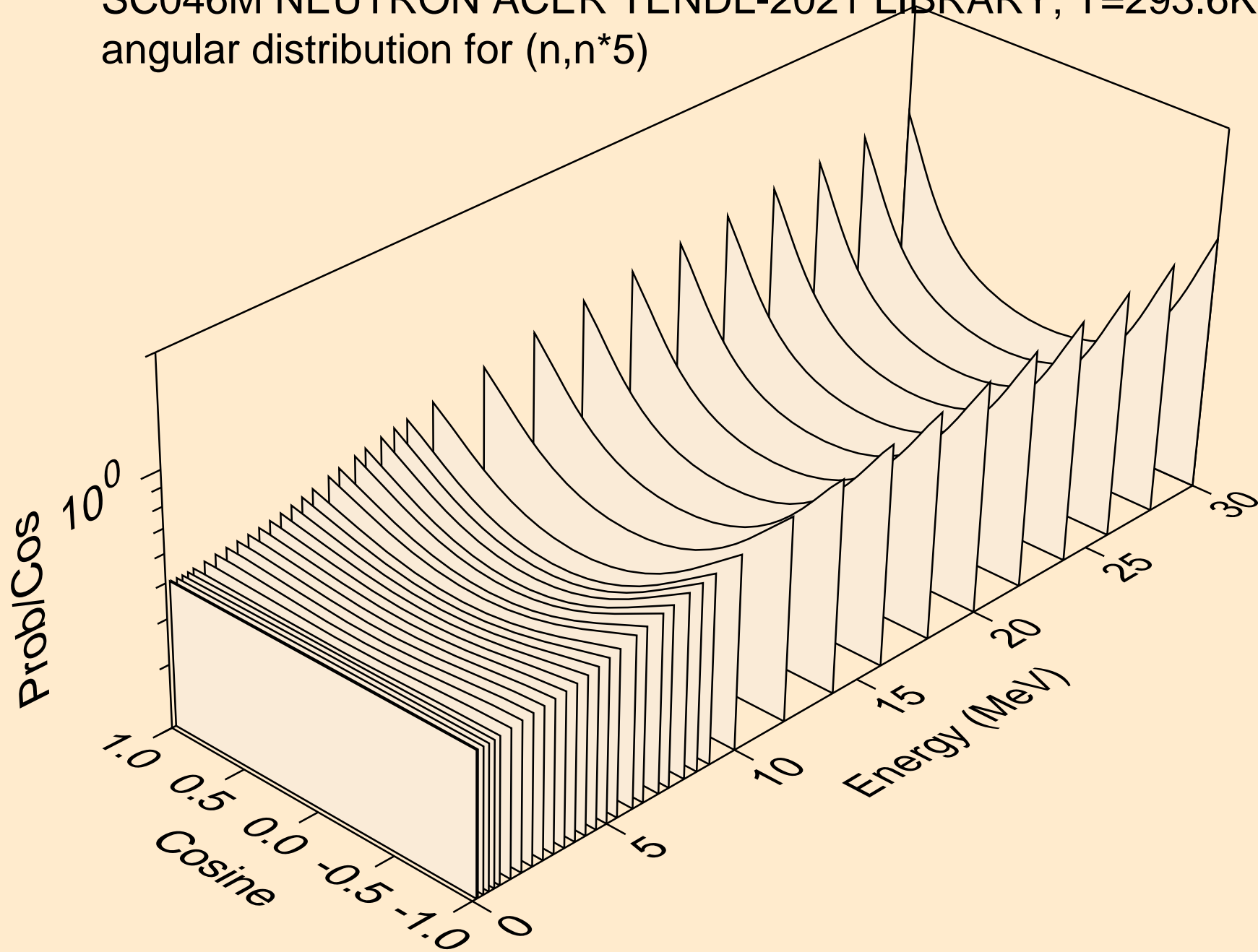

SC046M NEUTRON ACER TENDL-2021 LIBRARY; T=293.6K
angular distribution for (n,n*6)

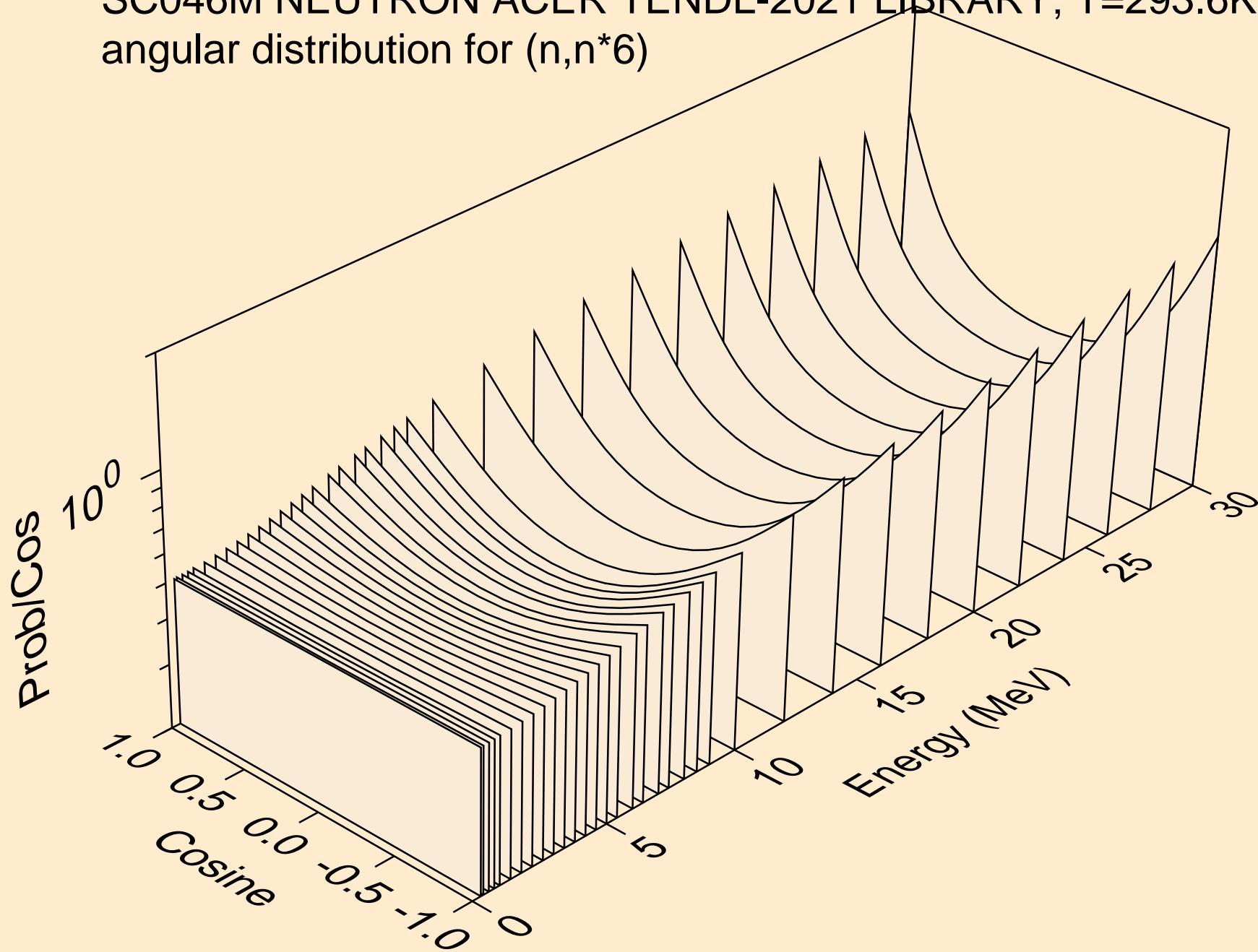

SC046M NEUTRON ACER TENDL-2021 LIBRARY; T=293.6K
angular distribution for (n,n*7)

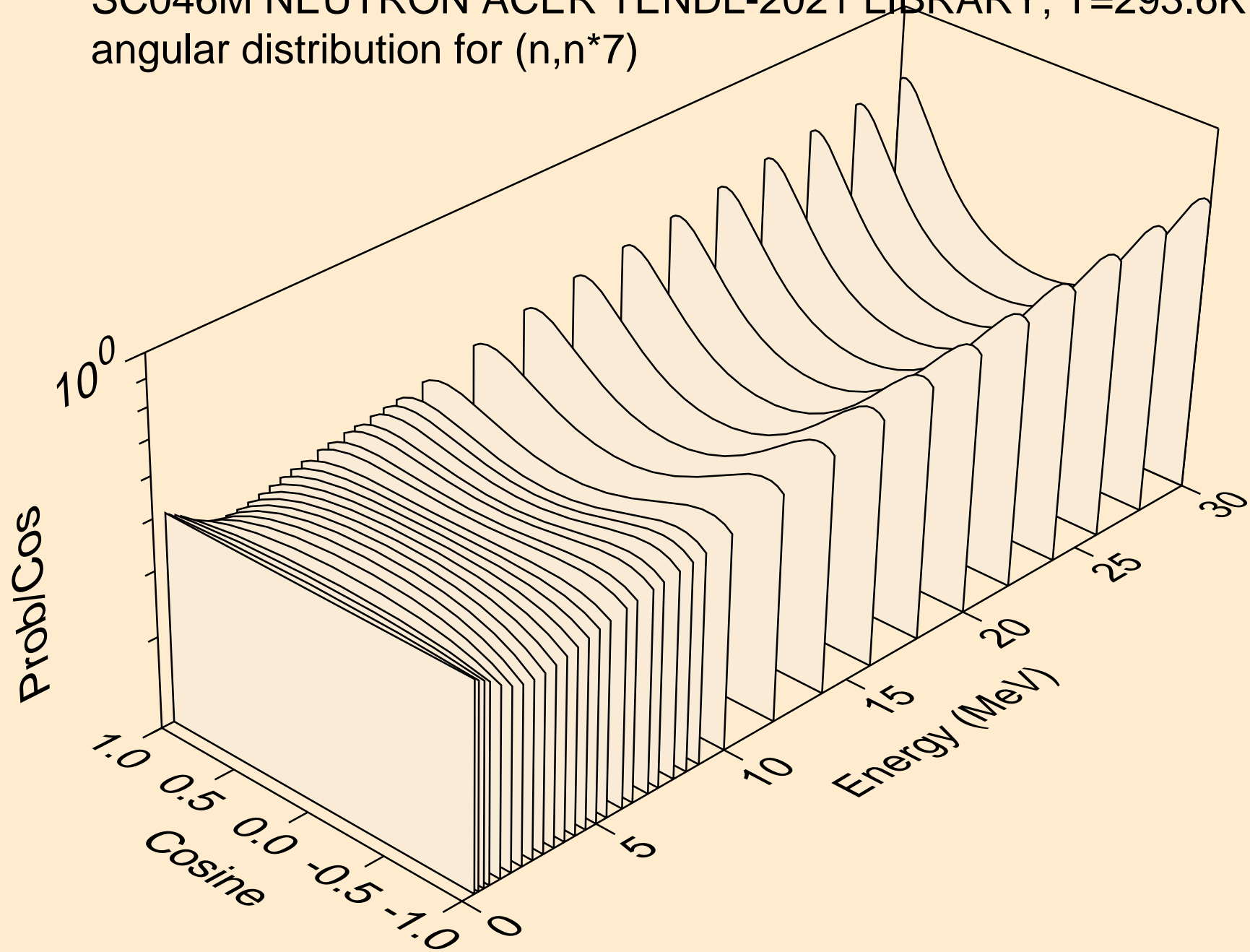

SC046M NEUTRON ACER TENDL-2021 LIBRARY; T=293.6K
angular distribution for (n,n*8)

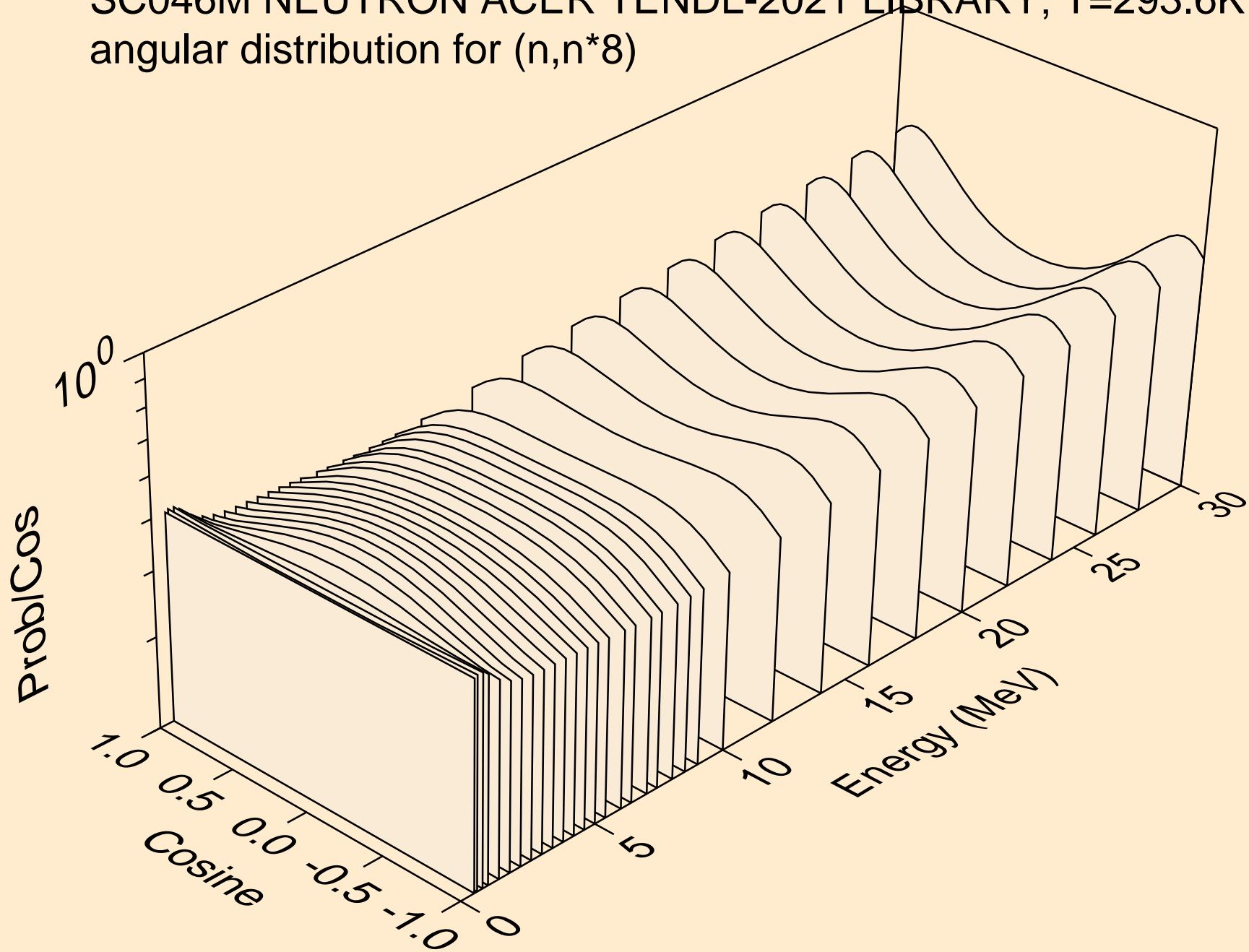

SC046M NEUTRON ACER TENDL-2021 LIBRARY; T=293.6K
angular distribution for (n,n*9)

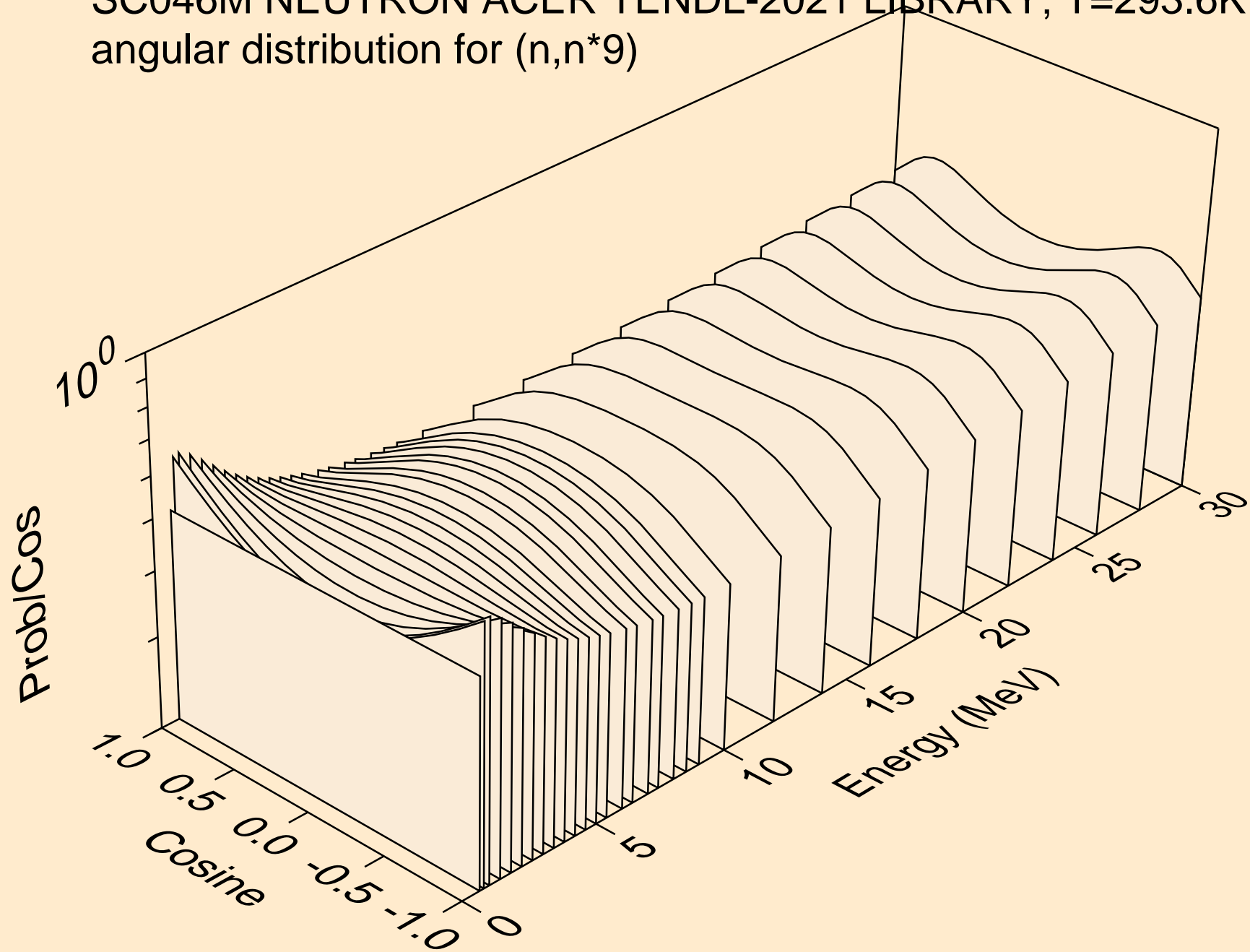

SC046M NEUTRON ACER TENDL-2021 LIBRARY; T=293.6K
angular distribution for (n,n*10)

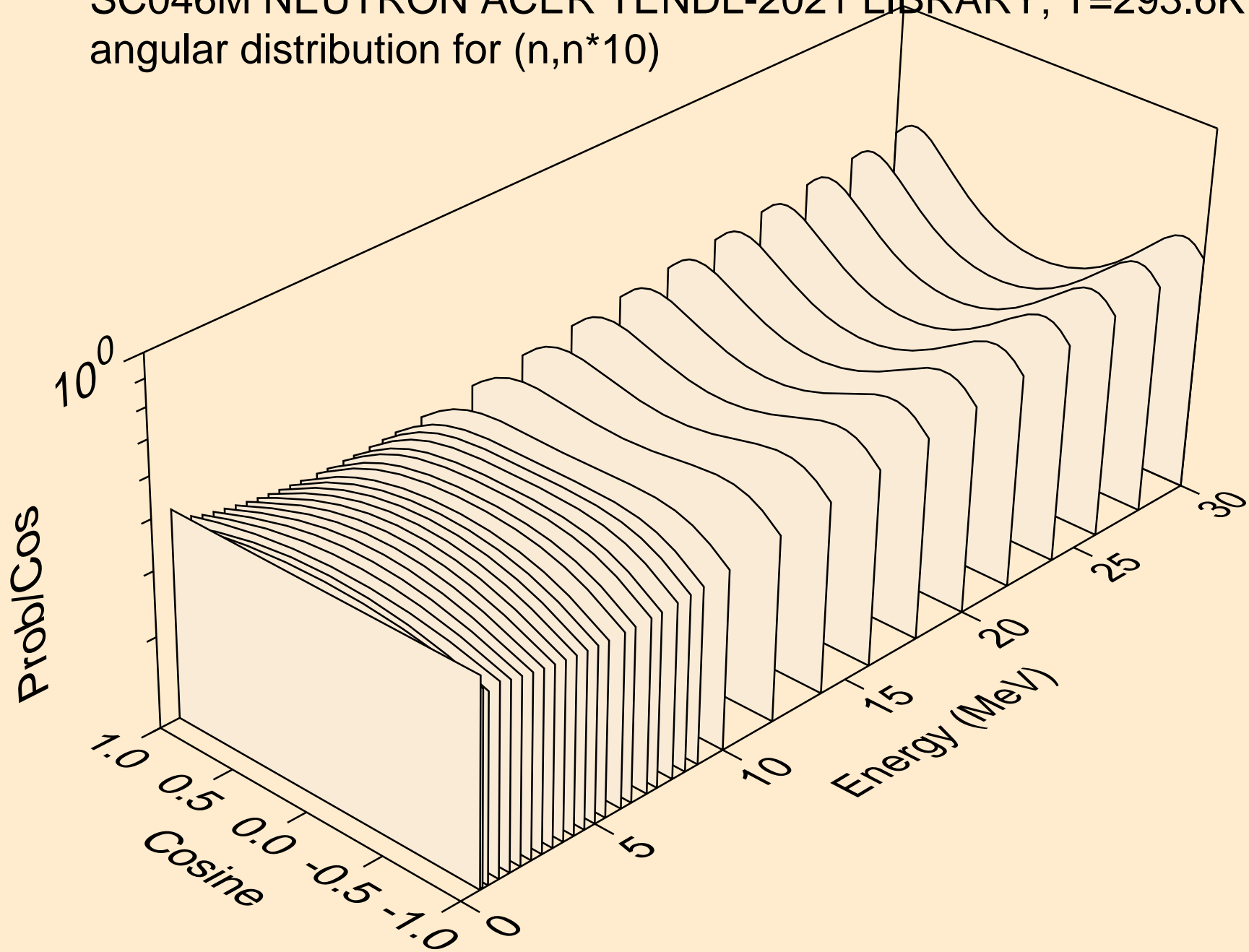

SC046M NEUTRON ACER TENDL-2021 LIBRARY; T=293.6K
angular distribution for (n,n*11)

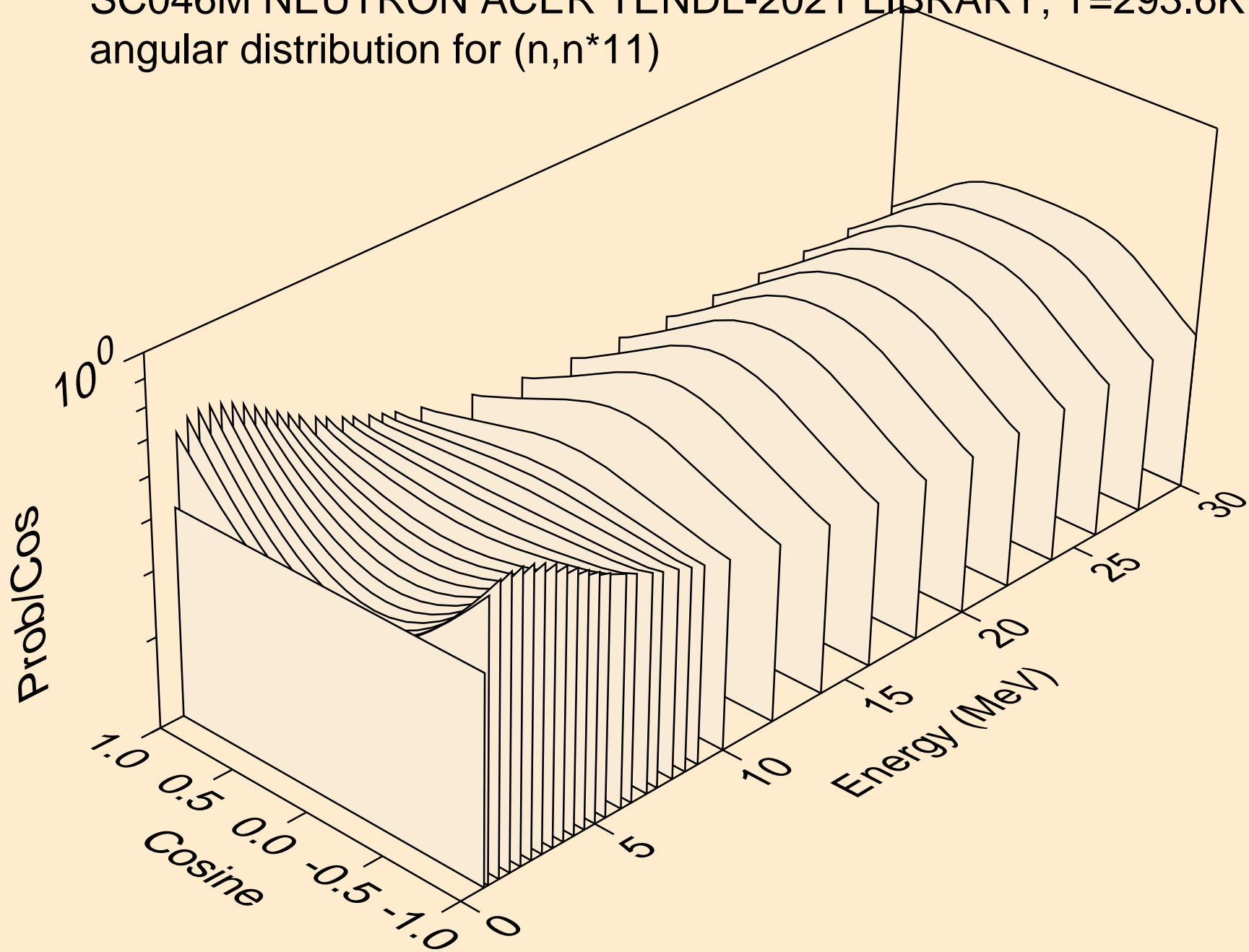

SC046M NEUTRON ACER TENDL-2021 LIBRARY; T=293.6K
angular distribution for (n,n*12)

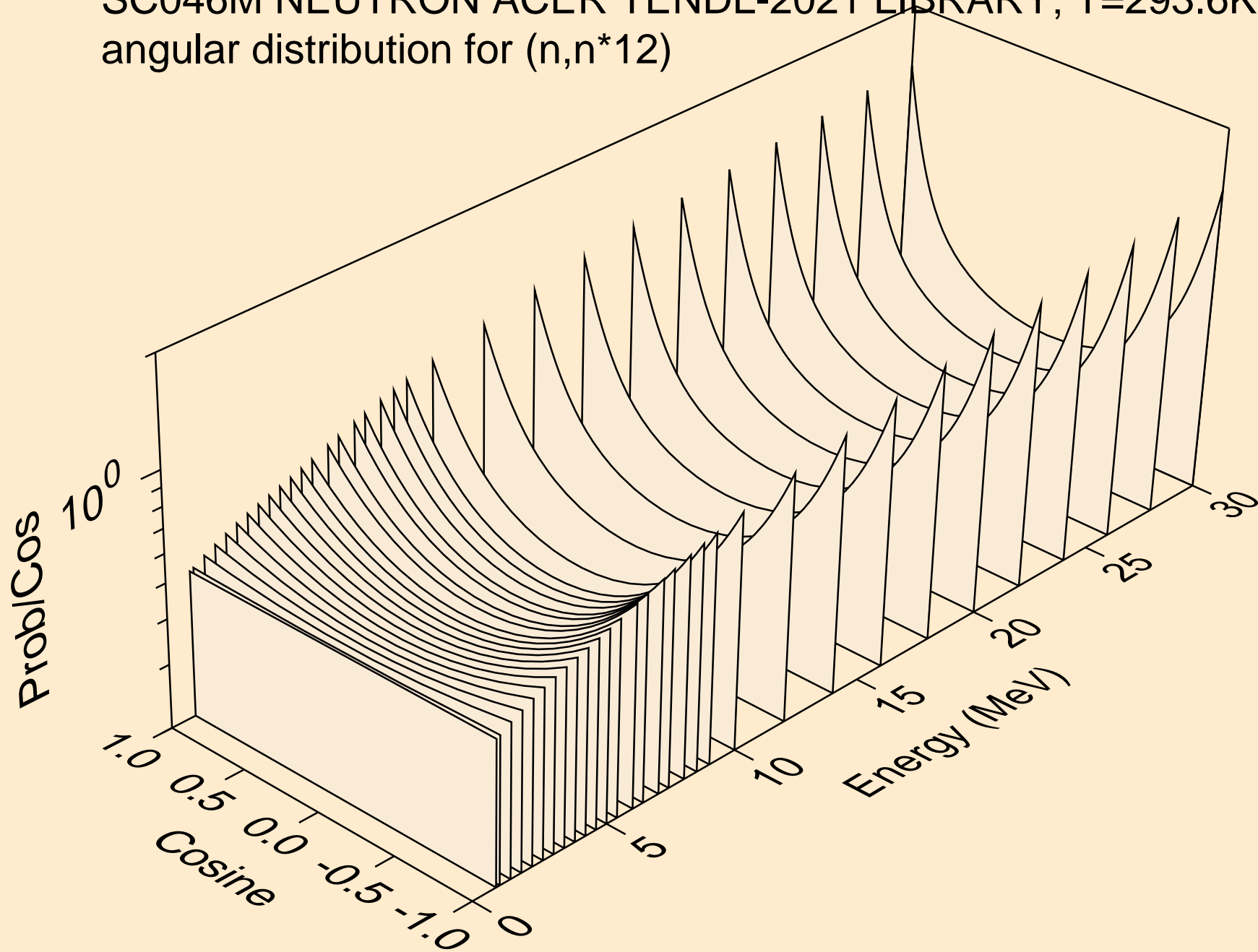

SC046M NEUTRON ACER TENDL-2021 LIBRARY; T=293.6K
angular distribution for (n,n*13)

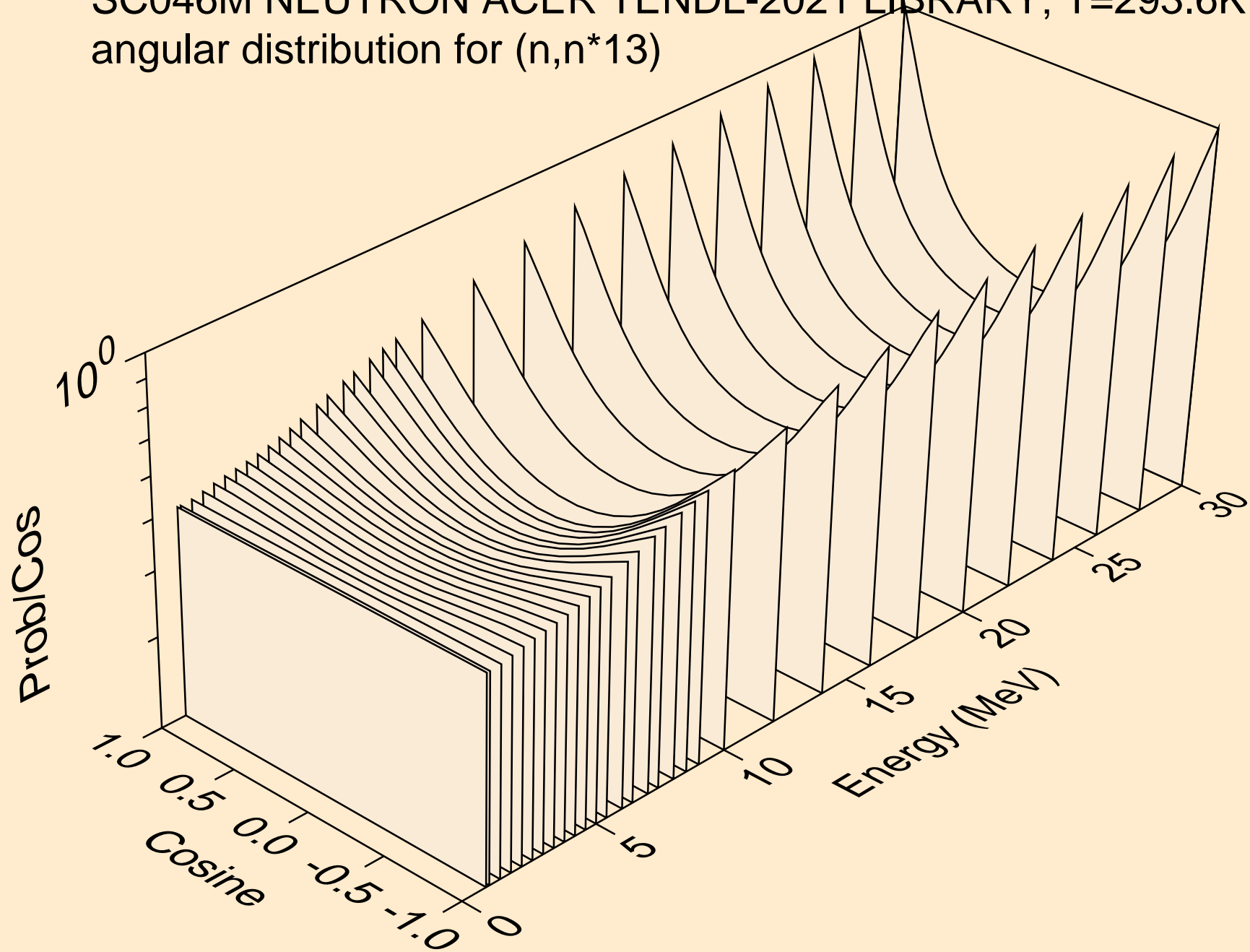

SC046M NEUTRON ACER TENDL-2021 LIBRARY; T=293.6K
angular distribution for (n,n*14)

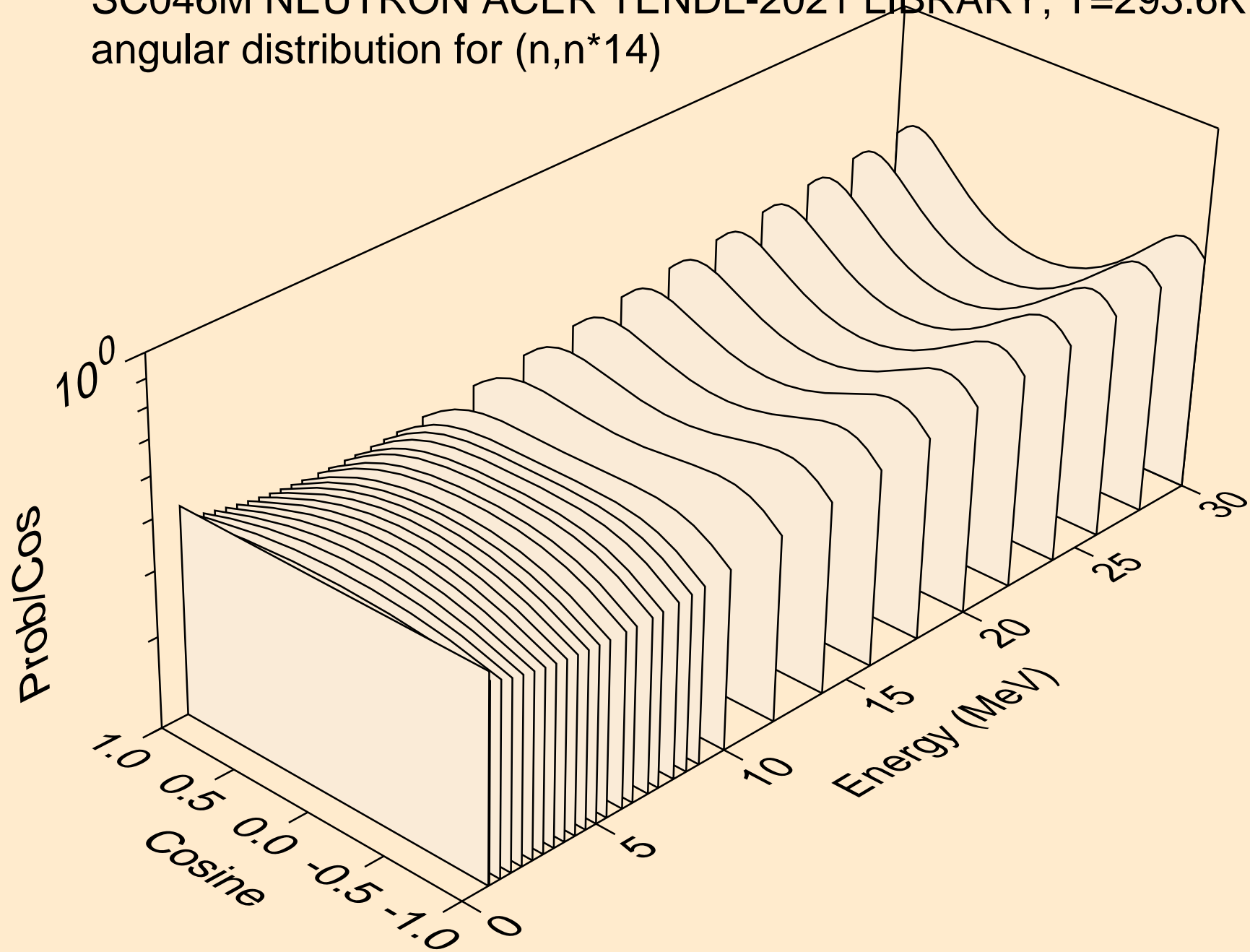

SC046M NEUTRON ACER TENDL-2021 LIBRARY; T=293.6K
angular distribution for (n,n*15)

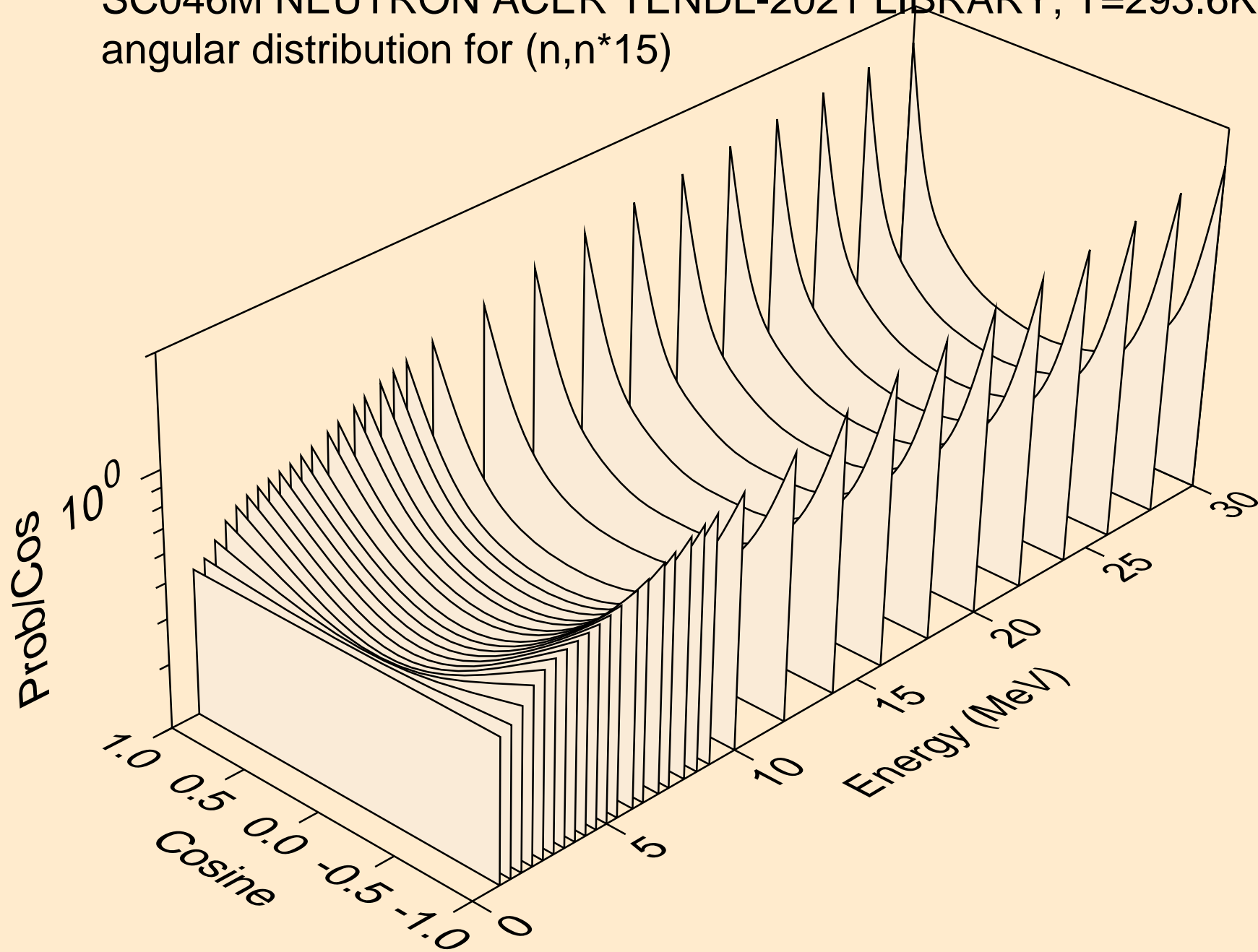

SC046M NEUTRON ACER TENDL-2021 LIBRARY; T=293.6K
angular distribution for (n,n*16)

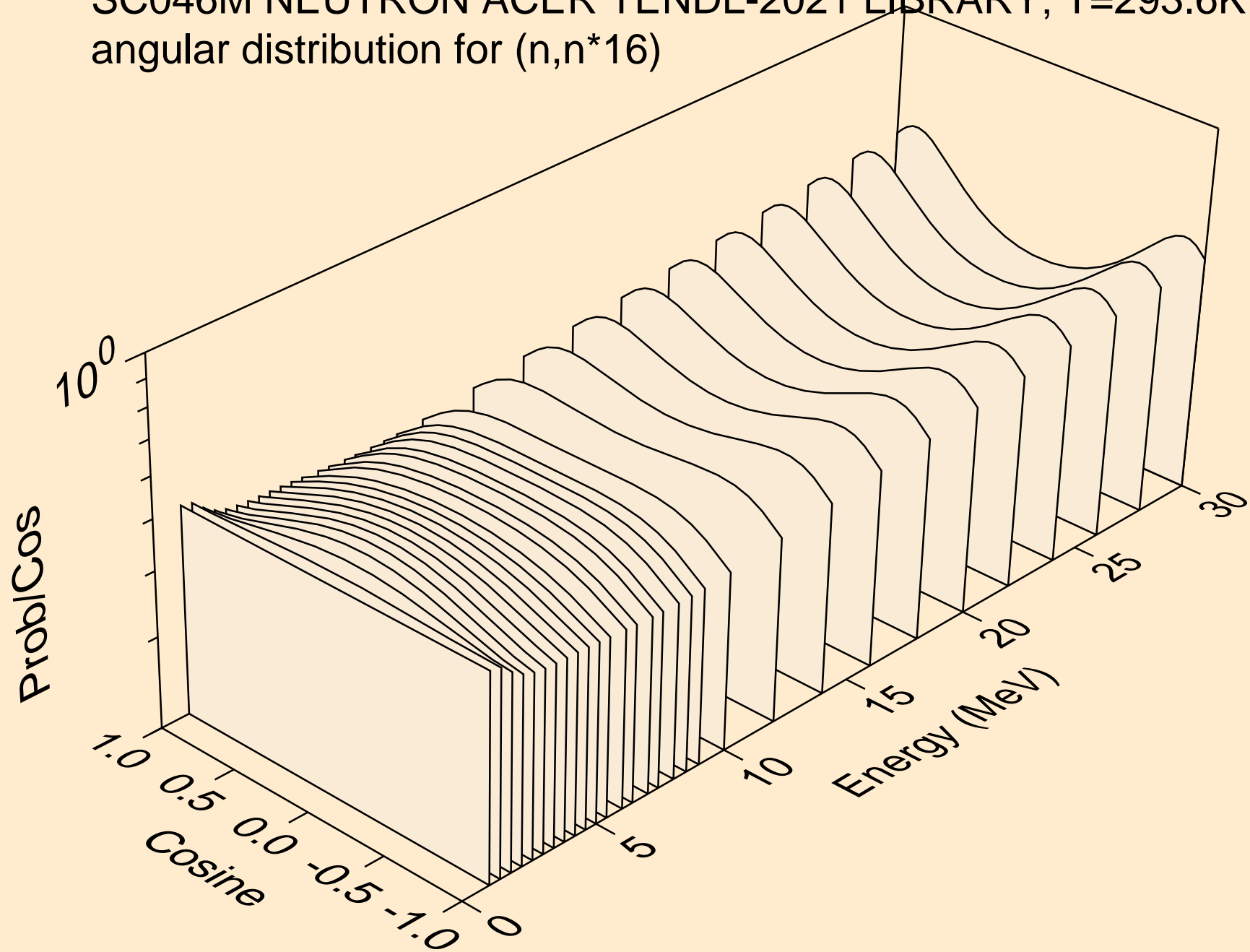

SC046M NEUTRON ACER TENDL-2021 LIBRARY; T=293.6K
angular distribution for (n,n*17)

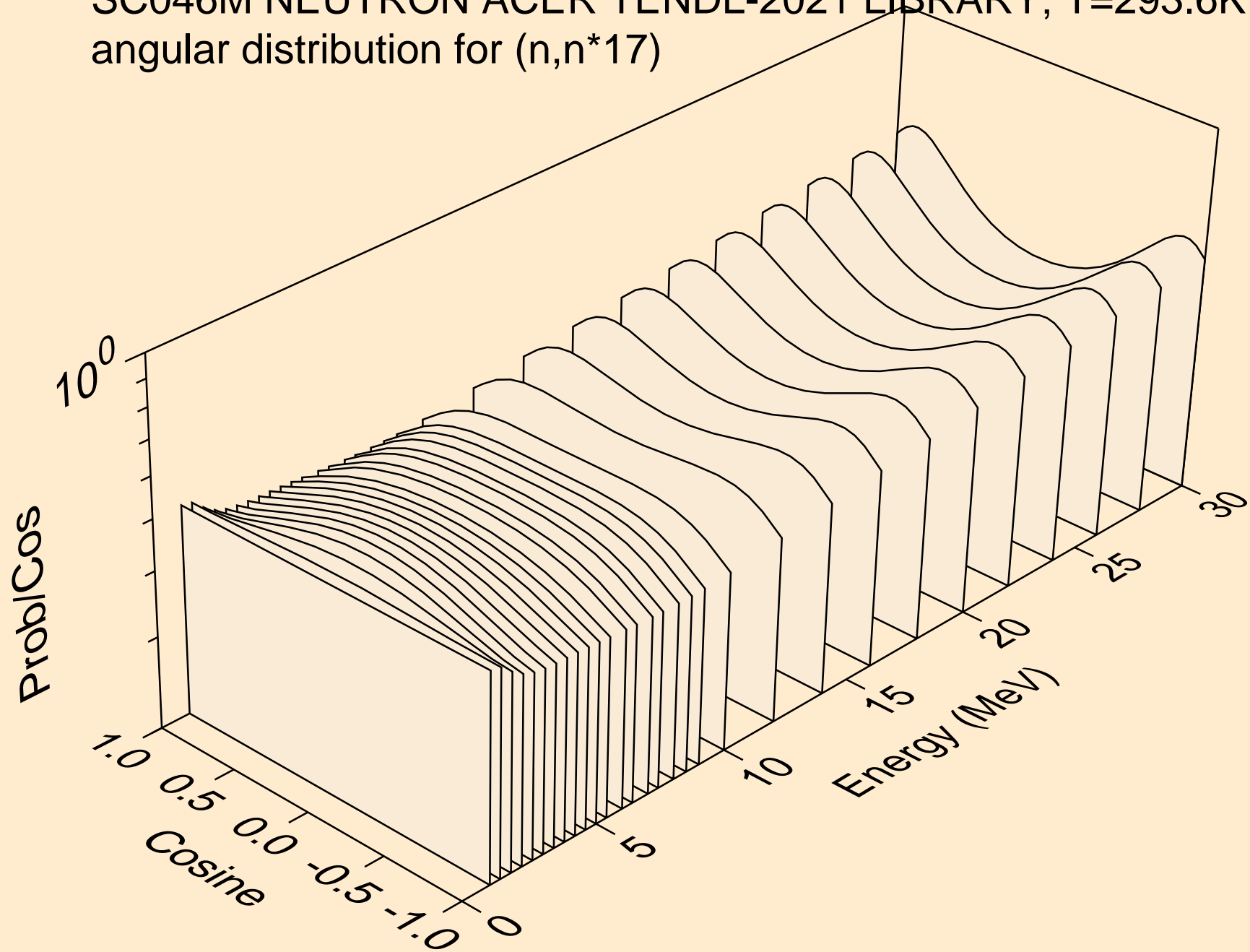

SC046M NEUTRON ACER TENDL-2021 LIBRARY; T=293.6K
angular distribution for (n,n*18)

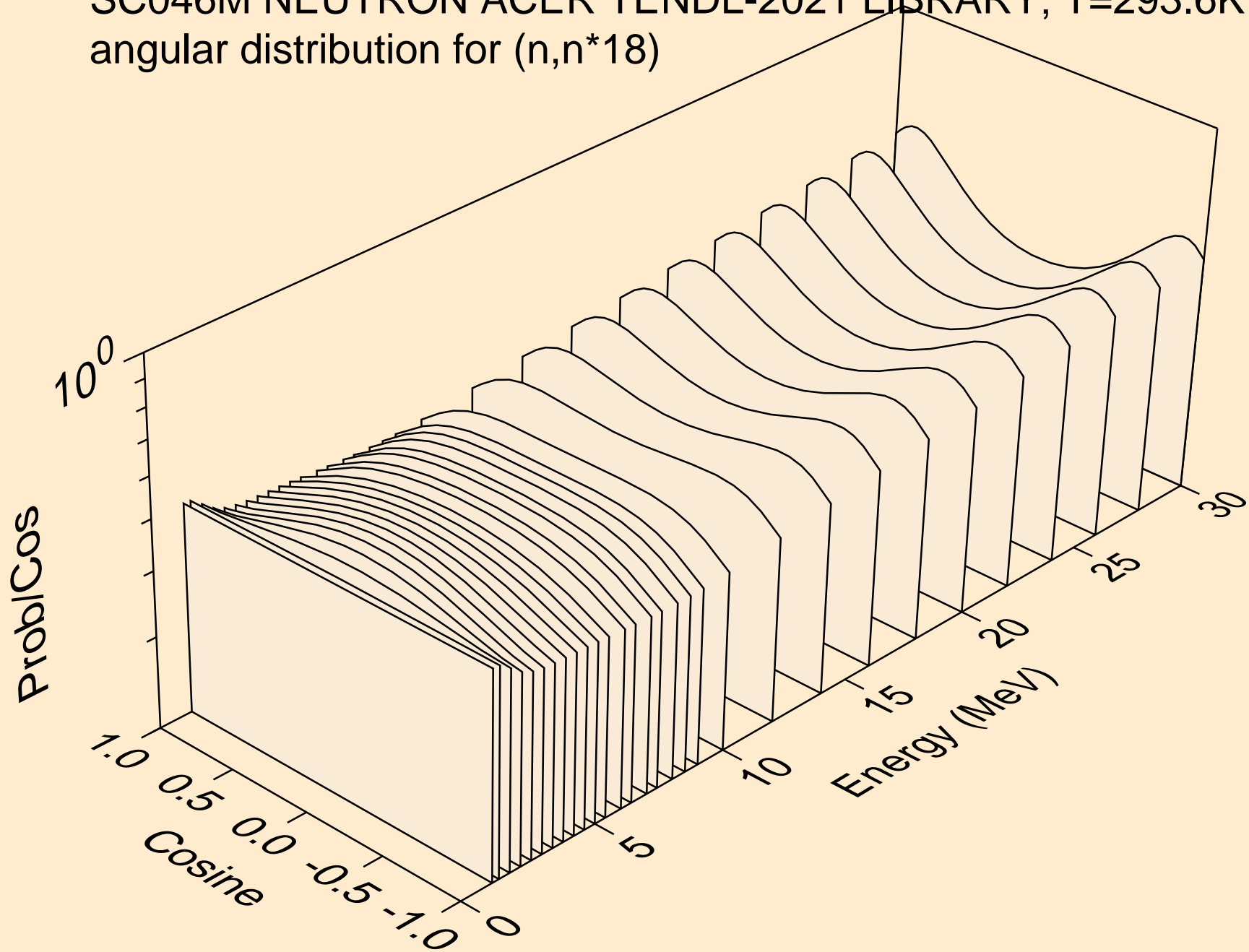

SC046M NEUTRON ACER TENDL-2021 LIBRARY; T=293.6K
angular distribution for (n,n*19)

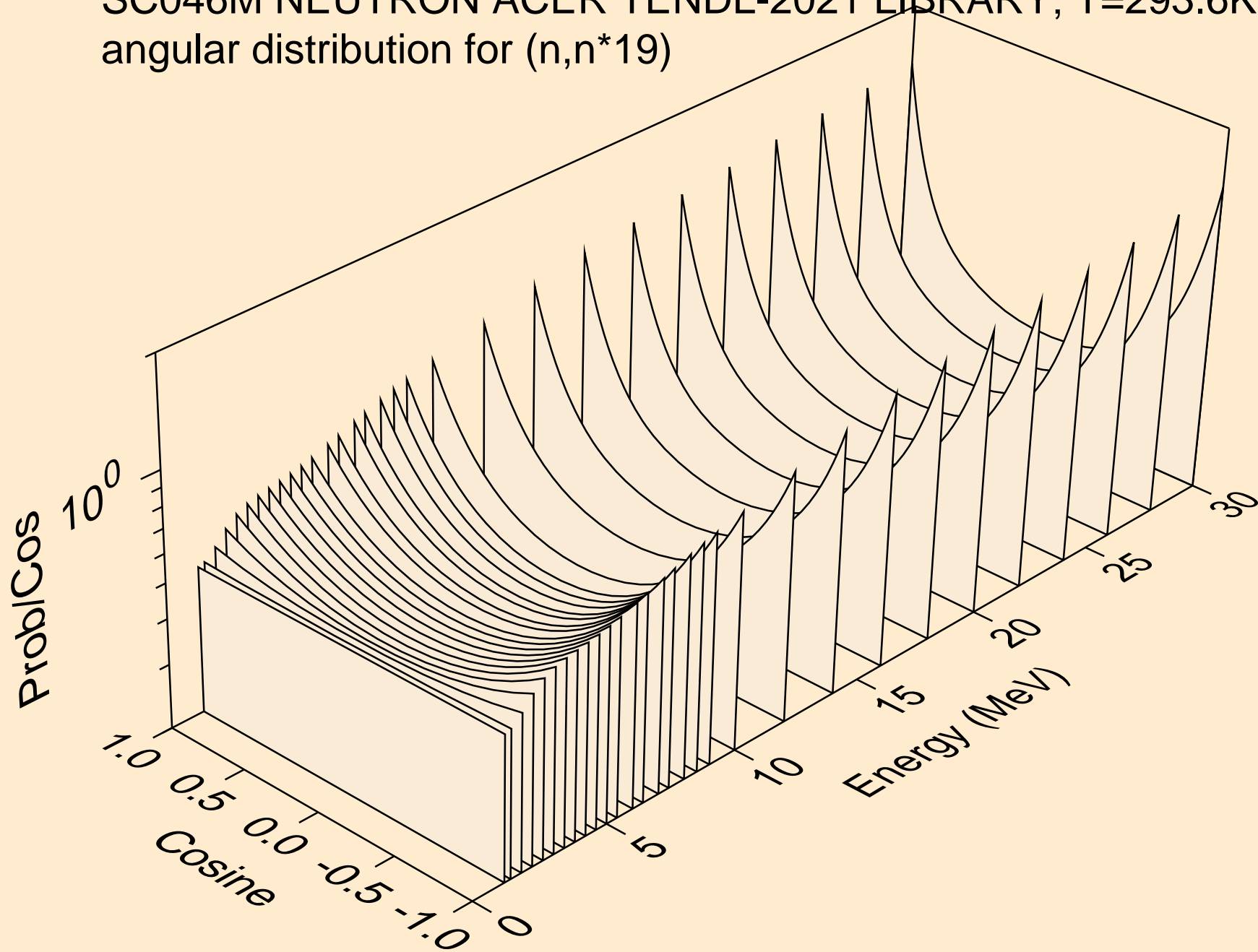

SC046M NEUTRON ACER TENDL-2021 LIBRARY; T=293.6K
angular distribution for (n,n*20)

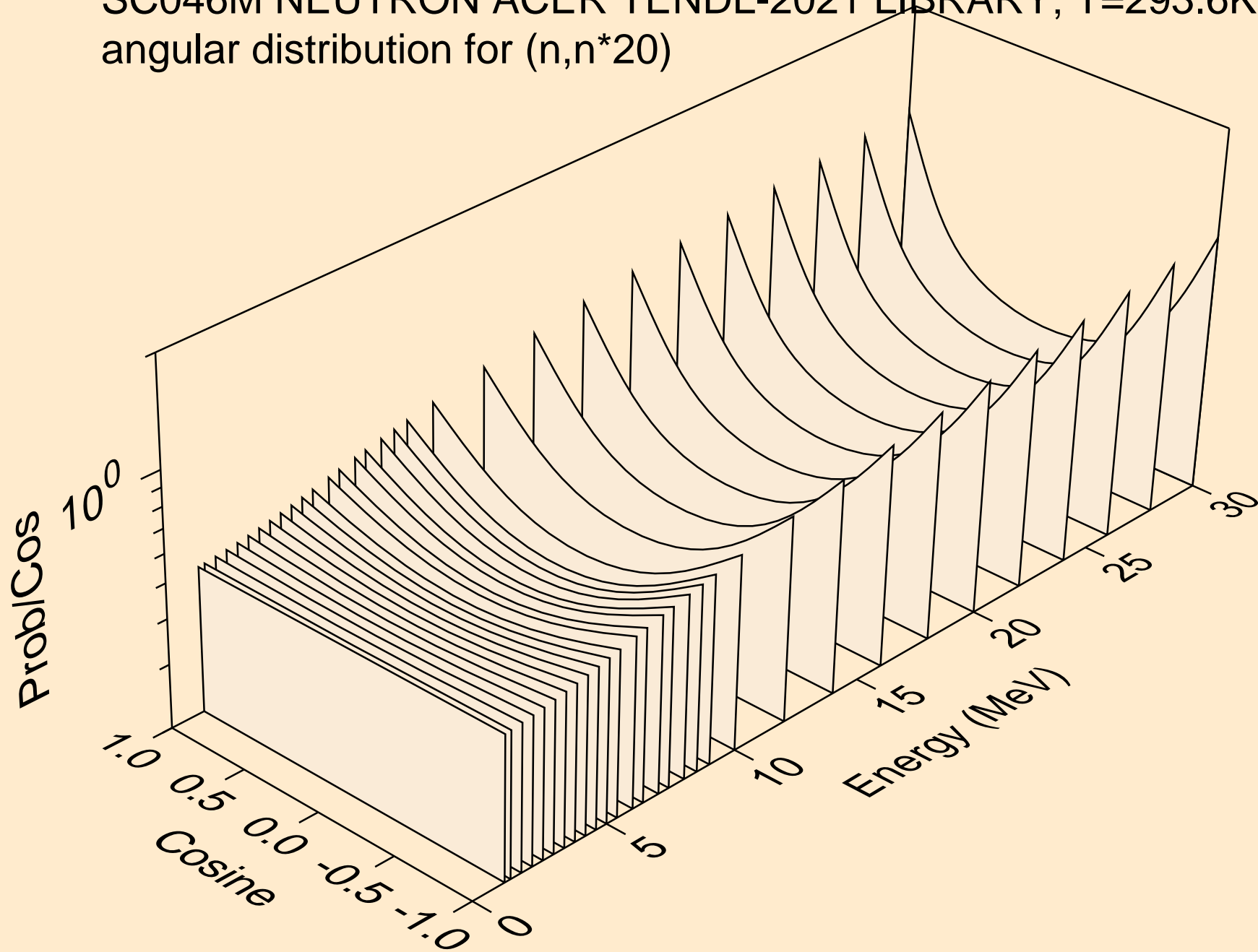

SC046M NEUTRON ACER TENDL-2021 LIBRARY; T=293.6K
angular distribution for (n,n*21)

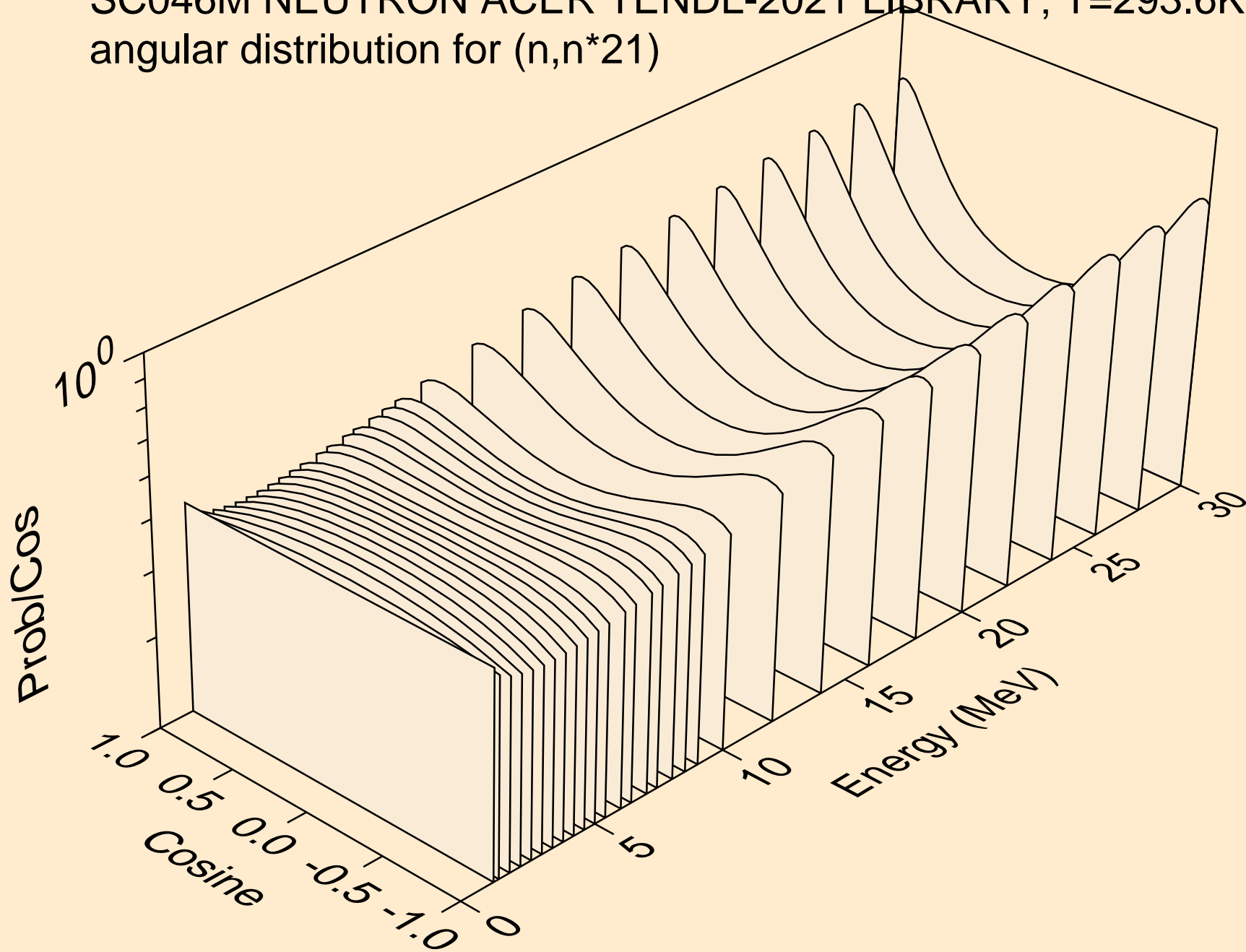

SC046M NEUTRON ACER TENDL-2021 LIBRARY; T=293.6K
angular distribution for (n,n*22)

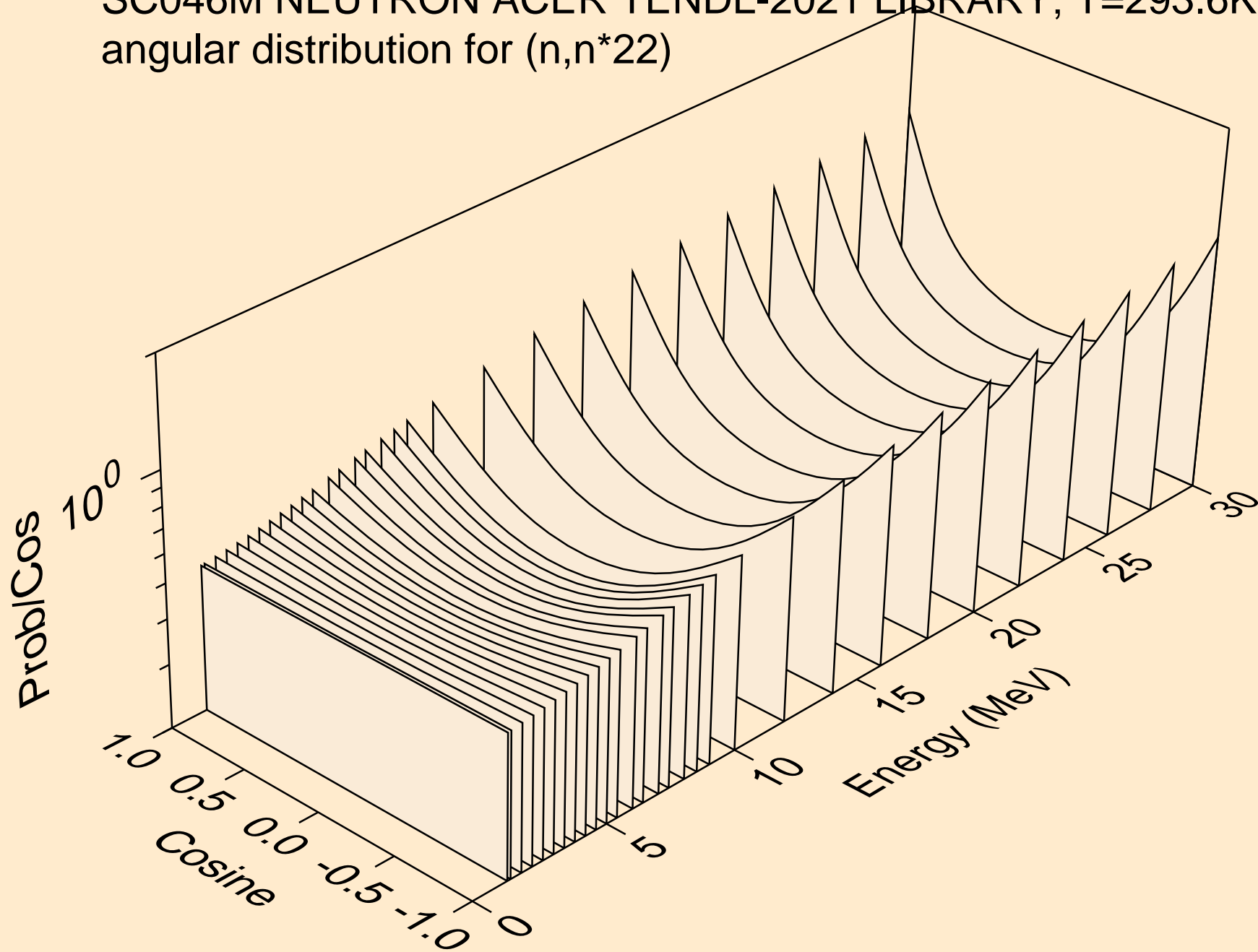

SC046M NEUTRON ACER TENDL-2021 LIBRARY; T=293.6K
angular distribution for (n,n*23)

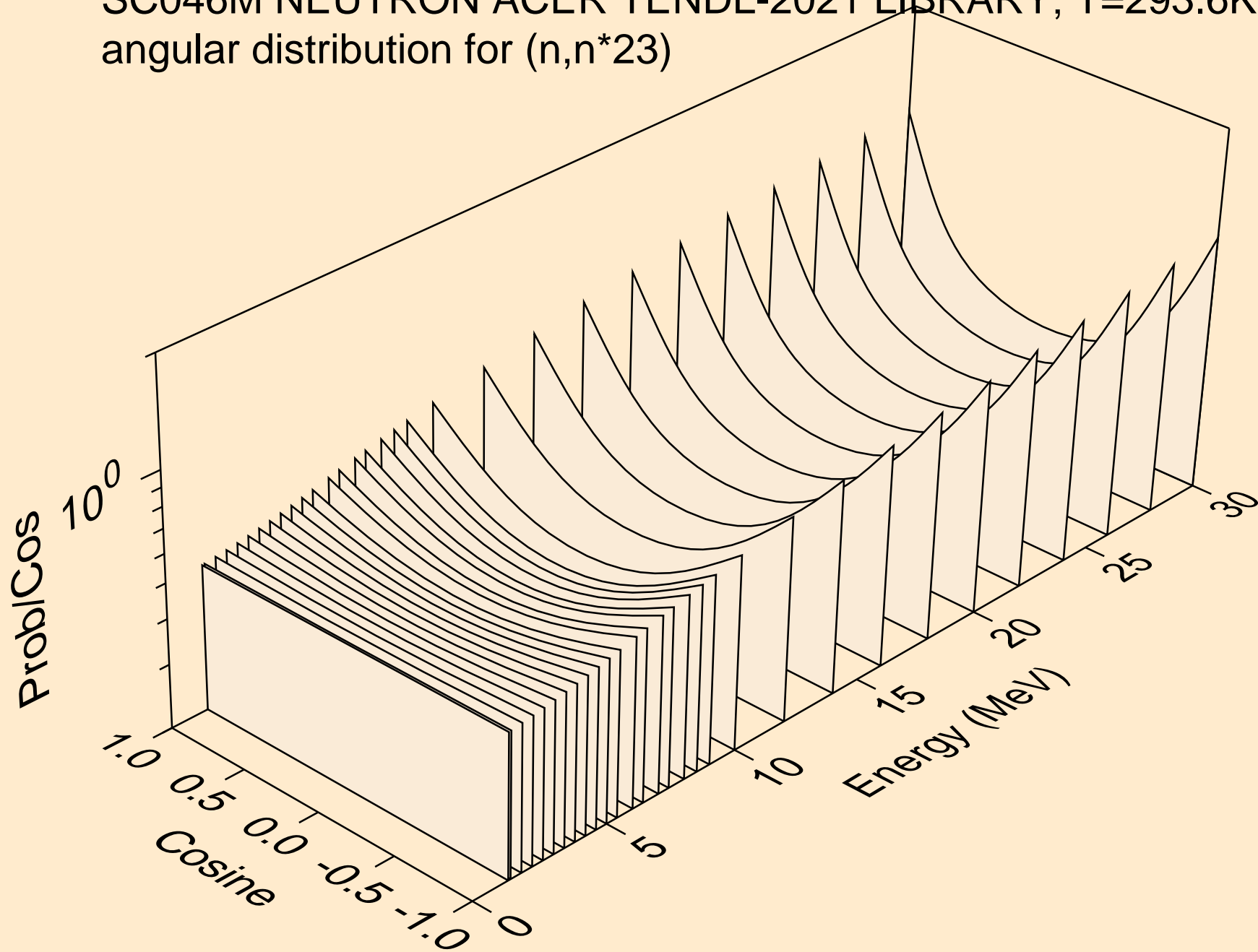

SC046M NEUTRON ACER TENDL-2021 LIBRARY; T=293.6K
angular distribution for (n,n*24)

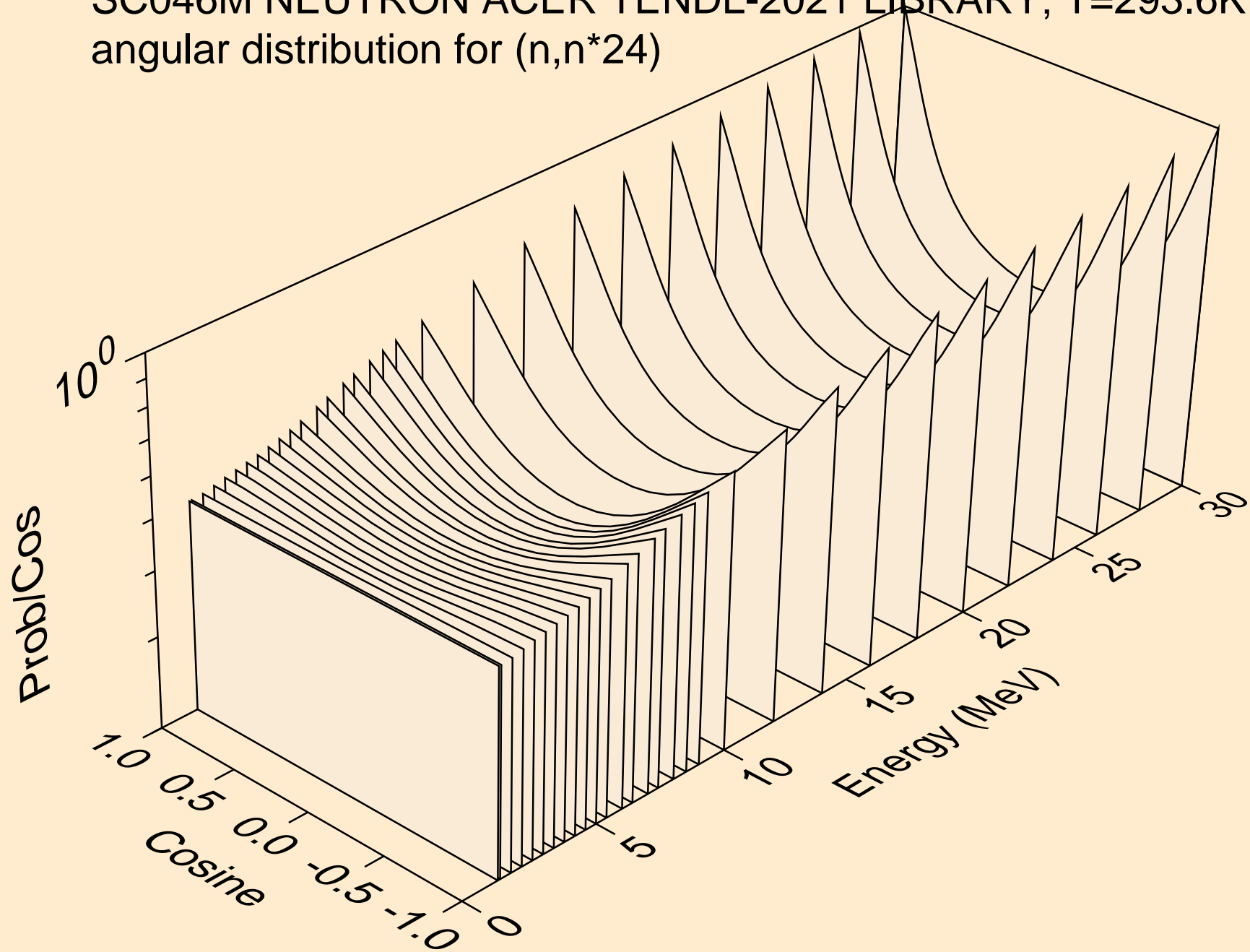

SC046M NEUTRON ACER TENDL-2021 LIBRARY; T=293.6K
angular distribution for (n,n*25)

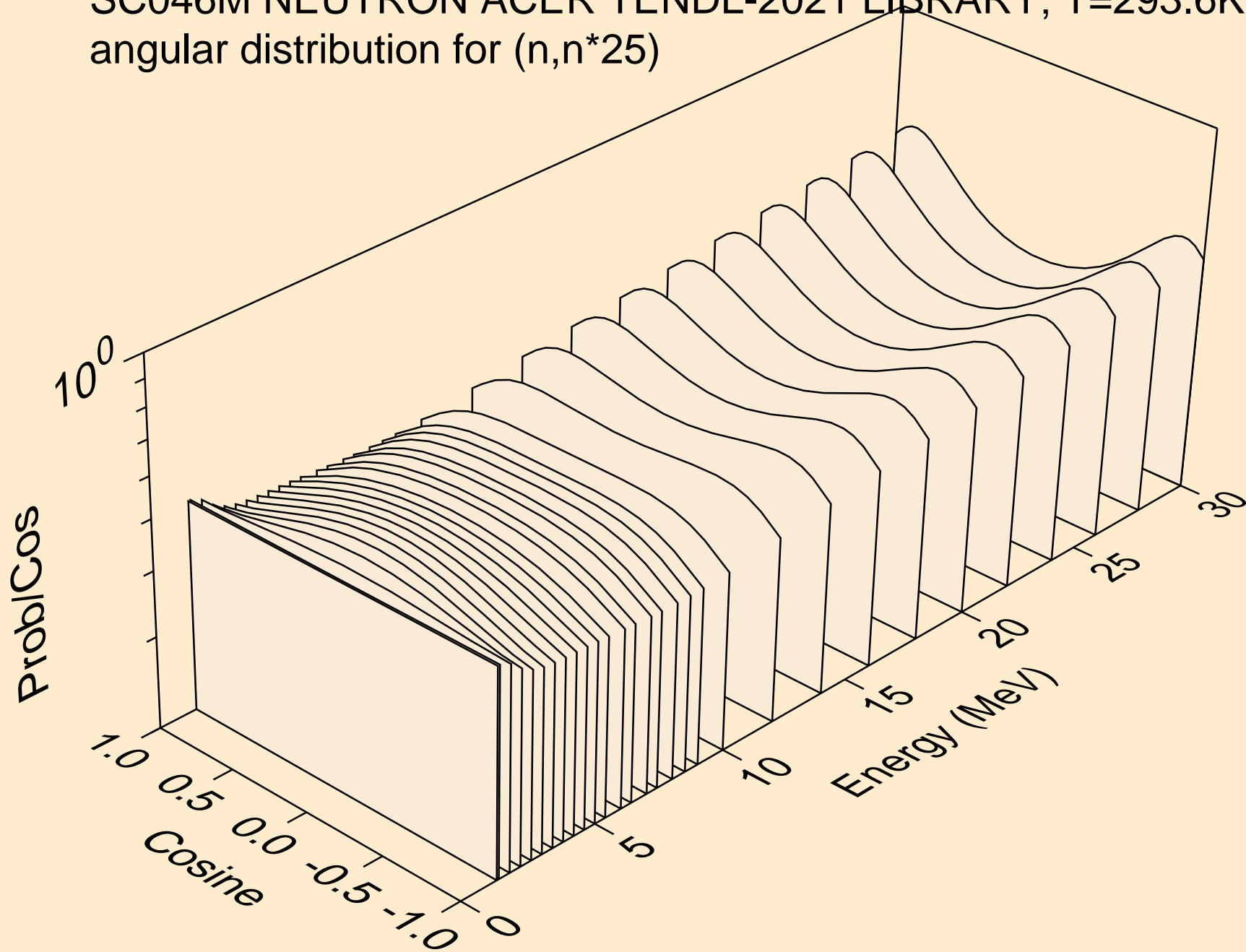

SC046M NEUTRON ACER TENDL-2021 LIBRARY; T=293.6K
angular distribution for (n,n*26)

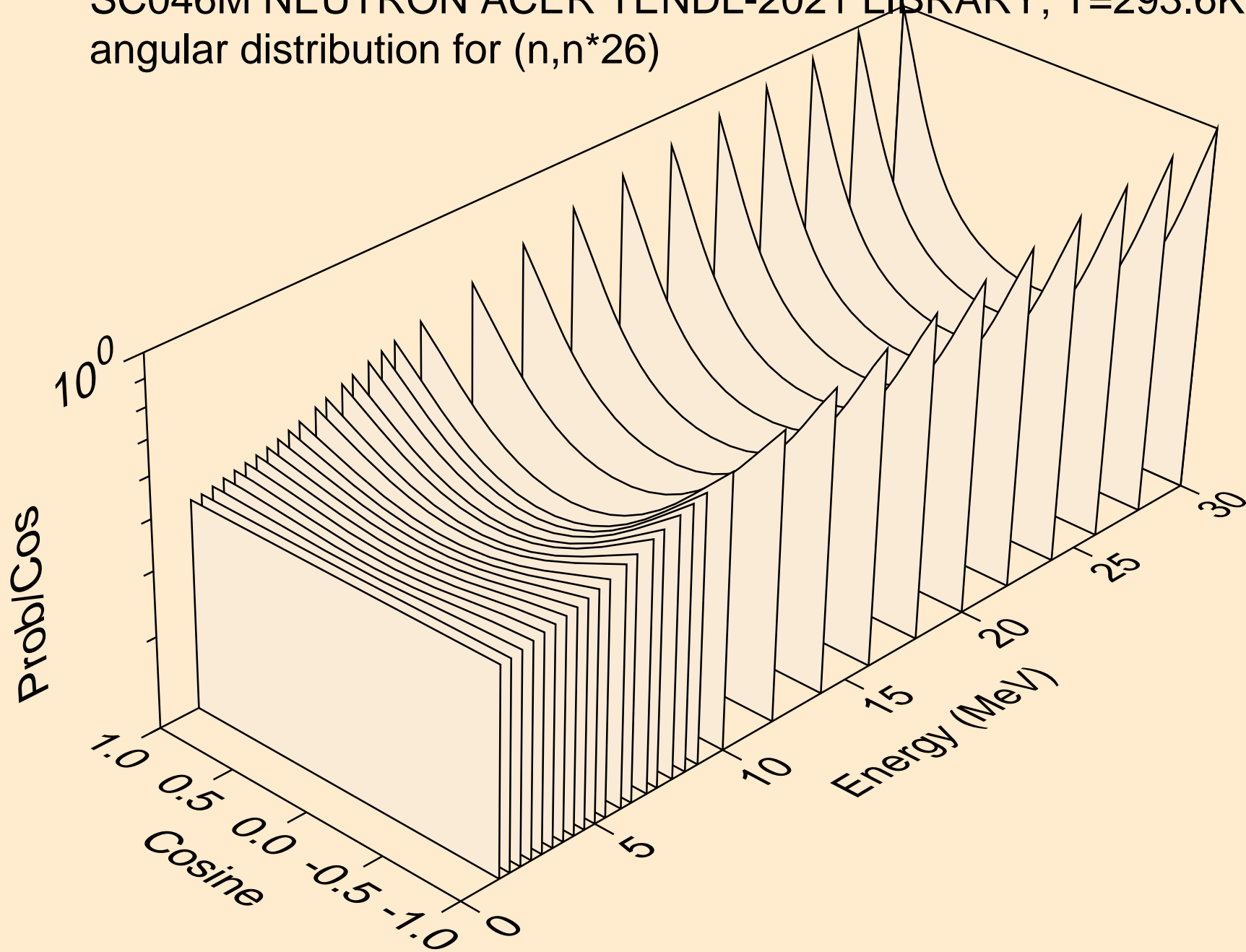

SC046M NEUTRON ACER TENDL-2021 LIBRARY; T=293.6K
angular distribution for (n,n*27)

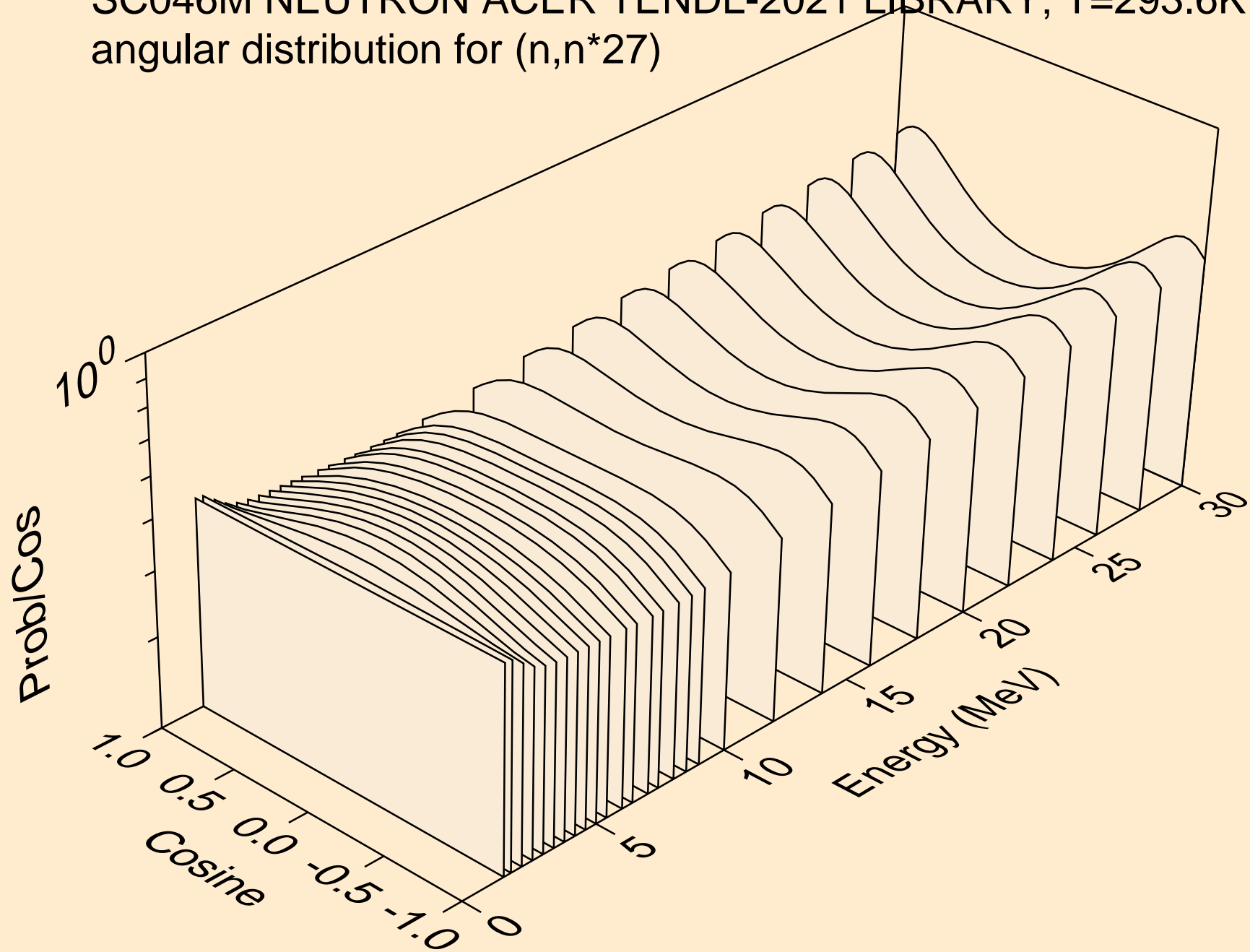

SC046M NEUTRON ACER TENDL-2021 LIBRARY; T=293.6K
angular distribution for (n,n*28)

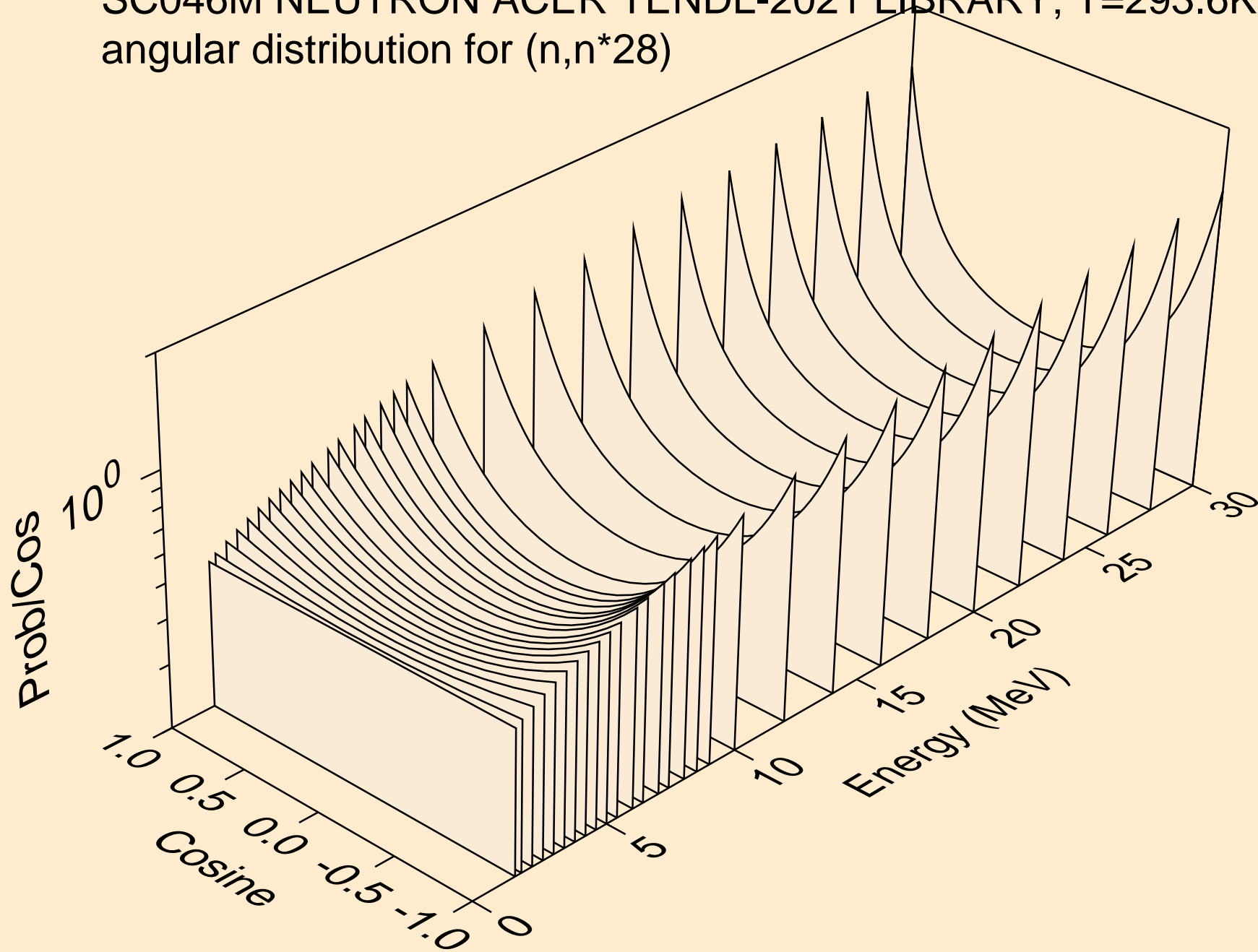

SC046M NEUTRON ACER TENDL-2021 LIBRARY; T=293.6K
angular distribution for (n,n*29)

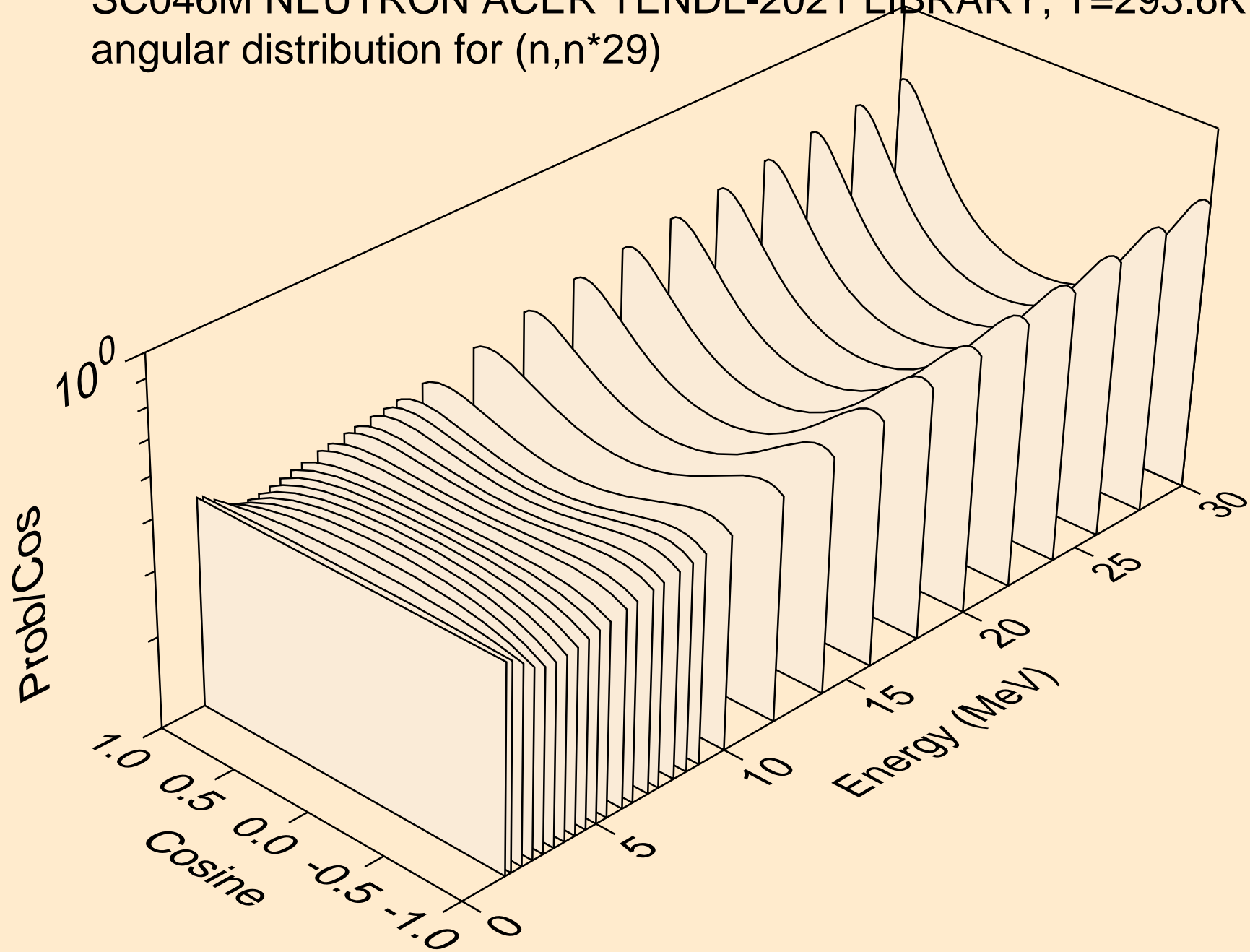

SC046M NEUTRON ACER TENDL-2021 LIBRARY; T=293.6K
angular distribution for (n,n*30)

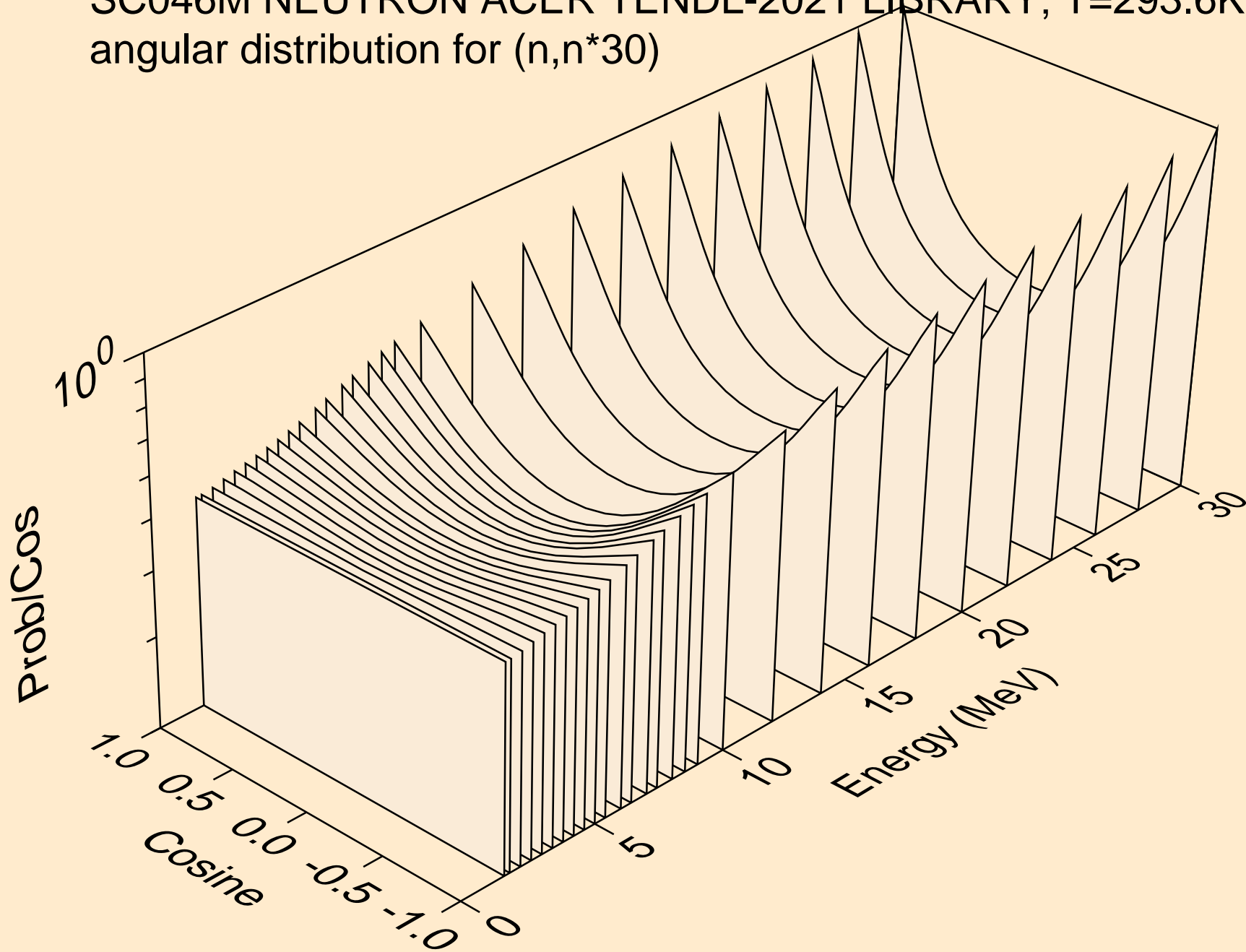

SC046M NEUTRON ACER TENDL-2021 LIBRARY; T=293.6K
Neutron emission for (n,x)

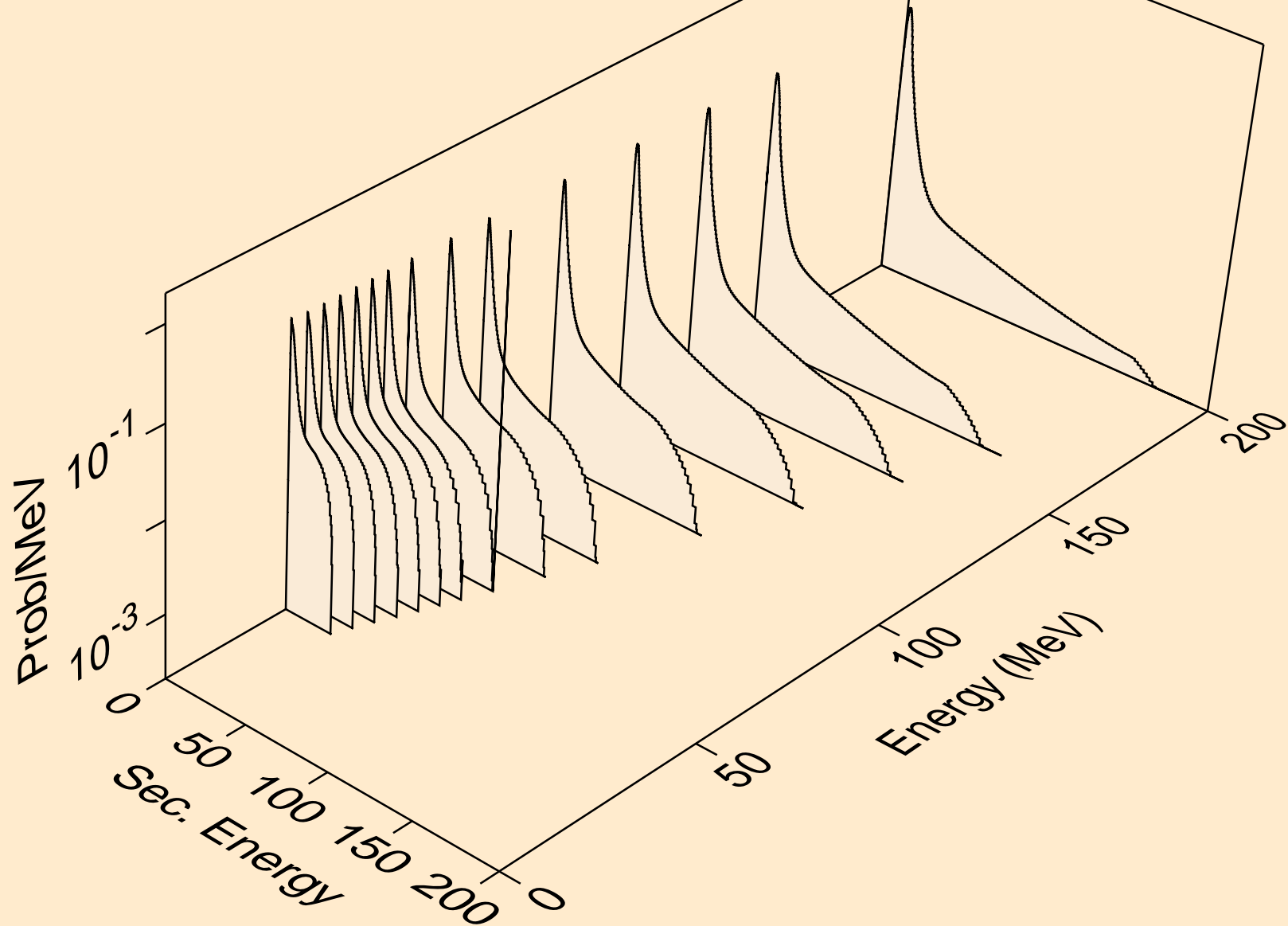

SC046M NEUTRON ACER TENDL-2021 LIBRARY; T=293.6K
Neutron emission for (n,2nd)

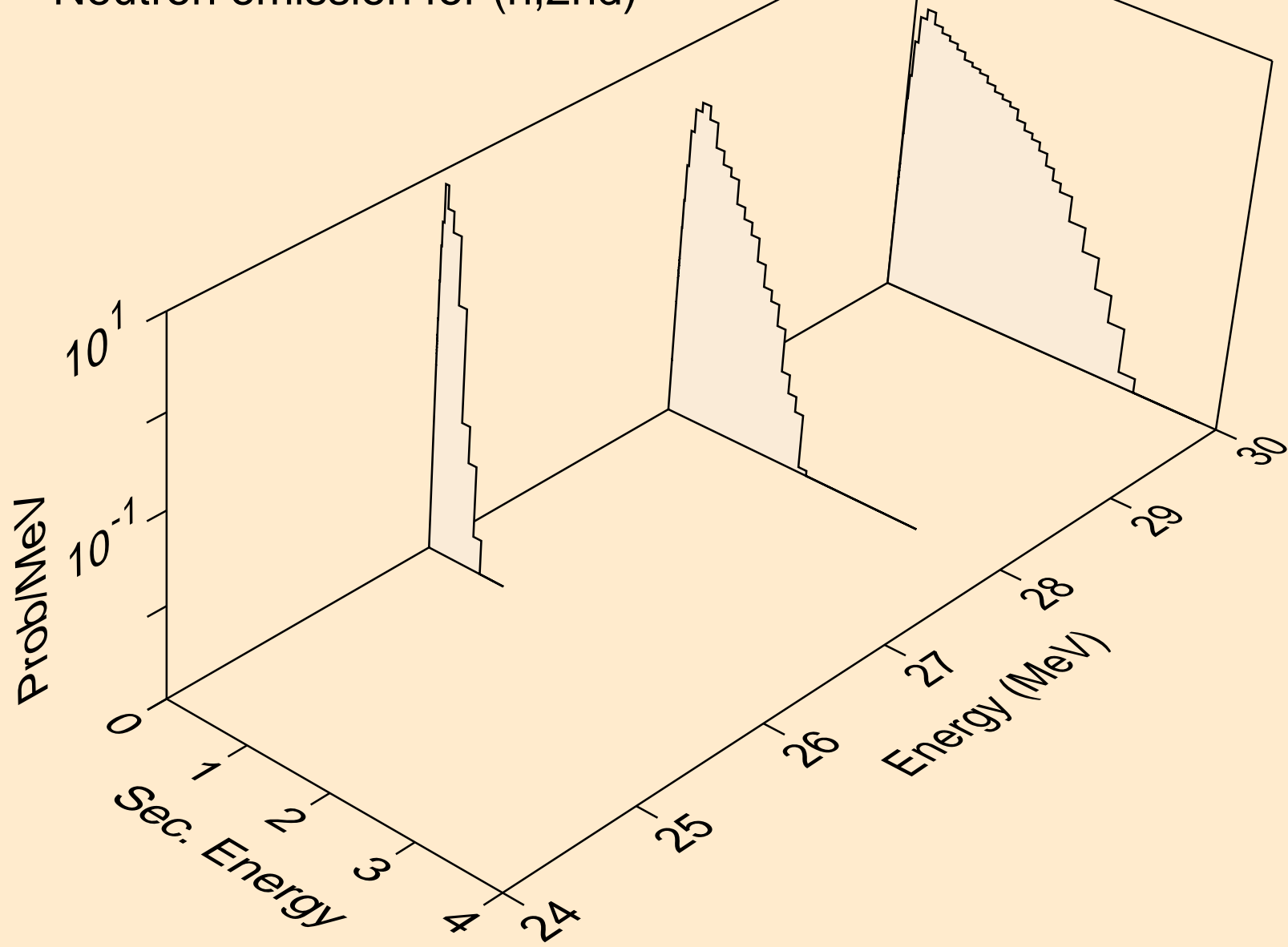

SC046M NEUTRON ACER TENDL-2021 LIBRARY; T=293.6K
Neutron emission for (n,2n)

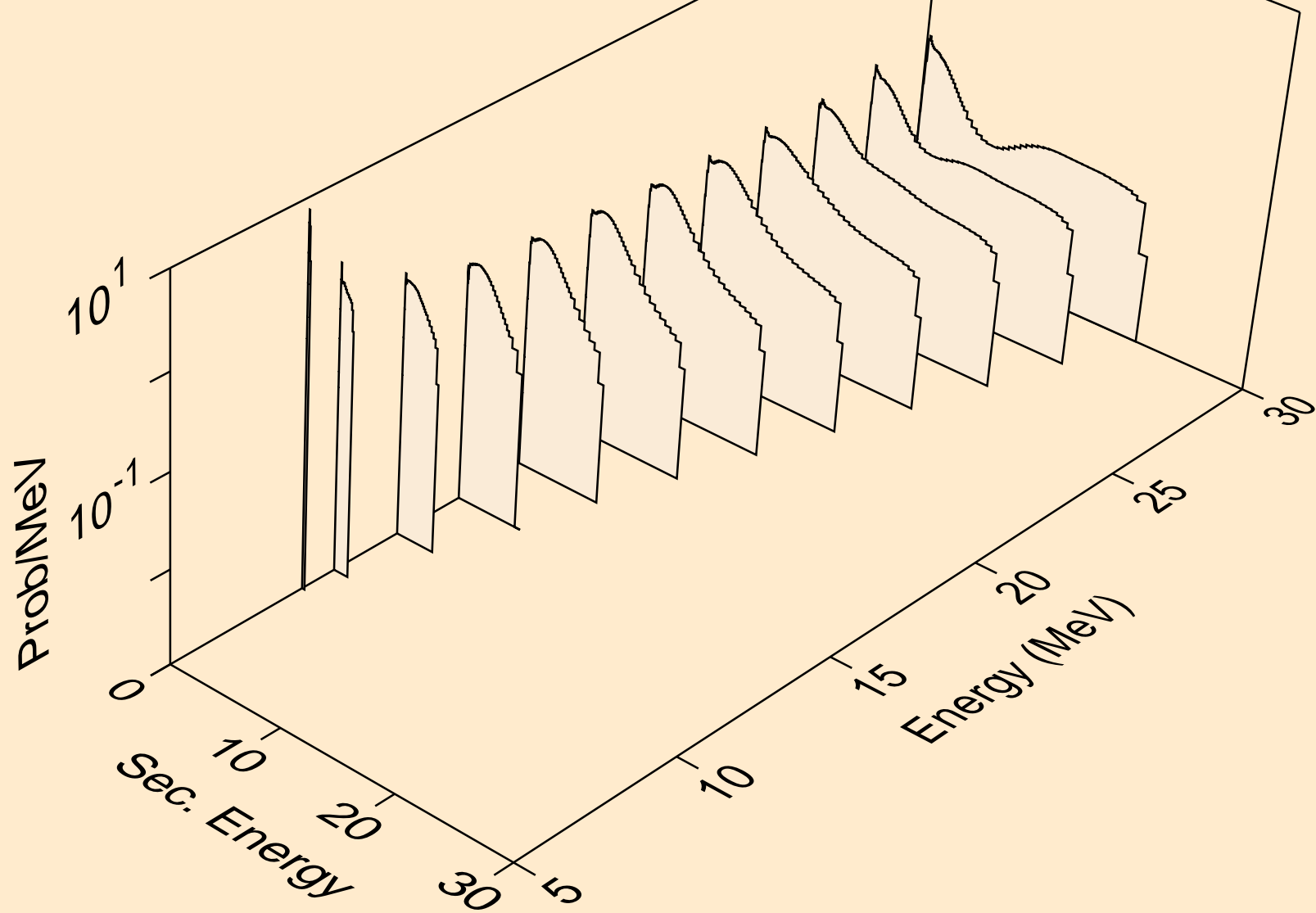

SC046M NEUTRON ACER TENDL-2021 LIBRARY; T=293.6K
Neutron emission for (n,3n)

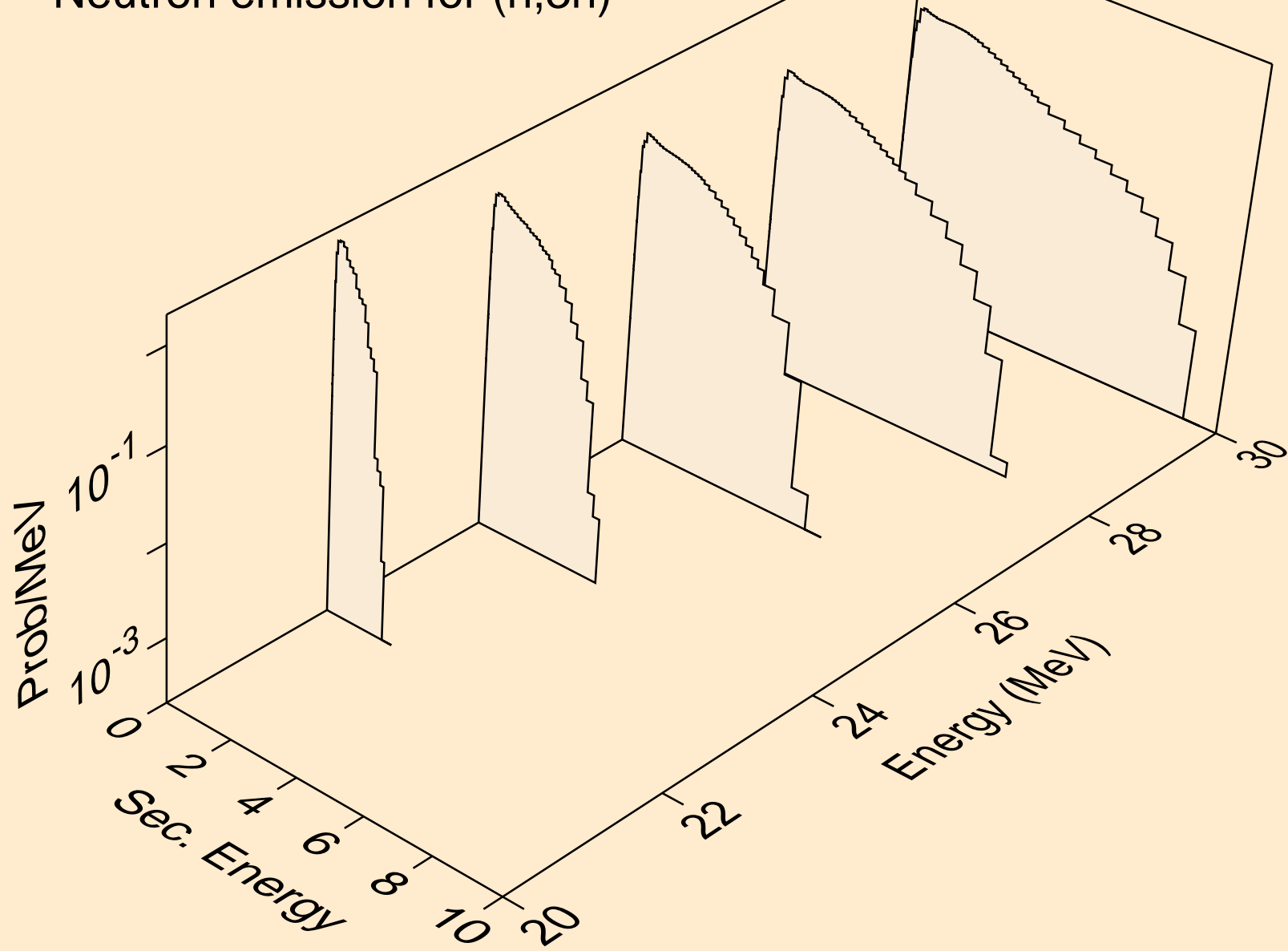

SC046M NEUTRON ACER TENDL-2021 LIBRARY; T=293.6K
Neutron emission for (n,n*)a

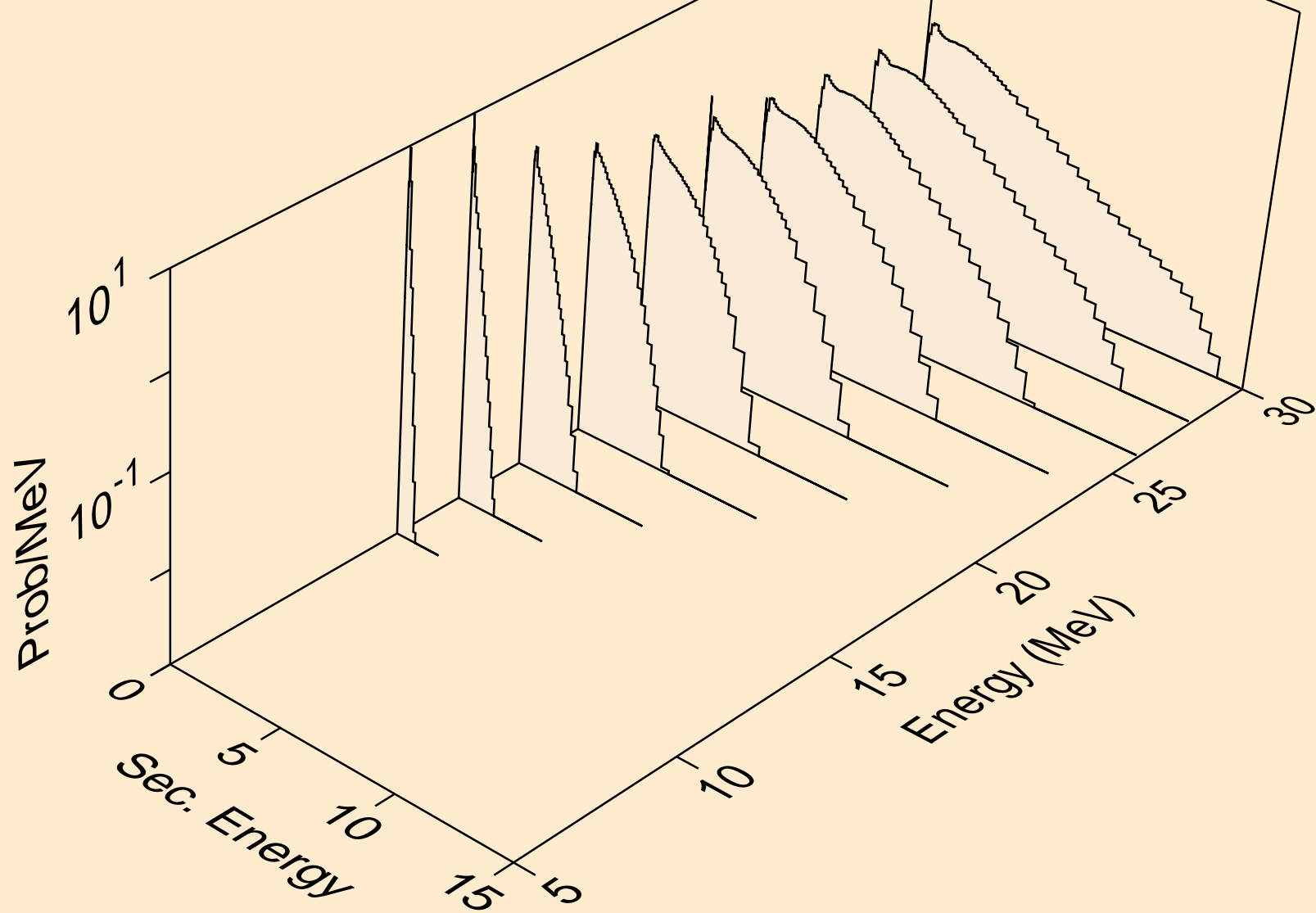

SC046M NEUTRON ACER TENDL-2021 LIBRARY; T=293.6K
Neutron emission for (n,2n)a

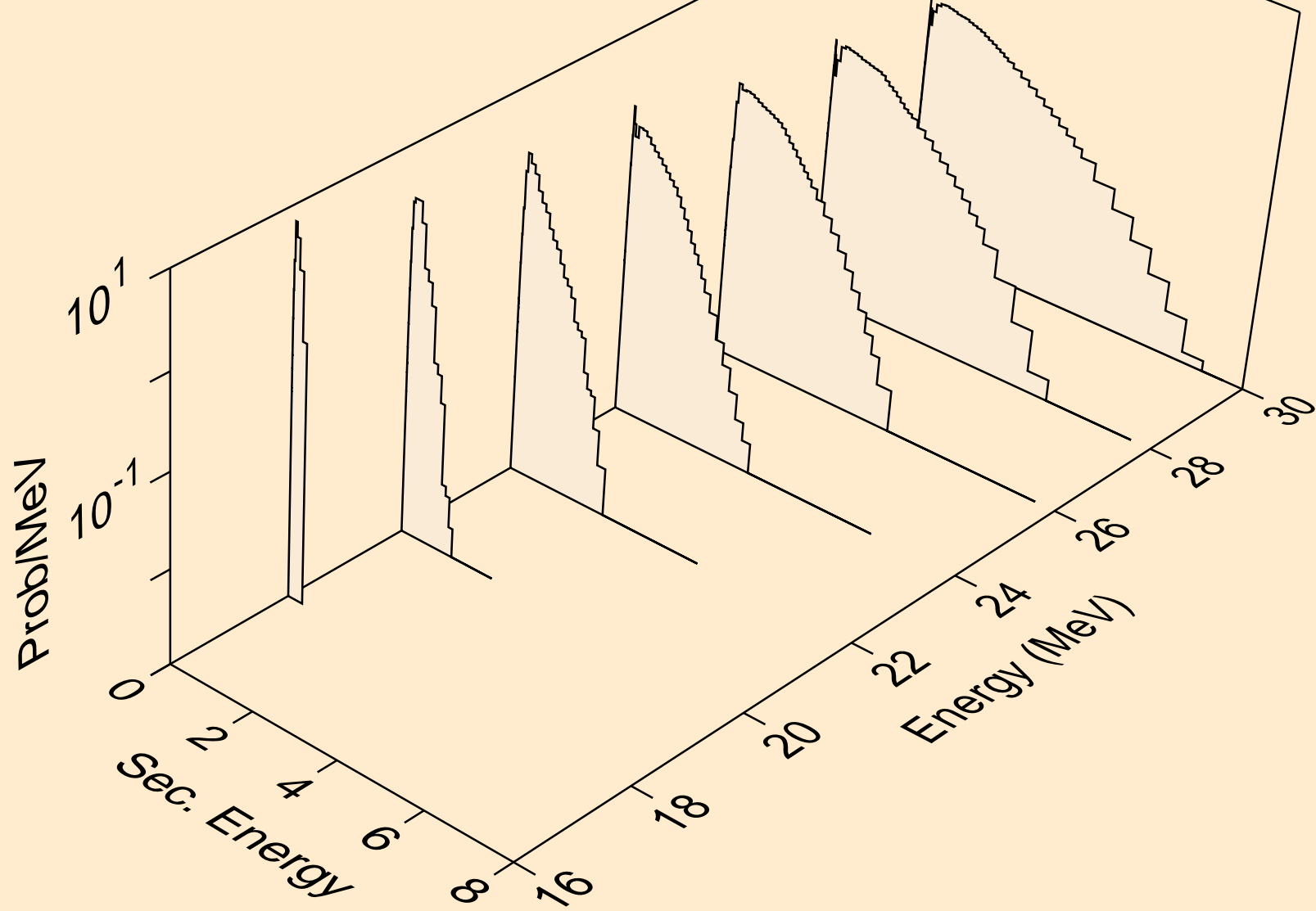

SC046M NEUTRON ACER TENDL-2021 LIBRARY; T=293.6K
Neutron emission for (n,n*)p

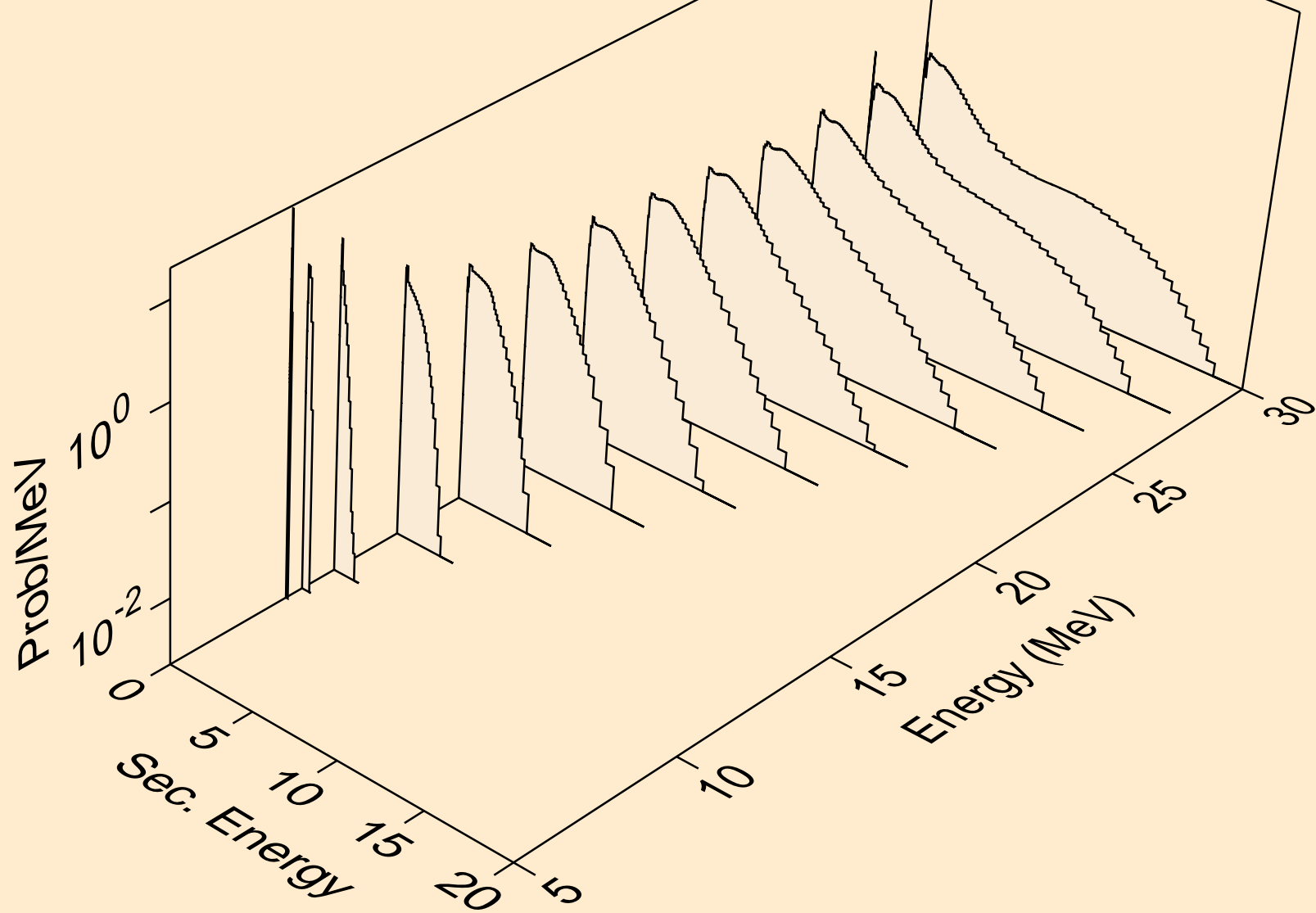

SC046M NEUTRON ACER TENDL-2021 LIBRARY; T=293.6K
Neutron emission for (n,n*)2a

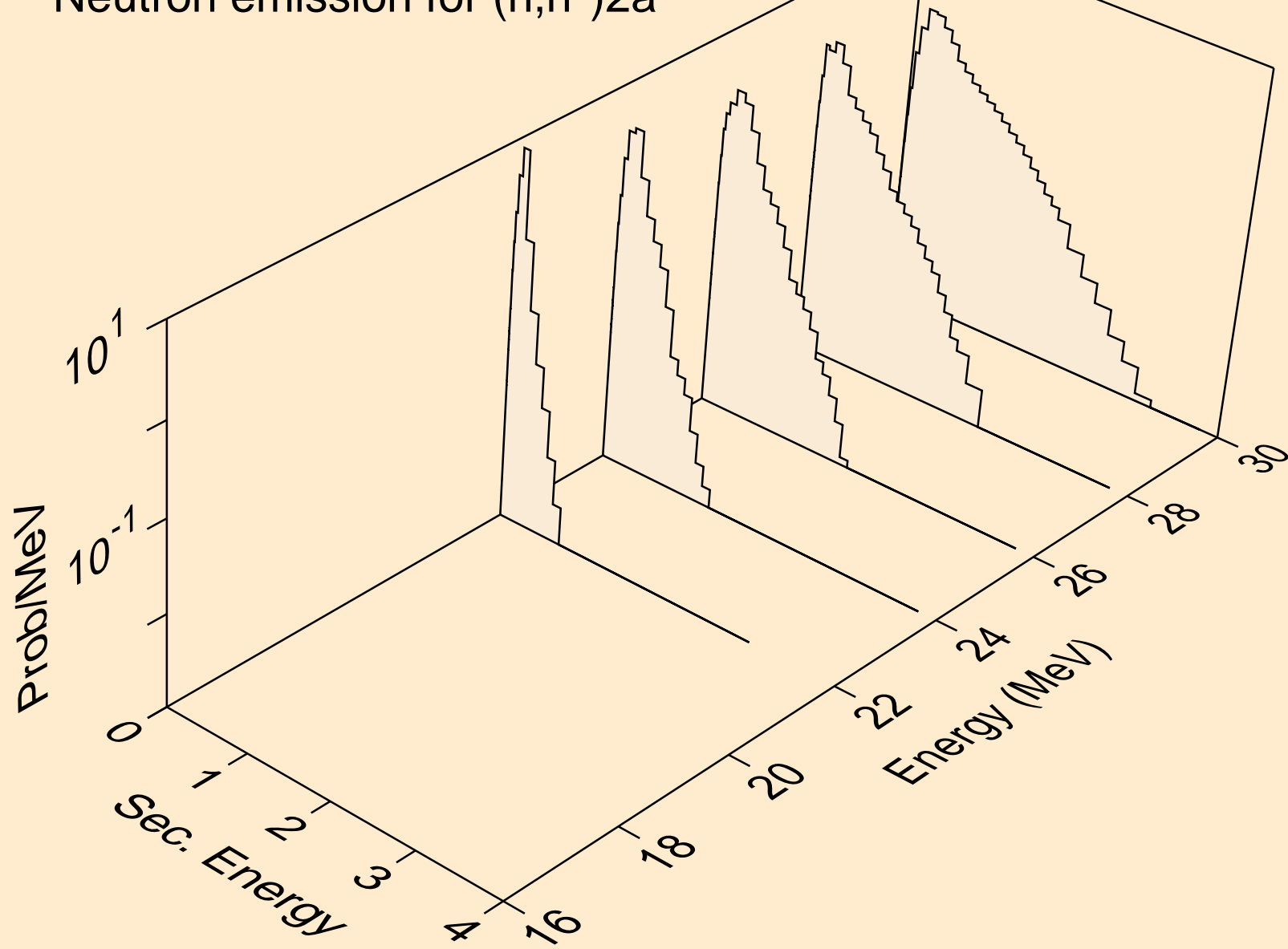

SC046M NEUTRON ACER TENDL-2021 LIBRARY; T=293.6K
Neutron emission for (n,n*)d

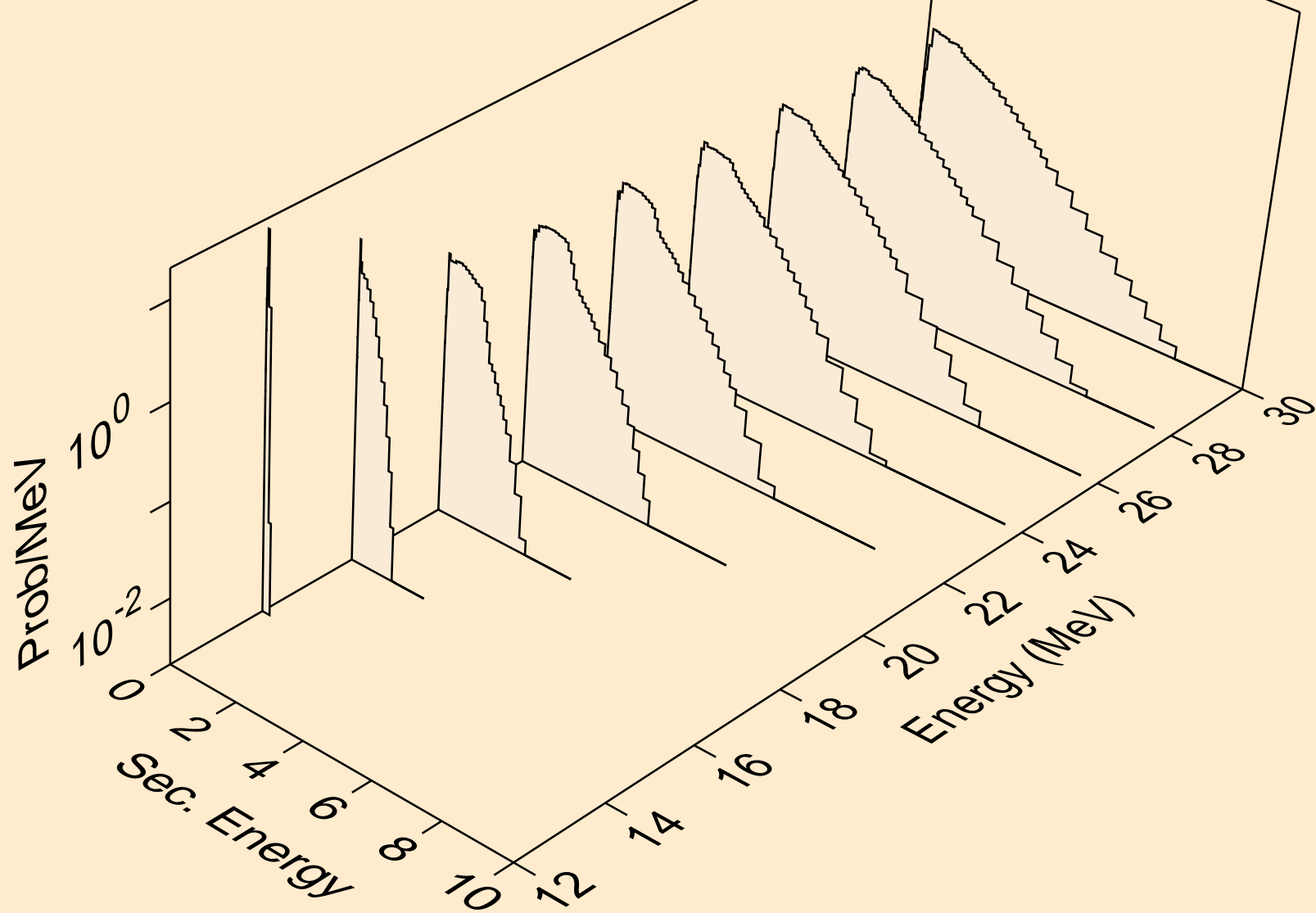

SC046M NEUTRON ACER TENDL-2021 LIBRARY; T=293.6K
Neutron emission for (n,n*)t

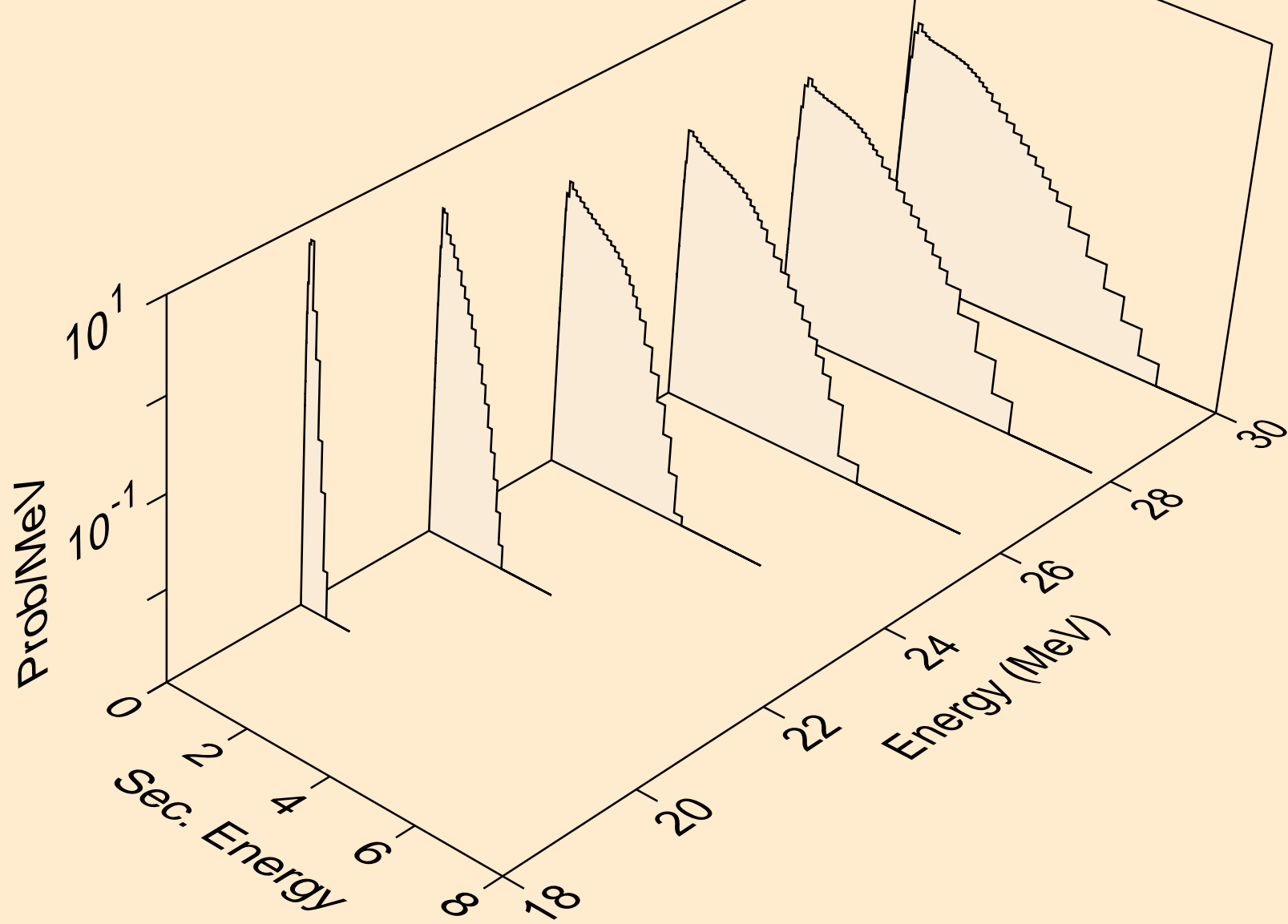

SC046M NEUTRON ACER TENDL-2021 LIBRARY; T=293.6K
Neutron emission for (n,n*)he3

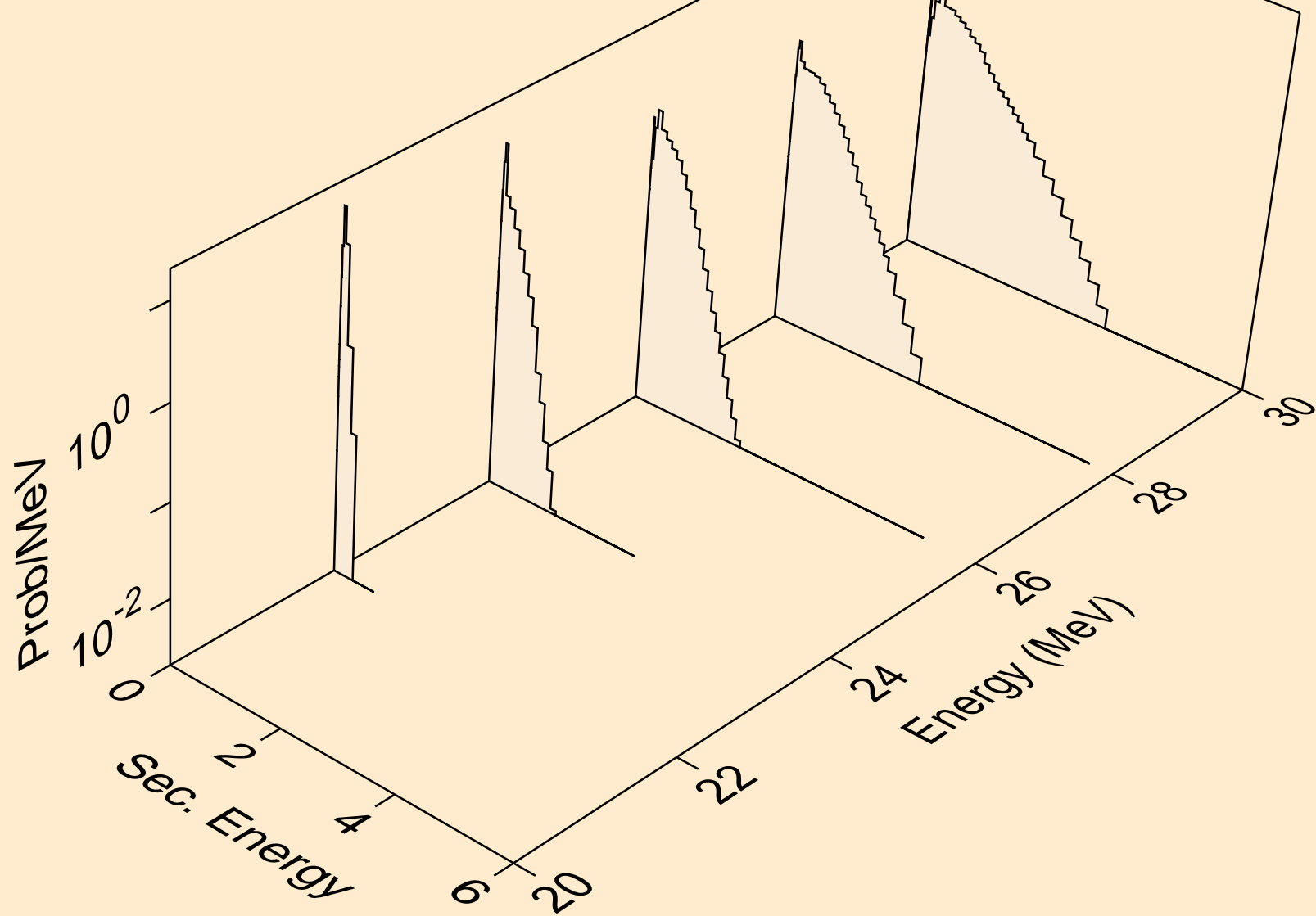

SC046M NEUTRON ACER TENDL-2021 LIBRARY; T=293.6K
Neutron emission for (n,2np)

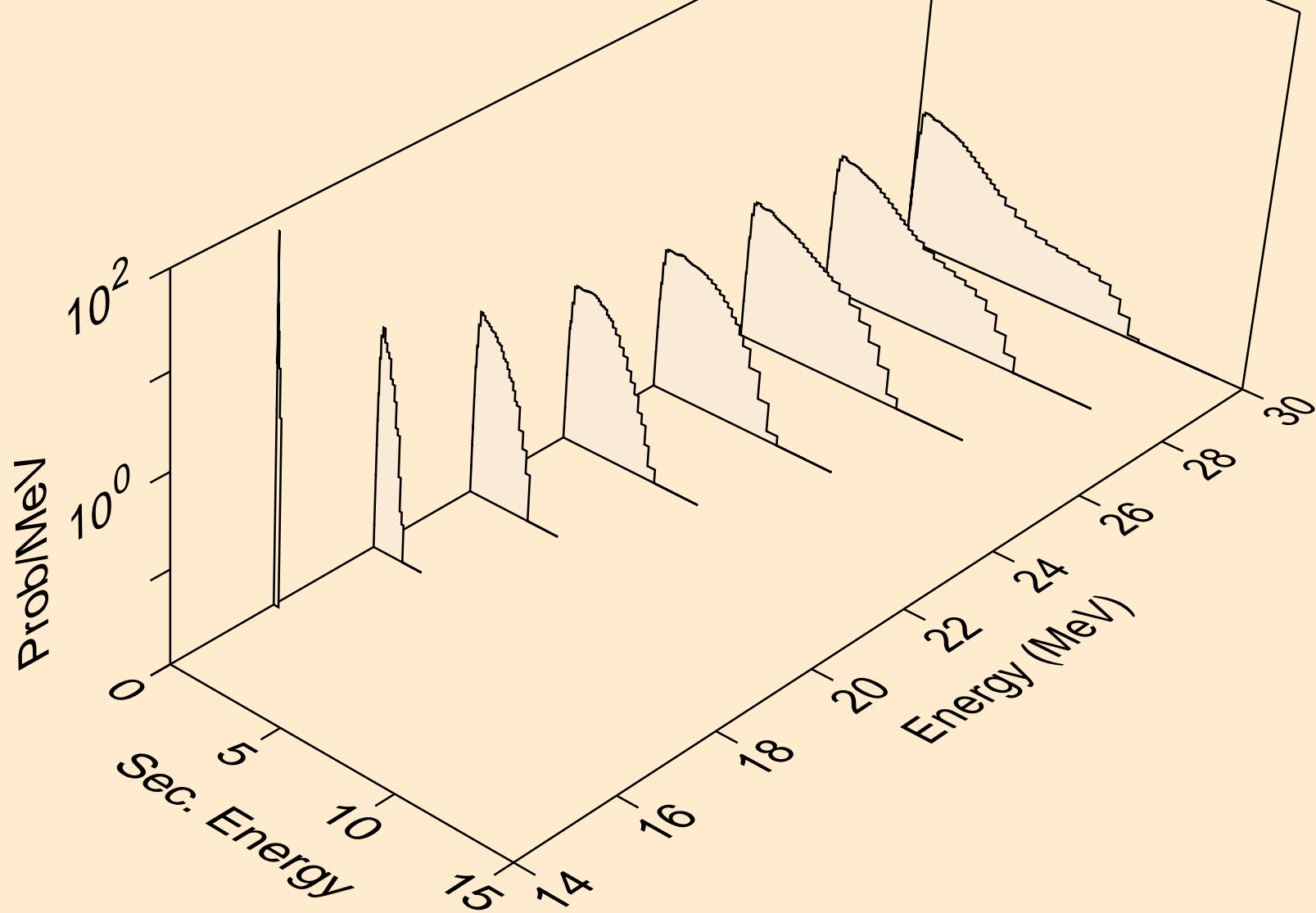

SC046M NEUTRON ACER TENDL-2021 LIBRARY; T=293.6K
Neutron emission for (n,3np)

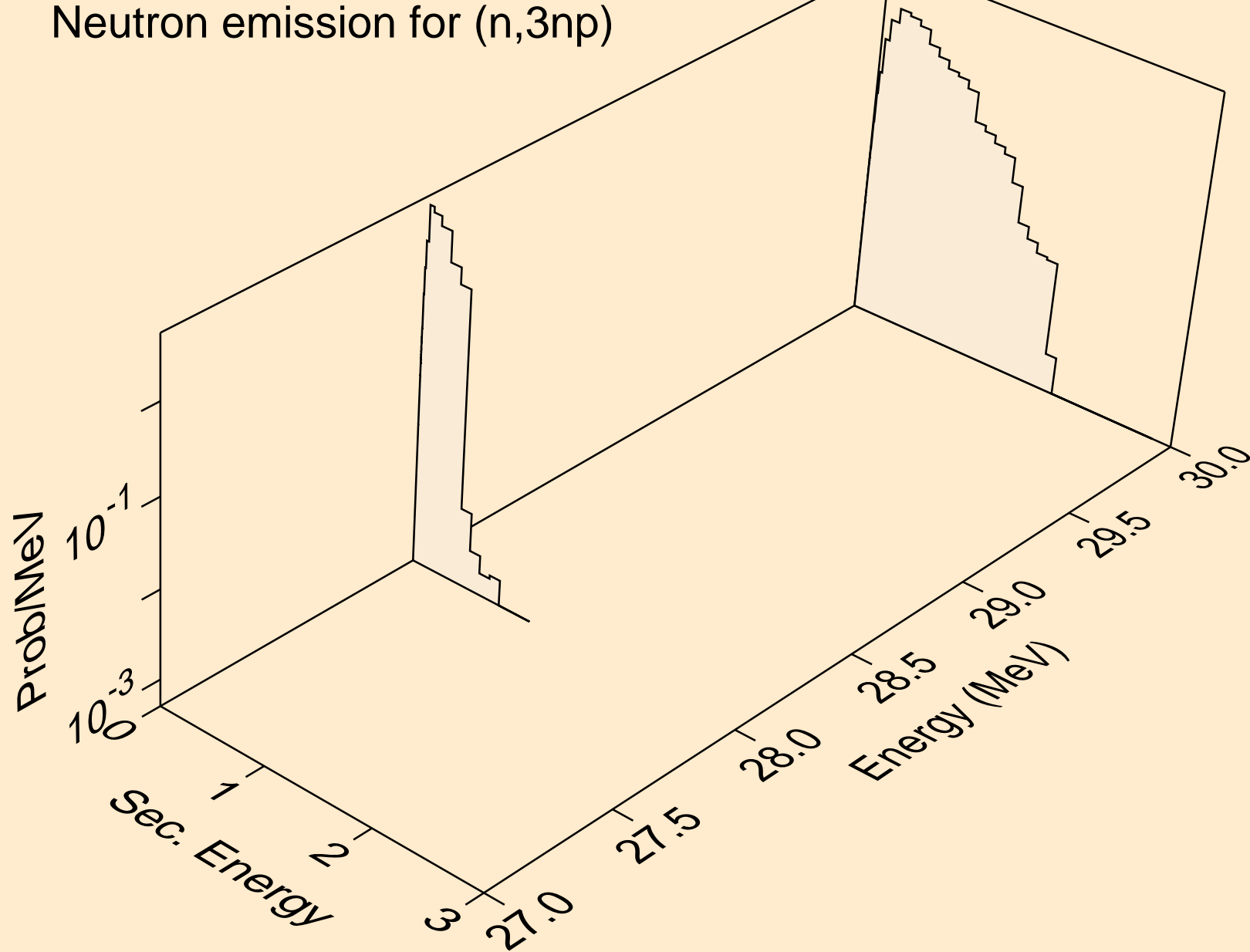

SC046M NEUTRON ACER TENDL-2021 LIBRARY; T=293.6K
Neutron emission for (n,2np)

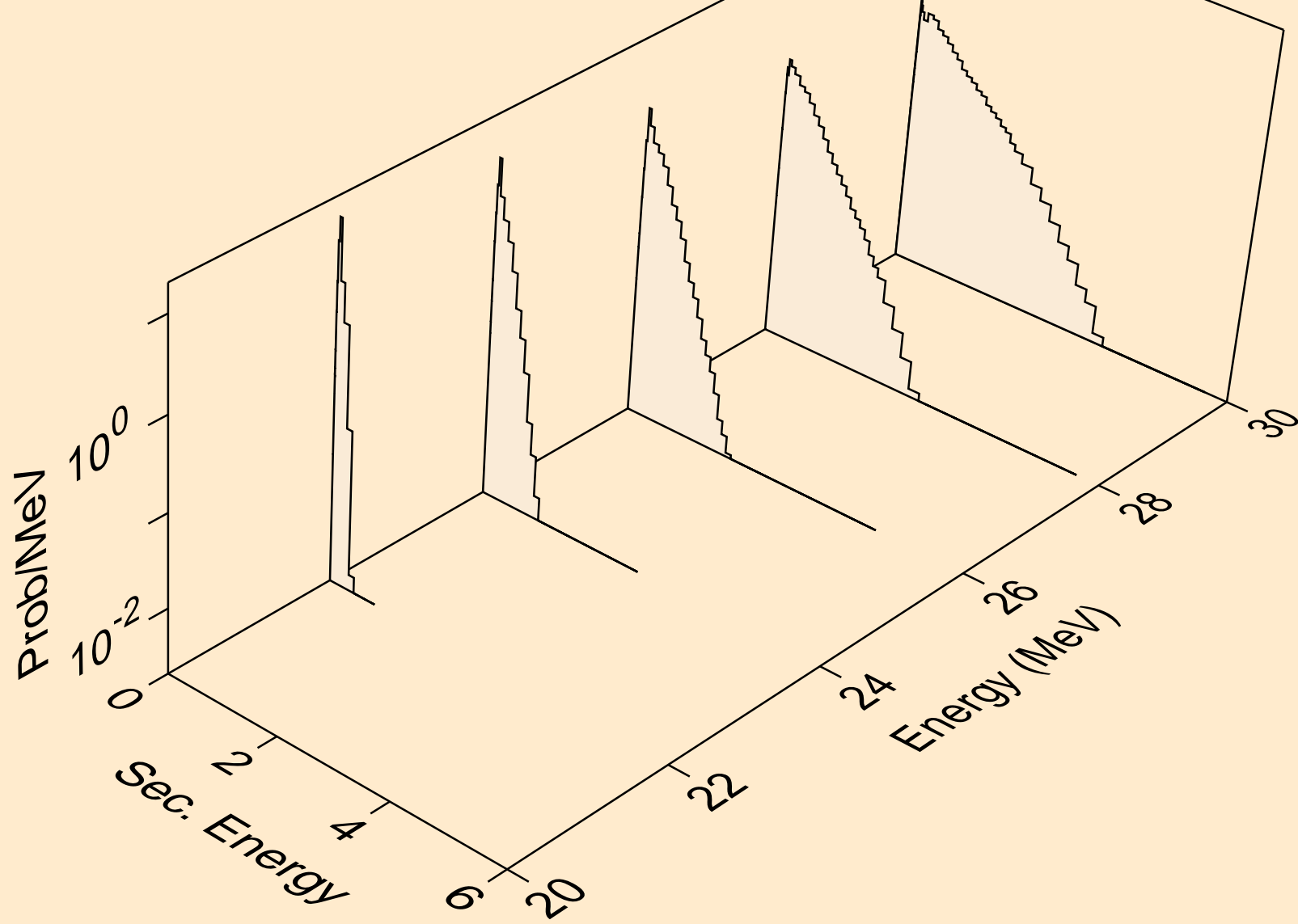

SC046M NEUTRON ACER TENDL-2021 LIBRARY; T=293.6K
Neutron emission for (n,npa)

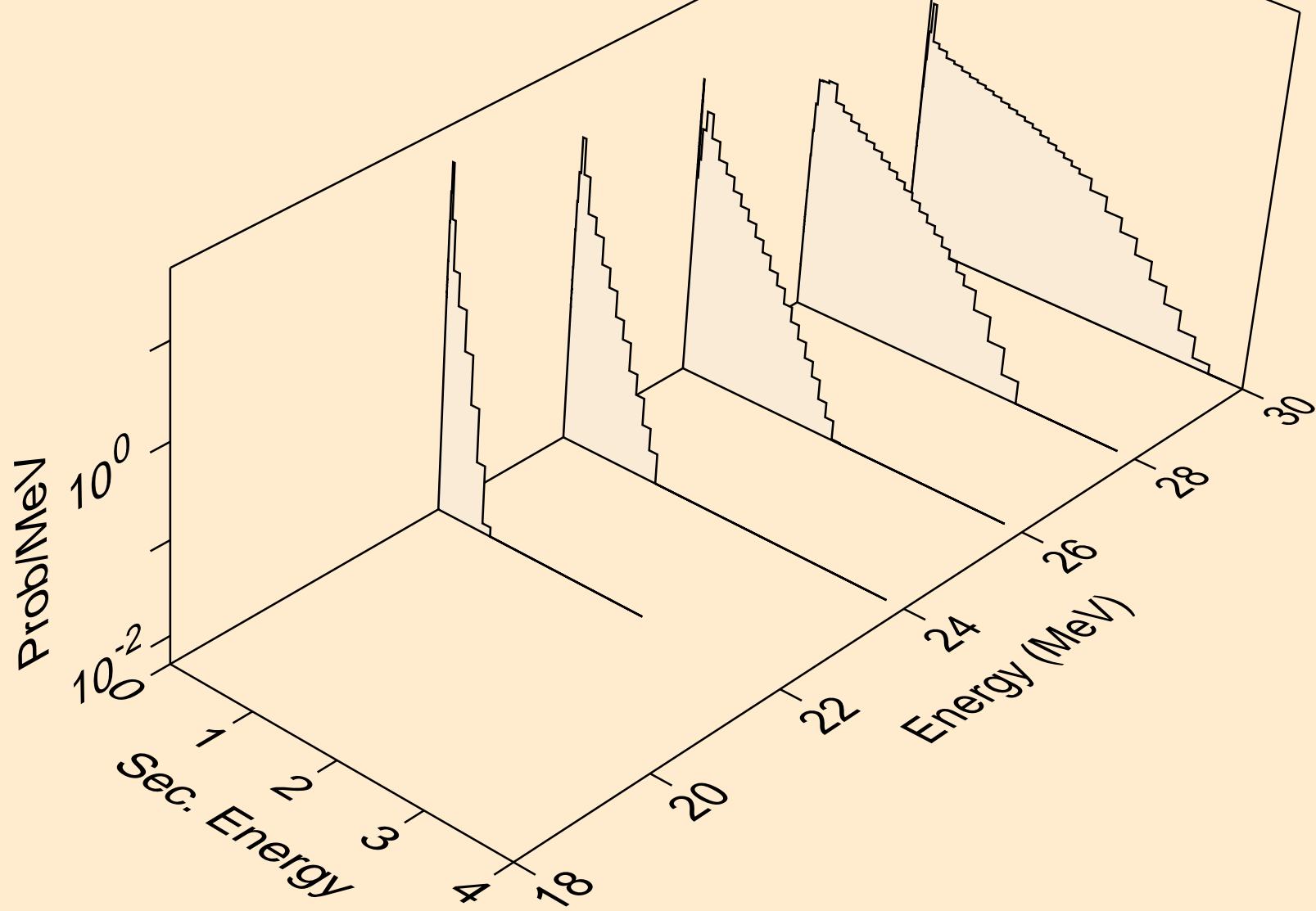

SC046M NEUTRON ACER TENDL-2021 LIBRARY; T=293.6K
Neutron emission for (n,n*c)

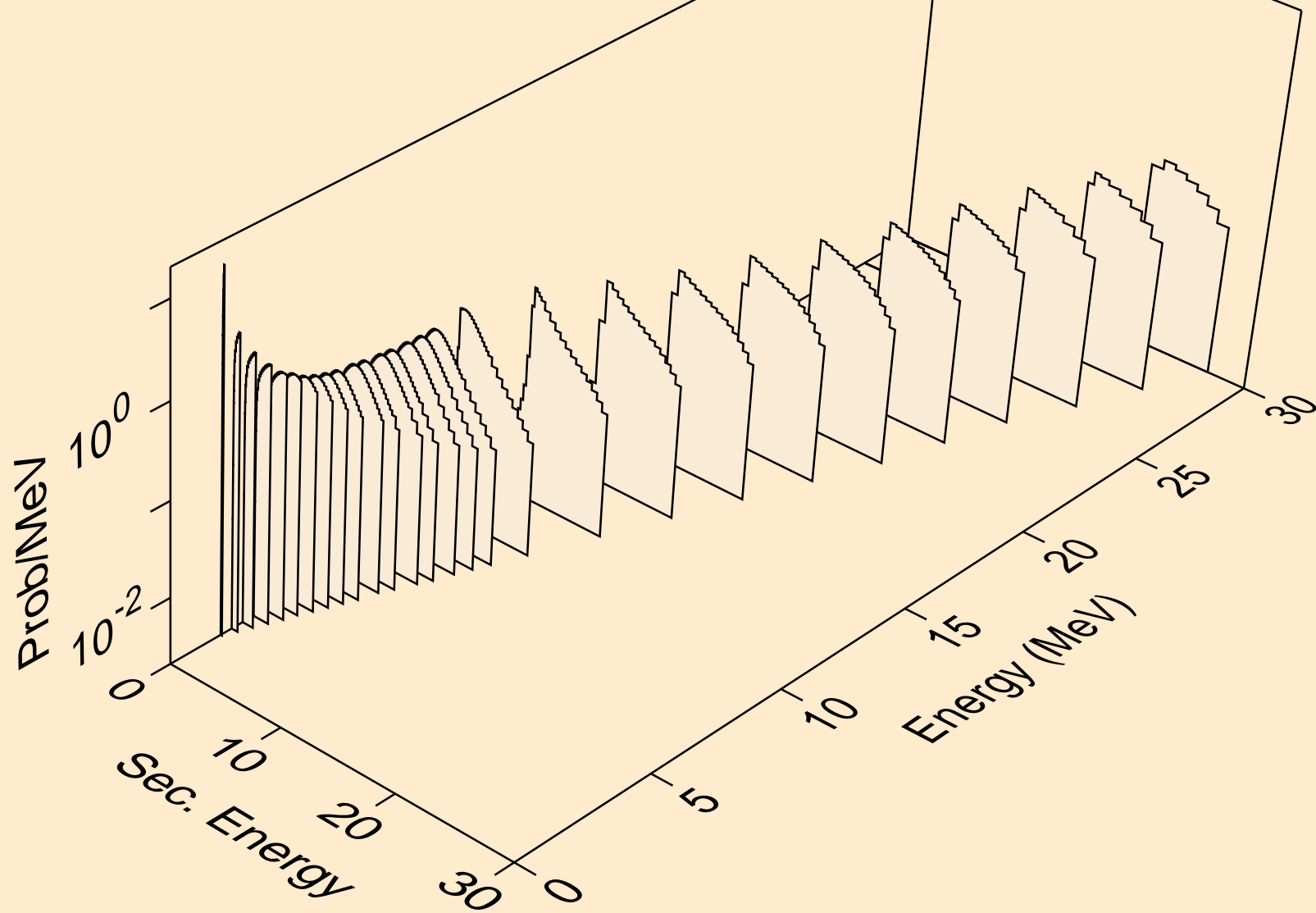

SC046M NEUTRON ACER TENDL-2021 LIBRARY; T=293.6K
Photon emission for (n,x)

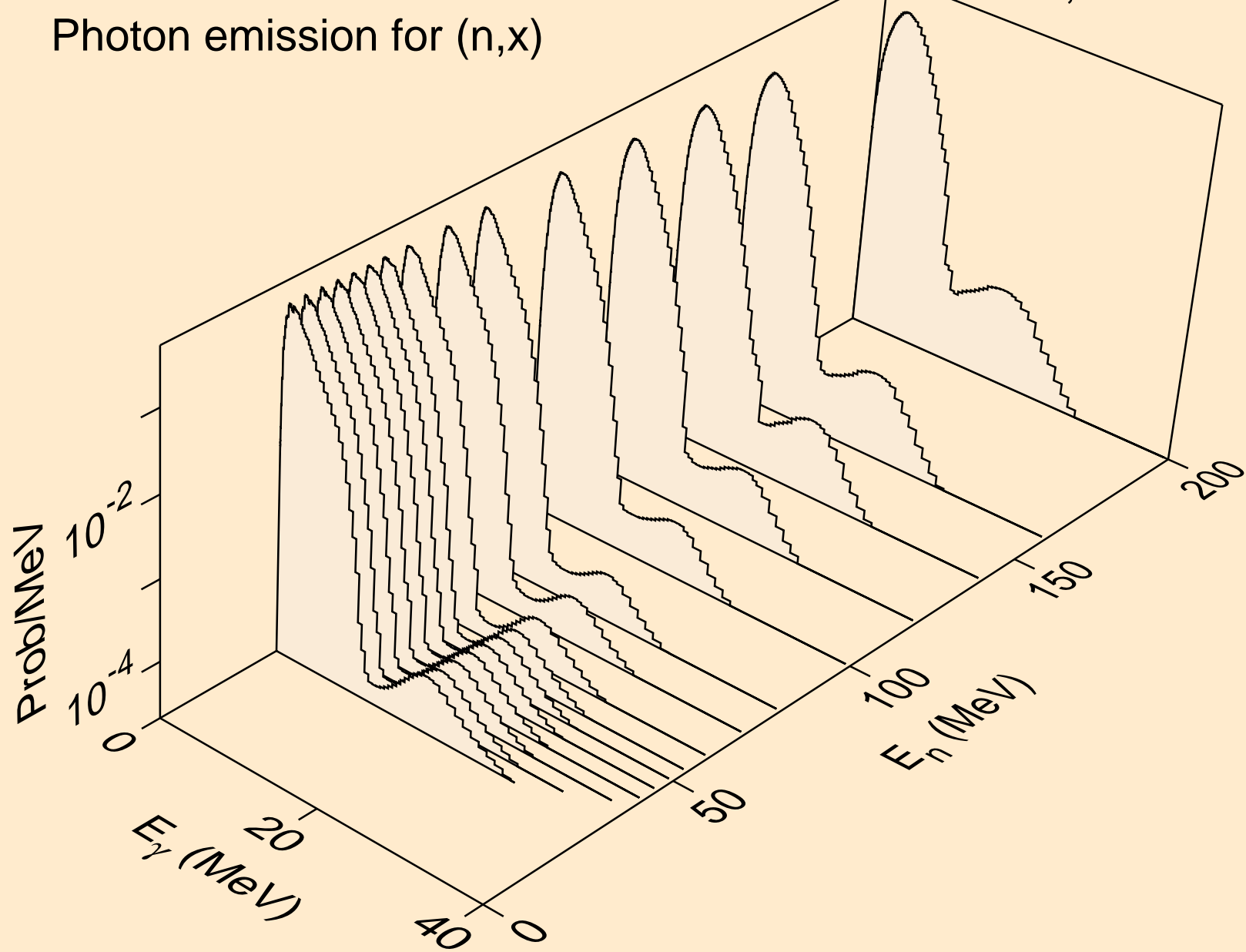

SC046M NEUTRON ACER TENDL-2021 LIBRARY; T=293.6K
Photon emission for (n,2nd)

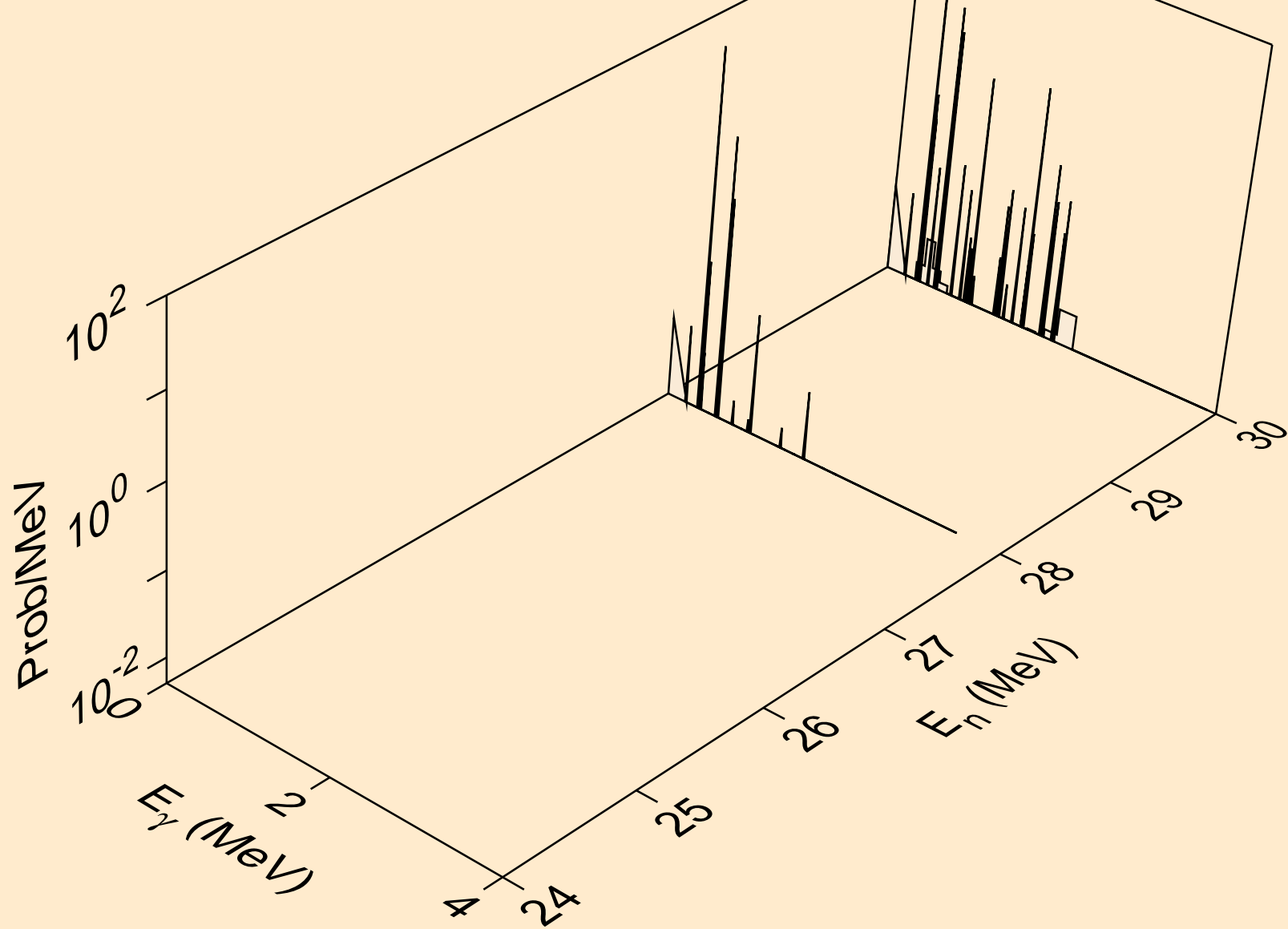

SC046M NEUTRON ACER TENDL-2021 LIBRARY; T=293.6K
Photon emission for (n,2n)

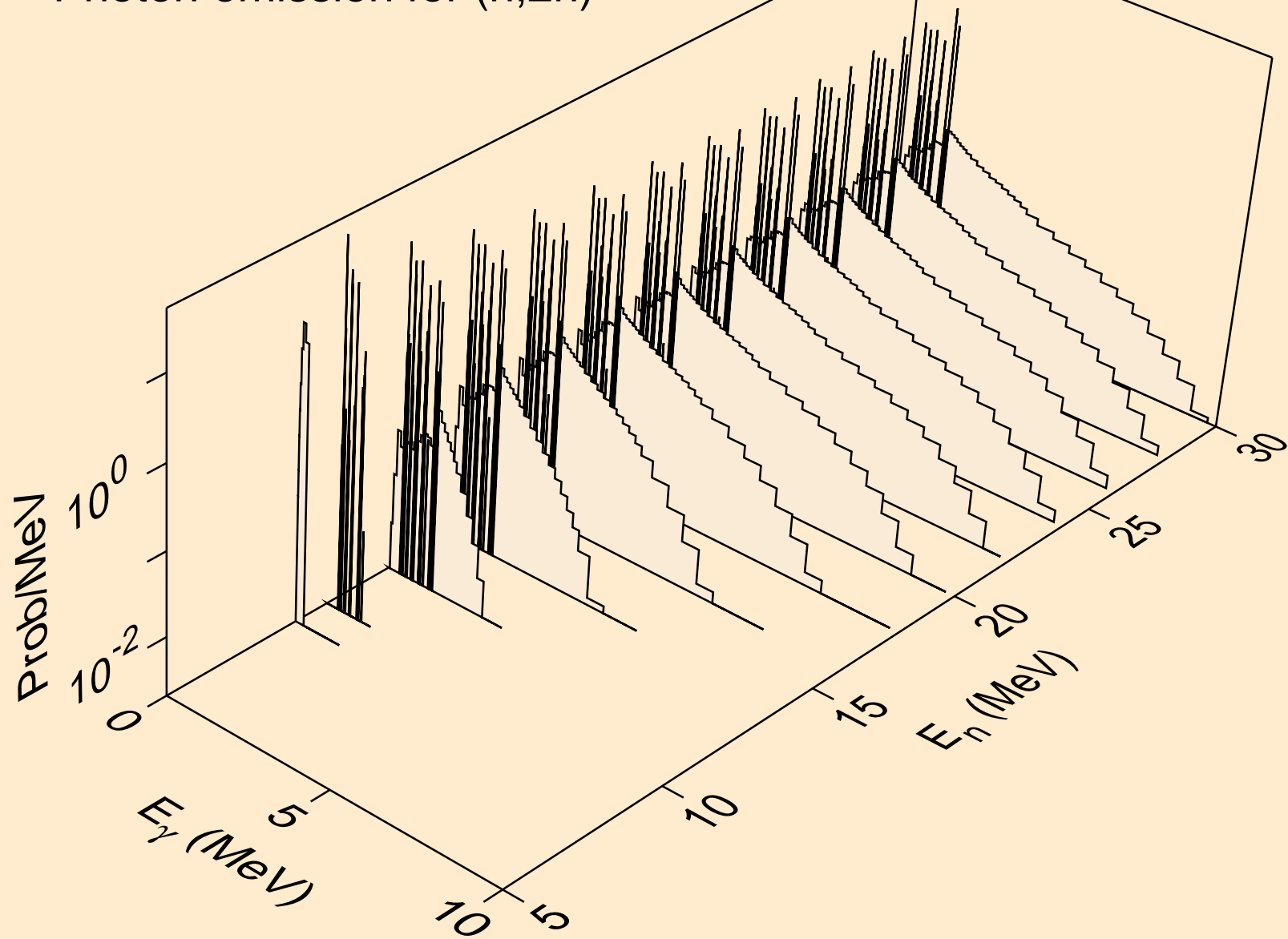

SC046M NEUTRON ACER TENDL-2021 LIBRARY; T=293.6K
Photon emission for (n,3n)

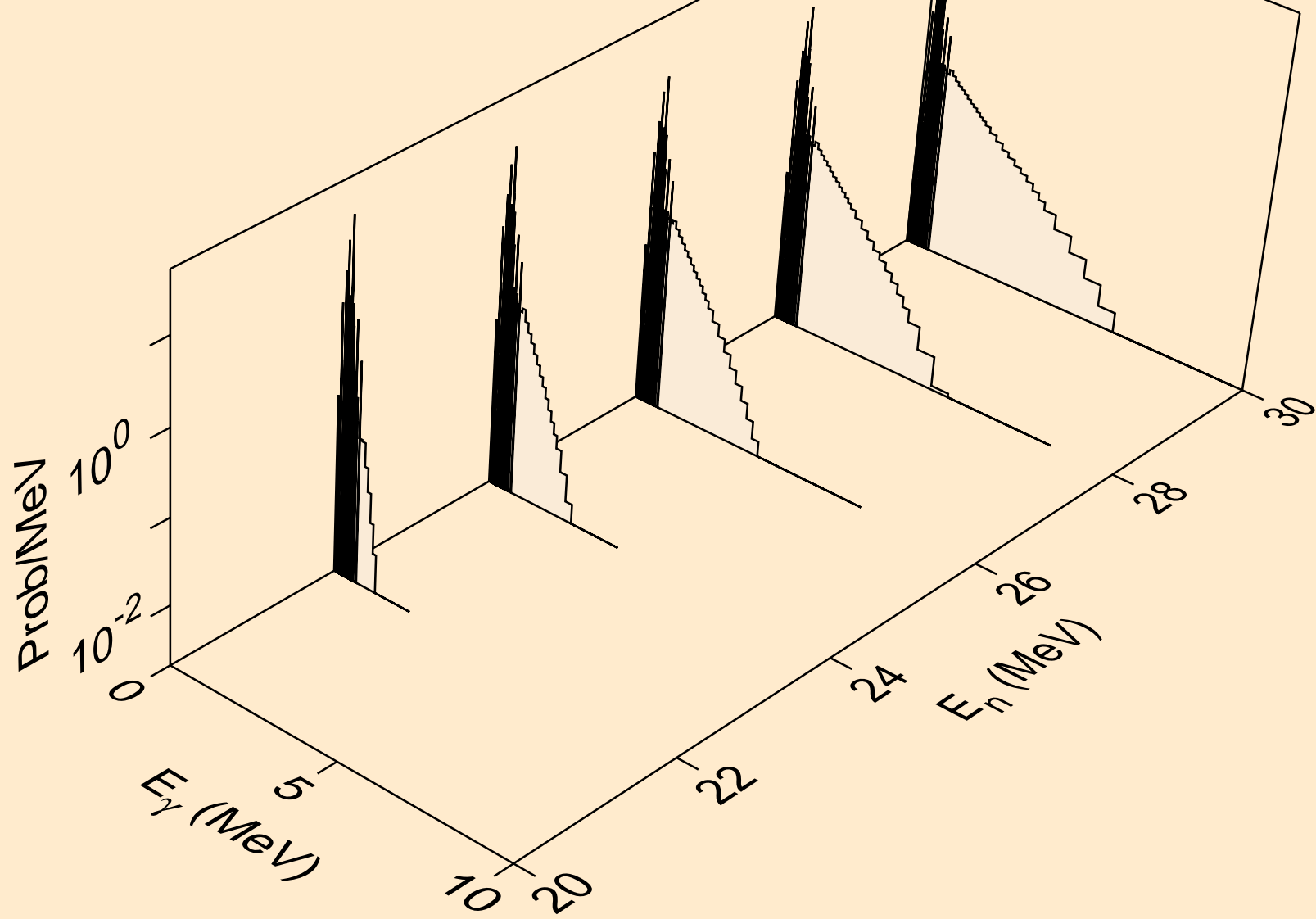

SC046M NEUTRON ACER TENDL-2021 LIBRARY; T=293.6K
Photon emission for (n,n*)a

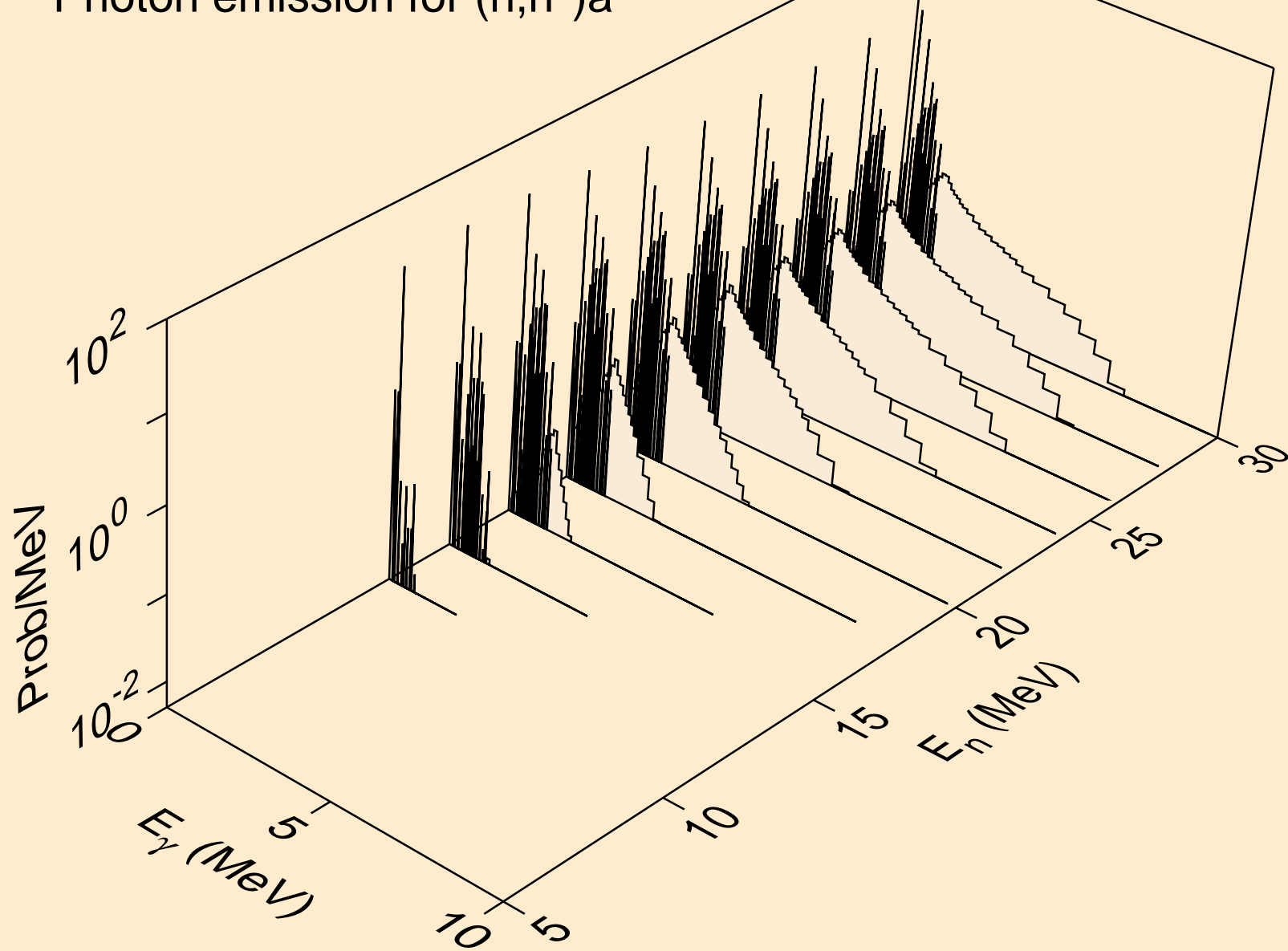

SC046M NEUTRON ACER TENDL-2021 LIBRARY; T=293.6K
Photon emission for (n,2n)a

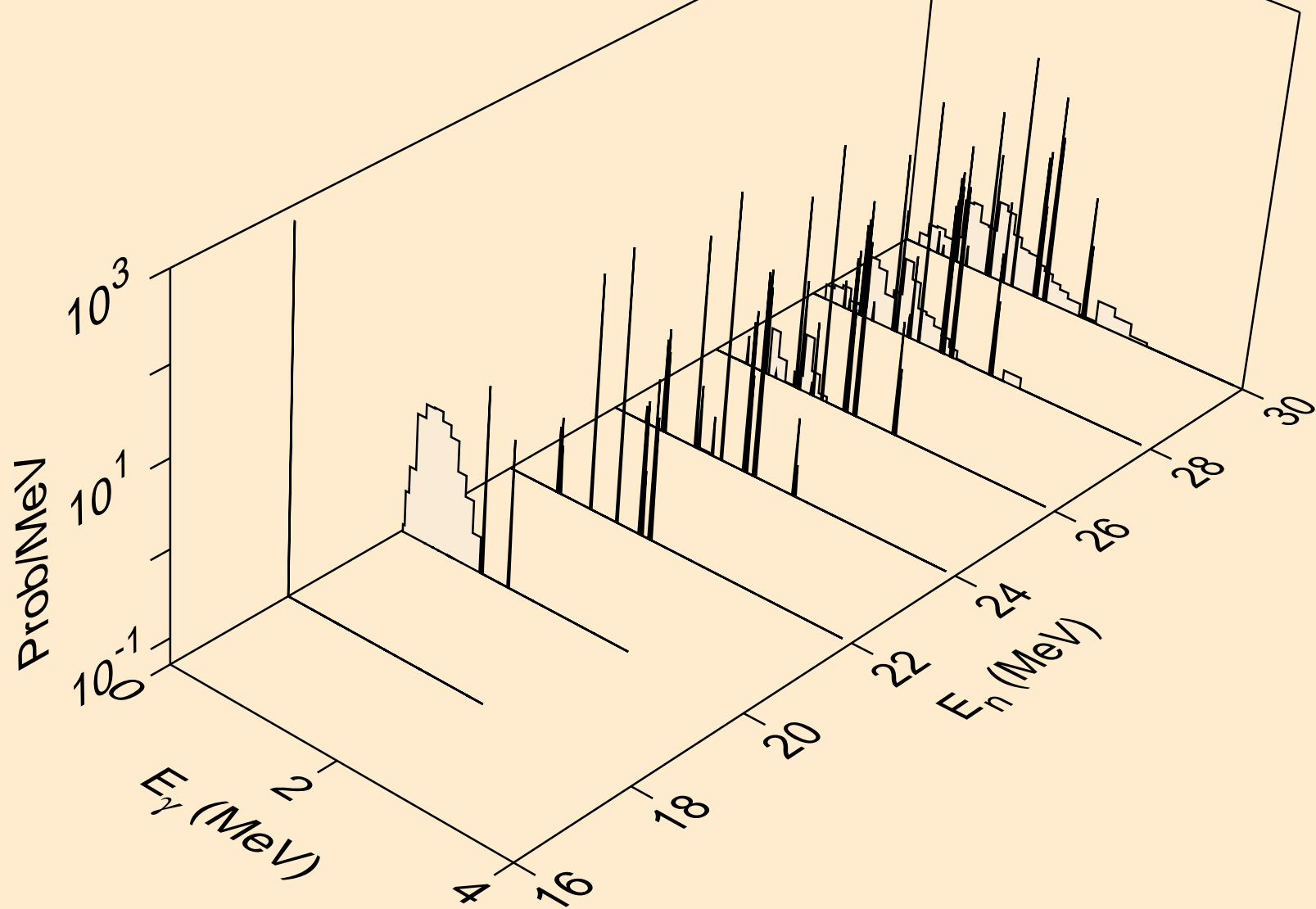

SC046M NEUTRON ACER TENDL-2021 LIBRARY; T=293.6K
Photon emission for (n,n*)p

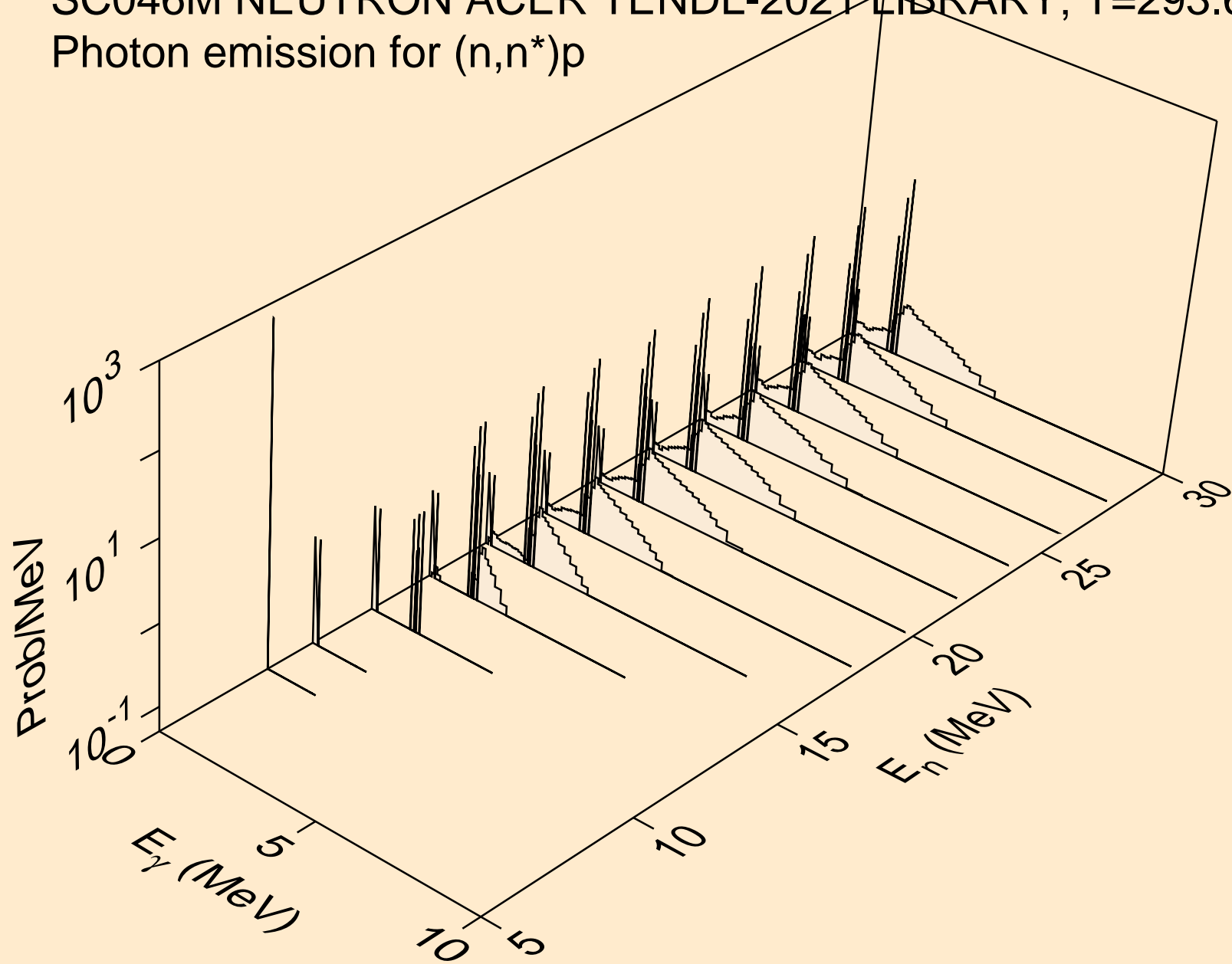

SC046M NEUTRON ACER TENDL-2021 LIBRARY; T=293.6K
Photon emission for (n,n*)2a

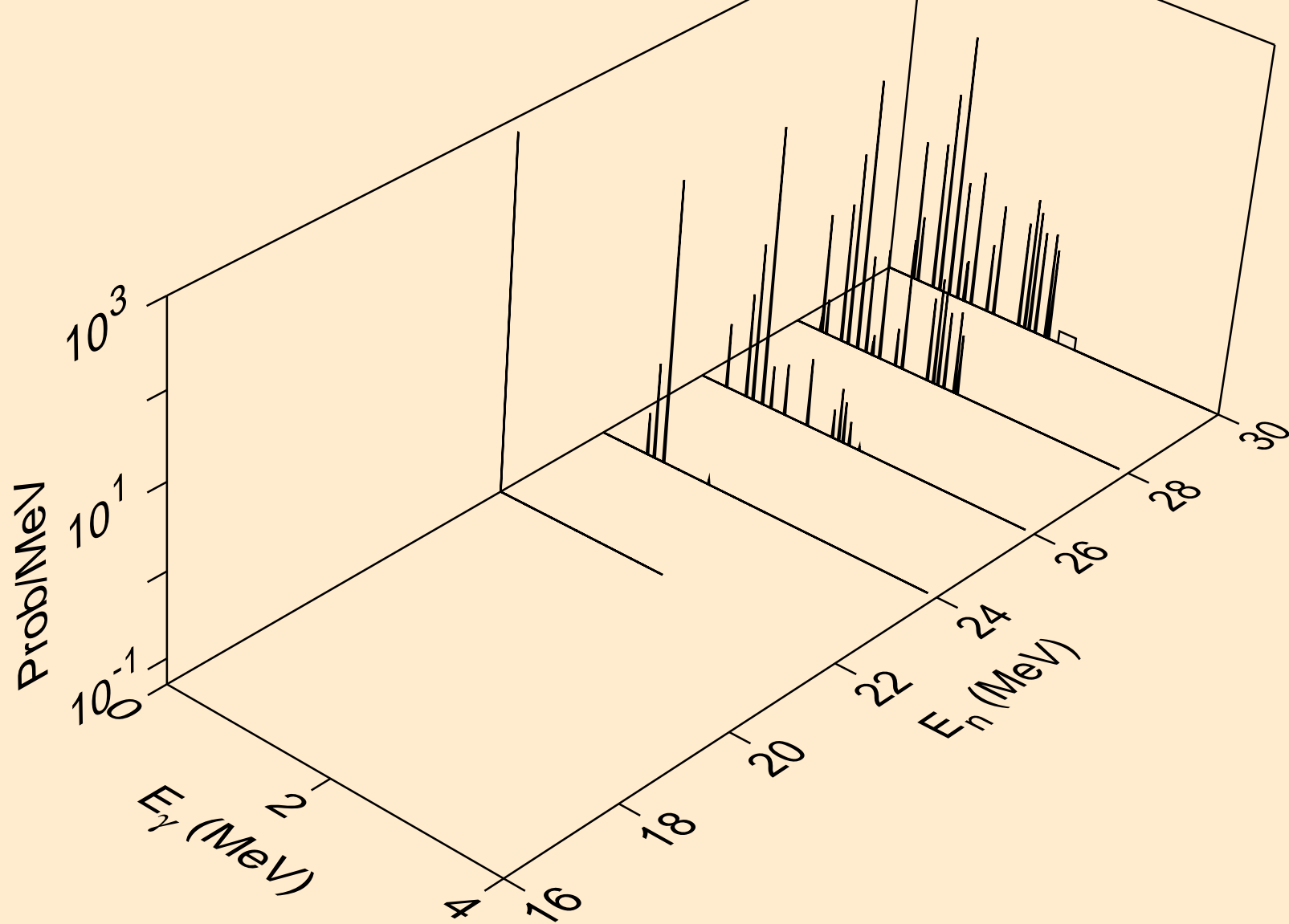

SC046M NEUTRON ACER TENDL-2021 LIBRARY; T=293.6K
Photon emission for (n,n*)d

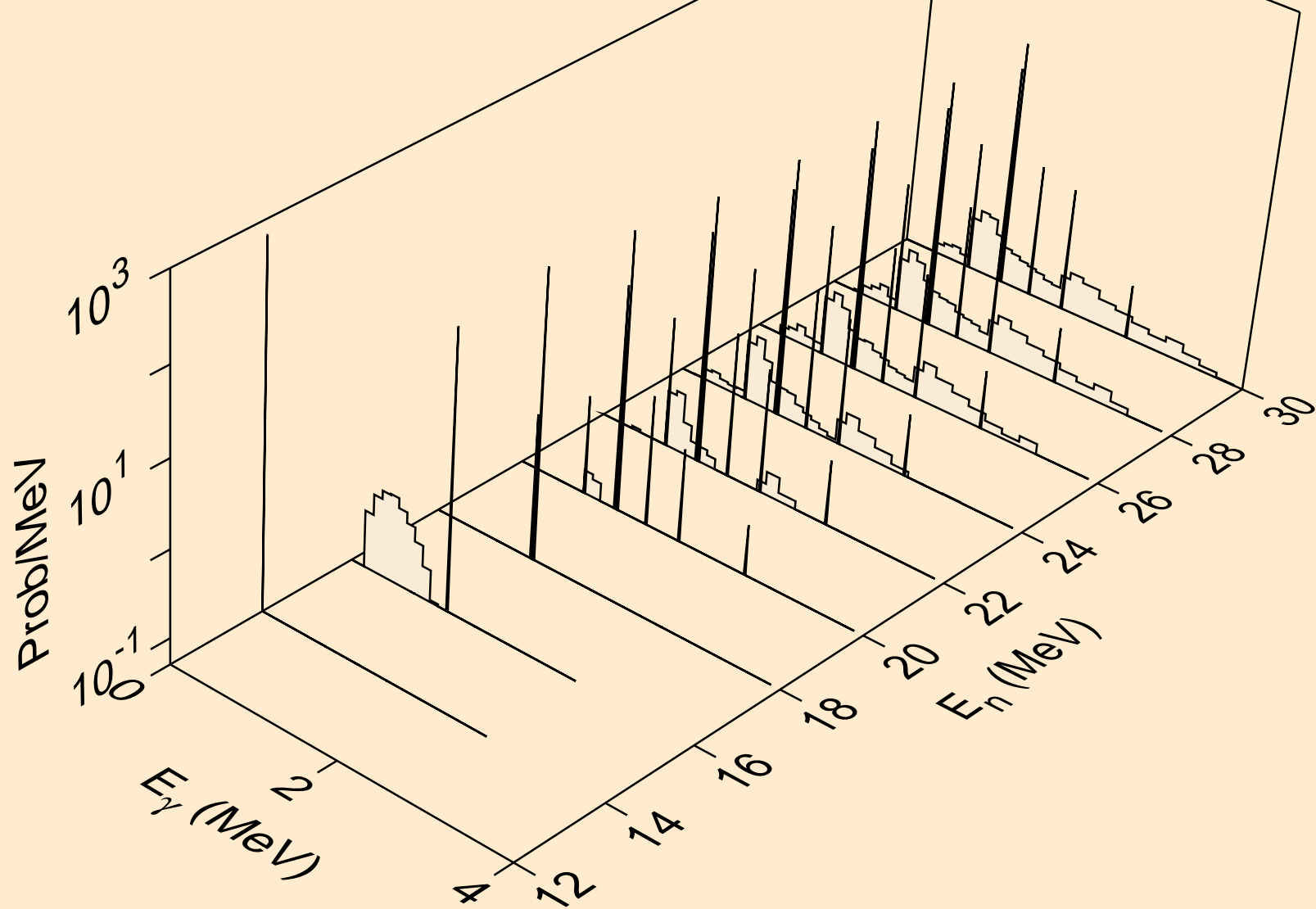

SC046M NEUTRON ACER TENDL-2021 LIBRARY; T=293.6K
Photon emission for (n,n*)t

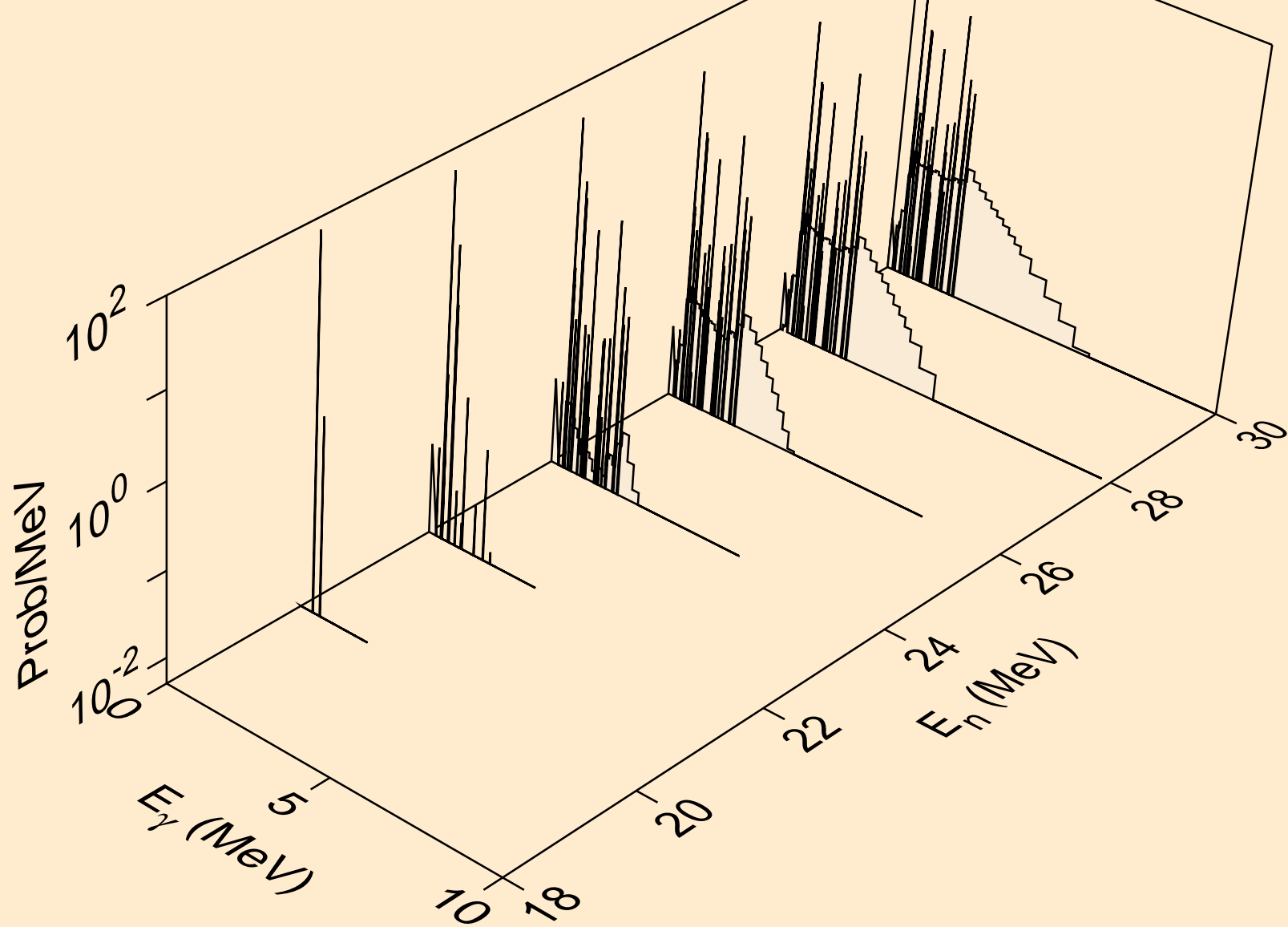

SC046M NEUTRON ACER TENDL-2021 LIBRARY; T=293.6K
Photon emission for (n,n*)he3

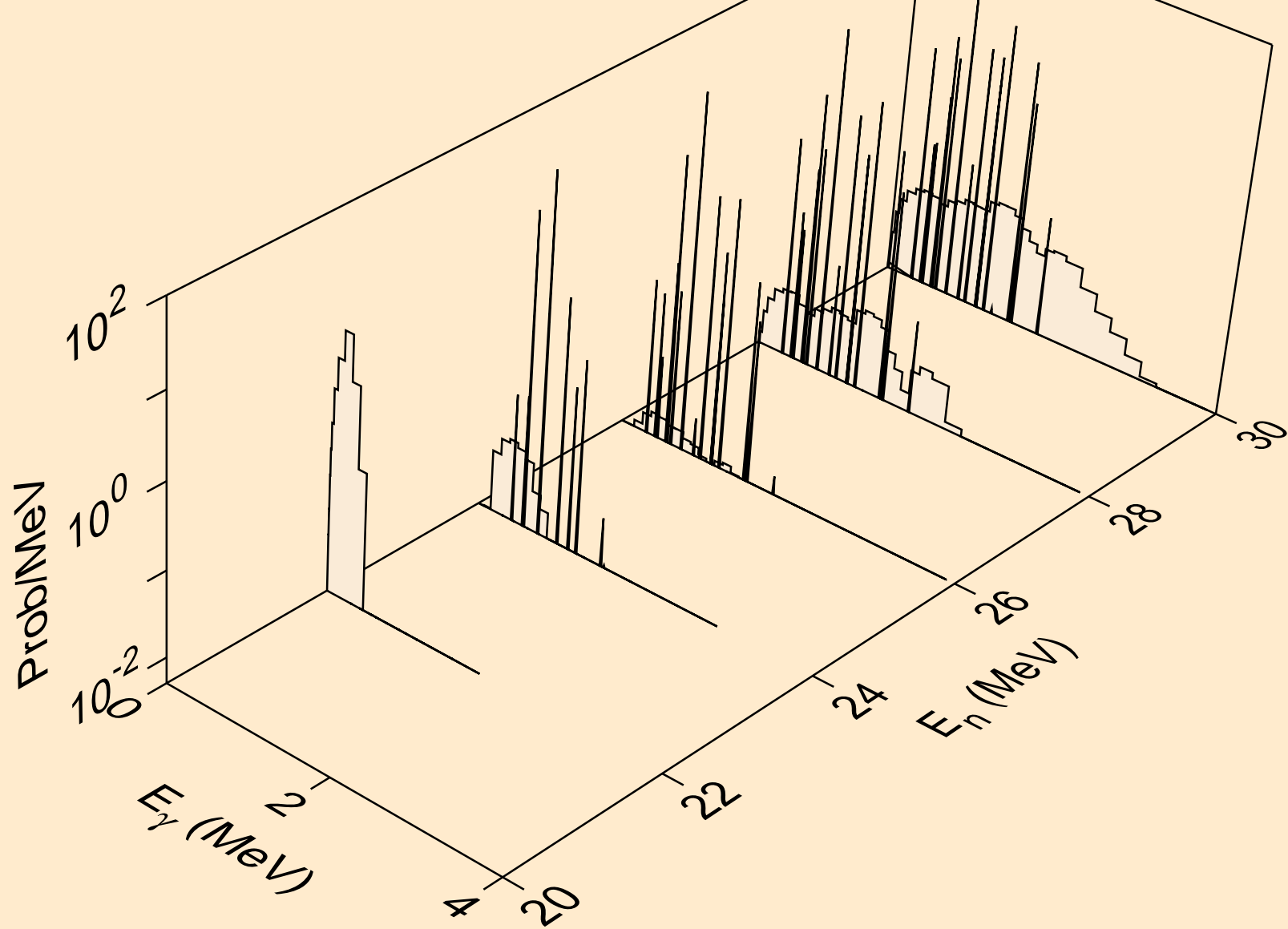

SC046M NEUTRON ACER TENDL-2021 LIBRARY; T=293.6K
Photon emission for (n,2np)

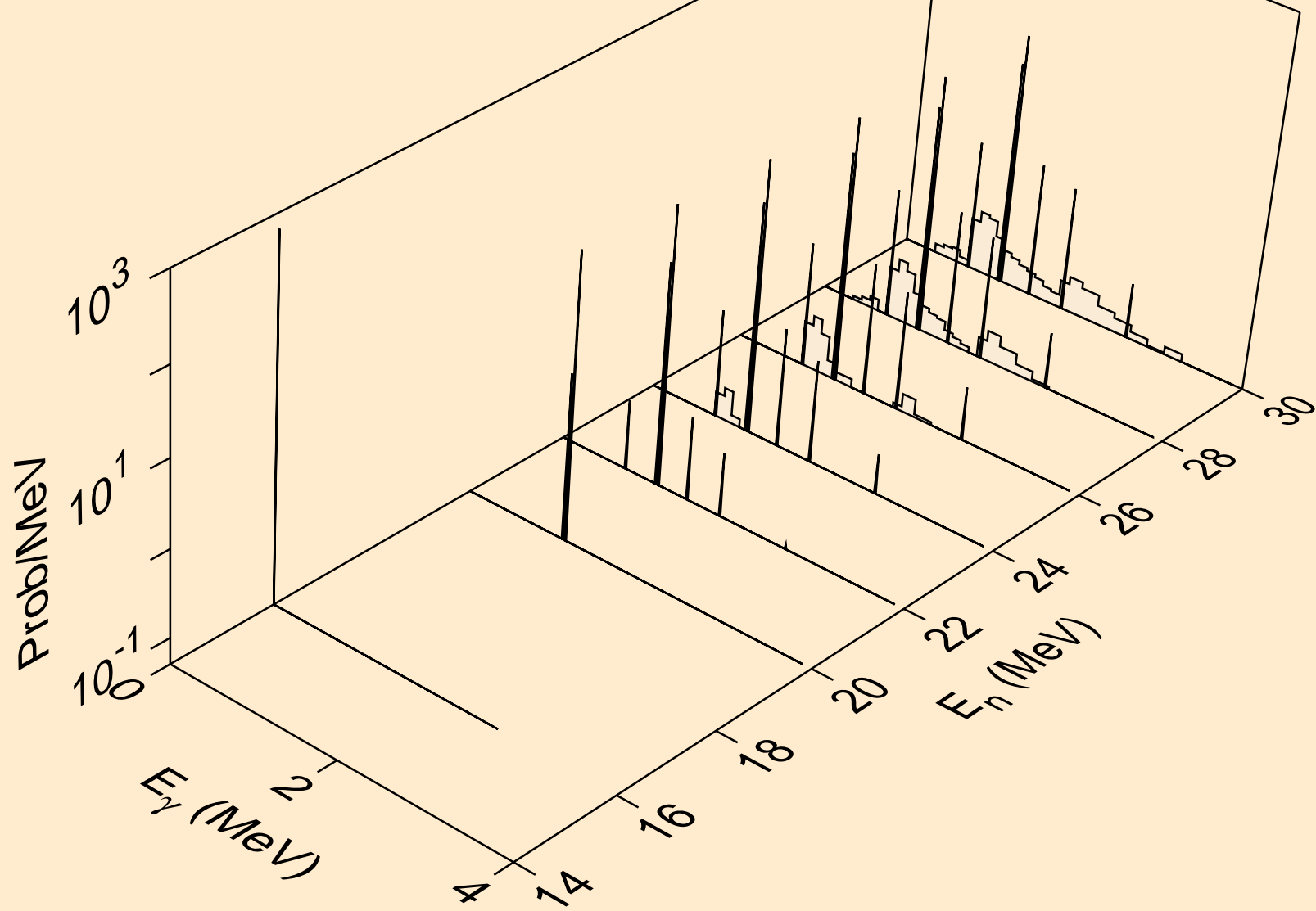

SC046M NEUTRON ACER TENDL-2021 LIBRARY; T=293.6K
Photon emission for (n,3np)

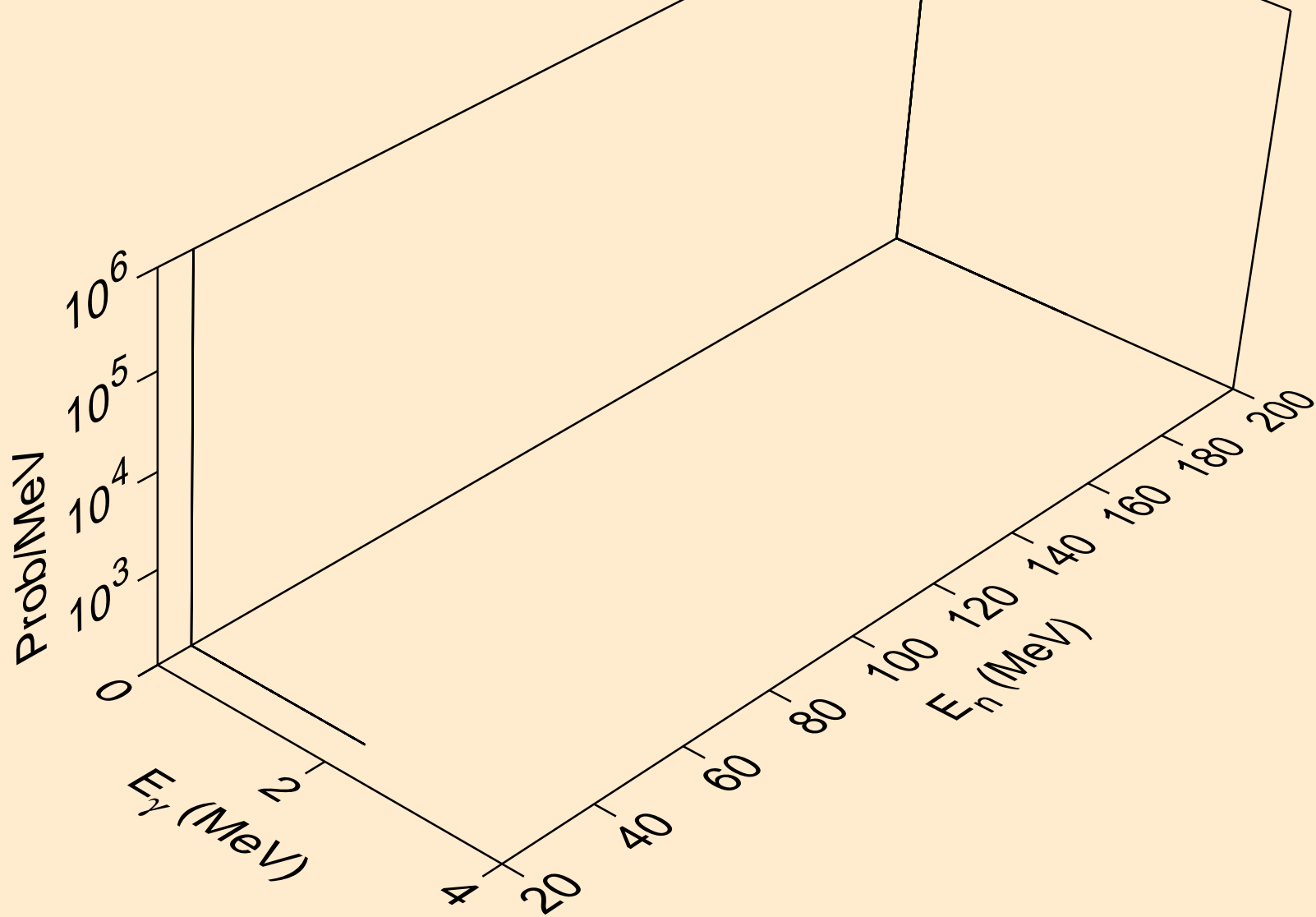

SC046M NEUTRON ACER TENDL-2021 LIBRARY; T=293.6K
Photon emission for (n,2np)

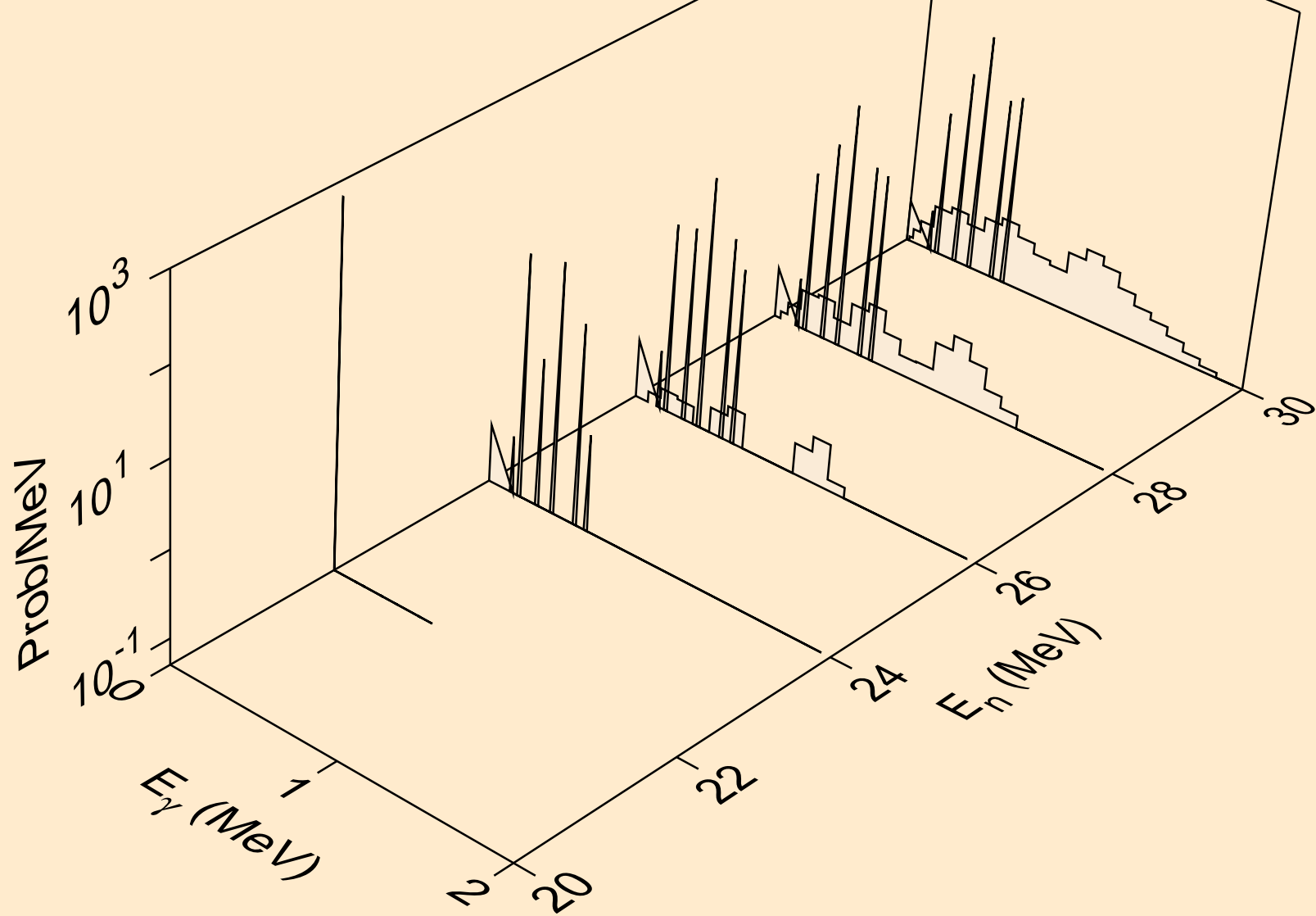

SC046M NEUTRON ACER TENDL-2021 LIBRARY; T=293.6K
Photon emission for (n,npa)

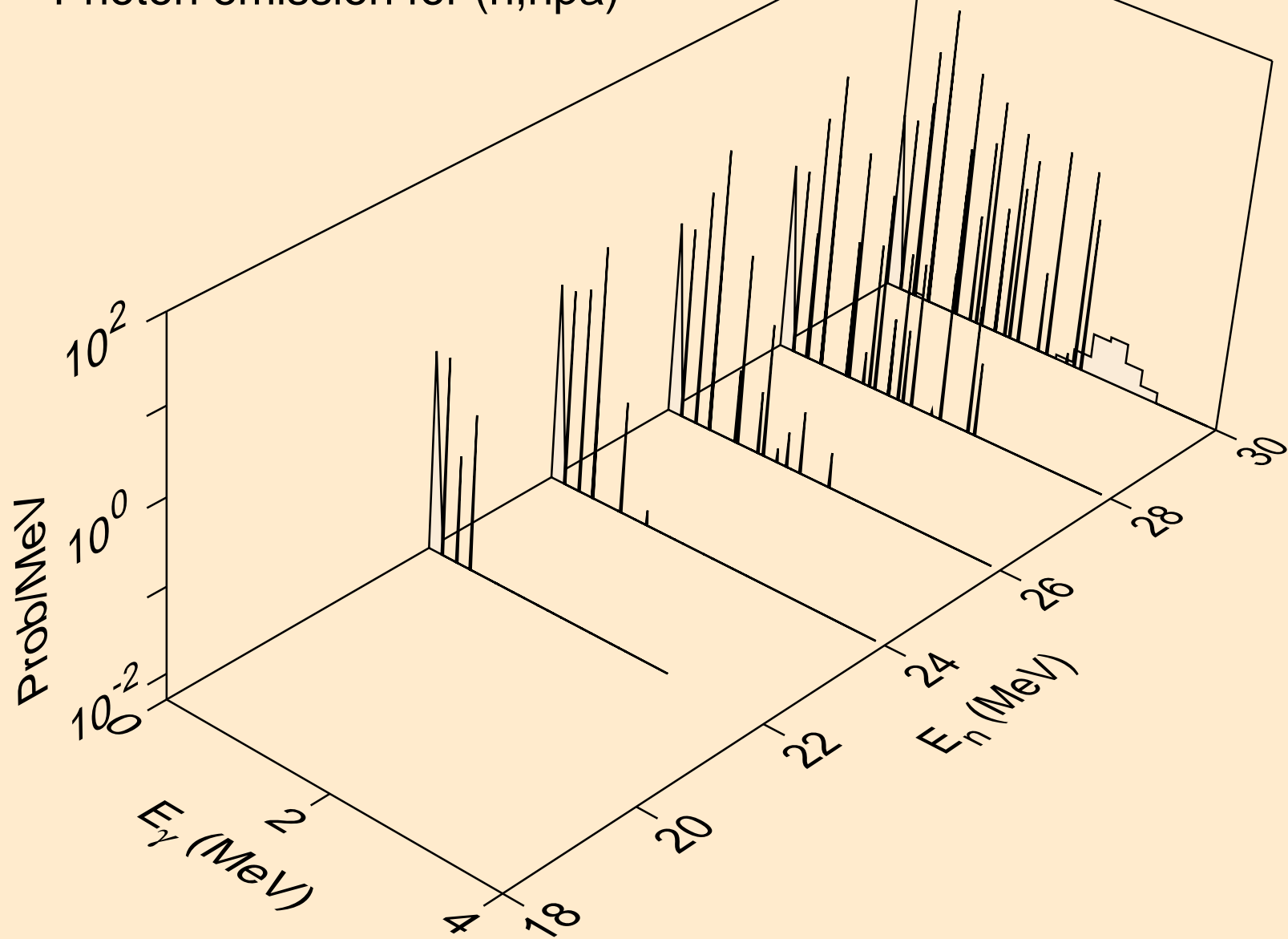

SC046M NEUTRON ACER TENDL-2021 LIBRARY; T=293.6K
Photon emission for (n,n*1)

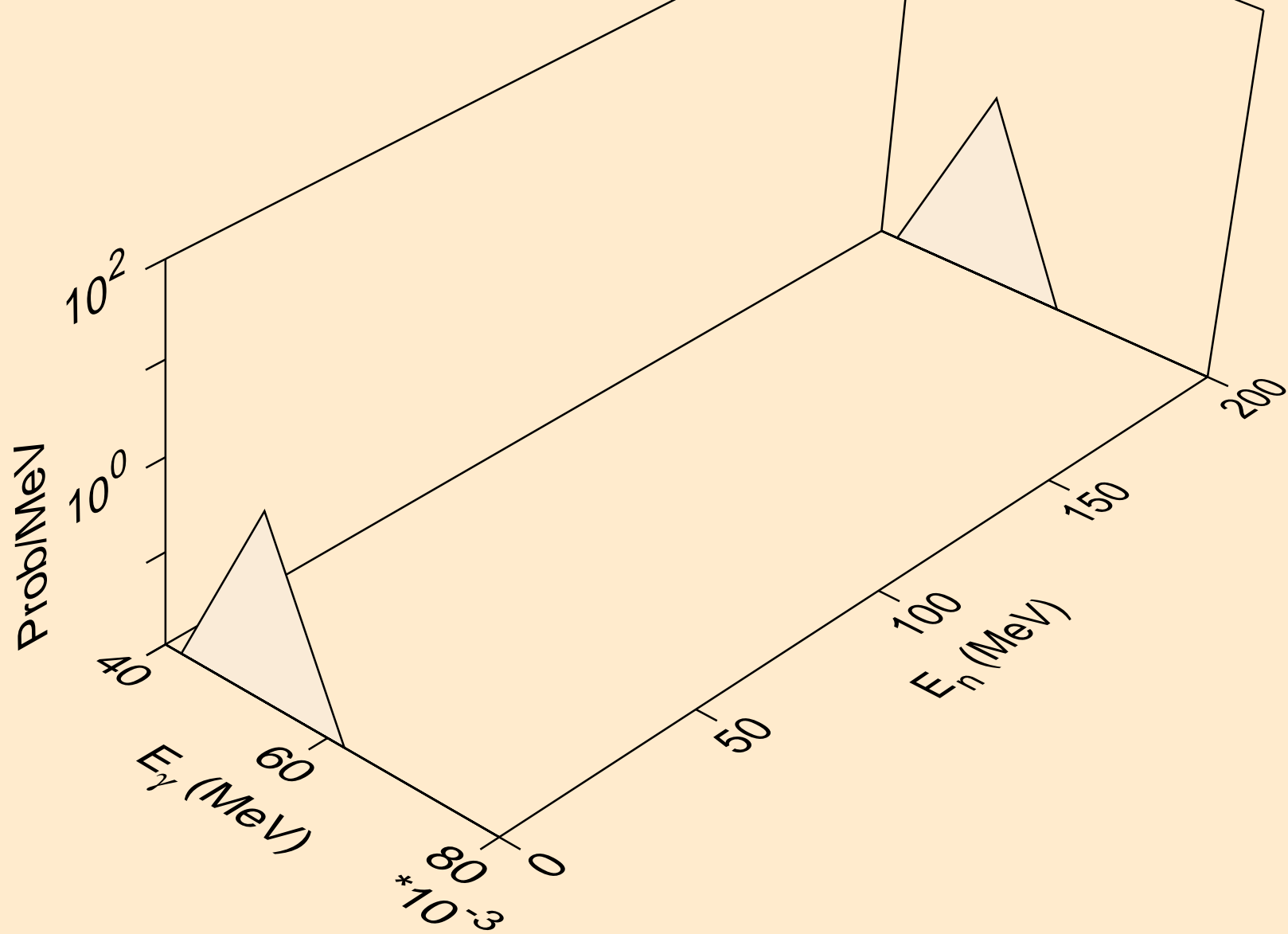

SC046M NEUTRON ACER TENDL-2021 LIBRARY; T=293.6K
Photon emission for (n,n*3)

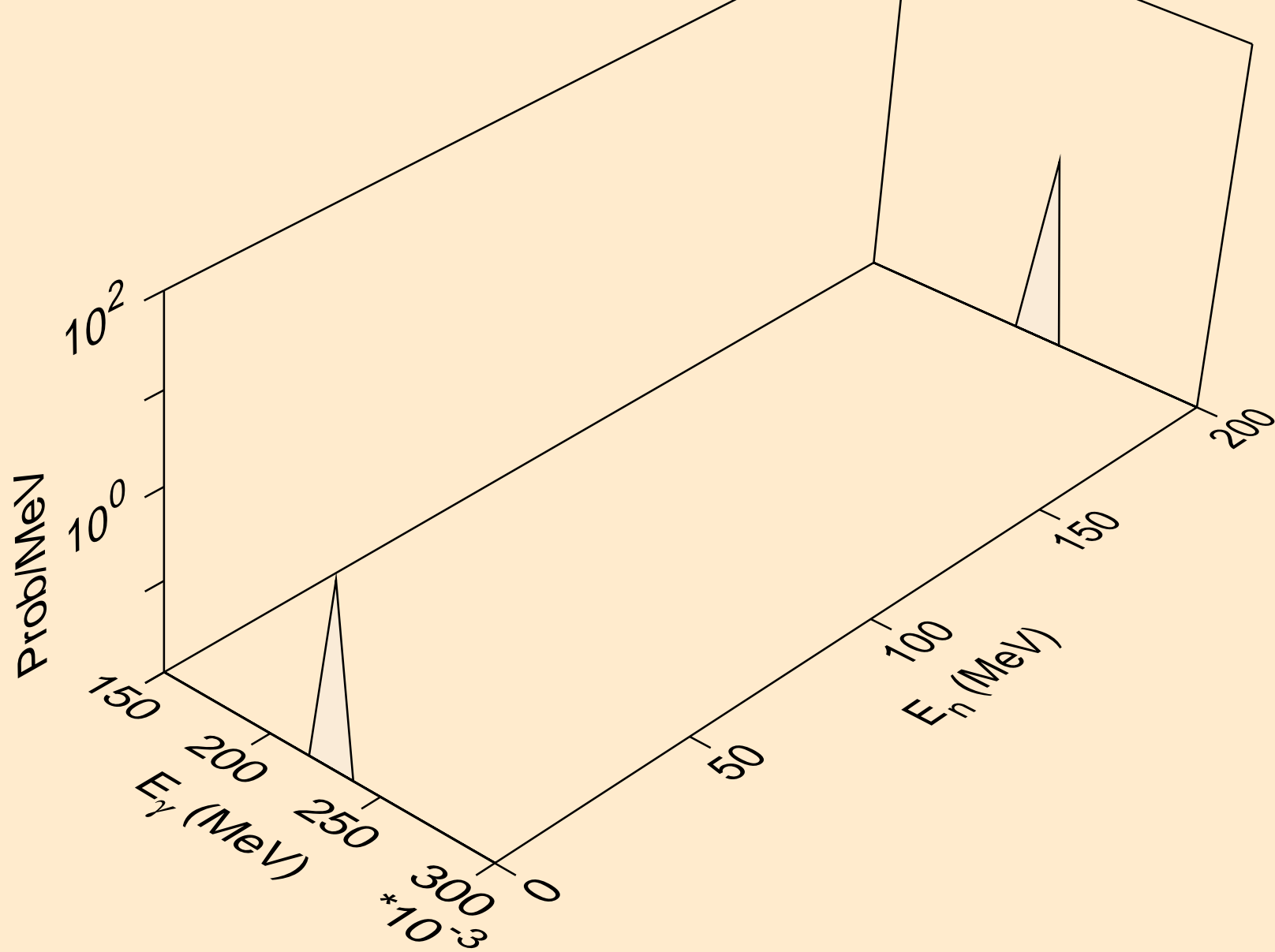

SC046M NEUTRON ACER TENDL-2021 LIBRARY; T=293.6K
Photon emission for (n,n*4)

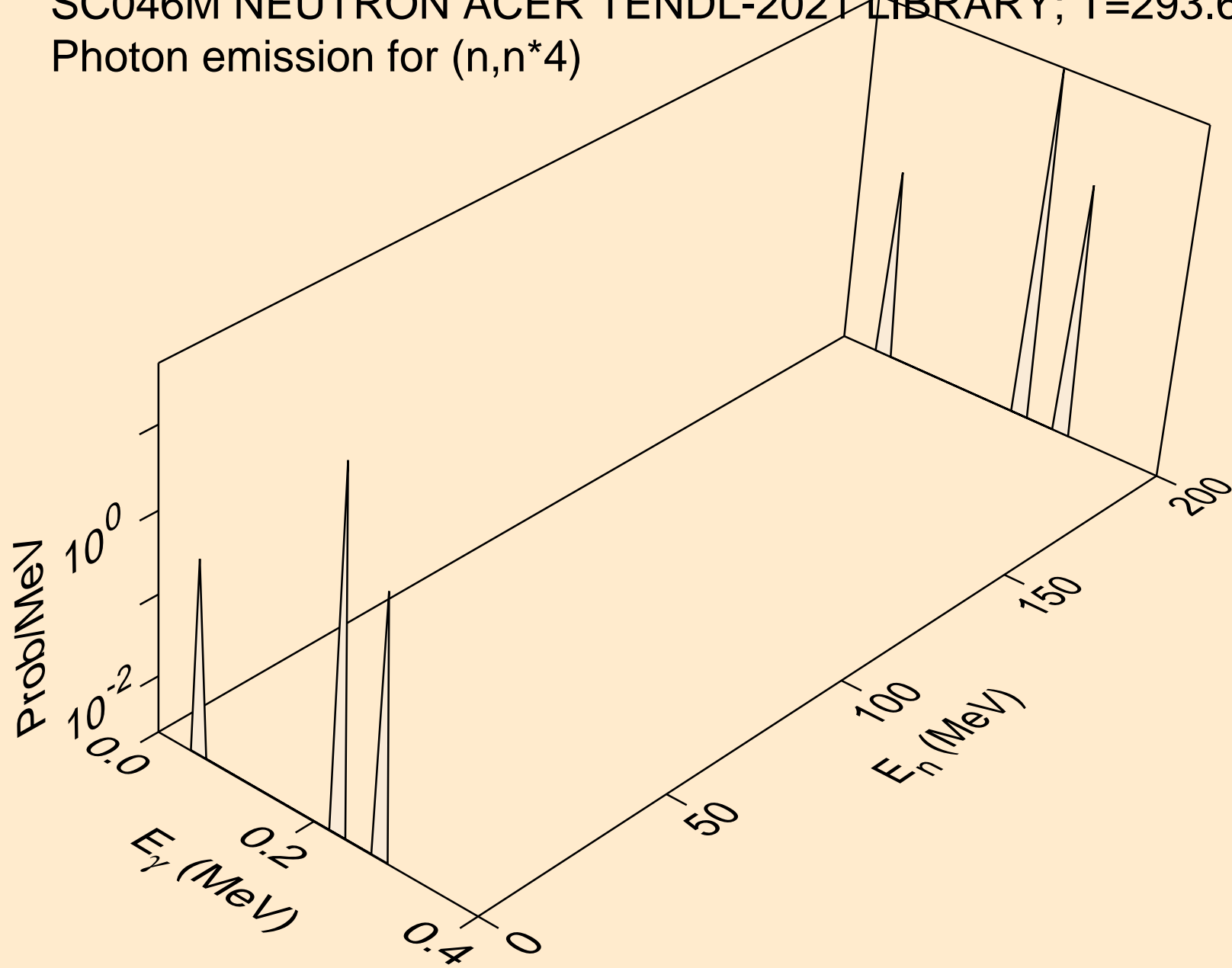

SC046M NEUTRON ACER TENDL-2021 LIBRARY; T=293.6K
Photon emission for (n,n*5)

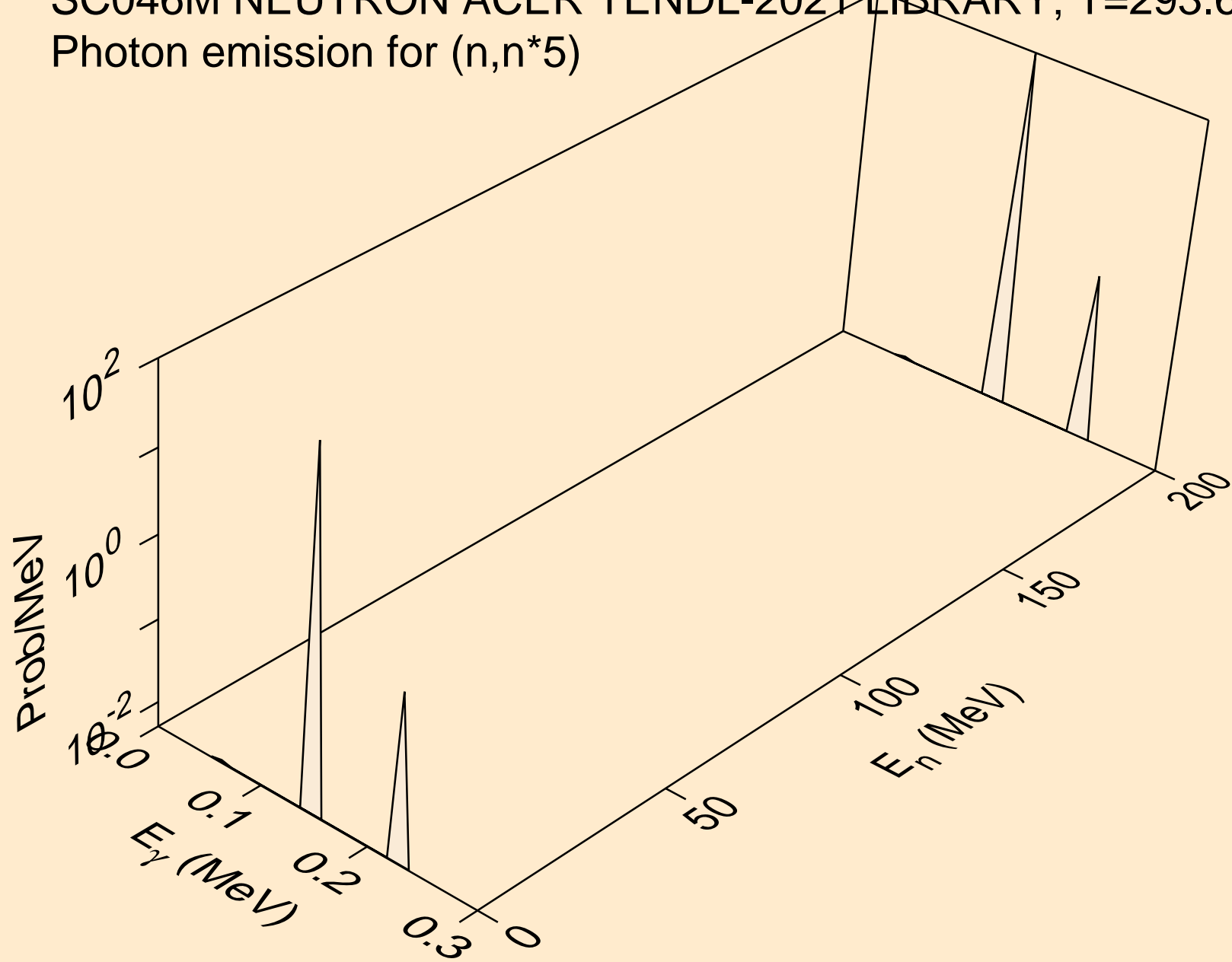

SC046M NEUTRON ACER TENDL-2021 LIBRARY; T=293.6K
Photon emission for (n,n*6)

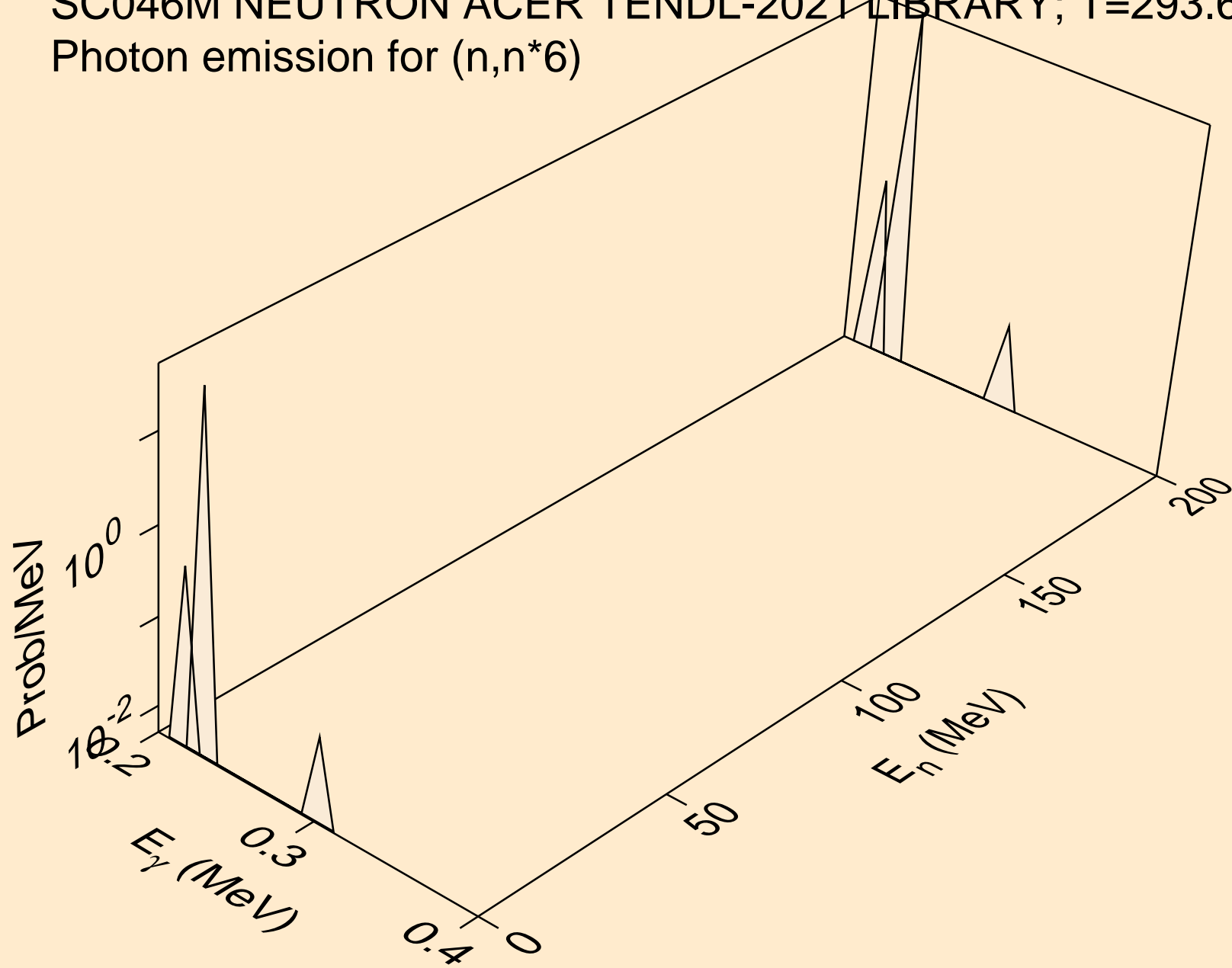

SC046M NEUTRON ACER TENDL-2021 LIBRARY; T=293.6K
Photon emission for (n,n*7)

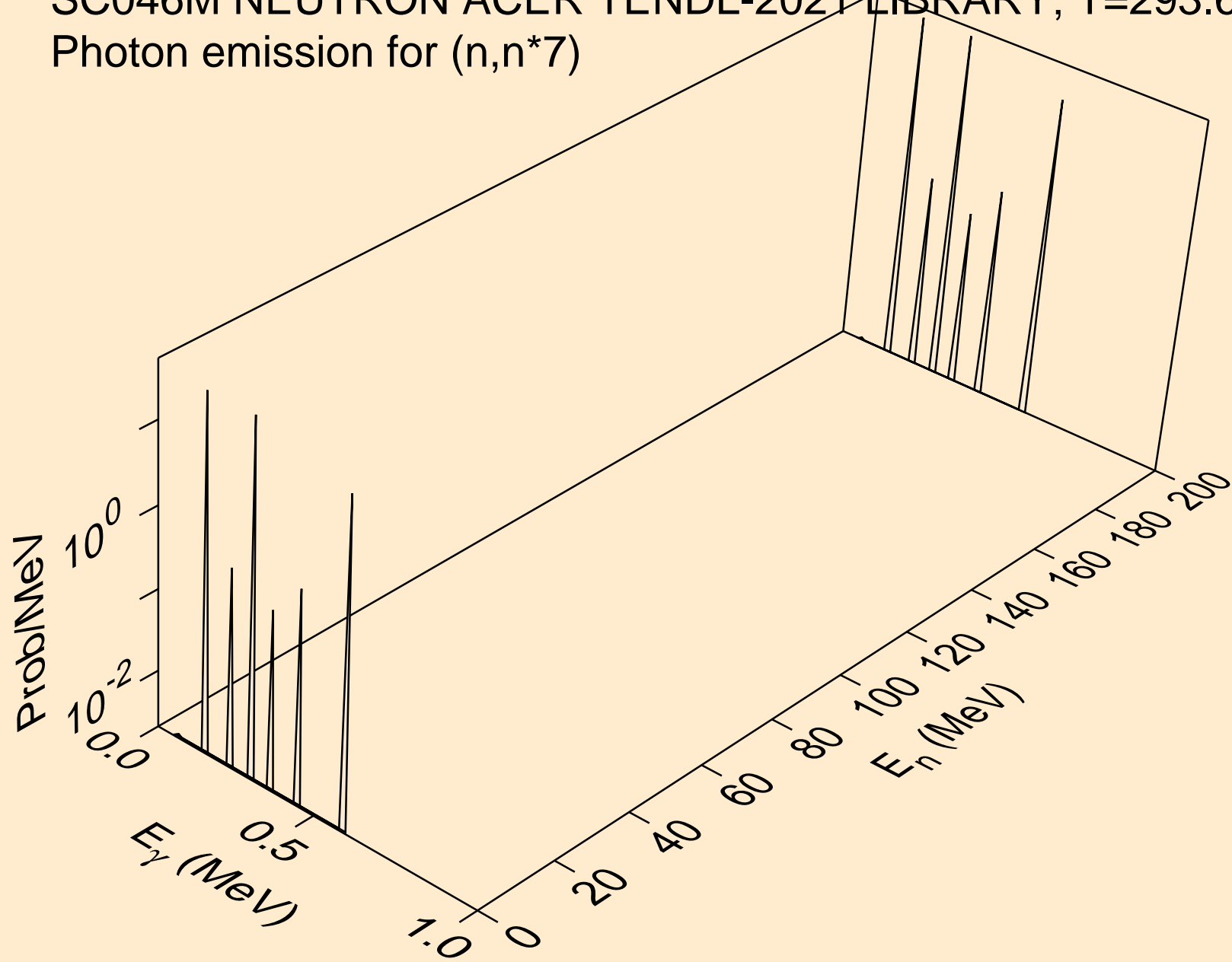

SC046M NEUTRON ACER TENDL-2021 LIBRARY; T=293.6K
Photon emission for (n,n*8)

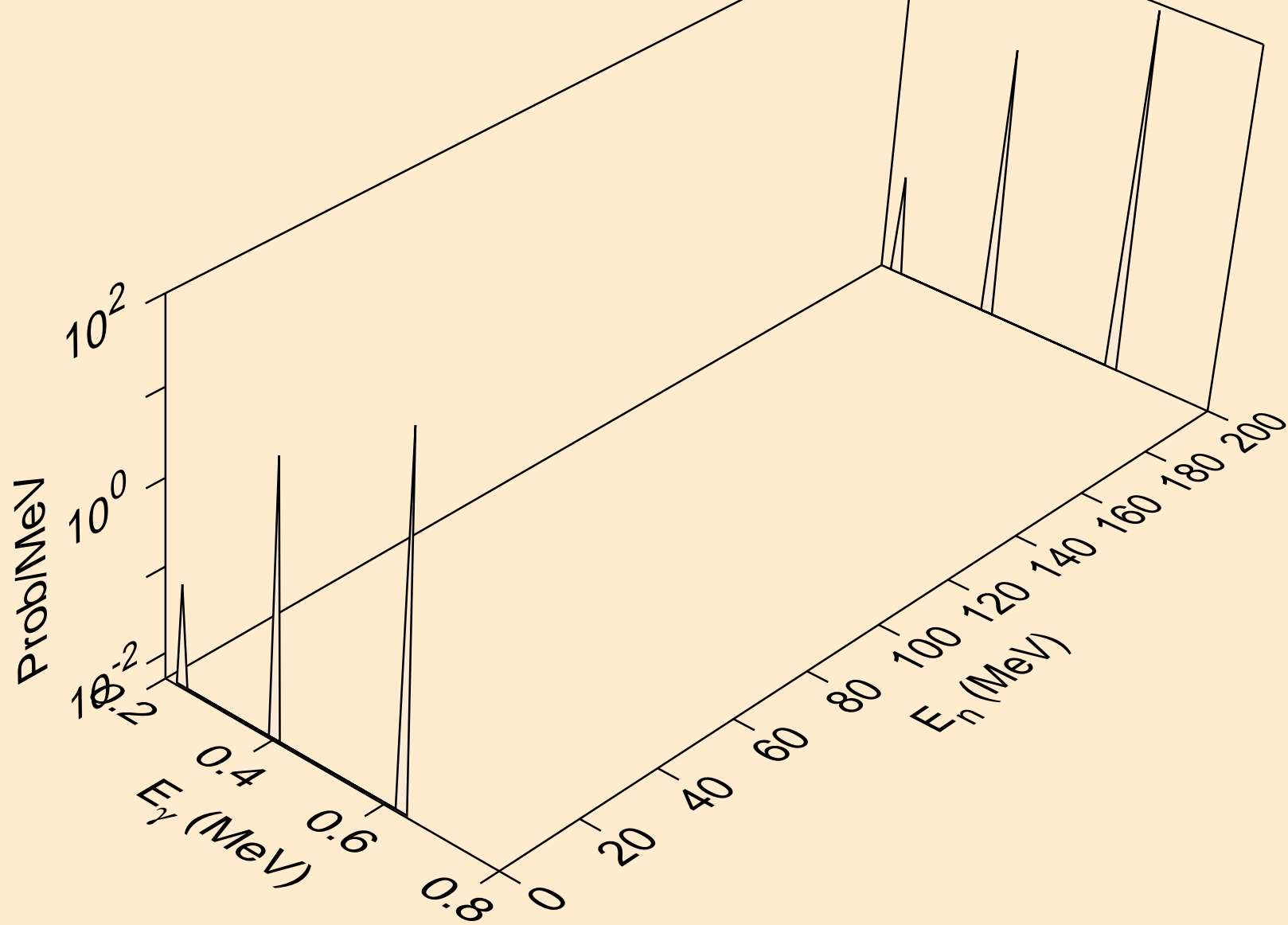

SC046M NEUTRON ACER TENDL-2021 LIBRARY; T=293.6K
Photon emission for (n,n*9)

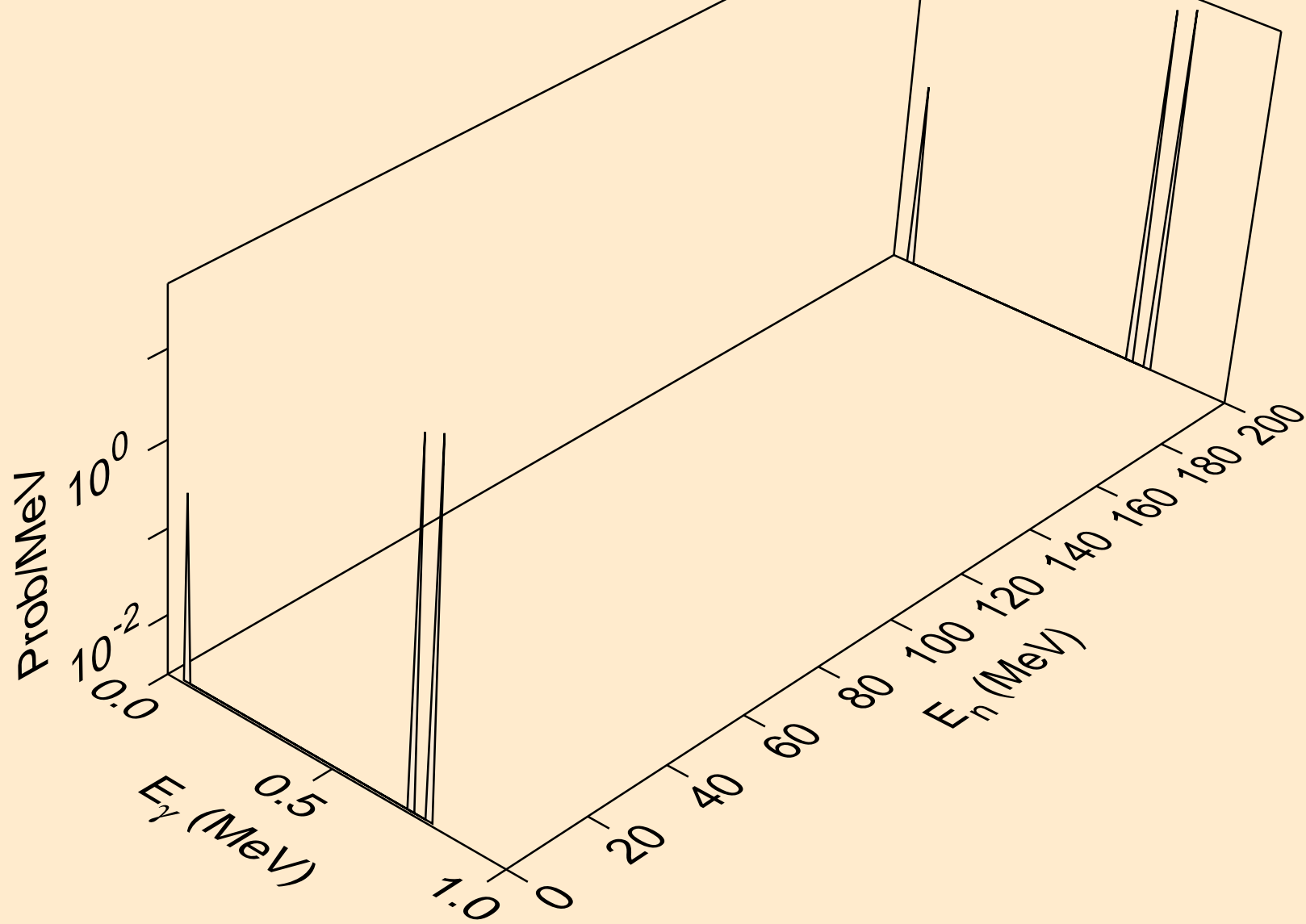

SC046M NEUTRON ACER TENDL-2021 LIBRARY; T=293.6K
Photon emission for (n,n*10)

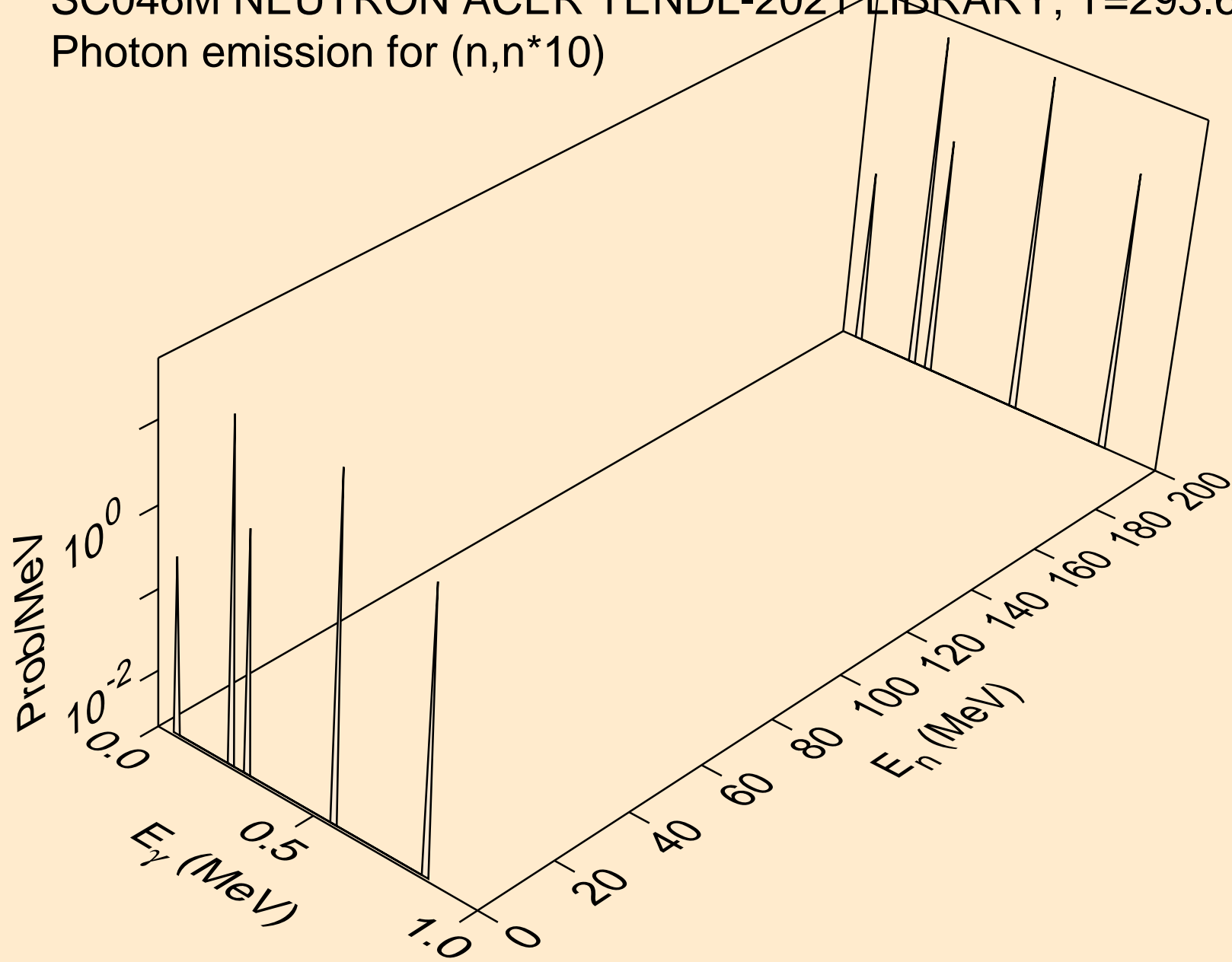

SC046M NEUTRON ACER TENDL-2021 LIBRARY; T=293.6K
Photon emission for (n,n*11)

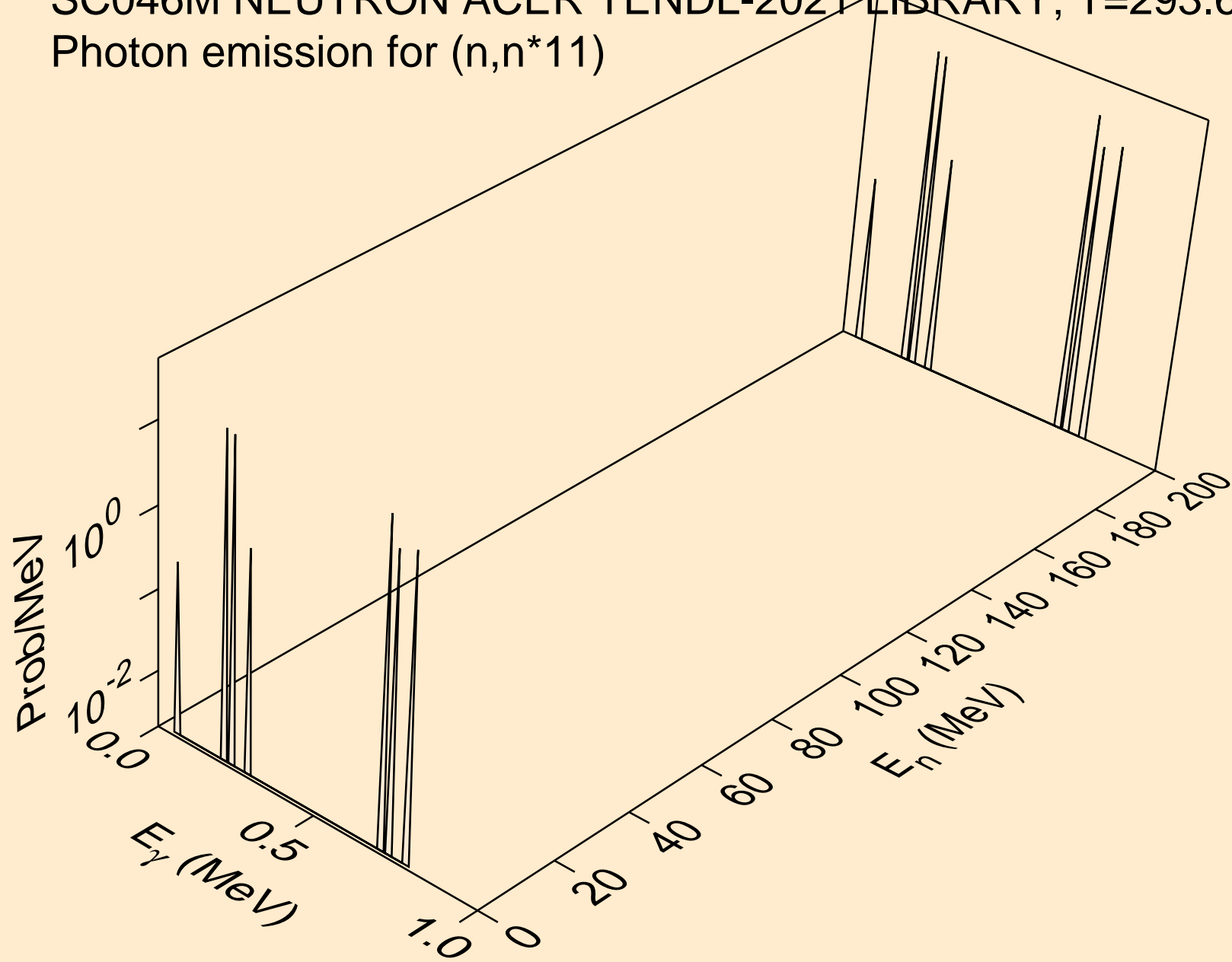

SC046M NEUTRON ACER TENDL-2021 LIBRARY; T=293.6K
Photon emission for (n,n*12)

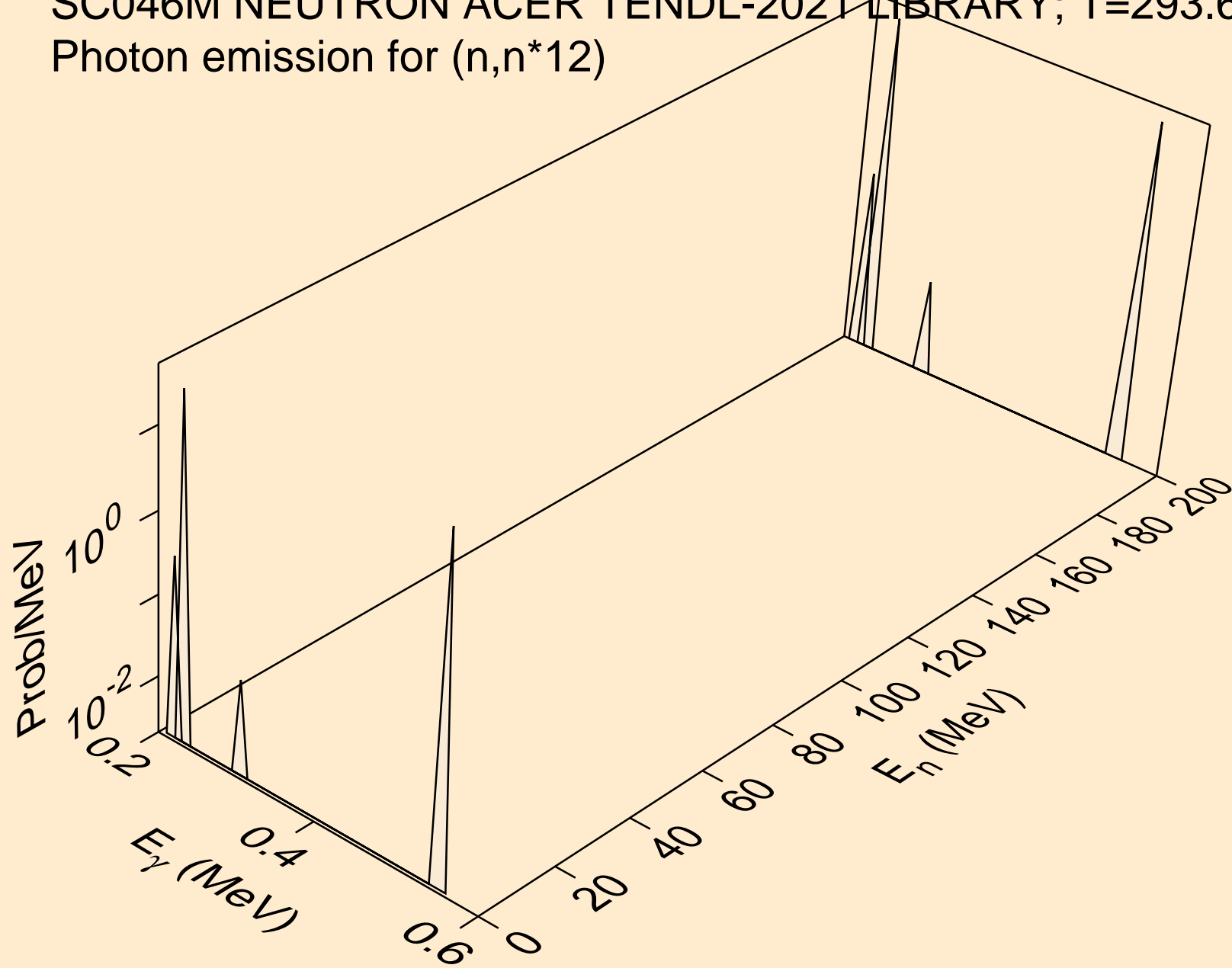

SC046M NEUTRON ACER TENDL-2021 LIBRARY; T=293.6K
Photon emission for (n,n*13)

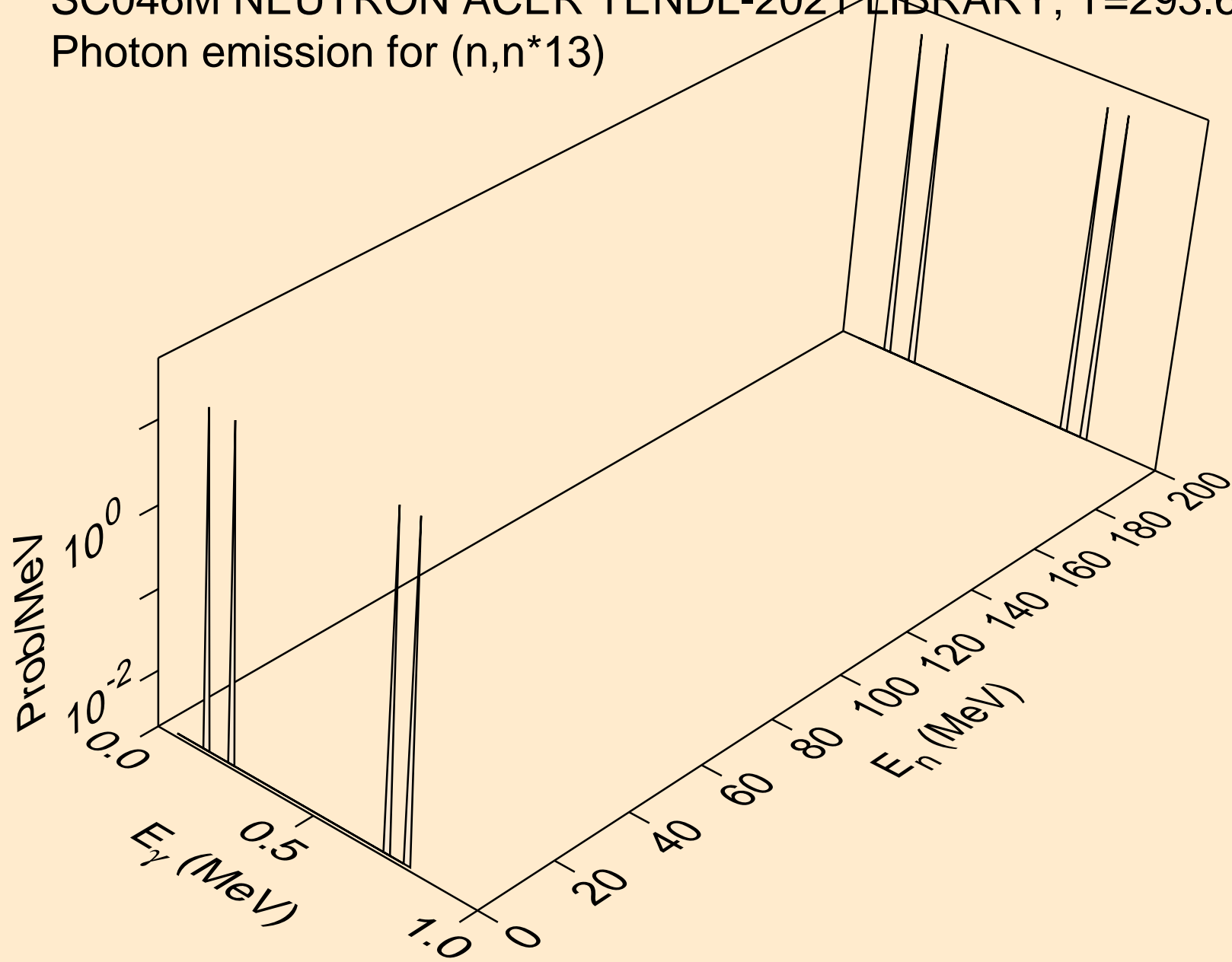

SC046M NEUTRON ACER TENDL-2021 LIBRARY; T=293.6K
Photon emission for (n,n*14)

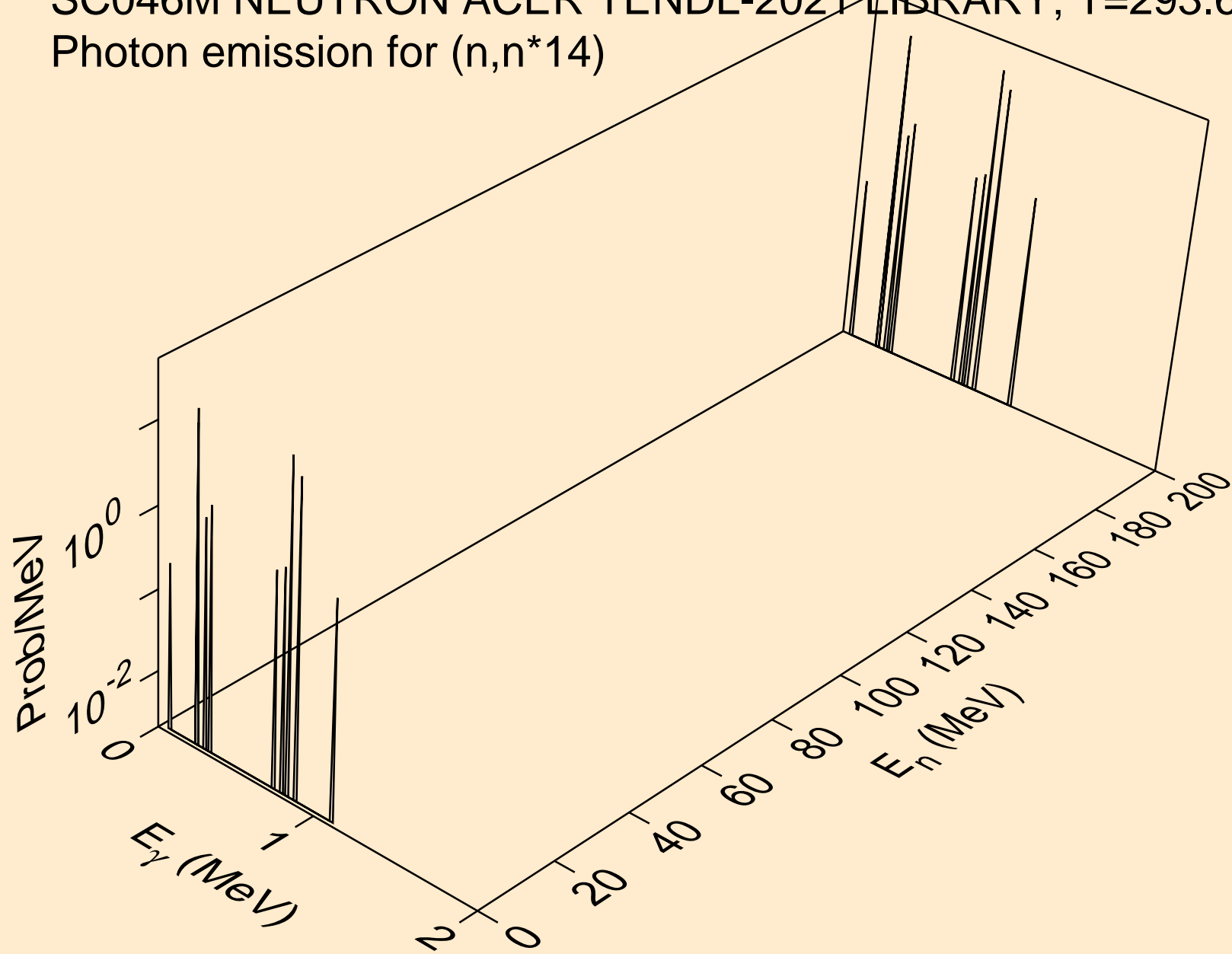

SC046M NEUTRON ACER TENDL-2021 LIBRARY; T=293.6K
Photon emission for (n,n*15)

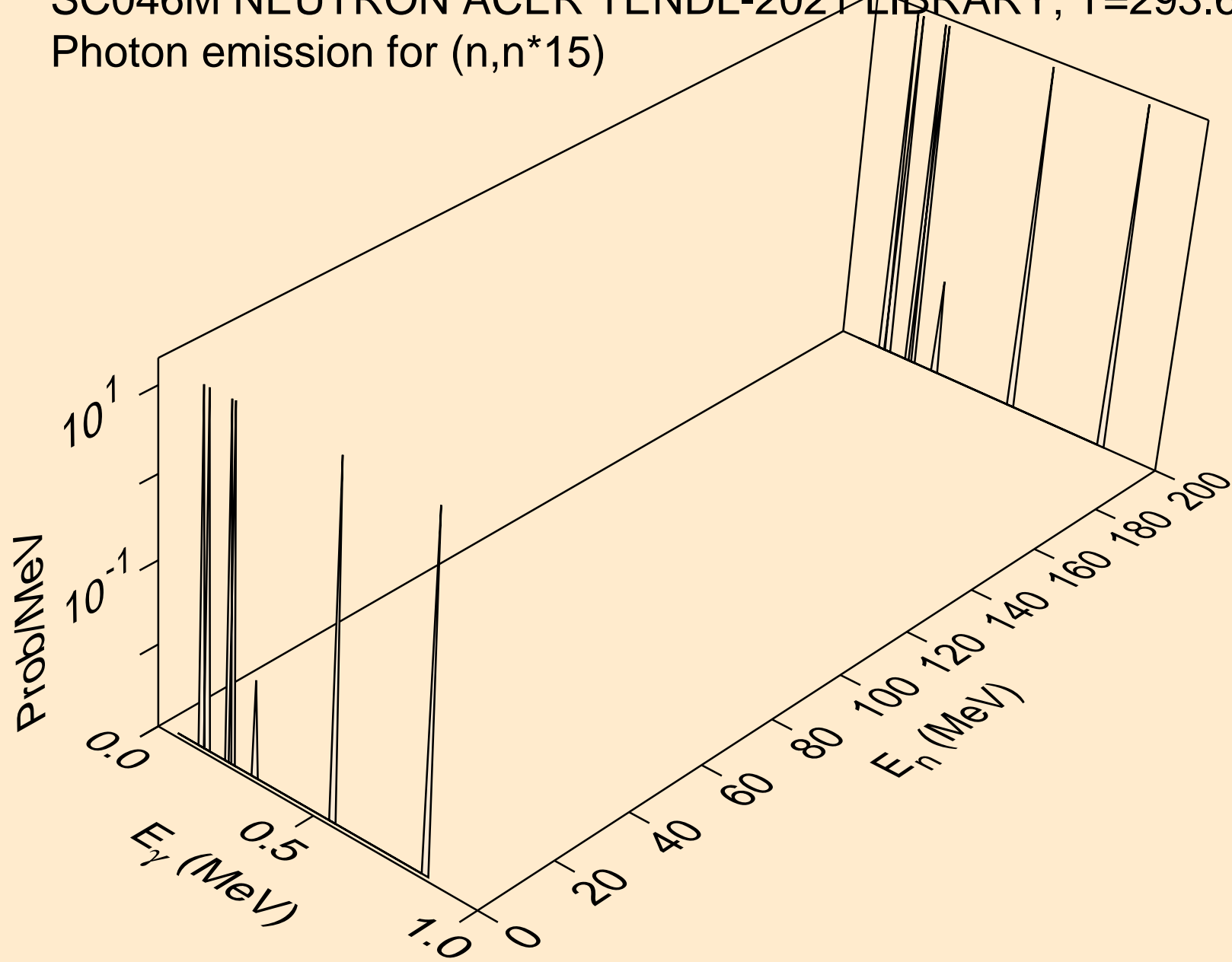

SC046M NEUTRON ACER TENDL-2021 LIBRARY; T=293.6K
Photon emission for (n,n*16)

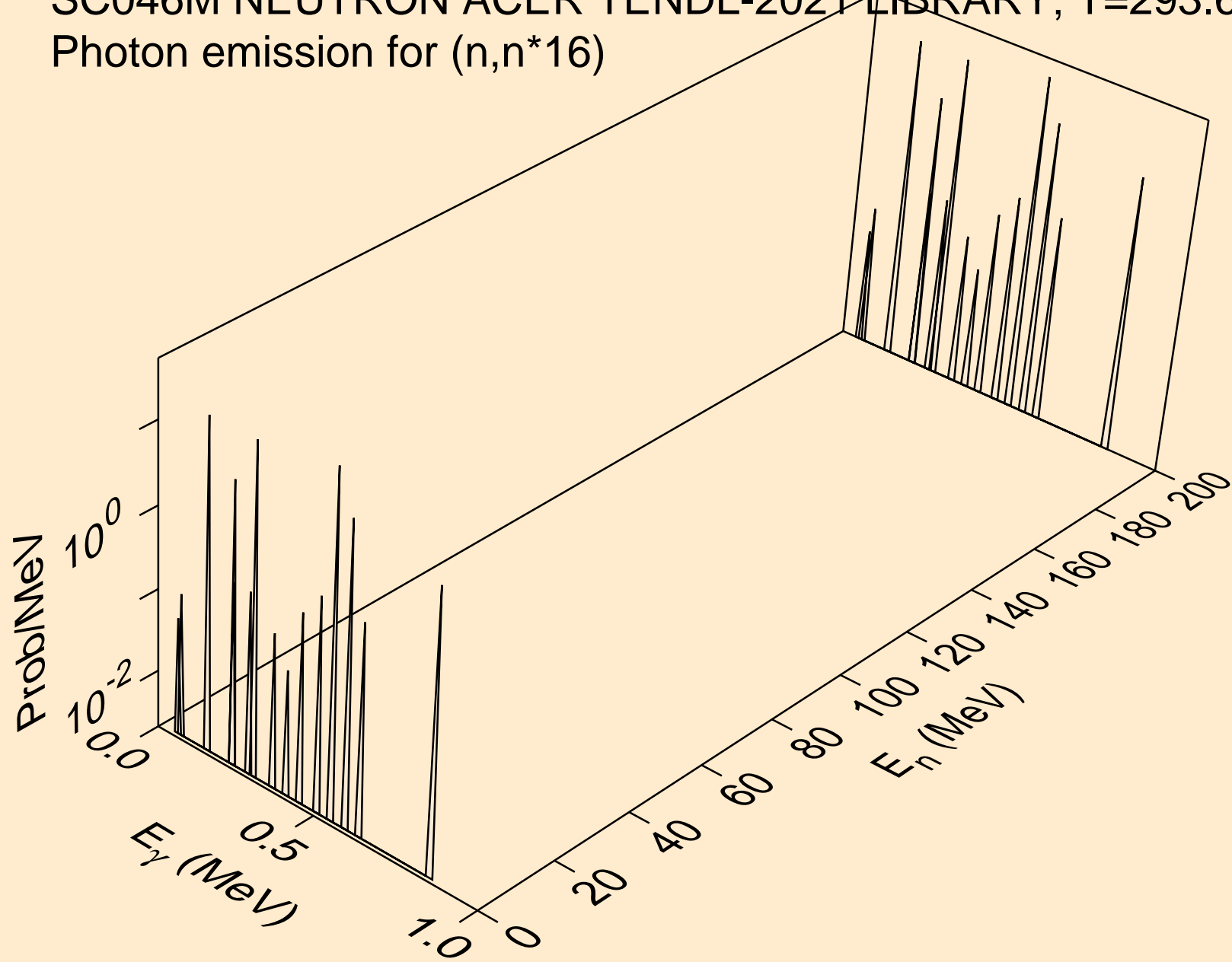

SC046M NEUTRON ACER TENDL-2021 LIBRARY; T=293.6K
Photon emission for (n,n*17)

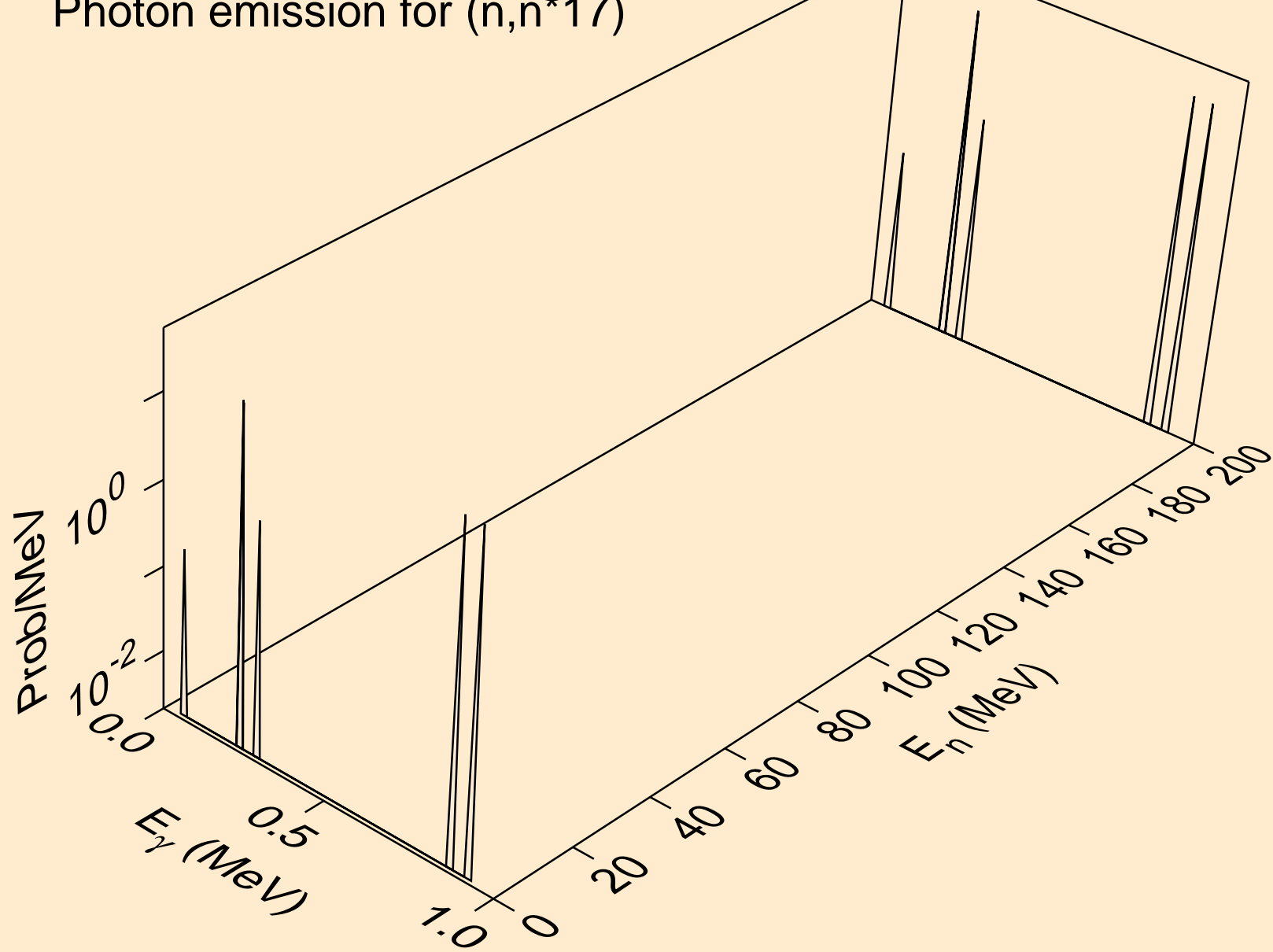

SC046M NEUTRON ACER TENDL-2021 LIBRARY; T=293.6K
Photon emission for (n,n*18)

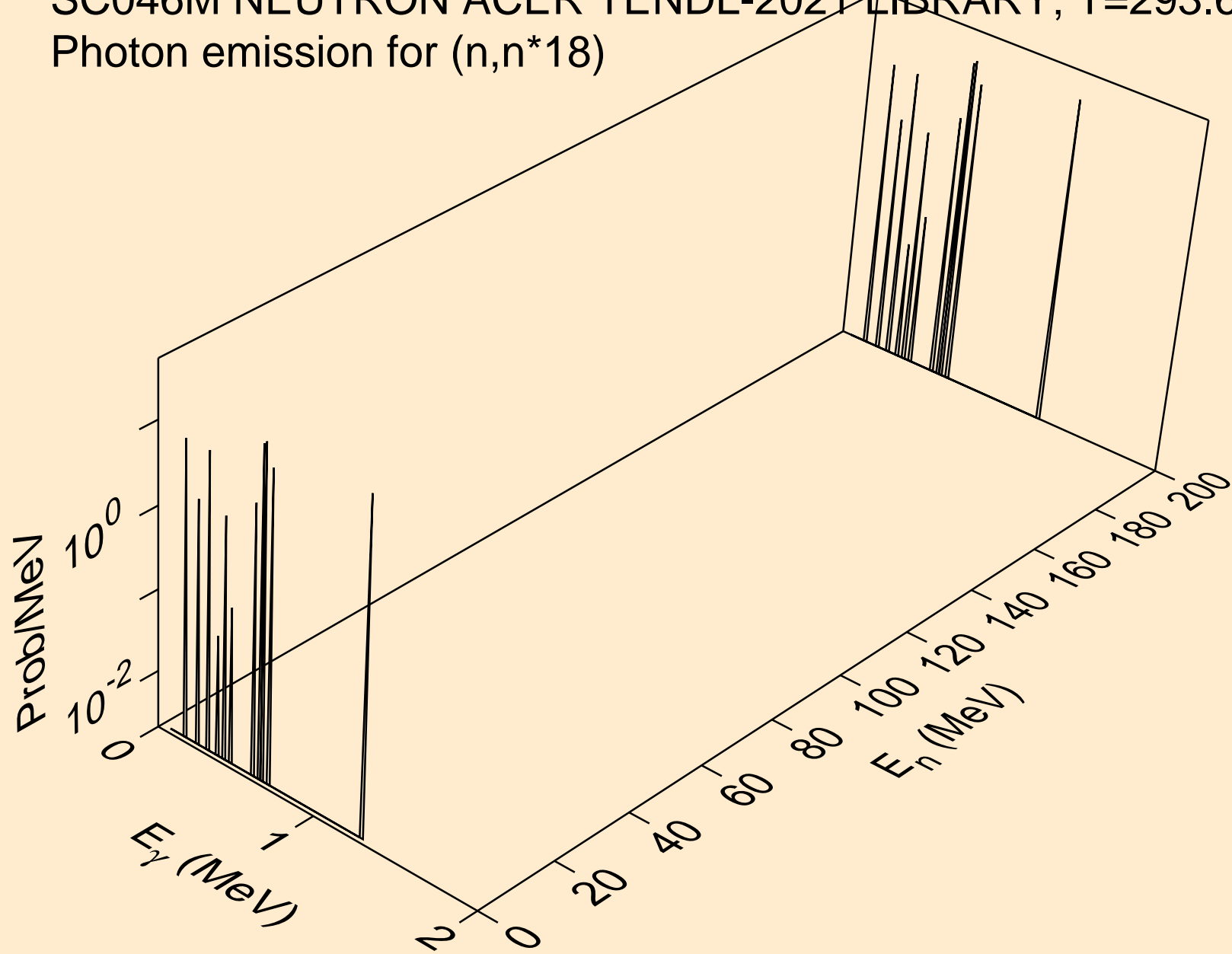

SC046M NEUTRON ACER TENDL-2021 LIBRARY; T=293.6K
Photon emission for (n,n*19)

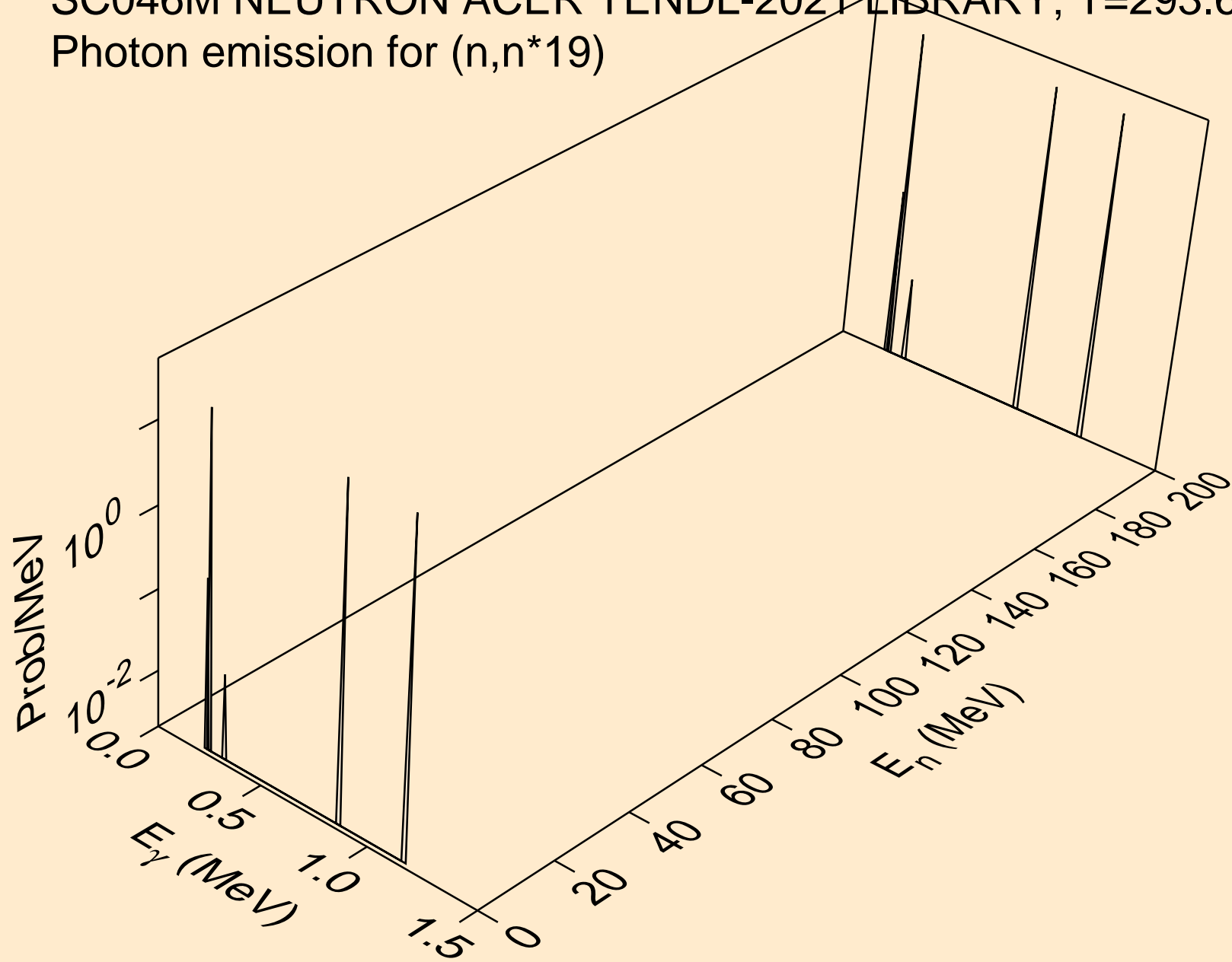

SC046M NEUTRON ACER TENDL-2021 LIBRARY; T=293.6K
Photon emission for (n,n*20)

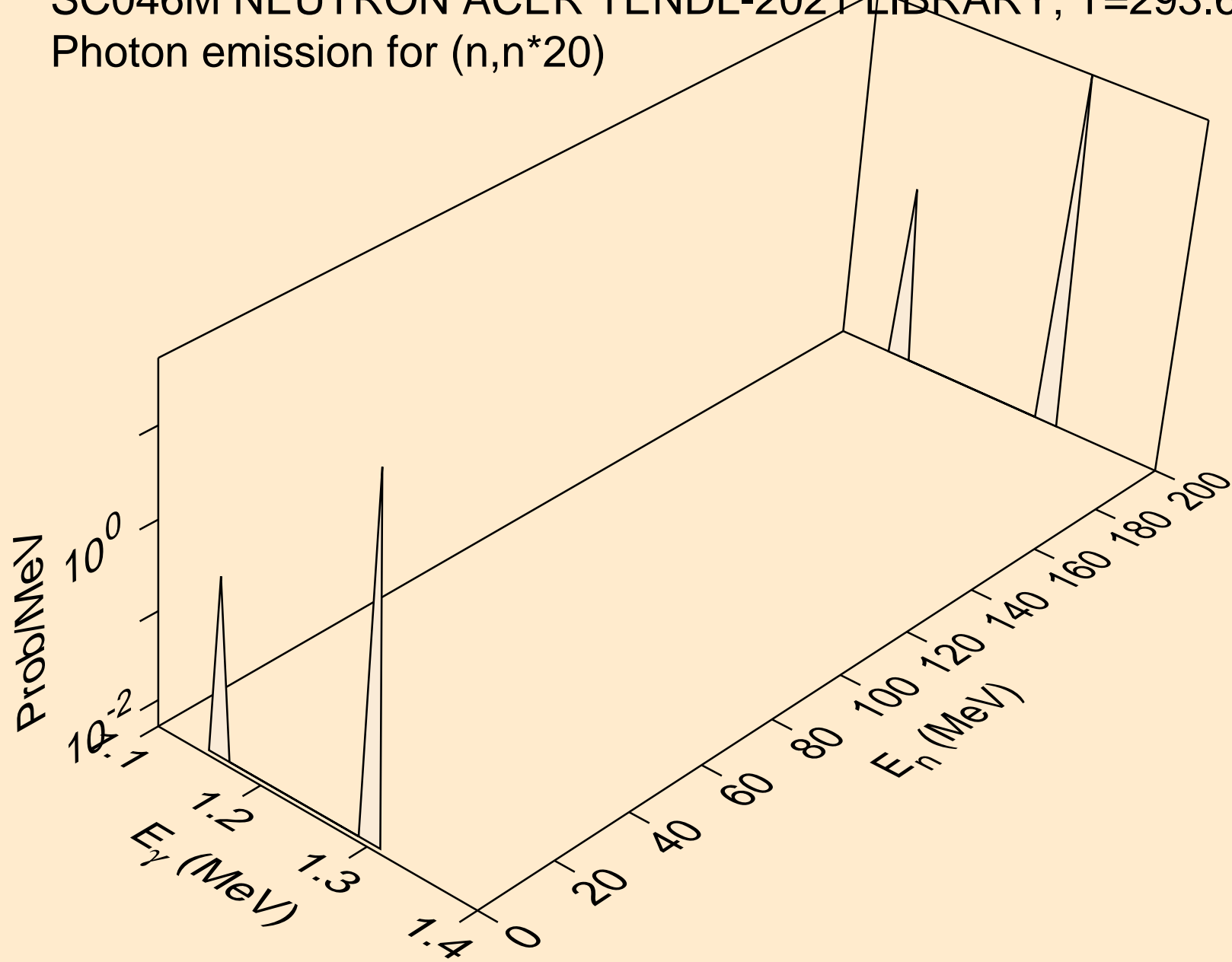

SC046M NEUTRON ACER TENDL-2021 LIBRARY; T=293.6K
Photon emission for (n,n*21)

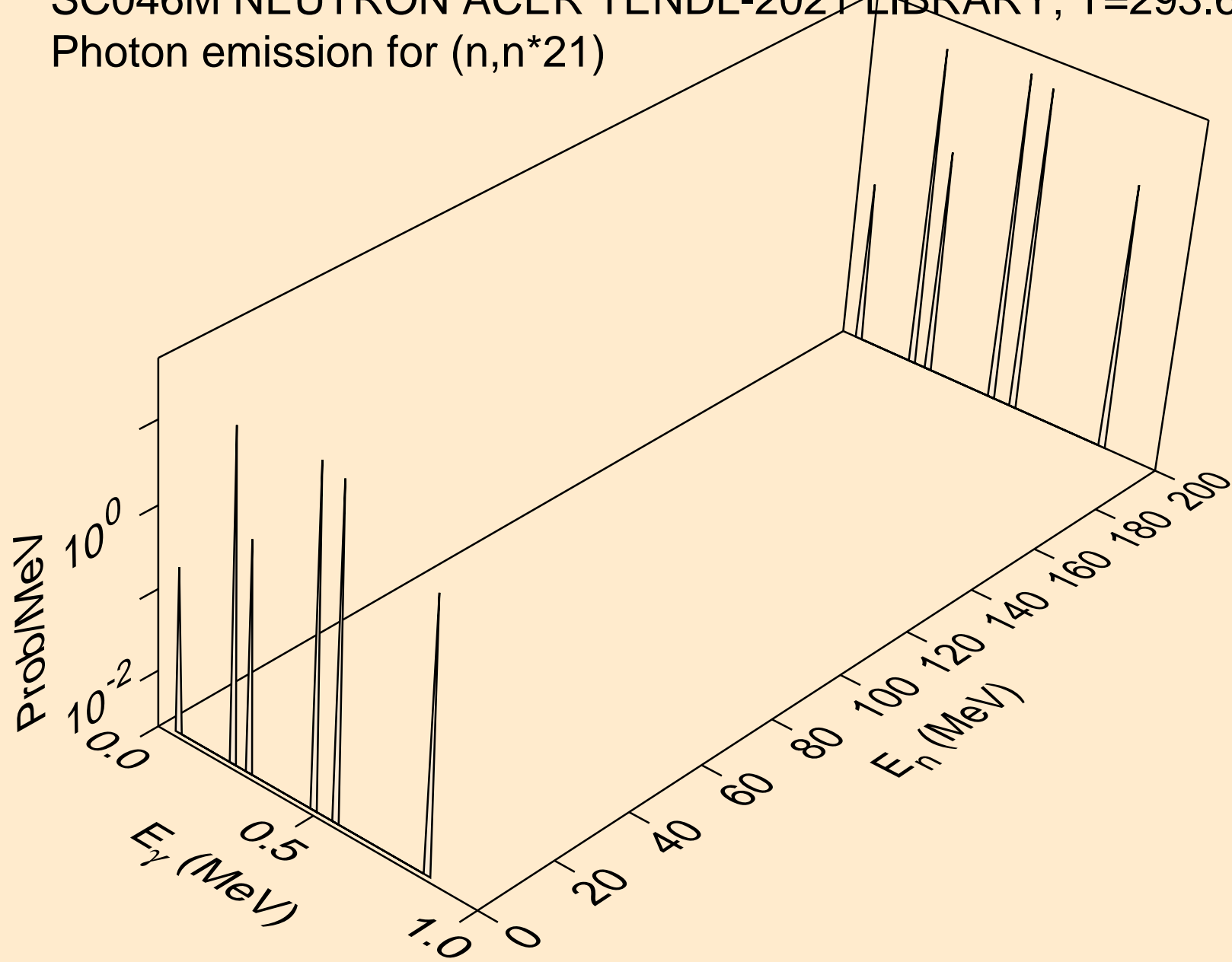

SC046M NEUTRON ACER TENDL-2021 LIBRARY; T=293.6K
Photon emission for (n,n*22)

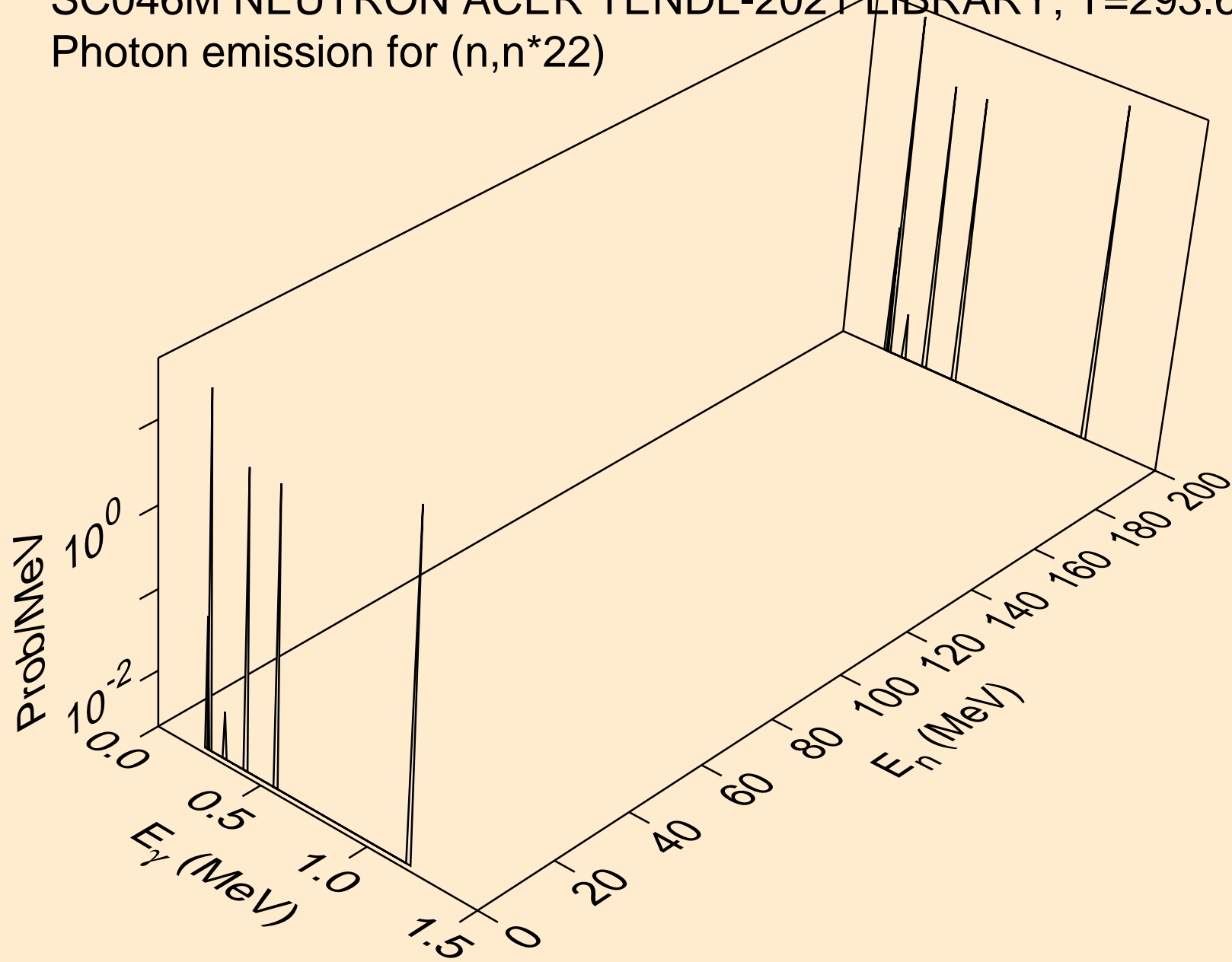

SC046M NEUTRON ACER TENDL-2021 LIBRARY; T=293.6K
Photon emission for (n,n*23)

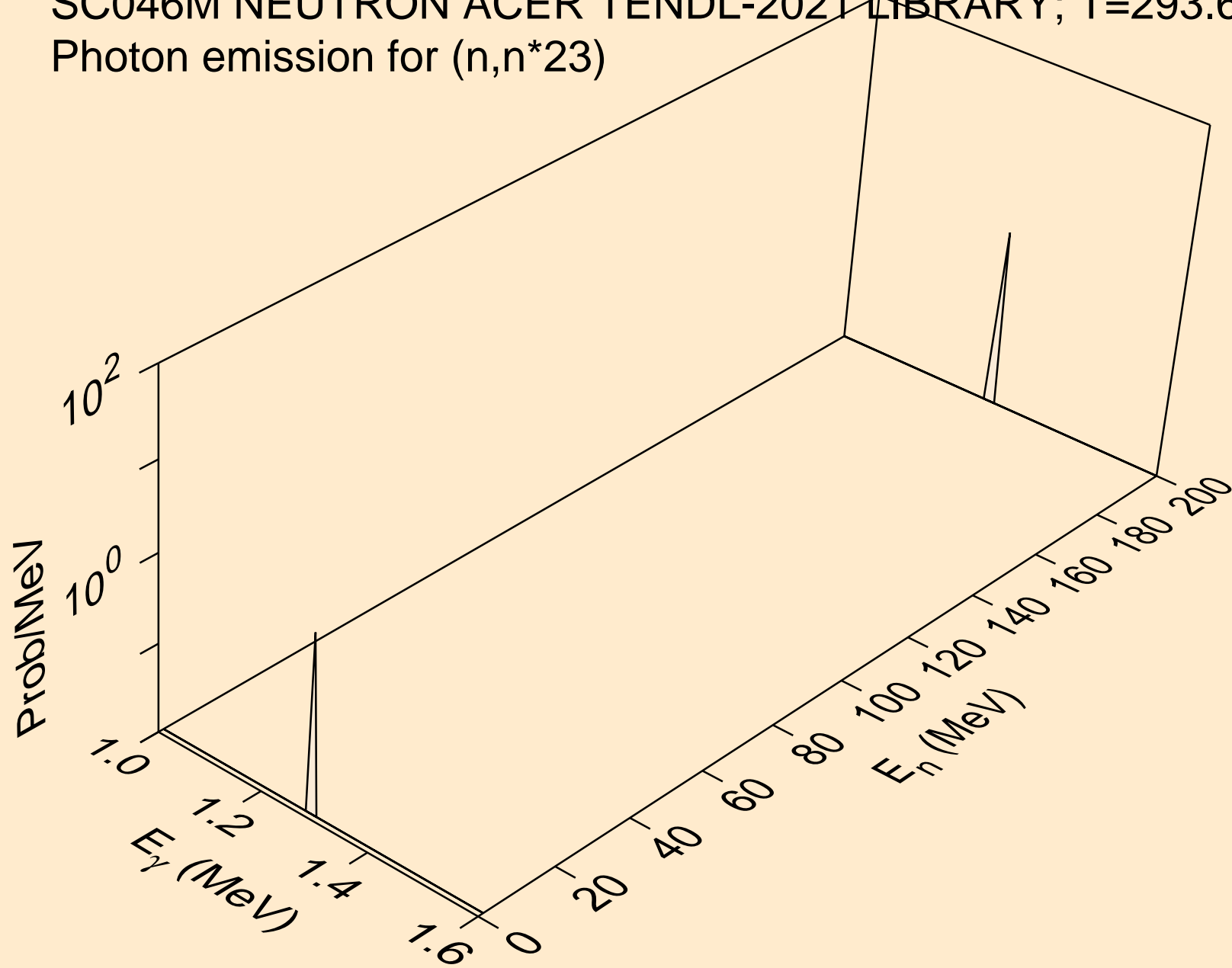

SC046M NEUTRON ACER TENDL-2021 LIBRARY; T=293.6K
Photon emission for (n,n*24)

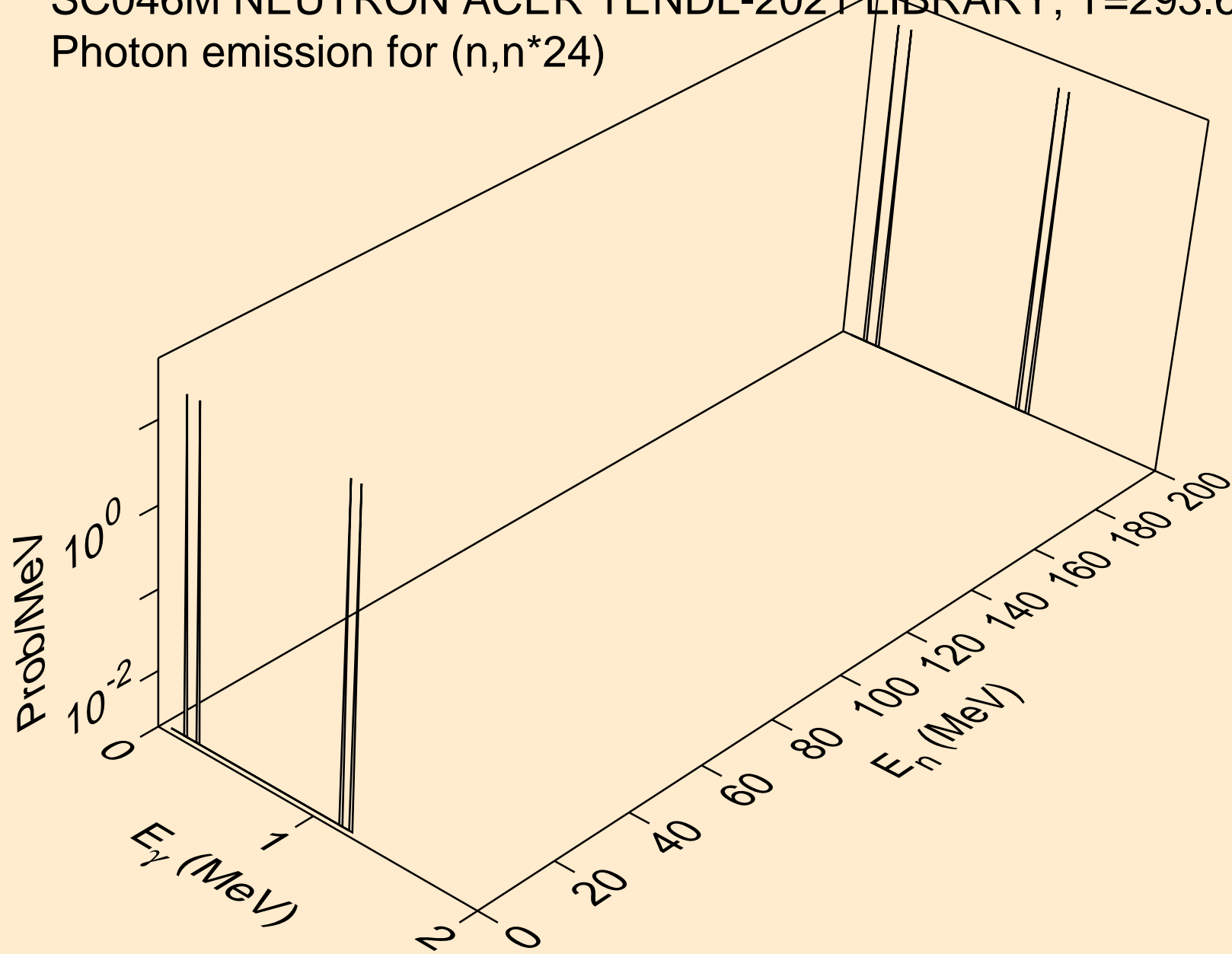

SC046M NEUTRON ACER TENDL-2021 LIBRARY; T=293.6K
Photon emission for (n,n*25)

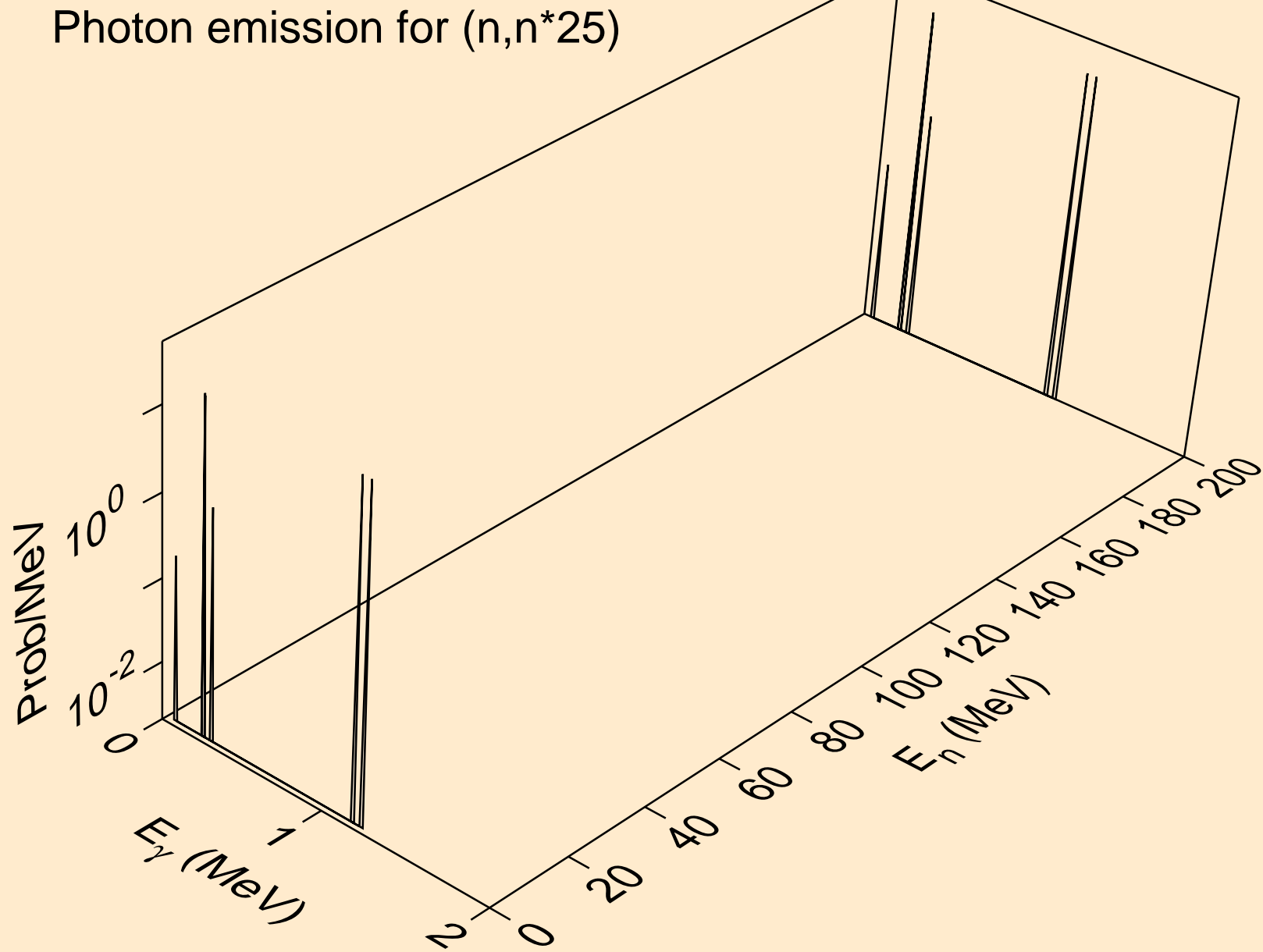

SC046M NEUTRON ACER TENDL-2021 LIBRARY; T=293.6K
Photon emission for (n,n*26)

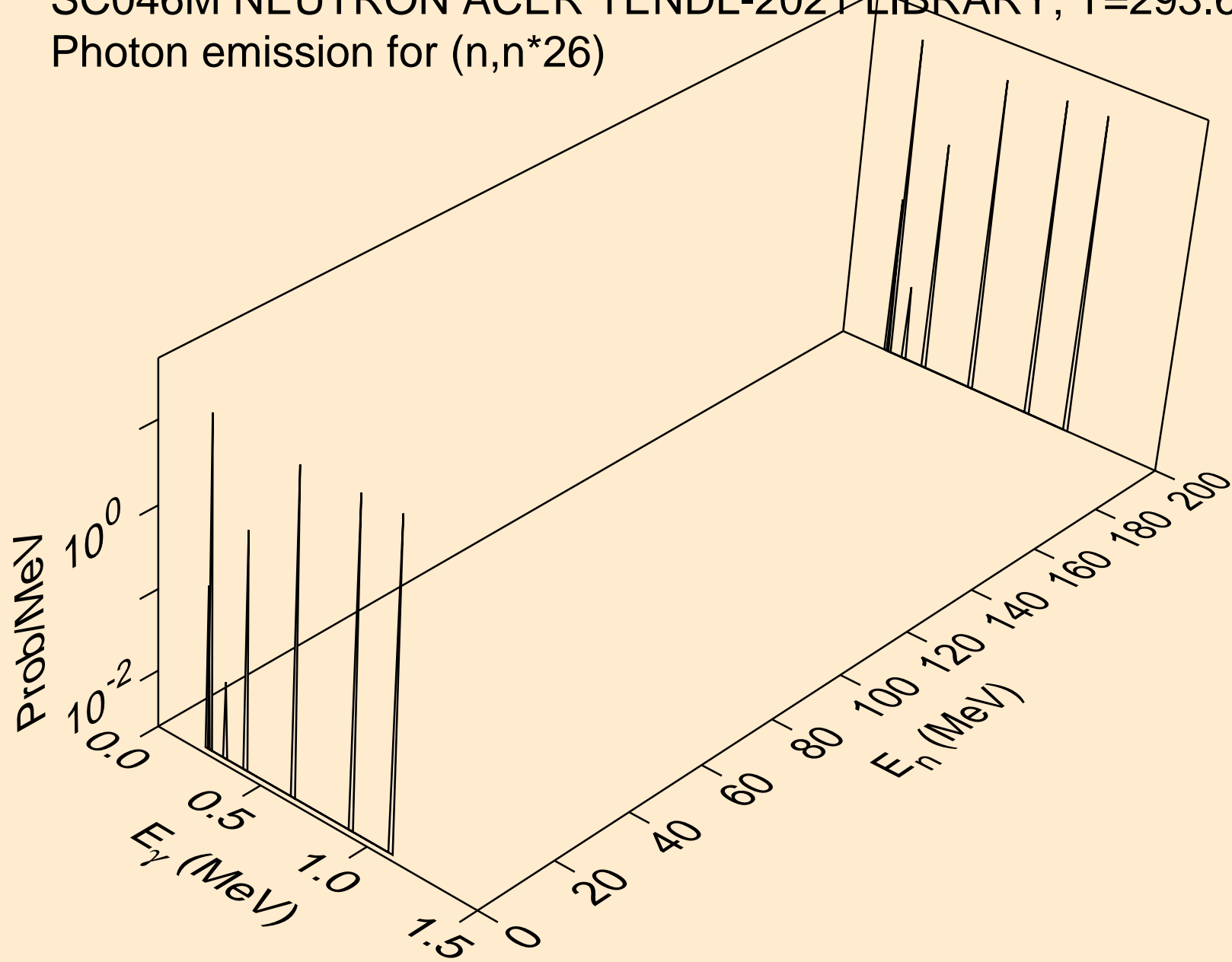

SC046M NEUTRON ACER TENDL-2021 LIBRARY; T=293.6K
Photon emission for (n,n*27)

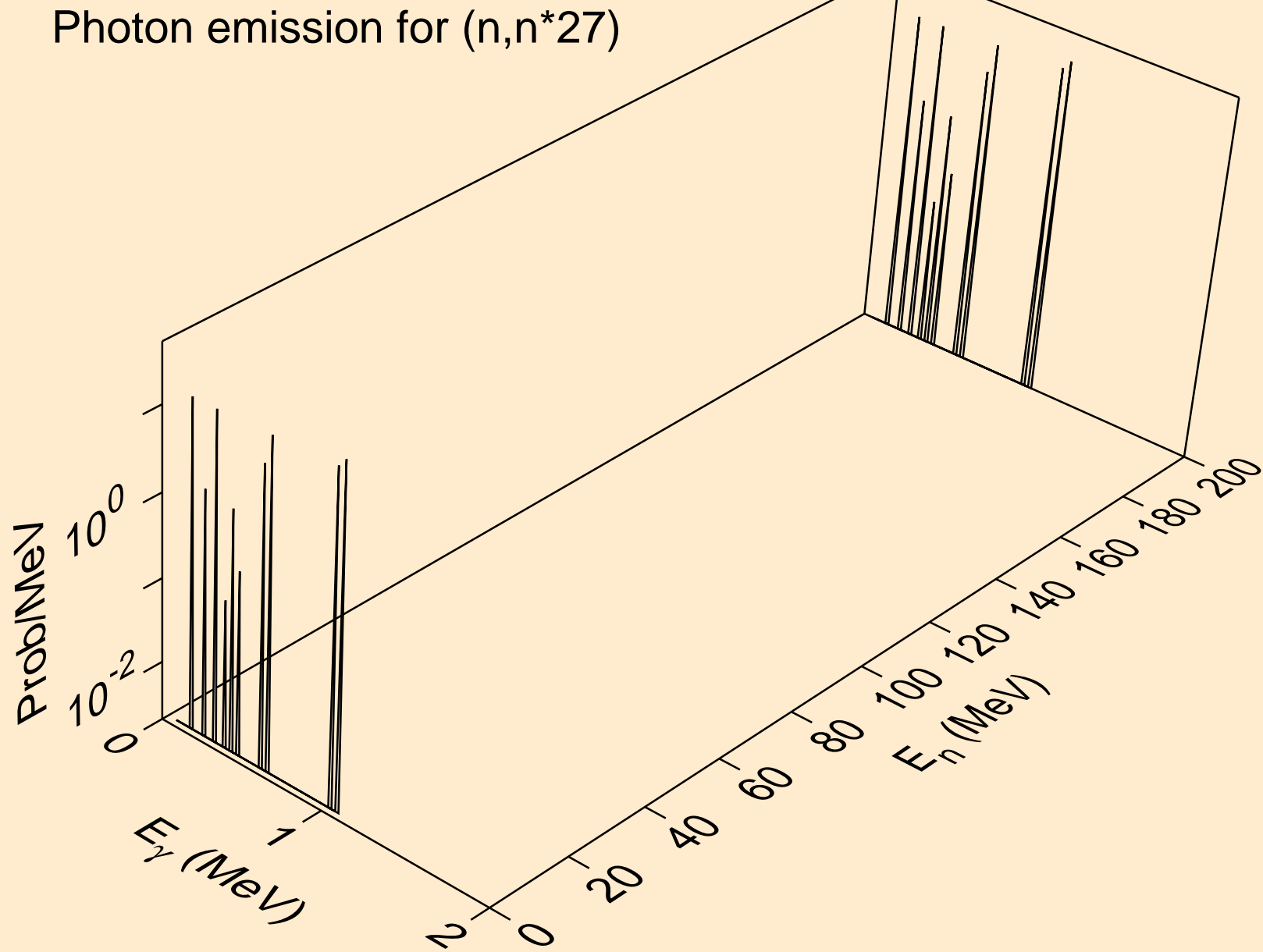

SC046M NEUTRON ACER TENDL-2021 LIBRARY; T=293.6K
Photon emission for (n,n*28)

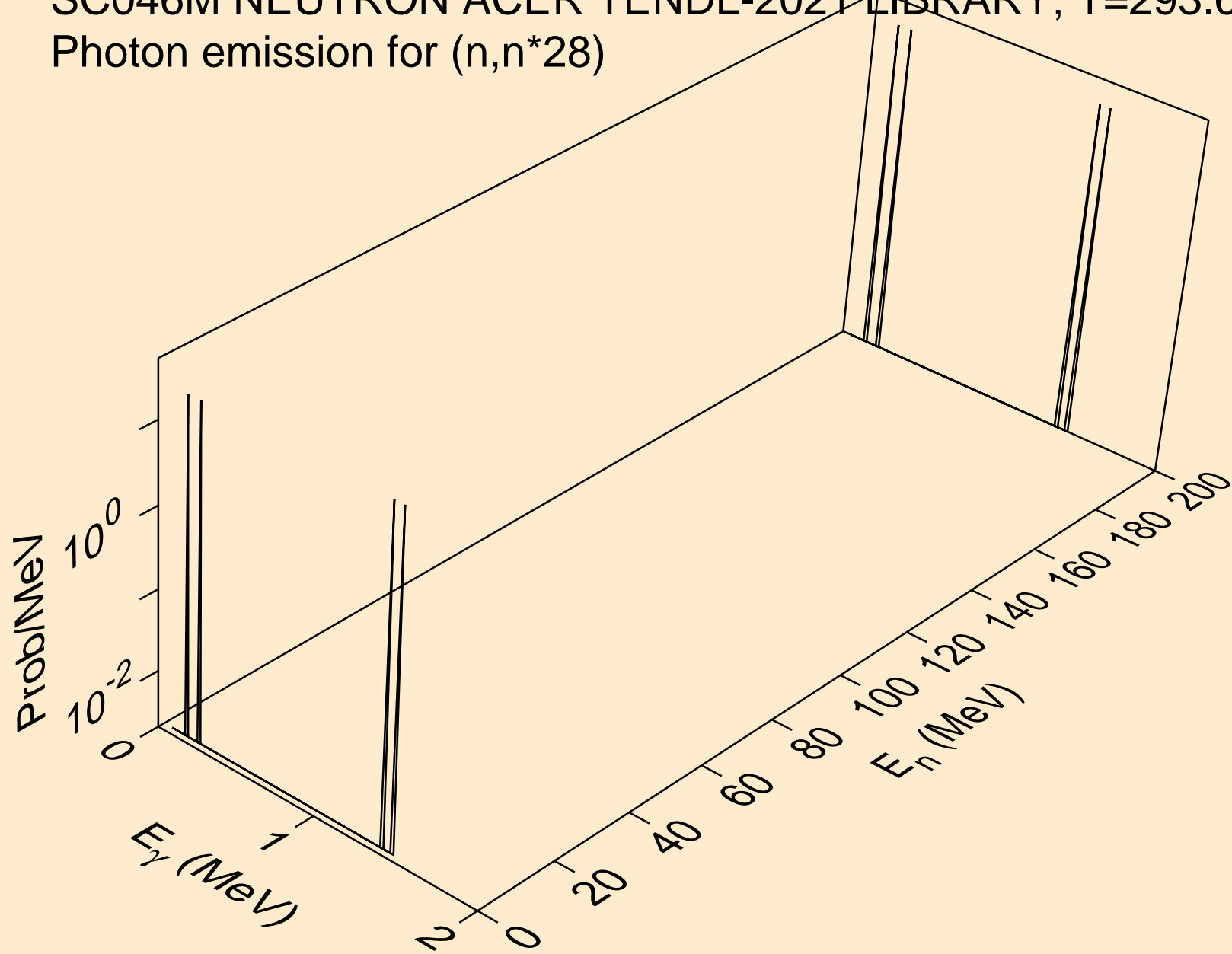

SC046M NEUTRON ACER TENDL-2021 LIBRARY; T=293.6K
Photon emission for (n,n*29)

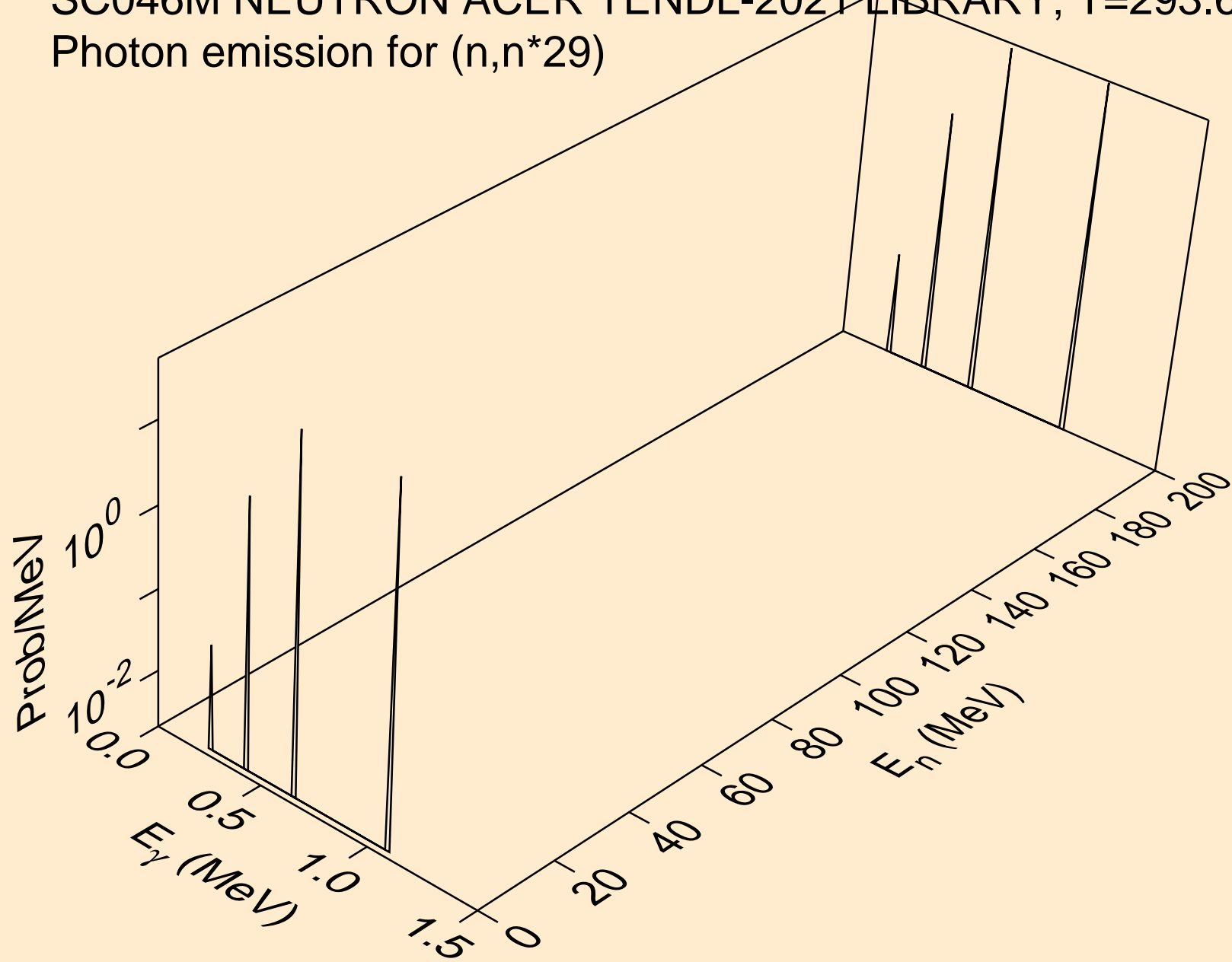

SC046M NEUTRON ACER TENDL-2021 LIBRARY; T=293.6K
Photon emission for (n,n*30)

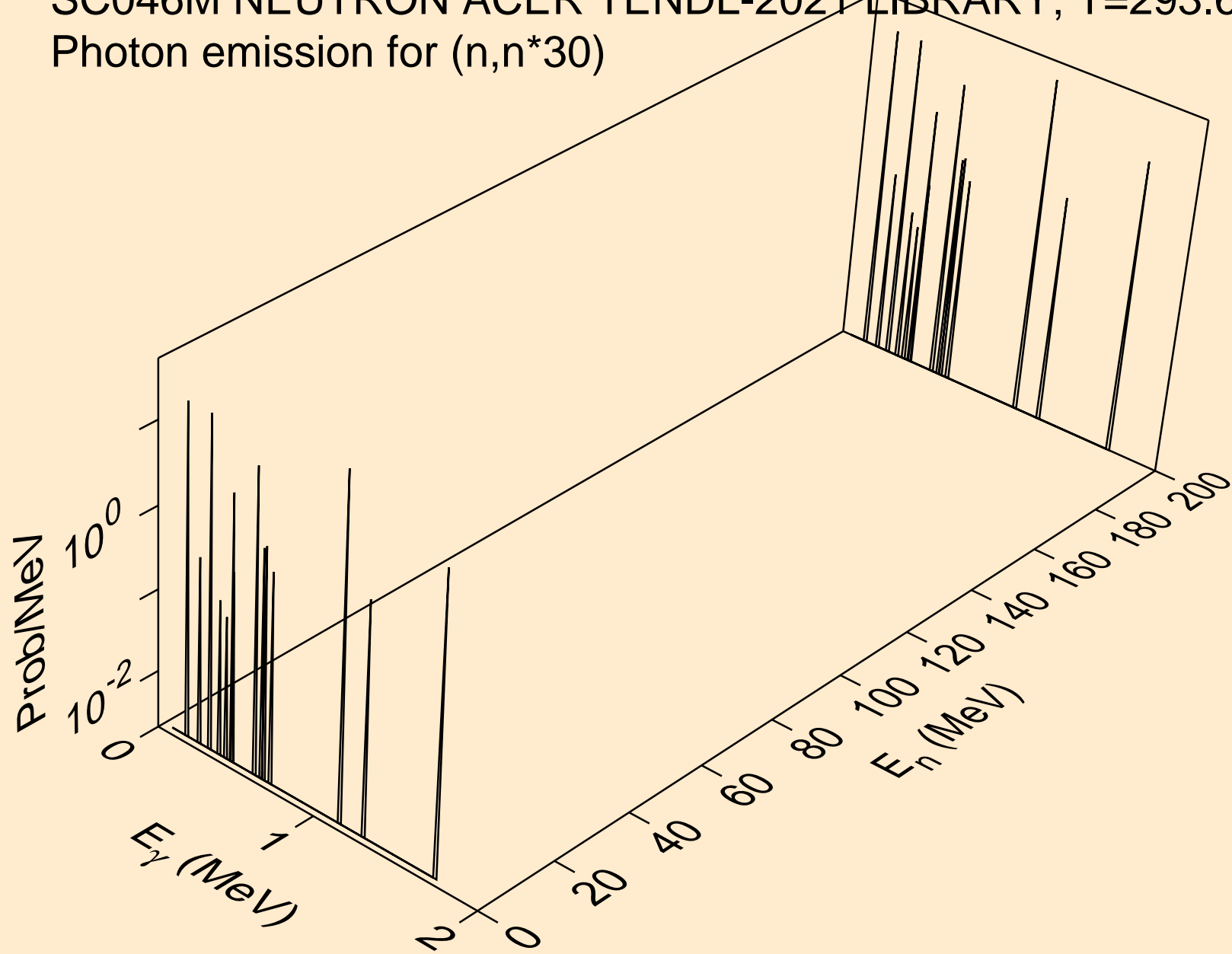

SC046M NEUTRON ACER TENDL-2021 LIBRARY; T=293.6K
Photon emission for (n,n*c)

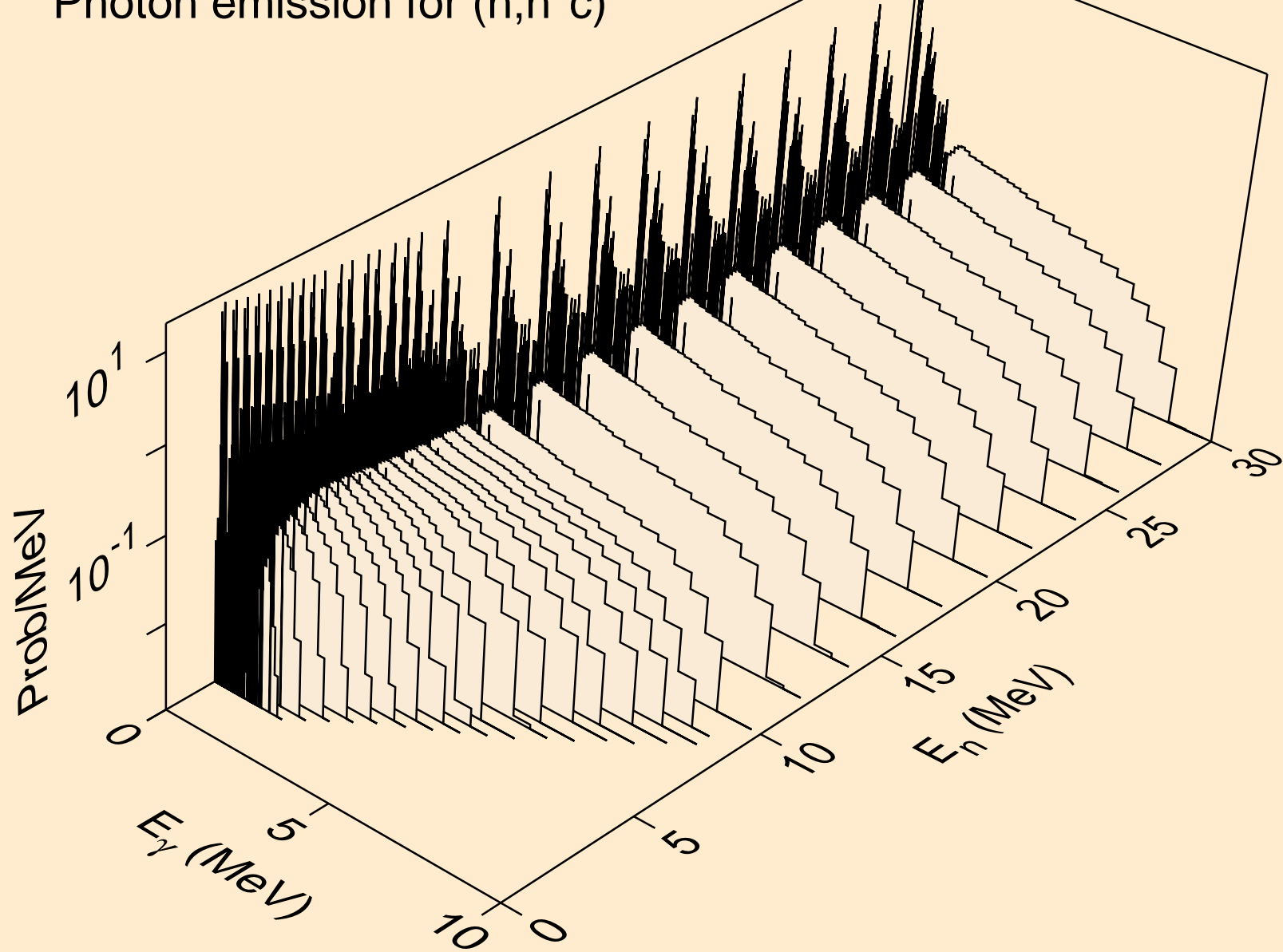

SC046M NEUTRON ACER TENDL-2021 LIBRARY; T=293.6K
Photon emission for (n,gma)

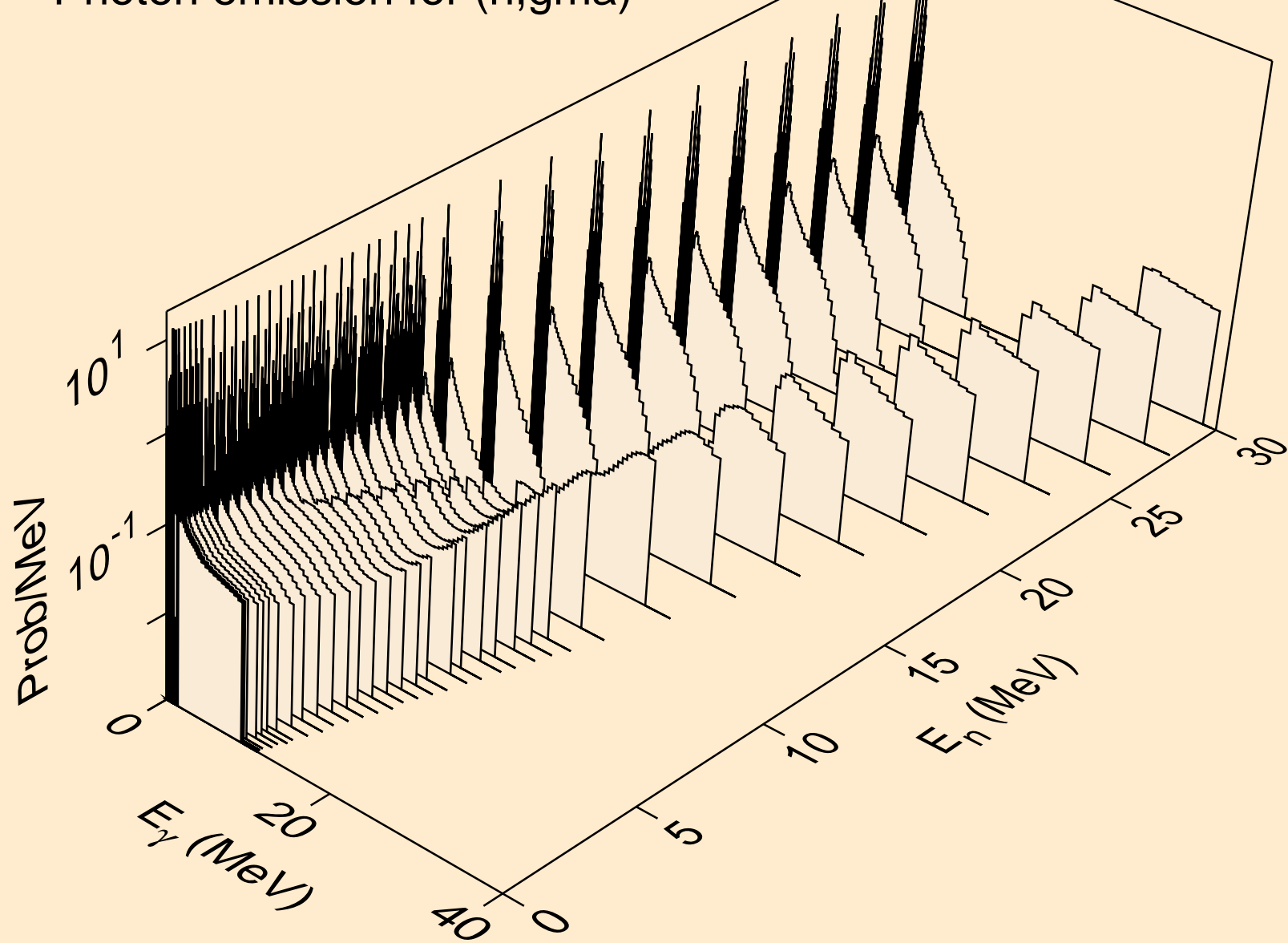

SC046M NEUTRON ACER TENDL-2021 LIBRARY; T=293.6K
Photon emission for (n,p)

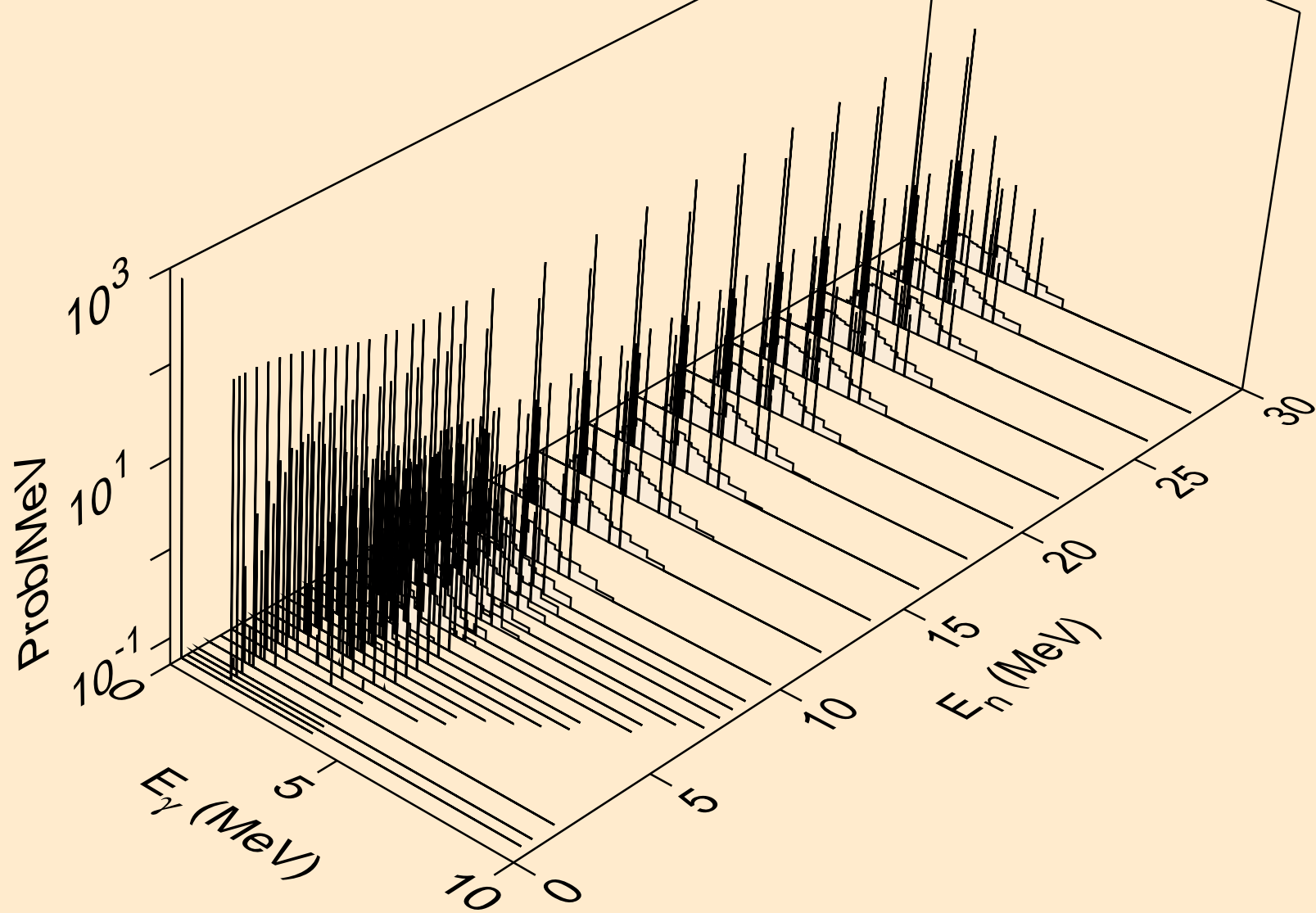

SC046M NEUTRON ACER TENDL-2021 LIBRARY; T=293.6K
Photon emission for (n,d)

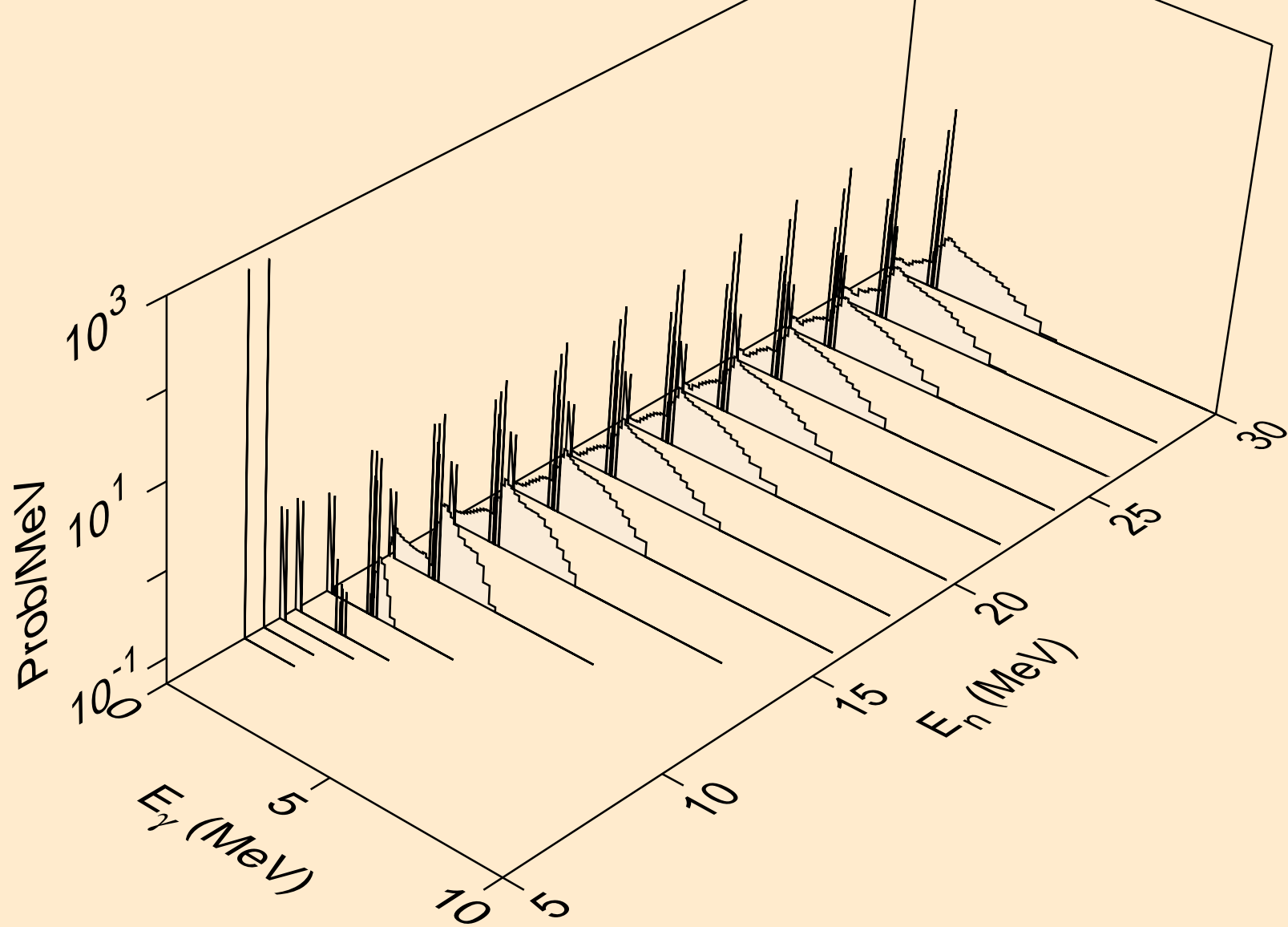

SC046M NEUTRON ACER TENDL-2021 LIBRARY; T=293.6K
Photon emission for (n,t)

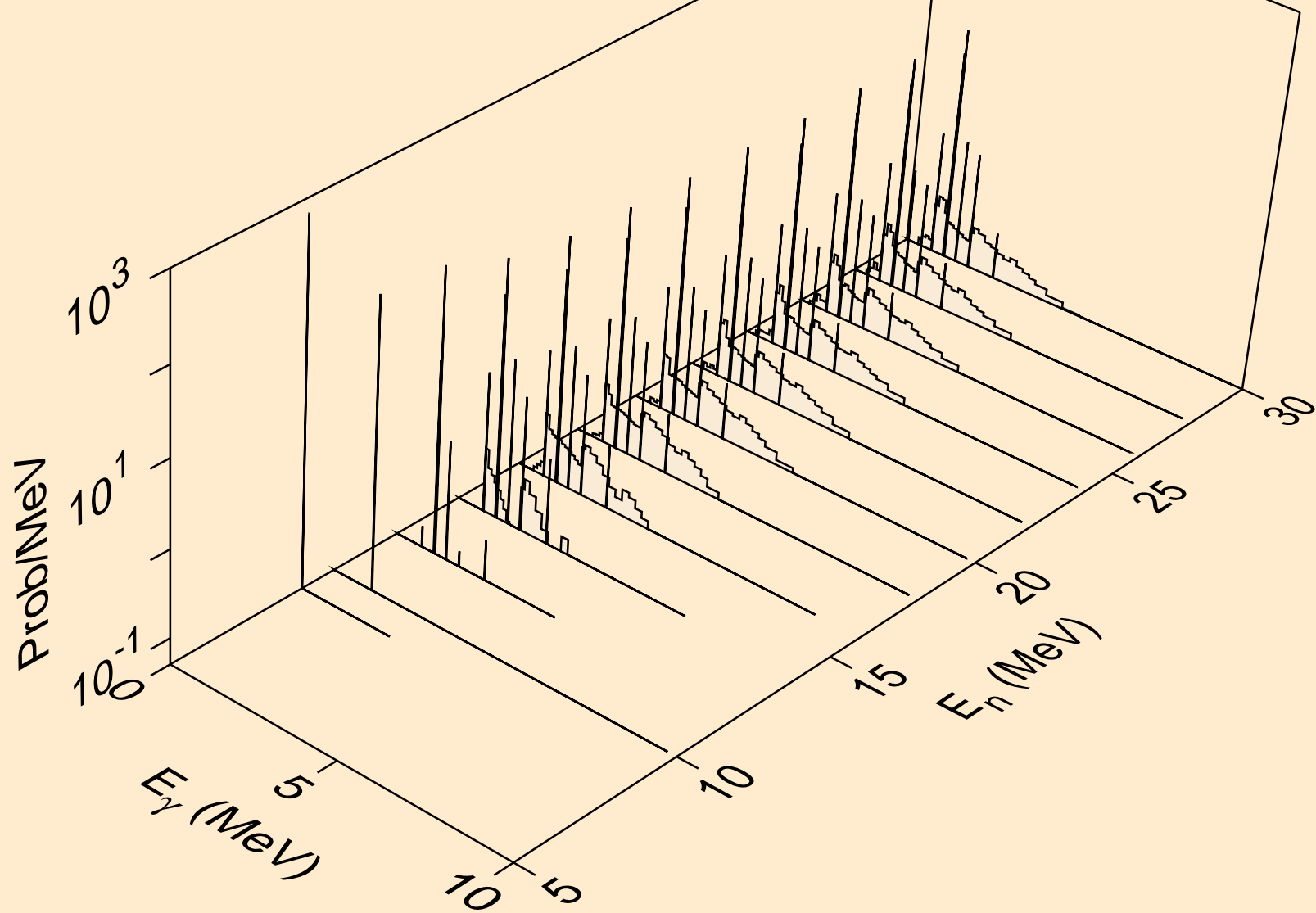

SC046M NEUTRON ACER TENDL-2021 LIBRARY; T=293.6K
Photon emission for (n,he3)

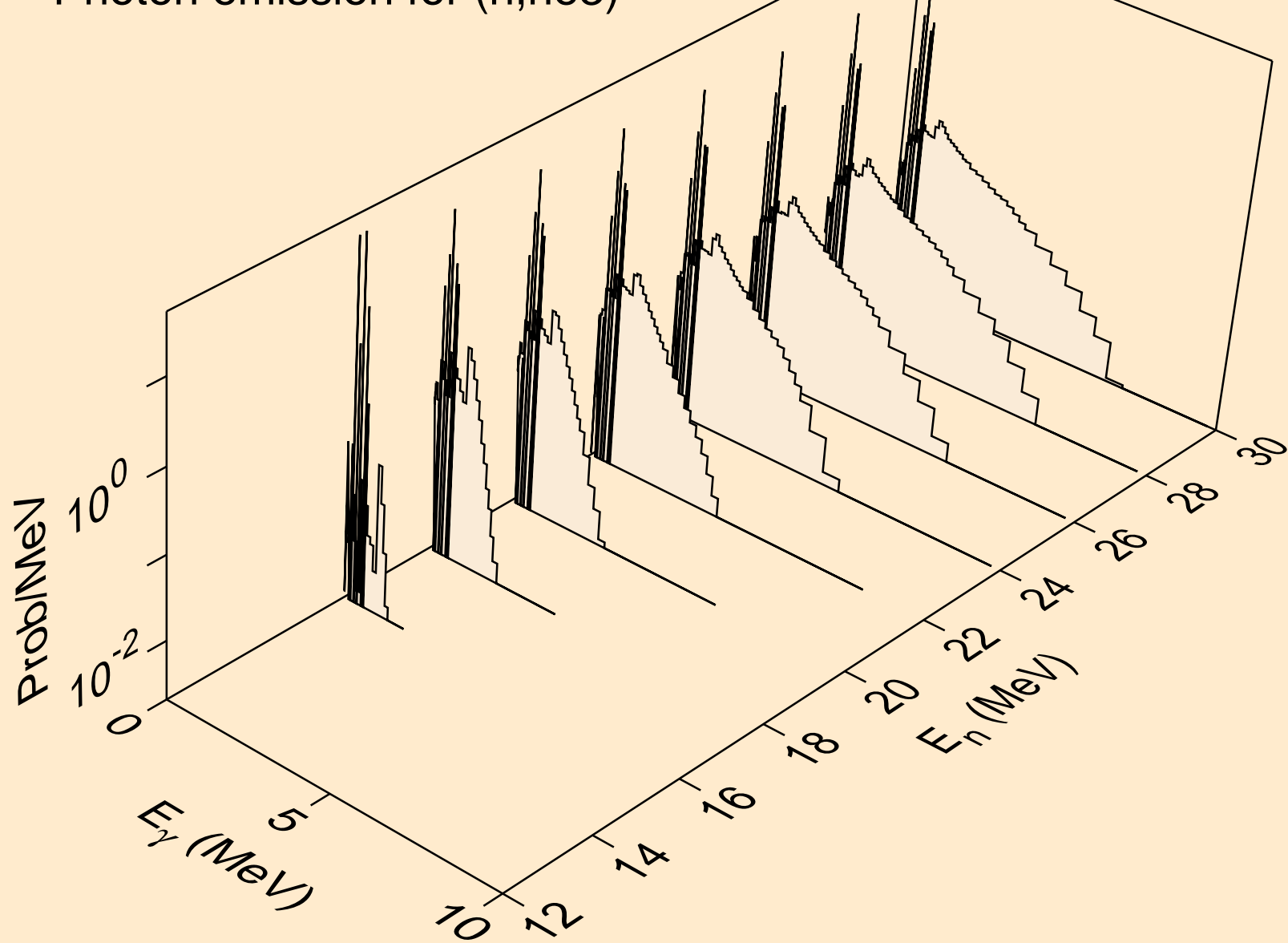

SC046M NEUTRON ACER TENDL-2021 LIBRARY; T=293.6K
Photon emission for (n,a)

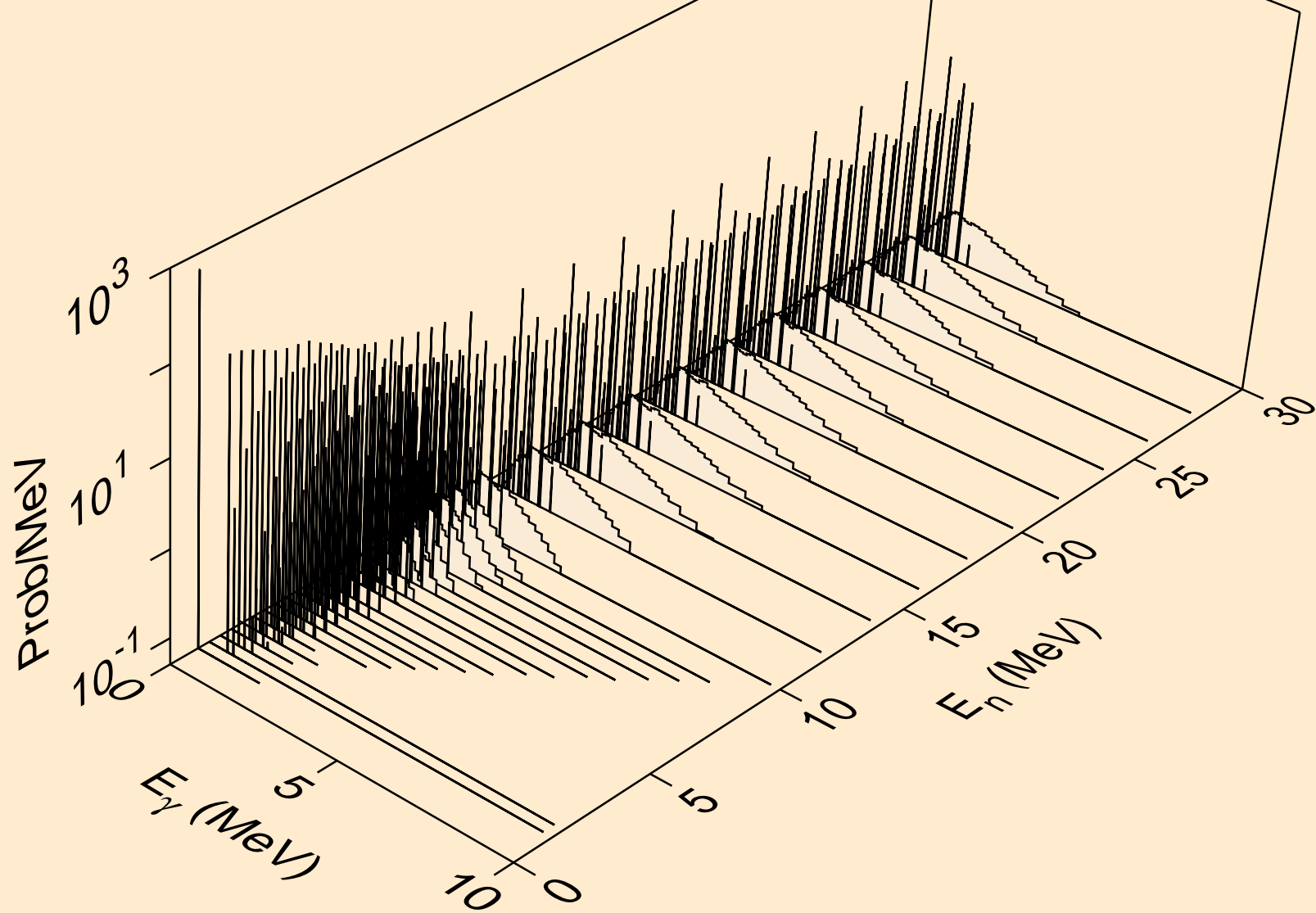

SC046M NEUTRON ACER TENDL-2021 LIBRARY; T=293.6K
Photon emission for (n,2a)

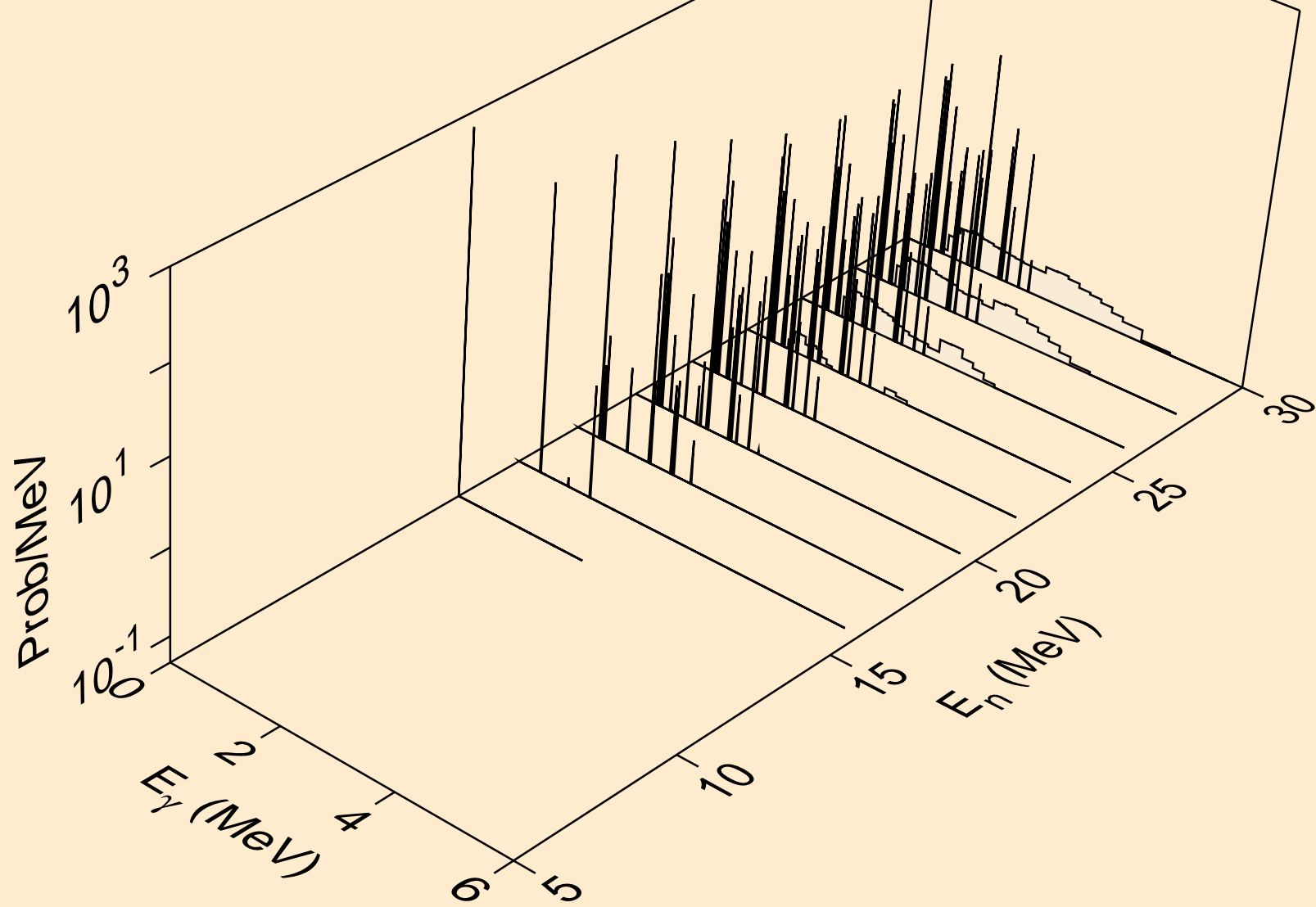

SC046M NEUTRON ACER TENDL-2021 LIBRARY; T=293.6K
Photon emission for (n,2p)

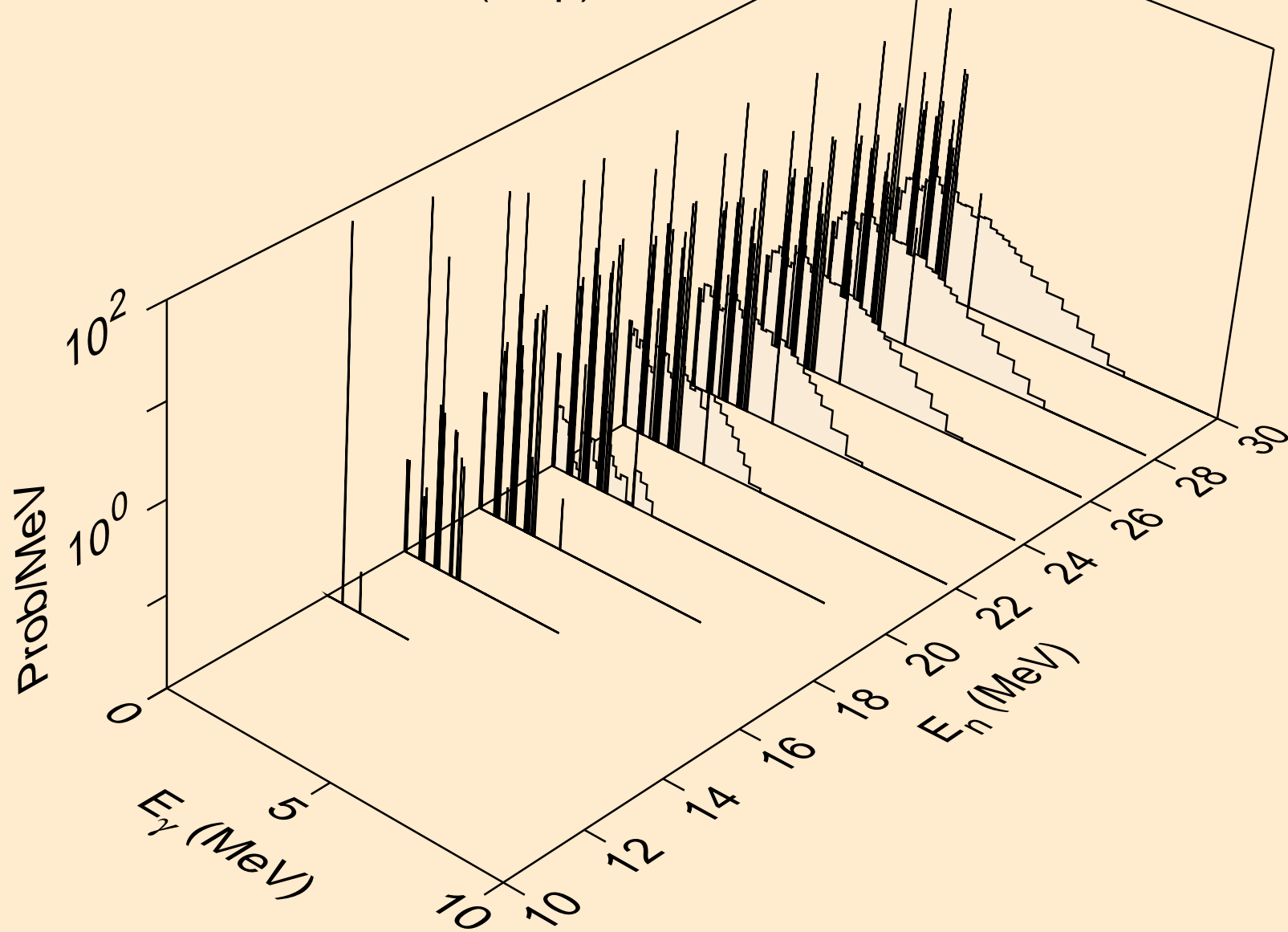

SC046M NEUTRON ACER TENDL-2021 LIBRARY; T=293.6K
Photon emission for (n,p α)

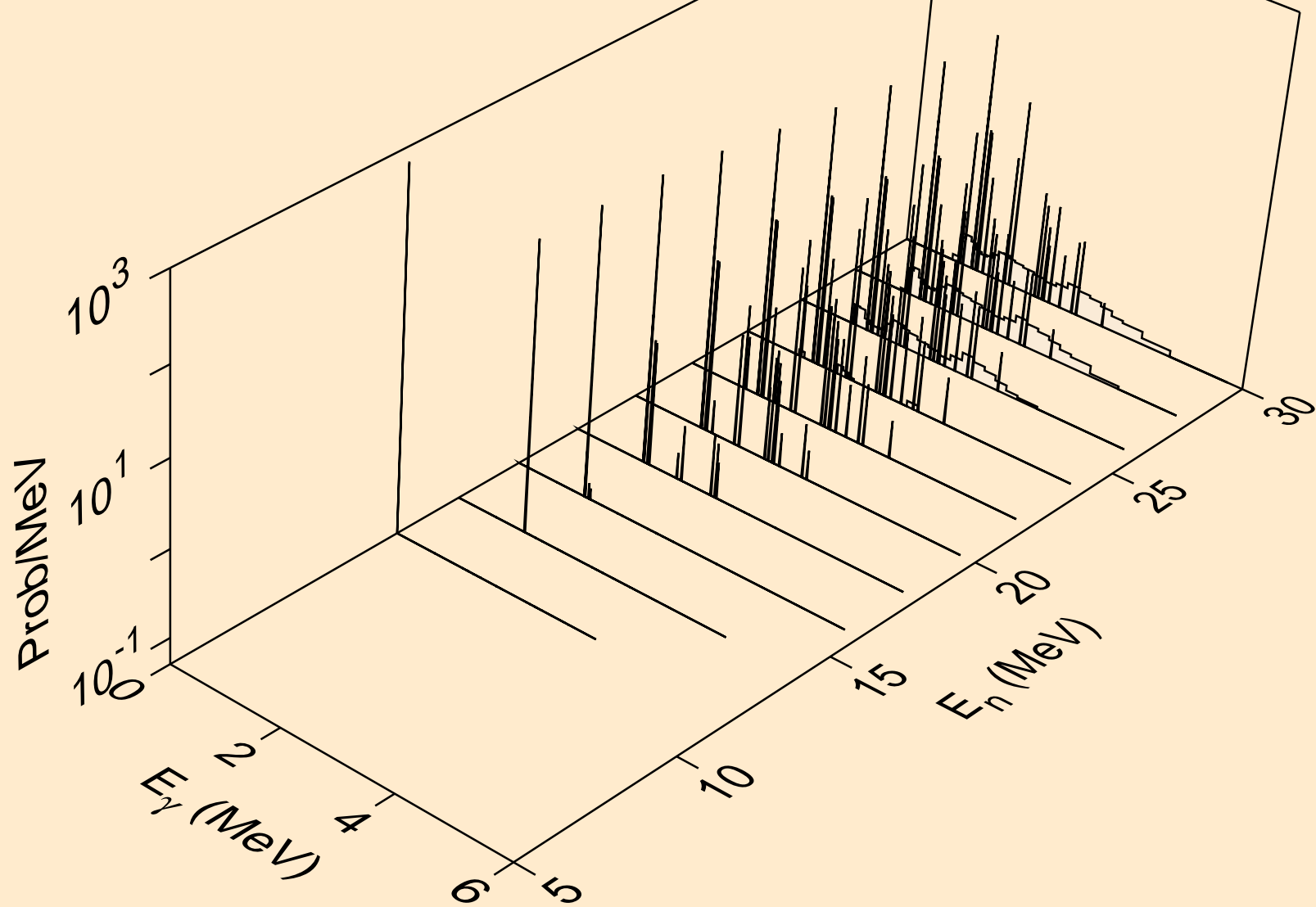

SC046M NEUTRON ACER TENDL-2021 LIBRARY; T=293.6K
Photon emission for (n,pd)

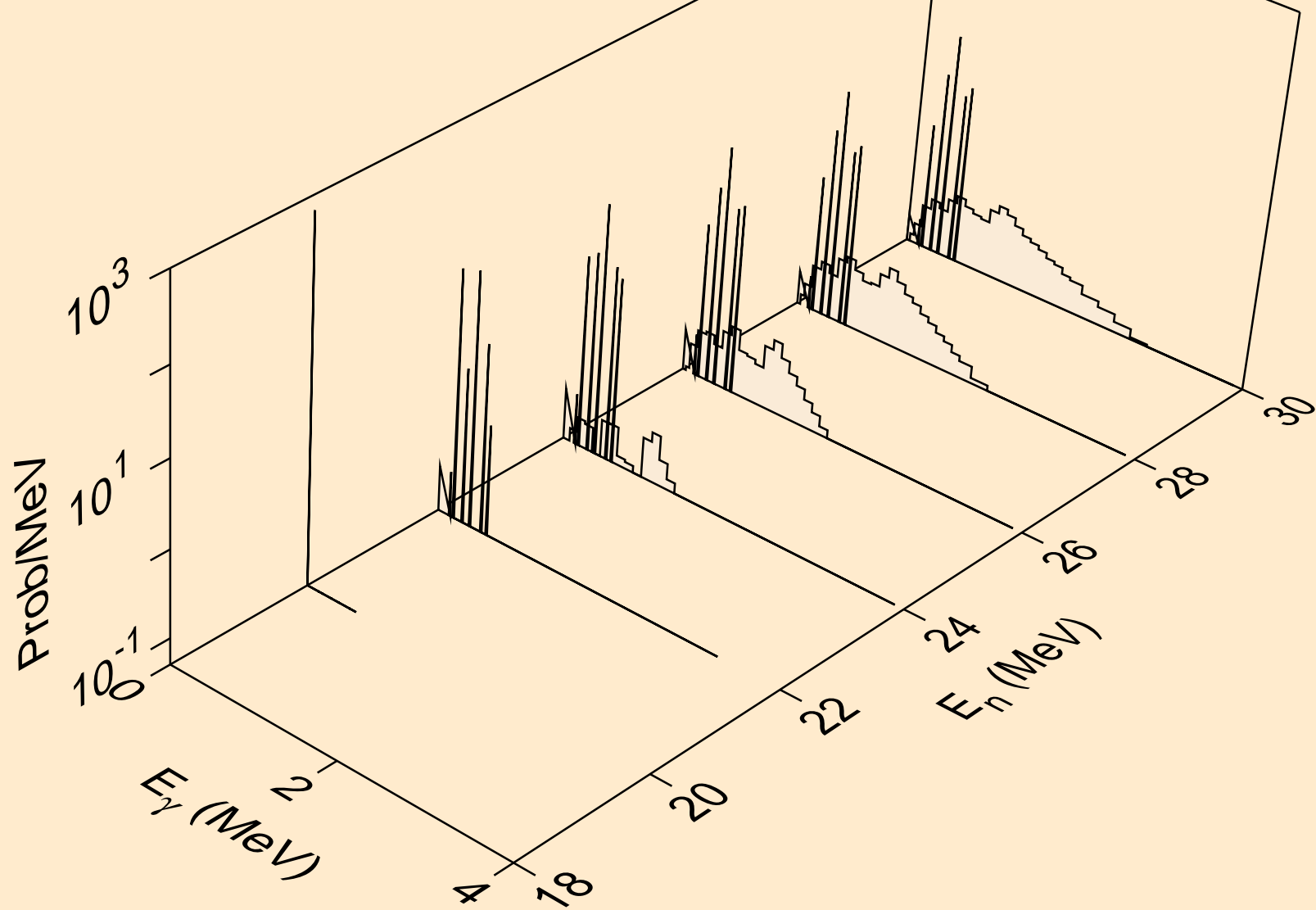

SC046M NEUTRON ACER TENDL-2021 LIBRARY; T=293.6K
Photon emission for (n,pt)

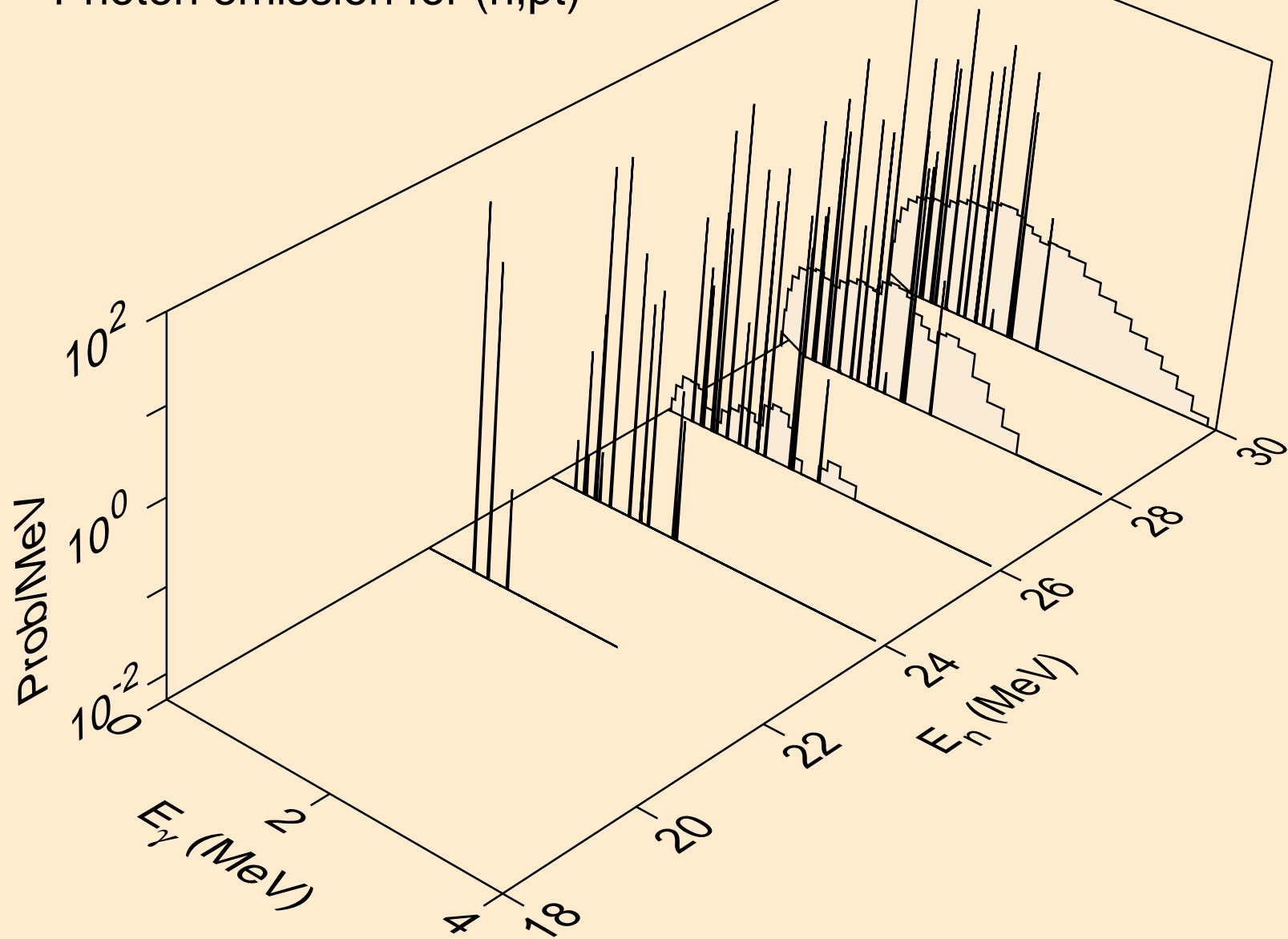

SC046M NEUTRON ACER TENDL-2021 LIBRARY; T=293.6K
Photon emission for (n,da)

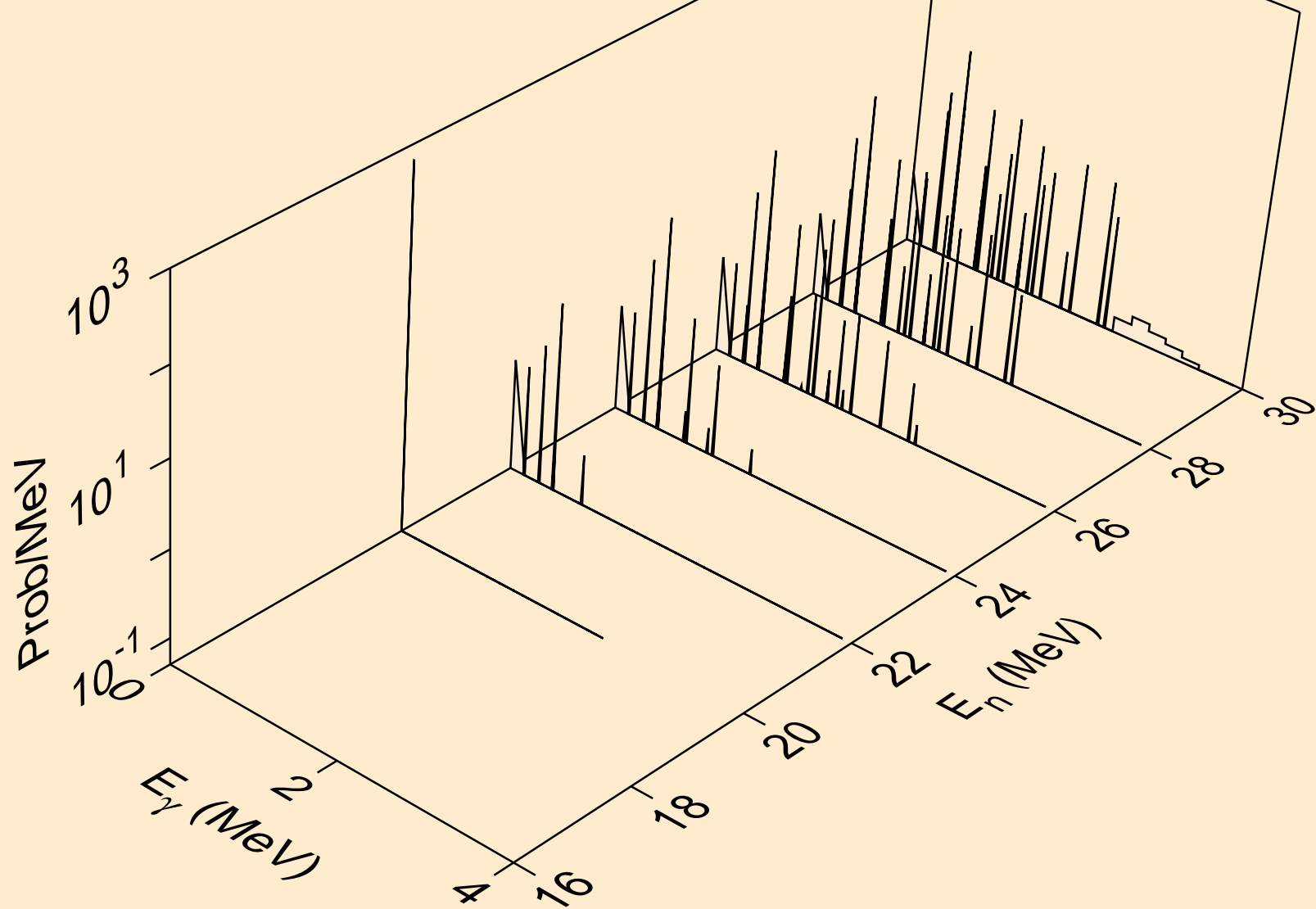

SC046M NEUTRON ACER TENDL-2021 LIBRARY; T=293.6K
thermal capture photon spectrum

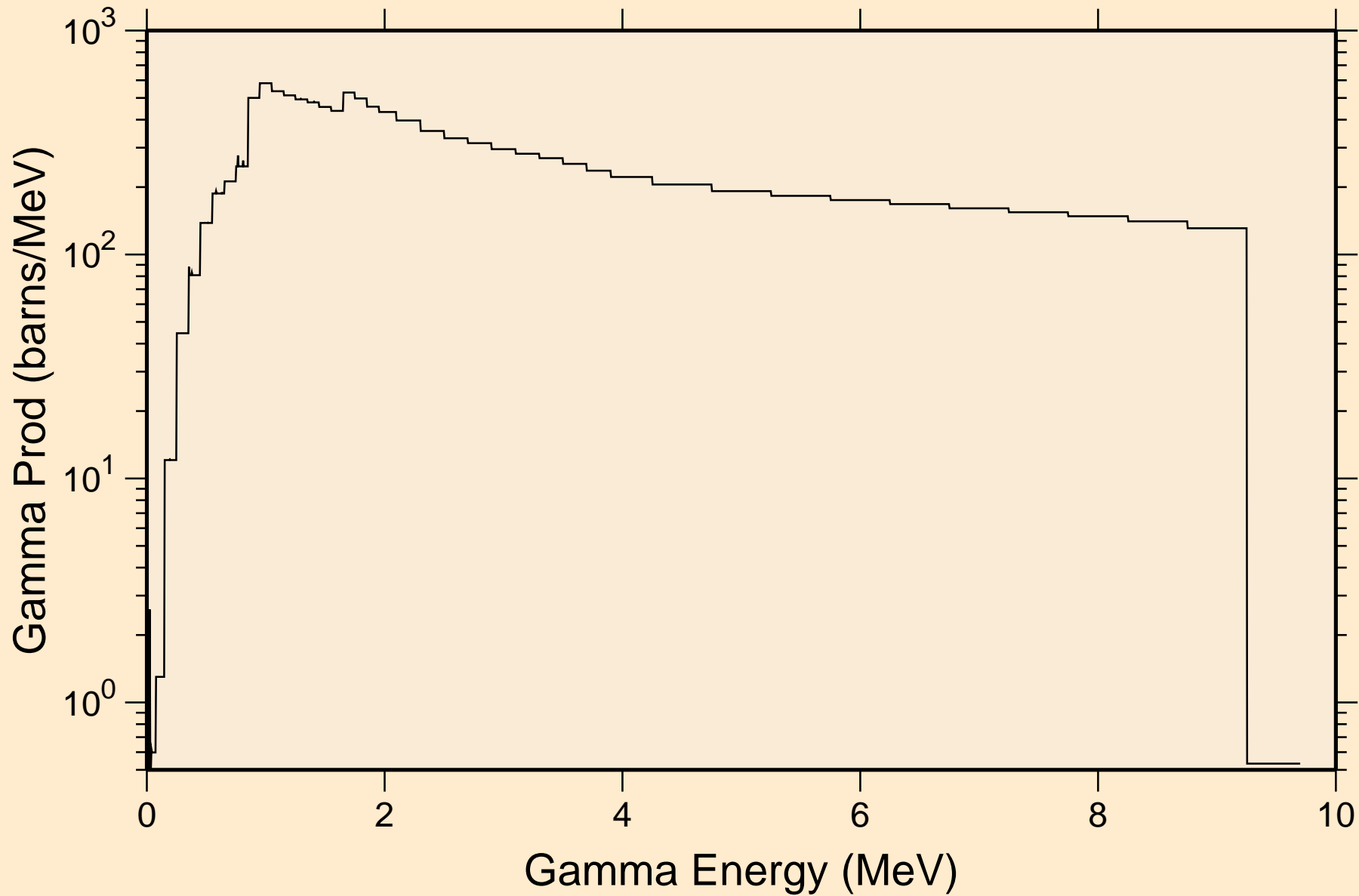

SC046M NEUTRON ACER TENDL-2021 LIBRARY; T=293.6K
14 MeV photon spectrum

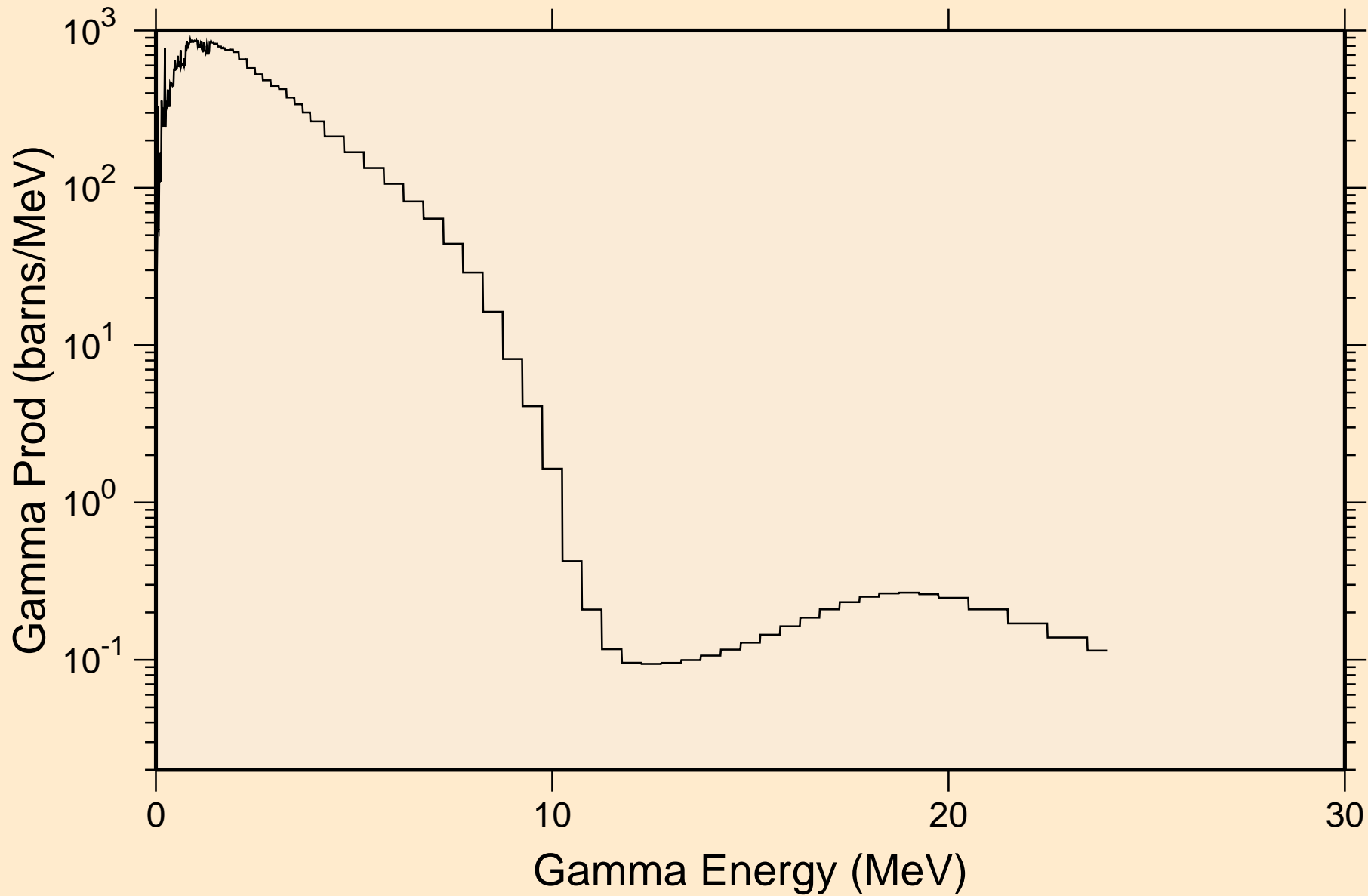

SC046M NEUTRON ACER TENDL-2021 LIBRARY; T=293.6K
Particle heating contributions

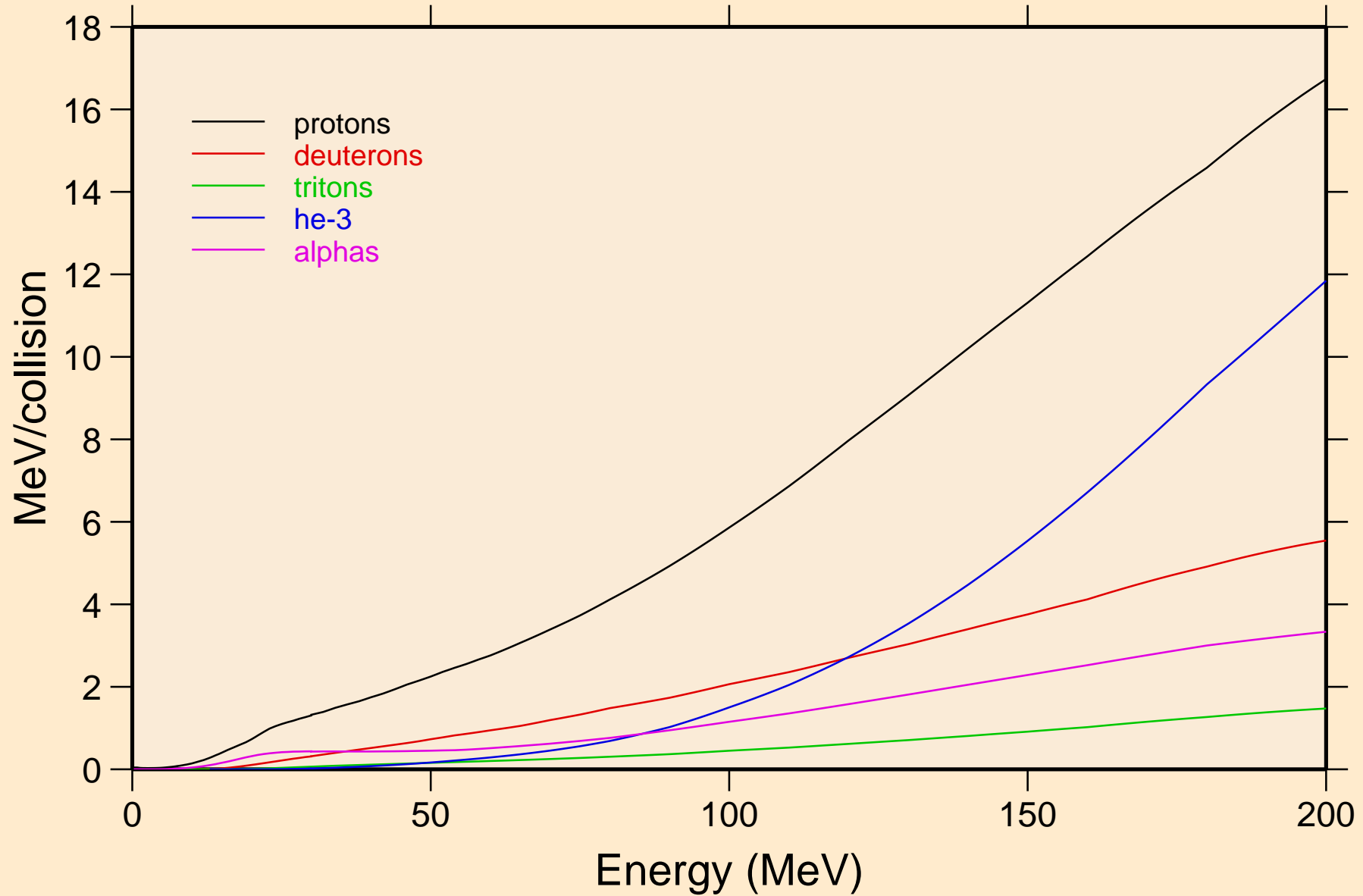

SC046M NEUTRON ACER TENDL-2021 LIBRARY; T=293.6K
Recoil Heating

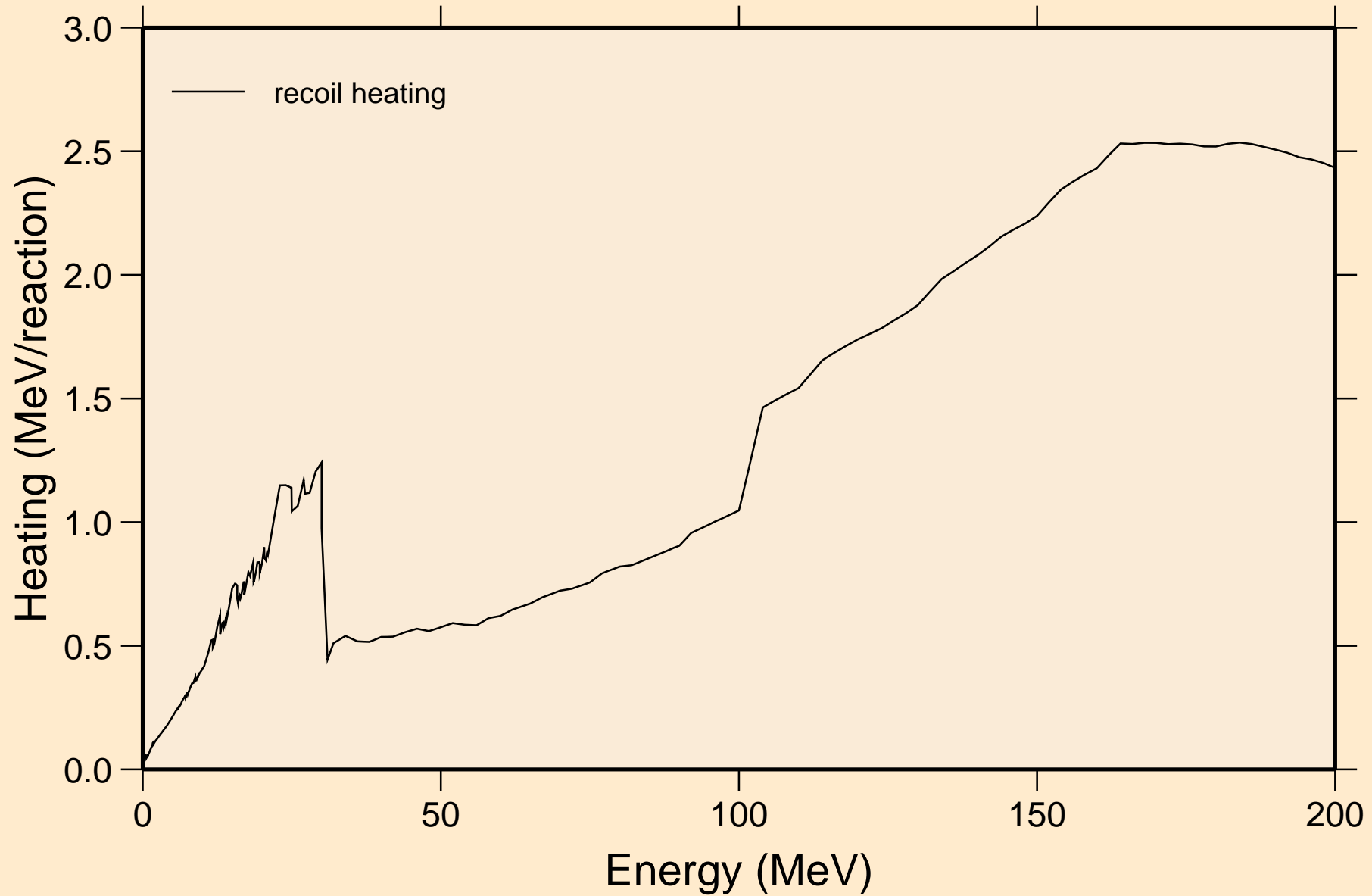

SC046M NEUTRON ACER TENDL-2021 LIBRARY; T=293.6K
Particle production cross sections

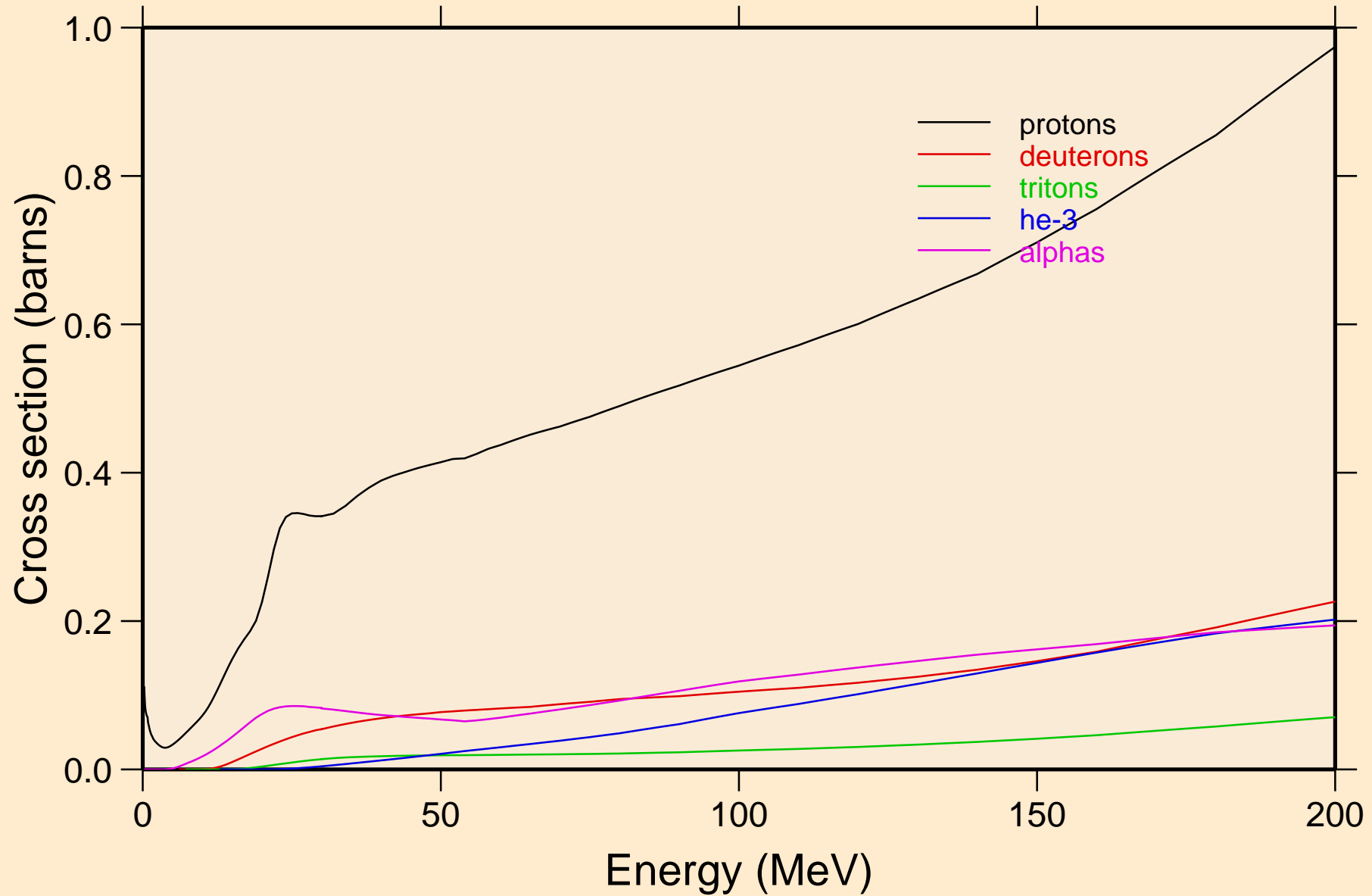

SC046M NEUTRON ACER TENDL-2021 LIBRARY; T=293.6K
protons from (n,x)

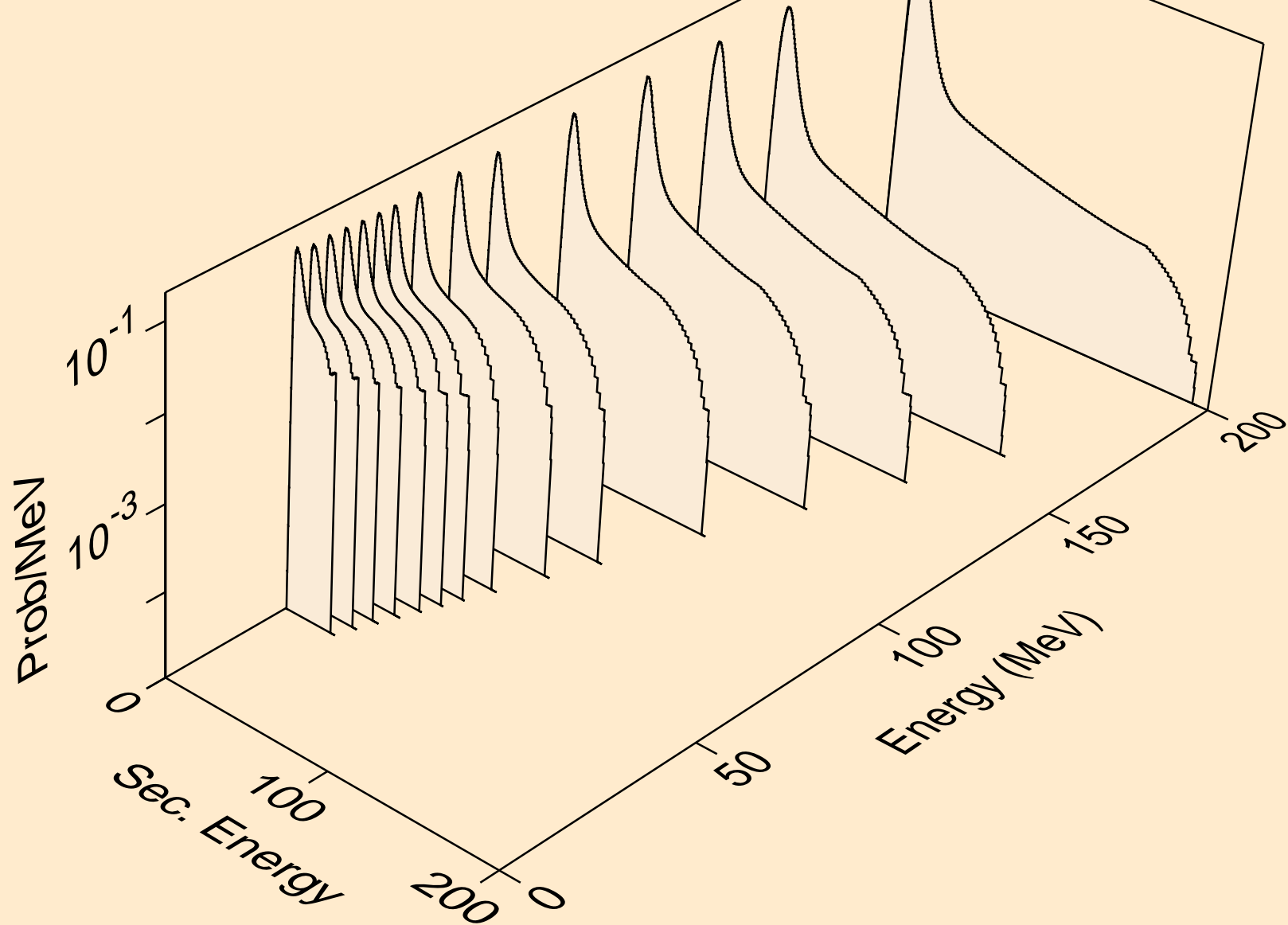

SC046M NEUTRON ACER TENDL-2021 LIBRARY; T=293.6K
protons from (n,n*)p

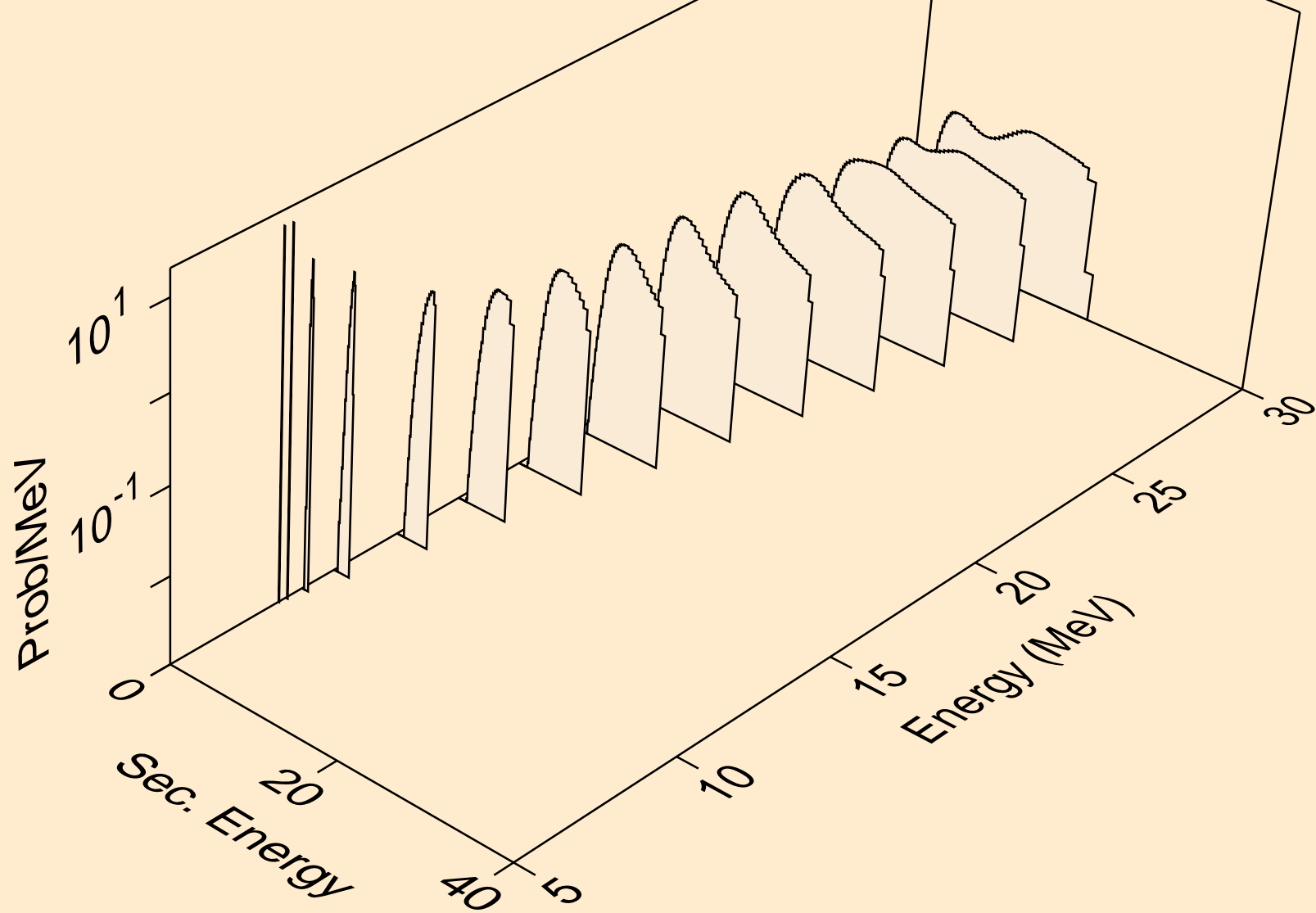

SC046M NEUTRON ACER TENDL-2021 LIBRARY; T=293.6K
protons from (n,2np)

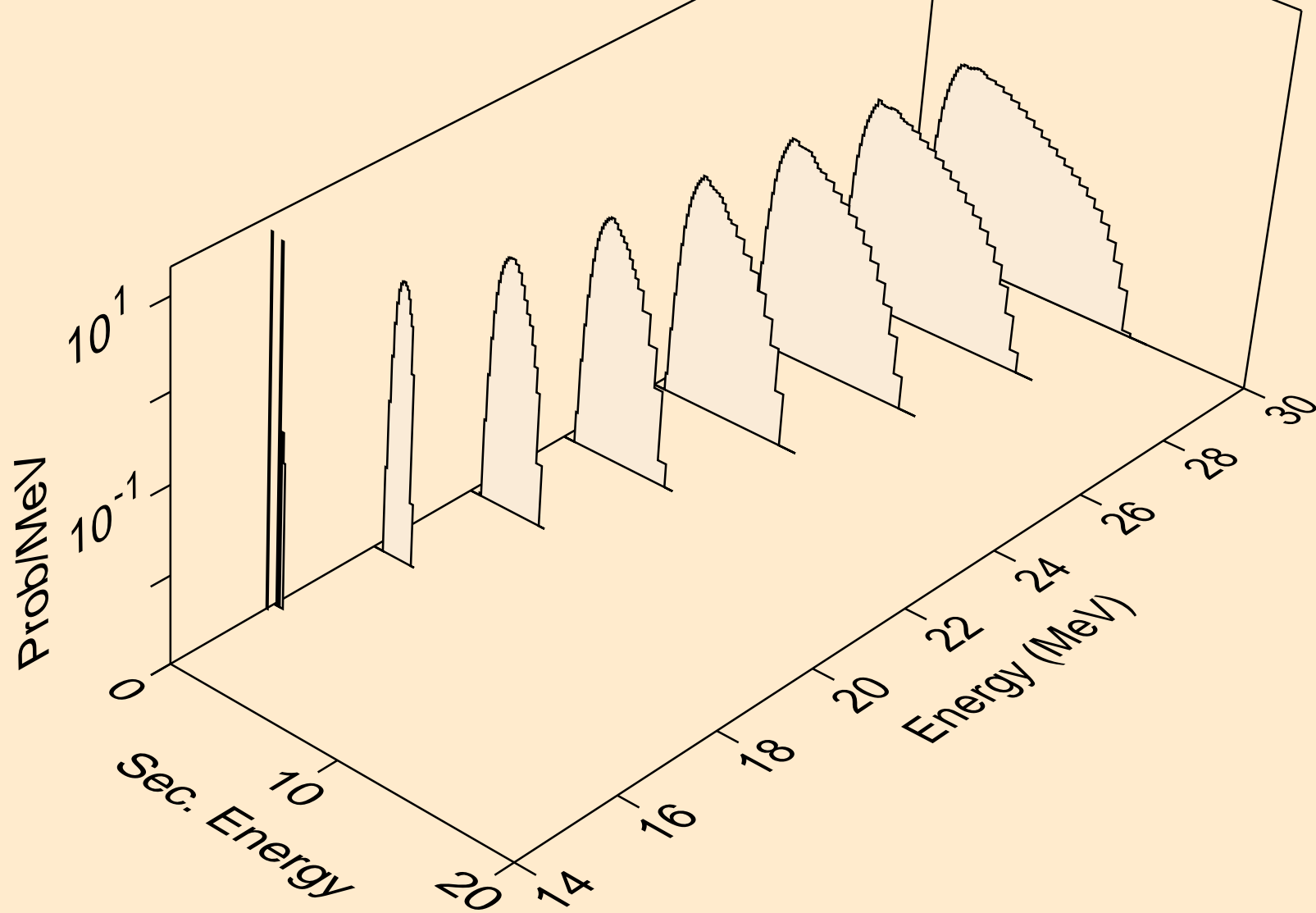

SC046M NEUTRON ACER TENDL-2021 LIBRARY; T=293.6K
protons from (n,3np)

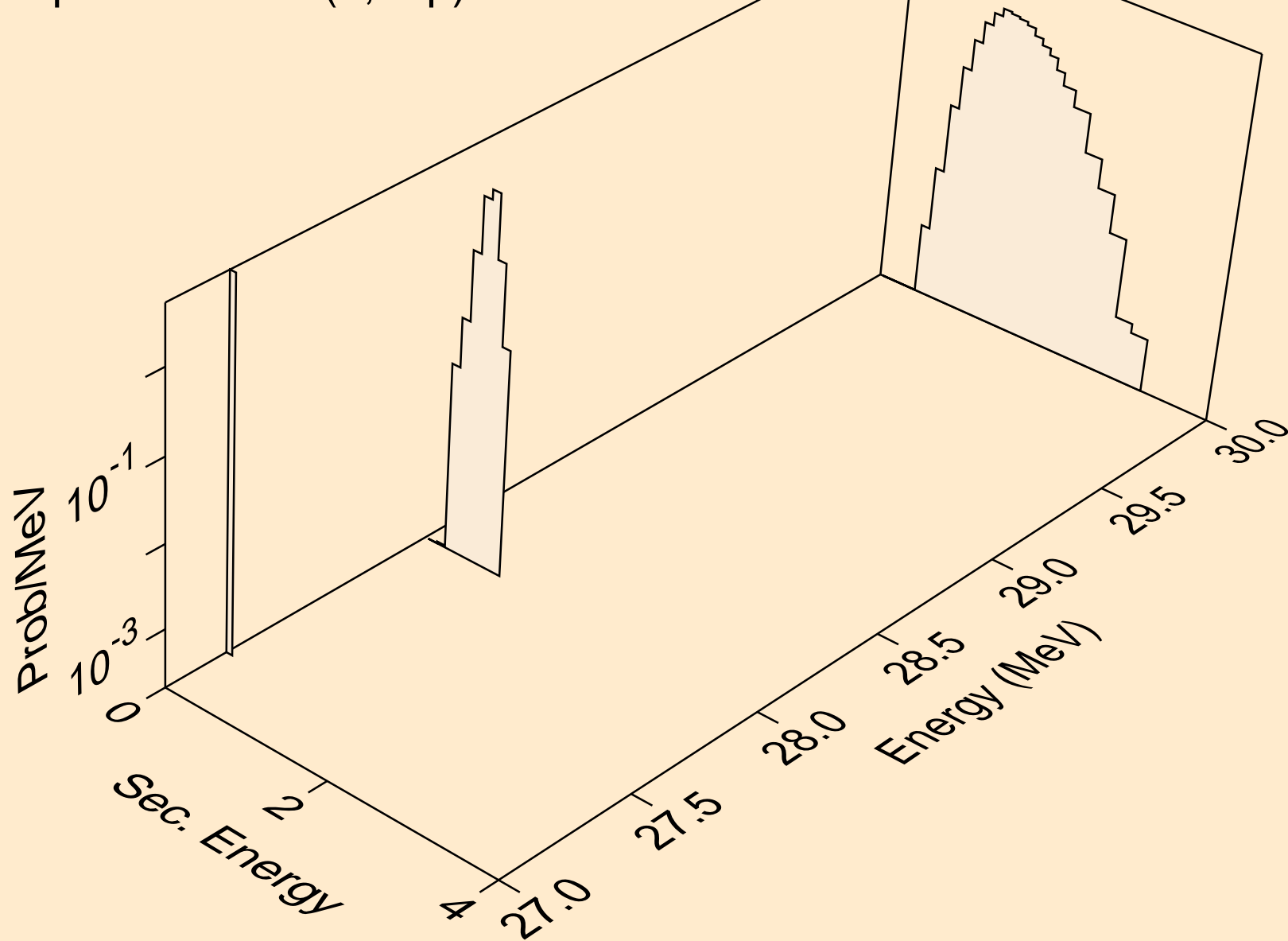

SC046M NEUTRON ACER TENDL-2021 LIBRARY; T=293.6K
protons from (n,2np)

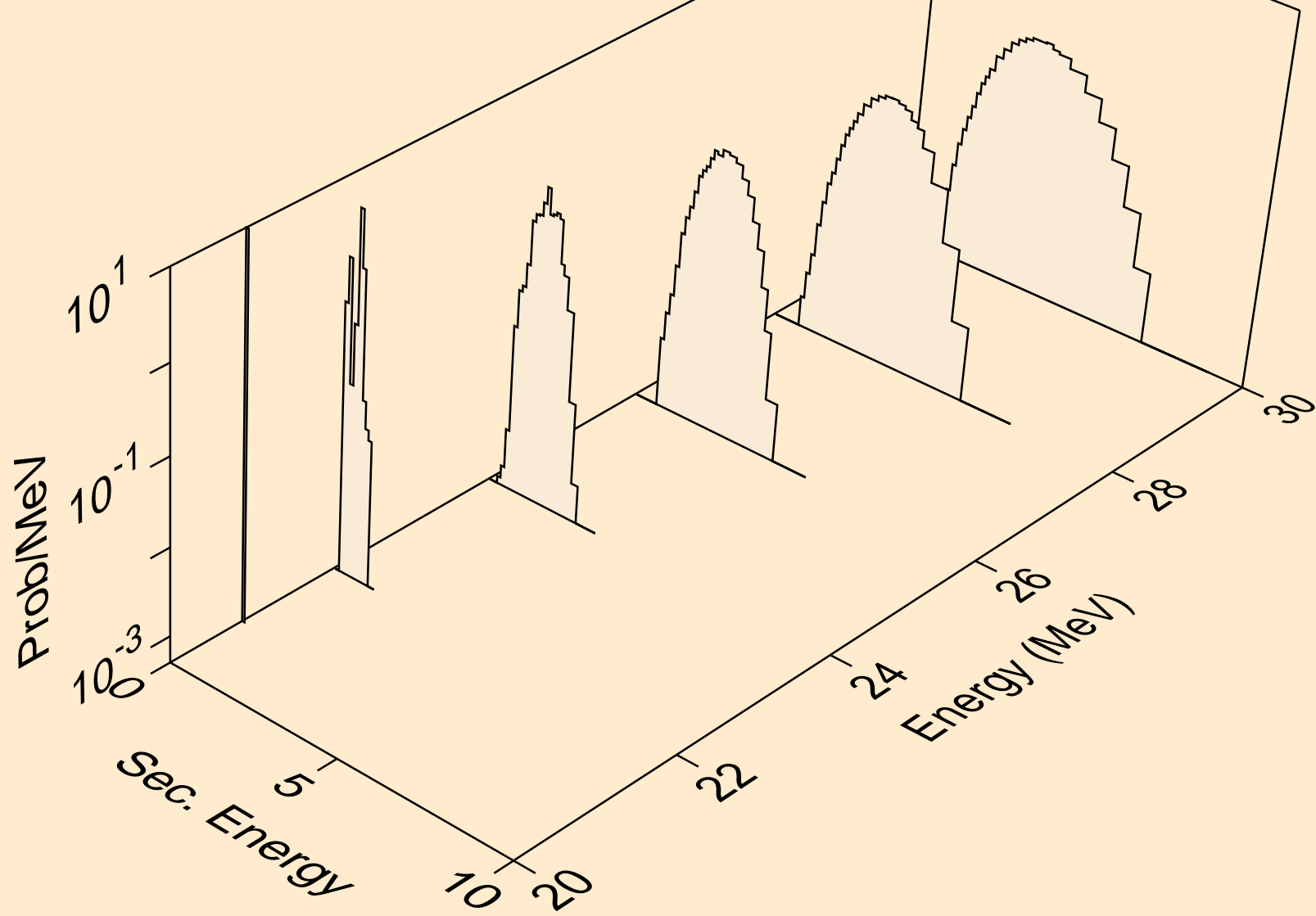

SC046M NEUTRON ACER TENDL-2021 LIBRARY; T=293.6K
protons from (n,npa)

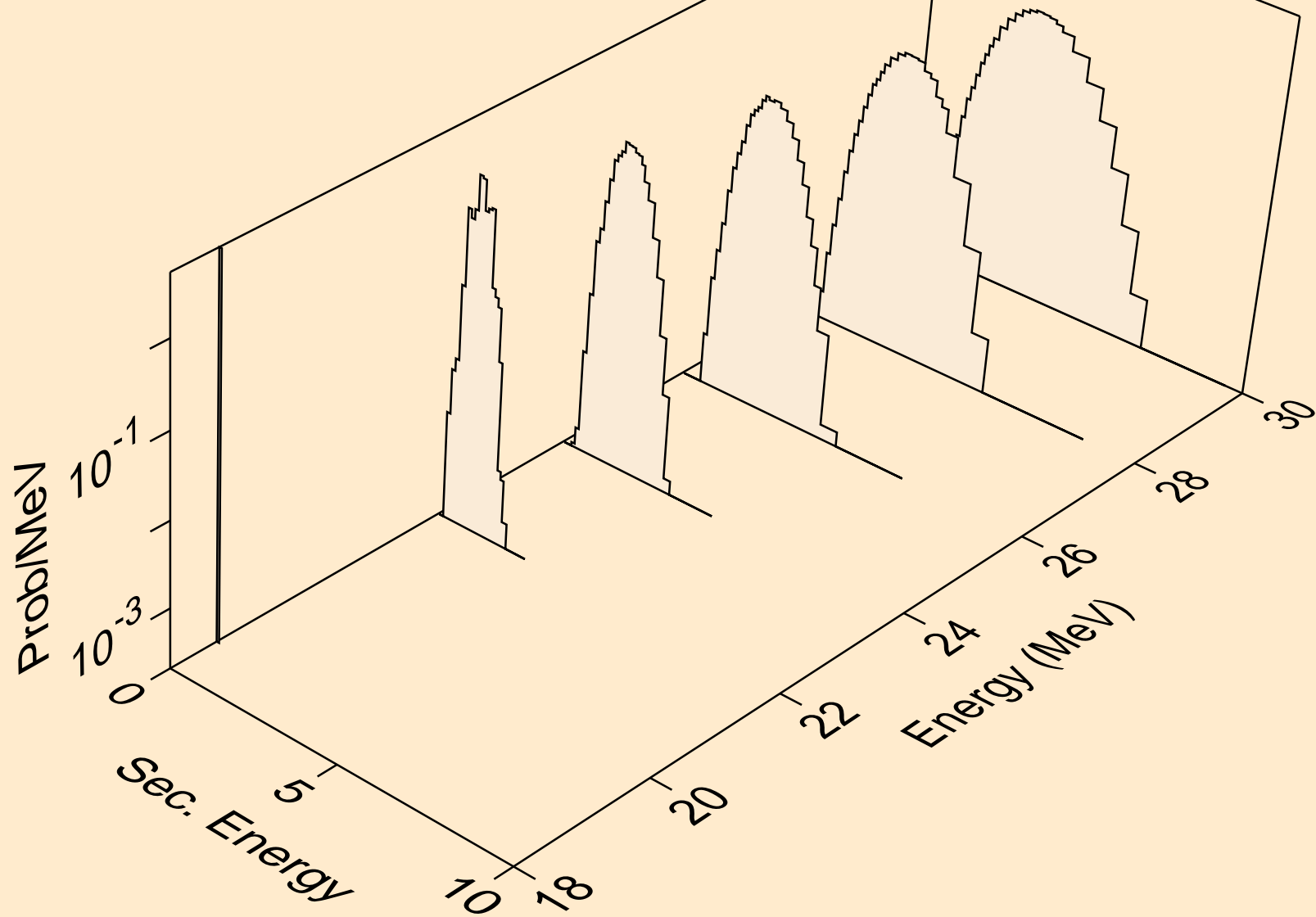

SC046M NEUTRON ACER TENDL-2021 LIBRARY; T=293.6K
protons from (n,p)

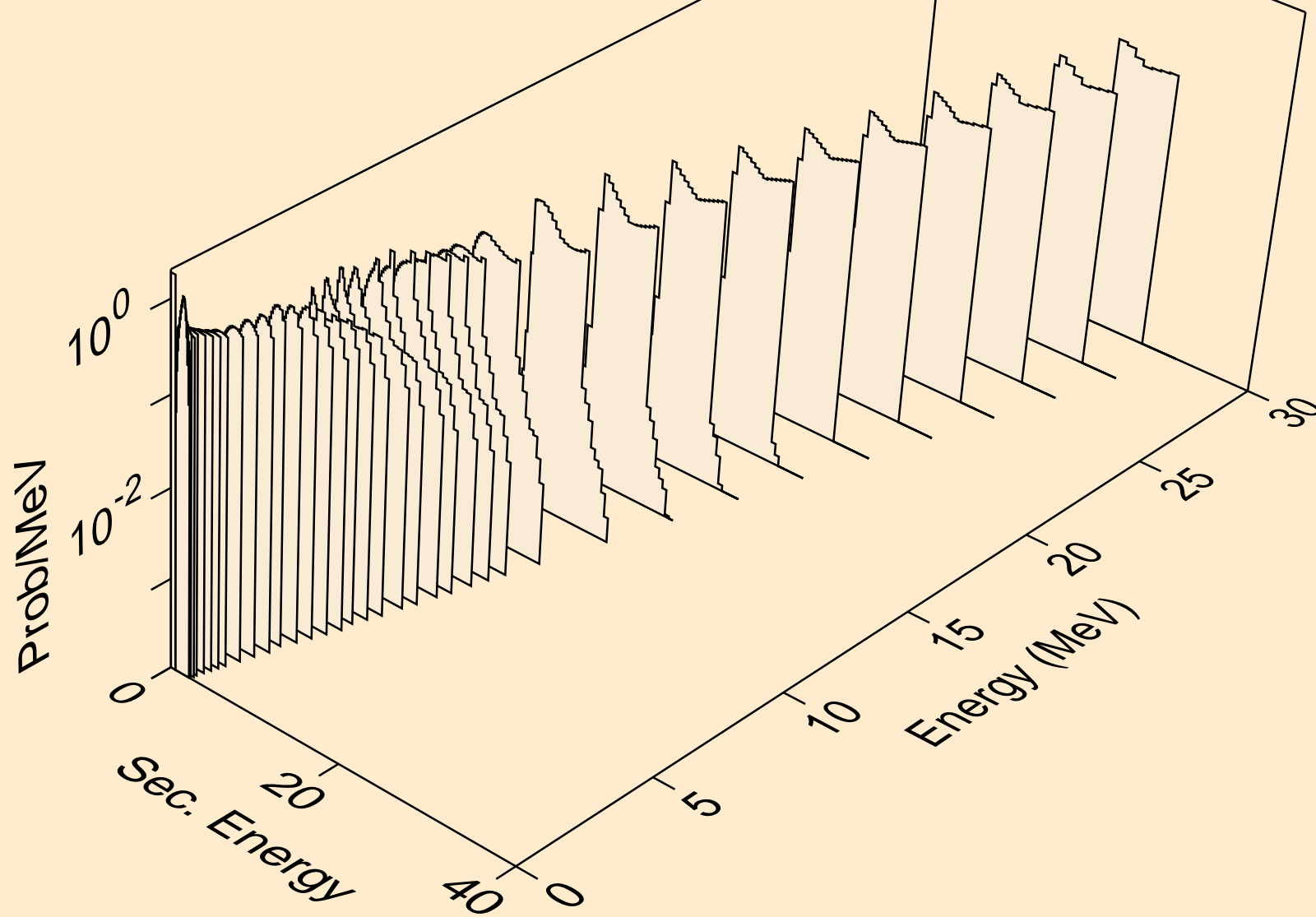

SC046M NEUTRON ACER TENDL-2021 LIBRARY; T=293.6K
protons from (n,2p)

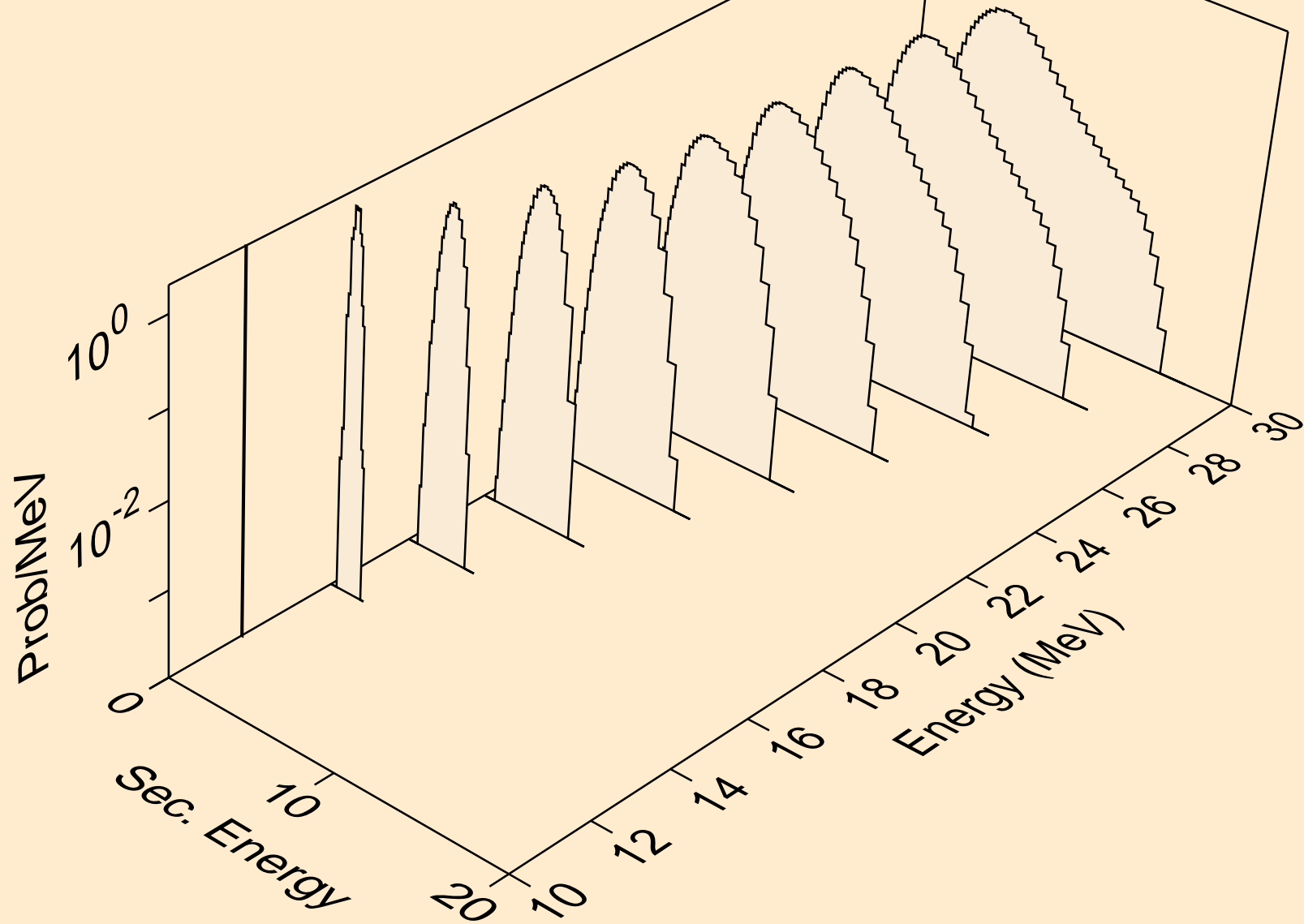

SC046M NEUTRON ACER TENDL-2021 LIBRARY; T=293.6K
protons from (n,p)

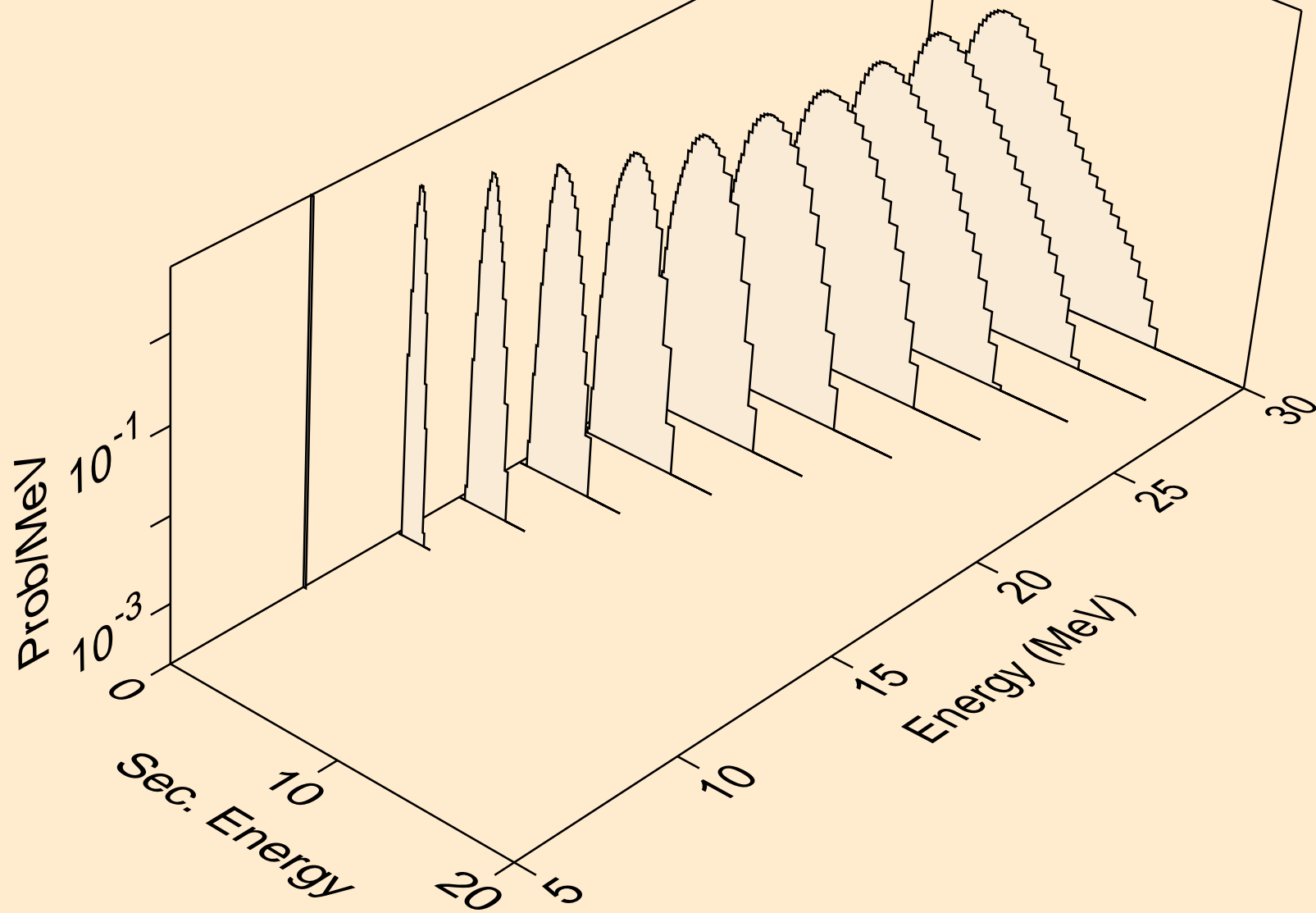

SC046M NEUTRON ACER TENDL-2021 LIBRARY; T=293.6K
protons from (n,pd)

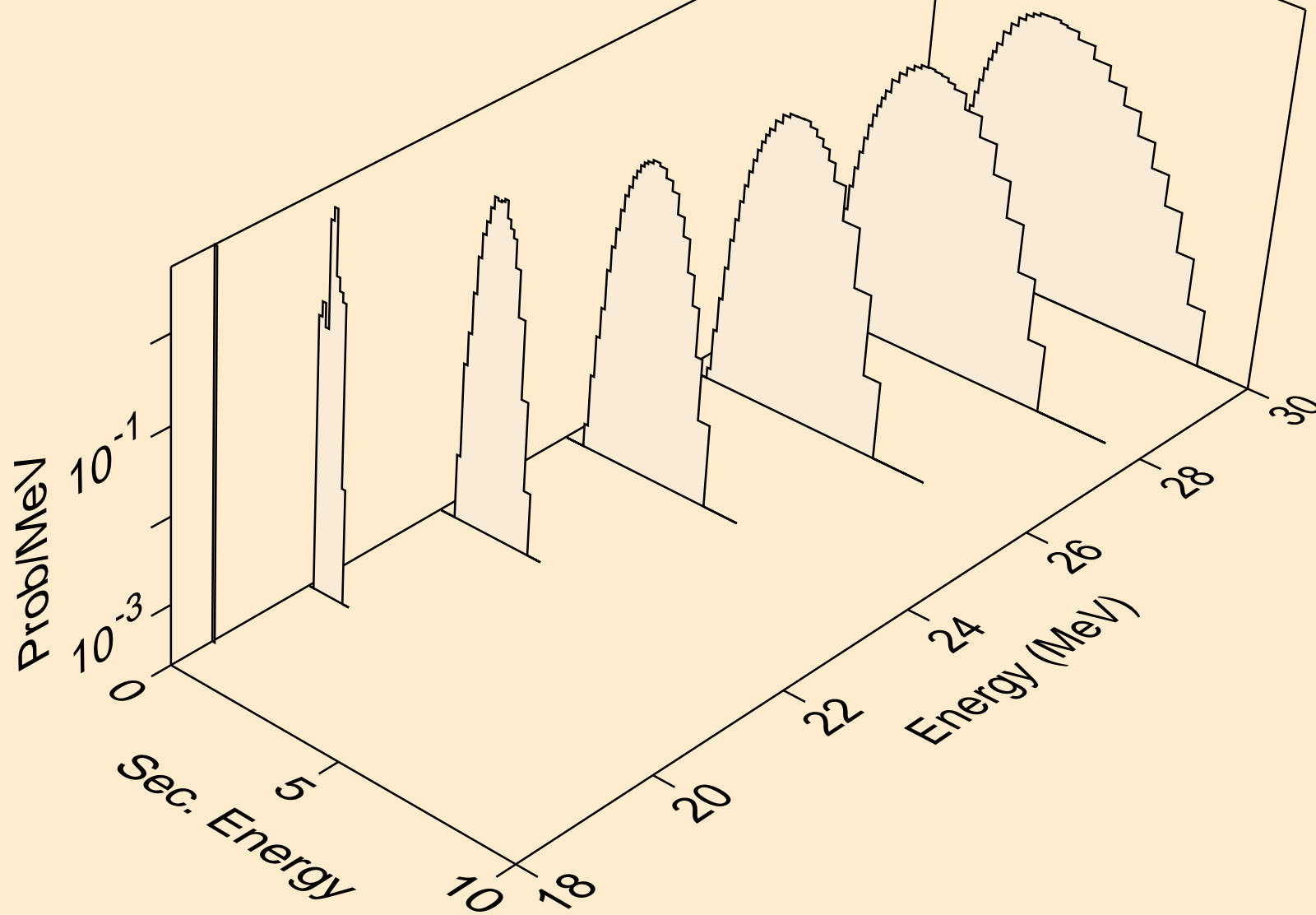

SC046M NEUTRON ACER TENDL-2021 LIBRARY; T=293.6K
protons from (n,pt)

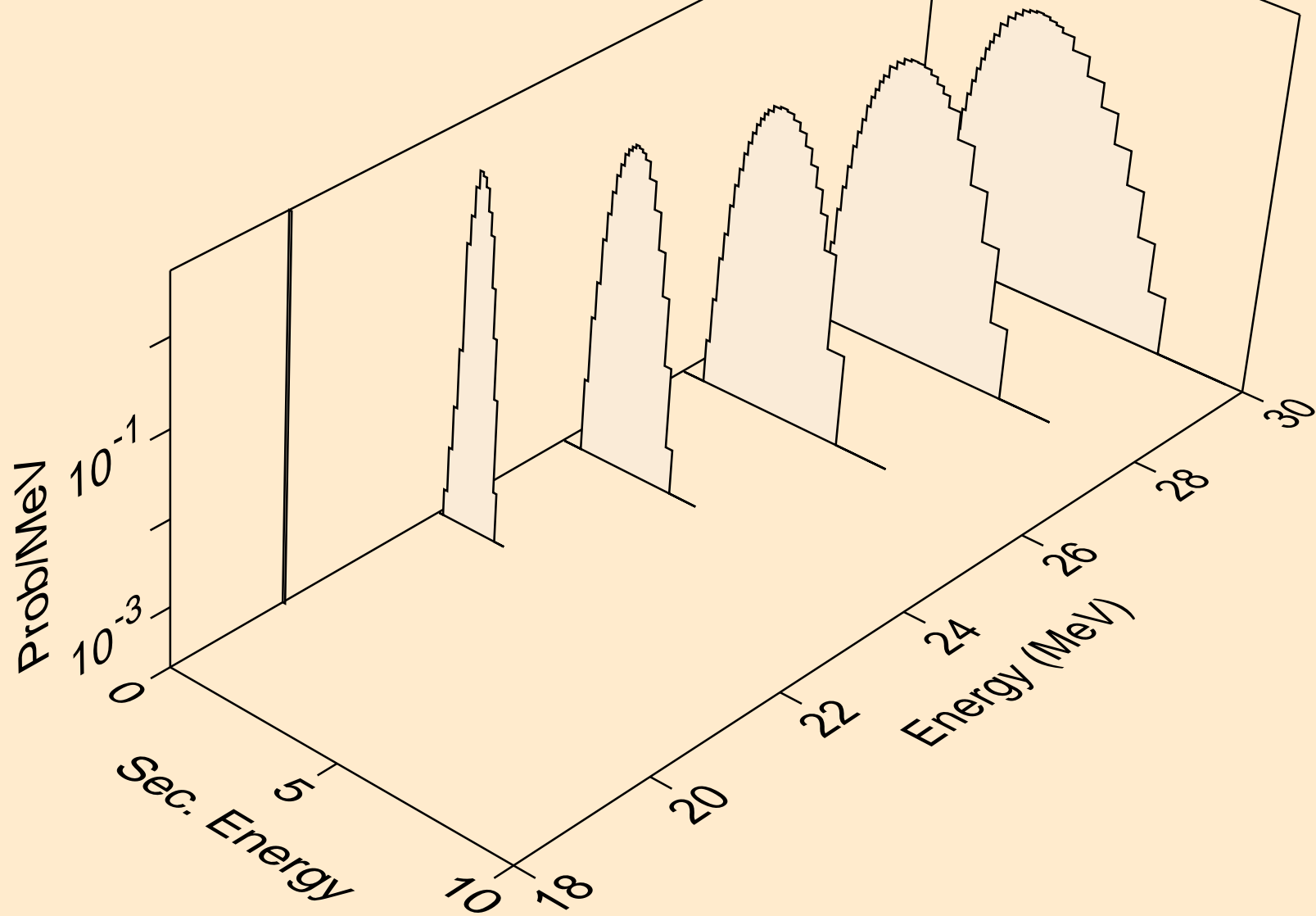

SC046M NEUTRON ACER TENDL-2021 LIBRARY; T=293.6K
deuterons from (n,x)

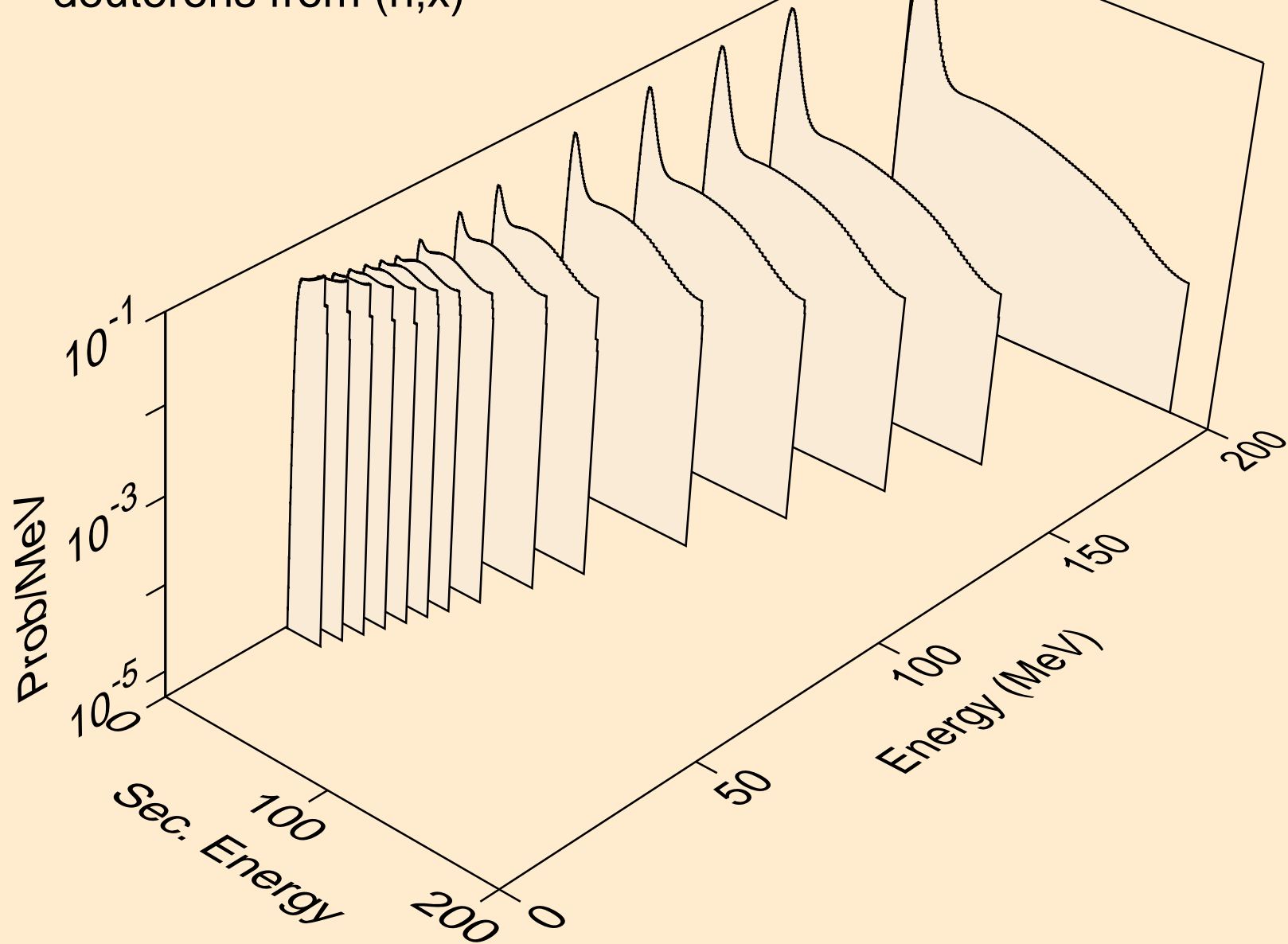

SC046M NEUTRON ACER TENDL-2021 LIBRARY; T=293.6K
deuterons from (n,2nd)

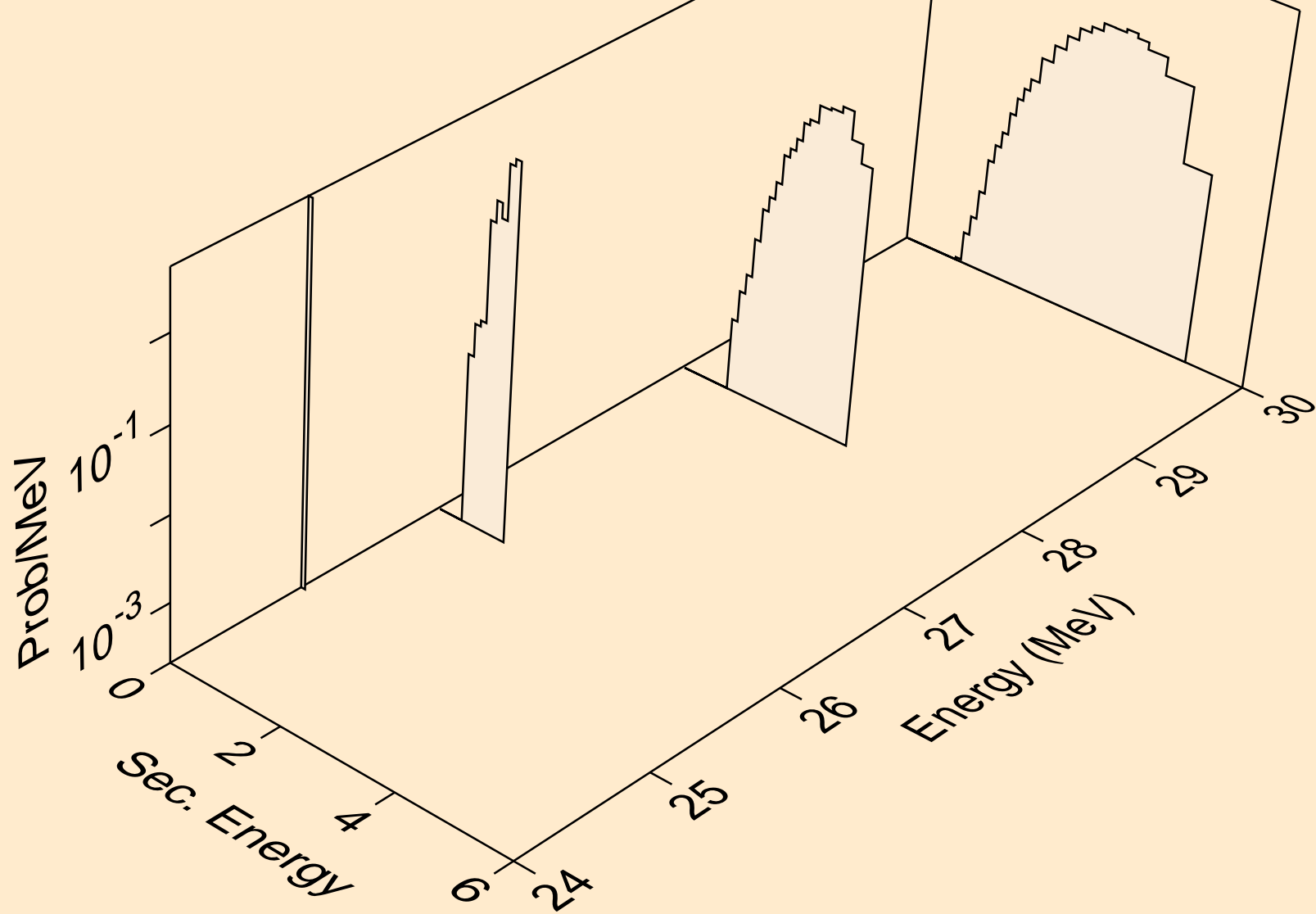

SC046M NEUTRON ACER TENDL-2021 LIBRARY; T=293.6K
deuterons from (n,n*)d

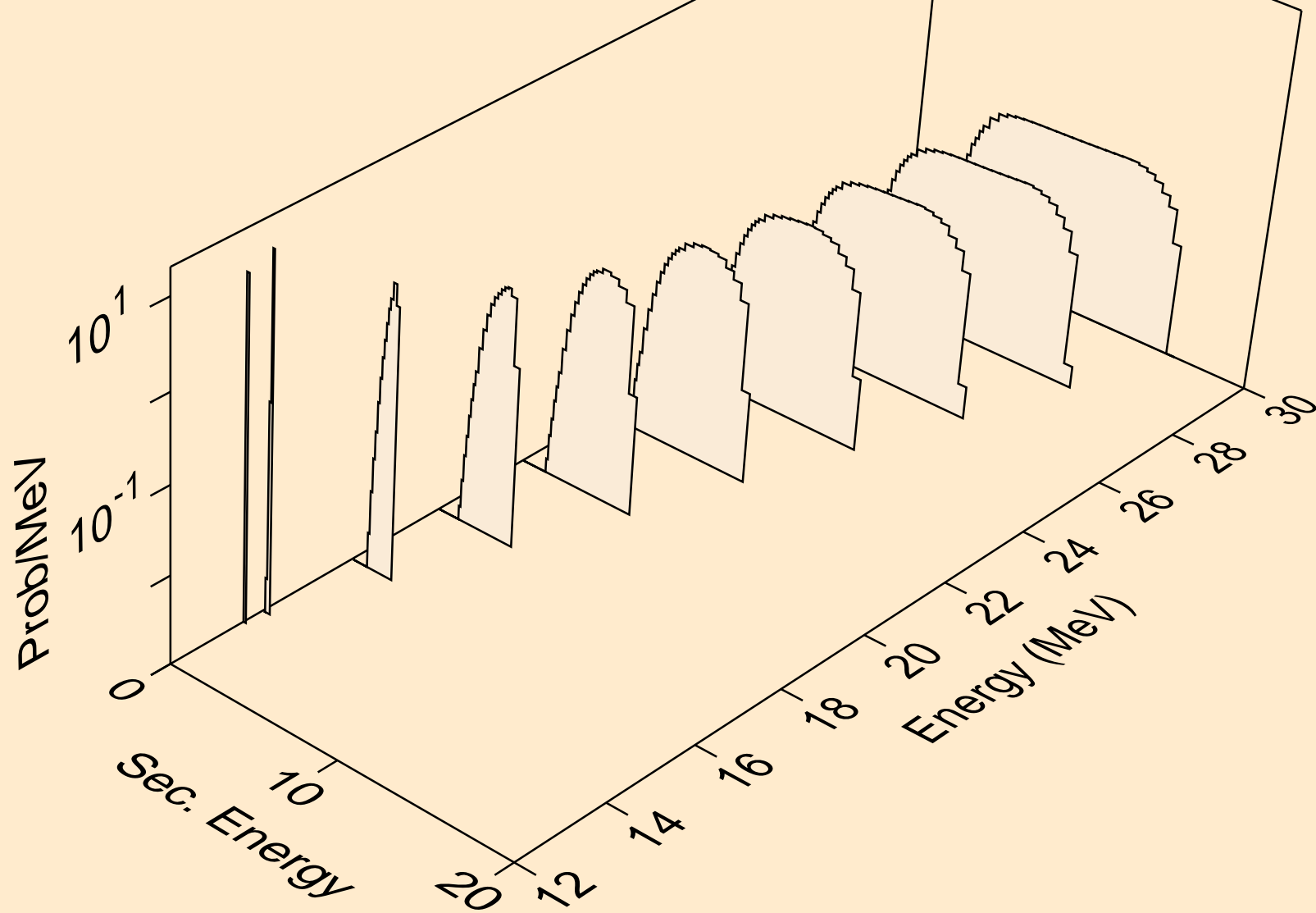

SC046M NEUTRON ACER TENDL-2021 LIBRARY; T=293.6K
deuterons from (n,d)

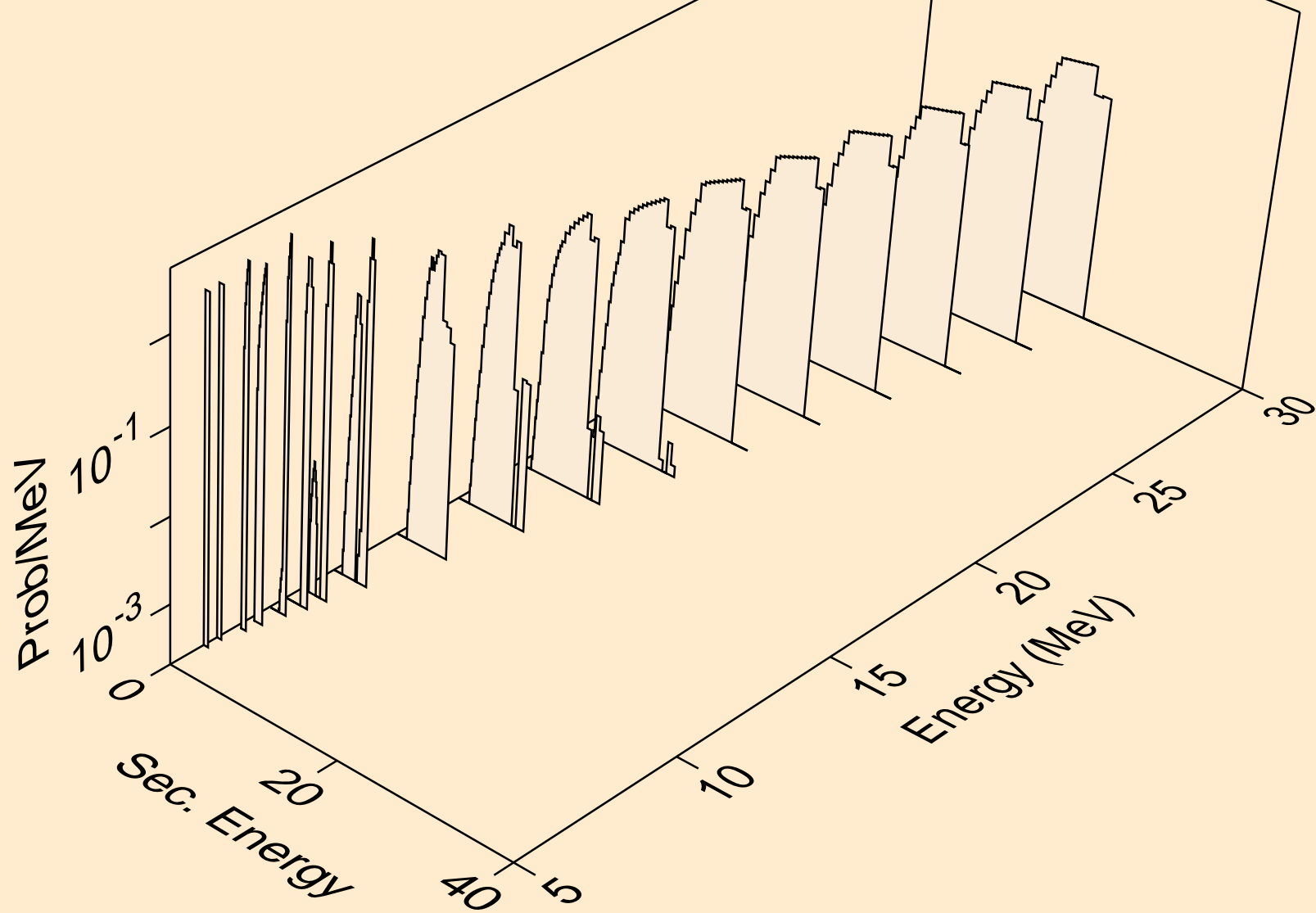

SC046M NEUTRON ACER TENDL-2021 LIBRARY; T=293.6K
deuterons from (n,pd)

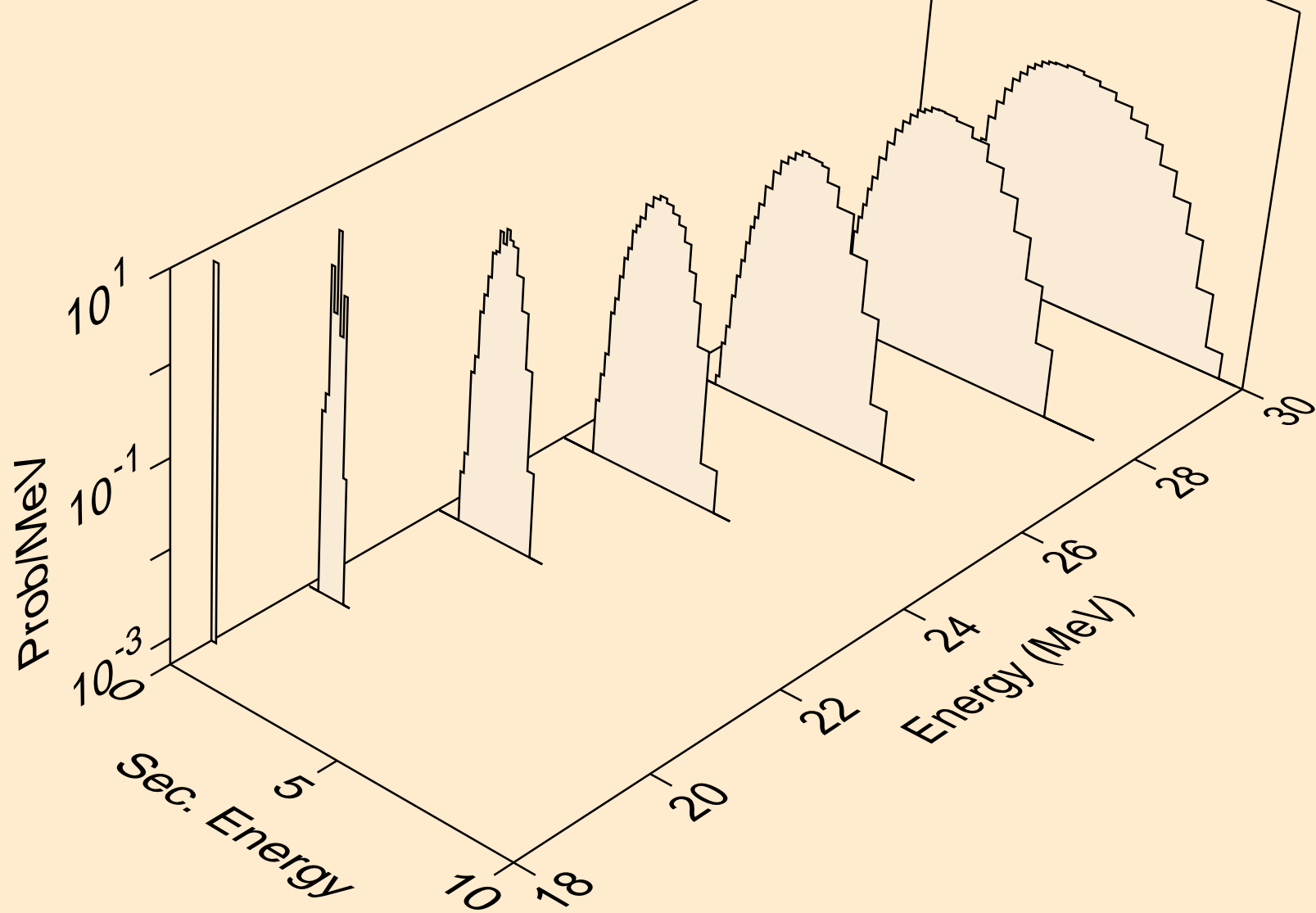

SC046M NEUTRON ACER TENDL-2021 LIBRARY; T=293.6K
deuterons from (n,da)

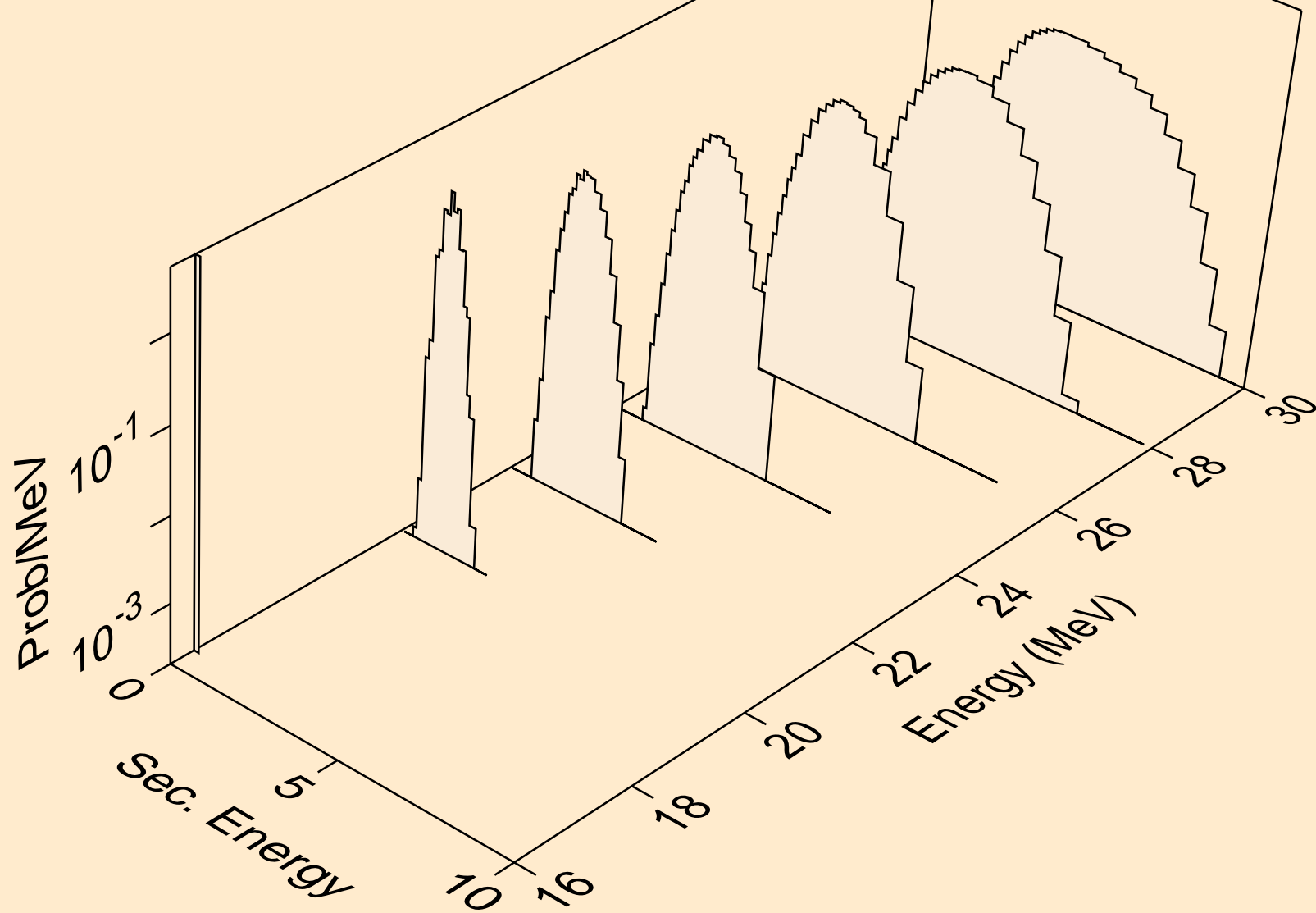

SC046M NEUTRON ACER TENDL-2021 LIBRARY; T=293.6K
tritons from (n,x)

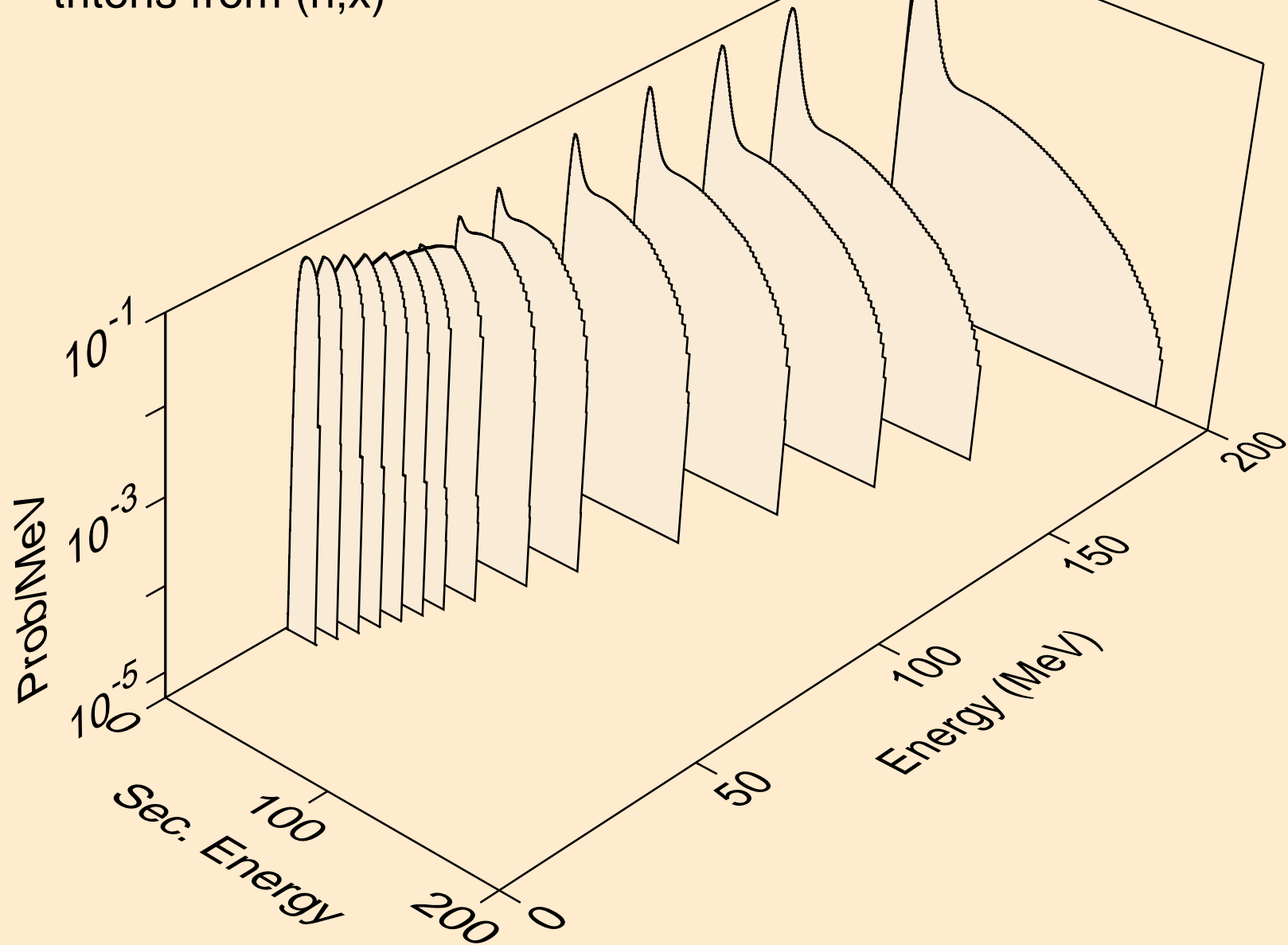

SC046M NEUTRON ACER TENDL-2021 LIBRARY; T=293.6K
tritons from (n,n*)t

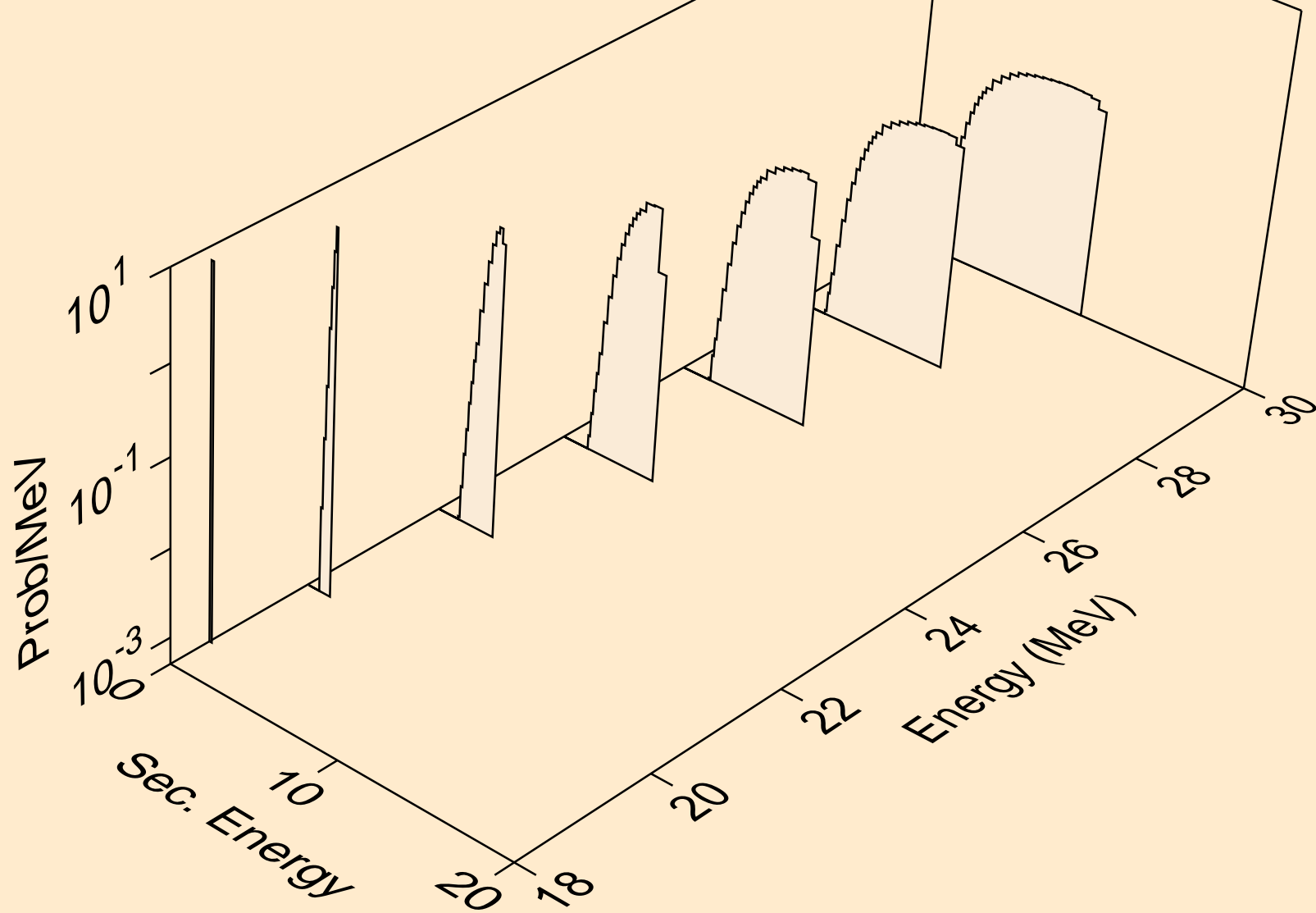

SC046M NEUTRON ACER TENDL-2021 LIBRARY; T=293.6K
tritons from (n,t)

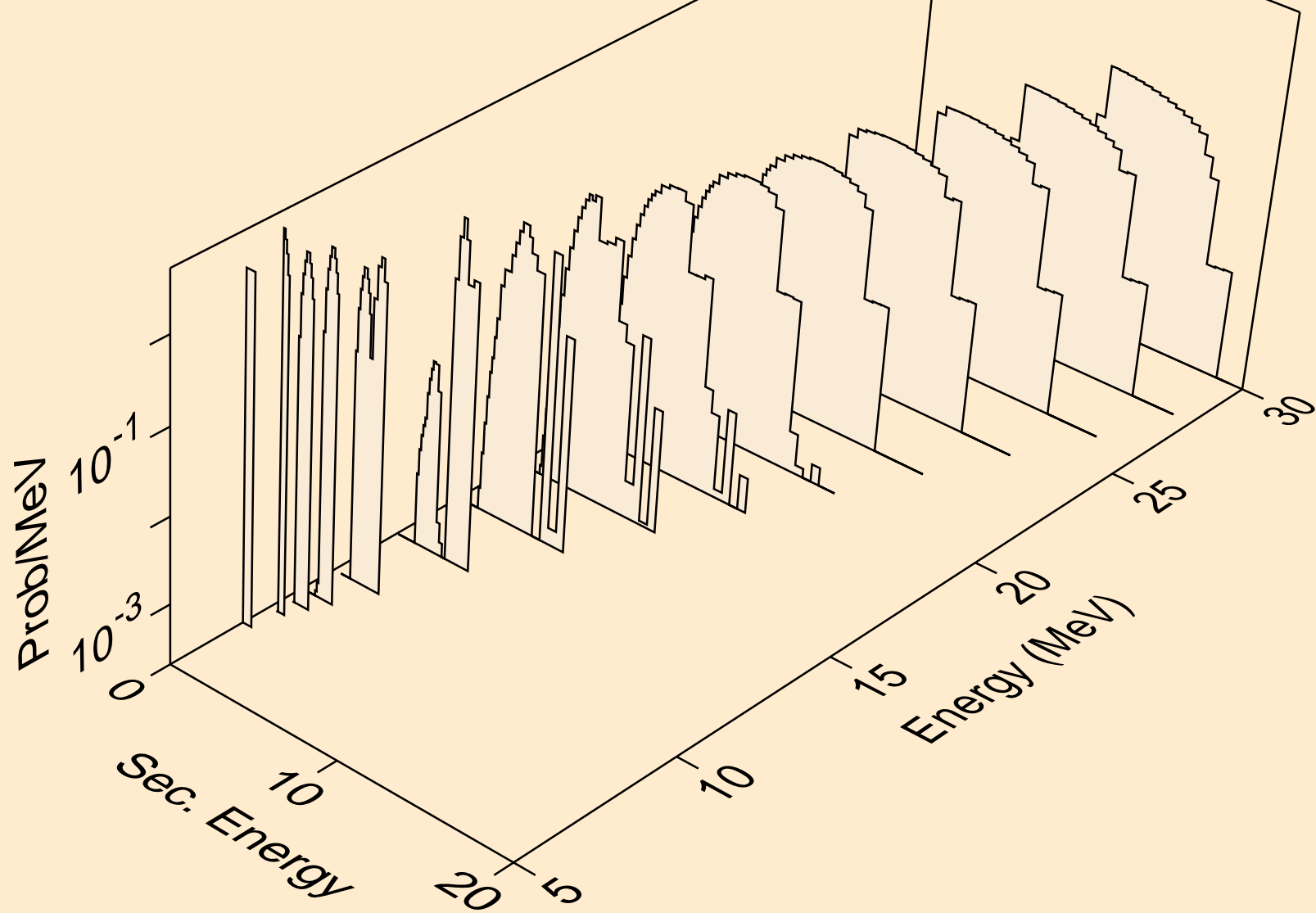

SC046M NEUTRON ACER TENDL-2021 LIBRARY; T=293.6K
tritons from (n,pt)

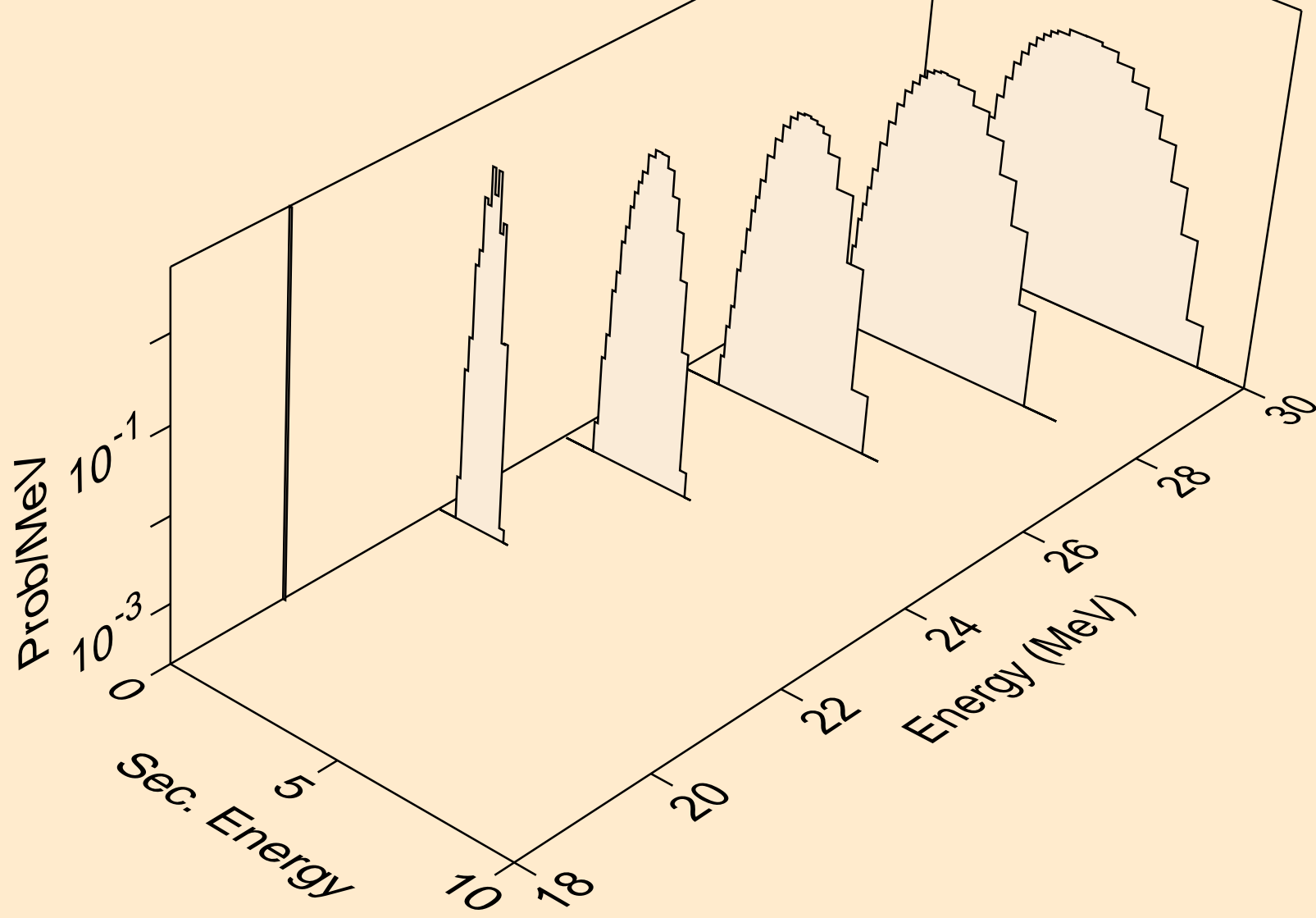

SC046M NEUTRON ACER TENDL-2021 LIBRARY; T=293.6K
he3s from (n,x)

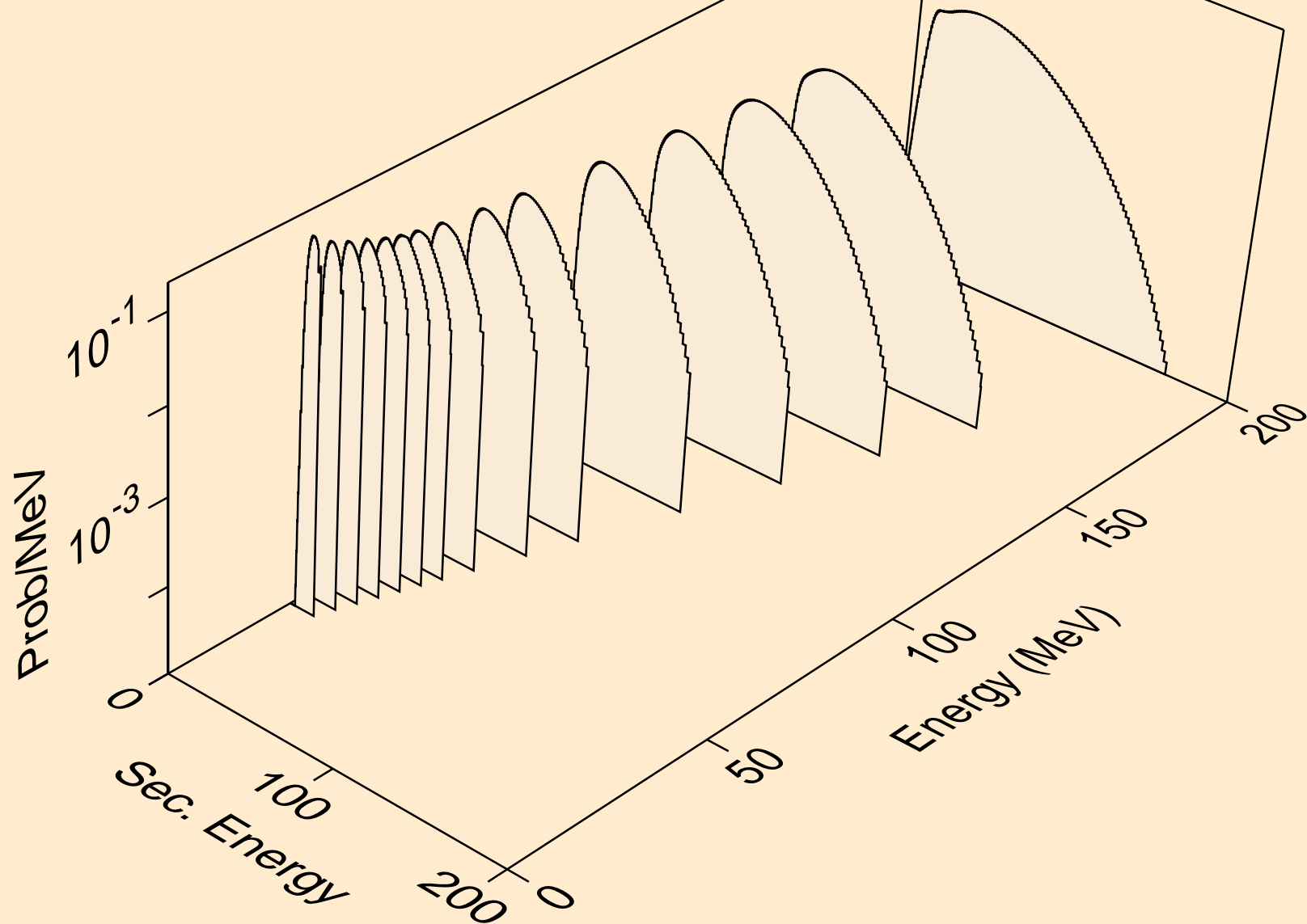

SC046M NEUTRON ACER TENDL-2021 LIBRARY; T=293.6K
he3s from (n,n*)he3

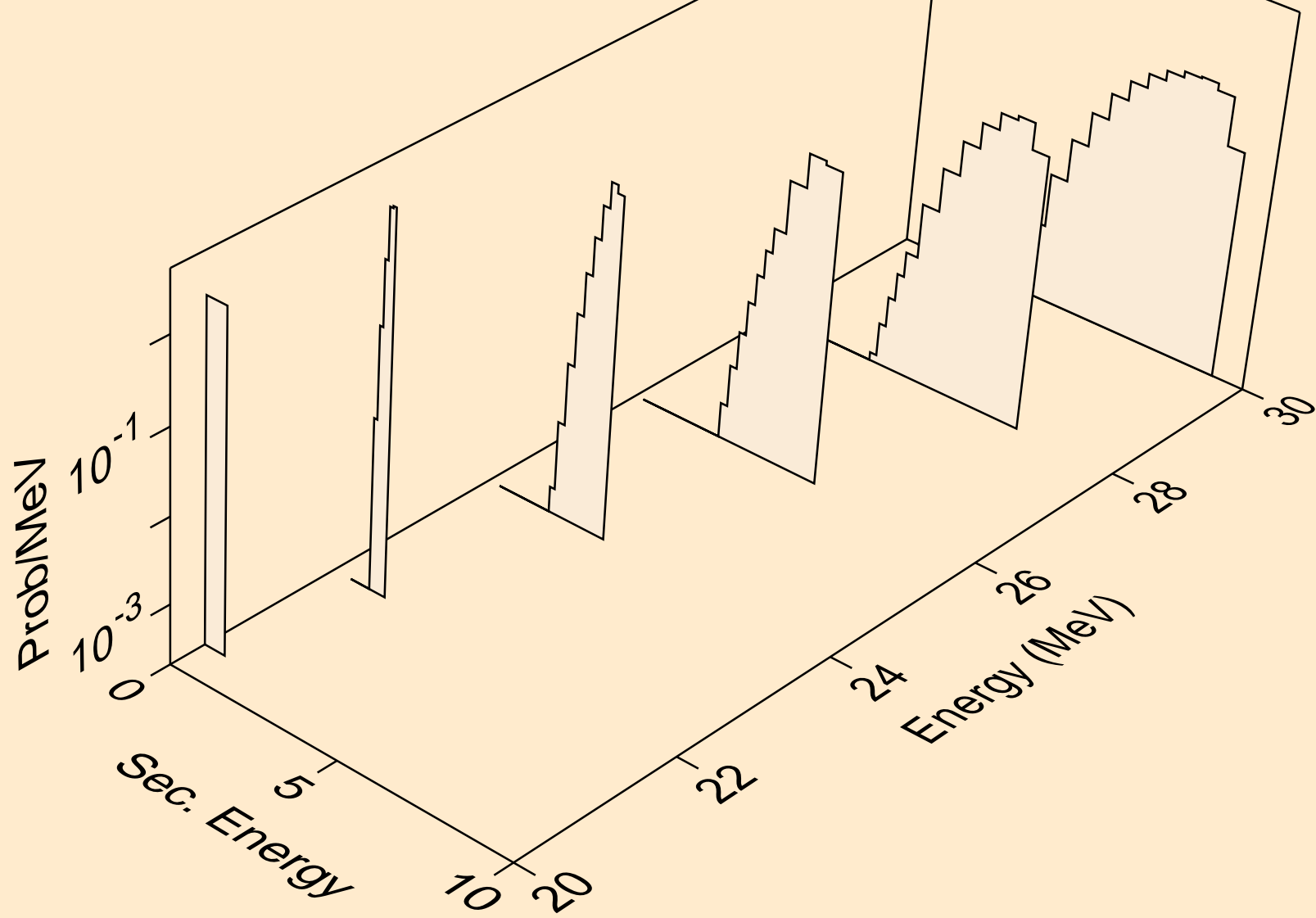

SC046M NEUTRON ACER TENDL-2021 LIBRARY; T=293.6K
he3s from (n,he3)

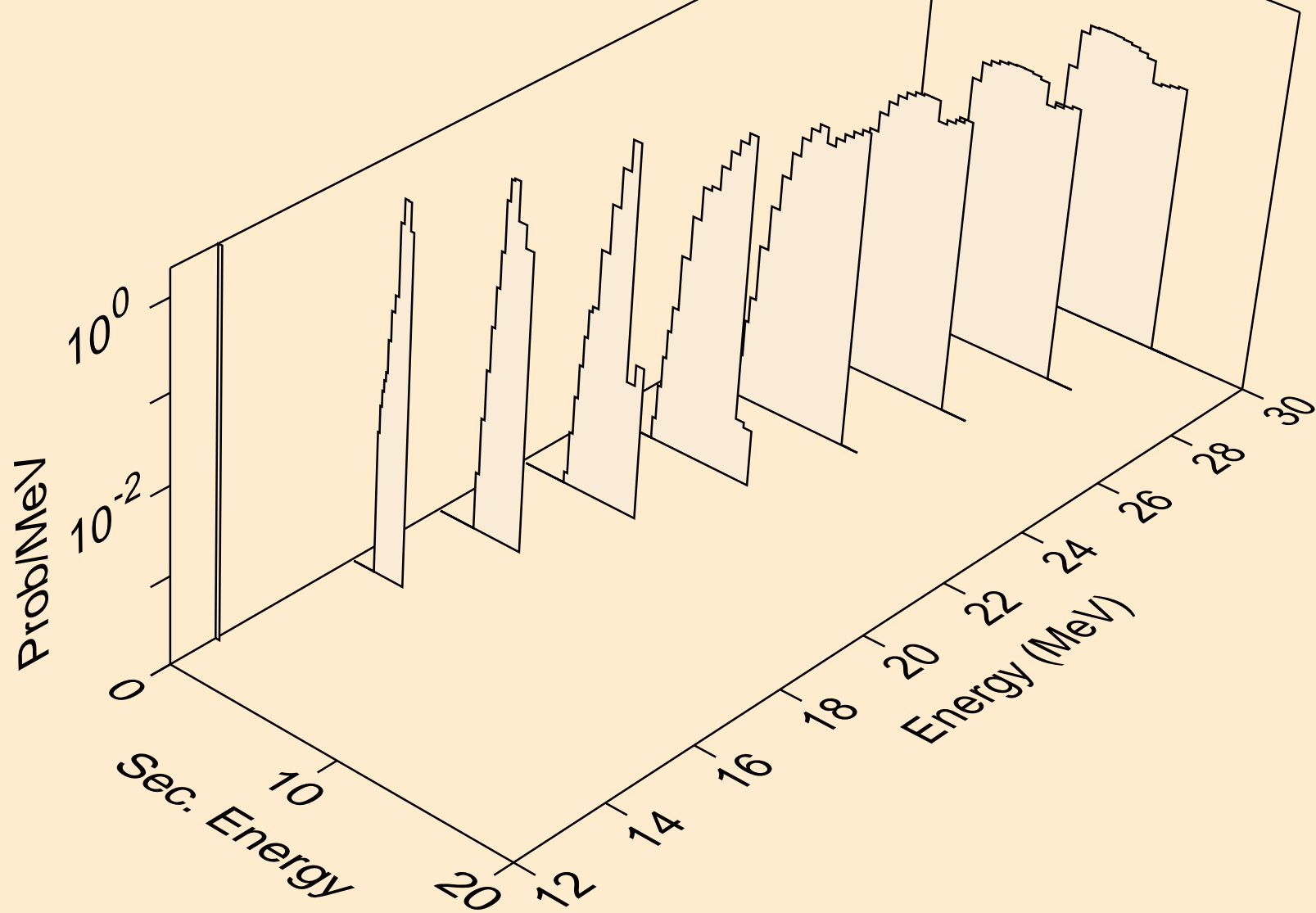

SC046M NEUTRON ACER TENDL-2021 LIBRARY; T=293.6K
alphas from (n,x)

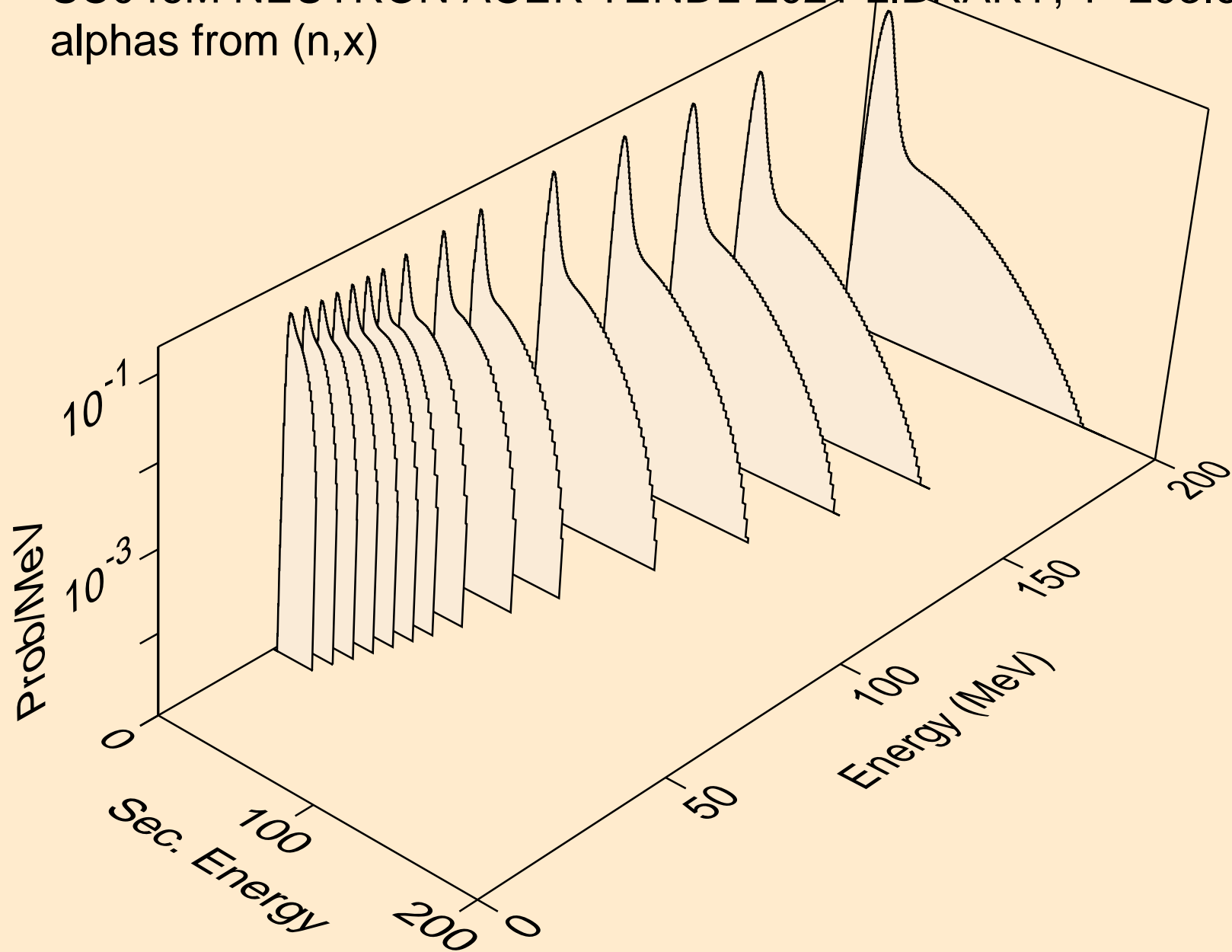

SC046M NEUTRON ACER TENDL-2021 LIBRARY; T=293.6K
alphas from (n,n*)a

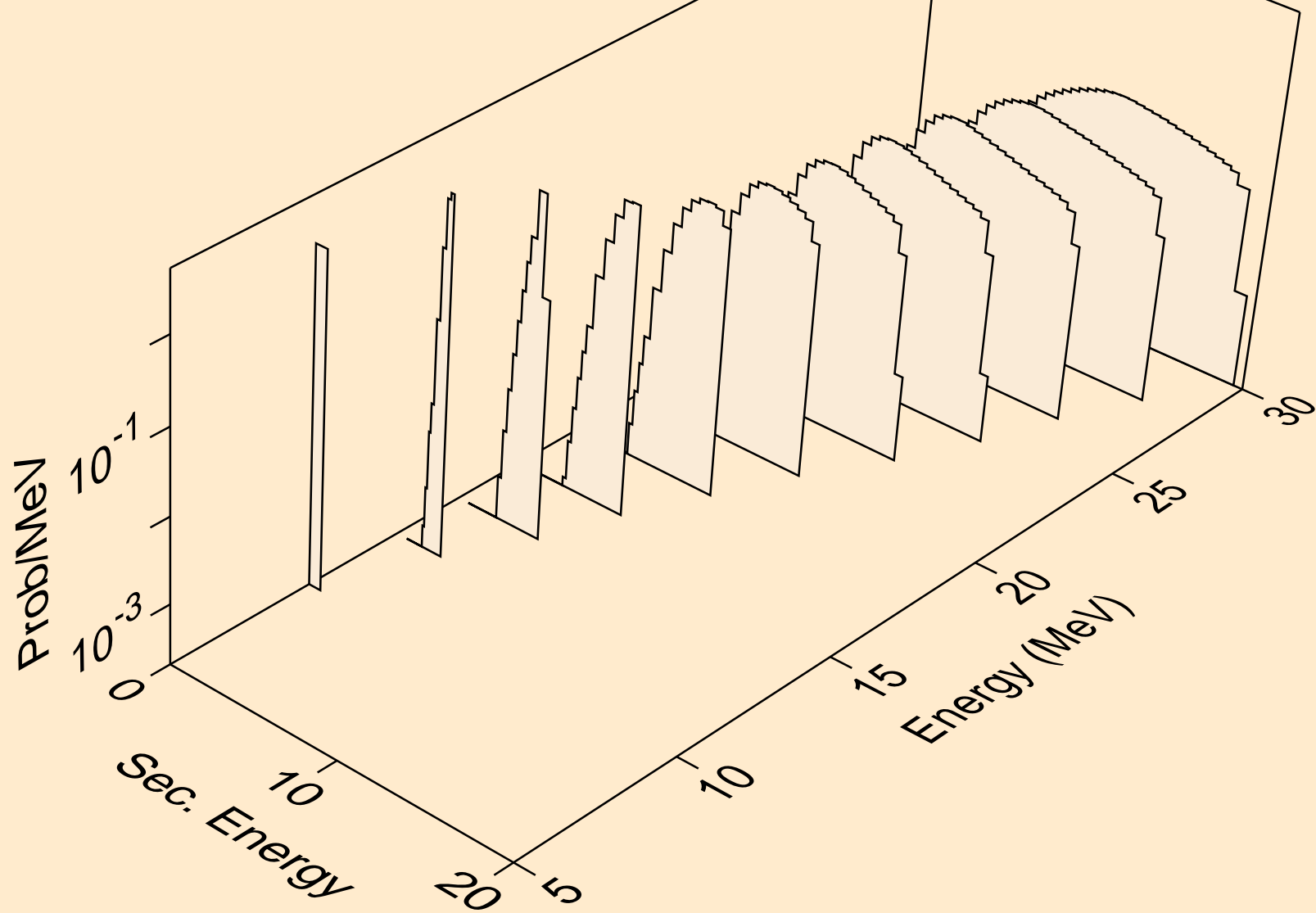

SC046M NEUTRON ACER TENDL-2021 LIBRARY; T=293.6K
alphas from (n,2n)a

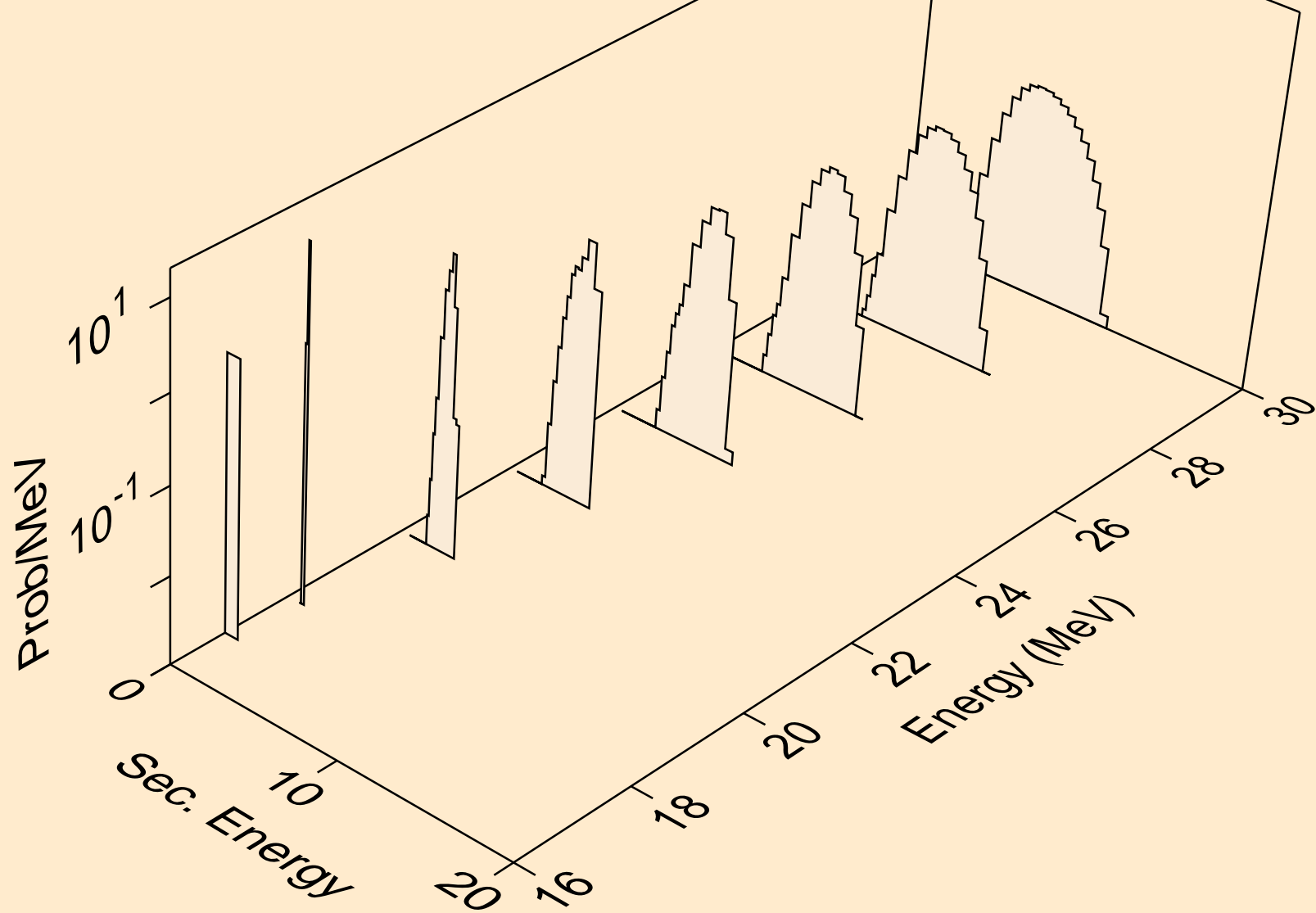

SC046M NEUTRON ACER TENDL-2021 LIBRARY; T=293.6K
alphas from (n,n*)2a

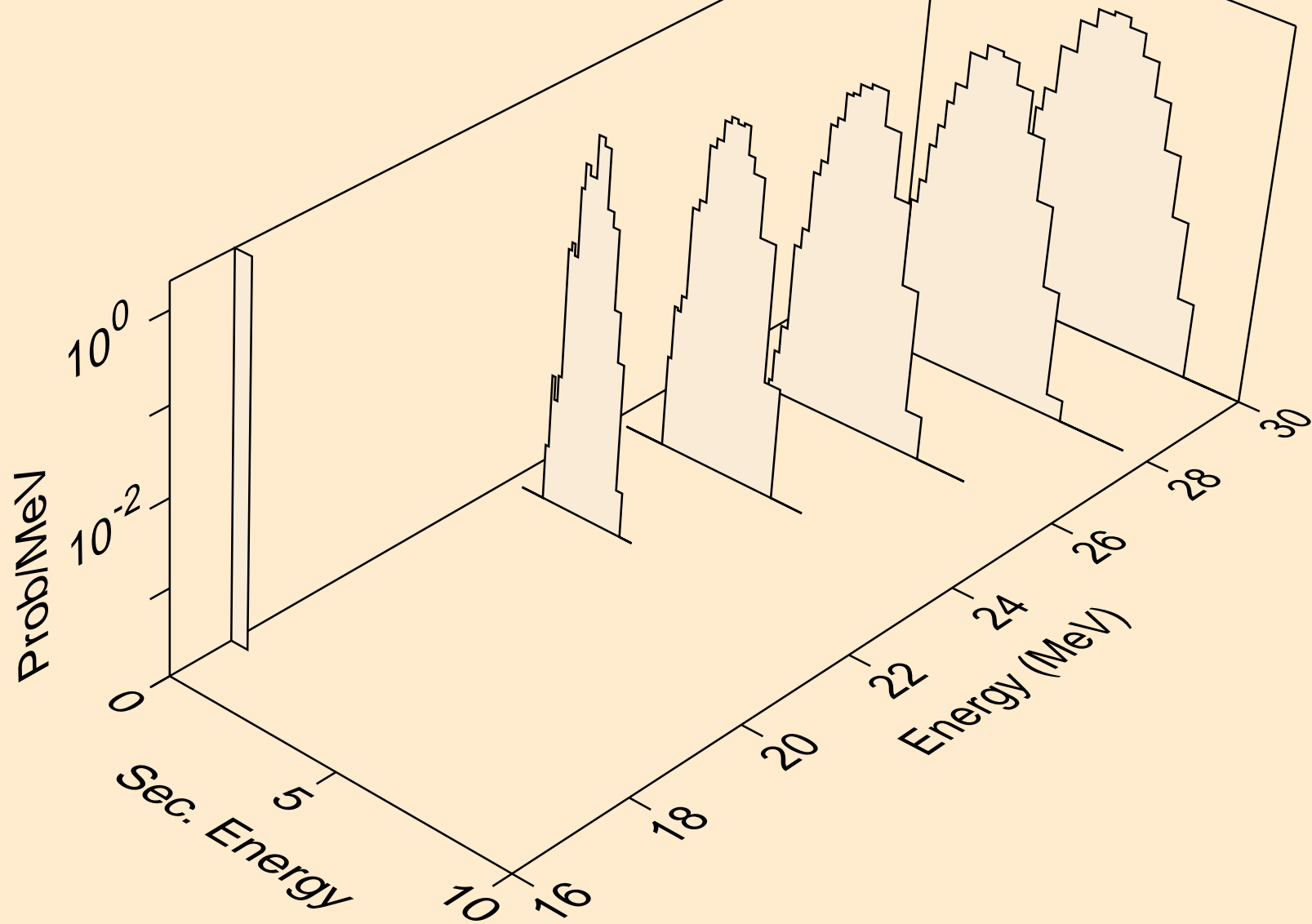

SC046M NEUTRON ACER TENDL-2021 LIBRARY; T=293.6K
alphas from (n,npa)

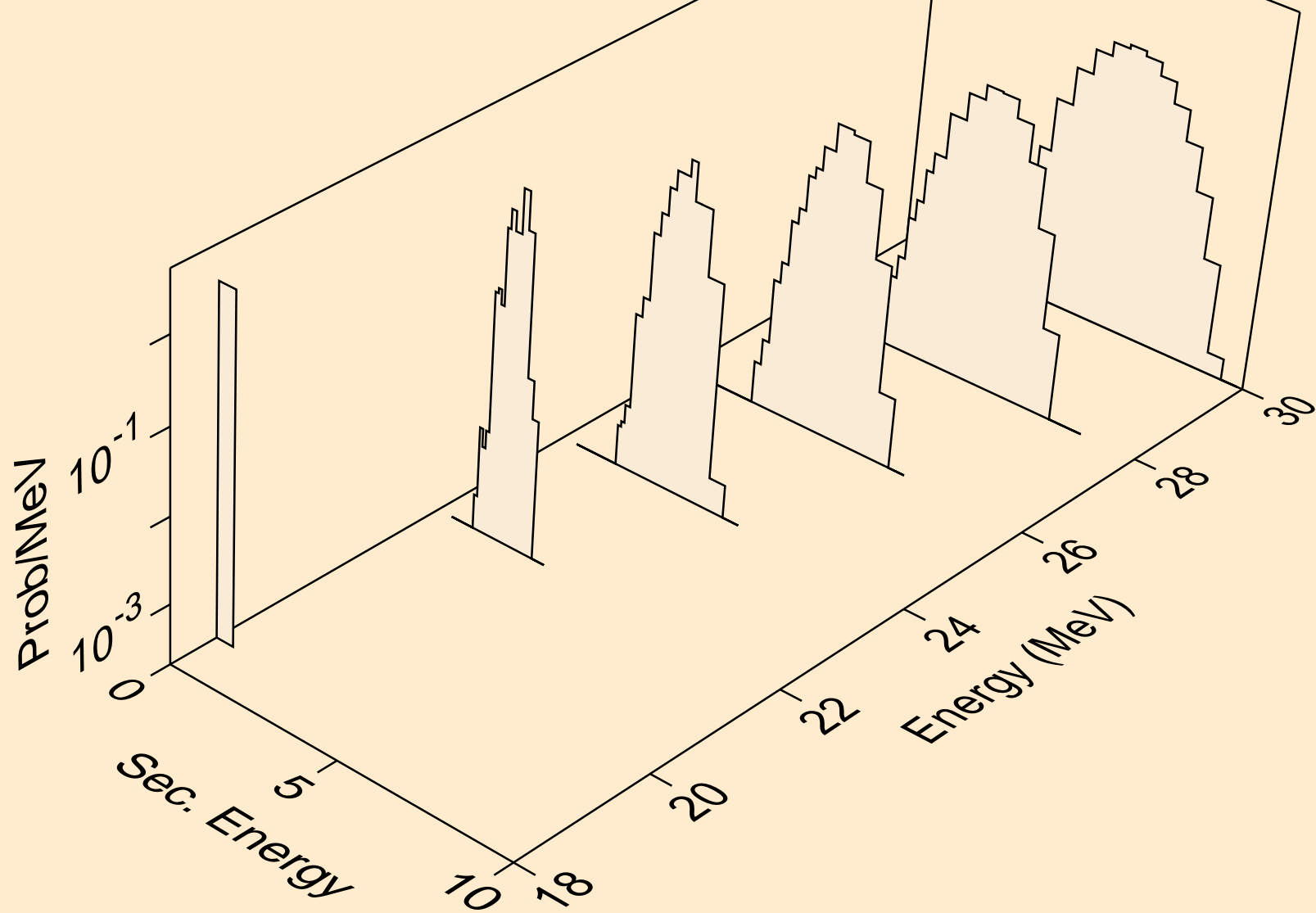

SC046M NEUTRON ACER TENDL-2021 LIBRARY; T=293.6K
alphas from (n,a)

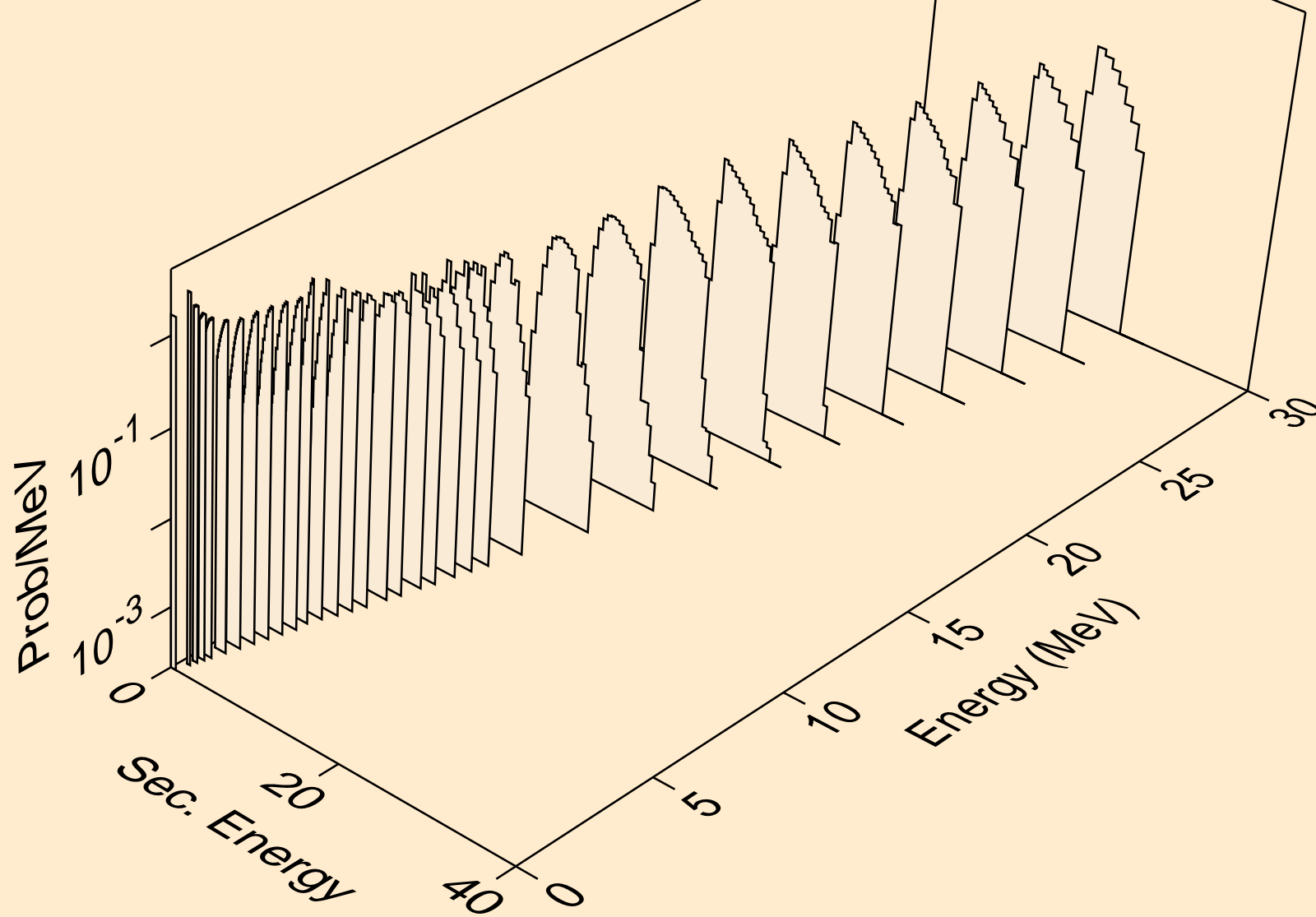

SC046M NEUTRON ACER TENDL-2021 LIBRARY; T=293.6K
alphas from (n,2a)

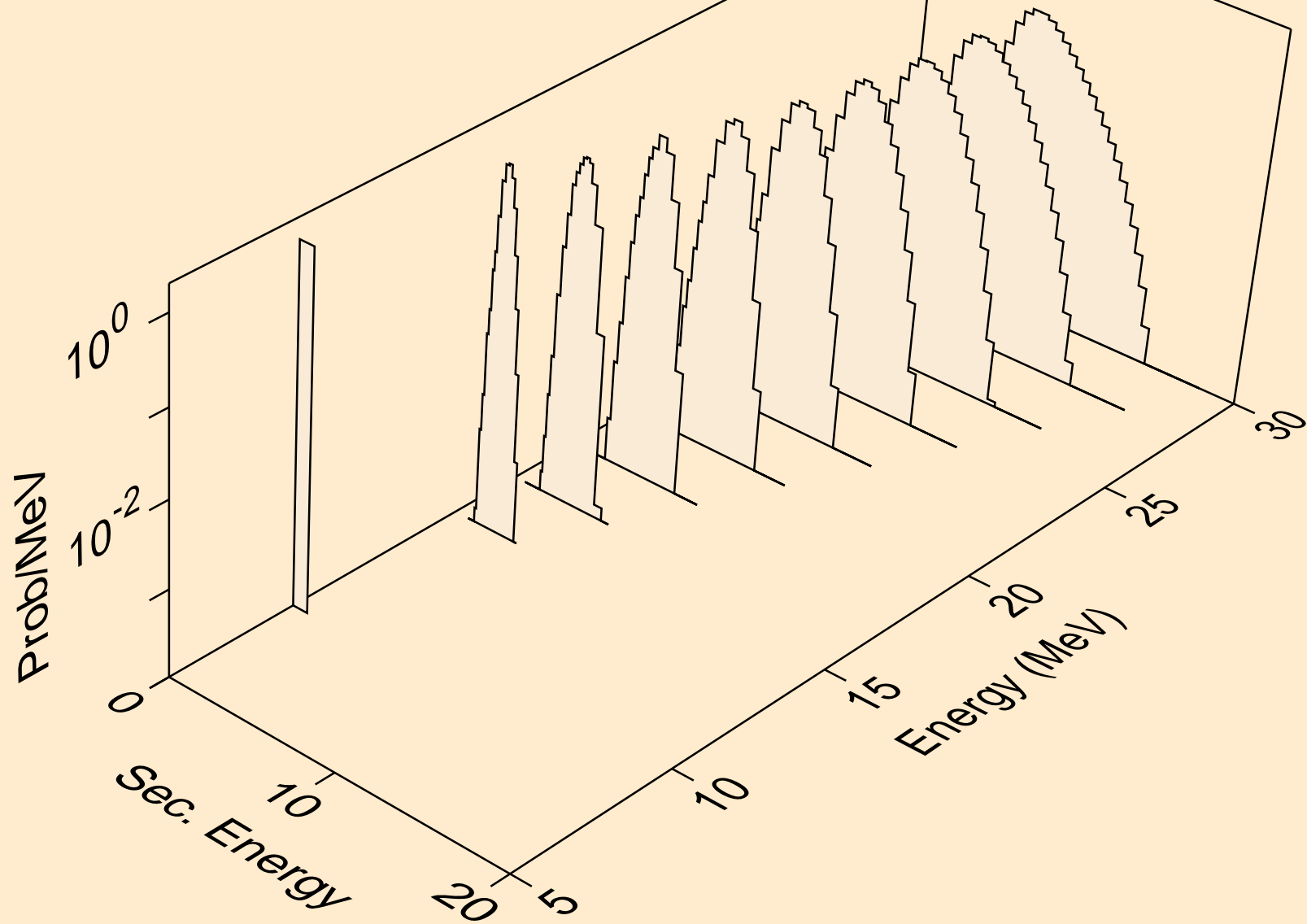

SC046M NEUTRON ACER TENDL-2021 LIBRARY; T=293.6K
alphas from (n,pa)

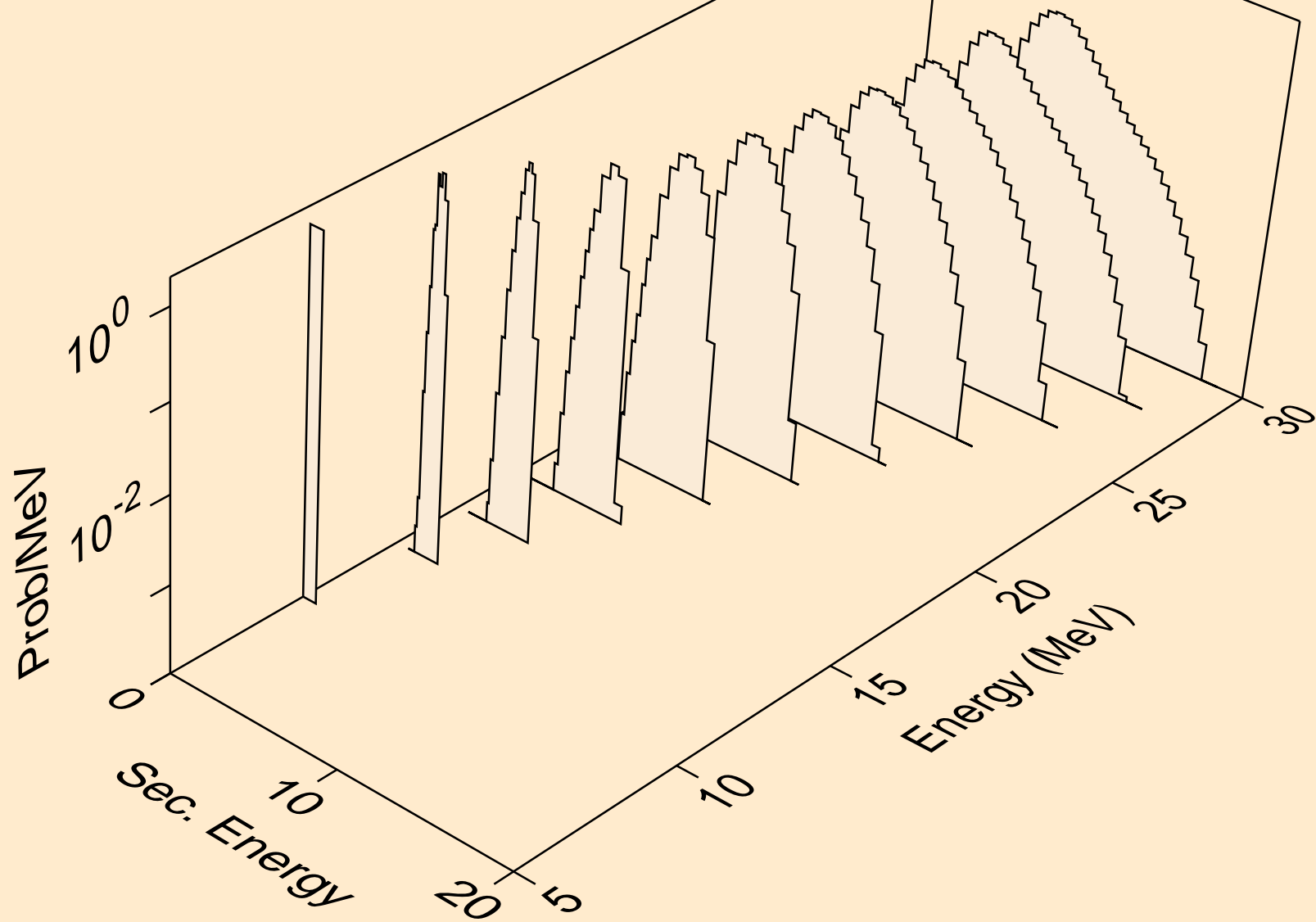

SC046M NEUTRON ACER TENDL-2021 LIBRARY; T=293.6K
alphas from (n,da)

